

Catalog #FRC-2011  
Supersedes FRC-2006

**PIONEER**  
**Automotive Industries LLC**

FRC-2011 POWERTRAIN

**POWERTRAIN**

**PIONEER**  
**Automotive Industries LLC**

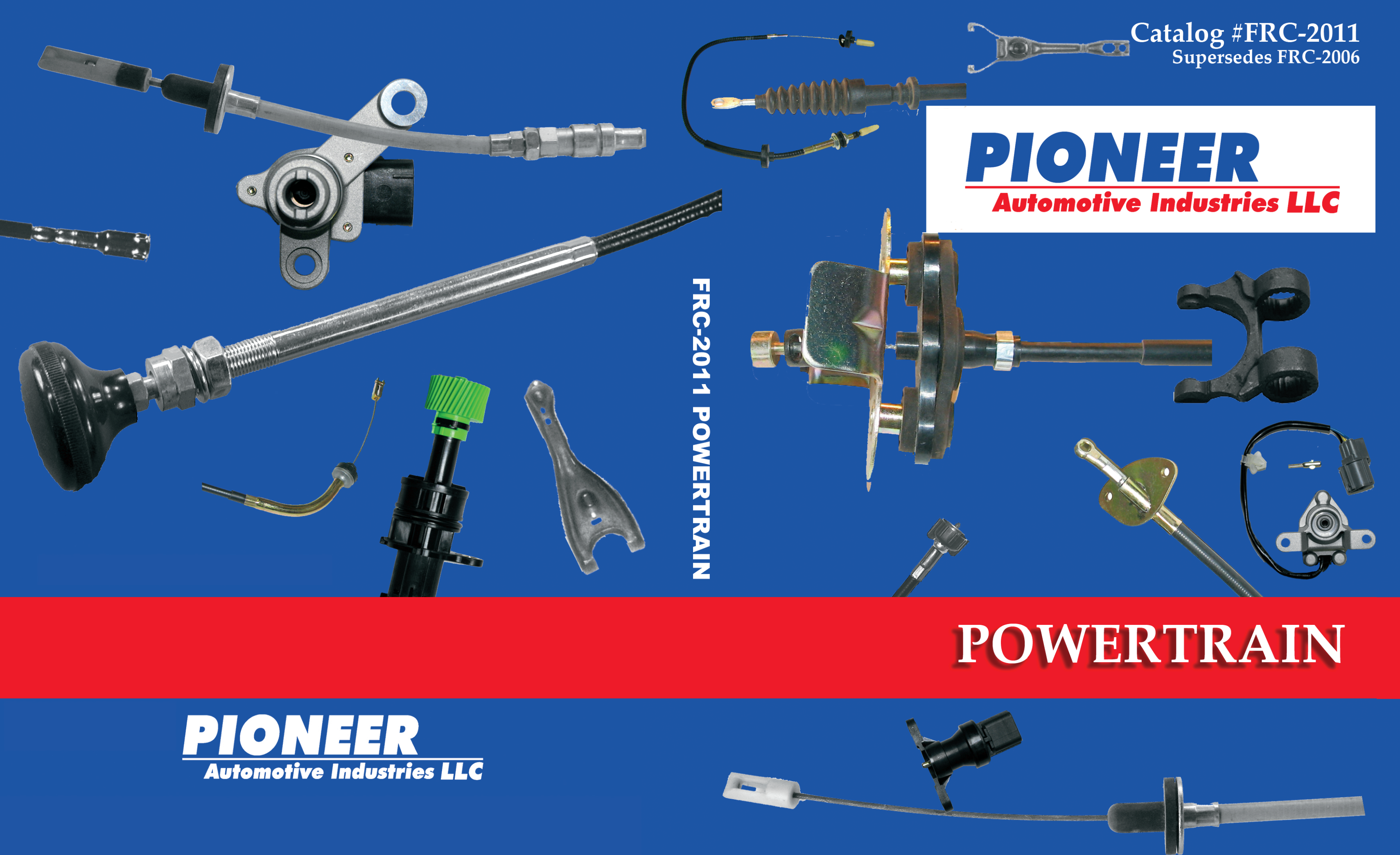



*"Proud of the past...committed to the future"  
is a slogan which accurately reflects Pioneer's heritage and its future.*

Pioneer was founded in 1946 by the late Herman A. Shields, who owned a successful automotive parts manufacturer's representative firm in his hometown of Meridian, Mississippi. He formed the company to service the needs of his clutch remanufacturer customers. His goal was simple: Supply the needed, hard-to-find parts for these businesses.

Little did he know that the company he founded would become a leading supplier of high quality components to the automotive parts aftermarket. For over 30 years under the guidance of the Shields family, Pioneer growth was based upon the twin cornerstones of customer service and reputation of the "Source for hard-to-find parts."

In 1979, Pioneer was purchased by The Barnes Group (Bristol, Connecticut) and the company became known as Pioneer/Barnes. During the Barnes Group's ownership, Pioneer purchased a 10-acre parcel in the G.V. (Sonny) Montgomery Industrial Park and built an 86,000 sq. ft. corporate head-quarters and distribution center on the site.

The product line expanded dramatically during the Barnes years, adding operating cables, flywheels, ring gears, shop supplies and performance parts to the company's mix, while further expanding the clutch, engine parts and water pump lines. Additionally, Pioneer added regional warehouses in Mt. Laurel, New Jersey and Cerritos, California to provide improved delivery service to its East and West Coast customers.

Additionally, Pioneer has made major commitments to its total quality assurance programs. These quality performance processes have been adapted to order taking and filling, distribution and inventory controls, further improving fill rates and on-time delivery.

The distribution facilities have also undergone modernization. In 1995, the Meridian facility's distribution center was expanded, bringing the warehousing space to over 200,000 sq. ft.

In May, 2000, Pioneer bought the new clutch business of L&S and through this acquisition have added New Clutch Kits to form a "5 Star" line-up which includes Powertrain, Transmission Parts, Engine and Transmission Mounts, and Harmonic Balancers...giving Pioneer a strong and competitive package of Driveline related products.

In August of 2010, Pioneer was acquired by the LODI Group with a continued focus on product line expansion and making major investments in product tooling.

*For over 60 years, the Pioneer story has been unique. Pioneer's growth has been based upon the philosophy of Herman Shields that success must be based upon customer service and satisfaction. Pioneer's Mission Statement reflects that philosophy:*

*"We are committed to the success of our customers. Our mission will be to provide customers with quality product and superior service. We believe the dedication of our employees and business partners is our most valued resource."*

*While the philosophy may seem passé in today's business environment, it has served Pioneer well through over six decades.*

## GUARANTEE

*All parts are guaranteed against defects in material and workmanship for a period of one year from the date of the original consumer purchase.*

*"Our obligation under this guarantee is limited to replacement of the defective part or, at our option, repayment of the purchase price, conditioned in either case upon the return of the part to us with an explanation of the circumstances and conditions under which failure occurred. We neither assume nor authorize any other person to assume for us any other liability. IN NO EVENT WILL PIONEER BE LIABLE FOR ANY CONSEQUENTIAL OR INCIDENTAL DAMAGES, including claims for labor charges, transportation, or loss of revenue."*

*The information listed herein is correct to the best of our knowledge and belief, having been compiled from reliable and official sources of information. However, WE CANNOT ASSUME ANY RESPONSIBILITY FOR POSSIBLE ERROR.*

*Thank you,  
Pioneer Automotive Products*

CONTENTS OF THIS CATALOG ARE COPYRIGHTED.  
REPRODUCTION OF ANY OR ALL OF ITS CONTENTS ARE PROHIBITED.

## NEW ITEMS!

Part	Description	Make	Years	Engines
CA-1189	TRANSHIFT CABLE	LINCOLN	1984-92	2.4L, 5.0L
CA-1196	TRANSHIFT CABLE	FORD	1995-97	4.6L, 4.9L, 5.0L, 5.4L, 5.8L, 7.3L, 7.5L
CA-1197	TRANSHIFT CABLE	FORD	1992-96	4.9L, 5.0L, 5.8L, 7.3L, 7.5L
CA-1198	TRANSHIFT CABLE	FORD	1992-97	3.0L, 4.0L
CA-1199	TRANSHIFT CABLE	FORD	1992-96	4.9L, 5.0L, 5.8L, 7.3L, 7.5L
CA-1219	TRANSHIFT CABLE	CHEVROLET, GMC	1999-07	4.3L, 4.8L, 5.3L, 6.0L, 6.6L, 8.1L
CA-1220	TRANSHIFT CABLE	CHEVROLET, GMC	1999-07	4.3L, 4.8L, 5.3L, 6.0L, 6.6L, 8.1L
CA-170	CLUTCH CABLE	FORD	1996-03	3.8L
CA-171	CLUTCH CABLE	FORD	1996-03	4.6L
CA-1910	DETENT CABLE	TOYOTA	1975-79	1.2L, 1.6L
CA-1911	DETENT CABLE	TOYOTA	1980-82	1.8L
CA-1912	DETENT CABLE	TOYOTA	1983-83	1.6L
CA-1913	DETENT CABLE	TOYOTA	1983-83	1.6L
CA-1915	DETENT CABLE	TOYOTA	1984-86	1.6L
CA-1916	DETENT CABLE	TOYOTA	1985-87	1.6L
CA-1917	DETENT CABLE	TOYOTA	1988-89	1.6L
CA-1918	DETENT CABLE	TOYOTA	1988-89	1.6L
CA-1919	DETENT CABLE	TOYOTA	1989-92	1.6L
CA-1920	DETENT CABLE	TOYOTA	1989-92	1.6L
CA-1921	DETENT CABLE	TOYOTA	1977-80	2.2L
CA-1922	DETENT CABLE	TOYOTA	1978-80	2.6L
CA-1923	DETENT CABLE	TOYOTA	1981-82	2.4L
CA-1924	DETENT CABLE	TOYOTA	1981-81	2.8L
CA-1925	DETENT CABLE	TOYOTA	1982-85	2.8L
CA-1926	DETENT CABLE	TOYOTA	1983-85	2.4L
CA-1927	DETENT CABLE	TOYOTA	1986-87	2.0L
CA-1985	DETENT CABLE	TOYOTA	1983-86	2.0L
CA-1986	DETENT CABLE	LEXUS, TOYOTA	1988-91	2.5L
CA-1989	DETENT CABLE	TOYOTA	1986-86	1.6L
CA-1990	DETENT CABLE	TOYOTA	1984-89	2.0L, 2.2L
CA-1991	DETENT CABLE	TOYOTA	1987-90	1.5L
CA-2034	DETENT CABLE	VOLVO	1981-85	2.1L
CA-3121	SPEEDOMETER CABLE	MERCEDES-BENZ	1965-84	2.0L, 2.2L, 2.4L, 2.5L, 2.8L, 3.0L, 3.1L, 4.5L
CA-3136	SPEEDOMETER CABLE	FORD, MAZDA	1972-84	1.8L, 2.0L, 2.2L, 2.3L
CA-3152	SPEEDOMETER CABLE	HONDA	1984-87	1.3L, 1.5L
CA-5042	BRAKE CABLE	DODGE, PLYMOUTH	1974-88	
CA-5216	BRAKE CABLE	FORD, LINCON, MERCURY	1978-82	
CA-5230	BRAKE CABLE	FORD, MERCURY	1980-82	
CA-5277	BRAKE CABLE	FORD, MERCURY	1987-88	
CA-5282	BRAKE CABLE	LINCOLN	1993-98	
CA-5523	BRAKE CABLE	BUICK, CHEVROLET, OLDSMOBILE, PONTIAC	1975-84	
CA-5624	BRAKE CABLE	CHEVROLET, GMC	1987-89	
CA-5640	BRAKE CABLE	BUICK, CADILLAC, OLDSMOBILE, PONTIAC	1987-91	
CA-5643	BRAKE CABLE	BUICK	1993-96	
CA-5644	BRAKE CABLE	BUICK	1993-96	

## NEW ITEMS!

Part	Description	Make	Years	Engines
CA-5645	BRAKE CABLE	DODGE, PLYMOUTH	1991-94	
CA-6001	BRAKE CABLE	HONDA	1976-85	
CA-6002	BRAKE CABLE	HONDA	1976-85	
CA-6283	BRAKE CABLE	FORD, MAZDA, MERCURY	1989-02	
CA-6284	BRAKE CABLE	JEEP	1990-91	
CA-6285	BRAKE CABLE	CHEVROLET, GMC	1992-93	
CA-6286	BRAKE CABLE	FORD	1993-93	
CA-6287	BRAKE CABLE	FORD, MERCURY	1992-96	
CA-6289	BRAKE CABLE	FORD, MERCURY	1992-96	
CA-6290	BRAKE CABLE	FORD	1992-97	
CA-6291	BRAKE CABLE	CHEVROLET, GMC	1992-94	
CA-6292	BRAKE CABLE	FORD, MAZDA	1993-00	
CA-6293	BRAKE CABLE	FORD	1994-98	
CA-6294	BRAKE CABLE	CHEVROLET, GMC	1995	
CA-6295	BRAKE CABLE	CHEVROLET, GMC	1995-97	
CA-6296	BRAKE CABLE	CHEVROLET, GMC	1995	
CA-6297	BRAKE CABLE	CHEVROLET, GMC	1995-97	
CA-6298	BRAKE CABLE	FORD	1997-97	
CA-6299	BRAKE CABLE	FORD	1994-98	
CA-6300	BRAKE CABLE	FORD	1992-96	
CA-6301	BRAKE CABLE	FORD	1997-97	
CA-6302	BRAKE CABLE	FORD, MERCURY	1992-96	
CA-6303	BRAKE CABLE	FORD	1997-97	
CA-6304	BRAKE CABLE	FORD	1992-97	
CA-6305	BRAKE CABLE	FORD	1992-97	
CA-6306	BRAKE CABLE	FORD	1996-04	
CA-6307	BRAKE CABLE	FORD, LINCOLN	1992-02	
CA-6309	BRAKE CABLE	FORD, MERCURY	1998-04	
CA-6310	BRAKE CABLE	FORD	1998-99	
CA-6311	BRAKE CABLE	FORD, LINCOLN	1997-01	
CA-6312	BRAKE CABLE	FORD, LINCON	1997-01	
CA-6313	BRAKE CABLE	FORD, MERCURY	1997-02	
CA-6314	BRAKE CABLE	FORD, MERCURY	1997-02	
CA-6315	BRAKE CABLE	FORD, MERCURY	1997-02	
CA-6316	BRAKE CABLE	FORD, MERCURY	1997-02	
CA-6317	BRAKE CABLE	FORD	1998-00	
CA-6318	BRAKE CABLE	FORD	1997-99	
CA-6319	BRAKE CABLE	FORD	1998-98	
CA-6320	BRAKE CABLE	FORD, LINCOLN	1998-02	
CA-6321	BRAKE CABLE	FORD, LINCOLN	1998-02	
CA-6322	BRAKE CABLE	TOYOTA	1988-95	
CA-6323	BRAKE CABLE	TOYOTA	1988-95	
CA-6324	BRAKE CABLE	TOYOTA	1988-95	
CA-6325	BRAKE CABLE	TOYOTA	1988-95	
CA-6326	BRAKE CABLE	TOYOTA	1988-95	
CA-6327	BRAKE CABLE	TOYOTA	1989-95	

## NEW ITEMS!

Part	Description	Make	Years	Engines
CA-6328	BRAKE CABLE	TOYOTA	1989-95	
CA-6329	BRAKE CABLE	TOYOTA	1989-95	
CA-6330	BRAKE CABLE	FORD, MERCURY	1981-94	
CA-684	CLUTCH CABLE	ISUZU	1990-92	1.6L
CA-685	CLUTCH CABLE	ISUZU	1991-92	1.6L, 1.8L
CA-8618	ACCELERATOR CABLE	VOLKSWAGEN	1975-79	1.8L, 2.0L
CA-8663	ACCELERATOR CABLE	JEEP	1985-86	2.1L
CA-8667	ACCELERATOR CABLE	JEEP	1987-87	2.1L
CA-8697	ACCELERATOR CABLE	CHEVROLET	1985-86	1.8L
CA-8760	ACCELERATOR CABLE	CHEVROLET	1976-80	1.8L
CA-8780	ACCELERATOR CABLE	MG	1975-76	1.5L
CA-8788	ACCELERATOR CABLE	TRIUMPH	1979-81	2.0L
CA-8972	ACCELERATOR CABLE	TOYOTA	1990-90	1.5L
CA-957	CLUTCH CABLE	VOLKSWAGEN	1960-61	1.2L
CA-989	CLUTCH CABLE	FORD	1988-93	1.3L
CF-119	CLUTCH FORK	FORD, MERCURY	1982-93	5.0L
CF-134	CLUTCH FORK	PONTIAC	1987-88	2.5L, 2.8L
CF-135	CLUTCH FORK	PONTIAC	1987-89	2.5L
SPS-1305	SPEED SENSOR	NISSAN	1998-01	1.6L, 2.4L
SPS-1307	SPEED SENSOR	HONDA	1998-02	2.3L, 3.0L
SPS-1310	SPEED SENSOR	MAZDA	1993-02	2.0L, 2.5L
SPS-1311	SPEED SENSOR	HONDA	1990-93	2.2L, 2.3L
SPS-1313	SPEED SENSOR	TOYOTA	1992-05	2.0L, 2.2L, 2.4L
SPS-1316	SPEED SENSOR	HONDA	2001-05	1.3L, 1.7L
SPS-1317	SPEED SENSOR	NISSAN	1995-99	1.6L, 2.0L
SPS-1318	SPEED SENSOR	NISSAN	1995-97	2.4L
SPS-1319	SPEED SENSOR	HONDA	1992-01	1.5L, 1.6L, 2.2L, 2.3L, 2.7L, 3.5L
SPS-1320	SPEED SENSOR	AUDI	1994-05	1.8L, 2.0L, 2.7L, 2.8L, 3.0L, 3.2L, 4.2L
SPS-1321	SPEED SENSOR	TOYOTA	1992-05	2.0L, 2.2L, 2.4L
SPS-1322	SPEED SENSOR	ACURA	2002-06	2.0L
SPS-1324	SPEED SENSOR	NISSAN	1995-97	3.0L
SPS-1326	SPEED SENSOR	LEXUS, TOYOTA	1992-98	3.0L
SPS-1328	SPEED SENSOR	HONDA	2000-03	1.0L
SPS-1329	SPEED SENSOR	HONDA	2005-05	1.7L
SPS-1331	SPEED SENSOR	HYUNDAI	2002-06	2.0L
SPS-1332	SPEED SENSOR	HONDA	1996-00	1.6L
SPS-1333	SPEED SENSOR	HONDA	1996-00	1.6L
SPS-1334	SPEED SENSOR	ACURA	1994-01	1.8L
SPS-1335	SPEED SENSOR	HONDA	1996-00	1.6L
SPS-1337	SPEED SENSOR	HONDA	1997-01	2.0L
SPS-1338	SPEED SENSOR	HONDA	1999-00	1.6L
SPS-1340	SPEED SENSOR	HYUNDAI	1995-98	2.0L, 3.0L
SPS-1341	SPEED SENSOR	HONDA	1990-91	2.0L, 2.1L
SPS-1343	SPEED SENSOR	TOYOTA	1993-97	3.0L
SPS-1344	SPEED SENSOR	ACURA	1996-04	3.5L
SPS-1345	SPEED SENSOR	HONDA	1998-00	1.6L

## NEW ITEMS!

Part	Description	Make	Years	Engines
SPS-1350	SPEED SENSOR	ACURA	1992-96	2.5L, 3.2L
SPS-1351	SPEED SENSOR	NISSAN	2002-03	1.8L, 2.5L
SPS-1352	SPEED SENSOR	HONDA	1998-01	2.0L
SPS-1353	SPEED SENSOR	HONDA	2002-06	2.4L
SPS-1356	SPEED SENSOR	TOYOTA	1992-95	2.2L
SPS-1357	SPEED SENSOR	HONDA	1996-00	1.6L
SPS-1358	SPEED SENSOR	ACURA	2002-06	2.0L
SPS-1359	SPEED SENSOR	NISSAN	1998-99	1.6L, 2.0L
SPS-1360	SPEED SENSOR	HONDA	1999-00	1.6L
SPS-1362	SPEED SENSOR	TOYOTA	1991-93	2.4L
SPS-1364	SPEED SENSOR	TOYOTA	1995-97	2.4L
SPS-1365	SPEED SENSOR	TOYOTA	1996-05	2.0L, 2.4L, 3.0L
SPS-1366	SPEED SENSOR	TOYOTA	1993-97	2.4L, 3.0L
SPS-1368	SPEED SENSOR	TOYOTA	2000-05	1.5L
TAT-5200	ALIGNMENT TOOL	CHEVROLET	1962-66	5.7L, 6.0L, 6.7L
TAT-5201	ALIGNMENT TOOL	ACURA, HONDA	1983-89	1.5L, 1.6L, 1.8L
TAT-5202	ALIGNMENT TOOL	HONDA	1989-00	1.5L, 1.6L
TAT-5203	ALIGNMENT TOOL	CHRYSLER, DODGE, PLYMOUTH	1991-95	2.2L, 2.5L, 3.0L
TAT-5206	ALIGNMENT TOOL	VOLVO	1976-97	2.3L, 2.3L, 2.4L, 2.4L, 2.7L
TAT-5207	ALIGNMENT TOOL	ALFA ROMEO	1975-89	2.0L, 2.5L, 3.0L
TAT-5208	ALIGNMENT TOOL	AUDI	1983-98	2.0L, 2.2L, 2.3L, 2.8L, 3.6L, 4.2L
TAT-5209	ALIGNMENT TOOL	INFINITI, NISSAN	1987-01	1.6L, 1.8L, 2.0L
TAT-5210	ALIGNMENT TOOL	DODGE	1992-93	2.5L, 3.9L, 5.2L, 5.9L
TAT-5211	ALIGNMENT TOOL	ACURA, HONDA, ISUZU, STERLING	1986-01	1.6L, 1.7L, 1.8L, 2.5L, 2.7L, 2.8L, 3.1L
TAT-5212	ALIGNMENT TOOL	DODGE, PLYMOUTH	1995-99	2.0L
TAT-5213	ALIGNMENT TOOL	AUDI, VOLKSWAGEN	1993-01	1.8L, 1.9L, 2.0L
TAT-5214	ALIGNMENT TOOL	TOYOTA	1996-98	3.0L
TAT-5215	ALIGNMENT TOOL	DODGE	1996-98	2.5L
TAT-5397	ALIGNMENT TOOL	CHEVROLET, GEO, ISUZU, PONTIAC	1985-93	1.5L, 1.6L
TAT-5400	ALIGNMENT TOOL	FORD	1988-97	1.3L
TAT-5401	ALIGNMENT TOOL	DODGE, MITSUBISHI	1989-99	3.0L, 3.5L
TAT-5402	ALIGNMENT TOOL	DAIHATSU	1988-92	L3 1.0L, 1.3L, 1.6L
TAT-5403	ALIGNMENT TOOL	VOLKSWAGEN	1986-99	1.8L, 1.9L, 2.0L 2.4L, 2.5L, 2.8L
TAT-5407	ALIGNMENT TOOL	SATURN	1991-99	1.9L
TAT-5408	ALIGNMENT TOOL	FORD, MAZDA, MERCURY, MERKUR, MITSUBISHI	1985-02	2.0L, 2.2L, 2.3L, 2.5L, 2.6L, 1.3L, 2.5L, 2.9L 3.0L, 4.0L
TAT-5409	ALIGNMENT TOOL	FORD	1987-02	6.8L, 5.4L, 6.9L, 7.3L, 7.5L
TAT-5412	ALIGNMENT TOOL	DODGE	1989-98	5.9L, 8.0L
TAT-5423	ALIGNMENT TOOL	ACURA, HONDA	1990-01	2.0L, 2.2L, 2.3L, 2.5L

# TABLE OF CONTENTS

<b>NEW ITEMS.....</b>	<b>I-IV</b>
<b>TABLE OF CONTENTS.....</b>	<b>V</b>
<b>CABLE INFORMATION.....</b>	<b>1</b>
<b>TRANSMISSION ID CHART.....</b>	<b>2</b>
<b>CONTROL CABLES.....</b>	<b>3</b>
<b>GROUND STRAP CABLE.....</b>	<b>4</b>
<b>ACCELERATOR CABLES.....</b>	<b>6-92</b>
<b>BRAKE CABLES.....</b>	<b>93-142</b>
<b>CLUTCH ALIGNMENT TOOLS.....</b>	<b>143-197</b>
<b>CLUTCH CABLES.....</b>	<b>198-235</b>
<b>CLUTCH FORKS.....</b>	<b>236-251</b>
<b>DETENT CABLES.....</b>	<b>252-322</b>
<b>SPEED SENSORS.....</b>	<b>323-327</b>
<b>SPEEDOMETER CABLES.....</b>	<b>328-556</b>
<b>TAILGATE CABLES.....</b>	<b>557-559</b>
<b>TRANSHIFT CABLES.....</b>	<b>560-591</b>
<b>CABLE ILLUSTRATIONS.....</b>	<b>591-707</b>
<b>NUMERCAL LISTING.....</b>	<b>709-737</b>

# CABLE INFORMATION

## **ACCELERATOR CABLE**

The Accelerator Cable is the connecting factor between the floorboard foot pedal and carburetor, thus, serving to control the speed of the vehicle.

## **CLUTCH CABLE**

The Clutch Cable carries the movement of the clutch pedal when depressed to the release bearing.

## **BRAKE CABLE**

The Brake Cable is required to set the parking brakes on a vehicle. Each vehicle has 4 cables.

## **CONTROL CABLES**

The Control Cables include choke, hood, power take-off and throttle control which are operated manually.

## **DETENT (Passing Gear) CABLE**

The Detent or Kickdown Cable serves as the passing gear cable. When the driver needs to use the passing gear, he presses the accelerator pedal to move the Detent Cable, in an upward motion. This activates a valve in the Automatic Transmission and causes the transmission to go from its highest gear to the next lower gear, commonly known as the Passing Gear.

## **GROUND STRAP**

The Ground Strap is adaptable to any Foreign or Domestic car. This strap grounds the engine to the chassis, which helps prevent electrical problems and premature internal transmission bushing wear.

## **MANUAL TRANSMISSION SHIFT CABLE**

The Manual Shift Cables require two types of cables. The first activates the first through fourth or fifth gears. This cable is referred to as the selector cable. The second cable operates reverse. Chrysler and Ford refer to this cable as a crossover cable; Chevrolet as a shift lever cable.

## **SPEEDOMETER CABLE**

The Speedometer Cable transfers the revolutions the transmission is turning to the speedometer. This enables the driver to read miles per hour and determine accurate travel speed.

## **TAILGATE SUPPORT CABLE**

The Tailgate Support Cable works to support the tailgate in the open position. Two cables are required. One on each side.

## **TRANS SHIFT CABLE**

The Trans Shift Cable controls the reverse, park, neutral and drive positions on column shift and center console cars. It also activates the backup lights when placed in the reverse position.



# TRANSMISSION ID CHART

## ENGINE CODE FROM VIN

Sometimes, just the engine size is not enough. Knowing the engine code will help in getting the right part.

VIN codes are a mixture of numbers, letters, or symbols usually from 13 to 17 characters long.

This chart will help in determining the Engine Code of the vehicle.

AM GENERAL	1995-2003	X X X <u>E</u> X X X X X X X X X X X X	<b>4th</b> Character
AMC / EAGLE (NOT JEEP)	1972-1980	X X X X X X <u>E</u> X X X X X X	<b>7th</b> Character
AMC / EAGLE (NOT JEEP)	1981-1988	X X X <u>E</u> X X X X X X X X X X X X	<b>4th</b> Character
AMC / EAGLE (NOT JEEP)	1989-1998	X X X X X X X <u>E</u> X X X X X X X X X	<b>8th</b> Character
CHRYSLER, FORD, GM, SAAB	1972-1980	X X X X <u>E</u> X X X X X X X X X X X X	<b>5th</b> Character
CHRYSLER, FORD, GM, SAAB	1981-2003	X X X X X X X <u>E</u> X X X X X X X X X	<b>8th</b> Character
JEEP ( to SN 100000)	1972-1974	X X X X X X X <u>E</u> X X X X X X	<b>8th</b> Character
JEEP ( from SN 100000)	1974-1980	X X X X X X <u>E</u> X X X X X X	<b>7th</b> Character
JEEP	1981-1988	X X X <u>E</u> X X X X X X X X X X X X X X	<b>4th</b> Character
JEEP	1989-2003	X X X X X X X <u>E</u> X X X X X X X X X X	<b>8th</b> Character
HYUNDAI	1981-2003	X X X X X X X <u>E</u> X X X X X X X X X X	<b>8th</b> Character
JAGUAR, LANDROVER	1981-2003	X X X X X X <u>E</u> X-X X X X X X X X X X	<b>7th</b> Character
KIA	1994-2003	X X X X X X X <u>E</u> X X X X X X X X X X X	<b>8th</b> Character
MITSUBISHI	1983-2003	X X X X X X X <u>E</u> X X X X X X X X X X X	<b>8th</b> Character
NISSAN (except Quest)	1995-2003	X X X <u>E</u> X X X X X X X X X X X X X X	<b>4th</b> Character
SUBARU, SUZUKI	1981-2003	X X X X X <u>E</u> X X X X X X X X X X X X X X	<b>6th</b> Character
TOYOTA	TO-1995	X X X <u>E</u> X X X X X X X X X X X X X X X X	<b>4th</b> Character
TOYOTA	1996-2004	X X X X <u>E</u> X X X X X X X X X X X X X X X X	<b>5th</b> Character

**NOTE :**

E is used as an example only.  
The actual code may be any letter or any number.

**VIN LOCATION :**

The VIN number is located on the far left hand corner of the driverside dash pad, in the corner closest to the windshield. It is also on a sticker located on the driverside doorjamb just below the striker plate.

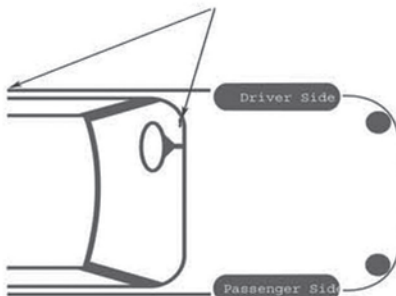

# CONTROL CABLES

## CONTROLS

### HOOD CONTROL

PIONEER NUMBER	SIZE - DESCRIPTION
CA-11	84" Long, Chrome "T" Handle



### "POWER TAKE-OFF" CONTROL

CA-12	96" Long, 14" Conduit, .092 Inner Wire, 2" Threaded Section, 2" Black Handle, Has 4" Movement, Corrosion Resistant (Not Boxed - Weight 1 1/4 Lbs.)
CA-13	Same as Above - Except 240" Long
CA-14	Same as Above - Except 120" Long



**A REAL HEAVY DUTY CONTROL**  
(Used primarily for power take-off units)

### UNIVERSAL CHOKE & THROTTLE CONTROL

CA-22	120" Long - Plastic Knob
CA-24	72" Long - Plastic Knob
CA-26	60" Long - Plastic Knob



### UNIVERSAL STOP CLAMPS

PIONEER NUMBER	SIZE - DESCRIPTION
----------------	--------------------

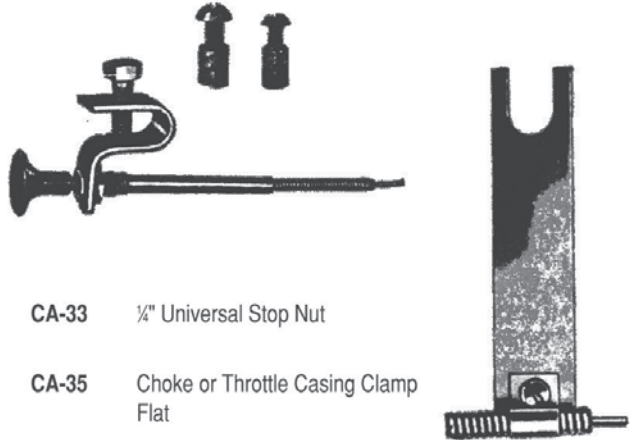

CA-33	1/4" Universal Stop Nut
CA-35	Choke or Throttle Casing Clamp Flat
CA-36	Universal Dash Assembly Clamp

CA-35

### UNIVERSAL PULL BACK SPRING

PT-1715-S	Used to give faster Clutch Pedal return (Skin-Packed - 1/Card)
-----------	--

### SPEEDOMETER CABLE REPAIR KIT

CA-4005	Includes Universal Metal Tip with square drive, Two spacer washers and staking tool for installation on standard .130" diameter speedometer cables.
---------	---

(Skin-Packed - 1 Kit/Card)

### PIONEER CABLE LUBE

CA-5000

Specially formulated, calcium based grease packaged in a convenient to use, single dose tube. Safe for use on all cables, in all temperatures - will not freeze in cold or run in hot temperatures. Eliminates vibration and noise, helps prevent corrosion and rust. Ideal for speedometer use.

(1 Tube - 5 grams by weight)

# GROUND STRAP CABLE

## — WARNING —

The Engine Ground Strap Cable must be connected and in good working condition to prevent the cable from welding together within the conduit and voiding the warranty.

**WARRANTY IS VOIDED IF TRANSHIFT CABLE IS WELDED.**

*The Ground Strap is adaptable to any Foreign or Domestic car. This strap grounds the engine to the chassis, which helps prevent electrical problems and premature internal transmission bushing wear.*

PIONEER NUMBER **CA-756**



*FOR COMPLETE SELECTION OF QUALITY AUTOMOTIVE PRODUCTS,  
ASK FOR INFORMATION ON PIONEER PRODUCTS LISTED BELOW.*

## **ENGINE COMPONENTS**

- EXPANSION PLUGS & KITS
- HARMONIC BALANCERS
- OIL PANS
- TIMING COVERS
- SPECIALITY ENGINE PARTS
  - Fasteners
  - Pipe Plugs
  - Oil System Components
  - Pilot Bushings
  - Harmonic Balancer Repair Sleeves\
- VALVE TRAIN COMPONENTS
  - Valve Guides
  - Valve Seals
  - Valve Keys
  - Valve Springs
  - Valve Retainers
  - Lifters
  - Push Rods
  - Rocker Arm & Related Items

## **POWERTRAIN PRODUCTS**

- CABLES
  - Accelerator
  - Brake
  - Clutch
  - Control
  - Detent
  - Ground Strap
  - Manual Transhift
  - Miscellaneous
  - Speedometer
  - Transhift
- FLYWHEEL ASSEMBLIES
- FLYWHEEL RING GEARS
- CLUTCH FORKS AND ADJUSTERS
- ALIGNMENT TOOLS
- STANDARD FLYWHEELS

## **TRANSMISSION PRODUCTS**

- FILTER KITS
- GASKET KITS
- OVERHAUL KITS
- BANNER KITS
- MASTER KITS
- SUPER KITS
- MODULATORS
- SEALS & BUSHINGS
- CLUTCH PLATES
- SPRAG KITS
- VALVE BODY KITS
- AND MUCH MORE!*

## **HIGH PERFORMANCE**

- CYLINDER HEAD COMPONENTS:  
Complete Valve Train Parts
- SHORT BLOCK COMPONENTS:  
Expansion Plugs, Fasteners, Oil Pumps,  
Pilot Bushings, Harmonic Balancers, Miscellaneous  
Components
- FASTENERS:  
12 Point & Miscellaneous, Rod Bolts & Nuts,  
Head Studs & Bolts, Main Studs & Bolts
- MISCELLANEOUS:  
Spring Inserts, Repair Sleeves,  
Flywheel Assemblies, Tools

## **SHOP SUPPLIES**

- ABRASIVES:  
Bonded - Grinding Wheels, Stones, Segments,  
Hones, Diamond Tools  
Coated - Sanding, Polishing, Chamfering
- CUTTERS:  
Carbide, Boring Bar, Files, Rotary, Blade, Box
- BRUSHES:  
Wheel, End, Cup, Loop, Scratch,  
Gallery, Cleaning, Brooms
- CHEMICALS:  
Paint, Adhesives, Aerosols, Cleaners,  
Solvents, Oils, Sealants, Silicone, Leak Detection
- FASTENERS:  
Grade 5, Grade 8, Metric, Specialty,  
Assortments, Thread Repair
- TOOLS & ACCESSORIES:  
Valve Equipment, Pullers, Crack Repair, Measuring  
Instruments, Brake Tools, Safety Equip. & Access.

## **MOUNTS**

- ENGINE MOUNTS - Solid
- ENGINE MOUNTS - Hydraulic
- TRANSMISSION MOUNTS
- TORQUE MOUNTS
- DRIVE SHAFT CENTER SUPPORT MOUNTS
- SUSPENSION STRUT MOUNTS
- BODY MOUNTS

# **ACCELERATOR CABLES**

# ACCELERATOR CABLES

Engine	Vin	Year	Remark	OE	Part
<b>ACURA</b>					
<b>INTEGRA</b>					
L4 1.8L 1797cc		1994	w/Auto. Trans.	19010ST7A81	CA-8893
L4 1.8L 1834cc		1994		17910SR3L01	CA-8922
<b>LEGEND</b>					
V6 3.2L 3206cc		1991		17910SP0A02	CA-8996
<b>VIGOR</b>					
L5 2.5L 2451cc		1992		17910SL5A02	CA-8930
<b>AMERICAN MOTORS</b>					
<b>AMX</b>					
L6 4.2L 258ci	A, C	1978		3231395	CA-8401
<b>CONCORD</b>					
L4 2.5L 151ci	B	1980	w/GMC Eng.	3235864	CA-8403
L6 3.8L 232ci	E	1978		3231395	CA-8401
L6 4.2L 258ci	A, C	1978		3231395	CA-8401
L6 4.2L 258ci	C	1981		3239640	CA-8404
<b>EAGLE</b>					
L4 2.5L 150ci	U	1983	w/AMC Eng.	8933001320	CA-8405
L4 2.5L 151ci	B	1981	w/GMC Eng.	3235864	CA-8403
L6 4.2L 258ci	C	1980		3231395	CA-8401
L6 4.2L 258ci	C	1981		3239640	CA-8404
<b>GREMLIN</b>					
L6 3.8L 232ci	E	1975		3225997	CA-8402
L6 3.8L 232ci	E	1978		3231395	CA-8401
L6 4.2L 258ci	A	1975		3225997	CA-8402
L6 4.2L 258ci	A, C	1978		3231395	CA-8401
L6 4.2L 258ci	C	1976		3225997	CA-8402
<b>HORNET</b>					
L6 3.8L 232ci	E	1975		3225997	CA-8402
L6 4.2L 258ci	A	1975		3225997	CA-8402
L6 4.2L 258ci	C	1976		3225997	CA-8402
<b>MATADOR</b>					
L6 4.2L 258ci	A	1975		3225997	CA-8402
L6 4.2L 258ci	A	1978		3231395	CA-8401
<b>PACER</b>					
L6 3.8L 232ci	E	1975-77		3225997	CA-8402
L6 3.8L 232ci	E	1978		3231395	CA-8401
L6 4.2L 258ci	A	1975-77		3225997	CA-8402
L6 4.2L 258ci	A	1978-79		3231395	CA-8401
L6 4.2L 258ci	C	1976-77		3225997	CA-8402
L6 4.2L 258ci	C	1978-80		3231395	CA-8401
<b>SPIRIT</b>					
L4 2.5L 151ci	B	1980-81	w/GMC Eng.	3235864	CA-8403
L6 3.8L 232ci	E	1979		3231395	CA-8401
L6 4.2L 258ci	A	1979		3231395	CA-8401
L6 4.2L 258ci	C	1979-80		3231395	CA-8401

# ACCELERATOR CABLES

Engine	Vin	Year	Remark	OE	Part
<b>AMERICAN MOTORS (con't)</b>					
<b>SPIRIT (con't)</b>					
L6 4.2L 258ci	C	1981-83		3239640	CA-8404
<b>AUDI</b>					
<b>100 SERIES</b>					
L4 1.9L 1871cc		1977		811.721.555B	CA-8532
<b>4000</b>					
L4 1.6L 1588cc		1980	Manual Trans 37.63" Cable	811.721.555AA	CA-8523
L4 1.6L 1588cc	G, H	1982-83	Manual Trans 37.63" Cable	811.721.555AA	CA-8523
L4 1.7L 1715cc	A	1981-83	Manual Trans 37.63" Cable	811.721.555AA	CA-8523
L4 1.7L 1715cc	A	1981-83	w/Auto. Trans. 20.25" Cable	811723555A	CA-8775
L5 2.2L 2144cc		1980	Manual Trans 37.63" Cable	811.721.555AB	CA-8524
L5 2.2L 2144cc		1980	w/Auto. Trans. 20.25" Cable	811723555A	CA-8775
L5 2.2L 2144cc	B	1981	Manual Trans 37.63" Cable	811.721.555AB	CA-8524
L5 2.2L 2144cc	B	1981-82	w/Auto. Trans. 20.25" Cable	811723555A	CA-8775
<b>5000</b>					
L5 2.0L 1986cc		1979-80	Diesel	431.721.555N	CA-8535
L5 2.0L 1986cc	G	1981	Diesel	431.721.555N	CA-8535
L5 2.0L 1986cc	H	1982	Diesel	431.721.555N	CA-8535
L5 2.2L 2144cc		1978-79		431.721.555J	CA-8534
<b>COUPE</b>					
L5 2.2L 2144cc	B	1981-84		811.721.555AB	CA-8524
L5 2.2L 2226cc	A, D	1984		811.721.555AB	CA-8524
<b>AUSTIN</b>					
<b>HEALEY SPRITE</b>					
L4 1.3L 1275cc		1967-69	w/Manual Trans.	AHA5746	CA-8850
<b>BMW</b>					
<b>318I</b>					
L4 1.8L 1766cc		1984-85		35411154625	CA-8779
<b>BUICK</b>					
<b>APOLLO</b>					
L6 4.1L 250ci	D	1975	exc. Integral Cyl. Head	1244463	CA-8473
V8 5.7L 350ci	H, J	1973-74		1244463	CA-8473
<b>CENTURY</b>					
L4 2.5L 151ci	5, R	1982-83	Canada or Export only	25501819	CA-8470
V6 2.8L 173ci	X	1983-86		476796	CA-8471
V6 3.0L 181ci	E	1982-84		25525523	CA-8699
V6 3.0L 181ci	E	1985		25509846	CA-8802
V6 3.2L 196ci	C	1978-79		25500209	CA-8474
V6 3.8L 231ci	A	1978-81	w/2 Bbl. Carb.	25500209	CA-8474
V6 3.8L 231ci	C	1975-77		1249758	CA-8478
V6 4.3L 260ci	T	1982-84	Diesel	22514409	CA-8324
V8 4.3L 265ci	S	1980-81		25508194	CA-8519
V8 4.4L 267ci	J	1981	w/Canada Emissions	25500209	CA-8474
V8 4.9L 301ci	W	1980		1254793	CA-8469
V8 5.0L 305ci	H	1978-81	w/4 Bbl. Carb.	1254180	CA-8475

# ACCELERATOR CABLES

Engine	Vin	Year	Remark	OE	Part
<b>BUICK (con't)</b>					
<b>CENTURY (con't)</b>					
V8 5.0L 305ci	U	1977		1248077	CA-8485
V8 5.0L 305ci	U	1978	w/2 Bbl. Carb.	25500209	CA-8474
V8 5.7L 350ci	L	1977	w/Chevrolet Eng.	1248077	CA-8485
V8 5.7L 350ci	L	1978-79	w/Chevrolet Eng.	1254180	CA-8475
V8 5.7L 350ci	N	1981	Diesel, VIN Code: N	25509332	CA-8495
V8 5.7L 350ci	R	1977	w/Olds. Eng.	1248690	CA-8477
V8 6.6L 403ci	K	1977		1248690	CA-8477
<b>ELECTRA</b>					
V6 3.0L 181ci	E	1985		25509846	CA-8802
V6 4.1L 252ci	4	1980-84		25509267	CA-8498
V8 4.9L 301ci	W	1980		1254793	CA-8469
V8 5.0L 307ci	Y	1981-89		25504323	CA-8493
V8 5.7L 350ci	N	1980-84	2nd Design, Diesel, w/25mm O.D. Bushing On B	25509332	CA-8495
V8 5.7L 350ci	R	1977-79	w/Olds. Eng.	25500209	CA-8474
V8 5.7L 350ci	R	1980	w/Olds. Eng.	25504323	CA-8493
V8 6.6L 403ci	K	1977-79		25500209	CA-8474
<b>ESTATE WAGON</b>					
V8 5.7L 350ci	R	1977-79	w/Olds. Eng.	25500209	CA-8474
V8 6.6L 403ci	K	1977-79		25500209	CA-8474
<b>LESABRE</b>					
V6 3.8L 231ci	A	1977-85		25509267	CA-8498
V6 3.8L 231ci	C	1976-77		1253188	CA-8468
V6 4.1L 252ci	4	1980-84		25509267	CA-8498
V8 4.4L 267ci	J	1982	w/Canadian Emmisions	1258506	CA-8480
V8 4.9L 301ci	W	1980		1254793	CA-8469
V8 4.9L 301ci	Y	1977-79		1254793	CA-8469
V8 5.0L 305ci	U	1978	w/2 Bbl. Carb.	1258505	CA-8799
V8 5.0L 307ci	Y	1981-90		25504323	CA-8493
V8 5.7L 350ci	N	1980	2nd Design, Diesel, w/25mm O.D. Bushing On B	25509332	CA-8495
V8 5.7L 350ci	N	1981-85	Diesel	25509332	CA-8495
V8 5.7L 350ci	R	1977-79	w/Olds. Eng.	25500209	CA-8474
V8 5.7L 350ci	R	1980	w/Olds. Eng.	25504323	CA-8493
V8 6.6L 403ci	K	1977-78		25500209	CA-8474
<b>REGAL</b>					
V6 3.2L 196ci	C	1978-79		25500209	CA-8474
V6 3.8L 231ci	9	1984-85	w/Singular Point Fuel Injection	25517319	CA-8799
V6 3.8L 231ci	A	1978-87	w/2 Bbl. Carb.	25500209	CA-8474
V6 3.8L 231ci	C	1975-77		1249758	CA-8478
V6 4.1L 252ci	4	1982-84		25500209	CA-8474
V8 4.3L 265ci	S	1980-81		25508194	CA-8519
V8 4.4L 267ci	J	1981	w/Canada Emissions; 20.50" Cable 11.50" Mounting Length	1244463	CA-8473
V8 4.4L 267ci	J	1981	w/Canada Emissions; 22.75" Cable 13.00" Mounting Length	1254179	CA-8474
V8 4.4L 267ci	J	1982	w/Canada Emissions	1244463, 1254179	CA-8473



# ACCELERATOR CABLES

Engine	Vin	Year	Remark	OE	Part
<b>BUICK (con't)</b>					
<b>REGAL (con't)</b>					
V8 5.0L 305ci	H	1978-87	w/4 Bbl. Carb.	1254180	CA-8475
V8 5.0L 305ci	U	1977		1248077	CA-8485
V8 5.0L 305ci	U	1978	w/2 Bbl. Carb.	25500209	CA-8474
V8 5.0L 307ci	Y	1986-87		25504322	CA-8497
V8 5.7L 350ci	L	1977	w/Chevrolet Eng.	1248077	CA-8485
V8 5.7L 350ci	N	1982-85	Diesel	25509332	CA-8495
V8 5.7L 350ci	R	1977	w/Olds. Eng.	1248690	CA-8477
<b>RIVIERA</b>					
V6 3.8L 231ci	9	1984-85	w/Singular Point Fuel Injection	25517319	CA-8799
V6 4.1L 252ci	4	1981-84		25509474	CA-8492
V8 5.7L 350ci	R	1977-79	w/Olds. Eng.	25500209	CA-8474
V8 6.6L 403ci	K	1977-78		25500209	CA-8474
<b>ROADMASTER</b>					
V8 5.7L 350ci	7	1992-93			CA-8696
<b>SKYHAWK</b>					
L4 1.8L 112ci	G	1982	w/Square Hole Detent Bracket	10174973	CA-8793
L4 2.0L 122ci	B	1983-84	w/Square Hole Detent Bracket	14062639	CA-8800
L4 2.0L 122ci	P	1984-86	w/Electronic Fuel Injection	14077000	CA-8321
V6 3.8L 231ci	A	1978-80		1249662	CA-8481
V6 3.8L 231ci	C	1975-77		1249662	CA-8481
<b>SKYLARK</b>					
L4 2.5L 151ci	5	1980-83		25501819	CA-8470
L4 2.5L 151ci	R	1982-83		25501819	CA-8470
V6 2.8L 173ci	X	1981-85		476796	CA-8471
V6 2.8L 173ci	Z	1982		476796	CA-8471
V6 3.8L 231ci	A	1978-79		1249554	CA-8490
V6 3.8L 231ci	C	1975-77		1249554	CA-8490
V8 5.0L 305ci	G	1979		1254175	CA-8472
V8 5.0L 305ci	U	1977-78		1254175	CA-8472
V8 5.7L 350ci	L	1977-79	w/Chevrolet Eng.	1254175	CA-8472
<b>CADILLAC</b>					
<b>CIMARRON</b>					
L4 1.8L 112ci	G	1982		10174973	CA-8793
L4 2.0L 122ci	P	1983	w/Throttle Body Injection	10079816	CA-8800
L4 2.0L 122ci	P	1984-86	w/Electronic Fuel Injection	14077000	CA-8321
V6 2.8L 173ci	W	1987-88	w/Multi Port Fuel Injection, w/High Output	10079816	CA-8800
<b>DEVILLE, FLEETWOOD</b>					
V6 4.1L 252ci	4	1980-82		25509267	CA-8498
<b>ELDORADO, SEVILLE</b>					
V6 4.1L 252ci	4	1981-82		25509474	CA-8492
V8 6.0L 368ci	9	1980-81		1618795	CA-8482
<b>CHEVROLET</b>					
<b>BEL AIR</b>					
V8 5.7L 350ci	L	1975		1254793	CA-8469

# ACCELERATOR CABLES

Engine	Vin	Year	Remark	OE	Part
<b>CHEVROLET (con't)</b>					
<b>BISCAYNE</b>					
L4 2.3L 140ci	A	1990-94	exc. Cruise Control	1018631	CA-8706
V6 2.8L 173ci	W	1987-89	w/Multi Port Fuel Injection, w/High Output	10079816	CA-8800
V6 3.1L 189ci	T	1990-93	w/Multi Port Fuel Injection, Labeled WS	10079816	CA-8800
<b>CAMARO</b>					
L4 2.5L 151ci	2, F	1982-83		14036101	CA-8325
V6 2.8L 173ci	1	1982-84		14036101	CA-8325
V6 3.8L 229ci	K	1980-81	w/2 Bbl. Carb.	25508907	CA-8799
V6 3.8L 231ci	A	1980-81	w/Auto. Trans.	1254791	CA-8491
V8 4.4L 267ci	J	1980-81		1248086	CA-8484
V8 5.0L 305ci	7	1982	w/Central Fuel Injection	14076913	CA-8794
V8 5.0L 305ci	7	1983	w/4 Bbl. Carb.	14076913	CA-8794
V8 5.0L 305ci	E	1988-92	w/Multi Port Fuel Injection, Labeled WAI	10054233	CA-8795
V8 5.0L 305ci	G	1979-85		1248086	CA-8484
V8 5.0L 305ci	G	1986	w/4 Bbl. Carb., w/High Output	14076913	CA-8794
V8 5.0L 305ci	H	1980-81		1248086	CA-8484
V8 5.0L 305ci	H	1982-83		14038639	CA-8326
V8 5.0L 305ci	H	1984-87	w/4 Bbl. Carb., w/High Output	14076913	CA-8794
V8 5.0L 305ci	Q	1976		1248086	CA-8484
V8 5.0L 305ci	S	1983	w/Throttle Body Injection	14076913	CA-8794
V8 5.0L 305ci	U	1977-78		1248086	CA-8484
V8 5.7L 350ci	L	1974-81		1248086	CA-8484
<b>CAPRICE</b>					
V6 3.8L 229ci	9	1983-84		25505901	CA-8494
V6 3.8L 229ci	K	1980-82	w/2 Bbl. Carb., 19.125" Cable	25508907	CA-8799
V6 3.8L 231ci	A	1980-85	exc. Wagon, Classic	25509267	CA-8498
V6 4.3L 262ci	Z	1985-86	18.50" Cable	25505901	CA-8494
V6 4.3L 262ci	Z	1985-86	w/Throttle Body Injection 19.125" Cable	25508907	CA-8799
V6 4.3L 262ci	Z	1987	RWD	25505901	CA-8494
V8 4.4L 267ci	J	1980-82		1258506	CA-8480
V8 5.0L 305ci	E	1989-93		10126422	CA-8319
V8 5.0L 305ci	H	1980-88		1258506	CA-8480
V8 5.0L 305ci	U	1977	20.67" Cable	25505901	CA-8483
V8 5.0L 305ci	U	1978		25505901	CA-8494
V8 5.0L 307ci	Y	1986-89		25504323	CA-8493
V8 5.7L 350ci	7	1989-90		10126422	CA-8319
V8 5.7L 350ci	7	1991-93			CA-8696
V8 5.7L 350ci	L	1976	w/4 Bbl. Carb., 23.86" Cable	1248080	CA-8469
V8 5.7L 350ci	L	1977		1254179	CA-8483
V8 5.7L 350ci	L	1978-81		1258506	CA-8480
V8 5.7L 350ci	N	1980-85	2nd Design, Diesel, w/25mm O.D. Bushing On End Of Cable Assembly	25509332	CA-8495
V8 5.7L 350ci	V	1976	w/4 Bbl. Carb., 23.86" Cable	1248080	CA-8469
V8 6.6L 400ci	R	1974		1244134	CA-8509
V8 6.6L 400ci	R	1975	w/4 Bbl. Carb.	1254793	CA-8469

# ACCELERATOR CABLES

Engine	Vin	Year	Remark	OE	Part
<b>CHEVROLET (con't)</b>					
<b>CAPRICE (con't)</b>					
V8 6.6L 400ci	U	1974		1244132	CA-8509
V8 6.6L 400ci	U	1974		1244134	CA-8509
V8 6.6L 400ci	U	1975	w/4 Bbl. Carb.	1254793	CA-8469
V8 6.6L 400ci	U	1976	w/4 Bbl. Carb., 23.86" Cable	1248080	CA-8469
V8 7.4L 454ci	S	1976	w/4 Bbl. Carb., 23.86" Cable	1248080	CA-8469
V8 7.4L 454ci	Y	1974		1244134	CA-8509
V8 7.4L 454ci	Y	1975	w/4 Bbl. Carb.	1248080	CA-8469
<b>CAVALIER</b>					
L4 1.8L 112ci	G	1982		10174973	CA-8793
L4 2.0L 122ci	B	1983-84	w/Square Hole Detent Bracket	14062639	CA-8800
L4 2.0L 122ci	P	1983	w/Throttle Body Injection	10079816	CA-8800
L4 2.0L 122ci	P	1984-86	w/Electronic Fuel Injection	14077000	CA-8321
V6 2.8L 173ci	W	1985-89	w/Multi Port Fuel Injection, w/High Output	10079816	CA-8800
V6 3.1L 189ci	T	1990-94	w/Multi Port Fuel Injection	10079816	CA-8800
<b>CELEBRITY</b>					
L4 2.5L 151ci	5	1982-83	w/Canadian Emmisions	25501819	CA-8470
V6 2.8L 173ci	X	1982-86		476796	CA-8471
V6 2.8L 173ci	Z	1984		476796	CA-8471
V6 4.3L 260ci	T	1982-84	Diesel	25514409	CA-8324
<b>CHEVETTE</b>					
L4 1.4L 85ci	I	1976-77		358488	CA-8487
L4 1.6L 98ci	0	1979-80		14030861	CA-8486
L4 1.6L 98ci	9	1980-81	TO 10/01/1981	14030861	CA-8486
L4 1.6L 98ci	9	1981	w/2 Bbl. Carb., Labeled Wn 29.53" Cable	14030861	CA-8798
L4 1.6L 98ci	C	1982	w/2 Bbl. Carb., Labeled Wn	14030861	CA-8798
L4 1.6L 98ci	C	1983-87		14046515	CA-8465
L4 1.6L 98ci	E	1976-78		358488	CA-8487
L4 1.6L 98ci	E	1979		14030861	CA-8486
L4 1.6L 98ci	J	1978		358488	CA-8487
L4 1.8L 110ci	D	1981-84	Diesel	14036189	CA-8714
L4 1.8L 110ci	D	1985-86		14080256	CA-8697
<b>CITATION</b>					
L4 2.5L 151ci	5	1980-83		25501819	CA-8470
V6 2.8L 173ci	X	1981-85		476796	CA-8471
V6 2.8L 173ci	Z	1981-84		476796	CA-8471
<b>CORSICA</b>					
V6 2.8L 173ci	W	1987-89	w/Multi Port Fuel Injection, w/High Output	10079816	CA-8800
V6 3.1L 189ci	T	1990-93	w/Multi Port Fuel Injection, Labeled WS	10079816	CA-8800
<b>IMPALA</b>					
V6 3.8L 229ci	9	1983-84		25505901	CA-8494
V6 3.8L 229ci	K	1980-82	18.50" Cable	25505901	CA-8494
V6 3.8L 229ci	K	1980-82	w/2 Bbl. Carb., 19.125" Cable	25508907	CA-8799
V6 3.8L 231ci	A	1980-85		25509267	CA-8498
V6 4.3L 262ci	Z	1985	18.50" Cable	25505901	CA-8494

# ACCELERATOR CABLES

Engine	Vin	Year	Remark	OE	Part
<b>CHEVROLET (con't)</b>					
<b>IMPALA (con't)</b>					
V6 4.3L 262ci	Z	1985	w/Throttle Body Injection 19.125" Cable	25508907	CA-8799
V8 4.4L 267ci	J	1980-82		1258506	CA-8480
V8 5.0L 305ci	H	1980-85		1258506	CA-8480
V8 5.0L 305ci	U	1977		1254179	CA-8483
V8 5.0L 305ci	U	1978		25505901	CA-8494
V8 5.7L 350ci	H, L	1975	w/4 Bbl. Carb.	1248080	CA-8469
V8 5.7L 350ci	L	1976	w/4 Bbl. Carb., 23.86" Cable	1248080	CA-8469
V8 5.7L 350ci	L	1977		1254179	CA-8483
V8 5.7L 350ci	L	1978-81		1258506	CA-8480
V8 5.7L 350ci	N	1980	2nd Design, Diesel, w/25mm O.D. Bushing On E	25509332	CA-8495
V8 5.7L 350ci	N	1981-85	Diesel	25509332	CA-8495
V8 5.7L 350ci	V	1976	w/4 Bbl. Carb., 23.86" Cable	1248080	CA-8469
V8 6.6L 400ci	R, U	1974		1244134	CA-8509
V8 6.6L 400ci	U	1975	w/4 Bbl. Carb.	1248080	CA-8469
V8 6.6L 400ci	U	1976	w/4 Bbl. Carb., 23.86" Cable	1254793	CA-8469
V8 7.4L 454ci	S	1976	w/4 Bbl. Carb.	1248080	CA-8469
V8 7.4L 454ci	Y	1974		1244134	CA-8509
V8 7.4L 454ci	Y	1975	w/4 Bbl. Carb.	1248080	CA-8469
<b>LAGUNA</b>					
V8 5.0L 305ci	Q	1976		1248077	CA-8485
V8 5.7L 350ci	H	1975		1248077	CA-8485
V8 5.7L 350ci	L	1975-76		1248077	CA-8485
V8 5.7L 350ci	V	1976		1248077	CA-8485
V8 6.6L 400ci	U	1975-76		1248077	CA-8485
<b>MALIBU</b>					
L6 4.1L 250ci	D	1973-77		1248075	CA-8485
V6 3.3L 200ci	M	1978-79		1258156	CA-8496
V6 3.8L 229ci	9	1983		1258156	CA-8496
V6 3.8L 229ci	K	1980-82	w/2 Bbl. Carb, 20.75" Cable	1258156	CA-8496
V6 3.8L 231ci	A	1978-83	22.75" Cable	25500209	CA-8474
V6 3.8L 231ci	A	1981	20.75" Cable	1258156	CA-8496
V8 4.4L 267ci	J	1979-82	22.75" Cable	25500209	CA-8474
V8 5.0L 305ci	H	1979-83		1254180	CA-8475
V8 5.0L 305ci	Q	1976		1248077	CA-8485
V8 5.0L 305ci	U	1977		1248077	CA-8485
V8 5.0L 305ci	U	1978		25500209	CA-8474
V8 5.7L 350ci	H	1974-75		1248077	CA-8485
V8 5.7L 350ci	L	1974-77		1248077	CA-8485
V8 5.7L 350ci	L	1978-81		1254180	CA-8475
V8 5.7L 350ci	N	1982-83	Diesel	25509332	CA-8495
V8 5.7L 350ci	V	1976		1248077	CA-8485
V8 6.6L 400ci	U	1975-76		1248077	CA-8485
V8 7.4L 454ci	Y	1975		1248075	CA-8485

# ACCELERATOR CABLES

Engine	Vin	Year	Remark	OE	Part
<b>CHEVROLET (con't)</b>					
<b>MONTE CARLO</b>					
V6 3.3L 200ci	M	1978-79		1258156	CA-8496
V6 3.8L 229ci	9	1983-84		1258156	CA-8496
V6 3.8L 229ci	K	1980-82		1258156	CA-8496
V6 3.8L 231ci	A	1978-87		25500209	CA-8474
V6 4.3L 262ci	Z	1985-88		1258156	CA-8496
V8 4.4L 267ci	J	1979-82		25500209	CA-8474
V8 5.0L 305ci	H	1979-88		1254180	CA-8475
V8 5.0L 305ci	Q	1976		1248077	CA-8485
V8 5.0L 305ci	U	1977		1248077	CA-8485
V8 5.0L 305ci	U	1978		25500209	CA-8474
V8 5.7L 350ci	L	1976-77		1248077	CA-8485
V8 5.7L 350ci	L	1981		1254180	CA-8475
V8 5.7L 350ci	N	1982-84	Diesel	25509332	CA-8495
V8 5.7L 350ci	V	1976		1248077	CA-8485
V8 7.4L 454ci	Y	1975		1248078	CA-8485
<b>MONZA</b>					
L4 2.3L 140ci	A	1975-76		354712	CA-8489
L4 2.3L 140ci	B	1975-77		354712	CA-8489
L4 2.5L 151ci	1	1978-79		25502349	CA-8488
L4 2.5L 151ci	9	1979		25502349	CA-8488
L4 2.5L 151ci	V	1978-80		25502349	CA-8488
V6 3.2L 196ci	C	1978-79		1249662	CA-8481
V6 3.8L 231ci	2	1979		1249662	CA-8481
V6 3.8L 231ci	A	1978-79		1249662	CA-8481
V8 5.0L 305ci	G	1979		1249662	CA-8481
<b>NOVA</b>					
L4 1.6L 98ci	4	1985-88	w/o CC	7818012651	CA-9008
L4 1.6L 98ci	5	1988	w/o CC	7818012651	CA-9008
L6 4.1L 250ci	D	1973-75	w/Integral Cyl. Head	1244463	CA-8473
L6 4.1L 250ci	D	1976-79		1254174	CA-8476
V8 5.0L 305ci	G	1979		1254175	CA-8472
V8 5.0L 305ci	Q	1976		1254175	CA-8472
V8 5.0L 305ci	U	1977-78		1254175	CA-8472
V8 5.7L 350ci	L	1976-79		1254175	CA-8472
<b>SPECTRUM</b>					
L4 1.5L 92ci	7	1986-87	w/Manual Trans.	94165358	CA-8869
L4 1.5L 92ci	9	1987	w/Manual Trans.	94165358	CA-8869
L4 1.5L 92ci	K	1985	w/Manual Trans.	94165358	CA-8869
<b>SPRINT</b>					
L3 1.0L 61ci	2	1987-88	w/Manual Trans.	1591082000	CA-8866
L3 1.0L 61ci	5	1986-88	w/Manual Trans.	1591082000	CA-8866
L3 1.0L 61ci	M	1985	w/Manual Trans.	1591082000	CA-8866
<b>VEGA</b>					
L4 2.3L 140ci	A	1974-76		354712	CA-8489

# ACCELERATOR CABLES

Engine	Vin	Year	Remark	OE	Part
<b>CHEVROLET (con't)</b>					
<b>VEGA (con't)</b>					
L4 2.3L 140ci	B	1972-77		354712	CA-8489
<b>CHEVROLET TRUCKS</b>					
<b>ASTRO</b>					
L4 2.5L 151ci	E	1985-88		15590109	CA-8506
V6 4.3L 262ci	B	1990-91		15604992	CA-8797
V6 4.3L 262ci	N	1985		15590110	CA-8507
V6 4.3L 262ci	Z	1986-92		15557348	CA-8499
<b>BLAZER</b>					
L6 4.1L 250ci	Q	1974		1244131	CA-8509
V8 5.7L 350ci	K	1988-91		15551476	CA-8314
V8 5.7L 350ci	K	1992-94		15552822	CA-8688
V8 5.7L 350ci	V, Y	1974		1244132	CA-8509
V8 6.2L 379ci	C	1987-90		14038644	CA-8503
<b>C10</b>					
L6 4.1L 250ci	D	1976-80	w/2 Bbl. Carb, 23.86" Cable	1248073	CA-8469
L6 4.1L 250ci	D	1979-84	35.63" Cable	14000307	CA-8317
L6 4.1L 250ci	Q	1974		1244131	CA-8509
L6 4.1L 250ci	Q	1975	w/2 Bbl. Carb, 23.86" Cable	1248073	CA-8469
L6 4.8L 292ci	S, T	1974		1244132	CA-8509
L6 4.8L 292ci	T	1975-76	w/2 Bbl. Carb, 23.86" Cable	1248073	CA-8469
L6 4.8L 292ci	T	1977-80		1248081	CA-8468
V6 4.3L 262ci	N	1985-86		15593743	CA-8508
V8 5.0L 305ci	F	1981	w/2 Bbl. Carb.	1248083	CA-8469
V8 5.0L 305ci	F	1981-82	w/4 Bbl. Carb.	1259333	CA-8500
V8 5.0L 305ci	F	1983-86		25515839	CA-8500
V8 5.0L 305ci	G	1980-81	w/2 Bbl. Carb, 23.86" Cable	1248083	CA-8469
V8 5.0L 305ci	G	1980-81	w/4 Bbl. Carb., 24.78" Cable	1259333	CA-8500
V8 5.0L 305ci	H	1981	w/2 Bbl. Carb.	1248083	CA-8469
V8 5.0L 305ci	H	1981-82	w/4 Bbl. Carb.	1259333	CA-8500
V8 5.0L 305ci	H	1983-86		25515839	CA-8500
V8 5.0L 305ci	Q	1976	w/2 Bbl. Carb, 23.86" Cable	1248073	CA-8469
V8 5.0L 305ci	U	1977-79		1248083	CA-8469
V8 5.7L 350ci	L	1976-77	w/2 Bbl. Carb, 23.86" Cable	1248073	CA-8469
V8 5.7L 350ci	L	1978-86	w/4 Bbl. Carb., 24.78" Cable	1259333	CA-8500
V8 5.7L 350ci	M	1980-86	w/4 Bbl. Carb., 24.78" Cable	1259333	CA-8500
V8 5.7L 350ci	P	1980		1259333	CA-8500
V8 5.7L 350ci	V, W, Y	1974		1244132	CA-8509
V8 5.7L 350ci	V	1975-76	w/2 Bbl. Carb, 23.86" Cable	1248073	CA-8469
V8 5.7L 350ci	Y	1975		1248073	CA-8469
V8 5.7L 350ci	Z	1978-81	Diesel	25509846	CA-8802
V8 6.2L 379ci	C, J	1982-86		14038644	CA-8503
V8 6.6L 400ci	R	1978-79		1259333	CA-8500
V8 6.6L 400ci	U	1976	w/2 Bbl. Carb, 23.86" Cable	1248073	CA-8469
V8 6.6L 400ci	U	1976	w/4 Bbl. Carb., 24.78" Cable	1259333	CA-8500

# ACCELERATOR CABLES

Engine	Vin	Year	Remark	OE	Part
<b>CHEVROLET TRUCKS (con't)</b>					
<b>C10 (con't)</b>					
V8 6.6L 400ci	X	1980	w/2 Bbl. Carb, 23.86" Cable	1248083	CA-8469
V8 6.6L 400ci	X	1980	w/4 Bbl. Carb., 24.78" Cable	1259333	CA-8500
V8 7.4L 454ci	S, W	1980	w/2 Bbl. Carb, 23.86" Cable	1248083	CA-8469
V8 7.4L 454ci	S, W	1980	w/4 Bbl. Carb., 24.78" Cable	1259333	CA-8500
V8 7.4L 454ci	S	1978-79		1259333	CA-8500
V8 7.4L 454ci	Z	1974		1244131	CA-8509
V8 7.4L 454ci	Z	1975	w/2 Bbl. Carb, 23.86" Cable	1248083	CA-8469
<b>C10 SUBURBAN</b>					
L6 4.1L 250ci	D	1977-78		1254793	CA-8469
L6 4.1L 250ci	D	1979-80		14000307	CA-8317
L6 4.1L 250ci	Q	1974		1244131	CA-8509
L6 4.1L 250ci	Q	1975		1254793	CA-8469
L6 4.8L 292ci	S, T	1974		1244132	CA-8509
V8 5.0L 305ci	F	1982	w/4 Bbl. Carb.	1259333	CA-8500
V8 5.0L 305ci	F	1983-86	w/4 Bbl. Carb., 24.78" Cable	25515839	CA-8500
V8 5.0L 305ci	G	1981	w/2 Bbl. Carb.	1254793	CA-8469
V8 5.0L 305ci	G	1981	w/4 Bbl. Carb.	1259333	CA-8500
V8 5.0L 305ci	H	1981-82	w/4 Bbl. Carb.	1259333	CA-8500
V8 5.0L 305ci	H	1981-86	w/2 Bbl. Carb.	1254793	CA-8469
V8 5.0L 305ci	H	1983-86	w/4 Bbl. Carb., 24.78" Cable	25515839	CA-8500
V8 5.0L 305ci	U	1978-79		1254793	CA-8469
V8 5.7L 350ci	L	1979-86	w/4 Bbl. Carb., 24.78" Cable	1259333	CA-8500
V8 5.7L 350ci	M	1980-86	w/4 Bbl. Carb., 24.78" Cable	1259333	CA-8500
V8 5.7L 350ci	V, W, Y	1974		1244133	CA-8509
V8 5.7L 350ci	V	1975-76		1254793	CA-8469
V8 5.7L 350ci	Y	1975		1254793	CA-8469
V8 5.7L 350ci	Z	1979	Diesel	25509846	CA-8802
V8 6.2L 379ci	C	1982-86		14038644	CA-8503
V8 7.4L 454ci	S, W	1980	w/2 Bbl. Carb, 23.86" Cable	1254793	CA-8469
V8 7.4L 454ci	S, W	1980	w/4 Bbl. Carb., 24.78" Cable	1259333	CA-8500
V8 7.4L 454ci	S	1976-77		1254793	CA-8469
V8 7.4L 454ci	S	1978-79		1259333	CA-8500
V8 7.4L 454ci	Z	1974		1244131	CA-8509
V8 7.4L 454ci	Z	1975		1254793	CA-8469
<b>C1500</b>					
V6 4.3L 262ci	Z	1988-95		15552822	CA-8688
V8 5.0L 305ci	H	1988-95		15552822	CA-8688
V8 5.7L 350ci	K	1988-95		15552822	CA-8688
V8 6.2L 379ci	C	1988-90		15552819	CA-8701
V8 7.4L 454ci	N	1990-93		15552822	CA-8688
<b>C1500 SUBURBAN</b>					
V8 5.7L 350ci	K	1992-95		15552822	CA-8688
<b>C20</b>					
L6 4.1L 250ci	D	1976-78		1248073	CA-8469

# ACCELERATOR CABLES

Engine	Vin	Year	Remark	OE	Part
<b>CHEVROLET TRUCKS (con't)</b>					
<b>C20 (con't)</b>					
L6 4.1L 250ci	D	1979-84		14000307	CA-8317
L6 4.1L 250ci	Q	1974		1244131	CA-8509
L6 4.1L 250ci	Q	1975	w/2 Bbl. Carb, 23.86" Cable	1248073	CA-8469
L6 4.8L 292ci	S, T	1974		1244132	CA-8509
L6 4.8L 292ci	T	1977-86		1248081	CA-8468
V6 4.3L 262ci	N	1985-86		15593743	CA-8508
V8 5.0L 305ci	H	1981	w/2 Bbl. Carb.	1248083	CA-8469
V8 5.0L 305ci	H	1981-82	w/4 Bbl. Carb.	1259333	CA-8500
V8 5.0L 305ci	H	1983-84		25515839	CA-8500
V8 5.0L 305ci	H	1985-86	w/4 Bbl. Carb., 24.78" Cable	25515839	CA-8500
V8 5.0L 305ci	U	1977-78		1248083	CA-8469
V8 5.7L 350ci	L	1976		1248073	CA-8469
V8 5.7L 350ci	L	1977		1248083	CA-8469
V8 5.7L 350ci	L	1978-84		1259333	CA-8500
V8 5.7L 350ci	L	1985-86	w/4 Bbl. Carb., 24.78" Cable	1259333	CA-8500
V8 5.7L 350ci	M	1980-84		1259333	CA-8500
V8 5.7L 350ci	M	1985-86	w/4 Bbl. Carb., 24.78" Cable	1259333	CA-8500
V8 5.7L 350ci	P	1980		1259333	CA-8500
V8 5.7L 350ci	V, W, Y	1974	24.00" Cable	1244134	CA-8509
V8 5.7L 350ci	V, Y	1975	w/2 Bbl. Carb, 23.86" Cable	1248073	CA-8469
V8 5.7L 350ci	V	1976		1248073	CA-8469
V8 6.2L 379ci	C, J	1982-86		14038644	CA-8503
V8 6.6L 400ci	R	1978-79		1259333	CA-8500
V8 6.6L 400ci	U	1976	w/2 Bbl. Carb, 23.86" Cable	1248083	CA-8469
V8 6.6L 400ci	U	1976	w/4 Bbl. Carb., 24.78" Cable	1259333	CA-8500
V8 6.6L 400ci	X	1980		1259333	CA-8500
V8 7.4L 454ci	S	1978-80		1259333	CA-8500
V8 7.4L 454ci	W	1983		25515839	CA-8500
V8 7.4L 454ci	W	1980-84		1259333	CA-8500
V8 7.4L 454ci	W	1985-86	w/2 Bbl. Carb, 23.86" Cable	1248083	CA-8469
V8 7.4L 454ci	W	1985-86	w/4 Bbl. Carb., 24.78" Cable	25515839	CA-8500
V8 7.4L 454ci	Z	1974		1244131	CA-8509
V8 7.4L 454ci	Z	1975	w/2 Bbl. Carb, 23.86" Cable	1248073	CA-8469
<b>C20 SUBURBAN</b>					
L6 4.1L 250ci	Q	1974		1244131	CA-8509
L6 4.8L 292ci	S, T	1974		1244132	CA-8509
L6 4.8L 292ci	T	1975-76		1254793	CA-8469
L6 4.8L 292ci	T	1977-82		1248081	CA-8468
V8 5.0L 305ci	H	1981	w/2 Bbl. Carb.	1254793	CA-8469
V8 5.0L 305ci	H	1981-82	w/4 Bbl. Carb.	1259333	CA-8500
V8 5.0L 305ci	H	1983-84		25515839	CA-8500
V8 5.0L 305ci	H	1986	w/2 Bbl. Carb, 23.86" Cable	1254793	CA-8469
V8 5.0L 305ci	H	1985-86	w/4 Bbl. Carb. 24.78" Cable	25515839	CA-8500
V8 5.0L 305ci	Q	1976		1254793	CA-8469



# ACCELERATOR CABLES

Engine	Vin	Year	Remark	OE	Part
<b>CHEVROLET TRUCKS (con't)</b>					
<b>C20 SUBURBAN (con't)</b>					
V8 5.0L 305ci	U	1978-79		1254793	CA-8469
V8 5.7L 350ci	L	1977		1254793	CA-8469
V8 5.7L 350ci	L	1978-81		1259333	CA-8500
V8 5.7L 350ci	L	1986	w/4 Bbl. Carb. 24.78" Cable	1259333	CA-8500
V8 5.7L 350ci	M	1980-84		1259333	CA-8500
V8 5.7L 350ci	M	1985-86	w/4 Bbl. Carb. 24.78" Cable	1259333	CA-8500
V8 5.7L 350ci	V, W, Y	1974		1244134	CA-8509
V8 5.7L 350ci	V	1975-76		1254793	CA-8469
V8 5.7L 350ci	Y	1975		1254793	CA-8469
V8 6.2L 379ci	J	1982-86		14038644	CA-8503
V8 6.6L 400ci	R	1979		1259333	CA-8500
V8 6.6L 400ci	U	1976		1254793	CA-8469
V8 6.6L 400ci	X	1980		1259333	CA-8500
V8 7.4L 454ci	S	1980		1259333	CA-8500
V8 7.4L 454ci	W	1980-82		1259333	CA-8500
V8 7.4L 454ci	W	1983-84	w/4 Bbl. Carb., 24.78" Cable	25515839	CA-8500
V8 7.4L 454ci	W	1985-86	w/2 Bbl. Carb, 23.86" Cable	1254793	CA-8469
V8 7.4L 454ci	W	1985-86	w/4 Bbl. Carb. 24.78" Cable	25515839	CA-8500
V8 7.4L 454ci	Z	1974		1244131	CA-8509
V8 7.4L 454ci	Z	1975		1254793	CA-8469
<b>C2500</b>					
V6 4.3L 262ci	Z	1988-95		15552822	CA-8688
V8 5.0L 305ci	H	1988-95		15552822	CA-8688
V8 5.7L 350ci	K	1988-95		15552822	CA-8688
V8 6.2L 379ci	C, J	1988-90		15552819	CA-8701
V8 7.4L 454ci	N	1991-95		15552822	CA-8688
<b>C2500 SUBURBAN</b>					
V8 5.7L 350ci	K	1992-95		15552822	CA-8688
V8 7.4L 454ci	N	1992-95		15552822	CA-8688
<b>C30</b>					
L6 4.1L 250ci	D	1979-80		14000307	CA-8317
L6 4.1L 250ci	Q	1974	24.00" Cable	1244134	CA-8509
L6 4.1L 250ci	Q	1975	w/2 Bbl. Carb, 23.86" Cable	1248073	CA-8469
L6 4.8L 292ci	S, T	1974	24.00" Cable	1244134	CA-8509
L6 4.8L 292ci	T	1975-76	w/2 Bbl. Carb, 23.86" Cable	1248073	CA-8469
L6 4.8L 292ci	T	1977-86		1248081	CA-8468
V8 5.0L 305ci	H	1986	w/4 Bbl. Carb., 24.78" Cable	25515839	CA-8500
V8 5.0L 305ci	U	1979	w/2 Bbl. Carb, 23.86" Cable	1248083	CA-8469
V8 5.7L 350ci	L	1976		1248073	CA-8469
V8 5.7L 350ci	L	1977		1248083	CA-8469
V8 5.7L 350ci	L	1978-80	w/4 Bbl. Carb., 24.78" Cable	1259333	CA-8500
V8 5.7L 350ci	M	1980-84	w/4 Bbl 24.78" Cable	1259333	CA-8500
V8 5.7L 350ci	M	1981	w/2 Bbl 28.28" Cable	358448	CA-8689
V8 5.7L 350ci	M	1985-86	w/4 Bbl. Carb., 24.78" Cable	1259333	CA-8500

# ACCELERATOR CABLES

Engine	Vin	Year	Remark	OE	Part
<b>CHEVROLET TRUCKS (con't)</b>					
<b>C30 (con't)</b>					
V8 5.7L 350ci	V, W, Y	1974	24.00" Cable	1244134	CA-8509
V8 5.7L 350ci	V, Y	1975	w/2 Bbl. Carb, 23.86" Cable	1248073	CA-8469
V8 5.7L 350ci	V	1976		1248073	CA-8469
V8 5.7L 350ci	Z	1978	Diesel	25509846	CA-8802
V8 6.2L 379ci	J	1982-86		14038644	CA-8503
V8 6.6L 400ci	R	1978		1259333	CA-8500
V8 6.6L 400ci	R	1979	w/2 Bbl. Carb, 23.86" Cable	1248083	CA-8469
V8 6.6L 400ci	R	1979	w/4 Bbl. Carb., 24.78" Cable	1259333	CA-8500
V8 6.6L 400ci	U	1976		1254793	CA-8469
V8 7.4L 454ci	S	1979	w/4 Bbl. Carb., 24.78" Cable	1259333	CA-8500
V8 7.4L 454ci	S	1978-80		1259333	CA-8500
V8 7.4L 454ci	W	1980-83		1259333	CA-8500
V8 7.4L 454ci	W	1984		25515839	CA-8500
V8 7.4L 454ci	W	1985-86	w/2 Bbl. Carb, 23.86" Cable	1248083	CA-8469
V8 7.4L 454ci	W	1985-86	w/4 Bbl. Carb., 24.78" Cable	25515839	CA-8500
V8 7.4L 454ci	Z	1974	24.00" Cable	1244134	CA-8509
V8 7.4L 454ci	Z	1975	w/2 Bbl. Carb, 23.86" Cable	1248073	CA-8469
<b>C3500</b>					
V8 5.7L 350ci	K	1988-95		15552822	CA-8688
V8 6.2L 379ci	J	1988-90		15552819	CA-8701
V8 7.4L 454ci	N	1988-95		15552822	CA-8688
<b>EL CAMINO</b>					
L6 4.1L 250ci	D	1975-77		1248075	CA-8485
V6 3.3L 200ci	M	1978-79		1258156	CA-8496
V6 3.8L 229ci	9	1983-84		1258156	CA-8496
V6 3.8L 229ci	K	1980-82		1258156	CA-8496
V6 3.8L 231ci	A	1978-84		25500209	CA-8474
V6 4.3L 262ci	Z	1985-87		1258156	CA-8496
V8 4.4L 267ci	J	1979-82		25500209	CA-8474
V8 5.0L 305ci	H	1979-87		1254180	CA-8475
V8 5.0L 305ci	Q	1976		1248077	CA-8485
V8 5.0L 305ci	U	1977		1248077	CA-8485
V8 5.0L 305ci	U	1978		25500209	CA-8474
V8 5.7L 350ci	L	1976-77		1248077	CA-8485
V8 5.7L 350ci	L	1978-79		1254180	CA-8475
V8 5.7L 350ci	N	1983-84	Diesel	25509332	CA-8495
V8 5.7L 350ci	V	1976		1248077	CA-8485
<b>G10</b>					
L6 4.1L 250ci	D	1976-84		1248087	CA-8687
L6 4.1L 250ci	Q	1975		1248087	CA-8687
V6 4.3L 262ci	N	1985-86		15590110	CA-8507
V6 4.3L 262ci	Z	1987-90		15552817	CA-8467
V8 5.0L 305ci	F	1981-86		376193	CA-8467
V8 5.0L 305ci	G	1980-81		376193	CA-8467

# ACCELERATOR CABLES

Engine	Vin	Year	Remark	OE	Part
<b>CHEVROLET TRUCKS (con't)</b>					
<b>G10 (con't)</b>					
V8 5.0L 305ci	H	1981-90		376193	CA-8467
V8 5.0L 305ci	U	1977-79		376193	CA-8467
V8 5.7L 350ci	K	1987-90		15552817	CA-8467
V8 5.7L 350ci	L	1976-86		1248088	CA-8467
V8 5.7L 350ci	P	1980		1248088	CA-8467
V8 5.7L 350ci	V	1975-76		1248088	CA-8467
V8 5.7L 350ci	Y	1975		1248088	CA-8467
<b>G20</b>					
L6 4.1L 250ci	D	1979-84		1248087	CA-8687
L6 4.1L 250ci	Q	1975		1248087	CA-8687
V6 4.3L 262ci	N	1985-86		15590110	CA-8507
V6 4.3L 262ci	Z	1987-90		15552817	CA-8467
V8 5.0L 305ci	F	1981-86		376193	CA-8467
V8 5.0L 305ci	G	1980-81		376193	CA-8467
V8 5.0L 305ci	H	1981-90		376193	CA-8467
V8 5.0L 305ci	U	1977-79		376193	CA-8467
V8 5.7L 350ci	K	1987-90		15552817	CA-8467
V8 5.7L 350ci	L	1976-86		1248088	CA-8467
V8 5.7L 350ci	M	1980-86		1248088	CA-8467
V8 5.7L 350ci	V	1975-76		1248088	CA-8467
V8 5.7L 350ci	Y	1975		1248088	CA-8467
V8 6.2L 379ci	C	1983-90		14047686	CA-8503
V8 6.2L 379ci	J	1984-85		14047686	CA-8503
V8 6.6L 400ci	M	1975		376193	CA-8467
V8 6.6L 400ci	R	1977-80		376193	CA-8467
V8 6.6L 400ci	U	1976		376193	CA-8467
V8 6.6L 400ci	X	1980		376193	CA-8467
<b>G30</b>					
L6 4.1L 250ci	D	1976-84		1248087	CA-8687
V6 4.3L 262ci	N	1986		15590110	CA-8507
V6 4.3L 262ci	Z	1987-90		15552817	CA-8467
V8 5.0L 305ci	F	1982		376193	CA-8467
V8 5.0L 305ci	H	1982		376193	CA-8467
V8 5.0L 305ci	U	1978-79		376193	CA-8467
V8 5.7L 350ci	K	1987-90		15552817	CA-8467
V8 5.7L 350ci	L	1976-86		1248088	CA-8467
V8 5.7L 350ci	M	1980-86		1248088	CA-8467
V8 5.7L 350ci	M	1987-88		15552817	CA-8467
V8 5.7L 350ci	V	1975-76		1248088	CA-8467
V8 5.7L 350ci	Y	1975		1248088	CA-8467
V8 6.2L 379ci	C	1984		14047686	CA-8503
V8 6.2L 379ci	J	1983-90		14047686	CA-8503
V8 6.6L 400ci	M	1975		376193	CA-8467
V8 6.6L 400ci	R	1977-80		376193	CA-8467

# ACCELERATOR CABLES

Engine	Vin	Year	Remark	OE	Part
<b>CHEVROLET TRUCKS (con't)</b>					
<b>G30 (con't)</b>					
V8 6.6L 400ci	U	1976		376193	CA-8467
V8 7.4L 454ci	N	1988-93		15552857	CA-8796
V8 7.4L 454ci	N	1994-96	w/o Speed Governor	15552857	CA-8796
<b>K10</b>					
L6 4.1L 250ci	D	1978		1254793	CA-8469
L6 4.1L 250ci	D	1979-84		14000307	CA-8317
L6 4.1L 250ci	Q	1974		1244131	CA-8509
L6 4.1L 250ci	Q	1975		1254793	CA-8469
L6 4.8L 292ci	T	1975-76		1254793	CA-8469
L6 4.8L 292ci	T	1979-80		1248081	CA-8468
V6 4.3L 262ci	N	1985-86		15593743	CA-8508
V8 5.0L 305ci	H	1981	w/2 Bbl. Carb.	1254793	CA-8469
V8 5.0L 305ci	H	1981-82	w/4 Bbl. Carb.	1259333	CA-8500
V8 5.0L 305ci	H	1983-86		25515839	CA-8500
V8 5.0L 305ci	U	1977-79		1254793	CA-8469
V8 5.7L 350ci	L	1976-77		1254793	CA-8469
V8 5.7L 350ci	L	1978-86		1259333	CA-8500
V8 5.7L 350ci	M	1980-85		1259333	CA-8500
V8 5.7L 350ci	V, Y	1974		1244134	CA-8509
V8 5.7L 350ci	V	1975-76		1254793	CA-8469
V8 5.7L 350ci	Y	1975		1254793	CA-8469
V8 6.2L 379ci	C	1982-86		14038644	CA-8503
V8 6.6L 400ci	R	1978-79		1259333	CA-8500
V8 6.6L 400ci	U	1976		1254793	CA-8469
V8 6.6L 400ci	X	1980		1259333	CA-8500
V8 7.4L 454ci	S	1976		1254793	CA-8469
V8 7.4L 454ci	S	1979-80		1259333	CA-8500
V8 7.4L 454ci	Z	1974		1244131	CA-8509
<b>K10 SUBURBAN</b>					
L6 4.1L 250ci	D	1976-78		1254793	CA-8469
L6 4.1L 250ci	D	1979-80		14000307	CA-8317
L6 4.1L 250ci	Q	1974		1244131	CA-8509
L6 4.1L 250ci	Q	1975		1254793	CA-8469
V8 5.0L 305ci	F	1982	w/4 Bbl. Carb.	1259333	CA-8500
V8 5.0L 305ci	F	1983-85		25515839	CA-8500
V8 5.0L 305ci	G	1980-81	w/2 Bbl. Carb.	1254793	CA-8469
V8 5.0L 305ci	G	1980-81	w/4 Bbl. Carb.	1259333	CA-8500
V8 5.0L 305ci	H	1981	w/2 Bbl. Carb.	1254793	CA-8469
V8 5.0L 305ci	H	1981-82	w/4 Bbl. Carb.	1259333	CA-8500
V8 5.0L 305ci	H	1986		25515839	CA-8500
V8 5.0L 305ci	U	1977-79		1254793	CA-8469
V8 5.7L 350ci	L	1979-86		1259333	CA-8500
V8 5.7L 350ci	M	1980-86		1259333	CA-8500
V8 5.7L 350ci	V, Y	1974		1244134.667	CA-8509

# ACCELERATOR CABLES

Engine	Vin	Year	Remark	OE	Part
<b>CHEVROLET TRUCKS (con't)</b>					
<b>K10 SUBURBAN (con't)</b>					
V8 5.7L 350ci	V	1975-76		1254793	CA-8469
V8 5.7L 350ci	Y	1975		1254793	CA-8469
V8 6.2L 379ci	C	1982-86		14038644	CA-8503
V8 6.6L 400ci	R	1977		1254793	CA-8469
V8 6.6L 400ci	R	1978-79		1259333	CA-8500
V8 6.6L 400ci	U	1976		1254793	CA-8469
<b>K1500</b>					
V6 4.3L 262ci	Z	1988-95		15552822	CA-8688
V8 5.0L 305ci	H	1988-95		15552822	CA-8688
V8 5.7L 350ci	K	1988-95		15552822	CA-8688
V8 6.2L 379ci	C	1988-90		15552819	CA-8701
<b>K1500 SUBURBAN</b>					
V8 5.7L 350ci	K	1992-95		15552822	CA-8688
<b>K20</b>					
L6 4.1L 250ci	D	1976	w/2 Bbl. Carb, 23.86" Cable	1248073	CA-8469
L6 4.1L 250ci	D	1979-80		14000307	CA-8317
L6 4.1L 250ci	Q	1974		1244131	CA-8509
L6 4.1L 250ci	Q	1975	w/2 Bbl. Carb, 23.86" Cable	1248073	CA-8469
L6 4.8L 292ci	S, T	1974		1244132	CA-8509
L6 4.8L 292ci	T	1977-86		1248081	CA-8468
V6 4.3L 262ci	N	1985		15593743	CA-8508
V8 5.0L 305ci	G	1980	w/2 Bbl. Carb.	1254793	CA-8469
V8 5.0L 305ci	G	1980	w/4 Bbl. Carb., 24.78" Cable	1259333	CA-8500
V8 5.0L 305ci	H	1985		25515839	CA-8500
V8 5.0L 305ci	U	1977-78		1248083	CA-8469
V8 5.7L 350ci	L	1976	w/2 Bbl. Carb, 23.86" Cable	1248073	CA-8469
V8 5.7L 350ci	L	1977		1248083	CA-8469
V8 5.7L 350ci	L	1979-86	w/4 Bbl. Carb., 24.78" Cable	1259333	CA-8500
V8 5.7L 350ci	M	1980	w/4 Bbl. Carb., 24.78" Cable	1259333	CA-8500
V8 5.7L 350ci	M	1981-86		1259333	CA-8500
V8 5.7L 350ci	V, Y	1974		1244134	CA-8509
V8 5.7L 350ci	V	1975-76	w/2 Bbl. Carb, 23.86" Cable	1248073	CA-8469
V8 5.7L 350ci	Y	1975	w/2 Bbl. Carb, 23.86" Cable	1248073	CA-8469
V8 6.2L 379ci	C, J	1982-86		14038644	CA-8503
V8 6.6L 400ci	R	1978	w/4 Bbl. Carb., 24.78" Cable	1259333	CA-8500
V8 6.6L 400ci	R	1979		1259333	CA-8500
V8 6.6L 400ci	U	1976	w/2 Bbl. Carb, 23.86" Cable	1248073	CA-8469
V8 6.6L 400ci	X	1980	w/4 Bbl. Carb., 24.78" Cable	1259333	CA-8500
V8 7.4L 454ci	S	1978-80	w/4 Bbl. Carb., 24.78" Cable	1259333	CA-8500
V8 7.4L 454ci	S	1978-80	w/2 Bbl. 23.86" Cable	1248083	CA-8469
V8 7.4L 454ci	Z	1974		1244131	CA-8509
<b>K20 SUBURBAN</b>					
L6 4.1L 250ci	Q	1974		1244131	CA-8509
L6 4.8L 292ci	T	1974		1244132	CA-8509

# ACCELERATOR CABLES

Engine	Vin	Year	Remark	OE	Part
<b>CHEVROLET TRUCKS (con't)</b>					
<b>K20 SUBURBAN (con't)</b>					
L6 4.8L 292ci	T	1975-76		1254793	CA-8469
L6 4.8L 292ci	T	1977-82		1248081	CA-8468
V8 5.0L 305ci	H	1985-86		25515839	CA-8500
V8 5.0L 305ci	U	1978		1254793	CA-8469
V8 5.7L 350ci	L	1976		1254793	CA-8469
V8 5.7L 350ci	L	1978-86		1259333	CA-8500
V8 5.7L 350ci	M	1980-86		1259333	CA-8500
V8 5.7L 350ci	P	1980		1259333	CA-8500
V8 5.7L 350ci	V, Y	1974		1244135.167	CA-8509
V8 5.7L 350ci	V	1975-76		1254793	CA-8469
V8 5.7L 350ci	Y	1975		1254793	CA-8469
V8 6.2L 379ci	J	1982-86		14038644	CA-8503
V8 6.6L 400ci	M	1975		1254793	CA-8469
V8 6.6L 400ci	R	1978-80		1259333	CA-8500
V8 6.6L 400ci	U	1976		1254793	CA-8469
V8 7.4L 454ci	W	1985		25515839	CA-8500
<b>K2500</b>					
V6 4.3L 262ci	Z	1988-95		15552822	CA-8688
V8 5.0L 305ci	H	1988-95		15552822	CA-8688
V8 5.7L 350ci	K	1988-95		15552822	CA-8688
V8 6.2L 379ci	C, J	1988-90		15552819	CA-8701
V8 7.4L 454ci	N	1991-95		15552822	CA-8688
<b>K2500 SUBURBAN</b>					
V8 5.7L 350ci	K	1992-95		15552822	CA-8688
V8 7.4L 454ci	N	1992-95		15552822	CA-8688
<b>K30</b>					
L6 4.1L 250ci	Q	1974		1244131	CA-8509
L6 4.8L 292ci	S, T	1974		1244132	CA-8509
L6 4.8L 292ci	T	1977-86		1248081	CA-8468
V8 5.7L 350ci	L	1977		1248083	CA-8469
V8 5.7L 350ci	L	1978-80		1259333	CA-8500
V8 5.7L 350ci	M	1980-86	w/4 Bbl. 24.78" Cable	1259333	CA-8500
V8 5.7L 350ci	M	1981	w/2 Bbl. 28.28" Cable	358448	CA-8689
V8 5.7L 350ci	V, Y	1974		1244134	CA-8509
V8 6.2L 379ci	J	1982-86		14038644	CA-8503
V8 6.6L 400ci	R	1977		1254793	CA-8469
V8 6.6L 400ci	R	1978-80		1259333	CA-8500
V8 7.4L 454ci	S	1980		1259333	CA-8500
V8 7.4L 454ci	W	1981-82		1259333	CA-8500
V8 7.4L 454ci	W	1984		25515839	CA-8500
V8 7.4L 454ci	W	1985	w/Stainless Steel Exhaust Manifold. 25.80" Cabl	15552837	CA-8505
V8 7.4L 454ci	W	1986	w/2 Bbl. Carb, 23.86" Cable	1248083	CA-8469
V8 7.4L 454ci	W	1986	w/Federal Emissions 25.80" Cable	15552837	CA-8505
V8 7.4L 454ci	W	1985-86	w/4 Bbl. Carb., 24.78" Cable	25515839	CA-8500

# ACCELERATOR CABLES

Engine	Vin	Year	Remark	OE	Part
<b>CHEVROLET TRUCKS (con't)</b>					
<b>K30 (con't)</b>					
V8 7.4L 454ci	Z	1974		1244131	CA-8509
<b>K3500</b>					
V8 5.7L 350ci	K	1988-95		15552822	CA-8688
V8 6.2L 379ci	J	1988-90		15552819	CA-8701
V8 7.4L 454ci	N	1988-95		15552822	CA-8688
<b>K5 BLAZER</b>					
L6 4.1L 250ci	D	1976		1248073	CA-8469
L6 4.1L 250ci	D	1978	w/2 Bbl. Carb, 23.86" Cable	1248073	CA-8469
L6 4.1L 250ci	D	1979-82		14000307	CA-8317
L6 4.1L 250ci	Q	1975		1248073	CA-8469
V8 5.0L 305ci	F	1981	w/2 Bbl. Carb.	1248083	CA-8469
V8 5.0L 305ci	F	1981-82	w/4 Bbl. Carb.	1259333	CA-8500
V8 5.0L 305ci	G	1980-81	w/2 Bbl. Carb.	1248083	CA-8469
V8 5.0L 305ci	G	1980-81	w/4 Bbl. Carb.	1259333	CA-8500
V8 5.0L 305ci	H	1981	w/2 Bbl. Carb.	1248083	CA-8469
V8 5.0L 305ci	H	1981-82	w/4 Bbl. Carb.	1259333	CA-8500
V8 5.0L 305ci	H	1983-86		25515839	CA-8500
V8 5.0L 305ci	U	1977-79		1248083	CA-8469
V8 5.7L 350ci	L	1976		1248073	CA-8469
V8 5.7L 350ci	L	1977		1248083	CA-8469
V8 5.7L 350ci	L	1979-86		1259333	CA-8500
V8 5.7L 350ci	V	1975-76		1248073	CA-8469
V8 5.7L 350ci	Y	1975		1248073	CA-8469
V8 6.2L 379ci	C	1982-86		14038644	CA-8503
V8 6.6L 400ci	R	1977		1248083	CA-8469
V8 6.6L 400ci	R	1978	w/2 Bbl. Carb, 23.86" Cable	1248083	CA-8469
V8 6.6L 400ci	R	1978	w/4 Bbl. Carb., 24.78" Cable	1259333	CA-8500
V8 6.6L 400ci	R	1979		1259333	CA-8500
V8 6.6L 400ci	U	1976	w/2 Bbl. Carb, 23.86" Cable	1248073	CA-8469
V8 6.6L 400ci	U	1976	w/4 Bbl. Carb., 24.78" Cable	1259333	CA-8500
V8 7.4L 454ci	S	1976		1248073	CA-8469
V8 7.4L 454ci	S	1977		1248083	CA-8469
V8 7.4L 454ci	S	1978	w/2 Bbl. Carb, 23.86" Cable	1248083	CA-8469
V8 7.4L 454ci	S	1978	w/4 Bbl. Carb., 24.78" Cable	1259333	CA-8500
<b>LUMINA APV</b>					
V6 3.1L 189ci	D	1990-92		10064691	CA-8692
<b>LUV PICKUP</b>					
L4 1.8L 111ci	N	1973-75			CA-8770
L4 1.8L 111ci	N	1976-80		8942383821	CA-8760
L4 1.8L 111ci	N	1981-82		8942383821	CA-8762
L4 2.2L 134ci	S	1981-82		8942415191	CA-8766
<b>P10</b>					
L6 4.8L 292ci	T	1977-80		1248090	CA-8499
V8 5.7L 350ci	L	1977-78		1248092	CA-8499

# ACCELERATOR CABLES

Engine	Vin	Year	Remark	OE	Part
<b>CHEVROLET TRUCKS (con't)</b>					
<b>P10 (con't)</b>					
V8 5.7L 350ci	Y	1975		1248092	CA-8499
<b>P20</b>					
L6 4.8L 292ci	T	1977-89	68.38" Cable	1248090	CA-8499
V8 5.7L 350ci	K	1987	68.38" Cable	1248092	CA-8499
V8 5.7L 350ci	K	1988-89		15551490	CA-8499
V8 5.7L 350ci	L	1978-79		1248092	CA-8499
V8 5.7L 350ci	M	1980-86		1248092	CA-8499
V8 5.7L 350ci	M	1987	68.38" Cable	1248092	CA-8499
V8 5.7L 350ci	Y	1975		1248092	CA-8499
V8 6.2L 379ci	J	1982-89		14046855	CA-8504
V8 7.4L 454ci	S	1979		1248092	CA-8499
V8 7.4L 454ci	Y	1976		1248092	CA-8499
<b>P30</b>					
L4 3.9L 239ci	L	1990-91		1248090	CA-8499
L6 4.8L 292ci	T	1977-89		1248090	CA-8499
V6 4.3L 262ci	Z	1991		1248090	CA-8499
V8 5.7L 350ci	K	1987-92		15551490	CA-8499
V8 5.7L 350ci	L	1976-80	exc. Motor Home Chassis	1248092	CA-8499
V8 5.7L 350ci	L	1976-80	w/Motor Home Chassis	352268	CA-8466
V8 5.7L 350ci	M	1980-86	w/Motor Home Chassis	352268	CA-8466
V8 5.7L 350ci	M	1980-88	exc. Motor Home Chassis	1248092	CA-8499
V8 6.2L 379ci	J	1982-90		14046855	CA-8504
V8 7.4L 454ci	L	1975		1248092	CA-8499
V8 7.4L 454ci	N	1990-91	exc. Motor Home Chassis, w/Forward Control	1248092	CA-8499
V8 7.4L 454ci	N	1990-91	w/Motor Home Chassis	1248092	CA-8466
V8 7.4L 454ci	N	1992		1248092	CA-8499
V8 7.4L 454ci	S	1976-78	exc. Motor Home Chassis	1248092	CA-8499
V8 7.4L 454ci	S	1976-80	w/Motor Home Chassis	1248092	CA-8466
V8 7.4L 454ci	S	1979-80	exc. Motor Home Chassis, w/Forward Control	1248092	CA-8499
V8 7.4L 454ci	W	1980-89	exc. Motor Home Chassis, w/Forward Control	1248092	CA-8499
V8 7.4L 454ci	W	1980-89	w/Motor Home Chassis	1248092	CA-8466
<b>R10</b>					
V6 4.3L 262ci	Z	1987		15551476	CA-8314
V8 5.0L 305ci	H	1987		15551476	CA-8314
V8 5.7L 350ci	K	1987		15551476	CA-8314
V8 6.2L 379ci	C	1987		14038644	CA-8503
<b>R10 SUBURBAN</b>					
V8 5.7L 350ci	K	1987-88		15551476	CA-8314
V8 6.2L 379ci	C	1987-88		14038644	CA-8503
<b>R1500 SUBURBAN</b>					
V8 5.7L 350ci	K	1989-91		15551476	CA-8314
V8 6.2L 379ci	C	1989-90		14038644	CA-8503



# ACCELERATOR CABLES

Engine	Vin	Year	Remark	OE	Part
<b>CHEVROLET TRUCKS (con't)</b>					
<b>R20</b>					
L6 4.8L 292ci	T	1987-88		1248081	CA-8468
V6 4.3L 262ci	Z	1987		15551476	CA-8314
V8 5.0L 305ci	H	1987		15551476	CA-8314
V8 5.7L 350ci	K	1987-88		15551476	CA-8314
V8 6.2L 379ci	C, J	1987-88		14038644	CA-8503
V8 7.4L 454ci	N	1988		1551476	CA-8314
<b>R20 SUBURBAN</b>					
V8 5.7L 350ci	K	1987-88		15551476	CA-8314
V8 6.2L 379ci	J	1987-88		14038644	CA-8503
V8 7.4L 454ci	N	1988		1551476	CA-8314
<b>R2500</b>					
V8 6.2L 379ci	J	1989		14038644	CA-8503
V8 7.4L 454ci	N	1989		1551476	CA-8314
<b>R2500 SUBURBAN</b>					
V8 5.7L 350ci	K	1989-91		15551476	CA-8314
V8 6.2L 379ci	J	1989-90		14038644	CA-8503
V8 7.4L 454ci	N	1989-91		1551476	CA-8314
<b>R30</b>					
L6 4.8L 292ci	T	1987-88		1248081	CA-8468
V8 5.7L 350ci	K, M	1987		15551476	CA-8314
V8 5.7L 350ci	K, M	1988		15551476	CA-8314
V8 6.2L 379ci	J	1987-88		14038644	CA-8503
V8 7.4L 454ci	N	1987-88	w/2 Bbl. 28.80" Cable	1551476	CA-8314
V8 7.4L 454ci	W	1987-88	w/4 Bbl. Carb.; 24.78" Cable	25515839	CA-8500
<b>R3500</b>					
V8 5.7L 350ci	K	1989-91		15551476	CA-8314
V8 6.2L 379ci	J	1989-90		14038644	CA-8503
V8 7.4L 454ci	N	1989-91		1551476	CA-8314
V8 7.4L 454ci	W	1989	w/4 Bbl. Carb.	25515839	CA-8500
<b>S10, S10 BLAZER</b>					
L4 1.9L 119ci	A	1982-85		14036109	CA-8501
L4 2.0L 122ci	Y	1983-84		14036109	CA-8501
L4 2.5L 151ci	E	1985-86		15592356	CA-8506
V6 2.8L 173ci	B	1982-85		14036110	CA-8502
V6 2.8L 173ci	R	1986-90		15622471	CA-8316
V6 4.3L 262ci	Z	1988-91		15622442	CA-8315
<b>TAHOE</b>					
V8 5.7L 350ci	K	1995		15552822	CA-8688
<b>V10</b>					
V6 4.3L 262ci	Z	1987		15551476	CA-8314
V8 5.0L 305ci	H	1987		15551476	CA-8314
V8 5.7L 350ci	K	1987		15551476	CA-8314
V8 6.2L 379ci	C	1987		14038644	CA-8503

# ACCELERATOR CABLES

Engine	Vin	Year	Remark	OE	Part
<b>CHEVROLET TRUCKS (con't)</b>					
<b>V10 SUBURBAN</b>					
V8 5.7L 350ci	K	1987-88		15551476	CA-8314
V8 6.2L 379ci	C	1987-88		14038644	CA-8503
<b>V1500 SUBURBAN</b>					
V8 5.7L 350ci	K	1989-91		15551476	CA-8314
V8 6.2L 379ci	C	1989-90		14038644	CA-8503
<b>V20</b>					
L6 4.8L 292ci	T	1987		1248081	CA-8468
V8 5.7L 350ci	K	1987		15551476	CA-8314
V8 6.2L 379ci	C, J	1987		14038644	CA-8503
<b>V20 SUBURBAN</b>					
V8 5.7L 350ci	K	1987-88		15551476	CA-8314
V8 6.2L 379ci	J	1987-88		14038644	CA-8503
V8 7.4L 454ci	N	1987-88		1551476	CA-8314
<b>V2500 SUBURBAN</b>					
V8 5.7L 350ci	K	1989-91		15551476	CA-8314
V8 6.2L 379ci	J	1989-90		14038644	CA-8503
V8 7.4L 454ci	N	1990		1551476	CA-8314
<b>V30</b>					
L6 4.8L 292ci	T	1987-88		1248081	CA-8468
V8 5.7L 350ci	K	1987-88		15551476	CA-8314
V8 5.7L 350ci	M	1987		1259333	CA-8500
V8 5.7L 350ci	M	1988		15551476	CA-8314
V8 6.2L 379ci	J	1987-88		14038644	CA-8503
V8 7.4L 454ci	N	1988		1551476	CA-8314
V8 7.4L 454ci	W	1987-88	w/4 Bbl. Carb.	15552837	CA-8505
<b>V3500</b>					
V8 5.7L 350ci	K	1989-91		15551476	CA-8314
V8 6.2L 379ci	J	1989-90		14038644	CA-8503
V8 7.4L 454ci	N	1989-91		1551476	CA-8314
V8 7.4L 454ci	W	1989	w/4 Bbl. Carb.	15552837	CA-8505
<b>CHRYSLER</b>					
<b>CORDOBA</b>					
L6 3.7L 225ci	E	1981-82	w/2 Bbl. Carb. w/Auto. Trans.	4095320	CA-8415
L6 3.7L 225ci	G	1981	w/2 Bbl. Carb. w/Auto. Trans.	4095320	CA-8415
L6 3.7L 225ci	H, K	1983	w/2 Bbl. Carb. w/Auto. Trans.	4095320	CA-8415
V8 5.2L 318ci	G, H	1975-80	w/2 Bbl. Carb. w/Auto. Trans.	3698839	CA-8410
V8 5.2L 318ci	G, H	1979-80	w/4 Bbl. Carb. w/Auto. Trans.	3769123	CA-8411
V8 5.2L 318ci	K, M	1981-82	w/2 Bbl. Carb.	4027358	CA-8414
V8 5.2L 318ci	K, M	1981-82	w/4 Bbl. Carb. w/Auto. Trans.	4027355	CA-8422
V8 5.2L 318ci	P	1983	w/2 Bbl. Carb.	4027358	CA-8414
V8 5.2L 318ci	P	1983	w/4 Bbl. Carb. w/Auto. Trans.	4027355	CA-8422
V8 5.9L 360ci	J, K, L	1975-79	w/2 Bbl. Carb. w/Auto. Trans.	3698839	CA-8410
V8 5.9L 360ci	J, K, L	1978-79	w/4 Bbl. Carb. w/Auto. Trans.	3769123	CA-8411
V8 6.6L 400ci	M	1975-76		3769123	CA-8411

# ACCELERATOR CABLES

Engine	Vin	Year	Remark	OE	Part
<b>CHRYSLER (con't)</b>					
<b>CORDOBA (con't)</b>					
V8 6.6L 400ci	N, P	1975-78		3769123	CA-8411
<b>DAYTONA</b>					
L4 2.2L 135ci	A	1989	Turbo	4458774	CA-8305
L4 2.2L 135ci	E	1984-86	Turbo 52.00" Cable	4287531	CA-8430
L4 2.2L 135ci	E	1984-87	Turbo w/Intercooler 49.49" Cable	4288197	CA-8309
L4 2.2L 135ci	E	1984-87	Turbo w/o Intercooler 61.27" Cable	4306190	CA-8312
L4 2.2L 135ci	E	1985	61.75" Cable	4287530	CA-8429
L4 2.5L 153ci	J	1989-92	Turbo	4458774	CA-8305
L4 2.5L 153ci	K	1987-90	w/Electronic Fuel Injection 50.66" Cable	4549216	CA-8302
L4 2.5L 153ci	K	1990-93	51.18" Cable	4300845	CA-8301
V6 3.0L 181ci	3	1990-93		4459135	CA-8306
<b>DYNASTY</b>					
L4 2.5L 153ci	K	1988-89	50.66" Cable	4549216	CA-8302
L4 2.5L 153ci	K	1990-91		4300845	CA-8301
L4 2.5L 153ci	K	1992		4459135	CA-8306
V6 3.0L 181ci	3	1989-90		4459135	CA-8306
V6 3.3L 201ci	R	1992		4459135	CA-8306
<b>E CLASS</b>					
L4 2.2L 135ci	C	1983	51.00" Cable	4275907	CA-8426
L4 2.2L 135ci	D	1984	w/Throttle Body Injection	4287530	CA-8429
L4 2.2L 135ci	E	1984	Turbo	4287531	CA-8430
L4 2.6L 156ci	G	1983-84	To 5/15/84; 36.55" Cable	4268825	CA-8427
L4 2.6L 156ci	G	1984	From 5/15/84; 37.75" Cable	4288191	CA-8428
<b>EXECUTIVE LIMOUSINE</b>					
L4 2.6L 156ci	G	1985	37.75" Cable	4288191	CA-8428
<b>EXECUTIVE SEDAN</b>					
L4 2.6L 156ci	G	1983-84	To 5/15/84; 36.55" Cable	4268825	CA-8427
L4 2.6L 156ci	G	1984	From 5/15/84; 37.75" Cable	4288191	CA-8428
<b>FIFTH AVENUE</b>					
L6 3.7L 225ci	H, K	1983	w/1 Bbl. Carb. w/Auto. Trans.	4095176	CA-8412
L6 3.7L 225ci	H, K	1983	w/2 Bbl. Carb.	4095320	CA-8415
V8 5.2L 318ci	P	1983	w/4 Bbl. Carb. w/Auto. Trans.	4027355	CA-8422
V8 5.2L 318ci	P	1983-89	w/2 Bbl. Carb.	4027358	CA-8414
V8 5.2L 318ci	P	1985	w/4 Bbl. Carb.	4027355	CA-8422
<b>IMPERIAL</b>					
V8 5.2L 318ci	J	1981-82		5214343	CA-8420
<b>LASER</b>					
L4 2.2L 135ci	D	1984-85	w/Throttle Body Injection	4287530	CA-8429
L4 2.2L 135ci	D	1986	w/Electronic Fuel Injection 50.66" Cable	4549216	CA-8302
L4 2.2L 135ci	E	1984-85	Turbo	4287531	CA-8430
L4 2.2L 135ci	E	1986	Turbo w/Intercooler	4288197	CA-8309
L4 2.2L 135ci	E	1986	Turbo w/o Intercooler	4306190	CA-8312
L4 2.5L 153ci	K	1986	w/Electronic Fuel Injection 50.66" Cable	4549216	CA-8302

# ACCELERATOR CABLES

Engine	Vin	Year	Remark	OE	Part
<b>CHRYSLER (con't)</b>					
<b>LEBARON</b>					
L4 2.2L 135ci	A	1989		4458774	CA-8305
L4 2.2L 135ci	B	1982		4268821	CA-8424
L4 2.2L 135ci	C	1983-84	51.00" Cable	4275907	CA-8426
L4 2.2L 135ci	C	1990		4458774	CA-8305
L4 2.2L 135ci	D	1984-85		4287530	CA-8429
L4 2.2L 135ci	D	1986-88	50.66" Cable	4549216	CA-8302
L4 2.2L 135ci	E	1984-86	Turbo; 52.00" Cable	4287531	CA-8430
L4 2.2L 135ci	E	1986	Turbo; 49.49" Cable	4288197	CA-8309
L4 2.2L 135ci	E	1987	Turbo w/Intercooler	4288197	CA-8309
L4 2.2L 135ci	E	1987	Turbo w/o Intercooler	4306190	CA-8312
L4 2.2L 135ci	E	1988		4458774	CA-8305
L4 2.5L 153ci	J	1989-90	Turbo	4458774	CA-8305
L4 2.5L 153ci	K	1986-88	w/Electronic Fuel Injection 50.66" Cable	4549216	CA-8302
L4 2.5L 153ci	K	1989	50.66" Cable	4549216	CA-8302
L4 2.5L 153ci	K	1990		4300845	CA-8301
L4 2.6L 156ci	D	1982	36.25" Cable	4241205	CA-8425
L4 2.6L 156ci	G	1983-84	To 5/15/84; 36.55" Cable	4268825	CA-8427
L4 2.6L 156ci	G	1984-85	From 5/15/84; 37.75" Cable	4288191	CA-8428
L6 3.7L 225ci	C, D	1978	w/1 Bbl. Carb.	4027354	CA-8413
L6 3.7L 225ci	C, D	1979-80	w/1 Bbl. Carb. w/Auto. Trans. 25.75" Cable	4095176	CA-8412
L6 3.7L 225ci	C, D	1979-80	w/1 Bbl. Carb. w/Manual Trans.	4027354	CA-8413
L6 3.7L 225ci	C, D	1979-80	w/2 Bbl. Carb. w/Auto. Trans. 30.25" Cable	4095320	CA-8415
L6 3.7L 225ci	E	1981	37.48" Cable	4459135	CA-8306
L6 3.7L 225ci	E, F, G	1981	w/1 Bbl. Carb. w/Auto. Trans. 25.75" Cable	4095176	CA-8412
L6 3.7L 225ci	E, G	1981	w/2 Bbl. Carb. w/Auto. Trans. 30.25" Cable	4095320	CA-8415
L6 3.7L 225ci	F	1981	w/2 Bbl. Carb. w/Auto. Trans.; 22.75" Cable	3698839	CA-8410
L6 3.7L 225ci	F	1981	w/2 Bbl. Carb. w/Auto. Trans. 30.25" Cable	4095320	CA-8415
L6 3.7L 225ci	F	1981	w/4 Bbl. Carb. w/Auto. Trans.	3769123	CA-8411
L6 3.7L 225ci	G	1981	37.48" Cable	4288096	CA-8307
V6 3.0L 181ci	3	1990-92	37.48" Cable	4459135	CA-8306
V8 5.2L 318ci	G, H	1977-80	w/2 Bbl. Carb. w/Auto. Trans.	4027358	CA-8414
V8 5.2L 318ci	G, H	1979-80	w/4 Bbl. Carb. w/Auto. Trans.	4027355	CA-8422
V8 5.2L 318ci	K, L, N	1981	w/2 Bbl. Carb. w/Auto. Trans.	4027358	CA-8414
V8 5.2L 318ci	K, L, N	1981	w/4 Bbl. Carb. w/Auto. Trans.	4027355	CA-8422
V8 5.2L 318ci	M	1981	w/2 Bbl. Carb.	4027358	CA-8414
V8 5.9L 360ci	J, K, L	1978-79	w/4 Bbl. Carb. w/Auto. Trans.	4027355	CA-8422
<b>NEW YORKER</b>					
L4 2.2L 135ci	D	1984	w/Throttle Body Injection	4287530	CA-8429
L4 2.2L 135ci	E	1984-85	Turbo	4287531	CA-8430
L4 2.2L 135ci	E	1986	w/Electronic Fuel Injection 50.66" Cable	4549216	CA-8302
L4 2.2L 135ci	E	1987	Turbo w/Intercooler	4288197	CA-8309
L4 2.2L 135ci	E	1987	Turbo w/o Intercooler	4306190	CA-8312
L4 2.5L 153ci	K	1986-87	w/Electronic Fuel Injection 50.66" Cable	4549216	CA-8302
L4 2.6L 156ci	G	1983-84	To 5/15/84; 36.55" Cable	4268825	CA-8427

# ACCELERATOR CABLES

Engine	Vin	Year	Remark	OE	Part
<b>CHRYSLER (con't)</b>					
<b>NEW YORKER (con't)</b>					
L4 2.6L 156ci	G	1984-85	From 5/15/84; 37.75" Cable	4288191	CA-8428
V6 3.0L 181ci	3	1988	37.48" Cable, Mounting Length 29.06"	4288096	CA-8307
V6 3.0L 181ci	3	1988-89	w/Auto. Trans. 37.48" Cable, Mounting Length 29.17"	4459135	CA-8306
V8 5.2L 318ci	G, H	1979-80	w/2 Bbl. Carb. w/Auto. Trans.	3698839	CA-8410
V8 5.2L 318ci	G, H	1979-80	w/4 Bbl. Carb. w/Auto. Trans.	3769123	CA-8411
V8 5.2L 318ci	K, M	1981	w/2 Bbl. Carb. w/Auto. Trans.	3698839	CA-8410
V8 5.2L 318ci	K, M	1981	w/4 Bbl. Carb. w/Auto. Trans.	3769123	CA-8411
V8 5.2L 318ci	K, M	1982	w/2 Bbl. Carb.	4027358	CA-8414
V8 5.2L 318ci	K, M	1982	w/4 Bbl. Carb. w/Auto. Trans.	4027355	CA-8422
V8 5.9L 360ci	J, K, L	1979-80	w/2 Bbl. Carb. w/Auto. Trans.	3698839	CA-8410
V8 5.9L 360ci	J, K, L	1979-80	w/4 Bbl. Carb. w/Auto. Trans.	3769123	CA-8411
<b>NEWPORT</b>					
L6 3.7L 225ci	E, G	1981	w/1 Bbl. Carb. w/Auto. Trans.	4095176	CA-8412
V8 5.2L 318ci	G, H	1979-80	w/2 Bbl. Carb. w/Auto. Trans.	3698839	CA-8410
V8 5.2L 318ci	G, H	1979-80	w/4 Bbl. Carb. w/Auto. Trans.	3769123	CA-8411
V8 5.2L 318ci	K, L, M	1981	w/2 Bbl. Carb. w/Auto. Trans.	3698839	CA-8410
V8 5.2L 318ci	K, L, M	1981	w/4 Bbl. Carb. w/Auto. Trans.	3769123	CA-8411
V8 5.9L 360ci	J, K, L	1979-80	w/2 Bbl. Carb. w/Auto. Trans.	3698839	CA-8410
V8 5.9L 360ci	J, K, L	1979-80	w/4 Bbl. Carb. w/Auto. Trans.	3769123	CA-8411
<b>TC MASERATI</b>					
L4 2.2L 135ci	P, R	1989	Turbo	4458774	CA-8305
V6 3.0L 181ci	S	1990	50.66" Cable	4549216	CA-8302
V6 3.0L 181ci	S	1990	51.00" Cable	4275907	CA-8426
V6 3.0L 181ci	S	1991	36.25" Cable	4241205	CA-8425
V6 3.0L 181ci	S	1991	37.75" Cable	4288191	CA-8428
<b>CHRYSLER TRUCKS</b>					
<b>TOWN &amp; COUNTRY</b>					
L4 2.2L 135ci	B	1982		4268821	CA-8424
L4 2.2L 135ci	C	1983	36.25" Cable	4241205	CA-8425
L4 2.2L 135ci	C	1983	37.75" Cable	4288191	CA-8428
L4 2.2L 135ci	E	1985-88	50.66" Cable	4549216	CA-8302
L4 2.2L 135ci	E	1987	51.00" Cable	4275907	CA-8426
L4 2.5L 153ci	K	1986-88	50.66" Cable	4549216	CA-8302
L4 2.6L 156ci	D	1982	36.55" Cable	4268825	CA-8427
L4 2.6L 156ci	D	1982	37.75" Cable	4288191	CA-8428
L4 2.6L 156ci	G	1984	From 5/15/84; 37.75" Cable	4288191	CA-8428
L4 2.6L 156ci	G	1984	To 5/15/84; 36.55" Cable	4268825	CA-8427
V8 5.2L 318ci	K, M	1981	w/2 Bbl. Carb.	4027358	CA-8414
V8 5.2L 318ci	K, M	1981	w/4 Bbl. Carb.	4027355	CA-8422
<b>DODGE</b>					
<b>400</b>					
L4 2.2L 135ci	B	1982		4268821	CA-8424
L4 2.2L 135ci	C	1983	51.00" Cable	4275907	CA-8426

# ACCELERATOR CABLES

Engine	Vin	Year	Remark	OE	Part
<b>DODGE (con't)</b>					
<b>400 (con't)</b>					
L4 2.6L 156ci	D	1982		4241205	CA-8425
L4 2.6L 156ci	G	1983		4268825	CA-8427
<b>600</b>					
L4 2.2L 135ci	C	1983-84	51.00" Cable	4275907	CA-8426
L4 2.2L 135ci	D	1984	51.00" Cable	4275907	CA-8426
L4 2.2L 135ci	D	1984-85	w/Throttle Body Injection; 61.75" Cable	4287530	CA-8429
L4 2.2L 135ci	D	1986-88	w/Electronic Fuel Injection 50.66" Cable	4549216	CA-8302
L4 2.2L 135ci	E	1984-85	Turbo; 52.00" Cable	4287531	CA-8430
L4 2.2L 135ci	E	1986	w/Electronic Fuel Injection 50.66" Cable	4549216	CA-8302
L4 2.2L 135ci	E	1987-88	Turbo w/Intercooler	4306190	CA-8309
L4 2.2L 135ci	E	1987-88	Turbo w/o Intercooler	4306190	CA-8312
L4 2.5L 153ci	K	1986-88	w/Electronic Fuel Injection 50.66" Cable	4549216	CA-8302
L4 2.6L 156ci	G	1983-84	To 5/15/84	4268825	CA-8427
L4 2.6L 156ci	G	1984-85	From 5/15/84	4288191	CA-8428
<b>ARIES</b>					
L4 2.2L 135ci	B	1981-82		4268821	CA-8424
L4 2.2L 135ci	C	1983-84	51.00" Cable	4275907	CA-8426
L4 2.2L 135ci	C	1985	52.00" Cable	4287531	CA-8430
L4 2.2L 135ci	D	1985	61.75" Cable	4287530	CA-8429
L4 2.2L 135ci	D	1986-89	50.66" Cable	4549216	CA-8302
L4 2.5L 153ci	K	1986-89	50.66" Cable	4549216	CA-8302
L4 2.6L 156ci	D	1981-82		4241205	CA-8425
L4 2.6L 156ci	G	1983-84	To 5/15/84	4268825	CA-8427
L4 2.6L 156ci	G	1984-85	From 5/15/84	4288191	CA-8428
<b>ASPEN</b>					
L6 3.7L 225ci	C, D	1976-78		4027354	CA-8413
L6 3.7L 225ci	C, D	1979-80	w/1 Bbl. Carb. w/Auto. Trans.	4095176	CA-8412
L6 3.7L 225ci	C, D	1979-80	w/1 Bbl. Carb. w/Manual Trans.	4027354	CA-8413
L6 3.7L 225ci	C, D	1979-80	w/2 Bbl. Carb. w/Auto. Trans.	4095320	CA-8415
V8 5.2L 318ci	G, H	1978	w/4 Bbl. Carb.	4027355	CA-8422
V8 5.2L 318ci	G, H	1976-78	w/2 Bbl. Carb.	4027358	CA-8414
V8 5.2L 318ci	G, H	1979-80	w/2 Bbl. Carb. w/Auto. Trans.	4027358	CA-8414
V8 5.2L 318ci	G, H	1979-80	w/4 Bbl. Carb. w/Auto. Trans.	4027355	CA-8422
V8 5.9L 360ci	K	1976-78	w/2 Bbl. Carb.	3027358	CA-8414
V8 5.9L 360ci	K	1977-78	w/4 Bbl. Carb. w/Auto. Trans.	4027355	CA-8422
V8 5.9L 360ci	L	1977-80	w/2 Bbl. Carb.	3027358	CA-8414
V8 5.9L 360ci	L	1977-80	w/4 Bbl. Carb. w/Auto. Trans.	4027355	CA-8422
<b>CHALLENGER</b>					
L4 2.6L 156ci	7	1981-83	w/AT or 5 Spd. MT	MB181013	CA-8868
V8 5.2L 318ci	G	1972-74	From 2/72	3698839	CA-8410
V8 5.9L 360ci	L	1974	w/2 Bbl. Carb.	3698839	CA-8410
<b>CHARGER</b>					
L4 2.2L 135ci	8	1985-86	50.59" Cable	4288065	CA-8311
L4 2.2L 135ci	C	1986	50.59" Cable	4288065	CA-8311

# ACCELERATOR CABLES

Engine	Vin	Year	Remark	OE	Part
<b>DODGE (con't)</b>					
<b>CHARGER (con't)</b>					
L4 2.2L 135ci	E	1985-87	Turbo w/Intercooler	4288197	CA-8309
L4 2.2L 135ci	E	1985-87	Turbo w/o Intercooler	4306190	CA-8312
L6 3.7L 225ci	C	1974-76	w/2 Bbl. Carb.	3698839	CA-8410
L6 3.7L 225ci	C	1974-76	w/4 Bbl. Carb.	3769123	CA-8411
V8 5.2L 318ci	G	1972-76	w/2 Bbl. Carb.	3698839	CA-8410
V8 5.2L 318ci	G	1974-76	w/4 Bbl. Carb.	3769123	CA-8411
V8 5.2L 318ci	G	1976	w/4 Bbl. Carb. w/Auto. Trans.	3769123	CA-8411
V8 5.2L 318ci	G, H	1977-78	w/2 Bbl. Carb. w/Auto. Trans., Special Edition	3698839	CA-8410
V8 5.2L 318ci	G, H	1977-78	w/4 Bbl. Carb. w/Auto. Trans., Special Edition	3769123	CA-8411
V8 5.9L 360ci	J	1976	w/2 Bbl. Carb. w/Auto. Trans.	3698839	CA-8410
V8 5.9L 360ci	J	1976	w/4 Bbl. Carb. w/Auto. Trans.	3769123	CA-8411
V8 5.9L 360ci	J, L	1978	w/2 Bbl. Carb. w/Auto. Trans., Special Edition	3698839	CA-8410
V8 5.9L 360ci	J, K, L	1977-78	w/4 Bbl. Carb. w/Auto. Trans., Special Edition	3769123	CA-8411
V8 5.9L 360ci	K	1975-76	w/2 Bbl. Carb. w/Auto. Trans.	3698839	CA-8410
V8 5.9L 360ci	K	1975-76	w/4 Bbl. Carb. w/Auto. Trans.	3769123	CA-8411
V8 5.9L 360ci	K	1977-78	w/2 Bbl. Carb. w/Auto. Trans., Special Edition	3698839	CA-8410
V8 6.6L 400ci	M	1973-76	w/4 Bbl. Carb.	3769123	CA-8411
V8 6.6L 400ci	N	1974-78	w/4 Bbl. Carb.	3769123	CA-8411
V8 6.6L 400ci	P	1973-78	w/4 Bbl. Carb.	3769123	CA-8411
V8 7.2L 440ci	U	1970-74		3769123	CA-8411
<b>COLT</b>					
L4 1.4L 1410cc	2	1981-83	FWD, Import	MB011530	CA-8636
L4 1.4L 1410cc	A	1984	FWD, Import	MB011530	CA-8636
L4 1.4L 1410cc	J	1979-80	FWD, Import	MB011530	CA-8636
L4 1.5L 90ci	A	1993-94		MB539806	CA-8914
L4 1.5L 90ci	K	1985-88		MB322196	CA-8785
L4 1.5L 90ci	P	1988		MB322196	CA-8785
L4 1.6L 98ci	3	1981-83	FWD, Import	MB011530	CA-8636
L4 1.6L 98ci	B, F	1984	FWD, Import	MB011530	CA-8636
L4 1.6L 98ci	K	1979-80	FWD, Import	MB011530	CA-8636
L4 2.0L 122ci	D	1984-85		MB011530	CA-8636
<b>CORONET</b>					
L6 3.7L 225ci	C	1974-76	w/2 Bbl. Carb.	3698839	CA-8410
L6 3.7L 225ci	C	1974-76	w/4 Bbl. Carb.	3769123	CA-8411
V8 5.2L 318ci	G	1976	w/4 Bbl. Carb. w/Auto. Trans.	3769123	CA-8411
V8 5.2L 318ci	G	1972-76	w/2 Bbl. Carb.	3698839	CA-8410
V8 5.2L 318ci	G	1974-76	w/4 Bbl. Carb.	3769123	CA-8411
V8 5.9L 360ci	J, K, L	1976	w/4 Bbl. Carb. w/Auto. Trans., From 8/19/76	3769123	CA-8411
V8 5.9L 360ci	J, K, L	1975-76	w/2 Bbl. Carb. w/Auto. Trans.	3698839	CA-8410
V8 5.9L 360ci	J, K, L	1975-76	w/4 Bbl. Carb. w/Auto. Trans.	3769123	CA-8411
V8 6.6L 400ci	M, N, P	1973-76	w/4 Bbl. Carb.	3769123	CA-8411

# ACCELERATOR CABLES

Engine	Vin	Year	Remark	OE	Part
<b>DODGE (con't)</b>					
<b>CORONET (con't)</b>					
V8 7.2L 440ci	U	1970-76		3769123	CA-8411
<b>DART</b>					
L6 3.2L 198ci	B	1972-74		2899335	CA-8418
L6 3.7L 225ci	C	1975		2899335	CA-8418
V8 5.2L 318ci	G, L	1975	w/2 Bbl. Carb.	2899336	CA-8417
V8 5.2L 318ci	G, L	1976	w/2 Bbl. Carb.	4027372	CA-8416
<b>DAYTONA</b>					
L4 2.2L 135ci	A	1987	Turbo w/Intercooler	4288197	CA-8309
L4 2.2L 135ci	A	1987	Turbo w/o Intercooler	4306190	CA-8312
L4 2.2L 135ci	A	1989	Turbo; 53.00" Cable	4458774	CA-8305
L4 2.2L 135ci	C	1990	Turbo 51.18" Cable	4300845	CA-8301
L4 2.2L 135ci	C	1990	Turbo; 53.00" Cable	4458774	CA-8305
L4 2.2L 135ci	D	1984	61.75" Cable	4287530	CA-8429
L4 2.2L 135ci	D	1985	w/Throttle Body Injection; 61.75" Cable	4287530	CA-8429
L4 2.2L 135ci	D	1986	w/Electronic Fuel Injection 50.66" Cable	4549216	CA-8302
L4 2.2L 135ci	E	1984-85	Turbo; 52.00" Cable	4287531	CA-8430
L4 2.2L 135ci	E	1986-87	Turbo w/Intercooler	4288197	CA-8309
L4 2.2L 135ci	E	1986-87	Turbo w/o Intercooler	4306190	CA-8312
L4 2.5L 153ci	J	1991	51.18" Cable	4300845	CA-8301
L4 2.5L 153ci	J	1989-92	Turbo; 53.00" Cable	4458774	CA-8305
L4 2.5L 153ci	K	1986-89	w/Electronic Fuel Injection 50.66" Cable	4549216	CA-8302
L4 2.5L 153ci	K	1990-93	51.18" Cable	4300845	CA-8301
V6 3.0L 181ci	3	1990-93		4459135	CA-8306
<b>DIPLOMAT</b>					
L6 3.7L 225ci	C, D	1978-80	w/1 Bbl. Carb. w/Manual Trans.	4027354	CA-8413
L6 3.7L 225ci	C, D	1979-80	w/1 Bbl. Carb. w/Auto. Trans.	4095176	CA-8412
L6 3.7L 225ci	C, D	1979-80	w/2 Bbl. Carb. w/Auto. Trans.	4095320	CA-8415
L6 3.7L 225ci	E, F, G	1981-82	w/1 Bbl. Carb. w/Auto. Trans.	4095176	CA-8412
L6 3.7L 225ci	E, F, G	1981-82	w/2 Bbl. Carb. w/Auto. Trans.	4095320	CA-8415
L6 3.7L 225ci	H, J, K	1983	w/1 Bbl. Carb. w/Auto. Trans.	4095176	CA-8412
L6 3.7L 225ci	H, J, K	1983	w/2 Bbl. Carb. w/Auto. Trans.	4095320	CA-8415
V8 5.2L 318ci	4	1983	w/2 Bbl. Carb. w/Auto. Trans.	4027358	CA-8414
V8 5.2L 318ci	4	1983	w/4 Bbl. Carb. w/Auto. Trans.	4027355	CA-8422
V8 5.2L 318ci	4	1984-85	w/4 Bbl. Carb.	4027355	CA-8422
V8 5.2L 318ci	4	1984-89	w/2 Bbl. Carb.	4027358	CA-8414
V8 5.2L 318ci	G	1977	w/2 Bbl. Carb. w/Manual Trans.	4027358	CA-8414
V8 5.2L 318ci	G	1978	w/2 Bbl. Carb.	4027358	CA-8414
V8 5.2L 318ci	G, H	1978-80	w/2 Bbl. Carb. w/Auto. Trans.	4027358	CA-8414
V8 5.2L 318ci	G, H	1979-80	w/4 Bbl. Carb. w/Auto. Trans.	4027355	CA-8422
V8 5.2L 318ci	H	1978	w/2 Bbl. Carb. w/Manual Trans.	4027358	CA-8414
V8 5.2L 318ci	K, J, M, N	1981-82	w/2 Bbl. Carb. w/Auto. Trans.	4027358	CA-8414
V8 5.2L 318ci	K, J, M, N	1981-82	w/4 Bbl. Carb. w/Auto. Trans.	4027355	CA-8422
V8 5.2L 318ci	P, R, S, Z	1983	w/2 Bbl. Carb. w/Auto. Trans.	4027358	CA-8414
V8 5.2L 318ci	P, R, S, Z	1983	w/4 Bbl. Carb. w/Auto. Trans.	4027355	CA-8422



# ACCELERATOR CABLES

Engine	Vin	Year	Remark	OE	Part
<b>DODGE (con't)</b>					
<b>DIPLOMAT (con't)</b>					
V8 5.2L 318ci	P, S	1984-85	w/4 Bbl. Carb.	4027355	CA-8422
V8 5.2L 318ci	P, S	1984-89	w/2 Bbl. Carb.	4027358	CA-8414
V8 5.9L 360ci	J, K, L	1978-79	w/2 Bbl. Carb.	4027358	CA-8414
V8 5.9L 360ci	J, K, L	1978-79	w/4 Bbl. Carb. w/Auto. Trans.	4027355	CA-8422
<b>DYNASTY</b>					
L4 2.5L 153ci	K	1988-89	50.66" Cable	4549216	CA-8302
L4 2.5L 153ci	K	1990	51.18" Cable	4300845	CA-8301
V6 3.0L 181ci	3	1988		4459135	CA-8307
V6 3.0L 181ci	3	1989-92		4459135	CA-8306
<b>LANCER</b>					
L4 2.2L 135ci	A	1988	Turbo; 50.66" Cable	4549216	CA-8302
L4 2.2L 135ci	A	1989	Turbo; 53.00" Cable	4458774	CA-8305
L4 2.2L 135ci	D	1985	w/Throttle Body Injection; 61.75" Cable	4287530	CA-8429
L4 2.2L 135ci	D	1986-87	w/Electronic Fuel Injection 50.66" Cable	4549216	CA-8302
L4 2.2L 135ci	D	1989	50.66" Cable	4549216	CA-8302
L4 2.2L 135ci	E	1985	61.75" Cable	4287530	CA-8429
L4 2.2L 135ci	E	1986-87	Turbo w/Intercooler	4288197	CA-8309
L4 2.2L 135ci	E	1986-87	Turbo w/o Intercooler	4306190	CA-8312
L4 2.2L 135ci	E	1988	Turbo; 50.66" Cable	4549216	CA-8302
L4 2.5L 153ci	J	1989	Turbo; 53.00" Cable	4458774	CA-8305
L4 2.5L 153ci	K	1986-88	w/Electronic Fuel Injection 50.66" Cable	4549216	CA-8302
L4 2.5L 153ci	K	1989	50.66" Cable	4549216	CA-8302
<b>M300, M350</b>					
V8 5.2L 318ci	G	1974	Motor Home	2960213	CA-8674
V8 7.2L 440ci	A	1974	Motor Home	2960213	CA-8674
<b>MAGNUM</b>					
V8 5.2L 318ci	G, H	1978-79	w/2 Bbl. Carb. w/Auto. Trans.	3698839	CA-8410
V8 5.2L 318ci	G, H	1978-79	w/4 Bbl. Carb. w/Auto. Trans.	3769123	CA-8411
V8 5.9L 360ci	J, K, L	1978-79	w/2 Bbl. Carb. w/Auto. Trans.	3698839	CA-8410
V8 5.9L 360ci	J, K, L	1978-79	w/4 Bbl. Carb. w/Auto. Trans.	3769123	CA-8411
V8 6.6L 400ci	N, P	1978		3769123	CA-8411
<b>MIRADA</b>					
L6 3.7L 225ci	E, G	1981-82	w/2 Bbl. Carb. w/Auto. Trans.	4095320	CA-8415
L6 3.7L 225ci	H, K	1983	w/2 Bbl. Carb. w/Auto. Trans.	4095320	CA-8415
V8 5.2L 318ci	G, H	1980	w/2 Bbl. Carb. w/Auto. Trans.	3698839	CA-8410
V8 5.2L 318ci	G, H	1980	w/4 Bbl. Carb. w/Auto. Trans.	3769123	CA-8411
V8 5.2L 318ci	K, M	1981-82	w/2 Bbl. Carb. w/Auto. Trans.	4027358	CA-8414
V8 5.2L 318ci	K, M	1981-82	w/4 Bbl. Carb. w/Auto. Trans.	4027355	CA-8422
V8 5.2L 318ci	P	1983	w/2 Bbl. Carb. w/Auto. Trans.	4027358	CA-8414
V8 5.2L 318ci	P	1983	w/4 Bbl. Carb. w/Auto. Trans.	4027355	CA-8422
V8 5.9L 360ci	L	1980	w/2 Bbl. Carb. w/Auto. Trans.	3698839	CA-8410
V8 5.9L 360ci	L	1980	w/4 Bbl. Carb. w/Auto. Trans.	3769123	CA-8411
<b>MONACO</b>					
L6 3.7L 225ci	C, D	1977-78	w/2 Bbl. Carb.	3698839	CA-8410

# ACCELERATOR CABLES

Engine	Vin	Year	Remark	OE	Part
<b>DODGE (con't)</b>					
<b>MONACO (con't)</b>					
L6 3.7L 225ci	C, D	1977-78	w/4 Bbl. Carb.	3769123	CA-8411
V6 3.0L 182ci	U	1990		33004423	CA-8304
V8 5.2L 318ci	G, H	1976-78	w/2 Bbl. Carb. w/Auto. Trans.	3698839	CA-8410
V8 5.2L 318ci	G, H	1976-78	w/2 Bbl. Carb. w/Manual Trans.	4027358	CA-8414
V8 5.9L 360ci	J, K, L	1975-78	w/2 Bbl. Carb. w/Auto. Trans.	3698839	CA-8410
V8 5.9L 360ci	J, K, L	1975-78	w/4 Bbl. Carb. w/Auto. Trans.	3769123	CA-8411
V8 6.6L 400ci	M, N, P	1973-78	w/4 Bbl. Carb.	3769123	CA-8411
V8 7.2L 440ci	T	1973-76		3769123	CA-8411
V8 7.2L 440ci	U	1974-78		3769123	CA-8411
<b>OMNI</b>					
L4 1.7L 105ci	A	1978-79		5214197	CA-8419
L4 1.7L 105ci	A	1980-82		5214732	CA-8421
L4 1.7L 105ci	B	1983		5214732	CA-8421
L4 2.2L 135ci	8	1985-87	50.59" Cable	4288065	CA-8311
L4 2.2L 135ci	B	1982		4268822	CA-8423
L4 2.2L 135ci	C	1985-87	50.59" Cable	4288065	CA-8311
L4 2.2L 135ci	D	1988	50.59" Cable	4288065	CA-8311
L4 2.2L 135ci	D	1988	50.66" Cable	4549216	CA-8302
L4 2.2L 135ci	D	1990	51.18" Cable	4300845	CA-8301
L4 2.2L 135ci	E	1986	Turbo w/Intercooler	4288197	CA-8309
L4 2.2L 135ci	E	1985-86	Turbo w/o Intercooler; 50.59" Cable	4288065	CA-8311
<b>ROYAL MONACO</b>					
V8 5.2L 318ci	G	1975	w/2 Bbl. Carb.	3698839	CA-8410
V8 5.2L 318ci	G	1975	w/4 Bbl. Carb.	3769123	CA-8411
V8 5.2L 318ci	G	1977	w/2 Bbl. Carb. w/Auto. Trans.	3698839	CA-8410
V8 5.2L 318ci	G	1977	w/2 Bbl. Carb. w/Manual Trans.	4027358	CA-8414
V8 5.9L 360ci	J, K	1975-77	w/2 Bbl. Carb. w/Auto. Trans.	3698839	CA-8410
V8 5.9L 360ci	J, K	1975-77	w/4 Bbl. Carb. w/Auto. Trans.	3769123	CA-8411
V8 6.6L 400ci	M, N, P	1975-77	w/4 Bbl. Carb.	3769123	CA-8411
V8 7.2L 440ci	T, U	1975-77		3769123	CA-8411
<b>SHADOW</b>					
L4 2.2L 135ci	A	1989	Turbo; 53.00" Cable	4458774	CA-8305
L4 2.2L 135ci	D	1987-94	w/Electronic Fuel Injection 50.66" Cable	4549216	CA-8302
L4 2.2L 135ci	D	1988-93	50.66" Cable	4549216	CA-8302
L4 2.2L 135ci	D	1990-94	51.18" Cable	4300845	CA-8301
L4 2.5L 153ci	J	1989	50.66" Cable	4549216	CA-8302
L4 2.5L 153ci	J	1990	Turbo; 53.00" Cable	4458774	CA-8305
L4 2.5L 153ci	J	1991-92	51.18" Cable	4300845	CA-8301
L4 2.5L 153ci	K	1988-94	50.66" Cable	4549216	CA-8302
L4 2.5L 153ci	K	1990-94	51.18" Cable	4300845	CA-8301
V6 3.0L 181ci	3	1993-94		4459135	CA-8306
<b>SPIRIT</b>					
L4 2.5L 153ci	J	1989-90	Turbo; 53.00" Cable	4458774	CA-8305
L4 2.5L 153ci	J	1991-92	51.18" Cable	4300845	CA-8301

# ACCELERATOR CABLES

Engine	Vin	Year	Remark	OE	Part
<b>DODGE (con't)</b>					
<b>SPIRIT (con't)</b>					
L4 2.5L 153ci	K	1989	50.66" Cable	4549216	CA-8302
L4 2.5L 153ci	K	1990-94	51.18" Cable	4300845	CA-8301
L4 2.5L 153ci	V	1993-94	51.18" Cable	4300845	CA-8301
V6 3.0L 181ci	3	1989-94		4459135	CA-8306
<b>ST. REGIS</b>					
L6 3.7L 225ci	E, F, G	1981	w/1 Bbl. Carb. w/Auto. Trans.	4095176	CA-8412
V8 5.2L 318ci	G, H	1979-80	w/2 Bbl. Carb. w/Auto. Trans.	3698839	CA-8410
V8 5.2L 318ci	G, H	1979-80	w/4 Bbl. Carb. w/Auto. Trans.	3769123	CA-8411
V8 5.2L 318ci	K, L, M, N	1981	w/2 Bbl. Carb. w/Auto. Trans.	3698839	CA-8410
V8 5.2L 318ci	K, L, M, N	1981	w/4 Bbl. Carb. w/Auto. Trans.	3769123	CA-8411
V8 5.9L 360ci	J, K, L	1979-80	w/2 Bbl. Carb. w/Auto. Trans.	3698839	CA-8410
V8 5.9L 360ci	J, K, L	1979-80	w/4 Bbl. Carb. w/Auto. Trans.	3769123	CA-8411
<b>DODGE TRUCKS</b>					
<b>B150</b>					
V6 3.9L 239ci	X	1989-91		4300846	CA-8300
V8 5.2L 318ci	Y	1989-91		4300846	CA-8300
<b>B250</b>					
V6 3.9L 239ci	X	1989-91		4300846	CA-8300
V8 5.2L 318ci	Y	1989-91		4300846	CA-8300
V8 5.9L 360ci	Z	1989-91		4300846	CA-8300
<b>B350</b>					
V8 5.2L 318ci	Y	1989-91		4300846	CA-8300
V8 5.9L 360ci	Z	1989-91		4300846	CA-8300
<b>CARAVAN</b>					
L4 2.2L 135ci	C	1984	51.00" Cable	4275907	CA-8426
L4 2.2L 135ci	C	1985	52.00" Cable	4287531	CA-8430
L4 2.2L 135ci	C	1987		4306190	CA-8312
L4 2.5L 153ci	K, J	1988-89	50.66" Cable	4549216	CA-8302
L4 2.5L 153ci	K, J	1990-95	51.18" Cable	4300845	CA-8301
L4 2.6L 156ci	G	1984	To 5/15/84	4268828	CA-8427
L4 2.6L 156ci	G	1984-86	From 5/15/84	4268828	CA-8428
V6 3.0L 181ci	3	1987-88		4288096	CA-8307
V6 3.0L 181ci	3	1989-90		4459135	CA-8306
<b>D100</b>					
L6 3.7L 225ci	B	1974		3820952	CA-8668
L6 3.7L 225ci	B	1975		3820952	CA-8668
L6 3.7L 225ci	B, N	1978-79		3820952	CA-8805
L6 3.7L 225ci	H	1986-87		4241226	CA-8408
L6 4.0L 243ci	H	1978-79	Diesel, w/MMC Eng.; 28.00" Cable	4039039	CA-8406
V8 5.2L 318ci	E	1972-74	28.00" Cable	4088095	CA-8406
V8 5.2L 318ci	E, P	1975-79	28.00" Cable	4088095	CA-8406
V8 5.2L 318ci	T	1986-87	27.00" Cable	4241224	CA-8407
V8 5.2L 318ci	Y	1988-89	51.18" Cable	4300845	CA-8301
V8 5.9L 360ci	F, T	1974-78	28.00" Cable	4088095	CA-8406

# ACCELERATOR CABLES

Engine	Vin	Year	Remark	OE	Part
<b>DODGE TRUCKS (con't)</b>					
<b>D100 (con't)</b>					
V8 5.9L 360ci	W	1986-87	27.00" Cable	4241224	CA-8407
V8 6.6L 400ci	J	1972-73	2WD	3632818	CA-8670
V8 6.6L 400ci	J	1974	28.00" Cable	4088095	CA-8406
V8 6.6L 400ci	J	1976-78	28.00" Cable	4088095	CA-8406
V8 7.2L 440ci	D	1974-78	28.00" Cable	4088095	CA-8406
<b>D150</b>					
L6 3.7L 225ci	B, E, N	1978-79		3820952	CA-8805
L6 3.7L 225ci	E, W	1981-82		4241226	CA-8408
L6 3.7L 225ci	H, M	1983-87		4241226	CA-8408
L6 3.7L 225ci	N	1980		4241226	CA-8408
L6 4.0L 243ci	H	1978-79	Diesel, w/MMC Eng.; 28.00" Cable	4039039	CA-8406
L6 4.0L 243ci	H	1980	Diesel, w/MMC Eng.	4241226	CA-8408
V6 3.9L 239ci	X	1989-90	51.18" Cable	4300845	CA-8301
V8 5.2L 318ci	E, P	1977-79	28.00" Cable	4088095	CA-8406
V8 5.2L 318ci	E, P, R	1980-82	27.00" Cable	4241224	CA-8407
V8 5.2L 318ci	T, U	1983-87	27.00" Cable	4241224	CA-8407
V8 5.2L 318ci	Y	1990-91	51.18" Cable	4300845	CA-8301
V8 5.9L 360ci	1	1987	27.00" Cable	4241224	CA-8407
V8 5.9L 360ci	F, S, T	1977-79	28.00" Cable	4088095	CA-8406
V8 5.9L 360ci	S	1980-81	27.00" Cable	4241224	CA-8407
V8 5.9L 360ci	T	1980-82	27.00" Cable	4241224	CA-8407
V8 5.9L 360ci	W	1984-87	27.00" Cable	4241224	CA-8407
V8 5.9L 360ci	Z	1990	51.18" Cable	4300845	CA-8301
V8 6.6L 400ci	J	1977-78	28.00" Cable	4088095	CA-8406
V8 7.2L 440ci	D	1978	28.00" Cable	4088095	CA-8406
<b>D200</b>					
L6 3.7L 225ci	B	1974-77		3820952	CA-8668
L6 3.7L 225ci	B, N	1978-79		3820952	CA-8805
L6 3.7L 225ci	N	1980		4241226	CA-8408
L6 4.0L 243ci	H	1978	Diesel, w/MMC Eng.; 28.00" Cable	4039039	CA-8406
L6 4.0L 243ci	H	1980	Diesel, w/MMC Eng.	4241226	CA-8408
V8 5.2L 318ci	E	1972-74	28.00" Cable	4088095	CA-8406
V8 5.2L 318ci	E, P	1975-79	28.00" Cable	4088095	CA-8406
V8 5.2L 318ci	E, P	1980	27.00" Cable	4241224	CA-8407
V8 5.9L 360ci	F	1974	28.00" Cable	4088095	CA-8406
V8 5.9L 360ci	F, T	1975-79	28.00" Cable	4088095	CA-8406
V8 5.9L 360ci	T	1980	27.00" Cable	4241224	CA-8407
V8 6.6L 400ci	J	1974	28.00" Cable	4088095	CA-8406
V8 6.6L 400ci	J	1972-73	2WD	3632818	CA-8670
V8 6.6L 400ci	J	1975-78	28.00" Cable	4088095	CA-8406
V8 7.2L 440ci	D	1974-78	28.00" Cable	4088095	CA-8406
<b>D250</b>					
L6 3.7L 225ci	E	1981-82		4241226	CA-8408
L6 3.7L 225ci	H	1983-87		4241226	CA-8408

# ACCELERATOR CABLES

Engine	Vin	Year	Remark	OE	Part
<b>DODGE TRUCKS (con't)</b>					
<b>D250 (con't)</b>					
V6 3.9L 239ci	X	1989-90	51.18" Cable	4300845	CA-8301
V8 5.2L 318ci	P, R	1981-82	27.00" Cable	4241224	CA-8407
V8 5.2L 318ci	T, U	1983-87	27.00" Cable	4241224	CA-8407
V8 5.2L 318ci	Y	1988-91	51.18" Cable	4300845	CA-8301
V8 5.9L 360ci	1	1986	27.00" Cable	4241224	CA-8407
V8 5.9L 360ci	5	1987	27.00" Cable	4241224	CA-8407
V8 5.9L 360ci	5	1990	51.18" Cable	4300845	CA-8301
V8 5.9L 360ci	S, T	1981	28.00" Cable	4088095	CA-8406
V8 5.9L 360ci	S, T	1981	58.50" Cable	3497463	CA-8669
V8 5.9L 360ci	T, U	1982	27.00" Cable	4241224	CA-8407
V8 5.9L 360ci	W	1984-87	27.00" Cable	4241224	CA-8407
V8 5.9L 360ci	Z	1990-91	51.18" Cable	4300845	CA-8301
<b>D300</b>					
L6 3.7L 225ci	B	1974		3820952	CA-8668
L6 3.7L 225ci	B	1975-77		3820952	CA-8668
L6 3.7L 225ci	B	1978		3820952	CA-8805
V8 5.2L 318ci	E, P	1972-80	28.00" Cable	4088095	CA-8406
V8 5.2L 318ci	E, P	1978-80	58.50" Cable	3497463	CA-8669
V8 5.9L 360ci	F	1974-78	28.00" Cable	4088095	CA-8406
V8 5.9L 360ci	F	1978	58.50" Cable	3497463	CA-8669
V8 5.9L 360ci	T	1979-80	28.00" Cable	4088095	CA-8406
V8 5.9L 360ci	T	1979-80	58.50" Cable	3497463	CA-8669
V8 6.6L 400ci	J	1972-73	2WD	3632818	CA-8670
V8 6.6L 400ci	J	1974	28.00" Cable	4088095	CA-8406
V8 6.6L 400ci	J	1976-78	28.00" Cable	4088095	CA-8406
V8 7.2L 440ci	D	1974-78	28.00" Cable	4088095	CA-8406
<b>D350</b>					
V8 5.2L 318ci	P	1982	27.00" Cable	4241224	CA-8407
V8 5.2L 318ci	R	1981	28.00" Cable	4088095	CA-8406
V8 5.2L 318ci	R	1981	58.50" Cable	3497463	CA-8669
V8 5.2L 318ci	R	1981-82	27.00" Cable	4241224	CA-8407
V8 5.2L 318ci	U	1983	27.00" Cable	4241224	CA-8407
V8 5.9L 360ci	1	1983-87	27.00" Cable	4241224	CA-8407
V8 5.9L 360ci	5	1987	27.00" Cable	4241224	CA-8407
V8 5.9L 360ci	5	1989-91	51.18" Cable	4300845	CA-8301
V8 5.9L 360ci	T	1981	28.00" Cable	4088095	CA-8406
V8 5.9L 360ci	T	1981	58.50" Cable	3497463	CA-8669
V8 5.9L 360ci	T	1982	27.00" Cable	4241224	CA-8407
V8 5.9L 360ci	W	1983-87	27.00" Cable	4241224	CA-8407
V8 5.9L 360ci	Z	1989-91	51.18" Cable	4300845	CA-8301
<b>DAKOTA</b>					
L4 2.2L 135ci	C	1987		4306176	CA-8675
L4 2.5L 153ci	G	1989-91	50.66" Cable	4549215	CA-8302
V6 3.9L 239ci	M	1987		4324577	CA-8409

# ACCELERATOR CABLES

Engine	Vin	Year	Remark	OE	Part
<b>DODGE TRUCKS (con't)</b>					
<b>DAKOTA (con't)</b>					
V6 3.9L 239ci	X	1989-91	51.18" Cable	4300845	CA-8301
V8 5.2L 318ci	Y	1989-91	51.18" Cable	4300845	CA-8301
<b>GRAND CARAVAN</b>					
L4 2.5L 153ci	K	1988	50.66" Cable	4549216	CA-8302
V6 3.0L 181ci	3	1988		4288096	CA-8307
V6 3.0L 181ci	3	1989		4459135	CA-8306
<b>MINI RAM</b>					
L4 2.2L 135ci	C	1985	52.00" Cable	4287531	CA-8430
L4 2.2L 135ci	C	1987		4306190	CA-8312
L4 2.5L 153ci	K	1987-88	50.66" Cable	4549216	CA-8302
L4 2.6L 156ci	G	1984	To 5/15/84	4268825	CA-8427
L4 2.6L 156ci	G	1984-86	From 5/15/84	4288191	CA-8428
V6 3.0L 181ci	3	1987-88		4288096	CA-8307
<b>POWER RAM 50</b>					
L4 2.6L 156ci	E	1986		MB181275	CA-8764
<b>RAM 50</b>					
L4 2.0L 122ci	D	1985-86		MB181275	CA-8764
L4 2.0L 122ci	D	1987-89		MB322754	CA-8912
L4 2.3L 143ci	J	1985		MB181275	CA-8764
L4 2.4L 2351cc	G	1993		MB539514	CA-9004
L4 2.4L 2351cc	W	1990-92		MB539514	CA-9004
L4 2.6L 156ci	E	1985-86		MB181275	CA-8764
L4 2.6L 156ci	E	1987-89		MB322754	CA-8912
<b>RAMCHARGER</b>					
L6 3.7L 225ci	B	1974-77		3820952	CA-8668
L6 3.7L 225ci	B	1978		3820952	CA-8805
L6 3.7L 225ci	N	1979		3820952	CA-8805
L6 3.7L 225ci	N	1980		4241226	CA-8408
V8 5.2L 318ci	E, P	1974-79	28.00" Cable	4088095	CA-8406
V8 5.2L 318ci	E	1980	27.00" Cable	4241224	CA-8407
V8 5.2L 318ci	P, R	1981-82	27.00" Cable	4241224	CA-8407
V8 5.2L 318ci	T, U	1983-85	27.00" Cable	4241224	CA-8407
V8 5.2L 318ci	Y	1990	51.18" Cable	4300845	CA-8301
V8 5.9L 360ci	F, T	1974-79	28.00" Cable	4088095	CA-8406
V8 5.9L 360ci	T	1980-81	27.00" Cable	4241224	CA-8407
V8 5.9L 360ci	W	1984-85	27.00" Cable	4241224	CA-8407
V8 5.9L 360ci	Z	1990	51.18" Cable	4300845	CA-8301
V8 6.6L 400ci	J	1976-78	28.00" Cable	4088095	CA-8406
V8 7.2L 440ci	D	1974-78	28.00" Cable	4088095	CA-8406
<b>RD200</b>					
V8 5.2L 318ci	E	1978	28.00" Cable	4088095	CA-8406
V8 5.2L 318ci	P	1980	27.00" Cable	4241224	CA-8407
V8 5.9L 360ci	T	1980	27.00" Cable	4241224	CA-8407

# ACCELERATOR CABLES

Engine	Vin	Year	Remark	OE	Part
<b>DODGE TRUCKS (con't)</b>					
<b>ROYAL MINI RAM</b>					
L4 2.2L 135ci	C	1984	51.00" Cable	4275907	CA-8426
L4 2.2L 135ci	C	1985	52.00" Cable	4287531	CA-8430
L4 2.2L 135ci	C	1987		4306190	CA-8312
L4 2.6L 156ci	G	1984	To 5/15/84	4268828	CA-8427
L4 2.6L 156ci	G	1984-86	From 5/15/84	4268828	CA-8428
V6 3.0L 181ci	3	1987		4288096	CA-8307
<b>W100</b>					
L6 3.7L 225ci	B	1974-77		3820952	CA-8668
L6 3.7L 225ci	H	1986-87		4241226	CA-8408
V6 3.9L 239ci	X	1989	51.18" Cable	4300845	CA-8301
V8 5.2L 318ci	E	1972-74	28.00" Cable	4088095	CA-8406
V8 5.2L 318ci	E	1975-77	28.00" Cable	4088095	CA-8406
V8 5.2L 318ci	T	1986-87	27.00" Cable	4241224	CA-8407
V8 5.2L 318ci	Y	1988-89	51.18" Cable	4300845	CA-8301
V8 5.9L 360ci	F	1974-77	28.00" Cable	4088095	CA-8406
V8 5.9L 360ci	T	1974	28.00" Cable	4088095	CA-8406
V8 5.9L 360ci	W	1986-87	27.00" Cable	4241224	CA-8407
V8 6.6L 400ci	J	1974-77	28.00" Cable	4088095	CA-8406
V8 7.2L 440ci	D	1974-77	28.00" Cable	4088095	CA-8406
<b>W150</b>					
L6 3.7L 225ci	B, N	1978-79		3820952	CA-8805
L6 3.7L 225ci	E	1981-82		4241226	CA-8408
L6 3.7L 225ci	H	1983-87		4241226	CA-8408
L6 3.7L 225ci	N	1980		4241226	CA-8408
L6 4.0L 243ci	H	1978-79	Diesel, w/MMC Eng.; 28.00" Cable	4039039	CA-8406
V6 3.9L 239ci	X	1989-90	51.18" Cable	4300845	CA-8301
V8 5.2L 318ci	E	1980	27.00" Cable	4241224	CA-8407
V8 5.2L 318ci	E, P	1977-79	28.00" Cable	4088095	CA-8406
V8 5.2L 318ci	P, R	1980-82	27.00" Cable	4241224	CA-8407
V8 5.2L 318ci	T, U	1983-87	27.00" Cable	4241224	CA-8407
V8 5.2L 318ci	Y	1990-91	51.18" Cable	4300845	CA-8301
V8 5.9L 360ci	F, S, T	1977-79	28.00" Cable	4088095	CA-8406
V8 5.9L 360ci	S, T	1980-81	27.00" Cable	4241224	CA-8407
V8 5.9L 360ci	W	1984-87	27.00" Cable	4241224	CA-8407
V8 5.9L 360ci	Z	1990-91	51.18" Cable	4300845	CA-8301
V8 6.6L 400ci	J	1977-78	28.00" Cable	4088095	CA-8406
V8 7.2L 440ci	D	1978	28.00" Cable	4088095	CA-8406
<b>W200</b>					
L6 3.7L 225ci	B	1974-77		3820952	CA-8668
L6 3.7L 225ci	B	1978-79		3820952	CA-8805
L6 3.7L 225ci	N	1980		4241226	CA-8408
L6 4.0L 243ci	H	1978-79	Diesel, w/MMC Eng.; 28.00" Cable	4039039	CA-8406
V8 5.2L 318ci	E	1980	27.00" Cable	4241224	CA-8407
V8 5.2L 318ci	E	1972-74	28.00" Cable	4088095	CA-8406

# ACCELERATOR CABLES

Engine	Vin	Year	Remark	OE	Part
<b>DODGE TRUCKS (con't)</b>					
<b>W200 (con't)</b>					
V8 5.2L 318ci	E, G, P	1975-79	28.00" Cable	4088095	CA-8406
V8 5.2L 318ci	P	1980	27.00" Cable	4241224	CA-8407
V8 5.9L 360ci	F, S, T	1974-79	28.00" Cable	4088095	CA-8406
V8 5.9L 360ci	T	1980	27.00" Cable	4241224	CA-8407
V8 6.6L 400ci	J	1974	28.00" Cable	4088095	CA-8406
V8 6.6L 400ci	J	1976-78	28.00" Cable	4088095	CA-8406
V8 7.2L 440ci	D	1974-78	28.00" Cable	4088095	CA-8406
<b>W250</b>					
V8 5.2L 318ci	P, R	1981-82	27.00" Cable	4241224	CA-8407
V8 5.2L 318ci	T, U	1983-87	27.00" Cable	4241224	CA-8407
V8 5.2L 318ci	Y	1988-91	51.18" Cable	4300845	CA-8301
V8 5.9L 360ci	1, 5	1985-87	27.00" Cable	4241224	CA-8407
V8 5.9L 360ci	5	1989-91	51.18" Cable	4300845	CA-8301
V8 5.9L 360ci	T	1981-82	27.00" Cable	4241224	CA-8407
V8 5.9L 360ci	W	1984-87	27.00" Cable	4241224	CA-8407
V8 5.9L 360ci	Z	1989	27.00" Cable	4241224	CA-8407
V8 5.9L 360ci	Z	1989-91	51.18" Cable	4300845	CA-8301
<b>W300</b>					
L6 3.7L 225ci	B	1974-77		3820952	CA-8668
L6 3.7L 225ci	B	1978		3820952	CA-8805
V8 5.2L 318ci	E, F	1972-74	28.00" Cable	4088095	CA-8406
V8 5.2L 318ci	E, F	1975-78	28.00" Cable	4088095	CA-8406
V8 5.2L 318ci	E	1980	27.00" Cable	4241224	CA-8407
V8 5.9L 360ci	T	1979	28.00" Cable	4088095	CA-8406
V8 5.9L 360ci	T	1980	27.00" Cable	4241224	CA-8407
V8 6.6L 400ci	J	1976-78	28.00" Cable	4088095	CA-8406
V8 7.2L 440ci	D	1975-78	28.00" Cable	4088095	CA-8406
<b>W350</b>					
V8 5.2L 318ci	P, R	1982	27.00" Cable	4241224	CA-8407
V8 5.2L 318ci	U	1983	27.00" Cable	4241224	CA-8407
V8 5.9L 360ci	1, 5	1983-87	27.00" Cable	4241224	CA-8407
V8 5.9L 360ci	5	1990	51.18" Cable	4300845	CA-8301
V8 5.9L 360ci	T, U	1981-82	27.00" Cable	4241224	CA-8407
V8 5.9L 360ci	W	1983-87	27.00" Cable	4241224	CA-8407
V8 5.9L 360ci	Z	1990	51.18" Cable	4300845	CA-8301
<b>EAGLE PREMIER</b>					
V6 3.0L 2972cc	J	1988		33004423	CA-8304
V6 3.0L 2972cc	U	1989-90		33004423	CA-8304
<b>SUMMIT</b>					
L4 1.5L 1468cc	A	1993-96		MB539806	CA-8914
<b>TALON</b>					
L4 1.8L 1755cc	B	1993	w/o CC	MB539494	CA-8978
L4 1.8L 1755cc	B	1993-94	exc. Speed Control	MB539494	CA-8791



# ACCELERATOR CABLES

Engine	Vin	Year	Remark	OE	Part
<b>EAGLE (con't)</b>					
<b>TALON (con't)</b>					
L4 2.0L 1997cc	E, F, Y	1993-95	exc. Speed Control	MB539010	CA-8792
L4 2.0L 1997cc	R, U	1990-92	exc. Speed Control	MB539010	CA-8792
<b>FIAT</b>					
<b>X-1/9</b>					
L4 1.3L 1290cc		1974-78		4418708	CA-8759
L4 1.5L 1498cc		1979-80		4425017	CA-8765
L4 1.5L 1498cc	A	1981-83		4425017	CA-8765
L4 2.0L 1995cc	B	1983		4425017	CA-8765
<b>FORD</b>					
<b>COUNTRY SQUIRE</b>					
V8 5.0L 302ci	F	1987-89	19.96" Cable	E5DZ9A758A	CA-8452
<b>CROWN VICTORIA</b>					
V8 4.6L 281ci	6, 9	1996-97		F6AZ-9A758-AB	CA-9025
V8 4.6L 281ci	9	1998-00		F8AZ-9A758-AA	CA-9026
V8 4.6L 281ci	9	2001-04		4W7Z-9A758-AA	CA-9027
V8 4.6L 281ci	W	1992-94		F2VY-9A758-A	CA-9023
V8 4.6L 281ci	W	1995		F5AZ-9A758-A	CA-9024
V8 4.6L 281ci	W	1996-97		F6AZ-9A758-AB	CA-9025
V8 4.6L 281ci	W	1998-00		F8AZ-9A758-AA	CA-9026
V8 4.6L 281ci	W	2001-04		4W7Z-9A758-AA	CA-9027
<b>CUSTOM 500</b>					
V8 5.8L 351ci	H	1977		D7AZ-9A758-A	CA-8443
V8 6.6L 400ci	S	1975-77		D7AZ9A758A	CA-8443
V8 7.5L 460ci	A, C	1974-76		D7AZ9A758B	CA-8442
<b>ESCORT, EXP</b>					
L4 1.6L 98ci	2, 4, 5, 7, 8	1981-85		E5FZ9A758A	CA-8454
L4 1.8L 112ci	8	1991-95		F1CZ9A758A	CA-8876
L4 1.9L 116ci	9, J	1985-87		E6FZ9A758A	CA-8454
L4 2.0L 122ci	H	1984-87		E6FZ9A758A	CA-8454
<b>FAIRMONT</b>					
L4 2.3L 140ci	A	1980-82	w/o Turbo	E0BZ9A758D	CA-8447
L4 2.3L 140ci	A	1983	w/o Turbo	E5ZZ9A758B	CA-8449
L4 2.3L 140ci	Y	1978-79	w/o Turbo	E0BZ9A758D	CA-8447
L6 3.3L 200ci	B	1980-82		E0BZ9A758B	CA-8448
L6 3.3L 200ci	T	1978-79		E0BZ9A758B	CA-8448
L6 3.3L 200ci	X	1983		E0BZ9A758B	CA-8448
V8 4.2L 255ci	D	1980		E0BZ9A758B	CA-8448
V8 4.2L 255ci	D	1981-82		E1SZ9A758A	CA-8453
<b>GRAN TORINO</b>					
V8 5.8L 351ci	H	1975-76		D7OZ9A758C	CA-8446
V8 6.6L 400ci	S	1975-76		D7OZ9A758C	CA-8446
<b>GRANADA</b>					
L4 2.3L 140ci	A	1981-82		E0BZ9A758D	CA-8447
L6 3.3L 200ci	B	1981		E0BZ9A758B	CA-8448

# ACCELERATOR CABLES

Engine	Vin	Year	Remark	OE	Part
<b>FORD (con't)</b>					
<b>GRANADA (con't)</b>					
L6 3.3L 200ci	T	1975-77		E4SZ-9A758-A	CA-8451
L6 4.1L 250ci	L	1975-79		E4SZ-9A758-A	CA-8451
V6 3.8L 232ci	3	1982		E0BZ9A758B	CA-8448
V8 4.2L 255ci	D	1980		E0DZ9A758B	CA-8440
V8 4.2L 255ci	D	1981		E1SZ9A758A	CA-8453
V8 5.0L 302ci	F	1975-80		E0DZ9A758B	CA-8440
V8 5.8L 351ci	H	1975-77		E0DZ9A758B	CA-8440
<b>LTD</b>					
V8 4.2L 255ci	D	1981-82	22.05" Cable	E1AZ9A758A	CA-8455
V8 5.0L 302ci	F	1977-78		D7AZ9A758A	CA-8443
V8 5.0L 302ci	F	1979	21.50" Cable	E0AZ9A758A	CA-8441
V8 5.0L 302ci	F	1980	w/Auto. Trans. 21.50" Cable	E0AZ9A758A	CA-8441
V8 5.0L 302ci	F	1981-85	22.05" Cable	E1AZ9A758B	CA-8455
V8 5.0L 302ci	F	1986	19.96" Cable	E5DZ9A758A	CA-8452
V8 5.0L 302ci	M	1984	To 2/84 22.05" Cable	E1AZ9A758A	CA-8455
V8 5.0L 302ci	M	1984-85	From 2/84 19.96" Cable	E5DZ9A758A	CA-8452
V8 5.8L 351ci	G	1980	w/Auto. Trans. 21.50" Cable	E0AZ-9A758-A	CA-8441
V8 5.8L 351ci	G	1980-86	22.05" Cable	E1AZ9A758B	CA-8455
V8 5.8L 351ci	H	1977-78		D7AZ-9A758-A	CA-8443
V8 5.8L 351ci	H	1979	21.50" Cable	E0AZ-9A758-A	CA-8441
V8 6.6L 400ci	S	1975-78	24.02" Cable	D7AZ9A758A	CA-8443
V8 6.6L 400ci	S	1977-78	20.87" Cable	D7OZ9A758C	CA-8446
V8 7.5L 460ci	A, C	1975-78		D7AZ9A758B	CA-8442
<b>LTD CROWN VICTORIA</b>					
V8 5.0L 302ci	F	1987-89	19.96" Cable	E5DZ9A758A	CA-8452
V8 5.8L 351ci	G	1987-89	22.05" Cable	E1AZ9A758B	CA-8455
<b>LTD II</b>					
V8 5.0L 302ci	F	1977-79		D7OZ9A758C	CA-8446
V8 5.8L 351ci	H	1977-79		D7OZ9A758C	CA-8446
V8 6.6L 400ci	S	1977-78		D7OZ9A758C	CA-8446
<b>MAVERICK</b>					
V8 5.0L 302ci	F	1975-77		E0DZ9A758B	CA-8440
<b>MUSTANG</b>					
L4 2.3L 140ci	A, T	1980-82	w/o Turbo	E0BZ9A758D	CA-8447
L4 2.3L 140ci	A	1983-86	w/o Turbo	E5ZZ9A758B	CA-8449
L4 2.3L 140ci	A	1987-89		E4SZ9A758A	CA-8451
L4 2.3L 140ci	T	1984-86	w/Man. Trans., Turbo	E4SZ9A758A	CA-8451
L4 2.3L 140ci	W	1983-84	w/Man. Trans., Turbo	E4SZ9A758A	CA-8451
L4 2.3L 140ci	Y	1979	w/o Turbo	E0BZ9A758D	CA-8447
L6 3.3L 200ci	B	1980-82		E0BZ9A758B	CA-8448
L6 3.3L 200ci	T	1979		E0BZ9A758B	CA-8448
V6 3.8L 232ci	3	1983-86		E5SZ9A758B	CA-8450
V8 4.2L 255ci	D	1981-82		E1SZ9A758A	CA-8453
V8 5.0L 302ci	D	1993	73.00" Cable	E6SZ-9A758-A	CA-9033

# ACCELERATOR CABLES

Engine	Vin	Year	Remark	OE	Part
<b>FORD (con't)</b>					
<b>MUSTANG (con't)</b>					
V8 5.0L 302ci	E	1987-93	73.00" Cable	E6SZ-9A758-A	CA-9033
V8 5.0L 302ci	F	1982	19.96" Cable	E5DZ9A758A	CA-8452
V8 5.0L 302ci	F	1983-84	w/Auto. Trans. 19.96" Cable	E5DZ9A758A	CA-8452
V8 5.0L 302ci	F	1983-84	w/Manual Trans. 22.05" Cable	E1AZ-9A758-A	CA-8455
V8 5.0L 302ci	M	1984-86	w/Auto. Trans. 19.96" Cable	E5DZ9A758A	CA-8452
V8 5.0L 302ci	M	1984-86	w/Manual Trans. 22.05" Cable	E1AZ-9A758-A	CA-8455
V8 5.0L 302ci	M	1986	73.00" Cable	E6SZ-9A758-A	CA-9033
<b>MUSTANG II</b>					
L4 2.3L 140ci	Y	1977-78		D7ZZ-9A758-B	CA-8444
V6 2.8L 171ci	Z	1975-78		D7ZZ-9A758-B	CA-8444
<b>P-350</b>					
L6 4.9L 300ci	B	1974-76	32.09" Cable	D4TZ-9A758-F	CA-8432
V8 5.0L 302ci	G	1976	32.09" Cable	D4TZ-9A758-F	CA-8432
V8 6.6L 400ci	S	1976	32.09" Cable	D4TZ-9A758-F	CA-8432
<b>PINTO</b>					
L4 2.3L 140ci	Y	1974-79		EOBZ-9A758-D	CA-8447
V6 2.8L 171ci	Z	1975-79		D9FZ9A758A	CA-8445
<b>PROBE</b>					
L4 2.0L 122ci	A	1993-95		GA2A41660C/D	CA-8880
L4 2.2L 133ci	L	1989-92		GJ2141660A	CA-8877
<b>TAURUS</b>					
L4 2.5L 153ci	D	1986-89	w/Manual Trans.	E6DZ9A758C	CA-8454
<b>TEMPO</b>					
L4 2.0L 122ci	H	1984-86		E63Z9A758A	CA-8454
L4 2.3L 140ci	R, S, X	1984-87		E63Z9A758A	CA-8454
<b>THUNDERBIRD</b>					
L4 2.3L 140ci	W	1983-86	w/Man. Trans., Turbo	E4SZ9A758A	CA-8451
L6 3.3L 200ci	B	1980-82		E0BZ9A758B	CA-8448
V6 3.8L 232ci	3	1982-87		E5SZ9A758B	CA-8450
V8 5.0L 302ci	F	1977-79		D7OZ9A758C	CA-8446
V8 5.0L 302ci	F	1981		E1SZ9A758A	CA-8453
V8 5.0L 302ci	F	1983-85	19.96" Cable	E5DZ9A758A	CA-8452
V8 5.8L 351ci	H	1977-79		D7OZ-9A758-C	CA-8446
V8 6.6L 400ci	S	1977-78		D7OZ9A758C	CA-8446
<b>TORINO</b>					
V8 5.8L 351ci	H	1975-76		D7OZ9A758C	CA-8446
V8 6.6L 400ci	S	1975-76		D7OZ9A758C	CA-8446
<b>FORD TRUCKS</b>					
<b>AEROSTAR</b>					
L4 2.3L 140ci	A	1986		E69Z9A758D	CA-8790
V6 2.8L 171ci	S	1986		E69Z9A758E	CA-8460
V6 3.0L 182ci	U	1986-89		E79Z9A758A	CA-8462
<b>BRONCO</b>					
L6 4.9L 300ci	E	1980-82	30.75" Cable	E0TZ9A758A	CA-8436

# ACCELERATOR CABLES

Engine	Vin	Year	Remark	OE	Part
<b>FORD TRUCKS (con't)</b>					
<b>BRONCO (con't)</b>					
L6 4.9L 300ci	Y	1983-86		E3TZ9A758B	CA-8438
L6 4.9L 300ci	Y	1987-88	C6, MT	E7TZ9A758L	CA-8463
L6 4.9L 300ci	Y	1989	C6, MT	E7TZ9A758A	CA-8463
L6 4.9L 300ci	Y	1990-92		F4TZ9A758M	CA-8806
V8 5.0L 302ci	F	1980-84	23.00" Cable	E0TZ9A758B	CA-8437
V8 5.0L 302ci	N	1985	w/AOD Auto. Trans.; 42.20" Cable	E5TZ9A758A	CA-8459
V8 5.0L 302ci	N	1986-88	42.20" Cable	E5TZ9A758A	CA-8459
V8 5.0L 302ci	N	1989	w/Electronic Fuel Injection, w/MT, w/C6 Auto. Trans.; 42.20" Cable	E6TZ9A758D	CA-8459
V8 5.0L 302ci	N	1990	From 3/90 42.69" Cable	E9TZ9A758P	CA-8682
V8 5.0L 302ci	N	1990	To 3/90 42.20" Cable	E6TZ9A758D	CA-8459
V8 5.0L 302ci	N	1991	w/Electronic Fuel Injection; 42.69" Cable	E9TZ9A758P	CA-8682
V8 5.0L 302ci	N	1991-92	w/3 Speed Manual Trans, w/C6, w/E4OD AT Trans 42.25" Cable	F1TZ9A758K	CA-8681
V8 5.0L 302ci	N	1991-92	w/4 Spd. MT, w/AOD Auto. Trans.; 39.74" Cable	F1TZ9A758J	CA-8680
V8 5.0L 302ci	N	1991-92	w/C6 AT, w/E4OD AT 42.25" Cable	F1TZ9A758K	CA-8681
V8 5.0L 302ci	N	1993-96	42.25" Cable	F1TZ9A758K	CA-8681
V8 5.8L 351ci	H	1985	w/4 Bbl. Carb.; 23.00" Cable	E1TZ-9A758-B	CA-8437
V8 5.8L 351ci	H	1985	w/AOD; 42.20" Cable	E1TZ-9A758-B	CA-8459
V8 5.8L 351ci	H	1986-89	w/AOD,C6, or MT; 42.20" Cable	E1TZ-9A758-B	CA-8459
V8 5.8L 351ci	H	1990	From 3/90 42.69" Cable	E9TZ9A758P	CA-8682
V8 5.8L 351ci	H	1990	To 3/90 42.20" Cable	E1TZ-9A758-B	CA-8459
V8 5.8L 351ci	H	1990-94	23.00" Cable	E1TZ-9A758-B	CA-8437
V8 5.8L 351ci	H	1991	42.69" Cable	E9TZ9A758P	CA-8682
V8 5.8L 351ci	H	1992-93	w/3 Speed Manual Trans, w/C6, w/E4OD AT Trans 42.25" Cable	F1TZ9A758K	CA-8681
V8 5.8L 351ci	H	1992-93	w/4 Spd. MT, w/AOD Auto. Trans.; 39.74" Cable	F1TZ9A758J	CA-8680
V8 5.8L 351ci	H	1992-93	w/C6 AT, w/E4OD AT 42.25" Cable	F1TZ9A758K	CA-8681
V8 5.8L 351ci	H	1994-96	42.25" Cable	F1TZ9A758K	CA-8681
V8 5.8L 351ci	H	1995	21.00" Cable	D9TZ-9A758-A	CA-8435
V8 6.6L 400ci	S	1979	21.00" Cable	D9TZ9A758A	CA-8435
<b>E SUPER DUTY</b>					
V8 7.3L 445ci	F	1996-97		F1TZ-9A758-E	CA-8683
<b>E-100 ECONOLINE</b>					
L6 2.8L 170ci	F	1971		C8UZ-9A758-A	CA-8676
L6 3.9L 240ci	A	1970-71		C8UZ-9A758-A	CA-8676
L6 3.9L 240ci	A	1974		D4TZ-9A758-E	CA-8431
L6 4.9L 300ci	B	1972		C8UZ9A758A	CA-8676
L6 4.9L 300ci	B	1974		D4UZ9A758G	CA-8433
L6 4.9L 300ci	E	1981-82	30.75" Cable	E1TZ9A758C	CA-8436
L6 4.9L 300ci	Y	1983	30.75" Cable	E3UZ9A758A	CA-8457
V8 5.0L 302ci	F	1980-83	30.75" Cable	E1TZ9A758C	CA-8436
V8 5.8L 351ci	G	1981-83	30.75" Cable	E1TZ9A758C	CA-8436

# ACCELERATOR CABLES

Engine	Vin	Year	Remark	OE	Part
<b>FORD TRUCKS (con't)</b>					
<b>E-150 ECONOLINE</b>					
L6 4.9L 300ci	9	1982	30.75" Cable	E1TZ9A758C	CA-8436
L6 4.9L 300ci	9	1983-85	30.75" Cable	E3UZ9A758A	CA-8457
L6 4.9L 300ci	E	1981-82	30.75" Cable	E1TZ9A758C	CA-8436
L6 4.9L 300ci	Y	1983-87	30.75" Cable	E3UZ9A758A	CA-8457
L6 4.9L 300ci	Y	1987	w/C6 Auto. Trans., w/Manual Trans. 44.00" Cable	E7UZ9A758E	CA-8458
L6 4.9L 300ci	Y	1987	w/Electronic Fuel Injection, w/AOD Auto. Trans. 44.00" Cable	E8UZ9A758D	CA-8458
L6 4.9L 300ci	Y	1988-89	44.00" Cable	E8UZ9A758D	CA-8458
L6 4.9L 300ci	Y	1990-91		E9UZ9A758G	CA-8685
V6 4.2L 256ci	2	1997-00		F7UZ-9A758-AB	CA-9031
V8 5.0L 302ci	F	1980-85	30.75" Cable	E1TZ9A758C	CA-8436
V8 5.0L 302ci	N	1986-88	30.75" Cable	E1TZ9A758C	CA-8436
V8 5.0L 302ci	N	1986-88	w/Electronic Fuel Injection; 49.47" Cable	E6UZ9A758A	CA-8464
V8 5.0L 302ci	N	1989-91		E9UZ9A758E	CA-8684
V8 5.0L 302ci	N	1992-96		F2UZ-9A758-C	CA-9030
V8 5.8L 351ci	G	1981-85	30.75" Cable	E1TZ9A758C	CA-8436
V8 5.8L 351ci	H	1984-87	30.75" Cable	E1TZ9A758C	CA-8436
V8 5.8L 351ci	H	1988-91	49.47" Cable	E8UZ-9A758-C	CA-8464
V8 5.8L 351ci	H	1992-96		F2UZ-9A758-C	CA-9030
V8 6.9L 420ci	1	1984	44.00" Cable	E4UZ9A758A	CA-8458
<b>E-200 ECONOLINE</b>					
L6 2.8L 170ci	F	1971		C8UZ-9A758-A	CA-8676
L6 3.9L 240ci	A	1970-71		C8UZ-9A758-A	CA-8676
L6 3.9L 240ci	A	1974		D4TZ-9A758-E	CA-8431
L6 4.9L 300ci	B	1972		C8UZ9A758A	CA-8676
L6 4.9L 300ci	B	1974		D4UZ9A758G	CA-8433
<b>E-250 ECONOLINE</b>					
L6 4.9L 300ci	9	1982	30.75" Cable	E1TZ9A758C	CA-8436
L6 4.9L 300ci	9	1983-85	30.75" Cable	E3UZ9A758A	CA-8457
L6 4.9L 300ci	E	1981-82	30.75" Cable	E1TZ9A758C	CA-8436
L6 4.9L 300ci	Y	1983-87	30.75" Cable	E3UZ9A758A	CA-8457
L6 4.9L 300ci	Y	1987	w/Electronic Fuel Injection, w/AOD Auto. Trans. 44.00" Cable	E8UZ9A758D	CA-8458
L6 4.9L 300ci	Y	1988-89	44.00" Cable	E8UZ9A758D	CA-8458
L6 4.9L 300ci	Y	1990-91		E9UZ9A758G	CA-8685
V6 4.2L 256ci	2	1997-00		F7UZ-9A758-AB	CA-9031
V8 5.0L 302ci	F	1980-85	30.75" Cable	E1TZ9A758C	CA-8436
V8 5.0L 302ci	N	1986-88	30.75" Cable	E1TZ9A758C	CA-8436
V8 5.0L 302ci	N	1986-88	w/Electronic Fuel Injection; 49.47" Cable	E6UZ9A758A	CA-8464
V8 5.0L 302ci	N	1989-91		E9UZ9A758E	CA-8684
V8 5.8L 351ci	G	1981-85	30.75" Cable	E1TZ9A758C	CA-8436
V8 5.8L 351ci	H	1984-87	30.75" Cable	E1TZ9A758C	CA-8436
V8 5.8L 351ci	H	1988-91	49.47" Cable	E8UZ-9A758-C	CA-8464
V8 5.8L 351ci	H	1992-96		F2UZ-9A758-C	CA-9030

# ACCELERATOR CABLES

Engine	Vin	Year	Remark	OE	Part
<b>FORD TRUCKS (con't)</b>					
<b>E-250 ECONOLINE (con't)</b>					
V8 6.6L 400ci	Z	1981-82	30.75" Cable	E1TZ9A758C	CA-8436
V8 6.9L 420ci	1	1983-87	44.00" Cable	E4UZ9A758A	CA-8458
V8 7.3L 445ci	M	1988-91	44.00" Cable	E4UZ9A758A	CA-8458
V8 7.5L 460ci	G	1988-91	44.00" Cable	E8UZ9A758A	CA-8458
V8 7.5L 460ci	L	1983-87	w/2 Bbl. Carb.; 30.75" Cable	E1TZ9A758C	CA-8436
V8 7.5L 460ci	L	1983-87	w/4 Bbl. Carb.; 23.00" Cable	E4TZ-9A758-D	CA-8437
<b>E-300 ECONOLINE</b>					
L6 3.9L 240ci	A	1971		C8UZ-9A758-A	CA-8676
L6 3.9L 240ci	A	1974		D4TZ-9A758-E	CA-8431
L6 4.9L 300ci	B	1972		C8UZ9A758A	CA-8676
L6 4.9L 300ci	B	1974		D4UZ9A758G	CA-8433
<b>E-350 ECONOLINE</b>					
L6 4.9L 300ci	9	1983-85	30.75" Cable	E3UZ9A758A	CA-8457
L6 4.9L 300ci	9	1985	w/Stripped Chassis; 20.71" Cable	EAUZ9A758B	CA-8679
L6 4.9L 300ci	B, E	1981-82	30.75" Cable	E1TZ9A758C	CA-8436
L6 4.9L 300ci	Y	1983-87	30.75" Cable	E3UZ9A758A	CA-8457
L6 4.9L 300ci	Y	1984-88	w/Stripped Chassis; 20.71" Cable	EAUZ9A758B	CA-8679
L6 4.9L 300ci	Y	1988-89	44.00" Cable	E8UZ9A758D	CA-8458
L6 4.9L 300ci	Y	1990-91		E9UZ9A758G	CA-8685
V10 6.8L 415ci	S	1997-00		F7UZ-9A758-DB	CA-9032
V8 5.0L 302ci	F	1980-82	30.75" Cable	E1TZ9A758C	CA-8436
V8 5.8L 351ci	G	1981-85	30.75" Cable	E1TZ9A758C	CA-8436
V8 5.8L 351ci	G	1984-85	w/Stripped Chassis; 20.71" Cable	E4UZ9A758C	CA-8678
V8 5.8L 351ci	H	1985-87	30.75" Cable	E1TZ9A758C	CA-8436
V8 5.8L 351ci	H	1985-88	w/Stripped Chassis; 20.71" Cable	E4UZ9A758C	CA-8678
V8 5.8L 351ci	H	1988-91	49.47" Cable	E8UZ-9A758-C	CA-8464
V8 5.8L 351ci	H	1992-96		F2UZ-9A758-C	CA-9030
V8 6.6L 400ci	Z	1981-82	30.75" Cable	E1TZ9A758C	CA-8436
V8 6.9L 420ci	1	1983-87	44.00" Cable	E4UZ9A758A	CA-8458
V8 7.3L 445ci	F	1995-97		F1TZ-9A758-E	CA-8683
V8 7.3L 445ci	M	1988-91	44.00" Cable	E4UZ9A758A	CA-8458
V8 7.3L 445ci	M	1992-94		F1TZ-9A758-E	CA-8683
V8 7.5L 460ci	G	1988-91	44.00" Cable	E8UZ9A758A	CA-8458
V8 7.5L 460ci	L	1983-87	w/2 Bbl. Carb.; 30.75" Cable	E1TZ9A758C	CA-8436
V8 7.5L 460ci	L	1983-87	w/4 Bbl. Carb.; 23.00" Cable	E4TZ-9A758-D	CA-8437
<b>F-100</b>					
L6 3.9L 240ci	A	1974		D4TZ-9A758-E	CA-8431
L6 4.9L 300ci	9	1982	30.75" Cable	E0TZ9A758A	CA-8436
L6 4.9L 300ci	B	1974		D4TZ9A758E	CA-8431
L6 4.9L 300ci	B	1975-79		D4TZ9A758E	CA-8431
L6 4.9L 300ci	E	1980	30.75" Cable	E0TZ9A758A	CA-8436
L6 4.9L 300ci	E	1981-82	30.75" Cable	E1TZ9A758D	CA-8436
L6 4.9L 300ci	Y	1983		E3TZ9A758B	CA-8438
V6 3.8L 232ci	3	1982	23.00" Cable	E1TZ9A758E	CA-8437

# ACCELERATOR CABLES

Engine	Vin	Year	Remark	OE	Part
<b>FORD TRUCKS (con't)</b>					
<b>F-100 (con't)</b>					
V8 4.2L 255ci	D	1981	23.00" Cable	E1TZ9A758B	CA-8437
V8 4.2L 255ci	D	1982	23.00" Cable	E1TZ9A758E	CA-8437
V8 5.0L 302ci	F	1980	23.00" Cable	E0TZ9A758B	CA-8437
V8 5.0L 302ci	F	1981	23.00" Cable	E1TZ9A758B	CA-8437
V8 5.0L 302ci	F	1982-83	23.00" Cable	E1TZ9A758E	CA-8437
V8 5.0L 302ci	G	1979	21.00" Cable	D9TZ9A758A	CA-8435
V8 5.8L 351ci	G	1981	23.00" Cable	E0TZ-9A758-B	CA-8437
V8 5.8L 351ci	H	1979	21.00" Cable	D9TZ-9A758-A	CA-8435
V8 6.6L 400ci	S	1979	21.00" Cable	D9TZ9A758A	CA-8435
V8 7.5L 460ci	J	1979	21.00" Cable	D9TZ9A758C	CA-8435
<b>F-150</b>					
L6 4.9L 300ci	9	1984-85		E3TZ9A758B	CA-8438
L6 4.9L 300ci	B	1975-79		D4TZ9A758E	CA-8431
L6 4.9L 300ci	E	1980	30.75" Cable	E0TZ9A758A	CA-8436
L6 4.9L 300ci	E	1981-82	30.75" Cable	E1TZ9A758D	CA-8436
L6 4.9L 300ci	K	1978-79		D4TZ9A758E	CA-8431
L6 4.9L 300ci	Y	1983-86		E3TZ9A758B	CA-8438
L6 4.9L 300ci	Y	1987-89	36.24" Cable	E7TZ9A758L	CA-8463
L6 4.9L 300ci	Y	1989-90	To 3/90; 36.24" Cable	E7TZ9A758A	CA-8463
L6 4.9L 300ci	Y	1990	From 3/90 42.69" Cable	E9TZ9A758P	CA-8682
L6 4.9L 300ci	Y	1991	w/Auto. Trans.	F4TZ9A758M	CA-8806
L6 4.9L 300ci	Y	1991	w/Manual Trans.; 42.69" Cable	E9TZ9A758P	CA-8682
L6 4.9L 300ci	Y	1992-96		F4TZ9A758M	CA-8806
L6 4.9L 300ci	Z	1995-96		F4TZ9A758M	CA-8806
V8 5.0L 302ci	F	1980	23.00" Cable	E0TZ9A758B	CA-8437
V8 5.0L 302ci	F	1981	23.00" Cable	E1TZ9A758B	CA-8437
V8 5.0L 302ci	F	1982-84	23.00" Cable	E1TZ9A758E	CA-8437
V8 5.0L 302ci	F	1985	w/2 Bbl. Carb.; 23.00" Cable	E1TZ9A758E	CA-8437
V8 5.0L 302ci	F	1985	w/AOD AT, C6 AT, MT; 42.20" Cable	E5TZ9A758A	CA-8459
V8 5.0L 302ci	G	1979	21.00" Cable	D9TZ9A758A	CA-8435
V8 5.0L 302ci	N	1985-90	To 3/90 42.20" Cable	E5TZ9A758A	CA-8459
V8 5.0L 302ci	N	1990-91	From 3/90 42.69" Cable	E9TZ9A758P	CA-8682
V8 5.0L 302ci	N	1992-93	w/3 Speed Manual Trans, w/C6, w/E4OD AT Trans 42.25" Cable	F1TZ9A758K	CA-8681
V8 5.0L 302ci	N	1992-93	w/AOD Auto. Trans., 39.74" Cable	F1TZ9A758J	CA-8680
V8 5.0L 302ci	N	1992-93	w/C6 AT, w/E4OD AT 42.25" Cable	F1TZ9A758K	CA-8681
V8 5.0L 302ci	N	1992-96	43.25" Cable	F4TZ-9A758-L	CA-9028
V8 5.0L 302ci	N	1994-96	42.25" Cable	F1TZ9A758K	CA-8681
V8 5.8L 351ci	G	1980-84	23.00" Cable	E0TZ-9A758-B	CA-8437
V8 5.8L 351ci	G	1985	42.20" Cable	E5TZ-9A758-A	CA-8459
V8 5.8L 351ci	H	1979	21.00" Cable	D9TZ-9A758-A	CA-8435
V8 5.8L 351ci	H	1984	23.00" Cable	E0TZ-9A758-B	CA-8437
V8 5.8L 351ci	H	1985-90	To 3/90 42.20" Cable	E5TZ-9A758-A	CA-8459
V8 5.8L 351ci	H	1990	From 3/90 42.69" Cable	E9TZ9A758P	CA-8682

# ACCELERATOR CABLES

Engine	Vin	Year	Remark	OE	Part
<b>FORD TRUCKS (con't)</b>					
<b>F-150 (con't)</b>					
V8 5.8L 351ci	H	1991	AOD, C6, MTw/Electronic Fuel Injection; 42.69" Cable	E9TZ9A758P	CA-8682
V8 5.8L 351ci	H	1992-93	AOD 39.74" Cable	F1TZ9A758J	CA-8680
V8 5.8L 351ci	H	1992-93	E4OD, C6, MT; 42.25" Cable	F1TZ-9A758-K	CA-8681
V8 5.8L 351ci	H	1992-96	43.25" Cable	F4TZ-9A758-L	CA-9028
V8 5.8L 351ci	H	1994-96	42.25" Cable	F1TZ9A758K	CA-8681
V8 5.8L 351ci	R	1993	AOD 39.74" Cable	F1TZ9A758J	CA-8680
V8 5.8L 351ci	R	1993	E4OD, C6, MT; 42.25" Cable	F1TZ-9A758-K	CA-8681
V8 5.8L 351ci	R	1993-95	43.25" Cable	F4TZ-9A758-L	CA-9028
V8 5.8L 351ci	R	1994-95	42.25" Cable	F1TZ9A758K	CA-8681
V8 6.6L 400ci	S	1979	21.00" Cable	D9TZ9A758A	CA-8435
V8 6.9L 420ci	1	1984	42.20" Cable	E7TZ9A758K	CA-8459
V8 7.5L 460ci	A, J	1979	21.00" Cable	D9TZ9A758C	CA-8435
<b>F-250</b>					
L6 3.9L 240ci	A	1974		D4TZ-9A758-E	CA-8431
L6 4.9L 300ci	9	1982	30.75" Cable	E0TZ9A758A	CA-8436
L6 4.9L 300ci	9	1985		E3TZ9A758B	CA-8438
L6 4.9L 300ci	B, K	1974-79		D4TZ9A758E	CA-8431
L6 4.9L 300ci	E	1980-82	30.75" Cable	E0TZ9A758A	CA-8436
L6 4.9L 300ci	Y	1983-86		E3TZ9A758B	CA-8438
L6 4.9L 300ci	Y	1987-89	36.24" Cable	E7TZ9A758L	CA-8463
L6 4.9L 300ci	Y	1990	From 3/90 42.69" Cable	E9TZ9A758P	CA-8682
L6 4.9L 300ci	Y	1990	To 3/90	E7TZ9A758A	CA-8463
L6 4.9L 300ci	Y	1991	w/Auto. Trans.	F4TZ9A758M	CA-8806
L6 4.9L 300ci	Y	1991	w/Manual Trans.; 42.69" Cable	E9TZ9A758P	CA-8682
L6 4.9L 300ci	Y	1992-96		F4TZ9A758M	CA-8806
L6 4.9L 300ci	Z	1995-96		F4TZ9A758M	CA-8806
V8 5.0L 302ci	F	1980	23.00" Cable	E0TZ9A758B	CA-8437
V8 5.0L 302ci	F	1981	23.00" Cable	E1TZ9A758B	CA-8437
V8 5.0L 302ci	F	1982-84	23.00" Cable	E1TZ9A758E	CA-8437
V8 5.0L 302ci	F	1985	w/2 Bbl. Carb.; 23.00" Cable	E1TZ9A758E	CA-8437
V8 5.0L 302ci	F	1985	w/AOD AT, C6 AT, MT; 42.20" Cable	E5TZ9A758A	CA-8459
V8 5.0L 302ci	G	1979	21.00" Cable	D9TZ9A758A	CA-8435
V8 5.0L 302ci	N	1985-90	To 3/90 42.20" Cable	E5TZ9A758A	CA-8459
V8 5.0L 302ci	N	1990-91	From 3/90 42.69" Cable	E9TZ9A758P	CA-8682
V8 5.0L 302ci	N	1992-93	w/3 Speed Manual Trans, w/C6, w/E4OD AT Trans 42.25" Cable	F1TZ9A758K	CA-8681
V8 5.0L 302ci	N	1992-93	w/AOD Auto. Trans., 39.74" Cable	F1TZ9A758J	CA-8680
V8 5.0L 302ci	N	1992-93	w/C6 AT, w/E4OD AT 42.25" Cable	F1TZ9A758K	CA-8681
V8 5.0L 302ci	N	1992-96	43.25" Cable	F4TZ-9A758-L	CA-9028
V8 5.0L 302ci	N	1994-96	42.25" Cable	F1TZ9A758K	CA-8681
V8 5.8L 351ci	G	1980-84	23.00" Cable	E0TZ-9A758-B	CA-8437
V8 5.8L 351ci	G	1985	42.20" Cable	E5TZ-9A758-A	CA-8459
V8 5.8L 351ci	H	1979	21.00" Cable	D9TZ-9A758-A	CA-8435
V8 5.8L 351ci	H	1984	23.00" Cable	E0TZ-9A758-B	CA-8437



# ACCELERATOR CABLES

Engine	Vin	Year	Remark	OE	Part
<b>FORD TRUCKS (con't)</b>					
<b>F-250 (con't)</b>					
V8 5.8L 351ci	H	1985-90	To 3/90 42.20" Cable	E5TZ-9A758-A	CA-8459
V8 5.8L 351ci	H	1990	From 3/90 42.69" Cable	E9TZ9A758P	CA-8682
V8 5.8L 351ci	H	1991	E4OD, C6, MT w/Electronic Fuel Injection	F1TZ-9A758-K	CA-8681
V8 5.8L 351ci	H	1992-93	AOD 39.74" Cable	F1TZ9A758J	CA-8680
V8 5.8L 351ci	H	1992-93	E4OD, C6, MT; 42.25" Cable	F1TZ-9A758-K	CA-8681
V8 5.8L 351ci	H	1992-97	43.25" Cable	F4TZ-9A758-L	CA-9028
V8 5.8L 351ci	H	1994-96	42.25" Cable	F1TZ9A758K	CA-8681
V8 6.6L 400ci	S	1979	21.00" Cable	D9TZ9A758A	CA-8435
V8 6.6L 400ci	Z	1980-82	23.00" Cable	E0TZ9A758B	CA-8437
V8 6.9L 420ci	1	1983-87	42.20" Cable	E7TZ9A758K	CA-8459
V8 7.3L 445ci	C	1993		F1TZ-9A758-E	CA-8683
V8 7.3L 445ci	F, K	1994		F1TZ-9A758-E	CA-8683
V8 7.3L 445ci	F	1995-97		F1TZ9A758E	CA-8807
V8 7.3L 445ci	M	1988-91	42.20" Cable	E7TZ9A758K	CA-8459
V8 7.3L 445ci	M	1992-94		F1TZ-9A758-E	CA-8683
V8 7.5L 460ci	A	1979	21.00" Cable	D9TZ9A758C	CA-8435
V8 7.5L 460ci	G	1988-90	42.20" Cable	E7TZ9A758E	CA-8459
V8 7.5L 460ci	G	1988-97	42.69" Cable	E9TZ9A758P	CA-8682
V8 7.5L 460ci	G	1992-96	37.50" Cable	F1TZ-9A758-D	CA-9029
V8 7.5L 460ci	J	1979	21.00" Cable	D9TZ9A758C	CA-8435
V8 7.5L 460ci	L	1983-85	23.00" Cable	E1TZ9A758E	CA-8437
V8 7.5L 460ci	L	1986-87	23.00" Cable	E4TZ9A758D	CA-8437
<b>F-350</b>					
L6 3.9L 240ci	A	1974		D4TZ-9A758-E	CA-8431
L6 4.9L 300ci	9	1982	30.75" Cable	E0TZ9A758A	CA-8436
L6 4.9L 300ci	9	1984-85		E3TZ9A758B	CA-8438
L6 4.9L 300ci	B, K	1974-79		D4TZ9A758E	CA-8431
L6 4.9L 300ci	E	1980	30.75" Cable	E0TZ9A758A	CA-8436
L6 4.9L 300ci	E	1981-82	30.75" Cable	E1TZ9A758D	CA-8436
L6 4.9L 300ci	Y	1983-86		E3TZ9A758B	CA-8438
L6 4.9L 300ci	Y	1987-90	To 3/90; 36.24" Cable	E7TZ9A758A	CA-8463
L6 4.9L 300ci	Y	1990	From 3/90 42.69" Cable	E9TZ9A758P	CA-8682
L6 4.9L 300ci	Y	1991	w/Auto. Trans.	F4TZ9A758M	CA-8806
L6 4.9L 300ci	Y	1991	w/Manual Trans.; 42.69" Cable	E9TZ9A758P	CA-8682
L6 4.9L 300ci	Y	1992-96		F4TZ9A758M	CA-8806
V8 5.0L 302ci	F	1980	23.00" Cable	E0TZ9A758B	CA-8437
V8 5.0L 302ci	G	1979	21.00" Cable	D9TZ9A758A	CA-8435
V8 5.8L 351ci	G	1980-83	23.00" Cable	E0TZ-9A758-B	CA-8437
V8 5.8L 351ci	H	1979	21.00" Cable	D9TZ-9A758-A	CA-8435
V8 5.8L 351ci	H	1985-90	To 3/90 42.20" Cable	E5TZ-9A758-A	CA-8459
V8 5.8L 351ci	H	1990	From 3/90 42.69" Cable	E9TZ9A758P	CA-8682
V8 5.8L 351ci	H	1991	C6 AT, MT; 42.69" Cable	E9TZ9A758P	CA-8682
V8 5.8L 351ci	H	1992-93	AOD 39.74" Cable	F1TZ9A758J	CA-8680
V8 5.8L 351ci	H	1992-93	E4OD, C6, MT; 42.25" Cable	F1TZ-9A758-K	CA-8681

# ACCELERATOR CABLES

Engine	Vin	Year	Remark	OE	Part
<b>FORD TRUCKS (con't)</b>					
<b>F-350 (con't)</b>					
V8 5.8L 351ci	H	1992-97	43.25" Cable	F4TZ-9A758-L	CA-9028
V8 5.8L 351ci	H	1994-96	42.25" Cable	F1TZ9A758K	CA-8681
V8 6.6L 400ci	S	1979	21.00" Cable	D9TZ9A758A	CA-8435
V8 6.6L 400ci	Z	1980-82	23.00" Cable	E0TZ9A758B	CA-8437
V8 6.9L 420ci	1	1983-87	42.20" Cable	E7TZ9A758K	CA-8459
V8 7.3L 445ci	C	1993		F1TZ-9A758-E	CA-8683
V8 7.3L 445ci	F, K	1994		F1TZ-9A758-E	CA-8683
V8 7.3L 445ci	F	1995-97		F1TZ9A758E	CA-8807
V8 7.3L 445ci	M	1988-91	42.20" Cable	E7TZ9A758K	CA-8459
V8 7.3L 445ci	M	1992-94		F1TZ-9A758-E	CA-8683
V8 7.5L 460ci	G	1988-90	42.20" Cable	E7TZ9A758E	CA-8459
V8 7.5L 460ci	G	1988-97	42.69" Cable	E9TZ9A758P	CA-8682
V8 7.5L 460ci	G	1992-96	37.50" Cable	F1TZ-9A758-D	CA-9029
V8 7.5L 460ci	J	1979	21.00" Cable	D9TZ9A758C	CA-8435
V8 7.5L 460ci	L	1983-85	23.00" Cable	E1TZ9A758E	CA-8437
V8 7.5L 460ci	L	1986-87	23.00" Cable	E4TZ9A758D	CA-8437
<b>RANCHERO</b>					
V8 7.5L 460ci	A	1977		D7OZ-9A758-C	CA-8446
<b>RANGER</b>					
L4 2.0L 122ci	C	1983-86		E3TZ9A758E	CA-8456
L4 2.0L 122ci	C	1987-88	42.20" Cable	E7TZ9A758G	CA-8459
L4 2.2L 134ci	P	1983-84	Diesel	E3TZ9A758C	CA-8439
L4 2.3L 140ci	A	1983-85		E3TZ9A758E	CA-8456
L4 2.3L 140ci	A	1986-89		E6TZ9A758C	CA-8461
L4 2.3L 140ci	E	1985-87	w/Man. Trans., Diesel	E5TZ9A758C	CA-8439
<b>GMC</b>					
<b>C15/C1500 PICKUP</b>					
L6 4.1L 250ci	D	1977-78	w/2 Bbl. Carb, 23.86" Cable	1248073	CA-8469
L6 4.1L 250ci	D	1979-84		14000307	CA-8317
L6 4.1L 250ci	Q	1974	24.00" Cable	1244131	CA-8509
L6 4.1L 250ci	Q	1975	w/2 Bbl. Carb, 23.86" Cable	1248073	CA-8469
L6 4.8L 292ci	S, T	1974	24.00" Cable	1244132	CA-8509
L6 4.8L 292ci	T	1975-76	w/2 Bbl. Carb, 23.86" Cable	1248073	CA-8469
L6 4.8L 292ci	T	1977-80		1248081	CA-8468
V6 4.3L 262ci	N	1985-86		15593743	CA-8508
V8 5.0L 305ci	F	1981	w/2 Bbl. Carb, 23.86" Cable	1248073	CA-8469
V8 5.0L 305ci	F	1981	w/4 Bbl. Carb., 24.78" Cable	1259333	CA-8500
V8 5.0L 305ci	F	1983-86	24.78" Cable	25515839	CA-8500
V8 5.0L 305ci	G	1980-81	w/2 Bbl. Carb, 23.86" Cable	1248073	CA-8469
V8 5.0L 305ci	G	1980-81	w/4 Bbl. Carb., 24.78" Cable	1259333	CA-8500
V8 5.0L 305ci	H	1981	w/2 Bbl. Carb, 23.86" Cable	1248073	CA-8469
V8 5.0L 305ci	H	1981	w/4 Bbl. Carb., 24.78" Cable	1259333	CA-8500
V8 5.0L 305ci	H	1983-86	24.78" Cable	25515839	CA-8500
V8 5.0L 305ci	Q	1976	w/2 Bbl. Carb, 23.86" Cable	1248073	CA-8469

# ACCELERATOR CABLES

Engine	Vin	Year	Remark	OE	Part
<b>GMC (con't)</b>					
<b>C15/C1500 PICKUP (con't)</b>					
V8 5.0L 305ci	U	1977-79	w/2 Bbl. Carb, 23.86" Cable	1248073	CA-8469
V8 5.7L 350ci	L	1977	w/2 Bbl. Carb, 23.86" Cable	1254793	CA-8469
V8 5.7L 350ci	L	1978	24.78" Cable	1259333	CA-8500
V8 5.7L 350ci	L	1976-77	w/2 Bbl. Carb, 23.86" Cable	1248073	CA-8469
V8 5.7L 350ci	L, M	1979-86	24.78" Cable	1259333	CA-8500
V8 5.7L 350ci	P	1980	24.78" Cable	1259333	CA-8500
V8 5.7L 350ci	V, W, Y	1974	24.00" Cable	1244134	CA-8509
V8 5.7L 350ci	V, Y	1975-76	w/2 Bbl. Carb, 23.86" Cable	1248073	CA-8469
V8 6.2L 379ci	C, J	1982-86		14038644	CA-8503
V8 6.6L 400ci	R	1978	24.78" Cable	1259333	CA-8500
V8 6.6L 400ci	R	1979	24.78" Cable	1259333	CA-8500
V8 6.6L 400ci	U	1976	w/2 Bbl. Carb, 23.86" Cable	1248073	CA-8469
V8 6.6L 400ci	X	1980	24.78" Cable	1259333	CA-8500
V8 7.4L 454ci	S	1976-77	w/2 Bbl. Carb, 23.86" Cable	1248073	CA-8469
V8 7.4L 454ci	S	1976-78	24.78" Cable	1259333	CA-8500
V8 7.4L 454ci	S	1979-80	24.78" Cable	1259333	CA-8500
V8 7.4L 454ci	W	1980	24.78" Cable	1259333	CA-8500
V8 7.4L 454ci	Y	1976	w/2 Bbl. Carb, 23.86" Cable	1248073	CA-8469
V8 7.4L 454ci	Z	1974	24.00" Cable	1244131	CA-8509
V8 7.4L 454ci	Z	1975	w/2 Bbl. Carb, 23.86" Cable	1248073	CA-8469
<b>C15/C1500 SUBURBAN</b>					
L6 4.1L 250ci	D	1976-78	w/2 Bbl. Carb, 23.86" Cable	1254793	CA-8469
L6 4.1L 250ci	D	1979-80		14000307	CA-8317
L6 4.1L 250ci	Q	1974	24.00" Cable	1244131	CA-8509
L6 4.1L 250ci	Q	1975	w/2 Bbl. Carb, 23.86" Cable	1254793	CA-8469
L6 4.8L 292ci	S, T	1974	24.00" Cable	1244132	CA-8509
V8 5.0L 305ci	F, H	1983-86	24.78" Cable	25515839	CA-8500
V8 5.0L 305ci	H	1981	w/2 Bbl. Carb, 23.86" Cable	1248083	CA-8469
V8 5.0L 305ci	H	1981-82	w/4 Bbl. Carb., 24.78" Cable	1259333	CA-8500
V8 5.0L 305ci	U	1979	w/2 Bbl. Carb, 23.86" Cable	1254793	CA-8469
V8 5.0L 305ci	U	1977-78	w/2 Bbl. Carb, 23.86" Cable	1254793	CA-8469
V8 5.7L 350ci	L	1977	w/2 Bbl. Carb, 23.86" Cable	1254793	CA-8469
V8 5.7L 350ci	L, M	1979-86	24.78" Cable	1259333	CA-8500
V8 5.7L 350ci	V, W, Y	1974	24.00" Cable	1244134	CA-8509
V8 5.7L 350ci	V, Y	1975-76	w/2 Bbl. Carb, 23.86" Cable	1254793	CA-8469
V8 5.7L 350ci	Z	1978-79	Diesel	25509846	CA-8802
V8 6.2L 379ci	C	1982-86		14038644	CA-8503
V8 7.4L 454ci	S	1976-77	24.78" Cable	1259333	CA-8500
V8 7.4L 454ci	S	1976-77	w/2 Bbl. Carb, 23.86" Cable	1254793	CA-8469
V8 7.4L 454ci	S, W	1979-80	24.78" Cable	1259333	CA-8500
V8 7.4L 454ci	Z	1974	24.00" Cable	1244131	CA-8509
V8 7.4L 454ci	Z	1975	w/2 Bbl. Carb, 23.86" Cable	1254793	CA-8469
<b>C1500</b>					
V6 4.3L 262ci	Z	1988-95		15552822	CA-8688

# ACCELERATOR CABLES

Engine	Vin	Year	Remark	OE	Part
<b>GMC (con't)</b>					
<b>C1500 (con't)</b>					
V8 5.0L 305ci	H	1988-95		15552822	CA-8688
V8 5.7L 350ci	K	1988-95		15552822	CA-8688
V8 6.2L 379ci	C	1988-90		15552819	CA-8701
<b>C1500 SUBURBAN</b>					
V8 5.7L 350ci	K	1992-95		15552822	CA-8688
<b>C25/C2500 PICKUP</b>					
L6 4.1L 250ci	D	1977-78	w/2 Bbl. Carb, 23.86" Cable	1248073	CA-8469
L6 4.1L 250ci	D	1979-84		14000307	CA-8317
L6 4.1L 250ci	Q	1974	24.00" Cable	1244131	CA-8509
L6 4.1L 250ci	Q	1975	w/2 Bbl. Carb, 23.86" Cable	1254793	CA-8469
L6 4.8L 292ci	S, T	1974	24.00" Cable	1244132	CA-8509
L6 4.8L 292ci	T	1976	w/2 Bbl. Carb, 23.86" Cable	1254793	CA-8469
L6 4.8L 292ci	T	1977-86		1248081	CA-8468
V6 4.3L 262ci	N	1985-86		15593743	CA-8508
V8 5.0L 305ci	G	1980	24.78" Cable	25515839	CA-8500
V8 5.0L 305ci	G	1980	w/2 Bbl. Carb, 23.86" Cable	1248083	CA-8469
V8 5.0L 305ci	G	1980	w/4 Bbl. Carb., 24.78" Cable	1259333	CA-8500
V8 5.0L 305ci	H	1982	w/4 Bbl. Carb., 24.78" Cable	1259333	CA-8500
V8 5.0L 305ci	H	1983-86	24.78" Cable	25515839	CA-8500
V8 5.0L 305ci	U	1977-78	w/2 Bbl. Carb, 23.86" Cable	1248083	CA-8469
V8 5.0L 305ci	U	1979	24.78" Cable	25515839	CA-8500
V8 5.0L 305ci	U	1979	w/2 Bbl. Carb, 23.86" Cable	1254793	CA-8469
V8 5.7L 350ci	L	1976	w/2 Bbl. Carb, 23.86" Cable	1248073	CA-8469
V8 5.7L 350ci	L	1977	w/2 Bbl. Carb, 23.86" Cable	1248083	CA-8469
V8 5.7L 350ci	L	1978	24.78" Cable	1259333	CA-8500
V8 5.7L 350ci	L, M	1979-86	24.78" Cable	1259333	CA-8500
V8 5.7L 350ci	V, W, Y	1974	24.00" Cable	1244134	CA-8509
V8 5.7L 350ci	V, Y	1975	w/2 Bbl. Carb, 23.86" Cable	1248073	CA-8469
V8 5.7L 350ci	V	1976	w/2 Bbl. Carb, 23.86" Cable	1254793	CA-8469
V8 6.2L 379ci	C, J	1982-86		14038644	CA-8503
V8 6.6L 400ci	R	1977	w/2 Bbl. Carb, 23.86" Cable	1248083	CA-8469
V8 6.6L 400ci	R	1978	24.78" Cable	1259333	CA-8500
V8 6.6L 400ci	U	1976	w/2 Bbl. Carb, 23.86" Cable	1254793	CA-8469
V8 7.4L 454ci	S	1976-77	w/2 Bbl. Carb, 23.86" Cable	1248083	CA-8469
V8 7.4L 454ci	S	1977	24.78" Cable	25515839	CA-8500
V8 7.4L 454ci	S	1978	24.78" Cable	1259333	CA-8500
V8 7.4L 454ci	S	1979-80	24.78" Cable	1259333	CA-8500
V8 7.4L 454ci	W	1980-82	24.78" Cable	1259333	CA-8500
V8 7.4L 454ci	W	1983-84	24.78" Cable	25515839	CA-8500
V8 7.4L 454ci	Y	1976	24.78" Cable	25515839	CA-8500
V8 7.4L 454ci	Y	1976	w/2 Bbl. Carb, 23.86" Cable	1254793	CA-8469
V8 7.4L 454ci	Z	1974	24.00" Cable	1244131	CA-8509
V8 7.4L 454ci	Z	1975	w/2 Bbl. Carb, 23.86" Cable	1248073	CA-8469

# ACCELERATOR CABLES

Engine	Vin	Year	Remark	OE	Part
<b>GMC (con't)</b>					
<b>C25/C2500 SUBURBAN</b>					
L6 4.1L 250ci	Q	1974	24.00" Cable	1244131	CA-8509
L6 4.8L 292ci	T	1974	24.00" Cable	1244132	CA-8509
L6 4.8L 292ci	T	1975-76	w/2 Bbl. Carb, 23.86" Cable	1254793	CA-8469
L6 4.8L 292ci	T	1977-86		1248081	CA-8468
V8 5.0L 305ci	H	1983-86	24.78" Cable	25515839	CA-8500
V8 5.0L 305ci	U	1977-78	w/2 Bbl. Carb, 23.86" Cable	1254793	CA-8469
V8 5.7L 350ci	L	1979-86	24.78" Cable	1259333	CA-8500
V8 5.7L 350ci	M	1980-86	24.78" Cable	1259333	CA-8500
V8 5.7L 350ci	V, Y	1974	24.00" Cable	1244134	CA-8509
V8 5.7L 350ci	V	1974	24.78" Cable	1259333	CA-8500
V8 5.7L 350ci	V, Y	1975-76	w/2 Bbl. Carb, 23.86" Cable	1254793	CA-8469
V8 6.2L 379ci	C, J	1982-86		14038644	CA-8503
V8 6.6L 400ci	X	1980	24.78" Cable	1259333	CA-8500
V8 7.4L 454ci	S	1976-77	w/4Bbl.; 24.78" Cable	25515839	CA-8500
V8 7.4L 454ci	S	1976-77	w/2 Bbl. Carb, 23.86" Cable	1254793	CA-8469
V8 7.4L 454ci	S	1979-80	24.78" Cable	1259333	CA-8500
V8 7.4L 454ci	W	1981-82	24.78" Cable	1259333	CA-8500
V8 7.4L 454ci	W	1983-84	24.78" Cable	25515839	CA-8500
V8 7.4L 454ci	Y	1976	w/2 Bbl. Carb, 23.86" Cable	1254793	CA-8469
V8 7.4L 454ci	Z	1974-75	24.00" Cable	1244131	CA-8509
V8 7.4L 454ci	Z	1974-75	w/2 Bbl. Carb, 23.86" Cable	1254793	CA-8469
<b>C2500</b>					
V6 4.3L 262ci	Z	1988-95		15552822	CA-8688
V8 5.0L 305ci	H	1988-95		15552822	CA-8688
V8 5.7L 350ci	K	1988-95		15552822	CA-8688
V8 6.2L 379ci	C, J	1988-90		15552819	CA-8701
V8 7.4L 454ci	N	1991-95		15552822	CA-8688
<b>C2500 SUBURBAN</b>					
V8 5.7L 350ci	K	1992-95		15552822	CA-8688
V8 7.4L 454ci	N	1992-95		15552822	CA-8688
<b>C35/C3500 PICKUP</b>					
L6 4.1L 250ci	D	1978	w/2 Bbl. Carb, 23.86" Cable	1254793	CA-8469
L6 4.1L 250ci	D	1980		14000307	CA-8317
L6 4.1L 250ci	Q	1974	24.00" Cable	1244131	CA-8509
L6 4.1L 250ci	Q	1975	w/2 Bbl. Carb, 23.86" Cable	1254793	CA-8469
L6 4.8L 292ci	S, T	1974	24.00" Cable	1244132	CA-8509
L6 4.8L 292ci	T	1977-86		1248081	CA-8468
V8 5.0L 305ci	H	1986	24.78" Cable	25515839	CA-8500
V8 5.0L 305ci	U	1978	w/2 Bbl. Carb, 23.86" Cable	1254793	CA-8469
V8 5.7L 350ci	L	1976	w/2 Bbl. Carb, 23.86" Cable	1248073	CA-8469
V8 5.7L 350ci	L	1977	w/2 Bbl. Carb, 23.86" Cable	1248083	CA-8469
V8 5.7L 350ci	L	1978-80	24.78" Cable	1259333	CA-8500
V8 5.7L 350ci	M	1981	w/2 Bbl. 28.28" Cable	358448	CA-8689
V8 5.7L 350ci	M	1979-86	w/4 Bbl 24.78" Cable	1259333	CA-8500

# ACCELERATOR CABLES

Engine	Vin	Year	Remark	OE	Part
<b>GMC (con't)</b>					
<b>C35/C3500 PICKUP (con't)</b>					
V8 5.7L 350ci	V, W, Y	1974	24.00" Cable	1244134	CA-8509
V8 5.7L 350ci	V, Y	1975-76	w/2 Bbl. Carb, 23.86" Cable	1248073	CA-8469
V8 6.2L 379ci	J	1982-86		14038644	CA-8503
V8 6.6L 400ci	R	1977	w/2 Bbl. Carb, 23.86" Cable	1248083	CA-8469
V8 6.6L 400ci	R	1978-79	24.78" Cable	1259333	CA-8500
V8 6.6L 400ci	U	1976	w/2 Bbl. Carb, 23.86" Cable	1248073	CA-8469
V8 7.4L 454ci	S	1976	w/2 Bbl. Carb, 23.86" Cable	1248073	CA-8469
V8 7.4L 454ci	S	1976-77	w/4 Bbl 24.78" Cable	25515839	CA-8500
V8 7.4L 454ci	S	1977	w/2 Bbl. Carb, 23.86" Cable	1248083	CA-8469
V8 7.4L 454ci	S	1978	24.78" Cable	1259333	CA-8500
V8 7.4L 454ci	S	1979-80	24.78" Cable	1259333	CA-8500
V8 7.4L 454ci	W	1980-82	24.78" Cable	1259333	CA-8500
V8 7.4L 454ci	W	1983-84	24.78" Cable	25515839	CA-8500
V8 7.4L 454ci	Y	1976	w/2 Bbl. Carb, 23.86" Cable	1254793	CA-8469
V8 7.4L 454ci	Z	1974	24.00" Cable	1244131	CA-8509
V8 7.4L 454ci	Z	1975	w/2 Bbl. Carb, 23.86" Cable	1248073	CA-8469
<b>C3500</b>					
V8 5.7L 350ci	K	1988-95		15552822	CA-8688
V8 6.2L 379ci	J	1988-90		15552819	CA-8701
V8 7.4L 454ci	N	1988-95		15552822	CA-8688
<b>CABALLERO</b>					
V6 3.3L 200ci	M	1978-79		1258156	CA-8496
V6 3.8L 229ci	9	1983-84		1258156	CA-8496
V6 3.8L 229ci	K	1980-82		1258156	CA-8496
V6 3.8L 231ci	A	1978-84		25500209	CA-8474
V6 4.3L 262ci	Z	1985-87		1258156	CA-8496
V8 4.4L 267ci	J	1980-82		25500209	CA-8474
V8 5.0L 305ci	H	1979-87		1254180	CA-8475
V8 5.0L 305ci	U	1978		25500209	CA-8474
V8 5.7L 350ci	L	1978		1254180	CA-8475
V8 5.7L 350ci	N	1983-84	Diesel	25509332	CA-8495
<b>G15</b>					
L6 4.1L 250ci	D	1976		1248087	CA-8687
L6 4.1L 250ci	D	1979-84		1248087	CA-8687
L6 4.1L 250ci	Q	1975		1248087	CA-8687
V6 4.3L 262ci	N	1985-86		15590110	CA-8507
V6 4.3L 262ci	Z	1987-90		15552817	CA-8467
V8 5.0L 305ci	F, G, H, U	1981-90		376193	CA-8467
V8 5.7L 350ci	K	1987-90		15552817	CA-8467
V8 5.7L 350ci	L	1976-86		1248088	CA-8467
V8 5.7L 350ci	V, Y	1975-76		1248088	CA-8467
V8 6.6L 400ci	R	1979		376193	CA-8467
V8 6.6L 400ci	U	1976		376193	CA-8467

# ACCELERATOR CABLES

Engine	Vin	Year	Remark	OE	Part
<b>GMC (con't)</b>					
<b>G25</b>					
L6 4.1L 250ci	D	1979-84		1248087	CA-8687
V6 4.3L 262ci	N	1985-86		15590110	CA-8507
V6 4.3L 262ci	Z	1987-90		15552817	CA-8467
V8 5.0L 305ci	F, G, H, U	1981-90		376193	CA-8467
V8 5.7L 350ci	L, M	1976-86		1248088	CA-8467
V8 5.7L 350ci	K	1987-90		15552817	CA-8467
V8 5.7L 350ci	V, Y	1975		1248088	CA-8467
V8 6.2L 379ci	C	1983-90		14047686	CA-8503
V8 6.6L 400ci	M	1975		376193	CA-8467
V8 6.6L 400ci	R	1977-80		376193	CA-8467
V8 6.6L 400ci	U	1976		376193	CA-8467
<b>G35</b>					
L6 4.1L 250ci	D	1979-84		1248087	CA-8687
V6 4.3L 262ci	N	1985-86		15590110	CA-8507
V6 4.3L 262ci	Z	1987-90		15552817	CA-8467
V8 5.0L 305ci	H	1981		376193	CA-8467
V8 5.7L 350ci	E	1984		1248088	CA-8467
V8 5.7L 350ci	K, M	1987-90		15552817	CA-8467
V8 5.7L 350ci	L, M	1976-86		1248088	CA-8467
V8 5.7L 350ci	Y	1975		1248088	CA-8467
V8 6.2L 379ci	J	1983-90		14047686	CA-8503
V8 6.6L 400ci	M	1975		376193	CA-8467
V8 6.6L 400ci	R	1977-80		376193	CA-8467
V8 6.6L 400ci	U	1976		376193	CA-8467
V8 7.4L 454ci	N	1988-93		15552857	CA-8796
V8 7.4L 454ci	N	1994-96	w/o Speed Governor	15552857	CA-8796
<b>JIMMY</b>					
L6 4.1L 250ci	D	1977-78	w/2 Bbl. Carb, 23.86" Cable	1248073	CA-8469
L6 4.1L 250ci	D	1979-82		14000307	CA-8317
L6 4.1L 250ci	Q	1974	24.00" Cable	1244131	CA-8509
L6 4.1L 250ci	Q	1975	w/2 Bbl. Carb, 23.86" Cable	1254793	CA-8469
V8 5.0L 305ci	F, G, H	1980-81	w/2 Bbl. Carb, 23.86" Cable	1248083	CA-8469
V8 5.0L 305ci	F, G	1980-81	w/4 Bbl. Carb., 24.78" Cable	1259333	CA-8500
V8 5.0L 305ci	H	1981-82	w/4 Bbl. Carb., 24.78" Cable	1259333	CA-8500
V8 5.0L 305ci	H	1983-86	24.78" Cable	25515839	CA-8500
V8 5.0L 305ci	U	1977-79	w/2 Bbl. Carb, 23.86" Cable	1248083	CA-8469
V8 5.7L 350ci	K	1987-91		15551476	CA-8314
V8 5.7L 350ci	L	1976	w/2 Bbl. Carb, 23.86" Cable	1248073	CA-8469
V8 5.7L 350ci	L	1977	w/2 Bbl. Carb, 23.86" Cable	1248083	CA-8469
V8 5.7L 350ci	L	1979-86	24.78" Cable	1259333	CA-8500
V8 5.7L 350ci	V, Y	1974	24.00" Cable	1244134	CA-8509
V8 5.7L 350ci	V, Y	1975-76	w/2 Bbl. Carb, 23.86" Cable	1248073	CA-8469
V8 6.2L 379ci	C	1982-89		14038644	CA-8503
V8 6.6L 400ci	M	1975	w/2 Bbl. Carb, 23.86" Cable	1248073	CA-8469

# ACCELERATOR CABLES

Engine	Vin	Year	Remark	OE	Part
<b>GMC (con't)</b>					
<b>JIMMY (con't)</b>					
V8 6.6L 400ci	R	1977	w/2 Bbl. Carb, 23.86" Cable	1248083	CA-8469
V8 6.6L 400ci	R	1979	24.78" Cable	1259333	CA-8500
V8 6.6L 400ci	U	1976	w/2 Bbl. Carb, 23.86" Cable	1248073	CA-8469
V8 7.4L 454ci	Y	1976	w/2 Bbl. Carb, 23.86" Cable	1248073	CA-8469
<b>K15/K1500 PICKUP</b>					
L6 4.1L 250ci	D	1977-78	w/2 Bbl. Carb, 23.86" Cable	1248073	CA-8469
L6 4.1L 250ci	D	1979-84		14000307	CA-8317
L6 4.1L 250ci	Q	1974	24.00" Cable	1244131	CA-8509
L6 4.1L 250ci	Q	1975	w/2 Bbl. Carb, 23.86" Cable	1254793	CA-8469
L6 4.8L 292ci	T	1975	w/2 Bbl. Carb, 23.86" Cable	1254793	CA-8469
L6 4.8L 292ci	T	1976	w/2 Bbl. Carb, 23.86" Cable	1248073	CA-8469
L6 4.8L 292ci	T	1979-80		1248081	CA-8468
V6 4.3L 262ci	N	1985-86		15593743	CA-8508
V8 5.0L 305ci	H	1983-86	24.78" Cable	25515839	CA-8500
V8 5.0L 305ci	Q	1976	w/2 Bbl. Carb, 23.86" Cable	1254793	CA-8469
V8 5.0L 305ci	U	1977-79	w/2 Bbl. Carb, 23.86" Cable	1248083	CA-8469
V8 5.7L 350ci	L	1976	w/2 Bbl. Carb, 23.86" Cable	1248073	CA-8469
V8 5.7L 350ci	L	1977	w/2 Bbl. Carb, 23.86" Cable	1248083	CA-8469
V8 5.7L 350ci	L, M	1978-86	24.78" Cable	1259333	CA-8500
V8 5.7L 350ci	V, Y	1974	24.00" Cable	1244134	CA-8509
V8 5.7L 350ci	V, Y	1975-76	w/2 Bbl. Carb, 23.86" Cable	1248073	CA-8469
V8 6.2L 379ci	C	1982-86		14038644	CA-8503
V8 6.6L 400ci	M	1975	w/2 Bbl. Carb, 23.86" Cable	1248073	CA-8469
V8 6.6L 400ci	R	1977	w/2 Bbl. Carb, 23.86" Cable	1248083	CA-8469
V8 6.6L 400ci	R	1978-79	24.78" Cable	1259333	CA-8500
V8 6.6L 400ci	U	1976	w/2 Bbl. Carb, 23.86" Cable	1248073	CA-8469
V8 6.6L 400ci	X	1980	24.78" Cable	1259333	CA-8500
V8 7.4L 454ci	S	1976	w/2 Bbl. Carb, 23.86" Cable	1248073	CA-8469
V8 7.4L 454ci	S	1979-80	24.78" Cable	1259333	CA-8500
V8 7.4L 454ci	Y	1976	24.78" Cable	1259333	CA-8500
V8 7.4L 454ci	Y	1976	w/2 Bbl. Carb, 23.86" Cable	1248083	CA-8469
<b>K15/K1500 SUBURBAN</b>					
L6 4.1L 250ci	D	1976-78	w/2 Bbl. Carb, 23.86" Cable	1254793	CA-8469
L6 4.1L 250ci	D	1979-80		14000307	CA-8317
L6 4.1L 250ci	Q	1974	24.00" Cable	1244131	CA-8509
L6 4.1L 250ci	Q	1975	w/2 Bbl. Carb, 23.86" Cable	1254793	CA-8469
V8 5.0L 305ci	H	1982	w/4 Bbl. Carb., 24.78" Cable	1259333	CA-8500
V8 5.0L 305ci	U	1977-79	w/2 Bbl. Carb, 23.86" Cable	1254793	CA-8469
V8 5.7L 350ci	L, M	1978-86	24.78" Cable	1259333	CA-8500
V8 5.7L 350ci	V, Y	1974	24.00" Cable	1244134	CA-8509
V8 5.7L 350ci	V, Y	1975-76	w/2 Bbl. Carb, 23.86" Cable	1254793	CA-8469
V8 6.2L 379ci	C	1982-86		14038644	CA-8503
V8 6.6L 400ci	R	1977	w/2 Bbl. Carb, 23.86" Cable	1254793	CA-8469
V8 6.6L 400ci	R	1978-79	24.78" Cable	1259333	CA-8500



# ACCELERATOR CABLES

Engine	Vin	Year	Remark	OE	Part
<b>GMC (con't)</b>					
<b>K15/K1500 SUBURBAN (con't)</b>					
V8 6.6L 400ci	U	1976	w/2 Bbl. Carb, 23.86" Cable	1254793	CA-8469
<b>K1500</b>					
V6 4.3L 262ci	Z	1988-95		15552822	CA-8688
V8 5.0L 305ci	H	1988-95		15552822	CA-8688
V8 5.7L 350ci	K	1988-95		15552822	CA-8688
V8 6.2L 379ci	C	1988-90		15552819	CA-8701
<b>K1500 SUBURBAN</b>					
V8 5.7L 350ci	K	1992-95		15552822	CA-8688
<b>K25/K2500 PICKUP</b>					
L6 4.1L 250ci	D	1976-78	w/2 Bbl. Carb, 23.86" Cable	1254793	CA-8469
L6 4.1L 250ci	D	1980		14000307	CA-8317
L6 4.1L 250ci	Q	1974	24.00" Cable	1244131	CA-8509
L6 4.1L 250ci	Q	1975	w/2 Bbl. Carb, 23.86" Cable	1254793	CA-8469
L6 4.8L 292ci	S, T	1974	24.00" Cable	1244132	CA-8509
L6 4.8L 292ci	T	1977-78		1248081	CA-8468
L6 4.8L 292ci	T	1980-86		1248081	CA-8468
V6 4.3L 262ci	N	1985		15593743	CA-8508
V8 5.0L 305ci	U	1977-78	w/2 Bbl. Carb, 23.86" Cable	1248083	CA-8469
V8 5.7L 350ci	L	1976	w/2 Bbl. Carb, 23.86" Cable	1248073	CA-8469
V8 5.7L 350ci	L	1977	w/2 Bbl. Carb, 23.86" Cable	1248083	CA-8469
V8 5.7L 350ci	L, M	1978-86	24.78" Cable	1259333	CA-8500
V8 5.7L 350ci	V, Y	1974	24.00" Cable	1244134	CA-8509
V8 5.7L 350ci	V, Y	1975-76	w/2 Bbl. Carb, 23.86" Cable	1248073	CA-8469
V8 6.2L 379ci	C, J	1982-86		14038644	CA-8503
V8 6.6L 400ci	M	1975	w/2 Bbl. Carb, 23.86" Cable	1248073	CA-8469
V8 6.6L 400ci	R	1977	w/2 Bbl. Carb, 23.86" Cable	1248083	CA-8469
V8 6.6L 400ci	R	1978-79	24.78" Cable	1259333	CA-8500
V8 6.6L 400ci	U	1976	w/2 Bbl. Carb, 23.86" Cable	1248073	CA-8469
V8 6.6L 400ci	X	1980	24.78" Cable	1259333	CA-8500
V8 7.4L 454ci	S	1977	w/2 Bbl. Carb, 23.86" Cable	1254793	CA-8469
V8 7.4L 454ci	S	1977-78	24.78" Cable	1259333	CA-8500
V8 7.4L 454ci	Y	1976	w/2 Bbl. Carb, 23.86" Cable	1248073	CA-8469
V8 7.4L 454ci	Z	1974	24.00" Cable	1244131	CA-8509
<b>K25/K2500 SUBURBAN</b>					
L6 4.1L 250ci	Q	1974	24.00" Cable	1244131	CA-8509
L6 4.8L 292ci	T	1974	24.00" Cable	1244132	CA-8509
L6 4.8L 292ci	T	1975-76	w/2 Bbl. Carb, 23.86" Cable	1254793	CA-8469
L6 4.8L 292ci	T	1977-86		1248081	CA-8468
V8 5.0L 305ci	U	1977-78	w/2 Bbl. Carb, 23.86" Cable	1254793	CA-8469
V8 5.7L 350ci	L	1977	w/2 Bbl. Carb, 23.86" Cable	1254793	CA-8469
V8 5.7L 350ci	L	1979-81	24.78" Cable	1259333	CA-8500
V8 5.7L 350ci	M	1980-86	24.78" Cable	1259333	CA-8500
V8 5.7L 350ci	V, Y	1974	24.00" Cable	1244134	CA-8509
V8 5.7L 350ci	V, Y	1975-76	w/2 Bbl. Carb, 23.86" Cable	1254793	CA-8469

# ACCELERATOR CABLES

Engine	Vin	Year	Remark	OE	Part
<b>GMC (con't)</b>					
<b>K25/K2500 SUBURBAN (con't)</b>					
V8 6.2L 379ci	J	1982-86		14038644	CA-8503
V8 6.6L 400ci	R	1978-79	24.78" Cable	1259333	CA-8500
V8 6.6L 400ci	U	1976	w/2 Bbl. Carb, 23.86" Cable	1254793	CA-8469
V8 6.6L 400ci	X	1980	24.78" Cable	1259333	CA-8500
V8 7.4L 454ci	S	1977	w/2 Bbl. Carb, 23.86" Cable	1254793	CA-8469
<b>K2500</b>					
V6 4.3L 262ci	Z	1988-95		15552822	CA-8688
V8 5.0L 305ci	H	1988-95		15552822	CA-8688
V8 5.7L 350ci	K	1988-95		15552822	CA-8688
V8 6.2L 379ci	C, J	1988-90		15552819	CA-8701
V8 7.4L 454ci	N	1991-95		15552822	CA-8688
<b>K2500 SUBURBAN</b>					
V8 5.7L 350ci	K	1992-95		15552822	CA-8688
V8 7.4L 454ci	N	1992-95		15552822	CA-8688
<b>K35/K3500 PICKUP</b>					
L6 4.1L 250ci	Q	1974	24.00" Cable	1244131	CA-8509
L6 4.8L 292ci	S, T	1974	24.00" Cable	1244132	CA-8509
L6 4.8L 292ci	T	1977-86		1248081	CA-8468
V8 5.7L 350ci	L	1977	w/2 Bbl. Carb, 23.86" Cable	1248083	CA-8469
V8 5.7L 350ci	L	1978-80	24.78" Cable	1259333	CA-8500
V8 5.7L 350ci	M	1979-86	w/4 Bbl 24.78" Cable	1259333	CA-8500
V8 5.7L 350ci	M	1981	w/2 Bbl. 28.28" Cable	358448	CA-8689
V8 5.7L 350ci	V, W, Y	1974	24.00" Cable	1244134	CA-8509
V8 6.2L 379ci	J	1982-86		14038644	CA-8503
V8 6.6L 400ci	R	1977	w/2 Bbl. Carb, 23.86" Cable	1248083	CA-8469
V8 6.6L 400ci	R	1978-79	24.78" Cable	1259333	CA-8500
V8 7.4L 454ci	S	1979-80	24.78" Cable	1259333	CA-8500
V8 7.4L 454ci	W	1981-82	24.78" Cable	1259333	CA-8500
V8 7.4L 454ci	W	1983-86	24.78" Cable	25515839	CA-8500
V8 7.4L 454ci	W	1985	w/Stainless Steel Exhaust Manifold. 25.80" Cable	15552837	CA-8505
V8 7.4L 454ci	W	1986	w/Federal Emissions 25.80" Cable	15552837	CA-8505
V8 7.4L 454ci	Z	1974	24.00" Cable	1244131	CA-8509
<b>K3500</b>					
V8 5.7L 350ci	K	1988-95		15552822	CA-8688
V8 6.2L 379ci	J	1988-90		15552819	CA-8701
V8 7.4L 454ci	N	1988-95		15552822	CA-8688
<b>P1500</b>					
L6 4.8L 292ci	T	1977-80		1248090	CA-8499
V8 7.4L 454ci	S	1979	exc. Motor Home Chassis, w/Forward Control	1248092	CA-8499
<b>P2500</b>					
L6 4.8L 292ci	T	1977-89		1248090	CA-8499
V8 5.7L 350ci	K	1988-89		15551490	CA-8499
V8 5.7L 350ci	L	1978-79		1248092	CA-8499

# ACCELERATOR CABLES

Engine	Vin	Year	Remark	OE	Part
<b>GMC (con't)</b>					
<b>P2500 (con't)</b>					
V8 5.7L 350ci	M	1980-86	exc. Motor Home Chassis, w/Forward Control	1248092	CA-8499
V8 5.7L 350ci	M	1987		1248092	CA-8499
V8 5.7L 350ci	Y	1975		1248092	CA-8499
V8 6.2L 379ci	J	1982-89		14046855	CA-8504
<b>P3500</b>					
L4 3.9L 239ci	L	1990-91		1248090	CA-8499
L6 4.8L 292ci	T	1977-89		1248090	CA-8499
V6 4.3L 262ci	Z	1991		1248090	CA-8499
V8 5.7L 350ci	K	1987-89		15551490	CA-8499
V8 5.7L 350ci	L	1976-80	exc. Motor Home Chassis	1248092	CA-8499
V8 5.7L 350ci	L	1976-80	w/Motor Home Chassis	352268	CA-8466
V8 5.7L 350ci	M	1980-86	w/Motor Home Chassis	352268	CA-8466
V8 5.7L 350ci	M	1980-88	exc. Motor Home Chassis	1248092	CA-8499
V8 6.2L 379ci	J	1982-91		14046855	CA-8504
V8 7.4L 454ci	L	1975		1248092	CA-8499
V8 7.4L 454ci	N	1991	exc. Motor Home Chassis, w/Forward Control	1248092	CA-8499
V8 7.4L 454ci	N	1991	w/Motor Home Chassis	1248092	CA-8466
V8 7.4L 454ci	N	1992		1248092	CA-8499
V8 7.4L 454ci	S	1978	exc. Motor Home Chassis	1248092	CA-8499
V8 7.4L 454ci	S	1978-79	w/Motor Home Chassis	1248092	CA-8466
V8 7.4L 454ci	S	1979	exc. Motor Home Chassis, w/Forward Control	1248092	CA-8499
V8 7.4L 454ci	W	1981-89	exc. Motor Home Chassis, w/Forward Control	1248092	CA-8499
V8 7.4L 454ci	W	1981-89	w/Motor Home Chassis	1248092	CA-8466
V8 7.4L 454ci	Y	1977	exc. Motor Home Chassis, w/Forward Control	1248092	CA-8499
V8 7.4L 454ci	Y	1977	w/Motor Home Chassis	1248092	CA-8466
<b>R1500</b>					
V6 4.3L 262ci	Z	1987		15551476	CA-8314
V8 5.0L 305ci	H	1987		15551476	CA-8314
V8 5.7L 350ci	K	1987		15551476	CA-8314
V8 6.2L 379ci	C	1987		14038644	CA-8503
<b>R1500 SUBURBAN</b>					
V8 5.7L 350ci	K	1987-91		15551476	CA-8314
V8 6.2L 379ci	C	1987-89		14038644	CA-8503
<b>R2500</b>					
L6 4.8L 292ci	T	1987-88		1248081	CA-8468
V6 4.3L 262ci	Z	1987		15551476	CA-8314
V8 5.0L 305ci	H	1987		15551476	CA-8314
V8 5.7L 350ci	K	1988-89		15551476	CA-8314
V8 6.2L 379ci	C, J	1987-89		14038644	CA-8503
V8 7.4L 454ci	N	1988-89		1551476	CA-8314

# ACCELERATOR CABLES

Engine	Vin	Year	Remark	OE	Part
<b>GMC (con't)</b>					
<b>R2500 SUBURBAN</b>					
V8 5.7L 350ci	K	1987-91		15551476	CA-8314
V8 6.2L 379ci	J	1987-89		14038644	CA-8503
V8 7.4L 454ci	N	1987-91		1551476	CA-8314
<b>R3500</b>					
L6 4.8L 292ci	T	1987-88		1248081	CA-8468
V8 5.7L 350ci	K	1988-90		15551476	CA-8314
V8 5.7L 350ci	M	1987	24.78" Cable	1259333	CA-8500
V8 5.7L 350ci	M	1988		15551476	CA-8314
V8 6.2L 379ci	J	1987-89		14038644	CA-8503
V8 7.4L 454ci	N	1988-91		1551476	CA-8314
V8 7.4L 454ci	W	1987-89	w/4 Bbl. Carb., 24.78" Cable	25515839	CA-8500
<b>S15, S15 JIMMY</b>					
L4 1.9L 119ci	A	1982-85		14036109	CA-8501
L4 2.0L 122ci	Y	1983-84		14036109	CA-8501
L4 2.5L 151ci	E	1985-86		15592356	CA-8506
V6 2.8L 173ci	B	1982-85		14036110	CA-8502
V6 2.8L 173ci	R	1986-90		15622471	CA-8316
V6 4.3L 262ci	Z	1988-90		15622442	CA-8315
<b>SAFARI</b>					
L4 2.5L 151ci	E	1985-88		15590109	CA-8506
V6 4.3L 262ci	B	1990-91		15604992	CA-8797
V6 4.3L 262ci	N	1985		15590110	CA-8507
V6 4.3L 262ci	Z	1986-92		15557348	CA-8499
<b>SONOMA</b>					
V6 4.3L 262ci	Z	1991		15622442	CA-8315
<b>SPRINT</b>					
L6 4.1L 250ci	D	1975-77		1248075	CA-8485
V8 5.0L 305ci	Q	1976		1248077	CA-8485
V8 5.0L 305ci	U	1977		1248077	CA-8485
V8 5.7L 350ci	H, L, V	1975-77		1248077	CA-8485
V8 7.4L 454ci	Y	1975		1248078	CA-8485
<b>V1500</b>					
V6 4.3L 262ci	Z	1987		15551476	CA-8314
V8 5.0L 305ci	H	1987		15551476	CA-8314
V8 5.7L 350ci	K	1987		15551476	CA-8314
V8 6.2L 379ci	C	1987		14038644	CA-8503
<b>V1500 SUBURBAN</b>					
V8 5.7L 350ci	K	1987-91		15551476	CA-8314
V8 6.2L 379ci	C	1987-89		14038644	CA-8503
<b>V2500</b>					
L6 4.8L 292ci	T	1987		1248081	CA-8468
V8 5.7L 350ci	K	1987		15551476	CA-8314
V8 6.2L 379ci	C	1987		14038644	CA-8503
V8 6.2L 379ci	J	1987		14038644	CA-8503

# ACCELERATOR CABLES

Engine	Vin	Year	Remark	OE	Part
<b>GMC (con't)</b>					
<b>V2500 SUBURBAN</b>					
V8 5.7L 350ci	K	1987-91		15551476	CA-8314
V8 6.2L 379ci	J	1987-89		14038644	CA-8503
<b>V3500</b>					
L6 4.8L 292ci	T	1987-88		1248081	CA-8468
V8 5.7L 350ci	K	1988-91		15551476	CA-8314
V8 5.7L 350ci	M	1987	24.78" Cable	1259333	CA-8500
V8 5.7L 350ci	M	1988		15551476	CA-8314
V8 6.2L 379ci	J	1987-89		14038644	CA-8503
V8 7.4L 454ci	N	1988-90		1551476	CA-8314
V8 7.4L 454ci	W	1987-89	w/4 Bbl. Carb.; 25.80" Cable	15552837	CA-8505
<b>YUKON</b>					
V8 5.7L 350ci	K	1992-95		15552822	CA-8688
<b>HONDA</b>					
<b>ACCORD</b>					
L4 1.6L 1599cc		1976-78		17910671670	CA-8541
L4 1.8L 1751cc		1979		17910671670	CA-8541
L4 1.8L 1751cc		1980-82	w/Auto. Trans.	17910689682	CA-8813
L4 1.8L 1751cc		1980-82	w/Manual Trans.	17910689671	CA-8810
L4 1.8L 1751cc		1983	w/Auto. Trans.	17910SA5771	CA-8814
L4 1.8L 1751cc		1983	w/Manual Trans.	17910SA5670	CA-8811
L4 1.8L 1829cc		1984-85	w/Auto. Trans.	17910SA5772	CA-8815
L4 1.8L 1829cc		1984-85	w/Manual Trans.	17910SA5671	CA-8812
L4 2.2L 2156cc		1990-93	29.50" Cable w/Auto. Trans.	17910SM4A82	CA-8927
L4 2.2L 2156cc		1990-93	30.00" Cable w/Manual Trans.	17910SM4A31	CA-8928
L4 2.2L 2156cc		1990-97	29.25" Cable w/Auto. Trans	17910SV4A81	CA-8926
L4 2.2L 2156cc		1990-97	30.50" Cable w/Manual Trans.	17910SV4A01	CA-8995
<b>CIVIC</b>					
L4 1.2L 1237cc		1973-76		17910634660	CA-8540
L4 1.3L 1335cc		1980		17910SA0671	CA-8816
L4 1.3L 1335cc		1981-83	w/Auto. Trans.	17910SA0710	CA-8818
L4 1.3L 1335cc		1981-83	w/Manual Trans.	17910SA0671	CA-8816
L4 1.3L 1342cc		1984-87	w/Auto. Trans.	17910SB2711	CA-8819
L4 1.3L 1342cc		1984-87	w/Manual Trans.	17910SB2671	CA-8817
L4 1.5L 1487cc		1975-79	CVCC	17910657673	CA-8809
L4 1.5L 1487cc		1981-83	w/Auto. Trans.	17910SA0710	CA-8818
L4 1.5L 1487cc		1981-83	w/Manual Trans.	17910SA0671	CA-8816
L4 1.5L 1487cc		1984-87	w/Auto. Trans.	17910SB2711	CA-8819
L4 1.5L 1487cc		1984-87	w/Manual Trans.	17910SB2671	CA-8817
L4 1.5L 1491cc		1987	w/Auto. Trans.	17910SB2711	CA-8819
L4 1.5L 1491cc		1987	w/Manual Trans.	17910SB2671	CA-8817
L4 1.5L 1493cc		1986	w/Auto. Trans.	17910SB2711	CA-8819
L4 1.5L 1493cc		1986	w/Manual Trans.	17910SB2671	CA-8817
L4 1.5L 1493cc		1992-93	16 Valve w/Manual Trans. 39.50"	17910SR3A91	CA-8921
L4 1.5L 1493cc	D	1992-95	16V SOHC	17910SR3A71	CA-8925

# ACCELERATOR CABLES

Engine	Vin	Year	Remark	OE	Part
<b>HONDA (con't)</b>					
<b>CIVIC (con't)</b>					
L4 1.5L 1493cc		1994-95	16 Valve w/Auto. Trans. 40.00"	17910SR3A51	CA-8924
L4 1.6L 1590cc		1992-95		17910SR3A91	CA-8921
<b>CIVIC DEL SOL</b>					
L4 1.5L 1493cc		1993-95	w/Auto. Trans.	17910SR3A51	CA-8924
L4 1.5L 1493cc		1993-95	w/Manual Trans.	17910SR3A71	CA-8925
L4 1.6L 1590cc		1993-97	w/Manual Trans. 39.50"	17910SR3A91	CA-8921
L4 1.6L 1590cc		1994-95	w/Auto. Trans. 40.00" Cable	17910SR3L01	CA-8922
<b>PRELUDE</b>					
L4 1.8L 1829cc		1983-87	w/Manual Trans.; 56.0" Cable	17910SB0671	CA-8861
L4 1.8L 1829cc		1985-86	38.78" Cable	17910SFG671	CA-8821
L4 1.8L 1829cc		1987	w/Manual Trans. 38.78" Cable	17910SFG671	CA-8821
L4 2.0L 1955cc		1985-87	38.78" Cable	17910SFG671	CA-8821
L4 2.2L 2156cc		1992-95		17910SS0A11	CA-8892
L4 2.3L 2259cc		1992-95		17910SS0A11	CA-8892
<b>HONDA TRUCKS</b>					
<b>ODYSSEY</b>					
L4 2.2L 2156cc		1995-97		17910SX0A81	CA-8923
<b>HYUNDAI</b>					
<b>ELANTRA</b>					
L4 1.6L 1596cc	R	1992-95	w/o CC	3279028020	CA-8998
L4 1.8L 1836cc	M	1993-95	w/o CC	3279028020	CA-8998
<b>EXCEL</b>					
L4 1.5L 1468cc	J	1986-89		3279021011	CA-8871
L4 1.5L 1468cc	J	1990-94		3279024020	CA-8989
<b>SCOUPE</b>					
L4 1.5L 1468cc	J	1991-92	w/o CC	3279024020	CA-8989
<b>INFINITI</b>					
<b>G20</b>					
L4 2.0L 1998cc	C	1991-93		1820162J05	CA-8983
L4 2.0L 1998cc	C	1994-96		1820178J10	CA-8991
<b>I30</b>					
V6 3.0L 2988cc	C	1996-97		1820144U00	CA-8949
<b>Q45</b>					
V8 4.5L 4494cc	N	1990-96	From Accelerator Drum to Petal	1820160U00	CA-9022
<b>QX4</b>					
V6 3.3L 3275cc	A	1997-99		182010W000	CA-9021
<b>ISUZU</b>					
<b>I-MARK</b>					
L4 1.5L 1471cc	7, 9	1986-89	w/Manual Trans.	94165358	CA-8869
L4 1.5L 1471cc	K	1985	w/Manual Trans.	94165358	CA-8869
<b>ISUZU TRUCKS</b>					
<b>PICKUP</b>					
L4 1.8L 1817cc	N	1981-82		8942383821	CA-8762
L4 1.9L 1949cc	A	1983-86	2WD	8942383821	CA-8762

# ACCELERATOR CABLES

Engine	Vin	Year	Remark	OE	Part
<b>ISUZU TRUCKS (con't)</b>					
<b>PICKUP (con't)</b>					
L4 2.2L 2238cc	S	1981-82		8942415191	CA-8766
L4 2.2L 2238cc	S, U	1983-86	2WD	8942415191	CA-8766
L4 2.3L 2254cc	L	1986	2WD	8942383821	CA-8762
<b>TROOPER</b>					
L4 1.9L 1949cc	A	1984-85		8942383821	CA-8762
L4 2.2L 2238cc	U	1987		89444950150	CA-8822
L4 2.3L 2254cc	L	1986-87		89444950150	CA-8822
<b>JEEP</b>					
<b>CHEROKEE</b>					
L4 2.1L 126ci	B	1985-86		53001795	CA-8663
L4 2.1L 126ci	B	1987		53005247	CA-8667
L4 2.5L 150ci	E	1989-90	w/Type 2 Accelerator Pedal	53005246	CA-8720
L4 2.5L 150ci	H	1986		53001572	CA-8515
L4 2.5L 150ci	H	1987	w/Type 1 Accelerator Pedal	53001572	CA-8515
L4 2.5L 150ci	H	1987-88	w/Fuel Injection, w/Type 1 Accelerator Pedal	53003652	CA-8516
L4 2.5L 150ci	H	1988	w/Type 2 Accelerator Pedal	53005246	CA-8720
L4 2.5L 150ci	U	1984-85		53001572	CA-8515
L6 4.0L 242ci	L	1989-90	26.46" Cable	53005245	CA-8721
L6 4.0L 242ci	L	1989-90	52.31" Cable	53004428	CA-8664
L6 4.0L 242ci	L	1990	36.50" Cable	53000038	CA-8722
L6 4.0L 242ci	M	1987	25.84" Cable	53003656	CA-8517
L6 4.0L 242ci	M	1987-88	52.31" Cable	53004428	CA-8664
L6 4.0L 242ci	M	1988	26.46" Cable	53005245	CA-8721
L6 4.2L 258ci	A	1974-76		5351420	CA-8655
L6 4.2L 258ci	C	1977-80		5357703	CA-8511
L6 4.2L 258ci	C	1981-83		5362800	CA-8511
V6 2.8L 173ci	W	1986	36.50" Cable	53000038	CA-8722
V8 5.9L 360ci	N, P	1974-77		5351419	CA-8510
V8 5.9L 360ci	N, P	1978-83		5357962	CA-8513
V8 6.6L 401ci	Z	1974-77		5351419	CA-8510
V8 6.6L 401ci	Z	1978		5357962	CA-8513
<b>CJ5</b>					
L4 2.5L 151ci	B	1980-83	w/GMC Eng.	5361067	CA-8514
L6 3.8L 232ci	E	1972-75		999923	CA-8653
L6 3.8L 232ci	E	1976-78	w/Blue I.D. Tape	5356483	CA-8656
L6 3.8L 232ci	E	1976-78	w/Brown I.D. Tape	5356484	CA-8652
L6 3.8L 232ci	E	1977-78	w/Left Hand Drive, w/Green I.D. Tape	5357847	CA-8512
L6 4.2L 258ci	A	1972-75		999923	CA-8653
L6 4.2L 258ci	A	1976-77	w/Blue I.D. Tape	5356483	CA-8656
L6 4.2L 258ci	A	1976-77	w/Brown I.D. Tape	5356484	CA-8652
L6 4.2L 258ci	A	1977	w/Left Hand Drive, w/Green I.D. Tape	5357847	CA-8512
L6 4.2L 258ci	A	1978		5357847	CA-8512
L6 4.2L 258ci	C	1979		5357847	CA-8512
L6 4.2L 258ci	C	1980		5358677	CA-8512

# ACCELERATOR CABLES

Engine	Vin	Year	Remark	OE	Part
<b>JEEP (con't)</b>					
<b>CJ5 (con't)</b>					
L6 4.2L 258ci	C	1981-83	w/Dual Throat Carburetor	5362801	CA-8512
V8 5.0L 304ci	H	1977-81		5357931	CA-8650
<b>CJ6</b>					
L6 3.8L 232ci	E	1972-75		999923	CA-8653
L6 4.2L 258ci	A	1972-75		999923	CA-8653
<b>CJ7</b>					
L4 2.5L 150ci	U	1983-85	w/GMC Eng.	5361067	CA-8514
L4 2.5L 151ci	B	1980-83	w/GMC Eng.	5361067	CA-8514
L6 3.8L 232ci	E	1976-78	w/Blue I.D. Tape	5356483	CA-8656
L6 3.8L 232ci	E	1976-78	w/Brown I.D. Tape	5356484	CA-8652
L6 3.8L 232ci	E	1977-78	w/Left Hand Drive, w/Green I.D. Tape	5357847	CA-8512
L6 4.2L 258ci	A	1976-77	w/Blue I.D. Tape	5356483	CA-8656
L6 4.2L 258ci	A	1976-77	w/Brown I.D. Tape	5356484	CA-8652
L6 4.2L 258ci	A	1977	w/Left Hand Drive, w/Green I.D. Tape	5357847	CA-8512
L6 4.2L 258ci	A	1978		5357847	CA-8512
L6 4.2L 258ci	C	1979-80		5357847	CA-8512
L6 4.2L 258ci	C	1981-86	w/Dual Throat Carburetor	5362801	CA-8512
V8 5.0L 304ci	H	1976-81		5357931	CA-8650
<b>COMANCHE</b>					
L4 2.1L 126ci	B	1986		53001795	CA-8663
L4 2.1L 126ci	B	1987		53005247	CA-8667
L4 2.5L 150ci	E	1989-90	w/Type 2 Accelerator Pedal	53005246	CA-8720
L4 2.5L 150ci	H	1986		53001572	CA-8515
L4 2.5L 150ci	H	1987	w/Type 1 Accelerator Pedal	53001572	CA-8515
L4 2.5L 150ci	H	1987-88	w/Fuel Injection, w/Type 1 Accelerator Pedal	53003652	CA-8516
L4 2.5L 150ci	H	1988	w/Type 2 Accelerator Pedal	53005246	CA-8720
L6 4.0L 242ci	L	1989-90	26.46" Cable	53005245	CA-8721
L6 4.0L 242ci	L	1989-90	52.31" Cable	53004428	CA-8664
L6 4.0L 242ci	M	1987	25.84" Cable	53003656	CA-8517
L6 4.0L 242ci	M	1987-88	52.31" Cable	53004428	CA-8664
L6 4.0L 242ci	M	1988	26.46" Cable	53005245	CA-8721
V6 2.8L 173ci	W	1986	36.50" Cable	53000038	CA-8722
<b>DJ5</b>					
L6 3.8L 232ci	E	1972-74		999923	CA-8653
L6 4.2L 258ci	A	1973		999923	CA-8653
L6 4.2L 258ci	A	1974		5351420	CA-8655
V8 5.0L 304ci	H	1974		5351419	CA-8510
<b>GRAND WAGONEER</b>					
L6 4.2L 258ci	C	1984-86		5362800	CA-8511
V8 5.9L 360ci	7	1989-91		53005205	CA-8518
V8 5.9L 360ci	N	1984-86		5357962	CA-8513
V8 5.9L 360ci	N	1987-88		53005205	CA-8518
<b>J10</b>					
L6 4.2L 258ci	A	1974-76		5351420	CA-8655



# ACCELERATOR CABLES

Engine	Vin	Year	Remark	OE	Part
<b>JEEP (con't)</b>					
<b>J10 (con't)</b>					
L6 4.2L 258ci	C	1977-80		5357703	CA-8511
L6 4.2L 258ci	C	1981-86		5362800	CA-8511
L6 4.2L 258ci	C	1987		53005203	CA-8657
V8 5.9L 360ci	N, P	1974-76		5351419	CA-8510
V8 5.9L 360ci	N, P	1977	w/2 Bbl. Carb.	5351419	CA-8510
V8 5.9L 360ci	N, P	1977	w/4 Bbl. Carb.	5357962	CA-8513
V8 5.9L 360ci	N, P	1978-86		5357962	CA-8513
V8 5.9L 360ci	P	1978		5357962	CA-8513
V8 6.6L 401ci	Z	1974-77		5351419	CA-8510
V8 6.6L 401ci	Z	1978		5357962	CA-8513
<b>J20</b>					
L6 4.2L 258ci	A	1974-76		5351420	CA-8655
V8 5.9L 360ci	N, P	1974-76		5351419	CA-8510
V8 5.9L 360ci	N, P	1977	w/2 Bbl. Carb.	5351419	CA-8510
V8 5.9L 360ci	N, P	1977	w/4 Bbl. Carb.	5357962	CA-8513
V8 5.9L 360ci	N, P	1978-86		5357962	CA-8513
V8 5.9L 360ci	N	1987-88		53005205	CA-8518
V8 6.6L 401ci	Z	1974-77		5351419	CA-8510
V8 6.6L 401ci	Z	1978		5357962	CA-8513
<b>J-2500, J-2600</b>					
L6 4.2L 258ci	A	1973		5351420	CA-8655
V8 5.9L 360ci	N, P	1973		5351419	CA-8510
<b>JEEPSTER</b>					
L6 3.8L 232ci	E	1972-73		999945	CA-8654
L6 4.2L 258ci	A	1972-73		999945	CA-8654
<b>SCRAMBLER</b>					
L4 2.5L 150ci	U	1983-84	w/GMC Eng.	5361067	CA-8514
L4 2.5L 151ci	B	1981-83	w/GMC Eng.	5361067	CA-8514
L6 4.2L 258ci	C	1981-85	w/Dual Throat Carburetor	5362801	CA-8512
<b>WAGONEER</b>					
L4 2.1L 126ci	B	1985		53001795	CA-8663
L4 2.5L 150ci	H	1986		53001572	CA-8515
L4 2.5L 150ci	H	1987	w/Fuel Injection, w/Type 1 Accelerator Pedal	53003652	CA-8516
L4 2.5L 150ci	H	1987	w/Type 1 Accelerator Pedal	53001572	CA-8515
L4 2.5L 150ci	U	1984-85		53001572	CA-8515
L6 4.0L 242ci	L	1989-90	26.46" Cable	53005245	CA-8721
L6 4.0L 242ci	L	1989-90	52.31" Cable	53004428	CA-8664
L6 4.0L 242ci	M	1987	25.84" Cable	53003656	CA-8517
L6 4.0L 242ci	M	1987-88	52.31" Cable	53004428	CA-8664
L6 4.0L 242ci	M	1988	26.46" Cable	53005245	CA-8721
L6 4.2L 258ci	A	1972-73		999923	CA-8653
L6 4.2L 258ci	C	1980		5357703	CA-8511
L6 4.2L 258ci	C	1981-83		5362800	CA-8511
V6 2.8L 173ci	W	1984-86	36.50" Cable	53000038	CA-8722

# ACCELERATOR CABLES

Engine	Vin	Year	Remark	OE	Part
<b>JEEP (con't)</b>					
<b>WAGONEER (con't)</b>					
V8 5.9L 360ci	N, P	1974-77		5351419	CA-8510
V8 5.9L 360ci	N, P	1978-83		5357962	CA-8513
V8 6.6L 401ci	Z	1974-77		5351419	CA-8510
V8 6.6L 401ci	Z	1978		5357962	CA-8513
<b>WRANGLER</b>					
L4 2.5L 150ci	E	1989-90		53005206	CA-8658
L4 2.5L 150ci	H	1987-88		53005206	CA-8658
L6 4.2L 258ci	C	1987-88		52040430	CA-8659
L6 4.2L 258ci	M, T	1988-89		52040430	CA-8659
<b>LEXUS</b>					
<b>ES300</b>					
V6 3.0L 2959cc	V	1992-93		7818033100	CA-8909
V6 3.0L 2995cc	G	1994-95		7818033100	CA-8909
<b>LS400</b>					
V8 4.0L 3967cc	U	1990-93		7818050010	CA-8910
V8 4.0L 3967cc	U	1995		7818050050	CA-8908
V8 4.0L 3969cc	H	1996-97		7818050050	CA-8908
<b>SC300</b>					
L6 3.0L 2997cc	D	1996-97	w/Auto. Trans.	7818024130	CA-8906
L6 3.0L 2997cc	J	1992-95	w/Auto. Trans.	7818024130	CA-8906
<b>SC400</b>					
V8 4.0L 3967cc	U	1992-95		7818024150	CA-8905
V8 4.0L 3969cc	H	1996-97		7818024150	CA-8905
<b>LINCOLN</b>					
<b>CONTINENTAL</b>					
V8 6.6L 400ci	S	1977-79		D7AZ-9A758-B	CA-8442
<b>MARK VI</b>					
V8 5.0L 302ci	F	1981-83		E1AZ9A758B	CA-8455
<b>TOWN CAR</b>					
V8 4.6L 281ci	W	1991-94	From 8/1/91	F2VY-9A758-A	CA-9023
V8 4.6L 281ci	W	1995		F5AZ-9A758-A	CA-9024
V8 4.6L 281ci	W	1996-97		F6AZ-9A758-AB	CA-9025
V8 4.6L 281ci	W	1998-00		F8AZ-9A758-AA	CA-9026
V8 4.6L 281ci	W	2001-04		4W7Z-9A758-AA	CA-9027
V8 5.0L 302ci	F	1981-85		E1AZ9A758B	CA-8455
V8 5.0L 302ci	F	1987-89		E8AZ-9A758-A	CA-8450
<b>MAZDA</b>					
<b>323</b>					
L4 1.6L 1597cc		1986-87		BF6741660B	CA-8884
L4 1.6L 1597cc		1990-94		BB7041660B	CA-8876
L4 1.8L 1839cc		1990-91		BB7041660B	CA-8876
<b>626</b>					
L4 2.0L 1970cc		1982		GA0241660B	CA-8863
L4 2.0L 1970cc		1983		GA9741660B	CA-8754

# ACCELERATOR CABLES

Engine	Vin	Year	Remark	OE	Part
<b>MAZDA (con't)</b>					
<b>626 (con't)</b>					
L4 2.0L 1991cc		1993-95		GA2A41660C/D	CA-8880
L4 2.0L 1998cc		1984-85		GA9741660B	CA-8754
L4 2.0L 1998cc		1986-87		GE6041660C	CA-8897
L4 2.2L 2184cc		1988-92		GJ2141660A	CA-8877
<b>929</b>					
V6 3.0L 2954cc		1988-91		HE1741660E	CA-8875
<b>GLC</b>					
L4 1.3L 1272cc		1977-78	exc. Wagon	395841660A	CA-8753
L4 1.4L 1415cc		1979-80	exc. Wagon	395841660A	CA-8753
L4 1.5L 1490cc		1981-83	exc. Cruise Control, exc. Wagon	BA2941660	CA-8748
<b>MIATA</b>					
L4 1.6L 1597cc		1990-93		NA0141660A	CA-8872
L4 1.8L 1839cc		1994-97		NA7541660B	CA-8896
<b>MILLENNIA</b>					
V6 2.5L 2497cc		1995-97		TA0241660A	CA-8997
<b>MIZER</b>					
L4 1.3L 1272cc		1976-77		395841660A	CA-8753
<b>MX-3</b>					
L4 1.6L 1597cc		1992-93		BB7041660B	CA-8876
L4 1.6L 1597cc		1994-95		EA7641660	CA-8900
V6 1.8L 1845cc		1992-94		EA0341660B/C	CA-8993
<b>MX-6</b>					
L4 2.0L 1991cc		1993-95		GA2A41660C/D	CA-8880
L4 2.2L 2184cc		1988-92		GJ2141660A	CA-8877
<b>PROTEGE</b>					
L4 1.5L 1489cc		1995-97		BC1D41660A	CA-9005
L4 1.8L 1839cc		1990-94		BB7041660B	CA-8876
L4 1.8L 1839cc		1995-97		BC1D41660A	CA-9005
<b>RX-7</b>					
R2 1.1L 1146cc		1981-82		FA0141660	CA-8865
R2 1.3L 1308cc		1986-88		FB0141660D	CA-8881
R2 1.3L 1308cc		1989-91		FC0141660	CA-8882
R2 1.3L 1308cc		1993-95		FD0141660B	CA-8899
<b>MAZDA TRUCKS</b>					
<b>B2000</b>					
L4 2.0L 1998cc		1986-87		UB3941660	CA-8777
L4 2.2L 2184cc		1987		UB3941660	CA-8777
<b>MPV</b>					
L4 2.6L 2606cc		1989-94		LA0841660B	CA-8874
V6 3.0L 2954cc		1989-95		LA0141660B	CA-8873
<b>MERCURY</b>					
<b>BOBCAT</b>					
L4 2.3L 140ci	A	1980		E0BZ9A758D	CA-8447
L4 2.3L 140ci	Y	1975-79		E0BZ9A758D	CA-8447

# ACCELERATOR CABLES

Engine	Vin	Year	Remark	OE	Part
<b>MERCURY (con't)</b>					
<b>BOBCAT (con't)</b>					
V6 2.8L 171ci	Z	1975-79		D9FZ9A758A	CA-8445
<b>CAPRI</b>					
L4 2.3L 140ci	A, T	1980-82		E0BZ9A758D	CA-8447
L4 2.3L 140ci	A	1983-86	w/o Turbo	E5ZZ9A758B	CA-8449
L4 2.3L 140ci	W, Y	1979		E0BZ9A758D	CA-8447
L4 2.3L 140ci	W	1983-84	w/Man. Trans., Turbo	E4SZ9A758A	CA-8451
L6 3.3L 200ci	B	1980-82		E0BZ9A758B	CA-8448
L6 3.3L 200ci	T	1979		E0BZ9A758B	CA-8448
V6 3.8L 232ci	3	1984-86	19.06" Cable	E5SZ9A758B	CA-8450
V8 4.2L 255ci	D	1981-82		E1SZ9A758A	CA-8453
V8 5.0L 302ci	F	1982		E1SZ9A758A	CA-8453
V8 5.0L 302ci	F	1983	w/Auto. Trans.	E5DZ9A758A	CA-8452
V8 5.0L 302ci	F	1983	w/Manual Trans.; 22.05" Cable	E1AZ-9A758-B	CA-8455
V8 5.0L 302ci	M	1984-86	w/Auto. Trans.	E5DZ9A758A	CA-8452
V8 5.0L 302ci	M	1984-86	w/Manual Trans.; 22.05" Cable	E1AZ-9A758-B	CA-8455
<b>COLONY PARK</b>					
V8 5.0L 302ci	F	1987-89	19.06" Cable	E5SZ-9A758-B	CA-8450
V8 5.0L 302ci	F	1988-89	22.05" Cable	E1AZ9A758B	CA-8455
V8 7.5L 460ci	A	1973		D7AZ9A758B	CA-8442
<b>COMET</b>					
V8 5.0L 302ci	F	1975-77		EODZ-9A758-B	CA-8440
<b>COUGAR</b>					
L4 2.3L 140ci	A	1981		E0BZ9A758D	CA-8447
L4 2.3L 140ci	W	1984-86	Turbo	E4SZ9A758A	CA-8451
L6 3.3L 200ci	B	1980-82		E0BZ9A758B	CA-8448
V6 3.8L 232ci	3, 4	1982-87	19.06" Cable	E5SZ9A758B	CA-8450
V8 5.0L 302ci	F	1977-79		D7OZ-9A758-C	CA-8446
V8 5.0L 302ci	F	1980-81		E1SZ9A758A	CA-8453
V8 5.0L 302ci	F	1983-85		E5DZ9A758A	CA-8452
V8 5.8L 351ci	H	1975-76		D7OZ-9A758-C	CA-8446
V8 5.8L 351ci	H	1977-79	351-Windsor Engine	D7OZ-9A758-C	CA-8446
V8 6.6L 400ci	S	1975-78		D7OZ9A758C	CA-8446
<b>GRAND MARQUIS</b>					
V8 5.0L 302ci	F	1979		E0AZ9A758A	CA-8441
V8 5.0L 302ci	F	1980	w/C4 Auto. Trans., w/C6 Auto. Trans., w/FMX Auto. Trans.	E0AZ9A758A	CA-8441
V8 5.0L 302ci	F	1981-89	22.05" Cable	E1AZ9A758B	CA-8455
V8 5.0L 302ci	F	1986-89	19.06" Cable	E5SZ-9A758-B	CA-8450
V8 5.8L 351ci	G	1980-89	351-Windsor Engine	E0AZ-9A758-A	CA-8441
V8 5.8L 351ci	H	1978	351-Modified Engine	D7AZ-9A758-A	CA-8443
V8 5.8L 351ci	H	1979	351-Windsor Engine	E0AZ-9A758-A	CA-8441
V8 6.6L 400ci	S	1975-78		D7AZ9A758A	CA-8443
V8 7.5L 460ci	A	1975-78		D7AZ9A758B	CA-8442

# ACCELERATOR CABLES

Engine	Vin	Year	Remark	OE	Part
<b>MERCURY (con't)</b>					
<b>LN7, LYNX</b>					
L4 1.6L 98ci	2, 4, 5	1981-85	48.72" Cable	E5FZ9A758A	CA-8454
L4 1.9L 116ci	9	1985-86	48.72" Cable	E6FZ9A758C	CA-8454
<b>MARQUIS</b>					
L4 2.3L 140ci	6	1983-84		E5ZZ-9A758-B	CA-8449
L4 2.3L 140ci	A	1983-86		E5ZZ-9A758-B	CA-8449
L6 3.3L 200ci	X	1983		E4SZ9A758A	CA-8451
V6 3.8L 232ci	3, C	1983-86	19.06" Cable	E5SZ-9A758-B	CA-8450
V8 5.0L 302ci	F	1979		E0AZ9A758A	CA-8441
V8 5.0L 302ci	F	1980	w/C4 Auto. Trans., w/C6 Auto. Trans., w/FMX Auto. Trans.	E0AZ9A758A	CA-8441
V8 5.0L 302ci	F	1981-82	22.05" Cable	E1AZ9A758B	CA-8455
V8 5.0L 302ci	M	1985		E5DZ9A758A	CA-8452
V8 5.8L 351ci	G	1980-82	351-Windsor Engine	E0AZ-9A758-A	CA-8441
V8 5.8L 351ci	H	1978	351-Modified Engine	D7AZ-9A758-A	CA-8443
V8 5.8L 351ci	H	1979	351-Windsor Engine	E0AZ-9A758-A	CA-8441
V8 6.6L 400ci	S	1975-78		D7AZ9A758A	CA-8443
V8 7.5L 460ci	A, C	1975-78		D7AZ9A758B	CA-8442
<b>MONARCH</b>					
L6 3.3L 200ci	T	1975-77		E4SZ-9A758-A	CA-8451
L6 4.1L 250ci	C	1980		E4SZ-9A758-A	CA-8451
L6 4.1L 250ci	L	1975-79		E4SZ-9A758-A	CA-8451
V8 4.2L 255ci	D	1980		E0DZ9A758B	CA-8440
V8 5.0L 302ci	F	1975-80		E0DZ9A758B	CA-8440
<b>MONTEGO</b>					
V8 6.6L 400ci	S	1975-76		D7OZ9A758C	CA-8446
V8 7.5L 460ci	A	1975-76		D7OZ9A758C	CA-8446
<b>SABLE</b>					
L4 2.5L 153ci	D	1986	48.72" Cable	E6DZ9A758C	CA-8454
<b>TOPAZ</b>					
L4 2.0L 122ci	H	1984-86	48.72" Cable	E63Z9A758B	CA-8454
L4 2.3L 140ci	R, S, X	1984-87	48.72" Cable	E63Z9A758B	CA-8454
<b>TRACER</b>					
L4 1.8L 112ci	8	1991-95		F1CZ9A758A	CA-8876
<b>ZEPHYR</b>					
L4 2.3L 140ci	A	1980-82	w/o Turbo	E0BZ9A758D	CA-8447
L4 2.3L 140ci	A	1983		E5ZZ-9A758-B	CA-8449
L4 2.3L 140ci	Y	1978-79	w/o Turbo	E0BZ9A758D	CA-8447
L6 3.3L 200ci	B	1980-82		E0BZ9A758B	CA-8448
L6 3.3L 200ci	T	1978-79		E0BZ9A758B	CA-8448
L6 3.3L 200ci	X	1983		E0BZ9A758B	CA-8448
V8 4.2L 255ci	D	1981-82		E1SZ9A758A	CA-8453
<b>MG</b>					
<b>MGB</b>					
L4 1.8L 1798cc	H	1974		AMG 29	CA-8632

# ACCELERATOR CABLES

Engine	Vin	Year	Remark	OE	Part
<b>MG (con't)</b>					
<b>MGB (con't)</b>					
L4 1.8L 1798cc	H	1975		TC200	CA-8755
L4 1.8L 1798cc	H	1976-77	To 3/77	TC36	CA-8786
L4 1.8L 1798cc	H	1977-79	From 3/77., 28.25" Cable	TC 37	CA-8633
L4 1.8L 1798cc	J	1980	28.25" Cable	TC 37	CA-8633
L4 1.8L 1798cc		1963-73	GT	AMG 29	CA-8632
<b>MIDGET</b>					
L4 1.1L 67ci		1964-66	w/Manual Trans.	AHA5746	CA-8850
L4 1.3L 1275cc		1967-73	w/Manual Trans.	AHA5746	CA-8850
L4 1.3L 1275cc	A	1974	w/Manual Trans.	AHA5746	CA-8850
L4 1.5L 1493cc	A	1975-76		TC31	CA-8780
L4 1.5L 1493cc	A	1977-79	w/Manual Trans.	HRA1117	CA-8854
<b>MITSUBISHI</b>					
<b>ECLIPSE</b>					
L4 1.8L 1755cc	B	1993-94	69.50" Cable	MB539494	CA-8791
L4 1.8L 1755cc	T	1990-92	69.50" Cable	MB539494	CA-8791
L4 2.0L 1997cc	E, F, Y	1993-95	exc. Speed Control	MB539010	CA-8792
L4 2.0L 1997cc	R, U	1990-92	exc. Speed Control	MB539010	CA-8792
<b>GALANT</b>					
L4 2.0L 1997cc	D	1993	2WD w/o CC	MB539465	CA-8886
L4 2.0L 1997cc	R, U, V	1989-92	2WD w/o CC	MB539465	CA-8886
L4 2.4L 2351cc	G	1994-98	w/o CC	MB891398	CA-8919
<b>MIRAGE</b>					
L4 1.5L 1468cc		1999		MR197616	CA-9017
L4 1.5L 1468cc	A	1993-96		MB539806	CA-8914
L4 1.5L 1468cc	A	1997-98		MR197616	CA-9017
L4 1.5L 1468cc	K	1985-88		MB322196	CA-8785
L4 1.6L 1597cc	F	1985-86		MB322196	CA-8785
L4 1.8L 1834cc	C	1997-98		MR197617	CA-9018
L4 1.8L 1834cc		1999		MR197617	CA-9018
<b>PRECIS</b>					
L4 1.5L 1468cc	J	1987-89		3279021011	CA-8871
L4 1.5L 1468cc	J	1990-94		3279024020	CA-8989
<b>STARION</b>					
L4 2.6L 2555cc	H, N	1984-87		MB322267	CA-8867
<b>MITSUBISHI TRUCKS</b>					
<b>MIGHTY MAX</b>					
L4 2.0L 1997cc	D	1985-86		MB181275	CA-8764
L4 2.0L 1997cc	D	1987-89		MB322754	CA-8912
L4 2.4L 2351cc	G	1993-96		MB539514	CA-9004
L4 2.4L 2351cc	W	1990-92		MB539514	CA-9004
L4 2.6L 2555cc	E	1985-86		MB181275	CA-8764
L4 2.6L 2555cc	E	1987-89		MB322754	CA-8912

# ACCELERATOR CABLES

Engine	Vin	Year	Remark	OE	Part
<b>NISSAN</b>					
<b>1200</b>					
L4 1.2L 1171cc		1971-73		18200-H1561	CA-8789
<b>200SX</b>					
L4 1.8L 1809cc	C	1984-86	38.07" Cable	18200-06F01	CA-8827
L4 1.8L 1809cc	C	1987	55.98" Cable	1820132F01	CA-8828
L4 2.0L 1952cc	H	1977-79	18.00" Cable	18200-N5802	CA-8746
L4 2.0L 1952cc	P	1980-81	17.25" Cable	18200N8502	CA-8611
L4 2.0L 1974cc	H	1987	17.25" Cable	18200N8502	CA-8611
L4 2.0L 1974cc	H	1987	38.07" Cable	18200-06F01	CA-8827
L4 2.0L 1974cc	H	1987	55.98" Cable	18200-32F01	CA-8828
L4 2.0L 1974cc	P	1984-86	38.07" Cable	18200-06F01	CA-8827
L4 2.0L 1974cc	P	1986	17.25" Cable	18200N8502	CA-8611
L4 2.0L 1974cc	P	1988	18.00" Cable	18200-N5802	CA-8746
L4 2.0L 1974cc	P	1988	55.98" Cable	18200-32F01	CA-8828
<b>210</b>					
L4 1.2L 1237cc		1979	w/Auto. Trans.	18200N5802	CA-8825
L4 1.2L 1237cc	C	1980-82	w/Auto. Trans.	18200N5802	CA-8825
L4 1.2L 1237cc	C	1980-82	w/Man. Trans., w/California Model	18200H9160	CA-8826
L4 1.4L 1393cc	H	1979-80	w/Auto. Trans.	18200N5802	CA-8825
L4 1.4L 1393cc	H	1979-80	w/Man. Trans., w/California Model	18200H9160	CA-8826
L4 1.5L 1488cc	P	1980-82	w/Auto. Trans.	18200N5802	CA-8825
L4 1.5L 1488cc	P	1980-82	w/Man. Trans., w/California Model	18200H9160	CA-8826
<b>240SX</b>					
L4 2.4L 2389cc	A	1995		1820170F00	CA-8950
L4 2.4L 2389cc	H	1989		1820140F00	CA-8829
L4 2.4L 2389cc	M	1991-94	To 1/94	1820154F00	CA-8889
L4 2.4L 2389cc	M	1994	From 2/94	1820170F00	CA-8950
<b>300ZX</b>					
V6 3.0L 2960cc	C, H, R	1988-91	51.0" Cable	18201-30P00	CA-8830
V6 3.0L 2960cc	C, R	1990-95	43.03" Cable	1820130P00	CA-8887
<b>510</b>					
L4 2.0L 1952cc	H	1978-79		18201-W5629	CA-8778
L4 2.0L 1952cc	H	1980-81		18201-W8800	CA-8769
<b>ALTIMA</b>					
L4 2.4L 2389cc	B	1993-94		182011E500	CA-9002
<b>B210</b>					
L4 1.3L 1288cc	H	1974		18200-H6102	CA-8610
L4 1.4L 1393cc	H	1975-78		18200-H6102	CA-8610
<b>MAXIMA</b>					
V6 3.0L 2960cc	E	1992-93	w/Man. Trans., From 10/92 58.00" Cable	1820196E00	CA-8939
V6 3.0L 2960cc	E	1994	From 2/94	1820144U00	CA-8949
V6 3.0L 2960cc	H	1988		1820117E00	CA-8932
V6 3.0L 2960cc	H	1989-93		1820185E00	CA-8931
V6 3.0L 2960cc	H	1994	From 2/94	1820144U00	CA-8949
V6 3.0L 2988cc	C	1995		1820144U00	CA-8949

# ACCELERATOR CABLES

Engine	Vin	Year	Remark	OE	Part
<b>NISSAN (con't)</b>					
<b>NX</b>					
L4 2.0L 1998cc	G	1991-93		1820162J05	CA-8983
<b>PULSAR NX</b>					
L4 1.5L 1488cc		1984		18201-04A00	CA-8750
L4 1.6L 1597cc		1987		1820165A00	CA-8901
L4 1.6L 1597cc	G	1989-90		1820184A00	CA-8903
L4 1.6L 1597cc	M	1985-86		18201-36A00	CA-8783
L4 1.6L 1597cc	P	1983		18201-36A00	CA-8783
L4 1.6L 1597cc	P	1987-88		1820169A00	CA-8902
L4 1.8L 1809cc	C	1988		1820165A00	CA-8901
<b>SENTRA</b>					
L4 1.5L 1488cc	M	1983		18201-04A00	CA-8750
L4 1.6L 1597cc	P	1983-86		18201-04A00	CA-8750
L4 1.6L 1597cc	P	1987	exc. California Emissions	1820173A00	CA-8969
L4 1.6L 1597cc	P	1987	w/California Emissions	1820161A00	CA-8970
L4 2.0L 1998cc	G	1991-93		1820162J05	CA-8983
<b>STANZA</b>					
L4 2.0L 1974cc	H	1982-83	w/CC	18201D1600	CA-8999
L4 2.0L 1974cc	H	1984-85	w/CC	18201D3360	CA-8990
L4 2.0L 1974cc	H	1984-86	w/o CC	18201D23300	CA-8888
L4 2.4L 2389cc	F	1990-91		1820165E00	CA-8971
<b>NISSAN TRUCKS</b>					
<b>520 PICKUP</b>					
L4 1.3L 1299cc		1966-68		18200B0301	CA-8823
<b>521 PICKUP</b>					
L4 1.3L 1299cc		1969-69		18200B0301	CA-8823
L4 1.6L 1595cc		1970-72		A8200-B4610	CA-8824
<b>620 PICKUP</b>					
L4 1.6L 1595cc		1972-73		18200B5500	CA-8635
L4 1.8L 1770cc	P	1974		18200B5500	CA-8635
L4 2.0L 1952cc	H	1975-76		18200B8001	CA-8734
L4 2.0L 1952cc	H	1977		18200B9800	CA-8733
L4 2.0L 1952cc	H	1978-79		18200B9801	CA-8734
<b>720</b>					
L4 2.0L 1952cc	H	1980		18200-44W10	CA-8752
L4 2.2L 2164cc	S	1981-83		18200-44W01	CA-8730
L4 2.2L 2187cc	M	1982		18200-44W01	CA-8730
L4 2.4L 2389cc	N	1985-86		18200-44W01	CA-8730
<b>AXXESS</b>					
L4 2.4L 2389cc	H	1990	w/o CC	1820130R00	CA-8938
<b>PATHFINDER</b>					
V6 3.0L 2960cc	H	1988-89	w/Auto. Trans.	1820142G00	CA-8936
V6 3.0L 2960cc	H	1990-94		1820131G10	CA-8937
V6 3.3L 3275cc	A	1996-98		182010W000	CA-9021
V6 3.3L 3275cc		1999		182010W000	CA-9021



# ACCELERATOR CABLES

Engine	Vin	Year	Remark	OE	Part
<b>NISSAN TRUCKS (con't)</b>					
<b>VAN</b>					
L4 2.4L 2389cc	S	1987-88		1820117C01	CA-8946
<b>OLDSMOBILE</b>					
<b>98</b>					
V6 3.0L 181ci	E	1985		25509846	CA-8802
V6 4.1L 252ci	4	1981-83		25509267	CA-8498
V6 4.3L 260ci	T	1985		25514409	CA-8324
V8 5.0L 307ci	Y	1980-84		25504323	CA-8493
V8 5.7L 350ci	N	1978-80	Diesel	25504323	CA-8493
V8 5.7L 350ci	N	1981-84	Diesel	25509332	CA-8495
V8 5.7L 350ci	R	1977-80	w/Olds. Eng.	25500209	CA-8474
V8 6.6L 403ci	K	1977-79		25500209	CA-8474
<b>CUSTOM CRUISER</b>					
V8 5.0L 307ci	Y	1980-89		25504323	CA-8493
V8 5.7L 350ci	N	1978-79		25502349	CA-8488
V8 5.7L 350ci	N, R	1980		25504323	CA-8493
V8 5.7L 350ci	N	1981-85		25509332	CA-8495
V8 5.7L 350ci	R	1977-79	23.82" Cable	1254180	CA-8475
V8 6.6L 403ci	K	1977-79	23.82" Cable	1254180	CA-8475
<b>CUTLASS</b>					
L6 4.1L 250ci	D	1975-76	w/Integral Cyl. Head 20.50" Cable	1244463	CA-8473
V6 3.8L 231ci	A	1978-81		25500209	CA-8474
V6 3.8L 231ci	C	1977		1249758	CA-8478
V8 4.3L 260ci	F	1976-77		1248690	CA-8477
V8 4.3L 260ci	F	1978-79	23.82" Cable	1254180	CA-8475
V8 4.3L 260ci	F	1980-81	23.82" Cable	25504322	CA-8497
V8 4.4L 267ci	J	1981	w/Canada Emissions	25500209	CA-8474
V8 5.0L 305ci	H	1978-80	23.82" Cable	1254180	CA-8475
V8 5.0L 305ci	H	1985-87	w/Canadian Emmisions; 23.82" Cable	1254180	CA-8475
V8 5.0L 305ci	U	1978		25500209	CA-8474
V8 5.7L 350ci	L	1978-79	23.82" Cable	1254180	CA-8475
V8 5.7L 350ci	N	1979-80	23.82" Cable	1254180	CA-8475
V8 5.7L 350ci	N	1981		25509332	CA-8495
V8 5.7L 350ci	R	1980	w/Olds. Eng.; 23.82" Cable	25504322	CA-8497
V8 6.6L 403ci	K	1977		1248690	CA-8477
V8 7.5L 455ci	T	1975-76		1248690	CA-8477
<b>CUTLASS CALAIS</b>					
V6 3.8L 231ci	A	1978-84		25500209	CA-8474
V6 4.3L 260ci	V	1982-83		22514409	CA-8324
V8 4.3L 260ci	8	1982	23.82" Cable	25504322	CA-8497
V8 4.3L 260ci	F, P	1978-79	23.82" Cable	1254180	CA-8475
V8 4.3L 260ci	F	1980-81	23.82" Cable	25504322	CA-8497
V8 4.4L 267ci	J	1982	w/Canada Emissions	25500209	CA-8474
V8 5.0L 305ci	H	1978-80	23.82" Cable	1254180	CA-8475
V8 5.0L 305ci	H	1984	w/Canadian Emmisions; 23.82" Cable	1254180	CA-8475

# ACCELERATOR CABLES

Engine	Vin	Year	Remark	OE	Part
<b>OLDSMOBILE (con't)</b>					
<b>CUTLASS CALAIS (con't)</b>					
V8 5.0L 305ci	U	1978		25500209	CA-8474
V8 5.0L 307ci	9, Y	1983-84	23.82" Cable	25504322	CA-8497
V8 5.7L 350ci	N	1982-84		25509332	CA-8495
V8 5.7L 350ci	R	1980	w/Olds. Eng.; 23.82" Cable	25504322	CA-8497
<b>CUTLASS CIERA</b>					
L4 2.5L 151ci	5	1982-83	Export, w/Canada Emissions	25501819	CA-8470
V6 2.8L 173ci	X	1982-86		476796	CA-8471
V6 3.0L 181ci	E	1982-85		25509846	CA-8802
V6 4.3L 260ci	T	1982-84		22514409	CA-8324
<b>CUTLASS CRUISER</b>					
V6 3.8L 231ci	A	1980-83		25500209	CA-8474
V8 4.3L 260ci	8	1982	23.82" Cable	25504322	CA-8497
V8 4.3L 260ci	F	1980-81	23.82" Cable	25504322	CA-8497
V8 4.4L 267ci	J	1982	w/Canada Emissions	25500209	CA-8474
V8 5.0L 305ci	H	1980	23.82" Cable	1254180	CA-8475
V8 5.0L 305ci	H	1982-83	w/Canadian Emmisions; 23.82" Cable	1254180	CA-8475
V8 5.0L 307ci	Y	1982-83	23.82" Cable	25504322	CA-8497
V8 5.7L 350ci	N	1981-83		25509332	CA-8495
V8 5.7L 350ci	R	1980	23.82" Cable	1254180	CA-8475
V8 5.7L 350ci	R	1980	w/Olds. Eng.; 23.82" Cable	25504322	CA-8497
<b>CUTLASS SALON</b>					
V6 3.8L 231ci	A	1978-87		25500209	CA-8474
V8 4.3L 260ci	F	1976-77		1248690	CA-8477
V8 4.3L 260ci	F, P	1978-79	23.82" Cable	1254180	CA-8475
V8 4.3L 260ci	F	1980	23.82" Cable	25504322	CA-8497
V8 5.0L 305ci	H	1978-80	23.82" Cable	1254180	CA-8475
V8 5.0L 305ci	U	1978		25500209	CA-8474
V8 5.0L 307ci	9	1985-86	23.82" Cable	25504322	CA-8497
V8 5.0L 307ci	Y	1986-87	23.82" Cable	25504322	CA-8497
V8 5.7L 350ci	N	1980	23.82" Cable	1254180	CA-8475
V8 5.7L 350ci	N	1985		25509332	CA-8495
V8 6.6L 403ci	K	1977		1248690	CA-8477
V8 7.5L 455ci	T	1975-76		1248690	CA-8477
<b>CUTLASS SUPREME</b>					
L6 4.1L 250ci	D	1975-76	w/Integral Cyl. Head 20.50" Cable	1244463	CA-8473
V6 3.8L 231ci	A	1978-87		25500209	CA-8474
V6 3.8L 231ci	C	1977		1249758	CA-8478
V6 4.3L 260ci	V	1982-84		22514409	CA-8324
V8 4.3L 260ci	8	1982	23.82" Cable	25504322	CA-8497
V8 4.3L 260ci	F	1976-77		1248690	CA-8477
V8 4.3L 260ci	F, P	1978-79	23.82" Cable	1254180	CA-8475
V8 4.3L 260ci	F	1980-81	23.82" Cable	25504322	CA-8497
V8 4.4L 267ci	J	1982	w/Canada Emissions	25500209	CA-8474
V8 5.0L 305ci	H	1978-79	23.82" Cable	1254180	CA-8475

# ACCELERATOR CABLES

Engine	Vin	Year	Remark	OE	Part
<b>OLDSMOBILE (con't)</b>					
<b>CUTLASS SUPREME (con't)</b>					
V8 5.0L 305ci	H	1983-87	w/Canadian Emmisions; 23.82" Cable	1254180	CA-8475
V8 5.0L 305ci	U	1978		25500209	CA-8474
V8 5.0L 307ci	9, Y	1982-88	23.82" Cable	25504322	CA-8497
V8 5.7L 350ci	N	1979	23.82" Cable	1254180	CA-8475
V8 5.7L 350ci	N	1982-85		25509332	CA-8495
V8 5.7L 350ci	R	1980	w/Olds. Eng.; 23.82" Cable	25504322	CA-8497
V8 6.6L 403ci	K	1977		1248690	CA-8477
V8 7.5L 455ci	T	1975-76		1248690	CA-8477
<b>DELTA 88</b>					
V6 3.8L 231ci	A	1977-85		25509267	CA-8498
V8 4.3L 260ci	8	1982		25504323	CA-8493
V8 4.3L 260ci	F	1977-79		25500209	CA-8474
V8 4.3L 260ci	F	1980-81		25504323	CA-8493
V8 4.4L 267ci	J	1981-82	w/Canada Emissions	1258506	CA-8480
V8 5.0L 307ci	Y	1980-83		25504323	CA-8493
V8 5.7L 350ci	G, L	1977		1254179	CA-8483
V8 5.7L 350ci	N	1980	Diesel	25504323	CA-8493
V8 5.7L 350ci	N	1981-85		25509332	CA-8495
V8 5.7L 350ci	R	1977-79	w/Olds. Eng.	25500209	CA-8474
V8 5.7L 350ci	R	1980	w/Olds. Eng.	25504323	CA-8493
V8 6.6L 403ci	K	1977-79		25500209	CA-8474
<b>FIRENZA</b>					
L4 1.8L 112ci	0	1982		1248087	CA-8687
L4 1.8L 112ci	G	1982		10174973	CA-8793
L4 2.0L 122ci	B	1983-84	w/Square Hole Detent Bracket	14062639	CA-8800
L4 2.0L 122ci	P	1984-86		14077000	CA-8321
<b>OMEGA</b>					
L4 2.5L 151ci	5	1980-83		25501819	CA-8470
L6 4.1L 250ci	D	1975	w/Integral Cyl. Head 20.50" Cable	1244463	CA-8473
L6 4.1L 250ci	D	1976		1254174	CA-8476
V6 2.8L 173ci	X	1981-84		476796	CA-8471
V6 3.8L 231ci	C	1977	19.35" Cable	1249554	CA-8490
V6 3.8L 231ci	C	1977	w/Integral Cyl. Head 20.50" Cable	1244463	CA-8473
V8 5.0L 305ci	G	1979		1254175	CA-8472
V8 5.0L 305ci	U	1977-78		1254175	CA-8472
V8 5.7L 350ci	L	1977-79		1254175	CA-8472
<b>STARFIRE</b>					
L4 2.3L 140ci	B	1976-77		354712	CA-8489
L4 2.5L 151ci	1, V	1979-80		25502349	CA-8488
V6 3.8L 231ci	A	1977-80		1249662	CA-8481
<b>TORONADO</b>					
V6 4.1L 252ci	4	1982-84		25509474	CA-8492
V8 5.0L 307ci	Y	1981-85		25502349	CA-8488
V8 5.7L 350ci	N	1981-85		22514409	CA-8324

# ACCELERATOR CABLES

Engine	Vin	Year	Remark	OE	Part
<b>OLDSMOBILE (con't)</b>					
<b>TORONADO (con't)</b>					
V8 5.7L 350ci	R	1979-80		25502349	CA-8488
<b>VISTA CRUISER</b>					
V8 6.6L 403ci	K	1977		1248690	CA-8477
V8 7.5L 455ci	T	1975-76		1248690	CA-8477
<b>OLDSMOBILE TRUCKS</b>					
<b>SILHOUETTE</b>					
V6 3.1L 189ci	D	1990-92		14038639	CA-8808
<b>PLYMOUTH</b>					
<b>ACCLAIM</b>					
L4 2.5L 153ci	J	1989-90	Turbo; 53.00" Cable	4458774	CA-8305
L4 2.5L 153ci	K	1989		4549216	CA-8302
L4 2.5L 153ci	K, V	1990-94	51.18" Cable	4300845	CA-8301
V6 3.0L 181ci	3	1989-94		4459135	CA-8306
<b>BARRACUDA, CUDA</b>					
V8 5.2L 318ci	G	1972-74	From 2/72	3698839	CA-8410
V8 5.9L 360ci	L	1974	w/2 Bbl. Carb.	3698839	CA-8410
<b>CARAVELLE</b>					
L4 2.2L 135ci	C, D	1988		4549216	CA-8302
L4 2.2L 135ci	D	1985	w/Throttle Body Injection	4287530	CA-8429
L4 2.2L 135ci	D	1986-87	w/Electronic Fuel Injection	4549216	CA-8302
L4 2.2L 135ci	E	1985-86	Turbo	4287531	CA-8430
L4 2.2L 135ci	E	1987	Turbo w/Intercooler	4288197	CA-8309
L4 2.2L 135ci	E	1987	Turbo w/o Intercooler	4306190	CA-8312
L4 2.2L 135ci	E	1988		4549216	CA-8302
L4 2.5L 153ci	K	1986-87	w/Electronic Fuel Injection	4549216	CA-8302
L4 2.5L 153ci	K	1988		4549216	CA-8302
V8 5.2L 318ci	P	1989	w/2 Bbl. Carb.	4027358	CA-8414
<b>CHAMP</b>					
L4 1.4L 1410cc	2	1981-82		MB011530	CA-8636
L4 1.4L 1410cc	J	1979-80		MB011530	CA-8636
L4 1.6L 98ci	3	1981-82		MB011530	CA-8636
L4 1.6L 98ci	K	1979-80		MB011530	CA-8636
<b>COLT</b>					
L4 1.4L 1410cc	2	1981-83	FWD, Import	MB011530	CA-8636
L4 1.4L 1410cc	A	1984	FWD, Import	MB011530	CA-8636
L4 1.4L 1410cc	J	1979-80	FWD, Import	MB011530	CA-8636
L4 1.5L 90ci	K, P	1985-88		MB322196	CA-8785
L4 1.6L 98ci	3	1981-83	FWD, Import	MB011530	CA-8636
L4 1.6L 98ci	B, F	1984	FWD, Import	MB011530	CA-8636
L4 1.6L 98ci	K	1979-80	FWD, Import	MB011530	CA-8636
L4 2.0L 122ci	D	1984		MB011530	CA-8636
<b>DUSTER</b>					
L6 3.7L 225ci	C	1975		2899335	CA-8418

# ACCELERATOR CABLES

Engine	Vin	Year	Remark	OE	Part
<b>PLYMOUTH (con't)</b>					
<b>FURY</b>					
L6 3.7L 225ci	C, D	1975-78	w/2 Bbl. Carb.	3698839	CA-8410
L6 3.7L 225ci	C, D	1975-78	w/4 Bbl. Carb.	3769123	CA-8411
V8 5.2L 318ci	G	1972-77	w/2 Bbl. Carb.	3698839	CA-8410
V8 5.2L 318ci	G	1975	w/4 Bbl. Carb.	3769123	CA-8411
V8 5.2L 318ci	G	1976-78	w/4 Bbl. Carb. w/Auto. Trans.	3769123	CA-8411
V8 5.2L 318ci	G, H	1978	w/2 Bbl. Carb. w/Auto. Trans.	3698839	CA-8410
V8 5.2L 318ci	H	1978	w/4 Bbl. Carb. w/Auto. Trans.	3769123	CA-8411
V8 5.9L 360ci	J, K, L	1975-78	w/2 Bbl. Carb. w/Auto. Trans.	3698839	CA-8410
V8 5.9L 360ci	J, K, L	1975-78	w/4 Bbl. Carb. w/Auto. Trans.	3769123	CA-8411
V8 6.6L 400ci	M, N, P	1973-78	w/4 Bbl. Carb.	3769123	CA-8411
V8 7.2L 440ci	T, U	1971-78		3769123	CA-8411
<b>GRAN FURY</b>					
L6 3.7L 225ci	E, F, G, H	1981-82	w/1 Bbl. Carb. w/Auto. Trans.	4095176	CA-8412
L6 3.7L 225ci	J, K, L	1983	w/1 Bbl. Carb. w/Auto. Trans.	4095176	CA-8412
V8 5.2L 318ci	4	1983-84	w/2 Bbl. Carb. w/Auto. Trans.	4027358	CA-8414
V8 5.2L 318ci	4	1983-85	w/4 Bbl. Carb.	4027355	CA-8422
V8 5.2L 318ci	4	1985-89	w/2 Bbl. Carb.	4027358	CA-8414
V8 5.2L 318ci	G, H	1980	w/2 Bbl. Carb. w/Auto. Trans.	3698839	CA-8410
V8 5.2L 318ci	G, H	1980	w/4 Bbl. Carb. w/Auto. Trans.	3769123	CA-8411
V8 5.2L 318ci	K, L, M, N	1981	w/2 Bbl. Carb. w/Auto. Trans.	3698839	CA-8410
V8 5.2L 318ci	K, L, M, N	1981	w/4 Bbl. Carb. w/Auto. Trans.	3679123	CA-8412
V8 5.2L 318ci	K, L, M, N	1982	w/2 Bbl. Carb. w/Auto. Trans.	4027358	CA-8414
V8 5.2L 318ci	K, L, M, N	1982	w/4 Bbl. Carb.	4027355	CA-8422
V8 5.2L 318ci	P, S	1983-84	w/2 Bbl. Carb. w/Auto. Trans.	4027358	CA-8414
V8 5.2L 318ci	P, S	1983-85	w/4 Bbl. Carb.	4027355	CA-8422
V8 5.2L 318ci	P, S	1985-89	w/2 Bbl. Carb.	4027358	CA-8414
V8 5.9L 360ci	K, L	1980	w/2 Bbl. Carb. w/Auto. Trans.	3698839	CA-8410
V8 5.9L 360ci	K, L	1980	w/4 Bbl. Carb. w/Auto. Trans.	3769123	CA-8411
<b>HORIZON</b>					
L4 1.7L 105ci	A	1978-79		5214197	CA-8419
L4 1.7L 105ci	A	1980-82		5214732	CA-8421
L4 1.7L 105ci	B	1983		5214732	CA-8421
L4 2.2L 135ci	8, C	1985-86		4288065	CA-8311
L4 2.2L 135ci	B	1981-82	TC3	4268822	CA-8423
L4 2.2L 135ci	C	1987		4306190	CA-8312
L4 2.2L 135ci	D	1988-89		4549216	CA-8302
L4 2.2L 135ci	D	1990	51.18" Cable	4300845	CA-8301
<b>LASER</b>					
L4 1.8L 107ci	B	1993	w/o CC	MB539494	CA-8978
L4 1.8L 107ci	B	1993-94	exc. Speed Control	MB539494	CA-8791
L4 1.8L 107ci	T	1990-92	exc. Speed Control	MB539494	CA-8791
L4 1.8L 107ci	T	1990-92	w/o CC	MB539494	CA-8978
L4 2.0L 122ci	E, F	1993-94	exc. Speed Control	MB539010	CA-8792
L4 2.0L 122ci	R, U	1990-92	exc. Speed Control	MB539010	CA-8792

# ACCELERATOR CABLES

Engine	Vin	Year	Remark	OE	Part
<b>PLYMOUTH (con't)</b>					
<b>RELIANT</b>					
L4 2.2L 135ci	B	1981-82		4268821	CA-8424
L4 2.2L 135ci	C	1983-84		4275907	CA-8426
L4 2.2L 135ci	C	1985		4287531	CA-8430
L4 2.2L 135ci	D	1985		4287530	CA-8429
L4 2.2L 135ci	D	1986-89		4549216	CA-8302
L4 2.5L 153ci	K	1986-89		4549216	CA-8302
L4 2.6L 156ci	7, D	1981-82		4241205	CA-8425
L4 2.6L 156ci	7	1983		4268825	CA-8427
L4 2.6L 156ci	G	1983-84	To 5/15/84	4268825	CA-8427
L4 2.6L 156ci	G	1984-85	From 5/15/84	4288191	CA-8428
<b>SAPPORO</b>					
L4 2.6L 156ci	7	1981-83	w/AT or 5 Spd. MT	MB181013	CA-8868
<b>SATELLITE</b>					
L6 3.7L 225ci	C	1974	w/2 Bbl. Carb.	3698839	CA-8410
L6 3.7L 225ci	C	1974	w/4 Bbl. Carb.	3769123	CA-8411
L6 3.7L 225ci	E	1972	w/2 Bbl. Carb.	3698839	CA-8410
L6 3.7L 225ci	E	1972	w/4 Bbl. Carb.	3769123	CA-8411
V8 5.2L 318ci	G	1972-74	w/2 Bbl. Carb.	3698839	CA-8410
V8 5.2L 318ci	G	1974	w/4 Bbl. Carb.	3769123	CA-8411
V8 6.6L 400ci	M, N, P	1973-74	w/4 Bbl. Carb.	3769123	CA-8411
V8 7.2L 440ci	U	1974		3769123	CA-8411
<b>SCAMP</b>					
L6 3.7L 225ci	C	1975-76		2899335	CA-8418
V8 5.2L 318ci	G	1975		2899336	CA-8417
<b>SUNDANCE</b>					
L4 2.2L 135ci	D	1987	w/Electronic Fuel Injection	4549216	CA-8302
L4 2.2L 135ci	D	1988-89		4549216	CA-8302
L4 2.2L 135ci	D	1990-92	51.18" Cable	4300845	CA-8301
L4 2.2L 135ci	E	1987	Turbo w/Intercooler	4288197	CA-8309
L4 2.2L 135ci	E	1987	Turbo w/o Intercooler	4306190	CA-8312
L4 2.5L 153ci	J	1989-90	Turbo; 53.00" Cable	4458774	CA-8305
L4 2.5L 153ci	J	1990-91	Turbo; 51.18" Cable	4300845	CA-8301
L4 2.5L 153ci	K	1988-89		4549216	CA-8302
L4 2.5L 153ci	K	1990-94	51.18" Cable	4300845	CA-8301
V6 3.0L 181ci	3	1993-94		4459135	CA-8306
<b>VALIANT</b>					
L6 3.2L 198ci	B	1972-74		2899335	CA-8418
L6 3.7L 225ci	C	1975		2899335	CA-8418
V8 5.2L 318ci	G	1975	w/2 Bbl. Carb.	2899336	CA-8417
V8 5.2L 318ci	G	1976	w/2 Bbl. Carb.	4027372	CA-8416
V8 5.9L 360ci	L	1976	w/2 Bbl. Carb.	4027372	CA-8416
<b>VOLARE</b>					
L6 3.7L 225ci	C, D	1976-78		4027354	CA-8413
L6 3.7L 225ci	C, D	1979-80	w/1 Bbl. Carb. w/Auto. Trans.	4095176	CA-8412

# ACCELERATOR CABLES

Engine	Vin	Year	Remark	OE	Part
<b>PLYMOUTH (con't)</b>					
<b>VOLARE (con't)</b>					
L6 3.7L 225ci	C, D	1979-80	w/1 Bbl. Carb. w/Manual Trans.	4027354	CA-8413
L6 3.7L 225ci	C, D	1979-80	w/2 Bbl. Carb. w/Auto. Trans.	4095320	CA-8415
V8 5.2L 318ci	G	1976-77	w/2 Bbl. Carb.	3027358	CA-8414
V8 5.2L 318ci	G, H	1978	w/2 Bbl. Carb.	4027358	CA-8414
V8 5.2L 318ci	G, H	1978	w/4 Bbl. Carb.	4027355	CA-8422
V8 5.2L 318ci	G, H	1979-80	w/2 Bbl. Carb. w/Auto. Trans.	3027358	CA-8414
V8 5.2L 318ci	G, H	1980	w/4 Bbl. Carb. w/Auto. Trans.	4027355	CA-8422
V8 5.9L 360ci	K	1976-78	w/2 Bbl. Carb.	3027358	CA-8414
V8 5.9L 360ci	K, L	1977-80	w/4 Bbl. Carb. w/Auto. Trans.	4027355	CA-8422
V8 5.9L 360ci	L	1977-80	w/2 Bbl. Carb.	3027358	CA-8414
<b>PLYMOUTH TRUCKS</b>					
<b>GRAND VOYAGER</b>					
L4 2.5L 153ci	K	1988		4549216	CA-8302
V6 3.0L 181ci	3	1988		4288096	CA-8307
V6 3.0L 181ci	3	1989		4459135	CA-8306
<b>PB100</b>					
L6 3.7L 225ci	B	1974-77		3820952	CA-8668
L6 3.7L 225ci	B	1978		3820952	CA-8805
L6 3.7L 225ci	N	1979		3820952	CA-8805
L6 3.7L 225ci	N	1980		4241226	CA-8408
V8 5.2L 318ci	E	1975-77		4088095	CA-8406
<b>PB150</b>					
L6 3.7L 225ci	E	1981-82		4241226	CA-8408
L6 3.7L 225ci	H	1983		4241226	CA-8408
V8 5.2L 318ci	P, R	1982		4241224	CA-8407
V8 5.2L 318ci	T	1983		4241224	CA-8407
<b>PB200</b>					
L6 3.7L 225ci	B	1974-77		3820952	CA-8668
L6 3.7L 225ci	B	1978		3820952	CA-8805
L6 3.7L 225ci	N	1980		4241226	CA-8408
V8 5.2L 318ci	E	1975-77		4088095	CA-8406
<b>PB250</b>					
L6 3.7L 225ci	E	1981-82		4241226	CA-8408
L6 3.7L 225ci	H	1983		4241226	CA-8408
V8 5.2L 318ci	P, R	1982		4241224	CA-8407
V8 5.2L 318ci	T, U	1983		4241224	CA-8407
<b>PB300</b>					
V8 5.2L 318ci	E	1975-77		4088095	CA-8406
<b>PB350</b>					
V8 5.2L 318ci	P, R	1982		4241224	CA-8407
V8 5.2L 318ci	T, U	1983		4241224	CA-8407
<b>TRAILDUSTER</b>					
L6 3.7L 225ci	B, N	1976-79		3820952	CA-8668
L6 3.7L 225ci	N	1980		4241226	CA-8408

# ACCELERATOR CABLES

Engine	Vin	Year	Remark	OE	Part
<b>PLYMOUTH TRUCKS (con't)</b>					
<b>TRAILDUSTER (con't)</b>					
V8 5.2L 318ci	E, P	1978-79		4088095	CA-8406
V8 5.2L 318ci	E	1980		4241224	CA-8407
V8 5.2L 318ci	P, R	1981		4241224	CA-8407
V8 5.9L 360ci	F, T	1974-79		4088095	CA-8406
V8 5.9L 360ci	T	1980-81		4241224	CA-8407
V8 6.6L 400ci	J	1976-78		4088095	CA-8406
V8 7.2L 440ci	D	1974-78		4088095	CA-8406
<b>VOYAGER</b>					
L4 2.2L 135ci	C	1984		4275907	CA-8426
L4 2.2L 135ci	C	1985		4287531	CA-8430
L4 2.2L 135ci	C	1987		4306190	CA-8312
L4 2.5L 153ci	J	1990	Turbo; 51.18" Cable	4300845	CA-8301
L4 2.5L 153ci	J, K	1987-89		4549216	CA-8302
L4 2.5L 153ci	K	1990-93	51.18" Cable	4300845	CA-8301
L4 2.6L 156ci	G	1984	To 5/15/84	4268828	CA-8427
L4 2.6L 156ci	G	1984-86	From 5/15/84	4268828	CA-8428
V6 3.0L 181ci	3	1987-88		4288096	CA-8307
V6 3.0L 181ci	3	1989-90		4459135	CA-8306
<b>PONTIAC</b>					
<b>6000</b>					
L4 2.5L 151ci	5	1982-83	w/Canadian Emmisions	25501819	CA-8470
V6 2.8L 173ci	X	1982-86		476796	CA-8471
V6 4.3L 260ci	T	1982-85	Diesel	22514409	CA-8324
<b>ASTRE</b>					
L4 2.3L 140ci	A, B	1976-77		354712	CA-8489
L4 2.5L 151ci	V	1977		354712	CA-8489
<b>BONNEVILLE</b>					
V6 3.8L 231ci	A	1980-81		25509267	CA-8498
V6 3.8L 231ci	A	1982-86		25500209	CA-8474
V6 4.1L 252ci	4	1982		25500209	CA-8474
V6 4.3L 262ci	Z	1986		1258156	CA-8496
V8 4.3L 265ci	S	1980-81		1254793	CA-8469
V8 4.9L 301ci	W	1978-80		1254793	CA-8469
V8 4.9L 301ci	Y	1977-79		1254793	CA-8469
V8 5.0L 305ci	H	1983-86		1254180	CA-8475
V8 5.0L 307ci	Y	1981		25504323	CA-8493
V8 5.7L 350ci	N	1980-84	Diesel, 25mm O.D. Bushing On Pump End Of Cable	25509332	CA-8495
V8 5.7L 350ci	R	1977-79	w/Olds. Eng.	25500209	CA-8474
V8 5.7L 350ci	R	1980	w/Olds. Eng.	25504323	CA-8493
V8 6.6L 400ci	N	1976		1254793	CA-8469
V8 6.6L 400ci	P, S	1973		1244463	CA-8473
V8 6.6L 400ci	R, S	1975		1254793	CA-8469
V8 6.6L 400ci	Z	1976		1254793	CA-8469



# ACCELERATOR CABLES

Engine	Vin	Year	Remark	OE	Part
<b>PONTIAC (con't)</b>					
<b>BONNEVILLE (con't)</b>					
V8 6.6L 403ci	K	1977-79		25500209	CA-8474
V8 7.5L 455ci	W	1973		1244463	CA-8473
V8 7.5L 455ci	W	1975	w/4 Bbl. Carb.	1248083	CA-8469
V8 7.5L 455ci	W	1976	w/4 Bbl. Carb.	1254793	CA-8469
<b>CATALINA</b>					
V6 3.8L 231ci	A	1977-81		25509267	CA-8498
V8 4.3L 265ci	S	1980-81		1254793	CA-8469
V8 4.9L 301ci	W	1979-80		1254793	CA-8469
V8 4.9L 301ci	Y	1977-79		1254793	CA-8469
V8 5.0L 305ci	H	1980		1258506	CA-8480
V8 5.0L 307ci	Y	1981		25504323	CA-8493
V8 5.7L 350ci	M	1973		1244463	CA-8473
V8 5.7L 350ci	N	1980-81	Diesel, 25mm O.D. Bushing On Pump End Of Cable	25509332	CA-8495
V8 5.7L 350ci	R	1977-79	w/Olds. Eng.	25500209	CA-8474
V8 5.7L 350ci	R	1980	w/Olds. Eng.	25504323	CA-8493
V8 6.6L 400ci	N, Z	1976		1254793	CA-8469
V8 6.6L 400ci	P, S	1973		1244463	CA-8473
V8 6.6L 400ci	R, S	1975		1254793	CA-8469
V8 6.6L 403ci	K	1977-79		25500209	CA-8474
V8 7.5L 455ci	W	1973		1244463	CA-8473
V8 7.5L 455ci	W	1975-76	w/4 Bbl. Carb.	1254793	CA-8469
<b>FIREBIRD</b>					
L4 2.5L 151ci	2, F	1982-83		14036101	CA-8325
L6 4.1L 250ci	D	1976		1254793	CA-8469
V6 2.8L 173ci	1	1982-84		14036101	CA-8325
V6 3.8L 231ci	A	1978-81		1254791	CA-8491
V8 4.3L 265ci	S	1980-81		25509846	CA-8802
V8 4.4L 267ci	J	1981	w/Canada Emissions	1248086	CA-8484
V8 4.9L 301ci	T	1981		25525523	CA-8699
V8 4.9L 301ci	W	1979-81		25509846	CA-8802
V8 5.0L 305ci	E	1988-92	w/Multi Port Fuel Injection, Trans Am, Labeled WAI	10054233	CA-8795
V8 5.0L 305ci	G	1984-86	w/4 Bbl. Carb.; 29.92" Cable	14076913	CA-8794
V8 5.0L 305ci	H	1980-81		1248086	CA-8484
V8 5.0L 305ci	H	1982	w/CFI; 29.92" Cable	14076913	CA-8794
V8 5.0L 305ci	H	1982-84	43.86" Cable	14038639	CA-8326
V8 5.0L 305ci	H	1982-84	w/4 Bbl. Carb.; 29.92" Cable	14076913	CA-8794
V8 5.0L 305ci	H	1985-87	w/4 Bbl. Carb., Trans AM; 29.92" Cable	14076913	CA-8794
V8 5.0L 305ci	S	1983	43.86" Cable	14038639	CA-8326
V8 5.0L 305ci	S	1983	w/Throttle Body Injection, Trans AM 29.92" Cable	14076913	CA-8794
V8 5.0L 305ci	U	1977-78		1248086	CA-8484
V8 5.7L 350ci	L	1978-79	w/Chevrolet Eng.	1248086	CA-8484
V8 5.7L 350ci	M	1976		1254793	CA-8469

# ACCELERATOR CABLES

Engine	Vin	Year	Remark	OE	Part
<b>PONTIAC (con't)</b>					
<b>FIREBIRD (con't)</b>					
V8 5.7L 350ci	R	1977	w/Olds. Eng.	1254793	CA-8469
V8 6.6L 403ci	K	1977-79		1254793	CA-8469
<b>FIREFLY</b>					
L3 1.0L 61ci	2, 5, M	1985-88	w/Manual Trans.	1591082000	CA-8866
<b>GRAND AM</b>					
V6 3.8L 231ci	A	1979		25500209	CA-8474
V8 5.0L 305ci	H	1979-80		1254180	CA-8475
V8 5.0L 305ci	U	1978		25500209	CA-8474
V8 5.7L 350ci	H	1975	23.75" Cable	1248078	CA-8485
V8 6.6L 400ci	R, S	1975	23.75" Cable	1248078	CA-8485
V8 7.5L 455ci	W	1975	w/4 Bbl. Carb.	1248078	CA-8485
<b>GRAND LEMANS</b>					
L6 4.1L 250ci	D	1975	w/2 Bbl. Carb.	25504322	CA-8479
L6 4.1L 250ci	D	1976-77	23.75" Cable	1248078	CA-8485
V6 3.8L 229ci	K	1980-81		1258156	CA-8496
V6 3.8L 231ci	A	1978-81		25500209	CA-8474
V8 4.3L 265ci	S	1980-81		25508194	CA-8519
V8 4.9L 301ci	W	1981		25508194	CA-8519
V8 5.0L 305ci	H	1979-80		1254180	CA-8475
V8 5.0L 305ci	H	1981	w/Canadian Emmisions	1254180	CA-8475
V8 5.0L 305ci	U	1977-78		1248077	CA-8485
V8 5.7L 350ci	E, H	1975	23.75" Cable	1248078	CA-8485
V8 5.7L 350ci	L, M	1976		1252955	CA-8479
V8 5.7L 350ci	L	1978-79		1254180	CA-8475
V8 5.7L 350ci	N	1982		25509332	CA-8495
V8 5.7L 350ci	R	1977		1252955	CA-8479
V8 6.6L 400ci	N, Z	1976	w/2 Bbl. Carb.	1252955	CA-8479
V8 6.6L 400ci	R, S	1975	23.75" Cable	1248078	CA-8485
V8 6.6L 403ci	K	1977	22.83" Cable	1248690	CA-8477
V8 7.5L 455ci	W	1975	w/4 Bbl. Carb.	1248078	CA-8485
<b>GRAND PRIX</b>					
V6 3.8L 231ci	A	1978-87		25500209	CA-8474
V6 4.1L 252ci	4	1982		25500209	CA-8474
V6 4.3L 262ci	Z	1986-87		1258156	CA-8496
V8 4.3L 265ci	S	1980-81		25508194	CA-8519
V8 4.4L 267ci	J	1981-82	w/Canada Emissions	25500209	CA-8474
V8 5.0L 305ci	H	1979-87		1254180	CA-8475
V8 5.7L 350ci	M, P	1976		1252955	CA-8479
V8 5.7L 350ci	N	1981-84	Diesel	25509332	CA-8495
V8 5.7L 350ci	R	1977	w/Olds. Eng.; 22.83" Cable	1248690	CA-8477
V8 6.6L 400ci	N, Z	1976	w/2 Bbl. Carb.	1252955	CA-8479
V8 6.6L 400ci	R, S	1975	23.75" Cable	1248078	CA-8485
V8 6.6L 403ci	K	1977	22.83" Cable	1248690	CA-8477
V8 6.6L 403ci	K	1977	23.75" Cable	1248078	CA-8485

# ACCELERATOR CABLES

Engine	Vin	Year	Remark	OE	Part
<b>PONTIAC (con't)</b>					
<b>GRAND PRIX (con't)</b>					
V8 7.5L 455ci	W	1975-76	23.75" Cable	1248078	CA-8485
<b>GRAND SAFARI</b>					
V8 4.9L 301ci	Y	1977		1254793	CA-8469
V8 5.7L 350ci	R	1977	w/Olds. Eng.	25500209	CA-8474
V8 6.6L 400ci	S	1973		1244463	CA-8473
V8 6.6L 400ci	S	1975		1254793	CA-8469
V8 6.6L 400ci	Z	1976		1254793	CA-8469
V8 6.6L 403ci	K	1977-78		25500209	CA-8474
V8 7.5L 455ci	W	1973		1244463	CA-8473
V8 7.5L 455ci	W	1975-76	w/4 Bbl. Carb.	1254793	CA-8469
<b>GRANDVILLE</b>					
V8 6.6L 400ci	R, S	1975		1254793	CA-8469
V8 6.6L 400ci	T	1973		1244463	CA-8473
V8 7.5L 455ci	W	1973		1244463	CA-8473
V8 7.5L 455ci	W	1975		1254793	CA-8469
<b>GTO</b>					
V8 6.6L 400ci		1973		1244463	CA-8473
V8 7.5L 455ci		1973		1244463	CA-8473
<b>J2000</b>					
L4 1.8L 112ci	G	1982	w/Square Hole Detent Bracket	10174973	CA-8793
L4 2.0L 122ci	B	1983-84	w/Square Hole Detent Bracket	14062639	CA-8800
L4 2.0L 122ci	P	1983	w/Throttle Body Injection	14062639	CA-8800
L4 2.0L 122ci	P	1984		14077000	CA-8321
<b>LEMANS</b>					
L4 1.6L 98ci	6	1988-92	w/Auto. Trans.	90231916	CA-8891
L4 1.6L 98ci	6	1988-92	w/Manual Trans.	90231915	CA-8894
L4 2.0L 122ci	K	1989-90	w/Auto. Trans.	90231916	CA-8891
L4 2.0L 122ci	K	1989-90	w/Manual Trans.	90231915	CA-8894
L6 4.1L 250ci	D	1975	w/2 Bbl. Carb.	25504322	CA-8479
L6 4.1L 250ci	D	1976-77	23.75" Cable	1248078	CA-8485
V6 3.8L 229ci	K	1980-81		1258156	CA-8496
V6 3.8L 231ci	A	1978-81		25500209	CA-8474
V8 4.3L 260ci	F	1976	22.83" Cable	1248690	CA-8477
V8 4.3L 265ci	S	1980-81		25508194	CA-8519
V8 4.4L 267ci	J	1981	w/Canada Emissions	25500209	CA-8474
V8 4.9L 301ci	W	1981		25508194	CA-8519
V8 5.0L 305ci	H	1979-80		1254180	CA-8475
V8 5.0L 305ci	H	1981	w/Canadian Emmisions	1254180	CA-8475
V8 5.0L 305ci	U	1977		1248077	CA-8485
V8 5.0L 305ci	U	1978		25500209	CA-8474
V8 5.7L 350ci	E, H, J, M	1975	23.75" Cable	1248078	CA-8485
V8 5.7L 350ci	L, M	1976-77		1252955	CA-8479
V8 5.7L 350ci	L	1978-79		1254180	CA-8475
V8 5.7L 350ci	R	1977	w/Olds. Eng.; 22.83" Cable	1248690	CA-8477

# ACCELERATOR CABLES

Engine	Vin	Year	Remark	OE	Part
<b>PONTIAC (con't)</b>					
<b>LEMANS (con't)</b>					
V8 6.6L 400ci	N, Z	1976	w/2 Bbl. Carb.	1252955	CA-8479
V8 6.6L 400ci	R, S	1975	23.75" Cable	1248078	CA-8485
V8 6.6L 403ci	K	1977	22.83" Cable	1248690	CA-8477
<b>PARISIENNE</b>					
V6 3.8L 229ci	9	1983	18.50" Cable	25505901	CA-8494
V6 3.8L 231ci	A	1981-83	18.50" Cable	25505901	CA-8494
V6 3.8L 231ci	A	1984-85	w/Canadian Emmisions	25509267	CA-8498
V6 4.3L 262ci	Z	1985-86	w/Throttle Body Injection; 19.125" Cable	25505901	CA-8799
V6 4.3L 262ci	Z	1985-86	18.50" Cable	25505901	CA-8494
V8 5.0L 305ci	H	1983-86		1258506	CA-8480
V8 5.0L 307ci	Y	1986		25504323	CA-8493
V8 5.7L 350ci	6	1985		1258506	CA-8480
V8 5.7L 350ci	N	1980-85	Diesel	25509332	CA-8495
<b>PHOENIX</b>					
L4 2.5L 151ci	5	1980-83		25501819	CA-8470
V6 2.8L 173ci	X, Z	1981-84		476796	CA-8471
V6 3.8L 231ci	A	1978-79		1249554	CA-8490
V6 3.8L 231ci	C	1977		1249554	CA-8490
V8 5.0L 305ci	U	1977-78		1254175	CA-8472
V8 5.7L 350ci	L	1977-79	w/Chevrolet Eng.	1254175	CA-8472
<b>SAFARI</b>					
V8 5.0L 307ci	Y	1987-88		25504323	CA-8493
<b>SUNBIRD</b>					
L4 2.0L 122ci	P	1985-86	w/Electronic Fuel Injection	14077000	CA-8321
L4 2.3L 140ci	A, B	1976-77		354712	CA-8489
L4 2.5L 151ci	9, V	1979-80		25502349	CA-8488
V6 3.8L 231ci	A	1978-80		1249662	CA-8481
V6 3.8L 231ci	C	1976-77		1249662	CA-8481
<b>T1000</b>					
L4 1.6L 98ci	9	1981	29.88" Cable	14030861	CA-8486
L4 1.6L 98ci	9	1981	w/2 Bbl. Carb., Labeled WN; 29.53" Cable	14030861	CA-8798
L4 1.6L 98ci	C	1982	29.88" Cable	14030861	CA-8486
L4 1.6L 98ci	C	1982	w/2 Bbl. Carb., Labeled WN; 29.53" Cable	14030861	CA-8798
L4 1.6L 98ci	C	1983-87	20.87" Cable	14056675	CA-8465
L4 1.6L 98ci	C	1983-87	w/2 Bbl. Carb., 29.53" Cable	10159512	CA-8798
<b>VENTURA</b>					
L6 4.1L 250ci	D	1976		1254174	CA-8476
V6 3.8L 231ci	C	1977		1249554	CA-8490
V8 5.0L 305ci	U	1977		1254175	CA-8472
V8 5.7L 350ci	L	1977	w/Chevrolet Eng.	1254175	CA-8472
V8 5.7L 350ci	M	1972-74		1244463	CA-8473
<b>PONTIAC TRUCKS</b>					
<b>SUNBURST</b>					
L4 1.5L 92ci	7, 9	1986-87	w/Manual Trans.	94165358	CA-8869

# ACCELERATOR CABLES

Engine	Vin	Year	Remark	OE	Part
<b>PONTIAC TRUCKS (con't)</b>					
<b>SUNBURST (con't)</b>					
L4 1.5L 92ci	K	1985	w/Manual Trans.	94165358	CA-8869
<b>TRANS SPORT</b>					
V6 3.1L 189ci	D	1990-92		14038639	CA-8808
<b>PORSCHE</b>					
<b>914</b>					
H6 2.0L 1991cc	4	1970-71		914.423.067.01	CA-8590
<b>RENAULT</b>					
<b>ALLIANCE, ENCORE</b>					
L4 1.4L 1397cc	D	1983-84	w/Multi Port Fuel Injection	3300 0129	CA-8628
L4 1.4L 1397cc	D	1983-84	w/Throttle Body Injection	3300 0263	CA-8630
L4 1.4L 1397cc	D	1985-87		3300 0263	CA-8630
L4 1.4L 1397cc	E	1983-84	w/Multi Port Fuel Injection	3300 0129	CA-8628
L4 1.4L 1397cc	E	1983-84	w/Throttle Body Injection	3300 0263	CA-8630
L4 1.4L 1397cc	E	1985-86		3300 0263	CA-8630
L4 1.7L 105ci	A	1985-87		3300 1839	CA-8629
<b>LECAR</b>					
L4 1.3L 1289cc		1977-79		77 01 002 453	CA-8631
L4 1.4L 1397cc	A	1980-83		77 01 002 453	CA-8631
<b>R5</b>					
L4 1.3L 1289cc		1976		77 01 002 453	CA-8631
<b>SAAB</b>					
<b>900</b>					
L4 2.0L 1985cc		1979-80	w/Auto. Trans.	83.39.996	CA-8554
L4 2.0L 1985cc		1979-80	w/Manual Trans.	83.35.986	CA-8553
<b>99</b>					
L4 2.0L 1985cc		1974-80	w/Auto. Trans.	83.23.230	CA-8552
<b>SUBARU</b>					
<b>BRAT</b>					
H4 1.8L 1781cc		1980	2WD	737065250	CA-8609
H4 1.8L 1781cc	5	1981-87	2WD	737065250	CA-8609
<b>DELUXE</b>					
H4 1.3L 1267cc		1972		637110172	CA-8560
H4 1.4L 1361cc		1973		637110172	CA-8560
<b>DL</b>					
H4 1.4L 1361cc		1974		637110172	CA-8560
H4 1.6L 1595cc	2	1980-84	2WD	737065250	CA-8609
H4 1.8L 1781cc	4, 5	1980-87	2WD	737065250	CA-8609
<b>GL</b>					
H4 1.3L 1267cc		1972		637110172	CA-8560
H4 1.4L 1361cc		1973-74		637110172	CA-8560
H4 1.6L 1595cc	2	1986-87	2WD	737065250	CA-8609
H4 1.6L 1595cc	3	1980	2WD	737065250	CA-8609
H4 1.8L 1781cc	4, 5, 7	1980-87	2WD	737065250	CA-8609

# ACCELERATOR CABLES

Engine	Vin	Year	Remark	OE	Part
<b>SUBARU (con't)</b>					
<b>GL-10</b>					
H4 1.8L 1781cc	4, 5, 7	1985-87	2WD	737065250	CA-8609
<b>GLF</b>					
H4 1.6L 1595cc	2	1980	2WD	737065250	CA-8609
H4 1.8L 1781cc	4	1980-82	2WD	737065250	CA-8609
<b>JUSTY</b>					
L3 1.2L 1189cc	7	1987	2WD	737065250	CA-8609
<b>RX</b>					
H4 1.8L 1781cc	5	1986-87	2WD	737065250	CA-8609
<b>STANDARD</b>					
H4 1.6L 1595cc	2	1980-87	2WD	737065250	CA-8609
H4 1.8L 1781cc	5	1981-87	2WD	737065250	CA-8609
<b>STAR</b>					
H4 1.3L 1267cc		1972		637110172	CA-8560
<b>XT</b>					
H4 1.8L 1781cc	4, 7	1985-87	2WD	737065250	CA-8609
<b>SUZUKI TRUCKS</b>					
<b>SAMURAI</b>					
L4 1.3L 1298cc	3	1990-95		1591083300	CA-8981
L4 1.3L 1325cc	5	1986-89		1591083300	CA-8981
<b>TOYOTA</b>					
<b>CAMRY</b>					
L4 2.0L 1995cc	S	1983-86		78180-32090	CA-8832
L4 2.0L 1998cc	S	1987-88	exc. Cruise Control	7818032230	CA-8833
L4 2.2L 2164cc	S	1992-95		7818033100	CA-8909
V6 2.5L 2508cc	V	1992		7818033100	CA-8909
V6 3.0L 2959cc	G	1994-95		7818033100	CA-8909
V6 3.0L 2959cc	V	1992-93		7818033100	CA-8909
V6 3.0L 2995cc	G	1994-95		7818033100	CA-8909
<b>CELICA</b>					
L4 1.6L 1587cc	A	1990-93	w/o CC	781802B470	CA-8961
L4 1.6L 1587cc	A	1991-93	w/CC	781802B490	CA-8962
L4 1.8L 1762cc	A	1994-95		781802D230	CA-8964
L4 2.0L 1998cc	S	1986	w/CC	7818020520	CA-8952
L4 2.0L 1998cc	S	1986-87	w/o CC	7818020470	CA-8954
L4 2.0L 1998cc	S	1986-89	w/Cruise Control, GTs	7818020500	CA-8835
L4 2.0L 1998cc	S	1987-89	w/CC	7818020760	CA-8953
L4 2.0L 1998cc	S	1987-89	w/o CC	7818020700	CA-8955
L4 2.2L 2164cc	S	1990-91	w/CC	781802B430	CA-8958
L4 2.2L 2164cc	S	1990-91	w/o CC	781802B400	CA-8957
L4 2.2L 2164cc	S	1992-93	w/CC	781802D030	CA-8960
L4 2.2L 2164cc	S	1992-93	w/o CC	781802B710	CA-8959
L4 2.2L 2164cc	S	1993-95	From 11/93	781802D340	CA-8963
L4 2.4L 2366cc	R	1982-85		7818014580	CA-8834

# ACCELERATOR CABLES

Engine	Vin	Year	Remark	OE	Part
<b>TOYOTA (con't)</b>					
<b>COROLLA</b>					
L4 1.6L 1587cc	A	1984-86	25.25" Cable	7818012430	CA-8941
L4 1.6L 1587cc	A	1984-88	w/o CC; 42.75" Cable	7818012651	CA-9008
L4 1.6L 1587cc	A	1986-87	w/o CC; 26.00" Cable	7818012710	CA-8942
L4 1.6L 1587cc	A	1988-89	37.75" Cable	781801A010	CA-8943
L4 1.6L 1587cc	A	1988-91	59.25" Cable	781801A030	CA-8982
L4 1.6L 1587cc	A	1990-92		781801A350	CA-8944
L4 1.6L 1587cc	A	1993-97		781801A520	CA-8934
L4 1.6L 1588cc	T	1975-76		78180-12211	CA-8736
L4 1.6L 1588cc	T	1977-79		78180-12213	CA-8737
L4 1.8L 1762cc	A	1993-95		781801A520	CA-8934
L4 1.8L 1762cc	B	1996-97		781801A520	CA-8934
L4 1.8L 1770cc	T	1980-82	Sedan, Wagon	78180-12340	CA-8738
<b>CRESSIDA</b>					
L6 3.0L 2954cc	M	1989-92		781802A010	CA-8975
<b>MR2</b>					
L4 1.6L 1587cc	A	1988-89		7818017030	CA-8973
<b>PASEO</b>					
L4 1.5L 1497cc	C	1996-97		7818016440	CA-8966
<b>SUPRA</b>					
L6 3.0L 2954cc		1986		781801B040	CA-8836
L6 3.0L 2954cc	M	1987-92	25.16" Cable	781801B041	CA-8837
L6 3.0L 2954cc	M	1988-92	22.00" Cable	781801B050	CA-8956
<b>TERCEL</b>					
L4 1.5L 1452cc	A	1980-82		78108-16030	CA-8772
L4 1.5L 1452cc	A	1983-86	w/o Cruise	78108-16070	CA-8776
L4 1.5L 1452cc	A	1987	Wagon	78108-16070	CA-8776
L4 1.5L 1456cc	E	1987	Wagon	78108-16070	CA-8776
L4 1.5L 1456cc	E	1988-90		7818016160	CA-8968
L4 1.5L 1456cc	E	1990	To 9/90	7818016230	CA-8972
L4 1.5L 1456cc	E	1990-94	From 9/90	7818016320	CA-8967
L4 1.5L 1497cc	C	1996-97		7818016440	CA-8966
<b>TOYOTA TRUCKS</b>					
<b>4RUNNER</b>					
L4 2.4L 2366cc	R	1985-86		7818089133	CA-8763
V6 3.4L 3378cc	N	1996-98		7818035240/60	CA-9010
V6 3.4L 3378cc		1999-00		7818035240/60	CA-9010
<b>LAND CRUISER</b>					
L6 3.9L 3878cc	F	1968-68		7818060030	CA-8831
L6 3.9L 3878cc		1969		7818060030	CA-8831
L6 4.0L 3956cc	F	1990-92	w/o CC	7818060080	CA-9013
L6 4.5L 4477cc	D	1993-95		7818060280	CA-9015
L6 4.5L 4477cc	J	1996-97		7818060280	CA-9015
<b>PICKUP</b>					
L4 2.2L 2188cc	L	1981	exc. 5 Spd. MT	7818089126	CA-8859

# ACCELERATOR CABLES

Engine	Vin	Year	Remark	OE	Part
<b>TOYOTA TRUCKS (cont)</b>					
<b>PICKUP (con't)</b>					
L4 2.2L 2188cc	L	1982-83		7818089126	CA-8859
L4 2.2L 2189cc	R	1979	31.25" Cable	78180-95112	CA-8739
L4 2.2L 2189cc	R	1979-80	4WD To 3/80 27.125" Cable	7818095112	CA-8860
L4 2.2L 2189cc	R	1979-80	4WD; 26.58" Cable	7818095112	CA-8839
L4 2.2L 2189cc	R	1980	2WD; 27.50" Cable	78180-89124	CA-8740
L4 2.4L 2366cc	R	1981	2WD; 27.50" Cable	78180-89124	CA-8740
L4 2.4L 2366cc	R	1981-83	4WD	7818095117	CA-8840
L4 2.4L 2366cc	R	1982-83	2WD	7818089125	CA-8741
L4 2.4L 2366cc	R	1984-86		7818089133	CA-8763
<b>PREVIA</b>					
L4 2.4L 2438cc	A	1991-95		7815095D02	CA-8977
<b>VAN</b>					
L4 2.0L 1998cc	Y	1984-85		7818028030	CA-8838
L4 2.2L 2237cc	Y	1986-89		7818028030	CA-8838
<b>TRIUMPH</b>					
<b>SPITFIRE</b>					
L4 1.3L 1296cc		1971-72	32.00 Cable	156345	CA-8851
L4 1.5L 1493cc		1973-75	32.00 Cable	156345	CA-8851
L4 1.5L 1493cc		1975-80	w/o OD 19.50" Cable	TKC3915	CA-8852
<b>TR7</b>					
L4 2.0L 1998cc	1	1981		UKC9515	CA-8788
L4 2.0L 1998cc		1975-78		UKC5873	CA-8853
L4 2.0L 1998cc		1979-80		UKC9515	CA-8788
<b>VOLKSWAGEN</b>					
<b>BEETLE</b>					
H4 1.2L 1192cc		1958-65		111.721.555C	CA-8634
H4 1.3L 1285cc		1966		111.721.555E	CA-8627
H4 1.5L 1457cc		1967-69		111.721.555E	CA-8627
H4 1.6L 1584cc		1971		111.721.555E	CA-8627
H4 1.6L 1584cc		1972-76	142.50" Cable	111.721.555J	CA-8625
H4 1.6L 1584cc		1972-79	102.60" Cable	133.721.555B	CA-8571
H4 1.6L 1584cc		1974	From 8/74 102.60" Cable	133.721.555B	CA-8571
H4 1.6L 1584cc		1974	To 8/74; 102.60" Cable	111.721.555J	CA-8625
<b>CABRIOLET</b>					
L4 1.8L 1780cc	A	1985-89	w/Auto. Trans.; 39.25" Cable	191.723.555A/B/C	CA-8585
L4 1.8L 1780cc	A	1985-89	w/Man. Trans., w/Fuel Injection	191.721.555	CA-8614
L4 1.8L 1780cc	B, C	1990-92	w/Man. Trans., w/Fuel Injection	191.721.555	CA-8614
L4 1.8L 1780cc	B, C	1990-93	w/Auto. Trans.; 39.25" Cable	191.723.555A/B/C	CA-8585
<b>CORRADO</b>					
L4 1.8L 1780cc	B, C	1990-92	w/Man. Trans., w/Fuel Injection	191.721.555	CA-8614
V6 2.8L 2792cc	D, E	1992	w/Man. Trans., w/Fuel Injection	191.721.555	CA-8614
<b>DASHER</b>					
L4 1.5L 1471cc		1975		321.721.555B	CA-8575
L4 1.5L 1471cc		1979-80		811.721.555AE	CA-8572



# ACCELERATOR CABLES

Engine	Vin	Year	Remark	OE	Part
<b>VOLKSWAGEN (con't)</b>					
<b>DASHER (con't)</b>					
L4 1.6L 1588cc	G	1981		811.721.555AE	CA-8572
L4 1.6L 1588cc		1976-80		811723555A	CA-8775
<b>FASTBACK</b>					
H4 1.6L 1584cc		1968-73	w/Auto. Trans.; 142.50" Cable	111.721.555J	CA-8625
H4 1.6L 1584cc		1968-73	w/Manual Trans.	311.721.555F	CA-8616
<b>GOLF</b>					
L4 1.6L 1588cc	G, H	1985-91	w/Man. Trans., w/Fuel Injection	171.721.555L	CA-8584
L4 1.8L 1780cc	A, B, C, K	1987-92	w/Man. Trans., w/Fuel Injection	191.721.555	CA-8614
L4 1.8L 1780cc	A, B, C, K	1985-92	w/Auto. Trans.	191723555	CA-8870
L4 2.0L 1984cc	E, J	1990-92	w/Auto. Trans.	191723555	CA-8870
L4 2.0L 1984cc	E, J	1990-92	w/Man. Trans., w/Fuel Injection	191.721.555	CA-8614
<b>JETTA</b>					
L4 1.6L 1588cc		1980	w/Auto. Trans.; 39.25" Cable	171.723.555C	CA-8585
L4 1.6L 1588cc		1980	w/Manual Trans.; 45.00" Cable	171.721.555K	CA-8580
L4 1.6L 1588cc	F, G, H	1981-92	w/Auto. Trans.; 39.25" Cable	171.723.555A/B/C	CA-8585
L4 1.6L 1588cc	F, G, H	1981-92	w/Manual Trans.	171.721.555L	CA-8584
L4 1.7L 1715cc	A, B	1981-84	w/Auto. Trans.; 39.25" Cable	171.723.555C	CA-8585
L4 1.7L 1715cc	A, B	1981-84	w/Manual Trans.; 45.00" Cable	171.721.555K	CA-8580
L4 1.8L 1780cc	A, B, C, K	1985-90	w/Manual Trans.	191.721.555	CA-8614
L4 2.0L 1984cc	E, J	1990	w/Manual Trans.	191.721.555	CA-8614
<b>KARMANN GHIA</b>					
H4 1.2L 1192cc		1958-65		111.721.555C	CA-8634
H4 1.3L 1285cc		1966		111.721.555E	CA-8627
H4 1.5L 1457cc		1967-69		111.721.555E	CA-8627
H4 1.6L 1584cc		1970-71		111.721.555E	CA-8627
H4 1.6L 1584cc		1972-74		111.721.555J	CA-8626
<b>PASSAT</b>					
L4 1.8L 1780cc	E	1991-92	w/Auto. Trans.	811.723.555A	CA-8591
L4 1.8L 1788cc	E	1993	w/Auto. Trans.	811.723.555A	CA-8591
L4 2.0L 1984cc	B, C	1991-93	w/Manual Trans.	191.721.555	CA-8614
<b>QUANTUM</b>					
L4 1.6L 1588cc	H	1982-83	w/Auto. Trans.	811723555A	CA-8775
L4 1.7L 1715cc	A	1982	w/Auto. Trans.	811723555A	CA-8775
L5 2.2L 2144cc	B	1983	w/Auto. Trans.	811723555A	CA-8775
<b>RABBIT</b>					
L4 1.5L 1457cc		1978-79	w/Manual Trans.; 38.00" Cable	171.721.555P	CA-8613
L4 1.5L 1457cc		1978-80	w/Auto. Trans.; 39.25" Cable	171.723.555C	CA-8585
L4 1.5L 1457cc		1979-80	w/Manual Trans.; 45.00" Cable	171.721.555K	CA-8580
L4 1.5L 1457cc		1980	w/Man. Trans., Convertible; 45.00" Cable	171.721.555K	CA-8580
L4 1.5L 1457cc		1980	w/Man. Trans., exc. Convertible	171.721.555T	CA-8573
L4 1.5L 1471cc		1975	w/Manual Trans.; 38.00" Cable	171.721.555P	CA-8613
L4 1.5L 1471cc		1975-79	w/Auto. Trans.; 39.25" Cable	171.723.555C	CA-8585
L4 1.5L 1471cc		1977-79	w/Manual Trans.	171.721.555L	CA-8584
L4 1.6L 1588cc		1976-80	w/Auto. Trans.; 39.25" Cable	171.723.555C	CA-8585

# ACCELERATOR CABLES

Engine	Vin	Year	Remark	OE	Part
<b>VOLKSWAGEN (con't)</b>					
<b>RABBIT (con't)</b>					
L4 1.6L 1588cc		1976-77	w/Manual Trans.; 38.00" Cable	171.721.555P	CA-8613
L4 1.6L 1588cc		1980	w/Auto. Trans.; 39.25" Cable	171.723.555C	CA-8585
L4 1.6L 1588cc		1980	w/Manual Trans.; 45.00" Cable	171.721.555K	CA-8580
L4 1.6L 1588cc	G, H	1981-83	w/Auto. Trans.; 39.25" Cable	171.723.555C	CA-8585
L4 1.6L 1588cc	G, H	1981-83	w/Manual Trans.	171.721.555L	CA-8584
L4 1.7L 1715cc	A, B	1981-83	w/Auto. Trans.; 39.25" Cable	171.723.555C	CA-8585
L4 1.7L 1715cc	A, B	1982-84	w/Man. Trans., Convertible; 45.00" Cable	171.721.555K	CA-8580
L4 1.7L 1715cc	A, B	1982-83	w/Man. Trans., exc. Convertible	175.721.555	CA-8617
L4 1.7L 1715cc	B	1981-82	w/Manual Trans.; 45.00" Cable	171.721.555K	CA-8580
L4 1.8L 1780cc	A, C	1984	w/Auto. Trans., Convertible; 39.25" Cable	171.723.555C	CA-8585
L4 1.8L 1780cc	C	1983	w/Auto. Trans., Convertible; 39.25" Cable	171.723.555C	CA-8585
L4 1.8L 1780cc	C	1983	w/Auto. Trans.; 39.25" Cable	171.723.555C	CA-8585
L4 1.8L 1780cc	C	1983	w/Man. Trans., Convertible; 45.00" Cable	171.721.555K	CA-8580
L4 1.8L 1780cc	C	1983	w/Man. Trans., exc. Convertible	175.721.555	CA-8617
<b>SCIROCCO</b>					
L4 1.6L 1588cc		1979	w/Auto. Trans.; 39.25" Cable	171.723.555C	CA-8585
L4 1.6L 1588cc		1979	w/Manual Trans.; 45.00" Cable	171.721.555K	CA-8580
L4 1.7L 1715cc	A	1981-82	w/Auto. Trans.; 39.25" Cable	171.723.555C	CA-8585
L4 1.7L 1715cc	A	1981-82	w/Manual Trans.; 45.00" Cable	171.721.555K	CA-8580
L4 1.8L 1780cc	A, B	1984-87	39.25" Cable	171.723.555C	CA-8585
L4 1.8L 1780cc	C	1983	w/Auto. Trans.; 39.25" Cable	171.723.555C	CA-8585
L4 1.8L 1780cc	C	1983	w/Manual Trans.; 45.00" Cable	171.721.555K	CA-8580
<b>SQUAREBACK</b>					
H4 1.6L 1584cc		1968-73	w/Auto. Trans.; 142.50" Cable	111.721.555J	CA-8625
H4 1.6L 1584cc		1968-73	w/Manual Trans.	311.721.555F	CA-8616
<b>SUPER BEETLE</b>					
H4 1.6L 1584cc		1973-74	To 8/74; 102.60" Cable	111.721.555J	CA-8625
H4 1.6L 1584cc		1974-75	From 8/74 102.60" Cable	133.721.555B	CA-8571
H4 1.6L 1584cc		1974	To 8/74 102.60" Cable	133.721.555A	CA-8571
<b>THING</b>					
H4 1.6L 1584cc		1973-74	w/Auto. Trans.	111.721.555J	CA-8626
H4 1.6L 1584cc		1973-74	w/Manual Trans.	311.721.555F	CA-8616
<b>VOLKSWAGEN TRUCKS</b>					
<b>RABBIT PICKUP</b>					
L4 1.5L 1457cc		1980	w/Auto. Trans.; 39.25" Cable	171.723.555C	CA-8585
L4 1.5L 1457cc		1980	w/Man. Trans., w/EGR counter box; 45.00" Cable	171.721.555K	CA-8580
L4 1.5L 1457cc		1980	w/Man. Trans., w/o EGR counter box	171.721.555T	CA-8573
L4 1.6L 1588cc		1980	w/Auto. Trans.; 39.25" Cable	171.723.555C	CA-8585
L4 1.6L 1588cc		1980	w/Man. Trans., w/EGR counter box; 45.00" Cable	171.721.555K	CA-8580
L4 1.6L 1588cc		1980	w/Man. Trans., w/o EGR counter box	171.721.555T	CA-8573
L4 1.6L 1588cc	G, H	1981-83	w/Auto. Trans.; 39.25" Cable	171.723.555C	CA-8585
L4 1.6L 1588cc	G, H	1981-83	w/Manual Trans.	171.721.555L	CA-8584
L4 1.7L 1715cc	A, B	1981-83	w/Auto. Trans.; 39.25" Cable	171.723.555C	CA-8585

# ACCELERATOR CABLES

Engine	Vin	Year	Remark	OE	Part
<b>VOLKSWAGEN TRUCKS (con't)</b>					
<b>RABBIT PICKUP (con't)</b>					
L4 1.7L 1715cc	A, B	1981-83	w/Man. Trans., w/EGR counter box; 45.00" Cable	171.721.555K	CA-8580
L4 1.7L 1715cc	A, B	1981-83	w/Man. Trans., w/o EGR counter box	171.721.555T	CA-8573
<b>TRANSPORTER</b>					
H4 1.2L 1192cc		1962-64	142.50" Cable	211.721.555A	CA-8623
H4 1.5L 1457cc		1963-64	142.50" Cable	211.721.555A	CA-8623
H4 1.5L 1457cc		1965-67		211.721.555C	CA-8622
H4 1.6L 1584cc		1968		211.721.555D	CA-8621
H4 1.6L 1584cc		1969-71		211.721.555G	CA-8620
H4 1.7L 1679cc		1972		211.721.555J	CA-8619
H4 1.7L 1679cc		1973	144.00" Cable	211.721.555M	CA-8615
H4 1.8L 1795cc		1974	144.00" Cable	211.721.555M	CA-8615
H4 1.8L 1795cc		1975	136.50" Cable	211.721.555AA	CA-8618
H4 2.0L 1970cc		1976-79	136.50" Cable	211.721.555AA	CA-8618
<b>VANAGON</b>					
H4 1.9L 1915cc	B	1983		251.721.555	CA-8624
H4 2.0L 1970cc	A	1980-83		251.721.555	CA-8624
L4 1.6L 1588cc	G	1982-83		251.721.555	CA-8624
<b>VOLVO</b>					
<b>242, 244, 245</b>					
L4 2.0L 1990cc		1975		1229439	CA-8607
L4 2.1L 2127cc	4	1980-82		1272897	CA-8608
L4 2.1L 2127cc		1976-78		1229439	CA-8607
L4 2.1L 2127cc		1979		1229438	CA-8607
L4 2.3L 2316cc	8	1981-82		1272897	CA-8608
L6 2.4L 2383cc	7	1982	244 only	1272897	CA-8608
<b>262, 264, 265</b>					
V6 2.7L 2673cc		1976-79		1229439	CA-8607
V6 2.8L 2849cc	6	1980	262 only	1272897	CA-8608

# **BRAKE CABLES**

# BRAKE CABLES

Year	Remark	Front	Intermediate	Rear Left	Rear Right
<b>AMERICAN MOTORS</b>					
<b>AMX</b>					
1974-79				CA-5008	CA-5007
<b>CONCORD</b>					
1980		CA-5019		CA-5008	CA-5019
1981-83		CA-5019		CA-5029	CA-5019
<b>EAGLE</b>					
1980-88		CA-5019		CA-5029	CA-5007
<b>GREMLIN</b>					
1973-78				CA-5008	CA-5007
<b>HORNET</b>					
1972-77				CA-5008	CA-5007
1973				CA-5007	CA-5007
<b>JAVELIN</b>					
1974				CA-5008	
<b>SPIRIT</b>					
1979-80				CA-5008	CA-5007
1981-83		CA-5018		CA-5029	CA-5007
<b>BMW</b>					
<b>1600, 1600TI</b>					
1967-71				CA-6159	CA-6159
<b>2002</b>					
1969-76				CA-6159	CA-6159
<b>2002TI</b>					
1968-71				CA-6159	CA-6159
<b>2002TII</b>					
1971-74				CA-6159	CA-6159
<b>320I</b>					
1977-83				CA-6160	CA-6160
<b>BUICK</b>					
<b>APOLLO</b>					
1973-74			CA-5506	CA-5510	CA-5510
1975			CA-5523	CA-5510	CA-5510
<b>CENTURION</b>					
1971-72			CA-5513	CA-5514	CA-5514
1973	exc. Police Car, exc. THM375B Auto. Trans.		CA-5509	CA-5517	CA-5517
<b>CENTURY</b>					
1973	2 Door, w/THM350 Trans.		CA-5504		
1973	4 Door, w/THM350			CA-5517	CA-5517
1973	w/Man. Trans., w/THM350 Auto. Trans.		CA-5504		
1973-74	2 Door, w/THM350, 4 Door w/THM400		CA-5504		
1973-74	w/THM350, w/THM400, w/Man. Trans.			CA-5517	CA-5517
1973-77		CA-5522		CA-5517	CA-5517
1974	2 Door, w/THM350 Auto. Trans., 4 Door w/THM400 Trans.		CA-5504		
1974	w/THM350 Trans., w/THM400 Trans.			CA-5517	CA-5517
1975	4 Door, w/THM350, exc. Wagon			CA-5517	CA-5517
1975	exc. Wagon	CA-5522			
1975-77	Wagon		CA-5502	CA-5518	CA-5518
1976-77	4 Door & Wagon		CA-5502		
1976-77	exc. Wagon	CA-5522		CA-5517	CA-5517
1977	2 & 4 Door & Wagon	CA-5522		CA-5517	CA-5517
1978-79	w/Auto. Trans.	CA-5536			
1978-79	w/Man. Trans.	CA-5543			
1978-79				CA-5525	
1978-81		CA-5536		CA-5540	CA-5592

# BRAKE CABLES

Year	Remark	Front	Intermediate	Rear Left	Rear Right
<b>BUICK (con't)</b>					
<b>CENTURY (con't)</b>					
1981		CA-5543			
1982-92		CA-5546		CA-5553	CA-5552
1993-96		CA-5546		CA-5643	CA-5644
<b>ELECTRA</b>					
1973-75				CA-5517	CA-5517
1975			CA-5509		
1979-84				CA-5541	CA-5539
1985-89		CA-5614	CA-5611	CA-5602	CA-5603
1990		CA-5614		CA-5636	CA-5635
1971-72	exc. Heavy Duty Power Brakes			CA-5514	CA-5514
1971-72	Heavy Duty Brakes			CA-5521	CA-5521
1971-74	119.625" Cable		CA-5507		
1977-78	w/Rear Disc Brakes			CA-5004	CA-5612
1977-78	w/Rear Drum Brakes			CA-5541	CA-5539
<b>ESTATE WAGON</b>					
1970			CA-5509		
1973	exc. Police Car, w/THM400 Trans. & 455 Eng.		CA-5513		
1971-72			CA-5003	CA-5514	CA-5514
1973-74	exc. Police Car, w/THM375B Auto. Trans.			CA-5517	CA-5517
1973-74	exc. Police Car, w/THM375B Auto. Trans. & 350 Engine		CA-5509		
1975				CA-5517	CA-5517
1977-79	w/Rear Disc Brakes			CA-5004	CA-5612
1977-79	w/Rear Drum Brakes	CA-5604		CA-5541	CA-5539
<b>GRAN SPORT</b>					
1966			CA-5502	CA-5503	CA-5503
1967	exc. THM400 Trans.		CA-5502	CA-5503	CA-5503
<b>GS, GS 455</b>					
1970-72	exc. THM400 Trans.		CA-5502	CA-5508	CA-5508
<b>GS 350, GS 400</b>					
1968-69	exc. THM400 Trans.		CA-5502	CA-5508	CA-5508
<b>LESABRE</b>					
1969-76	w/Man. Trans., w/THM350 Auto. Trans.		CA-5509		
1971-72			CA-5513	CA-5514	CA-5514
1973	w/THM400 Trans.		CA-5513	CA-5517	CA-5517
1973-74	exc. Police Car, w/THM375B Auto. Trans.		CA-5509		
1973-74				CA-5517	CA-5517
1974	w/THM400 Trans.		CA-5513		
1975	exc. Wagon w/THM375B Auto. Trans.			CA-5517	CA-5517
1976	Police Car			CA-5521	CA-5521
1976	w/11" Brakes			CA-5517	CA-5517
1977-79	w/Rear Disc Brakes			CA-5004	CA-5612
1977-79	w/Rear Drum Brakes			CA-5541	CA-5539
1977-85		CA-5604			
1980-81		CA-5538			
1980-84				CA-5541	CA-5539
1985				CA-5541	CA-5605
1986-87		CA-5614	CA-5611	CA-5602	CA-5603
1988-89	exc. Wagon	CA-5614	CA-5611	CA-5602	CA-5603
1988-89	Wagon	CA-5604		CA-5541	CA-5615
1990-99		CA-5614		CA-5636	CA-5635
<b>PARK AVENUE</b>					
1991-96		CA-5614		CA-5636	CA-5635
<b>REATTA</b>					
1988-91				CA-5622	CA-5623

# BRAKE CABLES

Year	Remark	Front	Intermediate	Rear Left	Rear Right
<b>BUICK (con't)</b>					
<b>REGAL</b>					
1973	2 Door, w/THM350 Trans.		CA-5504		
1973	w/THM400 Trans.		CA-5515		
1973-74	w/THM350, w/THM400, w/Man. Trans.			CA-5517	CA-5517
1974	2 Door, w/THM350, 4 Door w/THM400		CA-5504		
1975-77		CA-5522		CA-5517	CA-5517
1976-77	4 Door		CA-5502		
1978-79	w/Auto. Trans.	CA-5536		CA-5525	CA-5592
1978-79	w/Man. Trans.	CA-5543		CA-5525	CA-5592
1980		CA-5536		CA-5540	CA-5592
1981		CA-5543		CA-5540	CA-5592
1982-87		CA-5601		CA-5620	CA-5592
1988	w/Auto. Trans.	CA-5616		CA-5617	
1988	w/Man. Trans.			CA-5634	
1988-93				CA-5634	CA-5618
1989-91	w/Auto. Trans.	CA-5616			
<b>RIVIERA</b>					
1967-70			CA-5504	CA-5505	CA-5505
1971-73			CA-5504	CA-5514	CA-5514
1974			CA-5504	CA-5517	CA-5517
1975			CA-5002	CA-5517	CA-5517
1977-78		CA-5604		CA-5541	CA-5539
1979-81	exc. Export, w/Rear Disc Brakes	CA-5557		CA-5595	CA-5600
1979-81	w/Rear Drum Brakes	CA-5557		CA-5591	CA-5590
1981-85	Export	CA-5557		CA-5594	CA-5535
1982-85	exc. Export, w/Rear Disc Brakes, w/Power Anti-Lock Brakes	CA-5557		CA-5595	CA-5600
1982-85	w/Rear Drum Brakes, exc. Power Anti-Lock Brakes	CA-5557		CA-5591	CA-5590
1986-91				CA-5622	CA-5623
<b>ROADMASTER</b>					
1992-93	Sedan			CA-5637	CA-5638
1994-96	Sedan			CA-5637	
<b>SKYHAWK</b>					
1982-86		CA-5549		CA-5547	CA-5548
1987-89				CA-5619	CA-5640
<b>SKYLARK</b>					
1965-67			CA-5502	CA-5503	CA-5503
1968-70	Sedan, 4 Door, exc. THM400 Trans.		CA-5502	CA-5508	CA-5508
1971-72	Sedan, 4 Door, exc. THM400 Trans.		CA-5502	CA-5508	CA-5508
1971-72	w/THM400 Trans.		CA-5003		
1975-79			CA-5523	CA-5510	CA-5510
1980	1st Design, Cable Exits at Front of Dash			CA-5606	CA-5531
1980	2nd Design, Cable Exits Near Left Rear Seat Cushion and Follows Along Left Side of Vehicle	CA-5546		CA-5555	CA-5545
1981		CA-5546		CA-5555	CA-5545
1982-85		CA-5546		CA-5555	CA-5556
1986		CA-5626		CA-5547	CA-5548
1987-91				CA-5619	CA-5640
<b>SOMERSET</b>					
1987				CA-5619	CA-5640
<b>SOMERSET REGAL</b>					
1985		CA-5626		CA-5547	CA-5548
<b>SPECIAL</b>					
1967	exc. THM400 Trans.		CA-5502	CA-5503	CA-5503

# BRAKE CABLES

Year	Remark	Front	Intermediate	Rear Left	Rear Right
<b>BUICK (con't)</b>					
<b>SPECIAL (con't)</b>					
1968-69	Sedan, 4 Door, exc. THM400 Trans.		CA-5502	CA-5508	CA-5508
<b>SPORTWAGON</b>					
1965-66				CA-5503	CA-5503
1967-72				CA-5508	CA-5508
1968-70	w/THM400 Trans.		CA-5502		
1971-72	w/THM400 Trans.		CA-5003		
<b>WILDCAT</b>					
1969-70			CA-5509		
<b>CADILLAC</b>					
<b>60 SPECIAL</b>					
1993	Coupe & Sedan w/Heavy Duty	CA-5614		CA-5637	CA-5639
1993	Coupe Sedan Rear Cast Iron Drum Antilock Brakes, exc. Heavy Duty	CA-5614		CA-5636	CA-5635
<b>ALLANTE</b>					
1987	1st Design, w/850mm Brake Rotor, 2nd Design, w/938mm Brake Rotor			CA-5622	CA-5623
1988-92				CA-5622	CA-5623
<b>BROUGHAM</b>					
1987				CA-5541	CA-5605
1988-90	w/11" x 2" Brakes			CA-5541	CA-5605
1991-92	w/11" x 2" Brakes			CA-5637	CA-5638
<b>CIMARRON</b>					
1982-86		CA-5549		CA-5547	CA-5548
1987-88				CA-5619	CA-5640
<b>DEVILLE</b>					
1977-79	w/Rear Drum Brakes			CA-5541	CA-5539
1980-81	exc. 2.41 Rear Axle Ratio, w/Rear Drum Brakes				CA-5539
1980-83	w/Rear Drum Brakes				CA-5539
1980-83				CA-5541	
1984				CA-5541	CA-5539
1985-88		CA-5614	CA-5611	CA-5602	CA-5603
1989		CA-5614		CA-5602	CA-5603
1989	Coupe	CA-5614	CA-5611		
1990-93	w/Anti-Lock Brakes, exc. Heavy Duty, w/Cast Iron Drum	CA-5614		CA-5636	CA-5635
1990-93	w/Heavy Duty	CA-5614		CA-5637	CA-5639
<b>ELDORADO</b>					
1971-74			CA-5516		
1979-83	exc. Export	CA-5557		CA-5595	CA-5600
1979-83	Export	CA-5557		CA-5594	CA-5535
1984-85		CA-5557		CA-5595	CA-5600
1986-91				CA-5622	CA-5623
<b>FLEETWOOD</b>					
1977-79				CA-5541	CA-5612
1978	exc. 75, exc. Commercial Chassis			CA-5541	
1980-86				CA-5541	
1981-83	exc. 2.41 Rear Axle Ratio, exc. 75, exc. Commercial Chassis			CA-5541	CA-5539
1981-84					CA-5539
1985-86					CA-5605
1985-88	FWD Funeral Coach, Limousine, D'Elegance, Sixty Special		CA-5611	CA-5602	CA-5603
1985-89	Funeral Coach, Limousine, D'Elegance, Sixty Special	CA-5614			



# BRAKE CABLES

Year	Remark	Front	Intermediate	Rear Left	Rear Right
<b>CADILLAC (con't)</b>					
<b>FLEETWOOD (con't)</b>					
1989	Funeral Coach, D'Elegance Coupe		CA-5611		
1990-93	Coupe & Sedan w/Heavy Duty			CA-5637	CA-5639
1990-93	Coupe Sedan Rear Cast Iron Drum Antilock Brakes, exc. Heavy Duty			CA-5636	CA-5635
1990-93	exc. Brougham	CA-5614			
1993	w/11" x 2" Brakes			CA-5637	CA-5638
1994-96	w/11" x 2" Brakes			CA-5637	
<b>SEVILLE</b>					
1976			CA-5001		
1977-79			CA-5001	CA-5528	CA-5527
1980-85		CA-5557		CA-5595	CA-5600
1986-91				CA-5622	CA-5623
<b>CHEVROLET</b>					
<b>BEL AIR</b>					
1971-72	exc. Wagon, exc. THM400 Trans.		CA-5504		
1971-72	w/THM400 Trans., exc. Wagon, exc. Police Car			CA-5514	CA-5514
1973-74	exc. Wagon			CA-5517	CA-5517
1975	exc. Sport Coupe, exc. THM400 Trans.			CA-5517	CA-5517
<b>BERETTA</b>					
1987-89		CA-5631		CA-5628	CA-5627
1990	1st Design, Left Rear 662mm Long, Right Rear 586mm Long			CA-5628	CA-5627
<b>BISCAYNE</b>					
1971-72	exc. THM400 Trans.		CA-5507	CA-5514	CA-5514
1971-72	w/THM400 Trans., exc. Police Car		CA-5504	CA-5514	CA-5514
<b>BROOKWOOD</b>					
1971-72	w/THM350 Trans., w/THM400 Trans.			CA-5514	CA-5514
<b>CAMARO</b>					
1967	1st Design		CA-5003		
1967	2nd Design			CA-5510	CA-5510
1968	2nd Design, w/Rear Drum Brakes			CA-5510	CA-5510
1969	w/Rear Drum Brakes			CA-5510	CA-5510
1975-81		CA-5520		CA-5519	CA-5519
1982	exc. Export, w/Rear Drum Brakes			CA-5554	CA-5571
1982-83	export, w/Rear Disc Brakes			CA-5572	
1983	export, 2nd Design, w/Rear Disc Brakes, w/1205mm Cable				CA-5607
1983-89	exc. Export, w/Rear Drum Brakes	CA-5565		CA-5554	CA-5571
1984-87	export, w/Rear Disc Brakes			CA-5572	CA-5607
1988	w/Rear Disc Brakes and Export, exc. Performance Package			CA-5572	CA-5607
1988	w/Rear Disc Brakes, w/Performance Package			CA-5630	CA-5630
1989	w/Rear Disc Brakes			CA-5630	CA-5630
<b>CAPRICE</b>					
1971-72	Wagon, Police Car, w/THM400 Trans.		CA-5504	CA-5514	CA-5514
1973-74	Sport Coupe			CA-5517	CA-5517
1973-74	Sport Coupe, w/THM400 Trans.		CA-5513		
1973-74	w/THM400 Trans., exc. Sport Coupe		CA-5504		
1975	exc. Wagon			CA-5517	CA-5517
1975	w/THM400 Trans., exc. Wagon		CA-5513		
1976	Police Car, w/THM400 Trans., w/THM350 Auto. Trans., w/12" Brakes			CA-5521	CA-5521
1976	w/THM350 Auto. Trans., w/THM400 Trans, w/11" Brakes, exc. Police Car			CA-5517	CA-5517
1976	w/THM400 Trans., w/11" Brakes, w/12" Brakes		CA-5513		

# BRAKE CABLES

Year	Remark	Front	Intermediate	Rear Left	Rear Right
<b>CHEVROLET (con't)</b>					
<b>CAPRICE (con't)</b>					
1977-84		CA-5604		CA-5541	CA-5539
1985-90	exc. Wagon	CA-5604			CA-5605
1985-90	Wagon	CA-5604			CA-5615
1991-93	exc. Wagon			CA-5637	CA-5638
1994	Sedan, w/Light Weight Brake System			CA-5637	CA-5638
<b>CAVALIER</b>					
1982-86		CA-5549		CA-5547	CA-5548
1987-91				CA-5619	CA-5621
1989-90	exc. Z24			CA-5619	CA-5621
1992-94				CA-5632	CA-5633
<b>CELEBRITY</b>					
1982-90		CA-5546		CA-5553	CA-5552
1988-89	exc. Anti-Lock Brakes	CA-5546		CA-5553	CA-5552
<b>CHEVELLE</b>					
1964-66				CA-5503	CA-5503
1965-67	exc. Metallic Lining		CA-5502	CA-5503	CA-5503
1968-72				CA-5508	CA-5508
1973				CA-5517	CA-5517
<b>CHEVETTE</b>					
1976-79	w/6.50" Dia. Ring Gear			CA-5526	CA-5526
1980	1st Design, No Mounting Brackets			CA-5544	
1981	1st Design, No Mounting Brackets			CA-5544	CA-5544
1982	1st Design, No Mounting Brackets			CA-5544	CA-5550
1982-87	2nd Design, w/Mounting Brackets			CA-5596	CA-5597
<b>CHEVY II</b>					
1968			CA-5506	CA-5510	CA-5510
<b>CITATION</b>					
1980	1st Design, Cable Exits at Front of Dash and Follows Along Right Side of Vehicle.			CA-5606	CA-5531
1980	2nd Design, Cable Exits Near Left Rear Seat Cushion & Follows Along Left Side of Vehicle	CA-5546		CA-5555	CA-5545
1981		CA-5546		CA-5555	CA-5545
1982-83		CA-5546		CA-5555	CA-5556
1984-85		CA-5546		CA-5555	CA-5556
<b>CORSICA</b>					
1987-89		CA-5631		CA-5633	CA-5632
1989-91				CA-5632	CA-5633
1992-93	exc. Export			CA-5632	CA-5633
1994	exc. Export, exc. Ride & Handling Package			CA-5632	CA-5633
<b>CORVETTE</b>					
1965-82				CA-5511	CA-5511
<b>IMPALA</b>					
1971-72	exc. Wagon			CA-5514	CA-5514
1973-74	exc. Sport Coupe, w/THM400 Trans.		CA-5504		
1973-74	Sport Coupe, exc. THM400 Trans.; 119.625" Cable		CA-5507	CA-5517	CA-5517
1973-74	Sport Coupe, w/THM400 Trans.		CA-5513	CA-5517	CA-5517
1975	exc. Wagon, w/THM400 Trans.		CA-5513	CA-5517	CA-5517
1976	Police Car, w/THM400 Trans., w/THM350 Auto. Trans., w/12" Brakes				CA-5521
1976	w/THM350 Auto. Trans., w/THM400 Trans, w/11" Brakes, exc. Police Car			CA-5517	CA-5517
1976	w/THM400 Trans.		CA-5513		
1977-84		CA-5604		CA-5541	CA-5539
1985	exc. Wagon	CA-5604		CA-5541	CA-5605

# BRAKE CABLES

Year	Remark	Front	Intermediate	Rear Left	Rear Right
<b>CHEVROLET (con't)</b>					
<b>IMPALA (con't)</b>					
1985	Wagon	CA-5604		CA-5541	CA-5615
<b>KINGSWOOD</b>					
1971	w/THM400 Trans.		CA-5504	CA-5514	CA-5514
1971-72	exc. THM400 Trans.; 119.625" Cable		CA-5507		
1972	w/THM350 Auto. Trans., w/THM400 Trans.		CA-5504	CA-5514	CA-5514
<b>LUMINA</b>					
1990-91	Coupe & Sedan w/Auto. Trans.	CA-5616		CA-5634	CA-5618
1992	w/Metal Conduit			CA-5634	CA-5618
1994	Coupe & Sedan			CA-5634	CA-5618
<b>MALIBU</b>					
1967	exc. Turbo-Hydramatic Trans., exc. Metallic Lining		CA-5502	CA-5503	CA-5503
1975	Wagon	CA-5522	CA-5502	CA-5517	CA-5517
1976-77	2 Door Sport Coupe	CA-5522		CA-5517	CA-5517
1976-77	exc. 2 Door Sport Coupe	CA-5522	CA-5502		
1978-79		CA-5536		CA-5525	CA-5592
1980	w/Auto. Trans.	CA-5536		CA-5540	CA-5592
1981-83		CA-5543		CA-5540	CA-5592
<b>MONTE CARLO</b>					
1970	exc. THM400 Trans.			CA-5508	CA-5508
1971-72				CA-5508	CA-5508
1975-77		CA-5522		CA-5517	CA-5517
1978-79		CA-5536		CA-5525	CA-5592
1980	w/Auto. Trans.	CA-5536			
1980	w/Man. Trans.			CA-5540	CA-5592
1981		CA-5543		CA-5540	CA-5592
1982-88		CA-5601		CA-5620	CA-5592
<b>NOVA</b>					
1969-74			CA-5506	CA-5510	CA-5510
1975-79			CA-5523	CA-5510	CA-5510
<b>TOWNSMAN</b>					
1971	w/THM400 Trans.		CA-5504	CA-5514	CA-5514
1972	w/THM350 Auto. Trans., w/THM400 Trans.			CA-5514	CA-5514
1972	w/THM400 Trans.		CA-5504		
<b>CHEVROLET TRUCKS</b>					
<b>ASTRO</b>					
1985-90		CA-6198		CA-6180	CA-6182
1990-95		CA-6199		CA-6180	CA-6190
<b>BLAZER</b>					
1969-70	2WD			CA-5512	CA-5512
1971-72	2WD, w/Coil Springs			CA-5512	CA-5512
1973-74	2WD	CA-5568		CA-5534	CA-5534
1973-74	4WD	CA-5598		CA-5534	CA-5534
1987-91		CA-5576		CA-5579	CA-5580
<b>C10</b>					
1966-67	w/115" Wheel Base, exc. Turbo-Hydramatic Trans. exc. Leaf Springs			CA-5512	CA-5512
1966-67	w/127" Wheel Base, w/Turbo-Hydramatic Trans. exc. Leaf Springs			CA-5512	CA-5512
1966-68	w/127" Wheel Base, exc. Leaf Springs		CA-5507		
1968	w/Turbo-Hydramatic Trans. w/115" Wheel Base exc. Leaf Springs, w/127" Wheel Base exc. Leaf Springs			CA-5512	CA-5512
1969-70	w/127" Wheel Base, w/Coil Springs		CA-5507		

# BRAKE CABLES

Year	Remark	Front	Intermediate	Rear Left	Rear Right
<b>CHEVROLET TRUCKS (con't)</b>					
<b>C10 (con't)</b>					
1969-72	Coil Springs, w/115" Wheel Base, w/127" Wheel Base			CA-5512	CA-5512
1971-72	exc. THM400 Trans.		CA-5507		
1975	Coil Springs, w/115" Wheel Base, w/127" Wheel Base			CA-5512	CA-5512
1975	exc. THM400 Trans.		CA-5507		
1975	w/117.5" Wheel Base		CA-5504		
1976	2 Door, w/117.5" Wheel Base			CA-5534	CA-5534
1976-77	2 Door w/117.5" or 131.5" Wheel Base, exc. Heavy Duty	CA-5569		CA-5534	CA-5534
1976-77	2 Door, exc. Heavy Duty, w/117.5" Wheel Base		CA-5502	CA-5534	CA-5534
1976-77	2 Door, w/131.5" Wheel Base		CA-5551	CA-5534	CA-5534
1978	Diesel w/Heavy Duty, w/117.5" Wheel Base	CA-5568	CA-5502	CA-5534	CA-5534
1978	exc. California Emission	CA-5569		CA-5534	CA-5534
1979	2 Door Diesel w/131.5" Wheel Base	CA-5568			
1979	Gas exc. Heavy Duty Chassis, w/106.5" Wheel Base, w/131.5" Wheel Base		CA-5551		
1979	w/117" Wheel Base		CA-5504		
1979-80	w/106.5" Wheel Base, w/117" Wheel Base, w/131.5" Wheel Base	CA-5569		CA-5534	CA-5534
1980	w/106.5" Wheel Base, w/131.5" Wheel Base		CA-5551		
1981-83	w/106.5" Wheel Base, w/117" Wheel Base, w/131.5" Wheel Base			CA-5534	CA-5534
1981-83	w/106.5" Wheel Base, w/131.5" Wheel Base	CA-5569	CA-5551		
1984	w/117.5" Wheel Base, w/131.5" Wheel Base			CA-5579	CA-5580
1984-86	w/131.5" Wheel Base	CA-5578			
1985-86	w/117.5" Wheel Base, w/131.5" Wheel Base			CA-5641	CA-5580
<b>C10 SUBURBAN</b>					
1973-83				CA-5534	CA-5534
1975-78		CA-5569			
1978			CA-5504		
1979-83	w/131.5" Wheel Base	CA-5569	CA-5504		
1979-83	w/13" x 2.50" Brakes, w/11.15" x 2.75 Brakes	CA-5569			
1984-86		CA-5577		CA-5579	CA-5580
<b>C1500</b>					
1988	Extended Cab 155.5" Wheel Base, 2 Door Cab 117.5" Wheel Base, 2 Door Cab			CA-6195	CA-6197
1988-89	2 Door Cab 131.5" Wheel Base	CA-6196			
1989	2 Door Cab 117.5" Wheel Base, 2 Door Cab 131.5" Wheel Base			CA-6195	
1989	Extended Cab 141.5" Wheel Base, Extended Cab 155.5" Wheel Base			CA-6195	
1989-91	2 Door Cab 117.5" Wheel Base, 2 Door Cab 131.5" Wheel Base				CA-6197
1989-91	Extended Cab 141.5" Wheel Base, Extended Cab 155.5" Wheel Base				CA-6197
1990-91	2 Door Cab 117.5" Wheel Base, 2 Door Cab 131.5" Wheel Base			CA-6184	
1990-91	Extended Cab 141.5" Wheel Base, Extended Cab 155.5" Wheel Base			CA-6184	
1990-94	2 Door Cab 131.5" Wheel Base	CA-6183			
1992	1st Design Extended Cab 141.5" Wheel Base			CA-6184	CA-6197
1992	1st Design Extended Cab 155.5" Wheel Base, 2 Door Cab 117.5" Wheel Base, 2 Door Cab 131.5" Wheel Base			CA-6184	CA-6197

# BRAKE CABLES

Year	Remark	Front	Intermediate	Rear Left	Rear Right
<b>CHEVROLET TRUCKS (con't)</b>					
<b>C1500 (con't)</b>					
1992	2nd Design Extended Cab 141.5" Wheel Base			CA-6191	CA-6192
1992	2nd Design Extended Cab 155.5" Wheel Base			CA-6191	CA-6192
1993-94	2 Door Cab 131.5" Wheel Base			CA-6184	CA-6197
1993-94	Extended Cab w/141.5" Wheel Base			CA-6191	CA-6192
1993-94	Extended Cab w/155.5" Wheel Base			CA-6191	CA-6192
1995-96				CA-6191	
1997	Fleetside, 131.5" Wheel Base			CA-6191	
<b>C20</b>					
1966-67	w/127" Wheel Base; 119.625" Cable		CA-5507		
1968-69	w/133" Wheel Base, w/Turbo-Hydrumatic Trans.		CA-5005		
1968-70	exc. Turbo-Hydrumatic Trans.; 119.625" Cable		CA-5507		
1969	w/133" Wheel Base, exc. 11M lb. Axle, exc. Turbo-Hydrumatic Trans.		CA-5513		
1974	2 Door, w/13" x 2.50" Brakes	CA-5568	CA-5573		
1975	2 Door, w/11.15" x 2.75 Brakes, w/13" x 2.50" Brakes	CA-5568			
1975	2 Door, w/13" x 2.50" Brakes		CA-5573		
1976-77	w/11.15" x 2.75" Brakes	CA-5568			
1976-78	2 Door, w/13" x 2.50" Brakes	CA-5569	CA-5551	CA-5529	CA-5529
1978	4 Door, w/164.5" Wheel Base	CA-5568			
1979-80	2 & 4 Door			CA-5529	CA-5529
1979-80	2 Door	CA-5569			
1979-80	4 Door	CA-5568			
1979-83	2 Door, w/11.15" x 2.75 Brakes		CA-5551		
1979-83	2 Door, w/13" x 2.50" Brakes		CA-5516		
1981-82	2 Door	CA-5569		CA-5574	CA-5574
1981-83	4 Door	CA-5568		CA-5529	CA-5529
1983	2 Door w/10.5" Ring Gear	CA-5569		CA-5574	CA-5574
1983	2 Door, 43.2" Long used on 6 3/8" wide drum			CA-5529	CA-5529
1984	1st Design, 2 & 4 Door			CA-5579	CA-5580
1984	2 Door	CA-5578			
1984	2nd Design, 2 & 4 Door			CA-5529	CA-5529
1984-85	2 Door SRW, w/13" Brakes			CA-5583	CA-5584
1985	2 Door SRW, w/13" Brakes, w/131.5" Wheel Base, w/164.5" Wheel Base	CA-5578			
1985-86	2 Door, w/131.5" Wheel Base, w/164.5" Wheel Base, 4 Door w/164.5" Wheel Base			CA-5641	CA-5580
1986	2 Door, w/131.5" Wheel Base, w/164.5" Wheel Base	CA-5578			
<b>C20 SUBURBAN</b>					
1973-78		CA-5568			
1974-75	w/Vacuum Power Brakes	CA-5568			
1976-77	w/11.15" x 2.75" Brakes		CA-5504	CA-5529	CA-5529
1978	exc. California Emission		CA-5504		
1978	w/11.15" x 2.75" Brakes			CA-5529	CA-5529
1979-80		CA-5569		CA-5529	CA-5529
1981-83		CA-5569		CA-5574	CA-5574
1984	1st Design	CA-5577		CA-5579	CA-5580
1984	2nd Design	CA-5577		CA-5529	CA-5529
1985		CA-5577		CA-5641	CA-5580
1986	w/11.15" x 2.75" Brakes	CA-5577		CA-5641	
1986	w/13" x 2.50" Brakes	CA-5577			CA-5580
<b>C2500</b>					
1988-89	exc. Extended Cab	CA-6196			CA-6187

# BRAKE CABLES

Year	Remark	Front	Intermediate	Rear Left	Rear Right
<b>CHEVROLET TRUCKS (con't)</b>					
<b>C2500 (con't)</b>					
1990-91	1st Design exc. Extended Cab	CA-6183		CA-6188	CA-6187
1990-91	1st Design Extended Cab			CA-6189	CA-6186
1992-94	2 Door Cab exc. Limited Slip Rear Axle, Extended Cab 141.5" Wheel Base, Extended Cab 155.5" Wheel Base	CA-6183		CA-6189	CA-6186
1992-94	2 Door Cab Limited Slip Rear Axle	CA-6183		CA-6188	CA-6187
1995	Extended Cab Long Bed 155.5" Wheel Base 8600 lb.GVW			CA-6189	CA-6186
1995	Extended Cab Short Bed, 141.5" WB 7200 lb.GVW, Chassis Cab 131.5" Wheel Base			CA-6188	CA-6187
1995	Regular Cab, Long Bed 131.5" Wheel Base 7200 lb.GVW			CA-6188	CA-6186
1995	Regular Cab, Long Bed 131.5" Wheel Base 7200 lb.GVW			CA-6189	CA-6187
1996	Fleetside 131.5" Wheel Base, Fleetside Extended Cab 141.5" Wheel Base			CA-6188	CA-6187
1996	Fleetside Extended Cab 155.5" Wheel Base				CA-6187
1996	Fleetside Extended Cab 155.5" Wheel Base			CA-6188	
1997	Fleetside, 131.5" Wheel Base			CA-6188	CA-6187
1998	Short Bed Extended Cab, Long Bed Standard Cab 7200 lb.GVW			CA-6188	
1999-00	Long Bed				CA-6187
<b>C30</b>					
1967	2nd Design, w/133" Wheel Base		CA-5513		
1968-70	w/133" Wheel Base, w/Turbo-Hydramatic Trans.		CA-5005		
1969	w/133" Wheel Base, exc. 11M lb. Axle, exc. Turbo-Hydramatic Trans.		CA-5513		
1973-74	w/135.5" Wheel Base, w/141 5/16" Overall Length		CA-5573		
1973-74	w/135.5" Wheel Base, w/141 5/16" Overall Length, w/159.5" Wheel Base	CA-5568			
1975	SRW, exc.131.5" Wheel Base		CA-5504		
1975	w/131.5" Wheel Base, w/135.5" Wheel Base, w/159.5" Wheel Base	CA-5568			
1975	w/135.5" Wheel Base, DRW w/131.5" Wheel Base		CA-5573		
1976	w/135.5" Wheel Base, w/141 5/16" Overall Length, DRW w/131.5" Wheel Base, 4 Door w/164.5" Wheel Base			CA-5529	CA-5529
1976-77	w/135.5" Wheel Base, w/141 5/16" Overall Length, DRW w/131.5" Wheel Base		CA-5573		
1977	4 Door, w/164.5" Wheel Base, w/135.5" Wheel Base, w/141 5/16" Overall Length			CA-5529	CA-5529
1978	w/135.5" Wheel Base, w/159.5" Wheel Base, 4 Door w/164.5" Wheel Base	CA-5568			
1978-80	45.00" Cable			CA-5529	CA-5529
1978-83	w/135.5" Wheel Base		CA-5573		
1979	w/117.5" Wheel Base, w/131.5" Wheel Base, w/135.5" Wheel Base, w/159.5" Wheel Base	CA-5568			
1979	w/117.5" Wheel Base, w/131.5" Wheel Base, w/135.5" Wheel Base, w/159.5" Wheel Base, w/164.5" Wheel Base			CA-5529	CA-5529
1979-81	w/131.5" Wheel Base, w/117.5" Wheel Base		CA-5551		
1980		CA-5568			

# BRAKE CABLES

Year	Remark	Front	Intermediate	Rear Left	Rear Right
<b>CHEVROLET TRUCKS (con't)</b>					
<b>C30 (con't)</b>					
1981	exc. 164" Wheel Base	CA-5568			
1981	w/13" x 2.50" Brakes, w/135.5" Wheel Base, w/159.5" Wheel Base			CA-5574	CA-5574
1981	w/13" x 3.50" Brakes, w/135.5", 159.5", 131.5", 117.5", 164.5" Wheel Base			CA-5529	CA-5529
1982-83	exc. 164.5" Wheel Base	CA-5568			
1982-83	w/117.5" Wheel Base, w/131.5" Wheel Base		CA-5551		
1982-83	w/13" x 2.50" Brakes, exc. 164.5" Wheel Base			CA-5574	CA-5574
1982-83	w/13" x 3.50" Brakes, w/164.5" Wheel Base			CA-5529	CA-5529
1984	2 Door SRW, w/131.5" Wheel Base, DRW w/164.5" Wheel Base	CA-5578			
1984	DRW, w/135.5" Wheel Base, w/159.5" Wheel Base, w/164.5" Wheel Base, w/Dana Axle, SRW; 53.385" Cable			CA-5583	
1984	DRW, w/135.5" WB, w/159.5" Wheel Base, w/164.5" Wheel Base, w/Dana Axle, SRW				CA-5584
1984-86	DRW, exc. Dana Axle, w/135.5" Wheel Base, w/159.5" Wheel Base, w/164.5" Wheel Base			CA-5585	CA-5586
1984-86	w/135.5" Wheel Base	CA-5587			
1985	DRW, exc. Dana Axle, w/135" Wheel Base, w/164.5" Wheel Base; 73.50" Cable				CA-5586
1985	exc. Dana Axle; 51.625" Cable			CA-5585	
1985-86	2 Door SRW, exc. 131.5" Wheel Base	CA-5578			
1985-86	SRW, DRW w/Dana Axle; 53.385" Cable			CA-5583	
1986	2 Door SRW, w/131.5" Wheel Base	CA-5578			
1986	SRW, w/131.5" Wheel Base, w/159.5" Wheel Base; 53.385" Cable			CA-5583	
1986	w/159.5" Wheel Base, DRW w/135.5" Wheel Base, w/164.5" Wheel Base, w/Dana Axle, SRW, w/131.5" Wheel Base, w/159.5" Wheel Base			CA-5583	CA-5584
<b>C3500</b>					
1988-89	DRW	CA-6196			
1988-89	SRW	CA-6183			
1990-91	135.5" Wheel Base	CA-6183			
1990-91	1st Design; 131.5" Wheel Base, 155.5" Wheel Base	CA-6196		CA-6189	CA-6193
1990-91	2nd Design; 131.5" Wheel Base, 155.5" Wheel Base	CA-6196			CA-6186
1990-97	135.5" Wheel Base, 159.5" Wheel Base			CA-6193	
1992-94	2 Door Cab	CA-6183		CA-6193	
1992-94	Extended Cab; 86.50" Cable			CA-6189	
1995	Extended Cab Long Bed 155.5" Wheel Base, Wide Trak Rear Axle; 86.50" Cable			CA-6189	
1996	Fleetside 131.5" Wheel Base, Fleetside Extended Cab 155.5" Wheel Base; 86.50" Cable			CA-6189	
<b>EL CAMINO</b>					
1967	w/Man. Trans.		CA-5502	CA-5503	CA-5503
1968-72				CA-5508	CA-5508
1973-76		CA-5522		CA-5517	CA-5517
1977		CA-5522	CA-5502	CA-5517	CA-5517
1978-79	w/Man. Trans.	CA-5543		CA-5525	CA-5592
1980				CA-5540	CA-5592
1981		CA-5543		CA-5540	CA-5592

# BRAKE CABLES

Year	Remark	Front	Intermediate	Rear Left	Rear Right
<b>CHEVROLET TRUCKS (con't)</b>					
<b>EL CAMINO (con't)</b>					
1982-87				CA-5620	CA-5592
<b>G10</b>					
1975	w/110" Wheel Base			CA-5533	CA-5533
1976-78	w/110" Wheel Base, w/125" Wheel Base, w/146" Wheel Base			CA-5533	CA-5533
1979-82	w/125" Wheel Base, w/110" Wheel Base			CA-5533	CA-5533
1983-84	w/110" Wheel Base	CA-5561		CA-5582	CA-5581
1983-84	w/125" Wheel Base	CA-5563		CA-5559	CA-5560
1985-95	w/110" Wheel Base	CA-5561		CA-5582	CA-5581
1985-95	w/125" Wheel Base	CA-5563		CA-5582	CA-5581
<b>G20</b>					
1975-78	w/110" Wheel Base			CA-5533	CA-5533
1979-82	w/110" Wheel Base, w/125" Wheel Base			CA-5533	CA-5533
1983	w/110" Wheel Base	CA-5561		CA-5559	CA-5560
1983	w/125" Wheel Base	CA-5563		CA-5559	CA-5560
1984-95	w/110" Wheel Base	CA-5561		CA-5582	CA-5581
1984-95	w/125" Wheel Base	CA-5563		CA-5582	CA-5581
<b>G30</b>					
1976-78	w/164.5" Wheel Base	CA-5568			
1983-95	Dual and Single Rear Wheels, 146" Wheel Base	CA-6181			
1983-95	SRW, w/125" WB, w/146" Wheel Base	CA-5563		CA-5588	CA-5589
1984-95	DRW, w/125" WB, w/146" Wheel Base			CA-5608	CA-5609
1995-96	Dual and Single Rear Wheels, 146" Wheel Base, exc. Express w/Dual Rear Wheels	CA-6181			
<b>K10</b>					
1969	w/127" Wheel Base		CA-5004		
1973-74				CA-5534	CA-5534
1974	2 Door, w/117.5" Wheel Base	CA-5532	CA-5003	CA-5534	CA-5534
1975-76	2 Door, w/117.5" Wheel Base	CA-5532	CA-5003	CA-5534	CA-5534
1977-78	2 Door, w/131.5" Wheel Base	CA-5532	CA-5002	CA-5534	CA-5534
1979-83	w/117.5" Wheel Base	CA-5598	CA-5003	CA-5534	CA-5534
1979-83	w/131.5" Wheel Base	CA-5598	CA-5005	CA-5534	CA-5534
1984-86	w/117.5" Wheel Base, w/131.5" Wheel Base			CA-5579	CA-5580
1984-86	w/131.5" Wheel Base	CA-5578			
<b>K10 SUBURBAN</b>					
1973	w/129.5" Wheel Base			CA-5534	CA-5534
1974-78		CA-5532	CA-5502	CA-5534	CA-5534
1977-83	w/117.5" Wheel Base, w/131.5" Wheel Base			CA-5534	CA-5534
1977-83	w/131.5" Wheel Base		CA-5005		
1984		CA-5577		CA-5579	CA-5580
1985-86		CA-5577		CA-5641	CA-5580
<b>K1500</b>					
1988	2 Door Cab 117.5" Wheel Base, 2 Door Cab 131.5" Wheel Base, Extended Cab				CA-6197
1988-89	2 Door Cab 117.5" Wheel Base, 2 Door Cab 131.5" Wheel Base			CA-6195	
1988-89	2 Door Cab 131.5" Wheel Base	CA-6196			
1989-91	2 Door Cab 117.5" Wheel Base, 2 Door Cab 131.5" Wheel Base				CA-6197
1990-91	2 Door Cab 117.5" Wheel Base, 2 Door Cab 131.5" Wheel Base			CA-6184	
1990-91	2 Door Cab 131.5" Wheel Base	CA-6183			
1990-91	Extended Cab				CA-6187



# BRAKE CABLES

Year	Remark	Front	Intermediate	Rear Left	Rear Right
<b>CHEVROLET TRUCKS (con't)</b>					
<b>K1500 (con't)</b>					
1992	2 Door Cab, 129.5" Wheel Base, 131.5" Wheel Base, First Design	CA-6183		CA-6184	CA-6197
1992	2 Door Cab, 129.5" Wheel Base, 131.5" Wheel Base, Second Design	CA-6183		CA-6191	CA-6192
1992-94	Extended Cab w/155.5" Wheel Base				CA-6187
1992-97	Extended Cab w/141.5" Wheel Base				CA-6187
1993-94	2 Door Cab 117.5" Wheel Base, 2 Door Cab, 129.5" Wheel Base, 131.5" Wheel Base	CA-6183		CA-6191	CA-6192
1995	Extended Cab Short Bed 141.5" Wheel Base, Extended Cab Long Bed 155.5" Wheel Base			CA-6191	
1995	Heavy Duty Chassis				CA-6187
1995	Regular Cab Long Bed 131.5" Wheel Base			CA-6191	
1995	Regular Cab Short Bed 117.5" Wheel Base			CA-6191	
1996	117.5" Wheel Base			CA-6191	
1996	Extended Cab 141.5" Wheel Base, Heavy Duty Chassis, Extended Cab, 141.5" Wheel Base				CA-6187
1996	Extended Cab w/141.5" Wheel Base			CA-6191	
1996	Fleetside 131.5" Wheel Base			CA-6191	
1996	Fleetside Extended Cab 155.5" Wheel Base			CA-6191	
1997	Fleetside 131.5" Wheel Base, Extended Cab 141.5" Wheel Base			CA-6191	
<b>K20</b>					
1973	exc. 117.5" Wheel Base; 119.625" Cable		CA-5507		
1974	2 Door, w/13" x 2.50" Brakes	CA-5598	CA-5005		
1974	w/131.5" Wheel Base	CA-5598	CA-5513		
1975	2 Door, w/11.15" x 2.75 Brakes, w/13" x 2.50" Brakes	CA-5598			
1975	2 Door, w/13" x 2.50" Brakes		CA-5005		
1976-78	2 Door, w/11.15" x 2.75 Brakes		CA-5002		
1976-78	2 Door, w/13" x 2.50" Brakes		CA-5513		
1976-82		CA-5598		CA-5529	CA-5529
1983	2nd Design, 2 Door	CA-5598	CA-5513	CA-5529	CA-5529
1984	2 Door, w/131.5" Wheel Base	CA-5578		CA-5583	CA-5584
1984	exc. 2 Door w/131.5" Wheel Base			CA-5579	CA-5580
1985-86	2 Door, w/11.15" x 2.75 Brakes, w/131.5" Wheel Base	CA-5578			
1985-86	w/11" Brakes			CA-5641	CA-5580
1985-86	w/13" Brakes			CA-5583	CA-5584
<b>K20 SUBURBAN</b>					
1974	w/Vacuum Power Brakes	CA-5598	CA-5502		
1974-75	w/Vacuum Power Brakes, exc. Type c	CA-5598	CA-5005		
1975-82			CA-5504	CA-5529	CA-5529
1976-77	w/11.15" x 2.75" Brakes		CA-5502		
1976-78	w/13" x 2.50" Brakes		CA-5504		
1976-82		CA-5598			
1983	1st Design & 2nd Design	CA-5598	CA-5504		
1983	2nd Design			CA-5529	CA-5529
1984	w/11.15" x 2.75" Brakes	CA-5577		CA-5579	CA-5580
1984-86	w/13" x 2.50" Brakes	CA-5577		CA-5583	CA-5584
1985-86	w/11.15" x 2.75" Brakes	CA-5577		CA-5641	
<b>K2500</b>					
1988-89	exc. Extended Cab	CA-6196			
1988-89	Extended Cab				CA-6186
1990-91	exc. Extended Cab	CA-6196			CA-6187
1990	Extended Cab			CA-6189	CA-6186

# BRAKE CABLES

Year	Remark	Front	Intermediate	Rear Left	Rear Right
<b>CHEVROLET TRUCKS (con't)</b>					
<b>K2500 (con't)</b>					
1990-91	exc. Extended Cab; w/DRW	CA-6183		CA-6188	
1991	Extended Cab, First Design			CA-6189	CA-6186
1992-94	Extended Cab w/141.5" Wheel Base			CA-6189	
1992-94	Extended Cab w/155.5" Wheel Base			CA-6189	CA-6186
1992-94	Regular Cab	CA-6183		CA-6188	CA-6187
1995	Extended Cab Long Bed 155.5" Wheel Base 8600 lb.GVW			CA-6189	
1995	Extended Cab Short Bed, 141.5" WB, 7200 lb.GVW, Chassis Cab 131.5" Wheel Base			CA-6188	CA-6187
1995	Regular Cab, Long Bed 131.5" Wheel Base 7200 lb.GVW			CA-6188	CA-6187
1995	Regular Cab, Long Bed 131.5" Wheel Base 7200 lb.GVW			CA-6189	CA-6187
1996	Fleetside 131.5" Wheel Base, Fleetside Extended Cab 155.5" Wheel Base			CA-6188	CA-6187
1997	Fleetside 131.5" Wheel Base			CA-6188	CA-6187
<b>K2500 SUBURBAN</b>					
1992		CA-6183		CA-6188	CA-6187
<b>K30</b>					
1974		CA-5532			
1977	2 Door, w/131.5" Wheel Base		CA-5513		
1977-78	2 Door, w/135.5" Wheel Base	CA-5532	CA-5507	CA-5529	CA-5529
1977-80	w/131.5" Wheel Base, w/135.5" Wheel Base, w/159.5" Wheel Base, w/164.5" Wheel Base	CA-5598			
1978	2 Door, w/131.5" Wheel Base, w/164.5" Wheel Base		CA-5513		
1979-80	w/131.5" Wheel Base		CA-5513	CA-5529	CA-5529
1979-83	w/135.5" Wheel Base		CA-5507		
1981-83	w/13" x 2.50" Brakes			CA-5574	CA-5574
1981-83	w/13" x 3.50" Brakes			CA-5529	CA-5529
1981-83	w/131.5" Wheel Base, w/164.5" Wheel Base		CA-5513		
1981-83		CA-5598			
1984-86	SRW, DRW w/Dana Axle			CA-5583	CA-5584
1984-86	w/131" Wheel Base	CA-5578			
1984-86	w/135.5" Wheel Base	CA-5587			
<b>K3500</b>					
1988-89	DRW	CA-6196			
1988-89	SRW	CA-6183			CA-6186
1990-91	131.5" Wheel Base, 155.5" Wheel Base	CA-6196			
1990-91	135.5" Wheel Base	CA-6183			
1990-91	1st Design; 131.5" Wheel Base, 155.5" Wheel Base			CA-6189	CA-6193
1990-91	2nd Design; 131.5" Wheel Base, 155.5" Wheel Base				CA-6186
1990-97	135.5" Wheel Base, 159.5" Wheel Base			CA-6193	
1992-94	2 Door Cab	CA-6183		CA-6193	
1992-94	Extended Cab			CA-6189	
1995	Extended Cab Long Bed 155.5" Wheel Base, Wide Trak Rear Axle			CA-6189	
1996	Fleetside 131.5" Wheel Base, Fleetside, Extended Cab, 155.5" Wheel Base			CA-6189	
<b>K5 BLAZER</b>					
1975	2WD	CA-5568		CA-5534	CA-5534
1975-77	4WD	CA-5598			
1976-77	2WD	CA-5568	CA-5003	CA-5534	CA-5534

# BRAKE CABLES

Year	Remark	Front	Intermediate	Rear Left	Rear Right
<b>CHEVROLET TRUCKS (con't)</b>					
<b>K5 BLAZER (con't)</b>					
1978-83	4WD	CA-5598		CA-5534	CA-5534
1984-85		CA-5576	CA-5558	CA-5579	CA-5580
1986		CA-5576		CA-5579	CA-5580
<b>P10</b>					
1968-72				CA-5512	CA-5512
1973-80				CA-5534	CA-5534
<b>P20</b>					
1970	w/133" Wheel Base, exc. 11M lb. Axle		CA-5513		
1970	w/Leaf Springs		CA-5005		
1973	w/13" Brakes		CA-5504		
1973-74	w/133" Wheel Base, w/11.15" x 2.75 Brakes		CA-5573		
1975-78	w/125" Wheel Base, w/11.15" x 2.75 Brakes		CA-5504		
1975-78	w/133" Wheel Base, w/11.15" x 2.75 Brakes		CA-5573		
1976-83				CA-5529	CA-5529
1979-83	w/133" Wheel Base		CA-5573		
1982				CA-5574	CA-5574
1984	w/11.15" x 2.75" Brakes			CA-5579	CA-5580
1984	w/13" x 2.50" Brakes			CA-5583	CA-5584
1985-86	w/11.15" x 2.75" Brakes			CA-5641	CA-5580
1987-89	SRW, w/13" x 3.50" Brakes			CA-5583	CA-5584
1987-89	w/11.15" x 2.75" Brakes			CA-5641	CA-5624
<b>P30</b>					
1968-70	w/133" Wheel Base, exc. 11M lb. Axle, exc. Propeller Shaft Brake		CA-5513		
1973-78	w/157" Wheel Base, w/158.5" Wheel Base, exc. Prop Shaft Parking Brake			CA-5529	CA-5529
1979-81	exc. 13.75 x 1.53" Brakes			CA-5529	CA-5529
1979-81	Motor Home Chassis w/13" x 2.50" Brakes w/158" Wheel Base		CA-5576		
1982-83	w/13" x 2.50" Brakes			CA-5574	CA-5574
1982-83	w/13" x 3.50" Brakes			CA-5529	CA-5529
1984	DRW			CA-5585	CA-5586
1984	exc. Motor Home Chassis, Dual Rear Wheels, 178" Wheel Base			CA-5585	CA-5586
1984	SRW w/178" Wheel Base			CA-5583	CA-5584
1984	w/157" Wheel Base, w/158.5" Wheel Base, w/13" x 2.50" Brakes		CA-5575		
1985-86	DRW, w/13" x 3.50" Brakes, w/158.5" Wheel Base, w/13" x 2.50" Brakes			CA-5585	CA-5586
1985-87	SRW, w/13" x 3.50" Brakes, w/125", 133", 157" Wheel Base, w/13" x 2.50" Brakes exc MHC				CA-5584
1985-89	w/158.5" Wheel Base		CA-5575		
1987	DRW Motor Home Chassis, w/13" x 3.50" Brakes, w/125" Wheel Base, w/137" Wheel Base; 73.50" Cable				CA-5586
1987	DRW, exc. Motor Home Chassis, w/13" x 3.50" Brakes; 85.50" Cable				CA-5625
1987	exc. MHC, w/13" x 2.50" Brakes w/158.5" Wheel Base				CA-5586
1987	DRW, w/13" x 3.50" Brakes			CA-5585	CA-5625
1988-89	DRW, w/13" x 3.50" Brakes				CA-5625
1988-89	SRW, w/13" x 3.50" Brakes, w/125", 133", 157" Wheel Base, w/13" x 2.50" Brakes				CA-5584
1990-93	DRW w/125" & 137" & 158.5" Wheel Base			CA-5585	CA-5625

# BRAKE CABLES

Year	Remark	Front	Intermediate	Rear Left	Rear Right
<b>CHEVROLET TRUCKS (con't)</b>					
<b>P30 (con't)</b>					
1990-93	DRW, w/13" x 3.50" Brakes exc. MHC, w/135" & 157" & 178" WB, w/13" x 3.50" Brakes			CA-5585	CA-5625
1990-93	w/13" x 3.50" w/Motor Home Chassis, w/157" Wheel Base, w/13" x 2.50" Brakes, w/157" Wheel Base, w/158.5" Wheel Base		CA-5575		
<b>R10</b>					
1987	2 Door, w/117.5" Wheel Base			CA-5641	CA-5580
1987	2 Door, w/131.5" Wheel Base	CA-5578		CA-5641	CA-5580
<b>R10 SUBURBAN</b>					
1987-88		CA-5577		CA-5641	
<b>R20</b>					
1987-88	2 & 4 Door, w/13" x 2.50" Brakes w/13" x 3.50" Brakes SRW				CA-5584
1987-88	2 Door SRW, w/13" x 2.50" Brakes w/13" x 3.50" Brakes, w/11.15" x 2.75 Brakes	CA-5578			
1987-88	2 Door, w/11.15" x 2.75 Brakes				CA-5624
<b>R20 SUBURBAN</b>					
1987-88		CA-5577			
<b>R2500</b>					
1989	2 & 4 Door, w/13" x 2.50" Brakes w/13" x 3.50" Brakes SRW				CA-5584
1989	2 Door SRW, w/13" x 2.50" Brakes w/13" x 3.50" Brakes, w/11.15" x 2.75 Brakes	CA-5578			
1989	2 Door, w/11.15" x 2.75 Brakes				CA-5624
<b>R2500 SUBURBAN</b>					
1989		CA-5577			
<b>R30</b>					
1987-88	DRW w/Dana Axle; 53.385" Cable			CA-5583	
1987-88	DRW, exc. Dana Axle			CA-5585	CA-5625
1987-88	SRW, w/13" x 2.50" Brakes, w/13" x 3.50" Brakes				CA-5584
1987-88	w/135.5" Wheel Base	CA-5587			
1987-88	w/159.5" Wheel Base	CA-5578			
<b>R3500</b>					
1989-90	DRW w/Dana Axle			CA-5583	
1989-90	DRW, exc. Dana Axle			CA-5585	CA-5625
1989-90	SRW, w/13" x 2.50" Brakes, w/13" x 3.50" Brakes				CA-5584
1989-90	w/135.5" Wheel Base	CA-5587			
<b>S10</b>					
1982		CA-5562		CA-5570	CA-5570
1983-90	4WD	CA-5564		CA-5610	CA-5610
1983-91	2WD	CA-5562		CA-5570	CA-5566
1983-91	2WD Shortbed		CA-5558		
1991	4WD exc. Shortbed	CA-5564		CA-5610	CA-5610
1991	4WD, Short Bed	CA-5564		CA-6194	
1992-93	2WD	CA-6285		CA-6185	CA-6185
1992-94	4WD	CA-6291		CA-6194	
1994	2WD			CA-6185	CA-6185
1995	2WD			CA-6295	CA-6294
1995	4WD, High Wider Package			CA-6296	CA-6297
1996-97	4WD, High Wider Package, ZR2				CA-6297
1996-97	4WD, Offroad or Chassis Package			CA-6295	
<b>S10 BLAZER</b>					
1983	4WD	CA-5564		CA-5610	CA-5610

# BRAKE CABLES

Year	Remark	Front	Intermediate	Rear Left	Rear Right
<b>CHEVROLET TRUCKS (con't)</b>					
<b>S10 BLAZER (con't)</b>					
1984-91	4WD			CA-5610	CA-5610
1984-90	2 Door 4WD	CA-5564		CA-5610	CA-5610
1984-91	2WD	CA-5562		CA-5570	CA-5570
1992-93	2 Door	CA-6291			
1992-94				CA-6194	
<b>V10</b>					
1987	2 Door, w/117.5" Wheel Base			CA-5641	CA-5580
1987	2 Door, w/131.5" Wheel Base	CA-5578		CA-5641	CA-5580
<b>V10 SUBURBAN</b>					
1987-88		CA-5577		CA-5641	
<b>V1500 SUBURBAN</b>					
1989-91		CA-5577		CA-5641	
<b>V20</b>					
1987	2 & 4 Door, w/13" x 2.50" Brakes w/13" x 3.50" Brakes SRW				CA-5584
1987	2 Door SRW, w/11.15" x 2.75 Brakes, w/13" x 2.50" Brakes w/13" x 3.50" Brakes	CA-5578			
1987	2 Door, w/11.15" x 2.75 Brakes				CA-5624
<b>V20 SUBURBAN</b>					
1987-88	1st Design, w/77 3/4"	CA-5577			CA-5584
<b>V2500 SUBURBAN</b>					
1989-91	1st Design, w/77 3/4"	CA-5577			CA-5584
<b>V30</b>					
1987-88	2 Door Cab	CA-5578			
1987-88	DRW w/Dana Axle			CA-5583	
1987-88	DRW, exc. Dana Axle			CA-5585	CA-5625
1987-88	SRW, w/13" x 2.50" Brakes, w/13" x 3.50" Brakes				CA-5584
1987-88	w/135.5" Wheel Base	CA-5587			
<b>V3500</b>					
1989	w/135.5" Wheel Base	CA-5587			
1989-91	DRW w/Dana Axle			CA-5583	
1989-91	DRW, exc. Dana Axle			CA-5585	CA-5625
1989-91	SRW, w/13" x 2.50" Brakes, w/13" x 3.50" Brakes				CA-5584
<b>CHRYSLER</b>					
<b>CORDOBA</b>					
1980	exc. Taxi & Police Car			CA-5020	CA-5020
1980-83		CA-5012	CA-5034	CA-5030	CA-5030
<b>DAYTONA</b>					
1984-85		CA-5051	CA-5059	CA-5058	CA-5058
1987		CA-5081	CA-5006		
1988	w/Rear Disc Brakes	CA-5081		CA-5065	CA-5065
1988	w/Rear Drum Brakes	CA-5081		CA-5080	CA-5080
1989		CA-5081		CA-5085	CA-5085
<b>DYNASTY</b>					
1988	w/Rear Drum Brakes	CA-5081	CA-5003		
1989	w/Anti-Lock Brakes	CA-5081	CA-5003		
1990	w/Anti-Lock Brakes (Bendix)	CA-5081		CA-5084	CA-5084
1990	w/Rear Disc Brakes, w/Anti-Lock Brakes (Bosch)	CA-5081		CA-5086	CA-5086
1991-93		CA-5081		CA-5084	CA-5084
<b>E CLASS</b>					
1983		CA-5032		CA-5055	CA-5055
1984		CA-5032			

# BRAKE CABLES

Year	Remark	Front	Intermediate	Rear Left	Rear Right
<b>CHRYSLER (con't)</b>					
<b>FIFTH AVENUE</b>					
1983-89	exc. Taxi & Police Car	CA-5012	CA-5034	CA-5030	CA-5030
1983-89	Taxi & Police Car	CA-5012	CA-5034	CA-5062	CA-5062
<b>IMPERIAL</b>					
1981-83		CA-5012	CA-5034	CA-5030	CA-5030
1990	w/Rear Disc Brakes, w/Anti-Lock Brakes (Bosch)	CA-5081		CA-5086	CA-5086
1990	w/Rear Drum Brakes, w/Rear Disc Brakes w/Bendix Anti-Lock Brakes	CA-5081		CA-5084	CA-5084
1991-93		CA-5081		CA-5084	CA-5084
<b>LASER</b>					
1984-86		CA-5051	CA-5059	CA-5058	CA-5058
<b>LEBARON</b>					
1978	exc. Taxi & Police Car	CA-5012		CA-5017	
1978	Taxi & Police Car	CA-5012		CA-5016	CA-5062
1978-81	2 Door Special Coupe			CA-5030	
1978-81	exc. 2 Door Special Coupe		CA-5034		
1979-81	Taxi & Police Car				CA-5062
1979-81		CA-5012		CA-5013	CA-5013
1980	exc. Taxi & Police Car			CA-5020	CA-5020
1982			CA-5033		CA-5036
1982-86		CA-5032			
1983	w/200mm Brakes		CA-5033	CA-5038	CA-5038
1983	w/220mm Brakes			CA-5055	CA-5055
1984-85	w/200mm Brakes		CA-5575	CA-5075	CA-5075
1984-85	w/220mm Brakes			CA-5058	CA-5058
1984-85	w/220mm Brakes, exc. Limousine exc. Executive Sedan		CA-5006		
1986	w/200mm Brakes, exc. Limousine		CA-5575	CA-5061	CA-5061
1986-89	exc. Limousine, w/220mm Brakes	CA-5081	CA-5006	CA-5058	CA-5058
1986-89	Limousine	CA-5081		CA-5060	CA-5060
1986-92	Sedan	CA-5081	CA-5575	CA-5085	CA-5085
1987-88	Coupe	CA-5081	CA-5033	CA-5072	CA-5072
1987-88	GTS			CA-5075	CA-5075
1987-88				CA-5642	CA-5642
1987-89	w/200mm Brakes, exc. Limousine			CA-5061	CA-5061
1988	Sedan		CA-5006		
1989-95	Sedan	CA-5081		CA-5085	CA-5085
1990-91	Coupe & Sedan	CA-5081		CA-5080	CA-5080
1994	Sedan			CA-5080	CA-5080
<b>NEW YORKER</b>					
1982	exc. Taxi & Police Car			CA-5030	CA-5030
1982	Taxi & Police Car			CA-5062	CA-5062
1982		CA-5012	CA-5034		
1983		CA-5032		CA-5055	CA-5055
1984		CA-5032		CA-5058	CA-5058
1985-87		CA-5032		CA-5076	CA-5076
1988	Turbo	CA-5032	CA-5515	CA-5080	CA-5080
1988-90	w/Anti-Lock Brakes (Bendix)			CA-5084	CA-5084
1988-90	w/Rear Disc Brakes, w/Anti-Lock Brakes (Bosch)			CA-5086	CA-5086
1989-95	Rear Drum Brakes	CA-5081	CA-5003	CA-5642	CA-5642
1991-92	w/Rear Disc Brakes w/ABS	CA-5081	CA-5003	CA-5084	CA-5084
<b>TC MASERATI</b>					
1989-91		CA-5081		CA-5065	CA-5065

# BRAKE CABLES

Year	Remark	Front	Intermediate	Rear Left	Rear Right
<b>CHRYSLER TRUCKS</b>					
<b>TOWN &amp; COUNTRY</b>					
1978	exc. Taxi & Police Car			CA-5017	
1978	Taxi & Police Car			CA-5016	
1980	exc. Taxi & Police Car	CA-5012		CA-5020	CA-5020
1980	Taxi & Police Car	CA-5012		CA-5023	CA-5023
1981	exc. Taxi & Police Car	CA-5012	CA-5034	CA-5030	CA-5030
1981	Taxi & Police Car	CA-5012	CA-5034	CA-5062	CA-5062
1982		CA-5012	CA-5033		CA-5036
1982-88		CA-5032			
1983	w/200mm Brakes	CA-5012	CA-5059	CA-5038	CA-5038
1983	w/220mm Brakes	CA-5012		CA-5055	CA-5055
1984-87	w/200mm Brakes	CA-5012	CA-5575	CA-5075	CA-5075
1984-87	w/220mm Brakes	CA-5012	CA-5006	CA-5058	CA-5058
1986	w/200mm Brakes	CA-5012		CA-5061	CA-5061
1988		CA-5012	CA-5006	CA-5080	CA-5080
1990		CA-5012		CA-5039	CA-5039
2000		CA-5012			
<b>DODGE</b>					
<b>400</b>					
1982		CA-5032	CA-5033	CA-5036	CA-5036
1983	2.2L; w/200mm Brakes	CA-5032	CA-5033	CA-5038	CA-5038
1983	2.6L; w/220mm Brakes	CA-5032		CA-5055	CA-5055
<b>600</b>					
1983		CA-5032		CA-5055	CA-5055
1983-86	4 Door	CA-5032		CA-5076	CA-5076
1983-86	exc. 4 Door, w/200mm Brakes	CA-5032		CA-5075	CA-5075
1983-88	exc. 4 Door, w/220mm Brakes	CA-5032		CA-5058	CA-5058
1986-88	exc. 4 Door, w/200mm Brakes	CA-5032		CA-5061	CA-5061
1986-88		CA-5032		CA-5080	CA-5080
1987	w/220mm Brakes	CA-5032		CA-5076	CA-5076
<b>ARIES</b>					
1981	To 11/16/81			CA-5036	CA-5036
1981	To 2/10/81			CA-5035	
1981-85	From 11/16/81	CA-5032	CA-5033		
1981-87	w/200mm Brakes		CA-5575	CA-5075	CA-5075
1981-87	w/220mm Brakes		CA-5006	CA-5058	CA-5058
1982-83	w/200mm Brakes		CA-5033	CA-5038	CA-5038
1983	w/220mm Brakes			CA-5055	CA-5055
1986-89	w/200mm Brakes	CA-5032	CA-5006	CA-5642	CA-5642
1986-89	w/220mm Brakes	CA-5032	CA-5006	CA-5080	
<b>ASPEN</b>					
1976-77	2 Door Special Coupe & 4 Door Sedan exc. 3.54 Axle Ratio, 3.55 Axle Ratio	CA-5012		CA-5017	
1976-77	2 Door Special Coupe & 4 Door Sedan w/3.54 Axle Ratio, w/3.55 Axle Ratio, Wagon	CA-5012		CA-5016	
1978	2 Door Special Edition, exc. Taxi & Police	CA-5012		CA-5017	
1978	Special Edition, exc. Taxi, 2 Door & Police Car	CA-5012		CA-5016	
1979		CA-5012		CA-5013	CA-5013
1980	Taxi & Police Car	CA-5012			CA-5023
1980		CA-5012		CA-5020	CA-5020
<b>CHARGER</b>					
1983-86	From 11/20/83	CA-5024		CA-5039	CA-5039
1985-87	Shelby			CA-5078	CA-5078
1986-87	Shelby	CA-5024			
<b>DART</b>					
1960-76				CA-5009	CA-5009

# BRAKE CABLES

Year	Remark	Front	Intermediate	Rear Left	Rear Right
<b>DODGE (con't)</b>					
<b>DAYTONA</b>					
1984-93		CA-5051	CA-5059	CA-5058	CA-5058
1987-92		CA-5081	CA-5006		
1988-91	w/Rear Disc Brakes			CA-5065	CA-5065
1988-91	w/Rear Drum Brakes			CA-5080	CA-5080
<b>DIPLOMAT</b>					
1977	2 Door Special Coupe & 4 Door Sedan exc. 3.54 Axle Ratio, 3.55 Axle Ratio			CA-5017	
1977	2 Door Special Coupe & 4 Door Sedan w/3.54 Axle Ratio, w/3.55 Axle Ratio, 2 Seat Wagon			CA-5016	
1978	exc. Taxi & Police Car	CA-5012	CA-5034	CA-5017	CA-5030
1978	Taxi & Police Car	CA-5012	CA-5034	CA-5016	CA-5062
1979-89	exc. Taxi & Police Car	CA-5012	CA-5034	CA-5030	CA-5030
1979-89	Taxi & Police Car	CA-5012	CA-5034	CA-5062	CA-5062
1979-81	exc. 2 Door Special Coupe		CA-5034		
1979-83				CA-5013	CA-5013
1980	exc. Taxi & Police Car			CA-5020	CA-5020
1980	Taxi & Police Car			CA-5023	CA-5023
<b>DYNASTY</b>					
1988-91	w/Anti-Lock Brakes (Bendix)			CA-5084	CA-5084
1988-91	w/Rear Disc Brakes, w/Anti-Lock Brakes (Bosch)			CA-5086	CA-5086
1988-93	w/Rear Drum Brakes	CA-5081	CA-5003		
1988-93		CA-5081		CA-5084	CA-5084
1989	w/Anti-Lock Brakes	CA-5081	CA-5003		
<b>LANCER</b>					
1985-86			CA-5575		
1985-89		CA-5081		CA-5075	CA-5075
1987		CA-5032	CA-5033		
1988-89		CA-5032			
<b>MIRADA</b>					
1980	exc. Taxi & Police Car	CA-5012		CA-5020	CA-5020
1980	Taxi & Police Car	CA-5012		CA-5023	CA-5023
1981-83		CA-5012	CA-5034	CA-5030	CA-5030
<b>OMNI</b>					
1978-86	2 Door Hatchback	CA-5024			
1978-86	4 Door Hatchback	CA-5025			
1981				CA-5014	CA-5014
1981-82	From 2/10/81			CA-5037	CA-5037
1983-86	exc. GLH			CA-5039	CA-5039
1983-90		CA-5025		CA-5039	CA-5039
1985				CA-5078	CA-5078
1986	GLH			CA-5078	CA-5078
<b>SHADOW</b>					
1987	exc. Shelby		CA-5059	CA-5061	CA-5061
1988			CA-5059	CA-5642	CA-5642
1989-90			CA-5059	CA-5085	CA-5085
1991-94		CA-5081	CA-5059	CA-5645	CA-5645
1992-94	w/Rear Disc Brakes, w/Anti-Lock Brakes	CA-5081	CA-5059	CA-5085	CA-5085
1992-94	w/Rear Drum Brakes	CA-5081	CA-5059	CA-5645	CA-5645
<b>SPIRIT</b>					
1989-95		CA-5081		CA-5085	CA-5085
<b>DODGE TRUCKS</b>					
<b>B100</b>					
1971-73	w/10" x 2.50" Brakes, w/109" Wheel Base, w/127" Wheel Base, w/Rear Drum Brakes			CA-5015	CA-5015



# BRAKE CABLES

Year	Remark	Front	Intermediate	Rear Left	Rear Right
<b>DODGE TRUCKS (con't)</b>					
<b>B100 (con't)</b>					
1972-79	w/10" x 2.50" Brakes, w/109" Wheel Base, w/127" Wheel Base			CA-5015	CA-5015
1974	w/109" Wheel Base, w/127" Wheel Base			CA-5015	CA-5015
1977	w/109" Wheel Base, w/127" Wheel Base			CA-5015	CA-5015
1978	w/109" Wheel Base, w/127" Wheel Base			CA-5015	CA-5015
1980	w/109" Wheel Base, w/127" Wheel Base			CA-5022	CA-5021
<b>B150</b>					
1981	109" Wheel Base			CA-5022	CA-5021
1981-88	127" Wheel Base	CA-5052		CA-5022	CA-5021
1984-88	109" Wheel Base	CA-6233		CA-5053	CA-6030
1984-88	127" Wheel Base			CA-5053	CA-6030
1989	109" Wheel Base, w/127" Wheel Base, w/145" Wheel Base, w/163" Wheel Base	CA-6229		CA-5082	CA-5083
1990-92	109" Wheel Base, 127" Wheel Base	CA-6229		CA-5082	CA-6231
<b>B200</b>					
1972-79	w/109" Wheel Base, w/127" Wheel Base			CA-5015	CA-5015
1980	w/109" Wheel Base, w/127" Wheel Base			CA-5022	CA-5021
<b>B250</b>					
1981-83	109" Wheel Base, 127" Wheel Base			CA-5022	CA-5021
1981-94	127" Wheel Base	CA-5052			
1984-88	109" Wheel Base	CA-6233		CA-5053	CA-6030
1984-88	127" Wheel Base	CA-6229		CA-5053	CA-6030
1989	w/109" Wheel Base, w/127" Wheel Base, w/145" Wheel Base, w/163" Wheel Base	CA-6229		CA-5082	CA-5083
1990-92	109" Wheel Base, 127" Wheel Base	CA-6229		CA-5082	CA-6231
<b>B2500</b>					
1997					CA-6230
<b>B300</b>					
1971-74	School Bus, w/109" & w/127" Wheel Base			CA-5043	
1972-74	exc. School Bus, exc. 109" Wheel Base				CA-5044
1974					CA-5042
1975-77	School Bus			CA-5043	
1975-78	exc. School Bus, exc. 109" Wheel Base				CA-5044
1978-79	School Bus, w/109" & w/127" Wheel Base			CA-5043	
1980	From 3/3/80, School Bus			CA-5043	
1980					CA-5042
<b>B350</b>					
1981-83	School Bus			CA-5043	CA-5042
1984-88		CA-5079		CA-5043	CA-5042
1989	exc. 145", 163" Wheel Base	CA-6229		CA-5043	
1989	w/145" Wheel Base, w/163" Wheel Base			CA-5043	CA-6230
1990-93		CA-6229		CA-5043	CA-6230
1994	12" Brakes			CA-5043	CA-6230
<b>B3500</b>					
1995-96	12" Brakes				CA-6230
1997					CA-6230
<b>CARAVAN</b>					
1984-00	w/112" Wheel Base		CA-5049	CA-5071	CA-5071
1984-86		CA-5057	CA-5049		
1987		CA-5050	CA-5049	CA-5048	CA-5048
1987-89	119" Wheel Base	CA-5057		CA-6238	CA-6238
1987-89		CA-5057	CA-6237		
<b>CB300</b>					
1974-79	exc. School Bus, exc. 109" Wheel Base				CA-5044
1974-79	School Bus			CA-5043	

# BRAKE CABLES

Year	Remark	Front	Intermediate	Rear Left	Rear Right
<b>DODGE TRUCKS (con't)</b>					
<b>CB300 (con't)</b>					
1977	exc. School Bus, exc. 109" Wheel Base				CA-5043
1980	To 3/3/80, w/109" Wheel Base	CA-5028			
1980					CA-5042
<b>D100</b>					
1970-73	w/10" x 2.50" Brakes			CA-5011	CA-5567
1970-73	w/149" Wheel Base, w/11" x 2.50" Brakes			CA-5011	CA-5010
1971	w/115" Wheel Base, w/131" Wheel Base	CA-5027	CA-5026	CA-5047	CA-5046
1974				CA-5011	CA-5567
1976-77				CA-5011	CA-5567
1978-79	w/10" x 2.50" Brakes			CA-5011	CA-5567
1978-79	w/149" Wheel Base, w/11" x 2.50" Brakes			CA-5011	CA-5010
1986-87	w/115" Wheel Base, w/131" Wheel Base	CA-5027	CA-5026	CA-5047	CA-5046
1988-89	w/115" Wheel Base, w/131" Wheel Base	CA-5027	CA-5026	CA-5068	CA-5064
<b>D150</b>					
1977				CA-5011	CA-5567
1977-79	w/149" Wheel Base, w/11" x 2.50" Brakes				CA-5010
1977-81	w/10" x 2.50" Brakes				CA-5567
1978-81				CA-5011	
1978-83	w/115" Wheel Base, w/131" Wheel Base, w/149" Wheel Base	CA-5027	CA-5026	CA-5011	CA-5567
1980-81	2WD & 4WD w/131" Wheel Base & 11 x 2.50" Brakes, 2WD only with all other combinations	CA-5027	CA-5026		CA-5010
1984-87	w/115" Wheel Base, w/131" Wheel Base	CA-5027	CA-5026	CA-5047	CA-5046
1988-89	w/115" Wheel Base, w/131" Wheel Base	CA-5027	CA-5026	CA-5068	CA-5064
1990-93	w/115" Wheel Base, w/131" Wheel Base, w/149" Wheel Base	CA-5027	CA-5026	CA-5068	CA-5064
<b>D200</b>					
1968	w/131" Wheel Base	CA-5028	CA-5026		
1968-72	w/12" x 2.50" Brakes			CA-5044	CA-5041
1968-72	w/12" x 2.50" Brakes, w/12" x 3" Brakes				CA-5041
1968-72	w/12.12" x 2" Brakes			CA-5011	
1973-74	exc. 12" x 2" Brakes, 12" x 2.50" Brakes, w/12" x 3" Brakes, w/131", 149", 165" Wheel Base				CA-5041
1973-74	w/131" Wheel Base, w/149" Wheel Base, w/165" Wheel Base, exc. 12" x 3" Brakes			CA-5044	
1976-77	exc. 12" x 2" Brakes, 12" x 2.50" Brakes, 12" x 3" Brakes, w/131", 149", 165" Wheel Base				CA-5041
1976-77	w/131" Wheel Base, w/149" Wheel Base, w/165" Wheel Base, exc. 12" x 3" Brakes			CA-5044	
1978-80	w/12" x 2.50" Brakes			CA-5044	
1978-80	w/12" x 2.50" Brakes, w/12" x 3" Brakes			CA-5044	CA-5041
1978-80	w/12.12" x 2" Brakes			CA-5011	
1980	w/131" Wheel Base	CA-5028	CA-5026		
<b>D250</b>					
1981	131" Wheel Base	CA-5028	CA-5026		
1981	w/12" x 2.50" Brakes, w/12" x 3" Brakes	CA-5028		CA-5044	CA-5041
1981	w/12.12" x 2" Brakes	CA-5028		CA-5011	
1982	w/131" Wheel Base, w/149" Wheel Base, w/88.38" Rear Cable	CA-5028			CA-5041
1982	131" Wheel Base, 149" Wheel Base	CA-5028		CA-5044	
1983	131" Wheel Base, 149" Wheel Base	CA-5028		CA-5044	CA-5041
1984-87		CA-5028		CA-5044	CA-5041
1988		CA-5066		CA-5067	CA-5070
1989	131" Wheel Base	CA-5066		CA-5067	CA-6228
1990-93	131" Wheel Base, 149" Wheel Base	CA-5066		CA-5067	CA-6228

# BRAKE CABLES

Year	Remark	Front	Intermediate	Rear Left	Rear Right
<b>DODGE TRUCKS (con't)</b>					
<b>D300</b>					
1969-71				CA-5044	CA-5041
1976-77				CA-5044	CA-5041
1980		CA-5028			CA-5041
<b>D350</b>					
1981		CA-5028			CA-5041
1982-85		CA-5028		CA-5044	CA-5041
1986-87	w/131" Wheel Base, w/135" Wheel Base, w/159" Wheel Base	CA-5028		CA-5044	CA-5041
1988	w/131" Wheel Base, w/135" Wheel Base, w/159" Wheel Base				CA-5070
1988-93	w/131" Wheel Base, w/135" Wheel Base, w/159" Wheel Base			CA-5067	CA-5070
1989-93	131" Wheel Base, 149" Wheel Base				CA-6228
<b>D400, D450</b>					
1978-79				CA-5044	CA-5041
<b>DAKOTA</b>					
1987	4WD, w/111.9" Wheel Base		CA-5005		
1987-89	w/10" Brakes			CA-5074	CA-5074
1987-89	w/9" Brakes			CA-5073	CA-5073
1987-90	2WD; 111.9" Wheel Base		CA-6237		
1987-90	2WD; 123.9" Wheel Base		CA-6235		
1988-02	4WD, w/111.9" Wheel Base		CA-5003		
<b>MINI RAM</b>					
1984-88	119" Wheel Base			CA-6238	CA-6238
1987-88	w/112" Wheel Base	CA-5057	CA-6237	CA-5071	CA-5071
1984-85		CA-5050	CA-5049	CA-5048	CA-5048
1986		CA-5057	CA-5049	CA-5048	CA-5048
<b>RAMCHARGER</b>					
1986-87		CA-6234			CA-6236
1988-93		CA-6234			
<b>ROYAL MINI RAM</b>					
1984		CA-5050	CA-5049	CA-5048	CA-5048
1985-86		CA-5057	CA-5049	CA-5048	CA-5048
1987	w/112" Wheel Base	CA-5057		CA-5071	CA-5071
<b>W100</b>					
1969-70	115" Wheel Base, 131" Wheel Base	CA-5027	CA-5026	CA-5047	
1971-72	w/115" Wheel Base, w/133" Wheel Base			CA-5011	CA-5567
1971-72	w/133" Wheel Base				CA-5010
1976-77	w/115" Wheel Base			CA-5011	CA-5567
1976-77	w/133" Wheel Base			CA-5011	CA-5010
1986-87	115" Wheel Base, 131" Wheel Base	CA-5027	CA-5026	CA-5047	CA-6236
1988-89	115" Wheel Base, 131" Wheel Base	CA-5027	CA-5026	CA-5068	CA-5064
<b>W150</b>					
1978-79	w/115" Wheel Base, w/135" Wheel Base w/o Reinforcement			CA-5011	CA-5011
1978-79	w/131" Wheel Base				CA-5567
1978-79	w/149" Wheel Base				CA-5010
1980-81	2WD	CA-5027		CA-5011	
1980-81	w/133" Wheel Base		CA-5504	CA-5011	CA-5010
1980-83	115" Wheel Base, 131" Wheel Base		CA-5026		CA-5567
1982-83	w/115" Wheel Base, w/131" Wheel Base, w/149" Wheel Base	CA-5027	CA-5026	CA-5011	CA-5567
1984-85	115" Wheel Base, 131" Wheel Base	CA-5027	CA-5026	CA-5011	CA-5567
1986-87	115" Wheel Base, 131" Wheel Base		CA-5026	CA-5047	CA-6236
1988-89	115" Wheel Base, 131" Wheel Base	CA-5027	CA-5026	CA-5068	CA-5064

# BRAKE CABLES

Year	Remark	Front	Intermediate	Rear Left	Rear Right
<b>DODGE TRUCKS (con't)</b>					
<b>W150 (con't)</b>					
1990-93	w/115", w/131", w/149" Wheel Base	CA-5027	CA-5026	CA-5068	CA-5064
<b>W200</b>					
1969	w/131" Wheel Base, w/149" Wheel Base	CA-5028			
1970-71	w/131" Wheel Base, w/133" Wheel Base, w/135" Wheel Base, w/149" Wheel Base	CA-5028		CA-5044	CA-5041
1972	w/131" Wheel Base, w/149" Wheel Base	CA-5028		CA-5044	CA-5041
1976-79	w/131" Wheel Base, w/149" Wheel Base	CA-5028		CA-5044	CA-5041
1978-79	w/131", w/133", w/135", w/149" Wheel Base	CA-5028		CA-5044	CA-5041
1980	w/131" Wheel Base, w/149" Wheel Base	CA-5028			
<b>W250</b>					
1981-83	w/131" Wheel Base, w/149" Wheel Base	CA-5028		CA-5044	CA-5041
1984-87		CA-5028		CA-5044	CA-5041
1988		CA-5066		CA-5067	CA-5070
1989	131" Wheel Base	CA-5066		CA-5067	CA-6228
1990-93	131" Wheel Base	CA-5066		CA-5067	CA-6228
1990-93	135" Wheel Base	CA-5066			CA-6228
1990-93	w/149" Wheel Base			CA-5067	
<b>W300</b>					
1969-70				CA-5044	CA-5041
1976-79				CA-5044	CA-5041
1980	w/Frame Reinforcement, w/135" Wheel Base, w/149" Wheel Base, w/159" Wheel Base	CA-5028		CA-5044	CA-5041
<b>W350</b>					
1981	w/Frame Reinforcement, w/135" Wheel Base, w/149" Wheel Base, w/159" Wheel Base	CA-5028		CA-5044	CA-5041
1982-85	w/131", w/135", w/149" Wheel Base	CA-5028		CA-5044	CA-5041
1986-87	131" Wheel Base, 135" Wheel Base	CA-5028		CA-5044	CA-5041
1988	131" Wheel Base, 135" Wheel Base	CA-5066		CA-5067	CA-5070
1989-93	131" Wheel Base, 135" Wheel Base	CA-5066		CA-5067	CA-6228
<b>FORD</b>					
<b>COUNTRY SQUIRE</b>					
1969				CA-5202	CA-5283
1969-73					CA-5283
1970-74	To 4/8/74			CA-5203	CA-5283
1974	From 4/8/74			CA-5203	CA-5283
1987-89		CA-5212		CA-5229	CA-5232
<b>CROWN VICTORIA</b>					
2001		CA-6267		CA-6266	CA-6264
2001		CA-6267		CA-6272	CA-6265
2002	Long Wheel Base			CA-6273	
2002	Short Wheel Base			CA-6272	
2002					CA-6268
2002					CA-6271
2003	Long Wheel Base			CA-6276	
2003	Short Wheel Base			CA-6278	
2003		CA-6280			
2003-04					CA-6274
2003-04					CA-6277
<b>CUSTOM</b>					
1969				CA-5202	CA-5283
1970-72				CA-5203	CA-5283
<b>CUSTOM 500</b>					
1969				CA-5202	CA-5283
1970-74				CA-5203	CA-5283
1975-76				CA-5203	CA-5206

# BRAKE CABLES

Year	Remark	Front	Intermediate	Rear Left	Rear Right
<b>FORD (con't)</b>					
<b>ESCORT</b>					
1981-90	w/Equilizer Rod	CA-6330			
1981-98		CA-6283		CA-5227	CA-5227
1992-96	w/Rear Disc Brakes			CA-6289	CA-6287
1992-96	w/Rear Drum Brakes				CA-6302
1997-02	w/Rear Disc Brakes			CA-6316	CA-6313
1997-02	w/Rear Drum Brakes			CA-6315	CA-6314
1999-02		CA-6283			
<b>EXP</b>					
1982-85				CA-5227	CA-5227
<b>FAIRMONT</b>					
1983	Futura	CA-5231	CA-5223	CA-5233	CA-5233
<b>FIESTA</b>					
1978-80				CA-5261	
<b>GALAXIE 500</b>					
1969				CA-5202	CA-5283
1970-74	To 4/8/74			CA-5203	CA-5283
1974	From 4/8/74			CA-5203	CA-5283
<b>GRAN TORINO</b>					
1973-76				CA-5205	CA-5208
1975	2 Door Hardtop	CA-5204			
<b>GRANADA</b>					
1977-80	From 2/14/77, w/Rear Drum Brakes	CA-5215		CA-5209	CA-5209
1981-82	Transverse Cable		CA-5244		
1981-82		CA-5224	CA-5223	CA-5222	CA-5222
<b>LTD</b>					
1969				CA-5202	CA-5283
1970-74				CA-5203	CA-5283
1971-81		CA-5231	CA-5223		
1971-86	Transverse Cable		CA-5244		
1975-79	w/Front Disc Brakes	CA-5212		CA-5203	CA-5206
1980-81	exc. 5.0L High Output Taxi & Police Car				CA-5216
1980-81	From 3/3/80, 5.0L Taxi & Police Car, w/HO	CA-5212		CA-5229	CA-5228
1982-86		CA-5231	CA-5223	CA-5233	CA-5233
<b>LTD CROWN VICTORIA</b>					
1987-91		CA-5212		CA-5229	CA-5232
<b>LTD II</b>					
1977-79	From 3/14/77	CA-5204		CA-5205	CA-5208
<b>MUSTANG</b>					
1965				CA-5201	CA-5201
1968-95	exc. SVO			CA-5237	CA-5237
1971-82				CA-5217	CA-5217
1990-93	Rear Drum Brakes			CA-5237	CA-5237
1993	Rear Disc Brakes			CA-6286	CA-6286
1994-98				CA-6299	CA-6293
<b>PINTO</b>					
1976-80				CA-5207	CA-5207
<b>PROBE</b>					
1989-92		CA-6283			
<b>TAURUS</b>					
1986-92	w/Rear Drum Brakes, exc. SHo	CA-5272		CA-5270	CA-5271
1989-91	w/Rear Disc Brakes	CA-5272			
1993-94	Wagon, w/Rear Drum Brakes	CA-5272		CA-5270	CA-5271
<b>TEMPO</b>					
1984-94	w/Equilizer Rod	CA-6330			

# BRAKE CABLES

Year	Remark	Front	Intermediate	Rear Left	Rear Right
<b>FORD (con't)</b>					
<b>TEMPO (con't)</b>					
1985				CA-5264	CA-5264
1986-94	2WD			CA-5273	CA-5273
1986-94	AWD			CA-5264	CA-5264
<b>THUNDERBIRD</b>					
1969				CA-5202	CA-5283
1970-71					CA-5283
1975-76	w/Rear Drum Brakes			CA-5205	CA-5208
1977-79	From 3/14/77	CA-5204		CA-5205	CA-5208
1980-82	Transverse Cable		CA-5230		
1980-82		CA-5224		CA-5222	CA-5222
1983-86	w/Rear Drum Brakes	CA-5231	CA-5246	CA-5233	CA-5233
1983-95	Transverse Cable		CA-5251		
1987-88	w/Rear Disc Brakes or 2.3L Turbo			CA-5276	CA-5277
1987-88	w/Rear Drum Brakes or 2.3L Turbo	CA-5231	CA-5246	CA-5233	CA-5233
1989-95	w/Hand Control		CA-5246		
1989-95	w/Rear Disc Brakes				CA-5281
1989-95	w/Rear Drum Brakes			CA-5279	CA-5279
<b>TORINO</b>					
1975	To 12/10/75	CA-5204		CA-5205	CA-5208
1976				CA-5205	CA-5208
<b>FORD TRUCKS</b>					
<b>AEROSTAR</b>					
1986-94		CA-6202		CA-6045	CA-6045
1995-97		CA-6202			
<b>BRONCO</b>					
1978-79				CA-5220	CA-5221
1980-83				CA-5253	CA-5245
1984-87	To 2/87	CA-6225		CA-5253	CA-5257
1987-91	From 2/87	CA-6225		CA-5255	CA-5257
1992-96		CA-6290		CA-6220	CA-6219
<b>BRONCO II</b>					
1984	To 6/84	CA-5248		CA-5249	CA-5247
1984-86	From 6/84	CA-5263		CA-5267	CA-5266
1987-88		CA-5263		CA-5267	CA-5274
1989-90		CA-5263		CA-5267	CA-6206
<b>E SUPER DUTY</b>					
1996	6300, 7800 lb. Rear Axle, Commercial Stripped Chassis	CA-6212			
1996	8,000 lb. Rear Axle exc. 176" Wheel Base				CA-6218
1996	exc. 176" Wheel Base			CA-6216	
1996	exc. 8,000 lb. Rear Axle, exc. 176" Wheel Base				CA-6217
1996	exc. Commercial, exc. Recreation Stripped Chassis, 6300 lb., 7800 lb., 8000 lb. Rear Axle, exc. 176" Wheel Base	CA-6213			
<b>E-100 ECONOLINE</b>					
1980-83	w/124" Wheel Base	CA-5258		CA-5225	CA-5265
1980-83	w/138" Wheel Base	CA-5226		CA-5225	CA-5265
<b>E-150 ECONOLINE</b>					
1980-02	124" Wheel Base	CA-5258		CA-5225	CA-5265
1980-02	138" Wheel Base	CA-5226		CA-5225	CA-5265
1984-87	124" Wheel Base	CA-6204		CA-5225	CA-5265
1984-87	138" Wheel Base	CA-6203		CA-5225	CA-5265
1988-91	138" Wheel Base	CA-6207		CA-5225	CA-5265
1992-94	exc. Commercial, exc. Recreation Stripped Chassis	CA-6213			

# BRAKE CABLES

Year	Remark	Front	Intermediate	Rear Left	Rear Right
<b>FORD TRUCKS (con't)</b>					
<b>E-150 ECONOLINE (con't)</b>					
1992-96		CA-6213		CA-6211	CA-6210
1997-00				CA-6211	
<b>E-250 ECONOLINE</b>					
1975-79	138" Wheel Base	CA-5226		CA-5241	CA-5238
1980-87	To 2/87, w/138" Wheel Base	CA-5226		CA-5241	CA-5240
1987	From 2/87; 138" Wheel Base	CA-6203			
1988-91	138" Wheel Base	CA-6207			
1992-94	exc. Commercial, exc. Recreation Stripped Chassis	CA-6213		CA-6216	CA-6217
1995-96		CA-6213		CA-6216	CA-6217
<b>E-350 ECONOLINE</b>					
1975-79	w/138" Wheel Base				CA-5238
1980-82	w/138" Wheel Base, w/158" Wheel Base	CA-5226		CA-5241	CA-5240
1983-87	To 2/87, w/138" Wheel Base, exc. Stripped Chassis	CA-5226			
1983-91	w/138" Wheel Base, w/158" Wheel Base, w/176" Wheel Base			CA-5241	CA-5240
1984-91	158" Wheel Base, Stripped Chassis	CA-6205			
1987	From 2/87; 138" Wheel Base	CA-6203			
1988-91	138" Wheel Base, exc. Stripped Chassis	CA-6207			
1992-94	8,000 lb. Rear Axle			CA-6216	CA-6218
1992-94	Commercial Stripped Chassis	CA-6212		CA-6216	
1992-94	exc. 8,000 lb. Rear Axle			CA-6216	CA-6217
1992-94	exc. Commercial, exc. Recreation Stripped Chassis	CA-6213		CA-6216	
1995-96	6300, 7800 lb. Rear Axle, Commercial Stripped Chassis	CA-6212			
1995-96	8,000 lb. Rear Axle exc. 176" Wheel Base			CA-6216	CA-6218
1995-96	exc. 8,000 lb. Rear Axle, exc. 176" Wheel Base			CA-6216	CA-6217
1995-96	exc. Commercial, exc. Recreation Stripped Chassis, 6300 lb., 7800 lb., 8000 lb. Rear Axle, exc. 176" Wheel Base	CA-6213			
<b>EXPEDITION</b>					
1997-98		CA-6307		CA-6311	CA-6312
1998-02	from 9/16/98	CA-6307		CA-6321	CA-6320
<b>EXPLORER</b>					
1991-92				CA-6222	CA-5275
1998-02		CA-6309			
<b>F SUPER DUTY</b>					
1990-91	Ambulance Package			CA-6208	CA-6209
1992-95	exc. Ambulance Package			CA-6215	CA-6214
<b>F-100</b>					
1976-77	w/116" Wheel Base, w/133" Wheel Base, w/138" Wheel Base, w/155" Wheel Base	CA-5211		CA-5219	CA-5218
1978-79	w/116" Wheel Base, w/133" Wheel Base, w/155" Wheel Base	CA-5211		CA-5219	CA-5218
1980-83	Ambulance Package	CA-5236		CA-6208	CA-6209
1980-83	exc. Ambulance Package, w/116", 133", 138", 155" Wheel Base	CA-5236		CA-5253	CA-5245
<b>F-150</b>					
1976-77	w/116", w/133", w/138", w/155" Wheel Base	CA-5211		CA-5219	CA-5218
1977-84	exc. Ambulance Package, w/116", 133", 138", 155" Wheel Base			CA-5253	CA-5245
1978-79	w/116", w/133", w/155" Wheel Base			CA-5219	CA-5218
1980-83	w/133" Wheel Base	CA-5236			

# BRAKE CABLES

Year	Remark	Front	Intermediate	Rear Left	Rear Right
<b>FORD TRUCKS (con't)</b>					
<b>F-150 (con't)</b>					
1980-95	Ambulance Package			CA-6208	CA-6209
1984-86	w/133" Wheel Base, w/136" Wheel Base, exc. Ambulance Package	CA-5259			
1984-87	To 2/87, exc. Ambulance Package, w/116", 133", 136", 138", 155" Wheel Base			CA-5253	
1984-91	116" Wheel Base	CA-6226			
1984-91	138" Wheel Base	CA-6227			
1984-91	exc. Ambulance Package, w/116", 133", 136", 138", 155" Wheel Base				CA-5257
1987-91	From 2/87, exc. Ambulance Package, w/116", 133", 136", 138", 155" Wheel Base			CA-5255	
1987-91	w/133" Wheel Base, w/136" Wheel Base	CA-5259			
1992-95	exc. Ambulance Package			CA-6220	CA-6219
1992-95	w/97.5" Rear Right Cable	CA-6307		CA-6304	CA-6305
1992-96	113" & 157" Wheel Base	CA-6290		CA-6300	
1996	To 6/96; 120", 139" Wheel Base	CA-6290		CA-6220	
1996	To 6/96; 120", 139", 157" Wheel Base	CA-6290			CA-6219
1996	To 6/96; w/97.5" Rear Right Cable	CA-6307		CA-6304	CA-6305
1996	w/74.02" Intermedaite cable			CA-6306	
1997	To 9/97; 109" to 120" or 157" Wheel Base	CA-6307			
1997	To 9/97; 109" to 120" Wheel Base			CA-6306	CA-6303
1997	To 9/97; 139" Wheel Base	CA-6298		CA-6304	CA-6301
1997	To 9/97; w/157" Wheel Base			CA-6305	
1997-98	w/157" Wheel Base	CA-6307			CA-6318
1998	120" Wheel Base	CA-6307		CA-6306	
1998	w/139" Wheel Base	CA-6307			CA-6319
1998	w/139" Wheel Base exc. 7700 series	CA-6307			CA-6318
1998					CA-6310
1999	120" Wheel Base w/Rear Drum Brakes			CA-6306	CA-6310
1999	w/139" Wheel Base & Rear Drum Brakes exc. 7700 series				CA-6318
1999	w/157" Wheel Base & Rear Drum Brakes				CA-6318
2000-04	120" Wheel Base w/Rear Drum Brakes			CA-6306	
<b>F-250</b>					
1976-77	4WD, w/Regular Cab, From Serial #Y60,001	CA-5211		CA-5239	CA-5238
1978-79	Regular Cab			CA-5239	CA-5238
1978-96	4WD, w/Regular Cab, From Serial #Y60,001			CA-5239	
1980-83	133", 136" Wheel Base, Ambulance Package	CA-5236		CA-6208	CA-6209
1980-86	To 2/86, exc. Ambulance Package, w/133", 136", 138", 155", 168" Wheel Base			CA-5242	CA-5243
1984-86	To 2/86; 138" Wheel Base	CA-6227			
1984-91	w/133" Wheel Base, w/136" Wheel Base	CA-5259			
1984-97	Ambulance Package			CA-6208	CA-6209
1986	From 2/86, exc. Ambulance Package, w/133", 136", 138", 155", 160", 168" Wheel Base			CA-5278	
1986-91	exc. Ambulance Package, w/133", 136", 138", 155", 168" Wheel Base			CA-5278	CA-5243
1992-96	exc. Ambulance Package	CA-6290		CA-6215	CA-6214
1997-99	w/Rear Disc Brakes	CA-6307			
<b>F-350</b>					
1978-79	4WD, w/133" Wheel Base	CA-5211		CA-5239	CA-5238
1980-83	w/133" Wheel Base, w/136" Wheel Base	CA-5236			
1980-86	To 2/86, exc. Ambulance Package, w/133", 136", 138", 155", 160", 168" Wheel Base			CA-5242	CA-5243
1980-91	Ambulance Package			CA-6208	CA-6209



# BRAKE CABLES

Year	Remark	Front	Intermediate	Rear Left	Rear Right
<b>FORD TRUCKS (con't)</b>					
<b>F-350 (con't)</b>					
1984-91	w/133" Wheel Base, w/136" Wheel Base	CA-5259			
1986-91	From 2/86, exc. Ambulance Package, w/133", 136", 138", 155", 160", 168" Wheel Base			CA-5278	CA-5243
1992-95	exc. Ambulance Package	CA-6290		CA-6215	CA-6214
1996-97					
<b>RANCHERO</b>					
1975-79		CA-5204		CA-5205	CA-5208
<b>RANGER</b>					
1983		CA-5254			CA-5234
1984	w/114" Wheel Base	CA-5254			
1983-85	To 6/85, exc. 3,200 lb. Axle; w/108", w/114", w/125" Wheel Base			CA-5235	
1983-92	125" Wheel Base	CA-6201			
1984-85	From 6/84 To 6/85, w/3,200 lb. Axle			CA-5269	CA-5268
1984	To 6/84				CA-5234
1984	w/104" Wheel Base	CA-5248			
1985-86	w/104" Wheel Base	CA-5263			CA-5268
1985-89	From 6/85 To 3/90, w/114" Wheel Base	CA-5262			
1985-90	108" Wheel Base	CA-6200			
1987-88				CA-5269	CA-5275
1989-92	9" Brakes			CA-5269	CA-6206
1989-92	w/10" Brakes			CA-5269	CA-5280
1993-00	9" Brakes				CA-6292
1993-95	w/10" Brakes			CA-6223	CA-6224
1996-97	108" or 114" or 125" Wheel Base w/9" Brakes			CA-6223	
1996-97	108" or 114" Wheel Base w/10" Brakes			CA-6223	CA-6224
1998-00	10" Brakes w/Standard Suspension	CA-6309		CA-6223	CA-6224
1998-00	118" Wheel Base, w/Standard Suspension & 9" Brakes	CA-6309		CA-6223	CA-6317
1998-00	9" Brakes w/Standard Suspension	CA-6309		CA-6223	
2000		CA-6309			CA-6292
2001-02	9" or 10" Brakes w/Standard Suspension	CA-6309			CA-6224
<b>GEO TRUCKS</b>					
<b>TRACKER</b>					
1989-90				CA-6260	CA-6261
<b>GMC</b>					
<b>C15</b>					
1967	w/115" Wheel Base, exc. Turbo-Hydrumatic Trans. exc. Leaf Springs		CA-5507	CA-5512	CA-5512
1967	w/127" Wheel Base, w/Turbo-Hydrumatic Trans. exc. Leaf Springs		CA-5507	CA-5512	CA-5512
1968	w/Turbo-Hydrumatic Trans. w/115" Wheel Base exc. Leaf Springs, w/127" Wheel Base exc. Leaf Springs		CA-5507	CA-5512	CA-5512
1969-72	w/127" Wheel Base, exc. TH400		CA-5507	CA-5512	CA-5512
1975	w/117.5" Wheel Base		CA-5504		
1976-77	2 Door, exc. Heavy Duty, w/117.5" Wheel Base	CA-5569	CA-5502	CA-5534	CA-5534
1976-77	2 Door, w/131.5" Wheel Base	CA-5569	CA-5551	CA-5534	CA-5534
1978	exc. 131.5" Wheel Base		CA-5502	CA-5534	CA-5534
1978	exc. California Emission	CA-5569		CA-5534	CA-5534
1979	2 Door Diesel w/131.5" Wheel Base	CA-5568			
1979	Gas exc. Heavy Duty Chassis, w/106.5" Wheel Base, w/131.5" Wheel Base	CA-5569	CA-5551		
1979-83	w/106.5" Wheel Base, w/117" Wheel Base, w/131.5" Wheel Base	CA-5569		CA-5534	CA-5534

# BRAKE CABLES

Year	Remark	Front	Intermediate	Rear Left	Rear Right
<b>GMC (con't)</b>					
<b>C15 (con't)</b>					
1980-83	w/106.5" Wheel Base, w/131.5" Wheel Base	CA-5569	CA-5551		
1984	w/117.5" Wheel Base, w/131.5" Wheel Base	CA-5578		CA-5579	CA-5580
1984-86	w/131.5" Wheel Base	CA-5578		CA-5641	CA-5580
<b>C15 SUBURBAN</b>					
1973-74				CA-5534	CA-5534
1975		CA-5568			
1975-78		CA-5569	CA-5551	CA-5534	CA-5534
1977	w/305, 350, 454	CA-5569	CA-5551		
1978	exc. Heavy Duty Chassis	CA-5569	CA-5504		
1978	w/Heavy Duty Chassis	CA-5568	CA-5504		
1979-83	w/117.5" Wheel Base, w/131.5" Wheel Base		CA-5504	CA-5534	CA-5534
1979-83	w/131.5" Wheel Base, w/13" x 2.50" Brakes, w/11.15" x 2.75 Brakes	CA-5569			
1984		CA-5577		CA-5579	CA-5580
1985-86		CA-5577		CA-5641	CA-5580
<b>C1500</b>					
1988	Extended Cab 155.5" WB, 2 Door Cab 117.5" Wheel Base, 2 Door Cab 131.5" WB	CA-6196		CA-6195	CA-6197
1989	2 Door Cab 117.5" Wheel Base, 2 Door Cab 131.5" Wheel Base	CA-6196		CA-6195	CA-6197
1989	Extended Cab 141.5" Wheel Base, Extended Cab 155.5" Wheel Base			CA-6195	CA-6197
1990-91	2 Door Cab 117.5" Wheel Base, 2 Door Cab 131.5" Wheel Base			CA-6184	CA-6197
1990-91	Extended Cab 141.5" Wheel Base, Extended Cab 155.5" Wheel Base			CA-6184	CA-6197
1990-94	2 Door Cab 131.5" Wheel Base	CA-6183			
1992	1st Design Extended Cab 141.5" Wheel Base			CA-6184	CA-6197
1992	1st Design Extended Cab 155.5" Wheel Base, 2 Door Cab 117.5" Wheel Base			CA-6184	CA-6197
1992	2nd Design Extended Cab 141.5" Wheel Base			CA-6191	CA-6192
1992	2nd Design Extended Cab 155.5" Wheel Base			CA-6191	CA-6192
1993-94	2 Door Cab 131.5" Wheel Base			CA-6184	CA-6197
1993-94	Extended Cab w/141.5" Wheel Base			CA-6191	CA-6192
1993-94	Extended Cab w/155.5" Wheel Base			CA-6191	CA-6192
1995-96				CA-6191	
1997	Fleetside, 131.5" Wheel Base			CA-6191	
<b>C25</b>					
1967-68			CA-5507		
1969-70	w/127" Wheel Base		CA-5507		
1974	2 Door, w/13" x 2.50" Brakes	CA-5568	CA-5573		
1975	2 Door, w/13" x 2.50" Brakes	CA-5568	CA-5573		
1976-77	2 Door, w/13" x 2.50" Brakes		CA-5551	CA-5529	CA-5529
1978		CA-5568	CA-5551	CA-5529	CA-5529
1979-80	2 Door	CA-5569		CA-5529	CA-5529
1979-83	2 Door, w/11.15" x 2.75 Brakes		CA-5551		
1979-83	2 Door, w/13" x 2.50" Brakes		CA-5516		
1981-82	2 Door	CA-5569		CA-5574	CA-5574
1981-82	4 Door	CA-5568		CA-5529	CA-5529
1983	2 & 4 Door, w/11.15" x 2.75 Brakes w/6 3/8" Wide Drums			CA-5529	CA-5529
1983	2 Dr, w/13" x 2.50" Brakes w/10.5" Ring Gear			CA-5574	CA-5574
1984	1st Design, 2 & 4 Door	CA-5578		CA-5579	CA-5580
1984	2nd Design, 2 & 4 Door	CA-5578		CA-5529	CA-5529
1984-86	2 Door SRW, w/13" Brakes			CA-5583	CA-5584

# BRAKE CABLES

Year	Remark	Front	Intermediate	Rear Left	Rear Right
<b>GMC (con't)</b>					
<b>C25 (con't)</b>					
1985-86	2 Door SRW, w/13" Brakes, w/131.5" Wheel Base, w/164.5" Wheel Base	CA-5578			
1985-86	2 Door, w/131.5" Wheel Base, w/164.5" Wheel Base, 4 Door w/164.5" Wheel Base			CA-5641	CA-5580
1985-86	2nd Design, 2 Door, 43 3/16" Used on 6 3/8" Wide Brake Drum			CA-5529	CA-5529
<b>C25 SUBURBAN</b>					
1974	w/Vacuum Power Brakes	CA-5568			
1975	w/Vacuum Power Brakes	CA-5568			
1976-77	w/11.15" x 2.75" Brakes	CA-5568	CA-5504	CA-5529	CA-5529
1976-77	w/13" x 2.50" Brakes	CA-5568	CA-5516		
1978	exc. California Emission	CA-5568	CA-5504		
1978	w/13" x 2.50" Brakes, exc. California Emission	CA-5568		CA-5529	CA-5529
1979-80		CA-5569		CA-5529	CA-5529
1981-82		CA-5569		CA-5574	CA-5574
1983	43.2" Long used w/6 3/8" Wide Drum	CA-5569		CA-5529	CA-5529
1984	1st Design, 44 3/16" Used on 4 5/8" Wide Brake Drum	CA-5577		CA-5579	CA-5580
1984	2nd Design, 43 3/16" Used on 6 3/8" Wide Brake Drum	CA-5577		CA-5529	CA-5529
1985	w/Vacuum Power Brakes	CA-5568			
1985		CA-5577		CA-5641	CA-5580
1986	w/11.15" x 2.75" Brakes	CA-5577		CA-5641	
1986	w/13" x 2.50" Brakes	CA-5577			CA-5580
<b>C2500</b>					
1988-89	exc. Extended Cab	CA-6196			CA-6187
1990-91	1st Design exc. Extended Cab	CA-6183		CA-6188	CA-6187
1990-91	1st Design Extended Cab			CA-6189	CA-6186
1992-94	2 Door Cab exc. Limited Slip Rear Axle, Extended Cab 155.5" Wheel Base	CA-6183		CA-6189	CA-6186
1992-94	2 Door Cab Limited Slip Rear Axle	CA-6183		CA-6188	CA-6187
1995	Extended Cab Long Bed 155.5" Wheel Base 8600 lb.GVW			CA-6189	CA-6186
1995	Extended Cab Short Bed, 141.5" Wheel Base 7200 lb.GVW, Chassis Cab 131.5" WB			CA-6188	CA-6187
1995	Regular Cab, Long Bed 131.5" Wheel Base 7200 lb.GVW			CA-6188	CA-6186
1995	Regular Cab, Long Bed 131.5" Wheel Base 7200 lb.GVW			CA-6189	CA-6187
1996	Fleetside 131.5" Wheel Base, Fleetside Extended Cab 141.5" Wheel Base			CA-6188	CA-6187
1996	Fleetside Extended Cab 155.5" Wheel Base			CA-6188	CA-6187
1997	Fleetside, 131.5" Wheel Base			CA-6188	CA-6187
1998	Short Bed Extended Cab, Long Bed Standard Cab 7200 lb.GVW			CA-6188	
1999-00	Long Bed				CA-6187
<b>C35</b>					
1973-74	w/135.5" Wheel Base, w/141 5/16" Overall Length	CA-5568	CA-5573		
1975-76	DRW, w/131.5" Wheel Base, w/135.5" Wheel Base, w/141 5/16" Overall Length exc. 144 1/3" Overall length	CA-5568	CA-5573		
1977-78	DRW, w/131.5" Wheel Base, w/135.5" Wheel Base, w/141 5/16" Overall Length	CA-5568	CA-5573	CA-5529	CA-5529
1979-80	w/131.5" Wheel Base, w/117.5" Wheel Base		CA-5551	CA-5529	CA-5529

# BRAKE CABLES

Year	Remark	Front	Intermediate	Rear Left	Rear Right
<b>GMC (con't)</b>					
<b>C35 (con't)</b>					
1979-83	w/135.5" Wheel Base	CA-5568	CA-5573		
1981	w/13" x 2.50" Brakes, w/135.5" Wheel Base, w/159.5" Wheel Base			CA-5574	CA-5574
1981	w/131.5" Wheel Base, w/117.5" Wheel Base, w/135.5" Wheel Base w/13" x 3.50" Brakes, w/159.5" Wheel Base w/13" x 3.50" Brakes		CA-5551	CA-5529	CA-5529
1982-83	w/13" x 2.50" Brakes, exc. 164.5" Wheel Base			CA-5574	CA-5574
1982-83	w/13" x 3.50" Brakes, exc. 164.5" Wheel Base			CA-5529	CA-5529
1983	SRW, w/13" x 3.50" Brakes, exc. 164.5" Wheel Base			CA-5529	CA-5529
1984-85	2 Door SRW, w/131.5" Wheel Base, DRW w/164.5" Wheel Base	CA-5578			
1984-85	DRW, w/135.5", w/159.5", w/164.5", w/Dana Axle, SRW			CA-5583	CA-5584
1984-86	DRW, exc. Dana Axle, w/135.5" Wheel Base, w/159.5" Wheel Base, w/164.5" Wheel Base			CA-5585	CA-5586
1984-86	w/135.5" Wheel Base	CA-5587			
1986	2 Door SRW, w/131.5" Wheel Base	CA-5578			
1986	w/159.5" Wheel Base, DRW w/135.5", w/164.5" Wheel Base, w/Dana Axle, SRW, w/131.5" Wheel Base, w/159.5" Wheel Base			CA-5583	CA-5584
<b>C3500</b>					
1988-89	DRW	CA-6196			
1988-89	SRW	CA-6183			
1990-91	131.5" Wheel Base, 155.5" Wheel Base	CA-6196			
1990-91	135.5" Wheel Base	CA-6183			
1990-91	1st Design; 131.5" Wheel Base, 155.5" Wheel Base			CA-6189	CA-6193
1990-91	2nd Design; 131.5" Wheel Base, 155.5" Wheel Base				CA-6186
1990-97	135.5" Wheel Base, 159.5" Wheel Base			CA-6193	
1992-94	2 Door Cab	CA-6183		CA-6193	
1992-94	Extended Cab			CA-6189	
1995	Extended Cab Long Bed 155.5" Wheel Base, Wide Trak Rear Axle			CA-6189	
1996	Fleetside 131.5" Wheel Base, Fleetside Extended Cab 155.5" Wheel Base			CA-6189	
<b>CABALLERO</b>					
1978-79	w/Auto. Trans.			CA-5541	CA-5592
1978-79	w/Man. Trans.	CA-5543		CA-5525	CA-5592
1980	w/Auto. Trans.			CA-5540	CA-5592
1980	w/Man. Trans.			CA-5540	CA-5592
1981		CA-5543		CA-5540	CA-5592
1982-87				CA-5540	CA-5592
<b>G1500</b>					
1981-82	w/125" Wheel Base, w/110" Wheel Base			CA-5533	CA-5533
1983-84	w/110" Wheel Base	CA-5561		CA-5582	CA-5581
1983-84	w/125" Wheel Base	CA-5563		CA-5559	CA-5560
1985-94	w/110" Wheel Base, w/125" Wheel Base	CA-5561		CA-5582	CA-5581
<b>G2500</b>					
1981-82	w/125" Wheel Base, w/110" Wheel Base			CA-5533	CA-5533
1983	w/125" Wheel Base	CA-5561		CA-5582	CA-5581
1983	w/125" Wheel Base, w/110" Wheel Base			CA-5559	CA-5560
1983-94	w/110" Wheel Base	CA-5561		CA-5582	CA-5581
1983-94	w/125" Wheel Base	CA-5563		CA-5582	CA-5581

# BRAKE CABLES

Year	Remark	Front	Intermediate	Rear Left	Rear Right
<b>GMC (con't)</b>					
<b>G3500</b>					
1976-78	w/164.5" Wheel Base	CA-5568			
1983-94	SRW, w/125", w/146" Wheel Base			CA-5588	CA-5589
1983-94	w/125" Wheel Base	CA-5563			
1983-96	Dual & Single Rear Wheels, 146" Wheel Base	CA-6181			
1984-94	DRW, w/125", w/146" Wheel Base			CA-5608	CA-5609
1995-96	Dual and Single Rear Wheels, 146" Wheel Base, exc. Express w/Dual Rear Wheels	CA-6181			
<b>JIMMY</b>					
1970	2WD			CA-5512	CA-5512
1971-72	2WD, w/Coil Springs			CA-5512	CA-5512
1973-75	2WD	CA-5568		CA-5534	CA-5534
1976-77	2WD		CA-5003	CA-5534	CA-5534
1978-83	4WD	CA-5598		CA-5534	CA-5534
1984-91		CA-5576	CA-5558	CA-5579	CA-5580
<b>K15</b>					
1969	w/127" Wheel Base		CA-5004		
1973	2 Door, exc. 117.5" Wheel Base		CA-5507	CA-5534	CA-5534
1974	2 Door, w/117.5" Wheel Base, w/131.5" Wheel Base	CA-5532	CA-5003	CA-5534	CA-5534
1975	2 Door, w/117.5" Wheel Base	CA-5532	CA-5003	CA-5534	CA-5534
1976	2 Door, w/117.5" Wheel Base, w/131.5" Wheel Base	CA-5532	CA-5003	CA-5534	CA-5534
1977-78	2 Door, w/131.5" Wheel Base	CA-5532		CA-5534	CA-5534
1979-83	w/117.5" Wheel Base	CA-5598	CA-5003	CA-5534	CA-5534
1979-83	w/131.5" Wheel Base	CA-5598	CA-5005	CA-5534	CA-5534
1984	w/117.5" Wheel Base, w/131.5" Wheel Base	CA-5578		CA-5579	CA-5580
1985-86	w/117.5" Wheel Base, w/131.5" Wheel Base	CA-5578		CA-5641	CA-5580
<b>K15 SUBURBAN</b>					
1973	w/129.5" Wheel Base			CA-5534	CA-5534
1974		CA-5532		CA-5534	CA-5534
1976-78		CA-5532	CA-5502	CA-5534	CA-5534
1984		CA-5577		CA-5579	CA-5580
1985-86		CA-5577		CA-5641	CA-5580
<b>K1500</b>					
1988	2 Door Cab 117.5" Wheel Base, 2 Door Cab 131.5" Wheel Base, Extended Cab			CA-6195	CA-6197
1988-89	2 Door Cab 131.5" Wheel Base	CA-6196		CA-6195	
1989-91	2 Door Cab 117.5" Wheel Base, 2 Door Cab 131.5" Wheel Base			CA-6184	CA-6197
1990-91	2 Door Cab 131.5" Wheel Base	CA-6183		CA-6184	CA-6197
1990-91	Extended Cab				CA-6187
1992	2 Door Cab, 129.5" Wheel Base, 131.5" Wheel Base, First Design	CA-6183		CA-6184	CA-6197
1992	2 Door Cab, 129.5" Wheel Base, 131.5" Wheel Base, Second Design	CA-6183		CA-6191	CA-6192
1992-94	Extended Cab w/155.5" Wheel Base				CA-6187
1992-97	Extended Cab w/141.5" Wheel Base				CA-6187
1993-94	2 Door Cab 117.5" Wheel Base, 2 Door Cab, 129.5" Wheel Base, 131.5" Wheel Base	CA-6183		CA-6191	CA-6192
1995	Extended Cab Short Bed 141.5" Wheel Base, Extended Cab Long Bed 155.5" Wheel Base			CA-6191	
1995	Heavy Duty Chassis				CA-6187
1995	Regular Cab Long Bed 131.5" Wheel Base			CA-6191	
1995	Regular Cab Short Bed 117.5" Wheel Base			CA-6191	
1996	117.5" Wheel Base			CA-6191	

# BRAKE CABLES

Year	Remark	Front	Intermediate	Rear Left	Rear Right
<b>GMC (con't)</b>					
<b>K1500 (con't)</b>					
1996	Extended Cab 141.5" Wheel Base, Heavy Duty Chassis, Extended Cab, 141.5" Wheel Base				CA-6187
1996	Extended Cab w/141.5" Wheel Base			CA-6191	
1996	Fleetside 131.5" Wheel Base			CA-6191	
1996	Fleetside Extended Cab 155.5" Wheel Base			CA-6191	
1997	Fleetside 131.5" Wheel Base, Extended Cab 141.5" Wheel Base			CA-6191	
<b>K25</b>					
1973	exc. 117.5" Wheel Base; 119.625" Cable		CA-5507		
1974	2 Door Cab w/13" x 2.50" Brakes, w/131.5" Wheel Base	CA-5598	CA-5513		
1976-78	2 Door, w/13" x 2.50" Brakes	CA-5598	CA-5513	CA-5529	CA-5529
1979-81				CA-5529	CA-5529
1979-83		CA-5598			
1982	2 Door	CA-5598		CA-5529	CA-5529
1983	2nd Design, 2 Door			CA-5529	CA-5529
1984	2 Door, w/13" x 2.50" Brakes w/13" x 3.50" Brakes	CA-5578			
1984	4 Door			CA-5579	CA-5580
1984-86	2 Door, w/13" x 2.50" Brakes w/13" x 3.50" Brakes			CA-5583	CA-5584
1985-86	2 Door, w/11.15" x 2.75 Brakes, 4 Door w/13" x 2.50" Brakes w/13" x 3.50" Brakes	CA-5578		CA-5641	CA-5580
<b>K25 SUBURBAN</b>					
1974	w/Vacuum Power Brakes, exc. Type c	CA-5598	CA-5005		
1974	w/Vacuum Power Brakes, Type c	CA-5598	CA-5502		
1975	w/Vacuum Power Brakes, exc. Type c	CA-5598	CA-5005		
1975	w/Vacuum Power Brakes, Type c		CA-5502		
1976-77	w/11.15" x 2.75" Brakes		CA-5502		
1976-78	w/13" x 2.50" Brakes	CA-5598	CA-5504	CA-5529	CA-5529
1979-82		CA-5598	CA-5504	CA-5529	CA-5529
1983	2nd Design, w/6 3/8" Wide Drum	CA-5598	CA-5504	CA-5529	CA-5529
1984	w/11.15" x 2.75" Brakes	CA-5577		CA-5579	CA-5580
1984-86	w/13" x 2.50" Brakes	CA-5577		CA-5583	CA-5584
1985-86	w/11.15" x 2.75" Brakes	CA-5577		CA-5641	
<b>K2500</b>					
1988-89	exc. Extended Cab	CA-6196			CA-6187
1988-90	Extended Cab			CA-6189	CA-6186
1990-91	exc. Extended Cab	CA-6183		CA-6188	CA-6187
1991	Extended Cab, First Design			CA-6189	CA-6186
1992-94	Extended Cab w/141.5" Wheel Base			CA-6189	
1992-94	Extended Cab w/155.5" Wheel Base			CA-6189	CA-6186
1992-94	Regular Cab	CA-6183		CA-6188	CA-6187
1995	Extended Cab Long Bed 155.5" Wheel Base 8600 lb.GVW			CA-6189	
1995	Extended Cab Short Bed, 141.5" Wheel Base 7200 lb.GVW, Chassis Cab 131.5" WB			CA-6188	CA-6187
1995	Regular Cab, Long Bed 131.5" Wheel Base 7200 lb.GVW			CA-6188	CA-6187
1995	Regular Cab, Long Bed 131.5" Wheel Base 7200 lb.GVW			CA-6189	CA-6187
1996	Fleetside 131.5" Wheel Base, Fleetside Extended Cab 155.5" Wheel Base			CA-6188	CA-6187
1997	Fleetside 131.5" Wheel Base			CA-6188	CA-6187

# BRAKE CABLES

Year	Remark	Front	Intermediate	Rear Left	Rear Right
<b>GMC (con't)</b>					
<b>K2500 SUBURBAN</b>					
1992		CA-6183		CA-6188	CA-6187
<b>K35</b>					
1974		CA-5532			
1977	2 Door, w/131.5" Wheel Base	CA-5532	CA-5513	CA-5529	CA-5529
1977-78	2 Door, w/135.5" Wheel Base	CA-5532	CA-5507	CA-5529	CA-5529
1978	2 Door Cab w/131.5" Wheel Base, w/146.5" Wheel Base	CA-5532	CA-5513	CA-5529	CA-5529
1979-80	w/131.5" Wheel Base	CA-5598	CA-5513	CA-5529	CA-5529
1979-80	w/135.5" Wheel Base	CA-5598	CA-5507		
1981-83	13" x 2.50" Brakes, w/131.5" Wheel Base w/135.5" Wheel Base	CA-5598	CA-5507	CA-5574	CA-5574
1981-83	13" x 3.50" Brakes, w/131.5" Wheel Base w/164.5" Wheel Base	CA-5598	CA-5513	CA-5529	CA-5529
1981-83	13" x 3.50" Brakes, w/135.5" Wheel Base	CA-5598	CA-5507	CA-5529	CA-5529
1984	exc. Dana Axle			CA-5585	CA-5586
1984	w/Dana Axle			CA-5583	CA-5584
1984-86	w/131.5" Wheel Base	CA-5578			
1984-86	w/135.5" Wheel Base	CA-5587			
1985-86	DRW, exc. Dana Axle			CA-5585	CA-5586
1985-86	SRW, DRW w/Dana Axle			CA-5583	CA-5584
<b>K3500</b>					
1988-89	DRW	CA-6196			
1988-89	SRW	CA-6183			CA-6186
1990-91	131.5" Wheel Base, 155.5" Wheel Base	CA-6196			
1990-91	135.5" Wheel Base	CA-6183			
1990-91	1st Design; 131.5" Wheel Base, 155.5" Wheel Base			CA-6189	CA-6193
1990-91	2nd Design; 131.5" Wheel Base, 155.5" Wheel Base				CA-6186
1990-97	135.5" Wheel Base, 159.5" Wheel Base			CA-6193	
1992-94	2 Door Cab	CA-6183		CA-6193	
1992-94	Extended Cab			CA-6189	
1995	Extended Cab Long Bed 155.5" Wheel Base, Wide Trak Rear Axle			CA-6189	
1996	Fleetside 131.5" Wheel Base, Fleetside, Extended Cab, 155.5" Wheel Base			CA-6189	
<b>P15/P1500 VAN</b>					
1973-74				CA-5534	CA-5534
<b>P2500</b>					
1973-74	w/133" Wheel Base, w/11.15" x 2.75 Brakes		CA-5573		
1975	w/133" Wheel Base, w/11.15" x 2.75 Brakes		CA-5573		
1984	w/11.15" x 2.75" Brakes			CA-5579	CA-5580
1984	w/13" x 2.50" Brakes			CA-5583	CA-5584
1985-86	w/11.15" x 2.75" Brakes			CA-5641	CA-5580
1985-86	w/13" x 2.50" Brakes				CA-5584
1987	SRW, w/13" x 3.50" Brakes			CA-5583	CA-5584
1987-89	w/11.15" x 2.75" Brakes			CA-5641	CA-5624
1988-89	w/13" x 3.50" Brakes			CA-5583	CA-5584
<b>P3500</b>					
1976-78	w/157" Wheel Base, w/158.5" Wheel Base, exc. Prop Shaft Parking Brake			CA-5529	CA-5529
1979-81	DRW			CA-5585	CA-5586
1979-81	exc. 13.75 x 1.53" Brakes			CA-5529	CA-5529
1979-81	SRW, w/13" x 2.50" Brakes			CA-5583	CA-5584
1982	w/13" x 2.50" Brakes			CA-5574	CA-5574

# BRAKE CABLES

Year	Remark	Front	Intermediate	Rear Left	Rear Right
<b>GMC (con't)</b>					
<b>P3500 (con')</b>					
1982	w/13" x 3.50" Brakes			CA-5529	CA-5529
1990-93	DRW, w/13" x 2.50" Brakes, w/125" Wheel Base, w/133" Wheel Base, w/157" Wheel Base; 51.625" Cable			CA-5585	CA-5625
1990-93	DRW, w/13" x 2.50" Brakes, w/137" Wheel Base, w/158.5" Wheel Base				CA-5584
1990-93	DRW, w/13" x 3.50" Brakes, w/158.5" Wheel Base		CA-5575		
1990-93	w/13" x 2.50" Brakes, w/125" Wheel Base, w/133" Wheel Base				CA-5584
<b>R1500</b>					
1987	2 Door, w/117.5" Wheel Base			CA-5641	CA-5580
1987	2 Door, w/131.5" Wheel Base	CA-5578		CA-5641	CA-5580
<b>R1500 SUBURBAN</b>					
1987-91		CA-5577		CA-5641	
<b>R2500</b>					
1987-88	2 Door, w/11.15" x 2.75 Brakes	CA-5578		CA-5251	CA-5624
1987-89	SRW, w/13" x 2.50" Brakes, w/13" x 3.50" Brakes			CA-5639	CA-5584
1989	2 Door SRW, w/13" x 2.50" Brakes, w/13" x 3.50" Brakes	CA-5578			
<b>R2500 SUBURBAN</b>					
1987-91	SRW, w/13" x 2.50" Brakes, w/13" x 3.50" Brakes	CA-5577		CA-5639	
<b>R3500</b>					
1987-88	2 & 4 Door DRW exc. Dana Axle, w/131.5" Wheel Base, w/159.5" Wheel Base, w/164.5" Wheel Base			CA-5585	CA-5625
1987-88	2 Door Cab	CA-5578			
1987-88	2 Door SRW, w/13" x 2.50" Brakes, w/13" x 3.50" Brakes			CA-5639	CA-5584
1987-89	w/135.5" Wheel Base	CA-5587			
1987-90	DRW w/Dana Axle			CA-5583	
1989	DRW, exc. Dana Axle, w/135.5" Wheel base			CA-5585	CA-5625
1989-90	SRW, w/13" x 2.50" Brakes, w/13" x 3.50" Brakes				CA-5584
1990	2 Door SRW	CA-5587			
1990	DRW, exc. Dana Axle			CA-5585	CA-5625
<b>S15</b>					
1982		CA-5562		CA-5570	CA-5570
1983-90	2WD	CA-5562	CA-5558	CA-5570	CA-5566
1983-90	4WD	CA-5564		CA-5610	CA-5610
<b>S15 JIMMY</b>					
1983	4WD	CA-5564		CA-5610	CA-5610
1984-91	2 Door 4WD	CA-5564		CA-5610	CA-5610
1984-91	2WD	CA-5562		CA-5570	CA-5570
1992-93	2 Door	CA-6291			
1992-94				CA-6194	
<b>SONOMA</b>					
1992-93	2WD	CA-6285			
1992-94	4WD	CA-6291			
1995	2WD			CA-6295	CA-6294
1995	4WD, High Wider Package			CA-6296	CA-6297
1996-97	4WD, High Wider Package, ZR2				CA-6297
1996-97	4WD, Offroad or Chassis Package			CA-6295	



# BRAKE CABLES

Year	Remark	Front	Intermediate	Rear Left	Rear Right
<b>GMC (con't)</b>					
<b>SPRINT</b>					
1971-72				CA-5508	CA-5508
1973-76		CA-5522		CA-5517	CA-5517
1977		CA-5522	CA-5502	CA-5517	CA-5517
<b>V1500</b>					
1987	2 Door, w/117.5" Wheel Base			CA-5641	CA-5580
1987	2 Door, w/131.5" Wheel Base	CA-5578		CA-5641	CA-5580
<b>V1500 SUBURBAN</b>					
1987-91		CA-5577		CA-5641	
<b>V2500</b>					
1987	2 Door, w/11.15" x 2.75 Brakes	CA-5578		CA-5641	CA-5624
1987	SRW, w/13" x 2.50" Brakes, w/13" x 3.50" Brakes				CA-5584
<b>V2500 SUBURBAN</b>					
1987-89	2 Door SRW, w/13" x 2.50" Brakes, w/13" x 3.50" Brakes	CA-5577			
1989-91		CA-5577		CA-5639	
<b>V3500</b>					
1987-88	2 & 4 Door DRW exc. Dana Axle, w/131.5" Wheel Base, w/159.5" Wheel Base, w/164.5" Wheel Base			CA-5585	CA-5625
1987-88	2 Door Cab	CA-5578			
1987-88	2 Door SRW, w/13" x 2.50" Brakes, w/13" x 3.50" Brakes			CA-5639	CA-5584
1987-89	w/135.5" Wheel Base	CA-5587			
1987-90	DRW w/Dana Axle			CA-5583	
1989	DRW, exc. Dana Axle, w/135.5" Wheel base			CA-5585	CA-5625
1989-90	SRW, w/13" x 2.50" Brakes, w/13" x 3.50" Brakes				CA-5584
1990	2 Door SRW	CA-5587			
1990	DRW, exc. Dana Axle			CA-5585	CA-5625
<b>HONDA</b>					
<b>ACCORD</b>					
1976-85				CA-6001	CA-6002
1979-81				CA-6168	CA-6169
<b>CIVIC</b>					
1992-95	w/Rear Drums			CA-6240	CA-6241
<b>CIVIC DEL SOL</b>					
1993-97	w/Rear Disc			CA-6242	CA-6243
<b>PRELUDE</b>					
1979-82		CA-6003			
1992-93				CA-6262	CA-6263
<b>JEEP</b>					
<b>CHEROKEE</b>					
1981	4 Spd. w/Auto. Trans.			CA-5054	CA-5054
1982-86				CA-5054	CA-5054
1984-86	Wagon-Mid Size			CA-5056	CA-5056
1987-89				CA-5077	CA-5077
1990-91				CA-6284	CA-6284
<b>CJ5</b>					
1981-83					CA-5040
<b>CJ7</b>					
1981-86				CA-5045	CA-5040
<b>COMANCHE</b>					
1986				CA-5063	CA-5063

# BRAKE CABLES

Year	Remark	Front	Intermediate	Rear Left	Rear Right
<b>JEEP (con't)</b>					
<b>COMANCHE (con')</b>					
1987-89				CA-5069	CA-5069
<b>GRAND WAGONEER</b>					
1990				CA-6284	
1987-93				CA-5054	CA-5054
<b>J10, J20</b>					
1974-75	4 Spd. Man. Trans., w/Hydrumatic Trans., w/119" Wheel Base		CA-5003		
1974-75	4 Spd. Man. Trans., w/Hydrumatic Trans., w/131" Wheel Base		CA-5002		
1979	6 Cyl. w/Hydrumatic Trans.		CA-5003		
1979	V8 w/Hydrumatic Trans.		CA-5004		
<b>WAGONEER</b>					
1981	4 Spd. w/Auto. Trans.			CA-5054	CA-5054
1982-83	4 & 5 Spd. w/Auto. Trans.			CA-5054	CA-5054
1984-86	Wagon-Mid Size			CA-5056	CA-5056
1984-86				CA-5054	CA-5054
1987-89				CA-5077	CA-5077
1990				CA-6284	
<b>LEXUS</b>					
<b>ES300</b>					
1992-96				CA-6254	CA-6255
<b>LINCOLN</b>					
<b>CONTINENTAL</b>					
1975-77	w/Rear Drum Brakes				CA-5206
1978-79	w/Rear Disc Brakes, w/Rear Drum Brakes			CA-5214	CA-5206
1980	exc. Dual Exhaust	CA-5212		CA-5229	CA-5216
1982-83		CA-5224		CA-5260	CA-5260
1982-94	Transverse Cable		CA-5252		
1984-87		CA-5231		CA-5256	CA-5256
<b>MARK III</b>					
1968-69	From 7/29/68			CA-5202	CA-5283
1970-71					CA-5283
<b>MARK VI</b>					
1980		CA-5212		CA-5229	CA-5216
1981-82	exc. Dual Exhaust	CA-5212		CA-5229	CA-5216
1981-82	w/Dual Exhaust	CA-5212		CA-5229	CA-5228
1983		CA-5212		CA-5229	CA-5232
<b>MARK VII</b>					
1984-92	Transverse Cable	CA-5231	CA-5252		
1984-90		CA-5231		CA-5256	CA-5256
<b>MARK VIII</b>					
1993-96	Transverse Cable		CA-5252	CA-5282	CA-5282
1997-98				CA-5282	CA-5282
<b>TOWN CAR</b>					
1981	exc. Dual Exhaust	CA-5212		CA-5229	CA-5216
1981	w/Dual Exhaust	CA-5212		CA-5229	CA-5228
1982-89		CA-5212		CA-5229	CA-5232
<b>LINCOLN TRUCKS</b>					
<b>NAVIGATOR</b>					
1998-01		CA-6307		CA-6311	CA-6312
2002		CA-6307		CA-6321	CA-6320
<b>MAZDA</b>					
<b>323</b>					
1986-89	w/Rear Drums			CA-6245	CA-6244

# BRAKE CABLES

Year	Remark	Front	Intermediate	Rear Left	Rear Right
<b>MAZDA (con't)</b>					
<b>323 (con't)</b>					
1990-94		CA-6283			
<b>626</b>					
1988-91				CA-6247	CA-6246
<b>MX-3</b>					
1992-95		CA-6283			
<b>PROTEGE</b>					
1990-98		CA-6283			
<b>MAZDA TRUCKS</b>					
<b>B2300</b>					
1994-96	w/10" Brakes			CA-6223	CA-6224
1994-97	w/9" Brakes				CA-6292
<b>B2500</b>					
1998-99	w/9" or 10" Brakes			CA-6223	CA-6224
<b>B3000</b>					
1994-96	w/10" Brakes			CA-6223	CA-6224
1994-96	w/9" Brakes				CA-6292
1998-99	w/9" or 10" Brakes			CA-6223	CA-6224
<b>B4000</b>					
1994-96	w/10" Brakes			CA-6223	CA-6224
1994-97	w/9" Brakes				CA-6292
1998-99	w/9" or 10" Brakes			CA-6223	CA-6224
<b>NAVAJO</b>					
1991-94					CA-5275
<b>MERCURY</b>					
<b>BOBCAT</b>					
1976-80				CA-5207	CA-5207
<b>CAPRI</b>					
1979-82				CA-5217	CA-5217
1983-86				CA-5237	CA-5237
<b>COLONY PARK</b>					
1987-89		CA-5212		CA-5229	CA-5232
<b>COUGAR</b>					
1975-79		CA-5204		CA-5205	CA-5208
1980	XR-7	CA-5224		CA-5222	CA-5222
1980-82	Transverse Cable		CA-5230		
1981-82	exc. XR-7	CA-5224	CA-5223	CA-5222	CA-5222
1983-86	exc. XR-8	CA-5231	CA-5223	CA-5233	CA-5233
1983-94	Transverse Cable		CA-5251		
1987-88	w/Rear Disc Brakes		CA-5246	CA-5276	CA-5277
1987-88	w/Rear Drum Brakes	CA-5231		CA-5233	CA-5233
1989-94	w/Hand Control		CA-5246		
1989-94	w/Rear Disc Brakes				CA-5281
1989-94	w/Rear Drum Brakes			CA-5279	CA-5279
<b>GRAND MARQUIS</b>					
1975-78	w/Rear Drum Brakes			CA-5203	CA-5206
1979		CA-5212			CA-5216
1979-89		CA-5212		CA-5229	
1980-81	From 3/3/80, Taxi & Police Car, w/High Output	CA-5212		CA-5229	CA-5228
1980-81	From 3/3/80, Taxi & Police Car, w/High Output, exc. 5.0L	CA-5212			CA-5216
1982	Dual Exhaust	CA-5212			CA-5228
1982	exc. Dual Exhaust	CA-5212			CA-5232
1983-89	40 7/8" Cable	CA-5212			CA-5232

# BRAKE CABLES

Year	Remark	Front	Intermediate	Rear Left	Rear Right
<b>MERCURY (con't)</b>					
<b>LN7, LYNX</b>					
1981-87	w/Equilizer Rod	CA-6330		CA-5227	CA-5227
<b>MARQUIS</b>					
1969				CA-5202	CA-5283
1970-74				CA-5203	CA-5283
1975-78	w/Rear Drum Brakes			CA-5203	CA-5206
1979-82		CA-5212		CA-5229	CA-5283
1980	To 3/3/80	CA-5212		CA-5229	CA-5216
1981	5.0L Taxi & Police Car, w/High Output				CA-5228
1982	exc. Dual Exhaust				CA-5232
1982	w/Dual Exhaust				CA-5228
1983-84	Transverse Cable		CA-5244		
1983-84		CA-5231	CA-5223	CA-5233	CA-5233
<b>MONARCH</b>					
1977-80	From 2/14/77, w/Rear Drum Brakes	CA-5215		CA-5209	CA-5209
<b>MONTEGO</b>					
1975	To 12/10/75, 2 Door Hardtop	CA-5204		CA-5205	CA-5208
1975-76	From 12/10/75, 2 & 4 Door Hardtop, Wagon			CA-5205	CA-5208
<b>MONTEREY</b>					
1969				CA-5202	CA-5283
1970-74				CA-5203	CA-5283
<b>SABLE</b>					
1986-95	w/Rear Drum Brakes	CA-5272		CA-5270	CA-5271
1989-91		CA-5272			
1993-94	Wagon, w/Rear Drum Brakes (not Sedan)				CA-5271
<b>TOPAZ</b>					
1984-94	w/Equilizer Rod	CA-6330			
1985				CA-5264	CA-5264
1986-94	2WD			CA-5273	CA-5273
1986-94	AWD			CA-5264	CA-5264
<b>TRACER</b>					
1991		CA-6283			
1992-95	w/Rear Disc Brakes	CA-6283		CA-6289	CA-6287
1992-96	w/Rear Drum Brakes	CA-6283			CA-6302
1997-99	w/Rear Disc Brakes	CA-6283		CA-6316	CA-6313
1997-99	w/Rear Drum Brakes	CA-6283		CA-6315	CA-6314
<b>ZEPHYR</b>					
1978-79		CA-5213	CA-5210	CA-5222	CA-5222
1978-83	Transverse Cable		CA-5244		
1980-82		CA-5224	CA-5223	CA-5222	CA-5222
1983		CA-5231	CA-5223	CA-5233	CA-5233
<b>MERCURY TRUCKS</b>					
<b>MOUNTAINEER</b>					
1998-01		CA-6309			
<b>NISSAN</b>					
<b>280ZX</b>					
1982-83		CA-6173		CA-6167	CA-6167
<b>ALTIMA</b>					
1993-97	w/o ABS			CA-6248	CA-6249
<b>MAXIMA</b>					
1985-86	To 1/86				CA-6042
<b>PULSAR</b>					
1983				CA-6040	CA-6041
<b>PULSAR NX</b>					
1983-84				CA-6044	CA-6164

# BRAKE CABLES

Year	Remark	Front	Intermediate	Rear Left	Rear Right
<b>NISSAN (con't)</b>					
<b>PULSAR NX (con't)</b>					
1983-86				CA-6040	CA-6041
<b>SENTRA</b>					
1983-85	Diesel				CA-6164
1983-86				CA-6040	CA-6041
<b>NISSAN TRUCKS</b>					
<b>720</b>					
1980-81	4WD, Std. Bed, To 11/81			CA-6163	CA-6162
1980-86	2WD SRW, exc. King Cab & HD			CA-6154	
<b>OLDSMOBILE</b>					
<b>442</b>					
1968-71	2 Door, w/Turbo-Hydramatic Trans.		CA-5003	CA-5508	CA-5508
1968-71	4 Door		CA-5502	CA-5508	CA-5508
<b>88</b>					
1992	exc. Wagon	CA-5614		CA-5636	
1993-94		CA-5614			
1993-99				CA-5636	CA-5635
<b>98</b>					
1971-72	exc. Heavy Duty Power Brakes		CA-5507	CA-5514	CA-5514
1971-75	w/Heavy Duty Power Brakes			CA-5521	CA-5521
1973-75	exc. Heavy Duty Power Brakes		CA-5507	CA-5517	CA-5517
1976			CA-5507	CA-5517	CA-5517
1977-84				CA-5541	CA-5539
1985-89			CA-5611	CA-5602	CA-5603
1985-94		CA-5614			
1990-96				CA-5636	CA-5635
<b>CALAIS</b>					
1985-87		CA-5626		CA-5547	CA-5548
<b>CUSTOM CRUISER</b>					
1971-72			CA-5515		
1973				CA-5517	CA-5517
1974	exc. Heavy Duty Power Brakes			CA-5517	CA-5517
1974-75	w/Heavy Duty Power Brakes			CA-5521	CA-5521
1976	w/11" Brakes			CA-5517	CA-5517
1977-79		CA-5538		CA-5541	CA-5530
<b>CUTLASS</b>					
1962-74	Coupe, w/THM400 Trans.		CA-5515		
1966-67	w/Turbo-Hydramatic Trans.			CA-5503	CA-5503
1968-72	2 Door, w/Turbo-Hydramatic Trans.		CA-5003	CA-5508	CA-5508
1968-77	4 Door		CA-5502		
1973	Coupe, w/THM350 Auto. Trans., Sedan w/THM400 Trans.		CA-5504	CA-5517	CA-5517
1974	Coupe, w/THM350 Auto. Trans.		CA-5504	CA-5517	CA-5517
1975	w/THM350 Auto. Trans.	CA-5522		CA-5517	CA-5517
1976-77		CA-5522		CA-5517	CA-5517
1978-79				CA-5525	
1978-81	w/Auto. Trans.	CA-5536			CA-5592
1978-81	w/Man. Trans.	CA-5543			CA-5592
1980-81				CA-5540	CA-5592
1981		CA-5543			CA-5592
1985-87		CA-5601		CA-5620	CA-5592
<b>CUTLASS CALAIS</b>					
1978-79				CA-5525	CA-5592
1978-80	w/Auto. Trans.	CA-5536			CA-5592
1978-80	w/Man. Trans.	CA-5543			CA-5592

# BRAKE CABLES

Year	Remark	Front	Intermediate	Rear Left	Rear Right
<b>OLDSMOBILE (con't)</b>					
<b>CUTLASS CALAIS (con't)</b>					
1980-81				CA-5540	CA-5592
1981		CA-5543			CA-5592
1988-91				CA-5619	CA-5621
<b>CUTLASS CIERA</b>					
1982-91		CA-5546		CA-5553	CA-5552
1992-94		CA-5546			
<b>CUTLASS CRUISER</b>					
1980-81	w/Auto. Trans.	CA-5536		CA-5540	CA-5592
1980-81	w/Man. Trans.	CA-5543		CA-5540	CA-5592
1981-83		CA-5543		CA-5540	CA-5592
1987-90		CA-5546		CA-5553	CA-5552
<b>CUTLASS SALON</b>					
1976-77	4 Door	CA-5522	CA-5502	CA-5517	CA-5517
1978-79				CA-5525	
1978-80	w/Auto. Trans.	CA-5536			CA-5592
1978-80	w/Man. Trans.	CA-5543			CA-5592
1981-87					CA-5592
1980				CA-5540	
1985-87		CA-5601		CA-5620	
<b>CUTLASS SUPREME</b>					
1972	2 Door, w/Turbo-Hydrumatic Trans.		CA-5003	CA-5508	CA-5508
1972-77	4 Door		CA-5502		
1973	Coupe, w/THM350 Auto. Trans., Sedan w/THM400 Trans.		CA-5504	CA-5517	CA-5517
1973-74	Coupe, w/THM400 Trans.		CA-5515	CA-5517	CA-5517
1973-81	w/Auto. Trans.	CA-5536		CA-5517	CA-5517
1973-81	w/Man. Trans.	CA-5543		CA-5517	CA-5517
1974	Coupe, w/THM350 Auto. Trans.	CA-5522	CA-5504	CA-5517	CA-5517
1975-81	w/THM350 Auto. Trans.	CA-5522			
1978-79				CA-5525	CA-5592
1980-83				CA-5540	CA-5592
1981-83		CA-5543			CA-5592
1984-87		CA-5601		CA-5620	CA-5592
1988	w/Auto. Trans.			CA-5617	
1988	w/Man. Trans.			CA-5634	
1988-91	w/Auto. Trans.	CA-5616			
1988-93				CA-5634	CA-5618
1992	1st Design, w/Metal Conduit, w/2 Clips and Grommet				CA-5618
<b>DELTA 88</b>					
1971-72	exc. Heavy Duty Brakes & Wagon		CA-5513	CA-5514	CA-5514
1971-73	Heavy Duty Brakes exc. Wagon			CA-5521	CA-5521
1973-75	exc. Heavy Duty Brakes & Wagon			CA-5517	CA-5517
1974-75	Heavy Duty Brakes			CA-5521	CA-5521
1976	w/11" Brakes			CA-5517	CA-5517
1977	exc. Wagon				CA-5539
1977-79	Wagon	CA-5538			CA-5530
1978-85	exc. Wagon			CA-5541	CA-5605
1980	exc. Wagon	CA-5604			
1980	Wagon	CA-5538			
1981-85		CA-5604			CA-5539
1985-90	Wagon				CA-5615
1986-89	exc. Wagon	CA-5614	CA-5611	CA-5602	CA-5603
1986-90	Wagon	CA-5604		CA-5541	
1990-91	exc. Wagon	CA-5614		CA-5636	

# BRAKE CABLES

Year	Remark	Front	Intermediate	Rear Left	Rear Right
<b>OLDSMOBILE (con't)</b>					
<b>F85</b>					
1967	exc. Wagon, w/Turbo-Hydramatic Trans.			CA-5503	CA-5503
1968-70	2 Door, w/Turbo-Hydramatic Trans.		CA-5003	CA-5508	CA-5508
1968-70	4 Door, exc. Turbo-Hydramatic Trans.		CA-5502	CA-5508	CA-5508
1971				CA-5508	CA-5508
<b>FIRENZA</b>					
1982-86		CA-5549		CA-5547	CA-5548
1987-88				CA-5619	CA-5640
<b>LSS</b>					
1996-99				CA-5636	CA-5635
<b>OMEGA</b>					
1973-74			CA-5506	CA-5510	CA-5510
1973-79			CA-5523	CA-5510	CA-5510
1980	1st Design, Cable Exits at Front of Dash and Follows Along Right Side of Vehicle.	CA-5546		CA-5606	CA-5531
1980	2nd Design, Cable Exits Near Left Rear Seat Cushion & Follows Along Left Side of Vehicle	CA-5546		CA-5555	CA-5545
1981		CA-5546		CA-5555	CA-5545
1982-84		CA-5546		CA-5555	CA-5556
<b>TORONADO</b>					
1979-80	w/Rear Disc Brakes	CA-5557		CA-5595	CA-5600
1979-80	w/Rear Drum Brakes	CA-5557			CA-5590
1982-83		CA-5557		CA-5595	CA-5535
1984-85		CA-5557		CA-5595	CA-5600
1986-92				CA-5622	CA-5623
<b>VISTA CRUISER</b>					
1971-74	exc. Turbo-Hydramatic Trans.			CA-5517	CA-5517
1975	w/THM350 Auto. Trans.	CA-5522		CA-5517	CA-5517
1975			CA-5502	CA-5517	CA-5517
1976-77	3 Seat	CA-5522	CA-5502	CA-5517	CA-5517
1976-77					
<b>OLDSMOBILE TRUCKS</b>					
<b>BRAVADA</b>					
1991				CA-5610	CA-5610
<b>PLYMOUTH</b>					
<b>ACCLAIM</b>					
1989-90				CA-5080	CA-5080
1991-95		CA-5081		CA-5085	CA-5085
<b>CARAVELLE</b>					
1978	exc. Taxi & Police Car			CA-5017	
1978	Taxi & Police Car			CA-5016	
1979		CA-5012		CA-5013	CA-5013
1980	exc. Taxi & Police Car	CA-5012		CA-5020	CA-5020
1980	Taxi & Police Car	CA-5012		CA-5023	CA-5023
1982-85	exc. Taxi & Police Car	CA-5012	CA-5034	CA-5030	CA-5030
1982-85	Taxi & Police Car	CA-5012	CA-5034	CA-5062	CA-5062
1986-88		CA-5032	CA-5515	CA-5076	CA-5076
<b>DUSTER</b>					
1971-76				CA-5009	CA-5009
<b>GRAN FURY</b>					
1980-89	exc. Taxi & Police Car	CA-5012	CA-5034	CA-5030	CA-5030
1980-89	Taxi & Police Car	CA-5012	CA-5034	CA-5062	CA-5062
<b>HORIZON</b>					
1978-81	To 2/10/81			CA-5014	CA-5014
1978-82	2 Door	CA-5024			

# BRAKE CABLES

Year	Remark	Front	Intermediate	Rear Left	Rear Right
<b>PLYMOUTH (con't)</b>					
<b>HORIZON (con't)</b>					
1978-82	4 Door	CA-5025			
1981-82	From 2/10/81			CA-5037	CA-5037
1983-86	2 Door Hatchback	CA-5024			
1983-86	4 Door Hatchback	CA-5025			
1984-86		CA-5025			
1985-86				CA-5078	CA-5078
<b>RELIANT</b>					
1981	From 2/10/81	CA-5032		CA-5036	CA-5036
1981	To 2/10/81	CA-5032		CA-5035	CA-5035
1981-85		CA-5032	CA-5033		
1981-87	w/200mm Brakes	CA-5032	CA-5575	CA-5075	CA-5075
1981-87	w/220mm Brakes	CA-5032	CA-5006	CA-5058	CA-5058
1982		CA-5032			CA-5036
1982-83	w/200mm Brakes	CA-5032	CA-5033	CA-5038	CA-5038
1983	w/220mm Brakes	CA-5032		CA-5055	CA-5055
1986-89	w/200mm Brakes	CA-5032	CA-5006	CA-5642	CA-5642
1986-89	w/220mm Brakes	CA-5032	CA-5006	CA-5080	CA-5080
<b>SCAMP</b>					
1971-76	2 Door Hardtop			CA-5009	CA-5009
1976	2 Door Special Coupe			CA-5009	CA-5009
1976	2 Door Sport Coupe			CA-5009	CA-5009
<b>SUNDANCE</b>					
1987				CA-5061	CA-5061
1987-94			CA-5059		
1988	exc. 200mm Drum Brakes			CA-5058	CA-5058
1989-90				CA-5085	CA-5085
1990		CA-5081			
1991-94		CA-5081		CA-5645	CA-5645
1992-94	w/Rear Disc Brakes, w/Anti-Lock Brakes	CA-5081	CA-5058	CA-5085	CA-5085
1992-94	w/Rear Drum Brakes	CA-5081	CA-5058	CA-5645	CA-5645
<b>TURISMO</b>					
1983		CA-5025			
1985		CA-5024			
<b>VALIANT</b>					
1965-76				CA-5009	CA-5009
<b>VOLARE</b>					
1976-77	2 Door Special Coupe & 4 Door Sedan exc. 3.54 Axle Ratio, 3.55 Axle Ratio & Wagon	CA-5012		CA-5017	
1976-77	2 Door Special Coupe & 4 Door Sedan w/3.54 Axle Ratio, w/3.55 Axle Ratio, Wagon	CA-5012		CA-5016	
1976-77	4 Door Sedan exc. 3.54 Axle Ratio, exc. 3.55 Axle Ratio	CA-5012		CA-5017	
1978	exc. Taxi & Police Car	CA-5012		CA-5017	
1978	Taxi & Police Car	CA-5012		CA-5016	
1979		CA-5012		CA-5013	CA-5013
1980	exc. Taxi & Police Car	CA-5012		CA-5020	CA-5020
1980	Taxi & Police Car	CA-5012		CA-5023	CA-5023
<b>PLYMOUTH TRUCKS</b>					
<b>PB100</b>					
1974	w/109" Wheel Base, w/127" Wheel Base			CA-5015	CA-5015
1975-79	w/10" x 2.50" Brakes			CA-5015	CA-5015
1980	w/109" Wheel Base, w/127" Wheel Base			CA-5022	CA-5021
<b>PB150</b>					
1981	w/109" Wheel Base			CA-5022	CA-5021
1982-83	w/109" Wheel Base, w/127" Wheel Base			CA-5022	CA-5021



# BRAKE CABLES

Year	Remark	Front	Intermediate	Rear Left	Rear Right
<b>PLYMOUTH TRUCKS (con't)</b>					
<b>PB200</b>					
1974	w/109" Wheel Base, w/127" Wheel Base			CA-5015	CA-5015
1975-79	w/109" Wheel Base, w/127" Wheel Base			CA-5015	CA-5015
1980	w/109" Wheel Base, w/127" Wheel Base			CA-5022	CA-5021
<b>PB250</b>					
1981-83	w/109" Wheel Base, w/127" Wheel Base			CA-5022	CA-5021
<b>PB300</b>					
1974	109" Wheel Base exc. School Bus				CA-5044
1974	School Bus			CA-5043	
1975-77	109" Wheel Base exc. School Bus				CA-5044
1975-80	School Bus			CA-5043	
1978-79	School Bus, w/109" & w/127" Wheel Base			CA-5043	
1980					CA-5042
<b>PB350</b>					
1981-83	School Bus			CA-5043	CA-5042
<b>VOYAGER</b>					
1984-00	w/112" Wheel Base			CA-5071	CA-5071
1984-87		CA-5050	CA-5049	CA-5048	CA-5048
1985-89		CA-5057			
1987-89	119" Wheel Base		CA-6237	CA-6238	CA-6238
<b>PONTIAC</b>					
<b>6000</b>					
1982-83		CA-5546		CA-5553	CA-5552
1982-91	2WD	CA-5546		CA-5553	
1983-87	exc. Anti-Lock Brakes	CA-5546		CA-5553	
1983-88	2WD, w/Anti-Lock Brakes	CA-5546		CA-5613	CA-5629
1984-87	exc. STE	CA-5546		CA-5553	CA-5552
1984-87	STE	CA-5546		CA-5613	CA-5629
1988	2WD exc. Anti-Lock Brakes	CA-5546		CA-5553	CA-5552
1989	exc. Anti-Lock Brakes	CA-5546		CA-5553	CA-5552
1990-91	exc. AWD	CA-5546			CA-5552
<b>ACADIAN</b>					
1976-87	Canada, w/6.50" Dia. Ring Gear			CA-5526	CA-5526
1980-82	Canada, 1st Design, No Mounting Brackets			CA-5544	CA-5550
1980-86	Canada, 2nd Design, w/Mounting Brackets			CA-5596	CA-5597
1983-86	Canada, 1st Design, No Mounting Brackets				CA-5550
<b>BONNEVILLE</b>					
1967-70	Wagon		CA-5002	CA-5501	CA-5501
1971-72			CA-5513	CA-5514	CA-5514
1973-74	exc. Police Car		CA-5513	CA-5517	CA-5517
1975	exc. Police Car			CA-5517	CA-5517
1977-79		CA-5604		CA-5541	CA-5539
1980-81		CA-5538		CA-5541	CA-5539
1982-83		CA-5543		CA-5540	CA-5592
1984-86		CA-5601		CA-5540	CA-5592
1987-89			CA-5611	CA-5602	CA-5603
1987-94		CA-5614			
1990-99				CA-5636	CA-5635
<b>CATALINA</b>					
1967-70	2WD; Wagon		CA-5002	CA-5501	CA-5501
1971-72	exc. Wagon		CA-5513	CA-5514	CA-5514
1973-74	exc. Police Car		CA-5513	CA-5517	CA-5517
1975	exc. Police Car			CA-5517	CA-5517
1977-81		CA-5538		CA-5541	CA-5539
1978-79	exc. Wagon	CA-5538			CA-5539
1978-79	Wagon	CA-5538			CA-5530

# BRAKE CABLES

Year	Remark	Front	Intermediate	Rear Left	Rear Right
<b>PONTIAC (con't)</b>					
<b>FIERO</b>					
1984-88		CA-5593			CA-5599
<b>FIREBIRD</b>					
1967				CA-5510	CA-5510
1975-81	w/Rear Drum Brakes	CA-5520		CA-5519	CA-5519
1979-81	w/Rear Disc Brakes	CA-5520		CA-5537	CA-5542
1982-87	w/Rear Disc Brakes	CA-5565		CA-5572	CA-5607
1982-89	w/Rear Drum Brakes	CA-5565		CA-5554	CA-5571
1983	2nd Design, w/Rear Disc Brakes	CA-5565			CA-5607
1988	Performance package w/Rear Disc Brakes	CA-5565		CA-5630	CA-5630
1988	w/Rear Disc Brakes exc. Performance pkg	CA-5565		CA-5572	CA-5607
1989	w/Rear Disc Brakes	CA-5565		CA-5630	CA-5630
<b>GRAND AM</b>					
1973-74	2 Door, exc. THM400 Trans.		CA-5504	CA-5517	CA-5517
1978-79				CA-5525	CA-5592
1978-80	w/Auto. Trans.	CA-5536			CA-5592
1978-80	w/Man. Trans.	CA-5543			CA-5592
1985-86		CA-5626		CA-5547	CA-5548
1987-89		CA-5626		CA-5619	CA-5621
1990-91		CA-5626		CA-5619	CA-5640
<b>GRAND LEMANS</b>					
1975-77				CA-5517	CA-5517
1976-77	4 Door	CA-5522	CA-5502	CA-5525	
1978-80	w/Man. Trans.	CA-5543			
1978-81	w/Auto. Trans.	CA-5536			CA-5592
1980-81				CA-5540	
1981	Canada, Man. Trans.	CA-5543			
1982	Canada	CA-5549		CA-5547	CA-5592
<b>GRAND PRIX</b>					
1967-68			CA-5002	CA-5503	CA-5503
1969-72			CA-5003	CA-5503	CA-5503
1973-75		CA-5522	CA-5515		
1973-77		CA-5522		CA-5517	CA-5517
1978-79	w/Auto. Trans.			CA-5540	CA-5592
1978-79	w/Man. Trans.			CA-5525	CA-5592
1978-81	w/Auto. Trans.	CA-5536			CA-5592
1978-81	w/Man. Trans.	CA-5543			CA-5592
1982-83		CA-5543		CA-5540	CA-5592
1984-87		CA-5601		CA-5620	CA-5592
1988	w/Auto. Trans.	CA-5616		CA-5617	CA-5618
1988	w/Man. Trans.			CA-5634	CA-5618
1988-91	w/Auto. Trans.	CA-5616			CA-5618
1989-93				CA-5634	CA-5618
<b>GRANDVILLE</b>					
1971-72	exc. Wagon		CA-5513	CA-5514	CA-5514
1973-74	exc. Police Car		CA-5513	CA-5517	CA-5517
<b>GTO</b>					
1964-67	exc. Hydramatic Trans.		CA-5502	CA-5503	CA-5503
1968-69	w/Column Shift, w/THM350 Hydramatic Trans., 4 Door, Wagon		CA-5502	CA-5503	CA-5503
1968-69	w/Floor Shift, w/THM400 Hydramatic Trans.		CA-5003	CA-5503	CA-5503
<b>J2000</b>					
1982-84		CA-5549		CA-5547	CA-5548
<b>LEMANS</b>					
1967	exc. Hydramatic Trans.		CA-5502	CA-5503	CA-5503

# BRAKE CABLES

Year	Remark	Front	Intermediate	Rear Left	Rear Right
<b>PONTIAC (con't)</b>					
<b>LEMANS (con't)</b>					
1968-69	4 Door Wagon w/Column Shift manual or w/THM350 Hydramatic Trans.		CA-5502	CA-5503	CA-5503
1968-69	Manual w/Floor Shift or w/THM400 Hydramatic Trans.		CA-5003	CA-5503	CA-5503
1970-72	8 Cylinder		CA-5502	CA-5503	CA-5503
1973-74	2 Door, exc. THM400 Trans.		CA-5504	CA-5517	CA-5517
1976-77	4 Door	CA-5522	CA-5502	CA-5517	CA-5517
1978-79				CA-5525	CA-5592
1978-80	w/Man. Trans.	CA-5543			CA-5592
1978-81	w/Auto. Trans.	CA-5536			CA-5592
1981	Canada, Man. Trans.	CA-5543		CA-5540	CA-5592
<b>PARISIENNE</b>					
1982-84		CA-5538		CA-5541	CA-5539
1985-86	exc. Wagon	CA-5604		CA-5541	CA-5605
1985-86	Wagon	CA-5604		CA-5541	CA-5615
<b>PHOENIX</b>					
1977-79			CA-5523	CA-5510	CA-5510
1980	1st Design, Cable Exits at Front of Dash and Follows Along Right Side of Vehicle.	CA-5546		CA-5606	CA-5531
1980	2nd Design, Cable Exits Near Left Rear Seat Cushion & Follows Along Left Side of Vehicle	CA-5546		CA-5555	CA-5545
1981-83		CA-5546		CA-5555	CA-5545
1982-84		CA-5546		CA-5555	CA-5556
<b>SAFARI</b>					
1968	Wagon		CA-5002	CA-5501	CA-5501
1987-89		CA-5604		CA-5541	CA-5615
<b>SUNBIRD</b>					
1985-86		CA-5549		CA-5547	CA-5548
1987-89				CA-5619	CA-5621
1990-91				CA-5619	CA-5640
1992-94				CA-5632	CA-5633
<b>T1000</b>					
1981-82	1st Design, No Mounting Brackets			CA-5544	CA-5550
1982-86	2nd Design, w/Mounting Brackets			CA-5596	CA-5597
<b>TEMPEST</b>					
1967	exc. Hydramatic Trans.		CA-5502	CA-5503	CA-5503
1968-69	w/Column Shift, w/THM350 Hydramatic Trans., 4 Door, Wagon		CA-5502	CA-5503	CA-5503
1968-69	w/Floor Shift, w/THM400 Hydramatic Trans.		CA-5003	CA-5503	CA-5503
1970	V8		CA-5502	CA-5503	CA-5503
1987-89	Canada	CA-5631		CA-5633	CA-5632
1990-91	Canada			CA-5632	CA-5633
<b>VENTURA</b>					
1971-74			CA-5506	CA-5510	CA-5510
1976-77			CA-5523	CA-5510	CA-5510
<b>RENAULT</b>					
<b>ALLIANCE</b>					
1983-84				CA-6172	CA-6172
1984-87				CA-6060	CA-6060
<b>ENCORE</b>					
1984-86				CA-6172	CA-6172
<b>SUZUKI</b>					
<b>SWIFT</b>					
1989-94	3 Door			CA-6250	CA-6250

# BRAKE CABLES

Year	Remark	Front	Intermediate	Rear Left	Rear Right
<b>SUZUKI (con't)</b>					
<b>SWIFT (con't)</b>					
1989-94	5 Door			CA-6251	CA-6251
<b>SUZUKI TRUCKS</b>					
<b>SIDEKICK</b>					
1989-90				CA-6260	CA-6261
<b>TOYOTA</b>					
<b>CAMRY</b>					
1987-91	3SFE			CA-6252	CA-6253
1992-93	VCV10 3VZFE w/ABS			CA-6254	CA-6255
1992-96	SXV10 5SFE w/ABS			CA-6254	CA-6255
1994-96	MCV10 1MZFE w/ABS			CA-6254	CA-6255
<b>CARINA</b>					
1972-73		CA-6070			
<b>CELICA</b>					
1971-78		CA-6070			
1979-81		CA-6070		CA-6072	CA-6071
1982-85	exc. GTS			CA-6075	CA-6076
<b>COROLLA</b>					
1975-79		CA-6070			
1980-83	exc. Wagon				CA-6074
1988-92				CA-6256	CA-6257
<b>CORONA</b>					
1979-82					CA-6157
<b>PASEO</b>					
1992	To 8/92			CA-6258	CA-6259
1993		CA-6070			
<b>TERCEL</b>					
1980-82				CA-6073	CA-6073
1983-86	4WD Wagon	CA-6070		CA-6082	CA-6077
1983-86	Sedan	CA-6070		CA-6078	CA-6079
1987-94		CA-6070			
<b>TOYOTA TRUCKS</b>					
<b>4RUNNER</b>					
1984-85		CA-6081			
1989-95	4WD			CA-6327	CA-6328
<b>PICKUP</b>					
1979-83	2WD Short Wheel Base exc. H.D.			CA-6171	
1979-83	From 6/79, 2WD, Longbed	CA-6165			
1979-83	4WD, Longbed, From 6/79	CA-6166			
1984-85	2WD	CA-6080			
1984-85	4WD, w/Regular Cab	CA-6081			
1986-88	2WD, 1/2 & 3/4 Ton	CA-6080			
1988-95	2WD w/Long Wheel Base	CA-6329		CA-6324	CA-6323
1988-95	2WD w/Short Wheel Base	CA-6329		CA-6325	
1988-95	2WD w/Short Wheel Base	CA-6329		CA-6326	
1988-95	4WD			CA-6322	CA-6322
<b>VOLKSWAGEN</b>					
<b>BEETLE, KARMANN GHIA</b>					
1970-72				CA-6161	CA-6161
1973-79				CA-6152	CA-6152
<b>CABRIOLET</b>					
1985-90				CA-6150	CA-6150
<b>GOLF</b>					
1985-02	exc. GTI			CA-6151	CA-6151

# BRAKE CABLES

Year	Remark	Front	Intermediate	Rear Left	Rear Right
<b>VOLKSWAGEN (con't)</b>					
<b>JETTA</b>					
1981-92	exc. GLI			CA-6151	CA-6151
1982-85				CA-6150	CA-6150
<b>RABBIT</b>					
1981-84				CA-6150	CA-6150
<b>SCIROCCO</b>					
1982-89	exc. 16 Valve			CA-6150	CA-6150
<b>SUPER BEETLE</b>					
1971-75				CA-6152	CA-6152
<b>VOLKSWAGEN TRUCKS</b>					
<b>RABBIT PICKUP</b>					
1981-83				CA-6150	CA-6150

# **CLUTCH ALIGNMENT TOOLS**

# CLUTCH ALIGNMENT TOOLS

Year	Engine	Remark	Part
<b>ACURA</b>			
<b>CL</b>			
1997	L4 2.2L 2156cc	w/31/32" X 24 X 11/16"	TAT-5390
1998-99	L4 2.3L 2254cc	w/31/32" X 24 X 11/16"	TAT-5390
<b>INTEGRA</b>			
1986-89	L4 1.6L 1590cc		TAT-5201
1992-93	L4 1.7L 1678cc		TAT-5211
1994-01	L4 1.8L 1797cc		TAT-5211
1990-01	L4 1.8L 1834cc		TAT-5211
1996	L4 1.8L 1834cc	To Vin# 3316471	TAT-5211
<b>LEGEND</b>			
1986-87	V6 2.5L 2494cc		TAT-5211
1987-90	V6 2.7L 2675cc		TAT-5211
1993-95	V6 3.2L 3206cc	6 Speed w/31/32" X 24 X 11/16"	TAT-5390
<b>VIGOR</b>			
1992-94	L5 2.5L 2451cc		TAT-5423
<b>ALFA ROMEO</b>			
<b>164</b>			
1991-95	V6 3.0L 2959cc	w/1" X 10 X "early" 5/8"	TAT-5373
<b>ALFETTA</b>			
1975-77	L4 2.0L 1961cc		TAT-5207
<b>GTV-6</b>			
1981-86	V6 2.5L 2492cc	Kit incl two disc 38031 and 38030.w/1" X 10 X "early" 5/8"	TAT-5373
<b>MILANO</b>			
1987-89	V6 2.5L 2492cc		TAT-5207
1988-89	V6 3.0L 2959cc		TAT-5207
<b>AMERICAN MOTORS</b>			
<b>AMBASSADOR</b>			
1967	L6 3.3L 199ci	9-1/8" Disc w/1" X 10 X 49/64"	TAT-5349
1966-70	L6 3.8L 232ci	9-1/8", 10" Disc w/1" X 10 X 49/64"	TAT-5349
1971	L6 4.2L 258ci	9-1/8", 10" Disc w/1" X 10 X 49/64"	TAT-5349
1966	V8 4.7L 287ci	4 Speed w/1" 5/32" X 10 X 5/8"	TAT-5359
1968	V8 4.8L 290ci	4 Speed w/1" 5/32" X 10 X 5/8"	TAT-5359
1968-69	V8 4.8L 290ci	3 Speed w/1" 5/32" X 10 X 5/8"	TAT-5359
1960-66	V8 5.4L 327ci	w/1" 5/32" X 10 X 5/8"	TAT-5359
1967-69	V8 5.6L 343ci	w/1" 5/32" X 10 X 5/8"	TAT-5359
1970	V8 5.9L 360ci	w/1" 5/32" X 10 X 5/8"	TAT-5359
1968-70	V8 6.4L 390ci	w/1" 5/32" X 10 X 5/8"	TAT-5359
1971-74	V8 6.6L 401ci	11" Lever Type w/1" 5/32" X 10 X 5/8"	TAT-5359
<b>AMERICAN</b>			
1964-66	L6 3.2L 196ci	9-1/8" Disc w/1" X 10 X 49/64"	TAT-5349
1967-68	L6 3.3L 199ci	9-1/8" Disc w/1" X 10 X 49/64"	TAT-5349
<b>AMX</b>			
1978-80	L6 4.2L 258ci	9-1/8" Disc w/1" X 10 X 49/64"	TAT-5349
1968-69	V8 4.8L 290ci	w/1" X 10 X 49/64"	TAT-5349
1968-69	V8 5.6L 343ci	w/1" X 10 X 49/64"	TAT-5349
1970	V8 5.9L 360ci	w/1" X 10 X 49/64"	TAT-5349
1971-72	V8 5.9L 360ci	11" Lever Type w/1-3/32" X 10 X 5/8"	TAT-5365
1971-74	V8 5.9L 360ci	11" Lever Type w/1" 5/32" X 10 X 5/8"	TAT-5359
1968-70	V8 6.4L 390ci	w/1" X 10 X 49/64"	TAT-5349
1972-74	V8 6.6L 401ci	11" Lever Type w/1" 5/32" X 10 X 5/8"	TAT-5359
<b>CLASSIC</b>			
1964	L6 3.2L 196ci	9-1/8" Disc w/1" X 10 X "early" 3/4"	TAT-5376
1964	L6 3.2L 196ci	w/o E Stick w/1" X 10 X 49/64"	TAT-5349
1965	L6 3.3L 199ci	9-1/8" Disc w/1" X 10 X 49/64"	TAT-5349
1964-65	V8 4.7L 287ci	w/1" 5/32" X 10 X 5/8"	TAT-5359
1966	V8 5.4L 327ci	w/1" 5/32" X 10 X 5/8"	TAT-5359
<b>CONCORD</b>			
1978-79	L4 2.0L 121ci	w/1" X 23 X 19/32"	TAT-5311
1980-82	L4 2.5L 151ci	w/1-1/8" X 10 X 19/32"	TAT-5301

# CLUTCH ALIGNMENT TOOLS

Year	Engine	Remark	Part
<b>AMERICAN MOTORS (con't)</b>			
<b>EAGLE</b>			
1981-83	L4 2.5L 151ci	w/1-1/8" X 10 X 19/32"	TAT-5301
1982	L6 4.2L 258ci	From Engine #011C03 w/1-1/8" X 10 X 19/32"	TAT-5301
1980-88	L6 4.2L 258ci	10-1/2" Diaph Type w/1-1/8" X 10 X 19/32"	TAT-5301
<b>GREMLIN</b>			
1977-78	L4 2.0L 121ci	w/1" X 23 X 19/32"	TAT-5311
1970	L6 3.3L 199ci	9-1/8" Disc w/1" X 10 X 49/64"	TAT-5349
1970-74	L6 3.8L 232ci	9-1/8" & 10" Disc. w/1" X 10 X 49/64"	TAT-5349
1976-78	L6 3.8L 232ci	10" Disc w/1" X 10 X "early" 3/4"	TAT-5376
1971-74	L6 4.2L 258ci	10" Disc w/1" X 10 X 49/64"	TAT-5349
1975	L6 4.2L 258ci	9" X 1-1/16" X 10" Disc	TAT-5375
1975-76	L6 4.2L 258ci	10" Disc w/1" X 10 X "early" 3/4"	TAT-5376
1972-74	V8 5.0L 304ci	Early Type w/1" X 10 X 49/64"	TAT-5349
1974-76	V8 5.0L 304ci	Late Type w/1-1/16" X 10 X 21/32"	TAT-5375
<b>HORNET</b>			
1970-76	L6 3.8L 232ci	9-1/8" & 10" Disc. w/1" X 10 X 49/64"	TAT-5349
1975-76	L6 3.8L 232ci	9-1/4" Lever Type, 9" Disc. w/1-1/8" X 10 X 19/32"	TAT-5301
1972-74	L6 4.2L 258ci	9-1/8" & 10" Disc. w/1" X 10 X 49/64"	TAT-5349
1976	L6 4.2L 258ci	9-1/4" Lever Type, 9" Disc. w/1-1/8" X 10 X 19/32"	TAT-5301
1972-75	V8 5.0L 304ci	Early Type w/1" X 10 X 49/64"	TAT-5349
1972-75	V8 5.0L 304ci	Late Type w/1-1/16" X 10 X 21/32"	TAT-5375
1971	V8 5.9L 360ci	11" Lever Type w/1-5/32" X 10 X 5/8"	TAT-5359
1971-72	V8 5.9L 360ci	11" Lever Type w/1-1/8" X 10 X 5/8"	TAT-5365
<b>JAVELIN</b>			
1968-74	L6 3.8L 232ci	9-1/8" Disc. w/1" X 10 X 49/64"	TAT-5349
1968-69	V8 4.8L 290ci	w/1-5/32" X 10 X 5/8"	TAT-5359
1970-71	V8 5.0L 304ci	w/1-5/32" X 10 X 5/8"	TAT-5359
1972-74	V8 5.0L 304ci	10" Disc. w/1" X 10 X 49/64"	TAT-5349
1968-69	V8 5.6L 343ci	w/1" X 10 X 49/64"	TAT-5349
1970	V8 5.9L 360ci	w/1-5/32" X 10 X 5/8"	TAT-5359
1971	V8 5.9L 360ci	11" Lever Type w/1-1/8" X 10 X 5/8"	TAT-5365
1971-74	V8 5.9L 360ci	11" Lever Type w/1-5/32" X 10 X 5/8"	TAT-5359
1969-70	V8 6.4L 390ci	w/1-5/32" X 10 X 5/8"	TAT-5359
1971-74	V8 6.6L 401ci	11" Lever Type w/1-5/32" X 10 X 5/8"	TAT-5359
<b>MARLIN</b>			
1965-66	V8 4.7L 287ci	w/1-5/32" X 10 X 5/8"	TAT-5359
1967	V8 4.8L 290ci	w/1-5/32" X 10 X 5/8"	TAT-5359
1966	V8 5.4L 327ci	w/1-5/32" X 10 X 5/8"	TAT-5359
1967	V8 5.6L 343ci	w/1-5/32" X 10 X 5/8"	TAT-5359
<b>MATADOR</b>			
1971-74	L6 3.8L 232ci	9-1/8" Disc. w/1" X 10 X 49/64"	TAT-5349
1971-74	L6 4.2L 258ci	9-1/8" Disc. w/1" X 10 X 49/64"	TAT-5349
1975-77	L6 4.2L 258ci	10" Disc. w/1-1/8" X 10 X 5/8"	TAT-5365
1975-77	L6 4.2L 258ci	9" Disc. w/1-1/8" X 10 X 5/8"	TAT-5365
1974-76	V8 5.0L 304ci	w/1-1/16" X 10 X 21/32"	TAT-5375
1971	V8 5.9L 360ci	11" Lever Type w/1-1/8" X 10 X 5/8"	TAT-5365
1971-74	V8 5.9L 360ci	11" Lever Type w/1-5/32" X 10 X 5/8"	TAT-5359
1971-74	V8 6.6L 401ci	11" Lever Type w/1-5/32" X 10 X 5/8"	TAT-5359
<b>PACER</b>			
1978	L6 3.8L 232ci	w/1-1/16" X 10 X 21/32"	TAT-5375
1975-77	L6 3.8L 232ci	9-1/4" Lever Type, 9" Disc. w/1-1/8" X 10 X 19/32"	TAT-5301
1978	L6 4.2L 258ci	w/1-1/16" X 10 X 21/32"	TAT-5375
1980	L6 4.2L 258ci	w/1-1/8" X 10 X 19/32"	TAT-5301
1975-80	L6 4.2L 258ci	9-1/4" Lever Type, 9" Disc. w/1-1/8" X 10 X 19/32"	TAT-5301
<b>RAMBLER</b>			
1969	V8 4.8L 290ci	w/1" X 10 X 49/64"	TAT-5349
<b>REBEL</b>			
1969-70	L6 3.8L 232ci	9-1/8" Disc. w/1" X 10 X 49/64"	TAT-5349
1959-61	V8 4.1L 250ci	w/1-5/32" X 10 X 5/8"	TAT-5359



# CLUTCH ALIGNMENT TOOLS

Year	Engine	Remark	Part
<b>AMERICAN MOTORS (con't)</b>			
<b>REBEL (con't)</b>			
1968-69	V8 4.8L 290ci	w/1-5/32" X 10 X 5/8"	TAT-5359
1968-69	V8 5.6L 343ci	w/1-5/32" X 10 X 5/8"	TAT-5359
1969-70	V8 6.4L 390ci	w/1-5/32" X 10 X 5/8"	TAT-5359
<b>SPIRIT</b>			
1979	L4 2.0L 121ci	w/1" X 23 X 19/32"	TAT-5311
1980-82	L4 2.5L 151ci	w/1-1/8" X 10 X 19/32"	TAT-5301
<b>AUDI</b>			
<b>100, 100 QUATTRO</b>			
1989-91	L5 2.3L 2309cc		TAT-5208
1992-94	V6 2.8L 2771cc	Rigid Disc From Ch. 4A-P-080001, To Ch. 4A-P-080000	TAT-5208
1992-94	V6 2.8L 2771cc	Rigid Disc From Ch. 8CP2000001, To Ch. 8CP2000000	TAT-5208
<b>200, 200 QUATTRO</b>			
1989-91	L5 2.2L 2226cc	From Engine # MC049109 w/13/16" X 24 X 11/16"	TAT-5351
<b>4000, 4000 QUATTRO</b>			
1980	L4 1.6L 1588cc	w/13/16" X 24 X 39/64"	TAT-5302
1982-83	L4 1.6L 1588cc	Diesel w/13/16" X 24 X 39/64"	TAT-5302
1982-83	L4 1.6L 1588cc	Turbo Diesel w/13/16" X 24 X 39/64"	TAT-5302
1981-83	L4 1.7L 1715cc	w/13/16" X 24 X 39/64"	TAT-5302
1984-87	L4 1.8L 1780cc	w/13/16" X 24 X 39/64"	TAT-5302
1980-87	L5 2.2L 2144cc	w/13/16" X 24 X 11/16"	TAT-5351
1985-87	L5 2.2L 2226cc	w/13/16" X 24 X 11/16"	TAT-5351
<b>5000, 5000 QUATTRO</b>			
1979-84	L5 2.0L 1986cc	Diesel w/13/16" X 24 X 11/16"	TAT-5351
1982-84	L5 2.0L 1986cc	Turbo Diesel w/13/16" X 24 X 11/16"	TAT-5351
1978-85	L5 2.2L 2144cc	w/13/16" X 24 X 11/16"	TAT-5351
1985-88	L5 2.2L 2226cc	w/13/16" X 24 X 11/16"	TAT-5351
1987-88	L5 2.3L 2309cc	w/13/16" X 24 X 11/16"	TAT-5351
<b>80, 80 QUATTRO</b>			
1988-90	L4 2.0L 1983cc		TAT-5208
1988-92	L5 2.3L 2309cc		TAT-5208
<b>90, 90 QUATTRO</b>			
1988-91	L5 2.3L 2309cc	NG; SOHC Engine	TAT-5208
1990-91	L5 2.3L 2309cc	7A; DOHC Engine	TAT-5208
1993-95	V6 2.8L 2771cc	Rigid Disc, To Ch. 8CP2000000	TAT-5208
<b>A4 QUATTRO</b>			
2000-01	L4 1.8L 1781cc	5 Speed	TAT-5213
<b>A6, A6 QUATTRO</b>			
1995-98	V6 2.8L 2771cc	Rigid Disc To CH# 4A-S-026714, From CH# 4A-S-026714	TAT-5208
<b>CABRIOLET</b>			
1995	V6 2.8L 2771cc	Rigid Disc	TAT-5208
<b>COUPE</b>			
1981-84	L5 2.2L 2144cc	w/13/16" X 24 X 11/16"	TAT-5351
1983-84	L5 2.2L 2144cc	Rigid Disc	TAT-5208
1984-85	L5 2.2L 2226cc	Rigid Disc	TAT-5208
1984-87	L5 2.2L 2226cc	w/13/16" X 24 X 11/16"	TAT-5351
1987	L5 2.3L 2309cc	w/13/16" X 24 X 11/16"	TAT-5351
<b>COUPE QUATTRO</b>			
1990-91	L5 2.3L 2309cc		TAT-5208
<b>FOX</b>			
1973-74	L4 1.5L 1471cc	w/13/16" X 24 X 39/64"	TAT-5302
1975-79	L4 1.6L 1588cc	Gas w/13/16" X 24 X 39/64"	TAT-5302
<b>S4</b>			
1992-94	L5 2.2L 2226cc	Rigid Disc	TAT-5208
<b>S6</b>			
1995-96	L5 2.2L 2226cc	Rigid Disc	TAT-5208
<b>TT, TT QUATTRO</b>			
2000-01	L4 1.8L 1781cc	5 Speed	TAT-5213
2000-01	L4 1.8L 1781cc	5 Speed	TAT-5213

# CLUTCH ALIGNMENT TOOLS

Year	Engine	Remark	Part
<b>AUDI (con't)</b>			
<b>V8 QUATTRO</b>			
1990-91	V8 3.6L 3562cc		TAT-5208
1992	V8 4.2L 4172cc		TAT-5208
<b>BMW</b>			
<b>1600, 1600TI</b>			
1967-71	L4 1.6L 1573cc	w/1-1/8" X 10 X 15/32"	TAT-5317
<b>1800</b>			
1966-71	L4 1.8L 1766cc	w/1-1/8" X 10 X 15/32"	TAT-5317
<b>2000, 2000C, 2000TI</b>			
1966-72	L4 2.0L 1990cc	w/1-1/8" X 10 X 15/32"	TAT-5317
<b>2002</b>			
1967	L4 2.0L 1990cc	exc. TII w/1-1/8" X 10 X 15/32"	TAT-5317
1968-70	L4 2.0L 1990cc	To CH 1 665 243 w/1-1/8" X 10 X 15/32"	TAT-5317
1970-73	L4 2.0L 1990cc	From CH 1 665 244 w/1-1/8" X 10 X 15/32"	TAT-5317
1974-75	L4 2.0L 1990cc	w/1-1/8" X 10 X 15/32"	TAT-5317
<b>2002TII</b>			
1971-74	L4 2.0L 1990cc	w/1-1/8" X 10 X 15/32"	TAT-5317
<b>2500</b>			
1969-71	L6 2.5L 2494cc	w/1-1/8" X 10 X 15/32"	TAT-5317
<b>2800</b>			
1969-74	L6 2.8L 2788cc	w/1-1/8" X 10 X 15/32"	TAT-5317
<b>3.0CS, 3.0CSI, 3.0CSL, 3.0S, 3.0SI</b>			
1971-76	L6 3.0L 2985cc	w/1-1/8" X 10 X 15/32"	TAT-5317
<b>318I, 318IC, 318IS, 318TI</b>			
1984-85	L4 1.8L 1766cc	318i w/1-1/8" X 10 X 15/32"	TAT-5317
1991-95	L4 1.8L 1796cc	w/DMF, w/o DMF w/1-1/8" X 10 X 15/32"	TAT-5317
1996-98	L4 1.9L 1895cc	w/DMF, w/o DMF w/1-1/8" X 10 X 15/32"	TAT-5317
<b>320I</b>			
1980-83	L4 1.8L 1766cc	w/1-1/8" X 10 X 15/32"	TAT-5317
1977-79	L4 2.0L 1990cc	w/1-1/8" X 10 X 15/32"	TAT-5317
<b>323I, 323IC, 323IS</b>			
1999	L6 2.5L 2494cc	w/1-1/8" X 10 X 15/32"	TAT-5317
<b>325, 325I, 325IS, 325IX</b>			
1986-87	L6 2.7L 2693cc	325 only w/1-1/8" X 10 X 15/32"	TAT-5317
1987-88	L6 2.7L 2693cc	Rigid Disc; 325 only w/1-1/8" X 10 X 15/32"	TAT-5317
1987-95	L6 2.5L 2494cc	w/1-1/8" X 10 X 15/32"	TAT-5317
1989-93	L6 2.5L 2494cc	w/o DMF w/1-1/8" X 10 X 15/32"	TAT-5317
1992-95	L6 2.5L 2494cc	DMF, Rigid Disc w/1-1/8" X 10 X 15/32"	TAT-5317
<b>328I, 328IC, 328IS</b>			
1996-99	L6 2.8L 2793cc	w/1-1/16" X 10 X 39/64"	TAT-5341
<b>524TD</b>			
1985	L6 2.4L 2443cc	w/1-1/8" X 10 X 15/32"	TAT-5317
1986	L6 2.4L 2443cc	Rigid Disc w/1-1/8" X 10 X 15/32"	TAT-5317
<b>525I</b>			
1989-90	L6 2.5L 2494cc	w/1-1/8" X 10 X 15/32"	TAT-5317
1991-95	L6 2.5L 2494cc	M50 Twin Cam w/1-1/8" X 10 X 15/32"	TAT-5317
<b>528E</b>			
1982-88	L6 2.7L 2693cc	w/1-1/8" X 10 X 15/32"	TAT-5317
<b>528I</b>			
1979-81	L6 2.8L 2788cc	w/1-1/8" X 10 X 15/32"	TAT-5317
1997-98	L6 2.8L 2793cc	w/1-1/16" X 10 X 39/64"	TAT-5341
<b>530I, 530IT</b>			
1975-77	L6 3.0L 2985cc	530I w/1-1/8" X 10 X 15/32"	TAT-5317
1994-95	V8 3.0L 2997cc	DMF w/1-1/8" X 10 X 15/32"	TAT-5317
<b>533I</b>			
1984	L6 3.2L 3210cc	From 4/84 To 3/84 w/1-1/8" X 10 X 15/32"	TAT-5317
<b>535I, 535IS</b>			
1985-93	L6 3.5L 3430cc	w/1-1/8" X 10 X 15/32"	TAT-5317

# CLUTCH ALIGNMENT TOOLS

Year	Engine	Remark	Part
<b>BMW (con't)</b>			
<b>540I</b>			
1994-95	V8 4.0L 3982cc	w/1-1/4" X 10 X 39/64"	TAT-5352
1997-02	V8 4.4L 4398cc	w/1-1/4" X 10 X 39/64"	TAT-5352
<b>630CSI</b>			
1977	L6 3.0L 2985cc	w/1-1/8" X 10 X 15/32"	TAT-5317
<b>633CSI, 733I</b>			
1984	L6 3.2L 3210cc	From 4/84 To 3/84 w/1-1/8" X 10 X 15/32"	TAT-5317
1978-83	L6 3.2L 3210cc	w/1-1/8" X 10 X 15/32"	TAT-5317
<b>635CSI</b>			
1985-89	L6 3.5L 3430cc	w/1-1/8" X 10 X 15/32"	TAT-5317
<b>735I, 735IL</b>			
1985-92	L6 3.5L 3430cc	w/1-1/8" X 10 X 15/32"	TAT-5317
<b>850CI</b>			
1993-94	V12 5.0L 4988cc	w/1-1/4" X 10 X 39/64"	TAT-5352
1995	V12 5.4L 5379cc	w/1-1/4" X 10 X 39/64"	TAT-5352
<b>850CSI</b>			
1994-95	V12 5.6L 5576cc	w/1-1/4" X 10 X 39/64"	TAT-5352
<b>850I</b>			
1991-92	V12 5.0L 4988cc	w/1-1/4" X 10 X 39/64"	TAT-5352
<b>BAVARIA</b>			
1972-74	L6 3.0L 2985cc	w/1-1/8" X 10 X 15/32"	TAT-5317
<b>M3</b>			
1988-91	L4 2.3L 2302cc	w/1-1/8" X 10 X 15/32"	TAT-5317
1995	L6 3.0L 2990cc	DMF w/1-1/8" X 10 X 15/32"	TAT-5317
1996-01	L6 3.2L 3152cc	5 & 6 Speed w/1-1/8" X 10 X 15/32"	TAT-5317
<b>M5</b>			
1988	L6 3.5L 3453cc	w/1-1/8" X 10 X 15/32"	TAT-5317
1991-93	L6 3.6L 3553cc	w/1-1/8" X 10 X 15/32"	TAT-5317
<b>M6</b>			
1987-88	L6 3.5L 3453cc	w/1-1/8" X 10 X 15/32"	TAT-5317
<b>Z3</b>			
1996	L4 1.9L 1895cc	Rigid Disc w/1-1/8" X 10 X 15/32"	TAT-5317
1997	L4 1.9L 1895cc	From 3/97 To 3/97; Rigid Disc w/1-1/8" X 10 X 15/32"	TAT-5317
1998	L4 1.9L 1895cc	w/1-1/8" X 10 X 15/32"	TAT-5317
1997	L6 2.8L 2793cc	From 3/97 To 3/97 w/1-1/16" X 10 X 39/64"	TAT-5341
1998-99	L6 2.8L 2793cc	w/1-1/16" X 10 X 39/64"	TAT-5341
1998-99	L6 3.2L 3152cc	5 Speed w/1-1/8" X 10 X 15/32"	TAT-5317
2000	L6 3.2L 3152cc	w/1-1/8" X 10 X 15/32"	TAT-5317
2001	L6 3.2L 3246cc	w/1-1/8" X 10 X 15/32"	TAT-5317
<b>BMW TRUCKS</b>			
<b>X5</b>			
2001	L6 3.0L 2979cc	w/1-1/4" X 10 X 39/64"	TAT-5352
<b>BUICK</b>			
<b>APOLLO</b>			
1973-75	L6 4.1L 250ci	w/1-1/8" X 10 X 19/32"	TAT-5301
1975	V8 4.3L 260ci	w/1-1/8" X 10 X 19/32"	TAT-5301
1973	V8 5.7L 350ci	3 Speed, 10.4" Disc w/1-1/8" X 10 X 19/32"	TAT-5301
1973	V8 5.7L 350ci	4 Speed w/1-1/8" X 26 X 19/32"	TAT-5313
<b>CENTURION</b>			
1972-73	V8 5.7L 350ci	3 Speed, 10.4" Disc w/1-1/8" X 10 X 19/32"	TAT-5301
1972-73	V8 5.7L 350ci	4 Speed w/1-1/8" X 26 X 19/32"	TAT-5313
1971	V8 7.5L 455ci	2Bbl. w/1-1/8" X 10 X 19/32"	TAT-5301
1971-73	V8 7.5L 455ci	w/1-1/8" X 26 X 19/32"	TAT-5313
<b>CENTURY</b>			
1982	L4 2.5L 151ci	9-1/8" Disc w/1" X 14 X 53/64"	TAT-5342
1988-89	V6 2.8L 173ci	9-1/8" Disc w/1" X 14 X 53/64"	TAT-5342
1978-79	V6 3.2L 196ci	9-1/8" Disc w/1-1/8" X 10 X 19/32"	TAT-5301
1975-77	V6 3.8L 231ci	9-1/8" Disc w/1-1/8" X 10 X 19/32"	TAT-5301
1978-81	V6 3.8L 231ci	w/1-1/8" X 10 X 19/32"	TAT-5301

# CLUTCH ALIGNMENT TOOLS

Year	Engine	Remark	Part
<b>BUICK (con't)</b>			
<b>CENTURY (con't)</b>			
1982-84	V6 4.3L 260ci	w/1-1/8" X 10 X 19/32"	TAT-5301
1980-81	V8 4.3L 265ci	w/1-1/8" X 10 X 19/32"	TAT-5301
1973	V8 5.7L 350ci	3 Speed, 10.4" Disc w/1-1/8" X 10 X 19/32"	TAT-5301
1973	V8 5.7L 350ci	4 Speed w/1-1/8" X 26 X 19/32"	TAT-5313
1973	V8 7.5L 455ci	4Bbl. w/1-1/8" X 26 X 19/32"	TAT-5313
<b>ELECTRA</b>			
1966	V8 6.6L 401ci	w/1-1/8" X 10 X 19/32"	TAT-5301
1967-69	V8 7.0L 430ci	11" Diaph Type w/1-1/8" X 10 X 19/32"	TAT-5301
1970-71	V8 7.5L 455ci	2Bbl. w/1-1/8" X 10 X 19/32"	TAT-5301
1971-73	V8 7.5L 455ci	4Bbl. w/1-1/8" X 26 X 19/32"	TAT-5313
<b>GS</b>			
1970-72	V8 5.7L 350ci	3 Speed, 10.4" 11" Disc w/1-1/8" X 10 X 19/32"	TAT-5301
1970-72	V8 5.7L 350ci	4 Speed w/1-1/8" X 26 X 19/32"	TAT-5313
<b>GS 455</b>			
1970	V8 7.5L 455ci	2Bbl. w/1-1/8" X 10 X 19/32"	TAT-5301
1970	V8 7.5L 455ci	4Bbl. w/1-1/8" X 26 X 19/32"	TAT-5313
<b>LESABRE</b>			
1976-77	V6 3.8L 231ci	9-1/8" Disc w/1-1/8" X 10 X 19/32"	TAT-5301
1965	V8 4.9L 300ci	w/1-1/8" X 10 X 19/32"	TAT-5301
1967	V8 5.6L 340ci	11" Diaph Type w/1-1/8" X 10 X 19/32"	TAT-5301
1968-71	V8 5.7L 350ci	3 Speed, 11" Disc w/1-1/8" X 10 X 19/32"	TAT-5301
1968-73	V8 5.7L 350ci	3 Speed, 10.4" Disc w/1-1/8" X 10 X 19/32"	TAT-5301
1968-73	V8 5.7L 350ci	4 Speed w/1-1/8" X 26 X 19/32"	TAT-5313
1970-71	V8 7.5L 455ci	2Bbl. w/1-1/8" X 10 X 19/32"	TAT-5301
1971-73	V8 7.5L 455ci	4Bbl. w/1-1/8" X 26 X 19/32"	TAT-5313
<b>REGAL</b>			
1988-89	V6 2.8L 173ci	w/1" X 14 X 53/64"	TAT-5342
1978-79	V6 3.2L 196ci	9-1/8" Disc w/1-1/8" X 10 X 19/32"	TAT-5301
1975-77	V6 3.8L 231ci	9-1/8" Disc w/1-1/8" X 10 X 19/32"	TAT-5301
1978-81	V6 3.8L 231ci	w/1-1/8" X 10 X 19/32"	TAT-5301
1980-81	V8 4.3L 265ci	w/1-1/8" X 10 X 19/32"	TAT-5301
1973	V8 5.7L 350ci	3 Speed, 10.4" Disc w/1-1/8" X 10 X 19/32"	TAT-5301
1973	V8 5.7L 350ci	4 Speed w/1-1/8" X 26 X 19/32"	TAT-5313
1973	V8 7.5L 455ci	4Bbl. w/1-1/8" X 26 X 19/32"	TAT-5313
<b>SKYHAWK</b>			
1982-86	L4 1.8L 112ci	w/1" X 14 X 53/64"	TAT-5342
1985-86	L4 1.8L 112ci	4 Speed, Turbo w/1" X 14 X 53/64"	TAT-5342
1987	L4 2.0L 122ci	Turbo w/1" X 14 X 53/64"	TAT-5342
1983-89	L4 2.0L 122ci	8",9-1/8" Disc w/1" X 14 X 53/64"	TAT-5342
1985-87	L4 2.0L 122ci	9-1/8" Disc w/1" X 14 X 53/64"	TAT-5342
<b>SKYLARK</b>			
1980-84	L4 2.5L 151ci	9-1/8" Disc w/1" X 14 X 53/64"	TAT-5342
1985-89	L4 2.5L 151ci	FWD w/1" X 14 X 53/64"	TAT-5342
1968-71	L6 4.1L 250ci	w/1-1/8" X 10 X 19/32"	TAT-5301
1980-85	V6 2.8L 173ci	9-1/8" Disc w/1" X 14 X 53/64"	TAT-5342
1986-88	V6 3.0L 181ci	w/1" X 14 X 53/64"	TAT-5342
1964-67	V6 3.7L 225ci	w/1-1/8" X 10 X 19/32"	TAT-5301
1975-77	V6 3.8L 231ci	9-1/8" Disc w/1-1/8" X 10 X 19/32"	TAT-5301
1978-79	V6 3.8L 231ci	3 & 4 Speed w/1-1/8" X 10 X 19/32"	TAT-5301
1975-76	V8 4.3L 260ci	w/1-1/8" X 10 X 19/32"	TAT-5301
1964-67	V8 4.9L 300ci	w/1-1/8" X 10 X 19/32"	TAT-5301
1978-79	V8 5.0L 305ci	w/1-1/8" X 10 X 19/32"	TAT-5301
1967	V8 5.6L 340ci	11" Diaph Type w/1-1/8" X 10 X 19/32"	TAT-5301
1968-72	V8 5.7L 350ci	3 Speed, 10.4", 11" Disc w/1-1/8" X 10 X 19/32"	TAT-5301
1968-72	V8 5.7L 350ci	4 Speed w/1-1/8" X 26 X 19/32"	TAT-5313
1978-79	V8 5.7L 350ci	w/1-1/8" X 10 X 19/32"	TAT-5301
1967-68	V8 6.6L 400ci	11" Diaph Type w/1-1/8" X 10 X 19/32"	TAT-5301
1966	V8 6.6L 401ci	w/1-1/8" X 10 X 19/32"	TAT-5301

# CLUTCH ALIGNMENT TOOLS

Year	Engine	Remark	Part
<b>BUICK (con't)</b>			
<b>SKYLARK (con't)</b>			
1970	V8 7.5L 455ci	2Bbl. w/1-1/8" X 10 X 19/32"	TAT-5301
1972	V8 7.5L 455ci	4Bbl. w/1-1/8" X 26 X 19/32"	TAT-5313
<b>SOMERSET</b>			
1986-87	L4 2.5L 151ci	w/1-1/8" X 26 X 19/32"	TAT-5342
1986-87	V6 3.0L 181ci	w/1-1/8" X 26 X 19/32"	TAT-5342
<b>SPECIAL</b>			
1968-69	L6 4.1L 250ci	w/1-1/8" X 10 X 19/32"	TAT-5301
1964-67	V6 3.7L 225ci	w/1-1/8" X 10 X 19/32"	TAT-5301
1964-67	V8 4.9L 300ci	w/1-1/8" X 10 X 19/32"	TAT-5301
1968-69	V8 5.7L 350ci	3 Speed, 10.4", 11" Disc w/1-1/8" X 10 X 19/32"	TAT-5301
1968-69	V8 5.7L 350ci	4 Speed w/1-1/8" X 26 X 19/32"	TAT-5313
<b>SPORTWAGON</b>			
1964-65	V6 3.7L 225ci	w/1-1/8" X 10 X 19/32"	TAT-5301
1964-65	V8 4.9L 300ci	w/1-1/8" X 10 X 19/32"	TAT-5301
<b>WILDCAT</b>			
1967-69	V8 7.0L 430ci	11" Diaph Type w/1-1/8" X 10 X 19/32"	TAT-5301
1970	V8 7.5L 455ci	2Bbl. w/1-1/8" X 10 X 19/32"	TAT-5301
<b>CADILLAC</b>			
<b>CIMARRON</b>			
1982	L4 1.8L 112ci	4 Speed w/1-1/8" X 26 X 19/32"	TAT-5342
1983-86	L4 2.0L 122ci	5 Speed w/1-1/8" X 26 X 19/32"	TAT-5342
1985-88	V6 2.8L 173ci	4 & 5 Speed w/1-1/8" X 26 X 19/32"	TAT-5342
<b>CHECKER</b>			
<b>MARATHON</b>			
1968	L6 3.8L 230ci	11" Flat Diaph Type w/1-1/8" X 10 X 19/32"	TAT-5301
1969-79	L6 4.1L 250ci	11" Flat Diaph Type w/1-1/8" X 10 X 19/32"	TAT-5301
1969	V8 5.4L 327ci	11" Flat Diaph Type w/1-1/8" X 10 X 19/32"	TAT-5301
1969-79	V8 5.7L 350ci	12" Lever Type w/1-1/8" X 10 X 19/32"	TAT-5301
<b>CHEVROLET</b>			
<b>BEL AIR</b>			
1950-52	L6 3.6L 217ci	Diaph Type w/1-1/8" X 10 X 19/32"	TAT-5301
1963-65	L6 3.8L 230ci	11" Flat Diaph Type w/1-1/8" X 10 X 19/32"	TAT-5301
1955-62	L6 3.9L 235ci	9-1/2" Disc, 11" Flat Diaph Type w/1-1/8" X 10 X 19/32"	TAT-5301
1966-73	L6 4.1L 250ci	11" Diaph Type w/1-1/8" X 10 X 19/32"	TAT-5301
1955-57	V8 4.3L 265ci	11" Diaph, Flat Diaph Type w/1-1/8" X 10 X 19/32"	TAT-5301
1957-67	V8 4.6L 283ci	11" Diaph, Flat Diaph, Cone Diaph Type w/1-1/8" X 10 X 19/32"	TAT-5301
1962-69	V8 5.4L 327ci	11" Diaph, Flat Diaph Type w/1-1/8" X 10 X 19/32"	TAT-5301
1958-72	V8 5.7L 350ci	11" Diaph, Flat Diaph Type w/1-1/8" X 10 X 19/32"	TAT-5301
1969-72	V8 5.7L 350ci	w/1-1/8" X 26 X 19/32"	TAT-5313
1966-69	V8 6.5L 396ci	11" Diaph Type w/1-1/8" X 10 X 19/32"	TAT-5301
1962-64	V8 6.7L 409ci	w/1-1/8" X 10 X 19/32"	TAT-5301
1966-69	V8 7.0L 427ci	11" Diaph Type w/1-1/8" X 10 X 19/32"	TAT-5301
<b>BERETTA, CORSICA</b>			
1987-89	L4 2.0L 122ci	4 & 5 Speed w/1" X 14 X 53/64"	TAT-5342
1990-94	L4 2.2L 134ci	w/1" X 14 X 53/64"	TAT-5342
1995-96	L4 2.2L 134ci	CSC w/1" X 14 X 53/64"	TAT-5342
1990-92	L4 2.3L 140ci	Solid Flywheel # FW-124 w/1" X 14 X 53/64"	TAT-5342
1993-94	L4 2.3L 140ci	CSC, Solid Flywheel # FW-124 w/1" X 14 X 53/64"	TAT-5342
1987-89	V6 2.8L 173ci	w/1" X 14 X 53/64"	TAT-5342
1990-92	V6 3.1L 189ci	w/1" X 14 X 53/64"	TAT-5342
1993-96	V6 3.1L 189ci	CSC w/1" X 14 X 53/64"	TAT-5342
<b>BISCAYNE</b>			
1963-65	L6 3.8L 230ci	11" Flat Diaph Type w/1-1/8" X 10 X 19/32"	TAT-5301
1958-62	L6 3.9L 235ci	11" Flat Diaph Type w/1-1/8" X 10 X 19/32"	TAT-5301
1958-62	L6 3.9L 235ci	9-1/2" Disc w/1-1/8" X 10 X 19/32"	TAT-5301
1960	L6 3.9L 236ci	11" Flat Diaph Type w/1-1/8" X 10 X 19/32"	TAT-5301
1960	L6 3.9L 236ci	9-1/2" Disc w/1-1/8" X 10 X 19/32"	TAT-5301
1972	L6 4.1L 250ci	11" Diaph Type w/1-1/8" X 10 X 19/32"	TAT-5301

# CLUTCH ALIGNMENT TOOLS

Year	Engine	Remark	Part
<b>CHEVROLET (con't)</b>			
<b>BISCAYNE (con't)</b>			
1966-72	L6 4.1L 250ci	w/1-1/8" X 10 X 19/32"	TAT-5301
1958-67	V8 4.6L 283ci	11" Diaph & Flat Diaph Type w/1-1/8" X 10 X 19/32"	TAT-5301
1966-67	V8 4.6L 283ci	Cone Diaph Type w/1-1/8" X 10 X 19/32"	TAT-5301
1962-69	V8 5.4L 327ci	w/1-1/8" X 10 X 19/32"	TAT-5301
1958-61	V8 5.7L 348ci	11" Diaph Type w/1-1/8" X 10 X 19/32"	TAT-5301
1958-61	V8 5.7L 348ci	11" Flat Diaph Type w/1-1/8" X 10 X 19/32"	TAT-5301
1969-72	V8 5.7L 350ci	w/1-1/8" X 10 X 19/32"	TAT-5301
1969-72	V8 5.7L 350ci	w/1-1/8" X 26 X 19/32"	TAT-5313
1966-69	V8 6.5L 396ci	11" Diaph Type w/1-1/8" X 10 X 19/32"	TAT-5301
1962-64	V8 6.7L 409ci	w/1-1/8" X 10 X 19/32"	TAT-5301
1966-69	V8 7.0L 427ci	11" Diaph Type w/1-1/8" X 10 X 19/32"	TAT-5301
<b>CAMARO</b>			
1982-84	L4 2.5L 151ci	4 Speed w/1-1/8" X 10 X 19/32"	TAT-5301
1982-86	L4 2.5L 151ci	4 Speed & 5 Speed w/1" X 14 X 19/32"	TAT-5312
1967-69	L6 3.8L 230ci	w/1-1/8" X 10 X 19/32"	TAT-5301
1968-79	L6 4.1L 250ci	w/1-1/8" X 10 X 19/32"	TAT-5301
1982-84	V6 2.8L 173ci	4 Speed w/1-1/8" X 10 X 19/32"	TAT-5301
1982-84	V6 2.8L 173ci	5 Speed w/1" X 14 X 19/32"	TAT-5312
1985-89	V6 2.8L 173ci	w/1" X 14 X 19/32"	TAT-5312
1990-92	V6 3.1L 189ci	w/1" X 14 X 19/32"	TAT-5312
1993-95	V6 3.4L 207ci	w/1-1/8" X 26 X 19/32"	TAT-5313
1980-81	V6 3.8L 229ci	w/1-1/8" X 10 X 19/32"	TAT-5301
1980-81	V6 3.8L 231ci	w/1-1/8" X 10 X 19/32"	TAT-5301
1995-00	V6 3.8L 231ci	w/1-1/8" X 26 X 19/32"	TAT-5313
1980-81	V8 4.4L 267ci	w/1-1/8" X 10 X 19/32"	TAT-5301
1967-69	V8 5.0L 302ci	w/1-1/8" X 10 X 19/32"	TAT-5301
1976-78	V8 5.0L 305ci	Flat Diaphragm Type w/1-1/8" X 10 X 19/32"	TAT-5301
1976-80	V8 5.0L 305ci	Cone Diaph Type w/1-1/8" X 10 X 19/32"	TAT-5301
1981-82	V8 5.0L 305ci	Muncie Trans, Exc Z28 w/1-1/8" X 10 X 19/32"	TAT-5301
1981-82	V8 5.0L 305ci	Warner Trans, Exc Z28 w/1-1/8" X 26 X 19/32"	TAT-5313
1983-92	V8 5.0L 305ci	10.4" X 26 Spline w/1-1/8" X 26 X 19/32"	TAT-5313
1969-73	V8 5.0L 307ci	w/1-1/8" X 10 X 19/32"	TAT-5301
1967-69	V8 5.4L 327ci	3 & 4 Speed w/1-1/8" X 10 X 19/32"	TAT-5301
1967-81	V8 5.7L 350ci	w/1-1/8" X 10 X 19/32"	TAT-5301
1971-72	V8 5.7L 350ci	w/1-1/8" X 26 X 19/32"	TAT-5313
1987-92	V8 5.7L 350ci	Replaces 10" Clutch w/1-1/8" X 26 X 19/32"	TAT-5313
1998-00	V8 5.7L 350ci	Modular, 6 Speed w/1-1/8" X 10 X 19/32"	TAT-5301
1967-70	V8 6.5L 396ci	w/1-1/8" X 10 X 19/32"	TAT-5301
1970-71	V8 6.6L 402ci	w/1-1/8" X 26 X 19/32"	TAT-5313
<b>CAPRICE</b>			
1967-69	L6 4.1L 250ci	Use Flywheel FW-100 w/1-1/8" X 10 X 19/32"	TAT-5301
1966-67	V8 4.6L 283ci	11" Diaph & Flat Diaph Type w/1-1/8" X 10 X 19/32"	TAT-5301
1966-67	V8 4.6L 283ci	Cone Diaph Type w/1-1/8" X 10 X 19/32"	TAT-5301
1966-69	V8 5.4L 327ci	w/1-1/8" X 10 X 19/32"	TAT-5301
1967-69	V8 5.4L 327ci	Use Flywheel FW-100 w/1-1/8" X 10 X 19/32"	TAT-5301
1969-72	V8 5.7L 350ci	w/1-1/8" X 26 X 19/32"	TAT-5313
1969-72	V8 5.7L 350ci	w/1-1/8" X 10 X 19/32"	TAT-5301
1966-69	V8 6.5L 396ci	11" Diaph Type w/1-1/8" X 10 X 19/32"	TAT-5301
1966-69	V8 7.0L 427ci	11" Diaph Type w/1-1/8" X 10 X 19/32"	TAT-5301
<b>CAVALIER</b>			
1982	L4 1.8L 112ci	w/1" X 14 X 53/64"	TAT-5342
1983-89	L4 2.0L 122ci	4 & 5 Speed w/1" X 14 X 53/64"	TAT-5342
1990-94	L4 2.2L 134ci	w/1" X 14 X 53/64"	TAT-5342
1995-01	L4 2.2L 134ci	CSC w/1" X 14 X 53/64"	TAT-5342
1995	L4 2.3L 138ci	CSC w/1" X 14 X 53/64"	TAT-5342
1996-98	L4 2.4L 146ci	CSC w/1" X 14 X 53/64"	TAT-5342
1985-86	V6 2.8L 173ci	9-1/8" Disc w/1-1/8" X 10 X 19/32"	TAT-5342
1986	V6 2.8L 173ci	CSC w/1" X 14 X 53/64"	TAT-5342

# CLUTCH ALIGNMENT TOOLS

Year	Engine	Remark	Part
<b>CHEVROLET (con't)</b>			
<b>CAVALIER (con't)</b>			
1987-89	V6 2.8L 173ci	4 & 5 Speed w/1" X 14 X 53/64"	TAT-5342
1990-92	V6 3.1L 189ci	w/1" X 14 X 53/64"	TAT-5342
1993-94	V6 3.1L 189ci	CSC w/1" X 14 X 53/64"	TAT-5342
<b>CELEBRITY</b>			
1984-86	L4 2.5L 151ci	9-1/8" Disc w/1" X 14 X 53/64"	TAT-5342
1984-86	V6 2.8L 173ci	4 Speed w/1" X 14 X 53/64"	TAT-5342
1987-88	V6 2.8L 173ci	5 Speed w/1" X 14 X 53/64"	TAT-5342
<b>CHEVELLE</b>			
1964-66	L6 3.2L 194ci	w/1-1/8" X 10 X 19/32"	TAT-5301
1964-69	L6 3.8L 230ci	w/1-1/8" X 10 X 19/32"	TAT-5301
1968-73	L6 4.1L 250ci	w/1-1/8" X 10 X 19/32"	TAT-5301
1964-67	V8 4.6L 283ci	3 Speed w/1-1/8" X 10 X 19/32"	TAT-5301
1964-67	V8 4.6L 283ci	4 Speed w/1-1/8" X 10 X 19/32"	TAT-5301
1964-67	V8 4.6L 283ci	4 Speed, Flat Diaph Type w/1-1/8" X 10 X 19/32"	TAT-5301
1968-73	V8 5.0L 307ci	3 Speed w/1-1/8" X 10 X 19/32"	TAT-5301
1968-73	V8 5.0L 307ci	4 Speed w/1-1/8" X 10 X 19/32"	TAT-5301
1964-68	V8 5.4L 327ci	Cone Diaph Type w/1-1/8" X 10 X 19/32"	TAT-5301
1964-68	V8 5.4L 327ci	Flat Diaphragm Type w/1-1/8" X 10 X 19/32"	TAT-5301
1967	V8 5.4L 327ci	w/1-1/8" X 10 X 19/32"	TAT-5301
1969	V8 5.7L 350ci	w/1-1/8" X 26 X 19/32"	TAT-5313
1969-73	V8 5.7L 350ci	w/1-1/8" X 10 X 19/32"	TAT-5301
1966-69	V8 6.5L 396ci	11" Diaph Type w/1-1/8" X 10 X 19/32"	TAT-5301
1970-72	V8 6.6L 402ci	w/1-1/8" X 26 X 19/32"	TAT-5313
1970-72	V8 6.6L 402ci	11" Diaph Type w/1-1/8" X 10 X 19/32"	TAT-5301
1970-73	V8 7.4L 454ci	w/1-1/8" X 26 X 19/32"	TAT-5313
<b>CHEVETTE</b>			
1976-77	L4 1.4L 85ci	w/1" X 14 X 19/32"	TAT-5312
1976-87	L4 1.6L 98ci	w/1" X 14 X 19/32"	TAT-5312
1981-86	L4 1.8L 110ci	Diesel w/1" X 24 X 43/64"	TAT-5316
<b>CHEVY II</b>			
1963-67	L4 2.5L 153ci	Replaces OEM 10" System w/1-1/8" X 10 X 19/32"	TAT-5301
1962-66	L6 3.2L 194ci	w/1-1/8" X 10 X 19/32"	TAT-5301
1964-68	L6 3.8L 230ci	Heavy Duty w/1-1/8" X 10 X 19/32"	TAT-5301
1967-68	L6 4.1L 250ci	w/1-1/8" X 10 X 19/32"	TAT-5301
1964-67	V8 4.6L 283ci	3 & 4 Speed w/1-1/8" X 10 X 19/32"	TAT-5301
1968	V8 5.0L 307ci	w/1-1/8" X 10 X 19/32"	TAT-5301
1965-68	V8 5.4L 327ci	Flat & Cone Diaph Type w/1-1/8" X 10 X 19/32"	TAT-5301
1968	V8 5.7L 350ci	11" Diaph Type w/1-1/8" X 10 X 19/32"	TAT-5301
1968	V8 6.5L 396ci	11" Diaph Type w/1-1/8" X 10 X 19/32"	TAT-5301
<b>CITATION</b>			
1980-83	L4 2.5L 151ci	9-1/8" Disc w/1" X 14 X 53/64"	TAT-5342
1980-83	V6 2.8L 173ci	Solid Flywheel # FW-111 w/1" X 14 X 53/64"	TAT-5342
<b>CORVETTE</b>			
1957-61	V8 4.6L 283ci	Carburetor w/1-1/8" X 10 X 19/32"	TAT-5301
1957-61	V8 4.6L 283ci	Fuel Injection w/1-1/8" X 10 X 19/32"	TAT-5301
1962-64	V8 5.4L 327ci	w/1-1/8" X 10 X 19/32"	TAT-5301
1965-68	V8 5.4L 327ci	10.4" Disc w/1-1/8" X 26 X 19/32"	TAT-5313
1966-68	V8 5.4L 327ci	11" Diaph Type w/1-1/8" X 10 X 19/32"	TAT-5301
1969-72	V8 5.7L 350ci	10.4" Disc w/1-1/8" X 26 X 19/32"	TAT-5313
1969-72	V8 5.7L 350ci	11" Diaph Type w/1-1/8" X 10 X 19/32"	TAT-5301
1973-82	V8 5.7L 350ci	w/1-1/8" X 26 X 19/32"	TAT-5313
1984-88	V8 5.7L 350ci	L-98 w/1-1/8" X 26 X 19/32"	TAT-5313
1997-00	V8 5.7L 350ci	Modular Assembly w/1-1/8" X 10 X 19/32"	TAT-5301
1966-69	V8 7.0L 427ci	11" Diaph Type w/1-1/8" X 10 X 19/32"	TAT-5301
1970-74	V8 7.4L 454ci	w/1-1/8" X 26 X 19/32"	TAT-5313
<b>IMPALA</b>			
1963-65	L6 3.8L 230ci	11" Flat Diaph Type w/1-1/8" X 10 X 19/32"	TAT-5301
1959-62	L6 3.9L 235ci	11" Flat Diaph Type w/1-1/8" X 10 X 19/32"	TAT-5301

# CLUTCH ALIGNMENT TOOLS

Year	Engine	Remark	Part
<b>CHEVROLET (con't)</b>			
<b>IMPALA (con't)</b>			
1959-62	L6 3.9L 235ci	9-1/2" Disc w/1-1/8" X 10 X 19/32"	TAT-5301
1966-73	L6 4.1L 250ci	w/1-1/8" X 10 X 19/32"	TAT-5301
1959-67	V8 4.6L 283ci	Cone & Flat Diaph Type w/1-1/8" X 10 X 19/32"	TAT-5301
1962-69	V8 5.4L 327ci	w/1-1/8" X 10 X 19/32"	TAT-5301
1959-61	V8 5.7L 348ci	11" Diaph & Flat Diaph Type w/1-1/8" X 10 X 19/32"	TAT-5301
1969-72	V8 5.7L 350ci	w/1-1/8" X 26 X 19/32"	TAT-5313
1966-69	V8 6.5L 396ci	11" Diaph Type w/1-1/8" X 10 X 19/32"	TAT-5301
1962-64	V8 6.7L 409ci	w/1-1/8" X 10 X 19/32"	TAT-5301
1966-69	V8 7.0L 427ci	11" Diaph Type w/1-1/8" X 10 X 19/32"	TAT-5301
<b>LUMINA</b>			
1991-93	V6 3.4L 207ci	Solid Flywheel # FW-120 1" X 23 X 19/32"	TAT-5311
<b>MALIBU</b>			
1964-66	L6 3.2L 194ci	w/1-1/8" X 10 X 19/32"	TAT-5301
1966-67	L6 3.8L 230ci	w/1-1/8" X 10 X 19/32"	TAT-5301
1973-77	L6 4.1L 250ci	w/1-1/8" X 10 X 19/32"	TAT-5301
1978	V6 3.3L 200ci	Flat Diaphragm Type w/1-1/8" X 10 X 19/32"	TAT-5301
1979	V6 3.3L 200ci	Cone Diaph Type w/1-1/8" X 10 X 19/32"	TAT-5301
1980-81	V6 3.8L 229ci	w/1-1/8" X 10 X 19/32"	TAT-5301
1978-79	V6 3.8L 231ci	w/1-1/8" X 10 X 19/32"	TAT-5301
1979-80	V8 4.4L 267ci	w/1-1/8" X 10 X 19/32"	TAT-5301
1964-67	V8 4.6L 283ci	3 Speed w/1-1/8" X 10 X 19/32"	TAT-5301
1964-67	V8 4.6L 283ci	4 Speed w/1-1/8" X 10 X 19/32"	TAT-5301
1964-67	V8 4.6L 283ci	4 Speed, Flat Diaph Type w/1-1/8" X 10 X 19/32"	TAT-5301
1976-81	V8 5.0L 305ci	w/1-1/8" X 10 X 19/32"	TAT-5301
1973	V8 5.0L 307ci	3 Speed w/1-1/8" X 10 X 19/32"	TAT-5301
1973	V8 5.0L 307ci	4 Speed w/1-1/8" X 10 X 19/32"	TAT-5301
1964-66	V8 5.4L 327ci	Flat Diaphragm Type w/1-1/8" X 10 X 19/32"	TAT-5301
1964-67	V8 5.4L 327ci	w/1-1/8" X 10 X 19/32"	TAT-5301
1973-80	V8 5.7L 350ci	w/1-1/8" X 10 X 19/32"	TAT-5301
1966-67	V8 6.5L 396ci	11" Diaph Type w/1-1/8" X 10 X 19/32"	TAT-5301
1973-75	V8 7.4L 454ci	w/1-1/8" X 26 X 19/32"	TAT-5313
<b>METRO</b>			
1998-00	L3 1.0L 61ci	5 Speed w/47/64" X 18 X 25/64"	TAT-5386
1992	L4 1.3L 79ci	w/47/64" X 18 X 25/64"	TAT-5386
1998-01	L4 1.3L 79ci	5 Speed w/47/64" X 18 X 25/64"	TAT-5386
<b>MONTE CARLO</b>			
1978	V6 3.3L 200ci	Flat Diaphragm Type w/1-1/8" X 10 X 19/32"	TAT-5301
1979	V6 3.3L 200ci	Cone Diaph Type w/1-1/8" X 10 X 19/32"	TAT-5301
1980-81	V6 3.8L 229ci	w/1-1/8" X 10 X 19/32"	TAT-5301
1978-81	V6 3.8L 231ci	w/1-1/8" X 10 X 19/32"	TAT-5301
1979-80	V8 4.4L 267ci	w/1-1/8" X 10 X 19/32"	TAT-5301
1976-81	V8 5.0L 305ci	w/1-1/8" X 10 X 19/32"	TAT-5301
1971-77	V8 5.7L 350ci	w/1-1/8" X 10 X 19/32"	TAT-5301
1970-72	V8 6.6L 400ci	w/1-1/8" X 26 X 19/32"	TAT-5313
1970-71	V8 6.6L 402ci	11" Diaph Type w/1-1/8" X 10 X 19/32"	TAT-5301
1970-74	V8 7.4L 454ci	w/1-1/8" X 26 X 19/32"	TAT-5313
<b>MONZA</b>			
1975-77	L4 2.3L 140ci	9-1/8" Disc w/1-1/8" X 10 X 19/32"	TAT-5301
1978-80	L4 2.5L 151ci	9-1/8" Disc w/1-1/8" X 10 X 19/32"	TAT-5301
1978	V6 3.2L 196ci	9-1/8" Disc w/1-1/8" X 10 X 19/32"	TAT-5301
1979	V6 3.2L 196ci	w/1-1/8" X 10 X 19/32"	TAT-5301
1978	V6 3.8L 231ci	9-1/8" Disc w/1-1/8" X 10 X 19/32"	TAT-5301
1979-80	V6 3.8L 231ci	w/1-1/8" X 10 X 19/32"	TAT-5301
1975-76	V8 4.3L 262ci	9-1/8" Disc w/1-1/8" X 10 X 19/32"	TAT-5301
<b>NOVA</b>			
1985-88	L4 1.6L 98ci	15/16" X 21 X 15/32"	TAT-5306
1962-70	L4 2.5L 153ci	w/1-1/8" X 10 X 19/32"	TAT-5301
1962-66	L6 3.2L 194ci	w/1-1/8" X 10 X 19/32"	TAT-5301



# CLUTCH ALIGNMENT TOOLS

Year	Engine	Remark	Part
<b>CHEVROLET (con't)</b>			
<b>NOVA (con't)</b>			
1964-70	L6 3.8L 230ci	w/1-1/8" X 10 X 19/32"	TAT-5301
1967-79	L6 4.1L 250ci	w/1-1/8" X 10 X 19/32"	TAT-5301
1975	V8 4.3L 262ci	w/1-1/8" X 10 X 19/32"	TAT-5301
1964-67	V8 4.6L 283ci	Cone Diaph Type w/1-1/8" X 10 X 19/32"	TAT-5301
1964-67	V8 4.6L 283ci	Flat Diaphragm Type w/1-1/8" X 10 X 19/32"	TAT-5301
1979	V8 5.0L 305ci	Cone Diaph Type w/1-1/8" X 10 X 19/32"	TAT-5301
1976-78	V8 5.0L 305ci	Flat Diaphragm Type w/1-1/8" X 10 X 19/32"	TAT-5301
1970-73	V8 5.0L 307ci	w/1-1/8" X 10 X 19/32"	TAT-5301
1965-67	V8 5.4L 327ci	Cone Diaph Type w/1-1/8" X 10 X 19/32"	TAT-5301
1965-67	V8 5.4L 327ci	Flat Diaphragm Type w/1-1/8" X 10 X 19/32"	TAT-5301
1970-79	V8 5.7L 350ci	w/1-1/8" X 26 X 19/32"	TAT-5313
1970-79	V8 5.7L 350ci	11" Diaph Type w/1-1/8" X 10 X 19/32"	TAT-5301
1970	V8 6.5L 396ci	11" Diaph Type w/1-1/8" X 10 X 19/32"	TAT-5301
<b>PRIZM</b>			
1998-00	L4 1.8L 110ci	15/16" X 21 X 15/32"	TAT-5306
<b>SPECTRUM</b>			
1985-88	L4 1.5L 92ci	Non-Turbo	TAT-5397
1987-88	L4 1.5L 92ci	Turbo w/1" X 14 X 53/64"	TAT-5342
<b>SPRINT</b>			
1985-91	L3 1.0L 61ci	47/64" X 18 X 25/64"	TAT-5386
1987-88	L3 1.0L 61ci	7-1/2"; Turbo 47/64" X 18 X 25/64"	TAT-5386
<b>VEGA</b>			
1976	L4 2.0L 122ci	9-1/8" Disc w/1-1/8" X 10 X 19/32"	TAT-5301
1973-77	L4 2.3L 140ci	9-1/8" Disc w/1-1/8" X 10 X 19/32"	TAT-5301
<b>CHEVROLET TRUCKS</b>			
<b>ASTRO</b>			
1985-89	L4 2.5L 151ci	1" X 14 X 19/32"	TAT-5312
1985-91	V6 4.3L 262ci	1" X 14 X 19/32"	TAT-5312
<b>BLAZER</b>			
1969-74	L6 4.1L 250ci	10" Disc & 11" Flat Diaph Type w/1-1/8" X 10 X 19/32"	TAT-5301
1970-73	L6 4.8L 292ci	11" & 12" Diaph Type w/1-1/8" X 10 X 19/32"	TAT-5301
1987	V8 5.0L 305ci	w/o PDH w/1-1/8" X 10 X 19/32"	TAT-5301
1969-73	V8 5.0L 307ci	11" Diaph Type w/1-1/8" X 10 X 19/32"	TAT-5301
1969-74	V8 5.7L 350ci	11" Diaph Type & 12" Lever Type w/1-1/8" X 10 X 19/32"	TAT-5301
1969-94	V8 5.7L 350ci	12" Diaph Type w/1-1/8" X 10 X 19/32"	TAT-5301
1969-94	V8 5.7L 350ci	12" Diaph Type, PDH w/1-1/8" X 10 X 19/32"	TAT-5301
1987-91	V8 6.2L 379ci	12" Diaph Type, PDH w/1-1/8" X 10 X 19/32"	TAT-5301
1994	V8 6.5L 395ci	Diesel & DMF Type w/1-1/8" X 10 X 19/32"	TAT-5301
1978-79	V8 6.6L 400ci	w/1-1/8" X 26 X 19/32"	TAT-5313
1973	V8 7.4L 454ci	12" Lever Type w/1-1/8" X 10 X 19/32"	TAT-5301
<b>C10 PICKUP, C20 PICKUP, C30 PICKUP</b>			
1963-66	L6 3.8L 230ci	10" Disc & 11" Flat Diaph Type w/1-1/8" X 10 X 19/32"	TAT-5301
1961-62	L6 3.9L 235ci	10" Disc & 11" Flat Diaph Type w/1-1/8" X 10 X 19/32"	TAT-5301
1961-62	L6 3.9L 235ci	12" Diaph Type & w/Ceramic Button w/1-1/8" X 10 X 19/32"	TAT-5301
1966-76	L6 4.1L 250ci	10" Disc & 11" Flat Disc w/1-1/8" X 10 X 19/32"	TAT-5301
1977-84	L6 4.1L 250ci	11" Diaph Type w/1-1/8" X 10 X 19/32"	TAT-5301
1977-84	L6 4.1L 250ci	12" Diaph Type & w/Ceramic Button w/1-1/8" X 10 X 19/32"	TAT-5301
1963-68	L6 4.8L 292ci	11" Diaph & 11" Flat Diaph Type w/1-1/8" X 10 X 19/32"	TAT-5301
1969-74	L6 4.8L 292ci	12" Lever Type & w/Ceramic Button w/1-1/8" X 10 X 19/32"	TAT-5301
1975-80	L6 4.8L 292ci	11" & 12" Diaph Type w/1-1/8" X 10 X 19/32"	TAT-5301
1985-86	V6 4.3L 262ci	w/PDH or w/o PDH w/1-1/8" X 10 X 19/32"	TAT-5301
1961-67	V8 4.6L 283ci	11" Flat Diaph Type w/1-1/8" X 10 X 19/32"	TAT-5301
1961-67	V8 4.6L 283ci	12" Diaph Type & w/Ceramic Button w/1-1/8" X 10 X 19/32"	TAT-5301
1976-84	V8 5.0L 305ci	11" Diaph Type w/1-1/8" X 10 X 19/32"	TAT-5301
1976-84	V8 5.0L 305ci	12" Diaph Type & w/Ceramic Button w/1-1/8" X 10 X 19/32"	TAT-5301
1976-86	V8 5.0L 305ci	w/PDH & w/o PDH w/1-1/8" X 10 X 19/32"	TAT-5301
1969-73	V8 5.0L 307ci	11" Diaph Type w/1-1/8" X 10 X 19/32"	TAT-5301
1962-68	V8 5.4L 327ci	12" Lever Type & w/Ceramic Button w/1-1/8" X 10 X 19/32"	TAT-5301

# CLUTCH ALIGNMENT TOOLS

Year	Engine	Remark	Part
<b>CHEVROLET TRUCKS (con't)</b>			
<b>C10 PICKUP, C20 PICKUP, C30 PICKUP (con't)</b>			
1969-86	V8 5.7L 350ci	11" & 12" Diaph Type & w/Ceramic Button w/1-1/8" X 10 X 19/32"	TAT-5301
1969-86	V8 5.7L 350ci	12" Diaph Type, PDH w/1-1/8" X 10 X 19/32"	TAT-5301
1982-86	V8 6.2L 379ci	12" Diaph Type, PDH w/1-1/8" X 10 X 19/32"	TAT-5301
1968-69	V8 6.5L 396ci	11" & 12" Diaph Type & w/Ceramic Button w/1-1/8" X 10 X 19/32"	TAT-5301
1978-80	V8 6.6L 400ci	w/1-1/8" X 26 X 19/32"	TAT-5313
1970-71	V8 6.6L 402ci	11" & 12" Diaph Type w/1-1/8" X 10 X 19/32"	TAT-5301
1970-71	V8 6.6L 402ci	12" Lever Type & w/Ceramic Button w/1-1/8" X 10 X 19/32"	TAT-5301
1973-80	V8 7.4L 454ci	12" Lever Type & w/Ceramic Button w/1-1/8" X 10 X 19/32"	TAT-5301
<b>C1500, C2500, C3500</b>			
1988-95	V6 4.3L 262ci	PDH or w/o PDH w/1-1/8" X 10 X 19/32"	TAT-5301
1996-98	V6 4.3L 262ci	w/1-1/8" X 10 X 19/32"	TAT-5301
1988-90	V8 5.0L 305ci	w/o PDH w/1-1/8" X 10 X 19/32"	TAT-5301
1991-95	V8 5.0L 305ci	PDH w/1-1/8" X 10 X 19/32"	TAT-5301
1996-99	V8 5.0L 305ci	w/1-1/8" X 10 X 19/32"	TAT-5301
1988-95	V8 5.7L 350ci	12" Diaph Type & Ceramic Butt & w/1-1/8" X 10 X 19/32"	TAT-5301
1996-99	V8 5.7L 350ci	NVG 3500, NVG 4500 Trans w/1-1/8" X 10 X 19/32"	TAT-5301
1988-93	V8 6.2L 379ci	12" Diaph Type, PDH w/1-1/8" X 10 X 19/32"	TAT-5301
1992-95	V8 6.5L 395ci	Diesel, w/solid & w/DMF w/1-1/8" X 10 X 19/32"	TAT-5301
1996-99	V8 6.5L 395ci	12" Diaph Type w/1-1/8" X 10 X 19/32"	TAT-5301
1996-99	V8 6.5L 395ci	Turbo Diesel w/DMF or w/Solid w/1-1/8" X 10 X 19/32"	TAT-5301
1988-95	V8 7.4L 454ci	12" Diaph Type & w/Ceramic Button w/1-1/8" X 10 X 19/32"	TAT-5301
1988-95	V8 7.4L 454ci	12" Diaph Type, PDH w/1-1/8" X 10 X 19/32"	TAT-5301
1996-99	V8 7.4L 454ci	w/1-1/8" X 10 X 19/32"	TAT-5301
<b>EL CAMINO</b>			
1964-65	L6 3.2L 194ci	w/1-1/8" X 10 X 19/32"	TAT-5301
1964-69	L6 3.8L 230ci	w/1-1/8" X 10 X 19/32"	TAT-5301
1968-77	L6 4.1L 250ci	w/1-1/8" X 10 X 19/32"	TAT-5301
1978-79	V6 3.3L 200ci	w/1-1/8" X 10 X 19/32"	TAT-5301
1980-82	V6 3.8L 229ci	w/1-1/8" X 10 X 19/32"	TAT-5301
1978-79	V6 3.8L 231ci	w/Cone & w/Flat Diaph Type w/1-1/8" X 10 X 19/32"	TAT-5301
1980	V6 3.8L 231ci	w/1-1/8" X 10 X 19/32"	TAT-5301
1976-81	V8 5.0L 305ci	w/1-1/8" X 10 X 19/32"	TAT-5301
1971-73	V8 5.0L 307ci	w/1-1/8" X 10 X 19/32"	TAT-5301
1964-68	V8 5.4L 327ci	w/1-1/8" X 10 X 19/32"	TAT-5301
1969-78	V8 5.7L 350ci	w/1-1/8" X 10 X 19/32"	TAT-5301
1967-69	V8 6.5L 396ci	11" Diaph Type w/1-1/8" X 10 X 19/32"	TAT-5301
1970	V8 6.6L 400ci	11" Diaph Type w/1-1/8" X 10 X 19/32"	TAT-5301
1971-72	V8 6.6L 402ci	11" Diaph Type w/1-1/8" X 10 X 19/32"	TAT-5301
1972-74	V8 7.4L 454ci	w/1-1/8" X 26 X 19/32"	TAT-5313
<b>EXPRESS 1500, EXPRESS 2500, EXPRESS 3500</b>			
1996-98	V6 4.3L 262ci	w/1-1/8" X 10 X 19/32"	TAT-5301
1998	V8 5.0L 305ci	w/1-1/8" X 10 X 19/32"	TAT-5301
1998	V8 5.7L 350ci	NVG 3500, NVG 4500 Trans w/1-1/8" X 10 X 19/32"	TAT-5301
1996-98	V8 6.5L 395ci	12" Diaph Type w/1-1/8" X 10 X 19/32"	TAT-5301
1998	V8 7.4L 454ci	w/1-1/8" X 10 X 19/32"	TAT-5301
<b>G10 VAN, G20 VAN, G30 VAN</b>			
1964-65	L4 2.5L 153ci	w/1-1/8" X 10 X 19/32"	TAT-5301
1964-66	L6 3.2L 194ci	10" Disc & 11" Flat Diaph Type w/1-1/8" X 10 X 19/32"	TAT-5301
1966-69	L6 3.8L 230ci	10" Disc & 11" Flat Diaph Type w/1-1/8" X 10 X 19/32"	TAT-5301
1967-74	L6 4.1L 250ci	10" Disc & 11" Flat Diaph Type w/1-1/8" X 10 X 19/32"	TAT-5301
1973-74	L6 4.8L 292ci	11" & 12" Diaph Type & w/Ceramic Button w/1-1/8" X 10 X 19/32"	TAT-5301
1985-95	V6 4.3L 262ci	w/1-1/8" X 10 X 19/32"	TAT-5301
1996	V6 4.3L 262ci	w/1-1/8" X 10 X 19/32"	TAT-5301
1978-82	V8 5.0L 305ci	11" & 12" Diaph Type & w/Ceramic Button w/1-1/8" X 10 X 19/32"	TAT-5301
1978-82	V8 5.0L 305ci	12" Diaph Type, PDH w/1-1/8" X 10 X 19/32"	TAT-5301
1978-82	V8 5.0L 305ci	12" Lever Type & w/Ceramic Button w/1-1/8" X 10 X 19/32"	TAT-5301
1969-73	V8 5.0L 307ci	11" Diaph Type w/1-1/8" X 10 X 19/32"	TAT-5301
1970-74	V8 5.7L 350ci	11" & 12" Diaph Type & w/Ceramic Button w/1-1/8" X 10 X 19/32"	TAT-5301

# CLUTCH ALIGNMENT TOOLS

Year	Engine	Remark	Part
<b>CHEVROLET TRUCKS (con't)</b>			
<b>G10 VAN, G20 VAN, G30 VAN (con't)</b>			
1970-74	V8 5.7L 350ci	12" Diaph Type, PDH w/1-1/8" X 10 X 19/32"	TAT-5301
1970-74	V8 5.7L 350ci	12" Lever Type & w/Ceramic Button w/1-1/8" X 10 X 19/32"	TAT-5301
1983-93	V8 6.2L 379ci	12" Diaph Type, PDH w/1-1/8" X 10 X 19/32"	TAT-5301
1994-95	V8 6.5L 395ci	Diesel w/Solid & DMF w/1-1/8" X 10 X 19/32"	TAT-5301
1996	V8 6.5L 395ci	12" Diaph Type w/1-1/8" X 10 X 19/32"	TAT-5301
1978-80	V8 6.6L 400ci	w/1-1/8" X 26 X 19/32"	TAT-5313
1974	V8 7.4L 454ci	12" Lever Type & w/Ceramic Button w/1-1/8" X 10 X 19/32"	TAT-5301
<b>K10 PICKUP, K20 PICKUP, K30 PICKUP</b>			
1964-69	L6 3.8L 230ci	10" Disc & 11" Flat Diaph Type w/1-1/8" X 10 X 19/32"	TAT-5301
1961-62	L6 3.9L 235ci	10" Disc & 11" Flat Diaph Type w/1-1/8" X 10 X 19/32"	TAT-5301
1961-62	L6 3.9L 235ci	12" Diaph Type & w/Ceramic Button w/1-1/8" X 10 X 19/32"	TAT-5301
1968-76	L6 4.1L 250ci	10" Disc & 11" Flat Diaph w/1-1/8" X 10 X 19/32"	TAT-5301
1977-84	L6 4.1L 250ci	11" & 12" Diaph Type & w/Ceramic Button w/1-1/8" X 10 X 19/32"	TAT-5301
1961-62	L6 4.3L 261ci	11" & 12" Diaph Type & w/Ceramic Button w/1-1/8" X 10 X 19/32"	TAT-5301
1968	L6 4.8L 292ci	11" Flat Diaph Type w/1-1/8" X 10 X 19/32"	TAT-5301
1969-80	L6 4.8L 292ci	11" Diaph Type w/1-1/8" X 10 X 19/32"	TAT-5301
1969-80	L6 4.8L 292ci	12" Lever Type & w/Ceramic Button w/1-1/8" X 10 X 19/32"	TAT-5301
1985-86	L6 4.8L 292ci	w/o PDH w/1-1/8" X 10 X 19/32"	TAT-5301
1985-86	V6 4.3L 262ci	w/PDH & w/o PDH w/1-1/8" X 10 X 19/32"	TAT-5301
1961-67	V8 4.6L 283ci	11" Flat Diaph Type w/1-1/8" X 10 X 19/32"	TAT-5301
1961-67	V8 4.6L 283ci	12" Diaph Type & w/Ceramic Button w/1-1/8" X 10 X 19/32"	TAT-5301
1977-84	V8 5.0L 305ci	11" & 12" Diaph Type & w/Ceramic Button w/1-1/8" X 10 X 19/32"	TAT-5301
1977-84	V8 5.0L 305ci	12" Diaph Type, PDH w/1-1/8" X 10 X 19/32"	TAT-5301
1977-84	V8 5.0L 305ci	12" Lever Type & w/Ceramic Button w/1-1/8" X 10 X 19/32"	TAT-5301
1985-86	V8 5.0L 305ci	w/o PDH w/1-1/8" X 10 X 19/32"	TAT-5301
1969-73	V8 5.0L 307ci	11" Diaph Type w/1-1/8" X 10 X 19/32"	TAT-5301
1962-68	V8 5.4L 327ci	12" Lever Type & w/Ceramic Button w/1-1/8" X 10 X 19/32"	TAT-5301
1969-74	V8 5.7L 350ci	11" & 12" Diaph Type & w/Ceramic Button w/1-1/8" X 10 X 19/32"	TAT-5301
1969-84	V8 5.7L 350ci	12" Lever Type & w/Ceramic Button w/1-1/8" X 10 X 19/32"	TAT-5301
1969-86	V8 5.7L 350ci	12" Diaph Type, PDH w/1-1/8" X 10 X 19/32"	TAT-5301
1975-84	V8 5.7L 350ci	11" Diaph Type w/1-1/8" X 10 X 19/32"	TAT-5301
1975-86	V8 5.7L 350ci	12" Diaph Type & w/Ceramic Button w/1-1/8" X 10 X 19/32"	TAT-5301
1978-82	V8 5.7L 350ci	Flywheel # FW-109 w/1-1/8" X 10 X 19/32"	TAT-5301
1982-86	V8 6.2L 379ci	12" Diaph Type, PDH w/1-1/8" X 10 X 19/32"	TAT-5301
1968	V8 6.5L 396ci	11" & 12" Diaph Type & Ceramic Button w/1-1/8" X 10 X 19/32"	TAT-5301
1968	V8 6.5L 396ci	12" Lever Type & w/Ceramic Button w/1-1/8" X 10 X 19/32"	TAT-5301
1978-80	V8 6.6L 400ci	w/1-1/8" X 26 X 19/32"	TAT-5313
1970-71	V8 6.6L 402ci	11" & 12" Diaph Type w/1-1/8" X 10 X 19/32"	TAT-5301
1970-71	V8 6.6L 402ci	12" Lever Type & w/Ceramic Button w/1-1/8" X 10 X 19/32"	TAT-5301
1973-74	V8 7.4L 454ci	12" Lever Type & w/Ceramic Button w/1-1/8" X 10 X 19/32"	TAT-5301
1976-78	V8 7.4L 454ci	12" Lever Type & w/Ceramic Button w/1-1/8" X 10 X 19/32"	TAT-5301
1979-80	V8 7.4L 454ci	12" Diaph Type & w/Ceramic Button w/1-1/8" X 10 X 19/32"	TAT-5301
<b>K1500, K2500, K3500</b>			
1988-95	V6 4.3L 262ci	w/PDH & w/o PDH & w/1-1/8" X 10 X 19/32"	TAT-5301
1988-95	V8 5.0L 305ci	w/PDH or wo/PDH w/1-1/8" X 10 X 19/32"	TAT-5301
1996-99	V8 5.0L 305ci	w/1-1/8" X 10 X 19/32"	TAT-5301
2000	V8 5.7L 350ci	w/1-1/8" X 10 X 19/32"	TAT-5301
1988-95	V8 5.7L 350ci	12" Diaph Type & w/Ceramic Button w/1-1/8" X 10 X 19/32"	TAT-5301
1988-95	V8 5.7L 350ci	12" Diaph Type, PDH w/1-1/8" X 10 X 19/32"	TAT-5301
1996-99	V8 5.7L 350ci	NVG 3500, NVG 4500 Trans w/1-1/8" X 10 X 19/32"	TAT-5301
1988-93	V8 6.2L 379ci	12" Diaph Type, PDH w/1-1/8" X 10 X 19/32"	TAT-5301
1994	V8 6.5L 395ci	12" Dieah Type & Diesel w/Solid & DMF w/1-1/8" X 10 X 19/32"	TAT-5301
1992-95	V8 6.5L 395ci	w/DMF & Diesel w/1-1/8" X 10 X 19/32"	TAT-5301
1996-00	V8 6.5L 395ci	Turbo Diesel w/Solid & w/DMF w/1-1/8" X 10 X 19/32"	TAT-5301
1996-99	V8 6.5L 395ci	12" Diaph Type w/1-1/8" X 10 X 19/32"	TAT-5301
1988-95	V8 7.4L 454ci	12" Diaph Type & w/Ceramic Button w/1-1/8" X 10 X 19/32"	TAT-5301
1988-95	V8 7.4L 454ci	12" Diaph Type, PDH w/1-1/8" X 10 X 19/32"	TAT-5301
1996-00	V8 7.4L 454ci	w/1-1/8" X 10 X 19/32"	TAT-5301

# CLUTCH ALIGNMENT TOOLS

Year	Engine	Remark	Part
<b>CHEVROLET TRUCKS (con't)</b>			
<b>LUV PICKUP</b>			
1972-81	L4 1.8L 111ci	2WD & 4WD w/1" X 24 X 43/64"	TAT-5316
1981-82	L4 2.2L 134ci	Diesel w/1" X 24 X 43/64"	TAT-5316
<b>P10 SERIES, P20 SERIES, P30 SERIES</b>			
1963-65	L4 2.5L 153ci	w/1-1/8" X 10 X 19/32"	TAT-5301
1966	L6 3.2L 194ci	10" Disc & 11" Flat Diaph w/1-1/8" X 10 X 19/32"	TAT-5301
1963-67	L6 3.8L 230ci	10" Disc & 11" Flat Diaph w/1-1/8" X 10 X 19/32"	TAT-5301
1961-62	L6 3.9L 235ci	10" Disc & 11" Flat Diaph & w/1-1/8" X 10 X 19/32"	TAT-5301
1961-62	L6 3.9L 235ci	12" Diaph Type & w/Ceramic Button w/1-1/8" X 10 X 19/32"	TAT-5301
1961-62	L6 3.9L 235ci	12" Lever Type & w/Ceramic Button w/1-1/8" X 10 X 19/32"	TAT-5301
1966	L6 4.1L 250ci	10" Disc & 11" Flat Diaph w/1-1/8" X 10 X 19/32"	TAT-5301
1961-62	V8 4.6L 283ci	11" & 12" Diaph Type & w/Ceramic Button w/1-1/8" X 10 X 19/32"	TAT-5301
1961-62	V8 4.6L 283ci	11" Flat Diaph Type w/1-1/8" X 10 X 19/32"	TAT-5301
1961-62	V8 4.6L 283ci	12" Diaph Type & w/Ceramic Button w/1-1/8" X 10 X 19/32"	TAT-5301
1961-62	V8 4.6L 283ci	12" Lever Type & w/Ceramic Button w/1-1/8" X 10 X 19/32"	TAT-5301
1962	V8 5.4L 327ci	12" Lever Type & w/Ceramic Button w/1-1/8" X 10 X 19/32"	TAT-5301
1962	V8 5.4L 327ci	11" Diaph Type w/1-1/8" X 10 X 19/32"	TAT-5301
<b>P10 VAN, P20 VAN, P30 VAN</b>			
1989-91	L4 3.9L 239ci	12" Lever Type, Ceramic Button w/1-1/8" X 10 X 19/32"	TAT-5301
1968-69	L6 3.8L 230ci	10" Disc & 11" Flat Diaph w/1-1/8" X 10 X 19/32"	TAT-5301
1976	L6 4.1L 250ci	10" & 11" Disc & 11" Flat Diaph Type w/1-1/8" X 10 X 19/32"	TAT-5301
1979	L6 4.1L 250ci	12" Diaph Type & w/Ceramic Button w/1-1/8" X 10 X 19/32"	TAT-5301
1968-74	L6 4.1L 250ci	10" Disc & 11" Flat Diaph w/1-1/8" X 10 X 19/32"	TAT-5301
1975-84	L6 4.8L 292ci	11" Diaph Type w/1-1/8" X 10 X 19/32"	TAT-5301
1975-84	L6 4.8L 292ci	12" Lever Type & w/Ceramic Button w/1-1/8" X 10 X 19/32"	TAT-5301
1985-89	L6 4.8L 292ci	w/o PDH w/1-1/8" X 10 X 19/32"	TAT-5301
1990-95	V6 4.3L 262ci	w/PDH & w/o PDH w/1-1/8" X 10 X 19/32"	TAT-5301
1996-98	V6 4.3L 262ci	w/1-1/8" X 10 X 19/32"	TAT-5301
1979	V8 5.0L 305ci	11" & 12" Diaph Type & w/Ceramic Button w/1-1/8" X 10 X 19/32"	TAT-5301
1979	V8 5.0L 305ci	12" Diaph Type, PDH w/1-1/8" X 10 X 19/32"	TAT-5301
1969	V8 5.0L 307ci	11" Diaph Type w/1-1/8" X 10 X 19/32"	TAT-5301
1975-84	V8 5.7L 350ci	11" Diaph Type & 12" Lever Type w/1-1/8" X 10 X 19/32"	TAT-5301
1975-95	V8 5.7L 350ci	11" & 12" Diaph Type w/1-1/8" X 10 X 19/32"	TAT-5301
1975-95	V8 5.7L 350ci	12" Diaph Type & w/Ceramic Button w/1-1/8" X 10 X 19/32"	TAT-5301
1975-95	V8 5.7L 350ci	12" Diaph Type, PDH w/1-1/8" X 10 X 19/32"	TAT-5301
1996-99	V8 5.7L 350ci	NVG 3500, NVG 4500 Trans w/1-1/8" X 10 X 19/32"	TAT-5301
1982-93	V8 6.2L 379ci	12" Diaph Type, PDH w/1-1/8" X 10 X 19/32"	TAT-5301
1994-95	V8 6.5L 395ci	Use DMF FW-106 w/1-1/8" X 10 X 19/32"	TAT-5301
1996-99	V8 6.5L 395ci	12" Diaph Type w/1-1/8" X 10 X 19/32"	TAT-5301
1972	V8 6.6L 402ci	11" & 12" Diaph Type w/1-1/8" X 10 X 19/32"	TAT-5301
1972	V8 6.6L 402ci	12" Lever Type w/1-1/8" X 10 X 19/32"	TAT-5301
1973	V8 7.4L 454ci	12" Lever Type & w/Ceramic Button w/1-1/8" X 10 X 19/32"	TAT-5301
1975-78	V8 7.4L 454ci	12" Lever Type & w/Ceramic Button w/1-1/8" X 10 X 19/32"	TAT-5301
1979-95	V8 7.4L 454ci	12" Diaph Type & w/Ceramic Button w/1-1/8" X 10 X 19/32"	TAT-5301
1985-95	V8 7.4L 454ci	12" Diaph Type, PDH w/1-1/8" X 10 X 19/32"	TAT-5301
1996-99	V8 7.4L 454ci	w/1-1/8" X 10 X 19/32"	TAT-5301
<b>R10, V10</b>			
1987	V6 4.3L 262ci	w/PDH & w/o PDH w/1-1/8" X 10 X 19/32"	TAT-5301
1987	V8 5.0L 305ci	w/o PDH w/1-1/8" X 10 X 19/32"	TAT-5301
1987	V8 5.7L 350ci	12" Diaph Type & w/Ceramic Button w/1-1/8" X 10 X 19/32"	TAT-5301
1987	V8 5.7L 350ci	12" Diaph Type, PDH w/1-1/8" X 10 X 19/32"	TAT-5301
1987	V8 6.2L 379ci	12" Diaph Type, PDH w/1-1/8" X 10 X 19/32"	TAT-5301
<b>R1500 SUBURBAN, V1500 SUBURBAN</b>			
1989-91	V8 5.7L 350ci	12" Diaph Type & w/Ceramic Button w/1-1/8" X 10 X 19/32"	TAT-5301
1989-91	V8 5.7L 350ci	12" Diaph Type, PDH w/1-1/8" X 10 X 19/32"	TAT-5301
1989-91	V8 6.2L 379ci	12" Diaph Type, PDH w/1-1/8" X 10 X 19/32"	TAT-5301
<b>R20</b>			
1987-88	L6 4.8L 292ci	w/o PDH w/1-1/8" X 10 X 19/32"	TAT-5301
1987	V6 4.3L 262ci	w/PDH & w/o PDH w/1-1/8" X 10 X 19/32"	TAT-5301

# CLUTCH ALIGNMENT TOOLS

Year	Engine	Remark	Part
<b>CHEVROLET TRUCKS (con't)</b>			
<b>R20 (con't)</b>			
1987	V8 5.0L 305ci	w/o PDH w/1-1/8" X 10 X 19/32"	TAT-5301
1987-88	V8 5.7L 350ci	12" Diaph Type & w/Ceramic Button w/1-1/8" X 10 X 19/32"	TAT-5301
1987-88	V8 5.7L 350ci	12" Diaph Type, PDH w/1-1/8" X 10 X 19/32"	TAT-5301
1987-88	V8 6.2L 379ci	12" Diaph Type, PDH w/1-1/8" X 10 X 19/32"	TAT-5301
1987-88	V8 7.4L 454ci	12" Diaph Type & w/Ceramic Button w/1-1/8" X 10 X 19/32"	TAT-5301
1987-88	V8 7.4L 454ci	12" Diaph Type, PDH w/1-1/8" X 10 X 19/32"	TAT-5301
<b>R2500</b>			
1989	V8 6.2L 379ci	12" Diaph Type, PDH w/1-1/8" X 10 X 19/32"	TAT-5301
1989	V8 7.4L 454ci	12" Diaph Type & w/Ceramic Button w/1-1/8" X 10 X 19/32"	TAT-5301
1989	V8 7.4L 454ci	12" Diaph Type, PDH w/1-1/8" X 10 X 19/32"	TAT-5301
<b>R2500 SUBURBAN</b>			
1989-91	V8 5.7L 350ci	12" Diaph Type & w/Ceramic Button w/1-1/8" X 10 X 19/32"	TAT-5301
1989-91	V8 5.7L 350ci	12" Diaph Type, PDH w/1-1/8" X 10 X 19/32"	TAT-5301
<b>R30, V30</b>			
1987-88	L6 4.8L 292ci	w/o PDH w/1-1/8" X 10 X 19/32"	TAT-5301
1987-88	V8 5.7L 350ci	12" Diaph Type & w/Ceramic Button w/1-1/8" X 10 X 19/32"	TAT-5301
1987-88	V8 5.7L 350ci	12" Diaph Type, PDH w/1-1/8" X 10 X 19/32"	TAT-5301
1987-88	V8 6.2L 379ci	12" Diaph Type, PDH w/1-1/8" X 10 X 19/32"	TAT-5301
1987-88	V8 7.4L 454ci	12" Diaph Type, Ceramic Button w/1-1/8" X 10 X 19/32"	TAT-5301
1987-88	V8 7.4L 454ci	12" Diaph Type, PDH w/1-1/8" X 10 X 19/32"	TAT-5301
<b>R3500, V3500</b>			
1989-91	V8 5.7L 350ci	12" Diaph Type, Ceramic Button w/1-1/8" X 10 X 19/32"	TAT-5301
1989-91	V8 5.7L 350ci	12" Diaph Type, PDH w/1-1/8" X 10 X 19/32"	TAT-5301
1989-91	V8 6.2L 379ci	12" Diaph Type, PDH w/1-1/8" X 10 X 19/32"	TAT-5301
1989-91	V8 7.4L 454ci	12" Diaph Type, Ceramic Button w/1-1/8" X 10 X 19/32"	TAT-5301
1989-91	V8 7.4L 454ci	12" Diaph Type, PDH w/1-1/8" X 10 X 19/32"	TAT-5301
<b>S10</b>			
1982-85	L4 1.9L 119ci	w/1" X 14 X19/32"	TAT-5312
1983-84	L4 2.0L 122ci	10-1/2" Bolt Circle w/1" X 14 X19/32"	TAT-5312
1983-85	L4 2.2L 134ci	w/1" X 14 X 53/64"	TAT-5342
1994-02	L4 2.2L 134ci	w/1-1/8" X 26 X 19/32"	TAT-5313
1985-93	L4 2.5L 151ci	Solid Flywheel # FW-112 GAS w/1" X 14 X19/32"	TAT-5312
1982	V6 2.8L 173ci	w/1" X 14 X19/32"	TAT-5312
1983-93	V6 2.8L 173ci	10-1/2" Bolt Circle w/1" X 14 X19/32"	TAT-5312
1988-95	V6 4.3L 262ci	w/PDH & w/o PDH w/1-1/8" X 10 X 19/32"	TAT-5301
1996-99	V6 4.3L 262ci	w/1-1/8" X 10 X 19/32"	TAT-5301
2002	V6 4.3L 262ci	w/1-1/8" X 26 X 19/32"	TAT-5313
<b>SILVERADO 1500</b>			
1999-00	V8 4.8L 294ci	w/1-1/8" X 10 X 19/32"	TAT-5301
2001-02	V8 4.8L 294ci	12" Diaph Type w/1-1/8" X 10 X 19/32"	TAT-5301
<b>SILVERADO 2500</b>			
1999-00	V8 6.0L 364ci	11-3/4" w/1-1/8" X 10 X 19/32"	TAT-5301
<b>SUBURBAN</b>			
1961-67	L6 3.8L 230ci	10" Disc & 11" Flat Diaph Type w/1-1/8" X 10 X 19/32"	TAT-5301
1962	L6 3.9L 235ci	10" Disc & 11" Flat Diaph Type w/1-1/8" X 10 X 19/32"	TAT-5301
1966-67	L6 4.1L 250ci	10" Disc & 11" Flat Diaph Type w/1-1/8" X 10 X 19/32"	TAT-5301
1963-67	L6 4.8L 292ci	11" Flat Diaph Type w/1-1/8" X 10 X 19/32"	TAT-5301
1961-67	V8 4.6L 283ci	11" Flat, 12" Diaph Type, Ceramic Button w/1-1/8" X 10 X 19/32"	TAT-5301
1961-67	V8 4.6L 283ci	12" Lever Type & w/Ceramic Button w/1-1/8" X 10 X 19/32"	TAT-5301
1962-67	V8 5.4L 327ci	12" Lever Type & w/Ceramic Button w/1-1/8" X 10 X 19/32"	TAT-5301
1962-65	V8 5.7L 348ci	13" Lever & Diaph Type, Ceramic Button	TAT-5200
1966	V8 6.0L 366ci	13" Lever & Diaph Type, Ceramic Button	TAT-5200
1962-65	V8 6.7L 409ci	13" Lever & Diaph Type, Ceramic Button	TAT-5200
<b>TAHOE</b>			
2000	V8 4.8L 294ci	w/1-1/8" X 10 X 19/32"	TAT-5301
1995	V8 5.7L 350ci	12" Diaph Type & w/Ceramic Button w/1-1/8" X 10 X 19/32"	TAT-5301
1996-99	V8 5.7L 350ci	NVG 3500, NVG 4500 Trans w/1-1/8" X 10 X 19/32"	TAT-5301
1995	V8 6.5L 395ci	Diesel w/Solid & DMF w/1-1/8" X 10 X 19/32"	TAT-5301

# CLUTCH ALIGNMENT TOOLS

Year	Engine	Remark	Part
<b>CHEVROLET TRUCKS (con't)</b>			
<b>TAHOE (con't)</b>			
1996-99	V8 6.5L 395ci	12" Diaph Type w/1-1/8" X 10 X 19/32"	TAT-5301
<b>TRACKER</b>			
1998-00	L4 1.6L 98ci	w/13/16" X 20 X 25/64"	TAT-5393
1999-02	L4 2.0L 122ci	w/13/16" X 20 X 25/64"	TAT-5393
<b>TRUCK</b>			
1954-60	L6 3.9L 235ci	11 & 12" Diaph Type & w/Ceramic Button w/1-1/8" X 10 X 19/32"	TAT-5301
1954-60	L6 3.9L 235ci	12" Lever Type & w/Ceramic Button w/1-1/8" X 10 X 19/32"	TAT-5301
1954-59	L6 4.3L 261ci	11" Flat, 12" Diaph Type, Ceramic Button w/1-1/8" X 10 X 19/32"	TAT-5301
1954-59	L6 4.3L 261ci	12" Lever Type & w/Ceramic Button w/1-1/8" X 10 X 19/32"	TAT-5301
<b>V20</b>			
1987	L6 4.8L 292ci	w/o PDH w/1-1/8" X 10 X 19/32"	TAT-5301
1987	V8 5.7L 350ci	12" Diaph Type & w/Ceramic Button w/1-1/8" X 10 X 19/32"	TAT-5301
1987	V8 5.7L 350ci	12" Diaph Type, PDH w/1-1/8" X 10 X 19/32"	TAT-5301
1987	V8 6.2L 379ci	12" Diaph Type, PDH w/1-1/8" X 10 X 19/32"	TAT-5301
<b>V2500 SUBURBAN</b>			
1989-91	V8 5.7L 350ci	12" Diaph Type & w/Ceramic Button w/1-1/8" X 10 X 19/32"	TAT-5301
1989-91	V8 5.7L 350ci	12" Diaph Type, PDH w/1-1/8" X 10 X 19/32"	TAT-5301
1989-91	V8 6.2L 379ci	12" Diaph Type, PDH w/1-1/8" X 10 X 19/32"	TAT-5301
<b>CHEVROLET HEAVY DUTY TRUCKS</b>			
<b>C40, C50</b>			
1962-84	V8 6.0L 366ci	13" Lever & Diaph Type, Ceramic Button	TAT-5200
1985-89	V8 6.0L 366ci	13" Lever & Diaph Type, Ceramic Button	TAT-5200
1997-90	V8 6.0L 366ci	13" Lever & Diaph Type, Ceramic Button	TAT-5200
1962-97	V8 7.0L 427ci	13" Lever & Diaph Type & w/Ceramic Button	TAT-5200
<b>C60, C70</b>			
1961-84	L4 3.5L 212ci	13" Diaph & Lever Type & Ceramic Button	TAT-5200
1961-84	L4 3.5L 212ci	4-53 Detroit Diesel, Diaph Type w/ Organic Disc	TAT-5200
1962-97	V8 6.0L 366ci	13" Diaph & Lever Type & w/Ceramic Button	TAT-5200
1991-96	V8 7.0L 427ci	Diaphragm Type	TAT-5200
<b>C80, C90</b>			
1961-84	L4 3.5L 212ci	13" Diaph & Lever Type & w/Ceramic Button	TAT-5200
1961-84	L4 3.5L 212ci	4-53 Detroit Diesel, Diaph Type w/ Organic Disc	TAT-5200
<b>CHRYSLER</b>			
<b>300</b>			
1956-56	V8 5.8L 354ci	10" Disc w/1-1/8" X 10 X 19/32"	TAT-5349
1961-65	V8 6.8L 413ci	11" Diaph Type w/1" X 23 X 47/64"	TAT-5309
<b>LASER</b>			
1984-86	L4 2.2L 135ci	w/7/8" X 18 X 45/64"	TAT-5363
<b>LEBARON</b>			
1982-89	L4 2.2L 135ci	w/7/8" X 18 X 45/64"	TAT-5363
1986-90	L4 2.5L 153ci	w/7/8" X 18 X 45/64"	TAT-5363
1991-93	L4 2.5L 153ci		TAT-5203
1982-85	L4 2.6L 156ci	w/7/8" X 18 X 45/64"	TAT-5363
1978-80	L6 3.7L 225ci	9-1/4" Lever Type w/1" X 23 X 47/64"	TAT-5309
1990	V6 3.0L 181ci	w/7/8" X 18 X 45/64"	TAT-5363
1991-95	V6 3.0L 181ci		TAT-5203
<b>NEW YORKER</b>			
1956-56	V8 5.8L 354ci	10" Disc w/1-1/8" X 10 X 19/32"	TAT-5349
1961-65	V8 6.8L 413ci	11" Diaph Type w/1" X 23 X 47/64"	TAT-5309
<b>NEWPORT</b>			
1956-56	V8 5.8L 354ci	10" Disc w/1-1/8" X 10 X 19/32"	TAT-5349
1971	V8 5.9L 360ci	w/1" X 23 X 47/64"	TAT-5309
1961-64	V8 5.9L 361ci	w/1" X 23 X 47/64"	TAT-5309
1968-69	V8 6.3L 383ci	11" Diaph Type w/1" X 23 X 47/64"	TAT-5309
1970-71	V8 6.3L 383ci	Lever Type w/1" X 23 X 47/64"	TAT-5309
1962-64	V8 6.8L 413ci	11" Diaph Type w/1" X 23 X 47/64"	TAT-5309
<b>SARATOGA, WINDSOR</b>			
1957	V8 5.8L 354ci	10" Disc w/1-1/8" X 10 X 19/32"	TAT-5349

# CLUTCH ALIGNMENT TOOLS

Year	Engine	Remark	Part
<b>DAIHATSU</b>			
<b>CHARADE</b>			
1988-92	L3 1.0L 993cc		TAT-5402
1989-92	L4 1.3L 1295cc		TAT-5402
<b>DAIHATSU TRUCKS</b>			
<b>ROCKY</b>			
1990-92	L4 1.6L 1589cc		TAT-5402
<b>DODGE</b>			
<b>400, 600, ARIES</b>			
1981-89	L4 2.2L 135ci	w/7/8" X 18 X 45/64"	TAT-5363
1986-89	L4 2.5L 153ci	w/7/8" X 18 X 45/64"	TAT-5363
1981-85	L4 2.6L 156ci	w/7/8" X 18 X 45/64"	TAT-5363
<b>ASPEN</b>			
1976-80	L6 3.7L 225ci	9-1/4" & 10" Lever Type & 11" Diaph Type w/1" X 23 X 47/64"	TAT-5309
1976-79	V8 5.2L 318ci	10-1/2" Disc w/1" X 23 X 47/64"	TAT-5309
<b>CHALLENGER</b>			
1978-79	L4 1.6L 98ci	FWD w/7/8" X 20 X 39/64"	TAT-5337
1978-83	L4 2.6L 156ci	FWD w/1" X 23 X 19/32"	TAT-5311
1970-71	L6 3.2L 198ci	Lever Type, 10" Disc, RWD w/1" X 23 X 47/64"	TAT-5309
1970-72	L6 3.7L 225ci	w/10" Lever Type & 11" Disc, RWD w/1" X 23 X 47/64"	TAT-5309
1970-74	V8 5.2L 318ci	10-1/2" Disc, RWD w/1" X 23 X 47/64"	TAT-5309
1970-73	V8 5.6L 340ci	RWD w/1" X 23 X 47/64"	TAT-5309
1974	V8 5.9L 360ci	RWD w/1" X 23 X 47/64"	TAT-5309
1970-71	V8 6.3L 383ci	RWD w/1" X 23 X 47/64"	TAT-5309
<b>CHARGER</b>			
1984	L4 1.6L 97ci	FWD w/7/8" X 18 X 45/64"	TAT-5363
1983-87	L4 2.2L 135ci	FWD Turbo w/ or wo/Intercooler w/7/8" X 18 X 45/64"	TAT-5363
1971	V8 5.6L 340ci	RWD w/1" X 23 X 47/64"	TAT-5309
1971	V8 6.3L 383ci	RWD w/1" X 23 X 47/64"	TAT-5309
<b>COLT</b>			
1979-84	L4 1.4L 1410cc	4 & 8 Speed w/7/8" X 20 X 41/64"	TAT-5360
1985-94	L4 1.5L 90ci	4 & 5 Speed w/7/8" X 20 X 41/64"	TAT-5360
1971-73	L4 1.6L 98ci	w/1" X 24 X 15/32"	TAT-5322
1974-78	L4 1.6L 98ci	w/7/8 X 20 X 39/64"	TAT-5337
1979-90	L4 1.6L 98ci	w/7/8" X 20 X 41/64"	TAT-5360
1989	L4 1.6L 98ci	7-3/8" K Eng w/7/8" X 20 X 41/64"	TAT-5360
1989	L4 1.6L 98ci	7-7/8" Z Eng w/7/8" X 20 X 41/64"	TAT-5360
1989-90	L4 1.8L 107ci	w/7/8" X 20 X 41/64"	TAT-5360
1992-94	L4 1.8L 112ci	w/7/8" X 20 X 41/64"	TAT-5360
1974-77	L4 2.0L 122ci	w/7/8 X 20 X 39/64"	TAT-5337
1984-86	L4 2.0L 122ci	2WD w/7/8" X 20 X 41/64"	TAT-5360
1987-91	L4 2.0L 122ci	w/7/8" X 20 X 41/64"	TAT-5360
1993-94	L4 2.4L 2351cc	w/7/8" X 20 X 37/64"	TAT-5310
1978-80	L4 2.6L 156ci	w/1" X 23 X 19/32"	TAT-5311
<b>CONQUEST</b>			
1984-86	L4 2.6L 156ci	STI w/1" X 23 X 19/32"	TAT-5311
<b>CORONET</b>			
1973-76	L6 3.7L 225ci	10" Lever Type & 10" & 11" Diaph Type w/1" X 23 X 47/64"	TAT-5309
1957-59	L6 3.8L 230ci	9-1/8" & 10" Disc w/1 w/1" X 10 X 49/64"	TAT-5349
1976	V8 5.2L 318ci	w/1" X 23 X 47/64"	TAT-5309
1968-71	V8 6.3L 383ci	11" Diaph Type w/1" X 23 X 47/64"	TAT-5309
1972-74	V8 6.6L 400ci	w/1" X 23 X 47/64"	TAT-5309
<b>DART</b>			
1961-69	L6 2.8L 170ci	9-1/4" & 10" Lever Type, 10" Disc w/1" X 23 X 47/64"	TAT-5309
1970-74	L6 3.2L 198ci	9-1/4" & 10" Lever Type, 10" Disc w/1" X 23 X 47/64"	TAT-5309
1969-76	L6 3.7L 225ci	9-1/4", 10" Lever Type, 10" & 11" Disc & Diaph Type w/1" X 23 X 47/64"	TAT-5309
1964-69	V8 4.5L 273ci	10-1/2" Disc, 10-1/2" Diaph Type, 10" Disc w/1" X 23 X 47/64"	TAT-5309
1968-76	V8 5.2L 318ci	w/1" X 23 X 47/64"	TAT-5309
1968-73	V8 5.6L 340ci	w/1" X 23 X 47/64"	TAT-5309
1961-62	V8 5.9L 361ci	w/1" X 23 X 47/64"	TAT-5309

# CLUTCH ALIGNMENT TOOLS

Year	Engine	Remark	Part
<b>DODGE (con't)</b>			
<b>DART (con't)</b>			
1963-69	V8 6.3L 383ci	11" Diaph Type w/1" X 23 X 47/64"	TAT-5309
<b>DAYTONA</b>			
1984-88	L4 2.2L 135ci	Turbo w/7/8" X 18 X 45/64"	TAT-5363
1990	L4 2.2L 135ci	Turbo, w/Intercooler	TAT-5203
1984-90	L4 2.2L 135ci	w/7/8" X 18 X 45/64"	TAT-5363
1986-90	L4 2.5L 153ci	w/7/8" X 18 X 45/64"	TAT-5363
1991-93	L4 2.5L 153ci		TAT-5203
1990	V6 3.0L 181ci	w/7/8" X 18 X 45/64"	TAT-5363
1991-93	V6 3.0L 181ci		TAT-5203
<b>DIPLOMAT</b>			
1978-80	L6 3.7L 225ci	9-1/4", 10" Lever Type, 10" Disc, 11" Diaph Type w/1" X 23 X 47/64"	TAT-5309
1977-79	V8 5.2L 318ci	w/1" X 23 X 47/64"	TAT-5309
<b>LANCER</b>			
1985-89	L4 2.2L 135ci	w/7/8" X 18 X 45/64"	TAT-5363
1986-89	L4 2.5L 153ci	w/7/8" X 18 X 45/64"	TAT-5363
1962	L6 2.8L 170ci	9-1/4", 10" Lever Type, 10" Disc, w/1" X 23 X 47/64"	TAT-5309
1961-62	L6 3.7L 225ci	9-1/4", 10" Lever Type, 10" Disc, 11" Diaph Type w/1" X 23 X 47/64"	TAT-5309
<b>MONACO</b>			
1977-78	L6 3.7L 225ci	9-1/4", 10" Lever Type, 10" Disc, 11" Diaph Type w/1" X 23 X 47/64"	TAT-5309
1968-78	V8 5.2L 318ci	w/1" X 23 X 47/64"	TAT-5309
1971-74	V8 5.9L 360ci	w/1" X 23 X 47/64"	TAT-5309
1968-71	V8 6.3L 383ci	11" Diaph Type w/1" X 23 X 47/64"	TAT-5309
1972-74	V8 6.6L 400ci	w/1" X 23 X 47/64"	TAT-5309
<b>NEON</b>			
1995	L4 2.0L 122ci		TAT-5212
<b>OMNI</b>			
1983-86	L4 1.6L 97ci	w/7/8" X 18 X 45/64"	TAT-5363
1978-83	L4 1.7L 105ci	A412 Trans (VW) w/5-5/32" O.D. X 45/64" Nose Dia.	TAT-5378
1981-83	L4 1.7L 105ci	A460 Trans (New Process) w/7/8" X 18 X 45/64"	TAT-5363
1981-90	L4 2.2L 135ci	w/7/8" X 18 X 45/64"	TAT-5363
<b>POLARA</b>			
1963-64	L6 2.8L 170ci	9-1/4", 10" Lever Type, 10" Disc, w/1" X 23 X 47/64"	TAT-5309
1963-71	L6 3.7L 225ci	9-1/4", 10" Lever Type, 10" Disc, 11" Diaph Type w/1" X 23 X 47/64"	TAT-5309
1964-67	V8 4.5L 273ci	10-1/2" Diaph Type, 10", 10-1/2" Disc w/1" X 23 X 47/64"	TAT-5309
1961-73	V8 5.2L 318ci	10" Disc w/1 w/1" X 10 X 49/64"	TAT-5309
1971-73	V8 5.9L 360ci	w/1" X 23 X 47/64"	TAT-5309
1961-64	V8 5.9L 361ci	w/1" X 23 X 47/64"	TAT-5309
1968-71	V8 6.3L 383ci	11" Diaph Type w/1" X 23 X 47/64"	TAT-5309
1972-73	V8 6.6L 400ci	w/1" X 23 X 47/64"	TAT-5309
<b>SHADOW</b>			
1987-90	L4 2.2L 135ci	w/7/8" X 18 X 45/64"	TAT-5363
1991-94	L4 2.2L 135ci		TAT-5203
1988-90	L4 2.5L 153ci	w/7/8" X 18 X 45/64"	TAT-5363
1991-94	L4 2.5L 153ci		TAT-5203
1992-94	V6 3.0L 181ci		TAT-5203
<b>SPIRIT</b>			
1991	L4 2.2L 135ci	16V DOHC, Turbo	TAT-5203
1992	L4 2.2L 135ci	DOHC, Turbo	TAT-5203
1990	L4 2.5L 153ci	Turbo w/7/8" X 18 X 45/64"	TAT-5363
1989-90	L4 2.5L 153ci	w/7/8" X 18 X 45/64"	TAT-5363
1991-94	L4 2.5L 153ci		TAT-5203
1990-94	V6 3.0L 181ci		TAT-5203
<b>STEALTH</b>			
1991-96	V6 3.0L 181ci	2WD w/7/8" X 20 X 41/64"	TAT-5310
1991-96	V6 3.0L 181ci	Turbo, 4WD w/1" X 23 X 47/64"	TAT-5309
<b>DODGE TRUCKS</b>			
<b>A100</b>			
1964-69	L6 2.8L 170ci	9-1/4", 10" Lever Type, 10" Disc, w/1" X 23 X 47/64"	TAT-5309



# CLUTCH ALIGNMENT TOOLS

Year	Engine	Remark	Part
<b>DODGE TRUCKS (con't)</b>			
<b>A100 (con't)</b>			
1964-70	L6 3.7L 225ci	10" Lever Type, 10" Disc, 11" Diaph Type w/1" X 23 X 47/64"	TAT-5309
1964-70	L6 3.7L 225ci	12" Lever Type w/1" X 10 X 49/64"	TAT-5349
1964-67	V8 4.5L 273ci	12" Lever Type w/1" X 10 X 49/64"	TAT-5349
<b>B100 VAN, B200 VAN, B300 VAN</b>			
1971	L6 3.2L 198ci	9-1/4", 10" Lever Type, 10" Disc, w/1" X 23 X 47/64"	TAT-5309
1971-74	L6 3.7L 225ci	10", 12" Lever Type, 10" Disc, 11" Diaph w/1" X 23 X 47/64"	TAT-5309
1971-74	V8 5.2L 318ci	10", 10-1/2" Disc w/A833 Trans Gas w/1" X 23 X 47/64"	TAT-5309
1971-74	V8 5.2L 318ci	11" Diaph Type, w/A435 Trans w/1" X 23 X 47/64"	TAT-5309
1971-74	V8 5.9L 360ci	11" Diaph Type w/1" X 23 X 47/64"	TAT-5309
1971-74	V8 6.6L 400ci	12" Diaph Type, 12" Lever Type w/1" X 23 X 47/64"	TAT-5309
1974-78	V8 7.2L 440ci	12" Diaph, 12" Lever Type w/1" X 23 X 47/64"	TAT-5309
<b>B150, B250, B350</b>			
1981-87	L6 3.7L 225ci	10", 12" Lever Type, 10" Disc, 11" Diaph Type w/1" X 23 X 47/64"	TAT-5309
1988-91	V6 3.9L 239ci	4 & 5 Speed w/1" X 23 X 47/64"	TAT-5309
1992-94	V6 3.9L 239ci	w/1-5/32" X 10 X 5/8"	TAT-5359
1994	V8 5.2L 318ci	Replaces OE 11" System w/1-5/32" X 10 X 5/8"	TAT-5359
1994	V8 5.2L 318ci	w/1-5/32" X 10 X 5/8"	TAT-5359
1981-91	V8 5.2L 318ci	10-1/2" Disc; w/A535, w/A833 Trans; Gas w/1" X 23 X 47/64"	TAT-5309
1981-91	V8 5.2L 318ci	11" Diaph Type, w/A435 Trans w/1" X 23 X 47/64"	TAT-5309
1992-93	V8 5.2L 318ci		TAT-5210
1995-98	V8 5.2L 318ci	w/1-5/32" X 10 X 5/8"	TAT-5359
1994	V8 5.9L 360ci	w/1-5/32" X 10 X 5/8"	TAT-5359
1981-91	V8 5.9L 360ci	11" Diaph Type w/1" X 23 X 47/64"	TAT-5309
1992-93	V8 5.9L 360ci		TAT-5210
<b>B1500, B2500</b>			
1995-98	V6 3.9L 239ci	w/1-5/32" X 10 X 5/8"	TAT-5359
1995-98	V8 5.2L 318ci	w/1-5/32" X 10 X 5/8"	TAT-5359
1995-98	V8 5.9L 360ci	w/1-5/32" X 10 X 5/8"	TAT-5359
<b>CARAVAN</b>			
1984-87	L4 2.2L 135ci	w/7/8" X 18 X 45/64"	TAT-5363
1988-90	L4 2.5L 153ci	w/7/8" X 18 X 45/64"	TAT-5363
1991-92	L4 2.5L 153ci		TAT-5203
1984-86	L4 2.6L 156ci	w/1" X 23 X 19/32"	TAT-5311
1990	V6 3.0L 181ci	w/7/8" X 18 X 45/64"	TAT-5363
1991-94	V6 3.0L 181ci		TAT-5203
<b>D100 PICKUP</b>			
1970-71	L6 3.2L 198ci	9-1/4", 10" Lever Type, 10" Disc w/1" X 23 X 47/64"	TAT-5309
1975-87	L6 3.7L 225ci	10", 12" Lever Type, 10" Disc 11" Diaph Type w/1" X 23 X 47/64"	TAT-5309
1988-89	V6 3.9L 239ci	4 & 5 Speed w/1" X 23 X 47/64"	TAT-5309
1975-87	V8 5.2L 318ci	10-1/2" Diaph Type, 10" Disc, A435 Trans w/1" X 23 X 47/64"	TAT-5309
1975-89	V8 5.2L 318ci	10-1/2" Disc; w/A535, w/A833 Trans; Gas w/1" X 23 X 47/64"	TAT-5309
1988-89	V8 5.2L 318ci	11" Diaph Type, w/A435 Trans w/1" X 23 X 47/64"	TAT-5309
1975-88	V8 5.9L 360ci	11" Diaph Type w/1" X 23 X 47/64"	TAT-5309
1968	V8 6.3L 383ci	12" Lever Type w/1" X 10 X 49/64"	TAT-5349
1969-71	V8 6.3L 383ci	12" Diaph, 12" Lever Type w/1" X 23 X 47/64"	TAT-5309
1976-78	V8 6.6L 400ci	12" Diaph, 12" Lever Type w/1" X 23 X 47/64"	TAT-5309
1973-78	V8 7.2L 440ci	12" Diaph, 12" Lever Type w/1" X 23 X 47/64"	TAT-5309
<b>D100 SERIES, D200 SERIES, D300 SERIES</b>			
1961-65	L6 2.8L 170ci	10" Lever Type, 10" Disc w/1" X 23 X 47/64"	TAT-5309
1961-65	L6 2.8L 170ci	9-1/4" Lever Type w/1" X 23 X 47/64"	TAT-5309
1963-67	V8 6.3L 383ci	12" Lever Type w/1" X 10 X 49/64"	TAT-5349
<b>D150, D250, D350</b>			
1977-87	L6 3.7L 225ci	10" Lever, 11" Diaph Type, 10" Disc w/1" X 23 X 47/64"	TAT-5309
1977-87	L6 3.7L 225ci	12" Lever Type w/1" X 10 X 49/64"	TAT-5349
1989-93	L6 5.9L 359ci	12-1/4" & 13" Cummins Option	TAT-5412
1988-91	V6 3.9L 239ci	4 & 5 Speed w/1" X 23 X 47/64"	TAT-5309
1992-93	V6 3.9L 239ci	w/1-5/32" X 10 X 5/8"	TAT-5359
1977-91	V8 5.2L 318ci	10-1/2" Disc w/A535, 11" Diaph Type, w/A435 w/1" X 23 X 47/64"	TAT-5309

# CLUTCH ALIGNMENT TOOLS

Year	Engine	Remark	Part
<b>DODGE TRUCKS (con't)</b>			
<b>D150, D250, D350 (con't)</b>			
1977-91	V8 5.2L 318ci	10-1/2" Disc; w/A535, w/A833 Trans; Gas w/1" X 23 X 47/64"	TAT-5309
1981-91	V8 5.2L 318ci	11" Diaph Type, w/A435 Trans w/1" X 23 X 47/64"	TAT-5309
1992-93	V8 5.2L 318ci		TAT-5210
1977-91	V8 5.9L 360ci	11" Diaph Type w/1" X 23 X 47/64"	TAT-5309
1992-93	V8 5.9L 360ci		TAT-5210
1977-78	V8 6.6L 400ci	12" Diaph, 12" Lever Type w/1" X 23 X 47/64"	TAT-5309
1978	V8 7.2L 440ci	12" Diaph, Lever Type w/1" X 23 X 47/64"	TAT-5309
<b>D200 PICKUP, D300 PICKUP</b>			
1975-80	L6 3.7L 225ci	10" Lever 11" Diaph Type, 10" Disc w/1" X 23 X 47/64"	TAT-5309
1975-80	L6 3.7L 225ci	12" Lever Type w/1" X 10 X 49/64"	TAT-5349
1975-80	V8 5.2L 318ci	10-1/2" Disc; w/A833, A435 Trans; Gas w/1" X 23 X 47/64"	TAT-5309
1975-80	V8 5.9L 360ci	11" Diaph Type w/1" X 23 X 47/64"	TAT-5309
1968	V8 6.3L 383ci	12" Lever Type w/1" X 10 X 49/64"	TAT-5349
1969-70	V8 6.3L 383ci	12" Diaph Type, 12" Lever Type w/1" X 23 X 47/64"	TAT-5309
1975-78	V8 6.6L 400ci	12" Diaph Type, Lever Type w/1" X 23 X 47/64"	TAT-5309
1973-78	V8 7.2L 440ci	12" Diaph Type, 12" Lever Type w/1" X 23 X 47/64"	TAT-5309
<b>D400, D450</b>			
1978-81	V8 5.9L 360ci	11" Diaph Type w/1" X 23 X 47/64"	TAT-5309
<b>D50</b>			
1979-80	L4 2.0L 122ci	Gas w/7/8" X 20 X 41/64"	TAT-5360
1981-82	L4 2.0L 122ci	w/1" X 23 X 19/32"	TAT-5311
1979-82	L4 2.6L 156ci	w/1" X 23 X 19/32"	TAT-5311
<b>DAKOTA</b>			
1987-88	L4 2.2L 135ci	w/1" X 23 X 19/32"	TAT-5311
1989-91	L4 2.5L 153ci	w/1" X 23 X 19/32"	TAT-5311
1992-93	L4 2.5L 153ci	19 Spline	TAT-5210
1992-96	L4 2.5L 153ci	10 Spline w/1-5/32" X 10 X 5/8"	TAT-5359
1996-98	L4 2.5L 153ci	14 Spline	TAT-5215
1987-91	V6 3.9L 239ci	w/1" X 23 X 47/64"	TAT-5309
1992-99	V6 3.9L 239ci	w/1-5/32" X 10 X 5/8"	TAT-5359
2000	V8 4.7L 287ci	w/1-5/32" X 10 X 5/8"	TAT-5359
1994-99	V8 5.2L 318ci	w/1-5/32" X 10 X 5/8"	TAT-5359
<b>MINI RAM</b>			
1984-87	L4 2.2L 135ci	w/7/8" X 18 X 45/64"	TAT-5363
1987-88	L4 2.5L 153ci	w/7/8" X 18 X 45/64"	TAT-5363
1984-86	L4 2.6L 156ci	w/1" X 23 X 19/32"	TAT-5311
<b>P100, P200, P300</b>			
1968-72	L6 3.7L 225ci	10" Lever Type, 10" Disc 11" Diaph Type w/1" X 23 X 47/64"	TAT-5309
1968-72	L6 3.7L 225ci	12" Lever Type w/1" X 10 X 49/64"	TAT-5349
1971-72	V8 5.9L 360ci	11" Diaph Type w/1" X 23 X 47/64"	TAT-5309
<b>RAIDER</b>			
1987-89	L4 2.6L 156ci	w/1" X 23 X 19/32"	TAT-5311
1989	V6 3.0L 181ci		TAT-5401
<b>RAM 1500</b>			
1994-00	V6 3.9L 239ci	w/1-5/32" X 10 X 5/8"	TAT-5359
1994-98	V8 5.2L 318ci	Replaces OE 11" System; Gas w/1-5/32" X 10 X 5/8"	TAT-5359
1994-98	V8 5.9L 360ci	Replaces OE 11" System; Gas w/1-5/32" X 10 X 5/8"	TAT-5359
<b>RAM 1500 VAN</b>			
2001	V6 3.9L 239ci	w/1-5/32" X 10 X 5/8"	TAT-5359
<b>RAM 2500, RAM 3500</b>			
1998	L6 5.9L 359ci	12-1/4" 5 Speed, Cummins Turbo	TAT-5412
1994-97	L6 5.9L 359ci	12-1/4" Cummins Turbo	TAT-5412
1994-98	V10 8.0L 488ci	Gas	TAT-5412
1994-96	V8 5.2L 318ci	Replaces OE 11" System; Gas w/1-5/32" X 10 X 5/8"	TAT-5359
1994-98	V8 5.9L 360ci	Replaces OE 11" System; Gas w/1-5/32" X 10 X 5/8"	TAT-5359
<b>RAM 3500 VAN</b>			
1999-01	V8 5.2L 318ci	w/1-5/32" X 10 X 5/8"	TAT-5359

# CLUTCH ALIGNMENT TOOLS

Year	Engine	Remark	Part
<b>DODGE TRUCKS (con't)</b>			
<b>RAM 50</b>			
1983	L4 2.0L 122ci	w/1" X 23 X 19/32"	TAT-5311
1983-85	L4 2.3L 143ci	Diesel w/1" X 23 X 19/32"	TAT-5311
1990-93	L4 2.4L 2351cc	w/1" X 23 X 19/32"	TAT-5311
1983-89	L4 2.6L 156ci	w/1" X 23 X 19/32"	TAT-5311
1990-91	V6 3.0L 181ci		TAT-5401
<b>RAMPAGE</b>			
1982-84	L4 2.2L 135ci	w/7/8" X 18 X 45/64"	TAT-5363
<b>ROYAL MINI RAM</b>			
1984-87	L4 2.2L 135ci	w/7/8" X 18 X 45/64"	TAT-5363
1984-87	L4 2.6L 156ci	w/1" X 23 X 19/32"	TAT-5311
1987	V6 3.0L 181ci	w/1" X 23 X 19/32"	TAT-5311
<b>TRUCK</b>			
1960	L6 2.8L 170ci	9-1/4", 10" Lever Type, 10" Disc w/1" X 23 X 47/64"	TAT-5309
1957-59	L6 3.8L 230ci	9-1/4" Disc w/1" X 10 X 49/64"	TAT-5349
1959	V8 5.2L 318ci	10" Lever Type, 10" Disc w/1" X 23 X 47/64"	TAT-5309
1959	V8 5.2L 318ci	12" Lever Type w/1" X 10 X 49/64"	TAT-5349
<b>W100 PICKUP, W200 PICKUP, W300 PICKUP</b>			
1968-74	L6 3.7L 225ci	10",12" Lever Type,10" Disc 11" Diaph Type w/1" X 23 X 47/64"	TAT-5309
1989	V6 3.9L 239ci	4 & 5 Speed w/1" X 23 X 47/64"	TAT-5309
1969-74	V8 5.2L 318ci	10" & 10-1/2" Disc, Diaph,w/A833,A435 Trans;Gas w/1" X 23 X 47/64"	TAT-5309
1968	V8 5.2L 318ci	10" Lever Type, 10" Disc 10-1/2" Diaph Type w/1" X 23 X 47/64"	TAT-5309
1968	V8 5.2L 318ci	10", 12" Lever Type, 10" Disc w/1" X 23 X 47/64"	TAT-5309
1971-74	V8 5.9L 360ci	11" Diaph Type w/1" X 23 X 47/64"	TAT-5309
1968	V8 6.3L 383ci	12" Lever Type w/1" X 10 X 49/64"	TAT-5349
1969-74	V8 6.3L 383ci	12" Diaph Type, 12" Lever Type w/1" X 23 X 47/64"	TAT-5309
1971-78	V8 6.6L 400ci	12" Diaph Type, 12" Lever Type w/1" X 23 X 47/64"	TAT-5309
1974-78	V8 7.2L 440ci	12" Diaph Type,12" Lever Type w/1" X 23 X 47/64"	TAT-5309
<b>W100 SERIES, W200 SERIES</b>			
1963-67	V8 6.3L 383ci	12" Lever Type w/1" X 10 X 49/64"	TAT-5349
<b>W150, W250, W350</b>			
1978-87	L6 3.7L 225ci	10" Lever Type, 10" Disc 11" Diaph Type w/1" X 23 X 47/64"	TAT-5309
1978-87	L6 3.7L 225ci	12" Lever Type w/1" X 10 X 49/64"	TAT-5349
1989-93	L6 5.9L 359ci	12-1/4", 13" Cummins Option	TAT-5412
1989-91	V6 3.9L 239ci	10-1/2" 5 Speed, 11" 4 Speed w/1" X 23 X 47/64"	TAT-5309
1992-93	V6 3.9L 239ci		TAT-5210
1977-91	V8 5.2L 318ci	10-1/2" Disc; w/A833, w/A535 Trans;Gas w/1" X 23 X 47/64"	TAT-5309
1977-91	V8 5.2L 318ci	11" Diaph Type, w/A435 Trans w/1" X 23 X 47/64"	TAT-5309
1992-93	V8 5.2L 318ci		TAT-5210
1993	V8 5.9L 360ci		TAT-5210
1977-91	V8 5.9L 360ci	11" Diaph Type w/1" X 23 X 47/64"	TAT-5309
1992-93	V8 5.9L 360ci		TAT-5210
1977-78	V8 6.6L 400ci	12" Diaph Type,12" Lever Type w/1" X 23 X 47/64"	TAT-5309
1978	V8 7.2L 440ci	12" Diaph Type,12" Lever Type w/1" X 23 X 47/64"	TAT-5309
<b>DODGE HEAVY DUTY TRUCKS</b>			
<b>D501</b>			
1957	V8 5.8L 354ci	12" Lever Type w/1" X 10 X 49/64"	TAT-5349
<b>EAGLE</b>			
<b>2000 GTX</b>			
1992	L4 2.0L 1997cc	w/7/8" X 20 X 41/64"	TAT-5360
<b>MEDALLION</b>			
1988-89	L4 2.2L 2163cc	Pull Type w/7/8" X 20 X 41/64"	TAT-5360
<b>SUMMIT</b>			
1989-96	L4 1.5L 1468cc	w/7/8" X 20 X 41/64"	TAT-5360
1989-90	L4 1.6L 1597cc	w/7/8" X 20 X 41/64"	TAT-5360
1993-96	L4 1.8L 1834cc	w/7/8" X 20 X 41/64"	TAT-5360
1992-96	L4 2.4L 2351cc	w/7/8" X 20 X 37/64"	TAT-5310
<b>TALON</b>			
1993-94	L4 1.8L 1755cc	w/7/8" X 20 X 41/64"	TAT-5360

# CLUTCH ALIGNMENT TOOLS

Year	Engine	Remark	Part
<b>EAGLE (con't)</b>			
<b>TALON (con't)</b>			
1990-98	L4 2.0L 1997cc	w/7/8" X 20 X 37/64"	TAT-5310
<b>VISTA</b>			
1992	L4 1.5L 1468cc	w/7/8" X 20 X 41/64"	TAT-5360
<b>EDSEL</b>			
<b>BERMUDA, PACER, ROUNDUP</b>			
1958	V8 5.9L 361ci	w/1" X 23 X 19/32"	TAT-5311
<b>CITATION</b>			
1958	V8 6.7L 410ci	w/1" X 23 X 19/32"	TAT-5311
<b>CORSAIR</b>			
1959	V8 5.4L 332ci	w/1" X 23 X 19/32"	TAT-5311
1958	V8 6.7L 410ci	w/1" X 23 X 19/32"	TAT-5311
<b>RANGER, VILLAGER</b>			
1959-60	V8 4.8L 292ci	w/1" X 23 X 19/32"	TAT-5311
1958	V8 5.9L 361ci	w/1" X 23 X 19/32"	TAT-5311
<b>FIAT</b>			
<b>124</b>			
1969	L4 1.2L 1197cc	w/7/8" X 20 X 41/64"	TAT-5360
1971-73	L4 1.6L 1608cc	8-1/2" Disc w/7/8" X 20 X 41/64"	TAT-5360
1974-78	L4 1.8L 1756cc	8-1/2" Disc w/7/8" X 20 X 41/64"	TAT-5360
1979-81	L4 2.0L 1995cc	8-1/2" Disc w/7/8" X 20 X 41/64"	TAT-5360
<b>128</b>			
1971-73	L4 1.1L 1116cc	w/3/4" X 17 X 3/4"	TAT-5324
1973-79	L4 1.3L 1290cc	w/3/4" X 17 X 3/4"	TAT-5324
<b>131</b>			
1975-78	L4 1.8L 1756cc	8-1/2" Disc w/7/8" X 20 X 41/64"	TAT-5360
<b>STRADA</b>			
1979-82	L4 1.5L 1498cc	w/24/32" X 17 X 19/32"	TAT-5339
<b>X-1/9</b>			
1974-78	L4 1.3L 1290cc	w/3/4" X 17 X 3/4"	TAT-5324
1979-83	L4 1.5L 1498cc	w/24/32" X 17 X 19/32"	TAT-5339
<b>FORD</b>			
<b>ASPIRE</b>			
1994-97	L4 1.3L 1295cc		TAT-5400
<b>CONTOUR</b>			
1995-00	L4 2.0L 121ci	CSC	TAT-5408
1995-00	V6 2.5L 155ci	CSC, Solid Flywheel # FW-140	TAT-5408
<b>ESCORT, EXP</b>			
1981-85	L4 1.6L 98ci	w/7/8" X 20 X 37/64"	TAT-5310
1991-96	L4 1.8L 112ci	w/15/16" X 22 X 37/64"	TAT-5307
1985-90	L4 1.9L 116ci	Includes trans. quill repair sleeve, GAS w/7/8" X 20 X 37/64"	TAT-5310
1991-96	L4 1.9L 116ci	w/7/8" X 20 X 37/64"	TAT-5310
1998-01	L4 2.0L 121ci	Solid Flywheel # FW-141, GAS w/15/16" X 22 X 37/64"	TAT-5307
1984-87	L4 2.0L 122ci	Diesel w/7/8" X 20 X 37/64"	TAT-5310
1997-01	L4 2.0L 122ci	Solid Flywheel # FW-141, GAS w/15/16" X 22 X 37/64"	TAT-5307
<b>FAIRLANE</b>			
1966	L6 3.3L 200ci	9" Lever Type Disc w/15/16" X 10 X 5/8"	TAT-5336
1966	L6 3.3L 200ci	10.4" Lever Type Disc w/1-1/16" X 10 X 43/64"	TAT-5304
1967-68	L6 3.3L 200ci	10.4" Lever Type w/1-1/16" X 10 X 43/64"	TAT-5304
1958-61	L6 3.7L 223ci	11" Lever Type w/1" X 23 X 19/32"	TAT-5311
1969-70	L6 4.1L 250ci	10" Diaph Type Disc, w/1-1/16" X 10 X 43/64"	TAT-5304
1962	V8 3.6L 221ci	10" Diaph Type Disc w/1" X 23 X 19/32"	TAT-5311
1963	V8 3.6L 221ci	10" Diaph Type, 10" Lever Type, 10.4" Disc w/1-1/16" X 10 X 43/64"	TAT-5304
1963-64	V8 4.3L 260ci	Lever Type, 10.4" Disc w/1-1/16" X 10 X 43/64"	TAT-5304
1964-67	V8 4.7L 289ci	10" Diaph Type, 10" Lever Type, 10.4" Disc w/1-1/16" X 10 X 43/64"	TAT-5304
1958-61	V8 4.8L 292ci	11" Lever Type, 10" Diaph Type Disc w/1" X 23 X 19/32"	TAT-5311
1968-70	V8 5.0L 302ci	11" Lever Type, Diaph Type, 10" Disc w/1-1/16" X 10 X 43/64"	TAT-5304
1958-59	V8 5.4L 332ci	11" Lever Type w/1" X 23 X 19/32"	TAT-5311
1969-70	V8 5.8L 351ci	11" Lever Type w/1-1/16" X 10 X 43/64"	TAT-5304

# CLUTCH ALIGNMENT TOOLS

Year	Engine	Remark	Part
<b>FORD (con't)</b>			
<b>FAIRLANE (con't)</b>			
1959-61	V8 5.8L 352ci	11" Lever Type w/1" X 23 X 19/32"	TAT-5311
1964-69	V8 6.4L 390ci	11" Lever Type w1-1/16" X 10 X 43/64"	TAT-5304
<b>FAIRMONT</b>			
1978-83	L4 2.3L 140ci	German Transmission w/1" X 23 X 19/32"	TAT-5311
1978-82	L6 3.3L 200ci	9" Diaph Type w1-1/16" X 10 X 43/64"	TAT-5304
1979	V8 5.0L 302ci	w1-1/16" X 10 X 43/64"	TAT-5304
<b>FALCON</b>			
1969	L6 2.8L 170ci	9" Lever Type w1-1/16" X 10 X 43/64"	TAT-5304
1965-66	L6 3.3L 200ci	Lever Type 9" Disc w/15/16" X 10 X 5/8"	TAT-5336
1967-70	L6 3.3L 200ci	Lever Type w1-1/16" X 10 X 43/64"	TAT-5304
1964	V8 4.3L 260ci	10.4" Lever Type, 10" Diaph Type Disc w1-1/16" X 10 X 43/64"	TAT-5304
1965-67	V8 4.7L 289ci	10.4" Lever Type, 10" Diaph Type Disc w1-1/16" X 10 X 43/64"	TAT-5304
1968-70	V8 5.0L 302ci	10" Diaph Type Disc w1-1/16" X 10 X 43/64"	TAT-5304
1970	V8 5.8L 351ci	11" Lever Type w1-1/16" X 10 X 43/64"	TAT-5304
<b>FESTIVA</b>			
1988-93	L4 1.3L 1295cc		TAT-5400
<b>FIESTA</b>			
1978-80	L4 1.6L 98ci	w/24/32" X 17 X 19/32"	TAT-5339
<b>GALAXIE</b>			
1959-62	L6 3.7L 223ci	11" Disc w/1" X 23 X 19/32"	TAT-5311
1964	V8 4.3L 260ci	10" Diaph Type Disc w1-1/16" X 10 X 43/64"	TAT-5304
1964	V8 4.3L 260ci	Lever Type, 10.4" Disc w1-1/16" X 10 X 39/64"	TAT-5341
1960-62	V8 4.8L 292ci	10" Diaph Type, 11" Disc w/1" X 23 X 19/32"	TAT-5311
1963-65	V8 5.8L 352ci	11" Lever Type w/1" X 23 X 19/32"	TAT-5311
1962	V8 6.4L 390ci	11" Disc w/1" X 23 X 19/32"	TAT-5311
1963-64	V8 6.4L 390ci	11" Lever Type w1-1/16" X 10 X 43/64"	TAT-5304
1963	V8 6.7L 406ci	11" Lever Type w1-1/16" X 10 X 43/64"	TAT-5304
<b>GALAXIE 500</b>			
1968-71	V8 5.0L 302ci	w/Overdrive, w/o Overdrive w1-1/16" X 10 X 43/64"	TAT-5304
1969-71	V8 5.0L 302ci	11" Lever, Diaph Type w1-1/16" X 10 X 43/64"	TAT-5304
<b>GRANADA</b>			
1981-82	L4 2.3L 140ci	w/1" X 23 X 19/32"	TAT-5311
1975-77	L6 3.3L 200ci	9" Lever Type w1-1/16" X 10 X 43/64"	TAT-5304
1975-80	L6 4.1L 250ci	10" Diaph Type Disc w1-1/16" X 10 X 43/64"	TAT-5304
1975-79	V8 5.0L 302ci	Diaph Type, 10" Disc w1-1/16" X 10 X 43/64"	TAT-5304
<b>LTD</b>			
1977-79	V8 5.0L 302ci	Diaph Type, 10" Disc w1-1/16" X 10 X 43/64"	TAT-5304
1973	V8 5.8L 351ci	11" Lever Type, Diaph Type w1-1/16" X 10 X 43/64"	TAT-5304
<b>MAVERICK</b>			
1970-72	L6 2.8L 170ci	Diaph Replacement w1-1/16" X 10 X 43/64"	TAT-5304
1973-77	L6 3.3L 200ci	Diaph Replacement w1-1/16" X 10 X 43/64"	TAT-5304
1974	L6 4.1L 250ci	Diaph Type, 10" Disc w1-1/16" X 10 X 43/64"	TAT-5304
1973-74	V8 5.0L 302ci	Diaph Type, 10" Disc w1-1/16" X 10 X 43/64"	TAT-5304
<b>MUSTANG</b>			
1979-84	L4 2.3L 140ci	Ford Trans, 4 Spd; exc.SVO w1-1/16" X 10 X 39/64"	TAT-5341
1979-86	L4 2.3L 140ci	Ger Trans, 4 Speed (Except SVO & Turbo) w/1" X 23 X 19/32"	TAT-5311
1980	L4 2.3L 140ci	From 10/11/80, 5 Sp.; exc. SVO & Turbo w1-1/16" X 10 X 39/64"	TAT-5341
1983-86	L4 2.3L 140ci	Ger. Trans, 5 Spd w/or wo/SVO & Turbo w1-1/16" X 10 X 39/64"	TAT-5341
1987-93	L4 2.3L 140ci	w1-1/16" X 10 X 39/64"	TAT-5341
1966-70	L6 3.3L 200ci	Lever Type w1-1/16" X 10 X 43/64"	TAT-5304
1979-82	L6 3.3L 200ci	9" Diaph Type w1-1/16" X 10 X 43/64"	TAT-5304
1969-73	L6 4.1L 250ci	Diaph Type, 10" Disc w1-1/16" X 10 X 43/64"	TAT-5304
1979	V6 2.8L 171ci	Diaph Type w1-1/16" X 10 X 39/64"	TAT-5341
1994-02	V6 3.8L 232ci	w1-1/16" X 10 X 43/64"	TAT-5304
1996-01	V8 4.6L 281ci	T45 Trans, 6 & 8 Bolt Crank w1-1/16" X 10 X 43/64"	TAT-5304
1996-01	V8 4.6L 281ci	DOHC w1-1/16" X 10 X 43/64"	TAT-5304
1999-01	V8 4.6L 281ci	32 Valve w1-1/16" X 10 X 43/64"	TAT-5304
2001	V8 4.6L 281ci	Cobra & w/TR3650 Trans, w1-1/16" X 10 X 43/64"	TAT-5304

# CLUTCH ALIGNMENT TOOLS

Year	Engine	Remark	Part
<b>FORD (con't)</b>			
<b>MUSTANG (con't)</b>			
1965-68	V8 4.7L 289ci	10" Diaph, 10.4" Lever Type Disc w1-1/16" X 10 X 43/64"	TAT-5304
1968-73	V8 5.0L 302ci	10" Diaph, 10.4" Lever Type Disc w1-1/16" X 10 X 43/64"	TAT-5304
1979-85	V8 5.0L 302ci	w1-1/16" X 10 X 43/64"	TAT-5304
1986-95	V8 5.0L 302ci	w/High Clamp Load & T45 Trans w1-1/16" X 10 X 43/64"	TAT-5304
1969-73	V8 5.8L 351ci	11" Lever Type w1-1/16" X 10 X 43/64"	TAT-5304
1967-69	V8 6.4L 390ci	11" Lever Type w1-1/16" X 10 X 43/64"	TAT-5304
<b>MUSTANG II</b>			
1974	L4 2.3L 140ci	German Transmission, 4 Speed w1" X 23 X 19/32"	TAT-5311
1974-78	L4 2.3L 140ci	Ford Transmission, 4 Speed w1-1/16" X 10 X 39/64"	TAT-5341
1974-78	V6 2.8L 171ci	Diaph Type w1-1/16" X 10 X 39/64"	TAT-5341
1975-78	V8 5.0L 302ci	w1-1/16" X 10 X 43/64"	TAT-5304
<b>PINTO</b>			
1971-73	L4 1.6L 98ci	English Transmission w/7/8" X 20 X 41/64"	TAT-5360
1971-73	L4 1.6L 98ci	German Transmission w/7/8" X 20 X 39/64"	TAT-5337
1971-74	L4 2.0L 122ci	w1" X 23 X 19/32"	TAT-5311
1975-80	L4 2.3L 140ci	w1" X 23 X 19/32"	TAT-5311
<b>PROBE</b>			
1993	L4 2.0L 122ci	8-7/8" Disc w/15/16" X 22 X 37/64"	TAT-5307
1993-97	L4 2.0L 122ci	w/15/16" X 22 X 37/64"	TAT-5307
1989-92	L4 2.2L 133ci	w/15/16" X 22 X 37/64"	TAT-5307
1993-97	V6 2.5L 152ci	w/15/16" X 22 X 37/64"	TAT-5307
1990-92	V6 3.0L 182ci	w/ABS, w/o ABS	TAT-5408
<b>TAURUS</b>			
1986-90	L4 2.5L 153ci	Includes trans. quill repair sleeve w/7/8" X 20 X 37/64"	TAT-5310
1986-88	V6 3.0L 182ci	Includes trans. quill repair sleeve w/7/8" X 20 X 37/64"	TAT-5310
1989-95	V6 3.0L 182ci	SHO, Includes trans. quill repair sleeve w/7/8" X 20 X 37/64"	TAT-5310
1993-95	V6 3.2L 195ci	SHO, Includes trans. quill repair sleeve w/7/8" X 20 X 37/64"	TAT-5310
<b>TEMPO</b>			
1984-86	L4 2.0L 122ci	Diesel w/7/8" X 20 X 37/64"	TAT-5310
1984-94	L4 2.3L 140ci	Includes trans. quill repair sleeve w/7/8" X 20 X 37/64"	TAT-5310
1992-94	V6 3.0L 182ci	Includes trans. quill repair sleeve, GAS w/7/8" X 20 X 37/64"	TAT-5310
<b>THUNDERBIRD</b>			
1983-88	L4 2.3L 140ci	w1-1/16" X 10 X 39/64"	TAT-5341
1989-97	V6 3.8L 232ci	w1-1/16" X 10 X 43/64"	TAT-5304
<b>TORINO</b>			
1969-73	L6 4.1L 250ci	Diaph Type, 10" Disc w1-1/16" X 10 X 43/64"	TAT-5304
1968	V8 4.7L 289ci	Diaph Type, 10" Disc w1-1/16" X 10 X 43/64"	TAT-5304
1968-74	V8 5.0L 302ci	10" Diaph, 11" Lever Type w1-1/16" X 10 X 43/64"	TAT-5304
1969-74	V8 5.8L 351ci	11" Lever Type w1-1/16" X 10 X 43/64"	TAT-5304
1968-69	V8 6.4L 390ci	11" Lever Type w1-1/16" X 10 X 43/64"	TAT-5304
1968-69	V8 7.0L 428ci	11" Lever Type w1-1/16" X 10 X 43/64"	TAT-5304
1970-71	V8 7.0L 429ci	11" Lever Type w1-1/16" X 10 X 43/64"	TAT-5304
<b>FORD TRUCKS</b>			
<b>AEROSTAR</b>			
1986-87	L4 2.3L 140ci	w1" X 23 X 19/32"	TAT-5311
1986	V6 2.8L 171ci	w1" X 23 X 19/32"	TAT-5311
1986-87	V6 3.0L 182ci	w1" X 23 X 19/32"	TAT-5311
1988-97	V6 3.0L 182ci		TAT-5408
1990-97	V6 4.0L 245ci		TAT-5408
<b>BRONCO</b>			
1968-72	L6 2.8L 170ci	9" Lever & Diaph Replacement Type w1-1/16" X 10 X 43/64"	TAT-5304
1973-74	L6 3.3L 200ci	9" Lever & Diaph Replacement Type w1-1/16" X 10 X 43/64"	TAT-5304
1983-92	L6 4.9L 300ci	10", 11" Diaph Type, Ceramic Button w1-1/16" X 10 X 43/64"	TAT-5304
1980-82	L6 4.9L 300ci	11" Diaph Type, 12-3/8", 5/8 Bolt Cir, Cer Butt w1-1/16" X 10 X 43/64"	TAT-5304
1987-92	L6 4.9L 300ci	11" Diaph Type, 4 & 5 Speed w1-1/16" X 10 X 43/64"	TAT-5304
1966-68	V8 4.7L 289ci	10", 11" Diaph, Lever Type, Ceramic Button w1-1/16" X 10 X 43/64"	TAT-5304
1968-86	V8 5.0L 302ci	10", 11" Diaph, Lever Type, Ceramic Butt w1-1/16" X 10 X 43/64"	TAT-5304
1980-82	V8 5.0L 302ci	11" Diaph Type, 12-3/8", 5/8" Bolt Cir, Cer Butt w1-1/16" X 10 X 43/64"	TAT-5304

# CLUTCH ALIGNMENT TOOLS

Year	Engine	Remark	Part
<b>FORD TRUCKS (con't)</b>			
<b>BRONCO (con't)</b>			
1987-89	V8 5.0L 302ci	11" Diaph Type, 4 & 5 Speed w1-1/16" X 10 X 43/64"	TAT-5304
1988-92	V8 5.0L 302ci	5 Speed, 11" Disc w1-1/16" X 10 X 43/64"	TAT-5304
1993-96	V8 5.0L 302ci	w1-1/16" X 10 X 43/64"	TAT-5304
1978-82	V8 5.8L 351ci	11" Diaph Type, 12-3/8",5/8" Bolt Circle w1-1/16" X 10 X 43/64"	TAT-5304
1983-87	V8 5.8L 351ci	10",11" Diaph Type, Ceramic Button w1-1/16" X 10 X 43/64"	TAT-5304
1987-96	V8 5.8L 351ci	11" Disc 4 & 5 Speed w1-1/16" X 10 X 43/64"	TAT-5304
1978-79	V8 6.6L 400ci	12" Diaph, Lever Type w1-1/16" X 10 X 43/64"	TAT-5304
<b>BRONCO II</b>			
1984-85	V6 2.8L 171ci	w/1" X 23 X 19/32"	TAT-5311
1986-87	V6 2.9L 177ci	w/1" X 23 X 19/32"	TAT-5311
1988-90	V6 2.9L 177ci		TAT-5408
<b>COURIER</b>			
1972-79	L4 1.8L 110ci	w/15/16" X 22 X 37/64"	TAT-5307
1979-82	L4 2.0L 122ci	w/15/16" X 22 X 37/64"	TAT-5307
1977-82	L4 2.3L 140ci	w/15/16" X 22 X 37/64"	TAT-5307
<b>E SUPER DUTY</b>			
1996	V8 7.3L 445ci	12-1/4" Val,13" Luk, 5 Spd Turbo,DFI,DMF & Solid	TAT-5409
<b>E-100 ECONOLINE</b>			
1968-70	L6 2.8L 170ci	10" Diaph Type Disc w1-1/16" X 10 X 43/64"	TAT-5304
1968-74	L6 3.9L 240ci	10",11" Diaph Type & w/Ceramic Button w1-1/16" X 10 X 43/64"	TAT-5304
1968-74	L6 3.9L 240ci	11" Lever Type & w/Ceramic Button w1-1/16" X 10 X 43/64"	TAT-5304
1972-83	L6 4.9L 300ci	11" Diaph, Lever Type & w/Ceramic Button w1-1/16" X 10 X 43/64"	TAT-5304
1978-82	L6 4.9L 300ci	11" Diaph Type,12-3/8",5/8" Bolt Cir, Cer Butt w1-1/16" X 10 X 43/64"	TAT-5304
1978-83	L6 4.9L 300ci	10" Diaph Type Disc w1-1/16" X 10 X 43/64"	TAT-5304
1983	L6 4.9L 300ci	11" Disc, Ceramic Button w1-1/16" X 10 X 43/64"	TAT-5304
1968-83	V8 5.0L 302ci	10",11" Lever, Diaph Type & w/Ceramic Butt w1-1/16" X 10 X 43/64"	TAT-5304
1979-83	V8 5.0L 302ci	11" Diaph Type,12-3/8",5/8" Bolt Cir, Cer Butt w1-1/16" X 10 X 43/64"	TAT-5304
1975-76	V8 5.8L 351ci	11" Diaph, Lever Type,& w/Ceramic Button w1-1/16" X 10 X 43/64"	TAT-5304
1977-82	V8 5.8L 351ci	11" Diaph Type,12-3/8",5/8" Bolt Cir, Cer Butt w1-1/16" X 10 X 43/64"	TAT-5304
1980-81	V8 5.8L 351ci	12" Diaph Lever Type w1-1/16" X 10 X 43/64"	TAT-5304
1978	V8 7.5L 460ci	12" Diaph, Lever Type w1-1/16" X 10 X 43/64"	TAT-5304
<b>E-150 ECONOLINE, E-250 ECONOLINE, E-350 ECONOLINE</b>			
1975-90	L6 4.9L 300ci	11" Diaph, Lever Type, Ceramic Button w1-1/16" X 10 X 43/64"	TAT-5304
1978-82	L6 4.9L 300ci	11" Diaph Type, 12-3/8",5/8 Bolt Circle, Ceramic Button	TAT-5304
1978-87	L6 4.9L 300ci	10" & 11" Disc, Ceramic Button w1-1/16" X 10 X 43/64"	TAT-5304
1988-93	L6 4.9L 300ci	w1-1/16" X 10 X 43/64"	TAT-5304
1975-86	V8 5.0L 302ci	10, 11" Diaph, Lever Type, Ceramic Button w1-1/16" X 10 X 43/64"	TAT-5304
1979-82	V8 5.0L 302ci	11" Diaph, Type, 12-3/8",5/8" Bolt Circle, Ceramic Button	TAT-5304
1987	V8 5.0L 302ci	11" Disc w1-1/16" X 10 X 43/64"	TAT-5304
1988-89	V8 5.0L 302ci	w1-1/16" X 10 X 43/64"	TAT-5304
1990-91	V8 5.0L 302ci	11" Diaph Type, 4 & 5 Speed w1-1/16" X 10 X 43/64"	TAT-5304
1975-86	V8 5.8L 351ci	10",11" Diaph, Lever Type, Ceramic Button w1-1/16" X 10 X 43/64"	TAT-5304
1977-79	V8 5.8L 351ci	11" Diaph Type, 12-3/8",5/8 Bolt Circle, Ceramic Button	TAT-5304
1984-89	V8 5.8L 351ci	10",11" Disc, Ceramic Button w1-1/16" X 10 X 43/64"	TAT-5304
1988-89	V8 5.8L 351ci	w1-1/16" X 10 X 43/64"	TAT-5304
1990-91	V8 5.8L 351ci	11" Diaph Type, 4 & 5 Speed w1-1/16" X 10 X 43/64"	TAT-5304
1980-82	V8 6.6L 400ci	12" Diaph Lever Type w1-1/16" X 10 X 43/64"	TAT-5304
<b>E-200 ECONOLINE, E-300 ECONOLINE</b>			
1968-70	L6 2.8L 170ci	10" Diaph Type, Disc w1-1/16" X 10 X 43/64"	TAT-5304
1968-74	L6 3.9L 240ci	10" 11" Diaph, Lever Type, Ceramic Butt w1-1/16" X 10 X 43/64"	TAT-5304
1972-74	L6 4.9L 300ci	11" Diaph, Lever Type, Ceramic Button w1-1/16" X 10 X 43/64"	TAT-5304
1968-74	V8 5.0L 302ci	11" Diaph, Lever Type, Ceramic Button w1-1/16" X 10 X 43/64"	TAT-5304
<b>EXCURSION</b>			
2000-02	V8 5.4L 330ci		TAT-5409
2000-01	V8 7.3L 445ci	13" Valeo, Turbo, DFI, Dampened Disc, Modular Kit	TAT-5325
2000-02	V8 7.3L 445ci	13" Luk, 6 Spd, Turbo, DFI, Solid FW Included	TAT-5409
<b>EXPEDITION</b>			
1997-02	V8 4.6L 281ci	w1-1/16" X 10 X 43/64"	TAT-5304

# CLUTCH ALIGNMENT TOOLS

Year	Engine	Remark	Part
<b>FORD TRUCKS (con't)</b>			
<b>EXPEDITION (con't)</b>			
1997-02	V8 5.4L 330ci		TAT-5409
<b>EXPLORER</b>			
1991-01	V6 4.0L 245ci		TAT-5408
<b>F SERIES</b>			
1951-53	L6 3.5L 215ci	10" Diaph Type w1-1/16" X 10 X 43/64"	TAT-5304
1951-53	L6 3.5L 215ci	11" Lever Type w/1-3/8" X 10 43/64"	TAT-5325
1954-59	L6 3.7L 223ci	10" Diaph Type w1-1/16" X 10 X 43/64"	TAT-5304
1954-59	L6 3.7L 223ci	11" Lever Type w/1-3/8" X 10 43/64"	TAT-5325
1950-55	V8 3.9L 239ci	10" Diaph Type w1-1/16" X 10 X 43/64"	TAT-5304
1950-55	V8 3.9L 239ci	11" Lever Type w/1-3/8" X 10 43/64"	TAT-5325
1955-57	V8 4.5L 272ci	11" Lever Type w/1-3/8" X 10 43/64"	TAT-5325
1957-59	V8 4.8L 292ci	10" Diaph Type w1-1/16" X 10 X 43/64"	TAT-5304
1957-59	V8 4.8L 292ci	11", 12" Lever Type w/1-3/8" X 10 43/64"	TAT-5325
<b>F SUPER DUTY</b>			
1993	V8 7.5L 460ci	12-1/4" 5 Speed	TAT-5409
<b>F-100 PICKUP</b>			
1961-63	L6 3.7L 223ci	10" Diaph Type w1-1/16" X 10 X 43/64"	TAT-5304
1961-63	L6 3.7L 223ci	11" Lever Type w/1-3/8" X 10 43/64"	TAT-5325
1964	L6 3.7L 223ci	Diaph Type, 10" Disc w1-1/16" X 10 X 43/64"	TAT-5304
1970-74	L6 3.9L 240ci	11" Diaph, Lever Type, Ceramic Button w1-1/16" X 10 X 43/64"	TAT-5304
1968-74	L6 4.9L 300ci	11" Diaph, Lever Type, Ceramic Button w1-1/16" X 10 X 43/64"	TAT-5304
1982-83	V6 3.8L 232ci	10" Diaph Type, Disc w1-1/16" X 10 X 43/64"	TAT-5304
1981-82	V8 4.2L 255ci	10" Diaph Type, Disc w1-1/16" X 10 X 43/64"	TAT-5304
1960-64	V8 4.8L 292ci	10" Diaph Type w1-1/16" X 10 X 43/64"	TAT-5304
1960-64	V8 4.8L 292ci	11", 12" Lever Type w/1-3/8" X 10 43/64"	TAT-5325
1969-74	V8 5.0L 302ci	11" Diaph, Lever Type, Ceramic Button w1-1/16" X 10 X 43/64"	TAT-5304
1977-79	V8 5.8L 351ci	11" Diaph, Lever Type w1-1/16" X 10 X 43/64"	TAT-5304
1977-81	V8 5.8L 351ci	11" Diaph Type, 12-3/8", 5/8" Bolt Circle w1-1/16" X 10 X 43/64"	TAT-5304
1968-74	V8 5.9L 360ci	11" Diaph, Lever Type, Ceramic Button w1-1/16" X 10 X 43/64"	TAT-5304
1968-74	V8 6.4L 390ci	12" Diaph, Lever Type w1-1/16" X 10 X 43/64"	TAT-5304
1977-79	V8 6.6L 400ci	11" Diaph Type, 12-5/8" Bolt Circle w1-1/16" X 10 X 43/64"	TAT-5304
1977-79	V8 6.6L 400ci	11", 12" Diaph, Lever Type, Ceramic Button w1-1/16" X 10 X 43/64"	TAT-5304
1973-74	V8 7.5L 460ci	11" Diaph Type, 12-5/8" Bolt Circle w1-1/16" X 10 X 43/64"	TAT-5304
1973-74	V8 7.5L 460ci	12" Diaph, Lever Type w1-1/16" X 10 X 43/64"	TAT-5304
<b>F-150</b>			
1975-77	L6 4.9L 300ci	11" Lever Type; to Eng.Y80,000; GAS w1-1/16" X 10 X 43/64"	TAT-5304
1977-81	L6 4.9L 300ci	11" From Engine #Y80,001 GAS w1-1/16" X 10 X 43/64"	TAT-5304
1980-83	L6 4.9L 300ci	10" Diaph Type, Disc w1-1/16" X 10 X 43/64"	TAT-5304
1982	L6 4.9L 300ci	11" Diaph Type w/3/8" & 5/8" 12 Bolt Cir, Cer Butt w1-1/16" X 10 X 43/64"	TAT-5304
1983-86	L6 4.9L 300ci	11" Diaph Type, Ceramic Button w1-1/16" X 10 X 43/64"	TAT-5304
1984-96	L6 4.9L 300ci	10", 11" Disc 4 & 5 Speed, w1-1/16" X 10 X 43/64"	TAT-5304
1997-02	V6 4.2L 256ci	11-1/2" w1-1/16" X 10 X 43/64"	TAT-5304
1997-02	V8 4.6L 281ci	w1-1/16" X 10 X 43/64"	TAT-5304
1975-86	V8 5.0L 302ci	10", 11" Diaph, Lever Type, Ceramic Button w1-1/16" X 10 X 43/64"	TAT-5304
1978-82	V8 5.0L 302ci	11" Diaph Type, 12-5/8 Bolt Cir, Cer Butt w1-1/16" X 10 X 43/64"	TAT-5304
1984-96	V8 5.0L 302ci	11" Diaph Type, 4 & 5 Speed w1-1/16" X 10 X 43/64"	TAT-5304
1993	V8 5.0L 302ci	4 Speed, 11" Diaph Type, External Slave; GAS	TAT-5304
1993-96	V8 5.0L 302ci	10", 11" Diaph Type, 5 Speed w1-1/16" X 10 X 43/64"	TAT-5304
1999-02	V8 5.4L 330ci		TAT-5409
1977	V8 5.8L 351ci	11" Diaph, Lever Type, Ceramic Button w1-1/16" X 10 X 43/64"	TAT-5304
1983	V8 5.8L 351ci	11" Diaph, 11" Disc w1-1/16" X 10 X 43/64"	TAT-5304
1993	V8 5.8L 351ci	11" Diaph Type, 5 Speed w1-1/16" X 10 X 43/64"	TAT-5304
1994	V8 5.8L 351ci	11", 11.5 system 5 Spd. w1-1/16" X 10 X 43/64"	TAT-5304
1977-83	V8 5.8L 351ci	11" Diaph Type, 12-5/8 Bolt Circle, Cer Butt w1-1/16" X 10 X 43/64"	TAT-5304
1983-87	V8 5.8L 351ci	10", 11" Diaph, Disc, Ceramic Button w1-1/16" X 10 X 43/64"	TAT-5304
1988-94	V8 5.8L 351ci	11" Diaph Type, 4 & 5 Speed w1-1/16" X 10 X 43/64"	TAT-5304
1995-96	V8 5.8L 351ci	11.5" Clutch, 5 Speed w1-1/16" X 10 X 43/64"	TAT-5304
1975-76	V8 5.9L 360ci	11" Diaph, Lever Type, Ceramic Button w1-1/16" X 10 X 43/64"	TAT-5304



# CLUTCH ALIGNMENT TOOLS

Year	Engine	Remark	Part
<b>FORD TRUCKS (con't)</b>			
<b>F-150 (con't)</b>			
1975-76	V8 6.4L 390ci	12" Diaph, Lever Type w1-1/16" X 10 X 43/64"	TAT-5304
1977	V8 6.6L 400ci	11" Diaph Type, Cer. Butt,12-5/8" Bolt Cir. w1-1/16" X 10 X 43/64"	TAT-5304
1977-79	V8 6.6L 400ci	12" Lever Type w1-1/16" X 10 X 43/64"	TAT-5304
1984	V8 6.9L 420ci	11"; T-19; 4 Speed, Vin Code 1 w1-1/16" X 10 X 43/64"	TAT-5304
1975-79	V8 7.5L 460ci	12" Diaph, Lever Type w1-1/16" X 10 X 43/64"	TAT-5304
<b>F-250 PICKUP, F-350 PICKUP</b>			
1961-64	L6 3.7L 223ci	10" Diaph Type w1-1/16" X 10 X 43/64"	TAT-5304
1961-63	L6 3.7L 223ci	11" Lever Type w1-3/8" X 10 43/64"	TAT-5325
1966-74	L6 3.9L 240ci	11" Diaph, Lever Type, & Ceramic Button w1-1/16" X 10 X 43/64"	TAT-5304
1965	L6 3.9L 240ci	13" Diaph, Lever Type, & Ceramic Button w1-3/8" X 10 X 31/32"	TAT-5328
1965	L6 3.9L 240ci	Diaph Type, 10" Disc w1-1/16" X 10 X 43/64"	TAT-5304
1961-64	L6 4.3L 262ci	11" Lever Type w1-3/8" X 10 43/64"	TAT-5325
1968-74	L6 4.9L 300ci	11" Diaph, Lever Type; to Eng. #Y80,000; w1-1/16" X 10 X 43/64"	TAT-5304
1997-99	V8 4.6L 281ci	w1-1/16" X 10 X 43/64"	TAT-5304
1960-64	V8 4.8L 292ci	10" Diaph, 11",12" Lever Type w1-3/8" X 10 43/64"	TAT-5325
1972-74	V8 5.0L 302ci	11" Diaph,11",12" Lever Type & Ceramic Button w1-1/16" X 10 X 43/64"	TAT-5304
1998-99	V8 5.4L 330ci		TAT-5409
1960-63	V8 5.4L 332ci	13"Diaph, Lever Type, & Ceramic Button w1-3/8" X 10 X 31/32"	TAT-5328
1966-67	V8 5.8L 352ci	11" Diaph, Lever Type, & Ceramic Button w1-1/16" X 10 X 43/64"	TAT-5304
1968-74	V8 5.9L 360ci	11" Diaph, Lever Type, & Ceramic Button w1-1/16" X 10 X 43/64"	TAT-5304
1964	V8 5.9L 361ci	13" Lever Type, & Ceramic Button w1-3/8" X 10 X 31/32"	TAT-5328
1965-66	V8 5.9L 361ci	11" Diaph, Lever Type, & Ceramic Button w1-1/16" X 10 X 43/64"	TAT-5304
1968-74	V8 6.4L 390ci	12" Diaph, Lever Type w1-1/16" X 10 X 43/64"	TAT-5304
1977-82	V8 6.6L 400ci	11",12" Diaph, Lever Type,12-5/8"Bolt Cir,& Cer Butt w1-1/16" X 10 X 43/64"	TAT-5304
1987	V8 6.9L 420ci	ZF 5 Spd., Diesel	TAT-5409
1983-87	V8 6.9L 420ci	T-19 4 Spd. Trans. Diesel, Opt 12" Sys w1-1/16" X 10 X 43/64"	TAT-5304
1988-97	V8 7.3L 445ci	Diesel, Valeo Type, Non-Turbo, LUK Type	TAT-5409
1993-94	V8 7.3L 445ci	Turbo Diesel	TAT-5409
1994-97	V8 7.3L 445ci	Turbo Diesel, Valeo Type	TAT-5409
1973-74	V8 7.5L 460ci	12" Diaph Type w1-1/16" X 10 X 43/64"	TAT-5304
<b>F-250 SUPER DUTY, F-350 SUPER DUTY, F-450 SUPER DUTY, F-550 SUPER DUTY</b>			
1999-02	V10 6.8L 415ci		TAT-5409
1999-02	V8 5.4L 330ci		TAT-5409
1999-00	V8 7.3L 445ci	13" Valeo, Turbo, Modular, DFI, Dampened Disc,	TAT-5325
1999-02	V8 7.3L 445ci	13" Luk, 6 Spd, Turbo, DFI, Solid FW Included	TAT-5409
<b>F53</b>			
1988-97	V8 7.5L 460ci		TAT-5409
<b>P-100</b>			
1965-67	L6 2.8L 170ci	10" Diaph Type w1-1/16" X 10 X 43/64"	TAT-5304
<b>P-350</b>			
1968-72	L6 3.9L 240ci	11" Diaph, Lever Type, & Ceramic Button w1-1/16" X 10 X 43/64"	TAT-5304
1968-76	L6 4.9L 300ci	11" Diaph, Lever Type, & Ceramic Button w1-1/16" X 10 X 43/64"	TAT-5304
1972	V8 5.0L 302ci	Diaph Type, 10" Disc w1-1/16" X 10 X 43/64"	TAT-5304
1972-76	V8 5.0L 302ci	11" Diaph, Lever Type w1-1/16" X 10 X 43/64"	TAT-5304
1973	V8 5.9L 360ci	11" Diaph, Lever Type w1-1/16" X 10 X 43/64"	TAT-5304
1972-73	V8 6.4L 390ci	12" Diaph, Lever Type w1-1/16" X 10 X 43/64"	TAT-5304
<b>RANCHERO</b>			
1967-68	L6 3.3L 200ci	9" Lever Type w1-1/16" X 10 X 43/64"	TAT-5304
1969-73	L6 4.1L 250ci	Diaph Type, 10" Disc w1-1/16" X 10 X 43/64"	TAT-5304
1968-74	V8 5.0L 302ci	11" Diaph, Lever Type w1-1/16" X 10 X 43/64"	TAT-5304
1969-74	V8 5.8L 351ci	11" Diaph, Lever Type w1-1/16" X 10 X 43/64"	TAT-5304
1967-69	V8 6.4L 390ci	11" Diaph, Lever Type w1-1/16" X 10 X 43/64"	TAT-5304
<b>RANGER</b>			
1983-87	L4 2.0L 122ci	w1" X 23 X 19/32"	TAT-5311
1988	L4 2.0L 122ci	w13/16" X 19 X 37/64"	TAT-5408
1983-84	L4 2.2L 134ci	Diesel w15/16" X 22 X 37/64"	TAT-5307
1994	L4 2.3L 140ci	From 11/94; Gas w13/16" X 19 X 37/64"	TAT-5408
1983-87	L4 2.3L 140ci	w1" X 23 X 19/32"	TAT-5311

# CLUTCH ALIGNMENT TOOLS

Year	Engine	Remark	Part
<b>FORD TRUCKS (con't)</b>			
<b>RANGER (con't)</b>			
1988-97	L4 2.3L 140ci	w/13/16" X 19 X 37/64"	TAT-5408
1998-01	L4 2.5L 153ci	w/13/16" X 19 X 37/64"	TAT-5408
1983-85	V6 2.8L 171ci	w/1" X 23 X 19/32"	TAT-5311
1986-87	V6 2.9L 177ci	w/1" X 23 X 19/32"	TAT-5311
1988-92	V6 2.9L 177ci	w/13/16" X 19 X 37/64"	TAT-5408
1991-00	V6 3.0L 182ci	w/13/16" X 19 X 37/64"	TAT-5408
1990-02	V6 4.0L 245ci	w/13/16" X 19 X 37/64"	TAT-5408
<b>FORD HEAVY DUTY TRUCKS</b>			
<b>B500, B600, B700</b>			
1951-35	V6 3.8L	w/1-3/8" X 10 X 43/64"	TAT-5325
1976-55	V6 3.9L 240ci	w/1-3/8" X 10 X 43/64"	TAT-5325
1965-61	V6 4.3L 262ci	w/1-3/8" X 10 X 43/64"	TAT-5325
1965-61	V8 4.2L 292ci	w/1-3/8" X 10 X 43/64"	TAT-5325
<b>GEO</b>			
<b>METRO</b>			
1989-97	L3 1.0L 61ci	w/47/64" X 18 X 25/64"	TAT-5386
1995-97	L4 1.3L 79ci	w/47/64" X 18 X 25/64"	TAT-5386
<b>PRIZM</b>			
1989	L4 1.6L 98ci	SOHC, 8th DIGIT w/15/16" X 21 X 15/32"	TAT-5306
1993-97	L4 1.6L 98ci	w/15/16" X 21 X 15/32"	TAT-5306
1993-97	L4 1.8L 110ci	w/15/16" X 21 X 15/32"	TAT-5306
<b>STORM</b>			
1990-93	L4 1.6L 98ci		TAT-5397
1992-93	L4 1.8L 110ci	w/1" X 14 X 53/64"	TAT-5342
<b>GEO TRUCKS</b>			
<b>TRACKER</b>			
1994	L4 1.6L 98ci	w/13/16" X 20 X 25/64"	TAT-5393
1995	L4 1.6L 98ci	8-1/2" Disc To 9/95, w/13/16" X 20 X 25/64"	TAT-5393
1989-94	L4 1.6L 98ci	7 7/8" Disc w/13/16" X 20 X 25/64"	TAT-5393
1996-97	L4 1.6L 98ci	Begin with VIN# T6401813 w/13/16" X 20 X 25/64"	TAT-5393
<b>GMC</b>			
<b>1500 SERIES, 2500 SERIES</b>			
1965	L6 3.8L 230ci	10" Disc, 11" Flat Diaph w/1-1/8" X 10 X 19/32"	TAT-5301
1965	L6 3.8L 230ci	12" Lever Type, Ceramic Button w/1-1/8" X 10 X 19/32"	TAT-5301
1961-64	V6 5.0L 305ci	11" Diaph, 12" Lever Type, Ceramic Button w/1-1/8" X 10 X 19/32"	TAT-5301
<b>C15/C1500 PICKUP, C25/C2500 PICKUP, C35/C3500 PICKUP</b>			
1966	L6 3.8L 230ci	10" Disc, 11" Flat Diaph w/1-1/8" X 10 X 19/32"	TAT-5301
1966	L6 3.8L 230ci	12" Lever Type, Ceramic Button w/1-1/8" X 10 X 19/32"	TAT-5301
1967-80	L6 4.1L 250ci	10", 11" Diaph, 11" Flat Diaph Type w/1-1/8" X 10 X 19/32"	TAT-5301
1967-68	L6 4.8L 292ci	11" Flat Diaph Type w/1-1/8" X 10 X 19/32"	TAT-5301
1969-84	L6 4.8L 292ci	11" Diaph, 12" Lever Type & Ceramic Button w/1-1/8" X 10 X 19/32"	TAT-5301
1985-86	L6 4.8L 292ci	w/o PDH w/1-1/8" X 10 X 19/32"	TAT-5301
1985-86	V6 4.3L 262ci	w/1-1/8" X 10 X 19/32"	TAT-5301
1967	V8 4.6L 283ci	11" Flat Diaph Type w/1-1/8" X 10 X 19/32"	TAT-5301
1967	V8 4.6L 283ci	12" Diaph, Lever Type, Ceramic Button w/1-1/8" X 10 X 19/32"	TAT-5301
1976-78	V8 5.0L 305ci	11" Diaph, 12" Lever Type & Ceramic Button w/1-1/8" X 10 X 19/32"	TAT-5301
1986	V8 5.0L 305ci	w/o PDH w/1-1/8" X 10 X 19/32"	TAT-5301
1969-73	V8 5.0L 307ci	11" Diaph Type w/1-1/8" X 10 X 19/32"	TAT-5301
1967-68	V8 5.4L 327ci	12" Lever Type, & Ceramic Button w/1-1/8" X 10 X 19/32"	TAT-5301
1969-78	V8 5.7L 350ci	11" Diaph, 12" Lever Type & Ceramic Button w/1-1/8" X 10 X 19/32"	TAT-5301
1979-86	V8 5.7L 350ci	11", 12" Diaph, 12" Lever Type, & Ceramic Button w/1-1/8" X 10 X 19/32"	TAT-5301
1982-86	V8 6.2L 379ci	Diesel w/1-1/8" X 10 X 19/32"	TAT-5301
1968-69	V8 6.5L 396ci	11" Diaph, 12" Lever Type & Ceramic Button w/1-1/8" X 10 X 19/32"	TAT-5301
1978	V8 6.6L 400ci	w/1-1/8" X 26 X 19/32"	TAT-5313
1970	V8 6.6L 402ci	12" Diaph, Lever Type, & Ceramic Button w/1-1/8" X 10 X 19/32"	TAT-5301
1975-78	V8 7.4L 454ci	12" Lever Type, & Ceramic Button w/1-1/8" X 10 X 19/32"	TAT-5301
1979-86	V8 7.4L 454ci	12" Diaph Type, PDH, & Ceramic Button w/1-1/8" X 10 X 19/32"	TAT-5301

# CLUTCH ALIGNMENT TOOLS

Year	Engine	Remark	Part
<b>GMC (con't)</b>			
<b>C1500, C2500, C3500</b>			
1988-95	V6 4.3L 262ci	w/PDH, w/o PDH w/1-1/8" X 10 X 19/32"	TAT-5301
1996-98	V6 4.3L 262ci	w/1-1/8" X 10 X 19/32"	TAT-5301
1988-91	V8 5.0L 305ci	w/o PDH w/1-1/8" X 10 X 19/32"	TAT-5301
1992-95	V8 5.0L 305ci	PDH w/1-1/8" X 10 X 19/32"	TAT-5301
1996-99	V8 5.0L 305ci	w/1-1/8" X 10 X 19/32"	TAT-5301
1988-95	V8 5.7L 350ci	11", 12" Diaph, 12" Lever Type, & Ceramic Button w/1-1/8" X 10 X 19/32"	TAT-5301
1996-99	V8 5.7L 350ci	NVG 3500, NVG 4500 Trans w/1-1/8" X 10 X 19/32"	TAT-5301
2000	V8 5.7L 350ci	w/1-1/8" X 10 X 19/32"	TAT-5301
1988-93	V8 6.2L 379ci	Diesel w/1-1/8" X 10 X 19/32"	TAT-5301
1992-99	V8 6.5L 395ci	12" Diaph, Solid, DMF Type Turbo Diesel, Valeo w/1-1/8" X 10 X 19/32"	TAT-5301
1988-95	V8 7.4L 454ci	12" Diaph Type, PDH, & Ceramic Button w/1-1/8" X 10 X 19/32"	TAT-5301
1996-00	V8 7.4L 454ci	w/1-1/8" X 10 X 19/32"	TAT-5301
<b>CABALLERO</b>			
1978-79	V6 3.3L 200ci	w/1-1/8" X 10 X 19/32"	TAT-5301
1980-81	V6 3.8L 229ci	w/1-1/8" X 10 X 19/32"	TAT-5301
1978	V6 3.8L 231ci	w/1-1/8" X 10 X 19/32"	TAT-5301
1979	V8 4.4L 267ci	w/1-1/8" X 10 X 19/32"	TAT-5301
1978-81	V8 5.0L 305ci	w/1-1/8" X 10 X 19/32"	TAT-5301
1978	V8 5.7L 350ci	w/1-1/8" X 10 X 19/32"	TAT-5301
<b>G15/G1500 VAN, G25/G2500 VAN, G35/G3500 VAN</b>			
1967-69	L6 3.8L 230ci	10" Disc & 11" Flat Diaph Type w/1-1/8" X 10 X 19/32"	TAT-5301
1967-69	L6 3.8L 230ci	12" Lever Type, & Ceramic Button w/1-1/8" X 10 X 19/32"	TAT-5301
1967-74	L6 4.1L 250ci	10", 11" Disc, 11" Flat Diaph w/1-1/8" X 10 X 19/32"	TAT-5301
1974	L6 4.8L 292ci	11" Diaph Type w/1-1/8" X 10 X 19/32"	TAT-5301
1974	L6 4.8L 292ci	12" Lever Type w/1-1/8" X 10 X 19/32"	TAT-5301
1975-78	L6 4.8L 292ci	12" Lever Type, & Ceramic Button w/1-1/8" X 10 X 19/32"	TAT-5301
1985-95	V6 4.3L 262ci	w/PDH, w/o PDH w/1-1/8" X 10 X 19/32"	TAT-5301
1996	V6 4.3L 262ci	w/1-1/8" X 10 X 19/32"	TAT-5301
1967	V8 4.6L 283ci	11" Flat Diaph Type w/1-1/8" X 10 X 19/32"	TAT-5301
1967	V8 4.6L 283ci	12" Diaph, Lever Type, & Ceramic Button w/1-1/8" X 10 X 19/32"	TAT-5301
1981	V8 5.0L 305ci	11", 12" Diaph, Lever Type, & Ceramic Button w/1-1/8" X 10 X 19/32"	TAT-5301
1969	V8 5.0L 307ci	11" Diaph Type w/1-1/8" X 10 X 19/32"	TAT-5301
1967	V8 5.4L 327ci	12" Lever Type, & Ceramic Button w/1-1/8" X 10 X 19/32"	TAT-5301
1967	V8 5.4L 327ci	12" Lever Type, & Ceramic Button w/1-1/8" X 10 X 19/32"	TAT-5301
1967	V8 5.4L 327ci	12" Lever Type, & Ceramic Button w/1-1/8" X 10 X 19/32"	TAT-5301
1970-74	V8 5.7L 350ci	11" Diaph Type w/1-1/8" X 10 X 19/32"	TAT-5301
1970-74	V8 5.7L 350ci	12" Diaph, Lever Type, & Ceramic Button w/1-1/8" X 10 X 19/32"	TAT-5301
1972-74	V8 5.7L 350ci	11", 12" Diaph Type, & Ceramic Button w/1-1/8" X 10 X 19/32"	TAT-5301
1973-74	V8 5.7L 350ci	11", 12" Diaph, 12" Lever Type, & Ceramic Button w/1-1/8" X 10 X 19/32"	TAT-5301
1983-93	V8 6.2L 379ci	Diesel w/1-1/8" X 10 X 19/32"	TAT-5301
1983-93	V8 6.2L 379ci	Diesel w/1-1/8" X 10 X 19/32"	TAT-5301
1996	V8 6.5L 395ci	12" Diaph Type w/1-1/8" X 10 X 19/32"	TAT-5301
1994-95	V8 6.5L 395ci	Diesel, w/1-1/8" X 10 X 19/32"	TAT-5301
1994-95	V8 6.5L 395ci	Diesel, Solid, DMF w/1-1/8" X 10 X 19/32"	TAT-5301
1979	V8 6.6L 400ci	w/1-1/8" X 26 X 19/32"	TAT-5313
1978-80	V8 6.6L 400ci	w/1-1/8" X 26 X 19/32"	TAT-5313
1978-80	V8 6.6L 400ci	w/1-1/8" X 26 X 19/32"	TAT-5313
1996	V8 7.4L 454ci	w/1-1/8" X 10 X 19/32"	TAT-5301
1975-76	V8 7.4L 454ci	12" Lever Type, & Ceramic Button w/1-1/8" X 10 X 19/32"	TAT-5301
1976-95	V8 7.4L 454ci	12" Diaph, Lever Type, & Ceramic Button w/1-1/8" X 10 X 19/32"	TAT-5301
<b>JIMMY</b>			
1970-76	L6 4.1L 250ci	10" Disc w/1-1/8" X 10 X 19/32"	TAT-5301
1970-82	L6 4.1L 250ci	11" Diaph, Flat Diaph Type w/1-1/8" X 10 X 19/32"	TAT-5301
1981-82	L6 4.1L 250ci	12", 4 Spd Diaph, Lever Type, & Ceramic Button w/1-1/8" X 10 X 19/32"	TAT-5301
1973	L6 4.8L 292ci	11" Diaph Type w/1-1/8" X 10 X 19/32"	TAT-5301
1973	L6 4.8L 292ci	12" Lever Type, & Ceramic Button w/1-1/8" X 10 X 19/32"	TAT-5301
1977-84	V8 5.0L 305ci	11", 12" Diaph, Lever Type, PDH, & Ceramic Button w/1-1/8" X 10 X 19/32"	TAT-5301
1985-87	V8 5.0L 305ci	w/o PDH w/1-1/8" X 10 X 19/32"	TAT-5301

# CLUTCH ALIGNMENT TOOLS

Year	Engine	Remark	Part
<b>GMC (con't)</b>			
<b>JIMMY (con't)</b>			
1970	V8 5.0L 307ci	11" Diaph Type w/1-1/8" X 10 X 19/32"	TAT-5301
1970-84	V8 5.7L 350ci	12" Lever Type, & Ceramic Button w/1-1/8" X 10 X 19/32"	TAT-5301
1970-91	V8 5.7L 350ci	11", 12" Diaph Type, & Ceramic Button w/1-1/8" X 10 X 19/32"	TAT-5301
1982-91	V8 6.2L 379ci	w/1-1/8" X 10 X 19/32"	TAT-5301
1978-79	V8 6.6L 400ci	w/1-1/8" X 26 X 19/32"	TAT-5313
1973-76	V8 7.4L 454ci	12" Lever Type, & Ceramic Button w/1-1/8" X 10 X 19/32"	TAT-5301
<b>K15/K1500 PICKUP, K25/K2500 PICKUP, K35/K3500 PICKUP</b>			
1966-69	L6 3.8L 230ci	10" Disc, 11" Flat Diaph w/1-1/8" X 10 X 19/32"	TAT-5301
1966-69	L6 3.8L 230ci	12" Lever Type, & Ceramic Button w/1-1/8" X 10 X 19/32"	TAT-5301
1968-74	L6 4.1L 250ci	11" Diaph, Flat Diaph Type w/1-1/8" X 10 X 19/32"	TAT-5301
1975-76	L6 4.1L 250ci	10" Disc, 11" Diaph, 11" Flat Diaph Type w/1-1/8" X 10 X 19/32"	TAT-5301
1968-84	L6 4.8L 292ci	11" Diaph Type w/1-1/8" X 10 X 19/32"	TAT-5301
1975-78	L6 4.8L 292ci	11" Diaph, 12" Lever Type, Ceramic Button w/1-1/8" X 10 X 19/32"	TAT-5301
1969-84	L6 4.8L 292ci	12" Lever Type, & Ceramic Button w/1-1/8" X 10 X 19/32"	TAT-5301
1985-86	L6 4.8L 292ci	w/o PDH w/1-1/8" X 10 X 19/32"	TAT-5301
1985-86	V6 4.3L 262ci	w/PDH, w/o PDH w/1-1/8" X 10 X 19/32"	TAT-5301
1967	V8 4.6L 283ci	11" Flat Diaph Type w/1-1/8" X 10 X 19/32"	TAT-5301
1967	V8 4.6L 283ci	12" Diaph, Lever Type, Ceramic Button w/1-1/8" X 10 X 19/32"	TAT-5301
1976-78	V8 5.0L 305ci	11", 12" Diaph, 12" Lever Type, & Ceramic Button w/1-1/8" X 10 X 19/32"	TAT-5301
1969-73	V8 5.0L 307ci	11" Diaph Type w/1-1/8" X 10 X 19/32"	TAT-5301
1967-68	V8 5.4L 327ci	12" Lever Type, & Ceramic Button w/1-1/8" X 10 X 19/32"	TAT-5301
1969-86	V8 5.7L 350ci	11" 12" Diaph, Type, & Ceramic Button w/1-1/8" X 10 X 19/32"	TAT-5301
1982-86	V8 6.2L 379ci	Diesel w/1-1/8" X 10 X 19/32"	TAT-5301
1968-69	V8 6.5L 396ci	11", 12" Diaph Type, & Ceramic Button w/1-1/8" X 10 X 19/32"	TAT-5301
1968-69	V8 6.5L 396ci	12" Lever Type, & Ceramic Button w/1-1/8" X 10 X 19/32"	TAT-5301
1978-79	V8 6.6L 400ci	w/1-1/8" X 26 X 19/32"	TAT-5313
1970-74	V8 6.6L 402ci	12" Lever Type, & Ceramic Button w/1-1/8" X 10 X 19/32"	TAT-5301
1973-74	V8 7.4L 454ci	12" Lever Type, & Ceramic Button w/1-1/8" X 10 X 19/32"	TAT-5301
1976-78	V8 7.4L 454ci	12" Lever Type, & Ceramic Button w/1-1/8" X 10 X 19/32"	TAT-5301
1979-86	V8 7.4L 454ci	12" Diaph Type w/1-1/8" X 10 X 19/32"	TAT-5301
1985-86	V8 7.4L 454ci	12" Diaph Type, PDH, & Ceramic Button w/1-1/8" X 10 X 19/32"	TAT-5301
<b>K1500, K2500, K3500</b>			
1988-95	V6 4.3L 262ci	w/PDH, w/o PDH w/1-1/8" X 10 X 19/32"	TAT-5301
1996-98	V6 4.3L 262ci	w/1-1/8" X 10 X 19/32"	TAT-5301
1988-91	V8 5.0L 305ci	w/o PDH w/1-1/8" X 10 X 19/32"	TAT-5301
1992-95	V8 5.0L 305ci	PDH w/1-1/8" X 10 X 19/32"	TAT-5301
1996-99	V8 5.0L 305ci	w/1-1/8" X 10 X 19/32"	TAT-5301
1988-95	V8 5.7L 350ci	12" Diaph Type, & Ceramic Button w/1-1/8" X 10 X 19/32"	TAT-5301
1996-99	V8 5.7L 350ci	NVG 3500, NVG 4500 Trans w/1-1/8" X 10 X 19/32"	TAT-5301
1988-93	V8 6.2L 379ci	Diesel w/1-1/8" X 10 X 19/32"	TAT-5301
1994-98	V8 6.5L 395ci	Diesel, Solid, DMF, Turbo Diesel, Valeo Type w/1-1/8" X 10 X 19/32"	TAT-5301
1996-99	V8 6.5L 395ci	12" Diaph, Solid, DMF Type Turbo Diesel, Valeo w/1-1/8" X 10 X 19/32"	TAT-5301
1988-95	V8 7.4L 454ci	12" Diaph Type, PDH, & Ceramic Button w/1-1/8" X 10 X 19/32"	TAT-5301
1996-99	V8 7.4L 454ci	w/1-1/8" X 10 X 19/32"	TAT-5301
<b>P15/P1500 VAN, P25/P2500 VAN, P35/P3500 VAN</b>			
1967-69	L6 3.8L 230ci	10" Disc, 11" Flat Diaph w/1-1/8" X 10 X 19/32"	TAT-5301
1967-69	L6 3.8L 230ci	12" Lever Type, & Ceramic Button w/1-1/8" X 10 X 19/32"	TAT-5301
1968-74	L6 4.1L 250ci	10" Disc, 11" Diaph, 11" Flat Diaph Type w/1-1/8" X 10 X 19/32"	TAT-5301
1967-68	L6 4.8L 292ci	11" Flat Diaph Type w/1-1/8" X 10 X 19/32"	TAT-5301
1969-74	L6 4.8L 292ci	11" Diaph, 12" Lever Type, Ceramic Button w/1-1/8" X 10 X 19/32"	TAT-5301
1990-95	V6 4.3L 262ci	w/PDH, w/o PDH w/1-1/8" X 10 X 19/32"	TAT-5301
1996-98	V6 4.3L 262ci	w/1-1/8" X 10 X 19/32"	TAT-5301
1967	V8 4.6L 283ci	11" Flat Diaph Type w/1-1/8" X 10 X 19/32"	TAT-5301
1967	V8 4.6L 283ci	12" Diaph, Lever Type, Ceramic Button w/1-1/8" X 10 X 19/32"	TAT-5301
1969	V8 5.0L 307ci	11" Diaph Type w/1-1/8" X 10 X 19/32"	TAT-5301
1970-74	V8 5.7L 350ci	11", 12" Diaph Type, & Ceramic Button w/1-1/8" X 10 X 19/32"	TAT-5301
1982-89	V8 6.2L 379ci	Diesel w/1-1/8" X 10 X 19/32"	TAT-5301
1996-99	V8 6.5L 395ci	12" Diaph, Solid, DMF Type Diesel, Turbo Diesel, Valeo w/1-1/8" X 10 X 19/32"	TAT-5301

# CLUTCH ALIGNMENT TOOLS

Year	Engine	Remark	Part
<b>GMC (con't)</b>			
<b>P15/P1500 VAN, P25/P2500 VAN, P35/P3500 VAN (con't)</b>			
1970-74	V8 7.4L 454ci	12" Lever Type, & Ceramic Button w/1-1/8" X 10 X 19/32"	TAT-5301
<b>R1500, V1500</b>			
1987	V6 4.3L 262ci	w/PDH, w/o PDH w/1-1/8" X 10 X 19/32"	TAT-5301
1987	V8 5.0L 305ci	w/o PDH w/1-1/8" X 10 X 19/32"	TAT-5301
1987	V8 5.7L 350ci	12" Diaph Type, & Ceramic Button w/1-1/8" X 10 X 19/32"	TAT-5301
1987	V8 6.2L 379ci	Diesel w/1-1/8" X 10 X 19/32"	TAT-5301
<b>R2500</b>			
1988	L6 4.8L 292ci	w/o PDH w/1-1/8" X 10 X 19/32"	TAT-5301
1987	V6 4.3L 262ci	w/PDH, w/o PDH w/1-1/8" X 10 X 19/32"	TAT-5301
1987	V8 5.0L 305ci	w/o PDH w/1-1/8" X 10 X 19/32"	TAT-5301
1987-89	V8 5.7L 350ci	12" Diaph Type, & Ceramic Button w/1-1/8" X 10 X 19/32"	TAT-5301
1987-89	V8 6.2L 379ci	Diesel w/1-1/8" X 10 X 19/32"	TAT-5301
1987-89	V8 7.4L 454ci	12" Diaph Type, PDH & Ceramic Button w/1-1/8" X 10 X 19/32"	TAT-5301
<b>R3500, V3500</b>			
1987-88	L6 4.8L 292ci	w/o PDH w/1-1/8" X 10 X 19/32"	TAT-5301
1987-91	V8 5.7L 350ci	12" Diaph Type, & Ceramic Button w/1-1/8" X 10 X 19/32"	TAT-5301
1987-91	V8 6.2L 379ci	Diesel w/1-1/8" X 10 X 19/32"	TAT-5301
1987-91	V8 7.4L 454ci	12" Diaph Type, PDH, & Ceramic Button w/1-1/8" X 10 X 19/32"	TAT-5301
<b>S15</b>			
1983-84	L4 1.9L 119ci	w/1" X 14 X 53/64"	TAT-5342
1983-84	L4 2.0L 122ci	10-1/2" Bolt Circle w/1" X 14 X 19/32"	TAT-5312
1984-85	L4 2.2L 134ci	Diesel w/1" X 14 X 19/32"	TAT-5312
1985-90	L4 2.5L 151ci	10-1/2" Bolt Circle w/1" X 14 X 19/32"	TAT-5312
1982	V6 2.8L 173ci	w/1" X 14 X 19/32"	TAT-5312
1983-90	V6 2.8L 173ci	Solid Flywheel # FW-123, GAS w/1" X 14 X 19/32"	TAT-5312
1988-90	V6 4.3L 262ci	w/PDH, w/o PDH w/1-1/8" X 10 X 19/32"	TAT-5301
<b>SAFARI</b>			
1985-89	L4 2.5L 151ci	w/1" X 14 X 19/32"	TAT-5312
1985-90	V6 4.3L 262ci	w/1" X 14 X 19/32"	TAT-5312
<b>SAVANA 2500</b>			
1996-98	V6 4.3L 262ci	w/1-1/8" X 10 X 19/32"	TAT-5301
1996-98	V8 6.5L 395ci	12" Diaph Type, Turbo Diesel, Valeo Type w/1-1/8" X 10 X 19/32"	TAT-5301
<b>SAVANA 3500</b>			
1996-98	V8 6.5L 395ci	12" Diaph Type, Turbo Diesel, Valeo Type w/1-1/8" X 10 X 19/32"	TAT-5301
1996-98	V8 7.4L 454ci	w/1-1/8" X 10 X 19/32"	TAT-5301
<b>SIERRA 1500 HD, SIERRA 2500 HD, SIERRA 3500</b>			
2001	V8 6.0L 364ci	11-3/4" w/1-1/8" X 10 X 19/32"	TAT-5301
<b>SIERRA 2500</b>			
1999-00	V8 6.0L 364ci	11-3/4" w/1-1/8" X 10 X 19/32"	TAT-5301
<b>SPRINT</b>			
1971-77	L6 4.1L 250ci	w/1-1/8" X 10 X 19/32"	TAT-5301
1976-77	V8 5.0L 305ci	w/1-1/8" X 10 X 19/32"	TAT-5301
1971-77	V8 5.7L 350ci	w/1-1/8" X 10 X 19/32"	TAT-5301
1974-76	V8 6.6L 400ci	w/1-1/8" X 10 X 19/32"	TAT-5301
1975	V8 6.6L 402ci	w/1-1/8" X 10 X 19/32"	TAT-5301
1971-74	V8 7.4L 454ci	w/1-1/8" X 26 X 19/32"	TAT-5313
<b>V2500</b>			
1987	L6 4.8L 292ci	w/o PDH w/1-1/8" X 10 X 19/32"	TAT-5301
1987	V8 5.7L 350ci	12" Diaph Type, & Ceramic Button w/1-1/8" X 10 X 19/32"	TAT-5301
1987	V8 6.2L 379ci	Diesel w/1-1/8" X 10 X 19/32"	TAT-5301
<b>YUKON</b>			
1992-95	V8 5.7L 350ci	12" Diaph Type, & Ceramic Button w/1-1/8" X 10 X 19/32"	TAT-5301
1996-99	V8 5.7L 350ci	NVG 3500, NVG 4500 Trans w/1-1/8" X 10 X 19/32"	TAT-5301
1994-95	V8 6.5L 395ci	Diesel, Solid, DMF w/1-1/8" X 10 X 19/32"	TAT-5301
1996-97	V8 6.5L 395ci	12" Diaph Type w/1-1/8" X 10 X 19/32"	TAT-5301
<b>GMC HEAVY DUTY TRUCKS</b>			
<b>C40, C50, C60, C70, TOPKICK</b>			
1984-90	V8 6.0L 366ci	13" Diaph, 13" Lever Type, & Ceramic Button	TAT-5200

# CLUTCH ALIGNMENT TOOLS

Year	Engine	Remark	Part
<b>GMC HEAVY DUTY TRUCKS (con't)</b>			
<b>C40, C50, C60, C70, TOPKICK (con't)</b>			
1994-96	V8 6.6L 403ci	13" Diaph, 13" Lever Type, & Ceramic Button	TAT-5200
1962-85	V8 7.0L 427ci	13" Diaph, 13" Lever Type, & Ceramic Button	TAT-5200
1996-91	V8 7.0L 427ci	Diaphragm Type	TAT-5200
1990-97	V8 7.0L 427ci	13" Diaph, 13" Lever Type, & Ceramic Button	TAT-5200
<b>HONDA</b>			
<b>ACCORD</b>			
1976-78	L4 1.6L 1599cc	w/13/16" X 19 X 37/64"	TAT-5308
1979-83	L4 1.8L 1751cc	w/27/32" X 21 X 47/64"	TAT-5319
1984-85	L4 1.8L 1829cc		TAT-5201
1986-89	L4 2.0L 1955cc	w/27/32" X 21 X 47/64"	TAT-5319
1990-97	L4 2.2L 2156cc	Solid Flywheel w/31/32" X 24 X 11/16"	TAT-5390
1998-01	L4 2.3L 2254cc	w/31/32" X 24 X 11/16"	TAT-5390
<b>CIVIC</b>			
1973-79	L4 1.2L 1237cc	Flat cover stamping & flywheel w/13/16" X 19 X 37/64"	TAT-5308
1980-83	L4 1.3L 1335cc	Ribbed cover stamping & flywheel w/13/16" X 19 X 37/64"	TAT-5308
1984-87	L4 1.3L 1342cc	w/13/16" X 19 X 37/64"	TAT-5308
1975-80	L4 1.5L 1487cc	Flat cover stamping & flywheel w/13/16" X 19 X 37/64"	TAT-5308
1980-83	L4 1.5L 1487cc	Ribbed cover stamping & flywheel w/13/16" X 19 X 37/64"	TAT-5308
1984-87	L4 1.5L 1487cc	w/13/16" X 19 X 37/64"	TAT-5308
1987	L4 1.5L 1491cc	w/13/16" X 19 X 37/64"	TAT-5308
1986	L4 1.5L 1493cc	w/13/16" X 19 X 37/64"	TAT-5308
1988	L4 1.5L 1493cc		TAT-5201
1989-95	L4 1.5L 1493cc	Solid Flywheel, wo/VTEC Solid Flywheel	TAT-5202
1988	L4 1.6L 1590cc		TAT-5201
1989	L4 1.6L 1590cc	11.375" Disc w/7/8" X 20 X 37/64"	TAT-5310
1989-00	L4 1.6L 1590cc	11.1" Disc.	TAT-5202
<b>CIVIC DEL SOL</b>			
1993-95	L4 1.5L 1493cc		TAT-5202
1993-95	L4 1.6L 1590cc	SOHC	TAT-5202
1994-97	L4 1.6L 1590cc	V-Tech; DOHC	TAT-5211
1996-97	L4 1.6L 1590cc	exc. V-TEC	TAT-5202
<b>CRX</b>			
1988	L4 1.5L 1493cc		TAT-5201
1989-91	L4 1.5L 1493cc		TAT-5202
1988	L4 1.6L 1590cc		TAT-5201
1989-91	L4 1.6L 1590cc		TAT-5202
<b>PRELUDE</b>			
1979-82	L4 1.8L 1751cc	w/27/32" X 21 X 47/64"	TAT-5319
1983-87	L4 1.8L 1829cc		TAT-5201
1985-87	L4 2.0L 1955cc	w/27/32" X 21 X 47/64"	TAT-5319
1988-89	L4 2.0L 1958cc	w/31/32" X 24 X 11/16"	TAT-5390
1990-91	L4 2.0L 1958cc		TAT-5423
1992-96	L4 2.2L 2156cc	SOHC	TAT-5423
1993-01	L4 2.2L 2156cc	DOHC	TAT-5423
1997-99	L4 2.2L 2156cc	V-tech , DOHC w/31/32" X 24 X 11/16"	TAT-5390
1992-96	L4 2.3L 2259cc	Solid Flywheel # FW-138	TAT-5423
<b>S2000</b>			
2000-02	L4 2.0L 1997cc	8-3/8" w/1" X 24 X 43/64"	TAT-5316
<b>HONDA TRUCKS</b>			
<b>CR-V</b>			
1998-99	L4 2.0L 1972cc		TAT-5211
<b>PASSPORT</b>			
1994-96	L4 2.6L 2559cc	w/1" X 24 X 43/64"	TAT-5316
1994-01	V6 3.2L 3165cc	w/1" X 24 X 43/64"	TAT-5316
<b>HYUNDAI</b>			
<b>ACCENT</b>			
1995-99	L4 1.5L 1495cc	Includes DOHC w/7/8" X 20 X 41/64"	TAT-5360
2000-01	L4 1.5L 1495cc	w/7/8" X 20 X 41/64"	TAT-5360

# CLUTCH ALIGNMENT TOOLS

Year	Engine	Remark	Part
<b>HYUNDAI (con't)</b>			
<b>ELANTRA</b>			
1992-95	L4 1.6L 1596cc	w/7/8" X 20 X 41/64"	TAT-5360
1993-95	L4 1.8L 1836cc	w/7/8" X 20 X 41/64"	TAT-5360
<b>EXCEL</b>			
1986-94	L4 1.5L 1468cc	w/7/8" X 20 X 41/64"	TAT-5360
<b>PONY</b>			
1984-85	L4 1.4L 1393cc	Canada Only w/7/8" X 20 X 41/64"	TAT-5360
1985-87	L4 1.6L 1596cc	Canada Only w/7/8" X 20 X 41/64"	TAT-5360
<b>SCOUPE</b>			
1993-95	L4 1.5L 1495cc	w/7/8" X 20 X 41/64"	TAT-5360
<b>SONATA</b>			
1992-94	L4 2.0L 1997cc	To 11/94, 9.724" Bolt Circle w/7/8" X 20 X 41/64"	TAT-5360
1994-98	L4 2.0L 1997cc	From 11/94, 10.236" Bolt Circle w/7/8" X 20 X 37/64"	TAT-5310
1989-91	L4 2.4L 2351cc	w/7/8" X 20 X 37/64"	TAT-5310
<b>INFINITI</b>			
<b>G20</b>			
1991-96	L4 2.0L 1998cc		TAT-5209
<b>I30</b>			
1996-99	V6 3.0L 2988cc	w/1" X 24 X 41/64"	TAT-5300
<b>INTERNATIONAL</b>			
<b>M SERIES VAN</b>			
1961-67	L4 2.5L 152ci	11" Lever Type w/1-1/4" X 10 X 63/64"	TAT-5334
1963-67	L6 3.6L 220ci	11" Lever Type w/1-1/4" X 10 X 63/64"	TAT-5334
<b>SCOUT</b>			
1961-71	L4 2.5L 152ci	11" Lever Type w/1-1/4" X 10 X 63/64"	TAT-5334
1968	L4 3.2L 196ci	11" Lever Type w/1-1/4" X 10 X 63/64"	TAT-5334
1969-70	L6 4.3L 265ci	11", 12" Lever Type w/1-1/4" X 10 X 63/64"	TAT-5334
1968	V8 4.4L 266ci	11", 12" Lever Type w/1-1/4" X 10 X 63/64"	TAT-5334
1969-70	V8 5.0L 304ci	11", 12", 13" Lever Type w/1-1/4" X 10 X 63/64"	TAT-5334
<b>SCOUT II</b>			
1971-80	L4 3.2L 196ci	11" Lever Type w/1-1/4" X 10 X 63/64"	TAT-5334
1971-80	V8 5.0L 304ci	11", 12", 13" Lever Type w/1-1/4" X 10 X 63/64"	TAT-5334
1971-79	V8 5.6L 345ci	11" Lever Type w/1-1/4" X 10 X 63/64"	TAT-5334
1980	V8 5.6L 345ci	13" X 1-1/2" Spline w/1-1/2" X 10 X 1"	TAT-5379
1980	V8 5.6L 345ci	13" X 1-1/4" Spline w/1-1/4" X 10 X 63/64"	TAT-5334
<b>ISUZU</b>			
<b>I-MARK</b>			
1985-89	L4 1.5L 1471cc	SOHC, Gas	TAT-5397
1987-89	L4 1.5L 1471cc	Turbo, Gas w/1" X 14 X 53/64"	TAT-5342
1989	L4 1.6L 1588cc	DOHC, GAS w/1" X 14 X 53/64"	TAT-5342
1981-84	L4 1.8L 1817cc	w/1" X 24 X 43/64"	TAT-5316
<b>IMPULSE</b>			
1990-92	L4 1.6L 1588cc	Turbo w/1" X 14 X 53/64"	TAT-5342
1992	L4 1.8L 1817cc	w/1" X 14 X 53/64"	TAT-5342
1983-86	L4 1.9L 1949cc	w/1" X 24 X 43/64"	TAT-5316
1985-89	L4 2.0L 1994cc	w/1" X 24 X 43/64"	TAT-5316
1988-89	L4 2.3L 2254cc	w/1" X 24 X 43/64"	TAT-5316
<b>STYLUS</b>			
1991-93	L4 1.6L 1588cc		TAT-5397
1992	L4 1.8L 1817cc	w/1" X 14 X 53/64"	TAT-5342
<b>ISUZU TRUCKS</b>			
<b>AMIGO</b>			
1998-99	L4 2.2L 2180cc	w/1" X 24 X 43/64"	TAT-5316
2000	L4 2.2L 2180cc	2WD MUA Trans	TAT-5316
1989-93	L4 2.3L 2254cc	w/1" X 24 X 43/64"	TAT-5316
1989-94	L4 2.6L 2559cc	w/1" X 24 X 43/64"	TAT-5316
1998-00	V6 3.2L 3165cc	w/1" X 24 X 43/64"	TAT-5316
<b>HOMBRE</b>			
1996-00	L4 2.2L 2180cc	w/1-1/8" X 26 X 19/32"	TAT-5313

# CLUTCH ALIGNMENT TOOLS

Year	Engine	Remark	Part
<b>ISUZU TRUCKS (con't)</b>			
<b>HOMBRE (con't)</b>			
1997-99	V6 4.3L 4294cc	w/1-1/8" X 10 X 19/32"	TAT-5301
<b>PICKUP</b>			
1981-82	L4 1.8L 1817cc	w/1" X 24 X 43/64"	TAT-5316
1983-86	L4 1.9L 1949cc	w/1" X 24 X 43/64"	TAT-5316
1981-87	L4 2.2L 2238cc	Cable System; Diesel, Turbo Diesel w/1" X 24 X 43/64"	TAT-5316
1981-87	L4 2.2L 2238cc	Hydraulic System, Diesel w/1" X 24 X 43/64"	TAT-5316
1986-95	L4 2.3L 2254cc	w/1" X 24 X 43/64"	TAT-5316
1988-95	L4 2.6L 2559cc	w/1" X 24 X 43/64"	TAT-5316
1991-94	V6 3.1L 3137cc	Gas	TAT-5211
<b>RODEO</b>			
1998-02	L4 2.2L 2180cc	w/1" X 24 X 43/64"	TAT-5316
1991-92	L4 2.6L 2559cc	Borg Warner Trans. Option Code MM5 w/1" X 14 X 19/32"	TAT-5312
1991-96	L4 2.6L 2559cc	MUA Trans Code RMN, Borg Warner Code MM5 w/1" X 24 X 43/64"	TAT-5316
1991-92	V6 3.1L 3137cc	Borg Warner Trans. Option Code MM5 w/1" X 14 X 19/32"	TAT-5312
1991-92	V6 3.1L 3137cc	MUA Trans.; Option Code RMN	TAT-5211
1993-01	V6 3.2L 3165cc	MUA Trans Code RMN, Borg Warner Code MM5 w/1" X 24 X 43/64"	TAT-5316
2002	V6 3.2L 3165cc	w/1" X 24 X 43/64"	TAT-5316
<b>TROOPER</b>			
1984-85	L4 1.9L 1949cc	w/1" X 24 X 43/64"	TAT-5316
1986-87	L4 2.3L 2254cc	w/1" X 24 X 43/64"	TAT-5316
1988-91	L4 2.6L 2559cc	w/1" X 24 X 43/64"	TAT-5316
1989-91	V6 2.8L 2827cc		TAT-5211
1992-97	V6 3.2L 3165cc	w/1" X 24 X 43/64"	TAT-5316
1998-02	V6 3.5L 3475cc	w/1" X 24 X 43/64"	TAT-5316
<b>JEEP</b>			
<b>CHEROKEE</b>			
1985-87	L4 2.1L 126ci	Diesel XJ Series w/1" X 14 X 53/64"	TAT-5342
1984-98	L4 2.5L 150ci	XJ Series w/1" X 14 X 19/32"	TAT-5312
1987-92	L4 2.5L 150ci	CSC w/1" X 14 X 19/32"	TAT-5312
1987-89	L6 4.0L 242ci	Peugeot Trans. (Horizontal Split) CSC XJ Series w/1-1/8" X 10 X 19/32"	TAT-5301
1988-90	L6 4.0L 242ci	10-1/2" Diaph Type w/1-1/8" X 10 X 19/32"	TAT-5301
1989-91	L6 4.0L 242ci	Asian Trans. (Vertical Split) CSC XJ Series w/1-1/8" X 10 X 19/32"	TAT-5301
1992-93	L6 4.0L 242ci	CSC, XJ Series w/1-1/8" X 10 X 19/32"	TAT-5301
1994-98	L6 4.0L 242ci	XJ Series w/1-5/32" X 10 X 5/8"	TAT-5359
2000-01	L6 4.0L 242ci	w/1-5/32" X 10 X 5/8"	TAT-5359
1974-81	L6 4.2L 258ci	w/1-5/32" X 10 X 5/8"	TAT-5359
1982-83	L6 4.2L 258ci	10-1/2" Diaph Type w/1-1/8" X 10 X 19/32"	TAT-5301
1984-86	V6 2.8L 173ci	10.866 Bolt Circle, 10-1/2" Bolt Circle XJ Series w/1" X 14 X 19/32"	TAT-5312
1974-83	V8 5.9L 360ci	w/1-5/32" X 10 X 5/8"	TAT-5359
1974-75	V8 6.6L 401ci	w/1-5/32" X 10 X 5/8"	TAT-5359
<b>CJ3, CJ5A, CJ6A, CJ6, COMMANDO, DISPATCHER</b>			
1966-71	V6 3.7L 225ci	w/1-1/8" X 10 X 19/32"	TAT-5301
<b>CJ5, CJ7</b>			
1983	L4 2.5L 150ci	GM Eng w/1-1/8" X 10 X 19/32"	TAT-5301
1983-86	L4 2.5L 150ci	AMC Eng, XJ Series w/1" X 14 X 19/32"	TAT-5312
1980-83	L4 2.5L 151ci	GM Eng w/1-1/8" X 10 X 19/32"	TAT-5301
1976-78	L6 3.8L 232ci	w/1-1/16" X 10 X 43/64"	TAT-5304
1976-79	L6 4.2L 258ci	w/1-1/16" X 10 X 43/64"	TAT-5304
1980-86	L6 4.2L 258ci	10-1/2" Diaph Type w/1-1/8" X 10 X 19/32"	TAT-5301
1980-86	L6 4.2L 258ci	11" Lever Type w/1-5/32" X 10 X 5/8"	TAT-5359
1966-71	V6 3.7L 225ci	w/1-1/8" X 10 X 19/32"	TAT-5301
1976-80	V8 5.0L 304ci	w/1-1/16" X 10 X 43/64"	TAT-5304
<b>COMANCHE</b>			
1986-87	L4 2.1L 126ci	Diesel w/1" X 14 X 53/64"	TAT-5342
1986	L4 2.5L 150ci	w/1" X 14 X 19/32"	TAT-5312
<b>GLADIATOR</b>			
1966-67	L6 3.8L 230ci	w/1-5/32" X 10 X 5/8"	TAT-5359
1966-67	L6 3.8L 232ci	w/1-5/32" X 10 X 5/8"	TAT-5359



# CLUTCH ALIGNMENT TOOLS

Year	Engine	Remark	Part
<b>JEEP (con't)</b>			
<b>GLADIATOR (con't)</b>			
1965-67	V8 5.4L 327ci	w/1-5/32" X 10 X 5/8"	TAT-5359
<b>GRAND CHEROKEE</b>			
1993	L6 4.0L 242ci	CSC XJ Series w/1-1/8" X 10 X 19/32"	TAT-5301
1994-98	L6 4.0L 242ci	XJ Series w/1-5/32" X 10 X 5/8"	TAT-5359
2000-01	L6 4.0L 242ci	w/1-5/32" X 10 X 5/8"	TAT-5359
<b>GRAND WAGONEER</b>			
1984-86	L6 4.2L 258ci	10-1/2" Diaph Type w/1-1/8" X 10 X 19/32"	TAT-5301
1984-86	V8 5.9L 360ci	w/1-5/32" X 10 X 5/8"	TAT-5359
<b>J10, J20</b>			
1974-79	L6 4.2L 258ci	w/1-5/32" X 10 X 5/8"	TAT-5359
1980-81	L6 4.2L 258ci	11" Lever Type w/1-5/32" X 10 X 5/8"	TAT-5359
1980-87	L6 4.2L 258ci	10-1/2" Diaph Type w/1-1/8" X 10 X 19/32"	TAT-5301
1974-79	V8 5.9L 360ci	w/1-5/32" X 10 X 5/8"	TAT-5359
<b>J-100, J-2500, J-2600, J-2700, J-3500, J-3600, J-3700, J-3800, J-4500,0, J-4600, J-4700</b>			
1969-71	V8 5.7L 350ci	w/1-1/8" X 10 X 19/32"	TAT-5301
<b>TJ</b>			
2000-01	L6 4.0L 242ci	w/1-5/32" X 10 X 5/8"	TAT-5359
<b>WAGONEER</b>			
1985	L4 2.1L 126ci	Diesel XJ Series w/1" X 14 X 53/64"	TAT-5342
1984-86	L4 2.5L 150ci	CSC, XJ Series w/1" X 14 X 19/32"	TAT-5312
1963-65	L6 3.8L 230ci	9-1/4"; 2WD, 10-1/2"; 4WD w/1-1/8" X 10 X 19/32"	TAT-5301
1966-67	L6 3.8L 230ci	w/1-5/32" X 10 X 5/8"	TAT-5359
1965	L6 3.8L 232ci	9-1/4"; 2WD, 10-1/2"; 4WD w/1-1/8" X 10 X 19/32"	TAT-5301
1966-67	L6 3.8L 232ci	w/1-5/32" X 10 X 5/8"	TAT-5359
1987-89	L6 4.0L 242ci	Asian (Vertical Split), Peugeot Trans. (Horizontal Split) w/1-1/8" X 10 X 19/32"	TAT-5301
1972-81	L6 4.2L 258ci	w/1-5/32" X 10 X 5/8"	TAT-5359
1982-83	L6 4.2L 258ci	10-1/2" Diaph Type w/1-1/8" X 10 X 19/32"	TAT-5301
1984-86	V6 2.8L 173ci	10.866 Bolt Circle, 10-1/2"XJ Series w/1" X 14 X 19/32"	TAT-5312
1967	V8 5.4L 327ci	w/1-1/8" X 10 X 19/32"	TAT-5301
1965-66	V8 5.4L 327ci	w/1-5/32" X 10 X 5/8"	TAT-5359
1972-83	V8 5.9L 360ci	w/1-5/32" X 10 X 5/8"	TAT-5359
<b>WRANGLER</b>			
1987-93	L4 2.5L 150ci	CSC w/1" X 14 X 19/32"	TAT-5312
1994-98	L4 2.5L 150ci	w/1" X 14 X 19/32"	TAT-5312
1991-93	L6 4.0L 242ci	CSC w/1-1/8" X 10 X 19/32"	TAT-5301
1994-02	L6 4.0L 242ci	w/1-5/32" X 10 X 5/8"	TAT-5359
1987-89	L6 4.2L 258ci	Asian (Vertical Split), Peugeot Trans. (Horizontal Split) CSC w/1-1/8" X 10 X 19/32"	TAT-5301
<b>KIA</b>			
<b>SEPHIA</b>			
1994-97	L4 1.6L 1597cc	w/7/8" X 20 X 37/64"	TAT-5310
1996-97	L4 1.8L 1839cc	w/15/16" X 22 X 37/64"	TAT-5307
<b>SPECTRA</b>			
2000-02	L4 1.8L 1793cc	w/15/16" X 22 X 37/64"	TAT-5307
<b>KIA TRUCKS</b>			
<b>SPORTAGE</b>			
1995-01	L4 2.0L 1998cc	w/15/16" X 22 X 37/64"	TAT-5307
<b>LEXUS</b>			
<b>ES250</b>			
1990-91	V6 2.5L 2508cc	w/1-1/8" X 21 X 15/32"	TAT-5303
1992-93	V6 3.0L 2959cc	w/1-1/8" X 21 X 15/32"	TAT-5303
<b>SC300</b>			
1992-97	L6 3.0L 2997cc	w/1-1/8" X 21 X 15/32"	TAT-5303
<b>MAZDA</b>			
<b>1800</b>			
1970	L4 1.8L 1796cc	w/7/8" X 20 X 37/64"	TAT-5310
<b>323</b>			
1987-89	L4 1.6L 1597cc	w/7/8" X 20 X 39/64"	TAT-5337

# CLUTCH ALIGNMENT TOOLS

Year	Engine	Remark	Part
<b>MAZDA (con't)</b>			
<b>616</b>			
1971	L4 1.6L 1586cc	w/15/16" X 22 X 37/64"	TAT-5307
<b>618</b>			
1972	L4 1.8L 1796cc	w/15/16" X 22 X 37/64"	TAT-5307
<b>626</b>			
1979-83	L4 2.0L 1970cc	w/15/16" X 22 X 37/64"	TAT-5307
1999-01	L4 2.0L 1991cc	w/15/16" X 22 X 37/64"	TAT-5307
1984-87	L4 2.0L 1998cc	w/15/16" X 22 X 37/64"	TAT-5307
1988-91	L4 2.2L 2184cc	Turbo	TAT-5408
1988-92	L4 2.2L 2184cc	w/o Turbo w/15/16" X 22 X 37/64"	TAT-5307
1999-01	V6 2.5L 2497cc	w/15/16" X 22 X 37/64"	TAT-5307
<b>808</b>			
1972-77	L4 1.6L 1587cc	w/15/16" X 22 X 37/64"	TAT-5307
<b>929</b>			
1988-91	V6 3.0L 2954cc		TAT-5408
<b>COSMO</b>			
1976-78	R2 1.3L 1308cc	w/15/16" X 22 X 37/64"	TAT-5307
<b>GLC</b>			
1977-78	L4 1.3L 1272cc	w/7/8" X 20 X 41/64"	TAT-5360
1979-80	L4 1.4L 1415cc	w/7/8" X 20 X 41/64"	TAT-5360
1981-85	L4 1.5L 1490cc	w/7/8" X 20 X 41/64"	TAT-5360
<b>MIATA</b>			
1990-93	L4 1.6L 1597cc	w/15/16" X 22 X 37/64"	TAT-5307
1994-01	L4 1.8L 1839cc	w/15/16" X 22 X 37/64"	TAT-5307
<b>MIZER</b>			
1976-77	L4 1.3L 1272cc	w/7/8" X 20 X 41/64"	TAT-5360
<b>MX-3</b>			
1992-95	L4 1.6L 1597cc	w/7/8" X 20 X 37/64"	TAT-5310
1992-94	V6 1.8L 1845cc	w/15/16" X 22 X 37/64"	TAT-5307
<b>MX-6</b>			
1993-94	L4 2.0L 1991cc	w/15/16" X 22 X 37/64"	TAT-5307
1995-97	L4 2.0L 1991cc	w/7/8" X 20 X 37/64"	TAT-5310
1990-92	L4 2.2L 2184cc	w/o Turbo w/15/16" X 22 X 37/64"	TAT-5307
1992	L4 2.2L 2184cc	Turbo	TAT-5408
1993-97	V6 2.5L 2497cc	w/15/16" X 22 X 37/64"	TAT-5307
<b>PROTEGE</b>			
1995-97	L4 1.5L 1489cc	DOHC w/7/8" X 20 X 37/64"	TAT-5310
1991-93	L4 1.8L 1839cc	DOHC w/15/16" X 22 X 37/64"	TAT-5307
1991-93	L4 1.8L 1839cc	SOHC w/7/8" X 20 X 37/64"	TAT-5310
1997-99	L4 1.8L 1839cc	DOHC w/7/8" X 20 X 37/64"	TAT-5310
<b>RX-2, RX-3</b>			
1971-78	R2 1.1L 1146cc	12A Eng w/15/16" X 22 X 37/64"	TAT-5307
<b>RX-4</b>			
1974-78	R2 1.3L 1308cc	13B Eng w/15/16" X 22 X 37/64"	TAT-5307
<b>RX-7</b>			
1979-85	R2 1.1L 1146cc	12A Eng w/15/16" X 22 X 37/64"	TAT-5307
1986-91	R2 1.3L 1308cc	Turbo	TAT-5408
1993	R2 1.3L 1308cc	w/15/16" X 22 X 37/64"	TAT-5307
1993-94	R2 1.3L 1308cc		TAT-5408
<b>MAZDA TRUCKS</b>			
<b>B1600</b>			
1972-76	L4 1.6L 1586cc	w/15/16" X 22 X 37/64"	TAT-5307
<b>B1800</b>			
1977-78	L4 1.8L 1796cc	w/15/16" X 22 X 37/64"	TAT-5307
<b>B2000</b>			
1979-84	L4 2.0L 1970cc	w/15/16" X 22 X 37/64"	TAT-5307
<b>B2200</b>			
1982-84	L4 2.2L 2209cc	Diesel w/15/16" X 22 X 37/64"	TAT-5307

# CLUTCH ALIGNMENT TOOLS

Year	Engine	Remark	Part
<b>MAZDA TRUCKS (con't)</b>			
<b>B2300</b>			
1994-97	L4 2.3L 2295cc		TAT-5408
<b>B2500</b>			
1998-00	L4 2.5L 2492cc		TAT-5408
<b>B2600</b>			
1990-93	L4 2.6L 2606cc	Fuel Injection	TAT-5408
<b>B3000</b>			
1998-02	V6 3.0L 2954cc		TAT-5408
<b>B4000</b>			
1994-01	V6 4.0L 4016cc		TAT-5408
<b>MPV</b>			
1989-91	L4 2.6L 2606cc		TAT-5408
1989-91	V6 3.0L 2954cc		TAT-5408
<b>NAVAJO</b>			
1991-94	V6 4.0L 4016cc		TAT-5408
<b>MERCEDES-BENZ</b>			
<b>190</b>			
1964-65	L4 1.9L 116ci	w/1-1/8" X 10 X 19/32"	TAT-5301
<b>190E</b>			
1984-87	L4 2.3L 2299cc	16 Valve DOHC w/1-1/8" X 26 X 19/32"	TAT-5313
1984-87	L4 2.3L 2299cc	8 Valve SOHC w/1-1/8" X 26 X 19/32"	TAT-5313
1986-93	L4 2.3L 2299cc	w/1-1/8" X 26 X 19/32"	TAT-5313
1987-88	L6 2.6L 2599cc	From CH# F640 694 w/1-1/8" X 10 X 19/32"	TAT-5301
1989	L6 2.6L 2599cc	From CH# F640 695 w/1" X 14 X 19/32"	TAT-5312
1990-93	L6 2.6L 2599cc	w/1-1/8" X 26 X 19/32"	TAT-5313
<b>230</b>			
1974-78	L4 2.3L 2307cc	w/1-1/8" X 10 X 19/32"	TAT-5301
1966-69	L6 2.3L 2306cc	34mm, 34.5mm Diameter Bearing w/1-1/8" X 10 X 19/32"	TAT-5301
<b>240D</b>			
1974-75	L4 2.4L 2404cc	Type 115; To CH 118 544 w/1-1/8" X 10 X 19/32"	TAT-5301
1976-83	L4 2.4L 2404cc	Type 123; From CH 079 819 w/1-1/8" X 10 X 19/32"	TAT-5301
<b>260E</b>			
1987-89	L6 2.6L 2599cc	w/1-1/8" X 26 X 19/32"	TAT-5313
<b>280S, 280SEL, 280SL</b>			
1968-71	L6 2.8L 2778cc	8-1/2" Disc, From CH 029326 w/1-1/8" X 10 X 19/32"	TAT-5301
1968-71	L6 2.8L 2778cc	9" Disc, To CH 002863 w/1-1/8" X 10 X 19/32"	TAT-5301
<b>300E</b>			
1990-92	L6 2.6L 2599cc	w/1-1/8" X 26 X 19/32"	TAT-5313
1986-92	L6 3.0L 2962cc	w/1-1/8" X 26 X 19/32"	TAT-5313
1993	L6 3.2L 3199cc	w/1-1/8" X 26 X 19/32"	TAT-5313
<b>300CE, 300SE, 300SEL, 300SL, 300TE</b>			
1988-92	L6 3.0L 2962cc	w/1-1/8" X 26 X 19/32"	TAT-5313
<b>MERCURY</b>			
<b>BOBCAT</b>			
1975-80	L4 2.3L 140ci	w/1" X 23 X 19/32"	TAT-5311
<b>BROUGHAM</b>			
1967	V8 6.7L 410ci	11" Lever Type w/1-1/16" X 10 X 43/64"	TAT-5304
<b>CALIENTE</b>			
1964	V8 4.3L 260ci	Diaph Type, 10" Disc w/1-1/16" X 10 X 43/64"	TAT-5304
1966-67	V8 6.4L 390ci	11" Lever Type w/1-1/16" X 10 X 43/64"	TAT-5304
<b>CAPRI</b>			
1971-72	L4 1.6L 98ci	4 Speed w/7/8" X 20 X 41/64"	TAT-5360
1991-94	L4 1.6L 98ci	w/15/16" X 22 X 37/64"	TAT-5307
1991-94	L4 1.6L 98ci	5 Speed w/7/8" X 20 X 37/64"	TAT-5310
1971-74	L4 2.0L 122ci	4 Speed w/1" X 23 X 19/32"	TAT-5311
1979-80	L4 2.3L 140ci	To 8/80, 5 Speed w/1" X 23 X 19/32"	TAT-5311
1979-83	L4 2.3L 140ci	Ford Transmission, 4 Speed w/1-1/16" X 10 X 39/64"	TAT-5341
1979-86	L4 2.3L 140ci	4 Speed, German Transmission w/1" X 23 X 19/32"	TAT-5311
1980-83	L4 2.3L 140ci	From 12/80, Ford Transmission, 5 Speed w/1" X 23 X 19/32"	TAT-5311

# CLUTCH ALIGNMENT TOOLS

Year	Engine	Remark	Part
<b>MERCURY (con't)</b>			
<b>CAPRI (con't)</b>			
1984-86	L4 2.3L 140ci	5 Speed, Warner Transmission w/1-1/16" X 10 X 39/64"	TAT-5341
1980-82	L6 3.3L 200ci	9" Diaph Type w/1-1/16" X 10 X 43/64"	TAT-5304
1972-73	V6 2.6L 2606cc	w/1" X 23 X 33/64"	TAT-5331
1974	V6 2.8L 171ci	w/1" X 23 X 33/64"	TAT-5331
1979	V6 2.8L 171ci	Diaph Type w/1-1/16" X 10 X 39/64"	TAT-5341
1979-86	V8 5.0L 302ci	w/1-1/16" X 10 X 43/64"	TAT-5304
<b>COMET</b>			
1971-72	L6 2.8L 170ci	9" Lever, Diaph Replacement Type w/1-1/16" X 10 X 43/64"	TAT-5304
1967	L6 3.3L 200ci	Lever Type, 10.4" Disc w/1-1/16" X 10 X 43/64"	TAT-5341
1967-77	L6 3.3L 200ci	9" Lever, Diaph Replacement Type w/1-1/16" X 10 X 43/64"	TAT-5304
1967-77	L6 3.3L 200ci	Lever Type 9" Disc w/15/16" X 10 X 5/8"	TAT-5336
1968-77	L6 3.3L 200ci	Lever Type, 10.4" Disc w/1-1/16" X 10 X 43/64"	TAT-5304
1969-77	L6 4.1L 250ci	Diaph Type, 10" Disc w/1-1/16" X 10 X 43/64"	TAT-5304
1963-64	V8 4.3L 260ci	10" Diaph, 10.4" Lever Type w/1-1/16" X 10 X 43/64"	TAT-5304
1964-67	V8 4.7L 289ci	10" Diaph, 10.4" Lever Type w/1-1/16" X 10 X 43/64"	TAT-5304
1968-77	V8 5.0L 302ci	10" Diaph, 10.4" Lever Type w/1-1/16" X 10 X 43/64"	TAT-5304
1969	V8 5.8L 351ci	11" Diaph, Lever Type w/1-1/16" X 10 X 43/64"	TAT-5304
1966-69	V8 6.4L 390ci	11" Diaph, Lever Type w/1-1/16" X 10 X 43/64"	TAT-5304
<b>COUGAR</b>			
1999-01	L4 2.0L 121ci	CSC	TAT-5408
1981-86	L4 2.3L 140ci	4 Speed, German, Ford, 5 Speed Warner Transmission w/1-1/16" X 10 X 39/64"	TAT-5341
1984-86	L4 2.3L 140ci	5 Speed, Warner Transmission w/1-1/16" X 10 X 39/64"	TAT-5341
1980-81	L6 3.3L 200ci	9" Diaph Type w/1-1/16" X 10 X 43/64"	TAT-5304
1999-01	V6 2.5L 155ci	CSC	TAT-5408
1990-94	V6 3.8L 232ci	w/1-1/16" X 10 X 43/64"	TAT-5304
1967-68	V8 4.7L 289ci	Diaph Type, 10" Disc w/1-1/16" X 10 X 43/64"	TAT-5304
1968-70	V8 5.0L 302ci	Diaph Type, 10", Lever Type, 10.4" Disc w/1-1/16" X 10 X 43/64"	TAT-5304
1977-88	V8 5.0L 302ci	w/1-1/16" X 10 X 43/64"	TAT-5304
1969-74	V8 5.8L 351ci	11" Diaph, Lever Type w/1-1/16" X 10 X 43/64"	TAT-5304
1967-69	V8 6.4L 390ci	11" Diaph, Lever Type w/1-1/16" X 10 X 43/64"	TAT-5304
<b>CYCLONE</b>			
1964	V8 4.3L 260ci	Diaph Type, 10" Disc w/1-1/16" X 10 X 43/64"	TAT-5304
1968-70	V8 5.0L 302ci	Diaph Type, 10" Disc w/1-1/16" X 10 X 43/64"	TAT-5304
1971	V8 5.8L 351ci	11" Diaph, Lever Type w/1-1/16" X 10 X 43/64"	TAT-5304
1966-69	V8 6.4L 390ci	11" Lever Type w/1-1/4" X 10 X 63/64"	TAT-5304
<b>LYNX, LN7</b>			
1981-82	L4 1.6L 98ci	w/7/8" X 20 X 37/64"	TAT-5310
1983-85	L4 1.6L 98ci	Gas w/7/8" X 20 X 37/64"	TAT-5310
1985-87	L4 1.9L 116ci	Includes trans. quill repair sleeve w/7/8" X 20 X 37/64"	TAT-5310
1984-87	L4 2.0L 122ci	Diesel w/7/8" X 20 X 37/64"	TAT-5310
<b>MARQUIS</b>			
1983	L4 2.3L 140ci	w/1" X 23 X 19/32"	TAT-5311
1971	V8 5.8L 351ci	11" Lever Type w/1-1/4" X 10 X 63/64"	TAT-5304
1968-70	V8 6.4L 390ci	11" Lever Type w/1-1/4" X 10 X 63/64"	TAT-5304
1967	V8 6.7L 410ci	11" Lever Type w/1-1/4" X 10 X 63/64"	TAT-5304
<b>MONARCH</b>			
1975-77	L6 3.3L 200ci	9" Lever, Diaph Replacement Type w/1-1/16" X 10 X 43/64"	TAT-5304
1975-80	L6 4.1L 250ci	Diaph Type, 10" Disc w/1-1/16" X 10 X 43/64"	TAT-5304
1975-79	V8 5.0L 302ci	Diaph Type, 10" Disc w/1-1/16" X 10 X 43/64"	TAT-5304
<b>MONTEGO</b>			
1969-73	L6 4.1L 250ci	Diaph Type, 10" Disc w/1-1/16" X 10 X 43/64"	TAT-5304
1974	V8 5.0L 302ci	11" Diaph, Lever Type w/1-1/16" X 10 X 43/64"	TAT-5304
1969-73	V8 5.0L 302ci	Diaph Type, 10" Disc w/1-1/16" X 10 X 43/64"	TAT-5304
1969-74	V8 5.8L 351ci	11" Diaph, Lever Type w/1-1/16" X 10 X 43/64"	TAT-5304
1968-69	V8 6.4L 390ci	11" Diaph, Lever Type w/1-1/16" X 10 X 43/64"	TAT-5304
<b>MONTEREY</b>			
1962	V8 4.8L 292ci	11" Lever, 10" Diaph Type w/1" X 23 X 19/32"	TAT-5311
1971	V8 5.8L 351ci	11" Lever Type w/1-1/16" X 10 X 43/64"	TAT-5304

# CLUTCH ALIGNMENT TOOLS

Year	Engine	Remark	Part
<b>MERCURY (con't)</b>			
<b>MONTEREY (con't)</b>			
1961-62	V8 5.8L 352ci	11" Lever Type w/1-1/16" X 10 X 43/64"	TAT-5311
1963-70	V8 6.4L 390ci	11" Lever Type w/1" X 23 X 19/32"	TAT-5304
1966-67	V8 6.7L 410ci	11" Lever Type w/1" X 23 X 19/32"	TAT-5304
<b>MYSTIQUE</b>			
1995-00	L4 2.0L 121ci	CSC	TAT-5408
1995-00	V6 2.5L 155ci	CSC	TAT-5408
<b>PARK LANE</b>			
1964-68	V8 6.4L 390ci	11" Lever Type w/1-1/16" X 10 X 43/64"	TAT-5304
1966-67	V8 6.7L 410ci	11" Lever Type w/1-1/16" X 10 X 43/64"	TAT-5304
<b>SABLE</b>			
1986	L4 2.5L 153ci	Includes trans. quill repair sleeve w/7/8" X 20 X 37/64"	TAT-5310
<b>TOPAZ</b>			
1984-86	L4 2.0L 122ci	Diesel w/7/8" X 20 X 37/64"	TAT-5310
1984-94	L4 2.3L 140ci	Includes trans. quill repair sleeve, GAS w/7/8" X 20 X 37/64"	TAT-5310
1992-94	V6 3.0L 182ci	Includes trans. quill repair sleeve, GAS w/7/8" X 20 X 37/64"	TAT-5310
<b>TRACER</b>			
1987-89	L4 1.6L 98ci		TAT-5337
1991-95	L4 1.8L 112ci	w/15/16" X 22 X 37/64"	TAT-5307
1991-96	L4 1.9L 116ci	w/7/8" X 20 X 37/64"	TAT-5310
1997-99	L4 2.0L 122ci	w/15/16" X 22 X 37/64"	TAT-5307
<b>ZEPHYR</b>			
1978	L4 2.3L 140ci	w/1" X 23 X 19/32"	TAT-5311
1979-83	L4 2.3L 140ci	Ford, German Transmission w/1" X 23 X 19/32"	TAT-5311
1978-81	L6 3.3L 200ci	9" Diaph Type w/1-1/16" X 10 X 43/64"	TAT-5304
1978-79	V8 5.0L 302ci	Diaph Type, 10" Disc w/1-1/16" X 10 X 43/64"	TAT-5304
<b>MERKUR</b>			
<b>XR4TI</b>			
1985-89	L4 2.3L 140ci		TAT-5408
<b>MITSUBISHI</b>			
<b>3000GT</b>			
1991-96	V6 3.0L 2972cc	w/o Turbo w/7/8" X 20 X 37/64"	TAT-5310
1991-98	V6 3.0L 2972cc	Turbo, 4WD w/1" X 23 X 47/64"	TAT-5309
<b>CORDIA, TREDIA</b>			
1984-88	L4 1.8L 1795cc	Turbo w/7/8" X 20 X 41/64"	TAT-5360
1984-88	L4 2.0L 1997cc	w/7/8" X 20 X 41/64"	TAT-5360
<b>ECLIPSE</b>			
1990-94	L4 1.8L 1755cc	w/7/8" X 20 X 41/64"	TAT-5360
1990-93	L4 2.0L 1997cc	To 12/93 4WD, Turbo w/7/8" X 20 X 37/64"	TAT-5310
1990-94	L4 2.0L 1997cc	From 4/90 w/7/8" X 20 X 41/64"	TAT-5360
1994-99	L4 2.0L 1997cc	Turbo w/7/8" X 20 X 37/64"	TAT-5310
1996-01	L4 2.4L 2351cc	w/7/8" X 20 X 37/64"	TAT-5310
<b>EXPO, EXPO LRV</b>			
1992-94	L4 1.8L 1834cc	w/7/8" X 20 X 41/64"	TAT-5360
1992-95	L4 2.4L 2351cc	w/7/8" X 20 X 37/64"	TAT-5310
<b>GALANT</b>			
1989-93	L4 2.0L 1997cc	2WD w/7/8" X 20 X 41/64"	TAT-5360
1991-92	L4 2.0L 1997cc	4WD, Turbo w/7/8" X 20 X 37/64"	TAT-5310
1987-01	L4 2.4L 2351cc	2WD w/7/8" X 20 X 37/64"	TAT-5310
<b>MIRAGE</b>			
1985-01	L4 1.5L 1468cc	4 & 5 Speed w/7/8" X 20 X 41/64"	TAT-5360
1999-01	L4 1.5L 1468cc	w/7/8" X 20 X 41/64"	TAT-5360
1985-89	L4 1.6L 1597cc	Turbo w/7/8" X 20 X 41/64"	TAT-5360
1991-92	L4 1.6L 1597cc	5 Speed w/7/8" X 20 X 41/64"	TAT-5360
1993-99	L4 1.8L 1834cc	5 Speed w/7/8" X 20 X 41/64"	TAT-5360
2000-01	L4 1.8L 1834cc	w/7/8" X 20 X 41/64"	TAT-5360
<b>PRECIS</b>			
1987-93	L4 1.5L 1468cc	w/7/8" X 20 X 41/64"	TAT-5360

# CLUTCH ALIGNMENT TOOLS

Year	Engine	Remark	Part
<b>MITSUBISHI (con't)</b>			
<b>SIGMA</b>			
1989	V6 3.0L 2972cc	w/7/8" X 20 X 37/64"	TAT-5310
<b>STARION</b>			
1986-87	L4 2.6L 2555cc	To 5/87 Turbo, w/Intercooler w/1" X 23 X 19/32"	TAT-5311
1983-86	L4 2.6L 2555cc	Turbo w/1" X 23 X 19/32"	TAT-5311
1988-89	L4 2.6L 2555cc		TAT-5408
<b>MITSUBISHI TRUCKS</b>			
<b>MIGHTY MAX</b>			
1983-85	L4 2.3L 2346cc	Turbo w/1" X 23 X 19/32"	TAT-5311
1983-89	L4 2.6L 2555cc	w/1" X 23 X 19/32"	TAT-5311
1990-94	V6 3.0L 2972cc		TAT-5401
<b>MONTERO</b>			
1983-89	L4 2.6L 2555cc	w/1" X 23 X 19/32"	TAT-5311
1989-96	V6 3.0L 2972cc		TAT-5401
1999	V6 3.5L 3497cc		TAT-5401
<b>MONTERO SPORT</b>			
1997-99	L4 2.4L 2351cc	w/1" X 23 X 19/32"	TAT-5311
<b>VAN</b>			
1987-90	L4 2.4L 2351cc	w/1" X 23 X 19/32"	TAT-5311
<b>NISSAN</b>			
<b>1200</b>			
1971-73	L4 1.2L 1171cc		TAT-5305
<b>200SX</b>			
1995-98	L4 1.6L 1597cc		TAT-5209
1984-87	L4 1.8L 1809cc	Turbo w/1" X 24 X 41/64"	TAT-5300
1977-81	L4 2.0L 1952cc	Turbo w/1" X 24 X 41/64"	TAT-5300
1984-88	L4 2.0L 1974cc	Turbo w/1" X 24 X 41/64"	TAT-5300
1995-98	L4 2.0L 1998cc		TAT-5209
1982-83	L4 2.2L 2187cc	Turbo w/1" X 24 X 41/64"	TAT-5300
1987-88	V6 3.0L 2960cc	Turbo w/1" X 24 X 41/64"	TAT-5300
<b>210</b>			
1979-82	L4 1.2L 1237cc	w/13/16" X 18 X 15/32"	TAT-5305
1979-82	L4 1.4L 1393cc	w/13/16" X 18 X 15/32"	TAT-5305
1980-82	L4 1.5L 1488cc	w/13/16" X 18 X 15/32"	TAT-5305
<b>240SX</b>			
1989-90	L4 2.4L 2389cc	SOHC w/1" X 24 X 41/64"	TAT-5300
1991-98	L4 2.4L 2389cc	DOHC w/1" X 24 X 41/64"	TAT-5300
<b>240Z</b>			
1970-73	L6 2.4L 2393cc	w/1" X 24 X 41/64"	TAT-5300
<b>260Z</b>			
1974-75	L6 2.6L 2565cc	w/1" X 24 X 41/64"	TAT-5300
<b>280Z, 280ZX</b>			
1975-93	L6 2.8L 2753cc	w/1" X 24 X 41/64"	TAT-5300
<b>300ZX</b>			
1984-96	V6 3.0L 2960cc	w/1" X 24 X 41/64"	TAT-5300
<b>310</b>			
1982	L4 1.5L 1488cc		TAT-5391
<b>510</b>			
1968-73	L4 1.6L 1595cc	w/1" X 24 X 41/64"	TAT-5300
1978-81	L4 2.0L 1952cc	w/1" X 24 X 41/64"	TAT-5300
<b>610, 710</b>			
1973-74	L4 1.8L 1770cc	w/1" X 24 X 41/64"	TAT-5300
1974-77	L4 2.0L 1952cc	w/1" X 24 X 41/64"	TAT-5300
<b>810</b>			
1977-81	L6 2.4L 2393cc	w/1" X 24 X 41/64"	TAT-5300
1981	L6 2.8L 2793cc	Diesel w/1" X 24 X 41/64"	TAT-5300
<b>ALTIMA</b>			
1993-01	L4 2.4L 2389cc	w/1" X 24 X 41/64"	TAT-5300

# CLUTCH ALIGNMENT TOOLS

Year	Engine	Remark	Part
<b>NISSAN (con't)</b>			
<b>B210</b>			
1974	L4 1.3L 1288cc	w/13/16" X 18 X 15/32"	TAT-5305
1975-78	L4 1.4L 1393cc	4 Speed w/13/16" X 18 X 15/32"	TAT-5305
1975-78	L4 1.4L 1393cc	5 Speed w/1" X 24 X 15/32"	TAT-5322
<b>MAXIMA</b>			
1982-84	L6 2.4L 2393cc	w/1" X 24 X 41/64"	TAT-5300
1982-83	L6 2.8L 2793cc	Diesel w/1" X 24 X 41/64"	TAT-5300
1985-94	V6 3.0L 2960cc	w/1" X 24 X 41/64"	TAT-5300
1995-99	V6 3.0L 2988cc	w/1" X 24 X 41/64"	TAT-5300
<b>MULTI</b>			
1986-88	L4 2.0L 1974cc	Canada w/1" X 24 X 41/64"	TAT-5300
<b>NX</b>			
1991-93	L4 1.6L 1597cc		TAT-5209
1991-93	L4 2.0L 1998cc		TAT-5209
<b>PULSAR</b>			
1983	L4 1.6L 1597cc	SOHC	TAT-5391
<b>PULSAR NX</b>			
1988-89	L4 1.8L 1809cc	w/1" X 24 X 41/64"	TAT-5300
<b>SENTRA</b>			
1982-83	L4 1.5L 1488cc		TAT-5391
1984-99	L4 1.6L 1597cc		TAT-5391
1983-87	L4 1.7L 1688cc		TAT-5391
2000-01	L4 1.8L 1809cc		TAT-5209
1991-01	L4 2.0L 1998cc		TAT-5209
<b>STANZA</b>			
1982-85	L4 2.0L 1974cc		TAT-5391
1986-89	L4 2.0L 1974cc	w/1" X 24 X 41/64"	TAT-5300
1990-92	L4 2.4L 2389cc	w/1" X 24 X 41/64"	TAT-5300
<b>NISSAN TRUCKS</b>			
<b>520 PICKUP, 521 PICKUP</b>			
1965-69	L4 1.3L 1299cc	w/1" X 24 X 41/64"	TAT-5300
1970-72	L4 1.6L 1595cc	To 2/72 w/1" X 24 X 41/64"	TAT-5300
<b>620 PICKUP</b>			
1972-73	L4 1.6L 1595cc	w/1" X 24 X 41/64"	TAT-5300
1974	L4 1.8L 1770cc	w/1" X 24 X 41/64"	TAT-5300
1975-79	L4 2.0L 1952cc	w/1" X 24 X 41/64"	TAT-5300
<b>720</b>			
1980-85	L4 2.0L 1952cc	w/1" X 24 X 41/64"	TAT-5300
1981-83	L4 2.2L 2164cc	w/1" X 24 X 41/64"	TAT-5300
1981-83	L4 2.2L 2187cc	w/1" X 24 X 41/64"	TAT-5300
1983-86	L4 2.4L 2389cc	w/1" X 24 X 41/64"	TAT-5300
1983-86	L4 2.5L 2488cc	w/1" X 24 X 41/64"	TAT-5300
<b>AXXESS</b>			
1990-91	L4 2.4L 2389cc	w/1" X 24 X 41/64"	TAT-5300
<b>D21</b>			
1986-94	L4 2.4L 2389cc	w/1" X 24 X 41/64"	TAT-5300
1986-94	V6 3.0L 2960cc	w/1" X 24 X 41/64"	TAT-5300
<b>FRONTIER</b>			
1998-02	L4 2.4L 2389cc	w/1" X 24 X 41/64"	TAT-5300
1999-02	V6 3.3L 3275cc	w/1" X 24 X 41/64"	TAT-5300
<b>PATHFINDER</b>			
1987-88	L4 2.4L 2389cc	From 7/87 w/1" X 24 X 41/64"	TAT-5300
1987-95	V6 3.0L 2960cc	w/1" X 24 X 41/64"	TAT-5300
1996-00	V6 3.3L 3275cc	w/1" X 24 X 41/64"	TAT-5300
2001	V6 3.5L 3498cc	w/1" X 24 X 41/64"	TAT-5300
<b>PICKUP</b>			
1995-97	L4 2.4L 2389cc	OE Ductile Pressure Plate Option w/1" X 24 X 41/64"	TAT-5300
1995-96	V6 3.0L 2960cc	Hardbody, Gas w/1" X 24 X 41/64"	TAT-5300

# CLUTCH ALIGNMENT TOOLS

Year	Engine	Remark	Part
<b>NISSAN TRUCKS (con't)</b>			
<b>VAN</b>			
1987-88	L4 2.4L 2389cc	w/1" X 24 X 41/64"	TAT-5300
<b>XTERRA</b>			
2000-02	L4 2.4L 2389cc	5 Speed w/1" X 24 X 41/64"	TAT-5300
2000-02	V6 3.3L 3275cc	5 Speed w/1" X 24 X 41/64"	TAT-5300
<b>OLDSMOBILE</b>			
<b>442</b>			
1968-70	V8 5.7L 350ci	w/W-31, wo/W-31 Trans., 4 BBL, 3 Speed w/1-1/8" X 10 X 19/32"	TAT-5301
1965-69	V8 6.6L 400ci	11" Diaph Type w/1-1/8" X 10 X 19/32"	TAT-5301
<b>ACHIEVA</b>			
1992-94	L4 2.3L 138ci	CSC, SOHC, DOHC, External slave cylinder w/1" X 14 X 53/64"	TAT-5342
1996-97	L4 2.4L 146ci	DOHC, CSC w/1" X 14 X 53/64"	TAT-5342
<b>CALAIS</b>			
1985-87	L4 2.5L 151ci	w/1" X 14 X 53/64"	TAT-5342
<b>CUTLASS</b>			
1977-81	V6 3.8L 231ci	w/1-1/8" X 10 X 19/32"	TAT-5301
1975-79	V8 4.3L 260ci	w/1-1/8" X 10 X 19/32"	TAT-5301
1978-79	V8 5.0L 305ci	w/1-1/8" X 10 X 19/32"	TAT-5301
1965-67	V8 5.4L 330ci	11" Diaph Type w/1-1/8" X 10 X 19/32"	TAT-5301
1968-73	V8 5.7L 350ci	w/W-31, wo/W-31 Trans., 2 BBL, 4 BBL, 3, 4 Speed w/1-1/8" X 10 X 19/32"	TAT-5301
1974-76	V8 5.7L 350ci	w/1-1/8" X 26 X 19/32"	TAT-5313
1965-67	V8 6.6L 400ci	11" Diaph Type w/1-1/8" X 10 X 19/32"	TAT-5301
<b>CUTLASS CALAIS</b>			
1988-91	L4 2.3L 138ci	w/1" X 14 X 53/64"	TAT-5342
1990	L4 2.3L 140ci	w/1" X 14 X 53/64"	TAT-5342
<b>CUTLASS CIERA, CUTLASS CRUISER</b>			
1988-89	V6 2.8L 173ci	w/1" X 14 X 53/64"	TAT-5342
<b>CUTLASS SUPREME</b>			
1990	L4 2.3L 138ci	w/1" X 14 X 53/64"	TAT-5342
1990	L4 2.3L 140ci	w/1" X 14 X 53/64"	TAT-5342
1988-89	V6 2.8L 173ci	w/1" X 14 X 53/64"	TAT-5342
1989-90	V6 3.1L 189ci	w/1" X 14 X 53/64"	TAT-5342
1991-92	V6 3.4L 207ci	w/1" X 23 X 19/32"	TAT-5311
<b>DELMONT 88, DELTA 88, DYNAMIC</b>			
1967	V8 5.4L 330ci	11" Diaph Type w/1-1/8" X 10 X 19/32"	TAT-5301
1968-70	V8 5.7L 350ci	w/W-31, wo/W-31 Trans., 4 BBL, 3 Speed w/1-1/8" X 10 X 19/32"	TAT-5301
1971-73	V8 5.7L 350ci	2 Barrel, 3 Speed w/1-1/8" X 10 X 19/32"	TAT-5301
1971-73	V8 5.7L 350ci	2Bbl. 4Bbl 4 Speed w/1-1/8" X 26 X 19/32"	TAT-5313
1974-76	V8 5.7L 350ci	w/1-1/8" X 26 X 19/32"	TAT-5313
1965-67	V8 7.0L 425ci	w/1-1/8" X 10 X 19/32"	TAT-5301
<b>F85</b>			
1964-65	V6 3.7L 225ci	w/1-1/8" X 10 X 19/32"	TAT-5301
1965-67	V8 5.4L 330ci	11" Diaph Type w/1-1/8" X 10 X 19/32"	TAT-5301
1968-70	V8 5.7L 350ci	w/W-31, wo/W-31 Trans., 4 BBL, 3 Speed w/1-1/8" X 10 X 19/32"	TAT-5301
1971-72	V8 5.7L 350ci	2 Barrel, 3 Speed w/1-1/8" X 10 X 19/32"	TAT-5301
1971-72	V8 5.7L 350ci	2Bbl. 4Bbl 4 Speed w/1-1/8" X 26 X 19/32"	TAT-5313
1965-66	V8 6.6L 400ci	11" Diaph Type w/1-1/8" X 10 X 19/32"	TAT-5301
<b>FIRENZA</b>			
1983-86	L4 1.8L 112ci	4 Speed, 8.5" Disc 5 Speed w/1" X 14 X 53/64"	TAT-5342
1987-88	L4 2.0L 121ci	w/1" X 14 X 53/64"	TAT-5342
1983-88	L4 2.0L 122ci	4, 5 Speed, 8", 9-1/8" Disc w/1" X 14 X 53/64"	TAT-5342
1985-87	V6 2.8L 173ci	Solid Flywheel # FW-111 w/1" X 14 X 53/64"	TAT-5342
<b>OMEGA</b>			
1980-84	L4 2.5L 151ci	9-1/8" Disc w/1" X 14 X 53/64"	TAT-5342
1980-84	V6 2.8L 173ci	9-1/8" Disc w/1" X 14 X 53/64"	TAT-5342
1977-79	V6 3.8L 231ci	w/1-1/8" X 10 X 19/32"	TAT-5301
1975-76	V8 4.3L 260ci	w/1-1/8" X 10 X 19/32"	TAT-5301
1977-79	V8 5.0L 305ci	w/1-1/8" X 10 X 19/32"	TAT-5301
1973	V8 5.7L 350ci	2 Barrel, 3 Speed w/1-1/8" X 10 X 19/32"	TAT-5301



# CLUTCH ALIGNMENT TOOLS

Year	Engine	Remark	Part
<b>OLDSMOBILE (con't)</b>			
<b>OMEGA (con't)</b>			
1974-76	V8 5.7L 350ci	2Bbl. 4Bbl. 4 Speed w/1-1/8" X 26 X 19/32"	TAT-5313
<b>STARFIRE</b>			
1976-77	L4 2.3L 140ci	9-1/8" Disc w/1-1/8" X 10 X 19/32"	TAT-5301
1978-80	L4 2.5L 151ci	9-1/8" Disc w/1-1/8" X 10 X 19/32"	TAT-5301
1975-76	V6 3.8L 231ci	w/1-1/8" X 10 X 19/32"	TAT-5301
1977-80	V6 3.8L 231ci	w/1-1/8" X 10 X 19/32"	TAT-5301
1977-79	V8 5.0L 305ci	w/1-1/8" X 10 X 19/32"	TAT-5301
1965-66	V8 7.0L 425ci	w/1-1/8" X 10 X 19/32"	TAT-5301
<b>VISTA CRUISER</b>			
1964-65	V6 3.7L 225ci	w/1-1/8" X 10 X 19/32"	TAT-5301
1965-67	V8 5.4L 330ci	11" Diaph Type w/1-1/8" X 10 X 19/32"	TAT-5301
1968-70	V8 5.7L 350ci	w/W-31, wo/W-31 Trans., 4 BBL, 3 Speed w/1-1/8" X 10 X 19/32"	TAT-5301
1971-73	V8 5.7L 350ci	2 Barrel, 3 Speed w/1-1/8" X 10 X 19/32"	TAT-5301
1974-76	V8 5.7L 350ci	2Bbl. 4Bbl. 4 Speed w/1-1/8" X 26 X 19/32"	TAT-5313
<b>PEUGEOT</b>			
<b>504</b>			
1974-79	L4 2.0L 1971cc	Gas w/1-3/32 X 10 X 5/8"	TAT-5356
1975-76	L4 2.1L 2112cc	Diesel w/1-3/32 X 10 X 5/8"	TAT-5356
1977-83	L4 2.3L 2304cc	Diesel w/1-3/32 X 10 X 5/8"	TAT-5356
<b>505</b>			
1980-87	L4 2.0L 1971cc	Gas w/1-3/32 X 10 X 5/8"	TAT-5356
1985-91	L4 2.2L 2155cc	Turbo, Gas w/1-3/32 X 10 X 5/8"	TAT-5356
1987-89	L4 2.2L 2165cc	Gas w/1-3/32 X 10 X 5/8"	TAT-5356
1980-85	L4 2.3L 2304cc	Diesel, Turbo Diesel w/1-3/32 X 10 X 5/8"	TAT-5356
1985	L4 2.3L 2309cc	Turbo Diesel w/1-3/32 X 10 X 5/8"	TAT-5356
1987-88	L4 2.5L 2498cc	w/1-3/32 X 10 X 5/8"	TAT-5356
1987-89	V6 2.8L 2849cc	Gas w/1-3/32 X 10 X 5/8"	TAT-5356
<b>604</b>			
1982-84	L4 2.3L 2304cc	Diesel w/1-3/32 X 10 X 5/8"	TAT-5356
1977-78	L6 2.7L 2664cc	w/1-3/32 X 10 X 5/8"	TAT-5356
1979-80	V6 2.8L 2849cc	w/1-3/32 X 10 X 5/8"	TAT-5356
<b>PLYMOUTH</b>			
<b>ACCLAIM</b>			
1989	L4 2.5L 153ci	w/7/8" X 18 X 45/64"	TAT-5363
1990-93	L4 2.5L 153ci		TAT-5203
<b>ARROW</b>			
1976-80	L4 1.6L 98ci	w/7/8" X 20 X 39/64"	TAT-5337
1976-78	L4 2.0L 122ci	w/7/8" X 20 X 39/64"	TAT-5337
1979-80	L4 2.6L 156ci	w/1" X 23 X 19/32"	TAT-5311
<b>BARRACUDA, CUDA</b>			
1968-72	L6 3.7L 225ci	9-1/4", 10" Lever, 10" Disc w/1" X 23 X 47/64"	TAT-5309
1968-74	V8 5.2L 318ci	w/1" X 23 X 47/64"	TAT-5309
1968-73	V8 5.6L 340ci	w/1" X 23 X 47/64"	TAT-5309
1974	V8 5.9L 360ci	11" Diaph Type w/1" X 23 X 47/64"	TAT-5309
1968-71	V8 6.3L 383ci	w/1" X 23 X 47/64"	TAT-5309
<b>BELVEDERE</b>			
1960-70	L6 3.7L 225ci	11" Diaph, 9-1/4", 10" Lever, 10" Disc w/1" X 23 X 47/64"	TAT-5309
1964-68	V8 4.5L 273ci	10" Disc w/1" X 23 X 47/64"	TAT-5309
1961-70	V8 5.2L 318ci	w/1" X 23 X 47/64"	TAT-5309
1963-65	V8 5.9L 361ci	w/1" X 23 X 47/64"	TAT-5309
1969-70	V8 6.3L 383ci	11" Diaph Type w/1" X 23 X 47/64"	TAT-5309
1964-67	V8 7.0L 426ci	w/1" X 23 X 47/64"	TAT-5309
<b>CHAMP</b>			
1979-82	L4 1.4L 1410cc	w/7/8" X 20 X 41/64"	TAT-5360
1979-82	L4 1.6L 98ci	w/7/8" X 20 X 41/64"	TAT-5360
<b>DUSTER</b>			
1970-74	L6 3.2L 198ci	11" Diaph, 9-1/4", 10" Lever, w/1" X 23 X 47/64"	TAT-5309
1970-76	L6 3.7L 225ci	11" Diaph, 9-1/4", 10" Lever Type, w/1" X 23 X 47/64"	TAT-5309

# CLUTCH ALIGNMENT TOOLS

Year	Engine	Remark	Part
<b>PLYMOUTH (con't)</b>			
<b>DUSTER (con't)</b>			
1970-76	V8 5.2L 318ci	11" Diaph Type w/1" X 23 X 47/64"	TAT-5309
1970-73	V8 5.6L 340ci	11" Diaph Type w/1" X 23 X 47/64"	TAT-5309
1974-75	V8 5.9L 360ci	11" Diaph Type w/1" X 23 X 47/64"	TAT-5309
<b>FURY</b>			
1960-76	L6 3.7L 225ci	11" Diaph, 9-1/4", 10" Lever, 10" Disc w/1" X 23 X 47/64"	TAT-5309
1961	V8 5.2L 318ci	10" 10-1/2" Disc w/1" X 23 X 47/64"	TAT-5309
1968-76	V8 5.2L 318ci	11" Diaph Type w/1" X 23 X 47/64"	TAT-5309
1971-76	V8 5.9L 360ci	11" Diaph Type w/1" X 23 X 47/64"	TAT-5309
1961	V8 5.9L 361ci	10-1/2" Disc w/1" X 23 X 47/64"	TAT-5309
1961-63	V8 5.9L 361ci	10" Disc w/1" X 10 X 49/64"	TAT-5349
1962-66	V8 5.9L 361ci	11" Diaph Type w/1" X 23 X 47/64"	TAT-5309
1968-69	V8 6.3L 383ci	11" Diaph Type w/1" X 23 X 47/64"	TAT-5309
1972-74	V8 6.6L 400ci	11" Diaph Type w/1" X 23 X 47/64"	TAT-5309
1964-65	V8 7.0L 426ci	w/1" X 23 X 47/64"	TAT-5309
<b>GTX</b>			
1967	V8 5.2L 318ci	11" Diaph Type w/1" X 23 X 47/64"	TAT-5309
<b>HORIZON, TURISMO</b>			
1983-86	L4 1.6L 97ci	w/7/8" X 18 X 45/64"	TAT-5363
1978-83	L4 1.7L 105ci	A412 Trans (VW) w/5-5/32" O.D. X 45/64" Nose Dia.	TAT-5378
1981-83	L4 1.7L 105ci	A460 Trans (New Process) w/7/8" X 18 X 45/64"	TAT-5363
1981-90	L4 2.2L 135ci	w/7/8" X 18 X 45/64"	TAT-5363
<b>LASER</b>			
1990-94	L4 1.8L 107ci	w/7/8" X 20 X 41/64"	TAT-5360
1990-94	L4 2.0L 122ci	w/o Turbo w/7/8" X 20 X 41/64"	TAT-5360
1990-94	L4 2.0L 122ci	Turbo w/7/8" X 20 X 37/64"	TAT-5310
<b>NEON</b>			
1995-99	L4 2.0L 122ci		TAT-5212
<b>RELIANT</b>			
1981-89	L4 2.2L 135ci	w/7/8" X 18 X 45/64"	TAT-5363
1986-89	L4 2.5L 153ci	w/7/8" X 18 X 45/64"	TAT-5363
1981-85	L4 2.6L 156ci	w/7/8" X 18 X 45/64"	TAT-5363
<b>ROADRUNNER</b>			
1968	V8 4.5L 273ci	10" Disc w/1" X 23 X 47/64"	TAT-5309
1968-75	V8 5.2L 318ci	w/1" X 23 X 47/64"	TAT-5309
1971-73	V8 5.6L 340ci	w/1" X 23 X 47/64"	TAT-5309
1974	V8 5.9L 360ci	11" Diaph Type w/1" X 23 X 47/64"	TAT-5309
1969-71	V8 6.3L 383ci	11" Diaph Type w/1" X 23 X 47/64"	TAT-5309
1972-74	V8 6.6L 400ci	11" Diaph Type w/1" X 23 X 47/64"	TAT-5309
1968-71	V8 7.0L 426ci	w/1" X 23 X 47/64"	TAT-5309
<b>SAPORO</b>			
1978-79	L4 1.6L 98ci	w/7/8" X 20 X 39/64"	TAT-5337
1978-83	L4 2.6L 156ci	w/1" X 23 X 19/32"	TAT-5311
<b>SATELLITE</b>			
1966-74	L6 3.7L 225ci	9-1/4", 10" Lever, 11" Diaph, 10" Disc w/1" X 23 X 47/64"	TAT-5309
1965-68	V8 4.5L 273ci	10" Disc w/1" X 23 X 47/64"	TAT-5309
1965-74	V8 5.2L 318ci	w/1" X 23 X 47/64"	TAT-5309
1972	V8 5.6L 340ci	w/1" X 23 X 47/64"	TAT-5309
1974	V8 5.9L 360ci	11" Diaph Type w/1" X 23 X 47/64"	TAT-5309
1969-71	V8 6.3L 383ci	11" Diaph Type w/1" X 23 X 47/64"	TAT-5309
1972-74	V8 6.6L 400ci	11" Diaph Type w/1" X 23 X 47/64"	TAT-5309
1965-67	V8 7.0L 426ci	w/1" X 23 X 47/64"	TAT-5309
<b>SAVOY</b>			
1960-62	L6 3.7L 225ci	10" Disc w/1" X 23 X 47/64"	TAT-5309
1960-62	L6 3.7L 225ci	Lever Type, 9-1/4" Disc w/1" X 23 X 47/64"	TAT-5309
1961-64	V8 5.2L 318ci	10" Disc w/1" X 23 X 47/64"	TAT-5309
<b>SUNDANCE</b>			
1987-90	L4 2.2L 135ci	w/7/8" X 18 X 45/64"	TAT-5363
1991-94	L4 2.2L 135ci		TAT-5203

# CLUTCH ALIGNMENT TOOLS

Year	Engine	Remark	Part
<b>PLYMOUTH (con't)</b>			
<b>SUNDANCE (con't)</b>			
1989-90	L4 2.5L 153ci	Turbo w/7/8" X 18 X 45/64"	TAT-5363
1991-94	L4 2.5L 153ci		TAT-5203
1993-94	V6 3.0L 181ci		TAT-5203
<b>VALIANT</b>			
1960-69	L6 2.8L 170ci	9-1/4", 10" Lever, 11" Diaph, 10" Disc w/1" X 23 X 47/64"	TAT-5309
1970-74	L6 3.2L 198ci	9-1/4", 10" Lever, 11" Diaph, 10" Disc w/1" X 23 X 47/64"	TAT-5309
1961-76	L6 3.7L 225ci	9-1/4", 10" Lever, 11" Diaph, 10" Disc w/1" X 23 X 47/64"	TAT-5309
1964-69	V8 4.5L 273ci	10" Disc w/1" X 23 X 47/64"	TAT-5309
1968-76	V8 5.2L 318ci	11" Diaph Type w/1" X 23 X 47/64"	TAT-5309
1976	V8 5.9L 360ci	11" Diaph Type w/1" X 23 X 47/64"	TAT-5309
<b>VOLARE</b>			
1976-80	L6 3.7L 225ci	9-1/4", 10" Lever, 11" Diaph, 10" Disc w/1" X 23 X 47/64"	TAT-5309
1976-80	V8 5.2L 318ci	11" Diaph Type w/1" X 23 X 47/64"	TAT-5309
1976-80	V8 5.9L 360ci	11" Diaph Type w/1" X 23 X 47/64"	TAT-5309
<b>PLYMOUTH TRUCKS</b>			
<b>TRAILDUSTER</b>			
1975-78	L6 3.7L 225ci	12" Lever Type w/1" X 10 X 49/64"	TAT-5349
1975-80	L6 3.7L 225ci	11" Diaph Type A833 Trans w/1" X 23 X 47/64"	TAT-5309
1974-81	V8 5.2L 318ci	11" Diaph Type w/1" X 23 X 47/64"	TAT-5309
1974-81	V8 5.9L 360ci	11" Diaph Type w/1" X 23 X 47/64"	TAT-5309
<b>VOYAGER</b>			
1984-87	L4 2.2L 135ci	w/7/8" X 18 X 45/64"	TAT-5363
1987-90	L4 2.5L 153ci	w/7/8" X 18 X 45/64"	TAT-5363
1991-92	L4 2.5L 153ci	w/1-1/8" X 21 X 15/32"	TAT-5203
1984-86	L4 2.6L 156ci	w/7/8" X 18 X 45/64"	TAT-5363
1990	V6 3.0L 181ci	w/7/8" X 18 X 45/64"	TAT-5363
1991-92	V6 3.0L 181ci		TAT-5203
<b>PONTIAC</b>			
<b>6000</b>			
1984	L4 2.5L 151ci	9-1/8" Disc w/1" X 14 X 53/64"	TAT-5342
1986-89	V6 2.8L 173ci	w/1" X 14 X 53/64"	TAT-5342
<b>ASTRE</b>			
1975-77	L4 2.3L 140ci	9-1/8" Disc w/1-1/8" X 10 X 19/32"	TAT-5301
1977	L4 2.5L 151ci	9-1/8" Disc w/1-1/8" X 10 X 19/32"	TAT-5301
<b>BONNEVILLE, CATALINA, CHIEFTAIN, EXECUTIVE, GRANDVILLE</b>			
1957	V8 5.7L 347ci	RWD w/1-1/8" X 10 X 19/32"	TAT-5301
1970-73	V8 5.7L 350ci	3 Speed, RWD w/1-1/8" X 10 X 19/32"	TAT-5301
1970-77	V8 5.7L 350ci	4 Speed, RWD w/1-1/8" X 26 X 19/32"	TAT-5313
1959-66	V8 6.4L 389ci	11" Disc, 12 Lever Type 2bbl, 4bbl, RWD w/1-1/8" X 10 X 19/32"	TAT-5301
1968-70	V8 6.6L 400ci	10" Disc, RWD w/1-1/8" X 10 X 19/32"	TAT-5301
1970-72	V8 6.6L 400ci	3 Speed, RWD w/1-1/8" X 10 X 19/32"	TAT-5301
1971-72	V8 6.6L 400ci	4 Speed, RWD w/1-1/8" X 26 X 19/32"	TAT-5313
1967-69	V8 7.0L 428ci	RWD w/1-1/8" X 10 X 19/32"	TAT-5301
<b>FIREBIRD</b>			
1982	L4 2.5L 151ci	w/1-1/8" X 10 X 19/32"	TAT-5301
1984-86	L4 2.5L 151ci	w/1" X 14 X 19/32"	TAT-5312
1967	L6 3.8L 230ci	10" Disc, RWD w/1-1/8" X 10 X 19/32"	TAT-5301
1968-69	L6 4.1L 250ci	1 Bbl. 4Bbl w/1-1/8" X 10 X 19/32"	TAT-5301
1970-76	L6 4.1L 250ci	w/1-1/8" X 10 X 19/32"	TAT-5301
1982-84	V6 2.8L 173ci	4 Speed w/1-1/8" X 10 X 19/32"	TAT-5301
1983-84	V6 2.8L 173ci	5 Speed w/1" X 14 X 19/32"	TAT-5312
1985-89	V6 2.8L 173ci	w/1" X 14 X 19/32"	TAT-5312
1990-92	V6 3.1L 189ci	w/1" X 14 X 19/32"	TAT-5312
1993-95	V6 3.4L 207ci	w/1-1/8" X 26 X 19/32"	TAT-5313
1977-81	V6 3.8L 231ci	w/1-1/8" X 10 X 19/32"	TAT-5301
1996-00	V6 3.8L 231ci	w/1-1/8" X 26 X 19/32"	TAT-5313
1977	V8 4.9L 301ci	w/1-1/8" X 26 X 19/32"	TAT-5313
1979-81	V8 4.9L 301ci	w/1-1/8" X 10 X 19/32"	TAT-5301

# CLUTCH ALIGNMENT TOOLS

Year	Engine	Remark	Part
<b>PONTIAC (con't)</b>			
<b>FIREBIRD (con't)</b>			
1977-83	V8 5.0L 305ci	w/1-1/8" X 10 X 19/32"	TAT-5301
1980-92	V8 5.0L 305ci	10.4" X 26 Spline w/1-1/8" X 26 X 19/32"	TAT-5313
1967	V8 5.3L 326ci	w/1-1/8" X 10 X 19/32"	TAT-5301
1968-77	V8 5.7L 350ci	3 Speed w/1-1/8" X 10 X 19/32"	TAT-5301
1968-77	V8 5.7L 350ci	4 Speed w/1-1/8" X 26 X 19/32"	TAT-5313
1978	V8 5.7L 350ci	w/1-1/8" X 10 X 19/32"	TAT-5301
1998	V8 5.7L 350ci	w/1-1/8" X 26 X 19/32"	TAT-5313
1999-00	V8 5.7L 350ci	Modular, 6 Speed w/1-1/8" X 10 X 19/32"	TAT-5301
1968-72	V8 6.6L 400ci	3 Speed w/1-1/8" X 10 X 19/32"	TAT-5301
1971-77	V8 6.6L 400ci	4 Speed w/1-1/8" X 26 X 19/32"	TAT-5313
1973-79	V8 6.6L 400ci	w/1-1/8" X 26 X 19/32"	TAT-5313
1971-76	V8 7.5L 455ci	w/1-1/8" X 26 X 19/32"	TAT-5313
<b>FIREFLY</b>			
1987-90	L3 1.0L 61ci	Turbo; Canada w/47/64" X 18 X 25/64"	TAT-5386
1989-96	L3 1.0L 61ci	w/o Turbo, Canada w/47/64" X 18 X 25/64"	TAT-5386
1995-96	L4 1.3L 79ci	Canada w/47/64" X 18 X 25/64"	TAT-5386
<b>GRAND AM</b>			
1988-89	L4 2.0L 122ci	FWD, Turbo w/1" X 14 X 53/64"	TAT-5342
1995	L4 2.3L 138ci	DOHC, CSC FWD w/1" X 14 X 53/64"	TAT-5342
1988-94	L4 2.3L 138ci	CSC, FWD, External slave cylinder, FWD w/1" X 14 X 53/64"	TAT-5342
1996-97	L4 2.4L 146ci	DOHC, FWD, Vin Code T, CSC w/1" X 14 X 53/64"	TAT-5342
1985-91	L4 2.5L 151ci	External slave cylinder, FWD w/1" X 14 X 53/64"	TAT-5342
1979	V6 3.8L 231ci	RWD w/1-1/8" X 10 X 19/32"	TAT-5301
1978-80	V8 4.9L 301ci	RWD w/1-1/8" X 10 X 19/32"	TAT-5313
1978-80	V8 5.0L 305ci	RWD w/1-1/8" X 10 X 19/32"	TAT-5301
1973	V8 5.7L 350ci	4 Speed, RWD w/1-1/8" X 26 X 19/32"	TAT-5313
1973-75	V8 5.7L 350ci	3 Speed, RWD w/1-1/8" X 10 X 19/32"	TAT-5301
1975	V8 5.7L 350ci	RWD w/1-1/8" X 10 X 19/32"	TAT-5313
1973-75	V8 6.6L 400ci	4 Speed, RWD w/1-1/8" X 26 X 19/32"	TAT-5313
<b>GRAND PRIX</b>			
1988-89	V6 2.8L 173ci	FWD w/1" X 14 X 53/64"	TAT-5342
1989-92	V6 3.1L 189ci	FWD w/1" X 14 X 53/64"	TAT-5342
1991-93	V6 3.4L 207ci	FWD w/1" X 14 X 53/64"	TAT-5311
1976-77	V8 5.7L 350ci	4 Speed, RWD w/1-1/8" X 26 X 19/32"	TAT-5313
1962-66	V8 6.4L 389ci	2bbl. 4bbl.; RWD w/1-1/8" X 10 X 19/32"	TAT-5301
1968-70	V8 6.6L 400ci	10" Disc, RWD w/1-1/8" X 10 X 19/32"	TAT-5301
1970-72	V8 6.6L 400ci	3 Speed, RWD w/1-1/8" X 10 X 19/32"	TAT-5301
1971-72	V8 6.6L 400ci	4 Speed, RWD w/1-1/8" X 26 X 19/32"	TAT-5313
1967-69	V8 7.0L 428ci	RWD w/1-1/8" X 10 X 19/32"	TAT-5301
<b>GTO</b>			
1965-66	V8 6.4L 389ci	w/1-1/8" X 10 X 19/32"	TAT-5301
1968-71	V8 6.6L 400ci	3 Speed w/1-1/8" X 10 X 19/32"	TAT-5301
1968-71	V8 6.6L 400ci	4 Speed w/1-1/8" X 26 X 19/32"	TAT-5313
1970-73	V8 7.5L 455ci	3 Speed w/1-1/8" X 10 X 19/32"	TAT-5301
1970-73	V8 7.5L 455ci	4 Speed w/1-1/8" X 26 X 19/32"	TAT-5313
<b>J2000</b>			
1982	L4 1.8L 112ci	4 Speed w/1" X 14 X 53/64"	TAT-5342
1983-84	L4 1.8L 112ci	O-Type CSC, J-Type, Turbo, w/1" X 14 X 53/64"	TAT-5342
1983-84	L4 2.0L 122ci	4, 5 Speed w/1" X 14 X 53/64"	TAT-5342
<b>LEMANS</b>			
1964-65	L6 3.5L 215ci	w/1-1/8" X 10 X 19/32"	TAT-5301
1966-67	L6 3.8L 230ci	w/1-1/8" X 10 X 19/32"	TAT-5301
1968-69	L6 4.1L 250ci	1 Bbl. 4Bbl w/1-1/8" X 10 X 19/32"	TAT-5301
1970-76	L6 4.1L 250ci	w/1-1/8" X 10 X 19/32"	TAT-5301
1977-81	V6 3.8L 231ci	w/1-1/8" X 10 X 19/32"	TAT-5301
1976	V8 4.3L 260ci	w/1-1/8" X 10 X 19/32"	TAT-5301
1977-81	V8 4.9L 301ci	w/1-1/8" X 26 X 19/32"	TAT-5313
1977-81	V8 5.0L 305ci	w/1-1/8" X 10 X 19/32"	TAT-5301

# CLUTCH ALIGNMENT TOOLS

Year	Engine	Remark	Part
<b>PONTIAC (con't)</b>			
<b>LEMANS (con't)</b>			
1963-67	V8 5.3L 326ci	w/1-1/8" X 10 X 19/32"	TAT-5301
1968-74	V8 5.7L 350ci	3, 4 Speed, RWD, High OP Eng w/1-1/8" X 10 X 19/32"	TAT-5301
1975-77	V8 5.7L 350ci	Optional w/1-1/8" X 26 X 19/32"	TAT-5313
1978	V8 5.7L 350ci	w/1-1/8" X 10 X 19/32"	TAT-5301
1964-65	V8 6.4L 389ci	2Bbl. 4Bbl w/1-1/8" X 10 X 19/32"	TAT-5301
1968-72	V8 6.6L 400ci	3 Speed w/1-1/8" X 10 X 19/32"	TAT-5301
1971-77	V8 6.6L 400ci	4 Speed w/1-1/8" X 26 X 19/32"	TAT-5313
1970-76	V8 7.5L 455ci	3 Speed w/1-1/8" X 10 X 19/32"	TAT-5301
1970-76	V8 7.5L 455ci	4 Speed w/1-1/8" X 26 X 19/32"	TAT-5313
<b>PHOENIX</b>			
1980-84	L4 2.5L 151ci	9-1/8" Disc w/1" X 14 X 53/64"	TAT-5342
1980-84	V6 2.8L 173ci	Solid Flywheel # FW-111 w/1" X 14 X 53/64"	TAT-5342
1978-79	V6 3.8L 231ci	w/1-1/8" X 10 X 19/32"	TAT-5301
1978-79	V8 5.0L 305ci	w/1-1/8" X 10 X 19/32"	TAT-5301
<b>SAFARI</b>			
1968	L6 4.1L 250ci	1Bbl. 4bbl.; RWD w/1-1/8" X 10 X 19/32"	TAT-5301
1968-70	V8 5.7L 350ci	3 Speed, High Output Engine, RWD w/1-1/8" X 10 X 19/32"	TAT-5301
1961-65	V8 6.4L 389ci	2bbl. 4bbl; RWD w/1-1/8" X 10 X 19/32"	TAT-5301
1968-70	V8 6.6L 400ci	3 Speed, RWD w/1-1/8" X 10 X 19/32"	TAT-5301
<b>SUNBIRD</b>			
1985-86	L4 1.8L 112ci	CSC, O-Type, J-Type, Turbo w/1" X 14 X 53/64"	TAT-5342
1985	L4 2.0L 122ci	5 Speed w/1" X 14 X 53/64"	TAT-5342
1976-77	L4 2.3L 140ci	9-1/8" Disc w/1-1/8" X 10 X 19/32"	TAT-5301
1977	L4 2.5L 151ci	9-1/8" Disc w/1-1/8" X 10 X 19/32"	TAT-5301
1993-94	V6 3.1L 189ci	CSC w/1" X 14 X 53/64"	TAT-5342
1976-80	V6 3.8L 231ci	9-1/8" Disc w/1-1/8" X 10 X 19/32"	TAT-5301
1978-79	V8 5.0L 305ci	w/1-1/8" X 10 X 19/32"	TAT-5301
<b>SUNBURST</b>			
1985-88	L4 1.5L 92ci	w/o Turbo, Canada	TAT-5397
<b>SUNFIRE</b>			
1995-02	L4 2.2L 134ci	CSC w/1" X 14 X 53/64"	TAT-5342
1995	L4 2.3L 138ci	CSC w/1" X 14 X 53/64"	TAT-5342
1996-98	L4 2.4L 146ci	CSC w/1" X 14 X 53/64"	TAT-5342
<b>T1000</b>			
1981-87	L4 1.6L 98ci	w/1" X 14 X 19/32"	TAT-5312
1983-86	L4 1.6L 98ci	w/1" X 24 X 43/64"	TAT-5316
<b>TEMPEST</b>			
1964-65	L6 3.5L 215ci	RWD w/1-1/8" X 10 X 19/32"	TAT-5301
1966-67	L6 3.8L 230ci	1Bbl.4bbl; RWD w/1-1/8" X 10 X 19/32"	TAT-5301
1968-69	L6 4.1L 250ci	1Bbl.4bbl; RWD w/1-1/8" X 10 X 19/32"	TAT-5301
1963-67	V8 5.3L 326ci	RWD w/1-1/8" X 10 X 19/32"	TAT-5301
1968-70	V8 5.7L 350ci	3 Speed, High Output Engine, RWD w/1-1/8" X 10 X 19/32"	TAT-5301
1961-64	V8 6.4L 389ci	1Bbl.4bbl; RWD w/1-1/8" X 10 X 19/32"	TAT-5301
1968-70	V8 6.6L 400ci	3 Speed, RWD w/1-1/8" X 10 X 19/32"	TAT-5301
<b>VENTURA</b>			
1977	L4 2.5L 151ci	RWD w/1-1/8" X 10 X 19/32"	TAT-5301
1977	V6 3.8L 231ci	RWD w/1-1/8" X 10 X 19/32"	TAT-5301
1975-76	V8 4.3L 260ci	RWD w/1-1/8" X 10 X 19/32"	TAT-5301
1977	V8 4.9L 301ci	RWD w/1-1/8" X 26 X 19/32"	TAT-5313
1977	V8 5.0L 305ci	RWD w/1-1/8" X 10 X 19/32"	TAT-5301
1972-75	V8 5.7L 350ci	4 Speed, RWD w/1-1/8" X 26 X 19/32"	TAT-5313
1972-77	V8 5.7L 350ci	3 Speed, RWD w/1-1/8" X 10 X 19/32"	TAT-5301
1975-77	V8 5.7L 350ci	RWD w/1-1/8" X 26 X 19/32"	TAT-5313
1961	V8 6.4L 389ci	4bbl.; RWD w/1-1/8" X 10 X 19/32"	TAT-5301
<b>PORSCHE</b>			
<b>911</b>			
1965-69	H6 2.0L 1991cc	w/13/16" X 24 X 39/64"	TAT-5302
1970-71	H6 2.2L 2195cc	w/13/16" X 24 X 39/64"	TAT-5302

# CLUTCH ALIGNMENT TOOLS

Year	Engine	Remark	Part
<b>PORSCHE (con't)</b>			
<b>911 (con't)</b>			
1974-76	H6 2.7L 2688cc	w/7/8" X 20 X 41/64"	TAT-5360
1976-83	H6 3.0L 2999cc	w/7/8" X 20 X 41/64"	TAT-5360
1984-86	H6 3.2L 3163cc	w/7/8" X 20 X 41/64"	TAT-5360
1987-89	H6 3.2L 3163cc	w/1" X 23 X 19/32"	TAT-5311
1987-88	H6 3.3L 3294cc	930 Transmission, Turbo w/1" X 23 X 19/32"	TAT-5311
1991-92	H6 3.3L 3294cc	Turbo w/1" X 23 X 19/32"	TAT-5311
1990-98	H6 3.6L 3606cc	w/1" X 23 X 19/32"	TAT-5311
<b>914</b>			
1970-73	H4 1.7L 1679cc	w/13/16" X 24 X 19/32"	TAT-5335
1974-75	H4 1.8L 1795cc	w/13/16" X 24 X 19/32"	TAT-5335
1976	H4 2.0L 1967cc	w/13/16" X 24 X 19/32"	TAT-5335
1974-75	H4 2.0L 1971cc	w/13/16" X 24 X 19/32"	TAT-5335
<b>924</b>			
1977-82	L4 2.0L 1983cc	w/1" X 23 X 19/32"	TAT-5311
1987-88	L4 2.5L 2475cc	w/1" X 23 X 19/32"	TAT-5311
<b>928</b>			
1978-79	V8 4.5L 4474cc	Discs 38253 and 38254 w/1" X 23 X 19/32"	TAT-5311
1980-82	V8 4.5L 4474cc	Discs 38265 and 39032 w/1" X 23 X 19/32"	TAT-5311
1984	V8 4.7L 4671cc	Discs 38265 and 39032 w/1" X 23 X 19/32"	TAT-5311
1985-86	V8 5.0L 4950cc	Discs 38265 and 39032 w/1" X 23 X 19/32"	TAT-5311
1987-91	V8 5.0L 4950cc	w/1" X 23 X 19/32"	TAT-5311
1993-95	V8 5.4L 5392cc	w/1" X 23 X 19/32"	TAT-5311
<b>944</b>			
1983-88	L4 2.5L 2475cc	w/1" X 23 X 19/32"	TAT-5311
1989	L4 2.7L 2688cc	w/1" X 23 X 19/32"	TAT-5311
1990-91	L4 3.0L 2983cc	w/1" X 23 X 19/32"	TAT-5311
1989	L4 3.0L 2999cc	w/1" X 23 X 19/32"	TAT-5311
<b>968</b>			
1992-95	L4 3.0L 2983cc	6 Speed, Rigid Disc w/1" X 23 X 19/32"	TAT-5311
<b>RENAULT</b>			
<b>ALLIANCE, ENCORE</b>			
1983-87	L4 1.4L 1397cc		TAT-5388
1985-87	L4 1.7L 105ci		TAT-5388
1987	L4 2.0L 1965cc		TAT-5388
<b>FUEGO</b>			
1982-84	L4 1.6L 1565cc	Turbo w/15/16" X 21 X 15/32"	TAT-5306
1984-85	L4 2.2L 2152cc	352, NG, Transmission w/15/16" X 21 X 15/32"	TAT-5306
<b>LECAR</b>			
1980-83	L4 1.4L 1397cc	w/21/32" X 20 X 15/32"	TAT-5345
<b>R18I</b>			
1981-83	L4 1.6L 1647cc	352 & 395, NGO, NGI Transmission w/15/16" X 21 X 15/32"	TAT-5306
<b>SAAB</b>			
<b>900</b>			
1979-93	L4 2.0L 1985cc	w/24/32" X 17 X 19/32"	TAT-5339
1981-84	L4 2.0L 1985cc	w/23/32" X 16 X 15/32"	TAT-5340
1985-89	L4 2.0L 1985cc	16 Valve, Turbo w/23/32" X 16 X 15/32"	TAT-5340
1994-97	L4 2.0L 1985cc	w/1" X 14 X 19/32"	TAT-5312
1991-93	L4 2.1L 2119cc	16 Valve w/24/32" X 17 X 19/32"	TAT-5339
1994	L4 2.1L 2119cc	16 Valve w/1" X 14 X 19/32"	TAT-5312
1994	L4 2.3L 2290cc	w/1" X 14 X 19/32"	TAT-5312
1994-95	V6 2.5L 2498cc	w/1" X 23 X 1/2"	TAT-5332
<b>9000</b>			
1986-90	L4 2.0L 1985cc	Turbo w/1" X 23 X 1/2"	TAT-5332
1987-90	L4 2.0L 1985cc	w/o Turbo w/24/32" X 17 X 19/32"	TAT-5339
1991-93	L4 2.3L 2290cc	w/o Turbo w/24/32" X 17 X 19/32"	TAT-5339
1991-93	L4 2.3L 2290cc	Turbo w/1" X 23 X 1/2"	TAT-5332
1994	L4 2.3L 2290cc	w/1" X 23 X 1/2"	TAT-5332
1995-97	V6 3.0L 2961cc	w/1" X 23 X 1/2"	TAT-5332

# CLUTCH ALIGNMENT TOOLS

Year	Engine	Remark	Part
<b>SAAB (con't)</b>			
<b>9-3</b>			
1999	L4 2.0L 1985cc	w/1" X 14 X 19/32"	TAT-5312
<b>99</b>			
1978	L4 2.0L 1985cc	Turbo w/23/32" X 16 X 15/32"	TAT-5340
1976-80	L4 2.0L 1985cc	w/o Turbo w/24/32" X 17 X 19/32"	TAT-5339
<b>SATURN</b>			
<b>SC SERIES, SL SERIES, SW SERIES</b>			
1991-99	L4 1.9L 116ci	8-1/2" Diaph Type	TAT-5407
<b>STERLING</b>			
<b>825</b>			
1987-88	V6 2.5L 2494cc		TAT-5211
<b>STUDEBAKER</b>			
<b>AVANTI</b>			
1963-64	V8 4.8L 289ci	w/1-5/32" X 10 X 5/8"	TAT-5359
<b>CHAMPION, SCOTSMAN</b>			
1955-58	L6 3.0L 186ci	9-1/4" Disc w/1" X 10 X 49/64"	TAT-5349
<b>COMMANDER</b>			
1956-58	V8 4.2L 259ci	w/1-5/32" X 10 X 5/8"	TAT-5359
<b>HAWK, LARK</b>			
1961-62	L6 2.8L 170ci	9-1/4" Disc w/1" X 10 X 49/64"	TAT-5349
<b>SUBARU</b>			
<b>BRAT</b>			
1978-80	H4 1.6L 1595cc	w/3/4" X 23 X 15/32"	TAT-5321
1986-87	H4 1.8L 1781cc	w/7/8", 8-7/8" Disc w/7/8" X 21 X 15/32"	TAT-5327
<b>FORESTER</b>			
1998-02	H4 2.5L 2458cc	w/1" X 24 X 15/32"	TAT-5322
<b>IMPREZA</b>			
1993-95	H4 1.8L 1781cc	w/7/8" X 21 X 15/32"	TAT-5327
1994-97	H4 1.8L 1781cc	4WD w/1" X 24 X 15/32"	TAT-5322
1995-02	H4 2.2L 2212cc	Solid Flywheel # FW-142, w/1" X 24 X 15/32"	TAT-5322
<b>JUSTY</b>			
1987-94	L3 1.2L 1189cc		TAT-5392
<b>LEGACY</b>			
1990-96	H4 2.2L 2212cc	Pull Type Clutch, Turbo, Solid Flywheel # FW-142 w/1" X 24 X 15/32"	TAT-5322
1997-02	H4 2.5L 2458cc	w/1" X 24 X 15/32"	TAT-5322
<b>LOYALE</b>			
1990	H4 1.8L 1781cc	Turbo w/1" X 24 X 15/32"	TAT-5322
1990-93	H4 1.8L 1781cc	2WD w/7/8" X 21 X 15/32"	TAT-5327
1990-94	H4 1.8L 1781cc	4WD w/1" X 24 X 15/32"	TAT-5322
<b>XT</b>			
1985-91	H4 1.8L 1781cc	2WD, 4WD w/7/8" X 21 X 15/32"	TAT-5327
1988-91	H6 2.7L 2672cc	w/1" X 24 X 15/32"	TAT-5322
<b>SUZUKI</b>			
<b>ESTEEM</b>			
1995-98	L4 1.6L 1590cc	w/47/64" X 18 X 25/64"	TAT-5386
<b>FORSA</b>			
1985-88	L3 1.0L 993cc	w/47/64" X 18 X 25/64"	TAT-5386
<b>SWIFT</b>			
1989-01	L4 1.3L 1298cc	w/47/64" X 18 X 25/64"	TAT-5386
<b>SUZUKI TRUCKS</b>			
<b>SAMURAI</b>			
1990-95	L4 1.3L 1298cc	w/13/16" X 20 X 25/64"	TAT-5393
1986-89	L4 1.3L 1325cc	w/13/16" X 20 X 25/64"	TAT-5393
<b>SIDEKICK</b>			
1989	L4 1.3L 1325cc	w/13/16" X 20 X 25/64"	TAT-5393
1989-98	L4 1.6L 1590cc	2 Door w/13/16" X 20 X 25/64"	TAT-5393
1997-98	L4 1.8L 1840cc	w/13/16" X 20 X 25/64"	TAT-5393

# CLUTCH ALIGNMENT TOOLS

Year	Engine	Remark	Part
<b>SUZUKI TRUCKS (con't)</b>			
<b>VITARA</b>			
1999-01	L4 1.6L 1590cc	w/13/16" X 20 X 25/64"	TAT-5393
1999-02	L4 2.0L 2000cc	w/13/16" X 20 X 25/64"	TAT-5393
<b>X-90</b>			
1997-98	L4 1.6L 1590cc	w/13/16" X 20 X 25/64"	TAT-5393
<b>TOYOTA</b>			
<b>CAMRY</b>			
1984-86	L4 1.8L 1839cc	To 7/86 w/7/64" X 20 X 59/64"	TAT-5394
1986	L4 2.0L 1974cc	Turbo Diesel w/7/64" X 20 X 59/64"	TAT-5394
1983-86	L4 2.0L 1995cc	2WD, Gas w/7/64" X 20 X 59/64"	TAT-5394
1987-91	L4 2.0L 1998cc	2WD, To 3/90, Gas w/7/64" X 20 X 59/64"	TAT-5394
1992-01	L4 2.2L 2164cc	2WD, Gas w/7/64" X 20 X 59/64"	TAT-5394
1988-91	V6 2.5L 2508cc	2WD, GAS w/1-1/8" X 21 X 15/32"	TAT-5303
1992-95	V6 3.0L 2959cc	2WD, GAS w/1-1/8" X 21 X 15/32"	TAT-5303
1994-01	V6 3.0L 2995cc	2WD, GAS w/1-1/8" X 21 X 15/32"	TAT-5303
<b>CARINA</b>			
1972-73	L4 1.6L 1588cc	w/15/16" X 21 X 15/32"	TAT-5306
<b>CELICA</b>			
1990-93	L4 1.6L 1587cc	w/15/16" X 21 X 15/32"	TAT-5306
1994-97	L4 1.8L 1762cc	w/15/16" X 21 X 15/32"	TAT-5306
1971	L4 1.9L 1898cc	w/1-1/8" X 21 X 15/32"	TAT-5303
1972-74	L4 2.0L 1968cc	w/1-1/8" X 21 X 15/32"	TAT-5303
1986	L4 2.0L 1995cc	w/7/64" X 20 X 59/64"	TAT-5394
1986-89	L4 2.0L 1998cc	w/o Turbo w/7/64" X 20 X 59/64"	TAT-5394
1988-89	L4 2.0L 1998cc	Turbo w/1-1/8" X 21 X 15/32"	TAT-5303
1990-93	L4 2.0L 1998cc	Turbo w/15/16" X 21 X 59/64"	TAT-5395
1990-99	L4 2.2L 2164cc	w/7/64" X 20 X 59/64"	TAT-5394
1975-80	L4 2.2L 2189cc	w/1-1/8" X 21 X 15/32"	TAT-5303
1981-85	L4 2.4L 2366cc	w/1-1/8" X 21 X 15/32"	TAT-5303
<b>COROLLA</b>			
1968-69	L4 1.1L 1077cc	RWD, GAS w/23/32" X 16 X 15/32"	TAT-5340
1969	L4 1.2L 1166cc	w/23/32" X 16 X 15/32"	TAT-5340
1974	L4 1.2L 1166cc	From 5/74 RWD, GAS w/3/4" X 19 X 15/32"	TAT-5314
1977-79	L4 1.2L 1166cc	RWD, GAS w/3/4" X 19 X 15/32"	TAT-5314
1983-97	L4 1.6L 1587cc	RWD, GAS w/15/16" X 21 X 15/32"	TAT-5306
1988-92	L4 1.6L 1587cc	w/15/16" X 21 X 59/64"	TAT-5395
1989-91	L4 1.6L 1587cc	FWD, GAS w/15/16" X 21 X 15/32"	TAT-5306
1971-79	L4 1.6L 1588cc	RWD, GAS w/15/16" X 21 X 15/32"	TAT-5306
1993-97	L4 1.8L 1762cc	w/15/16" X 21 X 15/32"	TAT-5306
1980-82	L4 1.8L 1770cc	4 Door 5 Speed w/15/16" X 21 X 15/32"	TAT-5306
1984-85	L4 1.8L 1839cc	w/7/64" X 20 X 59/64"	TAT-5394
<b>CORONA</b>			
1969-70	L4 1.9L 1858cc	w/15/16" X 21 X 15/32"	TAT-5306
1970-71	L4 1.9L 1858cc	w/1-1/8" X 21 X 15/32"	TAT-5303
1968-69	L4 1.9L 1898cc	w/15/16" X 21 X 15/32"	TAT-5306
1970	L4 1.9L 1898cc	w/1-1/8" X 21 X 15/32"	TAT-5303
1972-74	L4 2.0L 1968cc	w/1-1/8" X 21 X 15/32"	TAT-5303
1975-80	L4 2.2L 2189cc	w/1-1/8" X 21 X 15/32"	TAT-5303
1981-82	L4 2.4L 2366cc	w/1-1/8" X 21 X 15/32"	TAT-5303
<b>CRESSIDA</b>			
1983-87	L6 2.8L 2754cc	w/1-1/8" X 21 X 15/32"	TAT-5303
<b>CROWN</b>			
1968-70	L6 2.3L 2253cc	To 1/70 w/15/16" X 21 X 15/32"	TAT-5306
1970-72	L6 2.6L 2563cc	From 2/70 w/1-1/8" X 21 X 15/32"	TAT-5303
<b>ECHO</b>			
2000-02	L4 1.5L 1497cc	w/15/16" X 21 X 15/32"	TAT-5306
<b>MARK II</b>			
1972	L6 2.3L 2253cc	w/1-1/8" X 21 X 15/32"	TAT-5303
1973-74	L6 2.6L 2563cc	w/1-1/8" X 21 X 15/32"	TAT-5303



# CLUTCH ALIGNMENT TOOLS

Year	Engine	Remark	Part
<b>TOYOTA (con't)</b>			
<b>MR2</b>			
1985-89	L4 1.6L 1587cc	exc. Supercharged w/15/16" X 21 X 15/32"	TAT-5306
1988-89	L4 1.6L 1587cc	Supercharged w/15/16" X 21 X 59/64"	TAT-5395
1991-95	L4 2.0L 1998cc	Turbo w/15/16" X 21 X 59/64"	TAT-5395
1991-95	L4 2.2L 2164cc	w/7/64" X 20 X 59/64"	TAT-5394
<b>MR2 SPYDER</b>			
2000-01	L4 1.8L 1794cc	w/15/16" X 21 X 15/32"	TAT-5306
<b>PASEO</b>			
1992-98	L4 1.5L 1497cc	w/15/16" X 21 X 15/32"	TAT-5306
<b>SOLARA</b>			
1999-01	L4 2.2L 2164cc	w/7/64" X 20 X 59/64"	TAT-5394
<b>STARLET</b>			
1981-83	L4 1.3L 1290cc	w/3/4" X 19 X 15/32"	TAT-5314
<b>SUPRA</b>			
1979-80	L6 2.6L 2563cc	w/1-1/8" X 21 X 15/32"	TAT-5303
1982-85	L6 2.8L 2754cc	To 12/85 w/1-1/8" X 21 X 15/32"	TAT-5303
1986-92	L6 3.0L 2954cc	From 1/86 w/1-1/8" X 21 X 15/32"	TAT-5303
1993-97	L6 3.0L 2997cc	w/1-1/8" X 21 X 15/32"	TAT-5303
1996-98	L6 3.0L 2997cc	Twin Turbo	TAT-5214
<b>TERCEL</b>			
1980-88	L4 1.5L 1452cc	w/15/16" X 21 X 15/32"	TAT-5306
1987-94	L4 1.5L 1456cc	4, 5 Speed w/15/16" X 21 X 15/32"	TAT-5306
1995-98	L4 1.5L 1497cc	w/15/16" X 21 X 15/32"	TAT-5306
<b>TOYOTA TRUCKS</b>			
<b>4RUNNER</b>			
1984-88	L4 2.4L 2366cc	w/1-1/8" X 21 X 15/32"	TAT-5303
1989-94	L4 2.4L 2366cc	2WD w/1-1/8" X 21 X 15/32"	TAT-5303
1993-95	L4 2.4L 2366cc	4WD w/1-1/8" X 21 X 15/32"	TAT-5303
1996-00	L4 2.7L 2694cc	w/1-1/8" X 21 X 15/32"	TAT-5303
1988-95	V6 3.0L 2959cc	w/1-1/8" X 21 X 15/32"	TAT-5303
1996-98	V6 3.4L 3378cc	w/1-1/8" X 21 X 15/32"	TAT-5303
1999-00	V6 3.4L 3378cc	5 Speed w/1-1/8" X 21 X 15/32"	TAT-5303
<b>LAND CRUISER</b>			
1969-74	L6 3.9L 3878cc	w/1-3/32" X 10 X 39/64"	TAT-5326
1975-87	L6 4.2L 4227cc	w/1-3/32" X 10 X 39/64"	TAT-5326
1981-87	L6 4.2L 4228cc	w/1-3/32" X 10 X 39/64"	TAT-5326
<b>PICKUP</b>			
1970-71	L4 1.9L 1858cc	w/15/16" X 21 X 15/32"	TAT-5306
1972-74	L4 2.0L 1968cc	w/1-1/8" X 21 X 15/32"	TAT-5303
1975-80	L4 2.2L 2189cc	w/1-1/8" X 21 X 15/32"	TAT-5303
1981-95	L4 2.4L 2366cc	Gas w/1-1/8" X 21 X 15/32"	TAT-5303
1985	L4 2.4L 2446cc	Turbo Diesel w/1-1/8" X 21 X 15/32"	TAT-5303
1988-95	V6 3.0L 2959cc	w/1-1/8" X 21 X 15/32"	TAT-5303
<b>PREVIA</b>			
1991-94	L4 2.4L 2438cc	w/1-1/8" X 21 X 15/32"	TAT-5303
<b>RAV4</b>			
1996-01	L4 2.0L 1998cc	w/1-1/8" X 21 X 15/32"	TAT-5303
<b>T100</b>			
1994-98	L4 2.7L 2694cc	w/1-1/8" X 21 X 15/32"	TAT-5303
1993-94	V6 3.0L 2959cc	w/1-1/8" X 21 X 15/32"	TAT-5303
1995-98	V6 3.4L 3378cc	DOHC w/1-1/8" X 21 X 15/32"	TAT-5303
<b>TACOMA</b>			
1995-01	L4 2.4L 2438cc	2WD, 4WD w/1-1/8" X 21 X 15/32"	TAT-5303
1995-01	L4 2.7L 2694cc	w/1-1/8" X 21 X 15/32"	TAT-5303
1995-01	V6 3.4L 3378cc	w/1-1/8" X 21 X 15/32"	TAT-5303
2000-01	V6 3.4L 3378cc	5 Speed w/1-1/8" X 21 X 15/32"	TAT-5303
<b>VAN</b>			
1984-85	L4 2.0L 1998cc	w/1-1/8" X 21 X 15/32"	TAT-5303
1986-89	L4 2.2L 2237cc	w/1-1/8" X 21 X 15/32"	TAT-5303

# CLUTCH ALIGNMENT TOOLS

Year	Engine	Remark	Part
<b>TRIUMPH</b>			
<b>SPITFIRE</b>			
1963-64	L4 1.2L 70ci	w/1" X 23 X 19/32"	TAT-5311
1973-74	L4 1.5L 1493cc	w/7/8" X 10 X 33/64"	TAT-5330
<b>TR250</b>			
1968	L6 2.5L 2498cc	w/1-1/4" X 10 X 1/2"	TAT-5318
<b>TR6</b>			
1969-76	L6 2.5L 2498cc	w/1-1/4" X 10 X 1/2"	TAT-5318
<b>TR7</b>			
1975-81	L4 2.0L 1998cc	4, 5 Speed w/1" X 23 X 33/64"	TAT-5331
<b>VOLKSWAGEN</b>			
<b>411, 412</b>			
1971-74	H4 1.7L 1679cc	Type 4 w/13/16" X 24 X 39/64"	TAT-5302
<b>BETLE, KARMANN GHIA, SUPER BETLE, THING</b>			
1954-63	H4 1.2L 1192cc	Type 1 w/13/16" X 24 X 39/64"	TAT-5302
1966	H4 1.3L 1285cc	Type 1 w/13/16" X 24 X 39/64"	TAT-5302
1967-69	H4 1.5L 1457cc	Type 1; Rigid Hub, Spring Hub w/13/16" X 24 X 39/64"	TAT-5302
1971-79	H4 1.6L 1584cc	Type 1; Rigid Hub, Spring Hub w/13/16" X 24 X 39/64"	TAT-5302
1973-75	H4 1.6L 1584cc	Type 1; Spring Hub w/13/16" X 24 X 39/64"	TAT-5302
1999	L4 1.8L 1781cc	Type 1; APH	TAT-5213
2000-01	L4 1.8L 1781cc		TAT-5213
1998-01	L4 2.0L 1984cc		TAT-5213
<b>CABRIO</b>			
1995-01	L4 2.0L 1984cc	w/5-5/32" O.D. X 45/64" Nose Dia.	TAT-5378
<b>CABRIOLET</b>			
1985-93	L4 1.8L 1780cc	w/5-5/32" O.D. X 45/64" Nose Dia.	TAT-5378
<b>CORRADO</b>			
1990-91	L4 1.8L 1780cc		TAT-5403
1992-95	V6 2.8L 2792cc		TAT-5403
<b>DASHER</b>			
1974-75	L4 1.5L 1471cc	w/13/16" X 24 X 39/64"	TAT-5302
1979-80	L4 1.5L 1471cc	Diesel w/15/16" X 22 X 37/64"	TAT-5302
1976-80	L4 1.6L 1588cc	Gas w/13/16" X 24 X 39/64"	TAT-5302
1981	L4 1.6L 1588cc	Diesel w/15/16" X 22 X 37/64"	TAT-5302
<b>FASTBACK, SQUAREBACK</b>			
1966-73	H4 1.6L 1584cc	Type 3; Rigid Hub w/13/16" X 24 X 39/64"	TAT-5302
1966-73	H4 1.6L 1584cc	Type 3; Spring Hub w/13/16" X 24 X 39/64"	TAT-5302
<b>FOX</b>			
1987-93	L4 1.8L 1780cc	w/13/16" X 24 X 39/64"	TAT-5302
<b>GOLF</b>			
1985-92	L4 1.6L 1588cc	w/5-5/32" O.D. X 45/64" Nose Dia.	TAT-5378
1989-90	L4 1.6L 1588cc	To CH# 1GLO15951 w/5-5/32" O.D. X 45/64" Nose Dia.	TAT-5378
1990-92	L4 1.6L 1588cc	From CH# 1GL015952 w/5-5/32" O.D. X 45/64" Nose Dia.	TAT-5378
1985-97	L4 1.8L 1780cc	8 Valve w/5-5/32" O.D. X 45/64" Nose Dia.	TAT-5378
1986-89	L4 1.8L 1780cc	16 Valve, Gas	TAT-5403
1996	L4 1.8L 1780cc	w/5-5/32" O.D. X 45/64" Nose Dia.	TAT-5378
2001	L4 1.8L 1781cc	8-5/8"; Turbo	TAT-5213
1993	L4 1.8L 1788cc	8 Valve w/5-5/32" O.D. X 45/64" Nose Dia.	TAT-5378
1995	L4 1.8L 1788cc	From CH# 1HR038601 w/5-5/32" O.D. X 45/64" Nose Dia.	TAT-5378
1993-94	L4 1.9L 1896cc	To CH# 1HR038600 w/5-5/32" O.D. X 45/64" Nose Dia.	TAT-5378
1995	L4 1.9L 1896cc	From CH# 1HR038601 w/5-5/32" O.D. X 45/64" Nose Dia.	TAT-5378
1990-92	L4 2.0L 1984cc	16 Valve, Gas	TAT-5403
1993-94	L4 2.0L 1984cc	8V, 2 Pins in Flywheel, Gas	TAT-5403
1994-97	L4 2.0L 1984cc	8V, 1 Pin in Flywheel, GAS w/5-5/32" O.D. X 45/64" Nose Dia.	TAT-5378
1998	L4 2.0L 1984cc	From Vin# 1HR061340 w/5-5/32" O.D. X 45/64" Nose Dia.	TAT-5378
1998-99	L4 2.0L 1984cc	w/5-5/32" O.D. X 45/64" Nose Dia.	TAT-5378
2000-01	L4 2.0L 1984cc		TAT-5213
1995-98	V6 2.8L 2792cc	VR6, Gas	TAT-5403
1998-99	V6 2.8L 2792cc	From 12/98 AFP, Gas	TAT-5403

# CLUTCH ALIGNMENT TOOLS

Year	Engine	Remark	Part
<b>VOLKSWAGEN (con't)</b>			
<b>JETTA</b>			
1980	L4 1.6L 1588cc	w/5-5/32" O.D. X 45/64" Nose Dia.	TAT-5378
1981-92	L4 1.6L 1588cc	Diesel w/15/16" X 22 X 37/64"	TAT-5378
1981-84	L4 1.7L 1715cc	w/5-5/32" O.D. X 45/64" Nose Dia.	TAT-5378
1984-92	L4 1.8L 1780cc	8 Valve w/5-5/32" O.D. X 45/64" Nose Dia.	TAT-5378
1987-89	L4 1.8L 1780cc	16 Valve, Gas	TAT-5403
1993-95	L4 1.8L 1788cc	8 Valve w/5-5/32" O.D. X 45/64" Nose Dia.	TAT-5378
1999	L4 1.9L 1896cc	TDI, Diesel w/1" X 23 X 33/64"	TAT-5331
1993-94	L4 1.9L 1896cc	To CH# 1H-R-038600, Diesel w/5-5/32" O.D. X 45/64" Nose Dia.	TAT-5378
1994-96	L4 1.9L 1896cc	From CH # 1H-R-038601, Diesel w/5-5/32" O.D. X 45/64" Nose Dia.	TAT-5378
1996-97	L4 1.9L 1896cc	TDI, Diesel	TAT-5213
1990-94	L4 2.0L 1984cc	16 Valve, Gas	TAT-5403
1994	L4 2.0L 1984cc	8V, 2 Pins in Flywheel, Gas	TAT-5403
1994-98	L4 2.0L 1984cc	8V, 1 Pin in Flywheel, GAS w/5-5/32" O.D. X 45/64" Nose Dia.	TAT-5378
2001	L4 2.0L 1984cc		TAT-5213
1995-97	V6 2.8L 2792cc		TAT-5403
<b>PASSAT</b>			
1991-92	L4 1.8L 1780cc	8 Valve w/5-5/32" O.D. X 45/64" NoseDia.	TAT-5378
1993-94	L4 1.9L 1896cc		TAT-5213
1996-97	L4 1.9L 1896cc		TAT-5403
1990-96	L4 2.0L 1984cc	16 Valve	TAT-5403
1993-97	V6 2.8L 2792cc		TAT-5403
<b>QUANTUM</b>			
1982-85	L4 1.6L 1588cc	Turbo Diesel w/13/16" X 24 X 39/64"	TAT-5302
1982-83	L4 1.7L 1715cc	Gas w/13/16" X 24 X 39/64"	TAT-5302
1985	L4 1.8L 1780cc	w/13/16" X 24 X 39/64"	TAT-5302
1983-84	L5 2.2L 2144cc	w/13/16" X 24 X 11/16"	TAT-5351
1985-88	L5 2.2L 2226cc	w/13/16" X 24 X 11/16"	TAT-5351
<b>RABBIT</b>			
1975-80	L4 1.5L 1471cc	w/5-5/32" O.D. X 45/64" Nose Dia.	TAT-5378
1977-80	L4 1.5L 1471cc	7 1/2" 7-7/8" Disc, Diesel w/5-5/32" O.D. X 45/64" Nose Dia.	TAT-5378
1976-80	L4 1.6L 1588cc	w/5-5/32" O.D. X 45/64" Nose Dia.	TAT-5378
1980	L4 1.6L 1588cc	w/13/16" X 24 X 11/16"	TAT-5351
1981-84	L4 1.6L 1588cc	Diesel w/15/16" X 22 X 37/64"	TAT-5378
1981-83	L4 1.7L 1715cc	Round Headlights w/5-5/32" O.D. X 45/64" Nose Dia.	TAT-5378
1981-83	L4 1.7L 1715cc	Round Headlights w/13/16" X 24 X 11/16"	TAT-5351
1983-84	L4 1.7L 1715cc	Rectangular Headlights, GAS w/5-5/32" O.D. X 45/64" Nose Dia.	TAT-5378
1983-84	L4 1.8L 1780cc	w/5-5/32" O.D. X 45/64" Nose Dia.	TAT-5378
<b>SCIROCCO</b>			
1978	L4 1.5L 1457cc	w/5-5/32" O.D. X 45/64" Nose Dia.	TAT-5378
1975	L4 1.5L 1471cc	w/5-5/32" O.D. X 45/64" Nose Dia.	TAT-5378
1976-80	L4 1.6L 1588cc	w/5-5/32" O.D. X 45/64" Nose Dia.	TAT-5378
1981-83	L4 1.7L 1715cc	w/5-5/32" O.D. X 45/64" Nose Dia.	TAT-5378
1983-89	L4 1.8L 1780cc	8 Valve w/5-5/32" O.D. X 45/64" Nose Dia.	TAT-5378
1986-89	L4 1.8L 1780cc	16 Valve, Gas	TAT-5403
<b>VOLKSWAGEN TRUCKS</b>			
<b>EUROVAN</b>			
1996	L5 2.4L 2370cc	Canada, Diesel	TAT-5403
1992-96	L5 2.5L 2459cc		TAT-5403
1997	V6 2.8L 2792cc		TAT-5403
<b>RABBIT PICKUP</b>			
1980	L4 1.5L 1457cc	w/5-5/32" O.D. X 45/64" Nose Dia.	TAT-5378
1980-83	L4 1.6L 1588cc	w/5-5/32" O.D. X 45/64" Nose Dia.	TAT-5378
1981-83	L4 1.7L 1715cc	w/5-5/32" O.D. X 45/64" Nose Dia.	TAT-5378
<b>TRANSPORTER</b>			
1954-62	H4 1.2L 1192cc	Type 2 w/13/16" X 24 X 39/64"	TAT-5302
1963-67	H4 1.5L 1457cc	Type 2; Rigid Hub, Spring Hub w/13/16" X 24 X 39/64"	TAT-5302
1968-71	H4 1.6L 1584cc	Type 2; Rigid Hub, Spring Hub w/13/16" X 24 X 39/64"	TAT-5302
1972-73	H4 1.7L 1679cc	Type 2 w/13/16" X 24 X 39/64"	TAT-5302

# CLUTCH ALIGNMENT TOOLS

Year	Engine	Remark	Part
<b>VOLKSWAGEN TRUCKS (con't)</b>			
<b>TRANSPORTER (con't)</b>			
1974-75	H4 1.8L 1795cc	From Eng 10016070 To Eng 10016069 TYPE 2 w/13/16" X 24 X 39/64"	TAT-5302
1979	H4 2.0L 1970cc	Type 2 w/13/16" X 24 X 19/32"	TAT-5335
1986-91	H4 2.1L 2109cc	Type 2 w/13/16" X 24 X 19/32"	TAT-5335
1993-94	L5 2.4L 2370cc		TAT-5403
1992-93	L5 2.5L 2459cc		TAT-5403
<b>VANAGON</b>			
1983	H4 1.9L 1915cc	To 3/83 w/13/16" X 24 X 39/64"	TAT-5302
1983-85	H4 1.9L 1915cc	From 3/83 w/13/16" X 24 X 19/32"	TAT-5335
1982-83	H4 2.0L 1970cc	Type 2 w/13/16" X 24 X 19/32"	TAT-5335
1986-91	H4 2.1L 2109cc	Type 2 w/13/16" X 24 X 19/32"	TAT-5335
<b>VOLVO</b>			
<b>122</b>			
1968	L4 1.8L 1780cc	w1" X 10 X 19/32"	TAT-5320
<b>164</b>			
1970-75	L6 3.0L 2980cc	w/1-1/8" X 10 X 19/32"	TAT-5301
<b>1800</b>			
1962-68	L4 1.8L 1780cc	w1" X 10 X 19/32"	TAT-5320
<b>240</b>			
1990-93	L4 2.3L 2316cc	w/15/16" X 22 X 37/64"	TAT-5307
<b>242, 244</b>			
1975	L4 2.0L 1990cc	w1" X 10 X 19/32"	TAT-5320
1976-78	L4 2.1L 2127cc	w1" X 10 X 19/32"	TAT-5320
1979-80	L4 2.1L 2127cc	w/15/16" X 22 X 37/64"	TAT-5307
1981-84	L4 2.1L 2127cc	Turbo w/o Intercooler w/15/16" X 22 X 37/64"	TAT-5307
1984	L4 2.1L 2127cc	Turbo w/Intercooler w/24/32" X 17 X 19/32"	TAT-5339
1981-89	L4 2.3L 2316cc	w/15/16" X 22 X 37/64"	TAT-5307
<b>245</b>			
1982-84	L6 2.4L 2383cc	Diesel w/15/16" X 22 X 37/64"	TAT-5307
<b>262, 264, 265</b>			
1981	L6 2.4L 2383cc	Diesel	TAT-5206
1976-79	V6 2.7L 2673cc		TAT-5206
<b>740</b>			
1985-90	L4 2.3L 2316cc	4, 5 Speed, GAS w/15/16" X 22 X 37/64"	TAT-5307
1988-90	L4 2.3L 2316cc	DOHC 16 Valve, GAS	TAT-5206
1990-92	L4 2.3L 2316cc	M47 Trans, Turbo, Gas w/15/16" X 22 X 37/64"	TAT-5307
1986	L6 2.4L 2377cc	Turbo Diesel	TAT-5206
<b>760</b>			
1984	L4 2.3L 2316cc	Turbo, Gas	TAT-5206
1985-89	L4 2.3L 2316cc	4, 5 Speed, M47 Trans GAS w/15/16" X 22 X 37/64"	TAT-5307
1988-90	L4 2.3L 2316cc	DOHC 16 Valve, GAS	TAT-5206
1990	L4 2.3L 2316cc	Turbo, Gas w/15/16" X 22 X 37/64"	TAT-5307
<b>850</b>			
1995-97	L5 2.3L 2319cc	Turbo	TAT-5206
1993-97	L5 2.4L 2435cc		TAT-5206
<b>940</b>			
1991	L4 2.3L 2316cc	w/o Turbo	TAT-5206
1991-93	L4 2.3L 2316cc	Turbo, Gas w/15/16" X 22 X 37/64"	TAT-5307
<b>YUGO</b>			
<b>CABRIO, GV, GVL, GVS, GVX</b>			
1986-89	L4 1.1L 1116cc	w/3/4" X 17 X 3/4"	TAT-5324
1989-90	L4 1.3L 1301cc	w/3/4" X 17 X 3/4"	TAT-5324

# **CLUTCH CABLES**

# CLUTCH CABLES

Year	Engine	Vin	Remark	Part	OE
<b>ACURA</b>					
<b>INTEGRA</b>					
1986	L4 1.6L 1590cc		59.75" Cable	CA-516	22910-SE7-671
1988	L4 1.6L 1590cc		58.25" Cable	CA-517	22910-SD2-A00
1992	L4 1.7L 1678cc		39.75" Cable	CA-660	22910SK7A02
1992	L4 1.7L 1678cc		59.50" Cable	CA-661	22910SK7A80
1990	L4 1.8L 1834cc		39.75" Cable	CA-660	22910SK7A02
1992	L4 1.8L 1834cc		59.50" Cable	CA-661	22910SK7A80
<b>LEGEND</b>					
1986	V6 2.5L 2494cc		59.75" Cable	CA-516	22910-SE7-671
1987	V6 2.7L 2675cc		59.75" Cable	CA-516	22910-SE7-671
1988	V6 2.7L 2675cc		58.25" Cable	CA-517	22910-SD2-A00
1990	V6 2.7L 2675cc		39.75" Cable	CA-660	22910SK7A02
1991	V6 3.2L 3206cc		39.75" Cable	CA-660	22910SK7A02
1992	V6 3.2L 3206cc		59.50" Cable	CA-661	22910SK7A80
<b>NSX</b>					
1991	V6 3.0L 2977cc		39.75" Cable	CA-660	22910SK7A02
1992	V6 3.0L 2977cc		59.50" Cable	CA-661	22910SK7A80
<b>VIGOR</b>					
1992	L5 2.5L 2451cc		39.75" Cable	CA-660	22910SK7A02
1992	L5 2.5L 2451cc		59.50" Cable	CA-661	22910SK7A80
<b>AMERICAN MOTORS</b>					
<b>AMX</b>					
1979	L6 4.2L 258ci	A, C	52.50" Cable	CA-101	3230847
1979	V8 5.0L 304ci	H	52.50" Cable	CA-101	3230847
<b>CONCORD</b>					
1978	L4 2.0L 121ci	G	52.50" Cable	CA-101	3230847
1979	L6 3.8L 232ci	E	52.50" Cable	CA-101	3230847
1979	L6 4.2L 258ci	A, C	52.50" Cable	CA-101	3230847
1979	V8 5.0L 304ci	H	52.50" Cable	CA-101	3230847
<b>GREMLIN</b>					
1977	L4 2.0L 121ci	K, G	52.50" Cable	CA-101	3230847
1977	L6 3.8L 232ci	E	52.50" Cable	CA-101	3230847
1977	L6 4.2L 258ci	A, C	52.50" Cable	CA-101	3230847
<b>HORNET, PACER</b>					
1977	L6 3.8L 232ci	E	52.50" Cable	CA-101	3230847
1977	L6 4.2L 258ci	A, C	52.50" Cable	CA-101	3230847
1977	V8 5.0L 304ci	H	52.50" Cable	CA-101	3230847
<b>MATADOR</b>					
1977	L6 4.2L 258ci	A	52.50" Cable	CA-101	3230847
1977	V8 5.0L 304ci	H	52.50" Cable	CA-101	3230847
1977	V8 5.9L 360ci	N	52.50" Cable	CA-101	3230847
<b>SPIRIT</b>					
1979	L4 2.0L 121ci	G	52.50" Cable	CA-101	3230847
1979	L6 3.8L 232ci	E	52.50" Cable	CA-101	3230847
1979	L6 4.2L 258ci	A, C	52.50" Cable	CA-101	3230847
1979	V8 5.0L 304ci	H	52.50" Cable	CA-101	3230847
<b>ASUNA</b>					
<b>SUNFIRE</b>					
1993	L4 1.8L 110ci	8	31.875" Cable	CA-167	90209335
<b>AUDI</b>					
<b>100 SERIES</b>					
1975	L4 1.9L 1871cc		39.01" Cable	CA-150	843 721 335
1972	L4 1.9L 1872cc		32.59" Cable	CA-152	803 721 335A
1973	L4 1.9L 1872cc		39.01" Cable	CA-150	843 721 335

# CLUTCH CABLES

Year	Engine	Vin	Remark	Part	OE
<b>AUDI (con't)</b>					
<b>4000</b>					
1980	L4 1.6L 1588cc		36.29" Cable	CA-155	811 721 335F
1982	L4 1.6L 1588cc	G, H	36.22" Cable	CA-154	811 721 335N/P
1982-83	L4 1.6L 1588cc	G, H	To 1/83; 36.49" Cable	CA-153	811 721 335H
1983	L4 1.6L 1588cc	G, H	From 2/83; 36.29" Cable	CA-156	811 721 335R
1981	L4 1.7L 1715cc	A	39.375" Cable	CA-151	811 721 335J
1982	L4 1.7L 1715cc	A	36.49" Cable	CA-153	811 721 335H
1982-83	L4 1.7L 1715cc	A	36.22" Cable	CA-154	811 721 335N/P
1980	L5 2.2L 2144cc		36.29" Cable	CA-155	811 721 335F
1981	L5 2.2L 2144cc	B	39.375" Cable	CA-151	811 721 335J
1982	L5 2.2L 2144cc	B	36.22" Cable	CA-154	811 721 335N/P
1982	L5 2.2L 2144cc	B	36.49" Cable	CA-153	811 721 335H
<b>5000</b>					
1980	L5 2.0L 1986cc		36.29" Cable	CA-155	811 721 335F
1981	L5 2.0L 1986cc	G	39.375" Cable	CA-151	811 721 335J
1982-83	L5 2.0L 1986cc	H	36.22" Cable	CA-154	811 721 335N/P
1982-83	L5 2.0L 1986cc	H	36.49" Cable	CA-153	811 721 335H
1983	L5 2.0L 1986cc	H	36.29" Cable	CA-156	811 721 335R
1978	L5 2.2L 2144cc		39.01" Cable	CA-150	843 721 335
1980	L5 2.2L 2144cc		36.29" Cable	CA-155	811 721 335F
1981	L5 2.2L 2144cc	B, C	39.375" Cable	CA-151	811 721 335J
1982-83	L5 2.2L 2144cc	B, C	36.22" Cable	CA-154	811 721 335N/P
1982-83	L5 2.2L 2144cc	B, C	36.49" Cable	CA-153	811 721 335H
1983	L5 2.2L 2144cc	B, C	36.29" Cable	CA-156	811 721 335R
<b>COUPE</b>					
1981	L5 2.2L 2144cc	B	39.375" Cable	CA-151	811 721 335J
1982-83	L5 2.2L 2144cc	B	36.22" Cable	CA-154	811 721 335N/P
1982-83	L5 2.2L 2144cc	B	36.49" Cable	CA-153	811 721 335H
1983	L5 2.2L 2144cc	B	36.29" Cable	CA-156	811 721 335R
<b>FOX</b>					
1973	L4 1.5L 1471cc		32.59" Cable	CA-152	803 721 335A
1973-74	L4 1.5L 1471cc		39.01" Cable	CA-150	843 721 335
1975-79	L4 1.6L 1588cc		39.01" Cable	CA-150	843 721 335
<b>QUATTRO</b>					
1983	L5 2.2L 2144cc	C	36.22" Cable	CA-154	811 721 335N/P
1983	L5 2.2L 2144cc	C	36.29" Cable	CA-156	811 721 335R
1983	L5 2.2L 2144cc	C	36.49" Cable	CA-153	811 721 335H
<b>SUPER 90</b>					
1972	L4 1.8L 1760cc		32.59" Cable	CA-152	803 721 335A
<b>BUICK</b>					
<b>APOLLO</b>					
1974	L6 4.1L 250ci	D	40.669" Cable	CA-852	669045
1975	L6 4.1L 250ci	D	41.259" Cable	CA-853	669050
1975	V8 4.3L 260ci	F	41.259" Cable	CA-853	669050
1974	V8 5.7L 350ci	H, J	40.669" Cable	CA-852	669045
1975	V8 5.7L 350ci	H, J	41.259" Cable	CA-853	669050
<b>CENTURION</b>					
1971	V8 7.5L 455ci		31.02" Cable, 22.64" Mounting Length	CA-850	669021
<b>CENTURY</b>					
1982	L4 2.5L 151ci	5, R	36.33" Cable	CA-409	14024991
1982-83	L4 2.5L 151ci	5	35.20" Cable	CA-410	14068795
1982-84	L4 2.5L 151ci	R	35.20" Cable	CA-410	14068795
1982	V6 2.8L 173ci	X	36.33" Cable	CA-409	14024991
1982-84	V6 2.8L 173ci	X	35.20" Cable	CA-410	14068795
1982	V6 3.0L 181ci	E	36.33" Cable	CA-409	14024991
1982-84	V6 3.0L 181ci	E	35.20" Cable	CA-410	14068795

# CLUTCH CABLES

Year	Engine	Vin	Remark	Part	OE
<b>BUICK (con't)</b>					
<b>CENTURY (con't)</b>					
1975	V6 3.8L 231ci	C	41.259" Cable	CA-853	669050
1976	V6 3.8L 231ci	C	44.17" Cable	CA-851	669034
1980	V6 3.8L 231ci	3	35.86" Cable	CA-407	14020838
1980-81	V6 3.8L 231ci	A	35.86" Cable	CA-407	14020838
1984	V6 3.8L 231ci	3	35.20" Cable	CA-410	14068795
1982	V6 4.3L 260ci	T	36.33" Cable	CA-409	14024991
1982-84	V6 4.3L 260ci	T	35.20" Cable	CA-410	14068795
1980-81	V8 4.3L 265ci	S	35.86" Cable	CA-407	14020838
1981	V8 4.4L 267ci	J	35.86" Cable	CA-407	14020838
1980	V8 4.9L 301ci	W	35.86" Cable	CA-407	14020838
1980-81	V8 5.0L 305ci	H	35.86" Cable	CA-407	14020838
1974	V8 5.7L 350ci	H, J	40.669" Cable	CA-852	669045
1975	V8 5.7L 350ci	H, J	41.259" Cable	CA-853	669050
1976	V8 5.7L 350ci	H, J	44.17" Cable	CA-851	669034
1981	V8 5.7L 350ci	N	35.86" Cable	CA-407	14020838
1974	V8 7.5L 455ci	R, U, V	40.669" Cable	CA-852	669045
<b>ELECTRA</b>					
1980-81	V6 4.1L 252ci	4	35.86" Cable	CA-407	14020838
1982	V6 4.1L 252ci	4	36.33" Cable	CA-409	14024991
1982-84	V6 4.1L 252ci	4	35.20" Cable	CA-410	14068795
1980	V8 4.9L 301ci	W	35.86" Cable	CA-407	14020838
1981	V8 5.0L 307ci	Y	35.86" Cable	CA-407	14020838
1982	V8 5.0L 307ci	Y	36.33" Cable	CA-409	14024991
1982-84	V8 5.0L 307ci	Y	35.20" Cable	CA-410	14068795
1980	V8 5.7L 350ci	R, X	35.86" Cable	CA-407	14020838
1980-81	V8 5.7L 350ci	N	35.86" Cable	CA-407	14020838
1981	V8 5.7L 350ci	B	35.86" Cable	CA-407	14020838
1982	V8 5.7L 350ci	N	36.33" Cable	CA-409	14024991
1982-84	V8 5.7L 350ci	N	35.20" Cable	CA-410	14068795
1968-69	V8 7.0L 430ci		31.02" Cable, 22.64" Mounting Length	CA-850	669021
1970-71	V8 7.5L 455ci		31.02" Cable, 22.64" Mounting Length	CA-850	669021
1974	V8 7.5L 455ci	T, U, W	40.669" Cable	CA-852	669045
1975	V8 7.5L 455ci	T	41.259" Cable	CA-853	669050
1976	V8 7.5L 455ci	T	44.17" Cable	CA-851	669034
<b>ESTATE WAGON</b>					
1970	V8 5.7L 350ci		31.02" Cable, 22.64" Mounting Length	CA-850	669021
1970-71	V8 7.5L 455ci		31.02" Cable, 22.64" Mounting Length	CA-850	669021
1974	V8 7.5L 455ci	R	40.669" Cable	CA-852	669045
1974	V8 7.5L 455ci	T	40.669" Cable	CA-852	669045
1974	V8 7.5L 455ci	U	40.669" Cable	CA-852	669045
1974	V8 7.5L 455ci	W	40.669" Cable	CA-852	669045
1975	V8 7.5L 455ci	T	41.259" Cable	CA-853	669050
1976	V8 7.5L 455ci	T	44.17" Cable	CA-851	669034
<b>GS</b>					
1970-71	V8 5.7L 350ci		31.02" Cable, 22.64" Mounting Length	CA-850	669021
<b>GS 350</b>					
1968-69	V8 5.7L 350ci		31.02" Cable, 22.64" Mounting Length	CA-850	669021
<b>GS 400</b>					
1968-69	V8 6.6L 400ci		31.02" Cable, 22.64" Mounting Length	CA-850	669021
<b>GS 455</b>					
1970	V8 7.5L 455ci		31.02" Cable, 22.64" Mounting Length	CA-850	669021
1971	V8 7.5L 455ci	U	31.02" Cable, 22.64" Mounting Length	CA-850	669021
<b>LESABRE</b>					
1970	L6 4.1L 250ci		31.02" Cable, 22.64" Mounting Length	CA-850	669021
1976	V6 3.8L 231ci	C	44.17" Cable	CA-851	669034



# CLUTCH CABLES

Year	Engine	Vin	Remark	Part	OE
<b>BUICK (con't)</b>					
<b>LESABRE (con't)</b>					
1980	V6 3.8L 231ci	3	35.86" Cable	CA-407	14020838
1980-81	V6 3.8L 231ci	A	35.86" Cable	CA-407	14020838
1982	V6 3.8L 231ci	A	36.33" Cable	CA-409	14024991
1982-84	V6 3.8L 231ci	A	35.20" Cable	CA-410	14068795
1980-81	V6 4.1L 252ci	4	35.86" Cable	CA-407	14020838
1982	V6 4.1L 252ci	4	36.33" Cable	CA-409	14024991
1982-84	V6 4.1L 252ci	4	35.20" Cable	CA-410	14068795
1982	V8 4.4L 267ci	J	35.20" Cable	CA-410	14068795
1982	V8 4.4L 267ci	J	36.33" Cable	CA-409	14024991
1980	V8 4.9L 301ci	W	35.86" Cable	CA-407	14020838
1981	V8 5.0L 307ci	Y	35.86" Cable	CA-407	14020838
1982	V8 5.0L 307ci	Y	36.33" Cable	CA-409	14024991
1982-84	V8 5.0L 307ci	Y	35.20" Cable	CA-410	14068795
1968-71	V8 5.7L 350ci		31.02" Cable, 22.64" Mounting Length	CA-850	669021
1974	V8 5.7L 350ci	H, J	40.669" Cable	CA-852	669045
1975	V8 5.7L 350ci	J	41.259" Cable	CA-853	669050
1976	V8 5.7L 350ci	J	44.17" Cable	CA-851	669034
1980	V8 5.7L 350ci	R, X	35.86" Cable	CA-407	14020838
1980-81	V8 5.7L 350ci	N	35.86" Cable	CA-407	14020838
1982	V8 5.7L 350ci	N	36.33" Cable	CA-409	14024991
1982-84	V8 5.7L 350ci	N	35.20" Cable	CA-410	14068795
1975	V8 6.6L 400ci	S	41.259" Cable	CA-853	669050
1970-71	V8 7.5L 455ci		31.02" Cable, 22.64" Mounting Length	CA-850	669021
1974	V8 7.5L 455ci	P, R, T, U, W	40.669" Cable	CA-852	669045
1975	V8 7.5L 455ci	T	41.259" Cable	CA-853	669050
1976	V8 7.5L 455ci	T	44.17" Cable	CA-851	669034
<b>REGAL</b>					
1975	V6 3.8L 231ci	C	41.259" Cable	CA-853	669050
1976	V6 3.8L 231ci	C	44.17" Cable	CA-851	669034
1980-81	V6 3.8L 231ci	3, A	35.86" Cable	CA-407	14020838
1982	V6 3.8L 231ci	3	35.20" Cable	CA-410	14068795
1982	V6 3.8L 231ci	3, A	36.33" Cable	CA-409	14024991
1982-84	V6 3.8L 231ci	A	35.20" Cable	CA-410	14068795
1983	V6 3.8L 231ci	8	35.20" Cable	CA-410	14068795
1984	V6 3.8L 231ci	9	35.20" Cable	CA-410	14068795
1982	V6 4.1L 252ci	4	36.33" Cable	CA-409	14024991
1982-84	V6 4.1L 252ci	4	35.20" Cable	CA-410	14068795
1982	V6 4.3L 260ci	V	36.33" Cable	CA-409	14024991
1982-84	V6 4.3L 260ci	V	35.20" Cable	CA-410	14068795
1980-81	V8 4.3L 265ci	S	35.86" Cable	CA-407	14020838
1981	V8 4.4L 267ci	J	35.86" Cable	CA-407	14020838
1982	V8 4.4L 267ci	J	35.20" Cable	CA-410	14068795
1982	V8 4.4L 267ci	J	36.33" Cable	CA-409	14024991
1980	V8 4.9L 301ci	W	35.86" Cable	CA-407	14020838
1980	V8 5.0L 305ci	H	35.86" Cable	CA-407	14020838
1982	V8 5.0L 305ci	H	36.33" Cable	CA-409	14024991
1982-84	V8 5.0L 305ci	H	35.20" Cable	CA-410	14068795
1974	V8 5.7L 350ci	H, J	40.669" Cable	CA-852	669045
1975	V8 5.7L 350ci	H, J	41.259" Cable	CA-853	669050
1976	V8 5.7L 350ci	H, J	44.17" Cable	CA-851	669034
1981	V8 5.7L 350ci	N	35.86" Cable	CA-407	14020838
1982	V8 5.7L 350ci	N	36.33" Cable	CA-409	14024991
1982-83	V8 5.7L 350ci	N	35.20" Cable	CA-410	14068795
1974	V8 7.5L 455ci		40.669" Cable	CA-852	669045

# CLUTCH CABLES

Year	Engine	Vin	Remark	Part	OE
<b>BUICK (con't)</b>					
<b>RIVIERA</b>					
1980-81	V6 3.8L 231ci	3	35.86" Cable	CA-407	14020838
1982	V6 3.8L 231ci	3	35.20" Cable	CA-410	14068795
1982	V6 3.8L 231ci	3	36.33" Cable	CA-409	14024991
1983	V6 3.8L 231ci	8	35.20" Cable	CA-410	14068795
1984	V6 3.8L 231ci	9	35.20" Cable	CA-410	14068795
1981	V6 4.1L 252ci	4	35.86" Cable	CA-407	14020838
1982	V6 4.1L 252ci	4	36.33" Cable	CA-409	14024991
1982-84	V6 4.1L 252ci	4	35.20" Cable	CA-410	14068795
1980-81	V8 5.0L 307ci	Y	35.86" Cable	CA-407	14020838
1982	V8 5.0L 307ci	Y	36.33" Cable	CA-409	14024991
1982-84	V8 5.0L 307ci	Y	35.20" Cable	CA-410	14068795
1980	V8 5.7L 350ci	R	35.86" Cable	CA-407	14020838
1980-81	V8 5.7L 350ci	N	35.86" Cable	CA-407	14020838
1982	V8 5.7L 350ci	N	36.33" Cable	CA-409	14024991
1982-84	V8 5.7L 350ci	N	35.20" Cable	CA-410	14068795
1968-69	V8 7.0L 430ci		31.02" Cable, 22.64" Mounting Length	CA-850	669021
1970-71	V8 7.5L 455ci		31.02" Cable, 22.64" Mounting Length	CA-850	669021
1974	V8 7.5L 455ci	U, W	40.669" Cable	CA-852	669045
1975	V8 7.5L 455ci	T	41.259" Cable	CA-853	669050
1976	V8 7.5L 455ci	T	44.17" Cable	CA-851	669034
<b>SKYHAWK</b>					
1982	L4 1.8L 112ci	G	35.20" Cable	CA-410	14068795
1982	L4 1.8L 112ci	0, G	36.33" Cable	CA-409	14024991
1982-84	L4 1.8L 112ci	0	35.20" Cable	CA-410	14068795
1984	L4 1.8L 112ci	J	35.20" Cable	CA-410	14068795
1983-84	L4 2.0L 122ci	B, P	35.20" Cable	CA-410	14068795
1975	V6 3.8L 231ci	C	41.259" Cable	CA-853	669050
1976	V6 3.8L 231ci	C	44.17" Cable	CA-851	669034
1980	V6 3.8L 231ci	A	35.86" Cable	CA-407	14020838
<b>SKYLARK</b>					
1980-83	L4 2.5L 151ci	5	35.86" Cable	CA-407	14020838
1982	L4 2.5L 151ci	R	35.86" Cable	CA-407	14056659
1982	L4 2.5L 151ci	5, R	36.33" Cable	CA-409	14024991
1982-83	L4 2.5L 151ci	5	35.20" Cable	CA-410	14068795
1982-83	L4 2.5L 151ci	5	35.86" Cable	CA-407	14056659
1982-84	L4 2.5L 151ci	R	35.20" Cable	CA-410	14068795
1982-85	L4 2.5L 151ci	R	35.86" Cable	CA-407	14020838
1968-71	L6 4.1L 250ci		31.02" Cable, 22.64" Mounting Length	CA-850	669021
1980	V6 2.8L 173ci	7	35.86" Cable	CA-407	14020838
1981	V6 2.8L 173ci	X	35.86" Cable	CA-407	14020838
1982	V6 2.8L 173ci	X, Z	36.33" Cable	CA-409	14024991
1982-84	V6 2.8L 173ci	X, Z	35.20" Cable	CA-410	14068795
1982-84	V6 2.8L 173ci	Z	35.86" Cable	CA-407	14056659
1982-85	V6 2.8L 173ci	X	35.86" Cable	CA-407	14056659
1985	V6 2.8L 173ci	W	35.86" Cable	CA-407	14020838
1975	V6 3.8L 231ci	C	41.259" Cable	CA-853	669050
1976	V6 3.8L 231ci	C	44.17" Cable	CA-851	669034
1977	V6 3.8L 231ci	C	48.89" Cable	CA-405	465472
1978-79	V6 3.8L 231ci	A	48.89" Cable	CA-405	465472
1975	V8 4.3L 260ci	F	41.259" Cable	CA-853	669050
1976	V8 4.3L 260ci	F	44.17" Cable	CA-851	669034
1977	V8 4.9L 301ci	Y	48.89" Cable	CA-405	465472
1977-78	V8 5.0L 305ci	U	48.89" Cable	CA-405	465472
1979	V8 5.0L 305ci	G	48.89" Cable	CA-405	465472
1968-71	V8 5.7L 350ci		31.02" Cable, 22.64" Mounting Length	CA-850	669021

# CLUTCH CABLES

Year	Engine	Vin	Remark	Part	OE
<b>BUICK (con't)</b>					
<b>SKYLARK (con't)</b>					
1975	V8 5.7L 350ci	H, J	41.259" Cable	CA-853	669050
1976	V8 5.7L 350ci	H, J	44.17" Cable	CA-851	669034
1977	V8 5.7L 350ci	R	48.89" Cable	CA-405	465472
1977-79	V8 5.7L 350ci	L	48.89" Cable	CA-405	465472
1968	V8 6.6L 400ci		31.02" Cable, 22.64" Mounting Length	CA-850	669021
1970-71	V8 7.5L 455ci		31.02" Cable, 22.64" Mounting Length	CA-850	669021
<b>SPECIAL</b>					
1968-69	L6 4.1L 250ci		31.02" Cable, 22.64" Mounting Length	CA-850	669021
1968-69	V8 5.7L 350ci		31.02" Cable, 22.64" Mounting Length	CA-850	669021
<b>SPORTWAGON</b>					
1968-71	V8 5.7L 350ci		31.02" Cable, 22.64" Mounting Length	CA-850	669021
1968	V8 6.6L 400ci		31.02" Cable, 22.64" Mounting Length	CA-850	669021
1970	V8 7.5L 455ci		31.02" Cable, 22.64" Mounting Length	CA-850	669021
<b>WILDCAT</b>					
1968-69	V8 7.0L 430ci		31.02" Cable, 22.64" Mounting Length	CA-850	669021
1970	V8 7.5L 455ci		31.02" Cable, 22.64" Mounting Length	CA-850	669021
<b>CADILLAC</b>					
<b>CIMARRON</b>					
1982	L4 1.8L 112ci	G	36.33" Cable	CA-409	14024991
1983-84	L4 2.0L 122ci	P	35.20" Cable	CA-410	14068795
<b>COMMERCIAL CHASSIS</b>					
1982	V8 6.0L 368ci	6	36.33" Cable	CA-409	14024991
1983-84	V8 6.0L 368ci	6	35.20" Cable	CA-410	14068795
<b>DEVILLE, ELDORADO, SEVILLE</b>					
1982	V6 4.1L 252ci	4, 8	36.33" Cable	CA-409	14024991
1983-84	V8 4.1L 250ci	8	35.20" Cable	CA-410	14068795
1982	V8 5.7L 350ci	N	36.33" Cable	CA-409	14024991
1983-84	V8 5.7L 350ci	N	35.20" Cable	CA-410	14068795
<b>FLEETWOOD</b>					
1982	V6 4.1L 252ci	4, 8	36.33" Cable	CA-409	14024991
1983-84	V8 4.1L 250ci	8	35.20" Cable	CA-410	14068795
1982	V8 5.7L 350ci	N	36.33" Cable	CA-409	14024991
1983-84	V8 5.7L 350ci	N	35.20" Cable	CA-410	14068795
1982	V8 6.0L 368ci	6, 9	36.33" Cable	CA-409	14024991
1983-84	V8 6.0L 368ci	9	35.20" Cable	CA-410	14068795
<b>CHEVROLET</b>					
<b>BEL AIR</b>					
1981	V8 4.4L 267ci	J	35.86" Cable	CA-407	14056659
1981	V8 4.4L 267ci	J	60.41" Cable	CA-408	465422
1981	V8 5.0L 305ci	H	35.86" Cable	CA-407	14056659
1981	V8 5.0L 305ci	H	60.41" Cable	CA-408	465422
1975	V8 5.7L 350ci	H, L	66.27" Cable	CA-404	361688
1975	V8 6.6L 400ci	U	66.27" Cable	CA-404	361688
1975	V8 7.4L 454ci	Y	66.27" Cable	CA-404	361688
<b>BERETTA</b>					
1987	L4 2.0L 122ci	1	60.41" Cable	CA-408	465422
1987-88	L4 2.0L 122ci	1	24.00" Cable	CA-162	96067823
1987-88	L4 2.0L 122ci	1	36.00" Cable, 22.50" Mounting Length	CA-580	
1987-88	L4 2.0L 122ci	1	36.00" Cable, 23.63" Mounting Length	CA-578	94322759
1987	V6 2.8L 173ci	W	60.41" Cable	CA-408	465422
1987-88	V6 2.8L 173ci	W	24.00" Cable	CA-162	96067823
1987-88	V6 2.8L 173ci	W	36.00" Cable, 22.50" Mounting Length	CA-580	
1987-88	V6 2.8L 173ci	W	36.00" Cable, 23.63" Mounting Length	CA-578	94322759

# CLUTCH CABLES

Year	Engine	Vin	Remark	Part	OE
<b>CHEVROLET (con't)</b>					
<b>CAMARO</b>					
1982	L4 2.5L 151ci	2, F	36.33" Cable	CA-409	14024991
1983	L4 2.5L 151ci	F	35.20" Cable	CA-410	14068795
1983	L4 2.5L 151ci	2	35.86" Cable	CA-407	14056659
1985	L4 2.5L 151ci	2	35.00" Cable	CA-679	93412539
1985	L4 2.5L 151ci	2	62.50" Cable	CA-672	96053809
1986	L4 2.5L 151ci	2	24.00" Cable	CA-162	96067823
1982-83	L4 2.5L 151ci	F	35.86" Cable	CA-407	14056659
1982-83	L4 2.5L 151ci	F	60.41" Cable	CA-408	465422
1982-86	L4 2.5L 151ci	2	60.41" Cable	CA-408	465422
1983-84	L4 2.5L 151ci	2	35.20" Cable	CA-410	14068795
1975	L6 4.1L 250ci	D	66.27" Cable	CA-404	361688
1976	L6 4.1L 250ci	D	60.22" Cable	CA-406	364654
1976-77	L6 4.1L 250ci	D	47.36" Cable	CA-402	364672
1976-77	L6 4.1L 250ci	D	61.91" Cable	CA-401	361612
1977-79	L6 4.1L 250ci	D	60.41" Cable	CA-408	465422
1978-79	L6 4.1L 250ci	D	48.89" Cable	CA-405	465472
1982	V6 2.8L 173ci	1	36.33" Cable	CA-409	14024991
1985	V6 2.8L 173ci	S	35.00" Cable	CA-679	93412539
1985	V6 2.8L 173ci	S	35.86" Cable	CA-407	14056659
1985	V6 2.8L 173ci	S	62.50" Cable	CA-672	96053809
1982-84	V6 2.8L 173ci	1	60.41" Cable	CA-408	465422
1983-84	V6 2.8L 173ci	1	35.20" Cable	CA-410	14068795
1985-87	V6 2.8L 173ci	S	60.41" Cable	CA-408	465422
1986-88	V6 2.8L 173ci	S	24.00" Cable	CA-162	96067823
1987-88	V6 2.8L 173ci	S	36.00" Cable, 22.50" Mounting Length	CA-580	
1987-88	V6 2.8L 173ci	S	36.00" Cable, 23.63" Mounting Length	CA-578	94322759
1981	V6 3.8L 229ci	K	35.86" Cable	CA-407	14056659
1980-81	V6 3.8L 229ci	K	60.41" Cable	CA-408	465422
1980	V6 3.8L 231ci	A	48.89" Cable	CA-405	465472
1981	V6 3.8L 231ci	A	35.86" Cable	CA-407	14056659
1980-81	V6 3.8L 231ci	A	60.41" Cable	CA-408	465422
1998-98	V6 3.8L 231ci	K	23.25" Cable	CA-678	30015828
1981	V8 4.4L 267ci	J	35.86" Cable	CA-407	14056659
1980-81	V8 4.4L 267ci	J	60.41" Cable	CA-408	465422
1976	V8 5.0L 305ci	Q	47.36" Cable	CA-402	364672
1976	V8 5.0L 305ci	Q	60.22" Cable	CA-406	364654
1976	V8 5.0L 305ci	Q	61.91" Cable	CA-401	361612
1977	V8 5.0L 305ci	U	47.36" Cable	CA-402	364672
1977	V8 5.0L 305ci	U	61.91" Cable	CA-401	361612
1978	V8 5.0L 305ci	U	48.89" Cable	CA-405	465472
1979	V8 5.0L 305ci	G	48.89" Cable	CA-405	465472
1981	V8 5.0L 305ci	H	35.86" Cable	CA-407	14056659
1982	V8 5.0L 305ci	7, H	36.33" Cable	CA-409	14024991
1983	V8 5.0L 305ci	S	35.20" Cable	CA-410	14068795
1983	V8 5.0L 305ci	S	60.41" Cable	CA-408	465422
1984	V8 5.0L 305ci	G	35.20" Cable	CA-410	14068795
1985	V8 5.0L 305ci	F, G, H	62.50" Cable	CA-672	96053809
1986	V8 5.0L 305ci	G	24.00" Cable	CA-162	96067823
1987	V8 5.0L 305ci	H	36.00" Cable, 22.50" Mounting Length	CA-580	
1987	V8 5.0L 305ci	H	36.00" Cable, 23.63" Mounting Length	CA-578	94322759
1988	V8 5.0L 305ci	E	24.00" Cable	CA-162	96067823
1988	V8 5.0L 305ci	E	36.00" Cable, 22.50" Mounting Length	CA-580	
1988	V8 5.0L 305ci	E	36.00" Cable, 23.63" Mounting Length	CA-578	94322759
1977-78	V8 5.0L 305ci	U	60.41" Cable	CA-408	465422
1979-86	V8 5.0L 305ci	G	60.41" Cable	CA-408	465422
1980-87	V8 5.0L 305ci	H	60.41" Cable	CA-408	465422

# CLUTCH CABLES

Year	Engine	Vin	Remark	Part	OE
<b>CHEVROLET (con't)</b>					
<b>CAMARO (con't)</b>					
1982-83	V8 5.0L 305ci	7	60.41" Cable	CA-408	465422
1983-84	V8 5.0L 305ci	H	35.20" Cable	CA-410	14068795
1985-87	V8 5.0L 305ci	F	60.41" Cable	CA-408	465422
1986-87	V8 5.0L 305ci	H	24.00" Cable	CA-162	96067823
1986-88	V8 5.0L 305ci	F	24.00" Cable	CA-162	96067823
1987-88	V8 5.0L 305ci	F	36.00" Cable, 22.50" Mounting Length	CA-580	
1987-88	V8 5.0L 305ci	F	36.00" Cable, 23.63" Mounting Length	CA-578	94322759
1975	V8 5.7L 350ci	H, L	66.27" Cable	CA-404	361688
1976	V8 5.7L 350ci	L	60.22" Cable	CA-406	364654
1981	V8 5.7L 350ci	L	35.86" Cable	CA-407	14056659
1987	V8 5.7L 350ci	8	60.41" Cable	CA-408	465422
1976-77	V8 5.7L 350ci	L	47.36" Cable	CA-402	364672
1976-77	V8 5.7L 350ci	L	61.91" Cable	CA-401	361612
1977-81	V8 5.7L 350ci	L	60.41" Cable	CA-408	465422
1978-79	V8 5.7L 350ci	L	48.89" Cable	CA-405	465472
1987-88	V8 5.7L 350ci	8	24.00" Cable	CA-162	96067823
1987-88	V8 5.7L 350ci	8	36.00" Cable, 22.50" Mounting Length	CA-580	
1987-88	V8 5.7L 350ci	8	36.00" Cable, 23.63" Mounting Length	CA-578	94322759
1998-98	V8 5.7L 350ci	G	23.25" Cable	CA-678	30015828
<b>CAPRICE</b>					
1977	L6 4.1L 250ci	D	47.36" Cable	CA-402	364672
1977	L6 4.1L 250ci	D	61.91" Cable	CA-401	361612
1977-79	L6 4.1L 250ci	D	60.41" Cable	CA-408	465422
1978-79	L6 4.1L 250ci	D	48.89" Cable	CA-405	465472
1981	V6 3.8L 229ci	K	35.86" Cable	CA-407	14056659
1982	V6 3.8L 229ci	K	36.33" Cable	CA-409	14024991
1980-82	V6 3.8L 229ci	K	60.41" Cable	CA-408	465422
1983-84	V6 3.8L 229ci	9	35.20" Cable	CA-410	14068795
1983-84	V6 3.8L 229ci	9	60.41" Cable	CA-408	465422
1980	V6 3.8L 231ci	A	48.89" Cable	CA-405	465472
1981	V6 3.8L 231ci	A	35.86" Cable	CA-407	14056659
1982	V6 3.8L 231ci	A	36.33" Cable	CA-409	14024991
1985	V6 3.8L 231ci	A	62.50" Cable	CA-672	96053809
1980-85	V6 3.8L 231ci	A	60.41" Cable	CA-408	465422
1983-84	V6 3.8L 231ci	A	35.20" Cable	CA-410	14068795
1985	V6 4.3L 262ci	Z	62.50" Cable	CA-672	96053809
1985-87	V6 4.3L 262ci	Z	60.41" Cable	CA-408	465422
1986-88	V6 4.3L 262ci	Z	24.00" Cable	CA-162	96067823
1987-88	V6 4.3L 262ci	Z	36.00" Cable, 22.50" Mounting Length	CA-580	
1987-88	V6 4.3L 262ci	Z	36.00" Cable, 23.63" Mounting Length	CA-578	94322759
1981	V8 4.4L 267ci	J	35.86" Cable	CA-407	14056659
1982	V8 4.4L 267ci	J	36.33" Cable	CA-409	14024991
1980-82	V8 4.4L 267ci	J	60.41" Cable	CA-408	465422
1977	V8 5.0L 305ci	U	47.36" Cable	CA-402	364672
1977	V8 5.0L 305ci	U	61.91" Cable	CA-401	361612
1978	V8 5.0L 305ci	U	48.89" Cable	CA-405	465472
1979	V8 5.0L 305ci	G	48.89" Cable	CA-405	465472
1979	V8 5.0L 305ci	G	60.41" Cable	CA-408	465422
1981	V8 5.0L 305ci	H	35.86" Cable	CA-407	14056659
1982	V8 5.0L 305ci	H	36.33" Cable	CA-409	14024991
1985	V8 5.0L 305ci	H	62.50" Cable	CA-672	96053809
1977-78	V8 5.0L 305ci	U	60.41" Cable	CA-408	465422
1980-87	V8 5.0L 305ci	H	60.41" Cable	CA-408	465422
1983-84	V8 5.0L 305ci	H	35.20" Cable	CA-410	14068795
1986-88	V8 5.0L 305ci	H	24.00" Cable	CA-162	96067823

# CLUTCH CABLES

Year	Engine	Vin	Remark	Part	OE
<b>CHEVROLET (con't)</b>					
<b>CAPRICE (con't)</b>					
1987-88	V8 5.0L 305ci	H	36.00" Cable, 22.50" Mounting Length	CA-580	
1987-88	V8 5.0L 305ci	H	36.00" Cable, 23.63" Mounting Length	CA-578	94322759
1986-87	V8 5.0L 307ci	Y	60.41" Cable	CA-408	465422
1986-88	V8 5.0L 307ci	Y	24.00" Cable	CA-162	96067823
1987-88	V8 5.0L 307ci	Y	36.00" Cable, 22.50" Mounting Length	CA-580	
1987-88	V8 5.0L 307ci	Y	36.00" Cable, 23.63" Mounting Length	CA-578	94322759
1975	V8 5.7L 350ci	H, L	66.27" Cable	CA-404	361688
1976	V8 5.7L 350ci	V	47.36" Cable	CA-402	364672
1976	V8 5.7L 350ci	L, V	60.22" Cable	CA-406	364654
1976	V8 5.7L 350ci	V	61.91" Cable	CA-401	361612
1981	V8 5.7L 350ci	L, N	35.86" Cable	CA-407	14056659
1982	V8 5.7L 350ci	N	36.33" Cable	CA-409	14024991
1985	V8 5.7L 350ci	6, N	62.50" Cable	CA-672	96053809
1976-77	V8 5.7L 350ci	L	47.36" Cable	CA-402	364672
1976-77	V8 5.7L 350ci	L	61.91" Cable	CA-401	361612
1977-81	V8 5.7L 350ci	L	60.41" Cable	CA-408	465422
1978-79	V8 5.7L 350ci	L	48.89" Cable	CA-405	465472
1980-85	V8 5.7L 350ci	N	60.41" Cable	CA-408	465422
1983-84	V8 5.7L 350ci	N	35.20" Cable	CA-410	14068795
1985-87	V8 5.7L 350ci	6	60.41" Cable	CA-408	465422
1986-88	V8 5.7L 350ci	6	24.00" Cable	CA-162	96067823
1987-88	V8 5.7L 350ci	6	36.00" Cable, 22.50" Mounting Length	CA-580	
1987-88	V8 5.7L 350ci	6	36.00" Cable, 23.63" Mounting Length	CA-578	94322759
1975	V8 6.6L 400ci	R, U	66.27" Cable	CA-404	361688
1976	V8 6.6L 400ci	U	47.36" Cable	CA-402	364672
1976	V8 6.6L 400ci	U	60.22" Cable	CA-406	364654
1976	V8 6.6L 400ci	U	61.91" Cable	CA-401	361612
1975	V8 7.4L 454ci	Y	66.27" Cable	CA-404	361688
1976	V8 7.4L 454ci	S	47.36" Cable	CA-402	364672
1976	V8 7.4L 454ci	S	60.22" Cable	CA-406	364654
1976	V8 7.4L 454ci	S	61.91" Cable	CA-401	361612
<b>CAVALIER</b>					
1982	L4 1.8L 112ci	G	36.33" Cable	CA-409	14024991
1982	L4 1.8L 112ci	G	60.41" Cable	CA-408	465422
1985	L4 2.0L 122ci	P	62.50" Cable	CA-672	96053809
1986	L4 2.0L 122ci	P	24.00" Cable	CA-162	96067823
1987	L4 2.0L 122ci	1	60.41" Cable	CA-408	465422
1983-84	L4 2.0L 122ci	B, P	35.20" Cable	CA-410	14068795
1983-84	L4 2.0L 122ci	B	60.41" Cable	CA-408	465422
1983-86	L4 2.0L 122ci	P	60.41" Cable	CA-408	465422
1987-88	L4 2.0L 122ci	1	24.00" Cable	CA-162	96067823
1987-88	L4 2.0L 122ci	1	36.00" Cable, 22.50" Mounting Length	CA-580	
1987-88	L4 2.0L 122ci	1	36.00" Cable, 23.63" Mounting Length	CA-578	94322759
1998-98	L4 2.2L 134ci	4	23.25" Cable	CA-678	30015828
1998-98	L4 2.4L 146ci	T	23.25" Cable	CA-678	30015828
1985	V6 2.8L 173ci	W	35.00" Cable	CA-679	93412539
1985	V6 2.8L 173ci	W	62.50" Cable	CA-672	96053809
1985-87	V6 2.8L 173ci	W	60.41" Cable	CA-408	465422
1986-88	V6 2.8L 173ci	W	24.00" Cable	CA-162	96067823
1987-88	V6 2.8L 173ci	W	36.00" Cable, 22.50" Mounting Length	CA-580	
1987-88	V6 2.8L 173ci	W	36.00" Cable, 23.63" Mounting Length	CA-578	94322759
<b>CELEBRITY</b>					
1982	L4 2.5L 151ci	5, R	36.33" Cable	CA-409	14024991
1983	L4 2.5L 151ci	5	35.20" Cable	CA-410	14068795
1985	L4 2.5L 151ci	R	62.50" Cable	CA-672	96053809

# CLUTCH CABLES

Year	Engine	Vin	Remark	Part	OE
<b>CHEVROLET (con't)</b>					
<b>CELEBRITY (con't)</b>					
1982-83	L4 2.5L 151ci	5	60.41" Cable	CA-408	465422
1982-87	L4 2.5L 151ci	R	60.41" Cable	CA-408	465422
1983-84	L4 2.5L 151ci	R	35.20" Cable	CA-410	14068795
1986-88	L4 2.5L 151ci	R	24.00" Cable	CA-162	96067823
1987-88	L4 2.5L 151ci	R	36.00" Cable, 22.50" Mounting Length	CA-580	
1987-88	L4 2.5L 151ci	R	36.00" Cable, 23.63" Mounting Length	CA-578	94322759
1982	V6 2.8L 173ci	X	36.33" Cable	CA-409	14024991
1984	V6 2.8L 173ci	Z	35.20" Cable	CA-410	14068795
1984	V6 2.8L 173ci	X	35.86" Cable	CA-407	14056659
1984	V6 2.8L 173ci	Z	60.41" Cable	CA-408	465422
1985	V6 2.8L 173ci	W, X	35.00" Cable	CA-679	93412539
1985	V6 2.8L 173ci	W, X	62.50" Cable	CA-672	96053809
1986	V6 2.8L 173ci	X	24.00" Cable	CA-162	96067823
1982-86	V6 2.8L 173ci	X	60.41" Cable	CA-408	465422
1983-84	V6 2.8L 173ci	X	35.20" Cable	CA-410	14068795
1985-87	V6 2.8L 173ci	W	60.41" Cable	CA-408	465422
1986-88	V6 2.8L 173ci	W	24.00" Cable	CA-162	96067823
1987-88	V6 2.8L 173ci	W	36.00" Cable, 22.50" Mounting Length	CA-580	
1987-88	V6 2.8L 173ci	W	36.00" Cable, 23.63" Mounting Length	CA-578	94322759
1982	V6 4.3L 260ci	T	36.33" Cable	CA-409	14024991
1985	V6 4.3L 260ci	T	62.50" Cable	CA-672	96053809
1982-85	V6 4.3L 260ci	T	60.41" Cable	CA-408	465422
1983-84	V6 4.3L 260ci	T	35.20" Cable	CA-410	14068795
<b>CHEVETTE</b>					
1976	L4 1.4L 85ci	I	60.22" Cable	CA-406	364654
1976	L4 1.4L 85ci	I	61.91" Cable	CA-401	361612
1977	L4 1.4L 85ci	I	2nd Design, w/Spherical Ball 60.41" Cable	CA-408	465422
1976-77	L4 1.4L 85ci	I	1st Design, w/Threaded Shaft w/Nuts; 61.91" Cable	CA-401	361612
1976-77	L4 1.4L 85ci	I	47.36" Cable	CA-402	364672
1976	L4 1.6L 98ci	E	1st Design, w/Threaded Shaft w/Nuts; 61.91" Cable	CA-401	361612
1976	L4 1.6L 98ci	E	60.22" Cable	CA-406	364654
1978	L4 1.6L 98ci	E	2nd Design, w/Spherical Ball 60.41" Cable	CA-408	465422
1978	L4 1.6L 98ci	J	2nd Design, w/Spherical Ball 60.41" Cable	CA-408	465422
1978	L4 1.6L 98ci	J	48.89" Cable	CA-405	465472
1978	L4 1.6L 98ci	J	60.41" Cable	CA-408	465422
1979	L4 1.6L 98ci	O	48.89" Cable	CA-405	465472
1981	L4 1.6L 98ci	9	35.86" Cable	CA-407	14056659
1982	L4 1.6L 98ci	C	36.33" Cable	CA-409	14024991
1985	L4 1.6L 98ci	C	62.50" Cable	CA-672	96053809
1987	L4 1.6L 98ci	C	36.00" Cable, 22.50" Mounting Length	CA-580	
1987	L4 1.6L 98ci	C	36.00" Cable, 23.63" Mounting Length	CA-578	94322759
1976-77	L4 1.6L 98ci	E	47.36" Cable	CA-402	364672
1976-77	L4 1.6L 98ci	E	61.91" Cable	CA-401	361612
1977-79	L4 1.6L 98ci	E	60.41" Cable	CA-408	465422
1978-79	L4 1.6L 98ci	E	48.89" Cable	CA-405	465472
1979-80	L4 1.6L 98ci	O	60.41" Cable	CA-408	465422
1980-81	L4 1.6L 98ci	9	60.41" Cable	CA-408	465422
1982-87	L4 1.6L 98ci	C	4 Spd. Man. Trans. 60.41" Cable	CA-408	14080793
1983-84	L4 1.6L 98ci	C	35.20" Cable	CA-410	14068795
1984-85	L4 1.6L 98ci	C	60.41" Cable	CA-408	465422
1986-87	L4 1.6L 98ci	C	24.00" Cable	CA-162	96067823
1981	L4 1.8L 110ci	D	35.86" Cable	CA-407	14056659
1982	L4 1.8L 110ci	D	36.33" Cable	CA-409	14024991

# CLUTCH CABLES

Year	Engine	Vin	Remark	Part	OE
<b>CHEVROLET (con't)</b>					
<b>CHEVETTE (con't)</b>					
1985	L4 1.8L 110ci	D	62.50" Cable	CA-672	96053809
1986	L4 1.8L 110ci	D	24.00" Cable	CA-162	96067823
1981-86	L4 1.8L 110ci	D	60.41" Cable	CA-408	465422
1983-84	L4 1.8L 110ci	D	35.20" Cable	CA-410	14068795
<b>CITATION</b>					
1982	L4 2.5L 151ci	5, R	35.86" Cable	CA-407	14046845
1982	L4 2.5L 151ci	5, R	36.33" Cable	CA-409	14024991
1983	L4 2.5L 151ci	5, R	35.20" Cable	CA-410	14068795
1983	L4 2.5L 151ci	5, R	35.86" Cable	CA-407	14056659
1980-81	L4 2.5L 151ci	5	35.86" Cable	CA-407	14020838
1980-83	L4 2.5L 151ci	5	60.41" Cable	CA-408	465422
1982-83	L4 2.5L 151ci	R	60.41" Cable	CA-408	465422
1980	V6 2.8L 173ci	7	35.86" Cable	CA-407	14056659
1980	V6 2.8L 173ci	7	60.41" Cable	CA-408	465422
1981	V6 2.8L 173ci	X, Z	35.86" Cable	CA-407	14020838
1982	V6 2.8L 173ci	X, Z	35.86" Cable	CA-407	14046845
1982	V6 2.8L 173ci	X, Z	36.33" Cable	CA-409	14024991
1983	V6 2.8L 173ci	X, Z	35.20" Cable	CA-410	14068795
1983	V6 2.8L 173ci	X, Z	35.86" Cable	CA-407	14056659
1981-83	V6 2.8L 173ci	X, Z	60.41" Cable	CA-408	465422
<b>CITATION II</b>					
1984	L4 2.5L 151ci	R	35.20" Cable	CA-410	14068795
1985	L4 2.5L 151ci	R	35.00" Cable	CA-679	93412539
1985	L4 2.5L 151ci	R	62.50" Cable	CA-672	96053809
1984-85	L4 2.5L 151ci	R	35.86" Cable	CA-407	14056659
1984-85	L4 2.5L 151ci	R	60.41" Cable	CA-408	465422
1984	V6 2.8L 173ci	X, Z	35.20" Cable	CA-410	14068795
1984	V6 2.8L 173ci	Z	35.86" Cable	CA-407	14056659
1984	V6 2.8L 173ci	Z	60.41" Cable	CA-408	465422
1985	V6 2.8L 173ci	W, X	35.00" Cable	CA-679	93412539
1985	V6 2.8L 173ci	W	35.86" Cable	CA-407	14056659
1985	V6 2.8L 173ci	W	60.41" Cable	CA-408	465422
1985	V6 2.8L 173ci	W, X	62.50" Cable	CA-672	96053809
1984-85	V6 2.8L 173ci	X	35.86" Cable	CA-407	14056659
1984-85	V6 2.8L 173ci	X	60.41" Cable	CA-408	465422
<b>CORSICA</b>					
1987	L4 2.0L 122ci	1	60.41" Cable	CA-408	465422
1987-88	L4 2.0L 122ci	1	24.00" Cable	CA-162	96067823
1987-88	L4 2.0L 122ci	1	36.00" Cable, 22.50" Mounting Length	CA-580	
1987-88	L4 2.0L 122ci	1	36.00" Cable, 23.63" Mounting Length	CA-578	94322759
1987	V6 2.8L 173ci	W	60.41" Cable	CA-408	465422
1987-88	V6 2.8L 173ci	W	24.00" Cable	CA-162	96067823
1987-88	V6 2.8L 173ci	W	36.00" Cable, 22.50" Mounting Length	CA-580	
1987-88	V6 2.8L 173ci	W	36.00" Cable, 23.63" Mounting Length	CA-578	94322759
<b>CORVETTE</b>					
1980	V8 5.0L 305ci	H	60.41" Cable	CA-408	465422
1975	V8 5.7L 350ci	J, T	66.27" Cable	CA-404	361688
1976	V8 5.7L 350ci	L, X	60.22" Cable	CA-406	364654
1977	V8 5.7L 350ci	X	60.41" Cable	CA-408	465422
1978	V8 5.7L 350ci	H	48.89" Cable	CA-405	465472
1978	V8 5.7L 350ci	H	60.41" Cable	CA-408	465422
1979	V8 5.7L 350ci	4, 8	48.89" Cable	CA-405	465472
1979	V8 5.7L 350ci	4	60.41" Cable	CA-408	465422
1981	V8 5.7L 350ci	6	35.86" Cable	CA-407	14056659
1982	V8 5.7L 350ci	8	36.33" Cable	CA-409	14024991



# CLUTCH CABLES

Year	Engine	Vin	Remark	Part	OE
<b>CHEVROLET (con't)</b>					
<b>CORVETTE (con't)</b>					
1984	V8 5.7L 350ci	8	35.20" Cable	CA-410	14068795
1985	V8 5.7L 350ci	8	62.50" Cable	CA-672	96053809
1976-77	V8 5.7L 350ci	L, X	47.36" Cable	CA-402	364672
1976-77	V8 5.7L 350ci	L, X	61.91" Cable	CA-401	361612
1977-79	V8 5.7L 350ci	L	60.41" Cable	CA-408	465422
1978-79	V8 5.7L 350ci	L	48.89" Cable	CA-405	465472
1979-87	V8 5.7L 350ci	8	60.41" Cable	CA-408	465422
1980-81	V8 5.7L 350ci	6	60.41" Cable	CA-408	465422
1986-88	V8 5.7L 350ci	8	24.00" Cable	CA-162	96067823
1987-88	V8 5.7L 350ci	8	36.00" Cable, 22.50" Mounting Length	CA-580	
1987-88	V8 5.7L 350ci	8	36.00" Cable, 23.63" Mounting Length	CA-578	94322759
1998-98	V8 5.7L 350ci	G	23.25" Cable	CA-678	30015828
<b>IMPALA</b>					
1977	L6 4.1L 250ci	D	47.36" Cable	CA-402	364672
1977	L6 4.1L 250ci	D	61.91" Cable	CA-401	361612
1977-79	L6 4.1L 250ci	D	60.41" Cable	CA-408	465422
1978-79	L6 4.1L 250ci	D	48.89" Cable	CA-405	465472
1981	V6 3.8L 229ci	K	35.86" Cable	CA-407	14056659
1982	V6 3.8L 229ci	K	36.33" Cable	CA-409	14024991
1980-82	V6 3.8L 229ci	K	60.41" Cable	CA-408	465422
1983-84	V6 3.8L 229ci	9	35.20" Cable	CA-410	14068795
1983-84	V6 3.8L 229ci	9	60.41" Cable	CA-408	465422
1980	V6 3.8L 231ci	A	48.89" Cable	CA-405	465472
1981	V6 3.8L 231ci	A	35.86" Cable	CA-407	14056659
1982	V6 3.8L 231ci	A	36.33" Cable	CA-409	14024991
1985	V6 3.8L 231ci	A	62.50" Cable	CA-672	96053809
1980-85	V6 3.8L 231ci	A	60.41" Cable	CA-408	465422
1983-84	V6 3.8L 231ci	A	35.20" Cable	CA-410	14068795
1985	V6 4.3L 262ci	Z	60.41" Cable	CA-408	465422
1985	V6 4.3L 262ci	Z	62.50" Cable	CA-672	96053809
1981	V8 4.4L 267ci	J	35.86" Cable	CA-407	14056659
1982	V8 4.4L 267ci	J	36.33" Cable	CA-409	14024991
1980-82	V8 4.4L 267ci	J	60.41" Cable	CA-408	465422
1977	V8 5.0L 305ci	U	47.36" Cable	CA-402	364672
1977	V8 5.0L 305ci	U	61.91" Cable	CA-401	361612
1978	V8 5.0L 305ci	U	48.89" Cable	CA-405	465472
1979	V8 5.0L 305ci	G	48.89" Cable	CA-405	465472
1979	V8 5.0L 305ci	G	60.41" Cable	CA-408	465422
1981	V8 5.0L 305ci	H	35.86" Cable	CA-407	14056659
1982	V8 5.0L 305ci	H	36.33" Cable	CA-409	14024991
1985	V8 5.0L 305ci	H	62.50" Cable	CA-672	96053809
1977-78	V8 5.0L 305ci	U	60.41" Cable	CA-408	465422
1980-85	V8 5.0L 305ci	H	60.41" Cable	CA-408	465422
1983-84	V8 5.0L 305ci	H	35.20" Cable	CA-410	14068795
1975	V8 5.7L 350ci	H, L	66.27" Cable	CA-404	361688
1976	V8 5.7L 350ci	V	47.36" Cable	CA-402	364672
1976	V8 5.7L 350ci	L, V	60.22" Cable	CA-406	364654
1976	V8 5.7L 350ci	V	61.91" Cable	CA-401	361612
1981	V8 5.7L 350ci	L, N	35.86" Cable	CA-407	14056659
1982	V8 5.7L 350ci	L, N	36.33" Cable	CA-409	14024991
1985	V8 5.7L 350ci	6, N	62.50" Cable	CA-672	96053809
1976-77	V8 5.7L 350ci	L	47.36" Cable	CA-402	364672
1976-77	V8 5.7L 350ci	L	61.91" Cable	CA-401	361612
1977-82	V8 5.7L 350ci	L	60.41" Cable	CA-408	465422
1978-79	V8 5.7L 350ci	L	48.89" Cable	CA-405	465472

# CLUTCH CABLES

Year	Engine	Vin	Remark	Part	OE
<b>CHEVROLET (con't)</b>					
<b>IMPALA (con't)</b>					
1980-85	V8 5.7L 350ci	N	60.41" Cable	CA-408	465422
1983-84	V8 5.7L 350ci	6	35.20" Cable	CA-410	14068795
1983-84	V8 5.7L 350ci	N	35.20" Cable	CA-410	14068795
1983-85	V8 5.7L 350ci	6	60.41" Cable	CA-408	465422
1975	V8 6.6L 400ci	M, U	66.27" Cable	CA-404	361688
1976	V8 6.6L 400ci	U	47.36" Cable	CA-402	364672
1976	V8 6.6L 400ci	U	60.22" Cable	CA-406	364654
1976	V8 6.6L 400ci	U	61.91" Cable	CA-401	361612
1975	V8 7.4L 454ci	Y	66.27" Cable	CA-404	361688
1976	V8 7.4L 454ci	S	47.36" Cable	CA-402	364672
1976	V8 7.4L 454ci	S	60.22" Cable	CA-406	364654
1976	V8 7.4L 454ci	S	61.91" Cable	CA-401	361612
<b>LAGUNA</b>					
1976	V8 5.0L 305ci	Q	47.36" Cable	CA-402	364672
1976	V8 5.0L 305ci	Q	60.22" Cable	CA-406	364654
1976	V8 5.0L 305ci	Q	61.91" Cable	CA-401	361612
1975	V8 5.7L 350ci	H, L	66.27" Cable	CA-404	361688
1976	V8 5.7L 350ci	L, V	47.36" Cable	CA-402	364672
1976	V8 5.7L 350ci	L, V	60.22" Cable	CA-406	364654
1976	V8 5.7L 350ci	L, V	61.91" Cable	CA-401	361612
1975	V8 6.6L 400ci	U	66.27" Cable	CA-404	361688
1976	V8 6.6L 400ci	U	47.36" Cable	CA-402	364672
1976	V8 6.6L 400ci	U	60.22" Cable	CA-406	364654
1976	V8 6.6L 400ci	U	61.91" Cable	CA-401	361612
1975	V8 7.4L 454ci	Y	66.27" Cable	CA-404	361688
<b>LUMINA</b>					
1998-98	V6 3.1L 189ci	M	23.25" Cable	CA-678	30015828
1998-98	V6 3.8L 231ci	K	23.25" Cable	CA-678	30015828
<b>MALIBU</b>					
1998-98	L4 2.4L 146ci	T		CA-678	30015828
1975	L6 4.1L 250ci	D	66.27" Cable	CA-404	361688
1976	L6 4.1L 250ci	D	60.22" Cable	CA-406	364654
1977	L6 4.1L 250ci	D	60.41" Cable	CA-408	465422
1976-77	L6 4.1L 250ci	D	47.36" Cable	CA-402	364672
1976-77	L6 4.1L 250ci	D	61.91" Cable	CA-401	361612
1998-98	V6 3.1L 189ci	M	23.25" Cable	CA-678	30015828
1978-79	V6 3.3L 200ci	M	48.89" Cable	CA-405	465472
1978-79	V6 3.3L 200ci	M	60.41" Cable	CA-408	465422
1981	V6 3.8L 229ci	K	35.86" Cable	CA-407	14056659
1982	V6 3.8L 229ci	K	36.33" Cable	CA-409	14024991
1983	V6 3.8L 229ci	9	35.20" Cable	CA-410	14068795
1983	V6 3.8L 229ci	9	60.41" Cable	CA-408	465422
1980-82	V6 3.8L 229ci	K	60.41" Cable	CA-408	465422
1979	V6 3.8L 231ci	2	48.89" Cable	CA-405	465472
1979	V6 3.8L 231ci	2	60.41" Cable	CA-408	465422
1981	V6 3.8L 231ci	A	35.86" Cable	CA-407	14056659
1982	V6 3.8L 231ci	A	36.33" Cable	CA-409	14024991
1983	V6 3.8L 231ci	A	35.20" Cable	CA-410	14068795
1978-80	V6 3.8L 231ci	A	48.89" Cable	CA-405	465472
1978-83	V6 3.8L 231ci	A	60.41" Cable	CA-408	465422
1982	V6 4.3L 260ci	V	36.33" Cable	CA-409	14024991
1983	V6 4.3L 260ci	V	35.20" Cable	CA-410	14068795
1982-83	V6 4.3L 260ci	V	60.41" Cable	CA-408	465422
1979	V8 4.4L 267ci	J	48.89" Cable	CA-405	465472
1981	V8 4.4L 267ci	J	35.86" Cable	CA-407	14056659

# CLUTCH CABLES

Year	Engine	Vin	Remark	Part	OE
<b>CHEVROLET (con't)</b>					
<b>MALIBU (con't)</b>					
1982	V8 4.4L 267ci	J	36.33" Cable	CA-409	14024991
1979-82	V8 4.4L 267ci	J	60.41" Cable	CA-408	465422
1976	V8 5.0L 305ci	Q	47.36" Cable	CA-402	364672
1976	V8 5.0L 305ci	Q	60.22" Cable	CA-406	364654
1976	V8 5.0L 305ci	Q	61.91" Cable	CA-401	361612
1977	V8 5.0L 305ci	U	47.36" Cable	CA-402	364672
1977	V8 5.0L 305ci	U	61.91" Cable	CA-401	361612
1979	V8 5.0L 305ci	H	48.89" Cable	CA-405	465472
1981	V8 5.0L 305ci	H	35.86" Cable	CA-407	14056659
1982	V8 5.0L 305ci	H	36.33" Cable	CA-409	14024991
1983	V8 5.0L 305ci	H	35.20" Cable	CA-410	14068795
1977-78	V8 5.0L 305ci	U	48.89" Cable	CA-405	465472
1977-78	V8 5.0L 305ci	U	60.41" Cable	CA-408	465422
1979-83	V8 5.0L 305ci	H	60.41" Cable	CA-408	465422
1975	V8 5.7L 350ci	H, L	66.27" Cable	CA-404	361688
1976	V8 5.7L 350ci	V	47.36" Cable	CA-402	364672
1976	V8 5.7L 350ci	L, V	60.22" Cable	CA-406	364654
1976	V8 5.7L 350ci	V	61.91" Cable	CA-401	361612
1981	V8 5.7L 350ci	L	35.86" Cable	CA-407	14056659
1982	V8 5.7L 350ci	N	36.33" Cable	CA-409	14024991
1983	V8 5.7L 350ci	N	35.20" Cable	CA-410	14068795
1976-77	V8 5.7L 350ci	L	47.36" Cable	CA-402	364672
1976-77	V8 5.7L 350ci	L	61.91" Cable	CA-401	361612
1977-81	V8 5.7L 350ci	L	60.41" Cable	CA-408	465422
1978-79	V8 5.7L 350ci	L	48.89" Cable	CA-405	465472
1982-83	V8 5.7L 350ci	N	60.41" Cable	CA-408	465422
1975	V8 6.6L 400ci	U	66.27" Cable	CA-404	361688
1976	V8 6.6L 400ci	U	47.36" Cable	CA-402	364672
1976	V8 6.6L 400ci	U	60.22" Cable	CA-406	364654
1976	V8 6.6L 400ci	U	61.91" Cable	CA-401	361612
1975	V8 7.4L 454ci	Y	66.27" Cable	CA-404	361688
<b>METRO</b>					
1998-98	L3 1.0L 61ci	6	23.25" Cable	CA-678	30015828
1998-98	L4 1.3L 79ci	2	23.25" Cable	CA-678	30015828
<b>MONTE CARLO</b>					
1998-98	V6 3.1L 189ci	M	23.25" Cable	CA-678	30015828
1978-79	V6 3.3L 200ci	M	48.89" Cable	CA-405	465472
1978-79	V6 3.3L 200ci	M	60.41" Cable	CA-408	465422
1981	V6 3.8L 229ci	K	35.86" Cable	CA-407	14056659
1982	V6 3.8L 229ci	K	36.33" Cable	CA-409	14024991
1980-82	V6 3.8L 229ci	K	60.41" Cable	CA-408	465422
1983-84	V6 3.8L 229ci	9	35.20" Cable	CA-410	14068795
1983-84	V6 3.8L 229ci	9	60.41" Cable	CA-408	465422
1979	V6 3.8L 231ci	2	48.89" Cable	CA-405	465472
1979	V6 3.8L 231ci	2	60.41" Cable	CA-408	465422
1980	V6 3.8L 231ci	3	48.89" Cable	CA-405	465472
1981	V6 3.8L 231ci	3, A	35.86" Cable	CA-407	14056659
1982	V6 3.8L 231ci	A	36.33" Cable	CA-409	14024991
1985	V6 3.8L 231ci	A	62.50" Cable	CA-672	96053809
1987	V6 3.8L 231ci	A	36.00" Cable, 22.50" Mounting Length	CA-580	
1987	V6 3.8L 231ci	A	36.00" Cable, 23.63" Mounting Length	CA-578	94322759
1978-80	V6 3.8L 231ci	A	48.89" Cable	CA-405	465472
1978-87	V6 3.8L 231ci	A	60.41" Cable	CA-408	465422
1980-81	V6 3.8L 231ci	3	60.41" Cable	CA-408	465422
1983-84	V6 3.8L 231ci	A	35.20" Cable	CA-410	14068795

# CLUTCH CABLES

Year	Engine	Vin	Remark	Part	OE
<b>CHEVROLET (con't)</b>					
<b>MONTE CARLO (con't)</b>					
1986-87	V6 3.8L 231ci	A	24.00" Cable	CA-162	96067823
1998-98	V6 3.8L 231ci	K	23.25" Cable	CA-678	30015828
1982	V6 4.3L 260ci	V	36.33" Cable	CA-409	14024991
1983	V6 4.3L 260ci	V	35.20" Cable	CA-410	14068795
1982-83	V6 4.3L 260ci	V	60.41" Cable	CA-408	465422
1985	V6 4.3L 262ci	Z	62.50" Cable	CA-672	96053809
1985-87	V6 4.3L 262ci	Z	60.41" Cable	CA-408	465422
1986-88	V6 4.3L 262ci	Z	24.00" Cable	CA-162	96067823
1987-88	V6 4.3L 262ci	Z	36.00" Cable, 22.50" Mounting Length	CA-580	
1987-88	V6 4.3L 262ci	Z	36.00" Cable, 23.63" Mounting Length	CA-578	94322759
1979	V8 4.4L 267ci	J	48.89" Cable	CA-405	465472
1981	V8 4.4L 267ci	J	35.86" Cable	CA-407	14056659
1982	V8 4.4L 267ci	J	36.33" Cable	CA-409	14024991
1979-82	V8 4.4L 267ci	J	60.41" Cable	CA-408	465422
1976	V8 5.0L 305ci	Q	47.36" Cable	CA-402	364672
1976	V8 5.0L 305ci	Q	60.22" Cable	CA-406	364654
1976	V8 5.0L 305ci	Q	61.91" Cable	CA-401	361612
1977	V8 5.0L 305ci	U	47.36" Cable	CA-402	364672
1977	V8 5.0L 305ci	U	61.91" Cable	CA-401	361612
1979	V8 5.0L 305ci	H	48.89" Cable	CA-405	465472
1981	V8 5.0L 305ci	H	35.86" Cable	CA-407	14056659
1982	V8 5.0L 305ci	H	36.33" Cable	CA-409	14024991
1983	V8 5.0L 305ci	7	35.20" Cable	CA-410	14068795
1983	V8 5.0L 305ci	7	60.41" Cable	CA-408	465422
1984	V8 5.0L 305ci	G	35.20" Cable	CA-410	14068795
1985	V8 5.0L 305ci	G, H	62.50" Cable	CA-672	96053809
1977-78	V8 5.0L 305ci	U	48.89" Cable	CA-405	465472
1977-78	V8 5.0L 305ci	U	60.41" Cable	CA-408	465422
1979-87	V8 5.0L 305ci	H	60.41" Cable	CA-408	465422
1983-84	V8 5.0L 305ci	H	35.20" Cable	CA-410	14068795
1984-87	V8 5.0L 305ci	G	60.41" Cable	CA-408	465422
1986-88	V8 5.0L 305ci	G, H	24.00" Cable	CA-162	96067823
1987-88	V8 5.0L 305ci	G, H	36.00" Cable, 22.50" Mounting Length	CA-580	
1987-88	V8 5.0L 305ci	G, H	36.00" Cable, 23.63" Mounting Length	CA-578	94322759
1975	V8 5.7L 350ci	H, L	66.27" Cable	CA-404	361688
1976	V8 5.7L 350ci	V	47.36" Cable	CA-402	364672
1976	V8 5.7L 350ci	L, V	60.22" Cable	CA-406	364654
1976	V8 5.7L 350ci	V	61.91" Cable	CA-401	361612
1981	V8 5.7L 350ci	L	35.86" Cable	CA-407	14056659
1982	V8 5.7L 350ci	N	36.33" Cable	CA-409	14024991
1976-77	V8 5.7L 350ci	L	47.36" Cable	CA-402	364672
1976-77	V8 5.7L 350ci	L	61.91" Cable	CA-401	361612
1977-81	V8 5.7L 350ci	L	60.41" Cable	CA-408	465422
1982-84	V8 5.7L 350ci	N	60.41" Cable	CA-408	465422
1983-84	V8 5.7L 350ci	N	35.20" Cable	CA-410	14068795
1975	V8 6.6L 400ci	U	66.27" Cable	CA-404	361688
1976	V8 6.6L 400ci	U	47.36" Cable	CA-402	364672
1976	V8 6.6L 400ci	U	60.22" Cable	CA-406	364654
1976	V8 6.6L 400ci	U	61.91" Cable	CA-401	361612
1975	V8 7.4L 454ci	Y	66.27" Cable	CA-404	361688
<b>MONZA</b>					
1975	L4 2.3L 140ci	A, B	66.27" Cable	CA-404	361688
1976	L4 2.3L 140ci	A	47.36" Cable	CA-402	364672
1976	L4 2.3L 140ci	A, B	60.22" Cable	CA-406	364654
1976	L4 2.3L 140ci	A	61.91" Cable	CA-401	361612

# CLUTCH CABLES

Year	Engine	Vin	Remark	Part	OE
<b>CHEVROLET (con't)</b>					
<b>MONZA (con't)</b>					
1976	L4 2.3L 140ci	A	w/Man. Trans.; 47.36" Cable	CA-402	364672
1977	L4 2.3L 140ci	B	48.89" Cable	CA-405	465472
1977	L4 2.3L 140ci	B	60.41" Cable	CA-408	465422
1976-77	L4 2.3L 140ci	B	47.36" Cable	CA-402	364672
1976-77	L4 2.3L 140ci	B	61.91" Cable	CA-401	361612
1976-77	L4 2.3L 140ci	B	w/Man. Trans.; 47.36" Cable	CA-402	364672
1979	L4 2.5L 151ci	9	48.89" Cable	CA-405	465472
1979	L4 2.5L 151ci	9	60.41" Cable	CA-408	465422
1980	L4 2.5L 151ci	V	35.86" Cable	CA-407	14056659
1978-79	L4 2.5L 151ci	1	48.89" Cable	CA-405	465472
1978-79	L4 2.5L 151ci	1	60.41" Cable	CA-408	465422
1978-80	L4 2.5L 151ci	V	48.89" Cable	CA-405	465472
1978-80	L4 2.5L 151ci	V	60.41" Cable	CA-408	465422
1978-79	V6 3.2L 196ci	C	48.89" Cable	CA-405	465472
1978-79	V6 3.2L 196ci	C	60.41" Cable	CA-408	465422
1979	V6 3.8L 231ci	2	48.89" Cable	CA-405	465472
1979	V6 3.8L 231ci	2	60.41" Cable	CA-408	465422
1978-80	V6 3.8L 231ci	A	48.89" Cable	CA-405	465472
1978-80	V6 3.8L 231ci	A	60.41" Cable	CA-408	465422
1975	V8 4.3L 262ci	G	66.27" Cable	CA-404	361688
1976	V8 4.3L 262ci	G	47.36" Cable	CA-402	364672
1976	V8 4.3L 262ci	G	60.22" Cable	CA-406	364654
1976	V8 4.3L 262ci	G	61.91" Cable	CA-401	361612
1976	V8 4.3L 262ci	G	w/Man. Trans.; 60.22" Cable	CA-406	364654
1976	V8 5.0L 305ci	Q	47.36" Cable	CA-402	364672
1976	V8 5.0L 305ci	Q	60.22" Cable	CA-406	364654
1976	V8 5.0L 305ci	Q	61.91" Cable	CA-401	361612
1977	V8 5.0L 305ci	U	47.36" Cable	CA-402	364672
1977	V8 5.0L 305ci	U	61.91" Cable	CA-401	361612
1979	V8 5.0L 305ci	G	48.89" Cable	CA-405	465472
1979	V8 5.0L 305ci	G	60.41" Cable	CA-408	465422
1977-78	V8 5.0L 305ci	U	48.89" Cable	CA-405	465472
1977-78	V8 5.0L 305ci	U	60.41" Cable	CA-408	465422
1975	V8 5.7L 350ci	H	66.27" Cable	CA-404	361688
<b>NOVA</b>					
1985	L4 1.6L 98ci	4	62.50" Cable	CA-672	96053809
1988	L4 1.6L 98ci	5	24.00" Cable	CA-162	96067823
1988	L4 1.6L 98ci	5	36.00" Cable, 22.50" Mounting Length	CA-580	
1988	L4 1.6L 98ci	5	36.00" Cable, 23.63" Mounting Length	CA-578	94322759
1985-87	L4 1.6L 98ci	4	60.41" Cable	CA-408	465422
1986-88	L4 1.6L 98ci	4	24.00" Cable	CA-162	96067823
1987-88	L4 1.6L 98ci	4	36.00" Cable, 22.50" Mounting Length	CA-580	
1987-88	L4 1.6L 98ci	4	36.00" Cable, 23.63" Mounting Length	CA-578	94322759
1975	L6 4.1L 250ci	D	66.27" Cable	CA-404	361688
1976	L6 4.1L 250ci	D	60.22" Cable	CA-406	364654
1976-77	L6 4.1L 250ci	D	47.36" Cable	CA-402	364672
1976-77	L6 4.1L 250ci	D	61.91" Cable	CA-401	361612
1977-79	L6 4.1L 250ci	D	60.41" Cable	CA-408	465422
1978-79	L6 4.1L 250ci	D	48.89" Cable	CA-405	465472
1975	V8 4.3L 262ci	G	66.27" Cable	CA-404	361688
1976	V8 5.0L 305ci	Q	47.36" Cable	CA-402	364672
1976	V8 5.0L 305ci	Q	60.22" Cable	CA-406	364654
1976	V8 5.0L 305ci	Q	61.91" Cable	CA-401	361612
1977	V8 5.0L 305ci	U	47.36" Cable	CA-402	364672
1977	V8 5.0L 305ci	U	61.91" Cable	CA-401	361612

# CLUTCH CABLES

Year	Engine	Vin	Remark	Part	OE
<b>CHEVROLET (con't)</b>					
<b>NOVA (con't)</b>					
1979	V8 5.0L 305ci	G	48.89" Cable	CA-405	465472
1979	V8 5.0L 305ci	G	60.41" Cable	CA-408	465422
1977-78	V8 5.0L 305ci	U	48.89" Cable	CA-405	465472
1977-78	V8 5.0L 305ci	U	60.41" Cable	CA-408	465422
1975	V8 5.7L 350ci	H, L	66.27" Cable	CA-404	361688
1976	V8 5.7L 350ci	L	60.22" Cable	CA-406	364654
1976-77	V8 5.7L 350ci	L	47.36" Cable	CA-402	364672
1976-77	V8 5.7L 350ci	L	61.91" Cable	CA-401	361612
1977-79	V8 5.7L 350ci	L	60.41" Cable	CA-408	465422
1978-79	V8 5.7L 350ci	L	48.89" Cable	CA-405	465472
<b>PRIZM</b>					
1998-98	L4 1.8L 110ci	8	23.25" Cable	CA-678	30015828
<b>SPECTRUM</b>					
1985	L4 1.5L 92ci	K	60.41" Cable	CA-408	465422
1985	L4 1.5L 92ci	K	62.50" Cable	CA-672	96053809
1987	L4 1.5L 92ci	9	Turbo 60.41" Cable	CA-408	465422
1986-87	L4 1.5L 92ci	7	60.41" Cable	CA-408	465422
1986-88	L4 1.5L 92ci	7	24.00" Cable	CA-162	96067823
1987-88	L4 1.5L 92ci	7	36.00" Cable, 22.50" Mounting Length	CA-580	
1987-88	L4 1.5L 92ci	7	36.00" Cable, 23.63" Mounting Length	CA-578	94322759
1987-88	L4 1.5L 92ci	9	Turbo 24.00" Cable	CA-162	96067823
1987-88	L4 1.5L 92ci	9	Turbo 36.00" Cable, 22.50" Mounting Length	CA-580	94322764
1987-88	L4 1.5L 92ci	9	Turbo 36.00" Cable, 23.63" Mounting Length	CA-578	94322759
<b>SPRINT</b>					
1985	L3 1.0L 61ci	M	24.00" Cable	CA-162	96067823
1985	L3 1.0L 61ci	M	60.41" Cable	CA-408	465422
1985	L3 1.0L 61ci	M	62.50" Cable	CA-672	96053809
1987	L3 1.0L 61ci	2	60.41" Cable	CA-408	465422
1986-87	L3 1.0L 61ci	5	60.41" Cable	CA-408	465422
1986-88	L3 1.0L 61ci	5	24.00" Cable	CA-162	96067823
1987-88	L3 1.0L 61ci	2	24.00" Cable	CA-162	96067823
1987-88	L3 1.0L 61ci	2, 5	36.00" Cable, 22.50" Mounting Length	CA-580	
1987-88	L3 1.0L 61ci	2, 5	36.00" Cable, 23.63" Mounting Length	CA-578	94322759
<b>VEGA</b>					
1975	L4 2.0L 122ci	O	w/Cosworth Eng.	CA-404	361688
1976	L4 2.0L 122ci	O	47.36" Cable	CA-402	364672
1976	L4 2.0L 122ci	O	60.22" Cable	CA-406	364654
1976	L4 2.0L 122ci	O	61.91" Cable	CA-401	361612
1975	L4 2.3L 140ci	A, B	66.27" Cable	CA-404	361688
1976	L4 2.3L 140ci	A, B	60.22" Cable	CA-406	364654
1976	L4 2.3L 140ci	A	61.91" Cable	CA-401	361612
1976	L4 2.3L 140ci	A	w/Man. Trans.; 47.36" Cable	CA-402	364672
1977	L4 2.3L 140ci	B	60.41" Cable	CA-408	465422
1976-77	L4 2.3L 140ci	B	61.91" Cable	CA-401	361612
1976-77	L4 2.3L 140ci	B	w/Man. Trans.; 47.36" Cable	CA-402	364672
<b>CHEVROLET TRUCKS</b>					
<b>C10, C20, C30, K10, K20, K30 PICKUP, K5 BLAZER</b>					
1978	L6 4.1L 250ci	D	61.00" Cable	CA-415	94027152
1978	L6 4.8L 292ci	T	61.00" Cable	CA-415	94027152
1978	V8 5.0L 305ci	U	61.00" Cable	CA-415	94027152
1978	V8 5.7L 350ci	L, Z	61.00" Cable	CA-415	94027152
1978	V8 6.6L 400ci	R	61.00" Cable	CA-415	94027152
1978	V8 7.4L 454ci	S	61.00" Cable	CA-415	94027152
<b>C10 SUBURBAN, C20 SUBURBAN, K10 SUBURBAN, K20 SUBURBAN</b>					
1978	L6 4.1L 250ci	D	61.00" Cable	CA-415	94027152

# CLUTCH CABLES

Year	Engine	Vin	Remark	Part	OE
<b>CHEVROLET TRUCKS (con't)</b>					
<b>C10 SUBURBAN, C20 SUBURBAN, K10 SUBURBAN, K20 SUBURBAN (con't)</b>					
1978	V8 5.0L 305ci	U	61.00" Cable	CA-415	94027152
1978	V8 5.7L 350ci	L	61.00" Cable	CA-415	94027152
1978	V8 5.7L 350ci	Z	61.00" Cable	CA-415	94027152
1978	V8 7.4L 454ci	S	61.00" Cable	CA-415	94027152
<b>EL CAMINO</b>					
1978	V6 3.3L 200ci	M	61.00" Cable	CA-415	94027152
1978	V6 3.8L 231ci	A	61.00" Cable	CA-415	94027152
1978	V8 5.0L 305ci	U	61.00" Cable	CA-415	94027152
1978	V8 5.7L 350ci	L	61.00" Cable	CA-415	94027152
<b>G10, G20, G30</b>					
1978	L6 4.1L 250ci	D	61.00" Cable	CA-415	94027152
1978	L6 4.8L 292ci	T	61.00" Cable	CA-415	94027152
1978	V8 5.0L 305ci	U	61.00" Cable	CA-415	94027152
1978	V8 5.7L 350ci	L	61.00" Cable	CA-415	94027152
1978	V8 6.6L 400ci	R	61.00" Cable	CA-415	94027152
<b>LUV</b>					
1980	L4 1.8L 111ci	N		CA-413	94028795
1981	L4 1.8L 111ci	N	Manual Steering	CA-416	8-94238-184-0
1981	L4 1.8L 111ci	N	w/Power Steering 65.27" Cable	CA-417	8-94251-468-1
1978-79	L4 1.8L 111ci	N	61.00" Cable	CA-415	94027152
1981-82	L4 2.2L 134ci	S	Diesel w/Manul Steering 61.41" Cable	CA-412	8-94238-185-1
1981-82	L4 2.2L 134ci	S	w/Power Steering 65.27" Cable	CA-417	8-94251-468-1
<b>P10, P20, P30</b>					
1978	L6 4.8L 292ci	T	61.00" Cable	CA-415	94027152
1978	V8 5.7L 350ci	L	61.00" Cable	CA-415	94027152
1978	V8 7.4L 454ci	S	61.00" Cable	CA-415	94027152
<b>S10, S10 BLAZER</b>					
1983	V6 2.8L 173ci	B	w/Clutch Fork Adjustable Cable, w/Lower Cable	CA-655	14062618
1983	V6 2.8L 173ci	B	w/Upper Cable	CA-654	14030848
<b>CHRYSLER</b>					
<b>E CLASS, NEW YORKER</b>					
1983	L4 2.2L 135ci	C	w/A460 Auto. Trans., w/A465 Auto. Trans. 42.00" Cable	CA-202	4377771
1983	L4 2.2L 135ci	C	w/A460, w/A465 Man.Trans. 42.00" Cable	CA-202	4377771
<b>LASER</b>					
1985-86	L4 2.2L 135ci	D, E	4 & 5 Spd. Man. Trans. 42.00" Cable	CA-202	4377771
<b>LEBARON</b>					
1982	L4 2.2L 135ci	B	w/A460 Auto. Trans. 42.00" Cable	CA-202	4377771
1982	L4 2.2L 135ci	B	w/A460 Man. Trans. 42.00" Cable	CA-202	4377771
1983	L4 2.2L 135ci	C	w/A460 Auto. Trans., w/A465 Auto. Trans. 42.00" Cable	CA-202	4377771
1983	L4 2.2L 135ci	C	w/A460, w/A465 Man.Trans. 42.00" Cable	CA-202	4377771
1985-86	L4 2.2L 135ci	D, E	w/Throttle Body Injection; 41.10" Cable	CA-981	4377769
1987	L4 2.2L 135ci	E	w/Electronic Fuel Injection, Turbo; 41.10" Cable	CA-981	4377769
1987-88	L4 2.2L 135ci	D	w/Electronic Fuel Injection; 41.10" Cable	CA-981	4377769
1988	L4 2.2L 135ci	E	w/Electronic Fuel Injection; 41.10" Cable	CA-981	4377769
1989	L4 2.2L 135ci	D	w/Electronic Fuel Injection; 41.10" Cable	CA-981	4505341
1986	L4 2.5L 153ci	K	w/Electronic Fuel Injection; 41.10" Cable	CA-981	4377769
1988	L4 2.5L 153ci	K	Convertible, Coupe w/Electronic Fuel Injection; 41.10" Cable	CA-981	4377769
1989	L4 2.5L 153ci	J, K	Convertible, Coupe w/Electronic Fuel Injection; 41.10" Cable	CA-981	4505341

# CLUTCH CABLES

Year	Engine	Vin	Remark	Part	OE
<b>CHRYSLER (con't)</b>					
<b>LEBARON (con't)</b>					
1990	L4 2.5L 153ci	J	2 Door, Sedan, w/Electronic Fuel Injection, Convertible, Turbo; 41.10" Cable	CA-981	4505533
1990	L4 2.5L 153ci	K	2 Door, Sedan, w/Electronic Fuel Injection, Convertible; 41.10" Cable	CA-981	4505533
1991-92	L4 2.5L 153ci	J	Sedan, 4 Door, w/Multi Port Fuel Injection, w/Turbo i; 41.10" Cable	CA-981	4641146
1991-92	L4 2.5L 153ci	K	w/Multi Port Fuel Injection; 41.10" Cable	CA-981	4641146
1993	L4 2.5L 153ci	K	w/Electronic Fuel Injection, w/5 Spd. Manual Trans.	CA-982	4670754
<b>CHRYSLER TRUCKS</b>					
<b>TOWN &amp; COUNTRY</b>					
1985-86	L4 2.2L 135ci	E	w/Throttle Body Injection, w/4 Spd. Trans., w/5 Spd. Man. Trans.; 41.10" Cable	CA-981	4377769
1991-93	V6 3.3L 201ci	R	42.50" Cable	CA-667	4511098
1994	V6 3.8L 230ci	L	42.50" Cable	CA-667	4511098
<b>DAIHATSU</b>					
<b>CHARADE</b>					
1988-92	L3 1.0L 993cc	0	31.50" Cable	CA-674	3.13409E+12
<b>DAIHATSU TRUCKS</b>					
<b>ROCKY</b>					
1990-92	L4 1.6L 1589cc	0	88.50" Cable	CA-161	313408 762500
<b>DODGE</b>					
<b>400</b>					
1982	L4 2.2L 135ci	B	w/A460 Auto. Trans. 42.00" Cable	CA-202	4377771
1982	L4 2.2L 135ci	B	w/A460 Man. Trans. 42.00" Cable	CA-202	4377771
1983	L4 2.2L 135ci	C	w/A460 Auto. Trans., w/A465 Auto. Trans. 42.00" Cable	CA-202	4377771
1983	L4 2.2L 135ci	C	w/A460, w/A465 Man.Trans. 42.00" Cable	CA-202	4377771
<b>600</b>					
1983	L4 2.2L 135ci	C	w/A460 Auto. Trans., w/A465 Auto. Trans. 42.00" Cable	CA-202	4377771
1983	L4 2.2L 135ci	C	w/A460, w/A465 Man.Trans. 42.00" Cable	CA-202	4377771
1985-86	L4 2.2L 135ci	D, E	4 & 5 Spd. Man. Trans. 42.00" Cable	CA-202	4377771
1986	L4 2.2L 135ci	D, E	w/Throttle Body Injection; 41.10" Cable	CA-981	4377769
1986	L4 2.5L 153ci	K	4 & 5 Spd. Man. Trans. 42.00" Cable	CA-202	4377771
<b>ARIES</b>					
1981-82	L4 2.2L 135ci	B	w/A460 Auto. Trans. 42.00" Cable	CA-202	4377771
1981-82	L4 2.2L 135ci	B	w/A460 Man. Trans. 42.00" Cable	CA-202	4377771
1983	L4 2.2L 135ci	C	w/A460 Auto. Trans., w/A465 Auto. Trans. 42.00" Cable	CA-202	4377771
1983	L4 2.2L 135ci	C	w/A460, w/A465 Man.Trans. 42.00" Cable	CA-202	4377771
1985	L4 2.2L 135ci	C	4 & 5 Spd. Man. Trans. 42.00" Cable	CA-202	4377771
1985	L4 2.2L 135ci	C	w/2 Bbl. Carb.; 41.10" Cable	CA-981	4377769
1985-86	L4 2.2L 135ci	D	w/Throttle Body Injection; 41.10" Cable	CA-981	4377769
1985-87	L4 2.2L 135ci	D	4 & 5 Spd. Man. Trans. 42.00" Cable	CA-202	4377771
1987-88	L4 2.2L 135ci	D	w/Electronic Fuel Injection; 41.10" Cable	CA-981	4377769
1989	L4 2.2L 135ci	D	w/Electronic Fuel Injection; 41.10" Cable	CA-981	4505341
1986	L4 2.5L 153ci	K	4 & 5 Spd. Man. Trans. 42.00" Cable	CA-202	4377771
1987	L4 2.5L 153ci	K	5 Spd. Man. Trans.; 42.00" Cable	CA-202	4377771
<b>CHALLENGER</b>					
1978	L4 1.6L 98ci	K	32.25" Cable	CA-209	MB-011955
1979	L4 1.6L 98ci	K	w/Man. Trans.; 31.8125" Cable	CA-204	MB011959
1979-80	L4 2.6L 156ci	F	w/Man. Trans.; 31.8125" Cable	CA-204	MB011959
1981-83	L4 2.6L 156ci	7	w/Man. Trans.; 32.00" Cable	CA-206	MB012117



# CLUTCH CABLES

Year	Engine	Vin	Remark	Part	OE
<b>DODGE (con't)</b>					
<b>CHARGER</b>					
1984	L4 1.6L 97ci	A	4 & 5 Spd. Man. Trans. 42.00" Cable	CA-202	4377771
1984	L4 2.2L 135ci	8, C	4 & 5 Spd. Man. Trans. 42.00" Cable	CA-202	4377771
1986	L4 2.2L 135ci	8, C	5 Spd. Man. Trans.; 42.00" Cable	CA-202	4377771
1986-87	L4 2.2L 135ci	E	5 Spd. Man. Trans.; 42.00" Cable	CA-202	4377771
<b>COLT</b>					
1979	L4 1.4L 1410cc	J	FWD exc. Wagon; 35.25" Cable	CA-205	MB012018
1979	L4 1.4L 1410cc	J	RWD, Wagon; 31.8125" Cable	CA-204	MB012000
1980	L4 1.4L 1410cc	J	exc. Wagon; 53.00" Cable	CA-207	MB012071
1981-83	L4 1.4L 1410cc	2	w/Man. Trans.; 53.00" Cable	CA-207	MB012071
1985-86	L4 1.5L 90ci	K	51.00" Cable	CA-664	MB527465
1987-88	L4 1.5L 90ci	K	54.92" Cable	CA-164	MB527467
1988	L4 1.5L 90ci	P	54.92" Cable	CA-164	MB527467
1989-90	L4 1.5L 90ci	X	59.00" Cable	CA-662	MB698993
1991	L4 1.5L 90ci	A	59.00" Cable	CA-662	MB698993
1992	L4 1.5L 90ci	A	32.00" Cable	CA-663	MB698993
1993-94	L4 1.5L 90ci	A	66.00" Cable	CA-665	MB912305
1979	L4 1.6L 98ci	K	FWD exc. Wagon; 35.25" Cable	CA-205	MB012018
1979	L4 1.6L 98ci	K	RWD, Wagon; 31.8125" Cable	CA-204	MB012000
1980	L4 1.6L 98ci	K	exc. Wagon; 53.00" Cable	CA-207	MB012071
1982-83	L4 1.6L 98ci	3	w/Man. Trans.; 53.00" Cable	CA-207	MB012071
1985-86	L4 1.6L 98ci	F	51.00" Cable	CA-664	MB527465
1988	L4 1.6L 98ci	F	54.92" Cable	CA-164	MB527467
1989-90	L4 1.8L 107ci	T	59.00" Cable	CA-662	MB698993
1992	L4 1.8L 112ci	D	32.00" Cable	CA-663	MB698993
1994	L4 1.8L 112ci	C	66.00" Cable	CA-665	MB912305
1985-86	L4 2.0L 122ci	D	51.00" Cable	CA-664	MB527465
1987-88	L4 2.0L 122ci	D	54.92" Cable	CA-164	MB527467
1989-91	L4 2.0L 122ci	V	59.00" Cable	CA-662	MB698993
1994	L4 2.4L 2351cc	G	66.00" Cable	CA-665	MB912305
1978-80	L4 2.6L 156ci	F	Wagon, w/Man. Trans.; 31.8125" Cable	CA-204	MB012000
1979	L4 2.6L 156ci	F	FWD exc. Wagon; 35.25" Cable	CA-205	MB012018
1979	L4 2.6L 156ci	F	RWD, Wagon, w/Man. Trans.; 31.8125" Cable	CA-204	MB012000
1980	L4 2.6L 156ci	F	exc. Wagon; 53.00" Cable	CA-207	MB012071
<b>DAYTONA</b>					
1986	L4 2.2L 135ci	D	4 & 5 Spd. Man. Trans. 42.00" Cable	CA-202	4377771
1987	L4 2.2L 135ci	E	4 & 5 Spd. Man. Trans. 42.00" Cable	CA-202	4377771
1987-88	L4 2.2L 135ci	E	w/Electronic Fuel Injection, w/Intercooled Turbo; 41.10" Cable	CA-981	4377769
1989	L4 2.2L 135ci	A	w/Electronic Fuel Injection; 41.10" Cable	CA-981	4505341
1987	L4 2.5L 153ci	K	5 Spd. Man. Trans.; 42.00" Cable	CA-202	4377771
1990	L4 2.5L 153ci	J, K	w/Electronic Fuel Injection; 41.10" Cable	CA-981	4505533
1991	L4 2.5L 153ci	J	w/Multi Port Fuel Injection, Turbo; 41.10" Cable	CA-981	4641146
1991-92	L4 2.5L 153ci	K	w/Multi Port Fuel Injection; 41.10" Cable	CA-981	4641146
1993	L4 2.5L 153ci	K	w/Electronic Fuel Injection, w/5 Spd. Manual Trans.	CA-982	4670754
1991	V6 3.0L 181ci	3	w/Multi Port Fuel Injection; 41.10" Cable	CA-981	4641146
<b>LANCER</b>					
1986	L4 2.2L 135ci	D, E	w/Throttle Body Injection; 41.10" Cable	CA-981	4377769
1986-87	L4 2.2L 135ci	D, E	4 & 5 Spd. Man. Trans. 42.00" Cable	CA-202	4377771
1987	L4 2.2L 135ci	D, E	w/Electronic Fuel Injection; 41.10" Cable	CA-981	4377769
1989	L4 2.2L 135ci	D	w/Electronic Fuel Injection; 41.10" Cable	CA-981	4505341
1986	L4 2.5L 153ci	K	4 & 5 Spd. Man. Trans. 42.00" Cable	CA-202	4377771
1987	L4 2.5L 153ci	K	5 Spd. Man. Trans.; 42.00" Cable	CA-202	4377771

# CLUTCH CABLES

Year	Engine	Vin	Remark	Part	OE
<b>DODGE (con't)</b>					
<b>OMNI</b>					
1983	L4 1.6L 97ci	A	Economy Price, w/A460 Auto. Trans., w/A465 Auto. Trans. 42.00" Cable	CA-202	4377771
1983	L4 1.6L 97ci	A	w/Man. Trans. 42.00" Cable	CA-202	4377771
1984-86	L4 1.6L 97ci	A	4 & 5 Spd. Man. Trans. 42.00" Cable	CA-202	4377771
1978-82	L4 1.7L 105ci	A	w/Man. Trans. 34.05" cable	CA-201	5206246
1982	L4 1.7L 105ci	A	w/A460, w/A465 Man. Trans. 42.00" Cable	CA-202	4377771
1983	L4 1.7L 105ci	B	Economy Price, w/A460 Auto. Trans., w/A465 Auto. Trans. 42.00" Cable	CA-202	4377771
1983	L4 1.7L 105ci	B	w/A412 Auto. Trans. 34.05" cable	CA-201	4318713
1983	L4 1.7L 105ci	B	w/Man. Trans. 34.05" cable	CA-201	5206246
1981-82	L4 2.2L 135ci	B	w/Man. Trans. 42.00" Cable	CA-202	4377771
1982	L4 2.2L 135ci	B	w/A460 Man. Trans. 42.00" Cable	CA-202	4377771
1984	L4 2.2L 135ci	8, C	4 & 5 Spd. Man. Trans. 42.00" Cable	CA-202	4377771
1986	L4 2.2L 135ci	E	5 Spd. Man. Trans.; 42.00" Cable	CA-202	4377771
1986-87	L4 2.2L 135ci	8, C	5 Spd. Man. Trans.; 42.00" Cable	CA-202	4377771
1988	L4 2.2L 135ci	D	From 4/1/88, w/Man. Trans. 42.50" Cable	CA-680	4505539
1988	L4 2.2L 135ci	D	To 4/1/88, w/5 Spd. Man. Trans. 42.00" Cable	CA-202	4377771
1989-90	L4 2.2L 135ci	D	42.50" Cable	CA-680	4505539
<b>SHADOW</b>					
1987	L4 2.2L 135ci	D, E	5 Spd. Man. Trans.; 42.00" Cable	CA-202	4377771
1987-88	L4 2.2L 135ci	E	w/Electronic Fuel Injection, Turbo; 41.10" Cable	CA-981	4377769
1989	L4 2.2L 135ci	A	w/Electronic Fuel Injection; 41.10" Cable	CA-981	4505341
1989-91	L4 2.2L 135ci	D	w/Electronic Fuel Injection; 41.10" Cable	CA-981	4505341
1991	L4 2.2L 135ci	D	w/Electronic Fuel Injection; 41.10" Cable	CA-981	4641146
1993-94	L4 2.2L 135ci	D	w/Electronic Fuel Injection, w/5 Spd. Manual Trans.; 44.80" Cable	CA-982	4670754
1990	L4 2.5L 153ci	J, K	w/Electronic Fuel Injection; 41.10" Cable	CA-981	4505533
1991-92	L4 2.5L 153ci	J	Turbo; 41.10" Cable	CA-981	4641146
1993-94	L4 2.5L 153ci	K	w/Electronic Fuel Injection, w/5 Spd. Manual Trans.; 44.80" Cable	CA-982	4670754
<b>SPIRIT</b>					
1991-92	L4 2.2L 135ci	A	16 Valve, R/T, w/Turbo Iii; 44.80" Cable	CA-982	4641232
1990	L4 2.5L 153ci	J, K	w/Electronic Fuel Injection; 41.10" Cable	CA-981	4505533
1991	L4 2.5L 153ci	J	w/Multi Port Fuel Injection; 41.10" Cable	CA-981	4641146
1991-92	L4 2.5L 153ci	K	w/Multi Port Fuel Injection; 41.10" Cable	CA-981	4641146
1993	L4 2.5L 153ci	K, V	w/Electronic Fuel Injection, w/5 Spd. Manual Trans.; 44.80" Cable	CA-982	4670754
<b>DODGE TRUCKS</b>					
<b>CARAVAN</b>					
1984-85	L4 2.2L 135ci	C	4 & 5 Spd. Man. Trans. 42.00" Cable	CA-203	4377770
1986-87	L4 2.2L 135ci	C	5 Spd. Man. Trans.; 42.00" Cable	CA-203	4377770
1988	L4 2.5L 153ci	K	4 & 5 Spd. Man. Trans. 42.00" Cable	CA-203	4377770
1988	L4 2.5L 153ci	K	w/Man. Trans. 42.00" Cable	CA-203	4377770
1991-94	L4 2.5L 153ci	K	42.50" Cable	CA-667	4511098
1984-85	L4 2.6L 156ci	G	4 & 5 Spd. Man. Trans. 42.00" Cable	CA-203	4377770
1989-90	V6 3.0L 181ci	3	5 Spd. Man. Trans.; 42.00" Cable	CA-203	4295599
1991-94	V6 3.0L 181ci	3	42.50" Cable	CA-667	4511098
1991-94	V6 3.3L 201ci	R	42.50" Cable	CA-667	4511098
1994	V6 3.3L 201ci	J	42.50" Cable	CA-667	4511098
<b>D50</b>					
1979-80	L4 2.0L 122ci	U	2WD; 32.48" Cable	CA-216	MB-012460
1979-80	L4 2.0L 122ci	U	4WD; 32.40" Cable	CA-217	MB-012475
1981-82	L4 2.0L 122ci	5	2WD; 32.48" Cable	CA-216	MB-012460
1981-82	L4 2.0L 122ci	5	4WD; 32.40" Cable	CA-217	MB-012475

# CLUTCH CABLES

Year	Engine	Vin	Remark	Part	OE
<b>DODGE TRUCKS (con't)</b>					
<b>D50 (con't)</b>					
1979-80	L4 2.6L 156ci	W	2WD; 32.48" Cable	CA-216	MB-012460
1979-80	L4 2.6L 156ci	W	4WD; 32.40" Cable	CA-217	MB-012475
1981-82	L4 2.6L 156ci	7	2WD; 32.48" Cable	CA-216	MB-012460
1981-82	L4 2.6L 156ci	7	4WD; 32.40" Cable	CA-217	MB-012475
<b>MINI RAM</b>					
1984-85	L4 2.2L 135ci	C	4 & 5 Spd. Man. Trans. 42.00" Cable	CA-203	4377770
1986-87	L4 2.2L 135ci	C	5 Spd. Man. Trans.; 42.00" Cable	CA-203	4377770
1987-88	L4 2.5L 153ci	K	w/Man. Trans. 42.00" Cable	CA-203	4377770
1984-85	L4 2.6L 156ci	G	4 & 5 Spd. Man. Trans. 42.00" Cable	CA-203	4377770
<b>RAMPAGE</b>					
1984	L4 2.2L 135ci	C	4 & 5 Spd. Man. Trans. 42.00" Cable	CA-202	4377771
<b>ROYAL MINI RAM</b>					
1984-85	L4 2.2L 135ci	C	4 & 5 Spd. Man. Trans. 42.00" Cable	CA-203	4377770
1984-85	L4 2.6L 156ci	G	4 & 5 Spd. Man. Trans. 42.00" Cable	CA-203	4377770
<b>EAGLE</b>					
<b>2000 GTX</b>					
1993	L4 2.0L 1995cc	D	66.00" Cable	CA-665	MB912305
1992	L4 2.0L 1997cc	R, V	32.00" Cable	CA-663	MB698993
<b>PREMIER</b>					
1992	V6 3.0L 2972cc	U	32.00" Cable	CA-663	MB698993
<b>SUMMIT</b>					
1992	L4 1.5L 1468cc	A	32.00" Cable	CA-663	MB698993
1993-96	L4 1.5L 1468cc	A	66.00" Cable	CA-665	MB912305
1992	L4 1.8L 1834cc	D	32.00" Cable	CA-663	MB698993
1993-96	L4 1.8L 1834cc	C	66.00" Cable	CA-665	MB912305
1992	L4 2.4L 2351cc	W	32.00" Cable	CA-663	MB698993
1993-96	L4 2.4L 2351cc	G	66.00" Cable	CA-665	MB912305
<b>TALON</b>					
1993-94	L4 1.8L 1755cc	B	66.00" Cable	CA-665	MB912305
1992	L4 2.0L 1997cc	R, U	32.00" Cable	CA-663	MB698993
1993-94	L4 2.0L 1997cc	E	66.00" Cable	CA-665	MB912305
1993-96	L4 2.0L 1997cc	F	66.00" Cable	CA-665	MB912305
1995-96	L4 2.0L 1997cc	Y	66.00" Cable	CA-665	MB912305
<b>VISION</b>					
1993-96	V6 3.3L 201ci	T	66.00" Cable	CA-665	MB912305
1993-96	V6 3.5L 3497cc	F	66.00" Cable	CA-665	MB912305
<b>VISTA</b>					
1992	L4 1.5L 1468cc	K	32.00" Cable	CA-663	MB698993
1992	L4 2.0L 1997cc	V	32.00" Cable	CA-663	MB698993
<b>FIAT</b>					
<b>124</b>					
1969	L4 1.2L 1197cc		Coupe, Spider; 35.20" Cable	CA-251	4297126
1969-73	L4 1.4L 1438cc		Coupe, Spider; 35.20" Cable	CA-251	4297126
1970-73	L4 1.4L 1438cc		Sedan; 38.00" Cable	CA-252	4285116
1979-81	L4 2.0L 1995cc		Spider; 35.20" Cable	CA-251	4297126
<b>128</b>					
1971-72	L4 1.1L 1116cc		20.75" Cable	CA-255	4306698
1973-74	L4 1.3L 1290cc		20.75" Cable	CA-255	4306698
1975-79	L4 1.3L 1290cc		20.59" Cable	CA-256	4305712
<b>850</b>					
1969-71	L4 0.8L 817cc		78.50" Cable	CA-250	4112752
1970-73	L4 0.9L 903cc		78.50" Cable	CA-250	4112752
<b>BRAVA</b>					
1979-80	L4 2.0L 1995cc		w/Air Cond.; 45.27" Cable	CA-258	4400487

# CLUTCH CABLES

Year	Engine	Vin	Remark	Part	OE
<b>FIAT (con't)</b>					
<b>BRAVA (con't)</b>					
1979-80	L4 2.0L 1995cc		w/o Air Cond.; 48.0" Cable	CA-257	4441735
1981	L4 2.0L 1995cc	B	w/Air Cond.; 45.27" Cable	CA-258	4400487
1981	L4 2.0L 1995cc	B	w/o Air Cond.; 48.0" Cable	CA-257	4441735
<b>STRADA</b>					
1979-80	L4 1.5L 1498cc		24.75" Cable	CA-259	4445326
1981-82	L4 1.5L 1498cc	A	24.75" Cable	CA-259	4445326
<b>FORD</b>					
<b>ASPIRE</b>					
1994-97	L4 1.3L 1295cc	H	28.62" Cable	CA-673	F4BZ-7K553-A
<b>ESCORT, EXP</b>					
1981-82	L4 1.6L 98ci	2	4 Spd. MTX Trans.; 27.49" Cable	CA-314	E3FZ-7K553-B
1982	L4 1.6L 98ci	4	4 Spd. MTX Trans.; 27.49" Cable	CA-314	E3FZ-7K553-B
1983	L4 1.6L 98ci	7	4 & 5 Spd. MTX Trans.; 27.49" Cable	CA-314	E3FZ-7K553-B
1983-84	L4 1.6L 98ci	2, 4, 5	4 & 5 Spd. MTX Trans.; 27.49" Cable	CA-314	E3FZ-7K553-B
1984	L4 1.6L 98ci	8	4 & 5 Spd. MTX Trans.; 27.49" Cable	CA-314	E3FZ-7K553-B
1985	L4 1.6L 98ci	2, 4, 5, 8	w/MTX Trans.; 27.49" Cable	CA-314	E5FZ-7K553-B
1985-90	L4 1.9L 116ci	9	w/MTX Trans.; 27.49" Cable	CA-314	E5FZ-7K553-B
1986-90	L4 1.9L 116ci	J	w/MTX Trans.; 27.49" Cable	CA-314	E5FZ-7K553-B
1985-87	L4 2.0L 122ci	H	w/MTX Trans.; 27.49" Cable	CA-314	E5FZ-7K553-B
<b>FAIRMONT</b>					
1978	L4 2.3L 140ci	Y	4 Spd. Man. Trans.; 41.05" Cable	CA-306	D8BZ-7K553-B
1979	L4 2.3L 140ci	Y	w/Man. Trans.; 41.05" Cable	CA-306	D9BZ-7K553-F
1980	L4 2.3L 140ci	A	w/Man. Trans., w/o Turbo; 41.05" Cable	CA-306	D9BZ-7K553-E
1981-83	L4 2.3L 140ci	A	w/Man. Trans.; 42.18" Cable	CA-311	E2DZ-7K553-A
1978	L6 3.3L 200ci	T	3 Spd. Man. Trans.; 41.05" Cable	CA-306	D8BZ-7K553-A
1979	L6 3.3L 200ci	T	w/Man. Trans.; 39.84" Cable	CA-307	D9BZ-7K553-C
1980	L6 3.3L 200ci	B	w/Man. Trans.; 39.84" Cable	CA-307	D9BZ-7K553-A
1981-82	L6 3.3L 200ci	B	w/Man. Trans.; 42.18" Cable	CA-311	E2DZ-7K553-A
1983	L6 3.3L 200ci	X	w/Man. Trans.; 42.18" Cable	CA-311	E2DZ-7K553-A
1981	V8 4.2L 255ci	D	w/Man. Trans.; 42.18" Cable	CA-311	E2DZ-7K553-A
1979	V8 5.0L 302ci	F	w/Man. Trans.; 56.41" Cable	CA-308	D9BZ-7K553-D
<b>FESTIVA</b>					
1988-89	L4 1.3L 1295cc	K, H		CA-989	F3BZ-7K553-AA
<b>FIESTA</b>					
1978-80	L4 1.6L 98ci		Manual Steering; 26.75" Cable	CA-321	D8RZ-7K553-JA
1978-80	L4 1.6L 98ci		w/Power Steering; 25.59" Cable	CA-322	D8RZ-7K553-A
<b>GRANADA</b>					
1981-82	L4 2.3L 140ci	A	w/Man. Trans.; 42.18" Cable	CA-311	E2DZ-7K553-A
1981-82	L6 3.3L 200ci	B	w/Man. Trans.; 42.18" Cable	CA-311	E2DZ-7K553-A
1982	V6 3.8L 232ci	3	w/Man. Trans.; 42.18" Cable	CA-311	E2DZ-7K553-A
1981	V8 4.2L 255ci	D	w/Man. Trans.; 42.18" Cable	CA-311	E2DZ-7K553-A
<b>MUSTANG</b>					
1979	L4 2.3L 140ci	Y	w/German 4 Spd. Man. Trans.; 41.05" Cable	CA-306	D9ZZ-7K553-C
1980	L4 2.3L 140ci	A	w/Man. Trans., w/o Turbo; 41.05" Cable	CA-306	D9BZ-7K553-E
1981-82	L4 2.3L 140ci	A, T	w/Man. Trans., w/o Turbo; 42.18" Cable	CA-311	E2DZ-7K553-A
1983	L4 2.3L 140ci	A, W	4 & 5 Spd. Man. Trans. 42.18" Cable	CA-311	E2DZ-7K553-A
1983	L4 2.3L 140ci	W	w/60.75" Cable, w/5 Spd. Man. Trans.	CA-315	E3SZ-7K553-B
1983	L4 2.3L 140ci	W	w/Borg-Warner 5 Spd. Trans., w/ 2.25" Cable	CA-653	E6ZZ-7535-A
1983-90	L4 2.3L 140ci	A	w/60.75" Cable, w/5 Spd. Man. Trans.	CA-315	E3SZ-7K553-B
1983-90	L4 2.3L 140ci	A	w/Borg-Warner 5 Spd. Trans., w/ 2.25" Cable	CA-653	E6ZZ-7535-A
1984-89	L4 2.3L 140ci	A	4 Spd. Man. Trans. 42.18" Cable	CA-311	E2DZ-7K553-A
1991-92	L4 2.3L 140ci	M	w/Borg-Warner 5 Spd. Trans., w/ 2.25" Cable	CA-653	E6ZZ-7535-A
1991-93	L4 2.3L 140ci	M	w/60.75" Cable, w/5 Spd. Man. Trans.	CA-315	E3SZ-7K553-B
1980	L6 3.3L 200ci	B	w/Man. Trans.; 39.84" Cable	CA-307	D9BZ-7K553-A
1981	L6 3.3L 200ci	B	w/Man. Trans.; 43.12" Cable	CA-313	E1ZZ-7K553-B

# CLUTCH CABLES

Year	Engine	Vin	Remark	Part	OE
<b>FORD (con't)</b>					
<b>MUSTANG (con't)</b>					
1979	V6 2.8L 171ci	Z	w/Man. Trans.; 49.36" Cable	CA-309	D9ZZ-7K553-F
1994-95	V6 3.8L 232ci	4	w/Multi Port Fuel Injection; 62.50" Cable	CA-983	F4ZZ-7K553-A
1996-98	V6 3.8L 232ci	4		CA-170	76ZZ-7535-BA
1999-03	V6 3.8L 232ci	4		CA-170	XR3Z-7K553-AA
1996-01	V8 4.6L 281ci	V	w/T45 Trans.; 71.250" Cable	CA-171	XR3Z-7535-CA
1996-03	V8 4.6L 281ci	X	w/T45 Trans.; 71.250" Cable	CA-171	XR3Z-7535-CA
2003	V8 4.6L 281ci	R, Y	w/T45 Trans.; 71.250" Cable	CA-171	XR3Z-7535-CA
1979	V8 5.0L 302ci	F	w/Man. Trans.; 56.41" Cable	CA-308	D9BZ-7K553-D
1982-84	V8 5.0L 302ci	F	w/Man. Trans.; 58.50" Cable	CA-318	E4ZZ-7K553-A
1986	V8 5.0L 302ci	M	w/Man. Trans.; 58.50" Cable	CA-318	E4ZZ-7K553-A
1987-93	V8 5.0L 302ci	E	w/Man. Trans.; 58.50" Cable	CA-318	E4ZZ-7K553-A
1993	V8 5.0L 302ci	D	w/Man. Trans.; 58.50" Cable	CA-318	E4ZZ-7K553-A
1994-95	V8 5.0L 302ci	D, T	w/Multi Port Fuel Injection, w/Overhead Valve; 62.50" Cable	CA-983	F4ZZ-7K553-A
<b>MUSTANG II</b>					
1974-75	L4 2.3L 140ci	Y	w/Ford 4 Spd. Man. Trans.; 49.92" Cable	CA-302	D4ZZ-7K553-B
1976-78	L4 2.3L 140ci	Y	w/Man. Trans.; 49.98" Cable	CA-304	D6ZZ-7K553-C
1974-75	V6 2.8L 171ci	Z	w/Man. Trans.; 49.92" Cable	CA-302	D4ZZ-7K553-B
1976-78	V6 2.8L 171ci	Z	4 Spd. Man. Trans.; 53.50" Cable	CA-305	D6ZZ-7K553-B
1976-78	V8 5.0L 302ci	F	w/Man. Trans.; 53.50" Cable	CA-305	D6ZZ-7K553-B
<b>PINTO</b>					
1975-79	L4 2.3L 140ci	Y	w/Man. Trans.; 44.32" Cable	CA-301	D5FZ-7K553-A
1980	L4 2.3L 140ci	A	w/Man. Trans.; 44.32" Cable	CA-301	D5FZ-7K553-A
<b>TAURUS</b>					
1986-89	L4 2.5L 153ci	D	w/MTX Trans.; 30.50" Cable	CA-317	E6DZ-7K553-B
1986-95	V6 3.0L 182ci	U	w/MTX Trans.; 30.50" Cable	CA-317	E6DZ-7K553-B
1989-95	V6 3.0L 182ci	Y	w/MTX Trans.; 30.50" Cable	CA-317	E6DZ-7K553-B
1993-95	V6 3.0L 182ci	1	w/MTX Trans.; 30.50" Cable	CA-317	E6DZ-7K553-B
1988-89	V6 3.8L 232ci	4	w/MTX Trans.; 30.50" Cable	CA-317	E6DZ-7K553-B
<b>TEMPO</b>					
1984-86	L4 2.0L 122ci	H	w/MTX Trans.; 27.49" Cable	CA-314	E5FZ-7K553-B
1984-87	L4 2.3L 140ci	R	w/MTX Trans.; 27.49" Cable	CA-314	E5FZ-7K553-B
1985-91	L4 2.3L 140ci	S	w/MTX Trans.; 27.49" Cable	CA-314	E5FZ-7K553-B
1985-94	L4 2.3L 140ci	X	w/MTX Trans.; 27.49" Cable	CA-314	E5FZ-7K553-B
1992-94	V6 3.0L 182ci	U	27.49" Cable	CA-314	E5TZ-7K553-B
<b>GEO</b>					
<b>METRO</b>					
1989-94	L3 1.0L 61ci	6	25.00" Cable	CA-166	96060189
<b>GMC</b>					
<b>S15, S15 JIMMY</b>					
1982	V6 2.8L 173ci	B	w/Clutch Fork Adjustable Cable, w/Lower Cable; 7.625" Cable	CA-655	14062618
1982	V6 2.8L 173ci	B	w/Upper Cable; 17.50" Cable	CA-654	14030848
<b>HONDA</b>					
<b>ACCORD</b>					
1982-83	L4 1.8L 1751cc		62.795" Cable	CA-508	22910-SA5-670
1984	L4 1.8L 1829cc		62.795" Cable	CA-508	22910-SA5-670
1985	L4 1.8L 1829cc		exc. SEI; 71.772" Cable	CA-509	22910-SA5-672
1985	L4 1.8L 1829cc		72.25" Cable	CA-826	22910-SD7-671
1986-89	L4 2.0L 1955cc		76.60" Cable	CA-503	22910-SE0-A01
<b>CIVIC</b>					
1973-79	L4 1.2L 1237cc		w/Man. Trans., exc. CVCC; 51.50" Cable	CA-502	22910-634-673
1984-87	L4 1.3L 1342cc		2WD 59.00" Cable	CA-816	22910-SB6-671
1984-87	L4 1.3L 1342cc		62.00" Cable	CA-511	22910-SB2-672

# CLUTCH CABLES

Year	Engine	Vin	Remark	Part	OE
<b>HONDA (con't)</b>					
<b>CIVIC (con't)</b>					
1975-79	L4 1.5L 1487cc		51 1/4" Long	CA-501	22910-657-670
1980-83	L4 1.5L 1487cc		w/Man. Trans. 57.00" Cable	CA-500	22910-SA0-674
1980-83	L4 1.5L 1487cc		Wagon 62.00" Cable	CA-511	22910-SB2-672
1984-87	L4 1.5L 1487cc		2WD 59.00" Cable	CA-816	22910-SB6-671
1984-87	L4 1.5L 1487cc		4WD, Wagon 58.54" Cable	CA-513	22910-SD9-671
1984-87	L4 1.5L 1487cc		62.00" Cable	CA-511	22910-SB2-672
1987	L4 1.5L 1491cc		2WD 59.00" Cable	CA-816	22910-SB6-671
1987	L4 1.5L 1491cc		4WD, Wagon 58.54" Cable	CA-513	22910-SD9-671
1987	L4 1.5L 1491cc		62.00" Cable	CA-511	22910-SB2-672
1986	L4 1.5L 1493cc		2WD 59.00" Cable	CA-816	22910-SB6-671
1986	L4 1.5L 1493cc		4WD, Wagon 58.54" Cable	CA-513	22910-SD9-671
1988-91	L4 1.5L 1493cc		4WD, Wagon; 61.50" Cable	CA-507	22910-SH5-A02
1988-91	L4 1.5L 1493cc		exc. Wagon, 1500, 1600	CA-514	22910-SH3-A05
1988	L4 1.6L 1590cc		exc. Wagon, 1500, 1600	CA-514	22910-SH3-A05
1988-91	L4 1.6L 1590cc		4WD, Wagon	CA-506	22910-SH5-A62
1989-91	L4 1.6L 1590cc		exc. Wagon, 1500, 1600	CA-514	22910-SH3-A01
<b>CRX</b>					
1988-91	L4 1.5L 1493cc		61.417" Cable	CA-514	22910-SH3-A05
1988-91	L4 1.6L 1590cc		61.417" Cable	CA-514	22910-SH3-A05
<b>PRELUDE</b>					
1983-87	L4 1.8L 1829cc		exc. SI; 57.283" Cable	CA-505	22910-SB0-671
1985-87	L4 2.0L 1955cc		SI; 79.50" Cable	CA-515	22910-SF0-671
<b>HYUNDAI</b>					
<b>EXCEL</b>					
1986-90	L4 1.5L 1468cc	J	50.50" Cable	CA-550	41510-21010
<b>SONATA</b>					
1992-95	L4 2.0L 1997cc	F	50.00" Cable	CA-683	41510-3110
1989-91	L4 2.4L 2351cc	S	50.00" Cable	CA-683	41510-3110
1990-95	V6 3.0L 2972cc	T	50.00" Cable	CA-683	41510-3110
<b>ISUZU</b>					
<b>I-MARK</b>					
1985	L4 1.5L 1471cc	K	w/1 Camshaft; 36.00" Cable, 23.63" Mounting Length	CA-578	8-94322-759-1
1986-89	L4 1.5L 1471cc	7	w/1 Camshaft; 36.00" Cable, 23.63" Mounting Length	CA-578	8-94322-759-1
1987-89	L4 1.5L 1471cc	9	w/1 Camshaft; 36.00" Cable, 22.50" Mounting Length	CA-580	8-94322-764-1
1989	L4 1.5L 1471cc	7, 9	w/Twin Camshaft; 35.50" Cable	CA-577	8-94322-765-2
1989	L4 1.6L 1588cc	5	w/Twin Camshaft; 35.50" Cable	CA-577	8-94322-765-2
1981-84	L4 1.8L 1817cc	B	50.4375" Cable	CA-823	8-94207-129-2
1981-84	L4 1.8L 1817cc	P	44.48" Cable	CA-669	8941343970
<b>IMPULSE</b>					
1990-91	L4 1.6L 1588cc	5		CA-684	8-97017-861-2
1991-92	L4 1.6L 1588cc	4	Turbo 36.00" Cable	CA-670	8970178612
1992	L4 1.8L 1817cc	8		CA-685	8-97034-271-0
<b>STYLUS</b>					
1991	L4 1.6L 1588cc	5	36.00" Cable	CA-670	8970178612
1991	L4 1.6L 1588cc	6		CA-685	8-97034-271-0
1992-93	L4 1.6L 1588cc	6	36.00" Cable	CA-670	8970178612
<b>ISUZU TRUCKS</b>					
<b>AMIGO</b>					
1989-92	L4 2.3L 2254cc	L	65.50" Cable	CA-581	8-94334-082-0
1989-92	L4 2.6L 2559cc	E	65.50" Cable	CA-581	8-94334-082-0

# CLUTCH CABLES

Year	Engine	Vin	Remark	Part	OE
<b>ISUZU TRUCKS (con't)</b>					
<b>PICKUP</b>					
1984-86	L4 1.9L 1949cc	A	w/Power Steering 65.27" Cable	CA-417	8-94251-468-2
1986-87	L4 1.9L 1949cc	A	62.50" Cable	CA-671	8944080201
1984-87	L4 2.2L 2238cc	S	To 11/87, Diesel w/Manul Steering 61.41" Cable	CA-412	8-94238-185-3
1984-87	L4 2.2L 2238cc	S	To 11/87, w/Power Steering 65.27" Cable	CA-417	8-94251-468-2
1986-87	L4 2.2L 2238cc	U	To 11/87, Diesel w/Manul Steering 61.41" Cable	CA-412	8-94238-185-3
1986-87	L4 2.2L 2238cc	U	To 11/87, Turbo Diesel w/Power Steering 65.27" Cable	CA-417	8-94251-468-2
1986-87	L4 2.2L 2238cc	U	Turbo Diesel w/Manul Steering 61.54" Cable	CA-687	8-94408-020-1
1986-87	L4 2.2L 2238cc	U	Turbo Diesel w/Power Steering 65.35" Cable	CA-686	8-94408-021-0
1986	L4 2.3L 2254cc	L	w/Power Steering 65.27" Cable	CA-417	8-94251-468-2
1986-87	L4 2.3L 2254cc	L	62.50" Cable	CA-671	8944080201
1989-90	L4 2.3L 2254cc	L	65.50" Cable	CA-581	8-94334-082-0
<b>TROOPER</b>					
1984-85	L4 1.9L 1949cc	A	w/Power Steering 65.00" Cable	CA-585	8-94182-353-0
1984	L4 2.2L 2238cc	S	w/Power Steering 65.00" Cable	CA-585	8-94182-353-0
1986	L4 2.2L 2238cc	U	To 10/86, w/Manual Steering 61.41" Cable	CA-412	8-94238-185-3
1986	L4 2.2L 2238cc	U	To 10/86, w/Power Steering 65.00" Cable	CA-585	8-94182-353-0
1986-87	L4 2.2L 2238cc	U	Turbo Diesel w/Manul Steering 61.54" Cable	CA-687	8-94408-020-1
1986-87	L4 2.2L 2238cc	U	Turbo Diesel w/Power Steering 65.35" Cable	CA-686	8-94408-021-0
1986	L4 2.3L 2254cc	L	From 10/86 65.50" Cable	CA-587	8-94460-504-2
1986	L4 2.3L 2254cc	L	From 2/86, w/Manual Steering 61.50" Cable	CA-583	8-94181-232-2
1986	L4 2.3L 2254cc	L	To 10/86, w/Power Steering 65.00" Cable	CA-585	8-94182-353-0
1987	L4 2.3L 2254cc	L	65.50" Cable	CA-587	8-94460-504-2
1987	L4 2.3L 2254cc	L	Manual Steering 61.50" Cable	CA-583	8-94181-232-2
1988-90	L4 2.6L 2559cc	E	65.50" Cable	CA-587	8-94460-504-2
1989-90	V6 2.8L 2827cc	R	65.50" Cable	CA-587	8-94460-504-2
<b>MAZDA</b>					
<b>323</b>					
1988-89	L4 1.6L 1597cc		2WD; 30.50" Cable	CA-606	BF67-41-150C
<b>626</b>					
1984-87	L4 2.0L 1998cc		30.25" Cable	CA-607	GA97-41-150D
<b>GLC</b>					
1977-78	L4 1.3L 1272cc		w/Man. Trans.; 28.125" Cable	CA-600	3690-41-150
1979	L4 1.4L 1415cc		Sedan 30.50" Cable	CA-604	8414-41-150
1979-80	L4 1.4L 1415cc		w/Man. Trans. 68.50" Cable	CA-601	8914-41-150
1980	L4 1.4L 1415cc		Sedan 30.50" Cable	CA-604	8410-41-150
1981	L4 1.5L 1490cc		Sedan 30.50" Cable	CA-604	8410-41-150
1981-85	L4 1.5L 1490cc		Sedan; 30.50" Cable	CA-603	BA29-41-150B
1982-83	L4 1.5L 1490cc		Wagon; 28.75" Cable	CA-605	BB62-41-150
1982-85	L4 1.5L 1490cc		RWD, Wagon, w/Man. Trans.; 28.75" Cable	CA-602	8862-41-150
<b>MERCURY</b>					
<b>BOBCAT</b>					
1975-79	L4 2.3L 140ci	Y	w/Man. Trans.; 44.32" Cable	CA-301	D5FZ-7K553-A
1980	L4 2.3L 140ci	A	w/Man. Trans.; 44.32" Cable	CA-301	D5FZ-7K553-A
<b>CAPRI</b>					
1971-72	L4 1.6L 98ci	L	34.00" Cable	CA-324	D1RY-7K553-C
1971-74	L4 2.0L 122ci		43.60" Cable	CA-323	D1RY-7K553-D
1976-77	L4 2.3L 140ci	Y	32.50" Cable	CA-326	D5RY-7K553-C
1979	L4 2.3L 140ci	Y	4 Spd. Man. Trans.; 41.05" Cable	CA-306	D9ZZ-7K553-C
1979	L4 2.3L 140ci	W	w/Man. Trans.; 41.05" Cable	CA-306	D9ZZ-7K553-E
1980	L4 2.3L 140ci	A	w/Man. Trans., w/o Turbo; 41.05" Cable	CA-306	D9BZ-7K553-E
1981-82	L4 2.3L 140ci	A	w/Man. Trans., w/o Turbo; 42.18" Cable	CA-311	E2DZ-7K553-A
1982	L4 2.3L 140ci	T	w/Man. Trans., w/o Turbo; 42.18" Cable	CA-311	E2DZ-7K553-A

# CLUTCH CABLES

Year	Engine	Vin	Remark	Part	OE
<b>MERCURY (con't)</b>					
<b>CAPRI (con't)</b>					
1983	L4 2.3L 140ci	A, W	5 Spd. Overdrive Trans., w/4 Spd. Man. Trans. 42.18" Cable	CA-311	E2DZ-7K553-A
1983-84	L4 2.3L 140ci	W	w/60.75" Cable, w/5 Spd. Man. Trans.	CA-315	E3SZ-7K553-B
1983-84	L4 2.3L 140ci	W	w/Borg-Warner 5 Spd. Trans., w/ 2.25" Cable	CA-653	E6ZZ-7535-A
1983-86	L4 2.3L 140ci	A	w/60.75" Cable, w/5 Spd. Man. Trans.	CA-315	E3SZ-7K553-B
1983-86	L4 2.3L 140ci	A	w/Borg-Warner 5 Spd. Trans., w/ 2.25" Cable	CA-653	E6ZZ-7535-A
1984	L4 2.3L 140ci	W	4 Spd. Man. Trans. 42.18" Cable	CA-311	E2DZ-7K553-A
1984-86	L4 2.3L 140ci	A	4 Spd. Man. Trans. 42.18" Cable	CA-311	E2DZ-7K553-A
1981	L6 3.3L 200ci	B	w/Man. Trans.; 43.12" Cable	CA-313	E1ZZ-7K553-B
1972-73	V6 2.6L 2606cc		33.00" Cable	CA-325	71EB-7K553-FB
1979	V6 2.8L 171ci	Z	w/Man. Trans.; 49.36" Cable	CA-309	D9ZZ-7K553-F
1981	V8 4.2L 255ci	D	w/Man. Trans.; 42.18" Cable	CA-311	E2DZ-7K553-A
1979	V8 5.0L 302ci	F	w/Man. Trans.; 56.41" Cable	CA-308	D9ZZ-7K553-B
1982	V8 5.0L 302ci	F	w/Man. Trans.; 58.50" Cable	CA-318	E4ZZ-7K553-A
1984-86	V8 5.0L 302ci	M	w/Man. Trans.; 58.50" Cable	CA-318	E4ZZ-7K553-A
<b>COUGAR</b>					
1981	L4 2.3L 140ci	A	w/Man. Trans.; 42.18" Cable	CA-311	E2DZ-7K553-A
1984-86	L4 2.3L 140ci	W	w/60.75" Cable, w/5 Spd. Man. Trans.	CA-315	E3SZ-7K553-B
1981-82	L6 3.3L 200ci	B	w/Man. Trans.; 42.18" Cable	CA-311	E2DZ-7K553-A
1982-83	V6 3.8L 232ci	3	w/Man. Trans.; 42.18" Cable	CA-311	E2DZ-7K553-A
<b>LN7, LYNX</b>					
1981-82	L4 1.6L 98ci	2	4 Spd. MTX Trans.; 27.49" Cable	CA-314	E3FZ-7K553-B
1982	L4 1.6L 98ci	4	4 Spd. MTX Trans.; 27.49" Cable	CA-314	E3FZ-7K553-B
1983-84	L4 1.6L 98ci	2, 4, 5	w/MTX Trans.; 27.49" Cable	CA-314	E3FZ-7K553-B
1985	L4 1.6L 98ci	2, 4	w/MTX Trans.; 27.49" Cable	CA-314	E5FZ-7K553-B
1985-87	L4 1.9L 116ci	9	w/MTX Trans.; 27.49" Cable	CA-314	E5FZ-7K553-B
1985-87	L4 2.0L 122ci	H	w/MTX Trans.; 27.49" Cable	CA-314	E5FZ-7K553-B
<b>MARQUIS</b>					
1983	L4 2.3L 140ci	6, A	w/Man. Trans.; 42.18" Cable	CA-311	E2DZ-7K553-A
1983	L6 3.3L 200ci	X	w/Man. Trans.; 42.18" Cable	CA-311	E2DZ-7K553-A
<b>SABLE</b>					
1986	L4 2.5L 153ci	D	30.50" Cable	CA-317	E6DZ-7K553-B
1986-89	V6 3.0L 182ci	U	30.50" Cable	CA-317	E6DZ-7K553-B
1988-89	V6 3.8L 232ci	4	30.50" Cable	CA-317	E6DZ-7K553-B
<b>TOPAZ</b>					
1984	L4 2.0L 122ci	H	w/MTX Trans.; 27.13" Cable	CA-320	E43Z-7K553-A
1985-86	L4 2.0L 122ci	H	w/MTX Trans.; 27.49" Cable	CA-314	E5FZ-7K553-B
1984	L4 2.3L 140ci	R	w/MTX Trans.; 27.13" Cable	CA-320	E43Z-7K553-A
1985-87	L4 2.3L 140ci	R	w/MTX Trans.; 27.49" Cable	CA-314	E5FZ-7K553-B
1985-89	L4 2.3L 140ci	S, X	w/MTX Trans.; 27.49" Cable	CA-314	E5FZ-7K553-B
1992-94	V6 3.0L 182ci	U	w/MTX Trans.; 27.49" Cable	CA-314	E5FZ-7K553-B
<b>TRACER</b>					
1987	L4 1.6L 98ci	7	30.50" Cable	CA-606	E7GZ-7K553-A
1988-89	L4 1.6L 98ci	5	30.50" Cable	CA-606	E7GZ-7K553-A
<b>ZEPHYR</b>					
1978	L4 2.3L 140ci	Y	4 Spd. Man. Trans.; 30.50" Cable	CA-306	D8BZ-7K553-B
1979	L4 2.3L 140ci	Y	w/Man. Trans.; 30.50" Cable	CA-306	D9BZ-7K553-E
1980	L4 2.3L 140ci	A	w/Man. Trans.; 30.50" Cable	CA-306	D9BZ-7K553-E
1981-83	L4 2.3L 140ci	A	w/Man. Trans.; 42.18" Cable	CA-311	E2DZ-7K553-A
1979	L6 3.3L 200ci	T	w/Man. Trans.; 39.84" Cable	CA-307	D9BZ-7K553-C
1980	L6 3.3L 200ci	B	w/Man. Trans.	CA-307	D9BZ-7K553-A
1981-82	L6 3.3L 200ci	B	w/Man. Trans.; 42.18" Cable	CA-311	E2DZ-7K553-A
1983	L6 3.3L 200ci	X	w/Man. Trans.; 42.18" Cable	CA-311	E2DZ-7K553-A
1981-82	V8 4.2L 255ci	D	w/Man. Trans.; 42.18" Cable	CA-311	E2DZ-7K553-A
1979	V8 5.0L 302ci	F	w/Man. Trans.; 56.41" Cable	CA-308	D9ZZ-7K553-B



# CLUTCH CABLES

Year	Engine	Vin	Remark	Part	OE
<b>MERKUR</b>					
<b>XR4TI</b>					
1986-89	L4 2.3L 140ci	W	62.40" Cable	CA-328	E5RY-7K553-A
<b>MITSUBISHI</b>					
<b>CORDIA, TREDIA</b>					
1983	L4 1.8L 1795cc	4	56.75" Cable	CA-650	MB-527433
1984-88	L4 1.8L 1795cc	G	56.75" Cable	CA-650	MB-527433
<b>MIRAGE</b>					
1985-88	L4 1.5L 1468cc	K	32.25" Cable	CA-209	MB-527465
1987-88	L4 1.5L 1468cc	K	54.92" Cable	CA-164	MB527467
1993-96	L4 1.5L 1468cc	A	66.00" Cable	CA-665	MB912305
1985	L4 1.6L 1597cc	F	Turbo; 50.50" Cable	CA-651	MB-527466
1986	L4 1.6L 1597cc	F	To 5/86, Turbo; 50.50" Cable	CA-651	MB-527466
1987-88	L4 1.6L 1597cc	F	54.92" Cable	CA-164	MB527467
1993-96	L4 1.8L 1834cc	C	66.00" Cable	CA-665	MB912305
<b>PRECIS</b>					
1987-92	L4 1.5L 1468cc	J	50.50" Cable	CA-550	41510-21010
<b>MITSUBISHI TRUCKS</b>					
<b>MIGHTY MAX</b>					
1987-89	L4 2.0L 1997cc	D	34.75" Cable	CA-815	MB-598411
1990-92	L4 2.4L 2351cc	W	34.75" Cable	CA-815	MB-598411
1993	L4 2.4L 2351cc	G	34.75" Cable	CA-815	MB-598411
1987-89	L4 2.6L 2555cc	E	34.75" Cable	CA-815	MB-598411
1990-92	V6 3.0L 2972cc	S	34.75" Cable	CA-815	MB-598411
1993	V6 3.0L 2972cc	H	34.75" Cable	CA-815	MB-598411
<b>NISSAN</b>					
<b>MICRA</b>					
1984-88	L4 1.2L 1229cc	H	Canada; 30.5118" Cable	CA-806	30770-84A00
<b>PULSAR NX</b>					
1983	L4 1.6L 1597cc	P	w/Man. Trans., Engine Code: E16; 27.56" Cable	CA-800	30670-04A00
1984-86	L4 1.6L 1597cc	M	w/Man. Trans., Engine Code: E16; 27.56" Cable	CA-800	30670-04A00
1990	L4 1.6L 1597cc	G	30.5118" Cable	CA-806	30770-84A00
<b>SENTRA</b>					
1982	L4 1.5L 1488cc	H	Engine Code: E16IS 27.56" Cable	CA-800	30670-04A00
1983	L4 1.5L 1488cc	M	Engine Code: E16IS 27.56" Cable	CA-800	30670-04A00
1984-85	L4 1.6L 1597cc	P	Engine Code: E16; 27.56" Cable	CA-800	30670-04A00
1986	L4 1.6L 1597cc	P	Engine Code: E16IS 27.56" Cable	CA-800	30670-04A00
1986-88	L4 1.6L 1597cc	P	From 1/86 to 7/88, 30.52" Cable	CA-807	30770-60A01
1989	L4 1.6L 1597cc	G	30.5118" Cable	CA-806	30770-84A00
1990	L4 1.6L 1597cc	G	29.50" Cable	CA-810	30770-62Y01
1991-93	L4 1.6L 1597cc	E, P	29.50" Cable	CA-810	30770-62Y01
1983-86	L4 1.7L 1688cc	S	30.125" Cable	CA-801	30670-17A00
1991-92	L4 2.0L 1998cc	G	28.50" Cable	CA-811	30770-64Y01
<b>STANZA</b>					
1982-83	L4 2.0L 1974cc	H	Engine Code: CA20S 25.79" Cable	CA-808	30670-D1200
1984-86	L4 2.0L 1974cc	H	To 1/86, Engine Code: CA20e; 31.38" Cable	CA-802	30670-D2801
<b>OLDSMOBILE</b>					
<b>FIRENZA</b>					
1983	L4 1.8L 112ci	0	35.20" Cable	CA-410	14068795
1983-84	L4 2.0L 122ci	B, P	35.20" Cable	CA-410	14068795
<b>OMEGA</b>					
1980-81	L4 2.5L 151ci	5	35.86" Cable	CA-407	14020838
1982	L4 2.5L 151ci	5, R	35.86" Cable	CA-407	14046845
1983	L4 2.5L 151ci	5	35.86" Cable	CA-407	14056659

# CLUTCH CABLES

Year	Engine	Vin	Remark	Part	OE
<b>OLDSMOBILE (con't)</b>					
<b>OMEGA (con't)</b>					
1983-84	L4 2.5L 151ci	R	35.86" Cable	CA-407	14056659
1980	V6 2.8L 173ci	7	35.86" Cable	CA-407	14020838
1981	V6 2.8L 173ci	X	35.86" Cable	CA-407	14020838
1982	V6 2.8L 173ci	X, Z	35.86" Cable	CA-407	14046845
1983-84	V6 2.8L 173ci	X, Z	35.86" Cable	CA-407	14056659
<b>STARFIRE</b>					
1976-77	L4 2.3L 140ci	B	w/Man. Trans.; 47.36" Cable	CA-402	364672
1978-79	L4 2.5L 151ci	1	w/Man. Trans.; 47.36" Cable	CA-402	463006
1978-80	L4 2.5L 151ci	V	w/Man. Trans.; 47.36" Cable	CA-402	463006
1976-77	V6 3.8L 231ci	C	48.89" Cable	CA-405	465472
1977-80	V6 3.8L 231ci	A	48.89" Cable	CA-405	465472
1977-78	V8 5.0L 305ci	U	48.89" Cable	CA-405	465472
1979	V8 5.0L 305ci	G	48.89" Cable	CA-405	465472
<b>OPEL</b>					
<b>1900</b>					
1971	L4 1.9L 1898cc		31.02" Cable, 22.64" Mounting Length	CA-850	669021
1972	L4 1.9L 1898cc		31.02" Cable, 22.32" Mounting Length	CA-854	669027
1973	L4 1.9L 1898cc	N	44.17" Cable	CA-851	669034
1974	L4 1.9L 1898cc	N	40.669" Cable	CA-852	669045
1975	L4 1.9L 1898cc	N	41.259" Cable	CA-853	669050
<b>DELUXE</b>					
1971	L4 1.1L 1077cc		31.02" Cable, 22.64" Mounting Length	CA-850	669021
<b>ISUZU</b>					
1976	L4 1.8L 1816cc	B	44.17" Cable	CA-851	669034
<b>KADETT, RALLYE</b>					
1967-71	L4 1.1L 1077cc		31.02" Cable, 22.64" Mounting Length	CA-850	669021
1968	L4 1.5L 1491cc		31.02" Cable, 22.64" Mounting Length	CA-850	669021
1968-70	L4 1.9L 1898cc		31.02" Cable, 22.64" Mounting Length	CA-850	669021
<b>MANTA</b>					
1971	L4 1.9L 1897cc		31.02" Cable, 22.64" Mounting Length	CA-850	669021
1972	L4 1.9L 1897cc	N	31.02" Cable, 22.32" Mounting Length	CA-854	669027
1973	L4 1.9L 1898cc	N	44.17" Cable	CA-851	669034
1974	L4 1.9L 1898cc	N	40.669" Cable	CA-852	669045
1975	L4 1.9L 1898cc	N	41.259" Cable	CA-853	669050
<b>OPEL</b>					
1969-70	L4 1.1L 1077cc		31.02" Cable, 22.64" Mounting Length	CA-850	669021
1969-71	L4 1.9L 1898cc		31.02" Cable, 22.64" Mounting Length	CA-850	669021
1971-72	L4 1.9L 1898cc		31.02" Cable, 22.32" Mounting Length	CA-854	669027
1973	L4 1.9L 1898cc	N	44.17" Cable	CA-851	669034
<b>PLYMOUTH</b>					
<b>ACCLAIM</b>					
1989	L4 2.2L 135ci	D	w/Electronic Fuel Injection; 41.10" Cable	CA-981	4505341
1989-90	L4 2.5L 153ci	J	Turbo; 41.10" Cable	CA-981	4505533
1989-90	L4 2.5L 153ci	J, K	w/Electronic Fuel Injection; 41.10" Cable	CA-981	4505341
1991-92	L4 2.5L 153ci	K	w/Multi Port Fuel Injection; 41.10" Cable	CA-981	4641146
1993	L4 2.5L 153ci	K	w/Electronic Fuel Injection, w/5 Spd. Manual Trans.	CA-982	4670754
1993	L4 2.5L 153ci	V	w/Multi Port Fuel Injection; 41.10" Cable	CA-981	4641146
<b>ARROW</b>					
1976-78	L4 1.6L 98ci	K	32.75" Cable	CA-210	MB-011943
1976-78	L4 2.0L 122ci	U	32.75" Cable	CA-210	MB-011943
1979-80	L4 2.6L 156ci	F	4WD; 32.40" Cable	CA-217	MB-012475
<b>CHAMP</b>					
1979	L4 1.4L 1410cc	J		CA-912	

# CLUTCH CABLES

Year	Engine	Vin	Remark	Part	OE
<b>PLYMOUTH (con't)</b>					
<b>CHAMP (con't)</b>					
1980	L4 1.4L 1410cc	J	exc. Wagon; 53.00" Cable	CA-207	MB012071
1981	L4 1.4L 1410cc	2	53.00" Cable	CA-207	MB-012071
1982	L4 1.4L 1410cc	2	w/Man. Trans.; 53.00" Cable	CA-207	MB012071
1979	L4 1.6L 98ci	K		CA-912	
1980	L4 1.6L 98ci	K	exc. Wagon; 53.00" Cable	CA-207	MB012071
1981	L4 1.6L 98ci	3	53.00" Cable	CA-207	MB-012071
1982	L4 1.6L 98ci	3	w/Man. Trans.; 53.00" Cable	CA-207	MB012071
<b>COLT</b>					
1980	L4 1.4L 1410cc	J	Hardtop; 53.00" Cable	CA-207	MB-012071
1981-83	L4 1.4L 1410cc	2	53.00" Cable	CA-207	MB-012071
1984	L4 1.4L 1410cc	A	53.00" Cable	CA-207	MB-012071
1976	L4 1.6L 98ci	K	32.75" Cable	CA-208	MA-152111
1977-78	L4 1.6L 98ci	K	Sedan, Coupe	CA-210	MB-011942
1977-79	L4 1.6L 98ci	K	Wagon; 32.75" Cable	CA-208	MA-152111
1980	L4 1.6L 98ci	K	53.00" Cable	CA-207	MB-012071
1981-83	L4 1.6L 98ci	3	53.00" Cable	CA-207	MB-012071
1984	L4 1.6L 98ci	B, F	53.00" Cable	CA-207	MB-012071
1976-78	L4 2.0L 122ci	U	Wagon; 32.75" Cable	CA-208	MA-152111
1984	L4 2.0L 122ci	D	53.00" Cable	CA-207	MB-012071
1984-85	L4 2.0L 122ci	D	53.93" Cable	CA-215	MB-527438
1986	L4 2.0L 122ci	D	To 11/86, 53.93" Cable	CA-215	MB-527438
1980	L4 2.6L 156ci	F	53.00" Cable	CA-207	MB-012071
<b>HORIZON</b>					
1983	L4 1.6L 97ci	A	Economy Price, w/A460 Auto. Trans., w/A465 Auto. Trans. 42.00" Cable	CA-202	4377771
1983	L4 1.6L 97ci	A	w/A460, w/A465 Man.Trans. 42.00" Cable	CA-202	4377771
1984-86	L4 1.6L 97ci	A	4 & 5 Spd. Man. Trans. 42.00" Cable	CA-202	4377771
1983	L4 1.6L 98ci	3	Economy Price, w/A460 Auto. Trans., w/A465 Auto. Trans. 42.00" Cable	CA-202	4377771
1983	L4 1.6L 98ci	3	w/A460, w/A465 Man.Trans. 42.00" Cable	CA-202	4377771
1978-80	L4 1.7L 105ci	A	w/Man. Trans. 34.05" cable	CA-201	5206246
1981	L4 1.7L 105ci	A	4 & 5 Spd. Man. Trans. 34.05" cable	CA-201	5206246
1981	L4 1.7L 105ci	A	4 Spd. Trans., TC3, w/A460, exc. Low Price 42.00" Cable	CA-202	4377771
1981	L4 1.7L 105ci	A	4 Spd. Trans., TC3, w/A460, Low Price 34.05" cable	CA-201	5206246
1981-82	L4 1.7L 105ci	A	w/A412 Auto. Trans. 34.05" cable	CA-201	5206246
1983	L4 1.7L 105ci	B	Economy Price, w/A460 Auto. Trans., w/A465 Auto. Trans. 42.00" Cable	CA-202	4377771
1983	L4 1.7L 105ci	B	w/A460, w/A465 Man.Trans. 42.00" Cable	CA-202	4377771
1983	L4 1.7L 105ci	B	w/A460, w/A465, w/A412 Trans. 34.05" cable	CA-201	5206246
1984	L4 2.2L 135ci	8, C	4 & 5 Spd. Man. Trans. 42.00" Cable	CA-202	4377771
1985-87	L4 2.2L 135ci	C	5 Spd. Man. Trans.; 42.00" Cable	CA-202	4377771
1988	L4 2.2L 135ci	D	To 4/1/88, w/5 Spd. Man. Trans. 42.00" Cable	CA-202	4377771
1989-90	L4 2.2L 135ci	D	42.50" Cable	CA-680	4505539
<b>RELIANT</b>					
1981-82	L4 2.2L 135ci	B	w/A460 Trans. 42.00" Cable	CA-202	4377771
1983	L4 2.2L 135ci	C	w/A460 Trans. 42.00" Cable	CA-202	4377771
1985	L4 2.2L 135ci	C	w/2 Bbl. Carb.; 41.10" Cable	CA-981	4377769
1985-86	L4 2.2L 135ci	D	w/Throttle Body Injection; 41.10" Cable	CA-981	4377769
1986-87	L4 2.2L 135ci	D	4 & 5 Spd. Man. Trans. 42.00" Cable	CA-202	4377771
1987-88	L4 2.2L 135ci	D	w/Electronic Fuel Injection; 41.10" Cable	CA-981	4377769
1989	L4 2.2L 135ci	D	w/Electronic Fuel Injection; 41.10" Cable	CA-981	4505341
1987	L4 2.5L 153ci	K	5 Spd. Man. Trans.; 42.00" Cable	CA-202	4377771
1989	L4 2.5L 153ci	K	w/Electronic Fuel Injection; 41.10" Cable	CA-981	4505341

# CLUTCH CABLES

Year	Engine	Vin	Remark	Part	OE
<b>PLYMOUTH (con't)</b>					
<b>SAPPORO</b>					
1979	L4 1.6L 98ci	K	w/Man. Trans.; 31.8125" Cable	CA-204	MB012000
1978	L4 2.6L 156ci	F	32.25" Cable	CA-209	MB-011945
1979-80	L4 2.6L 156ci	F	w/Man. Trans.; 31.8125" Cable	CA-204	MB012000
1981-83	L4 2.6L 156ci	7	w/Man. Trans.; 32.00" Cable	CA-206	MB012117
<b>SUNDANCE</b>					
1987	L4 2.2L 135ci	D, E	5 Spd. Man. Trans.; 42.00" Cable	CA-202	4377771
1987-88	L4 2.2L 135ci	D, E	w/Electronic Fuel Injection; 41.10" Cable	CA-981	4377769
1989	L4 2.2L 135ci	D	w/Electronic Fuel Injection; 41.10" Cable	CA-981	4505341
1993-94	L4 2.2L 135ci	D	w/Electronic Fuel Injection, w/5 Spd. Manual Trans.	CA-982	4670754
1989-91	L4 2.5L 153ci	J	Turbo; 41.10" Cable	CA-981	4505533
1990	L4 2.5L 153ci	J, K	w/Electronic Fuel Injection; 41.10" Cable	CA-981	4505341
1993-94	L4 2.5L 153ci	K	w/Electronic Fuel Injection, w/5 Spd. Manual Trans.; 44.80" Cable	CA-982	4670754
<b>TURISMO</b>					
1983	L4 1.6L 98ci	3	Economy Price, w/A460 Auto. Trans., w/A465 Auto. Trans. 42.00" Cable	CA-202	4377771
1983	L4 1.6L 98ci	3	w/A460, w/A465 Man.Trans. 42.00" Cable	CA-202	4377771
<b>PLYMOUTH TRUCKS</b>					
<b>ARROW PICKUP</b>					
1979-80	L4 2.0L 122ci	U	2WD; 32.48" Cable	CA-216	MB-012460
1979-80	L4 2.0L 122ci	U	4WD; 32.40" Cable	CA-217	MB-012475
1981-82	L4 2.0L 122ci	5	2WD; 32.48" Cable	CA-216	MB-012460
1981-82	L4 2.0L 122ci	5	4WD; 32.40" Cable	CA-217	MB-012475
1979	L4 2.6L 156ci	W	2WD; 32.48" Cable	CA-216	MB-012460
1979	L4 2.6L 156ci	W	4WD; 32.40" Cable	CA-217	MB-012475
1981-82	L4 2.6L 156ci	7	2WD; 32.48" Cable	CA-216	MB-012460
1981-82	L4 2.6L 156ci	7	4WD; 32.40" Cable	CA-217	MB-012475
<b>VOYAGER</b>					
1984	L4 2.2L 135ci	C	4 & 5 Spd. Man. Trans. 42.00" Cable	CA-203	4377770
1985	L4 2.2L 135ci	C	4 & 5 Spd. Man. Trans. 42.00" Cable	CA-203	4295599
1986-87	L4 2.2L 135ci	C	5 Spd. Man. Trans.; 42.00" Cable	CA-203	4377770
1987-89	L4 2.5L 153ci	K	5 Spd. Man. Trans.; 42.00" Cable	CA-203	4377770
1989	L4 2.5L 153ci	J	5 Spd. Man. Trans.; 42.00" Cable	CA-203	4377770
1991-94	L4 2.5L 153ci	K	42.50" Cable	CA-667	4511098
1984	L4 2.6L 156ci	G	4 & 5 Spd. Man. Trans. 42.00" Cable	CA-203	4377770
1985	L4 2.6L 156ci	G	4 & 5 Spd. Man. Trans. 42.00" Cable	CA-203	4295599
1989	V6 3.0L 181ci	3	5 Spd. Man. Trans.; 42.00" Cable	CA-203	4377770
1991-94	V6 3.0L 181ci	3	42.50" Cable	CA-667	4511098
1991-94	V6 3.3L 201ci	R	42.50" Cable	CA-667	4511098
<b>PONTIAC</b>					
<b>ASTRE</b>					
1975-76	L4 2.3L 140ci	A, B	w/Man. Trans., w/o Air Cond.; 54.24" Cable	CA-403	355592
1976	L4 2.3L 140ci	A	w/Man. Trans., w/Air Cond.; 47.36" Cable	CA-402	364672
1976-77	L4 2.3L 140ci	B	w/Man. Trans., w/Air Cond.; 47.36" Cable	CA-402	364672
<b>J2000</b>					
1982	L4 1.8L 112ci	G	36.33" Cable	CA-409	14024991
1983-84	L4 1.8L 112ci	0	35.20" Cable	CA-410	14068795
1983-84	L4 2.0L 122ci	B, P	35.20" Cable	CA-410	14068795
<b>LEMANS</b>					
1989-93	L4 1.6L 98ci	6	31.875" Cable	CA-167	90209335
1989-90	L4 2.0L 122ci	K	31.875" Cable	CA-167	90209335
<b>PHOENIX</b>					
1980-81	L4 2.5L 151ci	5	35.86" Cable	CA-407	14020838
1983	L4 2.5L 151ci	5	4 Spd. Man. Trans.; 35.86" Cable	CA-407	14056659

# CLUTCH CABLES

Year	Engine	Vin	Remark	Part	OE
<b>PONTIAC (con't)</b>					
<b>PHOENIX (con't)</b>					
1983-84	L4 2.5L 151ci	R	4 Spd. Man. Trans.; 35.86" Cable	CA-407	14056659
1980	V6 2.8L 173ci	7	35.86" Cable	CA-407	14020838
1981	V6 2.8L 173ci	X	35.86" Cable	CA-407	14020838
1982	V6 2.8L 173ci	X, Z	4 Spd. Man. Trans.; 35.86" Cable	CA-407	14046845
1983-84	V6 2.8L 173ci	X, Z	4 Spd. Man. Trans.; 35.86" Cable	CA-407	14056659
<b>SUNBIRD</b>					
1976	L4 2.3L 140ci	A	w/Man. Trans., w/Air Cond.; 47.36" Cable	CA-402	364672
1976-77	L4 2.3L 140ci	B	w/Man. Trans., w/Air Cond.; 47.36" Cable	CA-402	364672
1977-79	L4 2.5L 151ci	V	w/Man. Trans.; 47.36" Cable	CA-402	463006
1980	L4 2.5L 151ci	V	4 Spd. Man. Trans.; 47.36" Cable	CA-402	463006
1976-77	V6 3.8L 231ci	C	48.89" Cable	CA-405	465472
1977-80	V6 3.8L 231ci	A	48.89" Cable	CA-405	465472
1978	V8 5.0L 305ci	U	48.89" Cable	CA-405	465472
1979	V8 5.0L 305ci	G	48.89" Cable	CA-405	465472
<b>T1000</b>					
1982-87	L4 1.6L 98ci	C	4 Spd. Man. Trans. 60.41" Cable	CA-408	14080793
<b>PORSCHE</b>					
<b>911</b>					
1965-68	H6 2.0L 1991cc		81.75" Cable	CA-978	901 423 401 01
1969	H6 2.0L 1991cc		exc. Turbo; 81.75" Cable	CA-978	901 423 401 01
1970	H6 2.2L 2195cc		w/o Turbo 77.56" Cable	CA-979	911 423 401 00
1971	H6 2.2L 2195cc	1, 2, 3	w/o Turbo 77.56" Cable	CA-979	911 423 401 00
1972-73	H6 2.4L 2341cc	2	w/o Turbo 77.56" Cable	CA-979	911 423 401 00
1974	H6 2.7L 2688cc	1, 3	w/o Turbo 77.56" Cable	CA-979	911 423 401 00
1974-75	H6 2.7L 2688cc	4	w/o Turbo 77.56" Cable	CA-979	911 423 401 00
1975	H6 2.7L 2688cc	2	w/o Turbo 77.56" Cable	CA-979	911 423 401 00
1976	H6 2.7L 2688cc	2	w/o Turbo 77.56" Cable	CA-975	911 423 401 05
1976-77	H6 3.0L 2999cc	8	Turbo; 80.6875" Cable	CA-980	930 423 401 04
1978-79	H6 3.0L 2999cc	2	SC; 81.0236" Cable	CA-977	930 423 401 05
1980	H6 3.0L 2999cc		SC; 81.0236" Cable	CA-977	930 423 401 05
1981-83	H6 3.0L 2999cc	A	SC; 81.0236" Cable	CA-977	930 423 401 05
1986-88	H6 3.2L 3163cc	B	exc. Turbo; 81.0236" Cable	CA-977	930 434 401 06
<b>912</b>					
1965-67	H4 1.6L 1582cc		81.75" Cable	CA-978	901 423 401 01
1968-69	H4 1.6L 1582cc	0	81.75" Cable	CA-978	901 423 401 01
1976	H4 2.0L 1967cc	0	w/o Turbo 77.56" Cable	CA-975	911 423 401 05
<b>914</b>					
1970-73	H4 1.7L 1679cc	2	101.75" Cable	CA-973	914 423 402 00
1974-75	H4 1.8L 1795cc	2	101.75" Cable	CA-973	914 423 402 00
1976	H4 2.0L 1967cc	2	101.75" Cable	CA-973	914 423 402 00
1974-75	H4 2.0L 1971cc	2	101.75" Cable	CA-973	914 423 402 00
1970-71	H6 2.0L 1991cc	4	82.50" Cable	CA-974	914 423 405 05
<b>924</b>					
1977-79	L4 2.0L 1983cc	2	32.59" Cable	CA-152	803 721 335A
1980	L4 2.0L 1983cc		32.59" Cable	CA-152	803 721 335A
1981-82	L4 2.0L 1983cc	A	32.59" Cable	CA-152	803 721 335A
<b>930</b>					
1978-79	H6 3.3L 3294cc	8	Turbo; 80.6875" Cable	CA-980	930 423 401 04
<b>RENAULT</b>					
<b>ALLIANCE, ENCORE</b>					
1983-86	L4 1.4L 1397cc	E	41.8125" Cable	CA-818	TO783813
1983-87	L4 1.4L 1397cc	D	41.8125" Cable	CA-818	TO783813
1985-87	L4 1.7L 105ci	A	41.8125" Cable	CA-818	TO783813
1987	L4 2.0L 1965cc	V	GTA; 41.4173" Cable	CA-819	TO761086

# CLUTCH CABLES

Year	Engine	Vin	Remark	Part	OE
<b>RENAULT (con't)</b>					
<b>LECAR</b>					
1977-79	L4 1.3L 1289cc		24.25" Cable	CA-821	7700 653 308
1980-83	L4 1.4L 1397cc	A	25.125" Cable	CA-820	7700 663 947
<b>R5</b>					
1976	L4 1.3L 1289cc		24.25" Cable	CA-821	7700 653 308
<b>SUBARU</b>					
<b>DELUXE, STAR</b>					
1972	H4 1.3L 1267cc		2, 3 & 4 Door & Wagon; 24.00" Cable	CA-889	63712-0164
<b>DL</b>					
1974-76	H4 1.4L 1361cc		2, 3 & 4 Door & Wagon; 24.00" Cable	CA-889	63712-0164
1976-79	H4 1.6L 1595cc		24.00" Cable	CA-889	63712-0164
1980-83	H4 1.6L 1595cc	2	25.30" Cable	CA-890	73702-6012
1984	H4 1.6L 1595cc	2	25.25" Cable	CA-893	73702-6013
1980-83	H4 1.8L 1781cc	4	35.90" Cable	CA-891	73702-6032
1981-83	H4 1.8L 1781cc	5	35.90" Cable	CA-891	73702-6032
1984	H4 1.8L 1781cc	4, 5	34.64" Cable	CA-894	73702-6033
1985-89	H4 1.8L 1781cc	4, 5	2WD; 36.00" Cable	CA-892	37026-GA100
<b>FE</b>					
1979	H4 1.6L 1595cc		24.00" Cable	CA-889	63712-0164
<b>GF</b>					
1975	H4 1.4L 1361cc		2, 3 & 4 Door & Wagon; 24.00" Cable	CA-889	63712-0164
1976	H4 1.4L 1361cc		24.00" Cable	CA-889	63712-0164
1976	H4 1.6L 1595cc		2, 3 & 4 Door & Wagon; 24.00" Cable	CA-889	63712-0164
1977-79	H4 1.6L 1595cc		24.00" Cable	CA-889	63712-0164
<b>GL</b>					
1972	H4 1.3L 1267cc		2, 3 & 4 Door & Wagon; 24.00" Cable	CA-889	63712-0164
1973-75	H4 1.4L 1361cc		2, 3 & 4 Door & Wagon; 24.00" Cable	CA-889	63712-0164
1979	H4 1.6L 1595cc		24.00" Cable	CA-889	63712-0164
1980	H4 1.6L 1595cc	3	25.30" Cable	CA-890	73702-6012
1980-83	H4 1.8L 1781cc	4	35.90" Cable	CA-891	73702-6032
1981-83	H4 1.8L 1781cc	5	35.90" Cable	CA-891	73702-6032
1984	H4 1.8L 1781cc	4, 5	34.64" Cable	CA-894	73702-6033
1984-89	H4 1.8L 1781cc	5	2WD Turbo 33.50" Cable	CA-824	37026-GA081
1984-89	H4 1.8L 1781cc	5	4WD; 33.50" Cable	CA-824	37026-GA081
1985	H4 1.8L 1781cc	7	2WD Turbo 33.50" Cable	CA-824	37026-GA081
1985	H4 1.8L 1781cc	7	4WD; 33.50" Cable	CA-824	37026-GA081
1985-88	H4 1.8L 1781cc	5	2WD Turbo 36.00" Cable	CA-892	37026-GA100
1985-89	H4 1.8L 1781cc	4, 5	2WD; 36.00" Cable	CA-892	37026-GA100
<b>GLF</b>					
1980	H4 1.6L 1595cc	2	25.30" Cable	CA-890	73702-6012
1980-82	H4 1.8L 1781cc	4	35.90" Cable	CA-891	73702-6032
<b>IMPREZA</b>					
1993-95	H4 1.8L 1781cc	2	32.00" Cable	CA-668	37214-AA080
1996	H4 1.8L 1781cc	1	32.00" Cable	CA-688	37214-AA30
1996-97	H4 1.8L 1781cc	2	32.00" Cable	CA-688	37214-AA80
1995	H4 2.2L 2212cc	6		CA-668	37214-AA080
1996	H4 2.2L 2212cc	4	32.00" Cable	CA-688	37214-AA80
<b>JUSTY</b>					
1987-88	L3 1.2L 1189cc	7	47.00" Cable	CA-689	7370-26132
1989-94	L3 1.2L 1189cc	7, 8	47.50" Cable	CA-888	73702-6301
<b>LEGACY</b>					
1990	H4 2.2L 2212cc	6	32.00" Cable	CA-668	37214-AA080
1991-92	H4 2.2L 2212cc	6	exc. Turbo; 32.00" Cable	CA-668	37214-AA080
1991-92	H4 2.2L 2212cc	6	Turbo; 32.00" Cable	CA-668	37214-AA030
1993-95	H4 2.2L 2212cc	6	32.00" Cable	CA-688	37214-AA80
1996	H4 2.2L 2212cc	3	32.00" Cable	CA-688	37214-AA80

# CLUTCH CABLES

Year	Engine	Vin	Remark	Part	OE
<b>SUBARU (con't)</b>					
<b>LEGACY (con't)</b>					
1996-98	H4 2.2L 2212cc	4	32.00" Cable	CA-688	37214-AA80
<b>STANDARD</b>					
1977-79	H4 1.6L 1595cc		24.00" Cable	CA-889	63712-0164
1980-83	H4 1.6L 1595cc	2	25.30" Cable	CA-890	73702-6012
1984	H4 1.6L 1595cc	2	2, 3 & 4 Door & Wagon; 18.261" Cable	CA-900	73702-6013
1981-82	H4 1.8L 1781cc	5	35.90" Cable	CA-891	73702-6032
<b>XT</b>					
1985-87	H4 1.8L 1781cc	4, 7	Turbo; 33.66" Cable	CA-899	37206-GA310
1985-89	H4 1.8L 1781cc	4, 7	2WD w/o Turbo; 37.25" Cable	CA-896	37026-GA200
1989-90	H6 2.7L 2672cc	9	4WD; 33.66" Cable	CA-899	37206-GA310
1989-91	H6 2.7L 2672cc	8	4WD; 33.66" Cable	CA-899	37206-GA310
<b>SUBARU TRUCKS</b>					
<b>BRAT</b>					
1978-79	H4 1.6L 1595cc		24.00" Cable	CA-889	63712-0164
1980	H4 1.6L 1595cc	3	24.00" Cable	CA-889	63712-0164
1981	H4 1.8L 1781cc	5	32.25" Cable	CA-822	63712-0402
1982-83	H4 1.8L 1781cc	5	35.90" Cable	CA-891	73702-6032
1984	H4 1.8L 1781cc	5	2, 3 & 4 Door; 25.30" Cable	CA-890	73702-6012
<b>SUZUKI</b>					
<b>ESTEEM</b>					
1995-96	L4 1.6L 1590cc	3	25.25" Cable	CA-675	23710-60G20
<b>SWIFT</b>					
1989-93	L4 1.3L 1298cc	3	74.29" Cable	CA-813	23710-63B10
1995-98	L4 1.3L 1298cc	2	22.75" Cable	CA-676	23710-50GB0
<b>SUZUKI TRUCKS</b>					
<b>SAMURAI</b>					
1986-88	L4 1.3L 1325cc	5		CA-414	23710-83023
1989	L4 1.3L 1325cc	5		CA-814	23710-83024
<b>SIDEKICK</b>					
1989	L4 1.3L 1325cc	5	73.40" Cable	CA-809	23710-63A10
1989-91	L4 1.6L 1590cc	0	73.40" Cable	CA-809	23710-63A10
1992	L4 1.6L 1590cc	0	74.29" Cable	CA-813	23710-57B11
1992-96	L4 1.6L 1590cc	0	16 Valve 62.50" Cable	CA-677	23710-57B11
1993	L4 1.6L 1590cc	0	Hardtop 74.29" Cable	CA-813	23710-57B11
1995	L4 1.6L 1590cc	0	16 Valve 62.50" Cable	CA-677	237105B10
1997-98	L4 1.6L 1590cc	0	Japan Built, Canada Built; 62.50" Cable	CA-677	23710-5B12
<b>X-90</b>					
1996-98	L4 1.6L 1590cc	1	Japan Built, Canada Built; 62.50" Cable	CA-677	23710-5B12
<b>TOYOTA</b>					
<b>COROLLA</b>					
1969-70	L4 1.2L 1166cc		Engine Code: 3KC; 65.75" Cable	CA-910	31340-19105
1971-73	L4 1.2L 1166cc		Engine Code: 3KC; 68.50" Cable	CA-909	31340-19126
1974	L4 1.2L 1166cc	K	To 4/74, Engine Code: 3KC; 68.50" Cable	CA-909	31340-19126
1977-79	L4 1.2L 1166cc	K	w/Man. Trans.; 68.50" Cable	CA-902	31340-19155
<b>STARLET</b>					
1981	L4 1.3L 1290cc	K	65.67" Cable	CA-904	31340-19245
1982	L4 1.3L 1290cc	K	w/Man. Trans.; 65.67" Cable	CA-904	31340-19245
1983-84	L4 1.3L 1290cc	K	w/Man. Trans.; 66.00" Cable	CA-903	31340-19275
<b>TERCEL</b>					
1980	L4 1.5L 1452cc	A	37.00" Cable	CA-905	31340-16050
1981-82	L4 1.5L 1452cc	A	38.60" Cable	CA-907	31340-16070
1983-86	L4 1.5L 1452cc	A	w/Man. Trans.; 38.42" Cable	CA-908	31340-16110
1987-88	L4 1.5L 1456cc	E	w/Man. Trans.; 38.42" Cable	CA-908	31340-16110

# CLUTCH CABLES

Year	Engine	Vin	Remark	Part	OE
<b>VOLKSWAGEN</b>					
<b>BEETLE</b>					
1954-60	H4 1.2L 1192cc		To 7/60; 89.25" Cable	CA-812	111 721 335E
1960-61	H4 1.2L 1192cc		From 8/60 To 7/61; 88.70" Cable	CA-957	113 721 335A
1962-63	H4 1.2L 1192cc		To 2/63; 89.25" Cable	CA-812	111 721 335
1963-66	H4 1.2L 1192cc		From 3/63; 88.70" Cable	CA-950	111 721 335A
1966	H4 1.3L 1285cc		88.70" Cable	CA-950	111 721 335A
1967-69	H4 1.5L 1457cc		88.70" Cable	CA-950	111 721 335A
1970-71	H4 1.6L 1584cc		To 7/71; 88.70" Cable	CA-950	111 721 335A
1971-74	H4 1.6L 1584cc		From 8/71 To 4/74; 89.96" Cable	CA-958	111-721-335-C
1974-79	H4 1.6L 1584cc		From 5/74; 89.25" Cable	CA-812	111 721 335E
<b>CABRIO</b>					
1995-98	L4 2.0L 1984cc	B	33.00" Cable	CA-658	1H1 721 335A
1996-97	L4 2.0L 1984cc	A	33.00" Cable	CA-658	1H1 721 335A
<b>CABRIOLET</b>					
1985-89	L4 1.8L 1780cc	A	w/Man. Trans. 31.25" Cable	CA-953	171-721-335-D
1990-92	L4 1.8L 1780cc	B	88.70" Cable	CA-950	111-721-335-E
1991-92	L4 1.8L 1780cc	C	88.70" Cable	CA-950	111-721-335-E
<b>DASHER</b>					
1974-75	L4 1.5L 1471cc		36.61" Cable	CA-155	811 721 335F
1979-80	L4 1.5L 1471cc		Diesel; 36.49" Cable	CA-153	811 721 335H
1976-80	L4 1.6L 1588cc		36.61" Cable	CA-155	811 721 335F
1981	L4 1.6L 1588cc	G	Diesel; 36.61" Cable	CA-155	811 721 335F
<b>FASTBACK, SQUAREBACK</b>					
1966-67	H4 1.6L 1584cc	4	91.25" Cable	CA-960	311 721 335A
1968-73	H4 1.6L 1584cc		91.25" Cable	CA-960	311 721 335A
<b>FOX</b>					
1987-89	L4 1.8L 1780cc	A	38.70" Cable	CA-971	307 721 335 2
1990	L4 1.8L 1780cc	B	38.70" Cable	CA-971	307 721 335 2
1991-93	L4 1.8L 1780cc	A	39.75" Cable	CA-659	307 721 335
1991-93	L4 1.8L 1780cc	B	39.75" Cable	CA-659	307 721 335
<b>GOLF</b>					
1985-86	L4 1.6L 1588cc	G	w/Man. Trans., Diesel; 33.00" Cable	CA-951	191-721-335-D
1985-89	L4 1.8L 1780cc	B	32.38" Cable	CA-968	191 721 335M
1986-89	L4 1.8L 1780cc	B	Self Adjusting; 31.50" Cable	CA-970	191 721 335G
1987	L4 1.8L 1780cc	C	32.38" Cable	CA-968	191 721 335M
1987	L4 1.8L 1780cc	C	Self Adjusting; 31.50" Cable	CA-970	191 721 335G
1987-89	L4 1.8L 1780cc	A	32.38" Cable	CA-968	191 721 335M
1987-89	L4 1.8L 1780cc	A	Self Adjusting; 31.50" Cable	CA-970	191 721 335G
1990-92	L4 1.8L 1780cc	A, B, K	7.625" Cable	CA-657	191 721 335AB
1990-92	L4 2.0L 1984cc	E, J	7.625" Cable	CA-657	191 721 335AB
1993	L4 2.0L 1984cc	L	33.00" Cable	CA-658	1H1 721 335A
1994-97	L4 2.0L 1984cc	A	33.00" Cable	CA-658	1H1 721 335A
1995	L4 2.0L 1984cc	C	33.00" Cable	CA-658	1H1 721 335A
1995-97	L4 2.0L 1984cc	B	33.00" Cable	CA-658	1H1 721 335A
<b>JETTA</b>					
1980	L4 1.6L 1588cc		w/Man. Trans. 31.25" Cable	CA-953	171-721-335-E
1981-84	L4 1.6L 1588cc	G	w/Man. Trans. 31.25" Cable	CA-953	171-721-335-E
1983-84	L4 1.6L 1588cc	H	w/Man. Trans. 31.25" Cable	CA-953	171-721-335-E
1986	L4 1.6L 1588cc	H	From 8/86; 33.50" Cable	CA-969	191 721 335N
1987-88	L4 1.6L 1588cc	H	33.50" Cable	CA-969	191 721 335N
1988-90	L4 1.6L 1588cc	G	33.50" Cable	CA-969	191 721 335N
1990-92	L4 1.6L 1588cc	G	7.625" Cable	CA-657	191 721 335AB
1981-84	L4 1.7L 1715cc	A	w/Man. Trans. 31.25" Cable	CA-953	171-721-335-E
1984	L4 1.8L 1780cc	B	w/Man. Trans. 31.25" Cable	CA-953	171-721-335-E
1984-89	L4 1.8L 1780cc	A	Self Adjusting, From 8/84, 31.50" Cable	CA-970	191 721 335G
1986-92	L4 1.8L 1780cc	A	From 9/86; 32.38" Cable	CA-968	191 721 335M



# CLUTCH CABLES

Year	Engine	Vin	Remark	Part	OE
<b>VOLKSWAGEN (con't)</b>					
<b>JETTA (con't)</b>					
1989	L4 1.8L 1780cc	B	32.38" Cable	CA-968	191 721 335M
1989	L4 1.8L 1780cc	B	Self Adjusting; 31.50" Cable	CA-970	191 721 335G
1990-92	L4 2.0L 1984cc	E, J	7.625" Cable	CA-657	191 721 335AB
1993	L4 2.0L 1984cc		33.00" Cable	CA-658	1H1 721 335A
1994-95	L4 2.0L 1984cc	C	33.00" Cable	CA-658	1H1 721 335A
1994-97	L4 2.0L 1984cc	B	33.00" Cable	CA-658	1H1 721 335A
1994-98	L4 2.0L 1984cc	A	33.00" Cable	CA-658	1H1 721 335A
1996	L4 2.0L 1984cc	L	33.00" Cable	CA-658	1H1 721 335A
<b>KARMANN GHIA</b>					
1959-60	H4 1.2L 1192cc		To 7/60; 89.25" Cable	CA-812	111 721 335E
1960-61	H4 1.2L 1192cc		From 8/60 To 7/61	CA-957	113 721 335A
1961-63	H4 1.2L 1192cc		From 8/61 To 2/63; 89.25" Cable	CA-812	111 721 335
1963-65	H4 1.2L 1192cc		From 3/63; 88.70" Cable	CA-950	111 721 335A
1966	H4 1.3L 1285cc		88.70" Cable	CA-950	111 721 335A
1967-69	H4 1.5L 1457cc		88.70" Cable	CA-950	111 721 335A
1970-71	H4 1.6L 1584cc		To 7/71; 88.70" Cable	CA-950	111 721 335A
1971-74	H4 1.6L 1584cc		From 8/71 To 4/74; 33.00" Cable	CA-958	111-721-335-C
1974	H4 1.6L 1584cc		From 5/74; 89.25" Cable	CA-812	111 721 335E
<b>QUANTUM</b>					
1982-83	L4 1.6L 1588cc	H	Diesel, To 7/83; 37.875" Cable	CA-956	321 721 335D
1983-85	L4 1.6L 1588cc	H	From 8/83; 38.1875" Cable	CA-955	855 721 35
1983	L4 1.7L 1715cc	A	From 8/83; 38.1875" Cable	CA-955	855 721 35
1985	L4 1.8L 1780cc	A, B	38.1875" Cable	CA-955	855 721 35
1983-84	L5 2.2L 2144cc	B	38.267" Cable	CA-157	321 721 335G
1985	L5 2.2L 2226cc	E	38.267" Cable	CA-157	321 721 335G
1985-88	L5 2.2L 2226cc	B	38.267" Cable	CA-157	321 721 335G
<b>RABBIT</b>					
1975	L4 1.5L 1471cc		33.75" Cable	CA-961	171 721 335B
1977-80	L4 1.5L 1471cc		w/Man. Trans. 31.25" Cable	CA-953	171-721-335-E
1980	L4 1.6L 1588cc		w/Man. Trans. 31.25" Cable	CA-953	171-721-335-E
1981-84	L4 1.6L 1588cc	G	w/Man. Trans. 31.25" Cable	CA-953	171-721-335-E
1981-84	L4 1.7L 1715cc	B	w/Man. Trans. 31.25" Cable	CA-953	171-721-335-E
1983-84	L4 1.7L 1715cc	A	w/Man. Trans. 31.25" Cable	CA-953	171-721-335-E
1983-84	L4 1.8L 1780cc	C	w/Man. Trans. 31.25" Cable	CA-953	171-721-335-E
1984	L4 1.8L 1780cc	A	w/Man. Trans. 31.25" Cable	CA-953	171-721-335-E
<b>SCIROCCO</b>					
1978	L4 1.5L 1457cc		w/Man. Trans.; 35.50" Cable	CA-954	531-721-335-C
1975	L4 1.5L 1471cc		35.6875" Cable	CA-965	531 721 335A
1976-80	L4 1.6L 1588cc		w/Man. Trans.; 35.50" Cable	CA-954	531-721-335-C
1981-83	L4 1.7L 1715cc	A	w/Man. Trans.; 35.50" Cable	CA-954	531-721-335-C
1983	L4 1.8L 1780cc	C	w/Man. Trans.; 35.50" Cable	CA-954	531-721-335-C
1984-89	L4 1.8L 1780cc	A	w/Man. Trans.; 35.50" Cable	CA-954	531-721-335-C
1987-89	L4 1.8L 1780cc	B	w/Man. Trans.; 35.50" Cable	CA-954	531-721-335-C
1988-89	L4 1.8L 1780cc	A	16 Valve; 40.39" Cable	CA-959	531 721 335
1989	L4 1.8L 1780cc	B	16 Valve; 40.39" Cable	CA-959	531 721 335
<b>SUPER BEETLE, THING</b>					
1973-74	H4 1.6L 1584cc		w/Man. Trans.; 33.00" Cable	CA-958	111-721-335-C
<b>VOLKSWAGEN TRUCKS</b>					
<b>RABBIT PICKUP</b>					
1980	L4 1.5L 1457cc		w/Man. Trans. 31.25" Cable	CA-953	171-721-335-E
1980	L4 1.6L 1588cc		w/Man. Trans. 31.25" Cable	CA-953	171-721-335-E
1981-83	L4 1.6L 1588cc	G	w/Man. Trans. 31.25" Cable	CA-953	171-721-335-E
1981-82	L4 1.7L 1715cc	A	w/Man. Trans. 31.25" Cable	CA-953	171-721-335-E
1981-83	L4 1.7L 1715cc	B	w/Man. Trans. 31.25" Cable	CA-953	171-721-335-E

# CLUTCH CABLES

Year	Engine	Vin	Remark	Part	OE
<b>VOLKSWAGEN TRUCKS (con't)</b>					
<b>TRANSPORTER</b>					
1954-64	H4 1.2L 1192cc		123.25" Cable	CA-964	211 721 335B
1959-61	H4 1.2L 1192cc		From 6/59 To 10/61; 122.625" Cable	CA-967	211 721 335C
1961	H4 1.2L 1192cc		From 10/61; 123.25" Cable	CA-964	211 721 335B
1963-67	H4 1.5L 1457cc		To 7/67; 123.25" Cable	CA-964	211 721 335B
1967-71	H4 1.6L 1584cc		From 8/67 To 7/71; 125.24" Cable	CA-962	211 721 335E
1971-73	H4 1.7L 1679cc		From 8/71; 126.456" Cable	CA-963	211 721 335J
1974-75	H4 1.8L 1795cc		To 7/75; 126.456" Cable	CA-963	211 721 335J
1975	H4 1.8L 1795cc		From 8/75; 125.00" Cable	CA-966	211 721 335H
1976-79	H4 2.0L 1970cc		w/Man. Trans.; 35.50" Cable	CA-954	531-721-335-C
<b>VANAGON</b>					
1980-82	H4 2.0L 1970cc	A	w/Man. Trans.; 35.50" Cable	CA-954	531-721-335-C
1983	H4 2.0L 1970cc		w/Man. Trans.; 35.50" Cable	CA-954	531-721-335-C
<b>VOLVO</b>					
<b>142, 144, 145</b>					
1967-68	L4 1.8L 1780cc		45.625" Cable	CA-925	684670
<b>164</b>					
1970-75	L6 3.0L 2980cc		26.25" Cable	CA-926	684769-3
<b>240</b>					
1990-93	L4 2.3L 2316cc	8	41.90" Cable	CA-927	1377669.5
<b>242, 244, 245</b>					
1975	L4 2.0L 1990cc		41.90" Cable	CA-927	1377669.5
1976-79	L4 2.1L 2127cc		41.90" Cable	CA-927	1377669.5
1980-85	L4 2.1L 2127cc	4	41.90" Cable	CA-927	1377669.5
1981-89	L4 2.3L 2316cc	8	41.90" Cable	CA-927	1377669.5
1982-83	L6 2.4L 2383cc	7	Diesel; 43.40" Cable	CA-928	68142793
1984	L6 2.4L 2383cc	7	43.40" Cable	CA-928	68142793
<b>740</b>					
1985-91	L4 2.3L 2316cc	8	43.40" Cable	CA-928	68142793
1986-87	L4 2.3L 2316cc	8	43.40" Cable	CA-928	1227229
1986	L6 2.4L 2377cc	7	43.40" Cable	CA-928	68142793
<b>745</b>					
1985	L4 2.3L 2316cc	8	43.40" Cable	CA-928	68142793
1985	L6 2.4L 2383cc	7	43.40" Cable	CA-928	68142793
<b>760</b>					
1984-90	L4 2.3L 2316cc	8	43.40" Cable	CA-928	68142793
1985	L6 2.4L 2377cc	7	43.40" Cable	CA-928	68142793
1983	L6 2.4L 2383cc	7	43.40" Cable	CA-928	1227229
1983-84	L6 2.4L 2383cc	7	43.40" Cable	CA-928	68142793
1983-90	V6 2.8L 2849cc	6	43.40" Cable	CA-928	68142793
<b>YUGO</b>					
<b>GV</b>					
1986	L4 1.1L 1116cc	2	19.48" Cable	CA-253	4405475
1987-89	L4 1.1L 1116cc	2	20.25" Cable	CA-254	46625514
1990-91	L4 1.3L 1301cc	6	20.25" Cable	CA-254	46625514

# **CLUTCH FORKS**

# CLUTCH FORKS

Years	Engine	Remarks	OE	Part
<b>AMERICAN MOTORS</b>				
<b>AMX</b>				
1978-80	L6 4.2L 258ci		3224192	CF-112
1978-79	V8 5.0L 304ci	w/Manual Transmission	3224192	CF-112
<b>CONCORD, GREMLIN, HORNET, PACER, SPIRIT</b>				
1977-79	L6 3.8L 232ci		3224192	CF-112
1977-82	L6 4.2L 258ci		3224192	CF-112
1978-79	V8 5.0L 304ci		3224192	CF-112
<b>EAGLE</b>				
1980-88	L6 4.2L 258ci		3224192	CF-112
<b>MATADOR</b>				
1977-78	L6 4.2L 258ci		3224192	CF-112
1977	V8 5.0L 304ci		3224192	CF-112
1977-78	V8 5.9L 360ci		3224192	CF-112
<b>BUICK</b>				
<b>APOLLO</b>				
1973-75	L6 4.1L 250ci		14066235	CF-100
<b>CENTURY, REGAL</b>				
1982-85	L4 2.5L 151ci		14024930	CF-106
1976-77	V6 3.8L 231ci		14066235	CF-100
<b>SKYHAWK</b>				
1982-84	L4 1.8L 112ci	w/4 Spd. Manual Trans. (Shaft Type)	14024930	CF-106
1983-87	L4 2.0L 122ci	w/4 Spd. Manual Trans. (Shaft Type)	14024930	CF-106
<b>SKYLARK, SOMERSET REGAL</b>				
1980-85	L4 2.5L 151ci		14024930	CF-106
1980-85	V6 2.8L 173ci		14024930	CF-106
1976-79	V6 3.8L 231ci		14066235	CF-100
1978-79	V8 5.0L 305ci		14066235	CF-100
1978-79	V8 5.7L 350ci		14066235	CF-100
<b>CADILLAC</b>				
<b>CIMARRON</b>				
1982	L4 1.8L 112ci	w/4 Spd.	14024930	CF-106
1985	V6 2.8L 173ci	w/4 Spd.	14024930	CF-106
<b>CHEVROLET</b>				
<b>BEL AIR, BROOKWOOD, CAPRICE, IMPALA, LAGUNA, MALIBU, MONTE CARLO</b>				
1963-65	L6 3.8L 230ci		14066235	CF-100
1967-79	L6 4.1L 250ci		14066235	CF-100
1980-84	V6 3.8L 229ci		14066235	CF-100
1980-85	V6 3.8L 231ci		14066235	CF-100
1980-82	V8 4.4L 267ci		14066235	CF-100
1976-81	V8 5.0L 305ci		14066235	CF-100
1984-92	V8 5.0L 305ci		14075725	CF-133
1976-81	V8 5.7L 350ci		14066235	CF-100
1976	V8 6.6L 400ci		14066235	CF-100
<b>BERETTA, CORSICA</b>				
1987-88	L4 2.0L 122ci		14024930	CF-106
1987-89	V6 2.8L 173ci	4 Speed	14024930	CF-106
1987-89	V6 2.8L 173ci	exc. 4 Speed	14075718	CF-129
<b>CAMARO</b>				
1982-83	L4 2.5L 151ci		14024930	CF-106
1984-86	L4 2.5L 151ci		14075718	CF-129
1967-69	L6 3.8L 230ci		14066235	CF-100
1967-79	L6 4.1L 250ci		14066235	CF-100
1982-83	V6 2.8L 173ci		14024930	CF-106
1984-89	V6 2.8L 173ci		14075718	CF-129
1980-81	V6 3.8L 229ci		14066235	CF-100
1980-02	V6 3.8L 231ci		14066235	CF-100

# CLUTCH FORKS

Years	Engine	Remarks	OE	Part
<b>CHEVROLET (con't)</b>				
<b>CAMARO (con't)</b>				
1980-81	V8 4.4L 267ci		14066235	CF-100
1967-69	V8 5.0L 302ci		14066235	CF-100
1976-82	V8 5.0L 305ci		14066235	CF-100
1984-92	V8 5.0L 305ci		14075725	CF-133
1976-81	V8 5.7L 350ci		14066235	CF-100
<b>CAVALIER</b>				
1982	L4 1.8L 112ci		14024930	CF-106
1983-88	L4 2.0L 122ci	w/4 Spd. Manual Trans. (Shaft Type)	14024930	CF-106
1985-89	V6 2.8L 173ci	w/4 Spd. Manual Trans. (Shaft Type)	14024930	CF-106
<b>CELEBRITY</b>				
1982-83	L4 2.5L 151ci		14024930	CF-106
1984-86	L4 2.5L 151ci	w/4 Spd.	14024930	CF-106
1982-85	V6 2.8L 173ci	w/4 Spd.	14024930	CF-106
1982-89	V6 2.8L 173ci	exc. 4 Speed	14075718	CF-129
<b>CHEVELLE, CHEVY II</b>				
1964-69	L6 3.8L 230ci		14066235	CF-100
1967-73	L6 4.1L 250ci		14066235	CF-100
<b>CITATION</b>				
1980-85	L4 2.5L 151ci		14024930	CF-106
1980-85	V6 2.8L 173ci	w/4 Spd.	14024930	CF-106
<b>CORVETTE</b>				
1980	V8 5.0L 305ci		14066235	CF-100
1976-81	V8 5.7L 350ci		14066235	CF-100
<b>MONZA</b>				
1980	L4 2.5L 151ci		14024930	CF-106
1980	V6 3.8L 231ci		14066235	CF-100
1976-79	V8 5.0L 305ci		14066235	CF-100
<b>NOVA</b>				
1985-87	L4 1.6L 98ci		94840696	CF-132
1976-79	L6 4.1L 250ci		14066235	CF-100
1976-79	V8 5.0L 305ci		14066235	CF-100
1976-79	V8 5.7L 350ci		14066235	CF-100
<b>CHEVROLET TRUCKS</b>				
<b>ASTRO</b>				
1985-90	L4 2.5L 151ci	w/Getrag Trans.	15588262	CF-126
1985-90	L4 2.5L 151ci	w/Warner Trans.	14070374	CF-128
1988-96	V6 4.3L 262ci	w/Warner Trans.	14070374	CF-128
1988-96	V6 4.3L 262ci	w/Getrag Trans.	15588262	CF-126
<b>BLAZER, K5 BLAZER</b>				
1973-82	L6 4.1L 250ci		14066235	CF-100
1973	L6 4.8L 292ci		14066235	CF-100
1995-96	V6 4.3L 262ci	w/Getrag Trans.	15588262	CF-126
1995-96	V6 4.3L 262ci	w/Warner Trans.	14070374	CF-128
1977-82	V8 5.0L 305ci		14066235	CF-100
1985-87	V8 5.0L 305ci		15592270	CF-116
1973	V8 5.0L 307ci		14066235	CF-100
1973-82	V8 5.7L 350ci		14066235	CF-100
1983-84	V8 5.7L 350ci		3765372	CF-104
1985-86	V8 5.7L 350ci		15592270	CF-116
1988-94	V8 5.7L 350ci		15588262	CF-126
1982	V8 6.2L 379ci		14066235	CF-100
1985-86	V8 6.2L 379ci		15592270	CF-116
1988-91	V8 6.2L 379ci		15588262	CF-126
1994-94	V8 6.5L 395ci		15588262	CF-126
1975-79	V8 6.6L 400ci		14066235	CF-100
1973	V8 7.4L 454ci		14066235	CF-100

# CLUTCH FORKS

Years	Engine	Remarks	OE	Part
<b>CHEVROLET TRUCKS (con't)</b>				
<b>BLAZER, K5 BLAZER (con't)</b>				
1976-78	V8 7.4L 454ci		14066235	CF-100
<b>C10 PICKUP, C20 PICKUP, C30 PICKUP, K10 PICKUP, K20 PICKUP, K30 PICKUP</b>				
1963-69	L6 3.8L 230ci		14066235	CF-100
1966-84	L6 4.1L 250ci		14066235	CF-100
1973-84	L6 4.8L 292ci		14066235	CF-100
1985-86	L6 4.8L 292ci		15592270	CF-116
1976-82	V8 5.0L 305ci		14066235	CF-100
1985-86	V8 5.0L 305ci		15592270	CF-116
1973	V8 5.0L 307ci		14066235	CF-100
1973-82	V8 5.7L 350ci		14066235	CF-100
1983-84	V8 5.7L 350ci		3765372	CF-104
1985-86	V8 5.7L 350ci		15592270	CF-116
1982	V8 6.2L 379ci		14066235	CF-100
1985-86	V8 6.2L 379ci		15592270	CF-116
1975-80	V8 6.6L 400ci		14066235	CF-100
1973-82	V8 7.4L 454ci		14066235	CF-100
1985-86	V8 7.4L 454ci		15592270	CF-116
<b>C10 SUBURBAN, C20 SUBURBAN, K10 SUBURBAN, K20 SUBURBAN</b>				
1968-80	L6 4.1L 250ci		14066235	CF-100
1973-82	L6 4.8L 292ci		14066235	CF-100
1976-82	V8 5.0L 305ci		14066235	CF-100
1985-86	V8 5.0L 305ci		15592270	CF-116
1973	V8 5.0L 307ci		14066235	CF-100
1973-82	V8 5.7L 350ci		14066235	CF-100
1983-84	V8 5.7L 350ci		3765372	CF-104
1985-86	V8 5.7L 350ci		15592270	CF-116
1982	V8 6.2L 379ci		14066235	CF-100
1985-86	V8 6.2L 379ci		15592270	CF-116
1975-80	V8 6.6L 400ci		14066235	CF-100
1973-82	V8 7.4L 454ci		14066235	CF-100
1985-86	V8 7.4L 454ci		15592270	CF-116
<b>C1500, C2500, C3500, K1500, K2500, K3500</b>				
1988-95	V6 4.3L 262ci	w/Getrag Trans.	15588262	CF-126
1996	V6 4.3L 262ci	w/Warner Trans.	14070374	CF-128
1988-95	V8 5.0L 305ci		15588262	CF-126
1988-95	V8 5.7L 350ci		15588262	CF-126
1988-93	V8 6.2L 379ci		15588262	CF-126
1992-95	V8 6.5L 395ci		15588262	CF-126
1988-95	V8 7.4L 454ci		15588262	CF-126
<b>C1500 SUBURBAN, C2500 SUBURBAN, K1500 SUBURBAN, K2500 SUBURBAN</b>				
1992-95	V8 5.7L 350ci		15588262	CF-126
1994-95	V8 6.5L 395ci		15588262	CF-126
1992-95	V8 7.4L 454ci		15588262	CF-126
<b>EL CAMINO</b>				
1964-69	L6 3.8L 230ci		14066235	CF-100
1967-77	L6 4.1L 250ci		14066235	CF-100
1980-84	V6 3.8L 229ci		14066235	CF-100
1978-84	V6 3.8L 231ci		14066235	CF-100
1979-82	V8 4.4L 267ci		14066235	CF-100
1976-82	V8 5.0L 305ci		14066235	CF-100
1985-87	V8 5.0L 305ci		15592270	CF-116
1973	V8 5.0L 307ci		14066235	CF-100
1973-78	V8 5.7L 350ci		14066235	CF-100
1979	V8 5.7L 350ci		3765372	CF-104
1983-84	V8 5.7L 350ci	Diesel	3765372	CF-104
1975-76	V8 6.6L 400ci		14066235	CF-100

# CLUTCH FORKS

Years	Engine	Remarks	OE	Part
<b>CHEVROLET TRUCKS (con't)</b>				
<b>EL CAMINO (con't)</b>				
1973-74	V8 7.4L 454ci		14066235	CF-100
<b>EXPRESS 1500, EXPRESS 2500</b>				
1996	V6 4.3L 262ci		14070374	CF-128
<b>G10 VAN, G20 VAN, G30 VAN</b>				
1967-69	L6 3.8L 230ci		14066235	CF-100
1968-84	L6 4.1L 250ci		14066235	CF-100
1973-80	L6 4.8L 292ci		14066235	CF-100
1988-96	V6 4.3L 262ci		14070374	CF-128
1977-82	V8 5.0L 305ci		14066235	CF-100
1985-87	V8 5.0L 305ci		15592270	CF-116
1988-95	V8 5.0L 305ci		15588262	CF-126
1973	V8 5.0L 307ci		14066235	CF-100
1973-78	V8 5.7L 350ci		14066235	CF-100
1979-84	V8 5.7L 350ci		3765372	CF-104
1985-87	V8 5.7L 350ci		15592270	CF-116
1988-95	V8 5.7L 350ci		15588262	CF-126
1985-87	V8 6.2L 379ci		15592270	CF-116
1988-93	V8 6.2L 379ci		15588262	CF-126
1994-95	V8 6.5L 395ci		15588262	CF-126
1975-80	V8 6.6L 400ci		14066235	CF-100
1973-76	V8 7.4L 454ci		14066235	CF-100
1985-87	V8 7.4L 454ci		15592270	CF-116
1988-95	V8 7.4L 454ci		15588262	CF-126
<b>LLV</b>				
1987-93	L4 2.5L 151ci	w/Getrag Trans.	15588262	CF-126
1987-93	L4 2.5L 151ci	w/Warner Trans.	14070374	CF-128
<b>P10 VAN, P20 VAN, P30 VAN</b>				
1973-79	L6 4.1L 250ci		14066235	CF-100
1973-89	L6 4.8L 292ci		14066235	CF-100
1990-96	V6 4.3L 262ci	w/Getrag Trans.	15588262	CF-126
1990-96	V6 4.3L 262ci	w/Warner Trans.	14070374	CF-128
1979	V8 5.0L 305ci		14066235	CF-100
1973	V8 5.0L 307ci		14066235	CF-100
1973-82	V8 5.7L 350ci		14066235	CF-100
1979-84	V8 5.7L 350ci	Forward Control w/MT & Power Disc Brakes	3765372	CF-104
1985-91	V8 5.7L 350ci		15592270	CF-116
1988-95	V8 5.7L 350ci		15588262	CF-126
1982	V8 6.2L 379ci		14066235	CF-100
1985-87	V8 6.2L 379ci		15592270	CF-116
1988-93	V8 6.2L 379ci		15588262	CF-126
1994-95	V8 6.5L 395ci		15588262	CF-126
1976	V8 6.6L 400ci		14066235	CF-100
1973-82	V8 7.4L 454ci		14066235	CF-100
1985-87	V8 7.4L 454ci		15592270	CF-116
1988-95	V8 7.4L 454ci		15588262	CF-126
<b>R10, R20, R30, V10, V20, V30</b>				
1987-88	L6 4.8L 292ci		15592270	CF-116
1987	V6 4.3L 262ci		15592270	CF-116
1987	V8 5.0L 305ci		15592270	CF-116
1987-88	V8 5.7L 350ci		15592270	CF-116
1987-88	V8 6.2L 379ci		15592270	CF-116
1987-88	V8 7.4L 454ci		15592270	CF-116
<b>R10 SUBURBAN, V10 SUBURBAN, R20 SUBURBAN, V20 SUBURBAN</b>				
1987	V8 5.0L 305ci		15592270	CF-116
1987-88	V8 5.7L 350ci		15592270	CF-116
1987-88	V8 6.2L 379ci		15592270	CF-116

# CLUTCH FORKS

Years	Engine	Remarks	OE	Part
<b>CHEVROLET TRUCKS (con't)</b>				
<b>R10 SUBURBAN, V10 SUBURBAN, R20 SUBURBAN, V20 SUBURBAN (con't)</b>				
1987-88	V8 7.4L 454ci		15592270	CF-116
<b>R1500 SUBURBAN, V1500 SUBURBAN, R2500 SUBURBAN, V2500 SUBURBAN</b>				
1989-91	V8 5.7L 350ci		15592270	CF-116
1989-91	V8 6.2L 379ci		15592270	CF-116
1989-91	V8 7.4L 454ci		15592270	CF-116
<b>R2500, R3500, V3500</b>				
1989-91	V8 5.7L 350ci		15592270	CF-116
1989-91	V8 6.2L 379ci		15592270	CF-116
1989-91	V8 7.4L 454ci		15592270	CF-116
<b>S10, S10 BLAZER</b>				
1985	L4 1.9L 119ci	w/Getrag Trans.	15588262	CF-126
1984-85	L4 1.9L 119ci	w/Warner Trans. (1984 Hydraulic Type)	14070374	CF-128
1984	L4 2.0L 122ci	w/Warner Trans. (1984 Hydraulic Type)	14070374	CF-128
1984-96	L4 2.2L 134ci	w/Warner Trans. (1984 Hydraulic Type)	14070374	CF-128
1985-96	L4 2.2L 134ci	w/Getrag Trans.	15588262	CF-126
1985-93	L4 2.5L 151ci	w/Getrag Trans.	15588262	CF-126
1985-93	L4 2.5L 151ci	w/Warner Trans.	14070374	CF-128
1984-93	V6 2.8L 173ci	w/Warner Trans. (1984 Hydraulic Type)	14070374	CF-128
1985-93	V6 2.8L 173ci	w/Getrag Trans.	15588262	CF-126
1988-96	V6 4.3L 262ci	w/Getrag Trans.	15588262	CF-126
1988-96	V6 4.3L 262ci	w/Warner Trans.	14070374	CF-128
<b>TAHOE</b>				
1995	V8 5.7L 350ci		15588262	CF-126
1995	V8 6.5L 395ci		15588262	CF-126
<b>CHRYSLER</b>				
<b>CORDOBA, E CLASS, LEBARON, NEW YORKER, NEWPORT</b>				
1982-90	L4 2.2L 135ci		4511046	CF-142
1978-79	L6 3.7L 225ci		3743998	CF-131
1978-79	V8 5.2L 318ci		3743998	CF-131
1978-79	V8 5.9L 360ci		3743998	CF-131
1978	V8 6.6L 400ci		3743998	CF-131
1978	V8 7.2L 440ci		3743998	CF-131
<b>DAYTONA, LASER, TC MASERATI</b>				
1984-93	L4 2.2L 135ci		4511046	CF-142
<b>CHRYSLER TRUCKS</b>				
<b>TOWN &amp; COUNTRY</b>				
1982-88	L4 2.2L 135ci		4511046	CF-142
<b>DODGE</b>				
<b>400, 600, ARIES, CHARGER, DAYTONA, LANCER, OMNI, SHADOW, SPIRIT</b>				
1982-94	L4 2.2L 135ci		4511046	CF-142
<b>ASPEN, DIPLOMAT</b>				
1977-80	L6 3.7L 225ci		3743998	CF-131
1977-80	V8 5.2L 318ci		3743998	CF-131
1977-80	V8 5.9L 360ci		3743998	CF-131
<b>DODGE TRUCKS</b>				
<b>B100 VAN, B200 VAN, B300 VAN</b>				
1974-80	L6 3.7L 225ci		3743998	CF-131
1974-80	V8 5.2L 318ci		3743998	CF-131
1974-80	V8 5.9L 360ci		3743998	CF-131
1974-78	V8 6.6L 400ci		3743998	CF-131
1974-78	V8 7.2L 440ci		3743998	CF-131
<b>B150, B250, B350</b>				
1981-87	L6 3.7L 225ci		4210697	CF-115
1981-87	V8 5.2L 318ci		4210697	CF-115
1981-87	V8 5.9L 360ci		4210697	CF-115



# CLUTCH FORKS

Years	Engine	Remarks	OE	Part
<b>DODGE TRUCKS (con't)</b>				
<b>CARAVAN, MINI RAM, RAMPAGE, ROYAL MINI RAM</b>				
1982-87	L4 2.2L 135ci		4511046	CF-142
<b>CB300, RAMCHARGER</b>				
1974-80	L6 3.7L 225ci		3743998	CF-131
1974-80	V8 5.2L 318ci		3743998	CF-131
1981-87	V8 5.2L 318ci		4210697	CF-115
1988-91	V8 5.2L 318ci		4446231	CF-141
1974-80	V8 5.9L 360ci		3743998	CF-131
1981-87	V8 5.9L 360ci		4210697	CF-115
1976-78	V8 6.6L 400ci		3743998	CF-131
1974-79	V8 7.2L 440ci		3743998	CF-131
<b>D100 PICKUP, D200 PICKUP, D300 PICKUP, W100 PICKUP, W200 PICKUP, W300 PICKUP</b>				
1974-87	L6 3.7L 225ci		3743998	CF-131
1978-80	L6 4.0L 243ci		3743998	CF-131
1988-89	V6 3.9L 239ci		4446231	CF-141
1974-87	V8 5.2L 318ci		3743998	CF-131
1988-89	V8 5.2L 318ci		4446231	CF-141
1974-87	V8 5.9L 360ci		3743998	CF-131
1988	V8 5.9L 360ci		4446231	CF-141
1974-78	V8 6.6L 400ci		3743998	CF-131
1974-78	V8 7.2L 440ci		3743998	CF-131
<b>D150, D250, D350, W150, W250, W350</b>				
1977-80	L6 3.7L 225ci		3743998	CF-131
1981-87	L6 3.7L 225ci		4210697	CF-115
1978-80	L6 4.0L 243ci		3743998	CF-131
1989-91	L6 5.9L 359ci		4446231	CF-141
1988-91	V6 3.9L 239ci		4446231	CF-141
1977-80	V8 5.2L 318ci		3743998	CF-131
1981-87	V8 5.2L 318ci		4210697	CF-115
1988-91	V8 5.2L 318ci		4446231	CF-141
1977-80	V8 5.9L 360ci		3743998	CF-131
1981-87	V8 5.9L 360ci		4210697	CF-115
1988-91	V8 5.9L 360ci		4446231	CF-141
1977-78	V8 6.6L 400ci		3743998	CF-131
1978	V8 7.2L 440ci		3743998	CF-131
<b>D400, D450</b>				
1978-81	V8 5.9L 360ci		3743998	CF-131
1978	V8 7.2L 440ci		3743998	CF-131
<b>D50</b>				
1979-82	L4 2.0L 122ci		3743998	CF-131
1979-82	L4 2.6L 156ci		3743998	CF-131
<b>DAKOTA</b>				
1987	L4 2.2L 135ci		3743998	CF-131
1987-88	L4 2.2L 135ci		4511046	CF-142
1987	V6 3.9L 239ci		3743998	CF-131
1993-93	V6 3.9L 239ci		52107555	CF-146
2000-01	V8 4.7L 287ci		52107555	CF-146
1994-99	V8 5.2L 318ci		52107555	CF-146
1998-01	V8 5.9L 360ci		52107555	CF-146
<b>RAM 1500 PICKUP, RAM 2500 PICKUP, RAM 3500 PICKUP</b>				
1994-01	V6 3.9L 239ci		52107555	CF-146
1994-01	V8 5.2L 318ci		52107555	CF-146
1994-01	V8 5.9L 360ci		52107555	CF-146
<b>RAM 1500 VAN, RAM 2500 VAN, RAM 3500 VAN</b>				
1999-01	V6 3.9L 239ci		52107555	CF-146
1999-01	V8 5.2L 318ci		52107555	CF-146
1999-01	V8 5.9L 360ci		52107555	CF-146

# CLUTCH FORKS

Years	Engine	Remarks	OE	Part
<b>DODGE TRUCKS (con't)</b>				
<b>RD200</b>				
1978-80	V8 5.2L 318ci		3743998	CF-131
1978-80	V8 5.9L 360ci		3743998	CF-131
<b>FORD</b>				
<b>MUSTANG</b>				
1982-93	V8 5.0L 302ci		E6ZZ-7515-A	CF-119
<b>FORD TRUCKS</b>				
<b>BRONCO</b>				
1980-82	L6 4.9L 300ci		E0TZ-7515-A	CF-107
1984-92	L6 4.9L 300ci		E4TZ-7515-C	CF-117
1980-82	V8 5.0L 302ci		E0TZ-7515-A	CF-107
1984-96	V8 5.0L 302ci		E4TZ-7515-C	CF-117
1980-82	V8 5.8L 351ci		E0TZ-7515-A	CF-107
1984-96	V8 5.8L 351ci		E4TZ-7515-C	CF-117
<b>E-100 ECONOLINE, E-200 ECONOLINE, E-300 ECONOLINE</b>				
1973-74	L6 3.9L 240ci	w/3 Spd. Manual Trans.	D0TZ-7515-A	CF-101
1973-74	L6 4.9L 300ci	w/3 Spd. Manual Trans.	D0TZ-7515-A	CF-101
1975-79	L6 4.9L 300ci		D8TZ-7515-A	CF-102
1980-82	L6 4.9L 300ci		E0TZ-7515-A	CF-107
1973-74	V8 5.0L 302ci	w/3 Spd. Manual Trans.	D0TZ-7515-A	CF-101
1975-79	V8 5.0L 302ci		D8TZ-7515-A	CF-102
1980-82	V8 5.0L 302ci		E0TZ-7515-A	CF-107
1975-79	V8 5.8L 351ci		D8TZ-7515-A	CF-102
1980-82	V8 5.8L 351ci		E0TZ-7515-A	CF-107
1978	V8 7.5L 460ci		D8TZ-7515-A	CF-102
<b>E-150 ECONOLINE, E-250 ECONOLINE, E-350 ECONOLINE</b>				
1975-79	L6 4.9L 300ci		D8TZ-7515-A	CF-102
1980-82	L6 4.9L 300ci		E0TZ-7515-A	CF-107
1984-96	L6 4.9L 300ci		E4TZ-7515-C	CF-117
1997-98	V10 6.8L 415ci		E4TZ-7515-C	CF-117
1997-98	V6 4.2L 256ci		E4TZ-7515-C	CF-117
1997-98	V8 4.6L 281ci		E4TZ-7515-C	CF-117
1975-79	V8 5.0L 302ci		D8TZ-7515-A	CF-102
1980-82	V8 5.0L 302ci		E0TZ-7515-A	CF-107
1985-96	V8 5.0L 302ci		E4TZ-7515-C	CF-117
1997-98	V8 5.4L 330ci		E4TZ-7515-C	CF-117
1975-79	V8 5.8L 351ci		D8TZ-7515-A	CF-102
1980-82	V8 5.8L 351ci		E0TZ-7515-A	CF-107
1985-96	V8 5.8L 351ci		E4TZ-7515-C	CF-117
1980-82	V8 6.6L 400ci		E0TZ-7515-A	CF-107
1985-87	V8 6.9L 420ci		E4TZ-7515-C	CF-117
1988-97	V8 7.3L 445ci		E4TZ-7515-C	CF-117
1975-79	V8 7.5L 460ci		D8TZ-7515-A	CF-102
1980-82	V8 7.5L 460ci		E0TZ-7515-A	CF-107
1985-96	V8 7.5L 460ci		E4TZ-7515-C	CF-117
<b>F SERIES</b>				
1958-59	L6 3.7L 223ci	w/Clark 280, Warner T19, New Process 435 & 542, Spicer CM 50 & 5000 Series Trans.	B8C-7515-C	CF-123
1958-59	V8 4.8L 292ci	w/Clark 280, Warner T19, New Process 435 & 542, Spicer CM 50 & 5000 Series Trans.	B8C-7515-C	CF-123
1958-59	V8 5.8L 352ci	w/Clark 280, Warner T19, New Process 435 & 542, Spicer CM 50 & 5000 Series Trans.	B8C-7515-C	CF-123
<b>F-100 PICKUP, F-150, F-250 PICKUP, F-350 PICKUP</b>				
1970-75	L6 3.9L 240ci		D0TZ-7515-A	CF-101
1970-79	L6 4.9L 300ci		D0TZ-7515-A	CF-101
1980	L6 4.9L 300ci		E0TZ-7515-A	CF-107

# CLUTCH FORKS

Years	Engine	Remarks	OE	Part
<b>FORD TRUCKS (con't)</b>				
<b>F-100 PICKUP, F-150, F-250 PICKUP, F-350 PICKUP (con't)</b>				
1982	L6 4.9L 300ci		E0TZ-7515-B	CF-103
1984-96	L6 4.9L 300ci		E4TZ-7515-C	CF-117
1982	V6 3.8L 232ci		E0TZ-7515-B	CF-103
1997-98	V6 4.2L 256ci		E4TZ-7515-C	CF-117
1982	V8 4.2L 255ci		E0TZ-7515-B	CF-103
1997-98	V8 4.6L 281ci		E4TZ-7515-C	CF-117
1970-79	V8 5.0L 302ci		D0TZ-7515-A	CF-101
1980-81	V8 5.0L 302ci		E0TZ-7515-A	CF-107
1982	V8 5.0L 302ci		E0TZ-7515-B	CF-103
1984-96	V8 5.0L 302ci		E4TZ-7515-C	CF-117
1997-98	V8 5.4L 330ci		E4TZ-7515-C	CF-117
1977-79	V8 5.8L 351ci		D0TZ-7515-A	CF-101
1980-81	V8 5.8L 351ci	Modified Engine	E0TZ-7515-B	CF-103
1980-81	V8 5.8L 351ci	Windsor Engine	E0TZ-7515-A	CF-107
1981	V8 5.8L 351ci	From Serial Number DG0,001	E0TZ-7515-B	CF-103
1981	V8 5.8L 351ci	Windsor Engine	E0TZ-7515-A	CF-107
1982	V8 5.8L 351ci		E0TZ-7515-B	CF-103
1984-97	V8 5.8L 351ci		E4TZ-7515-C	CF-117
1970-76	V8 5.9L 360ci		D0TZ-7515-A	CF-101
1970-76	V8 6.4L 390ci		D0TZ-7515-A	CF-101
1977-78	V8 6.6L 400ci		D0TZ-7515-A	CF-101
1979-82	V8 6.6L 400ci		E0TZ-7515-B	CF-103
1984-87	V8 6.9L 420ci	w/ZF 5 Spd. MT	E7TZ-7515-A	CF-151
1984-97	V8 7.5L 460ci	w/ZF 5 Spd. MT	E7TZ-7515-A	CF-151
<b>GEO</b>				
<b>PRIZM, STORM</b>				
1989-92	L4 1.6L 98ci		94840696	CF-132
<b>GEO TRUCKS</b>				
<b>TRACKER</b>				
1989-92	L4 1.6L 98ci		94840696	CF-132
<b>GMC</b>				
<b>C15 PICKUP, C25 PICKUP, C35 PICKUP, K15 PICKUP, K25 PICKUP, K35 PICKUP</b>				
1973-84	L6 4.1L 250ci		14066235	CF-100
1973-84	L6 4.8L 292ci		14066235	CF-100
1985-86	L6 4.8L 292ci		15592270	CF-116
1985-86	V6 4.3L 262ci		15592270	CF-116
1976-84	V8 5.0L 305ci		14066235	CF-100
1985-86	V8 5.0L 305ci		15592270	CF-116
1973	V8 5.0L 307ci		14066235	CF-100
1973-84	V8 5.7L 350ci		14066235	CF-100
1985-86	V8 5.7L 350ci		15592270	CF-116
1982-84	V8 6.2L 379ci		14066235	CF-100
1985-86	V8 6.2L 379ci		15592270	CF-116
1973-84	V8 7.4L 454ci		14066235	CF-100
1979-81	V8 7.4L 454ci	exc. Power Disc Brakes	14066235	CF-100
1985-86	V8 7.4L 454ci		15592270	CF-116
<b>C15/C1500 SUBURBAN, C25/C2500 SUBURBAN, K15/K1500 SUBURBAN, K25/K2500 SUBURBAN</b>				
1973-80	L6 4.1L 250ci		14066235	CF-100
1973-84	L6 4.8L 292ci		14066235	CF-100
1985-86	L6 4.8L 292ci		15592270	CF-116
1976-84	V8 5.0L 305ci		14066235	CF-100
1985-86	V8 5.0L 305ci		15592270	CF-116
1973	V8 5.0L 307ci		14066235	CF-100
1973-84	V8 5.7L 350ci		14066235	CF-100
1985-86	V8 5.7L 350ci		15592270	CF-116

# CLUTCH FORKS

Years	Engine	Remarks	OE	Part
<b>GMC (con't)</b>				
<b>C15/C1500 SUBURBAN, C25/C2500 SUBURBAN, K15/K1500 SUBURBAN, K25/K2500 SUBURBAN (con't)</b>				
1982-84	V8 6.2L 379ci		14066235	CF-100
1985-86	V8 6.2L 379ci		15592270	CF-116
1973-78	V8 7.4L 454ci		14066235	CF-100
1979-81	V8 7.4L 454ci	exc. Power Disc Brakes	14066235	CF-100
1985-86	V8 7.4L 454ci		15592270	CF-116
<b>C1500, C2500, C3500, K1500, K2500, K3500</b>				
1988-96	V6 4.3L 262ci	w/Getrag Trans.	15588262	CF-126
1996	V6 4.3L 262ci	w/Warner Trans.	14070374	CF-128
1988-95	V8 5.0L 305ci		15588262	CF-126
1988-95	V8 5.7L 350ci		15588262	CF-126
1988-93	V8 6.2L 379ci		15588262	CF-126
1992-95	V8 6.5L 395ci		15588262	CF-126
1988-95	V8 7.4L 454ci		15588262	CF-126
<b>C1500 SUBURBAN, C2500 SUBURBAN, K1500 SUBURBAN, K2500 SUBURBAN</b>				
1992-95	V8 5.7L 350ci		15588262	CF-126
1994-95	V8 6.5L 395ci		15588262	CF-126
1992-95	V8 7.4L 454ci		15588262	CF-126
<b>CABALLERO</b>				
1985-87	V6 4.3L 262ci		15592270	CF-116
1978-84	V8 5.0L 305ci		14066235	CF-100
1985-87	V8 5.0L 305ci		15592270	CF-116
1978-79	V8 5.7L 350ci		14066235	CF-100
<b>G15/G1500 VAN, G25/G2500 VAN, G35/G3500 VAN</b>				
1973-84	L6 4.1L 250ci		14066235	CF-100
1974-78	L6 4.8L 292ci		14066235	CF-100
1985-87	V6 4.3L 262ci		15592270	CF-116
1988-96	V6 4.3L 262ci	w/Getrag Trans.	15588262	CF-126
1988-96	V6 4.3L 262ci	w/Warner Trans.	14070374	CF-128
1977-84	V8 5.0L 305ci		14066235	CF-100
1985-87	V8 5.0L 305ci		15592270	CF-116
1988-95	V8 5.0L 305ci		15588262	CF-126
1973	V8 5.0L 307ci		14066235	CF-100
1973-78	V8 5.7L 350ci		14066235	CF-100
1979-84	V8 5.7L 350ci		3765372	CF-104
1985-87	V8 5.7L 350ci		15592270	CF-116
1988-95	V8 5.7L 350ci		15588262	CF-126
1983-84	V8 6.2L 379ci		14066235	CF-100
1985-87	V8 6.2L 379ci		15592270	CF-116
1988-93	V8 6.2L 379ci		15588262	CF-126
1994-95	V8 6.5L 395ci		15588262	CF-126
1975-76	V8 7.4L 454ci		14066235	CF-100
1985-87	V8 7.4L 454ci		15592270	CF-116
1988-93	V8 7.4L 454ci		15588262	CF-126
<b>JIMMY</b>				
1973-82	L6 4.1L 250ci		14066235	CF-100
1973	L6 4.8L 292ci		14066235	CF-100
1995-96	V6 4.3L 262ci	w/Getrag Trans.	15588262	CF-126
1995-96	V6 4.3L 262ci	w/Warner Trans.	14070374	CF-128
1977-84	V8 5.0L 305ci		14066235	CF-100
1985-87	V8 5.0L 305ci		15592270	CF-116
1973-84	V8 5.7L 350ci		14066235	CF-100
1985-87	V8 5.7L 350ci		15592270	CF-116
1988-91	V8 5.7L 350ci		15588262	CF-126
1982-84	V8 6.2L 379ci		14066235	CF-100
1985-87	V8 6.2L 379ci		15592270	CF-116
1988-91	V8 6.2L 379ci		15588262	CF-126

# CLUTCH FORKS

Years	Engine	Remarks	OE	Part
<b>GMC (con't)</b>				
<b>JIMMY (con't)</b>				
1973-76	V8 7.4L 454ci		14066235	CF-100
<b>P15/P1500 VAN, P25/P2500 VAN, P35/P3500 VAN</b>				
1973-74	L6 4.1L 250ci		14066235	CF-100
1973-84	L6 4.8L 292ci		14066235	CF-100
1975-80	L6 4.8L 292ci		14066235	CF-100
1985-89	L6 4.8L 292ci	w/Forward Controls	14066235	CF-100
1990-96	V6 4.3L 262ci	w/Getrag Trans.	15588262	CF-126
1990-96	V6 4.3L 262ci	w/Warner Trans.	14070374	CF-128
1973	V8 5.0L 307ci		14066235	CF-100
1973-84	V8 5.7L 350ci		14066235	CF-100
1979-84	V8 5.7L 350ci	w/Forward Controls and Power Disc Brakes	3765372	CF-104
1985-87	V8 5.7L 350ci		15592270	CF-116
1988-95	V8 5.7L 350ci		15588262	CF-126
1982-84	V8 6.2L 379ci		14066235	CF-100
1985-87	V8 6.2L 379ci		15592270	CF-116
1988-93	V8 6.2L 379ci		15588262	CF-126
1994-95	V8 6.5L 395ci		15588262	CF-126
1973-84	V8 7.4L 454ci		14066235	CF-100
1979-81	V8 7.4L 454ci	exc. Power Disc Brakes	14066235	CF-100
1985-87	V8 7.4L 454ci		15592270	CF-116
1988-95	V8 7.4L 454ci		15588262	CF-126
<b>R1500, R2500, R3500, V1500, V2500, V3500</b>				
1987-88	L6 4.8L 292ci		15592270	CF-116
1987	V6 4.3L 262ci		15592270	CF-116
1987	V8 5.0L 305ci		15592270	CF-116
1987-91	V8 5.7L 350ci		15592270	CF-116
1987-91	V8 6.2L 379ci		15592270	CF-116
1987-91	V8 7.4L 454ci		15592270	CF-116
<b>R1500 SUBURBAN, R2500 SUBURBAN, V1500 SUBURBAN, V2500 SUBURBAN</b>				
1987	V8 5.0L 305ci		15592270	CF-116
1987-91	V8 5.7L 350ci		15592270	CF-116
1987-91	V8 6.2L 379ci		15592270	CF-116
1987-91	V8 7.4L 454ci		15592270	CF-116
<b>S15, S15 JIMMY, SONOMA, SYCLONE, TYPHOON</b>				
1985	L4 1.9L 119ci	w/Getrag Trans.	15588262	CF-126
1984-85	L4 1.9L 119ci	w/Warner Trans. (1984 Hydraulic Type)	14070374	CF-128
1984	L4 2.0L 122ci	w/Warner Trans. (1984 Hydraulic Type)	14070374	CF-128
1985	L4 2.2L 134ci	w/Getrag Trans.	15588262	CF-126
1984-85	L4 2.2L 134ci	w/Warner Trans. (1984 Hydraulic Type)	14070374	CF-128
1994-96	L4 2.2L 134ci	w/Getrag Trans.	15588262	CF-126
1994-96	L4 2.2L 134ci	w/Warner Trans.	14070374	CF-128
1985-90	L4 2.5L 151ci	w/Getrag Trans.	15588262	CF-126
1985-90	L4 2.5L 151ci	w/Warner Trans.	14070374	CF-128
1991-93	L4 2.5L 151ci	w/Getrag Trans.	15588262	CF-126
1991-93	L4 2.5L 151ci	w/Warner Trans.	14070374	CF-128
1984-90	V6 2.8L 173ci	w/Warner Trans. (1984 Hydraulic Type)	14070374	CF-128
1985-90	V6 2.8L 173ci	w/Getrag Trans.	15588262	CF-126
1991-93	V6 2.8L 173ci	w/Getrag Trans.	15588262	CF-126
1991-93	V6 2.8L 173ci	w/Warner Trans.	14070374	CF-128
1988-96	V6 4.3L 262ci	w/Getrag Trans.	15588262	CF-126
1988-96	V6 4.3L 262ci	w/Warner Trans.	14070374	CF-128
<b>SAFARI</b>				
1985-90	L4 2.5L 151ci	w/Getrag Trans.	15588262	CF-126
1985-90	L4 2.5L 151ci	w/Warner Trans.	14070374	CF-128
1985-87	V6 4.3L 262ci		15592270	CF-116
1988-96	V6 4.3L 262ci	w/Getrag Trans.	15588262	CF-126

# CLUTCH FORKS

Years	Engine	Remarks	OE	Part
<b>GMC (con't)</b>				
<b>SAFARI (con't)</b>				
1988-96	V6 4.3L 262ci	w/Warner Trans.	14070374	CF-128
<b>SPRINT</b>				
1975-77	L6 4.1L 250ci		14066235	CF-100
1977	V8 5.0L 305ci		14066235	CF-100
1973	V8 5.0L 307ci		14066235	CF-100
1973-77	V8 5.7L 350ci		14066235	CF-100
1973-75	V8 7.4L 454ci		14066235	CF-100
<b>YUKON</b>				
1992-95	V8 5.7L 350ci		15588262	CF-126
1994-95	V8 6.5L 395ci		15588262	CF-126
<b>JEEP</b>				
<b>475, CJ3, DISPATCHER, F4, FC150, FC170, UNIVERSAL, UTILITY, WILLYS</b>				
1946-67	L4 2.2L 134ci		J0630112	CF-125
<b>CHEROKEE</b>				
1987	L4 2.5L 150ci		5361620	CF-110
1987	L6 4.0L 242ci	4 Door (Thru Vin. #JOM18N040456)	3224192	CF-112
1974-79	L6 4.2L 258ci		3217480	CF-111
1980	L6 4.2L 258ci	4 Door (Vin. # JOM18NO40457 & Up)	5361620	CF-110
1980-83	L6 4.2L 258ci	4 Door (Thru Vin. #JOM18N040456)	3224192	CF-112
1984-86	V6 2.8L 173ci	4 Door (Thru Vin. #JOM18N040456)	3224192	CF-112
1974-79	V8 5.9L 360ci		3217480	CF-111
1980-83	V8 5.9L 360ci		5361620	CF-110
1974-78	V8 6.6L 401ci		3217480	CF-111
<b>CJ5, CJ5A, CJ6, CJ6A</b>				
1968-71	L4 2.2L 134ci		J0630112	CF-125
1980	L4 2.5L 151ci	From Vin. #JOM83EO40992 w/B engine code	5361620	CF-110
1981	L4 2.5L 151ci		3224192	CF-112
1983	L4 2.5L 151ci	2bbl.; Pontiac Engine	5361620	CF-110
1968	L4 3.1L 192ci		J0630112	CF-125
1974-75	L6 3.8L 232ci		3217480	CF-111
1974-79	L6 4.2L 258ci		3217480	CF-111
1980	L6 4.2L 258ci		5361620	CF-110
1981-83	L6 4.2L 258ci		3224192	CF-112
1966-71	V6 3.7L 225ci	Buick Engine	1378486	CF-113
1974-75	V8 5.0L 304ci		3217480	CF-111
1980	V8 5.0L 304ci		5361620	CF-110
<b>CJ7</b>				
1980	L4 2.5L 151ci		5361620	CF-110
1980-81	L4 2.5L 151ci		3224192	CF-112
1983	L4 2.5L 151ci	2bbl.; Pontiac Engine	5361620	CF-110
1976-79	L6 4.2L 258ci		3217480	CF-111
1980	L6 4.2L 258ci	From Vin. #JOM93A041926	5361620	CF-110
1980	L6 4.2L 258ci	To Vin. #JOM93A041925	3224192	CF-112
1981-86	L6 4.2L 258ci		3224192	CF-112
1980	V8 5.0L 304ci		5361620	CF-110
<b>COMANCHE, GRAND WAGONEER, WAGONEER, WRANGLER</b>				
1987	L4 2.5L 150ci		5361620	CF-110
1987	L6 4.0L 242ci		5361620	CF-110
1980	L6 4.2L 258ci		5361620	CF-110
1981-83	L6 4.2L 258ci		3224192	CF-112
1984-87	L6 4.2L 258ci		5361620	CF-110
1984-86	V6 2.8L 173ci		3224192	CF-112
1974-79	V8 5.9L 360ci		3217480	CF-111
1980-83	V8 5.9L 360ci		5361620	CF-110
1987	V8 5.9L 360ci		5361620	CF-110
1974-78	V8 6.6L 401ci		3217480	CF-111

# CLUTCH FORKS

Years	Engine	Remarks	OE	Part
<b>JEEP (con't)</b>				
<b>DJ5, DJ6, JEEPSTER</b>				
1967-71	L4 2.2L 134ci		J0630112	CF-125
1974	L6 3.8L 232ci		3217480	CF-111
1974	L6 4.2L 258ci		3217480	CF-111
1968	V6 3.7L 225ci	w/LA Head	J0630112	CF-125
1969-71	V6 3.7L 225ci		1378486	CF-113
1974	V8 5.0L 304ci		3217480	CF-111
<b>GRAND CHEROKEE</b>				
1998	V8 5.9L 360ci		52107555	CF-146
<b>J10, J20</b>				
1974-79	L6 4.2L 258ci		3217480	CF-111
1980-83	L6 4.2L 258ci		3224192	CF-112
1984-87	L6 4.2L 258ci		5361620	CF-110
1974-79	V8 5.9L 360ci		3217480	CF-111
1980-87	V8 5.9L 360ci		5361620	CF-110
1974-78	V8 6.6L 401ci		3217480	CF-111
<b>SCRAMBLER</b>				
1981	L4 2.5L 151ci		3224192	CF-112
1983	L4 2.5L 151ci	2bbl.; Pontiac Engine	5361620	CF-110
1981-83	L6 4.2L 258ci		3224192	CF-112
1984-85	L6 4.2L 258ci		5361620	CF-110
<b>MERCURY</b>				
<b>CAPRI</b>				
1982-86	V8 5.0L 302ci		E6ZZ-7515-A	CF-119
<b>NISSAN</b>				
<b>200SX</b>				
1984-87	L4 1.8L 1809cc		30531-P0151	CF-114
1980-81	L4 2.0L 1952cc		30531-P0151	CF-114
1984-88	L4 2.0L 1974cc		30531-P0151	CF-114
1982-83	L4 2.2L 2187cc		30531-P0151	CF-114
<b>280Z, 280ZX</b>				
1976-83	L6 2.8L 2753cc		30531-P0151	CF-114
<b>300ZX</b>				
1987-89	V6 3.0L 2960cc		30531-P0151	CF-114
<b>620, 710</b>				
1976-79	L4 2.0L 1952cc		30531-P0151	CF-114
<b>810, MAXIMA</b>				
1977-84	L6 2.4L 2393cc		30531-P0151	CF-114
1981-83	L6 2.8L 2793cc		30531-P0151	CF-114
<b>B210</b>				
1976-78	L4 1.4L 1393cc		30531-P0151	CF-114
<b>NISSAN TRUCKS</b>				
<b>720</b>				
1980-85	L4 2.0L 1952cc		30531-P0151	CF-114
1981-83	L4 2.2L 2164cc		30531-P0151	CF-114
1981-83	L4 2.2L 2187cc		30531-P0151	CF-114
1983-86	L4 2.4L 2389cc		30531-P0151	CF-114
1983-86	L4 2.5L 2488cc		30531-P0151	CF-114
<b>PATHFINDER, VAN</b>				
1987-88	L4 2.4L 2389cc		30531-P0151	CF-114
1987-89	V6 3.0L 2960cc		30531-P0151	CF-114
<b>OLDSMOBILE</b>				
<b>CUTLASS CALAIS, CUTLASS SUPREME</b>				
1991	L4 2.3L 138ci	w/Muncie Trans.	8672510	CF-136
1991	L4 2.3L 140ci		8672510	CF-136
1991	V6 3.3L 204ci	w/Muncie Trans.	8672510	CF-136

# CLUTCH FORKS

Years	Engine	Remarks	OE	Part
<b>OLDSMOBILE (con't)</b>				
<b>CUTLASS CIERA</b>				
1982-84	L4 2.5L 151ci		14024930	CF-106
1982-85	V6 2.8L 173ci		14024930	CF-106
1991	V6 3.3L 204ci		8672510	CF-136
<b>FIRENZA</b>				
1983-86	L4 1.8L 112ci	w/4 Spd. Manual Trans. (Shaft Type)	14024930	CF-106
1987	L4 2.0L 121ci	w/4 Spd. Manual Trans. (Shaft Type)	14024930	CF-106
1983-87	L4 2.0L 122ci	w/4 Spd. Manual Trans. (Shaft Type)	14024930	CF-106
1985	V6 2.8L 173ci	w/4 Spd. Manual Trans. (Shaft Type)	14024930	CF-106
<b>OMEGA</b>				
1982-84	L4 2.5L 151ci	w/4 Spd. Manual Trans. (Shaft Type)	14024930	CF-106
1982-84	V6 2.8L 173ci	w/4 Spd. Manual Trans. (Shaft Type)	14024930	CF-106
<b>PLYMOUTH</b>				
<b>ACCLAIM, RELIANT, SCAMP, SUNDANCE</b>				
1982-94	L4 2.2L 135ci		4511046	CF-142
<b>ARROW, CHAMP, COLT, SAPPORO</b>				
1979-80	L4 1.4L 1410cc		3743998	CF-131
1977-80	L4 1.6L 98ci		3743998	CF-131
1977-78	L4 2.0L 122ci		3743998	CF-131
1978-80	L4 2.6L 156ci		3743998	CF-131
<b>CARAVELLE, VOLARE</b>				
1983-88	L4 2.2L 135ci		4511046	CF-142
1978-80	L6 3.7L 225ci		3743998	CF-131
1978-80	V8 5.2L 318ci		3743998	CF-131
1978-79	V8 5.9L 360ci		3743998	CF-131
<b>EXPO, HORIZON</b>				
1978-80	L4 1.7L 105ci		3743998	CF-131
1983-90	L4 2.2L 135ci		4511046	CF-142
<b>PLYMOUTH TRUCKS</b>				
<b>TRAILDUSTER</b>				
1975-80	L6 3.7L 225ci		3743998	CF-131
1974-80	V8 5.2L 318ci		3743998	CF-131
1974-80	V8 5.9L 360ci		3743998	CF-131
1976-78	V8 6.6L 400ci		3743998	CF-131
1974-78	V8 7.2L 440ci		3743998	CF-131
<b>VOYAGER</b>				
1984-87	L4 2.2L 135ci		4511046	CF-142
<b>PONTIAC</b>				
<b>6000</b>				
1982-84	L4 2.5L 151ci	w/4 Speed (Shaft Type)	14024930	CF-106
1985-86	L4 2.5L 151ci		14075718	CF-129
1987-89	L4 2.5L 151ci	w/o Trans code 8ZR	8672942	CF-135
1987-89	L4 2.5L 151ci	w/Trans code 8ZR	8672937	CF-134
1982-86	V6 2.8L 173ci		14024930	CF-106
1987-89	V6 2.8L 173ci		14075718	CF-129
1988	V6 2.8L 173ci	w/Trans code 8ZR	8672937	CF-134
1989	V6 2.8L 173ci	w/ N, J & W Models	8672510	CF-136
1989-91	V6 3.1L 189ci		8672510	CF-136
<b>ACADIAN</b>				
1983	L4 1.8L 110ci		14024930	CF-106
<b>BONNEVILLE, CATALINA, LAURENTIAN, PARISIENNE</b>				
1977-79	V6 3.8L 231ci		14066235	CF-100
1977-79	V8 4.9L 301ci		14066235	CF-100
1977-81	V8 5.0L 305ci		14066235	CF-100
1984-86	V8 5.0L 305ci		14075725	CF-133
1973-79	V8 5.7L 350ci		14066235	CF-100



# CLUTCH FORKS

Years	Engine	Remarks	OE	Part
<b>PONTIAC (con't)</b>				
<b>BONNEVILLE, CATALINA, LAURENTIAN, PARISIENNE (con't)</b>				
1973-76	V8 7.5L 455ci		14066235	CF-100
<b>FIERO</b>				
1984	L4 2.5L 151ci	w/4 Spd. Manual Trans. (Shaft Type)	14024930	CF-106
1985-86	L4 2.5L 151ci		14075718	CF-129
1987-88	L4 2.5L 151ci	w/Trans code 8XL	8672937	CF-134
1985-86	V6 2.8L 173ci	w/4 Spd. Manual Trans. (Shaft Type)	14024930	CF-106
1987-88	V6 2.8L 173ci		14075718	CF-129
<b>FIREBIRD</b>				
1982-83	L4 2.5L 151ci		14024930	CF-106
1984-86	L4 2.5L 151ci		14075718	CF-129
1973-76	L6 4.1L 250ci		14066235	CF-100
1982-83	V6 2.8L 173ci		14024930	CF-106
1984-89	V6 2.8L 173ci		14075718	CF-129
1990-92	V6 3.1L 189ci		8672510	CF-136
1977-79	V6 3.8L 231ci		14066235	CF-100
1977-79	V8 4.9L 301ci		14066235	CF-100
1977-81	V8 5.0L 305ci		14066235	CF-100
1984-92	V8 5.0L 305ci		14075725	CF-133
1973-79	V8 5.7L 350ci		14066235	CF-100
1973-76	V8 7.5L 455ci		14066235	CF-100
<b>GRAND AM</b>				
1987	L4 2.0L 122ci		14024930	CF-106
1990-92	L4 2.3L 138ci		8672510	CF-136
1990-92	L4 2.3L 140ci		8672510	CF-136
1985-86	L4 2.5L 151ci		14075718	CF-129
1987-88	L4 2.5L 151ci	w/Trans code 8ZR	8672937	CF-134
1987-88	L4 2.5L 151ci	w/o Trans code 8ZR	8672942	CF-135
1979	V6 3.8L 231ci		14066235	CF-100
1979	V8 4.9L 301ci		14066235	CF-100
1978-80	V8 5.0L 305ci		14066235	CF-100
1973-75	V8 5.7L 350ci		14066235	CF-100
1973-75	V8 7.5L 455ci		14066235	CF-100
<b>GRAND PRIX</b>				
1990-91	L4 2.3L 138ci		8672510	CF-136
1988	V6 2.8L 173ci		14075718	CF-129
1989	V6 2.8L 173ci		8672510	CF-136
1989-92	V6 3.1L 189ci		8672510	CF-136
1991	V6 3.4L 207ci		8672510	CF-136
1978-79	V6 3.8L 231ci		14066235	CF-100
1977-79	V8 4.9L 301ci		14066235	CF-100
1978-80	V8 5.0L 305ci		14066235	CF-100
1984-87	V8 5.0L 305ci		14075725	CF-133
1976-77	V8 5.7L 350ci		14066235	CF-100
1973-76	V8 7.5L 455ci		14066235	CF-100
<b>GRAND LEMANS, GRAND SAFARI, GRANDVILLE, GTO, LEMANS, VENTURA</b>				
1973-76	L6 4.1L 250ci		14066235	CF-100
1977-79	V6 3.8L 231ci		14066235	CF-100
1975-76	V8 4.3L 260ci		14066235	CF-100
1977-79	V8 4.9L 301ci		14066235	CF-100
1976-81	V8 5.0L 305ci		14066235	CF-100
1973-79	V8 5.7L 350ci		14066235	CF-100
1973-76	V8 7.5L 455ci		14066235	CF-100
<b>J2000</b>				
1982-83	L4 1.8L 112ci	w/4 Spd. Manual Trans. (Shaft Type)	14024930	CF-106
1983	L4 2.0L 122ci	w/4 Spd. Manual Trans. (Shaft Type)	14024930	CF-106

# CLUTCH FORKS

Years	Engine	Remarks	OE	Part
<b>PONTIAC (con't)</b>				
<b>PHOENIX</b>				
1980-84	L4 2.5L 151ci		14024930	CF-106
1980-84	V6 2.8L 173ci		14024930	CF-106
1977-79	V6 3.8L 231ci		14066235	CF-100
1977-79	V8 5.0L 305ci		14066235	CF-100
1977-79	V8 5.7L 350ci		14066235	CF-100
<b>SUNBIRD</b>				
1986-87	L4 2.0L 122ci		14024930	CF-106
1980	L4 2.5L 151ci		14024930	CF-106
1991-92	V6 3.1L 189ci		8672510	CF-136
1977-79	V6 3.8L 231ci		14066235	CF-100
1978-79	V8 5.0L 305ci		14066235	CF-100
<b>TEMPEST</b>				
1987	L4 2.0L 122ci		14024930	CF-106
1991	L4 2.3L 138ci		8672510	CF-136
1989	V6 2.8L 173ci	w/N, J & W Models	8672510	CF-136
1987-89	V6 2.8L 173ci		14075718	CF-129
1990-91	V6 3.1L 189ci		8672510	CF-136

# **DETENT CABLES**

# INSTALLATION INSTRUCTIONS

## UNIVERSAL - STYLE DETENT CABLES

(Made in U.S.A.)

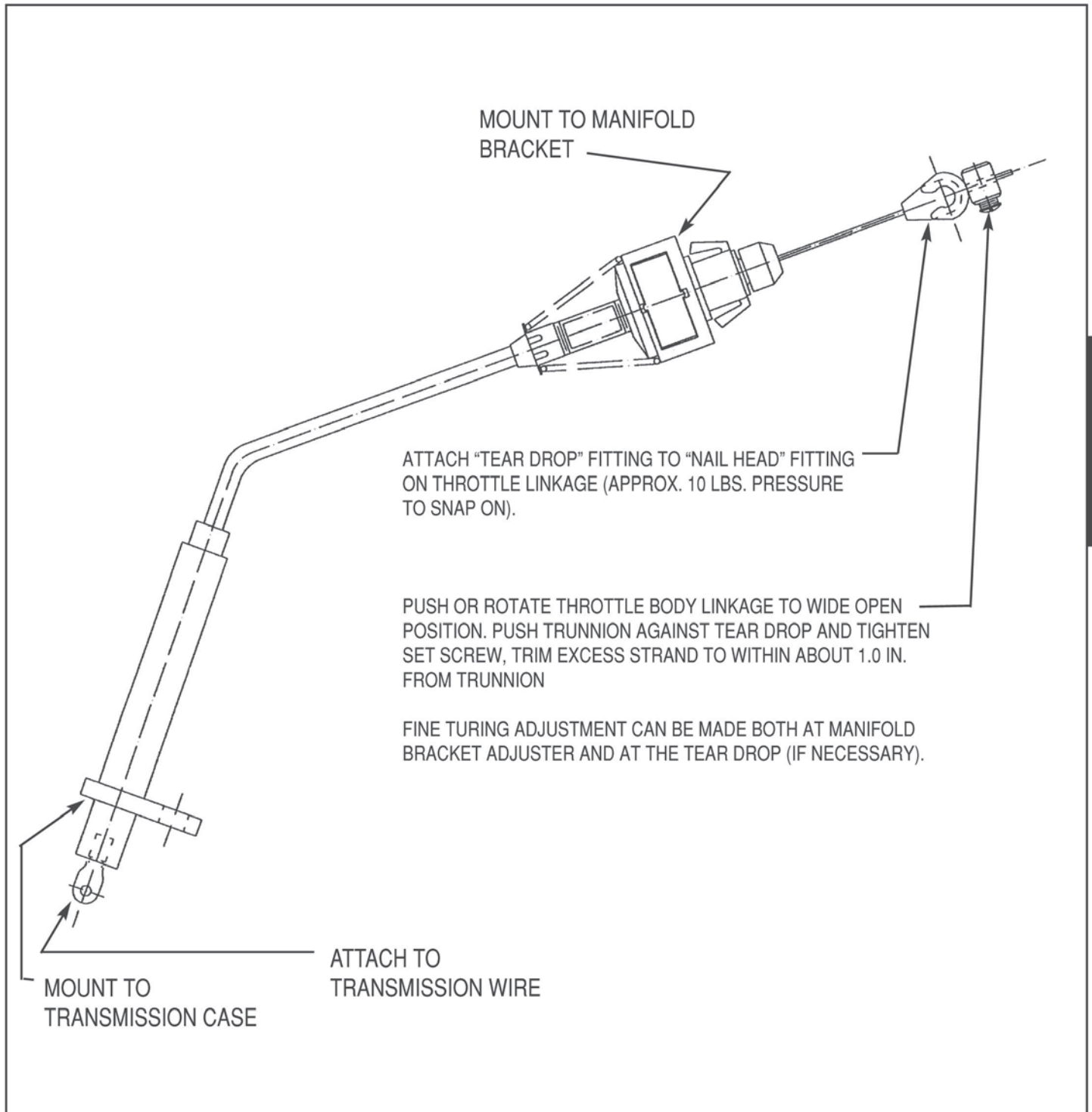

# DETENT (Passing Gear) CABLES

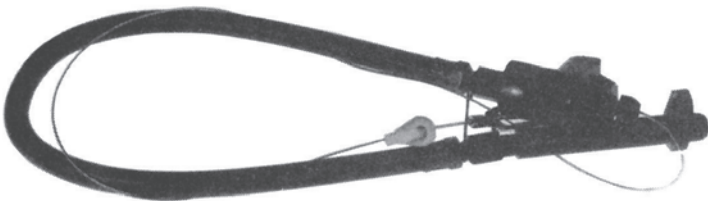
ENGINE C.I.D.	CYL.	YEAR	APPLICATION	O.E.M. NUMBER	PIONEER NUMBER
<b>UNIVERSAL APPLICATIONS</b>					
<p>Universal - Most General Motors.....  <b>Also Replaces Pioneer Numbers:</b>            CA-1930, CA-1931, CA-1932, CA-1935,            CA-1937, CA-1939, CA-1940, CA-1941,            CA-1942, CA-1943, CA-1946, CA-1947,            CA-1948, CA-1960, CA-1968, CA-1970</p>  <p><b>(Transmission Type THM 700R4</b></p>				<p>1253966, 1253967, 1254191,            1255630, 1255946, 1256298,            1256299, 1256968, 1257263            1257668, 1260588, 1262024,            1262487, 1262612, 1262613,            1262614, 1262615, 1262678,            1644356, 10054846, 10066487,            10066501, 10066510, 14040597,            14102146, 25503554, 25504775,            25504776, 25505174, 25505175,            25507542, 25507544, 25507545,            25507546, 25507548, 25507549,            25507550, 25507551, 25507552,            25507553, 25508262, 25508263,            25508265, 25509560, 25509561,            25509563, 25509607, 25509824,            25509825, 25510187, 25510188,            25510189, 25510971, 25512190,            25513017, 25513305, 25513388,            25513389, 25513393, 25513394,            25515162, 25515598, 25515599,            25515600, 25515601, 25516234,            25517312, 25517313, 25517316,            25517317, 25517536, 25519347,            25519361, 25521266, 25521267,            25521268, 25522513</p>	<p>CA-1980</p>
<p>Universal - Most General Motors.....  <b>Also Replaces Pioneer Numbers:</b>            CA-1933, CA-1951, CA-1952, CA-1953,            CA-1954, CA-1955</p>  <p><b>(Transmission Type THM 350</b></p>				<p>126458, 126459, 342486,            342487, 342488, 342489,            1248360, 1248361, 1249236,            1256301, 1256967, 1257152,            1257805, 1260676, 1262617,            1262618, 1262619, 1262620,            1262652, 1262653, 25503382,            25507541</p>	<p>CA-1981</p>

DETENT  
CABLES

# DETENT CABLES

Year	Engine	Vin	Remark	Part	OE
<b>BUICK</b>					
<b>APOLLO</b>					
1973-75	L6 4.1L 250ci	D	w/THM350 Auto. Trans.; 42.01" Cable	CA-1952	342486
1973-75	L6 4.1L 250ci	D	THM350 Auto. Trans.; 49.20" Cable, Universal cable for temporary fix, use CA-1952 for permanent fix	CA-1981	
1973-74	V8 5.7L 350ci	H	w/THM350 Auto. Trans.; 39.17" Cable	CA-1954	342486
1973-74	V8 5.7L 350ci	H	THM350 Auto. Trans.; 49.20" Cable, Universal cable for temporary fix, use CA-1954 for permanent fix	CA-1981	
1974	V8 5.7L 350ci	J	w/THM350 Auto. Trans.; 39.17" Cable	CA-1954	342486
1974	V8 5.7L 350ci	J	THM350 Auto. Trans.; 49.20" Cable, Universal cable for temporary fix, use CA-1954 for permanent fix	CA-1981	
<b>CENTURY</b>					
1982-83	L4 2.5L 151ci	5	w/THM125C Auto. Trans.; 25.70" Cable	CA-1932	25513389
1982-83	L4 2.5L 151ci	5	w/THM125C Auto. Trans., Universal cable for temporary fix, use CA-1932 for permanent fix	CA-1980	
1982-83	L4 2.5L 151ci	R	w/THM125C Auto. Trans.; 40.79" Cable	CA-1958	25513393
1984-86	L4 2.5L 151ci	R	w/THM125C Auto. Trans.; 47.00" Cable	CA-1935	25519347
1984-86	L4 2.5L 151ci	R	w/THM125C Auto. Trans., Universal cable for temporary fix, use CA-1935 for permanent fix	CA-1980	
1987	V6 2.8L 173ci	W	w/THM125C Auto. Trans., w/THM440-T4 Auto. Trans.; 44.50" Cable	CA-1970	10066501
1987	V6 2.8L 173ci	W	w/THM125C Auto. Trans., w/THM440-T4 Auto. Trans., Universal cable for temporary fix, use CA-1970 for permanent fix	CA-1980	
1983	V6 2.8L 173ci	X	Export, w/Canada Emissions, w/THM125C Auto. Trans. 51.00" Cable	CA-1930	1262487
1983	V6 2.8L 173ci	X	Export, w/Canada Emissions, w/THM125C Auto. Trans., w/THM125C or THM440-T4 A.T. 51.00" Cable	CA-1930	1262487
1983	V6 2.8L 173ci	X	Export, w/Canada Emissions, w/THM125C Auto. Trans., Universal cable for temporary fix, use CA-1930 for permanent fix	CA-1980	
1983	V6 2.8L 173ci	X	Export, Canada Emissions, w/THM125C A.T., w/THM125C or THM440-T4 A.T., Universal cable for temporary fix, use CA-1930 for permanent fix	CA-1980	
1984-86	V6 2.8L 173ci	X	w/THM125C Auto. Trans., w/THM440-T4 Auto. Trans. 51.00" Cable	CA-1930	1262487
1984-86	V6 2.8L 173ci	X	w/THM125C Auto. Trans., w/THM440-T4 Auto. Trans., Universal cable for temporary fix, use CA-1930 for permanent fix	CA-1980	
1982-85	V6 3.0L 181ci	E	w/Auto. Trans.; 36.10" Cable	CA-1960	25512190
1982-85	V6 3.0L 181ci	E	w/Auto. Trans., Universal cable for temporary fix, use CA-1960 for permanent fix	CA-1980	
1978-79	V6 3.2L 196ci	C	w/THM350 Auto. Trans., w/THM375 Auto. Trans.	CA-1955	1262652
1979	V6 3.8L 231ci	3	w/4 Bbl. Carb., w/THM350 Auto. Trans., w/THM375 Auto. Trans.; 33.95" Cable	CA-1955	1262653
1980	V6 3.8L 231ci	3	w/4 Bbl. Carb., w/THM350 Auto. Trans.; 33.95" Cable	CA-1955	1262653
1984-87	V6 3.8L 231ci	3	w/THM440-T4 Auto. Trans.; 35.35" Cable	CA-1937	25508262
1984-87	V6 3.8L 231ci	3	w/THM440-T4 Auto. Trans., Universal cable for temporary fix, use CA-1937 for permanent fix	CA-1980	
1981	V6 3.8L 231ci	A	w/THM200 Auto. Trans., w/THM250C Auto. Trans., w/THM350C Auto. Trans.; 36.10" Cable	CA-1960	25505174
1981	V6 3.8L 231ci	A	w/THM200 Auto. Trans., w/THM250C Auto. Trans., w/THM350C Auto. Trans., Universal cable for temporary fix, use CA-1960 for permanent fix	CA-1980	
1978-80	V6 3.8L 231ci	A	w/THM200C Auto. Trans., w/THM200 Auto. Trans.; 36.30" Cable	CA-1942	1262678
1978-80	V6 3.8L 231ci	A	w/THM350 Auto. Trans., w/THM375 Auto. Trans.	CA-1955	1262652

# DETENT CABLES

Year	Engine	Vin	Remark	Part	OE
<b>BUICK (con't)</b>					
<b>CENTURY (con't)</b>					
1978-80	V6 3.8L 231ci	A	w/THM200C Auto. Trans., w/THM200 Auto. Trans., Universal cable for temporary fix, use CA-1942 for permanent fix	CA-1980	
1975	V6 3.8L 231ci	C	w/THM350 Auto. Trans.	CA-1950	1245640
1976	V6 3.8L 231ci	C	w/Auto. Trans.	CA-1950	1245640
1977	V6 3.8L 231ci	C	w/THM350 Auto. Trans.; 33.95" Cable	CA-1955	1262617
1982-85	V6 4.3L 260ci	T	Diesel, w/THM125C Auto. Trans.; 37.51" Cable	CA-1943	25510971
1982-85	V6 4.3L 260ci	T	Diesel, w/THM125C Auto. Trans., Universal cable for temporary fix, use CA-1943 for permanent fix	CA-1980	
1981	V8 4.3L 265ci	S	w/THM200C Auto. Trans.; 37.51" Cable	CA-1943	25507550
1981	V8 4.3L 265ci	S	w/THM200C Auto. Trans., Universal cable for temporary fix, use CA-1943 for permanent fix	CA-1980	
1981	V8 4.4L 267ci	J	Export, w/Canada Emissions, w/THM350C Auto. Trans.; 37.80" Cable	CA-1933	25507541
1981	V8 4.4L 267ci	J	Export, w/Canada Emissions, w/THM350C Auto. Trans.; 49.20" Cable, Universal cable, for temporary fix only, for permanent fix use CA-1933	CA-1981	
1979	V8 4.9L 301ci	W	w/THM350 Auto. Trans.	CA-1964	1255739
1979	V8 4.9L 301ci	Y	w/THM350 Auto. Trans.	CA-1964	1255739
1978-79	V8 5.0L 305ci	H	w/THM200 Auto. Trans.; 38.40" Cable	CA-1941	1262613
1978-79	V8 5.0L 305ci	H	w/THM200 Auto. Trans., Universal cable for temporary fix, use CA-1941 for permanent fix	CA-1980	
1979-80	V8 5.0L 305ci	H	w/THM350 Auto. Trans., w/THM375 Auto. Trans.; 45.00" Cable	CA-1951	1262620
1979-80	V8 5.0L 305ci	H	w/THM350 Auto. Trans., w/THM375 Auto. Trans., Universal cable for temporary fix, use CA-1951 for permanent fix; 49.20" Cable	CA-1981	
1978	V8 5.0L 305ci	U	w/THM200 Auto. Trans.; 38.40" Cable	CA-1941	1262613
1978	V8 5.0L 305ci	U	w/THM200 Auto. Trans., Universal cable for temporary fix, use CA-1941 for permanent fix	CA-1980	
1977-78	V8 5.0L 305ci	U	w/THM350 Auto. Trans., w/THM375 Auto. Trans.; 45.00" Cable	CA-1951	1262620
1977-78	V8 5.0L 305ci	U	w/THM350 Auto. Trans., w/THM375 Auto. Trans., Universal cable for temporary fix, use CA-1951 for permanent fix; 49.20" Cable	CA-1981	
1977	V8 5.7L 350ci	H	w/THM350 Auto. Trans.; 39.17" Cable	CA-1954	1254178
1977	V8 5.7L 350ci	H	THM350 Auto. Trans.; 49.20" Cable, Universal cable for temporary fix, use CA-1954 for permanent fix	CA-1981	
1973-76	V8 5.7L 350ci	H, J	w/THM350 Auto. Trans.	CA-1950	1245640
1977	V8 5.7L 350ci	J	w/THM350 Auto. Trans.; 39.17" Cable	CA-1954	1254178
1977	V8 5.7L 350ci	J	THM350 Auto. Trans.; 49.20" Cable, Universal cable for temporary fix, use CA-1954 for permanent fix	CA-1981	
1977-79	V8 5.7L 350ci	L	w/THM350 Auto. Trans.; 45.00" Cable, w/Chevrolet Eng.	CA-1951	1262620
1977-79	V8 5.7L 350ci	L	w/THM350 Auto. Trans.; 49.20" Cable, w/Chevrolet Eng., Universal cable for temporary fix, use CA-1951 for permanent fix	CA-1981	
1981	V8 5.7L 350ci	N	w/THM200C Auto. Trans. 51.00" Cable	CA-1930	25508263
1981	V8 5.7L 350ci	N	w/THM200C Auto. Trans., Universal cable for temporary fix, use CA-1930 for permanent fix	CA-1980	
1977	V8 5.7L 350ci	R	w/THM350 Auto. Trans.; 37.00" Cable, w/Olds. Eng.	CA-1963	1254178
1977	V8 6.6L 403ci	K	w/THM350 Auto. Trans.; 37.00" Cable	CA-1963	1254178
1974	V8 7.5L 455ci	R, U, V	w/THM350 Auto. Trans.	CA-1950	1245640
1973	V8 7.5L 455ci	T	w/THM350 Auto. Trans.	CA-1950	1245640

# DETENT CABLES

Year	Engine	Vin	Remark	Part	OE
<b>BUICK (con't)</b>					
<b>ELECTRA</b>					
1985	V6 3.0L 181ci	E	w/THM440-T4 Auto. Trans.; 36.10" Cable	CA-1960	25512190
1985	V6 3.0L 181ci	E	w/THM440-T4 Auto. Trans., Universal cable for temporary fix, use CA-1960 for permanent fix	CA-1980	
1985-87	V6 3.8L 231ci	3	FWD, w/THM440T4 Auto. Trans.; 35.35" Cable	CA-1937	25517536
1985-87	V6 3.8L 231ci	3	FWD, w/THM440T4 Auto. Trans., Universal cable for temporary fix, use CA-1937 for permanent fix	CA-1980	
1986	V6 3.8L 231ci	B	FWD, w/THM440T4 Auto. Trans.; 35.35" Cable	CA-1937	25517536
1986	V6 3.8L 231ci	B	FWD, w/THM440T4 Auto. Trans., Universal cable for temporary fix, use CA-1937 for permanent fix	CA-1980	
1980	V6 4.1L 252ci	4	w/THM350 Auto. Trans., w/THM375 Auto. Trans.	CA-1955	1262652
1981-84	V6 4.1L 252ci	4	w/THM200-4R Auto. Trans.; 36.10" Cable	CA-1960	25505175
1981-84	V6 4.1L 252ci	4	w/THM200-4R Auto. Trans., Universal cable for temporary fix, use CA-1960 for permanent fix	CA-1980	
1982-83	V6 4.1L 252ci	4	w/THM350C Auto. Trans.; 36.10" Cable	CA-1960	25505175
1982-83	V6 4.1L 252ci	4	w/THM350C Auto. Trans., Universal cable for temporary fix, use CA-1960 for permanent fix	CA-1980	
1985	V6 4.3L 260ci	T	Diesel, w/THM440-T4 Auto. Trans.; 37.51" Cable	CA-1943	25510971
1985	V6 4.3L 260ci	T	Diesel, w/THM440-T4 Auto. Trans., Universal cable for temporary fix, use CA-1943 for permanent fix	CA-1980	
1981	V8 5.0L 307ci	Y	w/THM200C Auto. Trans.; 35.35" Cable	CA-1937	25508262
1981	V8 5.0L 307ci	Y	w/THM200C Auto. Trans., Universal cable for temporary fix, use CA-1937 for permanent fix	CA-1980	
1984	V8 5.0L 307ci	Y	w/THM200C Auto. Trans., w/THM200-4R Auto. Trans.; 35.35" Cable	CA-1937	25508262
1984	V8 5.0L 307ci	Y	w/THM200C Auto. Trans., w/THM200-4R Auto. Trans., Universal cable for temporary fix, use CA-1937 for permanent fix	CA-1980	
1982-83	V8 5.0L 307ci	Y	w/THM200-4R Auto. Trans.; 35.35" Cable	CA-1937	25508262
1982-83	V8 5.0L 307ci	Y	w/THM200-4R Auto. Trans., Universal cable for temporary fix, use CA-1937 for permanent fix	CA-1980	
1977	V8 5.7L 350ci	H, J	w/THM350 Auto. Trans.; 39.17" Cable	CA-1954	1262617
1977	V8 5.7L 350ci	H, J	THM350 Auto. Trans.; 49.20" Cable, Universal cable for temporary fix, use CA-1954 for permanent fix	CA-1981	
1981-83	V8 5.7L 350ci	N	Diesel, w/THM200C Auto. Trans. 51.00" Cable	CA-1930	25508263
1981-83	V8 5.7L 350ci	N	Diesel, w/THM200C Auto. Trans., Universal cable for temporary fix, use CA-1930 for permanent fix	CA-1980	
1982	V8 5.7L 350ci	N	Diesel, w/THM200-4R Auto. Trans., w/THM350C Auto. Trans. 51.00" Cable	CA-1930	25508263
1982	V8 5.7L 350ci	N	Diesel, w/THM200-4R Auto. Trans., w/THM350C Auto. Trans., Universal cable for temporary fix, use CA-1930 for permanent fix	CA-1980	
1984	V8 5.7L 350ci	N	Diesel, w/THM200-4R Auto. Trans.	CA-1930	25508263
1984	V8 5.7L 350ci	N	Diesel, w/THM200-4R Auto. Trans., Universal cable for temporary fix, use CA-1930 for permanent fix	CA-1980	
1977-78	V8 5.7L 350ci	R	w/THM350 Auto. Trans.; 37.00" Cable, w/Olds. Eng.	CA-1963	1254178
1977-78	V8 6.6L 403ci	K	w/THM350 Auto. Trans.; 37.00" Cable	CA-1963	1254178
<b>ESTATE WAGON</b>					
1977-78	V8 5.7L 350ci	R	w/Olds. Eng., w/THM200 Auto. Trans.; 38.40" Cable	CA-1941	1262615
1977-78	V8 5.7L 350ci	R	Olds. Eng., w/THM200 Auto. Trans., Universal cable for temporary fix, use CA-1941 for permanent fix	CA-1980	
1978-79	V8 5.7L 350ci	X	w/THM350 Auto. Trans., w/THM375 Auto. Trans., w/Buick Eng.; 39.17" Cable	CA-1954	1262617
1978-79	V8 5.7L 350ci	X	w/THM350 Auto. Trans., w/THM375 Auto. Trans., w/Buick Eng., Universal cable for temporary fix, use CA-1954 for permanent fix; 49.20" Cable	CA-1981	



# DETENT CABLES

Year	Engine	Vin	Remark	Part	OE
<b>BUICK (con't)</b>					
<b>ESTATE WAGON (con't)</b>					
1972-75	V8 7.5L 455ci	T	w/Auto. Trans.	CA-1950	1245641
1974	V8 7.5L 455ci	U, W	w/Auto. Trans.	CA-1950	1245641
<b>LESABRE</b>					
1979-80	V6 3.8L 231ci	3	w/2 Bbl. Carb., w/THM375 Auto. Trans.; 33.95" Cable	CA-1955	1262652
1986-87	V6 3.8L 231ci	3	w/THM440-T4 Auto. Trans.; 35.35" Cable	CA-1937	25517536
1986-87	V6 3.8L 231ci	3	w/THM440-T4 Auto. Trans., Universal cable for temporary fix, use CA-1937 for permanent fix	CA-1980	
1988	V6 3.8L 231ci	3	w/THM440-T4 Auto. Trans.; 35.35" Cable, w/High Output	CA-1937	25517536
1988	V6 3.8L 231ci	3	THM440-T4 Auto. Trans., w/HO, Universal cable for temporary fix, use CA-1937 for permanent fix	CA-1980	
1977-80	V6 3.8L 231ci	A	w/2 Bbl. Carb., w/THM375 Auto. Trans.; 33.95" Cable	CA-1955	1262652
1978	V6 3.8L 231ci	A	w/THM200 Auto. Trans.; 36.30" Cable	CA-1942	1262678
1978	V6 3.8L 231ci	A	w/THM200 Auto. Trans., Universal cable for temporary fix, use CA-1942 for permanent fix	CA-1980	
1982	V6 3.8L 231ci	A	w/THM350C Auto. Trans.; 36.10" Cable	CA-1960	25505174
1982	V6 3.8L 231ci	A	w/THM350C Auto. Trans., Universal cable for temporary fix, use CA-1960 for permanent fix	CA-1980	
1983-85	V6 3.8L 231ci	A	w/THM200C Auto. Trans.; 36.10" Cable	CA-1960	25505175
1983-85	V6 3.8L 231ci	A	w/THM200C Auto. Trans., Universal cable for temporary fix, use CA-1960 for permanent fix	CA-1980	
1984	V6 3.8L 231ci	A	w/THM200-4R Auto. Trans., w/THM200C Auto. Trans., w/THM250C Auto. Trans.; 36.10" Cable	CA-1960	25505175
1984	V6 3.8L 231ci	A	w/THM200-4R Auto. Trans., w/THM200C Auto. Trans., w/THM250C Auto. Trans., Universal cable for temporary fix, use CA-1960 for permanent fix	CA-1980	
1977	V6 3.8L 231ci	C	w/THM350 Auto. Trans.; 39.17" Cable	CA-1954	1262617
1977	V6 3.8L 231ci	C	THM350 Auto. Trans.; 49.20" Cable, Universal cable for temporary fix, use CA-1954 for permanent fix	CA-1981	
1980	V6 4.1L 252ci	4	w/THM350 Auto. Trans., w/THM375 Auto. Trans.	CA-1955	1262652
1981-84	V6 4.1L 252ci	4	w/THM200-4R Auto. Trans.; 36.10" Cable	CA-1960	25505175
1981-84	V6 4.1L 252ci	4	w/THM200-4R Auto. Trans., Universal cable for temporary fix, use CA-1960 for permanent fix	CA-1980	
1982-83	V6 4.1L 252ci	4	w/THM350C Auto. Trans.; 36.10" Cable	CA-1960	25505175
1982-83	V6 4.1L 252ci	4	w/THM350C Auto. Trans., Universal cable for temporary fix, use CA-1960 for permanent fix	CA-1980	
1982	V8 4.4L 267ci	J	Export, w/Canada Emissions, w/THM250C Auto. Trans.; 37.80" Cable	CA-1933	25507541
1982	V8 4.4L 267ci	J	w/THM350 Auto. Trans.; 37.80" Cable	CA-1933	25503382
1982	V8 4.4L 267ci	J	Export, w/Canada Emissions, w/THM250C Auto. Trans.; 49.20" Cable, Universal cable, for temporary fix only, for permanent fix use CA-1933	CA-1981	
1982	V8 4.4L 267ci	J	THM350 Auto. Trans.; 49.20" Cable, Universal cable for temporary fix only, for permanent fix use CA-1933	CA-1981	
1980	V8 4.9L 301ci	W	w/THM250 Auto. Trans., w/THM350 Auto. Trans.	CA-1964	1255739
1977-79	V8 4.9L 301ci	Y	w/THM350 Auto. Trans.	CA-1964	1255739
1978	V8 5.0L 305ci	U	w/THM200 Auto. Trans.; 38.40" Cable	CA-1941	1262613
1978	V8 5.0L 305ci	U	w/THM350 Auto. Trans.; 45.00" Cable	CA-1951	1262620
1978	V8 5.0L 305ci	U	w/THM200 Auto. Trans., Universal cable for temporary fix, use CA-1941 for permanent fix	CA-1980	
1978	V8 5.0L 305ci	U	THM350 Auto. Trans.; 49.20" Cable, Universal cable for temporary fix, use CA-1951 for permanent fix	CA-1981	
1981	V8 5.0L 307ci	Y	w/THM200C Auto. Trans.; 35.35" Cable	CA-1937	25508262
1981	V8 5.0L 307ci	Y	w/THM200C Auto. Trans., Universal cable for temporary fix, use CA-1937 for permanent fix	CA-1980	

# DETENT CABLES

Year	Engine	Vin	Remark	Part	OE
<b>BUICK (con't)</b>					
<b>LESABRE (con't)</b>					
1982-85	V8 5.0L 307ci	Y	w/THM200-4R Auto. Trans.; 35.35" Cable	CA-1937	25508262
1982-85	V8 5.0L 307ci	Y	w/THM200-4R Auto. Trans., Universal cable for temporary fix, use CA-1937 for permanent fix	CA-1980	
1984	V8 5.0L 307ci	Y	w/THM200C Auto. Trans., w/THM200-4R Auto. Trans.; 35.35" Cable	CA-1937	25508262
1984	V8 5.0L 307ci	Y	w/THM200C Auto. Trans., w/THM200-4R Auto. Trans., Universal cable for temporary fix, use CA-1937 for permanent fix	CA-1980	
1977	V8 5.7L 350ci	H, J	w/THM350 Auto. Trans.; 39.17" Cable	CA-1954	1262617
1977	V8 5.7L 350ci	H, J	w/THM350 Auto. Trans.; 37.00" Cable, w/Olds. Eng.	CA-1963	1254178
1977	V8 5.7L 350ci	H, J	THM350 Auto. Trans.; 49.20" Cable, Universal cable for temporary fix, use CA-1954 for permanent fix	CA-1981	
1976	V8 5.7L 350ci	J	w/THM350 Auto. Trans.	CA-1950	1245641
1981	V8 5.7L 350ci	N	w/THM200C Auto. Trans., w/THM350C Auto. Trans. 51.00" Cable	CA-1930	25508265
1981	V8 5.7L 350ci	N	w/THM200C Auto. Trans., w/THM350C Auto. Trans., Universal cable for temporary fix, use CA-1930 for permanent fix	CA-1980	
1982	V8 5.7L 350ci	N	Diesel, w/THM200-4R Auto. Trans., w/THM350C Auto. Trans. 51.00" Cable	CA-1930	25508263
1982	V8 5.7L 350ci	N	Diesel, w/THM200-4R Auto. Trans., w/THM350C Auto. Trans., Universal cable for temporary fix, use CA-1930 for permanent fix	CA-1980	
1983	V8 5.7L 350ci	N	Diesel, w/THM200C Auto. Trans. 51.00" Cable	CA-1930	25508263
1983	V8 5.7L 350ci	N	Diesel, w/THM200C Auto. Trans., Universal cable for temporary fix, use CA-1930 for permanent fix	CA-1980	
1984-85	V8 5.7L 350ci	N	Diesel, w/THM200-4R Auto. Trans.	CA-1930	25508263
1984-85	V8 5.7L 350ci	N	Diesel, w/THM200-4R Auto. Trans., Universal cable for temporary fix, use CA-1930 for permanent fix	CA-1980	
1980	V8 5.7L 350ci	N, R	w/THM350 Auto. Trans., w/Olds. Eng.; 37.80" Cable	CA-1933	25503382
1980	V8 5.7L 350ci	N, R	w/THM350 Auto. Trans.; 49.20" Cable, w/Olds. Eng., Universal cable, for temporary fix only, for permanent fix use CA-1933	CA-1981	
1977-78	V8 5.7L 350ci	R	w/Olds. Eng., w/THM200 Auto. Trans.; 38.40" Cable	CA-1941	1262615
1977-78	V8 5.7L 350ci	R	Olds. Eng., w/THM200 Auto. Trans., Universal cable for temporary fix, use CA-1941 for permanent fix	CA-1980	
1977-79	V8 5.7L 350ci	R	w/THM350 Auto. Trans.; 37.00" Cable, w/Olds. Eng.	CA-1963	1254178
1978-80	V8 5.7L 350ci	X	w/THM350 Auto. Trans., w/THM375 Auto. Trans., w/Buick Eng.; 39.17" Cable	CA-1954	1262617
1978-80	V8 5.7L 350ci	X	w/THM350 Auto. Trans., w/THM375 Auto. Trans., w/Buick Eng., Universal cable for temporary fix, use CA-1954 for permanent fix; 49.20" Cable	CA-1981	
1977-78	V8 6.6L 403ci	K	w/THM350 Auto. Trans.; 37.00" Cable	CA-1963	1254178
1974	V8 7.5L 455ci	P, R, U	w/Auto. Trans.	CA-1950	1245641
1972-75	V8 7.5L 455ci	T	w/Auto. Trans.	CA-1950	1245641
<b>REGAL</b>					
1978-79	V6 3.2L 196ci	C	w/THM350 Auto. Trans., w/THM375 Auto. Trans.	CA-1955	1262652
1978-80	V6 3.8L 231ci	A	w/THM200C Auto. Trans., w/THM200 Auto. Trans.; 36.30" Cable	CA-1942	1262678
1978-80	V6 3.8L 231ci	A	w/THM350 Auto. Trans., w/THM375 Auto. Trans.	CA-1955	1262652
1978-80	V6 3.8L 231ci	A	w/THM200C Auto. Trans., w/THM200 Auto. Trans., Universal cable for temporary fix, use CA-1942 for permanent fix	CA-1980	
1981	V6 3.8L 231ci	A	Auto. Trans.; 36.10" Cable	CA-1960	25505174

# DETENT CABLES

Year	Engine	Vin	Remark	Part	OE
<b>BUICK (con't)</b>					
<b>REGAL (con't)</b>					
1981-83	V6 3.8L 231ci	A	Auto. Trans., Universal cable for temporary fix, use CA-1960 for permanent fix	CA-1980	
1982	V6 3.8L 231ci	A	w/THM250C Auto. Trans., w/THM350C Auto. Trans.; 36.10" Cable	CA-1960	25505174
1982	V6 3.8L 231ci	A	w/THM250C Auto. Trans., w/THM350C Auto. Trans., Universal cable for temporary fix, use CA-1960 for permanent fix	CA-1980	
1983	V6 3.8L 231ci	A	Auto. Trans.; 36.10" Cable	CA-1960	25505175
1984	V6 3.8L 231ci	A	w/THM200C Auto. Trans.; 36.10" Cable, w/THM250C THM200C Auto. Trans., w/THM250C, Universal cable for temporary fix, use CA-1960 for permanent fix	CA-1960	25505175
1984	V6 3.8L 231ci	A	w/THM200C Auto. Trans.; 36.10" Cable	CA-1980	
1985-87	V6 3.8L 231ci	A	w/THM200C Auto. Trans., Universal cable for temporary fix, use CA-1960 for permanent fix	CA-1960	25505175
1985-87	V6 3.8L 231ci	A	w/THM200C Auto. Trans., Universal cable for temporary fix, use CA-1960 for permanent fix	CA-1980	
1976	V6 3.8L 231ci	C	w/Auto. Trans.	CA-1950	1245640
1977	V6 3.8L 231ci	C	w/THM350 Auto. Trans.; 39.17" Cable	CA-1954	1262617
1977	V6 3.8L 231ci	C	THM350 Auto. Trans.; 49.20" Cable, Universal cable for temporary fix, use CA-1954 for permanent fix	CA-1981	
1982-83	V6 4.1L 252ci	4	w/THM250C Auto. Trans., w/THM350C Auto. Trans.; 36.10" Cable	CA-1960	25505174
1982-83	V6 4.1L 252ci	4	w/THM250C Auto. Trans., w/THM350C Auto. Trans., Universal cable for temporary fix, use CA-1960 for permanent fix	CA-1980	
1984	V6 4.1L 252ci	4	w/THM200-4R Auto. Trans.; 36.10" Cable	CA-1960	25505175
1984	V6 4.1L 252ci	4	w/THM200-4R Auto. Trans., Universal cable for temporary fix, use CA-1960 for permanent fix	CA-1980	
1982-84	V6 4.3L 260ci	V	w/THM200C Auto. Trans., w/THM200-4R Auto. Trans.; 37.51" Cable	CA-1943	25510971
1982-84	V6 4.3L 260ci	V	w/THM200C Auto. Trans., w/THM200-4R Auto. Trans., Universal cable for temporary fix, use CA-1943 for permanent fix	CA-1980	
1981	V8 4.3L 265ci	S	w/THM200C Auto. Trans.; 37.51" Cable	CA-1943	25507550
1981	V8 4.3L 265ci	S	w/THM200C Auto. Trans., Universal cable for temporary fix, use CA-1943 for permanent fix	CA-1980	
1981	V8 4.4L 267ci	J	Export, w/Canada Emissions, w/THM350C Auto. Trans.; 37.80" Cable	CA-1933	25507541
1981	V8 4.4L 267ci	J	Export, w/Canada Emissions, w/THM350C Auto. Trans.; 49.20" Cable, Universal cable, for temporary fix only, for permanent fix use CA-1933	CA-1981	
1982	V8 4.4L 267ci	J	w/Auto. Trans.; 37.80" Cable, Export, w/Canada Emissions	CA-1933	25507541
1982	V8 4.4L 267ci	J	w/Auto. Trans.; 49.20" Cable, Export, w/Canada Emissions, Universal cable, for temporary fix only, for permanent fix use CA-1933	CA-1981	
1979-80	V8 4.9L 301ci	W	w/THM350 Auto. Trans.	CA-1964	1255739
1979	V8 4.9L 301ci	Y	w/THM350 Auto. Trans.	CA-1964	1255739
1978-79	V8 5.0L 305ci	H	w/THM200 Auto. Trans.; 38.40" Cable	CA-1941	1262613
1978-79	V8 5.0L 305ci	H	w/THM200 Auto. Trans., Universal cable for temporary fix, use CA-1941 for permanent fix	CA-1980	
1979-80	V8 5.0L 305ci	H	w/THM350 Auto. Trans., w/THM375 Auto. Trans.; 45.00" Cable	CA-1951	1262620
1979-80	V8 5.0L 305ci	H	w/THM350 Auto. Trans., w/THM375 Auto. Trans., Universal cable for temporary fix, use CA-1951 for permanent fix; 49.20" Cable	CA-1981	
1982	V8 5.0L 305ci	H	Export, w/Canada Emissions, w/THM350C Auto. Trans.; 37.80" Cable	CA-1933	25507541

# DETENT CABLES

Year	Engine	Vin	Remark	Part	OE
<b>BUICK (con't)</b>					
<b>REGAL (con't)</b>					
1982	V8 5.0L 305ci	H	Export, w/Canada Emissions, w/THM350C Auto. Trans.; 49.20" Cable, Universal cable, for temporary fix only, for permanent fix use CA-1933	CA-1981	
1983	V8 5.0L 305ci	H	Export, w/Canada Emissions, w/THM250C Auto. Trans., w/THM350C Auto. Trans.; 37.80" Cable	CA-1933	25507541
1983	V8 5.0L 305ci	H	Export, w/Canada Emissions, w/THM250C Auto. Trans., w/THM350C Auto. Trans., Universal cable, for temporary fix only, for permanent fix use CA-1933; 49.20" Cable	CA-1981	
1984	V8 5.0L 305ci	H	Export, w/Canada Emissions, w/THM250C Auto. Trans.; 37.80" Cable	CA-1933	25507541
1984	V8 5.0L 305ci	H	Export, w/Canada Emissions, w/THM200-4R Auto. Trans.; 37.51" Cable	CA-1943	25507546
1984	V8 5.0L 305ci	H	Export, w/Canada Emissions, w/THM200-4R Auto. Trans., Universal cable for temporary fix, use CA-1943 for permanent fix	CA-1980	
1984	V8 5.0L 305ci	H	Export, w/Canada Emissions, w/THM250C Auto. Trans.; 49.20" Cable, Universal cable, for temporary fix only, for permanent fix use CA-1933	CA-1981	
1985-87	V8 5.0L 305ci	H	Export, w/Canada Emissions, w/THM200C Auto. Trans., w/THM200-4R Auto. Trans.; 37.51" Cable	CA-1943	25507546
1985-87	V8 5.0L 305ci	H	Export, w/Canada Emissions, w/THM200C Auto. Trans., w/THM200-4R Auto. Trans., Universal cable for temporary fix, use CA-1943 for permanent fix	CA-1980	
1978	V8 5.0L 305ci	U	w/THM200 Auto. Trans.; 38.40" Cable	CA-1941	1262613
1978	V8 5.0L 305ci	U	w/THM200 Auto. Trans., Universal cable for temporary fix, use CA-1941 for permanent fix	CA-1980	
1977-78	V8 5.0L 305ci	U	w/THM350 Auto. Trans., w/THM375 Auto. Trans.; 45.00" Cable	CA-1951	1262620
1977-78	V8 5.0L 305ci	U	w/THM350 Auto. Trans., w/THM375 Auto. Trans., Universal cable for temporary fix, use CA-1951 for permanent fix; 49.20" Cable	CA-1981	
1986-87	V8 5.0L 307ci	Y	w/THM200C Auto. Trans., w/THM200-4R Auto. Trans.; 35.35" Cable	CA-1937	25508262
1986-87	V8 5.0L 307ci	Y	w/THM200C Auto. Trans., w/THM200-4R Auto. Trans., Universal cable for temporary fix, use CA-1937 for permanent fix	CA-1980	
1976	V8 5.7L 350ci	H, J	w/THM350 Auto. Trans.	CA-1950	1245640
1977	V8 5.7L 350ci	H, J	w/THM350 Auto. Trans.; 39.17" Cable	CA-1954	1262617
1977	V8 5.7L 350ci	H, J, L	w/THM350 Auto. Trans.; 37.00" Cable, w/Olds. Eng.	CA-1963	1254178
1977	V8 5.7L 350ci	H, J	THM350 Auto. Trans.; 49.20" Cable, Universal cable for temporary fix, use CA-1954 for permanent fix	CA-1981	
1977	V8 5.7L 350ci	L	w/THM350 Auto. Trans.; 45.00" Cable, w/Chevrolet Eng.	CA-1951	1262620
1977	V8 5.7L 350ci	L	w/THM350 Auto. Trans.; 49.20" Cable, w/Chevrolet Eng., Universal cable for temporary fix, use CA-1951 for permanent fix	CA-1981	
1982	V8 5.7L 350ci	N	w/THM350C Auto. Trans. 51.00" Cable	CA-1930	25508265
1982	V8 5.7L 350ci	N	w/THM350C Auto. Trans., Universal cable for temporary fix, use CA-1930 for permanent fix	CA-1980	
1983	V8 5.7L 350ci	N	w/THM200C Auto. Trans., w/THM350C Auto. Trans. 51.00" Cable	CA-1930	25508265
1983	V8 5.7L 350ci	N	w/THM200C Auto. Trans., w/THM350C Auto. Trans., Universal cable for temporary fix, use CA-1930 for permanent fix	CA-1980	
1985	V8 5.7L 350ci	N	w/THM200C Auto. Trans. 51.00" Cable	CA-1930	25508263

# DETENT CABLES

Year	Engine	Vin	Remark	Part	OE
<b>BUICK (con't)</b>					
<b>REGAL (con't)</b>					
1985	V8 5.7L 350ci	N	w/THM200C Auto. Trans., Universal cable for temporary fix, use CA-1930 for permanent fix	CA-1980	
1973-74	V8 7.5L 455ci		w/THM350 Auto. Trans.	CA-1950	1245640
<b>RIVIERA</b>					
1980-81	V6 3.8L 231ci	3	w/THM350 Auto. Trans., w/THM325 Auto. Trans.	CA-1960	25504775
1980-81	V6 3.8L 231ci	3	w/THM350 Auto. Trans., w/THM325 Auto. Trans., Universal cable for temporary fix, use CA-1960 for permanent fix	CA-1980	
1982	V6 3.8L 231ci	3	w/Auto. Trans.; 36.10" Cable	CA-1960	25504775
1982	V6 3.8L 231ci	3	w/Auto. Trans., Universal cable for temporary fix, use CA-1960 for permanent fix	CA-1980	
1987	V6 3.8L 231ci	3	w/THM440-T4 Auto. Trans.; 35.35" Cable	CA-1937	25517536
1987	V6 3.8L 231ci	3	w/THM440-T4 Auto. Trans., Universal cable for temporary fix, use CA-1937 for permanent fix	CA-1980	
1983	V6 3.8L 231ci	8	w/Auto. Trans.; 36.10" Cable	CA-1960	25504775
1983	V6 3.8L 231ci	8	w/Auto. Trans., Universal cable for temporary fix, use CA-1960 for permanent fix	CA-1980	
1984-85	V6 3.8L 231ci	9	w/THM200-4R Auto. Trans.; 36.10" Cable	CA-1960	25517317
1984-85	V6 3.8L 231ci	9	w/THM200-4R Auto. Trans., Universal cable for temporary fix, use CA-1960 for permanent fix	CA-1980	
1986	V6 3.8L 231ci	B	w/THM440-T4 Auto. Trans.; 35.35" Cable	CA-1937	25517536
1986	V6 3.8L 231ci	B	w/THM440-T4 Auto. Trans., Universal cable for temporary fix, use CA-1937 for permanent fix	CA-1980	
1981	V6 4.1L 252ci	4	w/Auto. Trans.; 36.10" Cable	CA-1960	25507552
1981	V6 4.1L 252ci	4	w/Auto. Trans., Universal cable for temporary fix, use CA-1960 for permanent fix	CA-1980	
1982-83	V6 4.1L 252ci	4	w/THM200-4R Auto. Trans., w/THM350C Auto. Trans.; 36.10" Cable	CA-1960	25507552
1982-83	V6 4.1L 252ci	4	w/THM200-4R Auto. Trans., w/THM350C Auto. Trans., Universal cable for temporary fix, use CA-1960 for permanent fix	CA-1980	
1984	V6 4.1L 252ci	4	w/THM325-4L Auto. Trans.; 36.10" Cable	CA-1960	25507552
1984	V6 4.1L 252ci	4	w/THM325-4L Auto. Trans., Universal cable for temporary fix, use CA-1960 for permanent fix	CA-1980	
1980-81	V8 5.0L 307ci	Y	w/Auto. Trans.; 37.51" Cable	CA-1943	25503387
1980-81	V8 5.0L 307ci	Y	w/Auto. Trans., Universal cable for temporary fix, use CA-1943 for permanent fix	CA-1980	
1982	V8 5.0L 307ci	Y	w/THM200-4R Auto. Trans., w/THM350C Auto. Trans.; 36.10" Cable	CA-1960	25507552
1982	V8 5.0L 307ci	Y	w/THM200-4R Auto. Trans., w/THM350C Auto. Trans., Universal cable for temporary fix, use CA-1960 for permanent fix	CA-1980	
1977	V8 5.7L 350ci	J	w/THM350 Auto. Trans.; 39.17" Cable	CA-1954	1262617
1977	V8 5.7L 350ci	J	THM350 Auto. Trans.; 49.20" Cable, Universal cable for temporary fix, use CA-1954 for permanent fix	CA-1981	
1977-78	V8 5.7L 350ci	R	w/Olds. Eng., w/THM200 Auto. Trans.; 38.40" Cable	CA-1941	1262615
1977-78	V8 5.7L 350ci	R	w/THM350 Auto. Trans.; 37.00" Cable, w/Olds. Eng.	CA-1963	1254178
1977-78	V8 5.7L 350ci	R	Olds. Eng., w/THM200 Auto. Trans., Universal cable for temporary fix, use CA-1941 for permanent fix	CA-1980	
1980	V8 5.7L 350ci	R	w/Auto. Trans.; 37.51" Cable, w/Olds. Eng.	CA-1943	25503387
1980	V8 5.7L 350ci	R	w/Auto. Trans., w/Olds. Eng., Universal cable for temporary fix, use CA-1943 for permanent fix	CA-1980	
1978	V8 5.7L 350ci	X	w/THM350 Auto. Trans., w/THM375 Auto. Trans., w/Buick Eng.; 39.17" Cable	CA-1954	1262617

# DETENT CABLES

Year	Engine	Vin	Remark	Part	OE
<b>BUICK (con't)</b>					
<b>RIVIERA</b>					
1978	V8 5.7L 350ci	X	w/THM350 AT., w/THM375 AT., w/Buick Eng., Universal cable for temporary fix, use CA-1954 for permanent fix; 49.20" Cable	CA-1981	
1977-78	V8 6.6L 403ci	K	w/THM350 Auto. Trans.; 37.00" Cable	CA-1963	1254178
<b>SKYHAWK</b>					
1982-86	L4 1.8L 112ci	0	w/THM125C Auto. Trans.; 36.10" Cable	CA-1960	25510188
1982-86	L4 1.8L 112ci	0	w/THM125C Auto. Trans., Universal cable for temporary fix, use CA-1960 for permanent fix	CA-1980	
1982	L4 1.8L 112ci	G	w/THM125C Auto. Trans.; 36.10" Cable	CA-1960	25509560
1982	L4 1.8L 112ci	G	w/THM125C Auto. Trans., Universal cable for temporary fix, use CA-1960 for permanent fix	CA-1980	
1983-84	L4 2.0L 122ci	B	Export, w/Canada Emissions, w/THM125C Auto. Trans.; 36.10" Cable	CA-1960	25509560
1983-84	L4 2.0L 122ci	B	Export, w/Canada Emissions, w/THM125C Auto. Trans., Universal cable for temporary fix, use CA-1960 for permanent fix	CA-1980	
1984-86	L4 2.0L 122ci	P	w/THM125C Auto. Trans.; 25.70" Cable	CA-1932	25513017
1984-86	L4 2.0L 122ci	P	w/THM125C Auto. Trans., Universal cable for temporary fix, use CA-1932 for permanent fix	CA-1980	
1980	V6 3.8L 231ci	A	w/Auto. Trans.; 33.95" Cable, exc. Closed Loop Emissions Control	CA-1955	1262652
1978-79	V6 3.8L 231ci	A	w/THM350 Auto. Trans., w/THM375 Auto. Trans.	CA-1955	1262652
1976	V6 3.8L 231ci	C	w/THM350 Auto. Trans.; 39.17" Cable	CA-1954	1248360
1977	V6 3.8L 231ci	C	w/THM350 Auto. Trans.; 39.17" Cable	CA-1954	1262617
1976-77	V6 3.8L 231ci	C	w/THM200 Auto. Trans.; 38.40" Cable	CA-1941	1256299
1976-77	V6 3.8L 231ci	C	w/THM200 Auto. Trans., Universal cable for temporary fix, use CA-1941 for permanent fix	CA-1980	
1976-77	V6 3.8L 231ci	C	THM350 Auto. Trans.; 49.20" Cable, Universal cable for temporary fix, use CA-1954 for permanent fix	CA-1981	
<b>SKYLARK</b>					
1982	L4 2.5L 151ci	5, R	w/THM125C Auto. Trans.; 40.79" Cable	CA-1958	25513393
1980-83	L4 2.5L 151ci	5	w/THM125C Auto. Trans.; 25.70" Cable	CA-1932	25513389
1980-83	L4 2.5L 151ci	5	w/THM125C Auto. Trans., Universal cable for temporary fix, use CA-1932 for permanent fix	CA-1980	
1983	L4 2.5L 151ci	R	w/THM125C Auto. Trans.; 25.70" Cable	CA-1932	25513389
1983	L4 2.5L 151ci	R	w/THM125C Auto. Trans., Universal cable for temporary fix, use CA-1932 for permanent fix	CA-1980	
1984-85	L4 2.5L 151ci	R	w/THM125C Auto. Trans.; 47.00" Cable	CA-1935	25519347
1984-85	L4 2.5L 151ci	R	w/THM125C Auto. Trans., Universal cable for temporary fix, use CA-1935 for permanent fix	CA-1980	
1985	V6 2.8L 173ci	W	w/Multi Port Fuel Injection, w/THM125C Auto. Trans.; 36.10" Cable, w/High Output	CA-1960	25515599
1985	V6 2.8L 173ci	W	w/Multi Port Fuel Injection, w/THM125C Auto. Trans., w/High Output, Universal cable for temporary fix, use CA-1960 for permanent fix	CA-1980	
1981-85	V6 2.8L 173ci	X	w/Auto. Trans. 51.00" Cable	CA-1930	1262487
1981-85	V6 2.8L 173ci	X	w/Auto. Trans., Universal cable for temporary fix, use CA-1930 for permanent fix	CA-1980	
1982-84	V6 2.8L 173ci	Z	w/Auto. Trans. 51.00" Cable	CA-1930	1262487
1982-84	V6 2.8L 173ci	Z	w/Auto. Trans., Universal cable for temporary fix, use CA-1930 for permanent fix	CA-1980	
1978-79	V6 3.8L 231ci	A	w/THM350 Auto. Trans., w/THM375 Auto. Trans.	CA-1955	1262652
1976	V6 3.8L 231ci	C	w/THM350 Auto. Trans.; 39.17" Cable	CA-1954	1248360
1977	V6 3.8L 231ci	C	w/THM350 Auto. Trans.; 39.17" Cable	CA-1954	1262617
1976-77	V6 3.8L 231ci	C	w/THM200 Auto. Trans.; 38.40" Cable	CA-1941	1256299

# DETENT CABLES

Year	Engine	Vin	Remark	Part	OE
<b>BUICK (con't)</b>					
<b>SKYLARK (con't)</b>					
1976-77	V6 3.8L 231ci	C	w/THM200 Auto. Trans., Universal cable for temporary fix, use CA-1941 for permanent fix	CA-1980	
1976-77	V6 3.8L 231ci	C	THM350 Auto. Trans.; 49.20" Cable, Universal cable for temporary fix, use CA-1954 for permanent fix	CA-1981	
1977	V8 4.9L 301ci	Y	w/THM350 Auto. Trans.	CA-1964	1255739
1979	V8 5.0L 305ci	G	w/THM200 Auto. Trans.; 45.00" Cable	CA-1951	1262620
1979	V8 5.0L 305ci	G	THM200 Auto. Trans.; 49.20" Cable, Universal cable for temporary fix, use CA-1951 for permanent fix	CA-1981	
1977	V8 5.0L 305ci	U	w/THM200 Auto. Trans.; 44.68" Cable	CA-1940	1253966
1977	V8 5.0L 305ci	U	w/THM200 Auto. Trans., Universal cable for temporary fix, use CA-1940 for permanent fix	CA-1980	
1978	V8 5.0L 305ci	U	w/THM350 Auto. Trans.; 45.00" Cable	CA-1951	1262620
1978	V8 5.0L 305ci	U	THM350 Auto. Trans.; 49.20" Cable, Universal cable for temporary fix, use CA-1951 for permanent fix	CA-1981	
<b>CADILLAC</b>					
<b>CIMARRON</b>					
1982	L4 1.8L 112ci	G	w/Auto. Trans.; 36.10" Cable	CA-1960	25509560
1982	L4 1.8L 112ci	G	w/Auto. Trans., Universal cable for temporary fix, use CA-1960 for permanent fix	CA-1980	
1983-86	L4 2.0L 122ci	P	w/Auto. Trans.; 25.70" Cable	CA-1932	25513017
1983-86	L4 2.0L 122ci	P	w/Auto. Trans., Universal cable for temporary fix, use CA-1932 for permanent fix	CA-1980	
<b>DEVILLE</b>					
1980	V6 4.1L 252ci	4	w/Auto. Trans.; 33.95" Cable	CA-1955	1626252
1981-82	V6 4.1L 252ci	4	w/Auto. Trans.; 36.10" Cable	CA-1960	25505175
1981-82	V6 4.1L 252ci	4	w/Auto. Trans., Universal cable for temporary fix, use CA-1960 for permanent fix	CA-1980	
1985	V6 4.3L 260ci	T	w/Auto. Trans.; 37.51" Cable	CA-1943	25510971
1985	V6 4.3L 260ci	T	w/Auto. Trans., Universal cable for temporary fix, use CA-1943 for permanent fix	CA-1980	
1981-84	V8 5.7L 350ci	N	w/Auto. Trans. 51.00" Cable	CA-1930	25508263
1981-84	V8 5.7L 350ci	N	w/Auto. Trans., Universal cable for temporary fix, use CA-1930 for permanent fix	CA-1980	
<b>ELDORADO</b>					
1981	V6 4.1L 252ci	4	w/Auto. Trans.; 36.10" Cable	CA-1960	25507552
1981	V6 4.1L 252ci	4	w/Auto. Trans., Universal cable for temporary fix, use CA-1960 for permanent fix	CA-1980	
1982	V6 4.1L 252ci	4	w/THM200-4R Auto. Trans., w/THM325-4L Auto. Trans.; 36.10" Cable	CA-1960	25507552
1982	V6 4.1L 252ci	4	w/THM200-4R Auto. Trans., w/THM325-4L Auto. Trans., Universal cable for temporary fix, use CA-1960 for permanent fix	CA-1980	
1980	V8 5.7L 350ci	8	w/Auto. Trans.; 36.10" Cable	CA-1960	25504776
1980	V8 5.7L 350ci	8	w/Auto. Trans., Universal cable for temporary fix, use CA-1960 for permanent fix	CA-1980	
1979	V8 5.7L 350ci	B	w/Auto. Trans.; 36.30" Cable, w/Electronic Fuel Injection	CA-1942	1260508
1979	V8 5.7L 350ci	B	w/AT, w/Electronic Fuel Injection, Universal cable for temporary fix, use CA-1942 for permanent fix	CA-1980	
1980-81	V8 6.0L 368ci	9	w/Auto. Trans.; 36.10" Cable	CA-1960	25504776
1980-81	V8 6.0L 368ci	9	w/Auto. Trans., Universal cable for temporary fix, use CA-1960 for permanent fix	CA-1980	
<b>FLEETWOOD</b>					
1980	V6 4.1L 252ci	4	w/Auto. Trans.; 33.95" Cable	CA-1955	1626252
1981-82	V6 4.1L 252ci	4	w/Auto. Trans.; 36.10" Cable	CA-1960	25505175

# DETENT CABLES

Year	Engine	Vin	Remark	Part	OE
<b>CADILLAC (con't)</b>					
<b>FLEETWOOD (con't)</b>					
1981-82	V6 4.1L 252ci	4	w/Auto. Trans., Universal cable for temporary fix, use CA-1960 for permanent fix	CA-1980	
1985	V6 4.3L 260ci	T	w/Auto. Trans.; 37.51" Cable	CA-1943	25510971
1985	V6 4.3L 260ci	T	w/Auto. Trans., Universal cable for temporary fix, use CA-1943 for permanent fix	CA-1980	
1981-85	V8 5.7L 350ci	N	w/Auto. Trans. 51.00" Cable	CA-1930	25508263
1981-85	V8 5.7L 350ci	N	w/Auto. Trans., Universal cable for temporary fix, use CA-1930 for permanent fix	CA-1980	
<b>SEVILLE</b>					
1981	V6 4.1L 252ci	4	w/Auto. Trans.; 36.10" Cable	CA-1960	25507552
1981	V6 4.1L 252ci	4	w/Auto. Trans., Universal cable for temporary fix, use CA-1960 for permanent fix	CA-1980	
1982	V6 4.1L 252ci	4	w/THM200-4R Auto. Trans., w/THM325-4L Auto. Trans.; 36.10" Cable	CA-1960	25507552
1982	V6 4.1L 252ci	4	w/THM200-4R Auto. Trans., w/THM325-4L Auto. Trans., Universal cable for temporary fix, use CA-1960 for permanent fix	CA-1980	
1980	V8 5.7L 350ci	8	w/Auto. Trans.; 36.10" Cable	CA-1960	25504776
1980	V8 5.7L 350ci	8	w/Auto. Trans., Universal cable for temporary fix, use CA-1960 for permanent fix	CA-1980	
1980-81	V8 6.0L 368ci	9	w/Auto. Trans.; 36.10" Cable	CA-1960	25504776
1980-81	V8 6.0L 368ci	9	w/Auto. Trans., Universal cable for temporary fix, use CA-1960 for permanent fix	CA-1980	
<b>CHEVROLET</b>					
<b>CAMARO</b>					
1982	L4 2.5L 151ci	2	w/THM200C Auto. Trans.; 52.95" Cable	CA-1939	25513394
1982	L4 2.5L 151ci	2	w/THM200C Auto. Trans., Universal cable for temporary fix, use CA-1939 for permanent fix	CA-1980	
1983	L4 2.5L 151ci	2	w/THM200C Auto. Trans., w/THM700-4R Auto. Trans.; 52.95" Cable	CA-1939	25513394
1983	L4 2.5L 151ci	2	w/THM200C Auto. Trans., w/THM700-4R Auto. Trans., Universal cable for temporary fix, use CA-1939 for permanent fix	CA-1980	
1984-85	L4 2.5L 151ci	2	w/Auto. Trans.; 52.95" Cable	CA-1939	25517312
1984-85	L4 2.5L 151ci	2	w/Auto. Trans., Universal cable for temporary fix, use CA-1939 for permanent fix	CA-1980	
1982-83	L4 2.5L 151ci	F	Export, w/Canada Emissions, w/THM200C Auto. Trans.; 25.70" Cable	CA-1932	1644356
1982-83	L4 2.5L 151ci	F	Export, w/Canada Emissions, w/THM200C Auto. Trans., Universal cable for temporary fix, use CA-1932 for permanent fix	CA-1980	
1975-79	L6 4.1L 250ci	D	w/THM350 Auto. Trans.; 45.00" Cable	CA-1951	1262618
1975-79	L6 4.1L 250ci	D	THM350 Auto. Trans.; 49.20" Cable, Universal cable for temporary fix, use CA-1951 for permanent fix	CA-1981	
1976-77	L6 4.1L 250ci	D	w/THM350 Auto. Trans.; 45.00" Cable, w/Integral Cyl. Head	CA-1951	1262618
1976-77	L6 4.1L 250ci	D	w/THM350 Auto. Trans.; 49.20" Cable, w/Integral Cyl. Head, Universal cable for temporary fix, use CA-1951 for permanent fix	CA-1981	
1982-83	V6 2.8L 173ci	1	w/THM200C Auto. Trans.; 36.10" Cable	CA-1960	14040597
1982-83	V6 2.8L 173ci	1	w/THM200C Auto. Trans., Universal cable for temporary fix, use CA-1960 for permanent fix	CA-1980	
1985-89	V6 2.8L 173ci	S	w/Auto. Trans.; 47.00" Cable	CA-1935	25521266
1985-89	V6 2.8L 173ci	S	w/Auto. Trans., Universal cable for temporary fix, use CA-1935 for permanent fix	CA-1980	



# DETENT CABLES

Year	Engine	Vin	Remark	Part	OE
<b>CHEVROLET (con't)</b>					
<b>CAMARO (con't)</b>					
1980	V6 3.8L 229ci	K	w/THM200C Auto. Trans.; 35.00" Cable	CA-1947	1262612
1980	V6 3.8L 229ci	K	w/THM200C Auto. Trans., Universal cable for temporary fix, use CA-1947 for permanent fix	CA-1980	
1981	V6 3.8L 229ci	K	w/THM350 Auto. Trans.; 37.80" Cable	CA-1933	25507541
1981	V6 3.8L 229ci	K	THM350 Auto. Trans.; 49.20" Cable, Universal cable for temporary fix only, for permanent fix use CA-1933	CA-1981	
1980	V6 3.8L 231ci	A	w/THM200C Auto. Trans.; 35.00" Cable	CA-1947	1262612
1980	V6 3.8L 231ci	A	w/THM350 Auto. Trans.; 33.95" Cable	CA-1955	1262652
1980	V6 3.8L 231ci	A	w/THM200C Auto. Trans., Universal cable for temporary fix, use CA-1947 for permanent fix	CA-1980	
1981	V6 3.8L 231ci	A	w/THM350 Auto. Trans.; 36.10" Cable	CA-1960	25505174
1981	V6 3.8L 231ci	A	w/THM350 Auto. Trans., Universal cable for temporary fix, use CA-1960 for permanent fix	CA-1980	
1980	V8 4.4L 267ci	J	w/THM350 Auto. Trans.; 45.00" Cable	CA-1951	1262620
1980	V8 4.4L 267ci	J	THM350 Auto. Trans.; 49.20" Cable, Universal cable for temporary fix, use CA-1951 for permanent fix	CA-1981	
1981	V8 4.4L 267ci	J	w/THM350C Auto. Trans.; 37.80" Cable	CA-1933	25507541
1981	V8 4.4L 267ci	J	w/THM350C Auto. Trans.; 49.20" Cable, Universal cable for temporary fix only, for permanent fix use CA-1933	CA-1981	
1982	V8 5.0L 305ci	7	w/Throttle Body Injection, w/THM200C Auto. Trans.; 36.10" Cable	CA-1960	25515601
1982	V8 5.0L 305ci	7	w/Throttle Body Injection, w/THM200C Auto. Trans., Universal cable for temporary fix, use CA-1960 for permanent fix	CA-1980	
1988-89	V8 5.0L 305ci	E	w/THM700-R4 Auto. Trans. 51.00" Cable	CA-1930	10066475
1988-89	V8 5.0L 305ci	E	w/THM700-R4 Auto. Trans., Universal cable for temporary fix, use CA-1930 for permanent fix	CA-1980	
1979	V8 5.0L 305ci	G	w/THM350 Auto. Trans.; 45.00" Cable	CA-1951	1262620
1979	V8 5.0L 305ci	G	THM350 Auto. Trans.; 49.20" Cable, Universal cable for temporary fix, use CA-1951 for permanent fix	CA-1981	
1980	V8 5.0L 305ci	H	w/THM350 Auto. Trans.; 45.00" Cable	CA-1951	1262620
1980	V8 5.0L 305ci	H	THM350 Auto. Trans.; 49.20" Cable, Universal cable for temporary fix, use CA-1951 for permanent fix	CA-1981	
1981	V8 5.0L 305ci	H	w/THM350C Auto. Trans.; 37.80" Cable	CA-1933	25507541
1981	V8 5.0L 305ci	H	w/THM350C Auto. Trans.; 49.20" Cable, Universal cable for temporary fix only, for permanent fix use CA-1933	CA-1981	
1982-83	V8 5.0L 305ci	H	w/THM200C Auto. Trans.; 37.51" Cable	CA-1943	25507546
1982-83	V8 5.0L 305ci	H	w/THM200C Auto. Trans., Universal cable for temporary fix, use CA-1943 for permanent fix	CA-1980	
1983-87	V8 5.0L 305ci	H	w/THM700-4R Auto. Trans.; 44.50" Cable	CA-1970	25515598
1983-87	V8 5.0L 305ci	H	w/THM700-4R Auto. Trans., Universal cable for temporary fix, use CA-1970 for permanent fix	CA-1980	
1976	V8 5.0L 305ci	Q	w/THM350 Auto. Trans.; 45.00" Cable	CA-1951	1262620
1976	V8 5.0L 305ci	Q	THM350 Auto. Trans.; 49.20" Cable, Universal cable for temporary fix, use CA-1951 for permanent fix	CA-1981	
1983	V8 5.0L 305ci	S	Auto. Trans.; 36.10" Cable, w/Throttle Body Injection	CA-1960	25515601
1983	V8 5.0L 305ci	S	Auto. Trans., Throttle Body Injection, Universal cable for temporary fix, use CA-1960 for permanent fix	CA-1980	
1977-78	V8 5.0L 305ci	U	w/THM350 Auto. Trans.; 45.00" Cable	CA-1951	1262620
1977-78	V8 5.0L 305ci	U	THM350 Auto. Trans.; 49.20" Cable, Universal cable for temporary fix, use CA-1951 for permanent fix	CA-1981	
1976-80	V8 5.7L 350ci	L	w/THM350 Auto. Trans.; 45.00" Cable	CA-1951	1262620
1976-80	V8 5.7L 350ci	L	THM350 Auto. Trans.; 49.20" Cable, Universal cable for temporary fix, use CA-1951 for permanent fix	CA-1981	

# DETENT CABLES

Year	Engine	Vin	Remark	Part	OE
<b>CHEVROLET (con't)</b>					
<b>CAMARO (con't)</b>					
1981	V8 5.7L 350ci	L	w/THM350 Auto. Trans.; 37.80" Cable	CA-1933	25507541
1981	V8 5.7L 350ci	L	THM350 Auto. Trans.; 49.20" Cable, Universal cable for temporary fix only, for permanent fix use CA-1933	CA-1981	
<b>CAPRICE</b>					
1977	L6 4.1L 250ci	D	w/THM350 Auto. Trans.; 45.00" Cable, w/Integral Cyl. Head	CA-1951	1262618
1977	L6 4.1L 250ci	D	w/THM350 Auto. Trans.; 49.20" Cable, w/Integral Cyl. Head, Universal cable for temporary fix, use CA-1951 for permanent fix	CA-1981	
1978-79	L6 4.1L 250ci	D	w/THM350 Auto. Trans.; 45.00" Cable	CA-1951	1262618
1978-79	L6 4.1L 250ci	D	THM350 Auto. Trans.; 49.20" Cable, Universal cable for temporary fix, use CA-1951 for permanent fix	CA-1981	
1980	V6 3.8L 229ci	K	w/THM200C Auto. Trans.; 35.00" Cable	CA-1947	1262612
1980	V6 3.8L 229ci	K	w/THM200C Auto. Trans., Universal cable for temporary fix, use CA-1947 for permanent fix	CA-1980	
1980	V6 3.8L 231ci	A	w/THM350 Auto. Trans.; 33.95" Cable	CA-1955	1262652
1981	V6 3.8L 231ci	A	w/THM350 Auto. Trans.; 36.10" Cable	CA-1960	25505174
1981	V6 3.8L 231ci	A	w/THM350 Auto. Trans., Universal cable for temporary fix, use CA-1960 for permanent fix	CA-1980	
1980	V8 4.4L 267ci	J	w/THM200C Auto. Trans.; 38.40" Cable	CA-1941	1262613
1980	V8 4.4L 267ci	J	w/Auto. Trans., exc. THM200C Auto. Trans.; 45.00" Cable	CA-1951	1262620
1980	V8 4.4L 267ci	J	w/THM200C Auto. Trans., Universal cable for temporary fix, use CA-1941 for permanent fix	CA-1980	
1980	V8 4.4L 267ci	J	w/Auto. Trans., exc. THM200C Auto. Trans., Universal cable for temporary fix, use CA-1951 for permanent fix; 49.20" Cable	CA-1981	
1981	V8 4.4L 267ci	J	w/THM250C Auto. Trans., w/THM350C Auto. Trans.; 37.80" Cable	CA-1933	25507541
1981	V8 4.4L 267ci	J	exc. Wagon, w/THM200C Auto. Trans.; 37.51" Cable	CA-1943	25507546
1981	V8 4.4L 267ci	J	exc. Wagon, w/THM200C A.T., Universal cable for temporary fix, use CA-1943 for permanent fix	CA-1980	
1981	V8 4.4L 267ci	J	w/THM250C Auto. Trans., w/THM350C Auto. Trans., Universal cable for temporary fix only, for permanent fix use CA-1933; 49.20" Cable	CA-1981	
1982	V8 4.4L 267ci	J	Classic, w/THM200-4R Auto. Trans. 51.00" Cable	CA-1930	25508263
1982	V8 4.4L 267ci	J	Export, w/Canada Emissions, w/THM250C Auto. Trans., w/THM350C Auto. Trans.; 37.80" Cable	CA-1933	25507541
1982	V8 4.4L 267ci	J	Classic, w/THM200-4R Auto. Trans., Universal cable for temporary fix, use CA-1930 for permanent fix	CA-1980	
1982	V8 4.4L 267ci	J	Export, w/Canada Emissions, w/THM250C Auto. Trans., w/THM350C Auto. Trans., Universal cable, for temporary fix only, for permanent fix use CA-1933; 49.20" Cable	CA-1981	
1979	V8 5.0L 305ci	G	w/THM350 Auto. Trans.; 45.00" Cable	CA-1951	1262620
1979	V8 5.0L 305ci	G	THM350 Auto. Trans.; 49.20" Cable, Universal cable for temporary fix, use CA-1951 for permanent fix	CA-1981	
1980	V8 5.0L 305ci	H	w/Auto. Trans.; 45.00" Cable	CA-1951	1262620
1980	V8 5.0L 305ci	H	w/Auto. Trans.; 49.20" Cable, Universal cable for temporary fix, use CA-1951 for permanent fix	CA-1981	
1981	V8 5.0L 305ci	H	w/THM250C Auto. Trans., w/THM350C Auto. Trans.; 37.80" Cable	CA-1933	25507541
1981	V8 5.0L 305ci	H	w/THM200-4R Auto. Trans.; 37.51" Cable	CA-1943	25507546
1981	V8 5.0L 305ci	H	w/THM200-4R Auto. Trans., Universal cable for temporary fix, use CA-1943 for permanent fix	CA-1980	

# DETENT CABLES

Year	Engine	Vin	Remark	Part	OE
<b>CHEVROLET (con't)</b>					
<b>CAPRICE (con't)</b>					
1981	V8 5.0L 305ci	H	w/THM250C Auto. Trans., w/THM350C Auto. Trans., Universal cable for temporary fix only, for permanent fix use CA-1933; 49.20" Cable	CA-1981	
1977	V8 5.0L 305ci	U	w/THM200 Auto. Trans.; 44.68" Cable	CA-1940	1253966
1977	V8 5.0L 305ci	U	w/THM200 Auto. Trans., Universal cable for temporary fix, use CA-1940 for permanent fix	CA-1980	
1978	V8 5.0L 305ci	U	w/THM200C Auto. Trans.; 38.40" Cable	CA-1941	1262613
1978	V8 5.0L 305ci	U	w/THM200C Auto. Trans., Universal cable for temporary fix, use CA-1941 for permanent fix	CA-1980	
1977-78	V8 5.0L 305ci	U	w/THM350 Auto. Trans.; 45.00" Cable	CA-1951	1262620
1977-78	V8 5.0L 305ci	U	THM350 Auto. Trans.; 49.20" Cable, Universal cable for temporary fix, use CA-1951 for permanent fix	CA-1981	
1976-79	V8 5.7L 350ci	L	w/THM350 Auto. Trans.; 45.00" Cable	CA-1951	1262620
1976-79	V8 5.7L 350ci	L	THM350 Auto. Trans.; 49.20" Cable, Universal cable for temporary fix, use CA-1951 for permanent fix	CA-1981	
1978-79	V8 5.7L 350ci	L	w/THM200 Auto. Trans.; 38.40" Cable	CA-1941	1262613
1978-79	V8 5.7L 350ci	L	w/THM200 Auto. Trans., Universal cable for temporary fix, use CA-1941 for permanent fix	CA-1980	
1980	V8 5.7L 350ci	L	w/Auto. Trans.; 45.00" Cable	CA-1951	1262620
1980	V8 5.7L 350ci	L	w/Auto. Trans.; 49.20" Cable, Universal cable for temporary fix, use CA-1951 for permanent fix	CA-1981	
1981	V8 5.7L 350ci	N	Diesel, w/THM350C Auto. Trans., w/THM200C Auto. 51.00" Cable	CA-1930	25508265
1981	V8 5.7L 350ci	N	Diesel, w/THM350C Auto. Trans., w/THM200C Auto., Universal cable for temporary fix, use CA-1930 for permanent fix	CA-1980	
1976	V8 6.6L 400ci	U	w/THM350 Auto. Trans.; 45.00" Cable	CA-1951	1262620
1976	V8 6.6L 400ci	U	THM350 Auto. Trans.; 49.20" Cable, Universal cable for temporary fix, use CA-1951 for permanent fix	CA-1981	
<b>CAVALIER</b>					
1982	L4 1.8L 112ci	G	w/THM125C Auto. Trans.; 36.10" Cable	CA-1960	25509560
1982	L4 1.8L 112ci	G	w/THM125C Auto. Trans., Universal cable for temporary fix, use CA-1960 for permanent fix	CA-1980	
1983-84	L4 2.0L 122ci	B	Export, w/Canada Emissions, w/THM125C Auto. Trans.; 36.10" Cable, exc. Throttle Body Injection	CA-1960	25509560
1983-84	L4 2.0L 122ci	B	Export, w/Canada Emissions, w/THM125C Auto. Trans., exc. Throttle Body Injection, Universal cable for temporary fix, use CA-1960 for permanent fix	CA-1980	
1983-86	L4 2.0L 122ci	P	w/THM125C Auto. Trans.; 25.70" Cable	CA-1932	25513017
1983-86	L4 2.0L 122ci	P	w/THM125C Auto. Trans., Universal cable for temporary fix, use CA-1932 for permanent fix	CA-1980	
1987	V6 2.8L 173ci	W	MPFIHO 51.00" Cable	CA-1930	10066597
1987-89	V6 2.8L 173ci	W	MPFIHO, Universal cable for temporary fix, use CA-1930 for permanent fix	CA-1980	
1988-89	V6 2.8L 173ci	W	MPFIHO 51.00" Cable	CA-1930	10085340
<b>CELEBRITY</b>					
1983	L4 2.5L 151ci	5	Export & Canada only; 25.70" Cable	CA-1932	25513389
1983	L4 2.5L 151ci	5	Export & Canada only, Universal cable for temporary fix, use CA-1932 for permanent fix	CA-1980	
1982-83	L4 2.5L 151ci	5	Export, w/Canada Emissions, w/THM125C Auto. Trans.; 25.70" Cable	CA-1932	25513389
1982-83	L4 2.5L 151ci	5	Export, w/Canada Emissions, w/THM125C Auto. Trans., Universal cable for temporary fix, use CA-1932 for permanent fix	CA-1980	
1982-83	L4 2.5L 151ci	R	w/THM125C Auto. Trans.; 40.79" Cable	CA-1958	25513393

# DETENT CABLES

Year	Engine	Vin	Remark	Part	OE
<b>CHEVROLET (con't)</b>					
<b>CELEBRITY (con't)</b>					
1984-86	L4 2.5L 151ci	R	w/THM125C Auto. Trans.; 47.00" Cable	CA-1935	25519347
1984-86	L4 2.5L 151ci	R	w/THM125C Auto. Trans., Universal cable for temporary fix, use CA-1935 for permanent fix	CA-1980	
1985	V6 2.8L 173ci	W	w/Auto. Trans.; 36.10" Cable, w/Multi Port Fuel Injection, w/High Output	CA-1960	25515599
1985	V6 2.8L 173ci	W	w/Auto. Trans., w/Multi Port Fuel Injection, w/High Output, Universal cable for temporary fix, use CA-1960 for permanent fix	CA-1980	
1987	V6 2.8L 173ci	W	w/THM125C Auto. Trans., w/THM440-T4 Auto. Trans.; 44.50" Cable	CA-1970	10066501
1987	V6 2.8L 173ci	W	w/THM125C Auto. Trans., w/THM440-T4 Auto. Trans., Universal cable for temporary fix, use CA-1970 for permanent fix	CA-1980	
1982-85	V6 2.8L 173ci	X	w/Auto. Trans. 51.00" Cable	CA-1930	1262487
1982-85	V6 2.8L 173ci	X	w/THM125C Auto. Trans., Universal cable for temporary fix, use CA-1930 for permanent fix	CA-1980	
1986	V6 2.8L 173ci	X	w/THM440-T4 Auto. Trans. 51.00" Cable	CA-1930	1262487
1986	V6 2.8L 173ci	X	w/THM440-T4 Auto. Trans., Universal cable for temporary fix, use CA-1930 for permanent fix	CA-1980	
1984	V6 2.8L 173ci	Z	w/THM440-T4 Auto. Trans. 51.00" Cable	CA-1930	1262487
1984	V6 2.8L 173ci	Z	w/THM440-T4 Auto. Trans., Universal cable for temporary fix, use CA-1930 for permanent fix	CA-1980	
1982-85	V6 4.3L 260ci	T	w/Auto. Trans.; 37.51" Cable	CA-1943	25510971
1982-85	V6 4.3L 260ci	T	w/Auto. Trans., Universal cable for temporary fix, use CA-1943 for permanent fix	CA-1980	
<b>CHEVELLE</b>					
1973	L6 4.1L 250ci	D	w/TH250, TH350	CA-1950	1245640
1968-71	V8 5.0L 307ci		w/TH350	CA-1952	342487
1968-71	V8 5.0L 307ci		w/TH350, Universal cable for temporary fix, use CA-1952 for permanent fix; 49.20" Cable	CA-1981	
1972	V8 5.0L 307ci	F	w/TH350	CA-1952	342487
1972	V8 5.0L 307ci	F	w/TH350, Universal cable for temporary fix, use CA-1952 for permanent fix; 49.20" Cable	CA-1981	
1973	V8 5.0L 307ci	F	w/TH250, TH350	CA-1950	1245640
1968-71	V8 5.7L 350ci		w/TH350	CA-1952	342487
1968-71	V8 5.7L 350ci		w/TH350, Universal cable for temporary fix, use CA-1952 for permanent fix; 49.20" Cable	CA-1981	
1972	V8 5.7L 350ci	H, J	w/TH350	CA-1952	342487
1972	V8 5.7L 350ci	H, J	w/TH350, Universal cable for temporary fix, use CA-1952 for permanent fix; 49.20" Cable	CA-1981	
1973	V8 5.7L 350ci	H, K	w/TH250, TH350	CA-1950	1245640
<b>CHEVETTE</b>					
1981	L4 1.6L 98ci	9	w/THM200 Auto. Trans.; 36.10" Cable, exc. Scooter	CA-1960	25515599
1981	L4 1.6L 98ci	9	THM200 Auto. Trans., exc. Scooter, Universal cable for temporary fix, use CA-1960 for permanent fix	CA-1980	
1982-83	L4 1.6L 98ci	C	w/THM200 Auto. Trans.; 36.10" Cable	CA-1960	25515599
1982-83	L4 1.6L 98ci	C	w/THM200 Auto. Trans., Universal cable for temporary fix, use CA-1960 for permanent fix	CA-1980	
<b>CHEVY II</b>					
1968	V8 5.0L 307ci		w/TH350	CA-1952	342487
1968	V8 5.0L 307ci		w/TH350, Universal cable for temporary fix, use CA-1952 for permanent fix; 49.20" Cable	CA-1981	
1968	V8 5.4L 327ci		w/TH350	CA-1952	342487
1968	V8 5.4L 327ci		w/TH350, Universal cable for temporary fix, use CA-1952 for permanent fix; 49.20" Cable	CA-1981	

# DETENT CABLES

Year	Engine	Vin	Remark	Part	OE
<b>CHEVROLET (con't)</b>					
<b>CHEVY II (con't)</b>					
1968	V8 5.7L 350ci		w/TH350	CA-1952	342487
1968	V8 5.7L 350ci		w/TH350, Universal cable for temporary fix, use CA-1952 for permanent fix; 49.20" Cable	CA-1981	
<b>CITATION</b>					
1980-81	L4 2.5L 151ci	5	w/THM125C Auto. Trans.; 25.70" Cable	CA-1932	25513389
1980-81	L4 2.5L 151ci	5	w/THM125C Auto. Trans., Universal cable for temporary fix, use CA-1932 for permanent fix	CA-1980	
1982-83	L4 2.5L 151ci	5	Export, w/Canada Emissions, w/THM125C Auto. Trans.; 25.70" Cable	CA-1932	25513389
1982-83	L4 2.5L 151ci	5	Export, w/Canada Emissions, w/THM125C Auto. Trans., Universal cable for temporary fix, use CA-1932 for permanent fix	CA-1980	
1982-83	L4 2.5L 151ci	R	w/THM125C Auto. Trans.; 40.79" Cable	CA-1958	25513393
1981-83	V6 2.8L 173ci	X	w/Auto. Trans. 51.00" Cable	CA-1930	1262487
1981-83	V6 2.8L 173ci	X	w/Auto. Trans., Universal cable for temporary fix, use CA-1930 for permanent fix	CA-1980	
<b>CITATION II</b>					
1984-85	L4 2.5L 151ci	R	w/THM125C Auto. Trans.; 47.00" Cable	CA-1935	25519347
1984-85	L4 2.5L 151ci	R	w/THM125C Auto. Trans., Universal cable for temporary fix, use CA-1935 for permanent fix	CA-1980	
1985	V6 2.8L 173ci	W	w/Multi Port Fuel Injection, w/THM125C Auto. Trans.; 36.10" Cable	CA-1960	25515599
1985	V6 2.8L 173ci	W	w/Multi Port Fuel Injection, w/THM125C Auto. Trans., Universal cable for temporary fix, use CA-1960 for permanent fix	CA-1980	
1984-85	V6 2.8L 173ci	X	w/Auto. Trans. 51.00" Cable	CA-1930	1262487
1984-85	V6 2.8L 173ci	X	w/Auto. Trans., Universal cable for temporary fix, use CA-1930 for permanent fix	CA-1980	
<b>CORVETTE</b>					
1982	V8 5.7L 350ci	8	w/Auto. Trans.; 36.10" Cable	CA-1960	25515601
1982	V8 5.7L 350ci	8	w/Auto. Trans., Universal cable for temporary fix, use CA-1960 for permanent fix	CA-1980	
1984	V8 5.7L 350ci	8	w/THM700-R4 Auto. Trans.; 36.10" Cable	CA-1960	25515601
1984	V8 5.7L 350ci	8	w/THM700-R4 Auto. Trans., Universal cable for temporary fix, use CA-1960 for permanent fix	CA-1980	
1976-79	V8 5.7L 350ci	L	w/Auto. Trans.; 45.00" Cable	CA-1951	1262620
1976-79	V8 5.7L 350ci	L	w/Auto. Trans.; 49.20" Cable, Universal cable for temporary fix, use CA-1951 for permanent fix	CA-1981	
<b>IMPALA</b>					
1977	L6 4.1L 250ci	D	w/THM350 Auto. Trans.; 45.00" Cable, w/Integral Cyl. Head	CA-1951	1262618
1977	L6 4.1L 250ci	D	w/THM350 Auto. Trans.; 49.20" Cable, w/Integral Cyl. Head, Universal cable for temporary fix, use CA-1951 for permanent fix	CA-1981	
1978-79	L6 4.1L 250ci	D	w/THM350 Auto. Trans.; 45.00" Cable	CA-1951	1262618
1978-79	L6 4.1L 250ci	D	THM350 Auto. Trans.; 49.20" Cable, Universal cable for temporary fix, use CA-1951 for permanent fix	CA-1981	
1980	V6 3.8L 229ci	K	w/THM200C Auto. Trans.; 35.00" Cable	CA-1947	1262612
1980	V6 3.8L 229ci	K	w/THM200C Auto. Trans., Universal cable for temporary fix, use CA-1947 for permanent fix	CA-1980	
1980	V6 3.8L 231ci	A	w/THM200C Auto. Trans.; 35.00" Cable	CA-1947	1262612
1980	V6 3.8L 231ci	A	w/THM350 Auto. Trans.; 33.95" Cable	CA-1955	1262652
1980	V6 3.8L 231ci	A	w/THM200C Auto. Trans., Universal cable for temporary fix, use CA-1947 for permanent fix	CA-1980	
1981	V6 3.8L 231ci	A	w/THM350 Auto. Trans.; 36.10" Cable	CA-1960	25505174

# DETENT CABLES

Year	Engine	Vin	Remark	Part	OE
<b>CHEVROLET (con't)</b>					
<b>IMPALA (con't)</b>					
1981	V6 3.8L 231ci	A	w/THM350 Auto. Trans., Universal cable for temporary fix, use CA-1960 for permanent fix	CA-1980	
1982-83	V6 3.8L 231ci	A	w/THM350C Auto. Trans.; 36.10" Cable	CA-1960	25505174
1982-83	V6 3.8L 231ci	A	w/THM350C Auto. Trans., Universal cable for temporary fix, use CA-1960 for permanent fix	CA-1980	
1984	V6 3.8L 231ci	A	w/THM200C Auto. Trans.; 36.10" Cable, w/THM250C	CA-1960	25505175
1984	V6 3.8L 231ci	A	THM200C Auto. Trans., w/THM250C, Universal cable for temporary fix, use CA-1960 for permanent fix	CA-1980	
1985	V6 3.8L 231ci	A	Export, w/Canada Emissions, w/THM200C Auto. Trans.; 36.10" Cable	CA-1960	25505175
1985	V6 3.8L 231ci	A	Export, w/Canada Emissions, w/THM200C Auto. Trans., Universal cable for temporary fix, use CA-1960 for permanent fix	CA-1980	
1985	V6 4.3L 262ci	Z	w/THM200C Auto. Trans.; 37.51" Cable	CA-1943	25521267
1985	V6 4.3L 262ci	Z	w/THM700-R4 Auto. Trans.; 44.50" Cable	CA-1970	25521268
1985	V6 4.3L 262ci	Z	w/THM200C Auto. Trans., Universal cable for temporary fix, use CA-1943 for permanent fix	CA-1980	
1985	V6 4.3L 262ci	Z	w/THM700-R4 Auto. Trans., Universal cable for temporary fix, use CA-1970 for permanent fix	CA-1980	
1980	V8 4.4L 267ci	J	w/THM200C Auto. Trans.; 38.40" Cable	CA-1941	1262613
1980	V8 4.4L 267ci	J	w/Auto. Trans., exc. THM200C Auto. Trans.; 45.00" Cable	CA-1951	1262620
1980	V8 4.4L 267ci	J	w/THM200C Auto. Trans., Universal cable for temporary fix, use CA-1941 for permanent fix	CA-1980	
1980	V8 4.4L 267ci	J	w/Auto. Trans., exc. THM200C Auto. Trans., Universal cable for temporary fix, use CA-1951 for permanent fix; 49.20" Cable	CA-1981	
1981	V8 4.4L 267ci	J	w/THM250C Auto. Trans., w/THM350C Auto. Trans.; 37.80" Cable	CA-1933	25507541
1981	V8 4.4L 267ci	J	exc. Wagon, w/THM200C Auto. Trans.; 37.51" Cable	CA-1943	25507546
1981	V8 4.4L 267ci	J	exc. Wagon, w/THM200C A.T., Universal cable for temporary fix, use CA-1943 for permanent fix	CA-1980	
1981	V8 4.4L 267ci	J	w/THM250C Auto. Trans., w/THM350C Auto. Trans., Universal cable for temporary fix only, for permanent fix use CA-1933; 49.20" Cable	CA-1981	
1982	V8 4.4L 267ci	J	w/THM200-4R Auto. Trans. 51.00" Cable	CA-1930	25508263
1982	V8 4.4L 267ci	J	Export, w/Canada Emissions, w/THM250C Auto. Trans., w/THM350C Auto. Trans.; 37.80" Cable	CA-1933	25507541
1982	V8 4.4L 267ci	J	w/THM200-4R Auto. Trans., Universal cable for temporary fix, use CA-1930 for permanent fix	CA-1980	
1982	V8 4.4L 267ci	J	Export, w/Canada Emissions, w/THM250C Auto. Trans., w/THM350C Auto. Trans., Universal cable, for temporary fix only, for permanent fix use CA-1933; 49.20" Cable	CA-1981	
1979	V8 5.0L 305ci	G	w/THM200 Auto. Trans.; 38.40" Cable	CA-1941	1262613
1979	V8 5.0L 305ci	G	w/THM350 Auto. Trans.; 45.00" Cable	CA-1951	1262620
1979	V8 5.0L 305ci	G	w/THM200 Auto. Trans., Universal cable for temporary fix, use CA-1941 for permanent fix	CA-1980	
1979	V8 5.0L 305ci	G	THM350 Auto. Trans.; 49.20" Cable, Universal cable for temporary fix, use CA-1951 for permanent fix	CA-1981	
1980	V8 5.0L 305ci	H	w/Auto. Trans.; 45.00" Cable	CA-1951	1262620
1980	V8 5.0L 305ci	H	w/Auto. Trans.; 49.20" Cable, Universal cable for temporary fix, use CA-1951 for permanent fix	CA-1981	
1981	V8 5.0L 305ci	H	w/THM200-4R Auto. Trans.; 37.51" Cable	CA-1943	25507546
1981	V8 5.0L 305ci	H	w/THM200-4R Auto. Trans., Universal cable for temporary fix, use CA-1943 for permanent fix	CA-1980	

# DETENT CABLES

Year	Engine	Vin	Remark	Part	OE
<b>CHEVROLET (con't)</b>					
<b>IMPALA (con't)</b>					
1981-84	V8 5.0L 305ci	H	w/THM250C Auto. Trans., w/THM350C Auto. Trans.; 37.80" Cable	CA-1933	25507541
1981-84	V8 5.0L 305ci	H	w/THM250C Auto. Trans., w/THM350C Auto. Trans., Universal cable for temporary fix only, for permanent fix use CA-1933; 49.20" Cable	CA-1981	
1982	V8 5.0L 305ci	H	w/THM200-4R Auto. Trans. 51.00" Cable	CA-1930	25508263
1982	V8 5.0L 305ci	H	Export, w/Canada Emissions, w/THM250C Auto. Trans., w/THM350C Auto. Trans.; 37.80" Cable	CA-1933	25507541
1982	V8 5.0L 305ci	H	w/THM200-4R Auto. Trans., Universal cable for temporary fix, use CA-1930 for permanent fix	CA-1980	
1982	V8 5.0L 305ci	H	Export, w/Canada Emissions, w/THM250C Auto. Trans., w/THM350C Auto. Trans., Universal cable, for temporary fix only, for permanent fix use CA-1933; 49.20" Cable	CA-1981	
1982-84	V8 5.0L 305ci	H	w/THM700-R4 Auto. Trans.; 44.50" Cable	CA-1970	25515598
1982-84	V8 5.0L 305ci	H	w/THM700-R4 Auto. Trans., Universal cable for temporary fix, use CA-1970 for permanent fix	CA-1980	
1985	V8 5.0L 305ci	H	Export, w/Canada Emissions, w/THM200C Auto. Trans.; 37.51" Cable	CA-1943	25507546
1985	V8 5.0L 305ci	H	w/THM700-4R Auto. Trans.; 44.50" Cable	CA-1970	25515598
1985	V8 5.0L 305ci	H	Export, w/Canada Emissions, w/THM200C Auto. Trans., Universal cable for temporary fix, use CA-1943 for permanent fix	CA-1980	
1985	V8 5.0L 305ci	H	w/THM700-4R Auto. Trans., Universal cable for temporary fix, use CA-1970 for permanent fix	CA-1980	
1977	V8 5.0L 305ci	U	w/THM200 Auto. Trans.; 44.68" Cable	CA-1940	1253966
1977	V8 5.0L 305ci	U	w/THM200 Auto. Trans., Universal cable for temporary fix, use CA-1940 for permanent fix	CA-1980	
1977-78	V8 5.0L 305ci	U	w/THM350 Auto. Trans.; 45.00" Cable	CA-1951	1262620
1977-78	V8 5.0L 305ci	U	THM350 Auto. Trans.; 49.20" Cable, Universal cable for temporary fix, use CA-1951 for permanent fix	CA-1981	
1978	V8 5.0L 305ci	U	w/THM200C Auto. Trans.; 38.40" Cable	CA-1941	1262613
1978	V8 5.0L 305ci	U	w/THM200C Auto. Trans., Universal cable for temporary fix, use CA-1941 for permanent fix	CA-1980	
1976-79	V8 5.7L 350ci	L	w/THM350 Auto. Trans.; 45.00" Cable	CA-1951	1262620
1976-79	V8 5.7L 350ci	L	THM350 Auto. Trans.; 49.20" Cable, Universal cable for temporary fix, use CA-1951 for permanent fix	CA-1981	
1978-79	V8 5.7L 350ci	L	w/THM200 Auto. Trans.; 38.40" Cable	CA-1941	1262613
1978-79	V8 5.7L 350ci	L	w/THM200 Auto. Trans., Universal cable for temporary fix, use CA-1941 for permanent fix	CA-1980	
1980	V8 5.7L 350ci	L	w/Auto. Trans.; 45.00" Cable	CA-1951	1262620
1980	V8 5.7L 350ci	L	w/Auto. Trans.; 49.20" Cable, Universal cable for temporary fix, use CA-1951 for permanent fix	CA-1981	
1981	V8 5.7L 350ci	L	w/THM250C Auto. Trans., w/THM350C Auto. Trans.; 37.80" Cable	CA-1933	25507541
1981	V8 5.7L 350ci	L	w/THM250C Auto. Trans., w/THM350C Auto. Trans., Universal cable for temporary fix only, for permanent fix use CA-1933; 49.20" Cable	CA-1981	
1981	V8 5.7L 350ci	N	w/THM200C Auto. Trans. 51.00" Cable	CA-1930	25508263
1981	V8 5.7L 350ci	N	w/THM200C, w/THM350C Auto. Trans. 51.00" Cable	CA-1930	25508265
1981	V8 5.7L 350ci	N	w/THM200C Auto. Trans., Universal cable for temporary fix, use CA-1930 for permanent fix	CA-1980	
1981	V8 5.7L 350ci	N	w/THM200C, THM350C Auto. Trans., Universal cable for temporary fix, use CA-1930 for permanent fix	CA-1980	
1982	V8 5.7L 350ci	N	w/THM350C Auto. Trans. 51.00" Cable	CA-1930	25508265

# DETENT CABLES

Year	Engine	Vin	Remark	Part	OE
<b>CHEVROLET (con't)</b>					
<b>IMPALA (con't)</b>					
1982	V8 5.7L 350ci	N	w/THM350C Auto. Trans., Universal cable for temporary fix, use CA-1930 for permanent fix	CA-1980	
1983	V8 5.7L 350ci	N	w/THM200C Auto. Trans., w/THM200-4R Auto. Trans., w/THM350C Auto. Trans. 51.00" Cable	CA-1930	25508263
1983	V8 5.7L 350ci	N	w/THM200C Auto. Trans., w/THM200-4R Auto. Trans., w/THM350C Auto. Trans., Universal cable for temporary fix, use CA-1930 for permanent fix	CA-1980	
1984-85	V8 5.7L 350ci	N	w/THM200C Auto. Trans., w/THM200-4R Auto. Trans. 51.00" Cable	CA-1930	25508263
1984-85	V8 5.7L 350ci	N	w/THM200C Auto. Trans., w/THM200-4R Auto. Trans., Universal cable for temporary fix, use CA-1930 for permanent fix	CA-1980	
1976	V8 6.6L 400ci	U	w/THM350 Auto. Trans.; 45.00" Cable	CA-1951	1262620
1976	V8 6.6L 400ci	U	THM350 Auto. Trans.; 49.20" Cable, Universal cable for temporary fix, use CA-1951 for permanent fix	CA-1981	
<b>MALIBU</b>					
1976-77	L6 4.1L 250ci	D	w/THM350 Auto. Trans.; 45.00" Cable, w/Integral Cyl. Head	CA-1951	1262618
1976-77	L6 4.1L 250ci	D	w/THM350 Auto. Trans.; 49.20" Cable, w/Integral Cyl. Head, Universal cable for temporary fix, use CA-1951 for permanent fix	CA-1981	
1978	V6 3.3L 200ci	M	exc. Wagon, w/THM350 Auto. Trans.; 45.00" Cable	CA-1951	1262619
1978	V6 3.3L 200ci	M	exc. Wagon, THM350 Auto. Trans.; 49.20" Cable, Universal cable for temporary fix, use CA-1951 for permanent fix	CA-1981	
1978-79	V6 3.3L 200ci	M	Wagon, w/THM200 Auto. Trans.; 35.00" Cable	CA-1947	1262612
1978-79	V6 3.3L 200ci	M	Wagon, w/THM200 Auto. Trans., Universal cable for temporary fix, use CA-1947 for permanent fix	CA-1980	
1979	V6 3.3L 200ci	M	w/Auto. Trans.; 45.00" Cable, exc. Wagon	CA-1951	1262619
1979	V6 3.3L 200ci	M	exc. Wagon, w/CBC350 Auto. Trans.; 33.95" Cable	CA-1955	1262652
1979	V6 3.3L 200ci	M	w/AT; 49.20" Cable, exc. Wagon, Universal cable for temporary fix, use CA-1951 for permanent fix	CA-1981	
1980	V6 3.8L 229ci	K	w/THM200C Auto. Trans.; 35.00" Cable	CA-1947	1262612
1980	V6 3.8L 229ci	K	w/THM200C Auto. Trans., Universal cable for temporary fix, use CA-1947 for permanent fix	CA-1980	
1981	V6 3.8L 229ci	K	w/THM200C Auto. Trans.; 37.51" Cable	CA-1943	25507545
1981	V6 3.8L 229ci	K	w/THM200C Auto. Trans., Universal cable for temporary fix, use CA-1943 for permanent fix	CA-1980	
1980	V6 3.8L 231ci	A	w/THM200C Auto. Trans.; 35.00" Cable	CA-1947	1262612
1980	V6 3.8L 231ci	A	w/THM200C Auto. Trans., Universal cable for temporary fix, use CA-1947 for permanent fix	CA-1980	
1981	V6 3.8L 231ci	A	w/THM200C Auto. Trans.; 37.51" Cable	CA-1943	25507545
1981	V6 3.8L 231ci	A	w/THM200C Auto. Trans.; 36.10" Cable	CA-1960	25505175
1981	V6 3.8L 231ci	A	w/THM200C Auto. Trans., Universal cable for temporary fix, use CA-1943 for permanent fix	CA-1980	
1981	V6 3.8L 231ci	A	w/THM200C Auto. Trans., Universal cable for temporary fix, use CA-1960 for permanent fix	CA-1980	
1982	V6 3.8L 231ci	A	Classic, w/THM250C Auto. Trans., w/THM350C Auto. Trans.; 36.10" Cable	CA-1960	25505174
1982	V6 3.8L 231ci	A	Classic, w/THM250C Auto. Trans., w/THM350C Auto. Trans., Universal cable for temporary fix, use CA-1960 for permanent fix	CA-1980	
1982	V6 4.3L 260ci	V	Diesel, w/THM200C Auto. Trans.; 37.51" Cable	CA-1943	25510971
1982	V6 4.3L 260ci	V	Diesel, w/THM200C Auto. Trans., Universal cable for temporary fix, use CA-1943 for permanent fix	CA-1980	



# DETENT CABLES

Year	Engine	Vin	Remark	Part	OE
<b>CHEVROLET (con't)</b>					
<b>MALIBU (con't)</b>					
1983	V6 4.3L 260ci	V	w/THM200C Auto. Trans.; 37.51" Cable	CA-1943	25510971
1983	V6 4.3L 260ci	V	w/THM200C Auto. Trans., Universal cable for temporary fix, use CA-1943 for permanent fix	CA-1980	
1979	V8 4.4L 267ci	J	w/THM200 Auto. Trans.; 38.40" Cable	CA-1941	1262613
1979	V8 4.4L 267ci	J	w/THM350 Auto. Trans.; 45.00" Cable	CA-1951	1262620
1979	V8 4.4L 267ci	J	w/THM200 Auto. Trans., Universal cable for temporary fix, use CA-1941 for permanent fix	CA-1980	
1979	V8 4.4L 267ci	J	THM350 Auto. Trans.; 49.20" Cable, Universal cable for temporary fix, use CA-1951 for permanent fix	CA-1981	
1980	V8 4.4L 267ci	J	w/THM250C Auto. Trans., w/THM350 Auto. Trans; 45.00" Cable	CA-1951	1262620
1980	V8 4.4L 267ci	J	w/THM250C Auto. Trans., w/THM350 Auto. Trans, Universal cable for temporary fix, use CA-1951 for permanent fix; 49.20" Cable	CA-1981	
1981	V8 4.4L 267ci	J	w/THM250C Auto. Trans., w/THM350C Auto. Trans.; 37.80" Cable	CA-1933	25507541
1981	V8 4.4L 267ci	J	w/THM200C Auto. Trans.; 37.51" Cable	CA-1943	25507546
1981	V8 4.4L 267ci	J	w/THM200C Auto. Trans., Universal cable for temporary fix, use CA-1943 for permanent fix	CA-1980	
1981	V8 4.4L 267ci	J	w/THM250C Auto. Trans., w/THM350C Auto. Trans., Universal cable for temporary fix only, for permanent fix use CA-1933; 49.20" Cable	CA-1981	
1982	V8 4.4L 267ci	J	w/Auto. Trans.; 37.80" Cable, Classic	CA-1933	25507541
1982	V8 4.4L 267ci	J	w/AT; 49.20" Cable, Classic, Universal cable, for temporary fix only, for permanent fix use CA-1933	CA-1981	
1979	V8 5.0L 305ci	H	w/THM200 Auto. Trans.; 38.40" Cable, w/THM200C	CA-1941	1262613
1979	V8 5.0L 305ci	H	w/THM200 Auto. Trans., THM200C, Universal cable for temporary fix, use CA-1941 for permanent fix	CA-1980	
1979-80	V8 5.0L 305ci	H	w/THM250C Auto. Trans., w/THM350C Auto. Trans.; 45.00" Cable	CA-1951	1262620
1979-80	V8 5.0L 305ci	H	w/THM250C Auto. Trans., w/THM350C Auto. Trans., Universal cable for temporary fix, use CA-1951 for permanent fix; 49.20" Cable	CA-1981	
1980	V8 5.0L 305ci	H	w/THM200C Auto. Trans.; 38.40" Cable	CA-1941	1262613
1980	V8 5.0L 305ci	H	w/THM200C Auto. Trans., Universal cable for temporary fix, use CA-1941 for permanent fix	CA-1980	
1981	V8 5.0L 305ci	H	w/THM200C Auto. Trans.; 37.51" Cable	CA-1943	25507546
1981	V8 5.0L 305ci	H	w/THM200C Auto. Trans., Universal cable for temporary fix, use CA-1943 for permanent fix	CA-1980	
1981-83	V8 5.0L 305ci	H	w/THM250C Auto. Trans., w/THM350C Auto. Trans.; 37.80" Cable	CA-1933	25507541
1981-83	V8 5.0L 305ci	H	w/THM250C Auto. Trans., w/THM350C Auto. Trans., Universal cable for temporary fix only, for permanent fix use CA-1933; 49.20" Cable	CA-1981	
1982	V8 5.0L 305ci	H	w/THM250C Auto. Trans., w/THM350 Auto. Trans; 37.80" Cable	CA-1933	25507541
1982	V8 5.0L 305ci	H	w/THM250C Auto. Trans.; 37.80" Cable	CA-1933	25507541
1982	V8 5.0L 305ci	H	w/THM250C Auto. Trans., w/THM350 Auto. Trans, Universal cable, for temporary fix only, for permanent fix use CA-1933; 49.20" Cable	CA-1981	
1982	V8 5.0L 305ci	H	w/THM250C Auto. Trans.; 49.20" Cable, Universal cable, for temporary fix only, for permanent fix use CA-1933	CA-1981	
1976	V8 5.0L 305ci	Q	w/THM350 Auto. Trans.; 45.00" Cable	CA-1951	1262620
1976	V8 5.0L 305ci	Q	THM350 Auto. Trans.; 49.20" Cable, Universal cable for temporary fix, use CA-1951 for permanent fix	CA-1981	

# DETENT CABLES

Year	Engine	Vin	Remark	Part	OE
<b>CHEVROLET (con't)</b>					
<b>MALIBU (con't)</b>					
1977-78	V8 5.0L 305ci	U	w/THM350 Auto. Trans.; 45.00" Cable	CA-1951	1262620
1977-78	V8 5.0L 305ci	U	THM350 Auto. Trans.; 49.20" Cable, Universal cable for temporary fix, use CA-1951 for permanent fix	CA-1981	
1978	V8 5.0L 305ci	U	w/THM200 Auto. Trans.; 38.40" Cable	CA-1941	1262613
1978	V8 5.0L 305ci	U	w/THM200 Auto. Trans., Universal cable for temporary fix, use CA-1941 for permanent fix	CA-1980	
1976-80	V8 5.7L 350ci	L	w/THM350 Auto. Trans.; 45.00" Cable	CA-1951	1262620
1976-80	V8 5.7L 350ci	L	THM350 Auto. Trans.; 49.20" Cable, Universal cable for temporary fix, use CA-1951 for permanent fix	CA-1981	
1978	V8 5.7L 350ci	L	w/THM200 Auto. Trans.; 38.40" Cable	CA-1941	1262613
1978	V8 5.7L 350ci	L	w/THM200 Auto. Trans., Universal cable for temporary fix, use CA-1941 for permanent fix	CA-1980	
1980	V8 5.7L 350ci	L	w/THM250C Auto. Trans., w/THM350 Auto. Trans; 45.00" Cable	CA-1951	1262620
1980	V8 5.7L 350ci	L	w/THM250C Auto. Trans., w/THM350 Auto. Trans, Universal cable for temporary fix, use CA-1951 for permanent fix; 49.20" Cable	CA-1981	
1981	V8 5.7L 350ci	L	w/Auto. Trans.; 37.80" Cable	CA-1933	25507541
1981	V8 5.7L 350ci	L	w/Auto. Trans.; 49.20" Cable, Universal cable, for temporary fix only, for permanent fix use CA-1933	CA-1981	
1982	V8 5.7L 350ci	N	Diesel, w/THM350C Auto. Trans. 51.00" Cable	CA-1930	25508265
1982	V8 5.7L 350ci	N	Diesel, w/THM350C Auto. Trans., Universal cable for temporary fix, use CA-1930 for permanent fix	CA-1980	
1983	V8 5.7L 350ci	N	w/THM350C Auto. Trans. 51.00" Cable	CA-1930	25508265
1983	V8 5.7L 350ci	N	w/THM350C Auto. Trans., Universal cable for temporary fix, use CA-1930 for permanent fix	CA-1980	
1976	V8 6.6L 400ci	U	w/THM350 Auto. Trans.; 45.00" Cable	CA-1951	1262620
1976	V8 6.6L 400ci	U	THM350 Auto. Trans.; 49.20" Cable, Universal cable for temporary fix, use CA-1951 for permanent fix	CA-1981	
<b>MONTE CARLO</b>					
1978-79	V6 3.3L 200ci	M	w/THM200 Auto. Trans.; 35.00" Cable	CA-1947	1262612
1978-79	V6 3.3L 200ci	M	w/THM200 Auto. Trans., Universal cable for temporary fix, use CA-1947 for permanent fix	CA-1980	
1979	V6 3.3L 200ci	M	exc. Wagon, w/THM350 Auto. Trans.; 45.00" Cable	CA-1951	1262619
1979	V6 3.3L 200ci	M	exc. Wagon, w/CBC350 Auto. Trans.; 33.95" Cable	CA-1955	1262652
1979	V6 3.3L 200ci	M	exc. Wagon, THM350 Auto. Trans.; 49.20" Cable, Universal cable for temporary fix, use CA-1951 for permanent fix	CA-1981	
1984	V6 3.8L 229ci	9	w/THM200-4R Auto. Trans.; 37.51" Cable	CA-1943	25507545
1984	V6 3.8L 229ci	9	w/THM200-4R Auto. Trans., Universal cable for temporary fix, use CA-1943 for permanent fix	CA-1980	
1980	V6 3.8L 229ci	K	w/THM200C Auto. Trans.; 35.00" Cable	CA-1947	1262612
1980	V6 3.8L 229ci	K	w/THM200C Auto. Trans., Universal cable for temporary fix, use CA-1947 for permanent fix	CA-1980	
1981	V6 3.8L 229ci	K	w/THM200C Auto. Trans.; 37.51" Cable	CA-1943	25507545
1981	V6 3.8L 229ci	K	w/THM200C Auto. Trans., Universal cable for temporary fix, use CA-1943 for permanent fix	CA-1980	
1980	V6 3.8L 231ci	3	w/THM200C Auto. Trans.; 35.00" Cable	CA-1947	1262612
1980	V6 3.8L 231ci	3	w/Auto. Trans.; 33.95" Cable	CA-1955	1262653
1980	V6 3.8L 231ci	3	w/THM200C Auto. Trans., Universal cable for temporary fix, use CA-1947 for permanent fix	CA-1980	
1981	V6 3.8L 231ci	3	w/THM200C Auto. Trans.; 37.51" Cable	CA-1943	25507545
1981	V6 3.8L 231ci	3	w/THM350 Auto. Trans.; 44.50" Cable	CA-1970	25507553
1981	V6 3.8L 231ci	3	w/THM200C Auto. Trans., Universal cable for temporary fix, use CA-1943 for permanent fix	CA-1980	

# DETENT CABLES

Year	Engine	Vin	Remark	Part	OE
<b>CHEVROLET (con't)</b>					
<b>MONTE CARLO (con't)</b>					
1981	V6 3.8L 231ci	3	w/THM350 Auto. Trans., Universal cable for temporary fix, use CA-1970 for permanent fix	CA-1980	
1980	V6 3.8L 231ci	A	w/THM200C Auto. Trans.; 35.00" Cable	CA-1947	1262612
1980	V6 3.8L 231ci	A	w/THM200C Auto. Trans., Universal cable for temporary fix, use CA-1947 for permanent fix	CA-1980	
1981	V6 3.8L 231ci	A	w/THM200C Auto. Trans.; 37.51" Cable	CA-1943	25507545
1981	V6 3.8L 231ci	A	w/THM200C Auto. Trans.; 36.10" Cable	CA-1960	25505175
1981	V6 3.8L 231ci	A	w/THM200C Auto. Trans., Universal cable for temporary fix, use CA-1943 for permanent fix	CA-1980	
1981	V6 3.8L 231ci	A	w/THM200C Auto. Trans., Universal cable for temporary fix, use CA-1960 for permanent fix	CA-1980	
1982-83	V6 3.8L 231ci	A	w/THM250C Auto. Trans., w/THM350C Auto. Trans.; 36.10" Cable	CA-1960	25505174
1982-83	V6 3.8L 231ci	A	w/THM250C Auto. Trans., w/THM350C Auto. Trans., Universal cable for temporary fix, use CA-1960 for permanent fix	CA-1980	
1984	V6 3.8L 231ci	A	w/THM200C Auto. Trans.; 36.10" Cable, w/THM250C	CA-1960	25505175
1984	V6 3.8L 231ci	A	THM200C Auto. Trans., w/THM250C, Universal cable for temporary fix, use CA-1960 for permanent fix	CA-1980	
1985-87	V6 3.8L 231ci	A	Export, w/Canada Emissions, w/THM200C Auto. Trans.; 36.10" Cable	CA-1960	25505175
1985-87	V6 3.8L 231ci	A	Export, w/Canada Emissions, w/THM200C Auto. Trans., Universal cable for temporary fix, use CA-1960 for permanent fix	CA-1980	
1982-83	V6 4.3L 260ci	V	w/THM200C Auto. Trans.; 37.51" Cable	CA-1943	25510971
1982-83	V6 4.3L 260ci	V	w/THM200C Auto. Trans., Universal cable for temporary fix, use CA-1943 for permanent fix	CA-1980	
1985-88	V6 4.3L 262ci	Z	w/THM200C Auto. Trans., w/THM200-4R Auto. Trans.; 37.51" Cable	CA-1943	25521267
1985-88	V6 4.3L 262ci	Z	w/THM200C Auto. Trans., w/THM200-4R Auto. Trans., Universal cable for temporary fix, use CA-1943 for permanent fix	CA-1980	
1979	V8 4.4L 267ci	J	w/THM200 Auto. Trans.; 38.40" Cable	CA-1941	1262613
1979	V8 4.4L 267ci	J	w/THM350 Auto. Trans.; 45.00" Cable	CA-1951	1262620
1979	V8 4.4L 267ci	J	w/THM200 Auto. Trans., Universal cable for temporary fix, use CA-1941 for permanent fix	CA-1980	
1979	V8 4.4L 267ci	J	THM350 Auto. Trans.; 49.20" Cable, Universal cable for temporary fix, use CA-1951 for permanent fix	CA-1981	
1980	V8 4.4L 267ci	J	w/THM250C Auto. Trans., w/THM350 Auto. Trans; 45.00" Cable	CA-1951	1262620
1980	V8 4.4L 267ci	J	w/THM250C Auto. Trans., w/THM350 Auto. Trans, Universal cable for temporary fix, use CA-1951 for permanent fix; 49.20" Cable	CA-1981	
1981	V8 4.4L 267ci	J	w/THM250C Auto. Trans., w/THM350C Auto. Trans.; 37.80" Cable	CA-1933	25507541
1981	V8 4.4L 267ci	J	w/THM200C Auto. Trans.; 37.51" Cable	CA-1943	25507546
1981	V8 4.4L 267ci	J	w/THM200C Auto. Trans., Universal cable for temporary fix, use CA-1943 for permanent fix	CA-1980	
1981	V8 4.4L 267ci	J	w/THM250C Auto. Trans., w/THM350C Auto. Trans., Universal cable for temporary fix only, for permanent fix use CA-1933; 49.20" Cable	CA-1981	
1982	V8 4.4L 267ci	J	w/Auto. Trans.; 37.80" Cable	CA-1933	25507541
1982	V8 4.4L 267ci	J	w/Auto. Trans.; 49.20" Cable, Universal cable, for temporary fix only, for permanent fix use CA-1933	CA-1981	
1979	V8 5.0L 305ci	H	w/THM200 Auto. Trans.; 38.40" Cable, w/THM200C	CA-1941	1262613

# DETENT CABLES

Year	Engine	Vin	Remark	Part	OE
<b>CHEVROLET (con't)</b>					
<b>MONTE CARLO (con't)</b>					
1979	V8 5.0L 305ci	H	w/THM200 Auto. Trans., THM200C, Universal cable for temporary fix, use CA-1941 for permanent fix	CA-1980	
1979-80	V8 5.0L 305ci	H	w/THM250C Auto. Trans., w/THM350C Auto. Trans.; 45.00" Cable	CA-1951	1262620
1979-80	V8 5.0L 305ci	H	w/THM250C Auto. Trans., w/THM350C Auto. Trans., Universal cable for temporary fix, use CA-1951 for permanent fix; 49.20" Cable	CA-1981	
1980	V8 5.0L 305ci	H	w/THM200C Auto. Trans.; 38.40" Cable	CA-1941	1262613
1980	V8 5.0L 305ci	H	w/THM200C Auto. Trans., Universal cable for temporary fix, use CA-1941 for permanent fix	CA-1980	
1981	V8 5.0L 305ci	H	w/THM200C Auto. Trans.; 37.51" Cable	CA-1943	25507546
1981	V8 5.0L 305ci	H	w/THM200C Auto. Trans., Universal cable for temporary fix, use CA-1943 for permanent fix	CA-1980	
1981-83	V8 5.0L 305ci	H	w/THM250C Auto. Trans., w/THM350C Auto. Trans.; 37.80" Cable	CA-1933	25507541
1981-83	V8 5.0L 305ci	H	w/THM250C Auto. Trans., w/THM350C Auto. Trans., Universal cable for temporary fix only, for permanent fix use CA-1933; 49.20" Cable	CA-1981	
1984	V8 5.0L 305ci	H	w/THM350C Auto. Trans., w/THM250C; 37.80" Cable	CA-1933	25507541
1984	V8 5.0L 305ci	H	w/THM350C Auto. Trans.; 37.80" Cable	CA-1933	25507541
1984	V8 5.0L 305ci	H	w/THM200-4R Auto. Trans.; 37.51" Cable	CA-1943	25507546
1984	V8 5.0L 305ci	H	w/THM200-4R Auto. Trans., Universal cable for temporary fix, use CA-1943 for permanent fix	CA-1980	
1984	V8 5.0L 305ci	H	w/THM350C Auto. Trans.; 49.20" Cable, Universal cable for temporary fix only, for permanent fix use CA-1933	CA-1981	
1984	V8 5.0L 305ci	H	w/THM350C Auto. Trans.; 49.20" Cable, w/THM250C, Universal cable, for temporary fix only, for permanent fix use CA-1933	CA-1981	
1985-88	V8 5.0L 305ci	H	w/THM200-4R Auto. Trans.; 37.51" Cable, w/THM700-4R THM200-4R A.T., THM700-4R, Universal cable for temporary fix, use CA-1943 for permanent fix	CA-1943	25507546
1985-88	V8 5.0L 305ci	H	w/THM200-4R A.T., THM700-4R, Universal cable for temporary fix, use CA-1943 for permanent fix	CA-1980	
1976	V8 5.0L 305ci	Q	w/THM350 Auto. Trans.; 45.00" Cable	CA-1951	1262620
1976	V8 5.0L 305ci	Q	THM350 Auto. Trans.; 49.20" Cable, Universal cable for temporary fix, use CA-1951 for permanent fix	CA-1981	
1977-78	V8 5.0L 305ci	U	w/THM350 Auto. Trans.; 45.00" Cable	CA-1951	1262620
1977-78	V8 5.0L 305ci	U	THM350 Auto. Trans.; 49.20" Cable, Universal cable for temporary fix, use CA-1951 for permanent fix	CA-1981	
1978	V8 5.0L 305ci	U	w/THM200 Auto. Trans.; 38.40" Cable	CA-1941	1262613
1978	V8 5.0L 305ci	U	w/THM200 Auto. Trans., Universal cable for temporary fix, use CA-1941 for permanent fix	CA-1980	
1976-77	V8 5.7L 350ci	L	w/THM350 Auto. Trans.; 45.00" Cable	CA-1951	1262620
1976-77	V8 5.7L 350ci	L	THM350 Auto. Trans.; 49.20" Cable, Universal cable for temporary fix, use CA-1951 for permanent fix	CA-1981	
1981	V8 5.7L 350ci	L	w/Auto. Trans.; 37.80" Cable	CA-1933	25507541
1981	V8 5.7L 350ci	L	w/Auto. Trans.; 49.20" Cable, Universal cable, for temporary fix only, for permanent fix use CA-1933	CA-1981	
1982	V8 5.7L 350ci	N	w/THM350C Auto. Trans. 51.00" Cable	CA-1930	25508265
1982	V8 5.7L 350ci	N	w/THM350C Auto. Trans., Universal cable for temporary fix, use CA-1930 for permanent fix	CA-1980	
1983	V8 5.7L 350ci	N	w/THM200C Auto. Trans., w/THM350C Auto. Trans. 51.00" Cable	CA-1930	25508263
1983	V8 5.7L 350ci	N	w/THM200C Auto. Trans., w/THM350C Auto. Trans., Universal cable for temporary fix, use CA-1930 for permanent fix	CA-1980	

# DETENT CABLES

Year	Engine	Vin	Remark	Part	OE
<b>CHEVROLET (con't)</b>					
<b>MONTE CARLO (con't)</b>					
1984	V8 5.7L 350ci	N	w/THM200C Auto. Trans. 51.00" Cable	CA-1930	25508263
1984	V8 5.7L 350ci	N	w/THM200C Auto. Trans., Universal cable for temporary fix, use CA-1930 for permanent fix	CA-1980	
1976	V8 6.6L 400ci	U	w/THM350 Auto. Trans.; 45.00" Cable	CA-1951	1262620
1976	V8 6.6L 400ci	U	THM350 Auto. Trans.; 49.20" Cable, Universal cable for temporary fix, use CA-1951 for permanent fix	CA-1981	
<b>MONZA</b>					
1976	L4 2.3L 140ci	A	w/THM350 Auto. Trans.; 42.01" Cable	CA-1952	342488
1976	L4 2.3L 140ci	A	THM350 Auto. Trans.; 49.20" Cable, Universal cable for temporary fix, use CA-1952 for permanent fix	CA-1981	
1976-77	L4 2.3L 140ci	B	w/THM350 Auto. Trans.; 42.01" Cable	CA-1952	342488
1976-77	L4 2.3L 140ci	B	THM350 Auto. Trans.; 49.20" Cable, Universal cable for temporary fix, use CA-1952 for permanent fix	CA-1981	
1978-79	V6 3.2L 196ci	C	w/THM350 Auto. Trans.; 33.95" Cable	CA-1955	1262652
1978-79	V6 3.8L 231ci	A	w/THM350 Auto. Trans.; 33.95" Cable	CA-1955	1262652
1980	V6 3.8L 231ci	A	w/THM350 Auto. Trans.; 33.95" Cable, exc. Closed Loop Emissions Control	CA-1955	1262652
1979	V8 5.0L 305ci	G	45.00" Cable	CA-1951	1262620
1979	V8 5.0L 305ci	G	Universal cable for temporary fix, use CA-1951 for permanent fix; 49.20" Cable	CA-1981	
1977	V8 5.0L 305ci	U	w/THM200 Auto. Trans.; 44.68" Cable	CA-1940	1253966
1977	V8 5.0L 305ci	U	w/THM200 Auto. Trans., Universal cable for temporary fix, use CA-1940 for permanent fix	CA-1980	
1977-78	V8 5.0L 305ci	U	w/THM350 Auto. Trans.; 45.00" Cable	CA-1951	1262620
1977-78	V8 5.0L 305ci	U	THM350 Auto. Trans.; 49.20" Cable, Universal cable for temporary fix, use CA-1951 for permanent fix	CA-1981	
<b>NOVA</b>					
1975-79	L6 4.1L 250ci	D	w/THM350 Auto. Trans.; 45.00" Cable	CA-1951	1262618
1975-79	L6 4.1L 250ci	D	THM350 Auto. Trans.; 49.20" Cable, Universal cable for temporary fix, use CA-1951 for permanent fix	CA-1981	
1976	L6 4.1L 250ci	D	w/THM200 Auto. Trans.; 44.68" Cable	CA-1940	1253967
1976	L6 4.1L 250ci	D	w/THM350 Auto. Trans.; 42.01" Cable, exc. Integral Cyl. Head	CA-1952	342486
1976	L6 4.1L 250ci	D	w/THM200 Auto. Trans., Universal cable for temporary fix, use CA-1940 for permanent fix	CA-1980	
1976	L6 4.1L 250ci	D	w/THM350 Auto. Trans.; 49.20" Cable, exc. Integral Cyl. Head, Universal cable for temporary fix, use CA-1952 for permanent fix	CA-1981	
1976-77	L6 4.1L 250ci	D	w/THM350 Auto. Trans.; 45.00" Cable, w/Integral Cyl. Head	CA-1951	1262618
1976-77	L6 4.1L 250ci	D	w/THM350 Auto. Trans.; 49.20" Cable, w/Integral Cyl. Head, Universal cable for temporary fix, use CA-1951 for permanent fix	CA-1981	
1979	V8 5.0L 305ci	G	w/Auto. Trans.; 45.00" Cable	CA-1951	1262620
1979	V8 5.0L 305ci	G	w/Auto. Trans.; 49.20" Cable, Universal cable for temporary fix, use CA-1951 for permanent fix	CA-1981	
1976	V8 5.0L 305ci	Q	w/THM350 Auto. Trans.; 45.00" Cable	CA-1951	1262620
1976	V8 5.0L 305ci	Q	THM350 Auto. Trans.; 49.20" Cable, Universal cable for temporary fix, use CA-1951 for permanent fix	CA-1981	
1977	V8 5.0L 305ci	U	w/THM200 Auto. Trans.; 44.68" Cable	CA-1940	1253966
1977	V8 5.0L 305ci	U	w/THM200 Auto. Trans., Universal cable for temporary fix, use CA-1940 for permanent fix	CA-1980	
1977-78	V8 5.0L 305ci	U	w/Auto. Trans.; 45.00" Cable	CA-1951	1262620
1977-78	V8 5.0L 305ci	U	w/Auto. Trans.; 49.20" Cable, Universal cable for temporary fix, use CA-1951 for permanent fix	CA-1981	

# DETENT CABLES

Year	Engine	Vin	Remark	Part	OE
<b>CHEVROLET (con't)</b>					
<b>NOVA (con't)</b>					
1969	V8 5.0L 307ci		w/TH350	CA-1952	342487
1969	V8 5.0L 307ci		w/TH350, Universal cable for temporary fix, use CA-1952 for permanent fix; 49.20" Cable	CA-1981	
1976-77	V8 5.7L 350ci	L	w/THM350 Auto. Trans.; 45.00" Cable	CA-1951	1262620
1976-77	V8 5.7L 350ci	L	THM350 Auto. Trans.; 49.20" Cable, Universal cable for temporary fix, use CA-1951 for permanent fix	CA-1981	
1978-79	V8 5.7L 350ci	L	w/Auto. Trans.; 45.00" Cable	CA-1951	1262620
1978-79	V8 5.7L 350ci	L	w/Auto. Trans.; 49.20" Cable, Universal cable for temporary fix, use CA-1951 for permanent fix	CA-1981	
1969	V8 5.7L 350ci		w/TH350	CA-1952	342487
1969	V8 5.7L 350ci		w/TH350, Universal cable for temporary fix, use CA-1952 for permanent fix; 49.20" Cable	CA-1981	
<b>VEGA</b>					
1975	L4 2.0L 122ci	O	w/THM350 Auto. Trans.; 42.01" Cable	CA-1952	342488
1975	L4 2.0L 122ci	O	THM350 Auto. Trans.; 49.20" Cable, Universal cable for temporary fix, use CA-1952 for permanent fix	CA-1981	
1974-76	L4 2.3L 140ci	A	w/THM350 Auto. Trans.; 42.01" Cable	CA-1952	342488
1974-76	L4 2.3L 140ci	A	THM350 Auto. Trans.; 49.20" Cable, Universal cable for temporary fix, use CA-1952 for permanent fix	CA-1981	
1971-77	L4 2.3L 140ci	B	w/THM350 Auto. Trans.; 42.01" Cable	CA-1952	342488
1971-77	L4 2.3L 140ci	B	THM350 Auto. Trans.; 49.20" Cable, Universal cable for temporary fix, use CA-1952 for permanent fix	CA-1981	
<b>CHEVROLET TRUCKS</b>					
<b>BLAZER</b>					
1973-74	L6 4.1L 250ci	Q	w/Auto. Trans.; 42.01" Cable	CA-1952	342486
1973-74	L6 4.1L 250ci	Q	w/Auto. Trans.; 49.20" Cable, Universal cable for temporary fix, use CA-1952 for permanent fix	CA-1981	
1973	L6 4.8L 292ci	T	w/Auto. Trans.; 42.01" Cable	CA-1952	342486
1973	L6 4.8L 292ci	T	w/Auto. Trans.; 49.20" Cable, Universal cable for temporary fix, use CA-1952 for permanent fix	CA-1981	
1973-74	V8 5.7L 350ci	V, Y	w/THM350 Auto. Trans.; 42.01" Cable	CA-1952	342487
1973-74	V8 5.7L 350ci	V, Y	THM350 Auto. Trans.; 49.20" Cable, Universal cable for temporary fix, use CA-1952 for permanent fix	CA-1981	
<b>C10</b>					
1976	L6 4.1L 250ci	D	w/Auto. Trans.; 42.01" Cable, w/Heavy Duty Chassis	CA-1952	342486
1976	L6 4.1L 250ci	D	w/Auto. Trans.; 49.20" Cable, w/Heavy Duty Chassis, Universal cable for temporary fix, use CA-1952 for permanent fix	CA-1981	
1976-77	L6 4.1L 250ci	D	w/Auto. Trans.; 42.01" Cable	CA-1952	342486
1976-77	L6 4.1L 250ci	D	w/Auto. Trans.; 49.20" Cable, Universal cable for temporary fix, use CA-1952 for permanent fix	CA-1981	
1977	L6 4.1L 250ci	D	w/THM350 Auto. Trans.; 42.01" Cable, w/Heavy Duty Chassis	CA-1952	342486
1977	L6 4.1L 250ci	D	w/THM350 Auto. Trans.; 49.20" Cable, w/Heavy Duty Chassis, Universal cable for temporary fix, use CA-1952 for permanent fix	CA-1981	
1978	L6 4.1L 250ci	D	w/THM350 Auto. Trans.; 45.00" Cable	CA-1951	1262618
1978	L6 4.1L 250ci	D	THM350 Auto. Trans.; 49.20" Cable, Universal cable for temporary fix, use CA-1951 for permanent fix	CA-1981	
1982	L6 4.1L 250ci	D	w/THM350C Auto. Trans.; 46.69" Cable	CA-1931	25507542
1982	L6 4.1L 250ci	D	w/THM350C Auto. Trans., Universal cable for temporary fix, use CA-1931 for permanent fix	CA-1980	
1982-84	L6 4.1L 250ci	D	w/THM350C Auto. Trans., w/THM700-4R Auto. Trans. 46.69" Cable	CA-1931	25507542

# DETENT CABLES

Year	Engine	Vin	Remark	Part	OE
<b>CHEVROLET TRUCKS (con't)</b>					
<b>C10 (con't)</b>					
1982-84	L6 4.1L 250ci	D	w/THM350C Auto. Trans., w/THM700-4R Auto. Trans., Universal cable for temporary fix, use CA-1931 for permanent fix	CA-1980	
1973-74	L6 4.1L 250ci	Q	w/Auto. Trans.; 42.01" Cable	CA-1952	342486
1973-74	L6 4.1L 250ci	Q	w/Auto. Trans.; 49.20" Cable, Universal cable for temporary fix, use CA-1952 for permanent fix	CA-1981	
1974	L6 4.8L 292ci	S	w/Auto. Trans.; 42.01" Cable	CA-1952	342486
1974	L6 4.8L 292ci	S	w/Auto. Trans.; 49.20" Cable, Universal cable for temporary fix, use CA-1952 for permanent fix	CA-1981	
1978	L6 4.8L 292ci	T	w/THM350 Auto. Trans.; 45.00" Cable	CA-1951	1262618
1978	L6 4.8L 292ci	T	THM350 Auto. Trans.; 49.20" Cable, Universal cable for temporary fix, use CA-1951 for permanent fix	CA-1981	
1973-74	L6 4.8L 292ci	T	w/Auto. Trans.; 42.01" Cable	CA-1952	342486
1973-74	L6 4.8L 292ci	T	w/Auto. Trans.; 49.20" Cable, Universal cable for temporary fix, use CA-1952 for permanent fix	CA-1981	
1975-76	L6 4.8L 292ci	T	w/Auto. Trans.; 42.01" Cable	CA-1952	342486
1975-76	L6 4.8L 292ci	T	w/Auto. Trans.; 49.20" Cable, Universal cable for temporary fix, use CA-1952 for permanent fix	CA-1981	
1981	V8 5.0L 305ci	F	w/THM350C Auto. Trans.; 37.80" Cable	CA-1933	25507541
1981	V8 5.0L 305ci	F	w/THM350C Auto. Trans.; 49.20" Cable, Universal cable for temporary fix only, for permanent fix use CA-1933	CA-1981	
1982-84	V8 5.0L 305ci	F, H	w/THM700-4R Auto. Trans.; 44.50" Cable	CA-1970	25515598
1982-84	V8 5.0L 305ci	F, H	w/THM700-4R Auto. Trans., Universal cable for temporary fix, use CA-1970 for permanent fix	CA-1980	
1980	V8 5.0L 305ci	G	w/THM350 Auto. Trans.; 45.00" Cable	CA-1951	1262620
1980	V8 5.0L 305ci	G	THM350 Auto. Trans.; 49.20" Cable, Universal cable for temporary fix, use CA-1951 for permanent fix	CA-1981	
1981-86	V8 5.0L 305ci	H	w/THM350C Auto. Trans.; 37.80" Cable	CA-1933	25507541
1981-86	V8 5.0L 305ci	H	w/THM350C Auto. Trans.; 49.20" Cable, Universal cable for temporary fix only, for permanent fix use CA-1933	CA-1981	
1976-80	V8 5.7L 350ci	L	w/THM350 Auto. Trans.; 45.00" Cable	CA-1951	1262620
1976-80	V8 5.7L 350ci	L	THM350 Auto. Trans.; 49.20" Cable, Universal cable for temporary fix, use CA-1951 for permanent fix	CA-1981	
1981	V8 5.7L 350ci	L	w/THM350C Auto. Trans.; 37.80" Cable	CA-1933	25507541
1981	V8 5.7L 350ci	L	w/THM350C Auto. Trans.; 49.20" Cable, Universal cable for temporary fix only, for permanent fix use CA-1933	CA-1981	
1982-86	V8 5.7L 350ci	L	w/THM700-4R Auto. Trans.; 44.50" Cable	CA-1970	25515598
1982-86	V8 5.7L 350ci	L	w/THM700-4R Auto. Trans., Universal cable for temporary fix, use CA-1970 for permanent fix	CA-1980	
1974	V8 5.7L 350ci	V, W	w/THM350 Auto. Trans.; 42.01" Cable	CA-1952	342487
1974	V8 5.7L 350ci	V, W	THM350 Auto. Trans.; 49.20" Cable, Universal cable for temporary fix, use CA-1952 for permanent fix	CA-1981	
1975-76	V8 5.7L 350ci	V	w/THM350 Auto. Trans.; 45.00" Cable	CA-1951	1262620
1975-76	V8 5.7L 350ci	V	THM350 Auto. Trans.; 49.20" Cable, Universal cable for temporary fix, use CA-1951 for permanent fix	CA-1981	
1973-74	V8 5.7L 350ci	Y	w/THM350 Auto. Trans.; 42.01" Cable	CA-1952	342487
1973-74	V8 5.7L 350ci	Y	THM350 Auto. Trans.; 49.20" Cable, Universal cable for temporary fix, use CA-1952 for permanent fix	CA-1981	
1975	V8 5.7L 350ci	Y	w/THM350 Auto. Trans.; 45.00" Cable	CA-1951	1262620
1975	V8 5.7L 350ci	Y	THM350 Auto. Trans.; 49.20" Cable, Universal cable for temporary fix, use CA-1951 for permanent fix	CA-1981	
1982-84	V8 6.2L 379ci	C, J	Diesel, w/THM700-4R Auto. Trans.; 36.10" Cable	CA-1960	25515599

# DETENT CABLES

Year	Engine	Vin	Remark	Part	OE
<b>CHEVROLET TRUCKS (con't)</b>					
<b>C10 (con't)</b>					
1982-84	V8 6.2L 379ci	C, J	Diesel, w/THM700-4R Auto. Trans., Universal cable for temporary fix, use CA-1960 for permanent fix	CA-1980	
<b>C10 SUBURBAN</b>					
1982-84	V8 5.0L 305ci	F, H	w/THM700-4R Auto. Trans.; 44.50" Cable	CA-1970	25515598
1982-84	V8 5.0L 305ci	F, H	w/THM700-4R Auto. Trans., Universal cable for temporary fix, use CA-1970 for permanent fix	CA-1980	
1982-86	V8 5.7L 350ci	L	w/THM700-4R Auto. Trans.; 44.50" Cable	CA-1970	25515598
1982-86	V8 5.7L 350ci	L	w/THM700-4R Auto. Trans., Universal cable for temporary fix, use CA-1970 for permanent fix	CA-1980	
1982-84	V8 6.2L 379ci	C	Diesel, w/THM700-4R Auto. Trans.; 36.10" Cable	CA-1960	25515599
1982-84	V8 6.2L 379ci	C	Diesel, w/THM700-4R Auto. Trans., Universal cable for temporary fix, use CA-1960 for permanent fix	CA-1980	
<b>C1500</b>					
1988-89	V6 4.3L 262ci	Z	w/THM700-4R Auto. Trans.; 44.50" Cable	CA-1970	25515598
1988-89	V6 4.3L 262ci	Z	w/THM700-4R Auto. Trans., Universal cable for temporary fix, use CA-1970 for permanent fix	CA-1980	
<b>C20</b>					
1978	L6 4.1L 250ci	D	w/THM350 Auto. Trans.; 45.00" Cable	CA-1951	1262618
1978	L6 4.1L 250ci	D	THM350 Auto. Trans.; 49.20" Cable, Universal cable for temporary fix, use CA-1951 for permanent fix	CA-1981	
1982-84	L6 4.1L 250ci	D	w/THM700-4R Auto. Trans.; 46.69" Cable	CA-1931	25515600
1982-84	L6 4.1L 250ci	D	w/THM700-4R Auto. Trans., Universal cable for temporary fix, use CA-1931 for permanent fix	CA-1980	
1973-74	L6 4.1L 250ci	Q	w/Auto. Trans.; 42.01" Cable	CA-1952	342486
1973-74	L6 4.1L 250ci	Q	w/Auto. Trans.; 49.20" Cable, Universal cable for temporary fix, use CA-1952 for permanent fix	CA-1981	
1974	L6 4.8L 292ci	S	w/Auto. Trans.; 42.01" Cable	CA-1952	342486
1974	L6 4.8L 292ci	S	w/Auto. Trans.; 49.20" Cable, Universal cable for temporary fix, use CA-1952 for permanent fix	CA-1981	
1978	L6 4.8L 292ci	T	w/THM350 Auto. Trans.; 45.00" Cable	CA-1951	1262618
1978	L6 4.8L 292ci	T	THM350 Auto. Trans.; 49.20" Cable, Universal cable for temporary fix, use CA-1951 for permanent fix	CA-1981	
1973-74	L6 4.8L 292ci	T	w/Auto. Trans.; 42.01" Cable	CA-1952	342486
1973-74	L6 4.8L 292ci	T	w/Auto. Trans.; 49.20" Cable, Universal cable for temporary fix, use CA-1952 for permanent fix	CA-1981	
1975-76	L6 4.8L 292ci	T	w/Auto. Trans.; 42.01" Cable	CA-1952	342486
1975-76	L6 4.8L 292ci	T	w/Auto. Trans.; 49.20" Cable, Universal cable for temporary fix, use CA-1952 for permanent fix	CA-1981	
1980	V8 5.0L 305ci	G	w/THM350 Auto. Trans.; 45.00" Cable	CA-1951	1262620
1980	V8 5.0L 305ci	G	THM350 Auto. Trans.; 49.20" Cable, Universal cable for temporary fix, use CA-1951 for permanent fix	CA-1981	
1981	V8 5.0L 305ci	H	w/THM350C Auto. Trans.; 37.80" Cable	CA-1933	25507541
1981	V8 5.0L 305ci	H	w/THM350C Auto. Trans.; 49.20" Cable, Universal cable for temporary fix only, for permanent fix use CA-1933	CA-1981	
1982-84	V8 5.0L 305ci	H	w/THM700-4R Auto. Trans.; 44.50" Cable	CA-1970	25515598
1982-84	V8 5.0L 305ci	H	w/THM700-4R Auto. Trans., Universal cable for temporary fix, use CA-1970 for permanent fix	CA-1980	
1976-80	V8 5.7L 350ci	L	w/THM350 Auto. Trans.; 45.00" Cable	CA-1951	1262620
1976-80	V8 5.7L 350ci	L	THM350 Auto. Trans.; 49.20" Cable, Universal cable for temporary fix, use CA-1951 for permanent fix	CA-1981	
1981	V8 5.7L 350ci	L	w/THM350C Auto. Trans.; 37.80" Cable	CA-1933	25507541
1981	V8 5.7L 350ci	L	w/THM350C Auto. Trans.; 49.20" Cable, Universal cable for temporary fix only, for permanent fix use CA-1933	CA-1981	



# DETENT CABLES

Year	Engine	Vin	Remark	Part	OE
<b>CHEVROLET TRUCKS (con't)</b>					
<b>C20 (con't)</b>					
1982-86	V8 5.7L 350ci	L	w/THM700-4R Auto. Trans.; 44.50" Cable	CA-1970	25515598
1982-86	V8 5.7L 350ci	L	w/THM700-4R Auto. Trans., Universal cable for temporary fix, use CA-1970 for permanent fix	CA-1980	
1974	V8 5.7L 350ci	V, W	w/THM350 Auto. Trans.; 42.01" Cable	CA-1952	342487
1974	V8 5.7L 350ci	V, W	THM350 Auto. Trans.; 49.20" Cable, Universal cable for temporary fix, use CA-1952 for permanent fix	CA-1981	
1975-76	V8 5.7L 350ci	V	w/THM350 Auto. Trans.; 45.00" Cable	CA-1951	1262620
1975-76	V8 5.7L 350ci	V	THM350 Auto. Trans.; 49.20" Cable, Universal cable for temporary fix, use CA-1951 for permanent fix	CA-1981	
1973-74	V8 5.7L 350ci	Y	w/THM350 Auto. Trans.; 42.01" Cable	CA-1952	342487
1973-74	V8 5.7L 350ci	Y	THM350 Auto. Trans.; 49.20" Cable, Universal cable for temporary fix, use CA-1952 for permanent fix	CA-1981	
1975	V8 5.7L 350ci	Y	w/THM350 Auto. Trans.; 45.00" Cable	CA-1951	1262620
1975	V8 5.7L 350ci	Y	THM350 Auto. Trans.; 49.20" Cable, Universal cable for temporary fix, use CA-1951 for permanent fix	CA-1981	
1982-84	V8 6.2L 379ci	C, J	Diesel, w/THM700-4R Auto. Trans.; 36.10" Cable	CA-1960	25515599
1982-84	V8 6.2L 379ci	C, J	Diesel, w/THM700-4R Auto. Trans., Universal cable for temporary fix, use CA-1960 for permanent fix	CA-1980	
<b>C20 SUBURBAN</b>					
1982-84	V8 5.0L 305ci	H	w/THM700-4R Auto. Trans.; 44.50" Cable	CA-1970	25515598
1982-84	V8 5.0L 305ci	H	w/THM700-4R Auto. Trans., Universal cable for temporary fix, use CA-1970 for permanent fix	CA-1980	
1982-84	V8 6.2L 379ci	J	Diesel, w/THM700-4R Auto. Trans.; 36.10" Cable	CA-1960	25515599
1982-84	V8 6.2L 379ci	J	Diesel, w/THM700-4R Auto. Trans., Universal cable for temporary fix, use CA-1960 for permanent fix	CA-1980	
<b>C30</b>					
1976	L6 4.8L 292ci	T	w/Auto. Trans.; 42.01" Cable	CA-1952	342486
1976	L6 4.8L 292ci	T	w/Auto. Trans.; 49.20" Cable, Universal cable for temporary fix, use CA-1952 for permanent fix	CA-1981	
1978	L6 4.8L 292ci	T	w/THM350 Auto. Trans.; 45.00" Cable	CA-1951	1262618
1978	L6 4.8L 292ci	T	THM350 Auto. Trans.; 49.20" Cable, Universal cable for temporary fix, use CA-1951 for permanent fix	CA-1981	
1976-80	V8 5.7L 350ci	L	w/THM350 Auto. Trans.; 45.00" Cable	CA-1951	1262620
1976-80	V8 5.7L 350ci	L	THM350 Auto. Trans.; 49.20" Cable, Universal cable for temporary fix, use CA-1951 for permanent fix	CA-1981	
1974	V8 5.7L 350ci	V, W	w/THM350 Auto. Trans.; 42.01" Cable	CA-1952	342487
1974	V8 5.7L 350ci	V, W	THM350 Auto. Trans.; 49.20" Cable, Universal cable for temporary fix, use CA-1952 for permanent fix	CA-1981	
1975-76	V8 5.7L 350ci	V	w/THM350 Auto. Trans.; 45.00" Cable	CA-1951	1262620
1975-76	V8 5.7L 350ci	V	THM350 Auto. Trans.; 49.20" Cable, Universal cable for temporary fix, use CA-1951 for permanent fix	CA-1981	
1973-74	V8 5.7L 350ci	Y	w/THM350 Auto. Trans.; 42.01" Cable	CA-1952	342487
1973-74	V8 5.7L 350ci	Y	THM350 Auto. Trans.; 49.20" Cable, Universal cable for temporary fix, use CA-1952 for permanent fix	CA-1981	
1975	V8 5.7L 350ci	Y	w/THM350 Auto. Trans.; 45.00" Cable	CA-1951	1262620
1975	V8 5.7L 350ci	Y	THM350 Auto. Trans.; 49.20" Cable, Universal cable for temporary fix, use CA-1951 for permanent fix	CA-1981	
1978	V8 5.7L 350ci	Z	w/THM350 Auto. Trans.; 45.00" Cable	CA-1951	1262620
1978	V8 5.7L 350ci	Z	THM350 Auto. Trans.; 49.20" Cable, Universal cable for temporary fix, use CA-1951 for permanent fix	CA-1981	
<b>EL CAMINO</b>					
1976-77	L6 4.1L 250ci	D	w/THM350 Auto. Trans.; 45.00" Cable, w/Integral Cyl. Head	CA-1951	1262618

# DETENT CABLES

Year	Engine	Vin	Remark	Part	OE
<b>CHEVROLET TRUCKS (con't)</b>					
<b>EL CAMINO (con't)</b>					
1976-77	L6 4.1L 250ci	D	w/THM350 Auto. Trans.; 49.20" Cable, w/Integral Cyl. Head, Universal cable for temporary fix, use CA-1951 for permanent fix	CA-1981	
1978-79	V6 3.3L 200ci	M	w/THM200 Auto. Trans.; 35.00" Cable	CA-1947	1262612
1978-79	V6 3.3L 200ci	M	w/THM200 Auto. Trans., Universal cable for temporary fix, use CA-1947 for permanent fix	CA-1980	
1984	V6 3.8L 229ci	9	w/THM200-4R Auto. Trans.; 37.51" Cable	CA-1943	25507545
1984	V6 3.8L 229ci	9	w/THM200-4R Auto. Trans., Universal cable for temporary fix, use CA-1943 for permanent fix	CA-1980	
1980	V6 3.8L 229ci	K	w/THM200C Auto. Trans.; 35.00" Cable	CA-1947	1262612
1980	V6 3.8L 229ci	K	w/THM200C Auto. Trans., Universal cable for temporary fix, use CA-1947 for permanent fix	CA-1980	
1981	V6 3.8L 229ci	K	w/THM200C Auto. Trans.; 37.51" Cable	CA-1943	25507545
1981	V6 3.8L 229ci	K	w/THM200C Auto. Trans., Universal cable for temporary fix, use CA-1943 for permanent fix	CA-1980	
1980	V6 3.8L 231ci	A	w/THM200C Auto. Trans.; 35.00" Cable	CA-1947	1262612
1980	V6 3.8L 231ci	A	w/THM200C Auto. Trans., Universal cable for temporary fix, use CA-1947 for permanent fix	CA-1980	
1981	V6 3.8L 231ci	A	w/THM200C Auto. Trans.; 37.51" Cable	CA-1943	25507545
1981	V6 3.8L 231ci	A	w/THM200C Auto. Trans.; 36.10" Cable	CA-1960	25505175
1981	V6 3.8L 231ci	A	w/THM200C Auto. Trans., Universal cable for temporary fix, use CA-1943 for permanent fix	CA-1980	
1981	V6 3.8L 231ci	A	w/THM200C Auto. Trans., Universal cable for temporary fix, use CA-1960 for permanent fix	CA-1980	
1982-83	V6 3.8L 231ci	A	w/THM250C Auto. Trans., w/THM350C Auto. Trans.; 36.10" Cable	CA-1960	25505174
1982-83	V6 3.8L 231ci	A	w/THM250C Auto. Trans., w/THM350C Auto. Trans., Universal cable for temporary fix, use CA-1960 for permanent fix	CA-1980	
1984	V6 3.8L 231ci	A	w/THM200C Auto. Trans.; 36.10" Cable, w/THM250C	CA-1960	25505175
1984	V6 3.8L 231ci	A	THM200C Auto. Trans., w/THM250C, Universal cable for temporary fix, use CA-1960 for permanent fix	CA-1980	
1985-87	V6 4.3L 262ci	Z	w/THM200C Auto. Trans., w/THM200-4R Auto. Trans.; 37.51" Cable	CA-1943	25521267
1985-87	V6 4.3L 262ci	Z	w/THM200C Auto. Trans., w/THM200-4R Auto. Trans., Universal cable for temporary fix, use CA-1943 for permanent fix	CA-1980	
1979	V8 4.4L 267ci	J	w/THM200 Auto. Trans.; 38.40" Cable	CA-1941	1262613
1979	V8 4.4L 267ci	J	w/THM350 Auto. Trans.; 45.00" Cable	CA-1951	1262620
1979	V8 4.4L 267ci	J	w/THM200 Auto. Trans., Universal cable for temporary fix, use CA-1941 for permanent fix	CA-1980	
1979	V8 4.4L 267ci	J	THM350 Auto. Trans.; 49.20" Cable, Universal cable for temporary fix, use CA-1951 for permanent fix	CA-1981	
1980	V8 4.4L 267ci	J	w/THM250C Auto. Trans., w/THM350 Auto. Trans.; 45.00" Cable	CA-1951	1262620
1980	V8 4.4L 267ci	J	w/THM250C Auto. Trans., w/THM350 Auto. Trans., Universal cable for temporary fix, use CA-1951 for permanent fix; 49.20" Cable	CA-1981	
1981	V8 4.4L 267ci	J	w/THM250C Auto. Trans., w/THM350C Auto. Trans.; 37.80" Cable	CA-1933	25507541
1981	V8 4.4L 267ci	J	w/THM200C Auto. Trans.; 37.51" Cable	CA-1943	25507546
1981	V8 4.4L 267ci	J	w/THM200C Auto. Trans., Universal cable for temporary fix, use CA-1943 for permanent fix	CA-1980	
1981	V8 4.4L 267ci	J	w/THM250C Auto. Trans., w/THM350C Auto. Trans., Universal cable for temporary fix only, for permanent fix use CA-1933; 49.20" Cable	CA-1981	

# DETENT CABLES

Year	Engine	Vin	Remark	Part	OE
<b>CHEVROLET TRUCKS (con't)</b>					
<b>EL CAMINO (con't)</b>					
1982	V8 4.4L 267ci	J	w/Auto. Trans.; 37.80" Cable	CA-1933	25507541
1982	V8 4.4L 267ci	J	w/Auto. Trans.; 49.20" Cable, Universal cable, for temporary fix only, for permanent fix use CA-1933	CA-1981	
1979	V8 5.0L 305ci	H	w/THM200 Auto. Trans.; 38.40" Cable, w/THM200C	CA-1941	1262613
1979	V8 5.0L 305ci	H	w/THM200 Auto. Trans., THM200C, Universal cable for temporary fix, use CA-1941 for permanent fix	CA-1980	
1979-80	V8 5.0L 305ci	H	w/THM250C Auto. Trans., w/THM350C Auto. Trans.; 45.00" Cable	CA-1951	1262620
1979-80	V8 5.0L 305ci	H	w/THM250C Auto. Trans., w/THM350C Auto. Trans., Universal cable for temporary fix, use CA-1951 for permanent fix; 49.20" Cable	CA-1981	
1980	V8 5.0L 305ci	H	w/THM200C Auto. Trans.; 38.40" Cable	CA-1941	1262613
1980	V8 5.0L 305ci	H	w/THM200C Auto. Trans., Universal cable for temporary fix, use CA-1941 for permanent fix	CA-1980	
1981	V8 5.0L 305ci	H	w/THM250C Auto. Trans., w/THM350C Auto. Trans.; 37.80" Cable	CA-1933	25507541
1981	V8 5.0L 305ci	H	w/THM200C Auto. Trans.; 37.51" Cable	CA-1943	25507546
1981	V8 5.0L 305ci	H	w/THM200C Auto. Trans., Universal cable for temporary fix, use CA-1943 for permanent fix	CA-1980	
1981	V8 5.0L 305ci	H	w/THM250C Auto. Trans., w/THM350C Auto. Trans., Universal cable for temporary fix only, for permanent fix use CA-1933; 49.20" Cable	CA-1981	
1982-83	V8 5.0L 305ci	H	w/THM250C Auto. Trans., w/THM350C; 37.80" Cable	CA-1933	25507541
1982-83	V8 5.0L 305ci	H	w/THM250C Auto. Trans.; 49.20" Cable, w/THM350C, Universal cable, for temporary fix only, for permanent fix use CA-1933	CA-1981	
1984	V8 5.0L 305ci	H	w/THM200-4R Auto. Trans., w/THM350C Auto. Trans.; 37.80" Cable	CA-1933	25507541
1984	V8 5.0L 305ci	H	w/THM200-4R Auto. Trans.; 49.20" Cable, w/THM350C Auto. Trans., Universal cable, for temporary fix only, for permanent fix use CA-1933	CA-1981	
1985-87	V8 5.0L 305ci	H	w/THM200-4R Auto. Trans.; 37.51" Cable, w/THM700-4R	CA-1943	25507546
1985-87	V8 5.0L 305ci	H	THM200-4R Auto. Trans., THM700-4R, Univ. cable for temporary fix, use CA-1943 for permanent fix	CA-1980	
1976	V8 5.0L 305ci	Q	w/THM350 Auto. Trans.; 45.00" Cable	CA-1951	1262620
1976	V8 5.0L 305ci	Q	THM350 Auto. Trans.; 49.20" Cable, Universal cable for temporary fix, use CA-1951 for permanent fix	CA-1981	
1977-78	V8 5.0L 305ci	U	w/THM350 Auto. Trans.; 45.00" Cable	CA-1951	1262620
1977-78	V8 5.0L 305ci	U	THM350 Auto. Trans.; 49.20" Cable, Universal cable for temporary fix, use CA-1951 for permanent fix	CA-1981	
1978	V8 5.0L 305ci	U	w/THM200 Auto. Trans.; 38.40" Cable	CA-1941	1262613
1978	V8 5.0L 305ci	U	w/THM200 Auto. Trans., Universal cable for temporary fix, use CA-1941 for permanent fix	CA-1980	
1976-79	V8 5.7L 350ci	L	w/THM350 Auto. Trans.; 45.00" Cable	CA-1951	1262620
1976-79	V8 5.7L 350ci	L	THM350 Auto. Trans.; 49.20" Cable, Universal cable for temporary fix, use CA-1951 for permanent fix	CA-1981	
1978	V8 5.7L 350ci	L	w/THM200 Auto. Trans.; 38.40" Cable	CA-1941	1262613
1978	V8 5.7L 350ci	L	w/THM200 Auto. Trans., Universal cable for temporary fix, use CA-1941 for permanent fix	CA-1980	
1983	V8 5.7L 350ci	N	w/THM200C Auto. Trans., w/THM350C 51.00" Cable	CA-1930	25508265
1983	V8 5.7L 350ci	N	THM200C Auto. Trans., w/THM350C, Universal cable for temporary fix, use CA-1930 for permanent fix	CA-1980	
1984	V8 5.7L 350ci	N	w/THM200C Auto. Trans. 51.00" Cable	CA-1930	25508263
1984	V8 5.7L 350ci	N	w/THM200C Auto. Trans., Universal cable for temporary fix, use CA-1930 for permanent fix	CA-1980	

# DETENT CABLES

Year	Engine	Vin	Remark	Part	OE
<b>CHEVROLET TRUCKS (con't)</b>					
<b>EL CAMINO (con't)</b>					
1976	V8 6.6L 400ci	U	w/THM350 Auto. Trans.; 45.00" Cable	CA-1951	1262620
1976	V8 6.6L 400ci	U	THM350 Auto. Trans.; 49.20" Cable, Universal cable for temporary fix, use CA-1951 for permanent fix	CA-1981	
<b>G10</b>					
1978	L6 4.1L 250ci	D	w/THM350 Auto. Trans.; 45.00" Cable	CA-1951	1262618
1978	L6 4.1L 250ci	D	THM350 Auto. Trans.; 49.20" Cable, Universal cable for temporary fix, use CA-1951 for permanent fix	CA-1981	
1984	L6 4.1L 250ci	D	w/THM350C Auto. Trans.; 46.69" Cable	CA-1931	25507542
1984	L6 4.1L 250ci	D	w/THM350C Auto. Trans., Universal cable for temporary fix, use CA-1931 for permanent fix	CA-1980	
1980	V8 5.0L 305ci	G	w/THM350 Auto. Trans.; 45.00" Cable	CA-1951	1262620
1980	V8 5.0L 305ci	G	THM350 Auto. Trans.; 49.20" Cable, Universal cable for temporary fix, use CA-1951 for permanent fix	CA-1981	
1981-86	V8 5.0L 305ci	H	w/THM350C Auto. Trans.; 37.80" Cable	CA-1933	25507541
1981-86	V8 5.0L 305ci	H	w/THM350C Auto. Trans.; 49.20" Cable, Universal cable for temporary fix only, for permanent fix use CA-1933	CA-1981	
1983-86	V8 5.0L 305ci	H	w/THM700-4R Auto. Trans.; 44.50" Cable	CA-1970	25515598
1983-86	V8 5.0L 305ci	H	w/THM700-4R Auto. Trans., Universal cable for temporary fix, use CA-1970 for permanent fix	CA-1980	
1976-80	V8 5.7L 350ci	L	w/THM350 Auto. Trans.; 45.00" Cable	CA-1951	1262620
1976-80	V8 5.7L 350ci	L	THM350 Auto. Trans.; 49.20" Cable, Universal cable for temporary fix, use CA-1951 for permanent fix	CA-1981	
1982	V8 5.7L 350ci	L	w/THM350C Auto. Trans.; 37.80" Cable	CA-1933	25507541
1982	V8 5.7L 350ci	L	w/THM350C Auto. Trans.; 49.20" Cable, Universal cable for temporary fix only, for permanent fix use CA-1933	CA-1981	
1983-84	V8 5.7L 350ci	L	w/THM700-4R Auto. Trans.; 44.50" Cable	CA-1970	25515598
1983-84	V8 5.7L 350ci	L	w/THM700-4R Auto. Trans., Universal cable for temporary fix, use CA-1970 for permanent fix	CA-1980	
1974	V8 5.7L 350ci	V	w/THM350 Auto. Trans.; 42.01" Cable	CA-1952	342487
1974	V8 5.7L 350ci	V	THM350 Auto. Trans.; 49.20" Cable, Universal cable for temporary fix, use CA-1952 for permanent fix	CA-1981	
1975-76	V8 5.7L 350ci	V	w/THM350 Auto. Trans.; 45.00" Cable	CA-1951	1262620
1975-76	V8 5.7L 350ci	V	THM350 Auto. Trans.; 49.20" Cable, Universal cable for temporary fix, use CA-1951 for permanent fix	CA-1981	
1973-74	V8 5.7L 350ci	Y	w/THM350 Auto. Trans.; 42.01" Cable	CA-1952	342487
1973-74	V8 5.7L 350ci	Y	THM350 Auto. Trans.; 49.20" Cable, Universal cable for temporary fix, use CA-1952 for permanent fix	CA-1981	
1975	V8 5.7L 350ci	Y	w/THM350 Auto. Trans.; 45.00" Cable	CA-1951	1262620
1975	V8 5.7L 350ci	Y	THM350 Auto. Trans.; 49.20" Cable, Universal cable for temporary fix, use CA-1951 for permanent fix	CA-1981	
<b>G20</b>					
1978	L6 4.1L 250ci	D	w/THM350 Auto. Trans.; 45.00" Cable	CA-1951	1262618
1978	L6 4.1L 250ci	D	THM350 Auto. Trans.; 49.20" Cable, Universal cable for temporary fix, use CA-1951 for permanent fix	CA-1981	
1984	L6 4.1L 250ci	D	w/THM350C Auto. Trans.; 46.69" Cable	CA-1931	25507542
1984	L6 4.1L 250ci	D	w/THM350C Auto. Trans., Universal cable for temporary fix, use CA-1931 for permanent fix	CA-1980	
1975-76	L6 4.8L 292ci	T	w/Auto. Trans.; 42.01" Cable	CA-1952	342486
1975-76	L6 4.8L 292ci	T	w/Auto. Trans.; 49.20" Cable, Universal cable for temporary fix, use CA-1952 for permanent fix	CA-1981	
1978	L6 4.8L 292ci	T	w/THM350 Auto. Trans.; 45.00" Cable	CA-1951	1262618
1978	L6 4.8L 292ci	T	THM350 Auto. Trans.; 49.20" Cable, Universal cable for temporary fix, use CA-1951 for permanent fix	CA-1981	

# DETENT CABLES

Year	Engine	Vin	Remark	Part	OE
<b>CHEVROLET TRUCKS (con't)</b>					
<b>G20 (con't)</b>					
1980	V8 5.0L 305ci	G	w/THM350 Auto. Trans.; 45.00" Cable	CA-1951	1262620
1980	V8 5.0L 305ci	G	THM350 Auto. Trans.; 49.20" Cable, Universal cable for temporary fix, use CA-1951 for permanent fix	CA-1981	
1981-86	V8 5.0L 305ci	H	w/THM350C Auto. Trans.; 37.80" Cable	CA-1933	25507541
1981-86	V8 5.0L 305ci	H	w/THM350C Auto. Trans.; 49.20" Cable, Universal cable for temporary fix only, for permanent fix use CA-1933	CA-1981	
1983-86	V8 5.0L 305ci	H	w/THM700-4R Auto. Trans.; 44.50" Cable	CA-1970	25515598
1983-86	V8 5.0L 305ci	H	w/THM700-4R Auto. Trans., Universal cable for temporary fix, use CA-1970 for permanent fix	CA-1980	
1976-80	V8 5.7L 350ci	L	w/THM350 Auto. Trans.; 45.00" Cable	CA-1951	1262620
1976-80	V8 5.7L 350ci	L	THM350 Auto. Trans.; 49.20" Cable, Universal cable for temporary fix, use CA-1951 for permanent fix	CA-1981	
1984-86	V8 5.7L 350ci	L	w/THM700-4R Auto. Trans.; 44.50" Cable	CA-1970	25515598
1984-86	V8 5.7L 350ci	L	w/THM700-4R Auto. Trans., Universal cable for temporary fix, use CA-1970 for permanent fix	CA-1980	
1981-82	V8 5.7L 350ci	M	w/THM350C Auto. Trans.; 37.80" Cable	CA-1933	25507541
1981-82	V8 5.7L 350ci	M	w/THM350C Auto. Trans.; 49.20" Cable, Universal cable for temporary fix only, for permanent fix use CA-1933	CA-1981	
1984-86	V8 5.7L 350ci	M	w/THM700-4R Auto. Trans.; 44.50" Cable	CA-1970	25515598
1984-86	V8 5.7L 350ci	M	w/THM700-4R Auto. Trans., Universal cable for temporary fix, use CA-1970 for permanent fix	CA-1980	
1974	V8 5.7L 350ci	V, W	w/THM350 Auto. Trans.; 42.01" Cable	CA-1952	342487
1974	V8 5.7L 350ci	V, W	THM350 Auto. Trans.; 49.20" Cable, Universal cable for temporary fix, use CA-1952 for permanent fix	CA-1981	
1975-76	V8 5.7L 350ci	V	w/THM350 Auto. Trans.; 45.00" Cable	CA-1951	1262620
1975-76	V8 5.7L 350ci	V	THM350 Auto. Trans.; 49.20" Cable, Universal cable for temporary fix, use CA-1951 for permanent fix	CA-1981	
1973-74	V8 5.7L 350ci	Y	w/THM350 Auto. Trans.; 42.01" Cable	CA-1952	342487
1973-74	V8 5.7L 350ci	Y	THM350 Auto. Trans.; 49.20" Cable, Universal cable for temporary fix, use CA-1952 for permanent fix	CA-1981	
1975	V8 5.7L 350ci	Y	w/THM350 Auto. Trans.; 45.00" Cable	CA-1951	1262620
1975	V8 5.7L 350ci	Y	THM350 Auto. Trans.; 49.20" Cable, Universal cable for temporary fix, use CA-1951 for permanent fix	CA-1981	
1983-84	V8 6.2L 379ci	C, J	w/Auto. Trans.; 36.10" Cable	CA-1960	25515599
1983-84	V8 6.2L 379ci	C, J	w/Auto. Trans., Universal cable for temporary fix, use CA-1960 for permanent fix	CA-1980	
<b>G30</b>					
1978	L6 4.1L 250ci	D	w/THM350 Auto. Trans.; 45.00" Cable	CA-1951	1262618
1978	L6 4.1L 250ci	D	THM350 Auto. Trans.; 49.20" Cable, Universal cable for temporary fix, use CA-1951 for permanent fix	CA-1981	
1975-76	L6 4.8L 292ci	T	w/Auto. Trans.; 42.01" Cable	CA-1952	342486
1975-76	L6 4.8L 292ci	T	w/Auto. Trans.; 49.20" Cable, Universal cable for temporary fix, use CA-1952 for permanent fix	CA-1981	
1978	L6 4.8L 292ci	T	w/THM350 Auto. Trans.; 45.00" Cable	CA-1951	1262618
1978	L6 4.8L 292ci	T	THM350 Auto. Trans.; 49.20" Cable, Universal cable for temporary fix, use CA-1951 for permanent fix	CA-1981	
1982	V8 5.0L 305ci	H	w/THM350C Auto. Trans.; 37.80" Cable	CA-1933	25507541
1982	V8 5.0L 305ci	H	w/THM350C Auto. Trans.; 49.20" Cable, Universal cable for temporary fix only, for permanent fix use CA-1933	CA-1981	
1976-80	V8 5.7L 350ci	L	w/THM350 Auto. Trans.; 45.00" Cable	CA-1951	1262620
1976-80	V8 5.7L 350ci	L	THM350 Auto. Trans.; 49.20" Cable, Universal cable for temporary fix, use CA-1951 for permanent fix	CA-1981	

# DETENT CABLES

Year	Engine	Vin	Remark	Part	OE
<b>CHEVROLET TRUCKS (con't)</b>					
<b>G30 (con't)</b>					
1981-82	V8 5.7L 350ci	M	w/THM350C Auto. Trans.; 37.80" Cable	CA-1933	25507541
1981-82	V8 5.7L 350ci	M	w/THM350C Auto. Trans.; 49.20" Cable, Universal cable for temporary fix only, for permanent fix use CA-1933	CA-1981	
1983-86	V8 5.7L 350ci	M	w/THM700-4R Auto. Trans.; 44.50" Cable	CA-1970	25515598
1983-86	V8 5.7L 350ci	M	w/THM700-4R Auto. Trans., Universal cable for temporary fix, use CA-1970 for permanent fix	CA-1980	
1974	V8 5.7L 350ci	V	w/THM350 Auto. Trans.; 42.01" Cable	CA-1952	342487
1974	V8 5.7L 350ci	V	THM350 Auto. Trans.; 49.20" Cable, Universal cable for temporary fix, use CA-1952 for permanent fix	CA-1981	
1975-76	V8 5.7L 350ci	V	w/THM350 Auto. Trans.; 45.00" Cable	CA-1951	1262620
1975-76	V8 5.7L 350ci	V	THM350 Auto. Trans.; 49.20" Cable, Universal cable for temporary fix, use CA-1951 for permanent fix	CA-1981	
1973-74	V8 5.7L 350ci	Y	w/THM350 Auto. Trans.; 42.01" Cable	CA-1952	342487
1973-74	V8 5.7L 350ci	Y	THM350 Auto. Trans.; 49.20" Cable, Universal cable for temporary fix, use CA-1952 for permanent fix	CA-1981	
1975	V8 5.7L 350ci	Y	w/THM350 Auto. Trans.; 45.00" Cable	CA-1951	1262620
1975	V8 5.7L 350ci	Y	THM350 Auto. Trans.; 49.20" Cable, Universal cable for temporary fix, use CA-1951 for permanent fix	CA-1981	
1983-84	V8 6.2L 379ci	J	w/Auto. Trans.; 36.10" Cable	CA-1960	25515599
1983-84	V8 6.2L 379ci	J	w/Auto. Trans., Universal cable for temporary fix, use CA-1960 for permanent fix	CA-1980	
<b>K10</b>					
1978	L6 4.1L 250ci	D	w/THM350 Auto. Trans.; 45.00" Cable	CA-1951	1262618
1978	L6 4.1L 250ci	D	THM350 Auto. Trans.; 49.20" Cable, Universal cable for temporary fix, use CA-1951 for permanent fix	CA-1981	
1982-84	L6 4.1L 250ci	D	w/THM700-4R Auto. Trans. 46.69" Cable	CA-1931	25515600
1982-84	L6 4.1L 250ci	D	w/THM700-4R Auto. Trans., Universal cable for temporary fix, use CA-1931 for permanent fix	CA-1980	
1973-74	L6 4.1L 250ci	Q	w/Auto. Trans.; 42.01" Cable	CA-1952	342486
1973-74	L6 4.1L 250ci	Q	w/Auto. Trans.; 49.20" Cable, Universal cable for temporary fix, use CA-1952 for permanent fix	CA-1981	
1975-76	L6 4.8L 292ci	T	w/Auto. Trans.; 42.01" Cable	CA-1952	342486
1975-76	L6 4.8L 292ci	T	w/Auto. Trans.; 49.20" Cable, Universal cable for temporary fix, use CA-1952 for permanent fix	CA-1981	
1981-82	V8 5.0L 305ci	H	w/THM350C Auto. Trans.; 37.80" Cable	CA-1933	25507541
1981-82	V8 5.0L 305ci	H	w/THM350C Auto. Trans.; 49.20" Cable, Universal cable for temporary fix only, for permanent fix use CA-1933	CA-1981	
1982-84	V8 5.0L 305ci	H	w/THM700-4R Auto. Trans.; 44.50" Cable	CA-1970	25515598
1982-84	V8 5.0L 305ci	H	w/THM700-4R Auto. Trans., Universal cable for temporary fix, use CA-1970 for permanent fix	CA-1980	
1976-80	V8 5.7L 350ci	L	w/THM350 Auto. Trans.; 45.00" Cable	CA-1951	1262620
1976-80	V8 5.7L 350ci	L	THM350 Auto. Trans.; 49.20" Cable, Universal cable for temporary fix, use CA-1951 for permanent fix	CA-1981	
1981	V8 5.7L 350ci	L	w/THM350C Auto. Trans.; 37.80" Cable	CA-1933	25507541
1981	V8 5.7L 350ci	L	w/THM350C Auto. Trans.; 49.20" Cable, Universal cable for temporary fix only, for permanent fix use CA-1933	CA-1981	
1982-86	V8 5.7L 350ci	L	w/THM700-4R Auto. Trans.; 44.50" Cable	CA-1970	25515598
1982-86	V8 5.7L 350ci	L	w/THM700-4R Auto. Trans., Universal cable for temporary fix, use CA-1970 for permanent fix	CA-1980	
1974	V8 5.7L 350ci	V	w/THM350 Auto. Trans.; 42.01" Cable	CA-1952	342487
1974	V8 5.7L 350ci	V	THM350 Auto. Trans.; 49.20" Cable, Universal cable for temporary fix, use CA-1952 for permanent fix	CA-1981	

# DETENT CABLES

Year	Engine	Vin	Remark	Part	OE
<b>CHEVROLET TRUCKS (con't)</b>					
<b>K10 (con't)</b>					
1975-76	V8 5.7L 350ci	V	w/THM350 Auto. Trans.; 45.00" Cable	CA-1951	1262620
1975-76	V8 5.7L 350ci	V	THM350 Auto. Trans.; 49.20" Cable, Universal cable for temporary fix, use CA-1951 for permanent fix	CA-1981	
1973-74	V8 5.7L 350ci	Y	w/THM350 Auto. Trans.; 42.01" Cable	CA-1952	342487
1973-74	V8 5.7L 350ci	Y	THM350 Auto. Trans.; 49.20" Cable, Universal cable for temporary fix, use CA-1952 for permanent fix	CA-1981	
1975	V8 5.7L 350ci	Y	w/THM350 Auto. Trans.; 45.00" Cable	CA-1951	1262620
1975	V8 5.7L 350ci	Y	THM350 Auto. Trans.; 49.20" Cable, Universal cable for temporary fix, use CA-1951 for permanent fix	CA-1981	
1982-84	V8 6.2L 379ci	C	Diesel, w/THM700-4R Auto. Trans.; 36.10" Cable	CA-1960	25515599
1982-84	V8 6.2L 379ci	C	Diesel, w/THM700-4R Auto. Trans., Universal cable for temporary fix, use CA-1960 for permanent fix	CA-1980	
<b>K10 SUBURBAN</b>					
1982	V8 5.0L 305ci	F, H	w/THM700-4R Auto. Trans.; 44.50" Cable	CA-1970	25515598
1982	V8 5.0L 305ci	F, H	w/THM700-4R Auto. Trans., Universal cable for temporary fix, use CA-1970 for permanent fix	CA-1980	
1982-86	V8 5.7L 350ci	L	w/THM700-4R Auto. Trans.; 44.50" Cable	CA-1970	25515598
1982-86	V8 5.7L 350ci	L	w/THM700-4R Auto. Trans., Universal cable for temporary fix, use CA-1970 for permanent fix	CA-1980	
1982-84	V8 6.2L 379ci	C	Diesel, w/THM700-4R Auto. Trans.; 36.10" Cable	CA-1960	25515599
1982-84	V8 6.2L 379ci	C	Diesel, w/THM700-4R Auto. Trans., Universal cable for temporary fix, use CA-1960 for permanent fix	CA-1980	
<b>K20</b>					
1978	L6 4.1L 250ci	D	w/THM350 Auto. Trans.; 45.00" Cable	CA-1951	1262618
1978	L6 4.1L 250ci	D	THM350 Auto. Trans.; 49.20" Cable, Universal cable for temporary fix, use CA-1951 for permanent fix	CA-1981	
1973-74	L6 4.1L 250ci	Q	w/Auto. Trans.; 42.01" Cable	CA-1952	342486
1973-74	L6 4.1L 250ci	Q	w/Auto. Trans.; 49.20" Cable, Universal cable for temporary fix, use CA-1952 for permanent fix	CA-1981	
1974	L6 4.8L 292ci	S	w/Auto. Trans.; 42.01" Cable	CA-1952	342486
1974	L6 4.8L 292ci	S	w/Auto. Trans.; 49.20" Cable, Universal cable for temporary fix, use CA-1952 for permanent fix	CA-1981	
1973-74	L6 4.8L 292ci	T	w/Auto. Trans.; 42.01" Cable	CA-1952	342486
1973-74	L6 4.8L 292ci	T	w/Auto. Trans.; 49.20" Cable, Universal cable for temporary fix, use CA-1952 for permanent fix	CA-1981	
1978	L6 4.8L 292ci	T	w/THM350 Auto. Trans.; 45.00" Cable	CA-1951	1262618
1978	L6 4.8L 292ci	T	THM350 Auto. Trans.; 49.20" Cable, Universal cable for temporary fix, use CA-1951 for permanent fix	CA-1981	
1975-76	L6 4.8L 292ci	T	w/Auto. Trans.; 42.01" Cable	CA-1952	342486
1975-76	L6 4.8L 292ci	T	w/Auto. Trans.; 49.20" Cable, Universal cable for temporary fix, use CA-1952 for permanent fix	CA-1981	
1980	V8 5.0L 305ci	G	w/THM350 Auto. Trans.; 45.00" Cable	CA-1951	1262620
1980	V8 5.0L 305ci	G	THM350 Auto. Trans.; 49.20" Cable, Universal cable for temporary fix, use CA-1951 for permanent fix	CA-1981	
1976-80	V8 5.7L 350ci	L	w/THM350 Auto. Trans.; 45.00" Cable	CA-1951	1262620
1976-80	V8 5.7L 350ci	L	THM350 Auto. Trans.; 49.20" Cable, Universal cable for temporary fix, use CA-1951 for permanent fix	CA-1981	
1981	V8 5.7L 350ci	L	w/THM350C Auto. Trans.; 37.80" Cable	CA-1933	25507541
1981	V8 5.7L 350ci	L	w/THM350C Auto. Trans.; 49.20" Cable, Universal cable for temporary fix only, for permanent fix use CA-1933	CA-1981	
1982-86	V8 5.7L 350ci	L	w/THM700-4R Auto. Trans.; 44.50" Cable	CA-1970	25515598
1982-86	V8 5.7L 350ci	L	w/THM700-4R Auto. Trans., Universal cable for temporary fix, use CA-1970 for permanent fix	CA-1980	
1974	V8 5.7L 350ci	V	w/THM350 Auto. Trans.; 42.01" Cable	CA-1952	342487

# DETENT CABLES

Year	Engine	Vin	Remark	Part	OE
<b>CHEVROLET TRUCKS (con't)</b>					
<b>K20 (con't)</b>					
1974	V8 5.7L 350ci	V	THM350 Auto. Trans.; 49.20" Cable, Universal cable for temporary fix, use CA-1952 for permanent fix	CA-1981	
1975-76	V8 5.7L 350ci	V	w/THM350 Auto. Trans.; 45.00" Cable	CA-1951	1262620
1975-76	V8 5.7L 350ci	V	THM350 Auto. Trans.; 49.20" Cable, Universal cable for temporary fix, use CA-1951 for permanent fix	CA-1981	
1973-74	V8 5.7L 350ci	Y	w/THM350 Auto. Trans.; 42.01" Cable	CA-1952	342487
1973-74	V8 5.7L 350ci	Y	THM350 Auto. Trans.; 49.20" Cable, Universal cable for temporary fix, use CA-1952 for permanent fix	CA-1981	
1975	V8 5.7L 350ci	Y	w/THM350 Auto. Trans.; 45.00" Cable	CA-1951	1262620
1975	V8 5.7L 350ci	Y	THM350 Auto. Trans.; 49.20" Cable, Universal cable for temporary fix, use CA-1951 for permanent fix	CA-1981	
1982-84	V8 6.2L 379ci	C, J	Diesel, w/THM700-4R Auto. Trans.; 36.10" Cable	CA-1960	25515599
1982-84	V8 6.2L 379ci	C, J	Diesel, w/THM700-4R Auto. Trans., Universal cable for temporary fix, use CA-1960 for permanent fix	CA-1980	
<b>K20 SUBURBAN</b>					
1982-84	V8 6.2L 379ci	J	Diesel, w/THM700-4R Auto. Trans.; 36.10" Cable	CA-1960	25515599
1982-84	V8 6.2L 379ci	J	Diesel, w/THM700-4R Auto. Trans., Universal cable for temporary fix, use CA-1960 for permanent fix	CA-1980	
<b>K2500</b>					
1988-89	V6 4.3L 262ci	Z	w/THM700-4R Auto. Trans.; 44.50" Cable	CA-1970	25521268
1988-89	V6 4.3L 262ci	Z	w/THM700-4R Auto. Trans., Universal cable for temporary fix, use CA-1970 for permanent fix	CA-1980	
<b>K30</b>					
1978	L6 4.8L 292ci	T	w/THM350 Auto. Trans.; 45.00" Cable	CA-1951	1262618
1978	L6 4.8L 292ci	T	THM350 Auto. Trans.; 49.20" Cable, Universal cable for temporary fix, use CA-1951 for permanent fix	CA-1981	
1977-80	V8 5.7L 350ci	L	w/THM350 Auto. Trans.; 45.00" Cable	CA-1951	1262620
1977-80	V8 5.7L 350ci	L	THM350 Auto. Trans.; 49.20" Cable, Universal cable for temporary fix, use CA-1951 for permanent fix	CA-1981	
1974	V8 5.7L 350ci	V	w/THM350 Auto. Trans.; 42.01" Cable	CA-1952	342487
1974	V8 5.7L 350ci	V	THM350 Auto. Trans.; 49.20" Cable, Universal cable for temporary fix, use CA-1952 for permanent fix	CA-1981	
1973-74	V8 5.7L 350ci	Y	w/THM350 Auto. Trans.; 42.01" Cable	CA-1952	342487
1973-74	V8 5.7L 350ci	Y	THM350 Auto. Trans.; 49.20" Cable, Universal cable for temporary fix, use CA-1952 for permanent fix	CA-1981	
1982-84	V8 6.2L 379ci	J	w/TH700-4R; 36.10" Cable	CA-1960	25515599
1982-84	V8 6.2L 379ci	J	TH700-4R, Universal cable for temporary fix, use CA-1960 for permanent fix	CA-1980	
<b>K5 BLAZER</b>					
1976	L6 4.1L 250ci	D	w/Auto. Trans.; 42.01" Cable	CA-1952	342486
1976	L6 4.1L 250ci	D	w/Auto. Trans.; 49.20" Cable, Universal cable for temporary fix, use CA-1952 for permanent fix	CA-1981	
1977	L6 4.1L 250ci	D	w/THM350 Auto. Trans.; 45.00" Cable, w/Integral Cyl. Head	CA-1951	1262618
1977	L6 4.1L 250ci	D	w/THM350 Auto. Trans.; 49.20" Cable, w/Integral Cyl. Head, Universal cable for temporary fix, use CA-1951 for permanent fix	CA-1981	
1977-78	L6 4.1L 250ci	D	w/THM350 Auto. Trans.; 45.00" Cable	CA-1951	1262618
1977-78	L6 4.1L 250ci	D	THM350 Auto. Trans.; 49.20" Cable, Universal cable for temporary fix, use CA-1951 for permanent fix	CA-1981	
1982	L6 4.1L 250ci	D	w/THM350C Auto. Trans., w/THM700-4R Auto. Trans. 46.69" Cable	CA-1931	25507542
1982	L6 4.1L 250ci	D	w/THM350C Auto. Trans., w/THM700-4R Auto. Trans., Universal cable for temporary fix, use CA-1931 for permanent fix	CA-1980	



# DETENT CABLES

Year	Engine	Vin	Remark	Part	OE
<b>CHEVROLET TRUCKS (con't)</b>					
<b>K5 BLAZER (con't)</b>					
1982	V8 5.0L 305ci	F	w/THM700-4R Auto. Trans.; 44.50" Cable	CA-1970	25515598
1982	V8 5.0L 305ci	F	w/THM700-4R Auto. Trans., Universal cable for temporary fix, use CA-1970 for permanent fix	CA-1980	
1981-82	V8 5.0L 305ci	F, H	w/THM350C Auto. Trans.; 37.80" Cable	CA-1933	25507541
1981-82	V8 5.0L 305ci	F, H	w/THM350C Auto. Trans.; 49.20" Cable, Universal cable for temporary fix only, for permanent fix use CA-1933	CA-1981	
1980	V8 5.0L 305ci	G	w/THM350 Auto. Trans.; 45.00" Cable	CA-1951	1262620
1980	V8 5.0L 305ci	G	THM350 Auto. Trans.; 49.20" Cable, Universal cable for temporary fix, use CA-1951 for permanent fix	CA-1981	
1982-86	V8 5.0L 305ci	H	w/THM700-4R Auto. Trans.; 44.50" Cable	CA-1970	25515598
1982-86	V8 5.0L 305ci	H	w/THM700-4R Auto. Trans., Universal cable for temporary fix, use CA-1970 for permanent fix	CA-1980	
1976-80	V8 5.7L 350ci	L	w/THM350 Auto. Trans.; 45.00" Cable	CA-1951	1262620
1976-80	V8 5.7L 350ci	L	THM350 Auto. Trans.; 49.20" Cable, Universal cable for temporary fix, use CA-1951 for permanent fix	CA-1981	
1982-86	V8 5.7L 350ci	L	w/THM700-4R Auto. Trans.; 44.50" Cable	CA-1970	25515598
1982-86	V8 5.7L 350ci	L	w/THM700-4R Auto. Trans., Universal cable for temporary fix, use CA-1970 for permanent fix	CA-1980	
1975-76	V8 5.7L 350ci	V	w/THM350 Auto. Trans.; 45.00" Cable	CA-1951	1262620
1975-76	V8 5.7L 350ci	V	THM350 Auto. Trans.; 49.20" Cable, Universal cable for temporary fix, use CA-1951 for permanent fix	CA-1981	
1975	V8 5.7L 350ci	Y	w/THM350 Auto. Trans.; 45.00" Cable	CA-1951	1262620
1975	V8 5.7L 350ci	Y	THM350 Auto. Trans.; 49.20" Cable, Universal cable for temporary fix, use CA-1951 for permanent fix	CA-1981	
1982-84	V8 6.2L 379ci	C	Diesel, w/THM700-4R Auto. Trans.; 36.10" Cable	CA-1960	25515599
1982-84	V8 6.2L 379ci	C	Diesel, w/THM700-4R Auto. Trans., Universal cable for temporary fix, use CA-1960 for permanent fix	CA-1980	
<b>P20</b>					
1974	V8 5.7L 350ci	V, Y	w/THM350 Auto. Trans.; 42.01" Cable, w/Forward Control	CA-1952	342487
1974	V8 5.7L 350ci	V, Y	w/THM350 Auto. Trans.; 49.20" Cable, w/Forward Control, Universal cable for temporary fix, use CA-1952 for permanent fix	CA-1981	
<b>P30</b>					
1979	L6 4.1L 250ci	D	w/THM350 Auto. Trans.; 45.00" Cable, w/Forward Control	CA-1951	1262618
1979	L6 4.1L 250ci	D	w/THM350 Auto. Trans.; 49.20" Cable, w/Forward Control, Universal cable for temporary fix, use CA-1951 for permanent fix	CA-1981	
1974	V8 5.7L 350ci	V, Y	w/THM350 Auto. Trans.; 42.01" Cable, w/Forward Control	CA-1952	342487
1974	V8 5.7L 350ci	V, Y	w/THM350 Auto. Trans.; 49.20" Cable, w/Forward Control, Universal cable for temporary fix, use CA-1952 for permanent fix	CA-1981	
<b>S10</b>					
1982	L4 1.9L 119ci	A	w/Auto. Trans.; 36.10" Cable	CA-1960	14040597
1982	L4 1.9L 119ci	A	w/Auto. Trans., Universal cable for temporary fix, use CA-1960 for permanent fix	CA-1980	
1983-84	L4 1.9L 119ci	A	w/THM200C Auto. Trans.; 36.10" Cable	CA-1960	14040597
1983-84	L4 1.9L 119ci	A	w/THM200C Auto. Trans., Universal cable for temporary fix, use CA-1960 for permanent fix	CA-1980	
1983-84	L4 2.0L 122ci	Y	THM200C, w/THM700-R4 Auto. Trans.; 36.10" Cable	CA-1960	25513305
1983-84	L4 2.0L 122ci	Y	THM200C, THM700-R4 Auto. Trans., Universal cable for temporary fix, use CA-1960 for permanent fix	CA-1980	

# DETENT CABLES

Year	Engine	Vin	Remark	Part	OE
<b>CHEVROLET TRUCKS (con't)</b>					
<b>S10 (con't)</b>					
1984	L4 2.2L 134ci	S	w/THM200C Auto. Trans.; 36.10" Cable	CA-1960	14040597
1984	L4 2.2L 134ci	S	w/THM200C Auto. Trans., Universal cable for temporary fix, use CA-1960 for permanent fix	CA-1980	
1985-86	L4 2.5L 151ci	E	w/Auto. Trans.; 52.95" Cable	CA-1939	25517312
1985-86	L4 2.5L 151ci	E	w/Auto. Trans., Universal cable for temporary fix, use CA-1939 for permanent fix	CA-1980	
1982	V6 2.8L 173ci	B	w/Auto. Trans.; 36.10" Cable	CA-1960	14040597
1982	V6 2.8L 173ci	B	w/Auto. Trans., Universal cable for temporary fix, use CA-1960 for permanent fix	CA-1980	
1983-84	V6 2.8L 173ci	B	THM200C Auto. Trans.; 36.10" Cable, w/THM700-R4	CA-1960	14040597
1983-84	V6 2.8L 173ci	B	THM200C Auto. Trans., THM700-R4, Universal cable for temporary fix, use CA-1960 for permanent fix	CA-1980	
1983-85	V6 2.8L 173ci	B	w/THM700-R4 Auto. Trans.; 36.10" Cable	CA-1960	14040597
1983-85	V6 2.8L 173ci	B	w/THM700-R4 Auto. Trans., Universal cable for temporary fix, use CA-1960 for permanent fix	CA-1980	
<b>S10 BLAZER</b>					
1983-84	L4 1.9L 119ci	A	w/THM200C Auto. Trans.; 36.10" Cable	CA-1960	14040597
1983-84	L4 1.9L 119ci	A	w/THM200C Auto. Trans., Universal cable for temporary fix, use CA-1960 for permanent fix	CA-1980	
1983-84	L4 2.0L 122ci	Y	THM200C, w/THM700-R4 Auto. Trans.; 36.10" Cable	CA-1960	25513305
1983-84	L4 2.0L 122ci	Y	THM200C, THM700-R4 Auto. Trans., Universal cable for temporary fix, use CA-1960 for permanent fix	CA-1980	
1984	L4 2.2L 134ci	S	w/THM200C Auto. Trans.; 36.10" Cable	CA-1960	14040597
1984	L4 2.2L 134ci	S	w/THM200C Auto. Trans., Universal cable for temporary fix, use CA-1960 for permanent fix	CA-1980	
1985-86	L4 2.5L 151ci	E	w/Auto. Trans.; 52.95" Cable	CA-1939	25517312
1985-86	L4 2.5L 151ci	E	w/Auto. Trans., Universal cable for temporary fix, use CA-1939 for permanent fix	CA-1980	
1983-84	V6 2.8L 173ci	B	THM200C Auto. Trans.; 36.10" Cable, w/THM700-R4	CA-1960	14040597
1983-84	V6 2.8L 173ci	B	THM200C Auto. Trans., THM700-R4, Universal cable for temporary fix, use CA-1960 for permanent fix	CA-1980	
1983-85	V6 2.8L 173ci	B	w/THM700-R4 Auto. Trans.; 36.10" Cable	CA-1960	14040597
1983-85	V6 2.8L 173ci	B	w/THM700-R4 Auto. Trans., Universal cable for temporary fix, use CA-1960 for permanent fix	CA-1980	
<b>CHRYSLER</b>					
<b>LEBARON, TOWN &amp; COUNTRY</b>					
1982	L4 2.2L 135ci	B	w/Auto. Trans.; 40.40" Cable	CA-1949	4268842
1983	L4 2.2L 135ci	C	w/Auto. Trans.; 40.40" Cable	CA-1949	4275918
<b>NEW YORKER</b>					
1983	L4 2.2L 135ci	C	w/Auto. Trans.; 40.40" Cable	CA-1949	4275918
<b>DODGE</b>					
<b>400, RAMPAGE</b>					
1982	L4 2.2L 135ci	B	w/Auto. Trans.; 40.40" Cable	CA-1949	4268842
1983	L4 2.2L 135ci	C	w/Auto. Trans.; 40.40" Cable	CA-1949	4275918
<b>600</b>					
1983	L4 2.2L 135ci	C	w/Auto. Trans.; 40.40" Cable	CA-1949	4275918
<b>ARIES, OMNI</b>					
1981-82	L4 2.2L 135ci	B	w/Auto. Trans.; 40.40" Cable	CA-1949	4268843
1983	L4 2.2L 135ci	C	w/Auto. Trans.; 40.40" Cable	CA-1949	4268843
<b>CHARGER</b>					
1983	L4 2.2L 135ci	8	w/Auto. Trans.; 40.40" Cable	CA-1949	4268843
<b>FORD</b>					
<b>TAURUS</b>					
1986-87	V6 3.0L 182ci	U	FWD, w/E,C2120 ME Bodies	CA-1961	E7DZ-7F042-A

# DETENT CABLES

Year	Engine	Vin	Remark	Part	OE
<b>FORD (con't)</b>					
<b>TAURUS (con't)</b>					
1988	V6 3.0L 182ci	U	FWD, w/E,C2120 ME Bodies 19.37" Cable	CA-1959	E8DZ-7F042-A
1989	V6 3.0L 182ci	U, Y	FWD, w/3 ME Bodies 19.37" Cable	CA-1962	E9DZ-7F042-A
1990	V6 3.0L 182ci	U	FWD, w/E,C2120 ME Bodies 19.37" Cable	CA-1962	E9DZ-7F042-A
1989	V6 3.8L 232ci	4	FWD, w/E,C2120 ME Bodies 19.37" Cable	CA-1962	E9DZ-7F042-A
<b>GMC</b>					
<b>C15</b>					
1976-77	L6 4.1L 250ci	D	w/THM350 Auto. Trans.; 42.01" Cable, w/Heavy Duty Chassis	CA-1952	342486
1976-77	L6 4.1L 250ci	D	w/THM350 Auto. Trans.; 49.20" Cable, w/Heavy Duty Chassis, Universal cable for temporary fix, use CA-1952 for permanent fix	CA-1981	
1978	L6 4.1L 250ci	D	w/THM350 Auto. Trans.; 45.00" Cable	CA-1951	1262618
1978	L6 4.1L 250ci	D	THM350 Auto. Trans.; 49.20" Cable, Universal cable for temporary fix, use CA-1951 for permanent fix	CA-1981	
1973-74	L6 4.1L 250ci	Q	w/Auto. Trans.; 42.01" Cable	CA-1952	342486
1973-74	L6 4.1L 250ci	Q	w/Auto. Trans.; 49.20" Cable, Universal cable for temporary fix, use CA-1952 for permanent fix	CA-1981	
1974	L6 4.8L 292ci	S	w/Auto. Trans.; 42.01" Cable	CA-1952	342486
1974	L6 4.8L 292ci	S	w/Auto. Trans.; 49.20" Cable, Universal cable for temporary fix, use CA-1952 for permanent fix	CA-1981	
1973-74	L6 4.8L 292ci	T	w/Auto. Trans.; 42.01" Cable	CA-1952	342486
1973-74	L6 4.8L 292ci	T	w/Auto. Trans.; 49.20" Cable, Universal cable for temporary fix, use CA-1952 for permanent fix	CA-1981	
1975-76	L6 4.8L 292ci	T	w/Auto. Trans.; 42.01" Cable	CA-1952	342486
1975-76	L6 4.8L 292ci	T	w/Auto. Trans.; 49.20" Cable, Universal cable for temporary fix, use CA-1952 for permanent fix	CA-1981	
1978	L6 4.8L 292ci	T	w/THM350 Auto. Trans.; 45.00" Cable	CA-1951	1262618
1978	L6 4.8L 292ci	T	THM350 Auto. Trans.; 49.20" Cable, Universal cable for temporary fix, use CA-1951 for permanent fix	CA-1981	
1980	V8 5.0L 305ci	G	w/THM350 Auto. Trans.; 45.00" Cable	CA-1951	1262620
1980	V8 5.0L 305ci	G	THM350 Auto. Trans.; 49.20" Cable, Universal cable for temporary fix, use CA-1951 for permanent fix	CA-1981	
1981-86	V8 5.0L 305ci	H	w/THM350C Auto. Trans.; 37.80" Cable	CA-1933	25507541
1981-86	V8 5.0L 305ci	H	w/THM350C Auto. Trans.; 49.20" Cable, Universal cable for temporary fix only, for permanent fix use CA-1933	CA-1981	
1976-78	V8 5.7L 350ci	L	w/THM350 Auto. Trans.; 45.00" Cable	CA-1951	1262620
1976-78	V8 5.7L 350ci	L	THM350 Auto. Trans.; 49.20" Cable, Universal cable for temporary fix, use CA-1951 for permanent fix	CA-1981	
1979-80	V8 5.7L 350ci	L	w/THM350 Auto. Trans.; 45.00" Cable	CA-1951	1262620
1979-80	V8 5.7L 350ci	L	THM350 Auto. Trans.; 49.20" Cable, Universal cable for temporary fix, use CA-1951 for permanent fix	CA-1981	
1981	V8 5.7L 350ci	L	w/THM350C Auto. Trans.; 37.80" Cable	CA-1933	25507541
1981	V8 5.7L 350ci	L	w/THM350C Auto. Trans.; 49.20" Cable, Universal cable for temporary fix only, for permanent fix use CA-1933	CA-1981	
1982-86	V8 5.7L 350ci	L	w/THM700-4R Auto. Trans.; 44.50" Cable	CA-1970	25515598
1982-86	V8 5.7L 350ci	L	w/THM700-4R Auto. Trans., Universal cable for temporary fix, use CA-1970 for permanent fix	CA-1980	
1974	V8 5.7L 350ci	V, W	w/THM350 Auto. Trans.; 42.01" Cable	CA-1952	342487
1974	V8 5.7L 350ci	V, W	THM350 Auto. Trans.; 49.20" Cable, Universal cable for temporary fix, use CA-1952 for permanent fix	CA-1981	
1975-76	V8 5.7L 350ci	V	w/THM350 Auto. Trans.; 45.00" Cable	CA-1951	1262620
1975-76	V8 5.7L 350ci	V	THM350 Auto. Trans.; 49.20" Cable, Universal cable for temporary fix, use CA-1951 for permanent fix	CA-1981	

# DETENT CABLES

Year	Engine	Vin	Remark	Part	OE
<b>GMC (con't)</b>					
<b>C15 (con't)</b>					
1973-74	V8 5.7L 350ci	Y	w/THM350 Auto. Trans.; 42.01" Cable	CA-1952	342487
1973-74	V8 5.7L 350ci	Y	THM350 Auto. Trans.; 49.20" Cable, Universal cable for temporary fix, use CA-1952 for permanent fix	CA-1981	
1975	V8 5.7L 350ci	Y	w/THM350 Auto. Trans.; 45.00" Cable	CA-1951	1262620
1975	V8 5.7L 350ci	Y	THM350 Auto. Trans.; 49.20" Cable, Universal cable for temporary fix, use CA-1951 for permanent fix	CA-1981	
1978	V8 5.7L 350ci	Z	w/THM350 Auto. Trans.; 45.00" Cable	CA-1951	1262620
1978	V8 5.7L 350ci	Z	THM350 Auto. Trans.; 49.20" Cable, Universal cable for temporary fix, use CA-1951 for permanent fix	CA-1981	
<b>C1500 SUBURBAN</b>					
1982-84	V8 6.2L 379ci	C	Diesel, w/THM700-R4 Auto. Trans.; 36.10" Cable	CA-1960	25515599
1982-84	V8 6.2L 379ci	C	Diesel, w/THM700-R4 Auto. Trans., Universal cable for temporary fix, use CA-1960 for permanent fix	CA-1980	
<b>C25</b>					
1977	L6 4.1L 250ci	D	w/THM350 Auto. Trans.; 42.01" Cable, w/Heavy Duty Chassis	CA-1952	342486
1977	L6 4.1L 250ci	D	w/THM350 Auto. Trans.; 49.20" Cable, w/Heavy Duty Chassis, Universal cable for temporary fix, use CA-1952 for permanent fix	CA-1981	
1978	L6 4.1L 250ci	D	w/THM350 Auto. Trans.; 45.00" Cable	CA-1951	1262618
1978	L6 4.1L 250ci	D	THM350 Auto. Trans.; 49.20" Cable, Universal cable for temporary fix, use CA-1951 for permanent fix	CA-1981	
1982-84	L6 4.1L 250ci	D	w/THM700-4R Auto. Trans.; 46.69" Cable	CA-1931	25515600
1982-84	L6 4.1L 250ci	D	w/THM700-4R Auto. Trans., Universal cable for temporary fix, use CA-1931 for permanent fix	CA-1980	
1973-74	L6 4.1L 250ci	Q	w/Auto. Trans.; 42.01" Cable	CA-1952	342486
1973-74	L6 4.1L 250ci	Q	w/Auto. Trans.; 49.20" Cable, Universal cable for temporary fix, use CA-1952 for permanent fix	CA-1981	
1974	L6 4.8L 292ci	S	w/Auto. Trans.; 42.01" Cable	CA-1952	342486
1974	L6 4.8L 292ci	S	w/Auto. Trans.; 49.20" Cable, Universal cable for temporary fix, use CA-1952 for permanent fix	CA-1981	
1973-74	L6 4.8L 292ci	T	w/Auto. Trans.; 42.01" Cable	CA-1952	342486
1973-74	L6 4.8L 292ci	T	w/Auto. Trans.; 49.20" Cable, Universal cable for temporary fix, use CA-1952 for permanent fix	CA-1981	
1975-76	L6 4.8L 292ci	T	w/Auto. Trans.; 42.01" Cable	CA-1952	342486
1975-76	L6 4.8L 292ci	T	w/Auto. Trans.; 49.20" Cable, Universal cable for temporary fix, use CA-1952 for permanent fix	CA-1981	
1978	L6 4.8L 292ci	T	w/THM350 Auto. Trans.; 45.00" Cable	CA-1951	1262618
1978	L6 4.8L 292ci	T	THM350 Auto. Trans.; 49.20" Cable, Universal cable for temporary fix, use CA-1951 for permanent fix	CA-1981	
1980	V8 5.0L 305ci	G	w/THM350 Auto. Trans.; 45.00" Cable	CA-1951	1262620
1980	V8 5.0L 305ci	G	THM350 Auto. Trans.; 49.20" Cable, Universal cable for temporary fix, use CA-1951 for permanent fix	CA-1981	
1981	V8 5.0L 305ci	H	w/THM350C Auto. Trans.; 37.80" Cable	CA-1933	25507541
1981	V8 5.0L 305ci	H	w/THM350C Auto. Trans.; 49.20" Cable, Universal cable for temporary fix only, for permanent fix use CA-1933	CA-1981	
1976-78	V8 5.7L 350ci	L	w/THM350 Auto. Trans.; 45.00" Cable	CA-1951	1262620
1976-78	V8 5.7L 350ci	L	THM350 Auto. Trans.; 49.20" Cable, Universal cable for temporary fix, use CA-1951 for permanent fix	CA-1981	
1979-80	V8 5.7L 350ci	L	w/THM350 Auto. Trans.; 45.00" Cable	CA-1951	1262620
1979-80	V8 5.7L 350ci	L	THM350 Auto. Trans.; 49.20" Cable, Universal cable for temporary fix, use CA-1951 for permanent fix	CA-1981	
1981	V8 5.7L 350ci	L	w/THM350C Auto. Trans.; 37.80" Cable	CA-1933	25507541
1982-86	V8 5.7L 350ci	L	w/THM700-4R Auto. Trans.; 44.50" Cable	CA-1970	25515598

# DETENT CABLES

Year	Engine	Vin	Remark	Part	OE
<b>GMC (con't)</b>					
<b>C25 (con't)</b>					
1981	V8 5.7L 350ci	L	w/THM350C Auto. Trans.; 49.20" Cable, Universal cable for temporary fix only, for permanent fix use CA-1933	CA-1981	
1982-86	V8 5.7L 350ci	L	w/THM700-4R Auto. Trans., Universal cable for temporary fix, use CA-1970 for permanent fix	CA-1980	
1974	V8 5.7L 350ci	V, W	w/THM350 Auto. Trans.; 42.01" Cable	CA-1952	342487
1974	V8 5.7L 350ci	V, W	THM350 Auto. Trans.; 49.20" Cable, Universal cable for temporary fix, use CA-1952 for permanent fix	CA-1981	
1975	V8 5.7L 350ci	V, Y	w/THM350 Auto. Trans.; 45.00" Cable	CA-1951	1262620
1975	V8 5.7L 350ci	V, Y	THM350 Auto. Trans.; 49.20" Cable, Universal cable for temporary fix, use CA-1951 for permanent fix	CA-1981	
1973-74	V8 5.7L 350ci	Y	w/THM350 Auto. Trans.; 42.01" Cable	CA-1952	342487
1973-74	V8 5.7L 350ci	Y	THM350 Auto. Trans.; 49.20" Cable, Universal cable for temporary fix, use CA-1952 for permanent fix	CA-1981	
<b>C2500 SUBURBAN</b>					
1982-84	V8 6.2L 379ci	C, J	Diesel, w/THM700-R4 Auto. Trans.; 36.10" Cable	CA-1960	25515599
1982-84	V8 6.2L 379ci	C, J	Diesel, w/THM700-R4 Auto. Trans., Universal cable for temporary fix, use CA-1960 for permanent fix	CA-1980	
<b>C35</b>					
1976	L6 4.8L 292ci	T	w/Auto. Trans.; 42.01" Cable	CA-1952	342486
1976	L6 4.8L 292ci	T	w/Auto. Trans.; 49.20" Cable, Universal cable for temporary fix, use CA-1952 for permanent fix	CA-1981	
1976-78	V8 5.7L 350ci	L	w/THM350 Auto. Trans.; 45.00" Cable	CA-1951	1262620
1976-78	V8 5.7L 350ci	L	THM350 Auto. Trans.; 49.20" Cable, Universal cable for temporary fix, use CA-1951 for permanent fix	CA-1981	
1979-80	V8 5.7L 350ci	L	w/THM350 Auto. Trans.; 45.00" Cable	CA-1951	1262620
1979-80	V8 5.7L 350ci	L	THM350 Auto. Trans.; 49.20" Cable, Universal cable for temporary fix, use CA-1951 for permanent fix	CA-1981	
1974	V8 5.7L 350ci	V, W	w/THM350 Auto. Trans.; 42.01" Cable	CA-1952	342487
1974	V8 5.7L 350ci	V, W	THM350 Auto. Trans.; 49.20" Cable, Universal cable for temporary fix, use CA-1952 for permanent fix	CA-1981	
1975-76	V8 5.7L 350ci	V	w/THM350 Auto. Trans.; 45.00" Cable	CA-1951	1262620
1975-76	V8 5.7L 350ci	V	THM350 Auto. Trans.; 49.20" Cable, Universal cable for temporary fix, use CA-1951 for permanent fix	CA-1981	
1973-74	V8 5.7L 350ci	Y	w/THM350 Auto. Trans.; 42.01" Cable	CA-1952	342487
1973-74	V8 5.7L 350ci	Y	THM350 Auto. Trans.; 49.20" Cable, Universal cable for temporary fix, use CA-1952 for permanent fix	CA-1981	
1975	V8 5.7L 350ci	Y	w/THM350 Auto. Trans.; 45.00" Cable	CA-1951	1262620
1975	V8 5.7L 350ci	Y	THM350 Auto. Trans.; 49.20" Cable, Universal cable for temporary fix, use CA-1951 for permanent fix	CA-1981	
<b>CABALLERO</b>					
1978-79	V6 3.3L 200ci	M	w/THM200 Auto. Trans.; 35.00" Cable	CA-1947	1262612
1978-79	V6 3.3L 200ci	M	w/THM200 Auto. Trans., Universal cable for temporary fix, use CA-1947 for permanent fix	CA-1980	
1984	V6 3.8L 229ci	9	w/THM200-4R Auto. Trans.; 37.51" Cable	CA-1943	25507545
1984	V6 3.8L 229ci	9	w/THM200-4R Auto. Trans., Universal cable for temporary fix, use CA-1943 for permanent fix	CA-1980	
1980	V6 3.8L 229ci	K	w/THM200 Auto. Trans.; 35.00" Cable	CA-1947	1262612
1980	V6 3.8L 229ci	K	w/THM200 Auto. Trans., Universal cable for temporary fix, use CA-1947 for permanent fix	CA-1980	
1981	V6 3.8L 229ci	K	w/THM200 Auto. Trans.; 37.51" Cable	CA-1943	25507545
1981	V6 3.8L 229ci	K	w/THM200 Auto. Trans., Universal cable for temporary fix, use CA-1943 for permanent fix	CA-1980	
1978	V6 3.8L 231ci	A	w/THM350 Auto. Trans., w/THM375 Auto. Trans.	CA-1955	1262652
1978-79	V6 3.8L 231ci	A	w/THM200 Auto. Trans.; 36.30" Cable	CA-1942	1262678

# DETENT CABLES

Year	Engine	Vin	Remark	Part	OE
<b>GMC (con't)</b>					
<b>CABALLERO (con't)</b>					
1978-79	V6 3.8L 231ci	A	w/THM200 Auto. Trans., Universal cable for temporary fix, use CA-1942 for permanent fix	CA-1980	
1980	V6 3.8L 231ci	A	w/THM200 Auto. Trans.; 35.00" Cable	CA-1947	1262612
1980	V6 3.8L 231ci	A	w/THM350 Auto. Trans.; 33.95" Cable	CA-1955	1262652
1980	V6 3.8L 231ci	A	w/THM200 Auto. Trans., Universal cable for temporary fix, use CA-1947 for permanent fix	CA-1980	
1981	V6 3.8L 231ci	A	w/THM200 Auto. Trans.; 36.10" Cable	CA-1960	25505175
1981	V6 3.8L 231ci	A	w/THM200 Auto. Trans., Universal cable for temporary fix, use CA-1960 for permanent fix	CA-1980	
1984	V6 3.8L 231ci	A	w/THM200C Auto. Trans.; 36.10" Cable	CA-1960	25505175
1984	V6 3.8L 231ci	A	w/THM200C Auto. Trans., Universal cable for temporary fix, use CA-1960 for permanent fix	CA-1980	
1985-87	V6 4.3L 262ci	Z	w/THM200C Auto. Trans., w/THM200-4R Auto. Trans.; 37.51" Cable	CA-1943	25521267
1985-87	V6 4.3L 262ci	Z	w/THM200C Auto. Trans., w/THM200-4R Auto. Trans., Universal cable for temporary fix, use CA-1943 for permanent fix	CA-1980	
1980	V8 4.4L 267ci	J	w/THM350 Auto. Trans.; 45.00" Cable	CA-1951	1262620
1980	V8 4.4L 267ci	J	THM350 Auto. Trans.; 49.20" Cable, Universal cable for temporary fix, use CA-1951 for permanent fix	CA-1981	
1981	V8 4.4L 267ci	J	w/THM200 Auto. Trans.; 37.51" Cable	CA-1943	25507546
1981	V8 4.4L 267ci	J	w/THM200 Auto. Trans., Universal cable for temporary fix, use CA-1943 for permanent fix	CA-1980	
1981-82	V8 4.4L 267ci	J	w/THM250 Auto. Trans., w/THM350 Auto. Trans.; 37.80" Cable	CA-1933	25507541
1981-82	V8 4.4L 267ci	J	w/THM250 Auto. Trans., w/THM350 Auto. Trans., Universal cable for temporary fix only, for permanent fix use CA-1933; 49.20" Cable	CA-1981	
1980	V8 5.0L 305ci	H	w/THM200 Auto. Trans.; 38.40" Cable	CA-1941	1262613
1980	V8 5.0L 305ci	H	w/THM250 Auto. Trans., w/THM350 Auto. Trans.; 45.00" Cable	CA-1951	1262620
1980	V8 5.0L 305ci	H	w/THM200 Auto. Trans., Universal cable for temporary fix, use CA-1941 for permanent fix	CA-1980	
1980	V8 5.0L 305ci	H	w/THM250 Auto. Trans., w/THM350 Auto. Trans., Universal cable for temporary fix, use CA-1951 for permanent fix; 49.20" Cable	CA-1981	
1981	V8 5.0L 305ci	H	w/THM350C Auto. Trans.; 37.80" Cable	CA-1933	25507541
1981	V8 5.0L 305ci	H	w/THM200 Auto. Trans.; 37.51" Cable	CA-1943	25507546
1981	V8 5.0L 305ci	H	w/THM200 Auto. Trans., Universal cable for temporary fix, use CA-1943 for permanent fix	CA-1980	
1981	V8 5.0L 305ci	H	w/THM350C Auto. Trans.; 49.20" Cable, Universal cable for temporary fix only, for permanent fix use CA-1933	CA-1981	
1982	V8 5.0L 305ci	H	w/THM250 Auto. Trans., w/THM350 Auto. Trans.; 37.80" Cable	CA-1933	25507541
1982	V8 5.0L 305ci	H	w/THM250 Auto. Trans., w/THM350 Auto. Trans., Universal cable for temporary fix only, for permanent fix use CA-1933; 49.20" Cable	CA-1981	
1983-84	V8 5.0L 305ci	H	w/THM250C Auto. Trans., w/THM350C Auto. Trans.; 37.80" Cable	CA-1933	25507541
1983-84	V8 5.0L 305ci	H	w/THM250C Auto. Trans., w/THM350C Auto. Trans., Universal cable for temporary fix only, for permanent fix use CA-1933; 49.20" Cable	CA-1981	
1984	V8 5.0L 305ci	H	w/THM200-4R Auto. Trans.; 37.51" Cable	CA-1943	25507546
1984	V8 5.0L 305ci	H	w/THM200-4R Auto. Trans., Universal cable for temporary fix, use CA-1943 for permanent fix	CA-1980	

# DETENT CABLES

Year	Engine	Vin	Remark	Part	OE
<b>GMC (con't)</b>					
<b>CABALLERO (con't)</b>					
1985-87	V8 5.0L 305ci	H	w/Auto. Trans.; 37.51" Cable	CA-1943	25507546
1985-87	V8 5.0L 305ci	H	w/Auto. Trans., Universal cable for temporary fix, use CA-1943 for permanent fix	CA-1980	
1978	V8 5.0L 305ci	U	w/THM350 Auto. Trans., w/THM375 Auto. Trans.; 45.00" Cable	CA-1951	1262620
1978	V8 5.0L 305ci	U	w/THM350 Auto. Trans., w/THM375 Auto. Trans., Universal cable for temporary fix, use CA-1951 for permanent fix; 49.20" Cable	CA-1981	
1978-79	V8 5.7L 350ci	L	w/THM350 Auto. Trans., w/THM375 Auto. Trans.; 45.00" Cable	CA-1951	1262620
1978-79	V8 5.7L 350ci	L	w/THM350 Auto. Trans., w/THM375 Auto. Trans., Universal cable for temporary fix, use CA-1951 for permanent fix; 49.20" Cable	CA-1981	
<b>G1500</b>					
1983-84	L6 4.1L 250ci	D	w/THM700-4R Auto. Trans.; 46.69" Cable	CA-1931	25515600
1983-84	L6 4.1L 250ci	D	w/THM700-4R Auto. Trans., Universal cable for temporary fix, use CA-1931 for permanent fix	CA-1980	
1981-86	V8 5.0L 305ci	H	w/THM350C Auto. Trans.; 37.80" Cable	CA-1933	25507541
1981-86	V8 5.0L 305ci	H	w/THM350C Auto. Trans.; 49.20" Cable, Universal cable for temporary fix only, for permanent fix use CA-1933	CA-1981	
1983-86	V8 5.0L 305ci	H	w/THM700-4R Auto. Trans.; 44.50" Cable	CA-1970	25515598
1983-86	V8 5.0L 305ci	H	w/THM700-4R Auto. Trans., Universal cable for temporary fix, use CA-1970 for permanent fix	CA-1980	
<b>G2500</b>					
1983-84	L6 4.1L 250ci	D	w/THM700-4R Auto. Trans.; 46.69" Cable	CA-1931	25515600
1983-84	L6 4.1L 250ci	D	w/THM700-4R Auto. Trans., Universal cable for temporary fix, use CA-1931 for permanent fix	CA-1980	
1983-86	V8 5.0L 305ci	F	w/THM700-4R Auto. Trans.; 44.50" Cable	CA-1970	25515598
1983-86	V8 5.0L 305ci	F	w/THM700-4R Auto. Trans., Universal cable for temporary fix, use CA-1970 for permanent fix	CA-1980	
1981-86	V8 5.0L 305ci	H	w/THM350C Auto. Trans.; 37.80" Cable	CA-1933	25507541
1981-86	V8 5.0L 305ci	H	w/THM350C Auto. Trans.; 49.20" Cable, Universal cable for temporary fix only, for permanent fix use CA-1933	CA-1981	
1983-86	V8 5.0L 305ci	H	w/THM700-4R Auto. Trans.; 44.50" Cable	CA-1970	25515598
1983-86	V8 5.0L 305ci	H	w/THM700-4R Auto. Trans., Universal cable for temporary fix, use CA-1970 for permanent fix	CA-1980	
1986	V8 5.7L 350ci	L	w/THM700-4R Auto. Trans.; 44.50" Cable	CA-1970	25515598
1986	V8 5.7L 350ci	L	w/THM700-4R Auto. Trans., Universal cable for temporary fix, use CA-1970 for permanent fix	CA-1980	
1981	V8 5.7L 350ci	M	w/THM350C Auto. Trans.; 37.80" Cable	CA-1933	25507541
1981	V8 5.7L 350ci	M	w/THM350C Auto. Trans.; 49.20" Cable, Universal cable for temporary fix only, for permanent fix use CA-1933	CA-1981	
1985	V8 5.7L 350ci	M	w/THM700-4R Auto. Trans.; 44.50" Cable	CA-1970	25515598
1985	V8 5.7L 350ci	M	w/THM700-4R Auto. Trans., Universal cable for temporary fix, use CA-1970 for permanent fix	CA-1980	
1983-84	V8 6.2L 379ci	C	w/Auto. Trans.; 36.10" Cable	CA-1960	25515599
1983-84	V8 6.2L 379ci	C	w/Auto. Trans., Universal cable for temporary fix, use CA-1960 for permanent fix	CA-1980	
<b>G3500</b>					
1975-76	L6 4.8L 292ci	T	w/Auto. Trans.; 42.01" Cable	CA-1952	342486
1975-76	L6 4.8L 292ci	T	w/Auto. Trans.; 49.20" Cable, Universal cable for temporary fix, use CA-1952 for permanent fix	CA-1981	

# DETENT CABLES

Year	Engine	Vin	Remark	Part	OE
<b>GMC (con't)</b>					
<b>G3500 (con't)</b>					
1978	L6 4.8L 292ci	T	w/THM350 Auto. Trans.; 45.00" Cable	CA-1951	1262618
1978	L6 4.8L 292ci	T	THM350 Auto. Trans.; 49.20" Cable, Universal cable for temporary fix, use CA-1951 for permanent fix	CA-1981	
1984	V8 5.7L 350ci	E	w/THM700-4R Auto. Trans.; 44.50" Cable	CA-1970	25515598
1984	V8 5.7L 350ci	E	w/THM700-4R Auto. Trans., Universal cable for temporary fix, use CA-1970 for permanent fix	CA-1980	
1976-78	V8 5.7L 350ci	L	w/THM350 Auto. Trans.; 45.00" Cable	CA-1951	1262620
1976-78	V8 5.7L 350ci	L	THM350 Auto. Trans.; 49.20" Cable, Universal cable for temporary fix, use CA-1951 for permanent fix	CA-1981	
1979	V8 5.7L 350ci	L	w/THM350 Auto. Trans.; 45.00" Cable	CA-1951	1262620
1979	V8 5.7L 350ci	L	THM350 Auto. Trans.; 49.20" Cable, Universal cable for temporary fix, use CA-1951 for permanent fix	CA-1981	
1981-82	V8 5.7L 350ci	M	w/THM350C Auto. Trans.; 37.80" Cable	CA-1933	25507541
1981-82	V8 5.7L 350ci	M	w/THM350C Auto. Trans.; 49.20" Cable, Universal cable for temporary fix only, for permanent fix use CA-1933	CA-1981	
1983-86	V8 5.7L 350ci	M	w/THM700-4R Auto. Trans.; 44.50" Cable	CA-1970	25515598
1983-86	V8 5.7L 350ci	M	w/THM700-4R Auto. Trans., Universal cable for temporary fix, use CA-1970 for permanent fix	CA-1980	
1975-76	V8 5.7L 350ci	V	w/THM350 Auto. Trans.; 45.00" Cable	CA-1951	1262620
1975-76	V8 5.7L 350ci	V	THM350 Auto. Trans.; 49.20" Cable, Universal cable for temporary fix, use CA-1951 for permanent fix	CA-1981	
1974	V8 5.7L 350ci	Y	w/THM350 Auto. Trans.; 42.01" Cable	CA-1952	342487
1974	V8 5.7L 350ci	Y	THM350 Auto. Trans.; 49.20" Cable, Universal cable for temporary fix, use CA-1952 for permanent fix	CA-1981	
1975	V8 5.7L 350ci	Y	w/THM350 Auto. Trans.; 45.00" Cable	CA-1951	1262620
1975	V8 5.7L 350ci	Y	THM350 Auto. Trans.; 49.20" Cable, Universal cable for temporary fix, use CA-1951 for permanent fix	CA-1981	
1983-84	V8 6.2L 379ci	J	w/Auto. Trans.; 36.10" Cable	CA-1960	25515599
1983-84	V8 6.2L 379ci	J	w/Auto. Trans., Universal cable for temporary fix, use CA-1960 for permanent fix	CA-1980	
<b>JIMMY</b>					
1976	L6 4.1L 250ci	D	w/Auto. Trans.; 42.01" Cable	CA-1952	342486
1976	L6 4.1L 250ci	D	w/Auto. Trans.; 49.20" Cable, Universal cable for temporary fix, use CA-1952 for permanent fix	CA-1981	
1977-78	L6 4.1L 250ci	D	w/THM350 Auto. Trans.; 45.00" Cable	CA-1951	1262618
1977-78	L6 4.1L 250ci	D	THM350 Auto. Trans.; 49.20" Cable, Universal cable for temporary fix, use CA-1951 for permanent fix	CA-1981	
1973-74	L6 4.1L 250ci	Q	w/Auto. Trans.; 42.01" Cable	CA-1952	342486
1973-74	L6 4.1L 250ci	Q	w/Auto. Trans.; 49.20" Cable, Universal cable for temporary fix, use CA-1952 for permanent fix	CA-1981	
1975	L6 4.1L 250ci	Q	w/Auto. Trans.; 45.00" Cable	CA-1951	1262618
1975	L6 4.1L 250ci	Q	w/Auto. Trans.; 49.20" Cable, Universal cable for temporary fix, use CA-1951 for permanent fix	CA-1981	
1973	L6 4.8L 292ci	T	w/Auto. Trans.; 42.01" Cable	CA-1952	342486
1973	L6 4.8L 292ci	T	w/Auto. Trans.; 49.20" Cable, Universal cable for temporary fix, use CA-1952 for permanent fix	CA-1981	
1982	V8 5.0L 305ci	F	w/THM700-4R Auto. Trans.; 44.50" Cable	CA-1970	25515598
1982	V8 5.0L 305ci	F	w/THM700-4R Auto. Trans., Universal cable for temporary fix, use CA-1970 for permanent fix	CA-1980	
1980	V8 5.0L 305ci	G	w/THM350 Auto. Trans.; 45.00" Cable	CA-1951	1262620
1980	V8 5.0L 305ci	G	THM350 Auto. Trans.; 49.20" Cable, Universal cable for temporary fix, use CA-1951 for permanent fix	CA-1981	
1981-82	V8 5.0L 305ci	H	w/THM350C Auto. Trans.; 37.80" Cable	CA-1933	25507541
1982-86	V8 5.0L 305ci	H	w/THM700-4R Auto. Trans.; 44.50" Cable	CA-1970	25515598



# DETENT CABLES

Year	Engine	Vin	Remark	Part	OE
<b>GMC (con't)</b>					
<b>JIMMY (con't)</b>					
1981-82	V8 5.0L 305ci	H	w/THM350C Auto. Trans.; 49.20" Cable, Universal cable for temporary fix only, for permanent fix use CA-1933	CA-1981	
1982-86	V8 5.0L 305ci	H	w/THM700-4R Auto. Trans., Universal cable for temporary fix, use CA-1970 for permanent fix	CA-1980	
1976-80	V8 5.7L 350ci	L	w/THM350 Auto. Trans.; 45.00" Cable	CA-1951	1262620
1976-80	V8 5.7L 350ci	L	THM350 Auto. Trans.; 49.20" Cable, Universal cable for temporary fix, use CA-1951 for permanent fix	CA-1981	
1982-86	V8 5.7L 350ci	L	w/THM700-4R Auto. Trans.; 44.50" Cable	CA-1970	25515598
1982-86	V8 5.7L 350ci	L	w/THM700-4R Auto. Trans., Universal cable for temporary fix, use CA-1970 for permanent fix	CA-1980	
1974	V8 5.7L 350ci	V	w/THM350 Auto. Trans.; 42.01" Cable	CA-1952	342487
1974	V8 5.7L 350ci	V	THM350 Auto. Trans.; 49.20" Cable, Universal cable for temporary fix, use CA-1952 for permanent fix	CA-1981	
1973-74	V8 5.7L 350ci	Y	w/THM350 Auto. Trans.; 42.01" Cable	CA-1952	342487
1973-74	V8 5.7L 350ci	Y	THM350 Auto. Trans.; 49.20" Cable, Universal cable for temporary fix, use CA-1952 for permanent fix	CA-1981	
1982-84	V8 6.2L 379ci	C	Diesel, w/THM700-R4 Auto. Trans.; 36.10" Cable	CA-1960	25515599
1982-84	V8 6.2L 379ci	C	Diesel, w/THM700-R4 Auto. Trans., Universal cable for temporary fix, use CA-1960 for permanent fix	CA-1980	
<b>K15</b>					
1978	L6 4.1L 250ci	D	w/THM350 Auto. Trans.; 45.00" Cable	CA-1951	1262618
1978	L6 4.1L 250ci	D	THM350 Auto. Trans.; 49.20" Cable, Universal cable for temporary fix, use CA-1951 for permanent fix	CA-1981	
1982-84	L6 4.1L 250ci	D	w/THM700-4R Auto. Trans. 46.69" Cable	CA-1931	25515600
1982-84	L6 4.1L 250ci	D	w/THM700-4R Auto. Trans., Universal cable for temporary fix, use CA-1931 for permanent fix	CA-1980	
1973-74	L6 4.1L 250ci	Q	w/Auto. Trans.; 42.01" Cable	CA-1952	342486
1973-74	L6 4.1L 250ci	Q	w/Auto. Trans.; 49.20" Cable, Universal cable for temporary fix, use CA-1952 for permanent fix	CA-1981	
1975-76	L6 4.8L 292ci	T	w/Auto. Trans.; 42.01" Cable	CA-1952	342486
1975-76	L6 4.8L 292ci	T	w/Auto. Trans.; 49.20" Cable, Universal cable for temporary fix, use CA-1952 for permanent fix	CA-1981	
1981	V8 5.0L 305ci	H	w/THM350C Auto. Trans.; 37.80" Cable	CA-1933	25507541
1981	V8 5.0L 305ci	H	w/THM350C Auto. Trans.; 49.20" Cable, Universal cable for temporary fix only, for permanent fix use CA-1933	CA-1981	
1976-78	V8 5.7L 350ci	L	w/THM350 Auto. Trans.; 45.00" Cable	CA-1951	1262620
1976-78	V8 5.7L 350ci	L	THM350 Auto. Trans.; 49.20" Cable, Universal cable for temporary fix, use CA-1951 for permanent fix	CA-1981	
1979-80	V8 5.7L 350ci	L	w/THM350 Auto. Trans.; 45.00" Cable	CA-1951	1262620
1979-80	V8 5.7L 350ci	L	THM350 Auto. Trans.; 49.20" Cable, Universal cable for temporary fix, use CA-1951 for permanent fix	CA-1981	
1981	V8 5.7L 350ci	L	w/THM350C Auto. Trans.; 37.80" Cable	CA-1933	25507541
1981	V8 5.7L 350ci	L	w/THM350C Auto. Trans.; 49.20" Cable, Universal cable for temporary fix only, for permanent fix use CA-1933	CA-1981	
1982-86	V8 5.7L 350ci	L	w/THM700-4R Auto. Trans.; 44.50" Cable	CA-1970	25515598
1982-86	V8 5.7L 350ci	L	w/THM700-4R Auto. Trans., Universal cable for temporary fix, use CA-1970 for permanent fix	CA-1980	
1974	V8 5.7L 350ci	V	w/THM350 Auto. Trans.; 42.01" Cable	CA-1952	342487
1974	V8 5.7L 350ci	V	THM350 Auto. Trans.; 49.20" Cable, Universal cable for temporary fix, use CA-1952 for permanent fix	CA-1981	
1975-76	V8 5.7L 350ci	V	w/THM350 Auto. Trans.; 45.00" Cable	CA-1951	1262620

# DETENT CABLES

Year	Engine	Vin	Remark	Part	OE
<b>GMC (con't)</b>					
<b>K15 (con't)</b>					
1975-76	V8 5.7L 350ci	V	THM350 Auto. Trans.; 49.20" Cable, Universal cable for temporary fix, use CA-1951 for permanent fix	CA-1981	
1973-74	V8 5.7L 350ci	Y	w/THM350 Auto. Trans.; 42.01" Cable	CA-1952	342487
1973-74	V8 5.7L 350ci	Y	THM350 Auto. Trans.; 49.20" Cable, Universal cable for temporary fix, use CA-1952 for permanent fix	CA-1981	
1975	V8 5.7L 350ci	Y	w/THM350 Auto. Trans.; 45.00" Cable	CA-1951	1262620
1975	V8 5.7L 350ci	Y	THM350 Auto. Trans.; 49.20" Cable, Universal cable for temporary fix, use CA-1951 for permanent fix	CA-1981	
<b>K1500 SUBURBAN</b>					
1982-84	V8 6.2L 379ci	C	Diesel, w/THM700-R4 Auto. Trans.; 36.10" Cable	CA-1960	25515599
1982-84	V8 6.2L 379ci	C	Diesel, w/THM700-R4 Auto. Trans., Universal cable for temporary fix, use CA-1960 for permanent fix	CA-1980	
<b>K25</b>					
1973-74	L6 4.1L 250ci	Q	w/Auto. Trans.; 42.01" Cable	CA-1952	342486
1973-74	L6 4.1L 250ci	Q	w/Auto. Trans.; 49.20" Cable, Universal cable for temporary fix, use CA-1952 for permanent fix	CA-1981	
1974	L6 4.8L 292ci	S	w/Auto. Trans.; 42.01" Cable	CA-1952	342486
1974	L6 4.8L 292ci	S	w/Auto. Trans.; 49.20" Cable, Universal cable for temporary fix, use CA-1952 for permanent fix	CA-1981	
1973-74	L6 4.8L 292ci	T	w/Auto. Trans.; 42.01" Cable	CA-1952	342486
1973-74	L6 4.8L 292ci	T	w/Auto. Trans.; 49.20" Cable, Universal cable for temporary fix, use CA-1952 for permanent fix	CA-1981	
1975-76	L6 4.8L 292ci	T	w/Auto. Trans.; 42.01" Cable	CA-1952	342486
1975-76	L6 4.8L 292ci	T	w/Auto. Trans.; 49.20" Cable, Universal cable for temporary fix, use CA-1952 for permanent fix	CA-1981	
1978	L6 4.8L 292ci	T	w/THM350 Auto. Trans.; 45.00" Cable	CA-1951	1262618
1978	L6 4.8L 292ci	T	THM350 Auto. Trans.; 49.20" Cable, Universal cable for temporary fix, use CA-1951 for permanent fix	CA-1981	
1976-78	V8 5.7L 350ci	L	w/THM350 Auto. Trans.; 45.00" Cable	CA-1951	1262620
1976-78	V8 5.7L 350ci	L	THM350 Auto. Trans.; 49.20" Cable, Universal cable for temporary fix, use CA-1951 for permanent fix	CA-1981	
1979-80	V8 5.7L 350ci	L	w/THM350 Auto. Trans.; 45.00" Cable	CA-1951	1262620
1979-80	V8 5.7L 350ci	L	THM350 Auto. Trans.; 49.20" Cable, Universal cable for temporary fix, use CA-1951 for permanent fix	CA-1981	
1981-82	V8 5.7L 350ci	L	w/THM350C Auto. Trans.; 37.80" Cable	CA-1933	25507541
1981-82	V8 5.7L 350ci	L	w/THM350C Auto. Trans.; 49.20" Cable, Universal cable for temporary fix only, for permanent fix use CA-1933	CA-1981	
1982-86	V8 5.7L 350ci	L	w/THM700-4R Auto. Trans.; 44.50" Cable	CA-1970	25515598
1982-86	V8 5.7L 350ci	L	w/THM700-4R Auto. Trans., Universal cable for temporary fix, use CA-1970 for permanent fix	CA-1980	
1974	V8 5.7L 350ci	V	w/THM350 Auto. Trans.; 42.01" Cable	CA-1952	342487
1974	V8 5.7L 350ci	V	THM350 Auto. Trans.; 49.20" Cable, Universal cable for temporary fix, use CA-1952 for permanent fix	CA-1981	
1975-76	V8 5.7L 350ci	V	w/THM350 Auto. Trans.; 45.00" Cable	CA-1951	1262620
1975-76	V8 5.7L 350ci	V	THM350 Auto. Trans.; 49.20" Cable, Universal cable for temporary fix, use CA-1951 for permanent fix	CA-1981	
1973-74	V8 5.7L 350ci	Y	w/THM350 Auto. Trans.; 42.01" Cable	CA-1952	342487
1973-74	V8 5.7L 350ci	Y	THM350 Auto. Trans.; 49.20" Cable, Universal cable for temporary fix, use CA-1952 for permanent fix	CA-1981	
1975	V8 5.7L 350ci	Y	w/THM350 Auto. Trans.; 45.00" Cable	CA-1951	1262620
1975	V8 5.7L 350ci	Y	THM350 Auto. Trans.; 49.20" Cable, Universal cable for temporary fix, use CA-1951 for permanent fix	CA-1981	
<b>K2500 SUBURBAN</b>					
1982-84	V8 6.2L 379ci	J	Diesel, w/THM700-R4 Auto. Trans.; 36.10" Cable	CA-1960	25515599

# DETENT CABLES

Year	Engine	Vin	Remark	Part	OE
<b>GMC (con't)</b>					
<b>K2500 SUBURBAN (con't)</b>					
1982-84	V8 6.2L 379ci	J	Diesel, w/THM700-R4 Auto. Trans., Universal cable for temporary fix, use CA-1960 for permanent fix	CA-1980	
<b>K35</b>					
1977-78	V8 5.7L 350ci	L	w/THM350 Auto. Trans.; 45.00" Cable	CA-1951	1262620
1977-78	V8 5.7L 350ci	L	THM350 Auto. Trans.; 49.20" Cable, Universal cable for temporary fix, use CA-1951 for permanent fix	CA-1981	
1979	V8 5.7L 350ci	L	w/THM350 Auto. Trans.; 45.00" Cable	CA-1951	1262620
1979	V8 5.7L 350ci	L	THM350 Auto. Trans.; 49.20" Cable, Universal cable for temporary fix, use CA-1951 for permanent fix	CA-1981	
1974	V8 5.7L 350ci	V, W	w/THM350 Auto. Trans.; 42.01" Cable	CA-1952	342487
1974	V8 5.7L 350ci	V, W	THM350 Auto. Trans.; 49.20" Cable, Universal cable for temporary fix, use CA-1952 for permanent fix	CA-1981	
1973-74	V8 5.7L 350ci	Y	w/THM350 Auto. Trans.; 42.01" Cable	CA-1952	342487
1973-74	V8 5.7L 350ci	Y	THM350 Auto. Trans.; 49.20" Cable, Universal cable for temporary fix, use CA-1952 for permanent fix	CA-1981	
<b>P25/P2500 VAN</b>					
1974	V8 5.7L 350ci	Y	w/THM350 Auto. Trans.; 42.01" Cable, w/Forward Control	CA-1952	342487
1974	V8 5.7L 350ci	Y	w/THM350 Auto. Trans.; 49.20" Cable, w/Forward Control, Universal cable for temporary fix, use CA-1952 for permanent fix	CA-1981	
<b>S15</b>					
1982	L4 1.9L 119ci	A	w/Auto. Trans.; 36.10" Cable	CA-1960	14040597
1982	L4 1.9L 119ci	A	w/Auto. Trans., Universal cable for temporary fix, use CA-1960 for permanent fix	CA-1980	
1983-84	L4 1.9L 119ci	A	w/THM200C Auto. Trans.; 36.10" Cable	CA-1960	14040597
1983-84	L4 1.9L 119ci	A	w/THM200C Auto. Trans., Universal cable for temporary fix, use CA-1960 for permanent fix	CA-1980	
1983-84	L4 2.0L 122ci	Y	THM200C, w/THM700-R4 Auto. Trans.; 36.10" Cable	CA-1960	25513305
1983-84	L4 2.0L 122ci	Y	THM200C, THM700-R4 Auto. Trans., Universal cable for temporary fix, use CA-1960 for permanent fix	CA-1980	
1984	L4 2.2L 134ci	S	w/THM200C Auto. Trans.; 36.10" Cable	CA-1960	14040597
1984	L4 2.2L 134ci	S	w/THM200C Auto. Trans., Universal cable for temporary fix, use CA-1960 for permanent fix	CA-1980	
1985-86	L4 2.5L 151ci	E	w/Auto. Trans.; 52.95" Cable	CA-1939	25517312
1985-86	L4 2.5L 151ci	E	w/Auto. Trans., Universal cable for temporary fix, use CA-1939 for permanent fix	CA-1980	
1982	V6 2.8L 173ci	B	w/Auto. Trans.; 36.10" Cable	CA-1960	14040597
1982	V6 2.8L 173ci	B	w/Auto. Trans., Universal cable for temporary fix, use CA-1960 for permanent fix	CA-1980	
1983-84	V6 2.8L 173ci	B	THM200C Auto. Trans.; 36.10" Cable, w/THM700-R4	CA-1960	14040597
1983-84	V6 2.8L 173ci	B	THM200C Auto. Trans., THM700-R4, Universal cable for temporary fix, use CA-1960 for permanent fix	CA-1980	
1985	V6 2.8L 173ci	B	w/THM700-R4 Auto. Trans.; 36.10" Cable	CA-1960	14040597
1985	V6 2.8L 173ci	B	w/THM700-R4 Auto. Trans., Universal cable for temporary fix, use CA-1960 for permanent fix	CA-1980	
<b>S15 JIMMY</b>					
1983-84	L4 1.9L 119ci	A	w/THM200C Auto. Trans.; 36.10" Cable	CA-1960	14040597
1983-84	L4 1.9L 119ci	A	w/THM200C Auto. Trans., Universal cable for temporary fix, use CA-1960 for permanent fix	CA-1980	
1983-84	L4 2.0L 122ci	Y	THM200C, w/THM700-R4 Auto. Trans.; 36.10" Cable	CA-1960	25513305
1983-84	L4 2.0L 122ci	Y	THM200C, THM700-R4 Auto. Trans., Universal cable for temporary fix, use CA-1960 for permanent fix	CA-1980	
1985-86	L4 2.5L 151ci	E	w/Auto. Trans.; 52.95" Cable	CA-1939	25517312

# DETENT CABLES

Year	Engine	Vin	Remark	Part	OE
<b>GMC (con't)</b>					
<b>S15 JIMMY (con't)</b>					
1985-86	L4 2.5L 151ci	E	w/Auto. Trans., Universal cable for temporary fix, use CA-1939 for permanent fix	CA-1980	
1983-84	V6 2.8L 173ci	B	THM200C Auto. Trans.; 36.10" Cable, w/THM700-R4	CA-1960	14040597
1983-84	V6 2.8L 173ci	B	THM200C Auto. Trans., THM700-R4, Universal cable for temporary fix, use CA-1960 for permanent fix	CA-1980	
1985	V6 2.8L 173ci	B	w/THM700-R4 Auto. Trans.; 36.10" Cable	CA-1960	14040597
1985	V6 2.8L 173ci	B	w/THM700-R4 Auto. Trans., Universal cable for temporary fix, use CA-1960 for permanent fix	CA-1980	
<b>LEXUS</b>					
<b>ES250</b>					
1990-91	V6 2.5L 2508cc	V		CA-1986	35520-32050
<b>LINCOLN</b>					
<b>CONTINENTAL</b>					
1988	V6 3.8L 232ci	4	FWD, w/DC Body 19.37" Cable	CA-1959	E8DZ-7F042-A
<b>MERCURY</b>					
<b>SABLE</b>					
1987-88	V6 3.0L 182ci	U	FWD, w/E,C2120 ME Bodies	CA-1961	E7DZ-7F042-A
1989	V6 3.0L 182ci	U	FWD, w/3 ME Bodies 19.37" Cable	CA-1962	E9DZ-7F042-A
1988	V6 3.8L 232ci	4	FWD, w/E,C2120 ME Bodies 19.37" Cable	CA-1959	E8DZ-7F042-A
1989	V6 3.8L 232ci	4	FWD, w/E,C2120 ME Bodies 19.37" Cable	CA-1962	E9DZ-7F042-A
<b>OLDSMOBILE</b>					
<b>98</b>					
1985	V6 3.0L 181ci	E	w/THM440-T4 Auto. Trans.; 36.10" Cable	CA-1960	25512190
1985	V6 3.0L 181ci	E	w/THM440-T4 Auto. Trans., Universal cable for temporary fix, use CA-1960 for permanent fix	CA-1980	
1985	V6 3.8L 231ci	3	w/THM440-T4 Auto. Trans.; 35.35" Cable	CA-1937	25517536
1985	V6 3.8L 231ci	3	w/THM440-T4 Auto. Trans., Universal cable for temporary fix, use CA-1937 for permanent fix	CA-1980	
1986	V6 3.8L 231ci	B	w/THM440-T4 Auto. Trans.; 35.35" Cable	CA-1937	25517536
1986	V6 3.8L 231ci	B	w/THM440-T4 Auto. Trans., Universal cable for temporary fix, use CA-1937 for permanent fix	CA-1980	
1982-83	V6 4.1L 252ci	4	w/Auto. Trans.; 36.10" Cable, Regency	CA-1960	25505175
1982-83	V6 4.1L 252ci	4	w/Auto. Trans., Regency, Universal cable for temporary fix, use CA-1960 for permanent fix	CA-1980	
1985	V6 4.3L 260ci	T	Diesel, w/THM440-T4 Auto. Trans.; 37.51" Cable	CA-1943	25510971
1985	V6 4.3L 260ci	T	Diesel, w/THM440-T4 Auto. Trans., Universal cable for temporary fix, use CA-1943 for permanent fix	CA-1980	
1982-83	V8 5.0L 307ci	Y	w/THM200-4R Auto. Trans.; 35.35" Cable	CA-1937	25508262
1982-83	V8 5.0L 307ci	Y	w/THM200-4R Auto. Trans., Universal cable for temporary fix, use CA-1937 for permanent fix	CA-1980	
1984	V8 5.0L 307ci	Y	w/THM200C Auto. Trans., w/THM200-4R Auto. Trans.; 35.35" Cable	CA-1937	25508262
1984	V8 5.0L 307ci	Y	w/THM200C Auto. Trans., w/THM200-4R Auto. Trans., Universal cable for temporary fix, use CA-1937 for permanent fix	CA-1980	
1982	V8 5.7L 350ci	N	w/THM200-4R Auto. Trans. 51.00" Cable	CA-1930	25508263
1982	V8 5.7L 350ci	N	w/THM200-4R Auto. Trans., Universal cable for temporary fix, use CA-1930 for permanent fix	CA-1980	
1983	V8 5.7L 350ci	N	Diesel, w/THM350C Auto. Trans. 51.00" Cable	CA-1930	25508265
1983	V8 5.7L 350ci	N	Diesel, w/THM350C Auto. Trans., Universal cable for temporary fix, use CA-1930 for permanent fix	CA-1980	
1984	V8 5.7L 350ci	N	Diesel, w/THM200C Auto. Trans., w/THM200-4R Auto. Trans. 51.00" Cable	CA-1930	25508263

# DETENT CABLES

Year	Engine	Vin	Remark	Part	OE
<b>OLDSMOBILE (con't)</b>					
<b>98 (con't)</b>					
1984	V8 5.7L 350ci	N	Diesel, w/THM200C Auto. Trans., w/THM200-4R Auto. Trans., Universal cable for temporary fix, use CA-1930 for permanent fix	CA-1980	
<b>CALAIS</b>					
1985	V6 3.0L 181ci	L	FWD, w/THM 125C Auto. Trans.; 35.35" Cable	CA-1937	25519361
1985	V6 3.0L 181ci	L	FWD, w/THM 125C Auto. Trans., Universal cable for temporary fix, use CA-1937 for permanent fix	CA-1980	
<b>CUTLASS</b>					
1978-80	V6 3.8L 231ci	A	w/THM200C Auto. Trans., w/THM200 Auto. Trans.; 36.30" Cable	CA-1942	1262678
1978-80	V6 3.8L 231ci	A	w/THM350 Auto. Trans.; 33.95" Cable	CA-1955	1262652
1978-80	V6 3.8L 231ci	A	w/THM200C Auto. Trans., w/THM200 Auto. Trans., Universal cable for temporary fix, use CA-1942 for permanent fix	CA-1980	
1980	V6 3.8L 231ci	A	w/THM200C Auto. Trans.; 36.10" Cable, w/Federal Closed Loop Emissions Control	CA-1960	25505175
1980	V6 3.8L 231ci	A	w/THM200C Auto. Trans., w/Federal Closed Loop Emissions Control, Universal cable for temporary fix, use CA-1960 for permanent fix	CA-1980	
1981	V6 3.8L 231ci	A	w/THM200C Auto. Trans.; 36.10" Cable	CA-1960	25505175
1981	V6 3.8L 231ci	A	w/THM200C Auto. Trans., Universal cable for temporary fix, use CA-1960 for permanent fix	CA-1980	
1977	V6 3.8L 231ci	C	w/THM350 Auto. Trans.; 39.17" Cable	CA-1954	1262617
1977	V6 3.8L 231ci	C	THM350 Auto. Trans.; 49.20" Cable, Universal cable for temporary fix, use CA-1954 for permanent fix	CA-1981	
1977-79	V8 4.3L 260ci	F	w/THM350 Auto. Trans.; 37.00" Cable	CA-1963	1254178
1978-79	V8 4.3L 260ci	F	w/THM200 Auto. Trans.; 38.40" Cable	CA-1941	1262615
1978-79	V8 4.3L 260ci	F	w/THM200 Auto. Trans., Universal cable for temporary fix, use CA-1941 for permanent fix	CA-1980	
1980	V8 4.3L 260ci	F	w/THM350 Auto. Trans.; 37.80" Cable	CA-1933	25503382
1980	V8 4.3L 260ci	F	THM350 Auto. Trans.; 49.20" Cable, Universal cable for temporary fix only, for permanent fix use CA-1933	CA-1981	
1981	V8 4.4L 267ci	J	Export, w/Canada Emissions, w/THM250C Auto. Trans., w/THM350C Auto. Trans.; 37.80" Cable	CA-1933	25507541
1981	V8 4.4L 267ci	J	Export, w/Canada Emissions, w/THM250C Auto. Trans., w/THM350C Auto. Trans., Universal cable, for temporary fix only, for permanent fix use CA-1933; 49.20" Cable	CA-1981	
1978-79	V8 5.0L 305ci	H	w/THM350 Auto. Trans.; 45.00" Cable	CA-1951	1262620
1978-79	V8 5.0L 305ci	H	THM350 Auto. Trans.; 49.20" Cable, Universal cable for temporary fix, use CA-1951 for permanent fix	CA-1981	
1978-80	V8 5.0L 305ci	H	w/THM200C Auto. Trans., w/THM200 Auto. Trans.; 38.40" Cable	CA-1941	1262613
1978-80	V8 5.0L 305ci	H	w/THM200C Auto. Trans., w/THM200 Auto. Trans., Universal cable for temporary fix, use CA-1941 for permanent fix	CA-1980	
1980	V8 5.0L 305ci	H	w/THM250C Auto. Trans., w/THM350 Auto. Trans., w/THM350C Auto. Trans.; 45.00" Cable	CA-1951	1262620
1980	V8 5.0L 305ci	H	w/THM250C Auto. Trans., w/THM350 Auto. Trans., w/THM350C Auto. Trans., Universal cable for temporary fix, use CA-1951 for permanent fix; 49.20" Cable	CA-1981	
1978	V8 5.0L 305ci	U	w/THM350 Auto. Trans.; 45.00" Cable	CA-1951	1262620
1978	V8 5.0L 305ci	U	THM350 Auto. Trans.; 49.20" Cable, Universal cable for temporary fix, use CA-1951 for permanent fix	CA-1981	

# DETENT CABLES

Year	Engine	Vin	Remark	Part	OE
<b>OLDSMOBILE (con't)</b>					
<b>CUTLASS (con't)</b>					
1978-79	V8 5.7L 350ci	L	w/THM350 Auto. Trans.; 45.00" Cable	CA-1951	1262620
1978-79	V8 5.7L 350ci	L	THM350 Auto. Trans.; 49.20" Cable, Universal cable for temporary fix, use CA-1951 for permanent fix	CA-1981	
1980	V8 5.7L 350ci	N, R	w/THM350 Auto. Trans., w/THM350C Auto. Trans.; 37.80" Cable	CA-1933	25503382
1980	V8 5.7L 350ci	N, R	w/THM350 Auto. Trans., w/THM350C Auto. Trans., Universal cable, for temporary fix only, for permanent fix use CA-1933; 49.20" Cable	CA-1981	
1977	V8 5.7L 350ci	R	w/THM350 Auto. Trans.; 37.00" Cable	CA-1963	1254178
<b>CUTLASS CALAIS</b>					
1978-79	V6 3.8L 231ci	A	w/THM200C Auto. Trans., w/THM200 Auto. Trans.; 36.30" Cable	CA-1942	1262678
1978-79	V6 3.8L 231ci	A	w/THM200C Auto. Trans., w/THM200 Auto. Trans., Universal cable for temporary fix, use CA-1942 for permanent fix	CA-1980	
1978-80	V6 3.8L 231ci	A	w/THM350 Auto. Trans.; 33.95" Cable	CA-1955	1262652
1981-84	V6 3.8L 231ci	A	w/THM200C Auto. Trans.; 36.10" Cable	CA-1960	25505175
1981-84	V6 3.8L 231ci	A	w/THM200C Auto. Trans., Universal cable for temporary fix, use CA-1960 for permanent fix	CA-1980	
1982-83	V6 3.8L 231ci	A	w/THM250C Auto. Trans., w/THM350C Auto. Trans.; 36.10" Cable	CA-1960	25505174
1982-83	V6 3.8L 231ci	A	w/THM250C Auto. Trans., w/THM350C Auto. Trans., Universal cable for temporary fix, use CA-1960 for permanent fix	CA-1980	
1983-84	V6 4.3L 260ci	V	w/THM200C Auto. Trans.; 37.51" Cable	CA-1943	25510971
1983-84	V6 4.3L 260ci	V	w/THM200C Auto. Trans., Universal cable for temporary fix, use CA-1943 for permanent fix	CA-1980	
1978-79	V8 4.3L 260ci	F	w/THM200 Auto. Trans.; 38.40" Cable	CA-1941	1262615
1978-79	V8 4.3L 260ci	F	w/THM350 Auto. Trans.; 37.00" Cable	CA-1963	1254178
1978-79	V8 4.3L 260ci	F	w/THM200 Auto. Trans., Universal cable for temporary fix, use CA-1941 for permanent fix	CA-1980	
1979	V8 4.3L 260ci	P	w/THM200 Auto. Trans.; 38.40" Cable	CA-1941	1262615
1979	V8 4.3L 260ci	P	w/THM350 Auto. Trans.; 37.00" Cable	CA-1963	1254178
1979	V8 4.3L 260ci	P	w/THM200 Auto. Trans., Universal cable for temporary fix, use CA-1941 for permanent fix	CA-1980	
1982	V8 4.4L 267ci	J	Export, w/Canada Emissions; 37.80" Cable	CA-1933	25507541
1982	V8 4.4L 267ci	J	Export, w/Canada Emissions, Universal cable, for temporary fix only, for permanent fix use CA-1933; 49.20" Cable	CA-1981	
1978-79	V8 5.0L 305ci	H	w/THM200C Auto. Trans., w/THM200 Auto. Trans.; 38.40" Cable	CA-1941	1262613
1978-79	V8 5.0L 305ci	H	w/THM350 Auto. Trans.; 45.00" Cable	CA-1951	1262620
1978-79	V8 5.0L 305ci	H	w/THM200C Auto. Trans., w/THM200 Auto. Trans., Universal cable for temporary fix, use CA-1941 for permanent fix	CA-1980	
1978-79	V8 5.0L 305ci	H	THM350 Auto. Trans.; 49.20" Cable, Universal cable for temporary fix, use CA-1951 for permanent fix	CA-1981	
1978	V8 5.0L 305ci	U	w/THM350 Auto. Trans.; 45.00" Cable	CA-1951	1262620
1978	V8 5.0L 305ci	U	THM350 Auto. Trans.; 49.20" Cable, Universal cable for temporary fix, use CA-1951 for permanent fix	CA-1981	
1984	V8 5.0L 307ci	9, Y	w/THM200C Auto. Trans.; 35.35" Cable	CA-1937	25508262
1984	V8 5.0L 307ci	9, Y	w/THM200C Auto. Trans., Universal cable for temporary fix, use CA-1937 for permanent fix	CA-1980	
1983-84	V8 5.7L 350ci	N	w/THM200C Auto. Trans., Universal cable for temporary fix, use CA-1930 for permanent fix	CA-1980	

# DETENT CABLES

Year	Engine	Vin	Remark	Part	OE
<b>OLDSMOBILE (con't)</b>					
<b>CUTLASS CALAIS (con't)</b>					
1983-84	V8 5.7L 350ci	N	w/THM200C Auto. Trans. 51.00" Cable	CA-1930	25508263
1980	V8 5.7L 350ci	R	w/THM350 Auto. Trans., w/THM350C Auto. Trans.; 37.80" Cable	CA-1933	25503382
1980	V8 5.7L 350ci	R	w/THM350 Auto. Trans., w/THM350C Auto. Trans., Universal cable, for temporary fix only, for permanent fix use CA-1933; 49.20" Cable	CA-1981	
<b>CUTLASS CIERA</b>					
1982	L4 2.5L 151ci	5, R	w/THM125C Auto. Trans.; 40.79" Cable	CA-1958	25513393
1982-83	L4 2.5L 151ci	5, R	Export, w/Canada Emissions, w/THM125C Auto. Trans.; 25.70" Cable	CA-1932	25513389
1982-83	L4 2.5L 151ci	5, R	Export, w/Canada Emissions, w/THM125C Auto. Trans., Universal cable for temporary fix, use CA-1932 for permanent fix	CA-1980	
1986	L4 2.5L 151ci	R	w/THM125C Auto. Trans.; 47.00" Cable	CA-1935	25519347
1986	L4 2.5L 151ci	R	w/THM125C Auto. Trans., Universal cable for temporary fix, use CA-1935 for permanent fix	CA-1980	
1987	V6 2.8L 173ci	W	w/THM125C Auto. Trans., w/THM440-T4 Auto. Trans.; 44.50" Cable	CA-1970	10066501
1987	V6 2.8L 173ci	W	w/THM125C Auto. Trans., w/THM440-T4 Auto. Trans., Universal cable for temporary fix, use CA-1970 for permanent fix	CA-1980	
1982-86	V6 2.8L 173ci	X	w/THM125C Auto. Trans., w/THM440-T4 Auto. Trans. 51.00" Cable	CA-1930	1262487
1982-86	V6 2.8L 173ci	X	w/THM125C Auto. Trans., w/THM440-T4 Auto. Trans., Universal cable for temporary fix, use CA-1930 for permanent fix	CA-1980	
1982	V6 3.0L 181ci	E	w/THM125C Auto. Trans., w/THM440-T4 Auto. Trans.; 36.10" Cable	CA-1960	25512190
1982	V6 3.0L 181ci	E	w/THM125C Auto. Trans., w/THM440-T4 Auto. Trans., Universal cable for temporary fix, use CA-1960 for permanent fix	CA-1980	
1986-88	V6 3.8L 231ci	3	w/THM440-T4 Auto. Trans.; 35.35" Cable	CA-1937	25517536
1986-88	V6 3.8L 231ci	3	w/THM440-T4 Auto. Trans., Universal cable for temporary fix, use CA-1937 for permanent fix	CA-1980	
1982	V6 4.3L 260ci	T	Diesel, w/THM125C Auto. Trans.; 37.51" Cable	CA-1943	25510971
1982	V6 4.3L 260ci	T	Diesel, w/THM125C Auto. Trans., Universal cable for temporary fix, use CA-1943 for permanent fix	CA-1980	
<b>CUTLASS CRUISER</b>					
1987	V6 2.8L 173ci	W	w/THM125C Auto. Trans., w/THM440-T4 Auto. Trans.; 44.50" Cable	CA-1970	10066501
1987	V6 2.8L 173ci	W	w/THM125C Auto. Trans., w/THM440-T4 Auto. Trans., Universal cable for temporary fix, use CA-1970 for permanent fix	CA-1980	
1987-88	V6 3.8L 231ci	3	w/THM440-T4 Auto. Trans.; 35.35" Cable	CA-1937	25517536
1987-88	V6 3.8L 231ci	3	w/THM440-T4 Auto. Trans., Universal cable for temporary fix, use CA-1937 for permanent fix	CA-1980	
1982	V8 4.4L 267ci	J	Export, w/Canada Emissions; 37.80" Cable	CA-1933	25507541
1982	V8 4.4L 267ci	J	Export, w/Canada Emissions, Universal cable, for temporary fix only, for permanent fix use CA-1933; 49.20" Cable	CA-1981	
<b>CUTLASS SALON</b>					
1978-80	V6 3.8L 231ci	A	w/THM200C Auto. Trans., w/THM200 Auto. Trans.; 36.30" Cable	CA-1942	1262678
1978-80	V6 3.8L 231ci	A	w/THM350 Auto. Trans.; 33.95" Cable	CA-1955	1262652

# DETENT CABLES

Year	Engine	Vin	Remark	Part	OE
<b>OLDSMOBILE (con't)</b>					
<b>CUTLASS SALON (con't)</b>					
1978-80	V6 3.8L 231ci	A	w/THM200C Auto. Trans., w/THM200 Auto. Trans., Universal cable for temporary fix, use CA-1942 for permanent fix	CA-1980	
1980	V6 3.8L 231ci	A	w/THM200C Auto. Trans.; 36.10" Cable, w/Federal Closed Loop Emissions Control	CA-1960	25505175
1980	V6 3.8L 231ci	A	w/THM200C Auto. Trans., w/Federal Closed Loop Emissions Control, Universal cable for temporary fix, use CA-1960 for permanent fix	CA-1980	
1977-79	V8 4.3L 260ci	F	w/THM350 Auto. Trans.; 37.00" Cable	CA-1963	1254178
1978-79	V8 4.3L 260ci	F	w/THM200 Auto. Trans.; 38.40" Cable	CA-1941	1262615
1978-79	V8 4.3L 260ci	F	w/THM200 Auto. Trans., Universal cable for temporary fix, use CA-1941 for permanent fix	CA-1980	
1980	V8 4.3L 260ci	F	w/THM350 Auto. Trans.; 37.80" Cable	CA-1933	25503382
1980	V8 4.3L 260ci	F	THM350 Auto. Trans.; 49.20" Cable, Universal cable for temporary fix only, for permanent fix use CA-1933	CA-1981	
1979	V8 4.3L 260ci	P	w/THM200 Auto. Trans.; 38.40" Cable	CA-1941	1262615
1979	V8 4.3L 260ci	P	w/THM350 Auto. Trans.; 37.00" Cable	CA-1963	1254178
1979	V8 4.3L 260ci	P	w/THM200 Auto. Trans., Universal cable for temporary fix, use CA-1941 for permanent fix	CA-1980	
1978-79	V8 5.0L 305ci	H	w/THM350 Auto. Trans.; 45.00" Cable	CA-1951	1262620
1978-79	V8 5.0L 305ci	H	THM350 Auto. Trans.; 49.20" Cable, Universal cable for temporary fix, use CA-1951 for permanent fix	CA-1981	
1978-80	V8 5.0L 305ci	H	w/THM200C Auto. Trans., w/THM200 Auto. Trans.; 38.40" Cable	CA-1941	1262613
1978-80	V8 5.0L 305ci	H	w/THM200C Auto. Trans., w/THM200 Auto. Trans., Universal cable for temporary fix, use CA-1941 for permanent fix	CA-1980	
1980	V8 5.0L 305ci	H	w/THM250C Auto. Trans., w/THM350 Auto. Trans., w/THM350C Auto. Trans.; 45.00" Cable	CA-1951	1262620
1980	V8 5.0L 305ci	H	w/THM250C Auto. Trans., w/THM350 Auto. Trans., w/THM350C Auto. Trans., Universal cable for temporary fix, use CA-1951 for permanent fix; 49.20" Cable	CA-1981	
1978	V8 5.0L 305ci	U	w/THM350 Auto. Trans.; 45.00" Cable	CA-1951	1262620
1978	V8 5.0L 305ci	U	THM350 Auto. Trans.; 49.20" Cable, Universal cable for temporary fix, use CA-1951 for permanent fix	CA-1981	
1986	V8 5.0L 307ci	9	w/THM200C Auto. Trans.; 35.35" Cable, Salon	CA-1937	25508262
1986	V8 5.0L 307ci	9	w/THM200C Auto. Trans., Salon, Universal cable for temporary fix, use CA-1937 for permanent fix	CA-1980	
1987	V8 5.0L 307ci	Y	Salon, w/THM200-4R Auto. Trans.; 35.35" Cable	CA-1937	25508262
1987	V8 5.0L 307ci	Y	Salon, w/THM200-4R Auto. Trans., Universal cable for temporary fix, use CA-1937 for permanent fix	CA-1980	
1980	V8 5.7L 350ci	N	w/THM350 Auto. Trans., w/THM350C Auto. Trans.; 37.80" Cable	CA-1933	25503382
1980	V8 5.7L 350ci	N	w/THM350 Auto. Trans., w/THM350C Auto. Trans., Universal cable, for temporary fix only, for permanent fix use CA-1933; 49.20" Cable	CA-1981	
1977	V8 5.7L 350ci	R	w/THM350 Auto. Trans.; 37.00" Cable	CA-1963	1254178
<b>CUTLASS SUPREME</b>					
1978-80	V6 3.8L 231ci	A	w/THM200C Auto. Trans., w/THM200 Auto. Trans.; 36.30" Cable	CA-1942	1262678
1978-80	V6 3.8L 231ci	A	w/THM350 Auto. Trans.; 33.95" Cable	CA-1955	1262652
1978-80	V6 3.8L 231ci	A	w/THM200C Auto. Trans., w/THM200 Auto. Trans., Universal cable for temporary fix, use CA-1942 for permanent fix	CA-1980	
1981	V6 3.8L 231ci	A	w/THM250C Auto. Trans.; 36.10" Cable	CA-1960	25505174



# DETENT CABLES

Year	Engine	Vin	Remark	Part	OE
<b>OLDSMOBILE (con't)</b>					
<b>CUTLASS SUPREME (con't)</b>					
1981	V6 3.8L 231ci	A	w/THM250C Auto. Trans., Universal cable for temporary fix, use CA-1960 for permanent fix	CA-1980	
1982-83	V6 3.8L 231ci	A	w/THM250C Auto. Trans., w/THM350C Auto. Trans.; 36.10" Cable	CA-1960	25505174
1982-83	V6 3.8L 231ci	A	w/THM250C Auto. Trans., w/THM350C Auto. Trans., Universal cable for temporary fix, use CA-1960 for permanent fix	CA-1980	
1984-87	V6 3.8L 231ci	A	w/THM200C Auto. Trans.; 36.10" Cable	CA-1960	25505175
1984-87	V6 3.8L 231ci	A	w/THM200C Auto. Trans., Universal cable for temporary fix, use CA-1960 for permanent fix	CA-1980	
1977	V6 3.8L 231ci	C	w/THM350 Auto. Trans.; 39.17" Cable	CA-1954	1262617
1977	V6 3.8L 231ci	C	THM350 Auto. Trans.; 49.20" Cable, Universal cable for temporary fix, use CA-1954 for permanent fix	CA-1981	
1983-84	V6 4.3L 260ci	V	w/THM200C Auto. Trans.; 37.51" Cable	CA-1943	25510971
1983-84	V6 4.3L 260ci	V	w/THM200C Auto. Trans., Universal cable for temporary fix, use CA-1943 for permanent fix	CA-1980	
1977-79	V8 4.3L 260ci	F	w/THM350 Auto. Trans.; 37.00" Cable	CA-1963	1254178
1978-79	V8 4.3L 260ci	F	w/THM200 Auto. Trans.; 38.40" Cable	CA-1941	1262615
1978-79	V8 4.3L 260ci	F	w/THM200 Auto. Trans., Universal cable for temporary fix, use CA-1941 for permanent fix	CA-1980	
1979	V8 4.3L 260ci	P	w/THM200 Auto. Trans.; 38.40" Cable	CA-1941	1262615
1979	V8 4.3L 260ci	P	w/THM350 Auto. Trans.; 37.00" Cable	CA-1963	1254178
1979	V8 4.3L 260ci	P	w/THM200 Auto. Trans., Universal cable for temporary fix, use CA-1941 for permanent fix	CA-1980	
1982	V8 4.4L 267ci	J	Export, w/Canada Emissions; 37.80" Cable	CA-1933	25507541
1982	V8 4.4L 267ci	J	Export, w/Canada Emissions, Universal cable, for temporary fix only, for permanent fix use CA-1933; 49.20" Cable	CA-1981	
1978-79	V8 5.0L 305ci	H	w/THM200C Auto. Trans., w/THM200 Auto. Trans.; 38.40" Cable	CA-1941	1262613
1978-79	V8 5.0L 305ci	H	w/THM350 Auto. Trans.; 45.00" Cable	CA-1951	1262620
1978-79	V8 5.0L 305ci	H	w/THM200C Auto. Trans., w/THM200 Auto. Trans., Universal cable for temporary fix, use CA-1941 for permanent fix	CA-1980	
1978-79	V8 5.0L 305ci	H	THM350 Auto. Trans.; 49.20" Cable, Universal cable for temporary fix, use CA-1951 for permanent fix	CA-1981	
1983	V8 5.0L 305ci	H	w/Auto. Trans.; 37.80" Cable, Export, w/Canada Emissions	CA-1933	25507541
1983	V8 5.0L 305ci	H	w/Auto. Trans.; 49.20" Cable, Export, w/Canada Emissions, Universal cable, for temporary fix only, for permanent fix use CA-1933	CA-1981	
1985	V8 5.0L 305ci	H	Export, w/Canada Emissions, w/THM200C Auto. Trans., w/THM200-4R Auto. Trans.; 37.51" Cable	CA-1943	25510971
1985-87	V8 5.0L 305ci	H	Export, w/Canada Emissions, w/THM200C Auto. Trans., w/THM200-4R Auto. Trans., Universal cable for temporary fix, use CA-1943 for permanent fix	CA-1980	
1986-87	V8 5.0L 305ci	H	Export, w/Canada Emissions, w/THM200C Auto. Trans., w/THM200-4R Auto. Trans.; 37.51" Cable	CA-1943	25507546
1978	V8 5.0L 305ci	U	w/THM350 Auto. Trans.; 45.00" Cable	CA-1951	1262620
1978	V8 5.0L 305ci	U	THM350 Auto. Trans.; 49.20" Cable, Universal cable for temporary fix, use CA-1951 for permanent fix	CA-1981	
1987	V8 5.0L 307ci	9	w/THM200C Auto. Trans.; 35.35" Cable	CA-1937	25508262
1987	V8 5.0L 307ci	9	w/THM200C Auto. Trans., Universal cable for temporary fix, use CA-1937 for permanent fix	CA-1980	
1984-87	V8 5.0L 307ci	Y	w/THM200-4R Auto. Trans., Universal cable for temporary fix, use CA-1937 for permanent fix	CA-1980	

# DETENT CABLES

Year	Engine	Vin	Remark	Part	OE
<b>OLDSMOBILE (con't)</b>					
<b>CUTLASS SUPREME (con't)</b>					
1984-87	V8 5.0L 307ci	Y	w/THM200-4R Auto. Trans.; 35.35" Cable	CA-1937	25508262
1983	V8 5.7L 350ci	N	w/THM200C Auto. Trans., w/THM350C Auto. Trans. 51.00" Cable	CA-1930	25508265
1983	V8 5.7L 350ci	N	w/THM200C Auto. Trans., w/THM350C Auto. Trans., Universal cable for temporary fix, use CA-1930 for permanent fix	CA-1980	
1983-85	V8 5.7L 350ci	N	w/THM200C Auto. Trans. 51.00" Cable	CA-1930	25508263
1983-85	V8 5.7L 350ci	N	w/THM200C Auto. Trans., Universal cable for temporary fix, use CA-1930 for permanent fix	CA-1980	
1977	V8 5.7L 350ci	R	w/THM350 Auto. Trans.; 37.00" Cable	CA-1963	1254178
<b>DELTA 88</b>					
1977-80	V6 3.8L 231ci	A	w/THM350 Auto. Trans., w/THM350C Auto. Trans.	CA-1955	1262652
1982	V6 3.8L 231ci	A	w/THM250C Auto. Trans., w/THM350C Auto. Trans.; 36.10" Cable	CA-1960	25505174
1982	V6 3.8L 231ci	A	w/THM250C Auto. Trans., w/THM350C Auto. Trans., Universal cable for temporary fix, use CA-1960 for permanent fix	CA-1980	
1983	V6 3.8L 231ci	A	w/Auto. Trans.; 36.10" Cable	CA-1960	25505174
1983	V6 3.8L 231ci	A	w/Auto. Trans., Universal cable for temporary fix, use CA-1960 for permanent fix	CA-1980	
1977	V6 3.8L 231ci	C	w/THM350 Auto. Trans.; 39.17" Cable	CA-1954	1262617
1977	V6 3.8L 231ci	C	THM350 Auto. Trans.; 49.20" Cable, Universal cable for temporary fix, use CA-1954 for permanent fix	CA-1981	
1977	V8 4.3L 260ci	F	w/THM200 Auto. Trans.; 38.40" Cable	CA-1941	1262615
1977	V8 4.3L 260ci	F	w/THM200 Auto. Trans., Universal cable for temporary fix, use CA-1941 for permanent fix	CA-1980	
1978	V8 4.3L 260ci	F	w/Man. & Auto. Trans.; 37.00" Cable	CA-1963	1254178
1979	V8 4.3L 260ci	F	w/THM350 Auto. Trans.; 37.00" Cable	CA-1963	1254178
1982	V8 4.4L 267ci	J	Export, w/Canada Emissions, w/THM250C Auto. Trans.; 37.80" Cable	CA-1933	25507541
1982	V8 4.4L 267ci	J	Export, w/Canada Emissions, w/THM250C Auto. Trans.; 49.20" Cable, Universal cable, for temporary fix only, for permanent fix use CA-1933	CA-1981	
1979	V8 4.9L 301ci	Y	w/THM350 Auto. Trans.	CA-1964	1255739
1980	V8 5.0L 307ci	Y	w/THM250C Auto. Trans., w/THM350 Auto. Trans., w/THM350C Auto. Trans.; 37.80" Cable	CA-1933	25503382
1980	V8 5.0L 307ci	Y	w/THM250C Auto. Trans., w/THM350 Auto. Trans., w/THM350C Auto. Trans., Universal cable, for temporary fix only, for permanent fix use CA-1933; 49.20" Cable	CA-1981	
1981	V8 5.0L 307ci	Y	Export, w/Canada Emissions, w/THM250C Auto. Trans.; 37.80" Cable	CA-1933	25507541
1981	V8 5.0L 307ci	Y	Export, w/Canada Emissions, w/THM250C Auto. Trans.; 49.20" Cable, Universal cable, for temporary fix only, for permanent fix use CA-1933	CA-1981	
1982-83	V8 5.0L 307ci	Y	w/THM200-4R Auto. Trans.; 35.35" Cable	CA-1937	25508262
1982-83	V8 5.0L 307ci	Y	w/THM200-4R Auto. Trans., Universal cable for temporary fix, use CA-1937 for permanent fix	CA-1980	
1978	V8 5.7L 350ci	N, R	w/Man. & Auto. Trans.; 37.00" Cable	CA-1963	1254178
1979	V8 5.7L 350ci	N, R	w/THM350 Auto. Trans.; 37.00" Cable, w/Olds. Eng.	CA-1963	1254178
1980	V8 5.7L 350ci	N, R	w/THM350 Auto. Trans., w/THM350C Auto. Trans.; 37.80" Cable	CA-1933	25503382
1980	V8 5.7L 350ci	N, R	w/THM350 Auto. Trans., w/THM350C Auto. Trans., Universal cable, for temporary fix only, for permanent fix use CA-1933; 49.20" Cable	CA-1981	
1982	V8 5.7L 350ci	N	w/THM200-4R Auto. Trans. 51.00" Cable	CA-1930	25508263

# DETENT CABLES

Year	Engine	Vin	Remark	Part	OE
<b>OLDSMOBILE (con't)</b>					
<b>DELTA 88 (con't)</b>					
1982	V8 5.7L 350ci	N	w/THM200-4R Auto. Trans., Universal cable for temporary fix, use CA-1930 for permanent fix	CA-1980	
1983	V8 5.7L 350ci	N	w/THM350C Auto. Trans. 51.00" Cable	CA-1930	25508265
1983	V8 5.7L 350ci	N	w/THM350C Auto. Trans., Universal cable for temporary fix, use CA-1930 for permanent fix	CA-1980	
1977	V8 5.7L 350ci	R	w/THM200 Auto. Trans.; 38.40" Cable	CA-1941	1262615
1977	V8 5.7L 350ci	R	w/THM200 Auto. Trans., Universal cable for temporary fix, use CA-1941 for permanent fix	CA-1980	
1979	V8 5.7L 350ci	R	w/THM350 Auto. Trans.; 37.00" Cable, w/Olds. Eng.	CA-1963	1254178
1978	V8 6.6L 403ci	K	w/Man. & Auto. Trans.; 37.00" Cable	CA-1963	1254178
<b>FIRENZA</b>					
1982	L4 1.8L 112ci	G	w/THM125C Auto. Trans.; 36.10" Cable	CA-1960	25509560
1982	L4 1.8L 112ci	G	w/THM125C Auto. Trans., Universal cable for temporary fix, use CA-1960 for permanent fix	CA-1980	
1983-84	L4 2.0L 122ci	B	Export, w/Canada Emissions, w/THM125C Auto. Trans.; 36.10" Cable	CA-1960	25509560
1983-84	L4 2.0L 122ci	B	Export, w/Canada Emissions, w/THM125C Auto. Trans., Universal cable for temporary fix, use CA-1960 for permanent fix	CA-1980	
1983-86	L4 2.0L 122ci	P	w/THM125C Auto. Trans.; 25.70" Cable	CA-1932	25513017
1983-86	L4 2.0L 122ci	P	w/THM125C Auto. Trans., Universal cable for temporary fix, use CA-1932 for permanent fix	CA-1980	
<b>OMEGA</b>					
1980-81	L4 2.5L 151ci	5	w/THM125C Auto. Trans.; 25.70" Cable	CA-1932	25513389
1980-81	L4 2.5L 151ci	5	w/THM125C Auto. Trans., Universal cable for temporary fix, use CA-1932 for permanent fix	CA-1980	
1982-83	L4 2.5L 151ci	5, R	Export, w/Canada Emissions, w/THM125C Auto. Trans.; 25.70" Cable	CA-1932	25513389
1982-83	L4 2.5L 151ci	5, R	w/THM125C Auto. Trans.; 40.79" Cable	CA-1958	25513393
1982-83	L4 2.5L 151ci	5, R	Export, w/Canada Emissions, w/THM125C Auto. Trans., Universal cable for temporary fix, use CA-1932 for permanent fix	CA-1980	
1984	L4 2.5L 151ci	R	w/THM125C Auto. Trans.; 47.00" Cable	CA-1935	25519347
1984	L4 2.5L 151ci	R	w/THM125C Auto. Trans., Universal cable for temporary fix, use CA-1935 for permanent fix	CA-1980	
1976	L6 4.1L 250ci	D	w/THM350 Auto. Trans.; 45.00" Cable	CA-1951	1262618
1976	L6 4.1L 250ci	D	THM350 Auto. Trans.; 49.20" Cable, Universal cable for temporary fix, use CA-1951 for permanent fix	CA-1981	
1981-84	V6 2.8L 173ci	X	w/Auto. Trans. 51.00" Cable	CA-1930	1262487
1981-84	V6 2.8L 173ci	X	w/THM125C Auto. Trans., Universal cable for temporary fix, use CA-1930 for permanent fix	CA-1980	
1978-79	V6 3.8L 231ci	A	w/THM350 Auto. Trans.; 33.95" Cable	CA-1955	1262652
1977	V6 3.8L 231ci	C	w/THM200 Auto. Trans.; 38.40" Cable	CA-1941	1256299
1977	V6 3.8L 231ci	C	w/THM350 Auto. Trans.; 45.00" Cable	CA-1951	1262620
1977	V6 3.8L 231ci	C	w/THM200 Auto. Trans., Universal cable for temporary fix, use CA-1941 for permanent fix	CA-1980	
1977	V6 3.8L 231ci	C	THM350 Auto. Trans.; 49.20" Cable, Universal cable for temporary fix, use CA-1951 for permanent fix	CA-1981	
1976	V8 4.3L 260ci	F	w/THM200 Auto. Trans.; 38.40" Cable	CA-1941	1262615
1976	V8 4.3L 260ci	F	w/THM200 Auto. Trans., Universal cable for temporary fix, use CA-1941 for permanent fix	CA-1980	
1976-77	V8 4.3L 260ci	F	w/THM350 Auto. Trans., w/THM375 Auto. Trans., Universal cable for temporary fix, use CA-1953 for permanent fix; 49.20" Cable	CA-1981	

# DETENT CABLES

Year	Engine	Vin	Remark	Part	OE
<b>OLDSMOBILE (con't)</b>					
<b>OMEGA (con't)</b>					
1976-77	V8 4.3L 260ci	F	w/THM350 Auto. Trans., w/THM375 Auto. Trans.; 43.86" Cable	CA-1953	1260676
1979	V8 5.0L 305ci	G	w/Auto. Trans.; 45.00" Cable	CA-1951	1262620
1979	V8 5.0L 305ci	G	w/Auto. Trans.; 49.20" Cable, Universal cable for temporary fix, use CA-1951 for permanent fix	CA-1981	
1977	V8 5.0L 305ci	U	w/THM200 Auto. Trans.; 44.68" Cable	CA-1940	1253966
1977	V8 5.0L 305ci	U	w/THM200 Auto. Trans., Universal cable for temporary fix, use CA-1940 for permanent fix	CA-1980	
1977-78	V8 5.0L 305ci	U	w/THM350 Auto. Trans.; 45.00" Cable	CA-1951	1262620
1977-78	V8 5.0L 305ci	U	THM350 Auto. Trans.; 49.20" Cable, Universal cable for temporary fix, use CA-1951 for permanent fix	CA-1981	
1977-78	V8 5.7L 350ci	L	w/THM350 Auto. Trans.; 45.00" Cable	CA-1951	1262620
1977-78	V8 5.7L 350ci	L	THM350 Auto. Trans.; 49.20" Cable, Universal cable for temporary fix, use CA-1951 for permanent fix	CA-1981	
1979	V8 5.7L 350ci	L	w/Auto. Trans.; 45.00" Cable	CA-1951	1262620
1979	V8 5.7L 350ci	L	w/Auto. Trans.; 49.20" Cable, Universal cable for temporary fix, use CA-1951 for permanent fix	CA-1981	
1977	V8 5.7L 350ci	R	w/THM350 Auto. Trans.; 37.00" Cable, w/Olds. Eng.	CA-1963	1254178
<b>VISTA CRUISER</b>					
1977	V8 5.7L 350ci	R	w/THM350 Auto. Trans.; 37.00" Cable	CA-1963	1254178
<b>PLYMOUTH</b>					
<b>HORIZON</b>					
1981-82	L4 2.2L 135ci	B	w/Auto. Trans.; 40.40" Cable	CA-1949	4241210
1983	L4 2.2L 135ci	C	w/Auto. Trans.; 40.40" Cable	CA-1949	4241210
<b>RELIANT</b>					
1981	L4 2.2L 135ci	B	w/Auto. Trans.; 40.40" Cable, To 12/1/81	CA-1949	4241210
1982	L4 2.2L 135ci	B	w/Auto. Trans.; 40.40" Cable	CA-1949	4268842
1983	L4 2.2L 135ci	C	w/Auto. Trans.; 40.40" Cable	CA-1949	4275918
<b>SCAMP</b>					
1983	L4 2.2L 135ci	C	w/Auto. Trans.; 40.40" Cable	CA-1949	4268843
<b>PONTIAC</b>					
<b>6000</b>					
1982-83	L4 2.5L 151ci	5, R	Export, w/Canada Emissions, w/THM125C Auto. Trans.; 25.70" Cable	CA-1932	25513389
1982-83	L4 2.5L 151ci	5, R	w/THM125C Auto. Trans.; 40.79" Cable	CA-1958	25513393
1982-83	L4 2.5L 151ci	5, R	Export, w/Canada Emissions, w/THM125C Auto. Trans., Universal cable for temporary fix, use CA-1932 for permanent fix	CA-1980	
1983	L4 2.5L 151ci	5, R	w/Auto. Trans. 51.00" Cable	CA-1930	1262487
1983	L4 2.5L 151ci	5, R	w/Auto. Trans.; 36.10" Cable, w/High Output	CA-1960	25515599
1983	L4 2.5L 151ci	5, R	w/Auto. Trans., Universal cable for temporary fix, use CA-1930 for permanent fix	CA-1980	
1983	L4 2.5L 151ci	5, R	w/Auto. Trans., w/High Output, Universal cable for temporary fix, use CA-1960 for permanent fix	CA-1980	
1984-86	L4 2.5L 151ci	R	w/THM125C Auto. Trans.; 47.00" Cable	CA-1935	25519347
1984-86	L4 2.5L 151ci	R	w/THM125C Auto. Trans., Universal cable for temporary fix, use CA-1935 for permanent fix	CA-1980	
1985	V6 2.8L 173ci	W	w/Auto. Trans.; 36.10" Cable, w/High Output	CA-1960	25515599
1985	V6 2.8L 173ci	W	w/Auto. Trans., w/High Output, Universal cable for temporary fix, use CA-1960 for permanent fix	CA-1980	
1982-86	V6 2.8L 173ci	X	w/Auto. Trans. 51.00" Cable	CA-1930	1262487
1982-86	V6 2.8L 173ci	X	w/Auto. Trans., Universal cable for temporary fix, use CA-1930 for permanent fix	CA-1980	
1982-85	V6 4.3L 260ci	T	w/Auto. Trans., Universal cable for temporary fix, use CA-1943 for permanent fix	CA-1980	

# DETENT CABLES

Year	Engine	Vin	Remark	Part	OE
<b>PONTIAC (con't)</b>					
<b>6000 (con't)</b>					
1982-85	V6 4.3L 260ci	T	w/Auto. Trans.; 37.51" Cable	CA-1943	25510971
<b>ASTRE</b>					
1976	L4 2.3L 140ci	A	w/THM350 Auto. Trans.; 42.01" Cable	CA-1952	342488
1976	L4 2.3L 140ci	A	THM350 Auto. Trans.; 49.20" Cable, Universal cable for temporary fix, use CA-1952 for permanent fix	CA-1981	
1976-77	L4 2.3L 140ci	B	w/THM350 Auto. Trans.; 42.01" Cable	CA-1952	342488
1976-77	L4 2.3L 140ci	B	THM350 Auto. Trans.; 49.20" Cable, Universal cable for temporary fix, use CA-1952 for permanent fix	CA-1981	
<b>BONNEVILLE</b>					
1987	V6 3.8L 231ci	3	w/THM440-T4 Auto. Trans.; 35.35" Cable, exc. High Output	CA-1937	25517536
1987-88	V6 3.8L 231ci	3	THM440-T4 Auto. Trans., exc. HO, Universal cable for temporary fix, use CA-1937 for permanent fix	CA-1980	
1988	V6 3.8L 231ci	3	exc. High Output, w/THM440-T4 Auto. Trans.; 35.35" Cable	CA-1937	25517536
1980	V6 3.8L 231ci	A	w/THM350 Auto. Trans.; 33.95" Cable	CA-1955	1262652
1981	V6 3.8L 231ci	A	w/THM350 Auto. Trans.; 36.10" Cable	CA-1960	25505174
1981	V6 3.8L 231ci	A	w/THM350 Auto. Trans., Universal cable for temporary fix, use CA-1960 for permanent fix	CA-1980	
1982-83	V6 3.8L 231ci	A	w/THM250C Auto. Trans., w/THM350C Auto. Trans.; 36.10" Cable	CA-1960	25505174
1982-83	V6 3.8L 231ci	A	w/THM250C Auto. Trans., w/THM350C Auto. Trans., Universal cable for temporary fix, use CA-1960 for permanent fix	CA-1980	
1984	V6 3.8L 231ci	A	w/THM200C Auto. Trans., w/THM250C Auto. Trans.; 36.10" Cable	CA-1960	25505174
1984	V6 3.8L 231ci	A	w/THM200C Auto. Trans., w/THM250C Auto. Trans., Universal cable for temporary fix, use CA-1960 for permanent fix	CA-1980	
1985-86	V6 3.8L 231ci	A	w/THM200C Auto. Trans.; 36.10" Cable	CA-1960	25505175
1985-86	V6 3.8L 231ci	A	w/THM200C Auto. Trans., Universal cable for temporary fix, use CA-1960 for permanent fix	CA-1980	
1982	V6 4.1L 252ci	4	w/THM250C Auto. Trans., w/THM350C Auto. Trans.; 36.10" Cable	CA-1960	25505174
1982	V6 4.1L 252ci	4	w/THM250C Auto. Trans., w/THM350C Auto. Trans., Universal cable for temporary fix, use CA-1960 for permanent fix	CA-1980	
1986	V6 4.3L 262ci	Z	w/THM200C Auto. Trans., w/THM200-4R Auto. Trans.; 37.51" Cable	CA-1943	25521267
1986	V6 4.3L 262ci	Z	w/THM200C Auto. Trans., w/THM200-4R Auto. Trans., Universal cable for temporary fix, use CA-1943 for permanent fix	CA-1980	
1981	V8 4.3L 265ci	S	w/THM200C Auto. Trans.; 37.51" Cable	CA-1943	25507550
1981	V8 4.3L 265ci	S	w/THM200C Auto. Trans., Universal cable for temporary fix, use CA-1943 for permanent fix	CA-1980	
1978-79	V8 4.9L 301ci	W	w/THM350 Auto. Trans.	CA-1964	1255739
1980	V8 4.9L 301ci	W	w/THM250 Auto. Trans., w/THM350 Auto. Trans.	CA-1964	1255739
1977-79	V8 4.9L 301ci	Y	w/THM350 Auto. Trans.	CA-1964	1255739
1983	V8 5.0L 305ci	H	w/THM250C Auto. Trans., w/THM350C Auto. Trans.; 37.80" Cable	CA-1933	25507541
1983	V8 5.0L 305ci	H	w/THM250C Auto. Trans., w/THM350C Auto. Trans., Universal cable for temporary fix only, for permanent fix use CA-1933; 49.20" Cable	CA-1981	
1984	V8 5.0L 305ci	H	w/THM250C Auto. Trans.; 37.80" Cable	CA-1933	25507541
1984	V8 5.0L 305ci	H	w/THM200-4R Auto. Trans.; 37.51" Cable	CA-1943	25507546

# DETENT CABLES

Year	Engine	Vin	Remark	Part	OE
<b>PONTIAC (con't)</b>					
<b>BONNEVILLE (con't)</b>					
1984	V8 5.0L 305ci	H	w/THM200-4R Auto. Trans., Universal cable for temporary fix, use CA-1943 for permanent fix	CA-1980	
1984	V8 5.0L 305ci	H	w/THM250C Auto. Trans.; 49.20" Cable, Universal cable, for temporary fix only, for permanent fix use CA-1933	CA-1981	
1985-86	V8 5.0L 305ci	H	w/Auto. Trans.; 37.51" Cable	CA-1943	25507546
1985-86	V8 5.0L 305ci	H	w/Auto. Trans., Universal cable for temporary fix, use CA-1943 for permanent fix	CA-1980	
1981	V8 5.0L 307ci	Y	w/THM200C Auto. Trans.; 35.35" Cable	CA-1937	25508262
1981	V8 5.0L 307ci	Y	w/THM200C Auto. Trans., Universal cable for temporary fix, use CA-1937 for permanent fix	CA-1980	
1980	V8 5.7L 350ci	N, R	w/THM350 Auto. Trans., w/Olds. Eng., w/THM350C Auto. Trans.; 37.80" Cable	CA-1933	25503382
1980	V8 5.7L 350ci	N, R	w/THM350 Auto. Trans., w/Olds. Eng., w/THM350C Auto. Trans., Universal cable, for temporary fix only, for permanent fix use CA-1933; 49.20" Cable	CA-1981	
1981-83	V8 5.7L 350ci	N	w/THM200C Auto. Trans., w/THM350C Auto. Trans. 51.00" Cable	CA-1930	25508265
1981-83	V8 5.7L 350ci	N	w/THM200C Auto. Trans., w/THM350C Auto. Trans., Universal cable for temporary fix, use CA-1930 for permanent fix	CA-1980	
1983	V8 5.7L 350ci	N	w/THM200C Auto. Trans., w/THM350C Auto. Trans. 51.00" Cable	CA-1930	25508263
1984	V8 5.7L 350ci	N	THM200-4R Auto. Trans., w/THM200C 51.00" Cable	CA-1930	25508263
1984	V8 5.7L 350ci	N	THM200-4R Auto. Trans., THM200C, Universal cable for temporary fix, use CA-1930 for permanent fix	CA-1980	
1977	V8 5.7L 350ci	R	w/THM200 Auto. Trans.; 38.40" Cable	CA-1941	1262615
1977	V8 5.7L 350ci	R	w/THM200 Auto. Trans., Universal cable for temporary fix, use CA-1941 for permanent fix	CA-1980	
1978-79	V8 5.7L 350ci	R	w/THM350 Auto. Trans.; 37.00" Cable, w/Olds. Eng.	CA-1963	1254178
1978-79	V8 5.7L 350ci	X	Buick Eng., w/THM350C Auto. Trans.; 39.17" Cable	CA-1954	1262617
1978-79	V8 5.7L 350ci	X	w/Buick Eng., w/THM350C Auto. Trans.; 49.20" Cable, Universal cable for temporary fix, use CA-1954 for permanent fix	CA-1981	
1977-78	V8 6.6L 400ci	Z	w/THM350 Auto. Trans.; 37.00" Cable	CA-1963	1254178
1977-79	V8 6.6L 403ci	K	w/THM350 Auto. Trans.; 37.00" Cable	CA-1963	1254178
<b>CATALINA</b>					
1980	V6 3.8L 229ci	K	w/THM350 Auto. Trans.; 37.00" Cable	CA-1963	1254178
1977-80	V6 3.8L 231ci	A	w/THM350 Auto. Trans.; 33.95" Cable	CA-1955	1262652
1978	V6 3.8L 231ci	A	w/THM200C Auto. Trans.; 36.30" Cable	CA-1942	1262678
1978	V6 3.8L 231ci	A	w/THM200C Auto. Trans., Universal cable for temporary fix, use CA-1942 for permanent fix	CA-1980	
1979	V6 3.8L 231ci	A	w/THM250 Auto. Trans., w/THM350 Auto. Trans.; 33.95" Cable	CA-1955	1262652
1981	V6 3.8L 231ci	A	w/THM350 Auto. Trans.; 36.10" Cable	CA-1960	25505174
1981	V6 3.8L 231ci	A	w/THM350 Auto. Trans., Universal cable for temporary fix, use CA-1960 for permanent fix	CA-1980	
1977	V6 3.8L 231ci	C	w/THM350 Auto. Trans.; 39.17" Cable	CA-1954	1262617
1977	V6 3.8L 231ci	C	THM350 Auto. Trans.; 49.20" Cable, Universal cable for temporary fix, use CA-1954 for permanent fix	CA-1981	
1981	V8 4.3L 265ci	S	w/THM200C Auto. Trans.; 37.51" Cable	CA-1943	25507550
1981	V8 4.3L 265ci	S	w/THM200C Auto. Trans., Universal cable for temporary fix, use CA-1943 for permanent fix	CA-1980	
1979	V8 4.9L 301ci	W	w/THM350 Auto. Trans.	CA-1964	1255739
1980	V8 4.9L 301ci	W	w/THM250 Auto. Trans., w/THM350 Auto. Trans.	CA-1964	1255739
1977-79	V8 4.9L 301ci	Y	w/THM350 Auto. Trans.	CA-1964	1255739

# DETENT CABLES

Year	Engine	Vin	Remark	Part	OE
<b>PONTIAC (con't)</b>					
<b>CATALINA (con't)</b>					
1980	V8 5.0L 305ci	H	w/THM350 Auto. Trans.; 45.00" Cable	CA-1951	1262620
1980	V8 5.0L 305ci	H	THM350 Auto. Trans.; 49.20" Cable, Universal cable for temporary fix, use CA-1951 for permanent fix	CA-1981	
1981	V8 5.0L 307ci	Y	w/THM200C Auto. Trans.; 35.35" Cable	CA-1937	25508262
1981	V8 5.0L 307ci	Y	w/THM200C Auto. Trans., Universal cable for temporary fix, use CA-1937 for permanent fix	CA-1980	
1980	V8 5.7L 350ci	N, R	w/THM350 Auto. Trans., w/Olds. Eng., w/THM350C Auto. Trans.; 37.80" Cable	CA-1933	25503382
1980	V8 5.7L 350ci	N, R	w/THM350 Auto. Trans., w/Olds. Eng., w/THM350C Auto. Trans., Universal cable, for temporary fix only, for permanent fix use CA-1933; 49.20" Cable	CA-1981	
1981	V8 5.7L 350ci	N	w/THM200C Auto. Trans., w/THM350C Auto. Trans. 51.00" Cable	CA-1930	25508265
1981	V8 5.7L 350ci	N	w/THM200C Auto. Trans., w/THM350C Auto. Trans., Universal cable for temporary fix, use CA-1930 for permanent fix	CA-1980	
1977	V8 5.7L 350ci	R	w/THM200 Auto. Trans.; 38.40" Cable	CA-1941	1262615
1977	V8 5.7L 350ci	R	w/THM200 Auto. Trans., Universal cable for temporary fix, use CA-1941 for permanent fix	CA-1980	
1978-79	V8 5.7L 350ci	R	w/THM350 Auto. Trans.; 37.00" Cable, w/Olds. Eng.	CA-1963	1254178
1978-79	V8 5.7L 350ci	X	Buick Eng., w/THM350C Auto. Trans.; 39.17" Cable	CA-1954	1262617
1978-79	V8 5.7L 350ci	X	w/Buick Eng., w/THM350C Auto. Trans.; 49.20" Cable, Universal cable for temporary fix, use CA-1954 for permanent fix	CA-1981	
1977-78	V8 6.6L 400ci	Z	w/THM350 Auto. Trans.; 37.00" Cable	CA-1963	1254178
1977-79	V8 6.6L 403ci	K	w/THM350 Auto. Trans.; 37.00" Cable	CA-1963	1254178
<b>FIERO</b>					
1984-86	L4 2.5L 151ci	R	w/THM125C Auto. Trans.; 47.00" Cable	CA-1935	25517313
1984-86	L4 2.5L 151ci	R	w/THM125C Auto. Trans., Universal cable for temporary fix, use CA-1935 for permanent fix	CA-1980	
<b>FIREBIRD</b>					
1982-83	L4 2.5L 151ci	2, F	w/Auto. Trans., Export, w/Canada Emissions; 25.70" Cable	CA-1932	1644356
1982-83	L4 2.5L 151ci	2, F	w/AT, Export, w/Canada Emissions, Universal cable for temporary fix, use CA-1932 for permanent fix	CA-1980	
1982	L4 2.5L 151ci	2	w/THM200C Auto. Trans.; 52.95" Cable	CA-1939	25513394
1982	L4 2.5L 151ci	2	w/THM200C Auto. Trans., Universal cable for temporary fix, use CA-1939 for permanent fix	CA-1980	
1983	L4 2.5L 151ci	2	THM200C Auto. Trans., w/THM700-R4; 52.95" Cable	CA-1939	25513394
1983	L4 2.5L 151ci	2	THM200C Auto. Trans., THM700-R4, Universal cable for temporary fix, use CA-1939 for permanent fix	CA-1980	
1984-85	L4 2.5L 151ci	2	w/Auto. Trans.; 52.95" Cable	CA-1939	25517312
1984-85	L4 2.5L 151ci	2	w/Auto. Trans., Universal cable for temporary fix, use CA-1939 for permanent fix	CA-1980	
1976	L6 4.1L 250ci	D	w/THM350 Auto. Trans.; 45.00" Cable	CA-1951	1262618
1976	L6 4.1L 250ci	D	THM350 Auto. Trans.; 49.20" Cable, Universal cable for temporary fix, use CA-1951 for permanent fix	CA-1981	
1982-83	V6 2.8L 173ci	1	w/Auto. Trans.; 36.10" Cable	CA-1960	14040597
1982-83	V6 2.8L 173ci	1	w/Auto. Trans., Universal cable for temporary fix, use CA-1960 for permanent fix	CA-1980	
1985-89	V6 2.8L 173ci	S	w/THM700-R4 Auto. Trans.; 47.00" Cable	CA-1935	25521266
1985-89	V6 2.8L 173ci	S	w/THM700-R4 Auto. Trans., Universal cable for temporary fix, use CA-1935 for permanent fix	CA-1980	
1979	V6 3.8L 231ci	A	w/THM250 Auto. Trans., w/THM350 Auto. Trans.; 33.95" Cable	CA-1955	1262652

# DETENT CABLES

Year	Engine	Vin	Remark	Part	OE
<b>PONTIAC (con't)</b>					
<b>FIREBIRD (con't)</b>					
1981	V6 3.8L 231ci	A	w/THM350 Auto. Trans.; 36.10" Cable	CA-1960	25505174
1981	V6 3.8L 231ci	A	w/THM350 Auto. Trans., Universal cable for temporary fix, use CA-1960 for permanent fix	CA-1980	
1978-80	V6 3.8L 231ci	A	w/THM350 Auto. Trans.; 33.95" Cable	CA-1955	1262652
1977	V6 3.8L 231ci	C	w/THM350 Auto. Trans.; 39.17" Cable	CA-1954	1262617
1977	V6 3.8L 231ci	C	THM350 Auto. Trans.; 49.20" Cable, Universal cable for temporary fix, use CA-1954 for permanent fix	CA-1981	
1980	V8 4.3L 265ci	S	w/THM250 Auto. Trans., w/THM350 Auto. Trans.	CA-1964	1255739
1981	V8 4.3L 265ci	S	w/THM200 Auto. Trans.; 37.51" Cable	CA-1943	25507550
1981	V8 4.3L 265ci	S	w/THM200 Auto. Trans., Universal cable for temporary fix, use CA-1943 for permanent fix	CA-1980	
1981	V8 4.4L 267ci	J	Export, w/Canada Emissions, w/THM350C Auto. Trans.; 37.80" Cable	CA-1933	25507541
1981	V8 4.4L 267ci	J	Export, w/Canada Emissions, w/THM350C Auto. Trans.; 49.20" Cable, Universal cable, for temporary fix only, for permanent fix use CA-1933	CA-1981	
1979-80	V8 4.9L 301ci	W	w/THM250 Auto. Trans., w/THM350 Auto. Trans.	CA-1964	1255739
1981	V8 4.9L 301ci	W	w/THM200C Auto. Trans.; 37.51" Cable	CA-1943	25507550
1981	V8 4.9L 301ci	W	w/THM200C Auto. Trans., Universal cable for temporary fix, use CA-1943 for permanent fix	CA-1980	
1977	V8 4.9L 301ci	Y	w/THM350 Auto. Trans.	CA-1964	1255739
1979	V8 4.9L 301ci	Y	w/THM250 Auto. Trans., w/THM350 Auto. Trans.	CA-1964	1255739
1988-89	V8 5.0L 305ci	E	w/THM700-R4 Auto. Trans. 51.00" Cable	CA-1930	10066475
1988-89	V8 5.0L 305ci	E	w/THM700-R4 Auto. Trans., Universal cable for temporary fix, use CA-1930 for permanent fix	CA-1980	
1980	V8 5.0L 305ci	H	45.00" Cable	CA-1951	1262620
1980	V8 5.0L 305ci	H	Universal cable for temporary fix, use CA-1951 for permanent fix; 49.20" Cable	CA-1981	
1981	V8 5.0L 305ci	H	w/THM350 Auto. Trans.; 37.80" Cable	CA-1933	25507541
1981	V8 5.0L 305ci	H	THM350 Auto. Trans.; 49.20" Cable, Universal cable for temporary fix only, for permanent fix use CA-1933	CA-1981	
1982-83	V8 5.0L 305ci	H	w/THM200C Auto. Trans.; 37.51" Cable	CA-1943	25507546
1982-83	V8 5.0L 305ci	H	w/THM200C Auto. Trans., Universal cable for temporary fix, use CA-1943 for permanent fix	CA-1980	
1983-87	V8 5.0L 305ci	H	w/THM700-R4 Auto. Trans.; 44.50" Cable	CA-1970	25515598
1983-87	V8 5.0L 305ci	H	w/THM700-R4 Auto. Trans., Universal cable for temporary fix, use CA-1970 for permanent fix	CA-1980	
1983	V8 5.0L 305ci	S	w/Throttle Body Injection, w/THM700-R4 Auto. Trans.; 36.10" Cable	CA-1960	25515601
1983	V8 5.0L 305ci	S	w/Throttle Body Injection, w/THM700-R4 Auto. Trans., Universal cable for temporary fix, use CA-1960 for permanent fix	CA-1980	
1978	V8 5.0L 305ci	U	w/THM350 Auto. Trans.; 45.00" Cable	CA-1951	1262620
1978	V8 5.0L 305ci	U	THM350 Auto. Trans.; 49.20" Cable, Universal cable for temporary fix, use CA-1951 for permanent fix	CA-1981	
1978-79	V8 5.7L 350ci	L	w/THM350 Auto. Trans.; 45.00" Cable, w/Chevrolet Eng.	CA-1951	1262620
1978-79	V8 5.7L 350ci	L	w/THM350 Auto. Trans.; 49.20" Cable, w/Chevrolet Eng., Universal cable for temporary fix, use CA-1951 for permanent fix	CA-1981	
1976	V8 5.7L 350ci	M	w/THM350 Auto. Trans., w/THM375 Auto. Trans.; 43.86" Cable	CA-1953	1256301
1976	V8 5.7L 350ci	M	w/THM350 Auto. Trans., w/THM375 Auto. Trans., Universal cable for temporary fix, use CA-1953 for permanent fix; 49.20" Cable	CA-1981	



# DETENT CABLES

Year	Engine	Vin	Remark	Part	OE
<b>PONTIAC (con't)</b>					
<b>FIREBIRD (con't)</b>					
1976-77	V8 5.7L 350ci	P	w/THM350 AT., w/THM375 Auto. Trans.; 43.86" Cable	CA-1953	1256301
1976-77	V8 5.7L 350ci	P	w/THM350 Auto. Trans., w/THM375 Auto. Trans., Universal cable for temporary fix, use CA-1953 for permanent fix; 49.20" Cable	CA-1981	
1977	V8 5.7L 350ci	R	w/THM350 Auto. Trans., w/THM375 Auto. Trans.; 43.86" Cable	CA-1953	1256301
1977	V8 5.7L 350ci	R	w/THM350 Auto. Trans., w/THM375 Auto. Trans., Universal cable for temporary fix, use CA-1953 for permanent fix; 49.20" Cable	CA-1981	
1976-77	V8 6.6L 400ci	Z	w/THM350 Auto. Trans., w/THM375 Auto. Trans.; 43.86" Cable	CA-1953	1256301
1976-77	V8 6.6L 400ci	Z	w/THM350 Auto. Trans., w/THM375 Auto. Trans., Universal cable for temporary fix, use CA-1953 for permanent fix; 49.20" Cable	CA-1981	
1977	V8 6.6L 403ci	K	w/THM350 Auto. Trans., w/THM375 Auto. Trans.; 43.86" Cable	CA-1953	1256301
1977	V8 6.6L 403ci	K	w/THM350 Auto. Trans., w/THM375 Auto. Trans., Universal cable for temporary fix, use CA-1953 for permanent fix; 49.20" Cable	CA-1981	
1978-79	V8 6.6L 403ci	K	w/THM350 Auto. Trans.; 37.00" Cable	CA-1963	1254178
<b>GRAND AM</b>					
1985	V6 3.0L 181ci	L	w/THM125C Auto. Trans.; 35.35" Cable	CA-1937	25519361
1985	V6 3.0L 181ci	L	w/THM125C Auto. Trans., Universal cable for temporary fix, use CA-1937 for permanent fix	CA-1980	
1979	V6 3.8L 231ci	A	w/THM200C Auto. Trans.; 36.30" Cable	CA-1942	1262678
1979	V6 3.8L 231ci	A	w/THM250 Auto. Trans.; 33.95" Cable, w/THM350	CA-1955	1262652
1979	V6 3.8L 231ci	A	w/THM200C Auto. Trans., Universal cable for temporary fix, use CA-1942 for permanent fix	CA-1980	
1979	V8 4.9L 301ci	W, Y	w/THM350 Auto. Trans.	CA-1964	1255739
1980	V8 4.9L 301ci	W	w/THM250 Auto. Trans.	CA-1964	1255739
1979	V8 5.0L 305ci	H	w/THM200 Auto. Trans.; 38.40" Cable	CA-1941	1262613
1979	V8 5.0L 305ci	H	w/THM200 Auto. Trans., Universal cable for temporary fix, use CA-1941 for permanent fix	CA-1980	
1979-80	V8 5.0L 305ci	H	w/THM350 Auto. Trans.; 45.00" Cable	CA-1951	1262620
1979-80	V8 5.0L 305ci	H	THM350 Auto. Trans.; 49.20" Cable, Universal cable for temporary fix, use CA-1951 for permanent fix	CA-1981	
1978	V8 5.0L 305ci	U	w/THM200 Auto. Trans.; 38.40" Cable	CA-1941	1262613
1978	V8 5.0L 305ci	U	w/THM200 Auto. Trans., Universal cable for temporary fix, use CA-1941 for permanent fix	CA-1980	
<b>GRAND LEMANS</b>					
1976	L6 4.1L 250ci	D	w/THM350 Auto. Trans.	CA-1950	1245640
1980	V6 3.8L 229ci	K	w/THM200 Auto. Trans.; 35.00" Cable	CA-1947	1262612
1980	V6 3.8L 229ci	K	w/THM200 Auto. Trans., Universal cable for temporary fix, use CA-1947 for permanent fix	CA-1980	
1978-80	V6 3.8L 231ci	A	w/THM200C Auto. Trans.; 36.30" Cable	CA-1942	1262678
1978-80	V6 3.8L 231ci	A	w/THM350 Auto. Trans.; 33.95" Cable	CA-1955	1262652
1979	V6 3.8L 231ci	A	w/THM250 Auto. Trans.; 33.95" Cable, w/THM350	CA-1955	1262652
1980	V6 3.8L 231ci	A	w/THM200 Auto. Trans.; 35.00" Cable	CA-1947	1262612
1980	V6 3.8L 231ci	A	w/THM200 Auto. Trans., Universal cable for temporary fix, use CA-1947 for permanent fix	CA-1980	
1981	V6 3.8L 231ci	A	w/THM200C, w/THM250C Auto. Trans., w/THM350C Auto. Trans.; 36.10" Cable	CA-1960	25505174
1981	V6 3.8L 231ci	A	w/THM200C, w/THM250C Auto. Trans., w/THM350C Auto. Trans., Universal cable for temporary fix, use CA-1960 for permanent fix	CA-1980	

# DETENT CABLES

Year	Engine	Vin	Remark	Part	OE
<b>PONTIAC (con't)</b>					
<b>GRAND LEMANS (con't)</b>					
1978-80	V6 3.8L 231ci	A	w/THM200C Auto. Trans., Universal cable for temporary fix, use CA-1942 for permanent fix	CA-1980	
1977	V6 3.8L 231ci	C	w/THM350 Auto. Trans.; 39.17" Cable	CA-1954	1262617
1977	V6 3.8L 231ci	C	THM350 Auto. Trans.; 49.20" Cable, Universal cable for temporary fix, use CA-1954 for permanent fix	CA-1981	
1976	V8 4.3L 260ci	F	w/THM350 Auto. Trans.	CA-1950	1245902
1981	V8 4.3L 265ci	S	w/THM200C Auto. Trans.; 37.51" Cable	CA-1943	25507550
1981	V8 4.3L 265ci	S	w/THM200C Auto. Trans., Universal cable for temporary fix, use CA-1943 for permanent fix	CA-1980	
1981	V8 4.4L 267ci	J	Export, w/Canada Emissions, w/THM350C Auto. Trans.; 37.80" Cable	CA-1933	25507541
1981	V8 4.4L 267ci	J	Export, w/Canada Emissions, w/THM350C Auto. Trans.; 49.20" Cable, Universal cable, for temporary fix only, for permanent fix use CA-1933	CA-1981	
1980	V8 4.9L 301ci	W	w/THM250 Auto. Trans.	CA-1964	1255739
1979	V8 4.9L 301ci	Y	w/THM350 Auto. Trans.	CA-1964	1255739
1979	V8 5.0L 305ci	H	w/THM200 Auto. Trans.; 38.40" Cable	CA-1941	1262613
1979	V8 5.0L 305ci	H	w/THM200 Auto. Trans., Universal cable for temporary fix, use CA-1941 for permanent fix	CA-1980	
1979-80	V8 5.0L 305ci	H	w/THM350 Auto. Trans.; 45.00" Cable	CA-1951	1262620
1979-80	V8 5.0L 305ci	H	THM350 Auto. Trans.; 49.20" Cable, Universal cable for temporary fix, use CA-1951 for permanent fix	CA-1981	
1981	V8 5.0L 305ci	H	Export, w/Canada Emissions, w/THM350C Auto. Trans.; 37.80" Cable	CA-1933	25507541
1981	V8 5.0L 305ci	H	Export, w/Canada Emissions, w/THM350C Auto. Trans.; 49.20" Cable, Universal cable, for temporary fix only, for permanent fix use CA-1933	CA-1981	
1978	V8 5.0L 305ci	U	w/THM200 Auto. Trans.; 38.40" Cable	CA-1941	1262613
1978	V8 5.0L 305ci	U	w/THM200 Auto. Trans., Universal cable for temporary fix, use CA-1941 for permanent fix	CA-1980	
1977	V8 5.7L 350ci	L, P	w/THM350 Auto. Trans.; 43.86" Cable	CA-1953	1256301
1977	V8 5.7L 350ci	L, P	THM350 Auto. Trans.; 49.20" Cable, Universal cable for temporary fix, use CA-1953 for permanent fix	CA-1981	
1978	V8 5.7L 350ci	L	w/THM350 Auto. Trans.; 45.00" Cable, w/Chevrolet Eng.	CA-1951	1262620
1978	V8 5.7L 350ci	L	w/THM350 Auto. Trans.; 49.20" Cable, w/Chevrolet Eng., Universal cable for temporary fix, use CA-1951 for permanent fix	CA-1981	
1977	V8 5.7L 350ci	R	w/THM350 Auto. Trans.; 37.00" Cable, w/Olds. Eng.	CA-1963	1254178
1977	V8 6.6L 400ci	Z	w/THM350 Auto. Trans.; 43.86" Cable	CA-1953	1256301
1977	V8 6.6L 400ci	Z	THM350 Auto. Trans.; 49.20" Cable, Universal cable for temporary fix, use CA-1953 for permanent fix	CA-1981	
1977	V8 6.6L 403ci	K	w/THM350 Auto. Trans.; 37.00" Cable	CA-1963	1254178
<b>GRAND PRIX</b>					
1979	V6 3.8L 231ci	A	w/THM250 Auto. Trans.; 33.95" Cable, w/THM350	CA-1955	1262652
1978-80	V6 3.8L 231ci	A	w/THM200C Auto. Trans.; 36.30" Cable	CA-1942	1262678
1978-80	V6 3.8L 231ci	A	w/THM350 Auto. Trans.; 33.95" Cable	CA-1955	1262652
1978-80	V6 3.8L 231ci	A	w/THM200C Auto. Trans., Universal cable for temporary fix, use CA-1942 for permanent fix	CA-1980	
1981	V6 3.8L 231ci	A	Auto. Trans.; 36.10" Cable	CA-1960	25505174
1981	V6 3.8L 231ci	A	Auto. Trans., Universal cable for temporary fix, use CA-1960 for permanent fix	CA-1980	
1982-83	V6 3.8L 231ci	A	w/THM250C AT., w/THM350C AT.; 36.10" Cable	CA-1960	25505174
1982-83	V6 3.8L 231ci	A	w/THM250C AT., w/THM350C AT., Universal cable for temporary fix, use CA-1960 for permanent fix	CA-1980	

# DETENT CABLES

Year	Engine	Vin	Remark	Part	OE
<b>PONTIAC (con't)</b>					
<b>GRAND PRIX (con't)</b>					
1984	V6 3.8L 231ci	A	w/THM200C Auto. Trans., w/THM250C Auto. Trans.; 36.10" Cable	CA-1960	25505174
1984	V6 3.8L 231ci	A	w/THM200C Auto. Trans., w/THM250C Auto. Trans., Universal cable for temporary fix, use CA-1960 for permanent fix	CA-1980	
1985-87	V6 3.8L 231ci	A	w/THM200C Auto. Trans.; 36.10" Cable	CA-1960	25505175
1985-87	V6 3.8L 231ci	A	w/THM200C Auto. Trans., Universal cable for temporary fix, use CA-1960 for permanent fix	CA-1980	
1982	V6 4.1L 252ci	4	w/THM250C Auto. Trans., w/THM350C Auto. Trans.; 36.10" Cable	CA-1960	25505174
1982	V6 4.1L 252ci	4	w/THM250C Auto. Trans., w/THM350C Auto. Trans., Universal cable for temporary fix, use CA-1960 for permanent fix	CA-1980	
1986-87	V6 4.3L 262ci	Z	w/THM200C Auto. Trans., w/THM200-4R Auto. Trans.; 37.51" Cable	CA-1943	25521267
1986-87	V6 4.3L 262ci	Z	w/THM200C Auto. Trans., w/THM200-4R Auto. Trans., Universal cable for temporary fix, use CA-1943 for permanent fix	CA-1980	
1981	V8 4.3L 265ci	S	w/THM200C Auto. Trans.; 37.51" Cable	CA-1943	25507550
1981	V8 4.3L 265ci	S	w/THM200C Auto. Trans., Universal cable for temporary fix, use CA-1943 for permanent fix	CA-1980	
1981	V8 4.4L 267ci	J	Export, w/Canada Emissions, w/THM350C Auto. Trans.; 37.80" Cable	CA-1933	25507541
1981	V8 4.4L 267ci	J	Export, w/Canada Emissions, w/THM350C Auto. Trans.; 49.20" Cable, Universal cable, for temporary fix only, for permanent fix use CA-1933	CA-1981	
1982	V8 4.4L 267ci	J	Export, w/Canada Emissions, w/THM250C Auto. Trans., w/THM350C Auto. Trans.; 37.80" Cable	CA-1933	25507541
1982	V8 4.4L 267ci	J	Export, w/Canada Emissions, w/THM250C Auto. Trans., w/THM350C Auto. Trans., Universal cable, for temporary fix only, for permanent fix use CA-1933; 49.20" Cable	CA-1981	
1980	V8 4.9L 301ci	W	w/THM250 Auto. Trans.	CA-1964	1255739
1977	V8 4.9L 301ci	Y	w/THM350 Auto. Trans.	CA-1964	1255739
1979	V8 5.0L 305ci	H	w/THM200 Auto. Trans.; 38.40" Cable	CA-1941	1262613
1979	V8 5.0L 305ci	H	w/THM200 Auto. Trans., Universal cable for temporary fix, use CA-1941 for permanent fix	CA-1980	
1979-80	V8 5.0L 305ci	H	w/THM350 Auto. Trans.; 45.00" Cable	CA-1951	1262620
1979-80	V8 5.0L 305ci	H	THM350 Auto. Trans.; 49.20" Cable, Universal cable for temporary fix, use CA-1951 for permanent fix	CA-1981	
1983	V8 5.0L 305ci	H	Auto. Trans.; 37.80" Cable	CA-1933	25507541
1983	V8 5.0L 305ci	H	w/THM250C Auto. Trans., w/THM350C Auto. Trans.; 37.80" Cable	CA-1933	25507541
1983	V8 5.0L 305ci	H	Auto. Trans.; 49.20" Cable, Universal cable, for temporary fix only, for permanent fix use CA-1933	CA-1981	
1983	V8 5.0L 305ci	H	w/THM250C Auto. Trans., w/THM350C Auto. Trans., Universal cable for temporary fix only, for permanent fix use CA-1933; 49.20" Cable	CA-1981	
1984	V8 5.0L 305ci	H	w/THM250C Auto. Trans.; 37.80" Cable	CA-1933	25507541
1984	V8 5.0L 305ci	H	w/THM200-4R Auto. Trans.; 37.51" Cable	CA-1943	25507546
1984	V8 5.0L 305ci	H	w/THM200-4R Auto. Trans., Universal cable for temporary fix, use CA-1943 for permanent fix	CA-1980	
1984	V8 5.0L 305ci	H	w/THM250C Auto. Trans.; 49.20" Cable, Universal cable, for temporary fix only, for permanent fix use CA-1933	CA-1981	
1985-87	V8 5.0L 305ci	H	w/Auto. Trans.; 37.51" Cable	CA-1943	25507546

# DETENT CABLES

Year	Engine	Vin	Remark	Part	OE
<b>PONTIAC (con't)</b>					
<b>GRAND PRIX (con't)</b>					
1985-87	V8 5.0L 305ci	H	w/Auto. Trans., Universal cable for temporary fix, use CA-1943 for permanent fix	CA-1980	
1978	V8 5.0L 305ci	U	w/THM200 Auto. Trans.; 38.40" Cable	CA-1941	1262613
1978	V8 5.0L 305ci	U	w/THM200 Auto. Trans., Universal cable for temporary fix, use CA-1941 for permanent fix	CA-1980	
1981	V8 5.7L 350ci	N	w/Auto. Trans. 51.00" Cable	CA-1930	25508263
1981	V8 5.7L 350ci	N	w/Auto. Trans., Universal cable for temporary fix, use CA-1930 for permanent fix	CA-1980	
1982	V8 5.7L 350ci	N	w/THM350C Auto. Trans. 51.00" Cable	CA-1930	25508265
1982	V8 5.7L 350ci	N	w/THM350C Auto. Trans., Universal cable for temporary fix, use CA-1930 for permanent fix	CA-1980	
1983	V8 5.7L 350ci	N	w/THM200C Auto. Trans., w/THM350C Auto. Trans. 51.00" Cable	CA-1930	25508265
1983	V8 5.7L 350ci	N	w/THM200C Auto. Trans., w/THM350C Auto. Trans., Universal cable for temporary fix, use CA-1930 for permanent fix	CA-1980	
1984	V8 5.7L 350ci	N	THM200-4R Auto. Trans., w/THM200C 51.00" Cable	CA-1930	25508263
1984	V8 5.7L 350ci	N	THM200-4R Auto. Trans., THM200C, Universal cable for temporary fix, use CA-1930 for permanent fix	CA-1980	
1977	V8 5.7L 350ci	P, R	w/THM350 Auto. Trans.; 43.86" Cable	CA-1953	1256301
1977	V8 5.7L 350ci	P, R	THM350 Auto. Trans.; 49.20" Cable, Universal cable for temporary fix, use CA-1953 for permanent fix	CA-1981	
1977	V8 5.7L 350ci	R	w/THM350 Auto. Trans.; 37.00" Cable, w/Olds. Eng.	CA-1963	1254178
1977	V8 6.6L 403ci	K	w/THM350 Auto. Trans.; 37.00" Cable	CA-1963	1254178
<b>J2000</b>					
1982-84	L4 1.8L 112ci	O	w/THM125C Auto. Trans.; 36.10" Cable	CA-1960	25510188
1982-84	L4 1.8L 112ci	O	w/THM125C Auto. Trans., Universal cable for temporary fix, use CA-1960 for permanent fix	CA-1980	
1982	L4 1.8L 112ci	G	w/THM125C Auto. Trans.; 36.10" Cable	CA-1960	25509560
1982	L4 1.8L 112ci	G	w/THM125C Auto. Trans., Universal cable for temporary fix, use CA-1960 for permanent fix	CA-1980	
1983-84	L4 2.0L 122ci	B	w/Auto. Trans.; 36.10" Cable, Export, w/Canada Emissions	CA-1960	25509560
1983-84	L4 2.0L 122ci	B	w/AT, Export, w/Canada Emissions, Universal cable for temporary fix, use CA-1960 for permanent fix	CA-1980	
<b>LEMANS</b>					
1976	L6 4.1L 250ci	D	w/THM350 Auto. Trans.	CA-1950	1245640
1980	V6 3.8L 229ci	K	w/THM200 Auto. Trans.; 35.00" Cable	CA-1947	1262612
1980	V6 3.8L 229ci	K	w/THM200 Auto. Trans., Universal cable for temporary fix, use CA-1947 for permanent fix	CA-1980	
1978-80	V6 3.8L 231ci	A	w/THM350 Auto. Trans.; 33.95" Cable	CA-1955	1262652
1978-81	V6 3.8L 231ci	A	w/THM200C Auto. Trans.; 36.30" Cable	CA-1942	1262678
1979	V6 3.8L 231ci	A	w/THM250 Auto. Trans.; 33.95" Cable, w/THM350	CA-1955	1262652
1978-81	V6 3.8L 231ci	A	w/THM200C Auto. Trans., Universal cable for temporary fix, use CA-1942 for permanent fix	CA-1980	
1980	V6 3.8L 231ci	A	w/THM200 Auto. Trans.; 35.00" Cable	CA-1947	1262612
1980	V6 3.8L 231ci	A	w/THM200 Auto. Trans., Universal cable for temporary fix, use CA-1947 for permanent fix	CA-1980	
1981	V6 3.8L 231ci	A	Auto. Trans.; 36.10" Cable	CA-1960	25505174
1981	V6 3.8L 231ci	A	w/THM200C, w/THM250C Auto. Trans., w/THM350C Auto. Trans.; 36.10" Cable	CA-1960	25505174
1981	V6 3.8L 231ci	A	w/THM200C, w/THM250C Auto. Trans., w/THM350C Auto. Trans., Universal cable for temporary fix, use CA-1960 for permanent fix	CA-1980	

# DETENT CABLES

Year	Engine	Vin	Remark	Part	OE
<b>PONTIAC (con't)</b>					
<b>LEMANS (con't)</b>					
1981	V6 3.8L 231ci	A	Auto. Trans., Universal cable for temporary fix, use CA-1960 for permanent fix	CA-1980	
1977	V6 3.8L 231ci	C	w/THM350 Auto. Trans.; 39.17" Cable	CA-1954	1262617
1977	V6 3.8L 231ci	C	THM350 Auto. Trans.; 49.20" Cable, Universal cable for temporary fix, use CA-1954 for permanent fix	CA-1981	
1976	V8 4.3L 260ci	F	w/THM350 Auto. Trans.	CA-1950	1245902
1981	V8 4.3L 265ci	S	w/THM200C Auto. Trans.; 37.51" Cable	CA-1943	25507550
1981	V8 4.3L 265ci	S	w/THM200C Auto. Trans., Universal cable for temporary fix, use CA-1943 for permanent fix	CA-1980	
1981	V8 4.4L 267ci	J	Export, w/Canada Emissions, w/THM350C Auto. Trans.; 37.80" Cable	CA-1933	25507541
1981	V8 4.4L 267ci	J	Export, w/Canada Emissions, w/THM350C Auto. Trans.; 49.20" Cable, Universal cable, for temporary fix only, for permanent fix use CA-1933	CA-1981	
1979	V8 4.9L 301ci	W	w/THM350 Auto. Trans.	CA-1964	1255739
1980	V8 4.9L 301ci	W	w/THM250 Auto. Trans.	CA-1964	1255739
1977-79	V8 4.9L 301ci	Y	w/THM350 Auto. Trans.	CA-1964	1255739
1979	V8 5.0L 305ci	H	w/THM200 Auto. Trans.; 38.40" Cable	CA-1941	1262613
1979	V8 5.0L 305ci	H	w/THM200 Auto. Trans., Universal cable for temporary fix, use CA-1941 for permanent fix	CA-1980	
1979-80	V8 5.0L 305ci	H	w/THM350 Auto. Trans.; 45.00" Cable	CA-1951	1262620
1979-80	V8 5.0L 305ci	H	THM350 Auto. Trans.; 49.20" Cable, Universal cable for temporary fix, use CA-1951 for permanent fix	CA-1981	
1981	V8 5.0L 305ci	H	Export, w/Canada Emissions, w/THM350C Auto. Trans.; 37.80" Cable	CA-1933	25507541
1981	V8 5.0L 305ci	H	Export, w/Canada Emissions, w/THM350C Auto. Trans.; 49.20" Cable, Universal cable, for temporary fix only, for permanent fix use CA-1933	CA-1981	
1978	V8 5.0L 305ci	U	w/THM200 Auto. Trans.; 38.40" Cable	CA-1941	1262613
1978	V8 5.0L 305ci	U	w/THM200 Auto. Trans., Universal cable for temporary fix, use CA-1941 for permanent fix	CA-1980	
1977	V8 5.7L 350ci	L, R	w/THM350 Auto. Trans.; 37.00" Cable, w/Olds. Eng.	CA-1963	1254178
1977	V8 5.7L 350ci	L, P, R	w/THM350 Auto. Trans.; 43.86" Cable	CA-1953	1256301
1977	V8 5.7L 350ci	L, P, R	THM350 Auto. Trans.; 49.20" Cable, Universal cable for temporary fix, use CA-1953 for permanent fix	CA-1981	
1978	V8 5.7L 350ci	L	w/THM350 Auto. Trans.; 45.00" Cable, w/Chevrolet Eng.	CA-1951	1262620
1978	V8 5.7L 350ci	L	w/THM350 Auto. Trans.; 49.20" Cable, w/Chevrolet Eng., Universal cable for temporary fix, use CA-1951 for permanent fix	CA-1981	
1977	V8 6.6L 400ci	Z	w/THM350 Auto. Trans.; 43.86" Cable	CA-1953	1256301
1977	V8 6.6L 400ci	Z	THM350 Auto. Trans.; 49.20" Cable, Universal cable for temporary fix, use CA-1953 for permanent fix	CA-1981	
1977	V8 6.6L 403ci	K	w/THM350 Auto. Trans.; 37.00" Cable	CA-1963	1254178
<b>PARISIENNE</b>					
1984	V6 3.8L 231ci	A	w/THM200C Auto. Trans., w/THM250C Auto. Trans.; 36.10" Cable	CA-1960	25505174
1984	V6 3.8L 231ci	A	w/THM200C Auto. Trans., w/THM250C Auto. Trans., Universal cable for temporary fix, use CA-1960 for permanent fix	CA-1980	
1985	V6 3.8L 231ci	A	Export, w/Canada Emissions, w/THM200C Auto. Trans.; 36.10" Cable	CA-1960	25505175
1985	V6 3.8L 231ci	A	Export, w/Canada Emissions, w/THM200C Auto. Trans., Universal cable for temporary fix, use CA-1960 for permanent fix	CA-1980	
1985-86	V6 4.3L 262ci	Z	w/THM200C Auto. Trans.; 37.51" Cable	CA-1943	25521267

# DETENT CABLES

Year	Engine	Vin	Remark	Part	OE
<b>PONTIAC (con't)</b>					
<b>PARISIENNE (con't)</b>					
1985-86	V6 4.3L 262ci	Z	w/THM700-R4 Auto. Trans.; 44.50" Cable	CA-1970	25521268
1985-86	V6 4.3L 262ci	Z	w/THM200C Auto. Trans., Universal cable for temporary fix, use CA-1943 for permanent fix	CA-1980	
1985-86	V6 4.3L 262ci	Z	w/THM700-R4 Auto. Trans., Universal cable for temporary fix, use CA-1970 for permanent fix	CA-1980	
1983-86	V8 5.0L 305ci	H	w/THM700-R4 Auto. Trans.; 44.50" Cable	CA-1970	25515598
1983-86	V8 5.0L 305ci	H	w/THM700-R4 Auto. Trans., Universal cable for temporary fix, use CA-1970 for permanent fix	CA-1980	
1984	V8 5.0L 305ci	H	w/THM250C Auto. Trans., w/THM350C Auto. Trans.; 37.80" Cable	CA-1933	25507541
1984	V8 5.0L 305ci	H	w/THM250C Auto. Trans., w/THM350C Auto. Trans., Universal cable for temporary fix only, for permanent fix use CA-1933; 49.20" Cable	CA-1981	
1985	V8 5.0L 305ci	H	Export, w/Canada Emissions, w/THM200C Auto. Trans.; 37.51" Cable	CA-1943	25507546
1985	V8 5.0L 305ci	H	Export, w/Canada Emissions, w/THM200C Auto. Trans., Universal cable for temporary fix, use CA-1943 for permanent fix	CA-1980	
1986	V8 5.0L 305ci	H	Export, w/Canada Emissions, w/THM200C Auto. Trans., w/THM200-4R Auto. Trans.; 37.51" Cable	CA-1943	25507546
1986	V8 5.0L 305ci	H	w/THM200-4R Auto. Trans.; 37.51" Cable	CA-1943	25507546
1986	V8 5.0L 305ci	H	Export, w/Canada Emissions, w/THM200C Auto. Trans., w/THM200-4R Auto. Trans, Universal cable for temporary fix, use CA-1943 for permanent fix	CA-1980	
1986	V8 5.0L 305ci	H	w/THM200-4R Auto. Trans., Universal cable for temporary fix, use CA-1943 for permanent fix	CA-1980	
1986	V8 5.0L 307ci	Y	w/THM200-4R Auto. Trans.; 35.35" Cable	CA-1937	25508262
1986	V8 5.0L 307ci	Y	w/THM200-4R Auto. Trans., Universal cable for temporary fix, use CA-1937 for permanent fix	CA-1980	
1985	V8 5.7L 350ci	6	Export, w/THM700-4R Auto. Trans.; 44.50" Cable	CA-1970	25515598
1985	V8 5.7L 350ci	6	Export, w/THM700-4R Auto. Trans., Universal cable for temporary fix, use CA-1970 for permanent fix	CA-1980	
1983	V8 5.7L 350ci	N	w/THM200C Auto. Trans., w/THM200-4R Auto. Trans., w/THM350C Auto. Trans. 51.00" Cable	CA-1930	25508263
1983	V8 5.7L 350ci	N	w/THM200C Auto. Trans., w/THM200-4R, w/THM350C Auto. Trans., Universal cable for temporary fix, use CA-1930 for permanent fix	CA-1980	
1984-85	V8 5.7L 350ci	N	w/THM200C Auto. Trans., w/THM200-4R Auto. Trans. 51.00" Cable	CA-1930	25508263
1984-85	V8 5.7L 350ci	N	w/THM200C Auto. Trans., w/THM200-4R Auto. Trans., Universal cable for temporary fix, use CA-1930 for permanent fix	CA-1980	
<b>PHOENIX</b>					
1980-81	L4 2.5L 151ci	5	w/THM125 Auto. Trans.; 25.70" Cable	CA-1932	25513389
1980-81	L4 2.5L 151ci	5	w/THM125 Auto. Trans., Universal cable for temporary fix, use CA-1932 for permanent fix	CA-1980	
1982-83	L4 2.5L 151ci	5, R	w/THM125 Auto. Trans.; 40.79" Cable	CA-1958	25513393
1984	L4 2.5L 151ci	R	w/THM125C Auto. Trans.; 47.00" Cable	CA-1935	25519347
1984	L4 2.5L 151ci	R	w/THM125C Auto. Trans., Universal cable for temporary fix, use CA-1935 for permanent fix	CA-1980	
1981-84	V6 2.8L 173ci	X	w/Auto. Trans. 51.00" Cable	CA-1930	1262487
1981-84	V6 2.8L 173ci	X	w/THM125C Auto. Trans., Universal cable for temporary fix, use CA-1930 for permanent fix	CA-1980	
1984	V6 2.8L 173ci	Z	w/Auto. Trans. 51.00" Cable	CA-1930	1262487
1984	V6 2.8L 173ci	Z	w/THM125C Auto. Trans., Universal cable for temporary fix, use CA-1930 for permanent fix	CA-1980	

# DETENT CABLES

Year	Engine	Vin	Remark	Part	OE
<b>PONTIAC (con't)</b>					
<b>PHOENIX (con't)</b>					
1978	V6 3.8L 231ci	A	w/THM350 Auto. Trans.; 33.95" Cable	CA-1955	1262652
1979	V6 3.8L 231ci	A	w/Auto. Trans.; 33.95" Cable	CA-1955	1262652
1977	V6 3.8L 231ci	C	w/THM200 Auto. Trans.; 38.40" Cable	CA-1941	1256299
1977	V6 3.8L 231ci	C	w/THM350 Auto. Trans.; 39.17" Cable	CA-1954	1262617
1977	V6 3.8L 231ci	C	w/THM200 Auto. Trans., Universal cable for temporary fix, use CA-1941 for permanent fix	CA-1980	
1977	V6 3.8L 231ci	C	THM350 Auto. Trans.; 49.20" Cable, Universal cable for temporary fix, use CA-1954 for permanent fix	CA-1981	
1979	V8 5.0L 305ci	G	w/THM200 Auto. Trans.; 45.00" Cable	CA-1951	1262620
1979	V8 5.0L 305ci	G	THM200 Auto. Trans.; 49.20" Cable, Universal cable for temporary fix, use CA-1951 for permanent fix	CA-1981	
1977	V8 5.0L 305ci	U	w/THM200 Auto. Trans.; 44.68" Cable	CA-1940	1253966
1977	V8 5.0L 305ci	U	w/THM200 Auto. Trans., Universal cable for temporary fix, use CA-1940 for permanent fix	CA-1980	
1977-78	V8 5.0L 305ci	U	w/THM350 Auto. Trans.; 45.00" Cable	CA-1951	1262620
1977-78	V8 5.0L 305ci	U	THM350 Auto. Trans.; 49.20" Cable, Universal cable for temporary fix, use CA-1951 for permanent fix	CA-1981	
1977	V8 5.7L 350ci	L, R	w/THM350 Auto. Trans., w/THM375 Auto. Trans.; 43.86" Cable	CA-1953	1256301
1977	V8 5.7L 350ci	L, R	w/THM350 Auto. Trans.; 37.00" Cable, w/Olds. Eng.	CA-1963	1254178
1977	V8 5.7L 350ci	L, R	w/THM350 Auto. Trans., w/THM375 Auto. Trans., Universal cable for temporary fix, use CA-1953 for permanent fix; 49.20" Cable	CA-1981	
1977	V8 5.7L 350ci	L	w/THM350 Auto. Trans.; 45.00" Cable	CA-1951	1262620
1977	V8 5.7L 350ci	L	THM350 Auto. Trans.; 49.20" Cable, Universal cable for temporary fix, use CA-1951 for permanent fix	CA-1981	
1978-79	V8 5.7L 350ci	L	w/THM350 Auto. Trans., w/THM375 Auto. Trans., w/Chevrolet Eng.; 45.00" Cable	CA-1951	1262620
1978-79	V8 5.7L 350ci	L	w/THM350 Auto. Trans., w/THM375 Auto. Trans., w/Chevrolet Eng., Universal cable for temporary fix, use CA-1951 for permanent fix; 49.20" Cable	CA-1981	
<b>SAFARI</b>					
1987-88	V8 5.0L 307ci	Y	w/THM350 Auto. Trans.; 42.01" Cable	CA-1952	342486
1987-88	V8 5.0L 307ci	Y	THM350 Auto. Trans.; 49.20" Cable, Universal cable for temporary fix, use CA-1952 for permanent fix	CA-1981	
1987-89	V8 5.0L 307ci	Y	w/THM200-4R Auto. Trans.; 35.35" Cable	CA-1937	25508262
1987-89	V8 5.0L 307ci	Y	w/THM200-4R Auto. Trans., Universal cable for temporary fix, use CA-1937 for permanent fix	CA-1980	
<b>SUNBIRD</b>					
1976	L4 2.3L 140ci	A	w/THM350 Auto. Trans.; 42.01" Cable	CA-1952	342488
1976	L4 2.3L 140ci	A	THM350 Auto. Trans.; 49.20" Cable, Universal cable for temporary fix, use CA-1952 for permanent fix	CA-1981	
1976-77	L4 2.3L 140ci	B	w/THM350 Auto. Trans.; 42.01" Cable	CA-1952	342488
1976-77	L4 2.3L 140ci	B	THM350 Auto. Trans.; 49.20" Cable, Universal cable for temporary fix, use CA-1952 for permanent fix	CA-1981	
1977-80	V6 3.8L 231ci	A	w/THM350 Auto. Trans.; 33.95" Cable	CA-1955	1262652
1976-77	V6 3.8L 231ci	C	w/THM200 Auto. Trans.; 38.40" Cable	CA-1941	1256299
1976-77	V6 3.8L 231ci	C	w/THM200 Auto. Trans., Universal cable for temporary fix, use CA-1941 for permanent fix	CA-1980	
1977	V6 3.8L 231ci	C	w/THM350 Auto. Trans.; 39.17" Cable	CA-1954	1262617
1977	V6 3.8L 231ci	C	THM350 Auto. Trans.; 49.20" Cable, Universal cable for temporary fix, use CA-1954 for permanent fix	CA-1981	
1979	V8 5.0L 305ci	G	w/THM350 Auto. Trans.; 45.00" Cable	CA-1951	1262620
1979	V8 5.0L 305ci	G	THM350 Auto. Trans.; 49.20" Cable, Universal cable for temporary fix, use CA-1951 for permanent fix	CA-1981	

# DETENT CABLES

Year	Engine	Vin	Remark	Part	OE
<b>PONTIAC (con't)</b>					
<b>SUNBIRD (con't)</b>					
1978	V8 5.0L 305ci	U	w/THM350 Auto. Trans.; 45.00" Cable	CA-1951	1262620
1978	V8 5.0L 305ci	U	THM350 Auto. Trans.; 49.20" Cable, Universal cable for temporary fix, use CA-1951 for permanent fix	CA-1981	
<b>VENTURA</b>					
1976	L6 4.1L 250ci	D	w/THM200 Auto. Trans.; 44.68" Cable	CA-1940	1253967
1976	L6 4.1L 250ci	D	w/THM200 Auto. Trans., Universal cable for temporary fix, use CA-1940 for permanent fix	CA-1980	
1977	V6 3.8L 231ci	C	w/THM200 Auto. Trans.; 38.40" Cable	CA-1941	1256299
1977	V6 3.8L 231ci	C	w/THM350 Auto. Trans.; 39.17" Cable	CA-1954	1262617
1977	V6 3.8L 231ci	C	w/THM200 Auto. Trans., Universal cable for temporary fix, use CA-1941 for permanent fix	CA-1980	
1977	V6 3.8L 231ci	C	THM350 Auto. Trans.; 49.20" Cable, Universal cable for temporary fix, use CA-1954 for permanent fix	CA-1981	
1976	V8 4.3L 260ci	F	w/THM200 Auto. Trans.; 38.40" Cable	CA-1941	1262615
1976	V8 4.3L 260ci	F	w/THM350 Auto. Trans., w/THM375 Auto. Trans.; 43.86" Cable	CA-1953	1256301
1976	V8 4.3L 260ci	F	w/THM200 Auto. Trans., Universal cable for temporary fix, use CA-1941 for permanent fix	CA-1980	
1976	V8 4.3L 260ci	F	w/THM350 Auto. Trans., w/THM375 Auto. Trans., Universal cable for temporary fix, use CA-1953 for permanent fix; 49.20" Cable	CA-1981	
1977	V8 4.9L 301ci	Y	w/THM350 Auto. Trans.	CA-1964	1255739
1976	V8 5.7L 350ci	H, J	w/THM350 Auto. Trans., w/THM375 Auto. Trans.; 43.86" Cable	CA-1953	1256301
1976	V8 5.7L 350ci	H, J	w/THM350 Auto. Trans., w/THM375 Auto. Trans., Universal cable for temporary fix, use CA-1953 for permanent fix; 49.20" Cable	CA-1981	
1977	V8 5.7L 350ci	L	w/THM350 Auto. Trans., w/THM375 Auto. Trans.; 43.86" Cable	CA-1953	1256301
1977	V8 5.7L 350ci	L	w/THM350 Auto. Trans., w/THM375 Auto. Trans., Universal cable for temporary fix, use CA-1953 for permanent fix; 49.20" Cable	CA-1981	
1977	V8 5.7L 350ci	R	w/THM350 Auto. Trans.; 37.00" Cable, w/Olds. Eng.	CA-1963	1254178
<b>TOYOTA</b>					
<b>CAMRY</b>					
1983-86	L4 2.0L 1995cc	S		CA-1985	35520-24020
1988-91	V6 2.5L 2508cc	V		CA-1986	35520-32050
<b>CELICA</b>					
1986-87	L4 2.0L 1998cc	S		CA-1927	35520-20161
1983-85	L4 2.4L 2366cc	R		CA-1926	35520-14061
1980	L6 2.6L 2563cc	M		CA-1922	35520-30010
1981	L6 2.8L 2759cc	M		CA-1924	35520-32020
<b>COROLLA</b>					
1975-79	L4 1.2L 1166cc	K		CA-1910	35520-12032
1983	L4 1.6L 1587cc	A	3 Speed	CA-1912	35520-12060
1983	L4 1.6L 1587cc	A	4 Speed	CA-1913	35520-120801
1989	L4 1.6L 1587cc	A	Sedan, Wagon 3 Speed U.S.A. Built	CA-1920	35520-12290
1984-86	L4 1.6L 1587cc	A		CA-1915	35520-12090
1985-86	L4 1.6L 1587cc	A	Coupe	CA-1915	35520-12090
1985-87	L4 1.6L 1587cc	A	4 Speed Sedan & Liftback	CA-1916	35520-20110
1988-89	L4 1.6L 1587cc	A	Wagon	CA-1917	35520-12250
1988-89	L4 1.6L 1587cc	A	Coupe, Sedan, Wagon Japan Built	CA-1918	35520-12240
1989-92	L4 1.6L 1587cc	A	Sedan, Wagon 4 Speed Japan Built	CA-1919	35520-20210
1989-92	L4 1.6L 1587cc	A	Sedan, Wagon 4 Speed U.S.A. Built	CA-1919	35520-20210
1989-92	L4 1.6L 1587cc	A	Sedan, Wagon 3 Speed Japan Built	CA-1920	35520-12290



# DETENT CABLES

Year	Engine	Vin	Remark	Part	OE
<b>TOYOTA (con't)</b>					
<b>COROLLA (con't)</b>					
1992	L4 1.6L 1587cc	A	Sedan, Wagon 3 Speed U.S.A. Built	CA-1920	35520-12290
1975-79	L4 1.6L 1588cc	T		CA-1910	35520-12032
1980-82	L4 1.8L 1770cc	T		CA-1911	35520-12050
<b>CORONA</b>					
1977-80	L4 2.2L 2189cc	R		CA-1921	35520-20060
1981-82	L4 2.4L 2366cc	R		CA-1923	35520-20070
<b>CRESSIDA</b>					
1978-80	L6 2.6L 2563cc	M		CA-1922	35520-30010
1983-85	L6 2.8L 2754cc	M		CA-1925	35520-24020
1982	L6 2.8L 2759cc	M		CA-1925	35520-24020
<b>MR2</b>					
1986	L4 1.6L 1587cc	A		CA-1989	35520-17010
<b>TERCEL</b>					
1987-88	L4 1.5L 1452cc	A		CA-1991	35520-10010
1987-90	L4 1.5L 1456cc	E		CA-1991	35520-10010
<b>TOYOTA TRUCKS</b>					
<b>VAN</b>					
1984-85	L4 2.0L 1998cc	Y		CA-1990	35520-28011
1986-89	L4 2.2L 2237cc	Y		CA-1990	35520-28011
<b>VOLVO</b>					
<b>242, 244, 245</b>					
1981-85	L4 2.1L 2127cc	4		CA-2034	1.233.224

# **SPEED SENSORS**

# SPEED SENSORS

Year	Engine	Remark	Type	Part	OE
<b>ACURA</b>					
<b>INTEGRA</b>					
1994-96	L4 1.8L 1797cc		A/T Speed Sensor	SPS-1334	78410-ST7-003
1997-99	L4 1.8L 1797cc	Coupe & Sedan	A/T Speed Sensor	SPS-1334	78410-ST7-003
2000-01	L4 1.8L 1797cc	Coupe & Sedan	w/Manual Trans	SPS-1334	78410-ST7-003
1994-96	L4 1.8L 1834cc		A/T Speed Sensor	SPS-1334	78410-ST7-003
1997-99	L4 1.8L 1834cc	Coupe & Sedan	A/T Speed Sensor	SPS-1334	78410-ST7-003
2000	L4 1.8L 1834cc	Coupe & Sedan	w/Manual Trans	SPS-1334	78410-ST7-003
2001	L4 1.8L 1834cc		w/Manual Trans	SPS-1334	78410-ST7-003
<b>RL</b>					
1996-04	V6 3.5L 3475cc		Vehicle Speed Sensor	SPS-1344	78410-SZ3-003
<b>RSX</b>					
2002-06	L4 2.0L 1998cc		w/Manual Trans	SPS-1322	78410-S7A-G01
2002-06	L4 2.0L 1998cc	Type S	w/Manual Trans	SPS-1358	78410-S6M-N01
<b>TL</b>					
1995-96	L5 2.5L 2451cc		Vehicle Speed Sensor	SPS-1350	78410-SL4-003
1996	V6 3.2L 3206cc		Vehicle Speed Sensor	SPS-1350	78410-SL4-003
<b>VIGOR</b>					
1992-94	L5 2.5L 2451cc		Vehicle Speed Sensor	SPS-1350	78410-SL4-003
<b>AUDI</b>					
<b>A4</b>					
2003-05	L4 1.8L 1781cc	Sedan	Vehicle Speed Sensor	SPS-1320	012-409-191D
2003-05	V6 3.0L 2976cc	Sedan	Vehicle Speed Sensor	SPS-1320	012-409-191D
<b>A4 QUATTRO</b>					
2003	L4 1.8L 1781cc	Sedan & Wagon	Vehicle Speed Sensor	SPS-1320	012-409-191D
2005	L4 1.8L 1781cc	Wagon	Vehicle Speed Sensor	SPS-1320	012-409-191D
2005	L4 2.0L 1984cc	Sedan & Wagon	Vehicle Speed Sensor	SPS-1320	012-409-191D
2003	V6 3.0L 2976cc	Sedan & Wagon	Vehicle Speed Sensor	SPS-1320	012-409-191D
2005	V6 3.0L 2976cc	Sedan & Wagon	Vehicle Speed Sensor	SPS-1320	012-409-191D
2005	V6 3.2L 3123cc	Sedan & Wagon	Vehicle Speed Sensor	SPS-1320	012-409-191D
<b>A6</b>					
1995-01	V6 2.8L 2771cc	Sedan & Wagon	Vehicle Speed Sensor	SPS-1320	012-409-191D
2002-03	V6 3.0L 2976cc	Sedan	Vehicle Speed Sensor	SPS-1320	012-409-191D
2004	V6 3.0L 2976cc		Vehicle Speed Sensor	SPS-1320	012-409-191D
<b>A6 QUATTRO</b>					
2000-03	V6 2.7L 2671cc	Sedan	Vehicle Speed Sensor	SPS-1320	012-409-191D
2004	V6 2.7L 2671cc		Vehicle Speed Sensor	SPS-1320	012-409-191D
1995-01	V6 2.8L 2771cc	Sedan & Wagon	Vehicle Speed Sensor	SPS-1320	012-409-191D
2002-03	V6 3.0L 2976cc	Sedan & Wagon	Vehicle Speed Sensor	SPS-1320	012-409-191D
2000-04	V8 4.2L 4172cc	Sedan	Vehicle Speed Sensor	SPS-1320	012-409-191D
<b>A8 QUATTRO</b>					
2001-03	V8 4.2L 4172cc	Sedan	Vehicle Speed Sensor	SPS-1320	012-409-191D
<b>ALLROAD QUATTRO</b>					
2001-05	V6 2.7L 2671cc		Vehicle Speed Sensor	SPS-1320	012-409-191D
2003-05	V8 4.2L 4172cc		Vehicle Speed Sensor	SPS-1320	012-409-191D
<b>CABRIOLET</b>					
1994-98	V6 2.8L 2771cc		Vehicle Speed Sensor	SPS-1320	012-409-191D
<b>HONDA</b>					
<b>ACCORD</b>					
1990-91	L4 2.2L 2156cc		Auto Transmission	SPS-1311	78410-SY0-003
1992-94	L4 2.2L 2156cc		A/T Speed Sensor	SPS-1319	78410-SV4-003
1995-97	L4 2.2L 2156cc	Coupe, Sedan & Wagon	A/T Speed Sensor	SPS-1319	78410-SV4-003
1998-02	L4 2.3L 2254cc	Coupe & Sedan	w/Manual Trans	SPS-1307	78410-S84-A01
1995-97	V6 2.7L 2675cc	Sedan	A/T Speed Sensor	SPS-1319	78410-SV4-003
1998-02	V6 3.0L 2997cc	Coupe & Sedan	w/Manual Trans	SPS-1307	78410-S84-A01

# SPEED SENSORS

CIVIC					
2003-05	L4 1.3L 1339cc		Speed Sensors	SPS-1316	78410-S5B-901
1992-94	L4 1.5L 1493cc		w/Matsushita Denshi Trans	SPS-1319	78410-SV4-003
1995	L4 1.5L 1493cc	Coupe & Hatchback	w/Matsushita Denshi Trans	SPS-1319	78410-SV4-003
1992-94	L4 1.6L 1590cc		w/Matsushita Denshi Trans	SPS-1319	78410-SV4-003
1995	L4 1.6L 1590cc	Coupe & Hatchback Coupe, Hatchback & Sedan	w/Matsushita Denshi Trans	SPS-1319	78410-SV4-003
1996-00	L4 1.6L 1590cc	Coupe, Hatchback & Sedan	A/T w/Matsushita Trans	SPS-1335	78410-S04-952
1996-00	L4 1.6L 1590cc	Coupe, Hatchback & Sedan	Manual Trans w/ND Trans	SPS-1332	78410-S04-901
1996-97	L4 1.6L 1590cc	Coupe, Hatchback & Sedan	A/T w/ND Trans	SPS-1333	78410-S04-951
1998-00	L4 1.6L 1590cc	Hatchback; w/HX Coupe, Hatchback & Sedan; w/o HX	A/T w/ND Trans	SPS-1345	78410-S04-971
1998-00	L4 1.6L 1590cc	Coupe, Hatchback & Sedan; w/ND Trans	A/T w/ND Trans	SPS-1333	78410-S04-951
1999-00	L4 1.6L 1590cc	Coupe, Hatchback & Sedan; w/ND Trans	w/Manual Trans w/Matsushita Denshi	SPS-1360	78410-S04-912
1999-00	L4 1.6L 1590cc	Coupe, Hatchback & Sedan; w/ND Trans	w/Manual Trans w/Denso w/Manual Trans w/Matsushita Denshi	SPS-1338	78410-S04-911
1999	L4 1.6L 1595cc	Coupe; w/ND Trans	Denshi	SPS-1360	78410-S04-912
1999	L4 1.6L 1595cc	Coupe; w/ND Trans	w/Manual Trans w/Denso	SPS-1338	78410-S04-911
2000	L4 1.6L 1595cc	2 Door Coupe	Manual Trans w/ND Trans w/Manual Trans w/Matsushita Denshi	SPS-1357	78410-S04-902
2000	L4 1.6L 1595cc	2 Door Coupe; w/ND Trans	Denshi	SPS-1360	78410-S04-912
2000	L4 1.6L 1595cc	2 Door Coupe; w/ND Trans	w/Manual Trans w/Denso	SPS-1338	78410-S04-911
2001	L4 1.7L 1668cc	Coupe & Sedan	A/T Matsushita Denshi	SPS-1316	78410-S5B-901
2005	L4 1.7L 1668cc	exc. HX	A/T w/Matsushita, w/ND Trans	SPS-1329	78410-S5A-912
CIVIC DEL SOL					
1993-95	L4 1.5L 1493cc		w/Matsushita Denshi Trans	SPS-1319	78410-SV4-003
1993-97	L4 1.6L 1590cc		w/Matsushita Denshi Trans	SPS-1319	78410-SV4-003
INSIGHT					
2000-03	L3 1.0L 995cc		Vehicle Speed Sensor	SPS-1328	78410-S3Y-003
PRELUDE					
1990-91	L4 2.0L 1958cc		w/Manual Trans	SPS-1341	78410-SF1-505
1990-91	L4 2.1L 2056cc		w/Manual Trans	SPS-1341	78410-SF1-505
1992-93	L4 2.2L 2156cc		Auto Transmission	SPS-1311	78410-SY0-003
1994-01	L4 2.2L 2156cc		Vehicle Speed Sensor	SPS-1319	78410-SV4-003
1992-93	L4 2.3L 2259cc		Auto Transmission	SPS-1311	78410-SY0-003
1994-96	L4 2.3L 2259cc		Vehicle Speed Sensor	SPS-1319	78410-SV4-003
HONDA TRUCKS					
CR-V					
1997-01	L4 2.0L 1972cc		A/T Speed Sensor	SPS-1337	78410-S10-003
1998-01	L4 2.0L 1972cc		w/Manual Trans	SPS-1352	78410-S10-901
2002-06	L4 2.4L 2354cc		w/Manual Trans	SPS-1353	78410-S9A-003
ODYSSEY					
1995-97	L4 2.2L 2156cc		w/Matsushita Denshi Trans	SPS-1319	78410-SV4-003
2000-01	V6 3.5L 3474cc		w/Matsushita Denshi Trans	SPS-1319	78410-SV4-003
HYUNDAI					
ELANTRA					
2002	L4 2.0L 1975cc	Hatchback & Sedan	w/Manual Trans	SPS-1331	96240-2D501
2003-06	L4 2.0L 1975cc		w/Manual Trans	SPS-1331	96240-2D501
SONATA					
1995-98	L4 2.0L 1997cc		Vehicle Speed Sensor	SPS-1340	96420-34500
1995-96	V6 3.0L 2972cc		Vehicle Speed Sensor	SPS-1340	96420-34500
LEXUS					
SC300					

# SPEED SENSORS

1992-97	L6 3.0L 2997cc		W/Manual Trans	SPS-1326	83181-24070
<b>MAZDA</b>					
<b>626</b>					
1993-02	L4 2.0L 1991cc		w/Manual Trans	SPS-1310	G577-17-400, G560-17-400
1993-02	V6 2.5L 2497cc		w/Manual Trans	SPS-1310	G577-17-400, G560-17-400
<b>NISSAN</b>					
<b>ALTIMA</b>					
1995-97	L4 2.4L 2389cc		A/T Speed Sensor	SPS-1318	32702-4E815
1999-01	L4 2.4L 2389cc		w/Manual Trans	SPS-1305	32702-3Y112
<b>MAXIMA</b>					
1995-97	V6 3.0L 2988cc		w/Manual Trans	SPS-1324	32702-32U00
<b>SENTRA</b>					
1995-99	L4 1.6L 1597cc		A/T Speed Sensor	SPS-1317	32702-0M116
1998-99	L4 1.6L 1597cc		w/Manual Trans	SPS-1359	32702-4E915
2002-03	L4 1.8L 1809cc		A/T Speed Sensor	SPS-1351	32702-5T000
1998-99	L4 2.0L 1998cc		A/T Speed Sensor	SPS-1317	32702-0M116
1998-99	L4 2.0L 1998cc		w/Manual Trans	SPS-1359	32702-4E915
2003	L4 2.5L 2500cc		A/T Speed Sensor	SPS-1351	32702-5T000
<b>TOYOTA</b>					
<b>CAMRY</b>					
1992-01	L4 2.2L 2164cc	Sedan	A/T Speed Sensor	SPS-1313	83181-12040
1992-01	L4 2.2L 2164cc	Sedan	w/Manual Trans	SPS-1321	83181-12030
1993-94	L4 2.2L 2164cc	Wagon	w/Manual Trans	SPS-1321	83181-12030
1993-96	L4 2.2L 2164cc	Wagon	A/T Speed Sensor	SPS-1313	83181-12040
1995-96	L4 2.2L 2164cc	2 Door Coupe	A/T Speed Sensor	SPS-1313	83181-12040
1995	L4 2.2L 2164cc	2 Door Coupe	w/Manual Trans	SPS-1321	83181-12030
1996	L4 2.2L 2164cc	Wagon	w/Manual Trans	SPS-1321	83181-12030
2002	L4 2.4L 2362cc	Sedan	w/Manual Trans	SPS-1321	83181-12030
2002-03	L4 2.4L 2362cc	Sedan	A/T Speed Sensor	SPS-1313	83181-12040
2004	L4 2.4L 2362cc		A/T Speed Sensor	SPS-1313	83181-12040
2004	L4 2.4L 2362cc		w/Manual Trans	SPS-1321	83181-12030
1999-02	V6 3.0L 2995cc	Sedan	w/Manual Trans	SPS-1365	83181-12050
<b>ECHO</b>					
2000-05	L4 1.5L 1497cc		w/Manual Trans	SPS-1368	83181-12020
<b>MR2</b>					
1992-95	L4 2.2L 2164cc		A/T Speed Sensor	SPS-1356	83180-12060
<b>PREVIA</b>					
1991-92	L4 2.4L 2438cc	4WD	A/T Speed Sensor	SPS-1362	83181-20040
1991-93	L4 2.4L 2438cc	2WD	A/T Speed Sensor	SPS-1362	83181-20040
1994-95	L4 2.4L 2438cc	2WD	A/T Speed Sensor	SPS-1366	83181-24050
1995	L4 2.4L 2438cc	4WD	Vehicle Speed Sensor	SPS-1364	83181-35051
1996	L4 2.4L 2438cc	RWD	A/T Speed Sensor	SPS-1366	83181-24050
1996-97	L4 2.4L 2438cc	4WD	Vehicle Speed Sensor	SPS-1364	83181-35051
1997	L4 2.4L 2438cc	2WD	A/T Speed Sensor	SPS-1366	83181-24050
<b>SOLARA</b>					
1999-01	L4 2.2L 2164cc		A/T Speed Sensor	SPS-1313	83181-12040
1999-01	L4 2.2L 2164cc		w/Manual Trans	SPS-1321	83181-12030
2002-03	L4 2.4L 2362cc		A/T Speed Sensor	SPS-1313	83181-12040
2002-03	L4 2.4L 2362cc		w/Manual Trans	SPS-1321	83181-12030
1999-02	V6 3.0L 2995cc		w/Manual Trans	SPS-1365	83181-12050
<b>SUPRA</b>					
1993-95	L6 3.0L 2997cc		A/T Speed Sensor	SPS-1366	83181-24050
1995-98	L6 3.0L 2997cc		W/Manual Trans	SPS-1326	83181-24070
1996	L6 3.0L 2997cc		A/T Speed Sensor	SPS-1366	83181-24050
1997	L6 3.0L 2997cc	Liftback	A/T Speed Sensor	SPS-1366	83181-24050
1997	L6 3.0L 2997cc	Liftback	W/Manual Trans	SPS-1326	83181-24070

# SPEED SENSORS

1998	L6 3.0L 2997cc		A/T Speed Sensor	SPS-1326	83181-24070
<b>TOYOTA TRUCKS</b>					
<b>RAV4</b>					
1996	L4 2.0L 1998cc	4WD	w/Manual Trans	SPS-1365	83181-12050
1997-00	L4 2.0L 1998cc	2WD - 2 & 4 Door	w/Manual Trans	SPS-1365	83181-12050
1997-00	L4 2.0L 1998cc	4WD - 4 Door	w/Manual Trans	SPS-1365	83181-12050
2001-03	L4 2.0L 1998cc	2WD	A/T Speed Sensor	SPS-1313	83181-12040
2001-03	L4 2.0L 1998cc	2WD	w/Manual Trans	SPS-1321	83181-12030
2001-05	L4 2.0L 1998cc	4WD	w/Manual Trans	SPS-1365	83181-12050
2004-05	L4 2.4L 2362cc	2WD	A/T Speed Sensor	SPS-1313	83181-12040
2004-05	L4 2.4L 2362cc	2WD	w/Manual Trans	SPS-1321	83181-12030

# **SPEEDOMETER CABLES**

# SPEEDOMETER CABLES

Pioneer Speedometer Cables have been designed to consolidate the numerous SKU's required to cover today's applications. Therefore, some cables may be longer than those being replaced by design. Be sure to route new cables as not to interfere with hot exhaust or moving parts, while avoiding sharp bends, which may kink the inner cable. Pioneer's consolidated Speedometer Cable program insures maximum application coverage with minimum SKU's.

---

## SPEEDOMETER CABLE CORE KITS

<b>CA-4000</b>	83"	Each core kit includes the appropriate length of replacement core cable, universal metal tip with square drive, two spacer washers and staking tool.
<b>CA-4001</b>	120"	

### INSTRUCTIONS FOR REPLACING YOUR SPEEDOMETER CORE CABLE:

- 1) Remove old core cable and measure length. Determine which Pioneer core kit to use.
- 2) Cut new core cable to correct length on round end. (Note: DO NOT cut core cable on square end).
- 3) Attach drive tip to round end of core cable then, with staking tool, secure tip by striking firmly with a hammer. Remove tool with a flat end screw driver.
- 4) Lubricate new core cable and insert into your speedometer cable casing with factory square end going to transmission.

### CABLE REPAIR KIT

#### CA-4005

Includes universal metal tip with square drive, two spacer washers, and staking tool for installation on your standard .130" diameter speedometer cable.

(Skin-packed – 1 Kit/card)

### CABLE LUBRICANT

#### CA-5000

Pioneer cable lube is a specially formulated, calcium based grease in a convenient, single dose tube. Safe for use in all temperatures, helps prevent rust and corrosion.

(1 Tube – 5 grams by weight)



# SPEEDOMETER CABLES

Year	Engine	Vin	Remark	Part
<b>AMERICAN MOTORS</b>				
<b>AMBASSADOR</b>				
1966	L6 3.3L 199ci		exc. Cruise Control; 83.00" Cable	CA-3010
1967	L6 3.3L 199ci		83.00" Cable	CA-3010
1968-69	L6 3.8L 232ci	B,C	exc. Cruise Control; 83.00" Cable	CA-3010
1970	L6 3.8L 232ci	G	exc. Cruise Control; 83.00" Cable	CA-3010
1970	L6 3.8L 232ci	G	w/Cruise Control, Upper; 63.00" Cable	CA-3002
1965	L6 3.8L 232ci		3 Spd., w/Overdrive Trans.; 83.00" Cable	CA-3010
1966	L6 3.8L 232ci		exc. Cruise Control; 83.00" Cable	CA-3010
1967	L6 3.8L 232ci		83.00" Cable	CA-3010
1971	L6 4.2L 258ci	A	w/Cruise Control, Upper; 63.00" Cable	CA-3002
1966	V8 4.7L 287ci		exc. Cruise Control; 83.00" Cable	CA-3010
1967	V8 4.7L 287ci		83.00" Cable	CA-3010
1968	V8 4.8L 290ci	M	exc. Cruise Control; 83.00" Cable	CA-3010
1970-71	V8 5.0L 304ci	H	w/Cruise Control, Upper; 63.00" Cable	CA-3002
1974	V8 5.0L 304ci	H	MT; 63.00" Cable	CA-3002
1963-64	V8 5.4L 327ci		AT; 83.00" Cable	CA-3010
1965	V8 5.4L 327ci		3 Spd., w/Overdrive Trans.; 83.00" Cable	CA-3010
1966	V8 5.4L 327ci		w/Overdrive Trans., exc. Cruise Control; 83.00" Cable	CA-3010
1967	V8 5.6L 343ci		83.00" Cable	CA-3010
1968	V8 5.6L 343ci	S,T	exc. Cruise Control; 83.00" Cable	CA-3010
1970-71	V8 5.9L 360ci	N,P	w/Cruise Control, Upper; 63.00" Cable	CA-3002
1974	V8 5.9L 360ci	N,P	MT; 63.00" Cable	CA-3002
1968	V8 6.4L 390ci	X	exc. Cruise Control; 83.00" Cable	CA-3010
1970	V8 6.4L 390ci	X	w/Cruise Control, Upper; 63.00" Cable	CA-3002
1971	V8 6.6L 401ci	Z	w/Cruise Control, Upper; 63.00" Cable	CA-3002
1974	V8 6.6L 401ci	Z	MT; 63.00" Cable	CA-3002
<b>AMERICAN</b>				
1964-65	L6 3.2L 196ci		AT; 83.00" Cable	CA-3010
1966	L6 3.2L 196ci		83.00" Cable	CA-3010
1966-67	L6 3.3L 199ci		83.00" Cable	CA-3010
1968	L6 3.3L 199ci	A	83.00" Cable	CA-3010
1964-65	L6 3.8L 232ci		AT; 83.00" Cable	CA-3010
1966-67	L6 3.8L 232ci		83.00" Cable	CA-3010
1968	L6 3.8L 232ci	B	83.00" Cable	CA-3010
1967	V8 4.8L 290ci		83.00" Cable	CA-3010
1968	V8 4.8L 290ci	M,N	83.00" Cable	CA-3010
1967	V8 5.6L 343ci		83.00" Cable	CA-3010
<b>AMX</b>				
1978-79	L6 4.2L 258ci	A,C	exc. Cruise Control; 63.00" Cable	CA-3002
1979	L6 4.2L 258ci	A,C	3 Spd. Trans.; 83.00" Cable	CA-3010
1980	L6 4.2L 258ci	C	Lower	CA-3026
1968-69	V8 4.8L 290ci	N	AT; 83.00" Cable	CA-3010
1978-79	V8 5.0L 304ci	H	exc. Cruise Control; 63.00" Cable	CA-3002
1979	V8 5.0L 304ci	H	3 Spd. Trans.; 83.00" Cable	CA-3010
1968-69	V8 5.6L 343ci	T	AT; 83.00" Cable	CA-3010
1970	V8 5.9L 360ci	P	AT; 83.00" Cable	CA-3010
1968-70	V8 6.4L 390ci	X	AT; 83.00" Cable	CA-3010
<b>CLASSIC</b>				
1963-64	L6 3.2L 196ci		AT; 83.00" Cable	CA-3010
1965	L6 3.3L 199ci		exc. Overdrive Trans.; 83.00" Cable	CA-3010
1964	L6 3.8L 232ci		AT; 83.00" Cable	CA-3010
1965	L6 3.8L 232ci		exc. Overdrive Trans.; 83.00" Cable	CA-3010
1963-64	V8 4.7L 287ci		AT; 83.00" Cable	CA-3010
1965	V8 4.7L 287ci		exc. Overdrive Trans.; 83.00" Cable	CA-3010
1966	V8 4.7L 287ci		exc. Cruise Control; 83.00" Cable	CA-3010
1966	V8 5.4L 327ci		w/Overdrive Trans., exc. Cruise Control; 83.00" Cable	CA-3010
<b>CONCORD</b>				
1979	L4 2.0L 121ci	G	exc. Cruise Control; 63.00" Cable	CA-3002
1979	L4 2.0L 121ci	G	MT; 83.00" Cable	CA-3010
1980	L4 2.5L 151ci	B	Lower	CA-3026
1980-82	L4 2.5L 151ci	B	exc. Cruise Control	CA-3024
1979	L6 3.8L 232ci	E	3 Spd. Trans.; 83.00" Cable	CA-3010
1979	L6 3.8L 232ci	E	exc. Cruise Control; 63.00" Cable	CA-3002

# SPEEDOMETER CABLES

Year	Engine	Vin	Remark	Part
<b>AMERICAN MOTORS (con't)</b>				
<b>CONCORD (con't)</b>				
1979	L6 4.2L 258ci	A,C	3 Spd. Trans.; 83.00" Cable	CA-3010
1979	L6 4.2L 258ci	A,C	exc. Cruise Control; 63.00" Cable	CA-3002
1980-81	L6 4.2L 258ci	C	Lower	CA-3026
1980-83	L6 4.2L 258ci	C	exc. Cruise Control	CA-3024
1981	L6 4.2L 258ci	C	Upper	CA-3025
1979	V8 5.0L 304ci	H	3 Spd. Trans.; 83.00" Cable	CA-3010
1979	V8 5.0L 304ci	H	exc. Cruise Control; 63.00" Cable	CA-3002
<b>EAGLE</b>				
1984	L4 2.5L 150ci	U	Upper	CA-3006
1983-84	L4 2.5L 150ci	U	exc. Cruise Control	CA-3024
1981-83	L4 2.5L 151ci	B	exc. Cruise Control	CA-3024
1980-88	L6 4.2L 258ci	C	exc. Cruise Control	CA-3024
1984-88	L6 4.2L 258ci	C	Upper	CA-3006
<b>GREMLIN</b>				
1977	L4 2.0L 121ci	G,K	AT; 63.00" Cable	CA-3002
1977	L4 2.0L 121ci	G,K	MT; 83.00" Cable	CA-3010
1970	L6 3.3L 199ci	A	AT, 3spd. MT; 83.00" Cable	CA-3010
1970-71	L6 3.8L 232ci	E	AT, 3spd. MT; 83.00" Cable	CA-3010
1972	L6 3.8L 232ci	E	63.00" Cable	CA-3002
1973	L6 3.8L 232ci	E	AT; 83.00" Cable	CA-3010
1973	L6 3.8L 232ci	E	MT; 63.00" Cable	CA-3002
1974-76	L6 3.8L 232ci	E	3 Spd. MT; 63.00" Cable	CA-3002
1975-76	L6 3.8L 232ci	E	AT exc. Overdrive Trans.; 83.00" Cable	CA-3010
1978	L6 3.8L 232ci	E	AT exc. Cruise Control; 60.00" Cable	CA-3015
1978	L6 3.8L 232ci	E	MT exc. Cruise Control; 63.00" Cable	CA-3002
1971	L6 4.2L 258ci	A	AT, 3spd. MT; 83.00" Cable	CA-3010
1972	L6 4.2L 258ci	A	63.00" Cable	CA-3002
1973	L6 4.2L 258ci	A	AT; 83.00" Cable	CA-3010
1973	L6 4.2L 258ci	A	MT; 63.00" Cable	CA-3002
1974-76	L6 4.2L 258ci	A,C	3 Spd. MT; 63.00" Cable	CA-3002
1975-76	L6 4.2L 258ci	A,C	AT exc. Overdrive Trans.; 83.00" Cable	CA-3010
1978	L6 4.2L 258ci	A,C	AT exc. Cruise Control; 60.00" Cable	CA-3015
1978	L6 4.2L 258ci	A,C	MT exc. Cruise Control; 63.00" Cable	CA-3002
1972-73	V8 5.0L 304ci	H	AT; 83.00" Cable	CA-3010
1973	V8 5.0L 304ci	H	MT; 63.00" Cable	CA-3002
1974-75	V8 5.0L 304ci	H	3 Spd. MT; 63.00" Cable	CA-3002
1975	V8 5.0L 304ci	H	AT exc. Overdrive Trans.; 83.00" Cable	CA-3010
<b>HORNET</b>				
1970	L6 3.3L 199ci	A	AT, 3 Spd. MT; 83.00" Cable	CA-3010
1970-71	L6 3.8L 232ci	E,G	AT, 3 Spd. MT; 83.00" Cable	CA-3010
1972-73	L6 3.8L 232ci	E	AT; 63.00" Cable	CA-3002
1972-73	L6 3.8L 232ci	E	MT; 83.00" Cable	CA-3010
1975-77	L6 3.8L 232ci	E	3 Spd. MT exc. Overdrive Trans.; 83.00" Cable	CA-3010
1971	L6 4.2L 258ci	A	AT, 3 Spd. MT; 83.00" Cable	CA-3010
1972-73	L6 4.2L 258ci	A	AT; 63.00" Cable	CA-3002
1972-73	L6 4.2L 258ci	A	MT; 83.00" Cable	CA-3010
1975-77	L6 4.2L 258ci	A,C	3 Spd. MT exc. Overdrive Trans.; 83.00" Cable	CA-3010
1970-71	V8 5.0L 304ci	H	AT, 3 Spd. MT; 83.00" Cable	CA-3010
1972-73	V8 5.0L 304ci	H	AT; 63.00" Cable	CA-3002
1972-73	V8 5.0L 304ci	H	MT; 83.00" Cable	CA-3010
1975-77	V8 5.0L 304ci	H	3 Spd. MT exc. Overdrive Trans.; 83.00" Cable	CA-3010
1971	V8 5.9L 360ci	N,P	AT, 3 Spd. MT; 83.00" Cable	CA-3010
1972-73	V8 5.9L 360ci	N	AT; 63.00" Cable	CA-3002
1972-73	V8 5.9L 360ci	N	MT; 83.00" Cable	CA-3010
<b>JAVELIN</b>				
1968-69	L6 3.8L 232ci	B	83.00" Cable	CA-3010
1970	L6 3.8L 232ci	E	83.00" Cable	CA-3010
1968-69	V8 4.8L 290ci	M,N	83.00" Cable	CA-3010
1970	V8 5.0L 304ci	H	83.00" Cable	CA-3010
1968-69	V8 5.6L 343ci	T	83.00" Cable	CA-3010
1970	V8 5.9L 360ci	N,P	83.00" Cable	CA-3010
1968-70	V8 6.4L 390ci	X	83.00" Cable	CA-3010

# SPEEDOMETER CABLES

Year	Engine	Vin	Remark	Part
<b>AMERICAN MOTORS (con't)</b>				
<b>MARLIN</b>				
1966	L6 3.3L 199ci		exc. Cruise Control; 83.00" Cable	CA-3010
1967	L6 3.3L 199ci		83.00" Cable	CA-3010
1966	L6 3.8L 232ci		exc. Cruise Control; 83.00" Cable	CA-3010
1967	L6 3.8L 232ci		83.00" Cable	CA-3010
1966	V8 4.7L 287ci		exc. Cruise Control; 83.00" Cable	CA-3010
1967	V8 4.8L 290ci		83.00" Cable	CA-3010
1966	V8 5.4L 327ci		w/Overdrive Trans., exc. Cruise Control; 83.00" Cable	CA-3010
1967	V8 5.6L 343ci		83.00" Cable	CA-3010
<b>MATADOR</b>				
1971	L6 3.8L 232ci	E	exc. Cruise Control; 83.00" Cable	CA-3010
1971	L6 3.8L 232ci	E	w/Cruise Control, Upper; 63.00" Cable	CA-3002
1974	L6 3.8L 232ci	E	MT; 63.00" Cable	CA-3002
1971	L6 4.2L 258ci	A	exc. Cruise Control; 83.00" Cable	CA-3010
1971	L6 4.2L 258ci	A	w/Cruise Control, Upper; 63.00" Cable	CA-3002
1974	L6 4.2L 258ci	A	MT; 63.00" Cable	CA-3002
1975-77	L6 4.2L 258ci	A	AT w/Cruise Control Lower, 3Spd. MT w/Cruise Lower; 63.00" Cable	CA-3002
1971	V8 5.0L 304ci	H	exc. Cruise Control; 83.00" Cable	CA-3010
1971	V8 5.0L 304ci	H	w/Cruise Control, Upper; 63.00" Cable	CA-3002
1974	V8 5.0L 304ci	H	MT; 63.00" Cable	CA-3002
1975-77	V8 5.0L 304ci	H	AT w/Cruise Control Lower, 3Spd. MT w/Cruise Lower; 63.00" Cable	CA-3002
1971	V8 5.9L 360ci	N,P	exc. Cruise Control; 83.00" Cable	CA-3010
1971	V8 5.9L 360ci	N,P	w/Cruise Control, Upper; 63.00" Cable	CA-3002
1974	V8 5.9L 360ci	N,P	MT; 63.00" Cable	CA-3002
1975-77	V8 5.9L 360ci	N,P	AT w/Cruise Control Lower, 3Spd. MT w/Cruise Lower; 63.00" Cable	CA-3002
1971	V8 6.6L 401ci	Z	exc. Cruise Control; 83.00" Cable	CA-3010
1971	V8 6.6L 401ci	Z	w/Cruise Control, Upper; 63.00" Cable	CA-3002
1974	V8 6.6L 401ci	Z	MT; 63.00" Cable	CA-3002
1975-76	V8 6.6L 401ci	Z	AT w/Cruise Control Lower, 3Spd. MT w/Cruise Lower; 63.00" Cable	CA-3002
<b>PACER</b>				
1979	L6 4.2L 258ci	A,C	3 Spd. Trans.; 83.00" Cable	CA-3010
1979	L6 4.2L 258ci	A,C	exc. Cruise Control; 63.00" Cable	CA-3002
1980	L6 4.2L 258ci	C	Lower, AT	CA-3026
1980	L6 4.2L 258ci	C	MT; 83.00" Cable	CA-3004
1980	L6 4.2L 258ci	C	Upper, Tach. Generator to Trans, AT & 4 Spd., exc Cruise	CA-3051
1979	V8 5.0L 304ci	H	3 Spd. Trans.; 83.00" Cable	CA-3010
1979	V8 5.0L 304ci	H	exc. Cruise Control; 63.00" Cable	CA-3002
<b>RAMBLER</b>				
1969	L6 3.3L 199ci	A	83.00" Cable	CA-3010
1969	L6 3.8L 232ci	B	83.00" Cable	CA-3010
1969	V8 4.8L 290ci	M	83.00" Cable	CA-3010
<b>REBEL</b>				
1967	L6 3.3L 199ci		AT w/Cruise Control	CA-3006
1967	L6 3.3L 199ci		AT w/o Cruise; 83.00" Cable	CA-3010
1968	L6 3.8L 232ci	B,C	AT w/o Cruise; 83.00" Cable	CA-3010
1968-69	L6 3.8L 232ci	B,C	AT w/Cruise Control	CA-3006
1969	L6 3.8L 232ci	B,C	AT w/o Cruise, MT; 83.00" Cable	CA-3010
1970	L6 3.8L 232ci	E,G	AT w/Cruise Control	CA-3006
1970	L6 3.8L 232ci	E,G	AT w/o Cruise, MT; 83.00" Cable	CA-3010
1967	L6 3.8L 232ci		AT w/Cruise Control	CA-3006
1967	L6 3.8L 232ci		AT w/o Cruise; 83.00" Cable	CA-3010
1968-69	V8 4.8L 290ci	M	AT w/Cruise Control	CA-3006
1968-69	V8 4.8L 290ci	M	AT w/o Cruise; 83.00" Cable	CA-3010
1967	V8 4.8L 290ci		AT w/Cruise Control	CA-3006
1967	V8 4.8L 290ci		AT w/o Cruise; 83.00" Cable	CA-3010
1970	V8 5.0L 304ci	H	AT w/Cruise Control	CA-3006
1970	V8 5.0L 304ci	H	AT w/o Cruise; 83.00" Cable	CA-3010
1968-69	V8 5.6L 343ci	S,T	AT w/Cruise Control	CA-3006
1968-69	V8 5.6L 343ci	S,T	AT w/o Cruise; 83.00" Cable	CA-3010
1967	V8 5.6L 343ci		AT w/Cruise Control	CA-3006
1967	V8 5.6L 343ci		AT w/o Cruise; 83.00" Cable	CA-3010
1970	V8 5.9L 360ci	N,P	AT w/Cruise Control	CA-3006
1970	V8 5.9L 360ci	N,P	AT w/o Cruise; 83.00" Cable	CA-3010

# SPEEDOMETER CABLES

Year	Engine	Vin	Remark	Part
<b>AMERICAN MOTORS (con't)</b>				
<b>SPIRIT</b>				
1979	L4 2.0L 121ci	G	3 Spd. Trans.; 83.00" Cable	CA-3010
1979	L4 2.0L 121ci	G	exc. Cruise Control; 63.00" Cable	CA-3002
1980-82	L4 2.5L 151ci	B	exc. Cruise Control	CA-3024
1982	L4 2.5L 151ci	B	AT w/Cruise Control, Lower; 100.00" Cable	CA-3052
1979	L6 3.8L 232ci	E	3 Spd. Trans.; 83.00" Cable	CA-3010
1979	L6 3.8L 232ci	E	exc. Cruise Control; 63.00" Cable	CA-3002
1979	L6 4.2L 258ci	A,C	3 Spd. Trans.; 83.00" Cable	CA-3010
1979	L6 4.2L 258ci	A,C	exc. Cruise Control; 63.00" Cable	CA-3002
1980	L6 4.2L 258ci	C	AT w/Cruise Control, Lower; 100.00" Cable	CA-3052
1980-83	L6 4.2L 258ci	C	exc. Cruise Control	CA-3024
1979	V8 5.0L 304ci	H	3 Spd. Trans.; 83.00" Cable	CA-3010
1979	V8 5.0L 304ci	H	exc. Cruise Control; 63.00" Cable	CA-3002
<b>AUDI</b>				
<b>4000</b>				
1980	L4 1.6L 1588cc			CA-3147
1982-83	L4 1.6L 1588cc	G,H	AT	CA-3172
1981	L4 1.7L 1715cc	A	AT	CA-3133
1981	L4 1.7L 1715cc	A	AT lower	CA-3172
1981-83	L4 1.7L 1715cc	A	MT lower	CA-3154
1982-83	L4 1.7L 1715cc	A	AT	CA-3172
1984	L4 1.8L 1780cc	A	AT	CA-3172
1987	L4 1.8L 1780cc	B	AT lower	CA-3172
1987	L4 1.8L 1780cc	B	MT lower	CA-3154
1980	L5 2.2L 2144cc			CA-3147
1981	L5 2.2L 2144cc	B	AT	CA-3133
1982-83	L5 2.2L 2144cc	B	Speedo to EGR counter box.	CA-3133
1982-84	L5 2.2L 2144cc	B	AT	CA-3172
<b>4000 QUATTRO</b>				
1984	L5 2.2L 2226cc	B	AT	CA-3172
1984	L5 2.2L 2226cc	B	Speedo to EGR counter box.	CA-3133
1985-87	L5 2.2L 2226cc	B	AT, Speedo to EGR counter box. 18.00" Cable	CA-3133
1986	L5 2.2L 2226cc	B	AT	CA-3133
<b>5000</b>				
1979-80	L5 2.0L 1986cc		AT	CA-3127
1981	L5 2.0L 1986cc	G	AT	CA-3127
1982-84	L5 2.0L 1986cc	H	AT	CA-3127
1978-80	L5 2.2L 2144cc		AT	CA-3127
1981-83	L5 2.2L 2144cc	B	AT	CA-3127
1985	L5 2.2L 2226cc	B	AT	CA-3127
<b>COUPE</b>				
1981-84	L5 2.2L 2144cc	B	AT, Speedo to EGR counter box. 18.00" Cable	CA-3133
1984	L5 2.2L 2226cc	A,D	AT, Speedo to EGR counter box. 18.00" Cable	CA-3133
<b>FOX</b>				
1975	L4 1.6L 1588cc		AT	CA-3172
1975-79	L4 1.6L 1588cc		MT lower	CA-3154
1976	L4 1.6L 1588cc		AT	CA-3135
1976	L4 1.6L 1588cc		MT	CA-3154
1978-79	L4 1.6L 1588cc		AT lower	CA-3172
1979	L4 1.6L 1588cc		Lower	CA-3154
<b>QUATTRO</b>				
1983-85	L5 2.2L 2144cc	C	AT, Speedo to EGR counter box. 18.00" Cable	CA-3133
<b>BMW</b>				
<b>320I</b>				
1980-83	L4 1.8L 1766cc		AT	CA-3182
1977-79	L4 2.0L 1990cc		AT	CA-3182
<b>BUICK</b>				
<b>APOLLO</b>				
1973	L6 4.1L 250ci	D	AT exc. 2 Spd.; 80.00" Cable	CA-3001
1974	L6 4.1L 250ci	D	AT w/Cruise Control, Lower; 40.00" Cable	CA-3033
1974	L6 4.1L 250ci	D	AT w/Cruise Upper, 3 Spd. MT Upper; 61.00" Cable	CA-3005
1974	L6 4.1L 250ci	D	AT w/o Cruise, 3 Spd. MT Lower; 80.00" Cable	CA-3001

# SPEEDOMETER CABLES

Year	Engine	Vin	Remark	Part
<b>BUICK (con't)</b>				
<b>APOLLO (con't)</b>				
1975	L6 4.1L 250ci	D	3 Spd. Trans.; 61.00" Cable	CA-3005
1975	L6 4.1L 250ci	D	exc. Cruise Control; 80.00" Cable	CA-3001
1975	L6 4.1L 250ci	D	w/Cruise Control, Lower; 83.00" Cable	CA-3004
1975	L6 4.1L 250ci	D	w/Cruise Control, Upper; 41.00" Cable	CA-3009
1975	V8 4.3L 260ci	F	3 Spd. Trans.; 61.00" Cable	CA-3005
1975	V8 4.3L 260ci	F	exc. Cruise Control; 80.00" Cable	CA-3001
1975	V8 4.3L 260ci	F	w/Cruise Control, Lower; 83.00" Cable	CA-3004
1975	V8 4.3L 260ci	F	w/Cruise Control, Upper; 41.00" Cable	CA-3009
1973-74	V8 5.7L 350ci	H,J	AT exc. 2 Spd.; 80.00" Cable	CA-3001
1974	V8 5.7L 350ci	H,J	AT w/Cruise Control, Lower; 40.00" Cable	CA-3033
1974	V8 5.7L 350ci	H,J	MT Upper; 61.00" Cable	CA-3005
1975	V8 5.7L 350ci	H,J	3 Spd. Trans.; 61.00" Cable	CA-3005
1975	V8 5.7L 350ci	H,J	exc. Cruise Control; 80.00" Cable	CA-3001
1975	V8 5.7L 350ci	H,J	w/Cruise Control, Lower; 83.00" Cable	CA-3004
1975	V8 5.7L 350ci	H,J	w/Cruise Control, Upper; 41.00" Cable	CA-3009
<b>CENTURION</b>				
1972	V8 5.7L 350ci	H,J	AT w/Cruise Upper, AT w/o Cruise, 3 Spd. MT; 61.00" Cable	CA-3005
1972-73	V8 5.7L 350ci	H,J	AT w/Cruise Control, Lower; 63.00" Cable	CA-3002
1973	V8 5.7L 350ci	H,J	AT w/Cruise Upper, AT w/o Cruise; 61.00" Cable	CA-3005
1971	V8 7.5L 455ci		AT w/Cruise Control, Lower; 63.00" Cable	CA-3002
1971	V8 7.5L 455ci		AT w/Cruise Upper, AT w/o Cruise, 3 Spd. MT; 61.00" Cable	CA-3005
1972	V8 7.5L 455ci	T	AT w/Cruise Upper, AT w/o Cruise, 3 Spd. MT; 61.00" Cable	CA-3005
1972-73	V8 7.5L 455ci	T	AT w/Cruise Control, Lower; 63.00" Cable	CA-3002
1973	V8 7.5L 455ci	T	AT w/Cruise Upper, AT w/o Cruise; 61.00" Cable	CA-3005
<b>CENTURY</b>				
1982-83	L4 2.5L 151ci	5,R	AT w/Cruise Control, Lower; 83.00" Cable	CA-3004
1982-83	L4 2.5L 151ci	5,R	AT w/Cruise Control, Upper; 41.00" Cable	CA-3009
1982-83	L4 2.5L 151ci	5,R	AT w/o Cruise w/Adapter; 100.00" Cable	CA-3003
1984-88	L4 2.5L 151ci	R	AT; 100.00" Cable	CA-3003
1987-88	V6 2.8L 173ci	W	AT; 100.00" Cable	CA-3003
1984-85	V6 2.8L 173ci	X	AT; 100.00" Cable	CA-3003
1982	V6 3.0L 181ci	E	AT w/Cruise Control, Lower; 83.00" Cable	CA-3004
1982	V6 3.0L 181ci	E	AT w/Cruise Control, Upper; 41.00" Cable	CA-3009
1982	V6 3.0L 181ci	E	AT w/o Cruise w/Adapter; 100.00" Cable	CA-3003
1984-85	V6 3.0L 181ci	E	AT; 100.00" Cable	CA-3003
1978-79	V6 3.2L 196ci	C	AT w/Cruise Control, Lower; 83.00" Cable	CA-3004
1978-79	V6 3.2L 196ci	C	AT w/Cruise Control, Upper; 61.00" Cable	CA-3005
1978-79	V6 3.2L 196ci	C	AT w/o Cruise, MT; 100.00" Cable	CA-3003
1978-79	V6 3.8L 231ci	2,3,A	AT w/o Cruise, MT; 100.00" Cable	CA-3003
1978-81	V6 3.8L 231ci	2,3,A	AT w/Cruise Control, Lower; 83.00" Cable	CA-3004
1978-81	V6 3.8L 231ci	2,3,A	AT w/Cruise Control, Upper; 61.00" Cable	CA-3005
1980	V6 3.8L 231ci	3,A	3 Spd. AT w/o Cruise w/Adapter Lower; 20.00" Cable	CA-3008
1980	V6 3.8L 231ci	3,A	3 Spd. AT w/o Cruise w/Adapter Upper; 80.00" Cable	CA-3001
1980	V6 3.8L 231ci	3,A	3 Spd. MT w/adapter Lower; 20.00" Cable	CA-3008
1980	V6 3.8L 231ci	3,A	3 Spd. MT w/adapter Upper; 80.00" Cable	CA-3001
1980	V6 3.8L 231ci	3,A	AT w/o Cruise w/o gear adapter, 3 Spd MT w/o adapter; 100.00" Cable	CA-3003
1984-88	V6 3.8L 231ci	3	AT; 100.00" Cable	CA-3003
1981	V6 3.8L 231ci	A	AT w/o Cruise Control, w/o Gear Adapter; 100.00" Cable	CA-3003
1981	V6 3.8L 231ci	A	AT w/o Cruise w/Adapter Lower; 20.00" Cable	CA-3008
1981	V6 3.8L 231ci	A	AT w/o Cruise w/Adapter Upper; 80.00" Cable	CA-3001
1977	V6 3.8L 231ci	C	AT w/Cruise Control, Lower; 63.00" Cable	CA-3002
1975-76	V6 3.8L 231ci	C	AT w/Cruise Control, Lower; 61.00" Cable	CA-3005
1975-77	V6 3.8L 231ci	C	AT w/Cruise Control, Upper; 41.00" Cable	CA-3009
1975-77	V6 3.8L 231ci	C	AT w/o Cruise, MT w/Console; 80.00" Cable	CA-3001
1982	V6 4.3L 260ci	T	AT w/Cruise Control, Lower; 83.00" Cable	CA-3004
1982	V6 4.3L 260ci	T	AT w/Cruise Control, Upper; 41.00" Cable	CA-3009
1982	V6 4.3L 260ci	T	AT w/o Cruise w/Adapter; 100.00" Cable	CA-3003
1984-85	V6 4.3L 260ci	T	AT; 100.00" Cable	CA-3003
1980	V8 4.3L 265ci	S	3 Spd. AT w/o Cruise w/Adapter Lower; 20.00" Cable	CA-3008
1980	V8 4.3L 265ci	S	3 Spd. AT w/o Cruise w/Adapter Upper; 80.00" Cable	CA-3001
1980	V8 4.3L 265ci	S	3 Spd. MT w/adapter Lower; 20.00" Cable	CA-3008
1980	V8 4.3L 265ci	S	3 Spd. MT w/adapter Upper; 80.00" Cable	CA-3001

# SPEEDOMETER CABLES

Year	Engine	Vin	Remark	Part
<b>BUICK (con't)</b>				
<b>CENTURY (con't)</b>				
1980	V8 4.3L 265ci	S	AT w/o Cruise w/o gear adapter, 3 Spd MT w/o adapter; 100.00" Cable	CA-3003
1980-81	V8 4.3L 265ci	S	AT w/Cruise Control, Lower; 83.00" Cable	CA-3004
1980-81	V8 4.3L 265ci	S	AT w/Cruise Control, Upper; 61.00" Cable	CA-3005
1981	V8 4.3L 265ci	S	AT w/o Cruise Control, w/o Gear Adapter; 100.00" Cable	CA-3003
1981	V8 4.3L 265ci	S	AT w/o Cruise w/Adapter Lower; 20.00" Cable	CA-3008
1981	V8 4.3L 265ci	S	AT w/o Cruise w/Adapter Upper; 80.00" Cable	CA-3001
1981	V8 4.4L 267ci	J	AT w/Cruise Control, Lower; 83.00" Cable	CA-3004
1981	V8 4.4L 267ci	J	AT w/Cruise Control, Upper; 61.00" Cable	CA-3005
1981	V8 4.4L 267ci	J	AT w/o Cruise Control, w/o Gear Adapter; 100.00" Cable	CA-3003
1981	V8 4.4L 267ci	J	AT w/o Cruise w/Adapter Lower; 20.00" Cable	CA-3008
1981	V8 4.4L 267ci	J	AT w/o Cruise w/Adapter Upper; 80.00" Cable	CA-3001
1979	V8 4.9L 301ci	W,Y	AT w/o Cruise, MT; 100.00" Cable	CA-3003
1979-80	V8 4.9L 301ci	W,Y	AT w/Cruise Control, Lower; 83.00" Cable	CA-3004
1979-80	V8 4.9L 301ci	W,Y	AT w/Cruise Control, Upper; 61.00" Cable	CA-3005
1980	V8 4.9L 301ci	W	3 Spd. AT w/o Cruise w/Adapter Lower; 20.00" Cable	CA-3008
1980	V8 4.9L 301ci	W	3 Spd. AT w/o Cruise w/Adapter Upper; 80.00" Cable	CA-3001
1980	V8 4.9L 301ci	W	3 Spd. MT w/adapter Lower; 20.00" Cable	CA-3008
1980	V8 4.9L 301ci	W	3 Spd. MT w/adapter Upper; 80.00" Cable	CA-3001
1980	V8 4.9L 301ci	W	AT w/o Cruise w/o gear adapter, 3 Spd MT w/o adapter; 100.00" Cable	CA-3003
1978-79	V8 5.0L 305ci	H,U	AT w/o Cruise, MT; 100.00" Cable	CA-3003
1978-81	V8 5.0L 305ci	H,U	AT w/Cruise Control, Lower; 83.00" Cable	CA-3004
1978-81	V8 5.0L 305ci	H,U	AT w/Cruise Control, Upper; 61.00" Cable	CA-3005
1980	V8 5.0L 305ci	H	3 Spd. AT w/o Cruise w/Adapter Lower; 20.00" Cable	CA-3008
1980	V8 5.0L 305ci	H	3 Spd. AT w/o Cruise w/Adapter Upper; 80.00" Cable	CA-3001
1980	V8 5.0L 305ci	H	3 Spd. MT w/adapter Lower; 20.00" Cable	CA-3008
1980	V8 5.0L 305ci	H	3 Spd. MT w/adapter Upper; 80.00" Cable	CA-3001
1980	V8 5.0L 305ci	H	AT w/o Cruise w/o gear adapter, 3 Spd MT w/o adapter; 100.00" Cable	CA-3003
1981	V8 5.0L 305ci	H	AT w/o Cruise Control, w/o Gear Adapter; 100.00" Cable	CA-3003
1981	V8 5.0L 305ci	H	AT w/o Cruise w/Adapter Lower; 20.00" Cable	CA-3008
1981	V8 5.0L 305ci	H	AT w/o Cruise w/Adapter Upper; 80.00" Cable	CA-3001
1977	V8 5.0L 305ci	U	AT w/Cruise Control, Lower; 63.00" Cable	CA-3002
1977	V8 5.0L 305ci	U	AT w/Cruise Control, Upper; 41.00" Cable	CA-3009
1977	V8 5.0L 305ci	U	AT w/o Cruise, MT w/Console; 80.00" Cable	CA-3001
1973-77	V8 5.7L 350ci	H,J,L,R	AT w/Cruise Control, Upper; 41.00" Cable	CA-3009
1977	V8 5.7L 350ci	H,J,L,R	AT w/Cruise Control, Lower; 63.00" Cable	CA-3002
1973-76	V8 5.7L 350ci	H,J	AT w/Cruise Control, Lower; 61.00" Cable	CA-3005
1973-77	V8 5.7L 350ci	H,J	AT w/o Cruise, MT w/Console; 80.00" Cable	CA-3001
1977	V8 5.7L 350ci	L,R	AT w/o Cruise, MT w/Console; 80.00" Cable	CA-3001
1978-79	V8 5.7L 350ci	L	AT w/Cruise Control, Lower; 83.00" Cable	CA-3004
1978-79	V8 5.7L 350ci	L	AT w/Cruise Control, Upper; 61.00" Cable	CA-3005
1978-79	V8 5.7L 350ci	L	AT w/o Cruise, MT; 100.00" Cable	CA-3003
1981	V8 5.7L 350ci	N	AT w/Cruise Control, Lower; 83.00" Cable	CA-3004
1981	V8 5.7L 350ci	N	AT w/Cruise Control, Upper; 61.00" Cable	CA-3005
1981	V8 5.7L 350ci	N	AT w/o Cruise Control, w/o Gear Adapter; 100.00" Cable	CA-3003
1981	V8 5.7L 350ci	N	AT w/o Cruise w/Adapter Lower; 20.00" Cable	CA-3008
1981	V8 5.7L 350ci	N	AT w/o Cruise w/Adapter Upper; 80.00" Cable	CA-3001
1974	V8 7.5L 455ci	R,U,V	AT w/Cruise Control, Lower; 61.00" Cable	CA-3005
1974	V8 7.5L 455ci	R,U,V	AT w/Cruise Control, Upper; 41.00" Cable	CA-3009
1974	V8 7.5L 455ci	R,U,V	AT w/o Cruise, MT w/Console; 80.00" Cable	CA-3001
1973	V8 7.5L 455ci	T	AT w/Cruise Control, Lower; 61.00" Cable	CA-3005
1973	V8 7.5L 455ci	T	AT w/Cruise Control, Upper; 41.00" Cable	CA-3009
1973	V8 7.5L 455ci	T	AT w/o Cruise, MT w/Console; 80.00" Cable	CA-3001
<b>ELECTRA</b>				
1985	V6 3.0L 181ci	E	AT; 80.00" Cable	CA-3001
1985	V6 3.8L 231ci	3	AT; 80.00" Cable	CA-3001
1981-84	V6 4.1L 252ci	4	w/Cruise Lower; 63.00" Cable	CA-3002
1981-84	V6 4.1L 252ci	4	w/Cruise Upper; 41.00" Cable	CA-3009
1981-84	V6 4.1L 252ci	4	w/o Cruise Control; 61.00" Cable	CA-3005
1984	V6 4.1L 252ci	4	AT; 80.00" Cable	CA-3001
1985	V6 4.3L 260ci	T	AT; 80.00" Cable	CA-3001
1982-84	V8 5.0L 307ci	Y	w/Cruise Lower; 63.00" Cable	CA-3002
1982-84	V8 5.0L 307ci	Y	w/Cruise Upper; 41.00" Cable	CA-3009

# SPEEDOMETER CABLES

Year	Engine	Vin	Remark	Part
<b>BUICK (con't)</b>				
<b>ELECTRA (con't)</b>				
1982-84	V8 5.0L 307ci	Y	w/o Cruise Control; 61.00" Cable	CA-3005
1984-85	V8 5.0L 307ci	Y	AT; 80.00" Cable	CA-3001
1977	V8 5.7L 350ci	H,J	w/Cruise Lower; 63.00" Cable	CA-3002
1977	V8 5.7L 350ci	H,j	w/Cruise Upper; 41.00" Cable	CA-3009
1977	V8 5.7L 350ci	H,J	w/o Cruise Control; 61.00" Cable	CA-3005
1981-83	V8 5.7L 350ci	N	w/Cruise Lower; 63.00" Cable	CA-3002
1981-83	V8 5.7L 350ci	N	w/Cruise Upper; 41.00" Cable	CA-3009
1981-83	V8 5.7L 350ci	N	w/o Cruise Control; 61.00" Cable	CA-3005
1984-85	V8 5.7L 350ci	N	AT; 80.00" Cable	CA-3001
1977-79	V8 5.7L 350ci	R	w/Cruise Lower; 63.00" Cable	CA-3002
1977-79	V8 5.7L 350ci	R	w/Cruise Upper; 41.00" Cable	CA-3009
1977-79	V8 5.7L 350ci	R	w/o Cruise Control; 61.00" Cable	CA-3005
1978-80	V8 5.7L 350ci	X	w/Cruise Lower; 63.00" Cable	CA-3002
1978-80	V8 5.7L 350ci	X	w/Cruise Upper; 41.00" Cable	CA-3009
1978-80	V8 5.7L 350ci	X	w/o Cruise Control; 61.00" Cable	CA-3005
1965	V8 6.6L 401ci		MT; 83.00" Cable	CA-3004
1966	V8 6.6L 401ci		AT & 4 Spd. MT; 63.00" Cable	CA-3002
1977-79	V8 6.6L 403ci	K	w/Cruise Lower; 63.00" Cable	CA-3002
1977-79	V8 6.6L 403ci	K	w/Cruise Upper; 41.00" Cable	CA-3009
1977-79	V8 6.6L 403ci	K	w/o Cruise Control; 61.00" Cable	CA-3005
1965	V8 7.0L 425ci		MT; 83.00" Cable	CA-3004
1966	V8 7.0L 425ci		AT & 4 Spd. MT; 63.00" Cable	CA-3002
1967	V8 7.0L 430ci		AT & 4 Spd. MT; 63.00" Cable	CA-3002
1968	V8 7.0L 430ci		w/Cruise Lower, w/o Cruise; 63.00" Cable	CA-3002
1968	V8 7.0L 430ci		w/Cruise Upper	CA-3006
1968-69	V8 7.0L 430ci		w/Cruise Control, Lower; 63.00" Cable	CA-3002
1969	V8 7.0L 430ci		exc. Cruise Control; 80.00" Cable	CA-3001
1970	V8 7.5L 455ci		exc. Cruise Control; 80.00" Cable	CA-3001
1970	V8 7.5L 455ci		w/Cruise Control, Lower; 83.00" Cable	CA-3004
1971	V8 7.5L 455ci		w/Cruise Upper, w/o Cruise; 61.00" Cable	CA-3005
1971	V8 7.5L 455ci		w/Cruise Lower; 63.00" Cable	CA-3002
1972-73	V8 7.5L 455ci	T	w/Cruise Upper, w/o Cruise; 61.00" Cable	CA-3005
1972-75	V8 7.5L 455ci	T	w/Cruise Lower; 63.00" Cable	CA-3002
1974-75	V8 7.5L 455ci	T,U,W	w/Cruise Upper, w/o Air Bag; 61.00" Cable	CA-3005
1974	V8 7.5L 455ci	U,W	w/Cruise Lower; 63.00" Cable	CA-3002
<b>GRAN SPORT</b>				
1967	V8 5.6L 340ci		exc. Cruise Control; 63.00" Cable	CA-3002
1967	V8 5.6L 340ci		MT; 83.00" Cable	CA-3004
1967	V8 6.6L 400ci		exc. Cruise Control; 63.00" Cable	CA-3002
1967	V8 6.6L 400ci		MT; 83.00" Cable	CA-3004
1965-66	V8 6.6L 401ci		w/Floor Shift, w/3 Spd. Trans.; 83.00" Cable	CA-3004
1965	V8 6.6L 401ci		MT; 63.00" Cable	CA-3002
1966	V8 6.6L 401ci		w/Column Shift, w/3 Spd. Trans., exc. Cruise Control; 63.00" Cable	CA-3002
<b>GS</b>				
1970-71	V8 5.7L 350ci		AT w/Cruise Control, Lower; 63.00" Cable	CA-3002
1970-71	V8 5.7L 350ci		AT w/Cruise Control, Upper; 41.00" Cable	CA-3009
1970-71	V8 5.7L 350ci		AT w/o Cruise, 3 Spd. MT; 61.00" Cable	CA-3005
1972	V8 5.7L 350ci	H,K	AT w/Cruise Control, Lower; 63.00" Cable	CA-3002
1972	V8 5.7L 350ci	H,K	AT w/Cruise Control, Upper; 41.00" Cable	CA-3009
1972	V8 5.7L 350ci	H,K	AT w/o Cruise, 3 Spd. MT; 61.00" Cable	CA-3005
<b>GS 350</b>				
1968	V8 5.7L 350ci		AT w/Cruise Control, Lower; 63.00" Cable	CA-3002
1968	V8 5.7L 350ci		AT w/Cruise Control, Upper; 41.00" Cable	CA-3009
1968	V8 5.7L 350ci		AT w/o Cruise, 3 Spd. MT; 61.00" Cable	CA-3005
1969	V8 5.7L 350ci		AT w/Cruise Control, Upper	CA-3006
1969	V8 5.7L 350ci		AT w/Cruise Lower, AT w/o Cruise, 3 Spd. MT; 83.00" Cable	CA-3004
<b>GS 400</b>				
1968	V8 6.6L 400ci		AT w/Cruise Control, Lower; 63.00" Cable	CA-3002
1968	V8 6.6L 400ci		AT w/Cruise Control, Upper; 41.00" Cable	CA-3009
1968	V8 6.6L 400ci		AT w/o Cruise, 3 Spd. MT; 61.00" Cable	CA-3005
1969	V8 6.6L 400ci		AT w/Cruise Control, Upper	CA-3006
1969	V8 6.6L 400ci		AT w/Cruise Lower, AT w/o Cruise, 3 Spd. MT; 83.00" Cable	CA-3004

# SPEEDOMETER CABLES

Year	Engine	Vin	Remark	Part
<b>BUICK (con't)</b>				
<b>GS 455</b>				
1970	V8 7.5L 455ci		AT w/Cruise Control, Lower; 63.00" Cable	CA-3002
1970	V8 7.5L 455ci		AT w/Cruise Control, Upper; 41.00" Cable	CA-3009
1970	V8 7.5L 455ci		AT w/o Cruise, 3 Spd. MT; 61.00" Cable	CA-3005
1971-72	V8 7.5L 455ci	U	AT w/Cruise Control, Lower; 63.00" Cable	CA-3002
1971-72	V8 7.5L 455ci	U	AT w/Cruise Control, Upper; 41.00" Cable	CA-3009
1971-72	V8 7.5L 455ci	U	AT w/o Cruise, 3 Spd. MT; 61.00" Cable	CA-3005
<b>INVICTA</b>				
1959-61	V8 6.6L 401ci		AT; 83.00" Cable	CA-3004
1961	V8 6.6L 401ci		3 Spd. Trans.; 63.00" Cable	CA-3002
1962	V8 6.6L 401ci		AT; 63.00" Cable	CA-3002
1963	V8 6.6L 401ci		63.00" Cable	CA-3002
<b>LESABRE</b>				
1986	V6 3.0L 181ci	L	AT; 80.00" Cable	CA-3001
1986	V6 3.8L 231ci	3	AT; 80.00" Cable	CA-3001
1977-83	V6 3.8L 231ci	A	AT w/Cruise Control, Lower; 63.00" Cable	CA-3002
1977-83	V6 3.8L 231ci	A,C	AT w/Cruise Control, Upper; 41.00" Cable	CA-3009
1977-83	V6 3.8L 231ci	A,C	AT w/o Cruise Control; 80.00" Cable	CA-3001
1977-83	V6 3.8L 231ci	A,C	MT; 83.00" Cable	CA-3004
1984-85	V6 3.8L 231ci	A	AT; 80.00" Cable	CA-3001
1976	V6 3.8L 231ci	C	AT w/Cruise w/o Airbag Upper; 41.00" Cable	CA-3009
1976	V6 3.8L 231ci	C	w/o Cruise w/o Air Bag, AT w/Cruise w/Airbag Upper; 61.00" Cable	CA-3005
1976-77	V6 3.8L 231ci	C	AT w/Cruise Control, Lower; 63.00" Cable	CA-3002
1984	V6 4.1L 252ci	4	AT; 80.00" Cable	CA-3001
1980-83	V6 4.1L 252ci	4	AT w/Cruise Control, Lower; 63.00" Cable	CA-3002
1980-83	V6 4.1L 252ci	4	AT w/Cruise Control, Upper; 41.00" Cable	CA-3009
1980-83	V6 4.1L 252ci	4	AT w/o Cruise Control; 80.00" Cable	CA-3001
1980-83	V6 4.1L 252ci	4	MT; 83.00" Cable	CA-3004
1982	V8 4.4L 267ci	J	AT w/Cruise Control, Lower; 63.00" Cable	CA-3002
1982	V8 4.4L 267ci	J	AT w/Cruise Control, Upper; 41.00" Cable	CA-3009
1982	V8 4.4L 267ci	J	AT w/o Cruise Control; 80.00" Cable	CA-3001
1982	V8 4.4L 267ci	J	MT; 83.00" Cable	CA-3004
1965	V8 4.9L 300ci		w/Floor Shift, w/3 Spd. Trans.; 83.00" Cable	CA-3004
1980	V8 4.9L 301ci	W	AT w/Cruise Control, Lower; 63.00" Cable	CA-3002
1980	V8 4.9L 301ci	W	AT w/Cruise Control, Upper; 41.00" Cable	CA-3009
1980	V8 4.9L 301ci	W	AT w/o Cruise Control; 80.00" Cable	CA-3001
1980	V8 4.9L 301ci	W	MT; 83.00" Cable	CA-3004
1977-79	V8 4.9L 301ci	Y	AT w/Cruise Control, Lower; 63.00" Cable	CA-3002
1977-79	V8 4.9L 301ci	Y	AT w/Cruise Control, Upper; 41.00" Cable	CA-3009
1977-79	V8 4.9L 301ci	Y	AT w/o Cruise Control; 80.00" Cable	CA-3001
1977-79	V8 4.9L 301ci	Y	MT; 83.00" Cable	CA-3004
1978	V8 5.0L 305ci	U	AT w/Cruise Control, Lower; 63.00" Cable	CA-3002
1978	V8 5.0L 305ci	U	AT w/Cruise Control, Upper; 41.00" Cable	CA-3009
1978	V8 5.0L 305ci	U	AT w/o Cruise Control; 80.00" Cable	CA-3001
1978	V8 5.0L 305ci	U	MT; 83.00" Cable	CA-3004
1981-83	V8 5.0L 307ci	Y	AT w/Cruise Control, Lower; 63.00" Cable	CA-3002
1981-83	V8 5.0L 307ci	Y	AT w/Cruise Control, Upper; 41.00" Cable	CA-3009
1981-83	V8 5.0L 307ci	Y	AT w/o Cruise Control; 80.00" Cable	CA-3001
1981-83	V8 5.0L 307ci	Y	MT; 83.00" Cable	CA-3004
1984-86	V8 5.0L 307ci	Y	AT; 80.00" Cable	CA-3001
1966	V8 5.6L 340ci		exc. Cruise Control; 63.00" Cable	CA-3002
1966	V8 5.6L 340ci		w/Floor Shift, w/3 Spd. Trans.; 83.00" Cable	CA-3004
1967	V8 5.6L 340ci		AT, w/Electro Cruise; 61.00" Cable	CA-3005
1967	V8 5.6L 340ci		AT, w/THM-400 Trans.; 63.00" Cable	CA-3002
1968	V8 5.7L 350ci		63.00" Cable	CA-3002
1969	V8 5.7L 350ci		AT w/Cruise Control, Lower; 63.00" Cable	CA-3002
1969-70	V8 5.7L 350ci		AT w/o Cruise, 3 Spd. MT; 80.00" Cable	CA-3001
1970	V8 5.7L 350ci		AT w/Cruise Control, Lower; 83.00" Cable	CA-3004
1970	V8 5.7L 350ci		AT w/Cruise Control, Upper; 61.00" Cable	CA-3005
1971	V8 5.7L 350ci		exc. Cruise Master, w/57" Cable; 61.00" Cable	CA-3005
1971	V8 5.7L 350ci		Lower; 63.00" Cable	CA-3002
1971	V8 5.7L 350ci		Upper; 41.00" Cable	CA-3009
1972	V8 5.7L 350ci	H,J	Lower; 63.00" Cable	CA-3002



# SPEEDOMETER CABLES

Year	Engine	Vin	Remark	Part
<b>BUICK (con't)</b>				
<b>LESABRE (con't)</b>				
1972	V8 5.7L 350ci	H,J	Upper; 41.00" Cable	CA-3009
1972-73	V8 5.7L 350ci	H,J	exc. Cruise Master, w/57" Cable; 61.00" Cable	CA-3005
1973	V8 5.7L 350ci	H,J	w/Cruise Control, Lower; 63.00" Cable	CA-3002
1973	V8 5.7L 350ci	H,J	w/Cruise Control, Upper; 41.00" Cable	CA-3009
1974	V8 5.7L 350ci	H,J	w/o Cruise w/o Air Bag; 61.00" Cable	CA-3005
1974-77	V8 5.7L 350ci	H,J	AT w/Cruise Control, Lower; 63.00" Cable	CA-3002
1974-77	V8 5.7L 350ci	H,J	AT w/Cruise Control, Upper; 41.00" Cable	CA-3009
1977	V8 5.7L 350ci	H,J	AT w/o Cruise Control; 80.00" Cable	CA-3001
1977	V8 5.7L 350ci	H,J	MT; 83.00" Cable	CA-3004
1975	V8 5.7L 350ci	J	AT w/Cruise w/o Airbag Upper; 41.00" Cable	CA-3009
1975	V8 5.7L 350ci	J	w/o Cruise w/o Air Bag, AT w/Cruise w/Airbag Upper; 61.00" Cable	CA-3005
1980-83	V8 5.7L 350ci	N	AT w/Cruise Control, Lower; 63.00" Cable	CA-3002
1980-83	V8 5.7L 350ci	N	AT w/Cruise Control, Upper; 41.00" Cable	CA-3009
1980-83	V8 5.7L 350ci	N	AT w/o Cruise Control; 80.00" Cable	CA-3001
1980-83	V8 5.7L 350ci	N	MT; 83.00" Cable	CA-3004
1984-85	V8 5.7L 350ci	N	AT; 80.00" Cable	CA-3001
1977-80	V8 5.7L 350ci	R,X	AT w/Cruise Control, Lower; 63.00" Cable	CA-3002
1977-80	V8 5.7L 350ci	R,X	AT w/Cruise Control, Upper; 41.00" Cable	CA-3009
1977-80	V8 5.7L 350ci	R,X	MT; 83.00" Cable	CA-3004
1977-80	V8 5.7L 350ci	R,X	AT w/o Cruise Control; 80.00" Cable	CA-3001
1959-61	V8 6.0L 364ci		AT; 83.00" Cable	CA-3004
1961	V8 6.0L 364ci		3 Spd. Trans.; 63.00" Cable	CA-3002
1960	V8 6.6L 401ci		3 Spd. Trans.; 83.00" Cable	CA-3004
1961	V8 6.6L 401ci		3 Spd. Trans.; 63.00" Cable	CA-3002
1961	V8 6.6L 401ci		AT; 83.00" Cable	CA-3004
1962	V8 6.6L 401ci		AT; 63.00" Cable	CA-3002
1963	V8 6.6L 401ci		63.00" Cable	CA-3002
1964	V8 6.6L 401ci		exc. Cruise Control; 63.00" Cable	CA-3002
1977-78	V8 6.6L 403ci	K	AT w/Cruise Control, Lower; 63.00" Cable	CA-3002
1977-78	V8 6.6L 403ci	K	AT w/Cruise Control, Upper; 41.00" Cable	CA-3009
1977-78	V8 6.6L 403ci	K	AT w/o Cruise Control; 80.00" Cable	CA-3001
1977-78	V8 6.6L 403ci	K	MT; 83.00" Cable	CA-3004
1964	V8 7.0L 425ci		exc. Cruise Control; 63.00" Cable	CA-3002
1970	V8 7.5L 455ci		AT w/Cruise Control, Lower; 83.00" Cable	CA-3004
1970	V8 7.5L 455ci		AT w/Cruise Control, Upper; 61.00" Cable	CA-3005
1970	V8 7.5L 455ci		AT w/o Cruise, 3 Spd. MT; 80.00" Cable	CA-3001
1971	V8 7.5L 455ci		Lower; 63.00" Cable	CA-3002
1971	V8 7.5L 455ci		Upper; 41.00" Cable	CA-3009
1971	V8 7.5L 455ci		exc. Cruise Master, w/57" Cable; 61.00" Cable	CA-3005
1974	V8 7.5L 455ci	P,R,U	AT w/Cruise Control, Lower; 63.00" Cable	CA-3002
1974	V8 7.5L 455ci	P,R,T,U	AT w/Cruise Control, Upper; 41.00" Cable	CA-3009
1974	V8 7.5L 455ci	P,R,T,U	w/o Cruise w/o Air Bag; 61.00" Cable	CA-3005
1972	V8 7.5L 455ci	T	Lower; 63.00" Cable	CA-3002
1972	V8 7.5L 455ci	T	Upper; 41.00" Cable	CA-3009
1972-73	V8 7.5L 455ci	T	exc. Cruise Master, w/57" Cable; 61.00" Cable	CA-3005
1973	V8 7.5L 455ci	T	w/Cruise Control, Lower; 63.00" Cable	CA-3002
1973	V8 7.5L 455ci	T	w/Cruise Control, Upper; 41.00" Cable	CA-3009
1974-75	V8 7.5L 455ci	T	AT w/Cruise Control, Lower; 63.00" Cable	CA-3002
1975	V8 7.5L 455ci	T	AT w/Cruise w/o Airbag Upper; 41.00" Cable	CA-3009
1975	V8 7.5L 455ci	T	w/o Cruise w/o Air Bag, AT w/Cruise w/Airbag Upper; 61.00" Cable	CA-3005
<b>REGAL</b>				
1978-79	V6 3.2L 196ci	C	AT w/Cruise Control, Lower; 83.00" Cable	CA-3004
1978-79	V6 3.2L 196ci	C	AT w/Cruise Control, Upper; 61.00" Cable	CA-3005
1978-79	V6 3.2L 196ci	C	AT w/o Cruise, MT; 100.00" Cable	CA-3003
1978-79	V6 3.8L 231ci	2,A	AT w/Cruise Control, Upper; 61.00" Cable	CA-3005
1978-79	V6 3.8L 231ci	2,A	AT w/o Cruise, MT; 100.00" Cable	CA-3003
1978-82	V6 3.8L 231ci	2,A	AT w/Cruise Control, Lower; 83.00" Cable	CA-3004
1980-81	V6 3.8L 231ci	A	w/Cruise w/adaptor Lower; 63.00" Cable	CA-3002
1980-81	V6 3.8L 231ci	A	w/Cruise w/o adaptor Lower; 83.00" Cable	CA-3004
1980-81	V6 3.8L 231ci	A	w/Cruise w/o adaptor Upper; 61.00" Cable	CA-3005
1980-81	V6 3.8L 231ci	A	w/Gear Adapter Upper; 80.00" Cable	CA-3001
1980-81	V6 3.8L 231ci	A	w/o Cruise w/Gear Adapter Lower; 20.00" Cable	CA-3008

# SPEEDOMETER CABLES

Year	Engine	Vin	Remark	Part
<b>BUICK (con't)</b>				
<b>REGAL (con't)</b>				
1980-81	V6 3.8L 231ci	A	w/o Cruise w/o Gear Adapter; 100.00" Cable	CA-3003
1982	V6 3.8L 231ci	A	AT w/Cruise Control, exc. Gear Adapter, Upper; 61.00" Cable	CA-3005
1982	V6 3.8L 231ci	A	AT w/Cruise Control, w/Adapter, Lower; 63.00" Cable	CA-3002
1982	V6 3.8L 231ci	A	AT w/o Cruise Control, exc. Gear Adapter, Upper; 41.00" Cable	CA-3009
1982	V6 3.8L 231ci	A	AT w/o Cruise Control, w/Gear Adapter, Upper; 80.00" Cable	CA-3001
1982	V6 3.8L 231ci	A	AT w/o Cruise Control; 100.00" Cable	CA-3003
1982-83	V6 3.8L 231ci	A	AT w/o Cruise Control, w/Gear Adapter, Lower; 20.00" Cable	CA-3008
1983	V6 3.8L 231ci	A	AT w/Cruise Control, exc. Gear Adapter, Lower; 83.00" Cable	CA-3004
1983	V6 3.8L 231ci	A	AT w/Cruise Control, w/Adapter, Lower, or w/Lower interconnector w/Gear Adapter; 63.00" Cable	CA-3002
1983	V6 3.8L 231ci	A	AT w/o Cruise Control, w/Gear Adapter, Upper or AT w/upper interconnector w/Gear Adapter; 80.00" Cable	CA-3001
1983	V6 3.8L 231ci	A	AT w/o Cruise Control, w/o Gear Adapter, 61.00" Cable	CA-3005
1983	V6 3.8L 231ci	A	AT w/o Cruise Control, w/o Gear Adapter, or MT; 100.00" Cable	CA-3003
1984-87	V6 3.8L 231ci	A	AT 3 Spd.w/Adapter, w/4 Spd. AT w/o Adapter; 80.00" Cable	CA-3001
1984-87	V6 3.8L 231ci	A	AT w/adapter Lower; 20.00" Cable	CA-3008
1984-87	V6 3.8L 231ci	A	AT w/o Gear Adapter; 100.00" Cable	CA-3003
1984-87	V6 3.8L 231ci	A	MT; 61.00" Cable	CA-3005
1975	V6 3.8L 231ci	C	AT w/Cruise Control, Upper; 61.00" Cable	CA-3005
1975-77	V6 3.8L 231ci	C	3 Spd. AT; 80.00" Cable	CA-3001
1975-77	V6 3.8L 231ci	C	3 Spd. MT w/o Cruise; 80.00" Cable	CA-3001
1975-77	V6 3.8L 231ci	C	AT w/Cruise Control, Lower; 63.00" Cable	CA-3002
1976-77	V6 3.8L 231ci	C	AT w/Cruise Control, Upper; 41.00" Cable	CA-3009
1982	V6 4.1L 252ci	4	AT w/Cruise Control, exc. Gear Adapter, Upper; 61.00" Cable	CA-3005
1982	V6 4.1L 252ci	4	AT w/Cruise Control, Lower; 83.00" Cable	CA-3004
1982	V6 4.1L 252ci	4	AT w/Cruise Control, w/Adapter, Lower; 63.00" Cable	CA-3002
1982	V6 4.1L 252ci	4	AT w/o Cruise Control, exc. Gear Adapter, Upper; 41.00" Cable	CA-3009
1982	V6 4.1L 252ci	4	AT w/o Cruise Control, w/Gear Adapter, Upper; 80.00" Cable	CA-3001
1982	V6 4.1L 252ci	4	AT w/o Cruise Control; 100.00" Cable	CA-3003
1982-83	V6 4.1L 252ci	4	AT w/o Cruise Control, w/Gear Adapter, Lower; 20.00" Cable	CA-3008
1983	V6 4.1L 252ci	4	AT w/Cruise Control, exc. Gear Adapter, Lower; 83.00" Cable	CA-3004
1983	V6 4.1L 252ci	4	AT w/Cruise Control, w/Adapter, Lower, or w/Lower interconnector w/Gear Adapter; 63.00" Cable	CA-3002
1983	V6 4.1L 252ci	4	AT w/o Cruise Control, w/Gear Adapter, Upper or AT w/upper interconnector w/Gear Adapter; 80.00" Cable	CA-3001
1983	V6 4.1L 252ci	4	AT w/o Cruise Control, w/o Gear Adapter, 61.00" Cable	CA-3005
1983	V6 4.1L 252ci	4	AT w/o Cruise Control, w/o Gear Adapter, or MT; 100.00" Cable	CA-3003
1984	V6 4.1L 252ci	4	AT 3 Spd.w/Adapter, w/4 Spd. AT w/o Adapter; 80.00" Cable	CA-3001
1984	V6 4.1L 252ci	4	AT w/adapter Lower; 20.00" Cable	CA-3008
1984	V6 4.1L 252ci	4	AT w/o Gear Adapter; 100.00" Cable	CA-3003
1984	V6 4.1L 252ci	4	MT; 61.00" Cable	CA-3005
1982	V6 4.3L 260ci	V	AT w/Cruise Control, exc. Gear Adapter, Upper; 61.00" Cable	CA-3005
1982	V6 4.3L 260ci	V	AT w/Cruise Control, Lower; 83.00" Cable	CA-3004
1982	V6 4.3L 260ci	V	AT w/Cruise Control, w/Adapter, Lower; 63.00" Cable	CA-3002
1982	V6 4.3L 260ci	V	AT w/o Cruise Control, exc. Gear Adapter, Upper; 41.00" Cable	CA-3009
1982	V6 4.3L 260ci	V	AT w/o Cruise Control, w/Gear Adapter, Upper; 80.00" Cable	CA-3001
1982	V6 4.3L 260ci	V	AT w/o Cruise Control; 100.00" Cable	CA-3003
1982-83	V6 4.3L 260ci	V	AT w/o Cruise Control, w/Gear Adapter, Lower; 20.00" Cable	CA-3008
1983	V6 4.3L 260ci	V	AT w/Cruise Control, exc. Gear Adapter, Lower; 83.00" Cable	CA-3004
1983	V6 4.3L 260ci	V	AT w/Cruise Control, w/Adapter, Lower, or w/Lower interconnector w/Gear Adapter; 63.00" Cable	CA-3002
1983	V6 4.3L 260ci	V	AT w/o Cruise Control, w/Gear Adapter, Upper or AT w/upper interconnector w/Gear Adapter; 80.00" Cable	CA-3001
1983	V6 4.3L 260ci	V	AT w/o Cruise Control, w/o Gear Adapter, 61.00" Cable	CA-3005
1983	V6 4.3L 260ci	V	AT w/o Cruise Control, w/o Gear Adapter, or MT; 100.00" Cable	CA-3003
1984	V6 4.3L 260ci	V	AT 3 Spd.w/Adapter, w/4 Spd. AT w/o Adapter; 80.00" Cable	CA-3001
1984	V6 4.3L 260ci	V	AT w/adapter Lower; 20.00" Cable	CA-3008
1984	V6 4.3L 260ci	V	AT w/o Gear Adapter; 100.00" Cable	CA-3003
1984	V6 4.3L 260ci	V	MT; 61.00" Cable	CA-3005
1980-81	V8 4.3L 265ci	S	w/Cruise w/adapter Lower; 63.00" Cable	CA-3002
1980-81	V8 4.3L 265ci	S	w/Cruise w/o adapter Lower; 83.00" Cable	CA-3004
1980-81	V8 4.3L 265ci	S	w/Cruise w/o adapter Upper; 61.00" Cable	CA-3005

# SPEEDOMETER CABLES

Year	Engine	Vin	Remark	Part
<b>BUICK (con't)</b>				
<b>REGAL (con't)</b>				
1980-81	V8 4.3L 265ci	S	w/Gear Adapter Upper; 80.00" Cable	CA-3001
1980-81	V8 4.3L 265ci	S	w/o Cruise w/Gear Adapter Lower; 20.00" Cable	CA-3008
1980-81	V8 4.3L 265ci	S	w/o Cruise w/o Gear Adapter; 100.00" Cable	CA-3003
1981	V8 4.4L 267ci	J	w/Cruise w/adapter Lower; 63.00" Cable	CA-3002
1981	V8 4.4L 267ci	J	w/Cruise w/o adapter Lower; 83.00" Cable	CA-3004
1981	V8 4.4L 267ci	J	w/Cruise w/o adapter Upper; 61.00" Cable	CA-3005
1981	V8 4.4L 267ci	J	w/Gear Adapter Upper; 80.00" Cable	CA-3001
1981	V8 4.4L 267ci	J	w/o Cruise w/Gear Adapter Lower; 20.00" Cable	CA-3008
1981	V8 4.4L 267ci	J	w/o Cruise w/o Gear Adapter; 100.00" Cable	CA-3003
1982	V8 4.4L 267ci	J	AT w/Cruise Control, exc. Gear Adapter, Upper; 61.00" Cable	CA-3005
1982	V8 4.4L 267ci	J	AT w/Cruise Control, Lower; 83.00" Cable	CA-3004
1982	V8 4.4L 267ci	J	AT w/Cruise Control, w/Adapter, Lower; 63.00" Cable	CA-3002
1982	V8 4.4L 267ci	J	AT w/o Cruise Control, exc. Gear Adapter, Upper; 41.00" Cable	CA-3009
1982	V8 4.4L 267ci	J	AT w/o Cruise Control, w/Gear Adapter, Lower; 20.00" Cable	CA-3008
1982	V8 4.4L 267ci	J	AT w/o Cruise Control, w/Gear Adapter, Upper; 80.00" Cable	CA-3001
1982	V8 4.4L 267ci	J	AT w/o Cruise Control; 100.00" Cable	CA-3003
1979	V8 4.9L 301ci	W,Y	AT w/Cruise Control, Lower; 83.00" Cable	CA-3004
1979	V8 4.9L 301ci	W,Y	AT w/Cruise Control, Upper; 61.00" Cable	CA-3005
1979	V8 4.9L 301ci	W,Y	AT w/o Cruise, MT; 100.00" Cable	CA-3003
1980	V8 4.9L 301ci	W	w/Cruise w/adapter Lower; 63.00" Cable	CA-3002
1980	V8 4.9L 301ci	W	w/Cruise w/o adapter Lower; 83.00" Cable	CA-3004
1980	V8 4.9L 301ci	W	w/Cruise w/o adapter Upper; 61.00" Cable	CA-3005
1980	V8 4.9L 301ci	W	w/Gear Adapter Upper; 80.00" Cable	CA-3001
1980	V8 4.9L 301ci	W	w/o Cruise w/Gear Adapter Lower; 20.00" Cable	CA-3008
1980	V8 4.9L 301ci	W	w/o Cruise w/o Gear Adapter; 100.00" Cable	CA-3003
1978-79	V8 5.0L 305ci	H,U	AT w/Cruise Control, Lower; 83.00" Cable	CA-3004
1978-79	V8 5.0L 305ci	H,U	AT w/Cruise Control, Upper; 61.00" Cable	CA-3005
1978-79	V8 5.0L 305ci	H	AT w/o Cruise, MT; 100.00" Cable	CA-3003
1980	V8 5.0L 305ci	H	w/Cruise w/adapter Lower; 63.00" Cable	CA-3002
1980	V8 5.0L 305ci	H	w/Cruise w/o adapter Lower; 83.00" Cable	CA-3004
1980	V8 5.0L 305ci	H	w/Cruise w/o adapter Upper; 61.00" Cable	CA-3005
1980	V8 5.0L 305ci	H	w/Gear Adapter Upper; 80.00" Cable	CA-3001
1980	V8 5.0L 305ci	H	w/o Cruise w/Gear Adapter Lower; 20.00" Cable	CA-3008
1980	V8 5.0L 305ci	H	w/o Cruise w/o Gear Adapter; 100.00" Cable	CA-3003
1983	V8 5.0L 305ci	H	AT w/Cruise Control, exc. Gear Adapter, Lower; 83.00" Cable	CA-3004
1983	V8 5.0L 305ci	H	AT w/Cruise Control, w/Adapter, Lower, or w/Lower interconnector w/Gear Adapter; 63.00" Cable	CA-3002
1983	V8 5.0L 305ci	H	AT w/o Cruise Control, w/Gear Adapter, Lower; 20.00" Cable	CA-3008
1983	V8 5.0L 305ci	H	AT w/o Cruise Control, w/Gear Adapter, Upper or AT w/upper interconnector w/Gear Adapter; 80.00" Cable	CA-3001
1983	V8 5.0L 305ci	H	AT w/o Cruise Control, w/o Gear Adapter, 61.00" Cable	CA-3005
1983	V8 5.0L 305ci	H	AT w/o Cruise Control, w/o Gear Adapter, or MT; 100.00" Cable	CA-3003
1984-87	V8 5.0L 305ci	H	AT 3 Spd.w/Adapter, w/4 Spd. AT w/o Adapter; 80.00" Cable	CA-3001
1984-87	V8 5.0L 305ci	H	AT w/adapter Lower; 20.00" Cable	CA-3008
1984-87	V8 5.0L 305ci	H	AT w/o Gear Adapter; 100.00" Cable	CA-3003
1984-87	V8 5.0L 305ci	H	MT; 61.00" Cable	CA-3005
1977	V8 5.0L 305ci	U	3 Spd. AT; 80.00" Cable	CA-3001
1977	V8 5.0L 305ci	U	3 Spd. MT w/o Cruise; 80.00" Cable	CA-3001
1977	V8 5.0L 305ci	U	AT w/Cruise Control, Lower; 63.00" Cable	CA-3002
1977	V8 5.0L 305ci	U	AT w/Cruise Control, Upper; 41.00" Cable	CA-3009
1978	V8 5.0L 305ci	U	AT w/o Cruise, MT; 100.00" Cable	CA-3003
1986-87	V8 5.0L 307ci	Y	AT 3 Spd.w/Adapter, w/4 Spd. AT w/o Adapter; 80.00" Cable	CA-3001
1986-87	V8 5.0L 307ci	Y	AT w/adapter Lower; 20.00" Cable	CA-3008
1986-87	V8 5.0L 307ci	Y	AT w/o Gear Adapter; 100.00" Cable	CA-3003
1986-87	V8 5.0L 307ci	Y	MT; 61.00" Cable	CA-3005
1973-75	V8 5.7L 350ci	H,J	AT w/Cruise Control, Upper; 61.00" Cable	CA-3005
1973-77	V8 5.7L 350ci	H,J	3 Spd. AT; 80.00" Cable	CA-3001
1973-77	V8 5.7L 350ci	H,J	3 Spd. MT w/o Cruise; 80.00" Cable	CA-3001
1973-77	V8 5.7L 350ci	H,J	AT w/Cruise Control, Lower; 63.00" Cable	CA-3002
1976-77	V8 5.7L 350ci	H,J	AT w/Cruise Control, Upper; 41.00" Cable	CA-3009
1977	V8 5.7L 350ci	L,R	3 Spd. AT; 80.00" Cable	CA-3001
1977	V8 5.7L 350ci	L,R	3 Spd. MT w/o Cruise; 80.00" Cable	CA-3001

# SPEEDOMETER CABLES

Year	Engine	Vin	Remark	Part
<b>BUICK (con't)</b>				
<b>REGAL (con't)</b>				
1977	V8 5.7L 350ci	L,R	AT w/Cruise Control, Lower; 63.00" Cable	CA-3002
1977	V8 5.7L 350ci	L,R	AT w/Cruise Control, Upper; 41.00" Cable	CA-3009
1982	V8 5.7L 350ci	N	AT w/Cruise Control, exc. Gear Adapter, Upper; 61.00" Cable	CA-3005
1982	V8 5.7L 350ci	N	AT w/Cruise Control, Lower; 83.00" Cable	CA-3004
1982	V8 5.7L 350ci	N	AT w/Cruise Control, w/Adapter, Lower; 63.00" Cable	CA-3002
1982	V8 5.7L 350ci	N	AT w/o Cruise Control, exc. Gear Adapter, Upper; 41.00" Cable	CA-3009
1982	V8 5.7L 350ci	N	AT w/o Cruise Control, w/Gear Adapter, Upper; 80.00" Cable	CA-3001
1982	V8 5.7L 350ci	N	AT w/o Cruise Control; 100.00" Cable	CA-3003
1982-83	V8 5.7L 350ci	N	AT w/o Cruise Control, w/Gear Adapter, Lower; 20.00" Cable	CA-3008
1983	V8 5.7L 350ci	N	AT w/Cruise Control, exc. Gear Adapter, Lower; 83.00" Cable	CA-3004
1983	V8 5.7L 350ci	N	AT w/Cruise Control, w/Adapter, Lower, or w/Lower interconnector w/Gear Adapter; 63.00" Cable	CA-3002
1983	V8 5.7L 350ci	N	AT w/o Cruise Control, w/Gear Adapter, Upper or AT w/upper interconnector w/Gear Adapter; 80.00" Cable	CA-3001
1983	V8 5.7L 350ci	N	AT w/o Cruise Control, w/o Gear Adapter, 61.00" Cable	CA-3005
1983	V8 5.7L 350ci	N	AT w/o Cruise Control, w/o Gear Adapter, or MT; 100.00" Cable	CA-3003
1985	V8 5.7L 350ci	N	MT; 61.00" Cable	CA-3005
1973-74	V8 7.5L 455ci		3 Spd. AT; 80.00" Cable	CA-3001
1973-74	V8 7.5L 455ci		3 Spd. MT w/o Cruise; 80.00" Cable	CA-3001
1973-74	V8 7.5L 455ci		AT w/Cruise Control, Lower; 63.00" Cable	CA-3002
1973-74	V8 7.5L 455ci		AT w/Cruise Control, Upper; 61.00" Cable	CA-3005
<b>RIVIERA</b>				
1979	V6 3.8L 231ci	3	w/Cruise Control, Lower	CA-3006
1979	V6 3.8L 231ci	3	w/Cruise Control, Upper; 61.00" Cable	CA-3005
1979-81	V6 3.8L 231ci	3	w/o Cruise Control; 80.00" Cable	CA-3001
1980	V6 3.8L 231ci	3	AT; 41.00" Cable	CA-3009
1980	V6 3.8L 231ci	3	w/Cruise Control, Upper	CA-3006
1980	V6 3.8L 231ci	3	w/Cruise Upper, OR exc. Cruise Control, exc. Diesel; 61.00" Cable	CA-3005
1981	V6 3.8L 231ci	3	w/Cruise Control, Lower	CA-3006
1981	V6 3.8L 231ci	3	w/Cruise Upper; 61.00" Cable	CA-3005
1985	V6 3.8L 231ci	9	AT; 41.00" Cable	CA-3009
1981	V6 4.1L 252ci	4	AT; 41.00" Cable	CA-3009
1981	V6 4.1L 252ci	4	w/Cruise Control, Lower	CA-3006
1981	V6 4.1L 252ci	4	w/Cruise Upper; 61.00" Cable	CA-3005
1981	V6 4.1L 252ci	4	w/o Cruise Control; 80.00" Cable	CA-3001
1982-83	V6 4.1L 252ci	4	Lower	CA-3006
1982-83	V6 4.1L 252ci	4	Upper; 61.00" Cable	CA-3005
1980	V8 5.0L 307ci	Y	AT; 41.00" Cable	CA-3009
1980	V8 5.0L 307ci	Y	w/o Cruise Control; 80.00" Cable	CA-3001
1980-81	V8 5.0L 307ci	Y	w/Cruise Control, Lower	CA-3006
1980-81	V8 5.0L 307ci	Y	w/Cruise Control, Upper; 61.00" Cable	CA-3005
1981	V8 5.0L 307ci	Y	AT exc. Cruise Control; 41.00" Cable	CA-3009
1981	V8 5.0L 307ci	Y	AT w/Cruise Control 41.00" Cable	CA-3009
1982-83	V8 5.0L 307ci	Y	Lower	CA-3006
1982-83	V8 5.0L 307ci	Y	Upper; 61.00" Cable	CA-3005
1977	V8 5.7L 350ci	J	w/o Cruise Control; 80.00" Cable	CA-3001
1977-78	V8 5.7L 350ci	J,R,X	w/Cruise Lower; 63.00" Cable	CA-3002
1977-78	V8 5.7L 350ci	J,R,X	w/Cruise Control, Upper; 41.00" Cable	CA-3009
1981	V8 5.7L 350ci	N	AT exc. Cruise Control; 41.00" Cable	CA-3009
1981	V8 5.7L 350ci	N	AT w/Cruise Control 41.00" Cable	CA-3009
1981	V8 5.7L 350ci	N	w/Cruise Control, Lower	CA-3006
1981	V8 5.7L 350ci	N	w/Cruise Control, Upper; 61.00" Cable	CA-3005
1982	V8 5.7L 350ci	N	AT; 41.00" Cable	CA-3009
1982-83	V8 5.7L 350ci	N	Lower	CA-3006
1982-83	V8 5.7L 350ci	N	Upper; 61.00" Cable	CA-3005
1977-80	V8 5.7L 350ci	R	w/o Cruise Control; 80.00" Cable	CA-3001
1979-80	V8 5.7L 350ci	R	w/Cruise Control, Lower	CA-3006
1979-80	V8 5.7L 350ci	R	w/Cruise Control, Upper; 61.00" Cable	CA-3005
1978	V8 5.7L 350ci	X	w/o Cruise Control; 80.00" Cable	CA-3001
1965	V8 6.6L 401ci		AT; 63.00" Cable	CA-3002
1977-78	V8 6.6L 403ci	K	w/Cruise Lower; 63.00" Cable	CA-3002
1977-78	V8 6.6L 403ci	K	w/Cruise Control, Upper; 41.00" Cable	CA-3009

# SPEEDOMETER CABLES

Year	Engine	Vin	Remark	Part
<b>BUICK (con't)</b>				
<b>RIVIERA (con't)</b>				
1977-78	V8 6.6L 403ci	K	w/o Cruise Control; 80.00" Cable	CA-3001
1965-66	V8 7.0L 425ci		AT; 63.00" Cable	CA-3002
1967	V8 7.0L 430ci		AT	CA-3006
1968	V8 7.0L 430ci		exc. Cruise Control; 63.00" Cable	CA-3002
1969	V8 7.0L 430ci		exc. Cruise Control; 61.00" Cable	CA-3005
1970	V8 7.5L 455ci		exc. Cruise Control; 61.00" Cable	CA-3005
1970	V8 7.5L 455ci		w/Cruise Control, Lower; 63.00" Cable	CA-3002
1970	V8 7.5L 455ci		w/Cruise Control, Upper; 41.00" Cable	CA-3009
1971	V8 7.5L 455ci		w/o Air Bags w/Cruise Lower; 63.00" Cable	CA-3002
1971	V8 7.5L 455ci		w/o Air Bags w/Cruise Upper, w/o Air Bags w/o Cruise; 61.00" Cable	CA-3005
1975	V8 7.5L 455ci	T	w/Cruise Control, Lower; 63.00" Cable	CA-3002
1975	V8 7.5L 455ci	T	w/Cruise Control, Upper; 61.00" Cable	CA-3005
1972-74	V8 7.5L 455ci	U,W	w/o Air Bags w/Cruise Lower; 63.00" Cable	CA-3002
1972-74	V8 7.5L 455ci	U,W	w/o Air Bags w/Cruise Upper, w/o Air Bags w/o Cruise; 61.00" Cable	CA-3005
<b>SKYHAWK</b>				
1982	L4 1.8L 112ci	0,G	AT w/o Cruise Control; 61.00" Cable	CA-3005
1982	L4 1.8L 112ci	0,G	MT w/Cruise Upper 41.00" Cable	CA-3009
1982	L4 1.8L 112ci	0,G	w/Cruise Lower	CA-3006
1982-83	L4 1.8L 112ci	0,G	MT w/o Cruise 41.00" Cable	CA-3009
1983-85	L4 1.8L 112ci	0,J	AT; 61.00" Cable	CA-3005
1983-85	L4 1.8L 112ci	0,J	MT; 41.00" Cable	CA-3009
1982	L4 1.8L 112ci	G	w/Cruise Upper; 41.00" Cable	CA-3009
1988-89	L4 2.0L 122ci	1,K	AT; 61.00" Cable	CA-3005
1988-89	L4 2.0L 122ci	1,K	MT; 41.00" Cable	CA-3009
1983	L4 2.0L 122ci	B	MT w/Cruise Upper 41.00" Cable	CA-3009
1983	L4 2.0L 122ci	B	MT w/o Cruise 41.00" Cable	CA-3009
1983	L4 2.0L 122ci	B	w/Cruise Lower	CA-3006
1983-86	L4 2.0L 122ci	B,P	AT; 61.00" Cable	CA-3005
1983-86	L4 2.0L 122ci	B,P	MT; 41.00" Cable	CA-3009
1987	L4 2.0L 122ci	M	AT; 61.00" Cable	CA-3005
1987	L4 2.0L 122ci	M	MT; 41.00" Cable	CA-3009
1980	V6 3.8L 231ci	A	exc. Gear Adapter, w/MT; 80.00" Cable	CA-3001
1980	V6 3.8L 231ci	A	Lower; 40.00" Cable	CA-3033
1980	V6 3.8L 231ci	A	Upper; 41.00" Cable	CA-3009
1978-79	V6 3.8L 231ci	2,A	exc. Cruise Control; 80.00" Cable	CA-3001
1976-77	V6 3.8L 231ci	C	4 & 5 Spd. MT w/Gear Adapter Upper; 41.00" Cable	CA-3009
1976-77	V6 3.8L 231ci	C	4 Spd. MT w/o Gear Adapter; 61.00" Cable	CA-3005
1976-77	V6 3.8L 231ci	C	AT California Emissions, OR 3 Spd. MT; 80.00" Cable	CA-3001
1976-77	V6 3.8L 231ci	C	AT Lower, exc. California Emissions, or 4 & 5 Spd. MT w/Gear Adapter Lower; 40.00" Cable	CA-3033
1976-77	V6 3.8L 231ci	C	AT Upper, exc. California Emissions; 41.00" Cable	CA-3009
<b>SKYLARK</b>				
1980-81	L4 2.5L 151ci	5	AT Upper, MT; 41.00" Cable	CA-3009
1980-81	L4 2.5L 151ci	5	AT w/Cruise Control, Lower	CA-3006
1980-81	L4 2.5L 151ci	5	AT w/o Cruise Lower; 40.00" Cable	CA-3033
1982	L4 2.5L 151ci	5,R	MT w/Cruise Upper; 41.00" Cable	CA-3009
1982-83	L4 2.5L 151ci	5,R	AT w/Cruise Control, Lower; 83.00" Cable	CA-3004
1982-83	L4 2.5L 151ci	5,R	AT w/o Cruise Control; 80.00" Cable	CA-3001
1982-83	L4 2.5L 151ci	5,R	MT w/Cruise Lower	CA-3006
1982-83	L4 2.5L 151ci	5,R	w/Cruise Upper; 41.00" Cable	CA-3009
1982-85	L4 2.5L 151ci	5,R	MT; 41.00" Cable	CA-3009
1984-85	L4 2.5L 151ci	R	AT; 80.00" Cable	CA-3001
1987	L4 2.5L 151ci	U	AT; 80.00" Cable	CA-3001
1987	L4 2.5L 151ci	U	MT; 41.00" Cable	CA-3009
1968	L6 4.1L 250ci		MT; 83.00" Cable	CA-3004
1968	L6 4.1L 250ci		w/Cruise Lower, AT w/o Cruise; 63.00" Cable	CA-3002
1968	L6 4.1L 250ci		w/Cruise Upper	CA-3006
1969-71	L6 4.1L 250ci		AT w/Cruise Control, Lower; 63.00" Cable	CA-3002
1969-71	L6 4.1L 250ci		AT w/Cruise Control, Upper; 41.00" Cable	CA-3009
1969-71	L6 4.1L 250ci		AT w/o Cruise, 3 Spd. MT; 61.00" Cable	CA-3005
1980	V6 2.8L 173ci	7	AT Upper, MT; 41.00" Cable	CA-3009
1980	V6 2.8L 173ci	7	AT w/Cruise Control, Lower	CA-3006

# SPEEDOMETER CABLES

Year	Engine	Vin	Remark	Part
<b>BUICK (con't)</b>				
<b>SKYLARK (con't)</b>				
1980	V6 2.8L 173ci	7	AT w/o Cruise Lower; 40.00" Cable	CA-3033
1981	V6 2.8L 173ci	X	AT Upper, MT; 41.00" Cable	CA-3009
1981	V6 2.8L 173ci	X	AT w/Cruise Control, Lower	CA-3006
1981	V6 2.8L 173ci	X	AT w/o Cruise Lower; 40.00" Cable	CA-3033
1982	V6 2.8L 173ci	X,Z	AT w/Cruise Control, Lower; 83.00" Cable	CA-3004
1982	V6 2.8L 173ci	X,Z	AT w/o Cruise Control; 80.00" Cable	CA-3001
1982	V6 2.8L 173ci	X,Z	MT w/Cruise Lower	CA-3006
1982	V6 2.8L 173ci	X,Z	w/Cruise Upper; 41.00" Cable	CA-3009
1984-85	V6 2.8L 173ci	W,X,Z	AT; 80.00" Cable	CA-3001
1984-85	V6 2.8L 173ci	W,X,Z	MT; 41.00" Cable	CA-3009
1988	V6 3.0L 181ci	L	AT; 80.00" Cable	CA-3001
1988	V6 3.0L 181ci	L	MT; 41.00" Cable	CA-3009
1965	V6 3.7L 225ci		2 Spd. AT; 63.00" Cable	CA-3002
1965	V6 3.7L 225ci		4 Spd. MT; 63.00" Cable	CA-3002
1965	V6 3.7L 225ci		exc. 2 Spd. AT & 4 Spd. MT; 83.00" Cable	CA-3004
1966	V6 3.7L 225ci		w/Column Shift, w/3 Spd. Trans., exc. Cruise Control; 63.00" Cable	CA-3002
1966	V6 3.7L 225ci		w/Floor Shift, w/3 Spd. Trans.; 83.00" Cable	CA-3004
1967	V6 3.7L 225ci		3 Spd. MT; 83.00" Cable	CA-3004
1967	V6 3.7L 225ci		AT; 63.00" Cable	CA-3002
1978-79	V6 3.8L 231ci	A	AT w/Cruise Control, Lower; 63.00" Cable	CA-3002
1978-79	V6 3.8L 231ci	A	AT w/Cruise Control, Upper; 41.00" Cable	CA-3009
1978-79	V6 3.8L 231ci	A	AT w/o Cruise, MT; 80.00" Cable	CA-3001
1975-76	V6 3.8L 231ci	C	3 Spd. MT; 61.00" Cable	CA-3005
1975-76	V6 3.8L 231ci	C	AT w/Cruise Control, Lower; 83.00" Cable	CA-3004
1975-76	V6 3.8L 231ci	C	AT w/o Cruise Control; 80.00" Cable	CA-3001
1975-77	V6 3.8L 231ci	C	AT w/Cruise Control, Upper; 41.00" Cable	CA-3009
1977	V6 3.8L 231ci	C	3 Spd. MT 2 pc. Cable Lower; 40.00" Cable	CA-3033
1977	V6 3.8L 231ci	C	3 Spd. MT 2 pc. Cable Upper; 61.00" Cable	CA-3005
1977	V6 3.8L 231ci	C	AT w/Cruise Control, Lower; 63.00" Cable	CA-3002
1977	V6 3.8L 231ci	C	AT w/o Cruise, MT w/1 pc. Cable; 80.00" Cable	CA-3001
1975-76	V8 4.3L 260ci	F	3 Spd. MT; 61.00" Cable	CA-3005
1975-76	V8 4.3L 260ci	F	AT w/Cruise Control, Lower; 83.00" Cable	CA-3004
1975-76	V8 4.3L 260ci	F	AT w/Cruise Control, Upper; 41.00" Cable	CA-3009
1975-76	V8 4.3L 260ci	F	AT w/o Cruise Control; 80.00" Cable	CA-3001
1965	V8 4.9L 300ci		2 Spd. AT; 63.00" Cable	CA-3002
1965	V8 4.9L 300ci		4 Spd. MT; 63.00" Cable	CA-3002
1965	V8 4.9L 300ci		exc. 2 Spd. AT & 4 Spd. MT; 83.00" Cable	CA-3004
1966	V8 4.9L 300ci		w/Column Shift, w/3 Spd. Trans.; 63.00" Cable	CA-3002
1966	V8 4.9L 300ci		w/Floor Shift, w/3 Spd. Trans.; 83.00" Cable	CA-3004
1967	V8 4.9L 300ci		3 Spd. MT; 83.00" Cable	CA-3004
1967	V8 4.9L 300ci		AT; 63.00" Cable	CA-3002
1977	V8 4.9L 301ci	Y	3 Spd. MT 2 pc. Cable Lower; 40.00" Cable	CA-3033
1977	V8 4.9L 301ci	Y	3 Spd. MT 2 pc. Cable Upper; 61.00" Cable	CA-3005
1977	V8 4.9L 301ci	Y	AT w/Cruise Control, Lower; 63.00" Cable	CA-3002
1977	V8 4.9L 301ci	Y	AT w/Cruise Control, Upper; 41.00" Cable	CA-3009
1977	V8 4.9L 301ci	Y	AT w/o Cruise, MT w/1 pc. Cable; 80.00" Cable	CA-3001
1979	V8 5.0L 305ci	G	AT w/Cruise Control, Lower; 83.00" Cable	CA-3004
1979	V8 5.0L 305ci	G	AT w/Cruise Control, Upper; 61.00" Cable	CA-3005
1979	V8 5.0L 305ci	G	AT w/o Cruise, MT; 80.00" Cable	CA-3001
1977	V8 5.0L 305ci	U	3 Spd. AT w/Cruise Upper; 61.00" Cable	CA-3005
1977	V8 5.0L 305ci	U	3 Spd. MT 2 pc. Cable Lower; 40.00" Cable	CA-3033
1977	V8 5.0L 305ci	U	3 Spd. MT 2 pc. Cable Upper; 61.00" Cable	CA-3005
1977	V8 5.0L 305ci	U	AT w/o Cruise, MT w/1 pc. Cable; 80.00" Cable	CA-3001
1977-78	V8 5.0L 305ci	U	AT w/Cruise Control, Lower; 83.00" Cable	CA-3004
1978	V8 5.0L 305ci	U	AT w/Cruise Control, Upper; 61.00" Cable	CA-3005
1978	V8 5.0L 305ci	U	AT w/o Cruise, MT; 80.00" Cable	CA-3001
1966	V8 5.6L 340ci		w/Column Shift, w/3 Spd. Trans., exc. Cruise Control; 63.00" Cable	CA-3002
1966	V8 5.6L 340ci		w/Floor Shift, w/3 Spd. Trans.; 83.00" Cable	CA-3004
1967	V8 5.6L 340ci		3 Spd. MT; 83.00" Cable	CA-3004
1967	V8 5.6L 340ci		AT; 63.00" Cable	CA-3002
1968	V8 5.7L 350ci		MT; 83.00" Cable	CA-3004
1968	V8 5.7L 350ci		w/Cruise Lower, AT w/o Cruise; 63.00" Cable	CA-3002

# SPEEDOMETER CABLES

Year	Engine	Vin	Remark	Part
<b>BUICK (con't)</b>				
<b>SKYLARK (con't)</b>				
1968	V8 5.7L 350ci		w/Cruise Upper	CA-3006
1969-71	V8 5.7L 350ci		AT w/Cruise Control, Lower; 63.00" Cable	CA-3002
1969-71	V8 5.7L 350ci		AT w/Cruise Control, Upper; 41.00" Cable	CA-3009
1969-71	V8 5.7L 350ci		AT w/o Cruise, 3 Spd. MT; 61.00" Cable	CA-3005
1972	V8 5.7L 350ci	H,J	AT w/Cruise Control, Lower; 63.00" Cable	CA-3002
1972	V8 5.7L 350ci	H,J	AT w/o Cruise, 3 Spd. MT; 61.00" Cable	CA-3005
1972-76	V8 5.7L 350ci	H,J	AT w/Cruise Control, Upper; 41.00" Cable	CA-3009
1975-76	V8 5.7L 350ci	H,J	3 Spd. MT; 61.00" Cable	CA-3005
1975-76	V8 5.7L 350ci	H,J	AT w/Cruise Control, Lower; 83.00" Cable	CA-3004
1975-76	V8 5.7L 350ci	H,J	AT w/o Cruise Control; 80.00" Cable	CA-3001
1977	V8 5.7L 350ci	L,R	3 Spd. AT w/Cruise Upper; 61.00" Cable	CA-3005
1977	V8 5.7L 350ci	L,R	3 Spd. MT 2 pc. Cable Lower; 40.00" Cable	CA-3033
1977	V8 5.7L 350ci	L	3 Spd. MT 2 pc. Cable Upper; 61.00" Cable	CA-3005
1977	V8 5.7L 350ci	L,R	AT w/o Cruise, MT w/1 pc. Cable; 80.00" Cable	CA-3001
1977-79	V8 5.7L 350ci	L,R	AT w/Cruise Control, Lower; 83.00" Cable	CA-3004
1978-79	V8 5.7L 350ci	L	AT w/Cruise Control, Upper; 61.00" Cable	CA-3005
1978-79	V8 5.7L 350ci	L	AT w/o Cruise, MT; 80.00" Cable	CA-3001
1977	V8 5.7L 350ci	R	3 Spd. MT 2 pc. Cable Upper; 61.00" Cable	CA-3005
1967	V8 6.6L 400ci		3 Spd. MT; 83.00" Cable	CA-3004
1967	V8 6.6L 400ci		AT; 63.00" Cable	CA-3002
1965	V8 6.6L 401ci		2 Spd. AT; 63.00" Cable	CA-3002
1965	V8 6.6L 401ci		4 Spd. MT; 63.00" Cable	CA-3002
1965	V8 6.6L 401ci		exc. 2 Spd. AT & 4 Spd. MT; 83.00" Cable	CA-3004
1966	V8 6.6L 401ci		w/Column Shift, w/3 Spd. Trans., exc. Cruise Control; 63.00" Cable	CA-3002
1966	V8 6.6L 401ci		w/Floor Shift, w/3 Spd. Trans.; 83.00" Cable	CA-3004
1972	V8 7.5L 455ci	U	AT w/Cruise Control, Lower; 63.00" Cable	CA-3002
1972	V8 7.5L 455ci	U	AT w/Cruise Control, Upper; 41.00" Cable	CA-3009
1972	V8 7.5L 455ci	U	AT w/o Cruise, 3 Spd. MT; 61.00" Cable	CA-3005
<b>SPECIAL</b>				
1968	L6 4.1L 250ci		3 Spd. MT, AT w/Cruise Lower, AT w/o Cruise; 63.00" Cable	CA-3002
1968	L6 4.1L 250ci		AT w/Cruise Control, Upper	CA-3006
1969	L6 4.1L 250ci		3 Spd. AT; 61.00" Cable	CA-3005
1969	L6 4.1L 250ci		3 Spd. MT w/o Cruise; 61.00" Cable	CA-3005
1969	L6 4.1L 250ci		AT w/Cruise Control, Lower; 63.00" Cable	CA-3002
1969	L6 4.1L 250ci		AT w/Cruise Control, Upper; 41.00" Cable	CA-3009
1962-63	V6 3.2L 198ci		AT; 83.00" Cable	CA-3004
1965	V6 3.7L 225ci		2 Spd. AT; 63.00" Cable	CA-3002
1965	V6 3.7L 225ci		4 Spd. MT; 63.00" Cable	CA-3002
1965	V6 3.7L 225ci		AT exc. 2 Spd.; 83.00" Cable	CA-3004
1966	V6 3.7L 225ci		w/Column Shift, w/3 Spd. Trans.; 63.00" Cable	CA-3002
1966	V6 3.7L 225ci		w/Floor Shift, w/3 Spd. Trans.; 83.00" Cable	CA-3004
1967	V6 3.7L 225ci		3 Spd. MT; 83.00" Cable	CA-3004
1967	V6 3.7L 225ci		AT; 63.00" Cable	CA-3002
1961	V8 3.5L 215ci		AT; 83.00" Cable	CA-3004
1961-63	V8 3.5L 215ci		3 Spd. MT; 63.00" Cable	CA-3002
1965	V8 4.9L 300ci		2 Spd. AT; 63.00" Cable	CA-3002
1965	V8 4.9L 300ci		4 Spd. MT; 63.00" Cable	CA-3002
1965	V8 4.9L 300ci		AT exc. 2 Spd.; 83.00" Cable	CA-3004
1966	V8 4.9L 300ci		w/Column Shift, w/3 Spd. Trans.; 63.00" Cable	CA-3002
1966	V8 4.9L 300ci		w/Floor Shift, w/3 Spd. Trans.; 83.00" Cable	CA-3004
1967	V8 4.9L 300ci		3 Spd. MT; 83.00" Cable	CA-3004
1967	V8 4.9L 300ci		AT; 63.00" Cable	CA-3002
1968	V8 5.7L 350ci		3 Spd. MT, AT w/Cruise Lower, AT w/o Cruise; 63.00" Cable	CA-3002
1968	V8 5.7L 350ci		AT w/Cruise Control, Upper	CA-3006
1969	V8 5.7L 350ci		3 Spd. AT; 61.00" Cable	CA-3005
1969	V8 5.7L 350ci		3 Spd. MT w/o Cruise; 61.00" Cable	CA-3005
1969	V8 5.7L 350ci		AT w/Cruise Control, Lower; 63.00" Cable	CA-3002
1969	V8 5.7L 350ci		AT w/Cruise Control, Upper; 41.00" Cable	CA-3009
<b>SPORTWAGON</b>				
1969-70	V8 5.7L 350ci		3 Spd. AT; 61.00" Cable	CA-3005
1969-70	V8 5.7L 350ci		3 Spd. MT w/o Cruise; 61.00" Cable	CA-3005
1969-71	V8 5.7L 350ci		AT w/Cruise Control, Lower; 63.00" Cable	CA-3002

# SPEEDOMETER CABLES

Year	Engine	Vin	Remark	Part
<b>BUICK (con't)</b>				
<b>SPORTWAGON (con't)</b>				
1969-71	V8 5.7L 350ci		AT w/Cruise Control, Upper; 41.00" Cable	CA-3009
1971	V8 5.7L 350ci		AT w/o Cruise Control; 80.00" Cable	CA-3001
1971	V8 5.7L 350ci		MT w/Console; 100.00" Cable	CA-3003
1972	V8 5.7L 350ci	H,J	AT w/Cruise Control, Lower; 63.00" Cable	CA-3002
1972	V8 5.7L 350ci	H,J	AT w/Cruise Control, Upper; 41.00" Cable	CA-3009
1972	V8 5.7L 350ci	H,J	MT w/Console; 100.00" Cable	CA-3003
1972	V8 5.7L 350ci	H,J	w/o Cruise Control; 80.00" Cable	CA-3001
1970	V8 7.5L 455ci		3 Spd. AT; 61.00" Cable	CA-3005
1970	V8 7.5L 455ci		3 Spd. MT w/o Cruise; 61.00" Cable	CA-3005
1970	V8 7.5L 455ci		AT w/Cruise Control, Lower; 63.00" Cable	CA-3002
1970	V8 7.5L 455ci		AT w/Cruise Control, Upper; 41.00" Cable	CA-3009
<b>WILDCAT</b>				
1966	V8 6.6L 401ci		AT & 4 Spd. MT; 63.00" Cable	CA-3002
1963-64	V8 6.6L 401ci		63.00" Cable	CA-3002
1965-66	V8 6.6L 401ci		w/Floor Shift, w/3 Spd. Trans.; 83.00" Cable	CA-3004
1964	V8 7.0L 425ci		63.00" Cable	CA-3002
1966	V8 7.0L 425ci		AT & 4 Spd. MT; 63.00" Cable	CA-3002
1965-66	V8 7.0L 425ci		w/Floor Shift, w/3 Spd. Trans.; 83.00" Cable	CA-3004
1968	V8 7.0L 430ci		3 Spd. Trans.; 83.00" Cable	CA-3004
1968	V8 7.0L 430ci		w/Cruise Lower; 63.00" Cable	CA-3002
1968	V8 7.0L 430ci		w/Cruise Upper	CA-3006
1969	V8 7.0L 430ci		3 Spd. AT; 80.00" Cable	CA-3001
1969	V8 7.0L 430ci		3 Spd. MT w/o Cruise; 80.00" Cable	CA-3001
1969	V8 7.0L 430ci		AT w/Cruise Control, Lower; 63.00" Cable	CA-3002
1970	V8 7.5L 455ci		3 Spd. AT; 80.00" Cable	CA-3001
1970	V8 7.5L 455ci		3 Spd. MT w/o Cruise; 80.00" Cable	CA-3001
1970	V8 7.5L 455ci		AT w/Cruise Control, Lower; 83.00" Cable	CA-3004
1970	V8 7.5L 455ci		AT w/Cruise Control, Upper; 61.00" Cable	CA-3005
<b>CADILLAC</b>				
<b>BROUGHAM</b>				
1987-88	V8 5.0L 307ci	9,Y	AT; 80.00" Cable	CA-3001
<b>CALAIS</b>				
1966	V8 7.0L 429ci		w/Cruise Control	CA-3006
1965-66	V8 7.0L 429ci		exc. Cruise Control; 83.00" Cable	CA-3004
1969	V8 7.7L 472ci		exc. Cruise Control; 80.00" Cable	CA-3001
1970	V8 7.7L 472ci		w/o Cruise Control; 61.00" Cable	CA-3005
1971	V8 7.7L 472ci		w/Cruise Upper; 61.00" Cable	CA-3005
1970-71	V8 7.7L 472ci		w/Cruise Lower; 63.00" Cable	CA-3002
1972	V8 7.7L 472ci	R	w/Cruise w/ABS Lower	CA-3006
1972	V8 7.7L 472ci	R	w/Cruise w/o ABS Lower; 63.00" Cable	CA-3002
1972	V8 7.7L 472ci	R	w/o Cruise w/ABS; 61.00" Cable	CA-3005
1972	V8 7.7L 472ci	R	w/o Cruise w/o ABS; 80.00" Cable	CA-3001
1972-74	V8 7.7L 472ci	R	w/Cruise Upper; 41.00" Cable	CA-3009
1973-74	V8 7.7L 472ci	R	w/Cruise Lower; 63.00" Cable	CA-3002
1973-74	V8 7.7L 472ci	R	w/o Cruise Control; 80.00" Cable	CA-3001
1975-76	V8 8.2L 500ci	S	w/Cruise Lower; 63.00" Cable	CA-3002
1975-76	V8 8.2L 500ci	S	w/Cruise Upper; 41.00" Cable	CA-3009
1975-76	V8 8.2L 500ci	S	w/o Cruise Control; 80.00" Cable	CA-3001
<b>CIMARRON</b>				
1982	L4 1.8L 112ci	G	AT w/Cruise Upper, MT w/o Cruise; 41.00" Cable	CA-3009
1982	L4 1.8L 112ci	G	AT w/o Cruise Control; 61.00" Cable	CA-3005
1982	L4 1.8L 112ci	G	w/Cruise Lower	CA-3006
1983	L4 2.0L 122ci	P	AT w/Cruise Upper, MT w/o Cruise; 41.00" Cable	CA-3009
1983	L4 2.0L 122ci	P	AT w/o Cruise Control; 61.00" Cable	CA-3005
1983	L4 2.0L 122ci	P	w/Cruise Lower	CA-3006
1984-86	L4 2.0L 122ci	P	AT; 61.00" Cable	CA-3005
1984-86	L4 2.0L 122ci	P	MT; 41.00" Cable	CA-3009
1985-86	V6 2.8L 173ci	W	AT; 80.00" Cable	CA-3001
1985-86	V6 2.8L 173ci	W	MT; 41.00" Cable	CA-3009
1987	V6 2.8L 173ci	W	5 Spd. Trans., w/Cluster Instrument Panel Including Climate Temp., Volts, Tachometer; 41.00" Cable	CA-3009
1987-88	V6 2.8L 173ci	W	AT w/o Digital Cluster; 80.00" Cable	CA-3001



# SPEEDOMETER CABLES

Year	Engine	Vin	Remark	Part
<b>CADILLAC (con't)</b>				
<b>DEVILLE</b>				
1980-82	V6 4.1L 252ci	4	AT; 80.00" Cable	CA-3001
1982-83	V8 4.1L 250ci	8	AT; 80.00" Cable	CA-3001
1953	V8 5.4L 331ci		AT; 83.00" Cable	CA-3004
1979-83	V8 5.7L 350ci	N	AT; 80.00" Cable	CA-3001
1956-58	V8 6.0L 365ci		AT; 63.00" Cable	CA-3002
1980	V8 6.0L 368ci	6	AT; 80.00" Cable	CA-3001
1981	V8 6.0L 368ci	9	AT; 80.00" Cable	CA-3001
1959-60	V8 6.4L 390ci		exc. Cruise Control; 61.00" Cable	CA-3005
1961-63	V8 6.4L 390ci		exc. Cruise Control; 83.00" Cable	CA-3004
1961-63	V8 6.4L 390ci		w/Cruise Control, Upper	CA-3006
1977-79	V8 7.0L 425ci	S,T	AT; 80.00" Cable	CA-3001
1964	V8 7.0L 429ci		w/Cruise Control, Upper	CA-3006
1966	V8 7.0L 429ci		w/Cruise Control	CA-3006
1964-66	V8 7.0L 429ci		exc. Cruise Control; 83.00" Cable	CA-3004
1969	V8 7.7L 472ci		80.00" Cable	CA-3001
1970	V8 7.7L 472ci		w/Cruise Lower; 63.00" Cable	CA-3002
1970-71	V8 7.7L 472ci		w/o Cruise Control; 61.00" Cable	CA-3005
1971	V8 7.7L 472ci		w/Cruise Control, Lower; 63.00" Cable	CA-3002
1971	V8 7.7L 472ci		w/Cruise Control, Upper; 41.00" Cable	CA-3009
1972	V8 7.7L 472ci	R	w/Cruise w/ABS Lower	CA-3006
1972	V8 7.7L 472ci	R	w/Cruise w/o ABS Lower; 63.00" Cable	CA-3002
1972	V8 7.7L 472ci	R	w/o Cruise w/ABS; 61.00" Cable	CA-3005
1972	V8 7.7L 472ci	R	w/o Cruise w/o ABS; 80.00" Cable	CA-3001
1972-74	V8 7.7L 472ci	R	w/Cruise Control, Upper; 41.00" Cable	CA-3009
1973-74	V8 7.7L 472ci	R	w/Cruise Lower; 63.00" Cable	CA-3002
1973-74	V8 7.7L 472ci	R	w/o Cruise Control; 80.00" Cable	CA-3001
1975-76	V8 8.2L 500ci	S	w/Cruise Lower; 63.00" Cable	CA-3002
1975-76	V8 8.2L 500ci	S	w/Cruise Control, Upper; 41.00" Cable	CA-3009
1975-76	V8 8.2L 500ci	S	w/o Cruise Control; 80.00" Cable	CA-3001
<b>ELDORADO</b>				
1981-82	V6 4.1L 252ci	4	41.00" Cable	CA-3009
1983-86	V8 4.1L 250ci	8	41.00" Cable	CA-3009
1980	V8 5.7L 350ci	8	41.00" Cable	CA-3009
1979-82	V8 5.7L 350ci	B,N	41.00" Cable	CA-3009
1980-81	V8 6.0L 368ci	9	41.00" Cable	CA-3009
1977-78	V8 7.0L 425ci	S,T	41.00" Cable	CA-3009
1969	V8 7.7L 472ci		w/Cruise Lower	CA-3006
1969	V8 7.7L 472ci		w/Cruise Upper; 61.00" Cable	CA-3005
1969	V8 7.7L 472ci		w/o Cruise Control; 41.00" Cable	CA-3009
1970	V8 8.2L 500ci		w/Cruise Lower	CA-3006
1970	V8 8.2L 500ci		w/Cruise Upper; 61.00" Cable	CA-3005
1970	V8 8.2L 500ci		w/o Cruise Control; 41.00" Cable	CA-3009
1971	V8 8.2L 500ci		w/Cruise Control, Lower	CA-3006
1971	V8 8.2L 500ci		w/Cruise Control, Upper; 41.00" Cable	CA-3009
1972-76	V8 8.2L 500ci	S	w/Cruise Lower	CA-3006
1972-76	V8 8.2L 500ci	S	w/Cruise Upper, w/o Cruise; 41.00" Cable	CA-3009
<b>FLEETWOOD</b>				
1986	V8 5.0L 307ci	Y	AT; 80.00" Cable	CA-3001
1980-82	V8 6.0L 368ci	6	AT; 80.00" Cable	CA-3001
1981-83	V8 6.0L 368ci	9	AT; 80.00" Cable	CA-3001
1977-79	V8 7.0L 425ci	S	AT; 80.00" Cable	CA-3001
1966	V8 7.0L 429ci		w/Cruise Control	CA-3006
1965-66	V8 7.0L 429ci		exc. Cruise Control; 83.00" Cable	CA-3004
1970-71	V8 7.7L 472ci		w/Cruise Control, Lower; 63.00" Cable	CA-3002
1970-71	V8 7.7L 472ci		w/o Cruise Control; 61.00" Cable	CA-3005
1971	V8 7.7L 472ci		w/Cruise Control, Upper; 41.00" Cable	CA-3009
1972	V8 7.7L 472ci	R	w/Cruise w/ABS Lower	CA-3006
1972	V8 7.7L 472ci	R	w/Cruise w/o ABS Lower; 63.00" Cable	CA-3002
1972	V8 7.7L 472ci	R	w/o Cruise w/ABS; 61.00" Cable	CA-3005
1972	V8 7.7L 472ci	R	w/o Cruise w/o ABS; 80.00" Cable	CA-3001
1972-74	V8 7.7L 472ci	R	w/Cruise Control, Upper; 41.00" Cable	CA-3009
1973-74	V8 7.7L 472ci	R	w/Cruise Control, Lower; 63.00" Cable	CA-3002

# SPEEDOMETER CABLES

Year	Engine	Vin	Remark	Part
<b>CADILLAC (con't)</b>				
<b>FLEETWOOD (con't)</b>				
1973-74	V8 7.7L 472ci	R	w/o Cruise Control; 80.00" Cable	CA-3001
1976	V8 8.2L 500ci	S	w/Cruise Control, Lower; 63.00" Cable	CA-3002
1976	V8 8.2L 500ci	S	w/Cruise Control, Upper; 41.00" Cable	CA-3009
1976	V8 8.2L 500ci	S	w/o Cruise Control; 80.00" Cable	CA-3001
<b>SERIES 60 FLEETWOOD, SERIES 62, SERIES 75 FLEETWOOD</b>				
1950-53	V8 5.4L 331ci		AT; 83.00" Cable	CA-3004
1956-58	V8 6.0L 365ci		AT; 63.00" Cable	CA-3002
1959-60	V8 6.4L 390ci		exc. Cruise Control; 61.00" Cable	CA-3005
1961-63	V8 6.4L 390ci		exc. Cruise Control; 83.00" Cable	CA-3004
1961-63	V8 6.4L 390ci		w/Cruise Control, Upper	CA-3006
1964	V8 7.0L 429ci		exc. Cruise Control; 83.00" Cable	CA-3004
1964	V8 7.0L 429ci		w/Cruise Control, Upper	CA-3006
<b>SEVILLE</b>				
1981-82	V6 4.1L 252ci	4	41.00" Cable	CA-3009
1983-86	V8 4.1L 250ci	8	41.00" Cable	CA-3009
1978-79	V8 5.7L 350ci	B,N	80.00" Cable	CA-3001
1980-81	V8 5.7L 350ci	8,N	41.00" Cable	CA-3009
1976	V8 5.7L 350ci	R	w/Cruise Lower; 63.00" Cable	CA-3002
1976	V8 5.7L 350ci	R	w/Cruise Upper; 61.00" Cable	CA-3005
1976	V8 5.7L 350ci	R	w/o Cruise Control; 80.00" Cable	CA-3001
1977	V8 5.7L 350ci	R	80.00" Cable	CA-3001
1980-81	V8 6.0L 368ci	9	41.00" Cable	CA-3009
<b>CHEVROLET</b>				
<b>BEL AIR</b>				
1950-52	L6 3.6L 217ci		AT; 83.00" Cable	CA-3004
1950-52	L6 3.6L 217ci		exc. Overdrive Trans.; 63.00" Cable	CA-3002
1963-64	L6 3.8L 230ci		63.00" Cable	CA-3002
1965	L6 3.8L 230ci		83.00" Cable	CA-3004
1954	L6 3.9L 235ci		exc. Overdrive Trans.; 63.00" Cable	CA-3002
1954-56	L6 3.9L 235ci		AT; 83.00" Cable	CA-3004
1955-58	L6 3.9L 235ci		MT; 63.00" Cable	CA-3002
1957	L6 3.9L 235ci		AT w/o Overdrive; 83.00" Cable	CA-3004
1959	L6 3.9L 235ci		w/o Tach.; 63.00" Cable	CA-3002
1959	L6 3.9L 235ci		w/Tach.; 83.00" Cable	CA-3004
1961	L6 3.9L 235ci		w/Powerglide Trans.; 83.00" Cable	CA-3004
1961	L6 3.9L 235ci		w/Turboglide Trans.; 63.00" Cable	CA-3002
1962	L6 3.9L 235ci		63.00" Cable	CA-3002
1950-53	L6 3.9L 236ci		AT; 83.00" Cable	CA-3004
1950-53	L6 3.9L 236ci		exc. Overdrive Trans.; 63.00" Cable	CA-3002
1965-68	L6 4.1L 250ci		AT; 83.00" Cable	CA-3004
1967	L6 4.1L 250ci		w/Cruise Upper	CA-3006
1967	L6 4.1L 250ci		w/o Cruise Control; 83.00" Cable	CA-3004
1967-71	L6 4.1L 250ci		w/Cruise Lower; 63.00" Cable	CA-3002
1969	L6 4.1L 250ci		Muncie 4 Spd. MT; 100.00" Cable	CA-3003
1969	L6 4.1L 250ci		w/Cruise Control; 63.00" Cable	CA-3002
1969	L6 4.1L 250ci		w/o Cruise Control; 80.00" Cable	CA-3001
1969-70	L6 4.1L 250ci		w/Cruise Upper; 41.00" Cable	CA-3009
1970	L6 4.1L 250ci		w/o Cruise, 4 Spd. Muncie MT; 80.00" Cable	CA-3001
1971	L6 4.1L 250ci		MT w/o Cruise, Powerglide w/o Cruise, THM w/Cruise; 61.00" Cable	CA-3005
1971	L6 4.1L 250ci		Upper; 41.00" Cable	CA-3009
1972-73	L6 4.1L 250ci	D	w/Cruise Lower; 63.00" Cable	CA-3002
1972-73	L6 4.1L 250ci	D	w/Cruise Upper; 41.00" Cable	CA-3009
1972-73	L6 4.1L 250ci	D	w/o Cruise Control; 61.00" Cable	CA-3005
1955-56	V8 4.3L 265ci		AT; 83.00" Cable	CA-3004
1955-57	V8 4.3L 265ci		MT; 63.00" Cable	CA-3002
1957	V8 4.3L 265ci		AT w/o Overdrive; 83.00" Cable	CA-3004
1981	V8 4.4L 267ci	J	w/Cruise Lower; 83.00" Cable	CA-3004
1981	V8 4.4L 267ci	J	w/Cruise Upper; 61.00" Cable	CA-3005
1981	V8 4.4L 267ci	J	w/o Cruise Control; 80.00" Cable	CA-3001
1957	V8 4.6L 283ci		AT w/o Overdrive; 83.00" Cable	CA-3004
1957-64	V8 4.6L 283ci		MT; 63.00" Cable	CA-3002
1959	V8 4.6L 283ci		w/o Tach.; 63.00" Cable	CA-3002

# SPEEDOMETER CABLES

Year	Engine	Vin	Remark	Part
<b>CHEVROLET (con't)</b>				
<b>BEL AIR (con't)</b>				
1959	V8 4.6L 283ci		w/Tach.; 83.00" Cable	CA-3004
1960-66	V8 4.6L 283ci		w/AT; 83.00" Cable	CA-3004
1961	V8 4.6L 283ci		w/Turboglide Trans.; 63.00" Cable	CA-3002
1967	V8 4.6L 283ci		w/Cruise Lower; 63.00" Cable	CA-3002
1967	V8 4.6L 283ci		w/Cruise Upper	CA-3006
1967	V8 4.6L 283ci		w/o Cruise Control; 83.00" Cable	CA-3004
1981	V8 5.0L 305ci	H	w/Cruise Lower; 83.00" Cable	CA-3004
1981	V8 5.0L 305ci	H	w/Cruise Upper; 61.00" Cable	CA-3005
1981	V8 5.0L 305ci	H	w/o Cruise Control; 80.00" Cable	CA-3001
1968	V8 5.0L 307ci		83.00" Cable	CA-3004
1962-64	V8 5.4L 327ci		63.00" Cable	CA-3002
1965-66	V8 5.4L 327ci		83.00" Cable	CA-3004
1969	V8 5.4L 327ci		Muncie 4 Spd. MT; 100.00" Cable	CA-3003
1969	V8 5.4L 327ci		w/Cruise Lower; 63.00" Cable	CA-3002
1969	V8 5.4L 327ci		w/Cruise Upper; 41.00" Cable	CA-3009
1969	V8 5.4L 327ci		w/o Cruise Control; 80.00" Cable	CA-3001
1968	V8 5.4L 327ci		83.00" Cable	CA-3004
1967	V8 5.4L 327ci		w/Cruise Lower; 63.00" Cable	CA-3002
1967	V8 5.4L 327ci		w/Cruise Upper	CA-3006
1967	V8 5.4L 327ci		w/o Cruise Control; 83.00" Cable	CA-3004
1958	V8 5.7L 348ci		63.00" Cable	CA-3002
1959	V8 5.7L 348ci		w/o Tach.; 63.00" Cable	CA-3002
1959	V8 5.7L 348ci		w/Tach.; 83.00" Cable	CA-3004
1960	V8 5.7L 348ci		83.00" Cable	CA-3004
1961	V8 5.7L 348ci		w/Powerglide Trans.; 83.00" Cable	CA-3004
1961	V8 5.7L 348ci		w/Turboglide Trans.; 63.00" Cable	CA-3002
1969	V8 5.7L 350ci		w/o Cruise Control; 80.00" Cable	CA-3001
1969-70	V8 5.7L 350ci		w/Cruise Upper; 41.00" Cable	CA-3009
1969-71	V8 5.7L 350ci		w/Cruise Lower; 63.00" Cable	CA-3002
1970	V8 5.7L 350ci		w/o Cruise, 4 Spd. Muncie MT; 80.00" Cable	CA-3001
1971	V8 5.7L 350ci		MT w/o Cruise, Powerglide w/o Cruise, THM w/Cruise; 61.00" Cable	CA-3005
1971	V8 5.7L 350ci		Upper; 41.00" Cable	CA-3009
1972-75	V8 5.7L 350ci	H,K,L	w/Cruise Lower; 63.00" Cable	CA-3002
1972-75	V8 5.7L 350ci	H,K,L	w/Cruise Upper; 41.00" Cable	CA-3009
1972-75	V8 5.7L 350ci	H,K,L	w/o Cruise Control; 61.00" Cable	CA-3005
1969	V8 5.7L 350ci		Muncie 4 Spd. MT; 100.00" Cable	CA-3003
1966-68	V8 6.5L 396ci		83.00" Cable	CA-3004
1967	V8 6.5L 396ci		w/Cruise Upper	CA-3006
1967	V8 6.5L 396ci		w/o Cruise Control; 83.00" Cable	CA-3004
1967-69	V8 6.5L 396ci		w/Cruise Lower; 63.00" Cable	CA-3002
1969	V8 6.5L 396ci		Muncie 4 Spd. MT; 100.00" Cable	CA-3003
1969	V8 6.5L 396ci		w/Cruise Upper; 41.00" Cable	CA-3009
1969	V8 6.5L 396ci		w/o Cruise Control; 80.00" Cable	CA-3001
1970	V8 6.6L 400ci		w/Cruise Upper; 41.00" Cable	CA-3009
1970	V8 6.6L 400ci		w/o Cruise, 4 Spd. Muncie MT; 80.00" Cable	CA-3001
1971	V8 6.6L 400ci		MT w/o Cruise, Powerglide w/o Cruise, THM w/Cruise; 61.00" Cable	CA-3005
1971	V8 6.6L 400ci		Upper; 41.00" Cable	CA-3009
1970-71	V8 6.6L 400ci		w/Cruise Lower; 63.00" Cable	CA-3002
1972-74	V8 6.6L 400ci	R	w/Cruise Lower; 63.00" Cable	CA-3002
1972-74	V8 6.6L 400ci	R	w/Cruise Upper; 41.00" Cable	CA-3009
1972-74	V8 6.6L 400ci	R	w/o Cruise Control; 61.00" Cable	CA-3005
1974-75	V8 6.6L 400ci	U	w/Cruise Lower; 63.00" Cable	CA-3002
1974-75	V8 6.6L 400ci	U	w/Cruise Upper; 41.00" Cable	CA-3009
1974-75	V8 6.6L 400ci	U	w/o Cruise Control; 61.00" Cable	CA-3005
1971	V8 6.6L 402ci		MT w/o Cruise, Powerglide w/o Cruise, THM w/Cruise; 61.00" Cable	CA-3005
1971	V8 6.6L 402ci		Upper; 41.00" Cable	CA-3009
1971	V8 6.6L 402ci		w/Cruise Lower; 63.00" Cable	CA-3002
1972	V8 6.6L 402ci	S	w/Cruise Lower; 63.00" Cable	CA-3002
1972	V8 6.6L 402ci	S	w/Cruise Upper; 41.00" Cable	CA-3009
1972	V8 6.6L 402ci	S	w/o Cruise Control; 61.00" Cable	CA-3005
1961	V8 6.7L 409ci		w/Powerglide Trans.; 83.00" Cable	CA-3004
1961	V8 6.7L 409ci		w/Turboglide Trans.; 63.00" Cable	CA-3002

# SPEEDOMETER CABLES

Year	Engine	Vin	Remark	Part
<b>CHEVROLET (con't)</b>				
<b>BEL AIR (con't)</b>				
1965	V8 6.7L 409ci		83.00" Cable	CA-3004
1962-64	V8 6.7L 409ci		63.00" Cable	CA-3002
1966-68	V8 7.0L 427ci		83.00" Cable	CA-3004
1967	V8 7.0L 427ci		w/Cruise Upper	CA-3006
1967	V8 7.0L 427ci		w/o Cruise Control; 83.00" Cable	CA-3004
1967-69	V8 7.0L 427ci		w/Cruise Lower; 63.00" Cable	CA-3002
1969	V8 7.0L 427ci		Muncie 4 Spd. MT; 100.00" Cable	CA-3003
1969	V8 7.0L 427ci		w/Cruise Upper; 41.00" Cable	CA-3009
1969	V8 7.0L 427ci		w/o Cruise Control; 80.00" Cable	CA-3001
1970	V8 7.4L 454ci		w/Cruise Upper; 41.00" Cable	CA-3009
1970	V8 7.4L 454ci		w/o Cruise, 4 Spd. Muncie MT; 80.00" Cable	CA-3001
1971	V8 7.4L 454ci		MT w/o Cruise, Powerglide w/o Cruise, THM w/Cruise; 61.00" Cable	CA-3005
1971	V8 7.4L 454ci		Upper; 41.00" Cable	CA-3009
1970-71	V8 7.4L 454ci		w/Cruise Lower; 63.00" Cable	CA-3002
1972	V8 7.4L 454ci	V	w/Cruise Lower; 63.00" Cable	CA-3002
1972	V8 7.4L 454ci	V	w/Cruise Upper; 41.00" Cable	CA-3009
1972	V8 7.4L 454ci	V	w/o Cruise Control; 61.00" Cable	CA-3005
1973	V8 7.4L 454ci	X	w/Cruise Lower; 63.00" Cable	CA-3002
1973	V8 7.4L 454ci	X	w/Cruise Upper; 41.00" Cable	CA-3009
1973	V8 7.4L 454ci	X	w/o Cruise Control; 61.00" Cable	CA-3005
1974-75	V8 7.4L 454ci	Y	w/Cruise Lower; 63.00" Cable	CA-3002
1974-75	V8 7.4L 454ci	Y	w/Cruise Upper; 41.00" Cable	CA-3009
1974-75	V8 7.4L 454ci	Y	w/o Cruise Control; 61.00" Cable	CA-3005
<b>BISCAYNE</b>				
1963-64	L6 3.8L 230ci		63.00" Cable	CA-3002
1965	L6 3.8L 230ci		83.00" Cable	CA-3004
1958-62	L6 3.9L 235ci		63.00" Cable	CA-3002
1959	L6 3.9L 235ci		w/o Tach.; 63.00" Cable	CA-3002
1959	L6 3.9L 235ci		w/Tach.; 83.00" Cable	CA-3004
1961	L6 3.9L 235ci		w/Powerglide Trans.; 83.00" Cable	CA-3004
1961	L6 3.9L 235ci		w/Turboglide Trans.; 63.00" Cable	CA-3002
1965-68	L6 4.1L 250ci		83.00" Cable	CA-3004
1967	L6 4.1L 250ci		w/Cruise Upper	CA-3006
1967	L6 4.1L 250ci		w/o Cruise Control; 83.00" Cable	CA-3004
1967-71	L6 4.1L 250ci		w/Cruise Lower; 63.00" Cable	CA-3002
1969	L6 4.1L 250ci		Muncie 4 Spd. MT; 100.00" Cable	CA-3003
1969	L6 4.1L 250ci		w/o Cruise Control; 80.00" Cable	CA-3001
1969-70	L6 4.1L 250ci		w/Cruise Upper; 41.00" Cable	CA-3009
1970	L6 4.1L 250ci		w/o Cruise, 4 Spd. Muncie MT; 80.00" Cable	CA-3001
1971	L6 4.1L 250ci		MT w/o Cruise, Powerglide w/o Cruise, THM w/Cruise; 61.00" Cable	CA-3005
1971	L6 4.1L 250ci		Upper; 41.00" Cable	CA-3009
1972	L6 4.1L 250ci	D	w/Cruise Lower; 63.00" Cable	CA-3002
1972	L6 4.1L 250ci	D	w/Cruise Upper; 41.00" Cable	CA-3009
1972	L6 4.1L 250ci	D	w/o Cruise Control; 61.00" Cable	CA-3005
1958-64	V8 4.6L 283ci		63.00" Cable	CA-3002
1959	V8 4.6L 283ci		w/o Tach.; 63.00" Cable	CA-3002
1959	V8 4.6L 283ci		w/Tach.; 83.00" Cable	CA-3004
1960	V8 4.6L 283ci		83.00" Cable	CA-3004
1961	V8 4.6L 283ci		w/Powerglide Trans.; 83.00" Cable	CA-3004
1961	V8 4.6L 283ci		w/Turboglide Trans.; 63.00" Cable	CA-3002
1965-67	V8 4.6L 283ci		w/o Cruise Control; 83.00" Cable	CA-3004
1967	V8 4.6L 283ci		w/Cruise Lower; 63.00" Cable	CA-3002
1968	V8 5.0L 307ci		83.00" Cable	CA-3004
1962-64	V8 5.4L 327ci		63.00" Cable	CA-3002
1965-66	V8 5.4L 327ci		83.00" Cable	CA-3004
1969	V8 5.4L 327ci		Muncie 4 Spd. MT; 100.00" Cable	CA-3003
1969	V8 5.4L 327ci		w/Cruise Lower; 63.00" Cable	CA-3002
1969	V8 5.4L 327ci		w/Cruise Upper; 41.00" Cable	CA-3009
1969	V8 5.4L 327ci		w/o Cruise Control; 80.00" Cable	CA-3001
1968	V8 5.4L 327ci		83.00" Cable	CA-3004
1967	V8 5.4L 327ci		w/Cruise Lower; 63.00" Cable	CA-3002
1967	V8 5.4L 327ci		w/Cruise Upper	CA-3006

# SPEEDOMETER CABLES

Year	Engine	Vin	Remark	Part
<b>CHEVROLET (con't)</b>				
<b>BISCAYNE (con't)</b>				
1967	V8 5.4L 327ci		w/o Cruise Control; 83.00" Cable	CA-3004
1958	V8 5.7L 348ci		63.00" Cable	CA-3002
1959	V8 5.7L 348ci		w/o Tach.; 63.00" Cable	CA-3002
1959	V8 5.7L 348ci		w/Tach.; 83.00" Cable	CA-3004
1960	V8 5.7L 348ci		83.00" Cable	CA-3004
1961	V8 5.7L 348ci		w/Powerglide Trans.; 83.00" Cable	CA-3004
1961	V8 5.7L 348ci		w/Turboglide Trans.; 63.00" Cable	CA-3002
1969	V8 5.7L 350ci		Muncie 4 Spd. MT; 100.00" Cable	CA-3003
1969	V8 5.7L 350ci		w/o Cruise Control; 80.00" Cable	CA-3001
1969-70	V8 5.7L 350ci		w/Cruise Upper; 41.00" Cable	CA-3009
1969-71	V8 5.7L 350ci		w/Cruise Lower; 63.00" Cable	CA-3002
1970	V8 5.7L 350ci		w/o Cruise, 4 Spd. Muncie MT; 80.00" Cable	CA-3001
1971	V8 5.7L 350ci		MT w/o Cruise, Powerglide w/o Cruise, THM w/Cruise; 61.00" Cable	CA-3005
1971	V8 5.7L 350ci		Upper; 41.00" Cable	CA-3009
1972	V8 5.7L 350ci	H	w/Cruise Lower; 63.00" Cable	CA-3002
1972	V8 5.7L 350ci	H	w/Cruise Upper; 41.00" Cable	CA-3009
1972	V8 5.7L 350ci	H	w/o Cruise Control; 61.00" Cable	CA-3005
1966-68	V8 6.5L 396ci		83.00" Cable	CA-3004
1967	V8 6.5L 396ci		w/Cruise Upper	CA-3006
1967	V8 6.5L 396ci		w/o Cruise Control; 83.00" Cable	CA-3004
1967-69	V8 6.5L 396ci		w/Cruise Lower; 63.00" Cable	CA-3002
1969	V8 6.5L 396ci		Muncie 4 Spd. MT; 100.00" Cable	CA-3003
1969	V8 6.5L 396ci		w/Cruise Upper; 41.00" Cable	CA-3009
1969	V8 6.5L 396ci		w/o Cruise Control; 80.00" Cable	CA-3001
1970	V8 6.6L 400ci		w/Cruise Upper; 41.00" Cable	CA-3009
1970	V8 6.6L 400ci		w/o Cruise, 4 Spd. Muncie MT; 80.00" Cable	CA-3001
1971	V8 6.6L 400ci		MT w/o Cruise, Powerglide w/o Cruise, THM w/Cruise; 61.00" Cable	CA-3005
1971	V8 6.6L 400ci		Upper; 41.00" Cable	CA-3009
1970-71	V8 6.6L 400ci		w/Cruise Lower; 63.00" Cable	CA-3002
1972	V8 6.6L 400ci	R	w/Cruise Lower; 63.00" Cable	CA-3002
1972	V8 6.6L 400ci	R	w/Cruise Upper; 41.00" Cable	CA-3009
1972	V8 6.6L 400ci	R	w/o Cruise Control; 61.00" Cable	CA-3005
1971	V8 6.6L 402ci		MT w/o Cruise, Powerglide w/o Cruise, THM w/Cruise; 61.00" Cable	CA-3005
1971	V8 6.6L 402ci		Upper; 41.00" Cable	CA-3009
1971	V8 6.6L 402ci		w/Cruise Lower; 63.00" Cable	CA-3002
1972	V8 6.6L 402ci	S	w/Cruise Lower; 63.00" Cable	CA-3002
1972	V8 6.6L 402ci	S	w/Cruise Upper; 41.00" Cable	CA-3009
1972	V8 6.6L 402ci	S	w/o Cruise Control; 61.00" Cable	CA-3005
1961	V8 6.7L 409ci		w/Powerglide Trans.; 83.00" Cable	CA-3004
1961	V8 6.7L 409ci		w/Turboglide Trans.; 63.00" Cable	CA-3002
1962-64	V8 6.7L 409ci		63.00" Cable	CA-3002
1965	V8 6.7L 409ci		83.00" Cable	CA-3004
1966-68	V8 7.0L 427ci		83.00" Cable	CA-3004
1967	V8 7.0L 427ci		w/Cruise Upper	CA-3006
1967	V8 7.0L 427ci		w/o Cruise Control; 83.00" Cable	CA-3004
1967-69	V8 7.0L 427ci		w/Cruise Lower; 63.00" Cable	CA-3002
1969	V8 7.0L 427ci		Muncie 4 Spd. MT; 100.00" Cable	CA-3003
1969	V8 7.0L 427ci		w/Cruise Upper; 41.00" Cable	CA-3009
1969	V8 7.0L 427ci		w/o Cruise Control; 80.00" Cable	CA-3001
1971	V8 7.4L 454ci		MT w/o Cruise, Powerglide w/o Cruise, THM w/Cruise; 61.00" Cable	CA-3005
1971	V8 7.4L 454ci		Upper; 41.00" Cable	CA-3009
1971	V8 7.4L 454ci		w/Cruise Lower; 63.00" Cable	CA-3002
1972	V8 7.4L 454ci	W	w/Cruise Lower; 63.00" Cable	CA-3002
1972	V8 7.4L 454ci	W	w/Cruise Upper; 41.00" Cable	CA-3009
1972	V8 7.4L 454ci	W	w/o Cruise Control; 61.00" Cable	CA-3005
<b>BROOKWOOD</b>				
1969	L6 4.1L 250ci		Muncie 4 Spd. MT; 100.00" Cable	CA-3003
1969	L6 4.1L 250ci		w/Cruise Lower; 63.00" Cable	CA-3002
1969	L6 4.1L 250ci		w/Cruise Upper; 41.00" Cable	CA-3009
1969	L6 4.1L 250ci		w/o Cruise Control; 80.00" Cable	CA-3001
1969	V8 5.7L 350ci		Muncie 4 Spd. MT; 100.00" Cable	CA-3003
1969	V8 5.7L 350ci		w/o Cruise Control; 80.00" Cable	CA-3001

# SPEEDOMETER CABLES

Year	Engine	Vin	Remark	Part
<b>CHEVROLET (con't)</b>				
<b>BROOKWOOD (con't)</b>				
1969-70	V8 5.7L 350ci		w/Cruise Upper; 41.00" Cable	CA-3009
1969-71	V8 5.7L 350ci		w/Cruise Lower; 63.00" Cable	CA-3002
1970	V8 5.7L 350ci		w/o Cruise, 4 Spd. Muncie MT; 80.00" Cable	CA-3001
1971	V8 5.7L 350ci		MT w/o Cruise, Powerglide w/o Cruise, THM w/Cruise; 61.00" Cable	CA-3005
1971	V8 5.7L 350ci		Upper; 41.00" Cable	CA-3009
1972	V8 5.7L 350ci	H	w/Cruise Lower; 63.00" Cable	CA-3002
1972	V8 5.7L 350ci	H	w/Cruise Upper; 41.00" Cable	CA-3009
1972	V8 5.7L 350ci	H	w/o Cruise Control; 61.00" Cable	CA-3005
1970	V8 6.6L 400ci		w/Cruise Lower; 63.00" Cable	CA-3002
1970	V8 6.6L 400ci		w/Cruise Upper; 41.00" Cable	CA-3009
1970	V8 6.6L 400ci		w/o Cruise, 4 Spd. Muncie MT; 80.00" Cable	CA-3001
1972	V8 6.6L 400ci	R	w/Cruise Lower; 63.00" Cable	CA-3002
1972	V8 6.6L 400ci	R	w/Cruise Upper; 41.00" Cable	CA-3009
1972	V8 6.6L 400ci	R	w/o Cruise Control; 61.00" Cable	CA-3005
1972	V8 6.6L 402ci	S	w/Cruise Lower; 63.00" Cable	CA-3002
1972	V8 6.6L 402ci	S	w/Cruise Upper; 41.00" Cable	CA-3009
1972	V8 6.6L 402ci	S	w/o Cruise Control; 61.00" Cable	CA-3005
<b>CAMARO</b>				
1982	L4 2.5L 151ci	2,F	w/Cruise Lower; 63.00" Cable	CA-3002
1982	L4 2.5L 151ci	2,F	w/Cruise Upper; 61.00" Cable	CA-3005
1982	L4 2.5L 151ci	2,F	w/o Cruise Control; 80.00" Cable	CA-3001
1983	L4 2.5L 151ci	2,F	AT w/Cruise Lower, 5 Spd. MT Lower; 63.00" Cable	CA-3002
1983	L4 2.5L 151ci	2,F	AT w/Cruise Upper, 5 Spd. MT Upper; 61.00" Cable	CA-3005
1983	L4 2.5L 151ci	2,F	AT w/o Cruise, 4 Spd. MT w/o Cruise; 80.00" Cable	CA-3001
1984-86	L4 2.5L 151ci	2	80.00" Cable	CA-3001
1967	L6 3.8L 230ci		MT w/Floor Shift; 40.00" Cable	CA-3033
1967	L6 3.8L 230ci		Upper	CA-3006
1967	L6 3.8L 230ci		w/Cruise Lower, w/o Cruise; 83.00" Cable	CA-3004
1968	L6 3.8L 230ci		3 Spd. MT Upper	CA-3006
1968	L6 3.8L 230ci		4 Spd. Muncie; 63.00" Cable	CA-3002
1968	L6 3.8L 230ci		AT; 83.00" Cable	CA-3004
1969	L6 3.8L 230ci		exc. Muncie exc. Saginaw; 80.00" Cable	CA-3001
1969	L6 3.8L 230ci		MT 3 & 4 Spd. Saginaw Lower; 40.00" Cable	CA-3033
1969	L6 3.8L 230ci		MT 3 & 4 Spd. Saginaw Upper, 4 Spd. Muncie; 61.00" Cable	CA-3005
1968	L6 4.1L 250ci		3 Spd. MT Upper	CA-3006
1968	L6 4.1L 250ci		4 Spd. Muncie; 63.00" Cable	CA-3002
1968	L6 4.1L 250ci		AT; 83.00" Cable	CA-3004
1969	L6 4.1L 250ci		exc. Muncie exc. Saginaw; 80.00" Cable	CA-3001
1969	L6 4.1L 250ci		MT 3 & 4 Spd. Saginaw Lower; 40.00" Cable	CA-3033
1969	L6 4.1L 250ci		MT 3 & 4 Spd. Saginaw Upper, 4 Spd. Muncie; 61.00" Cable	CA-3005
1970	L6 4.1L 250ci		3 Spd. MT Upper; 41.00" Cable	CA-3009
1970	L6 4.1L 250ci		Powerglide AT, 4 Spd. MT exc. Muncie; 80.00" Cable	CA-3001
1970	L6 4.1L 250ci		THM AT; 61.00" Cable	CA-3005
1971	L6 4.1L 250ci		MT 1 pc. Cable; 100.00" Cable	CA-3003
1971	L6 4.1L 250ci		MT 2 pc Lower; 20.00" Cable	CA-3008
1971	L6 4.1L 250ci		MT 2 pc Upper; 41.00" Cable	CA-3009
1971	L6 4.1L 250ci		MT w/Floor Shift; 40.00" Cable	CA-3033
1971	L6 4.1L 250ci		Powerglide AT; 61.00" Cable	CA-3005
1971	L6 4.1L 250ci		THM AT; 80.00" Cable	CA-3001
1972	L6 4.1L 250ci	D	AT; 61.00" Cable	CA-3005
1972	L6 4.1L 250ci	D	MT Lower; 20.00" Cable	CA-3008
1972	L6 4.1L 250ci	D	MT Upper; 41.00" Cable	CA-3009
1973	L6 4.1L 250ci	D	Muncie MT; 80.00" Cable	CA-3001
1973	L6 4.1L 250ci	D	Powerglide & 3 Spd. AT; 61.00" Cable	CA-3005
1973	L6 4.1L 250ci	D	Saginaw MT Lower; 20.00" Cable	CA-3008
1973	L6 4.1L 250ci	D	Saginaw MT Upper; 41.00" Cable	CA-3009
1974	L6 4.1L 250ci	D	AT; 80.00" Cable	CA-3001
1974	L6 4.1L 250ci	D	MT; 61.00" Cable	CA-3005
1975	L6 4.1L 250ci	D	1 pc. Cable; 80.00" Cable	CA-3001
1975-76	L6 4.1L 250ci	D	2 pc. Lower; 40.00" Cable	CA-3033
1975-77	L6 4.1L 250ci	D	2 pc. Upper; 61.00" Cable	CA-3005
1976-77	L6 4.1L 250ci	D	AT w/o Cruise, MT w/1 pc. Cable; 80.00" Cable	CA-3001

# SPEEDOMETER CABLES

Year	Engine	Vin	Remark	Part
<b>CHEVROLET (con't)</b>				
<b>CAMARO (con't)</b>				
1977	L6 4.1L 250ci	D	MT 2 pc Lower; 40.00" Cable	CA-3033
1977-79	L6 4.1L 250ci	D	AT w/Cruise Control, Lower; 83.00" Cable	CA-3004
1978-79	L6 4.1L 250ci	D	3 Spd. MT w/Cruise Upper; 61.00" Cable	CA-3005
1978-79	L6 4.1L 250ci	D	AT w/Cruise Upper, 4 Spd. MT Upper; 41.00" Cable	CA-3009
1978-79	L6 4.1L 250ci	D	AT w/o Cruise Control; 80.00" Cable	CA-3001
1978-79	L6 4.1L 250ci	D	MT Lower; 40.00" Cable	CA-3033
1982	V6 2.8L 173ci	1	w/Cruise Lower; 63.00" Cable	CA-3002
1982	V6 2.8L 173ci	1	w/Cruise Upper; 61.00" Cable	CA-3005
1982	V6 2.8L 173ci	1	w/o Cruise Control; 80.00" Cable	CA-3001
1983	V6 2.8L 173ci	1	AT w/Cruise Lower, 5 Spd. MT Lower; 63.00" Cable	CA-3002
1983	V6 2.8L 173ci	1	AT w/Cruise Upper, 5 Spd. MT Upper; 61.00" Cable	CA-3005
1983	V6 2.8L 173ci	1	AT w/o Cruise, 4 Spd. MT w/o Cruise; 80.00" Cable	CA-3001
1985-89	V6 2.8L 173ci	1,S	80.00" Cable	CA-3001
1980-81	V6 3.8L 229ci	K	3 Spd. MT w/Cruise Upper; 61.00" Cable	CA-3005
1980-81	V6 3.8L 229ci	K	AT w/Cruise Control, Lower; 83.00" Cable	CA-3004
1980-81	V6 3.8L 229ci	K	AT w/Cruise Upper, 4 Spd. MT Upper; 41.00" Cable	CA-3009
1980-81	V6 3.8L 229ci	K	AT w/o Cruise Control; 80.00" Cable	CA-3001
1980-81	V6 3.8L 229ci	K	MT Lower; 40.00" Cable	CA-3033
1980-81	V6 3.8L 231ci	A	3 Spd. MT w/Cruise Upper; 61.00" Cable	CA-3005
1980-81	V6 3.8L 231ci	A	AT w/Cruise Control, Lower; 83.00" Cable	CA-3004
1980-81	V6 3.8L 231ci	A	AT w/Cruise Upper, 4 Spd. MT Upper; 41.00" Cable	CA-3009
1980-81	V6 3.8L 231ci	A	AT w/o Cruise Control; 80.00" Cable	CA-3001
1980-81	V6 3.8L 231ci	A	MT Lower; 40.00" Cable	CA-3033
1980-81	V8 4.4L 267ci	J	3 Spd. MT w/Cruise Upper; 61.00" Cable	CA-3005
1980-81	V8 4.4L 267ci	J	AT w/Cruise Control, Lower; 83.00" Cable	CA-3004
1980-81	V8 4.4L 267ci	J	AT w/Cruise Upper, 4 Spd. MT Upper; 41.00" Cable	CA-3009
1980-81	V8 4.4L 267ci	J	AT w/o Cruise Control; 80.00" Cable	CA-3001
1980-81	V8 4.4L 267ci	J	MT Lower; 40.00" Cable	CA-3033
1967	V8 5.0L 302ci		MT w/Floor Shift; 40.00" Cable	CA-3033
1967	V8 5.0L 302ci		Upper	CA-3006
1967	V8 5.0L 302ci		w/Cruise Lower, w/o Cruise; 83.00" Cable	CA-3004
1968	V8 5.0L 302ci		3 Spd. MT Upper	CA-3006
1968	V8 5.0L 302ci		4 Spd. Muncie; 63.00" Cable	CA-3002
1968	V8 5.0L 302ci		AT; 83.00" Cable	CA-3004
1982	V8 5.0L 305ci	7,H	w/Cruise Lower; 63.00" Cable	CA-3002
1982	V8 5.0L 305ci	7,H	w/Cruise Upper; 61.00" Cable	CA-3005
1982	V8 5.0L 305ci	7,H	w/o Cruise Control; 80.00" Cable	CA-3001
1983	V8 5.0L 305ci	7,H,S	AT w/Cruise Lower, 5 Spd. MT Lower; 63.00" Cable	CA-3002
1983	V8 5.0L 305ci	7,H,S	AT w/Cruise Upper, 5 Spd. MT Upper; 61.00" Cable	CA-3005
1983	V8 5.0L 305ci	7,H,S	AT w/o Cruise, 4 Spd. MT w/o Cruise; 80.00" Cable	CA-3001
1985-89	V8 5.0L 305ci	E,F	80.00" Cable	CA-3001
1979	V8 5.0L 305ci	G	3 Spd. MT w/Cruise Upper; 61.00" Cable	CA-3005
1979	V8 5.0L 305ci	G	AT w/Cruise Control, Lower; 83.00" Cable	CA-3004
1979	V8 5.0L 305ci	G	AT w/Cruise Upper, 4 Spd. MT Upper; 41.00" Cable	CA-3009
1979	V8 5.0L 305ci	G	AT w/o Cruise Control; 80.00" Cable	CA-3001
1979	V8 5.0L 305ci	G	MT Lower; 40.00" Cable	CA-3033
1980-81	V8 5.0L 305ci	H	3 Spd. MT w/Cruise Upper; 61.00" Cable	CA-3005
1980-81	V8 5.0L 305ci	H	AT w/Cruise Control, Lower; 83.00" Cable	CA-3004
1980-81	V8 5.0L 305ci	H	AT w/Cruise Upper, 4 Spd. MT Upper; 41.00" Cable	CA-3009
1980-81	V8 5.0L 305ci	H	AT w/o Cruise Control; 80.00" Cable	CA-3001
1980-81	V8 5.0L 305ci	H	MT Lower; 40.00" Cable	CA-3033
1984-87	V8 5.0L 305ci	G,H	80.00" Cable	CA-3001
1976	V8 5.0L 305ci	Q	2 pc. Lower; 40.00" Cable	CA-3033
1976	V8 5.0L 305ci	Q	2 pc. Upper; 61.00" Cable	CA-3005
1976	V8 5.0L 305ci	Q	AT w/o Cruise, MT w/1 pc. Cable; 80.00" Cable	CA-3001
1977	V8 5.0L 305ci	U	2 pc. Upper; 61.00" Cable	CA-3005
1977	V8 5.0L 305ci	U	AT w/o Cruise, MT w/1 pc. Cable; 80.00" Cable	CA-3001
1977	V8 5.0L 305ci	U	MT 2 pc Lower; 40.00" Cable	CA-3033
1977-78	V8 5.0L 305ci	U	AT w/Cruise Control, Lower; 83.00" Cable	CA-3004
1978	V8 5.0L 305ci	U	3 Spd. MT w/Cruise Upper; 61.00" Cable	CA-3005
1978	V8 5.0L 305ci	U	AT w/Cruise Upper, 4 Spd. MT Upper; 41.00" Cable	CA-3009
1978	V8 5.0L 305ci	U	AT w/o Cruise Control; 80.00" Cable	CA-3001

# SPEEDOMETER CABLES

Year	Engine	Vin	Remark	Part
<b>CHEVROLET (con't)</b>				
<b>CAMARO (con't)</b>				
1978	V8 5.0L 305ci	U	MT Lower; 40.00" Cable	CA-3033
1969	V8 5.0L 307ci		exc. Muncie exc. Saginaw; 80.00" Cable	CA-3001
1969	V8 5.0L 307ci		MT 3 & 4 Spd. Saginaw Lower; 40.00" Cable	CA-3033
1969	V8 5.0L 307ci		MT 3 & 4 Spd. Saginaw Upper, 4 Spd. Muncie; 61.00" Cable	CA-3005
1970	V8 5.0L 307ci		3 Spd. MT Upper; 41.00" Cable	CA-3009
1970	V8 5.0L 307ci		Powerglide AT, 4 Spd. MT exc. Muncie; 80.00" Cable	CA-3001
1970	V8 5.0L 307ci		THM AT; 61.00" Cable	CA-3005
1971	V8 5.0L 307ci		MT 2 pc Lower; 20.00" Cable	CA-3008
1971	V8 5.0L 307ci		MT 2 pc Upper; 41.00" Cable	CA-3009
1971	V8 5.0L 307ci		Powerglide AT; 61.00" Cable	CA-3005
1971	V8 5.0L 307ci		THM AT, 3 Spd. MT 1 pc Cable; 80.00" Cable	CA-3001
1972	V8 5.0L 307ci	F	AT; 61.00" Cable	CA-3005
1972	V8 5.0L 307ci	F	MT Lower; 20.00" Cable	CA-3008
1972	V8 5.0L 307ci	F	MT Upper; 41.00" Cable	CA-3009
1973	V8 5.0L 307ci	F	Muncie MT; 80.00" Cable	CA-3001
1973	V8 5.0L 307ci	F	Powerglide & 3 Spd. AT; 61.00" Cable	CA-3005
1973	V8 5.0L 307ci	F	Saginaw MT Lower; 20.00" Cable	CA-3008
1973	V8 5.0L 307ci	F	Saginaw MT Upper; 41.00" Cable	CA-3009
1969	V8 5.4L 327ci		exc. Muncie exc. Saginaw; 80.00" Cable	CA-3001
1969	V8 5.4L 327ci		MT 3 & 4 Spd. Saginaw Lower; 40.00" Cable	CA-3033
1969	V8 5.4L 327ci		MT 3 & 4 Spd. Saginaw Upper, 4 Spd. Muncie; 61.00" Cable	CA-3005
1968	V8 5.4L 327ci		3 Spd. MT Upper	CA-3006
1968	V8 5.4L 327ci		4 Spd. Muncie; 63.00" Cable	CA-3002
1968	V8 5.4L 327ci		AT; 83.00" Cable	CA-3004
1967	V8 5.4L 327ci		MT w/Floor Shift; 40.00" Cable	CA-3033
1967	V8 5.4L 327ci		Upper	CA-3006
1967	V8 5.4L 327ci		w/Cruise Lower, w/o Cruise; 83.00" Cable	CA-3004
1967	V8 5.7L 350ci		MT w/Floor Shift; 40.00" Cable	CA-3033
1967	V8 5.7L 350ci		Upper	CA-3006
1967	V8 5.7L 350ci		w/Cruise Lower, w/o Cruise; 83.00" Cable	CA-3004
1968	V8 5.7L 350ci		3 Spd. MT Upper	CA-3006
1968	V8 5.7L 350ci		4 Spd. Muncie; 63.00" Cable	CA-3002
1968	V8 5.7L 350ci		AT; 83.00" Cable	CA-3004
1969	V8 5.7L 350ci		exc. Muncie exc. Saginaw; 80.00" Cable	CA-3001
1969	V8 5.7L 350ci		MT 3 & 4 Spd. Saginaw Lower; 40.00" Cable	CA-3033
1969	V8 5.7L 350ci		MT 3 & 4 Spd. Saginaw Upper, 4 Spd. Muncie; 61.00" Cable	CA-3005
1970	V8 5.7L 350ci		3 Spd. MT Upper; 41.00" Cable	CA-3009
1970	V8 5.7L 350ci		Powerglide AT, 4 Spd. MT exc. Muncie; 80.00" Cable	CA-3001
1970	V8 5.7L 350ci		THM AT; 61.00" Cable	CA-3005
1971	V8 5.7L 350ci		MT 2 pc Lower; 20.00" Cable	CA-3008
1971	V8 5.7L 350ci		MT 2 pc Upper; 41.00" Cable	CA-3009
1971	V8 5.7L 350ci		Powerglide AT; 61.00" Cable	CA-3005
1971	V8 5.7L 350ci		THM AT, 3 Spd. MT 1 pc Cable; 80.00" Cable	CA-3001
1987-89	V8 5.7L 350ci	8	80.00" Cable	CA-3001
1972	V8 5.7L 350ci	H,K	AT; 61.00" Cable	CA-3005
1972	V8 5.7L 350ci	H,K	MT Lower; 20.00" Cable	CA-3008
1972	V8 5.7L 350ci	H,K	MT Upper; 41.00" Cable	CA-3009
1973	V8 5.7L 350ci	H,K	Muncie MT; 80.00" Cable	CA-3001
1973	V8 5.7L 350ci	H,K	Powerglide & 3 Spd. AT; 61.00" Cable	CA-3005
1973	V8 5.7L 350ci	H,K	Saginaw MT Lower; 20.00" Cable	CA-3008
1973	V8 5.7L 350ci	H,K	Saginaw MT Upper; 41.00" Cable	CA-3009
1974	V8 5.7L 350ci	H,K,L,T	AT; 80.00" Cable	CA-3001
1974	V8 5.7L 350ci	H,K,L,T	MT; 61.00" Cable	CA-3005
1975	V8 5.7L 350ci	H,L	1 pc. Cable; 80.00" Cable	CA-3001
1975-76	V8 5.7L 350ci	H,L	2 pc. Lower; 40.00" Cable	CA-3033
1975-77	V8 5.7L 350ci	H,L	2 pc. Upper; 61.00" Cable	CA-3005
1977	V8 5.7L 350ci	L	MT 2 pc Lower; 40.00" Cable	CA-3033
1976-77	V8 5.7L 350ci	L	AT w/o Cruise, MT w/1 pc. Cable; 80.00" Cable	CA-3001
1977-81	V8 5.7L 350ci	L	AT w/Cruise Control, Lower; 83.00" Cable	CA-3004
1978-81	V8 5.7L 350ci	L	3 Spd. MT w/Cruise Upper; 61.00" Cable	CA-3005
1978-81	V8 5.7L 350ci	L	AT w/Cruise Upper, 4 Spd. MT Upper; 41.00" Cable	CA-3009
1978-81	V8 5.7L 350ci	L	AT w/o Cruise Control; 80.00" Cable	CA-3001



# SPEEDOMETER CABLES

Year	Engine	Vin	Remark	Part
<b>CHEVROLET (con't)</b>				
<b>CAMARO (con't)</b>				
1978-81	V8 5.7L 350ci	L	MT Lower; 40.00" Cable	CA-3033
1967	V8 6.5L 396ci		Upper	CA-3006
1967	V8 6.5L 396ci		w/Cruise Lower, w/o Cruise; 83.00" Cable	CA-3004
1968	V8 6.5L 396ci		3 Spd. MT Upper	CA-3006
1968	V8 6.5L 396ci		4 Spd. Muncie; 63.00" Cable	CA-3002
1968	V8 6.5L 396ci		AT; 83.00" Cable	CA-3004
1969	V8 6.5L 396ci		exc. Muncie exc. Saginaw; 80.00" Cable	CA-3001
1969	V8 6.5L 396ci		MT 3 & 4 Spd. Saginaw Lower; 40.00" Cable	CA-3033
1969	V8 6.5L 396ci		MT 3 & 4 Spd. Saginaw Upper, 4 Spd. Muncie; 61.00" Cable	CA-3005
1970	V8 6.5L 396ci		3 Spd. MT Upper; 41.00" Cable	CA-3009
1970	V8 6.5L 396ci		Powerglide AT, 4 Spd. MT exc. Muncie; 80.00" Cable	CA-3001
1970	V8 6.5L 396ci		THM AT; 61.00" Cable	CA-3005
1970	V8 6.6L 402ci		3 Spd. MT Upper; 41.00" Cable	CA-3009
1970	V8 6.6L 402ci		Powerglide AT, 4 Spd. MT exc. Muncie; 80.00" Cable	CA-3001
1970	V8 6.6L 402ci		THM AT; 61.00" Cable	CA-3005
1971	V8 6.6L 402ci		MT 2 pc Lower; 20.00" Cable	CA-3008
1971	V8 6.6L 402ci		MT 2 pc Upper; 41.00" Cable	CA-3009
1971	V8 6.6L 402ci		Powerglide AT; 61.00" Cable	CA-3005
1971	V8 6.6L 402ci		THM AT, 3 Spd. MT 1 pc Cable; 80.00" Cable	CA-3001
1972	V8 6.6L 402ci	U	AT; 61.00" Cable	CA-3005
1972	V8 6.6L 402ci	U	MT Lower; 20.00" Cable	CA-3008
1972	V8 6.6L 402ci	U	MT Upper; 41.00" Cable	CA-3009
<b>CAPRICE</b>				
1967	L6 4.1L 250ci		w/Cruise Upper	CA-3006
1967	L6 4.1L 250ci		w/o Cruise Control; 83.00" Cable	CA-3004
1967-69	L6 4.1L 250ci		w/Cruise Lower; 63.00" Cable	CA-3002
1968	L6 4.1L 250ci		83.00" Cable	CA-3004
1969	L6 4.1L 250ci		Muncie 4 Spd. MT; 100.00" Cable	CA-3003
1969	L6 4.1L 250ci		w/Cruise Upper; 41.00" Cable	CA-3009
1969	L6 4.1L 250ci		w/o Cruise Control; 80.00" Cable	CA-3001
1977-79	L6 4.1L 250ci	D	w/Cruise Lower; 63.00" Cable	CA-3002
1977-79	L6 4.1L 250ci	D	w/Cruise Upper; 41.00" Cable	CA-3009
1977-79	L6 4.1L 250ci	D	w/o Cruise Control; 80.00" Cable	CA-3001
1983	V6 3.8L 229ci	9	w/Cruise Lower; 83.00" Cable	CA-3004
1983	V6 3.8L 229ci	9	w/Cruise Upper; 61.00" Cable	CA-3005
1983	V6 3.8L 229ci	9	w/o Cruise Control; 80.00" Cable	CA-3001
1984	V6 3.8L 229ci	9	AT; 80.00" Cable	CA-3001
1980-82	V6 3.8L 229ci	K	w/Cruise Lower; 83.00" Cable	CA-3004
1980-82	V6 3.8L 229ci	K	w/Cruise Upper; 61.00" Cable	CA-3005
1980-82	V6 3.8L 229ci	K	w/o Cruise Control; 80.00" Cable	CA-3001
1980-83	V6 3.8L 231ci	A	w/Cruise Lower; 83.00" Cable	CA-3004
1980-83	V6 3.8L 231ci	A	w/Cruise Upper; 61.00" Cable	CA-3005
1980-83	V6 3.8L 231ci	A	w/o Cruise Control; 80.00" Cable	CA-3001
1984-85	V6 3.8L 231ci	A	AT; 80.00" Cable	CA-3001
1986-90	V6 4.3L 262ci	Z	AT; 41.00" Cable	CA-3009
1980-82	V8 4.4L 267ci	J	w/Cruise Lower; 83.00" Cable	CA-3004
1980-82	V8 4.4L 267ci	J	w/Cruise Upper; 61.00" Cable	CA-3005
1980-82	V8 4.4L 267ci	J	w/o Cruise Control; 80.00" Cable	CA-3001
1966	V8 4.6L 283ci		83.00" Cable	CA-3004
1967	V8 4.6L 283ci		w/Cruise Lower; 63.00" Cable	CA-3002
1967	V8 4.6L 283ci		w/Cruise Upper	CA-3006
1967	V8 4.6L 283ci		w/o Cruise Control; 83.00" Cable	CA-3004
1989-90	V8 5.0L 305ci	E	AT; 41.00" Cable	CA-3009
1979	V8 5.0L 305ci	G	w/Cruise Lower; 63.00" Cable	CA-3002
1979	V8 5.0L 305ci	G	w/Cruise Upper; 41.00" Cable	CA-3009
1979	V8 5.0L 305ci	G	w/o Cruise Control; 80.00" Cable	CA-3001
1984	V8 5.0L 305ci	H	AT; 80.00" Cable	CA-3001
1980-83	V8 5.0L 305ci	H	w/Cruise Lower; 83.00" Cable	CA-3004
1980-83	V8 5.0L 305ci	H	w/Cruise Upper; 61.00" Cable	CA-3005
1980-83	V8 5.0L 305ci	H	w/o Cruise Control; 80.00" Cable	CA-3001
1986-88	V8 5.0L 305ci	H	AT; 41.00" Cable	CA-3009
1977-78	V8 5.0L 305ci	U	w/Cruise Lower; 63.00" Cable	CA-3002

# SPEEDOMETER CABLES

Year	Engine	Vin	Remark	Part
<b>CHEVROLET (con't)</b>				
<b>CAPRICE (con't)</b>				
1977-78	V8 5.0L 305ci	U	w/Cruise Upper; 41.00" Cable	CA-3009
1977-78	V8 5.0L 305ci	U	w/o Cruise Control; 80.00" Cable	CA-3001
1968	V8 5.0L 307ci		83.00" Cable	CA-3004
1986-87	V8 5.0L 307ci	Y	AT; 41.00" Cable	CA-3009
1966	V8 5.4L 327ci		83.00" Cable	CA-3004
1967	V8 5.4L 327ci		w/Cruise Lower; 63.00" Cable	CA-3002
1967	V8 5.4L 327ci		w/Cruise Upper	CA-3006
1967	V8 5.4L 327ci		w/o Cruise Control; 83.00" Cable	CA-3004
1968	V8 5.4L 327ci		83.00" Cable	CA-3004
1969	V8 5.4L 327ci		Muncie 4 Spd. MT; 100.00" Cable	CA-3003
1969	V8 5.4L 327ci		w/Cruise Lower; 63.00" Cable	CA-3002
1969	V8 5.4L 327ci		w/Cruise Upper; 41.00" Cable	CA-3009
1969	V8 5.4L 327ci		w/o Cruise Control; 80.00" Cable	CA-3001
1969	V8 5.7L 350ci		Muncie 4 Spd. MT; 100.00" Cable	CA-3003
1969	V8 5.7L 350ci		w/o Cruise Control; 80.00" Cable	CA-3001
1969-70	V8 5.7L 350ci		w/Cruise Upper; 41.00" Cable	CA-3009
1969-71	V8 5.7L 350ci		w/Cruise Lower; 63.00" Cable	CA-3002
1970	V8 5.7L 350ci		w/o Cruise, 4 Spd. Muncie MT; 80.00" Cable	CA-3001
1971	V8 5.7L 350ci		MT w/o Cruise, Powerglide w/o Cruise, THM w/Cruise; 61.00" Cable	CA-3005
1971	V8 5.7L 350ci		Upper; 41.00" Cable	CA-3009
1986-88	V8 5.7L 350ci	6	AT; 41.00" Cable	CA-3009
1989-90	V8 5.7L 350ci	7	AT; 41.00" Cable	CA-3009
1972-75	V8 5.7L 350ci	H,K	w/Cruise Lower; 63.00" Cable	CA-3002
1972-75	V8 5.7L 350ci	H,K	w/Cruise Upper; 41.00" Cable	CA-3009
1972-75	V8 5.7L 350ci	H,K	w/o Cruise Control; 61.00" Cable	CA-3005
1975-76	V8 5.7L 350ci	L,V	w/o Cruise Control; 61.00" Cable	CA-3005
1975-79	V8 5.7L 350ci	L,V	w/Cruise Lower; 63.00" Cable	CA-3002
1975-79	V8 5.7L 350ci	L,V	w/Cruise Upper; 41.00" Cable	CA-3009
1977-80	V8 5.7L 350ci	L	w/o Cruise Control; 80.00" Cable	CA-3001
1984	V8 5.7L 350ci	N	AT; 80.00" Cable	CA-3001
1980-83	V8 5.7L 350ci	L,N	w/Cruise Lower; 83.00" Cable	CA-3004
1980-83	V8 5.7L 350ci	L,N	w/Cruise Upper; 61.00" Cable	CA-3005
1980-83	V8 5.7L 350ci	N	w/o Cruise Control; 80.00" Cable	CA-3001
1966-68	V8 6.5L 396ci		83.00" Cable	CA-3004
1967	V8 6.5L 396ci		w/Cruise Upper	CA-3006
1967	V8 6.5L 396ci		w/o Cruise Control; 83.00" Cable	CA-3004
1967-69	V8 6.5L 396ci		w/Cruise Lower; 63.00" Cable	CA-3002
1969	V8 6.5L 396ci		Muncie 4 Spd. MT; 100.00" Cable	CA-3003
1969	V8 6.5L 396ci		w/Cruise Upper; 41.00" Cable	CA-3009
1969	V8 6.5L 396ci		w/o Cruise Control; 80.00" Cable	CA-3001
1970	V8 6.6L 400ci		w/Cruise Upper; 41.00" Cable	CA-3009
1970	V8 6.6L 400ci		w/o Cruise, 4 Spd. Muncie MT; 80.00" Cable	CA-3001
1970-71	V8 6.6L 400ci		w/Cruise Lower; 63.00" Cable	CA-3002
1971	V8 6.6L 400ci		MT w/o Cruise, Powerglide w/o Cruise, THM w/Cruise; 61.00" Cable	CA-3005
1971	V8 6.6L 400ci		Upper; 41.00" Cable	CA-3009
1972-75	V8 6.6L 400ci	R	w/Cruise Lower; 63.00" Cable	CA-3002
1972-75	V8 6.6L 400ci	R	w/Cruise Upper; 41.00" Cable	CA-3009
1972-75	V8 6.6L 400ci	R	w/o Cruise Control; 61.00" Cable	CA-3005
1974-76	V8 6.6L 400ci	U	w/Cruise Lower; 63.00" Cable	CA-3002
1974-76	V8 6.6L 400ci	U	w/Cruise Upper; 41.00" Cable	CA-3009
1974-76	V8 6.6L 400ci	U	w/o Cruise Control; 61.00" Cable	CA-3005
1971	V8 6.6L 402ci		MT w/o Cruise, Powerglide w/o Cruise, THM w/Cruise; 61.00" Cable	CA-3005
1971	V8 6.6L 402ci		Upper; 41.00" Cable	CA-3009
1971	V8 6.6L 402ci		w/Cruise Lower; 63.00" Cable	CA-3002
1972	V8 6.6L 402ci	S	w/Cruise Lower; 63.00" Cable	CA-3002
1972	V8 6.6L 402ci	S	w/Cruise Upper; 41.00" Cable	CA-3009
1972	V8 6.6L 402ci	S	w/o Cruise Control; 61.00" Cable	CA-3005
1966-68	V8 7.0L 427ci		83.00" Cable	CA-3004
1967	V8 7.0L 427ci		w/Cruise Upper	CA-3006
1967	V8 7.0L 427ci		w/o Cruise Control; 83.00" Cable	CA-3004
1967-69	V8 7.0L 427ci		w/Cruise Lower; 63.00" Cable	CA-3002
1969	V8 7.0L 427ci		Muncie 4 Spd. MT; 100.00" Cable	CA-3003

# SPEEDOMETER CABLES

Year	Engine	Vin	Remark	Part
<b>CHEVROLET (con't)</b>				
<b>CAPRICE (con't)</b>				
1969	V8 7.0L 427ci		w/Cruise Upper; 41.00" Cable	CA-3009
1969	V8 7.0L 427ci		w/o Cruise Control; 80.00" Cable	CA-3001
1970	V8 7.4L 454ci		w/Cruise Upper; 41.00" Cable	CA-3009
1970	V8 7.4L 454ci		w/o Cruise, 4 Spd. Muncie MT; 80.00" Cable	CA-3001
1971	V8 7.4L 454ci		MT w/o Cruise, Powerglide w/o Cruise, THM w/Cruise; 61.00" Cable	CA-3005
1971	V8 7.4L 454ci		Upper; 41.00" Cable	CA-3009
1970-71	V8 7.4L 454ci		w/Cruise Lower; 63.00" Cable	CA-3002
1976	V8 7.4L 454ci	S	w/Cruise Lower; 63.00" Cable	CA-3002
1976	V8 7.4L 454ci	S	w/Cruise Upper; 41.00" Cable	CA-3009
1976	V8 7.4L 454ci	S	w/o Cruise Control; 61.00" Cable	CA-3005
1972	V8 7.4L 454ci	V	w/Cruise Lower; 63.00" Cable	CA-3002
1972	V8 7.4L 454ci	V	w/Cruise Upper; 41.00" Cable	CA-3009
1972	V8 7.4L 454ci	V	w/o Cruise Control; 61.00" Cable	CA-3005
1973-75	V8 7.4L 454ci	X,Y	w/Cruise Lower; 63.00" Cable	CA-3002
1973-75	V8 7.4L 454ci	X,Y	w/Cruise Upper; 41.00" Cable	CA-3009
1973-75	V8 7.4L 454ci	X,Y	w/o Cruise Control; 61.00" Cable	CA-3005
<b>CAVALIER</b>				
1982	L4 1.8L 112ci	G	AT w/o Cruise Control; 61.00" Cable	CA-3005
1982	L4 1.8L 112ci	G	w/Cruise Lower	CA-3006
1982	L4 1.8L 112ci	G	w/Cruise Upper, MT w/o Cruise; 41.00" Cable	CA-3009
1987-89	L4 2.0L 122ci	1	AT exc. Digital Panel; 61.00" Cable	CA-3005
1987-89	L4 2.0L 122ci	1	MT exc. Digital Panel; 41.00" Cable	CA-3009
1983	L4 2.0L 122ci	B,P	AT w/o Cruise Control; 61.00" Cable	CA-3005
1983	L4 2.0L 122ci	B,P	w/Cruise Lower	CA-3006
1983	L4 2.0L 122ci	B,P	w/Cruise Upper, MT w/o Cruise; 41.00" Cable	CA-3009
1984	L4 2.0L 122ci	B,P	AT; 61.00" Cable	CA-3005
1984	L4 2.0L 122ci	B,P	MT; 41.00" Cable	CA-3009
1985-86	L4 2.0L 122ci	P	AT exc. Digital Panel; 61.00" Cable	CA-3005
1985-86	L4 2.0L 122ci	P	MT exc. Digital Panel; 41.00" Cable	CA-3009
1990	L4 2.2L 134ci	G	AT exc. Digital Panel; 61.00" Cable	CA-3005
1990	L4 2.2L 134ci	G	MT exc. Digital Panel; 41.00" Cable	CA-3009
1985-89	V6 2.8L 173ci	W	AT exc. Digital Panel; 80.00" Cable	CA-3001
1985-89	V6 2.8L 173ci	W	MT exc. Digital Panel; 41.00" Cable	CA-3009
1990	V6 3.1L 189ci	T	AT exc. Digital Panel; 80.00" Cable	CA-3001
1990	V6 3.1L 189ci	T	MT exc. Digital Panel; 41.00" Cable	CA-3009
<b>CELEBRITY</b>				
1982-83	L4 2.5L 151ci	5,R	AT w/Cruise Control, Lower; 83.00" Cable	CA-3004
1982-83	L4 2.5L 151ci	5,R	MT w/Cruise Lower; 100.00" Cable	CA-3003
1982-83	L4 2.5L 151ci	5,R	w/Cruise Upper, MT w/o Cruise; 41.00" Cable	CA-3009
1982-83	L4 2.5L 151ci	5,R	AT w/o Cruise Control; 80.00" Cable	CA-3001
1984	L4 2.5L 151ci	R	MT; 61.00" Cable	CA-3005
1984-86	L4 2.5L 151ci	R	AT; 100.00" Cable	CA-3003
1985-86	L4 2.5L 151ci	R	MT; 41.00" Cable	CA-3009
1985-86	V6 2.8L 173ci	W,X	MT; 41.00" Cable	CA-3009
1982-83	V6 2.8L 173ci	X	AT w/Cruise Control, Lower; 83.00" Cable	CA-3004
1982-83	V6 2.8L 173ci	X	AT w/o Cruise Control; 80.00" Cable	CA-3001
1982-83	V6 2.8L 173ci	X	MT w/Cruise Lower; 100.00" Cable	CA-3003
1982-83	V6 2.8L 173ci	X	w/Cruise Upper, MT w/o Cruise; 41.00" Cable	CA-3009
1984	V6 2.8L 173ci	X,Z	MT; 61.00" Cable	CA-3005
1984-86	V6 2.8L 173ci	W,X,Z	AT; 100.00" Cable	CA-3003
1982-83	V6 4.3L 260ci	T	AT w/Cruise Control, Lower; 83.00" Cable	CA-3004
1982-83	V6 4.3L 260ci	T	AT w/o Cruise Control; 80.00" Cable	CA-3001
1982-83	V6 4.3L 260ci	T	MT w/Cruise Lower; 100.00" Cable	CA-3003
1982-83	V6 4.3L 260ci	T	w/Cruise Upper, MT w/o Cruise; 41.00" Cable	CA-3009
1984	V6 4.3L 260ci	T	MT; 61.00" Cable	CA-3005
1984-85	V6 4.3L 260ci	T	AT; 100.00" Cable	CA-3003
1985	V6 4.3L 260ci	T	MT; 41.00" Cable	CA-3009
<b>CHEVELLE</b>				
1964	L6 3.2L 194ci		63.00" Cable	CA-3002
1965	L6 3.2L 194ci		4 Spd. MT; 83.00" Cable	CA-3004
1965	L6 3.2L 194ci		AT & 3 Spd. MT; 63.00" Cable	CA-3002
1966	L6 3.2L 194ci		4 Spd. MT w/Cruise; 80.00" Cable	CA-3001

# SPEEDOMETER CABLES

Year	Engine	Vin	Remark	Part
<b>CHEVROLET (con't)</b>				
<b>CHEVELLE (con't)</b>				
1966	L6 3.2L 194ci		4 Spd. MT w/o Cruise; 83.00" Cable	CA-3004
1966	L6 3.2L 194ci		AT w/Cruise, 3 Spd. MT	CA-3006
1966	L6 3.2L 194ci		AT w/o Cruise, 3 Spd. MT w/o Cruise; 63.00" Cable	CA-3002
1964	L6 3.8L 230ci		63.00" Cable	CA-3002
1965	L6 3.8L 230ci		4 Spd. MT; 83.00" Cable	CA-3004
1965	L6 3.8L 230ci		AT & 3 Spd. MT; 63.00" Cable	CA-3002
1966	L6 3.8L 230ci		4 Spd. MT w/Cruise; 80.00" Cable	CA-3001
1966	L6 3.8L 230ci		AT w/Cruise, 3 Spd. MT	CA-3006
1966	L6 3.8L 230ci		AT w/o Cruise, 3 Spd. MT w/o Cruise; 63.00" Cable	CA-3002
1966-67	L6 3.8L 230ci		4 Spd. MT w/o Cruise; 83.00" Cable	CA-3004
1967	L6 3.8L 230ci		AT; 63.00" Cable	CA-3002
1968	L6 3.8L 230ci		4 Spd. MT w/o Cruise, MT w/Cruise lower; 83.00" Cable	CA-3004
1968	L6 3.8L 230ci		AT w/Cruise Control, Lower; 63.00" Cable	CA-3002
1968	L6 3.8L 230ci		w/Cruise Upper	CA-3006
1968-69	L6 3.8L 230ci		w/o Cruise exc. 4 Spd. MT; 61.00" Cable	CA-3005
1969	L6 3.8L 230ci		Muncie MT w/o Cruise, Powerglide At; 80.00" Cable	CA-3001
1969	L6 3.8L 230ci		w/Cruise Lower; 63.00" Cable	CA-3002
1969	L6 3.8L 230ci		w/Cruise Upper; 41.00" Cable	CA-3009
1968	L6 4.1L 250ci		4 Spd. MT w/o Cruise, MT w/Cruise lower; 83.00" Cable	CA-3004
1968	L6 4.1L 250ci		AT w/Cruise Control, Lower; 63.00" Cable	CA-3002
1968	L6 4.1L 250ci		w/Cruise Upper	CA-3006
1968-69	L6 4.1L 250ci		w/o Cruise exc. 4 Spd. MT; 61.00" Cable	CA-3005
1969	L6 4.1L 250ci		Muncie MT w/o Cruise, Powerglide At; 80.00" Cable	CA-3001
1969	L6 4.1L 250ci		w/Cruise Lower; 63.00" Cable	CA-3002
1969	L6 4.1L 250ci		w/Cruise Upper; 41.00" Cable	CA-3009
1970	L6 4.1L 250ci		w/o Cruise Control; 80.00" Cable	CA-3001
1971	L6 4.1L 250ci		3 Spd. MT; 80.00" Cable	CA-3001
1971	L6 4.1L 250ci		AT w/Cruise Control, Upper; 61.00" Cable	CA-3005
1971	L6 4.1L 250ci		AT w/Cruise Lower, AT w/o Cruise; 63.00" Cable	CA-3002
1972	L6 4.1L 250ci	D	AT w/Cruise Upper, AT w/o Cruise; 61.00" Cable	CA-3005
1972	L6 4.1L 250ci	D	Powerglide AT w/Cruise Lower, 3 Spd. MT; 80.00" Cable	CA-3001
1972	L6 4.1L 250ci	D	THM AT w/Cruise Lower; 63.00" Cable	CA-3002
1973	L6 4.1L 250ci	D	3 Spd. MT 2 pc. Cable Lower; 40.00" Cable	CA-3033
1973	L6 4.1L 250ci	D	AT w/Cruise Control, Lower; 83.00" Cable	CA-3004
1973	L6 4.1L 250ci	D	AT w/Cruise Upper, AT w/o Cruise, MT; 80.00" Cable	CA-3001
1964	V8 4.6L 283ci		63.00" Cable	CA-3002
1965	V8 4.6L 283ci		4 Spd. MT; 83.00" Cable	CA-3004
1965	V8 4.6L 283ci		AT & 3 Spd. MT; 63.00" Cable	CA-3002
1966	V8 4.6L 283ci		4 Spd. MT w/Cruise; 80.00" Cable	CA-3001
1966	V8 4.6L 283ci		AT w/Cruise, 3 Spd. MT	CA-3006
1966	V8 4.6L 283ci		AT w/o Cruise, 3 Spd. MT w/o Cruise; 63.00" Cable	CA-3002
1966-67	V8 4.6L 283ci		4 Spd. MT w/o Cruise; 83.00" Cable	CA-3004
1967	V8 4.6L 283ci		AT; 63.00" Cable	CA-3002
1968	V8 5.0L 307ci		4 Spd. MT w/o Cruise, MT w/Cruise lower; 83.00" Cable	CA-3004
1968	V8 5.0L 307ci		AT w/Cruise Control, Lower; 63.00" Cable	CA-3002
1968	V8 5.0L 307ci		w/Cruise Upper	CA-3006
1968	V8 5.0L 307ci		w/o Cruise exc. 4 Spd. MT; 61.00" Cable	CA-3005
1969	V8 5.0L 307ci		Muncie MT w/o Cruise, Powerglide At; 80.00" Cable	CA-3001
1969	V8 5.0L 307ci		w/Cruise Lower; 63.00" Cable	CA-3002
1969	V8 5.0L 307ci		w/Cruise Upper; 41.00" Cable	CA-3009
1969	V8 5.0L 307ci		w/o Cruise exc. 4 Spd. MT; 61.00" Cable	CA-3005
1970	V8 5.0L 307ci		w/o Cruise Control; 80.00" Cable	CA-3001
1971	V8 5.0L 307ci		3 Spd. MT; 80.00" Cable	CA-3001
1971	V8 5.0L 307ci		AT w/Cruise Control, Upper; 61.00" Cable	CA-3005
1971	V8 5.0L 307ci		AT w/Cruise Lower, AT w/o Cruise; 63.00" Cable	CA-3002
1972	V8 5.0L 307ci	F	AT w/Cruise Upper, AT w/o Cruise; 61.00" Cable	CA-3005
1972	V8 5.0L 307ci	F	Powerglide AT w/Cruise Lower, 3 Spd. MT; 80.00" Cable	CA-3001
1972	V8 5.0L 307ci	F	THM AT w/Cruise Lower; 63.00" Cable	CA-3002
1973	V8 5.0L 307ci	F	3 Spd. MT 2 pc. Cable Lower; 40.00" Cable	CA-3033
1973	V8 5.0L 307ci	F	AT w/Cruise Control, Lower; 83.00" Cable	CA-3004
1973	V8 5.0L 307ci	F	AT w/Cruise Upper, AT w/o Cruise, MT; 80.00" Cable	CA-3001
1964	V8 5.4L 327ci		63.00" Cable	CA-3002

# SPEEDOMETER CABLES

Year	Engine	Vin	Remark	Part
<b>CHEVROLET (con't)</b>				
<b>CHEVELLE (con't)</b>				
1965	V8 5.4L 327ci		4 Spd. MT; 83.00" Cable	CA-3004
1965	V8 5.4L 327ci		AT & 3 Spd. MT; 63.00" Cable	CA-3002
1966	V8 5.4L 327ci		4 Spd. MT w/Cruise; 80.00" Cable	CA-3001
1966	V8 5.4L 327ci		AT w/Cruise, 3 Spd. MT	CA-3006
1966	V8 5.4L 327ci		AT w/o Cruise, 3 Spd. MT w/o Cruise; 63.00" Cable	CA-3002
1966-67	V8 5.4L 327ci		4 Spd. MT w/o Cruise; 83.00" Cable	CA-3004
1967	V8 5.4L 327ci		AT; 63.00" Cable	CA-3002
1968	V8 5.4L 327ci		4 Spd. MT w/o Cruise, MT w/Cruise lower; 83.00" Cable	CA-3004
1968	V8 5.4L 327ci		AT w/Cruise Control, Lower; 63.00" Cable	CA-3002
1968	V8 5.4L 327ci		w/Cruise Upper	CA-3006
1968	V8 5.4L 327ci		w/o Cruise exc. 4 Spd. MT; 61.00" Cable	CA-3005
1969	V8 5.7L 350ci		Muncie MT w/o Cruise, Powerglide At; 80.00" Cable	CA-3001
1969	V8 5.7L 350ci		w/Cruise Lower; 63.00" Cable	CA-3002
1969	V8 5.7L 350ci		w/Cruise Upper; 41.00" Cable	CA-3009
1969	V8 5.7L 350ci		w/o Cruise exc. 4 Spd. MT; 61.00" Cable	CA-3005
1970	V8 5.7L 350ci		w/o Cruise Control; 80.00" Cable	CA-3001
1971	V8 5.7L 350ci		3 Spd. MT; 80.00" Cable	CA-3001
1971	V8 5.7L 350ci		AT w/Cruise Control, Upper; 61.00" Cable	CA-3005
1971	V8 5.7L 350ci		AT w/Cruise Lower, AT w/o Cruise; 63.00" Cable	CA-3002
1972	V8 5.7L 350ci	H,J	AT w/Cruise Upper, AT w/o Cruise; 61.00" Cable	CA-3005
1972	V8 5.7L 350ci	H,J	Powerglide AT w/Cruise Lower, 3 Spd. MT; 80.00" Cable	CA-3001
1972	V8 5.7L 350ci	H,J	THM AT w/Cruise Lower; 63.00" Cable	CA-3002
1973	V8 5.7L 350ci	H,K	3 Spd. MT 2 pc. Cable Lower; 40.00" Cable	CA-3033
1973	V8 5.7L 350ci	H,K	AT w/Cruise Control, Lower; 83.00" Cable	CA-3004
1973	V8 5.7L 350ci	H,K	AT w/Cruise Upper, AT w/o Cruise, MT; 80.00" Cable	CA-3001
1967	V8 6.5L 396ci		4 Spd. MT w/o Cruise; 83.00" Cable	CA-3004
1967	V8 6.5L 396ci		AT; 63.00" Cable	CA-3002
1968	V8 6.5L 396ci		4 Spd. MT w/o Cruise, MT w/Cruise lower; 83.00" Cable	CA-3004
1968	V8 6.5L 396ci		AT w/Cruise Control, Lower; 63.00" Cable	CA-3002
1968	V8 6.5L 396ci		w/Cruise Upper	CA-3006
1968-69	V8 6.5L 396ci		w/o Cruise exc. 4 Spd. MT; 61.00" Cable	CA-3005
1969	V8 6.5L 396ci		Muncie MT w/o Cruise, Powerglide At; 80.00" Cable	CA-3001
1969	V8 6.5L 396ci		w/Cruise Lower; 63.00" Cable	CA-3002
1969	V8 6.5L 396ci		w/Cruise Upper; 41.00" Cable	CA-3009
1970	V8 6.6L 400ci		w/o Cruise Control; 80.00" Cable	CA-3001
1970	V8 6.6L 402ci		w/o Cruise Control; 80.00" Cable	CA-3001
1972	V8 6.6L 402ci	U	AT w/Cruise Upper, AT w/o Cruise; 61.00" Cable	CA-3005
1972	V8 6.6L 402ci	U	Powerglide AT w/Cruise Lower, 3 Spd. MT; 80.00" Cable	CA-3001
1972	V8 6.6L 402ci	U	THM AT w/Cruise Lower; 63.00" Cable	CA-3002
1972	V8 7.4L 454ci	W	AT w/Cruise Upper, AT w/o Cruise; 61.00" Cable	CA-3005
1972	V8 7.4L 454ci	W	Powerglide AT w/Cruise Lower, 3 Spd. MT; 80.00" Cable	CA-3001
1972	V8 7.4L 454ci	W	THM AT w/Cruise Lower; 63.00" Cable	CA-3002
1973	V8 7.4L 454ci	Y	3 Spd. MT 2 pc. Cable Lower; 40.00" Cable	CA-3033
1973	V8 7.4L 454ci	Y	AT w/Cruise Control, Lower; 83.00" Cable	CA-3004
1973	V8 7.4L 454ci	Y	AT w/Cruise Upper, AT w/o Cruise, MT; 80.00" Cable	CA-3001
<b>CHEVETTE</b>				
1976-77	L4 1.4L 85ci	I	61.00" Cable	CA-3005
1979-80	L4 1.6L 98ci	0	AT; 80.00" Cable	CA-3001
1979-80	L4 1.6L 98ci	0	MT w/o Cruise; 61.00" Cable	CA-3005
1980-81	L4 1.6L 98ci	9	AT; 80.00" Cable	CA-3001
1980-81	L4 1.6L 98ci	9	MT w/o Cruise; 61.00" Cable	CA-3005
1982-87	L4 1.6L 98ci	C	4 Spd. MT; 61.00" Cable	CA-3005
1982-87	L4 1.6L 98ci	C	AT & 5 Spd. MT; 80.00" Cable	CA-3001
1982-87	L4 1.6L 98ci	C	w/Borg-Warner Trans.	CA-3046
1976-77	L4 1.6L 98ci	E	61.00" Cable	CA-3005
1978-79	L4 1.6L 98ci	E,J	AT; 80.00" Cable	CA-3001
1978-79	L4 1.6L 98ci	E,J	MT w/o Cruise; 61.00" Cable	CA-3005
1981	L4 1.8L 110ci	D	AT; 80.00" Cable	CA-3001
1981	L4 1.8L 110ci	D	MT w/o Cruise; 61.00" Cable	CA-3005
1982-86	L4 1.8L 110ci	D	4 Spd. MT; 61.00" Cable	CA-3005
1982-86	L4 1.8L 110ci	D	AT & 5 Spd. MT; 80.00" Cable	CA-3001
1982-86	L4 1.8L 110ci	D	w/Borg-Warner Trans.	CA-3046

# SPEEDOMETER CABLES

Year	Engine	Vin	Remark	Part
<b>CHEVROLET (con't)</b>				
<b>CHEVY II</b>				
1962	L4 2.5L 153ci		AT; 83.00" Cable	CA-3004
1962	L4 2.5L 153ci		MT; 63.00" Cable	CA-3002
1963	L4 2.5L 153ci		63.00" Cable	CA-3002
1964-65	L4 2.5L 153ci		3 Spd. MT; 63.00" Cable	CA-3002
1964-65	L4 2.5L 153ci		exc.3 Spd. MT; 83.00" Cable	CA-3004
1966-67	L4 2.5L 153ci		w/Cruise Lower; 83.00" Cable	CA-3004
1966-67	L4 2.5L 153ci		w/Cruise Upper	CA-3006
1966-67	L4 2.5L 153ci		w/o Cruise Control; 63.00" Cable	CA-3002
1968	L4 2.5L 153ci		4 Spd. Muncie MT; 63.00" Cable	CA-3002
1968	L4 2.5L 153ci		AT; 83.00" Cable	CA-3004
1968	L4 2.5L 153ci		MT w/o Muncie 4 Spd.	CA-3006
1962	L6 3.2L 194ci		AT; 83.00" Cable	CA-3004
1962	L6 3.2L 194ci		MT; 63.00" Cable	CA-3002
1963	L6 3.2L 194ci		63.00" Cable	CA-3002
1966	L6 3.2L 194ci		w/Cruise Lower; 83.00" Cable	CA-3004
1966	L6 3.2L 194ci		w/Cruise Upper	CA-3006
1966	L6 3.2L 194ci		w/o Cruise Control; 63.00" Cable	CA-3002
1964-65	L6 3.2L 194ci		3 Spd. MT; 63.00" Cable	CA-3002
1964-65	L6 3.2L 194ci		exc.3 Spd. MT; 83.00" Cable	CA-3004
1966	L6 3.8L 230ci		w/Cruise Lower; 83.00" Cable	CA-3004
1966	L6 3.8L 230ci		w/Cruise Upper	CA-3006
1966	L6 3.8L 230ci		w/o Cruise Control; 63.00" Cable	CA-3002
1968	L6 3.8L 230ci		4 Spd. Muncie MT; 61.00" Cable	CA-3005
1968	L6 3.8L 230ci		AT; 80.00" Cable	CA-3001
1968	L6 3.8L 230ci		MT w/o Muncie 4 Spd.; 41.00" Cable	CA-3009
1964-65	L6 3.8L 230ci		3 Spd. MT; 63.00" Cable	CA-3002
1964-65	L6 3.8L 230ci		exc.3 Spd. MT; 83.00" Cable	CA-3004
1967	L6 4.1L 250ci		w/Cruise Lower; 83.00" Cable	CA-3004
1967	L6 4.1L 250ci		w/Cruise Upper	CA-3006
1967	L6 4.1L 250ci		w/o Cruise Control; 63.00" Cable	CA-3002
1968	L6 4.1L 250ci		4 Spd. Muncie MT; 61.00" Cable	CA-3005
1968	L6 4.1L 250ci		AT; 80.00" Cable	CA-3001
1968	L6 4.1L 250ci		MT w/o Muncie 4 Spd.; 41.00" Cable	CA-3009
1962	V8 4.6L 283ci		AT; 83.00" Cable	CA-3004
1962	V8 4.6L 283ci		MT; 63.00" Cable	CA-3002
1963	V8 4.6L 283ci		63.00" Cable	CA-3002
1964-65	V8 4.6L 283ci		3 Spd. MT; 63.00" Cable	CA-3002
1964-65	V8 4.6L 283ci		exc.3 Spd. MT; 83.00" Cable	CA-3004
1966-67	V8 4.6L 283ci		w/Cruise Lower; 83.00" Cable	CA-3004
1966-67	V8 4.6L 283ci		w/Cruise Upper	CA-3006
1966-67	V8 4.6L 283ci		w/o Cruise Control; 63.00" Cable	CA-3002
1968	V8 5.0L 307ci		4 Spd. Muncie MT; 63.00" Cable	CA-3002
1968	V8 5.0L 307ci		AT; 83.00" Cable	CA-3004
1968	V8 5.0L 307ci		MT w/o Muncie 4 Spd.	CA-3006
1965	V8 5.4L 327ci		3 Spd. MT; 63.00" Cable	CA-3002
1965	V8 5.4L 327ci		exc.3 Spd. MT; 83.00" Cable	CA-3004
1966-67	V8 5.4L 327ci		w/Cruise Lower; 83.00" Cable	CA-3004
1966-67	V8 5.4L 327ci		w/Cruise Upper	CA-3006
1966-67	V8 5.4L 327ci		w/o Cruise Control; 63.00" Cable	CA-3002
1968	V8 5.4L 327ci		4 Spd. Muncie MT; 63.00" Cable	CA-3002
1968	V8 5.4L 327ci		AT; 83.00" Cable	CA-3004
1968	V8 5.4L 327ci		MT w/o Muncie 4 Spd.	CA-3006
1968	V8 5.7L 350ci		4 Spd. Muncie MT; 61.00" Cable	CA-3005
1968	V8 5.7L 350ci		AT; 80.00" Cable	CA-3001
1968	V8 5.7L 350ci		MT w/o Muncie 4 Spd.; 41.00" Cable	CA-3009
1968	V8 6.5L 396ci		4 Spd. Muncie MT; 61.00" Cable	CA-3005
1968	V8 6.5L 396ci		AT; 80.00" Cable	CA-3001
1968	V8 6.5L 396ci		MT w/o Muncie 4 Spd.; 41.00" Cable	CA-3009
<b>CITATION</b>				
1980-81	L4 2.5L 151ci	5	AT Upper, MT w/o Cruise; 41.00" Cable	CA-3009
1980-81	L4 2.5L 151ci	5	w/Cruise Lower	CA-3006
1980-81	L4 2.5L 151ci	5	w/o Cruise Lower; 40.00" Cable	CA-3033

# SPEEDOMETER CABLES

Year	Engine	Vin	Remark	Part
<b>CHEVROLET (con't)</b>				
<b>CITATION (con't)</b>				
1982-83	L4 2.5L 151ci	5,R	AT w/Cruise Control, Lower; 83.00" Cable	CA-3004
1982-83	L4 2.5L 151ci	5,R	AT w/Cruise Upper, MT w/o Cruise, MT w/Cruise Upper; 41.00" Cable	CA-3009
1982-83	L4 2.5L 151ci	5,R	AT w/o Cruise Control; 80.00" Cable	CA-3001
1982-83	L4 2.5L 151ci	5,R	MT w/Cruise Lower; 100.00" Cable	CA-3003
1980	V6 2.8L 173ci	7	AT Upper, MT w/o Cruise; 41.00" Cable	CA-3009
1980	V6 2.8L 173ci	7	w/Cruise Lower	CA-3006
1980	V6 2.8L 173ci	7	w/o Cruise Lower; 40.00" Cable	CA-3033
1981	V6 2.8L 173ci	X,Z	AT Upper, MT w/o Cruise; 41.00" Cable	CA-3009
1981	V6 2.8L 173ci	X,Z	w/Cruise Lower	CA-3006
1981	V6 2.8L 173ci	X,Z	w/o Cruise Lower; 40.00" Cable	CA-3033
1982-83	V6 2.8L 173ci	X,Z	AT w/Cruise Control, Lower; 83.00" Cable	CA-3004
1982-83	V6 2.8L 173ci	X,Z	AT w/Cruise Upper, MT w/o Cruise, MT w/Cruise Upper; 41.00" Cable	CA-3009
1982-83	V6 2.8L 173ci	X,Z	AT w/o Cruise Control; 80.00" Cable	CA-3001
1982-83	V6 2.8L 173ci	X,Z	MT w/Cruise Lower; 100.00" Cable	CA-3003
<b>CITATION II</b>				
1984-85	L4 2.5L 151ci	R	AT; 80.00" Cable	CA-3001
1984-85	L4 2.5L 151ci	R	MT; 41.00" Cable	CA-3009
1984-85	V6 2.8L 173ci	W,X,Z	AT; 80.00" Cable	CA-3001
1984-85	V6 2.8L 173ci	W,X,Z	MT; 41.00" Cable	CA-3009
<b>CORVETTE</b>				
1954-55	L6 3.9L 235ci		83.00" Cable	CA-3004
1953	L6 3.9L 236ci		83.00" Cable	CA-3004
1955	V8 4.3L 265ci		63.00" Cable	CA-3002
1956	V8 4.3L 265ci		3 Spd. MT; 63.00" Cable	CA-3002
1956	V8 4.3L 265ci		AT w/68" Cable; 83.00" Cable	CA-3004
1957-60	V8 4.6L 283ci		3 Spd. MT; 63.00" Cable	CA-3002
1957-61	V8 4.6L 283ci		AT w/68" Cable, 4 Spd. MT; 83.00" Cable	CA-3004
1961	V8 4.6L 283ci		AT w/56" to 60" Cable, 3 & 4 Spd. MT; 63.00" Cable	CA-3002
1980	V8 5.0L 305ci	H	exc. Cruise Control; 80.00" Cable	CA-3001
1980	V8 5.0L 305ci	H	w/Cruise Control, Lower; 63.00" Cable	CA-3002
1980	V8 5.0L 305ci	H	w/Cruise Control, Upper; 41.00" Cable	CA-3009
1962	V8 5.4L 327ci		AT w/56" to 60" Cable, 3 & 4 Spd. MT; 63.00" Cable	CA-3002
1962	V8 5.4L 327ci		AT w/68" Cable; 83.00" Cable	CA-3004
1963-64	V8 5.4L 327ci		exc. Tach drive; 63.00" Cable	CA-3002
1963-64	V8 5.4L 327ci		Tach Drive w/FI	CA-3006
1965-66	V8 5.4L 327ci		3 Spd. MT; 63.00" Cable	CA-3002
1965-66	V8 5.4L 327ci		AT	CA-3038
1965-67	V8 5.4L 327ci		4 Spd. MT; 83.00" Cable	CA-3004
1967	V8 5.4L 327ci		AT; 63.00" Cable	CA-3002
1968	V8 5.4L 327ci		w/Cruise Lower; 40.00" Cable	CA-3033
1968	V8 5.4L 327ci		w/Cruise Upper; 63.00" Cable	CA-3002
1968	V8 5.4L 327ci		w/o Cruise Control; 83.00" Cable	CA-3004
1969	V8 5.7L 350ci		4 Spd. exc. Muncie; 100.00" Cable	CA-3003
1969-70	V8 5.7L 350ci		4 Spd. Muncie MT; 80.00" Cable	CA-3001
1969	V8 5.7L 350ci		w/Cruise Lower; 40.00" Cable	CA-3033
1969	V8 5.7L 350ci		w/Cruise Upper; 61.00" Cable	CA-3005
1969	V8 5.7L 350ci		w/Tach drive; 41.00" Cable	CA-3009
1970	V8 5.7L 350ci		3 Spd. MT w/Cruise; 41.00" Cable	CA-3009
1970	V8 5.7L 350ci		3 Spd. MT w/o Cruise; 40.00" Cable	CA-3033
1971	V8 5.7L 350ci		3 & 4 Spd. Saginaw MT Upper; 41.00" Cable	CA-3009
1971	V8 5.7L 350ci		3 Spd. Synchro MT lower; 40.00" Cable	CA-3033
1971	V8 5.7L 350ci		AT or Muncie 4 Spd. MT; 100.00" Cable	CA-3003
1979-82	V8 5.7L 350ci	4,6,8	exc. Cruise Control; 80.00" Cable	CA-3001
1979-82	V8 5.7L 350ci	4,6,8	w/Cruise Control, Lower; 63.00" Cable	CA-3002
1979-82	V8 5.7L 350ci	4,6,8	w/Cruise Control, Upper; 41.00" Cable	CA-3009
1973	V8 5.7L 350ci	J	3 & 4 Spd. MT w/Mechanical Tach.; Upper; 41.00" Cable	CA-3009
1973	V8 5.7L 350ci	J	3 & 4 Spd. Saginaw MT Upper; 41.00" Cable	CA-3009
1973	V8 5.7L 350ci	J	AT w/1 pc.cable	CA-3016
1973-75	V8 5.7L 350ci	J,T	Muncie 4 Spd. MT; 100.00" Cable	CA-3003
1974-75	V8 5.7L 350ci	J,T	AT w/40" Cable; 61.00" Cable	CA-3005
1974	V8 5.7L 350ci	J,T	AT w/Synchro Lower; 40.00" Cable	CA-3033
1974	V8 5.7L 350ci	J,T	MT w/mech. Tach, AT w/synchro Upper; 41.00" Cable	CA-3009

# SPEEDOMETER CABLES

Year	Engine	Vin	Remark	Part
<b>CHEVROLET (con't)</b>				
<b>CORVETTE (con't)</b>				
1975	V8 5.7L 350ci	J,T	2 pc. Lower; 40.00" Cable	CA-3033
1975	V8 5.7L 350ci	J,T	2 pc. Upper; 41.00" Cable	CA-3009
1972	V8 5.7L 350ci	K	3 & 4 Spd. AT w/2 pc.cable Upper; 41.00" Cable	CA-3009
1972	V8 5.7L 350ci	K	3 & 4 Spd. MT w/Mechanical Tach.; 41.00" Cable	CA-3009
1972	V8 5.7L 350ci	K	3 & 4 Spd. Saginaw MT Upper; 41.00" Cable	CA-3009
1972	V8 5.7L 350ci	K	AT w/1 pc.cable	CA-3016
1972	V8 5.7L 350ci	K	AT w/2 pc. cable Lower, or 3 Spd. Synchro MT lower; 40.00" Cable	CA-3033
1972	V8 5.7L 350ci	K	Muncie 4 Spd. MT; 100.00" Cable	CA-3003
1976-77	V8 5.7L 350ci	L,X	1 pc. Cable; 100.00" Cable	CA-3003
1976-77	V8 5.7L 350ci	L,X	MT 2 pc Lower; 40.00" Cable	CA-3033
1976-77	V8 5.7L 350ci	L,X	MT 2 pc Upper; 41.00" Cable	CA-3009
1978-79	V8 5.7L 350ci	H,L	exc. Cruise Control; 80.00" Cable	CA-3001
1978-79	V8 5.7L 350ci	H,L	w/Cruise Control, Lower; 63.00" Cable	CA-3002
1978-79	V8 5.7L 350ci	H,L	w/Cruise Control, Upper; 41.00" Cable	CA-3009
1966	V8 7.0L 427ci		3 Spd. MT; 63.00" Cable	CA-3002
1966	V8 7.0L 427ci		AT	CA-3038
1966-67	V8 7.0L 427ci		4 Spd. MT; 83.00" Cable	CA-3004
1967	V8 7.0L 427ci		AT; 63.00" Cable	CA-3002
1968	V8 7.0L 427ci		w/Cruise Upper; 63.00" Cable	CA-3002
1968	V8 7.0L 427ci		w/o Cruise Control; 83.00" Cable	CA-3004
1968-69	V8 7.0L 427ci		w/Cruise Lower; 40.00" Cable	CA-3033
1969	V8 7.0L 427ci		4 Spd. exc. Muncie; 100.00" Cable	CA-3003
1969	V8 7.0L 427ci		4 Spd. Muncie MT; 80.00" Cable	CA-3001
1969	V8 7.0L 427ci		w/Cruise Upper; 61.00" Cable	CA-3005
1969	V8 7.0L 427ci		w/Tach drive; 41.00" Cable	CA-3009
1970	V8 7.4L 454ci		3 Spd. MT w/Cruise; 41.00" Cable	CA-3009
1970	V8 7.4L 454ci		3 Spd. MT w/o Cruise; 40.00" Cable	CA-3033
1970	V8 7.4L 454ci		4 Spd. Muncie MT; 80.00" Cable	CA-3001
1971	V8 7.4L 454ci		3 & 4 Spd. Saginaw MT Upper; 41.00" Cable	CA-3009
1971	V8 7.4L 454ci		3 Spd. Synchro MT lower; 40.00" Cable	CA-3033
1971	V8 7.4L 454ci		AT or Muncie 4 Spd. MT; 100.00" Cable	CA-3003
1972	V8 7.4L 454ci	W	3 & 4 Spd. AT w/2 pc.cable Upper; 41.00" Cable	CA-3009
1972	V8 7.4L 454ci	W	3 & 4 Spd. MT w/Mechanical Tach.; 41.00" Cable	CA-3009
1972	V8 7.4L 454ci	W	3 & 4 Spd. Saginaw MT Upper; 41.00" Cable	CA-3009
1972	V8 7.4L 454ci	W	AT w/1 pc.cable	CA-3016
1972	V8 7.4L 454ci	W	AT w/2 pc. cable Lower, or 3 Spd. Synchro MT lower; 40.00" Cable	CA-3033
1972	V8 7.4L 454ci	W	Muncie 4 Spd. MT; 100.00" Cable	CA-3003
1973	V8 7.4L 454ci	Z	3 & 4 Spd. MT w/Mechanical Tach.; Upper; 41.00" Cable	CA-3009
1973	V8 7.4L 454ci	Z	3 & 4 Spd. Saginaw MT Upper; 41.00" Cable	CA-3009
1973	V8 7.4L 454ci	Z	AT w/1 pc.cable	CA-3016
1973-74	V8 7.4L 454ci	Z	Muncie 4 Spd. MT; 100.00" Cable	CA-3003
1974	V8 7.4L 454ci	Z	AT w/40" Cable; 61.00" Cable	CA-3005
1974	V8 7.4L 454ci	Z	AT w/Synchro Lower; 40.00" Cable	CA-3033
1974	V8 7.4L 454ci	Z	MT w/mech. Tach, AT w/synchro Upper; 41.00" Cable	CA-3009
<b>IMPALA</b>				
1963-64	L6 3.8L 230ci		63.00" Cable	CA-3002
1965	L6 3.8L 230ci		83.00" Cable	CA-3004
1959	L6 3.9L 235ci		w/o Tach.; 63.00" Cable	CA-3002
1959	L6 3.9L 235ci		w/Tach.; 83.00" Cable	CA-3004
1961	L6 3.9L 235ci		w/Powerglide Trans.; 83.00" Cable	CA-3004
1961	L6 3.9L 235ci		w/Turboglide Trans.; 63.00" Cable	CA-3002
1962	L6 3.9L 235ci		63.00" Cable	CA-3002
1967	L6 4.1L 250ci		w/Cruise Upper	CA-3006
1967	L6 4.1L 250ci		w/o Cruise Control; 83.00" Cable	CA-3004
1967-71	L6 4.1L 250ci		w/Cruise Lower; 63.00" Cable	CA-3002
1969	L6 4.1L 250ci		Muncie 4 Spd. MT; 100.00" Cable	CA-3003
1969	L6 4.1L 250ci		w/o Cruise Control; 80.00" Cable	CA-3001
1969-70	L6 4.1L 250ci		w/Cruise Upper; 41.00" Cable	CA-3009
1970	L6 4.1L 250ci		w/o Cruise, 4 Spd. Muncie MT; 80.00" Cable	CA-3001
1971	L6 4.1L 250ci		MT w/o Cruise, Powerglide w/o Cruise, THM w/Cruise; 61.00" Cable	CA-3005
1971	L6 4.1L 250ci		Upper; 41.00" Cable	CA-3009
1972-73	L6 4.1L 250ci	D	w/o Cruise Control; 61.00" Cable	CA-3005



# SPEEDOMETER CABLES

Year	Engine	Vin	Remark	Part
<b>CHEVROLET (con't)</b>				
<b>IMPALA (con't)</b>				
1972-79	L6 4.1L 250ci	D	w/Cruise Lower; 63.00" Cable	CA-3002
1972-79	L6 4.1L 250ci	D	w/Cruise Upper; 41.00" Cable	CA-3009
1977-79	L6 4.1L 250ci	D	w/o Cruise Control; 80.00" Cable	CA-3001
1965-68	L6 4.1L 250ci		83.00" Cable	CA-3004
1983	V6 3.8L 229ci	9	w/Cruise Lower; 83.00" Cable	CA-3004
1983	V6 3.8L 229ci	9	w/Cruise Upper; 61.00" Cable	CA-3005
1983	V6 3.8L 229ci	9	w/o Cruise Control; 80.00" Cable	CA-3001
1984	V6 3.8L 229ci	9	AT; 80.00" Cable	CA-3001
1980-82	V6 3.8L 229ci	K	w/Cruise Lower; 83.00" Cable	CA-3004
1980-82	V6 3.8L 229ci	K	w/Cruise Upper; 61.00" Cable	CA-3005
1980-82	V6 3.8L 229ci	K	w/o Cruise Control; 80.00" Cable	CA-3001
1980-83	V6 3.8L 231ci	A	w/Cruise Lower; 83.00" Cable	CA-3004
1980-83	V6 3.8L 231ci	A	w/Cruise Upper; 61.00" Cable	CA-3005
1980-83	V6 3.8L 231ci	A	w/o Cruise Control; 80.00" Cable	CA-3001
1984-85	V6 3.8L 231ci	A	AT; 80.00" Cable	CA-3001
1985	V6 4.3L 262ci	Z	AT; 80.00" Cable	CA-3001
1980-82	V8 4.4L 267ci	J	w/Cruise Lower; 83.00" Cable	CA-3004
1980-82	V8 4.4L 267ci	J	w/Cruise Upper; 61.00" Cable	CA-3005
1980-82	V8 4.4L 267ci	J	w/o Cruise Control; 80.00" Cable	CA-3001
1959	V8 4.6L 283ci		w/o Tach.; 63.00" Cable	CA-3002
1959	V8 4.6L 283ci		w/Tach.; 83.00" Cable	CA-3004
1960-66	V8 4.6L 283ci		83.00" Cable	CA-3004
1961	V8 4.6L 283ci		w/Powerglide Trans.; 83.00" Cable	CA-3004
1961	V8 4.6L 283ci		w/Turboglide Trans.; 63.00" Cable	CA-3002
1962-64	V8 4.6L 283ci		63.00" Cable	CA-3002
1967	V8 4.6L 283ci		w/Cruise Lower; 63.00" Cable	CA-3002
1967	V8 4.6L 283ci		w/Cruise Upper	CA-3006
1967	V8 4.6L 283ci		w/o Cruise Control; 83.00" Cable	CA-3004
1979	V8 5.0L 305ci	G	w/Cruise Lower; 63.00" Cable	CA-3002
1979	V8 5.0L 305ci	G	w/Cruise Upper; 41.00" Cable	CA-3009
1979	V8 5.0L 305ci	G	w/o Cruise Control; 80.00" Cable	CA-3001
1980-83	V8 5.0L 305ci	H	w/Cruise Lower; 83.00" Cable	CA-3004
1980-83	V8 5.0L 305ci	H	w/Cruise Upper; 61.00" Cable	CA-3005
1980-83	V8 5.0L 305ci	H	w/o Cruise Control; 80.00" Cable	CA-3001
1984-85	V8 5.0L 305ci	H	AT; 80.00" Cable	CA-3001
1977-78	V8 5.0L 305ci	U	w/Cruise Lower; 63.00" Cable	CA-3002
1977-78	V8 5.0L 305ci	U	w/Cruise Upper; 41.00" Cable	CA-3009
1977-78	V8 5.0L 305ci	U	w/o Cruise Control; 80.00" Cable	CA-3001
1968	V8 5.0L 307ci		83.00" Cable	CA-3004
1962-64	V8 5.4L 327ci		63.00" Cable	CA-3002
1965-66	V8 5.4L 327ci		83.00" Cable	CA-3004
1967	V8 5.4L 327ci		w/Cruise Lower; 63.00" Cable	CA-3002
1967	V8 5.4L 327ci		w/Cruise Upper	CA-3006
1967	V8 5.4L 327ci		w/o Cruise Control; 83.00" Cable	CA-3004
1968	V8 5.4L 327ci		83.00" Cable	CA-3004
1969	V8 5.4L 327ci		Muncie 4 Spd. MT; 100.00" Cable	CA-3003
1969	V8 5.4L 327ci		w/Cruise Lower; 63.00" Cable	CA-3002
1969	V8 5.4L 327ci		w/Cruise Upper; 41.00" Cable	CA-3009
1969	V8 5.4L 327ci		w/o Cruise Control; 80.00" Cable	CA-3001
1959	V8 5.7L 348ci		w/o Tach.; 63.00" Cable	CA-3002
1959	V8 5.7L 348ci		w/Tach.; 83.00" Cable	CA-3004
1960	V8 5.7L 348ci		83.00" Cable	CA-3004
1961	V8 5.7L 348ci		w/Powerglide Trans.; 83.00" Cable	CA-3004
1961	V8 5.7L 348ci		w/Turboglide Trans.; 63.00" Cable	CA-3002
1969	V8 5.7L 350ci		Muncie 4 Spd. MT; 100.00" Cable	CA-3003
1969	V8 5.7L 350ci		w/o Cruise Control; 80.00" Cable	CA-3001
1969-70	V8 5.7L 350ci		w/Cruise Upper; 41.00" Cable	CA-3009
1969-71	V8 5.7L 350ci		w/Cruise Lower; 63.00" Cable	CA-3002
1970	V8 5.7L 350ci		w/o Cruise, 4 Spd. Muncie MT; 80.00" Cable	CA-3001
1971	V8 5.7L 350ci		MT w/o Cruise, Powerglide w/o Cruise, THM w/Cruise; 61.00" Cable	CA-3005
1971	V8 5.7L 350ci		Upper; 41.00" Cable	CA-3009
1984-85	V8 5.7L 350ci	6,N	AT; 80.00" Cable	CA-3001

# SPEEDOMETER CABLES

Year	Engine	Vin	Remark	Part
<b>CHEVROLET (con't)</b>				
<b>IMPALA (con't)</b>				
1972-75	V8 5.7L 350ci	H	w/Cruise Lower; 63.00" Cable	CA-3002
1972-75	V8 5.7L 350ci	H,J,K	w/Cruise Upper; 41.00" Cable	CA-3009
1972-75	V8 5.7L 350ci	H,J,K	w/o Cruise Control; 61.00" Cable	CA-3005
1973	V8 5.7L 350ci	J	w/Cruise Lower; 63.00" Cable	CA-3002
1972-74	V8 5.7L 350ci	K	w/Cruise Lower; 63.00" Cable	CA-3002
1974-76	V8 5.7L 350ci	L,V	w/o Cruise Control; 61.00" Cable	CA-3005
1974-79	V8 5.7L 350ci	L	w/Cruise Lower; 63.00" Cable	CA-3002
1974-79	V8 5.7L 350ci	L,V	w/Cruise Upper; 41.00" Cable	CA-3009
1977-82	V8 5.7L 350ci	L	w/o Cruise Control; 80.00" Cable	CA-3001
1980-83	V8 5.7L 350ci	6,L,N	w/Cruise Lower; 83.00" Cable	CA-3004
1980-83	V8 5.7L 350ci	6,L,N	w/Cruise Upper; 61.00" Cable	CA-3005
1980-83	V8 5.7L 350ci	6,N	w/o Cruise Control; 80.00" Cable	CA-3001
1976	V8 5.7L 350ci	V	w/Cruise Lower; 63.00" Cable	CA-3002
1966-68	V8 6.5L 396ci		83.00" Cable	CA-3004
1967	V8 6.5L 396ci		w/Cruise Upper	CA-3006
1967	V8 6.5L 396ci		w/o Cruise Control; 83.00" Cable	CA-3004
1967-69	V8 6.5L 396ci		w/Cruise Lower; 63.00" Cable	CA-3002
1969	V8 6.5L 396ci		Muncie 4 Spd. MT; 100.00" Cable	CA-3003
1969	V8 6.5L 396ci		w/Cruise Upper; 41.00" Cable	CA-3009
1969	V8 6.5L 396ci		w/o Cruise Control; 80.00" Cable	CA-3001
1970	V8 6.6L 400ci		w/Cruise Upper; 41.00" Cable	CA-3009
1970	V8 6.6L 400ci		w/o Cruise, 4 Spd. Muncie MT; 80.00" Cable	CA-3001
1970-71	V8 6.6L 400ci		w/Cruise Lower; 63.00" Cable	CA-3002
1971	V8 6.6L 400ci		MT w/o Cruise, Powerglide w/o Cruise, THM w/Cruise; 61.00" Cable	CA-3005
1971	V8 6.6L 400ci		Upper; 41.00" Cable	CA-3009
1972-74	V8 6.6L 400ci	R	w/Cruise Lower; 63.00" Cable	CA-3002
1972-74	V8 6.6L 400ci	R	w/Cruise Upper; 41.00" Cable	CA-3009
1972-74	V8 6.6L 400ci	R	w/o Cruise Control; 61.00" Cable	CA-3005
1974-76	V8 6.6L 400ci	M,U	w/Cruise Lower; 63.00" Cable	CA-3002
1974-76	V8 6.6L 400ci	M,U	w/Cruise Upper; 41.00" Cable	CA-3009
1974-76	V8 6.6L 400ci	M,U	w/o Cruise Control; 61.00" Cable	CA-3005
1971	V8 6.6L 402ci		MT w/o Cruise, Powerglide w/o Cruise, THM w/Cruise; 61.00" Cable	CA-3005
1971	V8 6.6L 402ci		Upper; 41.00" Cable	CA-3009
1971	V8 6.6L 402ci		w/Cruise Lower; 63.00" Cable	CA-3002
1972	V8 6.6L 402ci	S	w/Cruise Lower; 63.00" Cable	CA-3002
1972	V8 6.6L 402ci	S	w/Cruise Upper; 41.00" Cable	CA-3009
1972	V8 6.6L 402ci	S	w/o Cruise Control; 61.00" Cable	CA-3005
1961	V8 6.7L 409ci		w/Powerglide Trans.; 83.00" Cable	CA-3004
1961	V8 6.7L 409ci		w/Turboglide Trans.; 63.00" Cable	CA-3002
1962-64	V8 6.7L 409ci		63.00" Cable	CA-3002
1965	V8 6.7L 409ci		83.00" Cable	CA-3004
1966-68	V8 7.0L 427ci		83.00" Cable	CA-3004
1967	V8 7.0L 427ci		w/Cruise Upper	CA-3006
1967	V8 7.0L 427ci		w/o Cruise Control; 83.00" Cable	CA-3004
1967-69	V8 7.0L 427ci		w/Cruise Lower; 63.00" Cable	CA-3002
1969	V8 7.0L 427ci		Muncie 4 Spd. MT; 100.00" Cable	CA-3003
1969	V8 7.0L 427ci		w/Cruise Upper; 41.00" Cable	CA-3009
1969	V8 7.0L 427ci		w/o Cruise Control; 80.00" Cable	CA-3001
1970	V8 7.4L 454ci		w/Cruise Upper; 41.00" Cable	CA-3009
1970	V8 7.4L 454ci		w/o Cruise, 4 Spd. Muncie MT; 80.00" Cable	CA-3001
1971	V8 7.4L 454ci		MT w/o Cruise, Powerglide w/o Cruise, THM w/Cruise; 61.00" Cable	CA-3005
1971	V8 7.4L 454ci		Upper; 41.00" Cable	CA-3009
1970-71	V8 7.4L 454ci		w/Cruise Lower; 63.00" Cable	CA-3002
1976	V8 7.4L 454ci	S	w/Cruise Lower; 63.00" Cable	CA-3002
1976	V8 7.4L 454ci	S	w/Cruise Upper; 41.00" Cable	CA-3009
1976	V8 7.4L 454ci	S	w/o Cruise Control; 61.00" Cable	CA-3005
1972	V8 7.4L 454ci	V	w/Cruise Lower; 63.00" Cable	CA-3002
1972	V8 7.4L 454ci	V	w/Cruise Upper; 41.00" Cable	CA-3009
1972	V8 7.4L 454ci	V	w/o Cruise Control; 61.00" Cable	CA-3005
1973	V8 7.4L 454ci	X	w/Cruise Lower; 63.00" Cable	CA-3002
1973	V8 7.4L 454ci	X	w/Cruise Upper; 41.00" Cable	CA-3009
1973	V8 7.4L 454ci	X	w/o Cruise Control; 61.00" Cable	CA-3005

# SPEEDOMETER CABLES

Year	Engine	Vin	Remark	Part
<b>CHEVROLET (con't)</b>				
<b>IMPALA (con't)</b>				
1974-75	V8 7.4L 454ci	Y	w/Cruise Lower; 63.00" Cable	CA-3002
1974-75	V8 7.4L 454ci	Y	w/Cruise Upper; 41.00" Cable	CA-3009
1974-75	V8 7.4L 454ci	Y	w/o Cruise Control; 61.00" Cable	CA-3005
<b>KINGSWOOD</b>				
1969	V8 5.7L 350ci		Muncie 4 Spd. MT; 100.00" Cable	CA-3003
1969	V8 5.7L 350ci		w/o Cruise Control; 80.00" Cable	CA-3001
1969-70	V8 5.7L 350ci		w/Cruise Upper; 41.00" Cable	CA-3009
1969-71	V8 5.7L 350ci		w/Cruise Lower; 63.00" Cable	CA-3002
1970	V8 5.7L 350ci		w/o Cruise, 4 Spd. Muncie MT; 80.00" Cable	CA-3001
1971	V8 5.7L 350ci		MT w/o Cruise, Powerglide w/o Cruise, THM w/Cruise; 61.00" Cable	CA-3005
1971	V8 5.7L 350ci		Upper; 41.00" Cable	CA-3009
1972	V8 5.7L 350ci	H	w/Cruise Lower; 63.00" Cable	CA-3002
1972	V8 5.7L 350ci	H	w/Cruise Upper; 41.00" Cable	CA-3009
1972	V8 5.7L 350ci	H	w/o Cruise Control; 61.00" Cable	CA-3005
1970	V8 6.6L 400ci		w/Cruise Upper; 41.00" Cable	CA-3009
1970	V8 6.6L 400ci		w/o Cruise, 4 Spd. Muncie MT; 80.00" Cable	CA-3001
1970-71	V8 6.6L 400ci		w/Cruise Lower; 63.00" Cable	CA-3002
1971	V8 6.6L 400ci		MT w/o Cruise, Powerglide w/o Cruise, THM w/Cruise; 61.00" Cable	CA-3005
1971	V8 6.6L 400ci		Upper; 41.00" Cable	CA-3009
1972	V8 6.6L 400ci	R	w/Cruise Lower; 63.00" Cable	CA-3002
1972	V8 6.6L 400ci	R	w/Cruise Upper; 41.00" Cable	CA-3009
1972	V8 6.6L 400ci	R	w/o Cruise Control; 61.00" Cable	CA-3005
1971	V8 6.6L 402ci		MT w/o Cruise, Powerglide w/o Cruise, THM w/Cruise; 61.00" Cable	CA-3005
1971	V8 6.6L 402ci		Upper; 41.00" Cable	CA-3009
1971	V8 6.6L 402ci		w/Cruise Lower; 63.00" Cable	CA-3002
1972	V8 6.6L 402ci	S	w/Cruise Lower; 63.00" Cable	CA-3002
1972	V8 6.6L 402ci	S	w/Cruise Upper; 41.00" Cable	CA-3009
1972	V8 6.6L 402ci	S	w/o Cruise Control; 61.00" Cable	CA-3005
1970	V8 7.4L 454ci		w/Cruise Lower; 63.00" Cable	CA-3002
1970	V8 7.4L 454ci		w/Cruise Upper; 41.00" Cable	CA-3009
1970	V8 7.4L 454ci		w/o Cruise, 4 Spd. Muncie MT; 80.00" Cable	CA-3001
1972	V8 7.4L 454ci	V	w/Cruise Lower; 63.00" Cable	CA-3002
1972	V8 7.4L 454ci	V	w/Cruise Upper; 41.00" Cable	CA-3009
1972	V8 7.4L 454ci	V	w/o Cruise Control; 61.00" Cable	CA-3005
<b>MALIBU</b>				
1964	L6 3.2L 194ci		63.00" Cable	CA-3002
1965	L6 3.2L 194ci		4 Spd. MT; 83.00" Cable	CA-3004
1965	L6 3.2L 194ci		AT & 3 Spd. MT; 63.00" Cable	CA-3002
1966	L6 3.2L 194ci		4 Spd. MT w/Cruise; 80.00" Cable	CA-3001
1966	L6 3.2L 194ci		4 Spd. MT w/o Cruise; 83.00" Cable	CA-3004
1966	L6 3.2L 194ci		AT w/Cruise, 3 Spd. MT	CA-3006
1966	L6 3.2L 194ci		AT w/o Cruise, 3 Spd. MT w/o Cruise; 63.00" Cable	CA-3002
1964	L6 3.8L 230ci		63.00" Cable	CA-3002
1965	L6 3.8L 230ci		4 Spd. MT; 83.00" Cable	CA-3004
1965	L6 3.8L 230ci		AT & 3 Spd. MT; 63.00" Cable	CA-3002
1966	L6 3.8L 230ci		4 Spd. MT w/Cruise; 80.00" Cable	CA-3001
1966	L6 3.8L 230ci		AT w/Cruise, 3 Spd. MT	CA-3006
1966	L6 3.8L 230ci		AT w/o Cruise, 3 Spd. MT w/o Cruise; 63.00" Cable	CA-3002
1966-67	L6 3.8L 230ci		4 Spd. MT w/o Cruise; 83.00" Cable	CA-3004
1967	L6 3.8L 230ci		AT; 63.00" Cable	CA-3002
1973	L6 4.1L 250ci	D	3 Spd. MT 2 pc. Cable Lower; 40.00" Cable	CA-3033
1973	L6 4.1L 250ci	D	AT w/Cruise Control, Lower; 83.00" Cable	CA-3004
1973	L6 4.1L 250ci	D	AT w/Cruise Upper, AT w/o Cruise, MT; 80.00" Cable	CA-3001
1974	L6 4.1L 250ci	D	AT & 4 Spd. MT w/Cruise Upper; 80.00" Cable	CA-3001
1975	L6 4.1L 250ci	D	w/Cruise Upper, w/o Cruise; 80.00" Cable	CA-3001
1974-77	L6 4.1L 250ci	D	w/Cruise Lower; 83.00" Cable	CA-3004
1976-77	L6 4.1L 250ci	D	AT w/o Cruise Control; 61.00" Cable	CA-3005
1976-77	L6 4.1L 250ci	D	w/Cruise Upper; 80.00" Cable	CA-3001
1978-79	V6 3.3L 200ci	M	AT w/Cruise Control, w/Adapter, Lower; 63.00" Cable	CA-3002
1978-79	V6 3.3L 200ci	M	AT w/Cruise w/Adapter Upper, AT w/o Cruise w/Adapter Lower	CA-3008
1978-79	V6 3.3L 200ci	M	AT w/Cruise w/o Adapter Lower; 83.00" Cable	CA-3004
1978-79	V6 3.3L 200ci	M	AT w/Cruise w/o Adapter Upper; 61.00" Cable	CA-3005

# SPEEDOMETER CABLES

Year	Engine	Vin	Remark	Part
<b>CHEVROLET (con't)</b>				
<b>MALIBU (con't)</b>				
1978-79	V6 3.3L 200ci	M	AT w/o Cruise Control, w/o Gear Adapter, or MT; 100.00" Cable	CA-3003
1978-79	V6 3.3L 200ci	M	MT w/Adapter Upper, AT w/o Cruise w/Adapter Upper; 80.00" Cable	CA-3001
1983	V6 3.8L 229ci	9	w/Cruise Upper; 61.00" Cable	CA-3005
1983	V6 3.8L 229ci	9	w/Cruise w/Adapter Lower; 63.00" Cable	CA-3002
1983	V6 3.8L 229ci	9	w/Cruise w/o Adapter Lower; 83.00" Cable	CA-3004
1983	V6 3.8L 229ci	9	w/o Cruise w/Adapter Lower; 20.00" Cable	CA-3008
1983	V6 3.8L 229ci	9	w/o Cruise w/Adapter Upper; 80.00" Cable	CA-3001
1983	V6 3.8L 229ci	9	w/o Cruise w/o Adapter; 100.00" Cable	CA-3003
1980-81	V6 3.8L 229ci	K	AT w/Cruise Control, w/Adapter, Lower; 63.00" Cable	CA-3002
1980-81	V6 3.8L 229ci	K	AT w/Cruise w/Adapter Upper, AT w/o Cruise w/Adapter Lower	CA-3008
1980-81	V6 3.8L 229ci	K	AT w/Cruise w/o Adapter Lower; 83.00" Cable	CA-3004
1980-81	V6 3.8L 229ci	K	AT w/Cruise w/o Adapter Upper; 61.00" Cable	CA-3005
1980-81	V6 3.8L 229ci	K	AT w/o Cruise Control, w/o Gear Adapter, or MT; 100.00" Cable	CA-3003
1980-81	V6 3.8L 229ci	K	MT w/Adapter Upper, AT w/o Cruise w/Adapter Upper; 80.00" Cable	CA-3001
1982	V6 3.8L 229ci	K	w/Cruise Upper; 61.00" Cable	CA-3005
1982	V6 3.8L 229ci	K	w/Cruise w/Adapter Lower; 63.00" Cable	CA-3002
1982	V6 3.8L 229ci	K	w/Cruise w/o Adapter Lower; 83.00" Cable	CA-3004
1982	V6 3.8L 229ci	K	w/o Cruise w/Adapter Lower; 20.00" Cable	CA-3008
1982	V6 3.8L 229ci	K	w/o Cruise w/Adapter Upper; 80.00" Cable	CA-3001
1982	V6 3.8L 229ci	K	w/o Cruise w/o Adapter; 100.00" Cable	CA-3003
1979	V6 3.8L 231ci	2	AT w/Cruise w/o Adapter Lower; 83.00" Cable	CA-3004
1978-81	V6 3.8L 231ci	2,A	AT w/Cruise Control, w/Adapter, Lower; 63.00" Cable	CA-3002
1978-81	V6 3.8L 231ci	2,A	AT w/Cruise w/Adapter Upper, AT w/o Cruise w/Adapter Lower	CA-3008
1978-81	V6 3.8L 231ci	A	AT w/Cruise w/o Adapter Lower; 83.00" Cable	CA-3004
1978-81	V6 3.8L 231ci	2,A	AT w/Cruise w/o Adapter Upper; 61.00" Cable	CA-3005
1978-81	V6 3.8L 231ci	2,A	AT w/o Cruise Control, w/o Gear Adapter, or MT; 100.00" Cable	CA-3003
1978-81	V6 3.8L 231ci	2,A	MT w/Adapter Upper, AT w/o Cruise w/Adapter Upper; 80.00" Cable	CA-3001
1982-83	V6 3.8L 231ci	A	w/Cruise Upper; 61.00" Cable	CA-3005
1982-83	V6 3.8L 231ci	A	w/Cruise w/Adapter Lower; 63.00" Cable	CA-3002
1982-83	V6 3.8L 231ci	A	w/Cruise w/o Adapter Lower; 83.00" Cable	CA-3004
1982-83	V6 3.8L 231ci	A	w/o Cruise w/Adapter Lower; 20.00" Cable	CA-3008
1982-83	V6 3.8L 231ci	A	w/o Cruise w/Adapter Upper; 80.00" Cable	CA-3001
1982-83	V6 3.8L 231ci	A	w/o Cruise w/o Adapter; 100.00" Cable	CA-3003
1982-83	V6 4.3L 260ci	V	w/Cruise Upper; 61.00" Cable	CA-3005
1982-83	V6 4.3L 260ci	V	w/Cruise w/Adapter Lower; 63.00" Cable	CA-3002
1982-83	V6 4.3L 260ci	V	w/Cruise w/o Adapter Lower; 83.00" Cable	CA-3004
1982-83	V6 4.3L 260ci	V	w/o Cruise w/Adapter Lower; 20.00" Cable	CA-3008
1982-83	V6 4.3L 260ci	V	w/o Cruise w/Adapter Upper; 80.00" Cable	CA-3001
1982-83	V6 4.3L 260ci	V	w/o Cruise w/o Adapter; 100.00" Cable	CA-3003
1979-81	V8 4.4L 267ci	J	AT w/Cruise Control, w/Adapter, Lower; 63.00" Cable	CA-3002
1979-81	V8 4.4L 267ci	J	AT w/Cruise w/Adapter Upper, AT w/o Cruise w/Adapter Lower	CA-3008
1979-81	V8 4.4L 267ci	J	AT w/Cruise w/o Adapter Lower; 83.00" Cable	CA-3004
1979-81	V8 4.4L 267ci	J	AT w/Cruise w/o Adapter Upper; 61.00" Cable	CA-3005
1979-81	V8 4.4L 267ci	J	AT w/o Cruise Control, w/o Gear Adapter, or MT; 100.00" Cable	CA-3003
1979-81	V8 4.4L 267ci	J	MT w/Adapter Upper, AT w/o Cruise w/Adapter Upper; 80.00" Cable	CA-3001
1982	V8 4.4L 267ci	J	w/Cruise Upper; 61.00" Cable	CA-3005
1982	V8 4.4L 267ci	J	w/Cruise w/Adapter Lower; 63.00" Cable	CA-3002
1982	V8 4.4L 267ci	J	w/Cruise w/o Adapter Lower; 83.00" Cable	CA-3004
1982	V8 4.4L 267ci	J	w/o Cruise w/Adapter Lower; 20.00" Cable	CA-3008
1982	V8 4.4L 267ci	J	w/o Cruise w/Adapter Upper; 80.00" Cable	CA-3001
1982	V8 4.4L 267ci	J	w/o Cruise w/o Adapter; 100.00" Cable	CA-3003
1964	V8 4.6L 283ci		63.00" Cable	CA-3002
1965	V8 4.6L 283ci		4 Spd. MT; 83.00" Cable	CA-3004
1965	V8 4.6L 283ci		AT & 3 Spd. MT; 63.00" Cable	CA-3002
1966	V8 4.6L 283ci		4 Spd. MT w/Cruise; 80.00" Cable	CA-3001
1966	V8 4.6L 283ci		AT w/Cruise, 3 Spd. MT	CA-3006
1966	V8 4.6L 283ci		AT w/o Cruise, 3 Spd. MT w/o Cruise; 63.00" Cable	CA-3002
1966-67	V8 4.6L 283ci		4 Spd. MT w/o Cruise; 83.00" Cable	CA-3004
1967	V8 4.6L 283ci		AT; 63.00" Cable	CA-3002
1979-81	V8 5.0L 305ci	H	AT w/Cruise Control, w/Adapter, Lower; 63.00" Cable	CA-3002
1979-81	V8 5.0L 305ci	H	AT w/Cruise w/Adapter Upper, AT w/o Cruise w/Adapter Lower	CA-3008
1979-81	V8 5.0L 305ci	H	AT w/Cruise w/o Adapter Lower; 83.00" Cable	CA-3004

# SPEEDOMETER CABLES

Year	Engine	Vin	Remark	Part
<b>CHEVROLET (con't)</b>				
<b>MALIBU (con't)</b>				
1979-81	V8 5.0L 305ci	H	AT w/Cruise w/o Adapter Upper; 61.00" Cable	CA-3005
1979-81	V8 5.0L 305ci	H	AT w/o Cruise Control, w/o Gear Adapter, or MT; 100.00" Cable	CA-3003
1979-81	V8 5.0L 305ci	H	MT w/Adapter Upper, AT w/o Cruise w/Adapter Upper; 80.00" Cable	CA-3001
1982-83	V8 5.0L 305ci	H	w/Cruise Upper; 61.00" Cable	CA-3005
1982-83	V8 5.0L 305ci	H	w/Cruise w/Adapter Lower; 63.00" Cable	CA-3002
1982-83	V8 5.0L 305ci	H	w/Cruise w/o Adapter Lower; 83.00" Cable	CA-3004
1982-83	V8 5.0L 305ci	H	w/o Cruise w/Adapter Lower; 20.00" Cable	CA-3008
1982-83	V8 5.0L 305ci	H	w/o Cruise w/Adapter Upper; 80.00" Cable	CA-3001
1982-83	V8 5.0L 305ci	H	w/o Cruise w/o Adapter; 100.00" Cable	CA-3003
1976	V8 5.0L 305ci	Q	AT w/o Cruise Control; 61.00" Cable	CA-3005
1976	V8 5.0L 305ci	Q	w/Cruise Lower; 83.00" Cable	CA-3004
1976	V8 5.0L 305ci	Q	w/Cruise Upper; 80.00" Cable	CA-3001
1977	V8 5.0L 305ci	U	AT w/o Cruise Control; 61.00" Cable	CA-3005
1977	V8 5.0L 305ci	U	w/Cruise Lower; 83.00" Cable	CA-3004
1977	V8 5.0L 305ci	U	w/Cruise Upper; 80.00" Cable	CA-3001
1978	V8 5.0L 305ci	U	AT w/Cruise Control, w/Adapter, Lower; 63.00" Cable	CA-3002
1978	V8 5.0L 305ci	U	AT w/Cruise w/Adapter Upper, AT w/o Cruise w/Adapter Lower	CA-3008
1978	V8 5.0L 305ci	U	AT w/Cruise w/o Adapter Lower; 83.00" Cable	CA-3004
1978	V8 5.0L 305ci	U	AT w/Cruise w/o Adapter Upper; 61.00" Cable	CA-3005
1978	V8 5.0L 305ci	U	AT w/o Cruise Control, w/o Gear Adapter, or MT; 100.00" Cable	CA-3003
1978	V8 5.0L 305ci	U	MT w/Adapter Upper, AT w/o Cruise w/Adapter Upper; 80.00" Cable	CA-3001
1973	V8 5.0L 307ci	F	3 Spd. MT 2 pc. Cable Lower; 40.00" Cable	CA-3033
1973	V8 5.0L 307ci	F	AT w/Cruise Control, Lower; 83.00" Cable	CA-3004
1973	V8 5.0L 307ci	F	AT w/Cruise Upper, AT w/o Cruise, MT; 80.00" Cable	CA-3001
1964	V8 5.4L 327ci		63.00" Cable	CA-3002
1965	V8 5.4L 327ci		4 Spd. MT; 83.00" Cable	CA-3004
1965	V8 5.4L 327ci		AT & 3 Spd. MT; 63.00" Cable	CA-3002
1966	V8 5.4L 327ci		4 Spd. MT w/Cruise; 80.00" Cable	CA-3001
1966	V8 5.4L 327ci		AT w/Cruise, 3 Spd. MT	CA-3006
1966	V8 5.4L 327ci		AT w/o Cruise, 3 Spd. MT w/o Cruise; 63.00" Cable	CA-3002
1966-67	V8 5.4L 327ci		4 Spd. MT w/o Cruise; 83.00" Cable	CA-3004
1967	V8 5.4L 327ci		AT; 63.00" Cable	CA-3002
1973	V8 5.7L 350ci	H,J	3 Spd. MT 2 pc. Cable Lower; 40.00" Cable	CA-3033
1973	V8 5.7L 350ci	H,J	AT w/Cruise Control, Lower; 83.00" Cable	CA-3004
1973	V8 5.7L 350ci	H,J	AT w/Cruise Upper, AT w/o Cruise, MT; 80.00" Cable	CA-3001
1974	V8 5.7L 350ci	H,L	AT & 4 Spd. MT w/Cruise Upper; 80.00" Cable	CA-3001
1975	V8 5.7L 350ci	H,L	w/Cruise Upper, w/o Cruise; 80.00" Cable	CA-3001
1974-77	V8 5.7L 350ci	H,L,V	w/Cruise Lower; 83.00" Cable	CA-3004
1976-77	V8 5.7L 350ci	L,V	AT w/o Cruise Control; 61.00" Cable	CA-3005
1976-77	V8 5.7L 350ci	L,V	w/Cruise Upper; 80.00" Cable	CA-3001
1978-81	V8 5.7L 350ci	L	AT w/Cruise Control, w/Adapter, Lower; 63.00" Cable	CA-3002
1978-81	V8 5.7L 350ci	L	AT w/Cruise w/Adapter Upper, AT w/o Cruise w/Adapter Lower	CA-3008
1978-81	V8 5.7L 350ci	L	AT w/Cruise w/o Adapter Lower; 83.00" Cable	CA-3004
1978-81	V8 5.7L 350ci	L	AT w/Cruise w/o Adapter Upper; 61.00" Cable	CA-3005
1978-81	V8 5.7L 350ci	L	AT w/o Cruise Control, w/o Gear Adapter, or MT; 100.00" Cable	CA-3003
1978-81	V8 5.7L 350ci	L	MT w/Adapter Upper, AT w/o Cruise w/Adapter Upper; 80.00" Cable	CA-3001
1982-83	V8 5.7L 350ci	N	w/Cruise Upper; 61.00" Cable	CA-3005
1982-83	V8 5.7L 350ci	N	w/Cruise w/Adapter Lower; 63.00" Cable	CA-3002
1982-83	V8 5.7L 350ci	N	w/Cruise w/o Adapter Lower; 83.00" Cable	CA-3004
1982-83	V8 5.7L 350ci	N	w/o Cruise w/Adapter Lower; 20.00" Cable	CA-3008
1982-83	V8 5.7L 350ci	N	w/o Cruise w/Adapter Upper; 80.00" Cable	CA-3001
1982-83	V8 5.7L 350ci	N	w/o Cruise w/o Adapter; 100.00" Cable	CA-3003
1966	V8 6.5L 396ci		4 Spd. MT w/Cruise; 80.00" Cable	CA-3001
1966	V8 6.5L 396ci		AT w/Cruise, 3 Spd. MT	CA-3006
1966	V8 6.5L 396ci		AT w/o Cruise, 3 Spd. MT w/o Cruise; 63.00" Cable	CA-3002
1966-67	V8 6.5L 396ci		4 Spd. MT w/o Cruise; 83.00" Cable	CA-3004
1967	V8 6.5L 396ci		AT; 63.00" Cable	CA-3002
1975	V8 6.6L 400ci	M,U	w/Cruise Upper, w/o Cruise; 80.00" Cable	CA-3001
1974	V8 6.6L 400ci	R,U	AT & 4 Spd. MT w/Cruise Upper; 80.00" Cable	CA-3001
1976	V8 6.6L 400ci	U	AT w/o Cruise Control; 61.00" Cable	CA-3005
1976	V8 6.6L 400ci	U	w/Cruise Upper; 80.00" Cable	CA-3001
1974-76	V8 6.6L 400ci	M,R,U	w/Cruise Lower; 83.00" Cable	CA-3004

# SPEEDOMETER CABLES

Year	Engine	Vin	Remark	Part
<b>CHEVROLET (con't)</b>				
<b>MALIBU (con't)</b>				
1973	V8 7.4L 454ci	Y	3 Spd. MT 2 pc. Cable Lower; 40.00" Cable	CA-3033
1973	V8 7.4L 454ci	Y	AT w/Cruise Control, Lower; 83.00" Cable	CA-3004
1973	V8 7.4L 454ci	Y	AT w/Cruise Upper, AT w/o Cruise, MT; 80.00" Cable	CA-3001
1974	V8 7.4L 454ci	Y	AT & 4 Spd. MT w/Cruise Upper; 80.00" Cable	CA-3001
1974	V8 7.4L 454ci	Y	w/Cruise Lower; 83.00" Cable	CA-3004
<b>MONTE CARLO</b>				
1978-79	V6 3.3L 200ci	M	AT w/Cruise Control, w/Adapter, Lower; 63.00" Cable	CA-3002
1978-79	V6 3.3L 200ci	M	AT w/Cruise w/Adapter Upper, AT w/o Cruise w/Adapter Lower	CA-3008
1978-79	V6 3.3L 200ci	M	AT w/Cruise w/o Adapter Lower; 83.00" Cable	CA-3004
1978-79	V6 3.3L 200ci	M	AT w/Cruise w/o Adapter Upper; 61.00" Cable	CA-3005
1978-79	V6 3.3L 200ci	M	AT w/o Cruise Control, w/o Gear Adapter, or MT; 100.00" Cable	CA-3003
1978-79	V6 3.3L 200ci	M	MT w/Adapter Upper, AT w/o Cruise w/Adapter Upper; 80.00" Cable	CA-3001
1983	V6 3.8L 229ci	9	w/Cruise Upper; 61.00" Cable	CA-3005
1983	V6 3.8L 229ci	9	w/Cruise w/Adapter Lower; 63.00" Cable	CA-3002
1983	V6 3.8L 229ci	9	w/Cruise w/o Adapter Lower; 83.00" Cable	CA-3004
1983	V6 3.8L 229ci	9	w/o Cruise w/Adapter Lower; 20.00" Cable	CA-3008
1983	V6 3.8L 229ci	9	w/o Cruise w/Adapter Upper; 80.00" Cable	CA-3001
1983	V6 3.8L 229ci	9	w/o Cruise w/o Adapter; 100.00" Cable	CA-3003
1984	V6 3.8L 229ci	9	3 Spd. AT w/o Adapter; 100.00" Cable	CA-3003
1984	V6 3.8L 229ci	9	4 Spd. AT w/o Adapter, w/Adapter Upper; 80.00" Cable	CA-3001
1984	V6 3.8L 229ci	9	w/Adapter Lower; 20.00" Cable	CA-3008
1980-81	V6 3.8L 229ci	K	AT w/Cruise Control, w/Adapter, Lower; 63.00" Cable	CA-3002
1980-81	V6 3.8L 229ci	K	AT w/Cruise w/Adapter Upper, AT w/o Cruise w/Adapter Lower	CA-3008
1980-81	V6 3.8L 229ci	K	AT w/Cruise w/o Adapter Lower; 83.00" Cable	CA-3004
1980-81	V6 3.8L 229ci	K	AT w/Cruise w/o Adapter Upper; 61.00" Cable	CA-3005
1980-81	V6 3.8L 229ci	K	AT w/o Cruise Control, w/o Gear Adapter, or MT; 100.00" Cable	CA-3003
1980-81	V6 3.8L 229ci	K	MT w/Adapter Upper, AT w/o Cruise w/Adapter Upper; 80.00" Cable	CA-3001
1982	V6 3.8L 229ci	K	w/Cruise Upper; 61.00" Cable	CA-3005
1982	V6 3.8L 229ci	K	w/Cruise w/Adapter Lower; 63.00" Cable	CA-3002
1982	V6 3.8L 229ci	K	w/Cruise w/o Adapter Lower; 83.00" Cable	CA-3004
1982	V6 3.8L 229ci	K	w/o Cruise w/Adapter Lower; 20.00" Cable	CA-3008
1982	V6 3.8L 229ci	K	w/o Cruise w/Adapter Upper; 80.00" Cable	CA-3001
1982	V6 3.8L 229ci	K	w/o Cruise w/o Adapter; 100.00" Cable	CA-3003
1978-81	V6 3.8L 231ci	2,3,A	AT w/Cruise Control, w/Adapter, Lower; 63.00" Cable	CA-3002
1978-81	V6 3.8L 231ci	2,3,A	AT w/Cruise w/Adapter Upper, AT w/o Cruise w/Adapter Lower	CA-3008
1978-81	V6 3.8L 231ci	2,3,A	AT w/Cruise w/o Adapter Lower; 83.00" Cable	CA-3004
1978-81	V6 3.8L 231ci	2,3,A	AT w/Cruise w/o Adapter Upper; 61.00" Cable	CA-3005
1978-81	V6 3.8L 231ci	2,3,A	AT w/o Cruise Control, w/o Gear Adapter, or MT; 100.00" Cable	CA-3003
1978-81	V6 3.8L 231ci	2,3,A	MT w/Adapter Upper, AT w/o Cruise w/Adapter Upper; 80.00" Cable	CA-3001
1982-83	V6 3.8L 231ci	A	w/Cruise Upper; 61.00" Cable	CA-3005
1982-83	V6 3.8L 231ci	A	w/Cruise w/Adapter Lower; 63.00" Cable	CA-3002
1982-83	V6 3.8L 231ci	A	w/Cruise w/o Adapter Lower; 83.00" Cable	CA-3004
1982-83	V6 3.8L 231ci	A	w/o Cruise w/Adapter Lower; 20.00" Cable	CA-3008
1982-83	V6 3.8L 231ci	A	w/o Cruise w/Adapter Upper; 80.00" Cable	CA-3001
1982-83	V6 3.8L 231ci	A	w/o Cruise w/o Adapter; 100.00" Cable	CA-3003
1984-85	V6 3.8L 231ci	A	3 Spd. AT w/o Adapter; 100.00" Cable	CA-3003
1984-85	V6 3.8L 231ci	A	4 Spd. AT w/o Adapter, w/Adapter Upper; 80.00" Cable	CA-3001
1984-85	V6 3.8L 231ci	A	w/Adapter Lower; 20.00" Cable	CA-3008
1986-87	V6 3.8L 231ci	A	AT w/Adapter w/Interconnector Upper, 200-R4 AT w/o Adapter, TH-200 w/Adapter Upper; 80.00" Cable	CA-3001
1986-87	V6 3.8L 231ci	A	MT w/o Adapter, AT wo Adapter exc. TH-200, TH200-R4"; 100.00" Cable	CA-3003
1986-87	V6 3.8L 231ci	A	TH-200 w/Adapter Upper; 120.00" Cable	CA-3007
1986-87	V6 3.8L 231ci	A	TH-200 w/o Adapter; 61.00" Cable	CA-3005
1986-87	V6 3.8L 231ci	A	w/Adapter, w/interconnector; 20.00" Cable	CA-3008
1982-83	V6 4.3L 260ci	V	w/Cruise Upper; 61.00" Cable	CA-3005
1982-83	V6 4.3L 260ci	V	w/Cruise w/Adapter Lower; 63.00" Cable	CA-3002
1982-83	V6 4.3L 260ci	V	w/Cruise w/o Adapter Lower; 83.00" Cable	CA-3004
1982-83	V6 4.3L 260ci	V	w/o Cruise w/Adapter Lower; 20.00" Cable	CA-3008
1982-83	V6 4.3L 260ci	V	w/o Cruise w/Adapter Upper; 80.00" Cable	CA-3001
1982-83	V6 4.3L 260ci	V	w/o Cruise w/o Adapter; 100.00" Cable	CA-3003
1985	V6 4.3L 262ci	Z	3 Spd. AT w/o Adapter; 100.00" Cable	CA-3003
1985	V6 4.3L 262ci	Z	4 Spd. AT w/o Adapter, w/Adapter Upper; 80.00" Cable	CA-3001

# SPEEDOMETER CABLES

Year	Engine	Vin	Remark	Part
<b>CHEVROLET (con't)</b>				
<b>MONTE CARLO (con't)</b>				
1985	V6 4.3L 262ci	Z	w/Adapter Lower; 20.00" Cable	CA-3008
1986-87	V6 4.3L 262ci	Z	AT w/Adapter w/Interconnector Upper, 200-R4 AT w/o Adapter, TH-200 w/Adapter Upper; 80.00" Cable	CA-3001
1986-87	V6 4.3L 262ci	Z	MT w/o Adapter, AT wo Adapter exc. TH-200, TH200-R4"; 100.00" Cable	CA-3003
1986-87	V6 4.3L 262ci	Z	TH-200 w/Adapter Upper; 120.00" Cable	CA-3007
1986-87	V6 4.3L 262ci	Z	w/Adapter, w/interconnector; 20.00" Cable	CA-3008
1986-88	V6 4.3L 262ci	Z	TH-200 w/o Adapter; 61.00" Cable	CA-3005
1988	V6 4.3L 262ci	Z	TH-200-R4 AT w/o Adapter; 80.00" Cable	CA-3001
1988	V6 4.3L 262ci	Z	w/o Adapter exc. TH-200, TH200-R4"; 100.00" Cable	CA-3003
1979-81	V8 4.4L 267ci	J	AT w/Cruise Control, w/Adapter, Lower; 63.00" Cable	CA-3002
1979-81	V8 4.4L 267ci	J	AT w/Cruise w/Adapter Upper, AT w/o Cruise w/Adapter Lower	CA-3008
1979-81	V8 4.4L 267ci	J	AT w/Cruise w/o Adapter Lower; 83.00" Cable	CA-3004
1979-81	V8 4.4L 267ci	J	AT w/Cruise w/o Adapter Upper; 61.00" Cable	CA-3005
1979-81	V8 4.4L 267ci	J	AT w/o Cruise Control, w/o Gear Adapter, or MT; 100.00" Cable	CA-3003
1979-81	V8 4.4L 267ci	J	MT w/Adapter Upper, AT w/o Cruise w/Adapter Upper; 80.00" Cable	CA-3001
1982	V8 4.4L 267ci	J	w/Cruise Upper; 61.00" Cable	CA-3005
1982	V8 4.4L 267ci	J	w/Cruise w/Adapter Lower; 63.00" Cable	CA-3002
1982	V8 4.4L 267ci	J	w/Cruise w/o Adapter Lower; 83.00" Cable	CA-3004
1982	V8 4.4L 267ci	J	w/o Cruise w/Adapter Lower; 20.00" Cable	CA-3008
1982	V8 4.4L 267ci	J	w/o Cruise w/Adapter Upper; 80.00" Cable	CA-3001
1982	V8 4.4L 267ci	J	w/o Cruise w/o Adapter; 100.00" Cable	CA-3003
1979-81	V8 5.0L 305ci	H	AT w/Cruise Control, w/Adapter, Lower; 63.00" Cable	CA-3002
1979-81	V8 5.0L 305ci	H	AT w/Cruise w/Adapter Upper, AT w/o Cruise w/Adapter Lower	CA-3008
1979-81	V8 5.0L 305ci	H	AT w/Cruise w/o Adapter Lower; 83.00" Cable	CA-3004
1979-81	V8 5.0L 305ci	H	AT w/Cruise w/o Adapter Upper; 61.00" Cable	CA-3005
1979-81	V8 5.0L 305ci	H	AT w/o Cruise Control, w/o Gear Adapter, or MT; 100.00" Cable	CA-3003
1979-81	V8 5.0L 305ci	H	MT w/Adapter Upper, AT w/o Cruise w/Adapter Upper; 80.00" Cable	CA-3001
1982-83	V8 5.0L 305ci	H	w/Cruise Upper; 61.00" Cable	CA-3005
1982-83	V8 5.0L 305ci	H	w/Cruise w/Adapter Lower; 63.00" Cable	CA-3002
1982-83	V8 5.0L 305ci	H	w/Cruise w/o Adapter Lower; 83.00" Cable	CA-3004
1982-83	V8 5.0L 305ci	H	w/o Cruise w/Adapter Lower; 20.00" Cable	CA-3008
1982-83	V8 5.0L 305ci	H	w/o Cruise w/Adapter Upper; 80.00" Cable	CA-3001
1982-83	V8 5.0L 305ci	H	w/o Cruise w/o Adapter; 100.00" Cable	CA-3003
1984-85	V8 5.0L 305ci	H	3 Spd. AT w/o Adapter; 100.00" Cable	CA-3003
1984-85	V8 5.0L 305ci	H	4 Spd. AT w/o Adapter, w/Adapter Upper; 80.00" Cable	CA-3001
1984-85	V8 5.0L 305ci	H	w/Adapter Lower; 20.00" Cable	CA-3008
1986-87	V8 5.0L 305ci	H	AT w/Adapter w/Interconnector Upper, 200-R4 AT w/o Adapter, TH-200 w/Adapter Upper; 80.00" Cable	CA-3001
1986-87	V8 5.0L 305ci	H	MT w/o Adapter, AT wo Adapter exc. TH-200, TH200-R4"; 100.00" Cable	CA-3003
1986-87	V8 5.0L 305ci	H	TH-200 w/Adapter Upper; 120.00" Cable	CA-3007
1986-87	V8 5.0L 305ci	H	w/Adapter, w/interconnector; 20.00" Cable	CA-3008
1986-88	V8 5.0L 305ci	H	TH-200 w/o Adapter; 61.00" Cable	CA-3005
1988	V8 5.0L 305ci	H	TH-200-R4 AT w/o Adapter; 80.00" Cable	CA-3001
1988	V8 5.0L 305ci	H	w/o Adapter exc. TH-200, TH200-R4"; 100.00" Cable	CA-3003
1976	V8 5.0L 305ci	Q	AT w/o Cruise Control; 61.00" Cable	CA-3005
1976	V8 5.0L 305ci	Q	w/Cruise Lower; 83.00" Cable	CA-3004
1976	V8 5.0L 305ci	Q	w/Cruise Upper; 80.00" Cable	CA-3001
1977	V8 5.0L 305ci	U	AT w/o Cruise Control; 61.00" Cable	CA-3005
1977	V8 5.0L 305ci	U	w/Cruise Lower; 83.00" Cable	CA-3004
1977	V8 5.0L 305ci	U	w/Cruise Upper; 80.00" Cable	CA-3001
1978	V8 5.0L 305ci	U	AT w/Cruise Control, w/Adapter, Lower; 63.00" Cable	CA-3002
1978	V8 5.0L 305ci	U	AT w/Cruise w/Adapter Upper, AT w/o Cruise w/Adapter Lower	CA-3008
1978	V8 5.0L 305ci	U	AT w/Cruise w/o Adapter Lower; 83.00" Cable	CA-3004
1978	V8 5.0L 305ci	U	AT w/Cruise w/o Adapter Upper; 61.00" Cable	CA-3005
1978	V8 5.0L 305ci	U	AT w/o Cruise Control, w/o Gear Adapter, or MT; 100.00" Cable	CA-3003
1978	V8 5.0L 305ci	U	MT w/Adapter Upper, AT w/o Cruise w/Adapter Upper; 80.00" Cable	CA-3001
1970	V8 5.7L 350ci		w/o Cruise Control; 80.00" Cable	CA-3001
1971	V8 5.7L 350ci		3 Spd. MT; 80.00" Cable	CA-3001
1971	V8 5.7L 350ci		AT w/Cruise Control, Upper; 61.00" Cable	CA-3005
1971	V8 5.7L 350ci		AT w/Cruise Lower, AT w/o Cruise; 63.00" Cable	CA-3002
1972	V8 5.7L 350ci	H,J	AT w/Cruise Upper, AT w/o Cruise; 61.00" Cable	CA-3005
1972	V8 5.7L 350ci	H,J	Powerglide AT w/Cruise Lower, 3 Spd. MT; 80.00" Cable	CA-3001

# SPEEDOMETER CABLES

Year	Engine	Vin	Remark	Part
<b>CHEVROLET (con't)</b>				
<b>MONTE CARLO (con't)</b>				
1972	V8 5.7L 350ci	H,J	THM AT w/Cruise Lower; 63.00" Cable	CA-3002
1973	V8 5.7L 350ci	H,J	3 Spd. MT 2 pc. Cable Lower; 40.00" Cable	CA-3033
1973	V8 5.7L 350ci	H,J	AT w/Cruise Control, Lower; 83.00" Cable	CA-3004
1973	V8 5.7L 350ci	H,J	AT w/Cruise Upper, AT w/o Cruise, MT; 80.00" Cable	CA-3001
1974	V8 5.7L 350ci	H,L	AT & 4 Spd. MT w/Cruise Upper; 80.00" Cable	CA-3001
1975	V8 5.7L 350ci	H,L	w/Cruise Upper, w/o Cruise; 80.00" Cable	CA-3001
1974-77	V8 5.7L 350ci	H,L,V	w/Cruise Lower; 83.00" Cable	CA-3004
1976-77	V8 5.7L 350ci	L,V	AT w/o Cruise Control; 61.00" Cable	CA-3005
1976-77	V8 5.7L 350ci	L,V	w/Cruise Upper; 80.00" Cable	CA-3001
1981	V8 5.7L 350ci	L	AT w/Cruise Control, w/Adapter, Lower; 63.00" Cable	CA-3002
1981	V8 5.7L 350ci	L	AT w/Cruise w/Adapter Upper, AT w/o Cruise w/Adapter Lower	CA-3008
1981	V8 5.7L 350ci	L	AT w/Cruise w/o Adapter Lower; 83.00" Cable	CA-3004
1981	V8 5.7L 350ci	L	AT w/Cruise w/o Adapter Upper; 61.00" Cable	CA-3005
1981	V8 5.7L 350ci	L	AT w/o Cruise Control, w/o Gear Adapter, or MT; 100.00" Cable	CA-3003
1981	V8 5.7L 350ci	L	MT w/Adapter Upper, AT w/o Cruise w/Adapter Upper; 80.00" Cable	CA-3001
1984	V8 5.7L 350ci	N	3 Spd. AT w/o Adapter; 100.00" Cable	CA-3003
1984	V8 5.7L 350ci	N	4 Spd. AT w/o Adapter, w/Adapter Upper; 80.00" Cable	CA-3001
1984	V8 5.7L 350ci	N	w/Adapter Lower; 20.00" Cable	CA-3008
1982-83	V8 5.7L 350ci	N	w/Cruise Upper; 61.00" Cable	CA-3005
1982-83	V8 5.7L 350ci	N	w/Cruise w/Adapter Lower; 63.00" Cable	CA-3002
1982-83	V8 5.7L 350ci	N	w/Cruise w/o Adapter Lower; 83.00" Cable	CA-3004
1982-83	V8 5.7L 350ci	N	w/o Cruise w/Adapter Lower; 20.00" Cable	CA-3008
1982-83	V8 5.7L 350ci	N	w/o Cruise w/Adapter Upper; 80.00" Cable	CA-3001
1982-83	V8 5.7L 350ci	N	w/o Cruise w/o Adapter; 100.00" Cable	CA-3003
1970	V8 6.6L 400ci		w/o Cruise Control; 80.00" Cable	CA-3001
1971	V8 6.6L 400ci		3 Spd. MT; 80.00" Cable	CA-3001
1971	V8 6.6L 400ci		AT w/Cruise Control, Upper; 61.00" Cable	CA-3005
1971	V8 6.6L 400ci		AT w/Cruise Lower, AT w/o Cruise; 63.00" Cable	CA-3002
1970	V8 6.6L 402ci		w/o Cruise Control; 80.00" Cable	CA-3001
1972	V8 6.6L 400ci	R	AT w/Cruise Upper, AT w/o Cruise; 61.00" Cable	CA-3005
1972	V8 6.6L 400ci	R	Powerglide AT w/Cruise Lower, 3 Spd. MT; 80.00" Cable	CA-3001
1972	V8 6.6L 400ci	R	THM AT w/Cruise Lower; 63.00" Cable	CA-3002
1973	V8 6.6L 400ci	R	3 Spd. MT 2 pc. Cable Lower; 40.00" Cable	CA-3033
1973	V8 6.6L 400ci	R	AT w/Cruise Control, Lower; 83.00" Cable	CA-3004
1973	V8 6.6L 400ci	R	AT w/Cruise Upper, AT w/o Cruise, MT; 80.00" Cable	CA-3001
1974	V8 6.6L 400ci	R	AT & 4 Spd. MT w/Cruise Upper; 80.00" Cable	CA-3001
1974-75	V8 6.6L 400ci	U	w/Cruise Upper, w/o Cruise; 80.00" Cable	CA-3001
1974-76	V8 6.6L 400ci	R,U	w/Cruise Lower; 83.00" Cable	CA-3004
1976	V8 6.6L 400ci	U	AT w/o Cruise Control; 61.00" Cable	CA-3005
1976	V8 6.6L 400ci	U	w/Cruise Upper; 80.00" Cable	CA-3001
1972	V8 6.6L 402ci	S	AT w/Cruise Upper, AT w/o Cruise; 61.00" Cable	CA-3005
1972	V8 6.6L 402ci	S	Powerglide AT w/Cruise Lower, 3 Spd. MT; 80.00" Cable	CA-3001
1972	V8 6.6L 402ci	S	THM AT w/Cruise Lower; 63.00" Cable	CA-3002
1970	V8 7.4L 454ci		w/o Cruise Control; 80.00" Cable	CA-3001
1971	V8 7.4L 454ci		3 Spd. MT; 80.00" Cable	CA-3001
1971	V8 7.4L 454ci		AT w/Cruise Control, Upper; 61.00" Cable	CA-3005
1971	V8 7.4L 454ci		AT w/Cruise Lower, AT w/o Cruise; 63.00" Cable	CA-3002
1972	V8 7.4L 454ci	V	AT w/Cruise Upper, AT w/o Cruise; 61.00" Cable	CA-3005
1972	V8 7.4L 454ci	V	Powerglide AT w/Cruise Lower, 3 Spd. MT; 80.00" Cable	CA-3001
1972	V8 7.4L 454ci	V	THM AT w/Cruise Lower; 63.00" Cable	CA-3002
1973	V8 7.4L 454ci	X	3 Spd. MT 2 pc. Cable Lower; 40.00" Cable	CA-3033
1973	V8 7.4L 454ci	X	AT w/Cruise Control, Lower; 83.00" Cable	CA-3004
1973	V8 7.4L 454ci	X	AT w/Cruise Upper, AT w/o Cruise, MT; 80.00" Cable	CA-3001
1974	V8 7.4L 454ci	Y	AT & 4 Spd. MT w/Cruise Upper; 80.00" Cable	CA-3001
1975	V8 7.4L 454ci	Y	w/Cruise Upper, w/o Cruise; 80.00" Cable	CA-3001
1974-75	V8 7.4L 454ci	Y	w/Cruise Lower; 83.00" Cable	CA-3004
<b>MONZA</b>				
1975	L4 2.3L 140ci	B	61.00" Cable	CA-3005
1976-77	L4 2.3L 140ci	A,B	w/MT; 61.00" Cable	CA-3005
1978-79	L4 2.5L 151ci	1,9	61.00" Cable	CA-3005
1978-80	L4 2.5L 151ci	V	61.00" Cable	CA-3005
1978-79	V6 3.2L 196ci	C	80.00" Cable	CA-3001



# SPEEDOMETER CABLES

Year	Engine	Vin	Remark	Part
<b>CHEVROLET (con't)</b>				
<b>MONZA (con't)</b>				
1978-80	V6 3.8L 231ci	A	80.00" Cable	CA-3001
1975	V8 4.3L 262ci	G	5 Spd. MT; 80.00" Cable	CA-3001
1976	V8 4.3L 262ci	G	w/MT; 61.00" Cable	CA-3005
1976	V8 5.0L 305ci	Q	w/MT; 61.00" Cable	CA-3005
1977	V8 5.0L 305ci	U	w/MT; 61.00" Cable	CA-3005
1978	V8 5.0L 305ci	U	80.00" Cable	CA-3001
1975	V8 5.7L 350ci	H	61.00" Cable	CA-3005
<b>NOVA</b>				
1985-88	L4 1.6L 98ci	4,5	5 Spd. MT	CA-3042
1962	L4 2.5L 153ci		AT; 83.00" Cable	CA-3004
1962	L4 2.5L 153ci		MT; 63.00" Cable	CA-3002
1963	L4 2.5L 153ci		63.00" Cable	CA-3002
1964-65	L4 2.5L 153ci		3 Spd. MT; 63.00" Cable	CA-3002
1964-65	L4 2.5L 153ci		exc.3 Spd. MT; 83.00" Cable	CA-3004
1966-67	L4 2.5L 153ci		w/Cruise Lower; 83.00" Cable	CA-3004
1966-67	L4 2.5L 153ci		w/Cruise Upper	CA-3006
1966-67	L4 2.5L 153ci		w/o Cruise Control; 63.00" Cable	CA-3002
1969	L4 2.5L 153ci		4 Spd. Muncie MT; 61.00" Cable	CA-3005
1969-70	L4 2.5L 153ci		AT; 80.00" Cable	CA-3001
1969	L4 2.5L 153ci		MT w/o Muncie 4 Spd.; 41.00" Cable	CA-3009
1970	L4 2.5L 153ci		MT 3 & 4 Spd. Saginaw; 61.00" Cable	CA-3005
1970	L4 2.5L 153ci		MT 3 Spd. exc. Saginaw; 40.00" Cable	CA-3033
1962	L6 3.2L 194ci		AT; 83.00" Cable	CA-3004
1962	L6 3.2L 194ci		MT; 63.00" Cable	CA-3002
1963	L6 3.2L 194ci		63.00" Cable	CA-3002
1964-65	L6 3.2L 194ci		3 Spd. MT; 63.00" Cable	CA-3002
1964-65	L6 3.2L 194ci		exc.3 Spd. MT; 83.00" Cable	CA-3004
1966	L6 3.2L 194ci		w/Cruise Lower; 83.00" Cable	CA-3004
1966	L6 3.2L 194ci		w/Cruise Upper	CA-3006
1966	L6 3.2L 194ci		w/o Cruise Control; 63.00" Cable	CA-3002
1964-65	L6 3.8L 230ci		3 Spd. MT; 63.00" Cable	CA-3002
1964-65	L6 3.8L 230ci		exc.3 Spd. MT; 83.00" Cable	CA-3004
1966	L6 3.8L 230ci		w/Cruise Lower; 83.00" Cable	CA-3004
1966	L6 3.8L 230ci		w/Cruise Upper	CA-3006
1966	L6 3.8L 230ci		w/o Cruise Control; 63.00" Cable	CA-3002
1969	L6 3.8L 230ci		4 Spd. Muncie MT; 63.00" Cable	CA-3002
1969	L6 3.8L 230ci		AT; 83.00" Cable	CA-3004
1969	L6 3.8L 230ci		MT w/o Muncie 4 Spd.	CA-3006
1970	L6 3.8L 230ci		AT; 80.00" Cable	CA-3001
1970	L6 3.8L 230ci		MT 3 & 4 Spd. Saginaw; 61.00" Cable	CA-3005
1970	L6 3.8L 230ci		MT 3 Spd. exc. Saginaw; 40.00" Cable	CA-3033
1967	L6 4.1L 250ci		w/Cruise Lower; 83.00" Cable	CA-3004
1967	L6 4.1L 250ci		w/Cruise Upper	CA-3006
1967	L6 4.1L 250ci		w/o Cruise Control; 63.00" Cable	CA-3002
1969	L6 4.1L 250ci		4 Spd. Muncie MT; 63.00" Cable	CA-3002
1969	L6 4.1L 250ci		AT; 83.00" Cable	CA-3004
1969	L6 4.1L 250ci		MT w/o Muncie 4 Spd.	CA-3006
1970	L6 4.1L 250ci		AT; 80.00" Cable	CA-3001
1970	L6 4.1L 250ci		MT 3 & 4 Spd. Saginaw; 61.00" Cable	CA-3005
1970	L6 4.1L 250ci		MT 3 Spd. exc. Saginaw; 40.00" Cable	CA-3033
1971	L6 4.1L 250ci		4 Spd. Muncie MT, Convertible w/MT 3 & 4 Spd. Saginaw Upper	CA-3005
1971	L6 4.1L 250ci		MT 3 Spd. Synchronized; 40.00" Cable	CA-3033
1971	L6 4.1L 250ci		w/o Cruise Control; 80.00" Cable	CA-3001
1972	L6 4.1L 250ci	D	4 Spd. Muncie MT, Convertible w/MT 3 & 4 Spd. Saginaw Upper	CA-3005
1972	L6 4.1L 250ci	D	w/o Cruise Control; 80.00" Cable	CA-3001
1972-74	L6 4.1L 250ci	D	MT 3 Spd. Synchronized; 40.00" Cable	CA-3033
1973	L6 4.1L 250ci	D	Convertible w/MT 3 & 4 Spd. Saginaw Upper; 61.00" Cable	CA-3005
1973-74	L6 4.1L 250ci	D	3 Spd. AT w/o Cruise; 80.00" Cable	CA-3001
1973-74	L6 4.1L 250ci	D	3 Spd. MT w/o Floor Shift; 80.00" Cable	CA-3001
1975	L6 4.1L 250ci	D	4 Spd. MT, 3 Spd. MT w/1pc Cable exc. Floor Shift; 80.00" Cable	CA-3001
1975	L6 4.1L 250ci	D	AT w/o Cruise Control; 100.00" Cable	CA-3003
1975	L6 4.1L 250ci	D	MT w/o Cruise Lower; 40.00" Cable	CA-3033

# SPEEDOMETER CABLES

Year	Engine	Vin	Remark	Part
<b>CHEVROLET (con't)</b>				
<b>NOVA (con't)</b>				
1975	L6 4.1L 250ci	D	MT w/o Cruise Upper; 61.00" Cable	CA-3005
1976	L6 4.1L 250ci	D	w/Cruise Control, Upper, w/Floor Shift; 61.00" Cable	CA-3005
1976-77	L6 4.1L 250ci	D	Lower; 40.00" Cable	CA-3033
1976-77	L6 4.1L 250ci	D	w/o Cruise Control; 100.00" Cable	CA-3003
1976-79	L6 4.1L 250ci	D	3 Spd. MT 1 pc Cable exc. Floor Shift; 80.00" Cable	CA-3001
1977-79	L6 4.1L 250ci	D	w/o Cruise Upper; 61.00" Cable	CA-3005
1978-79	L6 4.1L 250ci	D	w/Cruise Upper & Lower; 83.00" Cable	CA-3004
1978-79	L6 4.1L 250ci	D	w/o Cruise Lower; 40.00" Cable	CA-3033
1975	V8 4.3L 262ci	G	4 Spd. MT, 3 Spd. MT w/1pc Cable exc. Floor Shift; 80.00" Cable	CA-3001
1975	V8 4.3L 262ci	G	AT w/o Cruise Control; 100.00" Cable	CA-3003
1975	V8 4.3L 262ci	G	MT w/o Cruise Lower; 40.00" Cable	CA-3033
1975	V8 4.3L 262ci	G	MT w/o Cruise Upper; 61.00" Cable	CA-3005
1962	V8 4.6L 283ci		AT; 83.00" Cable	CA-3004
1962	V8 4.6L 283ci		MT; 63.00" Cable	CA-3002
1963	V8 4.6L 283ci		63.00" Cable	CA-3002
1964-65	V8 4.6L 283ci		3 Spd. MT; 63.00" Cable	CA-3002
1964-65	V8 4.6L 283ci		exc.3 Spd. MT; 83.00" Cable	CA-3004
1966-67	V8 4.6L 283ci		w/Cruise Lower; 83.00" Cable	CA-3004
1966-67	V8 4.6L 283ci		w/Cruise Upper	CA-3006
1966-67	V8 4.6L 283ci		w/o Cruise Control; 63.00" Cable	CA-3002
1979	V8 5.0L 305ci	G	3 Spd. MT 1 pc Cable exc. Floor Shift; 80.00" Cable	CA-3001
1979	V8 5.0L 305ci	G	w/Cruise Upper & Lower; 83.00" Cable	CA-3004
1979	V8 5.0L 305ci	G	w/o Cruise Lower; 40.00" Cable	CA-3033
1979	V8 5.0L 305ci	G	w/o Cruise Upper; 61.00" Cable	CA-3005
1976	V8 5.0L 305ci	Q	3 Spd. MT 1 pc Cable exc. Floor Shift; 80.00" Cable	CA-3001
1976	V8 5.0L 305ci	Q	Lower; 40.00" Cable	CA-3033
1976	V8 5.0L 305ci	Q	w/Cruise Control, Upper, w/Floor Shift; 61.00" Cable	CA-3005
1976	V8 5.0L 305ci	Q	w/o Cruise Control; 100.00" Cable	CA-3003
1977	V8 5.0L 305ci	U	Lower; 40.00" Cable	CA-3033
1977	V8 5.0L 305ci	U	w/o Cruise Control; 100.00" Cable	CA-3003
1977-78	V8 5.0L 305ci	U	3 Spd. MT 1 pc Cable exc. Floor Shift; 80.00" Cable	CA-3001
1977-78	V8 5.0L 305ci	U	w/o Cruise Upper; 61.00" Cable	CA-3005
1978	V8 5.0L 305ci	U	w/Cruise Upper & Lower; 83.00" Cable	CA-3004
1978	V8 5.0L 305ci	U	w/o Cruise Lower; 40.00" Cable	CA-3033
1969	V8 5.0L 307ci		4 Spd. Muncie MT; 61.00" Cable	CA-3005
1969-70	V8 5.0L 307ci		AT; 80.00" Cable	CA-3001
1969	V8 5.0L 307ci		MT w/o Muncie 4 Spd.; 41.00" Cable	CA-3009
1970	V8 5.0L 307ci		MT 3 & 4 Spd. Saginaw; 61.00" Cable	CA-3005
1970	V8 5.0L 307ci		MT 3 Spd. exc. Saginaw; 40.00" Cable	CA-3033
1971	V8 5.0L 307ci		4 Spd. Muncie MT, Convertible w/MT 3 & 4 Spd. Saginaw Upper	CA-3005
1971	V8 5.0L 307ci		MT 3 Spd. Synchronized; 40.00" Cable	CA-3033
1971	V8 5.0L 307ci		w/o Cruise Control; 80.00" Cable	CA-3001
1972	V8 5.0L 307ci	F	4 Spd. Muncie MT, Convertible w/MT 3 & 4 Spd. Saginaw Upper	CA-3005
1972	V8 5.0L 307ci	F	w/o Cruise Control; 80.00" Cable	CA-3001
1973	V8 5.0L 307ci	F	3 Spd. AT w/o Cruise; 80.00" Cable	CA-3001
1973	V8 5.0L 307ci	F	3 Spd. MT w/o Floor Shift; 80.00" Cable	CA-3001
1973	V8 5.0L 307ci	F	Convertible w/MT 3 & 4 Spd. Saginaw Upper; 61.00" Cable	CA-3005
1972-73	V8 5.0L 307ci	F	MT 3 Spd. Synchronized; 40.00" Cable	CA-3033
1965	V8 5.4L 327ci		3 Spd. MT; 63.00" Cable	CA-3002
1965	V8 5.4L 327ci		exc.3 Spd. MT; 83.00" Cable	CA-3004
1966-67	V8 5.4L 327ci		w/Cruise Lower; 83.00" Cable	CA-3004
1966-67	V8 5.4L 327ci		w/Cruise Upper	CA-3006
1966-67	V8 5.4L 327ci		w/o Cruise Control; 63.00" Cable	CA-3002
1969	V8 5.7L 350ci		4 Spd. Muncie MT; 63.00" Cable	CA-3002
1969	V8 5.7L 350ci		AT; 83.00" Cable	CA-3004
1969	V8 5.7L 350ci		MT w/o Muncie 4 Spd.	CA-3006
1970	V8 5.7L 350ci		AT; 80.00" Cable	CA-3001
1970	V8 5.7L 350ci		MT 3 & 4 Spd. Saginaw; 61.00" Cable	CA-3005
1970	V8 5.7L 350ci		MT 3 Spd. exc. Saginaw; 40.00" Cable	CA-3033
1971	V8 5.7L 350ci		4 Spd. Muncie MT, Convertible w/MT 3 & 4 Spd. Saginaw Upper	CA-3005
1971	V8 5.7L 350ci		MT 3 Spd. Synchronized; 40.00" Cable	CA-3033
1971	V8 5.7L 350ci		w/o Cruise Control; 80.00" Cable	CA-3001

# SPEEDOMETER CABLES

Year	Engine	Vin	Remark	Part
<b>CHEVROLET (con't)</b>				
<b>NOVA (con't)</b>				
1972	V8 5.7L 350ci	H,K	4 Spd. Muncie MT, Convertible w/MT 3 & 4 Spd. Saginaw Upper	CA-3005
1972	V8 5.7L 350ci	H,K	w/o Cruise Control; 80.00" Cable	CA-3001
1972-73	V8 5.7L 350ci	H,K	MT 3 Spd. Synchronized; 40.00" Cable	CA-3033
1973	V8 5.7L 350ci	H,K	Convertible w/MT 3 & 4 Spd. Saginaw Upper; 61.00" Cable	CA-3005
1973-74	V8 5.7L 350ci	H,J,K,L	3 Spd. AT w/o Cruise; 80.00" Cable	CA-3001
1973-74	V8 5.7L 350ci	H,J,K,L	3 Spd. MT w/o Floor Shift; 80.00" Cable	CA-3001
1974	V8 5.7L 350ci	H,J,K,L	MT 3 Spd. Synchronized Lower; 40.00" Cable	CA-3033
1974	V8 5.7L 350ci	H,J,K,L	MT 3 Spd. Synchronized Upper; 61.00" Cable	CA-3005
1975	V8 5.7L 350ci	H,L	4 Spd. MT, 3 Spd. MT w/1pc Cable exc. Floor Shift; 80.00" Cable	CA-3001
1975	V8 5.7L 350ci	H,L	AT w/o Cruise Control; 100.00" Cable	CA-3003
1975	V8 5.7L 350ci	H,L	MT w/o Cruise Lower; 40.00" Cable	CA-3033
1975	V8 5.7L 350ci	H,L	MT w/o Cruise Upper; 61.00" Cable	CA-3005
1976	V8 5.7L 350ci	L	w/Cruise Control, Upper, w/Floor Shift; 61.00" Cable	CA-3005
1976-77	V8 5.7L 350ci	L	Lower; 40.00" Cable	CA-3033
1976-77	V8 5.7L 350ci	L	w/o Cruise Control; 100.00" Cable	CA-3003
1976-79	V8 5.7L 350ci	L	3 Spd. MT 1 pc Cable exc. Floor Shift; 80.00" Cable	CA-3001
1977-79	V8 5.7L 350ci	L	w/o Cruise Upper; 61.00" Cable	CA-3005
1978-79	V8 5.7L 350ci	L	w/Cruise Upper & Lower; 83.00" Cable	CA-3004
1978-79	V8 5.7L 350ci	L	w/o Cruise Lower; 40.00" Cable	CA-3033
1969	V8 6.5L 396ci		4 Spd. Muncie MT; 63.00" Cable	CA-3002
1969	V8 6.5L 396ci		AT; 83.00" Cable	CA-3004
1969	V8 6.5L 396ci		MT w/o Muncie 4 Spd.	CA-3006
1970	V8 6.5L 396ci		AT; 80.00" Cable	CA-3001
1970	V8 6.5L 396ci		MT 3 & 4 Spd. Saginaw; 61.00" Cable	CA-3005
1970	V8 6.5L 396ci		MT 3 Spd. exc. Saginaw; 40.00" Cable	CA-3033
1970	V8 6.6L 402ci		AT; 80.00" Cable	CA-3001
1970	V8 6.6L 402ci		MT 3 & 4 Spd. Saginaw; 61.00" Cable	CA-3005
1970	V8 6.6L 402ci		MT 3 Spd. exc. Saginaw; 40.00" Cable	CA-3033
<b>SPECTRUM</b>				
1986-88	L4 1.5L 92ci	7,9		CA-3156
1985	L4 1.5L 92ci	K		CA-3156
<b>TOWNSMAN</b>				
1969	V8 5.7L 350ci		Muncie 4 Spd. MT; 100.00" Cable	CA-3003
1969	V8 5.7L 350ci		w/o Cruise Control; 80.00" Cable	CA-3001
1969-70	V8 5.7L 350ci		w/Cruise Upper; 41.00" Cable	CA-3009
1969-71	V8 5.7L 350ci		w/Cruise Lower; 63.00" Cable	CA-3002
1970	V8 5.7L 350ci		w/o Cruise, 4 Spd. Muncie MT; 80.00" Cable	CA-3001
1971	V8 5.7L 350ci		MT w/o Cruise, Powerglide w/o Cruise, THM w/Cruise; 61.00" Cable	CA-3005
1971	V8 5.7L 350ci		Upper; 41.00" Cable	CA-3009
1972	V8 5.7L 350ci	H	w/Cruise Lower; 63.00" Cable	CA-3002
1972	V8 5.7L 350ci	H	w/Cruise Upper; 41.00" Cable	CA-3009
1972	V8 5.7L 350ci	H	w/o Cruise Control; 61.00" Cable	CA-3005
1970	V8 6.6L 400ci		w/Cruise Upper; 41.00" Cable	CA-3009
1970	V8 6.6L 400ci		w/o Cruise, 4 Spd. Muncie MT; 80.00" Cable	CA-3001
1970-71	V8 6.6L 400ci		w/Cruise Lower; 63.00" Cable	CA-3002
1971	V8 6.6L 400ci		MT w/o Cruise, Powerglide w/o Cruise, THM w/Cruise; 61.00" Cable	CA-3005
1971	V8 6.6L 400ci		Upper; 41.00" Cable	CA-3009
1972	V8 6.6L 400ci	R	w/Cruise Lower; 63.00" Cable	CA-3002
1972	V8 6.6L 400ci	R	w/Cruise Upper; 41.00" Cable	CA-3009
1972	V8 6.6L 400ci	R	w/o Cruise Control; 61.00" Cable	CA-3005
1972	V8 6.6L 402ci	S	w/Cruise Lower; 63.00" Cable	CA-3002
1972	V8 6.6L 402ci	S	w/Cruise Upper; 41.00" Cable	CA-3009
1972	V8 6.6L 402ci	S	w/o Cruise Control; 61.00" Cable	CA-3005
1970	V8 7.4L 454ci		w/Cruise Lower; 63.00" Cable	CA-3002
1970	V8 7.4L 454ci		w/Cruise Upper; 41.00" Cable	CA-3009
1970	V8 7.4L 454ci		w/o Cruise, 4 Spd. Muncie MT; 80.00" Cable	CA-3001
1972	V8 7.4L 454ci	V	w/Cruise Lower; 63.00" Cable	CA-3002
1972	V8 7.4L 454ci	V	w/Cruise Upper; 41.00" Cable	CA-3009
1972	V8 7.4L 454ci	V	w/o Cruise Control; 61.00" Cable	CA-3005
<b>VEGA</b>				
1975	L4 2.0L 122ci	O	61.00" Cable	CA-3005
1971-76	L4 2.3L 140ci	A,B	61.00" Cable	CA-3005

# SPEEDOMETER CABLES

Year	Engine	Vin	Remark	Part
<b>CHEVROLET (con't)</b>				
<b>VEGA (con't)</b>				
1977	L4 2.3L 140ci	B	4 Spd. MT; 61.00" Cable	CA-3005
1977	L4 2.3L 140ci	B	exc. 4 Spd. MT; 80.00" Cable	CA-3001
<b>CHEVROLET TRUCKS</b>				
<b>ASTRO</b>				
1985-88	L4 2.5L 151ci	E	100.00" Cable	CA-3003
1985	V6 4.3L 262ci	N	100.00" Cable	CA-3003
1986-88	V6 4.3L 262ci	Z	100.00" Cable	CA-3003
<b>BLAZER</b>				
1973-74	L6 4.1L 250ci	Q	3 & 4 Spd. MT, or THM AT w/o Cruise; 80.00" Cable	CA-3001
1973-74	L6 4.1L 250ci	Q	4WD; 80.00" Cable	CA-3001
1973-74	L6 4.1L 250ci	Q	AT w/Cruise Control, Lower; 63.00" Cable	CA-3002
1973-74	L6 4.1L 250ci	Q	AT w/Cruise Control, Upper	CA-3031
1973	L6 4.8L 292ci	T	3 & 4 Spd. MT, or THM AT w/o Cruise; 80.00" Cable	CA-3001
1973	L6 4.8L 292ci	T	4WD; 80.00" Cable	CA-3001
1973	L6 4.8L 292ci	T	AT w/Cruise Control, Lower; 63.00" Cable	CA-3002
1973	L6 4.8L 292ci	T	AT w/Cruise Control, Upper	CA-3031
1973	V8 5.0L 307ci	X	3 & 4 Spd. MT, or THM AT w/o Cruise; 80.00" Cable	CA-3001
1973	V8 5.0L 307ci	X	4 Spd. MT 1 pc. Cable 84" to 100"	CA-3003
1973	V8 5.0L 307ci	X	4 Spd. MT 2 pc. Cable Lower; 41.00" Cable	CA-3009
1973	V8 5.0L 307ci	X	4 Spd. MT 2 pc. Cable Upper; 61.00" Cable	CA-3005
1973	V8 5.0L 307ci	X	AT w/Cruise Control, Lower; 63.00" Cable	CA-3002
1973	V8 5.0L 307ci	X	AT w/Cruise Control, Upper	CA-3031
1973-74	V8 5.7L 350ci	V,Y	3 & 4 Spd. MT, or THM AT w/o Cruise; 80.00" Cable	CA-3001
1973-74	V8 5.7L 350ci	V,Y	4 Spd. MT 1 pc. Cable 84" to 100"	CA-3003
1973-74	V8 5.7L 350ci	V,Y	4 Spd. MT 2 pc. Cable Lower; 41.00" Cable	CA-3009
1973-74	V8 5.7L 350ci	V,Y	4 Spd. MT 2 pc. Cable Upper; 61.00" Cable	CA-3005
1973-74	V8 5.7L 350ci	V,Y	AT w/Cruise Control, Lower; 63.00" Cable	CA-3002
1973-74	V8 5.7L 350ci	V,Y	AT w/Cruise Control, Upper	CA-3031
1973	V8 7.4L 454ci	Z	3 & 4 Spd. MT, or THM AT w/o Cruise; 80.00" Cable	CA-3001
1973	V8 7.4L 454ci	Z	4 Spd. MT 1 pc. Cable 84" to 100"	CA-3003
1973	V8 7.4L 454ci	Z	4 Spd. MT 2 pc. Cable Lower; 41.00" Cable	CA-3009
1973	V8 7.4L 454ci	Z	4 Spd. MT 2 pc. Cable Upper; 61.00" Cable	CA-3005
1973	V8 7.4L 454ci	Z	AT w/Cruise Control, Lower; 63.00" Cable	CA-3002
1973	V8 7.4L 454ci	Z	AT w/Cruise Control, Upper	CA-3031
<b>C10</b>				
1976	L6 4.1L 250ci	D	4 Spd. MT Lower; 40.00" Cable	CA-3033
1976	L6 4.1L 250ci	D	AT THM w/Cruise Lower; 83.00" Cable	CA-3004
1976	L6 4.1L 250ci	D	AT THM w/Cruise Upper, OR 4 Spd. MT Upper; 41.00" Cable	CA-3009
1976	L6 4.1L 250ci	D	AT THM w/o Cruise, 3 Spd. MT w/o Cruise; 80.00" Cable	CA-3001
1977	L6 4.1L 250ci	D	w/Cruise Lower; 63.00" Cable	CA-3002
1977	L6 4.1L 250ci	D	w/Cruise Upper; 41.00" Cable	CA-3009
1978-79	L6 4.1L 250ci	D	3 Spd. MT w/o Cruise; 80.00" Cable	CA-3001
1978-79	L6 4.1L 250ci	D	4 Spd. MT; 61.00" Cable	CA-3005
1978-79	L6 4.1L 250ci	D	AT w/Catalytic Converter Lower	CA-3006
1978-79	L6 4.1L 250ci	D	AT w/Catalytic Converter w/Cruise Upper; 41.00" Cable	CA-3009
1978-79	L6 4.1L 250ci	D	AT w/o Catalytic Converter w/Cruise Lower; 63.00" Cable	CA-3002
1980	L6 4.1L 250ci	D	4 Spd. w/o Cruise Upper; 61.00" Cable	CA-3005
1980	L6 4.1L 250ci	D	exc. Cruise Control; 80.00" Cable	CA-3001
1980	L6 4.1L 250ci	D	w/Catalic Converter w/Cruise Control, Lower	CA-3006
1980	L6 4.1L 250ci	D	w/o Catalic Converter w/Cruise Control, Lower; 63.00" Cable	CA-3002
1981	L6 4.1L 250ci	D	3 Spd. AT 1 pc. Cable; 80.00" Cable	CA-3001
1981	L6 4.1L 250ci	D	MT w/o Cruise Upper; 61.00" Cable	CA-3005
1981	L6 4.1L 250ci	D	w/Cruise Control, Lower; 63.00" Cable	CA-3002
1981	L6 4.1L 250ci	D	w/Cruise Control, Upper; 41.00" Cable	CA-3009
1982	L6 4.1L 250ci	D	3 Spd. AT 1 pc. Cable, or MT w/o Cruise; 80.00" Cable	CA-3001
1982	L6 4.1L 250ci	D	4 Spd. AT w/innerconnector, Upper; 61.00" Cable	CA-3005
1982	L6 4.1L 250ci	D	AT w/Cruise Control, Intermediate	CA-3006
1982	L6 4.1L 250ci	D	MT w/Cruise Control, Lower; 63.00" Cable	CA-3002
1983-84	L6 4.1L 250ci	D	4 Spd. MT w/innerconnector Lower; 20.00" Cable	CA-3008
1983-84	L6 4.1L 250ci	D	TH700-R4 Auto. Trans., or w/4 Spd. MT Upper; 61.00" Cable	CA-3005
1983-84	L6 4.1L 250ci	D	THM-400 Auto. Trans.; 80.00" Cable	CA-3001
1973-74	L6 4.1L 250ci	Q	3 & 4 Spd. MT, or THM AT w/o Cruise; 80.00" Cable	CA-3001

# SPEEDOMETER CABLES

Year	Engine	Vin	Remark	Part
<b>CHEVROLET TRUCKS (con't)</b>				
<b>C10 (con't)</b>				
1973-74	L6 4.1L 250ci	Q	AT w/Cruise Control, Lower; 63.00" Cable	CA-3002
1973-74	L6 4.1L 250ci	Q	AT w/Cruise Control, Upper	CA-3031
1975	L6 4.1L 250ci	Q	4 Spd. MT Lower; 40.00" Cable	CA-3033
1975	L6 4.1L 250ci	Q	AT THM w/Cruise Lower; 63.00" Cable	CA-3002
1975	L6 4.1L 250ci	Q	AT THM w/Cruise Upper, OR 4 Spd. MT Upper; 41.00" Cable	CA-3009
1975	L6 4.1L 250ci	Q	AT THM w/o Cruise, 3 Spd. MT w/o Cruise; 80.00" Cable	CA-3001
1973-74	L6 4.8L 292ci	S,T	3 & 4 Spd. MT, or THM AT w/o Cruise; 80.00" Cable	CA-3001
1973-74	L6 4.8L 292ci	S,T	AT w/Cruise Control, Lower; 63.00" Cable	CA-3002
1973-74	L6 4.8L 292ci	S,T	AT w/Cruise Control, Upper	CA-3031
1975	L6 4.8L 292ci	T	AT THM w/Cruise Lower; 63.00" Cable	CA-3002
1975-76	L6 4.8L 292ci	T	4 Spd. MT Lower; 40.00" Cable	CA-3033
1975-76	L6 4.8L 292ci	T	AT THM w/Cruise Upper, OR 4 Spd. MT Upper; 41.00" Cable	CA-3009
1975-76	L6 4.8L 292ci	T	AT THM w/o Cruise, 3 Spd. MT w/o Cruise; 80.00" Cable	CA-3001
1976	L6 4.8L 292ci	T	AT THM w/Cruise Lower; 83.00" Cable	CA-3004
1977	L6 4.8L 292ci	T	w/Cruise Lower; 63.00" Cable	CA-3002
1977	L6 4.8L 292ci	T	w/Cruise Upper; 41.00" Cable	CA-3009
1978-79	L6 4.8L 292ci	T	3 Spd. MT w/o Cruise; 80.00" Cable	CA-3001
1978-79	L6 4.8L 292ci	T	4 Spd. MT; 61.00" Cable	CA-3005
1978-79	L6 4.8L 292ci	T	AT w/Catalytic Converter Lower	CA-3006
1978-79	L6 4.8L 292ci	T	AT w/Catalytic Converter w/Cruise Upper; 41.00" Cable	CA-3009
1978-79	L6 4.8L 292ci	T	AT w/o Catalytic Converter w/Cruise Lower; 63.00" Cable	CA-3002
1980	L6 4.8L 292ci	T	4 Spd. w/o Cruise Upper; 61.00" Cable	CA-3005
1980	L6 4.8L 292ci	T	exc. Cruise Control; 80.00" Cable	CA-3001
1980	L6 4.8L 292ci	T	w/Catalic Converter w/Cruise Control, Lower	CA-3006
1980	L6 4.8L 292ci	T	w/o Catalic Converter w/Cruise Control, Lower; 63.00" Cable	CA-3002
1985	V6 4.3L 262ci	N	TH700-R4 Auto. Trans., Lower; 20.00" Cable	CA-3008
1985	V6 4.3L 262ci	N	TH700-R4 Auto. Trans., Upper; 61.00" Cable	CA-3005
1985-86	V6 4.3L 262ci	N	THM-400 Auto. Trans.; 80.00" Cable	CA-3001
1986	V6 4.3L 262ci	N	Lower exc. AT THM-400 Trans.; 20.00" Cable	CA-3008
1986	V6 4.3L 262ci	N	Upper exc. AT THM-400 Trans.; 61.00" Cable	CA-3005
1981	V8 5.0L 305ci	F,G,H	3 Spd. AT 1 pc. Cable; 80.00" Cable	CA-3001
1981	V8 5.0L 305ci	F,G,H	MT w/o Cruise Upper; 61.00" Cable	CA-3005
1981	V8 5.0L 305ci	F,G,H	w/Cruise Control, Lower; 63.00" Cable	CA-3002
1981	V8 5.0L 305ci	F,G,H	w/Cruise Control, Upper; 41.00" Cable	CA-3009
1982	V8 5.0L 305ci	F,H	3 Spd. AT 1 pc. Cable, or MT w/o Cruise; 80.00" Cable	CA-3001
1982	V8 5.0L 305ci	F,H	4 Spd. AT w/innerconnector, Upper; 61.00" Cable	CA-3005
1982	V8 5.0L 305ci	F,H	AT w/Cruise Control, Intermediate	CA-3006
1982	V8 5.0L 305ci	F,H	MT w/Cruise Control, Lower; 63.00" Cable	CA-3002
1983-84	V8 5.0L 305ci	F,H	4 Spd. MT w/innerconnector Lower; 20.00" Cable	CA-3008
1983-84	V8 5.0L 305ci	F,H	TH700-R4 Auto. Trans., or w/4 Spd. MT Upper; 61.00" Cable	CA-3005
1983-86	V8 5.0L 305ci	F,H	THM-400 Auto. Trans.; 80.00" Cable	CA-3001
1985	V8 5.0L 305ci	F,H	TH700-R4 Auto. Trans., Lower; 20.00" Cable	CA-3008
1985	V8 5.0L 305ci	F,H	TH700-R4 Auto. Trans., Upper; 61.00" Cable	CA-3005
1986	V8 5.0L 305ci	F,H	Lower exc. AT THM-400 Trans.; 20.00" Cable	CA-3008
1986	V8 5.0L 305ci	F,H	Upper exc. AT THM-400 Trans.; 61.00" Cable	CA-3005
1980	V8 5.0L 305ci	G	4 Spd. w/o Cruise Upper; 61.00" Cable	CA-3005
1980	V8 5.0L 305ci	G	exc. Cruise Control; 80.00" Cable	CA-3001
1980	V8 5.0L 305ci	G	w/Catalic Converter w/Cruise Control, Lower	CA-3006
1980	V8 5.0L 305ci	G	w/o Catalic Converter w/Cruise Control, Lower; 63.00" Cable	CA-3002
1976	V8 5.0L 305ci	Q	4 Spd. MT Lower; 40.00" Cable	CA-3033
1976	V8 5.0L 305ci	Q	AT THM w/Cruise Lower; 83.00" Cable	CA-3004
1976	V8 5.0L 305ci	Q	AT THM w/Cruise Upper, OR 4 Spd. MT Upper; 41.00" Cable	CA-3009
1976	V8 5.0L 305ci	Q	AT THM w/o Cruise, 3 Spd. MT w/o Cruise; 80.00" Cable	CA-3001
1977	V8 5.0L 305ci	U	w/Cruise Lower; 63.00" Cable	CA-3002
1977	V8 5.0L 305ci	U	w/Cruise Upper; 41.00" Cable	CA-3009
1978-79	V8 5.0L 305ci	U	3 Spd. MT w/o Cruise; 80.00" Cable	CA-3001
1978-79	V8 5.0L 305ci	U	4 Spd. MT; 61.00" Cable	CA-3005
1978-79	V8 5.0L 305ci	U	AT w/Catalytic Converter Lower	CA-3006
1978-79	V8 5.0L 305ci	U	AT w/Catalytic Converter w/Cruise Upper; 41.00" Cable	CA-3009
1978-79	V8 5.0L 305ci	U	AT w/o Catalytic Converter w/Cruise Lower; 63.00" Cable	CA-3002
1973	V8 5.0L 307ci	X	3 & 4 Spd. MT, or THM AT w/o Cruise; 80.00" Cable	CA-3001
1973	V8 5.0L 307ci	X	AT w/Cruise Control, Lower; 63.00" Cable	CA-3002

# SPEEDOMETER CABLES

Year	Engine	Vin	Remark	Part
<b>CHEVROLET TRUCKS (con't)</b>				
<b>C10 (con't)</b>				
1973	V8 5.0L 307ci	X	AT w/Cruise Control, Upper	CA-3031
1976	V8 5.7L 350ci	L,V	AT THM w/Cruise Lower; 83.00" Cable	CA-3004
1977	V8 5.7L 350ci	L	w/Cruise Lower; 63.00" Cable	CA-3002
1977	V8 5.7L 350ci	L	w/Cruise Upper; 41.00" Cable	CA-3009
1978-79	V8 5.7L 350ci	L,Z	3 Spd. MT w/o Cruise; 80.00" Cable	CA-3001
1978-79	V8 5.7L 350ci	L,Z	4 Spd. MT; 61.00" Cable	CA-3005
1978-79	V8 5.7L 350ci	L,Z	AT w/Catalytic Converter Lower	CA-3006
1978-79	V8 5.7L 350ci	L,Z	AT w/Catalytic Converter w/Cruise Upper; 41.00" Cable	CA-3009
1978-79	V8 5.7L 350ci	L,Z	AT w/o Catalytic Converter w/Cruise Lower; 63.00" Cable	CA-3002
1980	V8 5.7L 350ci	L,M,P,Z	4 Spd. w/o Cruise Upper; 61.00" Cable	CA-3005
1980	V8 5.7L 350ci	L,M,P,Z	exc. Cruise Control; 80.00" Cable	CA-3001
1980	V8 5.7L 350ci	L,M,P,Z	w/Catalic Converter w/Cruise Control, Lower	CA-3006
1980	V8 5.7L 350ci	L,M,P,Z	w/o Catalic Converter w/Cruise Control, Lower; 63.00" Cable	CA-3002
1981	V8 5.7L 350ci	L,M,Z	3 Spd. AT 1 pc. Cable; 80.00" Cable	CA-3001
1981	V8 5.7L 350ci	L,M,Z	MT w/o Cruise Upper; 61.00" Cable	CA-3005
1981	V8 5.7L 350ci	L,M,Z	w/Cruise Control, Lower; 63.00" Cable	CA-3002
1981	V8 5.7L 350ci	L,M,Z	w/Cruise Control, Upper; 41.00" Cable	CA-3009
1982	V8 5.7L 350ci	L	3 Spd. AT 1 pc. Cable, or MT w/o Cruise; 80.00" Cable	CA-3001
1982	V8 5.7L 350ci	L	4 Spd. AT w/innerconnector, Upper; 61.00" Cable	CA-3005
1982	V8 5.7L 350ci	L	AT w/Cruise Control, Intermediate	CA-3006
1982	V8 5.7L 350ci	L	MT w/Cruise Control, Lower; 63.00" Cable	CA-3002
1983-84	V8 5.7L 350ci	L	4 Spd. MT w/innerconnector Lower; 20.00" Cable	CA-3008
1983-84	V8 5.7L 350ci	L	TH700-R4 Auto. Trans., or w/4 Spd. MT Upper; 61.00" Cable	CA-3005
1983-86	V8 5.7L 350ci	L,M	THM-400 Auto. Trans.; 80.00" Cable	CA-3001
1985	V8 5.7L 350ci	L,M	TH700-R4 Auto. Trans., Lower; 20.00" Cable	CA-3008
1985	V8 5.7L 350ci	L,M	TH700-R4 Auto. Trans., Upper; 61.00" Cable	CA-3005
1986	V8 5.7L 350ci	L,M	Lower exc. AT THM-400 Trans.; 20.00" Cable	CA-3008
1986	V8 5.7L 350ci	L,M	Upper exc. AT THM-400 Trans.; 61.00" Cable	CA-3005
1975	V8 5.7L 350ci	V,Y	AT THM w/Cruise Lower; 63.00" Cable	CA-3002
1975-76	V8 5.7L 350ci	L,V,Y	4 Spd. MT Lower; 40.00" Cable	CA-3033
1975-76	V8 5.7L 350ci	L,V,Y	AT THM w/Cruise Upper, OR 4 Spd. MT Upper; 41.00" Cable	CA-3009
1975-76	V8 5.7L 350ci	L,V,Y	AT THM w/o Cruise, 3 Spd. MT w/o Cruise; 80.00" Cable	CA-3001
1973-74	V8 5.7L 350ci	V,W,Y	3 & 4 Spd. MT, or THM AT w/o Cruise; 80.00" Cable	CA-3001
1973-74	V8 5.7L 350ci	V,W,Y	AT w/Cruise Control, Lower; 63.00" Cable	CA-3002
1973-74	V8 5.7L 350ci	V,W,Y	AT w/Cruise Control, Upper	CA-3031
1982	V8 6.2L 379ci	C,J	3 Spd. AT 1 pc. Cable, or MT w/o Cruise; 80.00" Cable	CA-3001
1982	V8 6.2L 379ci	C,J	4 Spd. AT w/innerconnector, Upper; 61.00" Cable	CA-3005
1982	V8 6.2L 379ci	C,J	AT w/Cruise Control, Intermediate	CA-3006
1982	V8 6.2L 379ci	C,J	MT w/Cruise Control, Lower; 63.00" Cable	CA-3002
1983-84	V8 6.2L 379ci	C	4 Spd. MT w/innerconnector Lower; 20.00" Cable	CA-3008
1983-84	V8 6.2L 379ci	C	TH700-R4 Auto. Trans., or w/4 Spd. MT Upper; 61.00" Cable	CA-3005
1983-86	V8 6.2L 379ci	C,J	THM-400 Auto. Trans.; 80.00" Cable	CA-3001
1985	V8 6.2L 379ci	C,J	TH700-R4 Auto. Trans., Lower; 20.00" Cable	CA-3008
1985	V8 6.2L 379ci	C,J	TH700-R4 Auto. Trans., Upper; 61.00" Cable	CA-3005
1986	V8 6.2L 379ci	C	Lower exc. AT THM-400 Trans.; 20.00" Cable	CA-3008
1986	V8 6.2L 379ci	C	Upper exc. AT THM-400 Trans.; 61.00" Cable	CA-3005
1977	V8 6.6L 400ci	R	w/Cruise Lower; 63.00" Cable	CA-3002
1977	V8 6.6L 400ci	R	w/Cruise Upper; 41.00" Cable	CA-3009
1978-79	V8 6.6L 400ci	R	3 Spd. MT w/o Cruise; 80.00" Cable	CA-3001
1978-79	V8 6.6L 400ci	R	4 Spd. MT; 61.00" Cable	CA-3005
1978-79	V8 6.6L 400ci	R	AT w/Catalytic Converter Lower	CA-3006
1978-79	V8 6.6L 400ci	R	AT w/Catalytic Converter w/Cruise Upper; 41.00" Cable	CA-3009
1978-79	V8 6.6L 400ci	R	AT w/o Catalytic Converter w/Cruise Lower; 63.00" Cable	CA-3002
1976	V8 6.6L 400ci	U	4 Spd. MT Lower; 40.00" Cable	CA-3033
1976	V8 6.6L 400ci	U	AT THM w/Cruise Lower; 83.00" Cable	CA-3004
1976	V8 6.6L 400ci	U	AT THM w/Cruise Upper, OR 4 Spd. MT Upper; 41.00" Cable	CA-3009
1976	V8 6.6L 400ci	U	AT THM w/o Cruise, 3 Spd. MT w/o Cruise; 80.00" Cable	CA-3001
1980	V8 6.6L 400ci	X	4 Spd. w/o Cruise Upper; 61.00" Cable	CA-3005
1980	V8 6.6L 400ci	X	exc. Cruise Control; 80.00" Cable	CA-3001
1980	V8 6.6L 400ci	X	w/Catalic Converter w/Cruise Control, Lower	CA-3006
1980	V8 6.6L 400ci	X	w/o Catalic Converter w/Cruise Control, Lower; 63.00" Cable	CA-3002
1976	V8 7.4L 454ci	S	4 Spd. MT Lower; 40.00" Cable	CA-3033

# SPEEDOMETER CABLES

Year	Engine	Vin	Remark	Part
<b>CHEVROLET TRUCKS (con't)</b>				
<b>C10 (con't)</b>				
1976	V8 7.4L 454ci	S	AT THM w/Cruise Lower; 83.00" Cable	CA-3004
1976	V8 7.4L 454ci	S	AT THM w/Cruise Upper, OR 4 Spd. MT Upper; 41.00" Cable	CA-3009
1976	V8 7.4L 454ci	S	AT THM w/o Cruise, 3 Spd. MT w/o Cruise; 80.00" Cable	CA-3001
1977	V8 7.4L 454ci	S	w/Cruise Lower; 63.00" Cable	CA-3002
1977	V8 7.4L 454ci	S	w/Cruise Upper; 41.00" Cable	CA-3009
1978-79	V8 7.4L 454ci	S	3 Spd. MT w/o Cruise; 80.00" Cable	CA-3001
1978-79	V8 7.4L 454ci	S	4 Spd. MT; 61.00" Cable	CA-3005
1978-79	V8 7.4L 454ci	S	AT w/Catalytic Converter Lower	CA-3006
1978-79	V8 7.4L 454ci	S	AT w/Catalytic Converter w/Cruise Upper; 41.00" Cable	CA-3009
1978-79	V8 7.4L 454ci	S	AT w/o Catalytic Converter w/Cruise Lower; 63.00" Cable	CA-3002
1980	V8 7.4L 454ci	S,W	4 Spd. w/o Cruise Upper; 61.00" Cable	CA-3005
1980	V8 7.4L 454ci	S,W	exc. Cruise Control; 80.00" Cable	CA-3001
1980	V8 7.4L 454ci	S,W	w/Catalic Converter w/Cruise Control, Lower	CA-3006
1980	V8 7.4L 454ci	S,W	w/o Catalic Converter w/Cruise Control, Lower; 63.00" Cable	CA-3002
1973-74	V8 7.4L 454ci	Z	3 & 4 Spd. MT, or THM AT w/o Cruise; 80.00" Cable	CA-3001
1973-74	V8 7.4L 454ci	Z	AT w/Cruise Control, Lower; 63.00" Cable	CA-3002
1973-74	V8 7.4L 454ci	Z	AT w/Cruise Control, Upper	CA-3031
1975	V8 7.4L 454ci	Z	4 Spd. MT Lower; 40.00" Cable	CA-3033
1975	V8 7.4L 454ci	Z	AT THM w/Cruise Lower; 63.00" Cable	CA-3002
1975	V8 7.4L 454ci	Z	AT THM w/Cruise Upper, OR 4 Spd. MT Upper; 41.00" Cable	CA-3009
1975	V8 7.4L 454ci	Z	AT THM w/o Cruise, 3 Spd. MT w/o Cruise; 80.00" Cable	CA-3001
<b>C10 SUBURBAN</b>				
1976	L6 4.1L 250ci	D	4 Spd. MT Lower; 40.00" Cable	CA-3033
1976	L6 4.1L 250ci	D	AT THM w/Cruise Lower; 83.00" Cable	CA-3004
1976	L6 4.1L 250ci	D	AT THM w/Cruise Upper, OR 4 Spd. MT Upper; 41.00" Cable	CA-3009
1976	L6 4.1L 250ci	D	AT THM w/o Cruise, 3 Spd. MT w/o Cruise; 80.00" Cable	CA-3001
1977	L6 4.1L 250ci	D	w/Cruise Lower; 63.00" Cable	CA-3002
1977	L6 4.1L 250ci	D	w/Cruise Upper; 41.00" Cable	CA-3009
1978-79	L6 4.1L 250ci	D	3 Spd. MT w/o Cruise; 80.00" Cable	CA-3001
1978-79	L6 4.1L 250ci	D	4 Spd. MT; 61.00" Cable	CA-3005
1978-79	L6 4.1L 250ci	D	AT w/Catalytic Converter Lower	CA-3006
1978-79	L6 4.1L 250ci	D	AT w/Catalytic Converter w/Cruise Upper; 41.00" Cable	CA-3009
1978-79	L6 4.1L 250ci	D	AT w/o Catalytic Converter w/Cruise Lower; 63.00" Cable	CA-3002
1975	L6 4.1L 250ci	Q	4 Spd. MT Lower; 40.00" Cable	CA-3033
1975	L6 4.1L 250ci	Q	AT THM w/Cruise Lower; 63.00" Cable	CA-3002
1975	L6 4.1L 250ci	Q	AT THM w/Cruise Upper, OR 4 Spd. MT Upper; 41.00" Cable	CA-3009
1975	L6 4.1L 250ci	Q	AT THM w/o Cruise, 3 Spd. MT w/o Cruise; 80.00" Cable	CA-3001
1976	V8 5.0L 305ci	Q	4 Spd. MT Lower; 40.00" Cable	CA-3033
1976	V8 5.0L 305ci	Q	AT THM w/Cruise Lower; 83.00" Cable	CA-3004
1976	V8 5.0L 305ci	Q	AT THM w/Cruise Upper, OR 4 Spd. MT Upper; 41.00" Cable	CA-3009
1976	V8 5.0L 305ci	Q	AT THM w/o Cruise, 3 Spd. MT w/o Cruise; 80.00" Cable	CA-3001
1977	V8 5.0L 305ci	U	w/Cruise Lower; 63.00" Cable	CA-3002
1977	V8 5.0L 305ci	U	w/Cruise Upper; 41.00" Cable	CA-3009
1978-79	V8 5.0L 305ci	U	3 Spd. MT w/o Cruise; 80.00" Cable	CA-3001
1978-79	V8 5.0L 305ci	U	4 Spd. MT; 61.00" Cable	CA-3005
1978-79	V8 5.0L 305ci	U	AT w/Catalytic Converter Lower	CA-3006
1978-79	V8 5.0L 305ci	U	AT w/Catalytic Converter w/Cruise Upper; 41.00" Cable	CA-3009
1978-79	V8 5.0L 305ci	U	AT w/o Catalytic Converter w/Cruise Lower; 63.00" Cable	CA-3002
1976	V8 5.7L 350ci	L,V	AT THM w/Cruise Lower; 83.00" Cable	CA-3004
1977	V8 5.7L 350ci	L	w/Cruise Lower; 63.00" Cable	CA-3002
1977	V8 5.7L 350ci	L	w/Cruise Upper; 41.00" Cable	CA-3009
1978-79	V8 5.7L 350ci	L,Z	3 Spd. MT w/o Cruise; 80.00" Cable	CA-3001
1978-79	V8 5.7L 350ci	L,Z	4 Spd. MT; 61.00" Cable	CA-3005
1978-79	V8 5.7L 350ci	L,Z	AT w/Catalytic Converter Lower	CA-3006
1978-79	V8 5.7L 350ci	L,Z	AT w/Catalytic Converter w/Cruise Upper; 41.00" Cable	CA-3009
1978-79	V8 5.7L 350ci	L,Z	AT w/o Catalytic Converter w/Cruise Lower; 63.00" Cable	CA-3002
1975	V8 5.7L 350ci	V,Y	AT THM w/Cruise Lower; 63.00" Cable	CA-3002
1975-76	V8 5.7L 350ci	L,V,Y	4 Spd. MT Lower; 40.00" Cable	CA-3033
1975-76	V8 5.7L 350ci	L,V,Y	AT THM w/Cruise Upper, OR 4 Spd. MT Upper; 41.00" Cable	CA-3009
1975-76	V8 5.7L 350ci	L,V,Y	AT THM w/o Cruise, 3 Spd. MT w/o Cruise; 80.00" Cable	CA-3001
1976	V8 7.4L 454ci	S	4 Spd. MT Lower; 40.00" Cable	CA-3033
1976	V8 7.4L 454ci	S	AT THM w/Cruise Lower; 83.00" Cable	CA-3004

# SPEEDOMETER CABLES

Year	Engine	Vin	Remark	Part
<b>CHEVROLET TRUCKS (con't)</b>				
<b>C10 SUBURBAN (con't)</b>				
1976	V8 7.4L 454ci	S	AT THM w/Cruise Upper, OR 4 Spd. MT Upper; 41.00" Cable	CA-3009
1976	V8 7.4L 454ci	S	AT THM w/o Cruise, 3 Spd. MT w/o Cruise; 80.00" Cable	CA-3001
1977	V8 7.4L 454ci	S	w/Cruise Lower; 63.00" Cable	CA-3002
1977	V8 7.4L 454ci	S	w/Cruise Upper; 41.00" Cable	CA-3009
1978-79	V8 7.4L 454ci	S	3 Spd. MT w/o Cruise; 80.00" Cable	CA-3001
1978-79	V8 7.4L 454ci	S	4 Spd. MT; 61.00" Cable	CA-3005
1978-79	V8 7.4L 454ci	S	AT w/Catalytic Converter Lower	CA-3006
1978-79	V8 7.4L 454ci	S	AT w/Catalytic Converter w/Cruise Upper; 41.00" Cable	CA-3009
1978-79	V8 7.4L 454ci	S	AT w/o Catalytic Converter w/Cruise Lower; 63.00" Cable	CA-3002
1975	V8 7.4L 454ci	Z	4 Spd. MT Lower; 40.00" Cable	CA-3033
1975	V8 7.4L 454ci	Z	AT THM w/Cruise Lower; 63.00" Cable	CA-3002
1975	V8 7.4L 454ci	Z	AT THM w/Cruise Upper, OR 4 Spd. MT Upper; 41.00" Cable	CA-3009
1975	V8 7.4L 454ci	Z	AT THM w/o Cruise, 3 Spd. MT w/o Cruise; 80.00" Cable	CA-3001
<b>C20</b>				
1976	L6 4.1L 250ci	D	4 Spd. MT Lower; 40.00" Cable	CA-3033
1976	L6 4.1L 250ci	D	AT THM w/Cruise Lower; 83.00" Cable	CA-3004
1976	L6 4.1L 250ci	D	AT THM w/Cruise Upper, OR 4 Spd. MT Upper; 41.00" Cable	CA-3009
1976	L6 4.1L 250ci	D	AT THM w/o Cruise, 3 Spd. MT w/o Cruise; 80.00" Cable	CA-3001
1977	L6 4.1L 250ci	D	w/Cruise Lower; 63.00" Cable	CA-3002
1977	L6 4.1L 250ci	D	w/Cruise Upper; 41.00" Cable	CA-3009
1978-79	L6 4.1L 250ci	D	3 Spd. MT w/o Cruise; 80.00" Cable	CA-3001
1978-79	L6 4.1L 250ci	D	4 Spd. MT; 61.00" Cable	CA-3005
1978-79	L6 4.1L 250ci	D	AT w/Catalytic Converter Lower	CA-3006
1978-79	L6 4.1L 250ci	D	AT w/Catalytic Converter w/Cruise Upper; 41.00" Cable	CA-3009
1978-79	L6 4.1L 250ci	D	AT w/o Catalytic Converter w/Cruise Lower; 63.00" Cable	CA-3002
1980	L6 4.1L 250ci	D	4 Spd. w/o Cruise Upper; 61.00" Cable	CA-3005
1980	L6 4.1L 250ci	D	exc. Cruise Control; 80.00" Cable	CA-3001
1980	L6 4.1L 250ci	D	w/Catalic Converter w/Cruise Control, Lower	CA-3006
1980	L6 4.1L 250ci	D	w/o Catalic Converter w/Cruise Control, Lower; 63.00" Cable	CA-3002
1981	L6 4.1L 250ci	D	3 Spd. AT 1 pc. Cable; 80.00" Cable	CA-3001
1981	L6 4.1L 250ci	D	MT w/o Cruise Upper; 61.00" Cable	CA-3005
1981	L6 4.1L 250ci	D	w/Cruise Control, Lower; 63.00" Cable	CA-3002
1981	L6 4.1L 250ci	D	w/Cruise Control, Upper; 41.00" Cable	CA-3009
1982	L6 4.1L 250ci	D	3 Spd. AT 1 pc. Cable, or MT w/o Cruise; 80.00" Cable	CA-3001
1982	L6 4.1L 250ci	D	4 Spd. AT w/innerconnector, Upper; 61.00" Cable	CA-3005
1982	L6 4.1L 250ci	D	AT w/Cruise Control, Intermediate	CA-3006
1982	L6 4.1L 250ci	D	MT w/Cruise Control, Lower; 63.00" Cable	CA-3002
1983-84	L6 4.1L 250ci	D	4 Spd. MT w/innerconnector Lower; 20.00" Cable	CA-3008
1983-84	L6 4.1L 250ci	D	TH700-R4 Auto. Trans., or w/4 Spd. MT Upper; 61.00" Cable	CA-3005
1983-84	L6 4.1L 250ci	D	THM-400 Auto. Trans.; 80.00" Cable	CA-3001
1973-74	L6 4.1L 250ci	Q	3 & 4 Spd. MT, or THM AT w/o Cruise; 80.00" Cable	CA-3001
1973-74	L6 4.1L 250ci	Q	AT w/Cruise Control, Lower; 63.00" Cable	CA-3002
1973-74	L6 4.1L 250ci	Q	AT w/Cruise Control, Upper	CA-3031
1975	L6 4.1L 250ci	Q	4 Spd. MT Lower; 40.00" Cable	CA-3033
1975	L6 4.1L 250ci	Q	AT THM w/Cruise Lower; 63.00" Cable	CA-3002
1975	L6 4.1L 250ci	Q	AT THM w/Cruise Upper, OR 4 Spd. MT Upper; 41.00" Cable	CA-3009
1975	L6 4.1L 250ci	Q	AT THM w/o Cruise, 3 Spd. MT w/o Cruise; 80.00" Cable	CA-3001
1973-74	L6 4.8L 292ci	S,T	3 & 4 Spd. MT, or THM AT w/o Cruise; 80.00" Cable	CA-3001
1973-74	L6 4.8L 292ci	S,T	AT w/Cruise Control, Lower; 63.00" Cable	CA-3002
1973-74	L6 4.8L 292ci	S,T	AT w/Cruise Control, Upper	CA-3031
1975	L6 4.8L 292ci	T	AT THM w/Cruise Lower; 63.00" Cable	CA-3002
1975-76	L6 4.8L 292ci	T	4 Spd. MT Lower; 40.00" Cable	CA-3033
1975-76	L6 4.8L 292ci	T	AT THM w/Cruise Upper, OR 4 Spd. MT Upper; 41.00" Cable	CA-3009
1975-76	L6 4.8L 292ci	T	AT THM w/o Cruise, 3 Spd. MT w/o Cruise; 80.00" Cable	CA-3001
1976	L6 4.8L 292ci	T	AT THM w/Cruise Lower; 83.00" Cable	CA-3004
1977	L6 4.8L 292ci	T	w/Cruise Lower; 63.00" Cable	CA-3002
1977	L6 4.8L 292ci	T	w/Cruise Upper; 41.00" Cable	CA-3009
1978-79	L6 4.8L 292ci	T	3 Spd. MT w/o Cruise; 80.00" Cable	CA-3001
1978-79	L6 4.8L 292ci	T	4 Spd. MT; 61.00" Cable	CA-3005
1978-79	L6 4.8L 292ci	T	AT w/Catalytic Converter Lower	CA-3006
1978-79	L6 4.8L 292ci	T	AT w/Catalytic Converter w/Cruise Upper; 41.00" Cable	CA-3009
1978-79	L6 4.8L 292ci	T	AT w/o Catalytic Converter w/Cruise Lower; 63.00" Cable	CA-3002



# SPEEDOMETER CABLES

Year	Engine	Vin	Remark	Part
<b>CHEVROLET TRUCKS (con't)</b>				
<b>C20 (con't)</b>				
1980	L6 4.8L 292ci	T	4 Spd. w/o Cruise Upper; 61.00" Cable	CA-3005
1980	L6 4.8L 292ci	T	exc. Cruise Control; 80.00" Cable	CA-3001
1980	L6 4.8L 292ci	T	w/Catalic Converter w/Cruise Control, Lower	CA-3006
1980	L6 4.8L 292ci	T	w/o Catalic Converter w/Cruise Control, Lower; 63.00" Cable	CA-3002
1981	L6 4.8L 292ci	T	3 Spd. AT 1 pc. Cable; 80.00" Cable	CA-3001
1981	L6 4.8L 292ci	T	MT w/o Cruise Upper; 61.00" Cable	CA-3005
1981	L6 4.8L 292ci	T	w/Cruise Control, Lower; 63.00" Cable	CA-3002
1981	L6 4.8L 292ci	T	w/Cruise Control, Upper; 41.00" Cable	CA-3009
1982	L6 4.8L 292ci	T	3 Spd. AT 1 pc. Cable, or MT w/o Cruise; 80.00" Cable	CA-3001
1982	L6 4.8L 292ci	T	4 Spd. AT w/innerconnector, Upper; 61.00" Cable	CA-3005
1982	L6 4.8L 292ci	T	AT w/Cruise Control, Intermediate	CA-3006
1982	L6 4.8L 292ci	T	MT w/Cruise Control, Lower; 63.00" Cable	CA-3002
1983-84	L6 4.8L 292ci	T	4 Spd. MT w/innerconnector Lower; 20.00" Cable	CA-3008
1983-84	L6 4.8L 292ci	T	TH700-R4 Auto. Trans., or w/4 Spd. MT Upper; 61.00" Cable	CA-3005
1983-85	L6 4.8L 292ci	T	THM-400 Auto. Trans.; 80.00" Cable	CA-3001
1985	L6 4.8L 292ci	T	TH700-R4 Auto. Trans., Lower; 20.00" Cable	CA-3008
1985	L6 4.8L 292ci	T	TH700-R4 Auto. Trans., Upper; 61.00" Cable	CA-3005
1985	V6 4.3L 262ci	N	TH700-R4 Auto. Trans., Lower; 20.00" Cable	CA-3008
1985	V6 4.3L 262ci	N	TH700-R4 Auto. Trans., Upper; 61.00" Cable	CA-3005
1985-86	V6 4.3L 262ci	N	THM-400 Auto. Trans.; 80.00" Cable	CA-3001
1986	V6 4.3L 262ci	N	Lower exc. AT THM-400 Trans.; 20.00" Cable	CA-3008
1986	V6 4.3L 262ci	N	Upper exc. AT THM-400 Trans.; 61.00" Cable	CA-3005
1980	V8 5.0L 305ci	G	4 Spd. w/o Cruise Upper; 61.00" Cable	CA-3005
1980	V8 5.0L 305ci	G	exc. Cruise Control; 80.00" Cable	CA-3001
1980	V8 5.0L 305ci	G	w/Catalic Converter w/Cruise Control, Lower	CA-3006
1980	V8 5.0L 305ci	G	w/o Catalic Converter w/Cruise Control, Lower; 63.00" Cable	CA-3002
1981	V8 5.0L 305ci	H	3 Spd. AT 1 pc. Cable; 80.00" Cable	CA-3001
1981	V8 5.0L 305ci	H	MT w/o Cruise Upper; 61.00" Cable	CA-3005
1981	V8 5.0L 305ci	H	w/Cruise Control, Lower; 63.00" Cable	CA-3002
1981	V8 5.0L 305ci	H	w/Cruise Control, Upper; 41.00" Cable	CA-3009
1982	V8 5.0L 305ci	H	3 Spd. AT 1 pc. Cable, or MT w/o Cruise; 80.00" Cable	CA-3001
1982	V8 5.0L 305ci	H	4 Spd. AT w/innerconnector, Upper; 61.00" Cable	CA-3005
1982	V8 5.0L 305ci	H	AT w/Cruise Control, Intermediate	CA-3006
1982	V8 5.0L 305ci	H	MT w/Cruise Control, Lower; 63.00" Cable	CA-3002
1983-84	V8 5.0L 305ci	H	4 Spd. MT w/innerconnector Lower; 20.00" Cable	CA-3008
1983-84	V8 5.0L 305ci	H	TH700-R4 Auto. Trans., or w/4 Spd. MT Upper; 61.00" Cable	CA-3005
1983-86	V8 5.0L 305ci	H	THM-400 Auto. Trans.; 80.00" Cable	CA-3001
1985	V8 5.0L 305ci	H	TH700-R4 Auto. Trans., Lower; 20.00" Cable	CA-3008
1985	V8 5.0L 305ci	H	TH700-R4 Auto. Trans., Upper; 61.00" Cable	CA-3005
1986	V8 5.0L 305ci	H	Lower exc. AT THM-400 Trans.; 20.00" Cable	CA-3008
1986	V8 5.0L 305ci	H	Upper exc. AT THM-400 Trans.; 61.00" Cable	CA-3005
1977	V8 5.0L 305ci	U	w/Cruise Lower; 63.00" Cable	CA-3002
1977	V8 5.0L 305ci	U	w/Cruise Upper; 41.00" Cable	CA-3009
1978-79	V8 5.0L 305ci	U	3 Spd. MT w/o Cruise; 80.00" Cable	CA-3001
1978-79	V8 5.0L 305ci	U	4 Spd. MT; 61.00" Cable	CA-3005
1978-79	V8 5.0L 305ci	U	AT w/Catalytic Converter Lower	CA-3006
1978-79	V8 5.0L 305ci	U	AT w/Catalytic Converter w/Cruise Upper; 41.00" Cable	CA-3009
1978-79	V8 5.0L 305ci	U	AT w/o Catalytic Converter w/Cruise Lower; 63.00" Cable	CA-3002
1973	V8 5.0L 307ci	X	3 & 4 Spd. MT, or THM AT w/o Cruise; 80.00" Cable	CA-3001
1973	V8 5.0L 307ci	X	AT w/Cruise Control, Lower; 63.00" Cable	CA-3002
1973	V8 5.0L 307ci	X	AT w/Cruise Control, Upper	CA-3031
1976	V8 5.7L 350ci	L,V	AT THM w/Cruise Lower; 83.00" Cable	CA-3004
1977	V8 5.7L 350ci	L	w/Cruise Lower; 63.00" Cable	CA-3002
1977	V8 5.7L 350ci	L	w/Cruise Upper; 41.00" Cable	CA-3009
1978-79	V8 5.7L 350ci	L	3 Spd. MT w/o Cruise; 80.00" Cable	CA-3001
1978-79	V8 5.7L 350ci	L	4 Spd. MT; 61.00" Cable	CA-3005
1978-79	V8 5.7L 350ci	L	AT w/Catalytic Converter Lower	CA-3006
1978-79	V8 5.7L 350ci	L	AT w/Catalytic Converter w/Cruise Upper; 41.00" Cable	CA-3009
1978-79	V8 5.7L 350ci	L	AT w/o Catalytic Converter w/Cruise Lower; 63.00" Cable	CA-3002
1980	V8 5.7L 350ci	L,M,P	4 Spd. w/o Cruise Upper; 61.00" Cable	CA-3005
1980	V8 5.7L 350ci	L,M,P	exc. Cruise Control; 80.00" Cable	CA-3001
1980	V8 5.7L 350ci	L,M,P	w/Catalic Converter w/Cruise Control, Lower	CA-3006

# SPEEDOMETER CABLES

Year	Engine	Vin	Remark	Part
<b>CHEVROLET TRUCKS (con't)</b>				
<b>C20 (con't)</b>				
1980	V8 5.7L 350ci	L,M,P	w/o Catalic Converter w/Cruise Control, Lower; 63.00" Cable	CA-3002
1981	V8 5.7L 350ci	L,M	3 Spd. AT 1 pc. Cable; 80.00" Cable	CA-3001
1981	V8 5.7L 350ci	L,M	MT w/o Cruise Upper; 61.00" Cable	CA-3005
1981	V8 5.7L 350ci	L,M	w/Cruise Control, Lower; 63.00" Cable	CA-3002
1981	V8 5.7L 350ci	L,M	w/Cruise Control, Upper; 41.00" Cable	CA-3009
1982	V8 5.7L 350ci	L,M	3 Spd. AT 1 pc. Cable, or MT w/o Cruise; 80.00" Cable	CA-3001
1982	V8 5.7L 350ci	L,M	4 Spd. AT w/innerconnector, Upper; 61.00" Cable	CA-3005
1982	V8 5.7L 350ci	L,M	AT w/Cruise Control, Intermediate	CA-3006
1982	V8 5.7L 350ci	L,M	MT w/Cruise Control, Lower; 63.00" Cable	CA-3002
1983-84	V8 5.7L 350ci	L,M	4 Spd. MT w/innerconnector Lower; 20.00" Cable	CA-3008
1983-84	V8 5.7L 350ci	L,M	TH700-R4 Auto. Trans., or w/4 Spd. MT Upper; 61.00" Cable	CA-3005
1983-86	V8 5.7L 350ci	L,M	THM-400 Auto. Trans.; 80.00" Cable	CA-3001
1985	V8 5.7L 350ci	L,M	TH700-R4 Auto. Trans., Lower; 20.00" Cable	CA-3008
1985	V8 5.7L 350ci	L,M	TH700-R4 Auto. Trans., Upper; 61.00" Cable	CA-3005
1986	V8 5.7L 350ci	L,M	Lower exc. AT THM-400 Trans.; 20.00" Cable	CA-3008
1986	V8 5.7L 350ci	L,M	Upper exc. AT THM-400 Trans.; 61.00" Cable	CA-3005
1975	V8 5.7L 350ci	V,Y	AT THM w/Cruise Lower; 63.00" Cable	CA-3002
1975-76	V8 5.7L 350ci	L,V,Y	4 Spd. MT Lower; 40.00" Cable	CA-3033
1975-76	V8 5.7L 350ci	L,V,Y	AT THM w/Cruise Upper, OR 4 Spd. MT Upper; 41.00" Cable	CA-3009
1975-76	V8 5.7L 350ci	L,V,Y	AT THM w/o Cruise, 3 Spd. MT w/o Cruise; 80.00" Cable	CA-3001
1973-74	V8 5.7L 350ci	V,W,Y	3 & 4 Spd. MT, or THM AT w/o Cruise; 80.00" Cable	CA-3001
1973-74	V8 5.7L 350ci	V,W,Y	AT w/Cruise Control, Lower; 63.00" Cable	CA-3002
1973-74	V8 5.7L 350ci	V,W,Y	AT w/Cruise Control, Upper	CA-3031
1982	V8 6.2L 379ci	C,J	3 Spd. AT 1 pc. Cable, or MT w/o Cruise; 80.00" Cable	CA-3001
1982	V8 6.2L 379ci	C,J	4 Spd. AT w/innerconnector, Upper; 61.00" Cable	CA-3005
1982	V8 6.2L 379ci	C,J	AT w/Cruise Control, Intermediate	CA-3006
1982	V8 6.2L 379ci	C,J	MT w/Cruise Control, Lower; 63.00" Cable	CA-3002
1983-84	V8 6.2L 379ci	C,J	4 Spd. MT w/innerconnector Lower; 20.00" Cable	CA-3008
1983-84	V8 6.2L 379ci	C,J	TH700-R4 Auto. Trans., or w/4 Spd. MT Upper; 61.00" Cable	CA-3005
1983-86	V8 6.2L 379ci	C,J	THM-400 Auto. Trans.; 80.00" Cable	CA-3001
1985	V8 6.2L 379ci	C,J	TH700-R4 Auto. Trans., Lower; 20.00" Cable	CA-3008
1985	V8 6.2L 379ci	C,J	TH700-R4 Auto. Trans., Upper; 61.00" Cable	CA-3005
1986	V8 6.2L 379ci	C,J	Lower exc. AT THM-400 Trans.; 20.00" Cable	CA-3008
1986	V8 6.2L 379ci	C,J	Upper exc. AT THM-400 Trans.; 61.00" Cable	CA-3005
1977	V8 6.6L 400ci	R	w/Cruise Lower; 63.00" Cable	CA-3002
1977	V8 6.6L 400ci	R	w/Cruise Upper; 41.00" Cable	CA-3009
1978-79	V8 6.6L 400ci	R	3 Spd. MT w/o Cruise; 80.00" Cable	CA-3001
1978-79	V8 6.6L 400ci	R	4 Spd. MT; 61.00" Cable	CA-3005
1978-79	V8 6.6L 400ci	R	AT w/Catalytic Converter Lower	CA-3006
1978-79	V8 6.6L 400ci	R	AT w/Catalytic Converter w/Cruise Upper; 41.00" Cable	CA-3009
1978-79	V8 6.6L 400ci	R	AT w/o Catalytic Converter w/Cruise Lower; 63.00" Cable	CA-3002
1976	V8 6.6L 400ci	U	4 Spd. MT Lower; 40.00" Cable	CA-3033
1976	V8 6.6L 400ci	U	AT THM w/Cruise Lower; 83.00" Cable	CA-3004
1976	V8 6.6L 400ci	U	AT THM w/Cruise Upper, OR 4 Spd. MT Upper; 41.00" Cable	CA-3009
1976	V8 6.6L 400ci	U	AT THM w/o Cruise, 3 Spd. MT w/o Cruise; 80.00" Cable	CA-3001
1980	V8 6.6L 400ci	X	4 Spd. w/o Cruise Upper; 61.00" Cable	CA-3005
1980	V8 6.6L 400ci	X	exc. Cruise Control; 80.00" Cable	CA-3001
1980	V8 6.6L 400ci	X	w/Catalic Converter w/Cruise Control, Lower	CA-3006
1980	V8 6.6L 400ci	X	w/o Catalic Converter w/Cruise Control, Lower; 63.00" Cable	CA-3002
1976	V8 7.4L 454ci	S	4 Spd. MT Lower; 40.00" Cable	CA-3033
1976	V8 7.4L 454ci	S	AT THM w/Cruise Lower; 83.00" Cable	CA-3004
1976	V8 7.4L 454ci	S	AT THM w/Cruise Upper, OR 4 Spd. MT Upper; 41.00" Cable	CA-3009
1976	V8 7.4L 454ci	S	AT THM w/o Cruise, 3 Spd. MT w/o Cruise; 80.00" Cable	CA-3001
1977	V8 7.4L 454ci	S	w/Cruise Lower; 63.00" Cable	CA-3002
1977	V8 7.4L 454ci	S	w/Cruise Upper; 41.00" Cable	CA-3009
1978-79	V8 7.4L 454ci	S	3 Spd. MT w/o Cruise; 80.00" Cable	CA-3001
1978-79	V8 7.4L 454ci	S	4 Spd. MT; 61.00" Cable	CA-3005
1978-79	V8 7.4L 454ci	S	AT w/Catalytic Converter Lower	CA-3006
1978-79	V8 7.4L 454ci	S	AT w/Catalytic Converter w/Cruise Upper; 41.00" Cable	CA-3009
1978-79	V8 7.4L 454ci	S	AT w/o Catalytic Converter w/Cruise Lower; 63.00" Cable	CA-3002
1980	V8 7.4L 454ci	S,W	4 Spd. w/o Cruise Upper; 61.00" Cable	CA-3005
1980	V8 7.4L 454ci	S,W	exc. Cruise Control; 80.00" Cable	CA-3001

# SPEEDOMETER CABLES

Year	Engine	Vin	Remark	Part
<b>CHEVROLET TRUCKS (con't)</b>				
<b>C20 (con't)</b>				
1980	V8 7.4L 454ci	S,W	w/Catalic Converter w/Cruise Control, Lower	CA-3006
1980	V8 7.4L 454ci	S,W	w/o Catalic Converter w/Cruise Control, Lower; 63.00" Cable	CA-3002
1981	V8 7.4L 454ci	W	3 Spd. AT 1 pc. Cable; 80.00" Cable	CA-3001
1981	V8 7.4L 454ci	W	MT w/o Cruise Upper; 61.00" Cable	CA-3005
1981	V8 7.4L 454ci	W	w/Cruise Control, Lower; 63.00" Cable	CA-3002
1981	V8 7.4L 454ci	W	w/Cruise Control, Upper; 41.00" Cable	CA-3009
1982	V8 7.4L 454ci	W	3 Spd. AT 1 pc. Cable, or MT w/o Cruise; 80.00" Cable	CA-3001
1982	V8 7.4L 454ci	W	4 Spd. AT w/innerconnector, Upper; 61.00" Cable	CA-3005
1982	V8 7.4L 454ci	W	AT w/Cruise Control, Intermediate	CA-3006
1982	V8 7.4L 454ci	W	MT w/Cruise Control, Lower; 63.00" Cable	CA-3002
1983-84	V8 7.4L 454ci	W	4 Spd. MT w/innerconnector Lower; 20.00" Cable	CA-3008
1983-84	V8 7.4L 454ci	W	TH700-R4 Auto. Trans., or w/4 Spd. MT Upper; 61.00" Cable	CA-3005
1983-86	V8 7.4L 454ci	W	THM-400 Auto. Trans.; 80.00" Cable	CA-3001
1985	V8 7.4L 454ci	W	TH700-R4 Auto. Trans., Lower; 20.00" Cable	CA-3008
1985	V8 7.4L 454ci	W	TH700-R4 Auto. Trans., Upper; 61.00" Cable	CA-3005
1986	V8 7.4L 454ci	W	Lower exc. AT THM-400 Trans.; 20.00" Cable	CA-3008
1986	V8 7.4L 454ci	W	Upper exc. AT THM-400 Trans.; 61.00" Cable	CA-3005
1973-74	V8 7.4L 454ci	Z	3 & 4 Spd. MT, or THM AT w/o Cruise; 80.00" Cable	CA-3001
1973-74	V8 7.4L 454ci	Z	AT w/Cruise Control, Lower; 63.00" Cable	CA-3002
1973-74	V8 7.4L 454ci	Z	AT w/Cruise Control, Upper	CA-3031
1975	V8 7.4L 454ci	Z	4 Spd. MT Lower; 40.00" Cable	CA-3033
1975	V8 7.4L 454ci	Z	AT THM w/Cruise Lower; 63.00" Cable	CA-3002
1975	V8 7.4L 454ci	Z	AT THM w/Cruise Upper, OR 4 Spd. MT Upper; 41.00" Cable	CA-3009
1975	V8 7.4L 454ci	Z	AT THM w/o Cruise, 3 Spd. MT w/o Cruise; 80.00" Cable	CA-3001
<b>C20 SUBURBAN</b>				
1975	L6 4.8L 292ci	T	4 Spd. MT Lower; 40.00" Cable	CA-3033
1975	L6 4.8L 292ci	T	AT THM w/Cruise Lower; 63.00" Cable	CA-3002
1975	L6 4.8L 292ci	T	AT THM w/Cruise Upper, OR 4 Spd. MT Upper; 41.00" Cable	CA-3009
1975	L6 4.8L 292ci	T	AT THM w/o Cruise, 3 Spd. MT w/o Cruise; 80.00" Cable	CA-3001
1981	L6 4.8L 292ci	T	3 Spd. AT 1 pc. Cable; 80.00" Cable	CA-3001
1981	L6 4.8L 292ci	T	MT w/o Cruise Upper; 61.00" Cable	CA-3005
1981	L6 4.8L 292ci	T	w/Cruise Control, Lower; 63.00" Cable	CA-3002
1981	L6 4.8L 292ci	T	w/Cruise Control, Upper; 41.00" Cable	CA-3009
1982	L6 4.8L 292ci	T	3 Spd. AT 1 pc. Cable, or MT w/o Cruise; 80.00" Cable	CA-3001
1982	L6 4.8L 292ci	T	4 Spd. AT w/innerconnector, Upper; 61.00" Cable	CA-3005
1982	L6 4.8L 292ci	T	AT w/Cruise Control, Intermediate	CA-3006
1982	L6 4.8L 292ci	T	MT w/Cruise Control, Lower; 63.00" Cable	CA-3002
1981	V8 5.0L 305ci	H	3 Spd. AT 1 pc. Cable; 80.00" Cable	CA-3001
1981	V8 5.0L 305ci	H	MT w/o Cruise Upper; 61.00" Cable	CA-3005
1981	V8 5.0L 305ci	H	w/Cruise Control, Lower; 63.00" Cable	CA-3002
1981	V8 5.0L 305ci	H	w/Cruise Control, Upper; 41.00" Cable	CA-3009
1982	V8 5.0L 305ci	H	3 Spd. AT 1 pc. Cable, or MT w/o Cruise; 80.00" Cable	CA-3001
1982	V8 5.0L 305ci	H	4 Spd. AT w/innerconnector, Upper; 61.00" Cable	CA-3005
1982	V8 5.0L 305ci	H	AT w/Cruise Control, Intermediate	CA-3006
1982	V8 5.0L 305ci	H	MT w/Cruise Control, Lower; 63.00" Cable	CA-3002
1983-84	V8 5.0L 305ci	H	4 Spd. MT w/innerconnector Lower; 20.00" Cable	CA-3008
1983-84	V8 5.0L 305ci	H	TH700-R4 Auto. Trans., or w/4 Spd. MT Upper; 61.00" Cable	CA-3005
1983-84	V8 5.0L 305ci	H	THM-400 Auto. Trans.; 80.00" Cable	CA-3001
1981	V8 5.7L 350ci	L,M	3 Spd. AT 1 pc. Cable; 80.00" Cable	CA-3001
1981	V8 5.7L 350ci	L,M	MT w/o Cruise Upper; 61.00" Cable	CA-3005
1981	V8 5.7L 350ci	L,M	w/Cruise Control, Lower; 63.00" Cable	CA-3002
1981	V8 5.7L 350ci	L,M	w/Cruise Control, Upper; 41.00" Cable	CA-3009
1982	V8 5.7L 350ci	M	3 Spd. AT 1 pc. Cable, or MT w/o Cruise; 80.00" Cable	CA-3001
1982	V8 5.7L 350ci	M	4 Spd. AT w/innerconnector, Upper; 61.00" Cable	CA-3005
1982	V8 5.7L 350ci	M	AT w/Cruise Control, Intermediate	CA-3006
1982	V8 5.7L 350ci	M	MT w/Cruise Control, Lower; 63.00" Cable	CA-3002
1983-84	V8 5.7L 350ci	M	4 Spd. MT w/innerconnector Lower; 20.00" Cable	CA-3008
1983-84	V8 5.7L 350ci	M	TH700-R4 Auto. Trans., or w/4 Spd. MT Upper; 61.00" Cable	CA-3005
1983-85	V8 5.7L 350ci	M	THM-400 Auto. Trans.; 80.00" Cable	CA-3001
1985	V8 5.7L 350ci	M	TH700-R4 Auto. Trans., Lower; 20.00" Cable	CA-3008
1985	V8 5.7L 350ci	M	TH700-R4 Auto. Trans., Upper; 61.00" Cable	CA-3005
1975	V8 5.7L 350ci	V,Y	4 Spd. MT Lower; 40.00" Cable	CA-3033

# SPEEDOMETER CABLES

Year	Engine	Vin	Remark	Part
<b>CHEVROLET TRUCKS (con't)</b>				
<b>C20 SUBURBAN (con't)</b>				
1975	V8 5.7L 350ci	V,Y	AT THM w/Cruise Lower; 63.00" Cable	CA-3002
1975	V8 5.7L 350ci	V,Y	AT THM w/Cruise Upper, OR 4 Spd. MT Upper; 41.00" Cable	CA-3009
1975	V8 5.7L 350ci	V,Y	AT THM w/o Cruise, 3 Spd. MT w/o Cruise; 80.00" Cable	CA-3001
1982	V8 6.2L 379ci	J	3 Spd. AT 1 pc. Cable, or MT w/o Cruise; 80.00" Cable	CA-3001
1982	V8 6.2L 379ci	J	4 Spd. AT w/innerconnector, Upper; 61.00" Cable	CA-3005
1982	V8 6.2L 379ci	J	AT w/Cruise Control, Intermediate	CA-3006
1982	V8 6.2L 379ci	J	MT w/Cruise Control, Lower; 63.00" Cable	CA-3002
1983-84	V8 6.2L 379ci	J	4 Spd. MT w/innerconnector Lower; 20.00" Cable	CA-3008
1983-84	V8 6.2L 379ci	J	TH700-R4 Auto. Trans., or w/4 Spd. MT Upper; 61.00" Cable	CA-3005
1983-84	V8 6.2L 379ci	J	THM-400 Auto. Trans.; 80.00" Cable	CA-3001
1981	V8 7.4L 454ci	W	3 Spd. AT 1 pc. Cable; 80.00" Cable	CA-3001
1981	V8 7.4L 454ci	W	MT w/o Cruise Upper; 61.00" Cable	CA-3005
1981	V8 7.4L 454ci	W	w/Cruise Control, Lower; 63.00" Cable	CA-3002
1981	V8 7.4L 454ci	W	w/Cruise Control, Upper; 41.00" Cable	CA-3009
1983-84	V8 7.4L 454ci	W	4 Spd. MT w/innerconnector Lower; 20.00" Cable	CA-3008
1983-84	V8 7.4L 454ci	W	TH700-R4 Auto. Trans., or w/4 Spd. MT Upper; 61.00" Cable	CA-3005
1983-84	V8 7.4L 454ci	W	THM-400 Auto. Trans.; 80.00" Cable	CA-3001
1975	V8 7.4L 454ci	Z	4 Spd. MT Lower; 40.00" Cable	CA-3033
1975	V8 7.4L 454ci	Z	AT THM w/Cruise Lower; 63.00" Cable	CA-3002
1975	V8 7.4L 454ci	Z	AT THM w/Cruise Upper, OR 4 Spd. MT Upper; 41.00" Cable	CA-3009
1975	V8 7.4L 454ci	Z	AT THM w/o Cruise, 3 Spd. MT w/o Cruise; 80.00" Cable	CA-3001
<b>C30</b>				
1978-79	L6 4.1L 250ci	D	3 Spd. MT w/o Cruise; 80.00" Cable	CA-3001
1978-79	L6 4.1L 250ci	D	4 Spd. MT; 61.00" Cable	CA-3005
1978-79	L6 4.1L 250ci	D	AT w/Catalytic Converter Lower	CA-3006
1978-79	L6 4.1L 250ci	D	AT w/Catalytic Converter w/Cruise Upper; 41.00" Cable	CA-3009
1978-79	L6 4.1L 250ci	D	AT w/o Catalytic Converter w/Cruise Lower; 63.00" Cable	CA-3002
1980	L6 4.1L 250ci	D	4 Spd. w/o Cruise Upper; 61.00" Cable	CA-3005
1980	L6 4.1L 250ci	D	exc. Cruise Control; 80.00" Cable	CA-3001
1980	L6 4.1L 250ci	D	w/Catalic Converter w/Cruise Control, Lower	CA-3006
1980	L6 4.1L 250ci	D	w/o Catalic Converter w/Cruise Control, Lower; 63.00" Cable	CA-3002
1973-74	L6 4.1L 250ci	Q	3 & 4 Spd. MT, or THM AT w/o Cruise; 80.00" Cable	CA-3001
1973-74	L6 4.1L 250ci	Q	AT w/Cruise Control, Lower; 63.00" Cable	CA-3002
1973-74	L6 4.1L 250ci	Q	AT w/Cruise Control, Upper	CA-3031
1975	L6 4.1L 250ci	Q	4 Spd. MT Lower; 40.00" Cable	CA-3033
1975	L6 4.1L 250ci	Q	AT THM w/Cruise Lower; 63.00" Cable	CA-3002
1975	L6 4.1L 250ci	Q	AT THM w/Cruise Upper, OR 4 Spd. MT Upper; 41.00" Cable	CA-3009
1975	L6 4.1L 250ci	Q	AT THM w/o Cruise, 3 Spd. MT w/o Cruise; 80.00" Cable	CA-3001
1973-74	L6 4.8L 292ci	S,T	3 & 4 Spd. MT, or THM AT w/o Cruise; 80.00" Cable	CA-3001
1973-74	L6 4.8L 292ci	S,T	AT w/Cruise Control, Lower; 63.00" Cable	CA-3002
1973-74	L6 4.8L 292ci	S,T	AT w/Cruise Control, Upper	CA-3031
1975	L6 4.8L 292ci	T	AT THM w/Cruise Lower; 63.00" Cable	CA-3002
1975-76	L6 4.8L 292ci	T	4 Spd. MT Lower; 40.00" Cable	CA-3033
1975-76	L6 4.8L 292ci	T	AT THM w/Cruise Upper, OR 4 Spd. MT Upper; 41.00" Cable	CA-3009
1975-76	L6 4.8L 292ci	T	AT THM w/o Cruise, 3 Spd. MT w/o Cruise; 80.00" Cable	CA-3001
1976	L6 4.8L 292ci	T	AT THM w/Cruise Lower; 83.00" Cable	CA-3004
1977	L6 4.8L 292ci	T	w/Cruise Lower; 63.00" Cable	CA-3002
1977	L6 4.8L 292ci	T	w/Cruise Upper; 41.00" Cable	CA-3009
1978-79	L6 4.8L 292ci	T	3 Spd. MT w/o Cruise; 80.00" Cable	CA-3001
1978-79	L6 4.8L 292ci	T	4 Spd. MT; 61.00" Cable	CA-3005
1978-79	L6 4.8L 292ci	T	AT w/Catalytic Converter Lower	CA-3006
1978-79	L6 4.8L 292ci	T	AT w/Catalytic Converter w/Cruise Upper; 41.00" Cable	CA-3009
1978-79	L6 4.8L 292ci	T	AT w/o Catalytic Converter w/Cruise Lower; 63.00" Cable	CA-3002
1980	L6 4.8L 292ci	T	4 Spd. w/o Cruise Upper; 61.00" Cable	CA-3005
1980	L6 4.8L 292ci	T	exc. Cruise Control; 80.00" Cable	CA-3001
1980	L6 4.8L 292ci	T	w/Catalic Converter w/Cruise Control, Lower	CA-3006
1980	L6 4.8L 292ci	T	w/o Catalic Converter w/Cruise Control, Lower; 63.00" Cable	CA-3002
1981	L6 4.8L 292ci	T	3 Spd. AT 1 pc. Cable; 80.00" Cable	CA-3001
1981	L6 4.8L 292ci	T	MT w/o Cruise Upper; 61.00" Cable	CA-3005
1981	L6 4.8L 292ci	T	w/Cruise Control, Lower; 63.00" Cable	CA-3002
1981	L6 4.8L 292ci	T	w/Cruise Control, Upper; 41.00" Cable	CA-3009
1982	L6 4.8L 292ci	T	3 Spd. AT Lower; 63.00" Cable	CA-3002

# SPEEDOMETER CABLES

Year	Engine	Vin	Remark	Part
<b>CHEVROLET TRUCKS (con't)</b>				
<b>C30 (con't)</b>				
1982	L6 4.8L 292ci	T	4 Spd. MT Upper; 61.00" Cable	CA-3005
1982	L6 4.8L 292ci	T	MT w/innerconnector Lower; 20.00" Cable	CA-3008
1982	L6 4.8L 292ci	T	MT w/innerconnector Upper; 41.00" Cable	CA-3009
1982	L6 4.8L 292ci	T	MT w/o innerconnector	CA-3006
1983	L6 4.8L 292ci	T	4 Spd. MT w/innerconnector Lower; 20.00" Cable	CA-3008
1983	L6 4.8L 292ci	T	TH700-R4 Auto. Trans., or w/4 Spd. MT Upper; 61.00" Cable	CA-3005
1983-86	L6 4.8L 292ci	T	THM-400 Auto. Trans.; 80.00" Cable	CA-3001
1986	L6 4.8L 292ci	T	Lower exc. AT THM-400 Trans.; 20.00" Cable	CA-3008
1986	L6 4.8L 292ci	T	Upper exc. AT THM-400 Trans.; 61.00" Cable	CA-3005
1986	V8 5.0L 305ci	H	Lower exc. AT THM-400 Trans.; 20.00" Cable	CA-3008
1986	V8 5.0L 305ci	H	THM-400 Auto. Trans.; 80.00" Cable	CA-3001
1986	V8 5.0L 305ci	H	Upper exc. AT THM-400 Trans.; 61.00" Cable	CA-3005
1978-79	V8 5.0L 305ci	U	3 Spd. MT w/o Cruise; 80.00" Cable	CA-3001
1978-79	V8 5.0L 305ci	U	4 Spd. MT; 61.00" Cable	CA-3005
1978-79	V8 5.0L 305ci	U	AT w/Catalytic Converter Lower	CA-3006
1978-79	V8 5.0L 305ci	U	AT w/Catalytic Converter w/Cruise Upper; 41.00" Cable	CA-3009
1978-79	V8 5.0L 305ci	U	AT w/o Catalytic Converter w/Cruise Lower; 63.00" Cable	CA-3002
1973	V8 5.0L 307ci	X	3 & 4 Spd. MT, or THM AT w/o Cruise; 80.00" Cable	CA-3001
1973	V8 5.0L 307ci	X	AT w/Cruise Control, Lower; 63.00" Cable	CA-3002
1973	V8 5.0L 307ci	X	AT w/Cruise Control, Upper	CA-3031
1976	V8 5.7L 350ci	L,V	AT THM w/Cruise Lower; 83.00" Cable	CA-3004
1977	V8 5.7L 350ci	L	w/Cruise Lower; 63.00" Cable	CA-3002
1977	V8 5.7L 350ci	L	w/Cruise Upper; 41.00" Cable	CA-3009
1978-79	V8 5.7L 350ci	L,Z	3 Spd. MT w/o Cruise; 80.00" Cable	CA-3001
1978-79	V8 5.7L 350ci	L,Z	4 Spd. MT; 61.00" Cable	CA-3005
1978-79	V8 5.7L 350ci	L,Z	AT w/Catalytic Converter Lower	CA-3006
1978-79	V8 5.7L 350ci	L,Z	AT w/Catalytic Converter w/Cruise Upper; 41.00" Cable	CA-3009
1978-79	V8 5.7L 350ci	L,Z	AT w/o Catalytic Converter w/Cruise Lower; 63.00" Cable	CA-3002
1980	V8 5.7L 350ci	L,M	4 Spd. w/o Cruise Upper; 61.00" Cable	CA-3005
1980	V8 5.7L 350ci	L,M	exc. Cruise Control; 80.00" Cable	CA-3001
1980	V8 5.7L 350ci	L,M	w/Catalic Converter w/Cruise Control, Lower	CA-3006
1980	V8 5.7L 350ci	L,M	w/o Catalic Converter w/Cruise Control, Lower; 63.00" Cable	CA-3002
1981	V8 5.7L 350ci	M	3 Spd. AT 1 pc. Cable; 80.00" Cable	CA-3001
1981	V8 5.7L 350ci	M	MT w/o Cruise Upper; 61.00" Cable	CA-3005
1981	V8 5.7L 350ci	M	w/Cruise Control, Lower; 63.00" Cable	CA-3002
1981	V8 5.7L 350ci	M	w/Cruise Control, Upper; 41.00" Cable	CA-3009
1982	V8 5.7L 350ci	M	3 Spd. AT Lower; 63.00" Cable	CA-3002
1982	V8 5.7L 350ci	M	4 Spd. MT Upper; 61.00" Cable	CA-3005
1982	V8 5.7L 350ci	M	MT w/innerconnector Lower; 20.00" Cable	CA-3008
1982	V8 5.7L 350ci	M	MT w/innerconnector Upper; 41.00" Cable	CA-3009
1982	V8 5.7L 350ci	M	MT w/o innerconnector	CA-3006
1983	V8 5.7L 350ci	M	4 Spd. MT w/innerconnector Lower; 20.00" Cable	CA-3008
1983	V8 5.7L 350ci	M	TH700-R4 Auto. Trans., or w/4 Spd. MT Upper; 61.00" Cable	CA-3005
1983-86	V8 5.7L 350ci	M	THM-400 Auto. Trans.; 80.00" Cable	CA-3001
1986	V8 5.7L 350ci	M	Lower exc. AT THM-400 Trans.; 20.00" Cable	CA-3008
1986	V8 5.7L 350ci	M	Upper exc. AT THM-400 Trans.; 61.00" Cable	CA-3005
1975	V8 5.7L 350ci	V,Y	AT THM w/Cruise Lower; 63.00" Cable	CA-3002
1975-76	V8 5.7L 350ci	L,V,Y	4 Spd. MT Lower; 40.00" Cable	CA-3033
1975-76	V8 5.7L 350ci	L,V,Y	AT THM w/Cruise Upper, OR 4 Spd. MT Upper; 41.00" Cable	CA-3009
1975-76	V8 5.7L 350ci	L,V,Y	AT THM w/o Cruise, 3 Spd. MT w/o Cruise; 80.00" Cable	CA-3001
1973-74	V8 5.7L 350ci	V,W,Y	3 & 4 Spd. MT, or THM AT w/o Cruise; 80.00" Cable	CA-3001
1973-74	V8 5.7L 350ci	V,W,Y	AT w/Cruise Control, Lower; 63.00" Cable	CA-3002
1973-74	V8 5.7L 350ci	V,W,Y	AT w/Cruise Control, Upper	CA-3031
1982	V8 6.2L 379ci	J	3 Spd. AT Lower; 63.00" Cable	CA-3002
1982	V8 6.2L 379ci	J	4 Spd. MT Upper; 61.00" Cable	CA-3005
1982	V8 6.2L 379ci	J	MT w/innerconnector Lower; 20.00" Cable	CA-3008
1982	V8 6.2L 379ci	J	MT w/innerconnector Upper; 41.00" Cable	CA-3009
1982	V8 6.2L 379ci	J	MT w/o innerconnector	CA-3006
1983	V8 6.2L 379ci	J	4 Spd. MT w/innerconnector Lower; 20.00" Cable	CA-3008
1983	V8 6.2L 379ci	J	TH700-R4 Auto. Trans., or w/4 Spd. MT Upper; 61.00" Cable	CA-3005
1983-86	V8 6.2L 379ci	J	THM-400 Auto. Trans.; 80.00" Cable	CA-3001
1986	V8 6.2L 379ci	J	Lower exc. AT THM-400 Trans.; 20.00" Cable	CA-3008

# SPEEDOMETER CABLES

Year	Engine	Vin	Remark	Part
<b>CHEVROLET TRUCKS (con't)</b>				
<b>C30 (con't)</b>				
1986	V8 6.2L 379ci	J	Upper exc. AT THM-400 Trans.; 61.00" Cable	CA-3005
1977	V8 6.6L 400ci	R	w/Cruise Lower; 63.00" Cable	CA-3002
1977	V8 6.6L 400ci	R	w/Cruise Upper; 41.00" Cable	CA-3009
1978-79	V8 6.6L 400ci	R	3 Spd. MT w/o Cruise; 80.00" Cable	CA-3001
1978-79	V8 6.6L 400ci	R	4 Spd. MT; 61.00" Cable	CA-3005
1978-79	V8 6.6L 400ci	R	AT w/Catalytic Converter Lower	CA-3006
1978-79	V8 6.6L 400ci	R	AT w/Catalytic Converter w/Cruise Upper; 41.00" Cable	CA-3009
1978-79	V8 6.6L 400ci	R	AT w/o Catalytic Converter w/Cruise Lower; 63.00" Cable	CA-3002
1976	V8 6.6L 400ci	U	4 Spd. MT Lower; 40.00" Cable	CA-3033
1976	V8 6.6L 400ci	U	AT THM w/Cruise Lower; 83.00" Cable	CA-3004
1976	V8 6.6L 400ci	U	AT THM w/Cruise Upper, OR 4 Spd. MT Upper; 41.00" Cable	CA-3009
1976	V8 6.6L 400ci	U	AT THM w/o Cruise, 3 Spd. MT w/o Cruise; 80.00" Cable	CA-3001
1976	V8 7.4L 454ci	S	4 Spd. MT Lower; 40.00" Cable	CA-3033
1976	V8 7.4L 454ci	S	AT THM w/Cruise Lower; 83.00" Cable	CA-3004
1976	V8 7.4L 454ci	S	AT THM w/Cruise Upper, OR 4 Spd. MT Upper; 41.00" Cable	CA-3009
1976	V8 7.4L 454ci	S	AT THM w/o Cruise, 3 Spd. MT w/o Cruise; 80.00" Cable	CA-3001
1977	V8 7.4L 454ci	S	w/Cruise Lower; 63.00" Cable	CA-3002
1977	V8 7.4L 454ci	S	w/Cruise Upper; 41.00" Cable	CA-3009
1978-79	V8 7.4L 454ci	S	3 Spd. MT w/o Cruise; 80.00" Cable	CA-3001
1978-79	V8 7.4L 454ci	S	4 Spd. MT; 61.00" Cable	CA-3005
1978-79	V8 7.4L 454ci	S	AT w/Catalytic Converter Lower	CA-3006
1978-79	V8 7.4L 454ci	S	AT w/Catalytic Converter w/Cruise Upper; 41.00" Cable	CA-3009
1978-79	V8 7.4L 454ci	S	AT w/o Catalytic Converter w/Cruise Lower; 63.00" Cable	CA-3002
1980	V8 7.4L 454ci	S,W	4 Spd. w/o Cruise Upper; 61.00" Cable	CA-3005
1980	V8 7.4L 454ci	S,W	exc. Cruise Control; 80.00" Cable	CA-3001
1980	V8 7.4L 454ci	S,W	w/Catalic Converter w/Cruise Control, Lower	CA-3006
1980	V8 7.4L 454ci	S,W	w/o Catalic Converter w/Cruise Control, Lower; 63.00" Cable	CA-3002
1981	V8 7.4L 454ci	W	3 Spd. AT 1 pc. Cable; 80.00" Cable	CA-3001
1981	V8 7.4L 454ci	W	MT w/o Cruise Upper; 61.00" Cable	CA-3005
1981	V8 7.4L 454ci	W	w/Cruise Control, Lower; 63.00" Cable	CA-3002
1981	V8 7.4L 454ci	W	w/Cruise Control, Upper; 41.00" Cable	CA-3009
1982	V8 7.4L 454ci	W	3 Spd. AT Lower; 63.00" Cable	CA-3002
1982	V8 7.4L 454ci	W	4 Spd. MT Upper; 61.00" Cable	CA-3005
1982	V8 7.4L 454ci	W	MT w/innerconnector Lower; 20.00" Cable	CA-3008
1982	V8 7.4L 454ci	W	MT w/innerconnector Upper; 41.00" Cable	CA-3009
1982	V8 7.4L 454ci	W	MT w/o innerconnector	CA-3006
1983	V8 7.4L 454ci	W	4 Spd. MT w/innerconnector Lower; 20.00" Cable	CA-3008
1983	V8 7.4L 454ci	W	TH700-R4 Auto. Trans., or w/4 Spd. MT Upper; 61.00" Cable	CA-3005
1983-86	V8 7.4L 454ci	W	THM-400 Auto. Trans.; 80.00" Cable	CA-3001
1986	V8 7.4L 454ci	W	Lower exc. AT THM-400 Trans.; 20.00" Cable	CA-3008
1986	V8 7.4L 454ci	W	Upper exc. AT THM-400 Trans.; 61.00" Cable	CA-3005
1973-74	V8 7.4L 454ci	Z	3 & 4 Spd. MT, or THM AT w/o Cruise; 80.00" Cable	CA-3001
1973-74	V8 7.4L 454ci	Z	AT w/Cruise Control, Lower; 63.00" Cable	CA-3002
1973-74	V8 7.4L 454ci	Z	AT w/Cruise Control, Upper	CA-3031
1975	V8 7.4L 454ci	Z	4 Spd. MT Lower; 40.00" Cable	CA-3033
1975	V8 7.4L 454ci	Z	AT THM w/Cruise Lower; 63.00" Cable	CA-3002
1975	V8 7.4L 454ci	Z	AT THM w/Cruise Upper, OR 4 Spd. MT Upper; 41.00" Cable	CA-3009
1975	V8 7.4L 454ci	Z	AT THM w/o Cruise, 3 Spd. MT w/o Cruise; 80.00" Cable	CA-3001
<b>EXPRESS 1500, EXPRESS 2500</b>				
1996-97	V8 5.0L 305ci	M	Lower Cable to interconnector; 61.00" Cable	CA-3013
1996-97	V8 5.0L 305ci	M	w/Cruise Upper; 41.00" Cable	CA-3009
1996-97	V8 5.0L 305ci	M	w/o Cruise w/o interconnector 2 pc. Cable Lower; 63.00" Cable	CA-3002
1996-97	V8 5.0L 305ci	M	w/o Cruise w/o interconnector; 120.00" Cable	CA-3007
<b>G10</b>				
1971	L6 4.1L 250ci	C,L	w/Powerglide AT to 120" long cable, w/4 Spd. MT	CA-3038
1971	L6 4.1L 250ci	C	w/Powerglide AT w/76" to 84" long cable	CA-3016
1971	L6 4.1L 250ci	C	w/THM AT to 120" long Cable, w/3 Spd. MT; 120.00" Cable	CA-3007
1971	L6 4.1L 250ci	C,L	w/THM AT w/60" to 76" long Cable; 83.00" Cable	CA-3004
1972	L6 4.1L 250ci	D	4 Spd. MT	CA-3038
1972	L6 4.1L 250ci	D	w/THM AT to 120" long Cable, w/3 Spd. MT; 120.00" Cable	CA-3007
1972	L6 4.1L 250ci	D	w/THM AT to 83" long Cable; 83.00" Cable	CA-3004
1976-77	L6 4.1L 250ci	D	4 Spd. MT Lower; 40.00" Cable	CA-3033

# SPEEDOMETER CABLES

Year	Engine	Vin	Remark	Part
<b>CHEVROLET TRUCKS (con't)</b>				
<b>G10 (con't)</b>				
1976-77	L6 4.1L 250ci	D	4 Spd. MT Upper; 41.00" Cable	CA-3009
1976-77	L6 4.1L 250ci	D	AT w/Cruise Control, Lower; 63.00" Cable	CA-3002
1976-77	L6 4.1L 250ci	D	AT w/Cruise Control, Upper; 80.00" Cable	CA-3001
1976-77	L6 4.1L 250ci	D	exc. Cruise Control; 120.00" Cable	CA-3007
1976-78	L6 4.1L 250ci	D	AT w/Cruise Upper 41.00" Cable	CA-3009
1976-82	L6 4.1L 250ci	D	Lower Cable to interconnector; 61.00" Cable	CA-3013
1976-82	L6 4.1L 250ci	D	w/Cruise Upper; 41.00" Cable	CA-3009
1976-82	L6 4.1L 250ci	D	w/o Cruise w/o interconnector 2 pc. Cable Lower; 63.00" Cable	CA-3002
1976-82	L6 4.1L 250ci	D	w/o Cruise w/o interconnector; 120.00" Cable	CA-3007
1977-80	L6 4.1L 250ci	D	Upper Cable to interconnector; 61.00" Cable	CA-3013
1978-79	L6 4.1L 250ci	D	w/o interconnector Cruise Upper; 41.00" Cable	CA-3009
1978-80	L6 4.1L 250ci	D	Lower Cable to interconnector; 63.00" Cable	CA-3002
1983-84	L6 4.1L 250ci	D	120.00" Cable	CA-3007
1971	L6 4.1L 250ci	L	w/Powerglide AT w/76" to 84" long cable	CA-3016
1971	L6 4.1L 250ci	L	w/THM AT to 120" long Cable, w/3 Spd. MT; 120.00" Cable	CA-3007
1970	L6 4.1L 250ci	N	All to 120" long cable	CA-3038
1970	L6 4.1L 250ci	N	MT w/40" to 56" long Cable; 63.00" Cable	CA-3002
1970	L6 4.1L 250ci	N	MT w/56" to 60" Cable; 61.00" Cable	CA-3005
1970	L6 4.1L 250ci	N	MT w/60" to 76" long Cable; 83.00" Cable	CA-3004
1970	L6 4.1L 250ci	N	MT w/under 36" long Cable	CA-3006
1970	L6 4.1L 250ci	N	w/76" to 84" long cable	CA-3016
1973-74	L6 4.1L 250ci	Q	120.00" Cable	CA-3007
1975	L6 4.1L 250ci	Q	exc. Cruise Control; 120.00" Cable	CA-3007
1975	L6 4.1L 250ci	Q	Lower Cable to interconnector; 61.00" Cable	CA-3013
1975	L6 4.1L 250ci	Q	w/Cruise Upper; 41.00" Cable	CA-3009
1975	L6 4.1L 250ci	Q	w/o Cruise w/o interconnector 2 pc. Cable Lower; 63.00" Cable	CA-3002
1975	L6 4.1L 250ci	Q	w/o Cruise w/o interconnector; 120.00" Cable	CA-3007
1975	L6 4.1L 250ci	Q	w/THM AT w/Cruise Control Upper; 80.00" Cable	CA-3001
1975	L6 4.1L 250ci	Q	w/THM AT w/Cruise Control, Lower; 63.00" Cable	CA-3002
1985-86	V6 4.3L 262ci	N	120.00" Cable	CA-3007
1987-88	V6 4.3L 262ci	Z	120.00" Cable	CA-3007
1989	V6 4.3L 262ci	Z	AT; 120.00" Cable	CA-3007
1984	V8 5.0L 305ci	F,H	w/o interconnector Cruise Upper; 41.00" Cable	CA-3009
1980	V8 5.0L 305ci	G	Upper Cable to interconnector; 61.00" Cable	CA-3013
1980-81	V8 5.0L 305ci	G	w/Cruise Upper; 41.00" Cable	CA-3009
1980-81	V8 5.0L 305ci	G	w/o Cruise w/o interconnector; 120.00" Cable	CA-3007
1981-92	V8 5.0L 305ci	F,G,H	Lower Cable to interconnector; 61.00" Cable	CA-3013
1981-92	V8 5.0L 305ci	F,G,H	w/o Cruise w/o interconnector 2 pc. Cable Lower; 63.00" Cable	CA-3002
1981-93	V8 5.0L 305ci	F,H	w/Cruise Upper; 41.00" Cable	CA-3009
1981-93	V8 5.0L 305ci	F,H	w/o Cruise w/o interconnector; 120.00" Cable	CA-3007
1983-88	V8 5.0L 305ci	F,H	120.00" Cable	CA-3007
1984-85	V8 5.0L 305ci	F,H	Lower Cable to interconnector; 63.00" Cable	CA-3002
1984-93	V8 5.0L 305ci	F,H	Upper Cable to interconnector; 61.00" Cable	CA-3013
1989	V8 5.0L 305ci	H	AT w/o Cruise w/o interconnector; 120.00" Cable	CA-3007
1989	V8 5.0L 305ci	H	AT; 120.00" Cable	CA-3007
1977	V8 5.0L 305ci	U	4 Spd. MT Lower; 40.00" Cable	CA-3033
1977	V8 5.0L 305ci	U	4 Spd. MT Upper; 41.00" Cable	CA-3009
1977	V8 5.0L 305ci	U	AT w/Cruise Control, Lower; 63.00" Cable	CA-3002
1977	V8 5.0L 305ci	U	AT w/Cruise Control, Upper; 80.00" Cable	CA-3001
1977	V8 5.0L 305ci	U	exc. Cruise Control; 120.00" Cable	CA-3007
1978	V8 5.0L 305ci	U	w/Cruise Upper; 41.00" Cable	CA-3009
1978-79	V8 5.0L 305ci	U	Lower Cable to interconnector; 63.00" Cable	CA-3002
1978-79	V8 5.0L 305ci	U	Upper Cable to interconnector; 61.00" Cable	CA-3013
1978-79	V8 5.0L 305ci	U	w/o Cruise w/o interconnector; 120.00" Cable	CA-3007
1979	V8 5.0L 305ci	U	w/o interconnector Cruise Upper; 41.00" Cable	CA-3009
1970	V8 5.0L 307ci	A	All to 120" long cable	CA-3038
1970	V8 5.0L 307ci	A	MT w/40" to 56" long Cable; 63.00" Cable	CA-3002
1970	V8 5.0L 307ci	A	MT w/56" to 60" Cable; 61.00" Cable	CA-3005
1970	V8 5.0L 307ci	A	MT w/60" to 76" long Cable; 83.00" Cable	CA-3004
1970	V8 5.0L 307ci	A	MT w/under 36" long Cable	CA-3006
1970	V8 5.0L 307ci	A	w/76" to 84" long cable	CA-3016
1972	V8 5.0L 307ci	F	4 Spd. MT	CA-3038

# SPEEDOMETER CABLES

Year	Engine	Vin	Remark	Part
<b>CHEVROLET TRUCKS (con't)</b>				
<b>G10 (con't)</b>				
1972	V8 5.0L 307ci	F	w/THM AT to 120" long Cable, w/3 Spd. MT; 120.00" Cable	CA-3007
1972	V8 5.0L 307ci	F	w/THM AT to 83" long Cable; 83.00" Cable	CA-3004
1971	V8 5.0L 307ci	H	w/Powerglide AT to 120" long cable, w/4 Spd. MT	CA-3038
1971	V8 5.0L 307ci	H	w/Powerglide AT w/76" to 84" long cable	CA-3016
1971	V8 5.0L 307ci	H	w/THM AT to 120" long Cable, w/3 Spd. MT; 120.00" Cable	CA-3007
1971	V8 5.0L 307ci	H	w/THM AT w/60" to 76" long Cable; 83.00" Cable	CA-3004
1973	V8 5.0L 307ci	X	120.00" Cable	CA-3007
1970	V8 5.7L 350ci	E	All to 120" long cable	CA-3038
1970	V8 5.7L 350ci	E	MT w/40" to 56" long Cable; 63.00" Cable	CA-3002
1970	V8 5.7L 350ci	E	MT w/56" to 60" Cable; 61.00" Cable	CA-3005
1970	V8 5.7L 350ci	E	MT w/60" to 76" long Cable; 83.00" Cable	CA-3004
1970	V8 5.7L 350ci	E	MT w/under 36" long Cable	CA-3006
1970	V8 5.7L 350ci	E	w/76" to 84" long cable	CA-3016
1971	V8 5.7L 350ci	E	w/Powerglide AT to 120" long cable, w/4 Spd. MT	CA-3038
1971	V8 5.7L 350ci	E	w/Powerglide AT w/76" to 84" long cable	CA-3016
1971	V8 5.7L 350ci	E	w/THM AT w/60" to 76" long Cable; 83.00" Cable	CA-3004
1971-72	V8 5.7L 350ci	E,H	w/THM AT to 120" long Cable, w/3 Spd. MT; 120.00" Cable	CA-3007
1972	V8 5.7L 350ci	E,H	4 Spd. MT	CA-3038
1972	V8 5.7L 350ci	E,H	w/THM AT to 83" long Cable; 83.00" Cable	CA-3004
1987	V8 5.7L 350ci	K	Lower Cable to interconnector; 63.00" Cable	CA-3002
1987	V8 5.7L 350ci	K	Upper Cable to interconnector; 61.00" Cable	CA-3013
1987	V8 5.7L 350ci	K	w/Cruise Upper; 41.00" Cable	CA-3009
1987	V8 5.7L 350ci	K	w/o Cruise w/o interconnector; 120.00" Cable	CA-3007
1982	V8 5.7L 350ci	L	Lower Cable to interconnector; 61.00" Cable	CA-3013
1976-77	V8 5.7L 350ci	L,V	4 Spd. MT Lower; 40.00" Cable	CA-3033
1976-77	V8 5.7L 350ci	L,V	4 Spd. MT Upper; 41.00" Cable	CA-3009
1976-77	V8 5.7L 350ci	L,V	AT w/Cruise Control, Lower; 63.00" Cable	CA-3002
1976-77	V8 5.7L 350ci	L,V,Y	AT w/Cruise Control, Upper; 80.00" Cable	CA-3001
1976-77	V8 5.7L 350ci	L	exc. Cruise Control; 120.00" Cable	CA-3007
1978-82	V8 5.7L 350ci	L	w/o Cruise w/o interconnector 2 pc. Cable Lower; 63.00" Cable	CA-3002
1978-86	V8 5.7L 350ci	L	Lower Cable to interconnector; 63.00" Cable	CA-3002
1978-86	V8 5.7L 350ci	L,P	Upper Cable to interconnector; 61.00" Cable	CA-3013
1978-86	V8 5.7L 350ci	L,P	w/Cruise Upper; 41.00" Cable	CA-3009
1978-86	V8 5.7L 350ci	L,P	w/o Cruise w/o interconnector; 120.00" Cable	CA-3007
1979-86	V8 5.7L 350ci	L	w/o interconnector Cruise Upper; 41.00" Cable	CA-3009
1983-84	V8 5.7L 350ci	L	120.00" Cable	CA-3007
1975	V8 5.7L 350ci	V,Y	w/THM AT w/Cruise Control, Lower; 63.00" Cable	CA-3002
1975-76	V8 5.7L 350ci	V,Y	exc. Cruise Control; 120.00" Cable	CA-3007
1976	V8 5.7L 350ci	V	AT w/Cruise Control, Upper; 80.00" Cable	CA-3001
1973-74	V8 5.7L 350ci	V,Y	AT; 63.00" Cable	CA-3002
<b>G20</b>				
1971	L6 4.1L 250ci	C	w/Powerglide AT to 120" long cable, w/4 Spd. MT	CA-3038
1971	L6 4.1L 250ci	C,L	w/Powerglide AT w/76" to 84" long cable	CA-3016
1971	L6 4.1L 250ci	C,L	w/THM AT to 120" long Cable, w/3 Spd. MT; 120.00" Cable	CA-3007
1971	L6 4.1L 250ci	C,L	w/THM AT w/60" to 76" long Cable; 83.00" Cable	CA-3004
1972	L6 4.1L 250ci	D	4 Spd. MT	CA-3038
1972	L6 4.1L 250ci	D	w/THM AT to 120" long Cable, w/3 Spd. MT; 120.00" Cable	CA-3007
1972	L6 4.1L 250ci	D	w/THM AT to 83" long Cable; 83.00" Cable	CA-3004
1977	L6 4.1L 250ci	D	4 Spd. MT Lower; 40.00" Cable	CA-3033
1977	L6 4.1L 250ci	D	4 Spd. MT w/Cruise Upper 41.00" Cable	CA-3009
1977	L6 4.1L 250ci	D	AT w/Cruise Control, Lower; 63.00" Cable	CA-3002
1977	L6 4.1L 250ci	D	AT w/Cruise Control, Upper; 80.00" Cable	CA-3001
1977	L6 4.1L 250ci	D	exc. Cruise Control; 120.00" Cable	CA-3007
1977-82	L6 4.1L 250ci	D	Lower Cable to interconnector; 61.00" Cable	CA-3013
1977-82	L6 4.1L 250ci	D	w/o Cruise w/o interconnector 2 pc. Cable Lower; 63.00" Cable	CA-3002
1977-82	L6 4.1L 250ci	D	w/o Cruise w/o interconnector; 120.00" Cable	CA-3007
1978-82	L6 4.1L 250ci	D	Lower Cable to interconnector; 63.00" Cable	CA-3002
1978-82	L6 4.1L 250ci	D	w/Cruise Upper; 41.00" Cable	CA-3009
1979-81	L6 4.1L 250ci	D	w/o interconnector Cruise Upper; 41.00" Cable	CA-3009
1983-84	L6 4.1L 250ci	D	120.00" Cable	CA-3007
1971	L6 4.1L 250ci	L	w/Powerglide AT to 120" long cable, w/4 Spd. MT	CA-3038
1970	L6 4.1L 250ci	N	All to 120" long cable	CA-3038



# SPEEDOMETER CABLES

Year	Engine	Vin	Remark	Part
<b>CHEVROLET TRUCKS (con't)</b>				
<b>G20 (con't)</b>				
1970	L6 4.1L 250ci	N	MT w/40" to 56" long Cable; 63.00" Cable	CA-3002
1970	L6 4.1L 250ci	N	MT w/56" to 60" Cable; 61.00" Cable	CA-3005
1970	L6 4.1L 250ci	N	MT w/60" to 76" long Cable; 83.00" Cable	CA-3004
1970	L6 4.1L 250ci	N	MT w/under 36" long Cable	CA-3006
1970	L6 4.1L 250ci	N	w/76" to 84" long cable	CA-3016
1973-74	L6 4.1L 250ci	Q	120.00" Cable	CA-3007
1975	L6 4.1L 250ci	Q	exc. Cruise Control; 120.00" Cable	CA-3007
1975	L6 4.1L 250ci	Q	w/THM AT w/Cruise Control Upper; 80.00" Cable	CA-3001
1975	L6 4.1L 250ci	Q	w/THM AT w/Cruise Control, Lower; 63.00" Cable	CA-3002
1973-74	L6 4.8L 292ci	T	120.00" Cable	CA-3007
1975	L6 4.8L 292ci	T	w/THM AT w/Cruise Control Upper; 80.00" Cable	CA-3001
1975	L6 4.8L 292ci	T	w/THM AT w/Cruise Control, Lower; 63.00" Cable	CA-3002
1975-77	L6 4.8L 292ci	T	exc. Cruise Control; 120.00" Cable	CA-3007
1976-77	L6 4.8L 292ci	T	4 Spd. MT Lower; 40.00" Cable	CA-3033
1976-77	L6 4.8L 292ci	T	4 Spd. MT Upper; 41.00" Cable	CA-3009
1976-77	L6 4.8L 292ci	T	AT w/Cruise Control, Lower; 63.00" Cable	CA-3002
1976-77	L6 4.8L 292ci	T	AT w/Cruise Control, Upper; 80.00" Cable	CA-3001
1978-79	L6 4.8L 292ci	T	Lower Cable to interconnector; 63.00" Cable	CA-3002
1978-80	L6 4.8L 292ci	T	Upper Cable to interconnector; 61.00" Cable	CA-3013
1978-80	L6 4.8L 292ci	T	w/Cruise Upper; 41.00" Cable	CA-3009
1978-80	L6 4.8L 292ci	T	w/o Cruise w/o interconnector; 120.00" Cable	CA-3007
1979	L6 4.8L 292ci	T	w/o interconnector Cruise Upper; 41.00" Cable	CA-3009
1985-86	V6 4.3L 262ci	N	120.00" Cable	CA-3007
1987-88	V6 4.3L 262ci	Z	120.00" Cable	CA-3007
1989	V6 4.3L 262ci	Z	AT; 120.00" Cable	CA-3007
1989-91	V6 4.3L 262ci	Z	w/Cruise Upper; 41.00" Cable	CA-3009
1989-91	V6 4.3L 262ci	Z	w/o Cruise w/o interconnector; 120.00" Cable	CA-3007
1989-92	V6 4.3L 262ci	Z	Upper Cable to interconnector; 61.00" Cable	CA-3013
1990	V6 4.3L 262ci	Z	w/o interconnector Cruise Upper; 41.00" Cable	CA-3009
1990-91	V6 4.3L 262ci	Z	Lower Cable to interconnector; 63.00" Cable	CA-3002
1980-81	V8 5.0L 305ci	G	Upper Cable to interconnector; 61.00" Cable	CA-3013
1980-81	V8 5.0L 305ci	G	w/Cruise Upper; 41.00" Cable	CA-3009
1980-81	V8 5.0L 305ci	G	w/o Cruise w/o interconnector; 120.00" Cable	CA-3007
1981-95	V8 5.0L 305ci	F,H	Lower Cable to interconnector; 61.00" Cable	CA-3013
1981-95	V8 5.0L 305ci	F,H	w/Cruise Upper; 41.00" Cable	CA-3009
1981-95	V8 5.0L 305ci	F,G,H	w/o Cruise w/o interconnector 2 pc. Cable Lower; 63.00" Cable	CA-3002
1981-95	V8 5.0L 305ci	F,H	w/o Cruise w/o interconnector; 120.00" Cable	CA-3007
1983-88	V8 5.0L 305ci	F,H	120.00" Cable	CA-3007
1984	V8 5.0L 305ci	H	w/o interconnector Cruise Upper; 41.00" Cable	CA-3009
1984-86	V8 5.0L 305ci	F,H	Lower Cable to interconnector; 63.00" Cable	CA-3002
1989	V8 5.0L 305ci	H	AT; 120.00" Cable	CA-3007
1977	V8 5.0L 305ci	U	4 Spd. MT Lower; 40.00" Cable	CA-3033
1977	V8 5.0L 305ci	U	4 Spd. MT Upper; 41.00" Cable	CA-3009
1977	V8 5.0L 305ci	U	AT w/Cruise Control, Lower; 63.00" Cable	CA-3002
1977	V8 5.0L 305ci	U	AT w/Cruise Control, Upper; 80.00" Cable	CA-3001
1977	V8 5.0L 305ci	U	exc. Cruise Control; 120.00" Cable	CA-3007
1978	V8 5.0L 305ci	U	w/Cruise Upper; 41.00" Cable	CA-3009
1979	V8 5.0L 305ci	U	w/o interconnector Cruise Upper; 41.00" Cable	CA-3009
1978-79	V8 5.0L 305ci	U	Lower Cable to interconnector; 63.00" Cable	CA-3002
1978-79	V8 5.0L 305ci	U	Upper Cable to interconnector; 61.00" Cable	CA-3013
1978-79	V8 5.0L 305ci	U	w/o Cruise w/o interconnector; 120.00" Cable	CA-3007
1970	V8 5.7L 350ci	E	All to 120" long cable	CA-3038
1970	V8 5.7L 350ci	E	MT w/40" to 56" long Cable; 63.00" Cable	CA-3002
1970	V8 5.7L 350ci	E	MT w/56" to 60" Cable; 61.00" Cable	CA-3005
1970	V8 5.7L 350ci	E	MT w/60" to 76" long Cable; 83.00" Cable	CA-3004
1970	V8 5.7L 350ci	E	MT w/under 36" long Cable	CA-3006
1970	V8 5.7L 350ci	E	w/76" to 84" long cable	CA-3016
1971	V8 5.7L 350ci	E	Lower Cable to interconnector; 61.00" Cable	CA-3013
1971	V8 5.7L 350ci	E	w/Cruise Upper; 41.00" Cable	CA-3009
1971	V8 5.7L 350ci	E	w/o Cruise w/o interconnector 2 pc. Cable Lower; 63.00" Cable	CA-3002
1971	V8 5.7L 350ci	E	w/o Cruise w/o interconnector; 120.00" Cable	CA-3007
1971	V8 5.7L 350ci	E	w/Powerglide AT to 120" long cable, w/4 Spd. MT	CA-3038

# SPEEDOMETER CABLES

Year	Engine	Vin	Remark	Part
<b>CHEVROLET TRUCKS (con't)</b>				
<b>G20 (con't)</b>				
1971	V8 5.7L 350ci	E	w/Powerglide AT w/76" to 84" long cable	CA-3016
1971	V8 5.7L 350ci	E	w/THM AT w/60" to 76" long Cable; 83.00" Cable	CA-3004
1971-72	V8 5.7L 350ci	E,H	w/THM AT to 120" long Cable, w/3 Spd. MT; 120.00" Cable	CA-3007
1972	V8 5.7L 350ci	E	4 Spd. MT	CA-3038
1972	V8 5.7L 350ci	E,H	w/THM AT to 83" long Cable; 83.00" Cable	CA-3004
1972	V8 5.7L 350ci	H	4 Spd. MT	CA-3038
1989	V8 5.7L 350ci	K	AT; 120.00" Cable	CA-3007
1987-88	V8 5.7L 350ci	K	120.00" Cable	CA-3007
1987-91	V8 5.7L 350ci	K	Upper Cable to interconnector; 61.00" Cable	CA-3013
1987-91	V8 5.7L 350ci	K	w/Cruise Upper; 41.00" Cable	CA-3009
1987-91	V8 5.7L 350ci	K	w/o Cruise w/o interconnector; 120.00" Cable	CA-3007
1988-90	V8 5.7L 350ci	K	w/o interconnector Cruise Upper; 41.00" Cable	CA-3009
1988-91	V8 5.7L 350ci	K	Lower Cable to interconnector; 63.00" Cable	CA-3002
1979	V8 5.7L 350ci	L	w/o interconnector Cruise Upper; 41.00" Cable	CA-3009
1976-77	V8 5.7L 350ci	L,V	4 Spd. MT Lower; 40.00" Cable	CA-3033
1976-77	V8 5.7L 350ci	L,V	4 Spd. MT Upper; 41.00" Cable	CA-3009
1976-77	V8 5.7L 350ci	L,V	AT w/Cruise Control, Lower; 63.00" Cable	CA-3002
1976-77	V8 5.7L 350ci	L,V	AT w/Cruise Control, Upper; 80.00" Cable	CA-3001
1976-77	V8 5.7L 350ci	L	exc. Cruise Control; 120.00" Cable	CA-3007
1978-79	V8 5.7L 350ci	L	Lower Cable to interconnector; 63.00" Cable	CA-3002
1978-86	V8 5.7L 350ci	L,M	Upper Cable to interconnector; 61.00" Cable	CA-3013
1978-86	V8 5.7L 350ci	L,M	w/Cruise Upper; 41.00" Cable	CA-3009
1978-86	V8 5.7L 350ci	L,M	w/o Cruise w/o interconnector; 120.00" Cable	CA-3007
1984-86	V8 5.7L 350ci	L,M	120.00" Cable	CA-3007
1981-86	V8 5.7L 350ci	L,M	w/o Cruise w/o interconnector 2 pc. Cable Lower; 63.00" Cable	CA-3002
1975	V8 5.7L 350ci	V,Y	w/THM AT w/Cruise Control Upper; 80.00" Cable	CA-3001
1975	V8 5.7L 350ci	V,Y	w/THM AT w/Cruise Control, Lower; 63.00" Cable	CA-3002
1975-76	V8 5.7L 350ci	V,Y	exc. Cruise Control; 120.00" Cable	CA-3007
1973-74	V8 5.7L 350ci	V,W,Y	AT; 63.00" Cable	CA-3002
1983-89	V8 6.2L 379ci	C,J	120.00" Cable	CA-3007
1985	V8 6.2L 379ci	J	80.00" Cable	CA-3001
1975	V8 6.6L 400ci	M	exc. Cruise Control; 120.00" Cable	CA-3007
1975	V8 6.6L 400ci	M	Upper Cable to interconnector; 61.00" Cable	CA-3013
1975	V8 6.6L 400ci	M	w/Cruise Upper; 41.00" Cable	CA-3009
1975	V8 6.6L 400ci	M	w/o Cruise w/o interconnector; 120.00" Cable	CA-3007
1975	V8 6.6L 400ci	M	w/THM AT w/Cruise Control Upper; 80.00" Cable	CA-3001
1975	V8 6.6L 400ci	M	w/THM AT w/Cruise Control, Lower; 63.00" Cable	CA-3002
1977	V8 6.6L 400ci	R	4 Spd. MT Lower; 40.00" Cable	CA-3033
1977	V8 6.6L 400ci	R	4 Spd. MT w/Cruise Upper 41.00" Cable	CA-3009
1977	V8 6.6L 400ci	R	AT w/Cruise Control, Lower; 63.00" Cable	CA-3002
1977	V8 6.6L 400ci	R	AT w/Cruise Control, Upper; 80.00" Cable	CA-3001
1977	V8 6.6L 400ci	R	exc. Cruise Control; 120.00" Cable	CA-3007
1977-79	V8 6.6L 400ci	R	Lower Cable to interconnector; 63.00" Cable	CA-3002
1977-79	V8 6.6L 400ci	R	w/o interconnector Cruise Upper; 41.00" Cable	CA-3009
1977-80	V8 6.6L 400ci	R	Upper Cable to interconnector; 61.00" Cable	CA-3013
1977-80	V8 6.6L 400ci	R	w/o Cruise w/o interconnector; 120.00" Cable	CA-3007
1978-80	V8 6.6L 400ci	R	w/Cruise Upper; 41.00" Cable	CA-3009
1976	V8 6.6L 400ci	U	4 Spd. MT Lower; 40.00" Cable	CA-3033
1976	V8 6.6L 400ci	U	4 Spd. MT Upper; 41.00" Cable	CA-3009
1976	V8 6.6L 400ci	U	AT w/Cruise Control, Lower; 63.00" Cable	CA-3002
1976	V8 6.6L 400ci	U	AT w/Cruise Control, Upper; 80.00" Cable	CA-3001
1976	V8 6.6L 400ci	U	exc. Cruise Control; 120.00" Cable	CA-3007
1976	V8 6.6L 400ci	U	Upper Cable to interconnector; 61.00" Cable	CA-3013
1976	V8 6.6L 400ci	U	w/Cruise Upper; 41.00" Cable	CA-3009
1976	V8 6.6L 400ci	U	w/o Cruise w/o interconnector; 120.00" Cable	CA-3007
1976	V8 7.4L 454ci	S	4 Spd. MT Lower; 40.00" Cable	CA-3033
1976	V8 7.4L 454ci	S	4 Spd. MT w/Cruise Upper 41.00" Cable	CA-3009
1976	V8 7.4L 454ci	S	AT w/Cruise Control, Lower; 63.00" Cable	CA-3002
1976	V8 7.4L 454ci	S	AT w/Cruise Control, Upper; 80.00" Cable	CA-3001
1976	V8 7.4L 454ci	S	exc. Cruise Control; 120.00" Cable	CA-3007
1976	V8 7.4L 454ci	S	Lower Cable to interconnector; 63.00" Cable	CA-3002
1976	V8 7.4L 454ci	S	Upper Cable to interconnector; 61.00" Cable	CA-3013

# SPEEDOMETER CABLES

Year	Engine	Vin	Remark	Part
<b>CHEVROLET TRUCKS (con't)</b>				
<b>G20 (con't)</b>				
1976	V8 7.4L 454ci	S	w/o Cruise w/o interconnector; 120.00" Cable	CA-3007
1976	V8 7.4L 454ci	S	w/o interconnector Cruise Upper; 41.00" Cable	CA-3009
1974	V8 7.4L 454ci	Z	120.00" Cable	CA-3007
<b>G30</b>				
1972	L6 4.1L 250ci	D	4 Spd. MT	CA-3038
1972	L6 4.1L 250ci	D	w/THM AT to 120" long Cable, w/3 Spd. MT; 120.00" Cable	CA-3007
1972	L6 4.1L 250ci	D	w/THM AT to 83" long Cable	CA-3004
1976	L6 4.1L 250ci	D	4 Spd. MT Lower; 40.00" Cable	CA-3033
1976	L6 4.1L 250ci	D	4 Spd. MT Upper; 41.00" Cable	CA-3009
1976	L6 4.1L 250ci	D	AT w/Cruise Control, Lower; 63.00" Cable	CA-3002
1976	L6 4.1L 250ci	D	AT w/Cruise Control, Upper; 80.00" Cable	CA-3001
1976	L6 4.1L 250ci	D	exc. Cruise Control; 120.00" Cable	CA-3007
1978-79	L6 4.1L 250ci	D	Lower Cable to interconnector; 63.00" Cable	CA-3002
1978-82	L6 4.1L 250ci	D	Upper Cable to interconnector; 61.00" Cable	CA-3013
1978-82	L6 4.1L 250ci	D	w/Cruise Upper; 41.00" Cable	CA-3009
1978-82	L6 4.1L 250ci	D	w/o Cruise w/o interconnector 2 pc. Cable Lower; 63.00" Cable	CA-3002
1978-82	L6 4.1L 250ci	D	w/o Cruise w/o interconnector; 120.00" Cable	CA-3007
1979-81	L6 4.1L 250ci	D	w/o interconnector Cruise Upper; 41.00" Cable	CA-3009
1983-84	L6 4.1L 250ci	D	120.00" Cable	CA-3007
1971	L6 4.1L 250ci	L,S	w/Powerglide AT to 120" long cable, w/4 Spd. MT	CA-3038
1971	L6 4.1L 250ci	L,S	w/Powerglide AT w/76" to 84" long cable	CA-3016
1971	L6 4.1L 250ci	L,S	w/THM AT to 120" long Cable, w/3 Spd. MT; 120.00" Cable	CA-3007
1971	L6 4.1L 250ci	L,S	w/THM AT w/60" to 76" long Cable; 83.00" Cable	CA-3004
1973-74	L6 4.1L 250ci	Q	120.00" Cable	CA-3007
1974	L6 4.8L 292ci	T	120.00" Cable	CA-3007
1975	L6 4.8L 292ci	T	w/THM AT w/Cruise Control Upper; 80.00" Cable	CA-3001
1975	L6 4.8L 292ci	T	w/THM AT w/Cruise Control, Lower; 63.00" Cable	CA-3002
1975-77	L6 4.8L 292ci	T	exc. Cruise Control; 120.00" Cable	CA-3007
1975-79	L6 4.8L 292ci	T	Upper Cable to interconnector; 61.00" Cable	CA-3013
1976-77	L6 4.8L 292ci	T	4 Spd. MT Lower; 40.00" Cable	CA-3033
1976-77	L6 4.8L 292ci	T	4 Spd. MT Upper; 41.00" Cable	CA-3009
1976-77	L6 4.8L 292ci	T	AT w/Cruise Control, Lower; 63.00" Cable	CA-3002
1976-77	L6 4.8L 292ci	T	AT w/Cruise Control, Upper; 80.00" Cable	CA-3001
1978	L6 4.8L 292ci	T	w/Cruise Upper; 41.00" Cable	CA-3009
1978-79	L6 4.8L 292ci	T	Lower Cable to interconnector; 63.00" Cable	CA-3002
1978-79	L6 4.8L 292ci	T	w/o Cruise w/o interconnector; 120.00" Cable	CA-3007
1979	L6 4.8L 292ci	T	w/o interconnector Cruise Upper; 41.00" Cable	CA-3009
1985-86	V6 4.3L 262ci	N	120.00" Cable	CA-3007
1987-88	V6 4.3L 262ci	Z	120.00" Cable	CA-3007
1989	V6 4.3L 262ci	Z	AT; 120.00" Cable	CA-3007
1989	V6 4.3L 262ci	Z	w/o interconnector Cruise Upper; 41.00" Cable	CA-3009
1989-90	V6 4.3L 262ci	Z	Lower Cable to interconnector; 63.00" Cable	CA-3002
1989-90	V6 4.3L 262ci	Z	Upper Cable to interconnector; 61.00" Cable	CA-3013
1989-90	V6 4.3L 262ci	Z	w/o Cruise w/o interconnector; 120.00" Cable	CA-3007
1990	V6 4.3L 262ci	Z	w/Cruise Upper; 41.00" Cable	CA-3009
1982-85	V8 5.0L 305ci	F,H	Lower Cable to interconnector; 61.00" Cable	CA-3013
1982-85	V8 5.0L 305ci	F,H	w/Cruise Upper; 41.00" Cable	CA-3009
1982-85	V8 5.0L 305ci	F,H	w/o Cruise w/o interconnector 2 pc. Cable Lower; 63.00" Cable	CA-3002
1982-85	V8 5.0L 305ci	F,H	w/o Cruise w/o interconnector; 120.00" Cable	CA-3007
1978-79	V8 5.0L 305ci	U	Lower Cable to interconnector; 63.00" Cable	CA-3002
1978-79	V8 5.0L 305ci	U	Upper Cable to interconnector; 61.00" Cable	CA-3013
1978-79	V8 5.0L 305ci	U	w/Cruise Upper; 41.00" Cable	CA-3009
1978-79	V8 5.0L 305ci	U	w/o Cruise w/o interconnector; 120.00" Cable	CA-3007
1978-79	V8 5.0L 305ci	U	w/o interconnector Cruise Upper; 41.00" Cable	CA-3009
1971	V8 5.7L 350ci	E	w/Powerglide AT to 120" long cable, w/4 Spd. MT	CA-3038
1971	V8 5.7L 350ci	E	w/Powerglide AT w/76" to 84" long cable	CA-3016
1971	V8 5.7L 350ci	E	w/THM AT w/60" to 76" long Cable; 83.00" Cable	CA-3004
1971-72	V8 5.7L 350ci	E,H	w/THM AT to 120" long Cable, w/3 Spd. MT; 120.00" Cable	CA-3007
1972	V8 5.7L 350ci	E,H	4 Spd. MT	CA-3038
1972	V8 5.7L 350ci	E,H	w/THM AT to 83" long Cable	CA-3004
1987-91	V8 5.7L 350ci	K	Lower Cable to interconnector; 61.00" Cable	CA-3013
1987-91	V8 5.7L 350ci	K	w/Cruise Upper; 41.00" Cable	CA-3009

# SPEEDOMETER CABLES

Year	Engine	Vin	Remark	Part
<b>CHEVROLET TRUCKS (con't)</b>				
<b>G30 (con't)</b>				
1987-91	V8 5.7L 350ci	K	w/o Cruise w/o interconnector; 120.00" Cable	CA-3007
1989	V8 5.7L 350ci	K	AT; 120.00" Cable	CA-3007
1990	V8 5.7L 350ci	K	w/o interconnector Cruise Upper; 41.00" Cable	CA-3009
1990-91	V8 5.7L 350ci	K	Lower Cable to interconnector; 63.00" Cable	CA-3002
1976-77	V8 5.7L 350ci	L,V	4 Spd. MT Lower; 40.00" Cable	CA-3033
1976-77	V8 5.7L 350ci	L,V	4 Spd. MT Upper; 41.00" Cable	CA-3009
1976-77	V8 5.7L 350ci	L,V	AT w/Cruise Control, Lower; 63.00" Cable	CA-3002
1976-77	V8 5.7L 350ci	L,V	AT w/Cruise Control, Upper; 80.00" Cable	CA-3001
1976-77	V8 5.7L 350ci	L	exc. Cruise Control; 120.00" Cable	CA-3007
1978-79	V8 5.7L 350ci	L	Lower Cable to interconnector; 63.00" Cable	CA-3002
1978-80	V8 5.7L 350ci	L	Upper Cable to interconnector; 61.00" Cable	CA-3013
1978-84	V8 5.7L 350ci	L	w/Cruise Upper; 41.00" Cable	CA-3009
1978-84	V8 5.7L 350ci	L	w/o Cruise w/o interconnector; 120.00" Cable	CA-3007
1979	V8 5.7L 350ci	L	w/o interconnector Cruise Upper; 41.00" Cable	CA-3009
1984	V8 5.7L 350ci	L	Lower Cable to interconnector; 61.00" Cable	CA-3013
1980-88	V8 5.7L 350ci	M	w/Cruise Upper; 41.00" Cable	CA-3009
1980-88	V8 5.7L 350ci	M	w/o Cruise w/o interconnector; 120.00" Cable	CA-3007
1980-88	V8 5.7L 350ci	M	Lower Cable to interconnector; 61.00" Cable	CA-3013
1981-88	V8 5.7L 350ci	K,L,M	w/o Cruise w/o interconnector 2 pc. Cable Lower; 63.00" Cable	CA-3002
1983-84	V8 5.7L 350ci	M	120.00" Cable	CA-3007
1975	V8 5.7L 350ci	V,Y	w/THM AT w/Cruise Control Upper; 80.00" Cable	CA-3001
1975	V8 5.7L 350ci	V,Y	w/THM AT w/Cruise Control, Lower; 63.00" Cable	CA-3002
1975-76	V8 5.7L 350ci	V,Y	exc. Cruise Control; 120.00" Cable	CA-3007
1973-74	V8 5.7L 350ci	V,Y	AT; 63.00" Cable	CA-3002
1983-88	V8 6.2L 379ci	J	120.00" Cable	CA-3007
1989	V8 6.2L 379ci	J	AT; 120.00" Cable	CA-3007
1975	V8 6.6L 400ci	M	exc. Cruise Control; 120.00" Cable	CA-3007
1975	V8 6.6L 400ci	M	w/THM AT w/Cruise Control Upper; 80.00" Cable	CA-3001
1975	V8 6.6L 400ci	M	w/THM AT w/Cruise Control, Lower; 63.00" Cable	CA-3002
1977	V8 6.6L 400ci	R	4 Spd. MT Lower; 40.00" Cable	CA-3033
1977	V8 6.6L 400ci	R	4 Spd. MT Upper; 41.00" Cable	CA-3009
1977	V8 6.6L 400ci	R	AT w/Cruise Control, Lower; 63.00" Cable	CA-3002
1977	V8 6.6L 400ci	R	AT w/Cruise Control, Upper; 80.00" Cable	CA-3001
1977	V8 6.6L 400ci	R	exc. Cruise Control; 120.00" Cable	CA-3007
1977-79	V8 6.6L 400ci	R	Lower Cable to interconnector; 63.00" Cable	CA-3002
1977-79	V8 6.6L 400ci	R	w/o interconnector Cruise Upper; 41.00" Cable	CA-3009
1977-80	V8 6.6L 400ci	R	Upper Cable to interconnector; 61.00" Cable	CA-3013
1977-80	V8 6.6L 400ci	R	w/o Cruise w/o interconnector; 120.00" Cable	CA-3007
1978-80	V8 6.6L 400ci	R	w/Cruise Upper; 41.00" Cable	CA-3009
1976	V8 6.6L 400ci	U	4 Spd. MT Lower; 40.00" Cable	CA-3033
1976	V8 6.6L 400ci	U	4 Spd. MT Upper; 41.00" Cable	CA-3009
1976	V8 6.6L 400ci	U	AT w/Cruise Control, Lower; 63.00" Cable	CA-3002
1976	V8 6.6L 400ci	U	AT w/Cruise Control, Upper; 80.00" Cable	CA-3001
1976	V8 6.6L 400ci	U	exc. Cruise Control; 120.00" Cable	CA-3007
1976	V8 6.6L 400ci	U	Upper Cable to interconnector; 61.00" Cable	CA-3013
1976	V8 6.6L 400ci	U	w/Cruise Upper; 41.00" Cable	CA-3009
1976	V8 6.6L 400ci	U	w/o Cruise w/o interconnector; 120.00" Cable	CA-3007
1988-89	V8 7.4L 454ci	N	120.00" Cable	CA-3007
1976	V8 7.4L 454ci	S	4 Spd. MT Lower; 40.00" Cable	CA-3033
1976	V8 7.4L 454ci	S	4 Spd. MT Upper; 41.00" Cable	CA-3009
1976	V8 7.4L 454ci	S	AT w/Cruise Control, Lower; 63.00" Cable	CA-3002
1976	V8 7.4L 454ci	S	AT w/Cruise Control, Upper; 80.00" Cable	CA-3001
1976	V8 7.4L 454ci	S	exc. Cruise Control; 120.00" Cable	CA-3007
1974	V8 7.4L 454ci	Z	120.00" Cable	CA-3007
1975	V8 7.4L 454ci	Z	exc. Cruise Control; 120.00" Cable	CA-3007
1975	V8 7.4L 454ci	Z	w/THM AT w/Cruise Control Upper; 80.00" Cable	CA-3001
1975	V8 7.4L 454ci	Z	w/THM AT w/Cruise Control, Lower; 63.00" Cable	CA-3002
<b>K10</b>				
1971	L6 4.1L 250ci	C,L	3 & 4 Spd. MT; 80.00" Cable	CA-3001
1971	L6 4.1L 250ci	C,L	w/THM AT to 120" long cable	CA-3038
1971	L6 4.1L 250ci	C,L	w/THM AT w/40" to 56" long Cable; 63.00" Cable	CA-3002
1971	L6 4.1L 250ci	C,L	w/THM AT w/60" to 76" long Cable; 83.00" Cable	CA-3004

# SPEEDOMETER CABLES

Year	Engine	Vin	Remark	Part
<b>CHEVROLET TRUCKS (con't)</b>				
<b>K10 (con't)</b>				
1971	L6 4.1L 250ci	C,L	w/THM AT w/76" to 84" long cable	CA-3016
1972	L6 4.1L 250ci	D	3 & 4 Spd. MT; 80.00" Cable	CA-3001
1972	L6 4.1L 250ci	D	w/THM AT to 120" long cable	CA-3038
1972	L6 4.1L 250ci	D	w/THM AT w/40" to 56" long Cable; 63.00" Cable	CA-3002
1972	L6 4.1L 250ci	D	w/THM AT w/60" to 76" long Cable; 83.00" Cable	CA-3004
1972	L6 4.1L 250ci	D	w/THM AT w/76" to 84" long cable	CA-3016
1977	L6 4.1L 250ci	D	w/Cruise Control, Lower; 83.00" Cable	CA-3004
1977	L6 4.1L 250ci	D	w/Cruise Control, Upper; 41.00" Cable	CA-3009
1977	L6 4.1L 250ci	D	w/o Cruise Control; 100.00" Cable	CA-3003
1978-79	L6 4.1L 250ci	D	AT Upper; 41.00" Cable	CA-3009
1978-79	L6 4.1L 250ci	D	AT w/Cruise Control, Lower; 83.00" Cable	CA-3004
1978-79	L6 4.1L 250ci	D	AT w/o Cruise, w/Single Exhaust w/TH350; 80.00" Cable	CA-3001
1978-79	L6 4.1L 250ci	D	MT w/o Cruise Control, AT w/o Cruise w/Dual Exhaust, AT w/o Cruise w/single Exhaust w/TH400"; 100.00" Cable	CA-3003
1980	L6 4.1L 250ci	D	All to 80" Cable; 83.00" Cable	CA-3004
1980	L6 4.1L 250ci	D	AT w/Cruise Control, Upper; 41.00" Cable	CA-3009
1980	L6 4.1L 250ci	D	AT w/o Cruise Control, MT; 100.00" Cable	CA-3003
1981	L6 4.1L 250ci	D	w/Dual Exhaust w/o Cruise; 80.00" Cable	CA-3001
1981	L6 4.1L 250ci	D	w/Single Exhaust; 100.00" Cable	CA-3003
1982	L6 4.1L 250ci	D	All to 80" Cable; 80.00" Cable	CA-3001
1982	L6 4.1L 250ci	D	All To 92" Cable; 100.00" Cable	CA-3003
1982	L6 4.1L 250ci	D	To 75" Cable; 83.00" Cable	CA-3004
1983-84	L6 4.1L 250ci	D	100.00" Cable	CA-3003
1970	L6 4.1L 250ci	N	3 & 4 Spd. MT; 80.00" Cable	CA-3001
1970	L6 4.1L 250ci	N	w/THM AT to 120" long cable	CA-3038
1970	L6 4.1L 250ci	N	w/THM AT w/40" to 56" long Cable; 63.00" Cable	CA-3002
1970	L6 4.1L 250ci	N	w/THM AT w/60" to 76" long Cable; 83.00" Cable	CA-3004
1970	L6 4.1L 250ci	N	w/THM AT w/76" to 84" long cable	CA-3016
1973-74	L6 4.1L 250ci	Q	80.00" Cable	CA-3001
1975	L6 4.1L 250ci	Q	3 Spd. MT; 80.00" Cable	CA-3001
1975	L6 4.1L 250ci	Q	4 Spd. MT Lower; 40.00" Cable	CA-3033
1975	L6 4.1L 250ci	Q	AT w/Cruise Control, Lower; 63.00" Cable	CA-3002
1975	L6 4.1L 250ci	Q	AT w/Cruise Upper, 4 Spd. MT Upper; 41.00" Cable	CA-3009
1975	L6 4.8L 292ci	T	3 Spd. MT; 80.00" Cable	CA-3001
1975	L6 4.8L 292ci	T	AT w/Cruise Control, Lower; 63.00" Cable	CA-3002
1975-76	L6 4.8L 292ci	T	4 Spd. MT Lower; 40.00" Cable	CA-3033
1975-76	L6 4.8L 292ci	T	AT w/Cruise Upper, 4 Spd. MT Upper; 41.00" Cable	CA-3009
1976	L6 4.8L 292ci	T	AT w/o Cruise Control; 80" Length; 80.00" Cable	CA-3001
1976	L6 4.8L 292ci	T	MT 1 pc. Cable; 100.00" Cable	CA-3003
1976-79	L6 4.8L 292ci	T	AT w/Cruise Control, Lower; 83.00" Cable	CA-3004
1979	L6 4.8L 292ci	T	AT Upper; 41.00" Cable	CA-3009
1979	L6 4.8L 292ci	T	AT w/o Cruise, w/Single Exhaust w/TH350; 80.00" Cable	CA-3001
1979	L6 4.8L 292ci	T	MT w/o Cruise Control, AT w/o Cruise w/Dual Exhaust, AT w/o Cruise w/single Exhaust w/TH400"; 100.00" Cable	CA-3003
1980	L6 4.8L 292ci	T	All to 80" Cable; 83.00" Cable	CA-3004
1980	L6 4.8L 292ci	T	AT w/Cruise Control, Upper; 41.00" Cable	CA-3009
1980	L6 4.8L 292ci	T	AT w/o Cruise Control, MT; 100.00" Cable	CA-3003
1981	V8 5.0L 305ci	H	w/Dual Exhaust w/o Cruise; 80.00" Cable	CA-3001
1981	V8 5.0L 305ci	H	w/Single Exhaust; 100.00" Cable	CA-3003
1982	V8 5.0L 305ci	H	All to 80" Cable; 80.00" Cable	CA-3001
1982	V8 5.0L 305ci	H	All To 92" Cable; 100.00" Cable	CA-3003
1982	V8 5.0L 305ci	H	To 75" Cable; 83.00" Cable	CA-3004
1983	V8 5.0L 305ci	H		CA-3016
1984	V8 5.0L 305ci	H	100.00" Cable	CA-3003
1977	V8 5.0L 305ci	U	w/Cruise Control, Lower; 83.00" Cable	CA-3004
1977	V8 5.0L 305ci	U	w/Cruise Control, Upper; 41.00" Cable	CA-3009
1977	V8 5.0L 305ci	U	w/o Cruise Control; 100.00" Cable	CA-3003
1978-79	V8 5.0L 305ci	U	AT Upper; 41.00" Cable	CA-3009
1978-79	V8 5.0L 305ci	U	AT w/Cruise Control, Lower; 83.00" Cable	CA-3004
1978-79	V8 5.0L 305ci	U	AT w/o Cruise, w/Single Exhaust w/TH350; 80.00" Cable	CA-3001
1978-79	V8 5.0L 305ci	U	MT w/o Cruise Control, AT w/o Cruise w/Dual Exhaust, AT w/o Cruise w/single Exhaust w/TH400"; 100.00" Cable	CA-3003

# SPEEDOMETER CABLES

Year	Engine	Vin	Remark	Part
<b>CHEVROLET TRUCKS (con't)</b>				
<b>K10 (con't)</b>				
1970-72	V8 5.7L 350ci	E	3 & 4 Spd. MT; 80.00" Cable	CA-3001
1970-72	V8 5.7L 350ci	E	w/THM AT to 120" long cable	CA-3038
1970-72	V8 5.7L 350ci	E	w/THM AT w/40" to 56" long Cable; 63.00" Cable	CA-3002
1970-72	V8 5.7L 350ci	E	w/THM AT w/60" to 76" long Cable; 83.00" Cable	CA-3004
1970-72	V8 5.7L 350ci	E	w/THM AT w/76" to 84" long cable	CA-3016
1976	V8 5.7L 350ci	L,V	AT w/o Cruise Control; 80" Length; 80.00" Cable	CA-3001
1976	V8 5.7L 350ci	L,V	MT 1 pc. Cable; 100.00" Cable	CA-3003
1976-79	V8 5.7L 350ci	L,V	AT w/Cruise Control, Lower; 83.00" Cable	CA-3004
1977	V8 5.7L 350ci	L	w/Cruise Control, Lower; 83.00" Cable	CA-3004
1977	V8 5.7L 350ci	L	w/Cruise Control, Upper; 41.00" Cable	CA-3009
1977	V8 5.7L 350ci	L	w/o Cruise Control; 100.00" Cable	CA-3003
1978-79	V8 5.7L 350ci	L	AT Upper; 41.00" Cable	CA-3009
1978-79	V8 5.7L 350ci	L	AT w/o Cruise, w/Single Exhaust w/TH350; 80.00" Cable	CA-3001
1978-79	V8 5.7L 350ci	L	MT w/o Cruise Control, AT w/o Cruise w/Dual Exhaust, AT w/o Cruise w/single Exhaust w/TH400"; 100.00" Cable	CA-3003
1980	V8 5.7L 350ci	L,M	All to 80" Cable; 83.00" Cable	CA-3004
1980	V8 5.7L 350ci	L,M	AT w/Cruise Control, Upper; 41.00" Cable	CA-3009
1980	V8 5.7L 350ci	L,M	AT w/o Cruise Control, MT; 100.00" Cable	CA-3003
1981	V8 5.7L 350ci	L	w/Dual Exhaust w/o Cruise; 80.00" Cable	CA-3001
1981	V8 5.7L 350ci	L	w/Single Exhaust; 100.00" Cable	CA-3003
1982	V8 5.7L 350ci	L	All to 80" Cable; 80.00" Cable	CA-3001
1982	V8 5.7L 350ci	L	All To 92" Cable; 100.00" Cable	CA-3003
1982	V8 5.7L 350ci	L	To 75" Cable; 83.00" Cable	CA-3004
1983-84	V8 5.7L 350ci	L	100.00" Cable	CA-3003
1975	V8 5.7L 350ci	V,Y	3 Spd. MT	CA-3016
1975	V8 5.7L 350ci	V,Y	AT w/Cruise Control, Lower; 63.00" Cable	CA-3002
1975	V8 5.7L 350ci	V,Y	AT w/o Cruise Control; 100.00" Cable	CA-3003
1975-76	V8 5.7L 350ci	L,V,Y	4 Spd. MT Lower; 40.00" Cable	CA-3033
1975-76	V8 5.7L 350ci	L,V,Y	AT w/Cruise Upper, 4 Spd. MT Upper; 41.00" Cable	CA-3009
1973-74	V8 5.7L 350ci	V,Y	4 Spd. MT 1 pc. Cable 84" to 100"; 100.00" Cable	CA-3003
1973-74	V8 5.7L 350ci	V,Y	4 Spd. MT 2 pc. Cable Lower; 41.00" Cable	CA-3009
1973-74	V8 5.7L 350ci	V,Y	4 Spd. MT 2 pc. Cable Upper; 61.00" Cable	CA-3005
1973-74	V8 5.7L 350ci	V,Y	AT, w/3 & 4 Spd. MT 1pc. Cable 76" to 80"; 80.00" Cable	CA-3001
1982	V8 6.2L 379ci	C	All to 80" Cable; 80.00" Cable	CA-3001
1982	V8 6.2L 379ci	C	All To 92" Cable; 100.00" Cable	CA-3003
1982	V8 6.2L 379ci	C	To 75" Cable; 83.00" Cable	CA-3004
1983-84	V8 6.2L 379ci	C	100.00" Cable	CA-3003
1975	V8 6.6L 400ci	M	3 Spd. MT	CA-3016
1975	V8 6.6L 400ci	M	4 Spd. MT Lower; 40.00" Cable	CA-3033
1975	V8 6.6L 400ci	M	AT w/Cruise Control, Lower; 63.00" Cable	CA-3002
1975	V8 6.6L 400ci	M	AT w/Cruise Upper, 4 Spd. MT Upper; 41.00" Cable	CA-3009
1975	V8 6.6L 400ci	M	AT w/o Cruise Control; 100.00" Cable	CA-3003
1977	V8 6.6L 400ci	R	w/Cruise Control, Lower; 83.00" Cable	CA-3004
1977	V8 6.6L 400ci	R	w/Cruise Control, Upper; 41.00" Cable	CA-3009
1977	V8 6.6L 400ci	R	w/o Cruise Control; 100.00" Cable	CA-3003
1978-79	V8 6.6L 400ci	R	AT Upper; 41.00" Cable	CA-3009
1978-79	V8 6.6L 400ci	R	AT w/Cruise Control, Lower; 83.00" Cable	CA-3004
1978-79	V8 6.6L 400ci	R	AT w/o Cruise, w/Single Exhaust w/TH350; 80.00" Cable	CA-3001
1978-79	V8 6.6L 400ci	R	MT w/o Cruise Control, AT w/o Cruise w/Dual Exhaust, AT w/o Cruise w/single Exhaust w/TH400"; 100.00" Cable	CA-3003
1976	V8 6.6L 400ci	U	4 Spd. MT Lower; 40.00" Cable	CA-3033
1976	V8 6.6L 400ci	U	AT w/Cruise Control, Lower; 83.00" Cable	CA-3004
1976	V8 6.6L 400ci	U	AT w/Cruise Upper, 4 Spd. MT Upper; 41.00" Cable	CA-3009
1976	V8 6.6L 400ci	U	AT w/o Cruise Control; 80" Length; 80.00" Cable	CA-3001
1976	V8 6.6L 400ci	U	MT 1 pc. Cable; 100.00" Cable	CA-3003
1980	V8 6.6L 400ci	X	All to 80" Cable; 83.00" Cable	CA-3004
1980	V8 6.6L 400ci	X	AT w/Cruise Control, Upper; 41.00" Cable	CA-3009
1980	V8 6.6L 400ci	X	AT w/o Cruise Control, MT; 100.00" Cable	CA-3003
1976	V8 7.4L 454ci	S	4 Spd. MT Lower; 40.00" Cable	CA-3033
1976	V8 7.4L 454ci	S	AT w/Cruise Upper, 4 Spd. MT Upper; 41.00" Cable	CA-3009
1976	V8 7.4L 454ci	S	AT w/o Cruise Control; 80" Length; 80.00" Cable	CA-3001
1976	V8 7.4L 454ci	S	MT 1 pc. Cable; 100.00" Cable	CA-3003

# SPEEDOMETER CABLES

Year	Engine	Vin	Remark	Part
<b>CHEVROLET TRUCKS (con't)</b>				
<b>K10 (con't)</b>				
1976-79	V8 7.4L 454ci	S	AT w/Cruise Control, Lower; 83.00" Cable	CA-3004
1979	V8 7.4L 454ci	S	AT Upper; 41.00" Cable	CA-3009
1979	V8 7.4L 454ci	S	AT w/o Cruise, w/Single Exhaust w/TH350; 80.00" Cable	CA-3001
1979	V8 7.4L 454ci	S	MT w/o Cruise Control, AT w/o Cruise w/Dual Exhaust, AT w/o Cruise w/single Exhaust w/TH400"; 100.00" Cable	CA-3003
1980	V8 7.4L 454ci	S	All to 80" Cable; 83.00" Cable	CA-3004
1980	V8 7.4L 454ci	S	AT w/Cruise Control, Upper; 41.00" Cable	CA-3009
1980	V8 7.4L 454ci	S	AT w/o Cruise Control, MT; 100.00" Cable	CA-3003
<b>K10 SUBURBAN</b>				
1982	V8 5.7L 350ci	L	All to 80" Cable; 80.00" Cable	CA-3001
1982	V8 5.7L 350ci	L	All To 92" Cable; 100.00" Cable	CA-3003
1982	V8 5.7L 350ci	L	To 75" Cable; 83.00" Cable	CA-3004
<b>K20</b>				
1971	L6 4.1L 250ci	C,L	3 & 4 Spd. MT; 80.00" Cable	CA-3001
1971	L6 4.1L 250ci	C,L	w/THM AT to 120" long cable	CA-3038
1971	L6 4.1L 250ci	C,L	w/THM AT w/40" to 56" long Cable; 63.00" Cable	CA-3002
1971	L6 4.1L 250ci	C,L	w/THM AT w/60" to 76" long Cable; 83.00" Cable	CA-3004
1971	L6 4.1L 250ci	C,L	w/THM AT w/76" to 84" long cable	CA-3016
1972	L6 4.1L 250ci	D	3 & 4 Spd. MT; 80.00" Cable	CA-3001
1972	L6 4.1L 250ci	D	w/THM AT to 120" long cable	CA-3038
1972	L6 4.1L 250ci	D	w/THM AT w/40" to 56" long Cable; 63.00" Cable	CA-3002
1972	L6 4.1L 250ci	D	w/THM AT w/60" to 76" long Cable; 83.00" Cable	CA-3004
1972	L6 4.1L 250ci	D	w/THM AT w/76" to 84" long cable	CA-3016
1976	L6 4.1L 250ci	D	4 Spd. MT Lower; 40.00" Cable	CA-3033
1976	L6 4.1L 250ci	D	AT w/Cruise Upper, 4 Spd. MT Upper; 41.00" Cable	CA-3009
1976	L6 4.1L 250ci	D	AT w/o Cruise Control; 80.00" Cable	CA-3001
1976	L6 4.1L 250ci	D	MT 1 pc. Cable; 100.00" Cable	CA-3003
1976-79	L6 4.1L 250ci	D	AT w/Cruise Control, Lower; 83.00" Cable	CA-3004
1978-79	L6 4.1L 250ci	D	AT Upper; 41.00" Cable	CA-3009
1978-79	L6 4.1L 250ci	D	AT w/o Cruise, w/Single Exhaust w/TH350; 80.00" Cable	CA-3001
1978-79	L6 4.1L 250ci	D	MT w/o Cruise Control, AT w/o Cruise w/Dual Exhaust, AT w/o Cruise w/single Exhaust w/TH400"; 100.00" Cable	CA-3003
1980	L6 4.1L 250ci	D	All to 80" Cable; 83.00" Cable	CA-3004
1980	L6 4.1L 250ci	D	AT w/Cruise Control, Upper; 41.00" Cable	CA-3009
1980	L6 4.1L 250ci	D	AT w/o Cruise Control, MT; 100.00" Cable	CA-3003
1970	L6 4.1L 250ci	N	3 & 4 Spd. MT; 80.00" Cable	CA-3001
1970	L6 4.1L 250ci	N	w/THM AT to 120" long cable	CA-3038
1970	L6 4.1L 250ci	N	w/THM AT w/40" to 56" long Cable; 63.00" Cable	CA-3002
1970	L6 4.1L 250ci	N	w/THM AT w/60" to 76" long Cable; 83.00" Cable	CA-3004
1970	L6 4.1L 250ci	N	w/THM AT w/76" to 84" long cable	CA-3016
1975	L6 4.1L 250ci	Q	3 Spd. MT; 80.00" Cable	CA-3001
1975	L6 4.1L 250ci	Q	4 Spd. MT Lower; 40.00" Cable	CA-3033
1975	L6 4.1L 250ci	Q	AT w/Cruise Control, Lower; 63.00" Cable	CA-3002
1975	L6 4.1L 250ci	Q	AT w/Cruise Upper, 4 Spd. MT Upper; 41.00" Cable	CA-3009
1973-74	L6 4.1L 250ci	Q	4WD; 80.00" Cable	CA-3001
1970-72	L6 4.8L 292ci	S	3 & 4 Spd. MT; 80.00" Cable	CA-3001
1970-72	L6 4.8L 292ci	S	w/THM AT to 120" long cable	CA-3038
1970-72	L6 4.8L 292ci	S	w/THM AT w/40" to 56" long Cable; 63.00" Cable	CA-3002
1970-72	L6 4.8L 292ci	S	w/THM AT w/60" to 76" long Cable; 83.00" Cable	CA-3004
1970-72	L6 4.8L 292ci	S	w/THM AT w/76" to 84" long cable	CA-3016
1973-74	L6 4.8L 292ci	S,T	80.00" Cable	CA-3001
1975	L6 4.8L 292ci	T	3 Spd. MT; 80.00" Cable	CA-3001
1975	L6 4.8L 292ci	T	AT w/Cruise Control, Lower; 63.00" Cable	CA-3002
1975-76	L6 4.8L 292ci	T	4 Spd. MT Lower; 40.00" Cable	CA-3033
1975-76	L6 4.8L 292ci	T	AT w/Cruise Upper, 4 Spd. MT Upper; 41.00" Cable	CA-3009
1976	L6 4.8L 292ci	T	AT w/o Cruise Control; 80.00" Cable	CA-3001
1976	L6 4.8L 292ci	T	MT 1 pc. Cable; 100.00" Cable	CA-3003
1976-79	L6 4.8L 292ci	T	AT w/Cruise Control, Lower; 83.00" Cable	CA-3004
1977	L6 4.8L 292ci	T	w/Cruise Control, Lower; 83.00" Cable	CA-3004
1977	L6 4.8L 292ci	T	w/Cruise Control, Upper; 41.00" Cable	CA-3009
1977	L6 4.8L 292ci	T	w/o Cruise Control; 100.00" Cable	CA-3003
1978-79	L6 4.8L 292ci	T	AT Upper; 41.00" Cable	CA-3009

# SPEEDOMETER CABLES

Year	Engine	Vin	Remark	Part
<b>CHEVROLET TRUCKS (con't)</b>				
<b>K20 (con't)</b>				
1978-79	L6 4.8L 292ci	T	AT w/o Cruise, w/Single Exhaust w/TH350; 80.00" Cable	CA-3001
1978-79	L6 4.8L 292ci	T	MT w/o Cruise Control, AT w/o Cruise w/Dual Exhaust, AT w/o Cruise w/single Exhaust w/TH400"; 100.00" Cable	CA-3003
1980	L6 4.8L 292ci	T	All to 80" Cable; 83.00" Cable	CA-3004
1980	L6 4.8L 292ci	T	AT w/Cruise Control, Upper; 41.00" Cable	CA-3009
1980	L6 4.8L 292ci	T	AT w/o Cruise Control, MT; 100.00" Cable	CA-3003
1981	L6 4.8L 292ci	T	w/Dual Exhaust w/o Cruise; 80.00" Cable	CA-3001
1981	L6 4.8L 292ci	T	w/Single Exhaust; 100.00" Cable	CA-3003
1982	L6 4.8L 292ci	T	All to 80" Cable; 80.00" Cable	CA-3001
1982	L6 4.8L 292ci	T	All To 92" Cable; 100.00" Cable	CA-3003
1982	L6 4.8L 292ci	T	To 75" Cable; 83.00" Cable	CA-3004
1983-86	L6 4.8L 292ci	T	100.00" Cable	CA-3003
1980	V8 5.0L 305ci	G	All to 80" Cable; 83.00" Cable	CA-3004
1980	V8 5.0L 305ci	G	AT w/Cruise Control, Upper; 41.00" Cable	CA-3009
1980	V8 5.0L 305ci	G	AT w/o Cruise Control, MT; 100.00" Cable	CA-3003
1977	V8 5.0L 305ci	U	w/Cruise Control, Lower; 83.00" Cable	CA-3004
1977	V8 5.0L 305ci	U	w/Cruise Control, Upper; 41.00" Cable	CA-3009
1977	V8 5.0L 305ci	U	w/o Cruise Control; 100.00" Cable	CA-3003
1978	V8 5.0L 305ci	U	AT Upper; 41.00" Cable	CA-3009
1978	V8 5.0L 305ci	U	AT w/Cruise Control, Lower; 83.00" Cable	CA-3004
1978	V8 5.0L 305ci	U	AT w/o Cruise, w/Single Exhaust w/TH350; 80.00" Cable	CA-3001
1978	V8 5.0L 305ci	U	MT w/o Cruise Control, AT w/o Cruise w/Dual Exhaust, AT w/o Cruise w/single Exhaust w/TH400"; 100.00" Cable	CA-3003
1970-72	V8 5.7L 350ci	E	3 & 4 Spd. MT; 80.00" Cable	CA-3001
1970-72	V8 5.7L 350ci	E	w/THM AT to 120" long cable	CA-3038
1970-72	V8 5.7L 350ci	E	w/THM AT w/40" to 56" long Cable; 63.00" Cable	CA-3002
1970-72	V8 5.7L 350ci	E	w/THM AT w/60" to 76" long Cable; 83.00" Cable	CA-3004
1970-72	V8 5.7L 350ci	E	w/THM AT w/76" to 84" long cable	CA-3016
1976	V8 5.7L 350ci	L	AT w/Cruise Upper, 4 Spd. MT Upper; 41.00" Cable	CA-3009
1976	V8 5.7L 350ci	L,V	AT w/o Cruise Control; 80.00" Cable	CA-3001
1976	V8 5.7L 350ci	L,V	MT 1 pc. Cable; 100.00" Cable	CA-3003
1976-79	V8 5.7L 350ci	L,V	AT w/Cruise Control, Lower; 83.00" Cable	CA-3004
1977	V8 5.7L 350ci	L	w/Cruise Control, Lower; 83.00" Cable	CA-3004
1977	V8 5.7L 350ci	L	w/Cruise Control, Upper; 41.00" Cable	CA-3009
1977	V8 5.7L 350ci	L	w/o Cruise Control; 100.00" Cable	CA-3003
1978-79	V8 5.7L 350ci	L	AT Upper; 41.00" Cable	CA-3009
1978-79	V8 5.7L 350ci	L	AT w/o Cruise, w/Single Exhaust w/TH350; 80.00" Cable	CA-3001
1978-79	V8 5.7L 350ci	L	MT w/o Cruise Control, AT w/o Cruise w/Dual Exhaust, AT w/o Cruise w/single Exhaust w/TH400"; 100.00" Cable	CA-3003
1980	V8 5.7L 350ci	L,M	All to 80" Cable; 83.00" Cable	CA-3004
1980	V8 5.7L 350ci	L,M	AT w/Cruise Control, Upper; 41.00" Cable	CA-3009
1980	V8 5.7L 350ci	L,M	AT w/o Cruise Control, MT; 100.00" Cable	CA-3003
1981	V8 5.7L 350ci	L,M	w/Dual Exhaust w/o Cruise; 80.00" Cable	CA-3001
1981	V8 5.7L 350ci	L,M	w/Single Exhaust; 100.00" Cable	CA-3003
1982	V8 5.7L 350ci	L,M	All to 80" Cable; 80.00" Cable	CA-3001
1982	V8 5.7L 350ci	L,M	All To 92" Cable; 100.00" Cable	CA-3003
1982	V8 5.7L 350ci	L,M	To 75" Cable; 83.00" Cable	CA-3004
1983-86	V8 5.7L 350ci	L,M	100.00" Cable	CA-3003
1975	V8 5.7L 350ci	V,Y	3 Spd. MT	CA-3016
1975	V8 5.7L 350ci	V,Y	AT w/Cruise Control, Lower; 63.00" Cable	CA-3002
1975	V8 5.7L 350ci	V,Y	AT w/o Cruise Control; 100.00" Cable	CA-3003
1975-76	V8 5.7L 350ci	L,V,Y	4 Spd. MT Lower; 40.00" Cable	CA-3033
1975-76	V8 5.7L 350ci	V,Y	AT w/Cruise Upper, 4 Spd. MT Upper; 41.00" Cable	CA-3009
1973-74	V8 5.7L 350ci	V,Y	4 Spd. MT 1 pc. Cable 84" to 100"; 100.00" Cable	CA-3003
1973-74	V8 5.7L 350ci	V,Y	4 Spd. MT 2 pc. Cable Lower; 41.00" Cable	CA-3009
1973-74	V8 5.7L 350ci	V,Y	4 Spd. MT 2 pc. Cable Upper; 61.00" Cable	CA-3005
1973-74	V8 5.7L 350ci	V,Y	AT, w/3 & 4 Spd. MT 1pc. Cable 76" to 80"; 80.00" Cable	CA-3001
1982	V8 6.2L 379ci	C,J	All to 80" Cable; 80.00" Cable	CA-3001
1982	V8 6.2L 379ci	C,J	All To 92" Cable; 100.00" Cable	CA-3003
1982	V8 6.2L 379ci	C,J	To 75" Cable; 83.00" Cable	CA-3004
1983-84	V8 6.2L 379ci	C,J	100.00" Cable	CA-3003
1975	V8 6.6L 400ci	M	3 Spd. MT	CA-3016



# SPEEDOMETER CABLES

Year	Engine	Vin	Remark	Part
<b>CHEVROLET TRUCKS (con't)</b>				
<b>K20 (con't)</b>				
1975	V8 6.6L 400ci	M	4 Spd. MT Lower; 40.00" Cable	CA-3033
1975	V8 6.6L 400ci	M	AT w/Cruise Control, Lower; 63.00" Cable	CA-3002
1975	V8 6.6L 400ci	M	AT w/Cruise Upper, 4 Spd. MT Upper; 41.00" Cable	CA-3009
1975	V8 6.6L 400ci	M	AT w/o Cruise Control; 100.00" Cable	CA-3003
1977	V8 6.6L 400ci	R	w/Cruise Control, Lower; 83.00" Cable	CA-3004
1977	V8 6.6L 400ci	R	w/Cruise Control, Upper; 41.00" Cable	CA-3009
1977	V8 6.6L 400ci	R	w/o Cruise Control; 100.00" Cable	CA-3003
1978-79	V8 6.6L 400ci	R	AT Upper; 41.00" Cable	CA-3009
1978-79	V8 6.6L 400ci	R	AT w/Cruise Control, Lower; 83.00" Cable	CA-3004
1978-79	V8 6.6L 400ci	R	AT w/o Cruise, w/Single Exhaust w/TH350; 80.00" Cable	CA-3001
1978-79	V8 6.6L 400ci	R	MT w/o Cruise Control, AT w/o Cruise w/Dual Exhaust, AT w/o Cruise w/single Exhaust w/TH400"; 100.00" Cable	CA-3003
1976	V8 6.6L 400ci	U	4 Spd. MT Lower; 40.00" Cable	CA-3033
1976	V8 6.6L 400ci	U	AT w/Cruise Control, Lower; 83.00" Cable	CA-3004
1976	V8 6.6L 400ci	U	AT w/Cruise Upper, 4 Spd. MT Upper; 41.00" Cable	CA-3009
1976	V8 6.6L 400ci	U	AT w/o Cruise Control; 80.00" Cable	CA-3001
1976	V8 6.6L 400ci	U	MT 1 pc. Cable; 100.00" Cable	CA-3003
1980	V8 6.6L 400ci	X	All to 80" Cable; 83.00" Cable	CA-3004
1980	V8 6.6L 400ci	X	AT w/Cruise Control, Upper; 41.00" Cable	CA-3009
1980	V8 6.6L 400ci	X	AT w/o Cruise Control, MT; 100.00" Cable	CA-3003
1976	V8 7.4L 454ci	S	4 Spd. MT Lower; 40.00" Cable	CA-3033
1976	V8 7.4L 454ci	S	AT w/Cruise Upper, 4 Spd. MT Upper; 41.00" Cable	CA-3009
1976	V8 7.4L 454ci	S	AT w/o Cruise Control; 80.00" Cable	CA-3001
1976	V8 7.4L 454ci	S	MT 1 pc. Cable; 100.00" Cable	CA-3003
1976-78	V8 7.4L 454ci	S	AT w/Cruise Control, Lower; 83.00" Cable	CA-3004
1977	V8 7.4L 454ci	S	w/Cruise Control, Lower; 83.00" Cable	CA-3004
1977	V8 7.4L 454ci	S	w/Cruise Control, Upper; 41.00" Cable	CA-3009
1977	V8 7.4L 454ci	S	w/o Cruise Control; 100.00" Cable	CA-3003
1978	V8 7.4L 454ci	S	AT Upper; 41.00" Cable	CA-3009
1978	V8 7.4L 454ci	S	AT w/o Cruise, w/Single Exhaust w/TH350; 80.00" Cable	CA-3001
1978	V8 7.4L 454ci	S	MT w/o Cruise Control, AT w/o Cruise w/Dual Exhaust, AT w/o Cruise w/single Exhaust w/TH400"; 100.00" Cable	CA-3003
1980	V8 7.4L 454ci	S	All to 80" Cable; 83.00" Cable	CA-3004
1980	V8 7.4L 454ci	S	AT w/Cruise Control, Upper; 41.00" Cable	CA-3009
1980	V8 7.4L 454ci	S	AT w/o Cruise Control, MT; 100.00" Cable	CA-3003
1973-74	V8 7.4L 454ci	Z	4 Spd. MT 1 pc. Cable 84" to 100"; 100.00" Cable	CA-3003
1973-74	V8 7.4L 454ci	Z	4 Spd. MT 2 pc. Cable Lower; 41.00" Cable	CA-3009
1973-74	V8 7.4L 454ci	Z	4 Spd. MT 2 pc. Cable Upper; 61.00" Cable	CA-3005
1973-74	V8 7.4L 454ci	Z	AT, w/3 & 4 Spd. MT 1pc. Cable 76" to 80"; 80.00" Cable	CA-3001
<b>K20 SUBURBAN</b>				
1971	L6 4.1L 250ci	C,L	3 & 4 Spd. MT; 80.00" Cable	CA-3001
1971	L6 4.1L 250ci	C,L	w/THM AT to 120" long cable	CA-3038
1971	L6 4.1L 250ci	C,L	w/THM AT w/40" to 56" long Cable; 63.00" Cable	CA-3002
1971	L6 4.1L 250ci	C,L	w/THM AT w/60" to 76" long Cable; 83.00" Cable	CA-3004
1971	L6 4.1L 250ci	C,L	w/THM AT w/76" to 84" long cable	CA-3016
1972	L6 4.1L 250ci	D	3 & 4 Spd. MT; 80.00" Cable	CA-3001
1972	L6 4.1L 250ci	D	w/THM AT to 120" long cable	CA-3038
1972	L6 4.1L 250ci	D	w/THM AT w/40" to 56" long Cable; 63.00" Cable	CA-3002
1972	L6 4.1L 250ci	D	w/THM AT w/60" to 76" long Cable; 83.00" Cable	CA-3004
1972	L6 4.1L 250ci	D	w/THM AT w/76" to 84" long cable	CA-3016
1970	L6 4.1L 250ci	N	3 & 4 Spd. MT; 80.00" Cable	CA-3001
1970	L6 4.1L 250ci	N	w/THM AT to 120" long cable	CA-3038
1970	L6 4.1L 250ci	N	w/THM AT w/40" to 56" long Cable; 63.00" Cable	CA-3002
1970	L6 4.1L 250ci	N	w/THM AT w/60" to 76" long Cable; 83.00" Cable	CA-3004
1970	L6 4.1L 250ci	N	w/THM AT w/76" to 84" long cable	CA-3016
1970-72	L6 4.8L 292ci	S	3 & 4 Spd. MT; 80.00" Cable	CA-3001
1970-72	L6 4.8L 292ci	S	w/THM AT to 120" long cable	CA-3038
1970-72	L6 4.8L 292ci	S	w/THM AT w/40" to 56" long Cable; 63.00" Cable	CA-3002
1970-72	L6 4.8L 292ci	S	w/THM AT w/60" to 76" long Cable; 83.00" Cable	CA-3004
1970-72	L6 4.8L 292ci	S	w/THM AT w/76" to 84" long cable	CA-3016
1981	L6 4.8L 292ci	T	w/Dual Exhaust w/o Cruise; 80.00" Cable	CA-3001
1981	L6 4.8L 292ci	T	w/Single Exhaust; 100.00" Cable	CA-3003

# SPEEDOMETER CABLES

Year	Engine	Vin	Remark	Part
<b>CHEVROLET TRUCKS (con't)</b>				
<b>K20 SUBURBAN (con't)</b>				
1970	V8 5.0L 307ci	A	3 & 4 Spd. MT; 80.00" Cable	CA-3001
1970	V8 5.0L 307ci	A	w/THM AT to 120" long cable	CA-3038
1970	V8 5.0L 307ci	A	w/THM AT w/40" to 56" long Cable; 63.00" Cable	CA-3002
1970	V8 5.0L 307ci	A	w/THM AT w/60" to 76" long Cable; 83.00" Cable	CA-3004
1970	V8 5.0L 307ci	A	w/THM AT w/76" to 84" long cable	CA-3016
1972	V8 5.0L 307ci	F	3 & 4 Spd. MT; 80.00" Cable	CA-3001
1972	V8 5.0L 307ci	F	w/THM AT to 120" long cable	CA-3038
1972	V8 5.0L 307ci	F	w/THM AT w/40" to 56" long Cable; 63.00" Cable	CA-3002
1972	V8 5.0L 307ci	F	w/THM AT w/60" to 76" long Cable; 83.00" Cable	CA-3004
1972	V8 5.0L 307ci	F	w/THM AT w/76" to 84" long cable	CA-3016
1971	V8 5.0L 307ci	H	3 & 4 Spd. MT; 80.00" Cable	CA-3001
1971	V8 5.0L 307ci	H	w/THM AT to 120" long cable	CA-3038
1971	V8 5.0L 307ci	H	w/THM AT w/40" to 56" long Cable; 63.00" Cable	CA-3002
1971	V8 5.0L 307ci	H	w/THM AT w/60" to 76" long Cable; 83.00" Cable	CA-3004
1971	V8 5.0L 307ci	H	w/THM AT w/76" to 84" long cable	CA-3016
1970-72	V8 5.7L 350ci	E	3 & 4 Spd. MT; 80.00" Cable	CA-3001
1970-72	V8 5.7L 350ci	E	w/THM AT to 120" long cable	CA-3038
1970-72	V8 5.7L 350ci	E	w/THM AT w/40" to 56" long Cable; 63.00" Cable	CA-3002
1970-72	V8 5.7L 350ci	E	w/THM AT w/60" to 76" long Cable; 83.00" Cable	CA-3004
1970-72	V8 5.7L 350ci	E	w/THM AT w/76" to 84" long cable	CA-3016
1981	V8 5.7L 350ci	L	w/Dual Exhaust w/o Cruise; 80.00" Cable	CA-3001
1981	V8 5.7L 350ci	L	w/Single Exhaust; 100.00" Cable	CA-3003
<b>K30</b>				
1971	L6 4.1L 250ci	C	3 & 4 Spd. MT; 80.00" Cable	CA-3001
1971	L6 4.1L 250ci	C	w/THM AT to 120" long cable	CA-3038
1971	L6 4.1L 250ci	C	w/THM AT w/40" to 56" long Cable; 63.00" Cable	CA-3002
1971	L6 4.1L 250ci	C	w/THM AT w/60" to 76" long Cable; 83.00" Cable	CA-3004
1971	L6 4.1L 250ci	C	w/THM AT w/76" to 84" long cable	CA-3016
1972	L6 4.1L 250ci	D	3 & 4 Spd. MT; 80.00" Cable	CA-3001
1972	L6 4.1L 250ci	D	w/THM AT to 120" long cable	CA-3038
1972	L6 4.1L 250ci	D	w/THM AT w/40" to 56" long Cable; 63.00" Cable	CA-3002
1972	L6 4.1L 250ci	D	w/THM AT w/60" to 76" long Cable; 83.00" Cable	CA-3004
1972	L6 4.1L 250ci	D	w/THM AT w/76" to 84" long cable	CA-3016
1970	L6 4.1L 250ci	N	3 & 4 Spd. MT; 80.00" Cable	CA-3001
1970	L6 4.1L 250ci	N	w/THM AT to 120" long cable	CA-3038
1970	L6 4.1L 250ci	N	w/THM AT w/40" to 56" long Cable; 63.00" Cable	CA-3002
1970	L6 4.1L 250ci	N	w/THM AT w/60" to 76" long Cable; 83.00" Cable	CA-3004
1970	L6 4.1L 250ci	N	w/THM AT w/76" to 84" long cable	CA-3016
1973-74	L6 4.1L 250ci	Q	80.00" Cable	CA-3001
1970-72	L6 4.8L 292ci	S	3 & 4 Spd. MT; 80.00" Cable	CA-3001
1970-72	L6 4.8L 292ci	S	w/THM AT to 120" long cable	CA-3038
1970-72	L6 4.8L 292ci	S	w/THM AT w/40" to 56" long Cable; 63.00" Cable	CA-3002
1970-72	L6 4.8L 292ci	S	w/THM AT w/60" to 76" long Cable; 83.00" Cable	CA-3004
1970-72	L6 4.8L 292ci	S	w/THM AT w/76" to 84" long cable	CA-3016
1973-74	L6 4.8L 292ci	S,T	80.00" Cable	CA-3001
1977	L6 4.8L 292ci	T	w/Cruise Control, Lower; 83.00" Cable	CA-3004
1977	L6 4.8L 292ci	T	w/Cruise Control, Upper; 41.00" Cable	CA-3009
1977-81	L6 4.8L 292ci	T	w/o Cruise Control; 100.00" Cable	CA-3003
1978-79	L6 4.8L 292ci	T	AT Upper; 41.00" Cable	CA-3009
1978-79	L6 4.8L 292ci	T	AT w/Cruise Control, Lower; 83.00" Cable	CA-3004
1978-79	L6 4.8L 292ci	T	AT w/o Cruise, w/Single Exhaust w/TH350; 80.00" Cable	CA-3001
1978-79	L6 4.8L 292ci	T	MT w/o Cruise Control, AT w/o Cruise w/Dual Exhaust, AT w/o Cruise w/single Exhaust w/TH400"; 100.00" Cable	CA-3003
1980	L6 4.8L 292ci	T	All to 80" Cable; 83.00" Cable	CA-3004
1980	L6 4.8L 292ci	T	AT w/Cruise Control, Upper; 41.00" Cable	CA-3009
1980	L6 4.8L 292ci	T	AT w/o Cruise Control, MT; 100.00" Cable	CA-3003
1981	L6 4.8L 292ci	T	w/Cruise Control, Upper; 41.00" Cable	CA-3009
1982	L6 4.8L 292ci	T	All to 80" Cable; 80.00" Cable	CA-3001
1982	L6 4.8L 292ci	T	All To 92" Cable; 100.00" Cable	CA-3003
1982	L6 4.8L 292ci	T	To 75" Cable; 83.00" Cable	CA-3004
1983-86	L6 4.8L 292ci	T	100.00" Cable	CA-3003
1970	V8 5.0L 307ci	A	3 & 4 Spd. MT; 80.00" Cable	CA-3001

# SPEEDOMETER CABLES

Year	Engine	Vin	Remark	Part
<b>CHEVROLET TRUCKS (con't)</b>				
<b>K30 (con't)</b>				
1970	V8 5.0L 307ci	A	w/THM AT to 120" long cable	CA-3038
1970	V8 5.0L 307ci	A	w/THM AT w/40" to 56" long Cable; 63.00" Cable	CA-3002
1970	V8 5.0L 307ci	A	w/THM AT w/60" to 76" long Cable; 83.00" Cable	CA-3004
1970	V8 5.0L 307ci	A	w/THM AT w/76" to 84" long cable	CA-3016
1972	V8 5.0L 307ci	F	3 & 4 Spd. MT; 80.00" Cable	CA-3001
1972	V8 5.0L 307ci	F	w/THM AT to 120" long cable	CA-3038
1972	V8 5.0L 307ci	F	w/THM AT w/40" to 56" long Cable; 63.00" Cable	CA-3002
1972	V8 5.0L 307ci	F	w/THM AT w/60" to 76" long Cable; 83.00" Cable	CA-3004
1972	V8 5.0L 307ci	F	w/THM AT w/76" to 84" long cable	CA-3016
1971	V8 5.0L 307ci	H	3 & 4 Spd. MT; 80.00" Cable	CA-3001
1971	V8 5.0L 307ci	H	w/THM AT to 120" long cable	CA-3038
1971	V8 5.0L 307ci	H	w/THM AT w/40" to 56" long Cable; 63.00" Cable	CA-3002
1971	V8 5.0L 307ci	H	w/THM AT w/60" to 76" long Cable; 83.00" Cable	CA-3004
1971	V8 5.0L 307ci	H	w/THM AT w/76" to 84" long cable	CA-3016
1973	V8 5.0L 307ci	X	4 Spd. MT 1 pc. Cable 84" to 100"; 100.00" Cable	CA-3003
1973	V8 5.0L 307ci	X	4 Spd. MT 2 pc. Cable Lower; 41.00" Cable	CA-3009
1973	V8 5.0L 307ci	X	4 Spd. MT 2 pc. Cable Upper; 61.00" Cable	CA-3005
1973	V8 5.0L 307ci	X	AT, w/3 & 4 Spd. MT 1pc. Cable 76" to 80"; 80.00" Cable	CA-3001
1970-72	V8 5.7L 350ci	E	3 & 4 Spd. MT; 80.00" Cable	CA-3001
1970-72	V8 5.7L 350ci	E	w/THM AT to 120" long cable	CA-3038
1970-72	V8 5.7L 350ci	E	w/THM AT w/40" to 56" long Cable; 63.00" Cable	CA-3002
1970-72	V8 5.7L 350ci	E	w/THM AT w/60" to 76" long Cable; 83.00" Cable	CA-3004
1970-72	V8 5.7L 350ci	E	w/THM AT w/76" to 84" long cable	CA-3016
1977	V8 5.7L 350ci	L	w/Cruise Control, Lower; 83.00" Cable	CA-3004
1977	V8 5.7L 350ci	L	w/Cruise Control, Upper; 41.00" Cable	CA-3009
1977	V8 5.7L 350ci	L	w/o Cruise Control; 100.00" Cable	CA-3003
1978-79	V8 5.7L 350ci	L	AT Upper; 41.00" Cable	CA-3009
1978-79	V8 5.7L 350ci	L	AT w/Cruise Control, Lower; 83.00" Cable	CA-3004
1978-79	V8 5.7L 350ci	L	AT w/o Cruise, w/Single Exhaust w/TH350; 80.00" Cable	CA-3001
1978-79	V8 5.7L 350ci	L	MT w/o Cruise Control, AT w/o Cruise w/Dual Exhaust, AT w/o Cruise w/single Exhaust w/TH400"; 100.00" Cable	CA-3003
1980	V8 5.7L 350ci	L,M	All to 80" Cable; 83.00" Cable	CA-3004
1980	V8 5.7L 350ci	L,M	AT w/Cruise Control, Upper; 41.00" Cable	CA-3009
1980	V8 5.7L 350ci	L,M	AT w/o Cruise Control, MT; 100.00" Cable	CA-3003
1981	V8 5.7L 350ci	M	w/Cruise Control, Upper; 41.00" Cable	CA-3009
1981	V8 5.7L 350ci	M	w/o Cruise Control; 100.00" Cable	CA-3003
1982	V8 5.7L 350ci	M	All to 80" Cable; 80.00" Cable	CA-3001
1982	V8 5.7L 350ci	M	All To 92" Cable; 100.00" Cable	CA-3003
1982	V8 5.7L 350ci	M	To 75" Cable; 83.00" Cable	CA-3004
1983-85	V8 5.7L 350ci	M	100.00" Cable	CA-3003
1973-74	V8 5.7L 350ci	V,Y	4 Spd. MT 1 pc. Cable 84" to 100"; 100.00" Cable	CA-3003
1973-74	V8 5.7L 350ci	V,Y	4 Spd. MT 2 pc. Cable Lower; 41.00" Cable	CA-3009
1973-74	V8 5.7L 350ci	V,Y	4 Spd. MT 2 pc. Cable Upper; 61.00" Cable	CA-3005
1973-74	V8 5.7L 350ci	V,Y	AT, w/3 & 4 Spd. MT 1pc. Cable 76" to 80"; 80.00" Cable	CA-3001
1982	V8 6.2L 379ci	J	All to 80" Cable; 80.00" Cable	CA-3001
1982	V8 6.2L 379ci	J	All To 92" Cable; 100.00" Cable	CA-3003
1982	V8 6.2L 379ci	J	To 75" Cable; 83.00" Cable	CA-3004
1983-84	V8 6.2L 379ci	J	100.00" Cable	CA-3003
1977	V8 6.6L 400ci	R	w/Cruise Control, Lower; 83.00" Cable	CA-3004
1977	V8 6.6L 400ci	R	w/Cruise Control, Upper; 41.00" Cable	CA-3009
1977	V8 6.6L 400ci	R	w/o Cruise Control; 100.00" Cable	CA-3003
1978-79	V8 6.6L 400ci	R	AT Upper; 41.00" Cable	CA-3009
1978-79	V8 6.6L 400ci	R	AT w/Cruise Control, Lower; 83.00" Cable	CA-3004
1978-79	V8 6.6L 400ci	R	AT w/o Cruise, w/Single Exhaust w/TH350; 80.00" Cable	CA-3001
1978-79	V8 6.6L 400ci	R	MT w/o Cruise Control, AT w/o Cruise w/Dual Exhaust, AT w/o Cruise w/single Exhaust w/TH400"; 100.00" Cable	CA-3003
1970-71	V8 6.6L 402ci	E	3 & 4 Spd. MT; 80.00" Cable	CA-3001
1970-71	V8 6.6L 402ci	E	w/THM AT to 120" long cable	CA-3038
1970-71	V8 6.6L 402ci	E	w/THM AT w/40" to 56" long Cable; 63.00" Cable	CA-3002
1970-71	V8 6.6L 402ci	E	w/THM AT w/60" to 76" long Cable; 83.00" Cable	CA-3004
1970-71	V8 6.6L 402ci	E	w/THM AT w/76" to 84" long cable	CA-3016
1977	V8 7.4L 454ci	S	w/Cruise Control, Lower; 83.00" Cable	CA-3004

# SPEEDOMETER CABLES

Year	Engine	Vin	Remark	Part
<b>CHEVROLET TRUCKS (con't)</b>				
<b>K30 (con't)</b>				
1977	V8 7.4L 454ci	S	w/Cruise Control, Upper; 41.00" Cable	CA-3009
1977	V8 7.4L 454ci	S	w/o Cruise Control; 100.00" Cable	CA-3003
1980	V8 7.4L 454ci	S	All to 80" Cable; 83.00" Cable	CA-3004
1980	V8 7.4L 454ci	S	AT w/Cruise Control, Upper; 41.00" Cable	CA-3009
1980	V8 7.4L 454ci	S	AT w/o Cruise Control, MT; 100.00" Cable	CA-3003
1981	V8 7.4L 454ci	W	w/Cruise Control, Upper; 41.00" Cable	CA-3009
1981	V8 7.4L 454ci	W	w/o Cruise Control; 100.00" Cable	CA-3003
1982	V8 7.4L 454ci	W	All to 80" Cable; 80.00" Cable	CA-3001
1982	V8 7.4L 454ci	W	All To 92" Cable; 100.00" Cable	CA-3003
1982	V8 7.4L 454ci	W	To 75" Cable; 83.00" Cable	CA-3004
1983-86	V8 7.4L 454ci	W	100.00" Cable	CA-3003
1973-74	V8 7.4L 454ci	Z	4 Spd. MT 1 pc. Cable 84" to 100"; 100.00" Cable	CA-3003
1973-74	V8 7.4L 454ci	Z	4 Spd. MT 2 pc. Cable Lower; 41.00" Cable	CA-3009
1973-74	V8 7.4L 454ci	Z	4 Spd. MT 2 pc. Cable Upper; 61.00" Cable	CA-3005
1973-74	V8 7.4L 454ci	Z	AT, w/3 & 4 Spd. MT 1pc. Cable 76" to 80"; 80.00" Cable	CA-3001
<b>K5 BLAZER</b>				
1976	L6 4.1L 250ci	D	4 Spd. MT Lower; 40.00" Cable	CA-3033
1976	L6 4.1L 250ci	D	AT THM w/Cruise Lower; 83.00" Cable	CA-3004
1976	L6 4.1L 250ci	D	AT THM w/Cruise Upper, OR 4 Spd. MT Upper; 41.00" Cable	CA-3009
1976	L6 4.1L 250ci	D	AT THM w/o Cruise, 3 Spd. MT w/o Cruise; 80.00" Cable	CA-3001
1976	L6 4.1L 250ci	D	AT w/Cruise Upper, 4 Spd. MT Upper; 41.00" Cable	CA-3009
1976	L6 4.1L 250ci	D	AT w/o Cruise Control; 80.00" Cable	CA-3001
1976	L6 4.1L 250ci	D	MT 1 pc. Cable; 100.00" Cable	CA-3003
1976-79	L6 4.1L 250ci	D	AT w/Cruise Control, Lower; 83.00" Cable	CA-3004
1977	L6 4.1L 250ci	D	w/Cruise Control, Lower; 83.00" Cable	CA-3004
1977	L6 4.1L 250ci	D	w/Cruise Control, Upper; 41.00" Cable	CA-3009
1977	L6 4.1L 250ci	D	w/Cruise Lower; 63.00" Cable	CA-3002
1977	L6 4.1L 250ci	D	w/o Cruise Control; 100.00" Cable	CA-3003
1978-79	L6 4.1L 250ci	D	3 Spd. MT w/o Cruise; 80.00" Cable	CA-3001
1978-79	L6 4.1L 250ci	D	4 Spd. MT; 61.00" Cable	CA-3005
1978-79	L6 4.1L 250ci	D	AT Upper; 41.00" Cable	CA-3009
1978-79	L6 4.1L 250ci	D	AT w/Catalytic Converter Lower	CA-3006
1978-79	L6 4.1L 250ci	D	AT w/Catalytic Converter w/Cruise Upper; 41.00" Cable	CA-3009
1978-79	L6 4.1L 250ci	D	AT w/o Catalytic Converter w/Cruise Lower; 63.00" Cable	CA-3002
1978-79	L6 4.1L 250ci	D	AT w/o Cruise, w/Single Exhaust w/TH350; 80.00" Cable	CA-3001
1978-79	L6 4.1L 250ci	D	MT w/o Cruise Control, AT w/o Cruise w/Dual Exhaust, AT w/o Cruise w/single Exhaust w/TH400"; 100.00" Cable	CA-3003
1980	L6 4.1L 250ci	D	4 Spd. w/o Cruise Upper; 61.00" Cable	CA-3005
1980	L6 4.1L 250ci	D	All to 80" Cable; 83.00" Cable	CA-3004
1980	L6 4.1L 250ci	D	AT w/Cruise Control, Upper; 41.00" Cable	CA-3009
1980	L6 4.1L 250ci	D	AT w/o Cruise Control, MT; 100.00" Cable	CA-3003
1980	L6 4.1L 250ci	D	exc. Cruise Control; 80.00" Cable	CA-3001
1980	L6 4.1L 250ci	D	w/Catalic Converter w/Cruise Control, Lower	CA-3006
1980	L6 4.1L 250ci	D	w/o Catalic Converter w/Cruise Control, Lower; 63.00" Cable	CA-3002
1982	L6 4.1L 250ci	D	3 Spd. AT 1 pc. Cable, or MT w/o Cruise; 80.00" Cable	CA-3001
1982	L6 4.1L 250ci	D	4 Spd. AT w/innerconnector, Upper; 61.00" Cable	CA-3005
1982	L6 4.1L 250ci	D	All to 80" Cable; 80.00" Cable	CA-3001
1982	L6 4.1L 250ci	D	All To 92" Cable; 100.00" Cable	CA-3003
1982	L6 4.1L 250ci	D	AT w/Cruise Control, Intermediate	CA-3006
1982	L6 4.1L 250ci	D	MT w/Cruise Control, Lower; 63.00" Cable	CA-3002
1982	L6 4.1L 250ci	D	To 75" Cable; 83.00" Cable	CA-3004
1975	L6 4.1L 250ci	Q	3 Spd. MT; 80.00" Cable	CA-3001
1975	L6 4.1L 250ci	Q	4 Spd. MT Lower; 40.00" Cable	CA-3033
1975	L6 4.1L 250ci	Q	AT THM w/Cruise Lower; 63.00" Cable	CA-3002
1975	L6 4.1L 250ci	Q	AT THM w/Cruise Upper, OR 4 Spd. MT Upper; 41.00" Cable	CA-3009
1975	L6 4.1L 250ci	Q	AT THM w/o Cruise, 3 Spd. MT w/o Cruise; 80.00" Cable	CA-3001
1975	L6 4.1L 250ci	Q	AT w/Cruise Control, Lower; 63.00" Cable	CA-3002
1975	L6 4.1L 250ci	Q	AT w/Cruise Upper, 4 Spd. MT Upper; 41.00" Cable	CA-3009
1982	V8 5.0L 305ci	F	3 Spd. AT 1 pc. Cable, or MT w/o Cruise; 80.00" Cable	CA-3001
1982	V8 5.0L 305ci	F	4 Spd. AT w/innerconnector, Upper; 61.00" Cable	CA-3005
1982	V8 5.0L 305ci	F,H	All to 80" Cable; 80.00" Cable	CA-3001
1982	V8 5.0L 305ci	F,H	All To 92" Cable; 100.00" Cable	CA-3003

# SPEEDOMETER CABLES

Year	Engine	Vin	Remark	Part
<b>CHEVROLET TRUCKS (con't)</b>				
<b>K5 BLAZER (con't)</b>				
1982	V8 5.0L 305ci	F	AT w/Cruise Control, Intermediate	CA-3006
1982	V8 5.0L 305ci	F	MT w/Cruise Control, Lower; 63.00" Cable	CA-3002
1982	V8 5.0L 305ci	F,H	To 75" Cable; 83.00" Cable	CA-3004
1980	V8 5.0L 305ci	G	4 Spd. w/o Cruise Upper; 61.00" Cable	CA-3005
1980	V8 5.0L 305ci	G	All to 80" Cable; 83.00" Cable	CA-3004
1980	V8 5.0L 305ci	G	AT w/Cruise Control, Upper; 41.00" Cable	CA-3009
1980	V8 5.0L 305ci	G	AT w/o Cruise Control, MT; 100.00" Cable	CA-3003
1980	V8 5.0L 305ci	G	exc. Cruise Control; 80.00" Cable	CA-3001
1980	V8 5.0L 305ci	G	w/Catalic Converter w/Cruise Control, Lower	CA-3006
1980	V8 5.0L 305ci	G	w/o Catalic Converter w/Cruise Control, Lower; 63.00" Cable	CA-3002
1983-84	V8 5.0L 305ci	H	4 Spd. MT w/innerconnector Lower; 20.00" Cable	CA-3008
1983-84	V8 5.0L 305ci	H	4WD; 100.00" Cable	CA-3003
1983-84	V8 5.0L 305ci	H	TH700-R4 Auto. Trans., or w/4 Spd. MT Upper; 61.00" Cable	CA-3005
1983-84	V8 5.0L 305ci	H	THM-400 Auto. Trans.; 80.00" Cable	CA-3001
1977	V8 5.0L 305ci	U	w/Cruise Control, Lower; 83.00" Cable	CA-3004
1977	V8 5.0L 305ci	U	w/Cruise Control, Upper; 41.00" Cable	CA-3009
1977	V8 5.0L 305ci	U	w/Cruise Lower; 63.00" Cable	CA-3002
1977	V8 5.0L 305ci	U	w/o Cruise Control; 100.00" Cable	CA-3003
1978-79	V8 5.0L 305ci	U	3 Spd. MT w/o Cruise; 80.00" Cable	CA-3001
1978-79	V8 5.0L 305ci	U	4 Spd. MT; 61.00" Cable	CA-3005
1978-79	V8 5.0L 305ci	U	AT Upper; 41.00" Cable	CA-3009
1978-79	V8 5.0L 305ci	U	AT w/Catalytic Converter Lower	CA-3006
1978-79	V8 5.0L 305ci	U	AT w/Catalytic Converter w/Cruise Upper; 41.00" Cable	CA-3009
1978-79	V8 5.0L 305ci	U	AT w/Cruise Control, Lower; 83.00" Cable	CA-3004
1978-79	V8 5.0L 305ci	U	AT w/o Catalytic Converter w/Cruise Lower; 63.00" Cable	CA-3002
1978-79	V8 5.0L 305ci	U	AT w/o Cruise, w/Single Exhaust w/TH350; 80.00" Cable	CA-3001
1978-79	V8 5.0L 305ci	U	MT w/o Cruise Control, AT w/o Cruise w/Dual Exhaust, AT w/o Cruise w/single Exhaust w/TH400"; 100.00" Cable	CA-3003
1976	V8 5.7L 350ci	L,V	AT THM w/Cruise Lower; 83.00" Cable	CA-3004
1976	V8 5.7L 350ci	L,V	AT w/o Cruise Control; 80.00" Cable	CA-3001
1976	V8 5.7L 350ci	L,V	MT 1 pc. Cable; 100.00" Cable	CA-3003
1976-79	V8 5.7L 350ci	L,V	AT w/Cruise Control, Lower; 83.00" Cable	CA-3004
1977	V8 5.7L 350ci	L	w/Cruise Control, Upper; 41.00" Cable	CA-3009
1977	V8 5.7L 350ci	L	w/Cruise Lower; 63.00" Cable	CA-3002
1977	V8 5.7L 350ci	L	w/o Cruise Control; 100.00" Cable	CA-3003
1977-80	V8 5.7L 350ci	L	All to 80" Cable; 83.00" Cable	CA-3004
1978-79	V8 5.7L 350ci	L	3 Spd. MT w/o Cruise; 80.00" Cable	CA-3001
1978-79	V8 5.7L 350ci	L	4 Spd. MT; 61.00" Cable	CA-3005
1978-79	V8 5.7L 350ci	L	AT Upper; 41.00" Cable	CA-3009
1978-79	V8 5.7L 350ci	L	AT w/Catalytic Converter Lower	CA-3006
1978-79	V8 5.7L 350ci	L	AT w/Catalytic Converter w/Cruise Upper; 41.00" Cable	CA-3009
1978-79	V8 5.7L 350ci	L	AT w/o Catalytic Converter w/Cruise Lower; 63.00" Cable	CA-3002
1978-79	V8 5.7L 350ci	L	AT w/o Cruise, w/Single Exhaust w/TH350; 80.00" Cable	CA-3001
1978-79	V8 5.7L 350ci	L	MT w/o Cruise Control, AT w/o Cruise w/Dual Exhaust, AT w/o Cruise w/single Exhaust w/TH400"; 100.00" Cable	CA-3003
1980	V8 5.7L 350ci	L	4 Spd. w/o Cruise Upper; 61.00" Cable	CA-3005
1980	V8 5.7L 350ci	L	AT w/Cruise Control, Upper; 41.00" Cable	CA-3009
1980	V8 5.7L 350ci	L	AT w/o Cruise Control, MT; 100.00" Cable	CA-3003
1980	V8 5.7L 350ci	L	exc. Cruise Control; 80.00" Cable	CA-3001
1980	V8 5.7L 350ci	L	w/Catalic Converter w/Cruise Control, Lower	CA-3006
1980	V8 5.7L 350ci	L	w/o Catalic Converter w/Cruise Control, Lower; 63.00" Cable	CA-3002
1982	V8 5.7L 350ci	L	3 Spd. AT 1 pc. Cable, or MT w/o Cruise; 80.00" Cable	CA-3001
1982	V8 5.7L 350ci	L	4 Spd. AT w/innerconnector, Upper; 61.00" Cable	CA-3005
1982	V8 5.7L 350ci	L	All to 80" Cable; 80.00" Cable	CA-3001
1982	V8 5.7L 350ci	L	All To 92" Cable; 100.00" Cable	CA-3003
1982	V8 5.7L 350ci	L	AT w/Cruise Control, Intermediate	CA-3006
1982	V8 5.7L 350ci	L	MT w/Cruise Control, Lower; 63.00" Cable	CA-3002
1982	V8 5.7L 350ci	L	To 75" Cable; 83.00" Cable	CA-3004
1983-84	V8 5.7L 350ci	L	4 Spd. MT w/innerconnector Lower; 20.00" Cable	CA-3008
1983-84	V8 5.7L 350ci	L	4WD; 100.00" Cable	CA-3003
1983-84	V8 5.7L 350ci	L	TH700-R4 Auto. Trans., or w/4 Spd. MT Upper; 61.00" Cable	CA-3005
1983-84	V8 5.7L 350ci	L	THM-400 Auto. Trans.; 80.00" Cable	CA-3001

# SPEEDOMETER CABLES

Year	Engine	Vin	Remark	Part
<b>CHEVROLET TRUCKS (con't)</b>				
<b>K5 BLAZER (con't)</b>				
1975	V8 5.7L 350ci	V,Y	3 Spd. MT	CA-3016
1975	V8 5.7L 350ci	V,Y	AT THM w/Cruise Lower; 63.00" Cable	CA-3002
1975	V8 5.7L 350ci	V,Y	AT w/Cruise Control, Lower; 63.00" Cable	CA-3002
1975	V8 5.7L 350ci	V,Y	AT w/o Cruise Control; 100.00" Cable	CA-3003
1975-76	V8 5.7L 350ci	L,V,Y	4 Spd. MT Lower; 40.00" Cable	CA-3033
1975-76	V8 5.7L 350ci	L,V,Y	AT THM w/Cruise Upper, OR 4 Spd. MT Upper; 41.00" Cable	CA-3009
1975-76	V8 5.7L 350ci	L,V,Y	AT THM w/o Cruise, 3 Spd. MT w/o Cruise; 80.00" Cable	CA-3001
1975-76	V8 5.7L 350ci	L,V,Y	AT w/Cruise Upper, 4 Spd. MT Upper; 41.00" Cable	CA-3009
1982	V8 6.2L 379ci	C	3 Spd. AT 1 pc. Cable, or MT w/o Cruise; 80.00" Cable	CA-3001
1982	V8 6.2L 379ci	C	4 Spd. AT w/innerconnector, Upper; 61.00" Cable	CA-3005
1982	V8 6.2L 379ci	C	All to 80" Cable; 80.00" Cable	CA-3001
1982	V8 6.2L 379ci	C	All To 92" Cable; 100.00" Cable	CA-3003
1982	V8 6.2L 379ci	C	AT w/Cruise Control, Intermediate	CA-3006
1982	V8 6.2L 379ci	C	MT w/Cruise Control, Lower; 63.00" Cable	CA-3002
1982	V8 6.2L 379ci	C	To 75" Cable; 83.00" Cable	CA-3004
1983-84	V8 6.2L 379ci	C	4WD; 100.00" Cable	CA-3003
1983-84	V8 6.2L 379ci	C	TH700-R4 Auto. Trans., or w/4 Spd. MT Upper; 61.00" Cable	CA-3005
1984	V8 6.2L 379ci	C	4 Spd. MT w/innerconnector Lower; 20.00" Cable	CA-3008
1984	V8 6.2L 379ci	C	THM-400 Auto. Trans.; 80.00" Cable	CA-3001
1975	V8 6.6L 400ci	M	3 Spd. MT	CA-3016
1975	V8 6.6L 400ci	M	4 Spd. MT Lower; 40.00" Cable	CA-3033
1975	V8 6.6L 400ci	M	AT THM w/Cruise Lower; 63.00" Cable	CA-3002
1975	V8 6.6L 400ci	M	AT THM w/Cruise Upper, OR 4 Spd. MT Upper; 41.00" Cable	CA-3009
1975	V8 6.6L 400ci	M	AT THM w/o Cruise, 3 Spd. MT w/o Cruise; 80.00" Cable	CA-3001
1975	V8 6.6L 400ci	M	AT w/Cruise Control, Lower; 63.00" Cable	CA-3002
1975	V8 6.6L 400ci	M	AT w/Cruise Upper, 4 Spd. MT Upper; 41.00" Cable	CA-3009
1975	V8 6.6L 400ci	M	AT w/o Cruise Control; 100.00" Cable	CA-3003
1977	V8 6.6L 400ci	R	w/Cruise Control, Lower; 83.00" Cable	CA-3004
1977	V8 6.6L 400ci	R	w/Cruise Control, Upper; 41.00" Cable	CA-3009
1977	V8 6.6L 400ci	R	w/o Cruise Control; 100.00" Cable	CA-3003
1978-79	V8 6.6L 400ci	R	3 Spd. MT w/o Cruise; 80.00" Cable	CA-3001
1978-79	V8 6.6L 400ci	R	4 Spd. MT; 61.00" Cable	CA-3005
1978-79	V8 6.6L 400ci	R	AT Upper; 41.00" Cable	CA-3009
1978-79	V8 6.6L 400ci	R	AT w/Catalytic Converter Lower	CA-3006
1978-79	V8 6.6L 400ci	R	AT w/Catalytic Converter w/Cruise Upper; 41.00" Cable	CA-3009
1978-79	V8 6.6L 400ci	R	AT w/Cruise Control, Lower; 83.00" Cable	CA-3004
1978-79	V8 6.6L 400ci	R	AT w/o Catalytic Converter w/Cruise Lower; 63.00" Cable	CA-3002
1978-79	V8 6.6L 400ci	R	AT w/o Cruise, w/Single Exhaust w/TH350; 80.00" Cable	CA-3001
1978-79	V8 6.6L 400ci	R	MT w/o Cruise Control, AT w/o Cruise w/Dual Exhaust, AT w/o Cruise w/single Exhaust w/TH400"; 100.00" Cable	CA-3003
1976	V8 6.6L 400ci	U	4 Spd. MT Lower; 40.00" Cable	CA-3033
1976	V8 6.6L 400ci	U	AT THM w/Cruise Lower; 83.00" Cable	CA-3004
1976	V8 6.6L 400ci	U	AT THM w/Cruise Upper, OR 4 Spd. MT Upper; 41.00" Cable	CA-3009
1976	V8 6.6L 400ci	U	AT THM w/o Cruise, 3 Spd. MT w/o Cruise; 80.00" Cable	CA-3001
1976	V8 6.6L 400ci	U	AT w/Cruise Control, Lower; 83.00" Cable	CA-3004
1976	V8 6.6L 400ci	U	AT w/Cruise Upper, 4 Spd. MT Upper; 41.00" Cable	CA-3009
1976	V8 6.6L 400ci	U	AT w/o Cruise Control; 80.00" Cable	CA-3001
1976	V8 6.6L 400ci	U	MT 1 pc. Cable; 100.00" Cable	CA-3003
1976	V8 7.4L 454ci	S	4 Spd. MT Lower; 40.00" Cable	CA-3033
1976	V8 7.4L 454ci	S	AT THM w/Cruise Lower; 83.00" Cable	CA-3004
1976	V8 7.4L 454ci	S	AT THM w/Cruise Upper, OR 4 Spd. MT Upper; 41.00" Cable	CA-3009
1976	V8 7.4L 454ci	S	AT THM w/o Cruise, 3 Spd. MT w/o Cruise; 80.00" Cable	CA-3001
1976	V8 7.4L 454ci	S	AT w/Cruise Upper, 4 Spd. MT Upper; 41.00" Cable	CA-3009
1976	V8 7.4L 454ci	S	AT w/o Cruise Control; 80.00" Cable	CA-3001
1976	V8 7.4L 454ci	S	MT 1 pc. Cable; 100.00" Cable	CA-3003
1976-78	V8 7.4L 454ci	S	AT w/Cruise Control, Lower; 83.00" Cable	CA-3004
1977	V8 7.4L 454ci	S	w/Cruise Control, Lower; 83.00" Cable	CA-3004
1977	V8 7.4L 454ci	S	w/Cruise Control, Upper; 41.00" Cable	CA-3009
1977	V8 7.4L 454ci	S	w/Cruise Lower; 63.00" Cable	CA-3002
1977	V8 7.4L 454ci	S	w/o Cruise Control; 100.00" Cable	CA-3003
1978	V8 7.4L 454ci	S	3 Spd. MT w/o Cruise; 80.00" Cable	CA-3001
1978	V8 7.4L 454ci	S	4 Spd. MT; 61.00" Cable	CA-3005

# SPEEDOMETER CABLES

Year	Engine	Vin	Remark	Part
<b>CHEVROLET TRUCKS (con't)</b>				
<b>K5 BLAZER (con't)</b>				
1978	V8 7.4L 454ci	S	AT Upper; 41.00" Cable	CA-3009
1978	V8 7.4L 454ci	S	AT w/Catalytic Converter Lower	CA-3006
1978	V8 7.4L 454ci	S	AT w/Catalytic Converter w/Cruise Upper; 41.00" Cable	CA-3009
1978	V8 7.4L 454ci	S	AT w/o Catalytic Converter w/Cruise Lower; 63.00" Cable	CA-3002
1978	V8 7.4L 454ci	S	AT w/o Cruise, w/Single Exhaust w/TH350; 80.00" Cable	CA-3001
1978	V8 7.4L 454ci	S	MT w/o Cruise Control, AT w/o Cruise w/Dual Exhaust, AT w/o Cruise w/single Exhaust w/TH400"; 100.00" Cable	CA-3003
<b>LUV</b>				
1972-75	L4 1.8L 111ci	N		CA-3149
1976-77	L4 1.8L 111ci	N		CA-3165
1978-80	L4 1.8L 111ci	N		CA-3177
<b>P10 SERIES</b>				
1963	L4 2.5L 153ci		w/Powerglide AT, w/4 Spd. MT	CA-3016
1964-65	L4 2.5L 153ci		to 120"	CA-3038
1964-65	L4 2.5L 153ci		to 80" exc. Powerglide; 83.00" Cable	CA-3004
1964-65	L4 2.5L 153ci		w/55" Cable exc. Powerglide; 63.00" Cable	CA-3002
1964-65	L4 2.5L 153ci		w/92" Cable	CA-3016
1964-65	L4 2.5L 153ci		w/THM AT 100" Cable; 100.00" Cable	CA-3003
1966	L6 3.2L 194ci		to 120"	CA-3038
1966	L6 3.2L 194ci		to 80" exc. Powerglide; 83.00" Cable	CA-3004
1966	L6 3.2L 194ci		w/55" Cable exc. Powerglide; 63.00" Cable	CA-3002
1966	L6 3.2L 194ci		w/92" Cable	CA-3016
1966	L6 3.2L 194ci		w/THM AT 100" Cable; 100.00" Cable	CA-3003
1963	L6 3.8L 230ci		w/Powerglide AT, w/4 Spd. MT	CA-3016
1964-67	L6 3.8L 230ci		to 120"	CA-3038
1964-67	L6 3.8L 230ci		to 80" exc. Powerglide; 83.00" Cable	CA-3004
1964-67	L6 3.8L 230ci		w/55" Cable exc. Powerglide; 63.00" Cable	CA-3002
1964-67	L6 3.8L 230ci		w/92" Cable	CA-3016
1964-67	L6 3.8L 230ci		w/THM AT 100" Cable; 100.00" Cable	CA-3003
1962	L6 3.9L 235ci		3 Spd. MT	CA-3038
1962	L6 3.9L 235ci		w/Powerglide AT, w/4 Spd. MT	CA-3016
1967	L6 4.8L 292ci		to 120"	CA-3038
1967	L6 4.8L 292ci		to 80" exc. Powerglide; 83.00" Cable	CA-3004
1967	L6 4.8L 292ci		w/55" Cable exc. Powerglide; 63.00" Cable	CA-3002
1967	L6 4.8L 292ci		w/92" Cable	CA-3016
1967	L6 4.8L 292ci		w/THM AT 100" Cable; 100.00" Cable	CA-3003
1962	V8 4.6L 283ci		3 Spd. MT	CA-3038
1962	V8 4.6L 283ci		w/Powerglide AT, w/4 Spd. MT	CA-3016
1962	V8 5.4L 327ci		3 Spd. MT	CA-3038
1962	V8 5.4L 327ci		w/Powerglide AT, w/4 Spd. MT	CA-3016
<b>P10</b>				
1973-74	L6 4.1L 250ci	Q	w/100" Cable; 100.00" Cable	CA-3003
1973-74	L6 4.1L 250ci	Q	w/114" Cable; 120.00" Cable	CA-3007
1975	L6 4.8L 292ci	T	w/100" Cable; 100.00" Cable	CA-3003
1975	L6 4.8L 292ci	T	w/114" Cable; 120.00" Cable	CA-3007
1976	L6 4.8L 292ci	T	3 & 4 Spd. MT with 2 Pc. Cable Lower; 40.00" Cable	CA-3033
1976	L6 4.8L 292ci	T	3 & 4 Spd. MT with 2 Pc. Cable Upper; 41.00" Cable	CA-3009
1976	L6 4.8L 292ci	T	w/THM AT w/Cruise, w/3 & 4 Spd. MT with 1 Pc. Cable; 100.00" Cable	CA-3003
1976	L6 4.8L 292ci	T	w/THM AT w/o Cruise; 80.00" Cable	CA-3001
1977	L6 4.8L 292ci	T	Step Van; 100.00" Cable	CA-3003
1978-80	L6 4.8L 292ci	T	exc. Motor Home Chassis; 100.00" Cable	CA-3003
1978-80	L6 4.8L 292ci	T	Motor Home Chassis; 120.00" Cable	CA-3007
1979	V8 5.0L 305ci	U	exc. Motor Home Chassis; 100.00" Cable	CA-3003
1979	V8 5.0L 305ci	U	Motor Home Chassis; 120.00" Cable	CA-3007
1973	V8 5.7L 350ci	Y	w/100" Cable; 100.00" Cable	CA-3003
1973	V8 5.7L 350ci	Y	w/114" Cable; 120.00" Cable	CA-3007
1975	V8 5.7L 350ci	Y	w/100" Cable; 100.00" Cable	CA-3003
1975	V8 5.7L 350ci	Y	w/114" Cable; 120.00" Cable	CA-3007
1977	V8 6.6L 400ci	R	Step Van; 100.00" Cable	CA-3003
1973	V8 7.4L 454ci	Z	w/100" Cable; 100.00" Cable	CA-3003
1973	V8 7.4L 454ci	Z	w/114" Cable; 120.00" Cable	CA-3007

# SPEEDOMETER CABLES

Year	Engine	Vin	Remark	Part
<b>CHEVROLET TRUCKS (con't)</b>				
<b>P20 SERIES</b>				
1963	L6 3.8L 230ci		to 80"; 83.00" Cable	CA-3004
1963	L6 3.8L 230ci		w/55" Cable; 63.00" Cable	CA-3002
1963	L6 3.8L 230ci		w/56" to 60" Cable; 61.00" Cable	CA-3005
1963-65	L6 3.8L 230ci		to 120"	CA-3038
1963-65	L6 3.8L 230ci		w/92" Cable	CA-3016
1964-65	L6 3.8L 230ci		to 80" exc. Powerglide; 83.00" Cable	CA-3004
1964-65	L6 3.8L 230ci		w/55" Cable exc. Powerglide; 63.00" Cable	CA-3002
1964-65	L6 3.8L 230ci		w/THM AT 100" Cable; 100.00" Cable	CA-3003
1961	L6 3.9L 235ci		w/Powerglide AT, w/4 Spd. MT	CA-3038
1966	L6 4.1L 250ci		to 120"	CA-3038
1966	L6 4.1L 250ci		to 80" exc. Powerglide; 83.00" Cable	CA-3004
1966	L6 4.1L 250ci		w/55" Cable exc. Powerglide; 63.00" Cable	CA-3002
1966	L6 4.1L 250ci		w/92" Cable	CA-3016
1966	L6 4.1L 250ci		w/THM AT 100" Cable; 100.00" Cable	CA-3003
1964-67	L6 4.8L 292ci		to 120"	CA-3038
1964-67	L6 4.8L 292ci		to 80" exc. Powerglide; 83.00" Cable	CA-3004
1964-67	L6 4.8L 292ci		w/55" Cable exc. Powerglide; 63.00" Cable	CA-3002
1964-67	L6 4.8L 292ci		w/92" Cable	CA-3016
1964-67	L6 4.8L 292ci		w/THM AT 100" Cable; 100.00" Cable	CA-3003
1961-62	V8 4.6L 283ci		w/Powerglide AT, w/4 Spd. MT	CA-3038
1962	V8 5.4L 327ci		w/Powerglide AT, w/4 Spd. MT	CA-3038
1961-62	V8 5.7L 348ci		w/Powerglide AT, w/4 Spd. MT	CA-3038
1964-65	V8 5.7L 348ci		to 120"	CA-3038
1964-65	V8 5.7L 348ci		to 80" exc. Powerglide; 83.00" Cable	CA-3004
1964-65	V8 5.7L 348ci		w/55" Cable exc. Powerglide; 63.00" Cable	CA-3002
1964-65	V8 5.7L 348ci		w/92" Cable	CA-3016
1964-65	V8 5.7L 348ci		w/THM AT 100" Cable; 100.00" Cable	CA-3003
1966-67	V8 6.0L 366ci		to 120"	CA-3038
1966-67	V8 6.0L 366ci		to 80" exc. Powerglide; 83.00" Cable	CA-3004
1966-67	V8 6.0L 366ci		w/55" Cable exc. Powerglide; 63.00" Cable	CA-3002
1966-67	V8 6.0L 366ci		w/92" Cable	CA-3016
1966-67	V8 6.0L 366ci		w/THM AT 100" Cable; 100.00" Cable	CA-3003
1962	V8 6.7L 409ci		w/Powerglide AT, w/4 Spd. MT	CA-3038
1964-65	V8 6.7L 409ci		to 120"	CA-3038
1964-65	V8 6.7L 409ci		to 80" exc. Powerglide; 83.00" Cable	CA-3004
1964-65	V8 6.7L 409ci		w/55" Cable exc. Powerglide; 63.00" Cable	CA-3002
1964-65	V8 6.7L 409ci		w/92" Cable	CA-3016
1964-65	V8 6.7L 409ci		w/THM AT 100" Cable; 100.00" Cable	CA-3003
<b>P20</b>				
1973-74	L6 4.1L 250ci	Q	100.00" Cable	CA-3003
1973-74	L6 4.1L 250ci	Q	w/114" Cable; 120.00" Cable	CA-3007
1973-75	L6 4.8L 292ci	T	100.00" Cable	CA-3003
1973-75	L6 4.8L 292ci	T	w/114" Cable; 120.00" Cable	CA-3007
1976	L6 4.8L 292ci	T	3 & 4 Spd. MT with 2 Pc. Cable Lower; 40.00" Cable	CA-3033
1976	L6 4.8L 292ci	T	3 & 4 Spd. MT with 2 Pc. Cable Upper; 41.00" Cable	CA-3009
1976	L6 4.8L 292ci	T	w/THM AT w/Cruise, w/3 & 4 Spd. MT with 1 Pc. Cable; 100.00" Cable	CA-3003
1976	L6 4.8L 292ci	T	w/THM AT w/o Cruise; 80.00" Cable	CA-3001
1977	L6 4.8L 292ci	T	Step Van; 100.00" Cable	CA-3003
1978-80	L6 4.8L 292ci	T	exc. Motor Home Chassis; 100.00" Cable	CA-3003
1978-80	L6 4.8L 292ci	T	Motor Home Chassis; 120.00" Cable	CA-3007
1981-84	L6 4.8L 292ci	T	100.00" Cable	CA-3003
1972	V8 5.7L 350ci	E	Lower	CA-3040
1972	V8 5.7L 350ci	E	Upper	CA-3039
1972	V8 5.7L 350ci	E	w/forward Control Chassis 1 pc.; 100.00" Cable	CA-3003
1976	V8 5.7L 350ci	L	3 & 4 Spd. MT with 2 Pc. Cable Lower; 40.00" Cable	CA-3033
1976	V8 5.7L 350ci	L	3 & 4 Spd. MT with 2 Pc. Cable Upper; 41.00" Cable	CA-3009
1976	V8 5.7L 350ci	L	Lower	CA-3040
1976	V8 5.7L 350ci	L	Upper	CA-3039
1976	V8 5.7L 350ci	L	w/forward Control Chassis 1 pc.; 100.00" Cable	CA-3003
1976	V8 5.7L 350ci	L	w/THM AT w/Cruise, w/3 & 4 Spd. MT with 1 Pc. Cable; 100.00" Cable	CA-3003
1976	V8 5.7L 350ci	L	w/THM AT w/o Cruise; 80.00" Cable	CA-3001
1977	V8 5.7L 350ci	L	Step Van; 100.00" Cable	CA-3003



# SPEEDOMETER CABLES

Year	Engine	Vin	Remark	Part
<b>CHEVROLET TRUCKS (con't)</b>				
<b>P20 (con't)</b>				
1978-79	V8 5.7L 350ci	L	exc. Motor Home Chassis; 100.00" Cable	CA-3003
1978-79	V8 5.7L 350ci	L	Motor Home Chassis; 120.00" Cable	CA-3007
1980	V8 5.7L 350ci	M	exc. Motor Home Chassis; 100.00" Cable	CA-3003
1980	V8 5.7L 350ci	M	Motor Home Chassis; 120.00" Cable	CA-3007
1981-84	V8 5.7L 350ci	M	100.00" Cable	CA-3003
1973-75	V8 5.7L 350ci	V,Y	100.00" Cable	CA-3003
1973-75	V8 5.7L 350ci	V,Y	w/114" Cable; 120.00" Cable	CA-3007
1982-84	V8 6.2L 379ci	J	100.00" Cable	CA-3003
1979	V8 7.4L 454ci	S	exc. Motor Home Chassis; 100.00" Cable	CA-3003
1979	V8 7.4L 454ci	S	Motor Home Chassis; 120.00" Cable	CA-3007
1976	V8 7.4L 454ci	Y	3 & 4 Spd. MT with 2 Pc. Cable Lower; 40.00" Cable	CA-3033
1976	V8 7.4L 454ci	Y	3 & 4 Spd. MT with 2 Pc. Cable Upper; 41.00" Cable	CA-3009
1976	V8 7.4L 454ci	Y	w/THM AT w/Cruise, w/3 & 4 Spd. MT with 1 Pc. Cable; 100.00" Cable	CA-3003
1976	V8 7.4L 454ci	Y	w/THM AT w/o Cruise; 80.00" Cable	CA-3001
1973	V8 7.4L 454ci	Z	100.00" Cable	CA-3003
1973	V8 7.4L 454ci	Z	w/114" Cable; 120.00" Cable	CA-3007
<b>P30 SERIES</b>				
1963	L6 3.8L 230ci		83.00" Cable	CA-3004
1963	L6 3.8L 230ci		w/55" Cable; 63.00" Cable	CA-3002
1963	L6 3.8L 230ci		w/56" to 60" Cable; 61.00" Cable	CA-3005
1963-65	L6 3.8L 230ci		to 120"	CA-3038
1963-65	L6 3.8L 230ci		w/92" Cable	CA-3016
1964-65	L6 3.8L 230ci		to 80" exc. Powerglide; 83.00" Cable	CA-3004
1964-65	L6 3.8L 230ci		w/55" Cable exc. Powerglide; 63.00" Cable	CA-3002
1964-65	L6 3.8L 230ci		w/THM AT 100" Cable; 100.00" Cable	CA-3003
1961	L6 3.9L 235ci		4 Spd. MT	CA-3038
1966	L6 4.1L 250ci		to 120"	CA-3038
1966	L6 4.1L 250ci		to 80" exc. Powerglide; 83.00" Cable	CA-3004
1966	L6 4.1L 250ci		w/55" Cable exc. Powerglide; 63.00" Cable	CA-3002
1966	L6 4.1L 250ci		w/92" Cable	CA-3016
1966	L6 4.1L 250ci		w/THM AT 100" Cable; 100.00" Cable	CA-3003
1964-67	L6 4.8L 292ci		to 120"	CA-3038
1964-67	L6 4.8L 292ci		to 80" exc. Powerglide; 83.00" Cable	CA-3004
1964-67	L6 4.8L 292ci		w/55" Cable exc. Powerglide; 63.00" Cable	CA-3002
1964-67	L6 4.8L 292ci		w/92" Cable	CA-3016
1964-67	L6 4.8L 292ci		w/THM AT 100" Cable; 100.00" Cable	CA-3003
1961-62	V8 4.6L 283ci		4 Spd. MT	CA-3038
1962	V8 5.4L 327ci		4 Spd. MT	CA-3038
1961-62	V8 5.7L 348ci		4 Spd. MT	CA-3038
1964-65	V8 5.7L 348ci		to 120"	CA-3038
1964-65	V8 5.7L 348ci		to 80" exc. Powerglide; 83.00" Cable	CA-3004
1964-65	V8 5.7L 348ci		w/55" Cable exc. Powerglide; 63.00" Cable	CA-3002
1964-65	V8 5.7L 348ci		w/92" Cable	CA-3016
1964-65	V8 5.7L 348ci		w/THM AT 100" Cable; 100.00" Cable	CA-3003
1966-67	V8 6.0L 366ci		to 120"	CA-3038
1966-67	V8 6.0L 366ci		to 80" exc. Powerglide; 83.00" Cable	CA-3004
1966-67	V8 6.0L 366ci		w/55" Cable exc. Powerglide; 63.00" Cable	CA-3002
1966-67	V8 6.0L 366ci		w/92" Cable	CA-3016
1966-67	V8 6.0L 366ci		w/THM AT 100" Cable; 100.00" Cable	CA-3003
1962	V8 6.7L 409ci		4 Spd. MT	CA-3038
1964-65	V8 6.7L 409ci		to 120"	CA-3038
1964-65	V8 6.7L 409ci		to 80" exc. Powerglide; 83.00" Cable	CA-3004
1964-65	V8 6.7L 409ci		w/55" Cable exc. Powerglide; 63.00" Cable	CA-3002
1964-65	V8 6.7L 409ci		w/92" Cable	CA-3016
1964-65	V8 6.7L 409ci		w/THM AT 100" Cable; 100.00" Cable	CA-3003
<b>P30</b>				
1989-90	L4 3.9L 239ci	L	1 pc. Cable; 120.00" Cable	CA-3007
1976	L6 4.1L 250ci	D	3 & 4 Spd. MT with 1 Pc. Cable; 100.00" Cable	CA-3003
1976	L6 4.1L 250ci	D	3 & 4 Spd. MT with 2 Pc. Cable Lower; 40.00" Cable	CA-3033
1976	L6 4.1L 250ci	D	3 & 4 Spd. MT with 2 Pc. Cable Upper; 41.00" Cable	CA-3009
1976	L6 4.1L 250ci	D	w/THM AT; 120.00" Cable	CA-3007
1979	L6 4.1L 250ci	D	exc. Motor Home Chassis; 100.00" Cable	CA-3003

# SPEEDOMETER CABLES

Year	Engine	Vin	Remark	Part
<b>CHEVROLET TRUCKS (con't)</b>				
<b>P30 (con't)</b>				
1979	L6 4.1L 250ci	D	Motor Home Chassis; 120.00" Cable	CA-3007
1973-74	L6 4.1L 250ci	Q	100.00" Cable	CA-3003
1973-74	L6 4.1L 250ci	Q	w/114" Cable; 120.00" Cable	CA-3007
1973-75	L6 4.8L 292ci	S,T	100.00" Cable	CA-3003
1973-75	L6 4.8L 292ci	S,T	w/114" Cable; 120.00" Cable	CA-3007
1976	L6 4.8L 292ci	T	3 & 4 Spd. MT with 1 Pc. Cable; 100.00" Cable	CA-3003
1976	L6 4.8L 292ci	T	3 & 4 Spd. MT with 2 Pc. Cable Lower; 40.00" Cable	CA-3033
1976	L6 4.8L 292ci	T	3 & 4 Spd. MT with 2 Pc. Cable Upper; 41.00" Cable	CA-3009
1976	L6 4.8L 292ci	T	w/THM AT; 120.00" Cable	CA-3007
1977	L6 4.8L 292ci	T	Step Van; 100.00" Cable	CA-3003
1978-81	L6 4.8L 292ci	T	exc. Motor Home Chassis; 100.00" Cable	CA-3003
1978-81	L6 4.8L 292ci	T	Motor Home Chassis; 120.00" Cable	CA-3007
1982-84	L6 4.8L 292ci	T	120.00" Cable	CA-3007
1985-86	L6 4.8L 292ci	T	w/conventional chassis, w/forward Control Chassis; 100.00" Cable	CA-3003
1985-86	L6 4.8L 292ci	T	w/Motorhome Chassis; 120.00" Cable	CA-3007
1987	L6 4.8L 292ci	T	Lower	CA-3040
1987	L6 4.8L 292ci	T	Upper	CA-3039
1987	L6 4.8L 292ci	T	w/forward Control Chassis 1 pc.; 100.00" Cable	CA-3003
1988-89	L6 4.8L 292ci	T	1 pc. Cable; 120.00" Cable	CA-3007
1990	V6 4.3L 262ci	Z	1 pc. Cable; 120.00" Cable	CA-3007
1988-90	V8 5.7L 350ci	K,M	1 pc. Cable; 120.00" Cable	CA-3007
1976	V8 5.7L 350ci	L	3 & 4 Spd. MT with 1 Pc. Cable; 100.00" Cable	CA-3003
1976	V8 5.7L 350ci	L	3 & 4 Spd. MT with 2 Pc. Cable Lower; 40.00" Cable	CA-3033
1976	V8 5.7L 350ci	L	3 & 4 Spd. MT with 2 Pc. Cable Upper; 41.00" Cable	CA-3009
1976	V8 5.7L 350ci	L	w/THM AT; 120.00" Cable	CA-3007
1977	V8 5.7L 350ci	L	Step Van; 100.00" Cable	CA-3003
1978-80	V8 5.7L 350ci	L	exc. Motor Home Chassis; 100.00" Cable	CA-3003
1978-80	V8 5.7L 350ci	L	Motor Home Chassis; 120.00" Cable	CA-3007
1980	V8 5.7L 350ci	L	Lower	CA-3040
1980	V8 5.7L 350ci	L	Upper	CA-3039
1980	V8 5.7L 350ci	L	w/forward Control Chassis 1 pc.; 100.00" Cable	CA-3003
1980-81	V8 5.7L 350ci	M	exc. Motor Home Chassis; 100.00" Cable	CA-3003
1980-81	V8 5.7L 350ci	M	Motor Home Chassis; 120.00" Cable	CA-3007
1982-84	V8 5.7L 350ci	M	120.00" Cable	CA-3007
1985-86	V8 5.7L 350ci	M	w/conventional chassis, w/forward Control Chassis; 100.00" Cable	CA-3003
1985-86	V8 5.7L 350ci	M	w/Motorhome Chassis; 120.00" Cable	CA-3007
1986-87	V8 5.7L 350ci	K,M	Lower	CA-3040
1986-87	V8 5.7L 350ci	K,M	Upper	CA-3039
1986-87	V8 5.7L 350ci	K,M	w/forward Control Chassis 1 pc.; 100.00" Cable	CA-3003
1973-75	V8 5.7L 350ci	V,Y	100.00" Cable	CA-3003
1973-75	V8 5.7L 350ci	V,Y	w/114" Cable; 120.00" Cable	CA-3007
1982-84	V8 6.2L 379ci	J	120.00" Cable	CA-3007
1985-86	V8 6.2L 379ci	J	w/conventional chassis, w/forward Control Chassis; 100.00" Cable	CA-3003
1985-86	V8 6.2L 379ci	J	w/Motorhome Chassis; 120.00" Cable	CA-3007
1987	V8 6.2L 379ci	J	Lower	CA-3040
1987	V8 6.2L 379ci	J	Upper	CA-3039
1987	V8 6.2L 379ci	J	w/forward Control Chassis 1 pc.; 100.00" Cable	CA-3003
1988-90	V8 6.2L 379ci	J	1 pc. Cable; 120.00" Cable	CA-3007
1976	V8 6.6L 400ci	U	3 & 4 Spd. MT with 1 Pc. Cable; 100.00" Cable	CA-3003
1976	V8 6.6L 400ci	U	3 & 4 Spd. MT with 2 Pc. Cable Lower; 40.00" Cable	CA-3033
1976	V8 6.6L 400ci	U	3 & 4 Spd. MT with 2 Pc. Cable Upper; 41.00" Cable	CA-3009
1976	V8 6.6L 400ci	U	w/THM AT; 120.00" Cable	CA-3007
1974-75	V8 7.4L 454ci	L	100.00" Cable	CA-3003
1974-75	V8 7.4L 454ci	L	w/114" Cable; 120.00" Cable	CA-3007
1990	V8 7.4L 454ci	N	1 pc. Cable; 120.00" Cable	CA-3007
1976	V8 7.4L 454ci	S,Y	3 & 4 Spd. MT with 1 Pc. Cable; 100.00" Cable	CA-3003
1976	V8 7.4L 454ci	S,Y	3 & 4 Spd. MT with 2 Pc. Cable Lower; 40.00" Cable	CA-3033
1976	V8 7.4L 454ci	S,Y	3 & 4 Spd. MT with 2 Pc. Cable Upper; 41.00" Cable	CA-3009
1976	V8 7.4L 454ci	S,Y	w/THM AT; 120.00" Cable	CA-3007
1978-80	V8 7.4L 454ci	S	exc. Motor Home Chassis; 100.00" Cable	CA-3003
1978-80	V8 7.4L 454ci	S	Motor Home Chassis; 120.00" Cable	CA-3007
1980-81	V8 7.4L 454ci	W	exc. Motor Home Chassis; 100.00" Cable	CA-3003

# SPEEDOMETER CABLES

Year	Engine	Vin	Remark	Part
<b>CHEVROLET TRUCKS (con't)</b>				
<b>P30 (con't)</b>				
1980-81	V8 7.4L 454ci	W	Motor Home Chassis; 120.00" Cable	CA-3007
1982-84	V8 7.4L 454ci	W	120.00" Cable	CA-3007
1985-86	V8 7.4L 454ci	W	w/conventional chassis, w/forward Control Chassis; 100.00" Cable	CA-3003
1985-86	V8 7.4L 454ci	W	w/Motorhome Chassis; 120.00" Cable	CA-3007
1987	V8 7.4L 454ci	W	Lower	CA-3040
1987	V8 7.4L 454ci	W	Upper	CA-3039
1987	V8 7.4L 454ci	W	w/forward Control Chassis 1 pc.; 100.00" Cable	CA-3003
1988-89	V8 7.4L 454ci	W	1 pc. Cable; 120.00" Cable	CA-3007
1977	V8 7.4L 454ci	Y	Step Van; 100.00" Cable	CA-3003
1973-74	V8 7.4L 454ci	Z	100.00" Cable	CA-3003
1973-74	V8 7.4L 454ci	Z	w/114" Cable; 120.00" Cable	CA-3007
<b>R10</b>				
1987	V6 4.3L 262ci	Z	AT Upper; 61.00" Cable	CA-3005
1987	V6 4.3L 262ci	Z	MT; 80.00" Cable	CA-3001
1987	V6 4.3L 262ci	Z	w/TH 400 Lower; 20.00" Cable	CA-3008
1987	V6 4.3L 262ci	Z	w/TH 700-R4 Lower; 40.00" Cable	CA-3033
1987	V8 5.0L 305ci	H	AT Upper; 61.00" Cable	CA-3005
1987	V8 5.0L 305ci	H	MT; 80.00" Cable	CA-3001
1987	V8 5.0L 305ci	H	w/TH 400 Lower; 20.00" Cable	CA-3008
1987	V8 5.0L 305ci	H	w/TH 700-R4 Lower; 40.00" Cable	CA-3033
1987	V8 5.7L 350ci	K	AT Upper; 61.00" Cable	CA-3005
1987	V8 5.7L 350ci	K	MT; 80.00" Cable	CA-3001
1987	V8 5.7L 350ci	K	w/TH 400 Lower; 20.00" Cable	CA-3008
1987	V8 5.7L 350ci	K	w/TH 700-R4 Lower; 40.00" Cable	CA-3033
1987	V8 6.2L 379ci	C	AT Upper; 61.00" Cable	CA-3005
1987	V8 6.2L 379ci	C	MT; 80.00" Cable	CA-3001
1987	V8 6.2L 379ci	C	w/TH 400 Lower; 20.00" Cable	CA-3008
1987	V8 6.2L 379ci	C	w/TH 700-R4 Lower; 40.00" Cable	CA-3033
<b>R10 SUBURBAN</b>				
1987	V8 5.0L 305ci	H	AT Upper; 61.00" Cable	CA-3005
1987	V8 5.0L 305ci	H	MT; 80.00" Cable	CA-3001
1987	V8 5.0L 305ci	H	w/TH 400 Lower; 20.00" Cable	CA-3008
1987	V8 5.0L 305ci	H	w/TH 700-R4 Lower; 40.00" Cable	CA-3033
1987-88	V8 5.7L 350ci	K	AT Upper; 61.00" Cable	CA-3005
1987-88	V8 5.7L 350ci	K	MT; 80.00" Cable	CA-3001
1987-88	V8 5.7L 350ci	K	w/TH 400 Lower; 20.00" Cable	CA-3008
1987-88	V8 5.7L 350ci	K	w/TH 700-R4 Lower; 40.00" Cable	CA-3033
1987-88	V8 6.2L 379ci	C	AT Upper; 61.00" Cable	CA-3005
1987-88	V8 6.2L 379ci	C	MT; 80.00" Cable	CA-3001
1987-88	V8 6.2L 379ci	C	w/TH 400 Lower; 20.00" Cable	CA-3008
1987-88	V8 6.2L 379ci	C	w/TH 700-R4 Lower; 40.00" Cable	CA-3033
<b>R20</b>				
1987-88	L6 4.8L 292ci	T	AT Upper; 61.00" Cable	CA-3005
1987-88	L6 4.8L 292ci	T	MT; 80.00" Cable	CA-3001
1987-88	L6 4.8L 292ci	T	w/TH 400 Lower; 20.00" Cable	CA-3008
1987-88	L6 4.8L 292ci	T	w/TH 700-R4 Lower; 40.00" Cable	CA-3033
1987	V6 4.3L 262ci	Z	AT Upper; 61.00" Cable	CA-3005
1987	V6 4.3L 262ci	Z	MT; 80.00" Cable	CA-3001
1987	V6 4.3L 262ci	Z	w/TH 400 Lower; 20.00" Cable	CA-3008
1987	V6 4.3L 262ci	Z	w/TH 700-R4 Lower; 40.00" Cable	CA-3033
1987	V8 5.0L 305ci	H	AT Upper; 61.00" Cable	CA-3005
1987	V8 5.0L 305ci	H	MT; 80.00" Cable	CA-3001
1987	V8 5.0L 305ci	H	w/TH 400 Lower; 20.00" Cable	CA-3008
1987	V8 5.0L 305ci	H	w/TH 700-R4 Lower; 40.00" Cable	CA-3033
1987-88	V8 5.7L 350ci	K	AT Upper; 61.00" Cable	CA-3005
1987-88	V8 5.7L 350ci	K	MT; 80.00" Cable	CA-3001
1987-88	V8 5.7L 350ci	K	w/TH 400 Lower; 20.00" Cable	CA-3008
1987-88	V8 5.7L 350ci	K	w/TH 700-R4 Lower; 40.00" Cable	CA-3033
1987-88	V8 6.2L 379ci	C,J	AT Upper; 61.00" Cable	CA-3005
1987-88	V8 6.2L 379ci	C,J	MT; 80.00" Cable	CA-3001
1987-88	V8 6.2L 379ci	C,J	w/TH 400 Lower; 20.00" Cable	CA-3008
1987-88	V8 6.2L 379ci	C,J	w/TH 700-R4 Lower; 40.00" Cable	CA-3033

# SPEEDOMETER CABLES

Year	Engine	Vin	Remark	Part
<b>CHEVROLET TRUCKS (con't)</b>				
<b>R20 (con't)</b>				
1987-88	V8 7.4L 454ci	N	AT Upper; 61.00" Cable	CA-3005
1987-88	V8 7.4L 454ci	N	MT; 80.00" Cable	CA-3001
1987-88	V8 7.4L 454ci	N	w/TH 400 Lower; 20.00" Cable	CA-3008
1987-88	V8 7.4L 454ci	N	w/TH 700-R4 Lower; 40.00" Cable	CA-3033
<b>R20 SUBURBAN</b>				
1987-88	V8 5.7L 350ci	K	AT Upper; 61.00" Cable	CA-3005
1987-88	V8 5.7L 350ci	K	MT; 80.00" Cable	CA-3001
1987-88	V8 5.7L 350ci	K	w/TH 400 Lower; 20.00" Cable	CA-3008
1987-88	V8 5.7L 350ci	K	w/TH 700-R4 Lower; 40.00" Cable	CA-3033
1987-88	V8 6.2L 379ci	J	AT Upper; 61.00" Cable	CA-3005
1987-88	V8 6.2L 379ci	J	MT; 80.00" Cable	CA-3001
1987-88	V8 6.2L 379ci	J	w/TH 400 Lower; 20.00" Cable	CA-3008
1987-88	V8 6.2L 379ci	J	w/TH 700-R4 Lower; 40.00" Cable	CA-3033
1987-88	V8 7.4L 454ci	N	AT Upper; 61.00" Cable	CA-3005
1987-88	V8 7.4L 454ci	N	MT; 80.00" Cable	CA-3001
1987-88	V8 7.4L 454ci	N	w/TH 400 Lower; 20.00" Cable	CA-3008
1987-88	V8 7.4L 454ci	N	w/TH 700-R4 Lower; 40.00" Cable	CA-3033
<b>R30</b>				
1987-88	L6 4.8L 292ci	T	AT Upper; 61.00" Cable	CA-3005
1987-88	L6 4.8L 292ci	T	MT; 80.00" Cable	CA-3001
1987-88	L6 4.8L 292ci	T	w/TH 400 Lower; 20.00" Cable	CA-3008
1987-88	L6 4.8L 292ci	T	w/TH 700-R4 Lower; 40.00" Cable	CA-3033
1987-88	V8 5.7L 350ci	K,M	AT Upper; 61.00" Cable	CA-3005
1987-88	V8 5.7L 350ci	K,M	MT; 80.00" Cable	CA-3001
1987-88	V8 5.7L 350ci	K,M	w/TH 400 Lower; 20.00" Cable	CA-3008
1987-88	V8 5.7L 350ci	K,M	w/TH 700-R4 Lower; 40.00" Cable	CA-3033
1987-88	V8 6.2L 379ci	J	AT Upper; 61.00" Cable	CA-3005
1987-88	V8 6.2L 379ci	J	MT; 80.00" Cable	CA-3001
1987-88	V8 6.2L 379ci	J	w/TH 400 Lower; 20.00" Cable	CA-3008
1987-88	V8 6.2L 379ci	J	w/TH 700-R4 Lower; 40.00" Cable	CA-3033
1987-88	V8 7.4L 454ci	N,W	AT Upper; 61.00" Cable	CA-3005
1987-88	V8 7.4L 454ci	N,W	MT; 80.00" Cable	CA-3001
1987-88	V8 7.4L 454ci	N,W	w/TH 400 Lower; 20.00" Cable	CA-3008
1987-88	V8 7.4L 454ci	N,W	w/TH 700-R4 Lower; 40.00" Cable	CA-3033
<b>S10</b>				
1982	L4 1.9L 119ci	A	exc. Cruise Control; 80.00" Cable	CA-3001
1982	L4 1.9L 119ci	A	w/Cruise Control, Lower; 63.00" Cable	CA-3002
1982	L4 1.9L 119ci	A	w/Cruise Control, Upper; 61.00" Cable	CA-3005
1983-85	L4 1.9L 119ci	A	80.00" Cable	CA-3001
1983-84	L4 2.0L 122ci	Y	80.00" Cable	CA-3001
1983-85	L4 2.2L 134ci	S	80.00" Cable	CA-3001
1985-88	L4 2.5L 151ci	E	80.00" Cable	CA-3001
1982	V6 2.8L 173ci	B	exc. Cruise Control; 80.00" Cable	CA-3001
1982	V6 2.8L 173ci	B	w/Cruise Control, Lower; 63.00" Cable	CA-3002
1982	V6 2.8L 173ci	B	w/Cruise Control, Upper; 61.00" Cable	CA-3005
1983-85	V6 2.8L 173ci	B	80.00" Cable	CA-3001
1986-88	V6 2.8L 173ci	R	80.00" Cable	CA-3001
1988	V6 4.3L 262ci	Z	80.00" Cable	CA-3001
<b>V10</b>				
1987	V6 4.3L 262ci	Z	100.00" Cable	CA-3003
1987	V8 5.0L 305ci	H	100.00" Cable	CA-3003
1987	V8 5.7L 350ci	K	100.00" Cable	CA-3003
1987	V8 6.2L 379ci	C	100.00" Cable	CA-3003
<b>V20</b>				
1987	L6 4.8L 292ci	T	100.00" Cable	CA-3003
1987	V8 5.7L 350ci	K	100.00" Cable	CA-3003
1987	V8 6.2L 379ci	C	100.00" Cable	CA-3003
1987	V8 6.2L 379ci	J	100.00" Cable	CA-3003
<b>V20 SUBURBAN</b>				
1988	V8 5.7L 350ci	K	100.00" Cable	CA-3003
1988	V8 6.2L 379ci	J	100.00" Cable	CA-3003

# SPEEDOMETER CABLES

Year	Engine	Vin	Remark	Part
<b>CHEVROLET TRUCKS (con't)</b>				
<b>V30</b>				
1987-88	L6 4.8L 292ci	T	100.00" Cable	CA-3003
1987-88	V8 5.7L 350ci	K,M	100.00" Cable	CA-3003
1987-88	V8 6.2L 379ci	J	100.00" Cable	CA-3003
1987-88	V8 7.4L 454ci	N,W	100.00" Cable	CA-3003
<b>CHRYSLER</b>				
<b>CORDOBA</b>				
1980	L6 3.7L 225ci	C,D	AT Speedo to Trans.	CA-3025
1980	L6 3.7L 225ci	C,D	AT, Speedo to Switch	CA-3051
1980	L6 3.7L 225ci	C,D	AT, w/Dual Exhaust, Cruise Control to Trans.	CA-3024
1981-82	L6 3.7L 225ci	E	AT Speedo to Trans.	CA-3030
1981-82	L6 3.7L 225ci	E,G	AT Speedo to Cruise Control	CA-3025
1981-82	L6 3.7L 225ci	E,G	Cruise Control to Trans.	CA-3024
1981	L6 3.7L 225ci	G	AT Speedo to Trans.	CA-3030
1983	L6 3.7L 225ci	H	AT Speedo to Trans.	CA-3030
1983	L6 3.7L 225ci	H,K	AT Speedo to Cruise Control	CA-3025
1983	L6 3.7L 225ci	H,K	Cruise Control to Trans.	CA-3024
1983	L6 3.7L 225ci	K	AT Speedo to Trans.	CA-3030
1976	V8 5.2L 318ci	G	w/Cruise Lower; 63.00" Cable	CA-3002
1976	V8 5.2L 318ci	G	w/Cruise Upper w/o EGR Switch	CA-3025
1976	V8 5.2L 318ci	G	w/o Cruise Control; 80.00" Cable	CA-3014
1975-77	V8 5.2L 318ci	G	w/Cruise Upper	CA-3025
1977-79	V8 5.2L 318ci	G	w/o Cruise Control	CA-3030
1980	V8 5.2L 318ci	G,H	AT Speedo to Trans.	CA-3025
1980	V8 5.2L 318ci	G,H	AT, Speedo to Switch	CA-3051
1980	V8 5.2L 318ci	G,H	AT, w/Dual Exhaust, Cruise Control to Trans.	CA-3024
1977-79	V8 5.2L 318ci	G,H	w/Cruise Lower	CA-3024
1978-79	V8 5.2L 318ci	H	w/o Cruise Control	CA-3030
1981-82	V8 5.2L 318ci	K	AT Speedo to Trans.	CA-3030
1981-82	V8 5.2L 318ci	K,M	AT Speedo to Cruise Control	CA-3025
1981-82	V8 5.2L 318ci	K,M	Cruise Control to Trans.	CA-3024
1981-82	V8 5.2L 318ci	M	AT Speedo to Trans.	CA-3030
1983	V8 5.2L 318ci	P	AT Speedo to Cruise Control	CA-3025
1983	V8 5.2L 318ci	P	AT Speedo to Trans.	CA-3030
1983	V8 5.2L 318ci	P	Cruise Control to Trans.	CA-3024
1977-79	V8 5.9L 360ci	J	w/o Cruise Control	CA-3030
1976	V8 5.9L 360ci	J,K	w/Cruise Lower; 63.00" Cable	CA-3002
1976	V8 5.9L 360ci	J,K	w/Cruise Upper w/o EGR Switch	CA-3025
1976	V8 5.9L 360ci	J,K	w/o Cruise Control; 80.00" Cable	CA-3014
1975-77	V8 5.9L 360ci	J,K	w/Cruise Upper	CA-3025
1977-79	V8 5.9L 360ci	J,K,L	w/Cruise Lower	CA-3024
1977-79	V8 5.9L 360ci	K	w/o Cruise Control	CA-3030
1978-79	V8 5.9L 360ci	L	w/o Cruise Control	CA-3030
1976	V8 6.6L 400ci	M,N,P	w/Cruise Lower; 63.00" Cable	CA-3002
1976	V8 6.6L 400ci	M,N,P	w/Cruise Upper w/o EGR Switch	CA-3025
1976	V8 6.6L 400ci	M,N,P	w/o Cruise Control; 80.00" Cable	CA-3014
1975-77	V8 6.6L 400ci	M,N,P	w/Cruise Upper	CA-3025
1977-78	V8 6.6L 400ci	N	w/o Cruise Control	CA-3030
1977-78	V8 6.6L 400ci	N,P	w/Cruise Lower	CA-3024
1978	V8 6.6L 400ci	P	w/o Cruise Control	CA-3030
<b>E CLASS</b>				
1983	L4 2.2L 135ci	C	w/Cruise Lower 23"	CA-3028
1983	L4 2.2L 135ci	C	w/Cruise Lower 33"	CA-3034
1983	L4 2.2L 135ci	C	w/Cruise Upper	CA-3029
1983	L4 2.2L 135ci	C	w/o Cruise Control	CA-3022
1984	L4 2.2L 135ci	D,E	Speed Control to Speed Sensor Switch	CA-3040
1984	L4 2.2L 135ci	D,E	Speedometer Control to Trans.	CA-3034
1984	L4 2.2L 135ci	D,E	Speed Sensor Switch to Trans.	CA-3028
1984	L4 2.2L 135ci	D,E	Upper	CA-3029
1984	L4 2.2L 135ci	D,E	w/o Cruise 1 pc. Cable	CA-3022
1983	L4 2.6L 156ci	G	w/Cruise Lower 23"	CA-3028
1983	L4 2.6L 156ci	G	w/Cruise Lower 33"	CA-3034
1983	L4 2.6L 156ci	G	w/Cruise Upper	CA-3029

# SPEEDOMETER CABLES

Year	Engine	Vin	Remark	Part
<b>CHRYSLER (con't)</b>				
<b>E CLASS (con't)</b>				
1983	L4 2.6L 156ci	G	w/o Cruise Control	CA-3022
1984	L4 2.6L 156ci	G	Speed Control to Speed Sensor Switch	CA-3040
1984	L4 2.6L 156ci	G	Speedometer Control to Trans.	CA-3034
1984	L4 2.6L 156ci	G	Speed Sensor Switch to Trans.	CA-3028
1984	L4 2.6L 156ci	G	Upper	CA-3029
1984	L4 2.6L 156ci	G	w/o Cruise 1 pc. Cable	CA-3022
<b>FIFTH AVENUE</b>				
1983	L6 3.7L 225ci	H,K	AT Speed Control to Trans.	CA-3024
1983	L6 3.7L 225ci	H,K	w/Cruise Upper; 41.00" Cable	CA-3035
1983	V8 5.2L 318ci	P	AT Speed Control to Trans.	CA-3024
1983	V8 5.2L 318ci	P	w/Cruise Upper; 41.00" Cable	CA-3035
1988	V8 5.2L 318ci	P		CA-3022
1984-87	V8 5.2L 318ci	P	w/Cruise Lower	CA-3024
1984-87	V8 5.2L 318ci	P	w/Cruise Upper	CA-3025
1984-87	V8 5.2L 318ci	P	w/o Cruise Control	CA-3030
<b>IMPERIAL</b>				
1981-82	V8 5.2L 318ci	J	Speed Sensor Switch to Trans.	CA-3022
1951-52	V8 5.4L 331ci		3 Spd., w/C54 Trans., w/Fluid Torque Drive; 83.00" Cable	CA-3004
1951-52	V8 5.4L 331ci		3 Spd., w/C54 Trans., w/Fluidmatic; 63.00" Cable	CA-3002
1953-55	V8 5.4L 331ci		AT; 83.00" Cable	CA-3004
1957-58	V8 6.4L 392ci		AT; 83.00" Cable	CA-3004
1959	V8 6.8L 413ci		AT; 83.00" Cable	CA-3004
1960-61	V8 6.8L 413ci		w/o Cruise Control; 83.00" Cable	CA-3004
1961-63	V8 6.8L 413ci		w/Cruise Control	CA-3006
1968	V8 7.2L 440ci	K	w/o Cruise Control; 80.00" Cable	CA-3014
1969	V8 7.2L 440ci	K	w/Cruise Lower; 63.00" Cable	CA-3002
1969	V8 7.2L 440ci	K	w/Cruise Upper	CA-3025
1969	V8 7.2L 440ci	K	w/o Cruise Control; 80.00" Cable	CA-3027
1970-75	V8 7.2L 440ci	T	w/Cruise Lower; 63.00" Cable	CA-3002
1970-75	V8 7.2L 440ci	T	w/Cruise Upper	CA-3025
1970-75	V8 7.2L 440ci	T	w/o Cruise Control; 80.00" Cable	CA-3027
1966	V8 7.2L 440ci		w/o Cruise Control; 83.00" Cable	CA-3004
1967	V8 7.2L 440ci		w/o Cruise Control; 80.00" Cable	CA-3014
<b>LASER</b>				
1984	L4 2.2L 135ci	D,E	w/Cruise Electronic Lower, w/o Cruise Lower	CA-3028
1984	L4 2.2L 135ci	D,E	w/Cruise Lower Non Electronic	CA-3034
1984	L4 2.2L 135ci	D,E	w/o Cruise 1 pc. Cable	CA-3022
1985	L4 2.2L 135ci	D,E	Upper 56"	CA-3022
1986	L4 2.2L 135ci	D,E	AT, Speed Control to Sensor, Speed Control to Trans.	CA-3006
1984-86	L4 2.2L 135ci	D,E	Upper	CA-3029
1985-86	L4 2.2L 135ci	D,E	Lower	CA-3036
1986	L4 2.5L 153ci	K	AT, Speed Control to Sensor, Speed Control to Trans.	CA-3006
1986	L4 2.5L 153ci	K	Lower	CA-3036
1986	L4 2.5L 153ci	K	Upper	CA-3029
<b>LEBARON</b>				
1982	L4 2.2L 135ci	B	Upper	CA-3025
1982	L4 2.2L 135ci	B	w/Cruise Lower, w/26" Cable	CA-3037
1982	L4 2.2L 135ci	B	w/Cruise Lower, w/31"-35" Cable	CA-3034
1982	L4 2.2L 135ci	B	w/o Cruise 1 pc. Cable	CA-3022
1982	L4 2.2L 135ci	B	w/o Cruise Lower	CA-3026
1983	L4 2.2L 135ci	C	AT, Speedometer to Trans.; 61.00" Cable	CA-3005
1983	L4 2.2L 135ci	C	Lower	CA-3028
1983	L4 2.2L 135ci	C	Speed Control to Speed Sensor Switch	CA-3040
1983	L4 2.2L 135ci	C	Speedometer Control to Trans.	CA-3034
1983	L4 2.2L 135ci	C	w/Cruise Upper	CA-3029
1983	L4 2.2L 135ci	C	w/o Cruise Upper	CA-3025
1984	L4 2.2L 135ci	C,D,E	w/Cruise Electronic Lower, w/o Cruise Lower	CA-3028
1984	L4 2.2L 135ci	C,D,E	w/Cruise Lower Non Electronic	CA-3034
1984	L4 2.2L 135ci	C,D,E	w/o Cruise 1 pc. Cable	CA-3022
1984-87	L4 2.2L 135ci	C,D,E	Upper	CA-3029
1985	L4 2.2L 135ci	D,E	Upper 56"	CA-3022
1986	L4 2.2L 135ci	D,E	AT, Speed Control to Sensor, Speed Control to Trans.	CA-3006

# SPEEDOMETER CABLES

Year	Engine	Vin	Remark	Part
<b>CHRYSLER (con't)</b>				
<b>LEBARON (con't)</b>				
1985-87	L4 2.2L 135ci	D,E	Lower	CA-3036
1986	L4 2.5L 153ci	K	AT, Speed Control to Sensor, Speed Control to Trans.	CA-3006
1986-87	L4 2.5L 153ci	K	Lower	CA-3036
1986-87	L4 2.5L 153ci	K	Upper	CA-3029
1982	L4 2.6L 156ci	D	Upper	CA-3025
1982	L4 2.6L 156ci	D	w/Cruise Lower, w/26" Cable	CA-3037
1982	L4 2.6L 156ci	D	w/Cruise Lower, w/31"-35" Cable	CA-3034
1982	L4 2.6L 156ci	D	w/o Cruise 1 pc. Cable	CA-3022
1982	L4 2.6L 156ci	D	w/o Cruise Lower	CA-3026
1983	L4 2.6L 156ci	G	AT, Speedometer to Trans.; 61.00" Cable	CA-3005
1983	L4 2.6L 156ci	G	Lower	CA-3028
1983	L4 2.6L 156ci	G	Speed Control to Speed Sensor Switch	CA-3040
1983	L4 2.6L 156ci	G	Speedometer Control to Trans.	CA-3034
1983	L4 2.6L 156ci	G	w/Cruise Upper	CA-3029
1983	L4 2.6L 156ci	G	w/o Cruise Upper	CA-3025
1984	L4 2.6L 156ci	G	Upper	CA-3029
1984	L4 2.6L 156ci	G	w/Cruise Electronic Lower, w/o Cruise Lower	CA-3028
1984	L4 2.6L 156ci	G	w/Cruise Lower Non Electronic	CA-3034
1984	L4 2.6L 156ci	G	w/o Cruise 1 pc. Cable	CA-3022
1985	L4 2.6L 156ci	G	Lower	CA-3036
1985	L4 2.6L 156ci	G	Upper 44"	CA-3029
1985	L4 2.6L 156ci	G	Upper 56"	CA-3022
1980	L6 3.7L 225ci	C,D	AT Speedo to Cruise Control; 41.00" Cable	CA-3035
1980	L6 3.7L 225ci	C,D	AT, w/Dual Exhaust, Cruise Control to Trans.	CA-3024
1981	L6 3.7L 225ci	E,F,G	AT Speedo to Cruise Control; 41.00" Cable	CA-3035
1981	L6 3.7L 225ci	E,F,G	Cruise Control to Trans.	CA-3024
1977	V8 5.2L 318ci	G	Cruise Control to Trans.	CA-3024
1980	V8 5.2L 318ci	G,H	AT Speedo to Cruise Control; 41.00" Cable	CA-3035
1980	V8 5.2L 318ci	G,H	AT, w/Dual Exhaust, Cruise Control to Trans.	CA-3024
1981	V8 5.2L 318ci	K,M	AT Speedo to Cruise Control; 41.00" Cable	CA-3035
1981	V8 5.2L 318ci	K,M	Cruise Control to Trans.	CA-3024
<b>NEW YORKER</b>				
1982	L6 3.7L 225ci	E,G	AT Speed Control to Trans.	CA-3024
1982	L6 3.7L 225ci	E,G	AT Speedo to Speed Control; 41.00" Cable	CA-3035
1979	V8 5.2L 318ci	G	AT, Police Car, Generator to Trans.	CA-3026
1979	V8 5.2L 318ci	G	exc. Dual Exhaust, Cruise Control to Trans.,exc. Console	CA-3030
1979	V8 5.2L 318ci	G	w/Cruise Control, Speedometer to Cruise Control; 41.00" Cable	CA-3035
1979	V8 5.2L 318ci	G	Cruise Control to Trans.	CA-3024
1980	V8 5.2L 318ci	G,H	Cruise Control to Switch	CA-3006
1980	V8 5.2L 318ci	G,H	Speedometer to Cruise Control; 41.00" Cable	CA-3035
1980	V8 5.2L 318ci	G,H	Speedometer to Switch	CA-3025
1981	V8 5.2L 318ci	K	AT Speedo to Trans.	CA-3030
1981	V8 5.2L 318ci	K,M	AT Speedo to Speed Control	CA-3025
1982	V8 5.2L 318ci	K,M	AT Speed Control to Trans.	CA-3024
1982	V8 5.2L 318ci	K,M	AT Speedo to Speed Control; 41.00" Cable	CA-3035
1981	V8 5.2L 318ci	M	AT Speedo to Trans.	CA-3030
1950	V8 5.3L 324ci		3 Spd. Trans.; 63.00" Cable	CA-3002
1950	V8 5.3L 324ci		AT, w/Prestomatic Trans.; 83.00" Cable	CA-3004
1951-52	V8 5.4L 331ci		AT; 63.00" Cable	CA-3002
1953-55	V8 5.4L 331ci		AT; 83.00" Cable	CA-3004
1956	V8 5.8L 354ci		AT; 83.00" Cable	CA-3004
1977	V8 5.9L 360ci	J	AT, Police Car, Generator to Trans.	CA-3026
1977	V8 5.9L 360ci	J	AT Speedo to Cruise Control, w/40" Cable	CA-3025
1977	V8 5.9L 360ci	J	w/o Cruise Control	CA-3030
1977	V8 5.9L 360ci	J	w/o Cruise, w/Cruise Speedo to Cruise Control; 41.00" Cable	CA-3035
1979	V8 5.9L 360ci	J	exc. Dual Exhaust, Cruise Control to Trans.,exc. Console	CA-3030
1979	V8 5.9L 360ci	J,K,L	AT, Police Car, Generator to Trans.	CA-3026
1979	V8 5.9L 360ci	J,K,L	w/Cruise Control, Speedometer to Cruise Control; 41.00" Cable	CA-3035
1979	V8 5.9L 360ci	J,K,L	Cruise Control to Trans.	CA-3024
1979	V8 5.9L 360ci	K	exc. Dual Exhaust, Cruise Control to Trans.,exc. Console	CA-3030
1980	V8 5.9L 360ci	K	Cruise Control to Switch	CA-3006
1980	V8 5.9L 360ci	K	Speedometer to Cruise Control; 41.00" Cable	CA-3035

# SPEEDOMETER CABLES

Year	Engine	Vin	Remark	Part
<b>CHRYSLER (con't)</b>				
<b>NEW YORKER (con't)</b>				
1980	V8 5.9L 360ci	K	Speedometer to Switch	CA-3025
1979	V8 5.9L 360ci	L	exc. Dual Exhaust, Cruise Control to Trans.,exc. Console	CA-3030
1957-58	V8 6.4L 392ci		AT; 83.00" Cable	CA-3004
1959	V8 6.8L 413ci		AT; 83.00" Cable	CA-3004
1960-61	V8 6.8L 413ci		w/o Cruise Control; 83.00" Cable	CA-3004
1962-64	V8 6.8L 413ci		w/Cruise Control	CA-3006
1963	V8 7.0L 426ci		w/Cruise Control	CA-3006
1966	V8 7.2L 440ci		w/o Cruise Control; 83.00" Cable	CA-3004
1967	V8 7.2L 440ci		w/o Cruise Control; 80.00" Cable	CA-3014
1969	V8 7.2L 440ci	K	w/Cruise Upper	CA-3025
1968-69	V8 7.2L 440ci	K	w/Cruise Lower; 63.00" Cable	CA-3002
1968-69	V8 7.2L 440ci	K	w/o Cruise Control; 80.00" Cable	CA-3014
1970-74	V8 7.2L 440ci	T	w/Cruise Lower; 63.00" Cable	CA-3002
1970-74	V8 7.2L 440ci	T	w/Cruise Upper	CA-3025
1970-74	V8 7.2L 440ci	T	w/o Cruise Control; 80.00" Cable	CA-3014
<b>NEWPORT</b>				
1980	L6 3.7L 225ci	C	Cruise Control to Switch	CA-3006
1980	L6 3.7L 225ci	C	Speedometer to Cruise Control; 41.00" Cable	CA-3035
1980	L6 3.7L 225ci	C	Speedometer to Switch	CA-3025
1979	L6 3.7L 225ci	D	AT, Police Car, Generator to Trans.	CA-3026
1979	L6 3.7L 225ci	D	exc. Dual Exhaust, Cruise Control to Trans.,exc. Console	CA-3030
1979	L6 3.7L 225ci	D	w/Cruise Control, Speedometer to Cruise Control; 41.00" Cable	CA-3035
1979	L6 3.7L 225ci	D	Cruise Control to Trans.	CA-3024
1981	L6 3.7L 225ci	E	AT Speedo to Trans.	CA-3030
1981	L6 3.7L 225ci	E,G	AT Speedo to Speed Control	CA-3025
1981	L6 3.7L 225ci	G	AT Speedo to Trans.	CA-3030
1950	L6 4.1L 250ci		3 Spd. Trans.; 63.00" Cable	CA-3002
1950	L6 4.1L 250ci		AT, w/Prestomatic Trans.; 83.00" Cable	CA-3004
1954	L6 4.3L 265ci		AT; 83.00" Cable	CA-3004
1955	V8 4.9L 301ci		AT; 83.00" Cable	CA-3004
1979	V8 5.2L 318ci	G	exc. Dual Exhaust, Cruise Control to Trans.,exc. Console	CA-3030
1979	V8 5.2L 318ci	G,H	AT, Police Car, Generator to Trans.	CA-3026
1979	V8 5.2L 318ci	G,H	w/Cruise Control, Speedometer to Cruise Control; 41.00" Cable	CA-3035
1979	V8 5.2L 318ci	G,H	Cruise Control to Trans.	CA-3024
1980	V8 5.2L 318ci	G,H	Cruise Control to Switch	CA-3006
1980	V8 5.2L 318ci	G,H	Speedometer to Cruise Control; 41.00" Cable	CA-3035
1980	V8 5.2L 318ci	G,H	Speedometer to Switch	CA-3025
1979	V8 5.2L 318ci	H	exc. Dual Exhaust, Cruise Control to Trans.,exc. Console	CA-3030
1981	V8 5.2L 318ci	K	AT Speedo to Trans.	CA-3030
1981	V8 5.2L 318ci	K,L,M	AT Speedo to Speed Control	CA-3025
1981	V8 5.2L 318ci	L	AT Speedo to Trans.	CA-3030
1981	V8 5.2L 318ci	M	AT Speedo to Trans.	CA-3030
1950	V8 5.3L 324ci		3 Spd. Trans.; 63.00" Cable	CA-3002
1950	V8 5.3L 324ci		AT, w/Prestomatic Trans.; 83.00" Cable	CA-3004
1954-56	V8 5.4L 331ci		AT; 83.00" Cable	CA-3004
1956	V8 5.8L 354ci		AT, U.S., w/Powerflite Trans.; 83.00" Cable	CA-3004
1977	V8 5.9L 360ci	J	AT, Police Car, Generator to Trans.	CA-3026
1977	V8 5.9L 360ci	J	AT Speedo to Cruise Control, w/40" Cable	CA-3025
1977	V8 5.9L 360ci	J	w/o Cruise Control	CA-3030
1977	V8 5.9L 360ci	J	w/o Cruise, w/Cruise Speedo to Cruise Control; 41.00" Cable	CA-3035
1979	V8 5.9L 360ci	J	exc. Dual Exhaust, Cruise Control to Trans.,exc. Console	CA-3030
1978	V8 5.9L 360ci	J,K	w/Cruise Lower	CA-3024
1971-76	V8 5.9L 360ci	J,K	w/Cruise Lower; 63.00" Cable	CA-3002
1971-76	V8 5.9L 360ci	J,K	w/Cruise Upper	CA-3025
1971-76	V8 5.9L 360ci	J,K	w/o Cruise Control; 80.00" Cable	CA-3014
1979	V8 5.9L 360ci	J,K,L	AT, Police Car, Generator to Trans.	CA-3026
1979	V8 5.9L 360ci	J,K,L	w/Cruise Control, Speedometer to Cruise Control; 41.00" Cable	CA-3035
1979	V8 5.9L 360ci	J,K,L	Cruise Control to Trans.	CA-3024
1979	V8 5.9L 360ci	K	exc. Dual Exhaust, Cruise Control to Trans.,exc. Console	CA-3030
1980	V8 5.9L 360ci	K	Cruise Control to Switch	CA-3006
1980	V8 5.9L 360ci	K	Speedometer to Cruise Control; 41.00" Cable	CA-3035
1980	V8 5.9L 360ci	K	Speedometer to Switch	CA-3025



# SPEEDOMETER CABLES

Year	Engine	Vin	Remark	Part
<b>CHRYSLER (con't)</b>				
<b>NEWPORT (con't)</b>				
1979	V8 5.9L 360ci	L	exc. Dual Exhaust, Cruise Control to Trans.,exc. Console	CA-3030
1961	V8 5.9L 361ci		w/o Cruise Control; 83.00" Cable	CA-3004
1961-64	V8 5.9L 361ci		w/Cruise Control	CA-3006
1969	V8 6.3L 383ci	G,H	w/Cruise Upper	CA-3025
1968-69	V8 6.3L 383ci	G,H	w/Cruise Lower; 63.00" Cable	CA-3002
1968-69	V8 6.3L 383ci	G,H	w/o Cruise Control; 80.00" Cable	CA-3014
1970-71	V8 6.3L 383ci	L,N	w/Cruise Lower; 63.00" Cable	CA-3002
1970-71	V8 6.3L 383ci	L,N	w/Cruise Upper	CA-3025
1970-71	V8 6.3L 383ci	L,N	w/o Cruise Control; 80.00" Cable	CA-3014
1966	V8 6.3L 383ci		w/o Cruise Control; 83.00" Cable	CA-3004
1967	V8 6.3L 383ci		w/o Cruise Control; 80.00" Cable	CA-3014
1957-58	V8 6.4L 392ci		AT; 83.00" Cable	CA-3004
1972-76	V8 6.6L 400ci	M,N	w/Cruise Lower; 63.00" Cable	CA-3002
1972-76	V8 6.6L 400ci	M,N	w/Cruise Upper	CA-3025
1972-76	V8 6.6L 400ci	M,N	w/o Cruise Control; 80.00" Cable	CA-3014
1977	V8 6.6L 400ci	N	AT, Police Car, Generator to Trans.	CA-3026
1977	V8 6.6L 400ci	N	AT Speedo to Cruise Control, w/40" Cable	CA-3025
1977	V8 6.6L 400ci	N	w/o Cruise Control	CA-3030
1977	V8 6.6L 400ci	N	w/o Cruise, w/Cruise Speedo to Cruise Control; 41.00" Cable	CA-3035
1978	V8 6.6L 400ci	N	w/Cruise Lower	CA-3024
1959	V8 6.8L 413ci		AT; 83.00" Cable	CA-3004
1960	V8 6.8L 413ci		w/o Cruise Control; 83.00" Cable	CA-3004
1962-64	V8 6.8L 413ci		w/Cruise Control	CA-3006
1963	V8 7.0L 426ci		w/Cruise Control	CA-3006
1968	V8 7.2L 440ci	K	w/Cruise Lower; 63.00" Cable	CA-3002
1968	V8 7.2L 440ci	K	w/o Cruise Control; 80.00" Cable	CA-3014
1969	V8 7.2L 440ci	L	w/Cruise Lower; 63.00" Cable	CA-3002
1969	V8 7.2L 440ci	L	w/Cruise Upper	CA-3025
1969	V8 7.2L 440ci	L	w/o Cruise Control; 80.00" Cable	CA-3014
1977	V8 7.2L 440ci	T	AT, Police Car, Generator to Trans.	CA-3026
1977	V8 7.2L 440ci	T	AT Speedo to Cruise Control, w/40" Cable	CA-3025
1977	V8 7.2L 440ci	T	w/o Cruise Control	CA-3030
1977	V8 7.2L 440ci	T	w/o Cruise, w/Cruise Speedo to Cruise Control; 41.00" Cable	CA-3035
1978	V8 7.2L 440ci	T	w/Cruise Lower	CA-3024
1970-76	V8 7.2L 440ci	T,U	w/Cruise Lower; 63.00" Cable	CA-3002
1970-76	V8 7.2L 440ci	T,U	w/Cruise Upper	CA-3025
1970-76	V8 7.2L 440ci	T,U	w/o Cruise Control; 80.00" Cable	CA-3014
1966	V8 7.2L 440ci		w/o Cruise Control; 83.00" Cable	CA-3004
1967	V8 7.2L 440ci		w/o Cruise Control; 80.00" Cable	CA-3014
<b>SARATOGA</b>				
1951-52	V8 5.4L 331ci		AT; 63.00" Cable	CA-3002
<b>WINDSOR</b>				
1951	L6 4.1L 250ci		AT, w/C51 Trans.; 83.00" Cable	CA-3004
1953	L6 4.3L 265ci		3 Spd. Trans.; 63.00" Cable	CA-3002
1952-53	L6 4.3L 265ci		AT, w/Fluid Drive; 83.00" Cable	CA-3004
1955	V8 4.9L 301ci		U.S., w/3 Spd. Trans.; 83.00" Cable	CA-3004
1956	V8 5.4L 331ci		U.S., w/3 Spd. Trans.; 83.00" Cable	CA-3004
1957	V8 5.8L 354ci		U.S., w/3 Spd. Trans.; 83.00" Cable	CA-3004
1961	V8 6.3L 383ci		w/o Cruise Control; 83.00" Cable	CA-3004
<b>CHRYSLER TRUCKS</b>				
<b>TOWN &amp; COUNTRY</b>				
1982	L4 2.2L 135ci	B	AT, Speedometer to Trans.	CA-3022
1982	L4 2.2L 135ci	B	Lower	CA-3034
1982	L4 2.2L 135ci	B	Speedometer to Cruise Control	CA-3025
1982	L4 2.2L 135ci	B	w/o Cruise 4 Door Upper	CA-3029
1983	L4 2.2L 135ci	C	AT, Speedometer to Trans.; 61.00" Cable	CA-3005
1983	L4 2.2L 135ci	C	Cruise Control to Trans.	CA-3034
1983	L4 2.2L 135ci	C	Speed Sensor Switch to Trans., exc. Turbo Charged	CA-3028
1983	L4 2.2L 135ci	C	MT Upper	CA-3025
1983	L4 2.2L 135ci	C	Speed Control to Speed Sensor Switch	CA-3040
1984	L4 2.2L 135ci	C	Upper	CA-3029
1984	L4 2.2L 135ci	C	w/Cruise Electronic Lower, w/o Cruise Lower	CA-3028

# SPEEDOMETER CABLES

Year	Engine	Vin	Remark	Part
<b>CHRYSLER TRUCKS (con't)</b>				
<b>TOWN &amp; COUNTRY (con't)</b>				
1984	L4 2.2L 135ci	C	w/Cruise Lower Non Electronic	CA-3034
1984	L4 2.2L 135ci	C	w/o Cruise 1 pc. Cable	CA-3022
1987	L4 2.2L 135ci	E	w/Cruise Upper, w/o Cruise 2 Door Upper	CA-3051
1987	L4 2.2L 135ci	E	w/o Cruise 4 Door Upper	CA-3029
1987	L4 2.2L 135ci	E	w/o Cruise Lower	CA-3036
1985-86	L4 2.2L 135ci	E	AT Lower	CA-3022
1985-86	L4 2.2L 135ci	E	MT Lower	CA-3036
1985-86	L4 2.2L 135ci	E	Upper	CA-3029
1986	L4 2.5L 153ci	K	AT Lower	CA-3022
1986	L4 2.5L 153ci	K	MT Lower	CA-3036
1986	L4 2.5L 153ci	K	Upper	CA-3029
1987	L4 2.5L 153ci	K	w/Cruise Upper, w/o Cruise 2 Door Upper	CA-3051
1987	L4 2.5L 153ci	K	w/o Cruise Lower	CA-3036
1986-87	L4 2.5L 153ci	K	w/o Cruise 4 Door Upper	CA-3029
1982	L4 2.6L 156ci	D	AT, Speedometer to Trans.	CA-3022
1982	L4 2.6L 156ci	D	Cruise Control to Trans.	CA-3037
1982	L4 2.6L 156ci	D	Speedometer to Cruise Control	CA-3025
1984	L4 2.6L 156ci	G	w/Cruise Electronic Lower, w/o Cruise Lower	CA-3028
1984	L4 2.6L 156ci	G	w/Cruise Lower Non Electronic	CA-3034
1984	L4 2.6L 156ci	G	w/o Cruise 1 pc. Cable	CA-3022
1985	L4 2.6L 156ci	G	AT Lower	CA-3022
1985	L4 2.6L 156ci	G	MT Lower	CA-3036
1984-85	L4 2.6L 156ci	G	Upper	CA-3029
1979	L6 3.7L 225ci	C	AT w/Cruise w/o Dual Exhaust w/o Console	CA-3030
1980	L6 3.7L 225ci	C	w/Cruise w/EGR intermediate	CA-3006
1980	L6 3.7L 225ci	C	w/EGR Switch Lower	CA-3026
1980	L6 3.7L 225ci	C	w/o Cruise w/EGR Switch Upper	CA-3029
1980	L6 3.7L 225ci	C	w/o Cruise w/o EGR Switch w/o Dual Exhaust	CA-3022
1978	L6 3.7L 225ci	C,D	w/Cruise Lower	CA-3024
1978	L6 3.7L 225ci	C,D	w/o Cruise Control	CA-3022
1979	L6 3.7L 225ci	C,D	AT, Police Car, Generator to Trans.	CA-3026
1979	L6 3.7L 225ci	C,D	AT w/Cruise Control, Upper; 41.00" Cable	CA-3035
1979	L6 3.7L 225ci	C,D	AT w/Cruise w/o Dual Exhaust w/Console Lower	CA-3024
1978-80	L6 3.7L 225ci	C,D	w/Cruise Upper; 41.00" Cable	CA-3035
1979	L6 3.7L 225ci	D	AT w/Cruise w/o Dual Exhaust w/o Console	CA-3030
1981	L6 3.7L 225ci	E	AT Speedo to Speed Control	CA-3025
1981	L6 3.7L 225ci	E	AT Speedo to Trans.	CA-3030
1981	L6 3.7L 225ci	E	w/Cruise Upper; 41.00" Cable	CA-3035
1954	L6 4.3L 265ci		AT; 83.00" Cable	CA-3004
1955	V8 4.9L 301ci		AT; 83.00" Cable	CA-3004
1979	V8 5.2L 318ci	G	AT w/Cruise w/o Dual Exhaust w/o Console	CA-3030
1980	V8 5.2L 318ci	G	w/o Cruise w/EGR Switch Upper	CA-3029
1978	V8 5.2L 318ci	G,H	w/Cruise Lower	CA-3024
1978	V8 5.2L 318ci	G,H	w/o Cruise Control	CA-3022
1979	V8 5.2L 318ci	G,H	AT, Police Car, Generator to Trans.	CA-3026
1979	V8 5.2L 318ci	G,H	AT w/Cruise Control, Upper; 41.00" Cable	CA-3035
1979	V8 5.2L 318ci	G,H	AT w/Cruise w/o Dual Exhaust w/Console Lower	CA-3024
1980	V8 5.2L 318ci	G,H	w/Cruise w/EGR intermediate	CA-3006
1980	V8 5.2L 318ci	G,H	w/EGR Switch Lower	CA-3026
1980	V8 5.2L 318ci	G,H	w/o Cruise w/o EGR Switch w/o Dual Exhaust	CA-3022
1978-80	V8 5.2L 318ci	G,H	w/Cruise Upper; 41.00" Cable	CA-3035
1979	V8 5.2L 318ci	H	AT w/Cruise w/o Dual Exhaust w/o Console	CA-3030
1980	V8 5.2L 318ci	H	w/o Cruise w/EGR Switch Upper	CA-3029
1981	V8 5.2L 318ci	K	AT Speedo to Trans.	CA-3030
1981	V8 5.2L 318ci	K,M	AT Speedo to Speed Control	CA-3025
1981	V8 5.2L 318ci	K,M	w/Cruise Upper; 41.00" Cable	CA-3035
1981	V8 5.2L 318ci	M	AT Speedo to Trans.	CA-3030
1950	V8 5.3L 324ci		3 Spd. Trans.; 63.00" Cable	CA-3002
1950	V8 5.3L 324ci		AT, w/Prestomatic Trans.; 83.00" Cable	CA-3004
1954-56	V8 5.4L 331ci		AT; 83.00" Cable	CA-3004
1956-58	V8 5.8L 354ci		AT; 83.00" Cable	CA-3004
1979	V8 5.9L 360ci	J	AT w/Cruise w/o Dual Exhaust w/o Console	CA-3030

# SPEEDOMETER CABLES

Year	Engine	Vin	Remark	Part
<b>CHRYSLER TRUCKS (con't)</b>				
<b>TOWN &amp; COUNTRY (con't)</b>				
1978	V8 5.9L 360ci	J,K,L	w/Cruise Lower	CA-3024
1978	V8 5.9L 360ci	J,K,L	w/Cruise Upper; 41.00" Cable	CA-3035
1978	V8 5.9L 360ci	J,K,L	w/o Cruise Control	CA-3022
1979	V8 5.9L 360ci	J,K,L	AT, Police Car, Generator to Trans.	CA-3026
1979	V8 5.9L 360ci	J,K,L	AT w/Cruise Control, Upper; 41.00" Cable	CA-3035
1979	V8 5.9L 360ci	J,K,L	AT w/Cruise w/o Dual Exhaust w/Console Lower	CA-3024
1979	V8 5.9L 360ci	K	AT w/Cruise w/o Dual Exhaust w/o Console	CA-3030
1979	V8 5.9L 360ci	L	AT w/Cruise w/o Dual Exhaust w/o Console	CA-3030
1961	V8 5.9L 361ci		Canada, AT, To Serial #120691"; 83.00" Cable	CA-3004
1962-64	V8 5.9L 361ci		AT w/Cruise	CA-3006
1969	V8 6.3L 383ci	G,H	w/Cruise Lower; 63.00" Cable	CA-3002
1969	V8 6.3L 383ci	G,H	w/Cruise Upper	CA-3025
1968-69	V8 6.3L 383ci	G,H	AT w/o Cruise Control; 80.00" Cable	CA-3014
1970-71	V8 6.3L 383ci	L,N	AT w/o Cruise Control; 80.00" Cable	CA-3014
1970-71	V8 6.3L 383ci	L,N	w/Cruise Lower; 63.00" Cable	CA-3002
1970-71	V8 6.3L 383ci	L,N	w/Cruise Upper	CA-3025
1959	V8 6.3L 383ci		AT; 83.00" Cable	CA-3004
1960	V8 6.3L 383ci		w/o Cruise Control; 83.00" Cable	CA-3004
1961	V8 6.3L 383ci		Canada, AT, To Serial #120691"; 83.00" Cable	CA-3004
1965	V8 6.3L 383ci		AT w/o Cruise Control; 83.00" Cable	CA-3004
1966	V8 6.3L 383ci		AT w/o Cruise Control; 80.00" Cable	CA-3014
1962-64	V8 6.3L 383ci		AT w/Cruise	CA-3006
1957-58	V8 6.4L 392ci		AT; 83.00" Cable	CA-3004
1972-75	V8 6.6L 400ci	M	w/Cruise Upper	CA-3025
1972-76	V8 6.6L 400ci	M,N	AT w/o Cruise Control; 80.00" Cable	CA-3014
1972-76	V8 6.6L 400ci	M,N	w/Cruise Lower; 63.00" Cable	CA-3002
1977	V8 6.6L 400ci	N	AT, Police Car, Generator to Trans.	CA-3026
1977	V8 6.6L 400ci	N	w/Cruise Lower	CA-3024
1977	V8 6.6L 400ci	N	w/Cruise Upper	CA-3025
1977	V8 6.6L 400ci	N	w/o Cruise exc. Police	CA-3030
1959	V8 6.8L 413ci		AT; 83.00" Cable	CA-3004
1960	V8 6.8L 413ci		w/o Cruise Control; 83.00" Cable	CA-3004
1961	V8 6.8L 413ci		Canada, AT, To Serial #120691"; 83.00" Cable	CA-3004
1962-64	V8 6.8L 413ci		AT w/Cruise	CA-3006
1963	V8 7.0L 426ci		AT w/Cruise	CA-3006
1969	V8 7.2L 440ci	K	w/Cruise Lower; 63.00" Cable	CA-3002
1969	V8 7.2L 440ci	K	w/Cruise Upper	CA-3025
1968-69	V8 7.2L 440ci	K	AT w/o Cruise Control; 80.00" Cable	CA-3014
1977	V8 7.2L 440ci	T	AT, Police Car, Generator to Trans.	CA-3026
1977	V8 7.2L 440ci	T	w/Cruise Lower	CA-3024
1977	V8 7.2L 440ci	T	w/o Cruise exc. Police	CA-3030
1970-76	V8 7.2L 440ci	T	AT w/o Cruise Control; 80.00" Cable	CA-3014
1970-76	V8 7.2L 440ci	T	w/Cruise Lower; 63.00" Cable	CA-3002
1970-77	V8 7.2L 440ci	T	w/Cruise Upper	CA-3025
<b>DODGE</b>				
<b>400</b>				
1982	L4 2.2L 135ci	B	4 Spd. MT Lower	CA-3028
1982	L4 2.2L 135ci	B	AT, Speedometer to Trans.	CA-3022
1982	L4 2.2L 135ci	B	Cruise Control to Trans.	CA-3034
1982	L4 2.2L 135ci	B	Upper	CA-3025
1983	L4 2.2L 135ci	C	4 Spd. MT Upper	CA-3025
1983	L4 2.2L 135ci	C	Cruise Control to Trans.	CA-3034
1983	L4 2.2L 135ci	C	Speed Control to Speed Sensor Switch	CA-3006
1983	L4 2.2L 135ci	C	Speed Control to Trans.	CA-3022
1983	L4 2.2L 135ci	C	Speed Sensor Switch to Trans.	CA-3028
1982	L4 2.6L 156ci	D	4 Spd. MT Lower	CA-3028
1982	L4 2.6L 156ci	D	AT, Speedometer to Trans.	CA-3022
1982	L4 2.6L 156ci	D	Upper	CA-3025
1983	L4 2.6L 156ci	G	4 Spd. MT Upper	CA-3025
1983	L4 2.6L 156ci	G	Cruise Control to Trans.	CA-3034
1983	L4 2.6L 156ci	G	Speed Control to Speed Sensor Switch	CA-3006
1983	L4 2.6L 156ci	G	Speed Control to Trans.	CA-3022

# SPEEDOMETER CABLES

Year	Engine	Vin	Remark	Part
<b>DODGE (con't)</b>				
<b>400 (con't)</b>				
1983	L4 2.6L 156ci	G	Speed Sensor Switch to Trans.	CA-3028
<b>600</b>				
1983	L4 2.2L 135ci	C	w/Cruise Lower 33" OE Cable	CA-3034
1983	L4 2.2L 135ci	C	w/Cruise Upper, w/o Cruise Lower 44" OE Cable	CA-3029
1983	L4 2.2L 135ci	C	w/o Cruise Upper	CA-3025
1984-88	L4 2.2L 135ci	C,D,E	Upper	CA-3029
1984	L4 2.2L 135ci	C,E	w/Cruise Lower 37" OE Cable	CA-3034
1984	L4 2.2L 135ci	C,E	w/o Cruise 1 pc. Cable	CA-3022
1983-84	L4 2.2L 135ci	C,E	Cruise to Speed Sensor Switch	CA-3040
1983-84	L4 2.2L 135ci	C,E	w/o Cruise Lower	CA-3028
1985-86	L4 2.2L 135ci	D,E	Lower to 12-1-86	CA-3036
1987-88	L4 2.2L 135ci	D,E	Lower From 12-1-86; 41.00" Cable	CA-3035
1986	L4 2.5L 153ci	K	Lower to 12-1-86	CA-3036
1986-88	L4 2.5L 153ci	K	Upper	CA-3029
1987-88	L4 2.5L 153ci	K	Lower From 12-1-86; 41.00" Cable	CA-3035
1983	L4 2.6L 156ci	G	w/Cruise Lower 33" OE Cable	CA-3034
1983	L4 2.6L 156ci	G	w/Cruise Upper, w/o Cruise Lower 44" OE Cable	CA-3029
1983	L4 2.6L 156ci	G	w/o Cruise Upper	CA-3025
1984	L4 2.6L 156ci	G	w/Cruise Lower 37" OE Cable	CA-3034
1984	L4 2.6L 156ci	G	w/o Cruise 1 pc. Cable	CA-3022
1985	L4 2.6L 156ci	G	Lower	CA-3036
1983-84	L4 2.6L 156ci	G	Cruise to Speed Sensor Switch	CA-3040
1983-84	L4 2.6L 156ci	G	w/o Cruise Lower	CA-3028
1984-85	L4 2.6L 156ci	G	Upper	CA-3029
<b>880</b>				
1964	V8 4.5L 273ci		w/Cruise Control	CA-3006
1963-64	V8 5.2L 318ci		w/Cruise Control	CA-3006
1963-64	V8 5.9L 361ci		w/Cruise Control	CA-3006
1963-64	V8 6.3L 383ci		w/Cruise Control	CA-3006
1963	V8 6.8L 413ci		w/Cruise Control	CA-3006
1963-64	V8 7.0L 426ci		w/Cruise Control	CA-3006
<b>ARIES</b>				
1981	L4 2.2L 135ci	B	Lower; 34" Length	CA-3036
1981	L4 2.2L 135ci	B	Lower; 36" length	CA-3026
1981	L4 2.2L 135ci	B	Upper; 40" Length	CA-3025
1981	L4 2.2L 135ci	B	Upper	CA-3029
1982	L4 2.2L 135ci	B	Lower	CA-3026
1982	L4 2.2L 135ci	B	Upper	CA-3025
1981-82	L4 2.2L 135ci	B	AT Speedo to Speed Control; 80.00" Cable	CA-3027
1981-82	L4 2.2L 135ci	B	Speedo to Trans., w/51" Cable; 63.00" Cable	CA-3002
1983	L4 2.2L 135ci	C	AT, Speed Control to Speed Sensor Switch	CA-3040
1983	L4 2.2L 135ci	C	AT, Speed Control to Trans.	CA-3034
1983	L4 2.2L 135ci	C	Lower	CA-3028
1983	L4 2.2L 135ci	C	Upper	CA-3025
1983	L4 2.2L 135ci	C	w/A465 Trans., Speedometer to Trans.; 61.00" Cable	CA-3005
1984	L4 2.2L 135ci	C	Speed Control to Speed Sensor Switch	CA-3040
1984	L4 2.2L 135ci	C	Speedometer Control to Trans.	CA-3034
1984	L4 2.2L 135ci	C	Speed Sensor Switch to Trans., exc. Turbo Charged	CA-3028
1984	L4 2.2L 135ci	C	Speedometer to Trans.; 61.00" Cable	CA-3005
1985-87	L4 2.2L 135ci	C,D	Lower	CA-3036
1985-89	L4 2.2L 135ci	C,D	Upper	CA-3029
1986-87	L4 2.2L 135ci	D	AT Speedo to Speed Control; 80.00" Cable	CA-3027
1988-89	L4 2.2L 135ci	D	Lower; 41.00" Cable	CA-3035
1988	L4 2.5L 153ci	K	Lower; 41.00" Cable	CA-3035
1986-89	L4 2.5L 153ci	K	AT Speedo to Speed Control; 80.00" Cable	CA-3027
1986-89	L4 2.5L 153ci	K	Lower	CA-3036
1986-89	L4 2.5L 153ci	K	Upper	CA-3029
1981-82	L4 2.6L 156ci	D	Cruise Control to Trans.	CA-3037
1981-82	L4 2.6L 156ci	D	Lower	CA-3026
1981-82	L4 2.6L 156ci	D	Speedo to Trans., w/51" Cable; 63.00" Cable	CA-3002
1981-82	L4 2.6L 156ci	D	Upper	CA-3025
1983	L4 2.6L 156ci	G	AT, Speed Control to Speed Sensor Switch	CA-3040

# SPEEDOMETER CABLES

Year	Engine	Vin	Remark	Part
<b>DODGE (con't)</b>				
<b>ARIES (con't)</b>				
1983	L4 2.6L 156ci	G	AT, Speed Control to Trans.	CA-3034
1983	L4 2.6L 156ci	G	Lower	CA-3028
1983	L4 2.6L 156ci	G	Upper	CA-3025
1984	L4 2.6L 156ci	G	Speed Sensor Switch to Trans., exc. Turbo Charged	CA-3028
1984	L4 2.6L 156ci	G	Speedometer to Trans.; 61.00" Cable	CA-3005
1985	L4 2.6L 156ci	G	Lower	CA-3036
1985	L4 2.6L 156ci	G	Upper	CA-3029
1983-84	L4 2.6L 156ci	G	Speed Control to Speed Sensor Switch	CA-3040
1983-84	L4 2.6L 156ci	G	Speedometer Control to Trans.	CA-3034
<b>ASPEN</b>				
1978	L6 3.7L 225ci	C	Speed Control to Trans.	CA-3030
1979	L6 3.7L 225ci	C	Speedometer to Trans.	CA-3030
1980	L6 3.7L 225ci	C	AT exc. Taxi, Speedometer to Trans.	CA-3030
1977	L6 3.7L 225ci	C,D	AT, Police Car, Generator to Trans.	CA-3026
1977	L6 3.7L 225ci	C,D	Lower	CA-3024
1978	L6 3.7L 225ci	C,D	Police Car w/3 & 4 Spd. MT, Speedometer to Generator or Switch, or non Police w/AT exc. Cruise	CA-3051
1979	L6 3.7L 225ci	C,D	AT exc. Cruise Control, Speedo to Generator or Switch	CA-3051
1980	L6 3.7L 225ci	C,D	3 & 4 Spd. Switch to Trans., EGR Maintenance, w/31" Cable	CA-3026
1980	L6 3.7L 225ci	C,D	3 Spd. MT Speedo to Cruise Control	CA-3025
1980	L6 3.7L 225ci	C,D	AT & 3 Spd. Cruise Control to Trans.	CA-3024
1980	L6 3.7L 225ci	C,D	AT & 3 Spd. Cruise to Switch	CA-3006
1980	L6 3.7L 225ci	C,D	AT & 3 Spd. MT, Speedo to Switch exc. Taxi	CA-3051
1978-79	L6 3.7L 225ci	C,D	Cruise Control to Trans.	CA-3024
1980	L6 3.7L 225ci	D	AT exc. Taxi, Speedometer to Trans.	CA-3030
1978-79	L6 3.7L 225ci	D	Speedometer to Trans.	CA-3030
1977	V8 5.2L 318ci	G	AT, Police Car, Generator to Trans.	CA-3026
1977	V8 5.2L 318ci	G	Lower	CA-3024
1980	V8 5.2L 318ci	G	AT exc. Taxi, Speedometer to Trans.	CA-3030
1978-79	V8 5.2L 318ci	G	Speedometer to Trans.	CA-3030
1978	V8 5.2L 318ci	G,H	Police Car w/3 & 4 Spd. MT, Speedometer to Generator or Switch, or non Police w/AT exc. Cruise	CA-3051
1979	V8 5.2L 318ci	G,H	AT exc. Cruise Control, Speedo to Generator or Switch	CA-3051
1980	V8 5.2L 318ci	G,H	3 & 4 Spd. Switch to Trans., EGR Maintenance, w/31" Cable	CA-3026
1980	V8 5.2L 318ci	G,H	3 Spd. MT Speedo to Cruise Control	CA-3025
1980	V8 5.2L 318ci	G,H	AT & 3 Spd. Cruise Control to Trans.	CA-3024
1980	V8 5.2L 318ci	G,H	AT & 3 Spd. Cruise to Switch	CA-3006
1980	V8 5.2L 318ci	G,H	AT & 3 Spd. MT, Speedo to Switch exc. Taxi	CA-3051
1978-79	V8 5.2L 318ci	G,H	Cruise Control to Trans.	CA-3024
1980	V8 5.2L 318ci	H	AT exc. Taxi, Speedometer to Trans.	CA-3030
1978-79	V8 5.2L 318ci	H	Speedometer to Trans.	CA-3030
1978	V8 5.9L 360ci	K	Speedometer to Trans.	CA-3030
1977	V8 5.9L 360ci	K,L	AT, Police Car, Generator to Trans.	CA-3026
1977	V8 5.9L 360ci	K,L	Lower	CA-3024
1978	V8 5.9L 360ci	K,L	Police Car w/3 & 4 Spd. MT, Speedometer to Generator or Switch, or non Police w/AT exc. Cruise	CA-3051
1978-79	V8 5.9L 360ci	K,L	Cruise Control to Trans.	CA-3024
1979	V8 5.9L 360ci	L	AT exc. Cruise Control, Speedo to Generator or Switch	CA-3051
1980	V8 5.9L 360ci	L	3 & 4 Spd. Switch to Trans., EGR Maintenance, w/31" Cable	CA-3026
1980	V8 5.9L 360ci	L	3 Spd. MT Speedo to Cruise Control	CA-3025
1980	V8 5.9L 360ci	L	AT & 3 Spd. Cruise Control to Trans.	CA-3024
1980	V8 5.9L 360ci	L	AT & 3 Spd. Cruise to Switch	CA-3006
1980	V8 5.9L 360ci	L	AT & 3 Spd. MT, Speedo to Switch exc. Taxi	CA-3051
1980	V8 5.9L 360ci	L	AT exc. Taxi, Speedometer to Trans.	CA-3030
1978-79	V8 5.9L 360ci	L	Speedometer to Trans.	CA-3030
<b>CHALLENGER</b>				
1970-71	L6 3.2L 198ci	B	AT w/Cruise Control, Lower; 63.00" Cable	CA-3002
1970-71	L6 3.2L 198ci	B	AT w/Cruise Control, Upper	CA-3025
1970-71	L6 3.2L 198ci	B	w/o Cruise Control; 80.00" Cable	CA-3014
1970-72	L6 3.7L 225ci	C	AT w/Cruise Control, Lower; 63.00" Cable	CA-3002
1970-72	L6 3.7L 225ci	C	AT w/Cruise Control, Upper	CA-3025
1970-72	L6 3.7L 225ci	C	w/o Cruise Control; 80.00" Cable	CA-3014

# SPEEDOMETER CABLES

Year	Engine	Vin	Remark	Part
<b>DODGE (con't)</b>				
<b>CHALLENGER (con't)</b>				
1970-74	V8 5.2L 318ci	G	AT w/Cruise Control, Lower; 63.00" Cable	CA-3002
1970-74	V8 5.2L 318ci	G	AT w/Cruise Control, Upper	CA-3025
1970-74	V8 5.2L 318ci	G	w/o Cruise Control; 80.00" Cable	CA-3014
1970-73	V8 5.6L 340ci	H,J	AT w/Cruise Control, Lower; 63.00" Cable	CA-3002
1970-73	V8 5.6L 340ci	H,J	AT w/Cruise Control, Upper	CA-3025
1970-73	V8 5.6L 340ci	H,J	w/o Cruise Control; 80.00" Cable	CA-3014
1974	V8 5.9L 360ci	L	AT w/Cruise Control, Lower; 63.00" Cable	CA-3002
1974	V8 5.9L 360ci	L	AT w/Cruise Control, Upper	CA-3025
1974	V8 5.9L 360ci	L	w/o Cruise Control; 80.00" Cable	CA-3014
1970-71	V8 6.3L 383ci	L,N	AT w/Cruise Control, Lower; 63.00" Cable	CA-3002
1970-71	V8 6.3L 383ci	L,N	AT w/Cruise Control, Upper	CA-3025
1970-71	V8 6.3L 383ci	L,N	w/o Cruise Control; 80.00" Cable	CA-3014
1970	V8 7.0L 426ci	J	AT w/Cruise Control, Lower; 63.00" Cable	CA-3002
1970	V8 7.0L 426ci	J	AT w/Cruise Control, Upper	CA-3025
1970	V8 7.0L 426ci	J	w/o Cruise Control; 80.00" Cable	CA-3014
<b>CHARGER</b>				
1984	L4 1.6L 97ci	A	4 Spd. MT, w/5 Spd. MT Speedometer to Trans.	CA-3028
1984	L4 1.6L 97ci	A	Cruise Control to Trans.	CA-3034
1984	L4 1.6L 97ci	A	Speedometer to Speed Control	CA-3025
1984	L4 1.6L 97ci	A	Speedometer to Trans.	CA-3022
1983	L4 2.2L 135ci	8	Lower	CA-3028
1983	L4 2.2L 135ci	8	Upper; 41.00" Cable	CA-3035
1986	L4 2.2L 135ci	8,C,E	AT, Speedometer to Speed Control	CA-3025
1986	L4 2.2L 135ci	8,C,E	Lower	CA-3036
1987	L4 2.2L 135ci	E	5 Spd. MT Speed Control to Sensor, Speed Control to Trans.	CA-3006
1987	L4 2.2L 135ci	E	AT, Sensor to Coupling, w/Speed Control	CA-3036
1987	L4 2.2L 135ci	E	AT, w/Speed Control, Speedometer to Coupling	CA-3025
1987	L4 2.2L 135ci	E	Speed Control to Trans.	CA-3022
1987	L4 2.2L 135ci	E	Speedo to Sensor	CA-3029
1968	L6 3.7L 225ci	B	w/Cruise Lower; 63.00" Cable	CA-3002
1968-69	L6 3.7L 225ci	B	w/o Cruise Control; 80.00" Cable	CA-3014
1969-76	L6 3.7L 225ci	B,C	AT w/Cruise Control, Lower; 63.00" Cable	CA-3002
1969-76	L6 3.7L 225ci	B,C	AT w/Cruise Control, Upper	CA-3025
1969-76	L6 3.7L 225ci	C	w/o Cruise Control; 80.00" Cable	CA-3014
1968	V8 5.2L 318ci	F	w/Cruise Lower; 63.00" Cable	CA-3002
1969	V8 5.2L 318ci	F	AT w/Cruise Control, Lower; 63.00" Cable	CA-3002
1969	V8 5.2L 318ci	F	AT w/Cruise Control, Upper	CA-3025
1968-69	V8 5.2L 318ci	F	w/o Cruise Control; 80.00" Cable	CA-3014
1977	V8 5.2L 318ci	G	Cruise Control to Trans.	CA-3024
1977	V8 5.2L 318ci	G	w/o Cruise Control	CA-3030
1970-76	V8 5.2L 318ci	G	AT w/Cruise Control, Lower; 63.00" Cable	CA-3002
1970-76	V8 5.2L 318ci	G	AT w/Cruise Control, Upper	CA-3025
1970-76	V8 5.2L 318ci	G	w/o Cruise Control; 80.00" Cable	CA-3014
1972-73	V8 5.6L 340ci	H	AT w/Cruise Control, Lower; 63.00" Cable	CA-3002
1972-73	V8 5.6L 340ci	H	AT w/Cruise Control, Upper	CA-3025
1972-73	V8 5.6L 340ci	H	w/o Cruise Control; 80.00" Cable	CA-3014
1977	V8 5.9L 360ci	J	w/o Cruise Control	CA-3030
1977	V8 5.9L 360ci	J,K	Cruise Control to Trans.	CA-3024
1974-76	V8 5.9L 360ci	J,K,L	AT w/Cruise Control, Lower; 63.00" Cable	CA-3002
1974-76	V8 5.9L 360ci	J,K,L	AT w/Cruise Control, Upper	CA-3025
1974-76	V8 5.9L 360ci	J,K,L	w/o Cruise Control; 80.00" Cable	CA-3014
1977	V8 5.9L 360ci	K	w/o Cruise Control	CA-3030
1968	V8 6.3L 383ci	G,H	w/Cruise Lower; 63.00" Cable	CA-3002
1969	V8 6.3L 383ci	G,H	AT w/Cruise Control, Lower; 63.00" Cable	CA-3002
1969	V8 6.3L 383ci	G,H	AT w/Cruise Control, Upper	CA-3025
1968-69	V8 6.3L 383ci	G,H	w/o Cruise Control; 80.00" Cable	CA-3014
1970-71	V8 6.3L 383ci	L,N	AT w/Cruise Control, Lower; 63.00" Cable	CA-3002
1970-71	V8 6.3L 383ci	L,N	AT w/Cruise Control, Upper	CA-3025
1970-71	V8 6.3L 383ci	L,N	w/o Cruise Control; 80.00" Cable	CA-3014
1972-75	V8 6.6L 400ci	M,N,P	AT w/Cruise Control, Lower; 63.00" Cable	CA-3002
1972-75	V8 6.6L 400ci	M,N,P	w/o Cruise Control; 80.00" Cable	CA-3014
1972-75	V8 6.6L 400ci	M,P	AT w/Cruise Control, Upper	CA-3025

# SPEEDOMETER CABLES

Year	Engine	Vin	Remark	Part
<b>DODGE (con't)</b>				
<b>CHARGER (con't)</b>				
1977	V8 6.6L 400ci	N	Cruise Control to Trans.	CA-3024
1977	V8 6.6L 400ci	N	w/o Cruise Control	CA-3030
1974-76	V8 6.6L 400ci	N	AT w/Cruise Control, Upper	CA-3025
1968	V8 7.0L 426ci	J	w/Cruise Lower; 63.00" Cable	CA-3002
1969	V8 7.0L 426ci	J	AT w/Cruise Control, Lower; 63.00" Cable	CA-3002
1969	V8 7.0L 426ci	J	AT w/Cruise Control, Upper	CA-3025
1968-69	V8 7.0L 426ci	J	w/o Cruise Control; 80.00" Cable	CA-3014
1968	V8 7.2L 440ci	K	w/o Cruise Control; 80.00" Cable	CA-3014
1968	V8 7.2L 440ci	K,L	w/Cruise Lower; 63.00" Cable	CA-3002
1969	V8 7.2L 440ci	L	AT w/Cruise Control, Lower; 63.00" Cable	CA-3002
1969	V8 7.2L 440ci	L	AT w/Cruise Control, Upper	CA-3025
1969	V8 7.2L 440ci	L	w/o Cruise Control; 80.00" Cable	CA-3014
1972-74	V8 7.2L 440ci	U,V	AT w/Cruise Control, Lower; 63.00" Cable	CA-3002
1972-74	V8 7.2L 440ci	U,V	AT w/Cruise Control, Upper	CA-3025
1972-74	V8 7.2L 440ci	U,V	w/o Cruise Control; 80.00" Cable	CA-3014
<b>CORONET</b>				
1968	L6 3.7L 225ci	B	w/Cruise Lower; 63.00" Cable	CA-3002
1969	L6 3.7L 225ci	B	AT w/Cruise Control, Lower; 63.00" Cable	CA-3002
1969	L6 3.7L 225ci	B	AT w/Cruise Control, Upper	CA-3025
1968-69	L6 3.7L 225ci	B	w/o Cruise Control; 80.00" Cable	CA-3014
1970-76	L6 3.7L 225ci	C	AT w/Cruise Control, Lower; 63.00" Cable	CA-3002
1970-76	L6 3.7L 225ci	C	AT w/Cruise Control, Upper	CA-3025
1970-76	L6 3.7L 225ci	C	w/o Cruise Control; 80.00" Cable	CA-3014
1959	L6 3.8L 230ci		AT; 83.00" Cable	CA-3004
1968	V8 4.5L 273ci	D	w/Cruise Lower; 63.00" Cable	CA-3002
1968	V8 4.5L 273ci	D	w/o Cruise Control; 80.00" Cable	CA-3014
1967	V8 4.5L 273ci		w/o Cruise Control; 83.00" Cable	CA-3004
1968	V8 5.2L 318ci	F	w/Cruise Lower; 63.00" Cable	CA-3002
1969	V8 5.2L 318ci	F	AT w/Cruise Control, Lower; 63.00" Cable	CA-3002
1969	V8 5.2L 318ci	F	AT w/Cruise Control, Upper	CA-3025
1968-69	V8 5.2L 318ci	F	w/o Cruise Control; 80.00" Cable	CA-3014
1970-76	V8 5.2L 318ci	G	AT w/Cruise Control, Lower; 63.00" Cable	CA-3002
1970-76	V8 5.2L 318ci	G	AT w/Cruise Control, Upper	CA-3025
1970-76	V8 5.2L 318ci	G	w/o Cruise Control; 80.00" Cable	CA-3014
1959	V8 5.3L 326ci		AT; 83.00" Cable	CA-3004
1973-76	V8 5.9L 360ci	J,K,L	AT w/Cruise Control, Lower; 63.00" Cable	CA-3002
1973-76	V8 5.9L 360ci	J,K,L	AT w/Cruise Control, Upper	CA-3025
1973-76	V8 5.9L 360ci	J,K,L	w/o Cruise Control; 80.00" Cable	CA-3014
1959	V8 5.9L 361ci		AT; 83.00" Cable	CA-3004
1968	V8 6.3L 383ci	G,H	w/Cruise Lower; 63.00" Cable	CA-3002
1969	V8 6.3L 383ci	G,H	AT w/Cruise Control, Lower; 63.00" Cable	CA-3002
1969	V8 6.3L 383ci	G,H	AT w/Cruise Control, Upper	CA-3025
1968-69	V8 6.3L 383ci	G,H	w/o Cruise Control; 80.00" Cable	CA-3014
1970-71	V8 6.3L 383ci	L,N	AT w/Cruise Control, Lower; 63.00" Cable	CA-3002
1970-71	V8 6.3L 383ci	L,N	AT w/Cruise Control, Upper	CA-3025
1970-71	V8 6.3L 383ci	L,N	w/o Cruise Control; 80.00" Cable	CA-3014
1959	V8 6.3L 383ci		AT; 83.00" Cable	CA-3004
1972-76	V8 6.6L 400ci	M,N,P	AT w/Cruise Control, Lower; 63.00" Cable	CA-3002
1972-76	V8 6.6L 400ci	M,N,P	AT w/Cruise Control, Upper	CA-3025
1972-76	V8 6.6L 400ci	M,N,P	w/o Cruise Control; 80.00" Cable	CA-3014
1968	V8 7.0L 426ci	J	w/Cruise Lower; 63.00" Cable	CA-3002
1969	V8 7.0L 426ci	J	AT w/Cruise Control, Lower; 63.00" Cable	CA-3002
1969	V8 7.0L 426ci	J	AT w/Cruise Control, Upper	CA-3025
1968-69	V8 7.0L 426ci	J	w/o Cruise Control; 80.00" Cable	CA-3014
1970	V8 7.0L 426ci	R	AT w/Cruise Control, Lower; 63.00" Cable	CA-3002
1970	V8 7.0L 426ci	R	AT w/Cruise Control, Upper	CA-3025
1970	V8 7.0L 426ci	R	w/o Cruise Control; 80.00" Cable	CA-3014
1967	V8 7.0L 426ci		w/o Cruise Control; 83.00" Cable	CA-3004
1969	V8 7.2L 440ci	L,M	AT w/Cruise Control, Lower; 63.00" Cable	CA-3002
1969	V8 7.2L 440ci	L,M	AT w/Cruise Control, Upper	CA-3025
1968-69	V8 7.2L 440ci	L,M	w/o Cruise Control; 80.00" Cable	CA-3014
1970-76	V8 7.2L 440ci	U,V	AT w/Cruise Control, Lower; 63.00" Cable	CA-3002

# SPEEDOMETER CABLES

Year	Engine	Vin	Remark	Part
<b>DODGE (con't)</b>				
<b>CORONET (con't)</b>				
1970-76	V8 7.2L 440ci	U,V	AT w/Cruise Control, Upper	CA-3025
1970-76	V8 7.2L 440ci	U,V	w/o Cruise Control; 80.00" Cable	CA-3014
<b>CUSTOM</b>				
1954	V8 3.9L 239ci		AT; 83.00" Cable	CA-3004
1955-56	V8 4.4L 270ci		AT; 83.00" Cable	CA-3004
1964	V8 4.5L 273ci		w/Cruise Control	CA-3006
1956	V8 5.2L 315ci		AT; 83.00" Cable	CA-3004
1963-64	V8 5.2L 318ci		w/Cruise Control	CA-3006
1957-58	V8 5.3L 325ci		AT; 83.00" Cable	CA-3004
1959	V8 5.3L 326ci		AT; 83.00" Cable	CA-3004
1958	V8 5.7L 350ci		AT; 83.00" Cable	CA-3004
1957	V8 5.8L 354ci		AT; 83.00" Cable	CA-3004
1961	V8 5.9L 361ci		w/o Cruise Control; 83.00" Cable	CA-3004
1961	V8 5.9L 361ci		w/Cruise Control	CA-3016
1958-60	V8 5.9L 361ci		AT; 83.00" Cable	CA-3004
1963-64	V8 5.9L 361ci		w/Cruise Control	CA-3006
1963-64	V8 6.3L 383ci		w/Cruise Control	CA-3006
1963	V8 6.8L 413ci		w/Cruise Control	CA-3006
1963-64	V8 7.0L 426ci		w/Cruise Control	CA-3006
<b>DART</b>				
1968	L6 2.8L 170ci	A	w/Nylon Ferrule; 80.00" Cable	CA-3027
1968-69	L6 2.8L 170ci	A	AT 3 & 4 Spd MT; 80.00" Cable	CA-3027
1961	L6 2.8L 170ci		AT, w/Powerflite Trans.; 83.00" Cable	CA-3004
1961	L6 2.8L 170ci		w/Cruise Control	CA-3006
1966	L6 2.8L 170ci		83.00" Cable	CA-3004
1967	L6 2.8L 170ci		w/Nylon Ferrule; 80.00" Cable	CA-3027
1967	L6 2.8L 170ci		w/Steel Ferrule; 83.00" Cable	CA-3004
1961-62	L6 2.8L 170ci		AT 3 & 4 Spd MT; 80.00" Cable	CA-3027
1970-74	L6 3.2L 198ci	B	AT 3 & 4 Spd MT; 80.00" Cable	CA-3027
1968-69	L6 3.7L 225ci	B	AT 3 & 4 Spd MT; 80.00" Cable	CA-3027
1969-76	L6 3.7L 225ci	C	AT 3 & 4 Spd MT; 80.00" Cable	CA-3027
1960	L6 3.7L 225ci		AT, U.S., w/3 Spd. Trans.; 83.00" Cable	CA-3004
1961	L6 3.7L 225ci		AT, w/Powerflite Trans.; 83.00" Cable	CA-3004
1961	L6 3.7L 225ci		w/Cruise Control	CA-3006
1966	L6 3.7L 225ci		83.00" Cable	CA-3004
1967	L6 3.7L 225ci		w/Nylon Ferrule; 80.00" Cable	CA-3027
1967	L6 3.7L 225ci		w/Steel Ferrule; 83.00" Cable	CA-3004
1960-67	L6 3.7L 225ci		AT 3 & 4 Spd MT; 80.00" Cable	CA-3027
1968	V8 4.5L 273ci	D	w/Nylon Ferrule; 80.00" Cable	CA-3027
1968-69	V8 4.5L 273ci	D	AT 3 & 4 Spd MT; 80.00" Cable	CA-3027
1966	V8 4.5L 273ci		83.00" Cable	CA-3004
1967	V8 4.5L 273ci		w/Nylon Ferrule; 80.00" Cable	CA-3027
1967	V8 4.5L 273ci		w/Steel Ferrule; 83.00" Cable	CA-3004
1964-65	V8 4.5L 273ci		AT 3 & 4 Spd MT; 80.00" Cable	CA-3027
1968	V8 5.2L 318ci	F	w/Nylon Ferrule; 80.00" Cable	CA-3027
1968-69	V8 5.2L 318ci	F	AT 3 & 4 Spd MT; 80.00" Cable	CA-3027
1970-76	V8 5.2L 318ci	G	AT 3 & 4 Spd MT; 80.00" Cable	CA-3027
1960	V8 5.2L 318ci		83.00" Cable	CA-3004
1961	V8 5.2L 318ci		AT, w/Powerflite Trans., exc. Cruise Control; 83.00" Cable	CA-3004
1961	V8 5.2L 318ci		w/Cruise Control	CA-3006
1960-63	V8 5.2L 318ci		AT 3 & 4 Spd MT; 80.00" Cable	CA-3027
1970-73	V8 5.6L 340ci	H	AT 3 & 4 Spd MT; 80.00" Cable	CA-3027
1968-69	V8 5.6L 340ci	P	AT 3 & 4 Spd MT; 80.00" Cable	CA-3027
1974-76	V8 5.9L 360ci	L	AT 3 & 4 Spd MT; 80.00" Cable	CA-3027
1960	V8 5.9L 361ci		83.00" Cable	CA-3004
1961	V8 5.9L 361ci		AT, w/Powerflite Trans., exc. Cruise Control; 83.00" Cable	CA-3004
1961	V8 5.9L 361ci		w/Cruise Control	CA-3006
1968-69	V8 6.3L 383ci	G,H	AT 3 & 4 Spd MT; 80.00" Cable	CA-3027
1961	V8 6.3L 383ci		AT, w/Powerflite Trans., exc. Cruise Control; 83.00" Cable	CA-3004
1961	V8 6.3L 383ci		w/Cruise Control	CA-3006
1967	V8 6.3L 383ci		w/Nylon Ferrule; 80.00" Cable	CA-3027
1967	V8 6.3L 383ci		w/Steel Ferrule; 83.00" Cable	CA-3004



# SPEEDOMETER CABLES

Year	Engine	Vin	Remark	Part
<b>DODGE (con't)</b>				
<b>DART (con't)</b>				
1960-66	V8 6.3L 383ci		83.00" Cable	CA-3004
1961	V8 6.8L 413ci		AT, w/Powerflite Trans.; 83.00" Cable	CA-3004
1961	V8 6.8L 413ci		w/Cruise Control	CA-3006
<b>DAYTONA</b>				
1989	L4 2.2L 135ci	A	5 Spd. MT	CA-3029
1989	L4 2.2L 135ci	A	AT Lower	CA-3006
1984	L4 2.2L 135ci	D,E	Cruise to Speed Sensor Switch	CA-3040
1984	L4 2.2L 135ci	D,E	w/Cruise Lower 37" OE Cable	CA-3034
1984	L4 2.2L 135ci	D,E	w/o Cruise 1 pc. Cable	CA-3022
1984	L4 2.2L 135ci	D,E	w/o Cruise Lower	CA-3028
1984-86	L4 2.2L 135ci	D,E	Upper	CA-3029
1985-86	L4 2.2L 135ci	D,E	Lower	CA-3036
1989	L4 2.5L 153ci	J,K	5 Spd. MT	CA-3029
1989	L4 2.5L 153ci	J,K	AT Lower	CA-3006
1986	L4 2.5L 153ci	K	Lower	CA-3036
1986	L4 2.5L 153ci	K	Upper	CA-3029
<b>DIPLOMAT</b>				
1980	L6 3.7L 225ci	C,D	Cruise Control to Switch	CA-3040
1978-80	L6 3.7L 225ci	C,D	w/Cruise Control, Speed Control to Trans.	CA-3024
1979-80	L6 3.7L 225ci	C,D	Speedometer to Cruise Control; 41.00" Cable	CA-3035
1982	L6 3.7L 225ci	E,F	Speedometer to Speed Control; 41.00" Cable	CA-3035
1981-82	L6 3.7L 225ci	E,F,G	w/Cruise Control, Speed Control to Trans.	CA-3024
1983	L6 3.7L 225ci	H,J,K	Speed Control to Trans.	CA-3024
1983	L6 3.7L 225ci	H,J,K	Speedometer to Speed Control; 41.00" Cable	CA-3035
1984-86	V8 5.2L 318ci	4	Speedometer to Trans.	CA-3030
1988	V8 5.2L 318ci	4,P,S	Upper	CA-3025
1984-86	V8 5.2L 318ci	4,P,S	Speed Control to Trans.	CA-3024
1984-86	V8 5.2L 318ci	4,P,S	Speedometer to Speed Control	CA-3025
1984-89	V8 5.2L 318ci	4,P,S	Fleet Car Upper	CA-3047
1987-89	V8 5.2L 318ci	4,P,S	Lower	CA-3024
1977	V8 5.2L 318ci	G	w/Cruise Control, Speedometer to Cruise Control; 41.00" Cable	CA-3035
1980	V8 5.2L 318ci	G,H	Cruise Control to Switch	CA-3040
1977-80	V8 5.2L 318ci	G,H	w/Cruise Control, Speed Control to Trans.	CA-3024
1979-80	V8 5.2L 318ci	G,H	Speedometer to Cruise Control; 41.00" Cable	CA-3035
1982	V8 5.2L 318ci	K,L,M,N	Speedometer to Speed Control; 41.00" Cable	CA-3035
1981-82	V8 5.2L 318ci	K,L,M,N	w/Cruise Control, Speed Control to Trans.	CA-3024
1984-87	V8 5.2L 318ci	P	Speedometer to Trans.	CA-3030
1984-87	V8 5.2L 318ci	S	Speedometer to Trans.	CA-3030
1979	V8 5.9L 360ci	J,K,L	Speedometer to Cruise Control; 41.00" Cable	CA-3035
1978-79	V8 5.9L 360ci	J,K,L	w/Cruise Control, Speed Control to Trans.	CA-3024
<b>LANCER</b>				
1986	L4 2.2L 135ci	D,E	AT Speedo to Speed Control; 80.00" Cable	CA-3027
1985-87	L4 2.2L 135ci	D,E	Lower	CA-3036
1985-89	L4 2.2L 135ci	D,E	Upper	CA-3029
1988-89	L4 2.2L 135ci	D,E	Lower; 41.00" Cable	CA-3035
1989	L4 2.5L 153ci	J	Upper	CA-3029
1988-89	L4 2.5L 153ci	J,K	Lower; 41.00" Cable	CA-3035
1986	L4 2.5L 153ci	K	AT Speedo to Speed Control; 80.00" Cable	CA-3027
1986-87	L4 2.5L 153ci	K	Lower	CA-3036
1986-89	L4 2.5L 153ci	K	Upper	CA-3029
<b>MAGNUM</b>				
1979	V8 5.2L 318ci	G	exc. Cruise Control	CA-3030
1979	V8 5.2L 318ci	G,H	AT, w/A404 Axle, XE	CA-3037
1979	V8 5.2L 318ci	G,H	exc. Dual Exhaust, Cruise Control to Trans.,exc. Console, Xe	CA-3024
1979	V8 5.2L 318ci	H	exc. Cruise Control	CA-3030
1979	V8 5.9L 360ci	J	exc. Cruise Control	CA-3030
1979	V8 5.9L 360ci	J,K,L	AT, w/A404 Axle, XE	CA-3037
1979	V8 5.9L 360ci	J,K,L	exc. Dual Exhaust, Cruise Control to Trans.,exc. Console, Xe	CA-3024
1979	V8 5.9L 360ci	K	exc. Cruise Control	CA-3030
1979	V8 5.9L 360ci	L	exc. Cruise Control	CA-3030
<b>MIRADA</b>				
1980	L6 3.7L 225ci	C,D	Cruise Control to Trans.	CA-3024

# SPEEDOMETER CABLES

Year	Engine	Vin	Remark	Part
<b>DODGE (con't)</b>				
<b>MIRADA (con't)</b>				
1980	L6 3.7L 225ci	C,D	Speedometer to Cruise Control	CA-3051
1980	L6 3.7L 225ci	C,D	Speedometer to Switch	CA-3025
1982	L6 3.7L 225ci	E	Speedometer to Speed Control, w/34" Cable	CA-3025
1981-82	L6 3.7L 225ci	E	Speedometer to Trans.	CA-3030
1981	L6 3.7L 225ci	E,G	Cruise Control to Trans.	CA-3024
1982	L6 3.7L 225ci	E,H,K	Speed Control to Trans.	CA-3024
1981	L6 3.7L 225ci	G	Speedometer to Trans.	CA-3030
1983	L6 3.7L 225ci	H	Speedometer to Trans.	CA-3030
1983	L6 3.7L 225ci	H,K	Speedometer to Speed Control, w/34" Cable	CA-3025
1983	L6 3.7L 225ci	K	Speedometer to Trans.	CA-3030
1980	V8 5.2L 318ci	G,H	Cruise Control to Trans.	CA-3024
1980	V8 5.2L 318ci	G,H	Speedometer to Cruise Control	CA-3051
1980	V8 5.2L 318ci	G,H	Speedometer to Switch	CA-3025
1981-82	V8 5.2L 318ci	K	Speedometer to Trans.	CA-3030
1981	V8 5.2L 318ci	K,M	Cruise Control to Trans.	CA-3024
1982	V8 5.2L 318ci	K,M	Speedometer to Speed Control, w/34" Cable	CA-3025
1982	V8 5.2L 318ci	K,M,P	Speed Control to Trans.	CA-3024
1981-82	V8 5.2L 318ci	M	Speedometer to Trans.	CA-3030
1983	V8 5.2L 318ci	P	Speedometer to Speed Control, w/34" Cable	CA-3025
1983	V8 5.2L 318ci	P	Speedometer to Trans.	CA-3030
1980	V8 5.9L 360ci	L	Cruise Control to Trans.	CA-3024
1980	V8 5.9L 360ci	L	Speedometer to Cruise Control	CA-3051
1980	V8 5.9L 360ci	L	Speedometer to Switch	CA-3025
<b>MONACO</b>				
1977	L6 3.7L 225ci	C	w/o Cruise w/o Dual Exhaust	CA-3030
1978	L6 3.7L 225ci	C	w/Cruise Police Lower	CA-3026
1978	L6 3.7L 225ci	C	w/o Cruise 1 pc. Cable	CA-3030
1977	L6 3.7L 225ci	C,D	w/Cruise w/Dual Exhaust Lower, w/o Cruise Upper	CA-3025
1977	L6 3.7L 225ci	C,D	w/o Cruise Police Car Generator to Trans.	CA-3026
1977	L6 3.7L 225ci	C,D	w/o Cruise Taxi Lower	CA-3024
1978	L6 3.7L 225ci	C,D	MT, Speedo to Generator w/large nut	CA-3051
1978	L6 3.7L 225ci	C,D	w/Cruise Lower	CA-3024
1978	L6 3.7L 225ci	C,D	w/Cruise Upper	CA-3025
1977	L6 3.7L 225ci	D	w/o Cruise w/o Dual Exhaust	CA-3030
1978	L6 3.7L 225ci	D	w/Cruise Police Lower	CA-3026
1978	L6 3.7L 225ci	D	w/o Cruise 1 pc. Cable	CA-3030
1968	V8 5.2L 318ci	F	AT & 3 Spd. MT w/o Cruise; 80.00" Cable	CA-3027
1969	V8 5.2L 318ci	F	w/Cruise Lower; 63.00" Cable	CA-3002
1969	V8 5.2L 318ci	F	w/o Cruise Control; 80.00" Cable	CA-3014
1968-69	V8 5.2L 318ci	F	w/Cruise Upper	CA-3025
1977	V8 5.2L 318ci	G	w/Cruise w/Dual Exhaust Lower, w/o Cruise Upper	CA-3025
1977	V8 5.2L 318ci	G	w/o Cruise Police Car Generator to Trans.	CA-3026
1977	V8 5.2L 318ci	G	w/o Cruise Taxi Lower	CA-3024
1977	V8 5.2L 318ci	G	w/o Cruise w/o Dual Exhaust	CA-3030
1978	V8 5.2L 318ci	G	w/Cruise Police Lower	CA-3026
1978	V8 5.2L 318ci	G	w/o Cruise 1 pc. Cable	CA-3030
1970-76	V8 5.2L 318ci	G	w/Cruise Lower; 63.00" Cable	CA-3002
1970-76	V8 5.2L 318ci	G	w/o Cruise Control; 80.00" Cable	CA-3014
1978	V8 5.2L 318ci	G,H	MT, Speedo to Generator w/large nut	CA-3051
1978	V8 5.2L 318ci	G,H	w/Cruise Lower	CA-3024
1970-78	V8 5.2L 318ci	G,H	w/Cruise Upper	CA-3025
1978	V8 5.2L 318ci	H	w/Cruise Police Lower	CA-3026
1978	V8 5.2L 318ci	H	w/o Cruise 1 pc. Cable	CA-3030
1977	V8 5.9L 360ci	J	w/o Cruise w/o Dual Exhaust	CA-3030
1978	V8 5.9L 360ci	J	w/Cruise Police Lower	CA-3026
1978	V8 5.9L 360ci	J	w/o Cruise 1 pc. Cable	CA-3030
1977	V8 5.9L 360ci	J,K,L	w/Cruise w/Dual Exhaust Lower, w/o Cruise Upper	CA-3025
1977	V8 5.9L 360ci	J,K,L	w/o Cruise Police Car Generator to Trans.	CA-3026
1977	V8 5.9L 360ci	J,K,L	w/o Cruise Taxi Lower	CA-3024
1978	V8 5.9L 360ci	J,K,L	MT, Speedo to Generator w/large nut	CA-3051
1978	V8 5.9L 360ci	J,K,L	w/Cruise Lower	CA-3024
1971-76	V8 5.9L 360ci	J,K,L	w/Cruise Lower; 63.00" Cable	CA-3002

# SPEEDOMETER CABLES

Year	Engine	Vin	Remark	Part
<b>DODGE (con't)</b>				
<b>MONACO (con't)</b>				
1971-76	V8 5.9L 360ci	J,K,L	w/o Cruise Control; 80.00" Cable	CA-3014
1971-78	V8 5.9L 360ci	J,K,L	w/Cruise Upper	CA-3025
1977	V8 5.9L 360ci	K	w/o Cruise w/o Dual Exhaust	CA-3030
1978	V8 5.9L 360ci	K	w/Cruise Police Lower	CA-3026
1978	V8 5.9L 360ci	K	w/o Cruise 1 pc. Cable	CA-3030
1977	V8 5.9L 360ci	L	w/o Cruise w/o Dual Exhaust	CA-3030
1978	V8 5.9L 360ci	L	w/Cruise Police Lower	CA-3026
1978	V8 5.9L 360ci	L	w/o Cruise 1 pc. Cable	CA-3030
1968	V8 6.3L 383ci	G,H	AT & 3 Spd. MT w/o Cruise; 80.00" Cable	CA-3027
1969	V8 6.3L 383ci	G,H	w/Cruise Lower; 63.00" Cable	CA-3002
1969	V8 6.3L 383ci	G,H	w/o Cruise Control; 80.00" Cable	CA-3014
1968-69	V8 6.3L 383ci	G,H	w/Cruise Upper	CA-3025
1970-71	V8 6.3L 383ci	L,N	w/Cruise Lower; 63.00" Cable	CA-3002
1970-71	V8 6.3L 383ci	L,N	w/Cruise Upper	CA-3025
1970-71	V8 6.3L 383ci	L,N	w/o Cruise Control; 80.00" Cable	CA-3014
1972-76	V8 6.6L 400ci	M,N,P	w/Cruise Lower; 63.00" Cable	CA-3002
1972-76	V8 6.6L 400ci	M,N,P	w/o Cruise Control; 80.00" Cable	CA-3014
1972-78	V8 6.6L 400ci	M,N,P	w/Cruise Upper	CA-3025
1977	V8 6.6L 400ci	N	w/o Cruise w/o Dual Exhaust	CA-3030
1978	V8 6.6L 400ci	N	w/Cruise Police Lower	CA-3026
1978	V8 6.6L 400ci	N	w/o Cruise 1 pc. Cable	CA-3030
1977	V8 6.6L 400ci	N,P	w/Cruise w/Dual Exhaust Lower, w/o Cruise Upper	CA-3025
1977	V8 6.6L 400ci	N,P	w/o Cruise Police Car Generator to Trans.	CA-3026
1977	V8 6.6L 400ci	N,P	w/o Cruise Taxi Lower	CA-3024
1978	V8 6.6L 400ci	N,P	MT, Speedo to Generator w/large nut	CA-3051
1978	V8 6.6L 400ci	N,P	w/Cruise Lower	CA-3024
1977	V8 6.6L 400ci	P	w/o Cruise w/o Dual Exhaust	CA-3030
1978	V8 6.6L 400ci	P	w/Cruise Police Lower	CA-3026
1978	V8 6.6L 400ci	P	w/o Cruise 1 pc. Cable	CA-3030
1969	V8 7.2L 440ci	K	w/Cruise Lower; 63.00" Cable	CA-3002
1969	V8 7.2L 440ci	K	w/Cruise Upper	CA-3025
1969	V8 7.2L 440ci	K	w/o Cruise Control; 80.00" Cable	CA-3014
1968	V8 7.2L 440ci	L	AT & 3 Spd. MT w/o Cruise; 80.00" Cable	CA-3027
1968	V8 7.2L 440ci	L	w/Cruise Upper	CA-3025
1970-75	V8 7.2L 440ci	T	w/Cruise Upper	CA-3025
1970-76	V8 7.2L 440ci	T,U	w/Cruise Lower; 63.00" Cable	CA-3002
1970-76	V8 7.2L 440ci	T,U	w/o Cruise Control; 80.00" Cable	CA-3014
1977	V8 7.2L 440ci	U	w/Cruise w/Dual Exhaust Lower, w/o Cruise Upper	CA-3025
1977	V8 7.2L 440ci	U	w/o Cruise Police Car Generator to Trans.	CA-3026
1977	V8 7.2L 440ci	U	w/o Cruise Taxi Lower	CA-3024
1977	V8 7.2L 440ci	U	w/o Cruise w/o Dual Exhaust	CA-3030
1978	V8 7.2L 440ci	U	MT, Speedo to Generator w/large nut	CA-3051
1978	V8 7.2L 440ci	U	w/Cruise Lower	CA-3024
1978	V8 7.2L 440ci	U	w/Cruise Police Lower	CA-3026
1978	V8 7.2L 440ci	U	w/o Cruise 1 pc. Cable	CA-3030
1974-78	V8 7.2L 440ci	U	w/Cruise Upper	CA-3025
1967	V8 7.2L 440ci		w/o Cruise Control; 83.00" Cable	CA-3004
<b>OMNI</b>				
1983	L4 1.6L 97ci	A	Speedometer to Speed Control; 41.00" Cable	CA-3035
1983	L4 1.6L 97ci	A	Speedometer to Trans.	CA-3037
1984	L4 1.6L 97ci	A	Speedometer Control to Trans.	CA-3034
1984	L4 1.6L 97ci	A	Speedometer to Speed Control	CA-3025
1984	L4 1.6L 97ci	A	Speedometer to Trans.	CA-3028
1985	L4 1.6L 97ci	A	Lower	CA-3036
1985	L4 1.6L 97ci	A	MT Upper	CA-3025
1986	L4 1.6L 97ci	A	AT Speedo to Speed Control	CA-3025
1986	L4 1.6L 97ci	A	MT Lower	CA-3036
1980	L4 1.7L 105ci	A	Cruise Control to Switch	CA-3036
1980	L4 1.7L 105ci	A	w/EGR Switch Lower	CA-3026
1980	L4 1.7L 105ci	A	w/Cruise AT Lower w/o EGR Switch, w/o Cruise Upper w/o EGR Switch	CA-3037
1980	L4 1.7L 105ci	A	w/Cruise MT Lower w/o EGR Switch	CA-3034
1980	L4 1.7L 105ci	A	w/Cruise Upper	CA-3050

# SPEEDOMETER CABLES

Year	Engine	Vin	Remark	Part
<b>DODGE (con't)</b>				
<b>OMNI (con't)</b>				
1981	L4 1.7L 105ci	A	Lower	CA-3028
1981	L4 1.7L 105ci	A	Speedometer to Trans.	CA-3037
1981	L4 1.7L 105ci	A	Upper; 41.00" Cable	CA-3035
1982	L4 1.7L 105ci	A	AT Speedo to Cruise, MT Speedo to Trans.	CA-3050
1982	L4 1.7L 105ci	A	AT Speedo to Trans.	CA-3037
1982	L4 1.7L 105ci	A	MT Speed Control to Trans.	CA-3034
1982	L4 1.7L 105ci	A	MT Speedo to Speed Control; 41.00" Cable	CA-3035
1978-79	L4 1.7L 105ci	A		CA-3037
1983	L4 1.7L 105ci	B	5 Spd. Trans., w/A460 Trans.	CA-3050
1983	L4 1.7L 105ci	B	Speedometer Control to Trans.	CA-3034
1983	L4 1.7L 105ci	B	Speedometer to Speed Control; 41.00" Cable	CA-3035
1983	L4 1.7L 105ci	B	Speedometer to Trans.	CA-3037
1984	L4 2.2L 135ci	8,C	Speedometer Control to Trans.	CA-3034
1984	L4 2.2L 135ci	8,C	Speedometer to Speed Control	CA-3025
1984	L4 2.2L 135ci	8,C	Speedometer to Trans.	CA-3028
1985	L4 2.2L 135ci	8,C,E	Lower	CA-3036
1985	L4 2.2L 135ci	8,C,E	MT Upper	CA-3025
1986	L4 2.2L 135ci	8,C,E	AT Speedo to Speed Control	CA-3025
1986	L4 2.2L 135ci	8,C,E	MT Lower	CA-3036
1981	L4 2.2L 135ci	B	Lower	CA-3028
1981	L4 2.2L 135ci	B	Upper; 41.00" Cable	CA-3035
1982	L4 2.2L 135ci	B	AT Speedo to Cruise Control	CA-3050
1982	L4 2.2L 135ci	B	AT Speedo to Trans.	CA-3037
1982	L4 2.2L 135ci	B	MT Lower	CA-3028
1982	L4 2.2L 135ci	B	MT Upper; 41.00" Cable	CA-3035
1983	L4 2.2L 135ci	C	AT Speedo to Trans.	CA-3037
1983	L4 2.2L 135ci	C	MT Lower	CA-3028
1983	L4 2.2L 135ci	C	Upper; 41.00" Cable	CA-3035
1987	L4 2.2L 135ci	C	AT Sensor to Coupling, w/Speed Control, MT Speedo to Trans. To 12/1/86	CA-3036
1987	L4 2.2L 135ci	C	AT, w/Speed Control, Speedometer to Coupling	CA-3025
1989-90	L4 2.2L 135ci	D	AT Lower; 41.00" Cable	CA-3035
<b>P200</b>				
1968-70	L6 3.7L 225ci	6		CA-3016
1971-72	L6 3.7L 225ci	B		CA-3016
1970	V8 5.9L 360ci	8		CA-3016
1971-72	V8 5.9L 360ci	Y		CA-3016
<b>P300</b>				
1968-70	L6 3.7L 225ci	6		CA-3016
1971-72	L6 3.7L 225ci	B,X		CA-3016
1971-72	V8 5.9L 360ci	Y		CA-3016
<b>POLARA</b>				
1963-64	L6 2.8L 170ci		w/Cruise Control	CA-3006
1970-71	L6 3.7L 225ci	C	w/Cruise Lower; 63.00" Cable	CA-3002
1970-71	L6 3.7L 225ci	C	w/Cruise Upper	CA-3025
1970-71	L6 3.7L 225ci	C	w/o Cruise Control; 80.00" Cable	CA-3014
1963-64	L6 3.7L 225ci		w/Cruise Control	CA-3006
1964	V8 4.5L 273ci		w/Cruise Control	CA-3006
1967	V8 4.5L 273ci		w/o Cruise Control; 83.00" Cable	CA-3004
1968	V8 5.2L 318ci	F	AT & 3 Spd. MT w/o Cruise; 80.00" Cable	CA-3027
1969	V8 5.2L 318ci	F	w/Cruise Lower; 63.00" Cable	CA-3002
1969	V8 5.2L 318ci	F	w/o Cruise Control; 80.00" Cable	CA-3014
1968-69	V8 5.2L 318ci	F	w/Cruise Upper	CA-3025
1970-73	V8 5.2L 318ci	G	w/Cruise Lower; 63.00" Cable	CA-3002
1970-73	V8 5.2L 318ci	G	w/Cruise Upper	CA-3025
1970-73	V8 5.2L 318ci	G	w/o Cruise Control; 80.00" Cable	CA-3014
1960	V8 5.2L 318ci		AT; 83.00" Cable	CA-3004
1961	V8 5.2L 318ci		w/Cruise Control	CA-3016
1961-67	V8 5.2L 318ci		w/o Cruise Control; 83.00" Cable	CA-3004
1963-64	V8 5.2L 318ci		w/Cruise Control	CA-3006
1971-73	V8 5.9L 360ci	K	w/Cruise Lower; 63.00" Cable	CA-3002
1971-73	V8 5.9L 360ci	K	w/Cruise Upper	CA-3025
1971-73	V8 5.9L 360ci	K	w/o Cruise Control; 80.00" Cable	CA-3014

# SPEEDOMETER CABLES

Year	Engine	Vin	Remark	Part
<b>DODGE (con't)</b>				
<b>POLARA (con't)</b>				
1960	V8 5.9L 361ci		AT; 83.00" Cable	CA-3004
1961	V8 5.9L 361ci		w/o Cruise Control; 83.00" Cable	CA-3004
1961	V8 5.9L 361ci		w/Cruise Control	CA-3016
1963-64	V8 5.9L 361ci		w/Cruise Control	CA-3006
1968	V8 6.3L 383ci	G,H	AT & 3 Spd. MT w/o Cruise; 80.00" Cable	CA-3027
1969	V8 6.3L 383ci	G,H	w/Cruise Lower; 63.00" Cable	CA-3002
1969	V8 6.3L 383ci	G,H	w/o Cruise Control; 80.00" Cable	CA-3014
1968-69	V8 6.3L 383ci	G,H	w/Cruise Upper	CA-3025
1970-71	V8 6.3L 383ci	L,N	w/Cruise Lower; 63.00" Cable	CA-3002
1970-71	V8 6.3L 383ci	L,N	w/Cruise Upper	CA-3025
1970-71	V8 6.3L 383ci	L,N	w/o Cruise Control; 80.00" Cable	CA-3014
1960	V8 6.3L 383ci		AT; 83.00" Cable	CA-3004
1962	V8 6.3L 383ci		w/Cruise Control	CA-3016
1966	V8 6.3L 383ci		2WD, w/o Cruise, 1 pc.; 80.00" Cable	CA-3014
1967	V8 6.3L 383ci		4WD, w/o Cruise 1 pc.; 80.00" Cable	CA-3027
1961-65	V8 6.3L 383ci		w/o Cruise Control; 83.00" Cable	CA-3004
1963-64	V8 6.3L 383ci		w/Cruise Control	CA-3006
1972-73	V8 6.6L 400ci	M,P	w/Cruise Lower; 63.00" Cable	CA-3002
1972-73	V8 6.6L 400ci	M,P	w/Cruise Upper	CA-3025
1972-73	V8 6.6L 400ci	M,P	w/o Cruise Control; 80.00" Cable	CA-3014
1961	V8 6.8L 413ci		w/o Cruise Control; 83.00" Cable	CA-3004
1961	V8 6.8L 413ci		w/Cruise Control	CA-3016
1963	V8 6.8L 413ci		w/Cruise Control	CA-3006
1964	V8 7.0L 426ci		w/Cruise Control	CA-3006
1967	V8 7.0L 426ci		w/o Cruise Control; 83.00" Cable	CA-3004
1969	V8 7.2L 440ci	K	w/Cruise Lower; 63.00" Cable	CA-3002
1969	V8 7.2L 440ci	K	w/Cruise Upper	CA-3025
1969	V8 7.2L 440ci	K	w/o Cruise Control; 80.00" Cable	CA-3014
1968	V8 7.2L 440ci	L	AT & 3 Spd. MT w/o Cruise; 80.00" Cable	CA-3027
1968	V8 7.2L 440ci	L	w/Cruise Upper	CA-3025
1970-73	V8 7.2L 440ci	T	w/Cruise Lower; 63.00" Cable	CA-3002
1970-73	V8 7.2L 440ci	T	w/Cruise Upper	CA-3025
1970-73	V8 7.2L 440ci	T	w/o Cruise Control; 80.00" Cable	CA-3014
1967	V8 7.2L 440ci		w/o Cruise Control; 83.00" Cable	CA-3004
<b>ROYAL MONACO</b>				
1975	V8 5.2L 318ci	G	w/Cruise Lower; 63.00" Cable	CA-3002
1975	V8 5.2L 318ci	G	w/Cruise Upper	CA-3025
1975	V8 5.2L 318ci	G	w/o Cruise Control; 80.00" Cable	CA-3014
1977	V8 5.2L 318ci	G	w/Cruise w/Dual Exhaust Lower, w/o Cruise Upper	CA-3025
1977	V8 5.2L 318ci	G	w/o Cruise Police Car Generator to Trans.	CA-3026
1977	V8 5.2L 318ci	G	w/o Cruise Taxi Lower	CA-3024
1977	V8 5.2L 318ci	G	w/o Cruise w/o Dual Exhaust	CA-3030
1977	V8 5.9L 360ci	J	w/o Cruise w/o Dual Exhaust	CA-3030
1975	V8 5.9L 360ci	J,K	w/Cruise Upper	CA-3025
1977	V8 5.9L 360ci	J,K	w/Cruise w/Dual Exhaust Lower, w/o Cruise Upper	CA-3025
1977	V8 5.9L 360ci	J,K	w/o Cruise Police Car Generator to Trans.	CA-3026
1977	V8 5.9L 360ci	J,K	w/o Cruise Taxi Lower	CA-3024
1975-76	V8 5.9L 360ci	J,K	w/Cruise Lower; 63.00" Cable	CA-3002
1975-76	V8 5.9L 360ci	J,K	w/o Cruise Control; 80.00" Cable	CA-3014
1977	V8 5.9L 360ci	K	w/o Cruise w/o Dual Exhaust	CA-3030
1975	V8 6.6L 400ci	M,N	w/Cruise Upper	CA-3025
1975-76	V8 6.6L 400ci	M,N	w/Cruise Lower; 63.00" Cable	CA-3002
1975-76	V8 6.6L 400ci	M,N	w/o Cruise Control; 80.00" Cable	CA-3014
1977	V8 6.6L 400ci	N	w/o Cruise w/o Dual Exhaust	CA-3030
1977	V8 6.6L 400ci	N,P	w/Cruise w/Dual Exhaust Lower, w/o Cruise Upper	CA-3025
1977	V8 6.6L 400ci	N,P	w/o Cruise Police Car Generator to Trans.	CA-3026
1977	V8 6.6L 400ci	N,P	w/o Cruise Taxi Lower	CA-3024
1977	V8 6.6L 400ci	P	w/o Cruise w/o Dual Exhaust	CA-3030
1977	V8 7.2L 440ci	T	w/o Cruise w/o Dual Exhaust	CA-3030
1975	V8 7.2L 440ci	T,U	w/Cruise Upper	CA-3025
1977	V8 7.2L 440ci	T,U	w/Cruise w/Dual Exhaust Lower, w/o Cruise Upper	CA-3025
1977	V8 7.2L 440ci	T,U	w/o Cruise Police Car Generator to Trans.	CA-3026

# SPEEDOMETER CABLES

Year	Engine	Vin	Remark	Part
<b>DODGE (con't)</b>				
<b>ROYAL MONACO (con't)</b>				
1977	V8 7.2L 440ci	T,U	w/o Cruise Taxi Lower	CA-3024
1975-76	V8 7.2L 440ci	T,U	w/Cruise Lower; 63.00" Cable	CA-3002
1975-76	V8 7.2L 440ci	T,U	w/o Cruise Control; 80.00" Cable	CA-3014
1977	V8 7.2L 440ci	U	w/o Cruise w/o Dual Exhaust	CA-3030
<b>SHADOW</b>				
1989-90	L4 2.2L 135ci	C,D	AT Speedo to Trans.; 41.00" Cable	CA-3035
1989-90	L4 2.5L 153ci	J,K	AT Speedo to Trans.; 41.00" Cable	CA-3035
<b>ST. REGIS</b>				
1980	L6 3.7L 225ci	C	Cruise Control to Switch	CA-3006
1980	L6 3.7L 225ci	C	w/Cruise Lower w/o Switch, w/o Cruise Upper w/Switch	CA-3025
1980	L6 3.7L 225ci	C	w/Cruise Upper	CA-3051
1980	L6 3.7L 225ci	C	w/o Cruise w/o ERG Switch	CA-3030
1979	L6 3.7L 225ci	D	w/Cruise Lower Police	CA-3006
1979	L6 3.7L 225ci	D	w/Cruise Upper	CA-3051
1979	L6 3.7L 225ci	D	w/o Cruise exc. Police	CA-3030
1979	L6 3.7L 225ci	D	w/o Cruise Lower Police	CA-3026
1979	L6 3.7L 225ci	D	w/o Cruise Upper Police, w/Cruise Lower exc. Police	CA-3025
1981	L6 3.7L 225ci	E	w/o Cruise Control	CA-3030
1981	L6 3.7L 225ci	E,F,G	w/Cruise Upper & Lower	CA-3025
1981	L6 3.7L 225ci	F	w/o Cruise Control	CA-3030
1981	L6 3.7L 225ci	G	w/o Cruise Control	CA-3030
1979	V8 5.2L 318ci	G	w/o Cruise exc. Police	CA-3030
1980	V8 5.2L 318ci	G	w/o Cruise w/o ERG Switch	CA-3030
1979	V8 5.2L 318ci	G,H	w/Cruise Lower Police	CA-3006
1979	V8 5.2L 318ci	G,H	w/o Cruise Lower Police	CA-3026
1979	V8 5.2L 318ci	G,H	w/o Cruise Upper Police, w/Cruise Lower exc. Police	CA-3025
1980	V8 5.2L 318ci	G,H	Cruise Control to Switch	CA-3006
1980	V8 5.2L 318ci	G,H	w/Cruise Lower w/o Switch, w/o Cruise Upper w/Switch	CA-3025
1979-80	V8 5.2L 318ci	G,H	w/Cruise Upper	CA-3051
1979	V8 5.2L 318ci	H	w/o Cruise exc. Police	CA-3030
1980	V8 5.2L 318ci	H	w/o Cruise w/o ERG Switch	CA-3030
1981	V8 5.2L 318ci	K	w/o Cruise Control	CA-3030
1981	V8 5.2L 318ci	K,L,M,N	w/Cruise Upper & Lower	CA-3025
1981	V8 5.2L 318ci	L	w/o Cruise Control	CA-3030
1981	V8 5.2L 318ci	M	w/o Cruise Control	CA-3030
1981	V8 5.2L 318ci	N	w/o Cruise Control	CA-3030
1979	V8 5.9L 360ci	J	w/o Cruise exc. Police	CA-3030
1979	V8 5.9L 360ci	J,K,L	w/Cruise Lower Police	CA-3006
1979	V8 5.9L 360ci	J,K,L	w/o Cruise Lower Police	CA-3026
1979	V8 5.9L 360ci	J,K,L	w/o Cruise Upper Police, w/Cruise Lower exc. Police	CA-3025
1979-80	V8 5.9L 360ci	J,K,L	w/Cruise Upper	CA-3051
1979	V8 5.9L 360ci	K	w/o Cruise exc. Police	CA-3030
1980	V8 5.9L 360ci	K	w/o Cruise w/o ERG Switch	CA-3030
1980	V8 5.9L 360ci	K,L	Cruise Control to Switch	CA-3006
1980	V8 5.9L 360ci	K,L	w/Cruise Lower w/o Switch, w/o Cruise Upper w/Switch	CA-3025
1979	V8 5.9L 360ci	L	w/o Cruise exc. Police	CA-3030
1980	V8 5.9L 360ci	L	w/o Cruise w/o ERG Switch	CA-3030
<b>DODGE TRUCKS</b>				
<b>A100</b>				
1968-69	L6 2.8L 170ci	6		CA-3031
1964-67	L6 2.8L 170ci			CA-3031
1970	L6 3.2L 198ci	A		CA-3031
1968-69	L6 3.7L 225ci	6		CA-3031
1970	L6 3.7L 225ci	B		CA-3031
1964-67	L6 3.7L 225ci			CA-3031
1964-67	V8 4.5L 273ci			CA-3031
1968-69	V8 5.2L 318ci	8		CA-3031
1970	V8 5.2L 318ci	E		CA-3031
1967	V8 5.2L 318ci			CA-3031
<b>B100</b>				
1971	L6 3.2L 198ci	A	w/o Cruise Control; 100.00" Cable	CA-3052
1971-73	L6 3.7L 225ci	B	w/o Cruise Control; 100.00" Cable	CA-3052

# SPEEDOMETER CABLES

Year	Engine	Vin	Remark	Part
<b>DODGE TRUCKS (con't)</b>				
<b>B100 (con't)</b>				
1978-79	L6 3.7L 225ci	B	w/o Cruise Control; 100.00" Cable	CA-3052
1979-80	L6 3.7L 225ci	N	w/o Cruise Control; 100.00" Cable	CA-3052
1971-73	V8 5.2L 318ci	E	w/o Cruise Control; 100.00" Cable	CA-3052
1979-80	V8 5.2L 318ci	E,P	w/o Cruise Control; 100.00" Cable	CA-3052
1971-73	V8 5.9L 360ci	F	w/o Cruise Control; 100.00" Cable	CA-3052
1976-78	V8 5.9L 360ci	F	w/o Cruise Control; 100.00" Cable	CA-3052
<b>B150</b>				
1986	L6 3.7L 225ci	H	w/o Cruise Upper; 41.00" Cable	CA-3035
1989-94	V6 3.9L 239ci	X	w/Cruise Lower	CA-3057
1989-94	V6 3.9L 239ci	X	w/Cruise Upper	CA-3025
1986	V8 5.2L 318ci	T	w/o Cruise Upper; 41.00" Cable	CA-3035
1984-85	V8 5.2L 318ci	T	w/Cruise Lower	CA-3057
1984-85	V8 5.2L 318ci	T	w/Cruise Upper	CA-3025
1988-89	V8 5.2L 318ci	Y	w/Cruise Lower	CA-3057
1988-89	V8 5.2L 318ci	Y	w/Cruise Upper	CA-3025
<b>B200</b>				
1971	L6 3.2L 198ci	A	w/o Cruise Control; 100.00" Cable	CA-3052
1971-73	L6 3.7L 225ci	B	w/o Cruise Control; 100.00" Cable	CA-3052
1976-79	L6 3.7L 225ci	B	w/o Cruise Control; 100.00" Cable	CA-3052
1980	L6 3.7L 225ci	N	w/o Cruise Control; 100.00" Cable	CA-3052
1971-73	V8 5.2L 318ci	E	w/o Cruise Control; 100.00" Cable	CA-3052
1979-80	V8 5.2L 318ci	E,P	w/o Cruise Control; 100.00" Cable	CA-3052
1971-73	V8 5.9L 360ci	F	w/o Cruise Control; 100.00" Cable	CA-3052
1979-80	V8 5.9L 360ci	F,S,T	w/o Cruise Control; 100.00" Cable	CA-3052
1971	V8 6.6L 400ci	J	w/o Cruise Control; 100.00" Cable	CA-3052
1978	V8 6.6L 400ci	J	w/o Cruise Control; 100.00" Cable	CA-3052
<b>B250</b>				
1986	L6 3.7L 225ci	H	w/o Cruise Upper; 41.00" Cable	CA-3035
1984-85	L6 3.7L 225ci	H	w/Cruise Upper; 41.00" Cable	CA-3035
1984-85	L6 3.7L 225ci	H	w/o Cruise Control	CA-3056
1993-94	V6 3.9L 239ci	X	w/Cruise Lower	CA-3057
1993-94	V6 3.9L 239ci	X	w/Cruise Upper	CA-3025
1986	V8 5.2L 318ci	T	w/o Cruise Upper; 41.00" Cable	CA-3035
1983-84	V8 5.2L 318ci	T	w/Cruise Lower	CA-3057
1983-84	V8 5.2L 318ci	T	w/Cruise Upper	CA-3025
1984-85	V8 5.2L 318ci	T	w/Cruise Upper; 41.00" Cable	CA-3035
1984-85	V8 5.2L 318ci	T	w/o Cruise Control	CA-3056
1986	V8 5.9L 360ci	W	w/o Cruise Upper; 41.00" Cable	CA-3035
1984-85	V8 5.9L 360ci	W	w/Cruise Upper; 41.00" Cable	CA-3035
1984-85	V8 5.9L 360ci	W	w/o Cruise Control	CA-3056
<b>B300</b>				
1971-73	L6 3.7L 225ci	B	w/o Cruise Control; 100.00" Cable	CA-3052
1975-79	L6 3.7L 225ci	B	w/o Cruise Control; 100.00" Cable	CA-3052
1979-80	L6 3.7L 225ci	N	w/o Cruise Control; 100.00" Cable	CA-3052
1971-73	V8 5.2L 318ci	E	w/o Cruise Control; 100.00" Cable	CA-3052
1979-80	V8 5.2L 318ci	E,P	w/o Cruise Control; 100.00" Cable	CA-3052
1971-73	V8 5.9L 360ci	F	w/o Cruise Control; 100.00" Cable	CA-3052
1979-80	V8 5.9L 360ci	F,T	w/o Cruise Control; 100.00" Cable	CA-3052
<b>B350</b>				
1984	V8 5.2L 318ci	T	w/Cruise Lower	CA-3057
1984	V8 5.2L 318ci	T	w/Cruise Upper	CA-3025
1986-87	V8 5.2L 318ci	T	w/o Cruise Upper; 41.00" Cable	CA-3035
1989	V8 5.2L 318ci	Y	w/Cruise Lower	CA-3057
1989	V8 5.2L 318ci	Y	w/Cruise Upper	CA-3025
1985	V8 5.9L 360ci	1	w/Cruise Lower	CA-3057
1985	V8 5.9L 360ci	1	w/Cruise Upper	CA-3025
1986-87	V8 5.9L 360ci	1,W	w/o Cruise Upper; 41.00" Cable	CA-3035
1983	V8 5.9L 360ci	W	w/Cruise Lower	CA-3057
1983	V8 5.9L 360ci	W	w/Cruise Upper	CA-3025
1989	V8 5.9L 360ci	Z	w/Cruise Lower	CA-3057
1989	V8 5.9L 360ci	Z	w/Cruise Upper	CA-3025

# SPEEDOMETER CABLES

Year	Engine	Vin	Remark	Part
<b>DODGE TRUCKS (con't)</b>				
<b>CARAVAN</b>				
1984	L4 2.2L 135ci	C	w/Cruise Lower Electronic	CA-3028
1984	L4 2.2L 135ci	C	w/Cruise Lower Non Electronic	CA-3034
1984	L4 2.2L 135ci	C	w/Cruise Upper Electronic; 76.00" Cable	CA-3011
1984	L4 2.2L 135ci	C	w/Cruise Upper Non Electronic	CA-3029
1985	L4 2.2L 135ci	C	4 Spd. MT w/o Cruise Lower	CA-3036
1985	L4 2.2L 135ci	C	AT w/Cruise Control, Lower	CA-3034
1985	L4 2.2L 135ci	C	MT w/Cruise	CA-3051
1985	L4 2.2L 135ci	C	w/o Cruise Upper	CA-3029
1986	L4 2.2L 135ci	C	AT 1 pc. Speedo to Trans.	CA-3022
1986	L4 2.2L 135ci	C	w/Cruise Upper, w/o Cruise MT	CA-3051
1989-90	L4 2.5L 153ci	J	w/o Cruise Speedometer to Trans.	CA-3029
1988-95	L4 2.5L 153ci	K	w/o Cruise Speedometer to Trans.	CA-3029
1984	L4 2.6L 156ci	G	w/Cruise Lower Electronic	CA-3028
1984	L4 2.6L 156ci	G	w/Cruise Lower Non Electronic	CA-3034
1984	L4 2.6L 156ci	G	w/Cruise Upper Electronic; 76.00" Cable	CA-3011
1984	L4 2.6L 156ci	G	w/Cruise Upper Non Electronic	CA-3029
1985	L4 2.6L 156ci	G	4 Spd. MT w/o Cruise Lower	CA-3036
1985	L4 2.6L 156ci	G	MT w/Cruise Lower	CA-3034
1985	L4 2.6L 156ci	G	w/Cruise Upper	CA-3029
1986	L4 2.6L 156ci	G	w/Cruise Upper, w/o Cruise MT	CA-3051
1986-87	L4 2.6L 156ci	G	AT 1 pc. Speedo to Trans.	CA-3022
1989-99	V6 3.0L 181ci	3	w/o Cruise Speedometer to Trans.	CA-3029
1998-99	V6 3.3L 201ci	G	w/o Cruise Speedometer to Trans.	CA-3029
1995	V6 3.3L 201ci	J	w/o Cruise Speedometer to Trans.	CA-3029
1991-98	V6 3.3L 201ci	R	w/o Cruise Speedometer to Trans.	CA-3029
<b>D100</b>				
1970-71	L6 3.2L 198ci	A	83.00" Cable	CA-3004
1968-70	L6 3.7L 225ci	6	83.00" Cable	CA-3004
1978	L6 3.7L 225ci	B	MT w/o Cruise w/o Tripmeter; 80.00" Cable	CA-3014
1972-73	L6 3.7L 225ci	B	AT w/o Cruise Control; 80.00" Cable	CA-3027
1972-73	L6 3.7L 225ci	B	MT w/o Cruise; 80.00" Cable	CA-3014
1972-73	L6 3.7L 225ci	B	MT w/o Cruise Control; 100.00" Cable	CA-3052
1972-73	L6 3.7L 225ci	B	w/Cruise Lower; 63.00" Cable	CA-3002
1974-77	L6 3.7L 225ci	B	w/EGR w/o Cruise switch to Trans.; 80.00" Cable	CA-3027
1974-77	L6 3.7L 225ci	B	w/o EGR w/o Cruise 62" Cable; 80.00" Cable	CA-3014
1974-77	L6 3.7L 225ci	B	w/o EGR w/o Cruise 95" Cable; 100.00" Cable	CA-3052
1979	L6 3.7L 225ci	B,N	w/o EGR w/o Cruise w/o Trip 60" Cable; 80.00" Cable	CA-3014
1979	L6 3.7L 225ci	B,N	w/o EGR w/o Cruise w/o Trip 91" Cable; 100.00" Cable	CA-3052
1978-79	L6 3.7L 225ci	B,N	AT Speedo to Trans.; 80.00" Cable	CA-3027
1970-71	L6 3.7L 225ci	B,X	83.00" Cable	CA-3004
1978	L6 4.0L 243ci	H	MT w/o Cruise w/o Tripmeter; 80.00" Cable	CA-3014
1979	L6 4.0L 243ci	H	w/o EGR w/o Cruise w/o Trip 60" Cable; 80.00" Cable	CA-3014
1979	L6 4.0L 243ci	H	w/o EGR w/o Cruise w/o Trip 91" Cable; 100.00" Cable	CA-3052
1978-79	L6 4.0L 243ci	H	AT Speedo to Trans.; 80.00" Cable	CA-3027
1968-69	V8 5.2L 318ci	8	83.00" Cable	CA-3004
1978	V8 5.2L 318ci	E	MT w/o Cruise w/o Tripmeter; 80.00" Cable	CA-3014
1970-71	V8 5.2L 318ci	E	83.00" Cable	CA-3004
1972-73	V8 5.2L 318ci	E	AT w/o Cruise Control; 80.00" Cable	CA-3027
1972-73	V8 5.2L 318ci	E	MT w/o Cruise; 80.00" Cable	CA-3014
1972-73	V8 5.2L 318ci	E	MT w/o Cruise Control; 100.00" Cable	CA-3052
1972-73	V8 5.2L 318ci	E	w/Cruise Lower; 63.00" Cable	CA-3002
1974-77	V8 5.2L 318ci	E	w/EGR w/o Cruise switch to Trans.; 80.00" Cable	CA-3027
1974-77	V8 5.2L 318ci	E	w/o EGR w/o Cruise 62" Cable; 80.00" Cable	CA-3014
1974-77	V8 5.2L 318ci	E	w/o EGR w/o Cruise 95" Cable; 100.00" Cable	CA-3052
1979	V8 5.2L 318ci	E,P	w/o EGR w/o Cruise w/o Trip 60" Cable; 80.00" Cable	CA-3014
1979	V8 5.2L 318ci	E,P	w/o EGR w/o Cruise w/o Trip 91" Cable; 100.00" Cable	CA-3052
1978-79	V8 5.2L 318ci	E,P	AT Speedo to Trans.; 80.00" Cable	CA-3027
1978	V8 5.9L 360ci	F	AT Speedo to Trans.; 80.00" Cable	CA-3027
1978	V8 5.9L 360ci	F	MT w/o Cruise w/o Tripmeter; 80.00" Cable	CA-3014
1972-73	V8 5.9L 360ci	F	AT w/o Cruise Control; 80.00" Cable	CA-3027
1972-73	V8 5.9L 360ci	F	MT w/o Cruise; 80.00" Cable	CA-3014
1972-73	V8 5.9L 360ci	F	MT w/o Cruise Control; 100.00" Cable	CA-3052



# SPEEDOMETER CABLES

Year	Engine	Vin	Remark	Part
<b>DODGE TRUCKS (con't)</b>				
<b>D100 (con't)</b>				
1972-73	V8 5.9L 360ci	F	w/Cruise Lower; 63.00" Cable	CA-3002
1974-77	V8 5.9L 360ci	F,T	w/EGR w/o Cruise switch to Trans.; 80.00" Cable	CA-3027
1974-77	V8 5.9L 360ci	F,T	w/o EGR w/o Cruise 62" Cable; 80.00" Cable	CA-3014
1974-77	V8 5.9L 360ci	F,T	w/o EGR w/o Cruise 95" Cable; 100.00" Cable	CA-3052
1971	V8 5.9L 360ci	F,Y	83.00" Cable	CA-3004
1968-69	V8 6.3L 383ci	8	83.00" Cable	CA-3004
1970-71	V8 6.3L 383ci	J	83.00" Cable	CA-3004
1971	V8 6.6L 400ci	J	83.00" Cable	CA-3004
1974	V8 6.6L 400ci	J	w/EGR w/o Cruise switch to Trans.; 80.00" Cable	CA-3027
1974	V8 6.6L 400ci	J	w/o EGR w/o Cruise 62" Cable; 80.00" Cable	CA-3014
1974	V8 6.6L 400ci	J	w/o EGR w/o Cruise 95" Cable; 100.00" Cable	CA-3052
1978	V8 6.6L 400ci	J	AT Speedo to Trans.; 80.00" Cable	CA-3027
1978	V8 6.6L 400ci	J	MT w/o Cruise w/o Tripmeter; 80.00" Cable	CA-3014
1972-73	V8 6.6L 400ci	J	AT w/o Cruise Control; 80.00" Cable	CA-3027
1972-73	V8 6.6L 400ci	J	MT w/o Cruise; 80.00" Cable	CA-3014
1972-73	V8 6.6L 400ci	J	MT w/o Cruise Control; 100.00" Cable	CA-3052
1972-73	V8 6.6L 400ci	J	w/Cruise Lower; 63.00" Cable	CA-3002
1976-77	V8 6.6L 400ci	J	w/EGR w/o Cruise switch to Trans.; 80.00" Cable	CA-3027
1976-77	V8 6.6L 400ci	J	w/o EGR w/o Cruise 62" Cable; 80.00" Cable	CA-3014
1976-77	V8 6.6L 400ci	J	w/o EGR w/o Cruise 95" Cable; 100.00" Cable	CA-3052
1973	V8 7.2L 440ci	D	AT w/o Cruise Control; 80.00" Cable	CA-3027
1973	V8 7.2L 440ci	D	MT w/o Cruise; 80.00" Cable	CA-3014
1973	V8 7.2L 440ci	D	MT w/o Cruise Control; 100.00" Cable	CA-3052
1973	V8 7.2L 440ci	D	w/Cruise Lower; 63.00" Cable	CA-3002
1978	V8 7.2L 440ci	D	AT Speedo to Trans.; 80.00" Cable	CA-3027
1978	V8 7.2L 440ci	D	MT w/o Cruise w/o Tripmeter; 80.00" Cable	CA-3014
1974-77	V8 7.2L 440ci	D	w/EGR w/o Cruise switch to Trans.; 80.00" Cable	CA-3027
1974-77	V8 7.2L 440ci	D	w/o EGR w/o Cruise 62" Cable; 80.00" Cable	CA-3014
1974-77	V8 7.2L 440ci	D	w/o EGR w/o Cruise 95" Cable; 100.00" Cable	CA-3052
<b>D100 SERIES</b>				
1961	L6 2.8L 170ci		U.S., w/Loadflite Trans.	CA-3016
1961	L6 2.8L 170ci		U.S., w/MT; 83.00" Cable	CA-3004
1962-65	L6 2.8L 170ci		83.00" Cable	CA-3004
1960	L6 3.7L 225ci		Canada; 83.00" Cable	CA-3004
1961	L6 3.7L 225ci		U.S., w/MT; 83.00" Cable	CA-3004
1960-61	L6 3.7L 225ci		U.S., w/Loadflite Trans.	CA-3016
1962-67	L6 3.7L 225ci		83.00" Cable	CA-3004
1960	V8 5.2L 318ci		Canada; 83.00" Cable	CA-3004
1961	V8 5.2L 318ci		U.S., w/MT; 83.00" Cable	CA-3004
1960-61	V8 5.2L 318ci		U.S., w/Loadflite Trans.	CA-3016
1962-67	V8 5.2L 318ci		83.00" Cable	CA-3004
1963-67	V8 6.3L 383ci		83.00" Cable	CA-3004
<b>D150</b>				
1978	L6 3.7L 225ci	B,E	MT w/o Cruise w/o Tripmeter; 80.00" Cable	CA-3014
1978-79	L6 3.7L 225ci	B,E	AT Speedo to Trans.; 80.00" Cable	CA-3027
1979	L6 3.7L 225ci	B,N	w/o EGR w/o Cruise w/o Trip 60" Cable; 80.00" Cable	CA-3014
1979	L6 3.7L 225ci	B,N	w/o EGR w/o Cruise w/o Trip 91" Cable; 100.00" Cable	CA-3052
1982	L6 3.7L 225ci	E,W	w/o Cruise Speedo to Trans.	CA-3023
1986-87	L6 3.7L 225ci	H	w/Cruise Servo to Sensor	CA-3040
1986-87	L6 3.7L 225ci	H	w/o Cruise Speedo to Trans.; 80.00" Cable	CA-3027
1983-85	L6 3.7L 225ci	H,M	w/o Cruise Speedo to Trans.	CA-3023
1980	L6 3.7L 225ci	N	MT w/o Cruise 1 pc.; 80.00" Cable	CA-3014
1980	L6 3.7L 225ci	N	w/91" Cable	CA-3048
1979-80	L6 3.7L 225ci	N	AT Speedo to Trans.; 80.00" Cable	CA-3027
1978	L6 4.0L 243ci	H	MT w/o Cruise w/o Tripmeter; 80.00" Cable	CA-3014
1979	L6 4.0L 243ci	H	w/o EGR w/o Cruise w/o Trip 60" Cable; 80.00" Cable	CA-3014
1979	L6 4.0L 243ci	H	w/o EGR w/o Cruise w/o Trip 91" Cable; 100.00" Cable	CA-3052
1980	L6 4.0L 243ci	H	MT w/o Cruise 1 pc.; 80.00" Cable	CA-3014
1980	L6 4.0L 243ci	H	w/91" Cable	CA-3048
1978-80	L6 4.0L 243ci	H	AT Speedo to Trans.; 80.00" Cable	CA-3027
1990	V6 3.9L 239ci	X	2WD, Speedo to sensor; 80.00" Cable	CA-3014
1990	V6 3.9L 239ci	X	w/Cruise Upper	CA-3025

# SPEEDOMETER CABLES

Year	Engine	Vin	Remark	Part
<b>DODGE TRUCKS (con't)</b>				
<b>D150 (con't)</b>				
1990	V6 3.9L 239ci	X	w/o Cruise Control; 80.00" Cable	CA-3027
1978	V8 5.2L 318ci	E	MT w/o Cruise w/o Tripmeter; 80.00" Cable	CA-3014
1980	V8 5.2L 318ci	E	2WD, Speedo to sensor; 80.00" Cable	CA-3014
1980	V8 5.2L 318ci	E	w/Cruise Upper	CA-3025
1980	V8 5.2L 318ci	E	w/o Cruise Control; 80.00" Cable	CA-3027
1979	V8 5.2L 318ci	E,P	w/o EGR w/o Cruise w/o Trip 60" Cable; 80.00" Cable	CA-3014
1979	V8 5.2L 318ci	E,P	w/o EGR w/o Cruise w/o Trip 91" Cable; 100.00" Cable	CA-3052
1980	V8 5.2L 318ci	E,P	MT w/o Cruise 1 pc.; 80.00" Cable	CA-3014
1980	V8 5.2L 318ci	E,P	w/91" Cable	CA-3048
1978-80	V8 5.2L 318ci	E,P	AT Speedo to Trans.; 80.00" Cable	CA-3027
1982	V8 5.2L 318ci	P,R	w/o Cruise Speedo to Trans.	CA-3023
1986-87	V8 5.2L 318ci	T	w/Cruise Servo to Sensor	CA-3040
1986-87	V8 5.2L 318ci	T	w/o Cruise Speedo to Trans.; 80.00" Cable	CA-3027
1983-85	V8 5.2L 318ci	T,U	w/o Cruise Speedo to Trans.	CA-3023
1986-87	V8 5.9L 360ci	1,W	w/Cruise Servo to Sensor	CA-3040
1986-87	V8 5.9L 360ci	1,W	w/o Cruise Speedo to Trans.; 80.00" Cable	CA-3027
1978	V8 5.9L 360ci	F	MT w/o Cruise w/o Tripmeter; 80.00" Cable	CA-3014
1979	V8 5.9L 360ci	F,S,T	w/o EGR w/o Cruise w/o Trip 60" Cable; 80.00" Cable	CA-3014
1979	V8 5.9L 360ci	F,S,T	w/o EGR w/o Cruise w/o Trip 91" Cable; 100.00" Cable	CA-3052
1978-79	V8 5.9L 360ci	F,S,T	AT Speedo to Trans.; 80.00" Cable	CA-3027
1980	V8 5.9L 360ci	T	MT w/o Cruise 1 pc.; 80.00" Cable	CA-3014
1980	V8 5.9L 360ci	T	w/91" Cable	CA-3048
1982	V8 5.9L 360ci	T	w/o Cruise Speedo to Trans.	CA-3023
1984-85	V8 5.9L 360ci	W	w/o Cruise Speedo to Trans.	CA-3023
1978	V8 6.6L 400ci	J	AT Speedo to Trans.; 80.00" Cable	CA-3027
1978	V8 6.6L 400ci	J	MT w/o Cruise w/o Tripmeter; 80.00" Cable	CA-3014
1978	V8 7.2L 440ci	D	AT Speedo to Trans.; 80.00" Cable	CA-3027
1978	V8 7.2L 440ci	D	MT w/o Cruise w/o Tripmeter; 80.00" Cable	CA-3014
<b>D200</b>				
1968-70	L6 3.7L 225ci	6	83.00" Cable	CA-3004
1978	L6 3.7L 225ci	B	MT w/o Cruise w/o Tripmeter; 80.00" Cable	CA-3014
1970-71	L6 3.7L 225ci	B	83.00" Cable	CA-3004
1972-73	L6 3.7L 225ci	B	AT w/o Cruise Control; 80.00" Cable	CA-3027
1972-73	L6 3.7L 225ci	B	MT w/o Cruise; 80.00" Cable	CA-3014
1972-73	L6 3.7L 225ci	B	MT w/o Cruise Control; 100.00" Cable	CA-3052
1972-73	L6 3.7L 225ci	B	w/Cruise Lower; 63.00" Cable	CA-3002
1974-77	L6 3.7L 225ci	B	w/EGR w/o Cruise switch to Trans.; 80.00" Cable	CA-3027
1974-77	L6 3.7L 225ci	B	w/o EGR w/o Cruise 62" Cable; 80.00" Cable	CA-3014
1974-77	L6 3.7L 225ci	B	w/o EGR w/o Cruise 95" Cable; 100.00" Cable	CA-3052
1978-79	L6 3.7L 225ci	B	AT Speedo to Trans.; 80.00" Cable	CA-3027
1979	L6 3.7L 225ci	B,N	w/o EGR w/o Cruise w/o Trip 60" Cable; 80.00" Cable	CA-3014
1979	L6 3.7L 225ci	B,N	w/o EGR w/o Cruise w/o Trip 91" Cable; 100.00" Cable	CA-3052
1980	L6 3.7L 225ci	N	MT w/o Cruise 1 pc.; 80.00" Cable	CA-3014
1980	L6 3.7L 225ci	N	w/91" Cable	CA-3048
1979-80	L6 3.7L 225ci	N	AT Speedo to Trans.; 80.00" Cable	CA-3027
1978	L6 4.0L 243ci	H	MT w/o Cruise w/o Tripmeter; 80.00" Cable	CA-3014
1980	L6 4.0L 243ci	H	MT w/o Cruise 1 pc.; 80.00" Cable	CA-3014
1980	L6 4.0L 243ci	H	w/91" Cable	CA-3048
1978-80	L6 4.0L 243ci	H	AT Speedo to Trans.; 80.00" Cable	CA-3027
1968-69	V8 5.2L 318ci	8	83.00" Cable	CA-3004
1978	V8 5.2L 318ci	E	MT w/o Cruise w/o Tripmeter; 80.00" Cable	CA-3014
1970-71	V8 5.2L 318ci	E	83.00" Cable	CA-3004
1972-73	V8 5.2L 318ci	E	AT w/o Cruise Control; 80.00" Cable	CA-3027
1972-73	V8 5.2L 318ci	E	MT w/o Cruise; 80.00" Cable	CA-3014
1972-73	V8 5.2L 318ci	E	MT w/o Cruise Control; 100.00" Cable	CA-3052
1972-73	V8 5.2L 318ci	E	w/Cruise Lower; 63.00" Cable	CA-3002
1974-77	V8 5.2L 318ci	E	w/EGR w/o Cruise switch to Trans.; 80.00" Cable	CA-3027
1974-77	V8 5.2L 318ci	E	w/o EGR w/o Cruise 62" Cable; 80.00" Cable	CA-3014
1974-77	V8 5.2L 318ci	E	w/o EGR w/o Cruise 95" Cable; 100.00" Cable	CA-3052
1979	V8 5.2L 318ci	E,P	w/o EGR w/o Cruise w/o Trip 60" Cable; 80.00" Cable	CA-3014
1979	V8 5.2L 318ci	E,P	w/o EGR w/o Cruise w/o Trip 91" Cable; 100.00" Cable	CA-3052
1980	V8 5.2L 318ci	E,P	MT w/o Cruise 1 pc.; 80.00" Cable	CA-3014

# SPEEDOMETER CABLES

Year	Engine	Vin	Remark	Part
<b>DODGE TRUCKS (con't)</b>				
<b>D200 (con't)</b>				
1980	V8 5.2L 318ci	E,P	w/91" Cable	CA-3048
1978-80	V8 5.2L 318ci	E,P	AT Speedo to Trans.; 80.00" Cable	CA-3027
1978	V8 5.9L 360ci	F	MT w/o Cruise w/o Tripmeter; 80.00" Cable	CA-3014
1972-73	V8 5.9L 360ci	F	AT w/o Cruise Control; 80.00" Cable	CA-3027
1972-73	V8 5.9L 360ci	F	MT w/o Cruise; 80.00" Cable	CA-3014
1972-73	V8 5.9L 360ci	F	MT w/o Cruise Control; 100.00" Cable	CA-3052
1972-73	V8 5.9L 360ci	F	w/Cruise Lower; 63.00" Cable	CA-3002
1974-77	V8 5.9L 360ci	F	w/EGR w/o Cruise switch to Trans.; 80.00" Cable	CA-3027
1974-77	V8 5.9L 360ci	F	w/o EGR w/o Cruise 62" Cable; 80.00" Cable	CA-3014
1974-77	V8 5.9L 360ci	F	w/o EGR w/o Cruise 95" Cable; 100.00" Cable	CA-3052
1978-79	V8 5.9L 360ci	F	AT Speedo to Trans.; 80.00" Cable	CA-3027
1979	V8 5.9L 360ci	F,T	w/o EGR w/o Cruise w/o Trip 60" Cable; 80.00" Cable	CA-3014
1979	V8 5.9L 360ci	F,T	w/o EGR w/o Cruise w/o Trip 91" Cable; 100.00" Cable	CA-3052
1971	V8 5.9L 360ci	F,Y	83.00" Cable	CA-3004
1980	V8 5.9L 360ci	T	MT w/o Cruise 1 pc.; 80.00" Cable	CA-3014
1980	V8 5.9L 360ci	T	w/91" Cable	CA-3048
1979-80	V8 5.9L 360ci	T	AT Speedo to Trans.; 80.00" Cable	CA-3027
1968-69	V8 6.3L 383ci	8	83.00" Cable	CA-3004
1970	V8 6.3L 383ci	J	83.00" Cable	CA-3004
1971	V8 6.6L 400ci	J	83.00" Cable	CA-3004
1978	V8 6.6L 400ci	J	AT Speedo to Trans.; 80.00" Cable	CA-3027
1978	V8 6.6L 400ci	J	MT w/o Cruise w/o Tripmeter; 80.00" Cable	CA-3014
1972-73	V8 6.6L 400ci	J	AT w/o Cruise Control; 80.00" Cable	CA-3027
1972-73	V8 6.6L 400ci	J	MT w/o Cruise; 80.00" Cable	CA-3014
1972-73	V8 6.6L 400ci	J	MT w/o Cruise Control; 100.00" Cable	CA-3052
1972-73	V8 6.6L 400ci	J	w/Cruise Lower; 63.00" Cable	CA-3002
1974-77	V8 6.6L 400ci	J	w/EGR w/o Cruise switch to Trans.; 80.00" Cable	CA-3027
1974-77	V8 6.6L 400ci	J	w/o EGR w/o Cruise 62" Cable; 80.00" Cable	CA-3014
1974-77	V8 6.6L 400ci	J	w/o EGR w/o Cruise 95" Cable; 100.00" Cable	CA-3052
1973	V8 7.2L 440ci	D	AT w/o Cruise Control; 80.00" Cable	CA-3027
1973	V8 7.2L 440ci	D	MT w/o Cruise; 80.00" Cable	CA-3014
1973	V8 7.2L 440ci	D	MT w/o Cruise Control; 100.00" Cable	CA-3052
1973	V8 7.2L 440ci	D	w/Cruise Lower; 63.00" Cable	CA-3002
1978	V8 7.2L 440ci	D	AT Speedo to Trans.; 80.00" Cable	CA-3027
1978	V8 7.2L 440ci	D	MT w/o Cruise w/o Tripmeter; 80.00" Cable	CA-3014
1974-77	V8 7.2L 440ci	D	w/EGR w/o Cruise switch to Trans.; 80.00" Cable	CA-3027
1974-77	V8 7.2L 440ci	D	w/o EGR w/o Cruise 62" Cable; 80.00" Cable	CA-3014
1974-77	V8 7.2L 440ci	D	w/o EGR w/o Cruise 95" Cable; 100.00" Cable	CA-3052
<b>D200 SERIES</b>				
1960	L6 3.7L 225ci		Canada; 83.00" Cable	CA-3004
1961	L6 3.7L 225ci		U.S., w/MT; 83.00" Cable	CA-3004
1960-61	L6 3.7L 225ci		U.S., w/Loadflite Trans.	CA-3016
1962-67	L6 3.7L 225ci		83.00" Cable	CA-3004
1960	V8 5.2L 318ci		Canada; 83.00" Cable	CA-3004
1961	V8 5.2L 318ci		U.S., w/MT; 83.00" Cable	CA-3004
1960-61	V8 5.2L 318ci		U.S., w/Loadflite Trans.	CA-3016
1962-67	V8 5.2L 318ci		83.00" Cable	CA-3004
1963-67	V8 6.3L 383ci		83.00" Cable	CA-3004
<b>D250</b>				
1982	L6 3.7L 225ci	E	w/o Cruise Speedo to Trans.	CA-3023
1983-85	L6 3.7L 225ci	H	w/o Cruise Speedo to Trans.	CA-3023
1986-87	L6 3.7L 225ci	H	w/Cruise Servo to Sensor	CA-3040
1986-87	L6 3.7L 225ci	H	w/o Cruise Speedo to Trans.; 80.00" Cable	CA-3027
1989-90	L6 5.9L 359ci	8	2WD, Speedo to sensor; 80.00" Cable	CA-3014
1989-90	L6 5.9L 359ci	8	w/Cruise Upper	CA-3025
1989-90	L6 5.9L 359ci	8	w/o Cruise Control; 80.00" Cable	CA-3027
1993	L6 5.9L 359ci	C	2WD, Speedo to sensor; 80.00" Cable	CA-3014
1993	L6 5.9L 359ci	C	w/Cruise Upper	CA-3025
1993	L6 5.9L 359ci	C	w/o Cruise Control; 80.00" Cable	CA-3027
1992-93	V6 3.9L 239ci	X	2WD, Speedo to sensor; 80.00" Cable	CA-3014
1992-93	V6 3.9L 239ci	X	w/Cruise Upper	CA-3025
1992-93	V6 3.9L 239ci	X	w/o Cruise Control; 80.00" Cable	CA-3027

# SPEEDOMETER CABLES

Year	Engine	Vin	Remark	Part
<b>DODGE TRUCKS (con't)</b>				
<b>D250 (con't)</b>				
1982	V8 5.2L 318ci	P,R	w/o Cruise Speedo to Trans.	CA-3023
1986-87	V8 5.2L 318ci	T	w/Cruise Servo to Sensor	CA-3040
1986-87	V8 5.2L 318ci	T	w/o Cruise Speedo to Trans.; 80.00" Cable	CA-3027
1983-85	V8 5.2L 318ci	T,U	w/o Cruise Speedo to Trans.	CA-3023
1991-93	V8 5.2L 318ci	Y	2WD, Speedo to sensor; 80.00" Cable	CA-3014
1991-93	V8 5.2L 318ci	Y	w/Cruise Upper	CA-3025
1991-93	V8 5.2L 318ci	Y	w/o Cruise Control; 80.00" Cable	CA-3027
1986-87	V8 5.9L 360ci	1,5,W	w/Cruise Servo to Sensor	CA-3040
1986-87	V8 5.9L 360ci	1,5,W	w/o Cruise Speedo to Trans.; 80.00" Cable	CA-3027
1987-93	V8 5.9L 360ci	5,W	2WD, Speedo to sensor; 80.00" Cable	CA-3014
1987-93	V8 5.9L 360ci	5,Z	w/Cruise Upper	CA-3025
1987-93	V8 5.9L 360ci	5,Z	w/o Cruise Control; 80.00" Cable	CA-3027
1982	V8 5.9L 360ci	U	2WD, Speedo to sensor; 80.00" Cable	CA-3014
1982	V8 5.9L 360ci	U	w/Cruise Upper	CA-3025
1982	V8 5.9L 360ci	U	w/o Cruise Control; 80.00" Cable	CA-3027
1982	V8 5.9L 360ci	U	w/o Cruise Speedo to Trans.	CA-3023
1984-85	V8 5.9L 360ci	W	w/o Cruise Speedo to Trans.	CA-3023
1984-88	V8 5.9L 360ci	W	2WD, Speedo to sensor; 80.00" Cable	CA-3014
1984-88	V8 5.9L 360ci	W	w/Cruise Upper	CA-3025
1984-88	V8 5.9L 360ci	W	w/o Cruise Control; 80.00" Cable	CA-3027
<b>D300</b>				
1968	L6 3.7L 225ci	6	MT w/o Cruise Control; 100.00" Cable	CA-3052
1968	L6 3.7L 225ci	6	w/Cruise Lower; 63.00" Cable	CA-3002
1968-70	L6 3.7L 225ci	6	83.00" Cable	CA-3004
1970	L6 3.7L 225ci	B	AT Speedo to Trans.; 80.00" Cable	CA-3027
1970	L6 3.7L 225ci	B	MT w/o Cruise w/o Tripmeter; 80.00" Cable	CA-3014
1978	L6 3.7L 225ci	B	AT Speedo to Trans.; 80.00" Cable	CA-3027
1978	L6 3.7L 225ci	B	MT w/o Cruise w/o Tripmeter; 80.00" Cable	CA-3014
1970-71	L6 3.7L 225ci	B	83.00" Cable	CA-3004
1972-74	L6 3.7L 225ci	B	AT w/o Cruise Control; 80.00" Cable	CA-3027
1972-74	L6 3.7L 225ci	B	MT w/o Cruise; 80.00" Cable	CA-3014
1972-74	L6 3.7L 225ci	B	MT w/o Cruise Control; 100.00" Cable	CA-3052
1972-74	L6 3.7L 225ci	B	w/Cruise Lower; 63.00" Cable	CA-3002
1974-77	L6 3.7L 225ci	B,C	w/EGR w/o Cruise switch to Trans.; 80.00" Cable	CA-3027
1974-77	L6 3.7L 225ci	B,C	w/o EGR w/o Cruise 62" Cable; 80.00" Cable	CA-3014
1975-77	L6 3.7L 225ci	B,C	w/o EGR w/o Cruise 95" Cable; 100.00" Cable	CA-3052
1968-69	V8 5.2L 318ci	8	AT Speedo to Trans.; 80.00" Cable	CA-3027
1968-69	V8 5.2L 318ci	8	MT w/o Cruise 1 pc.; 80.00" Cable	CA-3014
1968-69	V8 5.2L 318ci	8	w/91" Cable	CA-3048
1968-69	V8 5.2L 318ci	8	83.00" Cable	CA-3004
1970	V8 5.2L 318ci	E	w/o EGR w/o Cruise w/o Trip 60" Cable; 80.00" Cable	CA-3014
1970	V8 5.2L 318ci	E	w/o EGR w/o Cruise w/o Trip 91" Cable; 100.00" Cable	CA-3052
1971	V8 5.2L 318ci	E	MT w/o Cruise w/o Tripmeter; 80.00" Cable	CA-3014
1978	V8 5.2L 318ci	E	MT w/o Cruise w/o Tripmeter; 80.00" Cable	CA-3014
1970-71	V8 5.2L 318ci	E	AT Speedo to Trans.; 80.00" Cable	CA-3027
1970-71	V8 5.2L 318ci	E	83.00" Cable	CA-3004
1972-73	V8 5.2L 318ci	E	AT w/o Cruise Control; 80.00" Cable	CA-3027
1972-73	V8 5.2L 318ci	E	MT w/o Cruise; 80.00" Cable	CA-3014
1972-73	V8 5.2L 318ci	E	MT w/o Cruise Control; 100.00" Cable	CA-3052
1972-73	V8 5.2L 318ci	E	w/Cruise Lower; 63.00" Cable	CA-3002
1974-77	V8 5.2L 318ci	E	w/EGR w/o Cruise switch to Trans.; 80.00" Cable	CA-3027
1974-77	V8 5.2L 318ci	E	w/o EGR w/o Cruise 62" Cable; 80.00" Cable	CA-3014
1974-77	V8 5.2L 318ci	E	w/o EGR w/o Cruise 95" Cable; 100.00" Cable	CA-3052
1976-77	V8 5.2L 318ci	E	AT w/o Cruise Control; 80.00" Cable	CA-3027
1976-77	V8 5.2L 318ci	E	MT w/o Cruise; 80.00" Cable	CA-3014
1976-77	V8 5.2L 318ci	E	MT w/o Cruise Control; 100.00" Cable	CA-3052
1976-77	V8 5.2L 318ci	E	w/Cruise Lower; 63.00" Cable	CA-3002
1980	V8 5.2L 318ci	E,P	MT w/o Cruise 1 pc.; 80.00" Cable	CA-3014
1980	V8 5.2L 318ci	E,P	w/91" Cable	CA-3048
1978-80	V8 5.2L 318ci	E,P	AT Speedo to Trans.; 80.00" Cable	CA-3027
1973	V8 5.9L 360ci	F	w/o EGR w/o Cruise w/o Trip 60" Cable; 80.00" Cable	CA-3014
1973	V8 5.9L 360ci	F	w/o EGR w/o Cruise w/o Trip 91" Cable; 100.00" Cable	CA-3052

# SPEEDOMETER CABLES

Year	Engine	Vin	Remark	Part
<b>DODGE TRUCKS (con't)</b>				
<b>D300 (con't)</b>				
1975	V8 5.9L 360ci	F	w/o EGR w/o Cruise w/o Trip 60" Cable; 80.00" Cable	CA-3014
1975	V8 5.9L 360ci	F	w/o EGR w/o Cruise w/o Trip 91" Cable; 100.00" Cable	CA-3052
1972-73	V8 5.9L 360ci	F	AT w/o Cruise Control; 80.00" Cable	CA-3027
1972-73	V8 5.9L 360ci	F	MT w/o Cruise; 80.00" Cable	CA-3014
1972-73	V8 5.9L 360ci	F	MT w/o Cruise Control; 100.00" Cable	CA-3052
1972-73	V8 5.9L 360ci	F	w/Cruise Lower; 63.00" Cable	CA-3002
1972-74	V8 5.9L 360ci	F	MT w/o Cruise 1 pc.; 80.00" Cable	CA-3014
1972-74	V8 5.9L 360ci	F	w/91" Cable	CA-3048
1972-78	V8 5.9L 360ci	F	AT Speedo to Trans.; 80.00" Cable	CA-3027
1974-77	V8 5.9L 360ci	F	w/EGR w/o Cruise switch to Trans.; 80.00" Cable	CA-3027
1974-77	V8 5.9L 360ci	F	w/o EGR w/o Cruise 62" Cable; 80.00" Cable	CA-3014
1974-77	V8 5.9L 360ci	F	w/o EGR w/o Cruise 95" Cable; 100.00" Cable	CA-3052
1976-78	V8 5.9L 360ci	F	MT w/o Cruise w/o Tripmeter; 80.00" Cable	CA-3014
1980	V8 5.9L 360ci	S,T	AT w/o Cruise Control; 80.00" Cable	CA-3027
1980	V8 5.9L 360ci	S,T	MT w/o Cruise; 80.00" Cable	CA-3014
1980	V8 5.9L 360ci	S,T	MT w/o Cruise Control; 100.00" Cable	CA-3052
1980	V8 5.9L 360ci	S,T	w/Cruise Lower; 63.00" Cable	CA-3002
1979	V8 5.9L 360ci	T	w/o EGR w/o Cruise w/o Trip 60" Cable; 80.00" Cable	CA-3014
1979	V8 5.9L 360ci	T	w/o EGR w/o Cruise w/o Trip 91" Cable; 100.00" Cable	CA-3052
1980	V8 5.9L 360ci	T	MT w/o Cruise 1 pc.; 80.00" Cable	CA-3014
1980	V8 5.9L 360ci	T	w/91" Cable	CA-3048
1979-80	V8 5.9L 360ci	T	AT Speedo to Trans.; 80.00" Cable	CA-3027
1971	V8 5.9L 360ci	Y	83.00" Cable	CA-3004
1968-69	V8 6.3L 383ci	8	83.00" Cable	CA-3004
1970	V8 6.3L 383ci	J	83.00" Cable	CA-3004
1971	V8 6.6L 400ci	J	AT Speedo to Trans.; 80.00" Cable	CA-3027
1971	V8 6.6L 400ci	J	MT w/o Cruise w/o Tripmeter; 80.00" Cable	CA-3014
1971	V8 6.6L 400ci	J	83.00" Cable	CA-3004
1974	V8 6.6L 400ci	J	w/EGR w/o Cruise switch to Trans.; 80.00" Cable	CA-3027
1974	V8 6.6L 400ci	J	w/o EGR w/o Cruise 62" Cable; 80.00" Cable	CA-3014
1974	V8 6.6L 400ci	J	w/o EGR w/o Cruise 95" Cable; 100.00" Cable	CA-3052
1978	V8 6.6L 400ci	J	AT Speedo to Trans.; 80.00" Cable	CA-3027
1978	V8 6.6L 400ci	J	MT w/o Cruise w/o Tripmeter; 80.00" Cable	CA-3014
1972-73	V8 6.6L 400ci	J	AT w/o Cruise Control; 80.00" Cable	CA-3027
1972-73	V8 6.6L 400ci	J	MT w/o Cruise; 80.00" Cable	CA-3014
1972-73	V8 6.6L 400ci	J	MT w/o Cruise Control; 100.00" Cable	CA-3052
1972-73	V8 6.6L 400ci	J	w/Cruise Lower; 63.00" Cable	CA-3002
1976-77	V8 6.6L 400ci	J	AT w/o Cruise Control; 80.00" Cable	CA-3027
1976-77	V8 6.6L 400ci	J	MT w/o Cruise; 80.00" Cable	CA-3014
1976-77	V8 6.6L 400ci	J	MT w/o Cruise Control; 100.00" Cable	CA-3052
1976-77	V8 6.6L 400ci	J	w/Cruise Lower; 63.00" Cable	CA-3002
1976-77	V8 6.6L 400ci	J	w/EGR w/o Cruise switch to Trans.; 80.00" Cable	CA-3027
1976-77	V8 6.6L 400ci	J	w/o EGR w/o Cruise 62" Cable; 80.00" Cable	CA-3014
1976-77	V8 6.6L 400ci	J	w/o EGR w/o Cruise 95" Cable; 100.00" Cable	CA-3052
1973	V8 7.2L 440ci	D	AT Speedo to Trans.; 80.00" Cable	CA-3027
1973	V8 7.2L 440ci	D	AT w/o Cruise Control; 80.00" Cable	CA-3027
1973	V8 7.2L 440ci	D	MT w/o Cruise; 80.00" Cable	CA-3014
1973	V8 7.2L 440ci	D	MT w/o Cruise Control; 100.00" Cable	CA-3052
1973	V8 7.2L 440ci	D	MT w/o Cruise w/o Tripmeter; 80.00" Cable	CA-3014
1973	V8 7.2L 440ci	D	w/Cruise Lower; 63.00" Cable	CA-3002
1978	V8 7.2L 440ci	D	AT Speedo to Trans.; 80.00" Cable	CA-3027
1978	V8 7.2L 440ci	D	AT w/o Cruise Control; 80.00" Cable	CA-3027
1978	V8 7.2L 440ci	D	MT w/o Cruise; 80.00" Cable	CA-3014
1978	V8 7.2L 440ci	D	MT w/o Cruise Control; 100.00" Cable	CA-3052
1978	V8 7.2L 440ci	D	MT w/o Cruise w/o Tripmeter; 80.00" Cable	CA-3014
1978	V8 7.2L 440ci	D	w/Cruise Lower; 63.00" Cable	CA-3002
1974-77	V8 7.2L 440ci	D	w/EGR w/o Cruise switch to Trans.; 80.00" Cable	CA-3027
1974-77	V8 7.2L 440ci	D	w/o EGR w/o Cruise 62" Cable; 80.00" Cable	CA-3014
1974-77	V8 7.2L 440ci	D	w/o EGR w/o Cruise 95" Cable; 100.00" Cable	CA-3052
<b>D300 SERIES</b>				
1960	L6 3.7L 225ci		Canada; 83.00" Cable	CA-3004
1961	L6 3.7L 225ci		U.S., w/MT; 83.00" Cable	CA-3004

# SPEEDOMETER CABLES

Year	Engine	Vin	Remark	Part
<b>DODGE TRUCKS (con't)</b>				
<b>D300 SERIES (con't)</b>				
1960-61	L6 3.7L 225ci		U.S., w/Loadflite Trans.	CA-3016
1962-67	L6 3.7L 225ci		83.00" Cable	CA-3004
1960	V8 5.2L 318ci		Canada; 83.00" Cable	CA-3004
1961	V8 5.2L 318ci		U.S., w/MT; 83.00" Cable	CA-3004
1960-61	V8 5.2L 318ci		U.S., w/Loadflite Trans.	CA-3016
1962-67	V8 5.2L 318ci		83.00" Cable	CA-3004
1963-67	V8 6.3L 383ci		83.00" Cable	CA-3004
<b>D350</b>				
1989	L6 5.9L 359ci	8	2WD, Speedo to sensor; 80.00" Cable	CA-3014
1989	L6 5.9L 359ci	8	w/Cruise Upper	CA-3025
1989	L6 5.9L 359ci	8	w/o Cruise Control; 80.00" Cable	CA-3027
1990	L6 5.9L 359ci	8	w/Cruise Servo to Sensor	CA-3040
1990	L6 5.9L 359ci	8	w/o Cruise Speedo to Trans.; 80.00" Cable	CA-3027
1991	L6 5.9L 359ci	C	w/Cruise Servo to Sensor	CA-3040
1991	L6 5.9L 359ci	C	w/o Cruise Speedo to Trans.; 80.00" Cable	CA-3027
1982	V8 5.2L 318ci	P,R	w/o Cruise Speedo to Trans.	CA-3023
1983	V8 5.2L 318ci	U	w/o Cruise Speedo to Trans.	CA-3023
1986-87	V8 5.9L 360ci	1,5,W	w/Cruise Servo to Sensor	CA-3040
1986-87	V8 5.9L 360ci	1,5,W	w/o Cruise Speedo to Trans.; 80.00" Cable	CA-3027
1983-85	V8 5.9L 360ci	1,W	w/o Cruise Speedo to Trans.	CA-3023
1982	V8 5.9L 360ci	T	w/o Cruise Speedo to Trans.	CA-3023
1990	V8 5.9L 360ci	Z	w/Cruise Servo to Sensor	CA-3040
1990	V8 5.9L 360ci	Z	w/o Cruise Speedo to Trans.; 80.00" Cable	CA-3027
<b>DAKOTA</b>				
1988	L4 2.2L 135ci	C	4WD, Lower; 41.00" Cable	CA-3035
1988	L4 2.2L 135ci	C	Upper; 80.00" Cable	CA-3027
1989-90	L4 2.5L 153ci	G	4WD, Lower	CA-3036
1989-90	L4 2.5L 153ci	G	Upper; 80.00" Cable	CA-3027
1998-00	L4 2.5L 153ci	P	4WD, Lower	CA-3036
1998-00	L4 2.5L 153ci	P	Upper; 80.00" Cable	CA-3027
1988	V6 3.9L 239ci	X	4WD, Lower; 41.00" Cable	CA-3035
1988-98	V6 3.9L 239ci	X	Upper; 80.00" Cable	CA-3027
1989-98	V6 3.9L 239ci	X	4WD, Lower	CA-3036
1990-96	V8 5.2L 318ci	T,Y	4WD, Lower	CA-3036
1990-96	V8 5.2L 318ci	T,Y	Upper; 80.00" Cable	CA-3027
<b>MINI RAM</b>				
1984	L4 2.2L 135ci	C	Speedometer Control to Trans.	CA-3034
1985	L4 2.2L 135ci	C	4 Spd. MT Lower	CA-3036
1986	L4 2.2L 135ci	C	AT 1 pc.Cable	CA-3022
1988	L4 2.5L 153ci	K	w/o Cruise Speedometer to Trans.	CA-3029
1984	L4 2.6L 156ci	G	Speedometer Control to Trans.	CA-3034
1985	L4 2.6L 156ci	G	4 Spd. MT Lower	CA-3036
1986-87	L4 2.6L 156ci	G	AT 1 pc.Cable	CA-3022
1988	V6 3.0L 181ci	3	w/o Cruise Speedometer to Trans.	CA-3029
<b>RAMCHARGER</b>				
1975	L6 3.7L 225ci	B	2WD, w/o Cruise w/o EGR w/o Trip 1 pc.; 80.00" Cable	CA-3014
1975	L6 3.7L 225ci	B	4WD, w/o Cruise w/o Trip1 pc.; 80.00" Cable	CA-3027
1976	L6 3.7L 225ci	B	w/o Cruise w/o Trip; 80.00" Cable	CA-3014
1974-78	L6 3.7L 225ci	B	2WD, w/o Cruise w/o EGR 1 pc.; 80.00" Cable	CA-3014
1974-78	L6 3.7L 225ci	B	4WD, w/o Cruise w/o EGR 1 pc.; 100.00" Cable	CA-3052
1979-80	L6 3.7L 225ci	N	2WD, w/o Cruise w/o EGR 1 pc.; 80.00" Cable	CA-3014
1979-80	L6 3.7L 225ci	N	4WD, w/o Cruise w/o EGR 1 pc.; 100.00" Cable	CA-3052
1979	V8 5.2L 318ci	E	w/o Cruise 1 pc. Cable	CA-3023
1981-82	V8 5.2L 318ci	P,R	w/o Cruise 1 pc. Cable	CA-3023
1985	V8 5.2L 318ci	T	2WD, w/o Cruise w/o EGR w/o Trip 1 pc.; 80.00" Cable	CA-3014
1985	V8 5.2L 318ci	T	4WD, w/o Cruise w/o Trip1 pc.; 80.00" Cable	CA-3027
1986	V8 5.2L 318ci	T	2WD, w/o Cruise w/o EGR 1 pc.; 80.00" Cable	CA-3014
1986	V8 5.2L 318ci	T	4WD, w/o Cruise w/o EGR 1 pc.; 100.00" Cable	CA-3052
1987	V8 5.2L 318ci	T	2WD, w/o Cruise, 1 pc.; 80.00" Cable	CA-3014
1987	V8 5.2L 318ci	T	4WD, w/o Cruise 1 pc.; 80.00" Cable	CA-3027
1983-84	V8 5.2L 318ci	T,U	w/o Cruise 1 pc. Cable	CA-3023
1988	V8 5.2L 318ci	Y	2WD, w/o Cruise w/o EGR w/o Trip 1 pc.; 80.00" Cable	CA-3014

# SPEEDOMETER CABLES

Year	Engine	Vin	Remark	Part
<b>DODGE TRUCKS (con't)</b>				
<b>RAMCHARGER (con't)</b>				
1988	V8 5.2L 318ci	Y	4WD, w/o Cruise w/o Trip1 pc.; 80.00" Cable	CA-3027
1989	V8 5.2L 318ci	Y	w/o Cruise w/o Trip; 80.00" Cable	CA-3014
1990-93	V8 5.2L 318ci	Y	2WD, w/o Cruise w/o EGR 1 pc.; 80.00" Cable	CA-3014
1990-93	V8 5.2L 318ci	Y	4WD, w/o Cruise w/o EGR 1 pc.; 100.00" Cable	CA-3052
1980-81	V8 5.9L 360ci	T	w/o Cruise 1 pc. Cable	CA-3023
1984	V8 5.9L 360ci	W	2WD, w/o Cruise, 1 pc.; 80.00" Cable	CA-3014
1984	V8 5.9L 360ci	W	4WD, w/o Cruise 1 pc.; 80.00" Cable	CA-3027
1986	V8 5.9L 360ci	W	2WD, w/o Cruise w/o EGR 1 pc.; 80.00" Cable	CA-3014
1986	V8 5.9L 360ci	W	4WD, w/o Cruise w/o EGR 1 pc.; 100.00" Cable	CA-3052
1985-88	V8 5.9L 360ci	W	2WD, w/o Cruise w/o EGR w/o Trip 1 pc.; 80.00" Cable	CA-3014
1985-88	V8 5.9L 360ci	W	4WD, w/o Cruise w/o Trip1 pc.; 80.00" Cable	CA-3027
1989	V8 5.9L 360ci	Z	w/o Cruise w/o Trip; 80.00" Cable	CA-3014
1990-93	V8 5.9L 360ci	Z	2WD, w/o Cruise w/o EGR 1 pc.; 80.00" Cable	CA-3014
1990-93	V8 5.9L 360ci	Z	4WD, w/o Cruise w/o EGR 1 pc.; 100.00" Cable	CA-3052
1976	V8 6.6L 400ci	J	w/o Cruise w/o Trip; 80.00" Cable	CA-3014
1977-78	V8 6.6L 400ci	J	2WD, w/o Cruise w/o EGR 1 pc.; 80.00" Cable	CA-3014
1977-78	V8 6.6L 400ci	J	4WD, w/o Cruise w/o EGR 1 pc.; 100.00" Cable	CA-3052
1974	V8 7.2L 440ci	D	w/o Cruise w/o Trip; 80.00" Cable	CA-3014
1975-78	V8 7.2L 440ci	D	2WD, w/o Cruise w/o EGR 1 pc.; 80.00" Cable	CA-3014
1975-78	V8 7.2L 440ci	D	4WD, w/o Cruise w/o EGR 1 pc.; 100.00" Cable	CA-3052
<b>ROYAL MINI RAM</b>				
1984	L4 2.2L 135ci	C	Speedometer Control to Trans.	CA-3034
1985	L4 2.2L 135ci	C	4 Spd. MT Lower	CA-3036
1986	L4 2.2L 135ci	C	AT 1 pc.Cable	CA-3022
1984	L4 2.6L 156ci	G	Speedometer Control to Trans.	CA-3034
1985	L4 2.6L 156ci	G	4 Spd. MT Lower	CA-3036
1986-87	L4 2.6L 156ci	G	AT 1 pc.Cable	CA-3022
<b>W100</b>				
1972-75	L6 3.7L 225ci	B	w/o Cruise Control; 100.00" Cable	CA-3052
1974-77	L6 3.7L 225ci	B	w/o Cruise 1 pc. Cable; 100.00" Cable	CA-3052
1974-77	L6 3.7L 225ci	B	w/o Cruise Intermediate; 63.00" Cable	CA-3002
1974-77	L6 3.7L 225ci	B	w/o Cruise w/o EGR w/131" WB Upper; 80.00" Cable	CA-3014
1971	L6 3.7L 225ci	B,X	exc. Cruise Control	CA-3048
1986	L6 3.7L 225ci	H	w/o Cruise Control; 80.00" Cable	CA-3027
1987	L6 3.7L 225ci	H	AT w/o Cruise Control; 80.00" Cable	CA-3027
1986-87	L6 3.7L 225ci	H	w/Cruise Servo to Sensor	CA-3040
1971	V8 5.2L 318ci	E	exc. Cruise Control	CA-3048
1972-73	V8 5.2L 318ci	E	w/o Cruise Control; 100.00" Cable	CA-3052
1974-77	V8 5.2L 318ci	E	w/o Cruise 1 pc. Cable; 100.00" Cable	CA-3052
1974-77	V8 5.2L 318ci	E	w/o Cruise Intermediate; 63.00" Cable	CA-3002
1974-77	V8 5.2L 318ci	E	w/o Cruise w/o EGR w/131" WB Upper; 80.00" Cable	CA-3014
1976-77	V8 5.2L 318ci	E	w/o Cruise Control; 100.00" Cable	CA-3052
1986-87	V8 5.2L 318ci	T	w/Cruise Servo to Sensor	CA-3040
1986-87	V8 5.2L 318ci	T	w/o Cruise Control; 80.00" Cable	CA-3027
1972-73	V8 5.9L 360ci	F	w/o Cruise Control; 100.00" Cable	CA-3052
1974-77	V8 5.9L 360ci	F,T	w/o Cruise 1 pc. Cable; 100.00" Cable	CA-3052
1974-77	V8 5.9L 360ci	F,T	w/o Cruise Intermediate; 63.00" Cable	CA-3002
1974-77	V8 5.9L 360ci	F,T	w/o Cruise w/o EGR w/131" WB Upper; 80.00" Cable	CA-3014
1986-87	V8 5.9L 360ci	W	AT w/o Cruise Control; 80.00" Cable	CA-3027
1986-87	V8 5.9L 360ci	W	MT w/o Cruise Control; 100.00" Cable	CA-3052
1986-87	V8 5.9L 360ci	W	w/Cruise Servo to Sensor	CA-3040
1971	V8 6.6L 400ci	J	exc. Cruise Control	CA-3048
1974-77	V8 6.6L 400ci	J	w/o Cruise 1 pc. Cable; 100.00" Cable	CA-3052
1974-77	V8 6.6L 400ci	J	w/o Cruise Intermediate; 63.00" Cable	CA-3002
1974-77	V8 6.6L 400ci	J	w/o Cruise w/o EGR w/131" WB Upper; 80.00" Cable	CA-3014
1974-77	V8 7.2L 440ci	D	w/o Cruise 1 pc. Cable; 100.00" Cable	CA-3052
1974-77	V8 7.2L 440ci	D	w/o Cruise Intermediate; 63.00" Cable	CA-3002
1974-77	V8 7.2L 440ci	D	w/o Cruise w/o EGR w/131" WB Upper; 80.00" Cable	CA-3014
<b>W150</b>				
1978-79	L6 3.7L 225ci	B,N	80.00" Cable	CA-3027
1981-82	L6 3.7L 225ci	E		CA-3023
1983	L6 3.7L 225ci	H		CA-3023

# SPEEDOMETER CABLES

Year	Engine	Vin	Remark	Part
<b>DODGE TRUCKS (con't)</b>				
<b>W150 (con't)</b>				
1986	L6 3.7L 225ci	H	80.00" Cable	CA-3027
1986-87	L6 3.7L 225ci	H	w/Cruise Servo to Sensor	CA-3040
1986-87	L6 3.7L 225ci	H	w/o Cruise Control; 80.00" Cable	CA-3027
1989	V6 3.9L 239ci	X	Upper w/241 Transfer case or Upper w/4 Spd. MT; 80.00" Cable	CA-3027
1989	V6 3.9L 239ci	X	w/Cruise Upper	CA-3025
1989	V6 3.9L 239ci	X	w/o Cruise Lower; 41.00" Cable	CA-3035
1992	V6 3.9L 239ci	X	80.00" Cable	CA-3027
1982	V8 5.2L 318ci	P,R		CA-3023
1986-87	V8 5.2L 318ci	T	w/Cruise Servo to Sensor	CA-3040
1986-87	V8 5.2L 318ci	T	w/o Cruise Control; 80.00" Cable	CA-3027
1983	V8 5.2L 318ci	T,U		CA-3023
1988-89	V8 5.2L 318ci	Y	Upper w/241 Transfer case or Upper w/4 Spd. MT; 80.00" Cable	CA-3027
1988-89	V8 5.2L 318ci	Y	w/Cruise Upper	CA-3025
1988-89	V8 5.2L 318ci	Y	w/o Cruise Lower; 41.00" Cable	CA-3035
1988-91	V8 5.2L 318ci	Y	80.00" Cable	CA-3027
1981	V8 5.9L 360ci	T		CA-3023
1984	V8 5.9L 360ci	W		CA-3023
1988	V8 5.9L 360ci	W	Upper w/241 Transfer case or Upper w/4 Spd. MT; 80.00" Cable	CA-3027
1988	V8 5.9L 360ci	W	w/Cruise Upper	CA-3025
1988	V8 5.9L 360ci	W	w/o Cruise Lower; 41.00" Cable	CA-3035
1986-87	V8 5.9L 360ci	W	80.00" Cable	CA-3027
1986-87	V8 5.9L 360ci	W	w/Cruise Servo to Sensor	CA-3040
1986-87	V8 5.9L 360ci	W	w/o Cruise Control; 80.00" Cable	CA-3027
1989	V8 5.9L 360ci	Z	Upper w/241 Transfer case or Upper w/4 Spd. MT; 80.00" Cable	CA-3027
1989	V8 5.9L 360ci	Z	w/Cruise Upper	CA-3025
1989	V8 5.9L 360ci	Z	w/o Cruise Lower; 41.00" Cable	CA-3035
1989-90	V8 5.9L 360ci	Z	80.00" Cable	CA-3027
<b>W200</b>				
1971	L6 3.7L 225ci	B	exc. Cruise Control	CA-3048
1978	L6 3.7L 225ci	B	3 Spd. MT w/o Cruise; 100.00" Cable	CA-3052
1978	L6 3.7L 225ci	B	w/5/8" end"; 80.00" Cable	CA-3027
1978	L6 3.7L 225ci	B	w/7/8" end"; 80.00" Cable	CA-3014
1979	L6 3.7L 225ci	B	80.00" Cable	CA-3027
1972-73	L6 3.7L 225ci	B	w/o Cruise Control; 100.00" Cable	CA-3052
1974-77	L6 3.7L 225ci	B	w/o Cruise 1 pc. Cable; 100.00" Cable	CA-3052
1974-77	L6 3.7L 225ci	B	w/o Cruise Intermediate; 63.00" Cable	CA-3002
1974-77	L6 3.7L 225ci	B	w/o Cruise w/o EGR w/131" WB Upper; 80.00" Cable	CA-3014
1976-77	L6 3.7L 225ci	B	w/o Cruise Control; 100.00" Cable	CA-3052
1980	L6 3.7L 225ci	N	80.00" Cable	CA-3027
1978	L6 4.0L 243ci	H	w/5/8" end"; 80.00" Cable	CA-3027
1978	L6 4.0L 243ci	H	w/7/8" end"; 80.00" Cable	CA-3014
1979	L6 4.0L 243ci	H	80.00" Cable	CA-3027
1971	V8 5.2L 318ci	E	exc. Cruise Control	CA-3048
1978	V8 5.2L 318ci	E	w/5/8" end"; 80.00" Cable	CA-3027
1978	V8 5.2L 318ci	E	w/7/8" end"; 80.00" Cable	CA-3014
1972-73	V8 5.2L 318ci	E	w/o Cruise Control; 100.00" Cable	CA-3052
1974-77	V8 5.2L 318ci	E	w/o Cruise 1 pc. Cable; 100.00" Cable	CA-3052
1974-77	V8 5.2L 318ci	E	w/o Cruise Intermediate; 63.00" Cable	CA-3002
1974-77	V8 5.2L 318ci	E	w/o Cruise w/o EGR w/131" WB Upper; 80.00" Cable	CA-3014
1978-79	V8 5.2L 318ci	E	w/o Cruise Control; 100.00" Cable	CA-3052
1979-80	V8 5.2L 318ci	E,P	80.00" Cable	CA-3027
1979	V8 5.2L 318ci	P	3 Spd. MT w/o Cruise; 100.00" Cable	CA-3052
1978	V8 5.9L 360ci	F	w/5/8" end"; 80.00" Cable	CA-3027
1978	V8 5.9L 360ci	F	w/7/8" end"; 80.00" Cable	CA-3014
1971-73	V8 5.9L 360ci	F	w/o Cruise Control; 100.00" Cable	CA-3052
1974-77	V8 5.9L 360ci	F	w/o Cruise 1 pc. Cable; 100.00" Cable	CA-3052
1974-77	V8 5.9L 360ci	F	w/o Cruise Intermediate; 63.00" Cable	CA-3002
1974-77	V8 5.9L 360ci	F	w/o Cruise w/o EGR w/131" WB Upper; 80.00" Cable	CA-3014
1979-80	V8 5.9L 360ci	F,S,T	80.00" Cable	CA-3027
1979	V8 5.9L 360ci	F,T	w/o Cruise Control; 100.00" Cable	CA-3052
1971	V8 5.9L 360ci	F,Y	exc. Cruise Control	CA-3048
1979	V8 5.9L 360ci	S	3 Spd. MT w/o Cruise; 100.00" Cable	CA-3052



# SPEEDOMETER CABLES

Year	Engine	Vin	Remark	Part
<b>DODGE TRUCKS (con't)</b>				
<b>W200 (con't)</b>				
1971	V8 5.9L 360ci	Y	3 Spd. MT w/o Cruise; 100.00" Cable	CA-3052
1969	V8 6.3L 383ci	8	3 Spd. MT w/o Cruise; 100.00" Cable	CA-3052
1971	V8 6.6L 400ci	J	exc. Cruise Control	CA-3048
1974	V8 6.6L 400ci	J	w/o Cruise 1 pc. Cable; 100.00" Cable	CA-3052
1974	V8 6.6L 400ci	J	w/o Cruise Intermediate; 63.00" Cable	CA-3002
1974	V8 6.6L 400ci	J	w/o Cruise w/o EGR w/131" WB Upper; 80.00" Cable	CA-3014
1978	V8 6.6L 400ci	J	3 Spd. MT w/o Cruise; 100.00" Cable	CA-3052
1978	V8 6.6L 400ci	J	w/5/8" end"; 80.00" Cable	CA-3027
1978	V8 6.6L 400ci	J	w/7/8" end"; 80.00" Cable	CA-3014
1976-77	V8 6.6L 400ci	J	w/o Cruise 1 pc. Cable; 100.00" Cable	CA-3052
1976-77	V8 6.6L 400ci	J	w/o Cruise Intermediate; 63.00" Cable	CA-3002
1976-77	V8 6.6L 400ci	J	w/o Cruise w/o EGR w/131" WB Upper; 80.00" Cable	CA-3014
1978	V8 7.2L 440ci	D	w/5/8" end"; 80.00" Cable	CA-3027
1978	V8 7.2L 440ci	D	w/7/8" end"; 80.00" Cable	CA-3014
1974-77	V8 7.2L 440ci	D	w/o Cruise 1 pc. Cable; 100.00" Cable	CA-3052
1974-77	V8 7.2L 440ci	D	w/o Cruise Intermediate; 63.00" Cable	CA-3002
1974-77	V8 7.2L 440ci	D	w/o Cruise w/o EGR w/131" WB Upper; 80.00" Cable	CA-3014
<b>W250</b>				
1989	L6 5.9L 359ci	8	Upper w/241 Transfer case or Upper w/4 Spd. MT; 80.00" Cable	CA-3027
1989	L6 5.9L 359ci	8	w/Cruise Upper	CA-3025
1989	L6 5.9L 359ci	8	w/o Cruise Lower; 41.00" Cable	CA-3035
1990	L6 5.9L 359ci	8	4 Spd. MT Lower	CA-3036
1990	L6 5.9L 359ci	8	4 Spd. MT Upper; 80.00" Cable	CA-3027
1982	V8 5.2L 318ci	P,R		CA-3023
1986-87	V8 5.2L 318ci	T	w/Cruise Servo to Sensor	CA-3040
1986-87	V8 5.2L 318ci	T	w/o Cruise Control; 80.00" Cable	CA-3027
1983	V8 5.2L 318ci	T,U		CA-3023
1990	V8 5.2L 318ci	Y	4 Spd. MT Lower	CA-3036
1990	V8 5.2L 318ci	Y	4 Spd. MT Upper; 80.00" Cable	CA-3027
1988-89	V8 5.2L 318ci	Y	Upper w/241 Transfer case or Upper w/4 Spd. MT; 80.00" Cable	CA-3027
1988-89	V8 5.2L 318ci	Y	w/Cruise Upper	CA-3025
1988-89	V8 5.2L 318ci	Y	w/o Cruise Lower; 41.00" Cable	CA-3035
1988	V8 5.9L 360ci	1,5,W	Upper w/241 Transfer case or Upper w/4 Spd. MT; 80.00" Cable	CA-3027
1988	V8 5.9L 360ci	1,5,W	w/Cruise Upper	CA-3025
1988	V8 5.9L 360ci	1,5,W	w/o Cruise Lower; 41.00" Cable	CA-3035
1986-87	V8 5.9L 360ci	1,5,W	w/Cruise Servo to Sensor	CA-3040
1986-87	V8 5.9L 360ci	1,5,W	w/o Cruise Control; 80.00" Cable	CA-3027
1990	V8 5.9L 360ci	5,Z	4 Spd. MT Lower	CA-3036
1990	V8 5.9L 360ci	5,Z	4 Spd. MT Upper; 80.00" Cable	CA-3027
1982	V8 5.9L 360ci	T		CA-3023
1989	V8 5.9L 360ci	Z	Upper w/241 Transfer case or Upper w/4 Spd. MT; 80.00" Cable	CA-3027
1989	V8 5.9L 360ci	Z	w/Cruise Upper	CA-3025
1989	V8 5.9L 360ci	Z	w/o Cruise Lower; 41.00" Cable	CA-3035
1989-90	V8 5.9L 360ci	Z		CA-3023
<b>W300</b>				
1969	L6 3.7L 225ci	6	w/5/8" end"; 80.00" Cable	CA-3027
1969	L6 3.7L 225ci	6	w/7/8" end"; 80.00" Cable	CA-3014
1971	L6 3.7L 225ci	B	exc. Cruise Control	CA-3048
1975	L6 3.7L 225ci	B	AT & 3 Spd. MT w/o Cruise; 100.00" Cable	CA-3052
1978	L6 3.7L 225ci	B	w/5/8" end"; 80.00" Cable	CA-3027
1978	L6 3.7L 225ci	B	w/7/8" end"; 80.00" Cable	CA-3014
1972-74	L6 3.7L 225ci	B	w/o Cruise Control; 100.00" Cable	CA-3052
1970-71	L6 3.7L 225ci	B,C	AT, w/Motor Home Chassis	CA-3038
1968	V8 5.2L 318ci	8	80.00" Cable	CA-3027
1969	V8 5.2L 318ci	8	w/5/8" end"; 80.00" Cable	CA-3027
1969	V8 5.2L 318ci	8	w/7/8" end"; 80.00" Cable	CA-3014
1971	V8 5.2L 318ci	E	exc. Cruise Control	CA-3048
1975	V8 5.2L 318ci	E	w/o Cruise Control; 100.00" Cable	CA-3052
1976	V8 5.2L 318ci	E	AT & 3 Spd. MT w/o Cruise; 100.00" Cable	CA-3052
1978	V8 5.2L 318ci	E	w/5/8" end"; 80.00" Cable	CA-3027
1978	V8 5.2L 318ci	E	w/7/8" end"; 80.00" Cable	CA-3014
1980	V8 5.2L 318ci	E	80.00" Cable	CA-3027

# SPEEDOMETER CABLES

Year	Engine	Vin	Remark	Part
<b>DODGE TRUCKS (con't)</b>				
<b>W300 (con't)</b>				
1970-71	V8 5.2L 318ci	E	AT, w/Motor Home Chassis	CA-3038
1972-74	V8 5.2L 318ci	E	w/o Cruise Control; 100.00" Cable	CA-3052
1972	V8 5.9L 360ci	F	80.00" Cable	CA-3027
1973	V8 5.9L 360ci	F	w/5/8" end"; 80.00" Cable	CA-3027
1973	V8 5.9L 360ci	F	w/7/8" end"; 80.00" Cable	CA-3014
1978	V8 5.9L 360ci	F	w/5/8" end"; 80.00" Cable	CA-3027
1978	V8 5.9L 360ci	F	w/7/8" end"; 80.00" Cable	CA-3014
1978	V8 5.9L 360ci	F	w/o Cruise Control; 100.00" Cable	CA-3052
1972-73	V8 5.9L 360ci	F	w/o Cruise Control; 100.00" Cable	CA-3052
1979	V8 5.9L 360ci	T	w/o Cruise Control; 100.00" Cable	CA-3052
1979-80	V8 5.9L 360ci	T	80.00" Cable	CA-3027
1971	V8 5.9L 360ci	Y	AT & 3 Spd. MT w/o Cruise; 100.00" Cable	CA-3052
1971	V8 5.9L 360ci	Y	AT, w/Motor Home Chassis	CA-3038
1971	V8 5.9L 360ci	Y	exc. Cruise Control	CA-3048
1971	V8 6.3L 383ci		AT & 3 Spd. MT w/o Cruise; 100.00" Cable	CA-3052
1976-78	V8 6.6L 400ci	J	w/5/8" end"; 80.00" Cable	CA-3027
1976-78	V8 6.6L 400ci	J	w/7/8" end"; 80.00" Cable	CA-3014
1975-78	V8 7.2L 440ci	D	w/5/8" end"; 80.00" Cable	CA-3027
1975-78	V8 7.2L 440ci	D	w/7/8" end"; 80.00" Cable	CA-3014
<b>W350</b>				
1990	L6 5.9L 359ci	8	w/Cruise Servo to Sensor	CA-3040
1991	L6 5.9L 359ci	8		CA-3023
1982	V8 5.2L 318ci	R		CA-3023
1983	V8 5.2L 318ci	U		CA-3023
1983-87	V8 5.9L 360ci	1,5,W		CA-3023
1986-87	V8 5.9L 360ci	1,5,W	w/Cruise Servo to Sensor	CA-3040
1986-87	V8 5.9L 360ci	1,5,W	w/o Cruise Control; 80.00" Cable	CA-3027
1982	V8 5.9L 360ci	T,U		CA-3023
1990	V8 5.9L 360ci	Z	w/o Cruise Control; 80.00" Cable	CA-3027
<b>FIAT</b>				
<b>124</b>				
1975-78	L4 1.8L 1756cc			CA-3202
1979-81	L4 2.0L 1995cc			CA-3201
<b>FORD</b>				
<b>COUNTRY SQUIRE</b>				
1962	L6 2.4L 144ci		80.00" Cable	CA-3012
1962	L6 2.8L 170ci		80.00" Cable	CA-3012
1965	L6 2.8L 170ci		83.00" Cable	CA-3010
1967	L6 2.8L 170ci		3 Spd. MT w/o Cruise w/o Overdrive; 60.00" Cable	CA-3015
1967	L6 2.8L 170ci		Pump to Trans.; 63.00" Cable	CA-3002
1963-66	L6 2.8L 170ci		60.00" Cable	CA-3015
1965	L6 3.3L 200ci		83.00" Cable	CA-3010
1967	L6 3.3L 200ci		3 Spd. MT w/o Cruise w/o Overdrive; 60.00" Cable	CA-3015
1967	L6 3.3L 200ci		Pump to Trans.; 63.00" Cable	CA-3002
1963-66	L6 3.3L 200ci		60.00" Cable	CA-3015
1960	L6 3.7L 223ci		Canada, w/3 Spd. Trans., w/Overdrive Trans.; 66.00" Cable	CA-3020
1961	L6 3.7L 223ci		MT; 66.00" Cable	CA-3020
1962	L6 3.7L 223ci		80.00" Cable	CA-3012
1957-61	L6 3.7L 223ci		AT; 83.00" Cable	CA-3010
1963-64	L6 3.7L 223ci		60.00" Cable	CA-3015
1965	L6 3.9L 240ci		83.00" Cable	CA-3010
1966	L6 3.9L 240ci		60.00" Cable	CA-3015
1967	L6 3.9L 240ci		3 Spd. MT w/o Cruise w/o Overdrive; 60.00" Cable	CA-3015
1967	L6 3.9L 240ci		Pump to Trans.; 63.00" Cable	CA-3002
1963-64	V8 4.3L 260ci		60.00" Cable	CA-3015
1957	V8 4.5L 272ci		AT; 83.00" Cable	CA-3010
1965	V8 4.7L 289ci		83.00" Cable	CA-3010
1967	V8 4.7L 289ci		3 Spd. MT w/o Cruise w/o Overdrive; 60.00" Cable	CA-3015
1967	V8 4.7L 289ci		Pump to Trans.; 63.00" Cable	CA-3002
1963-66	V8 4.7L 289ci		60.00" Cable	CA-3015
1960	V8 4.8L 292ci		Canada, w/3 Spd. Trans., w/Overdrive Trans.; 66.00" Cable	CA-3020

# SPEEDOMETER CABLES

Year	Engine	Vin	Remark	Part
<b>FORD (con't)</b>				
<b>COUNTRY SQUIRE (con't)</b>				
1961	V8 4.8L 292ci		MT; 66.00" Cable	CA-3020
1962	V8 4.8L 292ci		80.00" Cable	CA-3012
1958-61	V8 4.8L 292ci		AT; 83.00" Cable	CA-3010
1971	V8 5.0L 302ci	D	AT w/Cruise Upper, 3 Spd. MT w/Cruise Upper	CA-3044
1971	V8 5.0L 302ci	D	C4 w/o Cruise, C6 w/o Cruise exc. Police; 63.00" Cable	CA-3021
1972	V8 5.0L 302ci	D	AT w/o Cruise Control; 63.00" Cable	CA-3021
1972	V8 5.0L 302ci	D	w/Cruise Upper; 80.00" Cable	CA-3001
1968	V8 5.0L 302ci	F	3 Spd. AT; 60.00" Cable	CA-3015
1968	V8 5.0L 302ci	F	3 Spd. MT w/o Cruise; 60.00" Cable	CA-3015
1969	V8 5.0L 302ci	F	C6 AT w/o Cruise, MT w/o Cruise; 80.00" Cable	CA-3012
1969-70	V8 5.0L 302ci	F	AT w/Cruise Upper, 3 Spd. MT w/Cruise Upper	CA-3044
1969-70	V8 5.0L 302ci	F	C4 w/o Cruise; 63.00" Cable	CA-3021
1958-59	V8 5.4L 332ci		AT; 83.00" Cable	CA-3010
1969	V8 5.8L 351ci	H	AT w/Cruise Control, Lower; 66.00" Cable	CA-3020
1969	V8 5.8L 351ci	H	AT w/Cruise Control, Upper	CA-3044
1969	V8 5.8L 351ci	H	AT w/o Cruise Control; 80.00" Cable	CA-3012
1969	V8 5.8L 351ci	H	C4 w/o Cruise; 63.00" Cable	CA-3021
1969	V8 5.8L 351ci	H	C6 AT w/o Cruise, MT w/o Cruise; 80.00" Cable	CA-3012
1970	V8 5.8L 351ci	H	FMX AT w/o Cruise; 63.00" Cable	CA-3021
1971	V8 5.8L 351ci	H	FMX w/o Cruise, C6 w/o Cruise exc. Police; 63.00" Cable	CA-3021
1972	V8 5.8L 351ci	H	AT w/o Cruise Control; 63.00" Cable	CA-3021
1973	V8 5.8L 351ci	H	w/Cruise Lower; 66.00" Cable	CA-3020
1974	V8 5.8L 351ci	H	w/Cruise exc. Police Upper; 80.00" Cable	CA-3001
1969-71	V8 5.8L 351ci	H	AT w/Cruise Upper, 3 Spd. MT w/Cruise Upper	CA-3044
1972-73	V8 5.8L 351ci	H	w/Cruise Upper; 80.00" Cable	CA-3001
1973-74	V8 5.8L 351ci	H	AT w/o Cruise exc. Police Car; 63.00" Cable	CA-3021
1960	V8 5.8L 352ci		Canada, w/3 Spd. Trans., w/Overdrive Trans.; 66.00" Cable	CA-3020
1961	V8 5.8L 352ci		MT; 66.00" Cable	CA-3020
1962	V8 5.8L 352ci		3 Spd. MT; 83.00" Cable	CA-3010
1967	V8 5.8L 352ci		3 Spd. MT w/o Cruise w/o Overdrive; 60.00" Cable	CA-3015
1967	V8 5.8L 352ci		Pump to Trans.; 63.00" Cable	CA-3002
1958-61	V8 5.8L 352ci		AT; 83.00" Cable	CA-3010
1963-64	V8 5.8L 352ci		60.00" Cable	CA-3015
1965-66	V8 5.8L 352ci		83.00" Cable	CA-3010
1969	V8 6.4L 390ci	S,X	C4 w/o Cruise; 63.00" Cable	CA-3021
1969	V8 6.4L 390ci	S,X	C6 AT w/o Cruise, MT w/o Cruise; 80.00" Cable	CA-3012
1969-70	V8 6.4L 390ci	S,X	AT w/Cruise Upper, 3 Spd. MT w/Cruise Upper	CA-3044
1970	V8 6.4L 390ci	X	3 Spd. MT; 63.00" Cable	CA-3021
1968	V8 6.4L 390ci	X,Z	3 Spd. AT; 60.00" Cable	CA-3015
1968	V8 6.4L 390ci	X,Z	3 Spd. MT w/o Cruise; 60.00" Cable	CA-3015
1971	V8 6.4L 390ci	Y	AT w/Cruise Upper, 3 Spd. MT w/Cruise Upper	CA-3044
1971	V8 6.4L 390ci	Y	AT w/o Cruise Control; 63.00" Cable	CA-3021
1962	V8 6.4L 390ci		80.00" Cable	CA-3012
1963-64	V8 6.4L 390ci		60.00" Cable	CA-3015
1971	V8 6.6L 400ci	S	AT w/Cruise Upper, 3 Spd. MT w/Cruise Upper	CA-3044
1973	V8 6.6L 400ci	S	w/Cruise Lower; 66.00" Cable	CA-3020
1974	V8 6.6L 400ci	S	Police w/Cruise Upper	CA-3044
1974	V8 6.6L 400ci	S	w/Cruise exc. Police Upper; 80.00" Cable	CA-3001
1971-72	V8 6.6L 400ci	S	AT w/o Cruise Control; 63.00" Cable	CA-3021
1972-73	V8 6.6L 400ci	S	w/Cruise Upper; 80.00" Cable	CA-3001
1973-74	V8 6.6L 400ci	S	AT w/o Cruise exc. Police Car; 63.00" Cable	CA-3021
1968	V8 7.0L 427ci	W	3 Spd. AT; 60.00" Cable	CA-3015
1968	V8 7.0L 427ci	W	3 Spd. MT w/o Cruise; 60.00" Cable	CA-3015
1964-66	V8 7.0L 427ci		60.00" Cable	CA-3015
1968	V8 7.0L 428ci	P	3 Spd. AT; 60.00" Cable	CA-3015
1968	V8 7.0L 428ci	P	3 Spd. MT w/o Cruise; 60.00" Cable	CA-3015
1969	V8 7.0L 428ci	P	AT w/Cruise Upper, 3 Spd. MT w/Cruise Upper	CA-3044
1969	V8 7.0L 428ci	P	C4 w/o Cruise; 63.00" Cable	CA-3021
1969	V8 7.0L 428ci	P	C6 AT w/o Cruise, MT w/o Cruise; 80.00" Cable	CA-3012
1969	V8 7.0L 429ci	K,N	C4 w/o Cruise; 63.00" Cable	CA-3021
1969	V8 7.0L 429ci	K,N	C6 AT w/o Cruise, MT w/o Cruise; 80.00" Cable	CA-3012
1970	V8 7.0L 429ci	K,N	3 Spd. MT; 63.00" Cable	CA-3021

# SPEEDOMETER CABLES

Year	Engine	Vin	Remark	Part
<b>FORD (con't)</b>				
<b>COUNTRY SQUIRE (con't)</b>				
1969-71	V8 7.0L 429ci	K,N	AT w/Cruise Upper, 3 Spd. MT w/Cruise Upper	CA-3044
1971-72	V8 7.0L 429ci	K,N	AT w/o Cruise Control; 63.00" Cable	CA-3021
1973	V8 7.0L 429ci	N	AT w/o Cruise exc. Police Car; 63.00" Cable	CA-3021
1973	V8 7.0L 429ci	N	w/Cruise Lower; 66.00" Cable	CA-3020
1972-73	V8 7.0L 429ci	N	w/Cruise Upper; 80.00" Cable	CA-3001
1972	V8 7.5L 460ci	A	AT w/o Cruise Control; 63.00" Cable	CA-3021
1973	V8 7.5L 460ci	A	w/Cruise Lower; 66.00" Cable	CA-3020
1974	V8 7.5L 460ci	A	Police w/Cruise Upper	CA-3044
1974	V8 7.5L 460ci	A	w/Cruise exc. Police Upper; 80.00" Cable	CA-3001
1972-73	V8 7.5L 460ci	A	w/Cruise Upper; 80.00" Cable	CA-3001
1973-74	V8 7.5L 460ci	A	AT w/o Cruise exc. Police Car; 63.00" Cable	CA-3021
<b>CROWN VICTORIA</b>				
1996-99	V8 4.6L 281ci	6,9,W	w/Cruise Control; 71.00" Cable	CA-3018
<b>CUSTOM</b>				
1957	L6 3.7L 223ci		AT; 83.00" Cable	CA-3010
1964	L6 3.7L 223ci		60.00" Cable	CA-3015
1968	L6 3.9L 240ci	B	3 Spd. AT; 60.00" Cable	CA-3015
1968	L6 3.9L 240ci	B	3 Spd. MT w/o Cruise; 60.00" Cable	CA-3015
1969	L6 3.9L 240ci	B	AT w/Cruise Upper, 3 Spd. MT w/Cruise Upper	CA-3044
1969	L6 3.9L 240ci	B	C4 w/o Cruise; 63.00" Cable	CA-3021
1969	L6 3.9L 240ci	B	C6 AT w/o Cruise, MT w/o Cruise; 80.00" Cable	CA-3012
1970	L6 3.9L 240ci	B	3 Spd. Trans.; 63.00" Cable	CA-3021
1970	L6 3.9L 240ci	B	w/Cruise Control, Upper	CA-3044
1971	L6 3.9L 240ci	E	AT w/Cruise Upper, 3 Spd. MT w/Cruise Upper	CA-3044
1972	L6 3.9L 240ci	E	w/Cruise Upper; 80.00" Cable	CA-3001
1971-72	L6 3.9L 240ci	E	AT w/o Cruise Control; 63.00" Cable	CA-3021
1964	V8 4.3L 260ci		60.00" Cable	CA-3015
1957	V8 4.5L 272ci		AT; 83.00" Cable	CA-3010
1965	V8 4.7L 289ci		83.00" Cable	CA-3010
1966	V8 4.7L 289ci		60.00" Cable	CA-3015
1967	V8 4.7L 289ci		3 Spd. MT w/o Cruise w/o Overdrive; 60.00" Cable	CA-3015
1967	V8 4.7L 289ci		Pump to Trans.; 63.00" Cable	CA-3002
1957	V8 4.8L 292ci		AT; 83.00" Cable	CA-3010
1969	V8 5.0L 302ci	D	C6 AT w/o Cruise, MT w/o Cruise; 80.00" Cable	CA-3012
1971	V8 5.0L 302ci	D	C4 w/o Cruise, C6 w/o Cruise exc. Police; 63.00" Cable	CA-3021
1972	V8 5.0L 302ci	D	AT w/o Cruise Control; 63.00" Cable	CA-3021
1972	V8 5.0L 302ci	D	w/Cruise Upper; 80.00" Cable	CA-3001
1969-70	V8 5.0L 302ci	D	C4 w/o Cruise; 63.00" Cable	CA-3021
1969-71	V8 5.0L 302ci	D	AT w/Cruise Upper, 3 Spd. MT w/Cruise Upper	CA-3044
1968	V8 5.0L 302ci	F	3 Spd. AT; 60.00" Cable	CA-3015
1968	V8 5.0L 302ci	F	3 Spd. MT w/o Cruise; 60.00" Cable	CA-3015
1969	V8 5.8L 351ci	H	C4 w/o Cruise; 63.00" Cable	CA-3021
1969	V8 5.8L 351ci	H	C6 AT w/o Cruise, MT w/o Cruise; 80.00" Cable	CA-3012
1970	V8 5.8L 351ci	H	FMX AT w/o Cruise; 63.00" Cable	CA-3021
1971	V8 5.8L 351ci	H	FMX w/o Cruise, C6 w/o Cruise exc. Police; 63.00" Cable	CA-3021
1972	V8 5.8L 351ci	H	AT w/o Cruise Control; 63.00" Cable	CA-3021
1972	V8 5.8L 351ci	H	w/Cruise Upper; 80.00" Cable	CA-3001
1969-71	V8 5.8L 351ci	H	AT w/Cruise Upper, 3 Spd. MT w/Cruise Upper	CA-3044
1965	V8 5.8L 352ci		83.00" Cable	CA-3010
1964-66	V8 5.8L 352ci		60.00" Cable	CA-3015
1969	V8 6.4L 390ci	Y	C4 w/o Cruise; 63.00" Cable	CA-3021
1969	V8 6.4L 390ci	Y	C6 AT w/o Cruise, MT w/o Cruise; 80.00" Cable	CA-3012
1970	V8 6.4L 390ci	Y	3 Spd. MT; 63.00" Cable	CA-3021
1971	V8 6.4L 390ci	Y	AT w/o Cruise Control; 63.00" Cable	CA-3021
1969-71	V8 6.4L 390ci	Y	AT w/Cruise Upper, 3 Spd. MT w/Cruise Upper	CA-3044
1968	V8 6.4L 390ci	Y,Z	3 Spd. AT; 60.00" Cable	CA-3015
1968	V8 6.4L 390ci	Y,Z	3 Spd. MT w/o Cruise; 60.00" Cable	CA-3015
1964	V8 6.4L 390ci		60.00" Cable	CA-3015
1971	V8 6.6L 400ci	S	AT w/Cruise Upper, 3 Spd. MT w/Cruise Upper	CA-3044
1972	V8 6.6L 400ci	S	w/Cruise Upper; 80.00" Cable	CA-3001
1971-72	V8 6.6L 400ci	S	AT w/o Cruise Control; 63.00" Cable	CA-3021
1966	V8 7.0L 427ci		60.00" Cable	CA-3015

# SPEEDOMETER CABLES

Year	Engine	Vin	Remark	Part
<b>FORD (con't)</b>				
<b>CUSTOM (con't)</b>				
1968	V8 7.0L 428ci	P	3 Spd. AT; 60.00" Cable	CA-3015
1968	V8 7.0L 428ci	P	3 Spd. MT w/o Cruise; 60.00" Cable	CA-3015
1969	V8 7.0L 428ci	P	C4 w/o Cruise; 63.00" Cable	CA-3021
1969	V8 7.0L 428ci	P	C6 AT w/o Cruise, MT w/o Cruise; 80.00" Cable	CA-3012
1970	V8 7.0L 428ci	P	3 Spd. MT; 63.00" Cable	CA-3021
1969-70	V8 7.0L 428ci	P	AT w/Cruise Upper, 3 Spd. MT w/Cruise Upper	CA-3044
1969	V8 7.0L 429ci	K,N	C4 w/o Cruise; 63.00" Cable	CA-3021
1969	V8 7.0L 429ci	K,N	C6 AT w/o Cruise, MT w/o Cruise; 80.00" Cable	CA-3012
1970	V8 7.0L 429ci	K,N	3 Spd. MT; 63.00" Cable	CA-3021
1969-71	V8 7.0L 429ci	K,N	AT w/Cruise Upper, 3 Spd. MT w/Cruise Upper	CA-3044
1971-72	V8 7.0L 429ci	K,N	AT w/o Cruise Control; 63.00" Cable	CA-3021
1972	V8 7.0L 429ci	N	w/Cruise Upper; 80.00" Cable	CA-3001
<b>CUSTOM 300</b>				
1958-59	L6 3.7L 223ci		AT; 83.00" Cable	CA-3010
1958-59	V8 4.8L 292ci		AT; 83.00" Cable	CA-3010
1958-59	V8 5.4L 332ci		AT; 83.00" Cable	CA-3010
1960	V8 5.8L 352ci		Canada, w/3 Spd. Trans., w/Overdrive Trans.; 66.00" Cable	CA-3020
1959-60	V8 5.8L 352ci		AT; 83.00" Cable	CA-3010
<b>CUSTOM 500</b>				
1973	V8 5.8L 351ci	H	w/Cruise Lower; 66.00" Cable	CA-3020
1973	V8 5.8L 351ci	H	w/Cruise Upper; 80.00" Cable	CA-3001
1973-75	V8 5.8L 351ci	H	AT w/o Cruise exc. Police Car; 63.00" Cable	CA-3021
1974-75	V8 5.8L 351ci	H	w/Cruise exc. Police Upper; 80.00" Cable	CA-3001
1976-77	V8 5.8L 351ci	H	w/Cruise Control, Upper	CA-3044
1976-77	V8 5.8L 351ci	H	w/o Cruise Control; 63.00" Cable	CA-3021
1973	V8 6.6L 400ci	S	w/Cruise Lower; 66.00" Cable	CA-3020
1973	V8 6.6L 400ci	S	w/Cruise Upper; 80.00" Cable	CA-3001
1973-75	V8 6.6L 400ci	S	AT w/o Cruise exc. Police Car; 63.00" Cable	CA-3021
1974-75	V8 6.6L 400ci	S	Police w/Cruise Upper	CA-3044
1974-75	V8 6.6L 400ci	S	w/Cruise exc. Police Upper; 80.00" Cable	CA-3001
1976-77	V8 6.6L 400ci	S	w/Cruise Control, Upper	CA-3044
1976-77	V8 6.6L 400ci	S	w/o Cruise Control; 63.00" Cable	CA-3021
1973	V8 7.0L 429ci	N	AT w/o Cruise exc. Police Car; 63.00" Cable	CA-3021
1973	V8 7.0L 429ci	N	w/Cruise Lower; 66.00" Cable	CA-3020
1973	V8 7.0L 429ci	N	w/Cruise Upper; 80.00" Cable	CA-3001
1973	V8 7.5L 460ci	A	w/Cruise Lower; 66.00" Cable	CA-3020
1973	V8 7.5L 460ci	A	w/Cruise Upper; 80.00" Cable	CA-3001
1976	V8 7.5L 460ci	A	w/Cruise Control, Upper	CA-3044
1973-75	V8 7.5L 460ci	A,C	AT w/o Cruise exc. Police Car; 63.00" Cable	CA-3021
1974-75	V8 7.5L 460ci	A,C	Police w/Cruise Upper	CA-3044
1974-75	V8 7.5L 460ci	A,C	w/Cruise exc. Police Upper; 80.00" Cable	CA-3001
1976	V8 7.5L 460ci	C	w/o Cruise Control; 63.00" Cable	CA-3021
<b>ELITE</b>				
1975-76	V8 5.8L 351ci	H	AT w/Cruise Control, Upper	CA-3044
1975-76	V8 5.8L 351ci	H	C6 w/Cruise Lower; 66.00" Cable	CA-3020
1975-76	V8 5.8L 351ci	H	C6 w/o Cruise; 80.00" Cable	CA-3012
1975-76	V8 6.6L 400ci	S	AT w/Cruise Control, Upper	CA-3044
1975-76	V8 6.6L 400ci	S	C6 w/Cruise Lower; 66.00" Cable	CA-3020
1975-76	V8 6.6L 400ci	S	C6 w/o Cruise; 80.00" Cable	CA-3012
1975-76	V8 7.5L 460ci	A	AT w/Cruise Control, Upper	CA-3044
1975-76	V8 7.5L 460ci	A	C6 w/Cruise Lower; 66.00" Cable	CA-3020
1975-76	V8 7.5L 460ci	A	C6 w/o Cruise; 80.00" Cable	CA-3012
<b>ESCORT, EXP</b>				
1981-83	L4 1.6L 98ci	2,4,5,7	w/Cruise Lower	CA-3040
1981-83	L4 1.6L 98ci	2,4,5,7	w/Cruise Upper	CA-3045
1981-85	L4 1.6L 98ci	2,4,5,7,8	w/o Cruise Control	CA-3017
1984-85	L4 1.6L 98ci	2,4,5,8	w/Cruise Upper	CA-3043
1985-86	L4 1.9L 116ci	9,J	w/Cruise Upper	CA-3043
1985-90	L4 1.9L 116ci	9,J	w/o Cruise Control	CA-3017
1984-86	L4 2.0L 122ci	H	w/Cruise Upper	CA-3043
1984-87	L4 2.0L 122ci	H	w/o Cruise Control	CA-3017

# SPEEDOMETER CABLES

Year	Engine	Vin	Remark	Part
<b>FORD (con't)</b>				
<b>FAIRLANE</b>				
1963	L6 2.8L 170ci		3 Spd. MT; 66.00" Cable	CA-3020
1963-65	L6 2.8L 170ci		60.00" Cable	CA-3015
1968	L6 3.3L 200ci	T	3 Spd. MT; 66.00" Cable	CA-3020
1968	L6 3.3L 200ci	T	C4 AT; 83.00" Cable	CA-3010
1965	L6 3.3L 200ci		60.00" Cable	CA-3015
1966	L6 3.3L 200ci		66.00" Cable	CA-3020
1962	L6 3.7L 223ci		60.00" Cable	CA-3015
1969	L6 4.1L 250ci	L	AT; 80.00" Cable	CA-3012
1969	L6 4.1L 250ci	L	MT; 66.00" Cable	CA-3020
1970	L6 4.1L 250ci	L	3 Spd. MT; 63.00" Cable	CA-3021
1970	L6 4.1L 250ci	L	C4, FMX w/o Cruise; 80.00" Cable	CA-3012
1970	L6 4.1L 250ci	L	C6	CA-3046
1962-63	V8 3.6L 221ci		60.00" Cable	CA-3015
1962-64	V8 4.3L 260ci		60.00" Cable	CA-3015
1968	V8 4.7L 289ci	C	3 Spd. MT; 66.00" Cable	CA-3020
1968	V8 4.7L 289ci	C	C4 AT; 83.00" Cable	CA-3010
1965	V8 4.7L 289ci		3 Spd. MT; 66.00" Cable	CA-3020
1966	V8 4.7L 289ci		66.00" Cable	CA-3020
1964-65	V8 4.7L 289ci		60.00" Cable	CA-3015
1968	V8 5.0L 302ci	F	3 Spd. MT; 66.00" Cable	CA-3020
1968	V8 5.0L 302ci	F	C4 AT; 83.00" Cable	CA-3010
1969	V8 5.0L 302ci	F	AT; 80.00" Cable	CA-3012
1969	V8 5.0L 302ci	F	MT; 66.00" Cable	CA-3020
1970	V8 5.0L 302ci	F	3 Spd. MT; 63.00" Cable	CA-3021
1970	V8 5.0L 302ci	F	C4, FMX w/o Cruise; 80.00" Cable	CA-3012
1970	V8 5.0L 302ci	F	C6	CA-3046
1969	V8 5.8L 351ci	H,M	AT; 80.00" Cable	CA-3012
1969	V8 5.8L 351ci	H,M	MT; 66.00" Cable	CA-3020
1970	V8 5.8L 351ci	H,M	3 Spd. MT; 63.00" Cable	CA-3021
1970	V8 5.8L 351ci	H,M	C4, FMX w/o Cruise; 80.00" Cable	CA-3012
1970	V8 5.8L 351ci	H,M	C6	CA-3046
1959	V8 5.8L 352ci		3 Spd. MT; 66.00" Cable	CA-3020
1969	V8 6.4L 390ci	S	80.00" Cable	CA-3012
1968	V8 6.4L 390ci	S,Y	83.00" Cable	CA-3010
1964	V8 6.4L 390ci		60.00" Cable	CA-3015
1967	V8 7.0L 427ci	R,W	3 Spd. MT; 66.00" Cable	CA-3020
1969	V8 7.0L 427ci	W	AT; 80.00" Cable	CA-3012
1969	V8 7.0L 427ci	W	MT; 66.00" Cable	CA-3020
1964-65	V8 7.0L 427ci		60.00" Cable	CA-3015
1969	V8 7.0L 428ci	Q	AT; 80.00" Cable	CA-3012
1969	V8 7.0L 428ci	Q	MT; 66.00" Cable	CA-3020
1968	V8 7.0L 428ci	R	3 Spd. MT; 66.00" Cable	CA-3020
1968	V8 7.0L 428ci	R	C4 AT; 83.00" Cable	CA-3010
1970	V8 7.0L 429ci	C	3 Spd. MT; 63.00" Cable	CA-3021
1970	V8 7.0L 429ci	C	C4, FMX w/o Cruise; 80.00" Cable	CA-3012
1970	V8 7.0L 429ci	C	C6	CA-3046
<b>FAIRMONT</b>				
1983	L4 2.3L 140ci	A	w/Cruise Control; 71.00" Cable	CA-3018
1980-83	L4 2.3L 140ci	A	w/Cruise Lower; 63.00" Cable	CA-3002
1980-83	L4 2.3L 140ci	A	w/Cruise Upper	CA-3045
1980-83	L4 2.3L 140ci	A	w/o Cruise Control; 76.00" Cable	CA-3011
1978	L4 2.3L 140ci	Y	4 Spd. MT w/Cruise Lower; 63.00" Cable	CA-3002
1978	L4 2.3L 140ci	Y	AT w/Cruise Upper, 4 Spd. MT w/Cruise Upper	CA-3045
1979	L4 2.3L 140ci	Y	w/o Cruise Control; 76.00" Cable	CA-3011
1980-82	L6 3.3L 200ci	B	w/Cruise Upper	CA-3043
1980-82	L6 3.3L 200ci	B	w/o Cruise Control; 76.00" Cable	CA-3011
1979	L6 3.3L 200ci	T	w/o Cruise Control; 76.00" Cable	CA-3011
1978-79	L6 3.3L 200ci	T	4 Spd. MT w/Cruise Lower; 63.00" Cable	CA-3002
1978-79	L6 3.3L 200ci	T	AT w/Cruise Upper, 4 Spd. MT w/Cruise Upper	CA-3045
1983	L6 3.3L 200ci	X	w/Cruise Control; 71.00" Cable	CA-3018
1983	L6 3.3L 200ci	X	w/Cruise Upper	CA-3043
1983	L6 3.3L 200ci	X	w/o Cruise Control; 76.00" Cable	CA-3011

# SPEEDOMETER CABLES

Year	Engine	Vin	Remark	Part
<b>FORD (con't)</b>				
<b>FAIRMONT (con't)</b>				
1980-82	V8 4.2L 255ci	D	w/Cruise Upper	CA-3043
1980-82	V8 4.2L 255ci	D	w/o Cruise Control; 76.00" Cable	CA-3011
1978	V8 5.0L 302ci	F	4 Spd. MT w/Cruise Lower; 63.00" Cable	CA-3002
1978	V8 5.0L 302ci	F	AT w/Cruise Upper, 4 Spd. MT w/Cruise Upper	CA-3045
1979	V8 5.0L 302ci	F	w/o Cruise Control; 76.00" Cable	CA-3011
<b>FALCON</b>				
1962	L6 2.4L 144ci		3 Spd., w/Overdrive Trans., To 4/23/62; 60.00" Cable	CA-3015
1962	L6 2.4L 144ci		AT, From 4/23/62; 83.00" Cable	CA-3010
1963	L6 2.4L 144ci		83.00" Cable	CA-3010
1964	L6 2.4L 144ci		AT, From 1/18/64; 60.00" Cable	CA-3015
1964	L6 2.4L 144ci		AT, To 1/18/64; 83.00" Cable	CA-3010
1968	L6 2.8L 170ci	U	66.00" Cable	CA-3020
1969	L6 2.8L 170ci	U	3 Spd. MT; 63.00" Cable	CA-3021
1969	L6 2.8L 170ci	U	AT w/o Cruise Control; 80.00" Cable	CA-3012
1962	L6 2.8L 170ci		3 Spd., w/Overdrive Trans., To 4/23/62; 60.00" Cable	CA-3015
1962	L6 2.8L 170ci		AT, From 4/23/62; 83.00" Cable	CA-3010
1963	L6 2.8L 170ci		83.00" Cable	CA-3010
1964	L6 2.8L 170ci		AT, From 1/18/64; 60.00" Cable	CA-3015
1964	L6 2.8L 170ci		AT, To 1/18/64; 83.00" Cable	CA-3010
1965	L6 2.8L 170ci		60.00" Cable	CA-3015
1968	L6 3.3L 200ci	T	66.00" Cable	CA-3020
1970	L6 3.3L 200ci	T	w/Cruise Lower; 66.00" Cable	CA-3020
1969-70	L6 3.3L 200ci	T	3 Spd. MT; 63.00" Cable	CA-3021
1969-70	L6 3.3L 200ci	T	AT w/o Cruise Control; 80.00" Cable	CA-3012
1963	L6 3.3L 200ci		3 Spd., w/Overdrive Trans.; 60.00" Cable	CA-3015
1963	L6 3.3L 200ci		83.00" Cable	CA-3010
1964	L6 3.3L 200ci		AT, From 1/18/64; 60.00" Cable	CA-3015
1964	L6 3.3L 200ci		AT, To 1/18/64; 83.00" Cable	CA-3010
1965	L6 3.3L 200ci		60.00" Cable	CA-3015
1970	L6 4.1L 250ci	L	3 Spd. MT; 63.00" Cable	CA-3021
1970	L6 4.1L 250ci	L	AT w/o Cruise Control; 80.00" Cable	CA-3012
1970	L6 4.1L 250ci	L	w/Cruise Lower; 66.00" Cable	CA-3020
1963	V8 4.3L 260ci		3 Spd., w/Overdrive Trans.; 60.00" Cable	CA-3015
1963	V8 4.3L 260ci		83.00" Cable	CA-3010
1964	V8 4.3L 260ci		AT, From 1/18/64; 60.00" Cable	CA-3015
1964	V8 4.3L 260ci		AT, To 1/18/64; 83.00" Cable	CA-3010
1968	V8 4.7L 289ci	C	66.00" Cable	CA-3020
1964	V8 4.7L 289ci		AT, From 1/18/64; 60.00" Cable	CA-3015
1964	V8 4.7L 289ci		AT, To 1/18/64; 83.00" Cable	CA-3010
1965	V8 4.7L 289ci		60.00" Cable	CA-3015
1969-70	V8 5.0L 302ci	F	3 Spd. MT; 63.00" Cable	CA-3021
1969-70	V8 5.0L 302ci	F	AT w/o Cruise Control; 80.00" Cable	CA-3012
1968	V8 5.0L 302ci	J	66.00" Cable	CA-3020
<b>FESTIVA</b>				
1988	L4 1.3L 1295cc	K	w/o Cruise Control	CA-3088
<b>FIESTA</b>				
1980	L4 1.6L 98ci		w/o Cruise Control	CA-3017
<b>GALAXIE</b>				
1963	L6 3.3L 200ci		60.00" Cable	CA-3015
1960	L6 3.7L 223ci		Canada, w/3 Spd. Trans., w/Overdrive Trans.; 66.00" Cable	CA-3020
1961	L6 3.7L 223ci		MT; 66.00" Cable	CA-3020
1962	L6 3.7L 223ci		80.00" Cable	CA-3012
1959-61	L6 3.7L 223ci		AT; 83.00" Cable	CA-3010
1963-64	L6 3.7L 223ci		60.00" Cable	CA-3015
1965	L6 3.9L 240ci		83.00" Cable	CA-3010
1966	L6 3.9L 240ci		60.00" Cable	CA-3015
1967	L6 3.9L 240ci		3 Spd. MT w/o Cruise w/o Overdrive; 60.00" Cable	CA-3015
1967	L6 3.9L 240ci		Pump to Trans.; 63.00" Cable	CA-3002
1964	V8 4.3L 260ci		60.00" Cable	CA-3015
1965	V8 4.7L 289ci		83.00" Cable	CA-3010
1967	V8 4.7L 289ci		3 Spd. MT w/o Cruise w/o Overdrive; 60.00" Cable	CA-3015
1967	V8 4.7L 289ci		Pump to Trans.; 63.00" Cable	CA-3002

# SPEEDOMETER CABLES

Year	Engine	Vin	Remark	Part
<b>FORD (con't)</b>				
<b>GALAXIE (con't)</b>				
1963-66	V8 4.7L 289ci		60.00" Cable	CA-3015
1960	V8 4.8L 292ci		Canada, w/3 Spd. Trans., w/Overdrive Trans.; 66.00" Cable	CA-3020
1961	V8 4.8L 292ci		MT; 66.00" Cable	CA-3020
1962	V8 4.8L 292ci		80.00" Cable	CA-3012
1959-61	V8 4.8L 292ci		AT; 83.00" Cable	CA-3010
1959	V8 5.4L 332ci		AT; 83.00" Cable	CA-3010
1960	V8 5.8L 352ci		Canada, w/3 Spd. Trans., w/Overdrive Trans.; 66.00" Cable	CA-3020
1961	V8 5.8L 352ci		MT; 66.00" Cable	CA-3020
1962	V8 5.8L 352ci		80.00" Cable	CA-3012
1965	V8 5.8L 352ci		83.00" Cable	CA-3010
1959-61	V8 5.8L 352ci		AT; 83.00" Cable	CA-3010
1963-66	V8 5.8L 352ci		60.00" Cable	CA-3015
1962	V8 6.4L 390ci		80.00" Cable	CA-3012
1963-64	V8 6.4L 390ci		60.00" Cable	CA-3015
1966	V8 7.0L 427ci		60.00" Cable	CA-3015
1966	V8 7.0L 428ci		60.00" Cable	CA-3015
<b>GALAXIE 500</b>				
1970	L6 3.9L 240ci	B	w/o Cruise Control; 63.00" Cable	CA-3021
1970	L6 3.9L 240ci	B	w/Cruise Control, Upper	CA-3044
1968	L6 3.9L 240ci	E	3 Spd. AT; 60.00" Cable	CA-3015
1968	L6 3.9L 240ci	E	3 Spd. MT w/o Cruise; 60.00" Cable	CA-3015
1969	L6 3.9L 240ci	E	C4 w/o Cruise; 63.00" Cable	CA-3021
1969	L6 3.9L 240ci	E	C6 AT w/o Cruise, MT w/o Cruise; 80.00" Cable	CA-3012
1972	L6 3.9L 240ci	E	w/Cruise Upper; 80.00" Cable	CA-3001
1969-71	L6 3.9L 240ci	E	AT w/Cruise Upper, 3 Spd. MT w/Cruise Upper	CA-3044
1971-72	L6 3.9L 240ci	E	AT w/o Cruise Control; 63.00" Cable	CA-3021
1972	V8 5.0L 302ci	D	AT w/o Cruise Control; 63.00" Cable	CA-3021
1972	V8 5.0L 302ci	D	w/Cruise Upper; 80.00" Cable	CA-3001
1968	V8 5.0L 302ci	F	3 Spd. AT; 60.00" Cable	CA-3015
1968	V8 5.0L 302ci	F	3 Spd. MT w/o Cruise; 60.00" Cable	CA-3015
1969	V8 5.0L 302ci	F	C6 AT w/o Cruise, MT w/o Cruise; 80.00" Cable	CA-3012
1971	V8 5.0L 302ci	F	C4 w/o Cruise, C6 w/o Cruise exc. Police; 63.00" Cable	CA-3021
1969-70	V8 5.0L 302ci	F	C4 w/o Cruise; 63.00" Cable	CA-3021
1969-71	V8 5.0L 302ci	F	AT w/Cruise Upper, 3 Spd. MT w/Cruise Upper	CA-3044
1969	V8 5.8L 351ci	H	C4 w/o Cruise; 63.00" Cable	CA-3021
1969	V8 5.8L 351ci	H	C6 AT w/o Cruise, MT w/o Cruise; 80.00" Cable	CA-3012
1970	V8 5.8L 351ci	H	FMX AT w/o Cruise; 63.00" Cable	CA-3021
1971	V8 5.8L 351ci	H	FMX w/o Cruise, C6 w/o Cruise exc. Police; 63.00" Cable	CA-3021
1972	V8 5.8L 351ci	H	AT w/o Cruise Control; 63.00" Cable	CA-3021
1973	V8 5.8L 351ci	H	w/Cruise Lower; 66.00" Cable	CA-3020
1974	V8 5.8L 351ci	H	w/Cruise exc. Police Upper; 80.00" Cable	CA-3001
1969-71	V8 5.8L 351ci	H	AT w/Cruise Upper, 3 Spd. MT w/Cruise Upper	CA-3044
1972-73	V8 5.8L 351ci	H	w/Cruise Upper; 80.00" Cable	CA-3001
1973-74	V8 5.8L 351ci	H	AT w/o Cruise exc. Police Car; 63.00" Cable	CA-3021
1969-71	V8 6.4L 390ci	S,X,Y	AT w/Cruise Upper, 3 Spd. MT w/Cruise Upper	CA-3044
1969	V8 6.4L 390ci	S,Y	C4 w/o Cruise; 63.00" Cable	CA-3021
1969	V8 6.4L 390ci	S,Y	C6 AT w/o Cruise, MT w/o Cruise; 80.00" Cable	CA-3012
1970	V8 6.4L 390ci	X,Y	3 Spd. MT; 63.00" Cable	CA-3021
1968	V8 6.4L 390ci	X,Z	3 Spd. AT; 60.00" Cable	CA-3015
1968	V8 6.4L 390ci	X,Z	3 Spd. MT w/o Cruise; 60.00" Cable	CA-3015
1971	V8 6.4L 390ci	Y	AT w/o Cruise Control; 63.00" Cable	CA-3021
1971	V8 6.6L 400ci	S	AT w/Cruise Upper, 3 Spd. MT w/Cruise Upper	CA-3044
1973	V8 6.6L 400ci	S	w/Cruise Lower; 66.00" Cable	CA-3020
1974	V8 6.6L 400ci	S	Police w/Cruise Upper	CA-3044
1974	V8 6.6L 400ci	S	w/Cruise exc. Police Upper; 80.00" Cable	CA-3001
1971-72	V8 6.6L 400ci	S	AT w/o Cruise Control; 63.00" Cable	CA-3021
1972-73	V8 6.6L 400ci	S	w/Cruise Upper; 80.00" Cable	CA-3001
1973-74	V8 6.6L 400ci	S	AT w/o Cruise exc. Police Car; 63.00" Cable	CA-3021
1968	V8 7.0L 427ci	W	3 Spd. AT; 60.00" Cable	CA-3015
1968	V8 7.0L 427ci	W	3 Spd. MT w/o Cruise; 60.00" Cable	CA-3015
1969	V8 7.0L 428ci	P	AT w/Cruise Upper, 3 Spd. MT w/Cruise Upper	CA-3044
1969	V8 7.0L 428ci	P	C4 w/o Cruise; 63.00" Cable	CA-3021



# SPEEDOMETER CABLES

Year	Engine	Vin	Remark	Part
<b>FORD (con't)</b>				
<b>GALAXIE 500 (con't)</b>				
1969	V8 7.0L 428ci	P	C6 AT w/o Cruise, MT w/o Cruise; 80.00" Cable	CA-3012
1968	V8 7.0L 428ci	P,Q	3 Spd. AT; 60.00" Cable	CA-3015
1968	V8 7.0L 428ci	P,Q	3 Spd. MT w/o Cruise; 60.00" Cable	CA-3015
1969	V8 7.0L 429ci	K,N	C4 w/o Cruise; 63.00" Cable	CA-3021
1969	V8 7.0L 429ci	K,N	C6 AT w/o Cruise, MT w/o Cruise; 80.00" Cable	CA-3012
1970	V8 7.0L 429ci	K,N	3 Spd. MT; 63.00" Cable	CA-3021
1969-71	V8 7.0L 429ci	K,N	AT w/Cruise Upper, 3 Spd. MT w/Cruise Upper	CA-3044
1971-72	V8 7.0L 429ci	K,N	AT w/o Cruise Control; 63.00" Cable	CA-3021
1973	V8 7.0L 429ci	N	AT w/o Cruise exc. Police Car; 63.00" Cable	CA-3021
1973	V8 7.0L 429ci	N	w/Cruise Lower; 66.00" Cable	CA-3020
1972-73	V8 7.0L 429ci	N	w/Cruise Upper; 80.00" Cable	CA-3001
1973	V8 7.5L 460ci	A	w/Cruise Lower; 66.00" Cable	CA-3020
1973	V8 7.5L 460ci	A	w/Cruise Upper; 80.00" Cable	CA-3001
1974	V8 7.5L 460ci	A,C	Police w/Cruise Upper	CA-3044
1974	V8 7.5L 460ci	A,C	w/Cruise exc. Police Upper; 80.00" Cable	CA-3001
1973-74	V8 7.5L 460ci	A,C	AT w/o Cruise exc. Police Car; 63.00" Cable	CA-3021
<b>GRAN TORINO</b>				
1973	L6 4.1L 250ci	L	w/Cruise Control, Upper	CA-3044
1974	L6 4.1L 250ci	L	AT exc. C6, MT; 80.00" Cable	CA-3012
1972-74	L6 4.1L 250ci	L	AT w/Cruise Control, Lower; 66.00" Cable	CA-3020
1972-74	L6 4.1L 250ci	L	AT w/Cruise Control, Upper	CA-3044
1972-74	L6 4.1L 250ci	L	AT w/o Cruise Control; 80.00" Cable	CA-3012
1973	V8 5.0L 302ci	F	w/Cruise Control, Upper	CA-3044
1974	V8 5.0L 302ci	F	AT exc. C6, MT; 80.00" Cable	CA-3012
1972-74	V8 5.0L 302ci	F	AT w/Cruise Control, Lower; 66.00" Cable	CA-3020
1972-74	V8 5.0L 302ci	F	AT w/Cruise Control, Upper	CA-3044
1972-74	V8 5.0L 302ci	F	AT w/o Cruise Control; 80.00" Cable	CA-3012
1975	V8 5.8L 351ci	H	w/Cruise Control, Upper	CA-3044
1972-76	V8 5.8L 351ci	H	AT exc. C6, MT; 80.00" Cable	CA-3012
1972-75	V8 5.8L 351ci	H,Q	C6 w/Cruise Lower; 66.00" Cable	CA-3020
1972-75	V8 5.8L 351ci	H,Q	C6 w/o Cruise; 80.00" Cable	CA-3012
1972-76	V8 5.8L 351ci	H,Q	AT w/Cruise Control, Lower; 66.00" Cable	CA-3020
1972-76	V8 5.8L 351ci	H,Q	AT w/Cruise Control, Upper	CA-3044
1972-76	V8 5.8L 351ci	H,Q	AT w/o Cruise Control; 80.00" Cable	CA-3012
1972	V8 5.8L 351ci	Q	w/Cruise Control, Upper	CA-3044
1973	V8 5.8L 351ci	Q	AT exc. C6, MT; 80.00" Cable	CA-3012
1972-75	V8 6.6L 400ci	S	C6 w/Cruise Lower; 66.00" Cable	CA-3020
1972-75	V8 6.6L 400ci	S	C6 w/o Cruise; 80.00" Cable	CA-3012
1972-76	V8 6.6L 400ci	S	AT w/Cruise Control, Upper	CA-3044
1973-76	V8 6.6L 400ci	S	AT w/Cruise Control, Lower; 66.00" Cable	CA-3020
1973-76	V8 6.6L 400ci	S	AT w/o Cruise Control; 80.00" Cable	CA-3012
1974-75	V8 6.6L 400ci	S	w/Cruise Control, Upper	CA-3044
1975-76	V8 6.6L 400ci	S	AT exc. C6, MT; 80.00" Cable	CA-3012
1972	V8 7.0L 429ci	N	AT w/Cruise Control, Lower; 66.00" Cable	CA-3020
1972	V8 7.0L 429ci	N	AT w/o Cruise Control; 80.00" Cable	CA-3012
1972	V8 7.0L 429ci	N	w/Cruise Control, Upper	CA-3044
1973	V8 7.0L 429ci	N	AT exc. C6, MT; 80.00" Cable	CA-3012
1974-75	V8 7.5L 460ci	A	C6 w/Cruise Lower; 66.00" Cable	CA-3020
1974-75	V8 7.5L 460ci	A	C6 w/o Cruise; 80.00" Cable	CA-3012
1974-76	V8 7.5L 460ci	A	AT w/Cruise Control, Lower; 66.00" Cable	CA-3020
1974-76	V8 7.5L 460ci	A	AT w/Cruise Control, Upper	CA-3044
1974-76	V8 7.5L 460ci	A	AT w/o Cruise Control; 80.00" Cable	CA-3012
<b>GRANADA</b>				
1981-82	L4 2.3L 140ci	A	w/Cruise Lower; 63.00" Cable	CA-3002
1981-82	L4 2.3L 140ci	A	w/Cruise Upper	CA-3043
1981-82	L4 2.3L 140ci	A	w/o Cruise Control; 76.00" Cable	CA-3011
1981-82	L6 3.3L 200ci	B	w/Cruise Lower; 63.00" Cable	CA-3002
1981-82	L6 3.3L 200ci	B	w/Cruise Upper	CA-3043
1981-82	L6 3.3L 200ci	B	w/o Cruise Control; 76.00" Cable	CA-3011
1975-77	L6 3.3L 200ci	T	AT w/o Cruise Control; 80.00" Cable	CA-3012
1975-77	L6 3.3L 200ci	T	MT w/o Cruise; 63.00" Cable	CA-3021
1975-77	L6 3.3L 200ci	T	w/Cruise Lower; 66.00" Cable	CA-3020

# SPEEDOMETER CABLES

Year	Engine	Vin	Remark	Part
<b>FORD (con't)</b>				
<b>GRANADA (con't)</b>				
1975-77	L6 3.3L 200ci	T	w/Cruise Control, Upper	CA-3044
1980	L6 4.1L 250ci	C	AT w/Cruise Control, Lower; 63.00" Cable	CA-3002
1980	L6 4.1L 250ci	C	AT w/Cruise Control, Upper	CA-3045
1980	L6 4.1L 250ci	C	AT w/o Cruise Control; 80.00" Cable	CA-3012
1980	L6 4.1L 250ci	C	MT w/Cruise Lower; 66.00" Cable	CA-3020
1980	L6 4.1L 250ci	C	MT w/Cruise Upper	CA-3044
1975-78	L6 4.1L 250ci	L	MT w/o Cruise; 63.00" Cable	CA-3021
1975-79	L6 4.1L 250ci	L	w/Cruise Lower; 66.00" Cable	CA-3020
1975-79	L6 4.1L 250ci	L	w/Cruise Control, Upper	CA-3044
1976-79	L6 4.1L 250ci	L	AT w/o Cruise Control; 80.00" Cable	CA-3012
1982	V6 3.8L 232ci	3	w/Cruise Lower; 63.00" Cable	CA-3002
1982	V6 3.8L 232ci	3	w/Cruise Upper	CA-3043
1982	V6 3.8L 232ci	3	w/o Cruise Control; 76.00" Cable	CA-3011
1980	V8 4.2L 255ci	D	AT w/Cruise Control, Lower; 63.00" Cable	CA-3002
1980	V8 4.2L 255ci	D	AT w/Cruise Control, Upper	CA-3045
1980	V8 4.2L 255ci	D	AT w/o Cruise Control; 80.00" Cable	CA-3012
1980	V8 4.2L 255ci	D	MT w/Cruise Lower; 66.00" Cable	CA-3020
1980	V8 4.2L 255ci	D	MT w/Cruise Upper	CA-3044
1981	V8 4.2L 255ci	D	w/Cruise Lower; 63.00" Cable	CA-3002
1981	V8 4.2L 255ci	D	w/Cruise Upper	CA-3043
1981	V8 4.2L 255ci	D	w/o Cruise Control; 76.00" Cable	CA-3011
1980	V8 5.0L 302ci	F	AT w/Cruise Control, Lower; 63.00" Cable	CA-3002
1980	V8 5.0L 302ci	F	AT w/Cruise Control, Upper	CA-3045
1980	V8 5.0L 302ci	F	MT w/Cruise Lower; 66.00" Cable	CA-3020
1980	V8 5.0L 302ci	F	MT w/Cruise Upper	CA-3044
1975-78	V8 5.0L 302ci	F	MT w/o Cruise; 63.00" Cable	CA-3021
1975-79	V8 5.0L 302ci	F	w/Cruise Lower; 66.00" Cable	CA-3020
1975-80	V8 5.0L 302ci	F	AT w/o Cruise Control; 80.00" Cable	CA-3012
1976-79	V8 5.0L 302ci	F	w/Cruise Control, Upper	CA-3044
1975-77	V8 5.8L 351ci	H	AT w/o Cruise Control; 80.00" Cable	CA-3012
1975-77	V8 5.8L 351ci	H	MT w/o Cruise; 63.00" Cable	CA-3021
1975-77	V8 5.8L 351ci	H	w/Cruise Lower; 66.00" Cable	CA-3020
1976-77	V8 5.8L 351ci	H	w/Cruise Control, Upper	CA-3044
<b>LTD</b>				
1983-86	L4 2.3L 140ci	6,A	w/Cruise Control; 71.00" Cable	CA-3018
1983-86	L4 2.3L 140ci	6,A	w/o Cruise Control; 76.00" Cable	CA-3011
1983	L6 3.3L 200ci	X	w/Cruise Control; 71.00" Cable	CA-3018
1983	L6 3.3L 200ci	X	w/o Cruise Control; 76.00" Cable	CA-3011
1983-86	V6 3.8L 232ci	3,C	w/Cruise Control; 71.00" Cable	CA-3018
1983-86	V6 3.8L 232ci	3,C	w/o Cruise Control; 76.00" Cable	CA-3011
1981-82	V8 4.2L 255ci	D	AT w/Cruise Control, Lower; 66.00" Cable	CA-3020
1981-82	V8 4.2L 255ci	D	AT w/Cruise Control, Upper	CA-3044
1981-82	V8 4.2L 255ci	D	AT w/o Cruise Control; 80.00" Cable	CA-3012
1968	V8 4.7L 289ci	C	3 Spd. AT; 60.00" Cable	CA-3015
1968	V8 4.7L 289ci	C	3 Spd. MT w/o Cruise; 60.00" Cable	CA-3015
1967	V8 4.7L 289ci		3 Spd. MT w/o Cruise w/o Overdrive; 60.00" Cable	CA-3015
1967	V8 4.7L 289ci		Pump to Trans.; 63.00" Cable	CA-3002
1971	V8 5.0L 302ci	D	AT w/Cruise Upper, 3 Spd. MT w/Cruise Upper	CA-3044
1971	V8 5.0L 302ci	D	C4 w/o Cruise, C6 w/o Cruise exc. Police; 63.00" Cable	CA-3021
1972	V8 5.0L 302ci	D	AT w/o Cruise Control; 63.00" Cable	CA-3021
1972	V8 5.0L 302ci	D	w/Cruise Upper; 80.00" Cable	CA-3001
1968	V8 5.0L 302ci	F	3 Spd. AT; 60.00" Cable	CA-3015
1968	V8 5.0L 302ci	F	3 Spd. MT w/o Cruise; 60.00" Cable	CA-3015
1969	V8 5.0L 302ci	F	C6 AT w/o Cruise, MT w/o Cruise; 80.00" Cable	CA-3012
1977	V8 5.0L 302ci	F	w/Cruise Control, Upper	CA-3044
1969-70	V8 5.0L 302ci	F	AT w/Cruise Upper, 3 Spd. MT w/Cruise Upper	CA-3044
1969-70	V8 5.0L 302ci	F	C4 w/o Cruise; 63.00" Cable	CA-3021
1972-82	V8 5.0L 302ci	F	AT w/Cruise Control, Lower; 66.00" Cable	CA-3020
1972-82	V8 5.0L 302ci	F	AT w/Cruise Control, Upper	CA-3044
1972-82	V8 5.0L 302ci	F	AT w/o Cruise Control; 80.00" Cable	CA-3012
1977-78	V8 5.0L 302ci	F	w/o Cruise Control; 63.00" Cable	CA-3021
1984-85	V8 5.0L 302ci	M	w/Cruise Control; 71.00" Cable	CA-3018

# SPEEDOMETER CABLES

Year	Engine	Vin	Remark	Part
<b>FORD (con't)</b>				
<b>LTD (con't)</b>				
1984-85	V8 5.0L 302ci	M	w/o Cruise Control; 76.00" Cable	CA-3011
1980-82	V8 5.8L 351ci	G	AT w/Cruise Control, Lower; 66.00" Cable	CA-3020
1980-82	V8 5.8L 351ci	G	AT w/Cruise Control, Upper	CA-3044
1980-82	V8 5.8L 351ci	G	AT w/o Cruise Control; 80.00" Cable	CA-3012
1985-86	V8 5.8L 351ci	G	w/Cruise Control; 71.00" Cable	CA-3018
1985-86	V8 5.8L 351ci	G	w/o Cruise Control; 76.00" Cable	CA-3011
1969	V8 5.8L 351ci	H	AT w/Cruise Control, Lower; 66.00" Cable	CA-3020
1969	V8 5.8L 351ci	H	AT w/Cruise Control, Upper	CA-3044
1969	V8 5.8L 351ci	H	AT w/o Cruise Control; 80.00" Cable	CA-3012
1969	V8 5.8L 351ci	H	C4 w/o Cruise; 63.00" Cable	CA-3021
1969	V8 5.8L 351ci	H	C6 AT w/o Cruise, MT w/o Cruise; 80.00" Cable	CA-3012
1970	V8 5.8L 351ci	H	FMX AT w/o Cruise; 63.00" Cable	CA-3021
1971	V8 5.8L 351ci	H	FMX w/o Cruise, C6 w/o Cruise exc. Police; 63.00" Cable	CA-3021
1972	V8 5.8L 351ci	H	AT w/o Cruise Control; 63.00" Cable	CA-3021
1973	V8 5.8L 351ci	H	w/Cruise Lower; 66.00" Cable	CA-3020
1969-71	V8 5.8L 351ci	H	AT w/Cruise Upper, 3 Spd. MT w/Cruise Upper	CA-3044
1972-73	V8 5.8L 351ci	H	w/Cruise Upper; 80.00" Cable	CA-3001
1973-75	V8 5.8L 351ci	H	AT w/o Cruise exc. Police Car; 63.00" Cable	CA-3021
1974-75	V8 5.8L 351ci	H	w/Cruise exc. Police Upper; 80.00" Cable	CA-3001
1976-77	V8 5.8L 351ci	H	w/Cruise Control, Upper	CA-3044
1976-78	V8 5.8L 351ci	H	w/o Cruise Control; 63.00" Cable	CA-3021
1969	V8 6.4L 390ci	S,X	C4 w/o Cruise; 63.00" Cable	CA-3021
1969	V8 6.4L 390ci	S,X	C6 AT w/o Cruise, MT w/o Cruise; 80.00" Cable	CA-3012
1969-70	V8 6.4L 390ci	S,X	AT w/Cruise Upper, 3 Spd. MT w/Cruise Upper	CA-3044
1970	V8 6.4L 390ci	X	3 Spd. MT; 63.00" Cable	CA-3021
1968	V8 6.4L 390ci	X,Z	3 Spd. AT; 60.00" Cable	CA-3015
1968	V8 6.4L 390ci	X,Z	3 Spd. MT w/o Cruise; 60.00" Cable	CA-3015
1971	V8 6.4L 390ci	Y	AT w/Cruise Upper, 3 Spd. MT w/Cruise Upper	CA-3044
1971	V8 6.4L 390ci	Y	AT w/o Cruise Control; 63.00" Cable	CA-3021
1971	V8 6.6L 400ci	S	AT w/Cruise Upper, 3 Spd. MT w/Cruise Upper	CA-3044
1973	V8 6.6L 400ci	S	w/Cruise Lower; 66.00" Cable	CA-3020
1971-72	V8 6.6L 400ci	S	AT w/o Cruise Control; 63.00" Cable	CA-3021
1972-73	V8 6.6L 400ci	S	w/Cruise Upper; 80.00" Cable	CA-3001
1973-75	V8 6.6L 400ci	S	AT w/o Cruise exc. Police Car; 63.00" Cable	CA-3021
1974-75	V8 6.6L 400ci	S	Police w/Cruise Upper	CA-3044
1974-75	V8 6.6L 400ci	S	w/Cruise exc. Police Upper; 80.00" Cable	CA-3001
1976-77	V8 6.6L 400ci	S	w/Cruise Control, Upper	CA-3044
1976-78	V8 6.6L 400ci	S	w/o Cruise Control; 63.00" Cable	CA-3021
1968	V8 7.0L 427ci	W	3 Spd. AT; 60.00" Cable	CA-3015
1968	V8 7.0L 427ci	W	3 Spd. MT w/o Cruise; 60.00" Cable	CA-3015
1968	V8 7.0L 428ci	P	3 Spd. AT; 60.00" Cable	CA-3015
1968	V8 7.0L 428ci	P	3 Spd. MT w/o Cruise; 60.00" Cable	CA-3015
1969	V8 7.0L 428ci	P	AT w/Cruise Upper, 3 Spd. MT w/Cruise Upper	CA-3044
1969	V8 7.0L 428ci	P	C4 w/o Cruise; 63.00" Cable	CA-3021
1969	V8 7.0L 428ci	P	C6 AT w/o Cruise, MT w/o Cruise; 80.00" Cable	CA-3012
1969	V8 7.0L 429ci	K,N	C4 w/o Cruise; 63.00" Cable	CA-3021
1969	V8 7.0L 429ci	K,N	C6 AT w/o Cruise, MT w/o Cruise; 80.00" Cable	CA-3012
1970	V8 7.0L 429ci	K,N	3 Spd. MT; 63.00" Cable	CA-3021
1969-71	V8 7.0L 429ci	K,N	AT w/Cruise Upper, 3 Spd. MT w/Cruise Upper	CA-3044
1971-72	V8 7.0L 429ci	K,N	AT w/o Cruise Control; 63.00" Cable	CA-3021
1973	V8 7.0L 429ci	N	AT w/o Cruise exc. Police Car; 63.00" Cable	CA-3021
1973	V8 7.0L 429ci	N	w/Cruise Lower; 66.00" Cable	CA-3020
1972-73	V8 7.0L 429ci	N	w/Cruise Upper; 80.00" Cable	CA-3001
1972	V8 7.5L 460ci	A	AT w/o Cruise Control; 63.00" Cable	CA-3021
1973	V8 7.5L 460ci	A	w/Cruise Lower; 66.00" Cable	CA-3020
1972-73	V8 7.5L 460ci	A	w/Cruise Upper; 80.00" Cable	CA-3001
1973-75	V8 7.5L 460ci	A,C	AT w/o Cruise exc. Police Car; 63.00" Cable	CA-3021
1974-75	V8 7.5L 460ci	A,C	Police w/Cruise Upper	CA-3044
1974-75	V8 7.5L 460ci	A,C	w/Cruise exc. Police Upper; 80.00" Cable	CA-3001
1976-77	V8 7.5L 460ci	A,C	w/Cruise Control, Upper	CA-3044
1976-78	V8 7.5L 460ci	A,C	w/o Cruise Control; 63.00" Cable	CA-3021

# SPEEDOMETER CABLES

Year	Engine	Vin	Remark	Part
<b>FORD (con't)</b>				
<b>LTD CROWN VICTORIA</b>				
1987-90	V8 5.0L 302ci	F	w/Cruise Control; 71.00" Cable	CA-3018
1987-90	V8 5.0L 302ci	F	w/o Cruise Control; 80.00" Cable	CA-3012
1987-90	V8 5.8L 351ci	G	w/Cruise Control; 71.00" Cable	CA-3018
1987-90	V8 5.8L 351ci	G	w/o Cruise Control; 80.00" Cable	CA-3012
<b>LTD II</b>				
1977-78	V8 5.0L 302ci	F	AT w/Cruise Control, Upper	CA-3044
1977-78	V8 5.0L 302ci	F	C6 w/Cruise Lower; 66.00" Cable	CA-3020
1977-78	V8 5.0L 302ci	F	C6 w/o Cruise; 80.00" Cable	CA-3012
1977-78	V8 5.8L 351ci	H	AT w/Cruise Control, Upper	CA-3044
1977-78	V8 5.8L 351ci	H	C6 w/Cruise Lower; 66.00" Cable	CA-3020
1977-78	V8 5.8L 351ci	H	C6 w/o Cruise; 80.00" Cable	CA-3012
1977-78	V8 6.6L 400ci	S	AT w/Cruise Control, Upper	CA-3044
1977-78	V8 6.6L 400ci	S	C6 w/Cruise Lower; 66.00" Cable	CA-3020
1977-78	V8 6.6L 400ci	S	C6 w/o Cruise; 80.00" Cable	CA-3012
<b>MAVERICK</b>				
1970-72	L6 2.8L 170ci	U	3 Spd. MT; 63.00" Cable	CA-3021
1970-72	L6 2.8L 170ci	U	AT w/Cruise Control, Lower; 66.00" Cable	CA-3020
1970-72	L6 2.8L 170ci	U	AT w/o Cruise Control; 80.00" Cable	CA-3012
1970-72	L6 3.3L 200ci	T	AT w/Cruise Control, Lower; 66.00" Cable	CA-3020
1970-75	L6 3.3L 200ci	T	3 Spd. MT; 63.00" Cable	CA-3021
1970-75	L6 3.3L 200ci	T	AT w/o Cruise Control; 80.00" Cable	CA-3012
1976-77	L6 3.3L 200ci	T	3 Spd. MT, AT w/o Cruise; 63.00" Cable	CA-3021
1970-72	L6 4.1L 250ci	L	AT w/Cruise Control, Lower; 66.00" Cable	CA-3020
1970-75	L6 4.1L 250ci	L	3 Spd. MT; 63.00" Cable	CA-3021
1970-75	L6 4.1L 250ci	L	AT w/o Cruise Control; 80.00" Cable	CA-3012
1976-77	L6 4.1L 250ci	L	3 Spd. MT, AT w/o Cruise; 63.00" Cable	CA-3021
1971-75	V8 5.0L 302ci	F	3 Spd. MT; 63.00" Cable	CA-3021
1971-75	V8 5.0L 302ci	F	AT w/o Cruise Control; 80.00" Cable	CA-3012
1976-77	V8 5.0L 302ci	F	3 Spd. MT, AT w/o Cruise; 63.00" Cable	CA-3021
<b>MUSTANG</b>				
1987-88	L4 2.3L 140ci	A	AT & 4 Spd. MT w/o Cruise; 76.00" Cable	CA-3011
1987-90	L4 2.3L 140ci	A	5 Spd. MT w/Cruise; 71.00" Cable	CA-3018
1980-84	L4 2.3L 140ci	A,T	w/Cruise Lower; 63.00" Cable	CA-3002
1980-84	L4 2.3L 140ci	A,T	w/o Turbo w/Cruise Upper; Length 55"	CA-3043
1980-84	L4 2.3L 140ci	A,T	w/o Turbo w/o Cruise; 76.00" Cable	CA-3011
1980-84	L4 2.3L 140ci	A,T	w/Turbo w/Cruise Upper	CA-3045
1980-84	L4 2.3L 140ci	A,T,W	AT & 5 Spd. MT w/Turbo w/o Cruise; 80.00" Cable	CA-3012
1983-84	L4 2.3L 140ci	A,W	w/Cruise Control; 71.00" Cable	CA-3018
1979	L4 2.3L 140ci	W,Y	w/o Turbo w/Cruise Lower; 63.00" Cable	CA-3002
1979	L4 2.3L 140ci	W,Y	w/o Turbo w/Cruise Upper; Length 35"	CA-3045
1979	L4 2.3L 140ci	W,Y	w/Turbo w/o Cruise; 80.00" Cable	CA-3012
1979-83	L4 2.3L 140ci	W,Y	w/o Turbo w/o Cruise; 76.00" Cable	CA-3011
1965	L6 2.8L 170ci		60.00" Cable	CA-3015
1980	L6 3.3L 200ci	B	w/o Turbo w/Cruise Lower; 63.00" Cable	CA-3002
1980	L6 3.3L 200ci	B	w/o Turbo w/Cruise Upper; Length 35"	CA-3045
1980	L6 3.3L 200ci	B	w/Turbo w/o Cruise; 80.00" Cable	CA-3012
1981	L6 3.3L 200ci	B	AT & 5 Spd. MT w/Turbo w/o Cruise; 80.00" Cable	CA-3012
1981	L6 3.3L 200ci	B	w/Cruise Lower; 63.00" Cable	CA-3002
1981	L6 3.3L 200ci	B	w/o Turbo w/Cruise Upper; Length 55"	CA-3043
1981	L6 3.3L 200ci	B	w/Turbo w/Cruise Upper	CA-3045
1980-81	L6 3.3L 200ci	B	w/o Turbo w/o Cruise; 76.00" Cable	CA-3011
1968	L6 3.3L 200ci	T	3 Spd. MT; 60.00" Cable	CA-3015
1968	L6 3.3L 200ci	T	4 Spd. MT; 83.00" Cable	CA-3010
1968	L6 3.3L 200ci	T	C4 AT, C6 AT w/o 3.91 & w/o 4.30 Rear Axle Ratio	CA-3056
1968	L6 3.3L 200ci	T	C6 AT w/3.91 or w/4.30 Rear Axle Ratio; 83.00" Cable	CA-3004
1969	L6 3.3L 200ci	T	C4 AT, MT w/o 3.91 & w/o 4.30 Rear Axle Ratio; 80.00" Cable	CA-3012
1969	L6 3.3L 200ci	T	C6 AT	CA-3056
1979	L6 3.3L 200ci	T	w/o Turbo w/Cruise Lower; 63.00" Cable	CA-3002
1979	L6 3.3L 200ci	T	w/o Turbo w/Cruise Upper; Length 35"	CA-3045
1979	L6 3.3L 200ci	T	w/o Turbo w/Cruise Upper; Length 55"	CA-3043
1979	L6 3.3L 200ci	T	w/Turbo w/o Cruise; 80.00" Cable	CA-3012
1969-70	L6 3.3L 200ci	T	w/o Turbo w/Cruise Upper; Length 55"	CA-3043

# SPEEDOMETER CABLES

Year	Engine	Vin	Remark	Part
<b>FORD (con't)</b>				
<b>MUSTANG (con't)</b>				
1969-70	L6 3.3L 200ci	T	w/Turbo w/Cruise Upper	CA-3045
1969-79	L6 3.3L 200ci	T	AT & 5 Spd. MT w/Turbo w/o Cruise; 80.00" Cable	CA-3012
1969-79	L6 3.3L 200ci	T	w/Cruise Lower; 63.00" Cable	CA-3002
1969-79	L6 3.3L 200ci	T	w/o Turbo w/o Cruise; 76.00" Cable	CA-3011
1965	L6 3.3L 200ci		w/o Turbo w/Cruise Lower; 63.00" Cable	CA-3002
1965	L6 3.3L 200ci		w/o Turbo w/Cruise Upper; Length 35"	CA-3045
1965	L6 3.3L 200ci		w/o Turbo w/o Cruise; 76.00" Cable	CA-3011
1965	L6 3.3L 200ci		w/Turbo w/o Cruise; 80.00" Cable	CA-3012
1966	L6 3.3L 200ci		3 Spd. MT w/o Cruise; 63.00" Cable	CA-3021
1966	L6 3.3L 200ci		AT w/Cruise Control, Lower; 66.00" Cable	CA-3020
1966	L6 3.3L 200ci		AT w/o Cruise, MT w/o 3.91 & w/o 4.30 Rear Axle Ratio; 80.00" Cable	CA-3012
1967	L6 3.3L 200ci		C6 AT, 3 Spd. MT; 83.00" Cable	CA-3010
1965-66	L6 3.3L 200ci		60.00" Cable	CA-3015
1969	L6 4.1L 250ci	L	C4 AT, MT w/o 3.91 & w/o 4.30 Rear Axle Ratio; 80.00" Cable	CA-3012
1969	L6 4.1L 250ci	L	C6 AT	CA-3056
1970	L6 4.1L 250ci	L	AT w/o Cruise Control; 80.00" Cable	CA-3012
1971	L6 4.1L 250ci	L	AT w/o Cruise, 4 Spd. MT; 80.00" Cable	CA-3012
1973	L6 4.1L 250ci	L	AT w/o Cruise, MT w/o 3.91 & w/o 4.30 Rear Axle Ratio; 80.00" Cable	CA-3012
1970-73	L6 4.1L 250ci	L	3 Spd. MT w/o Cruise; 63.00" Cable	CA-3021
1971-72	L6 4.1L 250ci	L	4 Spd. MT w/4Bbl., AT w/o Cruise; 80.00" Cable	CA-3012
1971-73	L6 4.1L 250ci	L	AT w/Cruise Control, Lower; 66.00" Cable	CA-3020
1979	V6 2.8L 171ci	Z	AT & 5 Spd. MT w/Turbo w/o Cruise; 80.00" Cable	CA-3012
1979	V6 2.8L 171ci	Z	w/Cruise Lower; 63.00" Cable	CA-3002
1979	V6 2.8L 171ci	Z	w/o Turbo w/Cruise Upper; Length 55"	CA-3043
1979	V6 2.8L 171ci	Z	w/o Turbo w/o Cruise; 76.00" Cable	CA-3011
1979	V6 2.8L 171ci	Z	w/Turbo w/Cruise Upper	CA-3045
1983-84	V6 3.8L 232ci	3	AT & 5 Spd. MT w/Turbo w/o Cruise; 80.00" Cable	CA-3012
1983-84	V6 3.8L 232ci	3	w/Cruise Control; 71.00" Cable	CA-3018
1983-84	V6 3.8L 232ci	3	w/o Turbo w/o Cruise; 76.00" Cable	CA-3011
1998	V6 3.8L 232ci	4	w/o Turbo w/Cruise Lower; 63.00" Cable	CA-3002
1998	V6 3.8L 232ci	4	w/o Turbo w/Cruise Upper; Length 35"	CA-3045
1998	V6 3.8L 232ci	4	w/o Turbo w/o Cruise; 76.00" Cable	CA-3011
1998	V6 3.8L 232ci	4	w/Turbo w/o Cruise; 80.00" Cable	CA-3012
1999	V6 3.8L 232ci	4	AT w/o Cruise Control; 80.00" Cable	CA-3012
1999-02	V6 3.8L 232ci	4	3 Spd. MT w/o Cruise; 63.00" Cable	CA-3021
2000	V6 3.8L 232ci	4	AT w/o Cruise, 4 Spd. MT; 80.00" Cable	CA-3012
2000-02	V6 3.8L 232ci	4	AT w/Cruise Control, Lower; 66.00" Cable	CA-3020
2001	V6 3.8L 232ci	4	4 Spd. MT w/4Bbl., AT w/o Cruise; 80.00" Cable	CA-3012
2002	V6 3.8L 232ci	4	AT w/o Cruise, MT w/o 3.91 & w/o 4.30 Rear Axle Ratio; 80.00" Cable	CA-3012
1980-82	V8 4.2L 255ci	D	AT & 5 Spd. MT w/Turbo w/o Cruise; 80.00" Cable	CA-3012
1980-82	V8 4.2L 255ci	D	w/Cruise Lower; 63.00" Cable	CA-3002
1980-82	V8 4.2L 255ci	D	w/o Turbo w/Cruise Upper; Length 55"	CA-3043
1980-82	V8 4.2L 255ci	D	w/o Turbo w/o Cruise; 76.00" Cable	CA-3011
1980-82	V8 4.2L 255ci	D	w/Turbo w/Cruise Upper	CA-3045
1968	V8 4.7L 289ci	C	3 Spd. MT; 60.00" Cable	CA-3015
1968	V8 4.7L 289ci	C	4 Spd. MT; 83.00" Cable	CA-3010
1968	V8 4.7L 289ci	C	C4 AT, C6 AT w/o 3.91 & w/o 4.30 Rear Axle Ratio	CA-3056
1968	V8 4.7L 289ci	C	C6 AT w/3.91 or w/4.30 Rear Axle Ratio; 83.00" Cable	CA-3004
1967	V8 4.7L 289ci		C6 AT, 3 Spd. MT; 83.00" Cable	CA-3010
1965-66	V8 4.7L 289ci		60.00" Cable	CA-3015
1987-88	V8 5.0L 302ci	E	AT & 4 Spd. MT w/o Cruise; 76.00" Cable	CA-3011
1987-90	V8 5.0L 302ci	E	5 Spd. MT w/Cruise; 71.00" Cable	CA-3018
1989-90	V8 5.0L 302ci	E	w/o Turbo w/o Cruise; 76.00" Cable	CA-3011
1969	V8 5.0L 302ci	F	C4 AT, MT w/o 3.91 & w/o 4.30 Rear Axle Ratio; 80.00" Cable	CA-3012
1969	V8 5.0L 302ci	F	C6 AT	CA-3056
1972	V8 5.0L 302ci	F	w/o Turbo w/Cruise Upper; Length 55"	CA-3043
1972	V8 5.0L 302ci	F	w/Turbo w/Cruise Upper	CA-3045
1979	V8 5.0L 302ci	F	w/o Turbo w/Cruise Lower; 63.00" Cable	CA-3002
1979	V8 5.0L 302ci	F	w/o Turbo w/Cruise Upper; Length 35"	CA-3045
1979	V8 5.0L 302ci	F	w/o Turbo w/Cruise Upper; Length 55"	CA-3043
1979	V8 5.0L 302ci	F	w/Turbo w/o Cruise; 80.00" Cable	CA-3012
1972-79	V8 5.0L 302ci	F	w/Cruise Lower; 63.00" Cable	CA-3002

# SPEEDOMETER CABLES

Year	Engine	Vin	Remark	Part
<b>FORD (con't)</b>				
<b>MUSTANG (con't)</b>				
1972-85	V8 5.0L 302ci	F	AT & 5 Spd. MT w/Turbo w/o Cruise; 80.00" Cable	CA-3012
1983-85	V8 5.0L 302ci	F	w/Cruise Control; 71.00" Cable	CA-3018
1970-79	V8 5.0L 302ci	F,G	AT w/o Cruise, 4 Spd. MT; 80.00" Cable	CA-3012
1970-82	V8 5.0L 302ci	F,G	AT w/o Cruise Control; 80.00" Cable	CA-3012
1970-83	V8 5.0L 302ci	F,G	3 Spd. MT w/o Cruise; 63.00" Cable	CA-3021
1970-83	V8 5.0L 302ci	F,G	AT w/o Cruise, MT w/o 3.91 & w/o 4.30 Rear Axle Ratio; 80.00" Cable	CA-3012
1972-85	V8 5.0L 302ci	F,G	w/o Turbo w/o Cruise; 76.00" Cable	CA-3011
1968	V8 5.0L 302ci	F,J	3 Spd. MT; 60.00" Cable	CA-3015
1968	V8 5.0L 302ci	F,J	4 Spd. MT; 83.00" Cable	CA-3010
1968	V8 5.0L 302ci	F,J	C4 AT, C6 AT w/o 3.91 & w/o 4.30 Rear Axle Ratio	CA-3056
1968	V8 5.0L 302ci	F,J	C6 AT w/3.91 or w/4.30 Rear Axle Ratio; 83.00" Cable	CA-3004
1972	V8 5.0L 302ci	G	w/o Turbo w/Cruise Lower; 63.00" Cable	CA-3002
1972	V8 5.0L 302ci	G	w/o Turbo w/Cruise Upper; Length 35"	CA-3045
1972	V8 5.0L 302ci	G	w/Turbo w/o Cruise; 80.00" Cable	CA-3012
1986	V8 5.0L 302ci	M	AT & 5 Spd. MT w/Turbo w/o Cruise; 80.00" Cable	CA-3012
1986	V8 5.0L 302ci	M	w/Cruise Control; 71.00" Cable	CA-3018
1986	V8 5.0L 302ci	M	w/o Turbo w/o Cruise; 76.00" Cable	CA-3011
1969	V8 5.8L 351ci	H,M	C4 AT, MT w/o 3.91 & w/o 4.30 Rear Axle Ratio; 80.00" Cable	CA-3012
1969	V8 5.8L 351ci	H,M	C6 AT	CA-3056
1969-73	V8 5.8L 351ci	H,M	3 Spd. MT w/o Cruise; 63.00" Cable	CA-3021
1969-72	V8 5.8L 351ci	H,M,Q	AT w/Cruise Control, Lower; 66.00" Cable	CA-3020
1969-73	V8 5.8L 351ci	H,M,Q	AT w/o Cruise Control; 80.00" Cable	CA-3012
1970-73	V8 5.8L 351ci	H,M,Q	AT w/o Cruise, MT w/o 3.91 & w/o 4.30 Rear Axle Ratio; 80.00" Cable	CA-3012
1971-73	V8 5.8L 351ci	Q	3 Spd. MT w/o Cruise; 63.00" Cable	CA-3021
1968	V8 6.4L 390ci	S	4 Spd. MT; 83.00" Cable	CA-3010
1968	V8 6.4L 390ci	S	C4 AT, C6 AT w/o 3.91 & w/o 4.30 Rear Axle Ratio	CA-3056
1968	V8 6.4L 390ci	S	C6 AT w/3.91 or w/4.30 Rear Axle Ratio; 83.00" Cable	CA-3004
1969	V8 6.4L 390ci	S	C4 AT, MT w/o 3.91 & w/o 4.30 Rear Axle Ratio; 80.00" Cable	CA-3012
1969	V8 6.4L 390ci	S	C6 AT	CA-3056
1967	V8 6.4L 390ci		C6 AT, 3 Spd. MT; 83.00" Cable	CA-3010
1968	V8 7.0L 427ci	W	3 Spd. MT w/o Cruise; 63.00" Cable	CA-3021
1968	V8 7.0L 427ci	W	AT w/o Cruise, MT w/o 3.91 & w/o 4.30 Rear Axle Ratio; 80.00" Cable	CA-3012
1969	V8 7.0L 428ci	Q	C4 AT, MT w/o 3.91 & w/o 4.30 Rear Axle Ratio; 80.00" Cable	CA-3012
1969	V8 7.0L 428ci	Q	C6 AT	CA-3056
1970	V8 7.0L 428ci	Q	3 Spd. MT w/o Cruise; 63.00" Cable	CA-3021
1970	V8 7.0L 428ci	Q	4 Spd. MT w/4Bbl., AT w/o Cruise; 80.00" Cable	CA-3012
1968	V8 7.0L 428ci	R	3 Spd. MT w/o Cruise; 63.00" Cable	CA-3021
1968	V8 7.0L 428ci	R	3 Spd. MT; 60.00" Cable	CA-3015
1968	V8 7.0L 428ci	R	4 Spd. MT w/4Bbl., AT w/o Cruise; 80.00" Cable	CA-3012
1968	V8 7.0L 428ci	R	4 Spd. MT; 83.00" Cable	CA-3010
1968	V8 7.0L 428ci	R	C4 AT, C6 AT w/o 3.91 & w/o 4.30 Rear Axle Ratio	CA-3056
1968	V8 7.0L 428ci	R	C6 AT w/3.91 or w/4.30 Rear Axle Ratio; 83.00" Cable	CA-3004
1971	V8 7.0L 429ci	C	3 Spd. MT w/o Cruise; 63.00" Cable	CA-3021
1971	V8 7.0L 429ci	C	AT w/o Cruise, MT w/o 3.91 & w/o 4.30 Rear Axle Ratio; 80.00" Cable	CA-3012
1970	V8 7.0L 429ci	Z	3 Spd. MT w/o Cruise; 63.00" Cable	CA-3021
1970	V8 7.0L 429ci	Z	4 Spd. MT w/4Bbl., AT w/o Cruise; 80.00" Cable	CA-3012
1970	V8 7.0L 429ci	Z	AT w/o Cruise, MT w/o 3.91 & w/o 4.30 Rear Axle Ratio; 80.00" Cable	CA-3012
<b>MUSTANG II</b>				
1975-78	L4 2.3L 140ci	Y	AT w/Cruise, 4 Spd. MT; 80.00" Cable	CA-3012
1975-78	V6 2.8L 171ci	Z	AT w/Cruise, 4 Spd. MT; 80.00" Cable	CA-3012
1975-78	V8 5.0L 302ci	F	AT w/Cruise, 4 Spd. MT; 80.00" Cable	CA-3012
<b>P-350</b>				
1968-69	L4 4.0L 242ci	J		CA-3038
1971	L4 4.2L 254ci	L		CA-3038
1968-72	L6 3.9L 240ci	A		CA-3038
1968-74	L6 4.9L 300ci	B		CA-3038
1972	V8 5.0L 302ci	G		CA-3038
1973	V8 5.9L 360ci	Y		CA-3038
1972-73	V8 6.4L 390ci	H		CA-3038
<b>PINTO</b>				
1971-73	L4 1.6L 98ci	W	AT; 63.00" Cable	CA-3021
1971-73	L4 1.6L 98ci	W	MT; 80.00" Cable	CA-3012

# SPEEDOMETER CABLES

Year	Engine	Vin	Remark	Part
<b>FORD (con't)</b>				
<b>PINTO (con't)</b>				
1971-74	L4 2.0L 122ci	X	AT; 63.00" Cable	CA-3021
1971-74	L4 2.0L 122ci	X	MT; 80.00" Cable	CA-3012
1980	L4 2.3L 140ci	A	w/o Cruise Control; 80.00" Cable	CA-3012
1974	L4 2.3L 140ci	Y	AT; 63.00" Cable	CA-3021
1974	L4 2.3L 140ci	Y	MT; 80.00" Cable	CA-3012
1975-76	L4 2.3L 140ci	Y	w/Cruise Control, Upper	CA-3044
1975-78	L4 2.3L 140ci	Y	w/o Cruise Control; 80.00" Cable	CA-3012
1975-76	V6 2.8L 171ci	Z	w/Cruise Control, Upper	CA-3044
1975-78	V6 2.8L 171ci	Z	w/o Cruise Control; 80.00" Cable	CA-3012
<b>TAURUS</b>				
1986-90	L4 2.5L 153ci	D	AT Upper w/o electronic Dash	CA-3053
1991	L4 2.5L 153ci		AT Upper w/o electronic Dash	CA-3053
1994	V6 3.0L 182ci	1	AT Lower w/ AX4S Trans. not Flex Fuel	CA-3222
1993-98	V6 3.0L 182ci	1,2,S	AT Upper w/o electronic Dash	CA-3053
1996-98	V6 3.0L 182ci	S	AT Lower w/ Flex Fuel	CA-3222
1993	V6 3.0L 182ci	U	AT Lower not Flex Fuel	CA-3222
1994	V6 3.0L 182ci	U	AT Lower w/ AX4S Trans. not Flex Fuel	CA-3222
1986-00	V6 3.0L 182ci	U	AT Upper w/o electronic Dash	CA-3053
1995-98	V6 3.0L 182ci	U	AT Lower w/ Flex Fuel	CA-3222
<b>TEMPO</b>				
1984-86	L4 2.0L 122ci	H	w/Cruise Control	CA-3053
1984-86	L4 2.0L 122ci	H	w/o Cruise Control	CA-3017
1984-87	L4 2.3L 140ci	R	w/Cruise Control	CA-3053
1984-87	L4 2.3L 140ci	R	w/o Cruise Control	CA-3017
1985-94	L4 2.3L 140ci	S,X	w/Cruise Control	CA-3053
1985-94	L4 2.3L 140ci	S,X	w/o Cruise Control	CA-3017
1992-94	V6 3.0L 182ci	U	w/Cruise Control	CA-3053
<b>THUNDERBIRD</b>				
1985	L4 2.3L 140ci	W	5 Spd. MT w/o Cruise; 76.00" Cable	CA-3011
1983-84	L4 2.3L 140ci	W	w/Cruise Control; 71.00" Cable	CA-3018
1983-84	L4 2.3L 140ci	W	w/o Cruise Control; 76.00" Cable	CA-3011
1980-82	L6 3.3L 200ci	B	w/Cruise Lower; 60.00" Cable	CA-3015
1980-82	L6 3.3L 200ci	B	w/Cruise Upper	CA-3045
1980-82	L6 3.3L 200ci	B	w/o Cruise Control; 76.00" Cable	CA-3011
1982	V6 3.8L 232ci	3	w/Cruise Lower; 63.00" Cable	CA-3002
1982	V6 3.8L 232ci	3	w/Cruise Upper	CA-3045
1985	V6 3.8L 232ci	3	5 Spd. MT w/o Cruise; 76.00" Cable	CA-3011
1982-84	V6 3.8L 232ci	3	w/o Cruise Control; 76.00" Cable	CA-3011
1983-84	V6 3.8L 232ci	3	w/Cruise Control; 71.00" Cable	CA-3018
1980-82	V8 4.2L 255ci	D	w/Cruise Lower; 60.00" Cable	CA-3015
1980-82	V8 4.2L 255ci	D	w/Cruise Upper	CA-3045
1980-82	V8 4.2L 255ci	D	w/o Cruise Control; 76.00" Cable	CA-3011
1957-58	V8 4.8L 292ci		60.00" Cable	CA-3015
1985	V8 5.0L 302ci	F	5 Spd. MT w/o Cruise; 76.00" Cable	CA-3011
1977-88	V8 5.0L 302ci	F	w/Cruise Lower; 66.00" Cable	CA-3020
1977-88	V8 5.0L 302ci	F	w/o Cruise Control; 80.00" Cable	CA-3012
1980-81	V8 5.0L 302ci	F	w/Cruise Lower; 60.00" Cable	CA-3015
1980-81	V8 5.0L 302ci	F	w/Cruise Upper	CA-3045
1980-84	V8 5.0L 302ci	F	w/o Cruise Control; 76.00" Cable	CA-3011
1983-84	V8 5.0L 302ci	F	w/Cruise Control; 71.00" Cable	CA-3018
1957	V8 5.1L 312ci		60.00" Cable	CA-3015
1958-59	V8 5.4L 332ci		60.00" Cable	CA-3015
1977-78	V8 5.8L 351ci	H	w/Cruise Lower; 66.00" Cable	CA-3020
1977-78	V8 5.8L 351ci	H	w/o Cruise Control; 80.00" Cable	CA-3012
1958-60	V8 5.8L 352ci		60.00" Cable	CA-3015
1968	V8 6.4L 390ci	Z	w/o Cruise Control; 83.00" Cable	CA-3004
1966	V8 6.4L 390ci		w/Cruise Lower; 83.00" Cable	CA-3010
1966	V8 6.4L 390ci		w/Cruise Upper; 83.00" Cable	CA-3004
1967	V8 6.4L 390ci		w/Cruise Upper; 83.00" Cable	CA-3010
1967	V8 6.4L 390ci		w/o Cruise Control; 83.00" Cable	CA-3004
1961-64	V8 6.4L 390ci		60.00" Cable	CA-3015
1972	V8 6.6L 400ci	S	w/Cruise Control, Upper	CA-3044

# SPEEDOMETER CABLES

Year	Engine	Vin	Remark	Part
<b>FORD (con't)</b>				
<b>THUNDERBIRD (con't)</b>				
1972-78	V8 6.6L 400ci	S	w/o Cruise Control; 80.00" Cable	CA-3012
1977-78	V8 6.6L 400ci	S	w/Cruise Lower; 66.00" Cable	CA-3020
1962-63	V8 6.7L 410ci		60.00" Cable	CA-3015
1966	V8 7.0L 427ci		w/Cruise Lower; 83.00" Cable	CA-3010
1966	V8 7.0L 427ci		w/Cruise Upper; 83.00" Cable	CA-3004
1967	V8 7.0L 427ci		w/Cruise Upper; 83.00" Cable	CA-3010
1967	V8 7.0L 427ci		w/o Cruise Control; 83.00" Cable	CA-3004
1963-64	V8 7.0L 427ci		60.00" Cable	CA-3015
1966	V8 7.0L 428ci		w/Cruise Lower; 83.00" Cable	CA-3010
1966	V8 7.0L 428ci		w/Cruise Upper; 83.00" Cable	CA-3004
1967	V8 7.0L 428ci		w/Cruise Upper; 83.00" Cable	CA-3010
1967	V8 7.0L 428ci		w/o Cruise Control; 83.00" Cable	CA-3004
1968	V8 7.0L 429ci	N	w/o Cruise Control; 83.00" Cable	CA-3004
1970	V8 7.0L 429ci	N	w/Cruise Upper; 60.00" Cable	CA-3015
1971	V8 7.0L 429ci	N	w/o Cruise Control; 80.00" Cable	CA-3001
1969-73	V8 7.0L 429ci	N	w/o Cruise Control; 80.00" Cable	CA-3012
1971-73	V8 7.0L 429ci	N	w/Cruise Control, Upper	CA-3044
1959-60	V8 7.0L 430ci		60.00" Cable	CA-3015
1972-76	V8 7.5L 460ci	A	w/Cruise Control, Upper	CA-3044
1972-76	V8 7.5L 460ci	A	w/o Cruise Control; 80.00" Cable	CA-3012
<b>TORINO</b>				
1968	L6 3.3L 200ci	T	3 Spd. MT; 66.00" Cable	CA-3020
1968	L6 3.3L 200ci	T	C4 AT; 83.00" Cable	CA-3010
1969	L6 4.1L 250ci	L	AT w/Cruise Control, Upper	CA-3044
1970	L6 4.1L 250ci	L	w/Cruise Control, Upper	CA-3044
1971	L6 4.1L 250ci	L	AT exc. C6, MT; 80.00" Cable	CA-3012
1973	L6 4.1L 250ci	L	3 Spd. MT; 63.00" Cable	CA-3021
1973	L6 4.1L 250ci	L	C4, FMX w/o Cruise; 80.00" Cable	CA-3012
1973	L6 4.1L 250ci	L	C6	CA-3046
1969-70	L6 4.1L 250ci	L	AT w/Cruise Control, Lower; 66.00" Cable	CA-3020
1969-70	L6 4.1L 250ci	L	AT w/o Cruise Control; 80.00" Cable	CA-3012
1969-74	L6 4.1L 250ci	L	AT; 80.00" Cable	CA-3012
1969-74	L6 4.1L 250ci	L	MT; 66.00" Cable	CA-3020
1971-72	L6 4.1L 250ci	L	80.00" Cable	CA-3012
1968	V8 4.7L 289ci	C	3 Spd. MT; 66.00" Cable	CA-3020
1968	V8 4.7L 289ci	C	C4 AT; 83.00" Cable	CA-3010
1968	V8 5.0L 302ci	F	AT w/Cruise Control, Upper	CA-3044
1969	V8 5.0L 302ci	F	w/Cruise Control, Upper	CA-3044
1970	V8 5.0L 302ci	F	AT; C4, FMX w/o Cruise; 80.00" Cable	CA-3012
1968-69	V8 5.0L 302ci	F	AT w/Cruise Control, Lower; 66.00" Cable	CA-3020
1968-69	V8 5.0L 302ci	F	AT w/o Cruise Control; 80.00" Cable	CA-3012
1968-71	V8 5.0L 302ci	F	80.00" Cable	CA-3012
1969-72	V8 5.0L 302ci	F	3 Spd. MT; 63.00" Cable	CA-3021
1969-72	V8 5.0L 302ci	F	C4, FMX w/o Cruise; 80.00" Cable	CA-3012
1969-72	V8 5.0L 302ci	F	C6	CA-3046
1970-73	V8 5.0L 302ci	F	MT; 66.00" Cable	CA-3020
1971-73	V8 5.0L 302ci	F	AT; 80.00" Cable	CA-3012
1971-74	V8 5.0L 302ci	F	3 Spd. MT; 66.00" Cable	CA-3020
1971-74	V8 5.0L 302ci	F	C4 AT; 83.00" Cable	CA-3010
1974	V8 5.8L 351ci	H	AT exc. C6, MT; 80.00" Cable	CA-3012
1969-71	V8 5.8L 351ci	H	80.00" Cable	CA-3012
1970-76	V8 5.8L 351ci	H	MT; 66.00" Cable	CA-3020
1971-76	V8 5.8L 351ci	H	AT; 80.00" Cable	CA-3012
1970	V8 5.8L 351ci	H,M	AT; C4, FMX w/o Cruise; 80.00" Cable	CA-3012
1969-73	V8 5.8L 351ci	H,M	AT w/o Cruise Control; 80.00" Cable	CA-3012
1969-75	V8 5.8L 351ci	H,M	3 Spd. MT; 63.00" Cable	CA-3021
1969-75	V8 5.8L 351ci	H,M	C4, FMX w/o Cruise; 80.00" Cable	CA-3012
1969-75	V8 5.8L 351ci	H,M	C6	CA-3046
1969-73	V8 5.8L 351ci	H,M,Q	AT w/Cruise Control, Lower; 66.00" Cable	CA-3020
1972	V8 5.8L 351ci	H,Q	C6 w/Cruise Lower; 66.00" Cable	CA-3020
1972	V8 5.8L 351ci	H,Q	C6 w/o Cruise; 80.00" Cable	CA-3012
1969-73	V8 5.8L 351ci	H,Q	AT w/Cruise Control, Upper	CA-3044



# SPEEDOMETER CABLES

Year	Engine	Vin	Remark	Part
<b>FORD (con't)</b>				
<b>TORINO (con't)</b>				
1969	V8 5.8L 351ci	M	w/Cruise Control, Upper	CA-3044
1973	V8 5.8L 351ci	Q	w/Cruise Control, Upper	CA-3044
1973-74	V8 5.8L 351ci	Q	AT w/o Cruise Control; 80.00" Cable	CA-3012
1968-69	V8 6.4L 390ci	S	MT; 66.00" Cable	CA-3020
1968-69	V8 6.4L 390ci	S,Y	AT; 80.00" Cable	CA-3012
1968	V8 6.4L 390ci	Y	MT; 66.00" Cable	CA-3020
1975	V8 6.6L 400ci	S	w/Cruise Control, Upper	CA-3044
1976	V8 6.6L 400ci	S	AT exc. C6, MT; 80.00" Cable	CA-3012
1972-73	V8 6.6L 400ci	S	C6 w/Cruise Lower; 66.00" Cable	CA-3020
1972-73	V8 6.6L 400ci	S	C6 w/o Cruise; 80.00" Cable	CA-3012
1972-74	V8 6.6L 400ci	S	AT w/Cruise Control, Upper	CA-3044
1974-75	V8 6.6L 400ci	S	AT w/Cruise Control, Lower; 66.00" Cable	CA-3020
1974-75	V8 6.6L 400ci	S	AT w/o Cruise Control; 80.00" Cable	CA-3012
1969	V8 7.0L 428ci	Q	3 Spd. MT; 63.00" Cable	CA-3021
1969	V8 7.0L 428ci	Q	AT w/Cruise Control, Lower; 66.00" Cable	CA-3020
1969	V8 7.0L 428ci	Q	AT w/o Cruise Control; 80.00" Cable	CA-3012
1969	V8 7.0L 428ci	Q	C4, FMX w/o Cruise; 80.00" Cable	CA-3012
1969	V8 7.0L 428ci	Q	C6	CA-3046
1969	V8 7.0L 428ci	Q	w/Cruise Control, Upper	CA-3044
1968	V8 7.0L 428ci	R	80.00" Cable	CA-3012
1970	V8 7.0L 429ci	C	3 Spd. MT; 66.00" Cable	CA-3020
1970	V8 7.0L 429ci	C	AT exc. C6, MT; 80.00" Cable	CA-3012
1970	V8 7.0L 429ci	C	C4 AT; 83.00" Cable	CA-3010
1971	V8 7.0L 429ci	C	AT; 80.00" Cable	CA-3012
1971	V8 7.0L 429ci	C	MT; 66.00" Cable	CA-3020
1970-71	V8 7.0L 429ci	C,J	80.00" Cable	CA-3012
1970-72	V8 7.0L 429ci	C,J,N	3 Spd. MT; 63.00" Cable	CA-3021
1970-72	V8 7.0L 429ci	C,J,N	C4, FMX w/o Cruise; 80.00" Cable	CA-3012
1970-72	V8 7.0L 429ci	C,J,N	C6	CA-3046
1973	V8 7.0L 429ci	N	AT; 80.00" Cable	CA-3012
1973	V8 7.0L 429ci	N	MT; 66.00" Cable	CA-3020
1974-76	V8 7.5L 460ci	A	C6 w/Cruise Lower; 66.00" Cable	CA-3020
1974-76	V8 7.5L 460ci	A	C6 w/o Cruise; 80.00" Cable	CA-3012
1973-76	V8 7.5L 460ci	A,C	AT w/Cruise Control, Upper	CA-3044
1973	V8 7.5L 460ci	C	C6 w/Cruise Lower; 66.00" Cable	CA-3020
1973	V8 7.5L 460ci	C	C6 w/o Cruise; 80.00" Cable	CA-3012
1975	V8 7.5L 460ci	C	w/Cruise Control, Upper	CA-3044
1975-76	V8 7.5L 460ci	C	AT w/Cruise Control, Lower; 66.00" Cable	CA-3020
1975-76	V8 7.5L 460ci	C	AT w/o Cruise Control; 80.00" Cable	CA-3012
<b>FORD TRUCKS</b>				
<b>AEROSTAR</b>				
1986-87	L4 2.3L 140ci	A	AT & 5 Spd. MT w/o Cruise Control, exc. Electronic Dash; 80.00" Cable	CA-3012
1986	V6 2.8L 171ci	S	AT & 5 Spd. MT w/o Cruise Control, exc. Electronic Dash; 80.00" Cable	CA-3012
1986-90	V6 3.0L 182ci	U	AT & 5 Spd. MT w/o Cruise Control, exc. Electronic Dash; 80.00" Cable	CA-3012
1989-92	V6 3.0L 182ci	U	AT & 5 Spd. MT w/Cruise	CA-3054
1990	V6 4.0L 245ci	X	AT & 5 Spd. MT w/o Cruise Control, exc. Electronic Dash; 80.00" Cable	CA-3012
<b>BRONCO</b>				
1968-72	L6 2.8L 170ci	F	95.00" Cable	CA-3032
1973-74	L6 3.3L 200ci	T	AT w/o Cruise, MT w/o Cruise From 6/73; 83.00" Cable	CA-3004
1967	L6 3.9L 240ci		95.00" Cable	CA-3032
1980	L6 4.9L 300ci	E	w/o ratio adapter Lower; 83.00" Cable	CA-3010
1980	L6 4.9L 300ci	E	w/ratio adapter Lower; 63.00" Cable	CA-3002
1980-82	L6 4.9L 300ci	E	w/Cruise Control, Upper	CA-3045
1981-82	L6 4.9L 300ci	E	AT w/Cruise w/o ratio adapter Lower; 83.00" Cable	CA-3010
1981-82	L6 4.9L 300ci	E	w/o Cruise Control; 95.00" Cable	CA-3032
1981-82	L6 4.9L 300ci	E	MT w/Cruise w/o ratio adapter Lower; 60.00" Cable	CA-3015
1981-82	L6 4.9L 300ci	E	w/Cruise w/ratio adapter Lower; 63.00" Cable	CA-3002
1983-85	L6 4.9L 300ci	Y	AT w/Cruise w/o ratio adapter Lower; 83.00" Cable	CA-3010
1983-85	L6 4.9L 300ci	Y	MT w/Cruise w/o ratio adapter Lower; 60.00" Cable	CA-3015
1983-85	L6 4.9L 300ci	Y	w/Cruise Control, Upper	CA-3045
1983-85	L6 4.9L 300ci	Y	w/Cruise w/ratio adapter Lower; 63.00" Cable	CA-3002
1983-86	L6 4.9L 300ci	Y	w/o Cruise Control; 95.00" Cable	CA-3032

# SPEEDOMETER CABLES

Year	Engine	Vin	Remark	Part
<b>FORD TRUCKS (con't)</b>				
<b>BRONCO (con't)</b>				
1983-90	L6 4.9L 300ci	Y	w/Cruise Control	CA-3054
1985-90	L6 4.9L 300ci	Y	w/o Cruise Control; 80.00" Cable	CA-3012
1987-89	L6 4.9L 300ci	Y	w/o Cruise Control; 90" Length	CA-3055
1968	V8 4.7L 289ci	N	95.00" Cable	CA-3032
1966-67	V8 4.7L 289ci		95.00" Cable	CA-3032
1980	V8 5.0L 302ci	F	w/o ratio adapter Lower; 83.00" Cable	CA-3010
1980	V8 5.0L 302ci	F	w/ratio adapter Lower; 63.00" Cable	CA-3002
1980-84	V8 5.0L 302ci	F	w/Cruise Control, Upper	CA-3045
1981-84	V8 5.0L 302ci	F	AT w/Cruise w/o ratio adapter Lower; 83.00" Cable	CA-3010
1981-84	V8 5.0L 302ci	F	w/o Cruise Control; 95.00" Cable	CA-3032
1981-84	V8 5.0L 302ci	F	MT w/Cruise w/o ratio adapter Lower; 60.00" Cable	CA-3015
1981-84	V8 5.0L 302ci	F	w/Cruise w/ratio adapter Lower; 63.00" Cable	CA-3002
1975	V8 5.0L 302ci	G	w/o Cruise Control; 80.00" Cable	CA-3012
1969-72	V8 5.0L 302ci	G	95.00" Cable	CA-3032
1971-75	V8 5.0L 302ci	G	w/Cruise Control	CA-3054
1973-77	V8 5.0L 302ci	G	AT w/o Cruise, MT w/o Cruise From 6/73; 83.00" Cable	CA-3004
1985	V8 5.0L 302ci	N	AT w/Cruise w/o ratio adapter Lower; 83.00" Cable	CA-3010
1985	V8 5.0L 302ci	N	MT w/Cruise w/o ratio adapter Lower; 60.00" Cable	CA-3015
1985	V8 5.0L 302ci	N	w/Cruise Control, Upper	CA-3045
1985	V8 5.0L 302ci	N	w/Cruise w/ratio adapter Lower; 63.00" Cable	CA-3002
1990	V8 5.0L 302ci	N	w/o Cruise Control; 80.00" Cable	CA-3012
1985-86	V8 5.0L 302ci	N	w/o Cruise Control; 95.00" Cable	CA-3032
1986-90	V8 5.0L 302ci	N	w/Cruise Control	CA-3054
1987-89	V8 5.0L 302ci	N	w/o Cruise Control; 90" Length	CA-3055
1980	V8 5.8L 351ci	G	w/o ratio adapter Lower; 83.00" Cable	CA-3010
1980	V8 5.8L 351ci	G	w/ratio adapter Lower; 63.00" Cable	CA-3002
1983	V8 5.8L 351ci	G	w/o Cruise Control; 80.00" Cable	CA-3012
1980-83	V8 5.8L 351ci	G	w/Cruise Control	CA-3054
1981-85	V8 5.8L 351ci	G	w/o Cruise Control; 95.00" Cable	CA-3032
1980-85	V8 5.8L 351ci	G,H	w/Cruise Control, Upper	CA-3045
1981-85	V8 5.8L 351ci	G,H	AT w/Cruise w/o ratio adapter Lower; 83.00" Cable	CA-3010
1981-85	V8 5.8L 351ci	G,H	MT w/Cruise w/o ratio adapter Lower; 60.00" Cable	CA-3015
1981-85	V8 5.8L 351ci	G,H	w/Cruise w/ratio adapter Lower; 63.00" Cable	CA-3002
1978-79	V8 5.8L 351ci	H	AT & 4 Spd. MT 4WD w/o Cruise; 95.00" Cable	CA-3032
1978-89	V8 5.8L 351ci	H	w/Cruise Control	CA-3054
1984-86	V8 5.8L 351ci	H	w/o Cruise Control; 95.00" Cable	CA-3032
1987-89	V8 5.8L 351ci	H	w/o Cruise Control; 90" Length	CA-3055
1978-79	V8 6.6L 400ci	S	AT & 4 Spd. MT 4WD w/o Cruise; 95.00" Cable	CA-3032
<b>BRONCO II</b>				
1984	V6 2.8L 171ci	S	2WD, w/Cruise Control	CA-3043
1984	V6 2.8L 171ci	S	4WD, w/Cruise Control; 71.00" Cable	CA-3018
1985	V6 2.8L 171ci	S	2WD, 4 Spd. MT w/Cruise Control	CA-3043
1985	V6 2.8L 171ci	S	2WD, AT w/Cruise Control; 71.00" Cable	CA-3018
1984-85	V6 2.8L 171ci	S	w/o Cruise Control; 80.00" Cable	CA-3012
1986	V6 2.9L 177ci	T	w/o Cruise Control; 80.00" Cable	CA-3012
1986-88	V6 2.9L 177ci	T	2WD, 4 Spd. MT w/Cruise Control	CA-3043
1986-90	V6 2.9L 177ci	T	2WD, AT w/Cruise Control; 71.00" Cable	CA-3018
1987-90	V6 2.9L 177ci	T	5 Spd. MT w/o Cruise; 80.00" Cable	CA-3012
1987-90	V6 2.9L 177ci	T	MT exc. Cruise; 63.00" Cable	CA-3021
1989-90	V6 2.9L 177ci	T	4WD 4 Spd. MT w/Cruise; 71.00" Cable	CA-3018
<b>COURIER</b>				
1977-78	L4 1.8L 110ci	A	AT	CA-3136
1979	L4 1.8L 110ci	C	AT	CA-3136
1972-76	L4 1.8L 110ci		AT	CA-3136
1981-82	L4 2.0L 122ci	1	AT	CA-3136
1979	L4 2.0L 122ci	C	AT	CA-3136
1981-82	L4 2.3L 140ci	2	AT	CA-3136
1977-80	L4 2.3L 140ci	B	AT	CA-3136
<b>E-100 ECONOLINE</b>				
1980-82	L6 4.9L 300ci	E	w/Cruise Control, Lower; 83.00" Cable	CA-3010
1980-82	L6 4.9L 300ci	E	w/Cruise Control, Upper	CA-3045
1980-82	L6 4.9L 300ci	E	w/o Cruise Control; 118" Length	CA-3019

# SPEEDOMETER CABLES

Year	Engine	Vin	Remark	Part
<b>FORD TRUCKS (con't)</b>				
<b>E-100 ECONOLINE (con't)</b>				
1983	L6 4.9L 300ci	Y	w/Cruise Control, Lower; 83.00" Cable	CA-3010
1983	L6 4.9L 300ci	Y	w/Cruise Control, Upper	CA-3045
1983	L6 4.9L 300ci	Y	w/o Cruise Control; 118" Length	CA-3019
1980-83	V8 5.0L 302ci	F	w/Cruise Control, Lower; 83.00" Cable	CA-3010
1980-83	V8 5.0L 302ci	F	w/Cruise Control, Upper	CA-3045
1980-83	V8 5.0L 302ci	F	w/o Cruise Control; 118" Length	CA-3019
1980-83	V8 5.8L 351ci	G	w/Cruise Control, Lower; 83.00" Cable	CA-3010
1980-83	V8 5.8L 351ci	G	w/Cruise Control, Upper	CA-3045
1980-83	V8 5.8L 351ci	G	w/o Cruise Control; 118" Length	CA-3019
<b>E-150 ECONOLINE</b>				
1983-85	L6 4.9L 300ci	9,Y	w/Cruise Control, Lower; 83.00" Cable	CA-3010
1983-85	L6 4.9L 300ci	9,Y	w/Cruise Control, Upper	CA-3045
1983-85	L6 4.9L 300ci	9,Y	w/o Cruise Control; 118" Length	CA-3019
1983-90	L6 4.9L 300ci	9,Y		CA-3054
1984-91	L6 4.9L 300ci	9,Y	w/Cruise Control	CA-3054
1986-88	L6 4.9L 300ci	9,Y	AT w/o Cruise Control	CA-3055
1986-88	L6 4.9L 300ci	9,Y	MT w/o Cruise; 95.00" Cable	CA-3032
1979	L6 4.9L 300ci	B	w/Cruise Control	CA-3054
1979	L6 4.9L 300ci	B	w/o Cruise Control; 90" Length	CA-3055
1980-82	L6 4.9L 300ci	E	w/Cruise Control, Lower; 83.00" Cable	CA-3010
1980-82	L6 4.9L 300ci	E	w/Cruise Control, Upper	CA-3045
1980-82	L6 4.9L 300ci	E	w/o Cruise Control; 118" Length	CA-3019
1981-82	L6 4.9L 300ci	E		CA-3054
1984-91	L6 4.9L 300ci	Y	w/o Cruise Control; 90" Length	CA-3055
1984	V8 5.0L 302ci	F	w/o Cruise Control; 90" Length	CA-3055
1980-83	V8 5.0L 302ci	F		CA-3054
1980-85	V8 5.0L 302ci	F	w/Cruise Control, Lower; 83.00" Cable	CA-3010
1980-85	V8 5.0L 302ci	F	w/Cruise Control, Upper	CA-3045
1980-85	V8 5.0L 302ci	F	w/o Cruise Control; 118" Length	CA-3019
1983-84	V8 5.0L 302ci	F	w/Cruise Control	CA-3054
1979	V8 5.0L 302ci	G	w/Cruise Control	CA-3054
1979	V8 5.0L 302ci	G	w/o Cruise Control; 90" Length	CA-3055
1986-88	V8 5.0L 302ci	N	AT w/o Cruise Control	CA-3055
1986-88	V8 5.0L 302ci	N	MT w/o Cruise; 95.00" Cable	CA-3032
1986-90	V8 5.0L 302ci	N	w/Cruise Control	CA-3054
1989-90	V8 5.0L 302ci	N	w/o Cruise Control; 90" Length	CA-3055
1980	V8 5.8L 351ci	G	w/o Cruise Control; 90" Length	CA-3055
1977-90	V8 5.8L 351ci	G,H	w/Cruise Control	CA-3054
1980-85	V8 5.8L 351ci	G,H	w/Cruise Control, Lower; 83.00" Cable	CA-3010
1980-85	V8 5.8L 351ci	G,H	w/Cruise Control, Upper	CA-3045
1980-85	V8 5.8L 351ci	G,H	w/o Cruise Control; 118" Length	CA-3019
1977	V8 5.8L 351ci	H	w/o Cruise Control; 90" Length	CA-3055
1977-79	V8 5.8L 351ci	H		CA-3054
1986-88	V8 5.8L 351ci	H	AT w/o Cruise Control	CA-3055
1986-88	V8 5.8L 351ci	H	MT w/o Cruise; 95.00" Cable	CA-3032
1989-90	V8 5.8L 351ci	H	w/o Cruise Control; 90" Length	CA-3055
1984	V8 6.9L 420ci	1	w/Cruise Control, Lower; 83.00" Cable	CA-3010
1984	V8 6.9L 420ci	1	w/Cruise Control, Upper	CA-3045
1984	V8 6.9L 420ci	1	w/o Cruise Control; 118" Length	CA-3019
1980	V8 7.5L 460ci	L	w/Cruise Control, Lower; 83.00" Cable	CA-3010
1980	V8 7.5L 460ci	L	w/Cruise Control, Upper	CA-3045
1980	V8 7.5L 460ci	L	w/o Cruise Control; 118" Length	CA-3019
<b>E-250 ECONOLINE</b>				
1983-85	L6 4.9L 300ci	9,Y	w/o Cruise Control; 118" Length	CA-3019
1983-85	L6 4.9L 300ci	9,Y	w/Cruise Control, Lower; 83.00" Cable	CA-3010
1978	L6 4.9L 300ci	B	w/EO4D w/o Cruise, w/Cruise	CA-3054
1978	L6 4.9L 300ci	B	w/o Cruise w/o E4OD	CA-3055
1980-82	L6 4.9L 300ci	E	w/o Cruise Control; 118" Length	CA-3019
1980-82	L6 4.9L 300ci	E	w/Cruise Control, Lower; 83.00" Cable	CA-3010
1980-82	L6 4.9L 300ci	E		CA-3054
1983-95	L6 4.9L 300ci	Y		CA-3054
1985-91	L6 4.9L 300ci	Y	w/EO4D w/o Cruise, w/Cruise	CA-3054

# SPEEDOMETER CABLES

Year	Engine	Vin	Remark	Part
<b>FORD TRUCKS (con't)</b>				
<b>E-250 ECONOLINE (con't)</b>				
1985-91	L6 4.9L 300ci	Y	w/o Cruise w/o E4OD	CA-3055
1986-88	L6 4.9L 300ci	Y	w/Cruise Control	CA-3054
1986-88	L6 4.9L 300ci	Y	w/o Cruise Control; 90" Length	CA-3055
1997	V6 4.2L 256ci	2		CA-3054
1980-85	V8 5.0L 302ci	F	w/o Cruise Control; 118" Length	CA-3019
1980-85	V8 5.0L 302ci	F	w/Cruise Control, Lower; 83.00" Cable	CA-3010
1975	V8 5.0L 302ci	G		CA-3054
1979	V8 5.0L 302ci	G	w/EO4D w/o Cruise, w/Cruise	CA-3054
1979	V8 5.0L 302ci	G	w/o Cruise w/o E4OD	CA-3055
1986-88	V8 5.0L 302ci	N	w/Cruise Control	CA-3054
1986-88	V8 5.0L 302ci	N	w/o Cruise Control; 90" Length	CA-3055
1989-90	V8 5.0L 302ci	N	w/EO4D w/o Cruise, w/Cruise	CA-3054
1989-90	V8 5.0L 302ci	N	w/o Cruise w/o E4OD	CA-3055
1980	V8 5.8L 351ci	G		CA-3054
1975-91	V8 5.8L 351ci	G,H	w/EO4D w/o Cruise, w/Cruise	CA-3054
1975-91	V8 5.8L 351ci	G,H	w/o Cruise w/o E4OD	CA-3055
1980-85	V8 5.8L 351ci	G,H	w/o Cruise Control; 118" Length	CA-3019
1980-85	V8 5.8L 351ci	G,H	w/Cruise Control, Lower; 83.00" Cable	CA-3010
1975-79	V8 5.8L 351ci	H		CA-3054
1986-88	V8 5.8L 351ci	H	w/Cruise Control	CA-3054
1986-88	V8 5.8L 351ci	H	w/o Cruise Control; 90" Length	CA-3055
1980	V8 6.6L 400ci	Z	w/o Cruise Control; 118" Length	CA-3019
1980	V8 6.6L 400ci	Z	w/Cruise Control, Lower; 83.00" Cable	CA-3010
1980	V8 6.6L 400ci	Z		CA-3054
1988	V8 7.3L 445ci	M	w/EO4D w/o Cruise, w/Cruise	CA-3054
1988	V8 7.3L 445ci	M	w/o Cruise w/o E4OD	CA-3055
1975	V8 7.5L 460ci	A	w/EO4D w/o Cruise, w/Cruise	CA-3054
1975	V8 7.5L 460ci	A	w/o Cruise w/o E4OD	CA-3055
1975-79	V8 7.5L 460ci	A		CA-3054
<b>E-350 ECONOLINE</b>				
1983	L6 4.9L 300ci	9,Y	w/EO4D w/o Cruise, w/Cruise	CA-3054
1983	L6 4.9L 300ci	9,Y	w/o Cruise w/o E4OD	CA-3055
1983-85	L6 4.9L 300ci	9,Y	w/Cruise Control, Lower; 83.00" Cable	CA-3010
1983-85	L6 4.9L 300ci	9,Y	w/o Cruise Control; 118" Length	CA-3019
1980-82	L6 4.9L 300ci	B,E	w/Cruise Control, Lower; 83.00" Cable	CA-3010
1980-82	L6 4.9L 300ci	B,E	w/o Cruise Control; 118" Length	CA-3019
1979-82	L6 4.9L 300ci	B,E,K		CA-3054
1982	L6 4.9L 300ci	E	w/EO4D w/o Cruise, w/Cruise	CA-3054
1982	L6 4.9L 300ci	E	w/o Cruise w/o E4OD	CA-3055
1986-88	L6 4.9L 300ci	Y	AT w/o Cruise Control	CA-3055
1986-88	L6 4.9L 300ci	Y	w/Cruise Control	CA-3054
1980	V8 5.0L 302ci	F	w/Cruise Control, Lower; 83.00" Cable	CA-3010
1980	V8 5.0L 302ci	F	w/o Cruise Control; 118" Length	CA-3019
1980-85	V8 5.8L 351ci	G,H	w/Cruise Control, Lower; 83.00" Cable	CA-3010
1980-85	V8 5.8L 351ci	G,H	w/o Cruise Control; 118" Length	CA-3019
1975-76	V8 5.8L 351ci	H	w/EO4D w/o Cruise, w/Cruise	CA-3054
1975-76	V8 5.8L 351ci	H	w/o Cruise w/o E4OD	CA-3055
1986-88	V8 5.8L 351ci	H	AT w/o Cruise Control	CA-3055
1986-88	V8 5.8L 351ci	H	w/Cruise Control	CA-3054
1982	V8 6.6L 400ci	Z	w/EO4D w/o Cruise, w/Cruise	CA-3054
1982	V8 6.6L 400ci	Z	w/o Cruise w/o E4OD	CA-3055
1980-81	V8 6.6L 400ci	Z		CA-3054
1980-82	V8 6.6L 400ci	Z	w/Cruise Control, Lower; 83.00" Cable	CA-3010
1980-82	V8 6.6L 400ci	Z	w/o Cruise Control; 118" Length	CA-3019
1983-85	V8 6.9L 420ci	1	w/Cruise Control, Lower; 83.00" Cable	CA-3010
1983-85	V8 6.9L 420ci	1	w/o Cruise Control; 118" Length	CA-3019
1986-87	V8 6.9L 420ci	1	AT w/o Cruise Control	CA-3055
1986-87	V8 6.9L 420ci	1	w/Cruise Control	CA-3054
1995	V8 7.3L 445ci	F		CA-3054
1988	V8 7.3L 445ci	M	AT w/o Cruise Control	CA-3055
1988	V8 7.3L 445ci	M	w/Cruise Control	CA-3054
1994	V8 7.3L 445ci	M		CA-3054

# SPEEDOMETER CABLES

Year	Engine	Vin	Remark	Part
<b>FORD TRUCKS (con't)</b>				
<b>E-350 ECONOLINE (con't)</b>				
1975-79	V8 7.5L 460ci	A		CA-3054
1988	V8 7.5L 460ci	G	AT w/o Cruise Control	CA-3055
1988	V8 7.5L 460ci	G	w/Cruise Control	CA-3054
1980-82	V8 7.5L 460ci	L	w/EO4D w/o Cruise, w/Cruise	CA-3054
1980-82	V8 7.5L 460ci	L	w/o Cruise w/o E4OD	CA-3055
1980-85	V8 7.5L 460ci	L	w/Cruise Control, Lower; 83.00" Cable	CA-3010
1980-85	V8 7.5L 460ci	L	w/o Cruise Control; 118" Length	CA-3019
1986-87	V8 7.5L 460ci	L	AT w/o Cruise Control	CA-3055
1986-87	V8 7.5L 460ci	L	w/Cruise Control	CA-3054
<b>F SUPER DUTY</b>				
1995-97	V8 7.3L 445ci	F	w/Cruise w/E4OD	CA-3054
1995-97	V8 7.3L 445ci	F	w/Cruise w/o E4OD; 71.00" Cable	CA-3018
1995-97	V8 7.3L 445ci	F	w/o Cruise Control; 118" Length	CA-3019
1990-94	V8 7.3L 445ci	M	w/Cruise w/E4OD	CA-3054
1990-94	V8 7.3L 445ci	M	w/Cruise w/o E4OD; 71.00" Cable	CA-3018
1990-94	V8 7.3L 445ci	M	w/o Cruise Control; 118" Length	CA-3019
1990-97	V8 7.5L 460ci	G	w/Cruise w/E4OD	CA-3054
1990-97	V8 7.5L 460ci	G	w/Cruise w/o E4OD; 71.00" Cable	CA-3018
1990-97	V8 7.5L 460ci	G	w/o Cruise Control; 118" Length	CA-3019
<b>F-100</b>				
1961-64	L6 3.7L 223ci		2WD, AT w/Overdrive; 83.00" Cable	CA-3010
1961-64	L6 3.7L 223ci		2WD, w/3 Spd. MT exc. Medium Duty; 83.00" Cable	CA-3010
1961-64	L6 3.7L 223ci		MT 2WD, Medium Duty"; 83.00" Cable	CA-3004
1973	L6 3.9L 240ci	A	2WD, Custom Cab; 76.00" Cable	CA-3011
1973	L6 3.9L 240ci	A	4WD, From serial # 500,001; 95.00" Cable	CA-3032
1973	L6 3.9L 240ci	A	4WD, to serial # 500,000; 76.00" Cable	CA-3011
1974	L6 3.9L 240ci	A	2WD; 76.00" Cable	CA-3011
1974	L6 3.9L 240ci	A	4WD; 95.00" Cable	CA-3032
1968-70	L6 3.9L 240ci	A	2WD, w/C6 AT; 83.00" Cable	CA-3004
1968-74	L6 3.9L 240ci	A	2WD, MT; 83.00" Cable	CA-3010
1973	L6 4.9L 300ci	B	2WD, Custom Cab; 76.00" Cable	CA-3011
1973	L6 4.9L 300ci	B	4WD, From serial # 500,001; 95.00" Cable	CA-3032
1973	L6 4.9L 300ci	B	4WD, to serial # 500,000; 76.00" Cable	CA-3011
1968-70	L6 4.9L 300ci	B	2WD, MT; 83.00" Cable	CA-3010
1968-70	L6 4.9L 300ci	B	2WD, w/C6 AT; 83.00" Cable	CA-3004
1974-79	L6 4.9L 300ci	B	2WD; 76.00" Cable	CA-3011
1974-79	L6 4.9L 300ci	B	4WD; 95.00" Cable	CA-3032
1980	L6 4.9L 300ci	E	2WD, MT w/o Cruise; 76.00" Cable	CA-3011
1980	L6 4.9L 300ci	E	4WD, 4 Spd. MT, w/Cruise, w/o ratio Lower, 4WD, AT, w/Cruise w/o ratio Lower; 83.00" Cable	CA-3010
1980-82	L6 4.9L 300ci	E	3 Spd. MT w/o Cruise	CA-3006
1980-82	L6 4.9L 300ci	E	4WD, exc. 3 Spd. w/Cruise, w/ratio Lower, 4WD, AT, w/Cruise Lower; 63.00" Cable	CA-3002
1980-82	L6 4.9L 300ci	E	AT w/o Cruise Control; 95.00" Cable	CA-3032
1980-82	L6 4.9L 300ci	E	w/Cruise Control, Upper	CA-3045
1981-82	L6 4.9L 300ci	E	2WD, 3 Spd. MT w/Cruise Lower; 60.00" Cable	CA-3015
1981-82	L6 4.9L 300ci	E	4WD, AT w/Cruise w/o ratio Lower; 83.00" Cable	CA-3010
1983	L6 4.9L 300ci	Y	2WD, 3 Spd. MT w/Cruise Lower; 60.00" Cable	CA-3015
1983	L6 4.9L 300ci	Y	3 Spd. MT w/o Cruise	CA-3006
1983	L6 4.9L 300ci	Y	4WD, AT w/Cruise w/o ratio Lower; 83.00" Cable	CA-3010
1983	L6 4.9L 300ci	Y	4WD, exc. 3 Spd. w/Cruise, w/ratio Lower, 4WD, AT, w/Cruise Lower; 63.00" Cable	CA-3002
1983	L6 4.9L 300ci	Y	AT w/o Cruise Control; 95.00" Cable	CA-3032
1983	L6 4.9L 300ci	Y	w/Cruise Control, Upper	CA-3045
1982-83	V6 3.8L 232ci	3	2WD, 3 Spd. MT w/Cruise Lower; 60.00" Cable	CA-3015
1982-83	V6 3.8L 232ci	3	3 Spd. MT w/o Cruise	CA-3006
1982-83	V6 3.8L 232ci	3	4WD, AT w/Cruise w/o ratio Lower; 83.00" Cable	CA-3010
1982-83	V6 3.8L 232ci	3	4WD, exc. 3 Spd. w/Cruise, w/ratio Lower, 4WD, AT, w/Cruise Lower; 63.00" Cable	CA-3002
1982-83	V6 3.8L 232ci	3	AT w/o Cruise Control; 95.00" Cable	CA-3032
1982-83	V6 3.8L 232ci	3	w/Cruise Control, Upper	CA-3045
1982	V8 4.2L 255ci	D	2WD, MT; 83.00" Cable	CA-3010

# SPEEDOMETER CABLES

Year	Engine	Vin	Remark	Part
<b>FORD TRUCKS (con't)</b>				
<b>F-100 (con't)</b>				
1981-82	V8 4.2L 255ci	D	2WD, 3 Spd. MT w/Cruise Lower; 60.00" Cable	CA-3015
1981-82	V8 4.2L 255ci	D	3 Spd. MT w/o Cruise	CA-3006
1981-82	V8 4.2L 255ci	D	4WD, AT w/Cruise w/o ratio Lower; 83.00" Cable	CA-3010
1981-82	V8 4.2L 255ci	D	4WD, exc. 3 Spd. w/Cruise, w/ratio Lower, 4WD, AT, w/Cruise Lower; 63.00" Cable	CA-3002
1981-82	V8 4.2L 255ci	D	AT w/o Cruise Control; 95.00" Cable	CA-3032
1981-82	V8 4.2L 255ci	D	w/Cruise Control, Upper	CA-3045
1960	V8 4.8L 292ci		3 Spd., w/Medium Duty Trans.; 83.00" Cable	CA-3004
1960	V8 4.8L 292ci		AT, w/Overdrive Trans.; 83.00" Cable	CA-3010
1961-64	V8 4.8L 292ci		2WD, AT w/Overdrive; 83.00" Cable	CA-3010
1961-64	V8 4.8L 292ci		2WD, w/3 Spd. MT exc. Medium Duty; 83.00" Cable	CA-3010
1961-64	V8 4.8L 292ci		MT 2WD, Medium Duty"; 83.00" Cable	CA-3004
1980	V8 5.0L 302ci	F	2WD, MT w/o Cruise; 76.00" Cable	CA-3011
1980	V8 5.0L 302ci	F	4WD, 4 Spd. MT, w/Cruise, w/o ratio Lower, 4WD, AT, w/Cruise w/o ratio Lower; 83.00" Cable	CA-3010
1980-83	V8 5.0L 302ci	F	3 Spd. MT w/o Cruise	CA-3006
1980-83	V8 5.0L 302ci	F	4WD, exc. 3 Spd. w/Cruise, w/ratio Lower, 4WD, AT, w/Cruise Lower; 63.00" Cable	CA-3002
1980-83	V8 5.0L 302ci	F	AT w/o Cruise Control; 95.00" Cable	CA-3032
1981-83	V8 5.0L 302ci	F	2WD, 3 Spd. MT w/Cruise Lower; 60.00" Cable	CA-3015
1981-83	V8 5.0L 302ci	F	4WD, AT w/Cruise w/o ratio Lower; 83.00" Cable	CA-3010
1973	V8 5.0L 302ci	G	2WD, Custom Cab; 76.00" Cable	CA-3011
1973	V8 5.0L 302ci	G	4WD, From serial # 500,001; 95.00" Cable	CA-3032
1973	V8 5.0L 302ci	G	4WD, to serial # 500,000; 76.00" Cable	CA-3011
1969-70	V8 5.0L 302ci	G	2WD, MT; 83.00" Cable	CA-3010
1969-70	V8 5.0L 302ci	G	2WD, w/C6 AT; 83.00" Cable	CA-3004
1974-79	V8 5.0L 302ci	G	2WD; 76.00" Cable	CA-3011
1974-79	V8 5.0L 302ci	G	4WD; 95.00" Cable	CA-3032
1976-77	V8 5.0L 302ci	G	2WD, MT; 83.00" Cable	CA-3010
1960	V8 5.4L 332ci		3 Spd., w/Medium Duty Trans.; 83.00" Cable	CA-3004
1960	V8 5.4L 332ci		U.S. w/3 Spd. Trans., w/Light Duty Trans., w/118" Wheel Base; 83.00" Cable	CA-3010
1961-63	V8 5.4L 332ci		2WD, AT w/Overdrive; 83.00" Cable	CA-3010
1961-63	V8 5.4L 332ci		2WD, w/3 Spd. MT exc. Medium Duty; 83.00" Cable	CA-3010
1961-63	V8 5.4L 332ci		MT 2WD, Medium Duty"; 83.00" Cable	CA-3004
1981	V8 5.8L 351ci	G	2WD, 3 Spd. MT w/Cruise Lower; 60.00" Cable	CA-3015
1981	V8 5.8L 351ci	G	3 Spd. MT w/o Cruise	CA-3006
1981	V8 5.8L 351ci	G	4WD, AT w/Cruise w/o ratio Lower; 83.00" Cable	CA-3010
1981	V8 5.8L 351ci	G	4WD, exc. 3 Spd. w/Cruise, w/ratio Lower, 4WD, AT, w/Cruise Lower; 63.00" Cable	CA-3002
1981	V8 5.8L 351ci	G	AT w/o Cruise Control; 95.00" Cable	CA-3032
1981	V8 5.8L 351ci	G	w/Cruise Control, Upper	CA-3045
1977-79	V8 5.8L 351ci	H	2WD; 76.00" Cable	CA-3011
1977-79	V8 5.8L 351ci	H	4WD; 95.00" Cable	CA-3032
1967	V8 5.8L 352ci		2WD, MT; 83.00" Cable	CA-3010
1967	V8 5.8L 352ci		2WD, w/C6 AT; 83.00" Cable	CA-3004
1973	V8 5.9L 360ci	Y	2WD, Custom Cab; 76.00" Cable	CA-3011
1973	V8 5.9L 360ci	Y	4WD, From serial # 500,001; 95.00" Cable	CA-3032
1973	V8 5.9L 360ci	Y	4WD, to serial # 500,000; 76.00" Cable	CA-3011
1968-70	V8 5.9L 360ci	Y	2WD, w/C6 AT; 83.00" Cable	CA-3004
1968-73	V8 5.9L 360ci	Y	2WD, MT; 83.00" Cable	CA-3010
1974-76	V8 5.9L 360ci	Y	2WD; 76.00" Cable	CA-3011
1974-76	V8 5.9L 360ci	Y	4WD; 95.00" Cable	CA-3032
1973	V8 6.4L 390ci	H	2WD, Custom Cab; 76.00" Cable	CA-3011
1973	V8 6.4L 390ci	H	4WD, From serial # 500,001; 95.00" Cable	CA-3032
1973	V8 6.4L 390ci	H	4WD, to serial # 500,000; 76.00" Cable	CA-3011
1968-70	V8 6.4L 390ci	H	2WD, w/C6 AT; 83.00" Cable	CA-3004
1968-74	V8 6.4L 390ci	H,M	2WD, MT; 83.00" Cable	CA-3010
1974-76	V8 6.4L 390ci	H,M	2WD; 76.00" Cable	CA-3011
1974-76	V8 6.4L 390ci	H,M	4WD; 95.00" Cable	CA-3032
1977-79	V8 6.6L 400ci	S	2WD; 76.00" Cable	CA-3011
1977-79	V8 6.6L 400ci	S	4WD; 95.00" Cable	CA-3032
1973	V8 7.5L 460ci	J	2WD, Custom Cab; 76.00" Cable	CA-3011

# SPEEDOMETER CABLES

Year	Engine	Vin	Remark	Part
<b>FORD TRUCKS (con't)</b>				
<b>F-100 (con't)</b>				
1973	V8 7.5L 460ci	J	4WD, From serial # 500,001; 95.00" Cable	CA-3032
1973	V8 7.5L 460ci	J	4WD, to serial # 500,000; 76.00" Cable	CA-3011
1974-79	V8 7.5L 460ci	J	2WD; 76.00" Cable	CA-3011
1974-79	V8 7.5L 460ci	J	4WD; 95.00" Cable	CA-3032
<b>F-150</b>				
1985	L6 4.9L 300ci	9	4WD, exc. 3 Spd. w/Cruise, w/ratio Lower, 4WD, AT, w/Cruise Lower; 63.00" Cable	CA-3002
1983-85	L6 4.9L 300ci	9,Y	2WD, 3 Spd. MT w/Cruise Lower; 60.00" Cable	CA-3015
1983-85	L6 4.9L 300ci	9,Y	w/Cruise Control, Upper	CA-3045
1983-86	L6 4.9L 300ci	9,Y	3 Spd. MT w/o Cruise	CA-3006
1983-86	L6 4.9L 300ci	9,Y	AT w/o Cruise Control; 95.00" Cable	CA-3032
1975-79	L6 4.9L 300ci	B,K	2WD; 76.00" Cable	CA-3011
1975-79	L6 4.9L 300ci	B,K	4WD; 95.00" Cable	CA-3032
1980	L6 4.9L 300ci	E	2WD, MT w/o Cruise; 76.00" Cable	CA-3011
1980	L6 4.9L 300ci	E	4WD, 4 Spd. MT, w/Cruise, w/o ratio Lower, 4WD, AT, w/Cruise w/o ratio Lower; 83.00" Cable	CA-3010
1980-82	L6 4.9L 300ci	E	3 Spd. MT w/o Cruise	CA-3006
1980-82	L6 4.9L 300ci	E	4WD, exc. 3 Spd. w/Cruise, w/ratio Lower, 4WD, AT, w/Cruise Lower; 63.00" Cable	CA-3002
1980-82	L6 4.9L 300ci	E	AT w/o Cruise Control; 95.00" Cable	CA-3032
1980-82	L6 4.9L 300ci	E	w/Cruise Control, Upper	CA-3045
1981-82	L6 4.9L 300ci	E	2WD, 3 Spd. MT w/Cruise Lower; 60.00" Cable	CA-3015
1981-82	L6 4.9L 300ci	E	4WD, AT w/Cruise w/o ratio Lower; 83.00" Cable	CA-3010
1987	L6 4.9L 300ci	Y	2WD, MT w/Cruise Control; 71.00" Cable	CA-3018
1987	L6 4.9L 300ci	Y	AT w/o Cruise Control; 80.00" Cable	CA-3012
1992	L6 4.9L 300ci	Y	4WD, w/E40D Trans	CA-3054
1983-84	L6 4.9L 300ci	Y	4WD, AT w/Cruise w/o ratio Lower; 83.00" Cable	CA-3010
1983-86	L6 4.9L 300ci	Y	4WD, exc. 3 Spd. w/Cruise, w/ratio Lower, 4WD, AT, w/Cruise Lower; 63.00" Cable	CA-3002
1986-94	L6 4.9L 300ci	Y	2WD, 4 Spd. MT w/Cruise Control; 71.00" Cable	CA-3018
1986-94	L6 4.9L 300ci	Y	2WD, MT w/o Cruise; 63.00" Cable	CA-3021
1986-94	L6 4.9L 300ci	Y	AT w/Cruise, 4WD, 4 Spd. MT w/Cruise	CA-3054
1986-94	L6 4.9L 300ci	Y	AT w/o Cruise, exc. E40D Trans., MT w/o Cruise; 80.00" Cable	CA-3012
1980	V8 5.0L 302ci	F	2WD, MT w/o Cruise; 76.00" Cable	CA-3011
1980	V8 5.0L 302ci	F	4WD, 4 Spd. MT, w/Cruise, w/o ratio Lower, 4WD, AT, w/Cruise w/o ratio Lower; 83.00" Cable	CA-3010
1980	V8 5.0L 302ci	F		CA-3054
1981	V8 5.0L 302ci	F	4WD, w/E40D Trans	CA-3054
1980-85	V8 5.0L 302ci	F	3 Spd. MT w/o Cruise	CA-3006
1980-85	V8 5.0L 302ci	F	4WD, exc. 3 Spd. w/Cruise, w/ratio Lower, 4WD, AT, w/Cruise Lower; 63.00" Cable	CA-3002
1980-85	V8 5.0L 302ci	F	AT w/o Cruise Control; 95.00" Cable	CA-3032
1981-84	V8 5.0L 302ci	F	4WD, AT w/Cruise w/o ratio Lower; 83.00" Cable	CA-3010
1982-84	V8 5.0L 302ci	F	2WD, 4 Spd. MT w/Cruise Control; 71.00" Cable	CA-3018
1982-84	V8 5.0L 302ci	F	2WD, MT w/o Cruise; 63.00" Cable	CA-3021
1982-84	V8 5.0L 302ci	F	AT w/Cruise, 4WD, 4 Spd. MT w/Cruise	CA-3054
1982-84	V8 5.0L 302ci	F	AT w/o Cruise, exc. E40D Trans., MT w/o Cruise; 80.00" Cable	CA-3012
1980-85	V8 5.0L 302ci	F,N	w/Cruise Control, Upper	CA-3045
1981-85	V8 5.0L 302ci	F,N	2WD, 3 Spd. MT w/Cruise Lower; 60.00" Cable	CA-3015
1975-79	V8 5.0L 302ci	G	2WD; 76.00" Cable	CA-3011
1975-79	V8 5.0L 302ci	G	4WD; 95.00" Cable	CA-3032
1987	V8 5.0L 302ci	N	2WD, MT w/Cruise Control; 71.00" Cable	CA-3018
1987	V8 5.0L 302ci	N	AT w/o Cruise Control; 80.00" Cable	CA-3012
1985-86	V8 5.0L 302ci	N	3 Spd. MT w/o Cruise	CA-3006
1985-86	V8 5.0L 302ci	N	4WD, exc. 3 Spd. w/Cruise, w/ratio Lower, 4WD, AT, w/Cruise Lower; 63.00" Cable	CA-3002
1985-86	V8 5.0L 302ci	N	AT w/o Cruise Control; 95.00" Cable	CA-3032
1985-90	V8 5.0L 302ci	N	2WD, 4 Spd. MT w/Cruise Control; 71.00" Cable	CA-3018
1985-90	V8 5.0L 302ci	N	2WD, MT w/o Cruise; 63.00" Cable	CA-3021
1985-90	V8 5.0L 302ci	N	AT w/Cruise, 4WD, 4 Spd. MT w/Cruise	CA-3054
1985-90	V8 5.0L 302ci	N	AT w/o Cruise, exc. E40D Trans., MT w/o Cruise; 80.00" Cable	CA-3012
1980	V8 5.8L 351ci	G	2WD, MT w/o Cruise; 76.00" Cable	CA-3011

# SPEEDOMETER CABLES

Year	Engine	Vin	Remark	Part
<b>FORD TRUCKS (con't)</b>				
<b>F-150 (con't)</b>				
1980	V8 5.8L 351ci	G	4WD, 4 Spd. MT, w/Cruise, w/o ratio Lower, 4WD, AT, w/Cruise w/o ratio Lower; 83.00" Cable	CA-3010
1981	V8 5.8L 351ci	G	4WD, w/E40D Trans	CA-3054
1980-85	V8 5.8L 351ci	G	3 Spd. MT w/o Cruise	CA-3006
1980-85	V8 5.8L 351ci	G	4WD, exc. 3 Spd. w/Cruise, w/ratio Lower, 4WD, AT, w/Cruise Lower; 63.00" Cable	CA-3002
1980-85	V8 5.8L 351ci	G	AT w/o Cruise Control; 95.00" Cable	CA-3032
1982-84	V8 5.8L 351ci	G	2WD, 4 Spd. MT w/Cruise Control; 71.00" Cable	CA-3018
1982-84	V8 5.8L 351ci	G	2WD, MT w/o Cruise; 63.00" Cable	CA-3021
1982-84	V8 5.8L 351ci	G	AT w/Cruise, 4WD, 4 Spd. MT w/Cruise	CA-3054
1982-84	V8 5.8L 351ci	G	AT w/o Cruise, exc. E40D Trans., MT w/o Cruise; 80.00" Cable	CA-3012
1980-85	V8 5.8L 351ci	G,H	w/Cruise Control, Upper	CA-3045
1981-84	V8 5.8L 351ci	G,H	4WD, AT w/Cruise w/o ratio Lower; 83.00" Cable	CA-3010
1981-85	V8 5.8L 351ci	G,H	2WD, 3 Spd. MT w/Cruise Lower; 60.00" Cable	CA-3015
1987	V8 5.8L 351ci	H	2WD, MT w/Cruise Control; 71.00" Cable	CA-3018
1987	V8 5.8L 351ci	H	AT w/o Cruise Control; 80.00" Cable	CA-3012
1977-79	V8 5.8L 351ci	H	2WD; 76.00" Cable	CA-3011
1977-79	V8 5.8L 351ci	H	4WD; 95.00" Cable	CA-3032
1984-86	V8 5.8L 351ci	H	3 Spd. MT w/o Cruise	CA-3006
1984-86	V8 5.8L 351ci	H	4WD, exc. 3 Spd. w/Cruise, w/ratio Lower, 4WD, AT, w/Cruise Lower; 63.00" Cable	CA-3002
1984-86	V8 5.8L 351ci	H	AT w/o Cruise Control; 95.00" Cable	CA-3032
1984-91	V8 5.8L 351ci	H	2WD, 4 Spd. MT w/Cruise Control; 71.00" Cable	CA-3018
1984-91	V8 5.8L 351ci	H	2WD, MT w/o Cruise; 63.00" Cable	CA-3021
1984-91	V8 5.8L 351ci	H	AT w/Cruise, 4WD, 4 Spd. MT w/Cruise	CA-3054
1984-91	V8 5.8L 351ci	H	AT w/o Cruise, exc. E40D Trans., MT w/o Cruise; 80.00" Cable	CA-3012
1992-95	V8 5.8L 351ci	H,R		CA-3054
1975-76	V8 5.9L 360ci	Y	2WD; 76.00" Cable	CA-3011
1975-76	V8 5.9L 360ci	Y	4WD; 95.00" Cable	CA-3032
1975-76	V8 6.4L 390ci	H,M	2WD; 76.00" Cable	CA-3011
1975-76	V8 6.4L 390ci	H,M	4WD; 95.00" Cable	CA-3032
1977-79	V8 6.6L 400ci	S	2WD; 76.00" Cable	CA-3011
1977-79	V8 6.6L 400ci	S	4WD; 95.00" Cable	CA-3032
1984	V8 6.9L 420ci	1	2WD, 3 Spd. MT w/Cruise Lower; 60.00" Cable	CA-3015
1984	V8 6.9L 420ci	1	3 Spd. MT w/o Cruise	CA-3006
1984	V8 6.9L 420ci	1	4WD, AT w/Cruise w/o ratio Lower; 83.00" Cable	CA-3010
1984	V8 6.9L 420ci	1	4WD, exc. 3 Spd. w/Cruise, w/ratio Lower, 4WD, AT, w/Cruise Lower; 63.00" Cable	CA-3002
1984	V8 6.9L 420ci	1	AT w/o Cruise Control; 95.00" Cable	CA-3032
1984	V8 6.9L 420ci	1	w/Cruise Control, Upper	CA-3045
1975-79	V8 7.5L 460ci	A,J	2WD; 76.00" Cable	CA-3011
1975-79	V8 7.5L 460ci	A,J	4WD; 95.00" Cable	CA-3032
<b>F-250</b>				
1961-64	L6 3.7L 223ci		2WD, MT Medium Duty; 83.00" Cable	CA-3004
1961-64	L6 3.7L 223ci		w/OD AT, w/3Spd. MT exc Medium Duty.; 83.00" Cable	CA-3010
1973	L6 3.9L 240ci	A	4WD	CA-3019
1974	L6 3.9L 240ci	A	4WD, AT, w/118 1/4" Cable	CA-3019
1974	L6 3.9L 240ci	A	Part Time 4WD, w/AT.; 95.00" Cable	CA-3032
1968-70	L6 3.9L 240ci	A	2WD, w/C6 AT; 83.00" Cable	CA-3004
1968-71	L6 3.9L 240ci	A	2WD, MT; 83.00" Cable	CA-3010
1973-74	L6 3.9L 240ci	A	2WD, Custom Cab; 76.00" Cable	CA-3011
1967	L6 3.9L 240ci		2WD, MT; 83.00" Cable	CA-3010
1967	L6 3.9L 240ci		2WD, w/C6 AT; 83.00" Cable	CA-3004
1984	L6 4.9L 300ci	9	2WD, AT w/o Cruise exc. E40D Trans.; 80.00" Cable	CA-3012
1984	L6 4.9L 300ci	9	2WD, w/Cruise Control; 71.00" Cable	CA-3018
1984	L6 4.9L 300ci	9	2WD, w/o Cruise; 63.00" Cable	CA-3021
1984	L6 4.9L 300ci	9	4WD, exc. Cruise Control, AT, exc. E40D Trans.	CA-3055
1984	L6 4.9L 300ci	9	4WD, w/Cruise, w/E40D w/o Cruise	CA-3054
1983-85	L6 4.9L 300ci	9,Y	2WD, MT w/Cruise Lower; 60.00" Cable	CA-3015
1983-85	L6 4.9L 300ci	9,Y	2WD, MT w/o Cruise; 76.00" Cable	CA-3011
1983-85	L6 4.9L 300ci	9,Y	w/Cruise Control, Upper	CA-3045
1983-86	L6 4.9L 300ci	9,Y	4WD, w/Cruise w/ratio adapter Lower; 63.00" Cable	CA-3002



# SPEEDOMETER CABLES

Year	Engine	Vin	Remark	Part
<b>FORD TRUCKS (con't)</b>				
<b>F-250 (con't)</b>				
1985-86	L6 4.9L 300ci	9,Y	4WD, w/o Cruise; 95.00" Cable	CA-3032
1973	L6 4.9L 300ci	B	4WD	CA-3019
1968-70	L6 4.9L 300ci	B	2WD, MT; 83.00" Cable	CA-3010
1968-70	L6 4.9L 300ci	B	2WD, w/C6 AT; 83.00" Cable	CA-3004
1973-79	L6 4.9L 300ci	B	2WD, Custom Cab; 76.00" Cable	CA-3011
1974-77	L6 4.9L 300ci	B	Part Time 4WD, w/AT.; 95.00" Cable	CA-3032
1974-79	L6 4.9L 300ci	B,K	4WD, AT, w/118 1/4" Cable	CA-3019
1978-79	L6 4.9L 300ci	B,K	Part Time 4WD, w/AT, 4WD, MT From serial number 500001"; 95.00" Cable	CA-3032
1980-81	L6 4.9L 300ci	E		CA-3054
1980-82	L6 4.9L 300ci	E	2WD, MT w/o Cruise; 76.00" Cable	CA-3011
1980-82	L6 4.9L 300ci	E	4WD, w/Cruise w/o ratio adapter Lower; 83.00" Cable	CA-3010
1980-82	L6 4.9L 300ci	E	4WD, w/Cruise w/ratio adapter Lower; 63.00" Cable	CA-3002
1980-82	L6 4.9L 300ci	E	w/o Cruise Control; 95.00" Cable	CA-3032
1980-82	L6 4.9L 300ci	E	w/Cruise Control, Upper	CA-3045
1981-82	L6 4.9L 300ci	E	2WD, MT w/Cruise Lower; 60.00" Cable	CA-3015
1978-79	L6 4.9L 300ci	K	2WD, Custom Cab; 76.00" Cable	CA-3011
1986	L6 4.9L 300ci	Y	4WD, w/E40D Trans	CA-3054
1986	L6 4.9L 300ci	Y	w/Cruise w/o ratio adapter	CA-3054
1983-84	L6 4.9L 300ci	Y	4WD, w/Cruise w/o ratio adapter Lower; 83.00" Cable	CA-3010
1983-84	L6 4.9L 300ci	Y	w/o Cruise Control; 95.00" Cable	CA-3032
1987-90	L6 4.9L 300ci	Y	2WD, AT w/o Cruise exc. E40D Trans.; 80.00" Cable	CA-3012
1987-90	L6 4.9L 300ci	Y	2WD, w/o Cruise; 63.00" Cable	CA-3021
1987-90	L6 4.9L 300ci	Y	4WD, exc. Cruise Control, AT, exc. E40D Trans.	CA-3055
1987-90	L6 4.9L 300ci	Y	4WD, w/Cruise, w/E40D w/o Cruise	CA-3054
1987-91	L6 4.9L 300ci	Y	2WD, w/Cruise Control; 71.00" Cable	CA-3018
1987-91	L6 4.9L 300ci	Y	2WD, w/o Cruise; 80.00" Cable	CA-3012
1987-91	L6 4.9L 300ci	Y	4WD, w/Cruise Control, 2WD, w/Cruise 80" Cable	CA-3054
1987-91	L6 4.9L 300ci	Y	4WD, w/o Cruise; Length 90"	CA-3055
1997	V8 4.6L 281ci	W	2WD, MT; 83.00" Cable	CA-3010
1960-64	V8 4.8L 292ci		2WD, MT Medium Duty; 83.00" Cable	CA-3004
1960-64	V8 4.8L 292ci		w/OD AT, w/3Spd. MT exc Medium Duty.; 83.00" Cable	CA-3010
1980-84	V8 5.0L 302ci	F	4WD, w/Cruise w/o ratio adapter Lower; 83.00" Cable	CA-3010
1980-84	V8 5.0L 302ci	F	w/o Cruise Control; 95.00" Cable	CA-3032
1980-85	V8 5.0L 302ci	F	4WD, w/Cruise w/ratio adapter Lower; 63.00" Cable	CA-3002
1980-85	V8 5.0L 302ci	F,N	2WD, MT w/o Cruise; 76.00" Cable	CA-3011
1980-85	V8 5.0L 302ci	F,N	w/Cruise Control, Upper	CA-3045
1981-85	V8 5.0L 302ci	F,N	2WD, MT w/Cruise Lower; 60.00" Cable	CA-3015
1985-86	V8 5.0L 302ci	F,N	4WD, w/o Cruise; 95.00" Cable	CA-3032
1973	V8 5.0L 302ci	G	4WD	CA-3019
1979	V8 5.0L 302ci	G	4WD, w/E40D Trans	CA-3054
1973-79	V8 5.0L 302ci	G	2WD, Custom Cab; 76.00" Cable	CA-3011
1974-77	V8 5.0L 302ci	G	Part Time 4WD, w/AT.; 95.00" Cable	CA-3032
1974-79	V8 5.0L 302ci	G	4WD, AT, w/118 1/4" Cable	CA-3019
1978-79	V8 5.0L 302ci	G	Part Time 4WD, w/AT, 4WD, MT From serial number 500001"; 95.00" Cable	CA-3032
1986	V8 5.0L 302ci	N	w/Cruise w/o ratio adapter	CA-3054
1990	V8 5.0L 302ci	N	2WD, MT; 83.00" Cable	CA-3010
1990	V8 5.0L 302ci	N	2WD, w/o Cruise; 80.00" Cable	CA-3012
1990	V8 5.0L 302ci	N	4WD, w/Cruise Control, 2WD, w/Cruise 80" Cable	CA-3054
1990	V8 5.0L 302ci	N	4WD, w/o Cruise; Length 90"	CA-3055
1985-86	V8 5.0L 302ci	N	4WD, w/Cruise w/ratio adapter Lower; 63.00" Cable	CA-3002
1987-89	V8 5.0L 302ci	N	2WD, AT w/o Cruise exc. E40D Trans.; 80.00" Cable	CA-3012
1987-89	V8 5.0L 302ci	N	2WD, w/o Cruise; 63.00" Cable	CA-3021
1987-89	V8 5.0L 302ci	N	4WD, exc. Cruise Control, AT, exc. E40D Trans.	CA-3055
1987-89	V8 5.0L 302ci	N	4WD, w/Cruise, w/E40D w/o Cruise	CA-3054
1987-90	V8 5.0L 302ci	N	2WD, w/Cruise Control; 71.00" Cable	CA-3018
1960-63	V8 5.4L 332ci		2WD, MT Medium Duty; 83.00" Cable	CA-3004
1960-63	V8 5.4L 332ci		w/OD AT, w/3Spd. MT exc Medium Duty.; 83.00" Cable	CA-3010
1983	V8 5.8L 351ci	G	4WD, w/E40D Trans	CA-3054
1980-85	V8 5.8L 351ci	G	4WD, w/Cruise w/ratio adapter Lower; 63.00" Cable	CA-3002
1984-85	V8 5.8L 351ci	G	2WD, w/Cruise Control; 71.00" Cable	CA-3018
1984-85	V8 5.8L 351ci	G	2WD, w/o Cruise; 80.00" Cable	CA-3012
1984-85	V8 5.8L 351ci	G	4WD, w/Cruise Control, 2WD, w/Cruise 80" Cable	CA-3054

# SPEEDOMETER CABLES

Year	Engine	Vin	Remark	Part
<b>FORD TRUCKS (con't)</b>				
<b>F-250 (con't)</b>				
1984-85	V8 5.8L 351ci	G	4WD, w/o Cruise; Length 90"	CA-3055
1980-84	V8 5.8L 351ci	G,H	4WD, w/Cruise w/o ratio adapter Lower; 83.00" Cable	CA-3010
1980-84	V8 5.8L 351ci	G,H	w/o Cruise Control; 95.00" Cable	CA-3032
1980-85	V8 5.8L 351ci	G,H	2WD, MT w/o Cruise; 76.00" Cable	CA-3011
1980-85	V8 5.8L 351ci	G,H	w/Cruise Control, Upper	CA-3045
1981-85	V8 5.8L 351ci	G,H	2WD, MT w/Cruise Lower; 60.00" Cable	CA-3015
1985-86	V8 5.8L 351ci	G,H	4WD, w/o Cruise; 95.00" Cable	CA-3032
1977	V8 5.8L 351ci	H	Part Time 4WD, w/AT.; 95.00" Cable	CA-3032
1986	V8 5.8L 351ci	H	w/Cruise w/o ratio adapter	CA-3054
1990	V8 5.8L 351ci	H	2WD, w/o Cruise; 80.00" Cable	CA-3012
1990	V8 5.8L 351ci	H	4WD, w/Cruise Control, 2WD, w/Cruise 80" Cable	CA-3054
1990	V8 5.8L 351ci	H	4WD, w/o Cruise; Length 90"	CA-3055
1977-79	V8 5.8L 351ci	H	2WD, Custom Cab; 76.00" Cable	CA-3011
1977-79	V8 5.8L 351ci	H	4WD, AT, w/118 1/4" Cable	CA-3019
1978-79	V8 5.8L 351ci	H	Part Time 4WD, w/AT, 4WD, MT From serial number 500001"; 95.00" Cable	CA-3032
1984-86	V8 5.8L 351ci	H	4WD, w/Cruise w/ratio adapter Lower; 63.00" Cable	CA-3002
1985-89	V8 5.8L 351ci	H	2WD, AT w/o Cruise exc. E40D Trans.; 80.00" Cable	CA-3012
1985-89	V8 5.8L 351ci	H	2WD, w/o Cruise; 63.00" Cable	CA-3021
1985-89	V8 5.8L 351ci	H	4WD, exc. Cruise Control, AT, exc. E40D Trans.	CA-3055
1985-89	V8 5.8L 351ci	H	4WD, w/Cruise, w/E40D w/o Cruise	CA-3054
1985-90	V8 5.8L 351ci	H	2WD, w/Cruise Control; 71.00" Cable	CA-3018
1967	V8 5.8L 352ci		2WD, MT; 83.00" Cable	CA-3010
1967	V8 5.8L 352ci		2WD, w/C6 AT; 83.00" Cable	CA-3004
1973	V8 5.9L 360ci	Y	4WD	CA-3019
1968-70	V8 5.9L 360ci	Y	2WD, w/C6 AT; 83.00" Cable	CA-3004
1968-73	V8 5.9L 360ci	Y	2WD, MT; 83.00" Cable	CA-3010
1973-76	V8 5.9L 360ci	Y	2WD, Custom Cab; 76.00" Cable	CA-3011
1974-76	V8 5.9L 360ci	Y	4WD, AT, w/118 1/4" Cable	CA-3019
1974-76	V8 5.9L 360ci	Y	Part Time 4WD, w/AT.; 95.00" Cable	CA-3032
1973	V8 6.4L 390ci	H	4WD	CA-3019
1968-70	V8 6.4L 390ci	H	2WD, w/C6 AT; 83.00" Cable	CA-3004
1973-75	V8 6.4L 390ci	H	2WD, Custom Cab; 76.00" Cable	CA-3011
1968-74	V8 6.4L 390ci	H,M	2WD, MT; 83.00" Cable	CA-3010
1974-76	V8 6.4L 390ci	H,M	4WD, AT, w/118 1/4" Cable	CA-3019
1974-76	V8 6.4L 390ci	H,M	Part Time 4WD, w/AT.; 95.00" Cable	CA-3032
1974-76	V8 6.4L 390ci	M	2WD, Custom Cab; 76.00" Cable	CA-3011
1977	V8 6.6L 400ci	S	Part Time 4WD, w/AT.; 95.00" Cable	CA-3032
1977-79	V8 6.6L 400ci	S	2WD, Custom Cab; 76.00" Cable	CA-3011
1977-79	V8 6.6L 400ci	S	4WD, AT, w/118 1/4" Cable	CA-3019
1978-79	V8 6.6L 400ci	S	Part Time 4WD, w/AT, 4WD, MT From serial number 500001"; 95.00" Cable	CA-3032
1980-82	V8 6.6L 400ci	Z	2WD, MT w/o Cruise; 76.00" Cable	CA-3011
1980-82	V8 6.6L 400ci	Z	4WD, w/Cruise w/o ratio adapter Lower; 83.00" Cable	CA-3010
1980-82	V8 6.6L 400ci	Z	4WD, w/Cruise w/ratio adapter Lower; 63.00" Cable	CA-3002
1980-82	V8 6.6L 400ci	Z	w/o Cruise Control; 95.00" Cable	CA-3032
1980-82	V8 6.6L 400ci	Z	w/Cruise Control, Upper	CA-3045
1981-82	V8 6.6L 400ci	Z	2WD, MT w/Cruise Lower; 60.00" Cable	CA-3015
1986	V8 6.9L 420ci	1	w/Cruise w/o ratio adapter	CA-3054
1987	V8 6.9L 420ci	1	2WD, AT w/o Cruise exc. E40D Trans.; 80.00" Cable	CA-3012
1987	V8 6.9L 420ci	1	2WD, w/Cruise Control; 71.00" Cable	CA-3018
1987	V8 6.9L 420ci	1	2WD, w/o Cruise; 63.00" Cable	CA-3021
1987	V8 6.9L 420ci	1	4WD, exc. Cruise Control, AT, exc. E40D Trans.	CA-3055
1987	V8 6.9L 420ci	1	4WD, w/Cruise, w/E40D w/o Cruise	CA-3054
1983-84	V8 6.9L 420ci	1	4WD, w/Cruise w/o ratio adapter Lower; 83.00" Cable	CA-3010
1983-84	V8 6.9L 420ci	1	w/o Cruise Control; 95.00" Cable	CA-3032
1983-85	V8 6.9L 420ci	1	2WD, MT w/Cruise Lower; 60.00" Cable	CA-3015
1983-85	V8 6.9L 420ci	1	2WD, MT w/o Cruise; 76.00" Cable	CA-3011
1983-85	V8 6.9L 420ci	1	w/Cruise Control, Upper	CA-3045
1983-86	V8 6.9L 420ci	1	4WD, w/Cruise w/ratio adapter Lower; 63.00" Cable	CA-3002
1985-86	V8 6.9L 420ci	1	4WD, w/o Cruise; 95.00" Cable	CA-3032
1992-94	V8 7.3L 445ci	C,F,K,M		CA-3054
1990	V8 7.3L 445ci	M	2WD, w/o Cruise; 80.00" Cable	CA-3012
1990	V8 7.3L 445ci	M	4WD, w/Cruise Control, 2WD, w/Cruise 80" Cable	CA-3054

# SPEEDOMETER CABLES

Year	Engine	Vin	Remark	Part
<b>FORD TRUCKS (con't)</b>				
<b>F-250 (con't)</b>				
1990	V8 7.3L 445ci	M	4WD, w/o Cruise; Length 90"	CA-3055
1988-89	V8 7.3L 445ci	M	2WD, AT w/o Cruise exc. E40D Trans.; 80.00" Cable	CA-3012
1988-89	V8 7.3L 445ci	M	2WD, w/o Cruise; 63.00" Cable	CA-3021
1988-89	V8 7.3L 445ci	M	4WD, exc. Cruise Control, AT, exc. E40D Trans.	CA-3055
1988-89	V8 7.3L 445ci	M	4WD, w/Cruise, w/E40D w/o Cruise	CA-3054
1988-90	V8 7.3L 445ci	M	2WD, w/Cruise Control; 71.00" Cable	CA-3018
1992	V8 7.5L 460ci	G	83.00" Cable	CA-3004
1992	V8 7.5L 460ci	G	92" Length	CA-3054
1988-89	V8 7.5L 460ci	G	2WD, AT w/o Cruise exc. E40D Trans.; 80.00" Cable	CA-3012
1988-89	V8 7.5L 460ci	G	2WD, w/o Cruise; 63.00" Cable	CA-3021
1988-89	V8 7.5L 460ci	G	4WD, exc. Cruise Control, AT, exc. E40D Trans.	CA-3055
1988-89	V8 7.5L 460ci	G	4WD, w/Cruise, w/E40D w/o Cruise	CA-3054
1988-91	V8 7.5L 460ci	G	2WD, w/Cruise Control; 71.00" Cable	CA-3018
1990-91	V8 7.5L 460ci	G	2WD, w/o Cruise; 80.00" Cable	CA-3012
1990-91	V8 7.5L 460ci	G	4WD, w/Cruise Control, 2WD, w/Cruise 80" Cable	CA-3054
1990-91	V8 7.5L 460ci	G	4WD, w/o Cruise; Length 90"	CA-3055
1973	V8 7.5L 460ci	J	4WD	CA-3019
1973-79	V8 7.5L 460ci	J	2WD, Custom Cab; 76.00" Cable	CA-3011
1974-77	V8 7.5L 460ci	J	Part Time 4WD, w/AT.; 95.00" Cable	CA-3032
1974-79	V8 7.5L 460ci	J	4WD, AT, w/118 1/4" Cable	CA-3019
1978-79	V8 7.5L 460ci	J	Part Time 4WD, w/AT, 4WD, MT From serial number 500001"; 95.00" Cable	CA-3032
1984	V8 7.5L 460ci	L	4WD, w/E40D Trans	CA-3054
1986	V8 7.5L 460ci	L	w/Cruise w/o ratio adapter	CA-3054
1987	V8 7.5L 460ci	L	2WD, AT w/o Cruise exc. E40D Trans.; 80.00" Cable	CA-3012
1987	V8 7.5L 460ci	L	2WD, w/o Cruise; 63.00" Cable	CA-3021
1987	V8 7.5L 460ci	L	4WD, exc. Cruise Control, AT, exc. E40D Trans.	CA-3055
1987	V8 7.5L 460ci	L	4WD, w/Cruise, w/E40D w/o Cruise	CA-3054
1983-84	V8 7.5L 460ci	L	4WD, w/Cruise w/o ratio adapter Lower; 83.00" Cable	CA-3010
1983-84	V8 7.5L 460ci	L	w/o Cruise Control; 95.00" Cable	CA-3032
1983-85	V8 7.5L 460ci	L	2WD, MT w/Cruise Lower; 60.00" Cable	CA-3015
1983-85	V8 7.5L 460ci	L	2WD, MT w/o Cruise; 76.00" Cable	CA-3011
1983-85	V8 7.5L 460ci	L	w/Cruise Control, Upper	CA-3045
1983-86	V8 7.5L 460ci	L	4WD, w/Cruise w/ratio adapter Lower; 63.00" Cable	CA-3002
1985-86	V8 7.5L 460ci	L	2WD, w/o Cruise; 80.00" Cable	CA-3012
1985-86	V8 7.5L 460ci	L	4WD, w/Cruise Control, 2WD, w/Cruise 80" Cable	CA-3054
1985-86	V8 7.5L 460ci	L	4WD, w/o Cruise; Length 90"	CA-3055
1985-86	V8 7.5L 460ci	L	4WD, w/o Cruise; 95.00" Cable	CA-3032
1985-87	V8 7.5L 460ci	L	2WD, w/Cruise Control; 71.00" Cable	CA-3018
<b>F-350</b>				
1961-62	L6 3.7L 223ci		83.00" Cable	CA-3004
1963-64	L6 3.7L 223ci		AT, w/3Spd. MT; 83.00" Cable	CA-3004
1968	L6 3.9L 240ci	A	w/Cruise-O-Matic Auto. Trans., w/3 Spd. MT; 83.00" Cable	CA-3004
1973	L6 3.9L 240ci	A	2WD, Custom Cab; 76.00" Cable	CA-3011
1974	L6 3.9L 240ci	A	2WD; 76.00" Cable	CA-3011
1969-70	L6 3.9L 240ci	A	C4 AT; 83.00" Cable	CA-3010
1969-70	L6 3.9L 240ci	A	MT	CA-3046
1969-72	L6 3.9L 240ci	A	C6 AT; 83.00" Cable	CA-3004
1971-72	L6 3.9L 240ci	A	MT; 60.00" Cable	CA-3015
1973-74	L6 3.9L 240ci	A	4WD	CA-3019
1965-67	L6 3.9L 240ci		w/Cruise-O-Matic Auto. Trans., w/3 Spd. MT; 83.00" Cable	CA-3004
1961-62	L6 4.3L 262ci		83.00" Cable	CA-3004
1963-64	L6 4.3L 262ci		AT, w/3Spd. MT; 83.00" Cable	CA-3004
1983-85	L6 4.9L 300ci	9,Y	2WD, AT w/o Cruise; 95.00" Cable	CA-3032
1983-85	L6 4.9L 300ci	9,Y	4 Spd. MT w/Cruise w/o Adapter Lower; 60.00" Cable	CA-3015
1983-85	L6 4.9L 300ci	9,Y	4WD, AT w/Cruise w/o Adapter Lower; 83.00" Cable	CA-3010
1983-85	L6 4.9L 300ci	9,Y	4WD, w/o Cruise; 95.00" Cable	CA-3032
1983-85	L6 4.9L 300ci	9,Y	w/Cruise Control, Upper	CA-3045
1983-86	L6 4.9L 300ci	9,Y	2WD, MT w/o Cruise; 76.00" Cable	CA-3011
1983-86	L6 4.9L 300ci	9,Y	w/Cruise w/Adapter Lower; 63.00" Cable	CA-3002
1968	L6 4.9L 300ci	B	w/Cruise-O-Matic Auto. Trans., w/3 Spd. MT; 83.00" Cable	CA-3004
1973	L6 4.9L 300ci	B	2WD, Custom Cab; 76.00" Cable	CA-3011
1969-70	L6 4.9L 300ci	B	C4 AT; 83.00" Cable	CA-3010

# SPEEDOMETER CABLES

Year	Engine	Vin	Remark	Part
<b>FORD TRUCKS (con't)</b>				
<b>F-350 (con't)</b>				
1969-70	L6 4.9L 300ci	B	MT	CA-3046
1969-72	L6 4.9L 300ci	B	C6 AT; 83.00" Cable	CA-3004
1971-72	L6 4.9L 300ci	B	MT; 60.00" Cable	CA-3015
1973-76	L6 4.9L 300ci	B	4WD	CA-3019
1974-79	L6 4.9L 300ci	B,K	2WD; 76.00" Cable	CA-3011
1977-79	L6 4.9L 300ci	B,K	2WD, 4 Spd. Warner w/78" Cable; 83.00" Cable	CA-3004
1977-79	L6 4.9L 300ci	B,K	4WD, AT w/Cruise Lower; 83.00" Cable	CA-3010
1977-79	L6 4.9L 300ci	B,K	4WD, AT w/o Cruise, 4 Spd. New Process MT	CA-3019
1977-79	L6 4.9L 300ci	B,K	MT w/Overdrive; 95.00" Cable	CA-3032
1977-79	L6 4.9L 300ci	B,K	w/Cruise Upper	CA-3044
1980-82	L6 4.9L 300ci	E	2WD, AT w/o Cruise; 95.00" Cable	CA-3032
1980-82	L6 4.9L 300ci	E	2WD, MT w/o Cruise; 76.00" Cable	CA-3011
1980-82	L6 4.9L 300ci	E	4 Spd. MT w/Cruise w/o Adapter Lower; 60.00" Cable	CA-3015
1980-82	L6 4.9L 300ci	E	4WD, AT w/Cruise w/o Adapter Lower; 83.00" Cable	CA-3010
1980-82	L6 4.9L 300ci	E	4WD, w/o Cruise; 95.00" Cable	CA-3032
1980-82	L6 4.9L 300ci	E	w/Cruise Control, Upper	CA-3045
1980-82	L6 4.9L 300ci	E	w/Cruise w/Adapter Lower; 63.00" Cable	CA-3002
1986	L6 4.9L 300ci	Y	2WD, MT w/Factory Installed Speed Control; 71.00" Cable	CA-3018
1986	L6 4.9L 300ci	Y	AT w/Cruise	CA-3054
1986	L6 4.9L 300ci	Y	AT w/o Cruise Control; 95.00" Cable	CA-3032
1987-90	L6 4.9L 300ci	Y	2WD, 5 Spd. MT; 71.00" Cable	CA-3018
1987-90	L6 4.9L 300ci	Y	2WD, AT w/Cruise Control; 71.00" Cable	CA-3018
1987-90	L6 4.9L 300ci	Y	2WD, w/o Cruise w/o E40D Trans.; 80.00" Cable	CA-3012
1987-90	L6 4.9L 300ci	Y	4 Spd. MT; 63.00" Cable	CA-3021
1987-90	L6 4.9L 300ci	Y	4WD, w/o Cruise w/E40D Trans.	CA-3054
1987-90	L6 4.9L 300ci	Y	4WD, w/o Cruise w/o E40D Trans.	CA-3055
1960-62	V8 4.8L 292ci		83.00" Cable	CA-3004
1963-64	V8 4.8L 292ci		AT, w/3Spd. MT; 83.00" Cable	CA-3004
1980	V8 5.0L 302ci	F	2WD, AT w/o Cruise; 95.00" Cable	CA-3032
1980	V8 5.0L 302ci	F	2WD, MT w/o Cruise; 76.00" Cable	CA-3011
1980	V8 5.0L 302ci	F	4 Spd. MT w/Cruise w/o Adapter Lower; 60.00" Cable	CA-3015
1980	V8 5.0L 302ci	F	4WD, AT w/Cruise w/o Adapter Lower; 83.00" Cable	CA-3010
1980	V8 5.0L 302ci	F	4WD, w/o Cruise; 95.00" Cable	CA-3032
1980	V8 5.0L 302ci	F	w/Cruise Control, Upper	CA-3045
1980	V8 5.0L 302ci	F	w/Cruise w/Adapter Lower; 63.00" Cable	CA-3002
1972	V8 5.0L 302ci	G	C6 AT; 83.00" Cable	CA-3004
1972	V8 5.0L 302ci	G	MT; 60.00" Cable	CA-3015
1973	V8 5.0L 302ci	G	2WD, Custom Cab; 76.00" Cable	CA-3011
1973-76	V8 5.0L 302ci	G	4WD	CA-3019
1974-79	V8 5.0L 302ci	G	2WD; 76.00" Cable	CA-3011
1977-79	V8 5.0L 302ci	G	2WD, 4 Spd. Warner w/78" Cable; 83.00" Cable	CA-3004
1977-79	V8 5.0L 302ci	G	4WD, AT w/Cruise Lower; 83.00" Cable	CA-3010
1977-79	V8 5.0L 302ci	G	4WD, AT w/o Cruise, 4 Spd. New Process MT	CA-3019
1977-79	V8 5.0L 302ci	G	MT w/Overdrive; 95.00" Cable	CA-3032
1977-79	V8 5.0L 302ci	G	w/Cruise Upper	CA-3044
1963	V8 5.4L 332ci		AT, w/3Spd. MT; 83.00" Cable	CA-3004
1961-62	V8 5.4L 332ci		83.00" Cable	CA-3004
1980-85	V8 5.8L 351ci	G	w/Cruise w/Adapter Lower; 63.00" Cable	CA-3002
1980-85	V8 5.8L 351ci	G,H	2WD, AT w/o Cruise; 95.00" Cable	CA-3032
1980-85	V8 5.8L 351ci	G,H	2WD, MT w/o Cruise; 76.00" Cable	CA-3011
1980-85	V8 5.8L 351ci	G,H	4 Spd. MT w/Cruise w/o Adapter Lower; 60.00" Cable	CA-3015
1980-85	V8 5.8L 351ci	G,H	4WD, AT w/Cruise w/o Adapter Lower; 83.00" Cable	CA-3010
1980-85	V8 5.8L 351ci	G,H	4WD, w/o Cruise; 95.00" Cable	CA-3032
1980-85	V8 5.8L 351ci	G,H	w/Cruise Control, Upper	CA-3045
1986	V8 5.8L 351ci	H	2WD, MT w/Factory Installed Speed Control; 71.00" Cable	CA-3018
1986	V8 5.8L 351ci	H	AT w/Cruise	CA-3054
1986	V8 5.8L 351ci	H	AT w/o Cruise Control; 95.00" Cable	CA-3032
1977-79	V8 5.8L 351ci	H	2WD, 4 Spd. Warner w/78" Cable; 83.00" Cable	CA-3004
1977-79	V8 5.8L 351ci	H	2WD; 76.00" Cable	CA-3011
1977-79	V8 5.8L 351ci	H	4WD, AT w/Cruise Lower; 83.00" Cable	CA-3010
1977-79	V8 5.8L 351ci	H	4WD, AT w/o Cruise, 4 Spd. New Process MT	CA-3019
1977-79	V8 5.8L 351ci	H	MT w/Overdrive; 95.00" Cable	CA-3032

# SPEEDOMETER CABLES

Year	Engine	Vin	Remark	Part
<b>FORD TRUCKS (con't)</b>				
<b>F-350 (con't)</b>				
1977-79	V8 5.8L 351ci	H	w/Cruise Upper	CA-3044
1985-86	V8 5.8L 351ci	H	w/Cruise w/Adapter Lower; 63.00" Cable	CA-3002
1987-90	V8 5.8L 351ci	H	2WD, 5 Spd. MT; 71.00" Cable	CA-3018
1987-90	V8 5.8L 351ci	H	2WD, AT w/Cruise Control; 71.00" Cable	CA-3018
1987-90	V8 5.8L 351ci	H	2WD, w/o Cruise w/o E40D Trans.; 80.00" Cable	CA-3012
1987-90	V8 5.8L 351ci	H	4 Spd. MT; 63.00" Cable	CA-3021
1987-90	V8 5.8L 351ci	H	4WD, w/o Cruise w/E40D Trans.	CA-3054
1987-90	V8 5.8L 351ci	H	4WD, w/o Cruise w/o E40D Trans.	CA-3055
1966-67	V8 5.8L 352ci		w/Cruise-O-Matic Auto. Trans., w/3 Spd. MT; 83.00" Cable	CA-3004
1968	V8 5.9L 360ci	Y	w/Cruise-O-Matic Auto. Trans., w/3 Spd. MT; 83.00" Cable	CA-3004
1973	V8 5.9L 360ci	Y	2WD, Custom Cab; 76.00" Cable	CA-3011
1969-70	V8 5.9L 360ci	Y	C4 AT; 83.00" Cable	CA-3010
1969-70	V8 5.9L 360ci	Y	MT	CA-3046
1969-72	V8 5.9L 360ci	Y	C6 AT; 83.00" Cable	CA-3004
1971-72	V8 5.9L 360ci	Y	MT; 60.00" Cable	CA-3015
1973-76	V8 5.9L 360ci	Y	4WD	CA-3019
1974-76	V8 5.9L 360ci	Y	2WD; 76.00" Cable	CA-3011
1964	V8 5.9L 361ci		AT, w/3Spd. MT; 83.00" Cable	CA-3004
1965-66	V8 5.9L 361ci		w/Cruise-O-Matic Auto. Trans., w/3 Spd. MT; 83.00" Cable	CA-3004
1968	V8 6.4L 390ci	H	w/Cruise-O-Matic Auto. Trans., w/3 Spd. MT; 83.00" Cable	CA-3004
1973	V8 6.4L 390ci	H	2WD, Custom Cab; 76.00" Cable	CA-3011
1969-70	V8 6.4L 390ci	H	C4 AT; 83.00" Cable	CA-3010
1969-70	V8 6.4L 390ci	H	MT	CA-3046
1969-72	V8 6.4L 390ci	H	C6 AT; 83.00" Cable	CA-3004
1971-72	V8 6.4L 390ci	H	MT; 60.00" Cable	CA-3015
1973-75	V8 6.4L 390ci	H	4WD	CA-3019
1974-76	V8 6.4L 390ci	H,M	2WD; 76.00" Cable	CA-3011
1974-76	V8 6.4L 390ci	M	4WD	CA-3019
1977-79	V8 6.6L 400ci	S	2WD, 4 Spd. Warner w/78" Cable; 83.00" Cable	CA-3004
1977-79	V8 6.6L 400ci	S	2WD; 76.00" Cable	CA-3011
1977-79	V8 6.6L 400ci	S	4WD, AT w/Cruise Lower; 83.00" Cable	CA-3010
1977-79	V8 6.6L 400ci	S	4WD, AT w/o Cruise, 4 Spd. New Process MT	CA-3019
1977-79	V8 6.6L 400ci	S	MT w/Overdrive; 95.00" Cable	CA-3032
1977-79	V8 6.6L 400ci	S	w/Cruise Upper	CA-3044
1980-82	V8 6.6L 400ci	Z	2WD, AT w/o Cruise; 95.00" Cable	CA-3032
1980-82	V8 6.6L 400ci	Z	2WD, MT w/o Cruise; 76.00" Cable	CA-3011
1980-82	V8 6.6L 400ci	Z	4 Spd. MT w/Cruise w/o Adapter Lower; 60.00" Cable	CA-3015
1980-82	V8 6.6L 400ci	Z	4WD, AT w/Cruise w/o Adapter Lower; 83.00" Cable	CA-3010
1980-82	V8 6.6L 400ci	Z	4WD, w/o Cruise; 95.00" Cable	CA-3032
1980-82	V8 6.6L 400ci	Z	w/Cruise Control, Upper	CA-3045
1980-82	V8 6.6L 400ci	Z	w/Cruise w/Adapter Lower; 63.00" Cable	CA-3002
1986	V8 6.9L 420ci	1	2WD, MT w/Factory Installed Speed Control; 71.00" Cable	CA-3018
1986	V8 6.9L 420ci	1	AT w/Cruise	CA-3054
1986	V8 6.9L 420ci	1	AT w/o Cruise Control; 95.00" Cable	CA-3032
1987	V8 6.9L 420ci	1	2WD, 5 Spd. MT; 71.00" Cable	CA-3018
1987	V8 6.9L 420ci	1	2WD, AT w/Cruise Control; 71.00" Cable	CA-3018
1987	V8 6.9L 420ci	1	2WD, w/o Cruise w/o E40D Trans.; 80.00" Cable	CA-3012
1987	V8 6.9L 420ci	1	4 Spd. MT; 63.00" Cable	CA-3021
1987	V8 6.9L 420ci	1	4WD, w/o Cruise w/E40D Trans.	CA-3054
1987	V8 6.9L 420ci	1	4WD, w/o Cruise w/o E40D Trans.	CA-3055
1983-85	V8 6.9L 420ci	1	2WD, AT w/o Cruise; 95.00" Cable	CA-3032
1983-85	V8 6.9L 420ci	1	4 Spd. MT w/Cruise w/o Adapter Lower; 60.00" Cable	CA-3015
1983-85	V8 6.9L 420ci	1	4WD, AT w/Cruise w/o Adapter Lower; 83.00" Cable	CA-3010
1983-85	V8 6.9L 420ci	1	4WD, w/o Cruise; 95.00" Cable	CA-3032
1983-85	V8 6.9L 420ci	1	w/Cruise Control, Upper	CA-3045
1983-86	V8 6.9L 420ci	1	2WD, MT w/o Cruise; 76.00" Cable	CA-3011
1983-86	V8 6.9L 420ci	1	w/Cruise w/Adapter Lower; 63.00" Cable	CA-3002
1992-94	V8 7.3L 445ci	C,K,M		CA-3054
1997	V8 7.3L 445ci	F	71" Length	CA-3018
1997	V8 7.3L 445ci	F	92" Length	CA-3054
1994-96	V8 7.3L 445ci	F		CA-3054
1988-90	V8 7.3L 445ci	M	2WD, 5 Spd. MT; 71.00" Cable	CA-3018

# SPEEDOMETER CABLES

Year	Engine	Vin	Remark	Part
<b>FORD TRUCKS (con't)</b>				
<b>F-350 (con't)</b>				
1988-90	V8 7.3L 445ci	M	2WD, AT w/Cruise Control; 71.00" Cable	CA-3018
1988-90	V8 7.3L 445ci	M	2WD, w/o Cruise w/o E40D Trans.; 80.00" Cable	CA-3012
1988-90	V8 7.3L 445ci	M	4 Spd. MT; 63.00" Cable	CA-3021
1988-90	V8 7.3L 445ci	M	4WD, w/o Cruise w/E40D Trans.	CA-3054
1988-90	V8 7.3L 445ci	M	4WD, w/o Cruise w/o E40D Trans.	CA-3055
1988-91	V8 7.5L 460ci	G	2WD, 5 Spd. MT; 71.00" Cable	CA-3018
1988-91	V8 7.5L 460ci	G	2WD, AT w/Cruise Control; 71.00" Cable	CA-3018
1988-91	V8 7.5L 460ci	G	2WD, w/o Cruise w/o E40D Trans.; 80.00" Cable	CA-3012
1988-91	V8 7.5L 460ci	G	4 Spd. MT; 63.00" Cable	CA-3021
1988-91	V8 7.5L 460ci	G	4WD, w/o Cruise w/E40D Trans.	CA-3054
1988-91	V8 7.5L 460ci	G	4WD, w/o Cruise w/o E40D Trans.	CA-3055
1992-94	V8 7.5L 460ci	G		CA-3054
1973	V8 7.5L 460ci	J	2WD, Custom Cab; 76.00" Cable	CA-3011
1973-76	V8 7.5L 460ci	J	4WD	CA-3019
1974-79	V8 7.5L 460ci	J	2WD; 76.00" Cable	CA-3011
1977-79	V8 7.5L 460ci	J	2WD, 4 Spd. Warner w/78" Cable; 83.00" Cable	CA-3004
1977-79	V8 7.5L 460ci	J	4WD, AT w/Cruise Lower; 83.00" Cable	CA-3010
1977-79	V8 7.5L 460ci	J	4WD, AT w/o Cruise, 4 Spd. New Process MT	CA-3019
1977-79	V8 7.5L 460ci	J	MT w/Overdrive; 95.00" Cable	CA-3032
1977-79	V8 7.5L 460ci	J	w/Cruise Upper	CA-3044
1986	V8 7.5L 460ci	L	2WD, MT w/Factory Installed Speed Control; 71.00" Cable	CA-3018
1986	V8 7.5L 460ci	L	AT w/Cruise	CA-3054
1986	V8 7.5L 460ci	L	AT w/o Cruise Control; 95.00" Cable	CA-3032
1987	V8 7.5L 460ci	L	2WD, 5 Spd. MT; 71.00" Cable	CA-3018
1987	V8 7.5L 460ci	L	2WD, AT w/Cruise Control; 71.00" Cable	CA-3018
1987	V8 7.5L 460ci	L	2WD, w/o Cruise w/o E40D Trans.; 80.00" Cable	CA-3012
1987	V8 7.5L 460ci	L	4 Spd. MT; 63.00" Cable	CA-3021
1987	V8 7.5L 460ci	L	4WD, w/o Cruise w/E40D Trans.	CA-3054
1987	V8 7.5L 460ci	L	4WD, w/o Cruise w/o E40D Trans.	CA-3055
1983-85	V8 7.5L 460ci	L	2WD, AT w/o Cruise; 95.00" Cable	CA-3032
1983-85	V8 7.5L 460ci	L	4 Spd. MT w/Cruise w/o Adapter Lower; 60.00" Cable	CA-3015
1983-85	V8 7.5L 460ci	L	4WD, AT w/Cruise w/o Adapter Lower; 83.00" Cable	CA-3010
1983-85	V8 7.5L 460ci	L	4WD, w/o Cruise; 95.00" Cable	CA-3032
1983-85	V8 7.5L 460ci	L	w/Cruise Control, Upper	CA-3045
1983-86	V8 7.5L 460ci	L	2WD, MT w/o Cruise; 76.00" Cable	CA-3011
1983-86	V8 7.5L 460ci	L	w/Cruise w/Adapter Lower; 63.00" Cable	CA-3002
<b>F-450 SUPER DUTY</b>				
1999	V8 7.3L 445ci	F	w/Cruise w/E40D	CA-3054
1999	V8 7.3L 445ci	F	w/Cruise w/o E40D; 71.00" Cable	CA-3018
1999	V8 7.3L 445ci	F	w/o Cruise Control; 118" Length	CA-3019
<b>RANGER</b>				
1983	L4 2.0L 122ci	C	2WD, w/o Cruise routes thru engine compartment; 76.00" Cable	CA-3011
1983	L4 2.0L 122ci	C	2WD, w/o Cruise routes thru passenger compartment; 63.00" Cable	CA-3021
1984	L4 2.0L 122ci	C	2WD, 4 Spd. MT w/o Cruise w/Adapter	CA-3046
1984	L4 2.0L 122ci	C	2WD, 4 Spd. MT w/o Cruise w/o adapter; 63.00" Cable	CA-3021
1984	L4 2.0L 122ci	C	2WD, AT w/o Cruise; 63.00" Cable	CA-3021
1983-84	L4 2.0L 122ci	C	2WD, w/Cruise Control	CA-3043
1983-84	L4 2.0L 122ci	C	4WD, w/Cruise Control; 71.00" Cable	CA-3018
1983-84	L4 2.0L 122ci	C	4WD, w/o Cruise; 80.00" Cable	CA-3012
1985-86	L4 2.0L 122ci	C	2WD, 5 Spd. MT w/o Cruise; 63.00" Cable	CA-3021
1985-86	L4 2.0L 122ci	C	2WD, MT w/Cruise Control	CA-3043
1985-86	L4 2.0L 122ci	C	2WD, MT w/o Cruise w/adapter w/3.73 axle ratio, w/185 X 75 X 14 tires	CA-3046
1985-88	L4 2.0L 122ci	C	2WD, w/Cruise Control; 71.00" Cable	CA-3018
1985-88	L4 2.0L 122ci	C	4WD, w/o Cruise, 2WD, w/AT w/o Cruise; 80.00" Cable	CA-3012
1987-88	L4 2.0L 122ci	C	2WD, MT w/o Cruise; 63.00" Cable	CA-3021
1983	L4 2.2L 134ci	P	2WD, w/o Cruise routes thru engine compartment; 76.00" Cable	CA-3011
1983	L4 2.2L 134ci	P	2WD, w/o Cruise routes thru passenger compartment; 63.00" Cable	CA-3021
1984	L4 2.2L 134ci	P	2WD, 4 Spd. MT w/o Cruise w/Adapter	CA-3046
1984	L4 2.2L 134ci	P	2WD, 4 Spd. MT w/o Cruise w/o adapter; 63.00" Cable	CA-3021
1984	L4 2.2L 134ci	P	2WD, AT w/o Cruise; 63.00" Cable	CA-3021
1983-84	L4 2.2L 134ci	P	2WD, w/Cruise Control	CA-3043
1983-84	L4 2.2L 134ci	P	4WD, w/Cruise Control; 71.00" Cable	CA-3018

# SPEEDOMETER CABLES

Year	Engine	Vin	Remark	Part
<b>FORD TRUCKS (con't)</b>				
<b>RANGER  (con't)</b>				
1983-84	L4 2.2L 134ci	P	4WD, w/o Cruise; 80.00" Cable	CA-3012
1983	L4 2.3L 140ci	A	2WD, w/o Cruise routes thru engine compartment; 76.00" Cable	CA-3011
1983	L4 2.3L 140ci	A	2WD, w/o Cruise routes thru passenger compartment; 63.00" Cable	CA-3021
1984	L4 2.3L 140ci	A	2WD, 4 Spd. MT w/o Cruise w/Adapter	CA-3046
1984	L4 2.3L 140ci	A	2WD, 4 Spd. MT w/o Cruise w/o adapter; 63.00" Cable	CA-3021
1984	L4 2.3L 140ci	A	2WD, AT w/o Cruise; 63.00" Cable	CA-3021
1990	L4 2.3L 140ci	A	2WD, w/o Cruise; 63.00" Cable	CA-3021
1990	L4 2.3L 140ci	A	w/Cruise Control; 71.00" Cable	CA-3018
1983-84	L4 2.3L 140ci	A	2WD, w/Cruise Control	CA-3043
1983-84	L4 2.3L 140ci	A	4WD, w/Cruise Control; 71.00" Cable	CA-3018
1983-84	L4 2.3L 140ci	A	4WD, w/o Cruise; 80.00" Cable	CA-3012
1985-86	L4 2.3L 140ci	A,E	2WD, 5 Spd. MT w/o Cruise; 63.00" Cable	CA-3021
1985-86	L4 2.3L 140ci	A,E	2WD, MT w/Cruise Control	CA-3043
1985-86	L4 2.3L 140ci	A,E	2WD, MT w/o Cruise w/adapter w/3.73 axle ratio, w/185 X 75 X 14 tires	CA-3046
1985-89	L4 2.3L 140ci	A,E	2WD, w/Cruise Control; 71.00" Cable	CA-3018
1985-89	L4 2.3L 140ci	A,E	4WD, w/o Cruise, 2WD, w/AT w/o Cruise; 80.00" Cable	CA-3012
1987-89	L4 2.3L 140ci	A,E	2WD, MT w/o Cruise; 63.00" Cable	CA-3021
1983	V6 2.8L 171ci	S	2WD, w/o Cruise routes thru engine compartment; 76.00" Cable	CA-3011
1983	V6 2.8L 171ci	S	2WD, w/o Cruise routes thru passenger compartment; 63.00" Cable	CA-3021
1984	V6 2.8L 171ci	S	2WD, 4 Spd. MT w/o Cruise w/Adapter	CA-3046
1984	V6 2.8L 171ci	S	2WD, 4 Spd. MT w/o Cruise w/o adapter; 63.00" Cable	CA-3021
1984	V6 2.8L 171ci	S	2WD, AT w/o Cruise; 63.00" Cable	CA-3021
1985	V6 2.8L 171ci	S	2WD, 5 Spd. MT w/o Cruise; 63.00" Cable	CA-3021
1985	V6 2.8L 171ci	S	2WD, MT w/Cruise Control	CA-3043
1985	V6 2.8L 171ci	S	2WD, MT w/o Cruise w/adapter w/3.73 axle ratio, w/185 X 75 X 14 tires	CA-3046
1985	V6 2.8L 171ci	S	2WD, w/Cruise Control; 71.00" Cable	CA-3018
1985	V6 2.8L 171ci	S	4WD, w/o Cruise, 2WD, w/AT w/o Cruise; 80.00" Cable	CA-3012
1983-84	V6 2.8L 171ci	S	2WD, w/Cruise Control	CA-3043
1983-84	V6 2.8L 171ci	S	4WD, w/Cruise Control; 71.00" Cable	CA-3018
1983-84	V6 2.8L 171ci	S	4WD, w/o Cruise; 80.00" Cable	CA-3012
1986	V6 2.9L 177ci	T	2WD, 5 Spd. MT w/o Cruise; 63.00" Cable	CA-3021
1986	V6 2.9L 177ci	T	2WD, MT w/Cruise Control	CA-3043
1986	V6 2.9L 177ci	T	2WD, MT w/o Cruise w/adapter w/3.73 axle ratio, w/185 X 75 X 14 tires	CA-3046
1990	V6 2.9L 177ci	T	2WD, w/o Cruise; 63.00" Cable	CA-3021
1990	V6 2.9L 177ci	T	w/Cruise Control; 71.00" Cable	CA-3018
1986-89	V6 2.9L 177ci	T	2WD, w/Cruise Control; 71.00" Cable	CA-3018
1986-89	V6 2.9L 177ci	T	4WD, w/o Cruise, 2WD, w/AT w/o Cruise; 80.00" Cable	CA-3012
1987-89	V6 2.9L 177ci	T	2WD, MT w/o Cruise; 63.00" Cable	CA-3021
1999-00	V6 3.0L 182ci	V	2WD, w/Cruise Control; 71.00" Cable	CA-3018
1990	V6 4.0L 245ci	X	2WD, w/o Cruise; 63.00" Cable	CA-3021
1990	V6 4.0L 245ci	X	w/Cruise Control; 71.00" Cable	CA-3018
1991-00	V6 4.0L 245ci	X	2WD, w/Cruise Control; 71.00" Cable	CA-3018
<b>GEO</b>				
<b>SPECTRUM</b>				
1989	L4 1.5L 92ci	7,9		CA-3156
<b>GMC</b>				
<b>1000 SERIES</b>				
1964	L6 3.8L 230ci		U.S., w/MT, w/SM318 Trans.; 63.00" Cable	CA-3002
1965	L6 3.8L 230ci		w/SM318 Trans., w/SM420 Trans.; 63.00" Cable	CA-3002
1961-62	L6 4.4L 270ci		exc. Hydramatic Trans.; 63.00" Cable	CA-3002
1961-62	L6 4.4L 270ci		w/Hydramatic Trans., w/MT; 83.00" Cable	CA-3004
1961-62	V6 5.0L 305ci		exc. Hydramatic Trans.; 63.00" Cable	CA-3002
1961-62	V6 5.0L 305ci		w/Hydramatic Trans., w/MT; 83.00" Cable	CA-3004
1963-64	V6 5.0L 305ci		U.S., w/MT, w/SM318 Trans.; 63.00" Cable	CA-3002
<b>1500 SERIES</b>				
1964	L6 3.8L 230ci		U.S., w/MT, w/SM318 Trans.; 63.00" Cable	CA-3002
1965	L6 3.8L 230ci		w/55" Cable; 63.00" Cable	CA-3002
1964-65	L6 3.8L 230ci		83.00" Cable	CA-3004
1964-65	L6 3.8L 230ci		w/92" Cable	CA-3016
1961	L6 4.4L 270ci		83.00" Cable	CA-3004
1962	L6 4.4L 270ci		U.S., w/MT, w/SM420 Trans.; 83.00" Cable	CA-3004

# SPEEDOMETER CABLES

Year	Engine	Vin	Remark	Part
<b>GMC (con't)</b>				
<b>1500 SERIES (con't)</b>				
1961-62	L6 4.4L 270ci		w/55" Cable; 63.00" Cable	CA-3002
1961-62	L6 4.4L 270ci		w/92" Cable	CA-3016
1961	V6 5.0L 305ci		83.00" Cable	CA-3004
1962	V6 5.0L 305ci		U.S., w/MT, w/Flat Back Cowl; 63.00" Cable	CA-3002
1962	V6 5.0L 305ci		U.S., w/MT, w/SM420 Trans.; 83.00" Cable	CA-3004
1964	V6 5.0L 305ci		U.S., w/MT, w/SM318 Trans.; 63.00" Cable	CA-3002
1961-63	V6 5.0L 305ci		w/55" Cable; 63.00" Cable	CA-3002
1961-64	V6 5.0L 305ci		w/92" Cable	CA-3016
1963-64	V6 5.0L 305ci		83.00" Cable	CA-3004
<b>2500 SERIES</b>				
1961-62	L6 4.4L 270ci		U.S., w/MT, w/Flat Back Cowl; 63.00" Cable	CA-3002
1961-62	L6 4.4L 270ci		U.S., w/MT, w/SM420 Trans.; 83.00" Cable	CA-3004
1961-62	V6 5.0L 305ci		U.S., w/MT, w/Flat Back Cowl; 63.00" Cable	CA-3002
1961-62	V6 5.0L 305ci		U.S., w/MT, w/SM420 Trans.; 83.00" Cable	CA-3004
<b>C15</b>				
1971	L6 4.1L 250ci	C,L	w/Powerglide & THM 120" length	CA-3038
1971	L6 4.1L 250ci	C,L	w/Powerglide & THM 80" length, w/3 & 4 Spd. MT; 83.00" Cable	CA-3004
1971	L6 4.1L 250ci	C,L	w/Powerglide & THM 95" length	CA-3016
1972	L6 4.1L 250ci	D	w/Powerglide & THM 120" length	CA-3038
1972	L6 4.1L 250ci	D	w/Powerglide & THM 80" length, w/3 & 4 Spd. MT; 83.00" Cable	CA-3004
1972	L6 4.1L 250ci	D	w/Powerglide & THM 95" length	CA-3016
1976	L6 4.1L 250ci	D	4 Spd. MT Lower; 40.00" Cable	CA-3033
1976	L6 4.1L 250ci	D	AT THM w/Cruise Lower; 83.00" Cable	CA-3004
1976	L6 4.1L 250ci	D	AT THM w/Cruise Upper, OR 4 Spd. MT Upper; 41.00" Cable	CA-3009
1976	L6 4.1L 250ci	D	AT THM w/o Cruise, 3 Spd. MT w/o Cruise; 80.00" Cable	CA-3001
1977	L6 4.1L 250ci	D	w/Cruise Control, Lower; 63.00" Cable	CA-3002
1977	L6 4.1L 250ci	D	w/Cruise Control, Upper; 41.00" Cable	CA-3009
1980	L6 4.1L 250ci	D	4 Spd. w/o Cruise Upper; 61.00" Cable	CA-3005
1980	L6 4.1L 250ci	D	exc. Cruise Control; 80.00" Cable	CA-3001
1980	L6 4.1L 250ci	D	w/Catalytic Converter w/Cruise Control, Lower	CA-3006
1980	L6 4.1L 250ci	D	w/o Catalytic Converter w/Cruise Control, Lower; 63.00" Cable	CA-3002
1981	L6 4.1L 250ci	D	3 Spd. AT 1 pc. Cable; 80.00" Cable	CA-3001
1981	L6 4.1L 250ci	D	MT w/o Cruise Upper; 61.00" Cable	CA-3005
1981	L6 4.1L 250ci	D	w/Cruise Control, Lower; 63.00" Cable	CA-3002
1981	L6 4.1L 250ci	D	w/Cruise Control, Upper; 41.00" Cable	CA-3009
1982	L6 4.1L 250ci	D	3 Spd. AT 1 pc. Cable, or MT w/o Cruise; 80.00" Cable	CA-3001
1982	L6 4.1L 250ci	D	4 Spd. AT w/innerconnector, Upper; 61.00" Cable	CA-3005
1982	L6 4.1L 250ci	D	AT w/Cruise Control, Intermediate	CA-3006
1982	L6 4.1L 250ci	D	MT w/Cruise Control, Lower; 63.00" Cable	CA-3002
1984	L6 4.1L 250ci	D	TH700-R4 Auto. Trans., or w/4 Spd. MT Upper; 61.00" Cable	CA-3005
1978-79	L6 4.1L 250ci	D	3 Spd. MT w/o Cruise; 80.00" Cable	CA-3001
1978-79	L6 4.1L 250ci	D	AT w/Catalytic Converter Lower	CA-3006
1978-79	L6 4.1L 250ci	D	AT w/Catalytic Converter w/Cruise Upper; 41.00" Cable	CA-3009
1978-79	L6 4.1L 250ci	D	4 Spd. MT; 61.00" Cable	CA-3005
1978-79	L6 4.1L 250ci	D	AT w/o Catalytic Converter w/Cruise Lower; 63.00" Cable	CA-3002
1983-84	L6 4.1L 250ci	D	4 Spd. MT w/innerconnector Lower; 20.00" Cable	CA-3008
1983-84	L6 4.1L 250ci	D	THM-400 Auto. Trans.; 80.00" Cable	CA-3001
1970	L6 4.1L 250ci	N	w/Powerglide & THM 120" length	CA-3038
1970	L6 4.1L 250ci	N	w/Powerglide & THM 80" length, w/3 & 4 Spd. MT; 83.00" Cable	CA-3004
1970	L6 4.1L 250ci	N	w/Powerglide & THM 95" length	CA-3016
1973	L6 4.1L 250ci	Q	3 & 4 Spd. MT, or THM AT w/o Cruise; 80.00" Cable	CA-3001
1973	L6 4.1L 250ci	Q	AT w/Cruise Control, Lower; 63.00" Cable	CA-3002
1973	L6 4.1L 250ci	Q	AT w/Cruise Control, Upper	CA-3031
1975	L6 4.1L 250ci	Q	4 Spd. MT Lower; 40.00" Cable	CA-3033
1975	L6 4.1L 250ci	Q	AT THM w/Cruise Lower; 63.00" Cable	CA-3002
1975	L6 4.1L 250ci	Q	AT THM w/Cruise Upper, OR 4 Spd. MT Upper; 41.00" Cable	CA-3009
1975	L6 4.1L 250ci	Q	AT THM w/o Cruise, 3 Spd. MT w/o Cruise; 80.00" Cable	CA-3001
1970-71	L6 4.8L 292ci	S	w/Powerglide & THM 120" length	CA-3038
1970-71	L6 4.8L 292ci	S	w/Powerglide & THM 80" length, w/3 & 4 Spd. MT; 83.00" Cable	CA-3004
1970-71	L6 4.8L 292ci	S	w/Powerglide & THM 95" length	CA-3016
1973-74	L6 4.8L 292ci	S,T	AT w/Cruise Control, Lower; 63.00" Cable	CA-3002
1973-74	L6 4.8L 292ci	S,T	3 & 4 Spd. MT, or THM AT w/o Cruise; 80.00" Cable	CA-3001



# SPEEDOMETER CABLES

Year	Engine	Vin	Remark	Part
<b>GMC (con't)</b>				
<b>C15 (con't)</b>				
1973-74	L6 4.8L 292ci	S,T	AT w/Cruise Control, Upper	CA-3031
1975	L6 4.8L 292ci	T	AT THM w/Cruise Lower; 63.00" Cable	CA-3002
1976	L6 4.8L 292ci	T	AT THM w/Cruise Lower; 83.00" Cable	CA-3004
1977	L6 4.8L 292ci	T	w/Cruise Control, Lower; 63.00" Cable	CA-3002
1977	L6 4.8L 292ci	T	w/Cruise Control, Upper; 41.00" Cable	CA-3009
1980	L6 4.8L 292ci	T	4 Spd. w/o Cruise Upper; 61.00" Cable	CA-3005
1980	L6 4.8L 292ci	T	exc. Cruise Control; 80.00" Cable	CA-3001
1980	L6 4.8L 292ci	T	w/Catalic Converter w/Cruise Control, Lower	CA-3006
1980	L6 4.8L 292ci	T	w/o Catalic Converter w/Cruise Control, Lower; 63.00" Cable	CA-3002
1975-76	L6 4.8L 292ci	T	4 Spd. MT Lower; 40.00" Cable	CA-3033
1975-76	L6 4.8L 292ci	T	AT THM w/Cruise Upper, OR 4 Spd. MT Upper; 41.00" Cable	CA-3009
1975-76	L6 4.8L 292ci	T	AT THM w/o Cruise, 3 Spd. MT w/o Cruise; 80.00" Cable	CA-3001
1978-79	L6 4.8L 292ci	T	3 Spd. MT w/o Cruise; 80.00" Cable	CA-3001
1978-79	L6 4.8L 292ci	T	4 Spd. MT; 61.00" Cable	CA-3005
1978-79	L6 4.8L 292ci	T	AT w/Catalytic Converter Lower	CA-3006
1978-79	L6 4.8L 292ci	T	AT w/Catalytic Converter w/Cruise Upper; 41.00" Cable	CA-3009
1978-79	L6 4.8L 292ci	T	AT w/o Catalytic Converter w/Cruise Lower; 63.00" Cable	CA-3002
1985	V6 4.3L 262ci	N	TH700-R4 Auto. Trans., Lower; 20.00" Cable	CA-3008
1985	V6 4.3L 262ci	N	TH700-R4 Auto. Trans., Upper; 61.00" Cable	CA-3005
1986	V6 4.3L 262ci	N	Lower exc. AT THM-400 Trans.; 20.00" Cable	CA-3008
1986	V6 4.3L 262ci	N	Upper exc. AT THM-400 Trans.; 61.00" Cable	CA-3005
1985-86	V6 4.3L 262ci	N	THM-400 Auto. Trans.; 80.00" Cable	CA-3001
1981	V8 5.0L 305ci	F	MT w/o Cruise Upper; 61.00" Cable	CA-3005
1983-84	V8 5.0L 305ci	F	TH700-R4 Auto. Trans., or w/4 Spd. MT Upper; 61.00" Cable	CA-3005
1981	V8 5.0L 305ci	F,G,H	3 Spd. AT 1 pc. Cable; 80.00" Cable	CA-3001
1981	V8 5.0L 305ci	F,G,H	w/Cruise Control, Lower; 63.00" Cable	CA-3002
1981	V8 5.0L 305ci	F,G,H	w/Cruise Control, Upper; 41.00" Cable	CA-3009
1982	V8 5.0L 305ci	F,H	3 Spd. AT 1 pc. Cable, or MT w/o Cruise; 80.00" Cable	CA-3001
1982	V8 5.0L 305ci	F,H	4 Spd. AT w/innerconnector, Upper; 61.00" Cable	CA-3005
1982	V8 5.0L 305ci	F,H	AT w/Cruise Control, Intermediate	CA-3006
1982	V8 5.0L 305ci	F,H	MT w/Cruise Control, Lower; 63.00" Cable	CA-3002
1985	V8 5.0L 305ci	F,H	TH700-R4 Auto. Trans., Lower; 20.00" Cable	CA-3008
1985	V8 5.0L 305ci	F,H	TH700-R4 Auto. Trans., Upper; 61.00" Cable	CA-3005
1986	V8 5.0L 305ci	F,H	Lower exc. AT THM-400 Trans.; 20.00" Cable	CA-3008
1986	V8 5.0L 305ci	F,H	Upper exc. AT THM-400 Trans.; 61.00" Cable	CA-3005
1983-84	V8 5.0L 305ci	F,H	4 Spd. MT w/innerconnector Lower; 20.00" Cable	CA-3008
1983-86	V8 5.0L 305ci	F,H	THM-400 Auto. Trans.; 80.00" Cable	CA-3001
1980	V8 5.0L 305ci	G	4 Spd. w/o Cruise Upper; 61.00" Cable	CA-3005
1980	V8 5.0L 305ci	G	exc. Cruise Control; 80.00" Cable	CA-3001
1980	V8 5.0L 305ci	G	w/Catalic Converter w/Cruise Control, Lower	CA-3006
1980	V8 5.0L 305ci	G	w/o Catalic Converter w/Cruise Control, Lower; 63.00" Cable	CA-3002
1981	V8 5.0L 305ci	G	MT w/o Cruise Upper; 61.00" Cable	CA-3005
1981	V8 5.0L 305ci	H	MT w/o Cruise Upper; 61.00" Cable	CA-3005
1983-84	V8 5.0L 305ci	H	TH700-R4 Auto. Trans., or w/4 Spd. MT Upper; 61.00" Cable	CA-3005
1976	V8 5.0L 305ci	Q	4 Spd. MT Lower; 40.00" Cable	CA-3033
1976	V8 5.0L 305ci	Q	AT THM w/Cruise Lower; 83.00" Cable	CA-3004
1976	V8 5.0L 305ci	Q	AT THM w/Cruise Upper, OR 4 Spd. MT Upper; 41.00" Cable	CA-3009
1976	V8 5.0L 305ci	Q	AT THM w/o Cruise, 3 Spd. MT w/o Cruise; 80.00" Cable	CA-3001
1977	V8 5.0L 305ci	U	w/Cruise Control, Lower; 63.00" Cable	CA-3002
1977	V8 5.0L 305ci	U	w/Cruise Control, Upper; 41.00" Cable	CA-3009
1978-79	V8 5.0L 305ci	U	3 Spd. MT w/o Cruise; 80.00" Cable	CA-3001
1978-79	V8 5.0L 305ci	U	4 Spd. MT; 61.00" Cable	CA-3005
1978-79	V8 5.0L 305ci	U	AT w/Catalytic Converter Lower	CA-3006
1978-79	V8 5.0L 305ci	U	AT w/Catalytic Converter w/Cruise Upper; 41.00" Cable	CA-3009
1978-79	V8 5.0L 305ci	U	AT w/o Catalytic Converter w/Cruise Lower; 63.00" Cable	CA-3002
1970	V8 5.0L 307ci	A	w/Powerglide & THM 120" length	CA-3038
1970	V8 5.0L 307ci	A	w/Powerglide & THM 80" length, w/3 & 4 Spd. MT; 83.00" Cable	CA-3004
1970	V8 5.0L 307ci	A	w/Powerglide & THM 95" length	CA-3016
1972	V8 5.0L 307ci	F	w/Powerglide & THM 120" length	CA-3038
1972	V8 5.0L 307ci	F	w/Powerglide & THM 80" length, w/3 & 4 Spd. MT; 83.00" Cable	CA-3004
1972	V8 5.0L 307ci	F	w/Powerglide & THM 95" length	CA-3016
1971	V8 5.0L 307ci	H	w/Powerglide & THM 120" length	CA-3038

# SPEEDOMETER CABLES

Year	Engine	Vin	Remark	Part
<b>GMC (con't)</b>				
<b>C15 (con't)</b>				
1971	V8 5.0L 307ci	H	w/Powerglide & THM 80" length, w/3 & 4 Spd. MT; 83.00" Cable	CA-3004
1971	V8 5.0L 307ci	H	w/Powerglide & THM 95" length	CA-3016
1973	V8 5.0L 307ci	X	3 & 4 Spd. MT, or THM AT w/o Cruise; 80.00" Cable	CA-3001
1973	V8 5.0L 307ci	X	AT w/Cruise Control, Lower; 63.00" Cable	CA-3002
1973	V8 5.0L 307ci	X	AT w/Cruise Control, Upper	CA-3031
1970-71	V8 5.7L 350ci	E	w/Powerglide & THM 120" length	CA-3038
1970-71	V8 5.7L 350ci	E	w/Powerglide & THM 80" length, w/3 & 4 Spd. MT; 83.00" Cable	CA-3004
1970-71	V8 5.7L 350ci	E	w/Powerglide & THM 95" length	CA-3016
1977	V8 5.7L 350ci	L	w/Cruise Control, Lower; 63.00" Cable	CA-3002
1977	V8 5.7L 350ci	L	w/Cruise Control, Upper; 41.00" Cable	CA-3009
1982	V8 5.7L 350ci	L	3 Spd. AT 1 pc. Cable, or MT w/o Cruise; 80.00" Cable	CA-3001
1982	V8 5.7L 350ci	L	4 Spd. AT w/innerconnector, Upper; 61.00" Cable	CA-3005
1982	V8 5.7L 350ci	L	AT w/Cruise Control, Intermediate	CA-3006
1982	V8 5.7L 350ci	L	MT w/Cruise Control, Lower; 63.00" Cable	CA-3002
1983-84	V8 5.7L 350ci	L	4 Spd. MT w/innerconnector Lower; 20.00" Cable	CA-3008
1983-84	V8 5.7L 350ci	L	TH700-R4 Auto. Trans., or w/4 Spd. MT Upper; 61.00" Cable	CA-3005
1985	V8 5.7L 350ci	L,M	TH700-R4 Auto. Trans., Lower; 20.00" Cable	CA-3008
1985	V8 5.7L 350ci	L,M	TH700-R4 Auto. Trans., Upper; 61.00" Cable	CA-3005
1986	V8 5.7L 350ci	L,M	Lower exc. AT THM-400 Trans.; 20.00" Cable	CA-3008
1986	V8 5.7L 350ci	L,M	Upper exc. AT THM-400 Trans.; 61.00" Cable	CA-3005
1983-86	V8 5.7L 350ci	L,M	THM-400 Auto. Trans.; 80.00" Cable	CA-3001
1980	V8 5.7L 350ci	L,M,P,Z	4 Spd. w/o Cruise Upper; 61.00" Cable	CA-3005
1980	V8 5.7L 350ci	L,M,P,Z	w/Catalytic Converter w/Cruise Control, Lower	CA-3006
1980	V8 5.7L 350ci	L,M,P,Z	w/o Catalytic Converter w/Cruise Control, Lower; 63.00" Cable	CA-3002
1980	V8 5.7L 350ci	L,M,P,Z	exc. Cruise Control; 80.00" Cable	CA-3001
1978-79	V8 5.7L 350ci	L,M,Z	3 Spd. MT w/o Cruise; 80.00" Cable	CA-3001
1978-79	V8 5.7L 350ci	L,M,Z	AT w/Catalytic Converter w/Cruise Upper; 41.00" Cable	CA-3009
1978-79	V8 5.7L 350ci	L,M,Z	4 Spd. MT; 61.00" Cable	CA-3005
1978-79	V8 5.7L 350ci	L,M,Z	AT w/Catalytic Converter Lower	CA-3006
1978-79	V8 5.7L 350ci	L,M,Z	AT w/o Catalytic Converter w/Cruise Lower; 63.00" Cable	CA-3002
1976	V8 5.7L 350ci	L,V	AT THM w/Cruise Lower; 83.00" Cable	CA-3004
1975-76	V8 5.7L 350ci	L,V,Y	4 Spd. MT Lower; 40.00" Cable	CA-3033
1975-76	V8 5.7L 350ci	L,V,Y	AT THM w/Cruise Upper, OR 4 Spd. MT Upper; 41.00" Cable	CA-3009
1975-76	V8 5.7L 350ci	L,V,Y	AT THM w/o Cruise, 3 Spd. MT w/o Cruise; 80.00" Cable	CA-3001
1981	V8 5.7L 350ci	L,Z	3 Spd. AT 1 pc. Cable; 80.00" Cable	CA-3001
1981	V8 5.7L 350ci	L,Z	MT w/o Cruise Upper; 61.00" Cable	CA-3005
1981	V8 5.7L 350ci	L,Z	w/Cruise Control, Lower; 63.00" Cable	CA-3002
1981	V8 5.7L 350ci	L,Z	w/Cruise Control, Upper; 41.00" Cable	CA-3009
1973-74	V8 5.7L 350ci	V,W,Y	AT w/Cruise Control, Lower; 63.00" Cable	CA-3002
1973-74	V8 5.7L 350ci	V,W,Y	3 & 4 Spd. MT, or THM AT w/o Cruise; 80.00" Cable	CA-3001
1973-74	V8 5.7L 350ci	V,W,Y	AT w/Cruise Control, Upper	CA-3031
1975	V8 5.7L 350ci	V,Y	AT THM w/Cruise Lower; 63.00" Cable	CA-3002
1986	V8 6.2L 379ci	C	Lower exc. AT THM-400 Trans.; 20.00" Cable	CA-3008
1986	V8 6.2L 379ci	C	Upper exc. AT THM-400 Trans.; 61.00" Cable	CA-3005
1983-84	V8 6.2L 379ci	C	4 Spd. MT w/innerconnector Lower; 20.00" Cable	CA-3008
1983-84	V8 6.2L 379ci	C	TH700-R4 Auto. Trans., or w/4 Spd. MT Upper; 61.00" Cable	CA-3005
1982	V8 6.2L 379ci	C,J	3 Spd. AT 1 pc. Cable, or MT w/o Cruise; 80.00" Cable	CA-3001
1982	V8 6.2L 379ci	C,J	4 Spd. AT w/innerconnector, Upper; 61.00" Cable	CA-3005
1982	V8 6.2L 379ci	C,J	AT w/Cruise Control, Intermediate	CA-3006
1982	V8 6.2L 379ci	C,J	MT w/Cruise Control, Lower; 63.00" Cable	CA-3002
1985	V8 6.2L 379ci	C,J	TH700-R4 Auto. Trans., Lower; 20.00" Cable	CA-3008
1985	V8 6.2L 379ci	C,J	TH700-R4 Auto. Trans., Upper; 61.00" Cable	CA-3005
1983-86	V8 6.2L 379ci	C,J	THM-400 Auto. Trans.; 80.00" Cable	CA-3001
1978-79	V8 6.6L 400ci	R	3 Spd. MT w/o Cruise; 80.00" Cable	CA-3001
1978-79	V8 6.6L 400ci	R	4 Spd. MT; 61.00" Cable	CA-3005
1978-79	V8 6.6L 400ci	R	AT w/Catalytic Converter Lower	CA-3006
1978-79	V8 6.6L 400ci	R	AT w/Catalytic Converter w/Cruise Upper; 41.00" Cable	CA-3009
1978-79	V8 6.6L 400ci	R	AT w/o Catalytic Converter w/Cruise Lower; 63.00" Cable	CA-3002
1976	V8 6.6L 400ci	U	4 Spd. MT Lower; 40.00" Cable	CA-3033
1976	V8 6.6L 400ci	U	AT THM w/Cruise Lower; 83.00" Cable	CA-3004
1976	V8 6.6L 400ci	U	AT THM w/Cruise Upper, OR 4 Spd. MT Upper; 41.00" Cable	CA-3009
1976	V8 6.6L 400ci	U	AT THM w/o Cruise, 3 Spd. MT w/o Cruise; 80.00" Cable	CA-3001

# SPEEDOMETER CABLES

Year	Engine	Vin	Remark	Part
<b>GMC (con't)</b>				
<b>C15 (con't)</b>				
1980	V8 6.6L 400ci	X	4 Spd. w/o Cruise Upper; 61.00" Cable	CA-3005
1980	V8 6.6L 400ci	X	exc. Cruise Control; 80.00" Cable	CA-3001
1980	V8 6.6L 400ci	X	w/Catalic Converter w/Cruise Control, Lower	CA-3006
1980	V8 6.6L 400ci	X	w/o Catalic Converter w/Cruise Control, Lower; 63.00" Cable	CA-3002
1970-71	V8 6.6L 402ci	E	w/Powerglide & THM 120" length	CA-3038
1970-71	V8 6.6L 402ci	E	w/Powerglide & THM 80" length, w/3 & 4 Spd. MT; 83.00" Cable	CA-3004
1970-71	V8 6.6L 402ci	E	w/Powerglide & THM 95" length	CA-3016
1972	V8 6.6L 402ci	U	w/Powerglide & THM 120" length	CA-3038
1972	V8 6.6L 402ci	U	w/Powerglide & THM 80" length, w/3 & 4 Spd. MT; 83.00" Cable	CA-3004
1972	V8 6.6L 402ci	U	w/Powerglide & THM 95" length	CA-3016
1977	V8 7.4L 454ci	S	w/Cruise Control, Lower; 63.00" Cable	CA-3002
1977	V8 7.4L 454ci	S	w/Cruise Control, Upper; 41.00" Cable	CA-3009
1980	V8 7.4L 454ci	S	4 Spd. w/o Cruise Upper; 61.00" Cable	CA-3005
1978-79	V8 7.4L 454ci	S	3 Spd. MT w/o Cruise; 80.00" Cable	CA-3001
1978-79	V8 7.4L 454ci	S	4 Spd. MT; 61.00" Cable	CA-3005
1978-79	V8 7.4L 454ci	S	AT w/Catalytic Converter Lower	CA-3006
1978-79	V8 7.4L 454ci	S	AT w/Catalytic Converter w/Cruise Upper; 41.00" Cable	CA-3009
1978-79	V8 7.4L 454ci	S	AT w/o Catalytic Converter w/Cruise Lower; 63.00" Cable	CA-3002
1980	V8 7.4L 454ci	S,W	w/Catalic Converter w/Cruise Control, Lower	CA-3006
1980	V8 7.4L 454ci	S,W	w/o Catalic Converter w/Cruise Control, Lower; 63.00" Cable	CA-3002
1980	V8 7.4L 454ci	S,W	exc. Cruise Control; 80.00" Cable	CA-3001
1976	V8 7.4L 454ci	S,Y	4 Spd. MT Lower; 40.00" Cable	CA-3033
1976	V8 7.4L 454ci	S,Y	AT THM w/Cruise Lower; 83.00" Cable	CA-3004
1976	V8 7.4L 454ci	S,Y	AT THM w/Cruise Upper, OR 4 Spd. MT Upper; 41.00" Cable	CA-3009
1976	V8 7.4L 454ci	S,Y	AT THM w/o Cruise, 3 Spd. MT w/o Cruise; 80.00" Cable	CA-3001
1980	V8 7.4L 454ci	W	4 Spd. w/o Cruise Upper; 61.00" Cable	CA-3005
1975	V8 7.4L 454ci	Z	4 Spd. MT Lower; 40.00" Cable	CA-3033
1975	V8 7.4L 454ci	Z	AT THM w/Cruise Lower; 63.00" Cable	CA-3002
1975	V8 7.4L 454ci	Z	AT THM w/Cruise Upper, OR 4 Spd. MT Upper; 41.00" Cable	CA-3009
1975	V8 7.4L 454ci	Z	AT THM w/o Cruise, 3 Spd. MT w/o Cruise; 80.00" Cable	CA-3001
1973-74	V8 7.4L 454ci	Z	3 & 4 Spd. MT, or THM AT w/o Cruise; 80.00" Cable	CA-3001
1973-74	V8 7.4L 454ci	Z	AT w/Cruise Control, Lower; 63.00" Cable	CA-3002
1973-74	V8 7.4L 454ci	Z	AT w/Cruise Control, Upper	CA-3031
<b>C15 SUBURBAN</b>				
1976	L6 4.1L 250ci	D	4 Spd. MT Lower; 40.00" Cable	CA-3033
1976	L6 4.1L 250ci	D	AT THM w/Cruise Lower; 83.00" Cable	CA-3004
1976	L6 4.1L 250ci	D	AT THM w/Cruise Upper, OR 4 Spd. MT Upper; 41.00" Cable	CA-3009
1976	L6 4.1L 250ci	D	AT THM w/o Cruise, 3 Spd. MT w/o Cruise; 80.00" Cable	CA-3001
1977	L6 4.1L 250ci	D	w/Cruise Control, Lower; 63.00" Cable	CA-3002
1977	L6 4.1L 250ci	D	w/Cruise Control, Upper; 41.00" Cable	CA-3009
1978-79	L6 4.1L 250ci	D	3 Spd. MT w/o Cruise; 80.00" Cable	CA-3001
1978-79	L6 4.1L 250ci	D	4 Spd. MT; 61.00" Cable	CA-3005
1978-79	L6 4.1L 250ci	D	AT w/Catalytic Converter Lower	CA-3006
1978-79	L6 4.1L 250ci	D	AT w/Catalytic Converter w/Cruise Upper; 41.00" Cable	CA-3009
1978-79	L6 4.1L 250ci	D	AT w/o Catalytic Converter w/Cruise Lower; 63.00" Cable	CA-3002
1975	L6 4.1L 250ci	Q	4 Spd. MT Lower; 40.00" Cable	CA-3033
1975	L6 4.1L 250ci	Q	AT THM w/Cruise Lower; 63.00" Cable	CA-3002
1975	L6 4.1L 250ci	Q	AT THM w/Cruise Upper, OR 4 Spd. MT Upper; 41.00" Cable	CA-3009
1975	L6 4.1L 250ci	Q	AT THM w/o Cruise, 3 Spd. MT w/o Cruise; 80.00" Cable	CA-3001
1976	V8 5.0L 305ci	Q	4 Spd. MT Lower; 40.00" Cable	CA-3033
1976	V8 5.0L 305ci	Q	AT THM w/Cruise Lower; 83.00" Cable	CA-3004
1976	V8 5.0L 305ci	Q	AT THM w/Cruise Upper, OR 4 Spd. MT Upper; 41.00" Cable	CA-3009
1976	V8 5.0L 305ci	Q	AT THM w/o Cruise, 3 Spd. MT w/o Cruise; 80.00" Cable	CA-3001
1977	V8 5.0L 305ci	U	w/Cruise Control, Lower; 63.00" Cable	CA-3002
1977	V8 5.0L 305ci	U	w/Cruise Control, Upper; 41.00" Cable	CA-3009
1978-79	V8 5.0L 305ci	U	3 Spd. MT w/o Cruise; 80.00" Cable	CA-3001
1978-79	V8 5.0L 305ci	U	4 Spd. MT; 61.00" Cable	CA-3005
1978-79	V8 5.0L 305ci	U	AT w/o Catalytic Converter w/Cruise Lower; 63.00" Cable	CA-3002
1978-79	V8 5.0L 305ci	U	AT w/Catalytic Converter Lower	CA-3006
1978-79	V8 5.0L 305ci	U	AT w/Catalytic Converter w/Cruise Upper; 41.00" Cable	CA-3009
1977	V8 5.7L 350ci	L	w/Cruise Control, Lower; 63.00" Cable	CA-3002
1977	V8 5.7L 350ci	L	w/Cruise Control, Upper; 41.00" Cable	CA-3009

# SPEEDOMETER CABLES

Year	Engine	Vin	Remark	Part
<b>GMC (con't)</b>				
<b>C15 SUBURBAN (con't)</b>				
1976	V8 5.7L 350ci	L,V	AT THM w/Cruise Lower; 83.00" Cable	CA-3004
1975-76	V8 5.7L 350ci	L,V,Y	4 Spd. MT Lower; 40.00" Cable	CA-3033
1975-76	V8 5.7L 350ci	L,V,Y	AT THM w/Cruise Upper, OR 4 Spd. MT Upper; 41.00" Cable	CA-3009
1975-76	V8 5.7L 350ci	L,V,Y	AT THM w/o Cruise, 3 Spd. MT w/o Cruise; 80.00" Cable	CA-3001
1978-79	V8 5.7L 350ci	L,Z	3 Spd. MT w/o Cruise; 80.00" Cable	CA-3001
1978-79	V8 5.7L 350ci	L,Z	AT w/Catalytic Converter w/Cruise Upper; 41.00" Cable	CA-3009
1978-79	V8 5.7L 350ci	L,Z	4 Spd. MT; 61.00" Cable	CA-3005
1978-79	V8 5.7L 350ci	L,Z	AT w/Catalytic Converter Lower	CA-3006
1978-79	V8 5.7L 350ci	L,Z	AT w/o Catalytic Converter w/Cruise Lower; 63.00" Cable	CA-3002
1975	V8 5.7L 350ci	V,Y	AT THM w/Cruise Lower; 63.00" Cable	CA-3002
1976	V8 7.4L 454ci	S	4 Spd. MT Lower; 40.00" Cable	CA-3033
1976	V8 7.4L 454ci	S	AT THM w/Cruise Lower; 83.00" Cable	CA-3004
1976	V8 7.4L 454ci	S	AT THM w/Cruise Upper, OR 4 Spd. MT Upper; 41.00" Cable	CA-3009
1976	V8 7.4L 454ci	S	AT THM w/o Cruise, 3 Spd. MT w/o Cruise; 80.00" Cable	CA-3001
1977	V8 7.4L 454ci	S	w/Cruise Control, Lower; 63.00" Cable	CA-3002
1977	V8 7.4L 454ci	S	w/Cruise Control, Upper; 41.00" Cable	CA-3009
1978-79	V8 7.4L 454ci	S	3 Spd. MT w/o Cruise; 80.00" Cable	CA-3001
1978-79	V8 7.4L 454ci	S	AT w/o Catalytic Converter w/Cruise Lower; 63.00" Cable	CA-3002
1978-79	V8 7.4L 454ci	S	4 Spd. MT; 61.00" Cable	CA-3005
1978-79	V8 7.4L 454ci	S	AT w/Catalytic Converter Lower	CA-3006
1978-79	V8 7.4L 454ci	S	AT w/Catalytic Converter w/Cruise Upper; 41.00" Cable	CA-3009
1975	V8 7.4L 454ci	Z	4 Spd. MT Lower; 40.00" Cable	CA-3033
1975	V8 7.4L 454ci	Z	AT THM w/Cruise Lower; 63.00" Cable	CA-3002
1975	V8 7.4L 454ci	Z	AT THM w/Cruise Upper, OR 4 Spd. MT Upper; 41.00" Cable	CA-3009
1975	V8 7.4L 454ci	Z	AT THM w/o Cruise, 3 Spd. MT w/o Cruise; 80.00" Cable	CA-3001
<b>C25</b>				
1971	L6 4.1L 250ci	C,L	w/Powerglide & THM 120" length	CA-3038
1971	L6 4.1L 250ci	C,L	w/Powerglide & THM 80" length, w/3 & 4 Spd. MT; 83.00" Cable	CA-3004
1971	L6 4.1L 250ci	C,L	w/Powerglide & THM 95" length	CA-3016
1972	L6 4.1L 250ci	D	w/Powerglide & THM 120" length	CA-3038
1972	L6 4.1L 250ci	D	w/Powerglide & THM 80" length, w/3 & 4 Spd. MT; 83.00" Cable	CA-3004
1972	L6 4.1L 250ci	D	w/Powerglide & THM 95" length	CA-3016
1977	L6 4.1L 250ci	D	w/Cruise Control, Lower; 63.00" Cable	CA-3002
1977	L6 4.1L 250ci	D	w/Cruise Control, Upper; 41.00" Cable	CA-3009
1980	L6 4.1L 250ci	D	4 Spd. w/o Cruise Upper; 61.00" Cable	CA-3005
1980	L6 4.1L 250ci	D	exc. Cruise Control; 80.00" Cable	CA-3001
1980	L6 4.1L 250ci	D	w/Catalytic Converter w/Cruise Control, Lower	CA-3006
1980	L6 4.1L 250ci	D	w/o Catalytic Converter w/Cruise Control, Lower; 63.00" Cable	CA-3002
1981	L6 4.1L 250ci	D	3 Spd. AT 1 pc. Cable; 80.00" Cable	CA-3001
1981	L6 4.1L 250ci	D	MT w/o Cruise Upper; 61.00" Cable	CA-3005
1981	L6 4.1L 250ci	D	w/Cruise Control, Lower; 63.00" Cable	CA-3002
1981	L6 4.1L 250ci	D	w/Cruise Control, Upper; 41.00" Cable	CA-3009
1982	L6 4.1L 250ci	D	3 Spd. AT 1 pc. Cable, or MT w/o Cruise; 80.00" Cable	CA-3001
1982	L6 4.1L 250ci	D	4 Spd. AT w/innerconnector, Upper; 61.00" Cable	CA-3005
1982	L6 4.1L 250ci	D	AT w/Cruise Control, Intermediate	CA-3006
1982	L6 4.1L 250ci	D	MT w/Cruise Control, Lower; 63.00" Cable	CA-3002
1978-79	L6 4.1L 250ci	D	3 Spd. MT w/o Cruise; 80.00" Cable	CA-3001
1978-79	L6 4.1L 250ci	D	4 Spd. MT; 61.00" Cable	CA-3005
1978-79	L6 4.1L 250ci	D	AT w/Catalytic Converter Lower	CA-3006
1978-79	L6 4.1L 250ci	D	AT w/Catalytic Converter w/Cruise Upper; 41.00" Cable	CA-3009
1978-79	L6 4.1L 250ci	D	AT w/o Catalytic Converter w/Cruise Lower; 63.00" Cable	CA-3002
1983-84	L6 4.1L 250ci	D	4 Spd. MT w/innerconnector Lower; 20.00" Cable	CA-3008
1983-84	L6 4.1L 250ci	D	TH700-R4 Auto. Trans., or w/4 Spd. MT Upper; 61.00" Cable	CA-3005
1983-84	L6 4.1L 250ci	D	THM-400 Auto. Trans.; 80.00" Cable	CA-3001
1970	L6 4.1L 250ci	N	w/Powerglide & THM 120" length	CA-3038
1970	L6 4.1L 250ci	N	w/Powerglide & THM 80" length, w/3 & 4 Spd. MT; 83.00" Cable	CA-3004
1970	L6 4.1L 250ci	N	w/Powerglide & THM 95" length	CA-3016
1975	L6 4.1L 250ci	Q	4 Spd. MT Lower; 40.00" Cable	CA-3033
1975	L6 4.1L 250ci	Q	AT THM w/Cruise Lower; 63.00" Cable	CA-3002
1975	L6 4.1L 250ci	Q	AT THM w/Cruise Upper, OR 4 Spd. MT Upper; 41.00" Cable	CA-3009
1975	L6 4.1L 250ci	Q	AT THM w/o Cruise, 3 Spd. MT w/o Cruise; 80.00" Cable	CA-3001
1973-74	L6 4.1L 250ci	Q	3 & 4 Spd. MT, or THM AT w/o Cruise; 80.00" Cable	CA-3001

# SPEEDOMETER CABLES

Year	Engine	Vin	Remark	Part
<b>GMC (con't)</b>				
<b>C25 (con't)</b>				
1973-74	L6 4.1L 250ci	Q	AT w/Cruise Control, Lower; 63.00" Cable	CA-3002
1973-74	L6 4.1L 250ci	Q	AT w/Cruise Control, Upper	CA-3031
1970-72	L6 4.8L 292ci	S	w/Powerglide & THM 120" length	CA-3038
1970-72	L6 4.8L 292ci	S	w/Powerglide & THM 80" length, w/3 & 4 Spd. MT; 83.00" Cable	CA-3004
1970-72	L6 4.8L 292ci	S	w/Powerglide & THM 95" length	CA-3016
1973-74	L6 4.8L 292ci	S,T	AT w/Cruise Control, Lower; 63.00" Cable	CA-3002
1973-74	L6 4.8L 292ci	S,T	3 & 4 Spd. MT, or THM AT w/o Cruise; 80.00" Cable	CA-3001
1973-74	L6 4.8L 292ci	S,T	AT w/Cruise Control, Upper	CA-3031
1975	L6 4.8L 292ci	T	AT THM w/Cruise Lower; 63.00" Cable	CA-3002
1976	L6 4.8L 292ci	T	AT THM w/Cruise Lower; 83.00" Cable	CA-3004
1977	L6 4.8L 292ci	T	w/Cruise Control, Lower; 63.00" Cable	CA-3002
1977	L6 4.8L 292ci	T	w/Cruise Control, Upper; 41.00" Cable	CA-3009
1980	L6 4.8L 292ci	T	4 Spd. w/o Cruise Upper; 61.00" Cable	CA-3005
1980	L6 4.8L 292ci	T	exc. Cruise Control; 80.00" Cable	CA-3001
1980	L6 4.8L 292ci	T	w/Catalic Converter w/Cruise Control, Lower	CA-3006
1980	L6 4.8L 292ci	T	w/o Catalic Converter w/Cruise Control, Lower; 63.00" Cable	CA-3002
1981	L6 4.8L 292ci	T	3 Spd. AT 1 pc. Cable; 80.00" Cable	CA-3001
1981	L6 4.8L 292ci	T	MT w/o Cruise Upper; 61.00" Cable	CA-3005
1981	L6 4.8L 292ci	T	w/Cruise Control, Lower; 63.00" Cable	CA-3002
1981	L6 4.8L 292ci	T	w/Cruise Control, Upper; 41.00" Cable	CA-3009
1982	L6 4.8L 292ci	T	3 Spd. AT 1 pc. Cable, or MT w/o Cruise; 80.00" Cable	CA-3001
1982	L6 4.8L 292ci	T	4 Spd. AT w/innerconnector, Upper; 61.00" Cable	CA-3005
1982	L6 4.8L 292ci	T	AT w/Cruise Control, Intermediate	CA-3006
1982	L6 4.8L 292ci	T	MT w/Cruise Control, Lower; 63.00" Cable	CA-3002
1985	L6 4.8L 292ci	T	TH700-R4 Auto. Trans., Lower; 20.00" Cable	CA-3008
1985	L6 4.8L 292ci	T	TH700-R4 Auto. Trans., Upper; 61.00" Cable	CA-3005
1975-76	L6 4.8L 292ci	T	4 Spd. MT Lower; 40.00" Cable	CA-3033
1975-76	L6 4.8L 292ci	T	AT THM w/Cruise Upper, OR 4 Spd. MT Upper; 41.00" Cable	CA-3009
1975-76	L6 4.8L 292ci	T	AT THM w/o Cruise, 3 Spd. MT w/o Cruise; 80.00" Cable	CA-3001
1978-79	L6 4.8L 292ci	T	3 Spd. MT w/o Cruise; 80.00" Cable	CA-3001
1978-79	L6 4.8L 292ci	T	4 Spd. MT; 61.00" Cable	CA-3005
1978-79	L6 4.8L 292ci	T	AT w/Catalytic Converter w/Cruise Upper; 41.00" Cable	CA-3009
1978-79	L6 4.8L 292ci	T	AT w/o Catalytic Converter w/Cruise Lower; 63.00" Cable	CA-3002
1978-79	L6 4.8L 292ci	T	AT w/Catalytic Converter Lower	CA-3006
1983-84	L6 4.8L 292ci	T	4 Spd. MT w/innerconnector Lower; 20.00" Cable	CA-3008
1983-84	L6 4.8L 292ci	T	TH700-R4 Auto. Trans., or w/4 Spd. MT Upper; 61.00" Cable	CA-3005
1983-85	L6 4.8L 292ci	T	THM-400 Auto. Trans.; 80.00" Cable	CA-3001
1985	V6 4.3L 262ci	N	TH700-R4 Auto. Trans., Lower; 20.00" Cable	CA-3008
1985	V6 4.3L 262ci	N	TH700-R4 Auto. Trans., Upper; 61.00" Cable	CA-3005
1986	V6 4.3L 262ci	N	Lower exc. AT THM-400 Trans.; 20.00" Cable	CA-3008
1986	V6 4.3L 262ci	N	Upper exc. AT THM-400 Trans.; 61.00" Cable	CA-3005
1985-86	V6 4.3L 262ci	N	THM-400 Auto. Trans.; 80.00" Cable	CA-3001
1980	V8 5.0L 305ci	G	4 Spd. w/o Cruise Upper; 61.00" Cable	CA-3005
1980	V8 5.0L 305ci	G	exc. Cruise Control; 80.00" Cable	CA-3001
1980	V8 5.0L 305ci	G	w/Catalic Converter w/Cruise Control, Lower	CA-3006
1980	V8 5.0L 305ci	G	w/o Catalic Converter w/Cruise Control, Lower; 63.00" Cable	CA-3002
1981	V8 5.0L 305ci	H	3 Spd. AT 1 pc. Cable; 80.00" Cable	CA-3001
1981	V8 5.0L 305ci	H	MT w/o Cruise Upper; 61.00" Cable	CA-3005
1981	V8 5.0L 305ci	H	w/Cruise Control, Lower; 63.00" Cable	CA-3002
1981	V8 5.0L 305ci	H	w/Cruise Control, Upper; 41.00" Cable	CA-3009
1982	V8 5.0L 305ci	H	3 Spd. AT 1 pc. Cable, or MT w/o Cruise; 80.00" Cable	CA-3001
1982	V8 5.0L 305ci	H	4 Spd. AT w/innerconnector, Upper; 61.00" Cable	CA-3005
1982	V8 5.0L 305ci	H	AT w/Cruise Control, Intermediate	CA-3006
1982	V8 5.0L 305ci	H	MT w/Cruise Control, Lower; 63.00" Cable	CA-3002
1985	V8 5.0L 305ci	H	TH700-R4 Auto. Trans., Lower; 20.00" Cable	CA-3008
1985	V8 5.0L 305ci	H	TH700-R4 Auto. Trans., Upper; 61.00" Cable	CA-3005
1986	V8 5.0L 305ci	H	Lower exc. AT THM-400 Trans.; 20.00" Cable	CA-3008
1986	V8 5.0L 305ci	H	Upper exc. AT THM-400 Trans.; 61.00" Cable	CA-3005
1983-84	V8 5.0L 305ci	H	4 Spd. MT w/innerconnector Lower; 20.00" Cable	CA-3008
1983-84	V8 5.0L 305ci	H	TH700-R4 Auto. Trans., or w/4 Spd. MT Upper; 61.00" Cable	CA-3005
1983-86	V8 5.0L 305ci	H	THM-400 Auto. Trans.; 80.00" Cable	CA-3001
1977	V8 5.0L 305ci	U	w/Cruise Control, Lower; 63.00" Cable	CA-3002

# SPEEDOMETER CABLES

Year	Engine	Vin	Remark	Part
<b>GMC (con't)</b>				
<b>C25 (con't)</b>				
1977	V8 5.0L 305ci	U	w/Cruise Control, Upper; 41.00" Cable	CA-3009
1978-79	V8 5.0L 305ci	U	3 Spd. MT w/o Cruise; 80.00" Cable	CA-3001
1978-79	V8 5.0L 305ci	U	4 Spd. MT; 61.00" Cable	CA-3005
1978-79	V8 5.0L 305ci	U	AT w/Catalytic Converter Lower	CA-3006
1978-79	V8 5.0L 305ci	U	AT w/Catalytic Converter w/Cruise Upper; 41.00" Cable	CA-3009
1978-79	V8 5.0L 305ci	U	AT w/o Catalytic Converter w/Cruise Lower; 63.00" Cable	CA-3002
1970	V8 5.0L 307ci	A	w/Powerglide & THM 120" length	CA-3038
1970	V8 5.0L 307ci	A	w/Powerglide & THM 80" length, w/3 & 4 Spd. MT; 83.00" Cable	CA-3004
1970	V8 5.0L 307ci	A	w/Powerglide & THM 95" length	CA-3016
1972	V8 5.0L 307ci	F	w/Powerglide & THM 120" length	CA-3038
1972	V8 5.0L 307ci	F	w/Powerglide & THM 80" length, w/3 & 4 Spd. MT; 83.00" Cable	CA-3004
1972	V8 5.0L 307ci	F	w/Powerglide & THM 95" length	CA-3016
1971	V8 5.0L 307ci	H	w/Powerglide & THM 120" length	CA-3038
1971	V8 5.0L 307ci	H	w/Powerglide & THM 80" length, w/3 & 4 Spd. MT; 83.00" Cable	CA-3004
1971	V8 5.0L 307ci	H	w/Powerglide & THM 95" length	CA-3016
1973	V8 5.0L 307ci	X	3 & 4 Spd. MT, or THM AT w/o Cruise; 80.00" Cable	CA-3001
1973	V8 5.0L 307ci	X	AT w/Cruise Control, Lower; 63.00" Cable	CA-3002
1973	V8 5.0L 307ci	X	AT w/Cruise Control, Upper	CA-3031
1970-72	V8 5.7L 350ci	E	w/Powerglide & THM 120" length	CA-3038
1970-72	V8 5.7L 350ci	E	w/Powerglide & THM 80" length, w/3 & 4 Spd. MT; 83.00" Cable	CA-3004
1970-72	V8 5.7L 350ci	E	w/Powerglide & THM 95" length	CA-3016
1976	V8 5.7L 350ci	L	4 Spd. MT Lower; 40.00" Cable	CA-3033
1976	V8 5.7L 350ci	L	AT THM w/Cruise Lower; 83.00" Cable	CA-3004
1976	V8 5.7L 350ci	L	AT THM w/Cruise Upper, OR 4 Spd. MT Upper; 41.00" Cable	CA-3009
1976	V8 5.7L 350ci	L	AT THM w/o Cruise, 3 Spd. MT w/o Cruise; 80.00" Cable	CA-3001
1977	V8 5.7L 350ci	L	w/Cruise Control, Lower; 63.00" Cable	CA-3002
1977	V8 5.7L 350ci	L	w/Cruise Control, Upper; 41.00" Cable	CA-3009
1978-79	V8 5.7L 350ci	L	3 Spd. MT w/o Cruise; 80.00" Cable	CA-3001
1978-79	V8 5.7L 350ci	L	AT w/Catalytic Converter w/Cruise Upper; 41.00" Cable	CA-3009
1978-79	V8 5.7L 350ci	L	4 Spd. MT; 61.00" Cable	CA-3005
1978-79	V8 5.7L 350ci	L	AT w/Catalytic Converter Lower	CA-3006
1978-79	V8 5.7L 350ci	L	AT w/o Catalytic Converter w/Cruise Lower; 63.00" Cable	CA-3002
1981	V8 5.7L 350ci	L,M	3 Spd. AT 1 pc. Cable; 80.00" Cable	CA-3001
1981	V8 5.7L 350ci	L,M	MT w/o Cruise Upper; 61.00" Cable	CA-3005
1981	V8 5.7L 350ci	L,M	w/Cruise Control, Lower; 63.00" Cable	CA-3002
1981	V8 5.7L 350ci	L,M	w/Cruise Control, Upper; 41.00" Cable	CA-3009
1982	V8 5.7L 350ci	L,M	3 Spd. AT 1 pc. Cable, or MT w/o Cruise; 80.00" Cable	CA-3001
1982	V8 5.7L 350ci	L,M	4 Spd. AT w/innerconnector, Upper; 61.00" Cable	CA-3005
1982	V8 5.7L 350ci	L,M	AT w/Cruise Control, Intermediate	CA-3006
1982	V8 5.7L 350ci	L,M	MT w/Cruise Control, Lower; 63.00" Cable	CA-3002
1985	V8 5.7L 350ci	L,M	TH700-R4 Auto. Trans., Lower; 20.00" Cable	CA-3008
1985	V8 5.7L 350ci	L,M	TH700-R4 Auto. Trans., Upper; 61.00" Cable	CA-3005
1986	V8 5.7L 350ci	L,M	Lower exc. AT THM-400 Trans.; 20.00" Cable	CA-3008
1986	V8 5.7L 350ci	L,M	Upper exc. AT THM-400 Trans.; 61.00" Cable	CA-3005
1983-84	V8 5.7L 350ci	L,M	4 Spd. MT w/innerconnector Lower; 20.00" Cable	CA-3008
1983-84	V8 5.7L 350ci	L,M	TH700-R4 Auto. Trans., or w/4 Spd. MT Upper; 61.00" Cable	CA-3005
1983-86	V8 5.7L 350ci	L,M	THM-400 Auto. Trans.; 80.00" Cable	CA-3001
1980	V8 5.7L 350ci	L,M,P	4 Spd. w/o Cruise Upper; 61.00" Cable	CA-3005
1980	V8 5.7L 350ci	L,M,P	w/Catalytic Converter w/Cruise Control, Lower	CA-3006
1980	V8 5.7L 350ci	L,M,P	w/o Catalytic Converter w/Cruise Control, Lower; 63.00" Cable	CA-3002
1980	V8 5.7L 350ci	L,M,P	exc. Cruise Control; 80.00" Cable	CA-3001
1973-74	V8 5.7L 350ci	V,W,Y	AT w/Cruise Control, Lower; 63.00" Cable	CA-3002
1973-74	V8 5.7L 350ci	V,W,Y	3 & 4 Spd. MT, or THM AT w/o Cruise; 80.00" Cable	CA-3001
1973-74	V8 5.7L 350ci	V,W,Y	AT w/Cruise Control, Upper	CA-3031
1975	V8 5.7L 350ci	V,Y	4 Spd. MT Lower; 40.00" Cable	CA-3033
1975	V8 5.7L 350ci	V,Y	AT THM w/Cruise Lower; 63.00" Cable	CA-3002
1975	V8 5.7L 350ci	V,Y	AT THM w/Cruise Upper, OR 4 Spd. MT Upper; 41.00" Cable	CA-3009
1975	V8 5.7L 350ci	V,Y	AT THM w/o Cruise, 3 Spd. MT w/o Cruise; 80.00" Cable	CA-3001
1982	V8 6.2L 379ci	C,J	3 Spd. AT 1 pc. Cable, or MT w/o Cruise; 80.00" Cable	CA-3001
1982	V8 6.2L 379ci	C,J	4 Spd. AT w/innerconnector, Upper; 61.00" Cable	CA-3005
1982	V8 6.2L 379ci	C,J	MT w/Cruise Control, Lower; 63.00" Cable	CA-3002
1982	V8 6.2L 379ci	C,J	AT w/Cruise Control, Intermediate	CA-3006

# SPEEDOMETER CABLES

Year	Engine	Vin	Remark	Part
<b>GMC (con't)</b>				
<b>C25 (con't)</b>				
1985	V8 6.2L 379ci	C,J	TH700-R4 Auto. Trans., Lower; 20.00" Cable	CA-3008
1985	V8 6.2L 379ci	C,J	TH700-R4 Auto. Trans., Upper; 61.00" Cable	CA-3005
1986	V8 6.2L 379ci	C,J	Lower exc. AT THM-400 Trans.; 20.00" Cable	CA-3008
1986	V8 6.2L 379ci	C,J	Upper exc. AT THM-400 Trans.; 61.00" Cable	CA-3005
1983-84	V8 6.2L 379ci	C,J	4 Spd. MT w/innerconnector Lower; 20.00" Cable	CA-3008
1983-84	V8 6.2L 379ci	C,J	TH700-R4 Auto. Trans., or w/4 Spd. MT Upper; 61.00" Cable	CA-3005
1983-86	V8 6.2L 379ci	C,J	THM-400 Auto. Trans.; 80.00" Cable	CA-3001
1977	V8 6.6L 400ci	R	w/Cruise Control, Lower; 63.00" Cable	CA-3002
1977	V8 6.6L 400ci	R	w/Cruise Control, Upper; 41.00" Cable	CA-3009
1978	V8 6.6L 400ci	R	3 Spd. MT w/o Cruise; 80.00" Cable	CA-3001
1978	V8 6.6L 400ci	R	4 Spd. MT; 61.00" Cable	CA-3005
1978	V8 6.6L 400ci	R	AT w/Catalytic Converter Lower	CA-3006
1978	V8 6.6L 400ci	R	AT w/Catalytic Converter w/Cruise Upper; 41.00" Cable	CA-3009
1978	V8 6.6L 400ci	R	AT w/o Catalytic Converter w/Cruise Lower; 63.00" Cable	CA-3002
1976	V8 6.6L 400ci	U	4 Spd. MT Lower; 40.00" Cable	CA-3033
1976	V8 6.6L 400ci	U	AT THM w/Cruise Lower; 83.00" Cable	CA-3004
1976	V8 6.6L 400ci	U	AT THM w/Cruise Upper, OR 4 Spd. MT Upper; 41.00" Cable	CA-3009
1976	V8 6.6L 400ci	U	AT THM w/o Cruise, 3 Spd. MT w/o Cruise; 80.00" Cable	CA-3001
1970	V8 6.6L 402ci	E	w/Powerglide & THM 120" length	CA-3038
1970	V8 6.6L 402ci	E	w/Powerglide & THM 80" length, w/3 & 4 Spd. MT; 83.00" Cable	CA-3004
1970	V8 6.6L 402ci	E	w/Powerglide & THM 95" length	CA-3016
1971	V8 6.6L 402ci	K	w/Powerglide & THM 120" length	CA-3038
1971	V8 6.6L 402ci	K	w/Powerglide & THM 80" length, w/3 & 4 Spd. MT; 83.00" Cable	CA-3004
1971	V8 6.6L 402ci	K	w/Powerglide & THM 95" length	CA-3016
1976	V8 7.4L 454ci	S	4 Spd. MT Lower; 40.00" Cable	CA-3033
1976	V8 7.4L 454ci	S	AT THM w/Cruise Lower; 83.00" Cable	CA-3004
1976	V8 7.4L 454ci	S	AT THM w/Cruise Upper, OR 4 Spd. MT Upper; 41.00" Cable	CA-3009
1976	V8 7.4L 454ci	S	AT THM w/o Cruise, 3 Spd. MT w/o Cruise; 80.00" Cable	CA-3001
1977	V8 7.4L 454ci	S	w/Cruise Control, Lower; 63.00" Cable	CA-3002
1977	V8 7.4L 454ci	S	w/Cruise Control, Upper; 41.00" Cable	CA-3009
1980	V8 7.4L 454ci	S	4 Spd. w/o Cruise Upper; 61.00" Cable	CA-3005
1978-79	V8 7.4L 454ci	S	3 Spd. MT w/o Cruise; 80.00" Cable	CA-3001
1978-79	V8 7.4L 454ci	S	4 Spd. MT; 61.00" Cable	CA-3005
1978-79	V8 7.4L 454ci	S	AT w/Catalytic Converter Lower	CA-3006
1978-79	V8 7.4L 454ci	S	AT w/Catalytic Converter w/Cruise Upper; 41.00" Cable	CA-3009
1978-79	V8 7.4L 454ci	S	AT w/o Catalytic Converter w/Cruise Lower; 63.00" Cable	CA-3002
1980	V8 7.4L 454ci	S,W	w/Catalytic Converter w/Cruise Control, Lower	CA-3006
1980	V8 7.4L 454ci	S,W	w/o Catalytic Converter w/Cruise Control, Lower; 63.00" Cable	CA-3002
1980	V8 7.4L 454ci	S,W	exc. Cruise Control; 80.00" Cable	CA-3001
1980	V8 7.4L 454ci	W	4 Spd. w/o Cruise Upper; 61.00" Cable	CA-3005
1981	V8 7.4L 454ci	W	3 Spd. AT 1 pc. Cable; 80.00" Cable	CA-3001
1981	V8 7.4L 454ci	W	MT w/o Cruise Upper; 61.00" Cable	CA-3005
1981	V8 7.4L 454ci	W	w/Cruise Control, Lower; 63.00" Cable	CA-3002
1981	V8 7.4L 454ci	W	w/Cruise Control, Upper; 41.00" Cable	CA-3009
1982	V8 7.4L 454ci	W	3 Spd. AT 1 pc. Cable, or MT w/o Cruise; 80.00" Cable	CA-3001
1982	V8 7.4L 454ci	W	4 Spd. AT w/innerconnector, Upper; 61.00" Cable	CA-3005
1982	V8 7.4L 454ci	W	AT w/Cruise Control, Intermediate	CA-3006
1982	V8 7.4L 454ci	W	MT w/Cruise Control, Lower; 63.00" Cable	CA-3002
1985	V8 7.4L 454ci	W	TH700-R4 Auto. Trans., Lower; 20.00" Cable	CA-3008
1985	V8 7.4L 454ci	W	TH700-R4 Auto. Trans., Upper; 61.00" Cable	CA-3005
1986	V8 7.4L 454ci	W	Lower exc. AT THM-400 Trans.; 20.00" Cable	CA-3008
1986	V8 7.4L 454ci	W	Upper exc. AT THM-400 Trans.; 61.00" Cable	CA-3005
1983-84	V8 7.4L 454ci	W	4 Spd. MT w/innerconnector Lower; 20.00" Cable	CA-3008
1983-84	V8 7.4L 454ci	W	TH700-R4 Auto. Trans., or w/4 Spd. MT Upper; 61.00" Cable	CA-3005
1983-86	V8 7.4L 454ci	W	THM-400 Auto. Trans.; 80.00" Cable	CA-3001
1975	V8 7.4L 454ci	Z	4 Spd. MT Lower; 40.00" Cable	CA-3033
1975	V8 7.4L 454ci	Z	AT THM w/Cruise Lower; 63.00" Cable	CA-3002
1975	V8 7.4L 454ci	Z	AT THM w/Cruise Upper, OR 4 Spd. MT Upper; 41.00" Cable	CA-3009
1975	V8 7.4L 454ci	Z	AT THM w/o Cruise, 3 Spd. MT w/o Cruise; 80.00" Cable	CA-3001
1973-74	V8 7.4L 454ci	Z	3 & 4 Spd. MT, or THM AT w/o Cruise; 80.00" Cable	CA-3001
1973-74	V8 7.4L 454ci	Z	AT w/Cruise Control, Lower; 63.00" Cable	CA-3002
1973-74	V8 7.4L 454ci	Z	AT w/Cruise Control, Upper	CA-3031

# SPEEDOMETER CABLES

Year	Engine	Vin	Remark	Part
<b>GMC (con't)</b>				
<b>C25 SUBURBAN</b>				
1975	L6 4.8L 292ci	T	4 Spd. MT Lower; 40.00" Cable	CA-3033
1975	L6 4.8L 292ci	T	AT THM w/Cruise Lower; 63.00" Cable	CA-3002
1975	L6 4.8L 292ci	T	AT THM w/Cruise Upper, OR 4 Spd. MT Upper; 41.00" Cable	CA-3009
1975	L6 4.8L 292ci	T	AT THM w/o Cruise, 3 Spd. MT w/o Cruise; 80.00" Cable	CA-3001
1981	L6 4.8L 292ci	T	3 Spd. AT 1 pc. Cable; 80.00" Cable	CA-3001
1981	L6 4.8L 292ci	T	MT w/o Cruise Upper; 61.00" Cable	CA-3005
1981	L6 4.8L 292ci	T	w/Cruise Control, Lower; 63.00" Cable	CA-3002
1981	L6 4.8L 292ci	T	w/Cruise Control, Upper; 41.00" Cable	CA-3009
1984	L6 4.8L 292ci	T	4 Spd. MT w/innerconnector Lower; 20.00" Cable	CA-3008
1984	L6 4.8L 292ci	T	TH700-R4 Auto. Trans., or w/4 Spd. MT Upper; 61.00" Cable	CA-3005
1984	L6 4.8L 292ci	T	THM-400 Auto. Trans.; 80.00" Cable	CA-3001
1983-84	V8 5.0L 305ci	H	4 Spd. MT w/innerconnector Lower; 20.00" Cable	CA-3008
1983-84	V8 5.0L 305ci	H	TH700-R4 Auto. Trans., or w/4 Spd. MT Upper; 61.00" Cable	CA-3005
1983-84	V8 5.0L 305ci	H	THM-400 Auto. Trans.; 80.00" Cable	CA-3001
1981	V8 5.7L 350ci	L,M	3 Spd. AT 1 pc. Cable; 80.00" Cable	CA-3001
1981	V8 5.7L 350ci	L,M	MT w/o Cruise Upper; 61.00" Cable	CA-3005
1981	V8 5.7L 350ci	L,M	w/Cruise Control, Lower; 63.00" Cable	CA-3002
1981	V8 5.7L 350ci	L,M	w/Cruise Control, Upper; 41.00" Cable	CA-3009
1982	V8 5.7L 350ci	L,M	3 Spd. AT 1 pc. Cable, or MT w/o Cruise; 80.00" Cable	CA-3001
1982	V8 5.7L 350ci	L,M	4 Spd. AT w/innerconnector, Upper; 61.00" Cable	CA-3005
1982	V8 5.7L 350ci	L,M	AT w/Cruise Control, Intermediate	CA-3006
1982	V8 5.7L 350ci	L,M	MT w/Cruise Control, Lower; 63.00" Cable	CA-3002
1983-84	V8 5.7L 350ci	L,M	4 Spd. MT w/innerconnector Lower; 20.00" Cable	CA-3008
1983-84	V8 5.7L 350ci	L,M	TH700-R4 Auto. Trans., or w/4 Spd. MT Upper; 61.00" Cable	CA-3005
1983-84	V8 5.7L 350ci	L,M	THM-400 Auto. Trans.; 80.00" Cable	CA-3001
1975	V8 5.7L 350ci	Y	4 Spd. MT Lower; 40.00" Cable	CA-3033
1975	V8 5.7L 350ci	Y	AT THM w/Cruise Lower; 63.00" Cable	CA-3002
1975	V8 5.7L 350ci	Y	AT THM w/Cruise Upper, OR 4 Spd. MT Upper; 41.00" Cable	CA-3009
1975	V8 5.7L 350ci	Y	AT THM w/o Cruise, 3 Spd. MT w/o Cruise; 80.00" Cable	CA-3001
1983-84	V8 6.2L 379ci	C,J	4 Spd. MT w/innerconnector Lower; 20.00" Cable	CA-3008
1983-84	V8 6.2L 379ci	C,J	TH700-R4 Auto. Trans., or w/4 Spd. MT Upper; 61.00" Cable	CA-3005
1983-84	V8 6.2L 379ci	C,J	THM-400 Auto. Trans.; 80.00" Cable	CA-3001
1981	V8 7.4L 454ci	W	3 Spd. AT 1 pc. Cable; 80.00" Cable	CA-3001
1981	V8 7.4L 454ci	W	MT w/o Cruise Upper; 61.00" Cable	CA-3005
1981	V8 7.4L 454ci	W	w/Cruise Control, Lower; 63.00" Cable	CA-3002
1981	V8 7.4L 454ci	W	w/Cruise Control, Upper; 41.00" Cable	CA-3009
1983-84	V8 7.4L 454ci	W	4 Spd. MT w/innerconnector Lower; 20.00" Cable	CA-3008
1983-84	V8 7.4L 454ci	W	TH700-R4 Auto. Trans., or w/4 Spd. MT Upper; 61.00" Cable	CA-3005
1983-84	V8 7.4L 454ci	W	THM-400 Auto. Trans.; 80.00" Cable	CA-3001
1975	V8 7.4L 454ci	Z	4 Spd. MT Lower; 40.00" Cable	CA-3033
1975	V8 7.4L 454ci	Z	AT THM w/Cruise Lower; 63.00" Cable	CA-3002
1975	V8 7.4L 454ci	Z	AT THM w/Cruise Upper, OR 4 Spd. MT Upper; 41.00" Cable	CA-3009
1975	V8 7.4L 454ci	Z	AT THM w/o Cruise, 3 Spd. MT w/o Cruise; 80.00" Cable	CA-3001
<b>C35</b>				
1971	L6 4.1L 250ci	C,L	w/Powerglide & THM 120" length	CA-3038
1971	L6 4.1L 250ci	C,L	w/Powerglide & THM 80" length, w/3 & 4 Spd. MT; 83.00" Cable	CA-3004
1971	L6 4.1L 250ci	C,L	w/Powerglide & THM 95" length	CA-3016
1972	L6 4.1L 250ci	D	w/Powerglide & THM 120" length	CA-3038
1972	L6 4.1L 250ci	D	w/Powerglide & THM 80" length, w/3 & 4 Spd. MT; 83.00" Cable	CA-3004
1972	L6 4.1L 250ci	D	w/Powerglide & THM 95" length	CA-3016
1980	L6 4.1L 250ci	D	4 Spd. w/o Cruise Upper; 61.00" Cable	CA-3005
1980	L6 4.1L 250ci	D	exc. Cruise Control; 80.00" Cable	CA-3001
1980	L6 4.1L 250ci	D	w/Catalytic Converter w/Cruise Control, Lower	CA-3006
1980	L6 4.1L 250ci	D	w/o Catalytic Converter w/Cruise Control, Lower; 63.00" Cable	CA-3002
1978-79	L6 4.1L 250ci	D	3 Spd. MT w/o Cruise; 80.00" Cable	CA-3001
1978-79	L6 4.1L 250ci	D	4 Spd. MT; 61.00" Cable	CA-3005
1978-79	L6 4.1L 250ci	D	AT w/Catalytic Converter Lower	CA-3006
1978-79	L6 4.1L 250ci	D	AT w/Catalytic Converter w/Cruise Upper; 41.00" Cable	CA-3009
1978-79	L6 4.1L 250ci	D	AT w/o Catalytic Converter w/Cruise Lower; 63.00" Cable	CA-3002
1970	L6 4.1L 250ci	N	w/Powerglide & THM 120" length	CA-3038
1970	L6 4.1L 250ci	N	w/Powerglide & THM 80" length, w/3 & 4 Spd. MT; 83.00" Cable	CA-3004
1970	L6 4.1L 250ci	N	w/Powerglide & THM 95" length	CA-3016



# SPEEDOMETER CABLES

Year	Engine	Vin	Remark	Part
<b>GMC (con't)</b>				
<b>C35 (con't)</b>				
1975	L6 4.1L 250ci	Q	4 Spd. MT Lower; 40.00" Cable	CA-3033
1975	L6 4.1L 250ci	Q	AT THM w/Cruise Lower; 63.00" Cable	CA-3002
1975	L6 4.1L 250ci	Q	AT THM w/Cruise Upper, OR 4 Spd. MT Upper; 41.00" Cable	CA-3009
1975	L6 4.1L 250ci	Q	AT THM w/o Cruise, 3 Spd. MT w/o Cruise; 80.00" Cable	CA-3001
1970-72	L6 4.8L 292ci	S	w/Powerglide & THM 120" length	CA-3038
1970-72	L6 4.8L 292ci	S	w/Powerglide & THM 80" length, w/3 & 4 Spd. MT; 83.00" Cable	CA-3004
1970-72	L6 4.8L 292ci	S	w/Powerglide & THM 95" length	CA-3016
1975	L6 4.8L 292ci	T	AT THM w/Cruise Lower; 63.00" Cable	CA-3002
1976	L6 4.8L 292ci	T	AT THM w/Cruise Lower; 83.00" Cable	CA-3004
1977	L6 4.8L 292ci	T	w/Cruise Control, Lower; 63.00" Cable	CA-3002
1977	L6 4.8L 292ci	T	w/Cruise Control, Upper; 41.00" Cable	CA-3009
1980	L6 4.8L 292ci	T	4 Spd. w/o Cruise Upper; 61.00" Cable	CA-3005
1980	L6 4.8L 292ci	T	exc. Cruise Control; 80.00" Cable	CA-3001
1980	L6 4.8L 292ci	T	w/Catalic Converter w/Cruise Control, Lower	CA-3006
1980	L6 4.8L 292ci	T	w/o Catalic Converter w/Cruise Control, Lower; 63.00" Cable	CA-3002
1981	L6 4.8L 292ci	T	3 Spd. AT 1 pc. Cable; 80.00" Cable	CA-3001
1981	L6 4.8L 292ci	T	MT w/o Cruise Upper; 61.00" Cable	CA-3005
1981	L6 4.8L 292ci	T	w/Cruise Control, Lower; 63.00" Cable	CA-3002
1981	L6 4.8L 292ci	T	w/Cruise Control, Upper; 41.00" Cable	CA-3009
1982	L6 4.8L 292ci	T	3 Spd. AT Lower; 63.00" Cable	CA-3002
1982	L6 4.8L 292ci	T	4 Spd. MT Upper; 61.00" Cable	CA-3005
1982	L6 4.8L 292ci	T	MT w/innerconnector Lower; 20.00" Cable	CA-3008
1982	L6 4.8L 292ci	T	MT w/innerconnector Upper; 41.00" Cable	CA-3009
1982	L6 4.8L 292ci	T	MT w/o innerconnector	CA-3006
1983	L6 4.8L 292ci	T	4 Spd. MT w/innerconnector Lower; 20.00" Cable	CA-3008
1983	L6 4.8L 292ci	T	TH700-R4 Auto. Trans., or w/4 Spd. MT Upper; 61.00" Cable	CA-3005
1986	L6 4.8L 292ci	T	Lower exc. AT THM-400 Trans.; 20.00" Cable	CA-3008
1986	L6 4.8L 292ci	T	Upper exc. AT THM-400 Trans.; 61.00" Cable	CA-3005
1975-76	L6 4.8L 292ci	T	4 Spd. MT Lower; 40.00" Cable	CA-3033
1975-76	L6 4.8L 292ci	T	AT THM w/Cruise Upper, OR 4 Spd. MT Upper; 41.00" Cable	CA-3009
1975-76	L6 4.8L 292ci	T	AT THM w/o Cruise, 3 Spd. MT w/o Cruise; 80.00" Cable	CA-3001
1978-79	L6 4.8L 292ci	T	3 Spd. MT w/o Cruise; 80.00" Cable	CA-3001
1978-79	L6 4.8L 292ci	T	AT w/Catalytic Converter Lower	CA-3006
1978-79	L6 4.8L 292ci	T	4 Spd. MT; 61.00" Cable	CA-3005
1978-79	L6 4.8L 292ci	T	AT w/Catalytic Converter w/Cruise Upper; 41.00" Cable	CA-3009
1978-79	L6 4.8L 292ci	T	AT w/o Catalytic Converter w/Cruise Lower; 63.00" Cable	CA-3002
1983-86	L6 4.8L 292ci	T	THM-400 Auto. Trans.; 80.00" Cable	CA-3001
1986	V8 5.0L 305ci	H	Lower exc. AT THM-400 Trans.; 20.00" Cable	CA-3008
1986	V8 5.0L 305ci	H	THM-400 Auto. Trans.; 80.00" Cable	CA-3001
1986	V8 5.0L 305ci	H	Upper exc. AT THM-400 Trans.; 61.00" Cable	CA-3005
1978	V8 5.0L 305ci	U	3 Spd. MT w/o Cruise; 80.00" Cable	CA-3001
1978	V8 5.0L 305ci	U	4 Spd. MT; 61.00" Cable	CA-3005
1978	V8 5.0L 305ci	U	AT w/Catalytic Converter Lower	CA-3006
1978	V8 5.0L 305ci	U	AT w/Catalytic Converter w/Cruise Upper; 41.00" Cable	CA-3009
1978	V8 5.0L 305ci	U	AT w/o Catalytic Converter w/Cruise Lower; 63.00" Cable	CA-3002
1970	V8 5.0L 307ci	A	w/Powerglide & THM 120" length	CA-3038
1970	V8 5.0L 307ci	A	w/Powerglide & THM 80" length, w/3 & 4 Spd. MT; 83.00" Cable	CA-3004
1970	V8 5.0L 307ci	A	w/Powerglide & THM 95" length	CA-3016
1972	V8 5.0L 307ci	F	w/Powerglide & THM 120" length	CA-3038
1972	V8 5.0L 307ci	F	w/Powerglide & THM 80" length, w/3 & 4 Spd. MT; 83.00" Cable	CA-3004
1972	V8 5.0L 307ci	F	w/Powerglide & THM 95" length	CA-3016
1971	V8 5.0L 307ci	H	w/Powerglide & THM 120" length	CA-3038
1971	V8 5.0L 307ci	H	w/Powerglide & THM 80" length, w/3 & 4 Spd. MT; 83.00" Cable	CA-3004
1971	V8 5.0L 307ci	H	w/Powerglide & THM 95" length	CA-3016
1970-72	V8 5.7L 350ci	E	w/Powerglide & THM 120" length	CA-3038
1970-72	V8 5.7L 350ci	E	w/Powerglide & THM 80" length, w/3 & 4 Spd. MT; 83.00" Cable	CA-3004
1970-72	V8 5.7L 350ci	E	w/Powerglide & THM 95" length	CA-3016
1977	V8 5.7L 350ci	L	w/Cruise Control, Lower; 63.00" Cable	CA-3002
1977	V8 5.7L 350ci	L	w/Cruise Control, Upper; 41.00" Cable	CA-3009
1980	V8 5.7L 350ci	L,M	4 Spd. w/o Cruise Upper; 61.00" Cable	CA-3005
1980	V8 5.7L 350ci	L,M	w/Catalic Converter w/Cruise Control, Lower	CA-3006
1980	V8 5.7L 350ci	L,M	w/o Catalic Converter w/Cruise Control, Lower; 63.00" Cable	CA-3002

# SPEEDOMETER CABLES

Year	Engine	Vin	Remark	Part
<b>GMC (con't)</b>				
<b>C35 (con't)</b>				
1980	V8 5.7L 350ci	L,M	exc. Cruise Control; 80.00" Cable	CA-3001
1978-79	V8 5.7L 350ci	L,M	AT w/Catalytic Converter w/Cruise Upper; 41.00" Cable	CA-3009
1978-79	V8 5.7L 350ci	L,M	3 Spd. MT w/o Cruise; 80.00" Cable	CA-3001
1978-79	V8 5.7L 350ci	L,M	4 Spd. MT; 61.00" Cable	CA-3005
1978-79	V8 5.7L 350ci	L,M	AT w/Catalytic Converter Lower	CA-3006
1978-79	V8 5.7L 350ci	L,M	AT w/o Catalytic Converter w/Cruise Lower; 63.00" Cable	CA-3002
1976	V8 5.7L 350ci	L,V	AT THM w/Cruise Lower; 83.00" Cable	CA-3004
1975-76	V8 5.7L 350ci	L,V,Y	4 Spd. MT Lower; 40.00" Cable	CA-3033
1975-76	V8 5.7L 350ci	L,V,Y	AT THM w/Cruise Upper, OR 4 Spd. MT Upper; 41.00" Cable	CA-3009
1975-76	V8 5.7L 350ci	L,V,Y	AT THM w/o Cruise, 3 Spd. MT w/o Cruise; 80.00" Cable	CA-3001
1981	V8 5.7L 350ci	M	3 Spd. AT 1 pc. Cable; 80.00" Cable	CA-3001
1981	V8 5.7L 350ci	M	MT w/o Cruise Upper; 61.00" Cable	CA-3005
1981	V8 5.7L 350ci	M	w/Cruise Control, Lower; 63.00" Cable	CA-3002
1981	V8 5.7L 350ci	M	w/Cruise Control, Upper; 41.00" Cable	CA-3009
1982	V8 5.7L 350ci	M	3 Spd. AT Lower; 63.00" Cable	CA-3002
1982	V8 5.7L 350ci	M	4 Spd. MT Upper; 61.00" Cable	CA-3005
1982	V8 5.7L 350ci	M	MT w/innerconnector Lower; 20.00" Cable	CA-3008
1982	V8 5.7L 350ci	M	MT w/innerconnector Upper; 41.00" Cable	CA-3009
1982	V8 5.7L 350ci	M	MT w/o innerconnector	CA-3006
1983	V8 5.7L 350ci	M	4 Spd. MT w/innerconnector Lower; 20.00" Cable	CA-3008
1983	V8 5.7L 350ci	M	TH700-R4 Auto. Trans., or w/4 Spd. MT Upper; 61.00" Cable	CA-3005
1986	V8 5.7L 350ci	M	Lower exc. AT THM-400 Trans.; 20.00" Cable	CA-3008
1986	V8 5.7L 350ci	M	Upper exc. AT THM-400 Trans.; 61.00" Cable	CA-3005
1983-86	V8 5.7L 350ci	M	THM-400 Auto. Trans.; 80.00" Cable	CA-3001
1975	V8 5.7L 350ci	V,Y	AT THM w/Cruise Lower; 63.00" Cable	CA-3002
1982	V8 6.2L 379ci	J	3 Spd. AT Lower; 63.00" Cable	CA-3002
1982	V8 6.2L 379ci	J	4 Spd. MT Upper; 61.00" Cable	CA-3005
1982	V8 6.2L 379ci	J	MT w/innerconnector Lower; 20.00" Cable	CA-3008
1982	V8 6.2L 379ci	J	MT w/innerconnector Upper; 41.00" Cable	CA-3009
1982	V8 6.2L 379ci	J	MT w/o innerconnector	CA-3006
1983	V8 6.2L 379ci	J	4 Spd. MT w/innerconnector Lower; 20.00" Cable	CA-3008
1983	V8 6.2L 379ci	J	TH700-R4 Auto. Trans., or w/4 Spd. MT Upper; 61.00" Cable	CA-3005
1986	V8 6.2L 379ci	J	Lower exc. AT THM-400 Trans.; 20.00" Cable	CA-3008
1986	V8 6.2L 379ci	J	Upper exc. AT THM-400 Trans.; 61.00" Cable	CA-3005
1983-86	V8 6.2L 379ci	J	THM-400 Auto. Trans.; 80.00" Cable	CA-3001
1977	V8 6.6L 400ci	R	w/Cruise Control, Lower; 63.00" Cable	CA-3002
1977	V8 6.6L 400ci	R	w/Cruise Control, Upper; 41.00" Cable	CA-3009
1978-79	V8 6.6L 400ci	R	3 Spd. MT w/o Cruise; 80.00" Cable	CA-3001
1978-79	V8 6.6L 400ci	R	4 Spd. MT; 61.00" Cable	CA-3005
1978-79	V8 6.6L 400ci	R	AT w/Catalytic Converter Lower	CA-3006
1978-79	V8 6.6L 400ci	R	AT w/Catalytic Converter w/Cruise Upper; 41.00" Cable	CA-3009
1978-79	V8 6.6L 400ci	R	AT w/o Catalytic Converter w/Cruise Lower; 63.00" Cable	CA-3002
1976	V8 6.6L 400ci	U	4 Spd. MT Lower; 40.00" Cable	CA-3033
1976	V8 6.6L 400ci	U	AT THM w/Cruise Lower; 83.00" Cable	CA-3004
1976	V8 6.6L 400ci	U	AT THM w/Cruise Upper, OR 4 Spd. MT Upper; 41.00" Cable	CA-3009
1976	V8 6.6L 400ci	U	AT THM w/o Cruise, 3 Spd. MT w/o Cruise; 80.00" Cable	CA-3001
1970	V8 6.6L 402ci	E	w/Powerglide & THM 120" length	CA-3038
1970	V8 6.6L 402ci	E	w/Powerglide & THM 80" length, w/3 & 4 Spd. MT; 83.00" Cable	CA-3004
1970	V8 6.6L 402ci	E	w/Powerglide & THM 95" length	CA-3016
1971	V8 6.6L 402ci	K	w/Powerglide & THM 120" length	CA-3038
1971	V8 6.6L 402ci	K	w/Powerglide & THM 80" length, w/3 & 4 Spd. MT; 83.00" Cable	CA-3004
1971	V8 6.6L 402ci	K	w/Powerglide & THM 95" length	CA-3016
1976	V8 7.4L 454ci	S	4 Spd. MT Lower; 40.00" Cable	CA-3033
1976	V8 7.4L 454ci	S	AT THM w/Cruise Lower; 83.00" Cable	CA-3004
1976	V8 7.4L 454ci	S	AT THM w/Cruise Upper, OR 4 Spd. MT Upper; 41.00" Cable	CA-3009
1976	V8 7.4L 454ci	S	AT THM w/o Cruise, 3 Spd. MT w/o Cruise; 80.00" Cable	CA-3001
1977	V8 7.4L 454ci	S	w/Cruise Control, Lower; 63.00" Cable	CA-3002
1977	V8 7.4L 454ci	S	w/Cruise Control, Upper; 41.00" Cable	CA-3009
1980	V8 7.4L 454ci	S	4 Spd. w/o Cruise Upper; 61.00" Cable	CA-3005
1978-79	V8 7.4L 454ci	S	AT w/o Catalytic Converter w/Cruise Lower; 63.00" Cable	CA-3002
1978-79	V8 7.4L 454ci	S	3 Spd. MT w/o Cruise; 80.00" Cable	CA-3001
1978-79	V8 7.4L 454ci	S	4 Spd. MT; 61.00" Cable	CA-3005

# SPEEDOMETER CABLES

Year	Engine	Vin	Remark	Part
<b>GMC (con't)</b>				
<b>C35 (con't)</b>				
1978-79	V8 7.4L 454ci	S	AT w/Catalytic Converter Lower	CA-3006
1978-79	V8 7.4L 454ci	S	AT w/Catalytic Converter w/Cruise Upper; 41.00" Cable	CA-3009
1980	V8 7.4L 454ci	S,W	exc. Cruise Control; 80.00" Cable	CA-3001
1980	V8 7.4L 454ci	S,W	w/Catalic Converter w/Cruise Control, Lower	CA-3006
1980	V8 7.4L 454ci	S,W	w/o Catalic Converter w/Cruise Control, Lower; 63.00" Cable	CA-3002
1980	V8 7.4L 454ci	W	4 Spd. w/o Cruise Upper; 61.00" Cable	CA-3005
1981	V8 7.4L 454ci	W	3 Spd. AT 1 pc. Cable; 80.00" Cable	CA-3001
1981	V8 7.4L 454ci	W	MT w/o Cruise Upper; 61.00" Cable	CA-3005
1981	V8 7.4L 454ci	W	w/Cruise Control, Lower; 63.00" Cable	CA-3002
1981	V8 7.4L 454ci	W	w/Cruise Control, Upper; 41.00" Cable	CA-3009
1982	V8 7.4L 454ci	W	3 Spd. AT Lower; 63.00" Cable	CA-3002
1982	V8 7.4L 454ci	W	4 Spd. MT Upper; 61.00" Cable	CA-3005
1982	V8 7.4L 454ci	W	MT w/innerconnector Lower; 20.00" Cable	CA-3008
1982	V8 7.4L 454ci	W	MT w/innerconnector Upper; 41.00" Cable	CA-3009
1982	V8 7.4L 454ci	W	MT w/o innerconnector	CA-3006
1983	V8 7.4L 454ci	W	4 Spd. MT w/innerconnector Lower; 20.00" Cable	CA-3008
1983	V8 7.4L 454ci	W	TH700-R4 Auto. Trans., or w/4 Spd. MT Upper; 61.00" Cable	CA-3005
1986	V8 7.4L 454ci	W	Lower exc. AT THM-400 Trans.; 20.00" Cable	CA-3008
1986	V8 7.4L 454ci	W	Upper exc. AT THM-400 Trans.; 61.00" Cable	CA-3005
1983-86	V8 7.4L 454ci	W	THM-400 Auto. Trans.; 80.00" Cable	CA-3001
1975	V8 7.4L 454ci	Z	4 Spd. MT Lower; 40.00" Cable	CA-3033
1975	V8 7.4L 454ci	Z	AT THM w/Cruise Lower; 63.00" Cable	CA-3002
1975	V8 7.4L 454ci	Z	AT THM w/Cruise Upper, OR 4 Spd. MT Upper; 41.00" Cable	CA-3009
1975	V8 7.4L 454ci	Z	AT THM w/o Cruise, 3 Spd. MT w/o Cruise; 80.00" Cable	CA-3001
<b>G15</b>				
1982	L6 4.1L 250ci	D	Lower Cable to interconnector; 61.00" Cable	CA-3013
1982	L6 4.1L 250ci	D	w/o Cruise w/o interconnector 2 pc. Cable Lower; 63.00" Cable	CA-3002
1976-81	L6 4.1L 250ci	D	Cable to interconnector; 61.00" Cable	CA-3013
1976-78	L6 4.1L 250ci	D	w/o Cruise w/o interconnector 2 pc. Cable Lower; 63.00" Cable	CA-3002
1976-82	L6 4.1L 250ci	D	w/o Cruise w/o interconnector; 120.00" Cable	CA-3007
1976-82	L6 4.1L 250ci	D	w/Cruise Control, Upper; 41.00" Cable	CA-3009
1979-80	L6 4.1L 250ci	D	w/o interconnector Cruise Upper; 41.00" Cable	CA-3009
1979-81	L6 4.1L 250ci	D	Lower Cable to interconnector; 63.00" Cable	CA-3002
1983-84	L6 4.1L 250ci	D	120.00" Cable	CA-3007
1985-86	V6 4.3L 262ci	N	120.00" Cable	CA-3007
1987-89	V6 4.3L 262ci	Z	120.00" Cable	CA-3007
1983-89	V8 5.0L 305ci	F,H	120.00" Cable	CA-3007
1981-82	V8 5.0L 305ci	G,H	Lower Cable to interconnector; 61.00" Cable	CA-3013
1981-82	V8 5.0L 305ci	G,H	w/Cruise Control, Upper; 41.00" Cable	CA-3009
1981-82	V8 5.0L 305ci	G,H	w/o Cruise w/o interconnector 2 pc. Cable Lower; 63.00" Cable	CA-3002
1981-82	V8 5.0L 305ci	G,H	w/o Cruise w/o interconnector; 120.00" Cable	CA-3007
1987-89	V8 5.7L 350ci	K	120.00" Cable	CA-3007
1976	V8 5.7L 350ci	L	Lower Cable to interconnector; 61.00" Cable	CA-3013
1976	V8 5.7L 350ci	L	w/o Cruise w/o interconnector 2 pc. Cable Lower; 63.00" Cable	CA-3002
1978	V8 5.7L 350ci	L	w/o interconnector Cruise Upper; 41.00" Cable	CA-3009
1979	V8 5.7L 350ci	L	w/Cruise Control, Upper; 41.00" Cable	CA-3009
1986	V8 5.7L 350ci	L	120.00" Cable	CA-3007
1976-77	V8 5.7L 350ci	L	w/Cruise Control, Upper; 41.00" Cable	CA-3009
1976-79	V8 5.7L 350ci	L	w/o Cruise w/o interconnector; 120.00" Cable	CA-3007
1977-79	V8 5.7L 350ci	L	Upper Cable to interconnector; 61.00" Cable	CA-3013
1978-79	V8 5.7L 350ci	L	Lower Cable to interconnector; 63.00" Cable	CA-3002
1979	V8 6.6L 400ci	R	Lower Cable to interconnector; 63.00" Cable	CA-3002
1979	V8 6.6L 400ci	R	Upper Cable to interconnector; 61.00" Cable	CA-3013
1979	V8 6.6L 400ci	R	w/o Cruise w/o interconnector; 120.00" Cable	CA-3007
1979	V8 6.6L 400ci	R	w/o interconnector Cruise Upper; 41.00" Cable	CA-3009
<b>G25</b>				
1978-82	L6 4.1L 250ci	D	Cable to interconnector; 61.00" Cable	CA-3013
1978-82	L6 4.1L 250ci	D	w/Cruise Control, Upper; 41.00" Cable	CA-3009
1978-82	L6 4.1L 250ci	D	w/o Cruise w/o interconnector 2 pc. Cable Lower; 63.00" Cable	CA-3002
1978-82	L6 4.1L 250ci	D	w/o Cruise w/o interconnector; 120.00" Cable	CA-3007
1981-82	L6 4.1L 250ci	D	Lower Cable to interconnector; 63.00" Cable	CA-3002
1981-82	L6 4.1L 250ci	D	w/o interconnector Cruise Upper; 41.00" Cable	CA-3009

# SPEEDOMETER CABLES

Year	Engine	Vin	Remark	Part
<b>GMC (con't)</b>				
<b>G25 (con't)</b>				
1983-84	L6 4.1L 250ci	D	120.00" Cable	CA-3007
1985-86	V6 4.3L 262ci	N	120.00" Cable	CA-3007
1987-89	V6 4.3L 262ci	Z	120.00" Cable	CA-3007
1981-82	V8 5.0L 305ci	F,G,H	Lower Cable to interconnector; 61.00" Cable	CA-3013
1981-82	V8 5.0L 305ci	F,G,H	w/Cruise Control, Upper; 41.00" Cable	CA-3009
1981-82	V8 5.0L 305ci	F,G,H	w/o Cruise w/o interconnector 2 pc. Cable Lower; 63.00" Cable	CA-3002
1981-82	V8 5.0L 305ci	F,G,H	w/o Cruise w/o interconnector; 120.00" Cable	CA-3007
1983-89	V8 5.0L 305ci	F,H	120.00" Cable	CA-3007
1987-89	V8 5.7L 350ci	K	120.00" Cable	CA-3007
1983-86	V8 5.7L 350ci	L,M	120.00" Cable	CA-3007
1981	V8 5.7L 350ci	M	Lower Cable to interconnector; 61.00" Cable	CA-3013
1981	V8 5.7L 350ci	M	w/Cruise Control, Upper; 41.00" Cable	CA-3009
1981	V8 5.7L 350ci	M	w/o Cruise w/o interconnector 2 pc. Cable Lower; 63.00" Cable	CA-3002
1981	V8 5.7L 350ci	M	w/o Cruise w/o interconnector; 120.00" Cable	CA-3007
1984-89	V8 6.2L 379ci	C	120.00" Cable	CA-3007
1977	V8 6.6L 400ci	R	w/o interconnector Cruise Upper; 41.00" Cable	CA-3009
1978	V8 6.6L 400ci	R	w/Cruise Control, Upper; 41.00" Cable	CA-3009
1977-78	V8 6.6L 400ci	R	Lower Cable to interconnector; 63.00" Cable	CA-3002
1977-78	V8 6.6L 400ci	R	Upper Cable to interconnector; 61.00" Cable	CA-3013
1977-78	V8 6.6L 400ci	R	w/o Cruise w/o interconnector; 120.00" Cable	CA-3007
1976	V8 6.6L 400ci	U	Upper Cable to interconnector; 61.00" Cable	CA-3013
1976	V8 6.6L 400ci	U	w/Cruise Control, Upper; 41.00" Cable	CA-3009
1976	V8 6.6L 400ci	U	w/o Cruise w/o interconnector; 120.00" Cable	CA-3007
<b>G35</b>				
1978	L6 4.1L 250ci	D	Lower Cable to interconnector; 61.00" Cable	CA-3013
1978	L6 4.1L 250ci	D	w/Cruise Control, Upper; 41.00" Cable	CA-3009
1978	L6 4.1L 250ci	D	w/o Cruise w/o interconnector 2 pc. Cable Lower; 63.00" Cable	CA-3002
1979	L6 4.1L 250ci	D	w/o interconnector Cruise Upper; 41.00" Cable	CA-3009
1982	L6 4.1L 250ci	D	w/Cruise Control, Upper; 41.00" Cable	CA-3009
1978-82	L6 4.1L 250ci	D	w/o Cruise w/o interconnector; 120.00" Cable	CA-3007
1979-82	L6 4.1L 250ci	D	Lower Cable to interconnector; 63.00" Cable	CA-3002
1979-82	L6 4.1L 250ci	D	Upper Cable to interconnector; 61.00" Cable	CA-3013
1974	L6 4.8L 292ci	T	120.00" Cable	CA-3007
1975	L6 4.8L 292ci	T	w/THM AT w/Cruise Control Upper; 80.00" Cable	CA-3001
1975	L6 4.8L 292ci	T	w/THM AT w/Cruise Control, Lower; 63.00" Cable	CA-3002
1978	L6 4.8L 292ci	T	Lower Cable to interconnector; 63.00" Cable	CA-3002
1978	L6 4.8L 292ci	T	Upper Cable to interconnector; 61.00" Cable	CA-3013
1978	L6 4.8L 292ci	T	w/Cruise Control, Upper; 41.00" Cable	CA-3009
1978	L6 4.8L 292ci	T	w/o Cruise w/o interconnector; 120.00" Cable	CA-3007
1975-77	L6 4.8L 292ci	T	exc. Cruise Control; 120.00" Cable	CA-3007
1976-77	L6 4.8L 292ci	T	4 Spd. MT Lower; 40.00" Cable	CA-3033
1976-77	L6 4.8L 292ci	T	4 Spd. MT Upper; 41.00" Cable	CA-3009
1976-77	L6 4.8L 292ci	T	AT w/Cruise Control, Lower; 63.00" Cable	CA-3002
1976-77	L6 4.8L 292ci	T	AT w/Cruise Control, Upper; 80.00" Cable	CA-3001
1981	V8 5.0L 305ci	H	Lower Cable to interconnector; 61.00" Cable	CA-3013
1981	V8 5.0L 305ci	H	w/Cruise Control, Upper; 41.00" Cable	CA-3009
1981	V8 5.0L 305ci	H	w/o Cruise w/o interconnector 2 pc. Cable Lower; 63.00" Cable	CA-3002
1981	V8 5.0L 305ci	H	w/o Cruise w/o interconnector; 120.00" Cable	CA-3007
1983-87	V8 5.7L 350ci	E,M	120.00" Cable	CA-3007
1987-90	V8 5.7L 350ci	K	120.00" Cable	CA-3007
1978	V8 5.7L 350ci	L	w/Cruise Control, Upper; 41.00" Cable	CA-3009
1979	V8 5.7L 350ci	L	w/o interconnector Cruise Upper; 41.00" Cable	CA-3009
1976-77	V8 5.7L 350ci	L	exc. Cruise Control; 120.00" Cable	CA-3007
1978-79	V8 5.7L 350ci	L	Upper Cable to interconnector; 61.00" Cable	CA-3013
1978-79	V8 5.7L 350ci	L	w/o Cruise w/o interconnector; 120.00" Cable	CA-3007
1978-79	V8 5.7L 350ci	L	Lower Cable to interconnector; 63.00" Cable	CA-3002
1976-77	V8 5.7L 350ci	L,V	4 Spd. MT Lower; 40.00" Cable	CA-3033
1976-77	V8 5.7L 350ci	L,V	4 Spd. MT Upper; 41.00" Cable	CA-3009
1976-77	V8 5.7L 350ci	L,V	AT w/Cruise Control, Upper; 80.00" Cable	CA-3001
1976-77	V8 5.7L 350ci	L,V	AT w/Cruise Control, Lower; 63.00" Cable	CA-3002
1980	V8 5.7L 350ci	M	Upper Cable to interconnector; 61.00" Cable	CA-3013
1980-82	V8 5.7L 350ci	M	w/Cruise Control, Upper; 41.00" Cable	CA-3009

# SPEEDOMETER CABLES

Year	Engine	Vin	Remark	Part
<b>GMC (con't)</b>				
<b>G35 (con't)</b>				
1980-82	V8 5.7L 350ci	M	w/o Cruise w/o interconnector; 120.00" Cable	CA-3007
1981-82	V8 5.7L 350ci	M	Lower Cable to interconnector; 61.00" Cable	CA-3013
1981-82	V8 5.7L 350ci	M	w/o Cruise w/o interconnector 2 pc. Cable Lower; 63.00" Cable	CA-3002
1975	V8 5.7L 350ci	V,Y	w/THM AT w/Cruise Control Upper; 80.00" Cable	CA-3001
1975	V8 5.7L 350ci	V,Y	w/THM AT w/Cruise Control, Lower; 63.00" Cable	CA-3002
1975-76	V8 5.7L 350ci	V,Y	exc. Cruise Control; 120.00" Cable	CA-3007
1974	V8 5.7L 350ci	Y	AT; 63.00" Cable	CA-3002
1983-89	V8 6.2L 379ci	J	120.00" Cable	CA-3007
1977	V8 6.6L 400ci	R	4 Spd. MT Lower; 40.00" Cable	CA-3033
1977	V8 6.6L 400ci	R	4 Spd. MT Upper; 41.00" Cable	CA-3009
1977	V8 6.6L 400ci	R	AT w/Cruise Control, Lower; 63.00" Cable	CA-3002
1977	V8 6.6L 400ci	R	AT w/Cruise Control, Upper; 80.00" Cable	CA-3001
1977	V8 6.6L 400ci	R	exc. Cruise Control; 120.00" Cable	CA-3007
1977-79	V8 6.6L 400ci	R	Lower Cable to interconnector; 63.00" Cable	CA-3002
1977-79	V8 6.6L 400ci	R	w/o interconnector Cruise Upper; 41.00" Cable	CA-3009
1977-80	V8 6.6L 400ci	R	Upper Cable to interconnector; 61.00" Cable	CA-3013
1977-80	V8 6.6L 400ci	R	w/Cruise Control, Upper; 41.00" Cable	CA-3009
1977-80	V8 6.6L 400ci	R	w/o Cruise w/o interconnector; 120.00" Cable	CA-3007
1976	V8 6.6L 400ci	U	4 Spd. MT Lower; 40.00" Cable	CA-3033
1976	V8 6.6L 400ci	U	4 Spd. MT Upper; 41.00" Cable	CA-3009
1976	V8 6.6L 400ci	U	AT w/Cruise Control, Lower; 63.00" Cable	CA-3002
1976	V8 6.6L 400ci	U	AT w/Cruise Control, Upper; 80.00" Cable	CA-3001
1976	V8 6.6L 400ci	U	exc. Cruise Control; 120.00" Cable	CA-3007
1976	V8 6.6L 400ci	U	Upper Cable to interconnector; 61.00" Cable	CA-3013
1976	V8 6.6L 400ci	U	w/Cruise Control, Upper; 41.00" Cable	CA-3009
1976	V8 6.6L 400ci	U	w/o Cruise w/o interconnector; 120.00" Cable	CA-3007
1976	V8 7.4L 454ci	S	4 Spd. MT Lower; 40.00" Cable	CA-3033
1976	V8 7.4L 454ci	S,Y	4 Spd. MT Upper; 41.00" Cable	CA-3009
1976	V8 7.4L 454ci	S,Y	AT w/Cruise Control, Upper; 80.00" Cable	CA-3001
1976	V8 7.4L 454ci	S,Y	exc. Cruise Control; 120.00" Cable	CA-3007
1976	V8 7.4L 454ci	S,Y	AT w/Cruise Control, Lower; 63.00" Cable	CA-3002
1976	V8 7.4L 454ci	Y	4 Spd. MT Lower; 40.00" Cable	CA-3033
<b>JIMMY</b>				
1976	L6 4.1L 250ci	D	4 Spd. MT Lower; 40.00" Cable	CA-3033
1976	L6 4.1L 250ci	D	AT THM w/Cruise Lower; 83.00" Cable	CA-3004
1976	L6 4.1L 250ci	D	AT THM w/Cruise Upper, OR 4 Spd. MT Upper; 41.00" Cable	CA-3009
1976	L6 4.1L 250ci	D	AT THM w/o Cruise, 3 Spd. MT w/o Cruise; 80.00" Cable	CA-3001
1976	L6 4.1L 250ci	D	AT w/Cruise Upper, 4 Spd. MT Upper; 41.00" Cable	CA-3009
1976	L6 4.1L 250ci	D	AT w/o Cruise Control; 80.00" Cable	CA-3001
1976	L6 4.1L 250ci	D	MT 1 pc. Cable; 100.00" Cable	CA-3003
1977	L6 4.1L 250ci	D	2WD w/Cruise Lower; 63.00" Cable	CA-3002
1977	L6 4.1L 250ci	D	4WD w/Cruise, Lower; 83.00" Cable	CA-3004
1977	L6 4.1L 250ci	D	w/Cruise Control, Upper; 41.00" Cable	CA-3009
1977	L6 4.1L 250ci	D	w/o Cruise Control; 100.00" Cable	CA-3003
1980	L6 4.1L 250ci	D	4 Spd. w/o Cruise Upper; 61.00" Cable	CA-3005
1980	L6 4.1L 250ci	D	All to 80" Cable; 83.00" Cable	CA-3004
1980	L6 4.1L 250ci	D	AT w/Cruise Control, Upper; 41.00" Cable	CA-3009
1980	L6 4.1L 250ci	D	AT w/o Cruise Control, MT; 100.00" Cable	CA-3003
1980	L6 4.1L 250ci	D	exc. Cruise Control; 80.00" Cable	CA-3001
1980	L6 4.1L 250ci	D	w/Catalic Converter w/Cruise Control, Lower	CA-3006
1980	L6 4.1L 250ci	D	w/o Catalic Converter w/Cruise Control, Lower; 63.00" Cable	CA-3002
1982	L6 4.1L 250ci	D	3 Spd. AT 1 pc. Cable, or MT w/o Cruise; 80.00" Cable	CA-3001
1982	L6 4.1L 250ci	D	4 Spd. AT w/innerconnector, Upper; 61.00" Cable	CA-3005
1982	L6 4.1L 250ci	D	All to 80" Cable; 80.00" Cable	CA-3001
1982	L6 4.1L 250ci	D	All To 92" Cable; 100.00" Cable	CA-3003
1982	L6 4.1L 250ci	D	AT w/Cruise Control, Intermediate	CA-3006
1982	L6 4.1L 250ci	D	MT w/Cruise Control, Lower; 63.00" Cable	CA-3002
1982	L6 4.1L 250ci	D	To 75" Cable; 83.00" Cable	CA-3004
1976-79	L6 4.1L 250ci	D	AT w/Cruise Control, Lower; 83.00" Cable	CA-3004
1978-79	L6 4.1L 250ci	D	3 Spd. MT w/o Cruise; 80.00" Cable	CA-3001
1978-79	L6 4.1L 250ci	D	4 Spd. MT; 61.00" Cable	CA-3005
1978-79	L6 4.1L 250ci	D	AT Upper; 41.00" Cable	CA-3009

# SPEEDOMETER CABLES

Year	Engine	Vin	Remark	Part
<b>GMC (con't)</b>				
<b>JIMMY (con't)</b>				
1978-79	L6 4.1L 250ci	D	AT w/Catalytic Converter Lower	CA-3006
1978-79	L6 4.1L 250ci	D	AT w/Catalytic Converter w/Cruise Upper; 41.00" Cable	CA-3009
1978-79	L6 4.1L 250ci	D	AT w/o Catalytic Converter w/Cruise Lower; 63.00" Cable	CA-3002
1978-79	L6 4.1L 250ci	D	AT w/o Cruise, w/Single Exhaust w/TH350; 80.00" Cable	CA-3001
1978-79	L6 4.1L 250ci	D	MT w/o Cruise Control, AT w/o Cruise w/Dual Exhaust, AT w/o Cruise w/single Exhaust w/TH400"; 100.00" Cable	CA-3003
1975	L6 4.1L 250ci	Q	3 Spd. MT; 80.00" Cable	CA-3001
1975	L6 4.1L 250ci	Q	4 Spd. MT Lower; 40.00" Cable	CA-3033
1975	L6 4.1L 250ci	Q	AT THM w/Cruise Lower; 63.00" Cable	CA-3002
1975	L6 4.1L 250ci	Q	AT THM w/Cruise Upper, OR 4 Spd. MT Upper; 41.00" Cable	CA-3009
1975	L6 4.1L 250ci	Q	AT THM w/o Cruise, 3 Spd. MT w/o Cruise; 80.00" Cable	CA-3001
1975	L6 4.1L 250ci	Q	AT w/Cruise Upper, 4 Spd. MT Upper; 41.00" Cable	CA-3009
1973-74	L6 4.1L 250ci	Q	3 & 4 Spd. MT, or THM AT w/o Cruise; 80.00" Cable	CA-3001
1973-74	L6 4.1L 250ci	Q	4WD; 80.00" Cable	CA-3001
1973-74	L6 4.1L 250ci	Q	AT w/Cruise Control, Upper	CA-3031
1973-75	L6 4.1L 250ci	Q	AT w/Cruise Control, Lower; 63.00" Cable	CA-3002
1973	L6 4.8L 292ci	T	3 & 4 Spd. MT, or THM AT w/o Cruise; 80.00" Cable	CA-3001
1973	L6 4.8L 292ci	T	4WD; 80.00" Cable	CA-3001
1973	L6 4.8L 292ci	T	AT w/Cruise Control, Lower; 63.00" Cable	CA-3002
1973	L6 4.8L 292ci	T	AT w/Cruise Control, Upper	CA-3031
1982	V8 5.0L 305ci	F,H	3 Spd. AT 1 pc. Cable, or MT w/o Cruise; 80.00" Cable	CA-3001
1982	V8 5.0L 305ci	F,H	4 Spd. AT w/innerconnector, Upper; 61.00" Cable	CA-3005
1982	V8 5.0L 305ci	F,H	All to 80" Cable; 80.00" Cable	CA-3001
1982	V8 5.0L 305ci	F,H	All To 92" Cable; 100.00" Cable	CA-3003
1982	V8 5.0L 305ci	F,H	AT w/Cruise Control, Intermediate	CA-3006
1982	V8 5.0L 305ci	F,H	MT w/Cruise Control, Lower; 63.00" Cable	CA-3002
1982	V8 5.0L 305ci	F,H	To 75" Cable; 83.00" Cable	CA-3004
1980	V8 5.0L 305ci	G	4 Spd. w/o Cruise Upper; 61.00" Cable	CA-3005
1980	V8 5.0L 305ci	G	All to 80" Cable; 83.00" Cable	CA-3004
1980	V8 5.0L 305ci	G	AT w/Cruise Control, Upper; 41.00" Cable	CA-3009
1980	V8 5.0L 305ci	G	AT w/o Cruise Control, MT; 100.00" Cable	CA-3003
1980	V8 5.0L 305ci	G	exc. Cruise Control; 80.00" Cable	CA-3001
1980	V8 5.0L 305ci	G	w/Catalic Converter w/Cruise Control, Lower	CA-3006
1980	V8 5.0L 305ci	G	w/o Catalic Converter w/Cruise Control, Lower; 63.00" Cable	CA-3002
1983-84	V8 5.0L 305ci	H	4 Spd. MT w/innerconnector Lower; 20.00" Cable	CA-3008
1983-84	V8 5.0L 305ci	H	4WD; 100.00" Cable	CA-3003
1983-84	V8 5.0L 305ci	H	TH700-R4 Auto. Trans., or w/4 Spd. MT Upper; 61.00" Cable	CA-3005
1983-84	V8 5.0L 305ci	H	THM-400 Auto. Trans.; 80.00" Cable	CA-3001
1977	V8 5.0L 305ci	U	2WD w/Cruise Lower; 63.00" Cable	CA-3002
1977	V8 5.0L 305ci	U	4WD w/Cruise, Lower; 83.00" Cable	CA-3004
1977	V8 5.0L 305ci	U	w/Cruise Control, Upper; 41.00" Cable	CA-3009
1977	V8 5.0L 305ci	U	w/o Cruise Control; 100.00" Cable	CA-3003
1978-79	V8 5.0L 305ci	U	3 Spd. MT w/o Cruise; 80.00" Cable	CA-3001
1978-79	V8 5.0L 305ci	U	4 Spd. MT; 61.00" Cable	CA-3005
1978-79	V8 5.0L 305ci	U	AT Upper; 41.00" Cable	CA-3009
1978-79	V8 5.0L 305ci	U	AT w/Catalytic Converter Lower	CA-3006
1978-79	V8 5.0L 305ci	U	AT w/Catalytic Converter w/Cruise Upper; 41.00" Cable	CA-3009
1978-79	V8 5.0L 305ci	U	AT w/Cruise Control, Lower; 83.00" Cable	CA-3004
1978-79	V8 5.0L 305ci	U	AT w/o Catalytic Converter w/Cruise Lower; 63.00" Cable	CA-3002
1978-79	V8 5.0L 305ci	U	AT w/o Cruise, w/Single Exhaust w/TH350; 80.00" Cable	CA-3001
1978-79	V8 5.0L 305ci	U	MT w/o Cruise Control, AT w/o Cruise w/Dual Exhaust, AT w/o Cruise w/single Exhaust w/TH400"; 100.00" Cable	CA-3003
1977	V8 5.7L 350ci	L	2WD w/Cruise Lower; 63.00" Cable	CA-3002
1977	V8 5.7L 350ci	L	4WD w/Cruise, Lower; 83.00" Cable	CA-3004
1977	V8 5.7L 350ci	L	w/Cruise Control, Upper; 41.00" Cable	CA-3009
1977	V8 5.7L 350ci	L	w/o Cruise Control; 100.00" Cable	CA-3003
1980	V8 5.7L 350ci	L	4 Spd. w/o Cruise Upper; 61.00" Cable	CA-3005
1980	V8 5.7L 350ci	L	All to 80" Cable; 83.00" Cable	CA-3004
1980	V8 5.7L 350ci	L	AT w/Cruise Control, Upper; 41.00" Cable	CA-3009
1980	V8 5.7L 350ci	L	AT w/o Cruise Control, MT; 100.00" Cable	CA-3003
1980	V8 5.7L 350ci	L	exc. Cruise Control; 80.00" Cable	CA-3001
1980	V8 5.7L 350ci	L	w/Catalic Converter w/Cruise Control, Lower	CA-3006

# SPEEDOMETER CABLES

Year	Engine	Vin	Remark	Part
<b>GMC (con't)</b>				
<b>JIMMY (con't)</b>				
1980	V8 5.7L 350ci	L	w/o Catalic Converter w/Cruise Control, Lower; 63.00" Cable	CA-3002
1982	V8 5.7L 350ci	L	3 Spd. AT 1 pc. Cable, or MT w/o Cruise; 80.00" Cable	CA-3001
1982	V8 5.7L 350ci	L	4 Spd. AT w/innerconnector, Upper; 61.00" Cable	CA-3005
1982	V8 5.7L 350ci	L	All to 80" Cable; 80.00" Cable	CA-3001
1982	V8 5.7L 350ci	L	All To 92" Cable; 100.00" Cable	CA-3003
1982	V8 5.7L 350ci	L	AT w/Cruise Control, Intermediate	CA-3006
1982	V8 5.7L 350ci	L	MT w/Cruise Control, Lower; 63.00" Cable	CA-3002
1982	V8 5.7L 350ci	L	To 75" Cable; 83.00" Cable	CA-3004
1978-79	V8 5.7L 350ci	L	3 Spd. MT w/o Cruise; 80.00" Cable	CA-3001
1978-79	V8 5.7L 350ci	L	4 Spd. MT; 61.00" Cable	CA-3005
1978-79	V8 5.7L 350ci	L	AT Upper; 41.00" Cable	CA-3009
1978-79	V8 5.7L 350ci	L	AT w/Catalytic Converter Lower	CA-3006
1978-79	V8 5.7L 350ci	L	AT w/Catalytic Converter w/Cruise Upper; 41.00" Cable	CA-3009
1978-79	V8 5.7L 350ci	L	AT w/o Catalytic Converter w/Cruise Lower; 63.00" Cable	CA-3002
1978-79	V8 5.7L 350ci	L	AT w/o Cruise, w/Single Exhaust w/TH350; 80.00" Cable	CA-3001
1978-79	V8 5.7L 350ci	L	MT w/o Cruise Control, AT w/o Cruise w/Dual Exhaust, AT w/o Cruise w/single Exhaust w/TH400"; 100.00" Cable	CA-3003
1983-84	V8 5.7L 350ci	L	4 Spd. MT w/innerconnector Lower; 20.00" Cable	CA-3008
1983-84	V8 5.7L 350ci	L	4WD; 100.00" Cable	CA-3003
1983-84	V8 5.7L 350ci	L	TH700-R4 Auto. Trans., or w/4 Spd. MT Upper; 61.00" Cable	CA-3005
1983-84	V8 5.7L 350ci	L	THM-400 Auto. Trans.; 80.00" Cable	CA-3001
1976	V8 5.7L 350ci	L,V	AT THM w/Cruise Lower; 83.00" Cable	CA-3004
1976	V8 5.7L 350ci	L,V	AT w/o Cruise Control; 80.00" Cable	CA-3001
1976	V8 5.7L 350ci	L,V	MT 1 pc. Cable; 100.00" Cable	CA-3003
1976-79	V8 5.7L 350ci	L,V	AT w/Cruise Control, Lower; 83.00" Cable	CA-3004
1975-76	V8 5.7L 350ci	L,V,Y	4 Spd. MT Lower; 40.00" Cable	CA-3033
1975-76	V8 5.7L 350ci	L,V,Y	AT THM w/Cruise Upper, OR 4 Spd. MT Upper; 41.00" Cable	CA-3009
1975-76	V8 5.7L 350ci	L,V,Y	AT THM w/o Cruise, 3 Spd. MT w/o Cruise; 80.00" Cable	CA-3001
1975-76	V8 5.7L 350ci	L,V,Y	AT w/Cruise Upper, 4 Spd. MT Upper; 41.00" Cable	CA-3009
1975	V8 5.7L 350ci	V,Y	3 Spd. MT	CA-3016
1975	V8 5.7L 350ci	V,Y	AT w/o Cruise Control; 100.00" Cable	CA-3003
1975	V8 5.7L 350ci	V,Y	AT THM w/Cruise Lower; 63.00" Cable	CA-3002
1973-74	V8 5.7L 350ci	V,Y	3 & 4 Spd. MT, or THM AT w/o Cruise; 80.00" Cable	CA-3001
1973-74	V8 5.7L 350ci	V,Y	4 Spd. MT 1 pc. Cable 84" to 100"; 100.00" Cable	CA-3003
1973-74	V8 5.7L 350ci	V,Y	4 Spd. MT 2 pc. Cable Lower; 41.00" Cable	CA-3009
1973-74	V8 5.7L 350ci	V,Y	4 Spd. MT 2 pc. Cable Upper; 61.00" Cable	CA-3005
1973-74	V8 5.7L 350ci	V,Y	AT w/Cruise Control, Upper	CA-3031
1973-74	V8 5.7L 350ci	V,Y	AT, w/3 & 4 Spd. MT 1pc. Cable 76" to 80"; 80.00" Cable	CA-3001
1973-75	V8 5.7L 350ci	V,Y	AT w/Cruise Control, Lower; 63.00" Cable	CA-3002
1982	V8 6.2L 379ci	C	3 Spd. AT 1 pc. Cable, or MT w/o Cruise; 80.00" Cable	CA-3001
1982	V8 6.2L 379ci	C	4 Spd. AT w/innerconnector, Upper; 61.00" Cable	CA-3005
1982	V8 6.2L 379ci	C	All to 80" Cable; 80.00" Cable	CA-3001
1982	V8 6.2L 379ci	C	All To 92" Cable; 100.00" Cable	CA-3003
1982	V8 6.2L 379ci	C	AT w/Cruise Control, Intermediate	CA-3006
1982	V8 6.2L 379ci	C	MT w/Cruise Control, Lower; 63.00" Cable	CA-3002
1982	V8 6.2L 379ci	C	To 75" Cable; 83.00" Cable	CA-3004
1983-84	V8 6.2L 379ci	C	4 Spd. MT w/innerconnector Lower; 20.00" Cable	CA-3008
1983-84	V8 6.2L 379ci	C	4WD; 100.00" Cable	CA-3003
1983-84	V8 6.2L 379ci	C	TH700-R4 Auto. Trans., or w/4 Spd. MT Upper; 61.00" Cable	CA-3005
1983-84	V8 6.2L 379ci	C	THM-400 Auto. Trans.; 80.00" Cable	CA-3001
1975	V8 6.6L 400ci	M	3 Spd. MT	CA-3016
1975	V8 6.6L 400ci	M	4 Spd. MT Lower; 40.00" Cable	CA-3033
1975	V8 6.6L 400ci	M	AT THM w/Cruise Lower; 63.00" Cable	CA-3002
1975	V8 6.6L 400ci	M	AT THM w/Cruise Upper, OR 4 Spd. MT Upper; 41.00" Cable	CA-3009
1975	V8 6.6L 400ci	M	AT THM w/o Cruise, 3 Spd. MT w/o Cruise; 80.00" Cable	CA-3001
1975	V8 6.6L 400ci	M	AT w/Cruise Control, Lower; 63.00" Cable	CA-3002
1975	V8 6.6L 400ci	M	AT w/Cruise Upper, 4 Spd. MT Upper; 41.00" Cable	CA-3009
1975	V8 6.6L 400ci	M	AT w/o Cruise Control; 100.00" Cable	CA-3003
1977	V8 6.6L 400ci	R	2WD w/Cruise Lower; 63.00" Cable	CA-3002
1977	V8 6.6L 400ci	R	4WD w/Cruise, Lower; 83.00" Cable	CA-3004
1977	V8 6.6L 400ci	R	w/Cruise Control, Upper; 41.00" Cable	CA-3009
1977	V8 6.6L 400ci	R	w/o Cruise Control; 100.00" Cable	CA-3003

# SPEEDOMETER CABLES

Year	Engine	Vin	Remark	Part
<b>GMC (con't)</b>				
<b>JIMMY (con't)</b>				
1978-79	V8 6.6L 400ci	R	3 Spd. MT w/o Cruise; 80.00" Cable	CA-3001
1978-79	V8 6.6L 400ci	R	4 Spd. MT; 61.00" Cable	CA-3005
1978-79	V8 6.6L 400ci	R	AT Upper; 41.00" Cable	CA-3009
1978-79	V8 6.6L 400ci	R	AT w/Catalytic Converter Lower	CA-3006
1978-79	V8 6.6L 400ci	R	AT w/Catalytic Converter w/Cruise Upper; 41.00" Cable	CA-3009
1978-79	V8 6.6L 400ci	R	AT w/Cruise Control, Lower; 83.00" Cable	CA-3004
1978-79	V8 6.6L 400ci	R	AT w/o Catalytic Converter w/Cruise Lower; 63.00" Cable	CA-3002
1978-79	V8 6.6L 400ci	R	AT w/o Cruise, w/Single Exhaust w/TH350; 80.00" Cable	CA-3001
1978-79	V8 6.6L 400ci	R	MT w/o Cruise Control, AT w/o Cruise w/Dual Exhaust, AT w/o Cruise w/single Exhaust w/TH400"; 100.00" Cable	CA-3003
1976	V8 6.6L 400ci	U	4 Spd. MT Lower; 40.00" Cable	CA-3033
1976	V8 6.6L 400ci	U	AT THM w/Cruise Lower; 83.00" Cable	CA-3004
1976	V8 6.6L 400ci	U	AT THM w/Cruise Upper, OR 4 Spd. MT Upper; 41.00" Cable	CA-3009
1976	V8 6.6L 400ci	U	AT THM w/o Cruise, 3 Spd. MT w/o Cruise; 80.00" Cable	CA-3001
1976	V8 6.6L 400ci	U	AT w/Cruise Control, Lower; 83.00" Cable	CA-3004
1976	V8 6.6L 400ci	U	AT w/Cruise Upper, 4 Spd. MT Upper; 41.00" Cable	CA-3009
1976	V8 6.6L 400ci	U	AT w/o Cruise Control; 80.00" Cable	CA-3001
1976	V8 6.6L 400ci	U	MT 1 pc. Cable; 100.00" Cable	CA-3003
1976	V8 7.4L 454ci	Y	4 Spd. MT Lower; 40.00" Cable	CA-3033
1976	V8 7.4L 454ci	Y	AT THM w/Cruise Lower; 83.00" Cable	CA-3004
1976	V8 7.4L 454ci	Y	AT THM w/Cruise Upper, OR 4 Spd. MT Upper; 41.00" Cable	CA-3009
1976	V8 7.4L 454ci	Y	AT THM w/o Cruise, 3 Spd. MT w/o Cruise; 80.00" Cable	CA-3001
1976	V8 7.4L 454ci	Y	AT w/Cruise Control, Lower; 83.00" Cable	CA-3004
1976	V8 7.4L 454ci	Y	AT w/Cruise Upper, 4 Spd. MT Upper; 41.00" Cable	CA-3009
1976	V8 7.4L 454ci	Y	AT w/o Cruise Control; 80.00" Cable	CA-3001
1976	V8 7.4L 454ci	Y	MT 1 pc. Cable; 100.00" Cable	CA-3003
1973	V8 7.4L 454ci	Z	3 & 4 Spd. MT, or THM AT w/o Cruise; 80.00" Cable	CA-3001
1973	V8 7.4L 454ci	Z	4 Spd. MT 1 pc. Cable 84" to 100"; 100.00" Cable	CA-3003
1973	V8 7.4L 454ci	Z	4 Spd. MT 2 pc. Cable Lower; 41.00" Cable	CA-3009
1973	V8 7.4L 454ci	Z	4 Spd. MT 2 pc. Cable Upper; 61.00" Cable	CA-3005
1973	V8 7.4L 454ci	Z	AT w/Cruise Control, Lower; 63.00" Cable	CA-3002
1973	V8 7.4L 454ci	Z	AT w/Cruise Control, Upper	CA-3031
1973	V8 7.4L 454ci	Z	AT, w/3 & 4 Spd. MT 1pc. Cable 76" to 80"; 80.00" Cable	CA-3001
<b>K15</b>				
1968-69	L6 3.8L 230ci	S	w/Powerglide to 78"; 80.00" Cable	CA-3012
1968-69	L6 3.8L 230ci	S	w/THM AT, w/3 & 4 Spd. MT to 60"; 63.00" Cable	CA-3002
1968-69	L6 3.8L 230ci	S	w/THM AT, w/3 & 4 Spd. MT to 80"; 83.00" Cable	CA-3004
1968-69	L6 3.8L 230ci	S	w/THM AT, w/Powerglide, w/3 & 4 Spd. MT to 120"	CA-3038
1968-69	L6 3.8L 230ci	S	w/THM AT, w/Powerglide, w/3 & 4 Spd. MT to 95"	CA-3016
1967	L6 3.8L 230ci		w/Powerglide to 78"; 80.00" Cable	CA-3012
1967	L6 3.8L 230ci		w/THM AT, w/3 & 4 Spd. MT to 60"; 63.00" Cable	CA-3002
1967	L6 3.8L 230ci		w/THM AT, w/3 & 4 Spd. MT to 80"; 83.00" Cable	CA-3004
1967	L6 3.8L 230ci		w/THM AT, w/Powerglide, w/3 & 4 Spd. MT to 120"	CA-3038
1967	L6 3.8L 230ci		w/THM AT, w/Powerglide, w/3 & 4 Spd. MT to 95"	CA-3016
1971	L6 4.1L 250ci	C,L	w/THM AT to 120" long cable	CA-3038
1971	L6 4.1L 250ci	C,L	w/THM AT w/40" to 56" long Cable; 63.00" Cable	CA-3002
1971	L6 4.1L 250ci	C,L	w/THM AT w/60" to 76" long Cable; 83.00" Cable	CA-3004
1971	L6 4.1L 250ci	C,L	w/THM AT w/76" to 84" long cable	CA-3016
1972	L6 4.1L 250ci	D	3 & 4 Spd. MT; 80.00" Cable	CA-3001
1972	L6 4.1L 250ci	D	w/THM AT to 120" long cable	CA-3038
1972	L6 4.1L 250ci	D	w/THM AT w/40" to 56" long Cable; 63.00" Cable	CA-3002
1972	L6 4.1L 250ci	D	w/THM AT w/60" to 76" long Cable; 83.00" Cable	CA-3004
1972	L6 4.1L 250ci	D	w/THM AT w/76" to 84" long cable	CA-3016
1977	L6 4.1L 250ci	D	w/Cruise Control, Lower; 83.00" Cable	CA-3004
1977	L6 4.1L 250ci	D	w/Cruise Control, Upper; 41.00" Cable	CA-3009
1977	L6 4.1L 250ci	D	w/o Cruise Control; 100.00" Cable	CA-3003
1978	L6 4.1L 250ci	D	AT w/o Cruise, w/Single Exhaust w/TH350; 80.00" Cable	CA-3001
1979	L6 4.1L 250ci	D	AT w/o Cruise, w/Single Exhaust w/TH350; 80.00" Cable	CA-3001
1980	L6 4.1L 250ci	D	All to 80" Cable; 83.00" Cable	CA-3004
1980	L6 4.1L 250ci	D	AT w/Cruise Control, Upper; 41.00" Cable	CA-3009
1980	L6 4.1L 250ci	D	AT w/o Cruise Control, MT; 100.00" Cable	CA-3003
1981	L6 4.1L 250ci	D	w/Dual Exhaust w/o Cruise; 80.00" Cable	CA-3001



# SPEEDOMETER CABLES

Year	Engine	Vin	Remark	Part
<b>GMC (con't)</b>				
<b>K15 (con't)</b>				
1981	L6 4.1L 250ci	D	w/Single Exhaust; 100.00" Cable	CA-3003
1982	L6 4.1L 250ci	D	All to 80" Cable; 80.00" Cable	CA-3001
1982	L6 4.1L 250ci	D	All To 92" Cable; 100.00" Cable	CA-3003
1982	L6 4.1L 250ci	D	To 75" Cable; 83.00" Cable	CA-3004
1978-79	L6 4.1L 250ci	D	AT Upper; 41.00" Cable	CA-3009
1978-79	L6 4.1L 250ci	D	MT w/o Cruise Control, AT w/o Cruise w/Dual Exhaust, AT w/o Cruise w/single Exhaust w/TH400"; 100.00" Cable	CA-3003
1978-79	L6 4.1L 250ci	D	AT w/Cruise Control, Lower; 83.00" Cable	CA-3004
1983-84	L6 4.1L 250ci	D	100.00" Cable	CA-3003
1971	L6 4.1L 250ci	L	3 & 4 Spd. MT; 80.00" Cable	CA-3001
1970	L6 4.1L 250ci	N	3 & 4 Spd. MT; 80.00" Cable	CA-3001
1970	L6 4.1L 250ci	N	w/THM AT to 120" long cable	CA-3038
1970	L6 4.1L 250ci	N	w/THM AT w/40" to 56" long Cable; 63.00" Cable	CA-3002
1970	L6 4.1L 250ci	N	w/THM AT w/60" to 76" long Cable; 83.00" Cable	CA-3004
1970	L6 4.1L 250ci	N	w/THM AT w/76" to 84" long cable	CA-3016
1975	L6 4.1L 250ci	Q	3 Spd. MT; 80.00" Cable	CA-3001
1975	L6 4.1L 250ci	Q	4 Spd. MT Lower; 40.00" Cable	CA-3033
1975	L6 4.1L 250ci	Q	AT w/Cruise Control, Lower; 63.00" Cable	CA-3002
1975	L6 4.1L 250ci	Q	AT w/Cruise Upper, 4 Spd. MT Upper; 41.00" Cable	CA-3009
1973-74	L6 4.1L 250ci	Q	80.00" Cable	CA-3001
1967	L6 4.1L 250ci		w/Powerglide to 78"; 80.00" Cable	CA-3012
1967	L6 4.1L 250ci		w/THM AT, w/3 & 4 Spd. MT to 60"; 63.00" Cable	CA-3002
1967	L6 4.1L 250ci		w/THM AT, w/3 & 4 Spd. MT to 80"; 83.00" Cable	CA-3004
1967	L6 4.1L 250ci		w/THM AT, w/Powerglide, w/3 & 4 Spd. MT to 120"	CA-3038
1967	L6 4.1L 250ci		w/THM AT, w/Powerglide, w/3 & 4 Spd. MT to 95"	CA-3016
1975	L6 4.8L 292ci	T	3 Spd. MT; 80.00" Cable	CA-3001
1975	L6 4.8L 292ci	T	AT w/Cruise Control, Lower; 63.00" Cable	CA-3002
1976	L6 4.8L 292ci	T	AT w/Cruise Control, Lower; 83.00" Cable	CA-3004
1976	L6 4.8L 292ci	T	AT w/o Cruise Control; 80.00" Cable	CA-3001
1976	L6 4.8L 292ci	T	MT 1 pc. Cable; 100.00" Cable	CA-3003
1979	L6 4.8L 292ci	T	AT Upper; 41.00" Cable	CA-3009
1979	L6 4.8L 292ci	T	AT w/Cruise Control, Lower; 83.00" Cable	CA-3004
1979	L6 4.8L 292ci	T	AT w/o Cruise, w/Single Exhaust w/TH350; 80.00" Cable	CA-3001
1979	L6 4.8L 292ci	T	MT w/o Cruise Control, AT w/o Cruise w/Dual Exhaust, AT w/o Cruise w/single Exhaust w/TH400"; 100.00" Cable	CA-3003
1980	L6 4.8L 292ci	T	All to 80" Cable; 83.00" Cable	CA-3004
1980	L6 4.8L 292ci	T	AT w/Cruise Control, Upper; 41.00" Cable	CA-3009
1980	L6 4.8L 292ci	T	AT w/o Cruise Control, MT; 100.00" Cable	CA-3003
1975-76	L6 4.8L 292ci	T	4 Spd. MT Lower; 40.00" Cable	CA-3033
1975-76	L6 4.8L 292ci	T	AT w/Cruise Upper, 4 Spd. MT Upper; 41.00" Cable	CA-3009
1967	L6 4.8L 292ci		w/Powerglide to 78"; 80.00" Cable	CA-3012
1967	L6 4.8L 292ci		w/THM AT, w/3 & 4 Spd. MT to 60"; 63.00" Cable	CA-3002
1967	L6 4.8L 292ci		w/THM AT, w/3 & 4 Spd. MT to 80"; 83.00" Cable	CA-3004
1967	L6 4.8L 292ci		w/THM AT, w/Powerglide, w/3 & 4 Spd. MT to 120"	CA-3038
1967	L6 4.8L 292ci		w/THM AT, w/Powerglide, w/3 & 4 Spd. MT to 95"	CA-3016
1967	V8 4.6L 283ci		w/Powerglide to 78"; 80.00" Cable	CA-3012
1967	V8 4.6L 283ci		w/THM AT, w/3 & 4 Spd. MT to 60"; 63.00" Cable	CA-3002
1967	V8 4.6L 283ci		w/THM AT, w/3 & 4 Spd. MT to 80"; 83.00" Cable	CA-3004
1967	V8 4.6L 283ci		w/THM AT, w/Powerglide, w/3 & 4 Spd. MT to 120"	CA-3038
1967	V8 4.6L 283ci		w/THM AT, w/Powerglide, w/3 & 4 Spd. MT to 95"	CA-3016
1981	V8 5.0L 305ci	H	w/Dual Exhaust w/o Cruise; 80.00" Cable	CA-3001
1981	V8 5.0L 305ci	H	w/Single Exhaust; 100.00" Cable	CA-3003
1982	V8 5.0L 305ci	H	All to 80" Cable; 80.00" Cable	CA-3001
1982	V8 5.0L 305ci	H	All To 92" Cable; 100.00" Cable	CA-3003
1982	V8 5.0L 305ci	H	To 75" Cable; 83.00" Cable	CA-3004
1983-84	V8 5.0L 305ci	H	100.00" Cable	CA-3003
1976	V8 5.0L 305ci	Q	4 Spd. MT Lower; 40.00" Cable	CA-3033
1976	V8 5.0L 305ci	Q	AT w/Cruise Control, Lower; 83.00" Cable	CA-3004
1976	V8 5.0L 305ci	Q	AT w/Cruise Upper, 4 Spd. MT Upper; 41.00" Cable	CA-3009
1976	V8 5.0L 305ci	Q	AT w/o Cruise Control; 80.00" Cable	CA-3001
1976	V8 5.0L 305ci	Q	MT 1 pc. Cable; 100.00" Cable	CA-3003
1977	V8 5.0L 305ci	U	w/Cruise Control, Lower; 83.00" Cable	CA-3004

# SPEEDOMETER CABLES

Year	Engine	Vin	Remark	Part
<b>GMC (con't)</b>				
<b>K15 (con't)</b>				
1977	V8 5.0L 305ci	U	w/Cruise Control, Upper; 41.00" Cable	CA-3009
1977	V8 5.0L 305ci	U	w/o Cruise Control; 100.00" Cable	CA-3003
1978-79	V8 5.0L 305ci	U	AT Upper; 41.00" Cable	CA-3009
1978-79	V8 5.0L 305ci	U	AT w/o Cruise, w/Single Exhaust w/TH350; 80.00" Cable	CA-3001
1978-79	V8 5.0L 305ci	U	MT w/o Cruise Control, AT w/o Cruise w/Dual Exhaust, AT w/o Cruise w/single Exhaust w/TH400"; 100.00" Cable	CA-3003
1978-79	V8 5.0L 305ci	U	AT w/Cruise Control, Lower; 83.00" Cable	CA-3004
1968-69	V8 5.0L 307ci	E	w/Powerglide to 78"; 80.00" Cable	CA-3012
1968-69	V8 5.0L 307ci	E	w/THM AT, w/3 & 4 Spd. MT to 60"; 63.00" Cable	CA-3002
1968-69	V8 5.0L 307ci	E	w/THM AT, w/3 & 4 Spd. MT to 80"; 83.00" Cable	CA-3004
1968-69	V8 5.0L 307ci	E	w/THM AT, w/Powerglide, w/3 & 4 Spd. MT to 120"	CA-3038
1968-69	V8 5.0L 307ci	E	w/THM AT, w/Powerglide, w/3 & 4 Spd. MT to 95"	CA-3016
1968	V8 5.4L 327ci	E	w/Powerglide to 78"; 80.00" Cable	CA-3012
1968	V8 5.4L 327ci	E	w/THM AT, w/3 & 4 Spd. MT to 60"; 63.00" Cable	CA-3002
1968	V8 5.4L 327ci	E	w/THM AT, w/3 & 4 Spd. MT to 80"; 83.00" Cable	CA-3004
1968	V8 5.4L 327ci	E	w/THM AT, w/Powerglide, w/3 & 4 Spd. MT to 120"	CA-3038
1968	V8 5.4L 327ci	E	w/THM AT, w/Powerglide, w/3 & 4 Spd. MT to 95"	CA-3016
1967	V8 5.4L 327ci		w/Powerglide to 78"; 80.00" Cable	CA-3012
1967	V8 5.4L 327ci		w/THM AT, w/3 & 4 Spd. MT to 60"; 63.00" Cable	CA-3002
1967	V8 5.4L 327ci		w/THM AT, w/3 & 4 Spd. MT to 80"; 83.00" Cable	CA-3004
1967	V8 5.4L 327ci		w/THM AT, w/Powerglide, w/3 & 4 Spd. MT to 120"	CA-3038
1967	V8 5.4L 327ci		w/THM AT, w/Powerglide, w/3 & 4 Spd. MT to 95"	CA-3016
1969	V8 5.7L 350ci	E	w/Powerglide to 78"; 80.00" Cable	CA-3012
1969	V8 5.7L 350ci	E	w/THM AT, w/3 & 4 Spd. MT to 60"; 63.00" Cable	CA-3002
1969	V8 5.7L 350ci	E	w/THM AT, w/3 & 4 Spd. MT to 80"; 83.00" Cable	CA-3004
1969	V8 5.7L 350ci	E	w/THM AT, w/Powerglide, w/3 & 4 Spd. MT to 120"	CA-3038
1969	V8 5.7L 350ci	E	w/THM AT, w/Powerglide, w/3 & 4 Spd. MT to 95"	CA-3016
1970-72	V8 5.7L 350ci	E	3 & 4 Spd. MT; 80.00" Cable	CA-3001
1970-72	V8 5.7L 350ci	E	w/THM AT to 120" long cable	CA-3038
1970-72	V8 5.7L 350ci	E	w/THM AT w/40" to 56" long Cable; 63.00" Cable	CA-3002
1970-72	V8 5.7L 350ci	E	w/THM AT w/60" to 76" long Cable; 83.00" Cable	CA-3004
1970-72	V8 5.7L 350ci	E	w/THM AT w/76" to 84" long cable	CA-3016
1977	V8 5.7L 350ci	L	w/Cruise Control, Lower; 83.00" Cable	CA-3004
1977	V8 5.7L 350ci	L	w/Cruise Control, Upper; 41.00" Cable	CA-3009
1977	V8 5.7L 350ci	L	w/o Cruise Control; 100.00" Cable	CA-3003
1981	V8 5.7L 350ci	L	w/Dual Exhaust w/o Cruise; 80.00" Cable	CA-3001
1981	V8 5.7L 350ci	L	w/Single Exhaust; 100.00" Cable	CA-3003
1982	V8 5.7L 350ci	L	All to 80" Cable; 80.00" Cable	CA-3001
1982	V8 5.7L 350ci	L	All To 92" Cable; 100.00" Cable	CA-3003
1982	V8 5.7L 350ci	L	To 75" Cable; 83.00" Cable	CA-3004
1978-79	V8 5.7L 350ci	L	AT Upper; 41.00" Cable	CA-3009
1978-79	V8 5.7L 350ci	L	AT w/o Cruise, w/Single Exhaust w/TH350; 80.00" Cable	CA-3001
1978-79	V8 5.7L 350ci	L	MT w/o Cruise Control, AT w/o Cruise w/Dual Exhaust, AT w/o Cruise w/single Exhaust w/TH400"; 100.00" Cable	CA-3003
1983-84	V8 5.7L 350ci	L	100.00" Cable	CA-3003
1980	V8 5.7L 350ci	L,M	All to 80" Cable; 83.00" Cable	CA-3004
1980	V8 5.7L 350ci	L,M	AT w/o Cruise Control, MT; 100.00" Cable	CA-3003
1980	V8 5.7L 350ci	L,M	AT w/Cruise Control, Upper; 41.00" Cable	CA-3009
1976	V8 5.7L 350ci	L,V	MT 1 pc. Cable; 100.00" Cable	CA-3003
1976	V8 5.7L 350ci	L,V	AT w/o Cruise Control; 80.00" Cable	CA-3001
1976-79	V8 5.7L 350ci	L,V	AT w/Cruise Control, Lower; 83.00" Cable	CA-3004
1975-76	V8 5.7L 350ci	L,V,Y	4 Spd. MT Lower; 40.00" Cable	CA-3033
1975-76	V8 5.7L 350ci	L,V,Y	AT w/Cruise Upper, 4 Spd. MT Upper; 41.00" Cable	CA-3009
1975	V8 5.7L 350ci	V,Y	3 Spd. MT	CA-3016
1975	V8 5.7L 350ci	V,Y	AT w/o Cruise Control; 100.00" Cable	CA-3003
1975	V8 5.7L 350ci	V,Y	AT w/Cruise Control, Lower; 63.00" Cable	CA-3002
1973-74	V8 5.7L 350ci	V,Y	4 Spd. MT 1 pc. Cable 84" to 100"; 100.00" Cable	CA-3003
1973-74	V8 5.7L 350ci	V,Y	4 Spd. MT 2 pc. Cable Lower; 41.00" Cable	CA-3009
1973-74	V8 5.7L 350ci	V,Y	4 Spd. MT 2 pc. Cable Upper; 61.00" Cable	CA-3005
1973-74	V8 5.7L 350ci	V,Y	AT, w/3 & 4 Spd. MT 1pc. Cable 76" to 80"; 80.00" Cable	CA-3001
1982	V8 6.2L 379ci	C	All to 80" Cable; 80.00" Cable	CA-3001
1982	V8 6.2L 379ci	C	All To 92" Cable; 100.00" Cable	CA-3003

# SPEEDOMETER CABLES

Year	Engine	Vin	Remark	Part
<b>GMC (con't)</b>				
<b>K15 (con't)</b>				
1982	V8 6.2L 379ci	C	To 75" Cable; 83.00" Cable	CA-3004
1983-84	V8 6.2L 379ci	C	100.00" Cable	CA-3003
1968-69	V8 6.5L 396ci	E	w/Powerglide to 78"; 80.00" Cable	CA-3012
1968-69	V8 6.5L 396ci	E	w/THM AT, w/3 & 4 Spd. MT to 60"; 63.00" Cable	CA-3002
1968-69	V8 6.5L 396ci	E	w/THM AT, w/3 & 4 Spd. MT to 80"; 83.00" Cable	CA-3004
1968-69	V8 6.5L 396ci	E	w/THM AT, w/Powerglide, w/3 & 4 Spd. MT to 120"	CA-3038
1968-69	V8 6.5L 396ci	E	w/THM AT, w/Powerglide, w/3 & 4 Spd. MT to 95"	CA-3016
1975	V8 6.6L 400ci	M	3 Spd. MT	CA-3016
1975	V8 6.6L 400ci	M	4 Spd. MT Lower; 40.00" Cable	CA-3033
1975	V8 6.6L 400ci	M	AT w/Cruise Control, Lower; 63.00" Cable	CA-3002
1975	V8 6.6L 400ci	M	AT w/Cruise Upper, 4 Spd. MT Upper; 41.00" Cable	CA-3009
1975	V8 6.6L 400ci	M	AT w/o Cruise Control; 100.00" Cable	CA-3003
1977	V8 6.6L 400ci	R	w/Cruise Control, Lower; 83.00" Cable	CA-3004
1977	V8 6.6L 400ci	R	w/Cruise Control, Upper; 41.00" Cable	CA-3009
1977	V8 6.6L 400ci	R	w/o Cruise Control; 100.00" Cable	CA-3003
1978-79	V8 6.6L 400ci	R	AT Upper; 41.00" Cable	CA-3009
1978-79	V8 6.6L 400ci	R	AT w/o Cruise, w/Single Exhaust w/TH350; 80.00" Cable	CA-3001
1978-79	V8 6.6L 400ci	R	MT w/o Cruise Control, AT w/o Cruise w/Dual Exhaust, AT w/o Cruise w/single Exhaust w/TH400"; 100.00" Cable	CA-3003
1978-79	V8 6.6L 400ci	R	AT w/Cruise Control, Lower; 83.00" Cable	CA-3004
1976	V8 6.6L 400ci	U	4 Spd. MT Lower; 40.00" Cable	CA-3033
1976	V8 6.6L 400ci	U	AT w/Cruise Control, Lower; 83.00" Cable	CA-3004
1976	V8 6.6L 400ci	U	AT w/Cruise Upper, 4 Spd. MT Upper; 41.00" Cable	CA-3009
1976	V8 6.6L 400ci	U	AT w/o Cruise Control; 80.00" Cable	CA-3001
1976	V8 6.6L 400ci	U	MT 1 pc. Cable; 100.00" Cable	CA-3003
1980	V8 6.6L 400ci	X	All to 80" Cable; 83.00" Cable	CA-3004
1980	V8 6.6L 400ci	X	AT w/Cruise Control, Upper; 41.00" Cable	CA-3009
1980	V8 6.6L 400ci	X	AT w/o Cruise Control, MT; 100.00" Cable	CA-3003
1979	V8 7.4L 454ci	S	AT Upper; 41.00" Cable	CA-3009
1979	V8 7.4L 454ci	S	AT w/Cruise Control, Lower; 83.00" Cable	CA-3004
1979	V8 7.4L 454ci	S	AT w/o Cruise, w/Single Exhaust w/TH350; 80.00" Cable	CA-3001
1979	V8 7.4L 454ci	S	MT w/o Cruise Control, AT w/o Cruise w/Dual Exhaust, AT w/o Cruise w/single Exhaust w/TH400"; 100.00" Cable	CA-3003
1980	V8 7.4L 454ci	S	All to 80" Cable; 83.00" Cable	CA-3004
1980	V8 7.4L 454ci	S	AT w/Cruise Control, Upper; 41.00" Cable	CA-3009
1980	V8 7.4L 454ci	S	AT w/o Cruise Control, MT; 100.00" Cable	CA-3003
1976	V8 7.4L 454ci	S,Y	4 Spd. MT Lower; 40.00" Cable	CA-3033
1976	V8 7.4L 454ci	S,Y	AT w/Cruise Control, Lower; 83.00" Cable	CA-3004
1976	V8 7.4L 454ci	S,Y	AT w/Cruise Upper, 4 Spd. MT Upper; 41.00" Cable	CA-3009
1976	V8 7.4L 454ci	S,Y	MT 1 pc. Cable; 100.00" Cable	CA-3003
1976	V8 7.4L 454ci	S,Y	AT w/o Cruise Control; 80.00" Cable	CA-3001
<b>K1500 SUBURBAN</b>				
1982	V8 5.7L 350ci	L	All to 80" Cable; 80.00" Cable	CA-3001
1982	V8 5.7L 350ci	L	All To 92" Cable; 100.00" Cable	CA-3003
1982	V8 5.7L 350ci	L	To 75" Cable; 83.00" Cable	CA-3004
<b>K25</b>				
1971	L6 4.1L 250ci	C,L	3 & 4 Spd. MT; 80.00" Cable	CA-3001
1972	L6 4.1L 250ci	D	3 & 4 Spd. MT; 80.00" Cable	CA-3001
1972	L6 4.1L 250ci	D	w/THM AT to 120" long cable	CA-3038
1972	L6 4.1L 250ci	D	w/THM AT w/40" to 56" long Cable; 63.00" Cable	CA-3002
1972	L6 4.1L 250ci	D	w/THM AT w/60" to 76" long Cable; 83.00" Cable	CA-3004
1972	L6 4.1L 250ci	D	w/THM AT w/76" to 84" long cable	CA-3016
1976	L6 4.1L 250ci	D	4 Spd. MT Lower; 40.00" Cable	CA-3033
1976	L6 4.1L 250ci	D	AT w/Cruise Upper, 4 Spd. MT Upper; 41.00" Cable	CA-3009
1976	L6 4.1L 250ci	D	AT w/o Cruise Control; 80.00" Cable	CA-3001
1976	L6 4.1L 250ci	D	MT 1 pc. Cable; 100.00" Cable	CA-3003
1978	L6 4.1L 250ci	D	AT Upper; 41.00" Cable	CA-3009
1978	L6 4.1L 250ci	D	AT w/o Cruise, w/Single Exhaust w/TH350; 80.00" Cable	CA-3001
1978	L6 4.1L 250ci	D	MT w/o Cruise Control, AT w/o Cruise w/Dual Exhaust, AT w/o Cruise w/single Exhaust w/TH400"; 100.00" Cable	CA-3003
1980	L6 4.1L 250ci	D	All to 80" Cable; 83.00" Cable	CA-3004
1980	L6 4.1L 250ci	D	AT w/Cruise Control, Upper; 41.00" Cable	CA-3009

# SPEEDOMETER CABLES

Year	Engine	Vin	Remark	Part
<b>GMC (con't)</b>				
<b>K25 (con't)</b>				
1980	L6 4.1L 250ci	D	AT w/o Cruise Control, MT; 100.00" Cable	CA-3003
1976-78	L6 4.1L 250ci	D	AT w/Cruise Control, Lower; 83.00" Cable	CA-3004
1971	L6 4.1L 250ci	L	w/THM AT to 120" long cable	CA-3038
1971	L6 4.1L 250ci	L	w/THM AT w/40" to 56" long Cable; 63.00" Cable	CA-3002
1971	L6 4.1L 250ci	L	w/THM AT w/60" to 76" long Cable; 83.00" Cable	CA-3004
1971	L6 4.1L 250ci	L	w/THM AT w/76" to 84" long cable	CA-3016
1970	L6 4.1L 250ci	N	3 & 4 Spd. MT; 80.00" Cable	CA-3001
1970	L6 4.1L 250ci	N	w/THM AT to 120" long cable	CA-3038
1970	L6 4.1L 250ci	N	w/THM AT w/40" to 56" long Cable; 63.00" Cable	CA-3002
1970	L6 4.1L 250ci	N	w/THM AT w/60" to 76" long Cable; 83.00" Cable	CA-3004
1970	L6 4.1L 250ci	N	w/THM AT w/76" to 84" long cable	CA-3016
1968-69	L6 4.1L 250ci	P	w/Powerglide to 78"; 80.00" Cable	CA-3012
1968-69	L6 4.1L 250ci	P	w/THM AT, w/3 & 4 Spd. MT to 60"; 63.00" Cable	CA-3002
1968-69	L6 4.1L 250ci	P	w/THM AT, w/3 & 4 Spd. MT to 80"; 83.00" Cable	CA-3004
1968-69	L6 4.1L 250ci	P	w/THM AT, w/Powerglide, w/3 & 4 Spd. MT to 120"	CA-3038
1968-69	L6 4.1L 250ci	P	w/THM AT, w/Powerglide, w/3 & 4 Spd. MT to 95"	CA-3016
1975	L6 4.1L 250ci	Q	3 Spd. MT; 80.00" Cable	CA-3001
1975	L6 4.1L 250ci	Q	4 Spd. MT Lower; 40.00" Cable	CA-3033
1975	L6 4.1L 250ci	Q	AT w/Cruise Control, Lower; 63.00" Cable	CA-3002
1975	L6 4.1L 250ci	Q	AT w/Cruise Upper, 4 Spd. MT Upper; 41.00" Cable	CA-3009
1973-74	L6 4.1L 250ci	Q	80.00" Cable	CA-3001
1967	L6 4.1L 250ci		w/Powerglide to 78"; 80.00" Cable	CA-3012
1967	L6 4.1L 250ci		w/THM AT, w/3 & 4 Spd. MT to 60"; 63.00" Cable	CA-3002
1967	L6 4.1L 250ci		w/THM AT, w/3 & 4 Spd. MT to 80"; 83.00" Cable	CA-3004
1967	L6 4.1L 250ci		w/THM AT, w/Powerglide, w/3 & 4 Spd. MT to 120"	CA-3038
1967	L6 4.1L 250ci		w/THM AT, w/Powerglide, w/3 & 4 Spd. MT to 95"	CA-3016
1970-72	L6 4.8L 292ci	S	3 & 4 Spd. MT; 80.00" Cable	CA-3001
1970-72	L6 4.8L 292ci	S	w/THM AT to 120" long cable	CA-3038
1970-72	L6 4.8L 292ci	S	w/THM AT w/40" to 56" long Cable; 63.00" Cable	CA-3002
1970-72	L6 4.8L 292ci	S	w/THM AT w/60" to 76" long Cable; 83.00" Cable	CA-3004
1970-72	L6 4.8L 292ci	S	w/THM AT w/76" to 84" long cable	CA-3016
1973-74	L6 4.8L 292ci	S,T	80.00" Cable	CA-3001
1975	L6 4.8L 292ci	T	3 Spd. MT; 80.00" Cable	CA-3001
1975	L6 4.8L 292ci	T	AT w/Cruise Control, Lower; 63.00" Cable	CA-3002
1976	L6 4.8L 292ci	T	AT w/o Cruise Control; 80.00" Cable	CA-3001
1976	L6 4.8L 292ci	T	MT 1 pc. Cable; 100.00" Cable	CA-3003
1977	L6 4.8L 292ci	T	w/Cruise Control, Lower; 83.00" Cable	CA-3004
1977	L6 4.8L 292ci	T	w/Cruise Control, Upper; 41.00" Cable	CA-3009
1977	L6 4.8L 292ci	T	w/o Cruise Control; 100.00" Cable	CA-3003
1980	L6 4.8L 292ci	T	All to 80" Cable; 83.00" Cable	CA-3004
1980	L6 4.8L 292ci	T	AT w/Cruise Control, Upper; 41.00" Cable	CA-3009
1980	L6 4.8L 292ci	T	AT w/o Cruise Control, MT; 100.00" Cable	CA-3003
1981	L6 4.8L 292ci	T	w/Dual Exhaust w/o Cruise; 80.00" Cable	CA-3001
1981	L6 4.8L 292ci	T	w/Single Exhaust; 100.00" Cable	CA-3003
1982	L6 4.8L 292ci	T	All to 80" Cable; 80.00" Cable	CA-3001
1982	L6 4.8L 292ci	T	All To 92" Cable; 100.00" Cable	CA-3003
1982	L6 4.8L 292ci	T	To 75" Cable; 83.00" Cable	CA-3004
1975-76	L6 4.8L 292ci	T	4 Spd. MT Lower; 40.00" Cable	CA-3033
1975-76	L6 4.8L 292ci	T	AT w/Cruise Upper, 4 Spd. MT Upper; 41.00" Cable	CA-3009
1976-79	L6 4.8L 292ci	T	AT w/Cruise Control, Lower; 83.00" Cable	CA-3004
1978-79	L6 4.8L 292ci	T	AT Upper; 41.00" Cable	CA-3009
1978-79	L6 4.8L 292ci	T	AT w/o Cruise, w/Single Exhaust w/TH350; 80.00" Cable	CA-3001
1978-79	L6 4.8L 292ci	T	MT w/o Cruise Control, AT w/o Cruise w/Dual Exhaust, AT w/o Cruise w/single Exhaust w/TH400"; 100.00" Cable	CA-3003
1983-86	L6 4.8L 292ci	T	100.00" Cable	CA-3003
1967	L6 4.8L 292ci		w/Powerglide to 78"; 80.00" Cable	CA-3012
1967	L6 4.8L 292ci		w/THM AT, w/3 & 4 Spd. MT to 60"; 63.00" Cable	CA-3002
1967	L6 4.8L 292ci		w/THM AT, w/3 & 4 Spd. MT to 80"; 83.00" Cable	CA-3004
1967	L6 4.8L 292ci		w/THM AT, w/Powerglide, w/3 & 4 Spd. MT to 120"	CA-3038
1967	L6 4.8L 292ci		w/THM AT, w/Powerglide, w/3 & 4 Spd. MT to 95"	CA-3016
1967	V8 4.6L 283ci		w/Powerglide to 78"; 80.00" Cable	CA-3012
1967	V8 4.6L 283ci		w/THM AT, w/3 & 4 Spd. MT to 60"; 63.00" Cable	CA-3002

# SPEEDOMETER CABLES

Year	Engine	Vin	Remark	Part
<b>GMC (con't)</b>				
<b>K25 (con't)</b>				
1967	V8 4.6L 283ci		w/THM AT, w/3 & 4 Spd. MT to 80"; 83.00" Cable	CA-3004
1967	V8 4.6L 283ci		w/THM AT, w/Powerglide, w/3 & 4 Spd. MT to 120"	CA-3038
1967	V8 4.6L 283ci		w/THM AT, w/Powerglide, w/3 & 4 Spd. MT to 95"	CA-3016
1977	V8 5.0L 305ci	U	w/Cruise Control, Lower; 83.00" Cable	CA-3004
1977	V8 5.0L 305ci	U	w/Cruise Control, Upper; 41.00" Cable	CA-3009
1977	V8 5.0L 305ci	U	w/o Cruise Control; 100.00" Cable	CA-3003
1978	V8 5.0L 305ci	U	AT Upper; 41.00" Cable	CA-3009
1978	V8 5.0L 305ci	U	AT w/Cruise Control, Lower; 83.00" Cable	CA-3004
1978	V8 5.0L 305ci	U	AT w/o Cruise, w/Single Exhaust w/TH350; 80.00" Cable	CA-3001
1978	V8 5.0L 305ci	U	MT w/o Cruise Control, AT w/o Cruise w/Dual Exhaust, AT w/o Cruise w/single Exhaust w/TH400"; 100.00" Cable	CA-3003
1968-69	V8 5.0L 307ci	E	w/Powerglide to 78"; 80.00" Cable	CA-3012
1968-69	V8 5.0L 307ci	E	w/THM AT, w/3 & 4 Spd. MT to 60"; 63.00" Cable	CA-3002
1968-69	V8 5.0L 307ci	E	w/THM AT, w/3 & 4 Spd. MT to 80"; 83.00" Cable	CA-3004
1968-69	V8 5.0L 307ci	E	w/THM AT, w/Powerglide, w/3 & 4 Spd. MT to 120"	CA-3038
1968-69	V8 5.0L 307ci	E	w/THM AT, w/Powerglide, w/3 & 4 Spd. MT to 95"	CA-3016
1968	V8 5.4L 327ci	E	w/Powerglide to 78"; 80.00" Cable	CA-3012
1968	V8 5.4L 327ci	E	w/THM AT, w/3 & 4 Spd. MT to 60"; 63.00" Cable	CA-3002
1968	V8 5.4L 327ci	E	w/THM AT, w/3 & 4 Spd. MT to 80"; 83.00" Cable	CA-3004
1968	V8 5.4L 327ci	E	w/THM AT, w/Powerglide, w/3 & 4 Spd. MT to 120"	CA-3038
1968	V8 5.4L 327ci	E	w/THM AT, w/Powerglide, w/3 & 4 Spd. MT to 95"	CA-3016
1967	V8 5.4L 327ci		w/Powerglide to 78"; 80.00" Cable	CA-3012
1967	V8 5.4L 327ci		w/THM AT, w/3 & 4 Spd. MT to 60"; 63.00" Cable	CA-3002
1967	V8 5.4L 327ci		w/THM AT, w/3 & 4 Spd. MT to 80"; 83.00" Cable	CA-3004
1967	V8 5.4L 327ci		w/THM AT, w/Powerglide, w/3 & 4 Spd. MT to 120"	CA-3038
1967	V8 5.4L 327ci		w/THM AT, w/Powerglide, w/3 & 4 Spd. MT to 95"	CA-3016
1969	V8 5.7L 350ci	E	w/Powerglide to 78"; 80.00" Cable	CA-3012
1969	V8 5.7L 350ci	E	w/THM AT, w/3 & 4 Spd. MT to 60"; 63.00" Cable	CA-3002
1969	V8 5.7L 350ci	E	w/THM AT, w/3 & 4 Spd. MT to 80"; 83.00" Cable	CA-3004
1969	V8 5.7L 350ci	E	w/THM AT, w/Powerglide, w/3 & 4 Spd. MT to 120"	CA-3038
1969	V8 5.7L 350ci	E	w/THM AT, w/Powerglide, w/3 & 4 Spd. MT to 95"	CA-3016
1970-72	V8 5.7L 350ci	E	3 & 4 Spd. MT; 80.00" Cable	CA-3001
1970-72	V8 5.7L 350ci	E	w/THM AT to 120" long cable	CA-3038
1970-72	V8 5.7L 350ci	E	w/THM AT w/40" to 56" long Cable; 63.00" Cable	CA-3002
1970-72	V8 5.7L 350ci	E	w/THM AT w/60" to 76" long Cable; 83.00" Cable	CA-3004
1970-72	V8 5.7L 350ci	E	w/THM AT w/76" to 84" long cable	CA-3016
1977	V8 5.7L 350ci	L	w/Cruise Control, Lower; 83.00" Cable	CA-3004
1977	V8 5.7L 350ci	L	w/Cruise Control, Upper; 41.00" Cable	CA-3009
1977	V8 5.7L 350ci	L	w/o Cruise Control; 100.00" Cable	CA-3003
1981	V8 5.7L 350ci	L	w/Dual Exhaust w/o Cruise; 80.00" Cable	CA-3001
1980	V8 5.7L 350ci	L,M	All to 80" Cable; 83.00" Cable	CA-3004
1980	V8 5.7L 350ci	L,M	AT w/o Cruise Control, MT; 100.00" Cable	CA-3003
1980	V8 5.7L 350ci	L,M	AT w/Cruise Control, Upper; 41.00" Cable	CA-3009
1981	V8 5.7L 350ci	L,M	w/Single Exhaust; 100.00" Cable	CA-3003
1982	V8 5.7L 350ci	L,M	All to 80" Cable; 80.00" Cable	CA-3001
1982	V8 5.7L 350ci	L,M	All To 92" Cable; 100.00" Cable	CA-3003
1982	V8 5.7L 350ci	L,M	To 75" Cable; 83.00" Cable	CA-3004
1978-79	V8 5.7L 350ci	L,M	AT Upper; 41.00" Cable	CA-3009
1978-79	V8 5.7L 350ci	L,M	AT w/o Cruise, w/Single Exhaust w/TH350; 80.00" Cable	CA-3001
1978-79	V8 5.7L 350ci	L,M	MT w/o Cruise Control, AT w/o Cruise w/Dual Exhaust, AT w/o Cruise w/single Exhaust w/TH400"; 100.00" Cable	CA-3003
1983-86	V8 5.7L 350ci	L,M	100.00" Cable	CA-3003
1976-79	V8 5.7L 350ci	L,M,V	AT w/Cruise Control, Lower; 83.00" Cable	CA-3004
1976	V8 5.7L 350ci	L,V	MT 1 pc. Cable; 100.00" Cable	CA-3003
1976	V8 5.7L 350ci	L,V	AT w/o Cruise Control; 80.00" Cable	CA-3001
1975-76	V8 5.7L 350ci	L,V,Y	4 Spd. MT Lower; 40.00" Cable	CA-3033
1975-76	V8 5.7L 350ci	L,V,Y	AT w/Cruise Upper, 4 Spd. MT Upper; 41.00" Cable	CA-3009
1981	V8 5.7L 350ci	M	w/Dual Exhaust w/o Cruise; 80.00" Cable	CA-3001
1975	V8 5.7L 350ci	V,Y	3 Spd. MT	CA-3016
1975	V8 5.7L 350ci	V,Y	AT w/Cruise Control, Lower; 63.00" Cable	CA-3002
1975	V8 5.7L 350ci	V,Y	AT w/o Cruise Control; 100.00" Cable	CA-3003
1973-74	V8 5.7L 350ci	V,Y	4 Spd. MT 1 pc. Cable 84" to 100"; 100.00" Cable	CA-3003

# SPEEDOMETER CABLES

Year	Engine	Vin	Remark	Part
<b>GMC (con't)</b>				
<b>K25 (con't)</b>				
1973-74	V8 5.7L 350ci	V,Y	4 Spd. MT 2 pc. Cable Lower; 41.00" Cable	CA-3009
1973-74	V8 5.7L 350ci	V,Y	4 Spd. MT 2 pc. Cable Upper; 61.00" Cable	CA-3005
1973-74	V8 5.7L 350ci	V,Y	AT, w/3 & 4 Spd. MT 1pc. Cable 76" to 80"; 80.00" Cable	CA-3001
1982	V8 6.2L 379ci	C,J	All to 80" Cable; 80.00" Cable	CA-3001
1982	V8 6.2L 379ci	C,J	All To 92" Cable; 100.00" Cable	CA-3003
1982	V8 6.2L 379ci	C,J	To 75" Cable; 83.00" Cable	CA-3004
1983-84	V8 6.2L 379ci	C,J	100.00" Cable	CA-3003
1968-69	V8 6.5L 396ci	E	w/Powerglide to 78"; 80.00" Cable	CA-3012
1968-69	V8 6.5L 396ci	E	w/THM AT, w/3 & 4 Spd. MT to 60"; 63.00" Cable	CA-3002
1968-69	V8 6.5L 396ci	E	w/THM AT, w/3 & 4 Spd. MT to 80"; 83.00" Cable	CA-3004
1968-69	V8 6.5L 396ci	E	w/THM AT, w/Powerglide, w/3 & 4 Spd. MT to 120"	CA-3038
1968-69	V8 6.5L 396ci	E	w/THM AT, w/Powerglide, w/3 & 4 Spd. MT to 95"	CA-3016
1975	V8 6.6L 400ci	M	3 Spd. MT	CA-3016
1975	V8 6.6L 400ci	M	4 Spd. MT Lower; 40.00" Cable	CA-3033
1975	V8 6.6L 400ci	M	AT w/Cruise Control, Lower; 63.00" Cable	CA-3002
1975	V8 6.6L 400ci	M	AT w/Cruise Upper, 4 Spd. MT Upper; 41.00" Cable	CA-3009
1975	V8 6.6L 400ci	M	AT w/o Cruise Control; 100.00" Cable	CA-3003
1977	V8 6.6L 400ci	R	w/Cruise Control, Lower; 83.00" Cable	CA-3004
1977	V8 6.6L 400ci	R	w/Cruise Control, Upper; 41.00" Cable	CA-3009
1977	V8 6.6L 400ci	R	w/o Cruise Control; 100.00" Cable	CA-3003
1978-79	V8 6.6L 400ci	R	AT Upper; 41.00" Cable	CA-3009
1978-79	V8 6.6L 400ci	R	AT w/o Cruise, w/Single Exhaust w/TH350; 80.00" Cable	CA-3001
1978-79	V8 6.6L 400ci	R	MT w/o Cruise Control, AT w/o Cruise w/Dual Exhaust, AT w/o Cruise w/single Exhaust w/TH400"; 100.00" Cable	CA-3003
1978-79	V8 6.6L 400ci	R	AT w/Cruise Control, Lower; 83.00" Cable	CA-3004
1976	V8 6.6L 400ci	U	4 Spd. MT Lower; 40.00" Cable	CA-3033
1976	V8 6.6L 400ci	U	AT w/Cruise Control, Lower; 83.00" Cable	CA-3004
1976	V8 6.6L 400ci	U	AT w/Cruise Upper, 4 Spd. MT Upper; 41.00" Cable	CA-3009
1976	V8 6.6L 400ci	U	AT w/o Cruise Control; 80.00" Cable	CA-3001
1976	V8 6.6L 400ci	U	MT 1 pc. Cable; 100.00" Cable	CA-3003
1980	V8 6.6L 400ci	X	All to 80" Cable; 83.00" Cable	CA-3004
1980	V8 6.6L 400ci	X	AT w/Cruise Control, Upper; 41.00" Cable	CA-3009
1980	V8 6.6L 400ci	X	AT w/o Cruise Control, MT; 100.00" Cable	CA-3003
1977	V8 7.4L 454ci	S	w/Cruise Control, Lower; 83.00" Cable	CA-3004
1977	V8 7.4L 454ci	S	w/Cruise Control, Upper; 41.00" Cable	CA-3009
1977	V8 7.4L 454ci	S	w/o Cruise Control; 100.00" Cable	CA-3003
1978	V8 7.4L 454ci	S	AT Upper; 41.00" Cable	CA-3009
1978	V8 7.4L 454ci	S	AT w/Cruise Control, Lower; 83.00" Cable	CA-3004
1978	V8 7.4L 454ci	S	AT w/o Cruise, w/Single Exhaust w/TH350; 80.00" Cable	CA-3001
1978	V8 7.4L 454ci	S	MT w/o Cruise Control, AT w/o Cruise w/Dual Exhaust, AT w/o Cruise w/single Exhaust w/TH400"; 100.00" Cable	CA-3003
1976	V8 7.4L 454ci	Y	4 Spd. MT Lower; 40.00" Cable	CA-3033
1976	V8 7.4L 454ci	Y	AT w/Cruise Control, Lower; 83.00" Cable	CA-3004
1976	V8 7.4L 454ci	Y	AT w/Cruise Upper, 4 Spd. MT Upper; 41.00" Cable	CA-3009
1976	V8 7.4L 454ci	Y	AT w/o Cruise Control; 80.00" Cable	CA-3001
1976	V8 7.4L 454ci	Y	MT 1 pc. Cable; 100.00" Cable	CA-3003
1973-74	V8 7.4L 454ci	Z	4 Spd. MT 1 pc. Cable 84" to 100"; 100.00" Cable	CA-3003
1973-74	V8 7.4L 454ci	Z	4 Spd. MT 2 pc. Cable Lower; 41.00" Cable	CA-3009
1973-74	V8 7.4L 454ci	Z	4 Spd. MT 2 pc. Cable Upper; 61.00" Cable	CA-3005
1973-74	V8 7.4L 454ci	Z	AT, w/3 & 4 Spd. MT 1pc. Cable 76" to 80"; 80.00" Cable	CA-3001
<b>K2500 SUBURBAN</b>				
1981	L6 4.8L 292ci	T	w/Dual Exhaust w/o Cruise; 80.00" Cable	CA-3001
1981	L6 4.8L 292ci	T	w/Single Exhaust; 100.00" Cable	CA-3003
1981	V8 5.7L 350ci	L	w/Dual Exhaust w/o Cruise; 80.00" Cable	CA-3001
1981	V8 5.7L 350ci	L	w/Single Exhaust; 100.00" Cable	CA-3003
<b>K35</b>				
1968-69	L6 4.1L 250ci	P	w/Powerglide to 78"; 80.00" Cable	CA-3012
1968-69	L6 4.1L 250ci	P	w/THM AT, w/3 & 4 Spd. MT to 60"; 63.00" Cable	CA-3002
1968-69	L6 4.1L 250ci	P	w/THM AT, w/3 & 4 Spd. MT to 80"; 83.00" Cable	CA-3004
1968-69	L6 4.1L 250ci	P	w/THM AT, w/Powerglide, w/3 & 4 Spd. MT to 120"	CA-3038
1968-69	L6 4.1L 250ci	P	w/THM AT, w/Powerglide, w/3 & 4 Spd. MT to 95"	CA-3016
1973-74	L6 4.1L 250ci	Q	80.00" Cable	CA-3001

# SPEEDOMETER CABLES

Year	Engine	Vin	Remark	Part
<b>GMC (con't)</b>				
<b>K35 (con't)</b>				
1968-69	L6 4.8L 292ci	S	w/Powerglide to 78"; 80.00" Cable	CA-3012
1968-69	L6 4.8L 292ci	S	w/THM AT, w/3 & 4 Spd. MT to 60"; 63.00" Cable	CA-3002
1968-69	L6 4.8L 292ci	S	w/THM AT, w/3 & 4 Spd. MT to 80"; 83.00" Cable	CA-3004
1968-69	L6 4.8L 292ci	S	w/THM AT, w/Powerglide, w/3 & 4 Spd. MT to 120"	CA-3038
1968-69	L6 4.8L 292ci	S	w/THM AT, w/Powerglide, w/3 & 4 Spd. MT to 95"	CA-3016
1973-74	L6 4.8L 292ci	S,T	80.00" Cable	CA-3001
1977	L6 4.8L 292ci	T	w/Cruise Control, Lower; 83.00" Cable	CA-3004
1977	L6 4.8L 292ci	T	w/Cruise Control, Upper; 41.00" Cable	CA-3009
1977	L6 4.8L 292ci	T	w/o Cruise Control; 100.00" Cable	CA-3003
1980	L6 4.8L 292ci	T	All to 80" Cable; 83.00" Cable	CA-3004
1980	L6 4.8L 292ci	T	AT w/Cruise Control, Upper; 41.00" Cable	CA-3009
1980	L6 4.8L 292ci	T	AT w/o Cruise Control, MT; 100.00" Cable	CA-3003
1981	L6 4.8L 292ci	T	w/Cruise Control, Upper; 41.00" Cable	CA-3009
1981	L6 4.8L 292ci	T	w/o Cruise Control; 100.00" Cable	CA-3003
1982	L6 4.8L 292ci	T	All to 80" Cable; 80.00" Cable	CA-3001
1982	L6 4.8L 292ci	T	All To 92" Cable; 100.00" Cable	CA-3003
1982	L6 4.8L 292ci	T	To 75" Cable; 83.00" Cable	CA-3004
1978-79	L6 4.8L 292ci	T	AT w/o Cruise, w/Single Exhaust w/TH350; 80.00" Cable	CA-3001
1978-79	L6 4.8L 292ci	T	AT Upper; 41.00" Cable	CA-3009
1978-79	L6 4.8L 292ci	T	MT w/o Cruise Control, AT w/o Cruise w/Dual Exhaust, AT w/o Cruise w/single Exhaust w/TH400"; 100.00" Cable	CA-3003
1978-79	L6 4.8L 292ci	T	AT w/Cruise Control, Lower; 83.00" Cable	CA-3004
1983-86	L6 4.8L 292ci	T	100.00" Cable	CA-3003
1968-69	V8 5.0L 307ci	E	w/Powerglide to 78"; 80.00" Cable	CA-3012
1968-69	V8 5.0L 307ci	E	w/THM AT, w/3 & 4 Spd. MT to 60"; 63.00" Cable	CA-3002
1968-69	V8 5.0L 307ci	E	w/THM AT, w/3 & 4 Spd. MT to 80"; 83.00" Cable	CA-3004
1968-69	V8 5.0L 307ci	E	w/THM AT, w/Powerglide, w/3 & 4 Spd. MT to 120"	CA-3038
1968-69	V8 5.0L 307ci	E	w/THM AT, w/Powerglide, w/3 & 4 Spd. MT to 95"	CA-3016
1973	V8 5.0L 307ci	X	4 Spd. MT 1 pc. Cable 84" to 100"; 100.00" Cable	CA-3003
1973	V8 5.0L 307ci	X	4 Spd. MT 2 pc. Cable Lower; 41.00" Cable	CA-3009
1973	V8 5.0L 307ci	X	4 Spd. MT 2 pc. Cable Upper; 61.00" Cable	CA-3005
1973	V8 5.0L 307ci	X	AT, w/3 & 4 Spd. MT 1pc. Cable 76" to 80"; 80.00" Cable	CA-3001
1968	V8 5.4L 327ci	E	w/Powerglide to 78"; 80.00" Cable	CA-3012
1968	V8 5.4L 327ci	E	w/THM AT, w/3 & 4 Spd. MT to 60"; 63.00" Cable	CA-3002
1968	V8 5.4L 327ci	E	w/THM AT, w/3 & 4 Spd. MT to 80"; 83.00" Cable	CA-3004
1968	V8 5.4L 327ci	E	w/THM AT, w/Powerglide, w/3 & 4 Spd. MT to 120"	CA-3038
1968	V8 5.4L 327ci	E	w/THM AT, w/Powerglide, w/3 & 4 Spd. MT to 95"	CA-3016
1967	V8 5.4L 327ci		w/Powerglide to 78"; 80.00" Cable	CA-3012
1967	V8 5.4L 327ci		w/THM AT, w/3 & 4 Spd. MT to 60"; 63.00" Cable	CA-3002
1967	V8 5.4L 327ci		w/THM AT, w/3 & 4 Spd. MT to 80"; 83.00" Cable	CA-3004
1967	V8 5.4L 327ci		w/THM AT, w/Powerglide, w/3 & 4 Spd. MT to 120"	CA-3038
1967	V8 5.4L 327ci		w/THM AT, w/Powerglide, w/3 & 4 Spd. MT to 95"	CA-3016
1969	V8 5.7L 350ci	E	w/Powerglide to 78"; 80.00" Cable	CA-3012
1969	V8 5.7L 350ci	E	w/THM AT, w/3 & 4 Spd. MT to 60"; 63.00" Cable	CA-3002
1969	V8 5.7L 350ci	E	w/THM AT, w/3 & 4 Spd. MT to 80"; 83.00" Cable	CA-3004
1969	V8 5.7L 350ci	E	w/THM AT, w/Powerglide, w/3 & 4 Spd. MT to 120"	CA-3038
1969	V8 5.7L 350ci	E	w/THM AT, w/Powerglide, w/3 & 4 Spd. MT to 95"	CA-3016
1977	V8 5.7L 350ci	L	w/Cruise Control, Lower; 83.00" Cable	CA-3004
1977	V8 5.7L 350ci	L	w/Cruise Control, Upper; 41.00" Cable	CA-3009
1977	V8 5.7L 350ci	L	w/o Cruise Control; 100.00" Cable	CA-3003
1978-79	V8 5.7L 350ci	L,M	AT Upper; 41.00" Cable	CA-3009
1978-79	V8 5.7L 350ci	L,M	AT w/o Cruise, w/Single Exhaust w/TH350; 80.00" Cable	CA-3001
1978-79	V8 5.7L 350ci	L,M	MT w/o Cruise Control, AT w/o Cruise w/Dual Exhaust, AT w/o Cruise w/single Exhaust w/TH400"; 100.00" Cable	CA-3003
1978-79	V8 5.7L 350ci	L,M	AT w/Cruise Control, Lower; 83.00" Cable	CA-3004
1980	V8 5.7L 350ci	M	All to 80" Cable; 83.00" Cable	CA-3004
1980	V8 5.7L 350ci	M	AT w/Cruise Control, Upper; 41.00" Cable	CA-3009
1980	V8 5.7L 350ci	M	AT w/o Cruise Control, MT; 100.00" Cable	CA-3003
1981	V8 5.7L 350ci	M	w/Cruise Control, Upper; 41.00" Cable	CA-3009
1981	V8 5.7L 350ci	M	w/o Cruise Control; 100.00" Cable	CA-3003
1982	V8 5.7L 350ci	M	All to 80" Cable; 80.00" Cable	CA-3001
1982	V8 5.7L 350ci	M	All To 92" Cable; 100.00" Cable	CA-3003

# SPEEDOMETER CABLES

Year	Engine	Vin	Remark	Part
<b>GMC (con't)</b>				
<b>K35 (con't)</b>				
1982	V8 5.7L 350ci	M	To 75" Cable; 83.00" Cable	CA-3004
1983-86	V8 5.7L 350ci	M	100.00" Cable	CA-3003
1973-74	V8 5.7L 350ci	V,W,Y	4 Spd. MT 1 pc. Cable 84" to 100"; 100.00" Cable	CA-3003
1973-74	V8 5.7L 350ci	V,W,Y	4 Spd. MT 2 pc. Cable Lower; 41.00" Cable	CA-3009
1973-74	V8 5.7L 350ci	V,W,Y	4 Spd. MT 2 pc. Cable Upper; 61.00" Cable	CA-3005
1973-74	V8 5.7L 350ci	V,W,Y	AT, w/3 & 4 Spd. MT 1pc. Cable 76" to 80"; 80.00" Cable	CA-3001
1982	V8 6.2L 379ci	J	All to 80" Cable; 80.00" Cable	CA-3001
1982	V8 6.2L 379ci	J	All To 92" Cable; 100.00" Cable	CA-3003
1982	V8 6.2L 379ci	J	To 75" Cable; 83.00" Cable	CA-3004
1983-84	V8 6.2L 379ci	J	100.00" Cable	CA-3003
1968-69	V8 6.5L 396ci	E	w/Powerglide to 78"; 80.00" Cable	CA-3012
1968-69	V8 6.5L 396ci	E	w/THM AT, w/3 & 4 Spd. MT to 60"; 63.00" Cable	CA-3002
1968-69	V8 6.5L 396ci	E	w/THM AT, w/3 & 4 Spd. MT to 80"; 83.00" Cable	CA-3004
1968-69	V8 6.5L 396ci	E	w/THM AT, w/Powerglide, w/3 & 4 Spd. MT to 120"	CA-3038
1968-69	V8 6.5L 396ci	E	w/THM AT, w/Powerglide, w/3 & 4 Spd. MT to 95"	CA-3016
1977	V8 6.6L 400ci	R	w/Cruise Control, Lower; 83.00" Cable	CA-3004
1977	V8 6.6L 400ci	R	w/Cruise Control, Upper; 41.00" Cable	CA-3009
1977	V8 6.6L 400ci	R	w/o Cruise Control; 100.00" Cable	CA-3003
1980	V8 6.6L 400ci	R	All to 80" Cable; 83.00" Cable	CA-3004
1980	V8 6.6L 400ci	R	AT w/Cruise Control, Upper; 41.00" Cable	CA-3009
1980	V8 6.6L 400ci	R	AT w/o Cruise Control, MT; 100.00" Cable	CA-3003
1978-79	V8 6.6L 400ci	R	AT Upper; 41.00" Cable	CA-3009
1978-79	V8 6.6L 400ci	R	AT w/o Cruise, w/Single Exhaust w/TH350; 80.00" Cable	CA-3001
1978-79	V8 6.6L 400ci	R	MT w/o Cruise Control, AT w/o Cruise w/Dual Exhaust, AT w/o Cruise w/single Exhaust w/TH400"; 100.00" Cable	CA-3003
1978-79	V8 6.6L 400ci	R	AT w/Cruise Control, Lower; 83.00" Cable	CA-3004
1979	V8 7.4L 454ci	S	AT Upper; 41.00" Cable	CA-3009
1979	V8 7.4L 454ci	S	AT w/Cruise Control, Lower; 83.00" Cable	CA-3004
1979	V8 7.4L 454ci	S	AT w/o Cruise, w/Single Exhaust w/TH350; 80.00" Cable	CA-3001
1979	V8 7.4L 454ci	S	MT w/o Cruise Control, AT w/o Cruise w/Dual Exhaust, AT w/o Cruise w/single Exhaust w/TH400"; 100.00" Cable	CA-3003
1980	V8 7.4L 454ci	S	All to 80" Cable; 83.00" Cable	CA-3004
1980	V8 7.4L 454ci	S	AT w/Cruise Control, Upper; 41.00" Cable	CA-3009
1980	V8 7.4L 454ci	S	AT w/o Cruise Control, MT; 100.00" Cable	CA-3003
1981	V8 7.4L 454ci	W	w/Cruise Control, Upper; 41.00" Cable	CA-3009
1981	V8 7.4L 454ci	W	w/o Cruise Control; 100.00" Cable	CA-3003
1982	V8 7.4L 454ci	W	All to 80" Cable; 80.00" Cable	CA-3001
1982	V8 7.4L 454ci	W	All To 92" Cable; 100.00" Cable	CA-3003
1982	V8 7.4L 454ci	W	To 75" Cable; 83.00" Cable	CA-3004
1983-86	V8 7.4L 454ci	W	100.00" Cable	CA-3003
1973-74	V8 7.4L 454ci	Z	4 Spd. MT 1 pc. Cable 84" to 100"; 100.00" Cable	CA-3003
1973-74	V8 7.4L 454ci	Z	4 Spd. MT 2 pc. Cable Lower; 41.00" Cable	CA-3009
1973-74	V8 7.4L 454ci	Z	4 Spd. MT 2 pc. Cable Upper; 61.00" Cable	CA-3005
1973-74	V8 7.4L 454ci	Z	AT, w/3 & 4 Spd. MT 1pc. Cable 76" to 80"; 80.00" Cable	CA-3001
<b>P15</b>				
1973-74	L6 4.1L 250ci	Q	100.00" Cable	CA-3003
1973-74	L6 4.1L 250ci	Q	120.00" Cable	CA-3007
1975	L6 4.8L 292ci	T	100.00" Cable	CA-3003
1975	L6 4.8L 292ci	T	120.00" Cable	CA-3007
1976	L6 4.8L 292ci	T	3 & 4 Spd. MT with 2 Pc. Cable Lower; 40.00" Cable	CA-3033
1976	L6 4.8L 292ci	T	3 & 4 Spd. MT with 2 Pc. Cable Upper; 41.00" Cable	CA-3009
1976	L6 4.8L 292ci	T	w/THM AT w/Cruise, w/3 & 4 Spd. MT with 1 Pc. Cable; 100.00" Cable	CA-3003
1976	L6 4.8L 292ci	T	w/THM AT w/o Cruise; 80.00" Cable	CA-3001
1977	L6 4.8L 292ci	T	Step Van; 100.00" Cable	CA-3003
1978-80	L6 4.8L 292ci	T	exc. Motor Home Chassis; 100.00" Cable	CA-3003
1978-80	L6 4.8L 292ci	T	Motor Home Chassis; 120.00" Cable	CA-3007
1979	V8 7.4L 454ci	S	exc. Motor Home Chassis; 100.00" Cable	CA-3003
1979	V8 7.4L 454ci	S	Motor Home Chassis; 120.00" Cable	CA-3007
<b>P25</b>				
1973-74	L6 4.1L 250ci	Q	100.00" Cable	CA-3003
1973-74	L6 4.1L 250ci	Q	120.00" Cable	CA-3007
1976	L6 4.8L 292ci	T	3 & 4 Spd. MT with 2 Pc. Cable Lower; 40.00" Cable	CA-3033



# SPEEDOMETER CABLES

Year	Engine	Vin	Remark	Part
<b>GMC (con't)</b>				
<b>P25 (con't)</b>				
1976	L6 4.8L 292ci	T	3 & 4 Spd. MT with 2 Pc. Cable Upper; 41.00" Cable	CA-3009
1976	L6 4.8L 292ci	T	w/THM AT w/Cruise, w/3 & 4 Spd. MT with 1 Pc. Cable; 100.00" Cable	CA-3003
1976	L6 4.8L 292ci	T	w/THM AT w/o Cruise; 80.00" Cable	CA-3001
1977	L6 4.8L 292ci	T	Step Van; 100.00" Cable	CA-3003
1973-75	L6 4.8L 292ci	T	100.00" Cable	CA-3003
1973-75	L6 4.8L 292ci	T	120.00" Cable	CA-3007
1978-80	L6 4.8L 292ci	T	Motor Home Chassis; 120.00" Cable	CA-3007
1978-80	L6 4.8L 292ci	T	exc. Motor Home Chassis; 100.00" Cable	CA-3003
1981-84	L6 4.8L 292ci	T	100.00" Cable	CA-3003
1976	V8 5.7L 350ci	L	3 & 4 Spd. MT with 2 Pc. Cable Lower; 40.00" Cable	CA-3033
1976	V8 5.7L 350ci	L	3 & 4 Spd. MT with 2 Pc. Cable Upper; 41.00" Cable	CA-3009
1976	V8 5.7L 350ci	L	w/THM AT w/Cruise, w/3 & 4 Spd. MT with 1 Pc. Cable; 100.00" Cable	CA-3003
1976	V8 5.7L 350ci	L	w/THM AT w/o Cruise; 80.00" Cable	CA-3001
1977	V8 5.7L 350ci	L	Step Van; 100.00" Cable	CA-3003
1978	V8 5.7L 350ci	L	exc. Motor Home Chassis; 100.00" Cable	CA-3003
1979	V8 5.7L 350ci	L	exc. Motor Home Chassis; 100.00" Cable	CA-3003
1978-79	V8 5.7L 350ci	L	Motor Home Chassis; 120.00" Cable	CA-3007
1980	V8 5.7L 350ci	M	exc. Motor Home Chassis; 100.00" Cable	CA-3003
1980	V8 5.7L 350ci	M	Motor Home Chassis; 120.00" Cable	CA-3007
1981-84	V8 5.7L 350ci	M	100.00" Cable	CA-3003
1975	V8 5.7L 350ci	Y	Lower	CA-3040
1975	V8 5.7L 350ci	Y	Upper	CA-3039
1975	V8 5.7L 350ci	Y	100.00" Cable	CA-3003
1975	V8 5.7L 350ci	Y	w/forward Control Chassis 1 pc.; 100.00" Cable	CA-3003
1973-74	V8 5.7L 350ci	Y	100.00" Cable	CA-3003
1973-75	V8 5.7L 350ci	Y	120.00" Cable	CA-3007
1982-84	V8 6.2L 379ci	J	100.00" Cable	CA-3003
<b>P35</b>				
1973-74	L6 4.1L 250ci	Q	100.00" Cable	CA-3003
1973-74	L6 4.1L 250ci	Q	120.00" Cable	CA-3007
1976	L6 4.8L 292ci	T	3 & 4 Spd. MT with 1 Pc. Cable; 100.00" Cable	CA-3003
1976	L6 4.8L 292ci	T	3 & 4 Spd. MT with 2 Pc. Cable Lower; 40.00" Cable	CA-3033
1976	L6 4.8L 292ci	T	3 & 4 Spd. MT with 2 Pc. Cable Upper; 41.00" Cable	CA-3009
1976	L6 4.8L 292ci	T	w/THM AT; 120.00" Cable	CA-3007
1985	L6 4.8L 292ci	T	w/conventional chassis, w/forward Control Chassis; 100.00" Cable	CA-3003
1985	L6 4.8L 292ci	T	Motor Home Chassis; 120.00" Cable	CA-3007
1973-75	L6 4.8L 292ci	T	100.00" Cable	CA-3003
1973-75	L6 4.8L 292ci	T	120.00" Cable	CA-3007
1978-81	L6 4.8L 292ci	T	exc. Motor Home Chassis; 100.00" Cable	CA-3003
1978-81	L6 4.8L 292ci	T	Motor Home Chassis; 120.00" Cable	CA-3007
1982-84	L6 4.8L 292ci	T	120.00" Cable	CA-3007
1987	V8 5.7L 350ci	K	Lower	CA-3040
1987	V8 5.7L 350ci	K	Upper	CA-3039
1987	V8 5.7L 350ci	K	w/forward Control Chassis 1 pc.; 100.00" Cable	CA-3003
1976	V8 5.7L 350ci	L	3 & 4 Spd. MT with 1 Pc. Cable; 100.00" Cable	CA-3003
1976	V8 5.7L 350ci	L	3 & 4 Spd. MT with 2 Pc. Cable Lower; 40.00" Cable	CA-3033
1976	V8 5.7L 350ci	L	3 & 4 Spd. MT with 2 Pc. Cable Upper; 41.00" Cable	CA-3009
1976	V8 5.7L 350ci	L	w/THM AT; 120.00" Cable	CA-3007
1977	V8 5.7L 350ci	L	Step Van; 100.00" Cable	CA-3003
1978	V8 5.7L 350ci	L	exc. Motor Home Chassis; 100.00" Cable	CA-3003
1978-80	V8 5.7L 350ci	L	Motor Home Chassis; 120.00" Cable	CA-3007
1979-80	V8 5.7L 350ci	L	exc. Motor Home Chassis; 100.00" Cable	CA-3003
1983	V8 5.7L 350ci	M	Lower	CA-3040
1983	V8 5.7L 350ci	M	Upper	CA-3039
1983	V8 5.7L 350ci	M	w/forward Control Chassis 1 pc.; 100.00" Cable	CA-3003
1985	V8 5.7L 350ci	M	w/conventional chassis, w/forward Control Chassis; 100.00" Cable	CA-3003
1985	V8 5.7L 350ci	M	Motor Home Chassis; 120.00" Cable	CA-3007
1980-81	V8 5.7L 350ci	M	exc. Motor Home Chassis; 100.00" Cable	CA-3003
1980-81	V8 5.7L 350ci	M	Motor Home Chassis; 120.00" Cable	CA-3007
1982-84	V8 5.7L 350ci	M	120.00" Cable	CA-3007
1973-75	V8 5.7L 350ci	Y	100.00" Cable	CA-3003
1973-75	V8 5.7L 350ci	Y	120.00" Cable	CA-3007

# SPEEDOMETER CABLES

Year	Engine	Vin	Remark	Part
<b>GMC (con't)</b>				
<b>P35 (con't)</b>				
1985	V8 6.2L 379ci	J	w/conventional chassis, w/forward Control Chassis; 100.00" Cable	CA-3003
1985	V8 6.2L 379ci	J	Motor Home Chassis; 120.00" Cable	CA-3007
1982-84	V8 6.2L 379ci	J	120.00" Cable	CA-3007
1974-75	V8 7.4L 454ci	L	100.00" Cable	CA-3003
1974-75	V8 7.4L 454ci	L	120.00" Cable	CA-3007
1978-79	V8 7.4L 454ci	S	exc. Motor Home Chassis; 100.00" Cable	CA-3003
1978-79	V8 7.4L 454ci	S	Motor Home Chassis; 120.00" Cable	CA-3007
1981	V8 7.4L 454ci	W	exc. Motor Home Chassis; 100.00" Cable	CA-3003
1981	V8 7.4L 454ci	W	Motor Home Chassis; 120.00" Cable	CA-3007
1985	V8 7.4L 454ci	W	w/conventional chassis, w/forward Control Chassis; 100.00" Cable	CA-3003
1985	V8 7.4L 454ci	W	Motor Home Chassis; 120.00" Cable	CA-3007
1982-84	V8 7.4L 454ci	W	120.00" Cable	CA-3007
1976	V8 7.4L 454ci	Y	3 & 4 Spd. MT with 1 Pc. Cable; 100.00" Cable	CA-3003
1976	V8 7.4L 454ci	Y	3 & 4 Spd. MT with 2 Pc. Cable Lower; 40.00" Cable	CA-3033
1976	V8 7.4L 454ci	Y	3 & 4 Spd. MT with 2 Pc. Cable Upper; 41.00" Cable	CA-3009
1976	V8 7.4L 454ci	Y	w/THM AT; 120.00" Cable	CA-3007
1977	V8 7.4L 454ci	Y	Step Van; 100.00" Cable	CA-3003
1973	V8 7.4L 454ci	Z	100.00" Cable	CA-3003
1973	V8 7.4L 454ci	Z	120.00" Cable	CA-3007
<b>R1500</b>				
1987	V6 4.3L 262ci	Z	AT Upper; 61.00" Cable	CA-3005
1987	V6 4.3L 262ci	Z	MT; 80.00" Cable	CA-3001
1987	V6 4.3L 262ci	Z	w/TH 400 Lower; 20.00" Cable	CA-3008
1987	V6 4.3L 262ci	Z	w/TH 700-R4 Lower; 40.00" Cable	CA-3033
1987	V8 5.0L 305ci	H	AT Upper; 61.00" Cable	CA-3005
1987	V8 5.0L 305ci	H	MT; 80.00" Cable	CA-3001
1987	V8 5.0L 305ci	H	w/TH 400 Lower; 20.00" Cable	CA-3008
1987	V8 5.0L 305ci	H	w/TH 700-R4 Lower; 40.00" Cable	CA-3033
1987	V8 5.7L 350ci	K	AT Upper; 61.00" Cable	CA-3005
1987	V8 5.7L 350ci	K	MT; 80.00" Cable	CA-3001
1987	V8 5.7L 350ci	K	w/TH 400 Lower; 20.00" Cable	CA-3008
1987	V8 5.7L 350ci	K	w/TH 700-R4 Lower; 40.00" Cable	CA-3033
1987	V8 6.2L 379ci	C	AT Upper; 61.00" Cable	CA-3005
1987	V8 6.2L 379ci	C	MT; 80.00" Cable	CA-3001
1987	V8 6.2L 379ci	C	w/TH 400 Lower; 20.00" Cable	CA-3008
1987	V8 6.2L 379ci	C	w/TH 700-R4 Lower; 40.00" Cable	CA-3033
<b>R1500 SUBURBAN</b>				
1987	V8 5.0L 305ci	H	AT Upper; 61.00" Cable	CA-3005
1987	V8 5.0L 305ci	H	MT; 80.00" Cable	CA-3001
1987	V8 5.0L 305ci	H	w/TH 400 Lower; 20.00" Cable	CA-3008
1987	V8 5.0L 305ci	H	w/TH 700-R4 Lower; 40.00" Cable	CA-3033
1987-89	V8 5.7L 350ci	K	AT Upper; 61.00" Cable	CA-3005
1987-89	V8 5.7L 350ci	K	MT; 80.00" Cable	CA-3001
1987-89	V8 5.7L 350ci	K	w/TH 400 Lower; 20.00" Cable	CA-3008
1987-89	V8 5.7L 350ci	K	w/TH 700-R4 Lower; 40.00" Cable	CA-3033
1987-89	V8 6.2L 379ci	C	AT Upper; 61.00" Cable	CA-3005
1987-89	V8 6.2L 379ci	C	MT; 80.00" Cable	CA-3001
1987-89	V8 6.2L 379ci	C	w/TH 400 Lower; 20.00" Cable	CA-3008
1987-89	V8 6.2L 379ci	C	w/TH 700-R4 Lower; 40.00" Cable	CA-3033
<b>R2500</b>				
1987-88	L6 4.8L 292ci	T	AT Upper; 61.00" Cable	CA-3005
1987-88	L6 4.8L 292ci	T	MT; 80.00" Cable	CA-3001
1987-88	L6 4.8L 292ci	T	w/TH 400 Lower; 20.00" Cable	CA-3008
1987-88	L6 4.8L 292ci	T	w/TH 700-R4 Lower; 40.00" Cable	CA-3033
1987	V6 4.3L 262ci	Z	AT Upper; 61.00" Cable	CA-3005
1987	V6 4.3L 262ci	Z	MT; 80.00" Cable	CA-3001
1987	V6 4.3L 262ci	Z	w/TH 400 Lower; 20.00" Cable	CA-3008
1987	V6 4.3L 262ci	Z	w/TH 700-R4 Lower; 40.00" Cable	CA-3033
1987	V8 5.0L 305ci	H	AT Upper; 61.00" Cable	CA-3005
1987	V8 5.0L 305ci	H	MT; 80.00" Cable	CA-3001
1987	V8 5.0L 305ci	H	w/TH 400 Lower; 20.00" Cable	CA-3008
1987	V8 5.0L 305ci	H	w/TH 700-R4 Lower; 40.00" Cable	CA-3033

# SPEEDOMETER CABLES

Year	Engine	Vin	Remark	Part
<b>GMC (con't)</b>				
<b>R2500 (con't)</b>				
1987-89	V8 5.7L 350ci	K	AT Upper; 61.00" Cable	CA-3005
1987-89	V8 5.7L 350ci	K	MT; 80.00" Cable	CA-3001
1987-89	V8 5.7L 350ci	K	w/TH 400 Lower; 20.00" Cable	CA-3008
1987-89	V8 5.7L 350ci	K	w/TH 700-R4 Lower; 40.00" Cable	CA-3033
1987	V8 6.2L 379ci	C	AT Upper; 61.00" Cable	CA-3005
1987	V8 6.2L 379ci	C	MT; 80.00" Cable	CA-3001
1987-89	V8 6.2L 379ci	C,J	w/TH 400 Lower; 20.00" Cable	CA-3008
1987-89	V8 6.2L 379ci	C,J	w/TH 700-R4 Lower; 40.00" Cable	CA-3033
1987-89	V8 6.2L 379ci	J	AT Upper; 61.00" Cable	CA-3005
1987-89	V8 6.2L 379ci	J	MT; 80.00" Cable	CA-3001
1987-89	V8 7.4L 454ci	N	AT Upper; 61.00" Cable	CA-3005
1987-89	V8 7.4L 454ci	N	MT; 80.00" Cable	CA-3001
1987-89	V8 7.4L 454ci	N	w/TH 400 Lower; 20.00" Cable	CA-3008
1987-89	V8 7.4L 454ci	N	w/TH 700-R4 Lower; 40.00" Cable	CA-3033
<b>R2500 SUBURBAN</b>				
1987-89	V8 5.7L 350ci	K	AT Upper; 61.00" Cable	CA-3005
1987-89	V8 5.7L 350ci	K	MT; 80.00" Cable	CA-3001
1987-89	V8 5.7L 350ci	K	w/TH 400 Lower; 20.00" Cable	CA-3008
1987-89	V8 5.7L 350ci	K	w/TH 700-R4 Lower; 40.00" Cable	CA-3033
1987-89	V8 6.2L 379ci	J	AT Upper; 61.00" Cable	CA-3005
1987-89	V8 6.2L 379ci	J	MT; 80.00" Cable	CA-3001
1987-89	V8 6.2L 379ci	J	w/TH 400 Lower; 20.00" Cable	CA-3008
1987-89	V8 6.2L 379ci	J	w/TH 700-R4 Lower; 40.00" Cable	CA-3033
1987-89	V8 7.4L 454ci	N	AT Upper; 61.00" Cable	CA-3005
1987-89	V8 7.4L 454ci	N	MT; 80.00" Cable	CA-3001
1987-89	V8 7.4L 454ci	N	w/TH 400 Lower; 20.00" Cable	CA-3008
1987-89	V8 7.4L 454ci	N	w/TH 700-R4 Lower; 40.00" Cable	CA-3033
<b>R3500</b>				
1987-88	L6 4.8L 292ci	T	AT Upper; 61.00" Cable	CA-3005
1987-88	L6 4.8L 292ci	T	MT; 80.00" Cable	CA-3001
1987-88	L6 4.8L 292ci	T	w/TH 400 Lower; 20.00" Cable	CA-3008
1987-88	L6 4.8L 292ci	T	w/TH 700-R4 Lower; 40.00" Cable	CA-3033
1990	V8 5.7L 350ci	K	w/Muncie 3 & 4 Spd. MT; 80.00" Cable	CA-3001
1987-89	V8 5.7L 350ci	K,M	AT Upper; 61.00" Cable	CA-3005
1987-89	V8 5.7L 350ci	K,M	MT; 80.00" Cable	CA-3001
1987-89	V8 5.7L 350ci	K,M	w/TH 400 Lower; 20.00" Cable	CA-3008
1987-89	V8 5.7L 350ci	K,M	w/TH 700-R4 Lower; 40.00" Cable	CA-3033
1990	V8 6.2L 379ci	J	w/Muncie 3 & 4 Spd. MT; 80.00" Cable	CA-3001
1987-89	V8 6.2L 379ci	J	AT Upper; 61.00" Cable	CA-3005
1987-89	V8 6.2L 379ci	J	MT; 80.00" Cable	CA-3001
1987-89	V8 6.2L 379ci	J	w/TH 400 Lower; 20.00" Cable	CA-3008
1987-89	V8 6.2L 379ci	J	w/TH 700-R4 Lower; 40.00" Cable	CA-3033
1990	V8 7.4L 454ci	N	w/Muncie 3 & 4 Spd. MT; 80.00" Cable	CA-3001
1987-89	V8 7.4L 454ci	N	AT Upper; 61.00" Cable	CA-3005
1987-89	V8 7.4L 454ci	N,W	MT; 80.00" Cable	CA-3001
1987-89	V8 7.4L 454ci	N,W	w/TH 400 Lower; 20.00" Cable	CA-3008
1987-89	V8 7.4L 454ci	N,W	w/TH 700-R4 Lower; 40.00" Cable	CA-3033
1987-89	V8 7.4L 454ci	W	AT Upper; 61.00" Cable	CA-3005
<b>S15</b>				
1982	L4 1.9L 119ci	A	exc. Cruise Control; 80.00" Cable	CA-3001
1982	L4 1.9L 119ci	A	w/Cruise Control, Lower; 63.00" Cable	CA-3002
1982	L4 1.9L 119ci	A	w/Cruise Control, Upper; 61.00" Cable	CA-3005
1983-85	L4 1.9L 119ci	A	80.00" Cable	CA-3001
1983-84	L4 2.0L 122ci	Y	80.00" Cable	CA-3001
1984-85	L4 2.2L 134ci	S	80.00" Cable	CA-3001
1985-88	L4 2.5L 151ci	E	80.00" Cable	CA-3001
1982	V6 2.8L 173ci	B	exc. Cruise Control; 80.00" Cable	CA-3001
1982	V6 2.8L 173ci	B	w/Cruise Control, Lower; 63.00" Cable	CA-3002
1982	V6 2.8L 173ci	B	w/Cruise Control, Upper; 61.00" Cable	CA-3005
1983-85	V6 2.8L 173ci	B	80.00" Cable	CA-3001
1986-88	V6 2.8L 173ci	R	80.00" Cable	CA-3001
1988	V6 4.3L 262ci	Z	80.00" Cable	CA-3001

# SPEEDOMETER CABLES

Year	Engine	Vin	Remark	Part
<b>GMC (con't)</b>				
<b>S15 JIMMY</b>				
1983-84	L4 1.9L 119ci	A	80.00" Cable	CA-3001
1983-84	L4 2.0L 122ci	Y	80.00" Cable	CA-3001
1985-88	L4 2.5L 151ci	E	80.00" Cable	CA-3001
1983-85	V6 2.8L 173ci	B	80.00" Cable	CA-3001
1986-88	V6 2.8L 173ci	R	80.00" Cable	CA-3001
1988	V6 4.3L 262ci	Z	80.00" Cable	CA-3001
<b>SAFARI</b>				
1985-88	L4 2.5L 151ci	E	100.00" Cable	CA-3003
1985	V6 4.3L 262ci	N	100.00" Cable	CA-3003
1986-88	V6 4.3L 262ci	Z	100.00" Cable	CA-3003
<b>V1500</b>				
1987	V6 4.3L 262ci	Z	100.00" Cable	CA-3003
1987	V8 5.0L 305ci	H	100.00" Cable	CA-3003
1987	V8 5.7L 350ci	K	100.00" Cable	CA-3003
1987	V8 6.2L 379ci	C	100.00" Cable	CA-3003
<b>V1500 SUBURBAN</b>				
1987-89	V8 5.7L 350ci	K	100.00" Cable	CA-3003
1987-89	V8 6.2L 379ci	C	100.00" Cable	CA-3003
<b>V2500</b>				
1987	L6 4.8L 292ci	T	100.00" Cable	CA-3003
1987	V8 5.7L 350ci	K	100.00" Cable	CA-3003
1987	V8 6.2L 379ci	C,J	100.00" Cable	CA-3003
<b>V2500 SUBURBAN</b>				
1988-89	V8 5.7L 350ci	K	100.00" Cable	CA-3003
1988-89	V8 6.2L 379ci	J	100.00" Cable	CA-3003
<b>V3500</b>				
1987-88	L6 4.8L 292ci	T	100.00" Cable	CA-3003
1987-90	V8 5.7L 350ci	K,M	100.00" Cable	CA-3003
1987-90	V8 6.2L 379ci	J	100.00" Cable	CA-3003
1987-90	V8 7.4L 454ci	N,W	100.00" Cable	CA-3003
<b>HONDA</b>				
<b>ACCORD</b>				
1976-78	L4 1.6L 1599cc			CA-3071
1979-81	L4 1.8L 1751cc		AT	CA-3151
1986-89	L4 2.0L 1955cc			CA-3070
<b>CIVIC</b>				
1973-76	L4 1.2L 1237cc			CA-3072
1977-79	L4 1.2L 1237cc		5 Spd. Trans.	CA-3072
1980	L4 1.3L 1335cc		5 Spd. Trans.	CA-3072
1980	L4 1.3L 1335cc		exc. SI, At	CA-3129
1984-87	L4 1.3L 1342cc			CA-3152
1980	L4 1.5L 1487cc		exc. SI, At	CA-3129
1981	L4 1.5L 1487cc		AT	CA-3129
1982	L4 1.5L 1487cc		MT	CA-3070
1980-81	L4 1.5L 1487cc		5 Spd. Trans.	CA-3072
1984-87	L4 1.5L 1487cc			CA-3152
1987	L4 1.5L 1491cc			CA-3152
1986	L4 1.5L 1493cc			CA-3152
<b>PRELUDE</b>				
1979	L4 1.8L 1751cc		5 Spd. Trans.	CA-3151
1979	L4 1.8L 1751cc		AT	CA-3070
1983-87	L4 1.8L 1829cc		AT	CA-3181
1983-87	L4 1.8L 1829cc		DX Model AT & 5 Spd. MT	CA-3073
<b>HYUNDAI</b>				
<b>EXCEL</b>				
1988-89	L4 1.5L 1468cc	J		CA-3205
<b>INTERNATIONAL</b>				
<b>SCOUT</b>				
1968	L4 2.5L 152ci		3 Spd., 800, w/Trans. Code 13014; 63.00" Cable	CA-3002
1961-65	L4 2.5L 152ci		4WD, 3 Spd. Trans., 80, From Chassis #FC75088; 63.00" Cable	CA-3002
1966-67	L4 2.5L 152ci		4WD, 3 Spd. Trans., 800, w/Trans. Code 13014; 63.00" Cable	CA-3002

# SPEEDOMETER CABLES

Year	Engine	Vin	Remark	Part
<b>INTERNATIONAL (con't)</b>				
<b>SCOUT (con't)</b>				
1966-68	L4 2.5L 152ci		4WD, 3 Spd. Trans., 800, w/Trans. Code 13045; 83.00" Cable	CA-3004
1968	L4 3.2L 196ci		3 Spd., 800, w/Trans. Code 13014; 63.00" Cable	CA-3002
1968	L4 3.2L 196ci		4WD, 3 Spd. Trans., 800, w/Trans. Code 13045; 83.00" Cable	CA-3004
1968	V8 4.4L 266ci		3 Spd., 800, w/Trans. Code 13014; 63.00" Cable	CA-3002
1968	V8 4.4L 266ci		4WD, 3 Spd. Trans., 800, w/Trans. Code 13045; 83.00" Cable	CA-3004
<b>ISUZU</b>				
<b>I-MARK</b>				
1986-89	L4 1.5L 1471cc	7,9		CA-3156
1985	L4 1.5L 1471cc	K		CA-3156
1989	L4 1.6L 1588cc	5		CA-3156
<b>IMPULSE</b>				
1983-86	L4 1.9L 1949cc	A	5 Spd. MT	CA-3138
1983-86	L4 1.9L 1949cc	A	AT	CA-3140
1985-86	L4 2.0L 1994cc	F	5 Spd. MT	CA-3138
1985-86	L4 2.0L 1994cc	F	AT	CA-3140
<b>ISUZU TRUCKS</b>				
<b>PICKUP</b>				
1981-82	L4 1.8L 1817cc	N		CA-3106
1981-82	L4 2.2L 2238cc	S		CA-3106
<b>JEEP</b>				
<b>CHEROKEE</b>				
1985	L4 2.1L 126ci	B	4 Spd. MT; 83.00" Cable	CA-3004
1985	L4 2.1L 126ci	B	5 Spd. w/o Cruise	CA-3016
1985	L4 2.1L 126ci	B	MT Lower, AT Lower w/208 or 229 Transfer Case; 63.00" Cable	CA-3002
1989-90	L4 2.5L 150ci	E	Lower; 63.00" Cable	CA-3002
1988	L4 2.5L 150ci	H	Lower; 63.00" Cable	CA-3002
1984-85	L4 2.5L 150ci	U	4 Spd. MT; 83.00" Cable	CA-3004
1984-85	L4 2.5L 150ci	U	5 Spd. w/o Cruise	CA-3016
1984-85	L4 2.5L 150ci	U	MT Lower, AT Lower w/208 or 229 Transfer Case; 63.00" Cable	CA-3002
1975-77	L6 4.2L 258ci	A	w/Cruise & Full Time Unit	CA-3006
1980	L6 4.2L 258ci	C	AT w/Cruise & Full Time Unit	CA-3006
1980	L6 4.2L 258ci	C	AT w/Part Time Unit	CA-3016
1981	L6 4.2L 258ci	C	Lower; 63.00" Cable	CA-3002
1977-79	L6 4.2L 258ci	C	w/Cruise & Full Time Unit	CA-3006
1982-83	L6 4.2L 258ci	C	4 Spd. MT; 83.00" Cable	CA-3004
1982-83	L6 4.2L 258ci	C	5 Spd. w/o Cruise	CA-3016
1982-83	L6 4.2L 258ci	C	MT Lower, AT Lower w/208 or 229 Transfer Case; 63.00" Cable	CA-3002
1984-85	V6 2.8L 173ci	W	4 Spd. MT; 83.00" Cable	CA-3004
1984-85	V6 2.8L 173ci	W	5 Spd. w/o Cruise	CA-3016
1984-85	V6 2.8L 173ci	W	MT Lower, AT Lower w/208 or 229 Transfer Case; 63.00" Cable	CA-3002
1980-81	V8 5.9L 360ci	N	AT w/Cruise & Full Time Unit	CA-3006
1980-81	V8 5.9L 360ci	N	AT w/o Cruise & w/Full Time Unit	CA-3016
1980-81	V8 5.9L 360ci	N	exc. Cruise Control, w/Part Time Unit; 83.00" Cable	CA-3004
1982-83	V8 5.9L 360ci	N	4 Spd. MT; 83.00" Cable	CA-3004
1982-83	V8 5.9L 360ci	N	5 Spd. w/o Cruise	CA-3016
1982-83	V8 5.9L 360ci	N	MT Lower, AT Lower w/208 or 229 Transfer Case; 63.00" Cable	CA-3002
1975-79	V8 5.9L 360ci	N,P	w/Cruise & Full Time Unit	CA-3006
1975-78	V8 6.6L 401ci	Z	w/Cruise & Full Time Unit	CA-3006
<b>CJ5</b>				
1980	L4 2.5L 151ci	B	MT; 83.00" Cable	CA-3004
1981	L4 2.5L 151ci	B	83.00" Cable	CA-3004
1982-83	L4 2.5L 151ci	B	Speedometer Switch to Speedometer	CA-3006
1980	L6 4.2L 258ci	C	MT; 83.00" Cable	CA-3004
1981-83	L6 4.2L 258ci	C	83.00" Cable	CA-3004
1966-70	V6 3.7L 225ci		63.00" Cable	CA-3002
1980	V8 5.0L 304ci	H	MT; 83.00" Cable	CA-3004
1981	V8 5.0L 304ci	H	83.00" Cable	CA-3004
<b>CJ6</b>				
1966-70	V6 3.7L 225ci		63.00" Cable	CA-3002
<b>CJ7</b>				
1983-85	L4 2.5L 150ci	U	Speedometer Switch to Speedometer	CA-3006

# SPEEDOMETER CABLES

Year	Engine	Vin	Remark	Part
<b>JEEP (con't)</b>				
<b>CJ7 (con't)</b>				
1980	L4 2.5L 151ci	B	MT; 83.00" Cable	CA-3004
1981	L4 2.5L 151ci	B	83.00" Cable	CA-3004
1982-83	L4 2.5L 151ci	B	Speedometer Switch to Speedometer	CA-3006
1980	L6 4.2L 258ci	C	MT; 83.00" Cable	CA-3004
1981-85	L6 4.2L 258ci	C	83.00" Cable	CA-3004
1980	V8 5.0L 304ci	H	MT; 83.00" Cable	CA-3004
1981	V8 5.0L 304ci	H	83.00" Cable	CA-3004
<b>COMANCHE</b>				
1989-90	L4 2.5L 150ci	E	2WD; 63.00" Cable	CA-3002
1988	L4 2.5L 150ci	H	2WD; 63.00" Cable	CA-3002
<b>J10</b>				
1975-76	L6 4.2L 258ci	A	w/Cruise & Full Time Unit	CA-3006
1980	L6 4.2L 258ci	C	AT w/Cruise & Full Time Unit	CA-3006
1980	L6 4.2L 258ci	C	AT w/Part Time Unit	CA-3016
1981	L6 4.2L 258ci	C	Lower; 63.00" Cable	CA-3002
1987	L6 4.2L 258ci	C	exc. Cruise Control; 83.00" Cable	CA-3004
1987	L6 4.2L 258ci	C	w/Cruise Control, Lower; 63.00" Cable	CA-3002
1987	L6 4.2L 258ci	C	w/Cruise Control, Upper	CA-3006
1977-79	L6 4.2L 258ci	C	w/Cruise & Full Time Unit	CA-3006
1982-85	L6 4.2L 258ci	C	4 Spd. MT; 83.00" Cable	CA-3004
1982-85	L6 4.2L 258ci	C	5 Spd. w/o Cruise	CA-3016
1982-85	L6 4.2L 258ci	C	MT Lower, AT Lower w/208 or 229 Transfer Case; 63.00" Cable	CA-3002
1980-81	V8 5.9L 360ci	N	AT w/Cruise & Full Time Unit	CA-3006
1980-81	V8 5.9L 360ci	N	AT w/o Cruise & w/Full Time Unit	CA-3016
1980-81	V8 5.9L 360ci	N	exc. Cruise Control, w/Part Time Unit; 83.00" Cable	CA-3004
1982-85	V8 5.9L 360ci	N	4 Spd. MT; 83.00" Cable	CA-3004
1982-85	V8 5.9L 360ci	N	5 Spd. w/o Cruise	CA-3016
1982-85	V8 5.9L 360ci	N	MT Lower, AT Lower w/208 or 229 Transfer Case; 63.00" Cable	CA-3002
1987-88	V8 5.9L 360ci	N	exc. Cruise Control; 83.00" Cable	CA-3004
1987-88	V8 5.9L 360ci	N	w/Cruise Control, Lower; 63.00" Cable	CA-3002
1987-88	V8 5.9L 360ci	N	w/Cruise Control, Upper	CA-3006
1975-79	V8 5.9L 360ci	N,P	w/Cruise & Full Time Unit	CA-3006
1975-78	V8 6.6L 401ci	Z	w/Cruise & Full Time Unit	CA-3006
<b>J20</b>				
1980-81	V8 5.9L 360ci	N	AT w/Cruise & Full Time Unit	CA-3006
1980-81	V8 5.9L 360ci	N	AT w/o Cruise & w/Full Time Unit	CA-3016
1980-81	V8 5.9L 360ci	N	exc. Cruise Control, w/Part Time Unit; 83.00" Cable	CA-3004
1982-85	V8 5.9L 360ci	N	4 Spd. MT Lower; 63.00" Cable	CA-3002
1987-88	V8 5.9L 360ci	N	exc. Cruise Control; 83.00" Cable	CA-3004
1987-88	V8 5.9L 360ci	N	w/Cruise Control, Lower; 63.00" Cable	CA-3002
1987-88	V8 5.9L 360ci	N	w/Cruise Control, Upper	CA-3006
1975-79	V8 5.9L 360ci	N,P	w/Cruise & Full Time Unit	CA-3006
<b>JEEPSTER</b>				
1968-70	L4 2.2L 134ci		4WD; 83.00" Cable	CA-3004
1968-70	V6 3.7L 225ci		4WD; 83.00" Cable	CA-3004
<b>SCRAMBLER</b>				
1983-85	L4 2.5L 150ci	U	Speedometer Switch to Speedometer, w/California Emissions	CA-3006
1981-83	L4 2.5L 151ci	B	Speedometer Switch to Speedometer, w/California Emissions	CA-3006
<b>UTILITY</b>				
1961	L4 2.2L 134ci		4WD; 63.00" Cable	CA-3002
<b>WAGONEER</b>				
1985	L4 2.1L 126ci	B	4 Spd. MT; 83.00" Cable	CA-3004
1985	L4 2.1L 126ci	B	5 Spd. w/o Cruise	CA-3016
1985	L4 2.1L 126ci	B	MT Lower, AT Lower w/208 or 229 Transfer Case; 63.00" Cable	CA-3002
1984-85	L4 2.5L 150ci	U	4 Spd. MT; 83.00" Cable	CA-3004
1984-85	L4 2.5L 150ci	U	5 Spd. w/o Cruise	CA-3016
1984-85	L4 2.5L 150ci	U	MT Lower, AT Lower w/208 or 229 Transfer Case; 63.00" Cable	CA-3002
1980	L6 4.2L 258ci	C	AT w/Cruise & Full Time Unit	CA-3006
1980	L6 4.2L 258ci	C	AT w/Part Time Unit	CA-3016
1981	L6 4.2L 258ci	C	Lower; 63.00" Cable	CA-3002
1982-83	L6 4.2L 258ci	C	4 Spd. MT; 83.00" Cable	CA-3004
1982-83	L6 4.2L 258ci	C	5 Spd. w/o Cruise	CA-3016

# SPEEDOMETER CABLES

Year	Engine	Vin	Remark	Part
<b>JEEP (con't)</b>				
<b>WAGONEER (con't)</b>				
1982-83	L6 4.2L 258ci	C	MT Lower, AT Lower w/208 or 229 Transfer Case; 63.00" Cable	CA-3002
1984-85	V6 2.8L 173ci	W	4 Spd. MT; 83.00" Cable	CA-3004
1984-85	V6 2.8L 173ci	W	5 Spd. w/o Cruise	CA-3016
1984-85	V6 2.8L 173ci	W	MT Lower, AT Lower w/208 or 229 Transfer Case; 63.00" Cable	CA-3002
1980-81	V8 5.9L 360ci	N	AT w/Cruise & Full Time Unit	CA-3006
1980-81	V8 5.9L 360ci	N	AT w/o Cruise & w/Full Time Unit	CA-3016
1980-81	V8 5.9L 360ci	N	exc. Cruise Control, w/Part Time Unit; 83.00" Cable	CA-3004
1982-83	V8 5.9L 360ci	N	4 Spd. MT; 83.00" Cable	CA-3004
1982-83	V8 5.9L 360ci	N	5 Spd. w/o Cruise	CA-3016
1982-83	V8 5.9L 360ci	N	MT Lower, AT Lower w/208 or 229 Transfer Case; 63.00" Cable	CA-3002
1975-79	V8 5.9L 360ci	N,P	w/Cruise & Full Time Unit	CA-3006
1975-78	V8 6.6L 401ci	Z	w/Cruise & Full Time Unit	CA-3006
<b>WRANGLER</b>				
1987-88	L4 2.5L 150ci	H	w/Cruise Control, Lower; 63.00" Cable	CA-3002
1987-88	L6 4.2L 258ci	C,M	w/Cruise Control, Lower; 63.00" Cable	CA-3002
<b>LINCOLN</b>				
<b>CONTINENTAL</b>				
1984-85	L6 2.4L 146ci	L	AT; 76.00" Cable	CA-3011
1982	V6 3.8L 232ci	3	AT w/o Cruise Control; 76.00" Cable	CA-3011
1982	V6 3.8L 232ci	3	w/Cruise Lower; 80.00" Cable	CA-3012
1982	V6 3.8L 232ci	3	w/Cruise Upper	CA-3044
1988-89	V6 3.8L 232ci	4	AT; 76.00" Cable	CA-3011
1980-82	V8 5.0L 302ci	F	AT w/o Cruise Control; 76.00" Cable	CA-3011
1980-82	V8 5.0L 302ci	F	w/Cruise Lower; 80.00" Cable	CA-3012
1980-82	V8 5.0L 302ci	F	w/Cruise Upper	CA-3044
1983-87	V8 5.0L 302ci	F	AT; 76.00" Cable	CA-3011
1980	V8 5.8L 351ci	G	AT w/o Cruise Control; 76.00" Cable	CA-3011
1980	V8 5.8L 351ci	G	w/Cruise Lower; 80.00" Cable	CA-3012
1980	V8 5.8L 351ci	G	w/Cruise Upper	CA-3044
1978	V8 6.6L 400ci	S	AT w/o Cruise Control; 76.00" Cable	CA-3011
1978-79	V8 6.6L 400ci	S	w/Cruise Upper	CA-3045
1968	V8 7.0L 429ci	N	63.00" Cable	CA-3002
1965	V8 7.0L 430ci		AT w/o Cruise Control; 63.00" Cable	CA-3002
1958-60	V8 7.0L 430ci		AT w/o Cruise Control; 60.00" Cable	CA-3015
1961-62	V8 7.0L 430ci		AT w/Cruise	CA-3006
1961-64	V8 7.0L 430ci		AT w/o Cruise Control; 83.00" Cable	CA-3004
1968	V8 7.5L 460ci	A	63.00" Cable	CA-3002
1969	V8 7.5L 460ci	A	w/Cruise Control; 63.00" Cable	CA-3002
1978	V8 7.5L 460ci	A	AT w/o Cruise Control; 76.00" Cable	CA-3011
1969-71	V8 7.5L 460ci	A	AT w/o Cruise Control	CA-3045
1972-74	V8 7.5L 460ci	A	AT w/o Cruise Control; 80.00" Cable	CA-3012
1972-78	V8 7.5L 460ci	A	w/Cruise Upper	CA-3045
1968	V8 7.6L 462ci	G	63.00" Cable	CA-3002
1966	V8 7.6L 462ci		AT w/o Cruise Control; 63.00" Cable	CA-3002
1967	V8 7.6L 462ci		AT; 63.00" Cable	CA-3002
<b>MARK III</b>				
1969-71	V8 7.5L 460ci	A	w/o Cruise Control; 80.00" Cable	CA-3012
<b>MARK IV</b>				
1972-76	V8 7.5L 460ci	A	w/Cruise Control	CA-3044
1972-76	V8 7.5L 460ci	A	w/o Cruise Control; 80.00" Cable	CA-3012
<b>MARK V</b>				
1977-79	V8 6.6L 400ci	S	w/Cruise Upper; 66.00" Cable	CA-3020
1977-79	V8 6.6L 400ci	S	w/o Cruise Control; 80.00" Cable	CA-3012
1977-78	V8 7.5L 460ci	A	w/Cruise Upper; 66.00" Cable	CA-3020
1977-78	V8 7.5L 460ci	A	w/o Cruise Control; 80.00" Cable	CA-3012
<b>MARK VI</b>				
1982	V8 5.0L 302ci	F	w/Cruise Upper, w/o Cruise	CA-3044
1983	V8 5.0L 302ci	F	w/Cruise Control; 71.00" Cable	CA-3018
1983	V8 5.0L 302ci	F	w/o Cruise Control; 80.00" Cable	CA-3012
1980-81	V8 5.0L 302ci	F	w/Cruise Upper	CA-3044
1980-81	V8 5.0L 302ci	F	w/o Cruise Control; 76.00" Cable	CA-3011

# SPEEDOMETER CABLES

Year	Engine	Vin	Remark	Part
<b>LINCOLN (con't)</b>				
<b>MARK VI (con't)</b>				
1980-82	V8 5.0L 302ci	F	w/Cruise Lower; 80.00" Cable	CA-3012
1980	V8 5.8L 351ci	G	w/Cruise Lower; 80.00" Cable	CA-3012
1980	V8 5.8L 351ci	G	w/Cruise Upper	CA-3044
1980	V8 5.8L 351ci	G	w/o Cruise Control; 76.00" Cable	CA-3011
<b>MARK VII</b>				
1984-85	L6 2.4L 146ci	L	w/o Cruise Control; 80.00" Cable	CA-3012
1984-87	V8 5.0L 302ci	F,M	w/o Cruise Control; 80.00" Cable	CA-3012
<b>TOWN CAR</b>				
1981	V8 5.0L 302ci	F	AT w/o Cruise Control; 76.00" Cable	CA-3011
1981	V8 5.0L 302ci	F	w/Cruise Lower; 80.00" Cable	CA-3012
1982	V8 5.0L 302ci	F	AT w/o Cruise, w/Cruise Lower; 80.00" Cable	CA-3012
1981-82	V8 5.0L 302ci	F	w/Cruise Upper	CA-3044
1983-90	V8 5.0L 302ci	F	w/Cruise Control; 71.00" Cable	CA-3018
<b>VERSAILLES</b>				
1977-80	V8 5.0L 302ci	F	w/Cruise Lower; 66.00" Cable	CA-3020
1977-80	V8 5.0L 302ci	F	w/Cruise Upper	CA-3044
1977-80	V8 5.0L 302ci	F	w/o Cruise Control; 80.00" Cable	CA-3012
1977	V8 5.8L 351ci	H	w/Cruise Lower; 66.00" Cable	CA-3020
1977	V8 5.8L 351ci	H	w/Cruise Upper	CA-3044
1977	V8 5.8L 351ci	H	w/o Cruise Control; 80.00" Cable	CA-3012
<b>MAZDA</b>				
<b>626</b>				
1983	L4 2.0L 1970cc			CA-3115
1979-82	L4 2.0L 1970cc		AT	CA-3110
1984-85	L4 2.0L 1998cc			CA-3115
<b>GLC</b>				
1981-82	L4 1.5L 1490cc		exc. Wagon	CA-3109
<b>RX-7</b>				
1979-82	R2 1.1L 1146cc		AT	CA-3107
<b>MAZDA TRUCKS</b>				
<b>B1800</b>				
1977-78	L4 1.8L 1796cc		AT	CA-3136
<b>B2000</b>				
1979-84	L4 2.0L 1970cc		AT	CA-3136
<b>B2200</b>				
1982-84	L4 2.2L 2209cc		AT	CA-3136
<b>MERCEDES-BENZ</b>				
<b>200, 200D</b>				
1966-68	L4 2.0L 121ci		AT	CA-3121
1966-68	L4 2.0L 121ci		MT	CA-3139
1968-73	L4 2.2L 2197cc		AT	CA-3121
1968-73	L4 2.2L 2197cc		MT	CA-3139
1965	L6 2.2L 134ci		AT	CA-3121
1965	L6 2.2L 134ci		MT	CA-3139
<b>230</b>				
1974-76	L4 2.3L 2307cc		MT	CA-3139
<b>240D</b>				
1974-82	L4 2.4L 2404cc		MT	CA-3139
1974-83	L4 2.4L 2404cc		AT	CA-3121
<b>250S</b>				
1966-67	L6 2.5L 2496cc		AT	CA-3121
<b>280, 280C, 280CE, 280E, 280S, 280SE</b>				
1973-80	L6 2.8L 2746cc		AT	CA-3121
1981	L6 2.8L 2778cc		AT	CA-3121
1968-72	L6 2.8L 2778cc		AT	CA-3121
1970	V8 3.5L 3504cc		AT	CA-3121
1972-73	V8 4.5L 4520cc		AT	CA-3121
<b>300CD, 300CDT, 300D, 300DT, 300SD, 300SEL, 300TD, 300TDT</b>				
1983-84	L5 3.0L 2998cc		AT	CA-3121
1983-84	L5 3.0L 2998cc		MT	CA-3139



# SPEEDOMETER CABLES

Year	Engine	Vin	Remark	Part
<b>MERCEDES-BENZ (con't)</b>				
<b>300CD, 300CDT, 300D, 300DT, 300SD, 300SEL, 300TD, 300TDT (con't)</b>				
1975-82	L5 3.0L 3005cc		AT	CA-3121
1975-82	L5 3.0L 3005cc		MT	CA-3139
1965	L6 3.0L 183ci		AT	CA-3121
<b>350SL</b>				
1972	V8 4.5L 4520cc		AT	CA-3121
<b>450SEL</b>				
1973-80	V8 4.5L 4520cc		AT	CA-3139
<b>450SL, 450SLC</b>				
1973-80	V8 4.5L 4520cc			CA-3121
<b>MERCURY</b>				
<b>BOBCAT</b>				
1980	L4 2.3L 140ci	A	AT & 4 Spd. MT w/o Cruise; 80.00" Cable	CA-3012
1975-77	L4 2.3L 140ci	Y	AT, 4 Spd. MT; 80.00" Cable	CA-3012
1978-79	L4 2.3L 140ci	Y	AT & 4 Spd. MT w/o Cruise; 80.00" Cable	CA-3012
1975-77	V6 2.8L 171ci	Z	AT, 4 Spd. MT; 80.00" Cable	CA-3012
1978-79	V6 2.8L 171ci	Z	AT & 4 Spd. MT w/o Cruise; 80.00" Cable	CA-3012
<b>CAPRI</b>				
1973-74	L4 2.0L 122ci		Lower; 83.00" Cable	CA-3010
1973-74	L4 2.0L 122ci		Upper	CA-3046
1983-86	L4 2.3L 140ci	A,	w/Cruise Control; 71.00" Cable	CA-3018
1980-82	L4 2.3L 140ci	A,T	w/Cruise Lower; 63.00" Cable	CA-3002
1980-82	L4 2.3L 140ci	A,T	w/Cruise Upper	CA-3045
1980-86	L4 2.3L 140ci	A,T,W	w/o Turbo w/o Cruise; 76.00" Cable	CA-3011
1980-86	L4 2.3L 140ci	A,T,W	w/Turbo w/o Cruise; 80.00" Cable	CA-3012
1979	L4 2.3L 140ci	W	Lower; 83.00" Cable	CA-3010
1979	L4 2.3L 140ci	W	Upper	CA-3046
1979	L4 2.3L 140ci	W,Y	w/Cruise Lower; 63.00" Cable	CA-3002
1979	L4 2.3L 140ci	W,Y	w/Cruise Upper	CA-3045
1979	L4 2.3L 140ci	W,Y	w/o Cruise Control; 76.00" Cable	CA-3011
1976-77	L4 2.3L 140ci	Y	Lower; 83.00" Cable	CA-3010
1976-77	L4 2.3L 140ci	Y	Upper	CA-3046
1980-82	L6 3.3L 200ci	B	w/Cruise Lower; 63.00" Cable	CA-3002
1980-82	L6 3.3L 200ci	B	w/Cruise Upper	CA-3045
1980-82	L6 3.3L 200ci	B	w/o Turbo w/o Cruise; 76.00" Cable	CA-3011
1980-82	L6 3.3L 200ci	B	w/Turbo w/o Cruise; 80.00" Cable	CA-3012
1979	L6 3.3L 200ci	T	w/Cruise Lower; 63.00" Cable	CA-3002
1979	L6 3.3L 200ci	T	w/Cruise Upper	CA-3045
1979	L6 3.3L 200ci	T	w/o Cruise Control; 76.00" Cable	CA-3011
1967	L6 3.3L 200ci		Lower; 83.00" Cable	CA-3010
1967	L6 3.3L 200ci		Upper	CA-3046
1973	V6 2.6L 2606cc		Lower; 83.00" Cable	CA-3010
1973	V6 2.6L 2606cc		Upper	CA-3046
1979	V6 2.8L 171ci	Z	w/Cruise Lower; 63.00" Cable	CA-3002
1979	V6 2.8L 171ci	Z	w/Cruise Upper	CA-3045
1979	V6 2.8L 171ci	Z	w/o Cruise Control; 76.00" Cable	CA-3011
1976-77	V6 2.8L 171ci	Z	Lower; 83.00" Cable	CA-3010
1976-77	V6 2.8L 171ci	Z	Upper	CA-3046
1974	V6 2.8L 171ci		Lower; 83.00" Cable	CA-3010
1974	V6 2.8L 171ci		Upper	CA-3046
1983-86	V6 3.8L 232ci	3	w/Cruise Control; 71.00" Cable	CA-3018
1983-86	V6 3.8L 232ci	3	w/o Turbo w/o Cruise; 76.00" Cable	CA-3011
1983-86	V6 3.8L 232ci	3	w/Turbo w/o Cruise; 80.00" Cable	CA-3012
1980-82	V8 4.2L 255ci	D	w/Cruise Lower; 63.00" Cable	CA-3002
1980-82	V8 4.2L 255ci	D	w/Cruise Upper	CA-3045
1980-82	V8 4.2L 255ci	D	w/o Turbo w/o Cruise; 76.00" Cable	CA-3011
1980-82	V8 4.2L 255ci	D	w/Turbo w/o Cruise; 80.00" Cable	CA-3012
1979	V8 5.0L 302ci	F	w/o Cruise Control; 76.00" Cable	CA-3011
1982	V8 5.0L 302ci	F	w/o Turbo w/o Cruise; 76.00" Cable	CA-3011
1982	V8 5.0L 302ci	F	w/Turbo w/o Cruise; 80.00" Cable	CA-3012
1979-82	V8 5.0L 302ci	F	w/Cruise Lower; 63.00" Cable	CA-3002
1979-82	V8 5.0L 302ci	F	w/Cruise Upper	CA-3045
1984-86	V8 5.0L 302ci	M	w/Cruise Control; 71.00" Cable	CA-3018

# SPEEDOMETER CABLES

Year	Engine	Vin	Remark	Part
<b>MERCURY (con't)</b>				
<b>CAPRI (con't)</b>				
1984-86	V8 5.0L 302ci	M	w/o Turbo w/o Cruise; 76.00" Cable	CA-3011
1984-86	V8 5.0L 302ci	M	w/Turbo w/o Cruise; 80.00" Cable	CA-3012
<b>COLONY PARK</b>				
1961	L6 3.7L 223ci		AT w/o Cruise Control; 83.00" Cable	CA-3010
1961	L6 3.7L 223ci		MT w/o Cruise; 60.00" Cable	CA-3015
1962	L6 3.7L 223ci		w/o Cruise Control; 83.00" Cable	CA-3010
1961-62	L6 3.7L 223ci		w/Cruise Control	CA-3006
1961	V8 4.8L 292ci		AT w/o Cruise Control; 83.00" Cable	CA-3010
1961	V8 4.8L 292ci		MT w/o Cruise; 60.00" Cable	CA-3015
1962	V8 4.8L 292ci		w/o Cruise Control; 83.00" Cable	CA-3010
1961-62	V8 4.8L 292ci		w/Cruise Control	CA-3006
1987-90	V8 5.0L 302ci	F	w/Cruise Control; 71.00" Cable	CA-3018
1987-90	V8 5.0L 302ci	F	w/o Cruise Control; 76.00" Cable	CA-3011
1959	V8 5.1L 312ci		3 Spd. Trans.; 60.00" Cable	CA-3015
1960	V8 5.1L 312ci		AT, U.S.; 66.00" Cable	CA-3020
1971	V8 5.8L 351ci	H	3 Spd. MT, FMX & C6 w/o Cruise; 63.00" Cable	CA-3021
1973	V8 5.8L 351ci	H	w/Cruise Lower; 66.00" Cable	CA-3020
1971-73	V8 5.8L 351ci	H	w/Cruise Upper	CA-3045
1972-73	V8 5.8L 351ci	H	FMX & C6 w/o Cruise; 63.00" Cable	CA-3021
1961	V8 5.8L 352ci		AT w/o Cruise Control; 83.00" Cable	CA-3010
1961	V8 5.8L 352ci		MT w/o Cruise; 60.00" Cable	CA-3015
1962	V8 5.8L 352ci		w/o Cruise Control; 83.00" Cable	CA-3010
1961-62	V8 5.8L 352ci		w/Cruise Control	CA-3006
1957	V8 6.0L 368ci		AT; 63.00" Cable	CA-3002
1958	V8 6.3L 383ci		AT; 63.00" Cable	CA-3002
1959	V8 6.3L 383ci		3 Spd. Trans.; 60.00" Cable	CA-3015
1968	V8 6.4L 390ci	X,Z	w/o Cruise Control; 60.00" Cable	CA-3015
1969-70	V8 6.4L 390ci	Y	3 Spd. MT; 63.00" Cable	CA-3021
1969-70	V8 6.4L 390ci	Y	AT w/o Cruise Control; 80.00" Cable	CA-3012
1962	V8 6.4L 390ci		w/Cruise Control	CA-3006
1963	V8 6.4L 390ci		w/Cruise Control; 63.00" Cable	CA-3002
1962-64	V8 6.4L 390ci		w/o Cruise Control; 83.00" Cable	CA-3010
1965-67	V8 6.4L 390ci		w/o Cruise Control; 60.00" Cable	CA-3015
1971	V8 6.6L 400ci	S	3 Spd. MT, FMX & C6 w/o Cruise; 63.00" Cable	CA-3021
1973	V8 6.6L 400ci	S	w/Cruise Lower; 66.00" Cable	CA-3020
1974	V8 6.6L 400ci	S	w/o Cruise exc. Police; 63.00" Cable	CA-3021
1971-73	V8 6.6L 400ci	S	w/Cruise Upper	CA-3045
1972-73	V8 6.6L 400ci	S	FMX & C6 w/o Cruise; 63.00" Cable	CA-3021
1966-67	V8 6.7L 410ci		w/o Cruise Control; 60.00" Cable	CA-3015
1965-67	V8 7.0L 427ci		w/o Cruise Control; 60.00" Cable	CA-3015
1968	V8 7.0L 428ci	Q	w/o Cruise Control; 60.00" Cable	CA-3015
1966-67	V8 7.0L 428ci		w/o Cruise Control; 60.00" Cable	CA-3015
1971	V8 7.0L 429ci	K,N	3 Spd. MT, FMX & C6 w/o Cruise; 63.00" Cable	CA-3021
1969-70	V8 7.0L 429ci	K,N	3 Spd. MT; 63.00" Cable	CA-3021
1971-73	V8 7.0L 429ci	K,N	w/Cruise Upper	CA-3045
1973	V8 7.0L 429ci	N	w/Cruise Lower; 66.00" Cable	CA-3020
1972-73	V8 7.0L 429ci	N	FMX & C6 w/o Cruise; 63.00" Cable	CA-3021
1958	V8 7.0L 430ci		AT; 63.00" Cable	CA-3002
1959	V8 7.0L 430ci		3 Spd. Trans.; 60.00" Cable	CA-3015
1974	V8 7.5L 460ci	A	w/Cruise Upper	CA-3044
1974	V8 7.5L 460ci	A	w/o Cruise exc. Police; 63.00" Cable	CA-3021
1972-73	V8 7.5L 460ci	A	FMX & C6 w/o Cruise; 63.00" Cable	CA-3021
1972-73	V8 7.5L 460ci	A	w/Cruise Upper	CA-3045
<b>COMET</b>				
1961-63	L6 2.4L 144ci		AT; 83.00" Cable	CA-3010
1961-63	L6 2.4L 144ci		MT 3 Spd. Trans.; 60.00" Cable	CA-3015
1972	L6 2.8L 170ci	U	3 Spd. MT; 63.00" Cable	CA-3021
1971-72	L6 2.8L 170ci	U	AT w/Cruise Control, Lower; 66.00" Cable	CA-3020
1971-72	L6 2.8L 170ci	U	AT w/o Cruise Control; 80.00" Cable	CA-3012
1961-64	L6 2.8L 170ci		AT; 83.00" Cable	CA-3010
1961-64	L6 2.8L 170ci		MT 3 Spd. Trans.; 60.00" Cable	CA-3015
1968	L6 3.3L 200ci	T	3 Spd. MT; 66.00" Cable	CA-3020

# SPEEDOMETER CABLES

Year	Engine	Vin	Remark	Part
<b>MERCURY (con't)</b>				
<b>COMET (con't)</b>				
1968	L6 3.3L 200ci	T	AT w/3.91 or 4.30 Rear End	CA-3046
1971-75	L6 3.3L 200ci	T	AT w/Cruise Control, Lower; 66.00" Cable	CA-3020
1971-75	L6 3.3L 200ci	T	AT w/o Cruise Control; 80.00" Cable	CA-3012
1972-75	L6 3.3L 200ci	T	3 Spd. MT; 63.00" Cable	CA-3021
1973-74	L6 3.3L 200ci	T	AT w/Cruise Control, Upper	CA-3044
1976-77	L6 3.3L 200ci	T	AT & 3 Spd. MT; 63.00" Cable	CA-3021
1964	L6 3.3L 200ci		AT; 83.00" Cable	CA-3010
1966	L6 3.3L 200ci		3 Spd. MT; 66.00" Cable	CA-3020
1964-65	L6 3.3L 200ci		MT 3 Spd. Trans.; 60.00" Cable	CA-3015
1969-75	L6 4.1L 250ci	L	3 Spd. MT; 63.00" Cable	CA-3021
1971-75	L6 4.1L 250ci	L	AT w/Cruise Control, Lower; 66.00" Cable	CA-3020
1971-75	L6 4.1L 250ci	L	AT w/o Cruise Control; 80.00" Cable	CA-3012
1973-74	L6 4.1L 250ci	L	AT w/Cruise Control, Upper	CA-3044
1976-77	L6 4.1L 250ci	L	AT & 3 Spd. MT; 63.00" Cable	CA-3021
1963-64	V8 4.3L 260ci		AT; 83.00" Cable	CA-3010
1963-64	V8 4.3L 260ci		MT 3 Spd. Trans.; 60.00" Cable	CA-3015
1964	V8 4.7L 289ci		AT; 83.00" Cable	CA-3010
1966	V8 4.7L 289ci		3 Spd. MT; 66.00" Cable	CA-3020
1964-65	V8 4.7L 289ci		MT 3 Spd. Trans.; 60.00" Cable	CA-3015
1971-75	V8 5.0L 302ci	F	AT w/Cruise Control, Lower; 66.00" Cable	CA-3020
1971-75	V8 5.0L 302ci	F	AT w/o Cruise Control; 80.00" Cable	CA-3012
1973-74	V8 5.0L 302ci	F	AT w/Cruise Control, Upper	CA-3044
1976-77	V8 5.0L 302ci	F	AT & 3 Spd. MT; 63.00" Cable	CA-3021
1968	V8 5.0L 302ci	F,J	AT w/3.91 or 4.30 Rear End	CA-3046
1968-75	V8 5.0L 302ci	F,J	3 Spd. MT; 63.00" Cable	CA-3021
1968	V8 6.4L 390ci	S,Y	3 Spd. MT; 63.00" Cable	CA-3021
1968	V8 6.4L 390ci	S,Y	AT w/3.91 or 4.30 Rear End	CA-3046
1965	V8 7.0L 427ci		MT 3 Spd. Trans.; 60.00" Cable	CA-3015
<b>COMMUTER</b>				
1961	L6 3.7L 223ci		AT w/o Cruise Control; 83.00" Cable	CA-3010
1961	L6 3.7L 223ci		MT w/o Cruise; 60.00" Cable	CA-3015
1961	L6 3.7L 223ci		w/Cruise Control	CA-3006
1967	V8 4.7L 289ci		w/o Cruise Control; 60.00" Cable	CA-3015
1961	V8 4.8L 292ci		AT w/o Cruise Control; 83.00" Cable	CA-3010
1961	V8 4.8L 292ci		MT w/o Cruise; 60.00" Cable	CA-3015
1961	V8 4.8L 292ci		w/Cruise Control	CA-3006
1959	V8 5.1L 312ci		3 Spd. Trans.; 60.00" Cable	CA-3015
1960	V8 5.1L 312ci		AT, U.S.; 66.00" Cable	CA-3020
1957-58	V8 5.1L 312ci		AT; 63.00" Cable	CA-3002
1961	V8 5.8L 352ci		AT w/o Cruise Control; 83.00" Cable	CA-3010
1961	V8 5.8L 352ci		MT w/o Cruise; 60.00" Cable	CA-3015
1961	V8 5.8L 352ci		w/Cruise Control	CA-3006
1957	V8 6.0L 368ci		AT; 63.00" Cable	CA-3002
1958	V8 6.3L 383ci		AT; 63.00" Cable	CA-3002
1959	V8 6.3L 383ci		3 Spd. Trans.; 60.00" Cable	CA-3015
1968	V8 6.4L 390ci	X,Z	w/o Cruise Control; 60.00" Cable	CA-3015
1961	V8 6.4L 390ci		AT w/o Cruise Control; 83.00" Cable	CA-3010
1961	V8 6.4L 390ci		MT w/o Cruise; 60.00" Cable	CA-3015
1961-62	V8 6.4L 390ci		w/Cruise Control	CA-3006
1962-64	V8 6.4L 390ci		w/o Cruise Control; 83.00" Cable	CA-3010
1965-67	V8 6.4L 390ci		w/o Cruise Control; 60.00" Cable	CA-3015
1966-67	V8 6.7L 410ci		w/o Cruise Control; 60.00" Cable	CA-3015
1965-67	V8 7.0L 427ci		w/o Cruise Control; 60.00" Cable	CA-3015
1968	V8 7.0L 428ci	Q	w/o Cruise Control; 60.00" Cable	CA-3015
1966-67	V8 7.0L 428ci		w/o Cruise Control; 60.00" Cable	CA-3015
1959	V8 7.0L 430ci		3 Spd. Trans.; 60.00" Cable	CA-3015
<b>COUGAR</b>				
1981	L4 2.3L 140ci	A	w/Cruise Lower; 63.00" Cable	CA-3002
1981	L4 2.3L 140ci	A	w/Cruise Upper	CA-3045
1981	L4 2.3L 140ci	A	w/o Cruise Control; 76.00" Cable	CA-3011
1984	L4 2.3L 140ci	W	w/Cruise Control; 71.00" Cable	CA-3018
1984-85	L4 2.3L 140ci	W	w/o Cruise Control; 76.00" Cable	CA-3011

# SPEEDOMETER CABLES

Year	Engine	Vin	Remark	Part
<b>MERCURY (con't)</b>				
<b>COUGAR (con't)</b>				
1980	L6 3.3L 200ci	B	w/Cruise Lower; 60.00" Cable	CA-3015
1980-82	L6 3.3L 200ci	B	w/Cruise Upper	CA-3045
1980-82	L6 3.3L 200ci	B	w/o Cruise Control; 76.00" Cable	CA-3011
1981-82	L6 3.3L 200ci	B	w/Cruise Lower; 63.00" Cable	CA-3002
1982	V6 3.8L 232ci	3	w/Cruise Lower; 63.00" Cable	CA-3002
1982	V6 3.8L 232ci	3	w/Cruise Upper	CA-3045
1982-85	V6 3.8L 232ci	3	w/o Cruise Control; 76.00" Cable	CA-3011
1983-84	V6 3.8L 232ci	3	w/Cruise Control; 71.00" Cable	CA-3018
1980-82	V8 4.2L 255ci	D	w/Cruise Lower; 60.00" Cable	CA-3015
1980-82	V8 4.2L 255ci	D	w/Cruise Upper	CA-3045
1980-82	V8 4.2L 255ci	D	w/o Cruise Control; 76.00" Cable	CA-3011
1968	V8 4.7L 289ci	C	AT, w/3.91 Rear Axle Ratio, C6 Trans., w/4.30 Rear Axle Ratio; 83.00" Cable	CA-3004
1968	V8 4.7L 289ci	C	AT, w/C4 Trans., w/C6 Trans., exc. 4.30 Rear Axle Ratio, exc. 3.91 Rear Axle Ratio; 83.00" Cable	CA-3010
1967	V8 4.7L 289ci		AT; 83.00" Cable	CA-3010
1977-83	V8 5.0L 302ci	F	w/Cruise Lower; 66.00" Cable	CA-3020
1977-83	V8 5.0L 302ci	F	w/o Cruise, w/Cruise Upper; 80.00" Cable	CA-3012
1980-81	V8 5.0L 302ci	F	w/Cruise Lower; 60.00" Cable	CA-3015
1980-81	V8 5.0L 302ci	F	w/Cruise Upper	CA-3045
1980-85	V8 5.0L 302ci	F	w/o Cruise Control; 76.00" Cable	CA-3011
1983-84	V8 5.0L 302ci	F	w/Cruise Control; 71.00" Cable	CA-3018
1968	V8 5.0L 302ci	F,J	3 Spd. Trans.; 60.00" Cable	CA-3015
1968	V8 5.0L 302ci	F,J	AT, w/3.91 Rear Axle Ratio, C6 Trans., w/4.30 Rear Axle Ratio; 83.00" Cable	CA-3004
1968	V8 5.0L 302ci	F,J	AT, w/C4 Trans., w/C6 Trans., exc. 4.30 Rear Axle Ratio, exc. 3.91 Rear Axle Ratio; 83.00" Cable	CA-3010
1970	V8 5.0L 302ci	G	C4 AT, Cruise-O-Matic to 12/15/69, 3 Spd. MT; 63.00" Cable	CA-3021
1970	V8 5.0L 302ci	G	C6 AT w/3.91 Rear Axle Ratio w/4.30 Rear Axle Ratio	CA-3046
1970	V8 5.0L 302ci	G	C6 AT w/o 3.91 Rear Axle Ratio w/o 4.30 Rear Axle Ratio, Cruise-O-Matic From 12/15/69, 4 Spd. MT; 80.00" Cable	CA-3012
1973	V8 5.8L 351ci	H	3 Spd. MT	CA-3044
1975	V8 5.8L 351ci	H	w/Cruise Upper to 3/5/75	CA-3044
1975-78	V8 5.8L 351ci	H	w/o Cruise, w/Cruise Upper From 3/5/75"; 80.00" Cable	CA-3012
1970	V8 5.8L 351ci	H,M	C4 AT, Cruise-O-Matic to 12/15/69, 3 Spd. MT; 63.00" Cable	CA-3021
1969-70	V8 5.8L 351ci	H,M	C6 AT w/o 3.91 Rear Axle Ratio w/o 4.30 Rear Axle Ratio, Cruise-O-Matic From 12/15/69, 4 Spd. MT; 80.00" Cable	CA-3012
1969-70	V8 5.8L 351ci	H,M	C6 AT w/3.91 Rear Axle Ratio w/4.30 Rear Axle Ratio	CA-3046
1971-72	V8 5.8L 351ci	H,M,Q	3 Spd. MT; 63.00" Cable	CA-3021
1971-72	V8 5.8L 351ci	H,M,Q	AT & 4 Spd. MT; 80.00" Cable	CA-3012
1973	V8 5.8L 351ci	H,Q	AT w/Cruise; 66.00" Cable	CA-3020
1973	V8 5.8L 351ci	H,Q	AT w/o Cruise Control; 80.00" Cable	CA-3012
1974	V8 5.8L 351ci	H,Q	C4 AT, Cruise-O-Matic, 3 Spd. MT, AT w/Cruise Lower; 66.00" Cable	CA-3020
1974	V8 5.8L 351ci	H,Q	C6 AT, 4 Spd. MT; 80.00" Cable	CA-3012
1972-78	V8 5.8L 351ci	H,Q	w/Cruise Lower; 66.00" Cable	CA-3020
1971	V8 5.8L 351ci	M	w/Cruise Lower; 66.00" Cable	CA-3020
1971	V8 5.8L 351ci	M	w/o Cruise, w/Cruise Upper; 80.00" Cable	CA-3012
1973	V8 5.8L 351ci	Q	3 Spd. MT	CA-3044
1969	V8 6.4L 390ci	S	C6 AT w/3.91 Rear Axle Ratio w/4.30 Rear Axle Ratio	CA-3046
1969	V8 6.4L 390ci	S	C6 AT w/o 3.91 Rear Axle Ratio w/o 4.30 Rear Axle Ratio, Cruise-O-Matic, MT; 80.00" Cable	CA-3012
1968	V8 6.4L 390ci	S,X	AT, w/3.91 Rear Axle Ratio, C6 Trans., w/4.30 Rear Axle Ratio; 83.00" Cable	CA-3004
1968	V8 6.4L 390ci	S,X	AT, w/C4 Trans., w/C6 Trans., exc. 4.30 Rear Axle Ratio, exc. 3.91 Rear Axle Ratio; 83.00" Cable	CA-3010
1967	V8 6.4L 390ci		AT; 83.00" Cable	CA-3010
1974	V8 6.6L 400ci	S	C4 AT, Cruise-O-Matic, 3 Spd. MT, AT w/Cruise Lower; 66.00" Cable	CA-3020
1974	V8 6.6L 400ci	S	C6 AT, 4 Spd. MT; 80.00" Cable	CA-3012
1974-75	V8 6.6L 400ci	S	w/Cruise Upper to 3/5/75	CA-3044
1975-78	V8 6.6L 400ci	S	w/Cruise Lower; 66.00" Cable	CA-3020
1975-78	V8 6.6L 400ci	S	w/o Cruise, w/Cruise Upper From 3/5/75"; 80.00" Cable	CA-3012
1968	V8 7.0L 427ci	W	3 Spd. Trans.; 60.00" Cable	CA-3015
1968	V8 7.0L 427ci	W	AT, w/3.91 Rear Axle Ratio, C6 Trans., w/4.30 Rear Axle Ratio; 83.00" Cable	CA-3004
1968	V8 7.0L 427ci	W	AT, w/C4 Trans., w/C6 Trans., exc. 4.30 Rear Axle Ratio, exc. 3.91 Rear Axle Ratio; 83.00" Cable	CA-3010

# SPEEDOMETER CABLES

Year	Engine	Vin	Remark	Part
<b>MERCURY (con't)</b>				
<b>COUGAR (con't)</b>				
1970	V8 7.0L 428ci	Q	C4 AT, Cruise-O-Matic to 12/15/69, 3 Spd. MT; 63.00" Cable	CA-3021
1970	V8 7.0L 428ci	Q	C6 AT w/3.91 Rear Axle Ratio w/4.30 Rear Axle Ratio	CA-3046
1970	V8 7.0L 428ci	Q	C6 AT w/o 3.91 Rear Axle Ratio w/o 4.30 Rear Axle Ratio, Cruise-O-Matic From 12/15/69, 4 Spd. MT; 80.00" Cable	CA-3012
1968	V8 7.0L 428ci	R	3 Spd. Trans.; 60.00" Cable	CA-3015
1968	V8 7.0L 428ci	R	AT, w/3.91 Rear Axle Ratio, C6 Trans., w/4.30 Rear Axle Ratio; 83.00" Cable	CA-3004
1968	V8 7.0L 428ci	R	AT, w/C4 Trans., w/C6 Trans., exc. 4.30 Rear Axle Ratio, exc. 3.91 Rear Axle Ratio; 83.00" Cable	CA-3010
1969	V8 7.0L 428ci	R	C6 AT w/3.91 Rear Axle Ratio w/4.30 Rear Axle Ratio	CA-3046
1969	V8 7.0L 428ci	R	C6 AT w/o 3.91 Rear Axle Ratio w/o 4.30 Rear Axle Ratio, Cruise-O-Matic, MT; 80.00" Cable	CA-3012
1971	V8 7.0L 429ci	C	3 Spd. MT; 63.00" Cable	CA-3021
1971	V8 7.0L 429ci	C	AT & 4 Spd. MT; 80.00" Cable	CA-3012
1974	V8 7.5L 460ci	A	C4 AT, Cruise-O-Matic, 3 Spd. MT, AT w/Cruise Lower; 66.00" Cable	CA-3020
1974	V8 7.5L 460ci	A	C6 AT, 4 Spd. MT; 80.00" Cable	CA-3012
1975	V8 7.5L 460ci	A	w/Cruise Upper to 3/5/75	CA-3044
1975-76	V8 7.5L 460ci	A	w/o Cruise, w/Cruise Upper From 3/5/75"; 80.00" Cable	CA-3012
1975-76	V8 7.5L 460ci	A	w/Cruise Lower; 66.00" Cable	CA-3020
<b>CYCLONE</b>				
1964	L6 3.3L 200ci		3 Spd. Trans.; 60.00" Cable	CA-3015
1964	L6 3.3L 200ci		AT; 83.00" Cable	CA-3010
1964	V8 4.3L 260ci		3 Spd. Trans.; 60.00" Cable	CA-3015
1964	V8 4.3L 260ci		AT; 83.00" Cable	CA-3010
1964	V8 4.7L 289ci		AT; 83.00" Cable	CA-3010
1966	V8 4.7L 289ci		3 Spd. MT; 66.00" Cable	CA-3020
1964-65	V8 4.7L 289ci		3 Spd. Trans.; 60.00" Cable	CA-3015
1968	V8 5.0L 302ci	F,J	AT w/3.91 or 4.30 Rear End	CA-3046
1968	V8 5.0L 302ci	F,J	3 Spd. MT; 63.00" Cable	CA-3021
1970	V8 5.8L 351ci	H	3 Spd. MT; 63.00" Cable	CA-3021
1970	V8 5.8L 351ci	H	C4, FMx; 80.00" Cable	CA-3012
1970	V8 5.8L 351ci	H	C6 w/3.91 or 4.30 Rear End	CA-3046
1968	V8 6.4L 390ci	S,Y	3 Spd. MT; 63.00" Cable	CA-3021
1968	V8 6.4L 390ci	S,Y	AT w/3.91 or 4.30 Rear End	CA-3046
1968	V8 7.0L 427ci	W	3 Spd. MT; 63.00" Cable	CA-3021
1968	V8 7.0L 427ci	W	C6 w/3.91 or 4.30 Rear End	CA-3046
1965	V8 7.0L 427ci		3 Spd. Trans.; 60.00" Cable	CA-3015
<b>GRAND MARQUIS</b>				
1981-82	V8 4.2L 255ci	D	w/Cruise Lower; 66.00" Cable	CA-3020
1981-82	V8 4.2L 255ci	D	w/Cruise Upper	CA-3044
1981-82	V8 4.2L 255ci	D	w/o Cruise Control; 80.00" Cable	CA-3012
2000-02	V8 4.6L 281ci	W	w/o Cruise Control; 80.00" Cable	CA-3012
2001-02	V8 4.6L 281ci	W	w/Cruise Control; 71.00" Cable	CA-3018
1979-87	V8 5.0L 302ci	F	w/Cruise Control; 71.00" Cable	CA-3018
1979-91	V8 5.0L 302ci	F	w/o Cruise Control; 80.00" Cable	CA-3012
1980-91	V8 5.0L 302ci	F	w/Cruise Lower; 66.00" Cable	CA-3020
1980-91	V8 5.0L 302ci	F	w/Cruise Upper	CA-3044
1983-87	V8 5.0L 302ci	F	4 Spd. MT w/o Cruise; 76.00" Cable	CA-3011
1984-86	V8 5.0L 302ci	F	w/o Cruise Control; 76.00" Cable	CA-3011
1980-88	V8 5.8L 351ci	G	w/Cruise Control; 71.00" Cable	CA-3018
1980-89	V8 5.8L 351ci	G	w/Cruise Lower; 66.00" Cable	CA-3020
1980-89	V8 5.8L 351ci	G	w/Cruise Upper	CA-3044
1980-89	V8 5.8L 351ci	G	w/o Cruise Control; 80.00" Cable	CA-3012
1983-87	V8 5.8L 351ci	G	4 Spd. MT w/o Cruise; 76.00" Cable	CA-3011
1978	V8 5.8L 351ci	H	w/Cruise Lower; 66.00" Cable	CA-3020
1978	V8 5.8L 351ci	H	w/Cruise Upper	CA-3044
1978	V8 5.8L 351ci	H	w/o Cruise Control; 80.00" Cable	CA-3012
1979	V8 5.8L 351ci	H	w/o Cruise exc. Police; 63.00" Cable	CA-3021
1975-78	V8 6.6L 400ci	S	w/o Cruise exc. Police; 63.00" Cable	CA-3021
1975-78	V8 7.5L 460ci	A	w/o Cruise exc. Police; 63.00" Cable	CA-3021
<b>LN7, LYNX</b>				
1981-83	L4 1.6L 98ci	2,4,5	w/Cruise Lower	CA-3040
1981-83	L4 1.6L 98ci	2,4,5	w/Cruise Upper	CA-3045

# SPEEDOMETER CABLES

Year	Engine	Vin	Remark	Part
<b>MERCURY (con't)</b>				
<b>LN7, LYNX (con't)</b>				
1981-85	L4 1.6L 98ci	2,4,5	w/o Cruise Control	CA-3017
1984-85	L4 1.6L 98ci	2,4,5	w/Cruise Control	CA-3053
1985-86	L4 1.9L 116ci	9	w/Cruise Control	CA-3053
1985-86	L4 1.9L 116ci	9	w/o Cruise Control	CA-3017
1986-87	L4 1.9L 116ci	J	w/Cruise Control	CA-3053
1986-87	L4 1.9L 116ci	J	w/o Cruise Control	CA-3017
1984-85	L4 2.0L 122ci	H	w/Cruise Control	CA-3053
1984-85	L4 2.0L 122ci	H	w/o Cruise Control	CA-3017
<b>MARQUIS</b>				
1983	L4 2.3L 140ci	6,A	4 Spd. MT w/o Cruise; 76.00" Cable	CA-3011
1983-86	L4 2.3L 140ci	6,A	w/Cruise Control; 71.00" Cable	CA-3018
1984-86	L4 2.3L 140ci	6,A	w/o Cruise Control; 76.00" Cable	CA-3011
1983	L6 3.3L 200ci	X	4 Spd. MT w/o Cruise; 76.00" Cable	CA-3011
1983	L6 3.3L 200ci	X	w/Cruise Control; 71.00" Cable	CA-3018
1983	V6 3.8L 232ci	3	4 Spd. MT w/o Cruise; 76.00" Cable	CA-3011
1983-86	V6 3.8L 232ci	3,C	w/Cruise Control; 71.00" Cable	CA-3018
1984-86	V6 3.8L 232ci	3,C	w/o Cruise Control; 76.00" Cable	CA-3011
1981-82	V8 4.2L 255ci	D	w/Cruise Lower; 66.00" Cable	CA-3020
1981-82	V8 4.2L 255ci	D	w/Cruise Upper	CA-3044
1981-82	V8 4.2L 255ci	D	w/o Cruise Control; 80.00" Cable	CA-3012
1980-82	V8 5.0L 302ci	F	w/Cruise Lower; 66.00" Cable	CA-3020
1980-82	V8 5.0L 302ci	F	w/Cruise Upper	CA-3044
1980-82	V8 5.0L 302ci	F	w/o Cruise Control; 80.00" Cable	CA-3012
1980-81	V8 5.8L 351ci	G	w/Cruise Lower; 66.00" Cable	CA-3020
1980-81	V8 5.8L 351ci	G	w/Cruise Upper	CA-3044
1980-81	V8 5.8L 351ci	G	w/o Cruise Control; 80.00" Cable	CA-3012
1971	V8 5.8L 351ci	H	3 Spd. MT, FMX & C6 w/o Cruise; 63.00" Cable	CA-3021
1973	V8 5.8L 351ci	H	w/Cruise Lower; 66.00" Cable	CA-3020
1978	V8 5.8L 351ci	H	w/o Cruise exc. Police; 63.00" Cable	CA-3021
1971-73	V8 5.8L 351ci	H	w/Cruise Upper	CA-3045
1972-73	V8 5.8L 351ci	H	FMX & C6 w/o Cruise; 63.00" Cable	CA-3021
1969-70	V8 6.4L 390ci	X	3 Spd. MT; 63.00" Cable	CA-3021
1969-70	V8 6.4L 390ci	X	AT w/o Cruise Control; 80.00" Cable	CA-3012
1968	V8 6.4L 390ci	Y,Z	w/o Cruise Control; 60.00" Cable	CA-3015
1971	V8 6.6L 400ci	S	3 Spd. MT, FMX & C6 w/o Cruise; 63.00" Cable	CA-3021
1973	V8 6.6L 400ci	S	w/Cruise Lower; 66.00" Cable	CA-3020
1974	V8 6.6L 400ci	S	w/Cruise Upper	CA-3044
1971-73	V8 6.6L 400ci	S	w/Cruise Upper	CA-3045
1972-73	V8 6.6L 400ci	S	FMX & C6 w/o Cruise; 63.00" Cable	CA-3021
1974-78	V8 6.6L 400ci	S	w/o Cruise exc. Police; 63.00" Cable	CA-3021
1967	V8 6.7L 410ci		w/o Cruise Control; 60.00" Cable	CA-3015
1967	V8 7.0L 427ci		w/o Cruise Control; 60.00" Cable	CA-3015
1969	V8 7.0L 428ci	P	3 Spd. MT; 63.00" Cable	CA-3021
1969	V8 7.0L 428ci	P	AT w/o Cruise Control; 80.00" Cable	CA-3012
1968	V8 7.0L 428ci	Q	w/o Cruise Control; 60.00" Cable	CA-3015
1967	V8 7.0L 428ci		w/o Cruise Control; 60.00" Cable	CA-3015
1971	V8 7.0L 429ci	K,N	3 Spd. MT, FMX & C6 w/o Cruise; 63.00" Cable	CA-3021
1969-70	V8 7.0L 429ci	K,N	3 Spd. MT; 63.00" Cable	CA-3021
1969-70	V8 7.0L 429ci	K,N	AT w/o Cruise Control; 80.00" Cable	CA-3012
1971-73	V8 7.0L 429ci	K,N	w/Cruise Upper	CA-3045
1973	V8 7.0L 429ci	N	w/Cruise Lower; 66.00" Cable	CA-3020
1972-73	V8 7.0L 429ci	N	FMX & C6 w/o Cruise; 63.00" Cable	CA-3021
1974	V8 7.5L 460ci	A	w/Cruise Upper	CA-3044
1972-73	V8 7.5L 460ci	A	FMX & C6 w/o Cruise; 63.00" Cable	CA-3021
1972-73	V8 7.5L 460ci	A	w/Cruise Upper	CA-3045
1974-78	V8 7.5L 460ci	A,C	w/o Cruise exc. Police; 63.00" Cable	CA-3021
<b>METEOR</b>				
1961	L6 2.8L 170ci		AT w/o Cruise Control; 83.00" Cable	CA-3010
1961	L6 2.8L 170ci		MT w/o Cruise; 60.00" Cable	CA-3015
1963	L6 2.8L 170ci		w/Cruise Control; 63.00" Cable	CA-3002
1961-62	L6 2.8L 170ci		w/Cruise Control	CA-3006
1962-63	L6 2.8L 170ci		w/o Cruise Control; 83.00" Cable	CA-3010

# SPEEDOMETER CABLES

Year	Engine	Vin	Remark	Part
<b>MERCURY (con't)</b>				
<b>METEOR (con't)</b>				
1963	L6 3.3L 200ci		w/Cruise Control; 63.00" Cable	CA-3002
1963	L6 3.3L 200ci		w/o Cruise Control; 83.00" Cable	CA-3010
1961	L6 3.7L 223ci		AT w/o Cruise Control; 83.00" Cable	CA-3010
1961	L6 3.7L 223ci		MT w/o Cruise; 60.00" Cable	CA-3015
1961	L6 3.7L 223ci		w/Cruise Control	CA-3006
1963	V8 3.6L 221ci		w/Cruise Control; 63.00" Cable	CA-3002
1962-63	V8 3.6L 221ci		w/o Cruise Control; 83.00" Cable	CA-3010
1961	V8 4.8L 292ci		AT w/o Cruise Control; 83.00" Cable	CA-3010
1961	V8 4.8L 292ci		MT w/o Cruise; 60.00" Cable	CA-3015
1961	V8 4.8L 292ci		w/Cruise Control	CA-3006
1961	V8 5.8L 352ci		AT w/o Cruise Control; 83.00" Cable	CA-3010
1961	V8 5.8L 352ci		MT w/o Cruise; 60.00" Cable	CA-3015
1961	V8 5.8L 352ci		w/Cruise Control	CA-3006
1961	V8 6.4L 390ci		AT w/o Cruise Control; 83.00" Cable	CA-3010
1961	V8 6.4L 390ci		MT w/o Cruise; 60.00" Cable	CA-3015
1961	V8 6.4L 390ci		w/Cruise Control	CA-3006
<b>MONARCH</b>				
1975-77	L6 3.3L 200ci	T	w/Cruise Lower; 66.00" Cable	CA-3020
1975-77	L6 3.3L 200ci	T	w/Cruise Upper	CA-3044
1975-77	L6 3.3L 200ci	T	w/o Cruise Control; 63.00" Cable	CA-3021
1980	L6 4.1L 250ci	C	w/Cruise Lower; 66.00" Cable	CA-3020
1980	L6 4.1L 250ci	C	w/Cruise Upper	CA-3044
1980	L6 4.1L 250ci	C	w/o Cruise Control; 63.00" Cable	CA-3021
1975-79	L6 4.1L 250ci	L	w/Cruise Lower; 66.00" Cable	CA-3020
1975-79	L6 4.1L 250ci	L	w/Cruise Upper	CA-3044
1975-79	L6 4.1L 250ci	L	w/o Cruise Control; 63.00" Cable	CA-3021
1980	V8 4.2L 255ci	D	w/Cruise Lower; 66.00" Cable	CA-3020
1980	V8 4.2L 255ci	D	w/Cruise Upper	CA-3044
1980	V8 4.2L 255ci	D	w/o Cruise Control; 63.00" Cable	CA-3021
1975-80	V8 5.0L 302ci	F	w/Cruise Lower; 66.00" Cable	CA-3020
1975-80	V8 5.0L 302ci	F	w/Cruise Upper	CA-3044
1975-80	V8 5.0L 302ci	F	w/o Cruise Control; 63.00" Cable	CA-3021
1975-77	V8 5.8L 351ci	H	w/Cruise Lower; 66.00" Cable	CA-3020
1975-77	V8 5.8L 351ci	H	w/Cruise Upper	CA-3044
1975-77	V8 5.8L 351ci	H	w/o Cruise Control; 63.00" Cable	CA-3021
<b>MONTCLAIR</b>				
1959	V8 5.1L 312ci		3 Spd. Trans.; 60.00" Cable	CA-3015
1960	V8 5.1L 312ci		AT, U.S.; 66.00" Cable	CA-3020
1957-58	V8 5.1L 312ci		AT; 63.00" Cable	CA-3002
1957	V8 6.0L 368ci		AT; 63.00" Cable	CA-3002
1958	V8 6.3L 383ci		AT; 63.00" Cable	CA-3002
1959	V8 6.3L 383ci		3 Spd. Trans.; 60.00" Cable	CA-3015
1968	V8 6.4L 390ci	X,Z	w/o Cruise Control; 60.00" Cable	CA-3015
1964	V8 6.4L 390ci		w/o Cruise Control; 83.00" Cable	CA-3010
1965-67	V8 6.4L 390ci		w/o Cruise Control; 60.00" Cable	CA-3015
1966-67	V8 6.7L 410ci		w/o Cruise Control; 60.00" Cable	CA-3015
1965-67	V8 7.0L 427ci		w/o Cruise Control; 60.00" Cable	CA-3015
1968	V8 7.0L 428ci	P	w/o Cruise Control; 60.00" Cable	CA-3015
1966-67	V8 7.0L 428ci		w/o Cruise Control; 60.00" Cable	CA-3015
1958	V8 7.0L 430ci		AT; 63.00" Cable	CA-3002
1959	V8 7.0L 430ci		3 Spd. Trans.; 60.00" Cable	CA-3015
<b>MONTEGO</b>				
1968	L6 3.3L 200ci	T	3 Spd. MT; 66.00" Cable	CA-3020
1968	L6 3.3L 200ci	T	AT w/3.91 or 4.30 Rear End	CA-3046
1973	L6 4.1L 250ci	L	C6 w/3.91 or 4.30 Rear End	CA-3046
1971-72	L6 4.1L 250ci	L	80.00" Cable	CA-3012
1973-74	L6 4.1L 250ci	L	3 Spd. MT; 63.00" Cable	CA-3021
1973-74	L6 4.1L 250ci	L	4 Spd. MT, C4 & FMX w/o Cruise; 80.00" Cable	CA-3012
1971-72	V8 5.0L 302ci	F	80.00" Cable	CA-3012
1973-74	V8 5.0L 302ci	F	3 Spd. MT; 63.00" Cable	CA-3021
1973-74	V8 5.0L 302ci	F	4 Spd. MT, C4 & FMX w/o Cruise; 80.00" Cable	CA-3012
1968	V8 5.0L 302ci	F,J	3 Spd. MT; 66.00" Cable	CA-3020

# SPEEDOMETER CABLES

Year	Engine	Vin	Remark	Part
<b>MERCURY (con't)</b>				
<b>MONTEGO (con't)</b>				
1968	V8 5.0L 302ci	F,J	AT w/3.91 or 4.30 Rear End	CA-3046
1976	V8 5.8L 351ci	H	AT w/Cruise; 66.00" Cable	CA-3020
1976	V8 5.8L 351ci	H	AT w/o Cruise Control; 80.00" Cable	CA-3012
1971-72	V8 5.8L 351ci	H,M,Q	80.00" Cable	CA-3012
1973-75	V8 5.8L 351ci	H,Q	AT w/Cruise Control, Lower; 66.00" Cable	CA-3020
1973-75	V8 5.8L 351ci	H,Q	AT w/Cruise Control, Upper	CA-3044
1973-75	V8 5.8L 351ci	H,Q	MT; 80.00" Cable	CA-3012
1968	V8 6.4L 390ci	S,Y	3 Spd. MT; 80.00" Cable	CA-3012
1968	V8 6.4L 390ci	S,Y	AT w/3.91 or 4.30 Rear End	CA-3046
1972	V8 6.6L 400ci	S	80.00" Cable	CA-3012
1973	V8 6.6L 400ci	S	2 Bbl. w/Cruise Lower; 66.00" Cable	CA-3020
1973	V8 6.6L 400ci	S	2 Bbl. w/Cruise Upper	CA-3044
1976	V8 6.6L 400ci	S	AT w/Cruise; 66.00" Cable	CA-3020
1976	V8 6.6L 400ci	S	AT w/o Cruise Control; 80.00" Cable	CA-3012
1973-75	V8 6.6L 400ci	S	3 Spd. MT; 63.00" Cable	CA-3021
1973-75	V8 6.6L 400ci	S	4 Spd. MT, C4 & FMX w/o Cruise; 80.00" Cable	CA-3012
1974-75	V8 6.6L 400ci	S	AT w/Cruise Control, Lower; 66.00" Cable	CA-3020
1974-75	V8 6.6L 400ci	S	AT w/Cruise Control, Upper	CA-3044
1970	V8 7.0L 429ci	N	C4, FMX; 80.00" Cable	CA-3012
1970	V8 7.0L 429ci	N	C6 w/3.91 or 4.30 Rear End	CA-3046
1972	V8 7.0L 429ci	N	80.00" Cable	CA-3012
1973	V8 7.0L 429ci	N	2 Bbl. w/Cruise Lower; 66.00" Cable	CA-3020
1973	V8 7.0L 429ci	N	2 Bbl. w/Cruise Upper	CA-3044
1973	V8 7.0L 429ci	N	4 Spd. MT, C4 & FMX w/o Cruise; 80.00" Cable	CA-3012
1970-73	V8 7.0L 429ci	N	3 Spd. MT; 63.00" Cable	CA-3021
1975	V8 7.5L 460ci	A	3 Spd. MT; 63.00" Cable	CA-3021
1975	V8 7.5L 460ci	A	4 Spd. MT, C4 & FMX w/o Cruise; 80.00" Cable	CA-3012
1975	V8 7.5L 460ci	A	AT w/Cruise Control, Lower; 66.00" Cable	CA-3020
1975	V8 7.5L 460ci	A	AT w/Cruise Control, Upper	CA-3044
1976	V8 7.5L 460ci	A	AT w/Cruise; 66.00" Cable	CA-3020
1976	V8 7.5L 460ci	A	AT w/o Cruise Control; 80.00" Cable	CA-3012
<b>MONTEREY</b>				
1961	L6 3.7L 223ci		AT w/o Cruise Control; 83.00" Cable	CA-3010
1961	L6 3.7L 223ci		MT w/o Cruise; 60.00" Cable	CA-3015
1962	L6 3.7L 223ci		w/o Cruise Control; 83.00" Cable	CA-3010
1961-62	L6 3.7L 223ci		w/Cruise Control	CA-3006
1961	V8 4.8L 292ci		AT w/o Cruise Control; 83.00" Cable	CA-3010
1961	V8 4.8L 292ci		MT w/o Cruise; 60.00" Cable	CA-3015
1962	V8 4.8L 292ci		w/o Cruise Control; 83.00" Cable	CA-3010
1961-62	V8 4.8L 292ci		w/Cruise Control	CA-3006
1959	V8 5.1L 312ci		3 Spd. Trans.; 60.00" Cable	CA-3015
1960	V8 5.1L 312ci		AT, U.S.; 66.00" Cable	CA-3020
1957-58	V8 5.1L 312ci		AT; 63.00" Cable	CA-3002
1971	V8 5.8L 351ci	H	3 Spd. MT, FMX & C6 w/o Cruise; 63.00" Cable	CA-3021
1973	V8 5.8L 351ci	H	w/Cruise Lower; 66.00" Cable	CA-3020
1971-73	V8 5.8L 351ci	H	w/Cruise Upper	CA-3045
1972-73	V8 5.8L 351ci	H	FMX & C6 w/o Cruise; 63.00" Cable	CA-3021
1961	V8 5.8L 352ci		AT w/o Cruise Control; 83.00" Cable	CA-3010
1961	V8 5.8L 352ci		MT w/o Cruise; 60.00" Cable	CA-3015
1962	V8 5.8L 352ci		w/o Cruise Control; 83.00" Cable	CA-3010
1961-62	V8 5.8L 352ci		w/Cruise Control	CA-3006
1957	V8 6.0L 368ci		AT; 63.00" Cable	CA-3002
1958	V8 6.3L 383ci		AT; 63.00" Cable	CA-3002
1959	V8 6.3L 383ci		3 Spd. Trans.; 60.00" Cable	CA-3015
1969-70	V8 6.4L 390ci	X	3 Spd. MT; 63.00" Cable	CA-3021
1969-70	V8 6.4L 390ci	X	AT w/o Cruise Control; 80.00" Cable	CA-3012
1968	V8 6.4L 390ci	X,Z	w/o Cruise Control; 60.00" Cable	CA-3015
1962	V8 6.4L 390ci		w/Cruise Control	CA-3006
1963	V8 6.4L 390ci		w/Cruise Control; 63.00" Cable	CA-3002
1962-64	V8 6.4L 390ci		w/o Cruise Control; 83.00" Cable	CA-3010
1965-67	V8 6.4L 390ci		w/o Cruise Control; 60.00" Cable	CA-3015
1971	V8 6.6L 400ci	S	3 Spd. MT, FMX & C6 w/o Cruise; 63.00" Cable	CA-3021



# SPEEDOMETER CABLES

Year	Engine	Vin	Remark	Part
<b>MERCURY (con't)</b>				
<b>MONTEREY (con't)</b>				
1973	V8 6.6L 400ci	S	w/Cruise Lower; 66.00" Cable	CA-3020
1974	V8 6.6L 400ci	S	w/Cruise Upper	CA-3044
1974	V8 6.6L 400ci	S	w/o Cruise exc. Police; 63.00" Cable	CA-3021
1971-73	V8 6.6L 400ci	S	w/Cruise Upper	CA-3045
1972-73	V8 6.6L 400ci	S	FMX & C6 w/o Cruise; 63.00" Cable	CA-3021
1966-67	V8 6.7L 410ci		w/o Cruise Control; 60.00" Cable	CA-3015
1965-67	V8 7.0L 427ci		w/o Cruise Control; 60.00" Cable	CA-3015
1968	V8 7.0L 428ci	P	w/o Cruise Control; 60.00" Cable	CA-3015
1969-70	V8 7.0L 428ci	P	3 Spd. MT; 63.00" Cable	CA-3021
1969-70	V8 7.0L 428ci	P	AT w/o Cruise Control; 80.00" Cable	CA-3012
1966-67	V8 7.0L 428ci		w/o Cruise Control; 60.00" Cable	CA-3015
1971	V8 7.0L 429ci	K,N	3 Spd. MT, FMX & C6 w/o Cruise; 63.00" Cable	CA-3021
1969-70	V8 7.0L 429ci	K,N	AT w/o Cruise Control; 80.00" Cable	CA-3012
1969-70	V8 7.0L 429ci	K,N	3 Spd. MT; 63.00" Cable	CA-3021
1971-73	V8 7.0L 429ci	K,N	w/Cruise Upper	CA-3045
1973	V8 7.0L 429ci	N	w/Cruise Lower; 66.00" Cable	CA-3020
1972-73	V8 7.0L 429ci	N	FMX & C6 w/o Cruise; 63.00" Cable	CA-3021
1959	V8 7.0L 430ci		3 Spd. Trans.; 60.00" Cable	CA-3015
1972-73	V8 7.5L 460ci	A	FMX & C6 w/o Cruise; 63.00" Cable	CA-3021
1972-73	V8 7.5L 460ci	A	w/Cruise Upper	CA-3045
1974	V8 7.5L 460ci	A,C	w/Cruise Upper	CA-3044
1974	V8 7.5L 460ci	A,C	w/o Cruise exc. Police; 63.00" Cable	CA-3021
<b>SABLE</b>				
1986	L4 2.5L 153ci	D	AT Upper, exc. electronic instrumentation	CA-3053
1996-02	V6 3.0L 182ci	S	AT Upper, exc. electronic instrumentation	CA-3053
1996-98	V6 3.0L 182ci	S	AT Lower w/ Flex Fuel	CA-3222
1993	V6 3.0L 182ci	U	AT Lower not Flex Fuel	CA-3222
1994	V6 3.0L 182ci	U	AT Lower w/ AX4S Trans. not Flex Fuel	CA-3222
1986-99	V6 3.0L 182ci	U	AT Upper, exc. electronic instrumentation	CA-3053
1995-98	V6 3.0L 182ci	U	AT Lower w/ Flex Fuel	CA-3222
1995	V6 3.8L 232ci	4	AT Lower w/ Flex Fuel	CA-3222
1992-95	V6 3.8L 232ci	4	AT Upper, exc. electronic instrumentation	CA-3053
<b>TOPAZ</b>				
1984-86	L4 2.0L 122ci	H	w/Cruise Control	CA-3053
1984-86	L4 2.0L 122ci	H	w/o Cruise Control	CA-3017
1984-87	L4 2.3L 140ci	R	w/Cruise Control	CA-3053
1984-87	L4 2.3L 140ci	R	w/o Cruise Control	CA-3017
1985-94	L4 2.3L 140ci	S,X	w/Cruise Control	CA-3053
1985-94	L4 2.3L 140ci	S,X	w/o Cruise Control	CA-3017
1992-94	V6 3.0L 182ci	U	w/Cruise Control	CA-3053
1992-94	V6 3.0L 182ci	U	w/o Cruise Control	CA-3017
<b>ZEPHYR</b>				
1983	L4 2.3L 140ci	A	w/Cruise Control; 71.00" Cable	CA-3018
1980-82	L4 2.3L 140ci	A	w/Cruise Lower; 60.00" Cable	CA-3015
1980-82	L4 2.3L 140ci	A	w/Cruise Upper	CA-3045
1980-83	L4 2.3L 140ci	A	w/o Cruise Control; 76.00" Cable	CA-3011
1978	L4 2.3L 140ci	Y	AT w/o Cruise Control; 76.00" Cable	CA-3011
1979	L4 2.3L 140ci	Y	w/Cruise Upper	CA-3045
1979	L4 2.3L 140ci	Y	w/o Cruise Control; 76.00" Cable	CA-3011
1980-82	L6 3.3L 200ci	B	w/Cruise Lower; 60.00" Cable	CA-3015
1980-82	L6 3.3L 200ci	B	w/Cruise Upper	CA-3045
1980-82	L6 3.3L 200ci	B	w/o Cruise Control; 76.00" Cable	CA-3011
1978	L6 3.3L 200ci	T	AT w/o Cruise Control; 76.00" Cable	CA-3011
1979	L6 3.3L 200ci	T	w/Cruise Upper	CA-3045
1979	L6 3.3L 200ci	T	w/o Cruise Control; 76.00" Cable	CA-3011
1983	L6 3.3L 200ci	X	w/Cruise Control; 71.00" Cable	CA-3018
1983	L6 3.3L 200ci	X	w/o Cruise Control; 76.00" Cable	CA-3011
1980-82	V8 4.2L 255ci	D	w/Cruise Lower; 60.00" Cable	CA-3015
1980-82	V8 4.2L 255ci	D	w/Cruise Upper	CA-3045
1980-82	V8 4.2L 255ci	D	w/o Cruise Control; 76.00" Cable	CA-3011
1978	V8 5.0L 302ci	F	AT w/o Cruise Control; 76.00" Cable	CA-3011
1979	V8 5.0L 302ci	F	w/Cruise Upper	CA-3045

# SPEEDOMETER CABLES

Year	Engine	Vin	Remark	Part
<b>MERCURY (con't)</b>				
<b>ZEPHYR (con't)</b>				
1979	V8 5.0L 302ci	F	w/o Cruise Control; 76.00" Cable	CA-3011
<b>MERKUR</b>				
<b>XR4TI</b>				
1985-86	L4 2.3L 140ci	W	w/Tripminder; 83.00" Cable	CA-3010
1985-87	L4 2.3L 140ci	W	w/o Tripminder; 95.00" Cable	CA-3032
1986-87	L4 2.3L 140ci	W	w/Tripminder w/Cruise Lower; 66.00" Cable	CA-3020
<b>MG</b>				
<b>MGB</b>				
1968-73	L4 1.8L 1798cc		MT	CA-3159
1968-73	L4 1.8L 1798cc		MT w/Overdrive	CA-3098
<b>MIDGET</b>				
1962	L4 1.0L 1000cc		MT	CA-3159
1963-65	L4 1.1L 67ci		MT	CA-3159
<b>MITSUBISHI</b>				
<b>PRECIS</b>				
1988-89	L4 1.5L 1468cc	J		CA-3205
<b>NISSAN</b>				
<b>200SX</b>				
1977-79	L4 2.0L 1952cc	H		CA-3082
1980-81	L4 2.0L 1952cc	P		CA-3122
1982-83	L4 2.2L 2187cc	R		CA-3077
<b>210</b>				
1980-82	L4 1.2L 1237cc	C	AT	CA-3117
1980-82	L4 1.2L 1237cc	C	MT	CA-3137
1979	L4 1.2L 1237cc		AT	CA-3117
1979	L4 1.2L 1237cc		MT	CA-3137
1979	L4 1.4L 1393cc	H	AT	CA-3117
1979	L4 1.4L 1393cc	H	MT	CA-3137
<b>240Z</b>				
1970-73	L6 2.4L 2393cc			CA-3162
<b>260Z</b>				
1974-75	L6 2.6L 2565cc	R		CA-3162
<b>280Z</b>				
1975-78	L6 2.8L 2753cc	H		CA-3162
<b>280ZX</b>				
1979-83	L6 2.8L 2753cc	C,H	Lower	CA-3079
1979-83	L6 2.8L 2753cc	C,H	Upper	CA-3078
<b>310</b>				
1979-80	L4 1.4L 1393cc	H	exc. Air Cond., w/5 Spd. Trans.	CA-3120
1981	L4 1.5L 1488cc	P	exc. Air Cond., w/5 Spd. Trans.	CA-3120
<b>510</b>				
1969	L4 1.6L 1595cc		From 10/69	CA-3083
1968-69	L4 1.6L 1595cc		AT, To 10/69	CA-3081
1970-72	L4 1.6L 1595cc		MT	CA-3083
1978-81	L4 2.0L 1952cc	H	5 Spd. Trans.	CA-3080
<b>610</b>				
1975-76	L4 2.0L 1952cc	H		CA-3079
<b>B210</b>				
1974	L4 1.3L 1288cc	H		CA-3161
1975-76	L4 1.4L 1393cc	H		CA-3161
1977-78	L4 1.4L 1393cc	H	AT	CA-3161
1977-78	L4 1.4L 1393cc	H	MT	CA-3079
<b>MAXIMA</b>				
1983-84	L6 2.4L 2393cc	H	AT	CA-3076
1983	L6 2.8L 2793cc	S	AT	CA-3076
1985-86	V6 3.0L 2960cc	H	AT, To 1/86, w/Electronic Indicating	CA-3074
<b>PULSAR NX</b>				
1984	L4 1.5L 1488cc			CA-3075
1984-86	L4 1.6L 1597cc	M		CA-3075
1983	L4 1.6L 1597cc	P		CA-3075

# SPEEDOMETER CABLES

Year	Engine	Vin	Remark	Part
<b>NISSAN (con't)</b>				
<b>SENTRA</b>				
1982	L4 1.5L 1488cc	H		CA-3075
1983	L4 1.5L 1488cc	M		CA-3075
1983-86	L4 1.6L 1597cc	P		CA-3075
1983-86	L4 1.7L 1688cc	S		CA-3075
<b>STANZA</b>				
1982-87	L4 2.0L 1974cc	H		CA-3134
<b>NISSAN TRUCKS</b>				
<b>520 PICKUP</b>				
1966-67	L4 1.3L 1299cc			CA-3119
<b>521 PICKUP</b>				
1969	L4 1.3L 1299cc			CA-3119
1970-72	L4 1.6L 1595cc			CA-3119
<b>620 PICKUP</b>				
1972-73	L4 1.6L 1595cc		AT	CA-3153
1972-73	L4 1.6L 1595cc		MT	CA-3081
1974	L4 1.8L 1770cc	P	AT	CA-3153
1975-79	L4 2.0L 1952cc	H	AT	CA-3153
<b>720</b>				
1983-84	L4 2.0L 1952cc	F	2WD	CA-3080
1985	L4 2.0L 1952cc	F	2WD, AT	CA-3080
1980	L4 2.0L 1952cc	H	2WD	CA-3126
1980	L4 2.0L 1952cc	H	4WD	CA-3128
1981	L4 2.2L 2164cc	S	2WD	CA-3126
1981	L4 2.2L 2164cc	S	4WD	CA-3128
1981	L4 2.2L 2164cc	S	From 10/81	CA-3083
1981	L4 2.2L 2187cc	M	2WD	CA-3126
1981	L4 2.2L 2187cc	M	4WD	CA-3128
1982	L4 2.2L 2187cc	M	2WD	CA-3148
1986	L4 2.4L 2389cc	N		CA-3083
1983-85	L4 2.4L 2389cc	N	4WD	CA-3083
1982	L4 2.5L 2488cc	J	4WD, To 12/82	CA-3083
<b>OLDSMOBILE</b>				
<b>88</b>				
1998	V6 3.8L 231ci	K	AT w/o Cruise Control; 80.00" Cable	CA-3001
1998	V6 3.8L 231ci	K	MT; 83.00" Cable	CA-3004
1998	V6 3.8L 231ci	K	w/Cruise Regulator to Speedometer; 61.00" Cable	CA-3005
1995-97	V6 3.8L 231ci	K	w/o Cruise Control; 80.00" Cable	CA-3001
1995-98	V6 3.8L 231ci	K	w/Cruise Control, Lower; 63.00" Cable	CA-3002
1995-98	V6 3.8L 231ci	K	w/Cruise Control, Upper; 41.00" Cable	CA-3009
1992-94	V6 3.8L 231ci	L	w/Cruise Control, Lower; 63.00" Cable	CA-3002
1992-94	V6 3.8L 231ci	L	w/Cruise Upper, w/o Cruise; 80.00" Cable	CA-3001
1957	V8 6.1L 371ci		3 Spd. Trans.; 63.00" Cable	CA-3002
<b>98</b>				
1981-83	V6 4.1L 252ci	4	w/Cruise Control, Lower; 63.00" Cable	CA-3002
1981-83	V6 4.1L 252ci	4	w/Cruise Upper, w/o Cruise; 80.00" Cable	CA-3001
1980	V8 5.0L 307ci	Y	w/Cruise Control, Upper; 41.00" Cable	CA-3009
1980	V8 5.0L 307ci	Y	w/o Cruise Control; 80.00" Cable	CA-3001
1984	V8 5.0L 307ci	Y	AT; 80.00" Cable	CA-3001
1980-83	V8 5.0L 307ci	Y	w/Cruise Control, Lower; 63.00" Cable	CA-3002
1981-83	V8 5.0L 307ci	Y	w/Cruise Upper, w/o Cruise; 80.00" Cable	CA-3001
1972-73	V8 5.7L 350ci	H,K	w/Cruise Control, Lower; 63.00" Cable	CA-3002
1972-73	V8 5.7L 350ci	H,K	w/o Cruise Control; 61.00" Cable	CA-3005
1984	V8 5.7L 350ci	N	AT; 80.00" Cable	CA-3001
1978-80	V8 5.7L 350ci	N	w/Cruise Control, Upper; 41.00" Cable	CA-3009
1978-83	V8 5.7L 350ci	N	w/Cruise Control, Lower; 63.00" Cable	CA-3002
1981-83	V8 5.7L 350ci	N	w/Cruise Upper, w/o Cruise; 80.00" Cable	CA-3001
1978-80	V8 5.7L 350ci	N,R	w/o Cruise Control; 80.00" Cable	CA-3001
1977	V8 5.7L 350ci	R	AT w/o Cruise Control; 80.00" Cable	CA-3001
1977	V8 5.7L 350ci	R	MT; 83.00" Cable	CA-3004
1977	V8 5.7L 350ci	R	w/Cruise Regulator to Speedometer; 61.00" Cable	CA-3005
1977-80	V8 5.7L 350ci	R	w/Cruise Control, Lower; 63.00" Cable	CA-3002

# SPEEDOMETER CABLES

Year	Engine	Vin	Remark	Part
<b>OLDSMOBILE (con't)</b>				
<b>98 (con't)</b>				
1977-80	V8 5.7L 350ci	R	w/Cruise Control, Upper; 41.00" Cable	CA-3009
1958	V8 6.1L 371ci		3 Spd. Trans.; 63.00" Cable	CA-3002
1964	V8 6.5L 394ci			CA-3006
1975	V8 6.6L 400ci	S	w/Cruise Control, Lower; 63.00" Cable	CA-3002
1975	V8 6.6L 400ci	S	w/Cruise Control, Upper; 61.00" Cable	CA-3005
1975	V8 6.6L 400ci	S	w/o Cruise Control; 80.00" Cable	CA-3001
1977	V8 6.6L 403ci	K	AT w/o Cruise Control; 80.00" Cable	CA-3001
1977	V8 6.6L 403ci	K	MT; 83.00" Cable	CA-3004
1977	V8 6.6L 403ci	K	w/Cruise Regulator to Speedometer; 61.00" Cable	CA-3005
1977-79	V8 6.6L 403ci	K	w/Cruise Control, Lower; 63.00" Cable	CA-3002
1977-79	V8 6.6L 403ci	K	w/Cruise Control, Upper; 41.00" Cable	CA-3009
1978-79	V8 6.6L 403ci	K	w/o Cruise Control; 80.00" Cable	CA-3001
1965-67	V8 7.0L 425ci		w/Cruise Upper	CA-3006
1975	V8 7.5L 455ci	T	w/Cruise Control, Upper; 61.00" Cable	CA-3005
1975	V8 7.5L 455ci	T	w/o Cruise Control; 80.00" Cable	CA-3001
1976	V8 7.5L 455ci	T	Regulator to Speedometer; 61.00" Cable	CA-3005
1976	V8 7.5L 455ci	T	w/Cruise Control, w/Regulator to Trans.; 63.00" Cable	CA-3002
1974	V8 7.5L 455ci	T,U	w/Cruise Control, Upper; 41.00" Cable	CA-3009
1972-74	V8 7.5L 455ci	T,U	w/o Cruise Control; 61.00" Cable	CA-3005
1972-75	V8 7.5L 455ci	T,U	w/Cruise Control, Lower; 63.00" Cable	CA-3002
1970	V8 7.5L 455ci		w/Cruise Control, Upper; 41.00" Cable	CA-3009
1971	V8 7.5L 455ci		w/o Cruise Control; 61.00" Cable	CA-3005
1969-71	V8 7.5L 455ci		w/Cruise Control, Lower; 63.00" Cable	CA-3002
<b>CALAIS</b>				
1987	L4 2.3L 138ci	D	4 Spd. AT w/Adapter Upper; 61.00" Cable	CA-3005
1987	L4 2.3L 138ci	D	4 Spd. AT w/o Adapter, 3 Spd. At; 20.00" Cable	CA-3008
1987	L4 2.3L 138ci	D	AT w/o Adapter; 100.00" Cable	CA-3003
1987	L4 2.3L 138ci	D	w/Adapter exc.4 Spd. AT Upper; 41.00" Cable	CA-3009
1985	L4 2.5L 151ci	U	4 Spd. AT w/Adapter Upper; 80.00" Cable	CA-3001
1985	L4 2.5L 151ci	U	4 Spd. AT w/o Adapter, 3 Spd. At; 100.00" Cable	CA-3003
1985	L4 2.5L 151ci	U	w/o Cruise w/Adapter Lower; 20.00" Cable	CA-3008
1985-87	L4 2.5L 151ci	U	w/Adapter exc.4 Spd. AT Upper; 41.00" Cable	CA-3009
1986-87	L4 2.5L 151ci	U	4 Spd. AT w/Adapter Upper; 61.00" Cable	CA-3005
1986-87	L4 2.5L 151ci	U	4 Spd. AT w/o Adapter, 3 Spd. At; 20.00" Cable	CA-3008
1986-87	L4 2.5L 151ci	U	AT w/o Adapter; 100.00" Cable	CA-3003
1985	V6 3.0L 181ci	L	4 Spd. AT w/Adapter Upper; 80.00" Cable	CA-3001
1985	V6 3.0L 181ci	L	4 Spd. AT w/o Adapter, 3 Spd. At; 100.00" Cable	CA-3003
1985	V6 3.0L 181ci	L	w/o Cruise w/Adapter Lower; 20.00" Cable	CA-3008
1985-87	V6 3.0L 181ci	L	w/Adapter exc.4 Spd. AT Upper; 41.00" Cable	CA-3009
1986-87	V6 3.0L 181ci	L	4 Spd. AT w/Adapter Upper; 61.00" Cable	CA-3005
1986-87	V6 3.0L 181ci	L	4 Spd. AT w/o Adapter, 3 Spd. At; 20.00" Cable	CA-3008
1986-87	V6 3.0L 181ci	L	AT w/o Adapter; 100.00" Cable	CA-3003
<b>CUSTOM CRUISER</b>				
1973	V8 5.7L 350ci	K	w/Cruise Control, Lower; 63.00" Cable	CA-3002
1973	V8 5.7L 350ci	K	w/Cruise Upper, w/o Cruise; 61.00" Cable	CA-3005
1977-79	V8 5.7L 350ci	L,N,R	w/Cruise Control, Lower; 63.00" Cable	CA-3002
1977-79	V8 5.7L 350ci	L,N,R	w/Cruise Control, Upper; 41.00" Cable	CA-3009
1977	V8 5.7L 350ci	L,R	AT w/o Cruise Control; 80.00" Cable	CA-3001
1977	V8 5.7L 350ci	L,R	MT; 83.00" Cable	CA-3004
1977	V8 5.7L 350ci	L,R	w/Cruise Regulator to Speedometer; 61.00" Cable	CA-3005
1978-79	V8 5.7L 350ci	N,R	w/o Cruise Control; 80.00" Cable	CA-3001
1975	V8 6.6L 400ci	R,S	w/Cruise Control, Lower; 63.00" Cable	CA-3002
1975	V8 6.6L 400ci	R,S	w/Cruise Control, Upper; 61.00" Cable	CA-3005
1975	V8 6.6L 400ci	R,S	w/o Cruise Control; 80.00" Cable	CA-3001
1977	V8 6.6L 403ci	K	AT w/o Cruise Control; 80.00" Cable	CA-3001
1977	V8 6.6L 403ci	K	MT; 83.00" Cable	CA-3004
1977	V8 6.6L 403ci	K	w/Cruise Regulator to Speedometer; 61.00" Cable	CA-3005
1977-79	V8 6.6L 403ci	K	w/Cruise Control, Lower; 63.00" Cable	CA-3002
1977-79	V8 6.6L 403ci	K	w/Cruise Control, Upper; 41.00" Cable	CA-3009
1978-79	V8 6.6L 403ci	K	w/o Cruise Control; 80.00" Cable	CA-3001
1974	V8 7.5L 455ci	T	w/Cruise Control, Upper; 41.00" Cable	CA-3009
1974	V8 7.5L 455ci	T	w/o Cruise Control; 61.00" Cable	CA-3005

# SPEEDOMETER CABLES

Year	Engine	Vin	Remark	Part
<b>OLDSMOBILE (con't)</b>				
<b>CUSTOM CRUISER (con't)</b>				
1975	V8 7.5L 455ci	T	w/Cruise Control, Upper; 61.00" Cable	CA-3005
1975	V8 7.5L 455ci	T	w/o Cruise Control; 80.00" Cable	CA-3001
1976	V8 7.5L 455ci	T	Regulator to Speedometer; 61.00" Cable	CA-3005
1976	V8 7.5L 455ci	T	w/Cruise Control, w/Regulator to Trans.; 63.00" Cable	CA-3002
1972-73	V8 7.5L 455ci	T	w/Cruise Upper, w/o Cruise; 61.00" Cable	CA-3005
1972-75	V8 7.5L 455ci	T	w/Cruise Control, Lower; 63.00" Cable	CA-3002
1971	V8 7.5L 455ci		w/Cruise Control, Lower; 63.00" Cable	CA-3002
1971	V8 7.5L 455ci		w/Cruise Upper, w/o Cruise; 61.00" Cable	CA-3005
<b>CUTLASS</b>				
1976	L6 4.1L 250ci	D	w/Cruise Control, w/Regulator to Trans.; 63.00" Cable	CA-3002
1975-76	L6 4.1L 250ci	D	exc. Cruise Control; 80.00" Cable	CA-3001
1975-76	L6 4.1L 250ci	D	w/Cruise Control, Upper; 41.00" Cable	CA-3009
1968	L6 4.1L 250ci		AT w/Cruise Control, Upper; 63.00" Cable	CA-3002
1968	L6 4.1L 250ci		w/o Cruise Control; 83.00" Cable	CA-3004
1969	L6 4.1L 250ci		3 Spd. MT w/o Cruise; 80.00" Cable	CA-3001
1969	L6 4.1L 250ci		AT w/Cruise Upper, 3 Spd. MT w/Cruise Upper; 41.00" Cable	CA-3009
1970	L6 4.1L 250ci		3 Spd. MT w/o Cruise; 41.00" Cable	CA-3009
1970	L6 4.1L 250ci		4 Spd. MT w/o Cruise exc. Synchro.; 41.00" Cable	CA-3009
1970	L6 4.1L 250ci		w/Cruise Control, Lower; 63.00" Cable	CA-3002
1971	L6 4.1L 250ci		AT w/Cruise Control, Lower; 63.00" Cable	CA-3002
1971	L6 4.1L 250ci		AT w/Cruise Control, Upper; 41.00" Cable	CA-3009
1971	L6 4.1L 250ci		w/o Cruise Control; 61.00" Cable	CA-3005
1969-70	L6 4.1L 250ci		AT w/o Cruise Control; 61.00" Cable	CA-3005
1969-71	L6 4.1L 250ci		4 Spd. MT exc. 3.91 Rear Axle Ratio; 80.00" Cable	CA-3001
1978-79	V6 3.8L 231ci	2,A	w/Adapter Lower; 20.00" Cable	CA-3008
1978-79	V6 3.8L 231ci	2,A	w/Adapter Upper; 80.00" Cable	CA-3001
1978-79	V6 3.8L 231ci	2,A	w/Cruise w/o Adapter Upper, w/Adapter w/Interconnector Upper	CA-3005
1978-81	V6 3.8L 231ci	2,A	w/Cruise w/o Adapter Lower; 83.00" Cable	CA-3004
1978-81	V6 3.8L 231ci	2,A	w/o Cruise w/o Adapter; 100.00" Cable	CA-3003
1980	V6 3.8L 231ci	A	w/Cruise Lower; 83.00" Cable	CA-3004
1980	V6 3.8L 231ci	A	w/Innerconnector Lower; 63.00" Cable	CA-3002
1980	V6 3.8L 231ci	A	w/Innerconnector Upper, w/Cruise Upper; 61.00" Cable	CA-3005
1980	V6 3.8L 231ci	A	w/o Innerconnector Lower; 20.00" Cable	CA-3008
1980	V6 3.8L 231ci	A	w/o Innerconnector Upper; 80.00" Cable	CA-3001
1981	V6 3.8L 231ci	A	w/Cruise Control, Upper; 61.00" Cable	CA-3005
1981	V6 3.8L 231ci	A	w/Cruise w/Adapter Lower; 63.00" Cable	CA-3002
1981	V6 3.8L 231ci	A	w/o Cruise w/Adapter Lower; 20.00" Cable	CA-3008
1981	V6 3.8L 231ci	A	w/o Cruise w/Adapter Upper; 80.00" Cable	CA-3001
1977	V6 3.8L 231ci	C	exc. Cruise Control; 80.00" Cable	CA-3001
1977	V6 3.8L 231ci	C	w/Cruise Control, Lower; 63.00" Cable	CA-3002
1977	V6 3.8L 231ci	C	w/Cruise Control, Upper; 41.00" Cable	CA-3009
1963	V8 3.5L 215ci		AT w/Cruise Control, Upper	CA-3006
1962-63	V8 3.5L 215ci		3 Spd. MT; 63.00" Cable	CA-3002
1976	V8 4.3L 260ci	F	w/Cruise Control, w/Regulator to Trans.; 63.00" Cable	CA-3002
1977	V8 4.3L 260ci	F	w/Cruise Control, Lower; 63.00" Cable	CA-3002
1980	V8 4.3L 260ci	F	w/Cruise Lower; 83.00" Cable	CA-3004
1980	V8 4.3L 260ci	F	w/Innerconnector Lower; 63.00" Cable	CA-3002
1980	V8 4.3L 260ci	F	w/Innerconnector Upper, w/Cruise Upper; 61.00" Cable	CA-3005
1980	V8 4.3L 260ci	F	w/o Innerconnector Lower; 20.00" Cable	CA-3008
1980	V8 4.3L 260ci	F	w/o Innerconnector Upper; 80.00" Cable	CA-3001
1981	V8 4.3L 260ci	F	w/Cruise Control, Upper; 61.00" Cable	CA-3005
1981	V8 4.3L 260ci	F	w/Cruise w/Adapter Lower; 63.00" Cable	CA-3002
1981	V8 4.3L 260ci	F	w/o Cruise w/Adapter Lower; 20.00" Cable	CA-3008
1981	V8 4.3L 260ci	F	w/o Cruise w/Adapter Upper; 80.00" Cable	CA-3001
1975-77	V8 4.3L 260ci	F	exc. Cruise Control; 80.00" Cable	CA-3001
1975-77	V8 4.3L 260ci	F	w/Cruise Control, Upper; 41.00" Cable	CA-3009
1978-79	V8 4.3L 260ci	F	w/Adapter Lower; 20.00" Cable	CA-3008
1978-79	V8 4.3L 260ci	F	w/Adapter Upper; 80.00" Cable	CA-3001
1978-79	V8 4.3L 260ci	F	w/Cruise w/o Adapter Upper, w/Adapter w/Interconnector Upper	CA-3005
1978-81	V8 4.3L 260ci	F	w/Cruise w/o Adapter Lower; 83.00" Cable	CA-3004
1978-81	V8 4.3L 260ci	F	w/o Cruise w/o Adapter; 100.00" Cable	CA-3003
1981	V8 4.4L 267ci	J	w/Cruise Control, Upper; 61.00" Cable	CA-3005

# SPEEDOMETER CABLES

Year	Engine	Vin	Remark	Part
<b>OLDSMOBILE (con't)</b>				
<b>CUTLASS</b>				
1981	V8 4.4L 267ci	J	w/Cruise w/Adapter Lower; 63.00" Cable	CA-3002
1981	V8 4.4L 267ci	J	w/Cruise w/o Adapter Lower; 83.00" Cable	CA-3004
1981	V8 4.4L 267ci	J	w/o Cruise w/Adapter Lower; 20.00" Cable	CA-3008
1981	V8 4.4L 267ci	J	w/o Cruise w/Adapter Upper; 80.00" Cable	CA-3001
1981	V8 4.4L 267ci	J	w/o Cruise w/o Adapter; 100.00" Cable	CA-3003
1980	V8 5.0L 305ci	H	w/Cruise Lower; 83.00" Cable	CA-3004
1980	V8 5.0L 305ci	H	w/Innerconnector Lower; 63.00" Cable	CA-3002
1980	V8 5.0L 305ci	H	w/Innerconnector Upper, w/Cruise Upper; 61.00" Cable	CA-3005
1980	V8 5.0L 305ci	H	w/o Innerconnector Lower; 20.00" Cable	CA-3008
1980	V8 5.0L 305ci	H	w/o Innerconnector Upper; 80.00" Cable	CA-3001
1985	V8 5.0L 305ci	H	4 Spd. AT w/Adapter Upper; 80.00" Cable	CA-3001
1985	V8 5.0L 305ci	H	4 Spd. AT w/o Adapter, 3 Spd. At; 100.00" Cable	CA-3003
1985	V8 5.0L 305ci	H	w/o Cruise w/Adapter Lower; 20.00" Cable	CA-3008
1978-79	V8 5.0L 305ci	H	w/o Cruise w/o Adapter; 100.00" Cable	CA-3003
1985-87	V8 5.0L 305ci	H	w/Adapter exc.4 Spd. AT Upper; 41.00" Cable	CA-3009
1986-87	V8 5.0L 305ci	H	4 Spd. AT w/Adapter Upper; 61.00" Cable	CA-3005
1986-87	V8 5.0L 305ci	H	4 Spd. AT w/o Adapter, 3 Spd. At; 20.00" Cable	CA-3008
1986-87	V8 5.0L 305ci	H	AT w/o Adapter; 100.00" Cable	CA-3003
1978-79	V8 5.0L 305ci	H,U	w/Adapter Lower; 20.00" Cable	CA-3008
1978-79	V8 5.0L 305ci	H,U	w/Adapter Upper; 80.00" Cable	CA-3001
1978-79	V8 5.0L 305ci	H,U	w/Cruise w/o Adapter Lower; 83.00" Cable	CA-3004
1978-79	V8 5.0L 305ci	H,U	w/Cruise w/o Adapter Upper, w/Adapter w/Interconnector Upper	CA-3005
1978	V8 5.0L 305ci	U	w/o Cruise w/o Adapter; 100.00" Cable	CA-3003
1967	V8 5.4L 330ci		AT w/Cruise Control, Upper	CA-3006
1964-65	V8 5.4L 330ci		63.00" Cable	CA-3002
1966-67	V8 5.4L 330ci		w/o Cruise Control; 83.00" Cable	CA-3004
1972	V8 5.7L 350ci	H,K	4 Spd. MT exc. 3.91 Rear Axle Ratio; 80.00" Cable	CA-3001
1972	V8 5.7L 350ci	H,K	AT w/Cruise Control, Upper; 41.00" Cable	CA-3009
1972	V8 5.7L 350ci	H,K	w/o Cruise Control; 61.00" Cable	CA-3005
1972-74	V8 5.7L 350ci	H,K,M	AT w/Cruise Control, Lower; 63.00" Cable	CA-3002
1973-74	V8 5.7L 350ci	H,K,M	MT w/Cruise Lower; 61.00" Cable	CA-3005
1973-74	V8 5.7L 350ci	H,K,M	MT w/Cruise Upper; 41.00" Cable	CA-3009
1973-74	V8 5.7L 350ci	H,K,M	w/o Cruise Control; 80.00" Cable	CA-3001
1975	V8 5.7L 350ci	K	exc. Cruise Control; 80.00" Cable	CA-3001
1975	V8 5.7L 350ci	K	w/Cruise Control, Upper; 41.00" Cable	CA-3009
1978-79	V8 5.7L 350ci	L,N,R	w/Adapter Lower; 20.00" Cable	CA-3008
1978-79	V8 5.7L 350ci	L,N,R	w/Adapter Upper; 80.00" Cable	CA-3001
1978-79	V8 5.7L 350ci	L,N,R	w/Cruise w/o Adapter Upper, w/Adapter w/Interconnector Upper	CA-3005
1978-79	V8 5.7L 350ci	L,R	w/Cruise w/o Adapter Lower; 83.00" Cable	CA-3004
1978-79	V8 5.7L 350ci	L,R	w/o Cruise w/o Adapter; 100.00" Cable	CA-3003
1981	V8 5.7L 350ci	N	w/Cruise Control, Upper; 61.00" Cable	CA-3005
1981	V8 5.7L 350ci	N	w/Cruise w/Adapter Lower; 63.00" Cable	CA-3002
1981	V8 5.7L 350ci	N	w/o Cruise w/Adapter Lower; 20.00" Cable	CA-3008
1981	V8 5.7L 350ci	N	w/o Cruise w/Adapter Upper; 80.00" Cable	CA-3001
1979-81	V8 5.7L 350ci	N	w/Cruise w/o Adapter Lower; 83.00" Cable	CA-3004
1979-81	V8 5.7L 350ci	N	w/o Cruise w/o Adapter; 100.00" Cable	CA-3003
1980	V8 5.7L 350ci	N,R	w/Cruise Lower; 83.00" Cable	CA-3004
1980	V8 5.7L 350ci	N,R	w/Innerconnector Lower; 63.00" Cable	CA-3002
1980	V8 5.7L 350ci	N,R	w/Innerconnector Upper, w/Cruise Upper; 61.00" Cable	CA-3005
1980	V8 5.7L 350ci	N,R	w/o Innerconnector Lower; 20.00" Cable	CA-3008
1980	V8 5.7L 350ci	N,R	w/o Innerconnector Upper; 80.00" Cable	CA-3001
1976	V8 5.7L 350ci	R	w/Cruise Control, w/Regulator to Trans.; 63.00" Cable	CA-3002
1977	V8 5.7L 350ci	R	w/Cruise Control, Lower; 63.00" Cable	CA-3002
1976-77	V8 5.7L 350ci	R	exc. Cruise Control; 80.00" Cable	CA-3001
1976-77	V8 5.7L 350ci	R	w/Cruise Control, Upper; 41.00" Cable	CA-3009
1968	V8 5.7L 350ci		AT w/Cruise Control, Upper; 63.00" Cable	CA-3002
1968	V8 5.7L 350ci		w/o Cruise Control; 83.00" Cable	CA-3004
1969	V8 5.7L 350ci		3 Spd. MT w/o Cruise; 80.00" Cable	CA-3001
1969	V8 5.7L 350ci		AT w/Cruise Upper, 3 Spd. MT w/Cruise Upper; 41.00" Cable	CA-3009
1970	V8 5.7L 350ci		3 Spd. MT w/o Cruise; 41.00" Cable	CA-3009
1970	V8 5.7L 350ci		4 Spd. MT w/o Cruise exc. Synchro.; 41.00" Cable	CA-3009
1970	V8 5.7L 350ci		w/Cruise Control, Lower; 63.00" Cable	CA-3002

# SPEEDOMETER CABLES

Year	Engine	Vin	Remark	Part
<b>OLDSMOBILE (con't)</b>				
<b>CUTLASS</b>				
1971	V8 5.7L 350ci		AT w/Cruise Control, Lower; 63.00" Cable	CA-3002
1971	V8 5.7L 350ci		AT w/Cruise Control, Upper; 41.00" Cable	CA-3009
1971	V8 5.7L 350ci		w/o Cruise Control; 61.00" Cable	CA-3005
1969-70	V8 5.7L 350ci		AT w/o Cruise Control; 61.00" Cable	CA-3005
1969-71	V8 5.7L 350ci		4 Spd. MT exc. 3.91 Rear Axle Ratio; 80.00" Cable	CA-3001
1965	V8 6.6L 400ci		63.00" Cable	CA-3002
1967	V8 6.6L 400ci		AT w/Cruise Control, Upper	CA-3006
1966-67	V8 6.6L 400ci		w/o Cruise Control; 83.00" Cable	CA-3004
1977	V8 6.6L 403ci	K	exc. Cruise Control; 80.00" Cable	CA-3001
1977	V8 6.6L 403ci	K	w/Cruise Control, Lower; 63.00" Cable	CA-3002
1977	V8 6.6L 403ci	K	w/Cruise Control, Upper; 41.00" Cable	CA-3009
1976	V8 7.5L 455ci	T	w/Cruise Control, w/Regulator to Trans.; 63.00" Cable	CA-3002
1975-76	V8 7.5L 455ci	T	exc. Cruise Control; 80.00" Cable	CA-3001
1975-76	V8 7.5L 455ci	T	w/Cruise Control, Upper; 41.00" Cable	CA-3009
1972	V8 7.5L 455ci	U	4 Spd. MT exc. 3.91 Rear Axle Ratio; 80.00" Cable	CA-3001
1972	V8 7.5L 455ci	U	AT w/Cruise Control, Upper; 41.00" Cable	CA-3009
1972	V8 7.5L 455ci	U	w/o Cruise Control; 61.00" Cable	CA-3005
1972-74	V8 7.5L 455ci	U	AT w/Cruise Control, Lower; 63.00" Cable	CA-3002
1973-74	V8 7.5L 455ci	U	MT w/Cruise Lower; 61.00" Cable	CA-3005
1973-74	V8 7.5L 455ci	U	MT w/Cruise Upper; 41.00" Cable	CA-3009
1973-74	V8 7.5L 455ci	U	w/o Cruise Control; 80.00" Cable	CA-3001
1970	V8 7.5L 455ci		3 Spd. MT w/o Cruise; 41.00" Cable	CA-3009
1970	V8 7.5L 455ci		4 Spd. MT exc. 3.91 Rear Axle Ratio; 80.00" Cable	CA-3001
1970	V8 7.5L 455ci		4 Spd. MT w/o Cruise exc. Synchro.; 41.00" Cable	CA-3009
1970	V8 7.5L 455ci		AT w/o Cruise Control; 61.00" Cable	CA-3005
1970	V8 7.5L 455ci		w/Cruise Control, Lower; 63.00" Cable	CA-3002
<b>CUTLASS CALAIS</b>				
1988	L4 2.3L 138ci	D	THM-200-4R w/o Gear Adapter; 80.00" Cable	CA-3001
1988	L4 2.5L 151ci	U	THM-200-4R w/o Gear Adapter; 80.00" Cable	CA-3001
1988	V6 3.0L 181ci	L	THM-200-4R w/o Gear Adapter; 80.00" Cable	CA-3001
1978-79	V6 3.8L 231ci	2,A	w/Adapter Lower; 20.00" Cable	CA-3008
1978-79	V6 3.8L 231ci	2,A	w/Adapter Upper; 80.00" Cable	CA-3001
1978-79	V6 3.8L 231ci	2,A	w/Cruise w/o Adapter Upper, w/Adapter w/Interconnector Upper	CA-3005
1978-83	V6 3.8L 231ci	2,A	w/Cruise w/o Adapter Lower; 83.00" Cable	CA-3004
1978-83	V6 3.8L 231ci	2,A	w/o Cruise w/o Adapter; 100.00" Cable	CA-3003
1984	V6 3.8L 231ci	A	4 Spd. AT w/Adapter Upper; 80.00" Cable	CA-3001
1984	V6 3.8L 231ci	A	4 Spd. AT w/o Adapter, 3 Spd. At; 100.00" Cable	CA-3003
1984	V6 3.8L 231ci	A	w/Adapter exc.4 Spd. AT Upper; 41.00" Cable	CA-3009
1984	V6 3.8L 231ci	A	w/o Cruise w/Adapter Lower; 20.00" Cable	CA-3008
1982-83	V6 3.8L 231ci	A	w/Cruise Control, Upper; 61.00" Cable	CA-3005
1982-83	V6 3.8L 231ci	A	w/Cruise w/Adapter Lower; 63.00" Cable	CA-3002
1982-83	V6 3.8L 231ci	A	w/o Cruise w/Adapter Upper; 80.00" Cable	CA-3001
1984	V6 4.3L 260ci	V	4 Spd. AT w/Adapter Upper; 80.00" Cable	CA-3001
1984	V6 4.3L 260ci	V	4 Spd. AT w/o Adapter, 3 Spd. At; 100.00" Cable	CA-3003
1984	V6 4.3L 260ci	V	w/Adapter exc.4 Spd. AT Upper; 41.00" Cable	CA-3009
1984	V6 4.3L 260ci	V	w/o Cruise w/Adapter Lower; 20.00" Cable	CA-3008
1982-83	V6 4.3L 260ci	V	w/Cruise Control, Upper; 61.00" Cable	CA-3005
1982-83	V6 4.3L 260ci	V	w/Cruise w/Adapter Lower; 63.00" Cable	CA-3002
1982-83	V6 4.3L 260ci	V	w/Cruise w/o Adapter Lower; 83.00" Cable	CA-3004
1982-83	V6 4.3L 260ci	V	w/o Cruise w/Adapter Upper; 80.00" Cable	CA-3001
1982-83	V6 4.3L 260ci	V	w/o Cruise w/o Adapter; 100.00" Cable	CA-3003
1982	V8 4.3L 260ci	8	w/Cruise Control, Upper; 61.00" Cable	CA-3005
1982	V8 4.3L 260ci	8	w/Cruise w/Adapter Lower; 63.00" Cable	CA-3002
1982	V8 4.3L 260ci	8	w/Cruise w/o Adapter Lower; 83.00" Cable	CA-3004
1982	V8 4.3L 260ci	8	w/o Cruise w/Adapter Upper; 80.00" Cable	CA-3001
1982	V8 4.3L 260ci	8	w/o Cruise w/o Adapter; 100.00" Cable	CA-3003
1978-79	V8 4.3L 260ci	F,P	w/Adapter Lower; 20.00" Cable	CA-3008
1978-79	V8 4.3L 260ci	F,P	w/Adapter Upper; 80.00" Cable	CA-3001
1978-79	V8 4.3L 260ci	F,P	w/Cruise w/o Adapter Lower; 83.00" Cable	CA-3004
1978-79	V8 4.3L 260ci	F,P	w/Cruise w/o Adapter Upper, w/Adapter w/Interconnector Upper	CA-3005
1978-79	V8 4.3L 260ci	F,P	w/o Cruise w/o Adapter; 100.00" Cable	CA-3003
1982	V8 4.4L 267ci	J	w/Cruise Control, Upper; 61.00" Cable	CA-3005

# SPEEDOMETER CABLES

Year	Engine	Vin	Remark	Part
<b>OLDSMOBILE (con't)</b>				
<b>CUTLASS CALAIS (con't)</b>				
1982	V8 4.4L 267ci	J	w/Cruise w/Adapter Lower; 63.00" Cable	CA-3002
1982	V8 4.4L 267ci	J	w/Cruise w/o Adapter Lower; 83.00" Cable	CA-3004
1982	V8 4.4L 267ci	J	w/o Cruise w/Adapter Upper; 80.00" Cable	CA-3001
1982	V8 4.4L 267ci	J	w/o Cruise w/o Adapter; 100.00" Cable	CA-3003
1984	V8 5.0L 305ci	H	4 Spd. AT w/Adapter Upper; 80.00" Cable	CA-3001
1984	V8 5.0L 305ci	H	4 Spd. AT w/o Adapter, 3 Spd. At; 100.00" Cable	CA-3003
1984	V8 5.0L 305ci	H	w/Adapter exc.4 Spd. AT Upper; 41.00" Cable	CA-3009
1984	V8 5.0L 305ci	H	w/o Cruise w/Adapter Lower; 20.00" Cable	CA-3008
1978-79	V8 5.0L 305ci	H,U	w/Adapter Lower; 20.00" Cable	CA-3008
1978-79	V8 5.0L 305ci	H,U	w/Adapter Upper; 80.00" Cable	CA-3001
1978-79	V8 5.0L 305ci	H,U	w/Cruise w/o Adapter Lower; 83.00" Cable	CA-3004
1978-79	V8 5.0L 305ci	H,U	w/Cruise w/o Adapter Upper, w/Adapter w/Interconnector Upper	CA-3005
1978-79	V8 5.0L 305ci	H,U	w/o Cruise w/o Adapter; 100.00" Cable	CA-3003
1984	V8 5.0L 307ci	9,Y	4 Spd. AT w/Adapter Upper; 80.00" Cable	CA-3001
1984	V8 5.0L 307ci	9,Y	4 Spd. AT w/o Adapter, 3 Spd. At; 100.00" Cable	CA-3003
1984	V8 5.0L 307ci	9,Y	w/Adapter exc.4 Spd. AT Upper; 41.00" Cable	CA-3009
1984	V8 5.0L 307ci	9,Y	w/o Cruise w/Adapter Lower; 20.00" Cable	CA-3008
1982-83	V8 5.0L 307ci	Y	w/Cruise Control, Upper; 61.00" Cable	CA-3005
1982-83	V8 5.0L 307ci	Y	w/Cruise w/Adapter Lower; 63.00" Cable	CA-3002
1982-83	V8 5.0L 307ci	Y	w/Cruise w/o Adapter Lower; 83.00" Cable	CA-3004
1982-83	V8 5.0L 307ci	Y	w/o Cruise w/Adapter Upper; 80.00" Cable	CA-3001
1982-83	V8 5.0L 307ci	Y	w/o Cruise w/o Adapter; 100.00" Cable	CA-3003
1984	V8 5.7L 350ci	N	4 Spd. AT w/Adapter Upper; 80.00" Cable	CA-3001
1984	V8 5.7L 350ci	N	4 Spd. AT w/o Adapter, 3 Spd. At; 100.00" Cable	CA-3003
1984	V8 5.7L 350ci	N	w/Adapter exc.4 Spd. AT Upper; 41.00" Cable	CA-3009
1984	V8 5.7L 350ci	N	w/o Cruise w/Adapter Lower; 20.00" Cable	CA-3008
1982-83	V8 5.7L 350ci	N	w/Cruise Control, Upper; 61.00" Cable	CA-3005
1982-83	V8 5.7L 350ci	N	w/Cruise w/Adapter Lower; 63.00" Cable	CA-3002
1982-83	V8 5.7L 350ci	N	w/Cruise w/o Adapter Lower; 83.00" Cable	CA-3004
1982-83	V8 5.7L 350ci	N	w/o Cruise w/Adapter Upper; 80.00" Cable	CA-3001
1982-83	V8 5.7L 350ci	N	w/o Cruise w/o Adapter; 100.00" Cable	CA-3003
1979	V8 5.7L 350ci	R	w/Adapter Lower; 20.00" Cable	CA-3008
1979	V8 5.7L 350ci	R	w/Adapter Upper; 80.00" Cable	CA-3001
1979	V8 5.7L 350ci	R	w/Cruise w/o Adapter Lower; 83.00" Cable	CA-3004
1979	V8 5.7L 350ci	R	w/Cruise w/o Adapter Upper, w/Adapter w/Interconnector Upper	CA-3005
1979	V8 5.7L 350ci	R	w/o Cruise w/o Adapter; 100.00" Cable	CA-3003
<b>CUTLASS CIERA</b>				
1982-83	L4 2.5L 151ci	5,R	w/Cruise Lower, w/o Cruise; 83.00" Cable	CA-3004
1982-83	L4 2.5L 151ci	5,R	w/Cruise Control, Upper; 41.00" Cable	CA-3009
1988	L4 2.5L 151ci	R	THM-200-4R w/o Gear Adapter; 80.00" Cable	CA-3001
1984-85	L4 2.5L 151ci	R	4 Spd. AT w/Adapter Upper; 80.00" Cable	CA-3001
1984-85	L4 2.5L 151ci	R	4 Spd. AT w/o Adapter, 3 Spd. At; 100.00" Cable	CA-3003
1984-85	L4 2.5L 151ci	R	w/o Cruise w/Adapter Lower; 20.00" Cable	CA-3008
1984-87	L4 2.5L 151ci	R	w/Adapter exc.4 Spd. AT Upper; 41.00" Cable	CA-3009
1986-87	L4 2.5L 151ci	R	4 Spd. AT w/Adapter Upper; 61.00" Cable	CA-3005
1986-87	L4 2.5L 151ci	R	4 Spd. AT w/o Adapter, 3 Spd. At; 20.00" Cable	CA-3008
1986-87	L4 2.5L 151ci	R	AT w/o Adapter; 100.00" Cable	CA-3003
1988	V6 2.8L 173ci	W	THM-200-4R w/o Gear Adapter; 80.00" Cable	CA-3001
1986-87	V6 2.8L 173ci	W	w/Adapter exc.4 Spd. AT Upper; 41.00" Cable	CA-3009
1986-87	V6 2.8L 173ci	W,X	4 Spd. AT w/Adapter Upper; 61.00" Cable	CA-3005
1986-87	V6 2.8L 173ci	W,X	4 Spd. AT w/o Adapter, 3 Spd. At; 20.00" Cable	CA-3008
1986-87	V6 2.8L 173ci	W,X	AT w/o Adapter; 100.00" Cable	CA-3003
1982-83	V6 2.8L 173ci	X	w/Cruise Lower, w/o Cruise; 83.00" Cable	CA-3004
1982-83	V6 2.8L 173ci	X	w/Cruise Control, Upper; 41.00" Cable	CA-3009
1984-85	V6 2.8L 173ci	X	4 Spd. AT w/Adapter Upper; 80.00" Cable	CA-3001
1984-85	V6 2.8L 173ci	X	4 Spd. AT w/o Adapter, 3 Spd. At; 100.00" Cable	CA-3003
1984-85	V6 2.8L 173ci	X	w/o Cruise w/Adapter Lower; 20.00" Cable	CA-3008
1984-86	V6 2.8L 173ci	X	w/Adapter exc.4 Spd. AT Upper; 41.00" Cable	CA-3009
1982-83	V6 3.0L 181ci	E	w/Cruise Lower, w/o Cruise; 83.00" Cable	CA-3004
1982-83	V6 3.0L 181ci	E	w/Cruise Control, Upper; 41.00" Cable	CA-3009
1984-85	V6 3.0L 181ci	E	4 Spd. AT w/Adapter Upper; 80.00" Cable	CA-3001
1984-85	V6 3.0L 181ci	E	4 Spd. AT w/o Adapter, 3 Spd. At; 100.00" Cable	CA-3003



# SPEEDOMETER CABLES

Year	Engine	Vin	Remark	Part
<b>OLDSMOBILE (con't)</b>				
<b>CUTLASS CIERA (con't)</b>				
1984-85	V6 3.0L 181ci	E	w/Adapter exc.4 Spd. AT Upper; 41.00" Cable	CA-3009
1984-85	V6 3.0L 181ci	E	w/o Cruise w/Adapter Lower; 20.00" Cable	CA-3008
1988	V6 3.8L 231ci	3	THM-200-4R w/o Gear Adapter; 80.00" Cable	CA-3001
1984-85	V6 3.8L 231ci	3	4 Spd. AT w/Adapter Upper; 80.00" Cable	CA-3001
1984-85	V6 3.8L 231ci	3	4 Spd. AT w/o Adapter, 3 Spd. At; 100.00" Cable	CA-3003
1984-85	V6 3.8L 231ci	3	w/o Cruise w/Adapter Lower; 20.00" Cable	CA-3008
1984-87	V6 3.8L 231ci	3	w/Adapter exc.4 Spd. AT Upper; 41.00" Cable	CA-3009
1986-87	V6 3.8L 231ci	3	4 Spd. AT w/Adapter Upper; 61.00" Cable	CA-3005
1986-87	V6 3.8L 231ci	3	4 Spd. AT w/o Adapter, 3 Spd. At; 20.00" Cable	CA-3008
1986-87	V6 3.8L 231ci	3	AT w/o Adapter; 100.00" Cable	CA-3003
1982-83	V6 4.3L 260ci	T	w/Cruise Lower, w/o Cruise; 83.00" Cable	CA-3004
1982-83	V6 4.3L 260ci	T	w/Cruise Control, Upper; 41.00" Cable	CA-3009
1984-85	V6 4.3L 260ci	T	4 Spd. AT w/Adapter Upper; 80.00" Cable	CA-3001
1984-85	V6 4.3L 260ci	T	4 Spd. AT w/o Adapter, 3 Spd. At; 100.00" Cable	CA-3003
1984-85	V6 4.3L 260ci	T	w/Adapter exc.4 Spd. AT Upper; 41.00" Cable	CA-3009
1984-85	V6 4.3L 260ci	T	w/o Cruise w/Adapter Lower; 20.00" Cable	CA-3008
<b>CUTLASS CRUISER</b>				
1987	L4 2.5L 151ci	R	4 Spd. AT w/Adapter Upper; 61.00" Cable	CA-3005
1987	L4 2.5L 151ci	R	4 Spd. AT w/o Adapter, 3 Spd. At; 20.00" Cable	CA-3008
1987	L4 2.5L 151ci	R	AT w/o Adapter; 100.00" Cable	CA-3003
1987	L4 2.5L 151ci	R	w/Adapter exc.4 Spd. AT Upper; 41.00" Cable	CA-3009
1988	L4 2.5L 151ci	R	THM-200-4R w/o Gear Adapter; 80.00" Cable	CA-3001
1987	V6 2.8L 173ci	W	4 Spd. AT w/Adapter Upper; 61.00" Cable	CA-3005
1987	V6 2.8L 173ci	W	4 Spd. AT w/o Adapter, 3 Spd. At; 20.00" Cable	CA-3008
1987	V6 2.8L 173ci	W	AT w/o Adapter; 100.00" Cable	CA-3003
1987	V6 2.8L 173ci	W	w/Adapter exc.4 Spd. AT Upper; 41.00" Cable	CA-3009
1988	V6 2.8L 173ci	W	THM-200-4R w/o Gear Adapter; 80.00" Cable	CA-3001
1987	V6 3.8L 231ci	3	4 Spd. AT w/Adapter Upper; 61.00" Cable	CA-3005
1987	V6 3.8L 231ci	3	4 Spd. AT w/o Adapter, 3 Spd. At; 20.00" Cable	CA-3008
1987	V6 3.8L 231ci	3	AT w/o Adapter; 100.00" Cable	CA-3003
1987	V6 3.8L 231ci	3	w/Adapter exc.4 Spd. AT Upper; 41.00" Cable	CA-3009
1988	V6 3.8L 231ci	3	THM-200-4R w/o Gear Adapter; 80.00" Cable	CA-3001
1982-83	V6 3.8L 231ci	A	w/Cruise Control, Upper; 61.00" Cable	CA-3005
1982-83	V6 3.8L 231ci	A	w/Cruise w/Adapter Lower; 63.00" Cable	CA-3002
1982-83	V6 3.8L 231ci	A	w/Cruise w/o Adapter Lower; 83.00" Cable	CA-3004
1982-83	V6 3.8L 231ci	A	w/o Cruise w/Adapter Upper; 80.00" Cable	CA-3001
1982-83	V6 3.8L 231ci	A	w/o Cruise w/o Adapter; 100.00" Cable	CA-3003
1982	V8 4.3L 260ci	8	w/Cruise Control, Upper; 61.00" Cable	CA-3005
1982	V8 4.3L 260ci	8	w/Cruise w/Adapter Lower; 63.00" Cable	CA-3002
1982	V8 4.3L 260ci	8	w/Cruise w/o Adapter Lower; 83.00" Cable	CA-3004
1982	V8 4.3L 260ci	8	w/o Cruise w/Adapter Upper; 80.00" Cable	CA-3001
1982	V8 4.3L 260ci	8	w/o Cruise w/o Adapter; 100.00" Cable	CA-3003
1982	V8 4.4L 267ci	J	w/Cruise Control, Upper; 61.00" Cable	CA-3005
1982	V8 4.4L 267ci	J	w/Cruise w/Adapter Lower; 63.00" Cable	CA-3002
1982	V8 4.4L 267ci	J	w/Cruise w/o Adapter Lower; 83.00" Cable	CA-3004
1982	V8 4.4L 267ci	J	w/o Cruise w/Adapter Upper; 80.00" Cable	CA-3001
1982	V8 4.4L 267ci	J	w/o Cruise w/o Adapter; 100.00" Cable	CA-3003
1982-83	V8 5.0L 305ci	H	w/Cruise Control, Upper; 61.00" Cable	CA-3005
1982-83	V8 5.0L 305ci	H	w/Cruise w/Adapter Lower; 63.00" Cable	CA-3002
1982-83	V8 5.0L 305ci	H	w/Cruise w/o Adapter Lower; 83.00" Cable	CA-3004
1982-83	V8 5.0L 305ci	H	w/o Cruise w/Adapter Upper; 80.00" Cable	CA-3001
1982-83	V8 5.0L 305ci	H	w/o Cruise w/o Adapter; 100.00" Cable	CA-3003
1982-83	V8 5.0L 307ci	Y	w/Cruise Control, Upper; 61.00" Cable	CA-3005
1982-83	V8 5.0L 307ci	Y	w/Cruise w/Adapter Lower; 63.00" Cable	CA-3002
1982-83	V8 5.0L 307ci	Y	w/Cruise w/o Adapter Lower; 83.00" Cable	CA-3004
1982-83	V8 5.0L 307ci	Y	w/o Cruise w/Adapter Upper; 80.00" Cable	CA-3001
1982-83	V8 5.0L 307ci	Y	w/o Cruise w/o Adapter; 100.00" Cable	CA-3003
1982-83	V8 5.7L 350ci	N	w/Cruise Control, Upper; 61.00" Cable	CA-3005
1982-83	V8 5.7L 350ci	N	w/Cruise w/Adapter Lower; 63.00" Cable	CA-3002
1982-83	V8 5.7L 350ci	N	w/Cruise w/o Adapter Lower; 83.00" Cable	CA-3004
1982-83	V8 5.7L 350ci	N	w/o Cruise w/Adapter Upper; 80.00" Cable	CA-3001
1982-83	V8 5.7L 350ci	N	w/o Cruise w/o Adapter; 100.00" Cable	CA-3003

# SPEEDOMETER CABLES

Year	Engine	Vin	Remark	Part
<b>OLDSMOBILE (con't)</b>				
<b>CUTLASS SALON</b>				
1978-79	V6 3.8L 231ci	2,A	w/Adapter Lower; 20.00" Cable	CA-3008
1978-79	V6 3.8L 231ci	2,A	w/Adapter Upper; 80.00" Cable	CA-3001
1978-79	V6 3.8L 231ci	2,A	w/Cruise w/o Adapter Lower; 83.00" Cable	CA-3004
1978-79	V6 3.8L 231ci	2,A	w/Cruise w/o Adapter Upper, w/Adapter w/Interconnector Upper	CA-3005
1978-79	V6 3.8L 231ci	2,A	w/o Cruise w/o Adapter; 100.00" Cable	CA-3003
1980	V6 3.8L 231ci	A	w/Cruise Lower; 83.00" Cable	CA-3004
1980	V6 3.8L 231ci	A	w/Innerconnector Lower; 63.00" Cable	CA-3002
1980	V6 3.8L 231ci	A	w/Innerconnector Upper, w/Cruise Upper; 61.00" Cable	CA-3005
1980	V6 3.8L 231ci	A	w/o Innerconnector Lower; 20.00" Cable	CA-3008
1980	V6 3.8L 231ci	A	w/o Innerconnector Upper; 80.00" Cable	CA-3001
1985	V6 3.8L 231ci	A	4 Spd. AT w/Adapter Upper; 80.00" Cable	CA-3001
1985	V6 3.8L 231ci	A	4 Spd. AT w/o Adapter, 3 Spd. At; 100.00" Cable	CA-3003
1985	V6 3.8L 231ci	A	w/o Cruise w/Adapter Lower; 20.00" Cable	CA-3008
1985-87	V6 3.8L 231ci	A	w/Adapter exc.4 Spd. AT Upper; 41.00" Cable	CA-3009
1986-87	V6 3.8L 231ci	A	4 Spd. AT w/Adapter Upper; 61.00" Cable	CA-3005
1986-87	V6 3.8L 231ci	A	4 Spd. AT w/o Adapter, 3 Spd. At; 20.00" Cable	CA-3008
1986-87	V6 3.8L 231ci	A	AT w/o Adapter; 100.00" Cable	CA-3003
1976	V8 4.3L 260ci	F	w/Cruise Control, w/Regulator to Trans.; 63.00" Cable	CA-3002
1977	V8 4.3L 260ci	F	w/Cruise Control, Lower; 63.00" Cable	CA-3002
1980	V8 4.3L 260ci	F	w/Cruise Lower; 83.00" Cable	CA-3004
1980	V8 4.3L 260ci	F	w/Innerconnector Lower; 63.00" Cable	CA-3002
1980	V8 4.3L 260ci	F	w/Innerconnector Upper, w/Cruise Upper; 61.00" Cable	CA-3005
1980	V8 4.3L 260ci	F	w/o Innerconnector Lower; 20.00" Cable	CA-3008
1980	V8 4.3L 260ci	F	w/o Innerconnector Upper; 80.00" Cable	CA-3001
1975-77	V8 4.3L 260ci	F	exc. Cruise Control; 80.00" Cable	CA-3001
1975-77	V8 4.3L 260ci	F	w/Cruise Control, Upper; 41.00" Cable	CA-3009
1978-79	V8 4.3L 260ci	F,P	w/Adapter Lower; 20.00" Cable	CA-3008
1978-79	V8 4.3L 260ci	F,P	w/Adapter Upper; 80.00" Cable	CA-3001
1978-79	V8 4.3L 260ci	F,P	w/Cruise w/o Adapter Lower; 83.00" Cable	CA-3004
1978-79	V8 4.3L 260ci	F,P	w/Cruise w/o Adapter Upper, w/Adapter w/Interconnector Upper	CA-3005
1978-79	V8 4.3L 260ci	F,P	w/o Cruise w/o Adapter; 100.00" Cable	CA-3003
1980	V8 5.0L 305ci	H	w/Cruise Lower; 83.00" Cable	CA-3004
1980	V8 5.0L 305ci	H	w/Innerconnector Lower; 63.00" Cable	CA-3002
1980	V8 5.0L 305ci	H	w/Innerconnector Upper, w/Cruise Upper; 61.00" Cable	CA-3005
1980	V8 5.0L 305ci	H	w/o Innerconnector Lower; 20.00" Cable	CA-3008
1980	V8 5.0L 305ci	H	w/o Innerconnector Upper; 80.00" Cable	CA-3001
1978-79	V8 5.0L 305ci	H,U	w/Adapter Lower; 20.00" Cable	CA-3008
1978-79	V8 5.0L 305ci	H,U	w/Adapter Upper; 80.00" Cable	CA-3001
1978-79	V8 5.0L 305ci	H,U	w/Cruise w/o Adapter Lower; 83.00" Cable	CA-3004
1978-79	V8 5.0L 305ci	H,U	w/Cruise w/o Adapter Upper, w/Adapter w/Interconnector Upper	CA-3005
1978-79	V8 5.0L 305ci	H,U	w/o Cruise w/o Adapter; 100.00" Cable	CA-3003
1985	V8 5.0L 307ci	9,Y	4 Spd. AT w/Adapter Upper; 80.00" Cable	CA-3001
1985	V8 5.0L 307ci	9,Y	4 Spd. AT w/o Adapter, 3 Spd. At; 100.00" Cable	CA-3003
1985	V8 5.0L 307ci	9,Y	w/o Cruise w/Adapter Lower; 20.00" Cable	CA-3008
1985-87	V8 5.0L 307ci	9,Y	w/Adapter exc.4 Spd. AT Upper; 41.00" Cable	CA-3009
1986-87	V8 5.0L 307ci	9,Y	4 Spd. AT w/Adapter Upper; 61.00" Cable	CA-3005
1986-87	V8 5.0L 307ci	9,Y	4 Spd. AT w/o Adapter, 3 Spd. At; 20.00" Cable	CA-3008
1986-87	V8 5.0L 307ci	9,Y	AT w/o Adapter; 100.00" Cable	CA-3003
1975	V8 5.7L 350ci	K	exc. Cruise Control; 80.00" Cable	CA-3001
1975	V8 5.7L 350ci	K	w/Cruise Control, Upper; 41.00" Cable	CA-3009
1980	V8 5.7L 350ci	N	w/Cruise Lower; 83.00" Cable	CA-3004
1980	V8 5.7L 350ci	N	w/Innerconnector Lower; 63.00" Cable	CA-3002
1980	V8 5.7L 350ci	N	w/Innerconnector Upper, w/Cruise Upper; 61.00" Cable	CA-3005
1980	V8 5.7L 350ci	N	w/o Innerconnector Lower; 20.00" Cable	CA-3008
1980	V8 5.7L 350ci	N	w/o Innerconnector Upper; 80.00" Cable	CA-3001
1985	V8 5.7L 350ci	N	4 Spd. AT w/Adapter Upper; 80.00" Cable	CA-3001
1985	V8 5.7L 350ci	N	4 Spd. AT w/o Adapter, 3 Spd. At; 100.00" Cable	CA-3003
1985	V8 5.7L 350ci	N	w/Adapter exc.4 Spd. AT Upper; 41.00" Cable	CA-3009
1985	V8 5.7L 350ci	N	w/o Cruise w/Adapter Lower; 20.00" Cable	CA-3008
1976	V8 5.7L 350ci	R	w/Cruise Control, w/Regulator to Trans.; 63.00" Cable	CA-3002
1977	V8 5.7L 350ci	R	w/Cruise Control, Lower; 63.00" Cable	CA-3002
1979	V8 5.7L 350ci	R	w/Adapter Lower; 20.00" Cable	CA-3008

# SPEEDOMETER CABLES

Year	Engine	Vin	Remark	Part
<b>OLDSMOBILE (con't)</b>				
<b>CUTLASS SALON (con't)</b>				
1979	V8 5.7L 350ci	R	w/Adapter Upper; 80.00" Cable	CA-3001
1979	V8 5.7L 350ci	R	w/Cruise w/o Adapter Lower; 83.00" Cable	CA-3004
1979	V8 5.7L 350ci	R	w/Cruise w/o Adapter Upper, w/Adapter w/Interconnector Upper	CA-3005
1979	V8 5.7L 350ci	R	w/o Cruise w/o Adapter; 100.00" Cable	CA-3003
1976-77	V8 5.7L 350ci	R	exc. Cruise Control; 80.00" Cable	CA-3001
1976-77	V8 5.7L 350ci	R	w/Cruise Control, Upper; 41.00" Cable	CA-3009
1977	V8 6.6L 403ci	K	exc. Cruise Control; 80.00" Cable	CA-3001
1977	V8 6.6L 403ci	K	w/Cruise Control, Lower; 63.00" Cable	CA-3002
1977	V8 6.6L 403ci	K	w/Cruise Control, Upper; 41.00" Cable	CA-3009
1976	V8 7.5L 455ci	T	w/Cruise Control, w/Regulator to Trans.; 63.00" Cable	CA-3002
1975-76	V8 7.5L 455ci	T	exc. Cruise Control; 80.00" Cable	CA-3001
1975-76	V8 7.5L 455ci	T	w/Cruise Control, Upper; 41.00" Cable	CA-3009
<b>CUTLASS SUPREME</b>				
1976	L6 4.1L 250ci	D	exc. Cruise Control; 80.00" Cable	CA-3001
1976	L6 4.1L 250ci	D	w/Cruise Control, w/Regulator to Trans.; 63.00" Cable	CA-3002
1976	L6 4.1L 250ci	D	w/Cruise Control, Upper; 41.00" Cable	CA-3009
1988	V6 2.8L 173ci	W	THM-200-4R w/o Gear Adapter; 80.00" Cable	CA-3001
1978-79	V6 3.8L 231ci	2,A	w/Adapter Lower; 20.00" Cable	CA-3008
1978-79	V6 3.8L 231ci	2,A	w/Adapter Upper; 80.00" Cable	CA-3001
1978-79	V6 3.8L 231ci	2,A	w/Cruise w/o Adapter Upper, w/Adapter w/Interconnector Upper	CA-3005
1978-83	V6 3.8L 231ci	2,A	w/Cruise w/o Adapter Lower; 83.00" Cable	CA-3004
1978-83	V6 3.8L 231ci	2,A	w/o Cruise w/o Adapter; 100.00" Cable	CA-3003
1982-83	V6 3.8L 231ci	A	w/Cruise Control, Upper; 61.00" Cable	CA-3005
1982-83	V6 3.8L 231ci	A	w/Cruise w/Adapter Lower; 63.00" Cable	CA-3002
1982-83	V6 3.8L 231ci	A	w/o Cruise w/Adapter Upper; 80.00" Cable	CA-3001
1984-85	V6 3.8L 231ci	A	4 Spd. AT w/Adapter Upper; 80.00" Cable	CA-3001
1984-85	V6 3.8L 231ci	A	4 Spd. AT w/o Adapter, 3 Spd. At; 100.00" Cable	CA-3003
1984-85	V6 3.8L 231ci	A	w/o Cruise w/Adapter Lower; 20.00" Cable	CA-3008
1984-87	V6 3.8L 231ci	A	w/Adapter exc.4 Spd. AT Upper; 41.00" Cable	CA-3009
1986-87	V6 3.8L 231ci	A	4 Spd. AT w/Adapter Upper; 61.00" Cable	CA-3005
1986-87	V6 3.8L 231ci	A	4 Spd. AT w/o Adapter, 3 Spd. At; 20.00" Cable	CA-3008
1986-87	V6 3.8L 231ci	A	AT w/o Adapter; 100.00" Cable	CA-3003
1977	V6 3.8L 231ci	C	exc. Cruise Control; 80.00" Cable	CA-3001
1977	V6 3.8L 231ci	C	w/Cruise Control, Lower; 63.00" Cable	CA-3002
1977	V6 3.8L 231ci	C	w/Cruise Control, Upper; 41.00" Cable	CA-3009
1984	V6 4.3L 260ci	V	4 Spd. AT w/Adapter Upper; 80.00" Cable	CA-3001
1984	V6 4.3L 260ci	V	4 Spd. AT w/o Adapter, 3 Spd. At; 100.00" Cable	CA-3003
1984	V6 4.3L 260ci	V	w/Adapter exc.4 Spd. AT Upper; 41.00" Cable	CA-3009
1984	V6 4.3L 260ci	V	w/o Cruise w/Adapter Lower; 20.00" Cable	CA-3008
1982-83	V6 4.3L 260ci	V	w/Cruise Control, Upper; 61.00" Cable	CA-3005
1982-83	V6 4.3L 260ci	V	w/Cruise w/Adapter Lower; 63.00" Cable	CA-3002
1982-83	V6 4.3L 260ci	V	w/Cruise w/o Adapter Lower; 83.00" Cable	CA-3004
1982-83	V6 4.3L 260ci	V	w/o Cruise w/Adapter Upper; 80.00" Cable	CA-3001
1982-83	V6 4.3L 260ci	V	w/o Cruise w/o Adapter; 100.00" Cable	CA-3003
1982	V8 4.3L 260ci	8	w/Cruise Control, Upper; 61.00" Cable	CA-3005
1982	V8 4.3L 260ci	8	w/Cruise w/Adapter Lower; 63.00" Cable	CA-3002
1982	V8 4.3L 260ci	8	w/Cruise w/o Adapter Lower; 83.00" Cable	CA-3004
1982	V8 4.3L 260ci	8	w/o Cruise w/Adapter Upper; 80.00" Cable	CA-3001
1982	V8 4.3L 260ci	8	w/o Cruise w/o Adapter; 100.00" Cable	CA-3003
1976	V8 4.3L 260ci	F	w/Cruise Control, w/Regulator to Trans.; 63.00" Cable	CA-3002
1977	V8 4.3L 260ci	F	w/Cruise Control, Lower; 63.00" Cable	CA-3002
1976-77	V8 4.3L 260ci	F	exc. Cruise Control; 80.00" Cable	CA-3001
1976-77	V8 4.3L 260ci	F	w/Cruise Control, Upper; 41.00" Cable	CA-3009
1978-79	V8 4.3L 260ci	F,P	w/Adapter Lower; 20.00" Cable	CA-3008
1978-79	V8 4.3L 260ci	F,P	w/Adapter Upper; 80.00" Cable	CA-3001
1978-79	V8 4.3L 260ci	F,P	w/Cruise w/o Adapter Lower; 83.00" Cable	CA-3004
1978-79	V8 4.3L 260ci	F,P	w/Cruise w/o Adapter Upper, w/Adapter w/Interconnector Upper	CA-3005
1978-79	V8 4.3L 260ci	F,P	w/o Cruise w/o Adapter; 100.00" Cable	CA-3003
1982	V8 4.4L 267ci	J	w/Cruise Control, Upper; 61.00" Cable	CA-3005
1982	V8 4.4L 267ci	J	w/Cruise w/Adapter Lower; 63.00" Cable	CA-3002
1982	V8 4.4L 267ci	J	w/Cruise w/o Adapter Lower; 83.00" Cable	CA-3004
1982	V8 4.4L 267ci	J	w/o Cruise w/Adapter Upper; 80.00" Cable	CA-3001

# SPEEDOMETER CABLES

Year	Engine	Vin	Remark	Part
<b>OLDSMOBILE (con't)</b>				
<b>CUTLASS SUPREME (con't)</b>				
1982	V8 4.4L 267ci	J	w/o Cruise w/o Adapter; 100.00" Cable	CA-3003
1983	V8 5.0L 305ci	H	w/Cruise Control, Upper; 61.00" Cable	CA-3005
1983	V8 5.0L 305ci	H	w/Cruise w/Adapter Lower; 63.00" Cable	CA-3002
1983	V8 5.0L 305ci	H	w/o Cruise w/Adapter Upper; 80.00" Cable	CA-3001
1985	V8 5.0L 305ci	H	4 Spd. AT w/Adapter Upper; 80.00" Cable	CA-3001
1985	V8 5.0L 305ci	H	4 Spd. AT w/o Adapter, 3 Spd. At; 100.00" Cable	CA-3003
1985	V8 5.0L 305ci	H	w/o Cruise w/Adapter Lower; 20.00" Cable	CA-3008
1985-87	V8 5.0L 305ci	H	w/Adapter exc.4 Spd. AT Upper; 41.00" Cable	CA-3009
1986-87	V8 5.0L 305ci	H	4 Spd. AT w/Adapter Upper; 61.00" Cable	CA-3005
1986-87	V8 5.0L 305ci	H	4 Spd. AT w/o Adapter, 3 Spd. At; 20.00" Cable	CA-3008
1986-87	V8 5.0L 305ci	H	AT w/o Adapter; 100.00" Cable	CA-3003
1978-79	V8 5.0L 305ci	H,U	w/Adapter Lower; 20.00" Cable	CA-3008
1978-79	V8 5.0L 305ci	H,U	w/Adapter Upper; 80.00" Cable	CA-3001
1978-79	V8 5.0L 305ci	H,U	w/Cruise w/o Adapter Upper, w/Adapter w/Interconnector Upper	CA-3005
1978-83	V8 5.0L 305ci	H,U	w/Cruise w/o Adapter Lower; 83.00" Cable	CA-3004
1978-83	V8 5.0L 305ci	H,U	w/o Cruise w/o Adapter; 100.00" Cable	CA-3003
1984-87	V8 5.0L 307ci	9,Y	w/Adapter exc.4 Spd. AT Upper; 41.00" Cable	CA-3009
1986-87	V8 5.0L 307ci	9,Y	4 Spd. AT w/Adapter Upper; 61.00" Cable	CA-3005
1986-87	V8 5.0L 307ci	9,Y	4 Spd. AT w/o Adapter, 3 Spd. At; 20.00" Cable	CA-3008
1986-87	V8 5.0L 307ci	9,Y	AT w/o Adapter; 100.00" Cable	CA-3003
1988	V8 5.0L 307ci	Y	THM-200-4R w/o Gear Adapter; 80.00" Cable	CA-3001
1982-83	V8 5.0L 307ci	Y	w/Cruise Control, Upper; 61.00" Cable	CA-3005
1982-83	V8 5.0L 307ci	Y	w/Cruise w/Adapter Lower; 63.00" Cable	CA-3002
1982-83	V8 5.0L 307ci	Y	w/Cruise w/o Adapter Lower; 83.00" Cable	CA-3004
1982-83	V8 5.0L 307ci	Y	w/o Cruise w/Adapter Upper; 80.00" Cable	CA-3001
1982-83	V8 5.0L 307ci	Y	w/o Cruise w/o Adapter; 100.00" Cable	CA-3003
1984-85	V8 5.0L 307ci	Y	4 Spd. AT w/Adapter Upper; 80.00" Cable	CA-3001
1984-85	V8 5.0L 307ci	Y	4 Spd. AT w/o Adapter, 3 Spd. At; 100.00" Cable	CA-3003
1984-85	V8 5.0L 307ci	Y	w/o Cruise w/Adapter Lower; 20.00" Cable	CA-3008
1979-83	V8 5.7L 350ci	N	w/o Cruise w/o Adapter; 100.00" Cable	CA-3003
1982-83	V8 5.7L 350ci	N	w/Cruise Control, Upper; 61.00" Cable	CA-3005
1982-83	V8 5.7L 350ci	N	w/Cruise w/Adapter Lower; 63.00" Cable	CA-3002
1982-83	V8 5.7L 350ci	N	w/o Cruise w/Adapter Upper; 80.00" Cable	CA-3001
1984-85	V8 5.7L 350ci	N	4 Spd. AT w/Adapter Upper; 80.00" Cable	CA-3001
1984-85	V8 5.7L 350ci	N	4 Spd. AT w/o Adapter, 3 Spd. At; 100.00" Cable	CA-3003
1984-85	V8 5.7L 350ci	N	w/Adapter exc.4 Spd. AT Upper; 41.00" Cable	CA-3009
1984-85	V8 5.7L 350ci	N	w/o Cruise w/Adapter Lower; 20.00" Cable	CA-3008
1979	V8 5.7L 350ci	N,R	w/Adapter Lower; 20.00" Cable	CA-3008
1979	V8 5.7L 350ci	N,R	w/Adapter Upper; 80.00" Cable	CA-3001
1979	V8 5.7L 350ci	N,R	w/Cruise w/o Adapter Upper, w/Adapter w/Interconnector Upper	CA-3005
1979-83	V8 5.7L 350ci	N,R	w/Cruise w/o Adapter Lower; 83.00" Cable	CA-3004
1976	V8 5.7L 350ci	R	w/Cruise Control, w/Regulator to Trans.; 63.00" Cable	CA-3002
1977	V8 5.7L 350ci	R	w/Cruise Control, Lower; 63.00" Cable	CA-3002
1979	V8 5.7L 350ci	R	w/o Cruise w/o Adapter; 100.00" Cable	CA-3003
1976-77	V8 5.7L 350ci	R	exc. Cruise Control; 80.00" Cable	CA-3001
1976-77	V8 5.7L 350ci	R	w/Cruise Control, Upper; 41.00" Cable	CA-3009
1977	V8 6.6L 403ci	K	exc. Cruise Control; 80.00" Cable	CA-3001
1977	V8 6.6L 403ci	K	w/Cruise Control, Lower; 63.00" Cable	CA-3002
1977	V8 6.6L 403ci	K	w/Cruise Control, Upper; 41.00" Cable	CA-3009
1976	V8 7.5L 455ci	T	exc. Cruise Control; 80.00" Cable	CA-3001
1976	V8 7.5L 455ci	T	w/Cruise Control, w/Regulator to Trans.; 63.00" Cable	CA-3002
1976	V8 7.5L 455ci	T	w/Cruise Control, Upper; 41.00" Cable	CA-3009
<b>DELTA 88</b>				
1986	V6 3.0L 181ci	L	AT; 80.00" Cable	CA-3001
1986-88	V6 3.8L 231ci	3	AT; 80.00" Cable	CA-3001
1983-85	V6 3.8L 231ci	A	AT; 80.00" Cable	CA-3001
1989	V6 3.8L 231ci	C	AT w/o Cruise Control; 80.00" Cable	CA-3001
1989	V6 3.8L 231ci	C	MT; 83.00" Cable	CA-3004
1989	V6 3.8L 231ci	C	w/Cruise Regulator to Speedometer; 61.00" Cable	CA-3005
1991	V6 3.8L 231ci	C	w/o Cruise Control; 80.00" Cable	CA-3001
1988-90	V6 3.8L 231ci	C	w/Cruise Upper, w/o Cruise; 80.00" Cable	CA-3001
1988-91	V6 3.8L 231ci	C	AT; 80.00" Cable	CA-3001

# SPEEDOMETER CABLES

Year	Engine	Vin	Remark	Part
<b>OLDSMOBILE (con't)</b>				
<b>DELTA 88 (con't)</b>				
1988-91	V6 3.8L 231ci	C	w/Cruise Control, Lower; 63.00" Cable	CA-3002
1989-91	V6 3.8L 231ci	C	w/Cruise Control, Upper; 41.00" Cable	CA-3009
1982	V8 4.3L 260ci	8	w/Cruise Control, Lower; 63.00" Cable	CA-3002
1982	V8 4.3L 260ci	8	w/Cruise Upper, w/o Cruise; 80.00" Cable	CA-3001
1981	V8 4.3L 260ci	F	AT w/o Cruise Control; 80.00" Cable	CA-3001
1981	V8 4.3L 260ci	F	MT; 83.00" Cable	CA-3004
1981	V8 4.3L 260ci	F	w/Cruise Regulator to Speedometer; 61.00" Cable	CA-3005
1977-80	V8 4.3L 260ci	F	w/Cruise Upper, w/o Cruise; 80.00" Cable	CA-3001
1977-81	V8 4.3L 260ci	F	w/Cruise Control, Lower; 63.00" Cable	CA-3002
1978-81	V8 4.3L 260ci	F	w/Cruise Control, Upper; 41.00" Cable	CA-3009
1978-81	V8 4.3L 260ci	F	w/o Cruise Control; 80.00" Cable	CA-3001
1981-82	V8 4.4L 267ci	J	w/Cruise Control, Lower; 63.00" Cable	CA-3002
1981-82	V8 4.4L 267ci	J	w/Cruise Upper, w/o Cruise; 80.00" Cable	CA-3001
1979	V8 4.9L 301ci	Y	w/Cruise Control, Lower; 63.00" Cable	CA-3002
1979	V8 4.9L 301ci	Y	w/Cruise Control, Upper; 41.00" Cable	CA-3009
1979	V8 4.9L 301ci	Y	w/o Cruise Control; 80.00" Cable	CA-3001
1985	V8 5.0L 307ci	Y	w/Cruise Control, Upper; 41.00" Cable	CA-3009
1985	V8 5.0L 307ci	Y	w/o Cruise Control; 80.00" Cable	CA-3001
1980-85	V8 5.0L 307ci	Y	AT; 80.00" Cable	CA-3001
1982-84	V8 5.0L 307ci	Y	w/Cruise Upper, w/o Cruise; 80.00" Cable	CA-3001
1982-85	V8 5.0L 307ci	Y	w/Cruise Control, Lower; 63.00" Cable	CA-3002
1967	V8 5.4L 330ci		w/Cruise Upper	CA-3006
1976-80	V8 5.7L 350ci	G,L,R	w/Cruise Control, Lower; 63.00" Cable	CA-3002
1977-78	V8 5.7L 350ci	G,L,R	w/Cruise Upper, w/o Cruise; 61.00" Cable	CA-3005
1973	V8 5.7L 350ci	H	Regulator to Speedometer; 61.00" Cable	CA-3005
1973	V8 5.7L 350ci	H	w/Cruise Control, w/Regulator to Trans.; 63.00" Cable	CA-3002
1972-74	V8 5.7L 350ci	H,K	w/Cruise Control, Upper; 41.00" Cable	CA-3009
1972-75	V8 5.7L 350ci	H,K	w/Cruise Control, Lower; 63.00" Cable	CA-3002
1972-75	V8 5.7L 350ci	H,K	w/o Cruise Control; 80.00" Cable	CA-3001
1975	V8 5.7L 350ci	K	w/Cruise Control, Upper; 61.00" Cable	CA-3005
1973-74	V8 5.7L 350ci	K	AT w/o Cruise Control; 80.00" Cable	CA-3001
1973-74	V8 5.7L 350ci	K	MT; 83.00" Cable	CA-3004
1973-74	V8 5.7L 350ci	K	w/Cruise Regulator to Speedometer; 61.00" Cable	CA-3005
1978	V8 5.7L 350ci	N	AT w/o Cruise Control; 80.00" Cable	CA-3001
1978	V8 5.7L 350ci	N	MT; 83.00" Cable	CA-3004
1978	V8 5.7L 350ci	N	w/Cruise Regulator to Speedometer; 61.00" Cable	CA-3005
1978-85	V8 5.7L 350ci	N	w/Cruise Control, Lower; 63.00" Cable	CA-3002
1978-85	V8 5.7L 350ci	N	w/Cruise Control, Upper; 41.00" Cable	CA-3009
1980-85	V8 5.7L 350ci	N	w/o Cruise Control; 80.00" Cable	CA-3001
1981-84	V8 5.7L 350ci	N	w/Cruise Upper, w/o Cruise; 80.00" Cable	CA-3001
1979-85	V8 5.7L 350ci	N,R	AT; 80.00" Cable	CA-3001
1976	V8 5.7L 350ci	R	w/o Cruise Control; 61.00" Cable	CA-3005
1980	V8 5.7L 350ci	R	w/Cruise Upper, w/o Cruise; 80.00" Cable	CA-3001
1976-79	V8 5.7L 350ci	R	w/Cruise Control, Upper; 41.00" Cable	CA-3009
1970	V8 5.7L 350ci		w/Cruise Control, Lower; 63.00" Cable	CA-3002
1970	V8 5.7L 350ci		w/Cruise Control, Upper; 41.00" Cable	CA-3009
1970	V8 5.7L 350ci		w/o Cruise Control; 80.00" Cable	CA-3001
1975	V8 6.6L 400ci	R	w/Cruise Control, Lower; 63.00" Cable	CA-3002
1975	V8 6.6L 400ci	R	w/Cruise Control, Upper; 41.00" Cable	CA-3009
1975	V8 6.6L 400ci	R	w/o Cruise Control; 80.00" Cable	CA-3001
1978	V8 6.6L 403ci	K	AT w/o Cruise Control; 80.00" Cable	CA-3001
1978	V8 6.6L 403ci	K	MT; 83.00" Cable	CA-3004
1978	V8 6.6L 403ci	K	w/Cruise Regulator to Speedometer; 61.00" Cable	CA-3005
1979	V8 6.6L 403ci	K	w/Cruise Control, Upper; 61.00" Cable	CA-3005
1977-78	V8 6.6L 403ci	K	w/Cruise Control, Upper; 41.00" Cable	CA-3009
1977-79	V8 6.6L 403ci	K	w/Cruise Control, Lower; 63.00" Cable	CA-3002
1977-79	V8 6.6L 403ci	K	w/o Cruise Control; 80.00" Cable	CA-3001
1965-67	V8 7.0L 425ci		w/Cruise Upper	CA-3006
1974-75	V8 7.5L 455ci	R,T	w/Cruise Upper, w/o Cruise; 61.00" Cable	CA-3005
1972-76	V8 7.5L 455ci	R,T,U	w/Cruise Control, Lower; 63.00" Cable	CA-3002
1972	V8 7.5L 455ci	T	w/Cruise Control, Upper; 61.00" Cable	CA-3005
1972	V8 7.5L 455ci	T	w/o Cruise Control; 80.00" Cable	CA-3001

# SPEEDOMETER CABLES

Year	Engine	Vin	Remark	Part
<b>OLDSMOBILE (con't)</b>				
<b>DELTA 88 (con't)</b>				
1973	V8 7.5L 455ci	T	w/o Cruise Control; 61.00" Cable	CA-3005
1973-76	V8 7.5L 455ci	T,U	w/Cruise Control, Upper; 41.00" Cable	CA-3009
1974	V8 7.5L 455ci	U	w/o Cruise Control; 61.00" Cable	CA-3005
1970	V8 7.5L 455ci		w/Cruise Control, Lower; 63.00" Cable	CA-3002
1970	V8 7.5L 455ci		w/Cruise Control, Upper; 41.00" Cable	CA-3009
1970	V8 7.5L 455ci		w/o Cruise Control; 61.00" Cable	CA-3005
1971	V8 7.5L 455ci		Regulator to Speedometer; 61.00" Cable	CA-3005
1971	V8 7.5L 455ci		w/Cruise Control, w/Regulator to Trans.; 63.00" Cable	CA-3002
<b>F85</b>				
1967	L6 4.1L 250ci		AT w/Cruise Control, Upper	CA-3006
1968	L6 4.1L 250ci		AT w/Cruise Control, Upper; 63.00" Cable	CA-3002
1969	L6 4.1L 250ci		3 Spd. MT w/o Cruise; 80.00" Cable	CA-3001
1969	L6 4.1L 250ci		AT w/Cruise Upper, 3 Spd. MT w/Cruise Upper; 41.00" Cable	CA-3009
1970	L6 4.1L 250ci		3 Spd. MT w/o Cruise; 41.00" Cable	CA-3009
1970	L6 4.1L 250ci		4 Spd. MT w/o Cruise exc. Synchro.; 41.00" Cable	CA-3009
1970	L6 4.1L 250ci		w/Cruise Control, Lower; 63.00" Cable	CA-3002
1971	L6 4.1L 250ci		AT w/Cruise Control, Lower; 63.00" Cable	CA-3002
1971	L6 4.1L 250ci		AT w/Cruise Control, Upper; 41.00" Cable	CA-3009
1971	L6 4.1L 250ci		w/o Cruise Control; 61.00" Cable	CA-3005
1966-68	L6 4.1L 250ci		w/o Cruise Control; 83.00" Cable	CA-3004
1969-70	L6 4.1L 250ci		AT w/o Cruise Control; 61.00" Cable	CA-3005
1969-71	L6 4.1L 250ci		4 Spd. MT exc. 3.91 Rear Axle Ratio; 80.00" Cable	CA-3001
1964-65	V6 3.7L 225ci		63.00" Cable	CA-3002
1963	V8 3.5L 215ci		AT w/Cruise Control, Upper	CA-3006
1961-63	V8 3.5L 215ci		3 Spd. MT; 63.00" Cable	CA-3002
1967	V8 5.4L 330ci		AT w/Cruise Control, Upper	CA-3006
1964-65	V8 5.4L 330ci		63.00" Cable	CA-3002
1966-67	V8 5.4L 330ci		w/o Cruise Control; 83.00" Cable	CA-3004
1972	V8 5.7L 350ci	H,K	4 Spd. MT exc. 3.91 Rear Axle Ratio; 80.00" Cable	CA-3001
1972	V8 5.7L 350ci	H,K	AT w/Cruise Control, Lower; 63.00" Cable	CA-3002
1972	V8 5.7L 350ci	H,K	AT w/Cruise Control, Upper; 41.00" Cable	CA-3009
1972	V8 5.7L 350ci	H,K	w/o Cruise Control; 61.00" Cable	CA-3005
1968	V8 5.7L 350ci		AT w/Cruise Control, Upper; 63.00" Cable	CA-3002
1968	V8 5.7L 350ci		w/o Cruise Control; 83.00" Cable	CA-3004
1969	V8 5.7L 350ci		3 Spd. MT w/o Cruise; 80.00" Cable	CA-3001
1969	V8 5.7L 350ci		AT w/Cruise Upper, 3 Spd. MT w/Cruise Upper; 41.00" Cable	CA-3009
1970	V8 5.7L 350ci		3 Spd. MT w/o Cruise; 41.00" Cable	CA-3009
1970	V8 5.7L 350ci		4 Spd. MT w/o Cruise exc. Synchro.; 41.00" Cable	CA-3009
1970	V8 5.7L 350ci		w/Cruise Control, Lower; 63.00" Cable	CA-3002
1971	V8 5.7L 350ci		AT w/Cruise Control, Lower; 63.00" Cable	CA-3002
1971	V8 5.7L 350ci		AT w/Cruise Control, Upper; 41.00" Cable	CA-3009
1971	V8 5.7L 350ci		w/o Cruise Control; 61.00" Cable	CA-3005
1969-70	V8 5.7L 350ci		AT w/o Cruise Control; 61.00" Cable	CA-3005
1969-71	V8 5.7L 350ci		4 Spd. MT exc. 3.91 Rear Axle Ratio; 80.00" Cable	CA-3001
1965	V8 6.6L 400ci		63.00" Cable	CA-3002
1966	V8 6.6L 400ci		w/o Cruise Control; 83.00" Cable	CA-3004
1972	V8 7.5L 455ci	U	4 Spd. MT exc. 3.91 Rear Axle Ratio; 80.00" Cable	CA-3001
1972	V8 7.5L 455ci	U	AT w/Cruise Control, Lower; 63.00" Cable	CA-3002
1972	V8 7.5L 455ci	U	AT w/Cruise Control, Upper; 41.00" Cable	CA-3009
1972	V8 7.5L 455ci	U	w/o Cruise Control; 61.00" Cable	CA-3005
1970	V8 7.5L 455ci		3 Spd. MT w/o Cruise; 41.00" Cable	CA-3009
1970	V8 7.5L 455ci		4 Spd. MT exc. 3.91 Rear Axle Ratio; 80.00" Cable	CA-3001
1970	V8 7.5L 455ci		4 Spd. MT w/o Cruise exc. Synchro.; 41.00" Cable	CA-3009
1970	V8 7.5L 455ci		AT w/o Cruise Control; 61.00" Cable	CA-3005
1970	V8 7.5L 455ci		w/Cruise Control, Lower; 63.00" Cable	CA-3002
<b>FIRENZA</b>				
1984	L4 1.8L 112ci	0	AT; 61.00" Cable	CA-3005
1984	L4 1.8L 112ci	0	MT; 41.00" Cable	CA-3009
1982-83	L4 1.8L 112ci	0,G	w/Cruise Control, Lower	CA-3006
1982-83	L4 1.8L 112ci	0,G	w/Cruise Control, Upper; 41.00" Cable	CA-3009
1982-83	L4 1.8L 112ci	0,G	w/o Cruise Control; 61.00" Cable	CA-3005
1988	L4 2.0L 121ci	1	AT; 61.00" Cable	CA-3005

# SPEEDOMETER CABLES

Year	Engine	Vin	Remark	Part
<b>OLDSMOBILE (con't)</b>				
<b>FIRENZA (con't)</b>				
1988	L4 2.0L 121ci	1	MT; 41.00" Cable	CA-3009
1983	L4 2.0L 122ci	B,P	w/Cruise Control, Lower	CA-3006
1983	L4 2.0L 122ci	B,P	w/Cruise Control, Upper; 41.00" Cable	CA-3009
1983	L4 2.0L 122ci	B,P	w/o Cruise Control; 61.00" Cable	CA-3005
1984	L4 2.0L 122ci	B,P	AT; 61.00" Cable	CA-3005
1984	L4 2.0L 122ci	B,P	MT; 41.00" Cable	CA-3009
1988	L4 2.0L 122ci	K	AT; 61.00" Cable	CA-3005
1988	L4 2.0L 122ci	K	MT; 41.00" Cable	CA-3009
1985-87	V6 2.8L 173ci	W	AT; 61.00" Cable	CA-3005
1985-87	V6 2.8L 173ci	W	MT; 41.00" Cable	CA-3009
<b>JETSTAR 88</b>				
1964	V8 5.4L 330ci		AT; 83.00" Cable	CA-3004
1964-66	V8 5.4L 330ci		MT; 63.00" Cable	CA-3002
1964	V8 6.5L 394ci		AT; 83.00" Cable	CA-3004
1964	V8 6.5L 394ci		MT; 63.00" Cable	CA-3002
1965	V8 7.0L 425ci		MT; 63.00" Cable	CA-3002
<b>OMEGA</b>				
1980	L4 2.5L 151ci	5	w/Cruise Lower; 40.00" Cable	CA-3033
1980	L4 2.5L 151ci	5	w/Cruise Control, Upper; 41.00" Cable	CA-3009
1980	L4 2.5L 151ci	5	w/o Cruise Control	CA-3006
1981	L4 2.5L 151ci	5	w/o Cruise Lower; 40.00" Cable	CA-3033
1981	L4 2.5L 151ci	5	w/o Cruise Upper; 41.00" Cable	CA-3009
1982-83	L4 2.5L 151ci	5,R	AT w/Cruise Control, Lower; 83.00" Cable	CA-3004
1982-83	L4 2.5L 151ci	5,R	AT w/o Cruise Control; 80.00" Cable	CA-3001
1982-83	L4 2.5L 151ci	5,R	MT w/Cruise Lower	CA-3006
1982-83	L4 2.5L 151ci	5,R	MT w/o Cruise, AT & MT w/Cruise Upper; 41.00" Cable	CA-3009
1984	L4 2.5L 151ci	R	AT; 80.00" Cable	CA-3001
1984	L4 2.5L 151ci	R	MT w/o Cruise; 41.00" Cable	CA-3009
1975	L6 4.1L 250ci	D	MT w/Cruise Upper; 40.00" Cable	CA-3033
1976	L6 4.1L 250ci	D	3 Spd. MT 2 pc. Cable Lower; 40.00" Cable	CA-3033
1976	L6 4.1L 250ci	D	3 Spd. MT 2 pc. Cable Upper; 61.00" Cable	CA-3005
1976	L6 4.1L 250ci	D	4 Spd. MT Upper; 61.00" Cable	CA-3005
1976	L6 4.1L 250ci	D	AT w/o Cruise, MT Column Shift, 3Spd. Floor Shift 1 pc Cable; 80.00" Cable	CA-3001
1973-75	L6 4.1L 250ci	D	AT w/o Cruise, MT Column Shift; 80.00" Cable	CA-3001
1973-75	L6 4.1L 250ci	D	MT w/Floor Shift; 61.00" Cable	CA-3005
1975-76	L6 4.1L 250ci	D	AT w/Cruise Control, Upper; 41.00" Cable	CA-3009
1975-76	L6 4.1L 250ci	D	w/Cruise Control, Lower; 63.00" Cable	CA-3002
1980	V6 2.8L 173ci	7	w/Cruise Lower; 40.00" Cable	CA-3033
1980	V6 2.8L 173ci	7	w/Cruise Control, Upper; 41.00" Cable	CA-3009
1980	V6 2.8L 173ci	7	w/o Cruise Control	CA-3006
1981	V6 2.8L 173ci	X	w/o Cruise Lower; 40.00" Cable	CA-3033
1981	V6 2.8L 173ci	X	w/o Cruise Upper; 41.00" Cable	CA-3009
1984	V6 2.8L 173ci	X	AT; 80.00" Cable	CA-3001
1984	V6 2.8L 173ci	X	MT w/o Cruise; 41.00" Cable	CA-3009
1982-83	V6 2.8L 173ci	X	AT w/Cruise Control, Lower; 83.00" Cable	CA-3004
1982-83	V6 2.8L 173ci	X	AT w/o Cruise Control; 80.00" Cable	CA-3001
1982-83	V6 2.8L 173ci	X	MT w/Cruise Lower	CA-3006
1982-83	V6 2.8L 173ci	X	MT w/o Cruise, AT & MT w/Cruise Upper; 41.00" Cable	CA-3009
1978	V6 3.8L 231ci	A	3 Spd. MT Floor Shift Lower; 40.00" Cable	CA-3033
1978	V6 3.8L 231ci	A	w/Cruise Control, Upper; 41.00" Cable	CA-3009
1978	V6 3.8L 231ci	A	w/o Cruise Control; 100.00" Cable	CA-3003
1979	V6 3.8L 231ci	A	AT w/Cruise Control, Upper; 41.00" Cable	CA-3009
1979	V6 3.8L 231ci	A	MT w/Cruise Upper; 61.00" Cable	CA-3005
1979	V6 3.8L 231ci	A	w/o Cruise Control; 80.00" Cable	CA-3001
1978-79	V6 3.8L 231ci	A	w/Cruise Lower; 83.00" Cable	CA-3004
1977	V6 3.8L 231ci	C	3 Spd. MT Floor Shift Lower; 40.00" Cable	CA-3033
1977	V6 3.8L 231ci	C	3 Spd. MT w/Air Bag; 80.00" Cable	CA-3001
1977	V6 3.8L 231ci	C	MT w/Cruise Upper; 61.00" Cable	CA-3005
1977	V6 3.8L 231ci	C	w/Cruise Lower; 83.00" Cable	CA-3004
1977	V6 3.8L 231ci	C	w/Cruise Control, Upper; 41.00" Cable	CA-3009
1977	V6 3.8L 231ci	C	w/o Cruise Control; 100.00" Cable	CA-3003
1975	V8 4.3L 260ci	F	AT w/o Cruise, MT Column Shift; 80.00" Cable	CA-3001

# SPEEDOMETER CABLES

Year	Engine	Vin	Remark	Part
<b>OLDSMOBILE (con't)</b>				
<b>OMEGA (con't)</b>				
1975	V8 4.3L 260ci	F	MT w/Cruise Upper; 40.00" Cable	CA-3033
1975	V8 4.3L 260ci	F	MT w/Floor Shift; 61.00" Cable	CA-3005
1976	V8 4.3L 260ci	F	3 Spd. MT 2 pc. Cable Lower; 40.00" Cable	CA-3033
1976	V8 4.3L 260ci	F	3 Spd. MT 2 pc. Cable Upper; 61.00" Cable	CA-3005
1976	V8 4.3L 260ci	F	4 Spd. MT Upper; 61.00" Cable	CA-3005
1976	V8 4.3L 260ci	F	AT w/o Cruise, MT Column Shift, 3Spd. Floor Shift 1 pc Cable; 80.00" Cable	CA-3001
1977	V8 4.3L 260ci	F	3 Spd. MT Floor Shift Lower; 40.00" Cable	CA-3033
1977	V8 4.3L 260ci	F	3 Spd. MT w/Air Bag; 80.00" Cable	CA-3001
1977	V8 4.3L 260ci	F	MT w/Cruise Upper; 61.00" Cable	CA-3005
1977	V8 4.3L 260ci	F	w/Cruise Lower	CA-3016
1977	V8 4.3L 260ci	F	w/Cruise Control, Upper; 41.00" Cable	CA-3009
1977	V8 4.3L 260ci	F	w/o Cruise Control; 100.00" Cable	CA-3003
1975-76	V8 4.3L 260ci	F	AT w/Cruise Control, Upper; 41.00" Cable	CA-3009
1975-76	V8 4.3L 260ci	F	w/Cruise Control, Lower; 63.00" Cable	CA-3002
1979	V8 5.0L 305ci	G	AT w/Cruise Control, Upper; 41.00" Cable	CA-3009
1979	V8 5.0L 305ci	G	MT w/Cruise Upper; 61.00" Cable	CA-3005
1979	V8 5.0L 305ci	G	w/Cruise Lower	CA-3016
1979	V8 5.0L 305ci	G	w/o Cruise Control; 80.00" Cable	CA-3001
1977	V8 5.0L 305ci	U	3 Spd. MT w/Air Bag; 80.00" Cable	CA-3001
1977	V8 5.0L 305ci	U	MT w/Cruise Upper; 61.00" Cable	CA-3005
1977-78	V8 5.0L 305ci	U	3 Spd. MT Floor Shift Lower; 40.00" Cable	CA-3033
1977-78	V8 5.0L 305ci	U	w/Cruise Lower	CA-3016
1977-78	V8 5.0L 305ci	U	w/Cruise Control, Upper; 41.00" Cable	CA-3009
1977-78	V8 5.0L 305ci	U	w/o Cruise Control; 100.00" Cable	CA-3003
1975	V8 5.7L 350ci	H,J	MT w/Cruise Upper; 40.00" Cable	CA-3033
1975	V8 5.7L 350ci	H,J	w/Cruise Control, Lower; 63.00" Cable	CA-3002
1976	V8 5.7L 350ci	H,J	3 Spd. MT 2 pc. Cable Lower; 40.00" Cable	CA-3033
1976	V8 5.7L 350ci	H,J	3 Spd. MT 2 pc. Cable Upper; 61.00" Cable	CA-3005
1976	V8 5.7L 350ci	H,J	4 Spd. MT Upper; 61.00" Cable	CA-3005
1976	V8 5.7L 350ci	H,J	AT w/o Cruise, MT Column Shift, 3Spd. Floor Shift 1 pc Cable; 80.00" Cable	CA-3001
1976	V8 5.7L 350ci	H,J	w/Cruise Lower; 83.00" Cable	CA-3004
1975-76	V8 5.7L 350ci	H,J	AT w/Cruise Control, Upper; 41.00" Cable	CA-3009
1973-75	V8 5.7L 350ci	H,J,K	AT w/o Cruise, MT Column Shift; 80.00" Cable	CA-3001
1973-75	V8 5.7L 350ci	H,J,K	MT w/Floor Shift; 61.00" Cable	CA-3005
1979	V8 5.7L 350ci	L	AT w/Cruise Control, Upper; 41.00" Cable	CA-3009
1979	V8 5.7L 350ci	L	w/o Cruise Control; 80.00" Cable	CA-3001
1977	V8 5.7L 350ci	L,R	3 Spd. MT w/Air Bag; 80.00" Cable	CA-3001
1977-78	V8 5.7L 350ci	L,R	3 Spd. MT Floor Shift Lower; 40.00" Cable	CA-3033
1977-78	V8 5.7L 350ci	L,R	w/Cruise Control, Upper; 41.00" Cable	CA-3009
1977-78	V8 5.7L 350ci	L,R	w/o Cruise Control; 100.00" Cable	CA-3003
1977-79	V8 5.7L 350ci	L,R	MT w/Cruise Upper; 61.00" Cable	CA-3005
1977-79	V8 5.7L 350ci	L,R	w/Cruise Lower	CA-3016
<b>STARFIRE</b>				
1977	L4 2.3L 140ci	B	4 Spd. MT 1 pc. Cable; 61.00" Cable	CA-3005
1977	L4 2.3L 140ci	B	MT 1 pc Cable exc. 4 Spd.; 80.00" Cable	CA-3001
1976-77	L4 2.3L 140ci	B	MT Lower; 40.00" Cable	CA-3033
1976-77	L4 2.3L 140ci	B	MT Upper; 41.00" Cable	CA-3009
1978	L4 2.5L 151ci	1,V	61.00" Cable	CA-3005
1979-80	L4 2.5L 151ci	1,V	1 pc. Cable; 61.00" Cable	CA-3005
1980	V6 3.8L 231ci	A	w/Cruise Lower; 40.00" Cable	CA-3033
1980	V6 3.8L 231ci	A	w/Cruise Control, Upper; 41.00" Cable	CA-3009
1980	V6 3.8L 231ci	A	w/o Cruise Control; 80.00" Cable	CA-3001
1978-79	V6 3.8L 231ci	A	1 pc. Cable; 80.00" Cable	CA-3001
1978-79	V6 3.8L 231ci	A	2 pc. Lower; 40.00" Cable	CA-3033
1978-79	V6 3.8L 231ci	A	2 pc. Upper; 41.00" Cable	CA-3009
1977	V6 3.8L 231ci	A,C	4 Spd. MT 1 pc. Cable; 61.00" Cable	CA-3005
1977	V6 3.8L 231ci	A,C	MT 1 pc Cable exc. 4 Spd.; 80.00" Cable	CA-3001
1976-77	V6 3.8L 231ci	A,C	MT Lower; 40.00" Cable	CA-3033
1976-77	V6 3.8L 231ci	A,C	MT Upper; 41.00" Cable	CA-3009
1976	V6 3.8L 231ci	C	AT; 80.00" Cable	CA-3001
1979	V8 5.0L 305ci	G	1 pc. Cable; 61.00" Cable	CA-3005
1977	V8 5.0L 305ci	U	4 Spd. MT 1 pc. Cable; 61.00" Cable	CA-3005



# SPEEDOMETER CABLES

Year	Engine	Vin	Remark	Part
<b>OLDSMOBILE (con't)</b>				
<b>STARFIRE (con't)</b>				
1977	V8 5.0L 305ci	U	MT 1 pc Cable exc. 4 Spd.; 80.00" Cable	CA-3001
1977	V8 5.0L 305ci	U	MT Lower; 40.00" Cable	CA-3033
1977	V8 5.0L 305ci	U	MT Upper; 41.00" Cable	CA-3009
1978	V8 5.0L 305ci	U	1 pc. Cable; 80.00" Cable	CA-3001
1978	V8 5.0L 305ci	U	2 pc. Lower; 40.00" Cable	CA-3033
1978	V8 5.0L 305ci	U	2 pc. Upper; 41.00" Cable	CA-3009
<b>TORONADO</b>				
1987	V6 3.8L 231ci	3	41.00" Cable	CA-3009
1981	V6 4.1L 252ci	4	41.00" Cable	CA-3009
1981	V6 4.1L 252ci	4	w/o Cruise Control; 80.00" Cable	CA-3001
1982-83	V6 4.1L 252ci	4	w/Cruise Control, Lower	CA-3006
1982-83	V6 4.1L 252ci	4	w/Cruise Control, Upper; 61.00" Cable	CA-3005
1980-83	V8 5.0L 307ci	Y	w/Cruise Control, Lower	CA-3006
1980-83	V8 5.0L 307ci	Y	w/Cruise Control, Upper; 61.00" Cable	CA-3005
1980-83	V8 5.0L 307ci	Y	w/o Cruise Control; 41.00" Cable	CA-3009
1979-83	V8 5.7L 350ci	N,R	w/Cruise Control, Lower	CA-3006
1979-83	V8 5.7L 350ci	N,R	w/Cruise Control, Upper; 61.00" Cable	CA-3005
1979-83	V8 5.7L 350ci	N,R	w/o Cruise Control; 41.00" Cable	CA-3009
1977-78	V8 6.6L 403ci	K	w/Cruise Control, Lower	CA-3006
1977-78	V8 6.6L 403ci	K	w/Cruise Control, Upper; 61.00" Cable	CA-3005
1977-78	V8 6.6L 403ci	K	w/o Cruise Control; 41.00" Cable	CA-3009
1966-67	V8 7.0L 425ci			CA-3006
1976	V8 7.5L 455ci	S	exc. Cruise Control; 41.00" Cable	CA-3009
1976	V8 7.5L 455ci	S	w/Cruise Control, Lower	CA-3006
1976	V8 7.5L 455ci	S	w/Cruise Control, Upper; 61.00" Cable	CA-3005
1976	V8 7.5L 455ci	S	w/Cruise Control, w/Regulator to Trans.; 63.00" Cable	CA-3002
1972-73	V8 7.5L 455ci	W	w/o Cruise Control; 41.00" Cable	CA-3009
1972-75	V8 7.5L 455ci	W	w/Cruise Control, Lower	CA-3006
1972-75	V8 7.5L 455ci	W	w/Cruise Control, Upper; 61.00" Cable	CA-3005
1974-75	V8 7.5L 455ci	W	w/o Cruise w/Air Bag; 80.00" Cable	CA-3001
1974-75	V8 7.5L 455ci	W	w/o Cruise w/o Air Bag; 41.00" Cable	CA-3009
1971	V8 7.5L 455ci		w/Cruise Control, Lower	CA-3006
1971	V8 7.5L 455ci		w/Cruise Control, Upper; 61.00" Cable	CA-3005
1971	V8 7.5L 455ci		w/o Cruise Control; 41.00" Cable	CA-3009
1968-70	V8 7.5L 455ci			CA-3006
<b>VISTA CRUISER</b>				
1964-65	V6 3.7L 225ci		63.00" Cable	CA-3002
1967	V8 5.4L 330ci		AT w/Cruise Control, Upper	CA-3006
1964-65	V8 5.4L 330ci		63.00" Cable	CA-3002
1966-67	V8 5.4L 330ci		w/o Cruise Control; 83.00" Cable	CA-3004
1972	V8 5.7L 350ci	H,K	4 Spd. MT exc. 3.91 Rear Axle Ratio; 80.00" Cable	CA-3001
1972	V8 5.7L 350ci	H,K	AT w/Cruise Control, Upper; 41.00" Cable	CA-3009
1972	V8 5.7L 350ci	H,K	w/o Cruise Control; 61.00" Cable	CA-3005
1972-74	V8 5.7L 350ci	H,K	AT w/Cruise Control, Lower; 63.00" Cable	CA-3002
1973-74	V8 5.7L 350ci	H,K	MT w/Cruise Lower; 61.00" Cable	CA-3005
1973-74	V8 5.7L 350ci	H,K	MT w/Cruise Upper; 41.00" Cable	CA-3009
1973-74	V8 5.7L 350ci	H,K	w/o Cruise Control; 80.00" Cable	CA-3001
1975	V8 5.7L 350ci	K	exc. Cruise Control; 80.00" Cable	CA-3001
1975	V8 5.7L 350ci	K	w/Cruise Control, Upper; 41.00" Cable	CA-3009
1976	V8 5.7L 350ci	R	w/Cruise Control, w/Regulator to Trans.; 63.00" Cable	CA-3002
1977	V8 5.7L 350ci	R	w/Cruise Control, Lower; 63.00" Cable	CA-3002
1976-77	V8 5.7L 350ci	R	exc. Cruise Control; 80.00" Cable	CA-3001
1976-77	V8 5.7L 350ci	R	w/Cruise Control, Upper; 41.00" Cable	CA-3009
1968	V8 5.7L 350ci		AT w/Cruise Control, Upper; 63.00" Cable	CA-3002
1968	V8 5.7L 350ci		w/o Cruise Control; 83.00" Cable	CA-3004
1969	V8 5.7L 350ci		3 Spd. MT w/o Cruise; 80.00" Cable	CA-3001
1969	V8 5.7L 350ci		AT w/Cruise Upper, 3 Spd. MT w/Cruise Upper; 41.00" Cable	CA-3009
1970	V8 5.7L 350ci		3 Spd. MT w/o Cruise; 41.00" Cable	CA-3009
1970	V8 5.7L 350ci		4 Spd. MT w/o Cruise exc. Synchron.; 41.00" Cable	CA-3009
1970	V8 5.7L 350ci		w/Cruise Control, Lower; 63.00" Cable	CA-3002
1971	V8 5.7L 350ci		AT w/Cruise Control, Lower; 63.00" Cable	CA-3002
1971	V8 5.7L 350ci		AT w/Cruise Control, Upper; 41.00" Cable	CA-3009

# SPEEDOMETER CABLES

Year	Engine	Vin	Remark	Part
<b>OLDSMOBILE (con't)</b>				
<b>VISTA CRUISER (con't)</b>				
1971	V8 5.7L 350ci		w/o Cruise Control; 61.00" Cable	CA-3005
1969-70	V8 5.7L 350ci		AT w/o Cruise Control; 61.00" Cable	CA-3005
1969-71	V8 5.7L 350ci		4 Spd. MT exc. 3.91 Rear Axle Ratio; 80.00" Cable	CA-3001
1977	V8 6.6L 403ci	K	exc. Cruise Control; 80.00" Cable	CA-3001
1977	V8 6.6L 403ci	K	w/Cruise Control, Lower; 63.00" Cable	CA-3002
1977	V8 6.6L 403ci	K	w/Cruise Control, Upper; 41.00" Cable	CA-3009
1976	V8 7.5L 455ci	T	w/Cruise Control, w/Regulator to Trans.; 63.00" Cable	CA-3002
1975-76	V8 7.5L 455ci	T	exc. Cruise Control; 80.00" Cable	CA-3001
1975-76	V8 7.5L 455ci	T	w/Cruise Control, Upper; 41.00" Cable	CA-3009
1972	V8 7.5L 455ci	U	4 Spd. MT exc. 3.91 Rear Axle Ratio; 80.00" Cable	CA-3001
1972	V8 7.5L 455ci	U	AT w/Cruise Control, Upper; 41.00" Cable	CA-3009
1972	V8 7.5L 455ci	U	w/o Cruise Control; 61.00" Cable	CA-3005
1972-74	V8 7.5L 455ci	U	AT w/Cruise Control, Lower; 63.00" Cable	CA-3002
1973-74	V8 7.5L 455ci	U	MT w/Cruise Lower; 61.00" Cable	CA-3005
1973-74	V8 7.5L 455ci	U	MT w/Cruise Upper; 41.00" Cable	CA-3009
1973-74	V8 7.5L 455ci	U	w/o Cruise Control; 80.00" Cable	CA-3001
1970	V8 7.5L 455ci		3 Spd. MT w/o Cruise; 41.00" Cable	CA-3009
1970	V8 7.5L 455ci		4 Spd. MT w/o Cruise exc. Synchro.; 41.00" Cable	CA-3009
1970	V8 7.5L 455ci		AT w/o Cruise Control; 61.00" Cable	CA-3005
1970	V8 7.5L 455ci		w/Cruise Control, Lower; 63.00" Cable	CA-3002
1971	V8 7.5L 455ci		AT w/Cruise Control, Lower; 63.00" Cable	CA-3002
1971	V8 7.5L 455ci		AT w/Cruise Control, Upper; 41.00" Cable	CA-3009
1971	V8 7.5L 455ci		w/o Cruise Control; 61.00" Cable	CA-3005
1970-71	V8 7.5L 455ci		4 Spd. MT exc. 3.91 Rear Axle Ratio; 80.00" Cable	CA-3001
<b>OPEL</b>				
<b>OPEL</b>				
1969-70	L4 1.1L 1077cc			CA-3145
1971-73	L4 1.9L 1898cc			CA-3145
<b>PLYMOUTH</b>				
<b>BARRACUDA</b>				
1966	L6 2.8L 170ci		83.00" Cable	CA-3004
1970-71	L6 3.2L 198ci	B	80.00" Cable	CA-3027
1968-69	L6 3.7L 225ci	B	80.00" Cable	CA-3027
1970-72	L6 3.7L 225ci	C	80.00" Cable	CA-3027
1966-67	L6 3.7L 225ci		83.00" Cable	CA-3004
1966-67	V8 4.5L 273ci		83.00" Cable	CA-3004
1968-69	V8 5.2L 318ci	F	80.00" Cable	CA-3027
1973	V8 5.2L 318ci	G	exc. Air Pump; 80.00" Cable	CA-3027
1973	V8 5.2L 318ci	G	w/Air Pump Lower; 63.00" Cable	CA-3002
1970-72	V8 5.2L 318ci	G	80.00" Cable	CA-3027
1972	V8 5.6L 340ci	H	80.00" Cable	CA-3027
1973	V8 5.6L 340ci	H	exc. Air Pump; 80.00" Cable	CA-3027
1973	V8 5.6L 340ci	H	w/Air Pump Lower; 63.00" Cable	CA-3002
1968-69	V8 5.6L 340ci	P	80.00" Cable	CA-3027
1968-69	V8 6.3L 383ci	H	80.00" Cable	CA-3027
1970-71	V8 6.3L 383ci	L,N	80.00" Cable	CA-3027
<b>BELVEDERE</b>				
1953-54	L6 3.6L 218ci		63.00" Cable	CA-3002
1968	L6 3.7L 225ci	B	AT & 3 Spd. MT w/o Cruise; 80.00" Cable	CA-3027
1969	L6 3.7L 225ci	B	AT w/o Cruise Control, exc. Nox; 80.00" Cable	CA-3027
1969	L6 3.7L 225ci	B	w/Cruise Control, Upper	CA-3025
1968-69	L6 3.7L 225ci	B	w/Cruise Control, Lower; 63.00" Cable	CA-3002
1970	L6 3.7L 225ci	C	AT w/o Cruise Control, exc. Nox; 80.00" Cable	CA-3027
1970	L6 3.7L 225ci	C	w/Cruise Control, Lower; 63.00" Cable	CA-3002
1970	L6 3.7L 225ci	C	w/Cruise Control, Upper	CA-3025
1960	L6 3.7L 225ci		83.00" Cable	CA-3004
1964	L6 3.7L 225ci		U.S., w/Heavy Duty, w/3 Spd. Trans.; 83.00" Cable	CA-3004
1967	L6 3.7L 225ci		exc. Supercharged, exc. Cruise Control; 83.00" Cable	CA-3004
1965-66	L6 3.7L 225ci		exc. Auto. Pilot; 83.00" Cable	CA-3004
1954	L6 3.8L 230ci		63.00" Cable	CA-3002
1955-57	L6 3.8L 230ci		3 Spd. Trans.; 63.00" Cable	CA-3002

# SPEEDOMETER CABLES

Year	Engine	Vin	Remark	Part
<b>PLYMOUTH (con't)</b>				
<b>BELVEDERE (con't)</b>				
1955-57	L6 3.8L 230ci		AT; 83.00" Cable	CA-3004
1958-59	L6 3.8L 230ci		83.00" Cable	CA-3004
1955	V8 3.9L 239ci		3 Spd. Trans.; 63.00" Cable	CA-3002
1955	V8 3.9L 239ci		AT; 83.00" Cable	CA-3004
1955	V8 4.2L 259ci		3 Spd. Trans.; 63.00" Cable	CA-3002
1955	V8 4.2L 259ci		AT; 83.00" Cable	CA-3004
1955	V8 4.3L 260ci		3 Spd. Trans.; 63.00" Cable	CA-3002
1955	V8 4.3L 260ci		AT; 83.00" Cable	CA-3004
1956	V8 4.4L 270ci		3 Spd. Trans.; 63.00" Cable	CA-3002
1956	V8 4.4L 270ci		AT; 83.00" Cable	CA-3004
1968	V8 4.5L 273ci	D	AT & 3 Spd. MT w/o Cruise; 80.00" Cable	CA-3027
1968	V8 4.5L 273ci	D	w/Cruise Control, Lower; 63.00" Cable	CA-3002
1964	V8 4.5L 273ci		U.S., w/Heavy Duty, w/3 Spd. Trans.; 83.00" Cable	CA-3004
1967	V8 4.5L 273ci		exc. Supercharged, exc. Cruise Control; 83.00" Cable	CA-3004
1956-57	V8 4.5L 273ci		3 Spd. Trans.; 63.00" Cable	CA-3002
1956-57	V8 4.5L 273ci		AT; 83.00" Cable	CA-3004
1965-66	V8 4.5L 273ci		exc. Auto. Pilot; 83.00" Cable	CA-3004
1957	V8 4.9L 299ci		3 Spd. Trans.; 63.00" Cable	CA-3002
1957	V8 4.9L 299ci		AT; 83.00" Cable	CA-3004
1958-59	V8 5.2L 317ci		83.00" Cable	CA-3004
1968	V8 5.2L 318ci	F	AT & 3 Spd. MT w/o Cruise; 80.00" Cable	CA-3027
1969	V8 5.2L 318ci	F	AT w/o Cruise Control, exc. Nox; 80.00" Cable	CA-3027
1969	V8 5.2L 318ci	F	w/Cruise Control, Upper	CA-3025
1968-69	V8 5.2L 318ci	F	w/Cruise Control, Lower; 63.00" Cable	CA-3002
1970	V8 5.2L 318ci	G	AT w/o Cruise Control, exc. Nox; 80.00" Cable	CA-3027
1970	V8 5.2L 318ci	G	w/Cruise Control, Lower; 63.00" Cable	CA-3002
1970	V8 5.2L 318ci	G	w/Cruise Control, Upper	CA-3025
1963	V8 5.2L 318ci		U.S., w/3 Spd. Trans., w/3.91 Rear Axle Ratio; 83.00" Cable	CA-3004
1964	V8 5.2L 318ci		U.S., w/Heavy Duty, w/3 Spd. Trans.; 83.00" Cable	CA-3004
1967	V8 5.2L 318ci		exc. Supercharged, exc. Cruise Control; 83.00" Cable	CA-3004
1958-61	V8 5.2L 318ci		83.00" Cable	CA-3004
1965-66	V8 5.2L 318ci		exc. Auto. Pilot; 83.00" Cable	CA-3004
1958	V8 5.7L 350ci		83.00" Cable	CA-3004
1959	V8 5.9L 360ci		83.00" Cable	CA-3004
1963	V8 5.9L 361ci		U.S., w/3 Spd. Trans., w/3.91 Rear Axle Ratio; 83.00" Cable	CA-3004
1964	V8 5.9L 361ci		U.S., w/Heavy Duty, w/3 Spd. Trans.; 83.00" Cable	CA-3004
1965	V8 5.9L 361ci		exc. Auto. Pilot; 83.00" Cable	CA-3004
1960-61	V8 5.9L 361ci		83.00" Cable	CA-3004
1968	V8 6.3L 383ci	G,H	AT & 3 Spd. MT w/o Cruise; 80.00" Cable	CA-3027
1969	V8 6.3L 383ci	G,H	AT w/o Cruise Control, exc. Nox; 80.00" Cable	CA-3027
1969	V8 6.3L 383ci	G,H	w/Cruise Control, Upper	CA-3025
1968-69	V8 6.3L 383ci	G,H	w/Cruise Control, Lower; 63.00" Cable	CA-3002
1970	V8 6.3L 383ci	L,N	AT w/o Cruise Control, exc. Nox; 80.00" Cable	CA-3027
1970	V8 6.3L 383ci	L,N	w/Cruise Control, Lower; 63.00" Cable	CA-3002
1970	V8 6.3L 383ci	L,N	w/Cruise Control, Upper	CA-3025
1960	V8 6.3L 383ci		83.00" Cable	CA-3004
1964	V8 6.3L 383ci		U.S., w/Heavy Duty, w/3 Spd. Trans.; 83.00" Cable	CA-3004
1967	V8 6.3L 383ci		exc. Supercharged, exc. Cruise Control; 83.00" Cable	CA-3004
1965-66	V8 6.3L 383ci		exc. Auto. Pilot; 83.00" Cable	CA-3004
1963	V8 7.0L 426ci		U.S., w/3 Spd. Trans., w/3.91 Rear Axle Ratio; 83.00" Cable	CA-3004
1964	V8 7.0L 426ci		U.S., w/Heavy Duty, w/3 Spd. Trans.; 83.00" Cable	CA-3004
1967	V8 7.0L 426ci		exc. Supercharged, exc. Cruise Control; 83.00" Cable	CA-3004
1965-66	V8 7.0L 426ci		exc. Auto. Pilot; 83.00" Cable	CA-3004
1966	V8 7.2L 440ci		exc. Auto. Pilot; 83.00" Cable	CA-3004
1967	V8 7.2L 440ci		exc. Supercharged, exc. Cruise Control; 83.00" Cable	CA-3004
<b>CARAVELLE</b>				
1983	L4 2.2L 135ci	C	Speed Control to Trans.	CA-3024
1983	L4 2.2L 135ci	C	Speedometer to Speed Control; 41.00" Cable	CA-3035
1988	L4 2.2L 135ci	C,D,E	Fleet Car; Upper	CA-3047
1988	L4 2.2L 135ci	C,D,E	Speed Control to Sensor	CA-3024
1988	L4 2.2L 135ci	C,D,E	Speedometer to Trans.; 41.00" Cable	CA-3035
1984-85	L4 2.2L 135ci	C,D,E	1 pc. Cable	CA-3030

# SPEEDOMETER CABLES

Year	Engine	Vin	Remark	Part
<b>PLYMOUTH (con't)</b>				
<b>CARAVELLE (con't)</b>				
1984-85	L4 2.2L 135ci	C,D,E	2 pc. Lower	CA-3024
1984-85	L4 2.2L 135ci	C,D,E	2 pc. Upper	CA-3047
1986-87	L4 2.2L 135ci	C,D,E	Lower	CA-3036
1986-87	L4 2.2L 135ci	C,D,E	Upper	CA-3029
1988	L4 2.5L 153ci	K	Fleet Car; Upper	CA-3047
1988	L4 2.5L 153ci	K	Speed Control to Sensor	CA-3024
1988	L4 2.5L 153ci	K	Speedometer to Trans.; 41.00" Cable	CA-3035
1986-87	L4 2.5L 153ci	K	Lower	CA-3036
1986-87	L4 2.5L 153ci	K	Upper	CA-3029
1983	L4 2.6L 156ci	7,G	Speed Control to Trans.	CA-3024
1983	L4 2.6L 156ci	7,G	Speedometer to Speed Control; 41.00" Cable	CA-3035
1984-85	L4 2.6L 156ci	G	1 pc. Cable	CA-3030
1984-85	L4 2.6L 156ci	G	2 pc. Lower	CA-3024
1984-85	L4 2.6L 156ci	G	2 pc. Upper	CA-3047
1978	L6 3.7L 225ci	C,D	Cruise Control to Trans.	CA-3024
1978	L6 3.7L 225ci	C,D	Speedometer to Trans.	CA-3030
1981	L6 3.7L 225ci	G,H	Cruise Control to Trans.	CA-3024
1981	L6 3.7L 225ci	G,H	Speedometer to Speed Control, w/41" Cable	CA-3025
1981	L6 3.7L 225ci	G,H	Speedometer to Trans.	CA-3030
1982	L6 3.7L 225ci	H	Speedometer to Speed Control; 41.00" Cable	CA-3035
1983	L6 3.7L 225ci	K	Speed Control to Trans.	CA-3024
1983	L6 3.7L 225ci	K	Speedometer to Speed Control; 41.00" Cable	CA-3035
1978	V8 5.2L 318ci	G,H	Cruise Control to Trans.	CA-3024
1978	V8 5.2L 318ci	G,H	Speedometer to Trans.	CA-3030
1982	V8 5.2L 318ci	K	Speedometer to Speed Control; 41.00" Cable	CA-3035
1981	V8 5.2L 318ci	K,N	Cruise Control to Trans.	CA-3024
1981	V8 5.2L 318ci	K,N	Speedometer to Speed Control, w/41" Cable	CA-3025
1981	V8 5.2L 318ci	K,N	Speedometer to Trans.	CA-3030
1983	V8 5.2L 318ci	P	Speed Control to Trans.	CA-3024
1983	V8 5.2L 318ci	P	Speedometer to Speed Control; 41.00" Cable	CA-3035
1988	V8 5.2L 318ci	P	Fleet Car; Upper	CA-3047
1988	V8 5.2L 318ci	P	Speed Control to Sensor	CA-3024
1988	V8 5.2L 318ci	P	Speedometer to Trans.; 41.00" Cable	CA-3035
1984-85	V8 5.2L 318ci	P	1 pc. Cable	CA-3030
1984-85	V8 5.2L 318ci	P	2 pc. Lower	CA-3024
1984-85	V8 5.2L 318ci	P	2 pc. Upper	CA-3047
1986-87	V8 5.2L 318ci	P,Z	Lower	CA-3036
1986-87	V8 5.2L 318ci	P,Z	Upper	CA-3029
1978	V8 5.9L 360ci	J,K	Cruise Control to Trans.	CA-3024
1978	V8 5.9L 360ci	J,K	Speedometer to Trans.	CA-3030
<b>DUSTER</b>				
1973	L6 3.2L 198ci	B	exc. Air Pump; 80.00" Cable	CA-3027
1973	L6 3.2L 198ci	B	w/Air Pump Lower; 63.00" Cable	CA-3002
1973	L6 3.7L 225ci	C	exc. Air Pump; 80.00" Cable	CA-3027
1973	L6 3.7L 225ci	C	w/Air Pump Lower; 63.00" Cable	CA-3002
1973	V8 5.2L 318ci	G	exc. Air Pump; 80.00" Cable	CA-3027
1973	V8 5.2L 318ci	G	w/Air Pump Lower; 63.00" Cable	CA-3002
<b>FURY</b>				
1968	L6 3.7L 225ci	B	AT & 3 Spd. MT w/o Cruise; 80.00" Cable	CA-3027
1968-69	L6 3.7L 225ci	B	w/Cruise Control, Lower; 63.00" Cable	CA-3002
1969-75	L6 3.7L 225ci	B,C	w/Cruise Control, Upper	CA-3025
1969-76	L6 3.7L 225ci	B,C	AT w/o Cruise Control, exc. Nox; 80.00" Cable	CA-3027
1969-76	L6 3.7L 225ci	C	w/Cruise Control, Lower; 63.00" Cable	CA-3002
1977	L6 3.7L 225ci	C,D	Speedometer to Cruise Control	CA-3025
1977	L6 3.7L 225ci	C,D	Speedometer to Trans. exc. Cruise, w/Cruise to Trans.	CA-3030
1977	L6 3.7L 225ci	C,D	Taxi, Meter to Trans.	CA-3024
1978	L6 3.7L 225ci	C,D	Cruise Control to Trans.	CA-3024
1978	L6 3.7L 225ci	C,D	Police Car, Speedometer to Generator	CA-3025
1978	L6 3.7L 225ci	C,D	Speedometer to Trans.	CA-3030
1977-78	L6 3.7L 225ci	C,D	Police Car, Generator to Trans.	CA-3026
1960	L6 3.7L 225ci		83.00" Cable	CA-3004
1956-57	L6 3.8L 230ci		3 Spd. Trans.; 63.00" Cable	CA-3002

# SPEEDOMETER CABLES

Year	Engine	Vin	Remark	Part
<b>PLYMOUTH (con't)</b>				
<b>FURY (con't)</b>				
1956-57	L6 3.8L 230ci		AT; 83.00" Cable	CA-3004
1958-59	L6 3.8L 230ci		83.00" Cable	CA-3004
1956	V8 4.4L 270ci		3 Spd. Trans.; 63.00" Cable	CA-3002
1956	V8 4.4L 270ci		AT; 83.00" Cable	CA-3004
1964	V8 4.5L 273ci		U.S., w/Heavy Duty, w/3 Spd. Trans.; 83.00" Cable	CA-3004
1965	V8 4.5L 273ci		exc. Auto. Pilot; 83.00" Cable	CA-3004
1956	V8 4.5L 276ci		3 Spd. Trans.; 63.00" Cable	CA-3002
1956	V8 4.5L 276ci		AT; 83.00" Cable	CA-3004
1957	V8 4.9L 299ci		3 Spd. Trans.; 63.00" Cable	CA-3002
1957	V8 4.9L 299ci		AT; 83.00" Cable	CA-3004
1956	V8 5.0L 303ci		3 Spd. Trans.; 63.00" Cable	CA-3002
1956	V8 5.0L 303ci		AT; 83.00" Cable	CA-3004
1957	V8 5.2L 317ci		3 Spd. Trans.; 63.00" Cable	CA-3002
1957	V8 5.2L 317ci		AT; 83.00" Cable	CA-3004
1958-59	V8 5.2L 317ci		83.00" Cable	CA-3004
1968	V8 5.2L 318ci	F	AT & 3 Spd. MT w/o Cruise; 80.00" Cable	CA-3027
1969	V8 5.2L 318ci	F	AT w/o Cruise Control, exc. Nox; 80.00" Cable	CA-3027
1969	V8 5.2L 318ci	F	w/Cruise Control, Upper	CA-3025
1968-69	V8 5.2L 318ci	F	w/Cruise Control, Lower; 63.00" Cable	CA-3002
1977	V8 5.2L 318ci	G	Speedometer to Cruise Control	CA-3025
1977	V8 5.2L 318ci	G	Speedometer to Trans. exc. Cruise, w/Cruise to Trans.	CA-3030
1977	V8 5.2L 318ci	G	Taxi, Meter to Trans.	CA-3024
1970-75	V8 5.2L 318ci	G	w/Cruise Control, Upper	CA-3025
1970-76	V8 5.2L 318ci	G	AT w/o Cruise Control, exc. Nox; 80.00" Cable	CA-3027
1970-76	V8 5.2L 318ci	G	w/Cruise Control, Lower; 63.00" Cable	CA-3002
1978	V8 5.2L 318ci	G,H	Cruise Control to Trans.	CA-3024
1978	V8 5.2L 318ci	G,H	Police Car, Speedometer to Generator	CA-3025
1978	V8 5.2L 318ci	G,H	Speedometer to Trans.	CA-3030
1977-78	V8 5.2L 318ci	G,H	Police Car, Generator to Trans.	CA-3026
1958-61	V8 5.2L 318ci		83.00" Cable	CA-3004
1958	V8 5.7L 350ci		83.00" Cable	CA-3004
1977	V8 5.9L 360ci	J,K,L	Speedometer to Cruise Control	CA-3025
1977	V8 5.9L 360ci	J,K,L	Speedometer to Trans. exc. Cruise, w/Cruise to Trans.	CA-3030
1977	V8 5.9L 360ci	J,K,L	Taxi, Meter to Trans.	CA-3024
1978	V8 5.9L 360ci	J,K,L	Cruise Control to Trans.	CA-3024
1978	V8 5.9L 360ci	J,K,L	Police Car, Speedometer to Generator	CA-3025
1978	V8 5.9L 360ci	J,K,L	Speedometer to Trans.	CA-3030
1971-75	V8 5.9L 360ci	J,K,L	w/Cruise Control, Upper	CA-3025
1971-76	V8 5.9L 360ci	J,K,L	AT w/o Cruise Control, exc. Nox; 80.00" Cable	CA-3027
1971-76	V8 5.9L 360ci	J,K,L	w/Cruise Control, Lower; 63.00" Cable	CA-3002
1977-78	V8 5.9L 360ci	J,K,L	Police Car, Generator to Trans.	CA-3026
1963	V8 5.9L 361ci		U.S., w/3 Spd. Trans., w/3.91 Rear Axle Ratio; 83.00" Cable	CA-3004
1964	V8 5.9L 361ci		U.S., w/Heavy Duty, w/3 Spd. Trans.; 83.00" Cable	CA-3004
1960-61	V8 5.9L 361ci		83.00" Cable	CA-3004
1965-66	V8 5.9L 361ci		exc. Auto. Pilot; 83.00" Cable	CA-3004
1968	V8 6.3L 383ci	G,H	AT & 3 Spd. MT w/o Cruise; 80.00" Cable	CA-3027
1969	V8 6.3L 383ci	G,H	AT w/o Cruise Control, exc. Nox; 80.00" Cable	CA-3027
1969	V8 6.3L 383ci	G,H	w/Cruise Control, Upper	CA-3025
1968-69	V8 6.3L 383ci	G,H	w/Cruise Control, Lower; 63.00" Cable	CA-3002
1970-71	V8 6.3L 383ci	L,N	AT w/o Cruise Control, exc. Nox; 80.00" Cable	CA-3027
1970-71	V8 6.3L 383ci	L,N	w/Cruise Control, Lower; 63.00" Cable	CA-3002
1970-71	V8 6.3L 383ci	L,N	w/Cruise Control, Upper	CA-3025
1960	V8 6.3L 383ci		83.00" Cable	CA-3004
1964	V8 6.3L 383ci		U.S., w/Heavy Duty, w/3 Spd. Trans.; 83.00" Cable	CA-3004
1967	V8 6.3L 383ci		exc. Supercharged, exc. Cruise Control; 83.00" Cable	CA-3004
1965-66	V8 6.3L 383ci		exc. Auto. Pilot; 83.00" Cable	CA-3004
1972-75	V8 6.6L 400ci	M,N,P	w/Cruise Control, Upper	CA-3025
1972-76	V8 6.6L 400ci	M,N,P	AT w/o Cruise Control, exc. Nox; 80.00" Cable	CA-3027
1972-76	V8 6.6L 400ci	M,N,P	w/Cruise Control, Lower; 63.00" Cable	CA-3002
1977	V8 6.6L 400ci	N,P	Speedometer to Cruise Control	CA-3025
1977	V8 6.6L 400ci	N,P	Speedometer to Trans. exc. Cruise, w/Cruise to Trans.	CA-3030
1977	V8 6.6L 400ci	N,P	Taxi, Meter to Trans.	CA-3024

# SPEEDOMETER CABLES

Year	Engine	Vin	Remark	Part
<b>PLYMOUTH (con't)</b>				
<b>FURY (con't)</b>				
1978	V8 6.6L 400ci	N,P	Cruise Control to Trans.	CA-3024
1978	V8 6.6L 400ci	N,P	Police Car, Speedometer to Generator	CA-3025
1978	V8 6.6L 400ci	N,P	Speedometer to Trans.	CA-3030
1977-78	V8 6.6L 400ci	N,P	Police Car, Generator to Trans.	CA-3026
1963	V8 7.0L 426ci		U.S., w/3 Spd. Trans., w/3.91 Rear Axle Ratio; 83.00" Cable	CA-3004
1964	V8 7.0L 426ci		U.S., w/Heavy Duty, w/3 Spd. Trans.; 83.00" Cable	CA-3004
1965-66	V8 7.0L 426ci		exc. Auto. Pilot; 83.00" Cable	CA-3004
1968	V8 7.2L 440ci	K,L	AT & 3 Spd. MT w/o Cruise; 80.00" Cable	CA-3027
1969	V8 7.2L 440ci	K,L	AT w/o Cruise Control, exc. Nox; 80.00" Cable	CA-3027
1969	V8 7.2L 440ci	K,L	w/Cruise Control, Upper	CA-3025
1968-69	V8 7.2L 440ci	K,L	w/Cruise Control, Lower; 63.00" Cable	CA-3002
1970-74	V8 7.2L 440ci	T,V	AT w/o Cruise Control, exc. Nox; 80.00" Cable	CA-3027
1970-74	V8 7.2L 440ci	T,V	w/Cruise Control, Lower; 63.00" Cable	CA-3002
1970-74	V8 7.2L 440ci	T,V	w/Cruise Control, Upper	CA-3025
1977	V8 7.2L 440ci	U	Speedometer to Cruise Control	CA-3025
1977	V8 7.2L 440ci	U	Speedometer to Trans. exc. Cruise, w/Cruise to Trans.	CA-3030
1977	V8 7.2L 440ci	U	Taxi, Meter to Trans.	CA-3024
1978	V8 7.2L 440ci	U	Cruise Control to Trans.	CA-3024
1978	V8 7.2L 440ci	U	Police Car, Speedometer to Generator	CA-3025
1978	V8 7.2L 440ci	U	Speedometer to Trans.	CA-3030
1971-75	V8 7.2L 440ci	U	AT w/o Cruise Control, exc. Nox; 80.00" Cable	CA-3027
1971-75	V8 7.2L 440ci	U	w/Cruise Control, Lower; 63.00" Cable	CA-3002
1971-75	V8 7.2L 440ci	U	w/Cruise Control, Upper	CA-3025
1977-78	V8 7.2L 440ci	U	Police Car, Generator to Trans.	CA-3026
<b>GRAN FURY</b>				
1981	L6 3.7L 225ci	E,F,G	Cruise Control to Trans.	CA-3024
1981	L6 3.7L 225ci	E,F,G	Speedometer to Speed Control, w/41" Cable	CA-3025
1981	L6 3.7L 225ci	E,F,G	Speedometer to Trans.	CA-3030
1982	L6 3.7L 225ci	E,F,G	Speedometer to Speed Control; 41.00" Cable	CA-3035
1982-83	L6 3.7L 225ci	H	Speedometer to Speed Control; 41.00" Cable	CA-3035
1983	L6 3.7L 225ci	H,J,K,L	Speed Control to Trans.	CA-3024
1983	L6 3.7L 225ci	J,K,L	Speedometer to Speed Control; 41.00" Cable	CA-3035
1986	V8 5.2L 318ci	4	Upper	CA-3047
1987	V8 5.2L 318ci	4	Speedometer to Speed Control, w/41" Cable	CA-3025
1983	V8 5.2L 318ci	4,P,S	Speed Control to Trans.	CA-3024
1983	V8 5.2L 318ci	4,P,S	Speedometer to Speed Control; 41.00" Cable	CA-3035
1987	V8 5.2L 318ci	4,P,S	Speed Control to Sensor	CA-3024
1988	V8 5.2L 318ci	4,P,S	Fleet Car; Upper	CA-3047
1984-85	V8 5.2L 318ci	4,P,S	2 pc. Lower	CA-3024
1984-85	V8 5.2L 318ci	4,P,S	2 pc. Upper	CA-3047
1984-87	V8 5.2L 318ci	4,P,S	1 pc. Cable 3 Spd. MT	CA-3030
1986-88	V8 5.2L 318ci	4,P,S	Lower	CA-3024
1977	V8 5.2L 318ci	G	Police Car, Generator to Trans.	CA-3026
1977	V8 5.2L 318ci	G	Speedometer to Cruise Control	CA-3025
1977	V8 5.2L 318ci	G	Speedometer to Trans. exc. Cruise, w/Cruise to Trans.	CA-3030
1977	V8 5.2L 318ci	G	Taxi, Meter to Trans.	CA-3024
1972-75	V8 5.2L 318ci	G	w/Cruise Control, Upper	CA-3025
1972-76	V8 5.2L 318ci	G	AT w/o Cruise Control, exc. Nox; 80.00" Cable	CA-3027
1972-76	V8 5.2L 318ci	G	w/Cruise Control, Lower; 63.00" Cable	CA-3002
1981	V8 5.2L 318ci	K,L,M,N	Cruise Control to Trans.	CA-3024
1981	V8 5.2L 318ci	K,L,M,N	Speedometer to Speed Control, w/41" Cable	CA-3025
1981	V8 5.2L 318ci	K,L,M,N	Speedometer to Trans.	CA-3030
1982	V8 5.2L 318ci	K,L,M,N	Speedometer to Speed Control; 41.00" Cable	CA-3035
1986	V8 5.2L 318ci	P	Upper	CA-3047
1987-88	V8 5.2L 318ci	P,S	Speedometer to Speed Control, w/41" Cable	CA-3025
1986	V8 5.2L 318ci	S	Upper	CA-3047
1977	V8 5.9L 360ci	J,K	Police Car, Generator to Trans.	CA-3026
1977	V8 5.9L 360ci	J,K	Speedometer to Cruise Control	CA-3025
1977	V8 5.9L 360ci	J,K	Speedometer to Trans. exc. Cruise, w/Cruise to Trans.	CA-3030
1977	V8 5.9L 360ci	J,K	Taxi, Meter to Trans.	CA-3024
1972-75	V8 5.9L 360ci	J,K	w/Cruise Control, Upper	CA-3025
1972-76	V8 5.9L 360ci	J,K	AT w/o Cruise Control, exc. Nox; 80.00" Cable	CA-3027

# SPEEDOMETER CABLES

Year	Engine	Vin	Remark	Part
<b>PLYMOUTH (con't)</b>				
<b>GRAN FURY (con't)</b>				
1972-76	V8 5.9L 360ci	J,K	w/Cruise Control, Lower; 63.00" Cable	CA-3002
1972-75	V8 6.6L 400ci	M,N,P	w/Cruise Control, Upper	CA-3025
1972-76	V8 6.6L 400ci	M,N,P	AT w/o Cruise Control, exc. Nox; 80.00" Cable	CA-3027
1972-76	V8 6.6L 400ci	M,N,P	w/Cruise Control, Lower; 63.00" Cable	CA-3002
1977	V8 6.6L 400ci	N,P	Speedometer to Cruise Control	CA-3025
1977	V8 6.6L 400ci	N,P	Taxi, Meter to Trans.	CA-3024
1977	V8 6.6L 400ci	N,P	Police Car, Generator to Trans.	CA-3026
1977	V8 6.6L 400ci	N,P	Speedometer to Trans. exc. Cruise, w/Cruise to Trans.	CA-3030
1972-74	V8 7.2L 440ci	T	w/Cruise Control, Upper	CA-3025
1977	V8 7.2L 440ci	T,U	Police Car, Generator to Trans.	CA-3026
1977	V8 7.2L 440ci	T,U	Speedometer to Cruise Control	CA-3025
1977	V8 7.2L 440ci	T,U	Speedometer to Trans. exc. Cruise, w/Cruise to Trans.	CA-3030
1977	V8 7.2L 440ci	T,U	Taxi, Meter to Trans.	CA-3024
1972-76	V8 7.2L 440ci	T,U	AT w/o Cruise Control, exc. Nox; 80.00" Cable	CA-3027
1972-76	V8 7.2L 440ci	T,U	w/Cruise Control, Lower; 63.00" Cable	CA-3002
1975	V8 7.2L 440ci	U	w/Cruise Control, Upper	CA-3025
<b>HORIZON</b>				
1983	L4 1.6L 97ci	A	MT Speedo to Cruise; 41.00" Cable	CA-3035
1983	L4 1.6L 97ci	A	Speed Control to Trans; 37"	CA-3037
1984	L4 1.6L 97ci	A	Speed Control to Trans; 19"	CA-3034
1984	L4 1.6L 97ci	A	Speedometer to Speed Control, w/41" Cable	CA-3025
1985	L4 1.6L 97ci	A	Lower	CA-3036
1985	L4 1.6L 97ci	A	Upper	CA-3025
1986	L4 1.6L 97ci	A	AT Upper	CA-3025
1986	L4 1.6L 97ci	A	MT Lower	CA-3036
1983	L4 1.6L 98ci	3	MT Speedo to Cruise; 41.00" Cable	CA-3035
1983	L4 1.6L 98ci	3	Speed Control to Trans; 37"	CA-3037
1980	L4 1.7L 105ci	A	4 Spd. MT Cruise to Switch	CA-3036
1980	L4 1.7L 105ci	A	4 Spd. MT Speedo to Cruise	CA-3050
1980	L4 1.7L 105ci	A	5 Spd. MT Switch to Trans.	CA-3026
1980	L4 1.7L 105ci	A	AT Speedo to Trans., AT Cruise to Trans.	CA-3037
1980	L4 1.7L 105ci	A	AT w/Cruise Control, Lower	CA-3034
1981	L4 1.7L 105ci	A	Speed Control to Trans; 19"	CA-3034
1981	L4 1.7L 105ci	A	Speed Control to Trans; 37"	CA-3037
1981	L4 1.7L 105ci	A	Speedo to Trans. Lower	CA-3028
1981	L4 1.7L 105ci	A	Speedo to Trans. Upper; 41.00" Cable	CA-3035
1982	L4 1.7L 105ci	A	4 Spd. MT Speedo to Trans. w/A460, AT Speedo to Cruise	CA-3050
1982	L4 1.7L 105ci	A	AT Speed Control to Trans., A412 MT Speedo to Trans.	CA-3037
1982	L4 1.7L 105ci	A	MT Speedo to Cruise; 41.00" Cable	CA-3035
1978-79	L4 1.7L 105ci	A		CA-3037
1983	L4 1.7L 105ci	B	A460 MT Speedo to Trans.	CA-3050
1983	L4 1.7L 105ci	B	AT & A412 MT Speedo to Trans.	CA-3037
1983	L4 1.7L 105ci	B	Speedometer to Speed Control; 41.00" Cable	CA-3035
1984	L4 2.2L 135ci	8,C	Speed Control to Trans; 19"	CA-3034
1984	L4 2.2L 135ci	8,C	Speedometer to Speed Control, w/41" Cable	CA-3025
1985	L4 2.2L 135ci	8,C	Lower	CA-3036
1985	L4 2.2L 135ci	8,C	Upper	CA-3025
1986	L4 2.2L 135ci	8,C	AT Upper	CA-3025
1986	L4 2.2L 135ci	8,C	MT Lower	CA-3036
1981	L4 2.2L 135ci	B	Speed Control to Trans; 19"	CA-3034
1981	L4 2.2L 135ci	B	Speedo to Trans. Lower	CA-3028
1981	L4 2.2L 135ci	B	Speedo to Trans. Upper; 41.00" Cable	CA-3035
1982	L4 2.2L 135ci	B	AT Speed Control to Trans., 5 Spd. MT Speedo to Trans.	CA-3034
1982	L4 2.2L 135ci	B	MT Speedo to Cruise; 41.00" Cable	CA-3035
1983	L4 2.2L 135ci	C	4 & 5 Spd. MT Lower	CA-3028
1983	L4 2.2L 135ci	C	4 & 5 Spd. MT Upper; 41.00" Cable	CA-3035
1983	L4 2.2L 135ci	C	AT Speedo to Cruise Control; 41.00" Cable	CA-3035
1983	L4 2.2L 135ci	C	AT Speedo to Trans.	CA-3037
1987	L4 2.2L 135ci	C	Sensor to Coupling, w/Speed Control	CA-3036
1987	L4 2.2L 135ci	C	Speedo to Coupling	CA-3025
1989-90	L4 2.2L 135ci	D	Speed Control to Trans.; 41.00" Cable	CA-3035

# SPEEDOMETER CABLES

Year	Engine	Vin	Remark	Part
<b>PLYMOUTH (con't)</b>				
<b>RELIANT</b>				
1981	L4 2.2L 135ci	B	Upper	CA-3025
1982	L4 2.2L 135ci	B	Speedometer to Speed Control, w/41" Cable	CA-3025
1981-82	L4 2.2L 135ci	B	Lower	CA-3028
1981-82	L4 2.2L 135ci	B	Speedometer to Trans., w/51" Cable; 61.00" Cable	CA-3005
1983	L4 2.2L 135ci	C	Speed Sensor Switch to Trans.	CA-3028
1983	L4 2.2L 135ci	C	Upper	CA-3025
1983	L4 2.2L 135ci	C	w/A465 Trans., Speedometer to Trans.; 61.00" Cable	CA-3005
1984	L4 2.2L 135ci	C	Speed Sensor Switch to Trans., exc. Turbo Charged	CA-3028
1984	L4 2.2L 135ci	C	w/56" Hose, Speedometer to Trans.; 61.00" Cable	CA-3005
1983-84	L4 2.2L 135ci	C	Speed Control to Speed Sensor Switch	CA-3040
1983-84	L4 2.2L 135ci	C	Speed Control to Trans; 19"	CA-3034
1985	L4 2.2L 135ci	C,D	AT Fleet Cars	CA-3022
1985	L4 2.2L 135ci	C,D	Lower	CA-3036
1985	L4 2.2L 135ci	C,D	Upper; 61.00" Cable	CA-3005
1986	L4 2.2L 135ci	D	Speed Control to Sensor, Speed Control to Trans.	CA-3006
1986	L4 2.2L 135ci	D	Speed Control to Trans.	CA-3036
1987-89	L4 2.2L 135ci	D	Speed Control to Trans.; 41.00" Cable	CA-3035
1986	L4 2.5L 153ci	K	Speed Control to Sensor, Speed Control to Trans.	CA-3006
1986	L4 2.5L 153ci	K	Speed Control to Trans.	CA-3036
1987-89	L4 2.5L 153ci	K	Speed Control to Trans.; 41.00" Cable	CA-3035
1982	L4 2.6L 156ci	7	Speedometer to Trans., w/51" Cable; 61.00" Cable	CA-3005
1982	L4 2.6L 156ci	7,D	Speed Control to Trans; 37"	CA-3037
1982	L4 2.6L 156ci	7,D	Speedometer to Speed Control, w/41" Cable	CA-3025
1981-82	L4 2.6L 156ci	7,D	Lower	CA-3028
1983	L4 2.6L 156ci	7,G	Speed Sensor Switch to Trans.	CA-3028
1983	L4 2.6L 156ci	7,G	Upper	CA-3025
1983-84	L4 2.6L 156ci	7,G	Speed Control to Speed Sensor Switch	CA-3040
1983-84	L4 2.6L 156ci	7,G	Speed Control to Trans; 19"	CA-3034
1981	L4 2.6L 156ci	D	Cruise Control to Trans.	CA-3037
1981	L4 2.6L 156ci	D	Upper	CA-3025
1981-82	L4 2.6L 156ci	D	Speedometer to Trans., w/51" Cable; 61.00" Cable	CA-3005
1984	L4 2.6L 156ci	G	Speed Sensor Switch to Trans., exc. Turbo Charged	CA-3028
1984	L4 2.6L 156ci	G	w/56" Hose, Speedometer to Trans.; 61.00" Cable	CA-3005
1985	L4 2.6L 156ci	G	AT Fleet Cars	CA-3022
1985	L4 2.6L 156ci	G	Lower	CA-3036
1985	L4 2.6L 156ci	G	Upper; 61.00" Cable	CA-3005
<b>ROADRUNNER</b>				
1968	V8 4.5L 273ci	D	w/Cruise Control, Lower; 63.00" Cable	CA-3002
1968	V8 5.2L 318ci	F	AT & 3 Spd. MT w/o Cruise; 80.00" Cable	CA-3027
1972-75	V8 5.2L 318ci	G	AT w/o Cruise Control, exc. Nox; 80.00" Cable	CA-3027
1972-75	V8 5.2L 318ci	G	w/Cruise Control, Lower; 63.00" Cable	CA-3002
1972-75	V8 5.2L 318ci	G	w/Cruise Control, Upper	CA-3025
1971-73	V8 5.6L 340ci	H	AT w/o Cruise Control, exc. Nox; 80.00" Cable	CA-3027
1971-73	V8 5.6L 340ci	H	w/Cruise Control, Lower; 63.00" Cable	CA-3002
1971-73	V8 5.6L 340ci	H	w/Cruise Control, Upper	CA-3025
1974-75	V8 5.9L 360ci	K,L	AT w/o Cruise Control, exc. Nox; 80.00" Cable	CA-3027
1974-75	V8 5.9L 360ci	K,L	w/Cruise Control, Lower; 63.00" Cable	CA-3002
1974-75	V8 5.9L 360ci	K,L	w/Cruise Control, Upper	CA-3025
1968	V8 6.3L 383ci	G	w/Cruise Control, Lower; 63.00" Cable	CA-3002
1968	V8 6.3L 383ci	H	AT & 3 Spd. MT w/o Cruise; 80.00" Cable	CA-3027
1969	V8 6.3L 383ci	H	AT w/o Cruise Control, exc. Nox; 80.00" Cable	CA-3027
1969	V8 6.3L 383ci	H	w/Cruise Control, Lower; 63.00" Cable	CA-3002
1969	V8 6.3L 383ci	H	w/Cruise Control, Upper	CA-3025
1970-71	V8 6.3L 383ci	N	AT w/o Cruise Control, exc. Nox; 80.00" Cable	CA-3027
1970-71	V8 6.3L 383ci	N	w/Cruise Control, Lower; 63.00" Cable	CA-3002
1970-71	V8 6.3L 383ci	N	w/Cruise Control, Upper	CA-3025
1972-75	V8 6.6L 400ci	M,N,P	AT w/o Cruise Control, exc. Nox; 80.00" Cable	CA-3027
1972-75	V8 6.6L 400ci	M,N,P	w/Cruise Control, Lower; 63.00" Cable	CA-3002
1972-75	V8 6.6L 400ci	M,N,P	w/Cruise Control, Upper	CA-3025
1969	V8 7.0L 426ci	J	AT w/o Cruise Control, exc. Nox; 80.00" Cable	CA-3027
1969	V8 7.0L 426ci	J	w/Cruise Control, Upper	CA-3025
1968-69	V8 7.0L 426ci	J	w/Cruise Control, Lower; 63.00" Cable	CA-3002



# SPEEDOMETER CABLES

Year	Engine	Vin	Remark	Part
<b>PLYMOUTH (con't)</b>				
<b>ROADRUNNER (con't)</b>				
1970-71	V8 7.0L 426ci	R	AT w/o Cruise Control, exc. Nox; 80.00" Cable	CA-3027
1970-71	V8 7.0L 426ci	R	w/Cruise Control, Lower; 63.00" Cable	CA-3002
1970-71	V8 7.0L 426ci	R	w/Cruise Control, Upper	CA-3025
1969	V8 7.2L 440ci	M	AT w/o Cruise Control, exc. Nox; 80.00" Cable	CA-3027
1969	V8 7.2L 440ci	M	w/Cruise Control, Lower; 63.00" Cable	CA-3002
1969	V8 7.2L 440ci	M	w/Cruise Control, Upper	CA-3025
1972-74	V8 7.2L 440ci	U	AT w/o Cruise Control, exc. Nox; 80.00" Cable	CA-3027
1972-74	V8 7.2L 440ci	U	w/Cruise Control, Lower; 63.00" Cable	CA-3002
1972-74	V8 7.2L 440ci	U	w/Cruise Control, Upper	CA-3025
1970-72	V8 7.2L 440ci	V	AT w/o Cruise Control, exc. Nox; 80.00" Cable	CA-3027
1970-72	V8 7.2L 440ci	V	w/Cruise Control, Lower; 63.00" Cable	CA-3002
1970-72	V8 7.2L 440ci	V	w/Cruise Control, Upper	CA-3025
<b>SATELLITE</b>				
1971-74	L6 3.7L 225ci	C	AT w/o Cruise Control, exc. Nox; 80.00" Cable	CA-3027
1971-74	L6 3.7L 225ci	C	w/Cruise Control, Lower; 63.00" Cable	CA-3002
1971-74	L6 3.7L 225ci	C	w/Cruise Control, Upper	CA-3025
1966	L6 3.7L 225ci		exc. Auto. Pilot; 83.00" Cable	CA-3004
1967	L6 3.7L 225ci		exc. Supercharged, exc. Cruise Control; 83.00" Cable	CA-3004
1968	V8 4.5L 273ci	D	AT & 3 Spd. MT w/o Cruise; 80.00" Cable	CA-3027
1968	V8 4.5L 273ci	D	w/Cruise Control, Lower; 63.00" Cable	CA-3002
1967	V8 4.5L 273ci		exc. Supercharged, exc. Cruise Control; 83.00" Cable	CA-3004
1965-66	V8 4.5L 273ci		exc. Auto. Pilot; 83.00" Cable	CA-3004
1968	V8 5.2L 318ci	F	AT & 3 Spd. MT w/o Cruise; 80.00" Cable	CA-3027
1969	V8 5.2L 318ci	F	AT w/o Cruise Control, exc. Nox; 80.00" Cable	CA-3027
1969	V8 5.2L 318ci	F	w/Cruise Control, Upper	CA-3025
1968-69	V8 5.2L 318ci	F	w/Cruise Control, Lower; 63.00" Cable	CA-3002
1970-74	V8 5.2L 318ci	G	AT w/o Cruise Control, exc. Nox; 80.00" Cable	CA-3027
1970-74	V8 5.2L 318ci	G	w/Cruise Control, Lower; 63.00" Cable	CA-3002
1970-74	V8 5.2L 318ci	G	w/Cruise Control, Upper	CA-3025
1967	V8 5.2L 318ci		exc. Supercharged, exc. Cruise Control; 83.00" Cable	CA-3004
1965-66	V8 5.2L 318ci		exc. Auto. Pilot; 83.00" Cable	CA-3004
1974	V8 5.9L 360ci	J,K	AT w/o Cruise Control, exc. Nox; 80.00" Cable	CA-3027
1974	V8 5.9L 360ci	J,K	w/Cruise Control, Lower; 63.00" Cable	CA-3002
1974	V8 5.9L 360ci	J,K	w/Cruise Control, Upper	CA-3025
1968	V8 6.3L 383ci	G,H	AT & 3 Spd. MT w/o Cruise; 80.00" Cable	CA-3027
1969	V8 6.3L 383ci	G,H	AT w/o Cruise Control, exc. Nox; 80.00" Cable	CA-3027
1969	V8 6.3L 383ci	G,H	w/Cruise Control, Upper	CA-3025
1968-69	V8 6.3L 383ci	G,H	w/Cruise Control, Lower; 63.00" Cable	CA-3002
1970-71	V8 6.3L 383ci	L,N	AT w/o Cruise Control, exc. Nox; 80.00" Cable	CA-3027
1970-71	V8 6.3L 383ci	L,N	w/Cruise Control, Lower; 63.00" Cable	CA-3002
1970-71	V8 6.3L 383ci	L,N	w/Cruise Control, Upper	CA-3025
1967	V8 6.3L 383ci		exc. Supercharged, exc. Cruise Control; 83.00" Cable	CA-3004
1965-66	V8 6.3L 383ci		exc. Auto. Pilot; 83.00" Cable	CA-3004
1972-74	V8 6.6L 400ci	M,N,P	AT w/o Cruise Control, exc. Nox; 80.00" Cable	CA-3027
1972-74	V8 6.6L 400ci	M,N,P	w/Cruise Control, Lower; 63.00" Cable	CA-3002
1972-74	V8 6.6L 400ci	M,N,P	w/Cruise Control, Upper	CA-3025
1967	V8 7.0L 426ci		exc. Supercharged, exc. Cruise Control; 83.00" Cable	CA-3004
1965-66	V8 7.0L 426ci		exc. Auto. Pilot; 83.00" Cable	CA-3004
1974	V8 7.2L 440ci	U	AT w/o Cruise Control, exc. Nox; 80.00" Cable	CA-3027
1974	V8 7.2L 440ci	U	w/Cruise Control, Lower; 63.00" Cable	CA-3002
1974	V8 7.2L 440ci	U	w/Cruise Control, Upper	CA-3025
1966	V8 7.2L 440ci		exc. Auto. Pilot; 83.00" Cable	CA-3004
1967	V8 7.2L 440ci		exc. Supercharged, exc. Cruise Control; 83.00" Cable	CA-3004
<b>SCAMP</b>				
1973	L6 3.2L 198ci	B	exc. Air Pump; 80.00" Cable	CA-3027
1973	L6 3.2L 198ci	B	w/Air Pump Lower; 63.00" Cable	CA-3002
1973	L6 3.7L 225ci	C	exc. Air Pump; 80.00" Cable	CA-3027
1973	L6 3.7L 225ci	C	w/Air Pump Lower; 63.00" Cable	CA-3002
1973	V8 5.2L 318ci	G	exc. Air Pump; 80.00" Cable	CA-3027
1973	V8 5.2L 318ci	G	w/Air Pump Lower; 63.00" Cable	CA-3002
<b>SUNDANCE</b>				
1989-90	L4 2.2L 135ci	D	Speed Control to Trans.; 41.00" Cable	CA-3035

# SPEEDOMETER CABLES

Year	Engine	Vin	Remark	Part
<b>PLYMOUTH (con't)</b>				
<b>SUNDANCE (con't)</b>				
1986	L4 2.2L 135ci	D,E	Speedo to Trans. To 12/1/86	CA-3036
1989-90	L4 2.5L 153ci	J,K	Speed Control to Trans.; 41.00" Cable	CA-3035
<b>TURISMO</b>				
1985	L4 1.6L 97ci	A	Lower	CA-3036
1985	L4 1.6L 97ci	A	Upper	CA-3025
1983	L4 1.6L 98ci	3	Speed Control to Trans; 37"	CA-3037
1983	L4 1.6L 98ci	3	Speedometer to Speed Control; 41.00" Cable	CA-3035
<b>VALIANT</b>				
1968-69	L6 2.8L 170ci	A	80.00" Cable	CA-3027
1962	L6 2.8L 170ci		U.S.; 63.00" Cable	CA-3002
1960-61	L6 2.8L 170ci		U.S., w/3 Spd. Trans.	CA-3016
1966-67	L6 2.8L 170ci		83.00" Cable	CA-3004
1970-72	L6 3.2L 198ci	B	80.00" Cable	CA-3027
1973-74	L6 3.2L 198ci	B	3 & 4 Spd. MT w/Air Pump; 63.00" Cable	CA-3002
1973-74	L6 3.2L 198ci	B	3 Spd. MT exc. Air Pump	CA-3025
1973-74	L6 3.2L 198ci	B	AT & 4 Spd. MT exc. Air Pump; 80.00" Cable	CA-3027
1968-69	L6 3.7L 225ci	B	80.00" Cable	CA-3027
1969-72	L6 3.7L 225ci	C	80.00" Cable	CA-3027
1973-76	L6 3.7L 225ci	C	3 & 4 Spd. MT w/Air Pump; 63.00" Cable	CA-3002
1973-76	L6 3.7L 225ci	C	3 Spd. MT exc. Air Pump	CA-3025
1973-76	L6 3.7L 225ci	C	AT & 4 Spd. MT exc. Air Pump; 80.00" Cable	CA-3027
1961	L6 3.7L 225ci		U.S., w/3 Spd. Trans.	CA-3016
1966-67	L6 3.7L 225ci		83.00" Cable	CA-3004
1968-69	V8 4.5L 273ci	D	80.00" Cable	CA-3027
1966-67	V8 4.5L 273ci		83.00" Cable	CA-3004
1968-69	V8 5.2L 318ci	F	80.00" Cable	CA-3027
1970-72	V8 5.2L 318ci	G	80.00" Cable	CA-3027
1973-76	V8 5.2L 318ci	G	3 & 4 Spd. MT w/Air Pump; 63.00" Cable	CA-3002
1973-76	V8 5.2L 318ci	G	3 Spd. MT exc. Air Pump	CA-3025
1973-76	V8 5.2L 318ci	G	AT & 4 Spd. MT exc. Air Pump; 80.00" Cable	CA-3027
1976	V8 5.9L 360ci	L	3 & 4 Spd. MT w/Air Pump; 63.00" Cable	CA-3002
1976	V8 5.9L 360ci	L	3 Spd. MT exc. Air Pump	CA-3025
1976	V8 5.9L 360ci	L	AT & 4 Spd. MT exc. Air Pump; 80.00" Cable	CA-3027
<b>VIP</b>				
1967	V8 5.2L 318ci		exc. Supercharged, exc. Cruise Control; 83.00" Cable	CA-3004
1967	V8 6.3L 383ci		exc. Supercharged, exc. Cruise Control; 83.00" Cable	CA-3004
1967	V8 7.2L 440ci		exc. Supercharged, exc. Cruise Control; 83.00" Cable	CA-3004
<b>VOLARE</b>				
1977	L6 3.7L 225ci	C,D	Police Car, Generator to Trans.	CA-3026
1978	L6 3.7L 225ci	C,D	Police Car, Speedometer to Generator	CA-3025
1979	L6 3.7L 225ci	C,D	exc. Cruise Control	CA-3025
1980	L6 3.7L 225ci	C,D	Cruise Control to Switch	CA-3040
1980	L6 3.7L 225ci	C,D	exc. Taxi, Speedometer to Trans.	CA-3030
1980	L6 3.7L 225ci	C,D	Speedometer to Cruise Control	CA-3025
1980	L6 3.7L 225ci	C,D	Switch to Trans.	CA-3026
1977-80	L6 3.7L 225ci	C,D	Cruise Control to Trans.	CA-3024
1978-79	L6 3.7L 225ci	C,D	Speedometer to Trans.	CA-3030
1977	V8 5.2L 318ci	G	Police Car, Generator to Trans.	CA-3026
1978	V8 5.2L 318ci	G,H	Police Car, Speedometer to Generator	CA-3025
1979	V8 5.2L 318ci	G,H	exc. Cruise Control	CA-3025
1980	V8 5.2L 318ci	G,H	Cruise Control to Switch	CA-3040
1980	V8 5.2L 318ci	G,H	exc. Taxi, Speedometer to Trans.	CA-3030
1980	V8 5.2L 318ci	G,H	Speedometer to Cruise Control	CA-3025
1980	V8 5.2L 318ci	G,H	Switch to Trans.	CA-3026
1977-80	V8 5.2L 318ci	G,H	Cruise Control to Trans.	CA-3024
1978-79	V8 5.2L 318ci	G,H	Speedometer to Trans.	CA-3030
1977	V8 5.9L 360ci	K,L	Police Car, Generator to Trans.	CA-3026
1978	V8 5.9L 360ci	K,L	Police Car, Speedometer to Generator	CA-3025
1977-80	V8 5.9L 360ci	K,L	Cruise Control to Trans.	CA-3024
1978-79	V8 5.9L 360ci	K,L	Speedometer to Trans.	CA-3030
1979	V8 5.9L 360ci	L	exc. Cruise Control	CA-3025
1980	V8 5.9L 360ci	L	Cruise Control to Switch	CA-3040

# SPEEDOMETER CABLES

Year	Engine	Vin	Remark	Part
<b>PLYMOUTH (con't)</b>				
<b>VOLARE (con't)</b>				
1980	V8 5.9L 360ci	L	exc. Taxi, Speedometer to Trans.	CA-3030
1980	V8 5.9L 360ci	L	Speedometer to Cruise Control	CA-3025
1980	V8 5.9L 360ci	L	Switch to Trans.	CA-3026
<b>PLYMOUTH TRUCKS</b>				
<b>VOYAGER</b>				
1984	L4 2.2L 135ci	C	w/Cruise Lower Electronic	CA-3028
1984	L4 2.2L 135ci	C	w/Cruise Lower non Electronic	CA-3034
1984	L4 2.2L 135ci	C	w/Cruise Upper non Electronic	CA-3029
1985	L4 2.2L 135ci	C	AT w/Cruise Lower	CA-3034
1985	L4 2.2L 135ci	C	MT w/o Cruise	CA-3051
1985	L4 2.2L 135ci	C	w/Cruise Upper	CA-3029
1986	L4 2.2L 135ci	C	w/Cruise Upper, w/o Cruise MT	CA-3051
1986-87	L4 2.2L 135ci	C	AT 1 pc. Speedo to Trans.	CA-3022
1984	L4 2.6L 156ci	G	w/Cruise Lower Electronic	CA-3028
1984	L4 2.6L 156ci	G	w/Cruise Lower non Electronic	CA-3034
1984	L4 2.6L 156ci	G	w/Cruise Upper non Electronic	CA-3029
1985	L4 2.6L 156ci	G	MT w/o Cruise	CA-3051
1985	L4 2.6L 156ci	G	w/Cruise Lower	CA-3034
1985	L4 2.6L 156ci	G	w/Cruise Upper	CA-3029
1986	L4 2.6L 156ci	G	w/Cruise Upper, w/o Cruise MT	CA-3051
1986-87	L4 2.6L 156ci	G	AT 1 pc. Speedo to Trans.	CA-3022
<b>PONTIAC</b>				
<b>6000</b>				
1982-83	L4 2.5L 151ci	5,R	exc. Cruise Control; 80.00" Cable	CA-3001
1982-83	L4 2.5L 151ci	5,R	w/Cruise Control, Lower; 83.00" Cable	CA-3004
1982-83	L4 2.5L 151ci	5,R	w/Cruise Control, Upper; 41.00" Cable	CA-3009
1984	L4 2.5L 151ci	R	exc. Digital Cluster Instrument Panel, Electronic"; 80.00" Cable	CA-3001
1984	V6 2.8L 173ci	X	exc. Digital Cluster Instrument Panel, Electronic"; 80.00" Cable	CA-3001
1982-83	V6 2.8L 173ci	X	exc. Cruise Control; 80.00" Cable	CA-3001
1982-83	V6 2.8L 173ci	X	w/Cruise Control, Lower; 83.00" Cable	CA-3004
1982-83	V6 2.8L 173ci	X	w/Cruise Control, Upper; 41.00" Cable	CA-3009
1984	V6 4.3L 260ci	T	exc. Digital Cluster Instrument Panel, Electronic"; 80.00" Cable	CA-3001
1982-83	V6 4.3L 260ci	T	exc. Cruise Control; 80.00" Cable	CA-3001
1982-83	V6 4.3L 260ci	T	w/Cruise Control, Lower; 83.00" Cable	CA-3004
1982-83	V6 4.3L 260ci	T	w/Cruise Control, Upper; 41.00" Cable	CA-3009
<b>ASTRE</b>				
1976	L4 2.3L 140ci	A,B	4 Spd. MT	CA-3031
1976	L4 2.3L 140ci	A,B	exc. 4 Spd. MT; 80.00" Cable	CA-3001
1977	L4 2.3L 140ci	B	61.00" Cable	CA-3005
1977	L4 2.5L 151ci	V	61.00" Cable	CA-3005
<b>BONNEVILLE</b>				
1987	V6 3.8L 231ci	3	AT w/o Gear Adapter; 61.00" Cable	CA-3005
1987	V6 3.8L 231ci	3	TH-200 w/Gear Adapter Lower; 41.00" Cable	CA-3009
1987	V6 3.8L 231ci	3	TH-200 w/Gear Adapter Upper; 20.00" Cable	CA-3008
1987	V6 3.8L 231ci	3	TH-200 w/o Gear Adapter, THM-200-4R AT; 100" Length	CA-3003
1988	V6 3.8L 231ci	3,C	w/THM-200-4R Trans., exc. Gear Adapter; 61.00" Cable	CA-3005
1980-81	V6 3.8L 231ci	A	AT w/Cruise Control, Lower; 63.00" Cable	CA-3002
1980-81	V6 3.8L 231ci	A	AT w/Cruise Control, Upper; 41.00" Cable	CA-3009
1980-81	V6 3.8L 231ci	A	w/o Cruise Control; 80.00" Cable	CA-3001
1981-86	V6 3.8L 231ci	A	AT w/o Gear Adapter; 61.00" Cable	CA-3005
1981-86	V6 3.8L 231ci	A	TH-200 w/Gear Adapter Lower; 41.00" Cable	CA-3009
1981-86	V6 3.8L 231ci	A	TH-200 w/Gear Adapter Upper; 20.00" Cable	CA-3008
1981-86	V6 3.8L 231ci	A	TH-200 w/o Gear Adapter, THM-200-4R AT; 100" Length	CA-3003
1982-83	V6 3.8L 231ci	A	AT w/Cruise Control, w/Adapter, Lower; 63.00" Cable	CA-3002
1982-83	V6 3.8L 231ci	A	AT w/Cruise w/o Adapter Lower; 83.00" Cable	CA-3004
1982-83	V6 3.8L 231ci	A	AT w/Cruise w/o Adapter Upper; 41.00" Cable	CA-3009
1982-83	V6 3.8L 231ci	A	AT w/o Cruise Upper, AT w/Cruise w/Adapter Upper; 80.00" Cable	CA-3001
1982-83	V6 3.8L 231ci	A	w/o Cruise Lower; 20.00" Cable	CA-3008
1982-83	V6 3.8L 231ci	A	w/o Cruise w/o Gear Adapter; 100.00" Cable	CA-3003
1983-84	V6 3.8L 231ci	A	AT exc. TH200-4R w/Adapter Lower; 20.00" Cable	CA-3008
1983-84	V6 3.8L 231ci	A	AT exc. TH200-4R w/Adapter Upper; 80.00" Cable	CA-3001

# SPEEDOMETER CABLES

Year	Engine	Vin	Remark	Part
<b>PONTIAC (con't)</b>				
<b>BONNEVILLE (con't)</b>				
1983-84	V6 3.8L 231ci	A	AT w/o Gear Adapter; 100.00" Cable	CA-3003
1982	V6 4.1L 252ci	4	AT w/Cruise Control, w/Adapter, Lower; 63.00" Cable	CA-3002
1982	V6 4.1L 252ci	4	AT w/Cruise w/o Adapter Lower; 83.00" Cable	CA-3004
1982	V6 4.1L 252ci	4	AT w/Cruise w/o Adapter Upper; 41.00" Cable	CA-3009
1982	V6 4.1L 252ci	4	AT w/o Cruise Upper, AT w/Cruise w/Adapter Upper; 80.00" Cable	CA-3001
1982	V6 4.1L 252ci	4	w/o Cruise Lower; 20.00" Cable	CA-3008
1982	V6 4.1L 252ci	4	w/o Cruise w/o Gear Adapter; 100.00" Cable	CA-3003
1986	V6 4.3L 262ci	Z	AT w/o Gear Adapter; 61.00" Cable	CA-3005
1986	V6 4.3L 262ci	Z	TH-200 w/Gear Adapter Lower; 41.00" Cable	CA-3009
1986	V6 4.3L 262ci	Z	TH-200 w/Gear Adapter Upper; 20.00" Cable	CA-3008
1986	V6 4.3L 262ci	Z	TH-200 w/o Gear Adapter, THM-200-4R AT; 100" Length	CA-3003
1980-81	V8 4.3L 265ci	S	AT w/Cruise Control, Lower; 63.00" Cable	CA-3002
1980-81	V8 4.3L 265ci	S	AT w/Cruise Control, Upper; 41.00" Cable	CA-3009
1980-81	V8 4.3L 265ci	S	w/o Cruise Control; 80.00" Cable	CA-3001
1978-80	V8 4.9L 301ci	W	AT w/Cruise Control, Lower; 63.00" Cable	CA-3002
1978-80	V8 4.9L 301ci	W	AT w/Cruise Control, Upper; 41.00" Cable	CA-3009
1978-80	V8 4.9L 301ci	W	w/o Cruise Control; 80.00" Cable	CA-3001
1977	V8 4.9L 301ci	Y	w/o Cruise Control; 61.00" Cable	CA-3005
1977-79	V8 4.9L 301ci	Y	AT w/Cruise Control, Lower; 63.00" Cable	CA-3002
1977-79	V8 4.9L 301ci	Y	AT w/Cruise Control, Upper; 41.00" Cable	CA-3009
1977-79	V8 4.9L 301ci	Y	w/o Cruise Control; 80.00" Cable	CA-3001
1983	V8 5.0L 305ci	H	AT w/Cruise Control, w/Adapter, Lower; 63.00" Cable	CA-3002
1983	V8 5.0L 305ci	H	AT w/Cruise w/o Adapter Lower; 83.00" Cable	CA-3004
1983	V8 5.0L 305ci	H	AT w/Cruise w/o Adapter Upper; 41.00" Cable	CA-3009
1983	V8 5.0L 305ci	H	AT w/o Cruise Upper, AT w/Cruise w/Adapter Upper; 80.00" Cable	CA-3001
1983	V8 5.0L 305ci	H	w/o Cruise Lower; 20.00" Cable	CA-3008
1983	V8 5.0L 305ci	H	w/o Cruise w/o Gear Adapter; 100.00" Cable	CA-3003
1984	V8 5.0L 305ci	H	AT w/o Gear Adapter; 100.00" Cable	CA-3003
1983-86	V8 5.0L 305ci	H	TH-200 w/o Gear Adapter, THM-200-4R AT; 100" Length	CA-3003
1983-86	V8 5.0L 305ci	H	AT w/o Gear Adapter; 61.00" Cable	CA-3005
1983-86	V8 5.0L 305ci	H	TH-200 w/Gear Adapter Lower; 41.00" Cable	CA-3009
1983-86	V8 5.0L 305ci	H	TH-200 w/Gear Adapter Upper; 20.00" Cable	CA-3008
1984-86	V8 5.0L 305ci	H	AT exc. TH200-4R w/Adapter Lower; 20.00" Cable	CA-3008
1984-86	V8 5.0L 305ci	H	AT exc. TH200-4R w/Adapter Upper; 80.00" Cable	CA-3001
1981	V8 5.0L 307ci	Y	AT w/Cruise Control, Lower; 63.00" Cable	CA-3002
1981	V8 5.0L 307ci	Y	AT w/Cruise Control, Upper; 41.00" Cable	CA-3009
1981	V8 5.0L 307ci	Y	w/o Cruise Control; 80.00" Cable	CA-3001
1957	V8 5.7L 347ci		83.00" Cable	CA-3004
1984	V8 5.7L 350ci	N	AT exc. TH200-4R w/Adapter Lower; 20.00" Cable	CA-3008
1984	V8 5.7L 350ci	N	AT exc. TH200-4R w/Adapter Upper; 80.00" Cable	CA-3001
1984	V8 5.7L 350ci	N	AT w/o Gear Adapter; 100.00" Cable	CA-3003
1980-81	V8 5.7L 350ci	N	AT w/Cruise Control, Lower; 63.00" Cable	CA-3002
1980-81	V8 5.7L 350ci	N	AT w/Cruise Control, Upper; 41.00" Cable	CA-3009
1980-81	V8 5.7L 350ci	N	w/o Cruise Control; 80.00" Cable	CA-3001
1982-83	V8 5.7L 350ci	N	AT w/Cruise Control, w/Adapter, Lower; 63.00" Cable	CA-3002
1982-83	V8 5.7L 350ci	N	AT w/Cruise w/o Adapter Lower; 83.00" Cable	CA-3004
1982-83	V8 5.7L 350ci	N	AT w/Cruise w/o Adapter Upper; 41.00" Cable	CA-3009
1982-83	V8 5.7L 350ci	N	AT w/o Cruise Upper, AT w/Cruise w/Adapter Upper; 80.00" Cable	CA-3001
1982-83	V8 5.7L 350ci	N	w/o Cruise Lower; 20.00" Cable	CA-3008
1982-83	V8 5.7L 350ci	N	w/o Cruise w/o Gear Adapter; 100.00" Cable	CA-3003
1977	V8 5.7L 350ci	P,R	w/o Cruise Control; 61.00" Cable	CA-3005
1977-80	V8 5.7L 350ci	P,R,X	AT w/Cruise Control, Lower; 63.00" Cable	CA-3002
1977-80	V8 5.7L 350ci	P,R,X	AT w/Cruise Control, Upper; 41.00" Cable	CA-3009
1977-80	V8 5.7L 350ci	P,R,X	w/o Cruise Control; 80.00" Cable	CA-3001
1980	V8 5.7L 350ci	X	AT exc. TH200-4R w/Adapter Lower; 20.00" Cable	CA-3008
1980	V8 5.7L 350ci	X	AT exc. TH200-4R w/Adapter Upper; 80.00" Cable	CA-3001
1980	V8 5.7L 350ci	X	AT w/o Gear Adapter; 100.00" Cable	CA-3003
1970	V8 5.7L 350ci		3 Spd. AT w/o Cruise; 61.00" Cable	CA-3005
1970	V8 5.7L 350ci		3 Spd. MT w/o Cruise; 61.00" Cable	CA-3005
1970	V8 5.7L 350ci		w/Cruise Control, Lower; 63.00" Cable	CA-3002
1970	V8 5.7L 350ci		w/Cruise Control, Upper; 41.00" Cable	CA-3009
1958	V8 6.1L 370ci		63.00" Cable	CA-3002

# SPEEDOMETER CABLES

Year	Engine	Vin	Remark	Part
<b>PONTIAC (con't)</b>				
<b>BONNEVILLE (con't)</b>				
1959	V8 6.4L 389ci		63.00" Cable	CA-3002
1960	V8 6.4L 389ci		Canada; 83.00" Cable	CA-3004
1960	V8 6.4L 389ci		USA; 63.00" Cable	CA-3002
1964	V8 6.4L 389ci		US exc. Cruise Control, At; 83.00" Cable	CA-3004
1965	V8 6.4L 389ci		83.00" Cable	CA-3004
1966	V8 6.4L 389ci		AT w/Cruise Control, Upper	CA-3006
1966	V8 6.4L 389ci		AT w/o Cruise, 3 Spd. MT; 83.00" Cable	CA-3004
1961-63	V8 6.4L 389ci		AT; 83.00" Cable	CA-3004
1961-63	V8 6.4L 389ci		MT; 63.00" Cable	CA-3002
1976	V8 6.6L 400ci	N,Z	AT w/Cruise Control, Lower; 41.00" Cable	CA-3009
1976	V8 6.6L 400ci	N,Z	AT w/Cruise Control, Upper; 80.00" Cable	CA-3001
1976-77	V8 6.6L 400ci	N,Z	w/o Cruise Control; 61.00" Cable	CA-3005
1973-75	V8 6.6L 400ci	P,R,S,T	w/Cruise Control, Lower; 83.00" Cable	CA-3004
1973-75	V8 6.6L 400ci	P,R,S,T	w/Cruise Upper, AT w/o Cruise; 61.00" Cable	CA-3005
1977-78	V8 6.6L 400ci	Z	w/o Cruise Control; 80.00" Cable	CA-3001
1977-78	V8 6.6L 400ci	Z	AT w/Cruise Control, Lower; 63.00" Cable	CA-3002
1977-78	V8 6.6L 400ci	Z	AT w/Cruise Control, Upper; 41.00" Cable	CA-3009
1968	V8 6.6L 400ci		w/Cruise Control	CA-3006
1968	V8 6.6L 400ci		w/o Cruise Control; 63.00" Cable	CA-3002
1969-71	V8 6.6L 400ci		3 Spd. AT w/o Cruise; 61.00" Cable	CA-3005
1969-71	V8 6.6L 400ci		3 Spd. MT w/o Cruise; 61.00" Cable	CA-3005
1969-71	V8 6.6L 400ci		w/Cruise Control, Lower; 63.00" Cable	CA-3002
1969-71	V8 6.6L 400ci		w/Cruise Control, Upper; 41.00" Cable	CA-3009
1977	V8 6.6L 403ci	K	w/o Cruise Control; 61.00" Cable	CA-3005
1977-79	V8 6.6L 403ci	K	AT w/Cruise Control, Lower; 63.00" Cable	CA-3002
1977-79	V8 6.6L 403ci	K	AT w/Cruise Control, Upper; 41.00" Cable	CA-3009
1977-79	V8 6.6L 403ci	K	w/o Cruise Control; 80.00" Cable	CA-3001
1964	V8 6.9L 421ci		US exc. Cruise Control, At; 83.00" Cable	CA-3004
1965	V8 6.9L 421ci		83.00" Cable	CA-3004
1963-66	V8 6.9L 421ci		AT; 83.00" Cable	CA-3004
1963-66	V8 6.9L 421ci		MT; 63.00" Cable	CA-3002
1967	V8 7.0L 428ci		AT w/o Cruise, 3 Spd. MT; 83.00" Cable	CA-3004
1967	V8 7.0L 428ci		w/Cruise Upper	CA-3006
1968	V8 7.0L 428ci		w/Cruise Control	CA-3006
1968	V8 7.0L 428ci		w/o Cruise Control; 63.00" Cable	CA-3002
1969	V8 7.0L 428ci		3 Spd. AT w/o Cruise; 61.00" Cable	CA-3005
1969	V8 7.0L 428ci		3 Spd. MT w/o Cruise; 61.00" Cable	CA-3005
1969	V8 7.0L 428ci		w/Cruise Control, Upper; 41.00" Cable	CA-3009
1967-69	V8 7.0L 428ci		w/Cruise Control, Lower; 63.00" Cable	CA-3002
1972	V8 7.5L 455ci	U,Y	3 Spd. AT w/o Cruise; 61.00" Cable	CA-3005
1972	V8 7.5L 455ci	U,Y	3 Spd. MT w/o Cruise; 61.00" Cable	CA-3005
1972	V8 7.5L 455ci	U,Y	w/Cruise Control, Lower; 63.00" Cable	CA-3002
1972	V8 7.5L 455ci	U,Y	w/Cruise Control, Upper; 41.00" Cable	CA-3009
1976	V8 7.5L 455ci	W	AT w/Cruise Control, Lower; 41.00" Cable	CA-3009
1976	V8 7.5L 455ci	W	AT w/Cruise Control, Upper; 80.00" Cable	CA-3001
1976	V8 7.5L 455ci	W	w/o Cruise Control; 61.00" Cable	CA-3005
1973-75	V8 7.5L 455ci	W,Y	w/Cruise Control, Lower; 83.00" Cable	CA-3004
1973-75	V8 7.5L 455ci	W,Y	w/Cruise Upper, AT w/o Cruise; 61.00" Cable	CA-3005
1970-71	V8 7.5L 455ci		3 Spd. AT w/o Cruise; 61.00" Cable	CA-3005
1970-71	V8 7.5L 455ci		3 Spd. MT w/o Cruise; 61.00" Cable	CA-3005
1970-71	V8 7.5L 455ci		w/Cruise Control, Lower; 63.00" Cable	CA-3002
1970-71	V8 7.5L 455ci		w/Cruise Control, Upper; 41.00" Cable	CA-3009
<b>CATALINA</b>				
1950-54	L6 3.9L 239ci		63.00" Cable	CA-3002
1977	L6 4.1L 250ci	D	w/o Cruise Control; 61.00" Cable	CA-3005
1977-79	L6 4.1L 250ci	D	AT w/Cruise Control, Lower; 63.00" Cable	CA-3002
1977-79	L6 4.1L 250ci	D	AT w/Cruise Control, Upper; 41.00" Cable	CA-3009
1977-79	L6 4.1L 250ci	D	w/o Cruise Control; 80.00" Cable	CA-3001
1950-54	L8 4.4L 268ci		63.00" Cable	CA-3002
1980	V6 3.8L 229ci	K	AT w/Cruise Control, Lower; 63.00" Cable	CA-3002
1980	V6 3.8L 229ci	K	AT w/Cruise Control, Upper; 41.00" Cable	CA-3009
1980	V6 3.8L 229ci	K	w/o Cruise Control; 80.00" Cable	CA-3001

# SPEEDOMETER CABLES

Year	Engine	Vin	Remark	Part
<b>PONTIAC (con't)</b>				
<b>CATALINA (con't)</b>				
1977	V6 3.8L 231ci	A,C	w/o Cruise Control; 61.00" Cable	CA-3005
1977-81	V6 3.8L 231ci	A,C	AT w/Cruise Control, Lower; 63.00" Cable	CA-3002
1977-81	V6 3.8L 231ci	A,C	AT w/Cruise Control, Upper; 41.00" Cable	CA-3009
1977-81	V6 3.8L 231ci	A,C	w/o Cruise Control; 80.00" Cable	CA-3001
1980-81	V8 4.3L 265ci	S	AT w/Cruise Control, Lower; 63.00" Cable	CA-3002
1980-81	V8 4.3L 265ci	S	AT w/Cruise Control, Upper; 41.00" Cable	CA-3009
1980-81	V8 4.3L 265ci	S	w/o Cruise Control; 80.00" Cable	CA-3001
1980-81	V8 4.4L 267ci	J	AT w/Cruise Control, Lower; 63.00" Cable	CA-3002
1980-81	V8 4.4L 267ci	J	AT w/Cruise Control, Upper; 41.00" Cable	CA-3009
1980-81	V8 4.4L 267ci	J	w/o Cruise Control; 80.00" Cable	CA-3001
1955	V8 4.7L 287ci		63.00" Cable	CA-3002
1979-80	V8 4.9L 301ci	W	AT w/Cruise Control, Lower; 63.00" Cable	CA-3002
1979-80	V8 4.9L 301ci	W	AT w/Cruise Control, Upper; 41.00" Cable	CA-3009
1979-80	V8 4.9L 301ci	W	w/o Cruise Control; 80.00" Cable	CA-3001
1977	V8 4.9L 301ci	Y	w/o Cruise Control; 61.00" Cable	CA-3005
1977-79	V8 4.9L 301ci	Y	AT w/Cruise Control, Lower; 63.00" Cable	CA-3002
1977-79	V8 4.9L 301ci	Y	AT w/Cruise Control, Upper; 41.00" Cable	CA-3009
1977-79	V8 4.9L 301ci	Y	w/o Cruise Control; 80.00" Cable	CA-3001
1980-81	V8 5.0L 305ci	H	AT w/Cruise Control, Lower; 63.00" Cable	CA-3002
1980-81	V8 5.0L 305ci	H	AT w/Cruise Control, Upper; 41.00" Cable	CA-3009
1980-81	V8 5.0L 305ci	H	w/o Cruise Control; 80.00" Cable	CA-3001
1981	V8 5.0L 307ci	Y	AT w/Cruise Control, Lower; 63.00" Cable	CA-3002
1981	V8 5.0L 307ci	Y	AT w/Cruise Control, Upper; 41.00" Cable	CA-3009
1981	V8 5.0L 307ci	Y	w/o Cruise Control; 80.00" Cable	CA-3001
1956	V8 5.2L 316ci		63.00" Cable	CA-3002
1957	V8 5.7L 347ci		83.00" Cable	CA-3004
1972	V8 5.7L 350ci	M	3 Spd. AT w/o Cruise; 61.00" Cable	CA-3005
1972	V8 5.7L 350ci	M	3 Spd. MT w/o Cruise; 61.00" Cable	CA-3005
1972	V8 5.7L 350ci	M	w/Cruise Control, Lower; 63.00" Cable	CA-3002
1972	V8 5.7L 350ci	M	w/Cruise Control, Upper; 41.00" Cable	CA-3009
1973	V8 5.7L 350ci	M	w/Cruise Control, Lower; 83.00" Cable	CA-3004
1973	V8 5.7L 350ci	M	w/Cruise Upper, AT w/o Cruise; 61.00" Cable	CA-3005
1976	V8 5.7L 350ci	M	AT w/Cruise Control, Lower; 41.00" Cable	CA-3009
1976	V8 5.7L 350ci	M	AT w/Cruise Control, Upper; 80.00" Cable	CA-3001
1976	V8 5.7L 350ci	M	w/o Cruise Control; 61.00" Cable	CA-3005
1980-81	V8 5.7L 350ci	N	AT w/Cruise Control, Lower; 63.00" Cable	CA-3002
1980-81	V8 5.7L 350ci	N	AT w/Cruise Control, Upper; 41.00" Cable	CA-3009
1980-81	V8 5.7L 350ci	N	w/o Cruise Control; 80.00" Cable	CA-3001
1977	V8 5.7L 350ci	P,R	w/o Cruise Control; 61.00" Cable	CA-3005
1977-80	V8 5.7L 350ci	P,R,X	AT w/Cruise Control, Lower; 63.00" Cable	CA-3002
1977-80	V8 5.7L 350ci	P,R,X	AT w/Cruise Control, Upper; 41.00" Cable	CA-3009
1977-80	V8 5.7L 350ci	P,R,X	w/o Cruise Control; 80.00" Cable	CA-3001
1970-71	V8 5.7L 350ci		3 Spd. AT w/o Cruise; 61.00" Cable	CA-3005
1970-71	V8 5.7L 350ci		3 Spd. MT w/o Cruise; 61.00" Cable	CA-3005
1970-71	V8 5.7L 350ci		w/Cruise Control, Lower; 63.00" Cable	CA-3002
1970-71	V8 5.7L 350ci		w/Cruise Control, Upper; 41.00" Cable	CA-3009
1958	V8 6.1L 370ci		63.00" Cable	CA-3002
1959	V8 6.4L 389ci		63.00" Cable	CA-3002
1960	V8 6.4L 389ci		Canada; 83.00" Cable	CA-3004
1960	V8 6.4L 389ci		USA; 63.00" Cable	CA-3002
1966	V8 6.4L 389ci		AT w/Cruise Control, Upper	CA-3006
1966	V8 6.4L 389ci		AT w/o Cruise, 3 Spd. MT; 83.00" Cable	CA-3004
1961-63	V8 6.4L 389ci		AT; 83.00" Cable	CA-3004
1961-63	V8 6.4L 389ci		MT; 63.00" Cable	CA-3002
1964-65	V8 6.4L 389ci		83.00" Cable	CA-3004
1976	V8 6.6L 400ci	N,Z	AT w/Cruise Control, Lower; 41.00" Cable	CA-3009
1976	V8 6.6L 400ci	N,Z	AT w/Cruise Control, Upper; 80.00" Cable	CA-3001
1976-77	V8 6.6L 400ci	N,Z	w/o Cruise Control; 61.00" Cable	CA-3005
1973-75	V8 6.6L 400ci	P,R,S,T	w/Cruise Control, Lower; 83.00" Cable	CA-3004
1973-75	V8 6.6L 400ci	P,R,S,T	w/Cruise Upper, AT w/o Cruise; 61.00" Cable	CA-3005
1972	V8 6.6L 400ci	P,S	3 Spd. AT w/o Cruise; 61.00" Cable	CA-3005
1972	V8 6.6L 400ci	P,S	3 Spd. MT w/o Cruise; 61.00" Cable	CA-3005

# SPEEDOMETER CABLES

Year	Engine	Vin	Remark	Part
<b>PONTIAC (con't)</b>				
<b>CATALINA (con't)</b>				
1972	V8 6.6L 400ci	P,S	w/Cruise Control, Lower; 63.00" Cable	CA-3002
1972	V8 6.6L 400ci	P,S	w/Cruise Control, Upper; 41.00" Cable	CA-3009
1977-78	V8 6.6L 400ci	Z	w/o Cruise Control; 80.00" Cable	CA-3001
1977-78	V8 6.6L 400ci	Z	AT w/Cruise Control, Lower; 63.00" Cable	CA-3002
1977-78	V8 6.6L 400ci	Z	AT w/Cruise Control, Upper; 41.00" Cable	CA-3009
1968	V8 6.6L 400ci		w/Cruise Control	CA-3006
1968	V8 6.6L 400ci		w/o Cruise Control; 63.00" Cable	CA-3002
1969-71	V8 6.6L 400ci		3 Spd. AT w/o Cruise; 61.00" Cable	CA-3005
1969-71	V8 6.6L 400ci		3 Spd. MT w/o Cruise; 61.00" Cable	CA-3005
1969-71	V8 6.6L 400ci		w/Cruise Control, Lower; 63.00" Cable	CA-3002
1969-71	V8 6.6L 400ci		w/Cruise Control, Upper; 41.00" Cable	CA-3009
1977	V8 6.6L 403ci	K	w/o Cruise Control; 61.00" Cable	CA-3005
1977-78	V8 6.6L 403ci	K	w/o Cruise Control; 80.00" Cable	CA-3001
1977-78	V8 6.6L 403ci	K	AT w/Cruise Control, Lower; 63.00" Cable	CA-3002
1977-78	V8 6.6L 403ci	K	AT w/Cruise Control, Upper; 41.00" Cable	CA-3009
1963	V8 6.9L 421ci		AT; 83.00" Cable	CA-3004
1963	V8 6.9L 421ci		MT; 63.00" Cable	CA-3002
1966	V8 6.9L 421ci		AT w/Cruise Control, Upper	CA-3006
1966	V8 6.9L 421ci		AT w/o Cruise, 3 Spd. MT; 83.00" Cable	CA-3004
1964-65	V8 6.9L 421ci		83.00" Cable	CA-3004
1967	V8 7.0L 428ci		AT w/o Cruise, 3 Spd. MT; 83.00" Cable	CA-3004
1967	V8 7.0L 428ci		w/Cruise Upper	CA-3006
1968	V8 7.0L 428ci		w/Cruise Control	CA-3006
1968	V8 7.0L 428ci		w/o Cruise Control; 63.00" Cable	CA-3002
1969	V8 7.0L 428ci		3 Spd. AT w/o Cruise; 61.00" Cable	CA-3005
1969	V8 7.0L 428ci		3 Spd. MT w/o Cruise; 61.00" Cable	CA-3005
1969	V8 7.0L 428ci		w/Cruise Control, Upper; 41.00" Cable	CA-3009
1967-69	V8 7.0L 428ci		w/Cruise Control, Lower; 63.00" Cable	CA-3002
1972	V8 7.5L 455ci	U,W	3 Spd. AT w/o Cruise; 61.00" Cable	CA-3005
1972	V8 7.5L 455ci	U,W	3 Spd. MT w/o Cruise; 61.00" Cable	CA-3005
1972	V8 7.5L 455ci	U,W	w/Cruise Control, Lower; 63.00" Cable	CA-3002
1972	V8 7.5L 455ci	U,W	w/Cruise Control, Upper; 41.00" Cable	CA-3009
1976	V8 7.5L 455ci	W	AT w/Cruise Control, Lower; 41.00" Cable	CA-3009
1976	V8 7.5L 455ci	W	AT w/Cruise Control, Upper; 80.00" Cable	CA-3001
1976	V8 7.5L 455ci	W	w/o Cruise Control; 61.00" Cable	CA-3005
1973-75	V8 7.5L 455ci	W,Y	w/Cruise Control, Lower; 83.00" Cable	CA-3004
1973-75	V8 7.5L 455ci	W,Y	w/Cruise Upper, AT w/o Cruise; 61.00" Cable	CA-3005
1970	V8 7.5L 455ci		3 Spd. AT w/o Cruise; 61.00" Cable	CA-3005
1970	V8 7.5L 455ci		3 Spd. MT w/o Cruise; 61.00" Cable	CA-3005
1970	V8 7.5L 455ci		w/Cruise Control, Lower; 63.00" Cable	CA-3002
1970	V8 7.5L 455ci		w/Cruise Control, Upper; 41.00" Cable	CA-3009
<b>FIREBIRD</b>				
1984-86	L4 2.5L 151ci	2	w/Cruise Control, Lower; 63.00" Cable	CA-3002
1984-86	L4 2.5L 151ci	2	w/Cruise Control, Upper; 61.00" Cable	CA-3005
1984-86	L4 2.5L 151ci	2	w/o Cruise Control; 80.00" Cable	CA-3001
1982-83	L4 2.5L 151ci	2,F	3 Spd. MT Floor Shift Lower; 40.00" Cable	CA-3033
1982-83	L4 2.5L 151ci	2,F	4 Spd. MT 2 pc. Cable Upper; 41.00" Cable	CA-3009
1982-83	L4 2.5L 151ci	2,F	4 Spd. MT 2 pc. Lower; 40.00" Cable	CA-3033
1982-83	L4 2.5L 151ci	2,F	AT w/Cruise Control, Lower; 63.00" Cable	CA-3002
1982-83	L4 2.5L 151ci	2,F	AT w/Cruise Upper, 3 Spd. MT Floor Shift Upper; 61.00" Cable	CA-3005
1982-83	L4 2.5L 151ci	2,F	AT w/o Cruise, 4 Spd. MT 1 pc Cable; 80.00" Cable	CA-3001
1967	L6 3.8L 230ci		AT w/Cruise Control, Lower; 63.00" Cable	CA-3002
1967	L6 3.8L 230ci		AT w/Cruise Control, Upper; 61.00" Cable	CA-3005
1967	L6 3.8L 230ci		AT w/o Cruise Control; 80" Length	CA-3001
1967	L6 3.8L 230ci		MT Lower; 40.00" Cable	CA-3033
1967	L6 3.8L 230ci		MT Upper; 41.00" Cable	CA-3009
1976	L6 4.1L 250ci	D	AT w/o Cruise Control; 80" Length	CA-3001
1976	L6 4.1L 250ci	D	MT Lower; 40.00" Cable	CA-3033
1975-76	L6 4.1L 250ci	D	3 & 4 Spd. MT Floor Shift Lower; 40.00" Cable	CA-3033
1975-76	L6 4.1L 250ci	D	4 Spd. MT 1 pc. Cable; 80.00" Cable	CA-3001
1975-76	L6 4.1L 250ci	D	AT w/Cruise Control, Lower; 63.00" Cable	CA-3002
1975-76	L6 4.1L 250ci	D	AT w/Cruise Control, Upper; 41.00" Cable	CA-3009

# SPEEDOMETER CABLES

Year	Engine	Vin	Remark	Part
<b>PONTIAC (con't)</b>				
<b>FIREBIRD (con't)</b>				
1975-76	L6 4.1L 250ci	D	AT w/o Cruise 61" Cable, 4 Spd. MT	CA-3005
1984	V6 2.8L 173ci	1	3 Spd. MT Floor Shift; 61.00" Cable	CA-3005
1984	V6 2.8L 173ci	1	AT exc. Powerglide; 80.00" Cable	CA-3001
1984	V6 2.8L 173ci	1	Powerglide AT, 3 Spd.Column MT; 100.00" Cable	CA-3003
1982-83	V6 2.8L 173ci	1	3 Spd. MT Floor Shift Lower; 40.00" Cable	CA-3033
1982-83	V6 2.8L 173ci	1	4 Spd. MT 2 pc. Cable Upper; 41.00" Cable	CA-3009
1982-83	V6 2.8L 173ci	1	4 Spd. MT 2 pc. Lower; 40.00" Cable	CA-3033
1982-83	V6 2.8L 173ci	1	AT w/Cruise Control, Lower; 63.00" Cable	CA-3002
1982-83	V6 2.8L 173ci	1	AT w/Cruise Upper, 3 Spd. MT Floor Shift Upper; 61.00" Cable	CA-3005
1982-83	V6 2.8L 173ci	1	AT w/o Cruise, 4 Spd. MT 1 pc Cable; 80.00" Cable	CA-3001
1983-84	V6 2.8L 173ci	L	80.00" Cable	CA-3001
1985-89	V6 2.8L 173ci	S	80.00" Cable	CA-3001
1989	V6 3.8L 231ci	7	80.00" Cable	CA-3001
1978	V6 3.8L 231ci	A	AT w/Cruise Upper, AT w/o Cruise; 61.00" Cable	CA-3005
1979	V6 3.8L 231ci	A	3 & 4 Spd. MT Floor Shift Lower; 40.00" Cable	CA-3033
1979	V6 3.8L 231ci	A	4 Spd. MT 1 pc. Cable; 80.00" Cable	CA-3001
1979	V6 3.8L 231ci	A	AT w/o Cruise Control; 61" Length	CA-3005
1980	V6 3.8L 231ci	A	AT w/o Cruise 61" Cable, 4 Spd. MT	CA-3005
1980	V6 3.8L 231ci	A	AT w/o Cruise 67" Cable, 3 Spd. MT 1 pc Cable, 4 Spd. MT w/67" Cable; 80.00" Cable	CA-3001
1981	V6 3.8L 231ci	A	4 Spd. MT 2 pc. Cable Upper; 41.00" Cable	CA-3009
1981	V6 3.8L 231ci	A	4 Spd. MT 2 pc. Lower; 40.00" Cable	CA-3033
1981	V6 3.8L 231ci	A	AT w/Cruise Control, Upper; 61.00" Cable	CA-3005
1981	V6 3.8L 231ci	A	AT w/Cruise Upper, 3 Spd. MT Floor Shift Upper; 61.00" Cable	CA-3005
1981	V6 3.8L 231ci	A	AT w/o Cruise Control; 80" Length	CA-3001
1978-81	V6 3.8L 231ci	A	MT Lower; 40.00" Cable	CA-3033
1978-81	V6 3.8L 231ci	A	MT Upper; 41.00" Cable	CA-3009
1979-80	V6 3.8L 231ci	A	AT w/Cruise Control, Upper; 41.00" Cable	CA-3009
1980-81	V6 3.8L 231ci	A	3 Spd. MT Floor Shift Lower; 40.00" Cable	CA-3033
1978-81	V6 3.8L 231ci	A,C	AT w/Cruise Control, Lower; 63.00" Cable	CA-3002
1977	V6 3.8L 231ci	C	AT w/Cruise Upper, AT w/o Cruise; 61.00" Cable	CA-3005
1977	V6 3.8L 231ci	C	MT Lower; 40.00" Cable	CA-3033
1977	V6 3.8L 231ci	C	MT Upper; 41.00" Cable	CA-3009
1981	V8 4.3L 265ci	S	AT w/Cruise Upper, AT w/o Cruise; 61.00" Cable	CA-3005
1980-81	V8 4.3L 265ci	S	AT w/Cruise Control, Lower; 63.00" Cable	CA-3002
1980-81	V8 4.3L 265ci	S	AT w/Cruise Control, Upper; 61.00" Cable	CA-3005
1980-81	V8 4.3L 265ci	S	AT w/o Cruise Control; 80" Length	CA-3001
1980-81	V8 4.3L 265ci	S	MT Lower; 40.00" Cable	CA-3033
1980-81	V8 4.3L 265ci	S	MT Upper; 41.00" Cable	CA-3009
1981	V8 4.4L 267ci	J	AT w/Cruise Control, Lower; 63.00" Cable	CA-3002
1981	V8 4.4L 267ci	J	AT w/Cruise Control, Upper; 61.00" Cable	CA-3005
1981	V8 4.4L 267ci	J	AT w/o Cruise Control; 80" Length	CA-3001
1981	V8 4.4L 267ci	J	MT Lower; 40.00" Cable	CA-3033
1981	V8 4.4L 267ci	J	MT Upper; 41.00" Cable	CA-3009
1980	V8 4.9L 301ci	T	3 & 4 Spd. MT Floor Shift Lower; 40.00" Cable	CA-3033
1980	V8 4.9L 301ci	T	4 Spd. MT 1 pc. Cable; 80.00" Cable	CA-3001
1980	V8 4.9L 301ci	T	AT w/Cruise Control, Upper; 41.00" Cable	CA-3009
1980	V8 4.9L 301ci	T	AT w/o Cruise 61" Cable, 4 Spd. MT	CA-3005
1979-81	V8 4.9L 301ci	T,W	AT w/Cruise Control, Lower; 63.00" Cable	CA-3002
1979-81	V8 4.9L 301ci	T,W	MT Lower; 40.00" Cable	CA-3033
1979-81	V8 4.9L 301ci	T,W	MT Upper; 41.00" Cable	CA-3009
1980-81	V8 4.9L 301ci	T,W	AT w/Cruise Upper, AT w/o Cruise; 61.00" Cable	CA-3005
1980	V8 4.9L 301ci	W	AT w/Cruise Control, Upper; 61.00" Cable	CA-3005
1979-80	V8 4.9L 301ci	W	AT w/o Cruise Control; 80" Length	CA-3001
1979	V8 4.9L 301ci	W,Y	AT w/o Cruise 61" Cable, 4 Spd. MT	CA-3005
1977	V8 4.9L 301ci	Y	AT w/Cruise Control, Upper; 61.00" Cable	CA-3005
1977	V8 4.9L 301ci	Y	AT w/Cruise Upper, AT w/o Cruise; 61.00" Cable	CA-3005
1977	V8 4.9L 301ci	Y	AT w/o Cruise Control; 80" Length	CA-3001
1979	V8 4.9L 301ci	Y	3 & 4 Spd. MT Floor Shift Lower; 40.00" Cable	CA-3033
1979	V8 4.9L 301ci	Y	4 Spd. MT 1 pc. Cable; 80.00" Cable	CA-3001
1977-79	V8 4.9L 301ci	Y	AT w/Cruise Control, Lower; 63.00" Cable	CA-3002
1977-79	V8 4.9L 301ci	Y	MT Lower; 40.00" Cable	CA-3033



# SPEEDOMETER CABLES

Year	Engine	Vin	Remark	Part
<b>PONTIAC (con't)</b>				
<b>FIREBIRD (con't)</b>				
1977-79	V8 4.9L 301ci	Y	MT Upper; 41.00" Cable	CA-3009
1980-83	V8 5.0L 305ci	7,H,S	AT w/Cruise Control, Lower; 63.00" Cable	CA-3002
1982-83	V8 5.0L 305ci	7,H,S	AT w/Cruise Control, Upper; 61.00" Cable	CA-3005
1982-83	V8 5.0L 305ci	7,H,S	w/o Cruise; 80.00" Cable	CA-3001
1985-89	V8 5.0L 305ci	E,F	80.00" Cable	CA-3001
1979	V8 5.0L 305ci	G	AT w/Cruise Control, Lower; 63.00" Cable	CA-3002
1979	V8 5.0L 305ci	G	AT w/Cruise Upper, AT w/o Cruise; 61.00" Cable	CA-3005
1979	V8 5.0L 305ci	G	MT Lower; 40.00" Cable	CA-3033
1979	V8 5.0L 305ci	G	MT Upper; 41.00" Cable	CA-3009
1984-87	V8 5.0L 305ci	G,H	80.00" Cable	CA-3001
1980	V8 5.0L 305ci	H	AT w/Cruise Upper, AT w/o Cruise; 61.00" Cable	CA-3005
1980	V8 5.0L 305ci	H	MT Upper; 41.00" Cable	CA-3009
1981	V8 5.0L 305ci	H	AT w/Cruise Upper, 3 Spd. MT Upper; 41.00" Cable	CA-3009
1981	V8 5.0L 305ci	H	AT w/o Cruise, 4 Spd. MT Upper; 61.00" Cable	CA-3005
1980-81	V8 5.0L 305ci	H	MT Lower; 40.00" Cable	CA-3033
1977	V8 5.0L 305ci	U	AT w/o Cruise Control; 61" Length	CA-3005
1977	V8 5.0L 305ci	U	w/Cruise Control, Lower; 63.00" Cable	CA-3002
1977	V8 5.0L 305ci	U	w/Cruise Control, Upper; 61.00" Cable	CA-3005
1977	V8 5.0L 305ci	U	w/o Cruise Control; 80.00" Cable	CA-3001
1978	V8 5.0L 305ci	U	AT w/o Cruise 61" Cable, 4 Spd. MT	CA-3005
1977-78	V8 5.0L 305ci	U	3 & 4 Spd. MT Floor Shift Lower; 40.00" Cable	CA-3033
1977-78	V8 5.0L 305ci	U	4 Spd. MT 1 pc. Cable; 80.00" Cable	CA-3001
1977-78	V8 5.0L 305ci	U	AT w/Cruise Control, Lower; 63.00" Cable	CA-3002
1977-78	V8 5.0L 305ci	U	AT w/Cruise Control, Upper; 41.00" Cable	CA-3009
1967	V8 5.3L 326ci		MT; 83.00" Cable	CA-3004
1987-88	V8 5.7L 350ci	8	80.00" Cable	CA-3001
1973-75	V8 5.7L 350ci	E,M	AT w/o Cruise, 4 Spd. MT 1 pc Cable; 80.00" Cable	CA-3001
1972-75	V8 5.7L 350ci	E,M,N	3 Spd. MT Floor Shift Lower; 40.00" Cable	CA-3033
1972-75	V8 5.7L 350ci	E,M,N	AT w/Cruise Control, Lower; 63.00" Cable	CA-3002
1973-75	V8 5.7L 350ci	E,M,N	4 Spd. MT 2 pc. Cable Upper; 41.00" Cable	CA-3009
1973-75	V8 5.7L 350ci	E,M,N	4 Spd. MT 2 pc. Lower; 40.00" Cable	CA-3033
1973-75	V8 5.7L 350ci	E,M,N	AT w/Cruise Upper, 3 Spd. MT Floor Shift Upper; 61.00" Cable	CA-3005
1979	V8 5.7L 350ci	L	AT w/Cruise Control, Lower; 63.00" Cable	CA-3002
1979	V8 5.7L 350ci	L	AT w/Cruise Upper, AT w/o Cruise; 61.00" Cable	CA-3005
1979	V8 5.7L 350ci	L	MT Lower; 40.00" Cable	CA-3033
1979	V8 5.7L 350ci	L	MT Upper; 41.00" Cable	CA-3009
1974	V8 5.7L 350ci	M,N	AT w/o Cruise Control; 80" Length	CA-3001
1972-74	V8 5.7L 350ci	M,N	AT w/Cruise Control, Upper; 41.00" Cable	CA-3009
1972-74	V8 5.7L 350ci	M,N	AT w/o Cruise 61" Cable, 4 Spd. MT	CA-3005
1972-74	V8 5.7L 350ci	M,N	AT w/o Cruise 67" Cable, 3 Spd. MT 1 pc Cable, 4 Spd. MT w/67" Cable; 80.00" Cable	CA-3001
1976	V8 5.7L 350ci	P	AT w/Cruise Upper, AT w/o Cruise; 61.00" Cable	CA-3005
1976	V8 5.7L 350ci	P	MT Lower; 40.00" Cable	CA-3033
1976	V8 5.7L 350ci	P	MT Upper; 41.00" Cable	CA-3009
1977	V8 5.7L 350ci	P,R	3 & 4 Spd. MT Floor Shift Lower; 40.00" Cable	CA-3033
1977	V8 5.7L 350ci	P,R	3 Spd. MT Floor Shift Lower; 40.00" Cable	CA-3033
1977	V8 5.7L 350ci	P,R	4 Spd. MT 1 pc. Cable; 80.00" Cable	CA-3001
1977	V8 5.7L 350ci	P,R	4 Spd. MT 2 pc. Cable Upper; 41.00" Cable	CA-3009
1977	V8 5.7L 350ci	P,R	4 Spd. MT 2 pc. Lower; 40.00" Cable	CA-3033
1977	V8 5.7L 350ci	P,R	AT w/Cruise Control, Upper; 41.00" Cable	CA-3009
1977	V8 5.7L 350ci	P,R	AT w/Cruise Upper, 3 Spd. MT Floor Shift Upper; 61.00" Cable	CA-3005
1977	V8 5.7L 350ci	P,R	AT w/o Cruise Control; 61" Length	CA-3005
1977	V8 5.7L 350ci	P,R	AT w/o Cruise Control; 80" Length	CA-3001
1976-77	V8 5.7L 350ci	P,R	AT w/Cruise Control, Lower; 63.00" Cable	CA-3002
1968	V8 5.7L 350ci		MT; 83.00" Cable	CA-3004
1969	V8 5.7L 350ci		AT w/Cruise Control, Lower; 63.00" Cable	CA-3002
1969	V8 5.7L 350ci		w/o Cruise Control; 61.00" Cable	CA-3005
1969-71	V8 5.7L 350ci		AT w/Cruise Control, Upper; 41.00" Cable	CA-3009
1970-71	V8 5.7L 350ci		3 & 4 Spd. MT Floor Shift Lower; 40.00" Cable	CA-3033
1970-71	V8 5.7L 350ci		4 Spd. MT 1 pc. Cable; 80.00" Cable	CA-3001
1970-71	V8 5.7L 350ci		AT w/Cruise Control, Lower; 63.00" Cable	CA-3002
1970-71	V8 5.7L 350ci		AT w/o Cruise 61" Cable, 4 Spd. MT	CA-3005

# SPEEDOMETER CABLES

Year	Engine	Vin	Remark	Part
<b>PONTIAC (con't)</b>				
<b>FIREBIRD (con't)</b>				
1974	V8 6.6L 400ci	P	AT w/Cruise Upper, AT w/o Cruise; 61.00" Cable	CA-3005
1974	V8 6.6L 400ci	P	MT Lower; 40.00" Cable	CA-3033
1974	V8 6.6L 400ci	P	MT Upper; 41.00" Cable	CA-3009
1974	V8 6.6L 400ci	P,R	AT w/o Cruise 61" Cable, 4 Spd. MT	CA-3005
1972-74	V8 6.6L 400ci	P,R,T	AT w/Cruise Control, Lower; 63.00" Cable	CA-3002
1972-74	V8 6.6L 400ci	P,R,T	AT w/Cruise Control, Upper; 41.00" Cable	CA-3009
1973-74	V8 6.6L 400ci	P,R,T	3 Spd. MT Floor Shift Lower; 40.00" Cable	CA-3033
1973-74	V8 6.6L 400ci	P,R,T	4 Spd. MT 2 pc. Cable Upper; 41.00" Cable	CA-3009
1973-74	V8 6.6L 400ci	P,R,T	4 Spd. MT 2 pc. Lower; 40.00" Cable	CA-3033
1973-74	V8 6.6L 400ci	P,R,T	AT w/Cruise Upper, 3 Spd. MT Floor Shift Upper; 61.00" Cable	CA-3005
1973-74	V8 6.6L 400ci	P,R,T	AT w/o Cruise, 4 Spd. MT 1 pc Cable; 80.00" Cable	CA-3001
1972-74	V8 6.6L 400ci	P,T	3 & 4 Spd. MT Floor Shift Lower; 40.00" Cable	CA-3033
1972-74	V8 6.6L 400ci	P,T	4 Spd. MT 1 pc. Cable; 80.00" Cable	CA-3001
1973	V8 6.6L 400ci	R	AT w/Cruise Upper, AT w/o Cruise; 61.00" Cable	CA-3005
1973	V8 6.6L 400ci	R	MT Lower; 40.00" Cable	CA-3033
1973	V8 6.6L 400ci	R	MT Upper; 41.00" Cable	CA-3009
1974	V8 6.6L 400ci	R	AT w/o Cruise 67" Cable, 3 Spd. MT 1 pc Cable, 4 Spd. MT w/67" Cable; 80.00" Cable	CA-3001
1974	V8 6.6L 400ci	R	AT w/o Cruise Control; 80" Length	CA-3001
1972	V8 6.6L 400ci	R,T	AT, HD MT; 80.00" Cable	CA-3001
1972	V8 6.6L 400ci	R,T	MT; 61.00" Cable	CA-3005
1975	V8 6.6L 400ci	S	3 & 4 Spd. MT Floor Shift Lower; 40.00" Cable	CA-3033
1975	V8 6.6L 400ci	S	4 Spd. MT 1 pc. Cable; 80.00" Cable	CA-3001
1975	V8 6.6L 400ci	S	AT w/Cruise Control, Lower; 63.00" Cable	CA-3002
1975	V8 6.6L 400ci	S	AT w/Cruise Control, Upper; 41.00" Cable	CA-3009
1975	V8 6.6L 400ci	S	AT w/o Cruise 61" Cable, 4 Spd. MT	CA-3005
1972-73	V8 6.6L 400ci	T	AT w/o Cruise 61" Cable, 4 Spd. MT	CA-3005
1972-74	V8 6.6L 400ci	T	AT w/o Cruise Control; 61" Length	CA-3005
1976	V8 6.6L 400ci	Z	AT w/Cruise Control, Upper; 41.00" Cable	CA-3009
1976	V8 6.6L 400ci	Z	AT w/o Cruise 61" Cable, 4 Spd. MT	CA-3005
1976	V8 6.6L 400ci	Z	AT w/o Cruise 67" Cable, 3 Spd. MT 1 pc Cable, 4 Spd. MT w/67" Cable; 80.00" Cable	CA-3001
1976	V8 6.6L 400ci	Z	w/o Cruise Control; 61.00" Cable	CA-3005
1977	V8 6.6L 400ci	Z	MT; 83.00" Cable	CA-3004
1979	V8 6.6L 400ci	Z	AT w/o Cruise Control; 80" Length	CA-3001
1976-79	V8 6.6L 400ci	Z	3 Spd. MT Floor Shift Lower; 40.00" Cable	CA-3033
1976-79	V8 6.6L 400ci	Z	AT w/Cruise Control, Lower; 63.00" Cable	CA-3002
1977-78	V8 6.6L 400ci	Z	AT w/o Cruise, 4 Spd. MT 1 pc Cable; 80.00" Cable	CA-3001
1977-79	V8 6.6L 400ci	Z	4 Spd. MT 2 pc. Cable Upper; 41.00" Cable	CA-3009
1977-79	V8 6.6L 400ci	Z	4 Spd. MT 2 pc. Lower; 40.00" Cable	CA-3033
1977-79	V8 6.6L 400ci	Z	AT w/Cruise Upper, 3 Spd. MT Floor Shift Upper; 61.00" Cable	CA-3005
1970	V8 6.6L 400ci		4 Spd. MT 2 pc. Cable Upper; 41.00" Cable	CA-3009
1970	V8 6.6L 400ci		4 Spd. MT 2 pc. Lower; 40.00" Cable	CA-3033
1970	V8 6.6L 400ci		AT w/Cruise Upper, 3 Spd. MT Floor Shift Upper; 61.00" Cable	CA-3005
1970	V8 6.6L 400ci		AT w/Cruise Upper, AT w/o Cruise; 61.00" Cable	CA-3005
1970	V8 6.6L 400ci		AT w/o Cruise Control; 80" Length	CA-3001
1970	V8 6.6L 400ci		MT Lower; 40.00" Cable	CA-3033
1971	V8 6.6L 400ci		80.00" Cable	CA-3001
1967-68	V8 6.6L 400ci		3 & 4 Spd. MT Floor Shift Lower; 40.00" Cable	CA-3033
1967-68	V8 6.6L 400ci		4 Spd. MT 1 pc. Cable; 80.00" Cable	CA-3001
1967-69	V8 6.6L 400ci		AT w/Cruise Control, Upper; 41.00" Cable	CA-3009
1967-70	V8 6.6L 400ci		AT w/Cruise Control, Lower; 63.00" Cable	CA-3002
1967-70	V8 6.6L 400ci		AT w/o Cruise 61" Cable, 4 Spd. MT	CA-3005
1969-70	V8 6.6L 400ci		3 Spd. MT Floor Shift Lower; 40.00" Cable	CA-3033
1969-70	V8 6.6L 400ci		AT w/o Cruise 67" Cable, 3 Spd. MT 1 pc Cable, 4 Spd. MT w/67" Cable; 80.00" Cable	CA-3001
1977-78	V8 6.6L 403ci	K	AT w/o Cruise Control; 80" Length	CA-3001
1977-79	V8 6.6L 403ci	K	3 Spd. MT Floor Shift Lower; 40.00" Cable	CA-3033
1977-79	V8 6.6L 403ci	K	4 Spd. MT 2 pc. Cable Upper; 41.00" Cable	CA-3009
1977-79	V8 6.6L 403ci	K	4 Spd. MT 2 pc. Lower; 40.00" Cable	CA-3033
1977-79	V8 6.6L 403ci	K	AT w/Cruise Control, Lower; 63.00" Cable	CA-3002
1977-79	V8 6.6L 403ci	K	AT w/Cruise Upper, 3 Spd. MT Floor Shift Upper; 61.00" Cable	CA-3005

# SPEEDOMETER CABLES

Year	Engine	Vin	Remark	Part
<b>PONTIAC (con't)</b>				
<b>FIREBIRD (con't)</b>				
1977-79	V8 6.6L 403ci	K	AT w/o Cruise, 4 Spd. MT 1 pc Cable; 80.00" Cable	CA-3001
1975	V8 7.5L 455ci	W	4 Spd. MT 2 pc. Cable Upper; 41.00" Cable	CA-3009
1975	V8 7.5L 455ci	W	4 Spd. MT 2 pc. Lower; 40.00" Cable	CA-3033
1975	V8 7.5L 455ci	W	AT w/Cruise Upper, 3 Spd. MT Floor Shift Upper; 61.00" Cable	CA-3005
1975	V8 7.5L 455ci	W	AT w/o Cruise Control; 80" Length	CA-3001
1976	V8 7.5L 455ci	W	AT w/Cruise Control, Upper; 41.00" Cable	CA-3009
1976	V8 7.5L 455ci	W	AT w/o Cruise 61" Cable, 4 Spd. MT	CA-3005
1976	V8 7.5L 455ci	W	AT w/o Cruise 67" Cable, 3 Spd. MT 1 pc Cable, 4 Spd. MT w/67" Cable; 80.00" Cable	CA-3001
1975-76	V8 7.5L 455ci	W	3 Spd. MT Floor Shift Lower; 40.00" Cable	CA-3033
1975-76	V8 7.5L 455ci	W	AT w/Cruise Control, Lower; 63.00" Cable	CA-3002
1972	V8 7.5L 455ci	X	AT, HD MT; 80.00" Cable	CA-3001
1972	V8 7.5L 455ci	X	MT; 61.00" Cable	CA-3005
1974	V8 7.5L 455ci	X	AT w/o Cruise 61" Cable, 4 Spd. MT	CA-3005
1974	V8 7.5L 455ci	X	AT w/o Cruise 67" Cable, 3 Spd. MT 1 pc Cable, 4 Spd. MT w/67" Cable; 80.00" Cable	CA-3001
1974	V8 7.5L 455ci	X	AT w/o Cruise Control; 80" Length	CA-3001
1973-74	V8 7.5L 455ci	X,Y	3 Spd. MT Floor Shift Lower; 40.00" Cable	CA-3033
1973-74	V8 7.5L 455ci	X,Y	4 Spd. MT 2 pc. Cable Upper; 41.00" Cable	CA-3009
1973-74	V8 7.5L 455ci	X,Y	4 Spd. MT 2 pc. Lower; 40.00" Cable	CA-3033
1973-74	V8 7.5L 455ci	X,Y	AT w/Cruise Control, Lower; 63.00" Cable	CA-3002
1973-74	V8 7.5L 455ci	X,Y	AT w/Cruise Upper, 3 Spd. MT Floor Shift Upper; 61.00" Cable	CA-3005
1973-74	V8 7.5L 455ci	X,Y	AT w/o Cruise, 4 Spd. MT 1 pc Cable; 80.00" Cable	CA-3001
1971	V8 7.5L 455ci		80.00" Cable	CA-3001
<b>GRAND AM</b>				
1979	V6 3.8L 231ci	A	AT w/Cruise Control, Upper; 61.00" Cable	CA-3005
1979	V6 3.8L 231ci	A	AT w/Cruise Control, w/Adapter, Lower; 63.00" Cable	CA-3002
1979	V6 3.8L 231ci	A	w/Cruise w/o Adapter Lower; 83.00" Cable	CA-3004
1979	V6 3.8L 231ci	A	w/o Cruise 2 pc. Cable Lower; 20.00" Cable	CA-3008
1979	V6 3.8L 231ci	A	w/o Cruise 2 pc. Cable Upper; 80.00" Cable	CA-3001
1979	V6 3.8L 231ci	A	w/o Cruise Control; 100.00" Cable	CA-3003
1980	V8 4.9L 301ci	W	w/Adapter Lower; 20.00" Cable	CA-3008
1980	V8 4.9L 301ci	W	w/Cruise Control, Upper; 61.00" Cable	CA-3005
1980	V8 4.9L 301ci	W	w/Cruise w/Adapter Lower; 83.00" Cable	CA-3004
1980	V8 4.9L 301ci	W	w/o Cruise w/Adapter Upper; 80.00" Cable	CA-3001
1980	V8 4.9L 301ci	W	w/o Cruise w/o Gear Adapter; 100.00" Cable	CA-3003
1978-79	V8 4.9L 301ci	W,Y	AT w/Cruise Control, Upper; 61.00" Cable	CA-3005
1978-79	V8 4.9L 301ci	W,Y	AT w/Cruise Control, w/Adapter, Lower; 63.00" Cable	CA-3002
1978-79	V8 4.9L 301ci	W,Y	w/Cruise w/o Adapter Lower; 83.00" Cable	CA-3004
1978-79	V8 4.9L 301ci	W,Y	w/o Cruise 2 pc. Cable Lower; 20.00" Cable	CA-3008
1978-79	V8 4.9L 301ci	W,Y	w/o Cruise 2 pc. Cable Upper; 80.00" Cable	CA-3001
1978-79	V8 4.9L 301ci	W,Y	w/o Cruise Control; 100.00" Cable	CA-3003
1979	V8 5.0L 305ci	H	AT w/Cruise Control, Upper; 61.00" Cable	CA-3005
1979	V8 5.0L 305ci	H	AT w/Cruise Control, w/Adapter, Lower; 63.00" Cable	CA-3002
1979	V8 5.0L 305ci	H	w/Cruise w/o Adapter Lower; 83.00" Cable	CA-3004
1979	V8 5.0L 305ci	H	w/o Cruise 2 pc. Cable Lower; 20.00" Cable	CA-3008
1979	V8 5.0L 305ci	H	w/o Cruise 2 pc. Cable Upper; 80.00" Cable	CA-3001
1979	V8 5.0L 305ci	H	w/o Cruise Control; 100.00" Cable	CA-3003
1980	V8 5.0L 305ci	H	w/Adapter Lower; 20.00" Cable	CA-3008
1980	V8 5.0L 305ci	H	w/Cruise Control, Upper; 61.00" Cable	CA-3005
1980	V8 5.0L 305ci	H	w/Cruise w/Adapter Lower; 83.00" Cable	CA-3004
1980	V8 5.0L 305ci	H	w/o Cruise w/Adapter Upper; 80.00" Cable	CA-3001
1980	V8 5.0L 305ci	H	w/o Cruise w/o Gear Adapter; 100.00" Cable	CA-3003
1978	V8 5.0L 305ci	U	AT w/Cruise Control, Upper; 61.00" Cable	CA-3005
1978	V8 5.0L 305ci	U	AT w/Cruise Control, w/Adapter, Lower; 63.00" Cable	CA-3002
1978	V8 5.0L 305ci	U	w/Cruise w/o Adapter Lower; 83.00" Cable	CA-3004
1978	V8 5.0L 305ci	U	w/o Cruise 2 pc. Cable Lower; 20.00" Cable	CA-3008
1978	V8 5.0L 305ci	U	w/o Cruise 2 pc. Cable Upper; 80.00" Cable	CA-3001
1978	V8 5.0L 305ci	U	w/o Cruise Control; 100.00" Cable	CA-3003
1975	V8 5.7L 350ci	H	AT w/Cruise Control, Lower; 63.00" Cable	CA-3002
1975	V8 5.7L 350ci	H	MT w/Cruise Lower; 83.00" Cable	CA-3004
1975	V8 5.7L 350ci	H	MT w/o Cruise; 80.00" Cable	CA-3001

# SPEEDOMETER CABLES

Year	Engine	Vin	Remark	Part
<b>PONTIAC (con't)</b>				
<b>GRAND AM (con't)</b>				
1975	V8 5.7L 350ci	H	w/Cruise Control, Upper; 61.00" Cable	CA-3005
1973	V8 5.7L 350ci	M	3 Spd. MT w/Cruise Lower; 40.00" Cable	CA-3033
1973	V8 5.7L 350ci	M	4 Spd. HD MT w/Cruise Lower; 20.00" Cable	CA-3008
1973	V8 5.7L 350ci	M	4 Spd. HD MT w/Cruise Upper; 83.00" Cable	CA-3004
1973	V8 5.7L 350ci	M	AT w/Cruise Control, Lower; 63.00" Cable	CA-3002
1973	V8 5.7L 350ci	M	AT w/Cruise Upper, AT w/o Cruise, 4 Spd. Muncie MT, 3 Spd. MT w/Cruise Upper; 61.00" Cable	CA-3005
1973	V8 5.7L 350ci	M	MT w/o Cruise; 80.00" Cable	CA-3001
1973-74	V8 6.6L 400ci	P,R,S,T	3 Spd. MT w/Cruise Lower; 40.00" Cable	CA-3033
1973-74	V8 6.6L 400ci	P,R,S,T	4 Spd. HD MT w/Cruise Lower; 20.00" Cable	CA-3008
1973-74	V8 6.6L 400ci	P,R,S,T	AT w/Cruise Upper, AT w/o Cruise, 4 Spd. Muncie MT, 3 Spd. MT w/Cruise Upper; 61.00" Cable	CA-3005
1973-74	V8 6.6L 400ci	P,T	4 Spd. HD MT w/Cruise Upper; 83.00" Cable	CA-3004
1973-74	V8 6.6L 400ci	P,T	AT w/Cruise Control, Lower; 63.00" Cable	CA-3002
1973-74	V8 6.6L 400ci	P,T	MT w/o Cruise; 80.00" Cable	CA-3001
1974	V8 6.6L 400ci	R,S	4 Spd. HD MT w/Cruise Upper; 83.00" Cable	CA-3004
1975	V8 6.6L 400ci	R,S	MT w/Cruise Lower; 83.00" Cable	CA-3004
1975	V8 6.6L 400ci	R,S	w/Cruise Control, Upper; 61.00" Cable	CA-3005
1974-75	V8 6.6L 400ci	R,S	AT w/Cruise Control, Lower; 63.00" Cable	CA-3002
1974-75	V8 6.6L 400ci	R,S	MT w/o Cruise; 80.00" Cable	CA-3001
1975	V8 7.5L 455ci	W	MT w/Cruise Lower; 83.00" Cable	CA-3004
1975	V8 7.5L 455ci	W	w/Cruise Control, Upper; 61.00" Cable	CA-3005
1974	V8 7.5L 455ci	W,Y	3 Spd. MT w/Cruise Lower; 40.00" Cable	CA-3033
1974	V8 7.5L 455ci	W,Y	4 Spd. HD MT w/Cruise Lower; 20.00" Cable	CA-3008
1974	V8 7.5L 455ci	W,Y	4 Spd. HD MT w/Cruise Upper; 83.00" Cable	CA-3004
1974	V8 7.5L 455ci	W,Y	AT w/Cruise Upper, AT w/o Cruise, 4 Spd. Muncie MT, 3 Spd. MT w/Cruise Upper; 61.00" Cable	CA-3005
1974-75	V8 7.5L 455ci	W,Y	AT w/Cruise Control, Lower; 63.00" Cable	CA-3002
1974-75	V8 7.5L 455ci	W,Y	MT w/o Cruise; 80.00" Cable	CA-3001
1973	V8 7.5L 455ci	X	3 Spd. MT w/Cruise Lower; 40.00" Cable	CA-3033
1973	V8 7.5L 455ci	X	4 Spd. HD MT w/Cruise Lower; 20.00" Cable	CA-3008
1973	V8 7.5L 455ci	X	4 Spd. HD MT w/Cruise Upper; 83.00" Cable	CA-3004
1973	V8 7.5L 455ci	X	AT w/Cruise Control, Lower; 63.00" Cable	CA-3002
1973	V8 7.5L 455ci	X	AT w/Cruise Upper, AT w/o Cruise, 4 Spd. Muncie MT, 3 Spd. MT w/Cruise Upper; 61.00" Cable	CA-3005
1973	V8 7.5L 455ci	X	MT w/o Cruise; 80.00" Cable	CA-3001
<b>GRAND PRIX</b>				
1979	V6 3.8L 231ci	2	w/Cruise w/Adapter Lower; 20.00" Cable	CA-3008
1978-79	V6 3.8L 231ci	2,A	w/Cruise Upper; 80.00" Cable	CA-3001
1978-79	V6 3.8L 231ci	2,A	w/Cruise w/Innerconnector; 63.00" Cable	CA-3002
1978-83	V6 3.8L 231ci	2,A	w/Cruise w/o Adapter Lower; 83.00" Cable	CA-3004
1978-83	V6 3.8L 231ci	2,A	w/o Cruise w/o Gear Adapter; 100.00" Cable	CA-3003
1987	V6 3.8L 231ci	A	AT exc. TH200-R4 w/Adapter Upper; 41.00" Cable	CA-3009
1978-79	V6 3.8L 231ci	A	w/Cruise w/Adapter Lower; 20.00" Cable	CA-3008
1980-83	V6 3.8L 231ci	A	w/Cruise w/Adapter Lower; 63.00" Cable	CA-3002
1980-83	V6 3.8L 231ci	A	w/Cruise Control, Upper; 61.00" Cable	CA-3005
1980-83	V6 3.8L 231ci	A	w/o Cruise w/Adapter Upper; 80.00" Cable	CA-3001
1982-83	V6 3.8L 231ci	A	w/o Cruise w/Adapter Lower; 20.00" Cable	CA-3008
1984-86	V6 3.8L 231ci	A	AT exc. TH200-R4 w/Adapter Upper; 80.00" Cable	CA-3001
1984-86	V6 3.8L 231ci	A	AT w/o Gear Adapter; 100.00" Cable	CA-3003
1984-87	V6 3.8L 231ci	A	AT exc. TH200-R4 w/Adapter Lower; 20.00" Cable	CA-3008
1984-87	V6 3.8L 231ci	A	TH-200-R4 w/Adapter Upper; 61.00" Cable	CA-3005
1982	V6 4.1L 252ci	4	w/Cruise Control, Upper; 61.00" Cable	CA-3005
1982	V6 4.1L 252ci	4	w/Cruise w/Adapter Lower; 63.00" Cable	CA-3002
1982	V6 4.1L 252ci	4	w/Cruise w/o Adapter Lower; 83.00" Cable	CA-3004
1982	V6 4.1L 252ci	4	w/o Cruise w/Adapter Lower; 20.00" Cable	CA-3008
1982	V6 4.1L 252ci	4	w/o Cruise w/Adapter Upper; 80.00" Cable	CA-3001
1982	V6 4.1L 252ci	4	w/o Cruise w/o Gear Adapter; 100.00" Cable	CA-3003
1986	V6 4.3L 262ci	Z	AT exc. TH200-R4 w/Adapter Upper; 80.00" Cable	CA-3001
1986	V6 4.3L 262ci	Z	AT w/o Gear Adapter; 100.00" Cable	CA-3003
1987	V6 4.3L 262ci	Z	AT exc. TH200-R4 w/Adapter Upper; 41.00" Cable	CA-3009
1986-87	V6 4.3L 262ci	Z	AT exc. TH200-R4 w/Adapter Lower; 20.00" Cable	CA-3008

# SPEEDOMETER CABLES

Year	Engine	Vin	Remark	Part
<b>PONTIAC (con't)</b>				
<b>GRAND PRIX (con't)</b>				
1986-87	V6 4.3L 262ci	Z	TH-200-R4 w/Adapter Upper; 61.00" Cable	CA-3005
1980-81	V8 4.3L 265ci	S	w/Cruise Control, Upper; 61.00" Cable	CA-3005
1980-81	V8 4.3L 265ci	S	w/Cruise w/o Adapter Lower; 83.00" Cable	CA-3004
1980-81	V8 4.3L 265ci	S	w/Cruise w/Adapter Lower; 63.00" Cable	CA-3002
1980-81	V8 4.3L 265ci	S	w/o Cruise w/Adapter Upper; 80.00" Cable	CA-3001
1980-81	V8 4.3L 265ci	S	w/o Cruise w/o Gear Adapter; 100.00" Cable	CA-3003
1982	V8 4.4L 267ci	J	w/o Cruise w/Adapter Lower; 20.00" Cable	CA-3008
1981-82	V8 4.4L 267ci	J	w/Cruise w/Adapter Lower; 63.00" Cable	CA-3002
1981-82	V8 4.4L 267ci	J	w/Cruise Control, Upper; 61.00" Cable	CA-3005
1981-82	V8 4.4L 267ci	J	w/Cruise w/o Adapter Lower; 83.00" Cable	CA-3004
1981-82	V8 4.4L 267ci	J	w/o Cruise w/Adapter Upper; 80.00" Cable	CA-3001
1981-82	V8 4.4L 267ci	J	w/o Cruise w/o Gear Adapter; 100.00" Cable	CA-3003
1980	V8 4.9L 301ci	W	w/Cruise Control, Upper; 61.00" Cable	CA-3005
1980	V8 4.9L 301ci	W	w/Cruise w/Adapter Lower; 63.00" Cable	CA-3002
1980	V8 4.9L 301ci	W	w/o Cruise w/Adapter Upper; 80.00" Cable	CA-3001
1978-79	V8 4.9L 301ci	W,Y	w/Cruise Upper; 80.00" Cable	CA-3001
1978-79	V8 4.9L 301ci	W,Y	w/Cruise w/Adapter Lower; 20.00" Cable	CA-3008
1978-79	V8 4.9L 301ci	W,Y	w/Cruise w/Innerconnector; 63.00" Cable	CA-3002
1978-80	V8 4.9L 301ci	W,Y	w/Cruise w/o Adapter Lower; 83.00" Cable	CA-3004
1978-80	V8 4.9L 301ci	W,Y	w/o Cruise w/o Gear Adapter; 100.00" Cable	CA-3003
1977	V8 4.9L 301ci	Y	3 Spd. MT; 80.00" Cable	CA-3001
1977	V8 4.9L 301ci	Y	AT w/Cruise Control, Lower; 83.00" Cable	CA-3004
1977	V8 4.9L 301ci	Y	AT w/Cruise Control, Upper; 61.00" Cable	CA-3005
1979	V8 5.0L 305ci	H	w/Cruise Upper; 80.00" Cable	CA-3001
1979	V8 5.0L 305ci	H	w/Cruise w/Adapter Lower; 20.00" Cable	CA-3008
1979	V8 5.0L 305ci	H	w/Cruise w/Innerconnector; 63.00" Cable	CA-3002
1980	V8 5.0L 305ci	H	w/Cruise w/Adapter Lower; 63.00" Cable	CA-3002
1983	V8 5.0L 305ci	H	w/Cruise w/Adapter Lower; 63.00" Cable	CA-3002
1983	V8 5.0L 305ci	H	w/o Cruise w/Adapter Lower; 20.00" Cable	CA-3008
1987	V8 5.0L 305ci	H	AT exc. TH200-R4 w/Adapter Upper; 41.00" Cable	CA-3009
1979-83	V8 5.0L 305ci	H	w/Cruise w/o Adapter Lower; 83.00" Cable	CA-3004
1979-83	V8 5.0L 305ci	H	w/o Cruise w/o Gear Adapter; 100.00" Cable	CA-3003
1980-83	V8 5.0L 305ci	H	w/Cruise Control, Upper; 61.00" Cable	CA-3005
1980-83	V8 5.0L 305ci	H	w/o Cruise w/Adapter Upper; 80.00" Cable	CA-3001
1984-86	V8 5.0L 305ci	H	AT exc. TH200-R4 w/Adapter Upper; 80.00" Cable	CA-3001
1984-86	V8 5.0L 305ci	H	AT w/o Gear Adapter; 100.00" Cable	CA-3003
1984-87	V8 5.0L 305ci	H	AT exc. TH200-R4 w/Adapter Lower; 20.00" Cable	CA-3008
1984-87	V8 5.0L 305ci	H	TH-200-R4 w/Adapter Upper; 61.00" Cable	CA-3005
1978	V8 5.0L 305ci	U	w/Cruise Upper; 80.00" Cable	CA-3001
1978	V8 5.0L 305ci	U	w/Cruise w/Adapter Lower; 20.00" Cable	CA-3008
1978	V8 5.0L 305ci	U	w/Cruise w/Innerconnector; 63.00" Cable	CA-3002
1978	V8 5.0L 305ci	U	w/Cruise w/o Adapter Lower; 83.00" Cable	CA-3004
1978	V8 5.0L 305ci	U	w/o Cruise w/o Gear Adapter; 100.00" Cable	CA-3003
1976	V8 5.7L 350ci	M,P	AT w/Cruise Control, Lower; 63.00" Cable	CA-3002
1976	V8 5.7L 350ci	M,P	AT w/Cruise Control, Upper; 41.00" Cable	CA-3009
1976	V8 5.7L 350ci	M,P	AT w/o Cruise Control; 61" Length	CA-3005
1976	V8 5.7L 350ci	M,P	MT w/o Cruise; 80.00" Cable	CA-3001
1984	V8 5.7L 350ci	N	AT exc. TH200-R4 w/Adapter Lower; 20.00" Cable	CA-3008
1984	V8 5.7L 350ci	N	AT exc. TH200-R4 w/Adapter Upper; 80.00" Cable	CA-3001
1984	V8 5.7L 350ci	N	AT w/o Gear Adapter; 100.00" Cable	CA-3003
1984	V8 5.7L 350ci	N	TH-200-R4 w/Adapter Upper; 61.00" Cable	CA-3005
1981-83	V8 5.7L 350ci	N	w/Cruise Control, Upper; 61.00" Cable	CA-3005
1981-83	V8 5.7L 350ci	N	w/Cruise w/o Adapter Lower; 83.00" Cable	CA-3004
1981-83	V8 5.7L 350ci	N	w/o Cruise w/Adapter Upper; 80.00" Cable	CA-3001
1981-83	V8 5.7L 350ci	N	w/o Cruise w/o Gear Adapter; 100.00" Cable	CA-3003
1981-83	V8 5.7L 350ci	N	w/Cruise w/Adapter Lower; 63.00" Cable	CA-3002
1982-83	V8 5.7L 350ci	N	w/o Cruise w/Adapter Lower; 20.00" Cable	CA-3008
1977	V8 5.7L 350ci	P,R	3 Spd. MT; 80.00" Cable	CA-3001
1977	V8 5.7L 350ci	P,R	AT w/Cruise Control, Lower; 83.00" Cable	CA-3004
1977	V8 5.7L 350ci	P,R	AT w/Cruise Control, Upper; 61.00" Cable	CA-3005
1976	V8 6.6L 400ci	N,Z	AT w/Cruise Control, Lower; 63.00" Cable	CA-3002
1976	V8 6.6L 400ci	N,Z	AT w/Cruise Control, Upper; 41.00" Cable	CA-3009

# SPEEDOMETER CABLES

Year	Engine	Vin	Remark	Part
<b>PONTIAC (con't)</b>				
<b>GRAND PRIX (con't)</b>				
1976	V8 6.6L 400ci	N,Z	AT w/o Cruise Control; 61" Length	CA-3005
1976	V8 6.6L 400ci	N,Z	MT w/o Cruise; 80.00" Cable	CA-3001
1972-75	V8 6.6L 400ci	R,S,T	AT w/Cruise Control, Lower; 63.00" Cable	CA-3002
1972-75	V8 6.6L 400ci	R,S,T	AT w/Cruise Control, Upper; 41.00" Cable	CA-3009
1972-75	V8 6.6L 400ci	R,S,T	AT w/o Cruise Control; 61" Length	CA-3005
1972-75	V8 6.6L 400ci	R,S,T	MT w/o Cruise; 80.00" Cable	CA-3001
1977	V8 6.6L 400ci	Z	3 Spd. MT; 80.00" Cable	CA-3001
1977	V8 6.6L 400ci	Z	AT w/Cruise Control, Lower; 83.00" Cable	CA-3004
1977	V8 6.6L 400ci	Z	AT w/Cruise Control, Upper; 61.00" Cable	CA-3005
1968	V8 6.6L 400ci		Lower; 63.00" Cable	CA-3002
1968	V8 6.6L 400ci		Upper; 83.00" Cable	CA-3004
1969	V8 6.6L 400ci		MT exc. Cruise; 61.00" Cable	CA-3005
1969	V8 6.6L 400ci		w/Cruise Control, Lower; 63.00" Cable	CA-3002
1969	V8 6.6L 400ci		w/Cruise Control, Upper; 41.00" Cable	CA-3009
1970	V8 6.6L 400ci		3 Spd. MT, 4 Spd. MT Lower; 80.00" Cable	CA-3001
1970	V8 6.6L 400ci		AT w/o Cruise, MT 1 pc. Cable, MT 2pc. Cable Upper; 61.00" Cable	CA-3005
1971	V8 6.6L 400ci		AT w/o Cruise Control; 61" Length	CA-3005
1971	V8 6.6L 400ci		MT; 80.00" Cable	CA-3001
1970-71	V8 6.6L 400ci		AT w/Cruise Control, Lower; 63.00" Cable	CA-3002
1970-71	V8 6.6L 400ci		AT w/Cruise Control, Upper; 41.00" Cable	CA-3009
1977	V8 6.6L 403ci	K	3 Spd. MT; 80.00" Cable	CA-3001
1977	V8 6.6L 403ci	K	AT w/Cruise Control, Lower; 83.00" Cable	CA-3004
1977	V8 6.6L 403ci	K	AT w/Cruise Control, Upper; 61.00" Cable	CA-3005
1969	V8 7.0L 428ci		MT exc. Cruise; 61.00" Cable	CA-3005
1969	V8 7.0L 428ci		w/Cruise Control, Lower; 63.00" Cable	CA-3002
1969	V8 7.0L 428ci		w/Cruise Control, Upper; 41.00" Cable	CA-3009
1967-68	V8 7.0L 428ci		Lower; 63.00" Cable	CA-3002
1967-68	V8 7.0L 428ci		Upper; 83.00" Cable	CA-3004
1973-76	V8 7.5L 455ci	W	AT w/Cruise Control, Lower; 63.00" Cable	CA-3002
1973-76	V8 7.5L 455ci	W	AT w/Cruise Control, Upper; 41.00" Cable	CA-3009
1973-76	V8 7.5L 455ci	W	AT w/o Cruise Control; 61" Length	CA-3005
1973-76	V8 7.5L 455ci	W	MT w/o Cruise; 80.00" Cable	CA-3001
1972-74	V8 7.5L 455ci	Y	AT w/Cruise Control, Lower; 63.00" Cable	CA-3002
1972-74	V8 7.5L 455ci	Y	AT w/Cruise Control, Upper; 41.00" Cable	CA-3009
1972-74	V8 7.5L 455ci	Y	AT w/o Cruise Control; 61" Length	CA-3005
1972-74	V8 7.5L 455ci	Y	MT w/o Cruise; 80.00" Cable	CA-3001
1970	V8 7.5L 455ci		3 Spd. MT, 4 Spd. MT Lower; 80.00" Cable	CA-3001
1970	V8 7.5L 455ci		AT w/o Cruise, MT 1 pc. Cable, MT 2pc. Cable Upper; 61.00" Cable	CA-3005
1971	V8 7.5L 455ci		AT w/o Cruise Control; 61" Length	CA-3005
1971	V8 7.5L 455ci		MT; 80.00" Cable	CA-3001
1970-71	V8 7.5L 455ci		AT w/Cruise Control, Lower; 63.00" Cable	CA-3002
1970-71	V8 7.5L 455ci		AT w/Cruise Control, Upper; 41.00" Cable	CA-3009
<b>GRANDVILLE</b>				
1975	V8 6.6L 400ci	R,S	w/Cruise Control, Lower; 83.00" Cable	CA-3004
1975	V8 6.6L 400ci	R,S	w/Cruise Upper, AT w/o Cruise; 61.00" Cable	CA-3005
1973	V8 6.6L 400ci	T	w/Cruise Control, Lower; 83.00" Cable	CA-3004
1971	V8 6.6L 400ci		3 Spd. AT w/o Cruise; 61.00" Cable	CA-3005
1971	V8 6.6L 400ci		3 Spd. MT w/o Cruise; 61.00" Cable	CA-3005
1971	V8 6.6L 400ci		w/Cruise Control, Lower; 63.00" Cable	CA-3002
1971	V8 6.6L 400ci		w/Cruise Control, Upper; 41.00" Cable	CA-3009
1972	V8 7.5L 455ci	W	3 Spd. AT w/o Cruise; 61.00" Cable	CA-3005
1972	V8 7.5L 455ci	W	3 Spd. MT w/o Cruise; 61.00" Cable	CA-3005
1972	V8 7.5L 455ci	W	w/Cruise Control, Lower; 63.00" Cable	CA-3002
1972	V8 7.5L 455ci	W	w/Cruise Control, Upper; 41.00" Cable	CA-3009
1973-75	V8 7.5L 455ci	W,Y	w/Cruise Control, Lower; 83.00" Cable	CA-3004
1973-75	V8 7.5L 455ci	W,Y	w/Cruise Upper, AT w/o Cruise; 61.00" Cable	CA-3005
1971	V8 7.5L 455ci		3 Spd. AT w/o Cruise; 61.00" Cable	CA-3005
1971	V8 7.5L 455ci		3 Spd. MT w/o Cruise; 61.00" Cable	CA-3005
1971	V8 7.5L 455ci		w/Cruise Control, Lower; 63.00" Cable	CA-3002
1971	V8 7.5L 455ci		w/Cruise Control, Upper; 41.00" Cable	CA-3009
<b>GTO</b>				
1964	L6 3.5L 215ci		AT; 83.00" Cable	CA-3004

# SPEEDOMETER CABLES

Year	Engine	Vin	Remark	Part
<b>PONTIAC (con't)</b>				
<b>GTO (con't)</b>				
1964	L6 3.5L 215ci		MT; 63.00" Cable	CA-3002
1964-66	V8 5.3L 326ci		AT; 83.00" Cable	CA-3004
1964-66	V8 5.3L 326ci		MT; 63.00" Cable	CA-3002
1970	V8 5.7L 350ci		3 Spd. MT Floor Shift; 80.00" Cable	CA-3001
1970	V8 5.7L 350ci		4 Spd. MT 1 pc. Cable, 4 Spd. MT 2 pc. Cable Upper; 61.00" Cable	CA-3005
1970	V8 5.7L 350ci		4 Spd. MT 2 pc. Cable Lower; 80.00" Cable	CA-3001
1970	V8 5.7L 350ci		AT w/Cruise Control, Lower; 63.00" Cable	CA-3002
1970	V8 5.7L 350ci		AT w/Cruise Control, Upper; 41.00" Cable	CA-3009
1970	V8 5.7L 350ci		AT w/o Cruise, 3 Spd. MT Column Shift; 61.00" Cable	CA-3005
1964-65	V8 6.4L 389ci		AT; 83.00" Cable	CA-3004
1964-66	V8 6.4L 389ci		MT; 63.00" Cable	CA-3002
1968	V8 6.6L 400ci		w/Cruise Lower, w/o Cruise; 63.00" Cable	CA-3002
1968	V8 6.6L 400ci		w/Cruise Upper	CA-3006
1969	V8 6.6L 400ci		AT w/o Cruise, 4 Spd. MT 1 pc. Cable, 4 Spd. MT 2 pc. Cable Upper; 61.00" Cable	CA-3005
1970	V8 6.6L 400ci		4 Spd. MT 1 pc. Cable, 4 Spd. MT 2 pc. Cable Upper; 61.00" Cable	CA-3005
1971	V8 6.6L 400ci		4 Spd. MT; 80.00" Cable	CA-3001
1969-70	V8 6.6L 400ci		4 Spd. MT 2 pc. Cable Lower; 80.00" Cable	CA-3001
1969-70	V8 6.6L 400ci		AT w/Cruise Control, Lower; 63.00" Cable	CA-3002
1969-71	V8 6.6L 400ci		3 Spd. MT Floor Shift; 80.00" Cable	CA-3001
1969-71	V8 6.6L 400ci		AT w/Cruise Control, Upper; 41.00" Cable	CA-3009
1970-71	V8 6.6L 400ci		AT w/o Cruise, 3 Spd. MT Column Shift; 61.00" Cable	CA-3005
1970	V8 7.5L 455ci		4 Spd. MT 1 pc. Cable, 4 Spd. MT 2 pc. Cable Upper; 61.00" Cable	CA-3005
1970	V8 7.5L 455ci		4 Spd. MT 2 pc. Cable Lower; 80.00" Cable	CA-3001
1970	V8 7.5L 455ci		AT w/Cruise Control, Lower; 63.00" Cable	CA-3002
1971	V8 7.5L 455ci		4 Spd. MT; 80.00" Cable	CA-3001
1970-71	V8 7.5L 455ci		3 Spd. MT Floor Shift; 80.00" Cable	CA-3001
1970-71	V8 7.5L 455ci		AT w/Cruise Control, Upper; 41.00" Cable	CA-3009
1970-71	V8 7.5L 455ci		AT w/o Cruise, 3 Spd. MT Column Shift; 61.00" Cable	CA-3005
<b>J2000</b>				
1982-83	L4 1.8L 112ci	0,G	AT w/o Cruise Control; 61" Length	CA-3005
1982-83	L4 1.8L 112ci	0,G	w/Cruise Lower	CA-3006
1982-83	L4 1.8L 112ci	0,G	w/Cruise Upper, MT w/o Cruise; 41.00" Cable	CA-3009
1984	L4 2.0L 122ci	B	AT w/o Cruise Control; 61" Length	CA-3005
1984	L4 2.0L 122ci	B	MT w/o Cruise; 41.00" Cable	CA-3009
1983	L4 2.0L 122ci	B,P	AT w/o Cruise Control; 61" Length	CA-3005
1983	L4 2.0L 122ci	B,P	w/Cruise Lower	CA-3006
1983	L4 2.0L 122ci	B,P	w/Cruise Upper, MT w/o Cruise; 41.00" Cable	CA-3009
<b>LEMANS</b>				
1988-90	L4 1.6L 98ci	6		CA-3041
1990	L4 2.0L 122ci	K		CA-3041
1964	L6 3.5L 215ci		63.00" Cable	CA-3002
1965	L6 3.5L 215ci		AT; 83.00" Cable	CA-3004
1965	L6 3.5L 215ci		MT; 63.00" Cable	CA-3002
1966	L6 3.8L 230ci		AT; 83.00" Cable	CA-3004
1966	L6 3.8L 230ci		MT; 63.00" Cable	CA-3002
1967	L6 3.8L 230ci		4 Spd. MT; 63.00" Cable	CA-3002
1967	L6 3.8L 230ci		THM AT, Heavy Duty 3 Spd. MT; 83.00" Cable	CA-3004
1972	L6 4.1L 250ci	D	3 Spd. MT Floor Shift; 80.00" Cable	CA-3001
1972	L6 4.1L 250ci	D	4 Spd. MT; 80.00" Cable	CA-3001
1972	L6 4.1L 250ci	D	AT w/Cruise Control, Upper; 41.00" Cable	CA-3009
1972	L6 4.1L 250ci	D	AT w/o Cruise, 3 Spd. MT Column Shift; 61.00" Cable	CA-3005
1975	L6 4.1L 250ci	D	MT w/Cruise Lower; 83.00" Cable	CA-3004
1975	L6 4.1L 250ci	D	w/Cruise Control, Upper; 61.00" Cable	CA-3005
1977	L6 4.1L 250ci	D	AT w/Cruise Control, Lower; 83.00" Cable	CA-3004
1973-74	L6 4.1L 250ci	D	3 Spd. MT w/Cruise Lower; 40.00" Cable	CA-3033
1973-74	L6 4.1L 250ci	D	4 Spd. HD MT w/Cruise Lower; 20.00" Cable	CA-3008
1973-74	L6 4.1L 250ci	D	4 Spd. HD MT w/Cruise Upper; 83.00" Cable	CA-3004
1973-74	L6 4.1L 250ci	D	AT w/Cruise Upper, AT w/o Cruise, 4 Spd. Muncie MT, 3 Spd. MT w/Cruise Upper; 61.00" Cable	CA-3005
1973-75	L6 4.1L 250ci	D	MT w/o Cruise; 80.00" Cable	CA-3001
1973-76	L6 4.1L 250ci	D	AT w/Cruise Control, Lower; 63.00" Cable	CA-3002

# SPEEDOMETER CABLES

Year	Engine	Vin	Remark	Part
<b>PONTIAC (con't)</b>				
<b>LEMANS (CON'T)</b>				
1976-77	L6 4.1L 250ci	D	3 Spd. MT; 80.00" Cable	CA-3001
1976-77	L6 4.1L 250ci	D	AT w/Cruise Upper, AT w/o Cruise; 61.00" Cable	CA-3005
1968	L6 4.1L 250ci		w/Cruise Lower, w/o Cruise; 63.00" Cable	CA-3002
1968	L6 4.1L 250ci		w/Cruise Upper	CA-3006
1969	L6 4.1L 250ci		AT w/o Cruise, 4 Spd. MT 1 pc. Cable, 4 Spd. MT 2 pc. Cable Upper; 61.00" Cable	CA-3005
1970	L6 4.1L 250ci		4 Spd. MT 1 pc. Cable, 4 Spd. MT 2 pc. Cable Upper; 61.00" Cable	CA-3005
1971	L6 4.1L 250ci		4 Spd. MT; 80.00" Cable	CA-3001
1969-70	L6 4.1L 250ci		4 Spd. MT 2 pc. Cable Lower; 80.00" Cable	CA-3001
1969-70	L6 4.1L 250ci		AT w/Cruise Control, Lower; 63.00" Cable	CA-3002
1969-71	L6 4.1L 250ci		3 Spd. MT Floor Shift; 80.00" Cable	CA-3001
1969-71	L6 4.1L 250ci		AT w/Cruise Control, Upper; 41.00" Cable	CA-3009
1970-71	L6 4.1L 250ci		AT w/o Cruise, 3 Spd. MT Column Shift; 61.00" Cable	CA-3005
1978-79	V6 3.3L 200ci	M	AT w/Cruise Control, Upper; 61.00" Cable	CA-3005
1978-79	V6 3.3L 200ci	M	AT w/Cruise Control, w/Adapter, Lower; 63.00" Cable	CA-3002
1978-79	V6 3.3L 200ci	M	w/Cruise w/o Adapter Lower; 83.00" Cable	CA-3004
1978-79	V6 3.3L 200ci	M	w/o Cruise 2 pc. Cable Lower; 20.00" Cable	CA-3008
1978-79	V6 3.3L 200ci	M	w/o Cruise 2 pc. Cable Upper; 80.00" Cable	CA-3001
1978-79	V6 3.3L 200ci	M	w/o Cruise Control; 100.00" Cable	CA-3003
1980-81	V6 3.8L 229ci	K	w/Adapter Lower; 20.00" Cable	CA-3008
1980-81	V6 3.8L 229ci	K	w/Cruise Control, Upper; 61.00" Cable	CA-3005
1980-81	V6 3.8L 229ci	K	w/Cruise w/Adapter Lower; 83.00" Cable	CA-3004
1980-81	V6 3.8L 229ci	K	w/o Cruise w/Adapter Upper; 80.00" Cable	CA-3001
1980-81	V6 3.8L 229ci	K	w/o Cruise w/o Gear Adapter; 100.00" Cable	CA-3003
1978-79	V6 3.8L 231ci	2,A	AT w/Cruise Control, Upper; 61.00" Cable	CA-3005
1978-79	V6 3.8L 231ci	2,A	AT w/Cruise Control, w/Adapter, Lower; 63.00" Cable	CA-3002
1978-79	V6 3.8L 231ci	2,A	w/Cruise w/o Adapter Lower; 83.00" Cable	CA-3004
1978-79	V6 3.8L 231ci	2,A	w/o Cruise 2 pc. Cable Lower; 20.00" Cable	CA-3008
1978-79	V6 3.8L 231ci	2,A	w/o Cruise 2 pc. Cable Upper; 80.00" Cable	CA-3001
1978-79	V6 3.8L 231ci	2,A	w/o Cruise Control; 100.00" Cable	CA-3003
1980-81	V6 3.8L 231ci	A	w/Adapter Lower; 20.00" Cable	CA-3008
1980-81	V6 3.8L 231ci	A	w/Cruise Control, Upper; 61.00" Cable	CA-3005
1980-81	V6 3.8L 231ci	A	w/Cruise w/Adapter Lower; 83.00" Cable	CA-3004
1980-81	V6 3.8L 231ci	A	w/o Cruise w/Adapter Upper; 80.00" Cable	CA-3001
1980-81	V6 3.8L 231ci	A	w/o Cruise w/o Gear Adapter; 100.00" Cable	CA-3003
1977	V6 3.8L 231ci	C	3 Spd. MT; 80.00" Cable	CA-3001
1977	V6 3.8L 231ci	C	AT w/Cruise Control, Lower; 83.00" Cable	CA-3004
1977	V6 3.8L 231ci	C	AT w/Cruise Upper, AT w/o Cruise; 61.00" Cable	CA-3005
1976	V8 4.3L 260ci	F	3 Spd. MT; 80.00" Cable	CA-3001
1976	V8 4.3L 260ci	F	AT w/Cruise Control, Lower; 83.00" Cable	CA-3004
1976	V8 4.3L 260ci	F	AT w/Cruise Upper, AT w/o Cruise; 61.00" Cable	CA-3005
1980-81	V8 4.3L 265ci	S	w/Adapter Lower; 20.00" Cable	CA-3008
1980-81	V8 4.3L 265ci	S	w/Cruise Control, Upper; 61.00" Cable	CA-3005
1980-81	V8 4.3L 265ci	S	w/Cruise w/Adapter Lower; 83.00" Cable	CA-3004
1980-81	V8 4.3L 265ci	S	w/o Cruise w/Adapter Upper; 80.00" Cable	CA-3001
1980-81	V8 4.3L 265ci	S	w/o Cruise w/o Gear Adapter; 100.00" Cable	CA-3003
1979	V8 4.4L 267ci	J	AT w/Cruise Control, Upper; 61.00" Cable	CA-3005
1979	V8 4.4L 267ci	J	AT w/Cruise Control, w/Adapter, Lower; 63.00" Cable	CA-3002
1979	V8 4.4L 267ci	J	w/Cruise w/o Adapter Lower; 83.00" Cable	CA-3004
1979	V8 4.4L 267ci	J	w/o Cruise 2 pc. Cable Lower; 20.00" Cable	CA-3008
1979	V8 4.4L 267ci	J	w/o Cruise 2 pc. Cable Upper; 80.00" Cable	CA-3001
1979	V8 4.4L 267ci	J	w/o Cruise Control; 100.00" Cable	CA-3003
1980-81	V8 4.4L 267ci	J	w/Adapter Lower; 20.00" Cable	CA-3008
1980-81	V8 4.4L 267ci	J	w/Cruise Control, Upper; 61.00" Cable	CA-3005
1980-81	V8 4.4L 267ci	J	w/Cruise w/Adapter Lower; 83.00" Cable	CA-3004
1980-81	V8 4.4L 267ci	J	w/o Cruise w/Adapter Upper; 80.00" Cable	CA-3001
1980-81	V8 4.4L 267ci	J	w/o Cruise w/o Gear Adapter; 100.00" Cable	CA-3003
1980	V8 4.9L 301ci	W	w/Adapter Lower; 20.00" Cable	CA-3008
1980	V8 4.9L 301ci	W	w/Cruise Control, Upper; 61.00" Cable	CA-3005
1980	V8 4.9L 301ci	W	w/Cruise w/Adapter Lower; 83.00" Cable	CA-3004
1980	V8 4.9L 301ci	W	w/o Cruise w/Adapter Upper; 80.00" Cable	CA-3001
1980	V8 4.9L 301ci	W	w/o Cruise w/o Gear Adapter; 100.00" Cable	CA-3003



# SPEEDOMETER CABLES

Year	Engine	Vin	Remark	Part
<b>PONTIAC (con't)</b>				
<b>LEMANS (CON'T)</b>				
1979	V8 4.9L 301ci	W,Y	AT w/Cruise Control, Upper; 61.00" Cable	CA-3005
1979	V8 4.9L 301ci	W,Y	AT w/Cruise Control, w/Adapter, Lower; 63.00" Cable	CA-3002
1979	V8 4.9L 301ci	W,Y	w/Cruise w/o Adapter Lower; 83.00" Cable	CA-3004
1979	V8 4.9L 301ci	W,Y	w/o Cruise 2 pc. Cable Lower; 20.00" Cable	CA-3008
1979	V8 4.9L 301ci	W,Y	w/o Cruise 2 pc. Cable Upper; 80.00" Cable	CA-3001
1979	V8 4.9L 301ci	W,Y	w/o Cruise Control; 100.00" Cable	CA-3003
1977	V8 4.9L 301ci	Y	3 Spd. MT; 80.00" Cable	CA-3001
1977	V8 4.9L 301ci	Y	AT w/Cruise Control, Lower; 83.00" Cable	CA-3004
1977	V8 4.9L 301ci	Y	AT w/Cruise Upper, AT w/o Cruise; 61.00" Cable	CA-3005
1979	V8 5.0L 305ci	H	AT w/Cruise Control, Upper; 61.00" Cable	CA-3005
1979	V8 5.0L 305ci	H	AT w/Cruise Control, w/Adapter, Lower; 63.00" Cable	CA-3002
1979	V8 5.0L 305ci	H	w/Cruise w/o Adapter Lower; 83.00" Cable	CA-3004
1979	V8 5.0L 305ci	H	w/o Cruise 2 pc. Cable Lower; 20.00" Cable	CA-3008
1979	V8 5.0L 305ci	H	w/o Cruise 2 pc. Cable Upper; 80.00" Cable	CA-3001
1979	V8 5.0L 305ci	H	w/o Cruise Control; 100.00" Cable	CA-3003
1980-81	V8 5.0L 305ci	H	w/Adapter Lower; 20.00" Cable	CA-3008
1980-81	V8 5.0L 305ci	H	w/Cruise Control, Upper; 61.00" Cable	CA-3005
1980-81	V8 5.0L 305ci	H	w/Cruise w/Adapter Lower; 83.00" Cable	CA-3004
1980-81	V8 5.0L 305ci	H	w/o Cruise w/Adapter Upper; 80.00" Cable	CA-3001
1980-81	V8 5.0L 305ci	H	w/o Cruise w/o Gear Adapter; 100.00" Cable	CA-3003
1976	V8 5.0L 305ci	Q	3 Spd. MT; 80.00" Cable	CA-3001
1976	V8 5.0L 305ci	Q	AT w/Cruise Control, Lower; 63.00" Cable	CA-3002
1976	V8 5.0L 305ci	Q	AT w/Cruise Upper, AT w/o Cruise; 61.00" Cable	CA-3005
1977	V8 5.0L 305ci	U	AT w/Cruise Control, Lower; 83.00" Cable	CA-3004
1977	V8 5.0L 305ci	U	AT w/Cruise Upper, 3 Spd. MT; 80.00" Cable	CA-3001
1977	V8 5.0L 305ci	U	w/o Cruise Control; 61.00" Cable	CA-3005
1978	V8 5.0L 305ci	U	AT w/Cruise Control, Upper; 61.00" Cable	CA-3005
1978	V8 5.0L 305ci	U	AT w/Cruise Control, w/Adapter, Lower; 63.00" Cable	CA-3002
1978	V8 5.0L 305ci	U	w/Cruise w/o Adapter Lower; 83.00" Cable	CA-3004
1978	V8 5.0L 305ci	U	w/o Cruise 2 pc. Cable Lower; 20.00" Cable	CA-3008
1978	V8 5.0L 305ci	U	w/o Cruise 2 pc. Cable Upper; 80.00" Cable	CA-3001
1978	V8 5.0L 305ci	U	w/o Cruise Control; 100.00" Cable	CA-3003
1964	V8 5.3L 326ci		63.00" Cable	CA-3002
1967	V8 5.3L 326ci		4 Spd. MT; 63.00" Cable	CA-3002
1967	V8 5.3L 326ci		THM AT, Heavy Duty 3 Spd. MT; 83.00" Cable	CA-3004
1965-66	V8 5.3L 326ci		AT; 83.00" Cable	CA-3004
1965-66	V8 5.3L 326ci		MT; 63.00" Cable	CA-3002
1973-75	V8 5.7L 350ci	A,B,E,H,M,N	MT w/o Cruise; 80.00" Cable	CA-3001
1973-74	V8 5.7L 350ci	A,B,M,N	3 Spd. MT w/Cruise Lower; 40.00" Cable	CA-3033
1973-74	V8 5.7L 350ci	A,B,M,N	4 Spd. HD MT w/Cruise Lower; 20.00" Cable	CA-3008
1973-74	V8 5.7L 350ci	A,B,M,N	4 Spd. HD MT w/Cruise Upper; 83.00" Cable	CA-3004
1973-74	V8 5.7L 350ci	A,B,M,N	AT w/Cruise Upper, AT w/o Cruise, 4 Spd. Muncie MT, 3 Spd. MT w/Cruise Upper; 61.00" Cable	CA-3005
1974	V8 5.7L 350ci	A,B,N	AT w/Cruise Control, Lower; 63.00" Cable	CA-3002
1975	V8 5.7L 350ci	E,H	AT w/Cruise Control, Lower; 63.00" Cable	CA-3002
1975	V8 5.7L 350ci	E,H,M	MT w/Cruise Lower; 83.00" Cable	CA-3004
1975	V8 5.7L 350ci	E,H,M	w/Cruise Control, Upper; 61.00" Cable	CA-3005
1976	V8 5.7L 350ci	L,M,P,R	3 Spd. MT; 80.00" Cable	CA-3001
1976-77	V8 5.7L 350ci	L,M,P,R	AT w/Cruise Upper, AT w/o Cruise; 61.00" Cable	CA-3005
1976	V8 5.7L 350ci	L,P	AT w/Cruise Control, Lower; 63.00" Cable	CA-3002
1977	V8 5.7L 350ci	L,P,R	AT w/Cruise Control, Lower; 83.00" Cable	CA-3004
1972	V8 5.7L 350ci	M	3 Spd. MT Floor Shift; 80.00" Cable	CA-3001
1972	V8 5.7L 350ci	M	4 Spd. MT; 80.00" Cable	CA-3001
1972	V8 5.7L 350ci	M	AT w/Cruise Control, Upper; 41.00" Cable	CA-3009
1972	V8 5.7L 350ci	M	AT w/o Cruise, 3 Spd. MT Column Shift; 61.00" Cable	CA-3005
1973-76	V8 5.7L 350ci	M	AT w/Cruise Control, Lower; 63.00" Cable	CA-3002
1968	V8 5.7L 350ci		w/Cruise Lower, w/o Cruise; 63.00" Cable	CA-3002
1968	V8 5.7L 350ci		w/Cruise Upper	CA-3006
1969	V8 5.7L 350ci		AT w/o Cruise, 4 Spd. MT 1 pc. Cable, 4 Spd. MT 2 pc. Cable Upper; 61.00" Cable	CA-3005
1970	V8 5.7L 350ci		4 Spd. MT 1 pc. Cable, 4 Spd. MT 2 pc. Cable Upper; 61.00" Cable	CA-3005
1971	V8 5.7L 350ci		4 Spd. MT; 80.00" Cable	CA-3001

# SPEEDOMETER CABLES

Year	Engine	Vin	Remark	Part
<b>PONTIAC (con't)</b>				
<b>LEMANS (CON'T)</b>				
1969-70	V8 5.7L 350ci		4 Spd. MT 2 pc.Cable Lower; 80.00" Cable	CA-3001
1969-70	V8 5.7L 350ci		AT w/Cruise Control, Lower; 63.00" Cable	CA-3002
1969-71	V8 5.7L 350ci		3 Spd. MT Floor Shift; 80.00" Cable	CA-3001
1969-71	V8 5.7L 350ci		AT w/Cruise Control, Upper; 41.00" Cable	CA-3009
1970-71	V8 5.7L 350ci		AT w/o Cruise, 3 Spd. MT Column Shift; 61.00" Cable	CA-3005
1964	V8 6.4L 389ci		63.00" Cable	CA-3002
1965	V8 6.4L 389ci		AT; 83.00" Cable	CA-3004
1965	V8 6.4L 389ci		MT; 63.00" Cable	CA-3002
1976	V8 6.6L 400ci	N,Z	AT w/Cruise Control, Lower; 63.00" Cable	CA-3002
1976-77	V8 6.6L 400ci	N,Z	3 Spd. MT; 80.00" Cable	CA-3001
1976-77	V8 6.6L 400ci	N,Z	AT w/Cruise Upper, AT w/o Cruise; 61.00" Cable	CA-3005
1973-74	V8 6.6L 400ci	P,R,S,T	3 Spd. MT w/Cruise Lower; 40.00" Cable	CA-3033
1973-74	V8 6.6L 400ci	P,R,S,T	4 Spd. HD MT w/Cruise Lower; 20.00" Cable	CA-3008
1973-74	V8 6.6L 400ci	P,R,S,T	AT w/Cruise Upper, AT w/o Cruise, 4 Spd. Muncie MT, 3 Spd. MT w/Cruise Upper; 61.00" Cable	CA-3005
1972	V8 6.6L 400ci	P,S	3 Spd. MT Floor Shift; 80.00" Cable	CA-3001
1972	V8 6.6L 400ci	P,S	4 Spd. MT; 80.00" Cable	CA-3001
1972	V8 6.6L 400ci	P,S	AT w/Cruise Control, Upper; 41.00" Cable	CA-3009
1972	V8 6.6L 400ci	P,S	AT w/o Cruise, 3 Spd. MT Column Shift; 61.00" Cable	CA-3005
1973-74	V8 6.6L 400ci	P,T	4 Spd. HD MT w/Cruise Upper; 83.00" Cable	CA-3004
1973-74	V8 6.6L 400ci	P,T	AT w/Cruise Control, Lower; 63.00" Cable	CA-3002
1973-74	V8 6.6L 400ci	P,T	MT w/o Cruise; 80.00" Cable	CA-3001
1974	V8 6.6L 400ci	R,S	4 Spd. HD MT w/Cruise Upper; 83.00" Cable	CA-3004
1974-75	V8 6.6L 400ci	R,S	AT w/Cruise Control, Lower; 63.00" Cable	CA-3002
1974-75	V8 6.6L 400ci	R,S	MT w/o Cruise; 80.00" Cable	CA-3001
1975	V8 6.6L 400ci	S	MT w/Cruise Lower; 83.00" Cable	CA-3004
1975	V8 6.6L 400ci	S	w/Cruise Control, Upper; 61.00" Cable	CA-3005
1977	V8 6.6L 400ci	Z	AT w/Cruise Control, Lower; 83.00" Cable	CA-3004
1968	V8 6.6L 400ci		w/Cruise Lower, w/o Cruise; 63.00" Cable	CA-3002
1968	V8 6.6L 400ci		w/Cruise Upper	CA-3006
1969	V8 6.6L 400ci		AT w/o Cruise, 4 Spd. MT 1 pc. Cable, 4 Spd. MT 2 pc. Cable Upper; 61.00" Cable	CA-3005
1970	V8 6.6L 400ci		4 Spd. MT 1 pc. Cable, 4 Spd. MT 2 pc. Cable Upper; 61.00" Cable	CA-3005
1971	V8 6.6L 400ci		4 Spd. MT; 80.00" Cable	CA-3001
1969-70	V8 6.6L 400ci		4 Spd. MT 2 pc.Cable Lower; 80.00" Cable	CA-3001
1969-70	V8 6.6L 400ci		AT w/Cruise Control, Lower; 63.00" Cable	CA-3002
1969-71	V8 6.6L 400ci		3 Spd. MT Floor Shift; 80.00" Cable	CA-3001
1969-71	V8 6.6L 400ci		AT w/Cruise Control, Upper; 41.00" Cable	CA-3009
1970-71	V8 6.6L 400ci		AT w/o Cruise, 3 Spd. MT Column Shift; 61.00" Cable	CA-3005
1977	V8 6.6L 403ci	K	3 Spd. MT; 80.00" Cable	CA-3001
1977	V8 6.6L 403ci	K	AT w/Cruise Control, Lower; 83.00" Cable	CA-3004
1977	V8 6.6L 403ci	K	AT w/Cruise Upper, AT w/o Cruise; 61.00" Cable	CA-3005
1968	V8 7.0L 428ci		w/Cruise Lower, w/o Cruise; 63.00" Cable	CA-3002
1968	V8 7.0L 428ci		w/Cruise Upper	CA-3006
1969	V8 7.0L 428ci		3 Spd. MT Floor Shift; 80.00" Cable	CA-3001
1969	V8 7.0L 428ci		4 Spd. MT 2 pc.Cable Lower; 80.00" Cable	CA-3001
1969	V8 7.0L 428ci		AT w/Cruise Control, Lower; 63.00" Cable	CA-3002
1969	V8 7.0L 428ci		AT w/Cruise Control, Upper; 41.00" Cable	CA-3009
1969	V8 7.0L 428ci		AT w/o Cruise, 4 Spd. MT 1 pc. Cable, 4 Spd. MT 2 pc. Cable Upper; 61.00" Cable	CA-3005
1973	V8 7.5L 455ci	W	3 Spd. MT w/Cruise Lower; 40.00" Cable	CA-3033
1973	V8 7.5L 455ci	W	4 Spd. HD MT w/Cruise Lower; 20.00" Cable	CA-3008
1973	V8 7.5L 455ci	W	4 Spd. HD MT w/Cruise Upper; 83.00" Cable	CA-3004
1973	V8 7.5L 455ci	W	AT w/Cruise Upper, AT w/o Cruise, 4 Spd. Muncie MT, 3 Spd. MT w/Cruise Upper; 61.00" Cable	CA-3005
1973	V8 7.5L 455ci	W	MT w/o Cruise; 80.00" Cable	CA-3001
1976	V8 7.5L 455ci	W	3 Spd. MT; 80.00" Cable	CA-3001
1976	V8 7.5L 455ci	W	AT w/Cruise Upper, AT w/o Cruise; 61.00" Cable	CA-3005
1972	V8 7.5L 455ci	W,X	3 Spd. MT Floor Shift; 80.00" Cable	CA-3001
1972	V8 7.5L 455ci	W,X	4 Spd. MT; 80.00" Cable	CA-3001
1972	V8 7.5L 455ci	W,X	AT w/Cruise Control, Upper; 41.00" Cable	CA-3009
1972	V8 7.5L 455ci	W,X	AT w/o Cruise, 3 Spd. MT Column Shift; 61.00" Cable	CA-3005

# SPEEDOMETER CABLES

Year	Engine	Vin	Remark	Part
<b>PONTIAC (con't)</b>				
<b>LEMANS (CON'T)</b>				
1973-76	V8 7.5L 455ci	W,Y	AT w/Cruise Control, Lower; 63.00" Cable	CA-3002
1974	V8 7.5L 455ci	Y	3 Spd. MT w/Cruise Lower; 40.00" Cable	CA-3033
1974	V8 7.5L 455ci	Y	4 Spd. HD MT w/Cruise Lower; 20.00" Cable	CA-3008
1974	V8 7.5L 455ci	Y	4 Spd. HD MT w/Cruise Upper; 83.00" Cable	CA-3004
1974	V8 7.5L 455ci	Y	AT w/Cruise Upper, AT w/o Cruise, 4 Spd. Muncie MT, 3 Spd. MT w/Cruise Upper; 61.00" Cable	CA-3005
1974	V8 7.5L 455ci	Y	MT w/o Cruise; 80.00" Cable	CA-3001
1970	V8 7.5L 455ci		3 Spd. MT Floor Shift; 80.00" Cable	CA-3001
1970	V8 7.5L 455ci		4 Spd. MT 1 pc. Cable, 4 Spd. MT 2 pc. Cable Upper; 61.00" Cable	CA-3005
1970	V8 7.5L 455ci		4 Spd. MT 2 pc. Cable Lower; 80.00" Cable	CA-3001
1970	V8 7.5L 455ci		AT w/Cruise Control, Lower; 63.00" Cable	CA-3002
1970	V8 7.5L 455ci		AT w/Cruise Control, Upper; 41.00" Cable	CA-3009
1970	V8 7.5L 455ci		AT w/o Cruise, 3 Spd. MT Column Shift; 61.00" Cable	CA-3005
<b>PARISIENNE</b>				
1977	L6 4.1L 250ci	D	w/o Cruise Control; 61.00" Cable	CA-3005
1977-79	L6 4.1L 250ci	D	AT w/Cruise Control, Lower; 63.00" Cable	CA-3002
1977-79	L6 4.1L 250ci	D	AT w/Cruise Control, Upper; 41.00" Cable	CA-3009
1977-79	L6 4.1L 250ci	D	w/o Cruise Control; 80.00" Cable	CA-3001
1980	V6 3.8L 229ci	K	AT w/Cruise Control, Lower; 63.00" Cable	CA-3002
1980	V6 3.8L 229ci	K	AT w/Cruise Control, Upper; 41.00" Cable	CA-3009
1980	V6 3.8L 229ci	K	w/o Cruise Control; 80.00" Cable	CA-3001
1981	V6 3.8L 231ci	A	AT w/Cruise Control, Lower; 63.00" Cable	CA-3002
1981	V6 3.8L 231ci	A	AT w/Cruise Control, Upper; 41.00" Cable	CA-3009
1981	V6 3.8L 231ci	A	w/o Cruise Control; 80.00" Cable	CA-3001
1983	V6 3.8L 231ci	A	exc. Cruise Control; 80.00" Cable	CA-3001
1983	V6 3.8L 231ci	A	w/Cruise Control, Lower; 83.00" Cable	CA-3004
1983	V6 3.8L 231ci	A	w/Cruise Control, Upper; 61.00" Cable	CA-3005
1984	V6 3.8L 231ci	A	AT; 80.00" Cable	CA-3001
1985	V6 3.8L 231ci	A	AT; 41.00" Cable	CA-3009
1985-86	V6 4.3L 262ci	Z	AT; 41.00" Cable	CA-3009
1981	V8 4.3L 265ci	S	AT w/Cruise Control, Lower; 63.00" Cable	CA-3002
1981	V8 4.3L 265ci	S	AT w/Cruise Control, Upper; 41.00" Cable	CA-3009
1981	V8 4.3L 265ci	S	w/o Cruise Control; 80.00" Cable	CA-3001
1980-81	V8 4.4L 267ci	J	AT w/Cruise Control, Lower; 63.00" Cable	CA-3002
1980-81	V8 4.4L 267ci	J	AT w/Cruise Control, Upper; 41.00" Cable	CA-3009
1980-81	V8 4.4L 267ci	J	w/o Cruise Control; 80.00" Cable	CA-3001
1979	V8 5.0L 305ci	G	AT w/Cruise Control, Lower; 63.00" Cable	CA-3002
1979	V8 5.0L 305ci	G	AT w/Cruise Control, Upper; 41.00" Cable	CA-3009
1979	V8 5.0L 305ci	G	w/o Cruise Control; 80.00" Cable	CA-3001
1983	V8 5.0L 305ci	H	exc. Cruise Control; 80.00" Cable	CA-3001
1983	V8 5.0L 305ci	H	w/Cruise Control, Lower; 83.00" Cable	CA-3004
1983	V8 5.0L 305ci	H	w/Cruise Control, Upper; 61.00" Cable	CA-3005
1984	V8 5.0L 305ci	H	AT; 80.00" Cable	CA-3001
1980-81	V8 5.0L 305ci	H	AT w/Cruise Control, Lower; 63.00" Cable	CA-3002
1980-81	V8 5.0L 305ci	H	AT w/Cruise Control, Upper; 41.00" Cable	CA-3009
1980-81	V8 5.0L 305ci	H	w/o Cruise Control; 80.00" Cable	CA-3001
1985-86	V8 5.0L 305ci	H	AT; 41.00" Cable	CA-3009
1977	V8 5.0L 305ci	U	w/o Cruise Control; 61.00" Cable	CA-3005
1977-78	V8 5.0L 305ci	U	w/o Cruise Control; 80.00" Cable	CA-3001
1977-78	V8 5.0L 305ci	U	AT w/Cruise Control, Lower; 63.00" Cable	CA-3002
1977-78	V8 5.0L 305ci	U	AT w/Cruise Control, Upper; 41.00" Cable	CA-3009
1981	V8 5.0L 307ci	Y	AT w/Cruise Control, Lower; 63.00" Cable	CA-3002
1981	V8 5.0L 307ci	Y	AT w/Cruise Control, Upper; 41.00" Cable	CA-3009
1981	V8 5.0L 307ci	Y	w/o Cruise Control; 80.00" Cable	CA-3001
1986	V8 5.0L 307ci	Y	AT; 41.00" Cable	CA-3009
1985	V8 5.7L 350ci	6,N	AT; 41.00" Cable	CA-3009
1978-79	V8 5.7L 350ci	L	AT w/Cruise Control, Lower; 63.00" Cable	CA-3002
1978-79	V8 5.7L 350ci	L	AT w/Cruise Control, Upper; 41.00" Cable	CA-3009
1978-79	V8 5.7L 350ci	L	w/o Cruise Control; 80.00" Cable	CA-3001
1976	V8 5.7L 350ci	L,V	AT w/Cruise Control, Lower; 41.00" Cable	CA-3009
1976	V8 5.7L 350ci	L,V	AT w/Cruise Control, Upper; 80.00" Cable	CA-3001
1976	V8 5.7L 350ci	L,V	w/o Cruise Control; 61.00" Cable	CA-3005

# SPEEDOMETER CABLES

Year	Engine	Vin	Remark	Part
<b>PONTIAC (con't)</b>				
<b>PARISIENNE (con't)</b>				
1983	V8 5.7L 350ci	N	exc. Cruise Control; 80.00" Cable	CA-3001
1983	V8 5.7L 350ci	N	w/Cruise Control, Lower; 83.00" Cable	CA-3004
1983	V8 5.7L 350ci	N	w/Cruise Control, Upper; 61.00" Cable	CA-3005
1984	V8 5.7L 350ci	N	AT; 80.00" Cable	CA-3001
1980-81	V8 5.7L 350ci	N,X	AT w/Cruise Control, Lower; 63.00" Cable	CA-3002
1980-81	V8 5.7L 350ci	N,X	AT w/Cruise Control, Upper; 41.00" Cable	CA-3009
1980-81	V8 5.7L 350ci	N,X	w/o Cruise Control; 80.00" Cable	CA-3001
1977	V8 5.7L 350ci	P	AT w/Cruise Control, Lower; 63.00" Cable	CA-3002
1977	V8 5.7L 350ci	P	AT w/Cruise Control, Upper; 41.00" Cable	CA-3009
1977	V8 5.7L 350ci	P	w/o Cruise Control; 61.00" Cable	CA-3005
1977	V8 5.7L 350ci	P	w/o Cruise Control; 80.00" Cable	CA-3001
1976	V8 6.6L 400ci	N,S	AT w/Cruise Control, Lower; 41.00" Cable	CA-3009
1976	V8 6.6L 400ci	N,S	AT w/Cruise Control, Upper; 80.00" Cable	CA-3001
1976	V8 6.6L 400ci	N,S	w/o Cruise Control; 61.00" Cable	CA-3005
1976	V8 7.5L 455ci	W	AT w/Cruise Control, Lower; 41.00" Cable	CA-3009
1976	V8 7.5L 455ci	W	AT w/Cruise Control, Upper; 80.00" Cable	CA-3001
1976	V8 7.5L 455ci	W	w/o Cruise Control; 61.00" Cable	CA-3005
<b>PHOENIX</b>				
1980-81	L4 2.5L 151ci	5	AT Upper, 4 Spd. MT; 41.00" Cable	CA-3009
1980-81	L4 2.5L 151ci	5	AT w/Cruise Control, Lower	CA-3006
1980-81	L4 2.5L 151ci	5	AT w/o Cruise Lower; 40.00" Cable	CA-3033
1982-83	L4 2.5L 151ci	5,R	AT w/Cruise Control, Lower; 83.00" Cable	CA-3004
1982-83	L4 2.5L 151ci	5,R	AT w/Cruise Upper, 4 Spd. MT Upper, MT w/o Cruise; 41.00" Cable	CA-3009
1982-83	L4 2.5L 151ci	5,R	MT w/Cruise Lower	CA-3006
1982-84	L4 2.5L 151ci	5,R	AT w/o Cruise Control; 80" Length	CA-3001
1984	L4 2.5L 151ci	R	MT w/o Cruise; 41.00" Cable	CA-3009
1977	L4 2.5L 151ci	V	AT w/Cruise Control, Lower; 83.00" Cable	CA-3004
1977	L4 2.5L 151ci	V	AT w/Cruise Control, Upper; 41.00" Cable	CA-3009
1977	L4 2.5L 151ci	V	AT w/o Cruise, MT w/Column Shift; 80.00" Cable	CA-3001
1977	L4 2.5L 151ci	V	MT Upper; 61.00" Cable	CA-3005
1977	L4 2.5L 151ci	V	w/Floor Shift, w/3 Spd. Trans., Lower; 40.00" Cable	CA-3033
1978	L4 2.5L 151ci	V	w/Cruise Control, Lower; 83.00" Cable	CA-3004
1978	L4 2.5L 151ci	V	w/Cruise Control, Upper; 61.00" Cable	CA-3005
1978	L4 2.5L 151ci	V	w/o Cruise Control; 80.00" Cable	CA-3001
1980	V6 2.8L 173ci	7	AT Upper, 4 Spd. MT; 41.00" Cable	CA-3009
1980	V6 2.8L 173ci	7	AT w/Cruise Control, Lower	CA-3006
1980	V6 2.8L 173ci	7	AT w/o Cruise Lower; 40.00" Cable	CA-3033
1981	V6 2.8L 173ci	X	AT Upper, 4 Spd. MT; 41.00" Cable	CA-3009
1981	V6 2.8L 173ci	X	AT w/Cruise Control, Lower	CA-3006
1981	V6 2.8L 173ci	X	AT w/o Cruise Lower; 40.00" Cable	CA-3033
1982-83	V6 2.8L 173ci	X	AT w/Cruise Control, Lower; 83.00" Cable	CA-3004
1982-83	V6 2.8L 173ci	X	AT w/Cruise Upper, 4 Spd. MT Upper, MT w/o Cruise; 41.00" Cable	CA-3009
1982-83	V6 2.8L 173ci	X	MT w/Cruise Lower	CA-3006
1984	V6 2.8L 173ci	X,Z	MT w/o Cruise; 41.00" Cable	CA-3009
1982-84	V6 2.8L 173ci	X,Z	AT w/o Cruise Control; 80" Length	CA-3001
1978	V6 3.8L 231ci	A	w/Cruise Control, Lower; 83.00" Cable	CA-3004
1978	V6 3.8L 231ci	A	w/Cruise Control, Upper; 61.00" Cable	CA-3005
1978	V6 3.8L 231ci	A	w/o Cruise Control; 80.00" Cable	CA-3001
1979	V6 3.8L 231ci	A	3 Spd. AT; 80.00" Cable	CA-3001
1979	V6 3.8L 231ci	A	3 Spd. MT w/o Cruise; 80.00" Cable	CA-3001
1979	V6 3.8L 231ci	A	4 Spd. MT Lower; 40.00" Cable	CA-3033
1979	V6 3.8L 231ci	A	AT w/Cruise Control, Lower; 63.00" Cable	CA-3002
1979	V6 3.8L 231ci	A	AT w/Cruise Upper, 4 Spd. MT Upper; 61.00" Cable	CA-3005
1977	V6 3.8L 231ci	C	AT w/Cruise Control, Lower; 83.00" Cable	CA-3004
1977	V6 3.8L 231ci	C	AT w/Cruise Control, Upper; 41.00" Cable	CA-3009
1977	V6 3.8L 231ci	C	AT w/o Cruise, MT w/Column Shift; 80.00" Cable	CA-3001
1977	V6 3.8L 231ci	C	MT Upper; 61.00" Cable	CA-3005
1977	V6 3.8L 231ci	C	w/Floor Shift, w/3 Spd. Trans., Lower; 40.00" Cable	CA-3033
1979	V8 5.0L 305ci	G	3 Spd. AT; 80.00" Cable	CA-3001
1979	V8 5.0L 305ci	G	3 Spd. MT w/o Cruise; 80.00" Cable	CA-3001
1979	V8 5.0L 305ci	G	4 Spd. MT Lower; 40.00" Cable	CA-3033
1979	V8 5.0L 305ci	G	AT w/Cruise Control, Lower; 83.00" Cable	CA-3004

# SPEEDOMETER CABLES

Year	Engine	Vin	Remark	Part
<b>PONTIAC (con't)</b>				
<b>PHOENIX (con't)</b>				
1979	V8 5.0L 305ci	G	AT w/Cruise Upper, 4 Spd. MT Upper; 61.00" Cable	CA-3005
1977	V8 5.0L 305ci	U	AT w/Cruise Control, Lower; 83.00" Cable	CA-3004
1977	V8 5.0L 305ci	U	AT w/Cruise Control, Upper; 41.00" Cable	CA-3009
1977	V8 5.0L 305ci	U	AT w/o Cruise, MT w/Column Shift; 80.00" Cable	CA-3001
1977	V8 5.0L 305ci	U	MT Upper; 61.00" Cable	CA-3005
1977	V8 5.0L 305ci	U	w/Floor Shift, w/3 Spd. Trans., Lower; 40.00" Cable	CA-3033
1978	V8 5.0L 305ci	U	w/Cruise Control, Lower; 83.00" Cable	CA-3004
1978	V8 5.0L 305ci	U	w/Cruise Control, Upper; 61.00" Cable	CA-3005
1978	V8 5.0L 305ci	U	w/o Cruise Control; 80.00" Cable	CA-3001
1978	V8 5.7L 350ci	L	w/Cruise Control, Lower; 83.00" Cable	CA-3004
1978	V8 5.7L 350ci	L	w/Cruise Control, Upper; 61.00" Cable	CA-3005
1978	V8 5.7L 350ci	L	w/o Cruise Control; 80.00" Cable	CA-3001
1979	V8 5.7L 350ci	L	3 Spd. AT; 80.00" Cable	CA-3001
1979	V8 5.7L 350ci	L	3 Spd. MT w/o Cruise; 80.00" Cable	CA-3001
1979	V8 5.7L 350ci	L	4 Spd. MT Lower; 40.00" Cable	CA-3033
1979	V8 5.7L 350ci	L	AT w/Cruise Upper, 4 Spd. MT Upper; 61.00" Cable	CA-3005
1977	V8 5.7L 350ci	L,R	AT w/Cruise Control, Upper; 41.00" Cable	CA-3009
1977	V8 5.7L 350ci	L,R	AT w/o Cruise, MT w/Column Shift; 80.00" Cable	CA-3001
1977	V8 5.7L 350ci	L,R	MT Upper; 61.00" Cable	CA-3005
1977	V8 5.7L 350ci	L,R	w/Floor Shift, w/3 Spd. Trans., Lower; 40.00" Cable	CA-3033
1977-79	V8 5.7L 350ci	L,R	AT w/Cruise Control, Lower; 83.00" Cable	CA-3004
<b>SAFARI</b>				
1968	L6 4.1L 250ci		w/Cruise Control	CA-3006
1968	L6 4.1L 250ci		w/o Cruise Control; 63.00" Cable	CA-3002
1970	L6 4.1L 250ci		3 Spd. AT w/o Cruise; 61.00" Cable	CA-3005
1970	L6 4.1L 250ci		3 Spd. MT w/o Cruise; 61.00" Cable	CA-3005
1970	L6 4.1L 250ci		w/Cruise Control, Lower; 63.00" Cable	CA-3002
1970	L6 4.1L 250ci		w/Cruise Control, Upper; 41.00" Cable	CA-3009
1988-89	V8 5.0L 307ci	Y	AT; 41.00" Cable	CA-3009
1968	V8 5.7L 350ci		w/Cruise Control	CA-3006
1968	V8 5.7L 350ci		w/o Cruise Control; 63.00" Cable	CA-3002
1970	V8 5.7L 350ci		3 Spd. AT w/o Cruise; 61.00" Cable	CA-3005
1970	V8 5.7L 350ci		3 Spd. MT w/o Cruise; 61.00" Cable	CA-3005
1970	V8 5.7L 350ci		w/Cruise Control, Lower; 63.00" Cable	CA-3002
1970	V8 5.7L 350ci		w/Cruise Control, Upper; 41.00" Cable	CA-3009
1961-63	V8 6.4L 389ci		AT; 83.00" Cable	CA-3004
1961-63	V8 6.4L 389ci		MT; 63.00" Cable	CA-3002
1964-65	V8 6.4L 389ci		83.00" Cable	CA-3004
1968	V8 6.6L 400ci		w/Cruise Control	CA-3006
1968	V8 6.6L 400ci		w/o Cruise Control; 63.00" Cable	CA-3002
1970	V8 6.6L 400ci		3 Spd. AT w/o Cruise; 61.00" Cable	CA-3005
1970	V8 6.6L 400ci		3 Spd. MT w/o Cruise; 61.00" Cable	CA-3005
1970	V8 6.6L 400ci		w/Cruise Control, Lower; 63.00" Cable	CA-3002
1970	V8 6.6L 400ci		w/Cruise Control, Upper; 41.00" Cable	CA-3009
1963	V8 6.9L 421ci		AT; 83.00" Cable	CA-3004
1963	V8 6.9L 421ci		MT; 63.00" Cable	CA-3002
1964-65	V8 6.9L 421ci		83.00" Cable	CA-3004
<b>STAR CHIEF</b>				
1954	L8 4.4L 268ci		63.00" Cable	CA-3002
1955	V8 4.7L 287ci		63.00" Cable	CA-3002
1956	V8 5.2L 316ci		63.00" Cable	CA-3002
1957	V8 5.7L 347ci		83.00" Cable	CA-3004
1958	V8 6.1L 370ci		63.00" Cable	CA-3002
1959	V8 6.4L 389ci		63.00" Cable	CA-3002
1960	V8 6.4L 389ci		Canada; 83.00" Cable	CA-3004
1960	V8 6.4L 389ci		USA; 63.00" Cable	CA-3002
1966	V8 6.4L 389ci		AT w/Cruise Control, Upper	CA-3006
1966	V8 6.4L 389ci		AT w/o Cruise, 3 Spd. MT; 83.00" Cable	CA-3004
1961-63	V8 6.4L 389ci		AT; 83.00" Cable	CA-3004
1961-63	V8 6.4L 389ci		MT; 63.00" Cable	CA-3002
1964-65	V8 6.4L 389ci		83.00" Cable	CA-3004
1963	V8 6.9L 421ci		AT; 83.00" Cable	CA-3004

# SPEEDOMETER CABLES

Year	Engine	Vin	Remark	Part
<b>PONTIAC (con't)</b>				
<b>STAR CHIEF (con't)</b>				
1963	V8 6.9L 421ci		MT; 63.00" Cable	CA-3002
1964-65	V8 6.9L 421ci		83.00" Cable	CA-3004
<b>SUNBIRD</b>				
1976-77	L4 2.3L 140ci	A,B	4 Spd. MT; 61.00" Cable	CA-3005
1976-77	L4 2.3L 140ci	A,B	MT exc. 4 Spd.; 80.00" Cable	CA-3001
1979-80	L4 2.5L 151ci	1,9,V	w/o Cruise Control; 61.00" Cable	CA-3005
1978	L4 2.5L 151ci	1,V	4 Spd. MT, At; 61.00" Cable	CA-3005
1977-78	L4 2.5L 151ci	1,V	MT exc. 4 Spd.; 80.00" Cable	CA-3001
1977	L4 2.5L 151ci	V	4 Spd. MT; 61.00" Cable	CA-3005
1978	V6 3.8L 231ci	A	4 Spd. MT, At; 61.00" Cable	CA-3005
1977-78	V6 3.8L 231ci	A	MT exc. 4 Spd.; 80.00" Cable	CA-3001
1979-80	V6 3.8L 231ci	A	w/o Cruise w/Adapter Lower; 40.00" Cable	CA-3033
1979-80	V6 3.8L 231ci	A	w/o Cruise w/Adapter Upper; 41.00" Cable	CA-3009
1979-80	V6 3.8L 231ci	A	w/o Cruise w/o Adapter; 80.00" Cable	CA-3001
1976-77	V6 3.8L 231ci	A,C	4 Spd. MT; 61.00" Cable	CA-3005
1976-77	V6 3.8L 231ci	C	MT exc. 4 Spd.; 80.00" Cable	CA-3001
1979	V8 5.0L 305ci	G	w/o Cruise Control; 80.00" Cable	CA-3001
1978	V8 5.0L 305ci	U	4 Spd. MT, At; 61.00" Cable	CA-3005
1978	V8 5.0L 305ci	U	MT exc. 4 Spd.; 80.00" Cable	CA-3001
<b>T1000</b>				
1981	L4 1.6L 98ci	9	AT	CA-3046
1982	L4 1.6L 98ci	C	MT; 61.00" Cable	CA-3005
1982-87	L4 1.6L 98ci	C	AT	CA-3046
1983-87	L4 1.6L 98ci	C	4 Spd. MT; 61.00" Cable	CA-3005
1983-87	L4 1.6L 98ci	C	Diesel w/5 Spd MT; 80.00" Cable	CA-3001
<b>TEMPEST</b>				
1965	L6 3.5L 215ci		AT; 83.00" Cable	CA-3004
1964-65	L6 3.5L 215ci		63.00" Cable	CA-3002
1966	L6 3.8L 230ci		AT; 83.00" Cable	CA-3004
1966	L6 3.8L 230ci		MT; 63.00" Cable	CA-3002
1967	L6 3.8L 230ci		4 Spd. MT; 63.00" Cable	CA-3002
1967	L6 3.8L 230ci		THM AT, Heavy Duty 3 Spd. MT; 83.00" Cable	CA-3004
1968	L6 4.1L 250ci		w/Cruise Lower, w/o Cruise; 63.00" Cable	CA-3002
1968	L6 4.1L 250ci		w/Cruise Upper	CA-3006
1969	L6 4.1L 250ci		AT w/o Cruise, 4 Spd. MT 1 pc. Cable, 4 Spd. MT 2 pc. Cable Upper; 61.00" Cable	CA-3005
1970	L6 4.1L 250ci		4 Spd. MT 1 pc. Cable, 4 Spd. MT 2 pc. Cable Upper; 61.00" Cable	CA-3005
1970	L6 4.1L 250ci		AT w/o Cruise, 3 Spd. MT Column Shift; 61.00" Cable	CA-3005
1969-70	L6 4.1L 250ci		3 Spd. MT Floor Shift; 80.00" Cable	CA-3001
1969-70	L6 4.1L 250ci		4 Spd. MT 2 pc. Cable Lower; 80.00" Cable	CA-3001
1969-70	L6 4.1L 250ci		AT w/Cruise Control, Lower; 63.00" Cable	CA-3002
1969-70	L6 4.1L 250ci		AT w/Cruise Control, Upper; 41.00" Cable	CA-3009
1966	V8 5.3L 326ci		MT; 63.00" Cable	CA-3002
1967	V8 5.3L 326ci		4 Spd. MT; 63.00" Cable	CA-3002
1967	V8 5.3L 326ci		THM AT, Heavy Duty 3 Spd. MT; 83.00" Cable	CA-3004
1964-65	V8 5.3L 326ci		63.00" Cable	CA-3002
1965-66	V8 5.3L 326ci		AT; 83.00" Cable	CA-3004
1968	V8 5.7L 350ci		w/Cruise Lower, w/o Cruise; 63.00" Cable	CA-3002
1968	V8 5.7L 350ci		w/Cruise Upper	CA-3006
1970	V8 5.7L 350ci		3 Spd. MT Floor Shift; 80.00" Cable	CA-3001
1970	V8 5.7L 350ci		4 Spd. MT 1 pc. Cable, 4 Spd. MT 2 pc. Cable Upper; 61.00" Cable	CA-3005
1970	V8 5.7L 350ci		4 Spd. MT 2 pc. Cable Lower; 80.00" Cable	CA-3001
1970	V8 5.7L 350ci		AT w/Cruise Control, Lower; 63.00" Cable	CA-3002
1970	V8 5.7L 350ci		AT w/Cruise Control, Upper; 41.00" Cable	CA-3009
1970	V8 5.7L 350ci		AT w/o Cruise, 3 Spd. MT Column Shift; 61.00" Cable	CA-3005
1964	V8 6.4L 389ci		63.00" Cable	CA-3002
1968	V8 6.6L 400ci		w/Cruise Lower, w/o Cruise; 63.00" Cable	CA-3002
1968	V8 6.6L 400ci		w/Cruise Upper	CA-3006
1970	V8 6.6L 400ci		3 Spd. MT Floor Shift; 80.00" Cable	CA-3001
1970	V8 6.6L 400ci		4 Spd. MT 1 pc. Cable, 4 Spd. MT 2 pc. Cable Upper; 61.00" Cable	CA-3005
1970	V8 6.6L 400ci		4 Spd. MT 2 pc. Cable Lower; 80.00" Cable	CA-3001
1970	V8 6.6L 400ci		AT w/Cruise Control, Lower; 63.00" Cable	CA-3002
1970	V8 6.6L 400ci		AT w/Cruise Control, Upper; 41.00" Cable	CA-3009
1970	V8 6.6L 400ci		AT w/o Cruise, 3 Spd. MT Column Shift; 61.00" Cable	CA-3005
1964	V8 6.4L 389ci		63.00" Cable	CA-3002
1968	V8 6.6L 400ci		w/Cruise Lower, w/o Cruise; 63.00" Cable	CA-3002
1968	V8 6.6L 400ci		w/Cruise Upper	CA-3006
1970	V8 6.6L 400ci		3 Spd. MT Floor Shift; 80.00" Cable	CA-3001
1970	V8 6.6L 400ci		4 Spd. MT 1 pc. Cable, 4 Spd. MT 2 pc. Cable Upper; 61.00" Cable	CA-3005
1970	V8 6.6L 400ci		4 Spd. MT 2 pc. Cable Lower; 80.00" Cable	CA-3001
1970	V8 6.6L 400ci		AT w/Cruise Control, Lower; 63.00" Cable	CA-3002
1970	V8 6.6L 400ci		AT w/Cruise Control, Upper; 41.00" Cable	CA-3009
1970	V8 6.6L 400ci		AT w/o Cruise, 3 Spd. MT Column Shift; 61.00" Cable	CA-3005

# SPEEDOMETER CABLES

Year	Engine	Vin	Remark	Part
<b>PONTIAC (con't)</b>				
<b>TEMPEST (con't)</b>				
1970	V8 6.6L 400ci		AT w/Cruise Control, Upper; 41.00" Cable	CA-3009
1970	V8 6.6L 400ci		AT w/o Cruise, 3 Spd. MT Column Shift; 61.00" Cable	CA-3005
1969	V8 7.0L 428ci		3 Spd. MT Floor Shift; 80.00" Cable	CA-3001
1969	V8 7.0L 428ci		4 Spd. MT 2 pc. Cable Lower; 80.00" Cable	CA-3001
1969	V8 7.0L 428ci		AT w/Cruise Control, Lower; 63.00" Cable	CA-3002
1969	V8 7.0L 428ci		AT w/Cruise Control, Upper; 41.00" Cable	CA-3009
1969	V8 7.0L 428ci		AT w/o Cruise, 4 Spd. MT 1 pc. Cable, 4 Spd. MT 2 pc. Cable Upper; 61.00" Cable	CA-3005
<b>VENTURA</b>				
1977	L4 2.5L 151ci	V	AT w/Cruise Control, Lower; 83.00" Cable	CA-3004
1977	L4 2.5L 151ci	V	AT w/Cruise Control, Upper; 41.00" Cable	CA-3009
1977	L4 2.5L 151ci	V	AT w/o Cruise, MT w/Column Shift; 80.00" Cable	CA-3001
1977	L4 2.5L 151ci	V	MT Upper; 61.00" Cable	CA-3005
1977	L4 2.5L 151ci	V	w/Floor Shift, w/3 Spd. Trans., Lower; 40.00" Cable	CA-3033
1972	L6 4.1L 250ci	D	w/Column Shift; 80.00" Cable	CA-3001
1972	L6 4.1L 250ci	D	w/Floor Shift, w/MT; 61.00" Cable	CA-3005
1973	L6 4.1L 250ci	D	4 Spd. Muncie MT; 61.00" Cable	CA-3005
1975	L6 4.1L 250ci	D	AT w/Cruise Control, Lower; 63.00" Cable	CA-3002
1975	L6 4.1L 250ci	D	AT w/o Cruise, 3 Spd. MT 1 pc. Cable; 80.00" Cable	CA-3001
1975	L6 4.1L 250ci	D	Upper; 61.00" Cable	CA-3005
1976	L6 4.1L 250ci	D	AT w/Cruise Control, Lower; 83.00" Cable	CA-3004
1976	L6 4.1L 250ci	D	AT w/Cruise Control, Upper; 41.00" Cable	CA-3009
1976	L6 4.1L 250ci	D	AT w/o Cruise Control; 80" Length	CA-3001
1976	L6 4.1L 250ci	D	MT Upper; 61.00" Cable	CA-3005
1973-74	L6 4.1L 250ci	D	3 Spd. MT Lower; 40.00" Cable	CA-3033
1973-74	L6 4.1L 250ci	D	3 Spd. MT Upper; 61.00" Cable	CA-3005
1973-74	L6 4.1L 250ci	D	AT; 80.00" Cable	CA-3001
1975-76	L6 4.1L 250ci	D	MT Lower; 40.00" Cable	CA-3033
1971	L6 4.1L 250ci		w/Column Shift; 80.00" Cable	CA-3001
1971	L6 4.1L 250ci		w/Floor Shift, w/MT; 61.00" Cable	CA-3005
1977	V6 3.8L 231ci	C	AT w/Cruise Control, Lower; 83.00" Cable	CA-3004
1977	V6 3.8L 231ci	C	AT w/Cruise Control, Upper; 41.00" Cable	CA-3009
1977	V6 3.8L 231ci	C	AT w/o Cruise, MT w/Column Shift; 80.00" Cable	CA-3001
1977	V6 3.8L 231ci	C	MT Upper; 61.00" Cable	CA-3005
1977	V6 3.8L 231ci	C	w/Floor Shift, w/3 Spd. Trans., Lower; 40.00" Cable	CA-3033
1975	V8 4.3L 260ci	F	AT w/Cruise Control, Lower; 63.00" Cable	CA-3002
1975	V8 4.3L 260ci	F	AT w/o Cruise, 3 Spd. MT 1 pc. Cable; 80.00" Cable	CA-3001
1975	V8 4.3L 260ci	F	Upper; 61.00" Cable	CA-3005
1976	V8 4.3L 260ci	F	AT w/Cruise Control, Lower; 83.00" Cable	CA-3004
1976	V8 4.3L 260ci	F	AT w/Cruise Control, Upper; 41.00" Cable	CA-3009
1976	V8 4.3L 260ci	F	AT w/o Cruise Control; 80" Length	CA-3001
1976	V8 4.3L 260ci	F	MT Upper; 61.00" Cable	CA-3005
1975-76	V8 4.3L 260ci	F	MT Lower; 40.00" Cable	CA-3033
1977	V8 4.9L 301ci	Y	AT w/Cruise Control, Lower; 83.00" Cable	CA-3004
1977	V8 4.9L 301ci	Y	AT w/Cruise Control, Upper; 41.00" Cable	CA-3009
1977	V8 4.9L 301ci	Y	AT w/o Cruise, MT w/Column Shift; 80.00" Cable	CA-3001
1977	V8 4.9L 301ci	Y	MT Upper; 61.00" Cable	CA-3005
1977	V8 4.9L 301ci	Y	w/Floor Shift, w/3 Spd. Trans., Lower; 40.00" Cable	CA-3033
1977	V8 5.0L 305ci	U	AT w/Cruise Control, Lower; 83.00" Cable	CA-3004
1977	V8 5.0L 305ci	U	AT w/Cruise Control, Upper; 41.00" Cable	CA-3009
1977	V8 5.0L 305ci	U	AT w/o Cruise, MT w/Column Shift; 80.00" Cable	CA-3001
1977	V8 5.0L 305ci	U	MT Upper; 61.00" Cable	CA-3005
1977	V8 5.0L 305ci	U	w/Floor Shift, w/3 Spd. Trans., Lower; 40.00" Cable	CA-3033
1972	V8 5.0L 307ci	F	w/Column Shift; 80.00" Cable	CA-3001
1972	V8 5.0L 307ci	F	w/Floor Shift, w/MT; 61.00" Cable	CA-3005
1971	V8 5.0L 307ci		w/Column Shift; 80.00" Cable	CA-3001
1971	V8 5.0L 307ci		w/Floor Shift, w/MT; 61.00" Cable	CA-3005
1973-74	V8 5.7L 350ci	A,B,M,N	3 Spd. MT Lower; 40.00" Cable	CA-3033
1973-74	V8 5.7L 350ci	A,B,M,N	3 Spd. MT Upper; 61.00" Cable	CA-3005
1973-74	V8 5.7L 350ci	A,B,M,N	AT; 80.00" Cable	CA-3001
1975	V8 5.7L 350ci	E,H,J	AT w/Cruise Control, Lower; 63.00" Cable	CA-3002
1975	V8 5.7L 350ci	E,H,J	AT w/o Cruise, 3 Spd. MT 1 pc. Cable; 80.00" Cable	CA-3001

# SPEEDOMETER CABLES

Year	Engine	Vin	Remark	Part
<b>PONTIAC (con't)</b>				
<b>VENTURA (con't)</b>				
1975	V8 5.7L 350ci	E,H,J	Upper; 61.00" Cable	CA-3005
1975-76	V8 5.7L 350ci	E,H,J	MT Lower; 40.00" Cable	CA-3033
1976	V8 5.7L 350ci	H,J	AT w/Cruise Control, Lower; 83.00" Cable	CA-3004
1976	V8 5.7L 350ci	H,J	AT w/Cruise Control, Upper; 41.00" Cable	CA-3009
1976	V8 5.7L 350ci	H,J	AT w/o Cruise Control; 80" Length	CA-3001
1976	V8 5.7L 350ci	H,J	MT Upper; 61.00" Cable	CA-3005
1977	V8 5.7L 350ci	L,R	AT w/Cruise Control, Lower; 83.00" Cable	CA-3004
1977	V8 5.7L 350ci	L,R	AT w/Cruise Control, Upper; 41.00" Cable	CA-3009
1977	V8 5.7L 350ci	L,R	AT w/o Cruise, MT w/Column Shift; 80.00" Cable	CA-3001
1977	V8 5.7L 350ci	L,R	MT Upper; 61.00" Cable	CA-3005
1977	V8 5.7L 350ci	L,R	w/Floor Shift, w/3 Spd. Trans., Lower; 40.00" Cable	CA-3033
1972	V8 5.7L 350ci	M	w/Column Shift; 80.00" Cable	CA-3001
1972	V8 5.7L 350ci	M	w/Floor Shift, w/MT; 61.00" Cable	CA-3005
1973	V8 5.7L 350ci	M	4 Spd. Muncie MT; 61.00" Cable	CA-3005
<b>PONTIAC TRUCKS</b>				
<b>SUNBURST</b>				
1986-88	L4 1.5L 92ci	7,9	AT w/o Cruise Control; 61" Length	CA-3005
1986-88	L4 1.5L 92ci	7,9	Canada	CA-3156
1986-88	L4 1.5L 92ci	7,9	MT w/o Cruise; 41.00" Cable	CA-3009
1985	L4 1.5L 92ci	K	AT w/o Cruise Control; 61" Length	CA-3005
1985	L4 1.5L 92ci	K	Canada	CA-3156
1985	L4 1.5L 92ci	K	MT w/o Cruise; 41.00" Cable	CA-3009
<b>PORSCHE</b>				
<b>924</b>				
1977	L4 2.0L 1983cc	2		CA-3102
<b>SUBARU</b>				
<b>DL, GL, GLF, STANDARD</b>				
1980-82	H4 1.6L 1595cc		MT	CA-3108
1980-82	H4 1.8L 1781cc		MT	CA-3108
<b>SUBARU TRUCKS</b>				
<b>BRAT</b>				
1982	H4 1.8L 1781cc	5		CA-3108
1983-84	H4 1.8L 1781cc	5	MT	CA-3108
<b>SUZUKI TRUCKS</b>				
<b>SAMURAI</b>				
1990-93	L4 1.3L 1298cc	3	5 Spd. MT	CA-3131
1986-89	L4 1.3L 1325cc	5	5 Spd. MT	CA-3131
<b>TOYOTA</b>				
<b>CARINA</b>				
1972-73	L4 1.6L 1588cc		5 Spd. Trans.	CA-3090
<b>CELICA</b>				
1971	L4 1.9L 1898cc			CA-3090
1974	L4 2.0L 1968cc	R		CA-3090
1972-73	L4 2.0L 1968cc			CA-3090
1976-77	L4 2.2L 2189cc	R	4 Spd. MT	CA-3141
1976-77	L4 2.2L 2189cc	R	5 Spd. MT	CA-3164
1976-80	L4 2.2L 2189cc	R	AT	CA-3155
1978-80	L4 2.2L 2189cc	R	MT	CA-3164
1981	L4 2.4L 2366cc	R	AT	CA-3087
1981	L4 2.4L 2366cc	R	MT	CA-3164
1982-85	L4 2.4L 2366cc	R	AT	CA-3144
1982-85	L4 2.4L 2366cc	R	MT	CA-3142
1982-83	L6 2.8L 2754cc	M	exc. Digital Speedometer	CA-3088
<b>COROLLA</b>				
1974	L4 1.2L 1166cc	K		CA-3090
1977-79	L4 1.2L 1166cc	K		CA-3180
1970-73	L4 1.2L 1166cc		AT, From 5/70	CA-3090
1975-79	L4 1.6L 1588cc	T		CA-3125
1980	L4 1.8L 1770cc	T		CA-3174
1981-82	L4 1.8L 1770cc	T		CA-3179



# SPEEDOMETER CABLES

Year	Engine	Vin	Remark	Part
<b>TOYOTA (con't)</b>				
<b>COROLLA (con't)</b>				
1967	L4 1.9L 1898cc		AT, 4SPD MT	CA-3091
1974	L4 2.0L 1968cc	R	MT	CA-3123
1976-79	L4 2.2L 2189cc	R	MT	CA-3123
<b>CRESSIDA</b>				
1981-82	L6 2.8L 2759cc	M		CA-3216
<b>STARLET</b>				
1981-82	L4 1.3L 1290cc	K		CA-3089
<b>TERCEL</b>				
1980-82	L4 1.5L 1452cc	A	MT	CA-3087
<b>TOYOTA TRUCKS</b>				
<b>PICKUP</b>				
1975	L4 2.2L 2189cc	R	MT	CA-3135
1976	L4 2.2L 2189cc	R	MT, AT From 5/76	CA-3135
1977-78	L4 2.2L 2189cc	R		CA-3135
1979-80	L4 2.2L 2189cc	R	2WD	CA-3147
1979-80	L4 2.2L 2189cc	R	4WD	CA-3178
1981	L4 2.4L 2366cc	R	2WD	CA-3147
1983	L4 2.4L 2366cc	R	4WD	CA-3140
1981-82	L4 2.4L 2366cc	R	4WD	CA-3178
1982-83	L4 2.4L 2366cc	R	2WD	CA-3180
<b>TRIUMPH</b>				
<b>SPITFIRE</b>				
1963-67	L4 1.2L 70ci		MT	CA-3158
1968-71	L4 1.3L 1296cc		MT	CA-3158
1977	L4 1.5L 1493cc		5 Spd. MT	CA-3175
1978-80	L4 1.5L 1493cc		5 Spd. Trans.	CA-3175
<b>VOLKSWAGEN</b>				
<b>BEETLE, KARMANN GHIA</b>				
1966	H4 1.2L 1192cc			CA-3097
1958-65	H4 1.2L 1192cc			CA-3220
1966	H4 1.3L 1285cc			CA-3097
1967-69	H4 1.5L 1457cc			CA-3097
1974	H4 1.6L 1584cc		55.375" Length	CA-3168
1970-74	H4 1.6L 1584cc			CA-3097
<b>DASHER</b>				
1974-75	L4 1.5L 1471cc		Speedometer to Counter	CA-3133
1974-80	L4 1.5L 1471cc		AT Counter to Trans.	CA-3172
1974-80	L4 1.5L 1471cc		MT Counter to Trans.	CA-3154
1976-77	L4 1.6L 1588cc		Speedometer to Counter	CA-3133
1976-80	L4 1.6L 1588cc		AT Counter to Trans.	CA-3172
1976-80	L4 1.6L 1588cc		MT Counter to Trans.	CA-3154
1977-79	L4 1.6L 1588cc		4SPD MT w/o Counter	CA-3096
<b>FASTBACK, SQUAREBACK</b>				
1966-67	H4 1.6L 1584cc	4		CA-3097
1968-73	H4 1.6L 1584cc			CA-3097
<b>JETTA</b>				
1981-83	L4 1.6L 1588cc	G,H	Lower	CA-3093
1981-83	L4 1.6L 1588cc	G,H	Upper	CA-3092
1980	L4 1.6L 1588cc		Lower	CA-3093
1980	L4 1.6L 1588cc		Upper	CA-3092
1981-83	L4 1.7L 1715cc	A	Lower	CA-3093
1981-83	L4 1.7L 1715cc	A	Upper	CA-3092
<b>RABBIT</b>				
1980	L4 1.5L 1457cc		AT Lower, 4 Spd. w/o Counter	CA-3093
1980	L4 1.5L 1457cc		AT Upper	CA-3092
1978-79	L4 1.5L 1457cc		4 Spd. w/o Counter, 4 Spd. w/Counter Lower From serial # 178-300-001	CA-3095
1978-79	L4 1.5L 1457cc		AT Lower, 4 Spd. Lower to Serial # 178-300-000	CA-3093
1978-79	L4 1.5L 1457cc		AT Lower, 4 Spd. Lower to Serial # 178-300-000, 5 Spd. w/o Counter	CA-3092
1975	L4 1.5L 1471cc		MT	CA-3095
1977	L4 1.5L 1471cc		4 Spd. MT Lower	CA-3095
1977	L4 1.5L 1471cc		5 Spd. MT Lower	CA-3092

# SPEEDOMETER CABLES

Year	Engine	Vin	Remark	Part
<b>VOLKSWAGEN (con't)</b>				
<b>RABBIT (con't)</b>				
1977	L4 1.5L 1471cc		AT Lower	CA-3093
1977	L4 1.5L 1471cc		Upper	CA-3094
1980	L4 1.5L 1471cc		AT Lower, 4 Spd. w/o Counter	CA-3093
1980	L4 1.5L 1471cc		AT Upper	CA-3092
1978-79	L4 1.5L 1471cc		4 Spd. w/o Counter, 4 Spd. w/Counter Lower From serial # 178-300-001	CA-3095
1978-79	L4 1.5L 1471cc		AT Lower, 4 Spd. Lower to Serial # 178-300-000	CA-3093
1978-79	L4 1.5L 1471cc		AT Lower, 4 Spd. Lower to Serial # 178-300-000, 5 Spd. w/o Counter	CA-3092
1976	L4 1.6L 1588cc		MT	CA-3095
1977	L4 1.6L 1588cc		4 Spd. MT Lower	CA-3095
1977	L4 1.6L 1588cc		5 Spd. MT Lower	CA-3092
1977	L4 1.6L 1588cc		AT Lower	CA-3093
1977	L4 1.6L 1588cc		Upper	CA-3094
1980	L4 1.6L 1588cc		AT Lower, 4 Spd. w/o Counter	CA-3093
1980	L4 1.6L 1588cc		AT Upper	CA-3092
1981-82	L4 1.7L 1715cc	B	AT Lower, 4 Spd. w/o Counter	CA-3093
1981-82	L4 1.7L 1715cc	B	AT Upper	CA-3092
1983	L4 1.8L 1780cc	C	AT Lower, 4 Spd. w/o Counter	CA-3093
1983	L4 1.8L 1780cc	C	AT Upper	CA-3092
<b>SCIROCCO</b>				
1978	L4 1.5L 1457cc		Lower	CA-3093
1978	L4 1.5L 1457cc		w/Counter, to 537-250-000	CA-3092
1978	L4 1.5L 1457cc		w/o Counter, to 537-250-000	CA-3095
1977	L4 1.6L 1588cc		w/Counter, to 537-250-000	CA-3092
1977	L4 1.6L 1588cc		w/o Counter, to 537-250-000	CA-3095
1979	L4 1.6L 1588cc		Lower	CA-3093
1979	L4 1.6L 1588cc		w/Counter	CA-3092
1979	L4 1.6L 1588cc		w/o Counter	CA-3095
1980	L4 1.6L 1588cc		AT Lower	CA-3093
1980	L4 1.6L 1588cc		MT Lower	CA-3095
1980	L4 1.6L 1588cc		Speedometer to Counter	CA-3094
1980	L4 1.6L 1588cc		Upper	CA-3092
1981-83	L4 1.7L 1715cc	A	AT Lower	CA-3093
1981-83	L4 1.7L 1715cc	A	MT Lower	CA-3095
1981-83	L4 1.7L 1715cc	A	Speedometer to Counter	CA-3094
1981-83	L4 1.7L 1715cc	A	Upper	CA-3092
1983	L4 1.8L 1780cc	C	AT Lower	CA-3093
1983	L4 1.8L 1780cc	C	MT Lower	CA-3095
1983	L4 1.8L 1780cc	C	Speedometer to Counter	CA-3094
1983	L4 1.8L 1780cc	C	Upper	CA-3092
<b>SUPER BEETLE, THING</b>				
1973-74	H4 1.6L 1584cc			CA-3097
<b>VOLKSWAGEN TRUCKS</b>				
<b>TRANSPORTER</b>				
1975	H4 1.8L 1795cc		Lower	CA-3170
1976-79	H4 2.0L 1970cc		Lower	CA-3170
<b>VOLVO</b>				
<b>242</b>				
1975	L4 2.0L 1990cc		w/Turbo, or w/Overdrive	CA-3143
1976-84	L4 2.1L 2127cc		w/Turbo, or w/Overdrive	CA-3143
1981-84	L4 2.3L 2316cc		w/Turbo, or w/Overdrive	CA-3143
<b>244</b>				
1976-82	L4 2.1L 2127cc		w/Turbo, or w/Overdrive	CA-3143
1981	L4 2.3L 2316cc		w/Turbo, or w/Overdrive	CA-3143
1984	L6 2.4L 2383cc		w/Turbo, or w/Overdrive	CA-3143
<b>245</b>				
1975	L4 2.0L 1990cc		w/Turbo, or w/Overdrive	CA-3143
1977-85	L4 2.1L 2127cc		w/Turbo, or w/Overdrive	CA-3143
1985-89	L4 2.3L 2316cc		w/Turbo, or w/Overdrive	CA-3143
1982	L6 2.4L 2383cc		w/Turbo, or w/Overdrive	CA-3143
<b>262</b>				
1976	V6 2.7L 2673cc			CA-3143

# SPEEDOMETER CABLES

Year	Engine	Vin	Remark	Part
<b>VOLVO (con't)</b>				
<b>262 (con't)</b>				
1978-79	V6 2.7L 2673cc			CA-3143
1980-81	V6 2.8L 2849cc			CA-3143
<b>264</b>				
1980-81	L4 2.1L 2127cc			CA-3143
1980-81	L6 2.4L 2383cc			CA-3143
1976-79	V6 2.7L 2673cc			CA-3143
1980-82	V6 2.8L 2849cc			CA-3143
<b>265</b>				
1980	L6 2.4L 2383cc			CA-3143
1976-79	V6 2.7L 2673cc			CA-3143
1980-81	V6 2.8L 2849cc			CA-3143

# **TAILGATE CABLES**

# TAILGATE CABLES

Year	Remark	Part	OE
<b>CHEVROLET TRUCKS</b>			
<b>BLAZER</b>			
1973-74	w/Removeable Hard Top 23.125" Cable	CA-2304	6274850
<b>C10, C20, C30</b>			
1973-82	w/Removeable Hard Top 23.125" Cable	CA-2304	6274850
<b>C10 SUBURBAN, C20 SUBURBAN</b>			
1973-82	w/Removeable Hard Top 23.125" Cable	CA-2304	6274850
1978-86	20.25" Cable	CA-2303	15599489
<b>C1500, C2500, C3500</b>			
1992-02		CA-2310	15673251
<b>EL CAMINO</b>			
1970-77		CA-2305	
<b>K10</b>			
1983-86	23.125" Cable	CA-2304	6274850
<b>K10 SUBURBAN</b>			
1978-86	20.25" Cable	CA-2303	15599489
1983	23.125" Cable	CA-2304	6274850
<b>K1500, K2500, K3500</b>			
1992-00		CA-2310	15673251
<b>K20 SUBURBAN</b>			
1978-86	20.25" Cable	CA-2303	15599489
<b>K5 BLAZER</b>			
1975-82	w/Removeable Hard Top 23.125" Cable	CA-2304	6274850
<b>S10, S10 BLAZER</b>			
1983-89		CA-2302	
<b>V10</b>			
1987	23.125" Cable	CA-2304	6274850
<b>V10 SUBURBAN, V20 SUBURBAN</b>			
1987-88	20.25" Cable	CA-2303	15599489
<b>DODGE TRUCKS</b>			
<b>RAM 1500, RAM 2500, RAM 3500</b>			
1994-96		CA-2307	
<b>FORD TRUCKS</b>			
<b>BRONCO</b>			
1978-88		CA-2300	
<b>F-150, F-250, F-350</b>			
1983-94		CA-2308	E8TZ-9943052-A
<b>RANCHERO</b>			
1973-79		CA-2300	
<b>RANGER</b>			
1983-92		CA-2309	E4TZ-9943052-A
<b>GMC</b>			
<b>C15 SUBURBAN, C25 SUBURBAN, K15 SUBURBAN, K25 SUBURBAN</b>			
1978-86	20.25" Cable	CA-2303	15599489
<b>C1500, C2500, C3500</b>			
1992-02		CA-2310	15673251
<b>JIMMY</b>			
1973-82	w/Removeable Hard Top 23.125" Cable	CA-2304	6274850
1983-88	23.125" Cable	CA-2304	6274850
1989		CA-2302	
<b>S15 JIMMY</b>			
1983-89		CA-2302	
<b>SPRINT</b>			
1971-77		CA-2305	

# TAILGATE CABLES

Year	Remark	Part	OE
<b>GMC</b>			
<b>V1500</b>			
1987	23.125" Cable	CA-2304	6274850
<b>V1500 SUBURBAN, V2500 SUBURBAN</b>			
1987-88	20.25" Cable	CA-2303	15599489
<b>JEEP</b>			
<b>CJ7</b>			
1977-86		CA-2301	

# **TRANSNIFT**

# **CABLES**

# TRANSHIFT CABLES

Year	Engine	Vin	Remark	Part	OE
<b>BUICK</b>					
<b>CENTURY</b>					
1994-95	L4 2.2L 134ci	4	59.09" Cable	CA-1157	10038603
1982	L4 2.5L 151ci	5, R	w/THM125C Auto. Trans., w/Console & Park Lock; 52.00" Cable	CA-1123	10027283
1982	L4 2.5L 151ci	5, R	w/Column Shift; 59.06" Cable	CA-1173	12552510
1982	L4 2.5L 151ci	5, R	w/Floor Shift; 96.46" Cable	CA-1178	10021329
1984-85	L4 2.5L 151ci	R	w/Column Shift, w/TH440-T4 AT; 58.50" Cable	CA-1131	10037686
1984-85	L4 2.5L 151ci	R	w/THM125C AT, exc. Console; 55.48" Cable	CA-1132	10024524
1984-85	L4 2.5L 151ci	R	w/Floor Shift, w/TH440-T4 AT; 104.37" Cable	CA-1152	10034330
1986-91	L4 2.5L 151ci	R	w/THM125C AT, Column Shift; 55.23" Cable	CA-1134	10038609
1986-91	L4 2.5L 151ci	R	w/Column Shift, w/TH440-T4 AT.; 59.09" Cable	CA-1157	10038603
1992	L4 2.5L 151ci	R	3 Spd. Auto. Trans.; 55.23" Cable	CA-1134	10038609
1992	L4 2.5L 151ci	R	4 Spd. Auto. Trans.; 59.09" Cable	CA-1157	10038603
1987-89	V6 2.8L 173ci	W	w/THM125C AT, Column Shift; 55.23" Cable	CA-1134	10038609
1987-89	V6 2.8L 173ci	W	w/Column Shift, w/TH440-T4 AT.; 59.09" Cable	CA-1157	10038603
1983	V6 2.8L 173ci	X	w/Range Selector, w/Console, w/THM125C Auto. Trans.; 97.63" Cable	CA-1129	10023729
1983-85	V6 2.8L 173ci	X	w/THM125C AT, exc. Console; 55.48" Cable	CA-1132	10024524
1984-85	V6 2.8L 173ci	X	w/Column Shift, w/TH440-T4 AT; 58.50" Cable	CA-1131	10037686
1984-85	V6 2.8L 173ci	X	w/Floor Shift, w/TH440-T4 AT; 104.37" Cable	CA-1152	10034330
1986	V6 2.8L 173ci	X	w/THM125C AT, Column Shift; 55.23" Cable	CA-1134	10038609
1986	V6 2.8L 173ci	X	w/Column Shift, w/TH440-T4 AT.; 59.09" Cable	CA-1157	10038603
1982	V6 3.0L 181ci	E	w/THM125C Auto. Trans., w/Console & Park Lock; 52.00" Cable	CA-1123	10027283
1982	V6 3.0L 181ci	E	w/THM125C AT, exc. Console, w/Shift Control; 49.68" Cable	CA-1124	10027422
1982	V6 3.0L 181ci	E	w/Column Shift; 59.06" Cable	CA-1173	12552510
1982	V6 3.0L 181ci	E	w/Floor Shift; 96.46" Cable	CA-1178	10021329
1983	V6 3.0L 181ci	E	w/Range Selector, w/Console, w/THM125C Auto. Trans.; 97.63" Cable	CA-1129	10023729
1983-85	V6 3.0L 181ci	E	w/THM125C AT, exc. Console; 55.48" Cable	CA-1132	10024524
1984-85	V6 3.0L 181ci	E	w/Column Shift, w/TH440-T4 AT; 58.50" Cable	CA-1131	10037686
1984-85	V6 3.0L 181ci	E	w/Floor Shift, w/TH440-T4 AT; 104.37" Cable	CA-1152	10034330
1994-95	V6 3.1L 189ci	M	59.09" Cable	CA-1157	10038603
1989-91	V6 3.3L 204ci	N	w/THM125C AT, Column Shift; 55.23" Cable	CA-1134	10038609
1989-91	V6 3.3L 204ci	N	w/Column Shift, w/TH440-T4 AT.; 59.09" Cable	CA-1157	10038603
1992	V6 3.3L 204ci	N	3 Spd. Auto. Trans.; 55.23" Cable	CA-1134	10038609
1992	V6 3.3L 204ci	N	4 Spd. Auto. Trans.; 59.09" Cable	CA-1157	10038603
1979-80	V6 3.8L 231ci	3	w/AT, w/Floor Shift; 29.33" Cable	CA-1102	22500579
1984-85	V6 3.8L 231ci	3	w/Column Shift, w/TH440-T4 AT.; 58.50" Cable	CA-1131	10037686
1984-85	V6 3.8L 231ci	3	w/THM125C AT, exc. Console; 55.48" Cable	CA-1132	10024524
1984-85	V6 3.8L 231ci	3	w/Floor Shift, w/TH440-T4 AT; 104.37" Cable	CA-1152	10034330
1987-88	V6 3.8L 231ci	3	w/THM125C AT, Column Shift; 55.23" Cable	CA-1134	10038609
1987-88	V6 3.8L 231ci	3	w/Column Shift, w/TH440-T4 AT.; 59.09" Cable	CA-1157	10038603
1978-81	V6 3.8L 231ci	A	w/AT, w/Floor Shift; 29.33" Cable	CA-1102	22500579
1975-77	V6 3.8L 231ci	C	w/Auto. Trans., w/Console	CA-1168	1246680
1982	V6 4.3L 260ci	T	w/Auto. Trans., Diesel, w/Console & Park Lock; 52.00" Cable	CA-1123	10027283
1982	V6 4.3L 260ci	T	w/Auto. Trans., Diesel, exc. Console; 49.68" Cable	CA-1124	10027422
1983	V6 4.3L 260ci	T	w/Range Selector, w/Console, w/THM125C Auto. Trans.; 97.63" Cable	CA-1129	10023729
1983-85	V6 4.3L 260ci	T	w/THM125C AT, exc. Console; 55.48" Cable	CA-1132	10024524
1984-85	V6 4.3L 260ci	T	w/Column Shift, w/TH440-T4 AT; 58.50" Cable	CA-1131	10037686
1984-85	V6 4.3L 260ci	T	w/Floor Shift, w/TH440-T4 AT; 104.37" Cable	CA-1152	10034330
1981	V8 4.3L 265ci	S	w/AT, w/Floor Shift; 29.33" Cable	CA-1102	22500579
1981	V8 4.4L 267ci	J	w/AT, w/Floor Shift; 29.33" Cable	CA-1102	22500579



# TRANSHIFT CABLES

Year	Engine	Vin	Remark	Part	OE
<b>BUICK (con't)</b>					
<b>CENTURY (con't)</b>					
1979-80	V8 4.9L 301ci	W	w/AT, w/Floor Shift; 29.33" Cable	CA-1102	22500579
1978-81	V8 5.0L 305ci	H	w/AT, w/Floor Shift; 29.33" Cable	CA-1102	22500579
1977	V8 5.0L 305ci	U	w/Auto. Trans., w/Console	CA-1168	1246680
1975-77	V8 5.7L 350ci	H, J	w/Auto. Trans., w/Console	CA-1168	1246680
1977	V8 5.7L 350ci	L, R	w/Auto. Trans., w/Console	CA-1168	1246680
1979	V8 5.7L 350ci	L	w/AT, w/Floor Shift; 29.33" Cable	CA-1102	22500579
1977	V8 6.6L 403ci	K	w/Auto. Trans., w/Console	CA-1168	1246680
<b>ELECTRA</b>					
1986	V6 3.8L 231ci	B	w/Auto. Trans., exc. JM-4 Anti-Lock Brakes	CA-1158	25523741
1981	V6 4.1L 252ci	4	w/Floor Shift, w/THM250 Auto. Trans., w/THM350 Auto. Trans.; 29.33" Cable	CA-1102	22500581
1981	V8 5.0L 307ci	Y	w/Floor Shift, w/THM250 Auto. Trans., w/THM350 Auto. Trans.; 29.33" Cable	CA-1102	22500581
1986	V8 5.0L 307ci	Y	w/Auto. Trans., exc. JM-4 Anti-Lock Brakes	CA-1158	25523741
1981	V8 5.7L 350ci	N	w/Floor Shift, w/THM250 Auto. Trans., w/THM350 Auto. Trans.; 29.33" Cable	CA-1102	22500581
<b>ESTATE WAGON</b>					
1978-79	V8 5.7L 350ci	R, X	w/Floor Shift, w/THM200, THM250 & THM350 Auto. Trans.; 29.33" Cable	CA-1102	22500581
1978-79	V8 6.6L 403ci	K	w/Floor Shift, w/THM200, THM250 & THM350 Auto. Trans.; 29.33" Cable	CA-1102	22500581
<b>LESABRE</b>					
1978-81	V6 3.8L 231ci	A	w/Floor Shift, w/THM200, THM250 & THM350 Auto. Trans.; 29.33" Cable	CA-1102	22500581
1980-81	V6 4.1L 252ci	4	w/Floor Shift, w/THM200, THM250 & THM350 Auto. Trans.; 29.33" Cable	CA-1102	22500581
1980	V8 4.9L 301ci	W	w/Floor Shift, w/THM200, THM250 & THM350 Auto. Trans.; 29.33" Cable	CA-1102	22500581
1978	V8 5.0L 305ci	U	w/Floor Shift, w/THM200, THM250 & THM350 Auto. Trans.; 29.33" Cable	CA-1102	22500581
1981	V8 5.0L 307ci	Y	w/Floor Shift, w/THM200, THM250 & THM350 Auto. Trans.; 29.33" Cable	CA-1102	22500581
1980-81	V8 5.7L 350ci	N	w/Floor Shift, w/THM200, THM250 & THM350 Auto. Trans.; 29.33" Cable	CA-1102	22500581
1978-80	V8 5.7L 350ci	R, X	w/Floor Shift, w/THM200, THM250 & THM350 Auto. Trans.; 29.33" Cable	CA-1102	22500581
1978	V8 6.6L 403ci	K	w/Floor Shift, w/THM200, THM250 & THM350 Auto. Trans.; 29.33" Cable	CA-1102	22500581
<b>REGAL</b>					
1978-79	V6 3.2L 196ci	C	w/Auto. Trans., w/Console; 29.33" Cable	CA-1102	22500579
1979	V6 3.8L 231ci	2	w/Auto. Trans., w/Console; 29.33" Cable	CA-1102	22500579
1978-81	V6 3.8L 231ci	3, A	w/Auto. Trans., w/Console; 29.33" Cable	CA-1102	22500579
1982	V6 3.8L 231ci	A	w/AT, w/Range Selector, w/Console; 29.33" Cable	CA-1102	22500579
1983	V6 3.8L 231ci	A	w/Range Selector, w/Console, w/THM200, THM250C & THM350 Auto. Trans.; 29.33" Cable	CA-1102	22500579
1983-84	V6 3.8L 231ci	A	w/Console, w/THM200-4R Auto. Trans.	CA-1130	22519497
1984	V6 3.8L 231ci	A	w/Range Selector, w/Console, w/THM200C Auto. Trans., w/THM250C Auto. Trans.; 29.33" Cable	CA-1102	22500579
1985-87	V6 3.8L 231ci	A	w/Range Selector, w/Console, w/THM200 Auto. Trans.; 29.33" Cable	CA-1102	22500579
1985-87	V6 3.8L 231ci	A	w/Range Selector, w/Console, w/THM200-4R Auto. Trans.	CA-1130	22519497
1975-77	V6 3.8L 231ci	C	w/Auto. Trans., w/Console	CA-1168	1246680
1978	V6 3.8L 231ci	G	w/Auto. Trans., w/Console; 29.33" Cable	CA-1102	22500579
1982	V6 4.1L 252ci	4	w/AT, w/Range Selector, w/Console; 29.33" Cable	CA-1102	22500579

# TRANSHIFT CABLES

Year	Engine	Vin	Remark	Part	OE
<b>BUICK (con't)</b>					
<b>REGAL (con't)</b>					
1983	V6 4.1L 252ci	4	w/Range Selector, w/Console, w/THM200, THM250C & THM350 Auto. Trans.; 29.33" Cable	CA-1102	22500579
1984	V6 4.1L 252ci	4	w/Range Selector, w/Console, w/THM200C Auto. Trans., w/THM250C Auto. Trans.; 29.33" Cable	CA-1102	22500579
1983-84	V6 4.1L 252ci	4	w/Console, w/THM200-4R Auto. Trans.	CA-1130	22519497
1982	V6 4.3L 260ci	V	w/Auto. Trans., Diesel, w/Range Selector, w/Console; 29.33" Cable	CA-1102	22500579
1983	V6 4.3L 260ci	V	w/Range Selector, w/Console, w/THM200, THM250C & THM350 Auto. Trans.; 29.33" Cable	CA-1102	22500579
1984	V6 4.3L 260ci	V	w/Range Selector, w/Console, w/THM200C Auto. Trans., w/THM250C Auto. Trans.; 29.33" Cable	CA-1102	22500579
1983-84	V6 4.3L 260ci	V	w/Console, w/THM200-4R Auto. Trans.	CA-1130	22519497
1980-81	V8 4.3L 265ci	S	w/Auto. Trans., w/Console; 29.33" Cable	CA-1102	22500579
1982	V8 4.4L 267ci	J	w/AT, w/Range Selector, w/Console; 29.33" Cable	CA-1102	22500579
1979-80	V8 4.9L 301ci	W, Y	w/Auto. Trans., w/Console; 29.33" Cable	CA-1102	22500579
1978-80	V8 5.0L 305ci	H	w/Auto. Trans., w/Console; 29.33" Cable	CA-1102	22500579
1982	V8 5.0L 305ci	H	w/AT, w/Range Selector, w/Console; 29.33" Cable	CA-1102	22500579
1983	V8 5.0L 305ci	H	w/Range Selector, w/Console, w/THM200, THM250C & THM350 Auto. Trans.; 29.33" Cable	CA-1102	22500579
1983-84	V8 5.0L 305ci	H	w/Console, w/THM200-4R Auto. Trans.	CA-1130	22519497
1984	V8 5.0L 305ci	H	w/Range Selector, w/Console, w/THM200C Auto. Trans., w/THM250C Auto. Trans.; 29.33" Cable	CA-1102	22500579
1985-87	V8 5.0L 305ci	H	w/Range Selector, w/Console, w/THM200 Auto. Trans.; 29.33" Cable	CA-1102	22500579
1985-87	V8 5.0L 305ci	H	w/Range Selector, w/Console, w/THM200-4R Auto. Trans.	CA-1130	22519497
1978	V8 5.0L 305ci	U	w/Auto. Trans., w/Console; 29.33" Cable	CA-1102	22500579
1986-87	V8 5.0L 307ci	Y	w/Range Selector, w/Console, w/THM200 Auto. Trans.; 29.33" Cable	CA-1102	22500579
1986-87	V8 5.0L 307ci	Y	w/Range Selector, w/Console, w/THM200-4R Auto. Trans.	CA-1130	22519497
1975-77	V8 5.7L 350ci	H, J	w/Auto. Trans., w/Console	CA-1168	1246680
1977	V8 5.7L 350ci	L, R	w/Auto. Trans., w/Console	CA-1168	1246680
1982	V8 5.7L 350ci	N	w/Range Selector, w/Console, w/THM350C Auto. Trans.; 29.33" Cable	CA-1102	22500579
1983	V8 5.7L 350ci	N	w/Range Selector, w/Console, w/THM200, THM250C & THM350 Auto. Trans.; 29.33" Cable	CA-1102	22500579
1983	V8 5.7L 350ci	N	w/Console, w/THM200-4R Auto. Trans.	CA-1130	22519497
1985	V8 5.7L 350ci	N	w/Range Selector, w/Console, w/THM200 Auto. Trans.; 29.33" Cable	CA-1102	22500579
1985	V8 5.7L 350ci	N	w/Range Selector, w/Console, w/THM200-4R Auto. Trans.	CA-1130	22519497
<b>RIVIERA</b>					
1982	V6 3.8L 231ci	3	w/Range Selector	CA-1147	22513487
1983	V6 3.8L 231ci	8	w/Range Selector	CA-1147	22513487
1984-85	V6 3.8L 231ci	9		CA-1147	22513487
1982-83	V6 4.1L 252ci	4	w/Range Selector	CA-1147	22513487
1982-83	V8 5.0L 307ci	Y	w/Range Selector	CA-1147	22513487
1982-83	V8 5.7L 350ci	N	w/Range Selector	CA-1147	22513487
1978	V8 5.7L 350ci	R, X	w/Floor Shift, w/THM250 Auto. Trans., w/THM350 Auto. Trans.; 29.33" Cable	CA-1102	22500581
1978	V8 6.6L 403ci	K	w/Floor Shift, w/THM250 Auto. Trans., w/THM350 Auto. Trans.; 29.33" Cable	CA-1102	22500581
<b>SKYHAWK</b>					
1982	L4 1.8L 112ci	0, G	w/THM125C Auto. Trans., w/Park Lock	CA-1128	10022405
1983	L4 1.8L 112ci	0	w/Auto. Trans., w/Trans. Park Lock	CA-1128	10027495

# TRANSHIFT CABLES

Year	Engine	Vin	Remark	Part	OE
<b>BUICK (con't)</b>					
<b>SKYHAWK (con't)</b>					
1984-86	L4 1.8L 112ci	0	w/Range Selector, w/THM125C Auto. Trans.	CA-1113	10034333
1982	L4 1.8L 112ci	G	w/Auto. Trans., w/Trans. Park Lock	CA-1128	10022405
1984-86	L4 1.8L 112ci	J	w/Range Selector, w/THM125C Auto. Trans.	CA-1113	10034333
1987-89	L4 2.0L 122ci	1	w/Range Selector, w/THM125C Auto. Trans.	CA-1113	10034333
1984	L4 2.0L 122ci	B	w/Range Selector, w/THM125C Auto. Trans.	CA-1113	10034333
1987-88	L4 2.0L 122ci	K	w/Range Selector, w/THM125C Auto. Trans.	CA-1113	10034333
1987	L4 2.0L 122ci	M	w/Range Selector, w/THM125C Auto. Trans.	CA-1113	10034333
1984-86	L4 2.0L 122ci	P	w/Range Selector, w/THM125C Auto. Trans.	CA-1113	10034333
1978-80	V6 3.8L 231ci	A	w/THM350 Auto. Trans.	CA-1101	470771
1976-77	V6 3.8L 231ci	C	w/THM200 Auto. Trans., w/THM350 Auto. Trans.	CA-1101	14067531
<b>SKYLARK</b>					
1980	L4 2.5L 151ci	5	w/THM125 Auto. Trans.	CA-1112	10009338
1981	L4 2.5L 151ci	5	w/Column Shift, w/THM125 Auto. Trans.	CA-1118	10014257
1982	L4 2.5L 151ci	5, R	w/AT, w/Console & Park Lock; 52.00" Cable	CA-1123	10027283
1982	L4 2.5L 151ci	5, R	w/Auto. Trans., exc. Console; 49.68" Cable	CA-1124	10027422
1984-85	L4 2.5L 151ci	R	w/Range Selector, exc. Console; 55.48" Cable	CA-1132	10024524
1986-90	L4 2.5L 151ci	U	w/Throttle Body Injection, w/Console	CA-1128	10032806
1985	V6 2.8L 173ci	W	w/Range Selector, w/Cruise Control, exc. Console; 58.50" Cable	CA-1131	10037686
1985	V6 2.8L 173ci	W	w/Range Selector, exc. Cruise Control, exc. Console; 55.48" Cable	CA-1132	10024524
1985	V6 2.8L 173ci	W	w/Range Selector, w/Cruise Control, w/Console; 104.37" Cable	CA-1152	10034330
1981	V6 2.8L 173ci	X	w/Column Shift, w/THM125 Auto. Trans.	CA-1118	10014257
1982	V6 2.8L 173ci	X, Z	w/AT, w/Console & Park Lock; 52.00" Cable	CA-1123	10027283
1982	V6 2.8L 173ci	X, Z	w/Auto. Trans., exc. Console; 49.68" Cable	CA-1124	10027422
1983	V6 2.8L 173ci	X, Z	w/Range Selector, w/Console; 97.63" Cable	CA-1129	10023729
1983-85	V6 2.8L 173ci	X, Z	w/Range Selector, exc. Console; 55.48" Cable	CA-1132	10041214
1987	V6 3.0L 181ci	L	w/Console	CA-1155	22531810
1978-79	V6 3.8L 231ci	A	w/Console	CA-1144	12249641
1975-77	V6 3.8L 231ci	C	w/Console	CA-1144	12249641
1977	V8 4.9L 301ci	Y	w/Console	CA-1144	12249641
1979	V8 5.0L 305ci	G	w/Console	CA-1144	12249641
1977-78	V8 5.0L 305ci	U	w/Console	CA-1144	12249641
1976	V8 5.7L 350ci	H, J	w/Console	CA-1144	12249641
1977-79	V8 5.7L 350ci	L, R	w/Console	CA-1144	12249641
<b>SOMERSET</b>					
1986-87	L4 2.5L 151ci	U	w/Throttle Body Injection, w/Console	CA-1128	10032806
1987	V6 3.0L 181ci	L	w/Console	CA-1155	22531810
<b>CADILLAC</b>					
<b>CIMARRON</b>					
1983	L4 2.0L 122ci	P	w/Auto. Trans., w/Range Selector	CA-1128	10027495
1984-86	L4 2.0L 122ci	P	w/Auto. Trans., w/Range Selector	CA-1113	10034333
1985-88	V6 2.8L 173ci	W	w/Auto. Trans., w/Range Selector	CA-1113	10042228
<b>CHEVROLET</b>					
<b>CAMARO</b>					
1982	L4 2.5L 151ci	2, F	w/THM200 Auto. Trans.	CA-1111	10019287
1983-86	L4 2.5L 151ci	2	w/Auto. Trans., w/Range Selector	CA-1110	10027632
1983	L4 2.5L 151ci	F	w/Auto. Trans., w/Range Selector	CA-1110	10027632
1973-79	L6 4.1L 250ci	D	w/Console, w/THM350 Auto. Trans.	CA-1103	498467
1974	L6 4.1L 250ci	D	w/Console, w/THM400 Auto. Trans.	CA-1103	498467
1982	V6 2.8L 173ci	1	w/THM200 Auto. Trans.	CA-1111	10019287
1983-84	V6 2.8L 173ci	1	w/Auto. Trans., w/Range Selector	CA-1110	10027632
1985-89	V6 2.8L 173ci	S	w/Auto. Trans., w/Range Selector	CA-1110	10034332
1980-81	V6 3.8L 229ci	K	w/Auto. Trans.	CA-1103	498467

# TRANSHIFT CABLES

Year	Engine	Vin	Remark	Part	OE
<b>CHEVROLET (con't)</b>					
<b>CAMARO (con't)</b>					
1980-81	V6 3.8L 231ci	A	w/Auto. Trans.	CA-1103	498467
1980-81	V8 4.4L 267ci	J	w/Auto. Trans.	CA-1103	498467
1982	V8 5.0L 305ci	7, H	w/THM200 Auto. Trans.	CA-1111	10019287
1983	V8 5.0L 305ci	7, S	w/Auto. Trans., w/Range Selector	CA-1110	10027632
1988-92	V8 5.0L 305ci	E	w/Auto. Trans., w/Range Selector	CA-1110	10034332
1985-92	V8 5.0L 305ci	F	w/Auto. Trans., w/Range Selector	CA-1110	10034332
1979	V8 5.0L 305ci	G	w/Console, w/THM350 Auto. Trans.	CA-1103	498467
1984	V8 5.0L 305ci	G	w/Auto. Trans., w/Range Selector	CA-1110	10027632
1985-86	V8 5.0L 305ci	G	w/Auto. Trans., w/Range Selector	CA-1110	10034332
1980-81	V8 5.0L 305ci	H	w/Auto. Trans.	CA-1103	498467
1983-84	V8 5.0L 305ci	H	w/Auto. Trans., w/Range Selector	CA-1110	10027632
1985-87	V8 5.0L 305ci	H	w/Auto. Trans., w/Range Selector	CA-1110	10034332
1977-78	V8 5.0L 305ci	U	w/Console, w/THM350 Auto. Trans.	CA-1103	498467
1973	V8 5.0L 307ci	F	w/Console, w/THM400 Auto. Trans.	CA-1103	498467
1987-89	V8 5.7L 350ci	8	w/Auto. Trans., w/Range Selector	CA-1110	10034332
1974-79	V8 5.7L 350ci	L	w/Console, w/THM350 Auto. Trans.	CA-1103	498467
1980-81	V8 5.7L 350ci	L	w/Auto. Trans.	CA-1103	498467
1974	V8 5.7L 350ci	T	w/Console, w/THM400 Auto. Trans.	CA-1103	498467
<b>CAVALIER</b>					
1987-89	L4 2.0L 122ci	1	w/Range Selector	CA-1113	10034333
1983	L4 2.0L 122ci	B, P	w/Range Selector, w/THM125 Auto. Trans.	CA-1128	10027495
1984	L4 2.0L 122ci	B, P	w/Range Selector, w/THM125 Auto. Trans.	CA-1113	10034333
1985-86	L4 2.0L 122ci	P	JD Model	CA-1113	10034333
1992-94	L4 2.2L 134ci	4		CA-1128	10027495
1990	L4 2.2L 134ci	G	w/Range Selector	CA-1113	10042228
1991	L4 2.2L 134ci	G	w/Range Selector	CA-1128	10027495
1985	V6 2.8L 173ci	W	w/Range Selector, 4 Door, w/THM125C AT	CA-1113	10042228
1985	V6 2.8L 173ci	W	w/Range Selector, w/THM125C Auto. Trans.	CA-1113	10042228
1988-89	V6 2.8L 173ci	W	w/Range Selector	CA-1113	10042228
1990	V6 3.1L 189ci	T	w/Range Selector	CA-1113	10042228
1991-92	V6 3.1L 189ci	T	w/Range Selector	CA-1128	10027495
<b>CELEBRITY</b>					
1982-83	L4 2.5L 151ci	5, R	w/AT, w/Console & Park Lock; 52.00" Cable	CA-1123	10027283
1982-83	L4 2.5L 151ci	5, R	w/Auto. Trans., exc. Console; 49.68" Cable	CA-1124	10027422
1984-85	L4 2.5L 151ci	R	4 Spd. exc. Console; 58.50" Cable	CA-1131	10037686
1984-85	L4 2.5L 151ci	R	3 Spd. exc. Console; 55.48" Cable	CA-1132	10041214
1984-85	L4 2.5L 151ci	R	4 Spd. w/Console; 104.37" Cable	CA-1152	10034330
1986	L4 2.5L 151ci	R	THM125C AT; exc. Cruise Control, exc. Console.; 55.23" Cable	CA-1134	10038609
1986	L4 2.5L 151ci	R	w/TH440-T4 exc. Front Console; 59.09" Cable	CA-1157	10038603
1987-90	L4 2.5L 151ci	R	w/THM125C AT, exc. Console; 55.23" Cable	CA-1134	10038609
1984-85	V6 2.8L 173ci	W, X, Z	4 Spd. exc. Console; 58.50" Cable	CA-1131	10037686
1985	V6 2.8L 173ci	W, X, Z	3 Spd. exc. Console, exc. Cruise; 55.48" Cable	CA-1132	10041214
1985	V6 2.8L 173ci	W, X	4 Spd. w/Console, 3 Spd. w/Console and Cruise; 104.37" Cable	CA-1152	10034330
1986	V6 2.8L 173ci	W, X	THM125C AT; exc. Cruise Control, exc. Console.; 55.23" Cable	CA-1134	10038609
1986-89	V6 2.8L 173ci	W, X	w/TH440-T4 exc. Front Console, w/THM125C Auto. Trans. w/Cruise Control exc. Front Console; 59.09" Cable	CA-1157	10038603
1984	V6 2.8L 173ci	X, Z	3 Spd. exc. Console; 55.48" Cable	CA-1132	10041214
1984	V6 2.8L 173ci	X, Z	4 Spd. w/Console; 104.37" Cable	CA-1152	10034330
1982-83	V6 2.8L 173ci	X	w/AT, w/Console & Park Lock; 52.00" Cable	CA-1123	10027283
1982-83	V6 2.8L 173ci	X	w/Auto. Trans., exc. Console; 49.68" Cable	CA-1124	10027422
1982-83	V6 4.3L 260ci	T	w/AT, w/Console & Park Lock; 52.00" Cable	CA-1123	10027283

# TRANSHIFT CABLES

Year	Engine	Vin	Remark	Part	OE
<b>CHEVROLET (con't)</b>					
<b>CELEBRITY (con't)</b>					
1982-83	V6 4.3L 260ci	T	w/Auto. Trans., exc. Console; 49.68" Cable	CA-1124	10027422
1984-85	V6 4.3L 260ci	T	4 Spd. exc. Console; 58.50" Cable	CA-1131	10037686
1984-85	V6 4.3L 260ci	T	3 Spd. exc. Console; 55.48" Cable	CA-1132	10041214
1984-85	V6 4.3L 260ci	T	4 Spd. w/Console; 104.37" Cable	CA-1152	10034330
<b>CHEVELLE</b>					
1973	L6 4.1L 250ci	D	w/Auto. Trans., w/Console	CA-1168	1246680
1973	V8 5.0L 307ci	F	w/Auto. Trans., w/Console	CA-1168	1246680
1973	V8 5.7L 350ci	H, K	w/Auto. Trans., w/Console	CA-1168	1246680
1973	V8 7.4L 454ci	Y	w/Auto. Trans., w/Console	CA-1168	1246680
<b>CITATION</b>					
1980	L4 2.5L 151ci	5	w/Auto. Trans.	CA-1112	10009338
1982	L4 2.5L 151ci	5, R	w/AT, w/Console & Park Lock; 52.00" Cable	CA-1123	10027283
1982	L4 2.5L 151ci	5, R	exc. Console; 49.68" Cable	CA-1124	10027422
1983	L4 2.5L 151ci	5, R	w/AT, w/Range Selector, w/Console; 97.63" Cable	CA-1129	10023729
1983	L4 2.5L 151ci	5, R	exc. Console; 55.48" Cable	CA-1132	10041214
1982	V6 2.8L 173ci	X, Z	w/AT, w/Console & Park Lock; 52.00" Cable	CA-1123	10027283
1982	V6 2.8L 173ci	X, Z	exc. Console; 49.68" Cable	CA-1124	10027422
1983	V6 2.8L 173ci	X, Z	w/AT, w/Range Selector, w/Console; 97.63" Cable	CA-1129	10023729
1983	V6 2.8L 173ci	X, Z	exc. Console; 55.48" Cable	CA-1132	10041214
<b>CITATION II</b>					
1984	L4 2.5L 151ci	R	w/AT, w/Range Selector, w/Console; 97.63" Cable	CA-1129	10023729
1984-85	L4 2.5L 151ci	R	exc. Console; 55.48" Cable	CA-1132	10041214
1984-85	V6 2.8L 173ci	W, X, Z	exc. Console; 55.48" Cable	CA-1132	10041214
1985	V6 2.8L 173ci	W	w/Cruise Control, exc. Console; 58.50" Cable	CA-1131	10037686
1985	V6 2.8L 173ci	W	w/Cruise Control, w/Console; 104.37" Cable	CA-1152	10034330
1984	V6 2.8L 173ci	X, Z	w/AT, w/Range Selector, w/Console; 97.63" Cable	CA-1129	10023729
<b>CORVETTE</b>					
1980	V8 5.0L 305ci	H	w/Auto. Trans.; 29.00" Cable	CA-1145	357746
1968	V8 5.4L 327ci	HJ	w/Auto. Trans.; 29.00" Cable	CA-1145	357746
1969-71	V8 5.7L 350ci		w/Auto. Trans.; 29.00" Cable	CA-1145	357746
1979	V8 5.7L 350ci	4	w/Auto. Trans.; 29.00" Cable	CA-1145	357746
1980-81	V8 5.7L 350ci	6	w/Auto. Trans.; 29.00" Cable	CA-1145	357746
1979-82	V8 5.7L 350ci	8	w/Auto. Trans.; 29.00" Cable	CA-1145	357746
1984-91	V8 5.7L 350ci	8	w/Auto. Trans.	CA-1162	14060120
1978	V8 5.7L 350ci	H	w/Auto. Trans.; 29.00" Cable	CA-1145	357746
1973-75	V8 5.7L 350ci	J	w/Auto. Trans.; 29.00" Cable	CA-1145	357746
1972	V8 5.7L 350ci	K	w/Auto. Trans.; 29.00" Cable	CA-1145	357746
1976-79	V8 5.7L 350ci	L	w/Auto. Trans.; 29.00" Cable	CA-1145	357746
1992-95	V8 5.7L 350ci	P	w/Auto. Trans.	CA-1162	14060120
1974-75	V8 5.7L 350ci	T	w/Auto. Trans.; 29.00" Cable	CA-1145	357746
1976-77	V8 5.7L 350ci	X	w/Auto. Trans.; 29.00" Cable	CA-1145	357746
1968-69	V8 7.0L 427ci		w/Auto. Trans.; 29.00" Cable	CA-1145	357746
1970-71	V8 7.4L 454ci		w/Auto. Trans.; 29.00" Cable	CA-1145	357746
1972	V8 7.4L 454ci	W	w/Auto. Trans.; 29.00" Cable	CA-1145	357746
1973-74	V8 7.4L 454ci	Z	w/Auto. Trans.; 29.00" Cable	CA-1145	357746
<b>MALIBU</b>					
1976	L6 4.1L 250ci	D	w/Auto. Trans., w/Console	CA-1168	1246680
1978-79	V6 3.3L 200ci	M	w/Auto. Trans., w/Console; 29.33" Cable	CA-1102	22500581
1980-81	V6 3.8L 229ci	K	w/Auto. Trans., w/Console; 29.33" Cable	CA-1102	22500581
1978-81	V6 3.8L 231ci	A	w/Auto. Trans., w/Console; 29.33" Cable	CA-1102	22500581
1979-81	V8 4.4L 267ci	J	w/Auto. Trans., w/Console; 29.33" Cable	CA-1102	22500581
1979-81	V8 5.0L 305ci	H	w/Auto. Trans., w/Console; 29.33" Cable	CA-1102	22500581
1976	V8 5.0L 305ci	Q	w/Auto. Trans., w/Console	CA-1168	1246680
1978	V8 5.0L 305ci	U	w/Auto. Trans., w/Console; 29.33" Cable	CA-1102	22500581
1976	V8 5.7L 350ci	L, V	w/Auto. Trans., w/Console	CA-1168	1246680

# TRANSHIFT CABLES

Year	Engine	Vin	Remark	Part	OE
<b>CHEVROLET (con't)</b>					
<b>MALIBU (con't)</b>					
1978-81	V8 5.7L 350ci	L	w/Auto. Trans., w/Console; 29.33" Cable	CA-1102	22500581
1976	V8 6.6L 400ci	U	w/Auto. Trans., w/Console	CA-1168	1246680
<b>MONTE CARLO</b>					
1978-79	V6 3.3L 200ci	M	w/Auto. Trans., w/Console; 29.33" Cable	CA-1102	22500581
1984	V6 3.8L 229ci	9	w/Range Selector, w/Console, w/THM200, THM250 & THM350 Auto. Trans.; 29.33" Cable	CA-1102	22500581
1984	V6 3.8L 229ci	9	w/Range Selector, w/Console, w/THM200-4R Auto. Trans.; 27.20" Cable	CA-1114	10026082
1980-81	V6 3.8L 229ci	K	w/Auto. Trans., w/Console; 29.33" Cable	CA-1102	22500581
1980-81	V6 3.8L 231ci	3	w/Auto. Trans., w/Console; 29.33" Cable	CA-1102	22500581
1978-81	V6 3.8L 231ci	A	w/Auto. Trans., w/Console; 29.33" Cable	CA-1102	22500581
1984	V6 3.8L 231ci	A	w/Range Selector, w/Console, w/THM200, THM250 & THM350 Auto. Trans.; 29.33" Cable	CA-1102	22500581
1984-87	V6 3.8L 231ci	A	w/Range Selector, w/Console, w/THM200-4R Auto. Trans.; 27.20" Cable	CA-1114	10026082
1985-87	V6 3.8L 231ci	A	w/Floor Shift, w/THM200 Auto. Trans.; 29.33" Cable	CA-1102	22500581
1985-87	V6 4.3L 262ci	Z	w/Floor Shift, w/THM200 Auto. Trans.; 29.33" Cable	CA-1102	22500581
1985-88	V6 4.3L 262ci	Z	w/Range Selector, w/Console, w/THM200-4R Auto. Trans.; 27.20" Cable	CA-1114	10026082
1979-81	V8 4.4L 267ci	J	w/Auto. Trans., w/Console; 29.33" Cable	CA-1102	22500581
1979-81	V8 5.0L 305ci	H	w/Auto. Trans., w/Console; 29.33" Cable	CA-1102	22500581
1984	V8 5.0L 305ci	H	w/Range Selector, w/Console, w/THM200, THM250 & THM350 Auto. Trans.; 29.33" Cable	CA-1102	22500581
1984-88	V8 5.0L 305ci	H	w/Range Selector, w/Console, w/THM200-4R Auto. Trans.; 27.20" Cable	CA-1114	10026082
1985-87	V8 5.0L 305ci	H	w/Floor Shift, w/THM200 Auto. Trans.; 29.33" Cable	CA-1102	22500581
1977	V8 5.0L 305ci	U	w/Auto. Trans., w/Console	CA-1168	1246680
1978	V8 5.0L 305ci	U	w/Auto. Trans., w/Console; 29.33" Cable	CA-1102	22500581
1981	V8 5.7L 350ci	L	w/Auto. Trans., w/Console; 29.33" Cable	CA-1102	22500581
1976-77	V8 5.7L 350ci	L, V	w/Auto. Trans., w/Console	CA-1168	1246680
1984	V8 5.7L 350ci	N	w/Range Selector, w/Console, w/THM200, THM250 & THM350 Auto. Trans.; 29.33" Cable	CA-1102	22500581
1984	V8 5.7L 350ci	N	w/Range Selector, w/Console, w/THM200-4R Auto. Trans.; 27.20" Cable	CA-1114	10026082
<b>MONZA</b>					
1977	L4 2.3L 140ci	B	w/THM200 Auto. Trans.	CA-1101	470769
1978-80	L4 2.5L 151ci	1, 9, V	w/THM200 Auto. Trans., w/THM350 Auto. Trans.	CA-1101	470769
1978-79	V6 3.2L 196ci	C	w/THM200 Auto. Trans., w/THM350 Auto. Trans.	CA-1101	470769
1978-80	V6 3.8L 231ci	2, A	w/THM200 Auto. Trans., w/THM350 Auto. Trans.	CA-1101	470769
1976	V8 4.3L 262ci	G	w/THM350 Auto. Trans.	CA-1101	470771
1979	V8 5.0L 305ci	G	w/THM200 Auto. Trans., w/THM350 Auto. Trans.	CA-1101	470769
1976	V8 5.0L 305ci	Q	w/THM350 Auto. Trans.	CA-1101	14067531
1977-78	V8 5.0L 305ci	U	w/THM200 Auto. Trans.	CA-1101	470769
<b>NOVA</b>					
1975-79	L6 4.1L 250ci	D	w/Console	CA-1144	12249641
1979	V8 5.0L 305ci	G	w/Console	CA-1144	12249641
1976	V8 5.0L 305ci	Q	w/Console	CA-1144	12249641
1977-78	V8 5.0L 305ci	U	w/Console	CA-1144	12249641
1975-76	V8 5.7L 350ci	H, L	w/Console	CA-1144	12249641
<b>VEGA</b>					
1976	L4 2.3L 140ci	A, B	w/THM350 Auto. Trans.	CA-1101	14067531
1977	L4 2.3L 140ci	B	w/THM200 Auto. Trans.	CA-1101	14067531
<b>CHEVROLET TRUCKS</b>					
<b>C1500, K1500</b>					
1996-98	V6 4.3L 262ci	W	w/4L60E Trans	CA-1191	15037353

# TRANSHIFT CABLES

Year	Engine	Vin	Remark	Part	OE
<b>CHEVROLET TRUCKS (con't)</b>					
<b>C1500, K1500 (con't)</b>					
1995	V6 4.3L 262ci	Z	w/4L60E Trans	CA-1191	15037353
1995	V8 5.0L 305ci	H	w/4L60E Trans	CA-1191	15037353
1996-99	V8 5.0L 305ci	M	w/4L60E Trans	CA-1191	15037353
1995	V8 5.7L 350ci	K	w/4L60E Trans	CA-1191	15037353
1996-99	V8 5.7L 350ci	R	w/4L60E Trans	CA-1191	15037353
1997-98	V8 6.5L 395ci	F	w/4L60E Trans	CA-1191	15037353
1995-96	V8 6.5L 395ci	P, S	w/4L60E Trans	CA-1191	15037353
<b>C2500, K2500</b>					
1995	V6 4.3L 262ci	Z	w/4L60E Trans	CA-1191	15037353
1995	V8 5.0L 305ci	H	w/4L60E Trans	CA-1191	15037353
1996-98	V8 5.0L 305ci	M	w/4L60E Trans	CA-1191	15037353
1995	V8 5.7L 350ci	K	w/4L60E Trans	CA-1191	15037353
1996-99	V8 5.7L 350ci	R	w/4L60E Trans	CA-1191	15037353
<b>EL CAMINO</b>					
1978-79	V6 3.3L 200ci	M	w/Auto. Trans., w/Console; 29.33" Cable	CA-1102	22500581
1984	V6 3.8L 229ci	9	w/Range Selector, w/Console, w/THM200, THM250 & THM350 Auto. Trans.; 29.33" Cable	CA-1102	22500581
1984	V6 3.8L 229ci	9	w/Range Selector, w/Console, w/THM200-4R Auto. Trans.; 27.20" Cable	CA-1114	10026082
1980-81	V6 3.8L 229ci	K	w/Auto. Trans., w/Console; 29.33" Cable	CA-1102	22500581
1978-81	V6 3.8L 231ci	A	w/Auto. Trans., w/Console; 29.33" Cable	CA-1102	22500581
1984	V6 3.8L 231ci	A	w/Range Selector, w/Console, w/THM200, THM250 & THM350 Auto. Trans.; 29.33" Cable	CA-1102	22500581
1984	V6 3.8L 231ci	A	w/Range Selector, w/Console, w/THM200-4R Auto. Trans.; 27.20" Cable	CA-1114	10026082
1985-87	V6 4.3L 262ci	Z	w/Floor Shift, w/THM200 Auto. Trans.; 29.33" Cable	CA-1102	22500581
1985-87	V6 4.3L 262ci	Z	w/Range Selector, w/Console, w/THM200-4R Auto. Trans.; 27.20" Cable	CA-1114	10026082
1979-81	V8 4.4L 267ci	J	w/Auto. Trans., w/Console; 29.33" Cable	CA-1102	22500581
1979-81	V8 5.0L 305ci	H	w/Auto. Trans., w/Console; 29.33" Cable	CA-1102	22500581
1984	V8 5.0L 305ci	H	w/Range Selector, w/Console, w/THM200, THM250 & THM350 Auto. Trans.; 29.33" Cable	CA-1102	22500581
1984-87	V8 5.0L 305ci	H	w/Range Selector, w/Console, w/THM200-4R Auto. Trans.; 27.20" Cable	CA-1114	10026082
1985-87	V8 5.0L 305ci	H	w/Floor Shift, w/THM200 Auto. Trans.; 29.33" Cable	CA-1102	22500581
1978	V8 5.0L 305ci	U	w/Auto. Trans., w/Console; 29.33" Cable	CA-1102	22500581
1976	V8 5.7L 350ci	L, V	w/Auto. Trans., w/Console	CA-1168	1246680
1978-79	V8 5.7L 350ci	L	w/Auto. Trans., w/Console; 29.33" Cable	CA-1102	22500581
1984	V8 5.7L 350ci	N	w/Range Selector, w/Console, w/THM200, THM250 & THM350 Auto. Trans.; 29.33" Cable	CA-1102	22500581
1984	V8 5.7L 350ci	N	w/Range Selector, w/Console, w/THM200-4R Auto. Trans.; 27.20" Cable	CA-1114	10026082
<b>SILVERADO 1500</b>					
1999	V6 4.3L 262ci	W	w/4L60E Trans	CA-1191	15037353
1999-00	V6 4.3L 262ci	W	New Body Style w/4L60E Trans	CA-1219	12477639
1999-00	V6 4.3L 262ci	W	4WD New Body Style w/4L60E Trans, 4L80E Trans	CA-1220	12477640
2000	V6 4.3L 262ci	W	New Body Style w/4L80E, 4L85E Trans	CA-1219	12477639
2001-02	V6 4.3L 262ci	W	w/4L60E, 4L65E, 4L80E, 4L85E Trans	CA-1219	12477639
2001-02	V6 4.3L 262ci	W	4WD w/4L60E, 4L65E, 4L80E, 4L85E Trans	CA-1220	12477640
2002-07	V6 4.3L 262ci	X	w/4L60E, 4L65E, 4L80E, 4L85E Trans	CA-1219	12477639
2002-07	V6 4.3L 262ci	X	4WD w/4L60E, 4L65E, 4L80E, 4L85E Trans	CA-1220	12477640
1999	V8 4.8L 294ci	V	w/4L60E Trans	CA-1191	15037353
1999-00	V8 4.8L 294ci	V	New Body Style w/4L60E Trans	CA-1219	12477639
1999-00	V8 4.8L 294ci	V	4WD New Body Style w/4L60E Trans, 4L80E Trans	CA-1220	12477640
2000	V8 4.8L 294ci	V	New Body Style w/4L80E, 4L85E Trans	CA-1219	12477639

# TRANSHIFT CABLES

Year	Engine	Vin	Remark	Part	OE
<b>CHEVROLET TRUCKS</b>					
<b>SILVERADO 1500 (con't)</b>					
2001-07	V8 4.8L 294ci	V	w/4L60E, 4L65E, 4L80E, 4L85E Trans	CA-1219	12477639
2001-07	V8 4.8L 294ci	V	4WD w/4L60E, 4L65E, 4L80E, 4L85E Trans	CA-1220	12477640
1999	V8 5.3L 323ci	T	w/4L60E Trans	CA-1191	15037353
1999-00	V8 5.3L 323ci	T	New Body Style w/4L60E Trans	CA-1219	12477639
1999-00	V8 5.3L 323ci	T	4WD New Body Style w/4L60E Trans, 4L80E Trans	CA-1220	12477640
2000	V8 5.3L 323ci	T	New Body Style w/4L80E, 4L85E Trans	CA-1219	12477639
2001-05	V8 5.3L 323ci	T, Z	w/4L60E, 4L65E, 4L80E, 4L85E Trans	CA-1219	12477639
2001-05	V8 5.3L 323ci	T, Z	4WD w/4L60E, 4L65E, 4L80E, 4L85E Trans	CA-1220	12477640
2006-07	V8 5.3L 325ci	B, T, Z	w/4L60E, 4L65E, 4L80E, 4L85E Trans	CA-1219	12477639
2006-07	V8 5.3L 325ci	B, T, Z	4WD w/4L60E, 4L65E, 4L80E, 4L85E Trans	CA-1220	12477640
2001-07	V8 6.0L 364ci	N, U	w/4L60E, 4L65E, 4L80E, 4L85E Trans	CA-1219	12477639
2001-07	V8 6.0L 364ci	N, U	4WD w/4L60E, 4L65E, 4L80E, 4L85E Trans	CA-1220	12477640
<b>SILVERADO 2500</b>					
1999	V8 5.3L 323ci	T	w/4L60E Trans	CA-1191	15037353
1999-00	V8 5.3L 323ci	T	New Body Style w/4L60E Trans	CA-1219	12477639
1999-00	V8 5.3L 323ci	T	4WD New Body Style w/4L60E Trans, 4L80E Trans	CA-1220	12477640
2000	V8 5.3L 323ci	T	w/4L80E, 4L85E Trans	CA-1219	12477639
1999-00	V8 6.0L 364ci	U	w/4L60E Trans	CA-1191	15037353
1999-00	V8 6.0L 364ci	U	New Body Style w/4L60E Trans	CA-1219	12477639
1999-00	V8 6.0L 364ci	U	4WD New Body Style w/4L60E, 4L80E Trans	CA-1220	12477640
2001-07	V8 6.0L 364ci	U	w/4L60E, 4L65E, 4L80E, 4L85E Trans	CA-1219	12477639
2001-07	V8 6.0L 364ci	U	4WD w/4L60E, 4L65E, 4L80E, 4L85E Trans	CA-1220	12477640
2001-04	V8 6.6L 400ci	1	w/4L60E, 4L65E, 4L80E, 4L85E Trans	CA-1219	12477639
2001-04	V8 6.6L 400ci	1	4WD w/4L60E, 4L65E, 4L80E, 4L85E Trans	CA-1220	12477640
2004-06	V8 6.6L 400ci	2	w/4L60E, 4L65E, 4L80E, 4L85E Trans	CA-1219	12477639
2004-06	V8 6.6L 400ci	2	4WD w/4L60E, 4L65E, 4L80E, 4L85E Trans	CA-1220	12477640
2006-07	V8 6.6L 400ci	D	w/4L60E, 4L65E, 4L80E, 4L85E Trans	CA-1219	12477639
2006-07	V8 6.6L 400ci	D	4WD w/4L60E, 4L65E, 4L80E, 4L85E Trans	CA-1220	12477640
2001-07	V8 8.1L 496ci	G	w/4L60E, 4L65E, 4L80E, 4L85E Trans	CA-1219	12477639
2001-07	V8 8.1L 496ci	G	4WD w/4L60E, 4L65E, 4L80E, 4L85E Trans	CA-1220	12477640
<b>SILVERADO 3500</b>					
2001-07	V8 6.0L 364ci	U	w/4L60E, 4L65E, 4L80E, 4L85E Trans	CA-1219	12477639
2001-07	V8 6.0L 364ci	U	4WD w/4L60E, 4L65E, 4L80E, 4L85E Trans	CA-1220	12477640
2001-04	V8 6.6L 400ci	1	w/4L60E, 4L65E, 4L80E, 4L85E Trans	CA-1219	12477639
2001-04	V8 6.6L 400ci	1	4WD w/4L60E, 4L65E, 4L80E, 4L85E Trans	CA-1220	12477640
2005-06	V8 6.6L 400ci	2	w/4L60E, 4L65E, 4L80E, 4L85E Trans	CA-1219	12477639
2005-06	V8 6.6L 400ci	2	4WD w/4L60E, 4L65E, 4L80E, 4L85E Trans	CA-1220	12477640
2006-07	V8 6.6L 400ci	D	w/4L60E, 4L65E, 4L80E, 4L85E Trans	CA-1219	12477639
2006-07	V8 6.6L 400ci	D	4WD w/4L60E, 4L65E, 4L80E, 4L85E Trans	CA-1220	12477640
2004	V8 6.6L 403ci	2	w/4L60E, 4L65E, 4L80E, 4L85E Trans	CA-1219	12477639
2004	V8 6.6L 403ci	2	4WD w/4L60E, 4L65E, 4L80E, 4L85E Trans	CA-1220	12477640
2001-07	V8 8.1L 496ci	G	w/4L60E, 4L65E, 4L80E, 4L85E Trans	CA-1219	12477639
2001-07	V8 8.1L 496ci	G	4WD w/4L60E, 4L65E, 4L80E, 4L85E Trans	CA-1220	12477640
<b>CHRYSLER</b>					
<b>DAYTONA</b>					
1988	L4 2.2L 135ci	A	w/AT, w/Floor Shift; 60.00" Cable	CA-1907	4377302
1989	L4 2.2L 135ci	A	w/AT, w/Floor Shift; 60.00" Cable	CA-1907	4340181
1992-93	L4 2.2L 135ci	A		CA-1180	4670133
1984-88	L4 2.2L 135ci	E	w/AT, w/Floor Shift; 60.00" Cable	CA-1907	4377302
1989-90	L4 2.5L 153ci	J	w/AT, w/Floor Shift; 60.00" Cable	CA-1907	4377302
1991-92	L4 2.5L 153ci	J		CA-1180	4670133
1987-90	L4 2.5L 153ci	K	w/AT, w/Floor Shift; 60.00" Cable	CA-1907	4377302
1991-93	L4 2.5L 153ci	K		CA-1180	4670133
1990	V6 3.0L 181ci	3	w/AT, w/Floor Shift; 60.00" Cable	CA-1907	4340181
1991-93	V6 3.0L 181ci	3		CA-1180	4670133



# TRANSHIFT CABLES

Year	Engine	Vin	Remark	Part	OE
<b>CHRYSLER (con't)</b>					
<b>DYNASTY</b>					
1988-90	L4 2.5L 153ci	K	w/AT, w/Column Shift; 42.32" Cable	CA-1903	4377317
1991-92	L4 2.5L 153ci	K	42.75" Cable	CA-1181	4543047
1989-90	V6 3.0L 181ci	3	w/AT, w/Column Shift; 42.32" Cable	CA-1903	4377317
1991-93	V6 3.3L 201ci	R	42.75" Cable	CA-1181	4543047
<b>E CLASS</b>					
1983	L4 2.2L 135ci	C	w/AT, w/Column Shift; 42.32" Cable	CA-1903	4269896
1983	L4 2.2L 135ci	C	w/AT, w/Floor Shift; 52.50" Cable	CA-1904	4295326
1984	L4 2.2L 135ci	D, E	w/AT, w/Column Shift; 42.32" Cable	CA-1903	4377317
1983	L4 2.6L 156ci	G	w/AT, w/Column Shift; 42.32" Cable	CA-1903	4269896
1983	L4 2.6L 156ci	G	w/AT, w/Floor Shift; 52.50" Cable	CA-1904	4295326
1984	L4 2.6L 156ci	G	w/AT, w/Column Shift; 42.32" Cable	CA-1903	4377317
<b>EXECUTIVE SEDAN</b>					
1984	L4 2.6L 156ci	G	w/AT, w/Column Shift; 42.32" Cable	CA-1903	4377317
<b>IMPERIAL</b>					
1991	V6 3.3L 201ci	R	42.75" Cable	CA-1181	4543047
1991-93	V6 3.8L 230ci	L	42.75" Cable	CA-1181	4543047
<b>LASER</b>					
1984-86	L4 2.2L 135ci	D, E	w/AT, w/Floor Shift; 60.00" Cable	CA-1907	4377302
1986	L4 2.5L 153ci	K	w/AT, w/Floor Shift; 60.00" Cable	CA-1907	4377302
<b>LEBARON</b>					
1989	L4 2.2L 135ci	A	w/AT, w/Floor Shift; 59.61" Cable	CA-1906	4348471
1982	L4 2.2L 135ci	B	w/AT, w/Floor Shift, To 10/4/82; 52.74" Cable	CA-1902	4269880
1982	L4 2.2L 135ci	B	w/AT, w/Column Shift; 42.32" Cable	CA-1903	5211915
1983	L4 2.2L 135ci	C	w/AT, w/Column Shift; 42.32" Cable	CA-1903	4269896
1983	L4 2.2L 135ci	C	w/AT, w/Floor Shift; 52.50" Cable	CA-1904	4295326
1984-90	L4 2.2L 135ci	C	w/AT, w/Column Shift; 42.32" Cable	CA-1903	4377317
1990	L4 2.2L 135ci	C	w/AT, w/Floor Shift, Coupe; 60.00" Cable	CA-1907	4377302
1990	L4 2.2L 135ci	C	w/AT, w/Floor Shift, 4 Door; 56.57" Cable	CA-1908	4377303
1984	L4 2.2L 135ci	D, E	w/AT, w/Column Shift; 42.32" Cable	CA-1903	4377317
1985-86	L4 2.2L 135ci	D, E	w/AT, w/Floor Shift, Convertible; 52.50" Cable	CA-1904	4340180
1985-88	L4 2.2L 135ci	D, E	w/AT, w/Floor Shift; 59.61" Cable	CA-1906	4348471
1985	L4 2.2L 135ci	D, E	w/AT, w/Column Shift; 42.32" Cable	CA-1903	4340184
1986	L4 2.2L 135ci	D, E	w/AT, w/Floor Shift, exc. Convertible; 56.57" Cable	CA-1908	4377303
1986-88	L4 2.2L 135ci	D, E	w/AT, w/Column Shift, Sedan; 42.32" Cable	CA-1903	4377317
1987-88	L4 2.2L 135ci	D, E	w/AT, w/Floor Shift, Coupe; 60.00" Cable	CA-1907	4377302
1987-88	L4 2.2L 135ci	D, E	w/AT, w/Floor Shift, Sedan; 56.57" Cable	CA-1908	4377303
1986-89	L4 2.5L 153ci	J, K	w/AT, w/Floor Shift; 59.61" Cable	CA-1906	4348471
1986-90	L4 2.5L 153ci	J, K	w/AT, w/Floor Shift, Coupe; 60.00" Cable	CA-1907	4377302
1990	L4 2.5L 153ci	J, K	w/AT, w/Column Shift; 42.32" Cable	CA-1903	4377317
1990	L4 2.5L 153ci	J, K	w/AT, w/Floor Shift, 4 Door; 56.57" Cable	CA-1908	4377303
1986	L4 2.5L 153ci	K	w/AT, w/Floor Shift, Convertible; 52.50" Cable	CA-1904	4340180
1986	L4 2.5L 153ci	K	w/AT, w/Floor Shift, exc. Convertible; 56.57" Cable	CA-1908	4377303
1986-88	L4 2.5L 153ci	K	w/AT, w/Column Shift, Sedan; 42.32" Cable	CA-1903	4377317
1986-88	L4 2.5L 153ci	K	w/AT, w/Floor Shift, Sedan; 56.57" Cable	CA-1908	4377303
1991-93	L4 2.5L 153ci	J, K, V	w/Column Shift; 42.75" Cable	CA-1181	4543047
1982	L4 2.6L 156ci	D	w/AT, w/Floor Shift, To 10/4/82; 52.74" Cable	CA-1902	4269880
1982	L4 2.6L 156ci	D	w/AT, w/Column Shift; 42.32" Cable	CA-1903	5211915
1983	L4 2.6L 156ci	G	w/AT, w/Column Shift; 42.32" Cable	CA-1903	4269896
1983	L4 2.6L 156ci	G	w/AT, w/Floor Shift; 52.50" Cable	CA-1904	4295326
1984	L4 2.6L 156ci	G	w/AT, w/Column Shift; 42.32" Cable	CA-1903	4377317
1985	L4 2.6L 156ci	G	w/AT, w/Column Shift; 42.32" Cable	CA-1903	4340184
1985	L4 2.6L 156ci	G	w/AT, w/Floor Shift, Convertible; 52.50" Cable	CA-1904	4340180
1990	V6 3.0L 181ci	3	w/AT, w/Column Shift; 42.32" Cable	CA-1903	4377317
1990	V6 3.0L 181ci	3	w/AT, w/Floor Shift, Coupe; 60.00" Cable	CA-1907	4377302
1990	V6 3.0L 181ci	3	w/AT, w/Floor Shift, 4 Door; 56.57" Cable	CA-1908	4377303

# TRANSHIFT CABLES

Year	Engine	Vin	Remark	Part	OE
<b>CHRYSLER (con't)</b>					
<b>LEBARON (con't)</b>					
1991-95	V6 3.0L 181ci	3	w/Column Shift; 42.75" Cable	CA-1181	4543047
<b>NEW YORKER</b>					
1983	L4 2.2L 135ci	C	w/AT, w/Column Shift; 42.32" Cable	CA-1903	4269896
1983	L4 2.2L 135ci	C	w/AT, w/Floor Shift; 52.50" Cable	CA-1904	4295326
1984	L4 2.2L 135ci	D	w/AT, w/Column Shift; 42.32" Cable	CA-1903	4377317
1984-88	L4 2.2L 135ci	E	w/AT, w/Column Shift; 42.32" Cable	CA-1903	4377317
1986	L4 2.5L 153ci	K	w/AT, w/Column Shift; 42.32" Cable	CA-1903	4377317
1983	L4 2.6L 156ci	G	w/AT, w/Column Shift; 42.32" Cable	CA-1903	4269896
1983	L4 2.6L 156ci	G	w/AT, w/Floor Shift; 52.50" Cable	CA-1904	4295326
1984	L4 2.6L 156ci	G	w/AT, w/Column Shift; 42.32" Cable	CA-1903	4377317
1985	L4 2.6L 156ci	G	w/AT, w/Column Shift; 42.32" Cable	CA-1903	4340184
1988-89	V6 3.0L 181ci	3	w/AT, w/Column Shift; 42.32" Cable	CA-1903	4377317
1991-93	V6 3.3L 201ci	R	w/Column Shift; 42.75" Cable	CA-1181	4543047
1991-93	V6 3.8L 230ci	L	w/Column Shift; 42.75" Cable	CA-1181	4543047
<b>CHRYSLER TRUCKS</b>					
<b>TOWN &amp; COUNTRY</b>					
1982	L4 2.2L 135ci	B	w/AT, w/Column Shift; 42.32" Cable	CA-1903	5211915
1982	L4 2.2L 135ci	B	w/AT, w/Floor Shift; 52.50" Cable	CA-1904	4377301
1984	L4 2.2L 135ci	C	w/AT, w/Column Shift; 42.32" Cable	CA-1903	4377317
1985	L4 2.2L 135ci	E	w/AT, w/Column Shift, Limousine; 42.32" Cable	CA-1903	4340184
1985	L4 2.2L 135ci	E	w/AT, w/Floor Shift, Limousine; 59.61" Cable	CA-1906	4348471
1986-87	L4 2.2L 135ci	E	w/AT, w/Column Shift; 42.32" Cable	CA-1903	4377317
1986-87	L4 2.2L 135ci	E	w/AT, w/Floor Shift, exc. Convertible; 56.57" Cable	CA-1908	4377303
1987-88	L4 2.5L 153ci	K	w/AT, w/Column Shift; 42.32" Cable	CA-1903	4377317
1987-88	L4 2.5L 153ci	K	w/AT, w/Floor Shift, exc. Convertible; 56.57" Cable	CA-1908	4377303
1982	L4 2.6L 156ci	D	w/AT, w/Column Shift; 42.32" Cable	CA-1903	5211915
1982	L4 2.6L 156ci	D	w/AT, w/Floor Shift; 52.50" Cable	CA-1904	4377301
1984	L4 2.6L 156ci	G	w/AT, w/Column Shift; 42.32" Cable	CA-1903	4377317
1985	L4 2.6L 156ci	G	w/AT, w/Column Shift, Limousine; 42.32" Cable	CA-1903	4340184
1985	L4 2.6L 156ci	G	w/AT, w/Floor Shift; 59.61" Cable	CA-1906	4348471
1990	V6 3.3L 201ci	R	w/AT, w/Column Shift; 42.32" Cable	CA-1903	4377317
1991-93	V6 3.3L 201ci	R	42.75" Cable	CA-1181	4543047
1994-95	V6 3.8L 230ci	L	42.75" Cable	CA-1181	4543047
<b>DODGE</b>					
<b>400</b>					
1982	L4 2.2L 135ci	B	w/AT, w/Floor Shift, To 10/4/82; 52.74" Cable	CA-1902	4269880
1982	L4 2.2L 135ci	B	w/AT, w/Column Shift; 42.32" Cable	CA-1903	5211915
1982	L4 2.2L 135ci	B	w/AT, w/Floor Shift, From 10/5/82; 52.50" Cable	CA-1904	4295326
1983	L4 2.2L 135ci	C	w/AT, w/Floor Shift, From 10/5/82; 52.50" Cable	CA-1904	4295326
1983	L4 2.2L 135ci	C	w/AT, w/Floor Shift; 52.50" Cable	CA-1904	4295326
1982	L4 2.6L 156ci	D	w/AT, w/Floor Shift, To 10/4/82; 52.74" Cable	CA-1902	4269880
1982	L4 2.6L 156ci	D	w/AT, w/Column Shift; 42.32" Cable	CA-1903	5211915
1982	L4 2.6L 156ci	D	w/AT, w/Floor Shift, From 10/5/82; 52.50" Cable	CA-1904	4295326
1983	L4 2.6L 156ci	G	w/AT, w/Column Shift; 42.32" Cable	CA-1903	4269896
1983	L4 2.6L 156ci	G	w/AT, w/Floor Shift, From 10/5/82; 52.50" Cable	CA-1904	4295326
<b>600</b>					
1983-84	L4 2.2L 135ci	C	w/AT, w/Column Shift; 42.32" Cable	CA-1903	4269896
1983-84	L4 2.2L 135ci	C	w/AT, w/Floor Shift; 52.50" Cable	CA-1904	4295326
1985	L4 2.2L 135ci	D, E	w/AT, w/Floor Shift; 52.50" Cable	CA-1904	4295326
1986	L4 2.2L 135ci	D, E	w/AT, w/Floor Shift, Convertible; 52.50" Cable	CA-1904	4377301
1986	L4 2.2L 135ci	D, E	w/AT, w/Floor Shift, exc. Convertible; 56.57" Cable	CA-1908	4377303
1985-86	L4 2.2L 135ci	D, E	w/AT, w/Column Shift; 42.32" Cable	CA-1903	4340184
1987-88	L4 2.2L 135ci	D, E	w/AT, w/Column Shift; 42.32" Cable	CA-1903	4377317
1987	L4 2.5L 153ci	K	w/AT, w/Column Shift; 42.32" Cable	CA-1903	4377317

# TRANSHIFT CABLES

Year	Engine	Vin	Remark	Part	OE
<b>DODGE (con't)</b>					
<b>600 (con't)</b>					
1985	L4 2.6L 156ci	G	w/AT, w/Column Shift; 42.32" Cable	CA-1903	4340184
1983-84	L4 2.6L 156ci	G	w/AT, w/Column Shift; 42.32" Cable	CA-1903	4269896
1983-85	L4 2.6L 156ci	G	w/AT, w/Floor Shift; 52.50" Cable	CA-1904	4295326
<b>ARIES</b>					
1981	L4 2.2L 135ci	B	w/AT, w/Floor Shift; 52.74" Cable	CA-1902	5211914
1982	L4 2.2L 135ci	B	w/AT, w/Floor Shift, To 10/4/82; 52.74" Cable	CA-1902	4269880
1981-82	L4 2.2L 135ci	B	w/AT, w/Column Shift; 42.32" Cable	CA-1903	5211915
1983-84	L4 2.2L 135ci	C	w/AT, w/Column Shift; 42.32" Cable	CA-1903	4269896
1983-84	L4 2.2L 135ci	C	w/AT, w/Floor Shift; 52.50" Cable	CA-1904	4295326
1985	L4 2.2L 135ci	C, D	w/AT, w/Column Shift; 42.32" Cable	CA-1903	4340184
1985	L4 2.2L 135ci	C, D	w/AT, w/Floor Shift; 59.61" Cable	CA-1906	4348471
1986-89	L4 2.2L 135ci	D	w/AT, w/Column Shift; 42.32" Cable	CA-1903	4377317
1986-89	L4 2.2L 135ci	D	w/AT, w/Floor Shift; 56.57" Cable	CA-1908	4377303
1986-89	L4 2.5L 153ci	K	w/AT, w/Column Shift; 42.32" Cable	CA-1903	4377317
1986-89	L4 2.5L 153ci	K	w/AT, w/Floor Shift; 56.57" Cable	CA-1908	4377303
1981	L4 2.6L 156ci	D	w/AT, w/Floor Shift; 52.74" Cable	CA-1902	5211914
1982	L4 2.6L 156ci	D	w/AT, w/Floor Shift, To 10/4/82; 52.74" Cable	CA-1902	4269880
1981-82	L4 2.6L 156ci	D	w/AT, w/Column Shift; 42.32" Cable	CA-1903	5211915
1983-84	L4 2.6L 156ci	G	w/AT, w/Column Shift; 42.32" Cable	CA-1903	4269896
1983-84	L4 2.6L 156ci	G	w/AT, w/Floor Shift; 52.50" Cable	CA-1904	4295326
1985	L4 2.6L 156ci	G	w/AT, w/Column Shift; 42.32" Cable	CA-1903	4340184
1985	L4 2.6L 156ci	G	w/AT, w/Floor Shift; 59.61" Cable	CA-1906	4348471
<b>CHARGER</b>					
1984	L4 1.6L 97ci	A	w/AT, w/Floor Shift; 52.50" Cable	CA-1904	4377301
1984	L4 2.2L 135ci	8, C	w/AT, w/Floor Shift; 52.50" Cable	CA-1904	4377301
1985	L4 2.2L 135ci	8, E	w/AT, w/Floor Shift; 52.74" Cable	CA-1902	4340179
1986	L4 2.2L 135ci	8, C	w/AT, w/Floor Shift; 52.74" Cable	CA-1902	4377308
1986-87	L4 2.2L 135ci	E	w/AT, w/Floor Shift; 52.74" Cable	CA-1902	4377308
<b>DAYTONA</b>					
1987	L4 2.2L 135ci	A	w/AT, w/Floor Shift; 60.00" Cable	CA-1907	4340181
1988-89	L4 2.2L 135ci	A	w/AT, w/Floor Shift; 60.00" Cable	CA-1907	4377302
1992-93	L4 2.2L 135ci	A		CA-1180	4670133
1990	L4 2.2L 135ci	C	w/AT, w/Floor Shift; 60.00" Cable	CA-1907	4377302
1984-86	L4 2.2L 135ci	D	w/AT, w/Floor Shift; 60.00" Cable	CA-1907	4377302
1984-88	L4 2.2L 135ci	E	w/AT, w/Floor Shift; 60.00" Cable	CA-1907	4377302
1989-90	L4 2.5L 153ci	J, K	w/AT, w/Floor Shift; 60.00" Cable	CA-1907	4377302
1991-93	L4 2.5L 153ci	J, K		CA-1180	4670133
1987	L4 2.5L 153ci	K	w/AT, w/Floor Shift; 60.00" Cable	CA-1907	4340181
1990	V6 3.0L 181ci	3	w/AT, w/Floor Shift; 60.00" Cable	CA-1907	4377302
1991-93	V6 3.0L 181ci	3		CA-1180	4670133
<b>DYNASTY</b>					
1988-90	L4 2.5L 153ci	K	w/AT, w/Column Shift; 42.32" Cable	CA-1903	4377317
1991-93	L4 2.5L 153ci	K	42.75" Cable	CA-1181	4543047
1988-90	V6 3.0L 181ci	3	w/AT, w/Column Shift; 42.32" Cable	CA-1903	4377317
1991-93	V6 3.0L 181ci	3	42.75" Cable	CA-1181	4543047
1990	V6 3.3L 201ci	R	w/AT, w/Column Shift; 42.32" Cable	CA-1903	4377317
1991-93	V6 3.3L 201ci	R	42.75" Cable	CA-1181	4543047
<b>LANCER</b>					
1988-89	L4 2.2L 135ci	A	w/AT, w/Floor Shift; 59.61" Cable	CA-1906	4377304
1985-86	L4 2.2L 135ci	D, E	w/AT, w/Column Shift; 42.32" Cable	CA-1903	4340184
1985-88	L4 2.2L 135ci	D, E	w/AT, w/Floor Shift; 59.61" Cable	CA-1906	4377304
1989	L4 2.5L 153ci	J	w/AT, w/Floor Shift; 59.61" Cable	CA-1906	4377304
1986	L4 2.5L 153ci	K	w/AT, w/Column Shift; 42.32" Cable	CA-1903	4340184
1986-89	L4 2.5L 153ci	K	w/AT, w/Floor Shift; 59.61" Cable	CA-1906	4377304

# TRANSHIFT CABLES

Year	Engine	Vin	Remark	Part	OE
<b>DODGE (con't)</b>					
<b>OMNI</b>					
1983-84	L4 1.6L 97ci	A	w/AT, w/Floor Shift; 52.50" Cable	CA-1904	4377301
1985	L4 1.6L 97ci	A	w/AT, w/Floor Shift; 52.74" Cable	CA-1902	4340179
1986	L4 1.6L 97ci	A	w/AT, w/Floor Shift; 52.74" Cable	CA-1902	4377308
1980-82	L4 1.7L 105ci	A	w/Floor Shift, w/A404 Trans.; 52.74" Cable	CA-1902	5211914
1983	L4 1.7L 105ci	B	w/AT, w/Floor Shift; 52.50" Cable	CA-1904	4377301
1984	L4 2.2L 135ci	8	w/AT, w/Floor Shift; 52.50" Cable	CA-1904	4377301
1985	L4 2.2L 135ci	8	w/AT, w/Floor Shift; 52.74" Cable	CA-1902	4340179
1986-87	L4 2.2L 135ci	8	w/AT, w/Floor Shift; 52.74" Cable	CA-1902	4377308
1981-82	L4 2.2L 135ci	B	w/Floor Shift, w/A404 Trans.; 52.74" Cable	CA-1902	5211914
1983-84	L4 2.2L 135ci	C	w/AT, w/Floor Shift; 52.50" Cable	CA-1904	4377301
1985	L4 2.2L 135ci	C, E	w/AT, w/Floor Shift; 52.74" Cable	CA-1902	4340179
1986-87	L4 2.2L 135ci	C, E	w/AT, w/Floor Shift; 52.74" Cable	CA-1902	4377308
1988	L4 2.2L 135ci	D	w/AT, w/Floor Shift; 52.74" Cable	CA-1902	4377308
<b>SHADOW</b>					
1989	L4 2.2L 135ci	A	w/AT, w/Floor Shift; 56.57" Cable	CA-1908	4377303
1987-88	L4 2.2L 135ci	D	w/AT, w/Floor Shift; 56.57" Cable	CA-1908	4377303
1991-94	L4 2.2L 135ci	D	56.10" Cable	CA-1179	4543042
1987-88	L4 2.2L 135ci	E	w/AT, w/Floor Shift; 56.57" Cable	CA-1908	4377303
1989-90	L4 2.5L 153ci	J, K	w/AT, w/Floor Shift; 56.57" Cable	CA-1908	4377303
1991-94	L4 2.5L 153ci	J, K	56.10" Cable	CA-1179	4543042
1993-94	V6 3.0L 181ci	3	56.10" Cable	CA-1179	4543042
<b>SPIRIT</b>					
1991-92	L4 2.2L 135ci	A	w/Floor Shift; 56.10" Cable	CA-1179	4543042
1991-92	L4 2.2L 135ci	A	w/Column Shift; 42.75" Cable	CA-1181	4543047
1989-90	L4 2.5L 153ci	J, K	w/AT, w/Column Shift; 42.32" Cable	CA-1903	4377315
1989-90	L4 2.5L 153ci	J, K	w/AT, w/Floor Shift; 56.57" Cable	CA-1908	4377303
1991-95	L4 2.5L 153ci	J, K, V	w/Floor Shift; 56.10" Cable	CA-1179	4543042
1991-95	L4 2.5L 153ci	J, K, V	w/Column Shift; 42.75" Cable	CA-1181	4543047
1989-90	V6 3.0L 181ci	3	w/AT, w/Column Shift; 42.32" Cable	CA-1903	4377315
1989-90	V6 3.0L 181ci	3	w/AT, w/Floor Shift; 56.57" Cable	CA-1908	4377303
1991-95	V6 3.0L 181ci	3	w/Floor Shift; 56.10" Cable	CA-1179	4543042
1991-95	V6 3.0L 181ci	3	w/Column Shift; 42.75" Cable	CA-1181	4543047
<b>DODGE TRUCKS</b>					
<b>CARAVAN</b>					
1984-87	L4 2.2L 135ci	C	w/AT, w/Column Shift; 42.32" Cable	CA-1903	4377315
1985-87	L4 2.2L 135ci	C	w/AT, w/Column Shift; 42.32" Cable	CA-1903	4348451
1988-90	L4 2.5L 153ci	J, K	w/AT, w/Column Shift; 42.32" Cable	CA-1903	4377315
1991-95	L4 2.5L 153ci	K	42.75" Cable	CA-1181	4543047
1984-87	L4 2.6L 156ci	G	w/AT, w/Column Shift; 42.32" Cable	CA-1903	4377315
1987-90	V6 3.0L 181ci	3	w/AT, w/Column Shift; 42.32" Cable	CA-1903	4377315
1991-95	V6 3.0L 181ci	3	42.75" Cable	CA-1181	4543047
1994-95	V6 3.3L 201ci	J	42.75" Cable	CA-1181	4543047
1990	V6 3.3L 201ci	R	w/AT, w/Column Shift; 42.32" Cable	CA-1903	4348451
1991-95	V6 3.3L 201ci	R	42.75" Cable	CA-1181	4543047
<b>GRAND CARAVAN</b>					
1988	L4 2.5L 153ci	K	w/AT, w/Column Shift; 42.32" Cable	CA-1903	4348451
1988-89	V6 3.0L 181ci	3	w/AT, w/Column Shift; 42.32" Cable	CA-1903	4377315
1992-95	V6 3.0L 181ci	3	42.75" Cable	CA-1181	4543047
1990	V6 3.3L 201ci	R	w/AT, w/Column Shift; 42.32" Cable	CA-1903	4377315
1991-95	V6 3.3L 201ci	R	42.75" Cable	CA-1181	4543047
1994-95	V6 3.8L 230ci	L	42.75" Cable	CA-1181	4543047
<b>MINI RAM</b>					
1984-87	L4 2.2L 135ci	C	w/AT, w/Column Shift; 42.32" Cable	CA-1903	4377315
1988	L4 2.5L 153ci	K	w/AT, w/Column Shift; 42.32" Cable	CA-1903	4377315
1984	L4 2.6L 156ci	G	w/AT, w/Column Shift; 42.32" Cable	CA-1903	4377315

# TRANSHIFT CABLES

Year	Engine	Vin	Remark	Part	OE
<b>DODGE TRUCKS (con't)</b>					
<b>MINI RAM (con't)</b>					
1985	L4 2.6L 156ci	G	w/AT, w/Column Shift; 42.32" Cable	CA-1903	4348451
1988	V6 3.0L 181ci	3	w/AT, w/Column Shift; 42.32" Cable	CA-1903	4377315
<b>RAMPAGE</b>					
1982	L4 2.2L 135ci	B	w/AT, w/Floor Shift; 52.74" Cable	CA-1902	5211914
1983	L4 2.2L 135ci	C	w/AT, w/Floor Shift; 52.50" Cable	CA-1904	4377301
1984	L4 2.2L 135ci	C	w/AT, w/Floor Shift; 52.74" Cable	CA-1902	5211914
<b>ROYAL MINI RAM</b>					
1984-86	L4 2.2L 135ci	C	w/AT, w/Column Shift; 42.32" Cable	CA-1903	4377315
1984-86	L4 2.6L 156ci	G	w/AT, w/Column Shift; 42.32" Cable	CA-1903	4377315
1987	V6 3.0L 181ci	3	w/AT, w/Column Shift; 42.32" Cable	CA-1903	4377315
<b>EAGLE</b>					
<b>PREMIER</b>					
1989	L4 2.5L 150ci	H	Column Shift w/ZF Trans.; 88.43" Cable	CA-1174	33004534
1989	L4 2.5L 150ci	H	Column Shift w/AR-4 Trans.; 30.63" Cable	CA-1175	33003065
1989	L4 2.5L 150ci	H	Column Shift w/ZF Trans.; 89.50" Cable	CA-1187	33004534
1989	L4 2.5L 150ci	H	Column Shift w/AR-4 Trans.; 31.25" Cable	CA-1188	33003065
1988	L4 2.5L 150ci	Z	Column Shift w/ZF Trans.; 88.43" Cable	CA-1174	33004534
1988	L4 2.5L 150ci	Z	Column Shift w/AR-4 Trans.; 30.63" Cable	CA-1175	33003065
1988	L4 2.5L 150ci	Z	Column Shift w/ZF Trans.; 89.50" Cable	CA-1187	33004534
1988	L4 2.5L 150ci	Z	Column Shift w/AR-4 Trans.; 31.25" Cable	CA-1188	33003065
1988	V6 3.0L 2972cc	J	Column Shift w/ZF Trans.; 88.43" Cable	CA-1174	33004534
1988	V6 3.0L 2972cc	J	Column Shift w/AR-4 Trans.; 30.63" Cable	CA-1175	33003065
1988	V6 3.0L 2972cc	J	Column Shift w/ZF Trans.; 89.50" Cable	CA-1187	33004534
1988	V6 3.0L 2972cc	J	Column Shift w/AR-4 Trans.; 31.25" Cable	CA-1188	33003065
1989	V6 3.0L 2972cc	U	Column Shift w/ZF Trans.; 88.43" Cable	CA-1174	33004534
1989	V6 3.0L 2972cc	U	Column Shift w/AR-4 Trans.; 30.63" Cable	CA-1175	33003065
1989	V6 3.0L 2972cc	U	Column Shift w/ZF Trans.; 89.50" Cable	CA-1187	33004534
1989	V6 3.0L 2972cc	U	Column Shift w/AR-4 Trans.; 31.25" Cable	CA-1188	33003065
<b>FORD</b>					
<b>GRANADA</b>					
1975-77	L6 3.3L 200ci	T	w/C4 Auto. Trans.	CA-1002	E0DZ-7E395-A
1980	L6 4.1L 250ci	C	w/Jatco Auto. Trans.	CA-1002	D7DZ-7E395-B
1975-77	L6 4.1L 250ci	L	w/C4 Auto. Trans.	CA-1002	E0DZ-7E395-A
1978-79	L6 4.1L 250ci	L	w/C4 Auto. Trans., w/Jatco Auto. Trans.	CA-1002	D7DZ-7E395-B
1975-79	V8 5.0L 302ci	F	w/C4 Auto. Trans.	CA-1002	E0DZ-7E395-A
<b>FORD TRUCKS</b>					
<b>AEROSTAR</b>					
1986-87	L4 2.3L 140ci	A	w/Auto. Trans., w/A4LD Trans.	CA-1006	E69Z-7E395-A
1986	V6 2.8L 171ci	S	w/Auto. Trans.	CA-1006	E69Z-7E395-A
1986	V6 3.0L 182ci	U	w/Auto. Trans.	CA-1006	E69Z-7E395-A
1987-91	V6 3.0L 182ci	U	w/Auto. Trans., w/A4LD Trans.	CA-1006	E69Z-7E395-A
1992-97	V6 3.0L 182ci	U	w/Auto. Trans., w/Column Shift; 62.80" Cable	CA-1198	F29Z-7E395-A
1990-91	V6 4.0L 245ci	X	w/Auto. Trans., w/A4LD Trans.	CA-1006	E69Z-7E395-A
1992-97	V6 4.0L 245ci	X	w/Auto. Trans., w/Column Shift; 62.80" Cable	CA-1198	F29Z-7E395-A
<b>BRONCO</b>					
1995-96	V8 5.0L 302ci	N	w/4R70W or E4OD Trans.; 55.63" Cable	CA-1196	F5TZ-7E395-A
1995-96	V8 5.8L 351ci	H	w/4R70W or E4OD Trans.; 55.63" Cable	CA-1196	F5TZ-7E395-A
<b>E SUPER DUTY</b>					
1996	V8 5.8L 351ci	H	w/C6 Trans.; 73.00" Cable	CA-1199	F2UZ-7E395-A
1996	V8 7.3L 445ci	F	w/C6 Trans.; 73.00" Cable	CA-1199	F2UZ-7E395-A
1996	V8 7.5L 460ci	G	w/C6 Trans.; 73.00" Cable	CA-1199	F2UZ-7E395-A
1996	V8 7.5L 460ci	G	w/E4OD Trans.; 73.00" Cable	CA-1199	F2UZ-7E395-A
<b>E-150 ECONOLINE</b>					
1992-96	L6 4.9L 300ci	Y	w/4R70W or E4OD Trans.; 73.00" Cable	CA-1199	F2UZ-7E395-A

# TRANSHIFT CABLES

Year	Engine	Vin	Remark	Part	OE
<b>FORD TRUCKS (con't)</b>					
<b>E-150 ECONOLINE (con't)</b>					
1992-96	L6 4.9L 300ci	Y	w/C6 Trans.; 73.00" Cable	CA-1199	F2UZ-7E395-A
1992-96	V8 5.0L 302ci	N	w/4R70W or E4OD Trans.; 73.00" Cable	CA-1199	F2UZ-7E395-A
1992-96	V8 5.0L 302ci	N	w/C6 Trans.; 73.00" Cable	CA-1199	F2UZ-7E395-A
1992-96	V8 5.8L 351ci	H	w/4R70W or E4OD Trans.; 73.00" Cable	CA-1199	F2UZ-7E395-A
1992-96	V8 5.8L 351ci	H	w/C6 Trans.; 73.00" Cable	CA-1199	F2UZ-7E395-A
<b>E-250 ECONOLINE</b>					
1992-96	L6 4.9L 300ci	Y, Z	w/4R70W or E4OD Trans.; 73.00" Cable	CA-1199	F2UZ-7E395-A
1992-96	L6 4.9L 300ci	Y, Z	w/C6 Trans.; 73.00" Cable	CA-1199	F2UZ-7E395-A
1992-96	V8 5.8L 351ci	H	w/4R70W or E4OD Trans.; 73.00" Cable	CA-1199	F2UZ-7E395-A
1992-96	V8 5.8L 351ci	H	w/C6 Trans.; 73.00" Cable	CA-1199	F2UZ-7E395-A
<b>E-350 ECONOLINE</b>					
1992-96	L6 4.9L 300ci	Y, Z	w/4R70W or E4OD Trans.; 73.00" Cable	CA-1199	F2UZ-7E395-A
1992-96	L6 4.9L 300ci	Y, Z	w/C6 Trans.; 73.00" Cable	CA-1199	F2UZ-7E395-A
1992-96	V8 5.8L 351ci	H	w/4R70W or E4OD Trans.; 73.00" Cable	CA-1199	F2UZ-7E395-A
1992-96	V8 5.8L 351ci	H	w/C6 Trans.; 73.00" Cable	CA-1199	F2UZ-7E395-A
1995-96	V8 7.3L 445ci	F	w/4R70W or E4OD Trans.; 73.00" Cable	CA-1199	F2UZ-7E395-A
1995-96	V8 7.3L 445ci	F	w/C6 Trans.; 73.00" Cable	CA-1199	F2UZ-7E395-A
1992-94	V8 7.3L 445ci	M	w/4R70W or E4OD Trans.; 73.00" Cable	CA-1199	F2UZ-7E395-A
1992-94	V8 7.3L 445ci	M	w/C6 Trans.; 73.00" Cable	CA-1199	F2UZ-7E395-A
1992-96	V8 7.5L 460ci	G	w/4R70W or E4OD Trans.; 73.00" Cable	CA-1199	F2UZ-7E395-A
1992-96	V8 7.5L 460ci	G	w/C6 Trans.; 73.00" Cable	CA-1199	F2UZ-7E395-A
<b>F SUPER DUTY</b>					
1995-96	V8 7.3L 445ci	F	w/C6 Trans.; 58.90" Cable	CA-1197	F3TZ-7E395-D
1994	V8 7.3L 445ci	K	w/C6 Trans.; 58.90" Cable	CA-1197	F3TZ-7E395-D
1992-94	V8 7.3L 445ci	M	w/C6 Trans.; 58.90" Cable	CA-1197	F3TZ-7E395-D
1992-96	V8 7.5L 460ci	G	w/C6 Trans.; 58.90" Cable	CA-1197	F3TZ-7E395-D
<b>F-150</b>					
1992-96	L6 4.9L 300ci	Y, Z	w/C6 Trans.; 58.90" Cable	CA-1197	F3TZ-7E395-D
1995-96	L6 4.9L 300ci	Y, Z	w/4R70W or E4OD Trans.; 55.63" Cable	CA-1196	F5TZ-7E395-A
1992-96	V8 5.0L 302ci	N	w/C6 Trans.; 58.90" Cable	CA-1197	F3TZ-7E395-D
1995-96	V8 5.0L 302ci	N	w/4R70W or E4OD Trans.; 55.63" Cable	CA-1196	F5TZ-7E395-A
1992-96	V8 5.8L 351ci	H, R	w/C6 Trans.; 58.90" Cable	CA-1197	F3TZ-7E395-D
1995-96	V8 5.8L 351ci	H, R	w/4R70W or E4OD Trans.; 55.63" Cable	CA-1196	F5TZ-7E395-A
<b>F-250</b>					
1992-96	L6 4.9L 300ci	Y, Z	w/C6 Trans.; 58.90" Cable	CA-1197	F3TZ-7E395-D
1995-96	L6 4.9L 300ci	Y, Z	w/4R70W or E4OD Trans.; 55.63" Cable	CA-1196	F5TZ-7E395-A
1997	V8 4.6L 281ci	6, W	w/4R70W or E4OD Trans.; 55.63" Cable	CA-1196	F5TZ-7E395-A
1992-96	V8 5.0L 302ci	N	w/C6 Trans.; 58.90" Cable	CA-1197	F3TZ-7E395-D
1995-96	V8 5.0L 302ci	N	w/4R70W or E4OD Trans.; 55.63" Cable	CA-1196	F5TZ-7E395-A
1997	V8 5.4L 330ci	L, M	w/4R70W or E4OD Trans.; 55.63" Cable	CA-1196	F5TZ-7E395-A
1992-96	V8 5.8L 351ci	H	w/C6 Trans.; 58.90" Cable	CA-1197	F3TZ-7E395-D
1995-97	V8 5.8L 351ci	H	w/4R70W or E4OD Trans.; 55.63" Cable	CA-1196	F5TZ-7E395-A
1993	V8 7.3L 445ci	C	w/C6 Trans.; 58.90" Cable	CA-1197	F3TZ-7E395-D
1994-96	V8 7.3L 445ci	F	w/C6 Trans.; 58.90" Cable	CA-1197	F3TZ-7E395-D
1995-97	V8 7.3L 445ci	F	w/4R70W or E4OD Trans.; 55.63" Cable	CA-1196	F5TZ-7E395-A
1994	V8 7.3L 445ci	K	w/C6 Trans.; 58.90" Cable	CA-1197	F3TZ-7E395-D
1992-94	V8 7.3L 445ci	M	w/C6 Trans.; 58.90" Cable	CA-1197	F3TZ-7E395-D
1992-96	V8 7.5L 460ci	G	w/C6 Trans.; 58.90" Cable	CA-1197	F3TZ-7E395-D
1995-97	V8 7.5L 460ci	G	w/4R70W or E4OD Trans.; 55.63" Cable	CA-1196	F5TZ-7E395-A
<b>F-350</b>					
1992-96	L6 4.9L 300ci	Y	w/C6 Trans.; 58.90" Cable	CA-1197	F3TZ-7E395-D
1995-96	L6 4.9L 300ci	Y	w/4R70W or E4OD Trans.; 55.63" Cable	CA-1196	F5TZ-7E395-A
1992-96	V8 5.8L 351ci	H	w/C6 Trans.; 58.90" Cable	CA-1197	F3TZ-7E395-D
1995-97	V8 5.8L 351ci	H	w/4R70W or E4OD Trans.; 55.63" Cable	CA-1196	F5TZ-7E395-A
1993	V8 7.3L 445ci	C	w/C6 Trans.; 58.90" Cable	CA-1197	F3TZ-7E395-D

# TRANSHIFT CABLES

Year	Engine	Vin	Remark	Part	OE
<b>FORD TRUCKS (con't)</b>					
<b>F-350 (con't)</b>					
1994-96	V8 7.3L 445ci	F	w/C6 Trans.; 58.90" Cable	CA-1197	F3TZ-7E395-D
1995-97	V8 7.3L 445ci	F	w/4R70W or E4OD Trans.; 55.63" Cable	CA-1196	F5TZ-7E395-A
1994	V8 7.3L 445ci	K	w/C6 Trans.; 58.90" Cable	CA-1197	F3TZ-7E395-D
1992-94	V8 7.3L 445ci	M	w/C6 Trans.; 58.90" Cable	CA-1197	F3TZ-7E395-D
1992-96	V8 7.5L 460ci	G	w/C6 Trans.; 58.90" Cable	CA-1197	F3TZ-7E395-D
1995-97	V8 7.5L 460ci	G	w/4R70W or E4OD Trans.; 55.63" Cable	CA-1196	F5TZ-7E395-A
<b>GMC</b>					
<b>C1500, K1500</b>					
1996-98	V6 4.3L 262ci	W	w/4L60E Trans	CA-1191	15037353
1995	V6 4.3L 262ci	Z	w/4L60E Trans	CA-1191	15037353
1995	V8 5.0L 305ci	H	w/4L60E Trans	CA-1191	15037353
1996-99	V8 5.0L 305ci	M	w/4L60E Trans	CA-1191	15037353
1995	V8 5.7L 350ci	K	w/4L60E Trans	CA-1191	15037353
1996-99	V8 5.7L 350ci	R	w/4L60E Trans	CA-1191	15037353
1997	V8 6.5L 395ci	F	w/4L60E Trans	CA-1191	15037353
1995-96	V8 6.5L 395ci	S	w/4L60E Trans	CA-1191	15037353
<b>C2500, K2500</b>					
1995	V6 4.3L 262ci	Z	w/4L60E Trans	CA-1191	15037353
1995	V8 5.0L 305ci	H	w/4L60E Trans	CA-1191	15037353
1996-97	V8 5.0L 305ci	M	w/4L60E Trans	CA-1191	15037353
1995	V8 5.7L 350ci	K	w/4L60E Trans	CA-1191	15037353
1996-99	V8 5.7L 350ci	R	w/4L60E Trans	CA-1191	15037353
<b>CABALLERO</b>					
1978-79	V6 3.3L 200ci	M	w/Auto. Trans., w/Console; 29.33" Cable	CA-1102	22500581
1984	V6 3.8L 229ci	9, A	w/Console, w/THM200 Auto. Trans., w/THM250 Auto. Trans., w/THM350 Auto Trans.; 29.33" Cable	CA-1102	22500581
1978-81	V6 3.8L 231ci	A	w/Auto. Trans., w/Console; 29.33" Cable	CA-1102	22500581
1985-87	V6 4.3L 262ci	Z	w/Console, w/THM200 Auto. Trans.; 29.33" Cable	CA-1102	22500581
1979-81	V8 5.0L 305ci	H	w/Auto. Trans., w/Console; 29.33" Cable	CA-1102	22500581
1984	V8 5.0L 305ci	H	w/Console, w/THM200 Auto. Trans., w/THM250 Auto. Trans., w/THM350 Auto Trans.; 29.33" Cable	CA-1102	22500581
1978	V8 5.0L 305ci	U	w/Auto. Trans., w/Console; 29.33" Cable	CA-1102	22500581
1978-79	V8 5.7L 350ci	L	w/Auto. Trans., w/Console; 29.33" Cable	CA-1102	22500581
1984	V8 5.7L 350ci	N	w/Console, w/THM200 Auto. Trans., w/THM250 Auto. Trans., w/THM350 Auto Trans.; 29.33" Cable	CA-1102	22500581
<b>SIERRA 1500</b>					
1999	V6 4.3L 262ci	W	w/4L60E Trans	CA-1191	15037353
1999-00	V6 4.3L 262ci	W	4WD New Body Style w/4L60E, 4L80E Trans	CA-1220	12477640
1999-02	V6 4.3L 262ci	W	w/4L60E, 4L65E, 4L80E, 4L85E Trans.	CA-1219	12477639
2001-02	V6 4.3L 262ci	W	4WD w/4L60E, 4L65E, 4L80E, 4L85E Trans.	CA-1220	12477640
2002-07	V6 4.3L 262ci	X	w/4L60E, 4L65E, 4L80E, 4L85E Trans.	CA-1219	12477639
2002-07	V6 4.3L 262ci	X	4WD w/4L60E, 4L65E, 4L80E, 4L85E Trans.	CA-1220	12477640
1999	V8 4.8L 294ci	V	w/4L60E Trans	CA-1191	15037353
1999-00	V8 4.8L 294ci	V	4WD New Body Style w/4L60E, 4L80E Trans	CA-1220	12477640
1999-07	V8 4.8L 294ci	V	w/4L60E, 4L65E, 4L80E, 4L85E Trans.	CA-1219	12477639
2001-07	V8 4.8L 294ci	V	4WD w/4L60E, 4L65E, 4L80E, 4L85E Trans.	CA-1220	12477640
1999	V8 5.3L 323ci	T	w/4L60E Trans	CA-1191	15037353
1999-00	V8 5.3L 323ci	T	4WD New Body Style w/4L60E, 4L80E Trans	CA-1220	12477640
1999-05	V8 5.3L 323ci	T, Z	w/4L60E, 4L65E, 4L80E, 4L85E Trans.	CA-1219	12477639
2001-05	V8 5.3L 323ci	T, Z	4WD w/4L60E, 4L65E, 4L80E, 4L85E Trans.	CA-1220	12477640
2006-07	V8 5.3L 325ci	B, T, Z	w/4L60E, 4L65E, 4L80E, 4L85E Trans.	CA-1219	12477639
2006-07	V8 5.3L 325ci	B, T, Z	4WD w/4L60E, 4L65E, 4L80E, 4L85E Trans.	CA-1220	12477640
2001-07	V8 6.0L 364ci	N, U	w/4L60E, 4L65E, 4L80E, 4L85E Trans.	CA-1219	12477639
2001-07	V8 6.0L 364ci	N, U	4WD w/4L60E, 4L65E, 4L80E, 4L85E Trans.	CA-1220	12477640

# TRANSHIFT CABLES

Year	Engine	Vin	Remark	Part	OE
<b>GMC (con't)</b>					
<b>SIERRA 2500</b>					
1999	V8 5.3L 323ci	T	w/4L60E Trans	CA-1191	15037353
1999-00	V8 5.3L 323ci	T	w/4L60E, 4L65E, 4L80E, 4L85E Trans.	CA-1219	12477639
1999-00	V8 5.3L 323ci	T	4WD New Body Style w/4L60E, 4L80E Trans	CA-1220	12477640
1999	V8 6.0L 364ci	U	w/4L60E Trans	CA-1191	15037353
1999-00	V8 6.0L 364ci	U	4WD New Body Style w/4L60E, 4L80E Trans	CA-1220	12477640
2001-07	V8 6.0L 364ci	U	w/4L60E, 4L65E, 4L80E, 4L85E Trans.	CA-1219	12477639
2001-07	V8 6.0L 364ci	U	4WD w/4L60E, 4L65E, 4L80E, 4L85E Trans.	CA-1220	12477640
2001-04	V8 6.6L 400ci	1	w/4L60E, 4L65E, 4L80E, 4L85E Trans.	CA-1219	12477639
2001-04	V8 6.6L 400ci	1	4WD w/4L60E, 4L65E, 4L80E, 4L85E Trans.	CA-1220	12477640
2005-06	V8 6.6L 400ci	2	w/4L60E, 4L65E, 4L80E, 4L85E Trans.	CA-1219	12477639
2005-06	V8 6.6L 400ci	2	4WD w/4L60E, 4L65E, 4L80E, 4L85E Trans.	CA-1220	12477640
2006-07	V8 6.6L 400ci	D	w/4L60E, 4L65E, 4L80E, 4L85E Trans.	CA-1219	12477639
2006-07	V8 6.6L 400ci	D	4WD w/4L60E, 4L65E, 4L80E, 4L85E Trans.	CA-1220	12477640
2004	V8 6.6L 403ci	2	w/4L60E, 4L65E, 4L80E, 4L85E Trans.	CA-1219	12477639
2004	V8 6.6L 403ci	2	4WD w/4L60E, 4L65E, 4L80E, 4L85E Trans.	CA-1220	12477640
2001-07	V8 8.1L 496ci	G	w/4L60E, 4L65E, 4L80E, 4L85E Trans.	CA-1219	12477639
2001-07	V8 8.1L 496ci	G	4WD w/4L60E, 4L65E, 4L80E, 4L85E Trans.	CA-1220	12477640
<b>SIERRA 3500</b>					
2001-07	V8 6.0L 364ci	U	w/4L60E, 4L65E, 4L80E, 4L85E Trans.	CA-1219	12477639
2001-07	V8 6.0L 364ci	U	4WD w/4L60E, 4L65E, 4L80E, 4L85E Trans.	CA-1220	12477640
2001-04	V8 6.6L 400ci	1	w/4L60E, 4L65E, 4L80E, 4L85E Trans.	CA-1219	12477639
2001-04	V8 6.6L 400ci	1	4WD w/4L60E, 4L65E, 4L80E, 4L85E Trans.	CA-1220	12477640
2005-06	V8 6.6L 400ci	2	w/4L60E, 4L65E, 4L80E, 4L85E Trans.	CA-1219	12477639
2005-06	V8 6.6L 400ci	2	4WD w/4L60E, 4L65E, 4L80E, 4L85E Trans.	CA-1220	12477640
2006-07	V8 6.6L 400ci	D	w/4L60E, 4L65E, 4L80E, 4L85E Trans.	CA-1219	12477639
2006-07	V8 6.6L 400ci	D	4WD w/4L60E, 4L65E, 4L80E, 4L85E Trans.	CA-1220	12477640
2004	V8 6.6L 403ci	2	w/4L60E, 4L65E, 4L80E, 4L85E Trans.	CA-1219	12477639
2004	V8 6.6L 403ci	2	4WD w/4L60E, 4L65E, 4L80E, 4L85E Trans.	CA-1220	12477640
2001-07	V8 8.1L 496ci	G	w/4L60E, 4L65E, 4L80E, 4L85E Trans.	CA-1219	12477639
2001-07	V8 8.1L 496ci	G	4WD w/4L60E, 4L65E, 4L80E, 4L85E Trans.	CA-1220	12477640
<b>SIERRA C3</b>					
2001	V8 6.0L 364ci	U	w/4L60E, 4L65E, 4L80E, 4L85E Trans.	CA-1219	12477639
<b>SIERRA DENALI</b>					
2005-07	V8 6.0L 364ci	N	w/4L60E, 4L65E, 4L80E, 4L85E Trans.	CA-1219	12477639
2005-07	V8 6.0L 364ci	N	4WD w/4L60E, 4L65E, 4L80E, 4L85E Trans.	CA-1220	12477640
2002-04	V8 6.0L 364ci	U	w/4L60E, 4L65E, 4L80E, 4L85E Trans.	CA-1219	12477639
2002-04	V8 6.0L 364ci	U	4WD w/4L60E, 4L65E, 4L80E, 4L85E Trans.	CA-1220	12477640
<b>HONDA</b>					
<b>ACCORD</b>					
1983	L4 1.8L 1751cc			CA-1170	54315-SA-982
1984-85	L4 1.8L 1829cc			CA-1170	54315-SA-982
1986-89	L4 2.0L 1955cc			CA-1171	54315-SE0-962
1990-93	L4 2.2L 2156cc			CA-1169	54315-SM4-989
1994-95	L4 2.2L 2156cc			CA-1172	54315-SEO-981
1995	V6 2.7L 2675cc			CA-1172	54315-SEO-981
<b>JEEP</b>					
<b>CHEROKEE</b>					
1989-90	L4 2.5L 150ci	E	w/Floor Shift	CA-1176	53004561
1988	L4 2.5L 150ci	H	w/Floor Shift	CA-1176	53004561
1991-96	L4 2.5L 150ci	P	w/Column Shift	CA-1177	53004562
1989-90	L6 4.0L 242ci	L	w/Floor Shift	CA-1176	53004561
1988	L6 4.0L 242ci	M	w/Floor Shift	CA-1176	53004561
1991-96	L6 4.0L 242ci	S	w/Column Shift	CA-1177	53004562
<b>COMANCHE</b>					
1986-87	L4 2.1L 126ci	B	w/Column Shift	CA-1177	53004562



# TRANSHIFT CABLES

Year	Engine	Vin	Remark	Part	OE
<b>JEEP (con't)</b>					
<b>COMANCHE (con't)</b>					
1989-90	L4 2.5L 150ci	E	w/Column Shift	CA-1177	53004562
1986-88	L4 2.5L 150ci	H	w/Column Shift	CA-1177	53004562
1991	L4 2.5L 150ci	P	w/Column Shift	CA-1177	53004562
1989-90	L6 4.0L 242ci	L	w/Column Shift	CA-1177	53004562
1987-88	L6 4.0L 242ci	M	w/Column Shift	CA-1177	53004562
1991-92	L6 4.0L 242ci	S	w/Column Shift	CA-1177	53004562
1986	V6 2.8L 173ci	W	w/Column Shift	CA-1177	53004562
<b>WAGONEER</b>					
1989-90	L6 4.0L 242ci	L	w/Floor Shift	CA-1176	53004561
1988	L6 4.0L 242ci	M	w/Floor Shift	CA-1176	53004561
<b>LINCOLN</b>					
<b>CONTINENTAL</b>					
1984-85	L6 2.4L 146ci	L		CA-1189	E4LY-7E395A/B
1984-85	V8 5.0L 302ci	F		CA-1189	E4LY-7E395A/B
<b>MARK VII</b>					
1984-85	L6 2.4L 146ci	L		CA-1189	E4LY-7E395A/B
1988-92	V8 5.0L 302ci	E		CA-1189	E4LY-7E395A/B
1984-87	V8 5.0L 302ci	F, M		CA-1189	E4LY-7E395A/B
<b>VERSAILLES</b>					
1980	V8 5.0L 302ci	F	w/C4 Auto. Trans., w/C5 Auto. Trans.	CA-1002	D7DZ-7E395-B
1977-79	V8 5.0L 302ci	F	w/C4 Auto. Trans.	CA-1002	D7DZ-7E395-B
1977	V8 5.8L 351ci	H	w/C4 Auto. Trans.	CA-1002	D7DZ-7E395-B
<b>MERCURY</b>					
<b>MONARCH</b>					
1975-77	L6 3.3L 200ci	T	w/C4 Auto. Trans.	CA-1002	E0DZ-7E395-A
1980	L6 4.1L 250ci	C	w/Jatco Auto. Trans.	CA-1002	D7DZ-7E395-B
1975-76	L6 4.1L 250ci	L	w/C4 Auto. Trans.	CA-1002	E0DZ-7E395-A
1977-79	L6 4.1L 250ci	L	w/C4 Auto. Trans., w/Jatco Auto. Trans.	CA-1002	E0DZ-7E395-A
1975-79	V8 5.0L 302ci	F	w/C4 Auto. Trans.	CA-1002	E0DZ-7E395-A
1975-77	V8 5.8L 351ci	H	w/C4 Auto. Trans.	CA-1002	E0DZ-7E395-A
<b>OLDSMOBILE</b>					
<b>98</b>					
1987	V6 3.8L 231ci	3		CA-1190	25527523
1986	V6 3.8L 231ci	B	w/ABS	CA-1190	25527523
1988-90	V6 3.8L 231ci	C		CA-1190	25527523
1991	V6 3.8L 231ci	L		CA-1190	25527523
1981	V8 5.0L 307ci	Y	w/Floor Shift, w/THM350 Auto. Trans., w/THM250 Auto. Trans.; 29.33" Cable	CA-1102	22500581
1981	V8 5.7L 350ci	N	w/Floor Shift, w/THM350 Auto. Trans.; 29.33" Cable	CA-1102	22500581
<b>CALAIS</b>					
1985-87	L4 2.5L 151ci	U	w/Throttle Body Injection, w/Console	CA-1128	10032806
1987	V6 3.0L 181ci	L	w/Console	CA-1155	22531810
<b>CUSTOM CRUISER</b>					
1978-79	V8 5.7L 350ci	N, R	w/Floor Shift, w/THM350 Auto. Trans.; 29.33" Cable	CA-1102	22500581
1978-79	V8 6.6L 403ci	K	w/Floor Shift, w/THM350 Auto. Trans.; 29.33" Cable	CA-1102	22500581
<b>CUTLASS</b>					
1979	V6 3.8L 231ci	2, A	w/Console, w/Hurst Dualgate; 28.78" Cable	CA-1150	22504467
1978-79	V6 3.8L 231ci	2, A	w/Floor Shift, w/THM350 Auto. Trans., exc. Hurst, w/THM200 Auto Trans.; 29.33" Cable	CA-1102	22500579
1980-81	V6 3.8L 231ci	A	w/Floor Shift, w/THM200, THM250 & THM350 Auto. Trans.; 29.33" Cable	CA-1102	22500579
1979	V8 4.3L 260ci	F	w/Console, w/Hurst Dualgate; 28.78" Cable	CA-1150	22504467
1980	V8 4.3L 260ci	F	w/Floor Shift, w/THM200, THM250 & THM350 Auto. Trans.; 29.33" Cable	CA-1102	22500579

# TRANSHIFT CABLES

Year	Engine	Vin	Remark	Part	OE
<b>OLDSMOBILE (con't)</b>					
<b>CUTLASS (con't)</b>					
1978-79	V8 4.3L 260ci	F	w/Floor Shift, w/THM350 Auto. Trans., exc. Hurst, w/THM200 Auto Trans.; 29.33" Cable	CA-1102	22500579
1981	V8 4.4L 267ci	J	w/Floor Shift, w/THM200, THM250 & THM350 Auto. Trans.; 29.33" Cable	CA-1102	22500579
1979	V8 5.0L 305ci	H	w/Console, w/Hurst Dualgate; 28.78" Cable	CA-1150	22504467
1980	V8 5.0L 305ci	H	w/Floor Shift, w/THM200, THM250 & THM350 Auto. Trans.; 29.33" Cable	CA-1102	22500579
1978-79	V8 5.0L 305ci	H	w/Floor Shift, w/THM350 Auto. Trans., exc. Hurst, w/THM200 Auto Trans.; 29.33" Cable	CA-1102	22500579
1985-87	V8 5.0L 305ci	H	w/Console, w/THM200 Auto. Trans.; 29.33" Cable	CA-1102	22500579
1985-87	V8 5.0L 305ci	H	w/Console, w/THM200-4R Auto. Trans.	CA-1130	22519497
1979	V8 5.7L 350ci	L, N, R	w/Console, w/Hurst Dualgate; 28.78" Cable	CA-1150	22504467
1978-79	V8 5.7L 350ci	L, N, R	w/Floor Shift, w/THM350 Auto. Trans., exc. Hurst, w/THM200 Auto Trans.; 29.33" Cable	CA-1102	22500579
1980-81	V8 5.7L 350ci	N, R	w/Floor Shift, w/THM200, THM250 & THM350 Auto. Trans.; 29.33" Cable	CA-1102	22500579
<b>CUTLASS CALAIS</b>					
1988	L4 2.5L 151ci	U	w/Console, w/THM200-4R Auto. Trans.	CA-1130	22519497
1979	V6 3.8L 231ci	A	w/Console, w/Hurst Dualgate; 28.78" Cable	CA-1150	22504467
1978-79	V6 3.8L 231ci	2, A	w/Floor Shift, w/THM350 Auto. Trans., exc. Hurst, w/THM200 Auto Trans.; 29.33" Cable	CA-1102	22500579
1980-84	V6 3.8L 231ci	A	w/Floor Shift, w/THM200, THM250 & THM350 Auto. Trans.; 29.33" Cable	CA-1102	22500579
1983-84	V6 3.8L 231ci	A	w/THM200-4R Auto. Trans.; 29.00" Cable	CA-1145	357746
1982-84	V6 4.3L 260ci	V	w/Floor Shift, w/THM200, THM250 & THM350 Auto. Trans.; 29.33" Cable	CA-1102	22500579
1983-84	V6 4.3L 260ci	V	w/THM200-4R Auto. Trans.; 29.00" Cable	CA-1145	357746
1982	V8 4.3L 260ci	8	w/Floor Shift, w/THM200, THM250 & THM350 Auto. Trans.; 29.33" Cable	CA-1102	22500579
1979	V8 4.3L 260ci	F	w/Console, w/Hurst Dualgate; 28.78" Cable	CA-1150	22504467
1978-79	V8 4.3L 260ci	F	w/Floor Shift, w/THM350 Auto. Trans., exc. Hurst, w/THM200 Auto Trans.; 29.33" Cable	CA-1102	22500579
1979	V8 4.3L 260ci	P	w/Floor Shift, w/THM350 Auto. Trans., exc. Hurst, w/THM200 Auto Trans.; 29.33" Cable	CA-1102	22500579
1979	V8 4.3L 260ci	P	w/Console, w/Hurst Dualgate; 28.78" Cable	CA-1150	22504467
1982	V8 4.4L 267ci	J	w/Floor Shift, w/THM200, THM250 & THM350 Auto. Trans.; 29.33" Cable	CA-1102	22500579
1979	V8 5.0L 305ci	H	w/Console, w/Hurst Dualgate; 28.78" Cable	CA-1150	22504467
1984	V8 5.0L 305ci	H	w/THM200-4R Auto. Trans.; 29.00" Cable	CA-1145	357746
1978-79	V8 5.0L 305ci	H	w/Floor Shift, w/THM350 Auto. Trans., exc. Hurst, w/THM200 Auto Trans.; 29.33" Cable	CA-1102	22500579
1980-84	V8 5.0L 305ci	H	w/Floor Shift, w/THM200, THM250 & THM350 Auto. Trans.; 29.33" Cable	CA-1102	22500579
1982-84	V8 5.0L 307ci	9, Y	w/Floor Shift, w/THM200, THM250 & THM350 Auto. Trans.; 29.33" Cable	CA-1102	22500579
1983-84	V8 5.0L 307ci	9, Y	w/THM200-4R Auto. Trans.; 29.00" Cable	CA-1145	357746
1982-84	V8 5.7L 350ci	N	w/Floor Shift, w/THM200, THM250 & THM350 Auto. Trans.; 29.33" Cable	CA-1102	22500579
1983-84	V8 5.7L 350ci	N	w/THM200-4R Auto. Trans.; 29.00" Cable	CA-1145	357746
1979	V8 5.7L 350ci	R	w/Floor Shift, w/THM350 Auto. Trans., exc. Hurst, w/THM200 Auto Trans.; 29.33" Cable	CA-1102	22500579
1979	V8 5.7L 350ci	R	w/Console, w/Hurst Dualgate; 28.78" Cable	CA-1150	22504467
<b>CUTLASS CIERA</b>					
1993	L4 2.2L 134ci	4	w/THM125 AT, exc. Front Console; 55.23" Cable	CA-1134	10038609
1995-96	L4 2.2L 134ci	4	w/Auto. Trans.; 59.06" Cable	CA-1173	12552510

# TRANSHIFT CABLES

Year	Engine	Vin	Remark	Part	OE
<b>OLDSMOBILE (con't)</b>					
<b>CUTLASS CIERA (con't)</b>					
1983	L4 2.5L 151ci	5, R	w/Console, w/THM125 Auto. Trans.; 97.63" Cable	CA-1129	10023729
1983	L4 2.5L 151ci	5, R	w/THM125 Auto. Trans., exc. Console; 55.48" Cable	CA-1132	10024524
1985	L4 2.5L 151ci	R	w/Console, w/THM200 Auto. Trans.; 29.33" Cable	CA-1102	22500579
1985	L4 2.5L 151ci	R	w/Console, w/THM200-4R Auto. Trans.	CA-1130	22519497
1982-84	L4 2.5L 151ci	5, R	w/Floor Shift, w/THM200, THM250 & THM350 Auto. Trans.; 29.33" Cable	CA-1102	22500579
1983-84	L4 2.5L 151ci	5, R	w/THM200-4R Auto. Trans.; 29.00" Cable	CA-1145	357746
1986-87	L4 2.5L 151ci	R	w/Column Shift, w/THM125, w/Cruise Control, w/THM440-T4; 59.09" Cable	CA-1157	10038603
1986-92	L4 2.5L 151ci	R	THM125 AT; exc. Cruise Control, exc. Console.; 55.23" Cable	CA-1134	10038609
1987-89	L4 2.5L 151ci	R	w/THM125 Auto. Trans., exc. Console; 55.23" Cable	CA-1134	10038609
1987-89	L4 2.5L 151ci	R	w/TH440-T4 AT, exc. Console; 59.09" Cable	CA-1157	10038603
1990-92	L4 2.5L 151ci	R	w/TH440-T4 exc. Front Console; 59.09" Cable	CA-1157	10038603
1991-92	L4 2.5L 151ci	R	w/THM125 AT, exc. Front Console; 55.23" Cable	CA-1134	10038609
1986-89	V6 2.8L 173ci	W, X	THM125 AT; exc. Cruise Control, exc. Console.; 55.23" Cable	CA-1134	10038609
1986	V6 2.8L 173ci	W, X	w/Column Shift, w/THM125, w/Cruise Control, w/THM440-T4; 59.09" Cable	CA-1157	10038603
1987-89	V6 2.8L 173ci	W	w/THM125, w/Cruise, w/TH440-T4, exc. Front Console; 59.09" Cable	CA-1157	10038603
1983	V6 2.8L 173ci	X	w/THM200-4R Auto. Trans.; 29.00" Cable	CA-1145	357746
1982-83	V6 2.8L 173ci	X	w/Floor Shift, w/THM200, THM250 & THM350 Auto. Trans.; 29.33" Cable	CA-1102	22500579
1984-85	V6 2.8L 173ci	X	w/TH440-T4 AT, exc. Console; 58.50" Cable	CA-1131	10037686
1984-85	V6 2.8L 173ci	X	w/THM125 Auto. Trans., exc. Console; 55.48" Cable	CA-1132	10024524
1984-85	V6 2.8L 173ci	X	w/TH440-T4 AT, w/Console; 104.37" Cable	CA-1152	10034330
1982	V6 3.0L 181ci	E	w/Floor Shift, w/THM200, THM250 & THM350 Auto. Trans.; 29.33" Cable	CA-1102	22500579
1983	V6 3.0L 181ci	E	w/Console, w/THM125 Auto. Trans.; 97.63" Cable	CA-1129	10023729
1983-85	V6 3.0L 181ci	E	w/THM125 Auto. Trans., exc. Console; 55.48" Cable	CA-1132	10024524
1984-85	V6 3.0L 181ci	E	w/TH440-T4 AT, exc. Console; 58.50" Cable	CA-1131	10037686
1984-85	V6 3.0L 181ci	E	w/TH440-T4 AT, w/Console; 104.37" Cable	CA-1152	10034330
1995-96	V6 3.1L 189ci	M	w/Auto. Trans.; 59.06" Cable	CA-1173	12552510
1989	V6 3.3L 204ci	N	w/THM125, w/Cruise, w/TH440-T4, exc. Front Console; 59.09" Cable	CA-1157	10038603
1993	V6 3.3L 204ci	N	w/THM125 AT, exc. Front Console; 55.23" Cable	CA-1134	10038609
1989-92	V6 3.3L 204ci	N	THM125 AT; exc. Cruise Control, exc. Console.; 55.23" Cable	CA-1134	10038609
1990-92	V6 3.3L 204ci	N	w/TH440-T4 exc. Front Console; 59.09" Cable	CA-1157	10038603
1984	V6 3.8L 231ci	3	w/Floor Shift, w/THM200, THM250 & THM350 Auto. Trans.; 29.33" Cable	CA-1102	22500579
1984	V6 3.8L 231ci	3	w/THM200-4R Auto. Trans.; 29.00" Cable	CA-1145	357746
1985	V6 3.8L 231ci	3	w/Console, w/THM200 Auto. Trans.; 29.33" Cable	CA-1102	22500579
1985	V6 3.8L 231ci	3	w/Console, w/THM200-4R Auto. Trans.	CA-1130	22519497
1986-88	V6 3.8L 231ci	3	THM125 AT; exc. Cruise Control, exc. Console.; 55.23" Cable	CA-1134	10038609
1986	V6 3.8L 231ci	3	w/Column Shift, w/THM125, w/Cruise Control, w/THM440-T4; 59.09" Cable	CA-1157	10038603
1987-88	V6 3.8L 231ci	3	w/THM125, w/Cruise, w/TH440-T4, exc. Front Console; 59.09" Cable	CA-1157	10038603
1982	V6 4.3L 260ci	T	w/Floor Shift, w/THM200, THM250 & THM350 Auto. Trans.; 29.33" Cable	CA-1102	22500579
1983	V6 4.3L 260ci	T	w/Console, w/THM125 Auto. Trans.; 97.63" Cable	CA-1129	10023729
1983-85	V6 4.3L 260ci	T	w/THM125 Auto. Trans., exc. Console; 55.48" Cable	CA-1132	10024524
1984-85	V6 4.3L 260ci	T	w/TH440-T4 AT, exc. Console; 58.50" Cable	CA-1131	10037686

# TRANSHIFT CABLES

Year	Engine	Vin	Remark	Part	OE
<b>OLDSMOBILE (con't)</b>					
<b>CUTLASS CIERA (con't)</b>					
1984-85	V6 4.3L 260ci	T	w/TH440-T4 AT, w/Console; 104.37" Cable	CA-1152	10034330
<b>CUTLASS CRUISER</b>					
1990	L4 2.5L 151ci	R	THM125 AT; exc. Cruise Control, exc. Console.; 55.23" Cable	CA-1134	10038609
1990	L4 2.5L 151ci	R	w/TH440-T4 exc. Front Console; 59.09" Cable	CA-1157	10038603
1987-89	L4 2.5L 151ci	R	w/THM125 Auto. Trans., exc. Console; 55.23" Cable	CA-1134	10038609
1987-89	L4 2.5L 151ci	R	w/TH440-T4 AT, exc. Console; 59.09" Cable	CA-1157	10038603
1987-89	V6 2.8L 173ci	W	THM125 AT; exc. Cruise Control, exc. Console; 55.23" Cable	CA-1134	10038609
1987-89	V6 2.8L 173ci	W	w/THM125, w/Cruise, w/TH440-T4, exc. Front Console; 59.09" Cable	CA-1157	10038603
1989	V6 3.3L 204ci	N	THM125 AT; exc. Cruise Control, exc. Console; 55.23" Cable	CA-1134	10038609
1989	V6 3.3L 204ci	N	w/THM125, w/Cruise, w/TH440-T4, exc. Front Console; 59.09" Cable	CA-1157	10038603
1990	V6 3.3L 204ci	N	THM125 AT; exc. Cruise Control, exc. Console.; 55.23" Cable	CA-1134	10038609
1990	V6 3.3L 204ci	N	w/TH440-T4 exc. Front Console; 59.09" Cable	CA-1157	10038603
1987-88	V6 3.8L 231ci	3	THM125 AT; exc. Cruise Control, exc. Console; 55.23" Cable	CA-1134	10038609
1987-88	V6 3.8L 231ci	3	w/THM125, w/Cruise, w/TH440-T4, exc. Front Console; 59.09" Cable	CA-1157	10038603
1983	V6 3.8L 231ci	A	w/THM200-4R Auto. Trans.; 29.00" Cable	CA-1145	357746
1982-83	V6 3.8L 231ci	A	w/Floor Shift, w/THM200, THM250 & THM350 Auto. Trans.; 29.33" Cable	CA-1102	22500579
1982	V8 4.3L 260ci	8	w/Floor Shift, w/THM200, THM250 & THM350 Auto. Trans.; 29.33" Cable	CA-1102	22500579
1982	V8 4.4L 267ci	J	w/Floor Shift, w/THM200, THM250 & THM350 Auto. Trans.; 29.33" Cable	CA-1102	22500579
1983	V8 5.0L 305ci	H	w/THM200-4R Auto. Trans.; 29.00" Cable	CA-1145	357746
1982-83	V8 5.0L 305ci	H	w/Floor Shift, w/THM200, THM250 & THM350 Auto. Trans.; 29.33" Cable	CA-1102	22500579
1983	V8 5.0L 307ci	Y	w/THM200-4R Auto. Trans.; 29.00" Cable	CA-1145	357746
1981-83	V8 5.0L 307ci	Y	w/Floor Shift, w/THM200, THM250 & THM350 Auto. Trans.; 29.33" Cable	CA-1102	22500579
1983	V8 5.7L 350ci	N	w/THM200-4R Auto. Trans.; 29.00" Cable	CA-1145	357746
1982-83	V8 5.7L 350ci	N	w/Floor Shift, w/THM200, THM250 & THM350 Auto. Trans.; 29.33" Cable	CA-1102	22500579
<b>CUTLASS SALON</b>					
1979	V6 3.8L 231ci	2, A	w/Console, w/Hurst Dualgate; 28.78" Cable	CA-1150	22504467
1980	V6 3.8L 231ci	A	w/Floor Shift, w/THM200, THM250 & THM350 Auto. Trans.; 29.33" Cable	CA-1102	22500579
1978-79	V6 3.8L 231ci	2, A	w/Floor Shift, w/THM350 Auto. Trans., exc. Hurst, w/THM200 Auto Trans.; 29.33" Cable	CA-1102	22500579
1985-87	V6 3.8L 231ci	A	w/Console, w/THM200 Auto. Trans.; 29.33" Cable	CA-1102	22500579
1985-87	V6 3.8L 231ci	A	w/Console, w/THM200-4R Auto. Trans.	CA-1130	22519497
1979	V8 4.3L 260ci	F, P	w/Console, w/Hurst Dualgate; 28.78" Cable	CA-1150	22504467
1980	V8 4.3L 260ci	F	w/Floor Shift, w/THM200, THM250 & THM350 Auto. Trans.; 29.33" Cable	CA-1102	22500579
1978-79	V8 4.3L 260ci	F, P	w/Floor Shift, w/THM350 Auto. Trans., exc. Hurst, w/THM200 Auto Trans.; 29.33" Cable	CA-1102	22500579
1979	V8 5.0L 305ci	H	w/Console, w/Hurst Dualgate; 28.78" Cable	CA-1150	22504467
1978-79	V8 5.0L 305ci	H	w/Floor Shift, w/THM350 Auto. Trans., exc. Hurst, w/THM200 Auto Trans.; 29.33" Cable	CA-1102	22500579

# TRANSHIFT CABLES

Year	Engine	Vin	Remark	Part	OE
<b>OLDSMOBILE (con't)</b>					
<b>CUTLASS SALON (con't)</b>					
1980	V8 5.0L 305ci	H	w/Floor Shift, w/THM200, THM250 & THM350 Auto. Trans.; 29.33" Cable	CA-1102	22500579
1985-87	V8 5.0L 307ci	9, Y	w/Console, w/THM200 Auto. Trans.; 29.33" Cable	CA-1102	22500579
1985-87	V8 5.0L 307ci	9, Y	w/Console, w/THM200-4R Auto. Trans.	CA-1130	22519497
1980	V8 5.7L 350ci	N	w/Floor Shift, w/THM200, THM250 & THM350 Auto. Trans.; 29.33" Cable	CA-1102	22500579
1985	V8 5.7L 350ci	N	w/Console, w/THM200 Auto. Trans.; 29.33" Cable	CA-1102	22500579
1985	V8 5.7L 350ci	N	w/Console, w/THM200-4R Auto. Trans.	CA-1130	22519497
1979	V8 5.7L 350ci	R	w/Floor Shift, w/THM350 Auto. Trans., exc. Hurst, w/THM200 Auto Trans.; 29.33" Cable	CA-1102	22500579
1979	V8 5.7L 350ci	R	w/Console, w/Hurst Dualgate; 28.78" Cable	CA-1150	22504467
<b>CUTLASS SUPREME</b>					
1979	V6 3.8L 231ci	2, A	w/Console, w/Hurst Dualgate; 28.78" Cable	CA-1150	22504467
1978-79	V6 3.8L 231ci	2, A	w/Floor Shift, w/THM350 Auto. Trans., exc. Hurst, w/THM200 Auto Trans.; 29.33" Cable	CA-1102	22500579
1982-84	V6 3.8L 231ci	A	w/Floor Shift, w/THM200, THM250 & THM350 Auto. Trans.; 29.33" Cable	CA-1102	22500579
1983-84	V6 3.8L 231ci	A	w/THM200-4R Auto. Trans.; 29.00" Cable	CA-1145	357746
1985-87	V6 3.8L 231ci	A	w/Console, w/THM200 Auto. Trans.; 29.33" Cable	CA-1102	22500579
1985-87	V6 3.8L 231ci	A	w/Console, w/THM200-4R Auto. Trans.	CA-1130	22519497
1982-84	V6 4.3L 260ci	V	w/Floor Shift, w/THM200, THM250 & THM350 Auto. Trans.; 29.33" Cable	CA-1102	22500579
1983-84	V6 4.3L 260ci	V	w/THM200-4R Auto. Trans.; 29.00" Cable	CA-1145	357746
1982	V8 4.3L 260ci	8	w/Floor Shift, w/THM200, THM250 & THM350 Auto. Trans.; 29.33" Cable	CA-1102	22500579
1979	V8 4.3L 260ci	F, P	w/Console, w/Hurst Dualgate; 28.78" Cable	CA-1150	22504467
1978-79	V8 4.3L 260ci	F, P	w/Floor Shift, w/THM350 Auto. Trans., exc. Hurst, w/THM200 Auto Trans.; 29.33" Cable	CA-1102	22500579
1982	V8 4.4L 267ci	J	w/Floor Shift, w/THM200, THM250 & THM350 Auto. Trans.; 29.33" Cable	CA-1102	22500579
1979	V8 5.0L 305ci	H	w/Console, w/Hurst Dualgate; 28.78" Cable	CA-1150	22504467
1983	V8 5.0L 305ci	H	w/Floor Shift, w/THM200, THM250 & THM350 Auto. Trans.; 29.33" Cable	CA-1102	22500579
1983	V8 5.0L 305ci	H	w/THM200-4R Auto. Trans.; 29.00" Cable	CA-1145	357746
1978-79	V8 5.0L 305ci	H	w/Floor Shift, w/THM350 Auto. Trans., exc. Hurst, w/THM200 Auto Trans.; 29.33" Cable	CA-1102	22500579
1985-87	V8 5.0L 305ci	H	w/Console, w/THM200 Auto. Trans.; 29.33" Cable	CA-1102	22500579
1985-87	V8 5.0L 305ci	H	w/Console, w/THM200-4R Auto. Trans.	CA-1130	22519497
1982-84	V8 5.0L 307ci	Y	w/Floor Shift, w/THM200, THM250 & THM350 Auto. Trans.; 29.33" Cable	CA-1102	22500579
1983-84	V8 5.0L 307ci	Y	w/THM200-4R Auto. Trans.; 29.00" Cable	CA-1145	357746
1985-87	V8 5.0L 307ci	9, Y	w/Console, w/THM200 Auto. Trans.; 29.33" Cable	CA-1102	22500579
1985-88	V8 5.0L 307ci	9, Y	w/Console, w/THM200-4R Auto. Trans.	CA-1130	22519497
1979	V8 5.7L 350ci	N, R	w/Floor Shift, w/THM350 Auto. Trans., exc. Hurst, w/THM200 Auto Trans.; 29.33" Cable	CA-1102	22500579
1979	V8 5.7L 350ci	N, R	w/Console, w/Hurst Dualgate; 28.78" Cable	CA-1150	22504467
1985	V8 5.7L 350ci	N	w/Console, w/THM200 Auto. Trans.; 29.33" Cable	CA-1102	22500579
1985	V8 5.7L 350ci	N	w/Console, w/THM200-4R Auto. Trans.	CA-1130	22519497
1982-84	V8 5.7L 350ci	N	w/Floor Shift, w/THM200, THM250 & THM350 Auto. Trans.; 29.33" Cable	CA-1102	22500579
1983-84	V8 5.7L 350ci	N	w/THM200-4R Auto. Trans.; 29.00" Cable	CA-1145	357746
<b>DELTA 88</b>					
1986	V6 3.0L 181ci	L		CA-1158	25523741
1986	V6 3.8L 231ci	3		CA-1158	25523741
1980-81	V6 3.8L 231ci	A	w/Floor Shift; 29.33" Cable	CA-1102	22500581

# TRANSHIFT CABLES

Year	Engine	Vin	Remark	Part	OE
<b>OLDSMOBILE (con't)</b>					
<b>DELTA 88 (con't)</b>					
1978-79	V6 3.8L 231ci	A	w/Floor Shift, w/THM200 Auto. Trans., w/THM350 Auto. Trans.; 29.33" Cable	CA-1102	22500581
1978-79	V8 4.3L 260ci	F	w/Floor Shift, w/THM200 Auto. Trans., w/THM350 Auto. Trans.; 29.33" Cable	CA-1102	22500581
1980-81	V8 4.3L 260ci	F	w/Floor Shift; 29.33" Cable	CA-1102	22500581
1981	V8 4.4L 267ci	J	w/Floor Shift; 29.33" Cable	CA-1102	22500581
1979	V8 4.9L 301ci	Y	w/Floor Shift, w/THM200 Auto. Trans., w/THM350 Auto. Trans.; 29.33" Cable	CA-1102	22500581
1980-81	V8 5.0L 307ci	Y	w/Floor Shift; 29.33" Cable	CA-1102	22500581
1978-79	V8 5.7L 350ci	N, R	w/Floor Shift, w/THM200 Auto. Trans., w/THM350 Auto. Trans.; 29.33" Cable	CA-1102	22500581
1980-81	V8 5.7L 350ci	N, R	w/Floor Shift; 29.33" Cable	CA-1102	22500581
1978-79	V8 6.6L 403ci	K	w/Floor Shift, w/THM200 Auto. Trans., w/THM350 Auto. Trans.; 29.33" Cable	CA-1102	22500581
<b>FIRENZA</b>					
1983	L4 1.8L 112ci	0	w/Range Selector, w/THM125C Auto. Trans.	CA-1128	10027495
1984-86	L4 1.8L 112ci	0	w/Range Selector, w/THM125C Auto. Trans.	CA-1113	10034333
1982	L4 1.8L 112ci	G	w/Range Selector, w/THM125C Auto. Trans.	CA-1128	10022405
1983	L4 2.0L 122ci	B	w/Range Selector, w/THM125C Auto. Trans.	CA-1128	10027495
1984	L4 2.0L 122ci	B	w/Range Selector, w/THM125C Auto. Trans.	CA-1113	10034333
1987-88	L4 2.0L 122ci	K	w/Range Selector, w/THM125C Auto. Trans.	CA-1113	10034333
1983	L4 2.0L 122ci	P	w/Range Selector, w/THM125C Auto. Trans.	CA-1128	10027495
1984-86	L4 2.0L 122ci	P	w/Range Selector, w/THM125C Auto. Trans.	CA-1113	10034333
1985-87	V6 2.8L 173ci	W	w/Range Selector, w/THM125C Auto. Trans.	CA-1113	10042228
<b>OMEGA</b>					
1980	L4 2.5L 151ci	5	w/Auto. Trans.	CA-1112	10009338
1981	L4 2.5L 151ci	5	w/Auto. Trans., exc. Console	CA-1118	10017823
1982	L4 2.5L 151ci	5, R	w/AT, w/Console & Park Lock; 52.00" Cable	CA-1123	10027283
1982	L4 2.5L 151ci	5, R	w/Auto. Trans., exc. Console; 49.68" Cable	CA-1124	10027422
1982	L4 2.5L 151ci	5, R	w/Console, w/Shift Select; 96.46" Cable	CA-1178	10021329
1983	L4 2.5L 151ci	5, R	w/Range Selector, w/THM125C Auto. Trans., w/Console; 97.63" Cable	CA-1129	10023729
1983-84	L4 2.5L 151ci	5, R	exc. Console; 55.48" Cable	CA-1132	10041214
1981	V6 2.8L 173ci	X	w/Auto. Trans., w/Console	CA-1118	10017823
1982	V6 2.8L 173ci	X	w/AT, w/Console & Park Lock; 52.00" Cable	CA-1123	10027283
1982	V6 2.8L 173ci	X	w/Auto. Trans., exc. Console; 49.68" Cable	CA-1124	10027422
1983	V6 2.8L 173ci	X	w/Range Selector, w/THM125C Auto. Trans., w/Console; 97.63" Cable	CA-1129	10023729
1981-82	V6 2.8L 173ci	X	w/Console, w/Shift Select; 96.46" Cable	CA-1178	10021329
1983-84	V6 2.8L 173ci	X	exc. Console; 55.48" Cable	CA-1132	10041214
<b>STARFIRE</b>					
1976	L4 2.3L 140ci	B	w/THM350 Auto. Trans.	CA-1101	470771
1977	L4 2.3L 140ci	B	w/THM250 Auto. Trans., w/THM350 Auto. Trans.	CA-1101	470771
1980	L4 2.5L 151ci	V	w/THM350 Auto. Trans.	CA-1101	470771
1978-80	V6 3.8L 231ci	A	w/THM350 Auto. Trans.	CA-1101	470771
1976	V6 3.8L 231ci	C	w/THM350 Auto. Trans.	CA-1101	14067531
1977	V6 3.8L 231ci	C	w/THM250 Auto. Trans., w/THM350 Auto. Trans.	CA-1101	14067531
1979	V8 5.0L 305ci	G	w/THM350 Auto. Trans.	CA-1101	470771
1977	V8 5.0L 305ci	U	w/THM250 Auto. Trans., w/THM350 Auto. Trans.	CA-1101	470771
<b>TORONADO</b>					
1984	V6 4.1L 252ci	4		CA-1147	22513487
1984-85	V8 5.0L 307ci	Y		CA-1147	22513487
1984-85	V8 5.7L 350ci	N		CA-1147	22513487

# TRANSHIFT CABLES

Year	Engine	Vin	Remark	Part	OE
<b>PLYMOUTH</b>					
<b>ACCLAIM</b>					
1991-95	L4 2.5L 153ci	K, V	w/Floor Shift; 56.10" Cable	CA-1179	4543042
1991-95	L4 2.5L 153ci	K, V	w/Column Shift; 42.75" Cable	CA-1181	4543047
1991-95	V6 3.0L 181ci	3	w/Floor Shift; 56.10" Cable	CA-1179	4543042
1991-95	V6 3.0L 181ci	3	w/Column Shift; 42.75" Cable	CA-1181	4543047
<b>CARAVELLE</b>					
1985	L4 2.2L 135ci	D, E	w/AT, w/Column Shift; 42.32" Cable	CA-1903	4340184
1986-88	L4 2.2L 135ci	C, D, E	w/AT, w/Column Shift; 42.32" Cable	CA-1903	4377317
1988	L4 2.5L 153ci	K	w/AT, w/Column Shift; 42.32" Cable	CA-1903	4377317
1985	L4 2.6L 156ci	G	w/AT, w/Column Shift; 42.32" Cable	CA-1903	4340184
<b>HORIZON</b>					
1983	L4 1.6L 97ci	A	w/AT, w/Floor Shift; 52.50" Cable	CA-1904	4377301
1984-86	L4 1.6L 97ci	A	w/AT, w/Floor Shift; 52.74" Cable	CA-1902	4340179
1980-82	L4 1.7L 105ci	A	w/Floor Shift, w/A404 Trans.; 52.74" Cable	CA-1902	5211914
1983	L4 1.7L 105ci	B	w/AT, w/Floor Shift; 52.50" Cable	CA-1904	4377301
1981-82	L4 2.2L 135ci	B	w/Floor Shift, w/A404 Trans.; 52.74" Cable	CA-1902	5211914
1983	L4 2.2L 135ci	C	w/AT, w/Floor Shift; 52.50" Cable	CA-1904	4377301
1984-87	L4 2.2L 135ci	8, C	w/AT, w/Floor Shift; 52.74" Cable	CA-1902	4340179
1988-90	L4 2.2L 135ci	D	w/AT, w/Floor Shift; 52.74" Cable	CA-1902	4340179
<b>RELIANT</b>					
1981-82	L4 2.2L 135ci	B	w/AT, w/Floor Shift, To 10/4/82; 52.74" Cable	CA-1902	4269880
1981-82	L4 2.2L 135ci	B	w/AT, w/Column Shift; 42.32" Cable	CA-1903	5211915
1983	L4 2.2L 135ci	C	w/AT, w/Column Shift; 42.32" Cable	CA-1903	4269896
1983	L4 2.2L 135ci	C	w/AT, w/Floor Shift; 52.50" Cable	CA-1904	4295326
1984	L4 2.2L 135ci	C	w/AT, w/Floor Shift; 52.74" Cable	CA-1902	5211914
1984	L4 2.2L 135ci	C	w/AT, w/Column Shift; 42.32" Cable	CA-1903	4377317
1985	L4 2.2L 135ci	C, D	w/AT, w/Column Shift; 42.32" Cable	CA-1903	4340184
1985	L4 2.2L 135ci	C, D	w/AT, w/Floor Shift; 59.61" Cable	CA-1906	4348471
1986-89	L4 2.2L 135ci	D	w/AT, w/Column Shift; 42.32" Cable	CA-1903	4377317
1986-89	L4 2.2L 135ci	D	w/AT, w/Floor Shift; 56.57" Cable	CA-1908	4377303
1986-89	L4 2.5L 153ci	K	w/AT, w/Column Shift; 42.32" Cable	CA-1903	4377317
1986-89	L4 2.5L 153ci	K	w/AT, w/Floor Shift; 56.57" Cable	CA-1908	4377303
1982	L4 2.6L 156ci	7	w/AT, w/Floor Shift, To 10/4/82; 52.74" Cable	CA-1902	4269880
1982	L4 2.6L 156ci	7	w/AT, w/Column Shift; 42.32" Cable	CA-1903	5211915
1983	L4 2.6L 156ci	7, G	w/AT, w/Column Shift; 42.32" Cable	CA-1903	4269896
1983	L4 2.6L 156ci	7, G	w/AT, w/Floor Shift; 52.50" Cable	CA-1904	4295326
1981-82	L4 2.6L 156ci	D	w/AT, w/Floor Shift, To 10/4/82; 52.74" Cable	CA-1902	4269880
1981-82	L4 2.6L 156ci	D	w/AT, w/Column Shift; 42.32" Cable	CA-1903	5211915
1984	L4 2.6L 156ci	G	w/AT, w/Floor Shift; 52.74" Cable	CA-1902	5211914
1984	L4 2.6L 156ci	G	w/AT, w/Column Shift; 42.32" Cable	CA-1903	4377317
1985	L4 2.6L 156ci	G	w/AT, w/Column Shift; 42.32" Cable	CA-1903	4340184
1985	L4 2.6L 156ci	G	w/AT, w/Floor Shift; 59.61" Cable	CA-1906	4348471
<b>SCAMP</b>					
1983	L4 2.2L 135ci	C	w/AT, w/Floor Shift; 52.50" Cable	CA-1904	4295326
<b>SUNDANCE</b>					
1987-88	L4 2.2L 135ci	D, E	w/AT, w/Floor Shift; 56.57" Cable	CA-1908	4377303
1991-94	L4 2.2L 135ci	D	56.10" Cable	CA-1179	4543042
1989-90	L4 2.5L 153ci	J, K	w/AT, w/Floor Shift; 56.57" Cable	CA-1908	4377303
1991-94	L4 2.5L 153ci	J, K	56.10" Cable	CA-1179	4543042
1992-94	V6 3.0L 181ci	3	56.10" Cable	CA-1179	4543042
<b>TURISMO</b>					
1985	L4 1.6L 97ci	A	w/AT, w/Floor Shift; 52.74" Cable	CA-1902	4340179
<b>PLYMOUTH TRUCKS</b>					
<b>GRAND VOYAGER</b>					
1994-95	V6 3.0L 181ci	3	42.75" Cable	CA-1181	4543047

# TRANSHIFT CABLES

Year	Engine	Vin	Remark	Part	OE
<b>PLYMOUTH TRUCKS (con't)</b>					
<b>VOYAGER</b>					
1984-87	L4 2.2L 135ci	C	w/AT, w/Column Shift; 42.32" Cable	CA-1903	4377315
1987-90	L4 2.5L 153ci	J, K	w/AT, w/Column Shift; 42.32" Cable	CA-1903	4348451
1991-95	L4 2.5L 153ci	K	42.75" Cable	CA-1181	4543047
1984-87	L4 2.6L 156ci	G	w/AT, w/Column Shift; 42.32" Cable	CA-1903	4348451
1987-90	V6 3.0L 181ci	3	w/AT, w/Column Shift; 42.32" Cable	CA-1903	4377315
1991-95	V6 3.0L 181ci	3	42.75" Cable	CA-1181	4543047
1991-95	V6 3.3L 201ci	J, R	42.75" Cable	CA-1181	4543047
<b>PONTIAC</b>					
<b>6000</b>					
1982	L4 2.5L 151ci	5, R	w/THM125C Auto. Trans., w/Console & Park Lock; 52.00" Cable	CA-1123	10027283
1982	L4 2.5L 151ci	5, R	w/THM125C AT, exc. Console; 49.68" Cable	CA-1124	10027422
1983	L4 2.5L 151ci	5, R	w/Range Selector, w/THM125C Auto. Trans., w/Console; 97.63" Cable	CA-1129	10023729
1983	L4 2.5L 151ci	5	3 Spd. Auto. Trans., exc. Console; 55.48" Cable	CA-1132	10041214
1984	L4 2.5L 151ci	R	w/Console; 104.37" Cable	CA-1152	10034330
1985	L4 2.5L 151ci	R	4 Spd. Auto. Trans., exc. Console; 58.50" Cable	CA-1131	10037686
1985	L4 2.5L 151ci	R	4 Spd. Auto. Trans., w/Console; 104.37" Cable	CA-1152	10034330
1986	L4 2.5L 151ci	R	4 Spd. AT, exc. Front Console; 59.09" Cable	CA-1157	10038603
1987	L4 2.5L 151ci	R	w/THM125C AT, exc. Console; 55.23" Cable	CA-1134	10038609
1987	L4 2.5L 151ci	R	w/Column Shift, w/TH440-T4 Trans.; 59.09" Cable	CA-1157	10038603
1983-85	L4 2.5L 151ci	R	3 Spd. Auto. Trans., exc. Console; 55.48" Cable	CA-1132	10041214
1986-88	L4 2.5L 151ci	R	THM125C AT; exc. Cruise Control, exc. Console.; 55.23" Cable	CA-1134	10038609
1986-90	L4 2.5L 151ci	R	exc. Cruise Control, exc. Console, w/MD-9 THM125C Auto. Trans.; 55.23" Cable	CA-1134	10038609
1985	V6 2.8L 173ci	W, X	3 Spd. Auto. Trans., w/Cruise, exc. Console, 4 Spd. Auto. Trans. exc. Console; 58.50" Cable	CA-1131	10037686
1985	V6 2.8L 173ci	W, X	3 Spd. AT, exc. Console, exc. Cruise; 55.48" Cable	CA-1132	10024524
1985	V6 2.8L 173ci	W, X	3 Spd. Auto. Trans., w/Console, w/Cruise, 4 Spd. Auto. Trans. w/Console; 104.37" Cable	CA-1152	10034330
1986	V6 2.8L 173ci	W	exc. Front Console; 59.09" Cable	CA-1157	10038603
1987	V6 2.8L 173ci	W	w/Column Shift; 59.09" Cable	CA-1157	10038603
1987	V6 2.8L 173ci	W	w/Cruise Control, w/Column Shift, w/TH440-T4 Trans.; 59.06" Cable	CA-1173	1252510
1986-89	V6 2.8L 173ci	W, X	THM125C AT; exc. Cruise Control, exc. Console.; 55.23" Cable	CA-1134	10038609
1986-89	V6 2.8L 173ci	W	w/Column Shift, w/TH440-T4 Trans.; 59.06" Cable	CA-1173	1252510
1988-89	V6 2.8L 173ci	W	w/Cruise Control, exc. Console, w/THM125C Auto. Trans.; 59.09" Cable	CA-1157	10038603
1982	V6 2.8L 173ci	X	w/THM125C Auto. Trans., w/Console & Park Lock; 52.00" Cable	CA-1123	10027283
1982	V6 2.8L 173ci	X	w/THM125C AT, exc. Console; 49.68" Cable	CA-1124	10027422
1983	V6 2.8L 173ci	X	w/Range Selector, w/THM125C Auto. Trans., w/Console; 97.63" Cable	CA-1129	10023729
1984	V6 2.8L 173ci	X	w/Console; 104.37" Cable	CA-1152	10034330
1986	V6 2.8L 173ci	X	exc. Front Console; 59.09" Cable	CA-1157	10038603
1983-84	V6 2.8L 173ci	X	3 Spd. Auto. Trans., exc. Console; 55.48" Cable	CA-1132	10024524
1983-86	V6 2.8L 173ci	X	w/Column Shift, w/TH440-T4 Trans.; 59.06" Cable	CA-1173	1252510
1990	V6 3.1L 189ci	T	exc. Cruise Control, exc. Console, w/MD-9 THM125C Auto. Trans.; 55.23" Cable	CA-1134	10038609
1990	V6 3.1L 189ci	T	THM125C AT; exc. Cruise Control, exc. Console.; 55.23" Cable	CA-1134	10038609
1988-89	V6 3.1L 189ci	T	w/Cruise Control, exc. Column Shift; 59.09" Cable	CA-1157	10038603
1988-91	V6 3.1L 189ci	T	w/Column Shift, w/TH440-T4 Trans.; 59.06" Cable	CA-1173	1252510



# TRANSHIFT CABLES

Year	Engine	Vin	Remark	Part	OE
<b>PONTIAC (con't)</b>					
<b>6000 (con't)</b>					
1990-91	V6 3.1L 189ci	T	w/Column Shift, exc. Cruise Control; 59.09" Cable	CA-1157	10038603
1982	V6 4.3L 260ci	T	w/AT, w/Console & Park Lock; 52.00" Cable	CA-1123	10027283
1982	V6 4.3L 260ci	T	w/THM125C AT, exc. Console; 49.68" Cable	CA-1124	10027422
1983	V6 4.3L 260ci	T	w/Range Selector, w/THM125C Auto. Trans., Diesel, w/Console; 97.63" Cable	CA-1129	10023729
1984	V6 4.3L 260ci	T	w/Console; 104.37" Cable	CA-1152	10034330
1985	V6 4.3L 260ci	T	4 Spd. Auto. Trans., exc. Console; 58.50" Cable	CA-1131	10037686
1985	V6 4.3L 260ci	T	3 Spd. Auto. Trans., exc. Console; 55.48" Cable	CA-1132	10041214
1985	V6 4.3L 260ci	T	4 Spd. Auto. Trans., w/Console; 104.37" Cable	CA-1152	10034330
1983-84	V6 4.3L 260ci	T	3 Spd. Auto. Trans., exc. Console; 55.48" Cable	CA-1132	10024524
<b>ASTRE</b>					
1976-77	L4 2.3L 140ci	A, B	w/THM250 Auto. Trans., w/THM350 Auto. Trans.	CA-1101	14067531
<b>BONNEVILLE</b>					
1982	V6 3.8L 231ci	A	w/Range Selector, w/Console; 29.33" Cable	CA-1102	10001532
1983	V6 3.8L 231ci	A	w/Floor Shift, w/THM200, THM250 & THM350 Auto. Trans.; 29.33" Cable	CA-1102	10001532
1984	V6 3.8L 231ci	A	w/Range Selector, w/Console, w/THM200 Auto. Trans., w/THM250 Auto. Trans.; 29.33" Cable	CA-1102	10001532
1980-81	V6 3.8L 231ci	A	w/Floor Shift, w/THM200, THM250 & THM350 Auto. Trans.; 29.33" Cable	CA-1102	10007999
1984-86	V6 3.8L 231ci	A	w/Range Selector, w/Console, w/THM200-4R Auto. Trans.; 27.20" Cable	CA-1114	10026082
1985-86	V6 3.8L 231ci	A	w/Range Selector, w/Console, w/THM200 Auto. Trans.; 29.33" Cable	CA-1102	10001532
1982	V6 4.1L 252ci	4	w/Range Selector, w/Console; 29.33" Cable	CA-1102	10001532
1986	V6 4.3L 262ci	Z	w/Range Selector, w/Console, w/THM200 Auto. Trans.; 29.33" Cable	CA-1102	10001532
1986	V6 4.3L 262ci	Z	w/Range Selector, w/Console, w/THM200-4R Auto. Trans.; 27.20" Cable	CA-1114	10026082
1980	V8 4.3L 265ci	S	w/Floor Shift, w/THM200, THM250 & THM350 Auto. Trans.; 29.33" Cable	CA-1102	10007998
1979	V8 4.9L 301ci	W, Y	w/Floor Shift, w/THM350 Auto. Trans.; 29.33" Cable	CA-1102	10007999
1980	V8 4.9L 301ci	W	w/Floor Shift, w/THM200, THM250 & THM350 Auto. Trans.; 29.33" Cable	CA-1102	10007999
1983	V8 5.0L 305ci	H	w/Floor Shift, w/THM200, THM250 & THM350 Auto. Trans.; 29.33" Cable	CA-1102	10001532
1984	V8 5.0L 305ci	H	w/Range Selector, w/Console, w/THM200 Auto. Trans., w/THM250 Auto. Trans.; 29.33" Cable	CA-1102	10001532
1984-86	V8 5.0L 305ci	H	w/Range Selector, w/Console, w/THM200-4R Auto. Trans.; 27.20" Cable	CA-1114	10026082
1985-86	V8 5.0L 305ci	H	w/Range Selector, w/Console, w/THM200 Auto. Trans.; 29.33" Cable	CA-1102	10001532
1981	V8 5.0L 307ci	Y	w/Floor Shift, w/THM200, THM250 & THM350 Auto. Trans.; 29.33" Cable	CA-1102	10007999
1982	V8 5.7L 350ci	N	w/Range Selector, w/Console; 29.33" Cable	CA-1102	10001532
1980-81	V8 5.7L 350ci	N	w/Floor Shift, w/THM200, THM250 & THM350 Auto. Trans.; 29.33" Cable	CA-1102	10007999
1983	V8 5.7L 350ci	N	w/Floor Shift, w/THM200, THM250 & THM350 Auto. Trans.; 29.33" Cable	CA-1102	22500579
1984	V8 5.7L 350ci	N	w/Range Selector, w/Console, w/THM200 Auto. Trans., w/THM250 Auto. Trans.; 29.33" Cable	CA-1102	10001532
1984	V8 5.7L 350ci	N	w/Range Selector, w/Console, w/THM200-4R Auto. Trans.; 27.20" Cable	CA-1114	10026082
1979	V8 5.7L 350ci	R, X	w/Floor Shift, w/THM350 Auto. Trans.; 29.33" Cable	CA-1102	10007999

# TRANSHIFT CABLES

Year	Engine	Vin	Remark	Part	OE
<b>PONTIAC (con't)</b>					
<b>BONNEVILLE</b>					
1980	V8 5.7L 350ci	R	w/Floor Shift, w/THM200, THM250 & THM350 Auto. Trans.; 29.33" Cable	CA-1102	10007999
1979	V8 6.6L 403ci	K	w/Floor Shift, w/THM350 Auto. Trans.; 29.33" Cable	CA-1102	10007999
<b>CATALINA</b>					
1980	V6 3.8L 229ci	K	w/Floor Shift, w/THM200, THM250 & THM350 Auto. Trans.; 29.33" Cable	CA-1102	10007999
1979	V6 3.8L 231ci	A	w/Floor Shift, w/THM350 Auto. Trans.; 29.33" Cable	CA-1102	10007999
1980-81	V6 3.8L 231ci	A	w/Floor Shift, w/THM200, THM250 & THM350 Auto. Trans.; 29.33" Cable	CA-1102	10007999
1980-81	V8 4.3L 265ci	S	w/Floor Shift, w/THM200, THM250 & THM350 Auto. Trans.; 29.33" Cable	CA-1102	10007998
1981	V8 4.4L 267ci	J	w/Floor Shift, w/THM200, THM250 & THM350 Auto. Trans.; 29.33" Cable	CA-1102	10007999
1979	V8 4.9L 301ci	W, Y	w/Floor Shift, w/THM350 Auto. Trans.; 29.33" Cable	CA-1102	10007999
1980	V8 4.9L 301ci	W	w/Floor Shift, w/THM200, THM250 & THM350 Auto. Trans.; 29.33" Cable	CA-1102	10007999
1980-81	V8 5.0L 305ci	H	w/Floor Shift, w/THM200, THM250 & THM350 Auto. Trans.; 29.33" Cable	CA-1102	10007999
1981	V8 5.0L 307ci	Y	w/Floor Shift, w/THM200, THM250 & THM350 Auto. Trans.; 29.33" Cable	CA-1102	10007999
1980-81	V8 5.7L 350ci	N, R	w/Floor Shift, w/THM200, THM250 & THM350 Auto. Trans.; 29.33" Cable	CA-1102	10007998
1979	V8 5.7L 350ci	R, X	w/Floor Shift, w/THM350 Auto. Trans.; 29.33" Cable	CA-1102	10007999
1979	V8 6.6L 403ci	K	w/Floor Shift, w/THM350 Auto. Trans.; 29.33" Cable	CA-1102	10007999
<b>FIREBIRD</b>					
1982	L4 2.5L 151ci	2, F	w/THM200 Auto. Trans.	CA-1111	10019287
1983-86	L4 2.5L 151ci	2, F	w/Auto. Trans., w/Range Selector	CA-1110	10027632
1975	L6 4.1L 250ci	D	w/Console	CA-1103	498467
1976	L6 4.1L 250ci	D	w/THM350 Auto. Trans.	CA-1103	498467
1982	V6 2.8L 173ci	1	w/THM200 Auto. Trans.	CA-1111	10019287
1983-84	V6 2.8L 173ci	1, L	w/Auto. Trans., w/Range Selector	CA-1110	10027632
1985-89	V6 2.8L 173ci	S	w/Auto. Trans., w/Range Selector	CA-1110	10027632
1990-92	V6 3.1L 189ci	T	w/Auto. Trans., w/Range Selector	CA-1110	10027632
1989	V6 3.8L 231ci	7	w/Auto. Trans., w/Range Selector	CA-1110	10027632
1978-81	V6 3.8L 231ci	A	w/THM350 Auto. Trans.	CA-1103	498467
1977	V6 3.8L 231ci	C	w/THM350 Auto. Trans.	CA-1103	498467
1980-81	V8 4.3L 265ci	S	w/THM350 Auto. Trans.	CA-1103	498467
1981	V8 4.4L 267ci	J	w/THM350 Auto. Trans.	CA-1103	498467
1979-81	V8 4.9L 301ci	T, W	w/THM350 Auto. Trans.	CA-1103	498467
1977-79	V8 4.9L 301ci	Y	w/THM350 Auto. Trans.	CA-1103	498467
1983	V8 5.0L 305ci	7	w/Auto. Trans., w/Range Selector	CA-1110	10027632
1982	V8 5.0L 305ci	7, H	w/THM200 Auto. Trans.	CA-1111	10019287
1988-91	V8 5.0L 305ci	E	w/Auto. Trans., w/Range Selector	CA-1110	10027632
1985-92	V8 5.0L 305ci	F	w/Auto. Trans., w/Range Selector	CA-1110	10027632
1983-87	V8 5.0L 305ci	G, H, S	w/Auto. Trans., w/Range Selector	CA-1110	10027632
1980-81	V8 5.0L 305ci	H	w/THM350 Auto. Trans.	CA-1103	498467
1977-78	V8 5.0L 305ci	U	w/THM350 Auto. Trans.	CA-1103	498467
1987-92	V8 5.7L 350ci	8	w/Auto. Trans., w/Range Selector	CA-1110	10027632
1972-75	V8 5.7L 350ci	E, M, N	w/Console	CA-1103	498467
1978-79	V8 5.7L 350ci	G, L	w/THM350 Auto. Trans.	CA-1103	498467
1976-77	V8 5.7L 350ci	M, P, R	w/THM350 Auto. Trans.	CA-1103	498467
1970-71	V8 5.7L 350ci		w/Console	CA-1103	498467
1972-74	V8 6.6L 400ci	P, R, T	w/Console	CA-1103	498467
1975	V8 6.6L 400ci	S	w/Console	CA-1103	498467
1976-79	V8 6.6L 400ci	Z	w/THM350 Auto. Trans.	CA-1103	498467

# TRANSHIFT CABLES

Year	Engine	Vin	Remark	Part	OE
<b>PONTIAC (con't)</b>					
<b>FIREBIRD (con't)</b>					
1970-71	V8 6.6L 400ci		w/Console	CA-1103	498467
1977-79	V8 6.6L 403ci	K	w/THM350 Auto. Trans.	CA-1103	498467
1975	V8 7.5L 455ci	W	w/Console	CA-1103	498467
1976	V8 7.5L 455ci	W	w/THM350 Auto. Trans.	CA-1103	498467
1972-74	V8 7.5L 455ci	X, Y	w/Console	CA-1103	498467
1971	V8 7.5L 455ci		w/Console	CA-1103	498467
<b>GRAND AM</b>					
1987	V6 3.0L 181ci	L	w/Console	CA-1155	22531810
1979	V6 3.8L 231ci	A	w/Floor Shift, w/THM200, THM250 & THM350 Auto. Trans.; 29.33" Cable	CA-1102	10001532
1978-80	V8 4.9L 301ci	W, Y	w/Floor Shift, w/THM200, THM250 & THM350 Auto. Trans.; 29.33" Cable	CA-1102	10001532
1979-80	V8 5.0L 305ci	H	w/Floor Shift, w/THM200, THM250 & THM350 Auto. Trans.; 29.33" Cable	CA-1102	10001532
1978	V8 5.0L 305ci	U	w/Floor Shift, w/THM200, THM250 & THM350 Auto. Trans.; 29.33" Cable	CA-1102	10001532
<b>GRAND LEMANS</b>					
1978-79	V6 3.3L 200ci	M	w/Floor Shift, w/THM200, THM250 & THM350 Auto. Trans.; 29.33" Cable	CA-1102	10001532
1980-81	V6 3.8L 229ci	K	w/Floor Shift, w/THM200, THM250 & THM350 Auto. Trans.; 29.33" Cable	CA-1102	10001532
1978-81	V6 3.8L 231ci	2, A	w/Floor Shift, w/THM200, THM250 & THM350 Auto. Trans.; 29.33" Cable	CA-1102	10001532
1980-81	V8 4.3L 265ci	S	w/Floor Shift, w/THM200, THM250 & THM350 Auto. Trans.; 29.33" Cable	CA-1102	10001532
1979-81	V8 4.4L 267ci	J	w/Floor Shift, w/THM200, THM250 & THM350 Auto. Trans.; 29.33" Cable	CA-1102	10001532
1979-81	V8 4.9L 301ci	W, Y	w/Floor Shift, w/THM200, THM250 & THM350 Auto. Trans.; 29.33" Cable	CA-1102	10001532
1979-81	V8 5.0L 305ci	H	w/Floor Shift, w/THM200, THM250 & THM350 Auto. Trans.; 29.33" Cable	CA-1102	10001532
1978	V8 5.0L 305ci	U	w/Floor Shift, w/THM200, THM250 & THM350 Auto. Trans.; 29.33" Cable	CA-1102	10001532
1978-79	V8 5.7L 350ci	L	w/Floor Shift, w/THM200, THM250 & THM350 Auto. Trans.; 29.33" Cable	CA-1102	10001532
<b>GRAND PRIX</b>					
1982	V6 3.8L 231ci	A	w/Range Selector, w/Console; 29.33" Cable	CA-1102	10001532
1983	V6 3.8L 231ci	A	w/Range Selector, w/Console, w/THM200, THM250 & THM350 Auto. Trans.; 29.33" Cable	CA-1102	10001532
1984	V6 3.8L 231ci	A	w/Range Selector, w/Console, w/THM200C Auto. Trans., w/THM250C Auto. Trans.; 29.33" Cable	CA-1102	10001532
1978-81	V6 3.8L 231ci	2, A	w/Floor Shift, w/THM200, THM250 & THM350 Auto. Trans.; 29.33" Cable	CA-1102	10001532
1984-87	V6 3.8L 231ci	A	w/Range Selector, w/Console, w/THM200-4R Auto. Trans.; 27.20" Cable	CA-1114	10026082
1985-87	V6 3.8L 231ci	A	w/Range Selector, w/Console, w/THM200 Auto. Trans.; 29.33" Cable	CA-1102	10001532
1982	V6 4.1L 252ci	4	w/Range Selector, w/Console; 29.33" Cable	CA-1102	10001532
1986-87	V6 4.3L 262ci	Z	w/Range Selector, w/Console, w/THM200 Auto. Trans.; 29.33" Cable	CA-1102	10001532
1986-87	V6 4.3L 262ci	Z	w/Range Selector, w/Console, w/THM200-4R Auto. Trans.; 27.20" Cable	CA-1114	10026082
1980-81	V8 4.3L 265ci	S	w/Floor Shift, w/THM200, THM250 & THM350 Auto. Trans.; 29.33" Cable	CA-1102	10001532

# TRANSHIFT CABLES

Year	Engine	Vin	Remark	Part	OE
<b>PONTIAC (con't)</b>					
<b>GRAND PRIX (con't)</b>					
1981	V8 4.4L 267ci	J	w/Floor Shift, w/THM200, THM250 & THM350 Auto. Trans.; 29.33" Cable	CA-1102	10001532
1982	V8 4.4L 267ci	J	w/Range Selector, w/Console; 29.33" Cable	CA-1102	10001532
1978-80	V8 4.9L 301ci	W, Y	w/Floor Shift, w/THM200, THM250 & THM350 Auto. Trans.; 29.33" Cable	CA-1102	10001532
1983	V8 5.0L 305ci	H	w/Range Selector, w/Console, w/THM200, THM250 & THM350 Auto. Trans.; 29.33" Cable	CA-1102	10001532
1984	V8 5.0L 305ci	H	w/Range Selector, w/Console, w/THM200C Auto. Trans., w/THM250C Auto. Trans.; 29.33" Cable	CA-1102	10001532
1979-80	V8 5.0L 305ci	H	w/Floor Shift, w/THM200, THM250 & THM350 Auto. Trans.; 29.33" Cable	CA-1102	10001532
1984-87	V8 5.0L 305ci	H	w/Range Selector, w/Console, w/THM200-4R Auto. Trans.; 27.20" Cable	CA-1114	10026082
1985-87	V8 5.0L 305ci	H	w/Range Selector, w/Console, w/THM200 Auto. Trans.; 29.33" Cable	CA-1102	10001532
1978	V8 5.0L 305ci	U	w/Floor Shift, w/THM200, THM250 & THM350 Auto. Trans.; 29.33" Cable	CA-1102	10001532
1981	V8 5.7L 350ci	N	w/Floor Shift, w/THM200, THM250 & THM350 Auto. Trans.; 29.33" Cable	CA-1102	10001532
1982	V8 5.7L 350ci	N	w/Range Selector, w/Console; 29.33" Cable	CA-1102	10001532
1983	V8 5.7L 350ci	N	w/Range Selector, w/Console, w/THM200, THM250 & THM350 Auto. Trans.; 29.33" Cable	CA-1102	10001532
1984	V8 5.7L 350ci	N	w/Range Selector, w/Console, w/THM200C Auto. Trans., w/THM250C Auto. Trans.; 29.33" Cable	CA-1102	10001532
1984	V8 5.7L 350ci	N	w/Range Selector, w/Console, w/THM200-4R Auto. Trans.; 27.20" Cable	CA-1114	10026082
1972	V8 6.6L 400ci	S	w/Console, w/THM400 Auto. Trans.	CA-1103	498469
1968-71	V8 6.6L 400ci		w/Console, w/THM400 Auto. Trans.	CA-1103	498469
1968-69	V8 7.0L 428ci		w/Console, w/THM400 Auto. Trans.	CA-1103	498469
1972	V8 7.5L 455ci	Y	w/Console, w/THM400 Auto. Trans.	CA-1103	498469
1970-71	V8 7.5L 455ci		w/Console, w/THM400 Auto. Trans.	CA-1103	498469
<b>J2000</b>					
1983	L4 1.8L 112ci	0	w/Range Selector	CA-1128	10032806
1984	L4 1.8L 112ci	0, J	w/Range Selector	CA-1113	10034333
1983	L4 2.0L 122ci	B	w/Range Selector	CA-1128	10032806
1984	L4 2.0L 122ci	B	w/Range Selector	CA-1113	10034333
<b>LEMANS</b>					
1969-71	L6 4.1L 250ci		w/Floor Shift, w/THM400Auto. Trans.; 29.33" Cable	CA-1102	10001532
1978-79	V6 3.3L 200ci	M	w/Floor Shift, w/THM200, THM250 & THM350 Auto. Trans.; 29.33" Cable	CA-1102	10001532
1980-81	V6 3.8L 229ci	K	w/Floor Shift, w/THM200, THM250 & THM350 Auto. Trans.; 29.33" Cable	CA-1102	10001532
1979	V6 3.8L 231ci	2	w/Floor Shift, w/THM200, THM250 & THM350 Auto. Trans.; 29.33" Cable	CA-1102	10001532
1978-81	V6 3.8L 231ci	2, A	w/Floor Shift, w/THM200, THM250 & THM350 Auto. Trans.; 29.33" Cable	CA-1102	10001532
1980-81	V8 4.3L 265ci	S	w/Floor Shift, w/THM200, THM250 & THM350 Auto. Trans.; 29.33" Cable	CA-1102	10001532
1979-81	V8 4.4L 267ci	J	w/Floor Shift, w/THM200, THM250 & THM350 Auto. Trans.; 29.33" Cable	CA-1102	10001532
1979-81	V8 4.9L 301ci	W, Y	w/Floor Shift, w/THM200, THM250 & THM350 Auto. Trans.; 29.33" Cable	CA-1102	10001532
1979-81	V8 5.0L 305ci	H	w/Floor Shift, w/THM200, THM250 & THM350 Auto. Trans.; 29.33" Cable	CA-1102	10001532

# TRANSHIFT CABLES

Year	Engine	Vin	Remark	Part	OE
<b>PONTIAC (con't)</b>					
<b>LEMANS (con't)</b>					
1978	V8 5.0L 305ci	U	w/Floor Shift, w/THM200, THM250 & THM350 Auto. Trans.; 29.33" Cable	CA-1102	10001532
1968-71	V8 5.7L 350ci		w/Floor Shift, w/THM400Auto. Trans.; 29.33" Cable	CA-1102	10001532
1978-79	V8 5.7L 350ci	L	w/Floor Shift, w/THM200, THM250 & THM350 Auto. Trans.; 29.33" Cable	CA-1102	10001532
1972	V8 5.7L 350ci	M	w/Floor Shift, w/THM400Auto. Trans.; 29.33" Cable	CA-1102	10001532
1968-71	V8 6.6L 400ci		w/Floor Shift, w/THM400Auto. Trans.; 29.33" Cable	CA-1102	10001532
1972	V8 6.6L 400ci	P, S	w/Floor Shift, w/THM400Auto. Trans.; 29.33" Cable	CA-1102	10001532
1968-69	V8 7.0L 428ci		w/Floor Shift, w/THM400Auto. Trans.; 29.33" Cable	CA-1102	10001532
1970	V8 7.5L 455ci		w/Floor Shift, w/THM400Auto. Trans.; 29.33" Cable	CA-1102	10001532
1972	V8 7.5L 455ci	W, X	w/Floor Shift, w/THM400Auto. Trans.; 29.33" Cable	CA-1102	10001532
<b>PHOENIX</b>					
1980	L4 2.5L 151ci	5	w/Auto. Trans.	CA-1112	10009338
1981	L4 2.5L 151ci	5	w/THM125 Auto. Trans., exc. Console	CA-1118	10017823
1982	L4 2.5L 151ci	5, R	w/AT, w/Console & Park Lock; 52.00" Cable	CA-1123	10027283
1982	L4 2.5L 151ci	5, R	w/Auto. Trans., exc. Console; 49.68" Cable	CA-1124	10027422
1982	L4 2.5L 151ci	5, R	w/Floor Shift, w/Shift Select; 96.46" Cable	CA-1178	10021329
1983	L4 2.5L 151ci	5, R	w/Range Selector, w/Auto. Trans.; 97.63" Cable	CA-1129	10023729
1983-84	L4 2.5L 151ci	5, R	exc. Console; 55.48" Cable	CA-1132	10024524
1978	L4 2.5L 151ci	V	w/Console, w/THM200 & THM350 Auto. Trans.	CA-1103	498469
1980	V6 2.8L 173ci	7	w/Auto. Trans.	CA-1112	10009338
1981	V6 2.8L 173ci	X	w/THM125 Auto. Trans., exc. Console	CA-1118	10017823
1982	V6 2.8L 173ci	X	w/AT, w/Console & Park Lock; 52.00" Cable	CA-1123	10027283
1982	V6 2.8L 173ci	X, Z	w/Auto. Trans., exc. Console; 49.68" Cable	CA-1124	10027422
1982	V6 2.8L 173ci	X	w/Floor Shift, w/Shift Select; 96.46" Cable	CA-1178	10021329
1983	V6 2.8L 173ci	X, Z	w/Range Selector, w/Auto. Trans.; 97.63" Cable	CA-1129	10023729
1983	V6 2.8L 173ci	X, Z	exc. Console; 55.48" Cable	CA-1132	10024524
1984	V6 2.8L 173ci	X, Z	exc. Console; 55.48" Cable	CA-1132	10041214
1978-79	V6 3.8L 231ci	A	w/Console, w/THM200 & THM350 Auto. Trans.	CA-1103	498469
1977	V6 3.8L 231ci	C	w/Console, w/THM200 & THM350 Auto. Trans.	CA-1103	498469
1979	V8 5.0L 305ci	G	w/Console, w/THM200 & THM350 Auto. Trans.	CA-1103	498469
1977-78	V8 5.0L 305ci	U	w/Console, w/THM200 & THM350 Auto. Trans.	CA-1103	498469
1977-79	V8 5.7L 350ci	L	w/Console, w/THM200 & THM350 Auto. Trans.	CA-1103	498469
<b>SUNBIRD</b>					
1985-86	L4 1.8L 112ci	0, J	w/Range Selector	CA-1113	10034333
1992-94	L4 2.0L 122ci	H	w/Range Selector, w/THM125 Auto. Trans.	CA-1128	10032806
1987-88	L4 2.0L 122ci	K, M	w/Range Selector	CA-1113	10034333
1989-91	L4 2.0L 122ci	K, M	w/Range Selector	CA-1128	10032806
1985-86	L4 2.0L 122ci	P	w/Range Selector	CA-1113	10034333
1976	L4 2.3L 140ci	B	w/THM350 Auto. Trans.	CA-1101	14067531
1977	L4 2.3L 140ci	B	w/THM200 Auto. Trans., w/THM350 Auto. Trans.	CA-1101	14067531
1978-79	L4 2.5L 151ci	1, 9	w/THM200 Auto. Trans., w/THM350 Auto. Trans.	CA-1101	470769
1978-80	L4 2.5L 151ci	V	w/THM200 Auto. Trans., w/THM350 Auto. Trans.	CA-1101	470769
1991	V6 3.1L 189ci	T	w/Range Selector	CA-1128	10032806
1992-94	V6 3.1L 189ci	T	w/Range Selector, w/THM125 Auto. Trans.	CA-1128	10032806
1978-80	V6 3.8L 231ci	A	w/THM200 Auto. Trans., w/THM350 Auto. Trans.	CA-1101	470771
1976	V6 3.8L 231ci	C	w/THM350 Auto. Trans.	CA-1101	14067531
1977	V6 3.8L 231ci	C	w/THM200 Auto. Trans., w/THM350 Auto. Trans.	CA-1101	14067532
1978	V8 5.0L 305ci	U	w/THM200 Auto. Trans., w/THM350 Auto. Trans.	CA-1101	14067531
<b>VENTURA</b>					
1975-76	L6 4.1L 250ci	D	w/Auto. Trans., w/Console	CA-1103	498469
1977	V6 3.8L 231ci	C	w/Auto. Trans., w/Console	CA-1103	498469
1975-76	V8 4.3L 260ci	F	w/Auto. Trans., w/Console	CA-1103	498469
1977	V8 4.9L 301ci	Y	w/Auto. Trans., w/Console	CA-1103	498469
1977	V8 5.0L 305ci	U	w/Auto. Trans., w/Console	CA-1103	498469

# TRANSHIFT CABLES

Year	Engine	Vin	Remark	Part	OE
<b>PONTIAC (con't)</b>					
<b>VENTURA (con't)</b>					
1975-76	V8 5.7L 350ci	E, H, J	w/Auto. Trans., w/Console	CA-1103	498469
1977	V8 5.7L 350ci	L, R	w/Auto. Trans., w/Console	CA-1103	498469
<b>TOYOTA</b>					
<b>CAMRY</b>					
1987-91	L4 2.0L 1998cc	S		CA-1186	33820-32161
1988-91	V6 2.5L 2508cc	V		CA-1186	33820-32161

# **CABLE ILLUSTRATIONS**

# CABLE ILLUSTRATIONS



**CA-1942**



**CA-1943**



**CA-1947**



**CA-1948**



**CA-1949**



**CA-1950**



**CA-1951**



**CA-1952**



**CA-1953**

NOTE: ILLUSTRATIONS ARE FOR REFERENCE USE ONLY. PHOTO MAY DIFFER FROM ORIGINAL.



# CABLE ILLUSTRATIONS



**CA-1954**



**CA-1955**



**CA-1956**



**CA-1958**

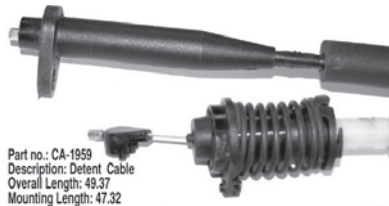

**CA-1959**

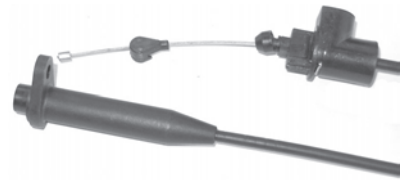

**CA-1960**



**CA-1961**

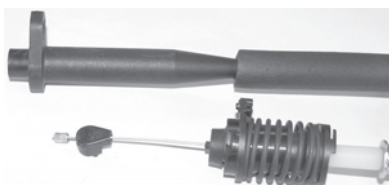

**CA-1962**



**CA-1963**

NOTE: ILLUSTRATIONS ARE FOR REFERENCE USE ONLY. PHOTO MAY DIFFER FROM ORIGINAL.

# CABLE ILLUSTRATIONS



**CA-1964**

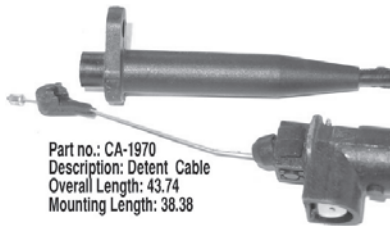

Part no.: CA-1970  
Description: Detent Cable  
Overall Length: 43.74  
Mounting Length: 38.38

**CA-1970**



**CA-1980**



Part no.: CA-1981  
Description: Detent Cable  
Overall Length: 49.2  
Mounting Length: 21.6 to 37

**CA-1981**



**ca-2300**



Part no.: CA-2301  
Description: Tailgate Support Cable  
Overall Length: 19.5  
Mounting Length: NONE

**CA-2301**



**ca-2302**



CA-2303  
Description: Tailgate Support  
Overall Length: 20.25

**CA-2303**



**ca-2304**

NOTE: ILLUSTRATIONS ARE FOR REFERENCE USE ONLY. PHOTO MAY DIFFER FROM ORIGINAL.

# CABLE ILLUSTRATIONS

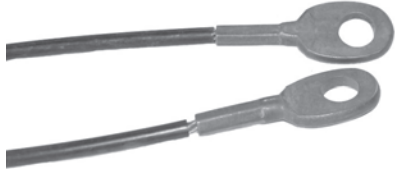

**CA-2305**



**ca-2307**



**CA-2308**

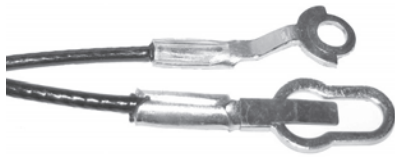

**ca-2309**



**CA-2310**



**ca-3032**



**ca-3097**



**ca-3222**



**CA-3637**

NOTE: ILLUSTRATIONS ARE FOR REFERENCE USE ONLY. PHOTO MAY DIFFER FROM ORIGINAL.

# CABLE ILLUSTRATIONS



**ca-4000**



**CA-4001**  
Description: Speed-o-cable  
Overall Length: 120

**CA-4001**



**CA-5000**

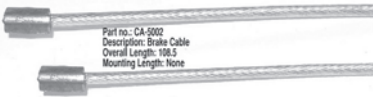

**CA-5002**



**CA-5003**

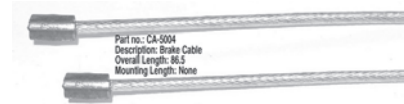

**CA-5004**



**CA-5005**



**CA-5006**



**CA-5007**

NOTE: ILLUSTRATIONS ARE FOR REFERENCE USE ONLY. PHOTO MAY DIFFER FROM ORIGINAL.

# CABLE ILLUSTRATIONS



**CA-5008**



**CA-5009**



**CA-5010**



**CA-5011**



**CA-5012**

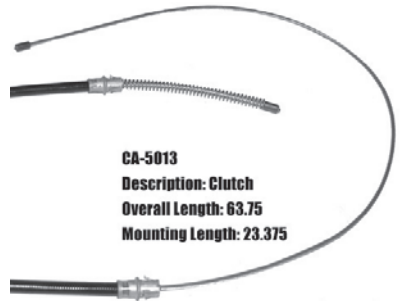

**CA-5013**



**CA-5014**



**CA-5015**



**CA-5016**

NOTE: ILLUSTRATIONS ARE FOR REFERENCE USE ONLY. PHOTO MAY DIFFER FROM ORIGINAL.

# CABLE ILLUSTRATIONS



**CA-5017**



CA-5018  
Description: Brake  
Overall Length: 79.25  
Mounting Length: 64.5

**CA-5018**



**CA-5019**



CA-5020  
Description: Brake  
Overall Length: 64.25  
Mounting Length: 23.125

**CA-5020**

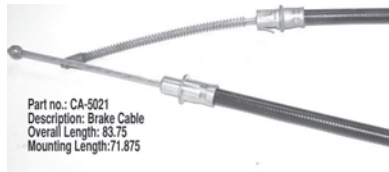

Part no.: CA-5021  
Description: Brake Cable  
Overall Length: 83.75  
Mounting Length: 71.875

**CA-5021**



**CA-5022**



Part no.: CA-5023  
Description: Brake Cable  
Overall Length: 64.25  
Mounting Length: 22.875

**CA-5023**



**CA-5024**



Part no.: CA-5025  
Description: Brake Cable  
Overall Length: 84.5  
Mounting Length: 54.437

**CA-5025**

NOTE: ILLUSTRATIONS ARE FOR REFERENCE USE ONLY. PHOTO MAY DIFFER FROM ORIGINAL.

# CABLE ILLUSTRATIONS



**CA-5026**



Part no.: CA-5027  
Description: Brake  
Overall Length: 69.375  
Mounting Length: 38.75

**CA-5027**



Part no.: CA-5028  
Description: Brake Cable  
Overall Length: 38.38  
Mounting Length: 16.92

**CA-5028**



**CA-5029**



Part no.: CA-5030  
Description: Brake Cable  
Overall Length: 66.25  
Mounting Length: 23.25

**CA-5030**



Part no.: CA-5031  
Description: Brake Cable  
Overall Length: 36.75  
Mounting Length: 27.625

**CA-5031**

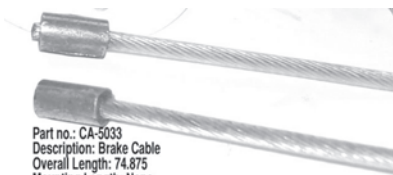

Part no.: CA-5033  
Description: Brake Cable  
Overall Length: 74.875  
Mounting Length: None

**CA-5033**



**CA-5034**



**CA-5035**

NOTE: ILLUSTRATIONS ARE FOR REFERENCE USE ONLY. PHOTO MAY DIFFER FROM ORIGINAL.

# CABLE ILLUSTRATIONS



**CA-5036**



**CA-5037**

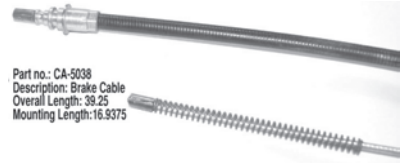

Part no.: CA-5038  
Description: Brake Cable  
Overall Length: 39.25  
Mounting Length: 16.9375

**CA-5038**



**CA-5039**



**CA-5041**



Part no.: CA-5042  
Description: Brake Cable  
Overall Length: 51.1975  
Mounting Length: 64.25

**CA-5042**

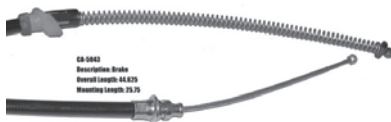

**CA-5043**



**CA-5045**

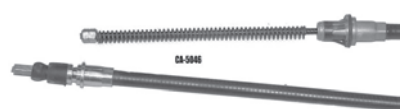

**CA-5046**

NOTE: ILLUSTRATIONS ARE FOR REFERENCE USE ONLY. PHOTO MAY DIFFER FROM ORIGINAL.



# CABLE ILLUSTRATIONS



**CA-5047**



**CA-5048**



**CA-5049**



Part no. - CA-5050  
Description: Brake Cable  
Overall Length: 51.125  
Mounting Length: 33.625

**CA-5050**



CA-5051  
Description: Brake  
Overall Length: 49  
Mounting Length: 32.75

**CA-5051**



CA-5052  
Description: Brake  
Overall Length: 125.5  
Mounting Length: 83.625

**CA-5052**



**CA-5053**

**CA-5053**



CA-5054  
Description: Brake  
Overall Length: 51.125  
Mounting Length: 31.125

**CA-5054**



**CA-5056**

NOTE: ILLUSTRATIONS ARE FOR REFERENCE USE ONLY. PHOTO MAY DIFFER FROM ORIGINAL.

# CABLE ILLUSTRATIONS



**CA-5057**



**CA-5058**



**CA-5060**



**CA-5061**



**CA-5062**



**CA-5063**



**CA-5064**



**CA-5065**



**CA-5066**

NOTE: ILLUSTRATIONS ARE FOR REFERENCE USE ONLY. PHOTO MAY DIFFER FROM ORIGINAL.

# CABLE ILLUSTRATIONS



**CA-5067**



**CA-5068**



**CA-5069**



**CA-5070**



**CA-5071**



**CA-5072**



**CA-5073**



**CA-5074**



**CA-5076**

NOTE: ILLUSTRATIONS ARE FOR REFERENCE USE ONLY. PHOTO MAY DIFFER FROM ORIGINAL.

# CABLE ILLUSTRATIONS



**CA-5077**



**CA-5078**



**CA-5079**



**CA-5080**



**CA-5081**



**CA-5082**



**CA-5083**



**CA-5084**



**CA-5085**

NOTE: ILLUSTRATIONS ARE FOR REFERENCE USE ONLY. PHOTO MAY DIFFER FROM ORIGINAL.

# CABLE ILLUSTRATIONS



**CA-5086**



**CA-5201**



**CA-5202**



**CA-5203**



**CA-5204**



**CA-5206**



**CA-5207**



**CA-5208**



**CA-5209**

NOTE: ILLUSTRATIONS ARE FOR REFERENCE USE ONLY. PHOTO MAY DIFFER FROM ORIGINAL.

# CABLE ILLUSTRATIONS



**CA-5210**



**CA-5212**



**CA-5213**



**CA-5214**



**CA-5215**



**CA-5216**



**CA-5217**



**CA-5218**



**CA-5219**

NOTE: ILLUSTRATIONS ARE FOR REFERENCE USE ONLY. PHOTO MAY DIFFER FROM ORIGINAL.

# CABLE ILLUSTRATIONS



**CA-5220**



Part no.: CA-5221  
Description: Brake Cable  
Overall Length: 75.706  
Mounting Length: 61.656

**CA-5221**



**CA-5222**

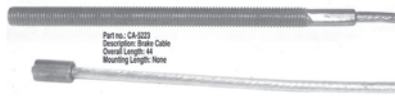

Part no.: CA-5223  
Description: Brake Cable  
Overall Length: 41  
Mounting Length: None

**CA-5223**

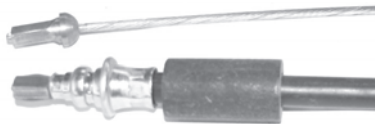

**CA-5224**



CA-5225  
Description: Brake  
Overall Length: 66.75  
Mounting Length: 48.75

**CA-5225**



**CA-5226**



CA-5227  
Description: Brake  
Overall Length: 54.75  
Mounting Length: 46.725

**CA-5227**



**CA-5228**

NOTE: ILLUSTRATIONS ARE FOR REFERENCE USE ONLY. PHOTO MAY DIFFER FROM ORIGINAL.

# CABLE ILLUSTRATIONS

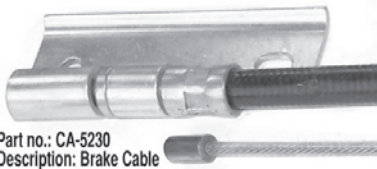

Part no.: CA-5230  
 Description: Brake Cable  
 Overall Length: 45.375  
 Mounting Length: 12

**CA-5230**



**CA-5231**

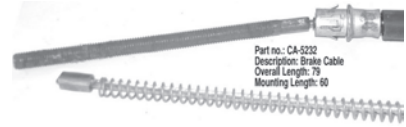

Part no.: CA-5232  
 Description: Brake Cable  
 Overall Length: 79  
 Mounting Length: 60

**CA-5232**



**CA-5233**

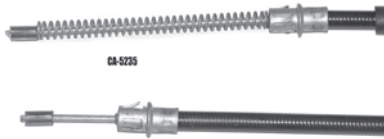

**CA-5235**



CA-5236  
 Description: Brake  
 Overall Length: 88.25  
 Mounting Length: 23.5

**CA-5236**



**CA-5237**



**CA-5238**

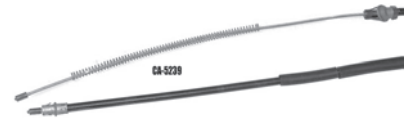

**CA-5239**

NOTE: ILLUSTRATIONS ARE FOR REFERENCE USE ONLY. PHOTO MAY DIFFER FROM ORIGINAL.



# CABLE ILLUSTRATIONS

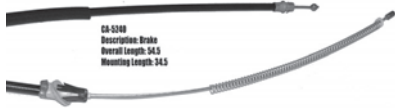

**CA-5240**



**CA-5241**



**CA-5242**

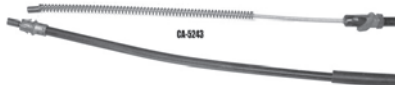

**CA-5243**



**CA-5244**



**CA-5245**



**CA-5246**



**CA-5247**



**CA-5251**

NOTE: ILLUSTRATIONS ARE FOR REFERENCE USE ONLY. PHOTO MAY DIFFER FROM ORIGINAL.

# CABLE ILLUSTRATIONS



**CA-5253**



**CA-5254**



**CA-5255**



**CA-5256**



**CA-5257**



**CA-5258**



**CA-5259**



**CA-5260**

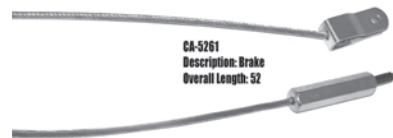

**CA-5261**

NOTE: ILLUSTRATIONS ARE FOR REFERENCE USE ONLY. PHOTO MAY DIFFER FROM ORIGINAL.

# CABLE ILLUSTRATIONS



**CA-5262**



**CA-5263**



**CA-5264**



**CA-5265**



**CA-5266**



**CA-5267**



**CA-5268**



**CA-5269**



**CA-5270**

NOTE: ILLUSTRATIONS ARE FOR REFERENCE USE ONLY. PHOTO MAY DIFFER FROM ORIGINAL.

# CABLE ILLUSTRATIONS



**CA-5271**



**CA-5272**



**CA-5273**



**CA-5274**



**CA-5275**



**CA-5276**



**CA-5278**



**CA-5279**

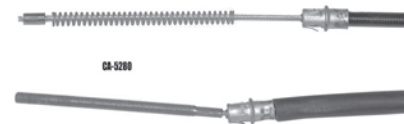

**CA-5280**

NOTE: ILLUSTRATIONS ARE FOR REFERENCE USE ONLY. PHOTO MAY DIFFER FROM ORIGINAL.

# CABLE ILLUSTRATIONS



**CA-5281**



**CA-5283**



**CA-5502**



**CA-5503**



**CA-5504**

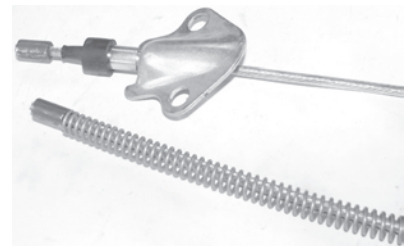

**CA-5505**

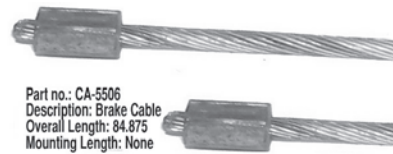

**CA-5506**



**CA-5507**



**CA-5508**

NOTE: ILLUSTRATIONS ARE FOR REFERENCE USE ONLY. PHOTO MAY DIFFER FROM ORIGINAL.

# CABLE ILLUSTRATIONS



**CA-5509**



**CA-5510**



**CA-5511**



**CA-5512**



**CA-5513**



**CA-5514**



**CA-5515**



**CA-5517**



**CA-5518**

NOTE: ILLUSTRATIONS ARE FOR REFERENCE USE ONLY. PHOTO MAY DIFFER FROM ORIGINAL.

# CABLE ILLUSTRATIONS



**CA-5519**

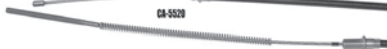

**CA-5520**



**CA-5521**



**CA-5522**

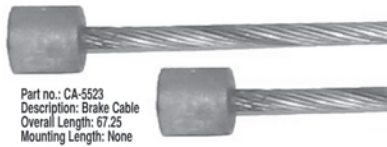

**CA-5523**



**CA-5524**

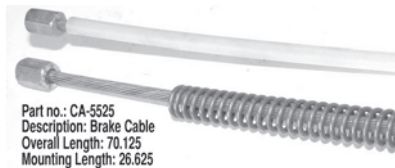

**CA-5525**



**CA-5526**

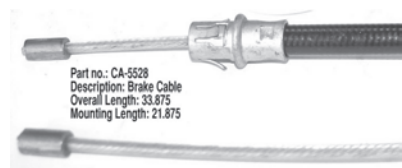

**CA-5528**

NOTE: ILLUSTRATIONS ARE FOR REFERENCE USE ONLY. PHOTO MAY DIFFER FROM ORIGINAL.

# CABLE ILLUSTRATIONS



**CA-5529**



Part no.: CA-5530  
Description: Brake Cable  
Overall Length: 81  
Mounting Length: 65.125

**CA-5530**



**CA-5531**



Part no.: CA-5532  
Description: Brake Cable  
Overall Length: 58.125  
Mounting Length: 40.5625

**CA-5532**



**CA-5533**



Part no.: CA-5534  
Description: Brake Cable  
Overall Length: 44.75  
Mounting Length: 27

**CA-5534**



**CA-5536**



Part no.: CA-5537  
Description: Brake Cable  
Overall Length: 51  
Mounting Length: 23

**CA-5537**



CA-5538  
Description: Brake  
Overall Length: 48.75  
Mounting Length: 21.5

**CA-5538**

NOTE: ILLUSTRATIONS ARE FOR REFERENCE USE ONLY. PHOTO MAY DIFFER FROM ORIGINAL.



# CABLE ILLUSTRATIONS



**CA-5540**



**CA-5541**



**CA-5542**



**CA-5543**



**CA-5544**



**CA-5545**



**CA-5546**



**CA-5547**

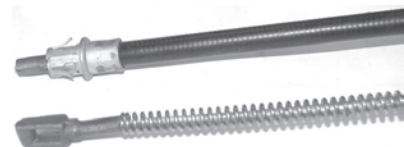

**CA-5548**

NOTE: ILLUSTRATIONS ARE FOR REFERENCE USE ONLY. PHOTO MAY DIFFER FROM ORIGINAL.

# CABLE ILLUSTRATIONS



**CA-5550**

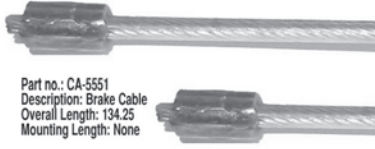

**CA-5551**



**CA-5552**



**CA-5553**



**CA-5554**



**CA-5555**



**CA-5556**

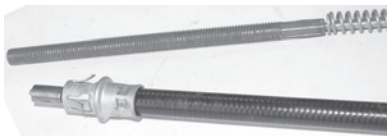

**CA-5557**



**CA-5558**

NOTE: ILLUSTRATIONS ARE FOR REFERENCE USE ONLY. PHOTO MAY DIFFER FROM ORIGINAL.

# CABLE ILLUSTRATIONS



**CA-5559**



**CA-5560**



**CA-5561**



**CA-5562**



**CA-5563**



**CA-5564**



**CA-5565**



**CA-5566**



**CA-5567**

NOTE: ILLUSTRATIONS ARE FOR REFERENCE USE ONLY. PHOTO MAY DIFFER FROM ORIGINAL.

# CABLE ILLUSTRATIONS



**CA-5568**



**CA-5569**

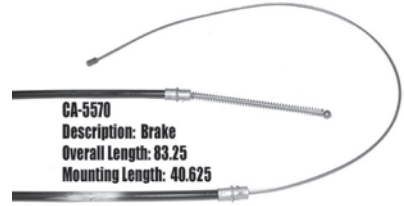

**CA-5570**



**CA-5571**



**CA-5573**



**CA-5574**



**CA-5575**



**CA-5576**



**CA-5577**

NOTE: ILLUSTRATIONS ARE FOR REFERENCE USE ONLY. PHOTO MAY DIFFER FROM ORIGINAL.

# CABLE ILLUSTRATIONS



**CA-5578**



**CA-5579**



**CA-5581**



**CA-5582**



**CA-5584**



**CA-5585**



**CA-5586**



**CA-5587**



**CA-5588**

NOTE: ILLUSTRATIONS ARE FOR REFERENCE USE ONLY. PHOTO MAY DIFFER FROM ORIGINAL.

# CABLE ILLUSTRATIONS



**CA-5589**



**CA-5590**



**CA-5591**



**CA-5592**



**CA-5593**



**CA-5594**



**CA-5595**



**CA-5596**



**CA-5598**

NOTE: ILLUSTRATIONS ARE FOR REFERENCE USE ONLY. PHOTO MAY DIFFER FROM ORIGINAL.

# CABLE ILLUSTRATIONS



**CA-5599**



Part no.: CA-5600  
Description: Brake Cable  
Overall Length: 95.25  
Mounting Length: 68.875

**CA-5600**



**CA-5601**

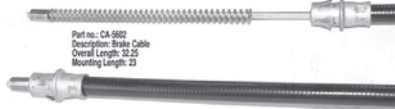

Part no.: CA-5602  
Description: Brake Cable  
Overall Length: 32.25  
Mounting Length: 23

**CA-5602**



CA-5603

**CA-5603**



Part no.: CA-5604  
Description: Brake Cable  
Overall Length: 47.244  
Mounting Length: 21.417

**CA-5604**



**CA-5605**



Part no.: CA-5606  
Description: Brake Cable  
Overall Length: 37  
Mounting Length: 23.5

**CA-5606**



CA-5607

**CA-5607**

NOTE: ILLUSTRATIONS ARE FOR REFERENCE USE ONLY. PHOTO MAY DIFFER FROM ORIGINAL.

# CABLE ILLUSTRATIONS



**CA-5608**



**CA-5609**

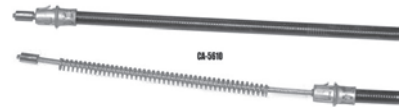

**CA-5610**



**CA-5611**



**CA-5612**



**CA-5613**



**CA-5614**



**CA-5615**



**CA-5616**

NOTE: ILLUSTRATIONS ARE FOR REFERENCE USE ONLY. PHOTO MAY DIFFER FROM ORIGINAL.



# CABLE ILLUSTRATIONS



**CA-5617**



**CA-5618**



**CA-5619**



**CA-5620**



**CA-5621**



**CA-5622**



**CA-5623**



**CA-5624**



**CA-5625**

NOTE: ILLUSTRATIONS ARE FOR REFERENCE USE ONLY. PHOTO MAY DIFFER FROM ORIGINAL.

# CABLE ILLUSTRATIONS



**CA-5626**



Part no.: CA-5627  
Description: Brake Cable  
Overall Length: 21  
Mounting Length: 15

**CA-5627**



CA-5628  
Description: Brake  
Overall Length: 26.75  
Mounting Length: 15.25

**CA-5628**



CA-5629  
Description: Brake  
Overall Length: 32.25  
Mounting Length: 18

**CA-5629**



**CA-5630**



Part no.: CA-5631  
Description: Brake Cable  
Overall Length: 75.875  
Mounting Length: 56.9375

**CA-5631**



**CA-5632**



Part no.: CA-5633  
Description: Brake Cable  
Overall Length: 26.5  
Mounting Length: 15

**CA-5633**



**CA-5634**

NOTE: ILLUSTRATIONS ARE FOR REFERENCE USE ONLY. PHOTO MAY DIFFER FROM ORIGINAL.

# CABLE ILLUSTRATIONS



**CA-5635**



**CA-5636**



**CA-5637**



**CA-5638**

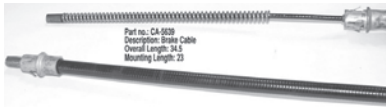

**CA-5639**



**CA-5640**



**CA-5641**



**CA-5642**



**CA-5643**

NOTE: ILLUSTRATIONS ARE FOR REFERENCE USE ONLY. PHOTO MAY DIFFER FROM ORIGINAL.

# CABLE ILLUSTRATIONS



**CA-5644**



Part no.: CA-5645  
Description: Brake Cable  
Overall Length: 62.75  
Mounting Length: 58.25

**CA-5645**



**CA-6001**

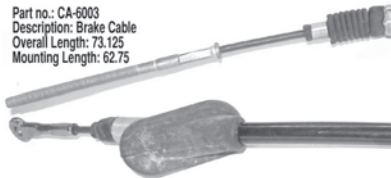

Part no.: CA-6003  
Description: Brake Cable  
Overall Length: 73.125  
Mounting Length: 62.75

**CA-6003**



**CA-6030**



Part no.: CA-6040  
Description: Brake Cable  
Overall Length: 43.75  
Mounting Length: 28.875

**CA-6040**



**CA-6041**



Part no.: CA-6042  
Description: Brake Cable  
Overall Length: 48.875  
Mounting Length: 41.875

**CA-6042**

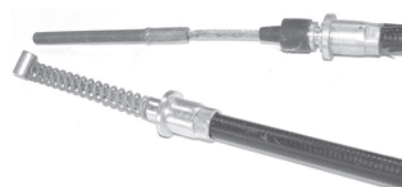

**CA-6043**

NOTE: ILLUSTRATIONS ARE FOR REFERENCE USE ONLY. PHOTO MAY DIFFER FROM ORIGINAL.

# CABLE ILLUSTRATIONS



**CA-6044**

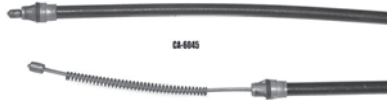

**CA-6045**



**CA-6060**



**CA-6071**

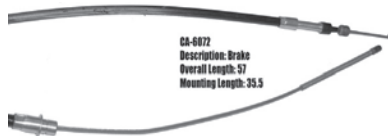

**CA-6072**

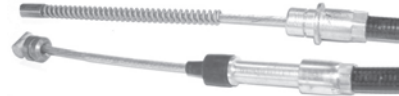

**CA-6073**



**CA-6074**



**CA-6075**



**CA-6076**

NOTE: ILLUSTRATIONS ARE FOR REFERENCE USE ONLY. PHOTO MAY DIFFER FROM ORIGINAL.

# CABLE ILLUSTRATIONS



**CA-6078**



**CA-6079**



**CA-6080**



**CA-6081**



**CA-6082**



**CA-6150**



**CA-6151**

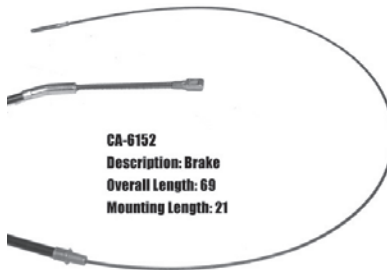

**CA-6152**



**CA-6153**

NOTE: ILLUSTRATIONS ARE FOR REFERENCE USE ONLY. PHOTO MAY DIFFER FROM ORIGINAL.

# CABLE ILLUSTRATIONS



**CA-6154**



**CA-6157**



**CA-6158**



**CA-6164**



**CA-6165**

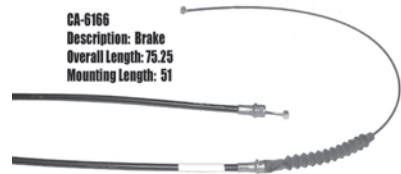

**CA-6166**

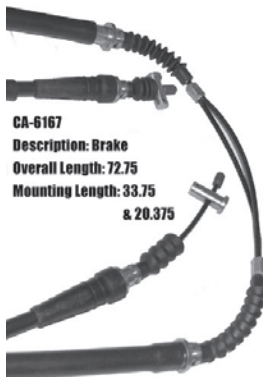

**CA-6167**



**CA-6168**



**CA-6169**

NOTE: ILLUSTRATIONS ARE FOR REFERENCE USE ONLY. PHOTO MAY DIFFER FROM ORIGINAL.

# CABLE ILLUSTRATIONS



**CA-6171**  
**Description: Brake**  
**Overall Length: 67.75**  
**Mounting Length: 35.625**

**CA-6171**



**CA-6172**



**CA-6173**  
**Description: Brake**  
**Overall Length: 29.75**  
**Mounting Length: 11**

**CA-6173**



**CA-8001**



**CA-8002**



**Part no.: CA-8003**  
**Description: Cabret Trans. Cable**  
**Overall Length: 47.58**  
**Mounting Length: 28.17**

**CA-8003**



**CA-8004**



**Part no.: CA-8005**  
**Description: Cabret Trans. Cable**  
**Overall Length: 48.65**  
**Mounting Length: 28.8**

**CA-8005**

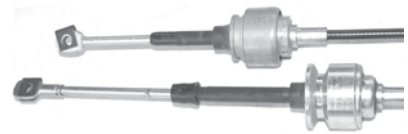

**CA-8006**

NOTE: ILLUSTRATIONS ARE FOR REFERENCE USE ONLY. PHOTO MAY DIFFER FROM ORIGINAL.



# CABLE ILLUSTRATIONS



**CA-8007**



**CA-8008**



Part no.: CA-8009  
Description: Detent Trans. Cable  
Overall Length: 48.43  
Mounting Length: 35.14

**CA-8009**



**CA-8010**

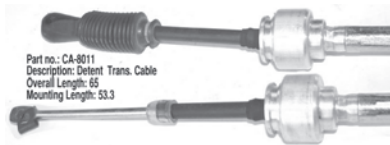

Part no.: CA-8011  
Description: Detent Trans. Cable  
Overall Length: 65  
Mounting Length: 53.3

**CA-8011**



**CA-8012**

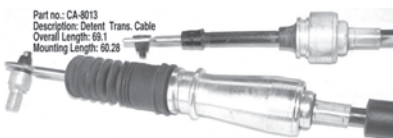

Part no.: CA-8013  
Description: Detent Trans. Cable  
Overall Length: 69.1  
Mounting Length: 60.28

**CA-8013**



**CA-8014**



CA-8015  
Description: Manual Transmission Shift  
Overall Length: 82.5  
Mounting Length: 50.5

**CA-8015**

NOTE: ILLUSTRATIONS ARE FOR REFERENCE USE ONLY. PHOTO MAY DIFFER FROM ORIGINAL.

# CABLE ILLUSTRATIONS



**CA-8016**



**CA-8017**

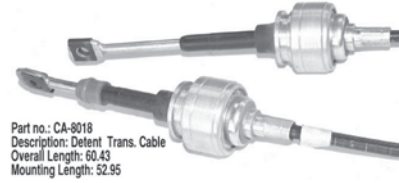

**CA-8018**



**CA-8019**



**CA-8020**

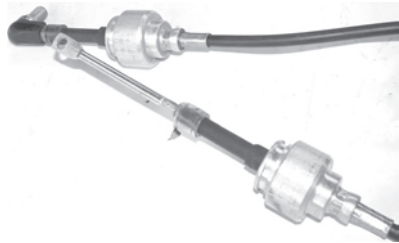

**CA-8021**

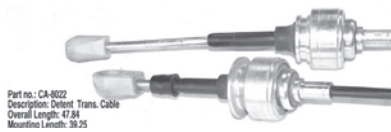

**CA-8022**



**CA-8023**

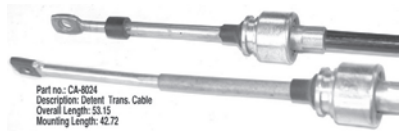

**CA-8024**

NOTE: ILLUSTRATIONS ARE FOR REFERENCE USE ONLY. PHOTO MAY DIFFER FROM ORIGINAL.

# CABLE ILLUSTRATIONS

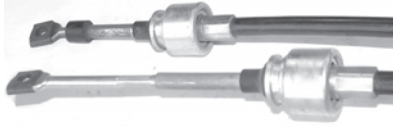

**CA-8025**

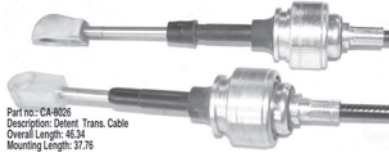

Part no.: CA-8026  
Description: Detent Trans. Cable  
Overall Length: 45.34  
Mounting Length: 37.75

**CA-8026**

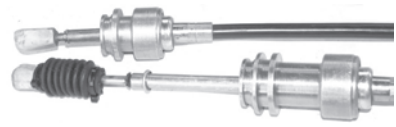

**CA-8101**



Part no.: CA-8201  
Description: Detent Trans. Cable  
Overall Length: 53.35  
Mounting Length: 40.43

**CA-8201**



**CA-8202**

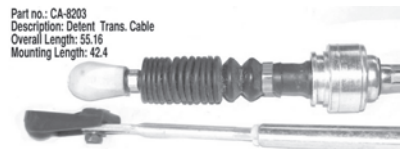

Part no.: CA-8203  
Description: Detent Trans. Cable  
Overall Length: 55.16  
Mounting Length: 42.4

**CA-8203**

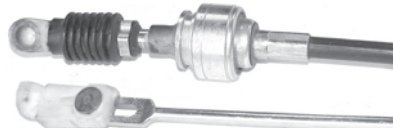

**CA-8204**



Part no.: CA-8205  
Description: Detent Trans. Cable  
Overall Length: 52.36  
Mounting Length: 39.21

**CA-8205**



**CA-8206**

NOTE: ILLUSTRATIONS ARE FOR REFERENCE USE ONLY. PHOTO MAY DIFFER FROM ORIGINAL.

# CABLE ILLUSTRATIONS

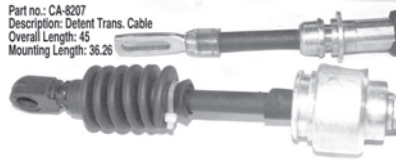

**CA-8207**



**CA-8300**

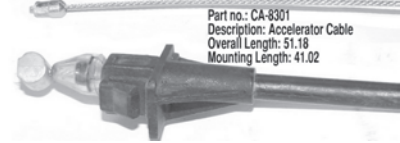

**CA-8301**



**CA-8302**



**CA-8304**



**CA-8305**



**CA-8306**



**CA-8307**



**CA-8309**

NOTE: ILLUSTRATIONS ARE FOR REFERENCE USE ONLY. PHOTO MAY DIFFER FROM ORIGINAL.

# CABLE ILLUSTRATIONS



**CA-8311**

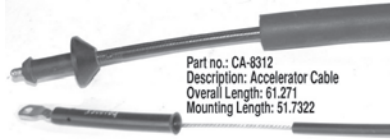

**CA-8312**



**CA-8314**



**CA-8315**



**CA-8316**



**CA-8317**

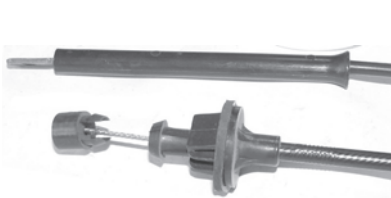

**CA-8319**



**CA-8321**



**CA-8324**

NOTE: ILLUSTRATIONS ARE FOR REFERENCE USE ONLY. PHOTO MAY DIFFER FROM ORIGINAL.

# CABLE ILLUSTRATIONS



**CA-8325**

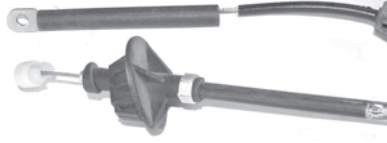

**CA-8326**



**CA-8401**



**CA-8402**



**CA-8403**



**CA-8404**



**CA-8405**

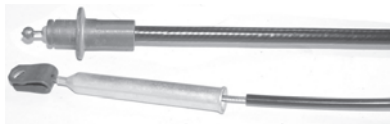

**CA-8406**

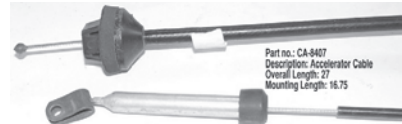

**CA-8407**

NOTE: ILLUSTRATIONS ARE FOR REFERENCE USE ONLY. PHOTO MAY DIFFER FROM ORIGINAL.

# CABLE ILLUSTRATIONS



**CA-8408**



**CA-8409**

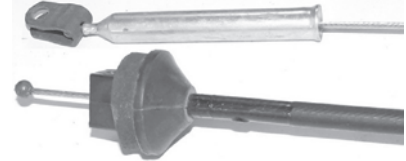

**CA-8410**



**CA-8412**



**CA-8413**



**CA-8414**

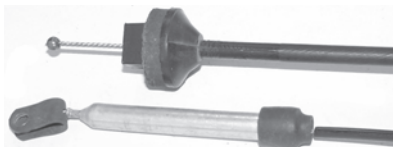

**CA-8415**

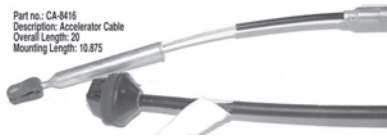

**CA-8416**



**CA-8417**

NOTE: ILLUSTRATIONS ARE FOR REFERENCE USE ONLY. PHOTO MAY DIFFER FROM ORIGINAL.

# CABLE ILLUSTRATIONS

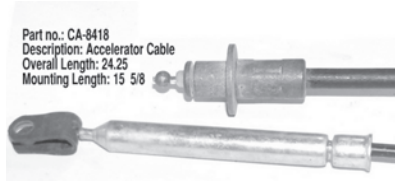

**CA-8418**



**CA-8419**

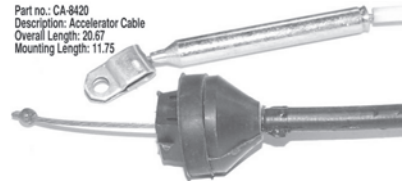

**CA-8420**



**CA-8421**



**CA-8422**



**CA-8423**



**CA-8424**



**CA-8425**



**CA-8426**

NOTE: ILLUSTRATIONS ARE FOR REFERENCE USE ONLY. PHOTO MAY DIFFER FROM ORIGINAL.



# CABLE ILLUSTRATIONS



**CA-8427**



Part no.: CA-8428  
Description: Accelerator  
Overall Length: 31.75  
Mounting Length: 28.25

**CA-8428**



**CA-8429**



Part no.: CA-8430  
Description: Accelerator Cable  
Overall Length: 52  
Mounting Length: 43

**CA-8430**

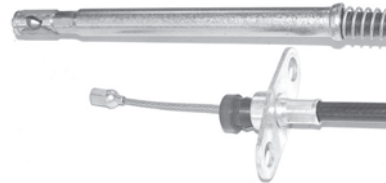

**CA-8431**



Part no.: CA-8432  
Description: Accelerator Cable  
Overall Length: 32.08  
Mounting Length: 19.88

**CA-8432**



**CA-8433**



Part no.: CA-8435  
Description: Accelerator Cable  
Overall Length: 13  
Mounting Length: NONE

**CA-8435**



**CA-8436**

NOTE: ILLUSTRATIONS ARE FOR REFERENCE USE ONLY. PHOTO MAY DIFFER FROM ORIGINAL.

# CABLE ILLUSTRATIONS

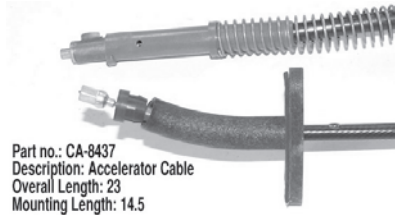

**CA-8437**



**CA-8438**



**CA-8439**

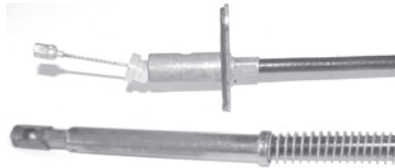

**CA-8440**

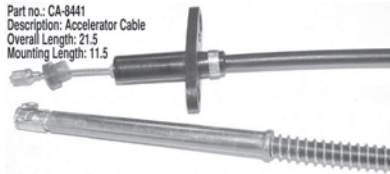

**CA-8441**



**CA-8442**



**CA-8443**

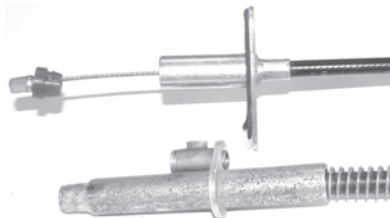

**CA-8444**

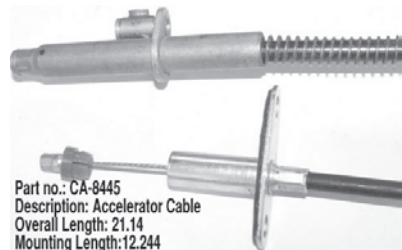

**CA-8445**

NOTE: ILLUSTRATIONS ARE FOR REFERENCE USE ONLY. PHOTO MAY DIFFER FROM ORIGINAL.

# CABLE ILLUSTRATIONS

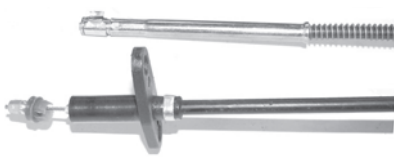

**CA-8446**

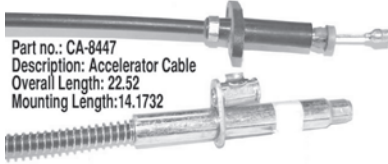

Part no.: CA-8447  
Description: Accelerator Cable  
Overall Length: 22.52  
Mounting Length: 14.1732

**CA-8447**



**CA-8448**

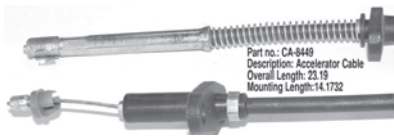

**CA-8449**



**CA-8450**



Part no.: CA-8451  
Description: Accelerator Cable  
Overall Length: 31.5  
Mounting Length: 21.062

**CA-8451**

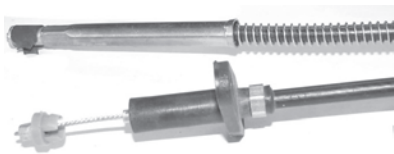

**CA-8452**



Part no.: CA-8453  
Description: Accelerator Cable  
Overall Length: 19.96  
Mounting Length: 9.468

**CA-8453**

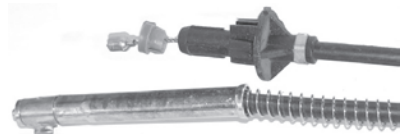

**CA-8454**

NOTE: ILLUSTRATIONS ARE FOR REFERENCE USE ONLY. PHOTO MAY DIFFER FROM ORIGINAL.

# CABLE ILLUSTRATIONS

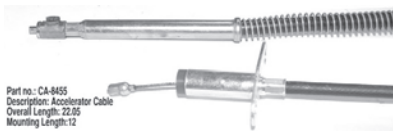

**CA-8455**



**CA-8456**



**CA-8457**



**CA-8458**



**CA-8459**



**CA-8460**



**CA-8461**



**CA-8462**



**CA-8463**

NOTE: ILLUSTRATIONS ARE FOR REFERENCE USE ONLY. PHOTO MAY DIFFER FROM ORIGINAL.

# CABLE ILLUSTRATIONS

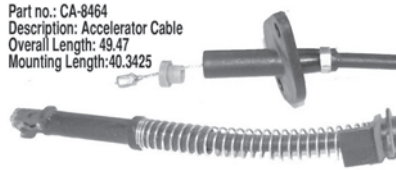

**CA-8464**



**CA-8465**



**CA-8466**

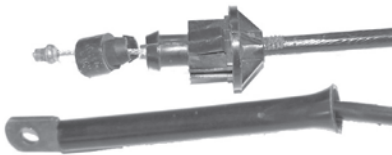

**CA-8467**

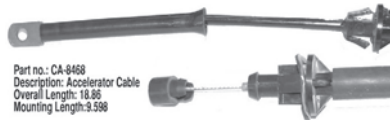

**CA-8468**



**CA-8469**



**CA-8470**



**CA-8471**

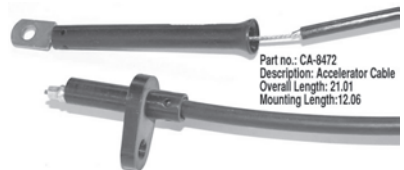

**CA-8472**

NOTE: ILLUSTRATIONS ARE FOR REFERENCE USE ONLY. PHOTO MAY DIFFER FROM ORIGINAL.

# CABLE ILLUSTRATIONS



**CA-8473**



CA-8474  
Description: Accelerator  
Overall Length: 13.5  
Mounting Length: 13.5

**CA-8474**



**CA-8475**

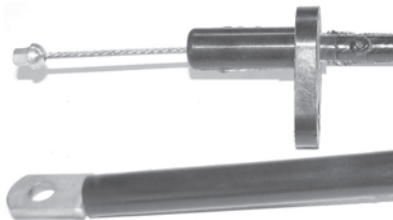

**CA-8476**



Part no.: CA-8477  
Description: Accelerator Cable  
Overall Length: 22.83  
Mounting Length: 13.66

**CA-8477**



**CA-8478**



Part no.: CA-8479  
Description: Accelerator Cable  
Overall Length: 20.71  
Mounting Length: 11.57

**CA-8479**



CA-8480  
Description: Accelerator  
Overall Length: 21.25  
Mounting Length: 11.75

**CA-8480**



Part no.: CA-8481  
Description: Accelerator Cable  
Overall Length: 26.94  
Mounting Length: 18.955

**CA-8481**

NOTE: ILLUSTRATIONS ARE FOR REFERENCE USE ONLY. PHOTO MAY DIFFER FROM ORIGINAL.

# CABLE ILLUSTRATIONS



**CA-8482**



**CA-8483**



**CA-8484**



**CA-8485**



**CA-8486**



**CA-8487**



**CA-8488**



**CA-8489**

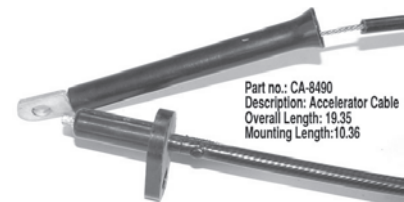

**CA-8490**

NOTE: ILLUSTRATIONS ARE FOR REFERENCE USE ONLY. PHOTO MAY DIFFER FROM ORIGINAL.

# CABLE ILLUSTRATIONS



**CA-8491**



**CA-8492**

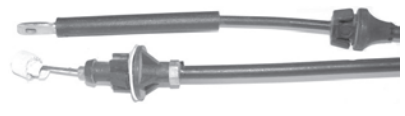

**CA-8493**



**CA-8494**



**CA-8495**

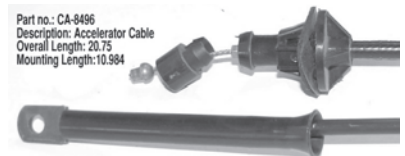

**CA-8496**

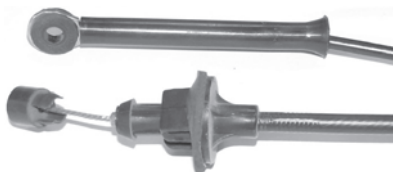

**CA-8497**

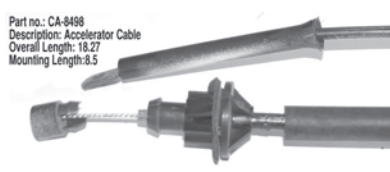

**CA-8498**



**CA-8499**

NOTE: ILLUSTRATIONS ARE FOR REFERENCE USE ONLY. PHOTO MAY DIFFER FROM ORIGINAL.



# CABLE ILLUSTRATIONS



**CA-8500**



**CA-8501**



**CA-8502**



**CA-8503**



**CA-8504**



**CA-8505**



**CA-8506**



**CA-8507**



**CA-8508**

NOTE: ILLUSTRATIONS ARE FOR REFERENCE USE ONLY. PHOTO MAY DIFFER FROM ORIGINAL.

# CABLE ILLUSTRATIONS



**CA-8509**



**CA-8510**

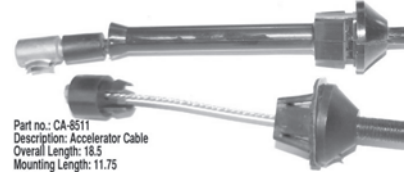

**CA-8511**



**CA-8512**



**CA-8513**



**CA-8514**



**CA-8515**



**CA-8516**



**CA-8517**

NOTE: ILLUSTRATIONS ARE FOR REFERENCE USE ONLY. PHOTO MAY DIFFER FROM ORIGINAL.

# CABLE ILLUSTRATIONS



**CA-8518**



**CA-8519**



**CA-8523**

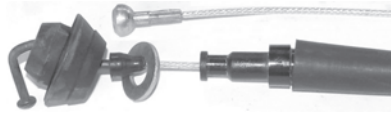

**CA-8524**



**CA-8532**



**CA-8534**



**CA-8535**



**CA-8540**



**CA-8541**

NOTE: ILLUSTRATIONS ARE FOR REFERENCE USE ONLY. PHOTO MAY DIFFER FROM ORIGINAL.

# CABLE ILLUSTRATIONS



**CA-8552**



**CA-8553**

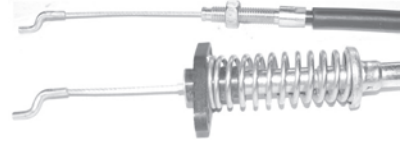

**CA-8554**

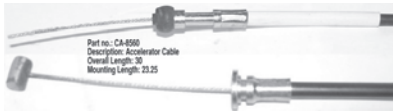

**CA-8560**



**CA-8571**



**CA-8572**



**CA-8573**



**CA-8574**

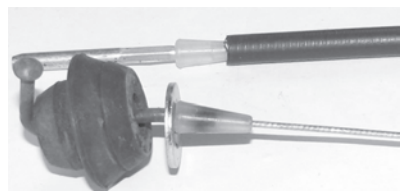

**CA-8575**

NOTE: ILLUSTRATIONS ARE FOR REFERENCE USE ONLY. PHOTO MAY DIFFER FROM ORIGINAL.

# CABLE ILLUSTRATIONS



**CA-8580**



**CA-8584**



**CA-8585**



**CA-8590**



**CA-8591**



**CA-8607**



**CA-8608**



**CA-8609**



**CA-8610**

NOTE: ILLUSTRATIONS ARE FOR REFERENCE USE ONLY. PHOTO MAY DIFFER FROM ORIGINAL.

# CABLE ILLUSTRATIONS



**CA-8611**



Part no.: CA-8613  
Description: Accelerator Cable  
Overall Length: 38  
Mounting Length: 35.25

**CA-8613**



**CA-8614**

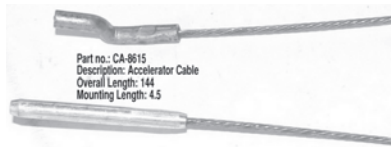

Part no.: CA-8615  
Description: Accelerator Cable  
Overall Length: 144  
Mounting Length: 4.5

**CA-8615**



CA-8616  
Description: Accelerator  
Overall Length: 315  
Mounting Length: 21.25

**CA-8616**



Part no.: CA-8617  
Description: Accelerator Cable  
Overall Length: 42  
Mounting Length: 33.275

**CA-8617**

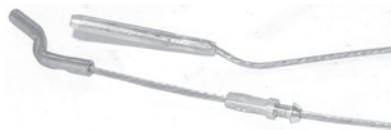

**CA-8618**

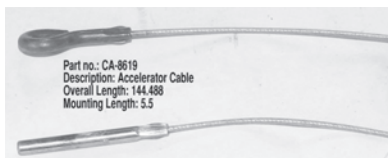

Part no.: CA-8619  
Description: Accelerator Cable  
Overall Length: 144.488  
Mounting Length: 5.5

**CA-8619**



CA-8620  
Description: Accelerator  
Overall Length: 143.25

**CA-8620**

NOTE: ILLUSTRATIONS ARE FOR REFERENCE USE ONLY. PHOTO MAY DIFFER FROM ORIGINAL.

# CABLE ILLUSTRATIONS

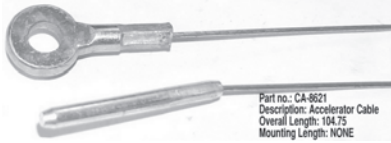

**CA-8621**



**CA-8622**



**CA-8623**



**CA-8624**



**CA-8625**



**CA-8626**



**CA-8628**



**CA-8629**



**CA-8630**

NOTE: ILLUSTRATIONS ARE FOR REFERENCE USE ONLY. PHOTO MAY DIFFER FROM ORIGINAL.

# CABLE ILLUSTRATIONS



**CA-8631**



CA-8632  
Description: Accelerator  
Overall Length: 30  
Mounting Length: 28.75

**CA-8632**



**CA-8633**



Part no.: CA-8634  
Description: Accelerator Cable  
Overall Length: 166.5  
Mounting Length: NONE

**CA-8634**



**CA-8635**

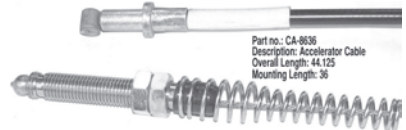

Part no.: CA-8636  
Description: Accelerator Cable  
Overall Length: 44.125  
Mounting Length: 36

**CA-8636**



CA-8650  
Description: Accelerator  
Overall Length: 65.125  
Mounting Length: 10

**ca-8650**



CA-8652  
Description: Accelerator  
Overall Length: 28.5  
Mounting Length: 22.25

**CA-8652**



**CA-8653**

NOTE: ILLUSTRATIONS ARE FOR REFERENCE USE ONLY. PHOTO MAY DIFFER FROM ORIGINAL.



# CABLE ILLUSTRATIONS

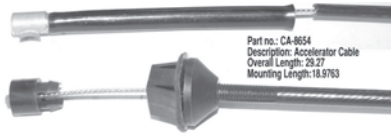

**CA-8654**



**CA-8655**



**CA-8656**



**CA-8657**



**CA-8658**



**CA-8659**



**CA-8663**



**CA-8664**



**CA-8667**

NOTE: ILLUSTRATIONS ARE FOR REFERENCE USE ONLY. PHOTO MAY DIFFER FROM ORIGINAL.

# CABLE ILLUSTRATIONS



**CA-8668**



**CA-8669**



**CA-8670**



**CA-8674**



**CA-8675**

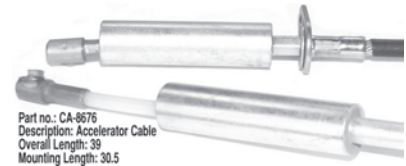

**CA-8676**



**CA-8678**

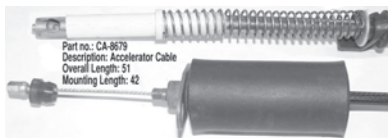

**CA-8679**



**CA-8680**

NOTE: ILLUSTRATIONS ARE FOR REFERENCE USE ONLY. PHOTO MAY DIFFER FROM ORIGINAL.

# CABLE ILLUSTRATIONS

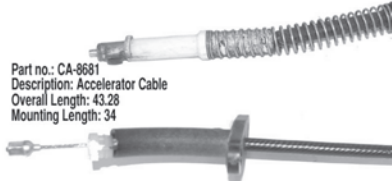

**CA-8681**



**CA-8682**

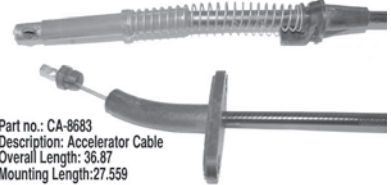

**CA-8683**



**CA-8684**

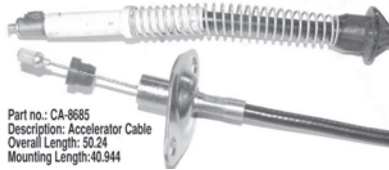

**CA-8685**

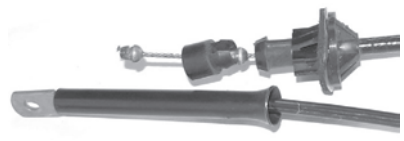

**CA-8687**

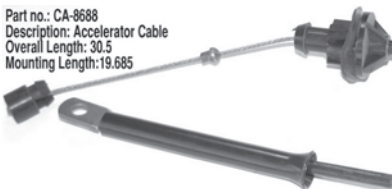

**CA-8688**



**CA-8689**



**CA-8692**

NOTE: ILLUSTRATIONS ARE FOR REFERENCE USE ONLY. PHOTO MAY DIFFER FROM ORIGINAL.

# CABLE ILLUSTRATIONS



**CA-8696**



**CA-8697**



**CA-8699**



**CA-8701**



**CA-8706**



**CA-8714**



**CA-8719**



**CA-8720**



**CA-8721**

NOTE: ILLUSTRATIONS ARE FOR REFERENCE USE ONLY. PHOTO MAY DIFFER FROM ORIGINAL.

# CABLE ILLUSTRATIONS



**CA-8722**



**CA-8724**

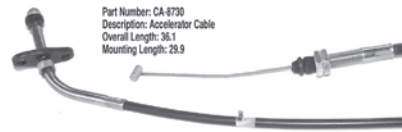

**CA-8730**



**CA-8732**



**ca-8733**



**CA-8734**



**CA-8736**



**ca-8738**



**CA-8739**

NOTE: ILLUSTRATIONS ARE FOR REFERENCE USE ONLY. PHOTO MAY DIFFER FROM ORIGINAL.

# CABLE ILLUSTRATIONS



**CA-8740**



**CA-8746**



**CA-8748**



**CA-8750**



**CA-8752**



**CA-8753**



**ca-8754**



**ca-8755**



**ca-8760**

NOTE: ILLUSTRATIONS ARE FOR REFERENCE USE ONLY. PHOTO MAY DIFFER FROM ORIGINAL.

# CABLE ILLUSTRATIONS



**CA-8762**



**CA-8763**



**CA-8766**



**CA-8769**



**CA-8770**



**CA-8771**

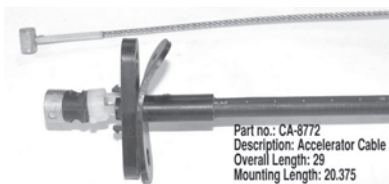

**CA-8772**



**CA-8774**



**CA-8775**

NOTE: ILLUSTRATIONS ARE FOR REFERENCE USE ONLY. PHOTO MAY DIFFER FROM ORIGINAL.

# CABLE ILLUSTRATIONS

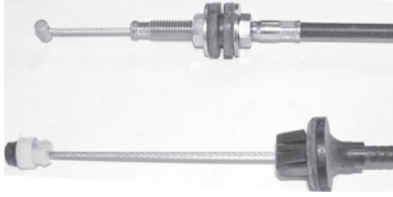

**CA-8777**



CA-8778  
Description: Accelerator  
Overall Length: 17.5  
Mounting Length: 11

**CA-8778**



CA-8779  
Description: Accelerator  
Overall Length: 28  
Mounting Length: 21.25

**CA-8779**



CA-8781  
Description: Accelerator  
Overall Length: 58  
Mounting Length: 49.275

**CA-8781**



**CA-8782**



CA-8783  
Description: Accelerator  
Overall Length: 37.75  
Mounting Length: 29.25

**CA-8783**



CA-8784  
Description: Accelerator  
Overall Length: 29.25  
Mounting Length: 22.25

**CA-8784**



CA-8785  
Description: Accelerator  
Overall Length: 42.25  
Mounting Length: 32.5

**CA-8785**



**CA-8789**

NOTE: ILLUSTRATIONS ARE FOR REFERENCE USE ONLY. PHOTO MAY DIFFER FROM ORIGINAL.



# CABLE ILLUSTRATIONS

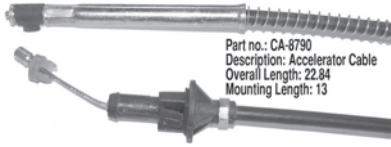

**CA-8790**



**CA-8793**



**CA-8794**



**CA-8795**

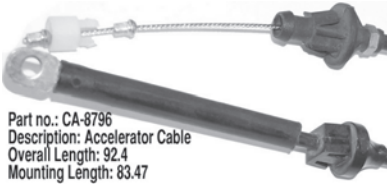

**CA-8796**



**CA-8797**



**CA-8798**



**CA-8799**



**CA-8800**

NOTE: ILLUSTRATIONS ARE FOR REFERENCE USE ONLY. PHOTO MAY DIFFER FROM ORIGINAL.

# CABLE ILLUSTRATIONS



**CA-8802**

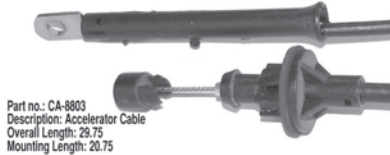

Part no.: CA-8803  
Description: Accelerator Cable  
Overall Length: 29.75  
Mounting Length: 20.75

**CA-8803**



**CA-8804**

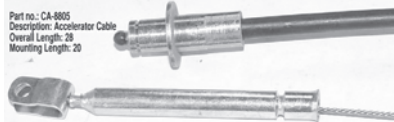

Part no.: CA-8805  
Description: Accelerator Cable  
Overall Length: 28  
Mounting Length: 20

**CA-8805**



**CA-8806**

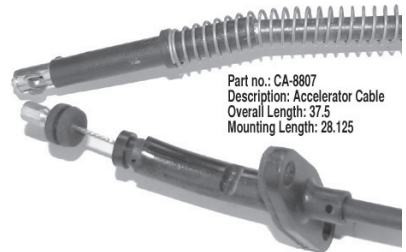

Part no.: CA-8807  
Description: Accelerator Cable  
Overall Length: 37.5  
Mounting Length: 28.125

**CA-8807**



**CA-8808**



Part no.: CA-8809  
Description: Accelerator Cable  
Overall Length: 37.05  
Mounting Length: 30.15

**CA-8809**



**CA-8810**

NOTE: ILLUSTRATIONS ARE FOR REFERENCE USE ONLY. PHOTO MAY DIFFER FROM ORIGINAL.

# CABLE ILLUSTRATIONS



**CA-8811**



**CA-8812**

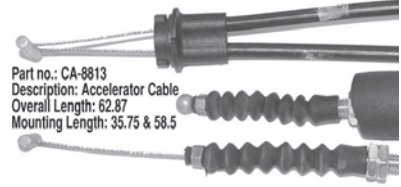

**CA-8813**



**CA-8814**

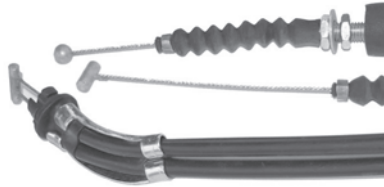

**CA-8815**



**CA-8816**



**CA-8817**



**CA-8818**

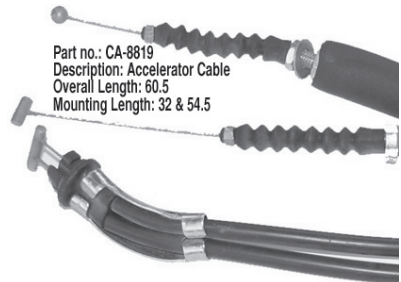

**CA-8819**

NOTE: ILLUSTRATIONS ARE FOR REFERENCE USE ONLY. PHOTO MAY DIFFER FROM ORIGINAL.

# CABLE ILLUSTRATIONS



**CA-8820**



**CA-8821**



**CA-8822**



**CA-8823**



**CA-8824**



**CA-8825**

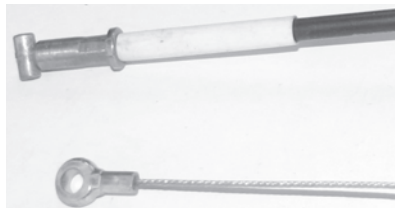

**CA-8826**



**CA-8827**



**CA-8828**

NOTE: ILLUSTRATIONS ARE FOR REFERENCE USE ONLY. PHOTO MAY DIFFER FROM ORIGINAL.

# CABLE ILLUSTRATIONS

Part no.: CA-8829  
Description: Accelerator Cable  
Overall Length: 42  
Mounting Length: 33.07

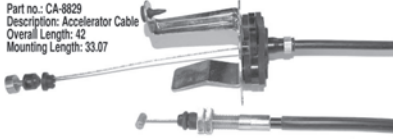

**CA-8829**

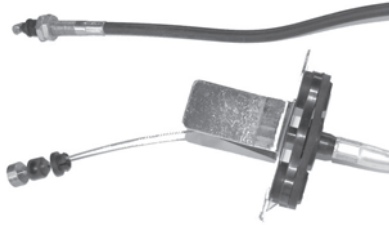

**CA-8830**

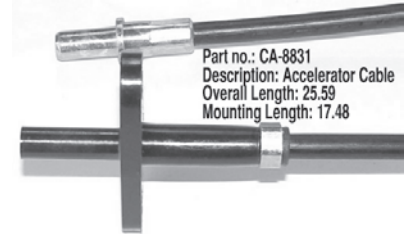

Part no.: CA-8831  
Description: Accelerator Cable  
Overall Length: 25.59  
Mounting Length: 17.48

**CA-8831**



**CA-8832**

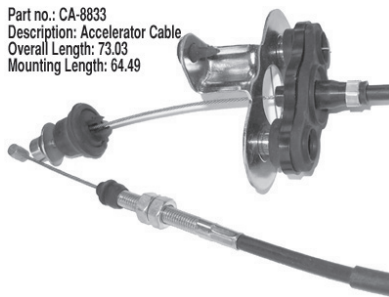

Part no.: CA-8833  
Description: Accelerator Cable  
Overall Length: 73.03  
Mounting Length: 64.49

**CA-8833**



**CA-8834**



Part no.: CA-8835  
Description: Accelerator Cable  
Overall Length: 57.32  
Mounting Length: 49.25

**CA-8835**



**CA-8836**

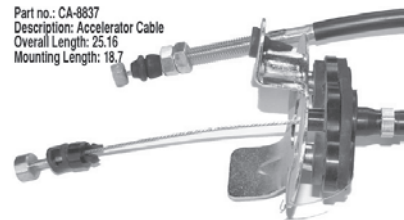

Part no.: CA-8837  
Description: Accelerator Cable  
Overall Length: 25.16  
Mounting Length: 18.7

**CA-8837**

NOTE: ILLUSTRATIONS ARE FOR REFERENCE USE ONLY. PHOTO MAY DIFFER FROM ORIGINAL.

# CABLE ILLUSTRATIONS



**CA-8838**

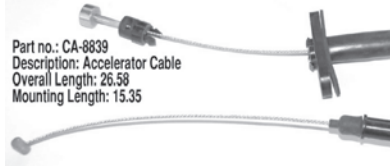

**CA-8839**



**CA-8840**



**CA-8851**



**CA-8866**



**ca-8871**



**CA-8876**



**CA-8880**



**CA-8882**

NOTE: ILLUSTRATIONS ARE FOR REFERENCE USE ONLY. PHOTO MAY DIFFER FROM ORIGINAL.

# CABLE ILLUSTRATIONS



**ca-8884**



**CA-8886**  
Description: Accelerator  
Overall Length: 70.25  
Mounting Length: 60

**CA-8886**



**ca-8890**



**CA-8897**  
Description: Accelerator  
Overall Length: 55.75  
Mounting Length: 45.25

**CA-8897**



**ca-8906**



**ca-8908**



**CA-8914**  
Description: Accelerator  
Overall Length: 66  
Mounting Length: 54.5

**CA-8914**



**CA-8924**  
Description: Accelerator  
Overall Length: 40  
Mounting Length: 30.5

**CA-8924**



**CA-8926**  
Description: Accelerator  
Overall Length: 29.75  
Mounting Length: 17.5

**CA-8926**

NOTE: ILLUSTRATIONS ARE FOR REFERENCE USE ONLY. PHOTO MAY DIFFER FROM ORIGINAL.

# CABLE ILLUSTRATIONS



**CA-8928**



**ca-8932**

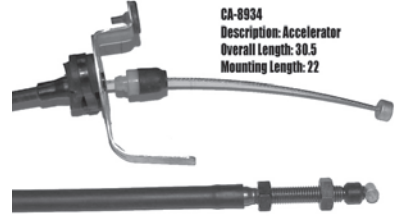

**CA-8934**



**CA-8937**



**CA-8941**



**CA-8942**



**CA-8943**



**ca-8944**



**ca-8952**

NOTE: ILLUSTRATIONS ARE FOR REFERENCE USE ONLY. PHOTO MAY DIFFER FROM ORIGINAL.



# CABLE ILLUSTRATIONS



**CA-8953**



**ca-8954**



**ca-8955**



**CA-8957**



**CA-8958**



**ca-8959**



**ca-8960**



**ca-8963**

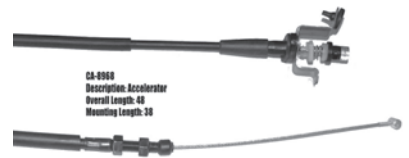

**CA-8968**

NOTE: ILLUSTRATIONS ARE FOR REFERENCE USE ONLY. PHOTO MAY DIFFER FROM ORIGINAL.

# CABLE ILLUSTRATIONS



**ca-8969**



CA-8971  
Description: Accelerator  
Overall Length: 73.5  
Mounting Length: 66

**CA-8971**



CA-8977  
Description: Accelerator  
Overall Length: 58.25  
Mounting Length: 42.5

**CA-8977**



CA-8981  
Description: Accelerator  
Overall Length: 43  
Mounting Length: 35.25

**CA-8981**



CA-8983  
Description: Accelerator  
Overall Length: 80.75  
Mounting Length: 72

**CA-8983**



CA-8995  
Description: Accelerator  
Overall Length: 38.5  
Mounting Length: 11.5

**CA-8995**



CA-8996  
Description: Accelerator  
Overall Length: 63  
Mounting Length: 53.25

**CA-8996**



CA-9002  
Description: Accelerator  
Overall Length: 89.75  
Mounting Length: 71  
Discontinued

**CA-9002**



CA-9005  
Description: Accelerator  
Overall Length: 42.25  
Mounting Length: 32.5

**CA-9005**

NOTE: ILLUSTRATIONS ARE FOR REFERENCE USE ONLY. PHOTO MAY DIFFER FROM ORIGINAL.

# CABLE ILLUSTRATIONS



**CA-9008**



**CA-9010**



**CA-9023**



**ca-9024**



**ca-9025**



**CA-9026**



**ca-9027**



**CA-9028**



**ca-9029**

NOTE: ILLUSTRATIONS ARE FOR REFERENCE USE ONLY. PHOTO MAY DIFFER FROM ORIGINAL.

# CABLE ILLUSTRATIONS

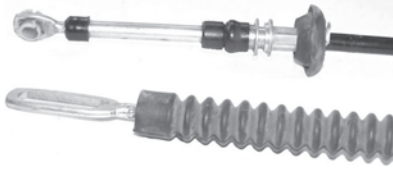

**CA-1003**



**CA-1006**

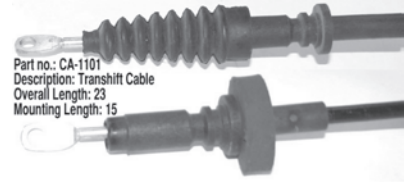

Part no.: CA-1101  
Description: Translift Cable  
Overall Length: 23  
Mounting Length: 15

**CA-1101**



**CA-1102**

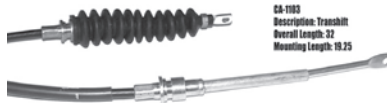

CA-1103  
Description: Translift  
Overall Length: 22  
Mounting Length: 18.25

**CA-1103**



**CA-1110**

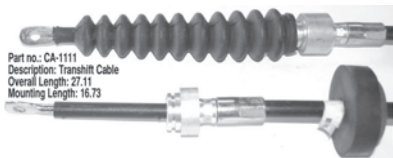

Part no.: CA-1111  
Description: Translift Cable  
Overall Length: 27.11  
Mounting Length: 16.73

**CA-1111**

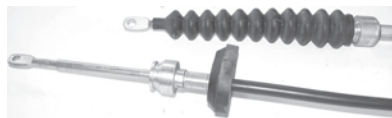

**CA-1112**



Part no.: CA-1113  
Description: Translift Cable  
Overall Length: 50.39  
Mounting Length: 39.52

**CA-1113**

NOTE: ILLUSTRATIONS ARE FOR REFERENCE USE ONLY. PHOTO MAY DIFFER FROM ORIGINAL.

# CABLE ILLUSTRATIONS



**CA-1114**



**CA-1118**



**CA-1123**

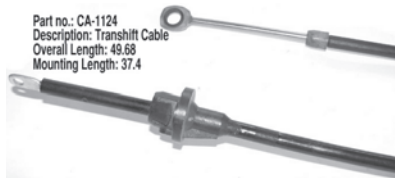

**CA-1124**



**CA-1128**

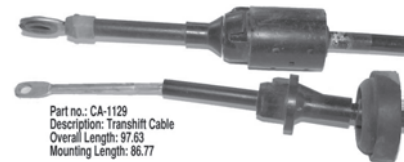

**CA-1129**



**CA-1130**



**CA-1131**



**CA-1132**

NOTE: ILLUSTRATIONS ARE FOR REFERENCE USE ONLY. PHOTO MAY DIFFER FROM ORIGINAL.

# CABLE ILLUSTRATIONS

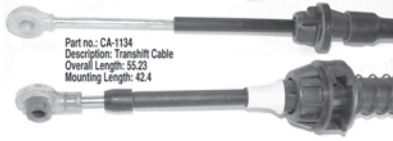

**CA-1134**



**CA-1144**

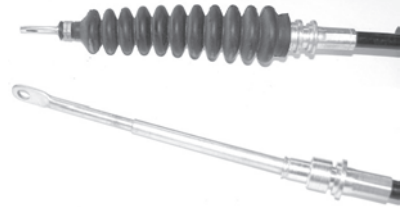

**CA-1145**

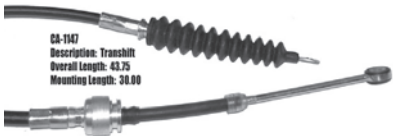

**CA-1147**



**CA-1150**



**CA-1152**



**CA-1155**

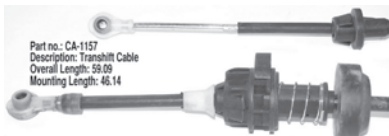

**CA-1157**



**CA-1158**

NOTE: ILLUSTRATIONS ARE FOR REFERENCE USE ONLY. PHOTO MAY DIFFER FROM ORIGINAL.

# CABLE ILLUSTRATIONS

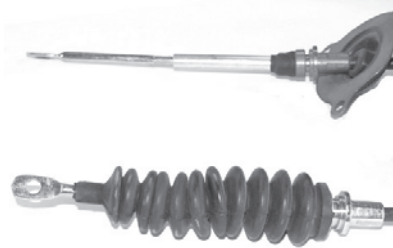

**CA-1162**



**CA-1168**

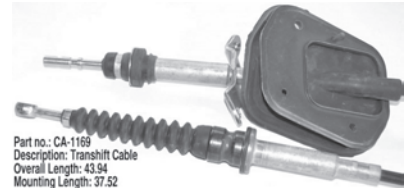

**CA-1169**

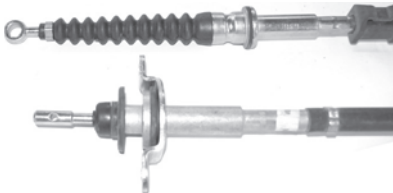

**CA-1170**

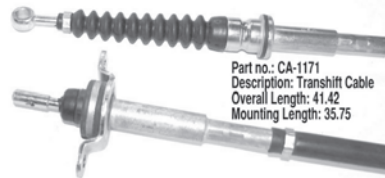

**CA-1171**

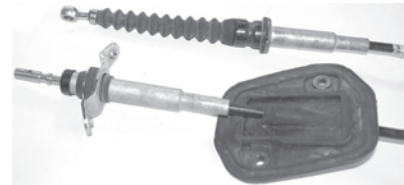

**CA-1172**

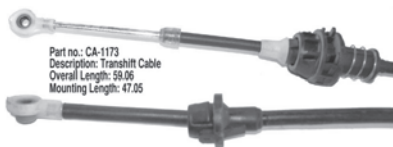

**CA-1173**



**CA-1174**



**CA-1176**

NOTE: ILLUSTRATIONS ARE FOR REFERENCE USE ONLY. PHOTO MAY DIFFER FROM ORIGINAL.

# CABLE ILLUSTRATIONS



**CA-1177**



Part no.: CA-1178  
Description: Transhift Cable  
Overall Length: 96.46  
Mounting Length: 61.46

**CA-1178**

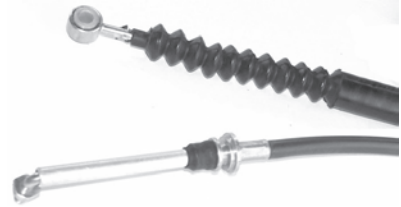

**CA-1179**

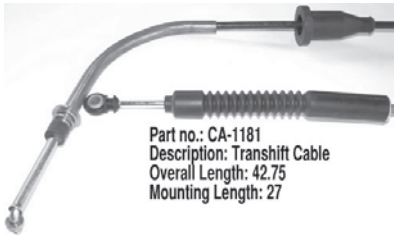

Part no.: CA-1181  
Description: Transhift Cable  
Overall Length: 42.75  
Mounting Length: 27

**CA-1181**



CA-1186  
Description: Transhift  
Overall Length: 65  
Mounting Length: 51.5

**CA-1186**

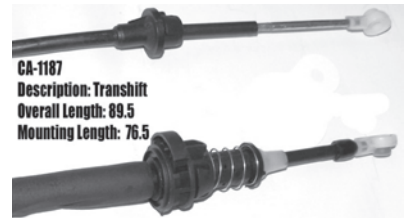

CA-1187  
Description: Transhift  
Overall Length: 89.5  
Mounting Length: 76.5

**CA-1187**



CA-1188  
Description: Transhift  
Overall Length: 31.25  
Mounting Length: 18.25

**CA-1188**



CA-1190  
Description: Transhift  
Overall Length: 54.25  
Mounting Length: 41

**CA-1190**



**ca-1196**

NOTE: ILLUSTRATIONS ARE FOR REFERENCE USE ONLY. PHOTO MAY DIFFER FROM ORIGINAL.



# CABLE ILLUSTRATIONS



**ca-1197**



**ca-1198**



**ca-1199**

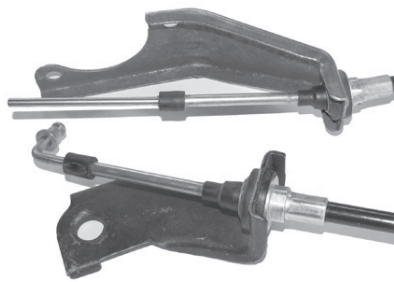

**CA-1901**

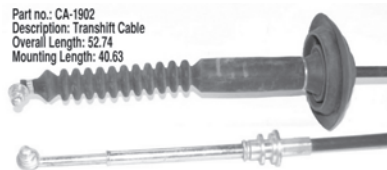

**CA-1902**



**CA-1903**



**CA-1904**



**CA-1906**



**CA-1907**

NOTE: ILLUSTRATIONS ARE FOR REFERENCE USE ONLY. PHOTO MAY DIFFER FROM ORIGINAL.

# CABLE ILLUSTRATIONS



**CA-1908**



Part no.: CA-150  
Description: Clutch Cable  
Overall Length: 39.01  
Mounting Length: 24.5

**CA-150**



**CA-151**



**CA-152**



Part no.: CA-154  
Description: Clutch Cable  
Overall Length: 36.5  
Mounting Length: 23.25

**CA-154**



**CA-155**



Part no.: CA-156  
Description: Clutch Cable  
Overall Length: 36.29  
Mounting Length: 22.4

**CA-156**



**CA-157**



CA-161  
Description: Clutch  
Overall Length: 89.25  
Mount Length: 78.5

**CA-161**

NOTE: ILLUSTRATIONS ARE FOR REFERENCE USE ONLY. PHOTO MAY DIFFER FROM ORIGINAL.

# CABLE ILLUSTRATIONS



**CA-162**

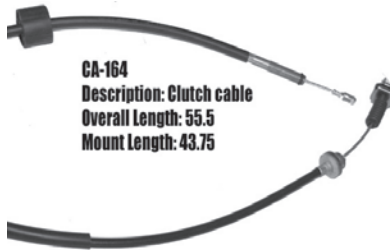

**CA-164**



**CA-166**



**CA-170**



**CA-171**



**CA-201**



**CA-202**



**CA-203**



**CA-204**

NOTE: ILLUSTRATIONS ARE FOR REFERENCE USE ONLY. PHOTO MAY DIFFER FROM ORIGINAL.

# CABLE ILLUSTRATIONS



**CA-205 copy**



**CA-206**



**CA-207**



**CA-208**

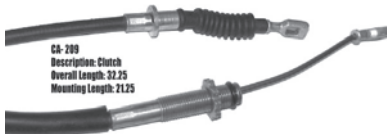

**CA-209**



**CA-210**



**CA-215**



**CA-216**



**CA-217**

NOTE: ILLUSTRATIONS ARE FOR REFERENCE USE ONLY. PHOTO MAY DIFFER FROM ORIGINAL.

# CABLE ILLUSTRATIONS



**CA-250**



Part no.: CA-251  
Description: Clutch Cable  
Overall Length: 35.62  
Mounting Length: 25.37

**CA-251**



**CA-252**



**CA-254**  
Description: Clutch  
Overall Length: 20.25  
Mount Length: 13

**CA-254**



**CA-255**



Part no.: CA-256  
Description: Clutch Cable  
Overall Length: 20.59  
Mounting Length: 11.18

**CA-256**



**CA-257**



**CA-258**



**CA-259**  
Description: Clutch  
Overall Length: 24.75  
Mounting Length: 14.25

**CA-259**

NOTE: ILLUSTRATIONS ARE FOR REFERENCE USE ONLY. PHOTO MAY DIFFER FROM ORIGINAL.

# CABLE ILLUSTRATIONS



**CA-301**



**CA-302**



**CA-304**



**CA-305**



**CA-306**



**CA-307**



**CA-308**



**CA-309**



**CA-311**

NOTE: ILLUSTRATIONS ARE FOR REFERENCE USE ONLY. PHOTO MAY DIFFER FROM ORIGINAL.

# CABLE ILLUSTRATIONS



**CA-313**



**CA-314**



**CA-315**



**CA-317**



**CA-320**



**CA-321**



**CA-322**



**CA-323**



**CA-324**

NOTE: ILLUSTRATIONS ARE FOR REFERENCE USE ONLY. PHOTO MAY DIFFER FROM ORIGINAL.

# CABLE ILLUSTRATIONS



**CA-325**



**CA-326**



**CA-328**



**CA-401**



**CA-402**



**CA-403**



**CA-404**

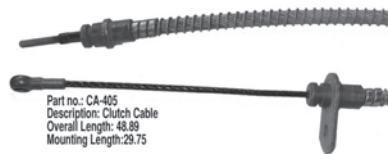

**CA-405**



**CA-406**

NOTE: ILLUSTRATIONS ARE FOR REFERENCE USE ONLY. PHOTO MAY DIFFER FROM ORIGINAL.



# CABLE ILLUSTRATIONS

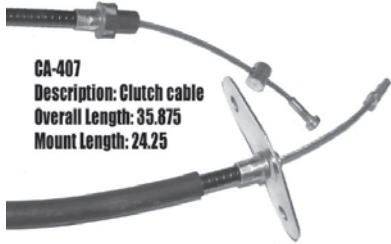

**CA-407**



**CA-408**



**CA-409**

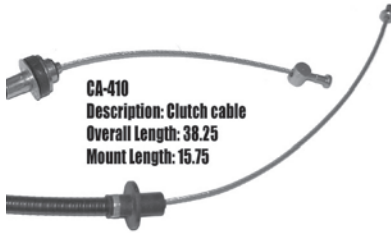

**CA-410**



**CA-412**



**CA-413**



**CA-414**



**CA-415**



**CA-416**

NOTE: ILLUSTRATIONS ARE FOR REFERENCE USE ONLY. PHOTO MAY DIFFER FROM ORIGINAL.

# CABLE ILLUSTRATIONS



**CA-417**



**CA-454**



Part no.: CA-500  
Description: Clutch Cable  
Overall Length: 54.5  
Mounting Length: 35

**CA-500**



Part no.: CA-501  
Description: Clutch Cable  
Overall Length: 51.25  
Mounting Length: 43.25

**CA-501**



**CA-502**



**CA-503**



Part no.: CA-505  
Description: Clutch Cable  
Overall Length: 52.263  
Mounting Length: 50.78

**CA-505**



CA-506  
Description: Clutch  
Overall Length: 62.5  
Mounting Length: 53.5

**CA-506**



CA-507  
Description: Clutch  
Overall Length: 61.5  
Mounting Length: 53.5

**CA-507**

NOTE: ILLUSTRATIONS ARE FOR REFERENCE USE ONLY. PHOTO MAY DIFFER FROM ORIGINAL.

# CABLE ILLUSTRATIONS



**CA-508**



**CA-509**



**CA-511**



**CA-513**



**CA-514**



**CA-515**



**CA-516**



**CA-517**



**CA-550**

NOTE: ILLUSTRATIONS ARE FOR REFERENCE USE ONLY. PHOTO MAY DIFFER FROM ORIGINAL.

# CABLE ILLUSTRATIONS



**CA-563 copy**



**CA-577**  
Description: Clutch  
Overall Length: 35.5  
Mount Length: 22

**CA-577**



**CA-578**  
Description: Clutch  
Overall Length: 36  
Mounting Length: 23.625

**CA-578**



**CA-580**  
Description: Clutch  
Overall Length: 36  
Mounting Length: 22.5

**CA-580**



**CA-581**  
Description: Clutch  
Overall Length: 68.5  
Mounting Length: 54

**CA-581**



**CA-583**  
Description: Clutch  
Overall Length: 61.5  
Mount Length: 43.5

**CA-583**



**CA-585**  
Description: Clutch  
Overall Length: 65  
Mounting Length: 53.5

**CA-585**



**CA-587**  
Description: Clutch  
Overall Length: 45.5  
Mounting Length: 54

**CA-587**



**CA-600**  
Description: Clutch  
Overall Length: 28.75  
Mounting Length: 20

**CA-600**

NOTE: ILLUSTRATIONS ARE FOR REFERENCE USE ONLY. PHOTO MAY DIFFER FROM ORIGINAL.

# CABLE ILLUSTRATIONS

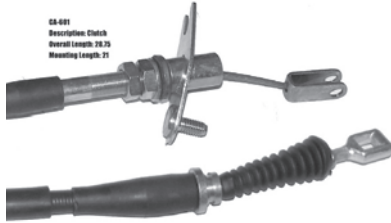

**CA-601**



**CA-602**



**CA-603**



**CA-604**



**CA-605**



**CA-606**



**CA-607**



**CA-650**



**CA-651**

NOTE: ILLUSTRATIONS ARE FOR REFERENCE USE ONLY. PHOTO MAY DIFFER FROM ORIGINAL.

# CABLE ILLUSTRATIONS



**CA-653**



**CA-654**  
Description: Clutch  
Overall Length: 17.5

**CA-654**



**CA-655**



**CA-657**



**CA-658**

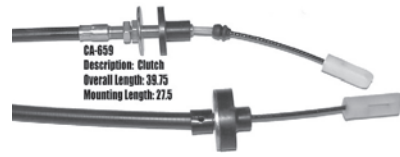

**CA-659**



**CA-660**



**CA-661**



**CA-662**

NOTE: ILLUSTRATIONS ARE FOR REFERENCE USE ONLY. PHOTO MAY DIFFER FROM ORIGINAL.

# CABLE ILLUSTRATIONS



**CA-663**

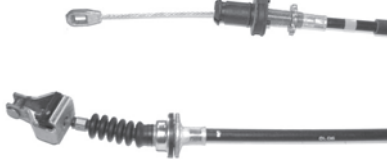

**CA-664**

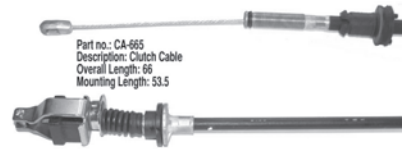

**CA-665**



**CA-667**



**CA-668**

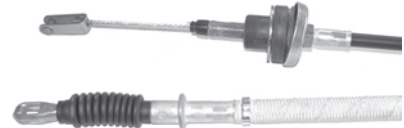

**CA-669**



**CA-670**

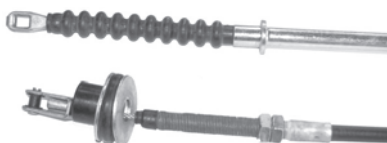

**CA-671**



**CA-672**

NOTE: ILLUSTRATIONS ARE FOR REFERENCE USE ONLY. PHOTO MAY DIFFER FROM ORIGINAL.

# CABLE ILLUSTRATIONS



**CA-673**



Part no.: CA-674  
Description: Clutch Cable  
Overall Length: 31.5  
Mounting Length: 22

**CA-674**



CA-675  
Description: Clutch  
Overall Length: 25.25  
Mounting Length: 15.375

**CA-675**



CA-676  
Description: Clutch  
Overall Length: 22.75  
Mounting Length: 15.25

**CA-676**

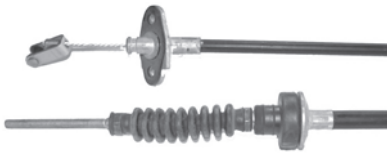

**CA-677**

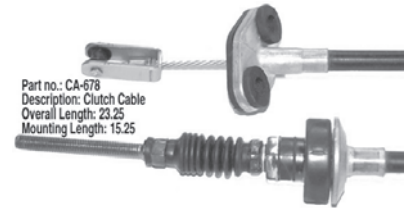

Part no.: CA-678  
Description: Clutch Cable  
Overall Length: 23.25  
Mounting Length: 15.25

**CA-678**



CA-679  
Description: Clutch  
Overall Length: 35  
Mounting Length: 21.5

**CA-679**



**CA-680**



Part no.: CA-683  
Description: Clutch Cable  
Overall Length: 50  
Mounting Length: 41.02

**CA-683**

NOTE: ILLUSTRATIONS ARE FOR REFERENCE USE ONLY. PHOTO MAY DIFFER FROM ORIGINAL.



# CABLE ILLUSTRATIONS



**CA-684**



**CA-685**



**CA-688**

Part no.: CA-689  
Description: Clutch Cable  
Overall Length: 47  
Mounting Length: 40

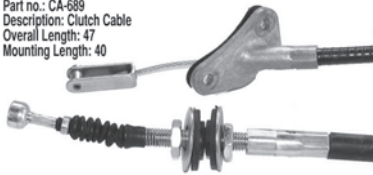

**CA-689**



**CA-800**



Part no.: CA-801  
Description: Clutch Cable  
Overall Length: 30.5  
Mounting Length: 19

**CA-801**



**CA-802**

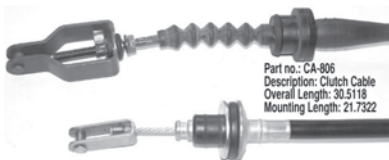

Part no.: CA-806  
Description: Clutch Cable  
Overall Length: 30.5118  
Mounting Length: 21.7322

**CA-806**



**CA-807**

NOTE: ILLUSTRATIONS ARE FOR REFERENCE USE ONLY. PHOTO MAY DIFFER FROM ORIGINAL.

# CABLE ILLUSTRATIONS



**CA-808**



**CA-809**



**CA-810**



**CA-811**



**CA-812**

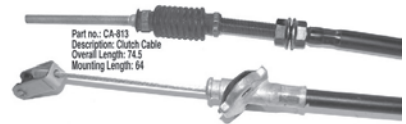

**CA-813**



**CA-814**



**CA-815**



**CA-816**

NOTE: ILLUSTRATIONS ARE FOR REFERENCE USE ONLY. PHOTO MAY DIFFER FROM ORIGINAL.

# CABLE ILLUSTRATIONS



**CA-818**



**CA-819**



**CA-820**



Part no.: CA-821  
Description: Clutch Cable  
Overall Length: 24.5  
Mounting Length: 18.25

**CA-821**



**CA-822**



CA-823  
Description: Clutch  
Overall Length: 51  
Mounting Length: 41.75

**CA-823**



**CA-824**



CA-826  
Description: Clutch  
Overall Length: 72.25  
Mounting Length: 64

**CA-826**



**CA-850**

NOTE: ILLUSTRATIONS ARE FOR REFERENCE USE ONLY. PHOTO MAY DIFFER FROM ORIGINAL.

# CABLE ILLUSTRATIONS



**CA-851**

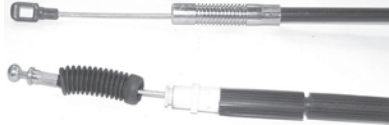

**CA-852**



**CA-853**



**CA-854**



**CA-862**



**CA-888**



**CA-889**



**CA-890**

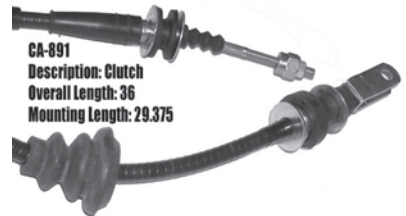

**CA-891**

NOTE: ILLUSTRATIONS ARE FOR REFERENCE USE ONLY. PHOTO MAY DIFFER FROM ORIGINAL.

# CABLE ILLUSTRATIONS



**CA-892**



**CA-893**



**CA-894**



**CA-896**



**CA-899**



**CA-900**



**CA-902**



**CA-903**

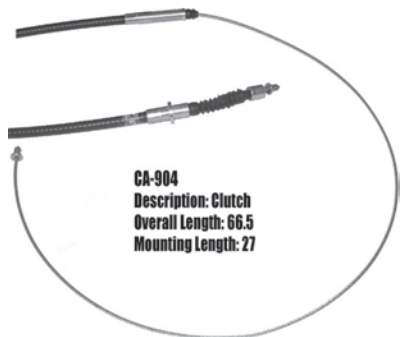

**CA-904**

NOTE: ILLUSTRATIONS ARE FOR REFERENCE USE ONLY. PHOTO MAY DIFFER FROM ORIGINAL.

# CABLE ILLUSTRATIONS



**CA-905**



Part no.: CA-907  
Description: Clutch Cable  
Overall Length: 38.6  
Mounting Length: 27.4

**CA-907**



CA-908  
Description: Clutch  
Overall Length: 39.325  
Mounting Length: 27

**CA-908**

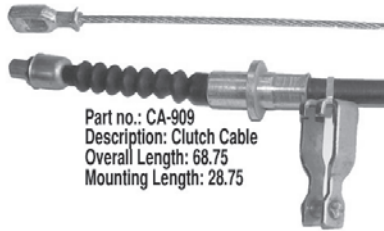

Part no.: CA-909  
Description: Clutch Cable  
Overall Length: 68.75  
Mounting Length: 28.75

**CA-909**



**CA-925**



Part no.: CA-926  
Description: Clutch Cable  
Overall Length: 27.125  
Mounting Length: 19.25

**CA-926**



**CA-927**

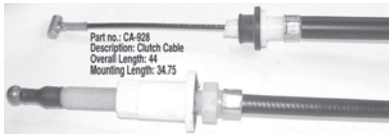

Part no.: CA-928  
Description: Clutch Cable  
Overall Length: 44  
Mounting Length: 34.75

**CA-928**



CA-950  
Description: Clutch  
Overall Length: 89

**CA-950**

NOTE: ILLUSTRATIONS ARE FOR REFERENCE USE ONLY. PHOTO MAY DIFFER FROM ORIGINAL.

# CABLE ILLUSTRATIONS



**CA-951**



**CA-953**



**CA-954**



**CA-955**



**CA-956**



**CA-957**



**CA-958**



**CA-959**



**CA-960**

NOTE: ILLUSTRATIONS ARE FOR REFERENCE USE ONLY. PHOTO MAY DIFFER FROM ORIGINAL.

# CABLE ILLUSTRATIONS



**CA-961**



CA-962  
Description: Clutch  
Overall Length: 125

**CA-962**



CA-963  
Description: Clutch  
Overall Length: 12.8

**CA-963**



CA-964  
Description: Clutch  
Overall Length: 12.5

**CA-964**



**CA-965**



Part no.: CA-966  
Description: Clutch Cable  
Overall Length: 127  
Mounting Length: NONE

**CA-966**



CA-967  
Description: Clutch  
Overall Length: 12.5

**CA-967**



**CA-968**



Part no.: CA-969  
Description: Clutch Cable  
Overall Length: 33.75  
Mounting Length: 24

**CA-969**

NOTE: ILLUSTRATIONS ARE FOR REFERENCE USE ONLY. PHOTO MAY DIFFER FROM ORIGINAL.



# CABLE ILLUSTRATIONS



**CA-970**



**CA-971**  
Description: Clutch  
Overall Length: 40.25  
Mounting Length: 28.25

**CA-971**



**CA-972**



**CA-973**  
Description: Clutch  
Overall Length: 101.75  
Mounting Length: 34

**CA-973**



Part no.: CA-974  
Description: Clutch Cable  
Overall Length: 102  
Mounting Length: 34.25

**CA-974**



Part no.: CA-975  
Description: Clutch Cable  
Overall Length: 77.5  
Mounting Length: 22.5

**CA-975**



Part no.: CA-976  
Description: Clutch Cable  
Overall Length: 82.5  
Mounting Length: 21.5

**CA-976**



CA-977  
Description: Clutch  
Overall Length: 81  
Mounting Length: 28

**CA-977**



Part no.: CA-978  
Description: Clutch Cable  
Overall Length: 82  
Mounting Length: NONE

**CA-978**

NOTE: ILLUSTRATIONS ARE FOR REFERENCE USE ONLY. PHOTO MAY DIFFER FROM ORIGINAL.

# CABLE ILLUSTRATIONS



**CA-979**

**CA-980**

NOTE: ILLUSTRATIONS ARE FOR REFERENCE USE ONLY. PHOTO MAY DIFFER FROM ORIGINAL.

*FOR COMPLETE SELECTION OF QUALITY AUTOMOTIVE PRODUCTS,  
ASK FOR INFORMATION ON PIONEER PRODUCTS LISTED BELOW.*

## **ENGINE COMPONENTS**

- EXPANSION PLUGS & KITS
- HARMONIC BALANCERS
- OIL PANS
- TIMING COVERS
- SPECIALITY ENGINE PARTS
  - Fasteners
  - Pipe Plugs
  - Oil System Components
  - Pilot Bushings
  - Harmonic Balancer Repair Sleeves\
- VALVE TRAIN COMPONENTS
  - Valve Guides
  - Valve Seals
  - Valve Keys
  - Valve Springs
  - Valve Retainers
  - Lifters
  - Push Rods
  - Rocker Arm & Related Items

## **POWERTRAIN PRODUCTS**

- CABLES
  - Accelerator
  - Brake
  - Clutch
  - Control
  - Detent
  - Ground Strap
  - Manual Transhift
  - Miscellaneous
  - Speedometer
  - Transhift
- FLYWHEEL ASSEMBLIES
- FLYWHEEL RING GEARS
- CLUTCH FORKS AND ADJUSTERS
- ALIGNMENT TOOLS
- STANDARD FLYWHEELS

## **TRANSMISSION PRODUCTS**

- FILTER KITS
- GASKET KITS
- OVERHAUL KITS
- BANNER KITS
- MASTER KITS
- SUPER KITS
- MODULATORS
- SEALS & BUSHINGS
- CLUTCH PLATES
- SPRAG KITS
- VALVE BODY KITS
- AND MUCH MORE!*

## **HIGH PERFORMANCE**

- CYLINDER HEAD COMPONENTS:  
Complete Valve Train Parts
- SHORT BLOCK COMPONENTS:  
Expansion Plugs, Fasteners, Oil Pumps,  
Pilot Bushings, Harmonic Balancers, Miscellaneous  
Components
- FASTENERS:  
12 Point & Miscellaneous, Rod Bolts & Nuts,  
Head Studs & Bolts, Main Studs & Bolts
- MISCELLANEOUS:  
Spring Inserts, Repair Sleeves,  
Flywheel Assemblies, Tools

## **SHOP SUPPLIES**

- ABRASIVES:  
Bonded - Grinding Wheels, Stones, Segments,  
Hones, Diamond Tools  
Coated - Sanding, Polishing, Chamfering
- CUTTERS:  
Carbide, Boring Bar, Files, Rotary, Blade, Box
- BRUSHES:  
Wheel, End, Cup, Loop, Scratch,  
Gallery, Cleaning, Brooms
- CHEMICALS:  
Paint, Adhesives, Aerosols, Cleaners,  
Solvents, Oils, Sealants, Silicone, Leak Detection
- FASTENERS:  
Grade 5, Grade 8, Metric, Specialty,  
Assortments, Thread Repair
- TOOLS & ACCESSORIES:  
Valve Equipment, Pullers, Crack Repair, Measuring  
Instruments, Brake Tools, Safety Equip. & Access.

## **MOUNTS**

- ENGINE MOUNTS - Solid
- ENGINE MOUNTS - Hydraulic
- TRANSMISSION MOUNTS
- TORQUE MOUNTS
- DRIVE SHAFT CENTER SUPPORT MOUNTS
- SUSPENSION STRUT MOUNTS
- BODY MOUNTS

Part	Description	Make	Years	Engines
CA-101	CLUTCH CABLE	AMERICAN MOTORS	1977-79	2.0L, 3.8L, 4.2L, 5.0L, 5.9L
CA-150	CLUTCH CABLE	AUDI	1973-79	1.5L, 1.6L, 1.9L, 2.2L
CA-151	CLUTCH CABLE	AUDI	1981	1.7L, 2.0L, 2.2L
CA-152	CLUTCH CABLE	AUDI, PORSCHE	1972-82	1.5L, 1.8L, 1.9L, 2.0L
CA-153	CLUTCH CABLE	AUDI, VOLKSWAGEN	1979-83	1.5L, 1.6L, 1.7L, 2.0L, 2.2L
CA-154	CLUTCH CABLE	AUDI	1982-82	1.6L, 1.7L, 2.0L, 2.2L
CA-155	CLUTCH CABLE	AUDI, VOLKSWAGEN	1974-81	1.5L, 1.6L, 2.0L, 2.2L
CA-156	CLUTCH CABLE	AUDI	1983	1.6L, 2.0L, 2.2L
CA-157	CLUTCH CABLE	VOLKSWAGEN	1983-88	2.2L
CA-161	CLUTCH CABLE	DAIHATSU	1990-92	1.6L
CA-162	CLUTCH CABLE	CHEVROLET	1985-88	1.0L, 1.5L, 1.6L, 1.8L, 2.0L, 2.5L, 2.8L, 3.8L, 4.3L, 5.0L, 5.7L
CA-164	CLUTCH CABLE	DODGE, MITSUBISHI	1987-88	1.5L, 1.6L, 2.0L
CA-166	CLUTCH CABLE	GEO	1989-94	1.0L
CA-167	CLUTCH CABLE	ASUNA, PONTIAC	1989-93	1.6L, 1.8L, 2.0L
CA-170	CLUTCH CABLE	FORD	1996-03	3.8L
CA-171	CLUTCH CABLE	FORD	1996-03	4.6L
CA-201	CLUTCH CABLE	DODGE, PLYMOUTH	1978-83	1.7L
CA-202	CLUTCH CABLE	CHRYSLER, DODGE, PLYMOUTH	1981-87	1.6L, 1.7L, 2.2L, 2.5L
CA-203	CLUTCH CABLE	DODGE, PLYMOUTH	1984-90	2.2L, 2.5L, 2.6L, 3.0L
CA-204	CLUTCH CABLE	DODGE, PLYMOUTH	1978-80	1.4L, 1.6L, 2.6L
CA-205	CLUTCH CABLE	DODGE	1979	1.4L, 1.6L, 2.6L
CA-206	CLUTCH CABLE	DODGE, PLYMOUTH	1981-83	2.6L
CA-207	CLUTCH CABLE	DODGE, PLYMOUTH	1980-84	1.4L, 1.6L, 2.0L, 2.6L
CA-208	CLUTCH CABLE	PLYMOUTH	1976-79	1.6L, 2.0L
CA-209	CLUTCH CABLE	DODGE, MITSUBISHI, PLYMOUTH	1978-88	1.5L, 1.6L, 2.6L
CA-210	CLUTCH CABLE	PLYMOUTH	1976-78	1.6L, 2.0L
CA-215	CLUTCH CABLE	PLYMOUTH	1984-86	2.0L
CA-216	CLUTCH CABLE	DODGE, PLYMOUTH	1979-82	2.0L, 2.6L
CA-217	CLUTCH CABLE	DODGE, PLYMOUTH	1979-82	2.0L, 2.6L
CA-250	CLUTCH CABLE	FIAT	1969-73	0.8L, 0.9L
CA-251	CLUTCH CABLE	FIAT	1969-81	1.2L, 1.4L, 2.0L
CA-252	CLUTCH CABLE	FIAT	1970-73	1.4L
CA-253	CLUTCH CABLE	YUGO	1986-86	1.1L
CA-254	CLUTCH CABLE	YUGO	1987-91	1.1L, 1.3L
CA-255	CLUTCH CABLE	FIAT	1971-74	1.1L, 1.3L
CA-256	CLUTCH CABLE	FIAT	1975-79	1.3L
CA-257	CLUTCH CABLE	FIAT	1979-81	2.0L
CA-258	CLUTCH CABLE	FIAT	1979-81	2.0L
CA-259	CLUTCH CABLE	FIAT	1979-82	1.5L
CA-301	CLUTCH CABLE	FORD, MERCURY	1975-80	2.3L
CA-302	CLUTCH CABLE	FORD	1974-75	2.3L, 2.8L
CA-304	CLUTCH CABLE	FORD	1976-78	2.3L
CA-305	CLUTCH CABLE	FORD	1976-78	5.0L
CA-306	CLUTCH CABLE	FORD, MERCURY	1978-80	2.3L, 3.3L
CA-307	CLUTCH CABLE	FORD, MERCURY	1979-80	3.3L
CA-308	CLUTCH CABLE	FORD, MERCURY	1979	5.0L
CA-309	CLUTCH CABLE	FORD, MERCURY	1979	2.8L
CA-311	CLUTCH CABLE	FORD, MERCURY	1981-89	2.3L, 3.3L, 3.8L, 4.2L
CA-313	CLUTCH CABLE	FORD, MERCURY	1981	3.3L
CA-314	CLUTCH CABLE	FORD, MERCURY	1981-94	1.6L, 1.9L, 2.0L, 2.3L, 3.0L
CA-315	CLUTCH CABLE	FORD, MERCURY	1983-93	2.3L
CA-317	CLUTCH CABLE	FORD, MERCURY	1986-95	2.5L, 3.0L, 3.8L
CA-318	CLUTCH CABLE	FORD, MERCURY	1982-93	5.0L
CA-320	CLUTCH CABLE	MERCURY	1984	2.0L, 2.3L
CA-321	CLUTCH CABLE	FORD	1978-80	1.6L
CA-322	CLUTCH CABLE	FORD	1978-80	1.6L
CA-323	CLUTCH CABLE	MERCURY	1971-74	2.0L
CA-324	CLUTCH CABLE	MERCURY	1971-72	1.6L
CA-325	CLUTCH CABLE	MERCURY	1972-73	2.6L
CA-326	CLUTCH CABLE	MERCURY	1976-77	2.3L
CA-328	CLUTCH CABLE	MERKUR	1986-89	2.3L
CA-401	CLUTCH CABLE	CHEVROLET	1976-77	1.4L, 1.6L, 2.0L, 2.3L, 4.1L, 4.3L, 5.0L, 5.7L, 6.6L, 7.4L
CA-402	CLUTCH CABLE	CHEVROLET, OLDSMOBILE, PONTIAC	1976-80	1.4L, 1.6L, 2.0L, 2.1L, 2.5L, 4.1L, 4.3L, 5.0L, 5.7L, 6.6L

Part	Description	Make	Years	Engines
CA-403	CLUTCH CABLE	PONTIAC	1975-76	2.3L
CA-404	CLUTCH CABLE	CHEVROLET	1975	2.0L, 2.3L, 4.1L, 4.3L, 5.7L, 6.6L, 7.4L
CA-405	CLUTCH CABLE	BUICK, CHEVROLET, OLDSMOBILE, PONTIAC	1976-80	1.6L, 2.3L, 2.5L, 3.2L, 3.3L, 3.8L, 4.9L, 5.0L, 5.7L
CA-406	CLUTCH CABLE	CHEVROLET	1976	1.4L, 1.6L, 2.0L, 2.3L, 4.1L, 4.3L, 5.0L, 5.7L, 6.6L, 7.4L
CA-407	CLUTCH CABLE	BUICK, CHEVROLET, OLDSMOBILE, PONTIAC	1980-85	1.6L, 1.8L, 2.5L, 2.8L, 3.8L, 4.1L, 4.3L, 4.4L, 4.9L, 5.0L, 5.7L
CA-408	CLUTCH CABLE	CHEVROLET, PONTIAC	1977-87	1.0L, 1.4L, 1.5L, 1.6L, 1.8L, 2.0L, 2.3L, 2.5L, 2.8L, 3.2L, 3.3L, 4.1L, 4.3L, 4.4L, 5.0L, 5.7L
CA-409	CLUTCH CABLE	BUICK, CADILLAC, CHEVROLET, PONTIAC	1982	1.6L, 1.8L, 2.5L, 2.8L, 3.0L, 3.8L, 4.1L, 4.3L, 4.4L, 5.0L, 5.7L
CA-410	CLUTCH CABLE	BUICK, CADILLAC, CHEVROLET, OLDSMOBILE, PONTIAC	1982-84	1.6L, 1.8L, 2.0L, 2.5L, 2.8L, 3.0L, 3.8L, 4.1L, 4.3L, 4.4L, 5.0L, 5.7L, 6.0L
CA-412	CLUTCH CABLE	CHEVROLET, ISUZU	1981-87	2.2L
CA-413	CLUTCH CABLE	CHEVROLET	1980-80	1.8L
CA-414	CLUTCH CABLE	SUZUKI	1986-88	1.3L
CA-415	CLUTCH CABLE	CHEVROLET	1978-79	1.8L, 3.3L, 3.8L, 4.1L, 4.8L, 5.0L, 5.7L, 6.6L, 7.4L
CA-416	CLUTCH CABLE	CHEVROLET	1981-81	1.8L
CA-417	CLUTCH CABLE	CHEVROLET, ISUZU	1981-87	1.8L, 1.9L, 2.2L, 2.3L
CA-500	CLUTCH CABLE	HONDA	1980-83	1.5L
CA-501	CLUTCH CABLE	HONDA	1975-79	1.5L
CA-502	CLUTCH CABLE	HONDA	1973-79	1.2L
CA-503	CLUTCH CABLE	HONDA	1986-89	2.0L
CA-503	CLUTCH CABLE	HONDA	1986-89	2.0L
CA-505	CLUTCH CABLE	HONDA	1983-87	1.8L
CA-506	CLUTCH CABLE	HONDA	1988-91	1.6L
CA-507	CLUTCH CABLE	HONDA	1988-91	1.5L
CA-508	CLUTCH CABLE	HONDA	1982-84	1.8L
CA-509	CLUTCH CABLE	HONDA	1985-85	1.8L
CA-511	CLUTCH CABLE	HONDA	1980-87	1.3L, 1.5L
CA-513	CLUTCH CABLE	HONDA	1984-87	1.5L
CA-514	CLUTCH CABLE	HONDA	1988-91	1.5L, 1.6L
CA-515	CLUTCH CABLE	HONDA	1985-87	2.0L
CA-516	CLUTCH CABLE	ACURA	1986-87	1.6L, 2.5L, 2.7L
CA-517	CLUTCH CABLE	ACURA	1988-89	1.6L, 2.7L
CA-550	CLUTCH CABLE	HYUNDAI, MITSUBISHI	1986-92	1.5L
CA-577	CLUTCH CABLE	ISUZU	1989	1.5L, 1.6L
CA-578	CLUTCH CABLE	CHEVROLET, ISUZU	1985-89	1.0L, 1.5L, 1.6L, 2.0L, 2.5L, 2.8L, 3.8L, 4.3L, 5.0L, 5.7L
CA-580	CLUTCH CABLE	CHEVROLET, ISUZU	1987-89	1.0L, 1.5L, 1.6L, 2.0L, 2.5L, 2.8L, 3.8L, 4.3L, 5.0L, 5.7L
CA-581	CLUTCH CABLE	ISUZU	1989-92	2.3L, 2.6L
CA-583	CLUTCH CABLE	ISUZU	1986-87	2.3L
CA-585	CLUTCH CABLE	ISUZU	1984-86	1.9L, 2.2L, 2.3L
CA-587	CLUTCH CABLE	ISUZU	1986-90	2.3L, 2.6L, 2.8L
CA-600	CLUTCH CABLE	MAZDA	1977-78	1.3L
CA-601	CLUTCH CABLE	MAZDA	1979-80	1.4L
CA-602	CLUTCH CABLE	MAZDA	1982-85	1.5L
CA-603	CLUTCH CABLE	MAZDA	1981-85	1.5L
CA-604	CLUTCH CABLE	MAZDA	1979-81	1.4L, 1.5L
CA-605	CLUTCH CABLE	MAZDA	1982-83	1.5L
CA-606	CLUTCH CABLE	MAZDA, MERCURY	1987-89	1.6L
CA-607	CLUTCH CABLE	MAZDA	1984-87	2.0L
CA-650	CLUTCH CABLE	MITSUBISHI	1983-88	1.8L
CA-651	CLUTCH CABLE	MITSUBISHI	1985-86	1.6L
CA-653	CLUTCH CABLE	FORD, MERCURY	1983-92	2.3L
CA-654	CLUTCH CABLE	CHEVROLET, GMC	1982-83	2.8L
CA-655	CLUTCH CABLE	CHEVROLET, GMC	1982-83	2.8L
CA-657	CLUTCH CABLE	VOLKSWAGEN	1990-92	1.6L, 1.8L, 2.0L
CA-658	CLUTCH CABLE	VOLKSWAGEN	1993-98	2.0L
CA-659	CLUTCH CABLE	VOLKSWAGEN	1991-93	1.8L
CA-660	CLUTCH CABLE	ACURA	1990-93	1.7L, 1.8L, 2.5L, 2.7L, 3.0L, 3.2L
CA-661	CLUTCH CABLE	ACURA	1992-93	1.7L, 1.8L, 2.5L, 3.0L, 3.2L
CA-662	CLUTCH CABLE	DODGE	1989-91	1.5L, 1.8L, 2.0L
CA-663	CLUTCH CABLE	DODGE, EAGLE	1992	1.5L, 1.8L, 2.0L, 2.4L, 3.0L
CA-664	CLUTCH CABLE	DODGE	1985-86	1.5L, 1.6L, 2.0L
CA-665	CLUTCH CABLE	DODGE, EAGLE, MITSUBISHI	1993-96	1.5L, 1.8L, 2.0L, 2.4L, 3.3L, 3.5L

Part	Description	Make	Years	Engines
CA-667	CLUTCH CABLE	CHRYSLER, DODGE, PLYMOUTH	1991-94	2.5L, 3.0L, 3.3L
CA-668	CLUTCH CABLE	SUBARU	1990-95	1.8L, 2.2L
CA-669	CLUTCH CABLE	ISUZU	1981-84	1.8L
CA-670	CLUTCH CABLE	ISUZU	1991-93	1.6L
CA-671	CLUTCH CABLE	ISUZU	1986-87	1.9L, 2.3L
CA-672	CLUTCH CABLE	CHEVROLET	1985	1.0L, 1.5L, 1.6L, 1.8L, 2.0L, 2.5L, 2.8L, 3.8L, 4.3L, 5.0L, 5.7L
CA-673	CLUTCH CABLE	FORD	1994-97	1.3L
CA-674	CLUTCH CABLE	DAIHATSU	1988-92	1.0L
CA-675	CLUTCH CABLE	SUZUKI	1995-96	1.6L
CA-676	CLUTCH CABLE	SUZUKI	1995-98	1.3L
CA-677	CLUTCH CABLE	SUZUKI	1992-98	1.6L
CA-678	CLUTCH CABLE	CHEVROLET	1998	1.0L, 1.3L, 1.8L, 2.2L, 2.4L, 3.1L, 3.8L, 5.7L
CA-679	CLUTCH CABLE	CHEVROLET	1985	2.5L, 2.8L
CA-680	CLUTCH CABLE	DODGE, PLYMOUTH	1988-90	2.2L
CA-683	CLUTCH CABLE	HYUNDAI	1989-95	2.0L, 2.4L, 3.0L
CA-684	CLUTCH CABLE	ISUZU	1990-92	1.6L
CA-685	CLUTCH CABLE	ISUZU	1991-92	1.6L, 1.8L
CA-686	CLUTCH CABLE	ISUZU	1986-87	2.2L
CA-687	CLUTCH CABLE	ISUZU	1986-87	2.2L
CA-688	CLUTCH CABLE	SUBARU	1993-98	1.8L, 2.2L
CA-689	CLUTCH CABLE	SUBARU	1987-88	1.2L
CA-800	CLUTCH CABLE	NISSAN	1982-86	1.5L, 1.6L
CA-801	CLUTCH CABLE	NISSAN	1983-86	1.7L
CA-802	CLUTCH CABLE	NISSAN	1984-86	2.0L
CA-806	CLUTCH CABLE	NISSAN	1984-90	1.2L, 1.6L
CA-807	CLUTCH CABLE	NISSAN	1986-88	1.6L
CA-808	CLUTCH CABLE	NISSAN	1982-83	2.0L
CA-809	CLUTCH CABLE	SUZUKI	1989-91	1.3L, 1.6L
CA-810	CLUTCH CABLE	NISSAN	1990-93	1.6L
CA-811	CLUTCH CABLE	NISSAN	1991-92	2.0L
CA-812	CLUTCH CABLE	VOLKSWAGEN	1954-79	1.2L, 1.6L
CA-813	CLUTCH CABLE	SUZUKI	1989-93	1.3L, 1.6L
CA-814	CLUTCH CABLE	SUZUKI	1989-89	1.3L
CA-815	CLUTCH CABLE	MITSUBISHI	1987-93	2.0L, 2.4L, 2.6L, 3.0L
CA-816	CLUTCH CABLE	HONDA	1984-87	1.3L, 1.5L
CA-818	CLUTCH CABLE	RENAULT	1983-87	1.4L, 1.7L
CA-819	CLUTCH CABLE	RENAULT	1984-87	1.4L, 1.7L, 2.0L
CA-820	CLUTCH CABLE	RENAULT	1980-83	1.4L
CA-821	CLUTCH CABLE	RENAULT	1976-79	1.3L
CA-822	CLUTCH CABLE	SUBARU	1981-81	1.8L
CA-823	CLUTCH CABLE	ISUZU	1981-84	1.8L
CA-824	CLUTCH CABLE	SUBARU	1984-89	1.8L
CA-826	CLUTCH CABLE	HONDA	1985-85	1.8L
CA-850	CLUTCH CABLE	BUICK, OPEL	1967-71	1.1L, 1.5L, 1.9L, 4.1L, 5.7L, 6.6L, 7.0L, 7.5L
CA-851	CLUTCH CABLE	BUICK, OPEL	1973-76	1.8L, 1.9L, 3.8L, 4.3L, 5.7L, 7.5L
CA-852	CLUTCH CABLE	BUICK, OPEL	1974	1.9L, 4.1L, 5.7L, 7.5L
CA-853	CLUTCH CABLE	BUICK, OPEL	1975	1.9L, 3.8L, 4.1L, 4.3L, 5.7L, 6.6L, 7.5L
CA-854	CLUTCH CABLE	OPEL	1971-72	1.9L
CA-888	CLUTCH CABLE	SUBARU	1989-94	1.2L
CA-889	CLUTCH CABLE	SUBARU	1972-80	1.3L, 1.4L, 1.6L
CA-890	CLUTCH CABLE	SUBARU	1980-84	1.6L, 1.8L
CA-891	CLUTCH CABLE	SUBARU	1980-83	1.8L
CA-892	CLUTCH CABLE	SUBARU	1985-89	1.8L
CA-893	CLUTCH CABLE	SUBARU	1984-84	1.6L
CA-894	CLUTCH CABLE	SUBARU	1984-84	1.8L
CA-896	CLUTCH CABLE	SUBARU	1985-89	1.8L
CA-899	CLUTCH CABLE	SUBARU	1985-91	1.8L, 2.7L,
CA-900	CLUTCH CABLE	SUBARU	1984-84	1.6L
CA-902	CLUTCH CABLE	TOYOTA	1977-79	1.2L
CA-903	CLUTCH CABLE	TOYOTA	1983-84	1.3L
CA-904	CLUTCH CABLE	TOYOTA	1981-82	1.3L
CA-905	CLUTCH CABLE	TOYOTA	1980-80	1.5L
CA-907	CLUTCH CABLE	TOYOTA	1981-82	1.5L
CA-908	CLUTCH CABLE	TOYOTA	1983-88	1.5L

Part	Description	Make	Years	Engines
CA-909	CLUTCH CABLE	TOYOTA	1971-74	1.2L
CA-910	CLUTCH CABLE	TOYOTA	1969-70	1.2L
CA-912	CLUTCH CABLE	PLYMOUTH	1979	1.4L, 1.6L
CA-925	CLUTCH CABLE	VOLVO	1967-68	1.8L
CA-926	CLUTCH CABLE	VOLVO	1970-75	3.0L
CA-927	CLUTCH CABLE	VOLVO	1975-93	2.0L, 2.1L, 2.3L
CA-928	CLUTCH CABLE	VOLVO	1982-91	2.3L, 2.4L, 2.8L
CA-950	CLUTCH CABLE	VOLKSWAGEN	1963-92	1.2L, 1.3L, 1.5L, 1.6L, 1.8L
CA-951	CLUTCH CABLE	VOLKSWAGEN	1985-86	1.6L
CA-953	CLUTCH CABLE	VOLKSWAGEN	1977-89	1.5L, 1.6L, 1.7L, 1.8L
CA-954	CLUTCH CABLE	VOLKSWAGEN	1976-89	1.5L, 1.6L, 1.7L, 1.8L, 2.0L
CA-955	CLUTCH CABLE	VOLKSWAGEN	1983-85	1.6L, 1.7L, 1.8L
CA-956	CLUTCH CABLE	VOLKSWAGEN	1982-83	1.6L
CA-957	CLUTCH CABLE	VOLKSWAGEN	1960-61	1.2L
CA-958	CLUTCH CABLE	VOLKSWAGEN	1971-74	1.6L
CA-959	CLUTCH CABLE	VOLKSWAGEN	1988-89	1.8L
CA-960	CLUTCH CABLE	VOLKSWAGEN	1966-73	1.6L
CA-961	CLUTCH CABLE	VOLKSWAGEN	1975-75	1.5L
CA-962	CLUTCH CABLE	VOLKSWAGEN	1967-1	1.5L, 1.6L
CA-963	CLUTCH CABLE	VOLKSWAGEN	1971-75	1.6L, 1.7L, 1.8L
CA-964	CLUTCH CABLE	VOLKSWAGEN	1954-67	1.2L, 1.5L
CA-965	CLUTCH CABLE	VOLKSWAGEN	1975-75	1.5L
CA-966	CLUTCH CABLE	VOLKSWAGEN	1975-75	1.8L
CA-967	CLUTCH CABLE	VOLKSWAGEN	1959-61	1.2L
CA-968	CLUTCH CABLE	VOLKSWAGEN	1985-92	1.8L
CA-969	CLUTCH CABLE	VOLKSWAGEN	1986-90	1.6L
CA-970	CLUTCH CABLE	VOLKSWAGEN	1984-89	1.8L
CA-971	CLUTCH CABLE	VOLKSWAGEN	1987-90	1.8L
CA-973	CLUTCH CABLE	PORSCHE	1970-76	1.7L, 1.8L, 2.0L
CA-974	CLUTCH CABLE	PORSCHE	1970-71	2.0L
CA-975	CLUTCH CABLE	PORSCHE	1976	2.0L, 2.7L
CA-977	CLUTCH CABLE	PORSCHE	1978-88	3.0L, 3.2L
CA-978	CLUTCH CABLE	PORSCHE	1965-69	1.6L, 2.0L
CA-979	CLUTCH CABLE	PORSCHE	1970-75	2.2L, 2.4L, 2.7L
CA-980	CLUTCH CABLE	PORSCHE	1976-79	3.0L, 3.3L
CA-981	CLUTCH CABLE	CHRYSLER, DODGE, PLYMOUTH	1985-92	, 2.5L, 3.0L
CA-982	CLUTCH CABLE	CHRYSLER, DODGE, PLYMOUTH	1991-94	2.2L, 2.5L
CA-983	CLUTCH CABLE	FORD	1994-95	3.8L, 5.0L
CA-989	CLUTCH CABLE	FORD	1988-93	1.3L
CA-1002	TRANSHIFT CABLE	FORD, LINCOLN, MERCURY	1975-80	3.3L, 4.1L, 5.0L, 5.8L
CA-1006	TRANSHIFT CABLE	FORD	1986-91	2.3L, 2.8L, 3.0L, 4.0L
CA-1101	TRANSHIFT CABLE	BUICK, CHEVROLET, OLDSMOBILE, PONTIAC	1976-80	2.3L, 2.5L, 3.2L, 3.8L, 4.3L, 5.0L
CA-1102	TRANSHIFT CABLE	BUICK, CHEVROLET, GMC, OLDSMOBILE, PONTIAC	1968-87	2.5L, 2.8L, 3.0L, 3.2L, 3.3L, 3.8L, 4.1L, 4.3L, 4.4L, 4.9L, 5.0L, 5.7L, 6.6L, 7.0L, 7.5L
CA-1103	TRANSHIFT CABLE	CHEVROLET, PONTIAC	1968-81	2.5L, 3.8L, 4.1L, 4.3L, 4.4L, 4.9L, 5.0L, 5.7L, 6.6L, 7.0L, 7.5L
CA-1110	TRANSHIFT CABLE	CHEVROLET, PONTIAC	1983-92	2.5L, 2.8L, 3.1L, 3.8L, 5.0L, 5.7L
CA-1111	TRANSHIFT CABLE	CHEVROLET, PONTIAC	1982	2.5L, 2.8L, 5.0L
CA-1112	TRANSHIFT CABLE	BUICK, CHEVROLET, OLDSMOBILE, PONTIAC	1980	2.5L, 2.8L
CA-1113	TRANSHIFT CABLE	BUICK, CADILLAC, CHEVROLET, OLDSMOBILE, PONTIAC	1984-90	1.8L, 2.0L, 2.8L, 3.1L
CA-1114	TRANSHIFT CABLE	CHEVROLET, PONTIAC	1984-88	3.8L, 4.3L, 5.0L, 5.7L
CA-1118	TRANSHIFT CABLE	BUICK, OLDSMOBILE, PONTIAC	1981	2.5L, 2.8L
CA-1123	TRANSHIFT CABLE	BUICK, CHEVROLET, OLDSMOBILE, PONTIAC	1982	2.5L, 2.8L, 3.0L, 4.3L
CA-1124	TRANSHIFT CABLE	BUICK, CHEVROLET, OLDSMOBILE, PONTIAC	1982	2.5L, 2.8L, 3.0L, 4.3L
CA-1128	TRANSHIFT CABLE	BUICK, CADILLAC, CHEVROLET, OLDSMOBILE, PONTIAC	1982-94	1.8L, 2.0L, 2.2L, 2.5L, 3.1L
CA-1129	TRANSHIFT CABLE	BUICK, CHEVROLET, OLDSMOBILE, PONTIAC	1983-84	2.5L, 2.8L, 3.0L, 4.3L
CA-1130	TRANSHIFT CABLE	BUICK, OLDSMOBILE	1983-88	2.5L, 3.8L, 4.1L, 4.3L, 5.0L, 5.7L
CA-1131	TRANSHIFT CABLE	BUICK, CHEVROLET, OLDSMOBILE, PONTIAC	1984-85	2.5L, 2.8L, 3.0L, 3.8L, 4.3L

Part	Description	Make	Years	Engines
CA-1132	TRANSHIFT CABLE	BUICK, CHEVROLET, OLDSMOBILE, PONTIAC	1983-85	2.5L, 2.8L, 3.0L, 3.8L, 4.3L
CA-1134	TRANSHIFT CABLE	BUICK, CHEVROLET, OLDSMOBILE, PONTIAC	1986-93	2.5L, 2.8L, 3.1L, 3.3L, 3.8L
CA-1144	TRANSHIFT CABLE	BUICK, CHEVROLET	1975-79	3.8L, 4.1L, 4.9L, 5.0L, 5.7L
CA-1145	TRANSHIFT CABLE	CHEVROLET, OLDSMOBILE	1968-82	2.5L, 2.8L, 3.8L, 4.3L, 5.0L, 5.4L, 5.7L, 7.0L, 7.4L
CA-1147	TRANSHIFT CABLE	BUICK, OLDSMOBILE	1982-85	3.8L, 4.1L, 5.0L, 5.7L
CA-1150	TRANSHIFT CABLE	OLDSMOBILE	1979	3.8L, 4.3L, 5.0L, 5.7L
CA-1152	TRANSHIFT CABLE	BUICK, CHEVROLET, OLDSMOBILE, PONTIAC	1984-85	2.5L, 2.8L, 3.0L, 3.8L, 4.3L
CA-1155	TRANSHIFT CABLE	BUICK, OLDSMOBILE, PONTIAC	1987	3.0L
CA-1157	TRANSHIFT CABLE	BUICK, CHEVROLET, OLDSMOBILE, PONTIAC	1986-95	2.2L, 2.5L, 2.8L, 3.1L, 3.3L, 3.8L
CA-1158	TRANSHIFT CABLE	BUICK, OLDSMOBILE	1986	3.8L, 5.0L
CA-1162	TRANSHIFT CABLE	CHEVROLET	1984-95	5.7L
CA-1168	TRANSHIFT CABLE	BUICK, CHEVROLET	1973-77	3.8L, 4.1L, 5.0L, 5.7L, 6.6L, 7.4L
CA-1169	TRANSHIFT CABLE	HONDA	1990-93	2.2L
CA-1170	TRANSHIFT CABLE	HONDA	1983-85	1.8L
CA-1171	TRANSHIFT CABLE	HONDA	1986-89	2.0L
CA-1172	TRANSHIFT CABLE	HONDA	1994-95	2.2L, 2.7L
CA-1173	TRANSHIFT CABLE	BUICK, OLDSMOBILE, PONTIAC	1983-96	2.2L, 2.5L, 2.8L, 3.1L
CA-1174	TRANSHIFT CABLE	EAGLE	1988-89	2.5L, 3.0L
CA-1175	TRANSHIFT CABLE	EAGLE	1988-89	2.5L, 3.0L
CA-1176	TRANSHIFT CABLE	JEEP	1988-90	2.5L, 4.0L
CA-1177	TRANSHIFT CABLE	JEEP	1986-96	2.1L, 2.5L, 2.8L, 4.0L
CA-1178	TRANSHIFT CABLE	BUICK, OLDSMOBILE, PONTIAC	1982	2.5L, 2.8L, 3.0L
CA-1179	TRANSHIFT CABLE	DODGE, PLYMOUTH	1991-95	2.2L, 2.5L, 3.0L
CA-1180	TRANSHIFT CABLE	CHRYSLER, DODGE	1991-93	2.2L, 2.5L, 3.0L
CA-1181	TRANSHIFT CABLE	CHRYSLER, DODGE, PLYMOUTH	1991-95	2.2L, 2.5L, 3.0L, 3.3L, 3.8L
CA-1186	TRANSHIFT CABLE	TOYOTA	1987-91	2.0L, 2.5L
CA-1187	TRANSHIFT CABLE	EAGLE	1988-89	2.5L, 3.0L
CA-1188	TRANSHIFT CABLE	EAGLE	1988-89	2.5L, 3.0L
CA-1189	TRANSHIFT CABLE	LINCOLN	1984-92	2.4L, 5.0L
CA-1190	TRANSHIFT CABLE	OLDSMOBILE	1986-91	3.8L
CA-1191	TRANSHIFT CABLE	CHEVROLET, GMC	1995-00	4.3L, 4.8L, 5.0L, 5.3L, 5.7L, 6.0L, 6.5L
CA-1196	TRANSHIFT CABLE	FORD	1995-97	4.6L, 4.9L, 5.0L, 5.4L, 5.8L, 7.3L, 7.5L
CA-1197	TRANSHIFT CABLE	FORD	1992-96	4.9L, 5.0L, 5.8L, 7.3L, 7.5L
CA-1198	TRANSHIFT CABLE	FORD	1992-97	3.0L, 4.0L
CA-1199	TRANSHIFT CABLE	FORD	1992-96	4.9L, 5.0L, 5.8L, 7.3L, 7.5L
CA-1219	TRANSHIFT CABLE	CHEVROLET, GMC	1999-07	4.3L, 4.8L, 5.3L, 6.0L, 6.6L, 8.1L
CA-1220	TRANSHIFT CABLE	CHEVROLET, GMC	1999-07	4.3L, 4.8L, 5.3L, 6.0L, 6.6L, 8.1L
CA-1902	TRANSHIFT CABLE	CHRYSLER, DODGE, PLYMOUTH	1980-90	1.6L, 1.7L, 2.2L, 2.6L
CA-1903	TRANSHIFT CABLE	CHRYSLER, DODGE, PLYMOUTH	1981-90	2.2L, 2.5L, 2.6L, 3.0L, 3.3L
CA-1904	TRANSHIFT CABLE	CHRYSLER, DODGE, PLYMOUTH	1982-86	1.6L, 1.7L, 2.2L, 2.5L, 2.6L
CA-1906	TRANSHIFT CABLE	CHRYSLER, DODGE, PLYMOUTH	1985-89	2.2L, 2.5L, 2.6L
CA-1907	TRANSHIFT CABLE	CHRYSLER, DODGE	1984-90	2.2L, 2.5L, 3.0L
CA-1908	TRANSHIFT CABLE	CHRYSLER, DODGE, PLYMOUTH	1986-90	2.2L, 2.5L, 3.0L
CA-1910	DETENT CABLE	TOYOTA	1975-79	1.2L, 1.6L
CA-1911	DETENT CABLE	TOYOTA	1980-82	1.8L
CA-1912	DETENT CABLE	TOYOTA	1983-83	1.6L
CA-1913	DETENT CABLE	TOYOTA	1983-83	1.6L
CA-1915	DETENT CABLE	TOYOTA	1984-86	1.6L
CA-1916	DETENT CABLE	TOYOTA	1985-87	1.6L
CA-1917	DETENT CABLE	TOYOTA	1988-89	1.6L
CA-1918	DETENT CABLE	TOYOTA	1988-89	1.6L
CA-1919	DETENT CABLE	TOYOTA	1989-92	1.6L
CA-1920	DETENT CABLE	TOYOTA	1989-92	1.6L
CA-1921	DETENT CABLE	TOYOTA	1977-80	2.2L
CA-1922	DETENT CABLE	TOYOTA	1978-80	2.6L
CA-1923	DETENT CABLE	TOYOTA	1981-82	2.4L
CA-1924	DETENT CABLE	TOYOTA	1981-81	2.8L
CA-1925	DETENT CABLE	TOYOTA	1982-85	2.8L
CA-1926	DETENT CABLE	TOYOTA	1983-85	2.4L
CA-1927	DETENT CABLE	TOYOTA	1986-87	2.0L



Part	Description	Make	Years	Engines
CA-1930	DETENT CABLE	BUICK, CADILLAC, CHEVROLET, OLDSMOBILE, PONTIAC	1981-89	2.5L, 2.8L, 4.4L, 5.0L, 5.7L
CA-1931	DETENT CABLE	CHEVROLET, GMC	1982-84	4.1L
CA-1932	DETENT CABLE	BUICK, CADILLAC, CHEVROLET, OLDSMOBILE, PONTIAC	1980-86	2.0L, 2.5L
CA-1933	DETENT CABLE	BUICK, CHEVROLET, GMC, OLDSMOBILE, PONTIAC	1980-86	3.8L, 4.3L, 4.4L, 5.0L, 5.7L
CA-1935	DETENT CABLE	BUICK, CHEVROLET, OLDSMOBILE, PONTIAC	1984-89	2.5L, 2.8L
CA-1937	DETENT CABLE	BUICK, OLDSMOBILE, PONTIAC	1981-89	3.8L, 5.0L
CA-1939	DETENT CABLE	CHEVROLET, GMC, PONTIAC	1982-86	2.5L
CA-1940	DETENT CABLE	BUICK, CHEVROLET, OLDSMOBILE, PONTIAC	1976-77	4.1L, 5.0L
CA-1941	DETENT CABLE	BUICK, CHEVROLET, GMC, OLDSMOBILE, PONTIAC	1976-80	3.8L, 4.3L, 4.4L, 5.0L, 5.7L
CA-1942	DETENT CABLE	BUICK, CADILLAC, GMC, OLDSMOBILE, PONTIAC	1978-81	3.8L, 5.7L
CA-1943	DETENT CABLE	BUICK, CADILLAC, CHEVROLET, GMC, OLDSMOBILE, PONTIAC	1980-88	3.8L, 4.3L, 4.4L, 5.0L, 5.7L
CA-1947	DETENT CABLE	CHEVROLET, GMC, PONTIAC	1978-80	3.3L, 3.8L
CA-1949	DETENT CABLE	CHRYSLER, DODGE, PLYMOUTH	1981-83	2.2L
CA-1950	DETENT CABLE	BUICK, CHEVROLET, PONTIAC	1973-76	3.8L, 4.1L, 4.3L, 5.7L, 7.5L
CA-1951	DETENT CABLE	BUICK, CHEVROLET, GMC, OLDSMOBILE, PONTIAC	1975-80	3.3L, 4.1L, 4.4L, 4.8L, 5.0L, 5.7L, 6.6L
CA-1952	DETENT CABLE	BUICK, CHEVROLET, GMC, PONTIAC	1968-88	2.0L, 2.3L, 4.1L, 4.8L, 5.0L, 5.4L, 5.7L
CA-1953	DETENT CABLE	OLDSMOBILE, PONTIAC	1976-77	4.3L, 5.7L, 6.6L
CA-1954	DETENT CABLE	BUICK, OLDSMOBILE, PONTIAC	1973-80	3.8L, 5.7L
CA-1955	DETENT CABLE	BUICK, CADILLAC, CHEVROLET, GMC, OLDSMOBILE, PONTIAC	1977-80	3.2L, 3.3L, 3.8L, 4.1L
CA-1958	DETENT CABLE	BUICK, CHEVROLET, OLDSMOBILE, PONTIAC	1982-83	2.5L
CA-1959	DETENT CABLE	FORD, LINCOLN, MERCURY	1988	3.0L, 3.8L
CA-1960	DETENT CABLE	BUICK, CADILLAC, CHEVROLET, GMC, OLDSMOBILE, PONTIAC	1980-87	1.6L, 1.8L, 1.9L, 2.0L, 2.2L, 2.5L, 2.8L, 3.0L, 3.8L, 4.1L, 5.7L, 6.0L, 6.2L
CA-1961	DETENT CABLE	FORD, MERCURY	1986-88	3.0L
CA-1962	DETENT CABLE	FORD, MERCURY	1989-90	3.0L, 3.8L
CA-1963	DETENT CABLE	BUICK, OLDSMOBILE, PONTIAC	1977-80	3.8L, 5.7L, 6.6L
CA-1964	DETENT CABLE	BUICK, OLDSMOBILE, PONTIAC	1977-80	4.3L, 4.9L
CA-1970	DETENT CABLE	BUICK, CHEVROLET, GMC, OLDSMOBILE, PONTIAC	1981-89	2.8L, 3.8L, 4.3L, 5.0L, 5.7L
CA-1980	DETENT CABLE	BUICK, CADILLAC, CHEVROLET, GMC, OLDSMOBILE, PONTIAC	1976-89	1.6L, 1.8L, 1.9L, 2.0L, 2.2L, 2.5L, 2.8L, 3.0L, 3.3L, 3.8L, 4.1L, 4.3L, 4.4L, 5.0L, 5.7L, 6.0L, 6.2L
CA-1981	DETENT CABLE	BUICK, CHEVROLET, GMC, OLDSMOBILE, PONTIAC	1968-88	2.0L, 2.3L, 3.3L, 3.8L, 4.1L, 4.3L, 4.4L, 4.8L, 5.0L, 5.4L, 5.7L, 6.6L
CA-1985	DETENT CABLE	TOYOTA	1983-86	2.0L
CA-1986	DETENT CABLE	LEXUS, TOYOTA	1988-91	2.5L
CA-1989	DETENT CABLE	TOYOTA	1986-86	1.6L
CA-1990	DETENT CABLE	TOYOTA	1984-89	2.0L, 2.2L
CA-1991	DETENT CABLE	TOYOTA	1987-90	1.5L
CA-2034	DETENT CABLE	VOLVO	1981-85	2.1L
CA-2300	TAILGATE CABLE	FORD	1973-88	
CA-2301	TAILGATE CABLE	JEEP	1977-86	
CA-2302	TAILGATE CABLE	CHEVROLET, GMC	1983-89	
CA-2303	TAILGATE CABLE	CHEVROLET, GMC	1978-88	
CA-2304	TAILGATE CABLE	CHEVROLET, GMC	1973-87	
CA-2305	TAILGATE CABLE	CHEVROLET, GMC	1970-77	
CA-2307	TAILGATE CABLE	DODGE	1994-96	
CA-2308	TAILGATE CABLE	FORD	1983-94	
CA-2309	TAILGATE CABLE	FORD	1983-92	
CA-2310	TAILGATE CABLE	CHEVROLET, GMC	1992-02	
CA-3001	SPEEDOMETER CABLE	BUICK, CADILLAC, CHEVROLET, FORD, GMC, OLDSMOBILE, PONTIAC	1950-02	1.6L, 1.8L, 1.9L, 2.0L, 2.2L, 2.3L, 2.5L, 2.8L, 3.0L, 3.1L, 3.2L, 3.3L, 3.8L, 3.9L, 4.1L, 4.3L, 4.4L, 4.6L, 4.8L, 4.9L, 5.0L, 5.4L, 5.7L, 5.8L, 6.2L, 6.5L, 6.6L, 7.0L, 7.4L, 7.5L, 7.7L, 8.2L

Part	Description	Make	Years	Engines
CA-3002	SPEEDOMETER CABLE	AMERICAN MOTORS, BUICK, CADILLAC, CHEVROLET, CHRYSLER, DODGE, FORD, GMC, INTERNATIONAL, JEEP, LINCOLN, MERCURY, OLDSMOBILE, PLYMOUTH, PONTIAC	1950-98	1.9L, 2.0L, 2.1L, 2.3L, 2.5L, 2.6L, 2.8L, 3.2L, 3.3L, 3.5L, 3.6L, 3.7L, 3.8L, 3.9L, 4.1L, 4.2L, 4.3L, 4.4L, 4.5L, 4.6L, 4.7L, 4.8L, 4.9L, 5.0L, 5.1L, 5.2L, 5.3L, 5.4L, 5.6L
CA-3002	SPEEDOMETER CABLE	AMERICAN MOTORS, BUICK, CADILLAC, CHEVROLET, CHRYSLER, DODGE, FORD, GMC, INTERNATIONAL, JEEP, LINCOLN, MERCURY, OLDSMOBILE, PLYMOUTH, PONTIAC	1950-98	5.7L, 5.8L, 5.9L, 6.0L, 6.1L, 6.2L, 6.3L, 6.4L, 6.5L, 6.6L, 6.7L, 6.9L, 7.0L, 7.2L, 7.4L, 7.5L, 7.6L, 7.7L, 8.2L
CA-3003	SPEEDOMETER CABLE	BUICK, CHEVROLET, GMC, OLDSMOBILE, PONTIAC	1964-90	2.3L, 2.5L, 2.8L, 3.0L, 3.2L, 3.3L, 3.8L, 4.1L, 4.3L, 4.4L, 4.8L, 4.9L, 5.0L, 5.4L, 5.7L, 6.0L, 6.2L, 6.5L, 6.6L, 7.0L, 7.4L
CA-3004	SPEEDOMETER CABLE	AMERICAN MOTORS, BUICK, CADILLAC, CHEVROLET, CHRYSLER, DODGE, FORD, GMC, INTERNATIONAL, JEEP, LINCOLN, MERCURY, OLDSMOBILE, PLYMOUTH, PONTIAC	1950-92	2.1L, 2.2L, 2.5L, 2.8L, 3.0L, 3.2L, 3.3L, 3.5L, 3.6L, 3.7L, 3.8L, 3.9L, 4.1L, 4.2L, 4.3L, 4.4L, 4.5L, 4.6L, 4.7L, 4.8L, 4.9L, 5.0L, 5.2L, 5.3L, 5.4L, 5.6L, 5.7L, 5.8L, 5.9L, 6.0L, 6.2L, 6.3L, 6.4L, 6.5L, 6.6L, 6.7L, 6.8L, 6.9L, 7.0L, 7.2L, 7.4L, 7.5L
CA-3005	SPEEDOMETER CABLE	BUICK, CADILLAC, CHEVROLET, CHRYSLER, DODGE, GMC, OLDSMOBILE, PLYMOUTH, PONTIAC	1959-98	1.4L, 1.5L, 1.6L, 1.8L, 1.9L, 2.0L, 2.2L, 2.3L, 2.5L, 2.6L, 2.8L, 3.0L, 3.2L, 3.3L, 3.8L, 4.1L, 4.3L, 4.4L, 4.8L, 4.9L, 5.0L, 5.4L, 5.6L, 5.7L, 6.2L, 6.4L, 6.5L, 6.6L, 7.0L, 7.4L, 7.5L, 7.7L, 8.2L
CA-3006	SPEEDOMETER CABLE	AMERICAN MOTORS, BUICK, CADILLAC, CHEVROLET, CHRYSLER, DODGE, FORD, GMC, JEEP, LINCOLN, MERCURY, OLDSMOBILE, PLYMOUTH, PONTIAC	1961-89	1.8L, 2.0L, 2.2L, 2.5L, 2.6L, 2.8L, 3.2L, 3.3L, 3.5L, 3.7L, 3.8L, 4.1L, 4.2L, 4.5L, 4.6L, 4.8L, 4.9L, 5.0L, 5.2L, 5.4L, 5.6L, 5.7L, 5.8L, 5.9L, 6.2L, 6.3L, 6.4L, 6.5L, 6.6L, 6.8L, 6.9L, 7.0L, 7.4L, 7.5L, 7.7L, 8.2L
CA-3007	SPEEDOMETER CABLE	CHEVROLET, GMC	1971-97	3.8L, 3.9L, 4.1L, 4.3L, 4.8L, 5.0L, 5.7L, 6.2L, 6.6L, 7.4L
CA-3008	SPEEDOMETER CABLE	BUICK, CHEVROLET, GMC, OLDSMOBILE, PONTIAC	1971-89	2.3L, 2.5L, 2.8L, 3.0L, 3.3L, 3.8L, 3.9L, 4.1L, 4.3L, 4.4L, 4.8L, 4.9L, 5.0L, 5.7L, 6.2L, 6.6L, 7.4L, 7.5L
CA-3009	SPEEDOMETER CABLE	BUICK, CADILLAC, CHEVROLET, GMC, OLDSMOBILE, PONTIAC	1967-98	1.5L, 1.8L, 2.0L, 2.2L, 2.3L, 2.5L, 2.8L, 3.0L, 3.1L, 3.8L, 4.1L, 4.3L, 4.4L, 4.8L, 4.9L, 5.0L, 5.4L, 5.7L, 6.0L, 6.2L, 6.5L, 6.6L, 7.0L, 7.5L, 7.4L, 7.7L, 8.2L
CA-3010	SPEEDOMETER CABLE	AMERICAN MOTORS, FORD, MERCURY, MERKUR	1957-97	2.0L, 2.3L, 2.4L, 2.6L, 2.8L, 3.2L, 3.3L, 3.6L, 3.7L, 3.8L, 3.9L, 4.2L, 4.3L, 4.5L, 4.6L, 4.7L, 4.8L, 4.9L, 5.0L, 5.4L, 5.6, 5.8L, 5.9L, 6.4L, 6.6L, 7.0L, 7.5L
CA-3011	SPEEDOMETER CABLE	DODGE, FORD, LINCOLN, MERCURY	1965-98	2.0L, 2.2L, 2.3L, 2.4L, 2.6L, 2.8L, 3.3L, 3.8L, 3.9L, 4.2L, 4.9L, 5.0L, 5.8L, 5.9L, 6.4L, 6.6L, 6.9L, 7.5L
CA-3012	SPEEDOMETER CABLE	FORD, GMC, LINCOLN, MERCURY	1962-02	1.6L, 2.0L, 2.2L, 2.3L, 2.4L, 2.8L, 2.9L, 3.0L, 3.3L, 3.7, 3.8L, 3.9L, 4.0L, 4.1L, 4.2L, 4.4L, 4.6L, 4.8L, 4.9L, 5.0L, 5.4L, 5.7L, 5.8L, 6.4L, 6.6L, 7.0L, 7.3L, 7.5L
CA-3013	SPEEDOMETER CABLE	CHEVROLET, GMC	1971-97	4.1L, 4.3L, 4.8L, 5.0L, 5.7L, 6.6L, 7.4L
CA-3014	SPEEDOMETER CABLE	CHRYSLER, DODGE	1966-93	3.2L, 3.7L, 3.9L, 4.0L, 4.5L, 5.2L, 5.6L, 5.9L, 6.3L, 6.6L, 7.0L, 7.2L
CA-3015	SPEEDOMETER CABLE	AMERICAN MOTORS, FORD, LINCOLN, MERCURY	1957-85	2.3L, 2.4L, 2.8L, 3.3L, 3.6L, 3.7L, 3.8L, 4.2L, 4.3L, 4.7L, 4.8L, 4.9L, 5.0L, 5.1L, 5.4L, 5.8L, 5.9L, 6.3L, 6.4L, 6.6L, 6.7L, 6.9L, 7.0L, 7.5L
CA-3016	SPEEDOMETER CABLE	CHEVROLET, DODGE, GMC, JEEP, OLDSMOBILE, PLYMOUTH	1960-85	2.1L, 2.5L, 2.8L, 3.2L, 3.8L, 3.7L, 3.8L, 3.9L, 4.1L, 4.2L, 4.3L, 4.4L, 4.6L, 4.8L, 5.0L, 5.2L, 5.4L, 5.7L, 5.9L, 6.0L, 6.3L, 6.5L, 6.6L, 6.7L, 6.8L, 7.4L
CA-3017	SPEEDOMETER CABLE	FORD, MERCURY	1980-94	1.6L, 1.9L, 2.0L, 2.3L, 3.0L
CA-3018	SPEEDOMETER CABLE	FORD, LINCOLN, MERCURY	1979-02	2.0L, 2.2L, 2.3L, 2.8L, 2.9L, 3.0L, 3.3L, 3.8L, 4.0L, 4.6L, 4.9L, 5.0L, 5.8L, 6.9L, 7.3L, 7.5L
CA-3019	SPEEDOMETER CABLE	FORD	1973-99	3.9L, 4.9L, 5.0L, 5.8L, 5.9L, 6.4L, 6.6L, 6.9L, 7.3L, 7.5L
CA-3020	SPEEDOMETER CABLE	FORD, LINCOLN, MERCURY, MERKRU	1959-02	2.3L, 2.8L, 3.3L, 3.7L, 3.8L, 4.1L, 4.2L, 4.7L, 4.8L, 5.0L, 5.1L, 5.8L, 6.4L, 6.6L, 7.0L, 7.5L
CA-3021	SPEEDOMETER CABLE	FORD, MERCURY	1966-02	1.6L, 2.0L, 2.2L, 2.3L, 2.8L, 2.9L, 3.3L, 3.8L, 3.9L, 4.0L, 4.1L, 4.2L, 4.9L, 5.0L, 5.8L, 6.4L, 6.6L, 6.9L, 7.0L, 7.3L, 7.5L
CA-3022	SPEEDOMETER CABLE	CHRYSLER, DODGE, PLYMOUTH	1978-87	1.6L, 2.2L, 2.5L, 2.6L, 3.7L, 5.2L, 5.9L
CA-3023	SPEEDOMETER CABLE	DODGE	1979-91	3.7L, 5.2L, 5.9L

Part	Description	Make	Years	Engines
CA-3024	SPEEDOMETER CABLE	AMERICAN MOTORS, CHRYSLER, DODGE, PLYMOUTH	1977-89	2.2L, 2.5L, 2.6L, 3.7L, 4.2L, 5.2L, 5.9L, 5.9L, 6.6L, 7.2L
CA-3025	SPEEDOMETER CABLE	AMERICAN MOTORS, CHRYSLER, DODGE, PLYMOUTH	1968-94	1.6L, 2.2L, 2.6L, 3.2L, 3.7L, 3.9L, 4.2L, 5.2L, 5.6L, 5.9L, 6.3L, 6.6L, 7.0L, 7.2L
CA-3026	SPEEDOMETER CABLE	AMERICAN MOTORS, CHRYSLER, DODGE, PLYMOUTH	1977-82	1.7L, 2.2L, 2.5L, 2.6L, 3.7L, 4.2L, 5.2L, 5.9L, 5.9L, 6.6L, 7.2L
CA-3027	SPEEDOMETER CABLE	CHRYSLER, DODGE, PLYMOUTH	1960-00	2.2L, 2.5L, 2.8L, 3.2L, 3.7L, 3.9L, 4.0L, 4.5L, 5.2L, 5.6L, 5.9L, 6.3L, 6.6L, 7.0L, 7.2L
CA-3028	SPEEDOMETER CABLE	CHRYSLER, DODGE, PLYMOUTH	1981-84	1.6L, 1.7L, 2.2L, 2.6L
CA-3029	SPEEDOMETER CABLE	CHRYSLER, DODGE, PLYMOUTH	1980-99	2.2L, 2.5L, 2.6L, 3.0L, 3.3L, 3.7L, 5.2L
CA-3030	SPEEDOMETER CABLE	CHRYSLER, DODGE, PLYMOUTH	1977-87	2.2L, 2.6L, 3.7L, 5.2L, 5.9L, 6.6L, 7.2L
CA-3031	SPEEDOMETER CABLE	CHEVROLET, DODGE, GMC, PONTIAC	1964-76	2.3L, 2.8L, 3.2L, 4.1L, 4.5L, 4.8L, 5.0L, 5.2L, 5.7L, 7.4L
CA-3032	SPEEDOMETER CABLE	FORD, MERKRU	1966-88	2.3L, 2.8L, 3.8L, 3.9L, 4.2L, 4.7L, 4.9L, 5.0L, 5.8L, 5.9L, 6.4L, 6.6L, 6.9L, 7.5L
CA-3033	SPEEDOMETER CABLE	BUICK, CHEVROLET, GMC, OLDSMOBILE, PONTIAC	1967-89	2.3L, 2.5L, 2.8L, 3.8L, 4.1L, 4.3L, 4.4L, 4.8L, 4.9L, 5.0L, 5.4L, 5.7L, 6.2L, 6.5L, 6.6L, 7.0L, 7.4L, 7.5L
CA-3034	SPEEDOMETER CABLE	CHRYSLER, DODGE, PLYMOUTH	1980-85	1.6L, 1.7L, 2.2L, 2.6L
CA-3035	SPEEDOMETER CABLE	CHRYSLER, DODGE, PLYMOUTH	1977-90	1.6L, 1.7L, 2.2L, 2.5L, 2.6L, 3.7L, 5.2L, 5.9L, 6.6L, 7.2L
CA-3036	SPEEDOMETER CABLE	CHRYSLER, DODGE, PLYMOUTH	1980-00	1.6L, 1.7L, 2.2L, 2.5L, 2.6L, 3.9L, 5.2L, 5.9L
CA-3037	SPEEDOMETER CABLE	CHRYSLER, DODGE, PLYMOUTH	1978-83	1.6L, 1.7L, 2.2L, 2.6L, 5.2L, 5.9L
CA-3038	SPEEDOMETER CABLE	CHEVROLET, DODGE, FORD, GMC	1961-74	2.5L, 3.2L, 3.7L, 3.8L, 3.9L, 4.0L, 4.1L, 4.2L, 4.6L, 4.8L, 4.9L, 5.0L, 5.2L, 5.4L, 5.7L, 5.9L, 6.0L, 6.4L, 6.5L, 6.6L, 6.7L, 7.0L
CA-3039	SPEEDOMETER CABLE	CHEVROLET, GMC	1972-87	4.8L, 5.7L, 6.2L, 7.4L
CA-3040	SPEEDOMETER CABLE	CHEVROLET, DODGE, FORD, GMC, MERCURY, PLYMOUTH	1972-91	1.6L, 2.2L, 2.6L, 3.7L, 4.8L, 5.2L, 5.9L, 6.2L, 7.4L
CA-3041	SPEEDOMETER CABLE	PONTIAC	1988-90	1.6L, 2.0L
CA-3042	SPEEDOMETER CABLE	CHEVROLET	1985-88	1.6L
CA-3043	SPEEDOMETER CABLE	FORD	1969-88	1.6L, 1.9L, 2.0L, 2.2L, 2.3L, 2.8L, 2.9L, 3.3L, 3.8L, 4.2L, 5.0L
CA-3044	SPEEDOMETER CABLE	FORD, LINCOLN, MERCURY	1968-91	2.3L, 2.8L, 3.3L, 3.8L, 3.9L, 4.1L, 4.2L, 4.9L, 5.0L, 5.8L, 6.4L, 6.6L, 7.0L, 7.5L
CA-3045	SPEEDOMETER CABLE	FORD, LINCOLN, MERCURY	1965-98	1.6L, 2.3L, 2.8L, 3.3L, 3.8L, 4.1L, 4.2L, 4.9L, 5.0L, 5.8L, 6.6L, 6.9L, 7.0L, 7.5L
CA-3046	SPEEDOMETER CABLE	CHEVROLET, FORD, MERCURY, PONTIAC	1967-87	1.6L, 1.8L, 2.0L, 2.2L, 2.3L, 2.6L, 2.8L, 2.9L, 3.3L, 3.9L, 4.1L, 4.9L, 5.0L, 5.8L, 5.9L, 6.4L, 7.0L
CA-3047	SPEEDOMETER CABLE	DODGE, PLYMOUTH	1984-89	2.2L, 2.5L, 2.6L, 5.2L
CA-3048	SPEEDOMETER CABLE	DODGE	1968-80	3.7L, 4.0L, 5.2L, 5.9L, 6.6L
CA-3050	SPEEDOMETER CABLE	DODGE, PLYMOUTH	1980-83	1.7L, 2.2L
CA-3051	SPEEDOMETER CABLE	AMERICAN MOTORS, CHRYSLER, DODGE, PLYMOUTH	1978-87	2.2L, 2.5L, 2.6L, 3.7L, 4.2L, 5.2L, 5.9L, 6.6L, 7.2L
CA-3052	SPEEDOMETER CABLE	AMERICAN MOTORS, DODGE	1968-93	2.5L, 3.2L, 3.7L, 4.0L, 4.2L, 5.2L, 5.9L, 6.3L, 6.6L, 7.2L
CA-3053	SPEEDOMETER CABLE	FORD, MERCURY	1984-02	1.6L, 1.9L, 2.0L, 2.3L, 2.5L, 3.0L, 3.8L
CA-3054	SPEEDOMETER CABLE	FORD	1971-97	3.0L, 4.2L, 4.9L, 5.0L, 5.8L, 6.6L, 6.9L, 7.3L, 7.5L
CA-3055	SPEEDOMETER CABLE	FORD	1975-91	4.9L, 5.0L, 5.8L, 6.6L, 6.9L, 7.3L, 7.5L
CA-3056	SPEEDOMETER CABLE	DODGE, FORD	1968-85	3.3L, 3.7L, 4.1L, 4.7L, 5.0L, 5.2L, 5.8L, 5.9L, 6.4L, 7.0L
CA-3057	SPEEDOMETER CABLE	DODGE	1983-94	3.9L, 5.2L, 5.9L
CA-3070	SPEEDOMETER CABLE	HONDA	1979-89	1.5L, 1.8L, 2.0L
CA-3071	SPEEDOMETER CABLE	HONDA	1976-78	1.6L
CA-3072	SPEEDOMETER CABLE	HONDA	1973-81	1.2L, 1.3L, 1.5L
CA-3073	SPEEDOMETER CABLE	HONDA	1983-87	1.8L
CA-3074	SPEEDOMETER CABLE	NISSAN	1985-86	3.0L
CA-3075	SPEEDOMETER CABLE	NISSAN	1982-86	1.5L, 1.6L, 1.7L
CA-3076	SPEEDOMETER CABLE	NISSAN	1983-84	2.4L, 2.8L
CA-3077	SPEEDOMETER CABLE	NISSAN	1982-83	2.2L
CA-3078	SPEEDOMETER CABLE	NISSAN	1979-83	2.8L
CA-3079	SPEEDOMETER CABLE	NISSAN	1975-83	1.4L, 2.0L, 2.8L
CA-3080	SPEEDOMETER CABLE	NISSAN	1978-85	2.0L
CA-3081	SPEEDOMETER CABLE	NISSAN	1968-73	1.6L
CA-3082	SPEEDOMETER CABLE	NISSAN	1977-79	2.0L
CA-3083	SPEEDOMETER CABLE	NISSAN	1969-86	1.6L, 2.2L, 2.4L, 2.5L
CA-3087	SPEEDOMETER CABLE	TOYOTA	1980-82	1.5L, 2.4L
CA-3088	SPEEDOMETER CABLE	FORD, TOYOTA	1982-88	1.3L, 2.8L
CA-3089	SPEEDOMETER CABLE	TOYOTA	1981-82	1.3L
CA-3090	SPEEDOMETER CABLE	TOYOTA	1970-74	1.2L, 1.6L, 1.9L, 2.0L

Part	Description	Make	Years	Engines
CA-3091	SPEEDOMETER CABLE	TOYOTA	1967-67	1.9L
CA-3092	SPEEDOMETER CABLE	VOLKSWAGEN	1977-83	1.5L, 1.6L, 1.7L, 1.8L
CA-3093	SPEEDOMETER CABLE	VOLKSWAGEN	1977-83	1.5L, 1.6L, 1.7L, 1.8L
CA-3094	SPEEDOMETER CABLE	VOLKSWAGEN	1977-83	1.5L, 1.6L, 1.7L, 1.8L
CA-3095	SPEEDOMETER CABLE	VOLKSWAGEN	1975-83	1.5L, 1.6L, 1.7L, 1.8L
CA-3096	SPEEDOMETER CABLE	VOLKSWAGEN	1977-79	1.6L
CA-3097	SPEEDOMETER CABLE	VOLKSWAGEN	1966-74	1.2L, 1.3L, 1.5L, 1.6L
CA-3098	SPEEDOMETER CABLE	MG	1968-73	1.8L
CA-3102	SPEEDOMETER CABLE	PORSCHE	1977-77	2.0L
CA-3106	SPEEDOMETER CABLE	ISUZU	1981-82	1.8L, 2.2L
CA-3107	SPEEDOMETER CABLE	MAZDA	1979-82	1.1L
CA-3108	SPEEDOMETER CABLE	SUBARU	1980-84	1.6L, 1.8L
CA-3109	SPEEDOMETER CABLE	MAZDA	1981-82	1.5L
CA-3110	SPEEDOMETER CABLE	MAZDA	1979-82	2.0L
CA-3115	SPEEDOMETER CABLE	MAZDA	1983-85	2.0L
CA-3117	SPEEDOMETER CABLE	NISSAN	1979-82	1.2L, 1.4L
CA-3119	SPEEDOMETER CABLE	NISSAN	1966-72	1.3L, 1.6L
CA-3120	SPEEDOMETER CABLE	NISSAN	1979-81	1.4L, 1.5L
CA-3121	SPEEDOMETER CABLE	MERCEDES-BENZ	1965-84	2.0L, 2.2L, 2.4L, 2.5L, 2.8L, 3.0L, 3.1L, 4.5L
CA-3122	SPEEDOMETER CABLE	NISSAN	1980-81	2.0L
CA-3123	SPEEDOMETER CABLE	TOYOTA	1974-79	2.0L, 2.2L
CA-3125	SPEEDOMETER CABLE	TOYOTA	1975-79	1.6L
CA-3126	SPEEDOMETER CABLE	NISSAN	1980-81	2.0L, 2.2L
CA-3127	SPEEDOMETER CABLE	AUDI	1978-85	2.0L, 2.2L
CA-3128	SPEEDOMETER CABLE	NISSAN	1980-81	2.0L, 2.2L
CA-3129	SPEEDOMETER CABLE	HONDA	1980-81	1.3L, 1.5L
CA-3131	SPEEDOMETER CABLE	SUZUKI	1986-93	1.3L
CA-3133	SPEEDOMETER CABLE	AUDI, VOLKSWAGEN	1974-87	1.5L, 1.6L, 1.7L, 2.2L
CA-3134	SPEEDOMETER CABLE	NISSAN	1982-87	2.0L
CA-3135	SPEEDOMETER CABLE	AUDI, TOYOTA	1975-78	1.6L, 2.2L
CA-3136	SPEEDOMETER CABLE	FORD, MAZDA	1972-84	1.8L, 2.0L, 2.2L, 2.3L
CA-3137	SPEEDOMETER CABLE	NISSAN	1979-82	1.2L, 1.4L
CA-3138	SPEEDOMETER CABLE	ISUZU	1983-86	1.9L, 2.0L
CA-3139	SPEEDOMETER CABLE	MERCEDES-BENZ	1965-84	2.0L, 2.2L, 2.3L, 2.4L, 3.0L, 4.5L
CA-3140	SPEEDOMETER CABLE	ISUZU, TOYOTA	1983-86	1.9L, 2.0L, 2.4L
CA-3141	SPEEDOMETER CABLE	TOYOTA	1976-77	2.2L
CA-3142	SPEEDOMETER CABLE	TOYOTA	1982-85	2.4L
CA-3143	SPEEDOMETER CABLE	VOLVO	1975-89	2.0L, 2.1L, 2.3L, 2.4L, 2.7L, 2.8L
CA-3144	SPEEDOMETER CABLE	TOYOTA	1982-85	2.4L
CA-3145	SPEEDOMETER CABLE	OPEL	1969-73	1.1L, 1.9L
CA-3147	SPEEDOMETER CABLE	AUDI, TOYOTA	1979-81	1.6L, 2.2L, 2.4L
CA-3148	SPEEDOMETER CABLE	NISSAN	1982-82	2.2L
CA-3149	SPEEDOMETER CABLE	CHEVROLET	1972-75	1.8L
CA-3151	SPEEDOMETER CABLE	HONDA	1979-81	1.8L
CA-3152	SPEEDOMETER CABLE	HONDA	1984-87	1.3L, 1.5L
CA-3153	SPEEDOMETER CABLE	NISSAN	1972-79	1.6L, 1.8L, 2.0L
CA-3154	SPEEDOMETER CABLE	AUDI, VOLKSWAGEN	1974-87	1.5L, 1.6L, 1.7L, 1.8L
CA-3155	SPEEDOMETER CABLE	TOYOTA	1976-80	2.2L
CA-3156	SPEEDOMETER CABLE	CHEVROLET, GEO, ISUZU, PONTIAC	1985-89	1.5L, 1.6L
CA-3157	SPEEDOMETER CABLE	CHEVROLET	1978-80	1.8L
CA-3158	SPEEDOMETER CABLE	TRIUMPH	1963-71	1.2L, 1.3L
CA-3159	SPEEDOMETER CABLE	MG	1962-73	1.0L, 1.1L, 1.8L
CA-3161	SPEEDOMETER CABLE	NISSAN	1974-78	1.3L, 1.4L
CA-3162	SPEEDOMETER CABLE	NISSAN	1970-78	2.4L, 2.6L, 2.8L
CA-3164	SPEEDOMETER CABLE	TOYOTA	1976-81	2.2L, 2.4L
CA-3165	SPEEDOMETER CABLE	CHEVROLET	1976-77	1.8L
CA-3168	SPEEDOMETER CABLE	VOLKSWAGEN	1974-74	1.6L
CA-3170	SPEEDOMETER CABLE	VOLKSWAGEN	1975-79	1.8L, 2.0L
CA-3172	SPEEDOMETER CABLE	AUDI, VOLKSWAGEN	1974-87	1.5L, 1.6L, 1.7L, 1.8L, 2.2L
CA-3174	SPEEDOMETER CABLE	TOYOTA	1980-80	1.8L
CA-3175	SPEEDOMETER CABLE	TRIUMPH	1977-80	1.5L
CA-3177	SPEEDOMETER CABLE	CHEVROLET	1978-80	1.8L
CA-3178	SPEEDOMETER CABLE	TOYOTA	1979-82	2.2L, 2.4L
CA-3179	SPEEDOMETER CABLE	TOYOTA	1981-82	1.8L

Part	Description	Make	Years	Engines
CA-3180	SPEEDOMETER CABLE	TOYOTA	1977-83	1.2L, 2.4L
CA-3181	SPEEDOMETER CABLE	HONDA	1983-87	1.8L
CA-3182	SPEEDOMETER CABLE	BMW	1977-83	1.8L, 2.0L
CA-3201	SPEEDOMETER CABLE	FIAT	1979-81	2.0L
CA-3202	SPEEDOMETER CABLE	FIAT	1975-78	1.8L
CA-3205	SPEEDOMETER CABLE	HYUNDAI, MITSUBISHI	1988-89	1.5L
CA-3216	SPEEDOMETER CABLE	TOYOTA	1981-82	2.8L
CA-3220	SPEEDOMETER CABLE	VOLKSWAGEN	1958-65	1.2L
CA-3222	SPEEDOMETER CABLE	FORD, MERCURY	1993-98	3.0L, 3.8L
CA-5001	BRAKE CABLE	CADILLAC	1976-79	
CA-5002	BRAKE CABLE	BUICK, CHEVROLET, JEEP, PONTIAC	1967-75	
CA-5003	BRAKE CABLE	BUICK, CHEVROLET, CHRYSLER, DODGE, GMC, JEEP, OLDSMOBILE, PONTIAC	1967-02	
CA-5004	BRAKE CABLE	BUICK, CHEVROLET, GMC, JEEP	1969-79	
CA-5005	BRAKE CABLE	CHEVROLET, DODGE, GMC	1968-87	
CA-5006	BRAKE CABLE	CHRYSLER, DODGE, PLYMOUTH	1981-92	
CA-5007	BRAKE CABLE	AMERICAN MOTORS	1972-88	
CA-5008	BRAKE CABLE	AMERICAN MOTORS	1972-80	
CA-5009	BRAKE CABLE	DODGE, PLYMOUTH	1960-76	
CA-5010	BRAKE CABLE	DODGE	1970-81	
CA-5011	BRAKE CABLE	DODGE	1968-85	
CA-5012	BRAKE CABLE	CHRYSLER, DODGE, PLYMOUTH	1976-00	
CA-5013	BRAKE CABLE	CHRYSLER, DODGE, PLYMOUTH	1979-99	
CA-5014	BRAKE CABLE	DODGE, PLYMOUTH	1978-81	
CA-5015	BRAKE CABLE	DODGE, PLYMOUTH	1971-79	
CA-5016	BRAKE CABLE	CHRYSLER, DODGE, PLYMOUTH	1976-78	
CA-5017	BRAKE CABLE	CHRYSLER, DODGE, PLYMOUTH	1976-78	
CA-5018	BRAKE CABLE	AMERICAN MOTORS	1980-83	
CA-5019	BRAKE CABLE	AMERICAN MOTORS	1980-88	
CA-5020	BRAKE CABLE	CHRYSLER, DODGE, PLYMOUTH	1980	
CA-5021	BRAKE CABLE	DODGE, PLYMOUTH	1980-83	
CA-5022	BRAKE CABLE	DODGE, PLYMOUTH	1980-83	
CA-5023	BRAKE CABLE	CHRYSLER, DODGE, PLYMOUTH	1980	
CA-5024	BRAKE CABLE	DODGE, PLYMOUTH	1978-87	
CA-5025	BRAKE CABLE	DODGE, PLYMOUTH	1978-90	
CA-5026	BRAKE CABLE	DODGE	1968-93	
CA-5027	BRAKE CABLE	DODGE	1969-93	
CA-5028	BRAKE CABLE	DODGE	1968-87	
CA-5029	BRAKE CABLE	AMERICAN MOTORS	1980-88	
CA-5030	BRAKE CABLE	CHRYSLER, DODGE, PLYMOUTH	1978-89	
CA-5032	BRAKE CABLE	CHRYSLER, DODGE, PLYMOUTH	1981-89	
CA-5033	BRAKE CABLE	CHRYSLER, DODGE, PLYMOUTH	1981-88	
CA-5034	BRAKE CABLE	CHRYSLER, DODGE, PLYMOUTH	1978-89	
CA-5035	BRAKE CABLE	DODGE, PLYMOUTH	1981	
CA-5036	BRAKE CABLE	CHRYSLER, DODGE, PLYMOUTH	1982-83	
CA-5037	BRAKE CABLE	DODGE, PLYMOUTH	1981-82	
CA-5038	BRAKE CABLE	CHRYSLER, DODGE, PLYMOUTH	1982-83	
CA-5039	BRAKE CABLE	CHRYSLER, DODGE	1983-90	
CA-5040	BRAKE CABLE	JEEP	1981-86	
CA-5041	BRAKE CABLE	DODGE	1968-87	
CA-5042	BRAKE CABLE	DODGE, PLYMOUTH	1974-88	
CA-5043	BRAKE CABLE	DODGE, PLYMOUTH	1971-94	
CA-5044	BRAKE CABLE	DODGE, PLYMOUTH	1968-87	
CA-5045	BRAKE CABLE	JEEP	1981-86	
CA-5046	BRAKE CABLE	DODGE	1971-87	
CA-5047	BRAKE CABLE	DODGE	1969-87	
CA-5048	BRAKE CABLE	DODGE, PLYMOUTH	1984-87	
CA-5049	BRAKE CABLE	DODGE, PLYMOUTH	1984-86	
CA-5050	BRAKE CABLE	DODGE, PLYMOUTH	1984-87	
CA-5051	BRAKE CABLE	CHRYSLER, DODGE	1984-93	
CA-5052	BRAKE CABLE	DODGE	1981-94	
CA-5053	BRAKE CABLE	DODGE	1984-88	
CA-5054	BRAKE CABLE	JEEP	1981-93	

Part	Description	Make	Years	Engines
CA-5055	BRAKE CABLE	CHRYSLER, DODGE, PLYMOUTH	1983	
CA-5056	BRAKE CABLE	JEEP	1984-86	
CA-5057	BRAKE CABLE	DODGE, PLYMOUTH	1984-89	
CA-5058	BRAKE CABLE	CHRYSLER, DODGE, PLYMOUTH	1981-94	
CA-5059	BRAKE CABLE	CHRYSLER, DODGE, PLYMOUTH	1983-94	
CA-5060	BRAKE CABLE	CHRYSLER	1986-89	
CA-5061	BRAKE CABLE	CHRYSLER, DODGE, PLYMOUTH	1986-89	
CA-5062	BRAKE CABLE	CHRYSLER, DODGE, PLYMOUTH	1978-89	
CA-5063	BRAKE CABLE	JEEP	1986-86	
CA-5064	BRAKE CABLE	DODGE	1988-93	
CA-5065	BRAKE CABLE	CHRYSLER, DODGE	1988-91	
CA-5066	BRAKE CABLE	DODGE	1988-93	
CA-5067	BRAKE CABLE	DODGE	1988-93	
CA-5068	BRAKE CABLE	DODGE	1988-93	
CA-5069	BRAKE CABLE	JEEP	1987-89	
CA-5070	BRAKE CABLE	DODGE	1988-88	
CA-5071	BRAKE CABLE	DODGE, PLYMOUTH	1984-00	
CA-5072	BRAKE CABLE	CHRYSLER	1987-88	
CA-5073	BRAKE CABLE	DODGE	1987-89	
CA-5074	BRAKE CABLE	DODGE	1987-89	
CA-5075	BRAKE CABLE	CHRYSLER, DODGE, PLYMOUTH	1981-89	
CA-5076	BRAKE CABLE	CHRYSLER, DODGE, PLYMOUTH	1983-88	
CA-5077	BRAKE CABLE	JEEP	1987-89	
CA-5078	BRAKE CABLE	DODGE, PLYMOUTH	1985-87	
CA-5079	BRAKE CABLE	DODGE	1984-88	
CA-5080	BRAKE CABLE	CHRYSLER, DODGE, PLYMOUTH	1986-94	
CA-5081	BRAKE CABLE	CHRYSLER, DODGE, PLYMOUTH	1986-96	
CA-5082	BRAKE CABLE	DODGE	1989-92	
CA-5083	BRAKE CABLE	DODGE	1989-89	
CA-5084	BRAKE CABLE	CHRYSLER, DODGE	1988-93	
CA-5085	BRAKE CABLE	CHRYSLER, DODGE, PLYMOUTH	1986-95	
CA-5086	BRAKE CABLE	CHRYSLER, DDGE	1988-91	
CA-5201	BRAKE CABLE	FORD	1965-65	
CA-5202	BRAKE CABLE	FORD, LINCON, MERCURY	1968-69	
CA-5203	BRAKE CABLE	FORD, MERCURY	1970-78	
CA-5204	BRAKE CABLE	FORD, MERCURY	1975-79	
CA-5205	BRAKE CABLE	FORD, MERCURY	1973-79	
CA-5206	BRAKE CABLE	FORD, LINCON, MERCURY	1975-79	
CA-5207	BRAKE CABLE	FORD, MERCURY	1976-80	
CA-5208	BRAKE CABLE	FORD, MERCURY	1973-79	
CA-5209	BRAKE CABLE	FORD, MERCURY	1977-80	
CA-5210	BRAKE CABLE	MERCURY	1978-79	
CA-5211	BRAKE CABLE	FORD	1976-79	
CA-5212	BRAKE CABLE	FORD, LINCON, MERCURY	1978-91	
CA-5213	BRAKE CABLE	MERCURY	1978-79	
CA-5214	BRAKE CABLE	LINCOLN	1978-79	
CA-5215	BRAKE CABLE	FORD, MERCURY	1977-80	
CA-5216	BRAKE CABLE	FORD, LINCON, MERCURY	1978-82	
CA-5217	BRAKE CABLE	FORD, MERCURY	1971-82	
CA-5218	BRAKE CABLE	FORD	1976-79	
CA-5219	BRAKE CABLE	FORD	1976-79	
CA-5220	BRAKE CABLE	FORD	1978-79	
CA-5221	BRAKE CABLE	FORD	1978-79	
CA-5222	BRAKE CABLE	FORD, MERCURY	1978-82	
CA-5223	BRAKE CABLE	FORD, MERCURY	1971-86	
CA-5224	BRAKE CABLE	FORD, LINCON, MERCURY	1980-83	
CA-5225	BRAKE CABLE	FORD	1977-02	
CA-5226	BRAKE CABLE	FORD	1977-02	
CA-5227	BRAKE CABLE	FORD, LINCON, MERCURY	1981-98	
CA-5228	BRAKE CABLE	FORD, LINCON, MERCURY	1980-81	
CA-5229	BRAKE CABLE	FORD, LINCON, MERCURY	1978-91	
CA-5230	BRAKE CABLE	FORD, MERCURY	1980-82	
CA-5231	BRAKE CABLE	FORD, LINCON, MERCURY	1971-92	
CA-5232	BRAKE CABLE	FORD, LINCON, MERCURY	1982-91	

Part	Description	Make	Years	Engines
CA-5233	BRAKE CABLE	FORD, MERCURY	1982-88	
CA-5234	BRAKE CABLE	FORD	1983-84	
CA-5235	BRAKE CABLE	FORD	1983-85	
CA-5236	BRAKE CABLE	FORD	1980-83	
CA-5237	BRAKE CABLE	FORD, MERCURY	1968-95	
CA-5238	BRAKE CABLE	FORD	1975-79	
CA-5239	BRAKE CABLE	FORD	1976-96	
CA-5240	BRAKE CABLE	FORD	1980-00	
CA-5241	BRAKE CABLE	FORD	1977-00	
CA-5242	BRAKE CABLE	FORD	1980-86	
CA-5243	BRAKE CABLE	FORD	1980-98	
CA-5244	BRAKE CABLE	FORD, MERCURY	1971-86	
CA-5245	BRAKE CABLE	FORD	1977-84	
CA-5246	BRAKE CABLE	FORD, MERCURY	1983-95	
CA-5247	BRAKE CABLE	FORD	1984-84	
CA-5248	BRAKE CABLE	FORD	1984-84	
CA-5249	BRAKE CABLE	FORD	1984-84	
CA-5251	BRAKE CABLE	FORD, GMC, MERCURY	1983-95	
CA-5252	BRAKE CABLE	LINCOLN	1982-96	
CA-5253	BRAKE CABLE	FORD	1977-87	
CA-5254	BRAKE CABLE	FORD	1983-84	
CA-5255	BRAKE CABLE	FORD	1987-91	
CA-5256	BRAKE CABLE	LINCOLN	1984-90	
CA-5257	BRAKE CABLE	FORD	1984-91	
CA-5258	BRAKE CABLE	FORD	1980-02	
CA-5259	BRAKE CABLE	FORD	1984-91	
CA-5260	BRAKE CABLE	LINCOLN	1982-83	
CA-5261	BRAKE CABLE	FORD	1978-80	
CA-5262	BRAKE CABLE	FORD	1985-90	
CA-5263	BRAKE CABLE	FORD	1985-90	
CA-5264	BRAKE CABLE	FORD, MERCURY	1985-94	
CA-5265	BRAKE CABLE	FORD	1977-02	
CA-5266	BRAKE CABLE	FORD	1984-86	
CA-5267	BRAKE CABLE	FORD	1984-90	
CA-5268	BRAKE CABLE	FORD	1984-86	
CA-5269	BRAKE CABLE	FORD	1984-92	
CA-5270	BRAKE CABLE	FORD, MERCURY	1986-95	
CA-5271	BRAKE CABLE	FORD, MERCURY	1986-95	
CA-5272	BRAKE CABLE	FORD, MERCURY	1986-95	
CA-5273	BRAKE CABLE	FORD, MERCURY	1986-94	
CA-5274	BRAKE CABLE	FORD	1987-88	
CA-5275	BRAKE CABLE	FORD, MAZDA	1987-92	
CA-5276	BRAKE CABLE	FORD, MERCURY	1987-88	
CA-5277	BRAKE CABLE	FORD, MERCURY	1987-88	
CA-5278	BRAKE CABLE	FORD	1986-91	
CA-5279	BRAKE CABLE	FORD, MERCURY	1989-95	
CA-5280	BRAKE CABLE	FORD	1989-92	
CA-5281	BRAKE CABLE	FORD, MERCURY	1989-95	
CA-5282	BRAKE CABLE	LINCOLN	1993-98	
CA-5283	BRAKE CABLE	FORD, LINCON, MERCURY	1968-82	
CA-5501	BRAKE CABLE	PONTIAC	1967-70	
CA-5502	BRAKE CABLE	BUICK, CHEVROLET, GMC, OLDSMOBILE, PONTIAC	1964-78	
CA-5503	BRAKE CABLE	BUICK, CHEVROLET, OLDSMOBILE, PONTIAC	1964-72	
CA-5504	BRAKE CABLE	BUICK, CHEVROLET, DODGE, GMC, OLDSMOBILE, PONTIAC	1967-83	
CA-5505	BRAKE CABLE	BUICK	1967-70	
CA-5506	BRAKE CABLE	BUICK, CHEVROLET, OLDSMOBILE, PONTIAC	1968-74	
CA-5507	BRAKE CABLE	BUICK, CHEVROLET, GMC, OLDSMOBILE	1966-83	
CA-5508	BRAKE CABLE	BUICK, CHEVROLET, GMC, OLDSMOBILE	1967-72	
CA-5509	BRAKE CABLE	BUICK	1969-76	

Part	Description	Make	Years	Engines
CA-5510	BRAKE CABLE	BUICK, CHEVROLET, OLDSMOBILE, PONTIAC	1967-79	
CA-5511	BRAKE CABLE	CHEVROLET	1965-82	
CA-5512	BRAKE CABLE	CHEVROLET, GMC	1966-75	
CA-5513	BRAKE CABLE	BUICK, CHEVROLET, GMC, OLDSMOBILE, PONTIAC	1967-83	
CA-5514	BRAKE CABLE	BUICK, CHEVROLET, OLDSMOBILE, PONTIAC	1971-73	
CA-5515	BRAKE CABLE	BUICK, CHRYSLER, OLDSMOBILE, PLYMOUTH, PONTIAC	1962-88	
CA-5516	BRAKE CABLE	CADILLAC, CHEVROLET, GMC	1971-83	
CA-5517	BRAKE CABLE	BUICK, CHEVROLET, GMC, OLDSMOBILE, PONTIAC	1971-77	
CA-5518	BRAKE CABLE	BUICK	1975-77	
CA-5519	BRAKE CABLE	CHEVROLET, PONTIAC	1975-81	
CA-5520	BRAKE CABLE	CHEVROLET, PONTIAC	1975-81	
CA-5521	BRAKE CABLE	BUICK, CHEVROLET, OLDSMOBILE	1971-76	
CA-5522	BRAKE CABLE	BUICK, CHEVROLET, GMC, OLDSMOBILE, PONTIAC	1973-81	
CA-5523	BRAKE CABLE	BUICK, CHEVROLET, OLDSMOBILE, PONTIAC	1975-84	
CA-5524	BRAKE CABLE	CADILLAC	1977-77	
CA-5525	BRAKE CABLE	BUICK, CHEVROLET, GMC, OLDSMOBILE, PONTIAC	1978-79	
CA-5526	BRAKE CABLE	CHEVROLET, PONTIAC	1976-87	
CA-5527	BRAKE CABLE	CADILLAC	1977-79	
CA-5528	BRAKE CABLE	CADILLAC	1977-79	
CA-5529	BRAKE CABLE	CHEVROLET, GMC	1973-86	
CA-5530	BRAKE CABLE	OLDSMOBILE, PONTIAC	1977-79	
CA-5531	BRAKE CABLE	BUICK, CHEVROLET, OLDSMOBILE, PONTIAC	1980	
CA-5532	BRAKE CABLE	CHEVROLET, GMC	1974-78	
CA-5533	BRAKE CABLE	CHEVROLET, GMC	1981-82	
CA-5534	BRAKE CABLE	CHEVROLET, GMC	1973-83	
CA-5535	BRAKE CABLE	BUICK, CADILLAC, OLDSMOBILE	1979-85	
CA-5536	BRAKE CABLE	BUICK, CHEVROLET, OLDSMOBILE, PONTIAC	1973-81	
CA-5537	BRAKE CABLE	PONTIAC	1979-81	
CA-5538	BRAKE CABLE	BUICK, OLDSMOBILE, PONTIAC	1977-84	
CA-5539	BRAKE CABLE	BUICK, CADILLAC, CHEVROLET, OLDSMOBILE, PONTIAC	1977-84	
CA-5540	BRAKE CABLE	BUICK, CHEVROLET, GMC, OLDSMOBILE, PONTIAC	1978-87	
CA-5541	BRAKE CABLE	BUICK, CADILLAC, CHEVROLET, GMC, OLDSMOBILE, PONTIAC	1977-90	
CA-5542	BRAKE CABLE	PONTIAC	1979-81	
CA-5543	BRAKE CABLE	BUICK, CHEVROLET, GMC, OLDSMOBILE, PONTIAC	1973-83	
CA-5544	BRAKE CABLE	CHEVROLET, PONTIAC	1980-82	
CA-5545	BRAKE CABLE	BUICK, CHEVROLET, OLDSMOBILE, PONTIAC	1980-83	
CA-5546	BRAKE CABLE	BUICK, CHEVROLET, OLDSMOBILE, PONTIAC	1978-96	
CA-5547	BRAKE CABLE	BUICK, CADILLAC, CHEVROLET, OLDSMOBILE, PONTIAC	1982-87	
CA-5548	BRAKE CABLE	BUICK, CADILLAC, CHEVROLET, OLDSMOBILE, PONTIAC	1982-87	
CA-5549	BRAKE CABLE	BUICK, CADILLAC, CHEVROLET, OLDSMOBILE, PONTIAC	1982-86	
CA-5550	BRAKE CABLE	CHEVROLET, PONTIAC	1980-86	
CA-5551	BRAKE CABLE	CHEVROLET, GMC	1976-83	
CA-5552	BRAKE CABLE	BUICK, CHEVROLET, OLDSMOBILE, PONTIAC	1982-92	
CA-5553	BRAKE CABLE	BUICK, CHEVROLET, OLDSMOBILE, PONTIAC	1982-92	



Part	Description	Make	Years	Engines
CA-5554	BRAKE CABLE	CHEVROLET, PONTIAC	1982-89	
CA-5555	BRAKE CABLE	BUICK, CHEVROLET, OLDSMOBILE, PONTIAC	1978-85	
CA-5556	BRAKE CABLE	BUICK, CHEVROLET, OLDSMOBILE, PONTIAC	1982-85	
CA-5557	BRAKE CABLE	BUICK, CADILLAC, OLDSMOBILE	1979-85	
CA-5558	BRAKE CABLE	CHEVROLET, GMC	1983-91	
CA-5559	BRAKE CABLE	CHEVROLET, GMC	1983-84	
CA-5560	BRAKE CABLE	CHEVROLET, GMC	1983-84	
CA-5561	BRAKE CABLE	CHEVROLET, GMC	1983-95	
CA-5562	BRAKE CABLE	CHEVROLET, GMC	1982-91	
CA-5563	BRAKE CABLE	CHEVROLET, GMC	1983-95	
CA-5564	BRAKE CABLE	CHEVROLET, GMC	1983-91	
CA-5565	BRAKE CABLE	CHEVROLET, PONTIAC	1982-89	
CA-5566	BRAKE CABLE	CHEVROLET, GMC	1983-91	
CA-5567	BRAKE CABLE	DODGE	1970-85	
CA-5568	BRAKE CABLE	CHEVROLET, GMC	1973-85	
CA-5569	BRAKE CABLE	CHEVROLET, GMC	1975-83	
CA-5570	BRAKE CABLE	CHEVROLET, GMC	1982-91	
CA-5571	BRAKE CABLE	CHEVROLET, PONTIAC	1982-89	
CA-5572	BRAKE CABLE	CHEVROLET, PONTIAC	1982-88	
CA-5573	BRAKE CABLE	CHEVROLET, GMC	1973-83	
CA-5574	BRAKE CABLE	CHEVROLET, GMC	1981-83	
CA-5575	BRAKE CABLE	CHEVROLET, CHRYSLER, DODGE, GMC, PLYMOUTH	1981-93	
CA-5576	BRAKE CABLE	CHEVROLET, GMC	1979-91	
CA-5577	BRAKE CABLE	CHEVROLET, GMC	1984-91	
CA-5578	BRAKE CABLE	CHEVROLET, GMC	1984-89	
CA-5579	BRAKE CABLE	CHEVROLET, GMC	1984-91	
CA-5580	BRAKE CABLE	CHEVROLET, GMC	1984-91	
CA-5581	BRAKE CABLE	CHEVROLET, GMC	1983-95	
CA-5582	BRAKE CABLE	CHEVROLET, GMC	1983-95	
CA-5583	BRAKE CABLE	CHEVROLET, GMC	1979-91	
CA-5584	BRAKE CABLE	CHEVROLET, GMC	1979-93	
CA-5585	BRAKE CABLE	CHEVROLET, GMC	1979-93	
CA-5586	BRAKE CABLE	CHEVROLET, GMC	1979-87	
CA-5587	BRAKE CABLE	CHEVROLET, GMC	1984-90	
CA-5588	BRAKE CABLE	CHEVROLET, GMC	1983-95	
CA-5589	BRAKE CABLE	CHEVROLET, GMC	1983-95	
CA-5590	BRAKE CABLE	BUICK, OLDSMOBILE	1979-85	
CA-5591	BRAKE CABLE	BUICK	1979-85	
CA-5592	BRAKE CABLE	BUICK, CHEVROLET, GMC, OLDSMOBILE, PONTIAC	1978-88	
CA-5593	BRAKE CABLE	PONTIAC	1984-88	
CA-5594	BRAKE CABLE	BUICK, CADILLAC	1979-85	
CA-5595	BRAKE CABLE	BUICK, CADILLAC, OLDSMOBILE	1979-85	
CA-5596	BRAKE CABLE	CHEVROLET, PONTIAC	1980-87	
CA-5597	BRAKE CABLE	CHEVROLET, PONTIAC	1980-87	
CA-5598	BRAKE CABLE	CHEVROLET, GMC	1973-83	
CA-5599	BRAKE CABLE	PONTIAC	1984-88	
CA-5600	BRAKE CABLE	BUICK, CADILLAC, OLDSMOBILE	1979-85	
CA-5601	BRAKE CABLE	BUICK, CHEVROLET, OLDSMOBILE, PONTIAC	1982-88	
CA-5602	BRAKE CABLE	BUICK, CADILLAC, OLDSMOBILE, PONTIAC	1985-89	
CA-5603	BRAKE CABLE	BUICK, CADILLAC, OLDSMOBILE, PONTIAC	1985-89	
CA-5604	BRAKE CABLE	BUICK, CHEVROLET, OLDSMOBILE, PONTIAC	1977-90	
CA-5605	BRAKE CABLE	BUICK, CADILLAC, CHEVROLET, OLDSMOBILE, PONTIAC	1978-90	
CA-5606	BRAKE CABLE	BUICK, CHEVROLET, OLDSMOBILE, PONTIAC	1980	
CA-5607	BRAKE CABLE	CHEVROLET, PONTIAC	1982-88	
CA-5608	BRAKE CABLE	CHEVROLET, GMC	1984-95	
CA-5609	BRAKE CABLE	CHEVROLET, GMC	1984-95	

Part	Description	Make	Years	Engines
CA-5610	BRAKE CABLE	CHEVROLET, GMC, OLDSMOBILE	1983-91	
CA-5611	BRAKE CABLE	BUICK, CADILLAC, OLDSMOBILE, PONTIAC	1985-89	
CA-5612	BRAKE CABLE	BUICK, CADILLAC	1977-79	
CA-5613	BRAKE CABLE	PONTIAC	1983-88	
CA-5614	BRAKE CABLE	BUICK, CADILLAC, OLDSMOBILE, PONTIAC	1985-96	
CA-5615	BRAKE CABLE	BUICK, CHEVROLET, OLDSMOBILE, PONTIAC	1985-90	
CA-5616	BRAKE CABLE	BUICK, CHEVROLET, OLDSMOBILE, PONTIAC	1988-91	
CA-5617	BRAKE CABLE	BUICK, OLDSMOBILE, PONTIAC	1988	
CA-5618	BRAKE CABLE	BUICK, CHEVROLET, OLDSMOBILE, PONTIAC	1988-94	
CA-5619	BRAKE CABLE	BUICK, CADILLAC, CHEVROLET, OLDSMOBILE, PONTIAC	1985-91	
CA-5620	BRAKE CABLE	BUICK, CHEVROLET, OLDSMOBILE, PONTIAC	1982-88	
CA-5621	BRAKE CABLE	CHEVROLET, OLDSMOBILE, PONTIAC	1985-91	
CA-5622	BRAKE CABLE	BUICK, CADILLAC, OLDSMOBILE	1986-92	
CA-5623	BRAKE CABLE	BUICK, CADILLAC, OLDSMOBILE	1986-92	
CA-5624	BRAKE CABLE	CHEVROLET, GMC	1987-89	
CA-5625	BRAKE CABLE	CHEVROLET, GMC	1987-93	
CA-5626	BRAKE CABLE	BUICK, OLDSMOBILE, PONTIAC	1985-91	
CA-5627	BRAKE CABLE	CHEVROLET	1987-90	
CA-5628	BRAKE CABLE	CHEVROLET	1987-90	
CA-5629	BRAKE CABLE	PONTIAC	1983-88	
CA-5630	BRAKE CABLE	CHEVROLET, PONTIAC	1988-89	
CA-5631	BRAKE CABLE	CHEVROLET, PONTIAC	1987-89	
CA-5632	BRAKE CABLE	CHEVROLET, PONTIAC	1987-94	
CA-5633	BRAKE CABLE	CHEVROLET, PONTIAC	1987-94	
CA-5634	BRAKE CABLE	BUICK, CHEVROLET, OLDSMOBILE, PONTIAC	1988-94	
CA-5635	BRAKE CABLE	BUICK, CADILLAC, OLDSMOBILE, PONTIAC	1990-99	
CA-5636	BRAKE CABLE	BUICK, CADILLAC, OLDSMOBILE, PONTIAC	1990-99	
CA-5637	BRAKE CABLE	BUICK, CADILLAC, CHEVROLET	1990-96	
CA-5638	BRAKE CABLE	BUICK, CADILLAC, CHEVROLET	1991-94	
CA-5639	BRAKE CABLE	CADILLAC, GMC	1987-93	
CA-5640	BRAKE CABLE	BUICK, CADILLAC, OLDSMOBILE, PONTIAC	1987-91	
CA-5641	BRAKE CABLE	CHEVROLET, GMC	1985-91	
CA-5642	BRAKE CABLE	CHRYSLER, DODGE, PLYMOUTH	1986-96	
CA-5643	BRAKE CABLE	BUICK	1993-96	
CA-5644	BRAKE CABLE	BUICK	1993-96	
CA-5645	BRAKE CABLE	DODGE, PLYMOUTH	1991-94	
CA-6001	BRAKE CABLE	HONDA	1976-85	
CA-6002	BRAKE CABLE	HONDA	1976-85	
CA-6003	BRAKE CABLE	HONDA	1979-82	
CA-6030	BRAKE CABLE	DODGE	1984-88	
CA-6040	BRAKE CABLE	NISSAN	1983-86	
CA-6041	BRAKE CABLE	NISSAN	1983-86	
CA-6042	BRAKE CABLE	NISSAN	1985-86	
CA-6044	BRAKE CABLE	NISSAN	1983-84	
CA-6045	BRAKE CABLE	FORD	1986-94	
CA-6060	BRAKE CABLE	RENAULT	1984-87	
CA-6070	BRAKE CABLE	TOYOTA	1971-94	
CA-6071	BRAKE CABLE	TOYOTA	1979-81	
CA-6072	BRAKE CABLE	TOYOTA	1979-81	
CA-6073	BRAKE CABLE	TOYOTA	1980-82	
CA-6074	BRAKE CABLE	TOYOTA	1980-83	
CA-6075	BRAKE CABLE	TOYOTA	1982-85	
CA-6076	BRAKE CABLE	TOYOTA	1982-85	
CA-6077	BRAKE CABLE	TOYOTA	1983-86	

Part	Description	Make	Years	Engines
CA-6078	BRAKE CABLE	TOYOTA	1983-86	
CA-6079	BRAKE CABLE	TOYOTA	1983-86	
CA-6080	BRAKE CABLE	TOYOTA	1984-88	
CA-6081	BRAKE CABLE	TOYOTA	1984-85	
CA-6082	BRAKE CABLE	TOYOTA	1983-86	
CA-6150	BRAKE CABLE	VOLKSWAGEN	1981-90	
CA-6151	BRAKE CABLE	VOLKSWAGEN	1981-02	
CA-6152	BRAKE CABLE	VOLKSWAGEN	1971-79	
CA-6154	BRAKE CABLE	NISSAN	1980-86	
CA-6157	BRAKE CABLE	TOYOTA	1979-82	
CA-6159	BRAKE CABLE	BMW	1967-76	
CA-6160	BRAKE CABLE	BMW	1977-83	
CA-6161	BRAKE CABLE	VOLKSWAGEN	1970-72	
CA-6162	BRAKE CABLE	NISSAN	1980-81	
CA-6163	BRAKE CABLE	NISSAN	1980-81	
CA-6164	BRAKE CABLE	NISSAN	1983-85	
CA-6165	BRAKE CABLE	TOYOTA	1979-83	
CA-6166	BRAKE CABLE	TOYOTA	1979-83	
CA-6167	BRAKE CABLE	NISSAN	1982-83	
CA-6168	BRAKE CABLE	HONDA	1979-81	
CA-6169	BRAKE CABLE	HONDA	1979-81	
CA-6171	BRAKE CABLE	TOYOTA	1979-83	
CA-6172	BRAKE CABLE	RENAULT	1983-86	
CA-6173	BRAKE CABLE	NISSAN	1982-83	
CA-6180	BRAKE CABLE	CHEVROLET	1985-95	
CA-6181	BRAKE CABLE	CHEVROLET, GMC	1983-96	
CA-6182	BRAKE CABLE	CHEVROLET	1985-90	
CA-6183	BRAKE CABLE	CHEVROLET, GMC	1988-94	
CA-6184	BRAKE CABLE	CHEVROLET, GMC	1990-94	
CA-6185	BRAKE CABLE	CHEVROLET	1992-94	
CA-6186	BRAKE CABLE	CHEVROLET, GMC	1988-95	
CA-6187	BRAKE CABLE	CHEVROLET, GMC	1988-00	
CA-6188	BRAKE CABLE	CHEVROLET, GMC	1990-98	
CA-6189	BRAKE CABLE	CHEVROLET, GMC	1990-96	
CA-6190	BRAKE CABLE	CHEVROLET	1990-95	
CA-6191	BRAKE CABLE	CHEVROLET, GMC	1992-97	
CA-6192	BRAKE CABLE	CHEVROLET, GMC	1992-94	
CA-6193	BRAKE CABLE	CHEVROLET, GMC	1990-97	
CA-6194	BRAKE CABLE	CHEVROLET, GMC	1991-94	
CA-6195	BRAKE CABLE	CHEVROLET, GMC	1988-89	
CA-6196	BRAKE CABLE	CHEVROLET, GMC	1988-91	
CA-6197	BRAKE CABLE	CHEVROLET, GMC	1988-94	
CA-6198	BRAKE CABLE	CHEVROLET	1985-90	
CA-6199	BRAKE CABLE	CHEVROLET	1990-95	
CA-6200	BRAKE CABLE	FORD	1985-90	
CA-6201	BRAKE CABLE	FORD	1983-92	
CA-6202	BRAKE CABLE	FORD	1986-97	
CA-6203	BRAKE CABLE	FORD	1984-87	
CA-6204	BRAKE CABLE	FORD	1984-87	
CA-6205	BRAKE CABLE	FORD	1984-91	
CA-6206	BRAKE CABLE	FORD	1989-92	
CA-6207	BRAKE CABLE	FORD	1988-91	
CA-6208	BRAKE CABLE	FORD	1980-97	
CA-6209	BRAKE CABLE	FORD	1980-97	
CA-6210	BRAKE CABLE	FORD	1992-96	
CA-6211	BRAKE CABLE	FORD	1992-00	
CA-6212	BRAKE CABLE	FORD	1992-96	
CA-6213	BRAKE CABLE	FORD	1992-96	
CA-6214	BRAKE CABLE	FORD	1992-96	
CA-6215	BRAKE CABLE	FORD	1992-96	
CA-6216	BRAKE CABLE	FORD	1992-96	
CA-6217	BRAKE CABLE	FORD	1992-96	
CA-6218	BRAKE CABLE	FORD	1992-96	
CA-6219	BRAKE CABLE	FORD	1992-96	

Part	Description	Make	Years	Engines
CA-6220	BRAKE CABLE	FORD	1992-96	
CA-6222	BRAKE CABLE	FORD	1991-92	
CA-6223	BRAKE CABLE	FORD, MAZDA	1993-00	
CA-6224	BRAKE CABLE	FORD, MAZDA	1993-02	
CA-6225	BRAKE CABLE	FORD	1984-91	
CA-6226	BRAKE CABLE	FORD	1984-91	
CA-6227	BRAKE CABLE	FORD	1984-91	
CA-6228	BRAKE CABLE	DODGE	1989-93	
CA-6229	BRAKE CABLE	DODGE	1989-93	
CA-6230	BRAKE CABLE	DODGE	1989-97	
CA-6231	BRAKE CABLE	DODGE	1990-92	
CA-6233	BRAKE CABLE	DODGE	1984-88	
CA-6234	BRAKE CABLE	DODGE	1986-93	
CA-6235	BRAKE CABLE	DODGE	1987-90	
CA-6236	BRAKE CABLE	DODGE	1986-87	
CA-6237	BRAKE CABLE	DODGE, PLYMOUTH	1987-90	
CA-6238	BRAKE CABLE	DODGE, PLYMOUTH	1984-89	
CA-6240	BRAKE CABLE	HONDA	1992-95	
CA-6241	BRAKE CABLE	HONDA	1992-95	
CA-6242	BRAKE CABLE	HONDA	1993-97	
CA-6243	BRAKE CABLE	HONDA	1993-97	
CA-6244	BRAKE CABLE	MAZDA	1986-89	
CA-6245	BRAKE CABLE	MAZDA	1986-89	
CA-6246	BRAKE CABLE	MAZDA	1988-91	
CA-6247	BRAKE CABLE	MAZDA	1988-91	
CA-6248	BRAKE CABLE	NISSAN	1993-97	
CA-6249	BRAKE CABLE	NISSAN	1993-97	
CA-6250	BRAKE CABLE	SUZUKI	1989-94	
CA-6251	BRAKE CABLE	SUZUKI	1989-94	
CA-6252	BRAKE CABLE	TOYOTA	1987-91	
CA-6253	BRAKE CABLE	TOYOTA	1987-91	
CA-6254	BRAKE CABLE	LEXUS, TOYOTA	1992-96	
CA-6255	BRAKE CABLE	LEXUS, TOYOTA	1992-96	
CA-6256	BRAKE CABLE	TOYOTA	1988-92	
CA-6257	BRAKE CABLE	TOYOTA	1988-92	
CA-6258	BRAKE CABLE	TOYOTA	1992-92	
CA-6259	BRAKE CABLE	TOYOTA	1992-92	
CA-6260	BRAKE CABLE	GEO, SUZUKI	1989-90	
CA-6261	BRAKE CABLE	GEO, SUZUKI	1989-90	
CA-6262	BRAKE CABLE	HONDA	1992-93	
CA-6263	BRAKE CABLE	HONDA	1992-93	
CA-6264	BRAKE CABLE	FORD	2001	
CA-6265	BRAKE CABLE	FORD	2001	
CA-6266	BRAKE CABLE	FORD	2001	
CA-6267	BRAKE CABLE	FORD	2001-02	
CA-6268	BRAKE CABLE	FORD	2002	
CA-6269	BRAKE CABLE	FORD	2002	
CA-6270	BRAKE CABLE	FORD	2002	
CA-6271	BRAKE CABLE	FORD	2002	
CA-6272	BRAKE CABLE	FORD	2001-02	
CA-6273	BRAKE CABLE	FORD	2002	
CA-6274	BRAKE CABLE	FORD	2003-04	
CA-6275	BRAKE CABLE	FORD	2003	
CA-6276	BRAKE CABLE	FORD	2003	
CA-6277	BRAKE CABLE	FORD	2003-04	
CA-6278	BRAKE CABLE	FORD	2003	
CA-6279	BRAKE CABLE	FORD	2003	
CA-6280	BRAKE CABLE	FORD	2003	
CA-6283	BRAKE CABLE	FORD, MAZDA, MERCURY	1989-02	
CA-6284	BRAKE CABLE	JEEP	1990-91	
CA-6285	BRAKE CABLE	CHEVROLET, GMC	1992-93	
CA-6286	BRAKE CABLE	FORD	1993-93	
CA-6287	BRAKE CABLE	FORD, MERCURY	1992-96	
CA-6289	BRAKE CABLE	FORD, MERCURY	1992-96	

Part	Description	Make	Years	Engines
CA-6290	BRAKE CABLE	FORD	1992-97	
CA-6291	BRAKE CABLE	CHEVROLET, GMC	1992-94	
CA-6292	BRAKE CABLE	FORD, MAZDA	1993-00	
CA-6293	BRAKE CABLE	FORD	1994-98	
CA-6294	BRAKE CABLE	CHEVROLET, GMC	1995	
CA-6295	BRAKE CABLE	CHEVROLET, GMC	1995-97	
CA-6296	BRAKE CABLE	CHEVROLET, GMC	1995	
CA-6297	BRAKE CABLE	CHEVROLET, GMC	1995-97	
CA-6298	BRAKE CABLE	FORD	1997-97	
CA-6299	BRAKE CABLE	FORD	1994-98	
CA-6300	BRAKE CABLE	FORD	1992-96	
CA-6301	BRAKE CABLE	FORD	1997-97	
CA-6302	BRAKE CABLE	FORD, MERCURY	1992-96	
CA-6303	BRAKE CABLE	FORD	1997-97	
CA-6304	BRAKE CABLE	FORD	1992-97	
CA-6305	BRAKE CABLE	FORD	1992-97	
CA-6306	BRAKE CABLE	FORD	1996-04	
CA-6307	BRAKE CABLE	FORD, LINCOLN	1992-02	
CA-6309	BRAKE CABLE	FORD, MERCURY	1998-04	
CA-6310	BRAKE CABLE	FORD	1998-99	
CA-6311	BRAKE CABLE	FORD, LINCOLN	1997-01	
CA-6312	BRAKE CABLE	FORD, LINCON	1997-01	
CA-6313	BRAKE CABLE	FORD, MERCURY	1997-02	
CA-6314	BRAKE CABLE	FORD, MERCURY	1997-02	
CA-6315	BRAKE CABLE	FORD, MERCURY	1997-02	
CA-6316	BRAKE CABLE	FORD, MERCURY	1997-02	
CA-6317	BRAKE CABLE	FORD	1998-00	
CA-6318	BRAKE CABLE	FORD	1997-99	
CA-6319	BRAKE CABLE	FORD	1998-98	
CA-6320	BRAKE CABLE	FORD, LINCOLN	1998-02	
CA-6321	BRAKE CABLE	FORD, LINCOLN	1998-02	
CA-6322	BRAKE CABLE	TOYOTA	1988-95	
CA-6323	BRAKE CABLE	TOYOTA	1988-95	
CA-6324	BRAKE CABLE	TOYOTA	1988-95	
CA-6325	BRAKE CABLE	TOYOTA	1988-95	
CA-6326	BRAKE CABLE	TOYOTA	1988-95	
CA-6327	BRAKE CABLE	TOYOTA	1989-95	
CA-6328	BRAKE CABLE	TOYOTA	1989-95	
CA-6329	BRAKE CABLE	TOYOTA	1989-95	
CA-6330	BRAKE CABLE	FORD, MERCURY	1981-94	
CA-8300	ACCELERATOR CABLE	DODGE	1989-91	3.9L, 5.2L, 5.9L
CA-8301	ACCELERATOR CABLE	CHRYSLER, DODGE, PLYMOUTH	1989-95	2.2L, 2.5L, 3.9L, 5.2L, 5.9L
CA-8302	ACCELERATOR CABLE	CHRYSLER, DODGE, PLYMOUTH	1985-90	2.2L, 2.5L, 3.0L
CA-8304	ACCELERATOR CABLE	DODGE, EAGLE	1988-90	3.0L
CA-8305	ACCELERATOR CABLE	CHRYSLER, DODGE, PLYMOUTH	1988-92	2.2L, 2.5L
CA-8306	ACCELERATOR CABLE	CHRYSLER, DODGE, PLYMOUTH	1981-94	2.5L, 3.0L, 3.3L, 3.7L
CA-8307	ACCELERATOR CABLE	CHRYSLER, DODGE, PLYMOUTH	1981-88	3.0L, 3.7L
CA-8309	ACCELERATOR CABLE	CHRYSLER, DODGE, PLYMOUTH	1984-88	2.2L
CA-8311	ACCELERATOR CABLE	DODGE, PLYMOUTH	1985-88	2.2L
CA-8312	ACCELERATOR CABLE	CHRYSLER, DODGE, PLYMOUTH	1984-88	2.2L
CA-8314	ACCELERATOR CABLE	CHEVROLET, GMC	1987-91	4.3L, 5.0L, 5.7L, 7.4L
CA-8315	ACCELERATOR CABLE	CHEVROLET, GMC	1988-91	4.3L
CA-8316	ACCELERATOR CABLE	CHEVROLET, GMC	1986-90	2.8L
CA-8317	ACCELERATOR CABLE	CHEVROLET, GMC	1979-84	4.1L
CA-8319	ACCELERATOR CABLE	CHEVROLET	1989-93	5.0L, 5.7L
CA-8321	ACCELERATOR CABLE	BUICK, CADILLAC, CHEVROLET, OLDSMOBILE, PONTIAC	1984-86	2.0L
CA-8324	ACCELERATOR CABLE	BUICK, CHEVROLET, OLDSMOBILE, PONTIAC	1981-85	4.3L, 5.7L
CA-8325	ACCELERATOR CABLE	CHEVROLET, PONTIAC	1982-84	2.5L, 2.8L
CA-8326	ACCELERATOR CABLE	CHEVROLET, PONTIAC	1982-84	5.0L
CA-8401	ACCELERATOR CABLE	AMERICAN MOTORS	1978-80	3.8L, 4.2L
CA-8402	ACCELERATOR CABLE	AMERICAN MOTORS	1975-77	3.8L, 4.2L
CA-8403	ACCELERATOR CABLE	AMERICAN MOTORS	1980-81	2.5L
CA-8404	ACCELERATOR CABLE	AMERICAN MOTORS	1981-87	4.2L

Part	Description	Make	Years	Engines
CA-8405	ACCELERATOR CABLE	AMERICAN MOTORS	1983-84	2.5L
CA-8406	ACCELERATOR CABLE	DODGE, PLYMOUTH	1972-81	4.0L, 5.2L, 5.9L, 6.6L, 7.2L
CA-8407	ACCELERATOR CABLE	DODGE, PLYMOUTH	1980-87	5.2L, 5.9L
CA-8408	ACCELERATOR CABLE	DODGE, PLYMOUTH	1980-87	3.7L, 4.0L
CA-8409	ACCELERATOR CABLE	DODGE	1987-87	3.9L
CA-8410	ACCELERATOR CABLE	CHRYSLER, DODGE, PLYMOUTH	1972-81	3.7L, 5.2L, 5.9L
CA-8411	ACCELERATOR CABLE	CHRYSLER, DODGE, PLYMOUTH	1970-81	3.7L, 5.2L, 5.9L, 6.6L, 7.2L
CA-8412	ACCELERATOR CABLE	CHRYSLER, DODGE, PLYMOUTH	1979-83	3.7L
CA-8413	ACCELERATOR CABLE	CHRYSLER, DODGE, PLYMOUTH	1976-80	3.7L
CA-8414	ACCELERATOR CABLE	CHRYSLER, DODGE, PLYMOUTH	1976-89	5.2L, 5.9L
CA-8415	ACCELERATOR CABLE	CHRYSLER, DODGE, PLYMOUTH	1979-83	3.7L
CA-8416	ACCELERATOR CABLE	DODGE, PLYMOUTH	1976	5.2L, 5.9L
CA-8417	ACCELERATOR CABLE	DODGE, PLYMOUTH	1975	5.2L, 5.9L
CA-8418	ACCELERATOR CABLE	DODGE, PLYMOUTH	1972-76	3.2L, 3.7L
CA-8419	ACCELERATOR CABLE	DODGE, PLYMOUTH	1978-79	1.7L
CA-8420	ACCELERATOR CABLE	CHRYSLER	1981-82	5.2L
CA-8421	ACCELERATOR CABLE	DODGE, PLYMOUTH	1980-83	1.7L
CA-8422	ACCELERATOR CABLE	CHRYSLER, DODGE, PLYMOUTH	1977-85	5.2L, 5.9L
CA-8423	ACCELERATOR CABLE	DODGE, PLYMOUTH	1981-82	2.2L
CA-8424	ACCELERATOR CABLE	CHRYSLER, DODGE, PLYMOUTH	1981-82	2.2L
CA-8425	ACCELERATOR CABLE	CHRYSLER, DODGE, PLYMOUTH	1981-91	2.2L, 2.6L, 3.0L
CA-8426	ACCELERATOR CABLE	CHRYSLER, DODGE, PLYMOUTH	1983-90	2.2L, 3.0L
CA-8427	ACCELERATOR CABLE	CHRYSLER, DODGE, PLYMOUTH	1982-84	2.6L
CA-8428	ACCELERATOR CABLE	CHRYSLER, DODGE, PLYMOUTH	1982-91	2.2L, 2.6L, 3.0L
CA-8429	ACCELERATOR CABLE	CHRYSLER, DODGE, PLYMOUTH	1984-85	2.2L
CA-8430	ACCELERATOR CABLE	CHRYSLER, DODGE, PLYMOUTH	1984-86	2.2L
CA-8431	ACCELERATOR CABLE	FORD	1974-79	3.9L, 4.9L
CA-8432	ACCELERATOR CABLE	FORD	1974-76	4.9L, 5.0L, 6.6L
CA-8433	ACCELERATOR CABLE	FORD	1974	4.9L
CA-8435	ACCELERATOR CABLE	FORD	1979-95	5.0L, 5.8L, 6.6L, 7.5L
CA-8436	ACCELERATOR CABLE	FORD	1980-88	4.9L, 5.0L, 5.8L, 6.6L, 7.5L
CA-8437	ACCELERATOR CABLE	FORD	1980-94	3.8L, 4.2L, 5.0L, 5.8L, 6.6L, 7.5L
CA-8438	ACCELERATOR CABLE	FORD	1983-86	4.9L
CA-8439	ACCELERATOR CABLE	FORD	1983-87	2.2L, 2.3L
CA-8440	ACCELERATOR CABLE	FORD, MERCURY	1975-80	4.2L, 5.0L, 5.8L
CA-8441	ACCELERATOR CABLE	FORD, MERCURY	1979-89	5.0L, 5.8L, 6.6L, 7.5L
CA-8442	ACCELERATOR CABLE	FORD, LINCOLN, MERCURY	1973-79	6.6L, 7.5L
CA-8443	ACCELERATOR CABLE	FORD, MERCURY	1975-78	5.0L, 5.8L, 6.6L
CA-8444	ACCELERATOR CABLE	FORD	1975-78	2.3L, 2.8L
CA-8445	ACCELERATOR CABLE	FORD, MERCURY	1975-79	2.8L
CA-8446	ACCELERATOR CABLE	FORD, MERCURY	1975-79	5.0L, 5.8L, 6.6L, 7.5L
CA-8447	ACCELERATOR CABLE	FORD, MERCURY	1974-82	2.3L
CA-8448	ACCELERATOR CABLE	FORD, MERCURY	1978-83	3.3L, 3.8L, 4.2L
CA-8449	ACCELERATOR CABLE	FORD, MERCURY	1983-86	2.3L
CA-8450	ACCELERATOR CABLE	FORD, LINCOLN, MERCURY	1982-89	3.8L, 5.0L
CA-8451	ACCELERATOR CABLE	FORD, MERCURY	1975-89	2.3L, 3.3L, 4.1L
CA-8452	ACCELERATOR CABLE	FORD, MERCURY	1982-89	5.0L
CA-8453	ACCELERATOR CABLE	FORD, MERCURY	1981-82	4.2L, 5.0L
CA-8454	ACCELERATOR CABLE	FORD, MERCURY	1981-89	1.6L, 1.9L, 2.0L, 2.3L, 2.5L,
CA-8455	ACCELERATOR CABLE	FORD, LINCOLN, MERCURY	1980-89	4.2L, 5.0L, 5.8L
CA-8456	ACCELERATOR CABLE	FORD	1983-86	2.0L, 2.3L
CA-8457	ACCELERATOR CABLE	FORD	1983-87	4.9L
CA-8458	ACCELERATOR CABLE	FORD	1983-91	4.9L, 6.9L, 7.5L
CA-8459	ACCELERATOR CABLE	FORD	1985-91	2.0L, 5.0L, 5.8L, 6.9L, 7.3L, 7.5L
CA-8460	ACCELERATOR CABLE	FORD	1986-86	2.8L
CA-8461	ACCELERATOR CABLE	FORD	1986-89	2.3L
CA-8462	ACCELERATOR CABLE	FORD	1986-89	3.0L
CA-8463	ACCELERATOR CABLE	FORD	1987-90	4.9L
CA-8464	ACCELERATOR CABLE	FORD	1986-91	5.0L, 5.8L
CA-8465	ACCELERATOR CABLE	CHEVROLET, PONTIAC	1983-87	1.6L
CA-8466	ACCELERATOR CABLE	CHEVROLET, GMC	1976-91	5.7L, 7.4L
CA-8467	ACCELERATOR CABLE	CHEVROLET, GMC	1975-90	4.3L, 5.0L, 5.7L, 6.6L
CA-8468	ACCELERATOR CABLE	BUICK, CHEVROLET, GMC	1976-88	3.8L, 4.8L
CA-8469	ACCELERATOR CABLE	BUICK, CHEVROLET, GMC, PONTIAC	1974-86	4.1L, 4.3L, 4.8L, 4.9L, 5.0L, 5.7L, 6.6L, 7.4L

Part	Description	Make	Years	Engines
CA-8470	ACCELERATOR CABLE	BUICK, CHEVROLET, OLDSMOBILE, PONTIAC	1980-83	2.5L
CA-8471	ACCELERATOR CABLE	BUICK, CHEVROLET, OLDSMOBILE, PONTIAC	1981-86	2.8L
CA-8472	ACCELERATOR CABLE	BUICK, CHEVROLET, OLDSMOBILE, PONTIAC	1976-79	5.0L, 5.7L
CA-8473	ACCELERATOR CABLE	BUICK, CHEVROLET, OLDSMOBILE, PONTIAC	1973-82	3.8L, 4.1L, 4.4L, 5.7L, 6.6L, 7.5L
CA-8474	ACCELERATOR CABLE	BUICK, CHEVROLET, GMC, OLDSMOBILE, PONTIAC	1977-87	3.2L, 3.8L, 4.1L, 4.4L, 5.0L, 5.7L, 6.6L
CA-8475	ACCELERATOR CABLE	BUICK, CHEVROLET, GMC, OLDSMOBILE, PONTIAC	1977-88	4.3L, 5.0L, 5.7L, 6.6L
CA-8476	ACCELERATOR CABLE	CHEVROLET, OLDSMOBILE, PONTIAC	1976-79	4.1L
CA-8477	ACCELERATOR CABLE	BUICK, OLDSMOBILE, PONTIAC	1975-77	4.3L, 5.7L, 6.6L, 7.5L
CA-8478	ACCELERATOR CABLE	BUICK, OLDSMOBILE	1975-77	3.8L
CA-8479	ACCELERATOR CABLE	PONTIAC	1975-77	4.1L, 5.7L, 6.6L
CA-8480	ACCELERATOR CABLE	BUICK, CHEVROLET, OLDSMOBILE, PONTIAC	1978-86	4.4L, 5.0L, 5.7L
CA-8481	ACCELERATOR CABLE	BUICK, CHEVROLET, OLDSMOBILE, PONTIAC	1975-80	3.2L, 3.8L, 5.0L
CA-8482	ACCELERATOR CABLE	CADILLAC	1980-81	6.0L
CA-8483	ACCELERATOR CABLE	CHEVROLET, OLDSMOBILE	1977	5.0L, 5.7L
CA-8484	ACCELERATOR CABLE	CHEVROLET, PONTIAC	1974-85	4.4L, 5.0L, 5.7L
CA-8485	ACCELERATOR CABLE	BUICK, CHEVROLET, GMC, PONTIAC	1973-77	4.1L, 5.0L, 5.7L, 6.6L, 7.5L
CA-8486	ACCELERATOR CABLE	CHEVROLET, PONTIAC	1979-82	1.6L
CA-8487	ACCELERATOR CABLE	CHEVROLET	1976-78	1.4L, 1.6
CA-8488	ACCELERATOR CABLE	CHEVROLET, OLDSMOBILE, PONTIAC	1978-85	2.5L, 5.0L, 5.7L
CA-8489	ACCELERATOR CABLE	CHEVROLET, OLDSMOBILE, PONTIAC	1972-77	2.3L, 2.5L
CA-8490	ACCELERATOR CABLE	BUICK, OLDSMOBILE, PONTIAC	1975-79	3.8L
CA-8491	ACCELERATOR CABLE	CHEVROLET, PONTIAC	1978-81	3.8L
CA-8492	ACCELERATOR CABLE	BUICK, CADILLAC, OLDSMOBILE	1981-84	4.1L
CA-8493	ACCELERATOR CABLE	BUICK, CHEVROLET, OLDSMOBILE, PONTIAC	1978-90	4.3L, 5.0L, 5.7L
CA-8494	ACCELERATOR CABLE	CHEVROLET, PONTIAC	1978-87	3.8L, 4.3L, 5.0L
CA-8495	ACCELERATOR CABLE	BUICK, CHEVROLET, GMC, OLDSMOBILE, PONTIAC	1980-85	5.7L
CA-8496	ACCELERATOR CABLE	CHEVROLET, GMC, PONTIAC	1978-87	3.3L, 3.8L, 4.3L
CA-8497	ACCELERATOR CABLE	BUICK, OLDSMOBILE	1980-88	4.3L, 5.0L, 5.7L
CA-8498	ACCELERATOR CABLE	BUICK, CADILLAC, CHEVROLET, OLDSMOBILE, PONTIAC	1977-85	3.8L, 4.1L
CA-8499	ACCELERATOR CABLE	CHEVROLET, GMC	1975-92	3.9L, 4.3L, 4.8L, 5.7L, 7.4L
CA-8500	ACCELERATOR CABLE	CHEVROLET, GMC	1974-87	5.0L, 5.7L, 6.6L, 7.4L
CA-8501	ACCELERATOR CABLE	CHEVROLET, GMC	1982-85	1.9L, 2.0L
CA-8502	ACCELERATOR CABLE	CHEVROLET, GMC	1982-85	2.8L
CA-8503	ACCELERATOR CABLE	CHEVROLET, GMC	1982-90	6.2L
CA-8504	ACCELERATOR CABLE	CHEVROLET, GMC	1982-91	6.2L
CA-8505	ACCELERATOR CABLE	CHEVROLET, GMC	1985-89	7.4L
CA-8506	ACCELERATOR CABLE	CHEVROLET, GMC	1985-88	2.5L
CA-8507	ACCELERATOR CABLE	CHEVROLET, GMC	1985-86	4.3L
CA-8508	ACCELERATOR CABLE	CHEVROLET, GMC	1985-86	4.3L
CA-8509	ACCELERATOR CABLE	CHEVROLET, GMC	1974-75	4.1L, 4.8L, 5.7L, 6.6L, 7.4L
CA-8510	ACCELERATOR CABLE	JEEP	1973-77	5.0L, 5.9L, 6.6L
CA-8511	ACCELERATOR CABLE	JEEP	1977-86	4.2L
CA-8512	ACCELERATOR CABLE	JEEP	1977-86	3.8L, 4.2L
CA-8513	ACCELERATOR CABLE	JEEP	1977-86	5.9L, 6.6L
CA-8514	ACCELERATOR CABLE	JEEP	1980-85	2.5L
CA-8515	ACCELERATOR CABLE	JEEP	1984-87	2.5L
CA-8516	ACCELERATOR CABLE	JEEP	1987-88	2.5L
CA-8517	ACCELERATOR CABLE	JEEP	1987-87	4.0L
CA-8518	ACCELERATOR CABLE	JEEP	1987-91	5.9L
CA-8519	ACCELERATOR CABLE	BUICK, PONTIAC	1980-81	4.3L, 4.9L
CA-8523	ACCELERATOR CABLE	AUDI	1980-83	1.6L, 1.7L

Part	Description	Make	Years	Engines
CA-8524	ACCELERATOR CABLE	AUDI	1980-84	2.2L
CA-8532	ACCELERATOR CABLE	AUDI	1977-77	1.9L
CA-8534	ACCELERATOR CABLE	AUDI	1978-79	2.2L
CA-8535	ACCELERATOR CABLE	AUDI	1979-82	2.0L
CA-8540	ACCELERATOR CABLE	HONDA	1973-76	1.2L
CA-8541	ACCELERATOR CABLE	HONDA	1976-79	1.6L, 1.8L
CA-8552	ACCELERATOR CABLE	SAAB	1974-80	2.0L
CA-8553	ACCELERATOR CABLE	SAAB	1979-80	2.0L
CA-8554	ACCELERATOR CABLE	SAAB	1979-80	2.0L
CA-8560	ACCELERATOR CABLE	SUBARU	1972-74	1.3L, 1.4L
CA-8571	ACCELERATOR CABLE	VOLKSWAGEN	1972-79	1.6L
CA-8572	ACCELERATOR CABLE	VOLKSWAGEN	1979-81	1.5L, 1.6L
CA-8573	ACCELERATOR CABLE	VOLKSWAGEN	1980-83	1.5L, 1.6L, 1.7L
CA-8575	ACCELERATOR CABLE	VOLKSWAGEN	1975-75	1.5L
CA-8580	ACCELERATOR CABLE	VOLKSWAGEN	1979-84	1.5L, 1.6L, 1.7L, 1.8L
CA-8584	ACCELERATOR CABLE	VOLKSWAGEN	1977-92	1.5L, 1.6L
CA-8585	ACCELERATOR CABLE	VOLKSWAGEN	1975-92	1.5L, 1.6L, 1.7L, 1.8L
CA-8590	ACCELERATOR CABLE	PORSCHE	1970-71	2.0L
CA-8591	ACCELERATOR CABLE	VOLKSWAGEN	1991-93	1.8L
CA-8607	ACCELERATOR CABLE	VOLVO	1975-79	2.0L, 2.1L, 2.7L
CA-8608	ACCELERATOR CABLE	VOLVO	1980-82	2.1L, 2.3L, 2.4L, 2.8L
CA-8609	ACCELERATOR CABLE	SUBARU	1980-87	1.2L, 1.6L, 1.8L
CA-8610	ACCELERATOR CABLE	NISSAN	1974-78	1.3L, 1.4L
CA-8611	ACCELERATOR CABLE	NISSAN	1980-87	2.0L
CA-8613	ACCELERATOR CABLE	VOLKSWAGEN	1975-79	1.5L, 1.6L
CA-8614	ACCELERATOR CABLE	VOLKSWAGEN	1985-93	1.8L, 2.0L, 2.8L
CA-8615	ACCELERATOR CABLE	VOLKSWAGEN	1973-74	1.7L, 1.8L
CA-8616	ACCELERATOR CABLE	VOLKSWAGEN	1968-74	1.6L
CA-8617	ACCELERATOR CABLE	VOLKSWAGEN	1982-83	1.7L, 1.8L
CA-8618	ACCELERATOR CABLE	VOLKSWAGEN	1975-79	1.8L, 2.0L
CA-8619	ACCELERATOR CABLE	VOLKSWAGEN	1972-72	1.7L
CA-8620	ACCELERATOR CABLE	VOLKSWAGEN	1969-71	1.6L
CA-8621	ACCELERATOR CABLE	VOLKSWAGEN	1968-68	1.6L
CA-8622	ACCELERATOR CABLE	VOLKSWAGEN	1965-67	1.5L
CA-8623	ACCELERATOR CABLE	VOLKSWAGEN	1962-64	1.2L, 1.5L
CA-8624	ACCELERATOR CABLE	VOLKSWAGEN	1980-83	1.6L, 1.9L, 2.0L
CA-8625	ACCELERATOR CABLE	VOLKSWAGEN	1968-76	1.6L
CA-8626	ACCELERATOR CABLE	VOLKSWAGEN	1972-74	1.6L
CA-8627	ACCELERATOR CABLE	VOLKSWAGEN	1966-71	1.3L, 1.5L, 1.6L
CA-8628	ACCELERATOR CABLE	RENAULT	1983-84	1.4L
CA-8629	ACCELERATOR CABLE	RENAULT	1985-87	1.7L
CA-8630	ACCELERATOR CABLE	RENAULT	1983-87	1.4L
CA-8631	ACCELERATOR CABLE	RENAULT	1976-83	1.3L, 1.4L
CA-8632	ACCELERATOR CABLE	MG	1963-74	1.8L
CA-8633	ACCELERATOR CABLE	MG	1977-80	1.8L
CA-8634	ACCELERATOR CABLE	VOLKSWAGEN	1958-65	1.2L
CA-8635	ACCELERATOR CABLE	NISSAN	1972-74	1.6L, 1.8L
CA-8636	ACCELERATOR CABLE	DODGE, PLYMOUTH	1979-85	1.4L, 1.6L, 2.0L
CA-8650	ACCELERATOR CABLE	JEEP	1976-81	5.0L
CA-8652	ACCELERATOR CABLE	JEEP	1976-78	3.8L, 4.2L
CA-8653	ACCELERATOR CABLE	JEEP	1972-75	3.8L, 4.2L
CA-8654	ACCELERATOR CABLE	JEEP	1972-73	3.8L, 4.2L
CA-8655	ACCELERATOR CABLE	JEEP	1973-76	4.2L
CA-8656	ACCELERATOR CABLE	JEEP	1976-78	3.8L, 4.2L
CA-8657	ACCELERATOR CABLE	JEEP	1987-87	4.2L
CA-8658	ACCELERATOR CABLE	JEEP	1987-90	2.5L
CA-8659	ACCELERATOR CABLE	JEEP	1987-89	4.2L
CA-8663	ACCELERATOR CABLE	JEEP	1985-86	2.1L
CA-8664	ACCELERATOR CABLE	JEEP	1987-90	4.0L
CA-8667	ACCELERATOR CABLE	JEEP	1987-87	2.1L
CA-8668	ACCELERATOR CABLE	DODGE, PLYMOUTH	1974-79	3.7L
CA-8669	ACCELERATOR CABLE	DODGE	1978-81	5.2L, 5.9L
CA-8670	ACCELERATOR CABLE	DODGE	1972-73	6.6L
CA-8674	ACCELERATOR CABLE	DODGE	1974	5.2L, 7.2L



Part	Description	Make	Years	Engines
CA-8675	ACCELERATOR CABLE	DODGE	1987-87	2.2L
CA-8676	ACCELERATOR CABLE	FORD	1970-72	2.8L, 3.9L, 4.9L
CA-8678	ACCELERATOR CABLE	FORD	1984-88	5.8L
CA-8679	ACCELERATOR CABLE	FORD	1984-88	4.9L
CA-8680	ACCELERATOR CABLE	FORD	1991-93	5.0L, 5.8L
CA-8681	ACCELERATOR CABLE	FORD	1991-96	5.0L, 5.8L
CA-8682	ACCELERATOR CABLE	FORD	1988-97	4.9L, 5.0L, 5.8L, 7.5L
CA-8683	ACCELERATOR CABLE	FORD	1992-97	7.3L
CA-8684	ACCELERATOR CABLE	FORD	1989-91	5.0L
CA-8685	ACCELERATOR CABLE	FORD	1990-91	4.9L
CA-8687	ACCELERATOR CABLE	CHEVROLET, GMC, OLDSMOBILE	1975-84	1.8L, 4.1L
CA-8688	ACCELERATOR CABLE	CHEVROLET, GMC	1988-95	4.3L, 5.0L, 5.7L, 7.4L
CA-8689	ACCELERATOR CABLE	CHEVROLET, GMC	1981	5.7L
CA-8692	ACCELERATOR CABLE	CHEVROLET	1990-92	3.1L
CA-8696	ACCELERATOR CABLE	BUICK, CHEVROLET	1991-93	5.7L
CA-8697	ACCELERATOR CABLE	CHEVROLET	1985-86	1.8L
CA-8699	ACCELERATOR CABLE	BUICK, PONTIAC	1981-84	3.0L, 4.9L
CA-8701	ACCELERATOR CABLE	CHEVROLET, GMC	1988-90	6.2L
CA-8706	ACCELERATOR CABLE	CHEVROLET	1990-94	2.3L
CA-8714	ACCELERATOR CABLE	CHEVROLET	1981-84	1.8L
CA-8720	ACCELERATOR CABLE	JEEP	1988-90	2.5L
CA-8721	ACCELERATOR CABLE	JEEP	1988-90	4.0L
CA-8722	ACCELERATOR CABLE	JEEP	1984-90	2.8L, 4.0L
CA-8730	ACCELERATOR CABLE	NISSAN	1981-86	2.2L, 2.4L
CA-8733	ACCELERATOR CABLE	NISSAN	1977-77	2.0L
CA-8734	ACCELERATOR CABLE	NISSAN	1975-79	2.0L
CA-8736	ACCELERATOR CABLE	TOYOTA	1975-76	1.6L
CA-8737	ACCELERATOR CABLE	TOYOTA	1977-79	1.6L
CA-8738	ACCELERATOR CABLE	TOYOTA	1980-82	1.8L
CA-8739	ACCELERATOR CABLE	TOYOTA	1979-79	2.2L
CA-8740	ACCELERATOR CABLE	TOYOTA	1980-81	2.2L, 2.4L
CA-8741	ACCELERATOR CABLE	TOYOTA	1982-83	2.4L
CA-8746	ACCELERATOR CABLE	NISSAN	1977-88	2.0L
CA-8748	ACCELERATOR CABLE	MAZDA	1981-83	1.5L
CA-8750	ACCELERATOR CABLE	NISSAN	1983-86	1.5L, 1.6L
CA-8752	ACCELERATOR CABLE	NISSAN	1980-80	2.0L
CA-8753	ACCELERATOR CABLE	MAZDA	1976-80	1.3L, 1.4L
CA-8754	ACCELERATOR CABLE	MAZDA	1983-85	2.0L
CA-8755	ACCELERATOR CABLE	MG	1975-75	1.8L
CA-8759	ACCELERATOR CABLE	FIAT	1974-78	1.3L
CA-8760	ACCELERATOR CABLE	CHEVROLET	1976-80	1.8L
CA-8762	ACCELERATOR CABLE	CHEVROLET, ISUZU	1981-86	1.8L, 1.9L, 2.3L
CA-8763	ACCELERATOR CABLE	TOYOTA	1984-86	2.4L
CA-8764	ACCELERATOR CABLE	DODGE, MITSUBISHI	1985-86	2.0L, 2.3L, 2.6L
CA-8765	ACCELERATOR CABLE	FIAT	1979-83	1.5L, 2.0L
CA-8766	ACCELERATOR CABLE	CHEVROLET, ISUZU	1981-86	2.2L
CA-8769	ACCELERATOR CABLE	NISSAN	1980-81	2.0L
CA-8770	ACCELERATOR CABLE	CHEVROLET	1973-75	1.8L
CA-8772	ACCELERATOR CABLE	TOYOTA	1980-82	1.5L
CA-8775	ACCELERATOR CABLE	AUDI, VOLKSWAGEN	1976-83	1.6L, 1.7L, 2.2L
CA-8776	ACCELERATOR CABLE	TOYOTA	1983-87	1.5L
CA-8777	ACCELERATOR CABLE	MAZDA	1986-87	2.0L, 2.2L
CA-8778	ACCELERATOR CABLE	NISSAN	1978-79	2.0L
CA-8779	ACCELERATOR CABLE	BMW	1984-85	1.8L
CA-8780	ACCELERATOR CABLE	MG	1975-76	1.5L
CA-8783	ACCELERATOR CABLE	NISSAN	1983-86	1.6L
CA-8785	ACCELERATOR CABLE	DODGE, MITSUBISHI, PLYMOUTH	1985-88	1.5L, 1.6L
CA-8786	ACCELERATOR CABLE	MG	1976-77	1.8L
CA-8788	ACCELERATOR CABLE	TRIUMPH	1979-81	2.0L
CA-8789	ACCELERATOR CABLE	NISSAN	1971-73	1.2L
CA-8790	ACCELERATOR CABLE	FORD	1986-86	2.3L
CA-8791	ACCELERATOR CABLE	EAGLE, MITSUBISHI, PLYMOUTH	1990-94	1.8L
CA-8792	ACCELERATOR CABLE	EAGLE, MITSUBISHI, PLYMOUTH	1990-95	2.0L
CA-8793	ACCELERATOR CABLE	BUICK, CADILLAC, CHEVROLET, OLDSMOBILE, PONTIAC	1982	1.8L

Part	Description	Make	Years	Engines
CA-8794	ACCELERATOR CABLE	CHEVROLET, PONTIAC	1982-87	5.0L
CA-8795	ACCELERATOR CABLE	CHEVROLET, PONTIAC	1988-92	5.0L
CA-8796	ACCELERATOR CABLE	CHEVROLET, GMC	1988-96	7.4L
CA-8797	ACCELERATOR CABLE	CHEVROLET, GMC	1990-91	4.3L
CA-8798	ACCELERATOR CABLE	CHEVROLET, PONTIAC	1981-87	1.6L
CA-8799	ACCELERATOR CABLE	BUICK, CHEVROLET, PONTIAC	1978-86	3.8L, 4.3L, 5.0L
CA-8800	ACCELERATOR CABLE	BUICK, CADILLAC, CHEVROLET, OLDSMOBILE, PONTIAC	1983-94	2.0L, 2.8L, 3.1L
CA-8802	ACCELERATOR CABLE	BUICK, CHEVROLET, GMC, OLDSMOBILE, PONTIAC	1978-85	3.0L, 4.3L, 4.9L, 5.7L
CA-8805	ACCELERATOR CABLE	DODGE, PLYMOUTH	1978-79	3.7L
CA-8806	ACCELERATOR CABLE	FORD	1990-96	4.9L
CA-8807	ACCELERATOR CABLE	FORD	1995-97	7.3L
CA-8808	ACCELERATOR CABLE	OLDSMOBILE, PONTIAC	1990-92	3.1L
CA-8809	ACCELERATOR CABLE	HONDA	1975-79	1.5L
CA-8810	ACCELERATOR CABLE	HONDA	1980-82	1.8L
CA-8811	ACCELERATOR CABLE	HONDA	1983-83	1.8L
CA-8812	ACCELERATOR CABLE	HONDA	1984-85	1.8L
CA-8813	ACCELERATOR CABLE	HONDA	1980-82	1.8L
CA-8814	ACCELERATOR CABLE	HONDA	1983-83	1.8L
CA-8815	ACCELERATOR CABLE	HONDA	1984-85	1.8L
CA-8816	ACCELERATOR CABLE	HONDA	1980-83	1.3L, 1.5L
CA-8817	ACCELERATOR CABLE	HONDA	1984-87	1.3L, 1.5L
CA-8818	ACCELERATOR CABLE	HONDA	1981-83	1.3L, 1.5L
CA-8819	ACCELERATOR CABLE	HONDA	1984-87	1.3L, 1.5L
CA-8821	ACCELERATOR CABLE	HONDA	1985-87	1.8L, 2.0L
CA-8822	ACCELERATOR CABLE	ISUZU	1986-87	2.2L, 2.3L
CA-8823	ACCELERATOR CABLE	NISSAN	1966-69	1.3L
CA-8824	ACCELERATOR CABLE	NISSAN	1970-72	1.6L
CA-8825	ACCELERATOR CABLE	NISSAN	1979-82	1.2L, 1.4L, 1.5L
CA-8826	ACCELERATOR CABLE	NISSAN	1979-82	1.2L, 1.4L, 1.5L
CA-8827	ACCELERATOR CABLE	NISSAN	1984-87	1.8L, 2.0L
CA-8828	ACCELERATOR CABLE	NISSAN	1987-88	1.8L, 2.0L
CA-8829	ACCELERATOR CABLE	NISSAN	1989-89	2.4L
CA-8830	ACCELERATOR CABLE	NISSAN	1988-91	3.0L
CA-8831	ACCELERATOR CABLE	TOYOTA	1968-69	3.9L
CA-8832	ACCELERATOR CABLE	TOYOTA	1983-86	2.0L
CA-8833	ACCELERATOR CABLE	TOYOTA	1987-88	2.0L
CA-8834	ACCELERATOR CABLE	TOYOTA	1982-85	2.4L
CA-8835	ACCELERATOR CABLE	TOYOTA	1986-89	2.0L
CA-8836	ACCELERATOR CABLE	TOYOTA	1986-86	3.0L
CA-8837	ACCELERATOR CABLE	TOYOTA	1987-92	3.0L
CA-8838	ACCELERATOR CABLE	TOYOTA	1984-89	2.0L, 2.2L
CA-8839	ACCELERATOR CABLE	TOYOTA	1979-80	2.2L
CA-8840	ACCELERATOR CABLE	TOYOTA	1981-83	2.4L
CA-8850	ACCELERATOR CABLE	AUSTIN, MG	1964-74	1.1L, 1.3L
CA-8851	ACCELERATOR CABLE	TRIUMPH	1971-75	1.3L, 1.5L
CA-8852	ACCELERATOR CABLE	TRIUMPH	1975-80	1.5L
CA-8853	ACCELERATOR CABLE	TRIUMPH	1975-78	2.0L
CA-8854	ACCELERATOR CABLE	MG	1977-79	1.5L
CA-8859	ACCELERATOR CABLE	TOYOTA	1981-83	2.2L
CA-8860	ACCELERATOR CABLE	TOYOTA	1979-80	2.2L
CA-8861	ACCELERATOR CABLE	HONDA	1983-87	1.8L
CA-8863	ACCELERATOR CABLE	MAZDA	1982-82	2.0L
CA-8865	ACCELERATOR CABLE	MAZDA	1981-82	1.1L
CA-8866	ACCELERATOR CABLE	CHEVROLET, PONTIAC	1985-88	1.0L
CA-8867	ACCELERATOR CABLE	MITSUBISHI	1984-87	2.6L
CA-8868	ACCELERATOR CABLE	DODGE, PLYMOUTH	1981-83	2.6L
CA-8869	ACCELERATOR CABLE	CHEVROLET, ISUZU, PONTIAC	1985-89	1.5L
CA-8870	ACCELERATOR CABLE	VOLKSWAGEN	1985-92	1.8L, 2.0L
CA-8871	ACCELERATOR CABLE	HYUNDAI, MITSUBISHI	1986-89	1.5L
CA-8872	ACCELERATOR CABLE	MAZDA	1990-93	1.6L
CA-8873	ACCELERATOR CABLE	MAZDA	1989-95	3.0L
CA-8874	ACCELERATOR CABLE	MAZDA	1989-94	2.6L
CA-8875	ACCELERATOR CABLE	MAZDA	1988-91	3.0L

Part	Description	Make	Years	Engines
CA-8876	ACCELERATOR CABLE	FORD, MAZDA, MERCURY	19901-95	1.6L, 1.8L
CA-8877	ACCELERATOR CABLE	FORD, MAZDA	1988-92	2.2L
CA-8880	ACCELERATOR CABLE	FORD, MAZDA	1993-95	2.0L
CA-8881	ACCELERATOR CABLE	MAZDA	1986-88	1.3L
CA-8882	ACCELERATOR CABLE	MAZDA	1989-91	1.3L
CA-8884	ACCELERATOR CABLE	MAZDA	1986-87	1.6L
CA-8886	ACCELERATOR CABLE	MINIBISHI	1989-93	2.0L
CA-8887	ACCELERATOR CABLE	NISSAN	1990-95	3.0L
CA-8888	ACCELERATOR CABLE	NISSAN	1984-86	2.0L
CA-8889	ACCELERATOR CABLE	NISSAN	1991-94	2.4L
CA-8891	ACCELERATOR CABLE	PONTIAC	1988-92	1.6L, 2.0L
CA-8892	ACCELERATOR CABLE	HONDA	1992-95	2.2L, 2.3L
CA-8893	ACCELERATOR CABLE	ACURA	1994-95	1.8L
CA-8894	ACCELERATOR CABLE	PONTIAC	1988-92	1.6L, 2.0L
CA-8896	ACCELERATOR CABLE	MAZDA	1994-97	1.8L
CA-8897	ACCELERATOR CABLE	MAZDA	1986-87	2.0L
CA-8899	ACCELERATOR CABLE	MAZDA	1993-95	1.3L
CA-8900	ACCELERATOR CABLE	MAZDA	1994-95	1.6L
CA-8901	ACCELERATOR CABLE	NISSAN	1987-88	1.6L, 1.8L
CA-8902	ACCELERATOR CABLE	NISSAN	1987-88	1.6L
CA-8903	ACCELERATOR CABLE	NISSAN	1989-90	1.6L
CA-8905	ACCELERATOR CABLE	LEXUS	1992-97	4.0L
CA-8906	ACCELERATOR CABLE	LEXUS	1992-97	3.0L
CA-8908	ACCELERATOR CABLE	LEXUS	1995-97	4.0L
CA-8909	ACCELERATOR CABLE	LEXUS, TOYOTA	1992-95	2.2L, 2.5L, 3.0L
CA-8910	ACCELERATOR CABLE	LEXUS	1990-93	4.0L
CA-8912	ACCELERATOR CABLE	DODGE, MITUBISHI	1987-89	2.0L, 2.6L
CA-8914	ACCELERATOR CABLE	DODGE, EAGLE, MITSUBISHI	1993-96	1.5L
CA-8919	ACCELERATOR CABLE	MINIBISHI	1994-98	2.4L
CA-8921	ACCELERATOR CABLE	HONDA	1992-97	1.5L, 1.6L
CA-8922	ACCELERATOR CABLE	ACURA, HONDA	1994-98	1.6L, 1.8L
CA-8923	ACCELERATOR CABLE	HONDA	1995-97	2.2L
CA-8924	ACCELERATOR CABLE	HONDA	1993-95	1.5L
CA-8925	ACCELERATOR CABLE	HONDA	1992-95	1.5L
CA-8926	ACCELERATOR CABLE	HONDA	1990-97	2.2L
CA-8927	ACCELERATOR CABLE	HONDA	1990-93	2.2L
CA-8928	ACCELERATOR CABLE	HONDA	1990-93	2.2L
CA-8930	ACCELERATOR CABLE	ACURA	1992-94	2.5L
CA-8931	ACCELERATOR CABLE	NISSAN	1989-93	3.0L
CA-8932	ACCELERATOR CABLE	NISSAN	1988-88	3.0L
CA-8934	ACCELERATOR CABLE	TOYOTA	1993-97	1.6L, 1.8L
CA-8936	ACCELERATOR CABLE	NISSAN	1988-89	3.0L
CA-8937	ACCELERATOR CABLE	NISSAN	1990-94	3.0L
CA-8938	ACCELERATOR CABLE	NISSAN	1990-90	2.4L
CA-8939	ACCELERATOR CABLE	NISSAN	1992-93	3.0L
CA-8941	ACCELERATOR CABLE	TOYOTA	1984-86	1.6L
CA-8942	ACCELERATOR CABLE	TOYOTA	1986-87	1.6L
CA-8943	ACCELERATOR CABLE	TOYOTA	1988-89	1.6L
CA-8944	ACCELERATOR CABLE	TOYOTA	1990-92	1.6L
CA-8946	ACCELERATOR CABLE	NISSAN	1987-88	2.4L
CA-8949	ACCELERATOR CABLE	INFINITI, NISSAN	1994-97	3.0L
CA-8950	ACCELERATOR CABLE	NISSAN	1994-95	2.4L
CA-8952	ACCELERATOR CABLE	TOYOTA	1986-86	2.0L
CA-8953	ACCELERATOR CABLE	TOYOTA	1987-89	2.0L
CA-8954	ACCELERATOR CABLE	TOYOTA	1986-87	2.0L
CA-8955	ACCELERATOR CABLE	TOYOTA	1987-89	2.0L
CA-8956	ACCELERATOR CABLE	TOYOTA	1988-92	3.0L
CA-8957	ACCELERATOR CABLE	TOYOTA	1990-91	2.2L
CA-8958	ACCELERATOR CABLE	TOYOTA	1990-91	2.2L
CA-8959	ACCELERATOR CABLE	TOYOTA	1992-93	2.2L
CA-8960	ACCELERATOR CABLE	TOYOTA	1992-93	2.2L
CA-8961	ACCELERATOR CABLE	TOYOTA	1990-93	1.6L
CA-8962	ACCELERATOR CABLE	TOYOTA	1991-93	1.6L
CA-8963	ACCELERATOR CABLE	TOYOTA	1993-95	2.2L

Part	Description	Make	Years	Engines
CA-8964	ACCELERATOR CABLE	TOYOTA	1994-95	1.8L
CA-8966	ACCELERATOR CABLE	TOYOTA	1996-97	1.5L
CA-8967	ACCELERATOR CABLE	TOYOTA	1990-94	1.5L
CA-8968	ACCELERATOR CABLE	TOYOTA	1988-90	1.5L
CA-8969	ACCELERATOR CABLE	NISSAN	1987-87	1.6L
CA-8970	ACCELERATOR CABLE	NISSAN	1987-87	1.6L
CA-8971	ACCELERATOR CABLE	NISSAN	1990-91	2.4L
CA-8972	ACCELERATOR CABLE	TOYOTA	1990-90	1.5L
CA-8973	ACCELERATOR CABLE	TOYOTA	1988-89	1.6L
CA-8975	ACCELERATOR CABLE	TOYOTA	1989-92	3.0L
CA-8977	ACCELERATOR CABLE	TOYOTA	1991-95	2.4L
CA-8978	ACCELERATOR CABLE	EAGLE, PLYMOUTH	1990-93	1.8L
CA-8981	ACCELERATOR CABLE	SUZUKI	1986-95	1.3L
CA-8982	ACCELERATOR CABLE	TOYOTA	1988-91	1.6L
CA-8983	ACCELERATOR CABLE	INFINITI, NISSAN	1991-93	2.0L
CA-8989	ACCELERATOR CABLE	HYUNDAI, MITSUBISHI	1990-94	1.5L
CA-8990	ACCELERATOR CABLE	NISSAN	1984-85	2.0L
CA-8991	ACCELERATOR CABLE	INFINITI	1994-96	2.0L
CA-8993	ACCELERATOR CABLE	MAZDA	1992-94	1.8L
CA-8995	ACCELERATOR CABLE	HONDA	1990-97	2.2L
CA-8996	ACCELERATOR CABLE	ACURA	1991-95	3.2L
CA-8997	ACCELERATOR CABLE	MAZDA	1995-97	2.5L
CA-8998	ACCELERATOR CABLE	HYUNDAI	1992-95	1.6L, 1.8L
CA-8999	ACCELERATOR CABLE	NISSAN	1982-83	2.0L
CA-9002	ACCELERATOR CABLE	NISSAN	1993-94	2.4L
CA-9004	ACCELERATOR CABLE	DODGE, MITSUBISHI	1990-96	2.4L
CA-9005	ACCELERATOR CABLE	MAZDA	1995-97	1.5L, 1.8L
CA-9008	ACCELERATOR CABLE	CHEVROLET, TOYOTA	1984-88	1.6L
CA-9010	ACCELERATOR CABLE	TOYOTA	1996-00	3.4L
CA-9013	ACCELERATOR CABLE	TOYOTA	1990-92	4.0L
CA-9015	ACCELERATOR CABLE	TOYOTA	1993-97	4.5L
CA-9017	ACCELERATOR CABLE	MITSUBISHI	1997-99	1.5L
CA-9018	ACCELERATOR CABLE	MITSUBISHI	1997-99	1.8L
CA-9021	ACCELERATOR CABLE	INFINITI, NISSAN	1996-99	3.3L
CA-9022	ACCELERATOR CABLE	INFINITI	1990-96	4.5L
CA-9023	ACCELERATOR CABLE	FORD, LINCOLN	1991-94	4.6L
CA-9024	ACCELERATOR CABLE	FORD, LINCOLN	1995	4.6L
CA-9025	ACCELERATOR CABLE	FORD, LINCOLN	1996-97	4.6L
CA-9026	ACCELERATOR CABLE	FORD, LINCOLN	1998-00	4.6L
CA-9027	ACCELERATOR CABLE	FORD, LINCOLN	2001-04	4.6L
CA-9028	ACCELERATOR CABLE	FORD	1992-97	5.0L, 5.8L
CA-9029	ACCELERATOR CABLE	FORD	1992-96	7.5L
CA-9030	ACCELERATOR CABLE	FORD	1992-96	5.0L, 5.8L
CA-9031	ACCELERATOR CABLE	FORD	1997-00	4.2L
CA-9032	ACCELERATOR CABLE	FORD	1997-00	6.8L
CA-9033	ACCELERATOR CABLE	FORD	1986-93	5.0L
CF-100	CLUTCH FORK	BUICK, CHEVROLET, GMC, PONTIAC	1963-05	3.8L, 4.1L, 4.4L, 3.8L, 4.3L, 4.4L, 4.9L, 5.0L, 5.7L, 6.2L, 6.6L, 7.4L, 7.5L
CF-101	CLUTCH FORK	FORD	1970-79	3.9L, 4.9L, 5.0L, 5.8L, 5.9L, 6.4L, 6.6L
CF-102	CLUTCH FORK	FORD	1975-79	4.9L, 5.0L, 5.8L, 7.5L
CF-103	CLUTCH FORK	FORD	1979-82	4.9L, 3.8L, 4.2L, 5.0L, 5.8L, 6.6L
CF-104	CLUTCH FORK	CHEVROLET, GMC	1979-84	5.7L
CF-106	CLUTCH FORK	BUICK, CADILLAC, CHEVROLET, OLDSMOBILE, PONTIAC	1980-89	1.8L, 2.0L, 2.5L, 2.8L
CF-107	CLUTCH FORK	FORD	1980-82	4.9L, 5.0L, 5.8L, 6.6L, 7.5L
CF-110	CLUTCH FORK	JEEP	1980-87	2.5L, 4.0L, 4.2L, 5.0L, 5.9L
CF-111	CLUTCH FORK	JEEP	1974-79	3.8L, 4.2L, 5.0L, 5.9L, 6.6L
CF-112	CLUTCH FORK	AMERICAN MOTORS, JEEP	1977-88	2.5L, 3.8L, 4.2L, 2.8L, 5.0L, 5.9L
CF-113	CLUTCH FORK	JEEP	1966-71	3.7L
CF-114	CLUTCH FORK	NISSAN	1976-89	1.4L, 1.8L, 2.0L, 2.2L, 2.4L, 2.5L, 2.4L, 2.8L, 3.0L
CF-115	CLUTCH FORK	DODGE	1981-87	3.7L, 5.2L, 5.9L
CF-116	CLUTCH FORK	CHEVROLET, GMC	1985-91	4.4L, 4.3L, 5.0L, 5.7L, 6.2L, 7.4L
CF-117	CLUTCH FORK	FORD	1984-98	4.9L, 6.8L, 4.28 4.6L, 5.0L, 5.4L, 5.8L, 6.9L, 7.3L, 7.5L
CF-119	CLUTCH FORK	FORD, MERCURY	1982-93	5.0L

Part	Description	Make	Years	Engines
CF-123	CLUTCH FORK	FORD	1958-59	3.7L, 4.8L, 5.8L
CF-125	CLUTCH FORK	JEEP	1946-71	2.2L, 3.1L, 3.7L
CF-126	CLUTCH FORK	CHEVROLET, GMC	1985-96	1.9L, 2.2L, 2.5L, 2.8L, 4.3L, 5.0L, 5.7L, 6.2L, 6.5L, 7.4L
CF-128	CLUTCH FORK	CHEVROLET, GMC	1984-96	1.9L, 2.0L, 2.2L, 2.5L, 2.8L, 4.3L
CF-129	CLUTCH FORK	CHEVROLET, PONTIAC	1984-89	2.5L, 2.8L
CF-131	CLUTCH FORK	CHRYSLER, DODGE, PLYMOUTH	1974-87	1.4L, 1.6L, 1.7L, 2.0L, 2.2L, 2.6L, 3.7L, 4.0L, 3.9L, 5.2L, 5.9L, 6.6L, 7.2L
CF-132	CLUTCH FORK	CHEVROLET, GEO	1985-92	1.6L
CF-133	CLUTCH FORK	CHEVROLET, PONTIAC	1984-92	5.0L
CF-134	CLUTCH FORK	PONTIAC	1987-88	2.5L, 2.8L
CF-135	CLUTCH FORK	PONTIAC	1987-89	2.5L
CF-136	CLUTCH FORK	OLDSMOBILE, PONTIAC	1989-92	2.3L, 2.8L, 3.1L, 3.3L, 3.4L
CF-141	CLUTCH FORK	DODGE	1989-91	5.9L, 3.9L, 5.2L, 5.9L
CF-142	CLUTCH FORK	CHRYSLER, DODGE, PLYMOUTH	1982-94	2.2L
CF-146	CLUTCH FORK	DODGE, JEEP	1993-01	3.9L, 4.7L, 5.2L, 5.9L
CF-151	CLUTCH FORK	FORD	1984-97	6.9L, 7.5L
SPS-1305	SPEED SENSOR	NISSAN	1998-01	1.6L, 2.4L
SPS-1307	SPEED SENSOR	HONDA	1998-02	2.3L, 3.0L
SPS-1310	SPEED SENSOR	MAZDA	1993-02	2.0L, 2.5L
SPS-1311	SPEED SENSOR	HONDA	1990-93	2.2L, 2.3L
SPS-1313	SPEED SENSOR	TOYOTA	1992-05	2.0L, 2.2L, 2.4L
SPS-1316	SPEED SENSOR	HONDA	2001-05	1.3L, 1.7L
SPS-1317	SPEED SENSOR	NISSAN	1995-99	1.6L, 2.0L
SPS-1318	SPEED SENSOR	NISSAN	1995-97	2.4L
SPS-1319	SPEED SENSOR	HONDA	1992-01	1.5L, 1.6L, 2.2L, 2.3L, 2.7L, 3.5L
SPS-1320	SPEED SENSOR	AUDI	1994-05	1.8L, 2.0L, 2.7L, 2.8L, 3.0L, 3.2L, 4.2L
SPS-1321	SPEED SENSOR	TOYOTA	1992-05	2.0L, 2.2L, 2.4L
SPS-1322	SPEED SENSOR	ACURA	2002-06	2.0L
SPS-1324	SPEED SENSOR	NISSAN	1995-97	3.0L
SPS-1326	SPEED SENSOR	LEXUS, TOYOTA	1992-98	3.0L
SPS-1328	SPEED SENSOR	HONDA	2000-03	1.0L
SPS-1329	SPEED SENSOR	HONDA	2005-05	1.7L
SPS-1331	SPEED SENSOR	HYUNDAI	2002-06	2.0L
SPS-1332	SPEED SENSOR	HONDA	1996-00	1.6L
SPS-1333	SPEED SENSOR	HONDA	1996-00	1.6L
SPS-1334	SPEED SENSOR	ACURA	1994-01	1.8L
SPS-1335	SPEED SENSOR	HONDA	1996-00	1.6L
SPS-1337	SPEED SENSOR	HONDA	1997-01	2.0L
SPS-1338	SPEED SENSOR	HONDA	1999-00	1.6L
SPS-1340	SPEED SENSOR	HYUNDAI	1995-98	2.0L, 3.0L
SPS-1341	SPEED SENSOR	HONDA	1990-91	2.0L, 2.1L
SPS-1343	SPEED SENSOR	TOYOTA	1993-97	3.0L
SPS-1344	SPEED SENSOR	ACURA	1996-04	3.5L
SPS-1345	SPEED SENSOR	HONDA	1998-00	1.6L
SPS-1350	SPEED SENSOR	ACURA	1992-96	2.5L, 3.2L
SPS-1351	SPEED SENSOR	NISSAN	2002-03	1.8L, 2.5L
SPS-1352	SPEED SENSOR	HONDA	1998-01	2.0L
SPS-1353	SPEED SENSOR	HONDA	2002-06	2.4L
SPS-1356	SPEED SENSOR	TOYOTA	1992-95	2.2L
SPS-1357	SPEED SENSOR	HONDA	1996-00	1.6L
SPS-1358	SPEED SENSOR	ACURA	2002-06	2.0L
SPS-1359	SPEED SENSOR	NISSAN	1998-99	1.6L, 2.0L
SPS-1360	SPEED SENSOR	HONDA	1999-00	1.6L
SPS-1362	SPEED SENSOR	TOYOTA	1991-93	2.4L
SPS-1364	SPEED SENSOR	TOYOTA	1995-97	2.4L
SPS-1365	SPEED SENSOR	TOYOTA	1996-05	2.0L, 2.4L, 3.0L
SPS-1366	SPEED SENSOR	TOYOTA	1993-97	2.4L, 3.0L
SPS-1368	SPEED SENSOR	TOYOTA	2000-05	1.5L
TAT-5200	ALIGNMENT TOOL	CHEVROLET	1962-66	5.7L, 6.0L, 6.7L
TAT-5201	ALIGNMENT TOOL	ACURA, HONDA	1983-89	1.5L, 1.6L, 1.8L
TAT-5202	ALIGNMENT TOOL	HONDA	1989-00	1.5L, 1.6L
TAT-5203	ALIGNMENT TOOL	CHRYSLER, DODGE, PLYMOUTH	1991-95	2.2L, 2.5L, 3.0L
TAT-5206	ALIGNMENT TOOL	VOLVO	1976-97	2.3L, 2.3L, 2.4L, 2.4L, 2.7L
TAT-5207	ALIGNMENT TOOL	ALFA ROMEO	1975-89	2.0L, 2.5L, 3.0L
TAT-5208	ALIGNMENT TOOL	AUDI	1983-98	2.0L, 2.2L, 2.3L, 2.8L, 3.6L, 4.2L

Part	Description	Make	Years	Engines
TAT-5209	ALIGNMENT TOOL	INFINITI, NISSAN	1987-01	1.6L, 1.8L, 2.0L
TAT-5210	ALIGNMENT TOOL	DODGE	1992-93	2.5L, 3.9L, 5.2L, 5.9L
TAT-5211	ALIGNMENT TOOL	ACURA, HONDA, ISUZU, STERLING	1986-01	1.6L, 1.7L, 1.8L, 2.5L, 2.7L, 2.8L, 3.1L
TAT-5212	ALIGNMENT TOOL	DODGE, PLYMOUTH	1995-99	2.0L
TAT-5213	ALIGNMENT TOOL	AUDI, VOLKSWAGEN	1993-01	1.8L, 1.9L, 2.0L
TAT-5214	ALIGNMENT TOOL	TOYOTA	1996-98	3.0L
TAT-5215	ALIGNMENT TOOL	DODGE	1996-98	2.5L
TAT-5300	ALIGNMENT TOOL	INFINITI, NISSAN	1965-02	1.3L, 1.6L, 1.8L, 2.0L, 2.2L, 2.4L, 2.5L, 2.4L, 2.6L, 2.8L, 3.0L, 3.3L, 3.5L
TAT-5301	ALIGNMENT TOOL	AMERICAN MOTORS, BUICK, CHECKER, CHEVROLET, GMC, ISUZU, JEEP, MERCEDES BENZ, OLDSMOBILE, PONTIAC, VOLVO	1950-02	1.9L, 2.9L, 2.3L, 2.4L, 2.5L, 3.9L, 2.3L, 2.6L, 2.8L, 3.0L, 3.2L, 3.5L, 3.6L, 3.8L, 3.9L, 4.0L, 4.1L, 4.2L, 4.3L, 4.8L, 2.8L, 3.2L, 3.3L, 3.7L, 3.8L, 4.3L, 5.0L, 4.3L, 4.4L,
TAT-5301	ALIGNMENT TOOL	AMERICAN MOTORS, BUICK, CHECKER, CHEVROLET, GMC, ISUZU, JEEP, MERCEDES BENZ, OLDSMOBILE, PONTIAC, VOLVO	1950-02	4.6L, 4.8L, 4.9L, 5.0L, 5.3L, 5.4L, 5.6L, 5.7L, 6.0L, 6.2L, 6.4L, 6.5L, 6.6L, 6.7, 7.0L, 7.4L, 7.5L
TAT-5302	ALIGNMENT TOOL	AUDI, PORSCHE, VOLKSWAGEN	1954-93	H4 1.2L, 1.3L, 1.5L, 1.6L, 1.7L, 1.8L, 1.9L, H6 2.0L, 2.2L, 1.5L, 1.6L, 1.7L, 1.8L
TAT-5303	ALIGNMENT TOOL	LEXUS, TOYOTA	1970-01	1.9L, 2.0L, 2.2L, 2.4L, 2.7L, 2.3L, 2.6L, 2.8L, 3.0L, 2.5L, 3.0L, 3.4L
TAT-5304	ALIGNMENT TOOL	FORD, JEEP, MERCURY	1950-02	2.8L, 3.3L, 3.5L, 3.7L, 3.8L, 3.9L, 4.1L, 4.2L, 4.9L, 3.8L, 4.2L, 3.6L, 3.9L, 4.2L, 4.3L, 4.6L, 4.7L, 4.8L, 5.0L, 5.8L, 5.9L, 6.4L, 6.6L, 6.9L, 7.0L, 7.5L
TAT-5305	ALIGNMENT TOOL	NISSAN	1971-82	1.2L, 1.3L, 1.4L, 1.5L
TAT-5306	ALIGNMENT TOOL	CHEVROLET, GEO, RENAULT, TOYOTA	1968-02	1.5L, 1.6L, 1.8L, 2.2L, 2.3L
TAT-5307	ALIGNMENT TOOL	FORD, KIA, MAZDA, MERCURY, VOLVO	1971-02	1.6L, 1.8L, 2.0L, 2.1L, 2.2L, 2.3L, L6, 2.4L, R2 1.1L, 1.3L, 1.8L, 2.5L
TAT-5308	ALIGNMENT TOOL	HONDA	1973-87	1.2L, 1.3L, 1.5L, 1.6L
TAT-5309	ALIGNMENT TOOL	CHRYSLER, DODGE, MITSUBISHI, PLYMOUTH	1959-98	2.8L, 3.2L, 3.7L, 3.0L, 3.9L, 4.5L, 5.2L, 5.6L, 5.9L, 6.3L, 6.6L, 6.8L, 7.0L, 7.2L
TAT-5310	ALIGNMENT TOOL	DODGE, EAGLE, FORD, HONDA, HYUNDAI, KIA, MAZDA, MERCURY, MITSUBISHI, PLYMOUTH	1970-01	1.5L, 1.6L, 1.8L, 1.9L, 2.0L, 2.3L, 2.4L, 2.5L, 3.0L, 3.2L
TAT-5311	ALIGNMENT TOOL	AMERICAN MOTORS, CHEVROLET, DODGE, EDEL, FORD, MERCURY, MITSUBISHI, OLDSMOBILE, PLYMOUTH, PONTIAC, PORSCHE, TRIUMPH	1958-99	H6 3.2L, 3.3L, 3.6L, 1.2L, 2.0L, 2.2L, 2.3L, 2.4, 2.5L, 2.6L, 2.7L, 3.0L, 3.7L, 2.8L, 2.9, 3.0L, 3.4L, 3.6L, 4.5L, 4.7L, 4.8L, 5.0L, 5.4L, 5.8L, 5.9L, 6.4L, 6.7L
TAT-5312	ALIGNMENT TOOL	CHEVROLET, GMC, ISUZU, JEEP, MERCEDES BENZ, PONTIAC, SAAB	1976-99	1.4L, 1.6L, 1.9L, 2.0L, 2.1L, 2.2L, 2.3L, 2.5L, 2.6L, 2.6L, 2.8L, 3.1L, 4.3L
TAT-5313	ALIGNMENT TOOL	BUICK, CHEVROLET, GMC, ISUZU, MERCEDES-BENZ, OLDSMOBILE, PONTIAC	1965-02	2.2L, 2.3L, L6, 2.6L, 3.0L, 3.2L, 3.4L, 3.8L, 4.3L, 4.9L, 5.0L, 5.4L, 5.7L, 6.6L, 7.4L, 7.5L
TAT-5314	ALIGNMENT TOOL	TOYOTA	1974-83	1.2L, 1.3L
TAT-5316	ALIGNMENT TOOL	CHEVROLET, HONDA, ISUZU, PONTIAC	1972-02	1.8L, 1.9L, 2.0L, 2.2L, 2.3L, 2.6L, 3.2L, 3.5L
TAT-5317	ALIGNMENT TOOL	BMW	1966-01	1.6L, 1.8L, 1.9L, 2.0L, 2.3L, 2.4L, 2.5L, 2.7L, 2.8L, 3.0L, 3.2L, 3.6L, 3.0L
TAT-5318	ALIGNMENT TOOL	TRIUMPH	1968-76	2.5L
TAT-5319	ALIGNMENT TOOL	HONDA	1979-89	1.8L, 2.0L
TAT-5320	ALIGNMENT TOOL	VOLVO	1962-78	1.8L, 2.0L, 2.1L
TAT-5321	ALIGNMENT TOOL	SUBARU	1978-80	H4 1.6L
TAT-5322	ALIGNMENT TOOL	DODGE, NISSA, SUBARU	1971-02	H4 1.8L, 2.2L, 2.5L, H6 2.7L, 1.4L, 1.6L
TAT-5324	ALIGNMENT TOOL	FIAT, YUGO	1971-90	1.1L, 1.3L
TAT-5325	ALIGNMENT TOOL	FORD	1951-01	3.5L, 3.7L, 4.3L, 3.9L, 4.5L, 4.8L, 7.3L
TAT-5326	ALIGNMENT TOOL	TOYOTA	1969-87	3.9L, 4.2L
TAT-5327	ALIGNMENT TOOL	SUBARU	1981-95	H4 1.8L
TAT-5328	ALIGNMENT TOOL	FORD	1960-65	3.9L, 5.4L, 5.9L
TAT-5330	ALIGNMENT TOOL	TRIUMPH	1973-74	1.5L
TAT-5331	ALIGNMENT TOOL	MERCURY, TRIUMPH, VOLKSWAGEN	1972-99	1.9L, 2.0L, 2.6L, 2.8L
TAT-5332	ALIGNMENT TOOL	SAAB	1986-97	2.0L, 2.3L, 2.5L, 3.0L

Part	Description	Make	Years	Engines
TAT-5334	ALIGNMENT TOOL	INTERNATIONAL	1961-70	2.5L, 3.2L, 3.6L, 4.3L, 4.4L, 5.0L, 5.6L
TAT-5335	ALIGNMENT TOOL	PORSCHE, VOLKSWAGEN	1970-91	H4 1.7L, 1.8L, 1.9L, 2.0L, 2.1L
TAT-5336	ALIGNMENT TOOL	FORD, MERCURY	1965-77	3.3L
TAT-5337	ALIGNMENT TOOL	DODGE, FORD, MAZDA, MERCURY, PLYMOUTH	1971-89	1.6L, 2.0L
TAT-5339	ALIGNMENT TOOL	FIAT, FORD, SAAB, VOLVO	1976-93	1.5L, 1.6L, 2.0L, 2.1L, 2.3L, 2.1L
TAT-5340	ALIGNMENT TOOL	SAAB, TOYOTA	1968-89	1.1L, 1.2L, 2.0L
TAT-5341	ALIGNMENT TOOL	BMW, FORD, MERCURY	1964-99	2.3L, 2.8L, 3.3L, 2.8L, 4.3L,
TAT-5342	ALIGNMENT TOOL	BUICK, CADILLAC, CHEVROLET, GEO, GMC, ISUZU, JEEP, OLDSMOBILE, PONTIAC	1980-02	1.5L, 1.6L, 1.8L, 1.9L, 2.0L, 2.1L, 2.2L, 2.3L, 2.4L, 2.5L, 2.8L, 3.0L, 3.1L
TAT-5345	ALIGNMENT TOOL	RENAULT	1980-83	1.4L
TAT-5349	ALIGNMENT TOOL	AMERICAN MOTORS, CHRYSLER, DODGE, PLYMOUTH, STUDEBAKER	1955-87	2.8L, 3.0L, 3.2L, 3.3L, 3.7L, 3.8L, 4.2L, 4.5, 4.8L, 5.0L, 5.2L, 5.6L, 5.8L, 5.9L, 6.3L, 6.4L
TAT-5351	ALIGNMENT TOOL	AUDI, VOLKSWAGEN	1978-91	1.6L, 1.7L, 2.0L, 2.2L, 2.3L
TAT-5352	ALIGNMENT TOOL	BMW	1991-02	3.0L, V12 5.0L, 5.4L, 5.6L, 4.0L, 4.4L
TAT-5356	ALIGNMENT TOOL	PEUGEOT	1974-91	2.0L, 2.1L, 2.2L, 2.3L, 2.5L, 2.7L, 2.8L
TAT-5359	ALIGNMENT TOOL	AMERICAN MOTORS	1959-61	4.1L
TAT-5359	ALIGNMENT TOOL	AMERICAN MOTORS	1964-66	4.7L
TAT-5359	ALIGNMENT TOOL	AMERICAN MOTORS	1967-69	4.8L
TAT-5359	ALIGNMENT TOOL	AMERICAN MOTORS	1970-71	5.0L
TAT-5359	ALIGNMENT TOOL	AMERICAN MOTORS	1960-66	5.4L
TAT-5359	ALIGNMENT TOOL	AMERICAN MOTORS	1967-69	5.6L
TAT-5359	ALIGNMENT TOOL	AMERICAN MOTORS	1970-74	5.9L
TAT-5359	ALIGNMENT TOOL	AMERICAN MOTORS	1968-70	6.4L
TAT-5359	ALIGNMENT TOOL	AMERICAN MOTORS	1971-74	6.6L
TAT-5359	ALIGNMENT TOOL	DODGE	1992-96	2.5L
TAT-5359	ALIGNMENT TOOL	DODGE	1992-01	3.9L
TAT-5359	ALIGNMENT TOOL	DODGE	2000	4.7L
TAT-5359	ALIGNMENT TOOL	DODGE	1994-01	5.2L
TAT-5359	ALIGNMENT TOOL	DODGE	1994-98	5.9L
TAT-5359	ALIGNMENT TOOL	JEEP	1966-67	3.8L
TAT-5359	ALIGNMENT TOOL	JEEP	1994-02	4.0L
TAT-5359	ALIGNMENT TOOL	JEEP	1972-86	4.2L
TAT-5359	ALIGNMENT TOOL	JEEP	1966-67	3.7L
TAT-5359	ALIGNMENT TOOL	JEEP	1965-67	5.4L
TAT-5359	ALIGNMENT TOOL	JEEP	1972-86	5.9L
TAT-5359	ALIGNMENT TOOL	JEEP	1974-75	6.6L
TAT-5359	ALIGNMENT TOOL	STUDEBAKER	1956-58	4.2L
TAT-5359	ALIGNMENT TOOL	STUDEBAKER	1963-64	4.8L
TAT-5360	ALIGNMENT TOOL	DODGE, EAGLE, FIAT, FORD, HYUNDAI, MAZDA, MERCURY, MITSUBISHI, PLYMOUTH, PORSCHE	1969-01	2.7L, 3.0L, 3.2L, 1.3L, 1.4L, 1.5L, 1.6L, 1.8L, 2.0L, 2.2L
TAT-5363	ALIGNMENT TOOL	CHRYSLER, DODGE, PLYMOUTH	1981-90	1.6L, 1.7L, 2.2L, 2.5L, 2.6L, 3.0L
TAT-5365	ALIGNMENT TOOL	AMERICAN MOTORS	1971-77	4.2L, 5.9L
TAT-5373	ALIGNMENT TOOL	ALFA ROMEO	1981-95	2.5L, 3.0L
TAT-5375	ALIGNMENT TOOL	AMERICAN MOTORS	1972-78	3.8L, 4.2L, 5.0L
TAT-5376	ALIGNMENT TOOL	AMERICAN MOTORS	1964-78	3.2L, 3.8L, 4.2L
TAT-5378	ALIGNMENT TOOL	DODGE, PLYMOUTH, VOLKSWAGEN	1975-01	1.5L, 1.6L, 1.7, 1.8L, 1.9L, 2.0L
TAT-5379	ALIGNMENT TOOL	INTERNATIONAL	1980-80	5.6L
TAT-5385	ALIGNMENT TOOL	DODGE	1968-68	5.2L
TAT-5386	ALIGNMENT TOOL	CHEVROLET, GEO, PONTIAC, SUZUKI	1985-01	L3 1.0L, 1.3L, 1.6L
TAT-5388	ALIGNMENT TOOL	RENAULT	1983-87	1.4L, 1.7L, 2.0L
TAT-5390	ALIGNMENT TOOL	ACURA, HONDA	1988-01	2.0L, 2.2L, 2.3L, 3.2L
TAT-5391	ALIGNMENT TOOL	NISSAN	1982-90	1.5L, 1.6L, 1.7L, 2.0L
TAT-5392	ALIGNMENT TOOL	SUBARU	1987-94	L3 1.2L
TAT-5393	ALIGNMENT TOOL	CHEVROLET, GOE, SUZUKI	1986-02	1.3L, 1.6L, 1.8L, 2.0L,
TAT-5394	ALIGNMENT TOOL	TOYOTA	1983-01	1.8L, 2.0L, 2.2L
TAT-5395	ALIGNMENT TOOL	TOYOTA	1988-95	1.6L, 2.0L
TAT-5397	ALIGNMENT TOOL	CHEVROLET, GEO, ISUZU, PONTIAC	1985-93	1.5L, 1.6L

<b>Part</b>	<b>Description</b>	<b>Make</b>	<b>Years</b>	<b>Engines</b>
TAT-5400	ALIGNMENT TOOL	FORD	1988-97	1.3L
TAT-5401	ALIGNMENT TOOL	DODGE, MITSUBISHI	1989-99	3.0L, 3.5L
TAT-5402	ALIGNMENT TOOL	DAIHATSU	1988-92	L3 1.0L, 1.3L, 1.6L
TAT-5403	ALIGNMENT TOOL	VOLKSWAGEN	1986-99	1.8L, 1.9L, 2.0L 2.4L, 2.5L, 2.8L
TAT-5407	ALIGNMENT TOOL	SATURN	1991-99	1.9L
TAT-5408	ALIGNMENT TOOL	FORD, MAZDA, MERCURY, MERKUR, MITSUBISHI	1985-02	2.0L, 2.2L, 2.3L, 2.5L, 2.6L, 1.3L, 2.5L, 2.9L 3.0L, 4.0L
TAT-5409	ALIGNMENT TOOL	FORD	1987-02	6.8L, 5.4L, 6.9L, 7.3L, 7.5L
TAT-5412	ALIGNMENT TOOL	DODGE	1989-98	5.9L, 8.0L
TAT-5423	ALIGNMENT TOOL	ACURA, HONDA	1990-01	2.0L, 2.2L, 2.3L, 2.5L