

Full Line Catalog



# 2012 Catalog

**Professional  
Products®**

- Intake Manifolds
- Harmonic Dampers
- [Fuel Injection Systems](#)
- Fuel System Components
- Distributors & Ignition
- Engine Accessories
- Throttle Bodies

**The Premier Line of Affordable Performance Products**

# Professional Products® 2012 Catalog Index

## Powerjection™ EFI Systems

Powerjection III™ & EFI Components Pages 3-7

## Powerfire Distributors & Coils

Powerfire Distributors & Coils Page 8

## Power+Plus® Intake Manifolds

Small Block Chevrolet Pages 9-12  
 GM LS1, LS2, LS6 Page 12  
 Big Block Chevrolet Page 13  
 Small Block Ford Page 14  
 5.0L Ford V8 Page 15  
 4.6L 2V Ford V8 Page 15  
 Small Block Chrysler Page 16  
 Pontiac V8 Page 16  
 Oldsmobile V8 Page 16  
 Acura Type R, GSR Page 17  
 RealChrome Manifolds Page 17  
 EFI Manifolds Page 18  
 Manifold Technical Specifications Page 19

## Intake Manifold Accessories & Engine Accessories

LS1, LS2, LS 6 Coil Covers Page 20  
 12-Point Stainless Bolt Kits Page 20  
 Airflo™ Power Enhancer Page 20  
 Upper Plenum & Elbow Adapter Page 20  
 Throttle Cable Bracket Kits Page 20  
 Gaskets Page 21  
 EGR Adapter, Carb Adapters Page 21  
 4.6L to 5.4L Adapter Plates Page 21  
 Carburetor Stud Kits Page 21  
 EFI Snorkle Inlet & Carb Adapters Pages 21-22

## Engine Accessories & Fuel Delivery Components

SB Chevy Water Pumps Page 22  
 Tire & Compression Gauges Page 22  
 Powerfire Ignition Systems & Coils Page 27  
 Powerfilter™ Oil Filters Page 23

## Power™ Throttle Bodies

Ford, Acura & GM Page 24

## Powerflow™ Fuel Filters

Street Fuel Filters Page 28  
 Competition Fuel Filters Page 28

## Powerflow™ Fuel Pumps

Fuel Pumps and EFI Pumps Page 29

## Powerflow™ Carburetor Inlet Kits

Carburetor Inlet Kits Page 29

## Powerflow™ Fuel Rail Kits

Powerflow™ Fuel Rail Kits, Ford & GM Page 25  
 Powerflow™ Fuel Rail Kits, Acura Page 23

## Powerflow™ Fuel Pressure Regulators

Powerflow™ Regulators Pages 26, 27

## Powerforce™ & Powerforce+Plus™ Harmonic Dampers

Features and benefits Page 30  
 Application Listing with weights Page 31  
 SB Chevy Page 32  
 BB Chevy Page 32  
 GM LT1 Page 32  
 GM LS1, & L92 Pages 32, 33  
 SB Ford Page 33  
 429-460 Ford, FE Ford Page 33  
 4.6L 2V & 4V Ford Page 33  
 4.6L 3V Ford Page 33  
 SB and BB Chrysler plus late Hemi Pages 33, 34  
 Dodge Viper Page 34  
 Pontiac Page 34  
 Oldsmobile Page 34  
 Honda, Acura, & Nissan Page 34  
 AMC, Jeep Page 34  
 Harmonic Damper Technical Notes Page 35  
 Harmonic Damper Accessories Page 36

**Important Note About the Professional Products Website:** Our website contains a large amount of additional information on our product line which cannot be included in the catalog. This includes dyno tests, copies of product instruction manuals, engineering drawings with bills of materials on certain products such as our Fuel Rail Kits, complete listings on our Powerflow Oil Filter applications and additional photos on some of our most popular items. Please go to our website at:

## Emission Codes

Professional Products, as well as other SEMA manufacturers, have adopted a series of color coded symbols that are used throughout the catalog to identify emission-sensitive products and to make the necessary information

available to consumers regarding the various uses that individual products will have related to any emissions regulations. Please review these symbols and their explanations as shown below.



The product marked with this symbol has been granted a California Air Resources Board (CARB) exemption, an "EO" number, or is a direct or consolidated replacement part. It is 50-state legal per the manufacturer's application guide. (Must be used on listed applications for that part to be legal.)



The manufacturer of the product marked with this symbol represents that it has not been found, nor is believed to be, unlawful for use under provisions of the clean air act, per the manufacturer's application guide. This product is not legal for sale or use in the state of California, or in states which have adopted the CA emissions standards, except on pre-emission controlled motor vehicles/motor vehicle engines (pre-1966 model years).



The product marked with this symbol is legal only for off-highway use (except in CA or states which have adopted CA emission standards), racing use or for use on pre-emission controlled motor vehicles/motor vehicle engines (pre-1966 domestic vehicles certified to CA standards, pre-1968 domestic vehicles certified to federal standards, and all pre-1968 foreign vehicles, per the manufacturer's application guide.



# POWERJECTION™ EFI SYSTEMS • The Standard of the Industry

Powerjection EFI systems are the most complete and most advanced EFI lineups available to the aftermarket today. Powerjection incorporates some of the most impressive feature sets available for the do-it-yourself hobbyist or professional shop. Powerjection consists of two distinct styles: Powerjection III is a throttle body style carburetor replacement EFI system with the EMS integrated into the throttle body for the hot-rodder who wants the look of a carburetor. Powerjection II is a port fuel injection system with the EMS mounted remotely. Powerjection II is designed for those who desire port fuel injection and/or very high horsepower capability. To the driver who is unaware what is under the hood there will be no discernable difference in the way the car drives with either system. We use interchangeable components that are OEM grade. We offer both designs to meet the needs and desires for the do-it-yourselfer.

Here are some of the features shared by all of our systems:

- Adaptive Learning EMS. While driving the system will adapt to your engine. The EMS is laptop programmable for the ultimate in tuning capability.
- Spark Timing Control integrated into the EMS for the ultimate in engine management. Note: Powerjection II can drive a coil directly and Powerjection III can drive the input to an ignition system
- A returnless option (**FuelOnDemand** 70035) is available for all kits. This eliminates the time consuming and sometimes difficult task of installing a return line to the fuel tank.
- No-weld oxygen sensor installation – drill a hole and install the clamp and sensor.
- Installation time is less than a day on all of our systems.

## POWERJECTION III

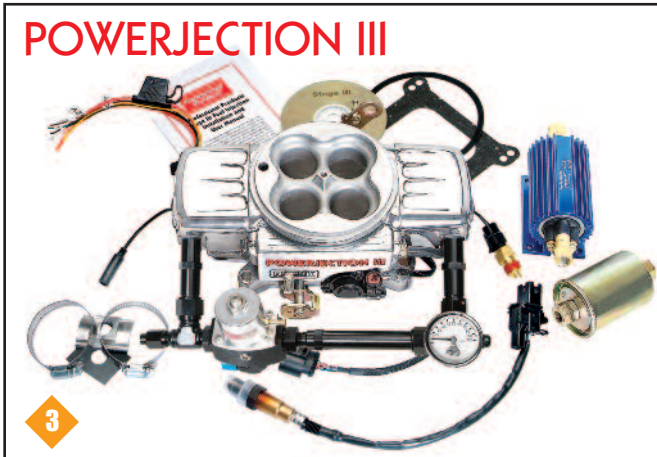

## POWERJECTION II

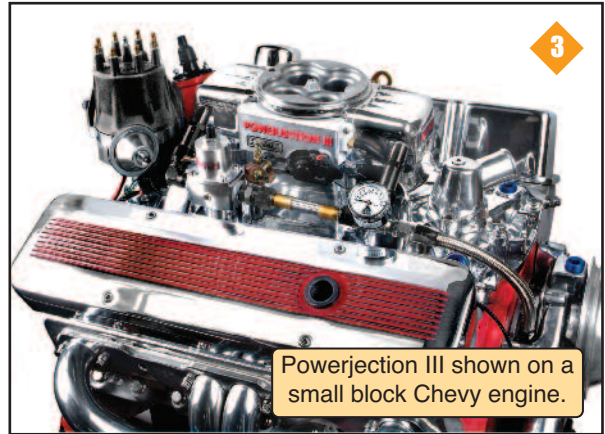
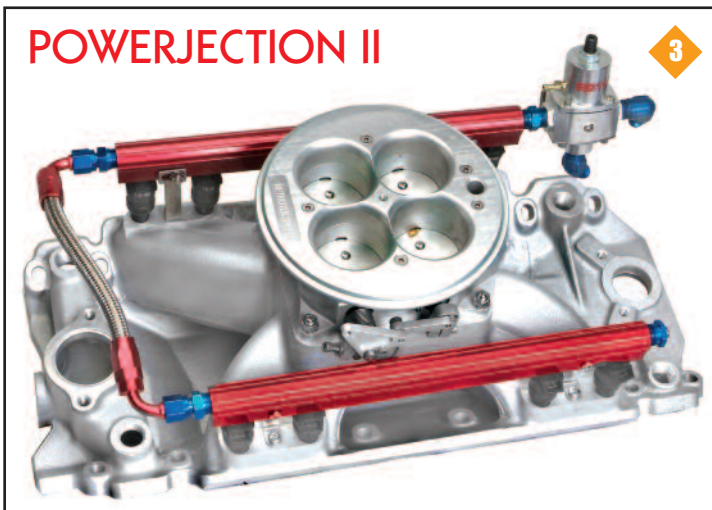

ABOVE - This is the POWERJECTION III on an engine. While the throttle body looks like a carburetor, it is actually a fully self-contained throttle body that includes four port style injectors, fuel rails, idle air control, MAP sensor, and throttle position sensor.

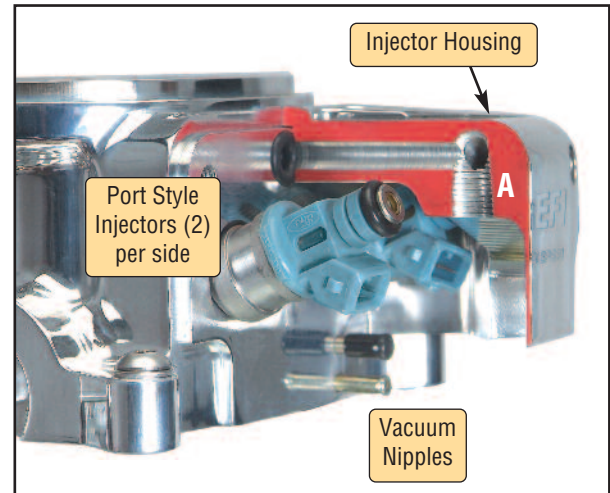

ABOVE - This cutaway shows how the part that looks like a carb float bowl is actually an injector housing. The two fuel inlets in the two end cap housings are threaded to accept a Professional Products Fuel Inlet Kit which is supplied with the Powerjection III kits. On systems using the Fuel Control Module to provide the returnless feature, the fuel pressure sensor threads into the tapped hole marked "A." The throttle body assembly incorporates the EMS (computer), idle air control (IAC) and the MAP sensor all into one compact unit.

Left - This photo shows one of our POWERJECTION II complete systems. This particular unit is our #72016 system which fits big block Chevys and utilizes a 2200 CFM 4500 (Dominator) style throttle body. The Dominator style throttle body is only available in billet form whereas our 1200 CFM 4150 style throttle bodies come in either billet or a more affordable cast design.

The POWERJECTION II is a complete system which includes a Stage 4 Engine Management System (EMS), harnesses, sensors, fuel pump, filter, fuel rails, regulator, and intake manifold. POWERJECTION II kits are currently available for SB Chevy, BB Chevy, SB Ford, SB 351W Ford, Pontiac and Oldsmobile. The Olds uses a dual plane manifold.

Powerjection II will include a totally new Stage 4 EMS (engine management system) that has an ignition driver that fires the coil. When used with a 2-wire distributor, such as our Powerfire II, an aftermarket ignition box (such as MSD-6A) is not required.

Part numbers and complete application information on all available POWERJECTION II, POWERJECTION III, and Powerjection+Plus kits, along with additional available components, are shown on the following pages.

**Harness for ignition switch, fuel pump, battery, and coil.**

**U.S. Patent #7,735,475**

**Installation/User Manual and Dashboard Software**

**Coolant Sensor and harness**

**EFI Fuel Pump and Filter**

**Laptop Connection**

**O<sup>2</sup> Sensor Bung, Gasket & Clamps. No welding required**

**Fuel Inlet Kit with Fuel Pressure Regulator and Gauge**

**Wideband O<sup>2</sup> is standard on all of our EFI Systems**

**O<sup>2</sup> Sensor Cable**

**Engine Management System - Includes TPS, MAP, and IAC. Eliminates an extensive amount of wiring.**

**70027 Kit shown, 70026 is same except it has a satin finish.**

**This is the Complete EFI kit. No other parts required.**

**What you see in the photo at left is the Complete Kit.**

- KEY FEATURES:**
- Most compact full featured aftermarket EFI available.
  - EMS (computer) mounts directly on the throttle body eliminating most of the wiring found on other systems.
  - No need to find a mounting spot for the computer. No hole through firewall for harness.
  - Utilizes wideband O<sup>2</sup> sensor which provides far better performance and tuning than found with narrow band sensor used on many competitive EFI systems.
  - Idle Air Control, Fuel Pressure Sensor (when utilized), throttle position sensor and MAP sensor all contained in throttle body assembly which eliminates mounting hassles and additional wiring.

**U.S. Patent #7,735,475**

**70021 Basic Kit shown, 70020 is same except it has a satin finish. This kit will require an EFI fuel pump, regulator and filter.**

750 CFM Pt. No.	1200 CFM* Pt. No.	Description
70020	70120	Powerjection III Basic Kit - Return - Satin
70021	70121	Powerjection III Basic Kit - Return - Polished
70026	70126	Powerjection III Complete Kit - Return - Satin
70027	70127	Powerjection III Complete Kit - Return - Polished
70028	70128	Powerjection III Complete Kit - Returnless - Satin
70029	70129	Powerjection III Complete Kit - Returnless - Polished
70107		P3 Fuel Fuel Delivery & Return Fuel Line Kit
70108		P3 Fuel Delivery Fuel Line Kit

The **Basic Kit** includes everything shown in the photo at left. Use the **Basic Kit** on vehicles that already have a return line, adequate fuel pump, and a fuel pressure regulator. The **Complete Kits** include everything shown in the photo above. The only option that may be required is the 70107 P3 Fuel Delivery & Return Line Kit. This kit includes enough -06AN stainless hose and fittings to plumb both the fuel delivery line and a fuel return line. Hose ends and fittings are included for the fuel pump and filter.

All of the listed kits are suitable for any V6 or V8 from stock up to 550 HP. Do not use on air cooled engines.

\*The 1200 CFM units are a limited production item that are available on a custom order basis only.

The Powerjection III is an amazing accomplishment in engineering. It is by far the simplest and cleanest aftermarket EFI system available. It is also one of the easiest to install and tune. The "Adaptive Learning" feature reduces the amount of interaction with the EMS that the Powerjection III owner needs to perform compared to other systems. With the minimal wiring exposed the Powerjection III has the cleanest installation for the street rod, street machine, or custom car enthusiast. This is the system you have been waiting for.

Just because this is one of the simplest and least expensive systems available that doesn't mean quality is left behind. We utilize wideband (actual Air Fuel Ratio, not some blinking lights) oxygen sensor measurements, a feature missing from many competitors. A 2.5 BAR MAP sensor is integrated into the EMS to measure up to 22 PSI boost for the supercharged / turbocharged aficionados. The fuel pump comes with a combination heat sink / mounting bracket for simplicity. The EMS mounts directly to the throttle body to eliminate unsightly

wiring and prevents unnecessary holes in the firewall.

We pioneered the "Adaptive Learning" feature which we have marketed for years. The Adaptive Learning handles much of the tuning chores for you in the background while you drive. When you choose a calibration for your engine you have the opportunity to customize it to your specific engine and the interface creates a base calibration for you. Then you take the car out for a spin with normal controlled driving and some full throttle runs and the EMS adjusts your fuel table for you. The more you drive the better the EMS will dial in your fueling and the system will adjust to temperature, altitude, and other driving scenarios you might encounter.

This is the most technologically advanced EFI system that is available to the aftermarket. We have moved the bar even higher with our returnless systems and the **FuelOnDemand** fuel pump control module which provides nearly unlimited control over your EFI electric fuel pump.



## Kit Contents

### Powerjection III - 70020/70021

- 750 CFM Throttle Body Assembly
- Throttle Body and Air Cleaner Gaskets
- (4) 62 lb./hr. 60MM o-ring to o-ring high impedance Bosch style connector injectors
- Built in EMS (computer) incorporated on the throttle body
- Harness and connectors
- Idle Air Control - Built in to the throttle body
- 2.5 BAR MAP Sensor - Built in to the EMS
- Coolant Temperature Sensor - 3/8-NPT threads
- Throttle Position Sensor mounted on throttle body
- Wideband O<sup>2</sup> Sensor and cable
- O<sup>2</sup> Sensor Bung and Clamps - No welding necessary for mounting
- 10409 Fuel Inlet Kit

## Kit Contents

### Powerjection III - 70028/70029

- 750 CFM Throttle Body Assembly
- Throttle Body and Air Cleaner Gaskets
- (4) 62 lb./hr. 60MM o-ring to o-ring high impedance Bosch style connector injectors
- Built in EMS (computer) incorporated on the throttle body
- Harness and connectors
- Idle Air Control - Built in to the throttle body
- 2.5 BAR MAP Sensor - Built in to the EMS
- Coolant Temperature Sensor - 3/8-NPT threads
- Throttle Position Sensor mounted on throttle body
- Wideband O<sup>2</sup> Sensor and cable
- O<sup>2</sup> Sensor Bung and Clamps - No welding necessary for mounting
- 10409 Fuel Inlet Kit
- 70151 EFI 220 L/H Fuel Pump
- 70160 EFI Fuel Filter
- 11113 EFI Fuel Pressure Gauge - 0-100 PSI
- 70035 **FuelOnDemand** Module (Mounts separately) See below.
- 71235 Fuel Pressure Sensor

## Kit Contents

### Powerjection III - 70026/70027

- 750 CFM Throttle Body Assembly
- Throttle Body and Air Cleaner Gaskets
- (4) 62 lb./hr. 60MM o-ring to o-ring high impedance Bosch style connector injectors
- Built in EMS (computer) incorporated on the throttle body
- Harness and connectors
- Idle Air Control - Built in to the throttle body
- 2.5 BAR MAP Sensor - Built in to the EMS
- Coolant Temperature Sensor - 3/8-NPT threads
- Throttle Position Sensor mounted on throttle body
- Wideband O<sup>2</sup> Sensor and cable
- O<sup>2</sup> Sensor Bung and Clamps - No welding necessary for mounting
- 10409 Fuel Inlet Kit • 70042 Fuel Inlet Kit w/10685 EFI Regulator
- 70151 EFI 220 L/H Fuel Pump
- 70160 EFI Fuel Filter
- 11113 EFI Fuel Pressure Gauge - 0-100 PSI

70108



Left - This kit provides 15 feet of -06AN stainless braided fuel line and -06AN hose ends and fittings to connect your fuel pump and filter to the EFI system for a returnless installation.

70107



Right - This kit provides 25 feet of -06AN stainless braided fuel line and -06AN hose ends and fittings to connect your fuel pump and filter to the EFI system and back to the tank for a return style fuel system.



70035

This is our **FuelOnDemand** Module. This kit is included in the 70028 and 70029 Complete Kits which allows them to function as a returnless system. Also, this kit can be used with any other aftermarket EFI system to convert it to a returnless type setup. All you need is a 1/8-NPT tapped hole into the pressurized fuel system where the Fuel Pressure Sensor can be installed. Note that from a performance standpoint a return style system is preferable but the returnless setup eliminates the need to install a return line.

Pt. No.	Description
70035	<b>FuelOnDemand</b> Kit w/fuel pressure sensor

## FuelOnDemand™ Kit

Here are the **FuelOnDemand's** various applications:

- **Use with a carburetor.** Use with a regulator to maintain correct 5-7 PSI while reducing pump duty cycle by as much as 70%. This is 70% less noise, heat and current draw. But when the engine needs more fuel, it's there.
- **EFI with return (bypass) regulator.** Allows the use of large high volume electric fuel pumps without the constant noise, and even more important, the heat produced by the pump is reduced. This equals longer life and reduced pump cavitation which is like engine detonation to your pump, the single largest cause of pump failure.
- **EFI Returnless.** Run a single inlet fuel line from the tank and let the **FuelOnDemand** Module control your fuel pressure.

The **FuelOnDemand** system is fully programmable. You can basically set it up to provide different fuel pressure at different load conditions. Here's an example. Let's say you are running a port injection system (such as Powerjection II) and you are running 30 lb./hr. injectors at 45 PSI. This will supply enough fuel to support 425 HP. If you try to run more pressure (which raises the lb./hr. rating) the car won't run properly at idle or low engine speeds. But with **FuelOnDemand** you can program it to run at 45 PSI at low or no load conditions and have the fuel pressure increase to 70 PSI under load. Now your 30 lb./hr. injectors become 38 lb./hr. injectors and are capable of supplying enough fuel for 540 HP. The unit incorporates a 2.5BAR (25PSI) MAP sensor which can handle blown engines up to 25 pounds of boost. Any vehicle running a high volume electric pump should use **FuelOnDemand** to lessen pump noise, decrease high fuel temperatures (which can lead to vapor lock), and extend pump life by eliminating dead heading.

# POWERJECTION™ EFI Accessories & Components 3

70042 Shown

3



## Fuel Inlet Kits for use with Powerjection III EFI Throttle Bodies

The 70042 Fuel Inlet Kit, shown at left as part of the Powerjection III, is supplied with the 70026 or 70027 versions of the Powerjection III that require a regulator. If you currently have either of these EFI kits and want to add on our **FuelOnDemand** module, then a regulator is not required when running a returnless system. In that instance you will need to switch the inlet kit to either a 10409 or 10416 (shown below). If you want to run a return line in conjunction with the **FuelOnDemand** system (preferred setup) you will continue to use the 70042 Fuel Inlet Kit that came with your 70026 or 70027 Powerjection III EFI system.

Pt. No.	Description
70042	Fuel Inlet Kit with regulator (Black) -06 Inlet (Replaces 70041)
10409	Fuel Inlet Kit (Black) -08 or -06 Inlet*
10416	Fuel Inlet Kit (Red/Blue) -08 or -06 Inlet*

\*See page 29 for more details on these kits.



This kit can be configured to have either a -06AN or -08AN inlet nipple.

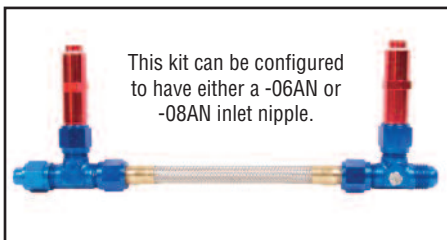

This kit can be configured to have either a -06AN or -08AN inlet nipple.

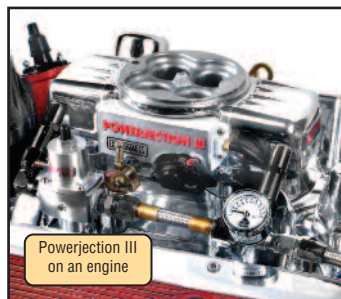

Powerjection III on an engine

The 10409 Inlet Kit (Black) shown above is supplied as part of the 70020, 70021, 70028 and 70029 Powerjection III kits. Or it can be used by those designing their own fuel system using a Powerjection III, or who have a FuelOnDemand module or it can be used on Demon carbureted applications. Additional styles of this Fuel Inlet Kit to fit Holley 4150 and 4500 carburetors can be found on page 29 of this catalog.

The 10416 Inlet Kit (Red/Blue) shown above, is a base fuel inlet for those designing their own fuel system using either a Powerjection III or a Demon carburetor. Additional kits of this type to fit other style carburetors (Holley 4150, 4500) can be found on page 29 of this catalog. The Professional Products Fuel Inlet Kits feature a wrench hex half way down the inlet extension which makes installation very easy.

## Fuel Injection Throttle Bodies

1200 CFM Cast

3



70202

Throttle Body as part of complete port injection system.

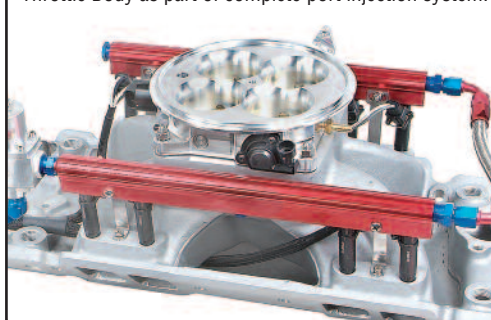

71200



71210



71220



71230



71235



71240



Can be clamped on or welded.

71250

### EFI Throttle Bodies

The cast throttle bodies have a linkage like a 4150 Holley so that the various cable and linkage combinations will connect properly. They also feature a special adapter that allows the use of either a Ford or a GM throttle position sensor. Our cast throttle body is a very high quality product and is substantially less expensive than other competitive 4-bbl style throttle bodies. If you are assembling your own EFI system using one of the many available computer systems, we can provide you with the necessary throttle body, fuel injection style intake manifold (see page 20) or fuel rail kits (see page 27). Please note that CFM ratings on EFI throttle bodies are not to be compared to carburetor CFM ratings. You can successful use a 1200 CFM throttle body on an engine as small as 350 CID.

Pt. No.	Description
70201	Cast 1200 CFM 4-bbl Throttle Body. - Satin
70202	Cast 1200 CFM 4-bbl Throttle Body - Polished

### Sensors and Accessories

Pt. No.	Description
71200	Throttle Position Sensor TPS
71210	Idle Air Control (IAC)
71220	MAP Sensor 1 BAR
71221	MAP Sensor 2.5 BAR
71230	Coolant Temperature Sensor
71235	Fuel Pressure Sensor
71240	Oxygen (O <sup>2</sup> ) Sensor
71250	O <sup>2</sup> Sensor Bung Assembly



## POWERFIRE I

### Adjustable • Ready-to-Run • 3-Wire

The Powerfire I represents the latest state-of-the-art design in modern ignitions systems. It won the Best Engineered New Product at the 2008/2009 SEMA Show. It's most outstanding feature is it has an external knob that allows timing adjustment while the engine is running. Each click of the knob advances or retards the timing 1/2 degree. Set your timing approximately with a timing light. Then dial it in exactly with the timing knob. Get a bad load of gas? Dial in some retard and you're good to go. Going racing and need some more timing? Just dial it in.

#### Check out these features:

- Easy 3-wire install with no external spark box necessary.
- Precision CNC machining and hand assembled construction.
- Patent pending positive lock manual advance/retard knob. Distributor can be accurately advanced or retarded in 1/2-degree increments on the fly by turning the external adjustment knob. Each click of the knob provides a 1/2-degree change to total ignition timing. This makes getting an accurate setting extremely easy.
- Accurate super hot spark all the way through 10,000 RPM.
- Hardened steel .50" diameter steel shaft with sealed roller bearing upper support and bronze bushed lower support for extreme stability at maximum rpm.
- Powerful magnetic pickup and CNC machined reluctor pickup.
- Fully adjustable advance mechanism with easy to use spring and bushing design for a nearly infinite advance curve.
- POWERFIRE module built in for drop-in reliability from 50 to 10,000 RPM.
- Hot cranking spark as low as 50 RPM for quick starting.
- Black anodized base with laser etched timing marks for easy visibility and high tech looks.
- High quality injection molded cap with brass terminals for long life and great conductivity.
- A terrific all-around ignition system for today's high performance street machines and race cars. This is the ultimate in a conventional distributor style ignition system.

## POWERFIRE I

2

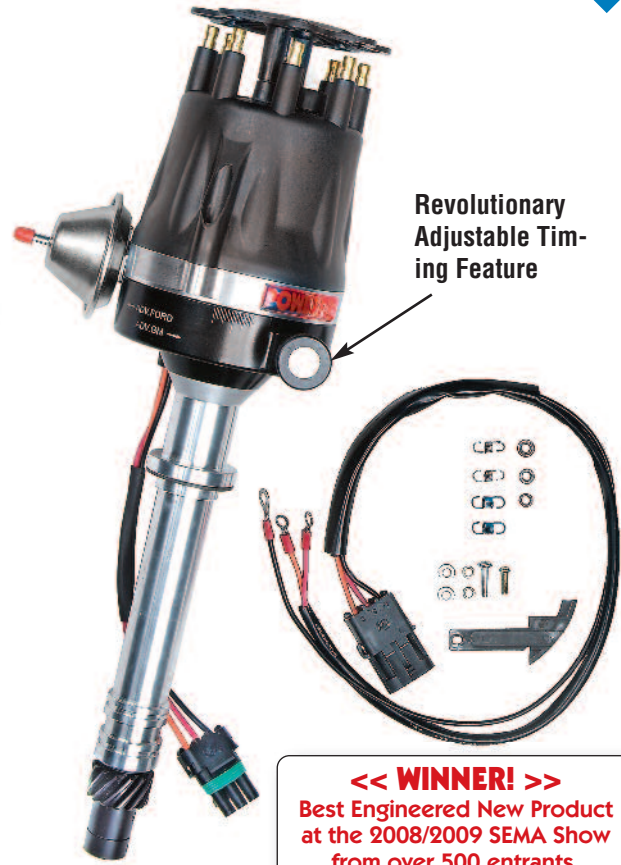

**<< WINNER! >>**  
**Best Engineered New Product**  
**at the 2008/2009 SEMA Show**  
**from over 500 entrants.**

## POWERFIRE II

### 2-Wire Distributor

The Powerfire II is a precision made distributor for two wire ignition systems. Includes vacuum advance canister for economy plus a mechanical advance system to dial in the perfect advance curve for your engine. An oversize steel shaft is coupled with an upper sealed ball bearing, brass cap terminals, adjustable mechanical advance and a high output magnetic trigger. This distributor is good for 10,000 rpm. Compare the Powerfire II to an MSD 8361 Standard Pro-Billet Distributor. This distributor requires the use of an aftermarket spark box.

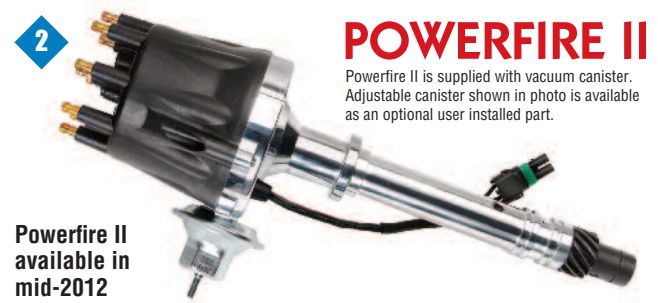

**Powerfire II**  
**available in**  
**mid-2012**

Pt. No.	Description
30000	Powerfire I for 262-454 Chevrolet V8
30001	Powerfire I for 289-302 Small Block Ford
30002	Powerfire I for 351W Small Block Ford
30040	Powerfire II for 262-454 Chevrolet V8
30041	Powerfire II for 289-302 Small Block Ford
30042	Powerfire II for 351W Small Block Ford
30100	Powerfire 2 Coil (Black Housing)
30200	Powerfire 2 Coil (Red Housing)
31000	Replacement Cap for all Powerfire Distributors
31002	Replacement Rotor for all Powerfire Distributors
31003	Advance Spring & Weight Kit
31004	Bronze Gear for Chevrolet
31005	Bronze Gear for SB Ford (except 351W)
31006	Advance Lockout Kit for SB Ford
31007	Advance Lockout Kit for Chevy
31008	Gasket for Chevy Distributor

Pt. No.	Description
31009	O-Ring for SB Ford
31010	Vacuum Advance Canister
31011	Ignition Module*
31012	Ignition Pickup Assy. (Chevy)
31013	Distributor to Coil Harness*
31014	Bronze Gear for Ford 351W
31015	Ignition Pickup Assy. (Ford)
31016	Iron Gear for Ford 351W
31017	Steel Gear for Chevy
31018	Steel Gear for Ford (exc. 351W)
31019	Steel Gear for Ford 351W
31020	Iron Gear for Ford (exc. 351W)
31021	Vacuum Advance Can. (Adj)

The replacement parts listed above in blue in most instances fit both Powerfire I and II.  
 \*For Powerfire I only.



The Powerfire 2 Coils provide a powerful spark and put out 45,000 volts, 15,000 more than the typical stock coil. They offer a peak current of 140 milliamps and a spark that lasts for a full 350 microseconds. A steel coil bracket is included.

# Professional Products POWER+PLUS® Manifold Features

Professional Products' Power+Plus is the newest line of performance intake manifolds available. As a result, we have been able to incorporate many new features in our manifolds not found in competitive models. Some of today's most popular manifolds were designed 40 years ago and the makers have never bothered to update the tooling to include many of the new features desired by performance enthusiasts. We engineered

those features into our manifolds. Our LSX manifolds and our recent model for 4.6L 2V Fords have led the way in manifold development. Our newest Hurricane+Plus is the ultimate racing manifold for SB Chevy and has been proven in numerous dyno tests to outperform the competition. Professional Products has pioneered a number of new developments in manifold technology that have now been adopted by others.



## Dual Distributor Holddowns

Sometimes the standard single distributor holddown is difficult to access. So we have provided dual distributor holddowns on most Power+Plus Chevy intake manifolds, which gives you an optional position. And on our 52030 and 52031 Racing Manifold, you can use two hold-downs for extra protection against distributor rotation in racing applications.

## Carburetor Adapter Plate

Many Chevy manifolds accept the stock Rochester Quadra-Jet spread-bore carb. But if you want to use one of the popular Holley or Edelbrock square bore carbs, you have to spend more bucks for a carb adapter plate. Power+Plus spread-bore manifolds include adapter plates and gaskets to accept square bore carbs. Adapter plates included with manifold.

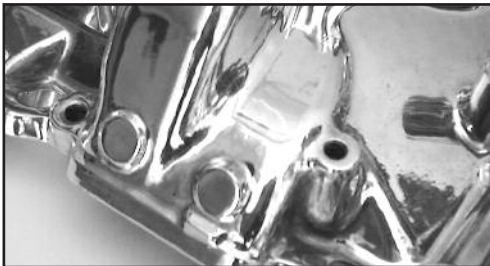
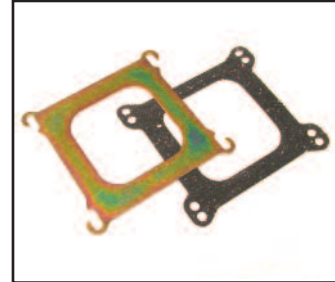

## Four Corner Water Ports

Most of our performance manifolds feature two extra water ports at the rear of the manifold, a feature normally only found in manifolds costing hundreds more. Some enthusiasts have found that plumbing a line between these two rear ports can reduce engine overheating. Many racers also find these ports to be an advantageous special feature for plumbing special additional water lines.



## Nitrous Bosses

If you want to run nitrous with the injectors mounted directly in the ports, Power+Plus Manifolds provide a simple solution. Many of our manifolds include cast-in nitrous bosses which provide the extra thickness not found in most competitive manifolds without spending a lot more money. This extra thickness is necessary to provide the proper amount of thread engagement. All you have to do is drill and tap the bosses to accept any manufacturer's nitrous injectors.

## Special Manifold Adapters

All Power+Plus Street and High Performance Street Manifolds for small block Chevys (except Vortec) come with special adapters that allow these manifolds to fit the '87-'95 cast iron heads. If you have '86 or earlier heads, or '87-'95 aluminum heads, our manifolds bolt right on without the adapters. For '87-'95 cast iron heads, drop the adapters in the four slotted holes and bolt up the manifold with no fuss and no special tools required.

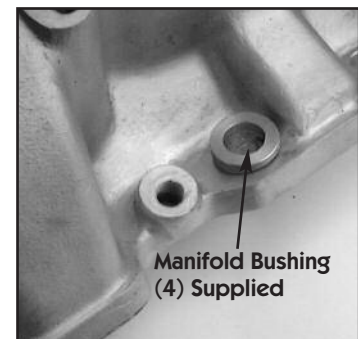

## Water Divider Baffle

The Power+Plus #52030/52031 Manifold is designed for both racing and street applications. It has all the necessary bosses and tapped holes to accommodate street accessories yet it also includes every feature found in manifolds costing hundreds more. One trick feature is the Water Divider Baffle. Expensive race manifolds have this baffle cast in place in the manifold but this precludes the use of a thermostat if you want to use one. The Power+Plus Manifold is machined for a thermostat but the package also includes a drop-in Water Divider Baffle for those who desire this feature.

## Other Special Features:

- Many Ford Manifolds includes rear water crossover passage.
- All ports very accurately positioned due to advanced permanent mold casting techniques. Not sand cast like most others.
- Before packing, every tapped hole in each manifold is chased with a tap to clear out polishing residue and to assure the threads are not damaged. Each manifold is pressure tested for leaks.
- All polished manifolds are meticulously hand polished to show levels.

## Manufacturing Processes

All Power+Plus Manifolds are cast in steel dies rather than in sand molds as used by all other manifold manufacturers. This type of tooling costs two or three times what conventional sand cast patterns cost, but the finished product is worth this additional expense. And because the cores (which form the internal ports and water passages) are mounted in steel instead of sand during the casting process, there is no chance of any core shifts, which can sometimes go undetected in sand castings. Core shifts can cause misalignment between the ports and the heads, or even actual air or water leakage. That is one problem you won't

have to worry about with Power+Plus. Each and every Power+Plus manifold is subjected to a very thorough pressure test that will detect any air or water leakage. We find any problems first so you don't have to go to the effort of installing your manifold only to find out that it leaks. Power+Plus Manifolds are manufactured in a factory which produces OE aluminum manifolds for major Japanese and European auto makers, so you know the quality is there. That same OE level quality can be found in every Power+Plus Manifold. And this high quality level is brought to you at the most affordable prices in the industry.



# Selecting the right manifold for your small block Chevy

We make a number of manifolds for small block Chevys and for some people, it may be confusing trying to figure out which one is the best for a specific application. The following information

should be helpful in allowing you to make an informed decision. All of these manifolds will fit up through model years 1995 (except Vortec) due to our unique supplied adapters.

## CYCLONE

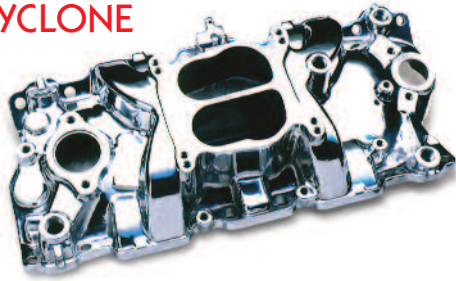

**CYCLONE** - The Cyclone is our lowest profile SB Chevy manifold and is also the only one that is street legal on pollution controlled vehicles. It is set up to accept a spread bore carb but comes with an adapter plate that permits the use of square bore carbs. To remain street legal with a square bore carb, you must use one that is also approved as street legal for your application. This is our largest selling manifold with tens of thousands of them in use. This manifold is available in eight different de-

sign configurations:

- 52000 - Polished for std heads
  - 52001 - Satin for standard heads
  - 52002 - RealChrome for std heads
  - 52003 - RealChrome/Vortec heads
  - 52006 - Polished for Vortec heads
  - 52007 - Standard for Vortec heads
  - 52008 - Polished w/EGR provision
  - 52009 - Satin w/EGR provision
- These are great all around street manifold for medium performance applications at affordable prices.

## CYCLONE+PLUS

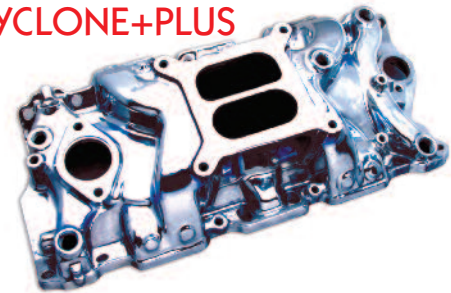

**CYCLONE+PLUS** - The terrific Cyclone+Plus is a step up from the Cyclone. Due to its slightly taller height, it can provide more power and torque. It is about 3/8" taller than the Cyclone. It also has a rear water crossover (the only SB Chevy manifold made by anyone with this feature), nitrous bosses and a square bore carburetor flange. It comes in a version with intake gaskets, a tube of gasket sealer, 12-point stainless bolts, and all necessary pipe plugs. The Cyclone+Plus is available in six

different versions:

- 52010 - Polished with complete kit
- 52011 - Satin with complete kit
- 52012 - Polished w/o kit
- 52013 - Satin w/o kit
- 52014 - RealChrome w/kit
- 52016 - RealChrome w/o kit

A great medium performance manifold that includes all the latest manifold technology for the street.

## TYPHOON

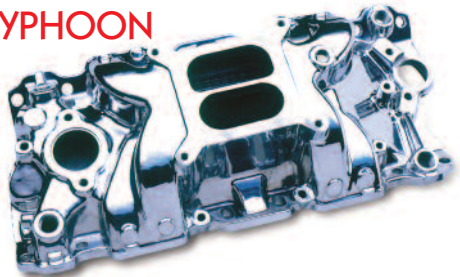

**TYPHOON** - The Typhoon manifolds, along with the similar CrossWind, are the most powerful dual plane manifolds available for a small block Chevy. For non-pollution controlled street machines, these are among the very best manifolds you can use. They feature a square bore carburetor flange, nitrous bosses, four corner water ports, and dual distributor holddowns. These manifolds are approximately 5/8" taller than the Cyclone series. On medium horsepower engines, our dyno tests have

shown that this manifold comes very close to producing similar power and torque numbers as our Hurricane racing intake manifold.

There are three part numbers in this series:

- 52020 - Polished finish
- 52021 - Satin finish
- 52022 - RealChrome finish

## CROSSWIND

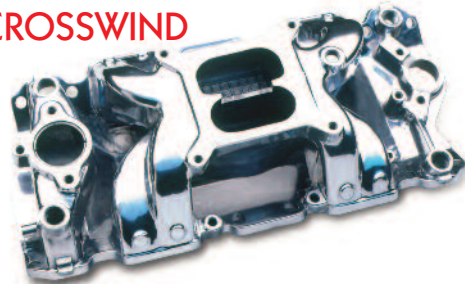

**CROSSWIND** - The CrossWind design features the identical plenum and runner design as the Typhoon. The main difference is that there is an open area under the plenum chamber. This feature is sometimes called an air gap design. The air flowing under the plenum provides a cooler charge for the incoming air with less heat transfer from the engine. This cooler air charge provides additional power. The CrossWind design is very popular. However, if looks is your main interest, along

with more power, the Typhoon might be a better choice because it is impractical to polish the open area below the plenum on the CrossWind.

- 52025 - Polished finish
- 52026 - Satin finish

RealChrome is not available on this manifold due to the difficulty in polishing under the plenum.

## HURRICANE Series

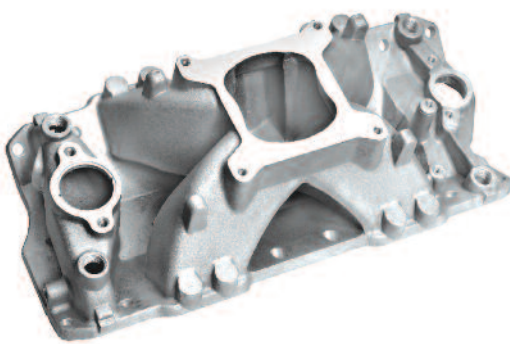

### HURRICANE, HURRICANE+PLUS & SUPER HURRICANE

We now offer three models of this outstanding racing manifold. The Hurricane is one of our very most popular race manifolds. If you are looking for the utmost performance for the very least cost, this is your manifold. Professional Products now offers the Hurricane+Plus which is an improved version of the Hurricane. Depending upon exact engine configuration, this manifold has shown as much as 20 hp over the Hurricane. Note that these increases mainly occur in the 7,500 to 8,000 rpm range. For all out racing with large cubic inch engines (420+) on gas, or any size alcohol engine, the Super Hurricane is the manifold to se-

lect. Dyno tests have shown significant power increases over competitive manifolds. The Super Hurricane is also available in a version with machined injector bosses.

- 52030 - Polished Hurricane
- 52031 - Satin Hurricane
- 52032 - Polished Vortec Hurricane+Plus
- 52033 - Satin Vortec Hurricane+Plus
- 52034 - Polished Hurricane+Plus
- 52035 - Satin Hurricane+Plus
- 52036 - Polished Super Hurricane
- 52037 - Satin Super Hurricane
- 52038 - Polished Super Hurricane\*
- 52039 - Satin Super Hurricane\*

\*Includes machined injector bosses

In comparison dyno tests, the Hurricane series of manifolds consistently outperform the competitor.

# Small Block Chevrolet V8 Intake Manifolds

CYCLONE™

CYCLONE+PLUS™

RPM RANGE  
Idle to  
5500

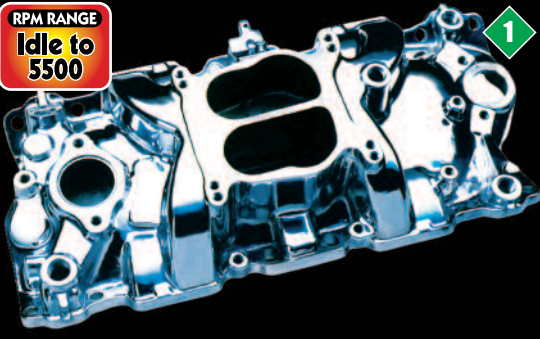

1

## CYCLONE™ for 1957-'95 Small Block Chevrolet V8\*

This is a great all around street manifold. It is a direct replacement for the stock intake manifold on non-EGR engines. The manifold includes special adapter bushings to allow fitment to 1987-'95 cylinder heads. Also includes an adapter plate to permit use of certain square bore carburetors. Professional Products intake manifolds are cast from steel molds, not sand. These permanent steel molds provide a tighter grain casting thereby reducing porosity as well as eliminating core shifting. Each manifold is 100% pressure tested to assure no leaks.

Pt. No.	Application
52000	1957-'95 SB Chevy V8 - Polished Finish (Non EGR)
52001	1957-'95 SB Chevy V8 - Satin Finish (Non EGR)
52002	1957-'95 SB Chevy V8 - RealChrome Finish (Non EGR)

RPM RANGE  
Idle to  
5500

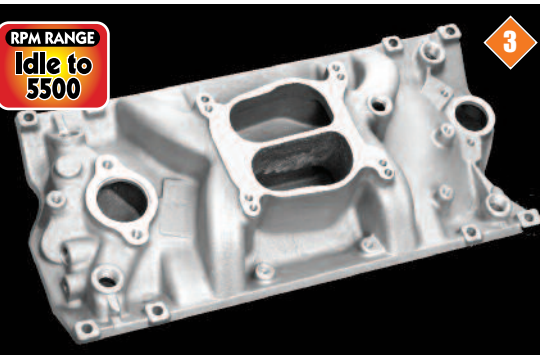

3

## CYCLONE™ for SB Chevrolet V8 w/Vortec heads

This manifold is essentially identical to the above Cyclone model except it is designed to fit the 1996 and later Vortec style cast iron head (Gen1+) which features eight vertical attachment bolts instead of twelve angled attachment bolts. Will also work on 1996 and later Vortec engines or engines equipped with Edelbrock E-Tec aluminum heads. As with most Professional Products manifolds, this one features four corner water ports and is also supplied with an adapter plate to permit the use of most square bore carburetors such as the popular Holley, Demon and Edelbrock.

Pt. No.	Application
52006	SB Chevy V8 w/1996 & later Vortec heads - Polished
52007	SB Chevy V8 w/1996 & later Vortec heads - Satin
52003	SB Chevy V8 w/1996 & later Vortec heads - RealChrome

RPM RANGE  
Idle to  
5500

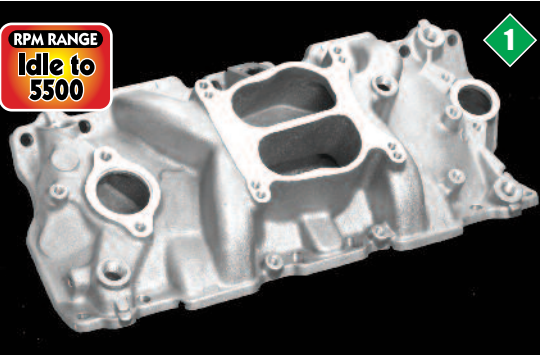

1

## CYCLONE™ for 1957-'95 SB Chevrolet V8 (EGR)\*

This manifold is a direct replacement for the stock 4-bbl manifold on 1972-'86 GM small block Chevy V8s with EGR and 1981-'86 GM Corporate 350 V8 engines with EGR. It is essentially the same design as the above two manifolds but incorporates EGR. Some applications may require our EGR adapter (52115) to provide clearance. This manifold is a great all around street manifold that is street legal on the listed applications. It will accept late model choke, waterneck, air conditioning, alternator, and HEI ignition systems. The manifold features dual distributor holddowns and four corner water ports. It is also supplied with an adapter plate and gasket to accept most square bore carbs.

Pt. No.	Application
52008	1957-'95 SB Chevy V8 - Polished Finish (EGR)
52009	1957-'95 SB Chevy V8 - Satin Finish (EGR)

RPM RANGE  
Idle to  
5500

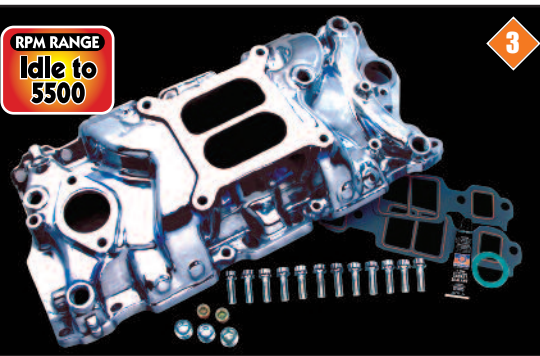

3

## CYCLONE+PLUS™ for 1957-'95 SB Chevrolet V8\*

The CYCLONE+PLUS is a unique new design unmatched by any other manifold manufacturer. It is approximately 3/8" taller than the Cyclone and it comes with a square bore carburetor flange which accepts most of the popular aftermarket carburetors. It's most distinctive feature is a rear water crossover passage. This is the only SB Chevy manifold with this feature. A feature which contributes significantly to a cooler running engine. The manifold also has nitrous bosses and four corner water ports. It also comes with stainless 12-pt bolts, intake gaskets, Permatex gasket sealer, pipe plugs, and insert bushings.

Pt. No.	Application
52010	1957-'95 SB Chevy V8 - Polished Finish
52011	1957-'95 SB Chevy V8 - Satin Finish
52014	1957-'95 SB Chevy V8 - RealChrome Finish

RPM RANGE  
Idle to  
5500

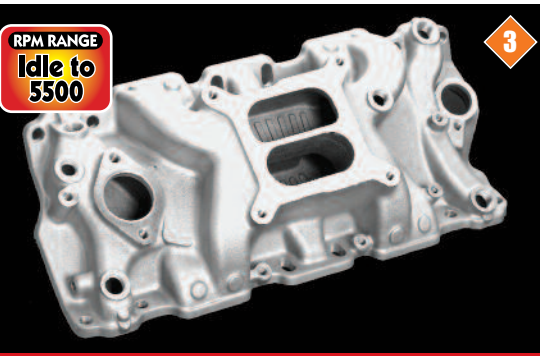

3

## CYCLONE+PLUS™ for 1957-'95 SB Chevrolet V8\*

This manifold is the same as the above Cyclone+Plus but comes without the stainless bolts, gaskets, and other supplied parts. It has all the same features outlined for the Cyclone+Plus shown above which includes the rear water crossover passage (an industry exclusive), four corner water ports, and nitrous bosses. This is an outstanding all around street manifold and is available in a polished finish, satin finish, or our terrific RealChrome finish which is a true triple chrome plated treatment. See page 13 for photo of RealChrome manifold.

Pt. No.	Application
52012	1957-'95 SB Chevy V8 - Polished Finish
52013	1957-'95 SB Chevy V8 - Satin Finish
52016	1957-'95 SB Chevy V8 - RealChrome Finish



# Small Block Chevrolet V8 Intake Manifolds

## TYPHOON™ for 1957-'95 Small Block Chevrolet V8\*

The Typhoon is one of our most popular high performance street manifolds. For most street applications we recommend a 600 to 700 CFM vacuum secondary carburetor. For high performance street use and bracket racing use a 700-800 CFM double pumper carburetor. This manifold produces outstanding power and is .70" taller than our low profile 52000/52001 Cyclone. It has a provision to machine for a front oil fill tube. No provision for exhaust heated or stock style chokes. This manifold will not fit under a stock Corvette hood.

Pt. No.	Application
52020	1957-'95 SB Chevy V8 - Polished Finish (Non EGR)
52021	1957-'95 SB Chevy V8 - Satin Finish (Non EGR)
52022	1957-'95 SB Chevy V8 - RealChrome Finish (Non EGR)

RPM RANGE  
1500 to  
6500

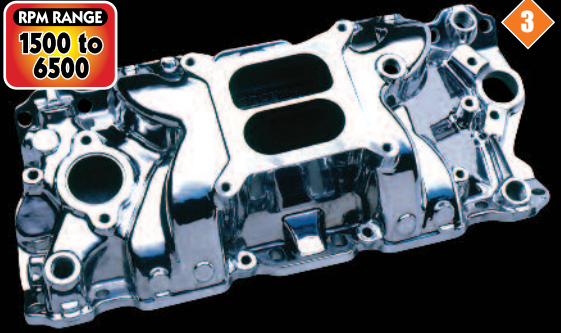

3

TYPHOON™

## CROSSWIND® for 1957-'95 SB Chevrolet V8\*

This manifold is essentially identical to the above Typhoon model except it is designed with an open area under the plenum (commonly referred to as an air gap design) which helps cool the incoming fuel/air charge and produces additional horsepower. It has all the same features as the above Typhoon. This is a truly outstanding high performance street manifold and one of our best sellers.

Pt. No.	Application
52025	1957-'95 Small Block Chevy V8 - Polished
52026	1957-'95 Small Block Chevy V8 - Satin

**\*Special Note: None of the marked manifolds for SB Chevys will work on engines with reverse flow heads as utilized on 1992-'96 LT1 Corvette or on 1993-'97 LT1 Camaro, Firebird, Caprice, Impala or Roadmaster.**

RPM RANGE  
1500 to  
6500

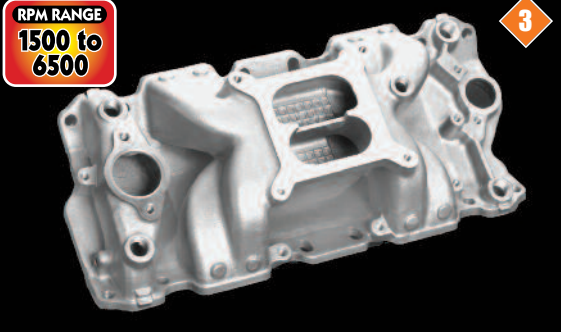

3

CROSSWIND®

## CROSSWIND® for SB Chevrolet V8 w/Vortec heads

This is one of our very top selling manifolds and is very popular on a number of crate engines. It has been selected for use by leading crate engine builders because comparison dyno tests showed that it outperformed every other competitive manifold by a significant margin and was also less costly. It features a similar design to our Typhoon and conventional Crosswind. It offers nitrous bosses, four corner water ports, and dual distributor holddowns. We recommend using our Power+Plus intake gaskets #52605 which feature silicone sealing beads and are also significantly less expensive than competitive gaskets. If your engine has Vortec heads you can't buy a better street manifold for it than this one.

Pt. No.	Application
52027	1957-'95 SB Chevy V8 - Polished Finish
52028	1957-'95 SB Chevy V8 - Satin Finish

RPM RANGE  
1500 to  
6500

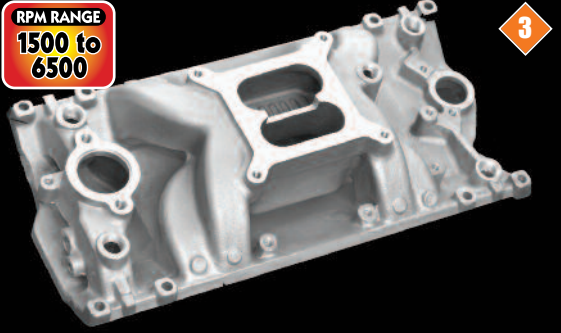

3

## HURRICANE™ for 1957-'95 SB Chevrolet V8\*

This manifold has long been the leader of the pack for single plane manifolds for small block Chevys with 23° cylinder heads. This manifold has consistently outperformed all of the well known brands which are also much more expensive. Numerous dyno tests have proven over and over that there is no better manifold of this type for achieving maximum power and torque while actually using less fuel doing it. Proving again the overall efficiency of the Hurricane. We have now developed the Hurricane+Plus which does the impossible by outperforming the Hurricane. However we will continue to offer the Hurricane as it is less expensive and provides more than enough power for most applications.

Pt. No.	Application
52030	1957-'95 SB Chevy V8 - Polished Finish
52031	1957-'95 SB Chevy V8 - Satin Finish

RPM RANGE  
3000 to  
7500

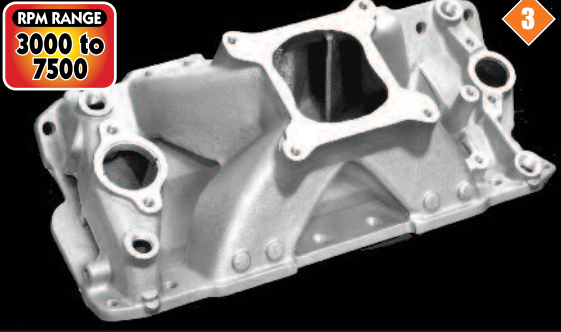

3

## SUPER HURRICANE™ for 1957-'95 SB Chevrolet V8\*

The Super Hurricane features a larger plenum and bigger runners than the other Hurricane manifolds. It was designed specifically for the new range of large cubic inch small blocks and works best on engines over 400 cubic inches. On the 427 and 454 small blocks now available there is no other manifold that will produce the power and torque of the Super Hurricane. It is also available machined for injectors. Use our 10608 Complete Fuel Rail Kit with this manifold when set up for fuel injection. This manifold can be ported out to a Fel-Pro 1209 gasket.

Pt. No.	Application
52036	1957-'95 SB Chevy V8 - Polished Finish
52037	1957-'95 SB Chevy V8 - Satin Finish
52038	1957-'95 SB Chevy V8 - EFI Version - Polished Finish
52039	1957-'95 SB Chevy V8 - EFI Version - Satin Finish

RPM RANGE  
3000 to  
7500

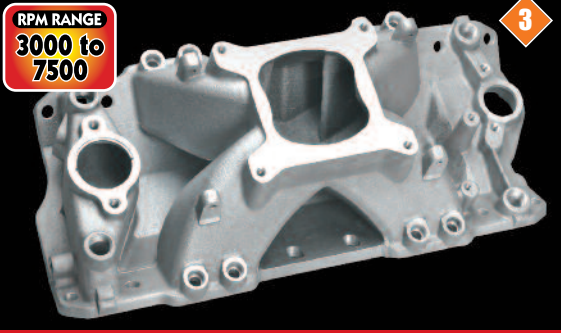

3

HURRICANE™

# Small Block Chevrolet V8 Intake Manifolds

HURRICANE™

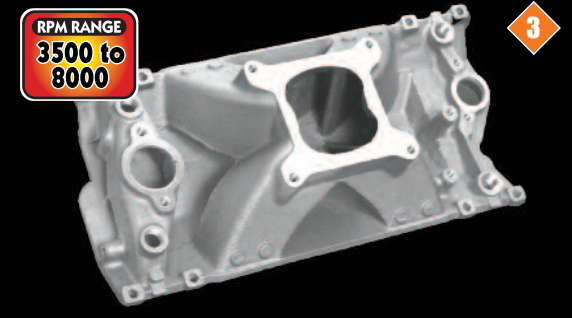

**HURRICANE+PLUS™ for SB Chevrolet V8 w/Vortec**  
 This manifold is the best performing single plane race style manifold available for engines using the 1996 and later Vortec (Gen 1+) cylinder heads. It has been proven over and over in dyno tests and on track use to provide unequalled power and performance. It features four corner water ports, a tapped fifth port in the front face, nitrous bosses, and dual distributor holddowns. We recommend our Power+Plus #52605 intake gaskets which have silicone sealing beads and are significantly less expensive than competitive gaskets for Vortec heads. This is one of our top selling manifolds.

Pt. No.	Application
52032	SB Chevy V8 w/Vortec Heads - Polished Finish
52033	SB Chevy V8 w/Vortec Heads - Satin Finish

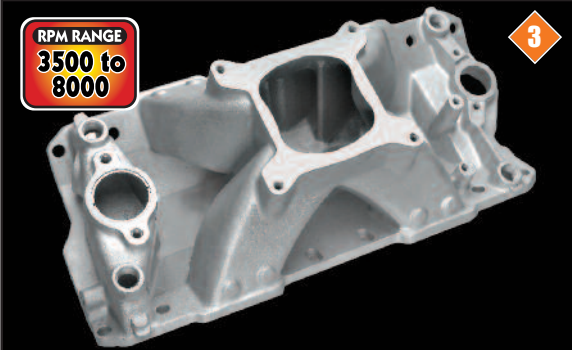

**HURRICANE+PLUS™ for 1957-'95 SB Chevrolet V8\***  
 They said it wasn't possible to improve on the standard Hurricane, the best performing single plane manifold for 23° heads. But we proved them wrong. After three years of extensive development we have a manifold that outperforms the Hurricane. Depending on the specific engine combination we have seen as much as 20 extra horsepower over the standard Hurricane. Note that this extra power is mostly showing up over 7,000 rpm. So if you aren't turning your engine in the 7,000 to 8,000 rpm range, stick with the standard Hurricane. Below 7,000 this manifold is only 3 or 4 more horsepower better. This manifold also has all the special features found in our other Hurricane manifolds. Can be ported to 1209.

Pt. No.	Application
52034	1957-'95 SB Chevy V8 - Polished Finish
52035	1957-'95 SB Chevy V8 - Satin Finish

# G.M. LSX V8 Intake Manifolds

TYPHOON™



**TYPHOON™ for LS1/LS6 and LS2**  
 The Typhoon manifold for LSX type engines was designed to provide extra plenum area which is very advantageous on larger displacement versions of the LS1/LS6 and LS2 engines. If you have a punched out LS engine the stock manifold will not be able to do the job. Additionally if you are running a supercharger or turbocharger a plastic manifold will not survive a backfire so our aluminum Typhoon is your answer. Note that all of our LSX manifolds come complete with the fuel rail kit as shown in the photos.

We offer this manifold in three basic configurations as follows:  
 A. The 52060/52061 is a direct replacement for any LS1 or LS6 intake. It has an 85MM inlet that can be enlarged for a 90MM throttle body.  
 B. The 52062/52063 is a direct replacement for any LS2 intake. It has a 96MM inlet but can be enlarged to accept a 101MM throttle body.  
 C. The 52064/52065 is a direct replacement for any LS1 or LS6 intake but has provision for the larger LS2 style throttle body. It also has a 96MM inlet that can be opened up to 101MM

Pt. No.	Application
52060	LS1/LS6 85MM Typhoon Manifold - Polished
52061	LS1/LS6 85MM Typhoon Manifold - Satin Finish
52062	LS2 96MM Typhoon Manifold - Polished
52063	LS2 96MM Typhoon Manifold - Satin
52064*	LS1/LS6 96MM Typhoon Manifold - Polished
52065*	LS1/LS6 96MM Typhoon Manifold - Satin

\*Requires use of LS2 style throttle body

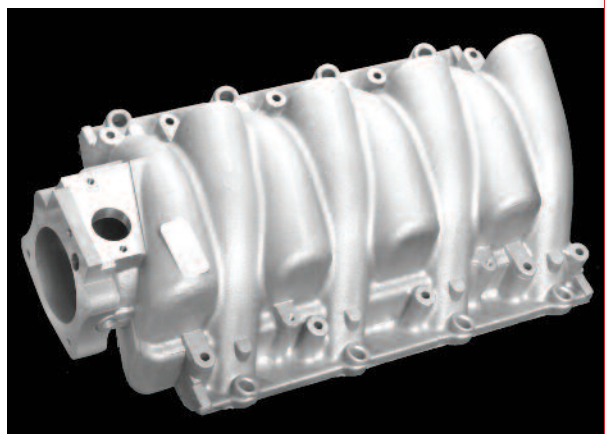

The above photo shows what the satin finish manifold looks like. The supplied fuel rail kit that comes with the manifold is not shown in this photo. Both the LS1/LS6 and LS2 manifolds are supplied with a stainless braided line that connects to the fuel rail on one end and to your stock GM fuel inlet line on the other. A blockoff cover plate is supplied for the top front of the manifold on the LS1/LS6 style manifolds. See our other sections of this catalog for a complete listing of available LSX throttle bodies, harmonic dampers and fuel rail kits.



# Big Block Chevrolet V8 Intake Manifolds

## CYCLONE™ for Big Block Chevrolet V8 w/Oval Ports

This manifold is a stock replacement/street legal part for 396, 402, 427, and 454 V8's with OEM 4-bbl carb; 1965-'72 (1973 non-CA) passenger cars and 1966-'83 trucks, Suburbans and heavy vehicles, except stock equipped EGR. This manifold design includes nitrous bosses, dual distributor holddowns, and four corner water ports. This manifold also includes a special carb adapter to allow the use of aftermarket square bore carburetors. This is an excellent street performance manifold. It will not fit under the hood of Corvettes without hood modifications.

Pt. No.	Application
53000	Big Block Chevy V8 w/oval ports - Polished Finish
53001	Big Block Chevy V8 w/oval ports - Satin Finish
53002	Big Block Chevy V8 w/oval ports - RealChrome Finish

RPM RANGE  
Idle to  
6000

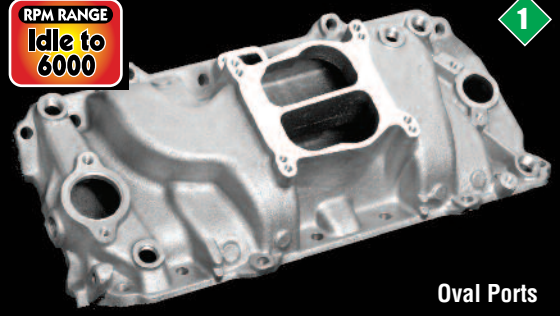

Oval Ports

1

CYCLONE™

## CROSSWIND® for BB Chevrolet V8 w/Oval Ports

Now available for big block Chevy engines with oval ports is our popular Crosswind manifold, commonly referred to as an air gap style design. This open area under the plenum chamber allows ambient air to provide additional cooling to the intake charge which produces additional power. This extra space also helps isolate the upper part of the manifold from the transference of engine heat. Like many of our manifolds, the Crosswind features nitrous bosses, four corner water ports and dual distributor holddowns. This is our best selling manifold for big block Chevrolet engines.

Pt. No.	Application
53025	Big Block Chevy V8 w/oval ports - Polished Finish
53026	Big Block Chevy V8 w/oval ports - Satin Finish

RPM RANGE  
1500 to  
6500

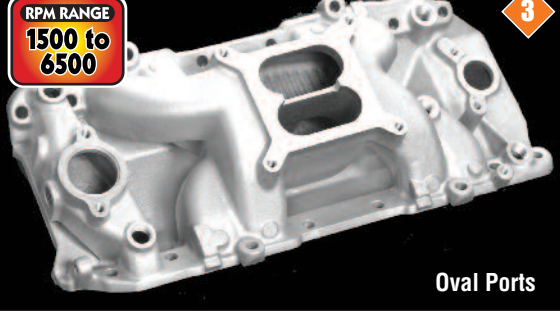

Oval Ports

3

CROSSWIND®

## HURRICANE™ for BB Chevrolet V8 w/rectangular ports

This manifold is primarily best on big block engines in the 396, 427, 454 displacement area producing power in the 600 to 700 horsepower range. The manifold features large rectangular ports (1.63" x 2.25") along with nitrous bosses, four corner water ports and dual distributor holddowns. Use the Professional Products Power+Plus Intake Gasket #53601. This is a very affordable manifold that makes outstanding power and torque. In numerous dyno tests this manifold has proven to match or exceed the performance of equivalent models of competitive manifolds that cost substantially more money.

Pt. No.	Application
53030	Big Block Chevy V8 - Polished Finish
53031	Big Block Chevy V8 - Satin Finish

RPM RANGE  
3000 to  
7500

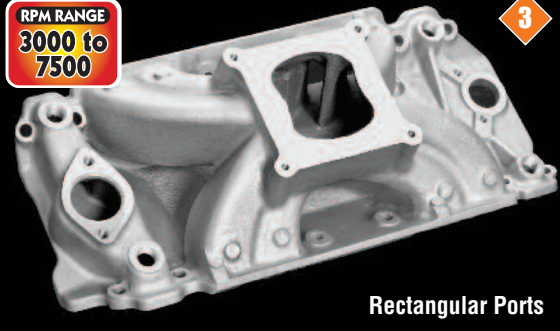

Rectangular Ports

3

## HURRICANE™ for BB Chevrolet V8 w/oval ports

This manifold is basically the same as the 53030/53031 but has oval ports instead of rectangular ports. It features four corner water ports, dual distributor holddowns and nitrous bosses. This is a proven design that produces outstanding torque and horsepower when used in the right engine combination. Best on engines with displacement in the 396 to 454 range producing from 600 to 700 horsepower. This is a terrific manifold and despite its low cost, it will equal or exceed the power produced by any similar competitive manifold.

Pt. No.	Application
53036	Big Block Chevy V8 w/oval ports - Polished Finish
53037	Big Block Chevy V8 w/oval ports - Satin Finish

RPM RANGE  
3000 to  
7500

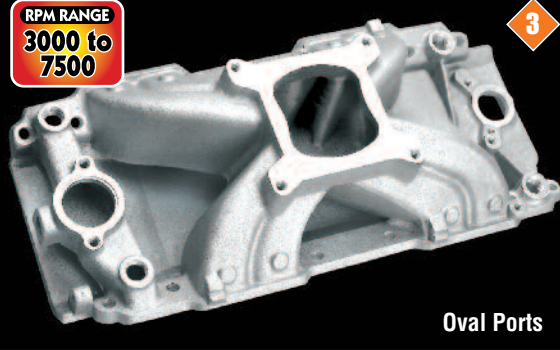

Oval Ports

3

HURRICANE™

## HURRICANE™ for BB Chevrolet V8 w/rectangular ports Accepts Dominator style carburetor

This manifold is very similar in design to our 53030/53031 Hurricane but has a carb flange that accommodates a Dominator (4500) type carburetor. This manifold also has pads on the ports which can be drilled and tapped for nitrous nozzles or it is available from Professional Products machined for injector nozzles. Use the Professional Products Complete Fuel Rail Kit #10626 with this manifold when being utilized in a port style fuel injection system.

Pt. No.	Application
53032	BB Chevy V8 w/machined injector ports - Polished
53033	BB Chevy V8 w/machined injector ports - Satin
53034	BB Chevy V8 w/rectangular ports - Polished
53035	BB Chevy V8 w/rectangular ports - Satin

RPM RANGE  
3000 to  
7500

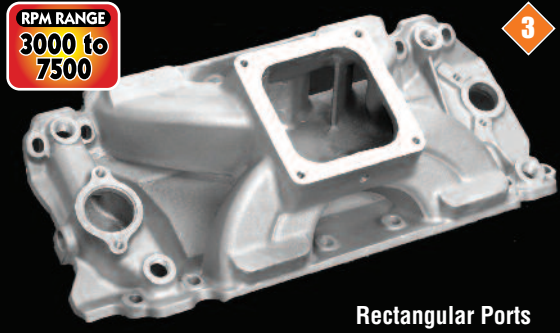

Rectangular Ports

3

# Small Block Ford V8 Intake Manifolds

TYPHOON™

RPM RANGE  
1500 to 6500



## TYPHOON™ for Small Block Ford except 351 Windsor

This is an ideal street performance manifold that delivers strong performance across nearly the entire power band while maintaining good throttle response at any speed. Will not fit 255, Boss 302, or 351W engines. It will also fit 1983 and later 5.0L Mustangs and will work with cruise control.

Pt. No.	Application
54000	Small Block Ford V8 - Polished Finish
54001	Small Block Ford V8 - Satin Finish
54002	Small Block Ford V8 - RealChrome Finish

This manifold is a stock replacement/street legal part for 289 1965-'66 Cobra V8s with OEM 4V carb. Certain exempt aftermarket carbs may also be legal.

RPM RANGE  
1500 to 6500

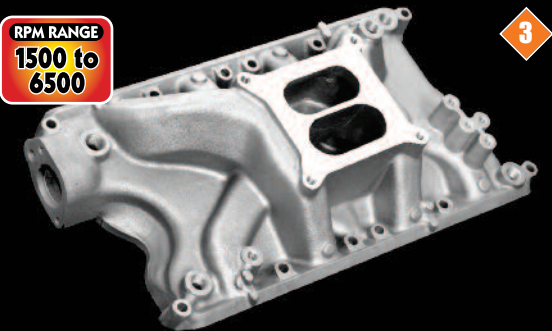

## TYPHOON™ for Small Block Ford 351W

The Typhoon for 351W engines is a great street manifold for this engine. It provides good top end power without sacrificing bottom end torque. Its long runner, dual plane design provides the best of both worlds. This manifold performs best with an aggressive street cam. For street, use a 600-750 CFM vacuum secondary or double pumper carburetor. For competition, use a 750-850 double pumper carb. One major feature on this manifold not found on competitive models is a rear water crossover passage which promotes a cooler running engine.

Pt. No.	Application
54022	Small Block Ford 351W - Polished Finish
54023	Small Block Ford 351W - Satin Finish
54024	Small Block Ford 351W - RealChrome Finish

CROSSWIND®

RPM RANGE  
1500 to 6500



Will not fit 255 CID V8 or Boss 302.

## CROSSWIND® for Small Block Ford except 351 Windsor

To create this manifold we took our popular 54000/54001 Typhoon manifold for small block Fords and modified it to produce an open area under the plenum (commonly called an air gap). This then became our Crosswind model. This design allows ambient air to pass beneath the plenum which has a cooling effect on the incoming fuel/air charge thus producing more power. This isolation also keeps engine heat from transferring into the plenum chamber. This manifold has several unique features such as a rear water crossover passage which contributes to a cooler running engine, nitrous bosses and four corner water ports.

Pt. No.	Application
54025	Small Block Ford V8 - Polished Finish
54026	Small Block Ford V8 - Satin Finish

HURRICANE™

RPM RANGE  
3500 to 8000

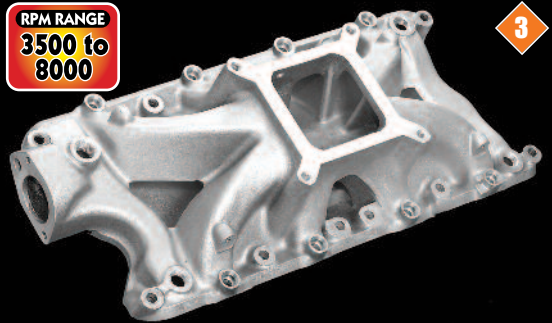

## HURRICANE™ for SB Ford V8 except 351W

The Hurricane manifold for SB Fords can be used for racing applications or for serious street performance. It has a number of unique features such as a rear water crossover passage, nitrous/injector bosses, and four corner water ports. This manifold is available with the injector bosses machined for injectors. The port size on this manifold is 1.06" x 1.94" which is somewhat larger than some competitive manifolds. Use Fuel Rail Kit #10607 with EFI manifold.

Pt. No.	Application
54030	Small Block Ford V8 - Polished Finish
54031	Small Block Ford V8 - Satin Finish
54038	Small Block Ford V8 - With EFI - Polished Finish
54039	Small Block Ford V8 - With EFI - Satin Finish

RPM RANGE  
3500 to 8000

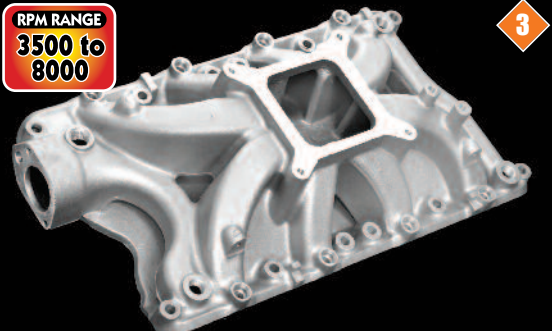

## HURRICANE+PLUS™ for SB Ford V8 351W

The Hurricane manifold for Ford 351W engines has a number of features not found in similar competitive manifolds. It has a bridged rear water crossover passage which contributes to a cooler running engine. It also comes with injector bosses than can be drilled and tapped for nitrous nozzles or can be purchased from Professional Products with the injector bosses machined. We also offer a Complete Fuel Rail Kit (#10607) for the EFI version of this manifold.

Pt. No.	Application
54032	Small Block Ford V8 - Polished Finish
54033	Small Block Ford V8 - Satin Finish
54034	Small Block Ford V8 - With EFI - Polished Finish
54035	Small Block Ford V8 - With EFI - Satin Finish



# 5.0L Ford Mustang Intake Manifolds

This is a proven manifold with thousands sold for the popular 5.0L Mustang V8 engine. Note that use of our 54100 spacer allows removal of valve cover without taking the plenum chamber off of the manifold.

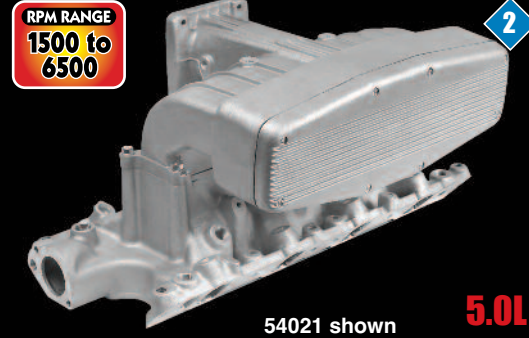
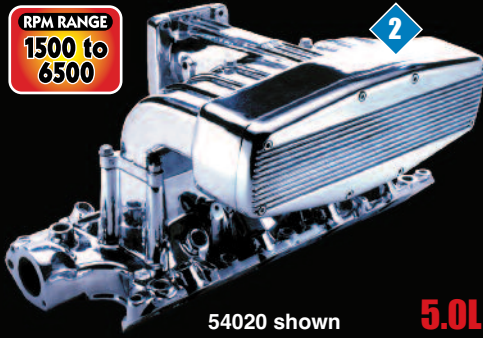

## TYPHOON™ for 5.0L Ford and 351W

The Typhoon Manifold System for 5.0L and 351W Fords is an ideal performance upgrade for your Mustang or other vehicle with one of these engines. The 5.0L System is sold as a complete kit with both the lower manifold and upper plenum in one package. However, if you have a 351W engine, you need to buy the 351W manifold and the upper plenum separately. Note that if your vehicle is a 1994 or 1995 Mustang, you will also need the optional Elbow Adapter and EGR Adapter available from Professional Products (listed below) as well as a strut tower brace available from Ford (M-20201-A51) or Edelbrock (#5225).

Note that our Upper Plenum will bolt to an Edelbrock #3821 or #7126 manifold. If a customer already has an Edelbrock setup it is an easy and economical swap to bolt on one of our polished upper plenum units.

Pt. No.	Application
54020	Complete System for 5.0L Ford - Polished Finish
54021	Complete System for 5.0L Ford - Satin Finish
54122	Manifold only for 5.0L Ford - Polished Finish
54123	Manifold only for 5.0L Ford - Satin Finish
54124	Upper Plenum - 5.0L or 351W - Polished Finish
54125	Upper Plenum - 5.0L or 351W - Satin Finish
54126	Manifold only for 351W - Polished Finish
54127	Manifold only for 351W - Satin Finish
54100	Phenolic Spacer - 1/2" thick
54150	Elbow Adapter for 1994-'95 - Polished Finish
54151	Elbow Adapter for 1994-'95 - Satin Finish
54152	EGR Adapter for 1994-'95

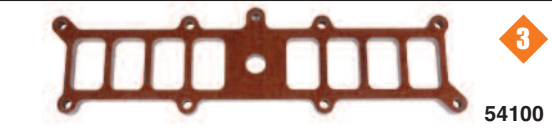
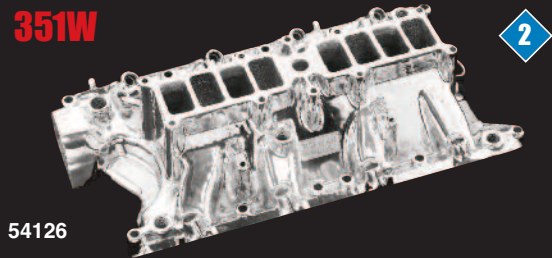

The Phenolic Spacer raises the Upper Plenum by 1/2". This provides heat isolation plus clearance for removing the valve cover. The two parts shown to the right are required when installing one of these systems on a 1994 or '95 Mustang. A strut tower brace is also required, available from Ford Racing (M-20201-A51) or Edelbrock (#5225).

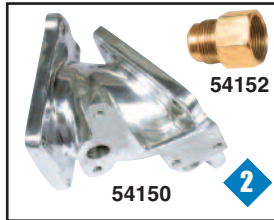

# 4.6L 2V Ford V8 Intake Manifolds

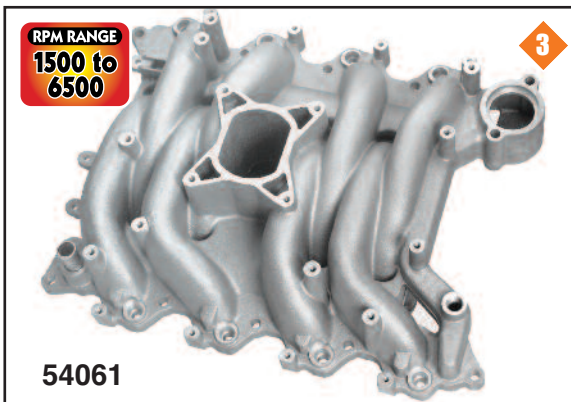

## TYPHOON™ for 4.6L 2V Ford V8

This manifold is an ideal street manifold. When used with stock cams it can produce good mid-range torque improvements. With cams that will allow the engine to rev to at least 6,300 RPM, as much as 20 additional horsepower is available with this manifold. This manifold is a bolt-in replacement for the stock manifold on 1999-'04 engines but can be used on earlier engines if '99 or later PI heads are used. We also offer an adapter kit that will allow this manifold to be used on a 5.4L 2V engine. We also have an Upper Plenum, Throttle Bodies, and Fuel Rail Kits for these engines. We offer the 54128 Center Plenum as a separate part for those tuners who feel they can improve the flow of this manifold.

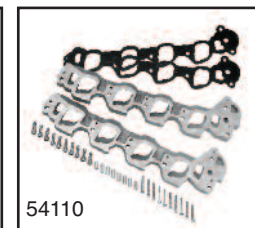
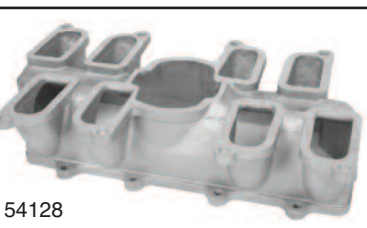

The Upper Plenum at right is a direct bolt-on replacement for the stock unit and is reported to provide as much as 10 additional horsepower with no additional changes. Available in either a satin or polished finish.



Pt. No.	Application
54060	4.6L 2V Ford V8 Typhoon Manifold - Polished
54061	4.6L 2V Ford V8 Typhoon Manifold - Satin Finish
54110	Adapter Plates for 4.6L manifold to 5.4L heads*
54128	Center Plenum for 54060/54061 manifold
54154	Upper Plenum - Polished
54155	Upper Plenum - Satin
54156	Stainless Alternator Bracket (Comes w/manifold kit)
54165	Upper Plenum to Manifold Gasket

\*Allows use of this manifold on a 5.4L engine.

TYPHOON™

# 318\*/340/360 Chrysler V8 Intake Manifolds

**CYCLONE™**

**RPM RANGE**  
1500 to 6500

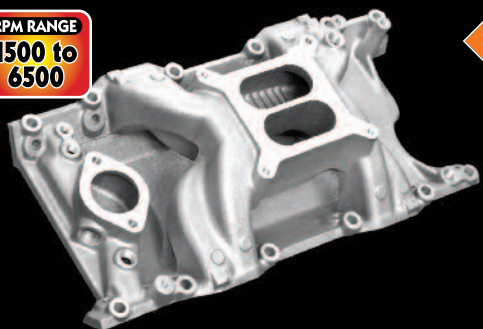

3

## CROSSWIND® for 318\*-340-360 Chrysler V8

This manifold is designed with two sets of bolt holes so that it will fit both the early style Chrysler heads and the later Magnum heads. This is an air gap style design which provides air space under the plenum which helps cool the intake charge and produce more power. This manifold includes nitrous bosses, an extra rear water port and is available in either a polished or satin finish. This is a terrific all around high performance street manifold. Use our intake manifold gasket #55600 (except Magnum) and #55601 for Magnums.

Pt. No.	Application
55025	318/340/360 Chrysler V8 - Polished Finish
55026	318/340/360 Chrysler V8 - Satin Finish

\*Fits 1967 and later 318's only.

# Pontiac V8 Intake Manifolds

**CROSSWIND®**

**RPM RANGE**  
1500 to 6500

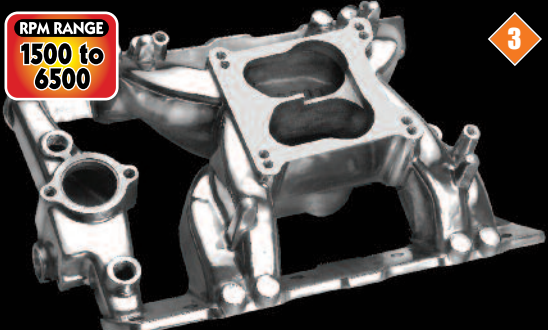

3

## CROSSWIND® for 1965-'79 325-455 Pontiac

This is an outstanding manifold for high performance street Pontiac engines. Unlike similar competitive manifolds, the Crosswind allows unlimited ambient air flow under the plenum and around the runners which helps create a cooler incoming air/fuel charge which produces additional power. This manifold is also available with machined injector bores. Use our Complete Fuel Rail Kit #10618 with this manifold for fuel injection applications.

Pt. No.	Application
56025	326-455 Pontiac V8 - Polished Finish
56026	326-455 Pontiac V8 - Satin Finish
56027	326-455 Pontiac V8 - EFI - Polished Finish
56028	326-455 Pontiac V8 - EFI - Satin Finish

**HURRICANE™**

**RPM RANGE**  
3000 to 7500

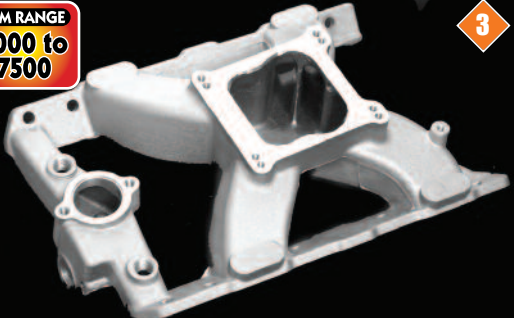

3

## HURRICANE™ for Pontiac V8

This manifold was developed in conjunction with Pontiac specialist Pacific Performance and porting expert Dave Bishop. It is a single plane manifold that will fit under all Pontiac hoods including the Trans Am "Shaker" hood. It accepts a stock Quadrajet carb but we also include an adapter plate for standard square bore carbs. This manifold is designed to work with cylinder heads up to 300 CFM. It is also available machined for injectors. Use Fuel Rail Kit #10625.

Pt. No.	Application
56030	1965-'79 326-455 Pontiac V8 - Polished Finish
56031	1965-'79 326-455 Pontiac V8 - Satin Finish
56032	1965-'79 326-455 Pontiac V8 - EFI - Polished Finish
56033	1965-'79 326-455 Pontiac V8 - EFI - Satin Finish

# Oldsmobile V8 Intake Manifolds

**CROSSWIND®**

**RPM RANGE**  
1500 to 6500

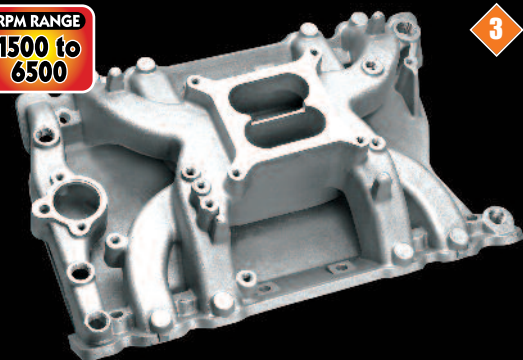

3

## CROSSWIND® for 400-425-455 Oldsmobile

This is the only available high rise high performance dual plane manifold for this engine. It is an inch and a quarter taller than competitive manifolds thereby producing more power. The Crosswind design provides an air gap under the plenum chamber which helps cool the intake charge providing additional power. Available with machined injector bosses. Use our Complete Fuel Rail Kit #10619 with this manifold in injected applications. NOTE: Hood clearance must be checked as this manifold is approximately 1.25" taller than a similar stock intake manifold.

Pt. No.	Application
57025	Oldsmobile V8 - Polished Finish
57026	Oldsmobile V8 - Satin Finish
57027	Oldsmobile V8 - EFI - Polished Finish
57028	Oldsmobile V8 - EFI - Satin Finish

**1st Place**

BEST ENGINEERED NEW PRODUCT

POWERFIRE I



POWERJECTION I  
BEST PERFORMANCE  
PRODUCT R.U.



POWERJECTION III  
BEST PERFORMANCE  
PRODUCT R.U.

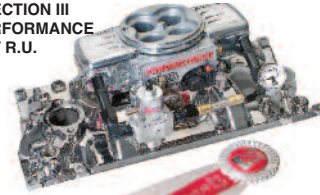



# REALCHROME™ Chrome Plated Intake Manifolds

RealChrome Intake Manifolds by Professional Products are true triple chrome plated. This is not a coating, or anything else other than true chrome plate. We use specially shaped plating anodes that eliminates the yellowing in corners and pockets typically found on most commercial chrome plated manifolds. Because RealChrome is

a true chrome plate, it is not susceptible to the chipping and peeling that has been a problem with some of the other chrome lookalike finishes. We currently offer eight different RealChrome manifolds. For a more complete description of the manifold's performance characteristics, refer to the part number in the bottom center of each photo.

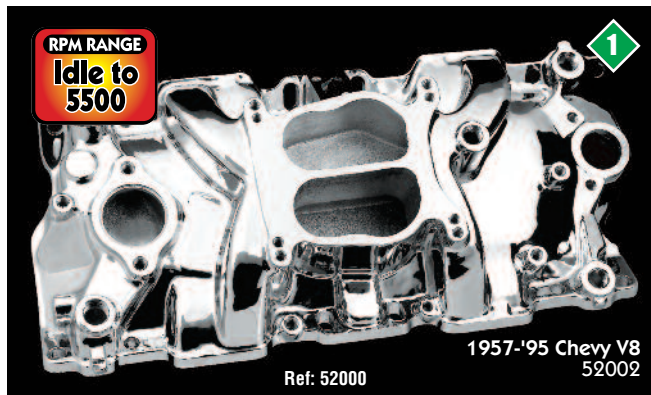

#52002 is a #52000 Manifold that has been chrome plated.

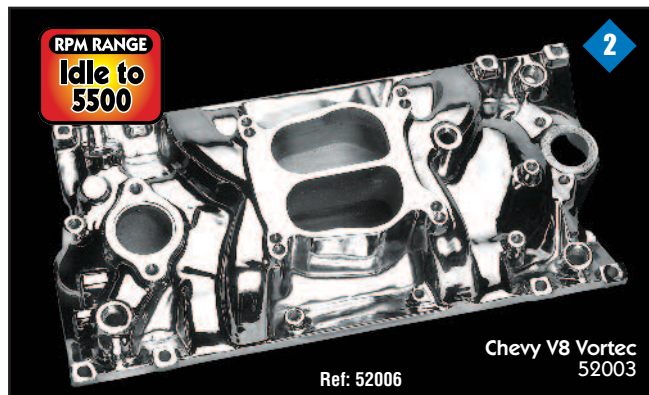

#52003 is a #52006 Manifold that has been chrome plated.

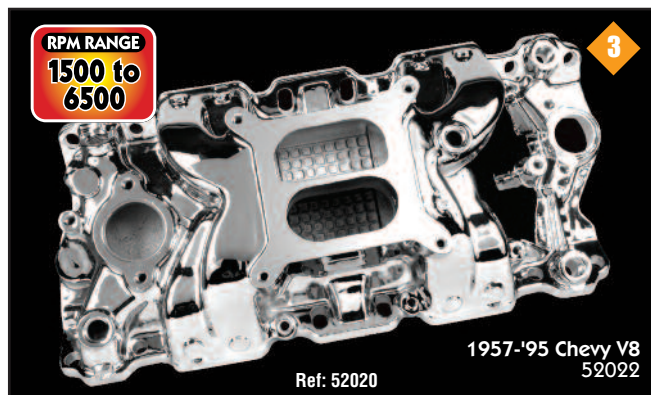

#52022 is a #52020 Manifold that has been chrome plated.

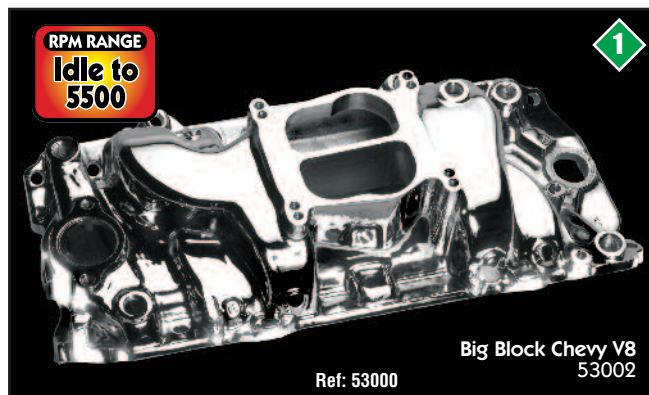

#53002 is a #53000 Manifold that has been chrome plated.

## Acura Intake Manifolds

### WHIRLWIND® for 1997-'01 Acura Type R

The Whirlwind for Acura Type R was developed in conjunction with AEBS, a leading Honda/Acura specialist. The plenum chamber is enlarged and also extends past the last port runner to provide adequate flow when using a supercharger, turbocharger or nitrous. In some respects this manifold is similar to the popular JDM manifold but will outperform it and costs substantially less. The manifold has a 65MM inlet but can be ground out larger if needed. See our line of compatible large bore precision throttle bodies in the throttle body section of this catalog. Dampers and fuel rails are also available from us for this engine.

Pt. No.	Application
59000	Acura Type R Manifold - Polished Finish
59001	Acura Type R Manifold - Satin Finish

### WHIRLWIND® for 1994-'01 Acura GSR

This design is similar in all respects to our Type R manifold. It is designed to eliminate the two stage design of the stock manifold. Note that O.E. injectors or equivalent must be used with this manifold. It has nitrous bosses on the underside of the runners for those of you who would like to utilize a port injected nitrous system. This manifold has had all of the vacuum ports as well as accessory pads moved to the back of the manifold to provide a cleaner overall look. Additional vacuum ports have been added as well.

Pt. No.	Application
59002	Acura GSR Manifold - Polished Finish
59003	Acura GSR Manifold - Satin Finish



WHIRLWIND®

# MANIFOLDS for EFI Applications.

The manifolds shown on this page are available with machined bosses for port injection applications. All of these manifolds also

have matching fuel rail kits which are shown on page 25. For additional fuel injection components, see the EFI section of this catalog.

**1957-'95  
SB Chevy**



52038 - Polished • 52039 - Satin



**1965-'79 - 325-455  
Pontiac V8**



56032 - Polished • 56033 - Satin



**289-302 5.0L  
SB Ford**

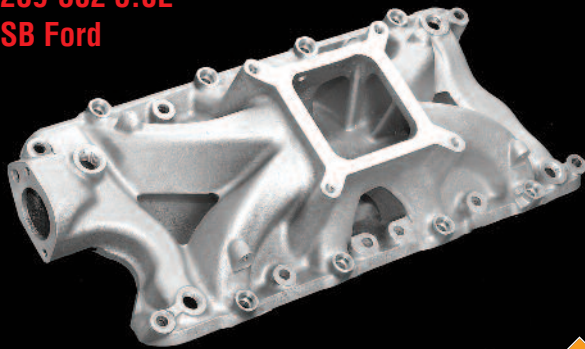

54038 - Polished • 54039 - Satin



**1965-'79 - 325-455  
Pontiac V8**

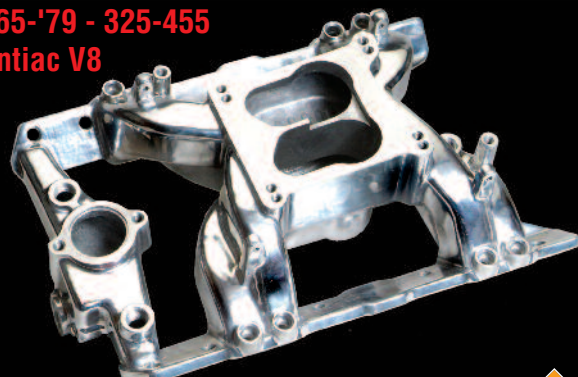

56027 - Polished • 56028 - Satin



**351 Windsor  
SB Ford**

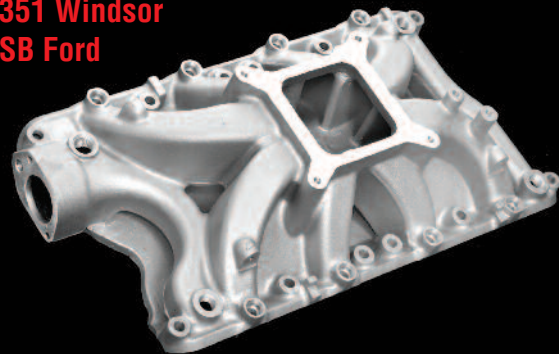

54034 - Polished • 54035 - Satin



**400-425-455  
Oldsmobile V8**

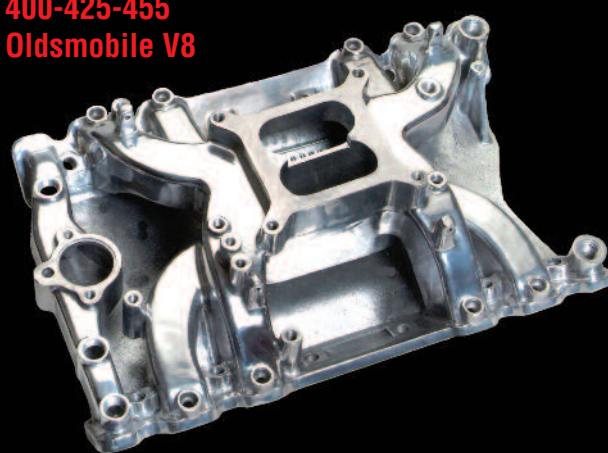

57027 - Polished • 57028 - Satin



**396-427-454-502  
BB Chevy**

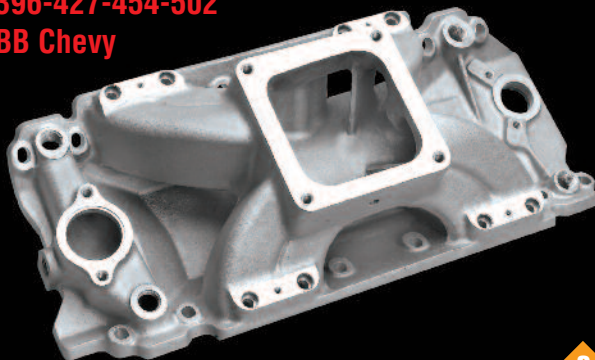

53032 - Polished • 53033 - Satin



**Left:** Currently, our only EFI style big block Chevy manifold has a Dominator carburetor flange. To use our 4150 style throttle body or 4150 style carburetor on this manifold requires the use of a special adapter shown at right. See page 23 for a complete listing of available adapters.





# Intake Manifold Technical Specifications

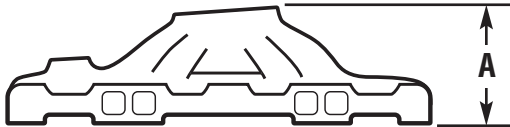

## Manifold Height

Note: Dimension "A" is measured from bottom machined surface of manifold to the highest portion of the carburetor flange or plenum housing.

## Port Dimensions

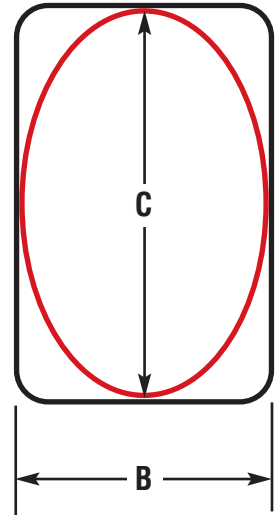

On any manifold that is taller than your stock manifold, it is extremely important to check for proper hood clearance before installing the manifold to avoid sheet metal damage to your hood.

Manifold Part No.	Dim. A	Dim. B	Dim. C	Pro Products Gasket	Fel-Pro Gasket
52000/52001/52002/52008/52009	4.05	1.19	1.90	#52600	#1204 or #1256
52003/52006/52007	4.25	1.18 <sup>1</sup>	2.06	#52605	#1255
52010/52011/52012/52013/52014 52016	4.40	1.25	2.02	#52600	#1204 or #1256
52020/52021/52022/52025/52026	4.65	1.25	2.09	#52601	#1205
52027/52028	4.65	1.18 <sup>1</sup>	2.06	#52605	#1255
52030/52031/52032/52033/52034 52035/52036/52037/52038/52039	6.06	1.11 <sup>2</sup>	1.80	#52601	#1205, #1206, #1207 #1208, or #1209 <sup>6</sup>
52060/52061/52062/52063 <sup>4</sup> 52064/52605 <sup>4</sup>	6.44	1.09	2.70	#52610	
53000/53001/53002	5.75	1.82	2.05	#53600	#1210 or #1212
53025/53026	5.22	1.82	2.05	#53600	#1212
53030/53031	6.16	1.63	2.25	#53601	#1211 or #1275
53034/53035	5.88	1.75	2.35	#53601	#1211 or #1275
53036/53037	5.87	1.82	2.05	#53600	#1212
54000/54001/54002	4.12	1.06	1.87	#54600	#1250
54020/54021 <small>Dimension to top of plenum</small>	11.05	1.06	1.87	#54600	#1250
54022/54023/54024	5.12	1.06	1.87	#54600	#1250
54025/54026	4.12	1.06	1.87	#54600	#1250
54030/54031	5.39	1.06	1.94	#54600	#1250
54032/54033/54034/54035	5.68	1.18	1.91	#54600	#1250
54060/54061 <sup>4</sup>	4.30	1.45	1.45	#54601	N/A
54122/54123	5.47	1.06	1.87	#54600	#1250
54126/54127	5.62	1.06	1.87	#54600	#1250
55025/55026	5.50	1.08	2.16	#55600 <sup>3</sup>	#1213 <sup>3</sup>
56025/56026/56027/56028	Note 5	1.10	2.06	N/A	#1233
56030/56031	Stock	1.10	2.06	N/A	#1233
57025/57026/57027/57028	6.50	1.32	2.38	N/A	Mr. Gasket #404

Note:  
53000/53001/53002/  
52025/53026/53036/  
53027 Big Block Chevys  
have oval ports (red line).

52006/52007/52003/  
52027/52028/52032/  
52033 SB Chevy Vortec  
heads have tapered ports.

54060/54061 4.6L Ford  
heads have round ports.

All other heads have rec-  
tangular ports.

The ports on Professional  
Products manifolds are  
typically made closer to  
the actual size of the gas-  
ket compared to other  
competitive manifolds.  
This reduces the necessity  
of port matching. Or if port  
matching is desired, it  
will require less grinding to get  
a proper match.

## NOTES:

**Note 1.** Measured at the widest area of the port which is at the bottom. The top of the Vortec port is 1.06".

**Note 2.** The ports on all SB Chevy Hurricanes are purposefully left smaller to allow a wide range of port sizes to match various head configurations. The port runners are typically much larger than the port openings.

**Note 3.** Use this gasket on non-Magnum engines. On Magnum engines use Professional Products gasket #55601 or Mopar Performance #P-4876049.

**Note 4.** Gaskets are supplied with manifold on these part numbers.

**Note 5.** This manifold is 1.25" taller than the stock intake manifold.

**Note 6.** The 52030 and 52031 Hurricanes can be ported out to a Fel-Pro #1207 intake gasket. All other small block Chevy Hurricanes can be ported out to a Fel-Pro #1209 intake gasket.

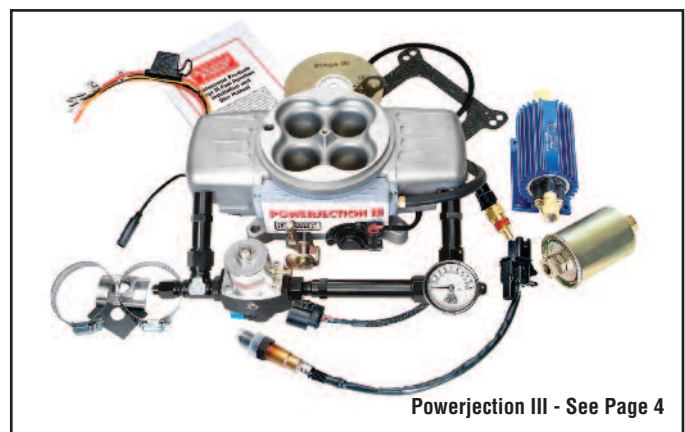

Powerjection III - See Page 4

# ENGINE ACCESSORIES and Manifold Accessories

## LSX Coil/Fuel Rail Covers

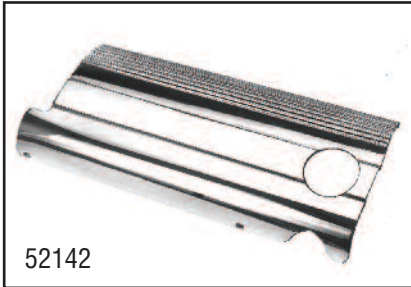

52142



52141



52142 Chrome Covers shown on engine

These Coil/Fuel Rail Covers make a fantastic finishing touch when using one of the Professional Products LSX intake manifolds. Note that these covers are designed to mount to the Professional Products LSX Fuel Rails which are supplied with our LSX manifolds and also sold separately. So you must have one of our LSX Fuel Rail Kits in order to utilize these covers. The Coil/Fuel Rail Covers come in two finishes. Above left is the 52142 Covers featuring a show chrome finish. The center cover is the 52141 which has a finely etched finish and is then clear anodized. While this finish doesn't show

its true appearance in a photo, it makes a stunning look on any engine. Above right is the 52142 Cover which has a bright chrome finish that is the ultimate in bling. All mounting brackets and mounting hardware are stainless steel. These covers fit F-body and Corvette.

Part No.	Description
52141	LSX Coil Covers w/etched & clear anodized finish
52142	LSX Coil Covers w/bright show chrome finish



## 12-Point Stainless Engine Bolt Kits

These premium stainless Bolt Kits are available for three popular engines and are also offered as just intake manifold sets. The bolt heads are polished. The various bolts in each engine kit are grouped together and labeled for size and length plus the specific use is given such as intake manifold, pan, alternator, water pump, distributor, timing cover, fuel pump and valve covers. Due to wide variations of SB Ford engines, the 54130 kit may contain some bolts not needed or may not include every bolt required on some engines.

Pt. No.	Application
52120	SB Chevy & Pontiac Intake Manifold Bolt Set
52130	SB Chevy Complete Engine Bolt Kit
53120	BB Chevy Intake Manifold Bolt Set
53130	BB Chevy Complete Engine Bolt Kit
54120	SB Ford Intake Manifold Bolt Set
54130	SB Ford Complete Engine Bolt Kit



## Upper Plenum Assembly for 4.6L 2V Mustang

The Upper Plenum is a direct bolt-on for all 4.6L 2V Mustangs and provides an additional 100 CFM of air flow over the stock unit. The inlet opening is 75MM but can be used with stock throttle bodies or our 70 or 75MM throttle bodies. This is an inexpensive bolt-on that provides in-stand additional performance.

54154	Upper Plenum Polished
54155	Upper Plenum Satin



## Elbow Adapter

These two parts are required when a 54020/54021 Professional Products Typhoon Manifold System is installed on a 1994-95 Mustang. These parts provide clearance from the stock strut brace but still requires an aftermarket strut brace. Use Ford Racing #M-20201-A51 Strut Tower Brace or Edelbrock #5225 Strut Brace.

54150	Elbow Adapter Polished
54151	Elbow Adapter Satin
54152	EGR Adapter Fitting



Stainless Steel



Zinc Plated Steel

## Throttle Cable Bracket Kit for SB Chevy

This Bracket Kit is designed for use on 1978 and earlier small block Chevs. It provides a mounting for the throttle, cruise control, and transmission kick-down cables. The Bracket Kit will fit on most manifolds and features wide adjustability. Each of the three cable brackets mount independently and can be positioned forward or backward by sliding the bracket in the slotted holes before tightening. The Bracket Kit is offered in either a zinc plated steel version or a polished stainless steel version. This kit significantly simplifies the task of connecting these cables.

52125	Throttle Cable Bracket Kit in polished stainless steel
52126	Throttle Cable Bracket Kit with zinc plated finish

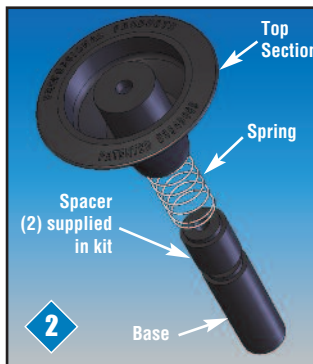

## AIRFLO™ Air Cleaner Insert

The AIRFLO is an amazingly simple device that will work on Holley or Demon four barrel carbs, with or without a choke tower and any round air cleaner with an inside space of 3.3" to 6.4". The AIRFLO works on a very simple principle. As air flows into the air cleaner, the air currents collide in the center and are slowed making their entry into the carburetor. The AIRFLO solves this problem by providing a smooth transition from the side entry right down into the carb. Tests have shown anywhere from 7 to 10 HP and as much as a tenth better e.t.

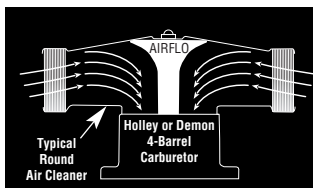

20001	Holley/Demon w/o choke
20003	Holley 4-bbl w/choke
20004	Demon 4-bbl w/choke



# ENGINE ACCESSORIES and Manifold Accessories



## POWER+PLUS® Gasket Sets

All Power+Plus Intake Gasket Sets feature silicone beading around the intake ports and water ports for additional sealing. These sets do not include end rail gaskets. Use RTV type gasket sealer.

Pt. No.	Application	Compare*to:
52600	SB Chevy (1.23" x 1.99" port size)	Fel-Pro #1256
52601	SB Chevy (1.28" x 2.09" port size)	Fel-Pro #1205
52605	SB Chevy Vortec (Tapered port)	Fel-Pro #1255
52610	GM LS1/LS2/LS6	Fel-Pro #1312-3
53600	BB Chevy w/oval ports	Fel-Pro #1212
53601	BB Chevy w/rectangular ports	Fel-Pro #1211
54600	SB Ford 289/302/351W/5.0L	Fel-Pro #1250
54601	4.6L 2V & 5.4L 2V Ford V8	
54160	Replacement Gaskets for 54020/54021/54124/54125 (except intake gaskets)	
54165	Upper Plenum to Manifold Gasket for 4.6L 2V Ford	
54170	Replacement Gaskets for 54060/54061 (except intake gaskets)	
55600	SB Chrysler (except Magnum)	Fel-Pro #1213
55601	SB Chrysler Magnum	Mopar #P4875049

\*Comparison refers only to port configuration.



## 4.6L 2V to 5.4L 2V Adapter Plate Kit

Many Mustang owners are replacing their stock 4.6L 2V engine with the larger 5.4L 2V truck engine. However there are no aftermarket performance manifolds for this engine. Now with this Adapter Plate Kit you can bolt on our popular 54060/54061 Typhoon manifold or any other 4.6L 2V performance manifold to the 5.4L 2V engine. Kit includes adapter plates, coil spacers, gaskets and necessary hardware.

54110 4.6L to 5.4L Manifold Adapter Plate Kit



## EGR Adapter

Use with our 52008/52009 manifold to solve clearance issues with valve covers or carburetors.

52115 EGR Adapter Kit - Polished

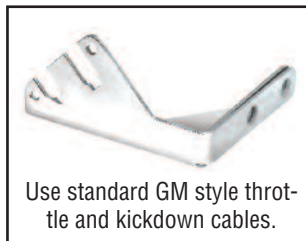

Use standard GM style throttle and kickdown cables.

## Throttle Cable Bracket

This stainless bracket bolts to our 52060-52065 LSX Intake Manifolds and also our 72012/72013 Snorkle.

52200 S/S Throttle Cable Bracket



52110



52112

## Adapter Bushings

These Bushings are supplied standard with all SB Chevy manifolds (except Vortec style) and are available as replacement items in case you might lose one or more.

52110 Angle Bushing  
52112 Straight Bushing



## Carb Stud Kit

The kits include stainless steel studs, nuts and washers. Bottom of stud is 5/16-18 thread and top of stud, and nut, is 5/16-24 thread. Rounded crown on top of stud makes starting nuts easy.

20150 1.700" Long Stud Kit  
20151 2.250" Long Stud Kit



## Replacement Throttle Body Gasket Sets

Pt. No.	Application
69400	For 69200 through 69205
69401	For 69210 through 69215 plus 69232 and 69233
69402	For 69220 through 69225
69403	For 69226 and 69227
69410	For 69600, 69601, 69604, 69605
69411	For 69602, 69603, 69606, 69607
69415	For 69700 through 69707
69416	For 69724 through 69728
69417	For 69728 through 69735

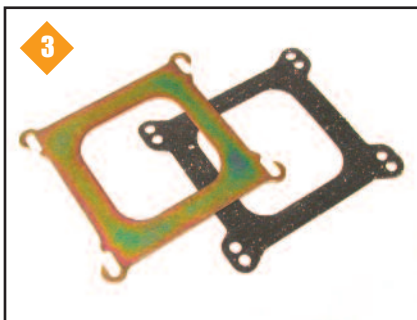

## Carburetor Adapter Plate & Gasket

This Adapter Plate is used when using a square bore carburetor on a spread bore manifold. While a square bore carb looks like it will bolt directly to a spread bore manifold, without this plate and gasket there is a possibility of a vacuum leak. So the plate is inexpensive insurance. Note that this Adapter Plate is supplied in all Professional Products manifolds that come with a spread bore carburetor flange.

52111 Manifold Adapter Plate Kit



## Carbretor Adapter - 1450 to 4500

This series of adapters allow the use of Dominator style carbs on 4150 manifolds and 4150 style carbs on Dominator manifolds. Available in either a satin or polished finish. Note that use of this adapter on our big block Hurricane EFI manifold allows the use of a 4150 throttle body.

20100 4150 Carb to 4500 Manifold - Satin  
20101 4500 Carb to 4150 Manifold - Satin  
20102 4150 Carb to 4500 Manifold - Polished  
20103 4500 Carb to 4150 Manifold - Polished

# ENGINE ACCESSORIES, Manifold Accessories & Gauges

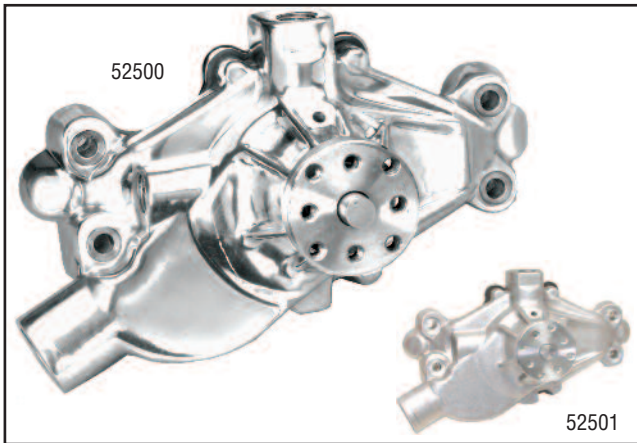

## POWERFLOW™ - SB Chevy Water Pump

This short style cast aluminum Water Pump for SB Chevy is a high quality product that has been well received in the marketplace. It features a high flow impeller design, a heavy duty double shaft bearing, and dual bolt patterns on the pulley flange to accept all popular fan designs. This is a great water pump produced by an O.E. level pump manufacturer specifically for Professional Products. This high level pump is a great addition to any street rod, street machine, or custom car. It is supplied with extra gaskets if needed to space out to clear some aftermarket timing covers. This is a permanent mold aluminum casting which provides an outstanding polished finish without porosity or other unsightly flaws. Available in a highly polished finish or in an attractive satin finish.

Pt. No.	Description
52500	Small Block Chevrolet Short Style Water Pump - Polished
52501	Small Block Chevrolet Short Style Water Pump - Satin

## EFI Snorkel Inlet

This Snorkel Assembly is unlike any of the competition. This one can be rotated in 15° increments which allows you to position it to avoid interference with any other engine components. Competitive models can normally only be positioned either in line with the engine or at 90° to it. The rotating seal area is handled by an o-ring. The Snorkel Assembly by itself will accept throttle bodies with LS2 bolt patterns. Various adapters are also available that will permit the use of LS1 style throttle bodies, 1986-'93 Mustang throttle bodies, and also one that will accept a 4" diameter inlet hose for supercharger or turbocharger applications.

Pt. No.	Description
70212	Complete Snorkel Assembly - Polished
70213	Complete Snorkel Assembly - Satin
70214	LS1 Adapter - Polished
70215	LS1 Adapter - Satin
70216	4" Inlet Adapter - Polished
70217	4" Inlet Adapter - Satin
70218	1986-'93 Mustang Adapter - Polished
70219	1986-'93 Mustang Adapter - Satin
70240	Replacement O-Ring

Base of unit bolts to either square bore or spread bore carb flange.

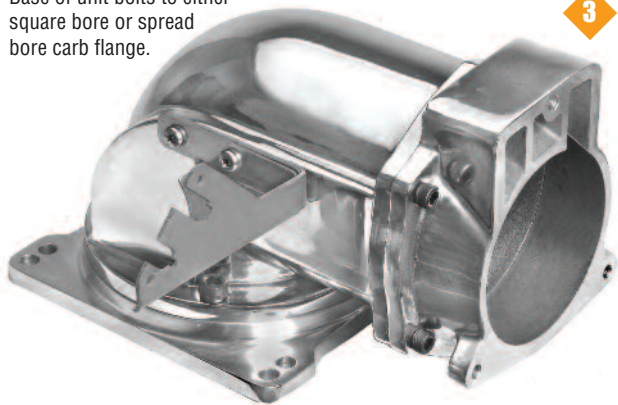

Shown with optional LS1 Adapter attached and also shown with optional #52200 stainless linkage bracket attached.

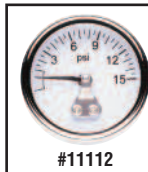
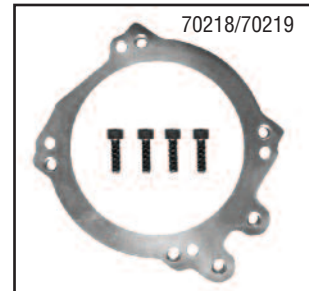
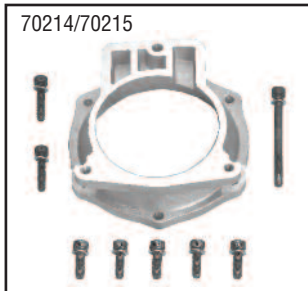
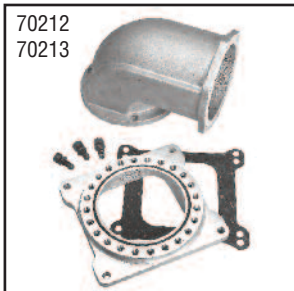

Professional Products Fuel Pressure Gauges feature a 1/8-NPT male pipe nipple on the back, a 1-1/2" diameter face and a chrome bezel. Not liquid filled. Not for use inside the passenger compartment unless a fuel pressure isolator is installed.

### Racing Tire Pressure Gauges

- 11100 0-15 PSI Tire Gauge with 13mm hose and rubber protector
- 11103 0-60 PSI Tire Gauge with 13mm hose and rubber protector

### Street Tire Pressure Gauges

- 11101 0-60 PSI Tire Gauge w/45° end and hard plastic case
- 11102 0-60 PSI Tire Gauge w/9" long hose and hard plastic case
- 11110 0-100 PSI Digital Tire Gauge (reads in 1/2-lb. increments)

### Fuel Pressure Gauges

- 11112 0-15 PSI Fuel Pressure Gauge for use on carbureted vehicles
- 11113 0-100 PSI Fuel Pressure Gauge for use on injected vehicles

### Compression Tester

- 11108 0-300 PSI Compression Tester - Fits both 14mm and 18mm spark plug holes with dual thread fitting on hose.

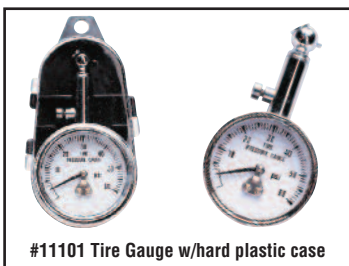



# POWERFILTER™ Lifetime Oil Filters

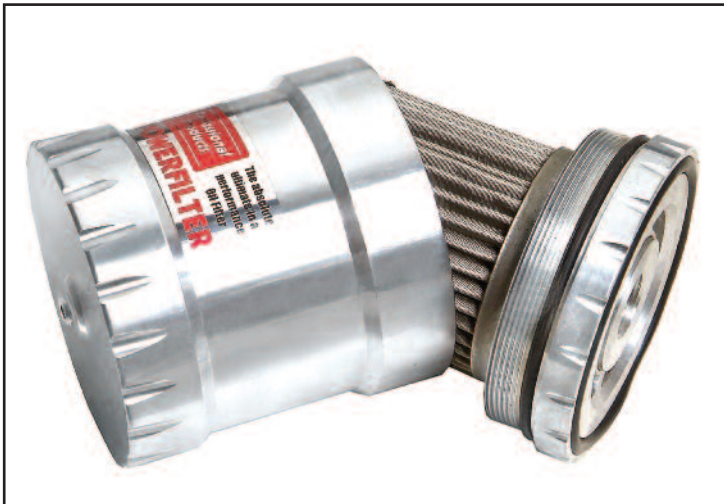

This outstanding line of Powerfilter Oil Filters consists of billet style precision machined products made of aircraft quality aluminum. The filter element itself is a finely woven 45 micron stainless steel mesh that is easily removed and can be washed clean and reused. That's why we call it a lifetime filter. However, we do offer inexpensive replacement elements in case your original one becomes damaged or otherwise in need of replacement. We also offer replacement o-ring kits as well. Additionally, extra fine elements are available for racing applications. Due to the extreme fine mesh used (10 microns) these filters should not be used on the street and when used in racing applications should be cleaned after each race event. These filters also feature a pipe plug in the bottom so that oil can be drained from the filter before removal. This eliminates the problem of having oil run down your arm when removing the filter housing. This page lists the most popular performance engine applications. For a complete listing for every vehicle made since 1985, please go to the Professional

## The Professional Products Powerfilter Oil Filter System

The Powerflow Oil Filter lineup consists of four basic filter canister sizes with different threaded bushings to make up our current twelve different filters. Note that if you change vehicles and both vehicles use the same basic canister size but with different threads, you can just switch the threaded bushings to use the filter on your new vehicle. Here is the current lineup of filters:

Filter Part No.	Filter Canister Size	Bushing Thread	Bushing Part Number	Replacement Element Std.	Replacement Element - Extra Fine
10854	Import	M20 x 1.5	10846	10815	10816
10857	Import	3/4-16 UNF	10843	10815	10816
10867	Small Domestic	13/16-16 UN	10840	10815	10816
10868	Small Domestic	M18 x 1.5	10842	10815	10816
10870	Small Domestic	M20 x 1.5	10846	10815	10816
10873	Small Domestic	3/4-16 UNF	10843	10815	10816
10874	Medium Domestic	1-16 UN	No bushing required	10810	10811
10875	Medium Domestic	13/16-16 UN	10840	10810	10811
10876	Medium Domestic	M18 x 1.5	10842	10810	10811
10879	Medium Domestic	M22 x 1.5	10847	10810	10811
10881	Medium Domestic	3/4-16 UNF	10843	10810	10811
10884	Large Domestic	13/16-16 UN	10845	10812	10814

10950	O-Ring Kit (Import)
10951	O-Ring Kit (Small/Medium)
10952	O-Ring Kit (Large)

Overall dimensions of various sizes of filters:	
Import - 3.25" diameter x 3.44" long	Medium Domestic - 3.25" diameter x 4.2" long
Small Domestic - 3.25" diameter x 3.6" long	Large Domestic - 3.90" diameter x 4.4" long

## Popular Early Powerfilter Oil Filter Applications

This chart goes back to 1985. Since many performance engines are based on earlier years, the application chart below covers most of the popular pre-1985 engines that are used in performance applications.

<b>Chevrolet</b> and similar GMC models	1969-'91 351W.....10881	1965-'67 425.....10875
1968-'70 396 BB Chevrolet V8.....10884	1970-'74 351C.....10881	1968-'76 455.....10875
1968-'69 427 BB Chevrolet V8.....10884	1971-'78 400.....10881	
1970-'76 454 BB Chevrolet V8.....10884	1963-'65 260.....10881	<b>Pontiac</b>
1967 283 & 350 SB Chevrolet V8.....10884	1963-'69 289.....10881	1961-'79 326.....10875
1976-'93 305 SB Chevrolet V8.....10884	1968-'95 302/5.0L.....10881	1961-'79 350.....10875
1968-'69 327 SB Chevrolet V8.....10884		1961-'79 389.....10875
1968-'97 350 SB Chevrolet V8.....10884	<b>Chrysler, Plymouth, Dodge</b>	1962 & later 421.....10875
1970-'76 400 SB Chevrolet V8.....10884	1968-'71 383.....10881	1967 & later 428.....10875
	1972-'78 400.....10881	1961-'79 455.....10875
	1968-'78 440.....10881	
<b>Ford, Lincoln, Mercury</b>	1975-'81 318.....10881	
1958-'66 352.....10881	1971-'80 360.....10881	
1961-'71 390.....10881		
1962-'63 406.....10881	<b>Oldsmobile</b>	
1963-'69 427.....10881	1967-'68 330.....10875	
1966-'70 428.....10881	1968-'80 350.....10875	
1968-'73 429.....10881	1965-'75 400.....10875	
1972-'78 460.....10881	1977-'79 403.....10875	

Note: Our filters fit a wide array of engines. What you see here is a limited listing for mostly pre-1985 engines. For more complete info for any 1985 or later vehicle, see full application chart on our website.

**10875 interchanges with Fram HP2 or HP5**  
**10881 interchanges with Fram HP1**  
**10884 interchanges with Fram HP4**

**Harley-Davidson Applications:** The #10873 Powerfilter fits all Evolution or Twin Cam engines with rigid motor mounts. Fits all Sportsters. Fits all early model H-D engines with threaded oil filters. Will not fit Dyna or Touring models with rubber mounted twin cam engines.

**Honda and Yamaha Applications:** The #10854 Powerfilter will fit most Honda and Yamaha motorcycles.

# POWER™ Throttle Bodies

Professional Products line of throttle bodies are generally considered by the performance industry as the highest quality throttle body available. These throttle bodies are precision engineered and many of them are made of aluminum die castings which is the same process used by the original equipment manufacturers. Those

that are not die cast are made from permanent mold castings, a superior casting process to the sand casting used by all other after-market throttle body manufacturers making cast throttle bodies. Additionally, not only is the Professional Products Power line of throttle bodies the best quality, they are also the least expensive.

Polish Pt. No.	Satin Pt. No.	Ford Application Descriptions	
69200	69203	65MM Throttle Body for 1986-'93 Mustang 5.0L V8	
69201	69204	70MM Throttle Body for 1986-'93 Mustang 5.0L V8	
69202	69205	75MM Throttle Body for 1986-'93 Mustang 5.0L V8	
69210	69213	65MM Throttle Body for 1994-'95 Mustang 5.0L V8	
69211	69214	70MM Throttle Body for 1994-'95 Mustang 5.0L V8	
69212	69215	75MM Throttle Body for 1994-'95 Mustang 5.0L V8	
69220	69222	70MM Throttle Body for 1996-'04 Mustang 4.6L 2V V8	
69221	69223	75MM Throttle Body for 1996-'04 Mustang 4.6L 2V V8	1
69224	69225	75MM Throttle Body for 1997-'04 4.6L & 5.4L Ford F-Series and Expedition & 1990-'95 4.6L 2V V8	1
69232	69233	75MM Throttle Body for 1989-'93 Ford V6 Thunderbird Super Coupe and Mercury Cougar XR7	
69500	69503	65MM EGR Plate for 1986-'93 Mustang 5.0L V8	
69501	69504	70MM EGR Plate for 1986-'93 Mustang 5.0L V8	
69502	69505	75MM EGR Plate for 1986-'93 Mustang 5.0L V8	
69209		Throttle Position Sensor for 1986-'93 Mustang 5.0L V8	
All part numbers above this point are assigned CARB E.O. #D-624 and are street legal in the state of CA.			
69226	69227	64MM Twin Throttle Body for 2005 & later 4.6L 3V Ford	2

Polish Pt. No.	Satin Pt. No.	Acura Application Descriptions	
69604	69605	68MM Throttle Body for 1994-'01 Acura GSR	2
69606	69607	68MM Throttle Body for 1997-'01 Acura Type R	2

Polish Pt. No.	Satin Pt. No.	General Motors Application Descriptions	
69700	69701	52MM Throttle Body for 1992-'97 LT1 (TPI only, will not fit TBI)	
69702	69703	58MM Throttle Body for 1992-'97 LT1 (TPI only, will not fit TBI)	
69704	69705	52MM Throttle Body for 1985-'92 305/350 (TPI only, will not fit TBI)	
69706	69707	58MM Throttle Body for 1985-'92 305/350 (TPI only, will not fit TBI)	
69724	69725	80MM Throttle Body for 1998-'02 LS1/LS6 Camaro & Firebird, 2004 GTO and full size 4.8, 5.3, & 6.0 engines with cable style throttle linkage.	2
69726	69727	85MM Throttle Body for 1998-'02 LS1/LS6 Camaro & Firebird, 2004 GTO and full size 4.8, 5.3, & 6.0 engines with cable style throttle linkage.	
69728	69729	96MM Throttle Body for LS2 where cable throttle linkage is used.	
69732	69733	101MM Throttle Body for LS2 where cable throttle linkage is used.	

See page 21 of this catalog for replacement gaskets for all throttle bodies.

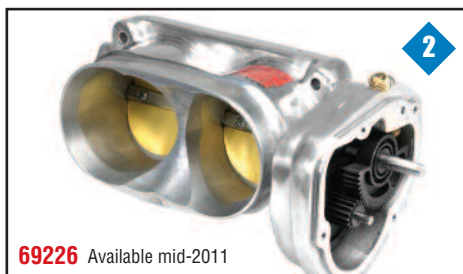
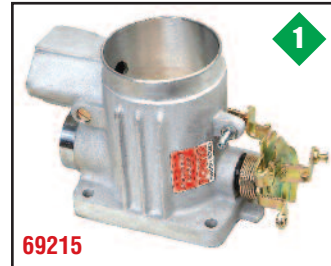



Our Basic Fuel Rail Kits typically contain the fuel rails, mounting brackets and hardware, and in some cases some fittings and other components. Note that we use stainless steel for all hardware and all mounting brackets in these kits instead of regular steel as found in most competitive kits. The Complete Kits include all the

components shown in the photos. All photos are Complete Kits. Also note that while the photos show a specific arrangement of crossover hoses and fuel regulators, in most cases the crossover hose can go at either end and the regulator can be mounted at any of the four ends of the rails or remote mounted on the firewall.

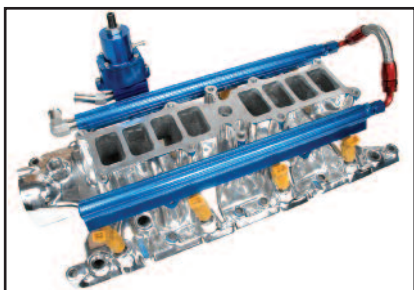

### 1986-'93 5.0L Ford Mustang

The 10600 kit will also fit a 1994-'95 Mustang if a smaller diameter (than stock) distributor is used. The 10601 will not fit the 1994-'95 Mustang due to interference between the regulator and the required throttle body elbow adapter. Both kits will work with O.E. and aftermarket manifolds.

- 10600** Basic Fuel Rail Kit
- 10601** Complete Fuel Rail Kit

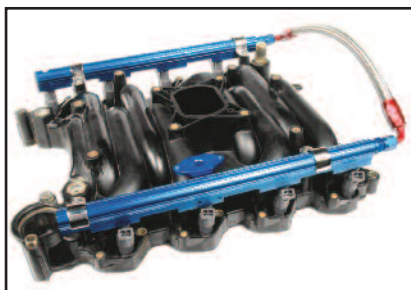

### 1996-'04 Ford 4.6L 2V

The early Complete Kits are supplied with a fuel pressure regulator. The late Basic and Complete Kits are supplied with an adapter mounted on the fuel rail to accept the stock fuel pressure sensor for returnless system.

- 10602** Basic Kit for 1999-'04 4.6L 2V
- 10603** Complete Kit for 1999-'04 4.6L 2V
- 10604** Basic Kit for 1996-'98 4.6L 2V
- 10605** Complete Kit for 1996-'98 4.6L 2V



### 289-302-351 Ford

These kits are designed to work with the EFI manifolds supplied by Professional Products for these engines. Use manifolds 54038/54039 for the 289/302/5.0L engines and use the 54034/54035 manifolds for the 351W. The kits include stainless steel brackets and hardware. Complete Kit includes regulator and crossover hose.

- 10606** Basic Kit for Small Block Ford
- 10607** Complete Kit for Small Block Ford



### Fuel Rail Kits - LS1/LS6/LS2

These are very complete kits and even include s/s fittings and a hose extension (not shown) for connecting the stock fuel lines to the fuel inlet.

- 10610** Basic Kit for 1997-'04 LS1/LS6
- 10611** Complete Kit for 1997-'98 LS1
- 10612** Complete Kit for 1999-'04 LS1/LS6
- 10613** Basic Kit for 2005-'07 LS2
- 10614** Complete Kit for 2005-'07 LS2

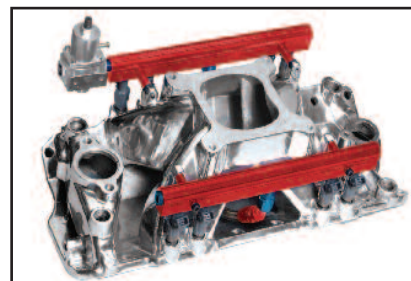

### Fuel Rail Kit for SB Chevy

This kit is designed to work with the Professional Products EFI manifolds 52038/52039 and includes a regulator and a stainless braided crossover hose that goes under the center of the plenum chamber. This is the same kit we supply in our Powerjection II EFI port injection systems.

- 10608** Complete Fuel Rail Kit for SB Chevy

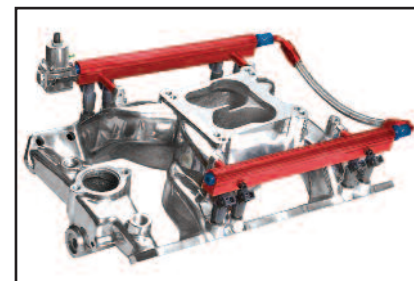

### Fuel Rail Kit for Pontiac

This fuel rail kit is compatible with our dual plane Pontiac manifolds for EFI. The manifolds are 56027/56028. The kit comes with an EFI fuel pressure regulator and a -06AN stainless braided crossover hose assembly. Professional Products also offers a Pontiac EFI setup using a single plane manifold.

- 10618** Pontiac Fuel Rail Kit (Dual Plane)

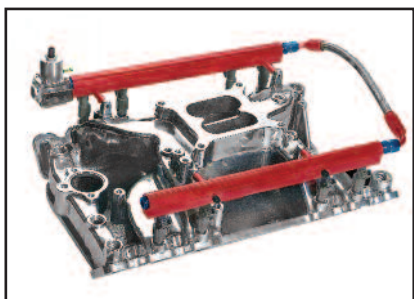

### Fuel Rail Kit for Oldsmobile

Use this kit with the Professional Products EFI manifolds 57027 or 57028. This is a dual plane manifold but we have seen excellent results with it used in an EFI application. This complete kit includes a fuel pressure regulator and crossover hose and all necessary AN adapter fittings.

- 10619** Fuel Rail Kit for Oldsmobile

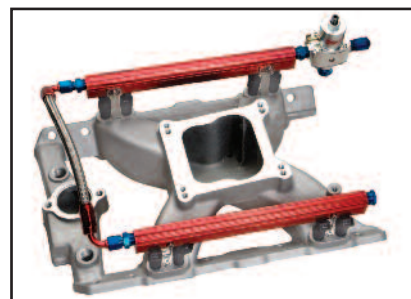

### Fuel Rail Kit for Pontiac

This fuel rail kit is designed to be used with our single plane Hurricane manifold for Pontiacs, 56032 or 56033. This is an outstanding performance manifold. The manifold comes with an adapter plate to accept the square bore carb flange on throttle bodies.

- 10625** Pontiac Fuel Rail Kit (Single Plane)

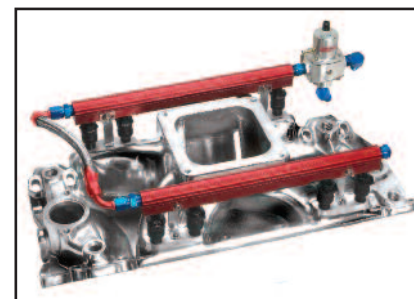

### Fuel Rail Kit - Big Block Chevy

Use this kit with our 53032 or 53033 manifold. Note that this manifold has a Dominator (4500) flange on it which will accept our Dominator sized throttle bodies or we also offer an adapter that permits the use of the standard 4150 base throttle bodies. See Engine Accessories for adapter.

- 10626** Fuel Rail Kit for Big Block Chevy

# POWERFLOW™ Fuel Pressure Regulators for Carburetors



**3**  
**2-Port**

**(1) 1/2-NPT Inlet Port**  
**(2) 3/8-NPT Outlet Ports**  
**Flows 150 GPH**  
**4.5 to 9 PSI Adjustability**  
**.437 (7/16") Restriction**

This is an ideal all around regulator. Suitable for one dual inlet carb or two single inlet carbs. Suitable for up to 650 HP. For higher HP use two regulators

10650 2-Port Regulator - Blue Anodize  
10651 2-Port Regulator - Clear Anodize

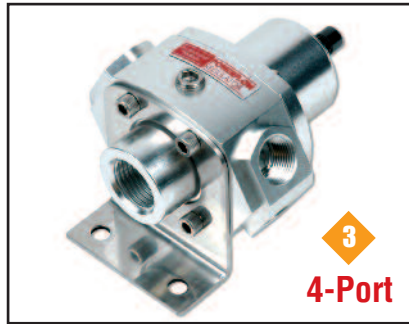

**3**  
**4-Port**

**(1) 1/2-NPT Inlet Port**  
**(4) 3/8-NPT Outlet Ports**  
**Flows 150 GPH**  
**4.5 to 9 PSI Adjustability**  
**.437 (7/16") Restriction**

Suitable for two dual inlet carbs on engines up to 1,200 HP. Note that HP rating relates to number of carb inlets. This is a terrific buy for a four port unit.

10656 4-Port Regulator - Blue Anodize  
10657 4-Port Regulator - Clear Anodize

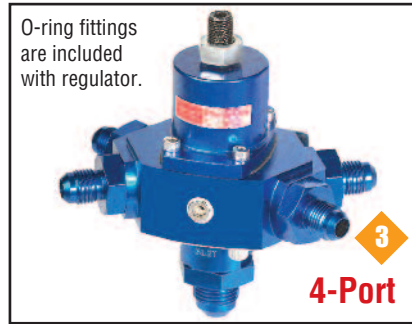

O-ring fittings are included with regulator.  
**3**  
**4-Port**

**(1) -08AN Inlet Port**  
**(4) -06AN Outlet Ports**  
**Flows 150 GPH**  
**4.5 to 9 PSI Adjustability**  
**.437 (7/16") Restriction**

Suitable for two dual inlet carbs on engines up to 1,200 HP. Note that HP rating relates to number of carb inlets. O-ring fittings are included with unit.

10654 4-Port Regulator - Blue Anodize  
10655 4-Port Regulator - Clear Anodize



**Bypass Style**  
**3**  
**3-Port**

**(1) 3/8-NPT Return Port**  
**(3) 3/8-NPT In/Out Ports**  
**Flows 150 GPH**  
**4.5 to 9 PSI Adjustability**  
**.437 (7/16") Restriction**

Same use as the 2-port but has a return port. For converting an EFI vehicle to a carb still using the EFI high pressure fuel pump and return line.

10652 3-Port Regulator - Blue Anodize  
10653 3-Port Regulator - Clear Anodize

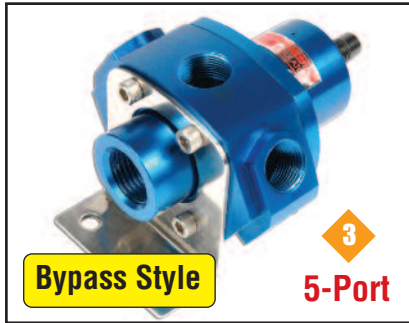

**Bypass Style**  
**3**  
**5-Port**

**(1) 3/8-NPT Return Port**  
**(4) 3/8-NPT In/Out Ports**  
**Flows 150 GPH**  
**4.5 to 9 PSI Adjustability**  
**.437 (7/16") Restriction**

Same use as 4-port unit but also has a return port. For converting an EFI vehicle to a carb still using the high pressure EFI fuel pump and return line.

10658 5-Port Regulator - Blue Anodize  
10659 5-Port Regulator - Clear Anodize

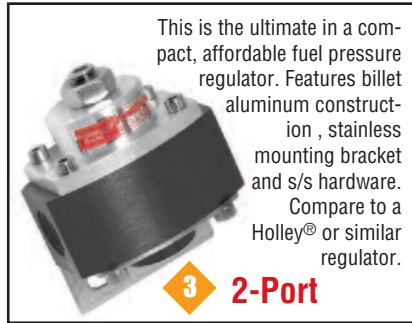

This is the ultimate in a compact, affordable fuel pressure regulator. Features billet aluminum construction, stainless mounting bracket and s/s hardware. Compare to a Holley® or similar regulator.

**3**  
**2-Port**

Suitable for engines up to 450 HP. Use two units for higher HP engines with dual carburetors.

10660 4.5 to 9 PSI - Blue Anodize - 3/8-NPT Ports  
10661 4.5 to 9 PSI - Clear Anodize - 3/8-NPT Ports  
10662 2 to 4 PSI - Blue Anodize - 3/8-NPT Ports  
10663 2 to 4 PSI - Clear Anodize - 3/8-NPT Ports  
10665 4.5 to 9 PSI - Black and clear Anodize with 9/16-18 ports

# POWERFLOW™ Fuel Pressure Regulators for Fuel Injection

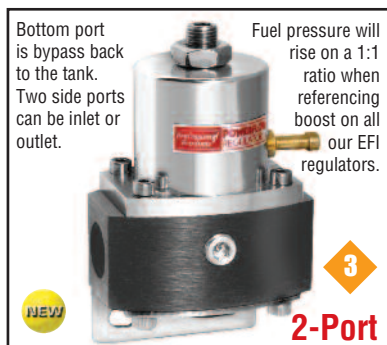

Bottom port is bypass back to the tank. Two side ports can be inlet or outlet.

Fuel pressure will rise on a 1:1 ratio when referencing boost on all our EFI regulators.

**NEW**  
**3**  
**2-Port**

Use on regular EFI systems with one feed line to the fuel rails and one return line to the gas tank. Wrench flats on 10686 makes it easy to install fittings. Adjustable from 25 to 75 PSI. Flows 200+ GPH. Stainless mounting bracket and screws are standard.

10685 2-Port Regulator - Black and clear aluminum. With 9/16-18 ports.  
10686 2-Port Regulator - Black and clear aluminum. With 3/8-NPT ports.  
**The 10686 regulator replaces the 10670 and 10671 fuel regulators.**



## EFI Mustang Regulators

**3**

These regulators bolt directly to the factory fuel rails in place of the stock units and provide adjustability from approximately 25 PSI to 75 PSI. Very easy to install. Stainless hardware and o-ring seals.

10678 Fits 1986-'93 5.0L Ford - Blue  
10679 Fits 1986-'93 5.0L Ford - Clear  
10680 Fits 1994-'95 5.0L Mustang & Cobra, 1996-'97 2V and 1996-'98 4V 4.6L Mustang & Cobra, and 1994-'98 3.8L Mustang - Blue  
10681 Fits 1994-'95 5.0L Mustang & Cobra, 1996-'97 2V and 1996-'98 4V 4.6L Mustang & Cobra, and 1994-'98 3.8L Mustang - Clear

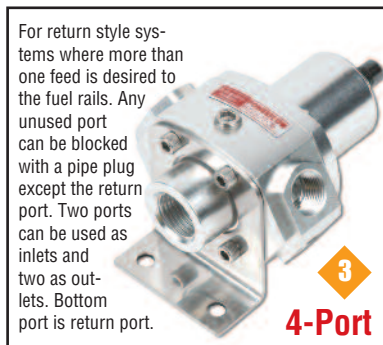

For return style systems where more than one feed is desired to the fuel rails. Any unused port can be blocked with a pipe plug except the return port. Two ports can be used as inlets and two as outlets. Bottom port is return port.

**3**  
**4-Port**

**(1) 1/2-NPT Return Port**  
**(4) 3/8-NPT In/Out Ports**  
**Flows 200+ GPH**  
**25 to 75 PSI Adjustability**  
**.437 (7/16") Restriction**  
**1/8-NPT Gauge Port**  
**Stainless Bracket/Screws**

These regulators, as with all our units, come with stainless steel mounting brackets and all stainless hardware. EFI regulators have a boost reference fitting and a 1/8-NPT gauge port in the side.

10672 4-Port Regulator - Blue Anodize  
10673 4-Port Regulator - Clear Anodize



# POWERFLOW Fuel Pressure Regulators

## Professional Products POWERFLOW™ Fuel Regulator Lineup:

Part No.	Description	Bypass	Pressure Range
10650	2-Port - (1) 1/2-NPT inlet, (2) 3/8-NPT outlets (Blue)	No	4.5 to 9 PSI
10651	2-Port - (1) 1/2-NPT inlet, (2) 3/8-NPT outlets (Aluminum)	No	4.5 to 9 PSI
10652	3-Port - (1) 3/8-NPT inlet, (3) 3/8-NPT outlets* (Blue)	Yes	4.5 to 9 PSI
10653	3-Port - (1) 3/8-NPT inlet, (3) 3/8-NPT outlets* (Aluminum)	Yes	4.5 to 9 PSI
10654	4-Port - (1) -8AN inlet, (4) -6AN outlets (Blue)	No	4.5 to 9 PSI
10655	4-Port - (1) -8AN inlet, (4) -6AN outlets (Aluminum)	No	4.5 to 9 PSI
10656	4-Port - (1) 1/2-NPT inlet, (4) 3/8-NPT outlets (Blue)	No	4.5 to 9 PSI
10657	4-Port - (1) 1/2-NPT inlet, (4) 3/8-NPT outlets (Aluminum)	No	4.5 to 9 PSI
10658	5-Port - (1) 3/8-NPT inlet, (5) 3/8-NPT outlets* (Blue)	Yes	4.5 to 9 PSI
10659	5-Port - (1) 3/8-NPT inlet, (5) 3/8-NPT outlets* (Aluminum)	Yes	4.5 to 9 PSI
10660	2-Port - (1) 3/8-NPT inlet, (2) 3/8-NPT outlets (Blue)	No	4.5 to 9 PSI
10661	2-Port - (1) 3/8-NPT inlet, (2) 3/8-NPT outlets (Aluminum)	No	4.5 to 9 PSI
10662	2-Port - (1) 3/8-NPT inlet, (2) 3/8-NPT outlets (Blue)	No	2 to 4 PSI
10663	2-Port - (1) 3/8-NPT inlet, (2) 3/8-NPT outlets (Aluminum)	No	2 to 4 PSI
10665	2-Port - (1) 9/16-18 inlet, (2) 9/16-18 outlets (Black & Alum.)	Yes	4.5 to 9 PSI
10685	2-Port - (1) 9/16-18 inlet, (2) 9/16-18 outlets* (Black & Alum.)	Yes	25 to 75 PSI
10671	2-Port - (1) 9/16-18 inlet, (2) 9/16-18 outlets* (Black & alum.)	Yes	25 to 75 PSI
10672	4-Port - (1) 3/8-NPT inlet, (4) 3/8-NPT outlets* (Blue)	Yes	25 to 75 PSI
10673	4-Port - (1) 3/8-NPT inlet, (4) 3/8-NPT outlets* (Aluminum)	Yes	25 to 75 PSI
10678	1986-'93 Ford 5.0L (Blue)	Yes	25 to 75 PSI
10679	1986-'93 Ford 5.0L (Aluminum)	Yes	25 to 75 PSI
10680**	1994-'95 Ford 5.0L and 1996-'97 4.6L (Blue)	Yes	25 to 75 PSI
10681**	1994-'95 Ford 5.0L and 1996-'97 4.6L (Aluminum)	Yes	25 to 75 PSI

\*One outlet is a bypass (return) line.

\*\*See opposite page (pg. 28) for complete application data.

Carbureted Models

EFI Models

### Fuel Pressure Settings

Note: For carbs set the regulator from 5 to 5.5 psi. Note that the higher you set the pressure, the more you are restricting the flow of fuel through the regulator. Injected applications typically run in the 40 to 50 psi range which is dependent upon your specific engine requirements. Here high pressure is desirable for proper injector function.

### Ports

In all of our designations, when we say "2-port" or "4-port" that means the total number of outlet ports, including a return or bypass line port if the regulator is so equipped. For example, our 5-port models have one inlet port and five outlet ports, one of which is a return or bypass line port. So there are still four usable outlet ports.

### Special Features

Professional Products POWERFLOW Fuel Pressure Regulators are packed with features, yet remain some of the least expensive regulators available. These regulators are a great combination of function, looks and price. We think it is an unbeatable package.

- CNC Machined from billet aluminum
- Stainless steel mounting bracket & hardware
- Wrench flats on inlet and outlet ports
- Viton O-rings and diaphragm are impervious to gas or alcohol
- All regulators have a 1/8-NPT gauge port
- Carb models pre-set to 6 psi
- EFI models preset to 40 psi
- Each unit fully tested at the factory
- EFI units include a boost reference hose barb for vacuum hose

### Regulator Selection Guide:

- 2-Port (Carbs) w/o return - For one carb with a dual inlet or two carbs with single inlets.
  - 4-Port (Carbs) w/o return - For engines with two dual inlet carbs or four single inlet carbs.
  - 3-Port (Carbs) w/return - Same as 2-port above but in vehicle using EFI fuel pump w/return line.<sup>1</sup>
  - 5-Port (Carbs) w/return - Same as 4-port above but in vehicle using EFI fuel pump w/return line.<sup>1</sup>
  - 2-Port (EFI) - Use this in EFI systems where only one outlet to fuel rails is required. Has return port.
  - 4-Port (EFI) - Use in EFI systems where up to three outlets to fuel rails are required. Has return port.
- Ford Mustang Regulators are replacement for stock regulators but provide adjustability.

1. If the vehicle was originally equipped with an EFI pump and return line and you are now switching to a carburetor, you need a regulator to drop the pressure to the 4.5 to 9 PSI range for carburetors. That also allows you to hook up the stock return line. Note that many 1997 and later vehicles utilize a "returnless" system. The fuel pump is in the gas tank and there is no regulator. If you are installing a carburetor on one of these vehicles, you should consider removing the pump, or disabling it, and use an external fuel pump suitable for carburetors and one of our conventional carburetor style regulators such as the 10650/10651/10656/10657/10660/10661.

## Sample Carburetor/Regulator Plumbing Configurations

### Two 4-bbl's with 4-Port Regulator

A 5-Port Regulator can be used with this combination but requires a return line to the fuel tank. This can be advantageous in keeping the fuel cooler by recirculating it via a return line.

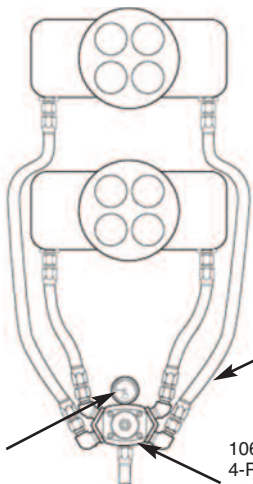

#11112  
0-15 PSI Fuel Pressure Gauge

-08 Fuel Inlet Line

10656/10657  
4-Port Regulator or  
10658/10659  
5-Port Regulator  
(Bypass)

-06 AN hose and fittings or 3/8 hard lines

-08 Fuel Inlet Line

### One 4-bbl with 2-Port Regulator

A 3-Port Regulator can be used with this combination but requires a return line to the fuel tank. This can be advantageous in keeping the fuel cooler by recirculating it via a return line, especially when using a high volume electric fuel pump.

10650/10651  
2-Port Regulator or  
10652/10653  
3-Port Regulator  
(Bypass)



### Regulator Rebuild Kits

Our regulator rebuild kits include a Viton diaphragm, springs, seals and o-rings.

**10690** - For regulators 10650, 10651, 10654, 10655, 10656, & 10657

**10691** - For regulators 10652, 10653, 10658, 10659, 10670, 10671, 10672, 10673, 10678, 10679, 10680, & 10681

**10692** - For regulators 10660, 10661, 10662, & 10663



### O-Ring Fittings

These are the same fittings supplied with our 10654 and 10655 Regulators. These fittings can be used anywhere there is a 5/8-18 tapped hole for the -6 AN fitting or a female 3/4-16 tapped hole for the -8 AN fitting. The O-rings are impervious to gasoline or alcohol. Blue anodized finish on aluminum.

**10250** - -6 AN to 5/8-18  
**10251** - -8 AN to 3/4-16

# POWERFLOW™ Fuel Filters for Street & Race Performance

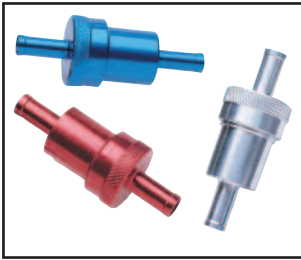

## Inline Street Filters

These filters can easily be installed in any stock hose or metal fuel line. Contains a washable sintered bronze filtering element that should be replaced over time. Filters available in three colors and two hose sizes.

Color	5/16"	3/8"
Blue	10200	10203
Red	10201	10204
Aluminum	10202	10205
Element	10220	

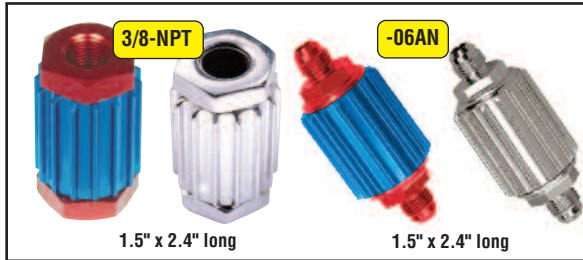

## Inline Street Filters

These filters are high performance street filters that are very affordable. Both inlet and outlet ports are 3/8-NPT which permits connection to a wide range of hose sizes. These filters will flow up to 160 GPH and will filter down to 35 microns using a very fine mesh stainless screen. Due to their light weight, a mounting bracket is not required. These filters are suitable for use as a pre-filter on fuel injection applications.

10210	Red/Blue Inline Filter
10211	Aluminum Inline Filter
10216	Red/Blue Inline Filter w/-06AN
10217	Aluminum Inline Filter w/-06AN
10221	Replacement Element Kit

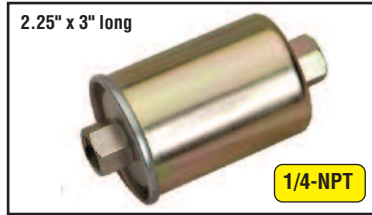

## Inline EFI Filters

This filter is designed specifically for EFI applications and features 1/4-NPT ports. Similar to a Purolator F33144 except for inlet and outlet ports. For -06AN connections use our Powerflow fitting #15239, for -08AN use #15242, or for 3/8" hose connection, use our fitting #10244. This filter is intended as a "post" filter which is placed between the pump and the engine. Use any of the 10210 through 10217 filters at left as a pre-filter.

70160 EFI Inline Fuel Filter

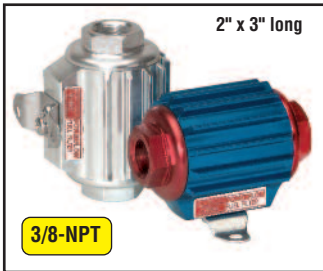

## Hi-Tech Inline Street Filters

The ultimate in a performance street filter, these also include a stainless mounting bracket. They have two staged stainless mesh screens inside. They flow 150 GPH and filter down to 35 microns. This is an excellent fuel filter that looks terrific on any street rod or tricked out street machine or custom car. Mount on inner fender panel or firewall.

10214	Red/Blue Inline Filter
10215	Aluminum Inline Filter
10222	Replacement Element Kit



## Competition Fuel Filter

This filter uses a replaceable paper element which filters down to 10 microns but still flows 144 GPH. This our best selling filter and features a high quality chrome finish on the housing and mounting bracket.

10100	Competition Fuel Filter
10120	Replacement Filter Element



## Street Rod Fuel Filter

This is a smaller version of our 10100 canister style filter. It also uses a replaceable paper element, flows 144 GPH and filters down to 10 microns. High quality chrome finish on housing and bracket.

10102	Street Rod Fuel Filter
10122	Replacement Element

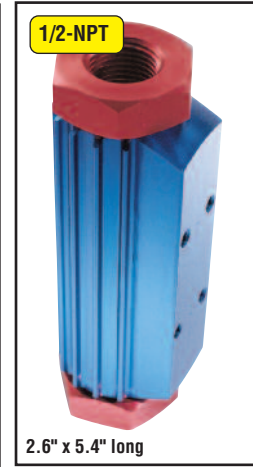

## Competition Inline Fuel Filter

Designed for racing applications with gas or alcohol on a carbureted engine. Flows 140 GPH and filters to 15 microns.

10302	Red/Blue Filter
10321	Element only

## Fittings for Fuel Filters



These fittings are sold in pairs and are intended for use with the fuel filters shown on this page.

Pt. No.	Description
10230	3/8-NPT to 1/4" Hose Nipple
10231	3/8-NPT to 5/16" Hose Nipple
10232	3/8-NPT to 3/8" Hose Nipple
10233	3/8-NPT to -06AN
10234	3/8-NPT to -08AN
10240	1/2-NPT to -06AN
10241	1/2-NPT to -08AN
10242	1/2-NPT to -10AN
10243	1/2-NPT to -12AN
10244	1/4-NPT to 3/8 Barbed Hose Nipple*

\*For EFI use. Use with Professional Products 70160 Filter or 70150, 70151, 70152 EFI Fuel Pumps. Sold individually.

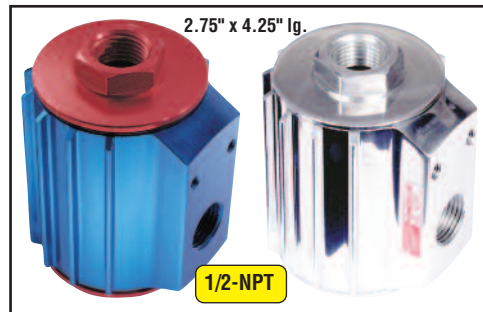

## Competition+Plus Filter

These filters are the finest racing style filters available. They flow 130 GPH at 7PSI or 330 at 40PSI and filter down to 10 microns with a replaceable paper filter. Viton o-rings are used throughout and new o-rings are included with element. Two tapped holes are provided for a mounting bracket. Since most installations will require a custom bracket, one is not supplied with the filter. Note that a Barry Grant element for the BG500 Filter will fit in this filter and the 10320 element will fit the BG500.

10300	Red/Blue Filter
10301	Aluminum Filter
10320	Replacement Element

All Replacement Element Kits on this page include new Viton O-rings, gaskets or seals, depending upon what was originally used in the Filter. Viton is impervious to most fuels and is the highest quality sealing material typically used. Kits also contain a new filtering element.



# POWERFLOW™ Carburetor Inlet Kits & Fuel Pumps

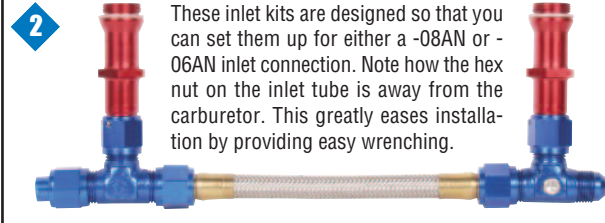

**2** These inlet kits are designed so that you can set them up for either a -08AN or -06AN inlet connection. Note how the hex nut on the inlet tube is away from the carburetor. This greatly eases installation by providing easy wrenching.

- #10401 - Holley 4500 with 7/8-20 threads -08AN inlet • Red/Blue Finish
  - #10403 - Holley 4160 (3310) with 5/8-18 threads -06AN & -08AN inlet • Red/Blue
  - #10415 - Holley 4150 with 7/8-20 threads -06AN & -08AN inlet • Red/Blue
  - #10416 - Demon with 9/16-24 threads -06AN & -08AN Inlet • Red/Blue
- #10415 replaces both 10400 and 10405 and is a universal kit with -06 & -08 inlets.  
#10416 replaces both 10402 & 10408 and is a universal kit with -06 & -08 inlets.



**2** These inlet kits are designed so that you can set them up for either a -08AN or -06AN inlet connection. Note how the hex nut on the inlet tube is away from the carburetor. This greatly eases installation by providing easy wrenching.

- #10406 - Holley 4150 with 7/8-20 threads -06AN & -08AN inlet • Black
- #10409 - Demon with 9/16-24 threads -06AN & -08AN Inlet • Black
- #10417 - Holley 4150 with 7/8-20 threads -08AN inlet only • Black

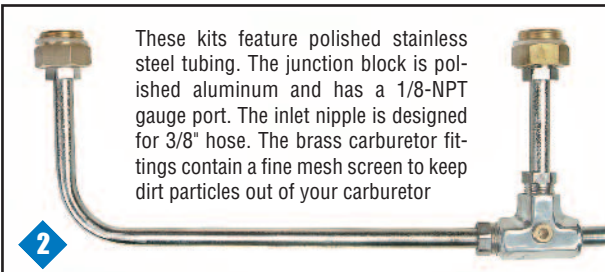

**2** These kits feature polished stainless steel tubing. The junction block is polished aluminum and has a 1/8-NPT gauge port. The inlet nipple is designed for 3/8" hose. The brass carburetor fittings contain a fine mesh screen to keep dirt particles out of your carburetor

- #10420 - Demon with 9/16-24 threads - 9-9/16" spacing
- #10421 - Holley 4150 with 7/8-20 threads - 9-13/32" spacing

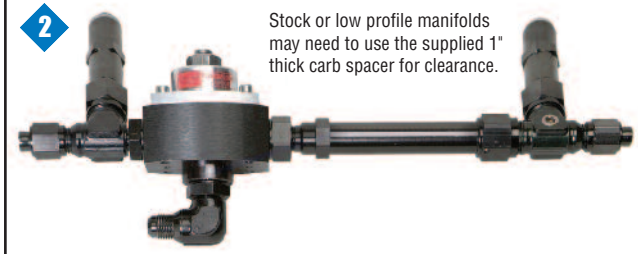

**2** Stock or low profile manifolds may need to use the supplied 1" thick carb spacer for clearance.

This new Inlet Kit incorporates one of our Fuel Pressure Regulators (10665) into the overall design. This vastly simplifies the plumbing and eliminates the need for a remote mounting of the regulator. All of the threads in this kit are 9/16-18 with o-ring seals. This allows for finite adjustment of all components and also permits a simple replacement of the regulator if needed. Inlet fitting on bottom of regulator easily swivels for either a front or rear routed fuel line connection. Regulator can also be repositioned to right side of assembly.

- #10430 - Holley 4150 with 7/8-20 threads -06AN inlet • Black anodized finish
- #10431 - Demon with 9/16-24 threads -06AN inlet • Black anodized finish

**Adapter**  
See illustration below for how to utilize this adapter fitting with above Inlet Kits.



**10450** Adapter Fitting

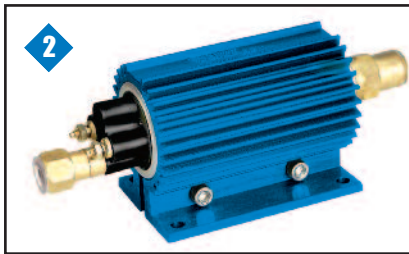
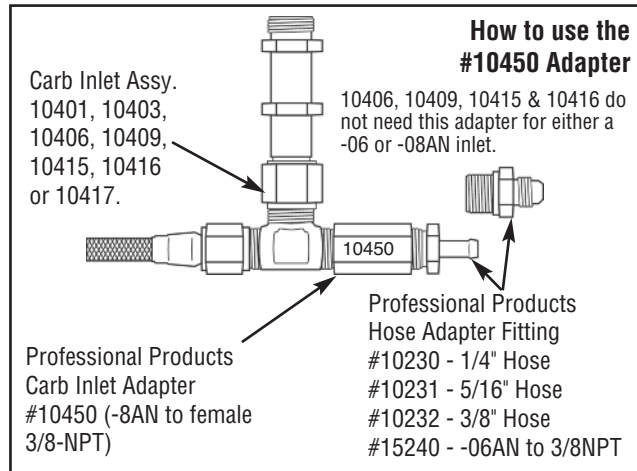

## Powerflow™ EFI Fuel Pump

Available in three sizes. All three pumps come with an attractive extruded mounting bracket that also functions as a heat sink and noise suppressor.

These pumps utilize a 1/4-NPT inlet and outlet port which provides for a wide variety of readily available fittings. You can run a hose nipple connection on the inlet side of the pump. Use the Professional Products fitting #10244 designed specifically for this purpose.

- 70150** 180 L/H 45 PSI EFI Fuel Pump (Red) Up to 460 HP\*
- 70151** 220 L/H 45 PSI EFI Fuel Pump (Blue) Up to 600 HP\*
- 70152** 255 L/H 45 PSI EFI Fuel Pump (Black) Up to 700 HP\*

\*Reduce HP ratings by 5% for supercharged or turbocharged applications and reduce by 30% if running E85.

## Electronic Fuel Pump

Professional Products offers two very inexpensive electronic fuel pumps. These pumps are ideal for replacing the stock pump when it dies. Easily installed, this pump comes in two versions. One has a working pressure of 4 to 7 PSI which is suitable for most domestic carbureted vehicles. The other is 2.5 to 4 PSI which is typically used on carbureted import vehicles. Check your vehicles requirements to select the correct pump. The 10700 is rated at 35 GPH and the 10701 is rated at 28 GPH. These pumps are an inexpensive solution to a failed pump in a non-high performance application.



- 10700** Electronic Fuel Pump - 4 to 7 PSI
- 10701** Electronic Fuel Pump - 2.5 to 4 PSI



## Carburetor Extension

Making up your own carburetor inlet kit? Use these handy Extension Fittings on either Holley or Demon carburetors. Has wrench flats away from carburetor for ease of installation. Coupler nut is -08AN.

- | Pt. No.      | Description                     |
|--------------|---------------------------------|
| <b>10410</b> | Fits Holley w/7/8-20 • Red/Blue |
| <b>10412</b> | Fits Demon w/9/16-24 • Red/Blue |

# Powerforce™ & Powerforce+Plus™ Harmonic Dampers

## High Performance Street models and SFI-Spec Race Dampers

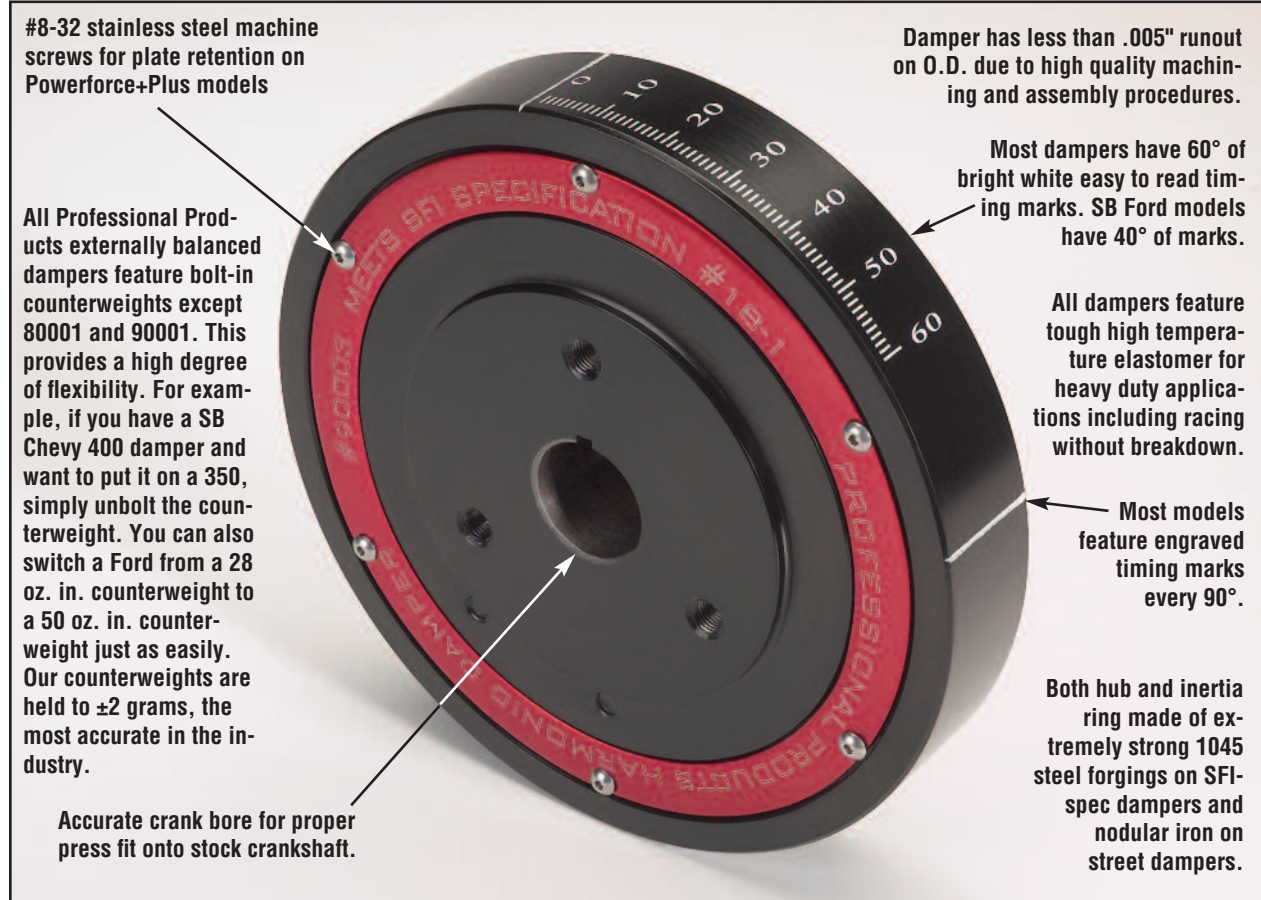

### Look at this list of features and competitive advantages with Professional Products Dampers

**Price:** Yes you can buy less expensive dampers but not at this quality level. We have tested a number of lesser priced dampers. In most instances they are not accurately balanced and in every case that we tested, the external balance was not only off, it was in the wrong position.

**Applications:** We have yet to find a competitive company that offers the wide range of applications that we have. We have dampers for nearly every performance engine currently available.

**Universality:** We are able to fit more applications with fewer part numbers than any other damper manufacturer. As a result of some of our universal features, we fit engines that no one else does.

**Quality:** Despite our extremely attractive prices, the quality of our dampers is equal to or, in most cases, exceeds that of any other harmonic damper manufacturer. You won't find any damper that is more accurately balanced or more closely machined than what you will find in the line of Pow-

erforce and Powerforce+Plus dampers.

**Features:** The Professional Products line of dampers offers features not found with any other damper manufacturer. For example, our small block Ford dampers are made to the early short length. This permits the engine swap of 1982 and later 5.0L engines (with the 50 in. oz. damper) into early Mustangs or street rods where the longer late damper might not fit. We offer a line of inexpensive spacers that allow the use of a wide range of pulleys that permit proper belt alignment. Additionally our SB Ford dampers have both three and four bolt pulley patterns to accept either early or late pulleys. They also have three sets of easy to read timing marks which will align with any of the various timing pointer locations that Ford has used. Our small block and big block Chrysler plus our AMC dampers all come with extra counterweights which allows the same damper to fit a wide variety of different model engines. Some of our Chrysler weights allow fitment to limited production engines that other damper manufacturers

have chosen to completely ignore.

**Easy to Read Timing Marks:** Our dampers all feature clear, white, easy to read timing marks against a painted black background. In addition, most models have engraved marks every 90° which many engine builders find to be a very important feature.

**Warranty:** Unlike many of the competitive dampers, we have a full one year limited warranty on both our street and race dampers. Most companies do not warranty any product used in racing.

**Bonded Construction:** All of our dampers feature a bonding process which adheres the elastomer to both the O.D. of the hub and the I.D. of the inertia ring. Through subsequent research and development we have perfected a new process that uses a stronger adhesive along with an improved elastomer that creates a much stronger bond. It now takes twice the force to separate the hub from the ring as it did with our previous bonding procedure. Our current design is practically indestructible.



# Powerforce™ & Powerforce+Plus™ Harmonic Dampers

Application	Int/Ext	Powerforce	Wgt.	Powerforce+Plus <sup>1</sup>	Wgt.
6" 350 SB Chevy Lightweight	Int	80010 <sup>2</sup>	5.08	90010	5.7
6-3/4" 283/327/350 SB Chevy	Int	80000	8.46	90000	9.3
6-3/4" 400 SB Chevy	Ext	80001	7.59	90001	8.4
8" 350 SB Chevy	Int	80002	11.77	90002	12.2
8" 400 SB Chevy	Ext	80003	12.59	90003	12.9
8" 396/427 BB Chevy	Int	80004	13.51	90004	14.5
8" 454/502 BB Chevy	Ext	80005	14.56	90005	15.5
6.4" Early SB Ford (28.4 oz. in.) <sup>3</sup>	Ext	80006 <sup>3</sup>	9.52	90006 <sup>3</sup>	10.25
6.4" Late SB Ford (50 oz. in.) Requires 81007 spacer <sup>3</sup>	Ext	80007 <sup>3</sup>	10.06	90007 <sup>3</sup>	11.0
6.7" 429-460 BB Ford	Int	80008	8.8	90008	9.6
7.5" 352/390/406/427/428 BB FE Ford	Int	80009	11.87	90009	12.3
6.8" 4.6L Ford Modular V8 Through 2004	Int	80011	6.10	90011	7.1
7.3" 318/340/360 SB Chrysler <sup>4</sup>	Int/Ext	80012 <sup>4</sup>	8.12	90012 <sup>4</sup>	9.0
7.3" Chrysler 383/400/413/426/440 <sup>4,5</sup>	Int/Ext	80013 <sup>4,5</sup>	8.00	90013 <sup>4,5</sup>	8.7
6.8" 5.7L Late Chrysler Hemi	Ext	80014	6.8	90014	7.2
7.4" 6.1L Late Chrysler Hemi	Ext	80015	7.0	90015	7.3
6.9" 1995-'02 Viper V-10	Ext	N/A	N/A	90016	6.9
6.9" 1995-'08 Viper V-10	Ext	N/A	N/A	90017	6.8
6.9" 1961-'79 Pontiac V8	Int	80020	8.25	90020	10.0
6.5" 350/400/403/425/455 Olds V8 <sup>7</sup>	Ext	80022	9.50	90022	10.0
7.5" LT1 (Camaro, Firebird, Impala, & Caprice <sup>8</sup> )	Int	80030	12.3	90030	13.7
7.5" LS1 Camaro, Firebird	Int	80032	13.6	90032	14.4
7.5" LS1, LS-6 Corvette	Int	80033	11.2	90033	13.2
7.7" L92 GM Truck & SUV	Int	80034	13.8	90034	13.9
7.6" Lightweight BB Chevy 396/427	Int	80036	9.35	90036	9.65
7.6" Lightweight BB Chevy 454/502	Ext	80037	10.40	90037	10.70
7.5" 4.6L 3V Ford	Int	80040	11.2	90040	11.5
6.4" Lightweight SB Ford, Early	Ext	80045	7.8	90045	8.2
6.4" Lightweight SB Ford, Late	Ext	80046	8.4	90046	8.8
5" Honda/Acura (Honda B-16, Acura GSR & Type R)	Int	N/A	N/A	90050	3.2
6" Honda B-16	Int	80051	6.6	N/A	N/A
5.6" Acura GSR 1994-'01 Integra	Int	80052	5.4	N/A	N/A
5.4" Acura Type R 1997-'01 Integra	Int	80053	5.6	N/A	N/A
6.9" L-Series Nissan 1970-'83	Int	80055	3.8	90055	4.0
7.2" 4.0L Jeep	Int	80100	7.1	N/A	N/A
6.8" AMC V8 (304, 360, & 401 cid) <sup>4</sup>	Ext	80101	10.6	90101	11.7
0.35" thick Spacer for SB Ford	N/A	81006	0.2	81006	0.2
0.95" thick Spacer for SB Ford		81007	0.53	81007	0.53
0.875" thick Spacer for SB Ford		81008	0.5	81008	0.5
Spacer for 426 Hemi (Use w/80013 or 90013)		81013	0.56	81013	0.56
C'weight for 6.75" SB Chevy 400		91001	1.05	91001	1.05
C'weight for SB Chevy 400		91003	0.7	91003	0.7
C'weight for BB Chevy 454/502		91005	0.95	91005	0.95
C'weight for early SB Ford (28.4 oz. in.)		91006	1.2	91006	1.2
C'weight for late SB Ford (50 oz. in.)		91007	1.8	91007	1.8
Ford Damper Pilot Adapter		91011	0.03	91011	0.03
C'weight for '71-'92 360 SB Chrysler		91012	1.15	91012	1.15
C'weight for '93-'97 360 SB Chrysler		91013	0.67	91013	0.67
C'weight for '72-'73 340 SB Chrysler		91014	0.23	91014	0.23
C'weight for BB Chrysler <sup>6</sup>		91015 <sup>6</sup>	0.69	91015 <sup>6</sup>	0.69
C'weight for BB Chrysler <sup>6</sup>		91016 <sup>6</sup>	0.29	91016 <sup>6</sup>	0.29
C'weight for Olds V8		91022	1.12	91022	1.12
C'weight for 360 AMC V8		91101	1.06	91101	1.06
C'weight for 304 AMC V8		91102	0.89	91102	0.89
C'weight for 401 AMC V8	N/A	91103	1.52	91103	1.52

**General Note:** All dampers listed as Ext include all necessary counterweights. Counterweights also sold separately.

**Note 1.** All the dampers in this column meet SFI-Spec 18-1.

**Note 2.** This damper is 1045 steel. All other 80000 series dampers are nodular iron. All 90000 series dampers are 1045 steel.

**Note 3.** See page 36 for information on spacers that may be needed. 1969 and later engines will normally require a spacer for pulleys to line up.

**Note 4.** Chrysler dampers come with several different counterweights to suit

various engines. Weights given in chart do not include counterweights.

























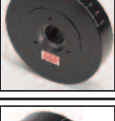

**Note 5.** Will also fit street and race 426 Hemi. Must use spacer #81013. These dampers will not fit early 331/354/392 early Hemi engines.

**Note 6.** These counterweights for cast crank engines only.

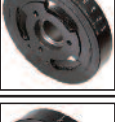
**Note 7.** Early 330 cid engine must have TDC remarked. Early 400/425 requires rebalancing of Professional Products damper.

**Note 8.** This damper fits 1993-'97 LT1 Camaro/Firebird, and 1994-'95 Caprice, Impala, and Roadmaster.

# Powerforce™ & Powerforce+Plus™ Harmonic Dampers

Damper Photos		Powerforce	Powerforce+Plus	Diameter	Description
Powerforce	Powerforce+Plus	Part No.	Part No.		
		80000	90000	6.75"	These dampers are 6.75" in diameter and approximately 1-1/8" thick. These are our most popular dampers for internally balanced small block Chevys. They both have 60° of timing marks with engraved marks every 90°. They are dimensionally identical to a stock 6-3/4" damper.
		<b>For 283-327-350 Internally Balanced V8 Engines</b>			
		80001	90001	6.75"	These dampers are 6.75" in diameter and approximately 1-1/8" thick. These are believed to be the only affordable dampers available in this size for externally balanced engines such as the 383 and 400 small block Chevy. Like all our Chevy dampers they have 60° of timing marks.
		<b>For 383-400 Externally Balanced V8 Engines</b>			
		80002	90002	8.00"	These are our 8" dampers for internally balanced small block Chevys and are among our most popular dampers. The larger 8" dampers do a more precision job of damping out engine harmonics but will not accelerate as quickly as the smaller, lighter 6" or 6.75" dampers we offer.
		<b>For 283-327-350 Internally Balanced V8 Engines</b>			
		80003	90003	8.00"	The dampers listed here are identical to the 80002/90002 but include a bolt-in counterweight that provides the necessary imbalance for externally balanced engines such as the 383 or 400. This damper can be easily converted to a neutral balance damper by simply unbolting the counterweight.
		<b>For 383-400 Externally Balanced V8 Engines</b>			
		80010	90010	6.10"	The 80010 and 90010 are our lightest dampers and both are made of forged 1045 steel. They both have 60 degrees of timing marks and engraved marks every 90 degrees. These are two of our most popular dampers and thousands of them are in use in both street and race vehicles.
		<b>For 283-327-350 Internally Balanced V8 Engines</b>			
		80030	90030	7.50"	These dampers will not fit 1996-'97 LT4 Corvette and Camaro or 1992-'96 LT1 Corvette. To identify an LT1 from an LT4 the VIN number for an LT1 has the eighth digit as a "P" and an LT4 has it as a "5." These dampers have a keyway (key supplied). Crank has a keyway but no key is used originally.
		<b>For GM LT1 Engines</b>			
		82000	N/A	6.75"	Here is the answer to a custom engine builder's dream. A polished all stainless steel harmonic damper available in the popular 6.75" diameter. This damper has an engraved TDC mark but all other markings have been eliminated by design to provide a super clean look.
		<b>For 283-327-350 Internally Balanced V8 Engines</b>			
		82001	N/A	6.75"	This is the externally balanced version of our all stainless polished damper. The damper is offered in the 6.75" diameter which is a popular size for street rod and custom car engines. These stainless dampers are the crowing touch for any small block Chevy show engine.
		<b>For 383-400 Externally Balanced V8 Engines</b>			
		80004	90004	8.00"	This is our standard 8" damper for 396/427 (or any internally balanced big block Chevy engine) and is one of the few dampers we make that does not match the original O.E. size which was 7" on these engines. Using the 8" diameter allows interchangeability with our 454/502 dampers.
		<b>For 396-427 Internally Balanced V8 Engines</b>			
		80005	90005	8.00"	These dampers are the identical dampers to the 80004/90004 but are fitted with a bolt-in counterweight to provide the proper imbalance for the 454/502 externally balanced engines. Remove the counterweight and it can be used on any neutral balance (internal) big block Chevy engine.
		<b>For 454-502 Externally Balanced V8 Engines</b>			
		80036	90036	7.60"	These are our new smaller lightweight dampers for big block Chevys. The 80036 is over four pounds lighter than our 80004 and the 90036 is just under five pounds lighter than the 90004. These dampers are also slightly smaller in diameter being 7.6" compared to 8.0" for further weight reduction.
		<b>For 396-427 Internally Balanced V8 Engines</b>			
		80037	90037	7.60"	Again, these dampers are identical to the 80036/90036 but include a bolt-in counterweight to provide the proper imbalance for the externally balanced engine. The 80037 is 4.2 pounds lighter than the 80005 and the 90037 is 4.8 pounds lighter than the 90005.
		<b>For 454-502 Externally Balanced V8 Engines</b>			
		80032	90032	7.50"	Although not found on the stock damper, these dampers have a TDC mark and a keyway for use on engines converted to a conventional distributor and a crank with a key. These dampers are the same overall dimensions as a stock damper to avoid fitment issues.
		<b>For 1997-'04 LS1-LS6 Camaro and Firebird</b>			

























Small Block Chevy

Big Block Chevy













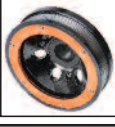





LSX GM



# Powerforce™ & Powerforce+Plus™ Harmonic Dampers

	Damper Photos		Powerforce	Powerforce+Plus	Diameter	Description	
	Powerforce	Powerforce+Plus	Part No.	Part No.			
GM LSX & L92			80033	90033	7.50"	The Corvette models of the LS1 damper are shorter than the 80032/90032 so may be more desirable for engine swaps where space is at a premium. If this swap is made, Corvette accessory mounting brackets will also need to be used to assure proper accessory drive belt alignment.	
				<b>For LS1-LS6-LS2 Corvette</b>			
			80034	90034	7.70"	The L92 engine is the cast iron version of the LSX range of engines. This is known as the LM7 engine option and is a 5.3L engine that was available in 2001 and later Tahoe, Yukon, Yukon XL, Escalade, ESV, EXT, Avalance, Sierra, and Silverado. Also sold by GM as a crate engine.	
			<b>L92 Truck &amp; SUV &amp; GM LSX Crate Engines</b>				
Small Block Ford V8			80006	90006	6.40"	Note that all of our small block Ford dampers are made to the early 1963-'69 length and require the use of spacers (see page 42) on '70 and later engines. These dampers have three sets of timing marks (60° of marks) to fit all small blocks. They also come with both 3 and 4 bolt pulley patterns.	
				<b>For early small block Ford w/28 oz.in. c'weight</b>			
			80007	90007	6.40"	1982 and later 5.0L applications require our spacer #91007 for proper belt alignment. Without the spacer the 5.0L engine can be used in swaps into earlier vehicles as long as early accessory pulleys, mounting brackets and belts are used. Damper has both 3 and 4 bolt pulley patterns.	
				<b>For late small block Ford w/50 oz. in. c'weight</b>			
			80045	90045	6.40"	These are lightweight versions of our regular Ford small block dampers. These dampers are essentially the same as the 80006/90006 but lighter by approximately two pounds. The lightweight dampers still use the same counterweights used in our regular dampers.	
				<b>For early small block Ford w/28 oz. in. c'weight</b>			
		80046	90046	6.40"	Again, this is our lightweight version for the late small block Ford. These dampers have all the same features found in our 80007/90007 dampers but are about two pounds lighter. They have three sets of timing marks to essentially match up to all small block Ford timing pointers.		
			<b>For late small block Ford w/50 oz. in. c'weight</b>				
	<b>Polished Stainless Steel</b>	82006	N/A	6.40"	This damper is a true work of art and is the finishing touch to any street rod or street custom vehicle with a fully detailed engine. It is a full polished all stainless steel damper which will never rust or corrode. Dimensionally the same as the 1963-'69 damper but will fit all engines using our spacers.		
			<b>For early small block Ford w/28 oz. in. c'weight</b>				
	<b>Polished Stainless Steel</b>	82007	N/A	6.40"	Use our 91007 spacer with this damper for a bolt-in to any 1986 or later 5.0L engine. This damper is made to the early (1963-'69) short length with both 3 and 4 bolt pulley patterns so is ideal for engine swaps where the longer 5.0L damper can cause interference issues.		
			<b>For late small block Ford w/50 oz.in. c'weight</b>				
Big Block Ford V8			80008	90008	6.70"	These dampers feature the stock 3/16" keyway plus a 1/4" keyway 180° from the stock one. This allows the damper to fit aftermarket dual keyway crankshafts. Note that while these engines are classed as an externally balanced engine, the counterweight is a separate (Ford #M-6359-D460) part.	
				<b>For 429-460 Big Block Ford V8's</b>			
			80009	90009	7.50"	These dampers are dimensionally the same as the 427 high performance damper. It comes with the 427 single groove pulley which can be removed and replaced with your stock multi-groove pulleys. A universal timing pointer is supplied so you can replace your 7" FE damper with this 7.5" one.	
			<b>For all FE style Big Block Fords</b>				
4.6L Ford V8 (2V, 3V, 4V)			80011	90011	6.80"	These dampers are dimensionally the same as the stock 2V damper. When used on a 4V engine the accessories (alternator, A/C, etc) will rotate 3% slower than the stock 4V accessories. For most applications, this is not a significant difference. These dampers have a TDC notch on the back rim.	
				<b>For 4.6L Ford V8 2V and 4V</b>			
			80040	90040	7.60"	If you are racing your late model Mustang you need one of our 90040 dampers to meet SFI specs. Save over \$100 compared to other aftermarket dampers for this engine. Our 80040 is a great choice for your street Mustang especially if you have any modifications to the engine.	
			<b>For 2005 &amp; later 4.6L Ford 3V V8 Engines</b>				
Chrysler			80012	90012	7.25"	These dampers come with three bolt-in counterweights which, when the proper weight is used, allow this damper to fit all small block Chrysler engines. With no weights, it is a neutral balance damper. The dampers have 60 degrees of timing marks and engraved marks every 90 degrees.	
			<b>For all small block Chrysler V8's</b>				

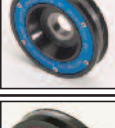
# Powerforce™ & Powerforce+Plus™ Harmonic Dampers

Damper Photos		Powerforce	Powerforce+Plus	Diameter	Description		
Powerforce	Powerforce+Plus	Part No.	Part No.				
Chrysler V8 and Viper V10			80013 <b>For all big block Chrysler V8's</b>	90013	7.25"	The big block dampers are supplied with two bolt-in counterweights which cover all big block applications. Use our spacer 81013 to fit late street or race 426 Hemi. Dampers will not fit early 331, 354, or 392 Hemis but will fit all other big block Chrysler engines. See "Damper Notes" for more specifics.	
			80014 <b>5.7L Late Dodge &amp; Chrysler Hemi</b>	90014	6.80"	The new Chrysler Hemis are now finding their way into many street rods and high performance street machines and we offer one of the most affordable dampers for these engines. Our models are dimensionally identical to the stock O.E. damper to avoid any clearance or fitment issues.	
			80015 <b>6.1 Late Dodge &amp; Chrysler Hemi</b>	90015	7.40"	The 6.1 Chrysler Hemi is becoming a popular high performance engine and needs a high performance harmonic damper to go with it. We offer some of the most affordable harmonic dampers for these engines. Our dampers are dimensionally the same as the stock damper to avoid clearance issues.	
	Damper not available for this application			90017 <b>90017 - 1992 &amp; later Dodge Viper</b>	90017	6.95"	The 90017 Powerforce+Plus Damper fits all Viper V-10's from 1992 through 2010. This is the least expensive SFI-Spec damper available for these engines. It features 1045 steel construction and contains retaining lips and rings to provide a safety feature.
Pontiac			80020 <b>For 1961-'79 Pontiac V8s</b>	90020	6.90"	To fit these dampers to an early 1961-'68 engine will require the use of the 1969 or later timing chain cover, water pump, and related accessories. The necessary parts can be obtained from Year One. Some aftermarket Pontiac specialists also offer the late timing cover in aluminum.	
Olds			80022 <b>For 330 through 455 Oldsmobile V8s</b>	90022	6.50"	These are externally balanced dampers with bolt in counterweights which can be removed for a neutral balance engine. This damper has both the stock Olds pulley bolt pattern as well as big block Chevy. TDC mark must be repositioned for 330's and damper fits only the late 400 and 425 only.	
Jeep		Damper not available for this application	80100 <b>For 4.0L Jeeps</b>	N/A	7.20"	This damper fits the popular 4.0L Jeep 6-cylinder engine. It matches the stock damper dimensionally but is made of tough nodular iron. This damper is an ideal choice for off-roaders who want the ultimate in damper reliability and strength. The elastomer is securely bonded to the hub and inertia ring.	
AMC V8			80101 <b>For 304, 360, 401 AMC V8</b>	90101	6.80"	These dampers are set up for the later model 4-bolt accessory pulleys. The damper is supplied as a neutral balance damper with three bolt-in counterweights to suit either the 304, 360, or 401 AMC engine. Note that these will not fit the 360 Chrysler engine used in some later model AMC's.	
Sport Compact Dampers for Honda, Acura and Nissan		Damper not available for this application	80051 <b>Honda B-16</b>	N/A	6.00"	This damper is a direct replacement for the stock Honda damper. The Professional Products Powerforce Harmonic Damper is made of tough nodular iron rather than gray iron, a 30% increase in strength. These dampers are now available with an engraved TDC mark.	
		Damper not available for this application	80052 <b>For Acura GSR 1994-'01 Integra</b>	N/A	5.60"	This damper is a direct replacement for the stock Acura GSR damper. The Professional Products Powerforce Harmonic Damper is made of tough nodular iron rather than gray iron, a 30% increase in strength. These dampers are now available with an engraved TDC mark.	
		Damper not available for this application	80053 <b>For Acura Type R 1997-'01 Integra</b>	N/A	5.40"	This damper is a direct replacement for the stock Acura Type R damper. The Professional Products Powerforce Harmonic Damper is made of tough nodular iron rather than gray iron, a 30% increase in strength. These dampers are now available with an engraved TDC mark.	
	Damper not available for this application		N/A	90050 <b>For Honda B-16, Acura GSR and Acura Type R</b>	90050	5.00"	Many Honda and Acura racers use the JDM single accessory pulley on their engines. However, that product is not a damper. Our model is a true damper and is dimensionally identical to the JDM pulley. To preserve the life of your crankshaft, a harmonic damper should be used on any race engine.
			80055 <b>For Nissan L-Series 1970-'83</b>	90055	90055	5.12"	These dampers are dimensionally identical to the O.E. 1970-'78 Nissan damper. Will also fit 1979-'83 engines requiring only one v-belt pulley. This damper is similar to the popular but now discontinued "Euro" damper from the Nissan Competition Division.



# Professional Products Harmonic Dampers

## What is a neutral balance damper? An externally balanced damper?

**An internally balanced damper?** - Some engines are designed that they cannot get enough weight on the counterweights on the crank to bring the engine into balance. Engine designers added counterweights onto the damper and the flexplate or flywheel. This type of damper is called an externally balanced damper. That's because some of the counterweight for the crank is external to the engine since it is on the damper and flywheel. Without counterweights on the damper or flywheel they are called internally balanced or neutral balanced. These two terms are interchangeable. Engine builders can convert an externally balanced engine to internally balanced by adding an extremely heavy material called mallory metal to the counterweights of the crank. When this is done, a neutral balance damper must be used on what was previously an externally balanced engine. With our bolt-in counterweights, any of our externally balanced dampers can quickly and easily be converted to neutral balance by simply removing the weight. This is a very valuable feature and provides for great flexibility in engine building.

**Small block Chevy** - These engines have used three different timing pointer locations. Pre '69 engines have the TDC mark 2° to the left of the keyway centerline. The '69 to '85 dampers have the TDC mark 10° to the left of the keyway centerline. The 1986 to 1991/1992 have the TDC mark 40° to the left of the keyway centerline. All of our SB Chevy dampers, as well as all other aftermarket dampers, use the 10° TDC position. Our 6.75" diameter models have two TDC marks, one that is 10° and one that is 40° to the left of the keyway. If you have a pre '69 vehicle you can use one of the aftermarket bolt-on timing pointers to align correctly with the timing marks on our dampers.

**Small & Big Block Chevy** - Both of these styles of engines utilize both internal and external balance dampers. All of our external dampers have bolt-in counterweights. Other than that, the dampers are identical for each style engine. So it is possible to have an internally balanced damper and convert it to external simply by adding one of our optional counterweights. Some big blocks may require an aftermarket timing pointer to align with the TDC mark on all our dampers.

**Small Block Ford** - Small block Ford (260/289/302/351/5.0L) dampers were made in five different lengths, two different accessory bolt patterns, and with two different external counterweights. They also had at least three different timing pointer locations. We make two models; the 80006/90006 has the 28.4 oz. in. counterweight and the 80007/90007 has the 50 oz. in. counterweight. Both of these dampers are made to the early style shortest length. This will allow users to install '82 & later 5.0L engines (w/50 oz. in. dampers) in early Mustangs or street rods and have more clearance in the front than if they had the stock longer damper. Our dampers also have both 3 and 4-bolt pulley patterns so either early or late pulleys can be used. For later applications with longer dampers, we offer a series of three inexpensive aluminum spacers (see page 19) that accommodate these various applications. Because some of the early three bolt accessory pulleys piloted on a male boss and some piloted into a female bore, we also provide (with every damper) a special pilot adapter to accommodate either style. Both our Ford small block dampers have three sets of timing marks on them to accommodate the various timing pointer locations Ford used. To the best of our knowledge, between our two dampers and three spacers, we can fit nearly every SB Ford engine ever made. Will not fit 1970-'77 Mercruiser.

**How to Determine Which Ford Spacer To Use** - Measure the overall length of your damper from the end of the snout to the front pulley face. If it is 3" long, no spacers are required. If it is 3.187" long, you can modify spacer #81006 to work. (See instructions that come with the damper) If it is 3.375" long, use spacer #81006. If it's 3.875" long, use spacer #81008. If it's 4.0" long, use spacer #81007. For additional information, see chart on page 19.

**Pontiac V8** - Our Pontiac dampers can be used on 1961 through 1979 V8

engines. However, in order to fit 1961 through 1968 you must use a '69 or later front timing cover, water pump, and related accessories. This damper has the stock accessory pulley bolt holes as well as a big block Chevy bolt pattern. This will accommodate big block Chevy crank trigger setups.

**Small Block Chrysler** - We provide one damper model that can be used without a counterweight for internally balanced engines. Or use one of three supplied counterweights for other engines. The 80012 and 90012 Dampers will fit the following applications:

a. All internally balanced 318 V8 standard and Magnum, all internally balanced 273 and 340 engines w/forged cranks. No counterweight is used with any of the above applications.

b. 340 externally balanced 1972-'73 engines w/cast crank. Use supplied 91014 counterweight.

c. 360 externally balanced 1993-'97 engines w/cast crank. Use supplied 91013 counterweight. Will not work with '93-'97 5.9L Magnum engine.

d. 360 externally balanced 1971-'92 engines w/cast crank. Use supplied 91012 counterweight.

**Big Block Chrysler** - Our one part number (80013/90013) damper fits all 351, 361, 383, 400, 413, 426, and 440 engines including Street and Race 426 Hemi models. Will not fit early 331/354/392 Hemi. These dampers are neutral balanced and also include two counterweights to fit externally balanced models. Damper includes two extra TDC marks to suit the Street and Race models of 426 Hemi. Our 81013 Hemi Spacer is required to ensure proper pulley alignment on 426 Hemi engines. To our knowledge, this damper should fit all big block Chrysler engines.

**Big Block FE Ford** - Our damper is identical in fit and function to the original big block high performance 427 FE Ford damper. It is supplied with a matching bolt-on single v-groove accessory pulley which may or may not be required in all applications. This pulley can be removed and using a supplied adapter you can bolt on any multiple groove FE pulley. This damper is classed as an internally balanced damper although the 428 FE is externally balanced. On that engine all of the external weight is on the flexplate or flywheel. The damper is still a neutral balance damper and has no weight attached to it. All other FE engines (except 428) are internally balanced. Our FE Ford dampers are supplied with a universal timing pointer that will fit any FE engine. This pointer is required because our supplied damper is larger in diameter (same as 427) than some FE dampers and the stock pointer will not work on engines that came stock with the smaller diameter damper.

**Big Block 429-460 Ford** - This damper utilizes a separate counterweight that is a spacer that goes over the crank and behind the damper. These weights are available from your Ford dealer (#M-6359-D460) and must be used unless the engine assembly has been converted to an internally balanced engine by incorporating heavy metal in the crankshaft. These engines have used different timing pointer locations. Looking at the front, most of these engines have a timing pointer in the "10 o'clock" position. Using the 1/4" keyway in our damper correctly positions the damper on a production crank (or aftermarket crank machined to stock specs) so a "10 o'clock" pointer lines up with the damper TDC mark. Use the 3/16" keyway with Ford Racing cranks #M63030-A600 and B600 to again align a "10 o'clock" pointer to the damper's TDC mark.

**AMC** - We supply a damper and three counterweights with each of our two AMC part numbers. The basic damper is neutral balance and can be used "as is" for neutral balance engines. One supplied counterweight is for the 304 engine, one for the 360, and one for the 401. These are all four bolt pulley style dampers. Note that AMC made a 343 and a 390 engine. These dampers used a three bolt pulley. If you have a 390 and convert to four bolt pulleys, you can use this damper. Compare your 390 damper to the instruction illustrations to determine which weight to use for your 390.

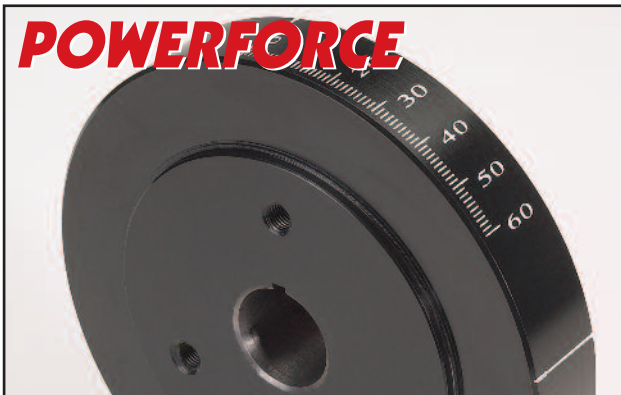

# Powerforce™ & Powerforce+Plus™ Harmonic Dampers

## Small Block Ford Harmonic Damper Spacer Selection Chart

Engine Type	Damper Length	Model Year	Use Spacer	3- or 4-Bolt Pulley
289/302/351W	3.050"	1963-'69	No Spacer Req'd	3-Bolt
351W/351C/400M <sup>1,2</sup>	3.400"	1969-'80	#81006 (.350")	4-Bolt
351 HO (351W) <sup>3</sup>	3.875"	1991 & later	#81008 (.875")	4-bolt
351W/302 <sup>3</sup>	3.875"	1980 & later	#81008 (.875")	4-bolt
302/5.0L	3.950"	1970-'96	#81007 (.950")	4-bolt
351W	3.950"	1980-'96	#81007 (.950") or #81009 Steel for blown engines.	4-bolt

### NOTES:

1. Remove .070" off of rear of damper if Ford .917" Crank Sprocket is used. See drawing at right.
2. A 3.187 damper length may have been used on some of the listed applications. This requires spacer modification. See modifications shown in instructions that come with the damper.
3. The 3.875" long dampers are used on engines equipped with Ford Racing .917" Crank Sprocket.

Remove .070"  
See Note #1

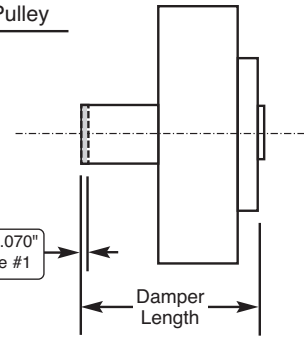

Our SB Ford Dampers are all made to the 1963-'69 length. This allows the use of both early and late style dampers in early chassis. You can use our late 5.0 damper with early three bolt pulleys and accessories. All of our SB Ford dampers also have both the three and four bolt pulley patterns. They also have three sets of timing marks to suit all SB engines. If your stock damper is longer than three inches, we make up the difference with a series

of spacers. To determine which spacer you need, measure the length of your damper (see drawing above) and refer to the chart to see which spacer you need. Our standard spacers are made of aluminum and are very inexpensive. If you have a 5.0L engine running a belt driven blower, we recommend that you use our 81009 Steel Spacer instead of the 81007 aluminum one. See photo and listing below left.

## Harmonic Damper Accessories and Service Parts

### Ford Pulley Spacers



81006  
.350" thick

81007\*  
.950" thick

81008  
.875" thick

\*Use the 81007 spacer on all 1986 and later 5.0L engines.

### About Our Bolt-In Counterweights

Bolt-in counterweights are a major plus feature in all of our externally balanced harmonic dampers. For example, if you purchased one of our externally balanced dampers and then during your engine build procedure, you decide you want to switch to a neutral balance assembly, you don't need to buy a new damper. You simply unbolt the counterweight and you are good to go. We have sold thousands and thousands of dampers with bolt-in counterweights and we have never heard of one single instance where a counterweight has come loose or fallen out. It just doesn't happen. So if you have concerns about this, you can forget about them.



### Steel Damper Spacer for Blown 5.0L Fords

Utilize this spacer instead of the standard 81007 aluminum spacer on a 5.0L Ford engine with a belt driven supercharger.

81009 Steel Spacer



### Timing Pointer for FE Ford

This universal Timing Pointer will fit all FE Ford engines. This pointer is intended to be used with the larger diameter 7.5" dampers such as the Professional Products models or the 427 FE high performance model.

When replacing a smaller diameter FE damper with our 7.5" model, this pointer will be used. This pointer is included with all of our FE dampers and fits both styles of timing covers.

92009

FE Ford Universal Timing Pointer



### Hemi Spacer

Use this Spacer with our 80013 or 90013 damper in order to fit to the late style 426 Street or Race Hemi engine. This spacer will ensure proper accessory belt alignment.

81013

Hemi Spacer



Your one stop source for a wide range of high quality performance auto parts at extremely reasonable prices.

**Professional Products®**