

POWER BY DESIGN



Several years ago an alliance was formed to find a cost-efficient method to produce high-quality, technically-advanced, yet affordably-priced performance engine parts. A small group of professionals, with over a hundred years of cumulative experience in the application of performance parts, collaborated to expand this concept.

Once focused, these visionary founders did not take long to put together a definitive plan to move forward. Years of experience had taught the team that preparation, planning, and consistent testing were factors paramount to success. Consequently, these areas were given top priority. A quality control team was immediately sought out and assembled to begin the arduous task of research and development.

At about the same time, the search for the most qualified manufacturing facilities was also initiated. Only factories with the ability to implement the most advanced equipment and modern metal fabrication technology would do. With these requirements in mind, a select group of manufacturing partners were chosen, and the production team was put into place.

The doors were opened in the summer of 2004 and the first orders were shipped. Since that time, the product quality has been fine-tuned and the assortment expanded. Our fifteen year heritage has confirmed consumer acceptance of the PRW line of high quality component engine parts.

This heritage of excellence is now available to the racing industry after years of testing and refinement. For the future, PRW will endeavor to lead the way with proven dependability and unique design features and benefits that are second to none. PRW branded products are in stock and ready for delivery from various warehouse distributors, engine builders, and jobbers across the United States.



PRW Customer Service Team



Award Winning Products!



Proud Sponsors of Hot Rodders of Tomorrow

TABLE OF CONTENTS

TABLE OF CONTENTS

COOLING SYSTEM & ACCESSORIES

Aluminum Racing Radiators & Cooling System Accessories	53 - 56
Electric Racing Water Pumps & Accessories	63 - 65
Mechanical COMPETITION* ™ Racing High Performance Water Pumps	57 - 62
Mechanical Water Pump Pulleys & Pulley Kits	59 - 60
Mechanical GM LS Series Water Pumps, Pulleys, & Girdles	60

DAMPERS, HARMONIC

High Performance Sportsman Dampers (Includes Import Vehicle Applications)	67 - 68
SFI-Rated Racing Steel Dampers (Includes Import Vehicle Applications)	69 - 70
SFI-Rated FluidGel ™ Harmonic Balancers & Pulley Dampers	71 - 72
Damper Accessories	73 - 74

ENGINE MAIN BEARING SUPPORT SYSTEMS

Main Girdles & Main Caps	49
--------------------------------	----

ENGINE TEST STANDS

Racing Engine Test Stands & Accessories	1 - 2
---	-------

FLEXPLATES

SFI-Rated Gold Series Steel Flexplates	75 - 76
SFI-Rated Platinum Series Steel Flexplates	77 - 78
SFI-Rated Diesel Flexplates	79 - 80

FLYWHEELS

SFI-Rated Billet Steel Flywheels GM LS	81 - 82
SFI-Rated Billet Aluminum Flywheels.....	83
Clutch Pattern Reference Table	84

SERVICE PARTS, HARDWARE, & MISCELLANEOUS

Assembly Lubes, Threadlockers, Books of Knowledge, Engine Oils & Additives	45 - 48
Stud Mount Rocker Arm Hardware & Replacement Parts	14, 21 - 22
Specialty Tools	22

VALVE COVERS

Fabricated Aluminum Valve Covers	39 - 41
Valve Cover Accessories	42 - 44

VALVETRAIN PARTS & ACCESSORIES

Distributor Gears	50
Dual Gear Drives, Timing Sets & Timing Chains	50
Pushrod Guide Plates	25
Pushrods, Sportsman Chromoly	26
Pushrods, Custom Racing by Manton Pushrods	27 - 35

ROCKER ARMS & ROCKER ARM SYSTEMS

GM LS OEM, BTP Upgrade Rocker Arms, Fulcrum Upgrade Kits & Rocker Arm Stands.....	4, 6 - 7
Sportsman Series Rocker Arms (Stud Mount)	5
GM LS BTP Upgrade Rocker Arms & Rocker Arm Stands.....	6 - 7
Pro Series Billet Aluminum Rocker Arms (Stud Mount)	9 - 10
PQX ® Platinum Pro Series Rocker Arms (Stud Mount)	11
PQX ® Platinum Pro Series Stainless Steel Rocker Arms (Stud Mount)	12 - 13
Platinum Series Shaft Mount Rocker Arm Systems	13 - 19
Platinum Series Modern Muscle Rocker Arm Systems	20
Rocker Arm Stud Girdles	23 - 24

X-REFERENCE TABLES & CHARTS

2022 CATALOG VEHICLE	37 - 38
-----------------------------------	---------

RACING ENGINE TEST STANDS

The U.S. Patented (US 7,810,799 B2) PRW Racing Engine Test Stand is the first U.S. Patent collapsible design that is manufactured with standard parts and readily available replacement parts from the manufacturer. For the small shop or race trailer, the ETS is a real space-saver when collapsed. It is available as a base unit including the Stand, Battery Tray, Gauge Panel, Casters, a Covered Toggle Switch, and a Momentary Push Button. The Fully Accessorized Unit includes everything the base unit has, plus a Fuel cell, Electric fan, Overflow Tank, Tachometer, Water Temperature Gauge, Oil Pressure Gauge, and our New Universal Radiator. The Low-Profile ETS is designed to accommodate most engines, and built to meet the demands of high-output racing engines and heavier big blocks, taking mobile engine test stands to a whole new level of functionality.

The ETS is also available with a Short Block Adapter that allows the mechanic to build the short block, and then rotate the engine to the upright position, just like a typical engine stand. Then temporarily support the short block and install the center supports, remove the rotating head unit, and re-attach the rear engine supports to finish the engine assembly. After final assembly, install the fuel cell, plumb for fuel, wire the electrical, connect the battery, and you are ready to run! Obviously, we have over-simplified the necessary preparation and hard work; but a great deal of satisfaction can be gained with the knowledge that your customer's engine is ready and worthy to be installed in their hot rod, race car, or street machine!

SET-UP IS AS EASY AS...

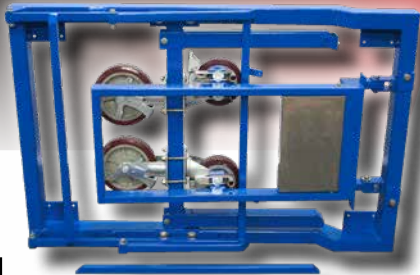

1.



3.

PN 1300101 - ETS Base Unit

ENGINE TEST STANDS	Part #
Engine Test Stand (ETS), Racing, Steel, Base Unit, Blue Powder Coat	1300101
Engine Test Stand (ETS), Racing, Steel, Base Unit w/ Short Block Adapter, Blue Powder Coat	1300102
Engine Test Stand (ETS), Racing, Steel, Base Unit & Full Accessory Kit, Blue Powder Coat	1300111
Engine Test Stand (ETS), Racing, Steel, Base Unit w/ Short Block Adapter & Accessory Kit, Blue Powder Coat	1300112

*SAVE TIME, MONEY & SPACE...
GET THE ORIGINAL RACING ENGINE
TEST STAND FROM PRW!*

2.

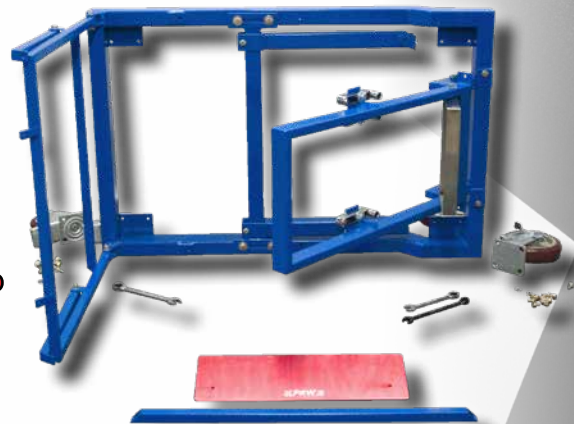

*PRW EXCLUSIVE
PATENTED COLLAPSIBLE
RACING ENGINE TEST STAND*

**We Support the National Automotive Technicians Education Foundation®.
Contact us to learn about the Educational Institution Advantage Program.**

RACING ENGINE TEST STANDS & ACCESSORIES



Shown with
Optional Accessories

Turn to page 56 to see more info on our new ETS Radiator!

- Find leaks
- Tune engines
- Save on Dyno time
- Showcase your engines
- Customer demonstrations
- Prevent expensive comebacks
- Test new, used or rebuilt engines
- Fully adaptable to most any engine design
- When not in use, simply folds up for easy storage
- Short block adapter allows it be used as a build stand

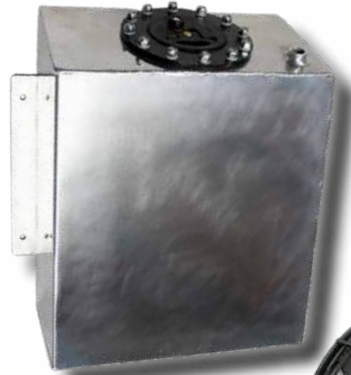

PN 1300500 - ETS Fuel Cell



PN 1311014 - ETS Electric Fan

JOIN WYOTECH, UTI & HUNDREDS OF OTHER PROFESSIONALS WHO ALREADY OWN THE ORIGINAL RACING ENGINE TEST STAND



Rotating Short Block Adapter is Included with PN's 1300102 & 1300112

ENGINE TEST STAND ACCESSORIES

ENGINE TEST STAND ACCESSORIES	Part #
ETS Instrument Panel, Red, Pre-Drilled for Instrumentation	1300313
ETS Center Uprights, Engine Support, Adjustable, Pair, 15.0" to 17.75"	1300323
ETS Center Brackets, Engine Mount, Pair, 1.5" Elev to 3.50" Drop	1300332
ETS Fuel Cell, Fabricated Aluminum, Includes Fuel Cap	1300500
ETS Rear Adapter, Rotating Short Block Bolt-on Accessory, Complete	1300503
ETS Switch, On-Off Toggle	1305582
ETS Fan, 14" Universal Electric Fan, Includes Mounting Kit	1311014
ETS Radiator, 19" x 28", Modular design to switch Left/Right Modular Inlet/Outlet for FORD/GM/MOPAR engines, Mounting Bungs, Petcock Drain	1300515
ETS Overflow Tank, Coolant, Stainless Steel	1326071
ETS Overflow Tank, Coolant, Polished Aluminum	1326075
ETS Gauge, Tachometer, 3 3/8" White, Back Lit, Aluminum Bezel, 0-8000 RPM	1338068
ETS Gauge, Water Temp, Mech, 2 5/8" White, Back-Lit, Aluminum Bezel, 130-280°	1338442
ETS Gauge, Oil Pressure, Mech, 2 5/8" White, Back-Lit, Silver Bezel, 0-100 Lbs	1338444
ETS Switch Guard, On-Off Toggle	1382468
ETS Switch, Momentary Starter	1390030



WARNING: Cancer and Reproductive Harm

PRW STUD MOUNT ROCKER ARMS



*SPORTSMAN SERIES
ROCKER ARMS*



*FORD SPORTSMAN
ALUMINUM FULL ROLLER
ROCKER ARMS*



*GM LS OEM
UPGRADE ROCKER ARMS*



*GM LS BTP UPGRADE
ROCKER ARMS*

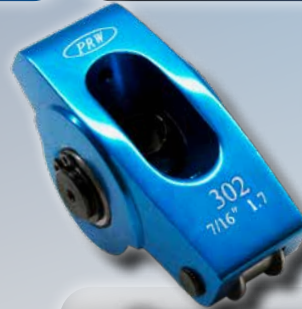

*PRO SERIES BILLET
ALUMINUM ROCKER ARMS*



*PQX[®] PLATINUM PRO
SERIES ROCKER ARMS*



*PQX[®] PLATINUM
PRO SERIES STAINLESS
STEEL ROCKER ARMS*

ROCKER ARM STYLE	OSPR (See Special Note Below)	Drawn & Cup Bearings	Bronze Bushing	PRW Rocker-Locs™ Included	Available in Split-Ratio Sets
SPORTSMAN SERIES ROCKER ARMS	350 lbs			✓	✓
FORD SPORTSMAN ALUMINUM FULL ROLLER ROCKER ARMS	400 lbs	✓	✓		
GM LS OEM UPGRADE SERIES ROCKER ARMS	400 lbs	✓	✓		
GM LS BTP UPGRADE ROCKER ARMS	600 lbs	✓			
PRO SERIES 6061 T-6 ALUMINUM ROCKER ARMS	650 lbs	✓		✓	✓
PQX [®] PLATINUM PRO 2024 ALUMINUM ROCKER ARMS	750/800 lbs	✓		✓	
PQX [®] PLATINUM PRO STAINLESS STEEL ROCKER ARMS	1000 lbs	✓		✓	✓

*May not be legal for sale or use on pollution controlled motor vehicles.
*GM is a registered trademark of General Motors.

SPECIAL NOTE: OSPR (Open Spring Pressure Rating) assumes that the engine builder is utilizing equally matched component parts throughout the valvetrain assembly. Pro-Series rocker arms are designed for aftermarket high-performance pushrods.

GM LS OEM UPGRADE ROCKER ARMS



PN - 0636417 GM LS Series L-92/LS3/LS9 1.7 x 8mm

GM LS OEM UPGRADE ROCKER ARMS	Part #
GM LS Series 4.8-6.2L 1.7 x 8mm	0634617
GM LS Series L-92/LS3/LS9 6.0L/6.2L 1.7 x 8mm	0636417
*GM is a registered trademark of General Motors.	

PRW GM LS Series OEM Upgrade Rocker Arms were designed as a drop-in system that replaces the OEM valvetrain. These rocker arms install easily on your GM LS cylinder heads without any modifications. Increase horsepower and strengthen your valvetrain with our OEM Upgrade Rocker Arms.

NEW! GM LS SERIES FULCRUM UPGRADE KITS FOR V8 OR V6, SPECIALTY FASTENERS, AND HIGH PERFORMANCE PEDESTALS

TRUNION UPGRADE KIT	Part #
GM LS Fulcrum Bearing Upgrade Kit, Set of 16	1213462
GM LS Fulcrum Bronze Bushed Upgrade Kit Set of 16	1213642
GM LS Fulcrum Bearing Upgrade Kit with Installation Tool	1213464
GM LS Fulcrum Bronze Bushed Upgrade Kit with Installation Tool	1213644
GM LS Fulcrum Removal/Installation Tool Kit	1213469
*GM is a registered trademark of General Motors.	



PN 1213462 GM LS Series Roller Bearing Fulcrum Upgrade Kit

PRW GM LS Series Fulcrum Upgrade kits are designed to upgrade stock GM LS Series rocker arms into stronger, more capable trunnions for performance applications. They include replacement fulcrums, bronze bushings or drawn cup bearings, circlips, and fasteners for a full set of 16. Strengthen your valvetrain with this Fulcrum Upgrade Kit.



PN 213642 GM LS Series Bronze Bushing Fulcrum Upgrade Kit

CALIFORNIA PROPOSITION 65 WARNING
WARNING: Products in this catalog contains chemicals known to the State of California to cause cancer and birth defects or other reproductive harm.

SPORTSMAN SERIES ROCKER ARMS

PRW Sportsman Steel Stud Mount Roller Tip Rocker Arms are the ideal choice for a large cross-section of engines; whether it is a mild street rebuild or the performance requirements of off-track, circle track and drag racing. The PRW 4340 chromoly steel rocker bodies feature a longer pivot slot for higher lift cam-shafts and are much stronger than stamped steel, so rocker arm flex is negligible. The roller tip minimizes scrubbing (the result of the valve stem pushing hard against the valve guide), reducing friction and freeing up an additional 15 to 30 horsepower over stock rockers.

- PRW ROCKERLOCS™ included
- Roller tip minimizes scrubbing
- Rated at 350 lbs open spring pressure
- Stronger than stamped steel rocker bodies
- 4340 steel rocker bodies and heat-treated pivot balls
- Excellent performance alternative compared to stock rockers

SPORTSMAN STEEL ROLLER TIP ROCKERS				
Application	Stud	Ratio	Part #	
AMC V8 1970-91	3/8"	1.6	0830201*	
CHEVY 200-262 V6 1978-86	3/8"	1.5	0822901*	
CHEVY 200-262 V6 1978-86	3/8"	1.6	0822904*	
CHEVY 262 V6 1987	3/8"	1.5	0826202	
CHEVY 262 V6 19873/8"	3/8"	1.6	08626205	
CHEVY 262-400 1955-86	3/8"	1.5	0835001*	
CHEVY 262-400 1987-00, Self-Align	3/8"	1.5	0835002	
CHEVY 262-400 1955-86, 1.6 x 3/8"	3/8"	1.6	0835004*	
CHEVY 262-400 1987-00, Self-Align	3/8"	1.6	0835005	
CHEVY 262-400 1955-86, Split Ratio Set	3/8"	1.5/1.6	0835014*	
CHEVY 262-400 1987-00, Self-Align, Split Ratio Set	3/8"	1.5/1.6	0835015	
CHEVY 262-400 1987-00, Self-align, Split Ratio Set	3/8"	1.52/1.6	0835016	
CHEVY 262-400 1955-86	3/8"	1.52	0835018*	
CHEVY 262-400 1987-00, Self-Align	3/8"	1.52	0835019	
CHEVY 262-400 1955-86	7/16"	1.5	0835020*	
CHEVY 262-400 1955-86	7/16"	1.6	0835021*	
CHEVY 262-400 1955-86, Split Ratio Set	7/16"	1.5/1.6	0835022*	
CHEVY 396-454 1965-00	7/16"	1.72	0845403	
FORD 289-351W 1962-01	3/8"	1.6	0830201*	
FORD 289-351W 1962-01, Self-Align	3/8"	1.6	0830202	
FORD 289-351W 1962-01	3/8"	1.7	0830203*	
FORD 289-351W 1962-01, Split Ratio Set	3/8"	1.6/1.7	0830209*	
FORD 289-351W 1962-01, Self-Align, Split Ratio Set	3/8"	1.6/1.7	0830210	
FORD Boss 302, 351C-M, 400, 429-460 1968-97	7/16"	1.7	0846000*	
OLDS V8 1964-80	3/8"	1.6	0845511*	
PONTIAC 287-455 & 4.3L V8 1958-81	7/16"	1.52	0845501*	
PONTIAC 287-455 & 4.3L V8 1958-81	7/16"	1.65	0845502*	
PONTIAC 301-455 1958-81, Split Ratio Set	7/16"	1.52/1.65	0845505*	

*Screw-In Studs and Guide Plates Required
 * May not be legal for sale or use on pollution controlled motor vehicles.



PN 0830201 - FORD 289-351W, Investment Cast 4340 Alloy Steel, Pivot Balls Included



Pivot Balls for Slotted Rocker Arm, 3/8" and 7/16" Available - See Page 14 for Details and Part Numbers



Tech Tip! Never install new rockers dry. They must be lubricated during initial start-up with the proper lubricant to avoid permanent damage. All PRW rocker arms should be thoroughly cleaned and soaked in oil prior to installation. Utilize CMD Valve Train Assembly Lube (Part #'s 1299882 & 1299884 Refer to page 45) on each rocker arm, pivot ball, pushrod cup and roller tip to prevent damage to new parts.

GM LS BTP UPGRADE ROCKER ARMS



PN 0642719 GM LS7 7.0 2008-2015
BTP with Bronze Bushings

The exclusive **PQ^x** Gen III/IV Bolt-to-Pedestal BTP design Rocker Arms by PRW, are the perfect alternatives to increase the durability and performance of your GM LS Series valve train. These upgrade drop-in replacements fit under stock valve covers and designed specifically for high RPM conditions. PRW factory engineering and technicians enhanced the design structure of proven stock rocker arms with heavy-duty rails and modifications to the nose to reduce drag.

- Alloy steel rocker body
- Shot-peened surface finish
- Designed for Increased lift capacity
- Choose upgraded fulcrums or bronze bushings
- Bearings/bushings are secured by snap rings

PQ^x GM LS BTP UPGRADE ROCKER ARMS	Part #
---	--------

GM LS Series 4.8-6.2L 1.7 x 8mm Fulcrum Upgrade NEW!	0637517
GM LS Series 4.8-6.2L 1.7 x 8mm Bronze Bushed NEW!	0637519
GM L92/LS3/LS9 6.0L/6.2L 1999-Up Fulcrum Upgrade NEW!	0637617
GM L92/LS3/LS9 6.0L/6.2L 1999-Up Bronze Bushed NEW!	0637619
GM LS7 7.0L 2008-2015 1.8 x 8mm Fulcrum Upgrade NEW!	0642718
GM LS7 7.0L 2008-2015 1.8 x 8mm Bronze Bushed NEW!	0642719

*GM is a registered trademark of General Motors.



PN 0637619 GM L92/LS3/LS9
1.7 x 8mm

PN 0637519 GM LS Series 1.7
x 8mm

GM LS ROCKER ARM STANDS

PRW now has replacement rocker arm mounting stands for various GM LS applications, such as use with a performance-upgraded GM LS engine. The flat rocker pedestals are reinforced for more rigidity in high-horsepower and boosted vehicles. Because rocker arms Pedestals are hard-working and vital parts in controlling intake valve operation, a reliable rail foundation is essential. PRW rocker arm mounting stands are constructed from high-quality Billet 7075 Aluminum to ensure longevity and proper function.



PN 0273642 GM 6.0L-6.2L LS3/L92 Series with Trick Flow® and other compatible heads only

These Rocker Arm Stands are compatible with Trick Flow® Heads made by Trick Flow Specialties.

Part # TFS-3261T001-C01, TFS-3261T002-C01, TFS-3261T003-C01, TFS-3261T004-C01, TFS-32610001-C01, TFS-32610002-C01

GM LS ROCKER ARM STANDS	Part #
GM 5.7-6.0L LS1/LS6 Series 1997-Up Steel Rocker Arm Pedestal Kit, Cathedral Port Heads Set of 8	0373462
GM 6.0L-6.2L LS3/L92 Series 1999-Up Steel Rocker Arm Pedestal Kit, Rectangular Port Heads, Set of 8	0373642
GM 5.7-6.0L LS1/GM LS6 Series 1997-Up 7075 Billet Aluminum Rocker Arm Pedestal Stands, Cathedral Port Heads NEW!	0273461
GM 6.0L-6.2L LS3/L92 Series 1999-Up 7075 Billet Aluminum Rocker Arm Pedestal Stands, Rectangular Port Heads NEW!	0273641
GM 6.0L-6.2L LS3/L92 Series 1999-Up with Trick Flow® Series and other compatible heads only, 7075 Billet Aluminum Rocker Arm Pedestal Stands NEW!	0273642

*GM is a registered trademark of General Motors.



PN 0373462 GM 5.7-6.0L LS1/LS6 Series 1997-Up Steel Rocker Arm Pedestal Stands



PN 0273461 GM 5.7-6.0L LS1/LS6 1997-Up

PN 0273641 GM 6.0L-6.2L LS3/L92 1999-Up

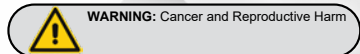

WARNING: Cancer and Reproductive Harm

FORD SPORTSMAN ALUMINUM FULL ROLLER ROCKER ARMS

PRW Sportsman Adjustable Pedestal Billet Aluminum Rocker Arms for FORD (5.0L) & 351 Windsor engines are manufactured from high strength 6061-T6 billet aluminum and utilize an adjustable pedestal that will help prevent excessive side-to-side movement of the rocker tip on valve. Each rocker is specially machined to allow for larger springs and retainers with full friction reducing needle bearings for added durability. The nose rollers and shafts are Bearing Steel, heat-treated and hardened to resist the severity of racing and to minimize scrubbing. Each rocker body is assembled and carefully inspected to provide our customers with some of the finest quality available to the racing and performance industry.

PN 0335101 - FORD 302 & 351W,
6061-T6 Aluminum Pedestal Mount



- 1.6 ratio
- Features 5/16" bolts
- Fully adjustable pedestal
- Chromoly pushrods required
- Manufactured from 6061-T6 billet aluminum
- Features full complement friction reducing needle bearings
- Installation may require new pushrod length for proper installation

FORD SPORTSMAN ALUMINUM FULL ROLLER ROCKER ARMS			
Application	OSPR	Ratio	Part #
FORD 302 (5.0L) & 351W 1978-95, Adjustable, Includes Pedestal Stand & PRW Hardware	400 lbs	1.6	0335101
*May not be legal for sale or use on pollution controlled motor vehicles			
FORD SPORTSMAN SPECIALTY PARTS			
Replacement Pedestal Stand FORD SB 351W, for PN 0335101 Series Rocker Arm, 19.5mm Tall, Alloy Steel, Black Oxide, Set of 16			1203517
Replacement Pedestal Stand FORD SB 351W, for PN 0335101 Series Rocker Arm, 21mm Tall, Alloy Steel, Black Oxide, Set of 16			1203518
Shim Kit 16 Each 0.030"/0.060", Set of 32			1203519

**NEW FOR EASY
HORSEPOWER UPGRADE!**



PN 1203518 - FORD SB
351W, Rocker Arm Stand
for PN 0335101, 16 Each

PN 1203519 - Shim Kit

PRO SERIES BILLET ALUMINUM ROCKER ARMS

Stud Mount Billet Aluminum Rocker Arms

PRW aluminum rockers are used around the world by professional racers, engine builders and hot rod enthusiasts, offering outstanding power and performance advantages for street, strip and track applications. Made from high strength 6061-T6 aluminum extrusions, each piece is precision CNC machined and finished by hand to ensure that our customers receive the very best PRW has to offer. PRW stud mount aluminum rockers are specially machined to allow for larger springs and retainers with full-cage drawn cup bearings for added durability. The nose rollers and axles are Cr20 steel, heat-treated and hardened to minimize the wear that naturally occurs between the roller tip and the valve stem.

- PRW ROCKERLOCS™ included
- Chromoly pushrods required
- Rated at 650 lbs open spring pressure
- Available in sets of 12 for Small Block Chevy V6
- Available for self-aligning applications and in split-sets
- Wide assortment of ratios to suit almost any cam profile
- Drawn cup bearings for reduced friction operation



PN 0335005 - CHEVY 262-400
1955-86, Self-Align



Studs Available in 3/8" or 7/16". See
Page 14 for Details and Part Numbers

PRO SERIES BILLET ALUMINUM ROCKER ARMS

Application	Stud	Ratio	Part #
AMC V8 1967-79	7/16"	1.6	0330205
CHEVY 262-400 1955-86	3/8"	1.5	0335001
CHEVY 262-400 1955-86	3/8"	1.6	0335004
CHEVY 262-400 1955-86, Self-Align	3/8"	1.6	0335005
CHEVY 262-400 1955-86	7/16"	1.5	0335009
CHEVY 262-400 1955-86	7/16"	1.6	0335012
CHEVY 262-400 1955-86, Split Ratio Set	3/8"	1.5/1.6	0335014
CHEVY 262-400 1955-86, Split Ratio Set	7/16"	1.5/1.6	0335016
CHEVY 262-400 1987-00, Vortec, Narrow Body	3/8"	1.5	0335018
CHEVY 262-400 1987-00, Vortec, Narrow Body, Self-Align	3/8"	1.5	0335019
CHEVY 262-400 1987-00, Vortec, Narrow Body	3/8"	1.6	0335020
CHEVY 262-400 1987-00, Vortec, Narrow Body, Self-Align	3/8"	1.6	0335021
CHEVY 262-400 1955-86	3/8"	1.65	0335022
CHEVY 262-400 1987-00, Vortec, Narrow Body, Self-Align	7/16"	1.5	0335024
CHEVY 262-400 1955-86	7/16"	1.65	0335025
CHEVY 262-400 1987-00 Vortec, Narrow Body, Self-Align	7/16"	1.6	0335026
CHEVY 262-400 1955-86, AFR 227/235 AM Heads	7/16"	1.6	0335027

*Screw-In Studs and Guide Plates Required

*May not be legal for sale or use on pollution controlled motor vehicles

Tech Tip!: Many aftermarket and OEM style cylinder heads easily adapt to various stud mount rocker arm applications, other than those published by the manufacturer. PRW Big Block Chevrolet rocker arms (for example) are commonly used by machine shops and engine builders on many of the FORD Boss 302, Modified engines and Big Block 429-460 cylinder heads. Before purchasing rocker arms for your engine, consult with your engine builder to confirm their preference.



WARNING: Cancer and Reproductive Harm

PRO SERIES BILLET ALUMINUM ROCKER ARMS



PN 0345404 - CHEVY 396-454,
6061-T6 Aluminum



PRW Custom-4135 Rocker Studs, Available for Most Applications, See Page 14 for Details and Part Numbers

PRO SERIES BILLET ALUMINUM ROCKER ARMS

Application	Stud	Ratio	Part #
CHEVY 396-454 1966-00	7/16"	1.7	0345402
CHEVY 396-454 1966-00	7/16"	1.72	0345403
CHEVY 396-454 1966-00	7/16"	1.8	0345404
CHEVY 396-454 1966-00, Split Ratio Set	7/16"	1.7/1.8	0345409
FORD 289-351W 1962-01, OLDS 350-455 1964-80	3/8"	1.6	0330201
FORD 289-351W 1962-01, Self-Align	3/8"	1.6	0330202
FORD 289-351W 1962-01	3/8"	1.7	0330203
FORD 289-351W 1962-01, Self-Align	3/8"	1.7	0330204
FORD 289-351W 1962-01	7/16"	1.6	0330205
FORD 289-351W 1962-01, Self-Align	7/16"	1.6	0330206
FORD 289-351W 1962-01	7/16"	1.7	0330207
FORD 289-351W 1962-01, Self-Align	7/16"	1.7	0330208
FORD 289-351W 1962-01, Split Ratio Set	3/8"	1.6/1.7	0330209
FORD 289-351W 1962-01, Self-Align, Split Ratio Set	3/8"	1.6/1.7	0330210
FORD 289-351W 1962-01, Split Ratio Set	7/16"	1.6/1.7	0330211
FORD 289-351W 1962-01, Self-Align, Split Ratio Set	7/16"	1.6/1.7	0330212
FORD Boss 351C-M, 400, 429, 460 1968-97	7/16"	1.73	0346002
OLDS 350-455 1964-80	7/16"	1.6	0330205
PONTIAC 287-455 & 4.3L V8 1958-81	7/16"	1.52	0345501
PONTIAC 287-455 & 4.3L V8 1958-81	7/16"	1.65	0345502

*Screw-In Studs and Guide Plates Required

*May not be legal for sale or use on pollution controlled motor vehicles

Tech Tip!: When purchasing stud mount rocker arms for your build, confirm with your engine builder various preference related to valve train operation and component parts. FORD applications are specific to the engines listed in the chart above, but keep in mind that there are many crossover part numbers that easily interchange between various OEM and aftermarket cylinder heads. Contact your local dealer or distributor for advice related PRW part number interchangeability.



WARNING: Cancer and Reproductive Harm

PQX® PLATINUM PRO SERIES ROCKER ARMS



PN 0542902 - FORD Boss
351C-M 400, 429, 460

2024 Billet Aluminum Rocker Arms

PQX® 2024 High strength heat-treated billet aluminum has superior strength and durability qualities. These rockers are designed to withstand rigorous racing conditions. Needle & cage bearings are utilized for superior performance and quiet operation. Full roller applications are available for a wide array of engine applications. The Super Duty designs are wider to handle higher spring pressures and extreme loads of Off-Road and Circle Track conditions. Surface finish is shot-peened and anodized for superior performance.

- Durable Anodized Finish
- PRW ROCKERLOCS™ included
- Rated at 750 lbs Open Spring Pressure
- Super Duty Models rated at 800 lbs Open Spring Pressure
- Shot-Peened Increases Strength & Reduce Stress Risers



PN 0545402 - CHEVY 396-454,
Super Duty

PQX® PLATINUM PRO SERIES ROCKER ARMS

Application	Stud	Ratio	Part #
AMC 290, 304, 343, 360 (5.9L), 390, 401ci 1966-91	3/8"	1.6	0529001
AMC 290, 304, 343, 360 (5.9L), 390, 401ci 1966-91	7/16"	1.6	0529002
CHEVY 262-400 1955-86	3/8"	1.5	0532701
CHEVY 262-400 1955-86	3/8"	1.6	0532704
CHEVY 262-400 1955-86	7/16"	1.5	0532709
CHEVY 262-400 1955-86, Self-Align	7/16"	1.6	0532712
CHEVY 262-400 1955-86, Split Set	3/8"	1.5/1.6	0532714
CHEVY 262-400 1955-86, Split Set	7/16"	1.5/1.6	0532716
CHEVY 262-400 1955-86, Narrow Body	3/8"	1.5	0532718
CHEVY 262-400 1955-86, Self-Align	3/8"	1.5	0532719
CHEVY 262-400 1955-86, Narrow Body	3/8"	1.6	0532720
CHEVY 262-400 1955-86, Self-Align	3/8"	1.6	0532721
CHEVY 262-400 1955-86, Split Ratio Set	7/16"	1.7	0539602
CHEVY 396-454 1966-00	7/16"	1.7	0539602
CHEVY 396-454 1966-00	7/16"	1.8	0539604
FORD 289-351W 1962-01	3/8"	1.6	0528901
FORD 289-351W 1962-01	7/16"	1.6	0528905
FORD 289-351W 1962-01	7/16"	1.7	0528907
FORD 289-351W 1962-01 Split Set	3/8"	1.6/1.7	0528909
FORD 289-351W 1962-01 Split Set	7/16"	1.6/1.7	0528911
FORD 289-351W 1962-01	7/16"	1.7	0529003
FORD Boss 351C-M 400, 429, 460 1968-97	7/16"	1.73	0542902
OLDS 260, 307, 350, 400, 403, 425, 455ci, 1967-1991	7/16"	1.7	0540302
PONTIAC 287-455 4.3 v8 1958-81	7/16"	1.52	0542101
PONTIAC 287-455 4.3 v8 1958-81	7/16"	1.65	0542102
SUPER DUTY Applications			
CHEVY 262-400 1955-86, Wide Body	7/16"	1.5	0535009
CHEVY 262-400 1955-86, Wide Body	7/16"	1.6	0535012
CHEVY 396-454 1966-00, Set, Super Duty	7/16"	1.7	0545402
FORD Boss 351C-M 400, 429, 460 1968-97 Wide Body	7/16"	1.73	0546002

PLATINUM PRO SERIES ROCKER BODIES CARRY A LIFETIME WARRANTY AGAINST BREAKAGE

*Limited to Original Purchase. *Proof of Purchase Required by Original Purchaser.

*May not be legal for sale or use on pollution controlled motor vehicles

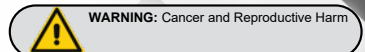

WARNING: Cancer and Reproductive Harm

PQ^x® PLATINUM PRO SERIES STAINLESS STEEL ROCKER ARMS

PRW stainless steel rocker arms incorporate an exceptional lightweight design that provides plenty of clearance for large diameter springs. These are manufactured from premium quality 17-4ph stainless steel, a superior alloy that is high in Nickel and Chromium. This rigid premium material provides high yield strength to help resist deflection and has extraordinary fatigue resistance. PRW stainless steel rocker arms feature drawn cup bearings with nose rollers and shafts made from bearing steel, heat-treated and hardened to withstand the severity of racing and minimize scrubbing. Each rocker body is tumbled in ceramic media and hand-polished, assembled and carefully inspected to provide our customers with some of the finest quality rocker arms available to the racing and performance industry.

- Lightweight design
- CNC machined pushrod cups
- Chromoly pushrods required
- Rated at 1,000 lbs Open Spring Pressure
- Wide assortment of ratios to suit almost any cam profile
- Also available for self-aligning applications and in split-sets
- Precision Sorted Drawn Cup bearings for smooth operation



PN 0235001 - CHEVY 262-400
17-4ph Stainless Steel

PQ ^x ® PLATINUM PRO SERIES STAINLESS STEEL ROCKER ARMS				
Application	Stud	Ratio	Part #	
AMC V8 1970-91	7/16"	1.6	0230205	
CHEVY 262-400 1955-86	3/8"	1.5	0235001	
CHEVY 262-400 1987-00, Self-Align	3/8"	1.5	0235002	
CHEVY 262-400 1955-86	3/8"	1.55	0235003	
CHEVY 262-400 1955-86	3/8"	1.6	0235004	
CHEVY 262-400 1987-00, Self-Align	3/8"	1.6	0235005	
CHEVY 262-400 1955-86	3/8"	1.65	0235006	
CHEVY 262-400 1955-86	7/16"	1.5	0235009	
CHEVY 262-400 1987-00, Self-Align	7/16"	1.5	0235010	
CHEVY 262-400 1955-86	7/16"	1.55	0235011	
CHEVY 262-400 1955-86	7/16"	1.6	0235012	
CHEVY 262-400 1987-00, Self-Align	7/16"	1.6	0235013	
CHEVY 262-400 1955-86, Split Ratio Set	3/8"	1.5/1.6	0235014	
CHEVY 262-400 1987-00, Self-Align, Split Ratio Set	3/8"	1.5/1.6	0235015	
CHEVY 262-400 1955-86, Split Ratio Set	7/16"	1.5/1.6	0235016	
CHEVY 262-400 1987-00, Self-Align, Split Ratio Set	7/16"	1.5/1.6	0235017	
CHEVY 262-400 1955-86	7/16"	1.65	0235018	
CHEVY 396-454, 348-409W 1958-00	7/16"	1.7	0245402	
CHEVY 396-454, 348-409W 1958-00	7/16"	1.73	0245403	
CHEVY 396-454, 348-409W 1958-00	7/16"	1.8	0245404	
DODGE MAGNUM 3.2L, 5.2L, 5.9L, for Edelbrock Heads	3/8"	1.65	0236006	

*Screw-In Studs and Guide Plates Required
*May not be legal for sale or use on pollution controlled motor vehicles



PN 1200336-16 - 3/8", 6 pt, 0.550"
OD Shank, 16 Each (Also Available
Individually) See Page 14 for Details
and Part Numbers



PRW Rocker Arm Studs Available for 3/8"
& 7/16" Rocker Arm Applications, See
Page 14 for Details and Part Numbers

*Limited to Original Purchase. *Proof of Purchase Required by Original Purchaser.

**PLATINUM PRO SERIES STAINLESS STEEL
& PLATINUM SERIES ALLOY ROCKER
BODIES CARRY A LIMITED LIFETIME
WARRANTY AGAINST BREAKAGE**

PQX[®] PLATINUM PRO SERIES STAINLESS STEEL ROCKER ARMS

Tech Tip! Split Ratios can be useful for horsepower gains by utilizing a higher ratio on the intake valve and a standard ratio on the exhaust side. Check with your PRW dealer, distributor, machine shop or engine builder for specifics.



PN 0245501 - PONTIAC 287-455 & 4.3L V8 1958-81 RockerLocs™ Included

PQX [®] PLATINUM PRO SERIES STAINLESS STEEL ROCKER ARMS			
Application	Stud	Ratio	Part #
FORD 260-351W 1962-01	3/8"	1.6	0230201
FORD 260-351W 1962-01, Self-Align	3/8"	1.6	0230202
FORD 260-351W 1962-01	3/8"	1.7	0230203
FORD 260-351W 1962-01, Self-Align	3/8"	1.7	0230204
FORD 260-351W 1962-01	7/16"	1.6	0230205
FORD 260-351W 1962-01, Self-Align	7/16"	1.6	0230206
FORD 260-351W 1962-01, Self-Align	7/16"	1.7	0230208
FORD 260-351W 1962-01, Split Ratio Set	3/8"	1.6/1.7	0230209
FORD 260-351W 1962-01, Self-Align, Split Ratio Set	3/8"	1.6/1.7	0230210
FORD 260-351W 1962-01, Split Ratio Set	7/16"	1.6/1.7	0230211
FORD 260-351W 1962-01, Self-Align, Split Ratio Set	7/16"	1.6/1.7	0230212
FORD 260-351W 1962-01	7/16"	1.8	0230213
FORD 351/400C-M 429-460 1968-97	7/16"	1.73	0246003
OLDS 350-455 1964-80	3/8"	1.6	0230201
OLDS 350-455 1964-80	7/16"	1.6	0230205
PONTIAC 287-455 & 4.3L V8 1958-81	7/16"	1.52	0245501
PONTIAC 287-455 & 4.3L V8 1958-81	7/16"	1.65	0245502
PONTIAC 287-455 & 4.3L V8 1958-81, Split Ratio Set	7/16"	1.52/1.65	0245505

*Screw-In Studs and Guide Plates Required
 *May not be legal for sale or use on pollution controlled motor vehicles

**PLATINUM PRO SERIES STAINLESS STEEL
 ROCKER ARMS CARRY A LIFETIME WARRANTY
 AGAINST BREAKAGE**

*Limited to Original Purchase. *Proof of Purchase Required by Original Purchaser.

PRW Rocker Arm Limited Warranty: : PRW warrants its products to be free from defects in material and workmanship for one year from the date of purchase. This warranty is valid when used in conjunction with newly manufactured pushrods and proper valve spring installation guidelines are followed. Platinum Pro Alloy Steel and 2024 Aluminum stud mount rocker arms carry a limited lifetime warranty.

STUD MOUNT ROCKER ARM HARDWARE & REPLACEMENT PARTS

ROCKERLOCS™ FOR ROCKER ARMS	Part #
3/8", 6 pt, 0.550" OD Shank, Set of 16 (For Full Roller Rocker Arms)	1200336
7/16" Stud, 6 Point, 0.550" OD Shank, Set of 16 (For Full Roller Rocker Arms)	1200337
7/16" Stud, 6 Point, 0.600" OD Shank, Set of 16 (For Sportsman Steel Roller Rockers)	1200339
7/16" Stud, 6 Point, 0.600" OD Shank w/ 0.550" Undercut, Set of 16 (For Stainless Steel Roller Rockers)	1200340
ROCKERLOCS™ FOR STUD GIRDLES	Part #
3/8", Standard Length, 6 pt, 0.530" OD Shank, Set of 16	1200315
3/8", Standard Length, 6 pt, 0.550" OD Shank, Set of 16	1200316
7/16" Standard Length, 6 pt, 0.600" OD Shank, Set of 16	1200317
3/8", Standard Length, 6 pt, 4 Each w/ Girdle Supporting Circlip, 0.550" OD Shank, Set of 4	1200318-04
7/16" Standard Length, 6 pt, 4 Each w/ Girdle Supporting Circlip, 0.600" OD Shank, Set of 4	1200319-04
7/16" Long, 6 pt, 0.600" OD Shank, Set of 8	1200327-08
7/16", 6 pt, 0.600" OD Shank, 8-Standard & 8-Long, Split Set of 16	1200328

ROCKERLOCS™ for Rocker Arms

- Heat-treated for added strength
- Made from 5140 Chromoly steel
- Available in 3/8" or 7/16" diameters
- Precision ground for excellent runout



ROCKERLOCS™ for Stud Girdles

- Designed to stabilize stud mount rockers
- Circlips support girdle during valve lash adjustments



Rocker Arm Studs

- Heat-treated
- Black Oxide
- Rolled threads
- 190,000 PSI Rating
- Premium race quality
- Cold headed from Custom-4135 alloy steel
- Available in Sets of 12 for Small Block Chevy V6

ROCKER ARM STUDS	Part #
3/8", 1.90" Stud Height, Skin-Pack of 16	1200406
7/16", 1.90" Stud Height, Skin-Pack of 16	1200407
3/8", 1.90" Stud Height, Box of 16	1200416
7/16", 1.90" Stud Height, Box of 16	1200417
8mm x 3/8" GM LS Series, 38mm Stud Height, Skin-Pack of 16	1200408

*GM is a registered trademark of General Motors.



Jam Nuts



Pivot Balls

SPORTSMAN ROCKER ARM JAM NUTS	Part #
Rocker Arm Adjusting, 3/8"-24, 5/8" Wrenching, Set of 16	1200246
Rocker Arm Adjusting, 7/16"-20, 5/8" Wrenching, Set of 16	1200247
SPORTSMAN ROCKER ARM PIVOT BALLS	Part #
Rocker Arm Pivot Ball, 3/8", Set of 16	1200301
Rocker Arm Pivot Ball, 7/16", Small Diameter, 0.804", Set of 16	1200302
Rocker Arm Pivot Ball, 7/16", Large Diameter, 0.954", Set of 16	1200304

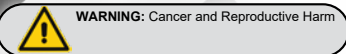

WARNING: Cancer and Reproductive Harm

PLATINUM SERIES SHAFT MOUNT ROCKER ARM SYSTEMS

PQX® MOPAR SHAFT MOUNT ROCKER SYSTEMS

STAINLESS STEEL

Complete Kit Includes: 16 Rockers, Hardened Shafts, Hold Downs, Spacers & Shims, Cup-Style Push Rod Adjusters & Push Rod Length Checkers

Application	OSPR	Ratio	Part #
MOPAR 273-360, 1964-91, "LA"	750 lbs	1.5	3231811
MOPAR 273-360, 1964-91, "LA"	750 lbs	1.6	3231812
MOPAR 383-440, 1959-78, "B" & "RB"	750 lbs	1.5	3244011
MOPAR 383-440, 1959-78, "B" & "RB"	750 lbs	1.6	3244012
MOPAR 383-440, 1959-78, "B" & "RB"	750 lbs	1.7	3244013

BILLET ALUMINUM

Complete Kit Includes: 16 Rockers, Hardened Shafts, Hold Downs, Spacers & Shims, Ball-Style Push Rod Adjusters & Push Rod Length Checkers

Application	OSPR	Ratio	Part #
MOPAR 273-360, 1964-91, "LA"	650 lbs	1.5	3331811
MOPAR 273-360, 1964-91, "LA"	650 lbs	1.6	3331812
MOPAR 383-440, 1959-78, "B" & "RB"	650 lbs	1.5	3344011
MOPAR 383-440, 1959-78, "B" & "RB"	650 lbs	1.6	3344012
MOPAR 383-440, 1959-78, "B" & "RB"	650 lbs	1.7	3344013

*May not be legal for sale or use on pollution controlled motor vehicles

PN 3231812 - MOPAR 273-360 Stainless Steel Bronze-Bushed Shaft Mount Rocker Arms



PN 3331812 - MOPAR 273-360 Aluminum Shaft Mount Rocker Arms

PQX® MOPAR Stainless Steel & Aluminum Rocker Arm Systems

PRW MOPAR Shaft Mount Rocker Arm systems are complete with everything needed to improve the performance of your stock MOPAR or aftermarket cylinder heads.

The custom alloy steel CNC machined castings incorporate silicone bronze bushings, roller tips, cup-style adjusters and 12 point lightweight locking nuts.

The 6061-T6 extruded aluminum rocker bodies utilize precision cylindrical needle and cage bearing assemblies, roller tips, and ball-type adjusters with 12 point lock nuts.

Both systems include 4135 chromoly steel alloy shafts, the finest quality hold downs, studs, fasteners, shims, spacers, pushrod length checkers and installation tools complete the assortment.

Tech Tip!: PRW rocker systems are designed for use with performance-rated camshafts, specialty pushrods such as Manton Pushrods and other related components. Open Spring Pressure Ratings (OSPR) should be determined by following camshaft and pushrod manufacturers' published ratings of component parts.



PN 3344013 - MOPAR 383-440, 2024 Billet Aluminum, Complete Kit



WARNING: Cancer and Reproductive Harm

PLATINUM SERIES SHAFT MOUNT ROCKER ARM SYSTEMS



NEW PRODUCT FEATURES
SILICON BRONZE BUSHINGS

PN PN 3544021 - MOPAR 383-440, Shaft Rocker Arm System for Edelbrock Victor and other aftermarket MOPAR Wedge Heads with .650" offset Intake Valves

PQX® MOPAR Aluminum Rocker Arm Systems

PRW MOPAR Shaft Mount Rocker Arm systems are complete with everything needed to improve the performance of your stock MOPAR or aftermarket cylinder heads. The 2024 Extruded Aluminum Rocker Bodies incorporate Silicon Bronze Bushings, Roller Tips, 5/16" Ball Adjusters and 12 Point Lightweight Locking Nuts. Our systems include 4135 steel alloy shafts, the finest quality hold downs, studs, fasteners, shims, spacers, pushrod length checkers and installation tools complete the assortment.

THIS KIT FITS EDELBROCK VICTOR SERIES AND OTHER AFTERMARKET WEDGE HEADS. PART # 77939 AND 77949

PQX® MOPAR ALUMINUM SHAFT MOUNT ROCKER SYSTEMS

Complete Kit Includes: Rockers, Hardened Shafts, Hold Downs, Spacers & Shims, Cup-Style Adjusters & Push Rod Length Checkers

Application	OSPR	Ratio	Part #
MOPAR 383-440, Shaft Rocker Arm System for Edelbrock Victor and other aftermarket MOPAR Wedge Heads with .650" Offset Intake Valves NEW!	750 lbs	1.5	3544021
MOPAR 383-440 For Edelbrock Victor and other aftermarket MOPAR Wedge Heads with .650" Offset Intake Valves NEW!	750 lbs	1.6	3544022

*May not be legal for sale or use on pollution controlled motor vehicles

PQX® MOPAR ALUMINUM SHAFT MOUNT ROCKER SYSTEMS

Complete Kit Includes: 16 Rockers, Hardened Shafts, Hold Downs, Spacers & Shims, Ball-Style Adjusters & Push Rod Length Checkers

Application	OSPR	Ratio	Part #
MOPAR 383-440 For OEM Production-Style Cylinder Heads	750 lbs	1.5	3544011
MOPAR 383-440 For OEM Production-Style Cylinder Heads	750 lbs	1.6	3544012

*May not be legal for sale or use on pollution controlled motor vehicles

PLATINUM SERIES SHAFT MOUNT ROCKER ARM SYSTEMS



PQX® FORD FE SHAFT MOUNT ROCKER SYSTEMS

Complete Kit Includes: 16 Rockers, Hardened Shafts, Individually Numbered Billet Aluminum Rocker Shaft Supports & Spacers, PRW Aircraft Quality Studs, 12 Point Nuts, Shims, Ball-Style Valve Lash Adjusters & Push Rod Length Checkers

Application	OSPR	Ratio	Part #
FORD 352-428 FE, 1958-76, 17-4ph Stainless Steel	450 lbs	1.75	3239022
FORD 352-428 FE, 1958-76, 2024 Billet Aluminum	550 lbs	1.75	3339032

*May not be legal for sale or use on pollution controlled motor vehicles
*Does not work on tunnel portheads.

**DOUBLE END PEDESTALS FOR
ADDED STRENGTH**

PN 3239022 - FORD 352-428 FE Stainless Steel
Shaft Mount Rocker Arms

PQX® FORD FE Alloy Steel & Aluminum Rocker Arm Systems

Featuring a refined design, these FORD FE shaft rocker systems are specifically designed to fit all Low-rise, Medium-rise and Tall Port OEM production heads, Edelbrock brand and other aftermarket cylinder heads, fulfilling the needs of racers and performance engine builders at every level. This complete rocker arm system is available with Platinum Series 2024 aluminum alloy or custom alloy steel rocker bodies (with silicon bronze bushings) and ball-style valve lash adjusters. The set includes chromoly alloy steel shafts, individually numbered billet aluminum rocker shaft supports and spacers, PRW aircraft quality studs and 12 point nuts. Both systems feature a double pedestal shaft mount. Other related hardware and shims are included for a custom installation.



PN 3339032 - FORD 352-428 FE
Aluminum Shaft Rocker Assembly

SPECIAL NOTE: PRW racing and performance rocker arm systems must be matched to the specifications provided by your camshaft manufacturer and other performance parts suppliers. The installer is responsible to assure that aftermarket cylinder heads and other valvetrain components are compatible with one another. Not designed for use with OEM-Rated pushrods. Custom pushrod information is available to assist you on Pages 26 - 35.



WARNING: Cancer and Reproductive Harm

PLATINUM SERIES SHAFT MOUNT ROCKER ARM SYSTEMS

PRW Aluminum Shaft Mount Rocker Arm Systems

PRW aluminum rocker arms are made from 6061-T6 aluminum alloy extrusions. Each rocker body is relieved for extra valve spring clearance and anodized for added strength. CNC machined billet steel pedestals, ground steel alloy rocker shafts, PRW SCM-4135 alloy steel fasteners and needle roller bearings from the finest manufacturers in the world comprise the foundation of these rocker arm systems. These complete kits include pushrod length checkers, components and hardware required for a professional installation.

PRW SHAFT MOUNT ROCKER ARM SYSTEMS			
Application	OSPR	Ratio	Part #
CHEVY Small Block 262-400	650 lbs	1.5	3335001
CHEVY Small Block 262-400	650 lbs	1.6	3335003
CHEVY Small Block 262-400, 1.5 Exh/1.6 Int, Split Ratio Set	650 lbs	1.5/1.6	3335013
FORD Small Block 289-351W	650 lbs	1.6	3330201
FORD Small Block 289-351W	650 lbs	1.7	3330202
CHEVY BB, Brodix-2, CHEVY OEM 24° 396-454	750 lbs	1.7	3345431

*May not be legal for sale or use on pollution controlled motor vehicles



PN 3335001 - CHEVY Small Block 262-400



PN 3345431 - CHEVY BB, Brodix-2, GM OEM

Recognizing that there were still some shortfall for certain applications, PRW engineers went to work in 2008 to design and build alternatives to meet the obvious demands of the performance market.

PRW BIG BLOCK CHEVY SHAFT ROCKER ARM SHIM KIT

Shim Kit, Rocker Arm Stand Kit, 0.930" OD x 0.450" ID x 16 Ea (Thickness: 0.175", 0.150", 0.115", 0.050", 0.030") 80 Pieces

9528104



PN 9528104 - Rocker Arm Stand Shim Kit, for BBC 33 Series Rocker Systems 0.930" OD x 0.450" ID x 16 Ea (Thickness: 0.175", 0.150", 0.115", 0.050", 0.030") 80 Pieces

GM LS SERIES ALLOY STEEL ROCKER ARMS

Application	OSPR	Ratio	Part #
GM LS1/LS2/LS6, 5.7L-6.0L 1997-Up, Cathedral Port, Includes 8mm Grade 12.9 Hex Socket Fasteners	450 lbs	1.7	0234631
GM LS3/L92 6.0L-6.2L 2007-Up, w/ Offset Intake, Square Port, Includes 8mm Grade 12.9 Hex Socket Fasteners	450 lbs	1.7	0236431

*May not be legal for sale or use on pollution controlled motor vehicles

*GM is a registered trademark of General Motors.



PN 0236431- GM LS3/L92 6.0L-6.2L *shown with optional parts

COMPATIBLE CYLINDER HEAD APPLICATIONS

SBC Application List

Chevy OEM	Early Model Heads w/ Standard Pivot and Std. Offset Vortec, Fast Burn, Late Model Bowtie, LT1/LT4
AFR	165cc-225cc w/ Standard Stud Spacing
All Pro	#200, #220, & SP Head, Street-Strip & 305-23
Brodix	-8, -10, -11, Track 1, FB 1000
Dart	Iron Eagle/Sportsman II
Edelbrock	Victor Jr./ E-Tec.
GM Performance	23° Aluminum
Profiler	23° Small Block Chevy, P/N 176
Pro Topline	23° Small Block Chevy
RHS	23° Pro Action
Trick Flow	23° Small Block Chevy & Super 23 SBC
World Products	SR/Sportsman II

BBC Application List

GM OEM	24°
Brodix	Brodix-2

SBF Application List

AFR	225cc Outlaw Race Heads
Edelbrock	Performer & Victor Jr.
FORD	SVO Windsor & GT 40
RHS	Pro-Action

PLATINUM SERIES SHAFT MOUNT ROCKER ARM SYSTEMS

PQX® Aluminum Shaft Rocker Arm Systems

In 2017, the PRW product development team recognized the need for an affordable collection of shaft rocker systems that would cost about the same as a set of roller rockers, new rocker arm studs and a stud girdle. These assemblies were designed with the sportsman racer in mind, and provided for longer pivot length rockers, various rocker ratios, adjustable stand heights, and implemented simple installations with minimal valve adjustments throughout the racing season.



PN 3536431 - GM LS3/L92 Style, Rectangular Port Heads 1.7 Ratio

PQX® GM LS ALUMINUM SHAFT MOUNT ROCKER ARM SYSTEMS

Application	OSPR	Ratio	Part #
GM LS1, LS2, LS6 Style Gen III Cathedral Port Heads, 2024 Billet Aluminum	750 lbs	1.7	3534631
GM LS1, LS2, LS6 Style Gen III Cathedral Port Heads, 2024 Billet Aluminum	750 lbs	1.8	3534632
GM L92, LS3 Style Gen III Rectangular Port Heads, 2024 Billet Aluminum	750 lbs	1.7	3536431

See Application List Below For Compatible Heads
 *May not be legal for sale or use on pollution controlled motor vehicles
 *GM is a registered trademark of General Motors.

PQX® Aluminum Shaft Rocker Arm Systems

Once the initial Sportsman-style shaft rocker systems became acceptable to the PRW customer base, our group immediately began moving forward with more aggressive race engine designs in 2024 custom aluminum formulas; specific to manufacturer's cylinder heads and specifications that fit the more popular OEM and aftermarket cylinder heads. The rocker arm assemblies listed herein and on the following pages, are the result of the last ten-year PRW commitment to pedestal-shaft rocker arm system evolution.

PQX® SBC WITH AFR HEADS ALUMINUM SHAFT MOUNT ROCKER ARM SYSTEMS

Application	OSPR	Ratio	Part #
CHEVY Small Block 262-400 AFR 190-195-210 Cylinder Heads NEW!	750 lbs	1.5	3535031
CHEVY Small Block 262-400 AFR 190-195-210 Cylinder Heads NEW!	750 lbs	1.5/1.6	3535032
CHEVY Small Block 262-400 AFR 190-195-210 Cylinder Heads NEW!	750 lbs	1.6	3535033
CHEVY Small Block 262-400 Brodix Track 1 Cylinder Heads NEW!	750 lbs	1.5	3535035
CHEVY Small Block 262-400 Brodix Track 1 Cylinder Heads NEW!	750 lbs	1.5/1.6	3535036
CHEVY Small Block 262-400 Brodix Track 1 Cylinder Heads NEW!	750 lbs	1.6	3535037

See Application List Below For Compatible Heads
 *May not be legal for sale or use on pollution controlled motor vehicles



PN 3535031 - CHEVY Small Block 262-400 AFR 190-195-1210 Cylinder Heads

NEW APPLICATIONS AVAILABLE!

Tech Tip! PRW Pro Series rocker arms are designed for heavier valve trains, higher spring pressures, roller cams and lifters. The fulcrums, shafts and material content are matched to the precision bearings to support operational loads above 650 lbs. Keep in mind that operational loads far exceed open spring pressures. A rocker arm rated at 450 lbs of open spring pressure operates at a much higher operational load. Consider component parts carefully and accordingly.

MODERN MUSCLE ROCKER ARM SYSTEMS

PQX[®] DODGE CUMMINS[®] Rocker Arm Systems



PN 3240811- Dodge CUMMINS[®],
5.9/6.7L 359-408 1998-2018



PN 3235911- Dodge CUMMINS[®],
5.9/359 1987-1998 12V 4bt-6bt

**NEW
PRODUCTS!**

PRW DODGE CUMMINS[®] high performance shaft rocker arm systems are the perfect upgrade to provide more power and run your diesel engine more efficiently. Each rocker is made from alloy steel substantially stronger than stock. PRW Cummins shaft systems are manufactured to exceed OEM specifications as a “drop in” assembly using the stock rocker arm ratios. The upgraded rocker arm systems are complete with everything you need from ball adjusters and fasteners, along with silicon bronze bushings for prolonged life expectancy. Some applications pre-machined for high performance cylinder head stud kits.

PQX [®] Dodge CUMMINS [®] ROCKER ARM SYSTEMS	
Application	Part #
DODGE CUMMINS [®] 5.9L/359 1987-98 12V 4bt-6bt High Performance Rocker Arm System, Bronze-Bushed, Standard Ratio NEW!	3235911
DODGE CUMMINS [®] 5.9L/359 1987-98, 12V 4bt-6bt High Performance Pedestal, ARP Stud Compatible, Bronze-Bushed, Standard Ratio NEW!	3235921
DODGE CUMMINS [®] 5.9L/6.7L 359-408 1998-2018 High Performance Rocker Arm System, Bronze-Bushed, Standard Ratio NEW!	3240811
DODGE CUMMINS [®] 5.9L/359 12V 6bt High Performance Rocker Arm Pedestal, Machined for Aftermarket Studs NEW!	9535910

DODGE CUMMINS[®] Diesel Fulcrum Upgrade Kit

PRW DODGE CUMMINS[®] Fulcrum Upgrade kits are designed to upgrade your rocker arms to a bronze bushed assembly. Upgrading with this kit helps to alleviate rocker body wear. Bushings are ensured lubrication with oil flow channels machined into the fulcrum. Strengthen your DODGE CUMMINS[®] with our new Fulcrum Upgrade Kit.



PN 9540810- DODGE CUMMINS[®]
Fulcrum Upgrade Kit

TRUNION UPGRADE KIT	Part #
DODGE CUMMINS [®] Fulcrum Bearing Upgrade Kit, Set of 12 NEW!	9540810

**UPGRADE YOUR STOCK ROCKER
ARMS AND CONVERT THEM TO A
BUSHED-STYLE ASSEMBLY!**

SHAFT MOUNT ROCKER ARM HARDWARE & REPLACEMENT PARTS

FORD FE SHAFT SYSTEM	
ROCKER ARM SHAFTS	Part #
FORD 390-428 FE, Chromoly Steel, 3/8" Bolts or Studs, Pair	9539002
ROCKER ARM SHIM KITS	Part #
FORD 352-428 FE (.060" .028" .016" x .870" ID) 48 Piece Set	9587050
ROCKER STUD KITS	Part #
FORD 390-428 FE, Rocker Stud Kit, MR/TP FORD OEM & Edelbrock heads, Ten (10) Each Alloy Steel Stud Kit	9539004
ADJUSTER SCREW KITS	Part #
FORD 390-428 FE, 3/8" Ball End Valve Lash Adjuster Screws 7/16"-20 x 1.55", Lock Nuts & Stainless Steel Washers, Set of 16	9539008



FORD FE Adjuster Screw Kit

Adjuster Screw Kits

- Custom-4135 alloy steel
- Cold-headed with rolled threads
- Available in 3/8" or 7/16" diameters
- Fits many other aftermarket rocker arms
- Designed for ultimate strength and locking force



PN 9539004 FORD FE Aftermarket Stud Kit

Rocker Stud Kits

- Rolled threads
- Custom-4135 alloy steel
- Available for MOPAR or FORD FE
- Provides better rocker shaft retention

12-POINT FLANGE NUTS				
Thread Size	Socket Size	12-Point (1 Pc)	12-Point (2 Pc Pack)	12-Point (10 Pc Pack)
5/16" - 24"	3/8"	1068306	1068307	1068331
3/8" - 24"	7/16"	1068312	1068313	1068314
7/16" - 20"	1/2"	1068303	1068323	1068326
1/2" - 20"	9/16"	1068336	1068325	1068338

MOPAR SHAFT SYSTEM	
ROCKER ARM SHAFTS	Part #
MOPAR 273-360, Chromoly Steel, 5/16" Bolts or Studs, Pair	9531801
MOPAR 273-360, Chromoly Steel, 3/8" Bolts or Studs, Pair	9531802
MOPAR 383-440, Chromoly Steel, 3/8" Bolts or Studs, for Stainless Rocker Systems, Pair	9544002
MOPAR 383-440 Chromoly Steel, 3/8" Bolts or Studs, Drilled for SSR with Bushings, 4.8mm x 18 Degree Offset Oiling Holes, Pair	9544003
HOLD DOWNS	Part #
MOPAR 273-360, 3/8" Shank x 5/16" x 18 UNC Fasteners, Machined Steel, Spacer & Shim Kit for Aluminum & Stainless Steel Rocker Arms	9531805
MOPAR 383-440, 3/8" Shank x 16 UNC Fasteners, Machined Steel, Spacer & Shim Kit for Aluminum & Stainless Steel Rocker Arms	9544005
VALVE LASH ADJUSTER SCREW KITS	Part #
MOPAR 273-440, 7/16 - 20, 5/16" 4135 Cup End, Set of 16	9531807
MOPAR 273-440, 7/16 - 20, 5/16" 4135 Ball End, Set of 16	9531808
SHIM KITS	Part #
MOPAR 273-440, Rocker Arm Shim Kit (0.060", 0.030", 0.015" x 0.875" ID) 48 Piece Set	9587550

12 Point Flange Nuts

- Available in many sizes
- Cold-forged from Custom-4135 alloy steel
- Designed for the ultimate strength and locking force



PN 1068331 5/16" - 24" 12-Point Flange Nuts

SHAFT MOUNT ROCKER ARM HARDWARE & REPLACEMENT PARTS

SHAFT MOUNT ROCKER REPLACEMENT SPARE PARTS	
SHIM KITS	
	Part #
CHEVY & FORD SB Rocker Arm Stand, Shim Kit, (0.030", 0.060", 0.100") 24 Piece Set	9528100
CHEVY BB Rocker Arm Stand, Shim Kit, (0.175", 0.150", 0.115", 0.050", 0.030") 80 Piece Set	9528104
TORX BOLT KITS, 4135 ALLOY STEEL	
	Part #
CHEVY SB, PRW PN: 33350nn Series Bolt Kit, Includes Torx Bit Tools, 64 Piece Set	9535003
VALVE LASH ADJUSTER SCREW KITS	
	Part #
3/8"-24, Top Oiler, Set of 16, Cup End	1205230
3/8"-24 x 29.46mm, 3.20mm Hex Socket, Pushrod Side Oiler X-Drilled, GM LS-SB, Specialty Part, Each, Cup End	8173016
3/8"-24 x 32.13mm OAL, Pushrod Top Oiler, SBC, SBF, Set of 16, Cup End	1273011
3/8"-24 x 29.50mm, Pushrod Side Oiler X-Drilled, GM LS, Std. Part, Set of 16, Cup End	1273018
3/8"-24 x 32.20mm, Pushrod Side Oiler X-Drilled, GM-BB, Std. Part, Set of 16, Cup End	1273019
SPECIALTY TOOLS, TORX BITS & SOCKETS	
RATED FOR TORQUE AT 80 FT/LBS	
	Part #
TOOL, 50+ Torx Plus, 3/8" Drive, Universal Bit Socket, T50+ Torx Bolts, 80 ft/lbs Rated, Each	1286191
GM LS Fulcrum Upgrade Removal/Installation Tools, Alignment Washers Only	1213468
GM LS Fulcrum Upgrade Removal/Installation Tool Kit, Includes Alignment Washers	1213469

*GM is a registered trademark of General Motors.



PN 1213469 GM LS Fulcrum Upgrade Removal/Installation Tool Kit

Valve Lash Adjuster Screw Kits



Specialty Tools



From Left to Right: Torx Plus Tool, Torx Tool & Torx Bit Driver

PRW specialty tools are available in a wide range of Torx and Torx+ sizes to fit the exact needs of PRW and other fasteners. These Bit Socket Drivers are designed for various rocker arm system fastener installation and/or removal and are also compatible for some belt drive components.

 **WARNING:** Cancer and Reproductive Harm

SHAFT MOUNT ROCKER ARM HARDWARE & REPLACEMENT PARTS

BILLET ALUMINUM STUD GIRDLES

PRW Billet Aluminum Stud Girdles are made from 6061-T6 aluminum, manufactured to exacting standards, and the solution to valvetrain instability. PRW stud girdles reduce rocker stud flex to retain critical valve lash adjustments. The result is more accurate valve lift and timing. PRW stud girdles are relieved at the factory to accommodate crankcase evacuation components without the need to visit your local machine shop. These products come complete with PRW ROCKERLOCS™.



PN 1545400 -
CHEVY 396-454

- CNC machined
- Reduce rocker stud flex
- Anodized for superior finish
- Made from 6061-T6 aluminum

BILLET ALUMINUM STUD GIRDLES

Application	Includes	Part #
CHEVY 262-400 1955-00, Spring-Loaded	3/8" RockerLocs™	1535000
CHEVY 262-400 1955-00, Spring-Loaded	7/16" RockerLocs™	1535001
CHEVY 262-400 1955-00, Solid Bar Design	3/8" RockerLocs™	1535002
CHEVY 262-400 1955-00, Solid Bar Design	7/16" RockerLocs™	1535003
CHEVY 262-400, Brodix, 40/60 Stud Spacing	3/8" RockerLocs™	1535004
CHEVY 262-400, Brodix, 40/60 Stud Spacing	7/16" RockerLocs™	1535005
CHEVY 262-400, AFR, Brownfield Cylinder Head	7/16" RockerLocs™	1535006
CHEVY 396-454, Brodix-2, Standard Stud Spacing	7/16" RockerLocs™	1545400

Relieved for Crankcase
Evacuation Components



PN 1535001- CHEVY 262-400

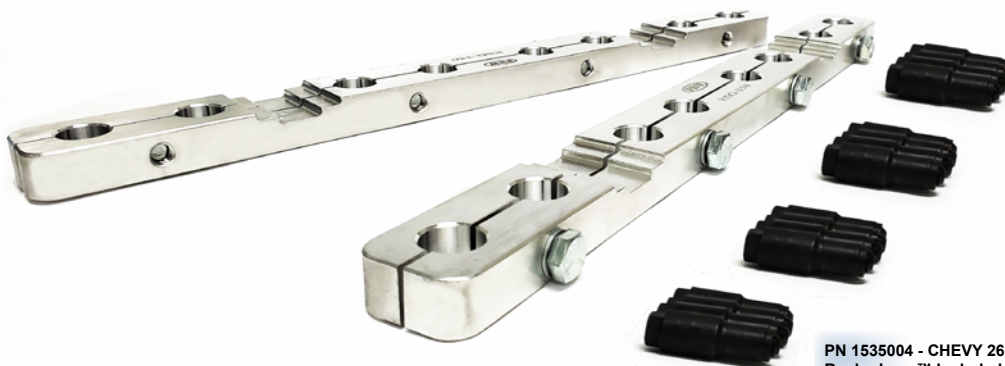

PN 1535004 - CHEVY 262-400,
RockerLocs™ Included



WARNING: Cancer and Reproductive Harm

BILLET ALUMINUM STUD GIRDLES

BILLET ALUMINUM STUD GIRDLES		
Application	Includes	Part #
FORD 260-351W 1962-01, Solid Bar	3/8" RockerLocs™	1530200
FORD 289-351W 1962-01, Solid Bar	7/16" RockerLocs™	1530201
FORD 351W, Boss, FMS Aluminum Head	7/16" RockerLocs™	1530202
FORD 351C & Performance Aftermarket Heads	7/16" RockerLocs™	1535100
FORD 429-460, TFS A460/SVO Aluminum Heads	7/16" RockerLocs™	1546000
FORD 429-460, Prod Heads, Cobra, Super Cobra	7/16" RockerLocs™	1546001
PONTIAC 326-455 1959-79, OEM Standard Stud Spacing	7/16" RockerLocs™	1545500
PONTIAC 326-455 1959-79, Edelbrock Heads	7/16" RockerLocs™	1545501

Tech Tip! Please follow Installation Instructions for the canted valve stud girdles to simplify installation on the cylinder head. Installation instructions



PN 1546000 FORD 429-460 TFS A460/SVO Aluminum Heads RockerLocs™ Included

ROCKERLOCS™ for Stud Girdles

- Designed to stabilize stud mount rockers
- Circlips support girdle during valve lash adjustments



PN 1200327-08 7/16" Long, 6 pt, 0.600" OD Shank, Set of 8

ROCKERLOCS™ FOR STUD GIRDLES	Part #
3/8", Standard Length, 6 pt, 0.530" OD Shank, Set of 16	1200315
3/8", Standard Length, 6 pt, 0.550" OD Shank, Set of 16	1200316
7/16" Standard Length, 6 pt, 0.600" OD Shank, Set of 16	1200317
3/8", Standard Length, 6 pt, 4 Each w/ Circlip, 0.550" OD Shank, Set of 4	1200318-04
7/16" Standard Length, 6 pt, 4 Each w/ Circlip, 0.600" OD Shank, Set of 4	1200319-04
7/16" Long, 6 pt, 0.600" OD Shank, Set of 8	1200327-08
7/16", 6 pt, 0.600" OD Shank, 8-Standard & 8-Long, Split Set of 16	1200328

POWERPLUS+™ CHROMOLY PUSHROD GUIDE PLATES

POWERPLUS+™ Chromoly pushrod guide plates are heat-treated steel alloy and a must have for today's high performance engines. Guide plates reduce the unwanted sideways motion of the pushrod under load. This keeps the rocker arm stabilized, making the valve operation much smoother and more efficient. PRW guide plates are designed to be used with chromoly racing or high performance pushrods (not for use with stock pushrods). These guide plates are heat-treated to help prevent premature wear, specially tumbled for a smoother finish and black oxide coated to resist corrosion.



PN 1145400 - CHEVY 396-454
1966-00, 3/8", Stepped,
Available in Sets of 8

- Made from heat-treated steel alloy
- Black Oxide coated to resist corrosion
- Heat-treated to prevent premature wear
- Makes valve operation smoother and more efficient
- Reduces unwanted sideways motion of the pushrod
- For use with high performance hardened pushrods



PN 1130201 - FORD 289-351W 1963-01,
Flat, Available in Sets of 8

POWERPLUS+™ CHROMOLY PUSHROD GUIDE PLATES

Application	Quantity in Set	Pushrod Diameter	Stud Diameter	Part #
CHEVY 265-400 1955-00, Flat	8	3/8"	7/16"	1128300
CHEVY 265-400 1955-00, Flat	8	5/16"	7/16"	1128301
CHEVY 265-400 1955-00, Stepped	8	3/8"	7/16"	1135002
CHEVY 265-400 1955-00, Stepped	8	5/16"	7/16"	1135003
CHEVY 396-454 1966-00, Stepped	8	3/8"	7/16"	1145400
CHEVY 396-454 1966-00, Stepped	8	7/16"	7/16"	1145402
FORD 289-351W 1963-01, Flat	8	3/8"	7/16"	1130200
FORD 289-351W 1963-01, Flat	8	5/16"	7/16"	1130201
FORD 351C, 351M, 400M 1970-74, Stepped	8	3/8"	7/16"	1135100
FORD 351C, 351M, 400M 1970-74, Stepped	8	5/16"	7/16"	1135101
FORD 429-460 1968-97, Stepped	8	3/8"	7/16"	1146000
FORD 429-460 1968-97, Stepped	8	5/16"	7/16"	1146001
GM LS1/LS6 4.6L-5.7L 1998-08, Flat	8	3/8"	8mm	1134600
GM LS1/LS6 4.6L-5.7L 1998-08, Flat	8	5/16"	8mm	1134601
GM LS3/L92, Angled	8	3/8"	8mm	1136400
GM LS3/L92, Angled	8	5/16"	8mm	1136401
OLDS 350-455 1965-80, Flat	8	3/8"	5/16"	1142500
OLDS 350-455 1965-80, Flat	8	5/16"	5/16"	1142501
PONTIAC 350-455 1958-79, Flat	8	3/8"	7/16"	1145500
PONTIAC 350-455 1958-79, Flat	8	5/16"	7/16"	1145501

*All guide plates require screw-in studs. Some installations may require machine work.

*GM is a registered trademark of General Motors.



WARNING: Cancer and Reproductive Harm

POWERPLUS+™ CHROMOLY PUSHRODS

4130 Chromoly One-Piece Pushrods

Cold formed seamless hardened 4130 Chromoly single piece pushrods with .080" wall thickness designed for racing and high performance applications. Able to withstand open spring pressures of 375 pounds. Standard 5/16" & 3/8" diameter pushrods are available in lengths from 6.200" - 9.900".



POWERPLUS+™ CHROMOLY PUSHRODS				
Application	Common Length	End Type	5/16" Part #	3/8" Part #
AMC 290-401	7.800"	Ball - Ball	94080517800	94080317800
BUICK 350	9.675"	Ball - Ball	94080519675	94080319675
BUICK 455	9.375"	Ball - Ball	94080519375	94080319375
CHEVY 262-400 Stock (w/ Flat Tappet)	7.800"	Ball - Ball	94080517800	94080317800
CHEVY 0.050" Long	7.850"	Ball - Ball	94080517850	94080317850
CHEVY 0.100" Long	7.900"	Ball - Ball	94080517900	94080317900
CHEVY 0.200" Long	8.000"	Ball - Ball	94080518000	94080318000
CHEVY Late Model 262-400 (w/ Hydraulic Roller)	7.200"	Ball - Ball	94080517200	94080317200
CHEVY GM LS Series Stock	7.400"	Ball - Ball	94080517400	94080317400
CHEVY 396-454 Intake	8.275"	Ball - Ball	94080518275	94080318275
CHEVY 396-454 Exhaust	9.250"	Ball - Ball	94080519250	94080319250
CHEVY 8.1L, 496, 2001-07, Intake	8.200"	Ball - Ball	*	94080318200
CHEVY 8.1L, 496, 2001-07, Exhaust	9.150"	Ball - Ball	*	94080319150
FORD 302 Retro-Fit Hydraulic Roller	6.400"	Ball - Ball	94080516400	94080316400
FORD Stock 5.0L	6.275"	Ball - Ball	94080516275	94080316275
FORD Stock 351W	8.150"	Ball - Ball	94080518150	94080318150
FORD Stock 351C & Cobra Jet	8.400"	Ball - Ball	94080518400	94080318400
FORD 351M-400M	9.500"	Ball - Ball	94080519500	94080319500
FORD 429-460	8.550"	Ball - Ball	94080518550	94080318550
FORD 332-428 FE (Hyd/Mech Lifter & Adj Rockers)	9.225"	Ball - Cup	*	*
FORD 332-428 FE (Shell Lifters & Adj Rockers)	10.650"	Ball - Cup	*	*
MOPAR 273-360, "A" Engines	7.500"	Ball - Ball	94080517500	94080317500
MOPAR 273-360, "A" Engines	7.500"	Ball - Cup	*	*
MOPAR 383-400, "B" Engines	8.550"	Ball - Ball	94080518550	94080318550
MOPAR 383-400, "B" Engines	8.550"	Ball - Cup	*	*
MOPAR 413-440, "RB" Engines	9.300"	Ball - Ball	94080519300	94080319400
MOPAR 413-440, "RB" Engines	9.300"	Ball - Cup	*	*
MOPAR Magnum, 5.2L & 5.9L	6.800"	Ball - Ball	94080516800	*
OLDS 260-403	8.225"	Ball - Ball	94080518225	94080318225
OLDS 400-455	9.750"	Ball - Ball	94080519750	94080319750
PONTIAC 350-455	9.150"	Ball - Ball	94080519150	94080319150

See Manton Custom Pushrod Details on Pages that Follow



* Available Through Manton Pushrods
 Note: When ordering pushrods, add 4 digits to the end of the part number to indicate the pushrod length.
 Example: 94080516050 indicates that the pushrod length is 6.050".

*GM is a registered trademark of General Motors.

POWERPLUS+™ CHROMOLY PUSHRODS

PRO SERIES CUSTOM PUSHRODS



Terry, Trevor & Jordon at the races.



The boys practicing the trade with Grandpa.



Robin & the boys, hands on at the track.

Manton Pushrods Past, Present & Future

The Manton Family has been involved with the Motorsports Industry since the late 1960's. The Manton name is most commonly associated with hardcore valvetrain hardware, quality race car engine components and exceptional service.

In 1978, at the age eleven Terry Manton assembled his first pushrods while working for Sig Erson Racing Cams. By 1983 Terry was manufacturing pushrods under the Manton name. Then, in 1995 Terry and Robin Manton opened Manton Pushrods, which is the start of what you see today. While Robin was dedicated to the business end of daily operations, Terry's focus was devoted to integrating customers needs while exceeding their expectations with Manton's products.

Today, led by Robin, Manton Pushrods is the leader in pushrod technology and sets the bar for outstanding customer service. The innovation that drives this company forward comes from a team of highly skilled and motivated individuals. This team has been assembled over many years and each member has a passion of some kind, related to the motorsports world.



PRW Industries Teams with Manton Pushrods for Custom Applications

With Manton Pushrods in close proximity to the PRW product development and warehouse facility, it seemed a natural progression for PRW engineering and technical staff to form a strategic alliance and distribution arrangement with Robin Manton and her team of professionals. PRW is extremely grateful to bring to market and distribute Manton products, thereby enhancing the value, durability and life cycle of the PRW and Performance Quotient line-up of Sportsman and Pro Series rocker arms.

On the following pages, you will find a great deal of pertinent information about pushrods and other parts that are critical to receiving the most benefit from PRW rocker arms. A complete listing of pushrods and component parts is available directly from Manton Pushrods). PRW has identified those most useful when put into service with PRW and Performance Quotient full roller and shaft style rocker arm systems. We offer Series 3, Series 4 and Series 5 Manton pushrods in the most popular combinations to suit the needs of our customers.

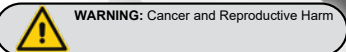

THREE PIECE PUSHRODS

Why a Three Piece Pushrod?

Before explaining why Manton manufactures only modular pushrods, one must first stop and describe the function of a pushrod. In simple terms, pushrod transfers energy from the lifter to the rocker arm. If a pushrod is not correctly matched to the application, incorrect valve lift and valve timing can cause engine failure. With a properly matched pushrod you will achieve maximum horsepower and minimize valve train wear.

To determine the proper pushrod for an engine, you must decide the pushrod length, diameter, wall thickness, materials, heat treating and end configurations to match the specific engine components and application. This may seem like a fairly easy process but, to accomplish this, there are several things that must be considered. That is the primary reason why Manton only produces custom modular pushrods.

1. Each end in a pushrod must be compatible with its mating components. This requires the use of material that can function as a bearing and at the same time, be as impact resistant as possible (see tip material on page 25). As an additional benefit this also allows for an unlimited amount of tip designs.
2. A modular pushrod design allows the flexibility to choose “unique” tapers for clearance issues. While changing the wall thickness, diameter and tapering the tube will change the natural frequency.
3. The column of the pushrod must be made out of a different material and heat treated differently than the tips. It must provide the strength to withstand the combined abuse of high engine speeds and cylinder pressure. By using a dissimilar material from the pushrod end, Manton has the ability to utilize any heat treatment we desire. In most applications we use a material that is commonly available 4130/4135 tubing. Our series 2 and 4 are intended for guide plate use and use a Melonite™ process for durability and wear resistance for guide plate use. The series 5 utilize a proprietary heat treating process to increase the material value to a Rockwell of approximately 46 “C”. This is critical to the function of a pushrod column. 4130/4135 is very tough, forgiving and durable when used at approximately 46 Rockwell “C”. We also offer a proprietary heat treated solid bar S-7 tool steel pushrod which is the same material used to produce quality chisels and hammers. It is very impact resistant and is the perfect material for extreme applications.

In our estimation the only reason to ever produce a one piece pushrod would be because of the reduced cost to manufacture. Manton produces the highest quality pushrods available and manufactures only modular pushrods for all custom applications.

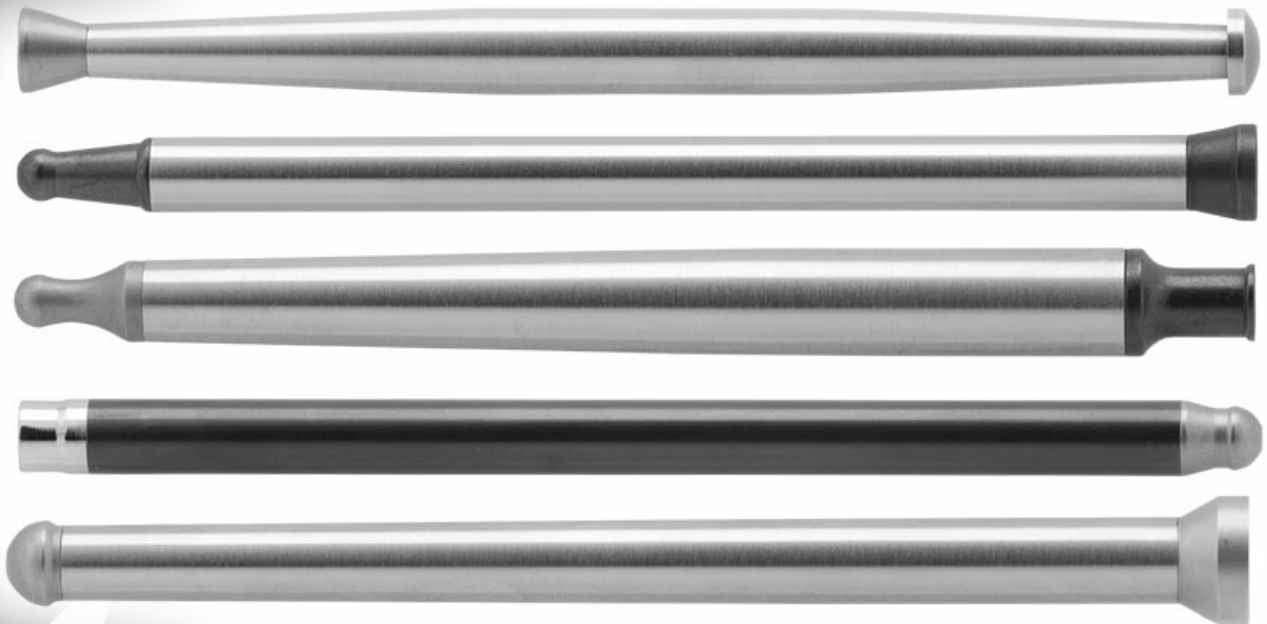

PUSHROD TIP & ADJUSTER SCREW COMPATIBILITY

Material Compatibility of Pushrod Tips & Adjusting Screws

To ensure proper wear of the pushrod tip and adjusting screw we offer pushrod tips in three different materials.

The most common material used by Manton is 8620, a basic material used to manufacture gears. This material, when heat treated correctly, exhibits excellent wear properties and is very impact resistant. This 8620 material is used in most pushrod tip applications and has a surface hardness of approximately 62 Rockwell "C". It can be used in conjunction with almost all rocker arm adjusting screws, of similar hardness, on the market today.

When using rocker arm adjusting screws made from harder and stronger materials such as H-13 tool steel or other grades of tool steel it is very common for the surface hardness, after heat treating, to be in excess of 70+ Rockwell "C". For these types of adjuster we usually recommend using our H-13 tool steel pushrod tips. We are very particular about the heat treat characteristics of our tool steel pushrod tips and adjusting screws. Different material core values will produce slight hardness changes to the surface. The rule of thumb is that you always want the ball surface to be as hard or harder than cup surface.

In some applications the use of a proprietary hybrid copper alloy insert is utilized. The copper insert is pressed into a tool steel body, formed into a cup, and used in conjunction with a tool steel ball adjusting screw. We use this copper alloy material because of its excellent coefficient of friction and superior lubricity characteristic. In the past few years the chemical makeup of engine oils has changed. This, combined with the used of low viscosity oil has increased the issue of premature wear in applications such as Pro Stock, Super Stock, Comp Eliminator, Sprint Car, etc. the copper alloy cup combination is extremely durable and reliable in this type of environment.

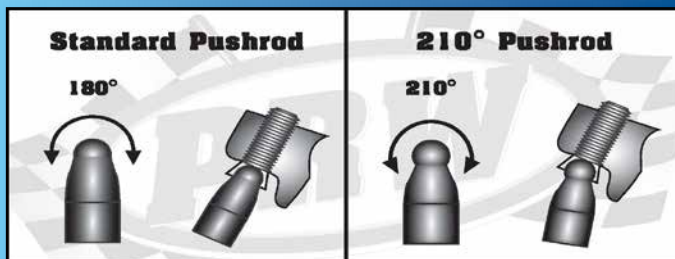

Tech Tip: The appropriate 210° custom push rod ends should be used with shaft mounted rocker arm systems. 8620 tips compatible with all PRW adjuster screws. The 210° design is used to avoid interference with the adjuster cup at full lift. This added clearance becomes critical with higher lift cams.

Pushrod Tips

Manton Pushrod Tips are CNC machined in house to ensure quality control and versatility. Made from high impact, wear resistant 8620 barstock, case hardened, heat treated and tempered.

In addition, pushrod tips are also available in H-13 tool steel. This material is heat treated, triple tempered and salt bath nitrided. Tool steel pushrod tips are almost always used in conjunction with tool steel rocker arm adjusting screws.

Our proprietary copper alloy inserted tip are available for our .281 and 5/16 ball adjusting screw in two designs. One radius cup and the other is a V cup.



IMPORTANT SPECIAL INSTRUCTIONS & SUGGESTIONS

- 1.** It is very important to determine proper pushrod length. Improper pushrod length can cause a number of problems, including, excessive valve guide wear, decreased valve lift, valve stem side thrust, coil bind, improper valve to piston clearance and also rocker arm to retainer interference (in some cases lash caps may be used to help correct rocker arm to retainer clearance problems).
- 2.** Check the radius of the lifter receiver cup and rocker arm cup/ball before ordering to help prevent mistakes. Improperly mated parts may result in parts failure. Watch for variations from stock radius in aftermarket lifters.
- 3.** Ensure that there is a significant oil volume to lubricate the rocker arm end of the pushrod. This will help prevent galling due to excessive heat generation. To prevent interrupted oil flow to the pushrod, it is very common and sometimes necessary to modify the lifter body so oil flows through it no matter where it's positioned in the lifter bore (call for details). Oil restriction in the engine block is not normally recommended, however some aftermarket manufacturers recommend the use of oil restrictors in the cylinder heads to reduce the amount of oil in the top end of the engine. Review and follow manufacturer's guidelines carefully.
- 4.** Many problems occur when a pushrod is inadequate for the application. Whenever possible, use larger diameter pushrods to spread out the load and lower the stress on the tube. This will help decrease pushrod deflection. Heavy wall tubing can minimize compression of the column.
- 5.** In high load applications, large diameter, heavy wall tubes are a must. These applications include: the use of a blower, turbo charger, nitrous oxide, nitromethane, high spring pressures and engine speeds over 7,000 rpm.
- 6.** Do not allow over clearance for the pushrod. This may cause the pushrod to move around or deflect more than needed. Clearance of .010" at the closest point of contact is sufficient. The surface of the cylinder head or engine block can often be utilized like a large guide plate and dampening device which stabilizes the pushrod. During assembly, turn the engine over to make sure there are no pushrod binding or interference problems.
- 7.** Tapered pushrods should not be used in applications that require guide plates. Improper clearance and interference problems are likely to occur. Use only straight tube pushrods that have been surface hardened for use with guide plates. Note: See Series #2 and #4 for guide plate applications.
- 8.** Tool steel rocker arm adjusting screws almost always require a tool steel pushrod tip, to be used at the rocker arm end, to ensure proper compatibility.
- 9.** In race applications, and engines with flat tappet camshafts, it is imperative to use engine oil containing sufficient friction modifiers. The most commonly known friction modifiers are zinc, phosphorus, sulfur and soluble moly disulfide. Read the bottle or contact your oil supplier.
- 10.** When installing new pushrods in an engine, or after replacing pushrod tips in repaired pushrods, it is a good idea to carefully check the rocker arm adjusting screws to make sure the contact surface of the screw has not been damaged. A damaged adjuster surface will damage the new pushrod tip.
- 11.** When using Manton pushrods, adjustments to valve/cam timing, valve to piston clearance and fuel curve may be required. This is due to increased rigidity in the pushrod column, making valve action more accurate and efficient.



WARNING: Cancer and Reproductive Harm

PUSHROD STRENGTH & DEFLECTION

Column Strength

A pushrod is an eccentrically loaded column due to angularity load and arc motion throughout pushrod travel. Pushrods want to deflect most toward the bottom of the column, near the lifter side of the pushrod. This is because of the angularity load. In most cases, it is best to use the largest diameter pushrod that will fit in the engine. The increased diameter will decrease deflection and provide more accurate lift and timing.

When checking and fitting for pushrod diameter, it may be necessary to use a single taper or dual offset taper design, with the large end being toward the bottom. This places the larger diameter and increased mass, of the pushrod where it wants to flex the most. The tapered design provides added clearance throughout the head and near the rocker arm which may be really helpful. The taper on the tube can also help dampen harmonics in the valvetrain.

With a stiffer pushrod column, increased valve lift should be able to be measured statically in applications using a lot of spring pressure. The higher the engine speed, the greater the increase will be at running speed. Keep in mind that while increasing wall thickness on a pushrod column does add strength, the percentage of increase is very small. The large gain in column strength comes from increasing the pushrod diameter.

Do not be overly concerned about pushrod weight. The pushrod is on the slow moving side of the valve train. The additional weight of a heavy wall pushrod usually provides a much needed increase in valve train stability.

Pushrod Deflection & Compression Diagrams

Note: In this simplified illustration, you can see that pushrod deflection and compression can cause reduced net valve lift, the result of a foreshortened pushrod. Valve timing (duration and timing) can also be affected by inadequate pushrod stiffness.

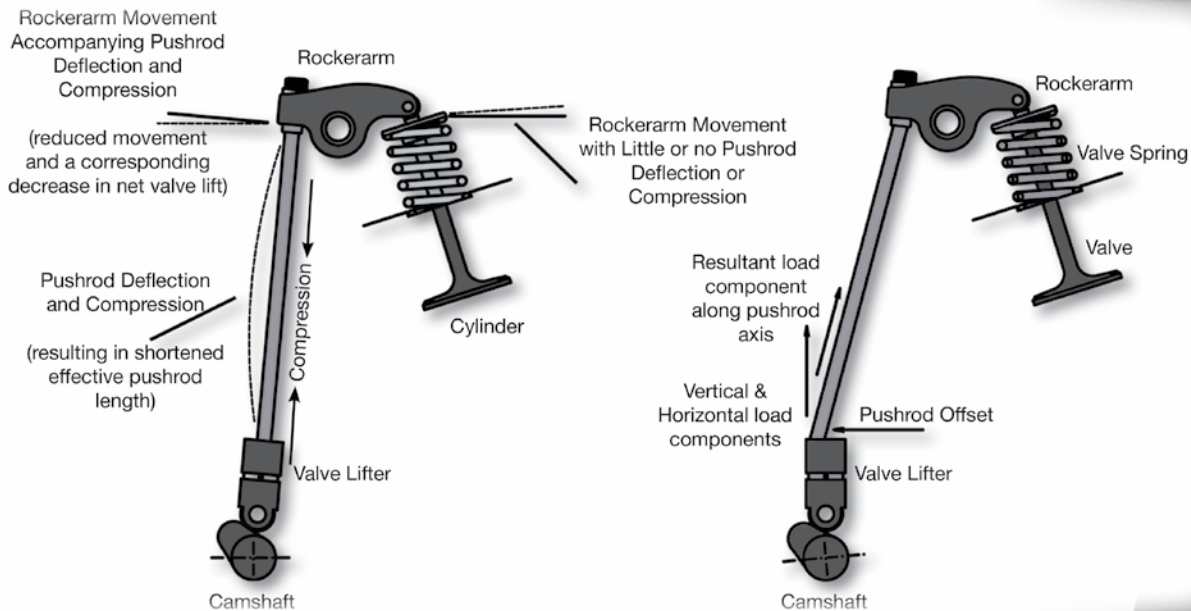

Tech Tip: Adding to the complexity of pushrod loading are compound angles resulting from offset pushrod cups (in lifters) and angularity relationships among the pushrod, valve lifter and rocker arm. Oblique angles contribute to side-loading and complex load patterns placed on the pushrod. Although some degree of pushrod “shock absorbing” is virtually unavoidable, minimizing such deflection and compression is critical for maintaining proper valve timing.

PUSHROD LENGTH DIAGRAMS

Rocker Arm Geometry & Proper Pushrod Length

Many variables directly affect determining proper pushrod length. Pushrod length is affected by all of the variables listed below.

- Block deck height
- Lifter receiver cup height
- Valve stem height
- Head deck height
- Rocker arm design
- Cam base circle diameter
- Head stud boss height / rocker arm stand mounting pad
- Adjusting screw placement per manufacture

Remember that every engine is different because the combination of these variables change from one engine to another. Take the time necessary to determine proper pushrod length with each engine you build. Do not assume that your pushrod length is the same as your friends engine. We have given some guidelines in this section to help you determine proper pushrod length for both roller rocker arms and shoe rocker arms. Each type of rocker arm style has different instructions.

With shaft mounted rocker arms, raising or lowering the stands to change the rocker arm shaft height is usually necessary to obtain proper rocker arm geometry. With stud mounted rocker arms, changing the pushrod length achieves the same effect.

1. Obtain an adjustable checking pushrod (available from Manton).

2. Light duty checking springs must be used in place of valve springs to allow you to rotate the valve train and check for proper contact pattern on the valve stem.

3. You will need an accurate measuring device to measure your adjustable pushrod once you have locked your adjustable pushrod at the correct length.

4. Ball/Ball designs are to be ordered by overall length measurement. (The standard flat diameter on the ends of the pushrods is .100")

5. Ball/Cup designs are most properly ordered by the effective length. This length is measured from the bottom of the cup radius to the tip of the ball. Overall length can also be given, but tell us how deep the cup depth is. Make sure when ordering ball/cup pushrods that you specify effective or overall length.

Note: PRW shaft mount rocker arm systems include pushrod length checkers.

Proper Pushrod Length With a Shoe Rocker Arm

See "Diagram A" for Shoe Rocker Arm

When using your adjustable pushrod checking tool and checking springs, you want the contact spot to start on the intake side of the valve tip with the lifter on the base of the camshaft (position #1). At approximately 1/3 lift, the contact spot should be in the center of the valve tip (position #2). At full lift, the contact spot should be the same distance past the center of the valve tip toward the exhaust side as it was when the lifter was on the base of the camshaft (position #3). Fully closed is back to position #1.



Proper Pushrod Length With Roller Rocker Arms

See "Diagram B" for Shoe Rocker Arm

As in diagram A, you should use a checking spring during this procedure. This allows you to rotate the valve train without damaging the checking pushrod and eliminates the unwanted deflection that would occur from spring pressure.

To obtain the roller positions listed below you will be re-locating the rocker arm pivot point (rocker shaft). By moving the shaft up or down the roller contact position on the valve will change.

With the valve completely closed and the lifter on the base circle of the camshaft, the roller should contact the valve at position #1 as shown in the diagram. As the valve train is rotated to 1/2 lift, the roller will have traveled as far as it can and will stop at position #2. Continue to rotate the engine and at full lift the roller contact will be at its starting point. We will call this position #3. If the roller is not in exactly the same position at full lift as it was when the valve was completely closed, the rocker shaft must be moved. If the roller stops early, the shaft must be shimmed up. If the roller stops late the shaft must be moved down. As you continue to rotate the valve train, the roller will move back to position #4 when the valve is at half lift on the closing side and will finish at position #5 when the valve is completely closed.



WARNING: Cancer and Reproductive Harm

SERIES DEFINITIONS

SERIES 3

Semi to high performance: **Non-guide plate use.** Hard drawn 4130/4135 seamless chromoly tubing, the highest quality available from mills. Originally formulated for aerospace/aircraft use, and a higher quality pushrod which provides approximately 170,000 psi tensile strength. (**Note** – Shaft or pedestal style rocker arms should be used in conjunction with this series of pushrod because we do not case harden the tube for guide plate use.)

Sizes: 5/16" • 11/32" • 3/8" • 7/16" • 1/2" • 9/16" diameters. Straight tube or tapered, any length or variation of taper.

Used for multiple applications such as Sportsman, Diesel, and Factory Performance engines.

SERIES 4

Semi to high performance: **Guide plate use.** Hard-drawn 4130/4135 seamless chromoly tubing, the highest quality available from mills. Originally formulated for aerospace/aircraft use. Melonite™ processed for durability and excellent wear resistance. A higher quality pushrod which provides approximately 180,000 psi tensile strength.

Sizes: 5/16" • 11/32" • 3/8" • 7/16" diameters. Straight tube any length.

Used with any guide plate pushrod engine.

SERIES 5

The strongest most durable chromoly pushrod ever produced in the world. **Non-guide plate use.** This series of pushrods are manufactured for the most extreme applications possible. Utilizing 4130/4135 chromoly tubing and proprietary heat treating techniques we are able to achieve a 275,000 p.s.i. tensile strength from the tubing without causing it to become brittle. (**Note** – Shaft or pedestal style rocker arms should be used in conjunction with this series of pushrod because we do not case harden the tube for guide plate use.)

Sizes: 5/16" • 11/32" • 3/8" • 7/16" • 1/2" • 9/16" • 5/8" • 3/4" diameters. Straight tube or tapered, any length or variation of taper.

Mainly used in Cup, Top Fuel, Pro Stock, Pro Modified, Blown Alcohol, Pulling Tractor, Sprint Car and Offshore Marine.

Tech Tip: PRW offers pushrods compatible with Pro Series and Platinum Series Rocker Arms and Rocker Arm Systems.





There are many wall thicknesses which allows you to vary the frequency and column strength of the pushrod. This provides a unique tunable valve train tool.



SERIES 3 MEDIUM TO HIGH PERFORMANCE - 4130-4135 HARD DRAWN

Part #	Straight Pushrod Tubes		Non-Guide Plate Use	
MP-301083	5/16"	x .083" Wall		
MP-301118	5/16"	x .118" Wall		
MP-302120	11/32"	x .120" Wall		
MP-304095	3/8"	x .095" Wall		
MP-304145	3/8"	x .145" Wall		
MP-305120	7/16"	x .120" Wall		
MP-305168	7/16"	x .168" Wall		
Part #	Tapered Pushrod Tubes		Non-Guide Plate Use	
MP-313120	3/8"	x 5/16"	.120" Wall	Single Taper
MP-316120	7/16"	x 3/8"	.120" Wall	Single Taper
MP-316168	7/16"	x 3/8"	.168" Wall	Single Taper
MP-317120	7/16"	x 3/8"	.120" Wall	Dual Taper
MP-317168	7/16"	x 3/8"	.168" Wall	Dual Taper

SERIES 4 MEDIUM TO HIGH PERFORMANCE - 4130-4135 MELONITE™ PROCESSED

Part #	Straight Pushrod Tubes		Guide Plate Use	
MP-401083	5/16"	x .083" Wall		
MP-401118	5/16"	x .118" Wall		
MP-404095	3/8"	x .095" Wall		
MP-404145	3/8"	x .145" Wall		
MP-405120	7/16"	x .120" Wall		

SERIES 5 MAXIMUM PERFORMANCE - 4130-4135 SALT HEAT TREATED TO 275,000 P.S.I. TENSIL

Part #	Straight Pushrod Tubes		Non-Guide Plate Use	
MP-501083	5/16"	x .083" Wall		
MP-501118	5/16"	x .118" Wall		
MP-502120	11/32"	x .120" Wall		
MP-503095	3/8"	x .095" Wall		
MP-503145	3/8"	x .145" Wall		
MP-504120	7/16"	x .120" Wall		
Part #	Tapered Pushrod Tubes		Non-Guide Plate Use	
MP-513145	3/8"	to 5/16"	.145" Wall	Single Taper
MP-516120	7/16"	to 3/8"	.120" Wall	Single Taper
MP-517120	7/16"	to 3/8"	.120" Wall	Dual Taper

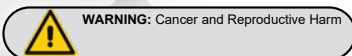

Adjustable Checking Tools

Part #	Description
MP-660660 - E, M, K, O, U, R	3/8" Adjustable Tool 6.000" to 7.000"
MP-629629	3/8" Adjustable Tool Kit 6.000" to 14.000" (Includes 8 Tubes, 8 - 5/16" Balls, 2 - 5/16" Cups, 2 - 3/8" Cups, 2 V Cups, 2 Springs)
MP-630630	Chrysler 3/8" Adjustable Tool Kit 10.000 to 14.000 (Includes 4 Tubes, 8 - 5/16" Balls, 2 - 5/16" Cups, 2 - 3/8" Cups, 2 Springs)
MP-631631	Pair of Checking Springs

Tips styles are indicated by the following letters:

E = 5/16" Ball **M** = 5/16" Cup **K** = 3/8" Cup **O** = V Cup **U** = 13/32" Cup **R** = Radius Cup



MP-629629 - 3/8" Adjustable Tool Kit 6.000" to 14.000" (Includes 8 Tubes, 8 - 5/16" Balls, 2 - 5/16" Cups, 2 - 3/8" Cups, 2 V Cups, & 2 Springs)

Pushrod Tips

Part #	Description
MP-7060	Pushrod Tip - 8620 Steel Ball Style
MP-7026	Pushrod Tip - 8620 Cup Style

Important Ordering Instructions

When ordering pushrods there are many factors in determining the correct pushrod for your application. Many questions will be asked of you during the ordering process. The correct answers to these questions are the responsibility of the customer. We will do our best in suggesting the proper pushrod for your application, but the final decision is the responsibility of the customer. Manton Pushrods will not be held responsible if the pushrods do not fit properly when you receive them unless it is due to a manufacturing error on our part.



2022 CATALOG CAR

Amidst the numerous disruptions caused by COVID-19 in 2020, PRW has worked hard to maintain our status in the automotive aftermarket parts industry and we're proud to have upheld our operations along with progressively growing throughout all aspects. We've put in the extra effort to provide our parts and additionally introduce new parts to our product line.

We'd like to introduce another project of ours, set to make a debut on our upcoming 2022 PRW Catalog. We'll be working alongside many outstanding companies for this build and will document our progress in the 2022 PRW Catalog!



Vehicle Specifications:

Year: 1966

Make: FORD

Model: Mustang

Exterior: Raven Black

Interior: Burgundy

To view more information on our build before the 2022 Catalog debuts, please use the QR code above to view our Blog.

2022 CATALOG CAR

Here's a sneak peek of our Catalog Project Vehicle and the companies involved with our exciting build. We left no stone unturned and chose the best possible for our 2022 Catalog Car. To say we're excited is an understatement and everyone involved has been very helpful and welcoming. Stay tuned...



2022 CATALOG CAR

FABRICATED ALUMINUM VALVE COVERS

**NEW
PRODUCT!**

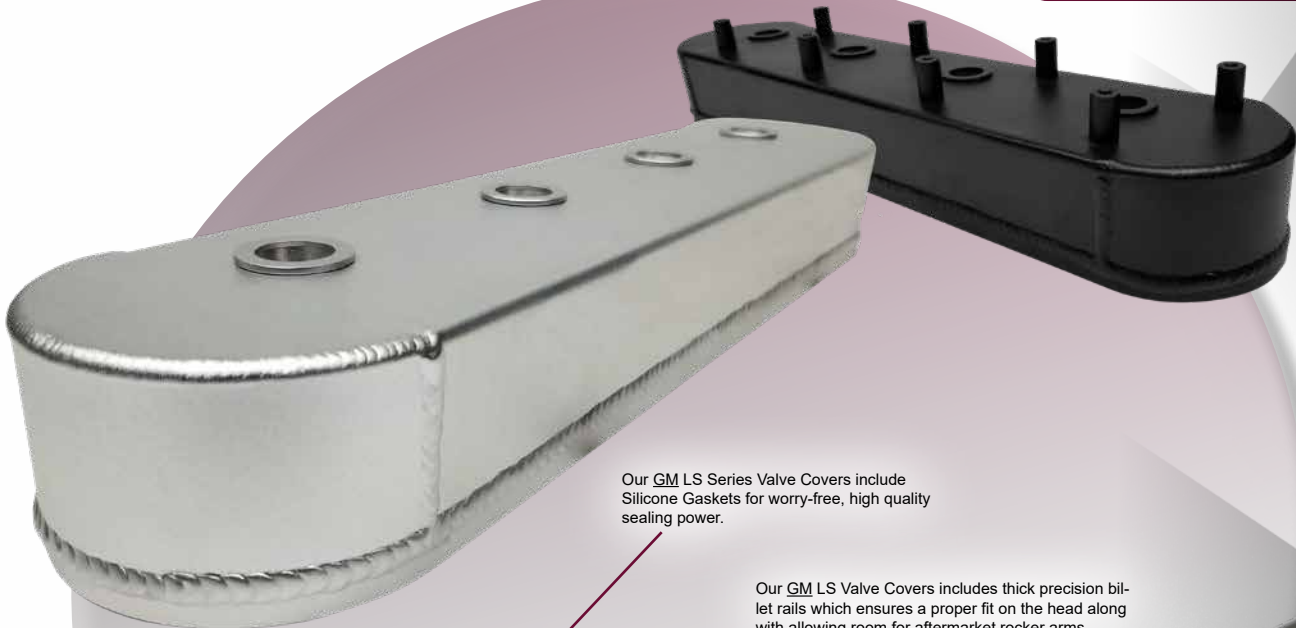

Our **GM** LS Series Valve Covers include Silicone Gaskets for worry-free, high quality sealing power.

Our **GM** LS Valve Covers includes thick precision billet rails which ensures a proper fit on the head along with allowing room for aftermarket rocker arms.



Vintage racers, competition junkies and machining enthusiasts trying to save weight; give your engine the edge. Crafted from 6061-T6 aluminum alloy, these valve covers have successfully endured rigorous testing, proving that they are built to last. The incredible ability to withstand the harsh elements of racing makes these the perfect solution for street rod and racing applications. 1/4" thick 6061-T6 billet rails assure long lasting durability. Individually pressure-tested. Valve covers are sold in pairs and include hardware. These valve covers are available in polished with clear anodizing; or black or silver shot-peened and anodized finish. Valve cover gaskets available for most applications.

*GM is a registered trademark of General Motors.

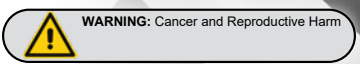

FABRICATED ALUMINUM VALVE COVERS

FABRICATED ALUMINUM VALVE COVERS



PN 4035007 - CHEVY, Small Block, Satin Black Anodized (Also Available in Satin Silver Anodized & Polished Finishes)



PN 4035030 - CHEVY, Small Block, Satin Silver Anodized (Also Available in Satin Black Anodized & Polished Finishes)

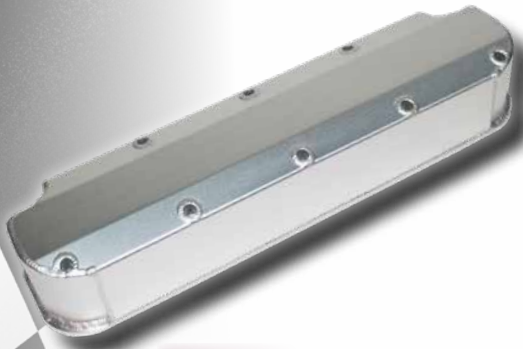

PN 4036000 - Dodge Magnum 5.2L/5.9L, Satin Silver Anodized (Also Available in Satin Black Anodized & Polished Finishes)



PN 4035047 - CHEVY, Small Block, Circle Track Satin Black Anodized (Also Available in Satin Silver Anodized Finish)



PN 4045410 - CHEVY, Big Block, Satin Silver Anodized (Also Available in Polished Finish)



PN 4045408 - CHEVY, Big Block, Polished (Also Available in Satin Black Anodized Finish)

FABRICATED ALUMINUM VALVE COVERS		
Application	Finish	Part #
CHEVY, SB, Standard Bolt Pattern w/ Vent Hole, Tall	Satin Silver Anodized	4035000
	Polished	4035001
CHEVY, SB, Standard Bolt Pattern, Tall Pitched w/o Vent Hole	Satin Silver Anodized	4035010
	Polished	4035011
CHEVY, SB, Center Bolt Pattern Cylinder Heads	Satin Silver Anodized	4035030
	Polished	4035031
	Satin Black Anodized	4035037
CHEVY, SB, Standard Bolt Pattern Cylinder Heads, Tall, for Short Bolts, Circle Track w/ One (1) Oil Stack & Crankcase Evacuation Threaded Bungs & Pipe Plugs	Satin Silver Anodized	4035040
	Satin Black Anodized	4035047
CHEVY, BB w/ Crankcase Evacuation Hole	Satin Black Anodized	4045407
CHEVY, BB, Standard Bolt Pattern Cylinder Heads, Tall	Polished	4045408
	Satin Silver Anodized	4045410
MOPAR, DODGE Magnum, 5.2L/5.9L 1992-03, No Vent Holes	Polished	4045411
	Satin Silver Anodized	4036000
	Satin Black Anodized	4036001
	Satin Black Anodized	4036007

FABRICATED ALUMINUM VALVE COVERS

FABRICATED ALUMINUM VALVE COVERS



PN 4035100 - FORD, 302B/351C/351M/400, Satin Silver Anodized (Also Available in Polished Finish)



PN 4030217 - FORD, 302/351W, Satin Black Anodized (Also Available in Satin Silver Anodized & Polished Finish)

FABRICATED ALUMINUM VALVE COVERS

Application	Finish	Part #
FORD, 302/351W Style Cylinder Heads, 3 Long Fasteners & 2 Short	Satin Silver Anodized	4030210
	Polished	4030211
	Satin Black Anodized	4030217
FORD, 302B/351C/351M/400 Style Cylinder Heads	Satin Silver Anodized	4035100
	Polished	4035101
FORD FE, 352-428 Style Cylinder Heads	Satin Silver Anodized	4039000
	Polished	4039001
	Black Satin Anodized	4039007
FORD, 429 & 460 Style Cylinder Heads	Satin Silver Anodized	4046000
	Polished	4046001
GM LS Series, w/o Coil Stand-Offs, Machined Inside Rail Design for Roller Rockers, Includes Silicon Gaskets, O-Ring	Satin Silver Anodized	4034620
	Polished	4034621
	Black Satin Anodized	4034627
GM LS Series, w/ Coil Stand-Offs, Machined Inside Rail Design for Roller Rockers, Includes Silicon Gaskets	Satin Silver Anodized	4034630
	Polished	4034631
	Black Satin Anodized	4034637
JEEP, 5.2L/5.9L 1993-98, No Vent Hole	Satin Silver Anodized	4036000
	Polished	4036001
	Satin Black Anodized	4036007
MOPAR, Small Block MOPAR 318-360, w/ Vent Hole	Satin Silver Anodized	4031800
	Polished	4031801
	Satin Black Anodized	4031807
MOPAR Big Block MOPAR 383-440, w/ Vent Hole	Satin Silver Anodized	4044000
	Polished	4044001
	Satin Black Anodized	4044007
PONTIAC, 301-455 Cylinder Heads	Satin Silver Anodized	4045500
	Polished	4045501
	Satin Black Anodized	4045507
PONTIAC, 301-455 Cylinder Heads, Short Design, 3mm Thick Top-Plate	Satin Silver Anodized	4045510
	Polished Clear Anodized	4045511
	Satin Black Anodized	4045517

*GM is a registered trademark of General Motors.



PN 4046000 - FORD, 429 & 460, Satin Silver Anodized (Also Available in Polished Finish)



PN 4034631 - GM LS Series, Polished (Also Available in Satin Silver & Satin Black Anodized Finishes)

**EXTRA THICK TOP-PLATE
FOR CUSTOM MACHINE
ENGRAVING**

PN 4044000 - MOPAR, Big Block, Satin Silver Anodized (Also Available in Satin Black Anodized & Polished Finishes)



PN 4045517 - PONTIAC, 301-455, Satin Black Anodized (Also Available in Satin Silver Anodized & Polished Finishes)

VALVE COVER GASKETS

Application	Part #
CHEVY 262-400, Blue Rubber w/ Steel Core, 3/16" Thick, Pair	4174841
CHEVY 396-454, Black Rubber w/ Steel Core, 3/16" Thick, Pair	4174850
CHEVY 396-454, Blue Rubber w/ Steel Core, 3/16" Thick, Pair	4174851
CHEVY Center Bolt, Black Rubber, 3/16" Thick, Pair	4174888
FORD Small Block, Black Rubber w/ Steel Core, 3/16" Thick, Pair	4174860



PN 4174888 - CHEVY Gaskets Center Bolt, Black Rubber, 3/16" Thick



PN 4134631 - GM LS Series Valve Cover Risers, 3/4" Thick

VALVE COVER RISERS

GM LS Series	Part #
3/4" Thick, Includes Silicone O-Ring Seals, Pair	4134631
1" Thick, Includes Silicone O-Ring Seals, Pair	4134632

*GM is a registered trademark of General Motors.

GM LS Series Valve Cover Risers

- Includes gaskets
- Constructed from billet aluminum
- Custom machined to clear roller rocker arms
- Perfect for enthusiasts who want to maintain OEM valve covers

Crankcase Evacuations

The PRW crankcase evacuation system reduces crankcase pressure throughout the entire rpm range. The result is improved piston ring seal and reduced intake charge contamination. Less crankcase pressure translates to fewer oil leaks.

CRANKCASE EVACUATION SYSTEM

Part #
UNIVERSAL, Kit Includes 2 Each Threaded Pipes, Gulp Valves, & Hose Clamps
4120500



PN 4120500 - UNIVERSAL, Kit Includes 2 Each Threaded Pipes, Gulp Valves, & Hose Clamps



WARNING: Cancer and Reproductive Harm

VALVE COVER ACCESSORIES

Modular Oil Filler Caps & Adapters

- Constructed from billet aluminum
- Complete with O-rings for the bung
- Easy to install without the need to weld in place
- Available in various colors with a clear coat anodized finish



PN 4120452 - MODULAR FILLER CAP, Modular, Billet Aluminum Screw-In Type to Prevent Seepage & Oil Loss, for 1.375" ID Hole, w/ O-Ring Seals, Red Anodized



PN 4120473 - MODULAR FITTING ADAPTER, Billet Aluminum, Screw-In Type w/ Tapped Bore Hole, For 1.250" Hole, Includes 3/8" NPT to 3/8" Barb, Silver Anodized w/ O-Ring Seals

MODULAR OIL FILLER CAPS & ADAPTERS

OIL FILLER CAP, Modular, Billet Aluminum Screw-In Type to Prevent Seepage & Oil Loss, for 1.375" ID Hole, w/ O-Ring Seals	Part #
Blue Anodized	4120450
Red Anodized	4120452
Silver Anodized	4120453
Black Anodized	4120457
Clear Anodized	4120458
MODULAR FITTING ADAPTER, Billet Aluminum, Screw-In Type w/ Tapped Bore Hole	Part #
For 1.250" ID Hole, Includes 3/8" NPT to 3/8" Barb, Silver Anodized, w/ O-Ring Seals	4120473
For 1.250" ID Hole, Includes 3/8" NPT to 3/8" Barb, Black Anodized, w/ O-Ring Seals	4120477

Tech Tip! Customize your valve covers with our valve cover accessories! Use a Holesaw or Step Drill bit to make a hole for your accessory. Remember to use Vibra-Tite threadlocker on your set screw which goes on the inside of your valve cover.



WARNING: Cancer and Reproductive Harm

VALVE COVER ACCESSORIES



PN 4120429 - Breather, Polished Die Cast Aluminum w/ Grommet & Vent Pipe



VALVE COVER BREATHER KIT, Push-In Style, w/ Modular Screw-In Oil Filler Adapter, Element, Grommet & Vent Pipe
 PN 4120443 (Shown) - Black Anodized Billet Aluminum
 PN 4120427 - Polished Billet Aluminum

Breather Caps & Kits

- Properly vent your crankcase
- Constructed from billet aluminum
- Easily installed for valve covers with pre-drilled filler holes
- Provides maximum air circulation to reduce oil temperatures
- Traps oil vapor reducing engine compartment contamination
- Modular oil breather fitting installs where required without welding

MODULAR BREATHER CAPS & KITS		Part #
Valve Cover Breather, Polished Die-Cast Aluminum		
w/ Grommet & Vent Pipe		4120429
w/ Grommet - No Vent Pipe		4120430
Breather, Push-in Style, Billet Aluminum, with Grommet		
Polished, Billet Aluminum w/ PCV & Vent Pipe		4120439
Polished, Billet Aluminum w/ PCV, w/o Vent Pipe		4120440
Black Anodized, Billet Aluminum w/ PCV & Vent Pipe		4120441
Black Anodized, Billet Aluminum w/ PCV, w/o Vent Pipe		4120442
Breather Kit, Push-in Style Breather w/ Color-matched Modular Screw-In Type Oil Filler Adapter (Black or Silver Anodized)		
Polished, Die-Cast Alum Breather w/ Vent Pipe & Silver Anodized Filler Adapter		4120427
Polished, Die-Cast Alum Breather w/o Vent Pipe & Silver Anodized Filler Adapter		4120428
Polished, Billet Alum Breather w/ PCV & Vent Pipe		4120437
Polished, Billet Alum Breather w/ PCV, w/o Vent Pipe		4120438
Black Anodized Billet Alum Breather w/ PCV & Vent Pipe		4120443
Black Anodized Billet Alum Breather w/ PCV, w/o Vent Pipe		4120444
Valve Cover Breather Adapter, Billet Aluminum, Modular Screw-in Type for 1.50" ID Hole		Part #
Silver Anodized w/ "O" Ring Seal		4120483
Black Anodized w/ "O" Ring Seal		4120487

POWERPLUS+™ ASSEMBLY LUBES & THREADLOCKERS

PRW caters to the Performance Automotive Aftermarket with specialized threadlockers, anti-seize formulas, and lubricants.

Anti-Seize Compound

Vibra-TITE® anti-seize is available in an aluminum, copper or nickel compound to protect metal parts against rust, corrosion and seizure up to 1800°F. Fine metallic and graphite particles in special grease protect parts even in high heat, high pressure and corrosive environments.

ANTI-SEIZE	Part #
Aluminum Compound, Silver, 2 mL Tube (Bullet)	1290702
Aluminum Compound, Silver, 4 oz Brushtop Can	1290704
Copper Compound, Copper, 2 mL Tube (Bullet)	1290712
Copper Compound, Copper, 3 oz Tube	1290713
Nickel Compound, Silver, 2 mL Tube (Bullet)	1290722

POWERPLUS+™ LUBES & ANTI-SEIZE



PN 1290704 - Anti-Seize, Aluminum Compound, Silver, 4 oz Brushtop Can



PN 1290722 - Anti-Seize, Nickel Compound, Silver, 2 mL Bullet

Assembly Lube

PRW exclusively recommends and markets CMD anti-scoring assembly lubricants. These are not ordinary lubricants. They are compounded of highly refined petroleum products containing no lead, graphite or minerals. They will not corrode the finest surfaces nor will they emulsify with cooling liquids. But these facts are not the most remarkable feature of CMD lubricants. The truly outstanding property of CMD is its ability to withstand extreme pressures! The thousands of firms who have used CMD have discovered that commonly used lubricants will provide a lubricating film at pressures of 500, 1000, 5000 and even 10,000 psi. By contrast, CMD EXTREME PRESSURE lubricants are regularly used from 40,000 to 50,000 psi.

ASSEMBLY LUBE	Part #
CMD Extreme Pressure #3, 1/4 oz Packet	1299882
CMD Extreme Pressure #3, 4 oz Shop Tube	1299884



PN 1299884 - CMD Extreme Pressure #3 Assembly Lube, 4 oz Shop Tube



PN 1299882 - CMD Extreme Pressure #3 Assembly Lube, 1/4 oz Packet

Threadlocker

Ideal for all nut, stud and bolt applications, Vibra-TITE® Threadlocker assures nuts and washers stay in place. Threadlocker locks and seals while preventing parts from loosening due to vibration and protects threads from corrosion. Available in medium strength, which is removable with hand tools for easy disassembly, to permanent strength. Suggested applications include: valve cover bolts, water pump bolts, rocker arm shaft studs and fasteners, and rocker arm adjustment nuts.



PN 1293110 - Threadlocker, Permanent Strength, Red, 10 mL Bottle



PN 1292535 - Threadlocker, Permanent Strength, Blue Gel, 35 mL Pump Dispenser

THREADLOCKER	Part #
Medium Strength, Blue, 2 mL Tube (Bullet)	1292102
Medium Strength, Blue Gel, 35 mL Pump Dispenser	1292535
Permanent Strength, Red, 2 mL Tube (Bullet)	1293102
Permanent Strength, Red, 10 mL Bottle	1293110
Permanent Strength, Red, 50 mL Bottle	1293150
Permanent Strength, Red Gel, 35 mL Pump Dispenser	1293535
High Strength, Red, 2 mL Tube (Bullet)	1294002



WARNING: Cancer and Reproductive Harm

POWERPLUS™ THREADLOCKERS & SHOP PACKS

Vibra-TITE® VC-3 Threadmate

- Stops fasteners from loosening from extreme shock & vibration
- Works on fasteners of any shape or size, from tiny hex set screws to harmonic balancer bolts
- Fasteners are easily adjusted, removed & reused
- Works with internal/external threads



Bullet Size is 2 mL

GREAT FOR STORE COUNTERS!



PN 1293199 - Threadlocker, Fishbowl, 100 ct, Permanent Strength, Red, 2 mL Tube

THREADLOCKER	Part #
Fishbowl, 100 Count, Medium Strength, Blue, 2 mL Tube (Bullet)	1292199
Fishbowl, 100 Count, Permanent Strength, Red, 2 mL Tube (Bullet)	1293199
VC-3 Threadmate 1 mL Packet (Pillow Pack)	1291302
VC-3 Threadmate 5 mL Tube	1291305

SHOP PACKS

Fast Lock 4, Threadlocking Kit Includes:

1. Medium Strength Removable Threadlocker. For Fasteners 1/4" to 3/4" Diameter. (10 mL)
2. Permanent Strength Threadlocker. Lock Fasteners up to 1" Diameter. (10 mL)
3. Medium Strength Gel Threadlocker. No Mess or Waste! (35 mL)
4. Anti Cam-Out Fluid. Easily Remove or Tighten Screws. (15 mL)

Part

1292535

Bench Pack 5, Kit Includes:

1. High Strength Retaining Compound. For Slip Fit Assemblies. (10 mL)
2. Wicking Grade, Medium Strength Threadlocker. For Fastener Asm. to 1/2" Diameter. (10 mL)
3. Medium Strength Removable Threadlocker. For fasteners 1/4" to 3/4" Diameter. (10 mL)
4. High Strength Threadlocker. Lock Fasteners Up to 1" Diameter. (10 mL)
5. Anti Cam-Out Fluid. Easily Remove or Tighten Screws! (15 mL)

1297005

Work Pack 6, Kit Includes:

1. VC-3 Threadmate (5 mL)
2. Threadlocker Gel Permanent Strength (Red) (8 mL)
3. Threadlocker Gel Medium Strength (Blue) (8 mL)
4. Instant SuperGlue Multi-Purpose (15 mL)
5. Drive Grip Anti Cam-Out Fluid (16 mL)
6. Anti-Seize Compound Nickel-Graphite (8 mL)

1297007

A MUST-HAVE THREADLOCKER KIT FOR EVERY TOOLBOX!



PN 1292535 - Fast Lock 4 Kit

PN 1297005 - Bench Pack 5 Kit

PN 1297007 - Work Pack 6 Kit



A SELECTION OF POPULAR FASTENER LOCKING & RETAINING PRODUCTS

CONTAINS ALL 6 Vibra-TITE® PRODUCTS!



POWERPLUS™ THREADLOCKERS & SHOP PACKS

Oil Extreme™ “Better Than Synthetic” Motor Oil is specially formulated using a full synthetic base oil just like the other big name synthetic brands. It also uses a standard additive package that meets the API SN and ILSAC GF-5 specifications. You may have heard about the API SN specification that greatly reduced the amount of ZDDP (Zinc) in today’s motor oils because of its harm to catalytic converter life.

At this point Oil Extreme is just like the other well-known synthetic brands. But this is where the difference comes in.

Because of this loss of ZDDP a lot of race engines that use flat tappet cam followers like NASCAR engines and many Hot Rods use, are having excessive cam lobe wear because of the loss of Zinc in the oil. This has resulted in a whole raft of new race oils that have the ZDDP put back in. However these oils are labeled for off--road use ONLY.

The difference is Oil Extreme’s™ Calcium Petroleum Sulfonate extreme pressure technology is far superior to the old fashioned ZDDP technology.

By filling the microscopic asperities in an engine’s metal surfaces with a hard tribochemical film, the force applied to each particular engine part can be spread over a much larger area. This lowers friction and wear dramatically. Reducing friction produces more horsepower and torque! Typically 5 to 7 extra H.P. Another tremendous breakthrough is the extremely high TBN (a 320 Total Base Number) that this additive package has. Just 3% or 1 ounce per quart of oil raises the normal TBN of 7 or 8, clear up to 18 to 20. This means the oil drain intervals can be safely extended 2 or 3 times thereby saving you lots of money.

Another important feature of Oil Extreme’s™ “Better Than Synthetic” motor oil that meets or exceeds API SN specifications, is that our oil can be used in all race engines AS WELL AS ALL PASSENGER CARS AND TRUCKS and still have the SN Energy Conserving properties.



PN - Oil Extreme 5W-30 Single Quart

OIL EXTREME MOTOR OIL AND OIL ADDITIVES

Oil Packages

- David Vizard's 3 Step Break-In System - 3 (16 oz Bottles)
- Oil Extreme Concentrate Additive (6 oz Single Bottle)
- Oil Extreme Concentrate Additive 6 Pack (6 oz Bottles)
- Oil Extreme Concentrate Additive (16 oz Single Bottle)
- Oil Extreme Concentrate Additive 6 Pack (16 oz Bottles)
- Oil Extreme Motor Oil 5W-30 (Single Quart)
- Oil Extreme Motor Oil For All Powersports 15W-40 (Single Quart)
- Oil Extreme Motor Oil For All Powersports V-TwinsS 20W-50 (Single Quart)
- Oil Extreme Motor Oil 5W-30 (12 Quart Case)
- Oil Extreme Motor Oil 15W-40 (12 Quart Case)
- Oil Extreme Motor Oil 20W-50 (12 Quart Case)



PN - Oil Extreme David Vizard's Step Break-In System

FOR MORE INFORMATION, SEE US AT
SEMA 2021! BOOTH #24120

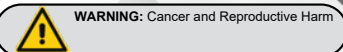

BOOKS OF KNOWLEDGE

DAVID VIZARD PERFORMANCE ENGINES, RECIPES, AND PARTS

David Vizard has been building and customizing engines for more than 50 years. He has written about 30 highly respected engine-building and automotive books and more than 4,000 magazine articles in addition to his dozens of online contributions. Often referred to as Vizard the Wizard because of his astounding prowess with engines, his work is frequently the subject of blogs and editorial pieces in popular automotive magazines.

PRW is happy to announce our partnership with Mr. Vizard. We will be carrying his book library to help enthusiasts take their engine building to the next level.

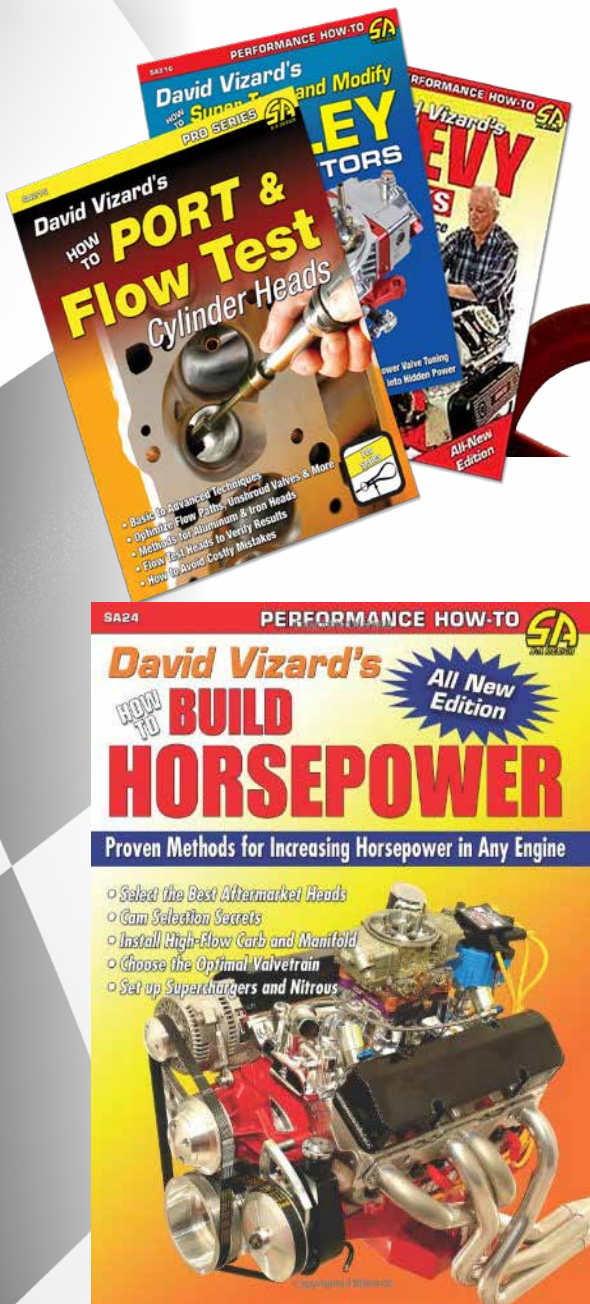

DAVID VIZARD Books

Book Title

- David Vizard's How to Port & Flow Test Cylinder Heads
- David Vizard's How to Build Max Performance Chevy Small Blocks on a Budget
- Chevy Big Blocks: How to Build Max Performance on a Budget
- David Vizard's How to Build Horsepower
- David Vizard's Holley Carburetors: How to Super Tune and Modify
- How to Rebuild Your Small-Block Chevy
- How to Build and Modify Chevrolet Small-Block V-8 Camshafts and Valves
- How to Build and Modify Chevrolet Small-Block V-8 Cylinder Heads
- How to Build Horsepower, Volume 2: Carburetors and Intake Manifolds
- Nitrous-Oxide Injection

SCAN THE QR CODE ABOVE VIEW DAVID VIZARD'S YOUTUBE CHANNEL!

MAIN GIRDLES & MAIN CAPS AND STUD KITS

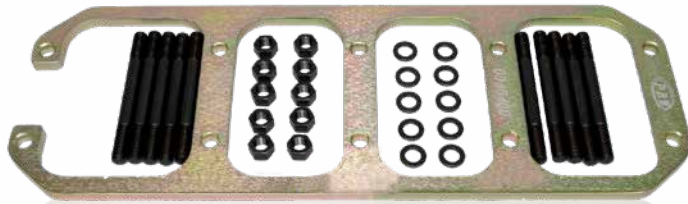

PN 0945400 - CHEVY 454

Billet Steel Main Girdles

PRW Billet Steel Main Girdles are engineered to help eliminate the block flex and cap walk that occurs as a result of stress while under extreme loads, including nitrous oxide power bursts in high performance engines. PRW main girdles are manufactured from premium quality 1045 billet steel.

BILLET STEEL MAIN GIRDLES

Application	Part #
CHEVY 350	0935000
CHEVY 400	0940000
CHEVY 454	0945400
FORD 289-302	0930200
FORD 351W	0935100
FORD 460	0946000
OLDS 350-403	0940311
OLDS 455	0945511

PQ^x BILLET STEEL MAIN GIRDLES FOR STROKER CRANKS

Application	Part #
FORD 289, 302 - 347ci	0934700
FORD FE 390, 406, 427, 428 - 448ci	0944800

MAIN GIRDLE STUD KITS

Application	Part #
CHEVY 350, Main Girdle Stud Kit, 10 Each	1000203
CHEVY 400, Main Girdle Stud Kit, 10 Each	1000207
CHEVY 454, Main Girdle Stud Kit, 10 Each	1000209
FORD 289-302, Main Girdle Stud Kit, 10 Each	1000202
FORD 351W, Main Girdle Stud Kit, 10 Each	1000205
FORD 460/FE Main Girdle Stud Kit, 10 Each	1000215
OLDS 350-403, Main Girdle Stud Kit, 8 Each	1000211
OLDS 455, Main Girdle Stud Kit, 8 Each	1000213



PN 1000202 - FORD 289-302, Stud Kit



PN 1735003- CHEVY 350 1967-86 2 Bolt to 4 Bolt Block, Straight Holes

Billet Steel Main Caps

PRW billet steel main bearing caps provide increased stability to the entire crankshaft rotating assembly and augment the strength and durability of high horsepower engines. These products are CNC machined from 1045 billet steel, HRC 10-14 for easy machining. Drill guides included on all main cap conversion kits.

BILLET STEEL MAIN CAPS

Application	Part #
CHEVY 305/350 1967-86, 4 Bolt Replacement	1735001
CHEVY 350 1967-86, 22 Degree Splayed Caps	1735002
CHEVY 350 1967-86, 2 Bolt to 4 Bolt Block, Straight Holes	1735003
CHEVY 400 1970-80, Splayed Caps	1740002
CHEVY 396-454 1966-90, Straight Caps, 4 Each	1745401
CHEVY 396-454 1966-90, Straight Caps, 3 Each	1745402
FORD 302 1968-95, 2 Bolt Replacement, Center Caps	1730201
FORD FE 332-428, 2 Bolt Replacement, 4 Each	1739001
MOPAR 383-440, 2 Bolt Replacement, 5 Each	1738301
MOPAR 383-440, Cross-Bolt Style, 3 Ea, 2 Bolt Std, 2 Each	1744002
PONTIAC 326-400 Small Journal, 4 Bolt Dowel Pinned Replacement or Conversion, 3 Each	1738901

GEAR DRIVES & BRONZE DISTRIBUTOR GEARS

PQ^x Dual Gear Drives

Replace your stock timing chain with a CNC machined dual gear drive, available in noisy or quiet for most applications. Unlike timing chains, gear drives will not stretch or wear prematurely. Most applications require little or no machining. Perfect for Circle Track applications. Whether it's on the street or at the track, let a PRW Dual Gear Drive help you make more horsepower.



PN 0130201 FORD 221-351W 1962-91, Noisy
*Does Not Include Cam Bushings

PRW DUAL GEAR DRIVES	
Application	Part #
CHEVY 262-400 1955-95 (Except Factory Roller Cam), Noisy	0135001
CHEVY 262-400 1955-95 (Except Factory Roller Cam), Quiet	0135002
FORD 221-351W 1962-91, Noisy	0130201
FORD 351/400 Cleveland/Modified 1970-74, Quiet	0130202
OLDS 307-455 1964-76, Quiet	0145512
PONTIAC 287-455 & 4.3L V8 1955-81, Quiet	0145502

Bronze Distributor Gears

PRW bronze distributor gears are designed to minimize wear to your high performance camshaft. These distributor gears are crafted from superior quality aluminum-bronze and are precision CNC machined to provide smooth consistent operation.



PN 0735001 -
CHEVY 262-454



PN 0146021 - FORD 429-460 1968-97,
Noisy, Made in USA

PQ ^x DUAL GEAR DRIVES	
Application	Part #
CHEVY 262-400 1955-95 (Except Factory Roller Cam), Noisy, Made in the USA NEW!	0135021
CHEVY 262-400 1955-95 (Except Factory Roller Cam), Quiet, Made in the USA NEW!	0135022
CHEVY 262-400 1955-95 (Factory Roller Cam), Noisy, Made in the USA NEW!	0135025
CHEVY 262-400 1955-95 (Factory Roller Cam), Quiet, Made in the USA NEW!	0135026
FORD 221-351W 1962-91 Noisy, Made in the USA NEW!	0130221
FORD 221-351W 1962-91 Quiet, Made in the USA NEW!	0130222
MOPAR/CHRYSLER 383-440 1959-79 Noisy, Made in the USA NEW!	0144021
MOPAR/CHRYSLER 383-440 1959-79 Quiet, Made in the USA NEW!	0144022
FORD 429-460 1968-97 Noisy, Made in the USA NEW!	0146021
FORD 429-460 1968-97 Quiet, Made in the USA NEW!	0146022

BRONZE DISTRIBUTOR GEARS	
Application	Part #
CHEVY 262-454 1955-00, 0.491"	0735001
CHEVY 262-454 1955-00, 0.500"	0735002
CHEVY 262-454 1955-00, 0.491", Reverse Rotation	0735003
FORD Small Block 1963-95, 0.467"	0730201
FORD Small Block 1963-95, 0.500"	0730202
FORD Small Block 1963-95, 0.531"	0730203
FORD 429-460 & 351C 1968-97, 0.500"	0746001
OLDS 350-455 1964-80, 0.491"	0745511
PONTIAC V8 1959-81, 0.491"	0745501

CYLINDER HEAD STUD KITS



PN 1035903- DODGE CUMMINS®
5.9L 12-Valve Diesel 1989-1998

Diesel Cylinder Head Stud Kits

PRW uses premium grade Custom 4150 Steel (4135 Japanese Alloy Steel for Part # 1036313) rated at “aircraft” quality. Our studs are then specially heat-treated to 190,000 psi. This heat treating procedure allows for total heat penetration which results in a stronger, more superior stud compared to lesser quality studs from other manufacturers.

To ensure perfect alignment with gaskets and cylinder heads, PRW studs are then centerless ground after being heat treated. This attention to detail results in remarkably straight and concentric studs.

PRW studs are then thread rolled which assures better fatigue strength than having this process done before heat treatment. This manufacturing process may cost more to do but the results are well worth the extra effort.

CYLINDER HEAD STUD KITS

Application	Part #
CHEVY DURAMAX 6.6L Diesel, 2001-16 NEW!	1040301
DODGE CUMMINS® 5.9L & 6.7L 24-Valve Diesel, 1998.5-2018 NEW!	1035902
DODGE CUMMINS® 5.9L 12 Valve Diesel, 1989-1998 NEW!	1035903
FORD POWERSTROKE 6.0 Diesel NEW!	1036313
FORD 7.3 Diesel, 1994-2003 NEW!	1044501

**NEW
PRODUCTS!**



MAIN CAP STUD KITS

Main Cap Stud Kits

PRW uses premium grade Custom 4150 Steel rated at "aircraft" quality. Our studs are then specially heat-treated to 190,000 psi. This heat treating procedure allows for total heat penetration which results in a stronger, more superior stud compared to lesser quality studs from other manufacturers.

To ensure perfect alignment with the main cap and main girdle, PRW studs are then centerless ground after being heat treated. This attention to detail results in remarkably straight and concentric studs.

PRW studs are then thread rolled which assures better fatigue strength than having this process done before heat treatment. This manufacturing process may cost more to do but the results are well worth the extra effort.



PN 1000313- DODGE CUMMINS®
5.9L 24V Main Cap Stud Kit

DIESEL MAIN CAP STUD KITS	
Application	Part #
FORD POWERSTROKE 6.0L Diesel NEW!	1000306
DODGE CUMMINS® 5.9 12V 1989-1997 NEW!	1000311
DODGE CUMMINS® 5.9 24V 1998-2008 NEW!	1000313

GM LS SERIES MAIN CAP STUD KITS	
Application	Part #
GM LS 4.8, 5.3 5.7, 6.0L 1997-2015 6-Bolt Main NEW!	1000098

*GM is a registered trademark of General Motors.



PN 1000098- GM LS Main Cap
Stud Kit

**NEW
PRODUCTS!**

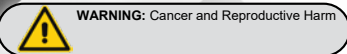

ALUMINUM RACING RADIATORS

PQX® Aluminum Racing Radiators are the perfect fit for racing, street rod, classic, muscle, exotic or late model cars and trucks. These radiators are available in a variety of sizes for both FORD and GM models. All radiators feature 2 rows of 1" tubes of which are single pass design.

- TIG welded
- Petcock drain included
- All radiators feature 2 rows of 1" tubes
- All aluminum construction for reduced weight
- Multiple threaded mounting bungs for easy installation
- Polished top-lines and end tanks create a super-clean appearance



PN 5401926, -
GM - 19" x 26"



Petcock Drains Standard



Polished Side-Saddle Tanks and Finished Topline

ALUMINUM RACING RADIATORS

Application	Part #
FORD 19" x 28", Single Pass, Includes Petcock Drain	5411928
GM 19" x 25", Single Pass, Includes Petcock Drain	5401925
GM 19" x 26", Single Pass, Includes Petcock Drain	5401926
GM 19" x 27", Single Pass, Includes Petcock Drain	5401927
GM 19" x 28", Single Pass, Includes Petcock Drain	5401928
GM 19" x 29", Single Pass, Includes Petcock Drain	5401929
GM 19" x 31", Single Pass, Includes Petcock Drain	5401931

*GM is a registered trademark of General Motors.



WARNING: Cancer and Reproductive Harm

ALUMINUM RACING RADIATORS & ACCESSORIES



Threaded Front and Side Mounting Bungs

ALUMINUM RACING RADIATORS WITH MODULAR FITTINGS

Application	Part #
GM 19" x 25", -20 AN "O" Ring Smooth Hose Adapters, Single Pass, Includes Petcock Drain	5421925
GM 19" x 26", -20 AN "O" Ring Smooth Hose Adapters, Single Pass, Includes Petcock Drain	5421926
GM 19" x 27", -20 AN "O" Ring Smooth Hose Adapters, Single Pass, Includes Petcock Drain	5421927
GM 19" x 28", -20 AN "O" Ring Smooth Hose Adapters, Single Pass, Includes Petcock Drain	5421928
GM 19" x 29", -20 AN "O" Ring Smooth Hose Adapters, Single Pass, Includes Petcock Drain	5421929
GM 19" x 31", -20 AN "O" Ring Smooth Hose Adapters, Single Pass, Includes Petcock Drain	5421931
FORD 19" x 26", -20 AN "O" Ring Smooth Hose Adapters, Single Pass, Includes Petcock Drain	5431926
FORD 19" x 28", -20 AN "O" Ring Smooth Hose Adapters, Single Pass, Includes Petcock Drain	5431928

*GM is a registered trademark of General Motors.

**ADAPTERS ARE AVAILABLE.
MODULAR BUNGS AND FITTINGS
ARE AVAILABLE SEPARATELY!**



PN 5292337 - Straight "O" Ring Union to Male Hose Barb, Includes Raw Finish Weld-In Bung

PN 5292410 - -20 AN Straight "O" Ring Union to -20 AN Male Braided Hose Fitting, Includes Raw Finish Weld-in Bung

RADIATOR ACCESSORIES

RADIATOR FITTING ADAPTER, -20 AN Straight "O" Ring Union to -20 AN Male Braided Hose Fitting, Includes Raw Finish Weld-in Bung	Part #
Blue Anodized, Inlet/Outlet w/ Bung	5292410
Silver Anodized, Inlet/Outlet w/ Bung	5292413
Black Anodized, Inlet/Outlet w/ Bung	5292417

RADIATOR FITTING ADAPTER, -20 AN Straight "O" Ring Union to Male Hose Barb, Includes Raw Finish Weld-in Bung	Part #
1.50" Hose, Silver Anodized	5292323
1.50" Hose, Black Anodized	5292327
1.75" Hose, Silver Anodized	5292333
1.75" Hose, Black Anodized	5292337

COOLING SYSTEM ACCESSORIES

COOLING SYSTEM ACCESSORIES	
WATER NECK OUTLETS	Part #
GM 2008-Up LS Series, Billet Aluminum Straight Male Hose Barb, (LS3, LS7, LS9, LSA, L76, or L92), Machine Polished	5234610
GM LS Series 1997-07, Billet Aluminum Straight Male Hose Barb, (LS1, LS2, LS6, & LS7 Pre-2008), Machine Polished	5234613
GM LS Series, Cast Aluminum 90°, (5.7L, 6.0L, 6.2L), As-Cast	5234681
GM LS Series, Cast Aluminum 90°, (5.7L, 6.0L, 6.2L), Polished	5234691
MOPAR Cast Aluminum 90°, All V6/Slant 6/V8, As-Cast	5244081
MOPAR Cast Aluminum 90°, All V6/Slant 6/V8, Polished	5244091
MOPAR Cast Straight Male Hose Barb, All V6/Slant 6/V8, Chrome	5244093
WATER NECK OUTLET & THERMOSTAT	Part #
GM LS Series, Cast Aluminum 90°, (5.7L, 6.0L, 6.2L), As-Cast, Temp 82 °C/180 °F	5234683
GM LS Series, Cast Aluminum 90°, (5.7L, 6.0L, 6.2L), Polished, Temp 82 °C/180 °F	5234693
WATER NECK MANIFOLD FILLERS	Part #
CHEVY, SB-BB, 90° Aluminum, As-Cast	5292200
CHEVY, SB-BB, 90° Aluminum, Black	5292270
WATER NECK THERMOSTAT	Part #
GM LS Series, Cast Aluminum 90°, (5.7L, 6.0L, 6.2L), As-Cast, Temp 82 °C/180 °F	5234685

*GM is a registered trademark of General Motors.



PN 5234610 - GM 2008-Up LS Series, Billet Aluminum Straight Male Hose Barb, (LS3, LS7, LS9, LSA, L76, or L92), Machine Polished



PN 5244081 - MOPAR, Cast Aluminum 90°, all V6/Slant 6/V8, As-Cast



PN 5292200 - CHEVY, SB-BB, 90° Aluminum, As-Cast (Also Available in Black, PN 5292270)



PN 5292272 - 1.50"/1.50" Male Hose Barb, Die-Cast Aluminum, Black



PN 5292293 - 1.50"/1.50" Male Hose Barb, Billet Aluminum

COOLING SYSTEM ACCESSORIES	
HOSE DRAIN, INLINE COOLANT, Universal	Part #
1.75"/1.75" Male Hose Barb, Die-Cast Aluminum, Universal, As-Cast	5292201
1.75"/1.75" Male Hose Barb, Die-Cast Aluminum, Universal, Black	5292271
HOSE FILLER, INLINE COOLANT, Universal	Part #
1.50"/1.50" Male Hose Barb, Die-Cast Aluminum, As-Cast	5292202
1.50"/1.50" Male Hose Barb, Die-Cast Aluminum, Black	5292272
1.25"/1.25" Male Hose Barb, Billet Aluminum	5292291
1.25"/1.50" Male Hose Barb, Billet Aluminum	5292292
1.50"/1.50" Male Hose Barb, Billet Aluminum	5292293

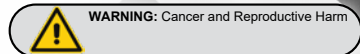

ETS ALUMINUM RACING RADIATOR & ACCESSORIES



ETS ALUMINUM RACING RADIATORS

Application	Part #
19" x 28", Single Pass, ETS Radiator GM/FM/MOPAR Modular Design, Includes Petcock Drain	1300515

*GM is a registered trademark of General Motors.



Threaded Front and Side Mounting Bungs

Tech Tip! Designed Exclusively for the PRW Patented Collapsible Engine Run-in and Test Stand. Modular Fittings Easily Adapt to Left or Right Water Pump Inlets/Outlets for GM, FORD, MOPAR Engine Testing

PN 1300515 - ETS Radiator GM, FM, MOPAR Modular Design

Finned Transmission / Oil Fluid Coolers



FINNED TRANSMISSION / OIL FLUID COOLERS

	Part #
Single Pass, 12" w/ Mounting Hardware & Fittings	5443250
Single Pass, 15" w/ Mounting Hardware & Fittings	5443251
Single Pass, 22" w/ Mounting Hardware & Fittings	5443255
Single Pass, 24" w/ Mounting Hardware & Fittings	5443257
Dual Pass, 14" w/ Mounting Hardware & Fittings	5443260
Dual Pass, 20" w/ Mounting Hardware & Fittings	5443262
Dual Pass, 26" w/ Mounting Hardware & Fittings	5443267

ETS ALUMINUM RACING RADIATORS & ACCESSORIES

HIGH PERFORMANCE ALUMINUM WATER PUMPS

INNOVATION - The act or process of introducing something new. With that in mind, PRW has continued the evolutionary process on our existing line of water pumps. *PQX*[®] engineered pumps will flow 35 gallons per minute at 4,000 RPM, with minimal cavitation and proportionally increased flow rates at 5,000 RPM and above.

Equalized water flow distribution and pressure balanced water passages minimize internal engine hot-spots making these pumps an excellent alternative for not only racers, but also trucks, towing, and motorhome applications. Cruisers and hot rodders will appreciate the improved cooling at low speeds and the availability of polished aluminum water pump bodies for nearly every application.

- 0.750" diameter steel shafts
- Aircraft industry tolerances
- A356 aluminum alloy pump bodies
- High flow cast iron CNC machined impellers
- Back plate O-ring sealed for most applications
- Billet steel hubs and shielded-seal roller ball bearings

PN 1435000 -
CHEVY SB, As-Cast



PRW casts the housings from A356 Aluminum. PRW designs are then CNC machined, assuring a first quality finished product.

Internal water passages are designed for equalized flow at a higher velocity; effectively cooling better - even at low RPM.

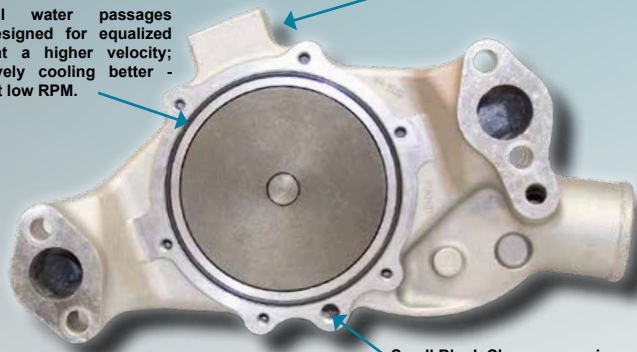

All Competition+ pumps and most other pumps designed with O-ring seals.



Small Block Chevy pumps incorporate an adjustable cam stop to minimize axial thrust and erratic distributor timing.



All designs include a 3/4" shaft integrated with ball/roller bearings rated at 12,000+ RPM.

The benefit is reduced harmonics and improved stability.



CNC machined nodular iron impeller assures reduced vibration, increased flow and minimal cavitation.



CNC machined billet steel hubs are used on all PRW mechanical water pumps

PRW's *PQX*[®] series high flow aluminum pumps are engineered to deliver faster, increased water flow. These super velocity pumps significantly improve cooling for all street, high performance, and racing applications. The low pressure-injected, aluminum alloy pump bodies are complemented by a precision cast-iron impeller design and pressure-balanced water passages to equalize flow and minimize engine hot spots at any speed. Other features include billet steel hubs, heavy duty, 0.750" shafts and shielded-sealed roller ball bearings.

HIGH PERFORMANCE ALUMINUM WATER PUMPS



PN 1445404 - CHEVY BB 1965-68
Cars-LDT, Short, As-Cast



PN 1435011 - CHEVY SB
1969-87, Long Style, Polished

SEVERAL PRW REVERSE ROTATION MECHANICAL WATER PUMPS ARE AVAILABLE FOR "AFTERMARKET" SERPENTINE APPLICATIONS. INSIST ON PRW HI-FLOW WATER PUMPS FOR YOUR PULLEY KIT.

CHEVY HIGH PERFORMANCE ALUMINUM WATER PUMPS

Application	Style	Pilot Size	Shaft O.D.	Block-to-Hub Height	Rotation	Inlet Size	Finish	Part #
AMC/JEEP 304-401, 1973-91	Long	5/8"	3/4"	4.8125"	Standard	1.80"	As-Cast Polished*	1440100 1440110
CHEVY SB 1955-72, Cars & Light Duty Trucks, 1969-70 350 Corvettes	Short	5/8"	3/4"	5.625"	Standard	1.80"	As-Cast Polished*	1435000 1435010
CHEVY SB 1969-87, Cars & 1973-86 Light Duty Trucks	Long	5/8"	3/4"	6.9375"	Standard	1.80"	As-Cast Polished*	1435001 1435011
CHEVY SB 1955-95, Gen I V8, Hi-Perf/Race, "O" Ring Sealed w/ Thick Cover & Auxiliary Fittings	Short	3/4"	3/4"	5.8125"	Standard	1.85"	As-Cast Polished* Black	1435002 1435012 1435022
CHEVY SB, 1971-82 Corvettes	Short	3/4"	3/4"	5.800"	Standard	1.80"	As-Cast Polished*	1435003 1435013
CHEVY 350 1984-91, Corvettes 350 w/ Reverse Rotation	Short	3/4"	3/4"	5.800"	Reverse	1.54"	As-Cast Polished*	1435004 1435014
CHEVY SB 1987-95, V8 & 90° V6 w/ Serpentine Belt Drive	Long	5/8"	3/4"	6.9375"	Serpentine Reverse	1.80"	As-Cast Polished*	1435005 1435015
CHEVY SB 1955-95, Gen I V8 w/ Aftermarket Serpentine Belt Drive	Short	5/8"	3/4"	5.625"	Serpentine Reverse	1.84"	As-Cast Polished*	1435006 1435016
CHEVY 348/409W, 1958-65	Short	5/8"	3/4"	5.500"	Standard	1.86"	As-Cast Polished*	1440900 1440910
CHEVY BB 1969-87, Cars, Some 1988-91 HD Trucks w/ Mark IV	Long	5/8"	3/4"	7.3125"	Standard	1.875"	As-Cast Polished*	1445401 1445411
CHEVY BB 1971-74 Corvettes	Short	3/4"	3/4"	5.750"	Standard	1.95"	As-Cast Polished*	1445402 1445412
CHEVY BB 1988-Up Vehicles w/ Aftermarket Serpentine Belt Drives	Short	5/8"	3/4"	5.750"	Serpentine Reverse	2.00"	As-Cast Polished*	1445403 1445413
CHEVY BB 1965-68 Cars, 1966-72 Trucks & 1969-70 BB Corvettes	Short	5/8"	3/4"	5.750"	Standard	1.95"	As-Cast Polished*	1445404 1445414
CHEVY BB CHEV 396-454 Mark IV 1969-87, Severe Duty, .0185" Cold Rolled Steel Backplate with "O" Ring Seal	Long	3/4"	3/4"	7.3125"	Standard	1.875"	As-Cast Polished*	1445406 1445416

*Custom Polishing Available; Please call for pricing



WARNING: Cancer and Reproductive Harm

HIGH PERFORMANCE ALUMINUM WATER PUMPS

PN 1439000 FORD
FE 352-428, 1965-76,
As-Cast



PN 1428104 FORD 4.6L 1996-01,
2005-10, Mustang GT & Cobra



FORD HIGH PERFORMANCE ALUMINUM WATER PUMPS

Application	Style	Pilot Size	Shaft O.D.	Block-to-Hub Height	Rotation	Inlet Size	Finish	Part #
FORD 4.6L, 1996-01, 2005-10 Mustang GT & Cobra, Cartridge	-	3/4"	3/4"	3.43"	Standard	-	As-Cast	1428104
FORD 289/302/351W, 1965-69 w/ Right-Hand Inlet & Backplate	-	5/8"	3/4"	5.42"	Standard	1.78"	As-Cast Polished*	1428900 1428910
FORD 302 1970-78, 351W 1970-87 w/ Left-Hand Inlet	-	5/8"	3/4"	5.70"	Standard	1.78"	As-Cast Polished*	1430200 1430210
FORD 5.0L, 1986-93 w/ Serpentine Accessory Belt Drive	-	5/8"	3/4"	5.75"	Reverse	1.78"	As-Cast Polished*	1430201 1430211
FORD 302/351W, 1970-Up Hi-Perf/Race w/ Left-Hand Inlet & Backplate - Competition+ Pump is Excellent for Endurance & Marine Applications as well.	-	5/8"	3/4"	5.70"	Standard	1.78"	As-Cast Polished* Black	1430202 1430212 1430222
FORD 351C/M & 400M, 1970-82 w/ Left-Hand Inlet, w/o Backplate	-	5/8"	3/4"	5.71"	Standard	1.78"	As-Cast Polished*	1435100 1435110
FORD FE 352-428, 1965-76 (May Fit Earlier Years w/ Aftermarket or Later Model Accessory Brackets)	-	5/8"	3/4"	7.56"	Standard	2.125"	As-Cast Polished*	1439000 1439010
FORD 429/460, Big Block, 1970-92	-	3/4"	3/4"	5.5"	Standard	1.98"	As-Cast Polished*	1446000 1446010
*Custom Polishing Available; Please call for pricing								

COMPETITION+™ APPLICATIONS
AVAILABLE FOR SMALL BLOCK
FORD 302/5.0L

WATER PUMP PULLEYS

Application	Pilot Size	Shaft O.D.	Inlet Size	Finish	Part #
FORD 302/5.0L, 1979-93, 3 Piece Steel, Kit Includes Crank, Water Pump & Alternator Pulleys	5/8"	3/4"	1.78"	Black Powder Coat	2630201

PN 1428910 - FORD
289/302/351W 1965-69



PN 2630201 - FORD 302 1979-93,
3 Piece Steel, Black Powder Coat



HIGH PERFORMANCE ALUMINUM WATER PUMPS



PN 1434601 - GM LS Gen III/IV Reverse Rotation



PN 1434606 - GM LS Gen III/IV Truck and SUV, Reverse Rotation



PN 1434607 - GM LS Gen III/IV (Shown with Part # 2634600 Pulley and 2636400 Supercharger Pulley Kit)

GM HIGH PERFORMANCE ALUMINUM WATER PUMPS

Application	Pilot Size	Shaft O.D.	Block-to-Hub Height	Inlet Size	Pulley/Pump Combo	Finish	Part #
GM LS Gen III & IV , 1997-2010 Firebird/Camaro "F" Body, 8-Hole Billet Hub, Front Inlet, Reverse Rotation	3/4"	3/4"	6.00"	1.78"	Requires Aftermarket Pulley and Accessory Mounting, 8-hole Billet Hub	As-Cast	1434601
GM LS Gen III & IV , 1997-06 Truck, & SUV (Sport Utility), 8-Hole Billet Hub, Top Inlet, Reverse Rotation	3/4"	3/4"	6.00"	1.78"	Water Pump Only (Requires PRW, March Performance or Similar Aftermarket Pulley)	As-Cast	1434606
GM LS Gen III & IV 1997-10 Corvette/Avanti II & 1998-10 Firebird/Camaro "F" Body, 8-Hole Billet Hub, Front Inlet, Reverse Rotation	3/4"	3/4"	6.00"	1.78"	Water Pump Only (Requires PRW, March Performance or Similar Aftermarket Pulley)	Black Satiin	1434607

*GM is a registered trademark of General Motors.

NEW PRODUCTS!



PN 2636400 - GM LS Gen III/IV Supercharged Pulley Girdle



PN 2634608 - GM LS Gen III/IV Series, Polished Anodized



PN 2634600 - GM LS Gen III/IV Series, Black Anodized

Water Pump Pulleys

- Available for PRW and other **GM LS Series Water Pump Brands**
- **Chrome, Polished or Black Surface finish**
- **CNC machined from billet steel or Aluminum**

GM LS SERIES WATER PUMP PULLEYS

Application	Pilot Size	Shaft O.D.	Finish	Part #
GM LS Gen III/IV Series , Firebird, Camaro, GM Sport Trucks, SUV, & Utility Vans for 4 Hole Aftermarket Hub, Billet Steel, 3.25" Deep	3/4"	3/4"	Black Anodized	2634600
GM LS Gen III/IV Series , Firebird, Camaro, GM Sport Trucks, SUV, & Utility Vans for 4 Hole Aftermarket Hub, Billet Steel, 3.25" Deep	3/4"	3/4"	Polished Anodized	2634608
GM LS Gen III/IV Series Pulley Girdle , Edelbrock, Stewart, PRW water pumps with GM 8-bolt hub, Includes Supercharger Girdle, Fasteners & Threadlocker, 6061 Billet Aluminum NEW!	3/4"	3/4"	Billet Aluminum	2636400

*GM is a registered trademark of General Motors.

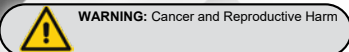

HIGH PERFORMANCE ALUMINUM WATER PUMPS

MOPAR HIGH PERFORMANCE ALUMINUM WATER PUMPS

Application	Pilot Size	Shaft O.D.	Block-to-Hub Height	Inlet Size	Pulley/Pump Combo	Finish	Part #
MOPAR 318-360 1970-91	5/8"	3/4"	5.550"	1.78"	Small Block MOPAR Water Pump	As-Cast Polished*	1431800 1431810
MOPAR 361-440 BB & 426 HEMI® 1958-79	5/8"	3/4"	3.075"	2.125"	Water Pump (Cartridge only) Water Pump (Cartridge only)	As-Cast Polished*	1444001 1444011
*Custom Polishing Available; Please call for pricing							

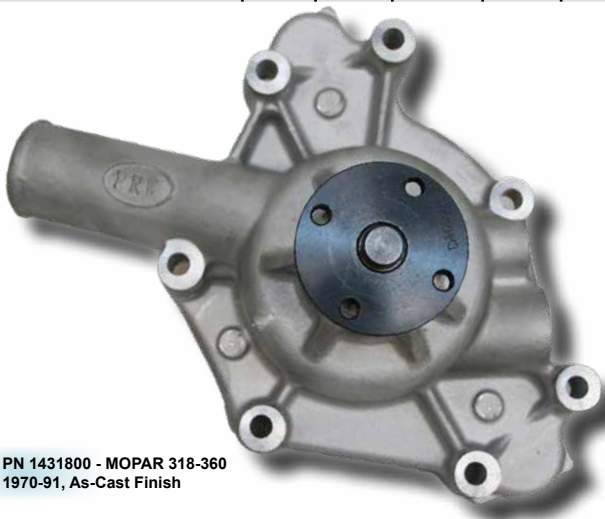

PN 1431800 - MOPAR 318-360 1970-91, As-Cast Finish



PN 1444011 - MOPAR 361-440 BB & 426 HEMI® 1958-79

MOPAR BIG BLOCK HOUSING WATER PASSAGES REDESIGNED FOR IMPROVED FLOW!

MOPAR WATER PUMP HOUSING

Application	Finish	Part #
MOPAR 361-440, 1958-79: High Quality Aluminum Alloy Injection Molded Housing w/ Bosses for Both HEMI® & Big Block Engine Applications	As-Cast Polished*	1444010 1444012
*Custom Polishing Available; Please call for pricing		



PN 5244002, MOPAR Water Pump Housing, As-Cast



PN 1445510 - PONTIAC 265-455 1969-79, Polished Finish

PONTIAC HIGH PERFORMANCE ALUMINUM WATER PUMPS

Application	Pilot Size	Shaft O.D.	Block-to-Hub Height	Finish	Part #
PONTIAC 265-455, 1969-79	5/8"	3/4"	4.5"	As-Cast Polished*	1445500 1445510
*Custom Polishing Available; Please call for pricing					



WARNING: Cancer and Reproductive Harm

COMPETITION+™ HIGH FLOW ALUMINUM RACING WATER PUMPS

PRW high flow aluminum pumps are engineered to deliver increased water flow that significantly improves cooling system demands of Circle Track and Endurance Racing. These pumps are sealed by the ceramic coating that blocks excessive heat radiation (rather than absorbing it), thus preserving and extending the pump's service life. This coating also provides superior corrosion resistance and rust protection. The low-pressure injected aluminum alloy pump bodies feature a precision cast-iron impeller design and pressure-balanced water passages to equalize flow and minimize engine hot spots at any speed. Other features include steel hubs and heavy duty shielded-sealed roller ball bearings.

- Auxiliary outlets for custom plumbing
- Ceramic coated to block excessive heat radiation
- Coated for corrosion resistance and rust protection
- Designed to equalize flow & minimize engine hot spots
- Features aluminum alloy pump bodies & cast-iron impellers



PN 1435022 - CHEVY SB, 1955-95, Black Ceramic



PN 1435012 - CHEVY SB, 1955-95, Polished Finish



COMPETITION+™ RACING WATER PUMPS ARE ALSO SUITABLE FOR MARINE APPLICATIONS!

PQ^x™ COMPETITION+™ HIGH FLOW PERFORMANCE ALUMINUM WATER PUMPS

Application	Pilot Size	Shaft O.D	Block- to-Hub Height	Inlet Size	Finish	Part #
CHEVY SB 1955-95, Revised Impeller Entry, 0.100" Backplate for Drag Race, Circle Track or Marine, All Auxiliary Outlets NPT/AN Fitting Ready, Short Style	3/4"	3/4"	5.8125"	1.85"	As-Cast	1435002
					Polished*	1435012
					Black Ceramic	1435022
FORD 289/302/351W, 1970-Up Hi-Perf/Race w/ Left-Hand Inlet & Backplate, Short Style - Competition+ Pump is also Available in As-Cast or Polished Surface Finishes as well.	3/4"	3/4"	5.700"	1.78"	As-Cast	1430202
					Polished*	1430212
					Black Ceramic	1430222

*Custom Polishing Available; Please call for pricing



PN 1430202 - FORD 302, 1970-78, 351W 1970-87, As-Cast



PN 1430222 - FORD 302, 1970-78, 351W 1970-87, Black Ceramic

HIGH FLOW ELECTRIC RACING WATER PUMPS & ACCESSORIES

PQ^x High Flow Die-Cast Aluminum Electric Racing Water Pumps

The electric water pump was designed to alleviate the power drag produced by conventional pulley drive units. A heavy duty electric motor, turning at approximately 1,500 rpm, is more than adequate to fulfill cooling needs without draining horsepower from the engine. The unit can be wired to operate manually, even with the engine off. The motor life is rated at 2,750 hours of continuous operation at 176° F. Kit is complete with gaskets, billet aluminum inlet fitting, mounting hardware, pigtail connector and timing cover block-off plate (FORD applications).

- Lightweight
- Suitable for Street or Strip
- Free flow rated at 35 gallons per minute
- FORD pumps available without the backplate
- Under normal use the pump will draw 6-7 amps
- 2,750 hours of life expectancy dependent upon use
- Pump will clear most timing belt drives and most blower drives
- Spacers may be required to clear belt drive distributor systems

PN 4430207 -
FORD SB 302-351W



"O" Ring Seal for
Racing Applications

PQ^x HIGH FLOW DIE-CAST ELECTRIC RACING WATER PUMPS

Application, Includes Hardware & Pig Tail	Part#
CHEVY SB 265-400, Black	4435007
CHEVY BB 396-454, Black	4445407
CHEVY SB 265-400, Chrome	4435009
FORD SB 302-351W, Black	4430207
FORD SB 302-351W, Chrome	4430209
FORD SB 302-351W, Black, Kit Includes Aluminum Backplate	4430217
FORD SB 302-351W, Chrome, Kit Includes Aluminum Backplate	4430219
FORD 351C, Black	4435107
FORD 351C, Black, Kit Includes Aluminum Backplate	4435117
FORD 351C, Chrome, Kit Includes Aluminum Backplate	4435119
FORD BB 400-460, Black	4446007
FORD BB 400-460, Chrome	4446009
FORD BB 400-460, Black, Kit Includes Aluminum Backplate	4446017
FORD BB 400-460, Chrome, Kit Includes Aluminum Backplate	4446019

BACKPLATES FOR DIE-CAST WATER PUMPS

	Part#
FORD SB 302-351W, Black, (Includes Fastener Kit, Gaskets for Timing Covers & Elbow Gaskets)	5293028
FORD SB 302-351W, Silver, (Includes Fastener Kit, Gaskets for Timing Covers & Elbow Gaskets)	5293029
FORD 351C/351M/400M, Black, (Includes Fastener Kit, Gaskets for Timing Covers & Elbow Gaskets)	5293518
FORD 351C/351M/400M, Silver, (Includes Fastener Kit, Gaskets for Timing Covers & Elbow Gaskets)	5293519
FORD BB 429/460, Black (Includes Fastener Kit, Gaskets for Timing Covers & Elbow Gaskets) NEW!	5294298
FORD BB 429/460, Silver (Includes Fastener Kit, Gaskets for Timing Covers & Elbow Gaskets) NEW!	5294299

FITTINGS & ACCESSORIES

FITTINGS, Straight, 3/4" NPT, Billet Aluminum, Each	Part#
3/4" NPT to 1.25" Hose x 3" Long	5292063
3/4" NPT to 1.50" Hose x 3" Long	5292073
3/4" NPT to 1.50" Hose x 5" Long	5292075
3/4" NPT to 1.75" Hose x 3" Long	5292083
3/4" NPT to 1.75" Hose x 5" Long	5292085
3/4" NPT to AN-12 Male Fitting x 3.25" Long	5292091
3/4" NPT to AN-16 Male Fitting x 2.25" Long	5292092
3/4" NPT to AN-16 Male Fitting x 3.5" Long	5292093
3/4" NPT to AN-20 Male Fitting x 3.25" Long	5292096



PN 5292085



PN 5292063



PN 5292083



PN 5292073



PN 5292092

HIGH FLOW ELECTRIC RACING WATER PUMPS & ACCESSORIES

PQ[®] High Flow Billet Aluminum Electric Racing Water Pumps

The new Performance Quotient High Flow Billet Aluminum Electric Racing Water Pumps are designed to equalize the flow into both sides of the engine with smooth radiused and transitions. The pump housing and elbows are CNC machined from high grade aluminum billets with O-ring seals at each connection.

The impeller is a multi-vane, axial design that efficiently pumps the water through the engine with no cavitation. The 100 watt motor draws less than 9 amps on a 12 volt system and continued to flow over 50 gallons per minute in a closed system through PRW's extensive testing. In fact, the motor tested to over 3,250 continuous hours - well over 100,000 miles of reliable cooling performance.

An inlet fitting is supplied with each pump and seals with an O-ring for a secure connection. PRW offers a variety of inlet sizes and lengths to match your application. Each Billet Electric Pump is supplied with gaskets, mounting hardware and wiring connector. Direct fit and universal pumps are available from your Performance Quotient dealer.

- Lightweight
- Suitable for Street or Strip
- Free flow rated at over 50 gallons per minute
- 3250 hours of life expectancy dependent upon use
- Under normal use the pump will draw less than 9 amps
- FORD billet pumps include silver backplate and fasteners
- Pump will clear most timing belt drives and most blower drives
- Spacers may be required to clear belt drive distributor systems



PN 4530221 - FORD SB 302-351W, Right Inlet, Polished

PQ[®] HIGH FLOW BILLET ELECTRIC RACING WATER PUMPS

Application, Includes Mounting Hardware & Pig Tail	Part#
CHEVY SB 265-400, Left Inlet, Polished Clear Anodized	4535021
CHEVY BB 396-502, Left Inlet, Polished Clear Anodized	4545421
FORD SB 302-351W, Right Inlet, Polished Clear Anodized	4530221
FORD 351C, 351/400M Right Inlet, Polished Clear Anodized	4535121
FORD BB 429-460, Right Inlet, Polished Clear Anodized, Includes Housing Coverplate	4546021



PN 5294608 - FORD 429-460, Black, Each



Additional Inlet Fitting Sizes Available

BACKPLATES FOR BILLET WATER PUMPS

Application	Part#
FORD 302-351W, Black	5293028
FORD 302-351W, Silver	5293029
FORD 351C, 351/400M, Black	5293518
FORD 351C, 351/400M, Silver	5293519
FORD 429-460, Black	5294608
FORD 429/460, Silver	5294509

FITTINGS & ACCESSORIES

FITTINGS, Straight, 3/4" NPT, Billet Aluminum, Each	Part#
(1-1/16"-20) 1.0625 w/ -20UN to 1.25" Hose x 3" Long	5282063
(1-1/16"-20) 1.0625 w/ -20UN to 1.50" Hose x 3" Long	5282073
(1-1/16"-20) 1.0625 w/ -20UN to 1.50" Hose x 5" Long	5282075
(1-1/16"-20) 1.0625 w/ -20UN to 1.750" Hose x 3" Long	5282083
(1-1/16"-20) 1.0625 w/ -20UN to 1.750" Hose x 5" Long	5282085

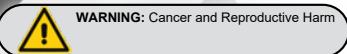

WARNING: Cancer and Reproductive Harm

HIGH FLOW ELECTRIC RACING WATER PUMPS & ACCESSORIES

PQX® High Flow Electric Water Pump Insert (Fits Factory Water Pump Housing)

PRW's PQX® series high flow electric water pump was designed to alleviate the power drag produced by conventional pulley drive units. A heavy duty electric motor, turning at approximately 1,500 rpm, is more than adequate to fulfill cooling needs without draining horsepower from the engine. The unit can be wired to operate manually, even with the engine off. The motor life is rated at 2,750 hours of continuous operation at 176° F.

- Under normal use the pump will draw less than 9 amps
- 3250 hours of life expectancy dependent upon use
- Use Stock Pump Housing or Aftermarket Housing
- Impeller is made of 6061 Billet Aluminum
- Suitable for Street or Strip
- Installs in Minutes
- Lightweight

Electric Water Pump Assembly Kit	
Application	Part#
MOPAR Electric Water Pump & Housing Kit, As-Cast NEW!	4544010
MOPAR Electric Water Pump & Housing Kit, Polished* NEW!	4544012

*Custom Polishing Available; Please call for pricing



CNC Billet Machine Impeller
Rated at 42-48 GPM

Electric Water Pump Motor

Application	Part#
MOPAR Electric Water Pump Motor Assembly NEW!	4544007

**NEW
PRODUCT!**

HIGH PERFORMANCE AND SFI-RATED DAMPERS

STRUCTURE - the arrangement of and relationship between the parts or elements of something complex. PRW continues to raise the bar by combining design and structure to our dampers. Starting at 30% stronger than OEM, our dampers range from designs for street rebuilds to SFI-Rated for added safety and sanctioned racing.

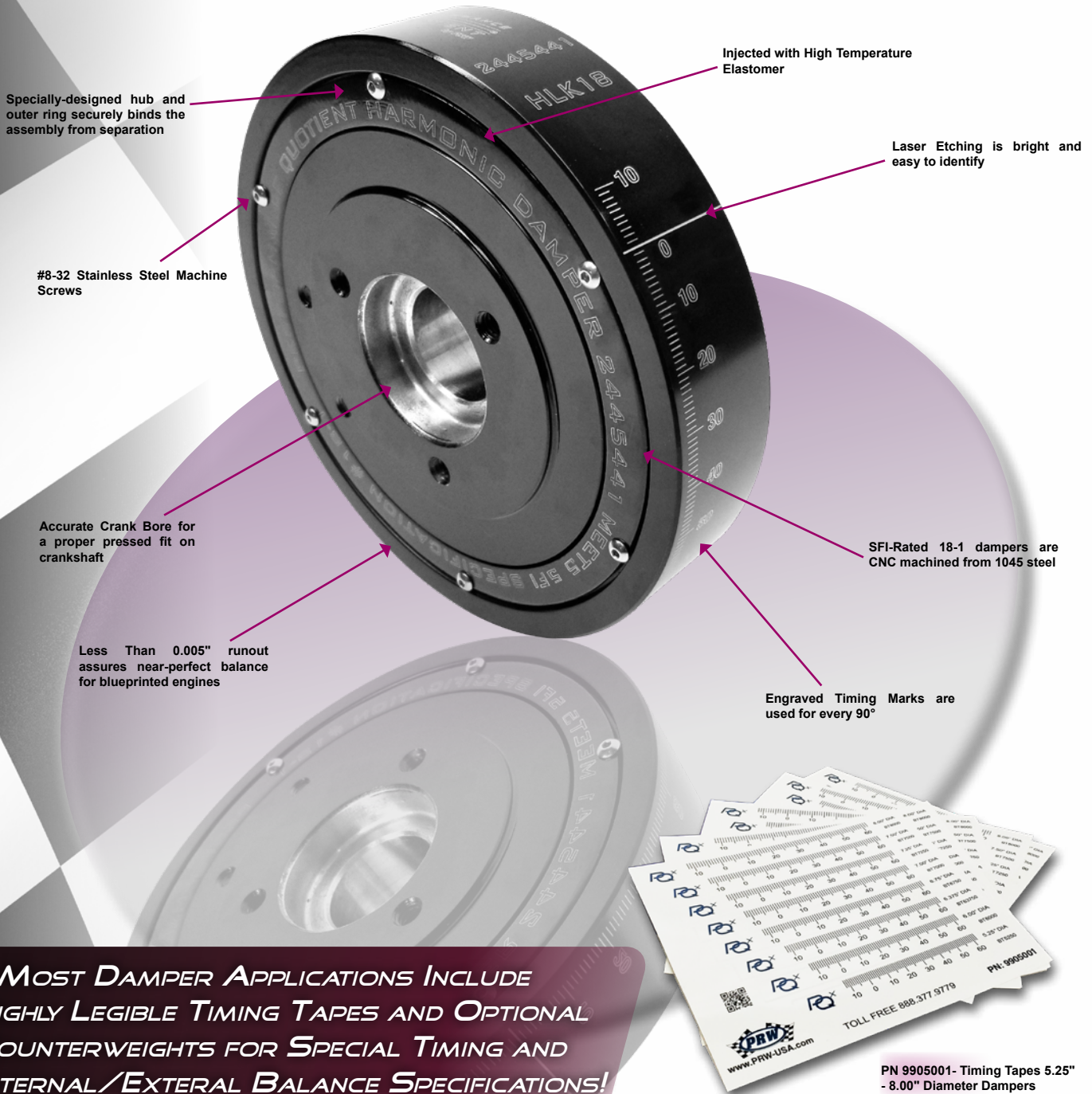

MOST DAMPER APPLICATIONS INCLUDE HIGHLY LEGIBLE TIMING TAPES AND OPTIONAL COUNTERWEIGHTS FOR SPECIAL TIMING AND INTERNAL/EXTERNAL BALANCE SPECIFICATIONS!

PRW and PQX® dampers are perfect for the weekend warrior or all out racing. Designs are application specific; whether for Sportsman or severe racing conditions. SFI-Rated dampers are manufactured from high quality steel; available in elastomer or FluidGel™ designs. Sportsman dampers are nodular iron' adding more strength and resistance to "spinning" on the hub and to assure accurate timing for years to come. Damper are surface finished in high quality automotive grade Black epoxy.

WARNING: Cancer and Reproductive Harm

HIGH PERFORMANCE AND SFI-RATED RACING DAMPERS

HIGH PERFORMANCE SPORTSMAN DAMPERS

These dampers are cast from nodular iron and suitable for moderate racing applications and engines. Unlike most OEM dampers, the hub and ring are splined to prevent radial movement of the outer ring. These dampers are 30% stronger than OEM dampers made from grey iron, but are not SFI certified.

- Ideal for street rebuilds
- 30% stronger than OEM dampers
- Accurate crank bore for a proper pressed fit
- Available in black with laser etched timing marks
- Splined ring & hub to prevent outer hub radial movement
- Externally balanced dampers include removable counterweights

**NEW
MODELS!**



PN 2332740 - CHEVY 262-350, 1955-00



PN 2328951 - FORD 221-260, 289-351W, 302B, 1963-69, Early Model SB FORD, Spacer Pictured Not Required for All Models; Available Separately (See Page 74)

HIGH PERFORMANCE SPORTSMAN DAMPERS

Application	Diameter	Balance	Weight	Part #
AMC/JEEP 304, 360, 401 V8 1970-91	6.80" OD	External	10.60 lbs	2330441
CHEVY 262-350, 1955-00 Gen I, Small Block Chevy V8	6.75" OD	Internal	8.46 lbs	2326540
CHEVY 262-350, 1955-00 Gen I, Small Block Chevy V8	8.00" OD	Internal	11.77 lbs	2328340
CHEVY 262-350, 1955-00 Gen I, Small Block Chevy V8, Specialty SBC Lightweight Damper	6.10" OD	Internal	7.00 lbs	2332740
CHEVY 400, 1970-80 Gen I, 400 & 383 Stroker Crank Small Block Chevy V8	6.75" OD	External	7.59 lbs	2338341
CHEVY 400, 1970-80 Gen I, 400 & 383 Stroker Crank Small Block Chevy V8	8.00" OD	External	12.59 lbs	2340041
CHEVY 396-427, 1965-72 Mark IV, Big Block Chevy V8	8.00" OD	Internal	13.51 lbs	2339640
CHEVY 454 & 502, 1970-00, Mark IV, Gen V & VI, Big Block Chevy V8	8.00" OD	External	14.56 lbs	2345441
CHEVY 4.3L-5.7L, 1993-97 Gen II, LT1 GM Camaro/Firebird, 1994-95, Chevy & Buick/GM Full-Size Cars	7.50" OD	Internal	12.30 lbs	2335040
FORD 221-289, 351W, 302B, 1963-69, Small Block FORD V8, 28 oz	6.40" OD	External	9.52 lbs	2328941
FORD 221-289, 351W, 302B, 1963-69, Small Block FORD V8, Lightweight, 28 oz	6.40" OD	External	7.80 lbs	2328951
FORD 302-351W, 1981-95, Lightweight, 50 oz	6.40" OD	External	8.40 lbs	2330251
FORD 352-428, 1957-77, Big Block FE FORD V8, Includes Front Pulley and Engine Timing Pointer	6.50" OD	Internal	11.87 lbs	2339040
FORD 429-460, 1986-97, Big Block FORD OEM 3/16" Keyway & 1/4" Specialty Keyway	6.70" OD	Internal	8.80 lbs	2346040

*GM is a registered trademark of General Motors.



WARNING: Cancer and Reproductive Harm

HIGH PERFORMANCE SPORTSMAN DAMPERS

HIGH PERFORMANCE SPORTSMAN DAMPERS

Application	Diameter	Balance	Weight	Part #
JEEP 4.0L/242 L6, 1987-06, 4.0L Jeep Inline 6-Cylinder	7.20" OD	Internal	7.10 lbs	2324240
MOPAR 273-360, 1964-03 LA & Magnum, Small Block Chrysler V8	7.30" OD	Int / Ext	8.12 lbs	2331841
MOPAR 383-440, 1959-79, Chrysler Big Block "B" & "RB" V8	7.30" OD	Int / Ext	8.00 lbs	2344041
MOPAR 426 HEMI®, 1964-71, Chrysler 426 Street HEMI® V8	7.30" OD	Internal	8.00 lbs	2342639
MOPAR 426 HEMI®, 1964-71, Chrysler 426 Race HEMI® V8	7.30" OD	Internal	8.00 lbs	2342640
OLDS 330-455, 1964-80, Oldsmobile V8 Engines	6.50" OD	External	9.50 lbs	2338940
PONTIAC, 326-455, 1961-79, Pontiac V8 Engines w/ 1969 or Later Timing Chain Cover	6.90" OD	Internal	8.25 lbs	2338940
PONTIAC 4.3L-5.7L, 1993-97 Gen II, LT1 GM Camaro/Firebird, 1994-95 Chevy & Buick/GM Full-Size Cars	7.50" OD	Internal	12.30 lbs	2335040

*GM is a registered trademark of General Motors.



PN 2338940 - PONTIAC 326-455, 1961-79



PN 2338940 - OLDS 330-455, 1964-80, Olds V8 Engines



PN 9905001- Timing Tapes 5.25" - 8.00" Diameter Dampers

 **WARNING:** Cancer and Reproductive Harm

HIGH PERFORMANCE SPORTSMAN DAMPERS

SFI-RATED RACING STEEL DAMPERS

PQX® SFI-Rated Racing Steel Dampers

PRW SFI Certified steel dampers are perfect for the weekend warrior or the all out racer. Unless otherwise identified, this series of steel-elastomer racing dampers are OEM compatible and designed to work with the accessories and mounting brackets specified for the model years identified. Many features have been added to broaden the spectrum of fitment and adaptability. The inner hub and outer ring are manufactured from high quality billet steel or forgings, with heated elastomer injected under high pressure between the two component parts. Inner and outer grooved ridgelines further secure the inner hub to the outer ring. All dampers feature primary laser etched timing marks and useful timing indicators generally provided at 90°, 180°, and 270° whenever possible. Some models include secondary timing marks for ancillary keyways or expanded model year applications. These products are available in black automotive grade epoxy.



PN 2428340 - CHEVY
262-350, 1955-87

- Meets SFI 18.1 specification
- Easy to read laser engraved timing marks
- Accurate crank bore for a proper pressed fit
- Manufactured from high grade billet carbon steel forgings
- Injected with elastomer between the inner hub and outer ring
- Externally balanced dampers include removable counterweights

PN 2446040 - FORD 429-460 BB,
1986-97

PQX® SFI-RATED RACING STEEL DAMPERS

Application	Diameter	Balance	Weight	Part #
CHEVY 262-350, 1955-00, Gen I, Small Block Chevy V8	6.75" OD	Internal	12.20 lbs	2426540
CHEVY 262-350, 1955-00, Gen I, Small Block Chevy V8, Specialty SBC Lightweight Damper	6.10" OD	Internal	8.0 lbs	2432740
CHEVY 262-350, 1955-00, Gen I, Small Block Chevy V8	8.00" OD	Internal	8.40 lbs	2428340
CHEVY 396-427, 1965-72, Mark IV, Big Block Chevy V8	8.00" OD	Internal	12.90 lbs	2439640
CHEVY 400, 1970-80, Gen I, 400 & 383 Small Block Chevy V8	6.75" OD	External	15.50 lbs	2438341
CHEVY 400, 1970-80, Gen I, 400 & 383 Small Block Chevy V8	8.00" OD	External	13.70 lbs	2440041
CHEVY 454 & 502, 1970-00, Mark IV, Gen V & VI, Big Block Chevy V8	8.00" OD	External	14.40 lbs	2445441
CHEVY 4.3L-5.7L, 1993-97, Gen II, LT1 GM Camaro/Firebird, 1994-95, Chevy & Buick/GM Full-Size Cars	7.50" OD	Internal	12.45 lbs	2435040
CHEVY 5.7L, 1997-02, Gen III, GM LS1 Camaro/Firebird	7.50" OD	Internal	13.90 lbs	2434640
CHEVY-GM, 5.3L-6.2L, 2002-08, Gen III/IV, Cadillac, Chevy, GMC, L92 Truck & SUV	7.70" OD	Internal	12.5 lbs	2432340
FORD 221-289, 351W, 302B, 1963-69, Small Block FORD V8, 28 oz	6.40" OD	External	10.25 lbs	2428941
FORD 221-289, 351W, 302B, 1963-69, Early Model SB FORD, Lightweight, 28 oz	6.40" OD	External	8.20 lbs	2428951
FORD 302-351W, 1981-95, Late Model SB FORD, Lightweight, 50 oz	6.40" OD	External	8.80 lbs	2430251
FORD 302-351W, 1981-95, Late Model SB FORD, 50 oz	6.40" OD	External	11.00 lbs	2430241
FORD 352-428, 1957-77, Big Block FE FORD, Includes Front Pulley and Engine Timing Pointer	6.50" OD	Internal	12.30 lbs	2439040
FORD 429-460, 1986-97, Big Block w/ OEM 3/16" Keyway; 1/4" Keyway 180° from OEM Standard	6.70" OD	Internal	9.60 lbs	2446040

*GM is a registered trademark of General Motors.



WARNING: Cancer and Reproductive Harm

SFI-RATED RACING STEEL DAMPERS



PQX® SFI-RATED RACING STEEL DAMPERS

Application	Diameter	Balance	Weight	Part #
MOPAR 273-360, 1964-03 LA & Magnum, Small Block Chrysler V8, Includes 3 Counterweights	7.30" OD	Int / Ext	9.00 lbs	2431841
MOPAR 426 HEMI®, 1964-71, Chrysler 426 Street HEMI® V8	7.30" OD	Internal	8.70 lbs	2442639
MOPAR 426 HEMI®, 1964-71, Chrysler 426 Race HEMI® V8	7.30" OD	Internal	8.70 lbs	2442640
MOPAR 383-440 "B" & "RB", 1959-79, Chrysler Big Block "B" & "RB" V8	7.30" OD	Int / Ext	8.70 lbs	2444041
OLDS 330-455, 1964-80, Olds V8 Engines	6.50" OD	External	10.00 lbs	2445541
PONTIAC 326-455, 1961-79, Pontiac V8 Engines w/ 1969 or Later Timing Chain Cover	6.90" OD	Internal	10.00 lbs	2438940
PONTIAC 4.3L-5.7L, 1993-97 Gen II, LT1 GM Camaro/Firebird, 1994-95, Chevy/Buick/GM Full-Size Cars	7.50" OD	Internal	12.45 lbs	2435040

*GM is a registered trademark of General Motors.

Tech Tip! All Chrysler MOPAR Race HEMI, Street HEMI, and Big Block "B" and "RB" Dampers Have Correct Timing Marks By Application. Easy to Read; and easy to Time!

PQX® SFI-Rated Dampers for Imports

PQX® SFI-RATED RACING STEEL DAMPERS FOR IMPORTS					
Application	Diameter	Balance	Weight	Finish	Part #
HONDA-ACURA 1.6L-1.8L "B" Series, 1994-01, Honda B-16, Acura GSR & Type R Engines	5.6" OD	Internal	3.20 lbs	Black	2411040



SFI-RATED RACING FluidGel™ DAMPERS

PQ[®] SFI-Rated Racing FluidGel™ Dampers

These dampers are made with an internal steel inertia ring that is surrounded by a high viscosity silicone gel. The inertia ring “floats” in the silicone gel to combat the engine harmonics at all RPM ranges. External balance applications feature a removable hub in order to accurately blueprint the engine and balance the assembly.



PN 2535001 - CHEVY 262-350,
348-409 1955-95

PQ[®] SFI-RATED RACING FluidGel™ DAMPERS

Application	Diameter	Balance	Weight	Finish	Part #
CHEVY 262-350 1955-95	7.25" OD	Internal	13.25	Black	2528300
CHEVY 262-350, 348-409, 1955-95	6.25" OD	Internal	8.85 lbs	Black	2535001
CHEVY 262-350, 348-409 1955-95 (Except LT & GM LS 5.7L)	6.25" OD	Internal	8.85 lbs	Polished/Chrome	2535018
CHEVY 396-427, 1965-72, Mark IV, Big Block Chevy V8	6.25" OD	Internal	9.10 lbs	Black	2542701
CHEVY 400, 1970-80, Gen I, 400 & 383 Small Block Chevy V8	7.25" OD	External	14.25 lbs	Black	2540001
CHEVY 400, 1970-80, Gen I, 400 & 383 Small Block Chevy V8	7.25" OD	External	14.25 lbs	Polished/Chrome	2540018
CHEVY 454 & 502, 1970-00, Mark IV, Gen V & VI, Big Block Chevy V8	8.00" OD	External	17.25 lbs	Black	2545401
FORD 289-351W, 1963-Up, OEM & Aftermarket Neutral Balance Cranks	6.54" OD	Internal	11.8 lbs	Black	2530200
FORD 289-351W 1963-97, 28 oz, Removable Hub	6.54" OD	External	12.20 lbs	Black	2530201
FORD 302/HO 1981-95, 50 oz, Removable Hub	6.54" OD	External	13.40 lbs	Black	2530202
FORD 332-428 FE, 429-460 1958-97*	7.25" OD	Internal	13.00 lbs	Black	2546001*

*Keyway machining may be required for some OEM & Aftermarket cranks

*GM is a registered trademark of General Motors.

PN 2546001 - FORD 332-428 FE,
429-460 1958-97



- Meets SFI 18.1 specification
- Available in a black epoxy finish
- Easy to read laser engraved timing marks
- Accurate crank bore for a proper pressed fit
- Manufactured from billet carbon steel forgings
- Externally balanced dampers include removable counterweights

SFI-RATED FluidGel™ SERPENTINE PULLEY DAMPERS

PN 2528101 - FORD 4.6L (Except Mach I)
1996-04, UnderDrive



PQX® SFI-Rated Racing FluidGel™ Serpentine Pulley Dampers

- Available in Standard or UnderDrive
- UnderDrive dampers free up horsepower
- Constructed from billet carbon steel forgings
- Feature easy to read laser etching timing marks
- Includes alternator pulley; shorter drive belt is required
- Meets SFI specification 18.1 and combats engine harmonics at all RPM ranges
- Features an internal steel inertia ring surrounded by a high viscosity silicone gel



PN 2510901 - BMW Mini Cooper,
2001-06 Gen 1, Tritec 1.6 L



PN 2534602 - GM LS Series 4.6L, 5.3,
5.7L, 6.0L 1998-08, UnderDrive

PQX® SFI-RATED RACING FluidGel™ SERPENTINE PULLEY DAMPERS

Application	Detail	Weight	Part #
BMW Mini Cooper, 2001-06 Gen 1, Tritec 1.6 L, Supercharged Only	138mm, Black, OEM Standard Drive	8.45 lbs	2510900
BMW Mini Cooper, 2001-06 Gen 1, Tritec 1.6 L, Naturally Aspirated	127mm, Black, 8.7% UnderDrive	7.50 lbs	2510901
BMW Mini Cooper, 2001-06 Gen 1, Tritec 1.6 L, Naturally Aspirated	138mm, Black, OEM Standard Drive	8.35 lbs	2510902
FORD 4.6L Mustang (Except Mach I) 1996-04	Black, 25% UnderDrive	7.15 lbs	2528101
GM LS Series 5.7L/6.0L for Camaro, Firebird, GTO, 1998-06	Black, 25% UnderDrive	11.40 lbs	2534601

*GM is a registered trademark of General Motors.

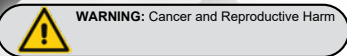

Harmonic Damper Bolts

Crankshafts flex and your damper absorbs incredible amounts of energy. PRW harmonic damper bolts will ensure that your balancer is locked into position. These feature a 1/4" thick wide-area washer and an extra tall 12-point head that accepts a deep socket to eliminate the fear of stripping the head when torqued to specification.

- 190,000 PSI rating
- Extra tall 12 pt head
- Includes 1/4" thick wide area washer



PN 1042289 - FORD SB V8, 302-351W, 12 Point w/ Washer

HARMONIC DAMPER BOLTS	
Application	Part #
CHEVY SB 265-400, 12 Point	1042265
CHEVY BB 396-454, 12 Point	1042396
FORD 289-460 (Except 351C), 12 Point	1042289
FORD 351C, 12 Point, 5/8" Wrenching	1042351
GM LS SERIES, Gen III/IV, 12 Point, 1-1/16" Wrenching	1042346
PONTIAC 350-455, 12 Point	1042389

*GM is a registered trademark of General Motors.

DAMPER COUNTERWEIGHTS		
Application	Weight	Part #
AMC 360 V8	16.96 oz	2391101
AMC 304 V8	14.24 oz	2391102
AMC 401 V8	24.32 oz	2391103
CHEVY SB 400	16.80 oz	2391001
CHEVY SB 400	11.20 oz	2391003
CHEVY BB Chevy 454/502	15.20 oz	2391005
FORD SB (28 oz)	19.20 oz	2391006
FORD SB (50 oz)	28.80 oz	2391007
MOPAR SB 360, Chrysler, 1971-92	18.40 oz	2391012
MOPAR SB 360, Chrysler, 1993-97	10.72 oz	2391013
MOPAR SB 340, Chrysler, 1972-73	3.68 oz	2391014
MOPAR BB, Chrysler	11.04 oz	2391015
MOPAR BB, Chrysler	4.64 oz	2391016
OLDS V8	17.92 oz	2391022



PN 2394014 - MOPAR SB 340, Chrysler, 1972-73



PN 2391103 - AMC 401 V8

Harmonic Damper Pulley Spacers

PRW Harmonic Balancer Spacers are constructed from high quality aluminum to meet various demands of the performance and racing industry. The chart below illustrates some of the correct spacer applications to assist the installer to use OEM and aftermarket pulleys and other components for performance and racing engines. Please refer to the installation instructions for specific data for vehicle fitment.

PULLEY SPACERS FOR HARMONIC DAMPERS	
Application	Part #
FORD 289-351W 1963-87, 0.630" Thick, 4 Hole Aftermarket Billet Aluminum Spacer, Black Anodized	2593021
FORD 351W-C / 400M, 302 (5.0L) 1969-80, 0.350" Thick, 4-Bolt Pulley, Black Anodized	2381006
FORD 302 (5.0L) / 351W, 1980-95, 0.950" Thick, 4-Bolt Pulley, Black Anodized	2381007
FORD 351 HO, 351W, 302 (5.0L) 1980-95, 0.875" Thick, 4-Bolt Pulley, Black Anodized	2381008
FORD 302 (5.0L) / 351W, 1980-95, 0.950" Thick Steel for Applications w/ Belt Driven Supercharger	2381009
MOPAR 426 Street or Race HEMI® (Use w/ PN 2342639, 2342640, 2442639 or 2442640)	2381013



PN 2381008 - FRONT, 0.875" Thick for SB FORD



PN 2381009 - FRONT, STEEL, 0.95" Thick for SB FORD w/ Belt Driven Blower



PN 2381009 - FRONT, STEEL, 0.95" Thick for SB FORD w/ Belt Driven Blower



PN 9905001 - Timing Tapes 5.25" - 8.00" Diameter Dampers

SFI-RATED GOLD SERIES STEEL FLEXPLATES

SFI Certified, .035" thicker than stock flexplates, designed and built for racing, and manufactured to exceed OEM specifications. Features double-welded ring gears designed to withstand the RPM and stress of engine torque associated with high stall converters. PRW Chromoly Steel Flexplates are OEM Compatible.

- SFI 29.1 Certified
- Direct bolt-on component
- 0.035" thicker than stock flexplates
- Features double-welded ring gears
- Constructed from cold-rolled chromoly steel
- Designed to fit all standard OEM, aftermarket replacement, and high performance torque converters for published applications

**ALL PRW GOLD
SERIES SFI-RATED
FLEXPLATES ARE OEM
COMPATIBLE**

CHROMOLY SFI-RATED FLEXPLATES				
Application <small>See Flexplate Footnotes Below for Bolt Circle Info</small>	Balance	Teeth	Bolt Circle	Part #
AMC/JEEP 304-401 1971-77, 3.8/4.2L I-6 1969-88	External	164	3, 4	1840100
AMC/JEEP 304-401 1971-77, 3.8/4.2L I-6 1969-88	Internal	164	3, 4	1840102
BUICK 403-455 1967-76, TH350 & TH400	External	166	6, 7	1845507
CADILLAC 368-500 1968-84	Internal	166	6, 7	1850001
CHEVY 1957-85, 90° V6, 2 Piece Rear Seal	Internal	168	6, 7	1835001
CHEVY SB 1957-85, 90° V6, 2 Piece Rear Seal	Internal	153	6, 8	1835002
CHEVY 350 1986-97, 1 Piece Rear Seal	External	168	6, 7	1835003
CHEVY SB 1986-97, 90° V6, 1 Piece Rear Seal	External	153	6	1835004
CHEVY 350 1986-97, 1 Piece Rear Seal	Internal	168	6, 7	1835005
CHEVY SB 1986-97, 90° V6, 1 Piece Rear Seal	Internal	153	6	1835006
CHEVY 400/383 1970-80, 2 Piece Rear Seal	External	168	6, 7	1840000
CHEVY 454 1970-90, 2 Piece Rear Seal	External	168	6, 7	1845400
CHEVY 454 Gen V/VI 1991-97, 1 Pc Rear Seal, 14.13" OD	External	168	6, 7	1845401
CHEVY 8.1L, 2001-07, 6 Bolt Converter	Internal	168	9	1849600
<u>GM</u> LS Series, LS1/LS2/LS3/LS6 & 4.8L/5.3L/6.0L/6.2L 1997-Up	Internal	168	5, 6	1834600
<u>GM</u> LS Series 2009-15 8 Bolt	Internal	168	6, 9, 10, 12	1836400

*GM is a registered trademark of General Motors.



PN 1836400 GM LS Series 2009-15 8 Bolt

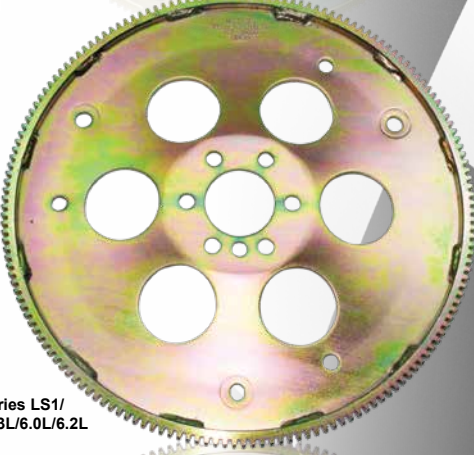

PN 1834600 GM LS Series LS1/LS2/LS3/LS6 & 4.8L/5.3L/6.0L/6.2L 1997-Up

FLEXPLATE FOOTNOTES						
1. 4 x 11.40" FORD	2. 4 x 10.50" FORD	3. 4 x 11.125" MOPAR	4. 4 x 10.00" MOPAR	5. 3 x 11.00" <u>GM</u>	6. 3 x 10.75" <u>GM</u>	7. 3 x 11.50" <u>GM</u>
8. 3 x 9.75" <u>GM</u>	9. 6 x 11.50" <u>GM</u>	10. 6 x 11.00" <u>GM</u>		12. 3 x 10.50" <u>GM</u>		

WARNING: Cancer and Reproductive Harm

SFI-RATED GOLD SERIES STEEL FLEXPLATES

SFI-RATED GOLD SERIES STEEL FLEXPLATES

CHROMOLY SFI-RATED FLEXPLATES

Application See Flexplate Footnotes Below for Bolt Circle Info	Balance	Teeth	Bolt Circle	Part #
FORD 4.6L Modular V8 1992-09, 6 Bolt Crankshaft	Internal	164	1	1828100
FORD 289-351W 1963-82	Internal	164	1	1830200
FORD 289-351W 1963-82, 28 oz	External	164	1	1830201
FORD 302 1982-95, 50 oz	External	164	1	1830202
FORD 289-351W, 1963-82	Internal	157	2	1830203
FORD 289-351W 1963-82, 28 oz	External	157	2	1830204
FORD 302 1982-95, 50 oz	External	157	2	1830205
FORD 289-351W/C/M/400 1963-88, C-6, 28 oz	External	164	1	1835100
FORD FE 352-428 1957-Up	Internal	184	1	1839000
FORD FE 427-428 1966-70 & 429/460. C-6, 28 oz	External	184	1	1842801
FORD 429/460, 332-428 FE, 1968-97	Internal	164	1	1846003
FORD 429/460, 332-428 FE, 1968-97, 28 oz	External	164	1	1846004
MOPAR/JEEP 5.7L/6.1L Mod HEMI® 2002-Up, 8 Bolt Crankshaft (Will Not Fit 545/65RFE)	Internal	131	13	1834500
MOPAR/JEEP 5.7/6.1L Mod Hemi to 727/904 Trans, 8 Bolt Crankshaft, No Ring Gear	Internal	-	3,4	1839200
MOPAR SB & BB 1956-Up, 6 Bolt Crankshaft	Internal	-	3,4	1831800
OLDS V8 1968-90, TH350 & TH400	External	166	6,7	1845505
PONTIAC 326-455 1957-79, TH350 & TH400, PowerGlide	External	166	6,7	1845500
PONTIAC 326-455 1967-79, TH350 & TH400, P/Glide	Internal	166	6,7	1845501



PN 1839000 FORD FE 352-428
1957-Up



PN 1845501 PONTIAC 326-455
1967-79 TH350 & TH400,
PowerGlide



PN 1831800 - MOPAR SB & BB
1956-Up, 6 Bolt Crankshaft

FLEXPLATE FOOTNOTES

1. 4 x 11.40" FORD	2. 4 x 10.50" FORD	3. 4 x 11.125" MOPAR	4. 4 x 10.00" MOPAR	5. 3 x 11.00" GM	6. 3 x 10.75" GM	7. 3 x 11.50" GM
8. 3 x 9.75" GM	9. 6 x 11.50" GM					13. 8 x 12" MOPAR

SFI-RATED PLATINUM SERIES STEEL FLEXPLATES

PQ[®] XTREME DUTY SFI-RATED FLEXPLATES, HIGH INERTIA DESIGN

Application See Flexplate Footnotes Below for Bolt Circle Info	Balance	Teeth	Bolt Circle	Part #
CHEVY SB 1957-85, 90° V6, 2 Piece Rear Seal	Internal	153	6, 8	1832720
CHEVY SB/BB, Includes 2001-07 8.1L BB, 2 Piece Rear Seal	Internal	168	6, 8, 9	1835021
CHEVY 454 1970-90, 2 Piece Rear Seal	External	168	6, 7, 8	1845420
FORD 4.6L DOHC 1992-06, 6 Bolt Crank*	Internal	164	1, 2, 6, 7	1828110
FORD 4.6L DOHC 1992-06, 8 Bolt Crank*	Internal	164	1, 2, 6, 7	1828111
FORD 289-351W 1963-95, Eagle Crank, Small Bell*	Internal	164	1, 2, 6, 7	1830210
FORD 289-351W 1963-82, 28 oz, Small Bell*	External	164	1, 2, 6, 7	1830211
FORD 302 1982-95, 50 oz*	External	164	1, 2, 6, 7	1830212
FORD 289-351W 1963-95, Eagle Crank, Small Bell*	Internal	157	2, 6	1830213
FORD 289-351W 1963-82, 28 oz*	External	157	2, 6	1830214
FORD 302 1982-95, 50 oz*	External	157	2, 6	1830215
FORD 429-460 1966-97*	External	164	1, 6, 7	1846010
FORD 429-460, Eagle Crank*	Internal	164	1, 6, 7	1846011

*Small & Big Block FORD applications feature both FORD & GM converter patterns

Due to these flexplates having dual bolt patterns an aftermarket torque converter may be required.

GM LS Series, LS1, LS2, LS3, LS6 & 4.8L, 5.3L, 6.0L, 6.2L 1997-Up **Will Fit Turbo 350 & 400 Transmissions w/ Adapter	Internal	168	5, 6 7, 9, 10	1834620
GM LS Series, LS1, LS2, LS3, LS6 & 4.8L, 5.3L, 6.0L, 6.2L 1997-Up **Will Fit Specialty 6-bolt Turbo 350 & 400 Convertors w/ Adapter	Internal	168	5, 6, 7 9, 10, 14	1834624
MOPAR 5.7L/6.1L Mod HEMI®, 2002-Up, 8 Bolt Crankshaft (Will Not Fit 545/65RFE)	Internal	131	13	1837010
MOPAR SB & BB 1962-91 TF-727 & TF-904 10" or 11.125" 8 Bolt	Internal	-	3, 4	1841310
PONTIAC 326-455 1957-79	External	166	6, 7	1845502
PONTIAC 326-455 1957-79	Neutral	166	6, 7	1845503

*GM is a registered trademark of General Motors.



PN 1834620 - GM LS Series, High Inertia Quick-Launch Design, Internal Design

**HIGH INERTIA DESIGN
FOR TRANS-BRAKE
APPLICATIONS!**



Crank Sleeve Adapters Available for FORD & GM Applications, Fit both High Inertia and High Integrity

FORD & GM CRANK SLEEVE ADAPTERS

Application	Part #
FORD, for Use w/ PQ [®] Series SBF to GM Transmission	1800302
FORD, for Use w/ PQ [®] Series BBF to GM Transmission	1800460
GM GM LS, Adapter for Older GM Converter to LS Engine	1800346

*GM is a registered trademark of General Motors.

FLEXPLATE FOOTNOTES

1. 4 x 11.40" FORD	2. 4 x 10.50" FORD	3. 4 x 11.125" MOPAR	4. 4 x 10.00" MOPAR	5. 3 x 11.00" GM	6. 3 x 10.75" GM	7. 3 x 11.50" GM
8. 3 x 9.75" GM	9. 6 x 11.50" GM	10. 6 x 11.00" GM	11. 6 x 12.25" MOPAR	12. 3 x 10.50" GM	13. 8 x 12" MOPAR	14. 3 - T350 and 3 - T400 Specialty

SFI-RATED PLATINUM SERIES STEEL FLEXPLATES

PQX[®] Xtreme Duty Platinum SFI-Rated Flexplates

Xtreme Duty SFI-Rated Flexplates are engineered to handle extreme performance applications and designed to take the punishment of today's high horsepower engines. The 4mm thick centerplate provides a solid foundation for these new designs. Ring gears are precision welded to meet SFI specifications, utilizing robotic machinery and a cold-welding process. Platinum Series Flexplates are engineered for excellence and are rigorously inspected throughout the manufacturing cycle to ensure that our customers receive the quality that they have come to expect from PRW.

- Exceeds SFI Specification 29.1
- FORD applications small bell adapts to GM torque convertor
- FORD crankshaft adapters available for use with GM torque converters



PN 1845431 - CHEVY 454 1970-90, Early, 0.187" Thick Core, High Integrity Design



PN 1834610 - GM LS Series, High Integrity Design

HIGH INTEGRITY DESIGN APPLICATIONS!

PQX[®] XTREME DUTY SFI-RATED FLEXPLATES, HIGH INTEGRITY DESIGN

Application See Flexplate Footnotes on Page 77 for Bolt Circle Info	Balance	Teeth	Bolt Circle	Part #
CHEVY SB 1957-85, 90° V6, 2 Piece Rear Seal	Internal	153	6, 8	1832730
CHEVY SB/BB 1957-85, 90° V6, 2 Piece Rear Seal, Includes 2001-07 8.1L BB	Internal	168	6, 8, 9	1835030
CHEVY 454 1970-90, 2 Piece Rear Seal	External	168	6, 7, 8	1845431
CHEVY 454/502 Gen V/VI 1991-97, 1 Piece Rear Seal	External	168	6, 7, 8	1850231
GM LS Series, LS1, LS2, LS3, LS6 & 4.8L, 5.3L, 6.0L, 6.2L 1997-Up **Will Fit Turbo 350 & 400 Transmissions w/ Adapter	Internal	168	5, 6	1834610
GM LS Series, LS1, LS2, LS3, LS6 & 4.8L, 5.3L, 6.0L, 6.2L 1997-Up **Will Fit Specialty 6-bolt Turbo 350 & 400 Convertors w/ Adapter	Internal	168	5, 6, 14	1834614
MOPAR SB & BB 1956-91, 6 Bolt Crankshaft, 4mm Thick Centerplate	Internal	-	3, 4	1844010

*GM is a registered trademark of General Motors.

Tech Tip: What's the difference between PRW's High Integrity and High Inertia Designs? Both are manufactured for high-horsepower applications. High Integrity designs are lightened for quicker throttle response. Perfect for off-road, road racing or use on the street. The High Inertia designs are manufactured with a robust solid flat plate of cold-rolled steel for harder drag race launches and improved 60-foot times.



WARNING: Cancer and Reproductive Harm

SFI-RATED FORD DIESEL FLEXPLATES

SFI-RATED FORD DIESEL FLEXPLATES

PQ^X SFI-Rated Platinum Series Diesel Steel Flexplates

The PQ^X SFI-Rated Platinum Series Diesel Steel Flexplates are now available for FORD Powerstroke applications. They are SFI-Rated and solve the common problem of breakage from heavy duty towing or racing! The 4mm thick centerplate provides a solid foundation for these new designs. With this, our Platinum Series Diesel Flexplates are able to absorb more stress from the drivetrain compared to the factory flexplate. An excellent upgrade from a trusted brand.

- Exceeds SFI Specification 29.1
- Ideal for stock to mildly modified
- Excellent alternative for heavy duty towing requirement
- OEM Compatible as listed



PN 1836311 - FORD 6.0L/6.4L Powerstroke Diesel

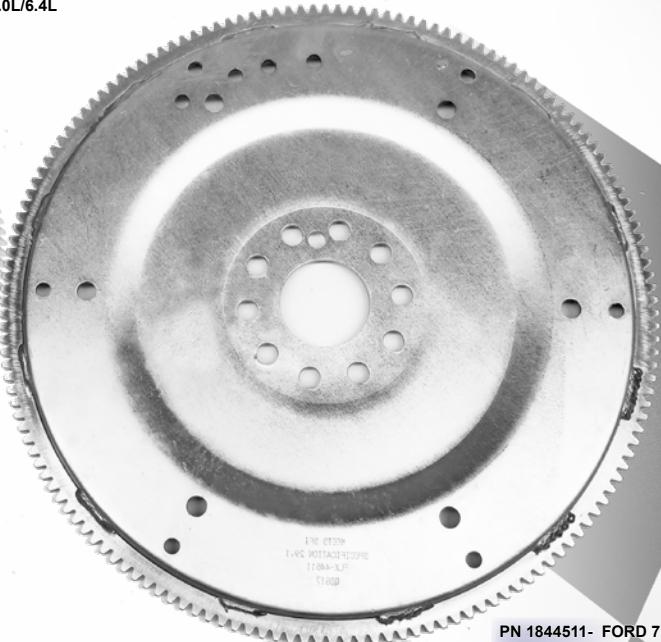

PN 1844511- FORD 7.3 Powerstroke Diesel

**NEW
FORD DIESEL
APPLICATIONS!**

SFI-RATED DIESEL PLATINUM SERIES STEEL FLEXPLATES

Application	Balance	Teeth	Weight	Part #
FORD 6.0L/6.4L Powerstroke Diesel, 2003-2007 363ci for 5R110 Trans NEW!	External	141	9.39 lbs	1836311
FORD 7.3L Powerstroke Diesel, 1994.5-2003 445ci for E4OD or 4R100 Transmissions NEW!	External	155	9.53 lbs	1844511



WARNING: Cancer and Reproductive Harm

SFI-RATED CUMMINS DIESEL FLEXPLATES

PQX® SFI-Rated Signature Series Diesel Steel Flexplates

Modified Cummins engines deliver power and torque that can crack or shatter the stock flexplate. The PRW Signature Series steel flexplates are manufactured from billet steel forgings, designed and built to withstand 1,500 lbs. ft. of torque. All are precision-balanced, laser engraved, and SFI 29.3 approved for use in high output diesel applications.



PN 1840821 - Dodge Cummins 6.7L, Black Oxide

PQX® SFI-RATED DIESEL SIGNATURE SERIES STEEL FLEXPLATES

Application	Balance	Teeth	Weight	Part #
DODGE 5.9L Cummins 1994-07, One Piece Billet Steel, Meets SFI Diesel Spec 29.3, Black Oxide	Internal	152	11.5 lbs	1835921
DODGE 6.7L Cummins 2007.5-2013, For 68RFE Transmission, One Piece Billet Steel, Meets SFI Diesel Spec 29.3, Black Oxide	Internal	152	12.25 lbs	1840821



PN 1835910 - Dodge Cummins 5.9L

PQX® SFI-Rated Platinum Series Diesel Steel Flexplates

The PQX® SFI-Rated Platinum Series Diesel Steel Flexplates are engineered to handle extreme performance applications and designed to take the punishment of today's high horsepower engines. The 4mm thick centerplate provides a solid foundation for these new designs. Ring gears are precision welded to meet SFI specifications, utilizing robotic machinery and a cold-welding process. Platinum Series Diesel Flexplates are engineered for excellence and are rigorously inspected throughout the manufacturing cycle to ensure that our customers receive the quality that they have come to expect from PRW.

- Exceeds SFI Specification 29.1
- Ideal for stock to mildly modified
- Excellent alternative for heavy duty towing requirement
- OEM Compatible as listed (prior years may require spacer)

SFI-RATED DIESEL PLATINUM SERIES STEEL FLEXPLATES

Application	Balance	Teeth	Weight	Part #
DODGE 5.9L Cummins 1994-07 (Prior Years May Require Aftermarket Transmission Spacer)	Internal	152	9.75 lbs	1835910
DODGE 6.7L Cummins 2007.5-2013 For 68RFE Transmission	Internal	152	9.70 lbs	1840810

SFI-RATED BILLET STEEL FLYWHEELS

PQX® SFI-Rated Steel Flywheels

PRW Flywheels are CAD engineered, and precision CNC machined from 1045 billet steel. Each Flywheels is balanced and carefully inspected throughout the manufacturing process. PRW steel Flywheels are SFI Certified and feature removable counterweights for versatility.

- SFI certified
- CNC machined
- CAD engineered
- Bolt-on counterweight
- Made from 1045 billet steel forgings



PN 1635080 -
CHEVY 265-427



PN 1626500 -
CHEVY SB

PQX® SFI-RATED BILLET STEEL Flywheels				
Application	Teeth	Balance	Weight	Part #
See Flywheels Footnotes on Page 84 for Additional Information				
AMC-JEEP 343-360-390 1966-71 [See Notes 1, 2] NEW!	164	Internal	30.5 lbs.	1634380
AMC-JEEP 360 V8 1967-70 1972-91 4.610" Crank Register [See Notes 1, 2] NEW!	164	Internal	31.5 lbs.	1630480
AMC-JEEP 360 V8 1972-91 4.610" 23 In Oz Crank Register [See Notes 1, 2] NEW!	164	External	31.5 lbs.	1630481
AMC-JEEP 360 V8 1972-91 [See Notes 1, 2] NEW!	164	External	30 lbs.	1630484
CHEVY 265-427 1955-85, Circle Track Spec [Requires High Performance Clutch]	153	Internal	18 lbs	1626500
CHEVY 265-427 V6/V8 1955-85 [Requires High Performance Clutch]	168	Internal	21.4 lbs	1628300
CHEVY 305-350 1986-92, 1 Piece Rear Seal [See Notes 1, 3, 4]	153	Internal	29 lbs	1630580
CHEVY 305-350 1986-92, 1 Piece Rear Seal [See Notes 1, 3, 4]	153	External	29.3 lbs	1630581
CHEVY 327-427 1963-85 (Except 400) & 572 GM Crate Motor [See Notes 1, 3, 4]	153	Internal	29 lbs	1632780
CHEVY 265-427 1955-85 (Except 400) & 572 GM Crate Motor [See Notes 1, 3, 5]	168	Internal	30 lbs	1635080
CHEVY 383 1986-92, 1 Piece Rear Seal, SCAT/Eagle Stroker [See Notes 1, 3, 4]	153	External	29 lbs	1640061
CHEVY 383-400 1970-85 [See Notes 1, 3, 4]	153	External	29 lbs	1640071
CHEVY 383-400 1970-85 [See Notes 1, 3, 5]	168	External	30 lbs	1640081
CHEVY 454 1970-90, 2 Piece Rear Seal [See Notes 1, 3, 4]	153	External	29 lbs	1645471
CHEVY 454 1990-00, 1 Piece Rear Seal [See Notes 1, 3, 4]	153	External	29.6 lbs	1645472
CHEVY 454 1970-90, 2 Piece Rear Seal [See Notes 1, 2, 5]	168	Internal	31 lbs	1645480
CHEVY 454 1970-90, 2 Piece Rear Seal [See Notes 1, 2, 5]	168	External	31 lbs	1645481
CHEVY 454 1990-00, 1 Piece Rear Seal [See Notes 1, 2, 5]	168	External	31 lbs	1645482
CHEVY 502 1991-Up, 1 Piece Rear Seal, Steel Crank [See Notes 1, 3, 4]	153	External	29 lbs	1650272
CHEVY 502 1991-Up, 1 Piece Rear Seal, Steel Crank [See Notes 1, 2, 5]	168	External	30 lbs	1650282



WARNING: Cancer and Reproductive Harm

SFI-RATED BILLET STEEL FLYWHEELS

PQX [®] SFI-RATED BILLET STEEL Flywheels				
Application See Flywheel Footnotes on Page 84 for Additional Information	Teeth	Balance	Weight	Part #
FORD 4.6L 1996-04 SOHC-DOHC, 6 Bolt [See Notes 5, 9, 10, 12]	164	Internal	26.30 lbs	1628100
FORD 4.6L 1992-08 Modular V8, 8 Bolt [See Notes 10,12]	164	Internal	26.55 lbs	1628180
FORD 260-302 1964-95 [See Notes 1, 3, 4, 10]	157	Internal	23.40 lbs	1628980
FORD 260-289 1964-69, 28 in-OZ [See Notes 1, 3, 4, 5, 10]	157	External	23.95 lbs	1628981
FORD 302 5.0L 1980-95, 50 in-OZ [See Notes 1, 3, 4, 5, 10]	157	External	24.10 lbs	1628982
FORD 289-302-351 1963-95 [See Notes 3, 4, 9, 10]	164	Internal	30.20 lbs	1630280
FORD 289-302-351 1963-79, 28 in-OZ [See Notes 3, 4, 9, 10]	164	External	30.45 lbs	1630281
FORD 302 5.0L 1980-95, 50 in-OZ [See Notes 3, 4, 9, 10]	164	External	33.90 lbs	1630282
FORD FE 332-427 1963-74, [See Notes 5, 6, 7, 9]	184	Internal	33.00 lbs	1642780
FORD 332-428 1963-74, 28 in-OZ [See Notes 5, 7, 9]	184	External	33.25 lbs	1642781
FORD 332-427 1963-74 [See Notes 5, 7, 9]	184	Internal	34.00 lbs	1642880
FORD FE BB 332-428 1966-70, 28 in-OZ [See Notes 5, 7, 9]	184	External	34.30 lbs	1642881
FORD 429-460 1969-78 [See Notes 5, 7, 9]	176	Internal	33.00 lbs	1642980
FORD 429-460 1969-78, 28 in-OZ [See Notes 5, 7, 9]	176	External	33.30 lbs	1642981
FORD 460 1979-99 [See Notes 5, 7, 9]	176	Internal	35.15 lbs	1646080
FORD 429-460 1979-99 [See Notes 5, 7, 9]	176	External	35.45 lbs	1646081
GM (5.7L) LS1 - LS6 1998-08, OEM Replacement [See Notes 2, 11]	168	Internal	25.45 lbs	1634680
CHEV 265-427 1955-85 [See Notes 1, 3, 4]	168	Internal	36.00 lbs	1635090
CHEV SB 383-400 1970-85 [See Notes 1, 3, 4]	168	External	36.00 lbs	1640091
CHEV, 1970-90 BB 454 [See Notes 1, 3, 4]	168	External	36.00 lbs	1645491
MOPAR 225 Slant 6 1960-87, 318, 340 1964-99, 383, 400, 440 1964-78, 6 Bolt, Clutch Pattern- 10", 10.5", 10.95" B&B, 10" & 10.5" Long, & 10" Diaphragm	130	Internal	27.00 lbs	1631880
PONTIAC 326-455 1964-85, Removable 2.50" Crankshaft Pilot Ring & Counterweight [See Notes 1, 2, 3, 4]	166	External	30.40 lbs	1645570
PONTIAC 326-455 1964-85, 2.50" or 2.75" Crankshaft Pilot [See Notes 1, 2, 3, 4]	166	Internal	30.35 lbs	1645571
PONTIAC 326-455 1964-85, 2.60" or 2.75" Crankshaft Pilot [See Notes 1, 2, 3, 4]	166	Internal	30.35 lbs	1645572
PONTIAC 326-455 1964-85, Removable 2.60" or 2.75" Crankshaft Pilot & Counterweight [See Notes 1, 2, 3, 4]	166	External	30.40 lbs	1645573
OLDS 307, 350-455 1964-85 & 400 1968-70 [See Notes 1, 3, 4, 5]	166	External	30.60 lbs	1645580
OLDS 307, 350-455 1964-85 & 400 1968-70 [See Notes 1, 3, 4, 5]	166	Internal	30.35 lbs	1645581

*GM is a registered trademark of General Motors.



PN 1628981 - FORD Small Block, w/ Removable Counterweight

Tech Tip: Flywheels Footnotes and Clutch Patterns on Page 84



WARNING: Cancer and Reproductive Harm

SFI-RATED BILLET ALUMINUM FLYWHEELS

PQ^x SFI-Rated Aluminum Flywheels

PRW billet aluminum Flywheels are manufactured from the highest quality 6061-T6 billet aluminum. These Flywheels feature excellent heat dissipation and weight reduction. The replaceable friction surface is constructed from 1045 steel and attached with military-grade fasteners. PRW billet aluminum Flywheels also feature a forged heat-treated steel ring gear, secured with button screws. Dowel pins included where required.



PN 1928100 - FORD, 4.6L Modular V8, 6 Bolt

- Manufactured from 6061-T6 billet aluminum
- Excellent heat dissipation and weight reduction
- Replaceable friction plate for long term durability

PQ^x SFI-RATED BILLET ALUMINUM Flywheels

Application See Flywheel Footnotes on Page 84 for Additional Information	Teeth	Balance	Weight	Part #
CHEVY SBC, WBC, BBC, 1955-85 Small Block 262-400 V6/V8, Big Block V8 396-427 & 572, and "W" Block 348-409 [Requires High Performance Clutch]	153	Neutral	13.00 lbs	1932700
CHEVY SB 262-400 V6/V8, 1955-85, BB V8 396-427, & "WB" 348-409, Includes 383/400 Counterweight [Requires High Performance Clutch]	168	Internal	13.90 lbs	1935000
CHEVY BB 454-502 1970-00, w/ Early/Late Bolt-On Counterweights [See Notes 1, 3, 4]	153	External	15.00 lbs	1945400
CHEVY BB 454 1970-90, w/ Early Design Bolt-On Counterweight [See Notes 1, 2, 5]	168	External	14.00 lbs	1945401
CHEVY, 1991-Up BB 454-502 [See Notes 1, 3, 4]	153	External	14.00 lbs	1950200
CHEVY BB 502, 1991-Up, w/ Bolt-On Counterweight [See Notes 1, 2, 5]	168	External	14.00 lbs	1950201
FORD 4.6L 1992-08 Modular V8, 12 lbs, 6 Bolt [See Notes 5, 9, 10, 12]	164	Internal	12.25 lbs	1928100
FORD 4.6L 1992-08 Modular V8, 12 lbs, 8 Bolt [See Notes 10,12]	164	Internal	12.30 lbs	1928101
FORD 289-351W, Includes 28 & 50 oz Counterweights [See Notes 1, 3, 4, 5, 10]	157	External	11.25 lbs	1928900
GM 1997-Up LS1/LS2 [See Notes 2,11]	168	Internal	11.65 lbs	1934600
Flywheels Friction Plate, 1045 Carbon Steel, Universal PRW, 11.0" OD x 6.25" ID x 0.150" Thick				1999101

*GM is a registered trademark of General Motors.



PN 1935000 - CHEVY SB 262-400 V6/V8, BB V8 396-427, & "WB" 348-409, Includes 383/400 Counterweight

NEW APPLICATIONS AVAILABLE!



WARNING: Cancer and Reproductive Harm

CLUTCH PATTERN REFERENCES

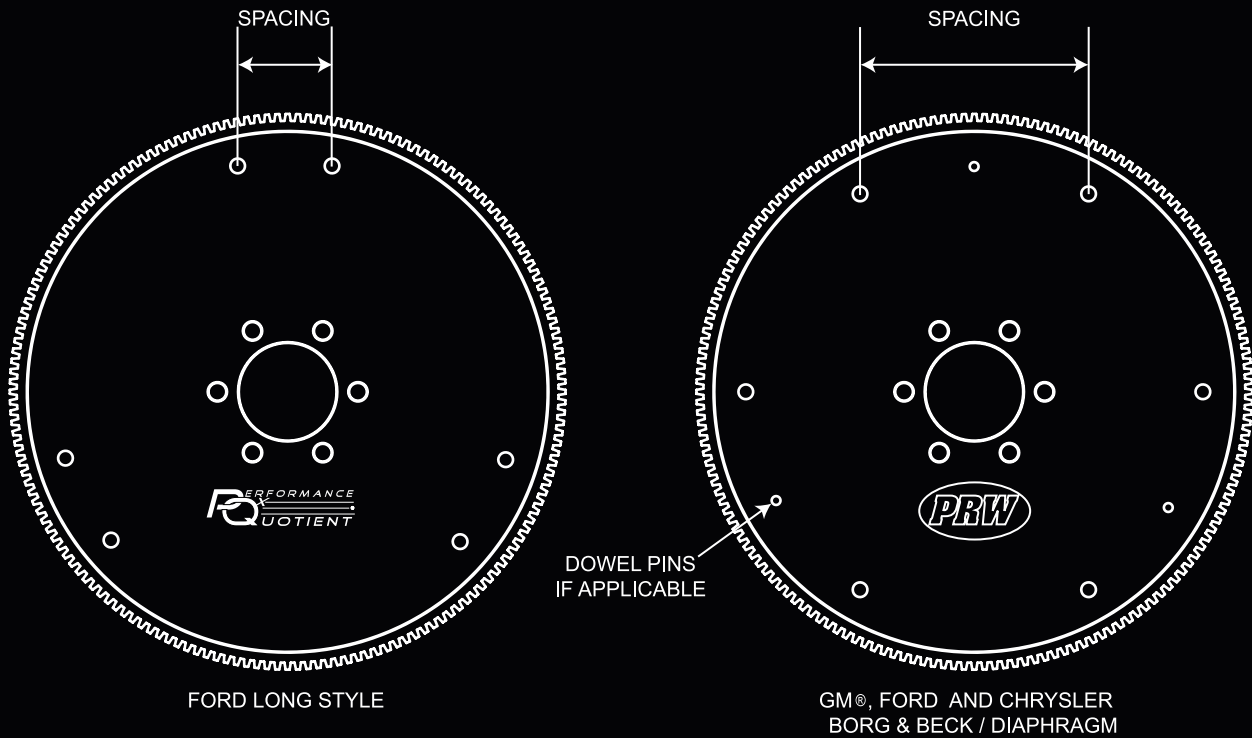

CLUTCH PATTERN REFERENCE CHART

Make	Clutch Diameter	Clutch Style	Bolt to Bolt Spacing	Mounting Bolt Thread Size	Dowel Pins Required
Chrysler	10" or 10.4"	BB/D	5-13/16"	3/8-16 UNC	No
Chrysler	11" or 12"	BB/D	6-5/16"	3/8-16 UNC	No
GM	10" or 10.4"	BB/D	5-13/16"	3/8-16 UNC	No
GM	11" or 12"	BB/D	6-5/16"	3/8-16 UNC	No
GM LS1	11" or 11.5"	BB/D	6-5/16"	10mm x 1.50	Yes
GM LT1	11" (Pull Type)	BB/D	5-13/16"	3/8-16 UNC	No
FORD	10" (Long Pattern)	D	3-1/8"	5/16-18 UNC	No
FORD	10" or 10.5"	Long	3-1/8"	5/16-18 UNC	No
FORD 1986-Up	10.4" (Mustang)	D	5-5/8"	8mm x 1.25	Yes
FORD	11"	Long	3-3/8"	5/16-18 UNC	No
FORD	11"	D	6-3/16"	3/8-16 UNC	No
FORD 4.6L	11" (Mustang)	D	6-3/16"	8mm x 1.25	Yes
FORD	11.5"	Long	3-9/16"	5/16-18 UNC	No

Flywheels FOOTNOTES

1. 10", 10.5", 10.95" B & B-Diaphragm	2. 11" & 12" B & B-Diaphragm	3. 10" & 10.5" Long	4. 10" Diaphragm	5. 11" Long w/ 5/16" Bolts	6. 11" Long-Diaphragm w/ 3/8" Bolts
7. 11.5" & 12" Long-Diaphragm	8. 12" Long-8 Bolt Cover	9. 11" Diaphragm FORD Trucks Even Pattern	10. 10.5" Mustang Diaphragm w/ 8mm Bolts	11. 12" GM LS1 Diaphragm w/ 10mm Bolts	12. 11" Mustang w/ Dowel Pin Holes 2000 & Up