



**RETRAC<sup>®</sup>**



**DRIVING BUSINESS FORWARD**

**2021 CATALOG & APPLICATION GUIDES**

# YOUR ONE-STOP SHOP

## FOR TOWING & TRUCK ACCESSORIES



Guided by three generations of family leadership, LCI has grown tremendously over the last 62 years. Today, LCI is an industry leader of premium components to the RV, marine, heavy truck, equestrian trailer, bus and residential industries.

RETRAC has joined the LCI family, bringing its robust product portfolio to these related industries and rounding out the LCI offering to better serve the aftermarket. Our cultures, our values and our vision are well-aligned to ultimately bring greater success to our customers.



## CUSTOMER-FIRST SERVICE

RETRAC is committed to a customer-first mentality. That means approaching each new challenge by thinking from the customer's perspective first.

Our goal is to offer our customers the best service, fastest order-fill, richest marketing resources and highest-quality products. Take advantage of our marketing literature, training presentations, videos and more.



### Dedicated Support

Our Product Support Team is ready to answer all of your product questions, concerning fitment, function, installation and more.



### Marketing Materials

Get high-caliber literature pieces and displays for your store to give your associates and customers a tangible reference as they come to a buying decision. We offer catalogs, posters, header cards, counter mats and more.



### Presentations

Train and educate your associates on the key selling points of our products. For each product category, we maintain high-quality training presentations, complete with unique selling points, photography and videos.

**THINKING OF THE CUSTOMER FIRST**



# PRODUCT INDEX

|   |    |
|---|----|
| Accessory mounting tabs                         | 21 |
| Adjustable stabilizers and braces               | 70 |
| Aerodynamic convex mirror heads                 | 50 |
| Aerodynamic west coast mirror heads             | 34 |
| Aerodynamic west coast replacement glass        | 36 |
| Angle-back west coast mirror heads              | 44 |
| Auxiliary mirror mounting brackets              | 72 |
| Bubble mirror heads                             | 51 |
| Bubble-back west coast mirror heads             | 41 |
| Center-mount convex mirror heads                | 52 |
| Chevron west coast mirror heads                 | 40 |
| Convex step van mirror heads                    | 67 |
| Custom light-duty west coast mirror assemblies  | 62 |
| Custom west coast mirror assemblies             | 46 |
| Economy west coast mirror heads                 | 39 |
| Grab handles                                    | 31 |
| Grille guard mounting systems                   | 20 |
| HighRise™ folding rear entry step               | 30 |
| Junior west coast mirror head                   | 62 |
| LED light bars                                  | 31 |
| LED work lights                                 | 31 |
| License plate bracket, MileStone™ bumper guards | 08 |
| License plate bracket, grille guards            | 21 |
| Light-duty mirror heads                         | 63 |
| Look-down convex mirror assemblies              | 57 |
| MagLatch™ grille guard mounting systems         | 20 |
| MileStone™ bumper guards                        | 06 |
| MileStone™ bumper guards, license plate bracket | 08 |
| MileStone™ bumper guards, light cage            | 08 |
| Mirror clamps                                   | 73 |

|   |    |
|---|----|
| Mirror gooseneck extension                      | 63 |
| Mirror J-brackets                               | 73 |
| Mirror loops                                    | 70 |
| Motorized west coast mirror heads               | 39 |
| OEM step van mirror assembly sets               | 66 |
| Off-road west coast mirror heads                | 37 |
| Offset-mount convex mirror heads                | 54 |
| Pedestal-mount mirror assemblies                | 38 |
| ProTec™ grille guards                           | 16 |
| ProTec Edge™ grille guard                       | 18 |
| Pyramid-back west coast mirror heads            | 42 |
| Rear view mirror                                | 63 |
| Rear-mount safety mirror assemblies             | 59 |
| Rectangular convex mirror heads                 | 56 |
| Rectangular convex utility mirror assembly      | 57 |
| Rib-back west coast mirror heads                | 41 |
| Safety mirror assemblies                        | 58 |
| Standard grille guard mounting systems          | 20 |
| Stick-on convex mirrors                         | 56 |
| Tuff Guard® grille guards                       | 10 |
| Tuff Guard® van grille guards                   | 26 |
| Tuff Guard® van mounting brackets               | 27 |
| Tuff Guard XT™ grille guards                    | 12 |
| Tuff Guard II™ grille guards                    | 14 |
| Universal cabover mirror assembly               | 47 |
| Universal conventional mirror assembly          | 47 |
| Universal light-duty mirror head with gooseneck | 63 |
| Universal step van mirror assembly set          | 66 |
| West coast conversion mounting kit              | 72 |
| West coast step van mirror heads                | 67 |

# TABLE OF CONTENTS

## HEAVY-DUTY GRILLE GUARDS

MileStone™ bumper guards, Tuff Guard®, Tuff Guard XT™, Tuff Guard II™, ProTec™, ProTec Edge™, accessories

04 - 27

## ACCESSORIES

HighRise™ folding rear entry step, LED lights, grab handles

28 - 31

## HEAVY-DUTY MIRRORS

Aerodynamic, off-road, west coast, custom and universal assemblies

32 - 47

## CONVEX & SAFETY MIRRORS

Aerodynamic, bubble, center and offset-mount, rectangular, stick-on, safety assemblies

48 - 59

## LIGHT-DUTY MIRRORS

Custom and universal assemblies, mirror heads, junior west coast, rear view

60 - 63

## STEP VAN MIRRORS

OEM and universal assembly sets, west coast and convex mirror heads, FedEx and USPS color-matching

64 - 67

## COMPONENT PARTS

Clamps, loops, J-brackets, stabilizers, braces, grab handles

68 - 73

## MARKETING SUPPORT

Literature, catalog, banners, retail signage, display stands

74 - 76



# HEAVY-DUTY GRILLE GUARDS

**DRIVING BUSINESS FORWARD**

Tuff Guard II™ on Peterbilt 567

## FEATURED PRODUCTS



### ProTec Edge™

Available in chrome or black bedliner finish, this grille guard contours to modern trucks and offers superior protection for the front end.



### MileStone™

With a low profile and optional integrated light cage, this guard offers enhanced road safety without obstructing the fold-down hood.



### Tuff Guard II™

With high-strength, overlapping, 14-gauge, stainless steel tubing, this guard is now available with 38° bends for greater vehicle coverage.

## PRODUCT INDEX

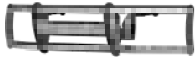

**06**  
MileStone™  
Bumper Guards



**08**  
MileStone™  
Light Cages



**09**  
LED Light Bars  
& Work Lights



**10**  
Tuff Guard®  
Grille Guards



**12**  
Tuff Guard XT™  
Grille Guards



**14**  
Tuff Guard II™  
Grille Guards



**16**  
ProTec™  
Grille Guards



**18**  
ProTec Edge™  
Grille Guards



**20**  
Grille Guard  
Brackets



**21**  
Grille Guard  
Accessories



**26**  
Tuff Guard® Van  
Grille Guards

# 3"

# MILESTONE™ BUMPER GUARDS

## Product Details

- Sleek, subtle design contours to the truck bumper for a streamlined fit
- Available with or without patented light cage and 30" LED light bar
- Integrated light bar for enhanced visibility and safety on the road
- Patented light cage keeps the light bar protected from theft and the elements
- Channel mount allows light bar to be adjusted and aligned unlike welded tabs
- Low profile for full under-the-hood access without needing to fold down the guard
- 3" diameter, 14-gauge stainless steel tubing for solid front-end protection
- 6mm upright plates provide enhanced strength and a highly secure mount
- Heavy-duty extruded rubber facings shield uprights against scuffs and scratches
- Easy installation with no drilling or front-end modification required
- Limited lifetime warranty (see last page for details)
- Patent# US9108581B2
- **See adjacent page for application information**



207800



208805

## Finishes & Materials



**Finish:**  
Polished  
stainless

**Material:**  
Stainless  
steel



**Finish:**  
Smooth  
black

**Material:**  
Stainless  
steel

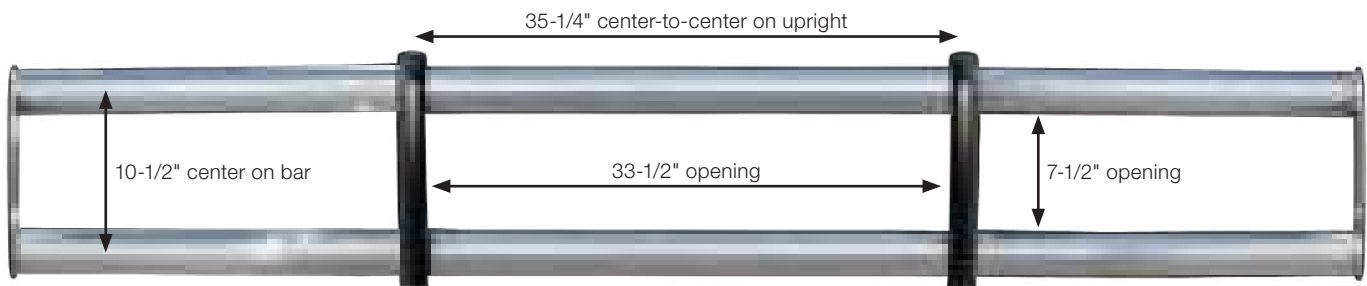





Volvo VNL 300

## MILESTONE™ BUMPER GUARD APPLICATION GUIDE

### MileStone™ Bumper Guards

| Make / Model         | Years   | Kit† (Guard, Brackets, Light Cage and Light Bar) |         | Guard & Brackets |        | Light Cage Only† |         | Light Bar Only* |
|----------------------|---------|--|---------|------------------|--------|------------------|---------|-----------------|
|                      |         | Polished#  | Black#  | Polished#        | Black# | Polished#        | Black#  | Light Bar#      |
| <b>Freightliner</b>  |         |  |         |                  |        |                  |         |                 |
| B2                   | 09 - 21 | 208775†  | 208770† | 207775           | 207770 | 207715†          | 207710† | 391264*         |
| M2 106               | 09 - 21 | 208775†  | 208770† | 207775           | 207770 | 207715†          | 207710† | 391264*         |
| New Cascadia         | 18 - 21 | 208805†  | 208800† | 207805           | 207800 | 207715†          | 207710† | 391264*         |
| <b>International</b> |         |  |         |                  |        |                  |         |                 |
| LT625                | 17 - 21 | 208755†  | 208750† | 207755           | 207750 | 207715†          | 207710† | 391264*         |
| ProStar              | 08 - 21 | 208755†  | 208750† | 207755           | 207750 | 207715†          | 207710† | 391264*         |
| <b>Volvo</b>         |         |  |         |                  |        |                  |         |                 |
| VNL                  | 04 - 21 | 208705†  | 208700† | 207705           | 207700 | 207715†          | 207710† | 391264*         |

\* LED light may require additional wire for proper installation

† Light cage is not compatible with VORAD systems



# MILESTONE™ BUMPER ACCESSORIES

## / Light Cages

- Compatible with all MileStone™ bumper guards
- Channel-style bracket accepts one or multiple light bars up to 30" in total length (see adjacent page for LED lights)
- Helps protect light bar from theft and the elements
- Non-corrosive stainless steel construction in two finish options
- Includes mounting hardware for bolting onto the guard

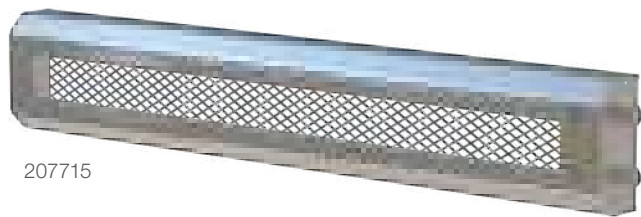

207715



207710

| Part#  | Inside Width | Inside Height | Inside Depth   | Finish       |
|--------|--------------|---------------|----------------|--------------|
| 207715 | 34-3/8"      | 4-1/4"        | 2" (open back) | Polished     |
| 207710 | 34-3/8"      | 4-1/4"        | 2" (open back) | Smooth black |

## / License Plate Bracket

- Easily bolts onto the crossbar, using included hardware
- Provides a solid mounting location to keep license plate visible
- Strong steel construction with a durable black powder coat finish
- Includes license plate mounting bolts



207735

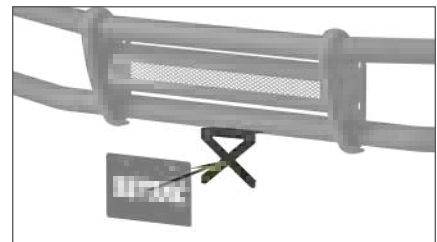

| Part#  | Includes                      | Finish                       |
|--------|-------------------------------|------------------------------|
| 207735 | Bracket and mounting hardware | Steel with black powder coat |



## / LED Light Bars & Work Lights

- Durable, painted, UV-resistant and mar-resistant finish
- Advanced optics system reduces wasted light for 96% reflector efficiency
- Dual, oversize heat sinks maintain low, efficient running temperatures
- Instant on-off requires no warmup time
- 50,000+ hours average lifespan for five years of continuous use
- Passes CE, RoHS, UV, extreme temperature, vibration, dust and salt testing
- Operates in temperatures from -40°F up to 145°F for extreme conditions
- Fitted with a strong, waterproof wiring harness for a reliable connection
- Includes stainless steel screws and a pivoting bracket for custom angling
- Limited lifetime warranty (see last page for details)



Constructed with grade-A, LED chips for superior quality



Rust-free aluminum housing with rugged, crack-resistant Lexan lens



IP68 and IP69K waterproof and dustproof ratings keep water and air from getting inside



391252



391262

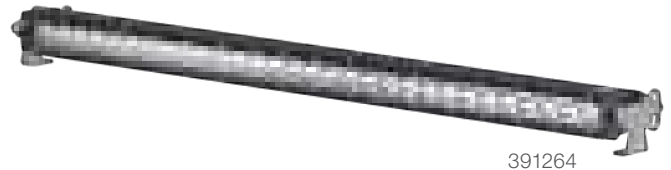

391264

| Part#  | Light Type | Configuration       | Light Size | Beam  | Lumens |
|--------|------------|---------------------|------------|-------|--------|
| 391252 | Work light | Square (set of two) | 2"         | Spot  | 2,200  |
| 391262 | Light bar  | Single-row          | 20"        | Combo | 9,800  |
| 391264 | Light bar  | Single-row          | 30"        | Combo | 14,800 |

# 3"

# TUFF GUARD® GRILLE GUARDS

## Product Details

- 3" diameter, 14-gauge stainless steel tubing for added vehicle protection
- Compatible with VORAD systems and fog lights
- Compatible with standard latch or MagLatch™ brackets (both sold separately, see page 20)
- Versatile design fits multiple heavy-duty trucks (brackets vehicle-specific)
- Folds down for convenient access under the hood
- Easy installation with no drilling or front-end modification required
- Limited lifetime warranty (see last page for details)
- See page 22 for application information



## Finishes & Materials

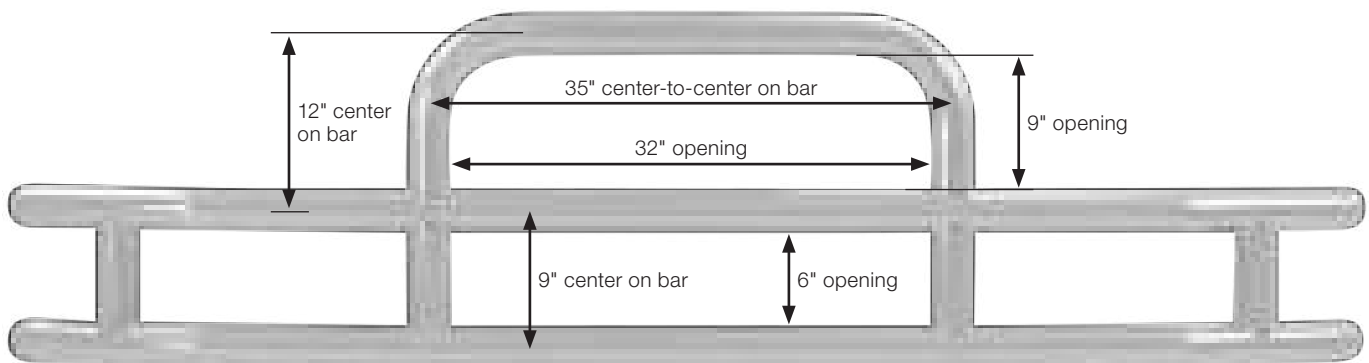
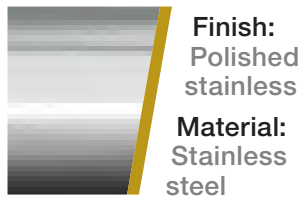



Kenworth W900



Volvo VNL 760

# 3"

# TUFF GUARD XT™ GRILLE GUARDS

## Product Details

- 3" diameter, 14-gauge stainless steel tubing for added vehicle protection
- Taller frame allows compatibility with VORAD systems and fog lights on select applications
- Compatible with standard latch or MagLatch™ brackets (both sold separately, see page 20)
- Versatile design fits multiple heavy-duty trucks (brackets vehicle-specific)
- Folds down for convenient access under the hood
- Easy installation with no drilling or front-end modification required
- Limited lifetime warranty (see last page for details)
- See page 22 for application information

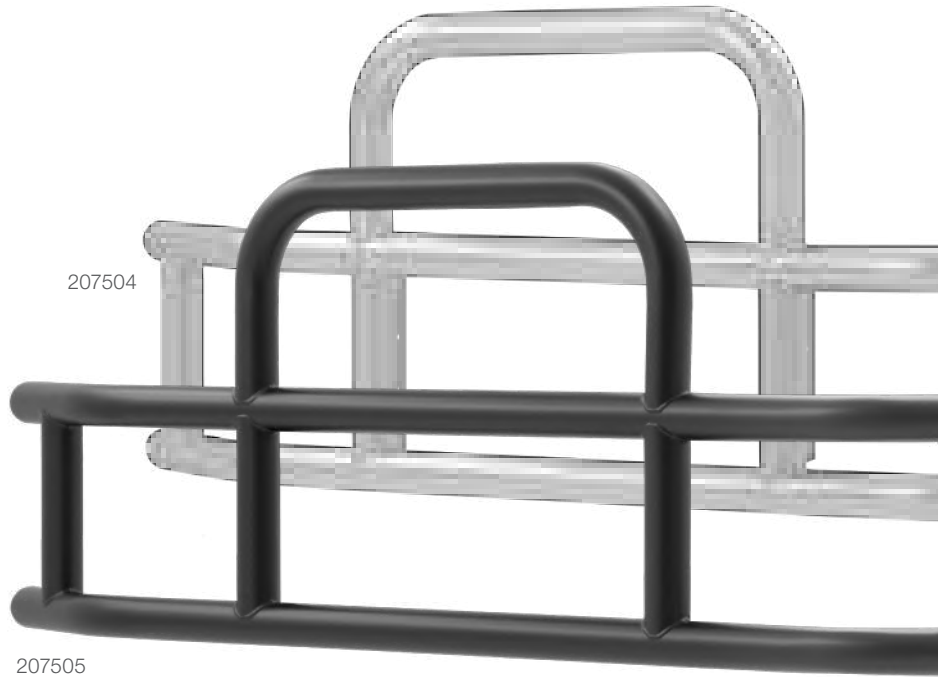

## Finishes & Materials

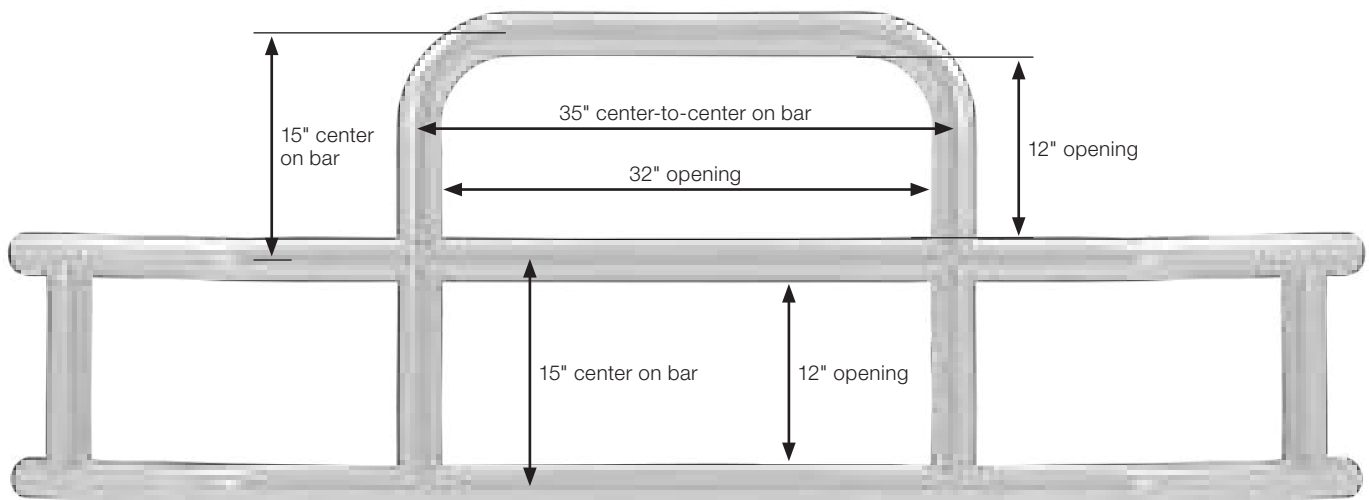
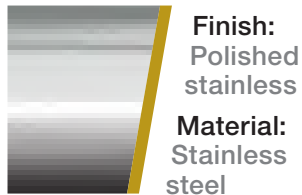
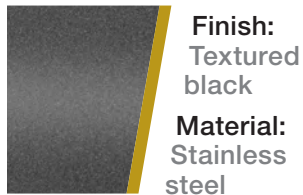



Freightliner Cascadia



Hino 268

# 3"

# TUFF GUARD II™ GRILLE GUARDS

## Product Details

- **NEW guard with 38° bend to better fit modern, aerodynamic trucks**
- 3" diameter, 14-gauge stainless steel tubing for added vehicle protection
- Welded, overlapping tube layout for enhanced strength
- Compatible with VORAD systems and fog lights
- Compatible with standard latch or MagLatch™ brackets (both sold separately, see page 20)
- Versatile design fits multiple heavy-duty trucks (brackets vehicle-specific)
- Folds down for convenient access under the hood
- Easy installation with no drilling or front-end modification required
- Limited lifetime warranty (see last page for details)
- **See page 22 for application information**

**NEW**



## Finishes & Materials



**Finish:**  
Textured black  
**Material:**  
Stainless steel



**Finish:**  
Polished stainless  
**Material:**  
Stainless steel

## Did You Know?

Tuff Guard II™ is available in two configurations: 15° bend for older trucks and 38° for modern, aerodynamic trucks.



**NEW**

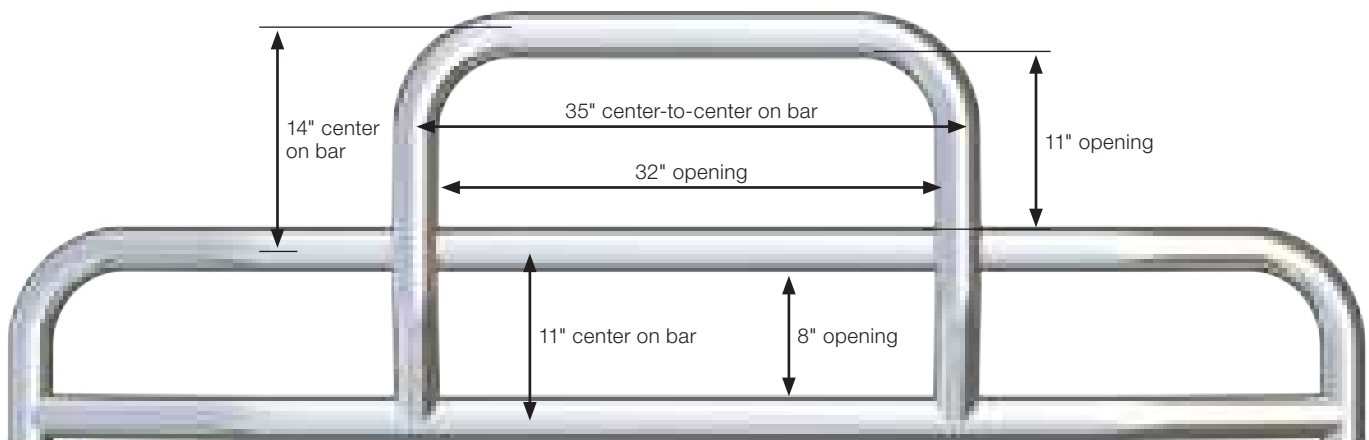





Volvo VNL 860

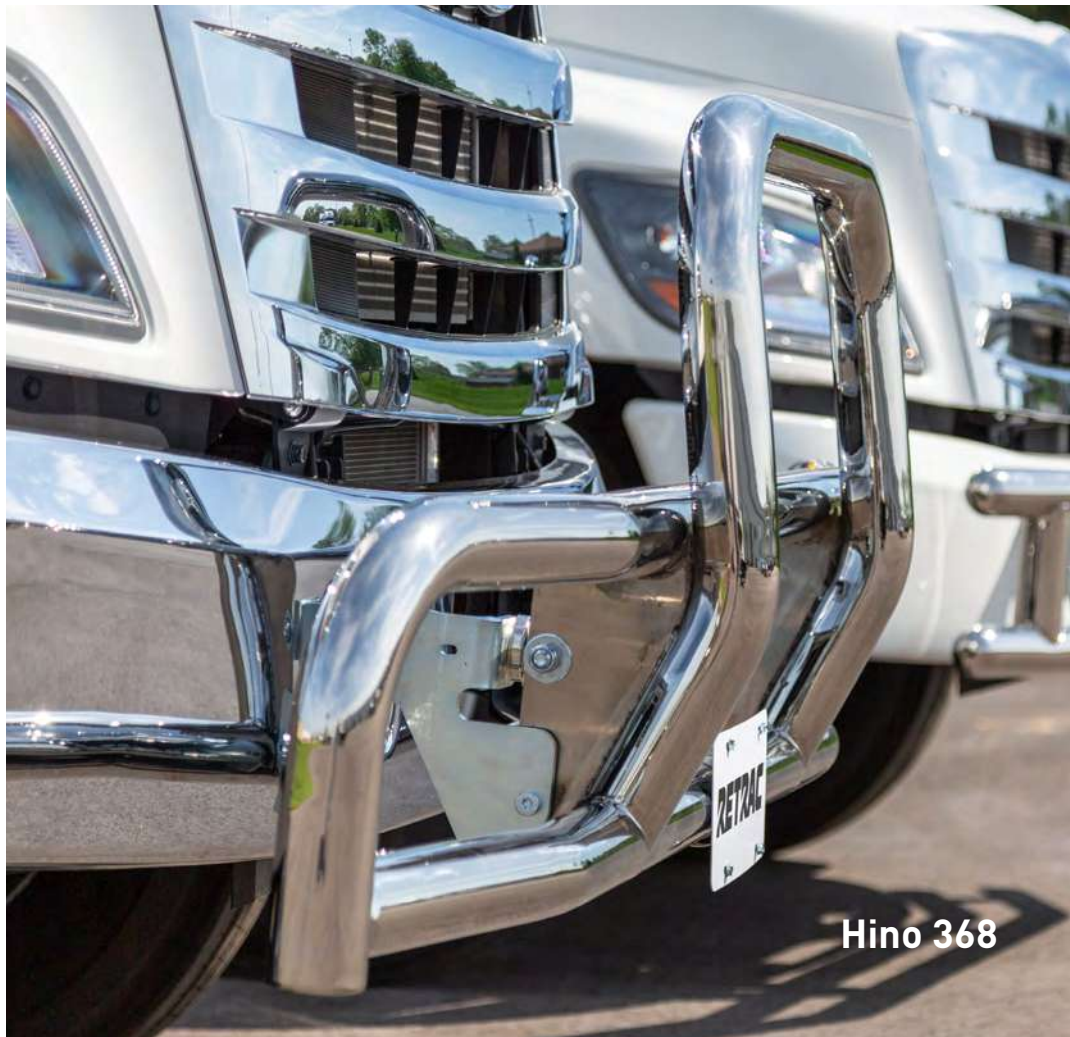

Hino 368

# 3"

# PROTEC™ GRILLE GUARDS

## Product Details

- 3" diameter, 14-gauge stainless steel tubing for added vehicle protection (11-gauge for carbon steel)
- Welded, double-stacked layout protects bumper, grille and lights
- Compatible with VORAD systems and fog lights
- Compatible with standard latch or MagLatch™ brackets (both sold separately, see page 20)
- Versatile design fits multiple heavy-duty trucks (brackets vehicle-specific)
- Folds down for convenient access under the hood
- Easy installation with no drilling or front-end modification required
- Limited lifetime warranty (see last page for details)
- **See page 22 for application information**

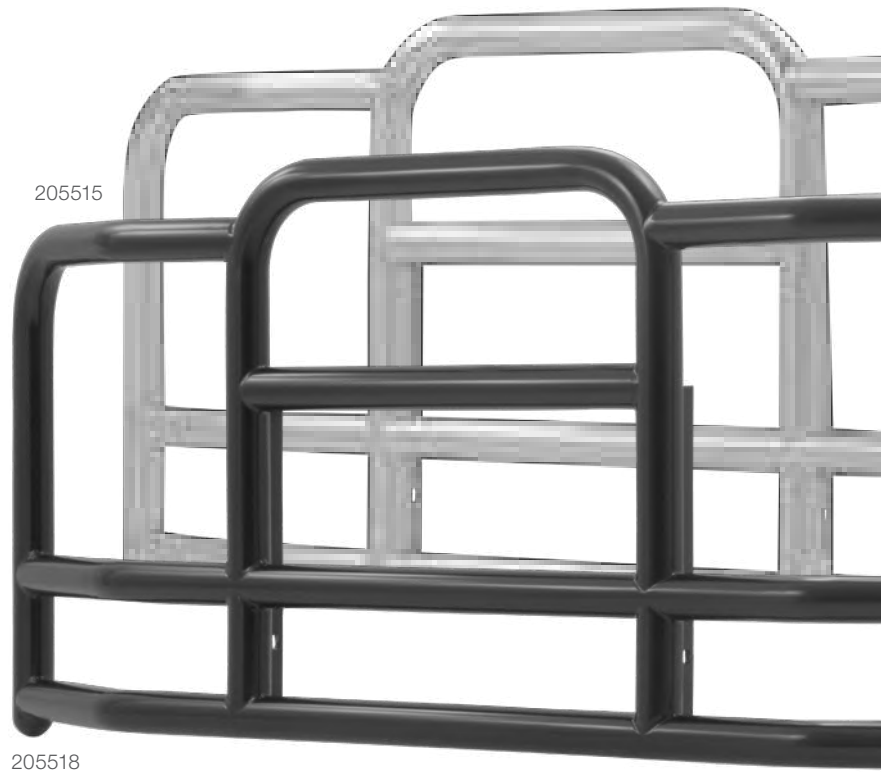

## Finishes & Materials

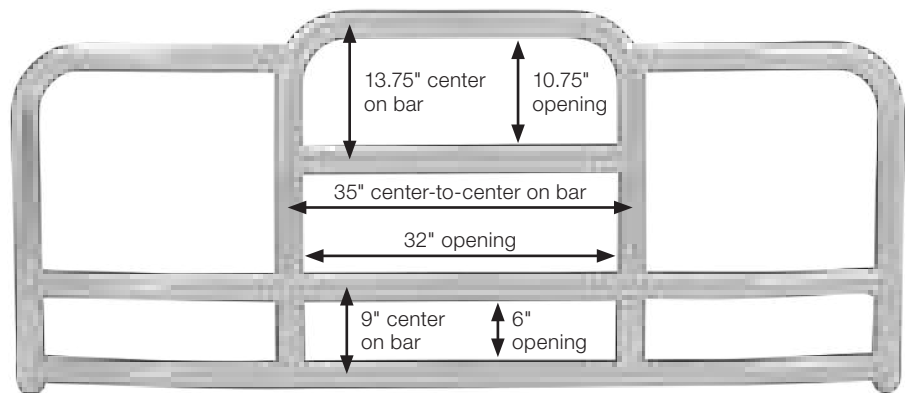
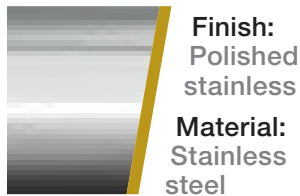
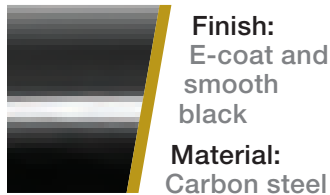



**Kenworth W900**



**Freightliner Cascadia**



# 2 1/2"

# PROTEC EDGE™ GRILLE GUARDS

## Product Details

- 2-1/2" diameter, 14-gauge steel tubing for solid front-end strength
- Contoured design follows body lines of modern aerodynamic trucks
- Multiple crossbars and curved sides provide superior protection
- Textured, bedliner-type finish with E-coat for exceptional corrosion resistance (also available in polished stainless steel)
- Compatible with standard latch or MagLatch™ brackets (both sold separately, see page 20)
- Versatile design fits multiple heavy-duty trucks (brackets vehicle-specific)
- Compatible with VORAD systems and fog lights (most applications)
- Folds down for convenient access under the hood
- Easy installation with no drilling or front-end modification required
- Limited lifetime warranty (see last page for details)
- **See page 22 for application information**



207520

## Finishes & Materials

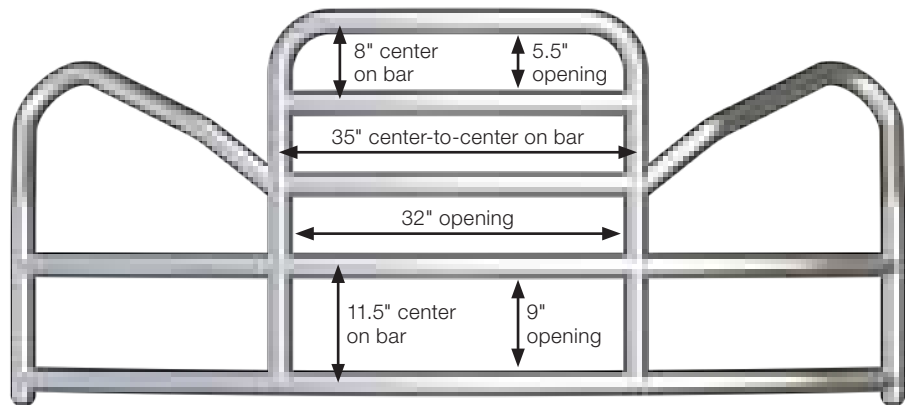
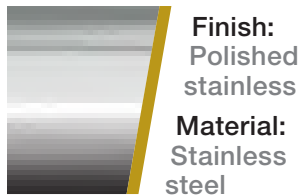



Peterbilt 579



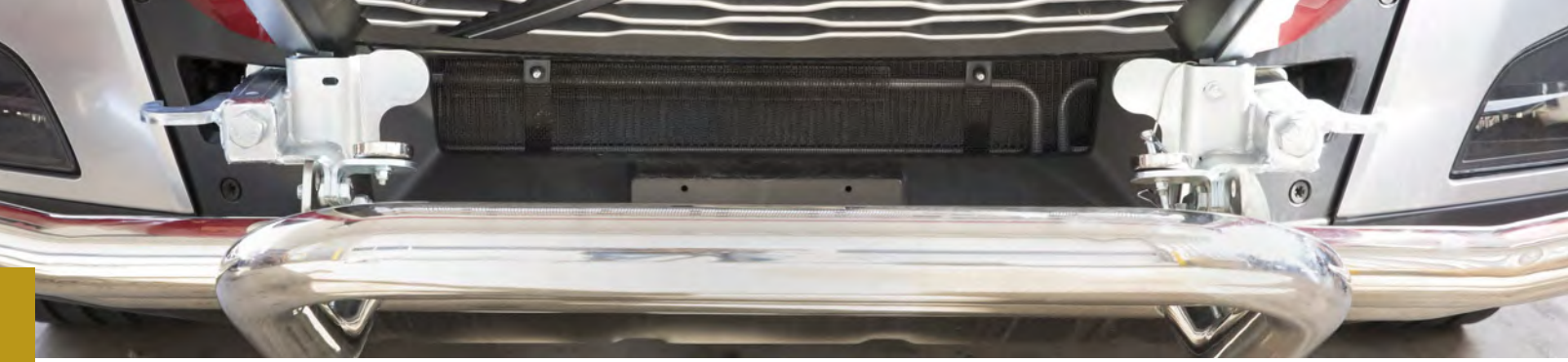

# GRILLE GUARD BRACKETS

See page 22 for application information

## / MagLatch™ Brackets

- Vehicle-specific design with built-in adjustments for an easy, secure, no-drill install
- Fold-down latches use rare-earth magnets to secure grille guard upright
- Included safety pin adds security (see below)
- High-strength steel build with a zinc-plated finish
- Patent# 9,505,364

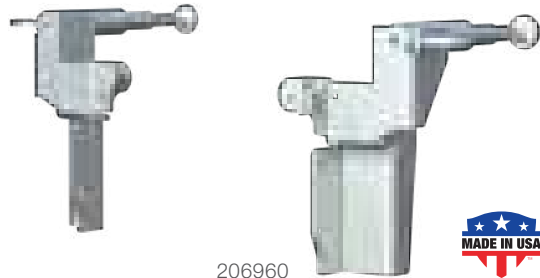

206960

## / MagLatch™ Safety Pins

- Adds security to MagLatch™ bracket magnets while maintaining simple operation
- Zinc-plated finish for lasting rust resistance



206492

206494



Pin adds security to the magnetic system

| Part#  | Description                   |
|--------|-------------------------------|
| 206492 | Short latch                   |
| 206494 | Long latch (only fits 206840) |

## / Standard Brackets

- Vehicle-specific design for secure, no-drill install
- Fold-down latches use rubber bushings and T-handle locks to secure grille guard upright
- High-strength steel build with a zinc-plated finish

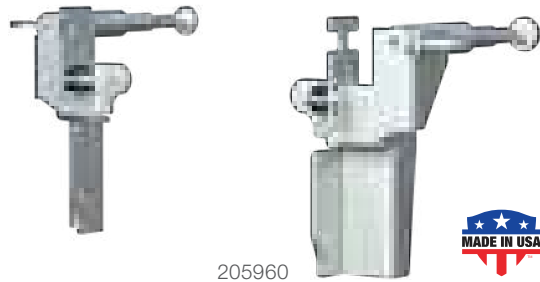

205960

## / Mounting Bracket Spacer Kit

- For select trucks with all-metal bumpers
- Spaces out grille guard mounting brackets for bumper clearance

| Part#  | Includes     | Finish            |
|--------|--------------|-------------------|
| 205696 | Four spacers | Zinc-plated steel |



205696



# GRILLE GUARD ACCESSORIES

## / License Plate Bracket

- Universal design fits any RETRAC heavy-duty grille guard
- Provides a solid mounting point to keep license plate visible
- High-strength carbon steel construction with a durable black powder coat finish
- Includes license plate bracket and mounting hardware

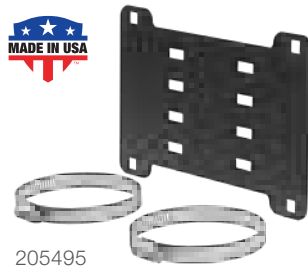

| Part#  | Finish                              |
|--------|-------------------------------------|
| 205495 | Carbon steel with black powder coat |

## / 3" Accessory Mounting Tabs

- Fits most RETRAC grille guards or any 3" diameter tube (does not fit ProTec Edge™)
- 14mm hole for mounting lights, license plate bracket or other accessories
- Rust-free, powder-coated cast aluminum construction
- Includes two tabs and mounting hardware

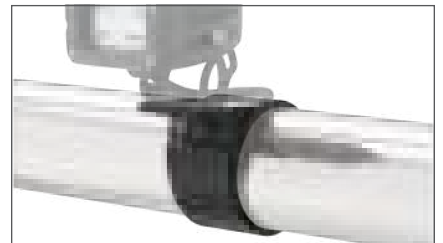
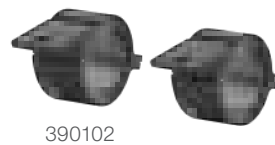

| Part#  | Fits              | Finish                          |
|--------|-------------------|---------------------------------|
| 390102 | 3" diameter tubes | Aluminum with black powder coat |

# APPLICATION GUIDE

## Heavy-Duty Grille Guards & Brackets

| Make / Model         | Style / Notes                   | Years   | Footnotes | Brackets Only |           |
|----------------------|---------------------------------|---------|-----------|---------------|-----------|
|                      |                                 |         |           | MagLatch™#    | Standard# |
| <b>Freightliner</b>  |                                 |         |           |               |           |
| B2                   | All                             | 09 - 21 | --        | 206220        | --        |
| Business Class M2    | All                             | 09 - 12 | --        | 206220        | --        |
| Cascadia             | Excluding 505 HP or larger      | 08 - 21 | --        | 206760        | 205760    |
| Classic              | All                             | 01 - 11 | --        | --            | 205560    |
| Columbia             | Painted 3-piece standard bumper | 01 - 21 | --        | --            | 205600    |
| Coronado             | Glider                          | 01 - 21 | --        | 206120        | --        |
|                      | SD, forward set axle            | 10 - 21 | --        | 206140        | --        |
|                      | SD, rearward set axle           | 10 - 21 | --        | 206160        | --        |
| M2 106               | All                             | 09 - 21 | --        | 206220        | --        |
| M2 112               | All                             | 09 - 21 | --        | 206220        | --        |
| New Cascadia         | Excluding fog lights            | 18 - 21 | --        | 206940        | 205940    |
|                      | Excluding radar                 | 18 - 21 | --        | 206960        | 205960    |
|                      | With fog lights and radar       | 18 - 21 | --        | 206960        | 205960    |
| <b>Hino</b>          |                                 |         |           |               |           |
| 238                  | Excludes extended bumper        | 10 - 14 | --        | 206200        | --        |
| 258                  | Excludes extended bumper        | 10 - 21 | --        | 206200        | --        |
| 268                  | Excludes extended bumper        | 10 - 21 | --        | 206200        | --        |
| 338                  | Excludes extended bumper        | 10 - 21 | --        | 206200        | --        |
| <b>International</b> |                                 |         |           |               |           |
| 4400                 | All                             | 02 - 21 | --        | --            | 205740    |
| 8600 TranStar        | All                             | 08 - 18 | --        | --            | 205740    |
| 9200 SBA             | All                             | 97 - 00 | --        | 206580        | 205580*   |
| 9200i SBA            | All                             | 00 - 11 | --        | 206580        | 205580*   |
| 9400                 | All                             | 97 - 00 | --        | 206580        | 205580*   |
| 9400i SBA            | All                             | 00 - 11 | --        | 206580        | 205580*   |
| 9900                 | All                             | 99 - 00 | --        | 206100        | --        |
| 9900i                | Excluding fog lights            | 00 - 18 | --        | 206580        | 205580*   |
|                      | With fog lights                 | 00 - 18 | --        | 206100        | --        |
| 9900i SFA            | Excluding fog lights            | 00 - 03 | --        | 206580        | 205580*   |
| 9900ix               | Excluding fog lights            | 00 - 09 | --        | 206580        | 205580*   |
| 9900ix SFA           | Excluding fog lights            | 01 - 03 | --        | 206580        | 205580*   |
| Durastar             | All                             | 13 - 13 | --        | --            | 205740    |
| LT625                | All                             | 17 - 21 | 1         | 206695        | 205695    |
| MV607                | All                             | 19 - 21 | --        | --            | 205740    |
| ProStar              | All                             | 08 - 21 | 1         | 206695        | 205695    |
| <b>Kenworth</b>      |                                 |         |           |               |           |
| T600A                | All                             | 88 - 07 | --        | --            | 205660    |
| T660                 | All                             | 08 - 19 | --        | 206720        | 205720    |
| T680                 | All                             | 13 - 21 | --        | 206840        | 205840    |
| T700                 | All                             | 11 - 15 | --        | 206840        | 205840    |
| T800                 | All                             | 87 - 21 | --        | 206540        | --        |
| T880                 | All                             | 14 - 21 | --        | 206540        | --        |
| W900                 | Excluding four-bolt bumper      | 82 - 21 | --        | 206640        | --        |
| W990                 | All                             | 19 - 21 | --        | 206660        | --        |

1. All metal bumpers require kit #205696

\* Continued while supplies last



|  | Tuff Guard® Guard Only# |        | Tuff Guard XT™ Guard Only# |        | Tuff Guard II™ Guard Only# |        | ProTec™ Guard Only# |        | ProTec Edge™ Guard Only# |                      |
|--|-------------------------|--------|----------------------------|--------|----------------------------|--------|---------------------|--------|--------------------------|----------------------|
|  | Polished#               | Black# | Polished#                  | Black# | Polished#                  | Black# | Polished#           | Black# | Polished#                | Black#               |
|  |                         |        |                            |        |                            |        |                     |        |                          | <b>Freightliner</b>  |
|  | 205504                  | 205505 | 207504                     | 207505 | 206525                     | 206526 | 205517              | 205518 | --                       | --                   |
|  | 205504                  | 205505 | 207504                     | 207505 | 206510                     | 206511 | 205517              | 205518 | --                       | --                   |
|  | 205504                  | 205505 | --                         | --     | 206525                     | 206526 | 205517              | 205518 | --                       | --                   |
|  | 205500                  | 205501 | --                         | --     | 206510                     | 206511 | 205515              | 205516 | --                       | --                   |
|  | 205500                  | 205501 | --                         | --     | 206510                     | 206511 | 205515              | 205516 | --                       | --                   |
|  | 205500                  | 205501 | --                         | --     | 206510                     | 206511 | 205515              | 205516 | --                       | --                   |
|  | 205500                  | 205501 | --                         | --     | 206510                     | 206511 | 205515              | 205516 | --                       | --                   |
|  | 205504                  | 205505 | 207504                     | 207505 | 206525                     | 206526 | 205517              | 205518 | --                       | --                   |
|  | 205504                  | 205505 | 207504                     | 207505 | 206525                     | 206526 | 205517              | 205518 | --                       | --                   |
|  | 205504                  | 205505 | --                         | --     | 206525                     | 206526 | 205517              | 205518 | 207525                   | 207520               |
|  | --                      | --     | --                         | --     | 206525                     | 206526 | 205517              | 205518 | --                       | --                   |
|  | --                      | --     | 207504                     | 207505 | --                         | --     | --                  | --     | --                       | --                   |
|  |                         |        |                            |        |                            |        |                     |        |                          | <b>Hino</b>          |
|  | 205504                  | 205505 | --                         | --     | 206525                     | 206526 | 205517              | 205518 | --                       | --                   |
|  | 205504                  | 205505 | --                         | --     | 206525                     | 206526 | 205517              | 205518 | --                       | --                   |
|  | 205504                  | 205505 | --                         | --     | 206525                     | 206526 | 205517              | 205518 | --                       | --                   |
|  | 205504                  | 205505 | --                         | --     | 206525                     | 206526 | 205517              | 205518 | --                       | --                   |
|  |                         |        |                            |        |                            |        |                     |        |                          | <b>International</b> |
|  | 205504                  | 205505 | --                         | --     | 206510                     | 206511 | 205515              | 205516 | --                       | --                   |
|  | 205504                  | 205505 | --                         | --     | 206525                     | 206526 | 205517              | 205518 | --                       | --                   |
|  | 205500                  | 205501 | --                         | --     | 206510                     | 206511 | 205515              | 205516 | --                       | --                   |
|  | 205500                  | 205501 | --                         | --     | 206510                     | 206511 | 205515              | 205516 | --                       | --                   |
|  | 205500                  | 205501 | --                         | --     | 206510                     | 206511 | 205515              | 205516 | --                       | --                   |
|  | 205500                  | 205501 | --                         | --     | 206510                     | 206511 | 205515              | 205516 | --                       | --                   |
|  | 205500                  | 205501 | --                         | --     | 206510                     | 206511 | 205515              | 205516 | --                       | --                   |
|  | 205500                  | 205501 | --                         | --     | 206510                     | 206511 | 205515              | 205516 | --                       | --                   |
|  | 205500                  | 205501 | --                         | --     | 206510                     | 206511 | 205515              | 205516 | --                       | --                   |
|  | 205500                  | 205501 | --                         | --     | 206510                     | 206511 | 205515              | 205516 | --                       | --                   |
|  | 205504                  | 205505 | --                         | --     | 206525                     | 206526 | 205517              | 205518 | --                       | --                   |
|  | 205504                  | 205505 | 207504                     | 207505 | 206525                     | 206526 | 205517              | 205518 | 207525                   | 207520               |
|  | 205504                  | 205505 | --                         | --     | 206510                     | 206511 | 205517              | 205518 | --                       | --                   |
|  | 205504                  | 205505 | 207504                     | 207505 | 206525                     | 206526 | 205517              | 205518 | 207525                   | 207520               |
|  |                         |        |                            |        |                            |        |                     |        |                          | <b>Kenworth</b>      |
|  | 205504                  | 205505 | --                         | --     | 206525                     | 206526 | 205517              | 205518 | --                       | --                   |
|  | 205504                  | 205505 | --                         | --     | 206525                     | 206526 | 205517              | 205518 | --                       | --                   |
|  | 205504                  | 205505 | --                         | --     | 206525                     | 206526 | 205517              | 205518 | 207525                   | 207520               |
|  | 205504                  | 205505 | --                         | --     | 206525                     | 206526 | 205517              | 205518 | 207525                   | 207520               |
|  | 205500                  | 205501 | 207504                     | 207505 | 206510                     | 206511 | 205515              | 205516 | 207525                   | 207520               |
|  | 205500                  | 205501 | 207504                     | 207505 | 206510                     | 206511 | 205515              | 205516 | 207525                   | 207520               |
|  | 205500                  | 205501 | --                         | --     | 206510                     | 206511 | 205515              | 205516 | --                       | --                   |
|  | 205500                  | 205501 | --                         | --     | 206510                     | 206511 | 205515              | 205516 | --                       | --                   |

Applications continued on the following page

# APPLICATION GUIDE

## Heavy-Duty Grille Guards & Brackets

| Make / Model        | Style / Notes  | Years   | Footnotes | Brackets Only |           |
|---------------------|--|---------|-----------|---------------|-----------|
|                     |  |         |           | MagLatch™#    | Standard# |
| <b>Mack</b>         |  |         |           |               |           |
| Anthem              | High mount brackets                                  | 18 - 21 | --        | 206980        | --        |
|                     | Excluding all metal bumper (standard mount brackets) | 18 - 21 | --        | 206990        | --        |
| CHU                 | Excluding fog lights                                 | 08 - 19 | --        | 206880        | 205880    |
|                     | With fog lights                                      | 08 - 19 | --        | 206780        | 205780    |
| CXU                 | Steel bumper with plastic end caps, excl. fog lights | 08 - 19 | --        | 206880        | 205880    |
|                     | Steel bumper with plastic end caps, with fog lights  | 08 - 19 | --        | 206780        | 205780    |
| <b>Peterbilt</b>    |  |         |           |               |           |
| 378                 | Excluding kick back bumper                           | 88 - 07 | --        | --            | 205520    |
|                     | With kick back bumper                                | 88 - 07 | --        | --            | 205520    |
| 379                 | All  | 87 - 09 | --        | --            | 205520    |
| 386                 | All  | 06 - 16 | --        | 206720        | 205720    |
| 388                 | Excluding fog lights                                 | 08 - 15 | --        | 206820        | --        |
| 389                 | Excluding fog lights                                 | 08 - 21 | --        | 206820        | --        |
| 567                 | SD forward set axle, excluding fog lights            | 14 - 21 | --        | 206820        | --        |
| 579                 | All  | 13 - 21 | --        | 206840        | 205840    |
| 587                 | All  | 11 - 18 | --        | 206720        | 205720    |
| <b>Volvo</b>        |  |         |           |               |           |
| VNL                 | Excluding fog lights                                 | 18 - 21 | --        | 206180        | --        |
|                     | With fog lights                                      | 18 - 21 | --        | 206180        | --        |
|                     | All  | 04 - 17 | --        | 206620        | 205620    |
| VNM                 | All  | 04 - 18 | --        | 206620        | 205620    |
| VNR                 | Excluding fog lights                                 | 18 - 21 | --        | 206180        | --        |
|                     | With fog lights                                      | 18 - 21 | --        | 206180        | --        |
| VNX                 | All  | 15 - 21 | --        | 206620        | 205620    |
| VT                  | All  | 06 - 10 | --        | 206620        | 205620    |
| <b>Western Star</b> |  |         |           |               |           |
| 4900SB              | Rearward set axle                                    | 11 - 21 | --        | --            | 205900*   |
| 5700XE              | Excluding fog lights                                 | 16 - 21 | --        | 206940        | 205940    |
|                     | Excluding radar                                      | 16 - 21 | --        | 206940        | 205940    |
|                     | With fog lights                                      | 16 - 21 | --        | 206960        | 205960    |
|                     | With fog lights and radar (high mount brackets)      | 16 - 21 | --        | 206940        | 205940    |
|                     | With fog lights and radar (low mount brackets)       | 16 - 21 | --        | 206940        | 205940    |
|                     | With radar   | 16 - 21 | --        | 206960        | 205960    |

1. All metal bumpers require kit #205696

\*Continued while supplies last

|                     | Tuff Guard® Guard Only# |        | Tuff Guard XT™ Guard Only# |        | Tuff Guard II™ Guard Only# |        | ProTec™ Guard Only# |        | ProTec Edge™ Guard Only# |        |
|---------------------|-------------------------|--------|----------------------------|--------|----------------------------|--------|---------------------|--------|--------------------------|--------|
|                     | Polished#               | Black# | Polished#                  | Black# | Polished#                  | Black# | Polished#           | Black# | Polished#                | Black# |
| <b>Mack</b>         |                         |        |                            |        |                            |        |                     |        |                          |        |
|                     | 205504                  | 205505 | --                         | --     | 206525                     | 206526 | 205517              | 205518 | --                       | --     |
|                     | 205504                  | 205505 | --                         | --     | 206525                     | 206526 | 205517              | 205518 | --                       | --     |
|                     | 205504                  | 205505 | --                         | --     | 206525                     | 206526 | 205517              | 205518 | --                       | --     |
|                     | 205504                  | 205505 | --                         | --     | 206525                     | 206526 | 205517              | 205518 | --                       | --     |
|                     | 205504                  | 205505 | --                         | --     | 206525                     | 206526 | 205517              | 205518 | --                       | --     |
|                     | 205504                  | 205505 | --                         | --     | 206525                     | 206526 | 205517              | 205518 | --                       | --     |
| <b>Peterbilt</b>    |                         |        |                            |        |                            |        |                     |        |                          |        |
|                     | 205500                  | 205501 | --                         | --     | 206510                     | 206511 | 205515              | 205516 | --                       | --     |
|                     | 205504                  | 205505 | --                         | --     | 206525                     | 206526 | 205517              | 205518 | --                       | --     |
|                     | 205500                  | 205501 | --                         | --     | 206510                     | 206511 | 205515              | 205516 | --                       | --     |
|                     | 205504                  | 205505 | --                         | --     | 206525                     | 206526 | 205517              | 205518 | --                       | --     |
|                     | 205500                  | 205501 | --                         | --     | 206510                     | 206511 | 205515              | 205516 | --                       | --     |
|                     | 205500                  | 205501 | --                         | --     | 206510                     | 206511 | 205515              | 205516 | --                       | --     |
|                     | 205500                  | 205501 | --                         | --     | 206510                     | 206511 | 205515              | 205516 | --                       | --     |
|                     | 205504                  | 205505 | --                         | --     | 206525                     | 206526 | 205517              | 205518 | 207525                   | 207520 |
|                     | 205504                  | 205505 | --                         | --     | 206510                     | 206511 | 205517              | 205518 | --                       | --     |
| <b>Volvo</b>        |                         |        |                            |        |                            |        |                     |        |                          |        |
|                     | 205504                  | 205505 | --                         | --     | 206525                     | 206526 | 205517              | 205518 | 207525                   | 207520 |
|                     | --                      | --     | --                         | --     | 206525                     | 206526 | 205517              | 205518 | 207525                   | 207520 |
|                     | 205500                  | 205501 | --                         | --     | 206510                     | 206511 | 205515              | 205516 | 207525                   | 207520 |
|                     | 205500                  | 205501 | --                         | --     | 206510                     | 206511 | 205515              | 205516 | 207525                   | 207520 |
|                     | 205504                  | 205505 | --                         | --     | 206510                     | 206511 | 205515              | 205516 | --                       | --     |
|                     | --                      | --     | --                         | --     | 206510                     | 206511 | 205515              | 205516 | --                       | --     |
|                     | 205500                  | 205501 | --                         | --     | 206510                     | 206511 | 205515              | 205516 | 207525                   | 207520 |
|                     | 205500                  | 205501 | --                         | --     | 206510                     | 206511 | 205515              | 205516 | 207525                   | 207520 |
| <b>Western Star</b> |                         |        |                            |        |                            |        |                     |        |                          |        |
|                     | 205504                  | 205505 | --                         | --     | 206525                     | 206526 | 205517              | 205518 | --                       | --     |
|                     | 205504                  | 205505 | --                         | --     | 206525                     | 206526 | 205517              | 205518 | 207525                   | 207520 |
|                     | --                      | --     | --                         | --     | 206525                     | 206526 | 205517              | 205518 | --                       | --     |
|                     | --                      | --     | --                         | --     | --                         | --     | --                  | --     | 207525                   | 207520 |
|                     | --                      | --     | --                         | --     | --                         | --     | --                  | --     | 207525                   | 207520 |
|                     | --                      | --     | 207504                     | 207505 | --                         | --     | --                  | --     | --                       | --     |
|                     | --                      | --     | --                         | --     | --                         | --     | --                  | --     | 207525                   | 207520 |

# 3"

# TUFF GUARD® VAN GRILLE GUARDS



## Product Details

- Durable, textured black powder coat for a sleek, professional finish
- Solid, bolt-on installation using pre-existing mounting points (some models may require minor drilling into plastic)
- High-strength steel mounting brackets with a durable black powder coat finish
- Limited lifetime warranty (see last page for details)
- See adjacent page for application information



205530

## Key Features



Provides a professional look and long-lasting front-end protection for commercial vans



Powder-coated stainless steel construction for maximum corrosion resistance



3" diameter, 14-gauge stainless steel tube design for added vehicle protection

## Finish & Material

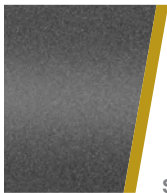

**Finish:**  
Textured black

**Material:**  
Stainless steel

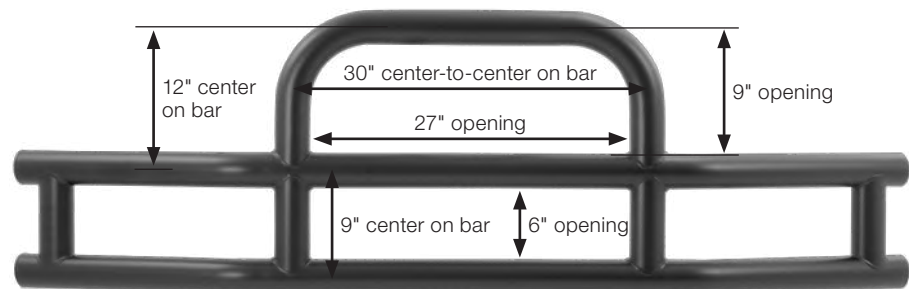

## / 3" Accessory Mounting Tabs

- Fits RETRAC Tuff Guard® or any 3" diameter tube
- 14mm hole for mounting lights, license plate bracket or other accessories
- Rust-free, powder-coated cast aluminum construction
- Includes two tabs and mounting hardware

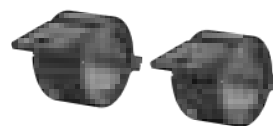

390103

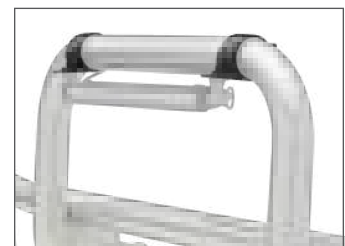

| Part#  | Fits              | Finish                          |
|--------|-------------------|---------------------------------|
| 390102 | 3" diameter tubes | Aluminum with black powder coat |



## TUFF GUARD® VAN APPLICATION GUIDE

### Tuff Guard® Van Grille Guard and Mounting Brackets

| Make / Model                 | Years   | Foot Notes | Guard Only# | Brackets Only# |
|------------------------------|---------|------------|-------------|----------------|
| <b>Dodge</b>                 |         |            |             |                |
| Sprinter 2500 / 3500         | 07 - 09 | --         | 205530      | 205860*        |
| <b>Ford</b>                  |         |            |             |                |
| Transit 150 / 250 / 350      | 15 - 21 | 1          | 205530      | 205920         |
| <b>Freightliner</b>          |         |            |             |                |
| Sprinter 2500 / 3500         | 14 - 17 | 1          | 205530      | 205930         |
|                              | 07 - 13 | --         | 205530      | 205860*        |
| <b>Mercedes-Benz</b>         |         |            |             |                |
| Sprinter 2500 / 3500         | 14 - 17 | 1          | 205530      | 205930         |
|                              | 10 - 13 | --         | 205530      | 205860*        |
| <b>Ram</b>                   |         |            |             |                |
| ProMaster 1500 / 2500 / 3500 | 14 - 21 | --         | 205530      | 205910         |

1. Will interfere with parking sensors

\* Continued while supplies last



# ACCESSORIES

**DRIVING BUSINESS FORWARD**

HighRise™ folding rear entry step

## FEATURED PRODUCTS



### HighRise™ folding rear step

For safer, easier access to the trailer, HighRise™ bolts onto the 4" bumper and has an auto-stowing design to prevent damage when backing up.



### LED lights

Our LED light bars and work lights feature grade-A LED chips, an IP68 breather, a waterproof aluminum build and a 50,000+ hour lifespan.



### Grab handles

These handles provide a sturdy hold for climbing up into the truck or trailer. They are made from stainless steel and come in multiple lengths.

## PRODUCT INDEX

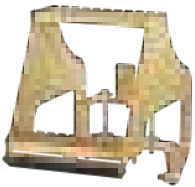

**30**  
HighRise™  
Folding Step



**31**  
LED Light Bars  
& Work Lights



**31**  
Grab  
Handles

# HIGHRISE™ FOLDING REAR ENTRY STEP

**NEW**

## Product Details

- Auto-stowing polyurethane roller mechanism prevents damage when backing up
- Ergonomic design reduces strain and promotes worker health and wellness
- Easier rear access increases speed and efficiency on the job
- Counter-balanced design keeps step in stowed position during travel
- Fits 4" bumper beam on most semi trailers, box trucks and flat decks
- 600-pound work load limit
- High-strength 7-gauge steel construction
- Quick, easy, 4-bolt installation in minutes
- Limited lifetime warranty (see last page for details)
- Patent pending



409924

## Improves safety and trailer accessibility



Greatly enhances safety for climbing in and out of the trailer or cargo area

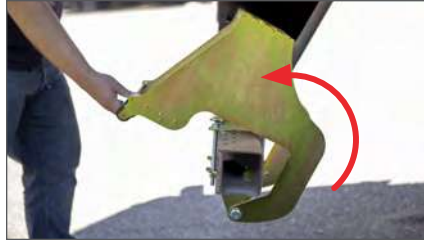

Pivoting, fold-out design positions the stepping surface behind the trailer



Grated steps provide exceptional traction, even when wet

## Finish & Material



**Finish:**  
Yellow  
zinc

**Material:**  
Carbon  
steel

| Part#           | Fits                 | Minimum Pocket Dimensions   |
|-----------------|----------------------|---|
| 409924 <b>N</b> | 4" x 4" bumper beams | 12.8" wide<br>12.25" deep from the back of the bumper<br>15.75" from the bottom of the bumper to the deck |

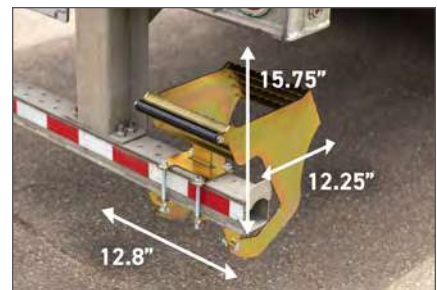



# LED LIGHT BARS & WORK LIGHTS

- Constructed with grade-A, LED chips for superior quality
- Rust-free aluminum housing with rugged, crack-resistant Lexan lens
- Durable, painted, UV-resistant and mar-resistant finish
- Advanced optics system reduces wasted light for 96% reflector efficiency
- Dual, oversize heat sinks maintain low, efficient running temperatures
- Instant on-off requires no warmup time
- 50,000+ hours average lifespan for five years of continuous use
- Passes CE, RoHS, UV, extreme temperature, vibration, dust and salt testing
- Operates in temperatures from -40°F up to 145°F for extreme conditions
- Fitted with a strong, waterproof wiring harness for a reliable connection
- Includes stainless steel screws and a pivoting bracket for custom angling
- Limited lifetime warranty (see last page for details)



IP68 and IP69K waterproof and dustproof ratings keep water and air from getting inside

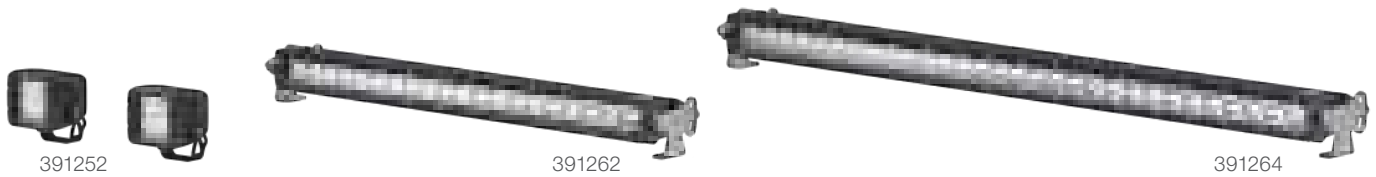

| Part#  | Light Type | Configuration       | Light Size | Beam  | Lumens |
|--------|------------|---------------------|------------|-------|--------|
| 391252 | Work light | Square (set of two) | 2"         | Spot  | 2,200  |
| 391262 | Light bar  | Single-row          | 20"        | Combo | 9,800  |
| 391264 | Light bar  | Single-row          | 30"        | Combo | 14,800 |



## GRAB HANDLES

- Provides a sturdy, 5/8" diameter handle for easier vehicle entry and exit
- Polished stainless steel construction for a bright, rust-free accent
- Includes one grab handle (mounting hardware not included)

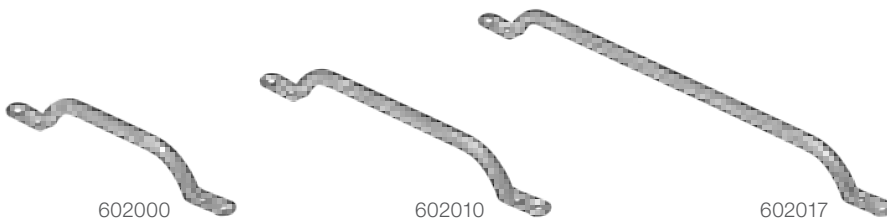

Provides a sturdy anchor for a quick, easy grip

| Part#  | Handle Dimension (End-to-End) | Mounting Hole Dimensions   |                             | Finish             |
|--------|-------------------------------|----------------------------|-----------------------------|--------------------|
|        |                               | Inside Hole to Inside Hole | Inside Hole to Outside Hole |                    |
| 602000 | 11-9/16"                      | 8-11/16" center-to-center  | 1" center-to-center         | Polished stainless |
| 602010 | 14"                           | 11-1/8" center-to-center   | 1" center-to-center         | Polished stainless |
| 602017 | 27-1/2"                       | 24-5/8" center-to-center   | 1" center-to-center         | Polished stainless |



# HEAVY-DUTY MIRRORS

**DRIVING BUSINESS FORWARD**

Dual-vision west coast mirror head

## FEATURED PRODUCTS



### West coast mirror heads

RETRAC offers a wide variety of west coast mirrors to provide the perfect OE replacement for any heavy-duty or medium-duty truck.



### Aerodynamic mirror heads

Engineered to promote maximum efficiency and safety, aerodynamic mirrors feature a sleek design to reduce wind resistance and drag.



### Custom mirror assemblies

These vehicle-specific mirror mounts and heads integrate with the truck design, offering an exact replacement with no drilling required.

## PRODUCT INDEX



**34**

Aerodynamic  
West Coast  
Mirror Heads



**37**

Off-Road  
West Coast  
Mirror Heads



**38**

Pedestal-Mount  
Mirror  
Assemblies



**39**

West Coast  
Mirror Heads



**46**

Custom West  
Coast Mirror  
Assemblies



**47**

Universal  
Mirror  
Assemblies

# AERODYNAMIC WEST COAST MIRROR HEADS

- Aerodynamic head design for reduced drag and wind resistance
- Original equipment, west coast style to provide a perfect OEM replacement
- Universal clamp easily attaches to any 3/4" to 1-1/4" diameter tube
- Flat mirror provides an extra-wide view to minimize blind spots
- First-surface electro-chrome glass eliminates glare for maximum safety
- Motorized glass angles horizontally and vertically with 4-way actuator (select models)
- Automated smart heater evenly defrosts glass to maintain visibility (select models)
- Marker light provides additional safety by signaling other drivers (select models)
- Injection-molded ABS plastic available in bright chrome or **paintable black**

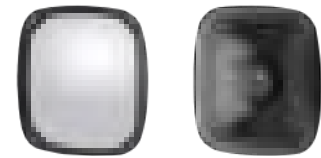

Convex aerodynamic mirrors available, see page 50

| Part#                | Flat Glass Size (W x H) | Convex Glass Size (W x H) | Finish | Adjustable Glass | Heated | Lighted |
|----------------------|-------------------------|---------------------------|--------|------------------|--------|---------|
| <b>Single-Vision</b> |                         |                           |        |                  |        |         |
| 610872               | 8" x 17"                | --                        | Black  | Not adjustable   | No     | No      |
| 610873               | 8" x 17"                | --                        | Black  | Not adjustable   | Yes    | No      |
| 610878               | 8" x 17"                | --                        | Chrome | Not adjustable   | No     | No      |
| 610879               | 8" x 17"                | --                        | Chrome | Not adjustable   | Yes    | No      |
| 613410               | 8" x 19"                | --                        | Black  | Motorized        | No     | No      |
| 613412               | 8" x 19"                | --                        | Black  | Motorized        | Yes    | No      |
| 613510               | 8" x 19"                | --                        | Black  | Manual           | No     | No      |
| 613512               | 8" x 19"                | --                        | Black  | Manual           | Yes    | No      |
| 613413               | 8" x 19"                | --                        | Chrome | Motorized        | Yes    | No      |
| 613415               | 8" x 19"                | --                        | Chrome | Motorized        | Yes    | Yes     |
| 613511               | 8" x 19"                | --                        | Chrome | Manual           | No     | No      |
| 613515               | 8" x 19"                | --                        | Chrome | Manual           | Yes    | Yes     |
| <b>Dual-Vision</b>   |                         |                           |        |                  |        |         |
| 613420               | 7" x 13-1/2"            | 7" x 4-1/2"               | Black  | Motorized        | No     | No      |
| 613422               | 7" x 13-1/2"            | 7" x 4-1/2"               | Black  | Motorized        | Yes    | No      |
| 613424               | 7" x 13-1/2"            | 7" x 4-1/2"               | Black  | Motorized        | Yes    | Yes     |
| 613520               | 7" x 13-1/2"            | 7" x 4-1/2"               | Black  | Manual           | No     | No      |
| 613522               | 7" x 13-1/2"            | 7" x 4-1/2"               | Black  | Manual           | Yes    | No      |
| 613524               | 7" x 13-1/2"            | 7" x 4-1/2"               | Black  | Manual           | Yes    | Yes     |
| 613421               | 7" x 13-1/2"            | 7" x 4-1/2"               | Chrome | Motorized        | No     | No      |
| 613423               | 7" x 13-1/2"            | 7" x 4-1/2"               | Chrome | Motorized        | Yes    | No      |
| 613425               | 7" x 13-1/2"            | 7" x 4-1/2"               | Chrome | Motorized        | Yes    | Yes     |
| 613521               | 7" x 13-1/2"            | 7" x 4-1/2"               | Chrome | Manual           | No     | No      |
| 613523               | 7" x 13-1/2"            | 7" x 4-1/2"               | Chrome | Manual           | Yes    | No      |
| 613525               | 7" x 13-1/2"            | 7" x 4-1/2"               | Chrome | Manual           | Yes    | Yes     |

# AERODYNAMIC WEST COAST MIRROR HEADS

See page 36 for replacement glass



610873



610879



613410  
613412  
613512  
front



613420  
613422  
613424  
613522  
613524  
front



613410  
613412  
613512  
613420  
613422  
613522  
back



613514  
613424  
613524  
back



613413  
613415  
613515  
front



613421  
613423  
613425  
613523  
613525  
front



613413  
613421  
613423  
613523  
back



613415  
613515  
613425  
613525  
back



613510  
front



613520  
front



613510 and 613520  
back



613511  
front



613521  
front



613511 and 613521  
back



## AERODYNAMIC WEST COAST MIRROR HEAD REPLACEMENT GLASS

- Flat mirror provides an extra-wide view to minimize blind spots
- Convex glass provides a wide view of blind spots
- First-surface electro-chrome glass eliminates glare for maximum safety
- Available for heated and non-heated mirrors



613474



613495



613496



613465



610885 (heated)  
610884 (not heated)



613460

| Part#                     | Description   | Heated | Compatibility         | Flat Glass Size (W x H) | Convex Glass Size (W x H) |
|---------------------------|---|--------|-----------------------|-------------------------|---------------------------|
| <b>Single-Vision</b>      |   |        |                       |                         |                           |
| 613465                    | Flat glass  | Yes    | Heated and non-heated | 8" x 19"                | --                        |
| 610885                    | Flat glass  | Yes    | Heated only           | 8" x 17"                | --                        |
| 610884                    | Flat glass  | No     | Non-heated only       | 8" x 17"                | --                        |
| <b>Dual-Vision</b>        |   |        |                       |                         |                           |
| 613474                    | Flat and convex glass kit                                 | Yes    | Heated and non-heated | 7" x 13-1/2"            | 7" x 4-1/2"               |
| 613495                    | Flat glass  | Yes    | Heated and non-heated | 7" x 13-1/2"            | --                        |
| 613496                    | Convex glass  | Yes    | Heated and non-heated | --                      | 7" x 4-1/2"               |
| <b>Replacement Switch</b> |   |        |                       |                         |                           |
| 613460                    | 4-way actuator switch for single- and dual-vision mirrors |        |                       |                         |                           |

# OFF-ROAD WEST COAST MIRROR HEADS

- Shatterproof glass ideal for agricultural, mining and military applications
- E-stamped approved and certified
- Universal clamp sizes to easily mount onto an existing loop
- Semi-convex mirror provides an extra-wide view to minimize blind spots
- First-surface electro-chrome glass eliminates glare for maximum safety
- Black injection-molded ABS plastic can be painted to match any vehicle

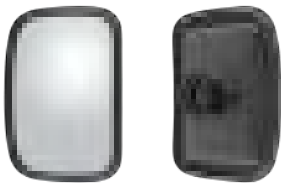

611770

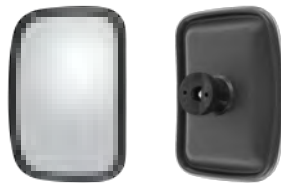

611773



610295



611774



610290

| Part#  | Glass Size (W x H) | Finish            | Vision Type   | Fits Tube    |
|--------|--------------------|-------------------|---------------|--------------|
| 611770 | 7" x 9"            | Black ABS plastic | Single-vision | 5/8" to 7/8" |
| 611773 | 7" x 9"            | Black ABS plastic | Single-vision | 1" to 1-1/8" |
| 610295 | 8" x 16"           | Black ABS plastic | Single-vision | 5/8" to 3/4" |
| 610290 | 9" x 17"           | Black ABS plastic | Single-vision | 5/8" to 7/8" |
| 611774 | 9" x 17"           | Black ABS plastic | Single-vision | 1" to 1-1/8" |

# PEDESTAL-MOUNT MIRROR ASSEMBLIES

- No-drill, vehicle-specific design to perfectly match the factory holes
- Aerodynamic head design for reduced drag and wind resistance
- Motorized glass angles vertically and horizontally with 4-way actuator (switch not included)
- Automated smart heater evenly defrosts glass to maintain visibility
- Computer-printed heating element self-regulates based on ambient temperatures
- Flat mirror provides a wide view to minimize blind spots
- First-surface electro-chrome glass eliminates glare for maximum safety
- Chrome injection-molded ABS plastic construction for a bright, rust-free accent



Convex glass helps eliminate blind spots for safer maneuvering



No-drill, vehicle-specific design to perfectly match the factory holes



612165 front



612165 back



612167 front



612167 back

## Pedestal-Mount Mirror Assemblies

| Make / Model        | Style | Years   | Flat Glass Size (W x H) | Convex Glass Size (W x H) | Motorized | Heated | Vision Type   | Driver / Left Part# | Passenger / Right Part# |
|---------------------|-------|---------|-------------------------|---------------------------|-----------|--------|---------------|---------------------|-------------------------|
| <b>Freightliner</b> |       |         |                         |                           |           |        |               |                     |                         |
| Cascadia            | 113   | 09 - 21 | 7" x 12-1/2"            | 7" x 5"                   | Yes       | Yes    | Dual-vision   | 612165              | 612166                  |
|                     |       |         | --                      | 8" x 6"                   | No        | No     | Single-vision | 612167              | 612168                  |
|                     | 125   | 08 - 21 | 7" x 12-1/2"            | 7" x 5"                   | Yes       | Yes    | Dual-vision   | 612165              | 612166                  |
|                     |       |         | --                      | 8" x 6"                   | No        | No     | Single-vision | 612167              | 612168                  |



# MOTORIZED WEST COAST MIRROR HEADS

- Motorized glass angles vertically and horizontally with 4-way actuator
- Universal mounts attach to all standard loops
- Fits most class 8 trucks
- Automated smart heater evenly defrosts glass to maintain visibility (select models)
- First-surface electro-chrome glass eliminates glare for maximum safety
- Stamped metal construction with rigid mounts to reduce vibrations
- Includes 14' electrical cord and switch for motorized adjustment



Marker light provides additional safety by signaling other drivers (select models)



Motorized glass angles vertically and horizontally with 4-way actuator



613460



Single vision front



Dual vision front

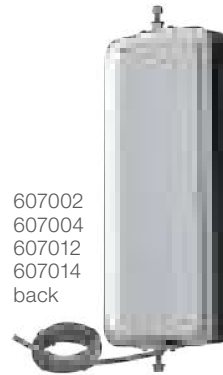

607002  
607004  
607012  
607014  
back

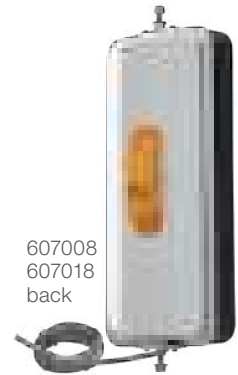

607008  
607018  
back

| Part#                     | Flat Glass Size (W x H)                                   | Heated | Convex Glass Size (W x H) | Heated | Finish             | Vision Type   | Lighted |
|---------------------------|---|--------|---------------------------|--------|--------------------|---------------|---------|
| <b>Mirror Heads</b>       |   |        |                           |        |                    |               |         |
| 607002                    | 7" x 16"  | No     | --                        | --     | Polished stainless | Single-vision | No      |
| 607004                    | 7" x 16"  | Yes    | --                        | --     | Polished stainless | Single-vision | No      |
| 607008                    | 7" x 16"  | Yes    | --                        | --     | Polished stainless | Single-vision | Yes     |
| 607012                    | 7" x 16"  | No     | 6-1/4" x 4"               | No     | Polished stainless | Dual-vision   | No      |
| 607014                    | 6-1/4" x 10-3/4"  | Yes    | 6-1/4" x 4"               | No     | Polished stainless | Dual-vision   | No      |
| 607018                    | 6-1/4" x 10-3/4"  | Yes    | 6-1/4" x 4"               | No     | Polished stainless | Dual-vision   | Yes     |
| <b>Replacement Switch</b> |   |        |                           |        |                    |               |         |
| 613460                    | 4-way actuator switch for single- and dual-vision mirrors |        |                           |        |                    |               |         |

# ECONOMY WEST COAST MIRROR HEADS

- Universal mounts easily attach to all standard loops
- Original equipment, west coast style to fit most class 8 trucks
- Flat mirror provides a wide view to help minimize blind spots
- Stamped aluminum construction to be strong, lightweight and rust-free

| Part#  | Bulk 10-Pack# | Glass Size (W x H) | Finish                                       | Vision Type   |
|--------|---------------|--------------------|--|---------------|
| 610321 | --            | 6" x 16"           | Brushed aluminum                             | Single-vision |
| --     | 610278        | 6" x 16"           | Brushed aluminum with black plastic end caps | Single-vision |



610321

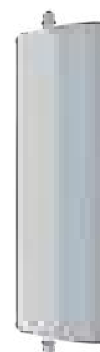

610278  
back



## CHEVRON WEST COAST MIRROR HEADS

- Bright chevrons add style and visibility to the vehicle
- Universal flange mounts easily attach to all standard loops and swedged loops
- Automated smart heater evenly defrosts glass to maintain visibility (select models)
- Marker light provides additional safety by signaling other drivers (select models)
- Flat mirror provides a wide view to help minimize blind spots
- First-surface electro-chrome glass eliminates glare for maximum safety



| Part#                         | Flat Glass Size (W x H) | Convex Glass Size (W x H) | Finish            | Vision Type   | Heated | Lighted |
|-------------------------------|-------------------------|---------------------------|-------------------|---------------|--------|---------|
| <b>Yellow Chevron Style</b>   |                         |                           |                   |               |        |         |
| 600932                        | 6" x 16"                | --                        | Anodized aluminum | Single-vision | No     | No      |
| 600960                        | 6" x 16"                | --                        | Anodized aluminum | Single-vision | Yes    | No      |
| 601010*                       | 6" x 16"                | --                        | Anodized aluminum | Single-vision | Yes    | Yes     |
| 601017                        | 6" x 12"                | 6" x 4"                   | Anodized aluminum | Dual-vision   | No     | No      |
| <b>Embossed Chevron Style</b> |                         |                           |                   |               |        |         |
| 601142                        | 6" x 16"                | --                        | Anodized aluminum | Single-vision | No     | No      |
| 601250                        | 6" x 16"                | --                        | Anodized aluminum | Single-vision | Yes    | Yes     |



\* Continued while supplies last



## RIB-BACK & BUBBLE-BACK WEST COAST MIRROR HEADS

- Universal stud mounts easily attach to all standard loops
- Built-in heater evenly defrosts glass to maintain visibility (select models)
- Flat mirror provides a wide view to help minimize blind spots



610226  
rib back



610216  
rib back

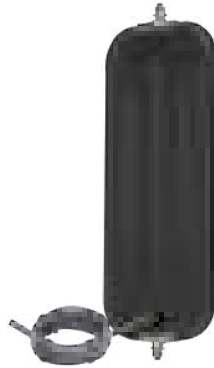

610221  
rib back

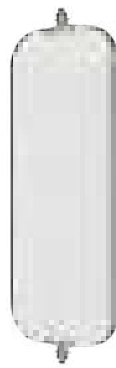

610236  
rib back

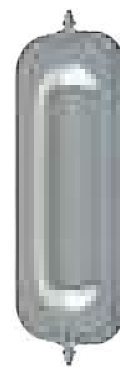

610256  
bubble back

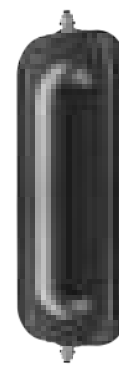

610246  
bubble back



610266  
bubble back

| Part#                    | Glass Size (W x H) | Finish                         | Vision Type   | Heated |
|--------------------------|--------------------|--------------------------------|---------------|--------|
| <b>Rib-Back Style</b>    |                    |                                |               |        |
| 610226                   | 7" x 16"           | Polished stainless             | Single-vision | No     |
| 610231                   | 7" x 16"           | Polished stainless             | Single-vision | Yes    |
| 610216                   | 7" x 16"           | Carbon steel with black enamel | Single-vision | No     |
| 610221                   | 7" x 16"           | Carbon steel with black enamel | Single-vision | Yes    |
| 610236                   | 7" x 16"           | Carbon steel with white enamel | Single-vision | No     |
| <b>Bubble-Back Style</b> |                    |                                |               |        |
| 610256                   | 7" x 16"           | Polished stainless             | Single-vision | No     |
| 610246                   | 7" x 16"           | Carbon steel with black enamel | Single-vision | No     |
| 610266                   | 7" x 16"           | Carbon steel with white enamel | Single-vision | No     |
| 610271*                  | 7" x 16"           | Carbon steel with white enamel | Single-vision | Yes    |



610271  
bubble  
back

\* Continued while supplies last



## PYRAMID-BACK WEST COAST MIRROR HEADS

- Universal stud mounts easily attach to all standard loops
- Automated smart heater evenly defrosts glass to maintain visibility (select models)
- Flat mirror provides a wide view to help minimize blind spots
- First-surface electro-chrome glass eliminates glare for maximum safety



Large corner radius with stud mount

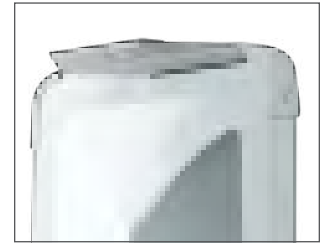

Small corner radius with flange mount

| Part#                      | Glass Size (W x H) | Finish                              | Vision Type   | Heated | Lighted |
|----------------------------|--------------------|-------------------------------------|---------------|--------|---------|
| <b>Large Corner Radius</b> |                    |                                     |               |        |         |
| 605403                     | 7" x 16"           | Polished stainless                  | Single-vision | No     | No      |
| 610331                     | 7" x 16"           | Polished stainless                  | Single-vision | No     | No      |
| 610204                     | 7" x 16"           | Polished stainless                  | Single-vision | Yes    | No      |
| 610336                     | 7" x 16"           | Polished stainless                  | Single-vision | Yes    | No      |
| 605409†                    | 7" x 16"           | Polished stainless                  | Single-vision | Yes    | No      |
| 605448‡                    | 7" x 16"           | Polished stainless                  | Single-vision | Yes    | No      |
| 610351                     | 7" x 16"           | Carbon steel with black powder coat | Single-vision | No     | No      |
| <b>Small Corner Radius</b> |                    |                                     |               |        |         |
| 600807                     | 7" x 16"           | Polished stainless                  | Single-vision | No     | No      |
| 600835                     | 7" x 16"           | Polished stainless                  | Single-vision | Yes    | No      |
| 600682                     | 7" x 16"           | Carbon steel with white powder coat | Single-vision | No     | No      |
| 600710*                    | 7" x 16"           | Carbon steel with white powder coat | Single-vision | Yes    | No      |
| 600685                     | 7" x 16"           | Carbon steel with black powder coat | Single-vision | No     | No      |

† #605409 includes GM-specific wiring harness (29" wire length)

‡ #605448 includes Isuzu-specific wiring harness (42.37" wire length)

\* Continued while supplies last

# PYRAMID-BACK WEST COAST MIRROR HEADS



605403



610204



GM plug  
(29" wire)

605409



610331



610336



Isuzu plug  
(42.37" wire)

605448



610351



600682



600807



600685



600710



600835



## ANGLE-BACK WEST COAST MIRROR HEADS

- Universal stud mounts easily attach to all standard loops
- Built-in heater evenly defrosts glass to maintain visibility (select models)
- Flush-mount marker light provides additional safety by signaling other drivers (select models)
- Flat mirror provides a wide view to help minimize blind spots
- First-surface electro-chrome glass eliminates glare for maximum safety



Round corners with contoured end caps

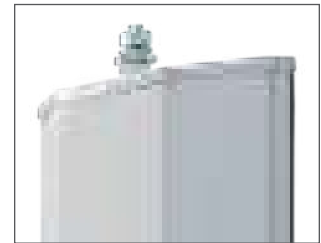

Square corners with flat end cap

| Part#                 | Flat Glass Size (W x H) | Convex Glass Size (W x H) | Finish             | Vision Type   | Heated | Lighted |
|-----------------------|-------------------------|---------------------------|--------------------|---------------|--------|---------|
| <b>Round Corners</b>  |                         |                           |                    |               |        |         |
| 605400                | 7" x 16"                | --                        | Black ABS plastic  | Single-vision | No     | No      |
| 601272                | 7" x 16"                | --                        | Polished stainless | Single-vision | No     | No      |
| 601285                | 7" x 16"                | --                        | Polished stainless | Single-vision | Yes    | No      |
| 601288                | 7" x 16"                | --                        | Polished stainless | Single-vision | Yes    | Yes     |
| 601268                | 6" x 10"                | 6" x 4"                   | Polished stainless | Dual-vision   | No     | No      |
| 601274                | 6" x 10"                | 6" x 4"                   | Polished stainless | Dual-vision   | Yes    | No      |
| <b>Square Corners</b> |                         |                           |                    |               |        |         |
| 601292                | 6" x 16"                | --                        | Polished stainless | Single-vision | No     | No      |
| 610301                | 7" x 16"                | --                        | Polished stainless | Single-vision | No     | No      |
| 610311                | 7" x 16"                | --                        | Polished stainless | Single-vision | No     | Yes     |
| 601305                | 6" x 16"                | --                        | Polished stainless | Single-vision | Yes    | No      |
| 610306                | 7" x 16"                | --                        | Polished stainless | Single-vision | Yes    | No      |
| 610316                | 7" x 16"                | --                        | Polished stainless | Single-vision | Yes    | Yes     |

# ANGLE-BACK WEST COAST MIRROR HEADS



605400



601272



601285

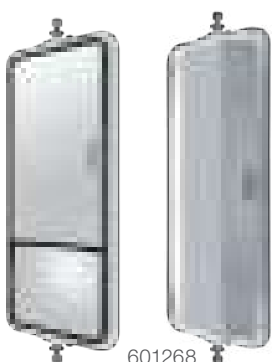

601268



601274



601288

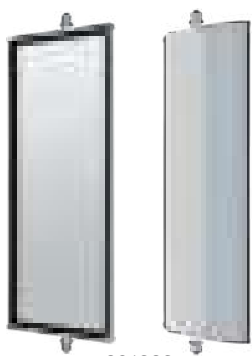

601292



601305



610306



610301



610311



610316



# CUSTOM WEST COAST MIRROR ASSEMBLIES

- Patented retractable assembly for added clearance
- Universal 5/16" studs easily attach the mirror head to the loop
- Stainless steel, 7" x 16" flat mirror provides a wide view to help minimize blind spots (mirror not included with #611786 and #611788)
- First-surface electro-chrome glass eliminates glare for maximum safety
- Constructed from rust-free, polished stainless steel
- Includes mounting hardware

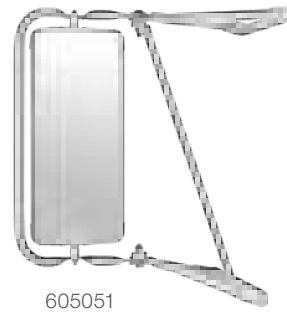
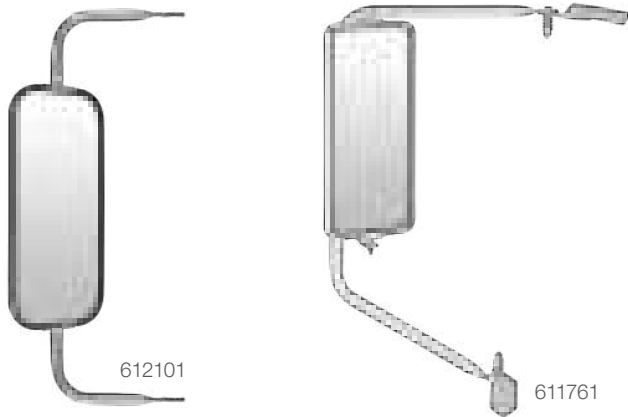

## Custom West Coast Mirror Assemblies

| Make / Model        | Style | Years   | Driver Side# | Passenger Side# |
|---------------------|-------|---------|--------------|-----------------|
| <b>Ford</b>         |       |         |              |                 |
| F600                | --    | 70 - 94 | 605051       | 605053          |
| F700                | --    | 70 - 98 | 605051       | 605053          |
| F7000               | --    | 70 - 87 | 605051       | 605053          |
| L800                | --    | 80 - 85 | 605051       | 605053          |
| L8000               | --    | 81 - 88 | 605051       | 605053          |
| L9000               | --    | 81 - 97 | 605051       | 605053          |
| <b>Freightliner</b> |       |         |              |                 |
| FL106               | --    | 94 - 03 | 612116       | 612118          |
| FL112               | Base  | 96 - 03 | 612116       | 612118          |
| FL50                | --    | 95 - 05 | 612116       | 612118          |
| FL60                | --    | 92 - 04 | 612116       | 612118          |
| FL70                | --    | 93 - 05 | 612116       | 612118          |
| FL80                | --    | 93 - 06 | 612116       | 612118          |
| FLD112              | --    | 91 - 06 | 612101       | 612103          |
| FLD120              | --    | 89 - 11 | 612101       | 612103          |
| FLD120SD            | --    | 03 - 12 | 612101       | 612103          |
| FLD132              | --    | 01 - 11 | 612101       | 612103          |

\* Mirror head not included

## Custom West Coast Mirror Assemblies

| Make / Model         | Style | Years   | Driver Side# | Passenger Side# |
|----------------------|-------|---------|--------------|-----------------|
| <b>International</b> |       |         |              |                 |
| 4200                 | --    | 02 - 10 | 611786       | 611788          |
|                      |       |         | 611761       | 611763          |
| 4300                 | --    | 02 - 18 | 611786       | 611788          |
|                      |       |         | 611761       | 611763          |
| 4400                 | --    | 02 - 19 | 611786       | 611788          |
|                      |       |         | 611761       | 611763          |
| 4700                 | --    | 01 - 08 | 611786       | 611788          |
|                      |       |         | 611761       | 611763          |
| 7300 / 7400 / 7500   | --    | 02 - 18 | 611786       | 611788          |
|                      |       |         | 611761       | 611763          |
| 7600                 | --    | 03 - 17 | 611786       | 611788          |
|                      |       |         | 611761       | 611763          |
| 7700                 | --    | 05 - 07 | 611786       | 611788          |
|                      |       |         | 611761       | 611763          |
| 8500                 | --    | 02 - 07 | 611786       | 611788          |
|                      |       |         | 611761       | 611763          |
| S-Series             | --    | 80 - 80 | 603515       | 603516          |
| <b>Mack</b>          |       |         |              |                 |
| CH                   | --    | 89 - 05 | 611781       | 611783          |
| CHN                  | --    | 06 - 07 | 611781       | 611783          |
| CHU                  | --    | 08 - 18 | 611781       | 611783          |

\* Mirror head not included





## UNIVERSAL CONVENTIONAL MIRROR ASSEMBLY

- Universal design fits a wide variety of heavy-duty applications
- Patented retractable assembly for added clearance whenever needed
- Universal stud mounts easily attach the mirror head to the loop
- 7" x 16" flat mirror provides a wide view to help minimize blind spots
- First-surface electro-chrome glass eliminates glare for maximum safety
- Polished stainless steel construction for a bright, rust-free accent
- Includes mirror head, mounting assembly and hardware
- Fits driver side or passenger side

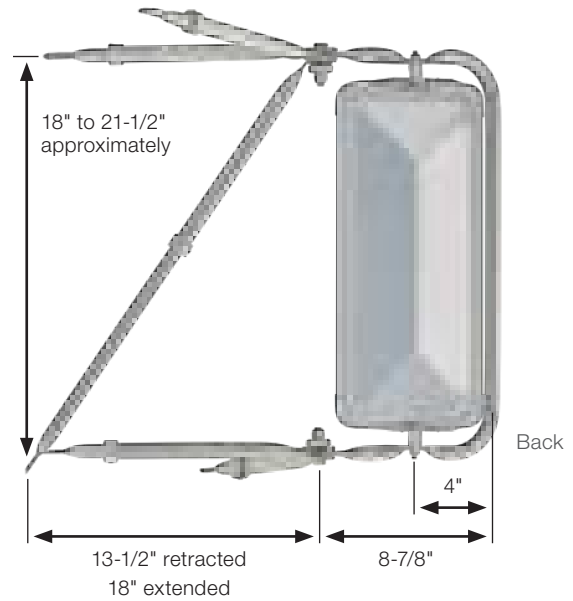

| Part#  | Glass Size (W x H) | Finish             |
|--------|--------------------|--------------------|
| 603862 | 7" x 16"           | Polished stainless |



## UNIVERSAL CABOVER MIRROR ASSEMBLY

- Universal design fits a wide variety of heavy-duty applications
- Patented retractable assembly for added clearance whenever needed
- Vertically adjustable to fit 20" to 34" window and door sizes
- Universal clamp mounts easily attach the mirror head to the loop
- 7" x 16" flat mirror provides a wide view to help minimize blind spots
- First-surface electro-chrome glass eliminates glare for maximum safety
- Polished stainless steel construction for a bright, rust-free accent
- Includes mirror head, mounting assembly and hardware
- Fits driver side or passenger side

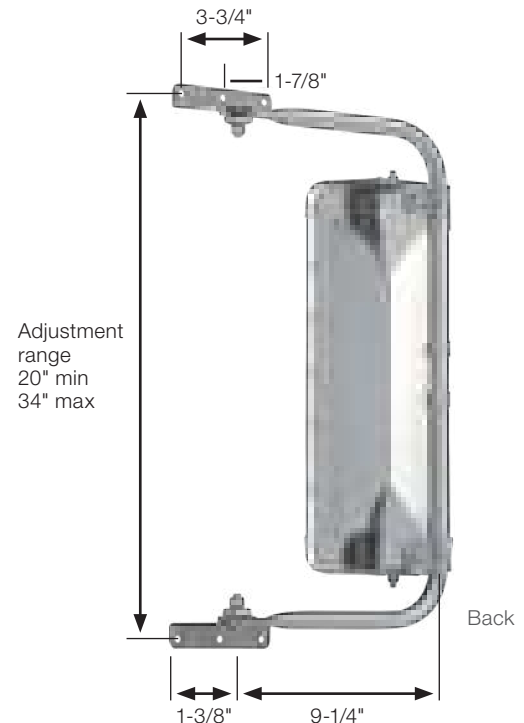

| Part#  | Glass Size (W x H) | Finish             |
|--------|--------------------|--------------------|
| 603890 | 7" x 16"           | Polished stainless |



# CONVEX & SAFETY MIRRORS

**DRIVING BUSINESS FORWARD**

Offset-mount convex mirror and safety assembly

## FEATURED PRODUCTS



### | Safety mirror assemblies

With a universal design, these assemblies allow our safety mirrors to be mounted on a variety of trucks, adding visibility on the road.



### | Offset-mount mirror heads

The offset mounting option provides an extended view and wider range of adjustment for maximum visibility of blind spots.



### | Center-mount mirror heads

Center-mount safety mirrors offer enhanced vibration resistance, and most are available with a plastic ball stud for greater weather resistance.

## PRODUCT INDEX



**50**

Aerodynamic  
Mirror Heads



**51**

Bubble  
Mirror Heads



**52**

Center-Mount  
Mirror Heads



**54**

Offset-Mount  
Mirror Heads



**56**

Rectangular  
Mirror Heads



**56**

Stick-On  
Mirrors



**57**

Rectangular  
Utility Mirror  
Assembly



**57**

Look-Down  
Mirror  
Assemblies



**58**

Safety Mirror  
Assemblies

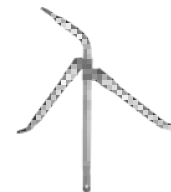

**59**

Rear-Mount  
Safety Mirror  
Assemblies

# AERODYNAMIC CONVEX MIRROR HEADS

- Aerodynamic head design for reduced drag and wind resistance
- Original equipment style to provide a perfect OEM replacement
- Universal clamp easily attaches to any 3/4" to 1-1/4" diameter tube
- Automated smart heater evenly defrosts glass to maintain visibility (select models)
- Convex glass helps eliminate blind spots for safer maneuvering
- First-surface electro-chrome glass eliminates glare for maximum safety
- Injection-molded ABS plastic available in bright chrome or **paintable black**

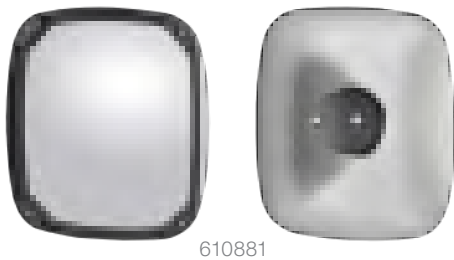
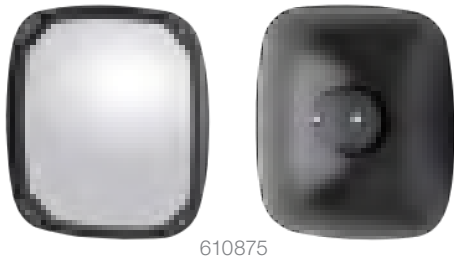

| Part#                    | Glass Size (W x H) | Finish | Heated |
|--------------------------|--------------------|--------|--------|
| <b>Mirror Heads</b>      |                    |        |        |
| 610875                   | 8" x 8-1/2"        | Black  | --     |
| 610876                   | 8" x 8-1/2"        | Black  | Yes    |
| 610881                   | 8" x 8-1/2"        | Chrome | --     |
| 610882                   | 8" x 8-1/2"        | Chrome | Yes    |
| <b>Replacement Glass</b> |                    |        |        |
| 610886                   | 8" x 8-1/2"        | --     | --     |
| 610887                   | 8" x 8-1/2"        | --     | Yes    |

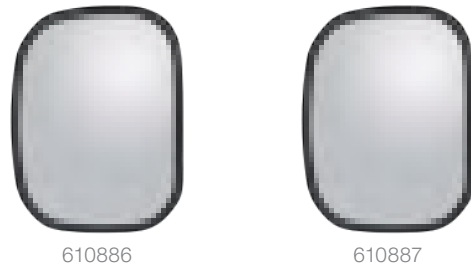



## BUBBLE MIRROR HEADS

- Bubble glass helps eliminate blind spots for safer maneuvering
- Center-mount ball stud for added stability and easy tilt adjustment
- Plastic ball stud will never rust and will not crack the mirror backing (select models)
- Vibration-tested and salt-spray-tested for a minimum of 360 hours to ensure long life

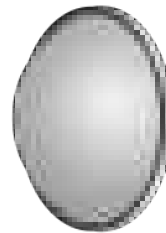

609955  
semi-bubble

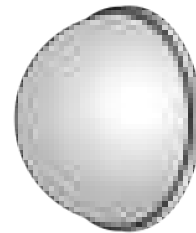

610775  
full bubble

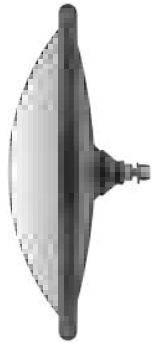

604947  
semi-bubble



609955



609965



610775



610750



604945

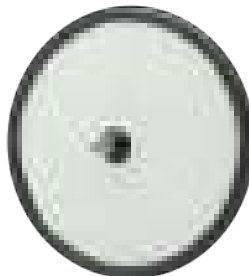

604946



604953

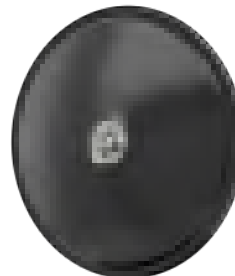

604954



604947

| Part#   | Glass Diameter | Finish                              | Bubble Depth | J-Bracket Included | Ball Stud |
|---------|----------------|-------------------------------------|--------------|--------------------|-----------|
| 609955  | 8"             | Polished stainless                  | Semi-bubble  | --                 | Metal     |
| 609965  | 8"             | Polished stainless                  | Semi-bubble  | --                 | Plastic   |
| 610775  | 8"             | Polished stainless                  | Full bubble  | --                 | Metal     |
| 610750  | 8"             | Carbon steel with black powder coat | Full bubble  | --                 | Metal     |
| 604945  | 10"            | Black plastic                       | Semi-bubble  | --                 | Plastic   |
| 604946  | 10"            | White plastic                       | Semi-bubble  | --                 | Plastic   |
| 604953  | 10"            | Polished stainless                  | Semi-bubble  | --                 | Metal     |
| 604954* | 10"            | Carbon steel with black powder coat | Semi-bubble  | --                 | Metal     |
| 604947  | 12"            | Black plastic                       | Semi-bubble  | --                 | Plastic   |

\* Continued while supplies last



## CENTER-MOUNT CONVEX MIRROR HEADS

See page 73 for our J-bracket options

- Center-mount ball stud allows for added stability and easy tilt adjustment
- Convex glass helps eliminate blind spots for safer maneuvering
- Built-in heater evenly defrosts glass to maintain visibility (select models)
- Plastic ball stud will never rust and will not crack the mirror backing (select models)
- Vibration-tested and salt-spray-tested for a minimum of 360 hours to ensure long life

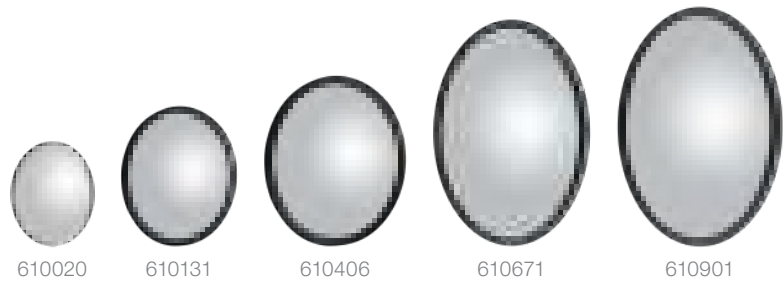

| Part#  | Glass Diam. | Finish                              | Heated | Brkt. Incl. | Ball Stud |
|--------|-------------|-------------------------------------|--------|-------------|-----------|
| 610020 | 3-3/4"      | Brushed aluminum                    | --     | --          | Metal     |
| 610146 | 5"          | Polished stainless                  | --     | --          | Metal     |
| 610148 | 5"          | Polished stainless                  | --     | Yes         | Metal     |
| 604950 | 5"          | Brushed aluminum                    | --     | --          | Metal     |
| 610131 | 5"          | Carbon steel with black powder coat | --     | --          | Metal     |
| 610133 | 5"          | Carbon steel with black powder coat | --     | Yes         | Metal     |
| 610401 | 6"          | Polished stainless                  | --     | --          | Plastic   |
| 610191 | 6"          | Polished stainless                  | --     | --          | Metal     |
| 610403 | 6"          | Polished stainless                  | --     | Yes         | Plastic   |
| 610193 | 6"          | Polished stainless                  | --     | Yes         | Metal     |
| 610176 | 6"          | Anodized aluminum                   | --     | --          | Metal     |
| 610178 | 6"          | Anodized aluminum                   | --     | Yes         | Metal     |
| 610161 | 6"          | Aluminum with black powder coat     | --     | --          | Metal     |
| 610406 | 6"          | Carbon steel with black powder coat | --     | --          | Metal     |
| 610408 | 6"          | Carbon steel with black powder coat | --     | Yes         | Metal     |
| 604976 | 7-1/2"      | Polished stainless                  | --     | --          | Metal     |

| Part#   | Glass Diam. | Finish                              | Heated | Brkt. Incl. | Ball Stud |
|---------|-------------|-------------------------------------|--------|-------------|-----------|
| 604978  | 7-1/2"      | Polished stainless                  | --     | Yes         | Metal     |
| 609816  | 7-1/2"      | Polished stainless                  | --     | --          | Plastic   |
| 609818  | 7-1/2"      | Polished stainless                  | --     | Yes         | Plastic   |
| 604983  | 7-1/2"      | Carbon steel with black powder coat | --     | Yes         | Metal     |
| 604895  | 8"          | Polished stainless                  | Yes    | --          | Plastic   |
| 604898  | 8"          | Polished stainless                  | --     | --          | Plastic   |
| 610671  | 8"          | Polished stainless                  | --     | --          | Metal     |
| 610673  | 8"          | Polished stainless                  | --     | Yes         | Metal     |
| 610703  | 8"          | Polished stainless                  | --     | Yes         | Plastic   |
| 610676  | 8"          | Polished stainless                  | Yes    | --          | Metal     |
| 610711  | 8"          | Carbon steel with black powder coat | --     | --          | Metal     |
| 604913* | 8"          | Carbon steel with black powder coat | --     | --          | Plastic   |
| 610713  | 8"          | Carbon steel with black powder coat | --     | Yes         | Metal     |
| 610743  | 8"          | Carbon steel with black powder coat | --     | Yes         | Plastic   |
| 610901  | 8-1/2"      | Polished stainless                  | --     | Yes         | Metal     |

\* Continued while supplies last

\* Continued while supplies last

# CENTER-MOUNT CONVEX MIRROR HEADS



610020



610146



610148



604950



610131



610133



610401



610191



610403



610193



610176



610178



610161



610406



610408



604976



604978



609816



609818



604983



604895



604898



610671



610673



610703



610676

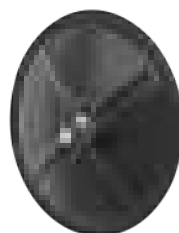

610711



604913



610713



610743



610901



## OFFSET-MOUNT CONVEX MIRROR HEADS

See page 73 for our J-bracket options

- Offset ball stud provides a wider view with easy tilt adjustment
- Convex glass helps eliminate blind spots for safer maneuvering
- Built-in heater evenly defrosts glass to maintain visibility (select models)
- Plastic ball stud will never rust and will not crack the mirror backing (select models)
- Vibration-tested and salt-spray-tested for a minimum of 360 hours to ensure long life



609841



610556



609936

| Part#   | Glass Diameter | Finish                              | Heated | J-Bracket Included | Ball Stud |
|---------|----------------|-------------------------------------|--------|--------------------|-----------|
| 609876  | 7-1/2"         | Polished stainless                  | --     | --                 | Plastic   |
| 609836  | 7-1/2"         | Polished stainless                  | --     | --                 | Metal     |
| 609878  | 7-1/2"         | Polished stainless                  | --     | Yes                | Plastic   |
| 609838  | 7-1/2"         | Polished stainless                  | --     | Yes                | Metal     |
| 609841* | 7-1/2"         | Carbon steel with black powder coat | --     | --                 | Metal     |
| 609843  | 7-1/2"         | Carbon steel with black powder coat | --     | Yes                | Metal     |
| 604798  | 8"             | Polished stainless                  | --     | --                 | Plastic   |
| 610551  | 8"             | Polished stainless                  | --     | --                 | Metal     |
| 610583  | 8"             | Polished stainless                  | --     | Yes                | Plastic   |
| 610553  | 8"             | Polished stainless                  | --     | Yes                | Metal     |
| 604793  | 8"             | Polished stainless                  | Yes    | --                 | Plastic   |
| 610556  | 8"             | Polished stainless                  | Yes    | --                 | Metal     |
| 604827  | 8"             | Carbon steel with black powder coat | --     | --                 | Plastic   |
| 610591  | 8"             | Carbon steel with black powder coat | --     | --                 | Metal     |
| 610623  | 8"             | Carbon steel with black powder coat | --     | Yes                | Plastic   |
| 610596  | 8"             | Carbon steel with black powder coat | Yes    | --                 | Metal     |
| 609936  | 8-1/2"         | Polished stainless                  | --     | --                 | Plastic   |
| 609896  | 8-1/2"         | Polished stainless                  | --     | --                 | Metal     |
| 609938  | 8-1/2"         | Polished stainless                  | --     | Yes                | Plastic   |
| 609898  | 8-1/2"         | Polished stainless                  | --     | Yes                | Metal     |
| 609946  | 8-1/2"         | Polished stainless                  | Yes    | --                 | Plastic   |
| 609903  | 8-1/2"         | Carbon steel with black powder coat | --     | Yes                | Metal     |

\* Continued while supplies last



# OFFSET-MOUNT CONVEX MIRROR HEADS



609876



609836



609878



609838



609841



609843



604798



610551



610583



610553



604793



610556



604827



610591



610623



610596



609936



609896



609938



609898



609946

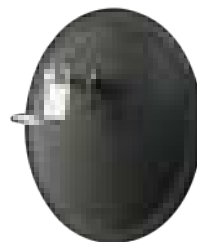

609903

## RECTANGULAR CONVEX MIRROR HEADS

- Center-mount ball stud for added stability and easy tilt adjustment (select models)
- Convex glass helps eliminate blind spots for safer maneuvering
- Vibration-tested and salt-spray-tested for a minimum of 360 hours to ensure long life



| Part#  | Glass Diameter (W x H) | Finish                          | Ball Stud |
|--------|------------------------|---------------------------------|-----------|
| 610450 | 5-1/2" x 7-1/2"        | Stainless steel                 | Metal     |
| 610465 | 5-1/2" x 7-1/2"        | Aluminum with black powder coat | Metal     |
| 610456 | 5-1/2" x 7-1/2"        | Anodized aluminum               | Metal     |

## STICK-ON CONVEX MIRRORS

- Convex glass helps eliminate blind spots for safer maneuvering
- Tape backing allows for fast, easy installation on existing mirrors
- Double-sided, water-resistant tape to easily outlast the elements

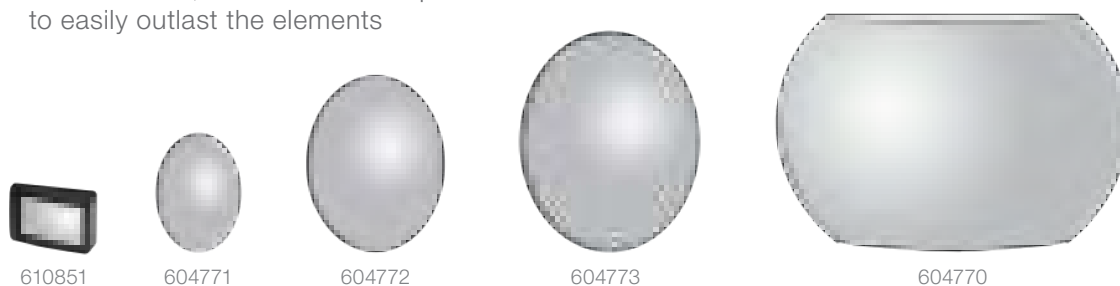

| Part#  | Glass Size (W x H) | Style       | Finish            |
|--------|--------------------|-------------|-------------------|
| 610851 | 2" x 1"            | Wedge       | Black ABS plastic |
| 604770 | 5-1/4" x 4"        | Rectangular | Black ABS plastic |
| 604771 | 2" diameter        | Round       | Stamped aluminum  |
| 604772 | 3" diameter        | Round       | Stamped aluminum  |
| 604773 | 3-3/4" diameter    | Round       | Stamped aluminum  |

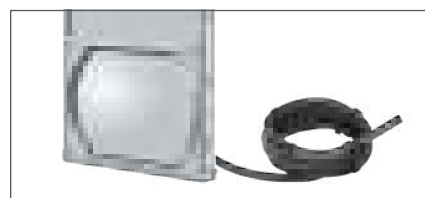

Easily sticks onto a pre-existing mirror for added visibility



## LOOK-DOWN CONVEX MIRROR ASSEMBLIES

- Universal design for over-the-door, peek-a-boo or back window applications
- Adjustable design to find the perfect angle for each application
- Convex mirror provides a wide-angle view wherever needed
- Shatterproof glass ideal for agricultural, mining and military applications (#612785)
- Includes mirror head and mounting bracket



610868



612785

| Part#  | Glass Size (W x H) | Finish             |
|--------|--------------------|--------------------|
| 610868 | 8" x 4"            | Polished stainless |
| 612785 | 10" x 6"           | Black ABS plastic  |



## RECTANGULAR CONVEX UTILITY MIRROR ASSEMBLY

- Universal I-bracket fits a wide variety of heavy-duty applications
- Adjustable design to find the perfect angle for each application
- Convex mirror provides a wide-angle view wherever needed
- Bright, anodized aluminum construction is lightweight and rust-free
- Includes mirror head and mounting bracket



Front

Back

| Part#  | Glass Size (W x H) | Finish            |
|--------|--------------------|-------------------|
| 604650 | 7-1/2" x 5-1/2"    | Anodized aluminum |

# SAFETY MIRROR ASSEMBLIES

- Universal mounts fit a wide variety of heavy-duty applications
- Adjustable design to find the perfect angle for each application
- Convex mirrors help eliminate blind spots for safer maneuvering (select models)
- Compatible with all round and rectangular convex mirrors, starting on page 50
- Most models include mounting assembly only
- Most models made in USA (#604673 and #611922 excluded)



| Part#  | Adjustment Range | Application Type     | Mount Style                     | Mirror Included | Glass Diameter | Finish             |
|--------|------------------|----------------------|---------------------------------|-----------------|----------------|--------------------|
| 604671 | --               | Cabover mount        | Bolts onto side mirror assembly | --              | --             | Polished stainless |
| 604674 | 12" to 19"       | Cowl or fender mount | Bell-type mount                 | --              | --             | Polished stainless |
| 604696 | 14" to 19"       | Hood mount           | Four-bolt pod mount             | --              | --             | Polished stainless |
| 604697 | 18" to 23"       | Hood mount           | Four-bolt pod mount             | --              | --             | Polished stainless |
| 611922 | 16" to 23"       | Fender mount         | Bell-type mount                 | --              | --             | Polished stainless |
| 604676 | 16" to 23"       | Fender mount         | Bell-type mount                 | Yes             | 8"             | Polished stainless |
| 604677 | 22" to 31"       | Fender mount         | Bell-type mount                 | --              | --             | Polished stainless |
| 604673 | 22" to 31"       | Fender mount         | Bell-type mount                 | Yes             | 8"             | Polished stainless |



## REAR-MOUNT SAFETY MIRROR ASSEMBLIES

- Universal design for rear van, straight truck or look-down applications
- Ideal for adding visibility on delivery and emergency vehicles
- Includes mounting assembly only



608135



608100



608137



608102

| Part#   | Finish                              | Mount Style                        |
|---------|-------------------------------------|------------------------------------|
| 608135  | Polished stainless                  | Four-bolt vertical bracket mount   |
| 608100  | Polished stainless                  | Four-bolt horizontal bracket mount |
| 608102* | Carbon steel with black powder coat | Four-bolt horizontal bracket mount |
| 608137* | Carbon steel with black powder coat | Four-bolt vertical bracket mount   |

\* Continued while supplies last



# LIGHT-DUTY MIRRORS

**DRIVING BUSINESS FORWARD**

Rear view mirror

## FEATURED PRODUCTS

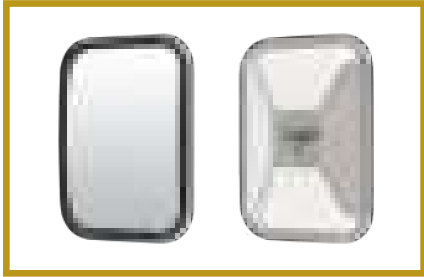

### Light-duty mirror heads

For pickups from Chevrolet, Dodge, Ford, GMC, Ram and more, these mirrors offer the look and functionality of original equipment.

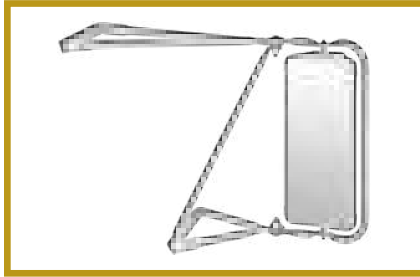

### Custom assemblies

These assemblies are designed to be a perfect, vehicle-specific mirror replacement option for light-duty pickup trucks and SUVs.



### Universal mirrors

With a universal design, these mirrors fit a wide variety of light-duty pickup trucks. All come with first-surface glass to eliminate glare.

## PRODUCT INDEX

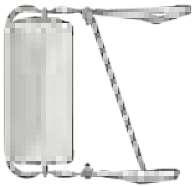

**62**  
Custom  
West Coast  
Assemblies



**62**  
Junior  
West Coast  
Mirror Head



**63**  
Light-Duty  
Mirror Heads



**63**  
Universal  
Mirror Head  
with Gooseneck



**63**  
Rear View  
Mirror



## CUSTOM WEST COAST MIRROR ASSEMBLIES

- Original equipment, light-duty style to provide a perfect OEM replacement
- No-drill, vehicle-specific design to perfectly match the factory holes
- Patented retractable assembly for added clearance when needed
- Universal stud mounts easily attach the mirror head to the loop
- 7" x 16" flat mirror provides a wide view to help minimize blind spots
- First-surface electro-chrome glass eliminates glare for maximum safety
- Polished stainless steel construction for a bright, rust-free accent
- Includes mirror head, mounting assembly and hardware

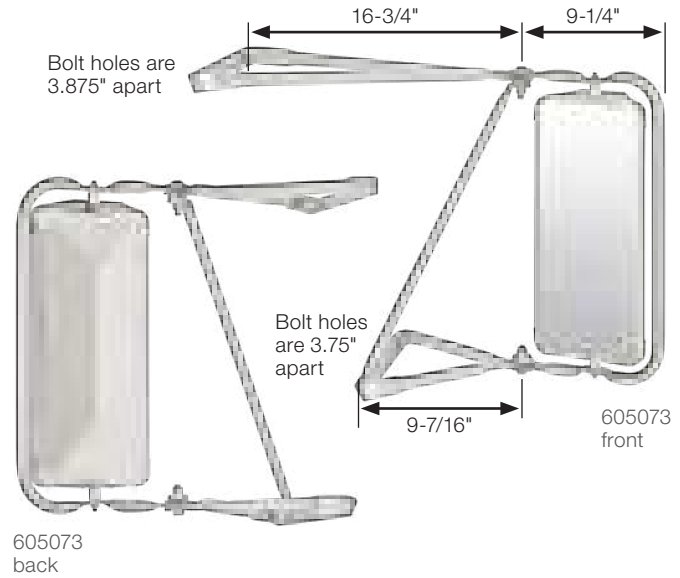

| Custom West Coast Mirror Assemblies |         |              |                 |
|-------------------------------------|---------|--------------|-----------------|
| Make / Model                        | Years   | Driver-Side# | Passenger-Side# |
| <b>Ford</b>                         |         |              |                 |
| F-150                               | 80 - 98 | 605071       | 605073          |
| F-250                               | 80 - 98 | 605071       | 605073          |
| F-350                               | 80 - 97 | 605071       | 605073          |



## JUNIOR WEST COAST MIRROR HEAD

- Bright, yellow, embossed chevrons add style and visibility to the vehicle
- Universal flange mounts easily attach to all standard loops and swedged loops
- Provides a wide view to help minimize blind spots
- First-surface electro-chrome glass eliminates glare for maximum safety
- Stamped aluminum construction to be strong, lightweight and rust-free
- Includes mirror head only (mounting assembly not included)

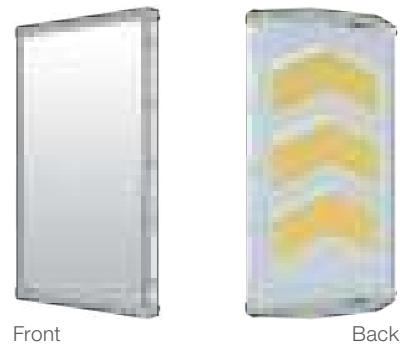

| Part#  | Glass Size (W x H) | Finish            |
|--------|--------------------|-------------------|
| 601331 | 6" x 12"           | Anodized aluminum |





## LIGHT-DUTY MIRROR HEADS

- Original equipment, light-duty style
- Flat glass provides a clear view
- First-surface electro-chrome glass eliminates glare for maximum safety
- Center-mount ball stud for easy tilt adjustment (#610480, #610485)
- Includes mirror head only (mounting assembly not included)



610480



610485



604768



604769

| Part#  | Glass Size (W x H) | Finish             | Center Ball Stud |
|--------|--------------------|--------------------|------------------|
| 604768 | 9" x 6"            | Polished stainless | --               |
| 604769 | 8" x 5"            | Polished stainless | --               |
| 610480 | 5-1/2" x 7-1/2"    | Stainless steel    | Metal            |
| 610485 | 5-1/2" x 7-1/2"    | Anodized aluminum  | Metal            |



## UNIVERSAL MIRROR WITH GOOSENECK

- Provides a wide view to help minimize blind spots
- First-surface electro-chrome glass eliminates glare for maximum safety
- Gooseneck positions mirror for an extended view
- Includes mirror head and gooseneck only

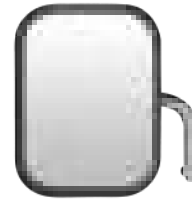

Front

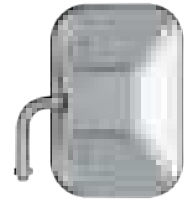

Back

| Part#  | Glass Size (W x H) | Finish             |
|--------|--------------------|--------------------|
| 611600 | 7-1/2" x 10-1/2"   | Polished stainless |

## GOOSENECK MIRROR EXTENSION

- Positions mirror for an extended view

| Part#  | Description         | Finish             |
|--------|---------------------|--------------------|
| 605755 | Gooseneck extension | Polished stainless |

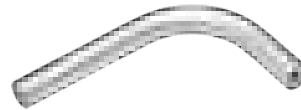

605755  
(10" before being bent at 90°)

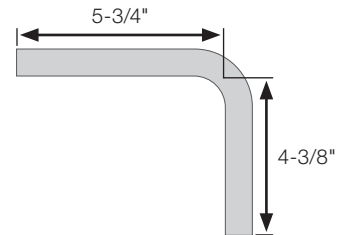

## REAR VIEW MIRROR

- Day / night prismatic ground glass can be tilted down to dim bright lights
- First-surface electro-chrome glass eliminates glare for maximum safety
- Stick-on adhesive pad allows for quick, easy installation
- Includes mirror head and mounting bracket with double-sided tape

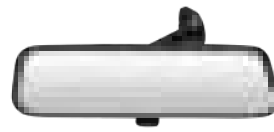

Front



Back

| Part#  | Glass Size | Finish      |
|--------|------------|-------------|
| 102558 | 10" width  | Black vinyl |



# STEP VAN MIRRORS

**DRIVING BUSINESS FORWARD**

OEM assembly set on USPS delivery van

## FEATURED PRODUCTS



### West coast mirror heads

These west-coast-style mirrors come ready to mount onto an existing mirror loop on the van, providing a clear view and OE look.



### Convex mirror heads

Our convex mirrors offer a wide-angle view to reduce dangerous blind spots. They are available in multiple finishes.

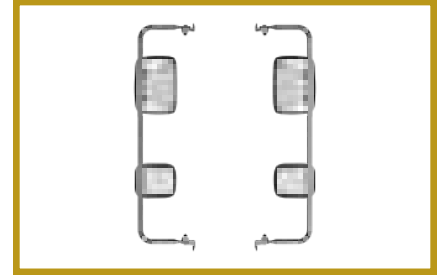

### Custom mirror assemblies

For a complete OE solution, our step van mirrors are available in sets, including the driver and passenger-side mirrors and assemblies.

## PRODUCT INDEX



**66**  
OEM  
Step Van  
Assembly Sets

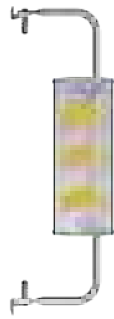

**66**  
Universal  
Step Van Mirror  
Assembly Set

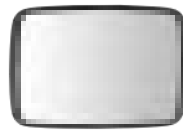

**67**  
West Coast  
Step Van Mirror  
Heads

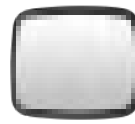

**67**  
Convex  
Step Van Mirror  
Heads



## OEM STEP VAN ASSEMBLY SETS

- Original equipment, light-duty style to provide a perfect OEM replacement
- No-drill, vehicle-specific design to perfectly match the factory holes
- Patented retractable assembly for added clearance when needed
- First-surface electro-chrome glass eliminates glare for maximum safety
- Available in multiple finishes to match various step vans
- Includes driver-side and passenger-side mirror heads, assemblies and hardware

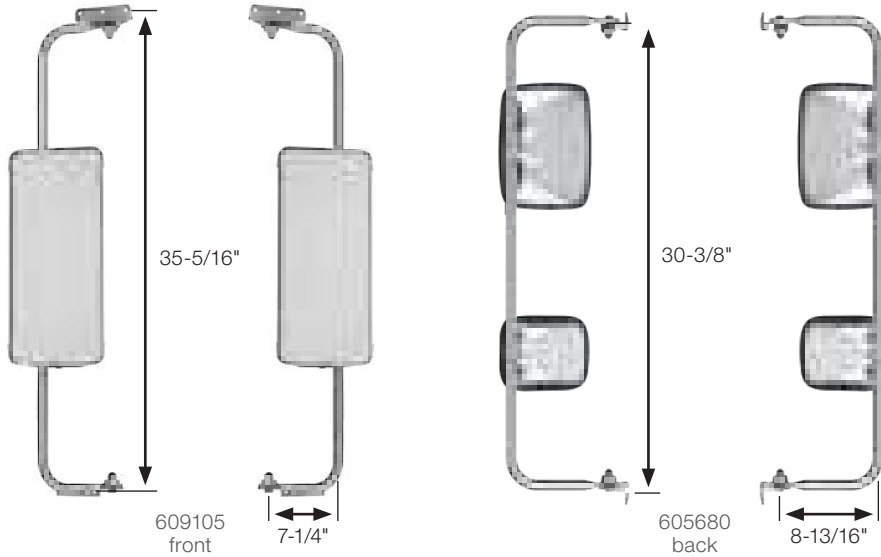

| Part#  | Loop  | Mirror Head Size (W x H) | Convex Head Size (W x H) | Finish          |
|--------|-------|--------------------------|--------------------------|-----------------|
| 609105 | Long  | 7" x 16"                 | 6-1/2" x 6"              | Stainless steel |
| 605680 | Short | 6-1/2" x 10"             | 5-3/4" x 6-1/4"          | Stainless steel |



## UNIVERSAL STEP VAN MIRROR ASSEMBLY SET

- Universal design to fit all models of step vans
- Bright chevrons add style and visibility to the vehicle
- Patented retractable assembly for added clearance when needed
- Mirror adjusts up or down on the loop to fit various window and door sizes
- First-surface electro-chrome glass eliminates glare for maximum safety
- Includes driver-side and passenger-side mirror heads, assemblies and hardware

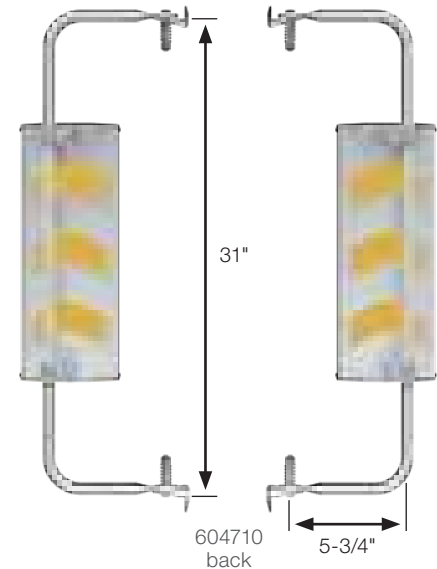

| Part#  | Mirror Head Finish | Assembly Finish                     | Flat Glass Size  |
|--------|--------------------|-------------------------------------|------------------|
| 604710 | Polished stainless | Carbon steel with white powder coat | 5-5/8" x 16-1/4" |



# WEST COAST STEP VAN MIRROR HEADS

- Original equipment, light-duty style to provide a perfect OEM replacement
- Flat mirror provides a wide view to help minimize blind spots
- Clamp mounts securely attach to an existing loop
- First-surface electro-chrome glass eliminates glare for maximum safety
- Available in multiple finishes to match FedEx, USPS and other step vans
- Includes mirror head only (mounting assembly sold separately)

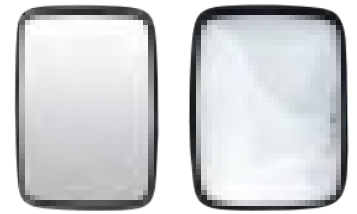

610827



610829



610840

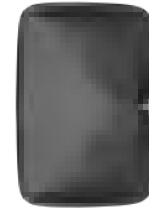

610848



607972

| Part#                    | Glass Size (W x H) | Finish                              |
|--------------------------|--------------------|-------------------------------------|
| <b>Mirror Heads</b>      |                    |                                     |
| 610827                   | 6-1/2" x 10"       | Carbon steel with white powder coat |
| 610829                   | 6-1/2" x 10"       | Polished stainless                  |
| 610840                   | 6-1/2" x 10"       | White ABS plastic                   |
| 610848                   | 6-1/2" x 10"       | Black ABS plastic                   |
| 610809                   | 7-1/2" x 10-1/2"   | Anodized aluminum                   |
| <b>Replacement Glass</b> |                    |                                     |
| 607972                   | 6-1/2" x 10"       | --                                  |



610809



# CONVEX STEP VAN MIRROR HEADS

- Original equipment, light-duty style to provide a perfect OEM replacement
- Convex glass helps eliminate blind spots for safer maneuvering
- First-surface electro-chrome glass eliminates glare for maximum safety
- Available in multiple finishes to match FedEx, USPS and other step vans
- Includes mirror head only (mounting assembly sold separately)



610815



610819



610836



610844

| Part#               | Glass Size (W x H) | Finish                              |
|---------------------|--------------------|-------------------------------------|
| <b>Mirror Heads</b> |                    |                                     |
| 610815              | 6-1/2" x 6"        | Polished stainless                  |
| 610819              | 6-1/2" x 6"        | Carbon steel with white powder coat |
| 610836              | 6-1/2" x 6"        | White ABS plastic                   |
| 610844              | 6-1/2" x 6"        | Black ABS plastic                   |
| 610806*             | 7-1/2" x 10-1/2"   | Aluminum with black powder coat     |

\* Continued while supplies last



610806



# COMPONENT PARTS

**DRIVING BUSINESS FORWARD**

Loop shown with bubble-back west coast mirror

## FEATURED PRODUCTS



### Stabilizers & braces

RETRAC stabilizers and braces add strength and rigidity to your mirror mount. They are adjustable and available in multiple lengths.



### Mirror loops

RETRAC loops come in two different styles: plain-type and swedge-type. Both are available in various sizes and finishes.

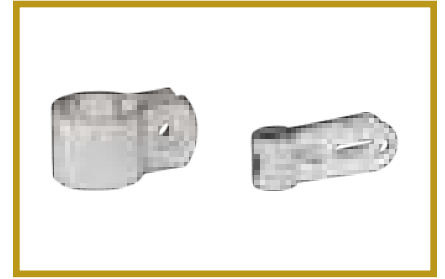

### Mirror clamps

Our mirror clamps come in a range of sizes and various styles to securely attach a heavy-duty west coast mirror onto a mirror loop.

## PRODUCT INDEX



**70**

Stabilizers  
& Braces



**70**

Mirror  
Loops



**72**

Auxiliary Mirror  
Mounting  
Brackets



**72**

West Coast  
Conversion  
Mounting Kit



**73**

Mirror  
Clamps



**73**

Mirror  
J-Brackets



# ADJUSTABLE STABILIZERS AND BRACES

- Helps stabilize mirror head and mounting assembly for reduced vibration
- Adjustable design extends to fit multiple applications

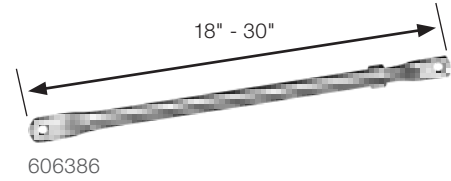
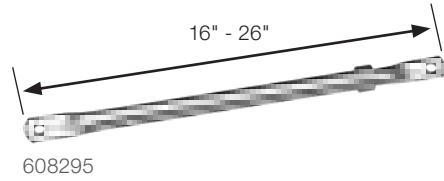
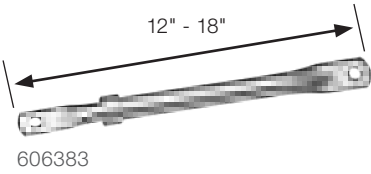
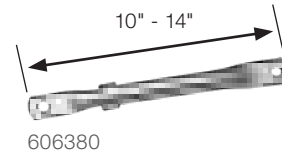
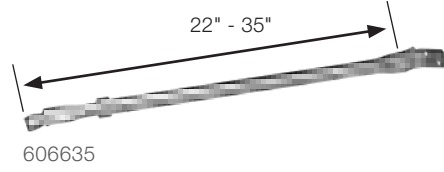
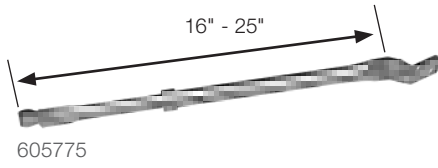

| Part#  | Mount Style | Retracted Length | Extended Length | Finish             |
|--------|-------------|------------------|-----------------|--------------------|
| 605775 | Stabilizer  | 16"              | 25"             | Polished stainless |
| 606635 | Stabilizer  | 22"              | 35"             | Polished stainless |
| 606380 | Brace       | 10"              | 14"             | Polished stainless |
| 606383 | Brace       | 12"              | 18"             | Polished stainless |
| 608295 | Brace       | 16"              | 26"             | Polished stainless |
| 606386 | Brace       | 18"              | 30"             | Polished stainless |



Reduces vibrations and stabilizes assembly



# MIRROR LOOPS

- Plain-type design to accept west coast mirror heads with clamp mounts
- Swedge-type design to accept RETRAC west coast mirror heads with stud mounts
- A wide variety of sizes available to fit virtually any heavy-duty mirror and assembly
- Available in polished stainless or powder-coated steel in a variety of colors
- Includes 3/4" diameter loop only (mirror head and other mounting assembly components not included)



## Finishes & Materials

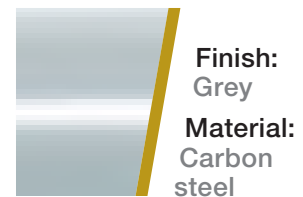
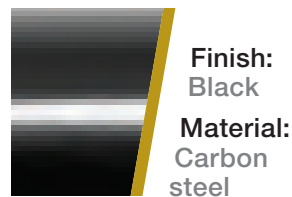
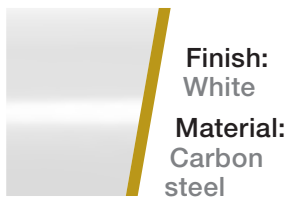
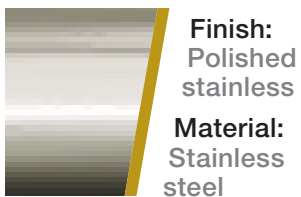





## MIRROR LOOPS

| Dimensions         |                 | Finishes   |        |        |        |
|--------------------|-----------------|------------|--------|--------|--------|
| Width              | Height          | Stainless# | White# | Black# | Grey#  |
| <b>Swedge-Type</b> |                 |            |        |        |        |
| 7.25"              | 18"             | --         | 601959 | --     | --     |
| 8.875"             | 18"             | 601870     | 601873 | --     | 601872 |
| 12"                | 18.50"          | 601970     | --     | --     | 601972 |
| 17"                | 18.50"          | 608160     | --     | --     | --     |
| 30.3125"           | 18.50"          | --         | --     | --     | 601985 |
| <b>Plain-Type</b>  |                 |            |        |        |        |
| 8.78"              | 17.096"         | 604425     | --     | 604427 | --     |
| 12"                | 18.50"          | 601885     | --     | --     | --     |
| 9.25"              | 18.50" - 30.50" | 602105     | --     | --     | --     |
| 5.25"              | 19.675"         | 606745     | --     | --     | --     |
| 15.25"             | 20.675"         | 604378     | --     | --     | --     |
| 8.50"              | 20"             | 612305*    | --     | --     | --     |
| 9.25"              | 20" - 32"       | 602104     | 602106 | --     | --     |
| 16.375"            | 21.192"         | 608185     | --     | --     | --     |
| 7.50"              | 21.75"          | 601890     | --     | --     | --     |
| 5.50"              | 22.50"          | 601900     | --     | --     | --     |
| 5.75"              | 23.25"          | 601905     | --     | --     | --     |
| 10"                | 23.25"          | --         | 601834 | --     | --     |
| 11.50"             | 24.50"          | 601835     | 601839 | --     | --     |
| 14.50"             | 24.50"          | 601960     | --     | --     | --     |
| 8.9375"            | 25.125"         | --         | --     | 606742 | --     |
| 7.25"              | 26.25"          | 601925     | --     | --     | --     |
| 13.5625"           | 28.875"         | 601994     | --     | --     | --     |
| 5.75"              | 29.875"         | 601920     | 601924 | --     | 601923 |
| 10"                | 30"             | 601860     | --     | 601862 | --     |
| 20.75"             | 30"             | 612200     | --     | --     | --     |
| 8.81"              | 30.182"         | --         | --     | --     | 606789 |
| 7.58"              | 33.24"          | --         | --     | 606737 | --     |
| 7.25"              | 34.105"         | 608225     | --     | 608227 | --     |
| 8.81"              | 35.125"         | --         | 608183 | 608182 | --     |
| 10.125"            | 35.142"         | 606720     | --     | --     | --     |
| 15.50"             | 36.50"          | 601935     | --     | --     | --     |

\*612305 is used for aerodynamic mirror heads

### Measuring a loop

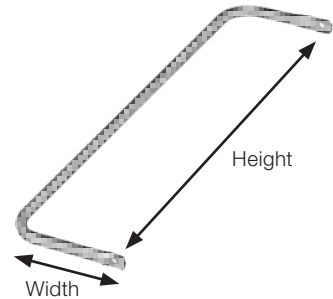

### Loop type

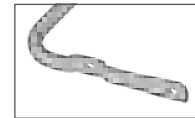

Swedge-type

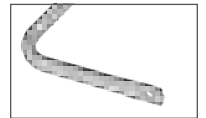

Plain-type



602105

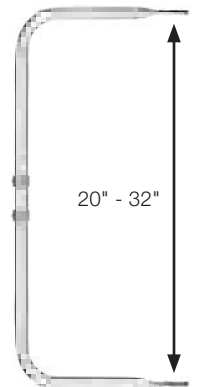

602106



## AUXILIARY MIRROR MOUNTING BRACKETS

- Provides a solid mount for an auxiliary mirror
- Standard J-bracket design fits most RETRAC convex mirrors
- Available in polished stainless or grey powder-coated steel



| Part#  | Stud Hole | Leg Length | Includes  | Finish                             |
|--------|-----------|------------|---|------------------------------------|
| 608351 | --        | 4"         | Brace and tube clamp                                  | Polished stainless                 |
| 608357 | --        | 4"         | Brace and tube clamp                                  | Carbon steel with grey powder coat |
| 608359 | --        | 6"         | Brace and tube clamp                                  | Polished stainless                 |
| 608365 | --        | 6"         | Brace and tube clamp                                  | Carbon steel with grey powder coat |
| 608361 | 3/8"      | 4"         | Brace and tube clamp (608351) with J-bracket (607968) | Polished stainless                 |
| 608367 | 3/8"      | 6"         | Brace and tube clamp (608359) with J-bracket (607968) | Polished stainless                 |



## WEST COAST CONVERSION MOUNTING KIT

- Converts a swedge-type loop to a plain-type
- Allows swedged loops to work with a wider variety of west coast mirrors
- Polished stainless steel construction for a bright, rust-free accent



| Part#  | Finish             |
|--------|--------------------|
| 604205 | Polished stainless |



# MIRROR CLAMPS

- Mounts a west coast mirror head or spot mirror to a standard mirror loop

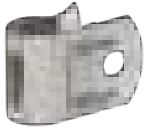

607965



607956 (shown apart)



607961



607962



607958



607959



607956



612994



612995



612996



607952

| Part#  | Mount Style        | Fits             | Stub Hole     | Finish                            |
|--------|--------------------|------------------|---------------|-----------------------------------|
| 607965 | OEM                | 3/4" O.D. tube   | 5/16"         | Carbon steel with plastic coating |
| 607961 | Two-piece dovetail | 3/4" O.D. tube   | 3/8"          | Polished stainless                |
| 607962 | Two-piece dovetail | 3/4" O.D. tube   | 3/8"          | Carbon steel with zinc plating    |
| 607958 | Two-piece dovetail | 3/4" O.D. tube   | 1/4"          | Polished stainless                |
| 607959 | Two-piece dovetail | 3/4" O.D. tube   | 1/4"          | Carbon steel with zinc plating    |
| 607956 | Two-piece dovetail | 5/8" O.D. tube   | 3/8"          | Carbon steel with zinc plating    |
| 612994 | Two-piece dovetail | 1" O.D. tube     | 3/8"          | Polished stainless                |
| 612995 | Two-piece dovetail | 1-1/8" O.D. tube | 3/8"          | Polished stainless                |
| 612996 | Two-piece dovetail | 1-1/4" O.D. tube | 3/8"          | Polished stainless                |
| 607952 | Twisted            | 1/4" hole        | 1/4"          | Polished stainless                |
| 607964 | GM-style           | 1/4" hole        | 5/16" slotted | Carbon steel with plastic coating |



607964



# MIRROR J-BRACKETS

- Standard J-bracket design fits most RETRAC convex mirrors
- Available in polished stainless or zinc-plated carbon steel



607969



607968



607966



607967

| Part#  | Stud Hole                          | Finish                         |
|--------|------------------------------------|--------------------------------|
| 607969 | 3/8"                               | Carbon steel with zinc plating |
| 607968 | 3/8"                               | Polished stainless             |
| 607967 | 1/4"                               | Carbon steel with zinc plating |
| 607966 | 1/4"                               | Polished stainless             |
| 607978 | 1/4" stud (slot is 5/16" x 1-1/8") | Polished stainless             |



Allows for attachment of convex mirrors to the mirror assembly



607978



# MARKETING SUPPORT

**ADVANCE YOUR BUSINESS**

Display stands and signage

# POINT-OF-PURCHASE

## Literature & Catalog

- Tri-fold literature (8-1/2" x 3-1/2") focuses on educating the consumer about the advantages of RETRAC HD grille guards
- The catalog provides a complete listing of RETRAC products and vehicle applications
- Clear plastic stands available for displaying literature



## Banner & Retail Signage

- Attractive signage for use on walls, displays and in-store to help customers identify your RETRAC product offering
- Banner for use in-store and outdoors to help identify and promote your RETRAC offering

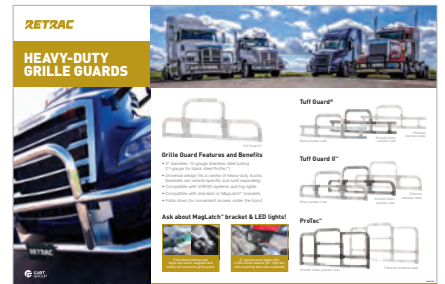
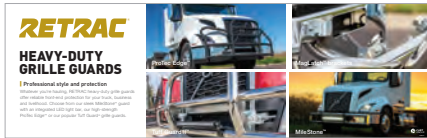

## Display Stands & Adapters

- Contact your RETRAC sales representative to determine the product lineup best tailored to meet your needs
- Floor stand display can mount the Tuff Guard® with use of the adapter
- Floor stand display for mounting the Tuff Guard®
- Counter display for mounting mirror heads

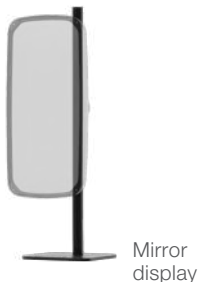

Contact your sales representative for a complete list of available items and to place your order.



**RETRAC**

# DRIVING BUSINESS FORWARD.

For your customers, their truck is their livelihood. It's not just a shiny toy or a status symbol but something they should be proud to own and operate. As such, when it comes to heavy-duty truck accessories, functionality and reliability are of the utmost importance.

Every product your customers buy is an investment in themselves. They expect the same dependability that's required of them every day.

Since 1958, RETRAC has become an industry leader and recognized name for quality mirrors and front-end protection for heavy-duty and medium-duty trucks. We've accomplished this following the same principles your customers use every time they get behind the wheel: functionality and reliability.



Learn more about semi truck grill guards we have.