



RIGID INDUSTRIES LED LIGHTING®

2013 MASTER CATALOG 5.2



RIGID 101

Learn more about the technology behind the light
and why Rigid Industries is the world leader.

WHAT IS AN LED?

An LED or Light Emitting Diode is a semiconductor diode that emits light when an electric current is applied in the forward direction of the device in the LED circuit. The effect is a form of electroluminescence where incoherent and narrow spectrum light is emitted from the P-N junction in a solid state material. The results -- a highly efficient, very bright light source, while drawing less power.

WHAT IS A LUMEN?

Lumen (symbol: lm) is the unit of measurement used for the total amount of visible light emitted by a source. Or more simply, a measurement of emitted light from the direct source, the LED.

WHAT IS LUX?

Lux (symbol: lx) is the unit of illuminance and luminous emittance, measuring luminous flux per unit area. It is equal to one lumen per square meter. In photometry, this is used as a measure of the intensity, as perceived by the human eye, of light that hits a surface. Or more simply, a measurement of emitted light from a specific distance. This measurement takes into account more variables and is a more accurate method of measurement for certain circumstances.



SPECIFICATION CHARTS

On each product family page in the Rigid Industries catalog you will find specification charts particular to that family. Within these charts are pieces of useful information to help you determine which light is best suited for your application.

AMP Draw

The measurement of electrical current drawn from a storage battery (or battery), while the motor is being operated.

Raw Lumens

Described above, this number is a measurement of light emitted (in all directions) from the source, the LED.

Lux @ 10m

Described above, this number is a measurement of light emitted 10 meters (in one direction) from the light.

Beam Distance

A measurement of distance the light travels until reaching .25 lux, the minimum lux reading of usable light.

Peak Beam Intensity

Measured in Candela, this number is the peak amount of light emitted in a certain direction of the beam.

EXAMPLE:

Product Description	Part #	Weight (lbs)	Watts	AMP Draw	LED's	Raw Lumens*	Lux @ 10m	Beam Distance (m)**	Peak Beam Intensity (cd)**
D2 - Driving	50131	1.25	34.5	2.50	6	3030	206.1	287.1	20612

* Based on LED manufacturer specifications

** Tested using ANSI/NEMA FL Standards

WHY DOES COOLING MATTER?

Keeping LED temperatures cool is key to having a reliable unit because the high-powered LEDs used on super-bright units create a significant amount of heat. We've effectively designed housings with heat sinks that transfer the heat from the circuit board efficiently. This prevents damage to the LED and surrounding components. Rigid lights are designed to maximize light output, while still protecting the light from damage. This ensures years of trouble-free operation for you.

PROBLEMS WITH OVERHEATING LEDs

- Decreased light output
- Discolored light output
- Decreased efficiency
- Shorter life span
- Unit failure



OUR SOLUTION

Rigid Industries' US made extruded housing has triple the surface area compared to our competitors' import housing.



RIGID ELECTRONICS

We measure all our lights according to the ANSI FL1 standards which are lighting standards designed for flashlights and portable lighting. We are the only vehicle light company that has joined PLATO (Portable Lights American Trade Organization). We continually test our products to ensure a higher standard of accuracy.

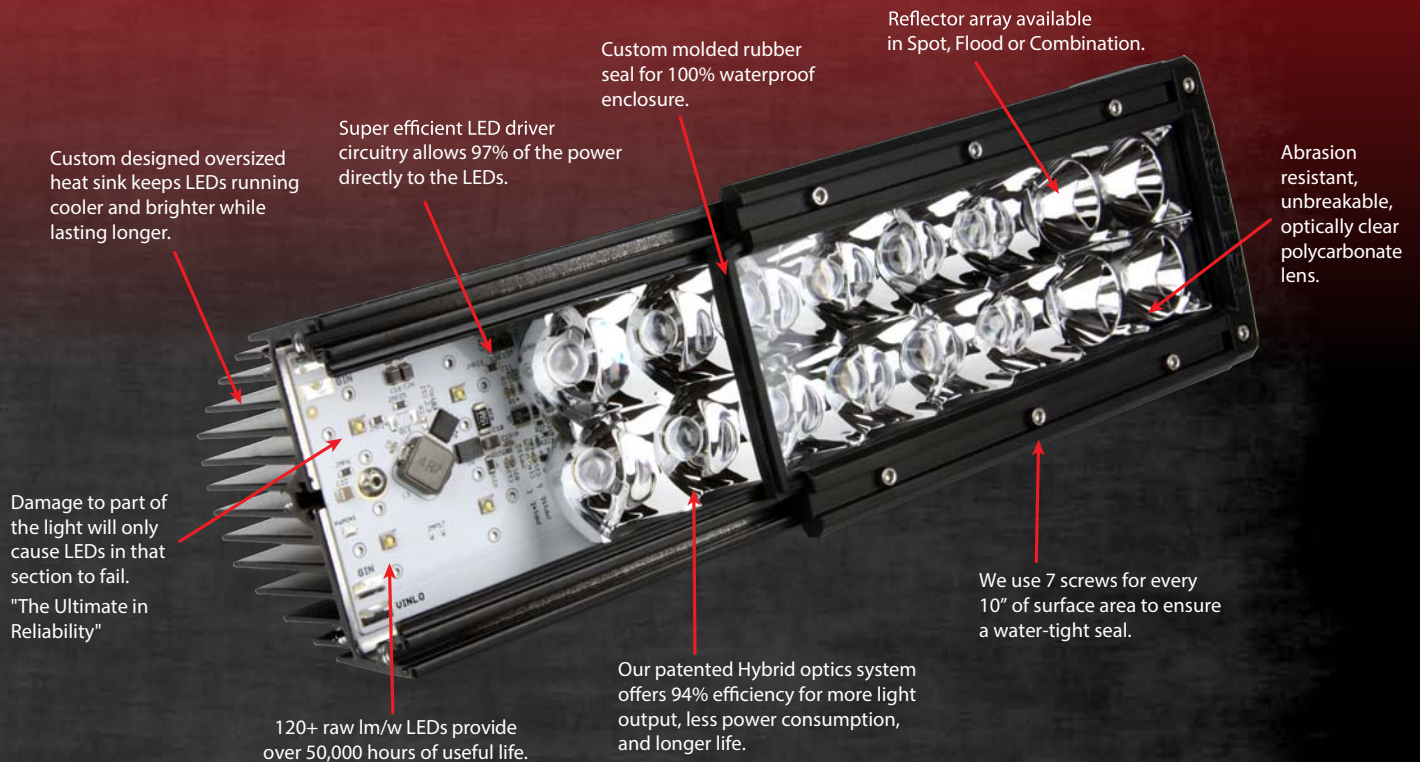

WHY ARE SUPERIOR ELECTRONICS IMPORTANT?

LED lighting requires an efficient circuitry design to maximize light output per watt consumed. Superior products are backed by superior company standards. Our circuitry designs use the latest technologies to give you the most efficient, most reliable lights available. As design innovators, our products offer you the latest state-of-the-art technology.

WE PUT OUR LIGHTS TO THE TEST

- Vibration Tested (MIL-STD-810G)
- Corrosion Tested (ASTM B117)
- Water Pressure Tested (IP-69K)
- Submersion Tested (IP-68)
- Dust Tested (IP-68)
- Variable Voltage Range 9-36V DC
- Over/Under Voltage Protection
- Full Range of Accessories & Mounting Options
- Unbreakable Polycarbonate Lens
- GORE® Pressure Equalizing Vent
- Limited Lifetime Warranties

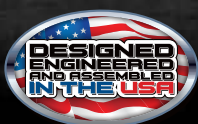

RIGID OPTICS

WHY DO OPTICS MATTER?

Practically all LED fixtures measure light output in lumens at the source - the LED itself. Rigid Industries has revolutionized the way LED light is projected. Our patented Hybrid LED reflector system projects significantly more LED light forward than other comparable products. Our patented Hybrid and Specter optics capture the maximum amount of light rays emitted from the LED and project the light forward exactly where you want it.

Superior optics is a key advantage of LED lighting. Rigid Industries will continue to lead optic innovation for forward projecting LED technology.

RIGID INDUSTRIES SPECTER OPTIC

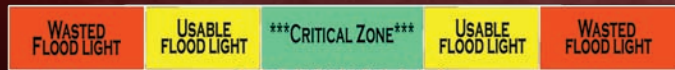

ADVANTAGES

- Small Footprint
- Extremely Efficient
- Smooth Beam
- Minimal Waste of Light
- Available in Wide & Driving
- Patented Technology



RIGID INDUSTRIES HYBRID OPTIC

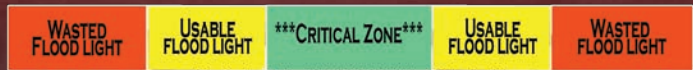

ADVANTAGES

- Extremely Efficient (93%+)
- Incredible Light Control
- Durable
- Max Distance (10° Spot)
- Broad Beam (20° Flood)
- Patented (Patent #'s 6,986,593 B2, 7,114,832 B2)



HYBRID VS SPECTER OPTICS

Rigid's patented Hybrid and Specter optics offer the highest in forward projecting LED technology. Visually, these are both chrome reflectors which encompass the LED and project the light forward. The Hybrid Optic System comes in either a Flood or Spot configuration. Our Specter Optic comes in either a Driving Beam or Wide Beam. Both optics serve their individual purposes and can work together for a perfect balance of distance and spread.

RIGID DIFFUSION LENS

The Rigid Diffusion lens offers the ultimate in scene and area lighting. Visually they can be identified by their textured appearance. This lens is engineered specifically to distribute the light at a 60 degree angle to create smooth, even coverage. This is a great option for area lighting where slow to no vehicular movement is involved.



HOW TO READ A LUX CHART

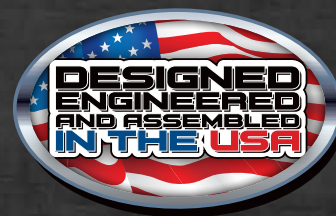
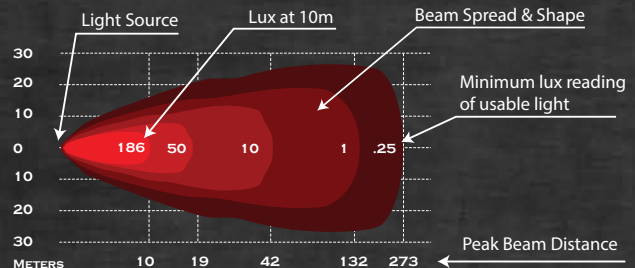

Throughout this catalog and other Rigid Industries material, you will see this badge. It represents something that few American companies are able to claim these days. It is a badge we wear proudly.

Rigid Industries is proud to design, engineer, and assemble its products in the United States of America.

BEAM PATTERNS

Each Rigid Industries patented optical systems provide a unique solution to any lighting requirement. From the Specter Diffusion's 60 degree spread of light to the Hybrid Spot's mile long beam, Rigid has perfected the way you light up the night. See below our different graphs showing height and distance projections. While they are not representative of an individual light, the patterns below will show you the general spread and distance of a particular optic setup.

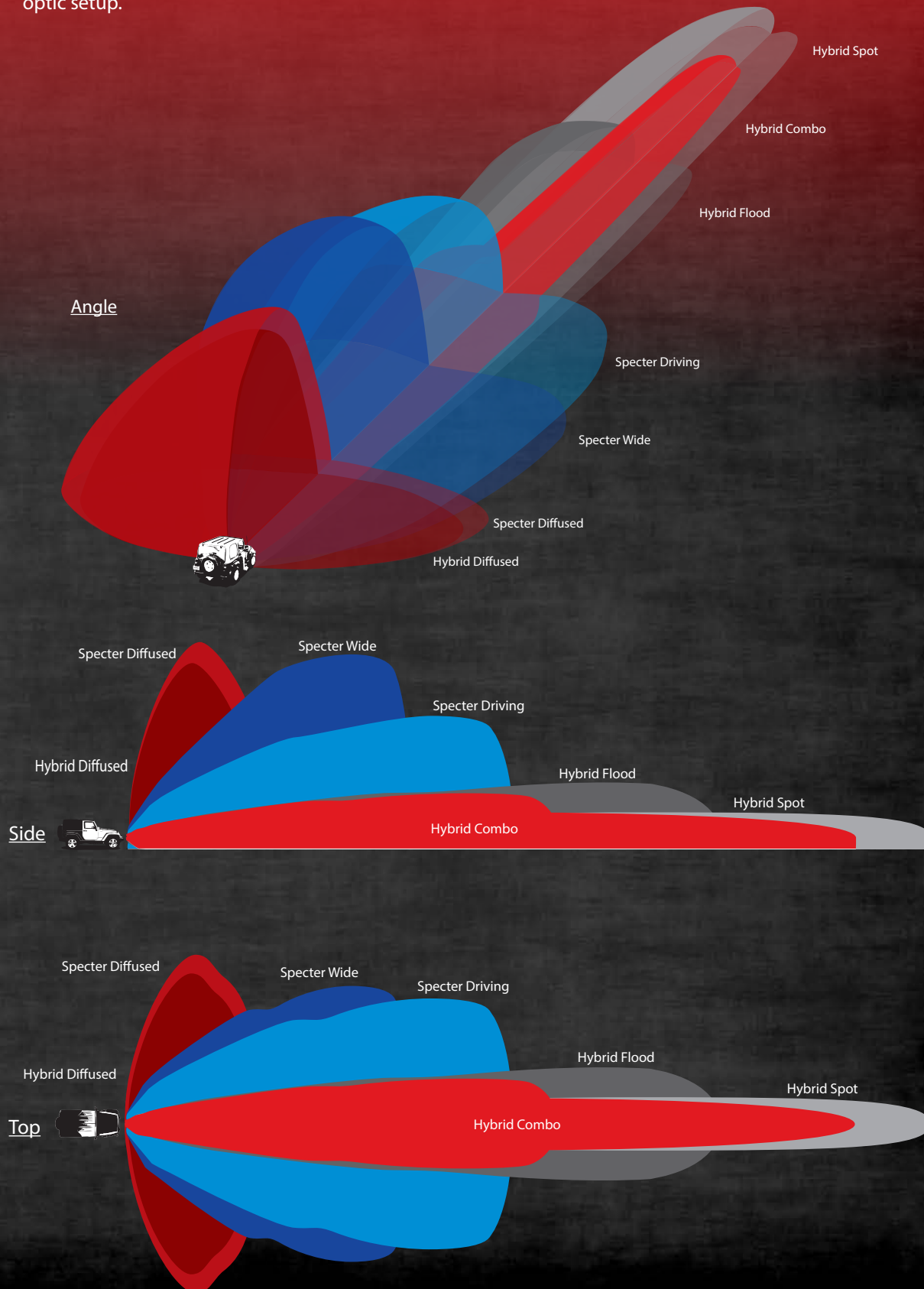

E-SERIES



TORTURE TESTED

As LED technology evolves, so does the E-Series product line. This flagship Rigid product best utilizes the patented Hybrid optic system. It is available in a Hybrid Spot for the max distance coverage, or choose the Hybrid Flood for a broader beam pattern. The ideal light bar is Rigid's Combination optic system that features a row of Spot optics with outer Flood optics to provide impressive exposure over a great distance and width. Rigid's latest improvements include an updated extrusion, an improved GORE® pressure equalizing system, ultra efficient circuitry, and unmatched strength and durability. Add in Rigid's limited lifetime warranty and there's only one choice: Rigid Industries.



4" to 50"



FACTS

- Available in Hybrid Optics System
- GORE® Pressure Equalizing Vent
- Unbreakable Polycarbonate Lens
- 6063 Aluminum Extrusion
- Durable UV 3800 Polyester Powder-coat
- Sealed Deutsch Connector
- Runs on 9 to 36V DC
- 50,000+ Hour Lifespan
- IP68 Certified
- MIL810-STDG Vibration Certified
- ROHS Compliant
- Over / Under Voltage Protection
- Operating temp -40° F ~ +145° F
- Protected Against RFI/EMI
- Integrated Thermal Management System
- Updated Hybrid Optic System
- Patented Optics (6,986,593 b2, 7,114,832 b2)

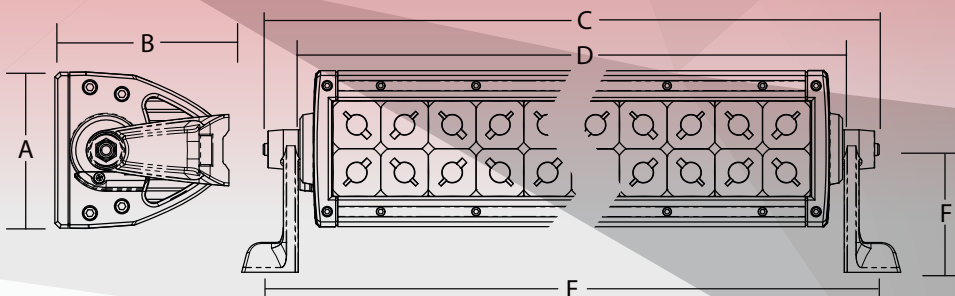

SIZING CHART

E-Series	A	B	C	D	E	F
E-Series 4"	3 ¹ / ₄	3 ³ / ₄	6 ⁷ / ₈	5 ³ / ₈	6 ¹⁵ / ₁₆	2 ⁵ / ₈
E-Series 6"	3 ¹ / ₄	3 ³ / ₄	8 ⁷ / ₈	7 ³ / ₈	8 ¹⁵ / ₁₆	2 ⁵ / ₈
E-Series 10"	3 ¹ / ₄	3 ³ / ₄	12 ⁷ / ₈	11 ³ / ₈	12 ¹⁵ / ₁₆	2 ⁵ / ₈
E-Series 20"	3 ¹ / ₄	3 ³ / ₄	22 ⁷ / ₈	21 ³ / ₈	22 ¹⁵ / ₁₆	2 ⁵ / ₈
E-Series 30"	3 ¹ / ₄	3 ³ / ₄	32 ⁷ / ₈	31 ³ / ₈	32 ¹⁵ / ₁₆	2 ⁵ / ₈
E-Series 40"	3 ¹ / ₄	3 ³ / ₄	42 ⁷ / ₈	41 ³ / ₈	42 ¹⁵ / ₁₆	2 ⁵ / ₈
E-Series 50"	3 ¹ / ₄	3 ³ / ₄	52 ⁷ / ₈	51 ³ / ₈	52 ¹⁵ / ₁₆	2 ⁵ / ₈

SPECIFICATIONS

* Based on LED manufacturer Specifications
 ** Tested using ANSI/NEMA FL Standards

Product Description	Part #	Weight (lbs)	Watts	AMP Draw	LED's	Raw Lumens*	Lux @ 10m	Beam Distance (m)**	Peak Beam Intensity (cd)**
E-Series 4" - Flood	10411	1.9	16	1.16	8	1680	186	273.3	18667
E-Series 4" - Spot	10421	1.9	16	1.16	8	1680	525	458.3	52500
E-Series 4" - Diffused	10451	1.9	16	1.16	8	1680	20	91.0	2069
E-Series 6" - Flood	10611	2.35	24	1.74	12	2520	280	334.7	27000
E-Series 6" - Spot	10621	2.35	24	1.74	12	2520	787	561.2	78750
E-Series 6" - Combo	10631	2.35	24	1.74	12	2520	484	440.3	48462
E-Series 6" - Diffused	10651	2.35	24	1.74	12	2520	31	114.4	3103
E-Series 10" - Flood	11011	3.45	40	2.9	20	4200	466	432	46667
E-Series 10" - Spot	11021	3.45	40	2.9	20	4200	1312	724	131250
E-Series 10" - Combo	11031	3.45	40	2.9	20	4200	807	568	80769
E-Series 20" - Combo	12031	6.15	80	5.8	40	8400	2240	946.6	224000
E-Series 30" - Combo	13031	8.85	120	8.7	60	12600	3600	1200	360000
E-Series 40" - Combo	14031	11.55	160	11.59	80	16800	4800	1385.6	480000
E-Series 50" - Combo	15031	14.25	200	14.49	100	21000	6000	1549.2	600000



E-SERIES 4"

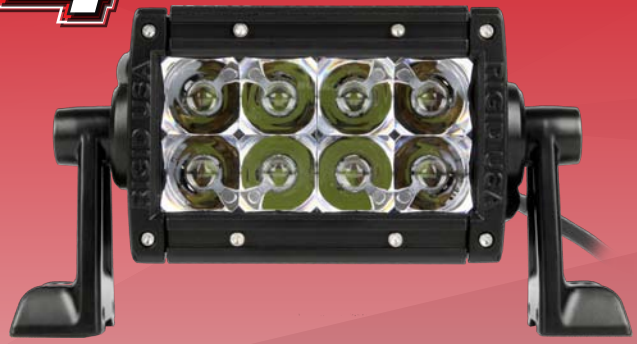
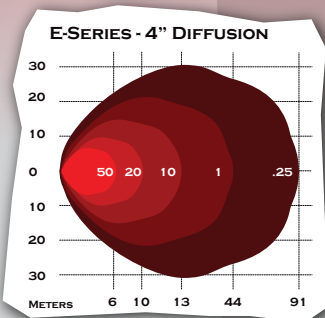
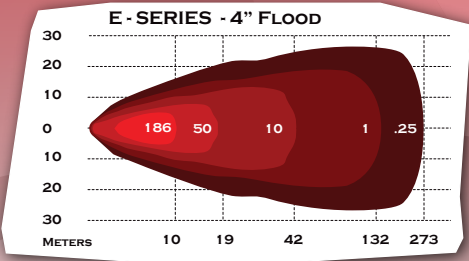
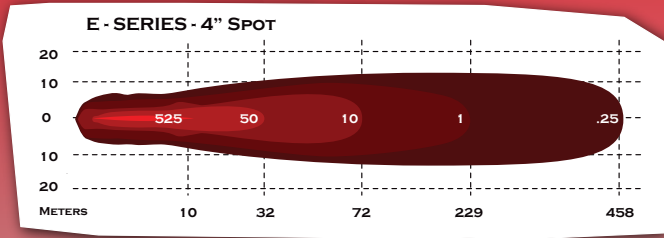

Product Description **Part #**

E-Series 4" - Flood	10411
E-Series 4" - Spot	10421
E-Series 4" - Diffused	10451

Light Kit Includes...

- Plug & Play wiring harness with switch
- Mounting Brackets (2)
- Mounting Hardware



Also Available in...

- Amber LED
- Marine Grade



E-SERIES 6"

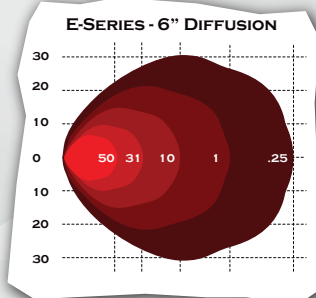
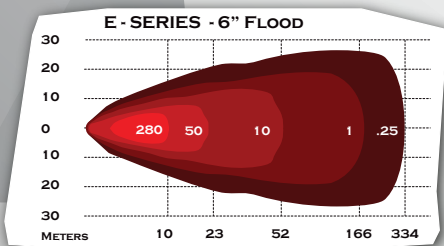
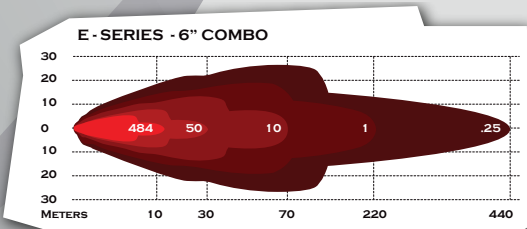
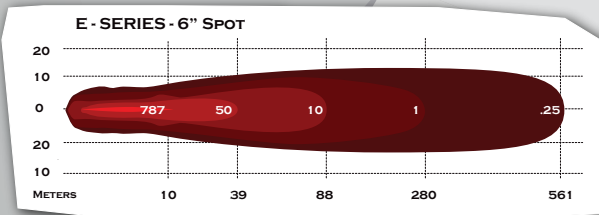

Product Description **Part #**

E-Series 6" - Flood	10611
E-Series 6" - Spot	10621
E-Series 6" - Combo	10631
E-Series 6" - Diffused	10651

Light Kit Includes...

- Plug & Play wiring harness with switch
- Mounting Brackets (2)
- Mounting Hardware



Also Available in...

- Amber LED
- Marine Grade



E-SERIES 10"

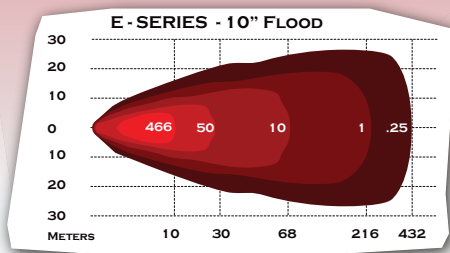
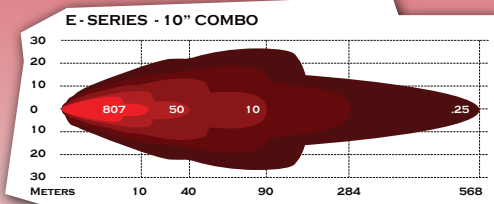
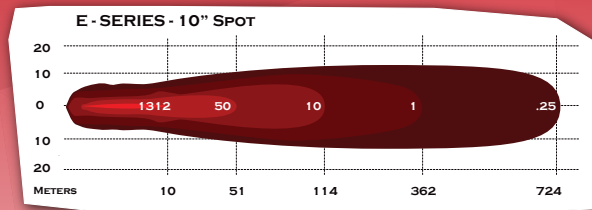

Product Description

Part #

E-Series 10" - Flood	11011
E-Series 10" - Spot	11021
E-Series 10" - Combo	11031

Light Kit Includes...

- Plug & Play wiring harness with switch
- Mounting Brackets (2)
- Mounting Hardware



Also Available in...

- Amber LED
- Marine Grade



E-SERIES 20"

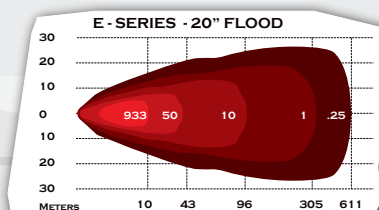
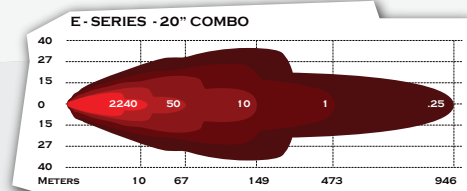
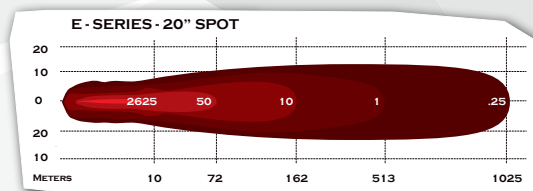

Product Description

Part #

E-Series 20" - Flood	12011
E-Series 20" - Spot	12021
E-Series 20" - Combo	12031

Light Kit Includes...

- Plug & Play wiring harness with switch
- Mounting Brackets (2)
- Mounting Hardware



Also Available in...

- Amber LED
- Marine Grade



E-SERIES 30"

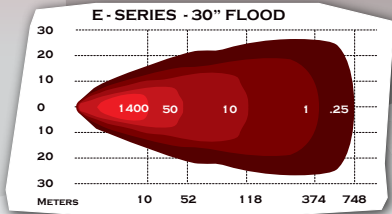
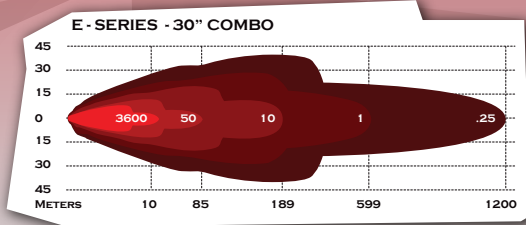
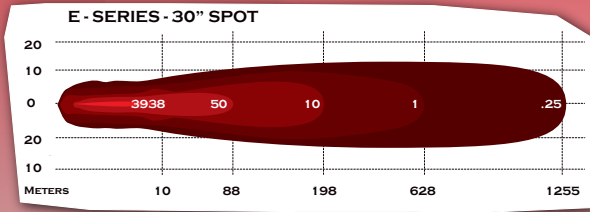
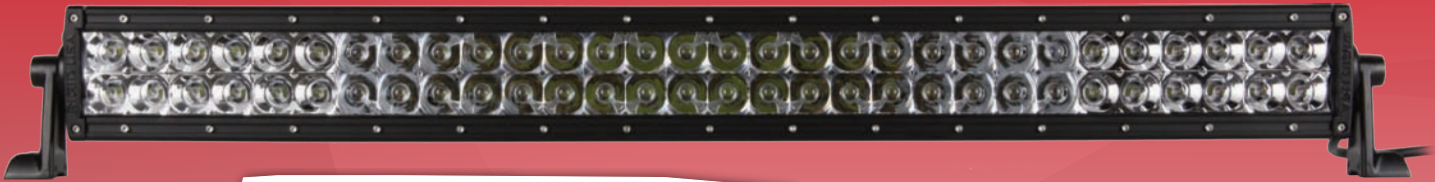

Product Description

Part #

E-Series 30" - Flood	13011
E-Series 30" - Spot	13021
E-Series 30" - Combo	13031

Light Kit Includes...

Plug & Play wiring harness with switch
 Mounting Brackets (2)
 Mounting Hardware



Also Available in...

Amber LED
 Marine Grade

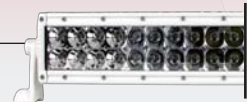

E-SERIES 40"

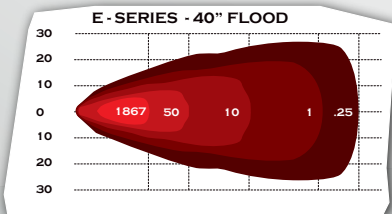
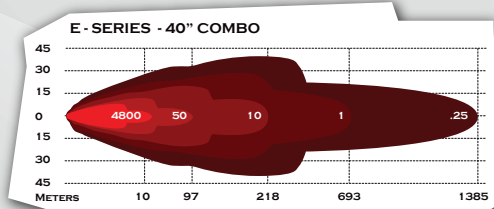
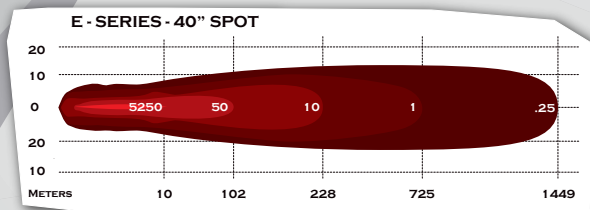

Product Description

Part #

E-Series 40" - Flood	14011
E-Series 40" - Spot	14021
E-Series 40" - Combo	14031

Light Kit Includes...

Plug & Play wiring harness with switch
 Mounting Brackets (2)
 Mounting Hardware



Also Available in...

Amber LED
 Marine Grade

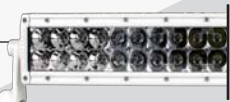

E-SERIES 50"

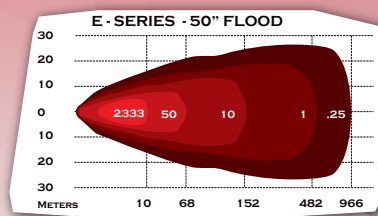
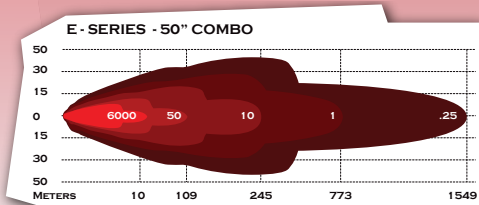
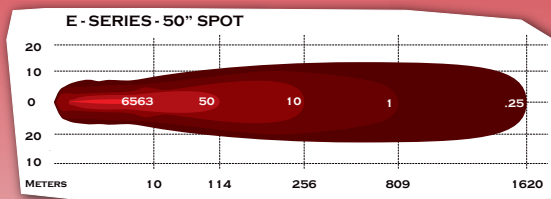

Product Description	Part #
E-Series 50" - Flood	15011
E-Series 50" - Spot	15021
E-Series 50" - Combo	15031

Light Kit Includes...

- Plug & Play wiring harness with switch
- Mounting Brackets (2)
- Mounting Hardware



Also Available in...

- Amber LED
- Marine Marine



E-SERIES ACCESSORIES

CLAMP KITS



Our 3 piece adjustable clamps are the perfect way to mount your new light bar to virtually any size tubing from .875" to 3.25". The sleek design allows for easy installation and extreme versatility in positioning your light. These clamps are machined from aircraft-grade billet aluminum and hard anodized in black for a durable finish. Hardware included.

Lights Sold Separately



Tubing Size	Part #	Tubing Size	Part #
.875"	40820	2.0"	42020
1.0"	41020	2.25"	42220
1.125"	41120	2.375"	42320
1.25"	42520	2.50"	45220
1.50"	45020	2.625"	42620
1.625"	46220	2.75"	42720
1.70"	47020	2.87"	42820
1.75"	47520	3.0"	43020
1.875"	48720	3.25"	43220

WELD ON TABS



Style	Part #
Flat (pair)	40291
Round (pair)	40292

Lights Sold Separately

Your choice of flat surfaced or 1 3/4" radius.

CRADLES

Cradles are another option for mounting the light. They are powder-coated black for a durable finish. Hardware included.



Light Size	Part #
4" Light	40410
6" Light	40610
10" Light	41010
20" Light	42010
30" Light	43010
40" Light	44010

Lights Sold Separately



E-SERIES COVERS

COVERS

E-SERIES

- Black 50" (5 x 10" covers) - 15091
- Black 40" (4 x 10" covers) - 14091
- Black 30" (3 x 10" covers) - 13091
- Black 20" (2 x 10" covers) - 12091
- Black 10" - 11091
- Clear 10" - 11092
- Amber 10" - 11093
- Blue 10" - 11094
- Red 10" - 11095
- White 10" - 11096
- Green 10" - 11097
- Smoked 10" - 11098



Rigid E-Series light covers not only give your LED light bars a unique look, they also provide another layer of protection. Available in 10" increments, these covers are made from durable polycarbonate plastic and are designed to snap onto your lights with ease. Our E-Series LED light covers are available in a variety of colors. The white and black versions are opaque and feature the Rigid Industries star logo. The translucent version comes in red, blue, green, amber, clear, and smoked. Our light covers are often used to improve visibility in harsh environments.

AMBER LED

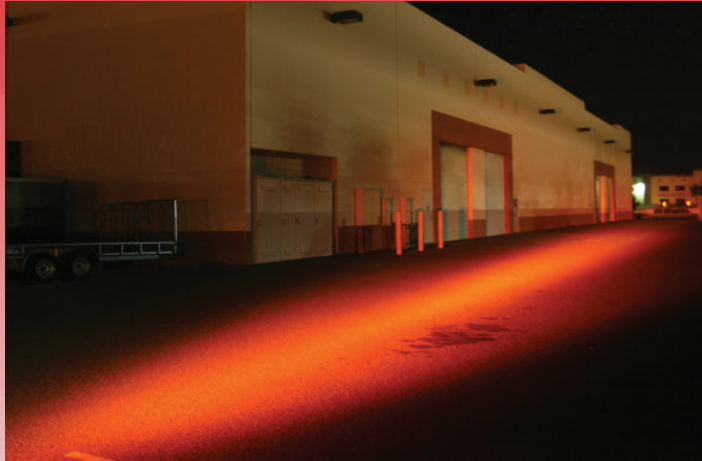

- Cuts Through Fog, Dust and Other Air Debris
- Patented Hybrid & Specter Optical Systems
- Available in Spot, Flood or Combination
- 50,000+ Hours Average Lifespan
- 93% Optical System Efficiency
- 9-36V DC Input
- 100% Optically Clear, Scratch Resistant Lens
- Instant On / Off - No Warm-up
- Operating Temp: -40° F ~ +145° F
- Shock Proof
- Over / Under Voltage Protection
- Limited Lifetime Warranty
- Oversized Heat Sink
- Low Power Consumption
- IP68 Rating
- Integrated Thermal Management
- Zero UV Emissions

Rigid Industries' amber LED lights are designed to work in rain, snow, fog, smoke and dust. To achieve the best light output, use a narrow beam amber light. By using a dedicated amber LED, all the light produced is between 550 and 590nm wavelength. By only projecting narrow wavelength light, it cuts through the elements better than any other light system. Rigid recommends our Hybrid Spot or Specter Driving as the ideal beam patterns for amber lights.

SPECIFICATIONS

* Based on LED manufacturer specifications
 ** Tested using ANSI/NEMA FL standards

Product Description	Part #	Weight (lbs)	Watts	AMP Draw	LED's	Raw Lumens*	Beam Distance (m)**
Amber E-Series 4" - Flood	10412	1.9	12.4	.9	8	840	193.2
Amber E-Series 4" - Spot	10422	1.9	12.4	.9	8	840	324
Amber E-Series 4" - Diffused	10452	1.9	12.4	.9	8	1580	64.3
Amber E-Series 6" - Flood	10612	2.35	18.6	1.35	12	1260	236.60
Amber E-Series 6" - Spot	10622	2.35	18.6	1.35	12	2370	396.9
Amber E-Series 6" - Diffused	10652	2.35	18.6	1.35	12	1260	78.8
Amber E-Series 6" - Combo	10632	2.35	18.6	1.35	12	1260	311.3
Amber E-Series 10" - Flood	11012	3.45	31	2.25	20	2100	305.5
Amber E-Series 10" - Spot	11022	3.45	31	2.25	20	2100	512.3
Amber E-Series 10" - Combo	11032	3.45	31	2.15	20	2100	401.9
Amber E-Series 20" - Combo	12032	6.15	62	4.49	40	4200	669.3
Amber E-Series 30" - Combo	13032	8.85	93	6.74	60	6300	848.5
Amber E-Series 40" - Combo	14032	11.55	124	8.99	80	8400	979.8
Amber E-Series 50" - Combo	15032	14.25	155	11.23	100	10500	1095.4

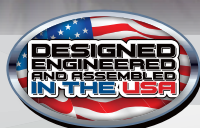

D-SERIES



SPECIFICATIONS

* Based on LED manufacturer specifications

** Tested using ANSI/NEMA FL standards

Product Description	Part #	Weight (lbs)	Watts	AMP Draw	LED's	Raw Lumens*	Lux @ 10m	Beam Distance (m)**	Peak Beam Intensity (cd)**
Dually - Flood	20111	1.25	20	1.45	4	1568	174.2	264.0	17422
Dually - Spot	20121	1.25	20	1.45	4	1568	490	442.7	49000
Dually - Diffused	20151	1.25	20	1.45	4	1568	19.3	87.9	1931
D2 - Driving	50131	1.25	34.5	2.50	6	3030	206.1	287.1	20612
D2 - Wide	50111	1.25	34.5	2.50	6	3030	178.2	267.0	17824
D2 - Diffused	50151	1.25	34.5	2.50	6	3030	37.3	122.2	3732

COMPACT DESIGN. EXTREME PERFORMANCE.

DUALLY

The Rigid Dually offers many uses. A 4 LED light in a compact package can be used for virtually anything -- from a reverse light for a truck to a handlebar light for a motorcycle to a flood light for a trailer. With 1,568 lumens of light, this small unit has more light output than a 50 watt MR16. At just 3" x 3", this light can fit anywhere. Pulling only 20 watts, you won't find a more efficient, compact light source anywhere.

D2

The Rigid D2 is one of our most powerful LED lights. Versatile mounting options and superior patented optics make the D2 a preferred solution to many high-performance lighting needs. At only 34.5 watts, the Rigid D2 produces 3,030 lumens. Thermally managed circuitry prevents overheating. The D2 is one of the brightest compact auxiliary lights available and is backed by a limited lifetime warranty.

DUALLY / D2 DIFFUSED

Rigid Industries' Diffusion lens is the ultimate small package area light. Using a Hybrid Flood optic and a Diffusion lens, the D-Series produces a 60 degree spread reaching 87 meters. The Driving D2 LED light can use the Diffusion lens to create the same 60 degree spread reaching 122 meters. It is a great option for all types of area lighting.

FACTS

- GORE® Pressure Equalizing Vent
- Unbreakable Polycarbonate Lens
- Durable UV 3800 Polyester Powder-coat
- Sealed Deutsch Connector
- Runs on 9 to 36V DC
- 50,000+ Hour Lifespan
- Available in Hybrid & Specter Optics
- IP68 Certified
- MIL810-STDG Vibration Certified
- ROHS Compliant
- Over / Under Voltage Protection
- Operating Temp -40° F ~ +145° F
- Protected Against RFI / EMI
- Integrated Thermal Management System
- Patented Optics (6,986,593 b2, 7,114,832 b2)

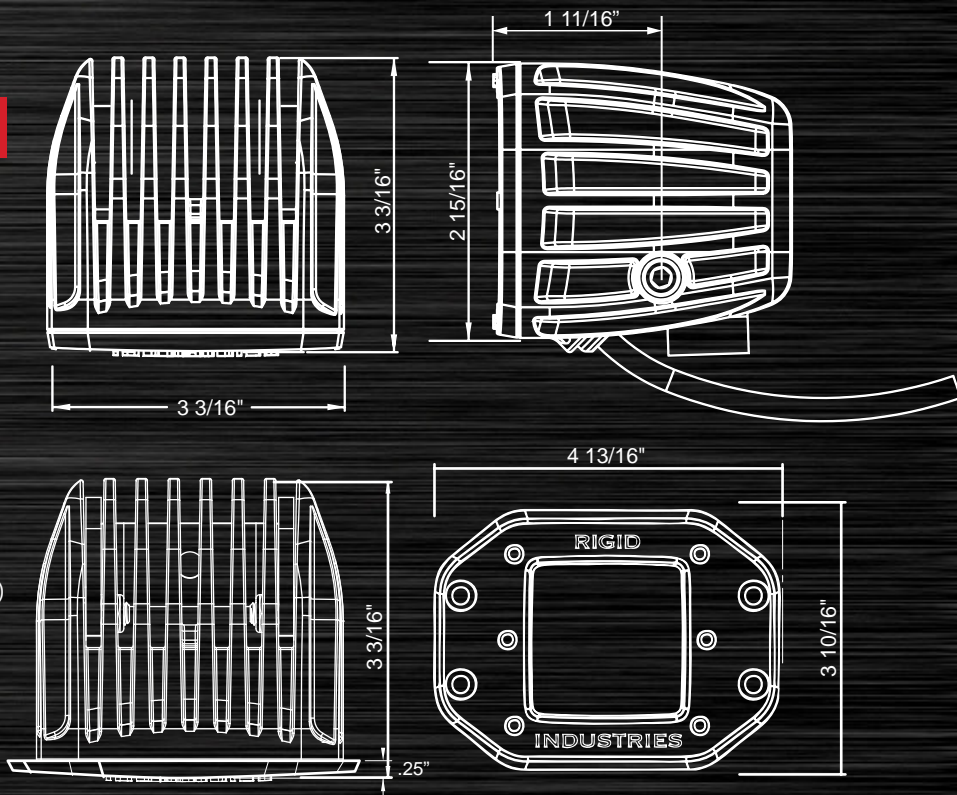

DUALITY

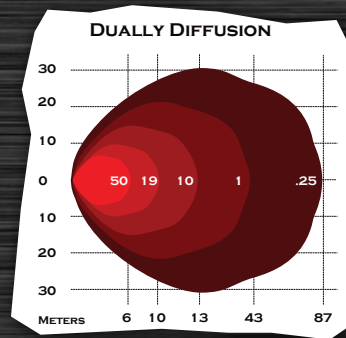

Product Description	Part #
Dually - Diffused	20151
Dually - Diffused Set of 2	20251

Light Kit Includes...

- Plug & Play wiring harness with switch
- Mounting Bracket
- Mounting Hardware

Also Available in...

- Marine Grade
- Flush Mount
- Amber LED

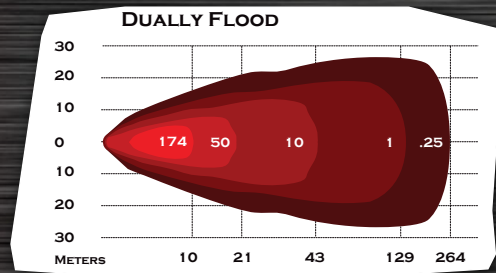

Product Description	Part #
Dually - Flood	20111
Dually - Flood Set of 2	20211

Light Kit Includes...

- Plug & Play wiring harness with switch
- Mounting Bracket
- Mounting Hardware

Also Available in...

- Marine Grade
- Flush Mount
- Amber LED

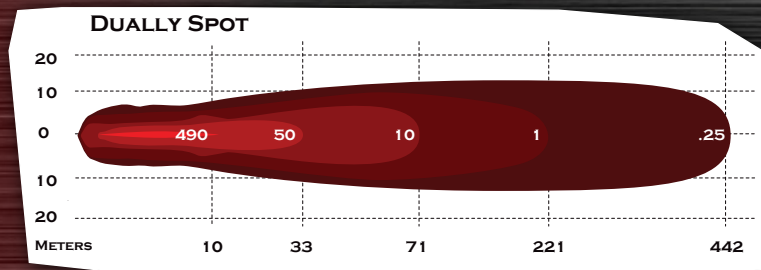

Also Available in...	Product Description	Part #
Marine Grade	Dually - Spot	20121
Flush Mount	Dually - Spot Set of 2	20221
Amber LED		

Light Kit Includes...

- Plug & Play wiring harness with switch
- Mounting Bracket
- Mounting Hardware



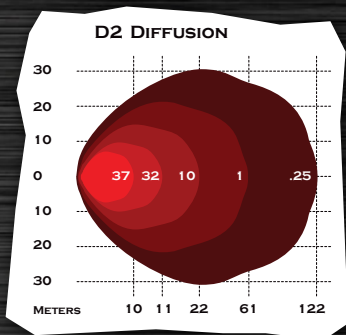

Product Description **Part #**

D2 - Diffused 50151
 D2 - Diffused Set of 2 50251

Light Kit Includes...

Plug & Play wiring harness with switch
 Mounting Bracket
 Mounting Hardware

Also Available in...

Marine Grade
 Flush Mount
 Amber LED

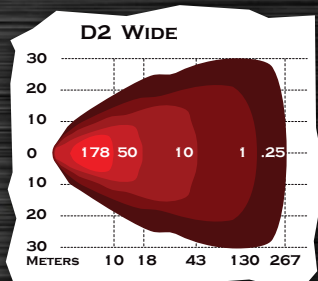

Product Description **Part #**

D2 - Wide 50111
 D2 - Wide Set of 2 50211

Light Kit Includes...

Plug & Play wiring harness with switch
 Mounting Bracket
 Mounting Hardware

Also Available in...

Marine Grade
 Flush Mount
 Amber LED

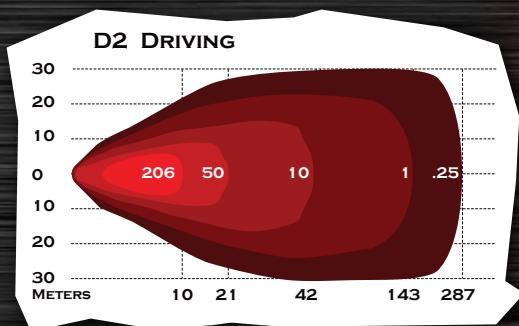

Also Available in...

Marine Grade
 Flush Mount
 Amber LED

Product Description

D2 - Driving 50131
 D2 - Driving Set of 2 50231

Light Kit Includes...

Plug & Play wiring harness with switch
 Mounting Bracket
 Mounting Hardware



BAR MOUNTS



**A-PILLAR
BAR MOUNT**



**HORIZONTAL
BAR MOUNT**



**VERTICAL
BAR MOUNT**

Lights Sold Separately

Tube Size	Mounting Style		
	A-Pillar Part #	Horizontal Part #	Vertical Part #
.875"	40830	40840	47050
1"	41030	41040	41050
1.125"	41230	41240	41250
1.25"	42530	42540	42550
1.50"	45030	45040	45050
1.625"	46230	46240	46250
1.70"	47030	47040	47050
1.75"	47530	47540	47550
1.875"	48530	48540	48550
2"	42030	42040	42050
2.25"	42230	42240	42250
2.375"	42330	42340	42350
2.5"	45230	45240	45250
2.625"	42630	42640	42650
2.75"	42730	42740	42750
2.875"	42830	42840	42850
3"	43030	43040	43050
3.25"	43230	43240	43250

All clamp styles are designed for E-Series, D-Series, SR-Series, SR-M, SR-Q and M-Series lights.

Fresh water applications only.

FLUSH MOUNTS

This model is designed to be recessed into a bumper, a utility bed, on a boat or any application where you need the light to look clean and out of the way. Once installed, the light is only 1/4" exposed, which means you can have all the benefits of our surface mount lights in an OEM quality, flush installation.



Product Description	Part #	Product Description	Part #	Product Description	Part #
Dually FM - Flood	21111	Dually FM - Spot	21121	Dually FM - Diffused	21151
Dually FM - Flood Set of 2	21211	Dually FM - Spot Set of 2	21221	Dually FM - Diffused Set of 2	21251



Product Description	Part #	Product Description	Part #	Product Description	Part #
D2 FM - Wide	51111	D2 FM - Driving	51131	D2 FM - Diffused	51151
D2 FM - Wide Set of 2	51211	D2 FM - Driving Set of 2	51231	D2 FM - Diffused Set of 2	51251

SPECIFICATIONS

* Based on LED manufacturer specifications
 ** Tested using ANSI/NEMA FL Standards

Product Description	Part #	Weight (lbs)	Watts	AMP Draw	LED's	Raw Lumens*	Lux @ 10m	Beam Distance (m)**	Peak Beam Intensity (cd)**
Dually Flush Mount - Flood	21111	1.25	20	1.45	4	1568	174.2	264.0	17422
Dually Flush Mount - Spot	21121	1.25	20	1.45	4	1568	490	442.7	49000
Dually Flush Mount - Diffused	21151	1.25	20	1.45	4	1568	19.3	87.9	1931
D2 Flush Mount - Driving	51131	1.25	34.5	2.50	6	3030	206.1	287.1	20612
D2 Flush Mount - Wide	51111	1.25	34.5	2.50	6	3030	178.2	267.0	17824
D2 Flush Mount - Diffused	51151	1.25	34.5	2.50	6	3030	37.3	122.2	3732

Each Dually and D2 light kit comes with plug and play wiring harness and switch. 



D-SERIES COVERS



COVERS

D-SERIES

- Black - 20191
- Clear - 20192
- Amber - 20193
- Blue - 20194
- Red - 20195
- White - 20196
- Green - 20197
- Smoked - 20198

Rigid snap-on light covers are perfect for the Dually/D2 line of products. Made of polycarbonate plastic, these covers are tough and snap easily into place to protect your light. The black and white covers are opaque and meet DOT regs in most states. Also available in clear, amber, blue, red, green, and smoked for different colored tinting applications. The amber cover provides instant improvements in harsh environments.

AMBER LED

Rigid Industries' amber LED lights are designed to work in rain, snow, fog, smoke and dust. To achieve the best light output, use a narrow beam amber light. By using a dedicated amber LED, all the light produced is between 550 and 590nm wavelength. By only projecting narrow wavelength light, it cuts through the elements better than any other light system. Rigid recommends our Hybrid Spot or Specter Driving as the ideal beam patterns for amber lights.



- Cuts Through Fog, Dust and Other Air Debris
- Patented Hybrid & Specter Optical Systems
- Available in Spot, Flood or Combination
- 50,000+ Hours Average Lifespan
- 93% Optical System Efficiency
- 9-36V DC Input
- 100% Optically Clear, Scratch Resistant Lens
- Instant On / Off - No Warm-up
- Operating Temp: -40° F ~ +145° F
- Shock Proof
- Over / Under Voltage Protection
- Limited Lifetime Warranty
- Oversized Heat Sink
- Low Power Consumption
- IP68 Rating
- Integrated Thermal Management
- Zero UV Emissions

SPECIFICATIONS

* Based on LED manufacturer specifications
 ** Tested using ANSI/NEMA FL standards

Product Description	Part #	Weight (lbs)	Watts	AMP Draw	LED's	Raw Lumens*	Beam Distance (m)**
Amber Dually - Flood	20112	1.25	8.8	.64	4	560	157.8
Amber Dually - Spot	20122	1.25	12	.87	4	600	273.9
Amber Dually - Diffused	20152	1.25	8.8	.64	4	560	52.5
Amber D2 - Driving	50112	1.25	13.2	.96	6	840	140.6
Amber D2 - Wide	50132	1.25	13.2	.96	6	840	151.2
Amber D2 - Diffused	50152	1.25	13.2	.96	6	840	64.3



SR-SERIES



Short and long brackets are included with every SR-Series light bar for mounting versatility.

Measuring only 1.5" tall, our SR-Series light bars are half the footprint of the E-Series. Only Rigid offers the brightest, furthest projecting LED light bars. SR-Series is offered in both Hybrid and Specter optics systems producing over 5,000 raw lumens in the Specter 10" version. Limited lifetime warranty.

LIGHT SIZE COMPARISON

10" E-SERIES LED LIGHT BAR



10" SR-SERIES LED LIGHT BAR



6" to 50"

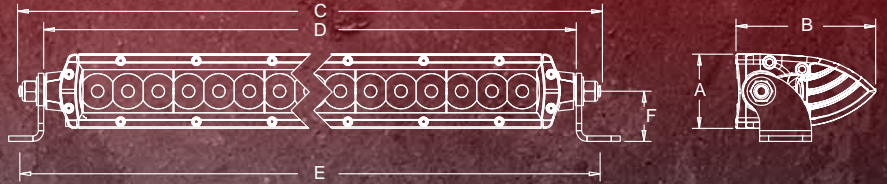

FACTS

- Available in Hybrid or Specter Optical Systems
- GORE® Pressure Equalizing Vent
- Unbreakable Polycarbonate Lens
- Durable UV 3800 Polyester Powder-coat
- Runs on 9 to 36V DC
- Sealed Deutsch Connector
- 50,000+ Hour Lifespan
- IP68 Certified
- MIL810-STDG Vibration Certified
- ROHS Compliant
- Patented Optics (6,986,593 b2, 7,114,832 b2)

SIZING CHART

*For Long Brackets add 1 13/16" to Size F

SR-Series	A	B	C	D	E	*F
SR-Series 6"	1 ⁵ / ₈	3	8 ⁷ / ₈	7 ⁵ / ₈	8 ¹⁵ / ₁₆	1 ¹ / ₈
SR-Series 10"	1 ⁵ / ₈	3	12 ⁷ / ₈	11 ⁵ / ₈	12 ¹⁵ / ₁₆	1 ¹ / ₈
SR-Series 20"	1 ⁵ / ₈	3	22 ⁷ / ₈	21 ⁵ / ₈	22 ¹⁵ / ₁₆	1 ¹ / ₈
SR-Series 30"	1 ⁵ / ₈	3	32 ⁷ / ₈	31 ⁵ / ₈	32 ¹⁵ / ₁₆	1 ¹ / ₈
SR-Series 40"	1 ⁵ / ₈	3	42 ⁷ / ₈	41 ⁵ / ₈	42 ¹⁵ / ₁₆	1 ¹ / ₈
SR-Series 50"	1 ⁵ / ₈	3	52 ⁷ / ₈	51 ⁵ / ₈	52 ¹⁵ / ₁₆	1 ¹ / ₈

SPECIFICATIONS

HYBRID

Product Description	Part #	Weight (lbs)	Watts	AMP Draw	LED's	Raw Lumens*	Lux @ 10m	Beam Distance (m)**	Peak Beam Intensity (cd)**
SR-Series 6" - Flood	90611	1.4	22.5	1.63	6	2016	224	299.3	22400
SR-Series 6" - Spot	90621	1.4	22.5	1.63	6	2016	630	502.0	63000
SR-Series 10" - Flood	91011	2.1	37.5	2.72	10	3360	373	386.4	37333
SR-Series 10" - Spot	91021	2.1	37.5	2.72	10	3360	1050	648.1	105000

SPECIFICATIONS

SPECTER

Product Description	Part #	Weight (lbs)	Watts	AMP Draw	LED's	Raw Lumens*	Lux @ 10m	Beam Distance (m)**	Peak Beam Intensity (cd)**
SR-Series 6" - Driving	90661	1.4	33.75	2.45	9	3375	229	303.0	22959
SR-Series 10" - Driving	91061	2.1	56.25	4.08	15	5625	382	391.2	38265

SPECIFICATIONS

COMBO FLOOD & SPOT

Product Description	Part #	Weight (lbs)	Watts	AMP Draw	LED's	Raw Lumens*	Lux @ 10m	Beam Distance (m)**	Peak Beam Intensity (cd)**
SR-Series 6" - Combo	90631	1.4	22.5	1.63	6	2016	387	393.8	38769
SR-Series 10" - Combo	91031	2.1	37.5	2.72	10	3360	646.2	508.4	64615
SR-Series 20" - Combo	92031	3.65	75.0	5.43	20	6720	1600	800.0	160000
SR-Series 30" - Combo	93031	5.2	112.5	8.15	30	10080	2400	979.8	240000
SR-Series 40" - Combo	94031	6.75	150.0	10.87	40	13440	3200	1131.4	320000
SR-Series 50" - Combo	95031	8.3	187.5	13.59	50	16800	4000	1264.9	400000

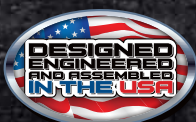

* Based on LED manufacturer specifications
 ** Tested using ANSI/NEMA FL Standards

SR-SERIES 6"

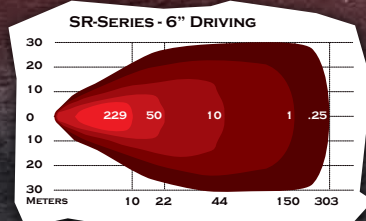
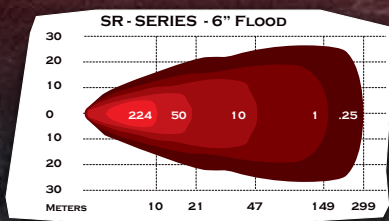
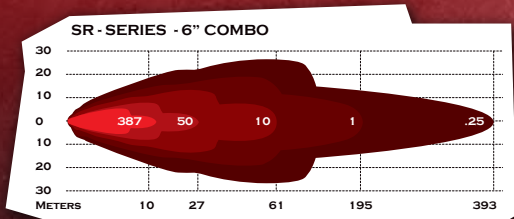
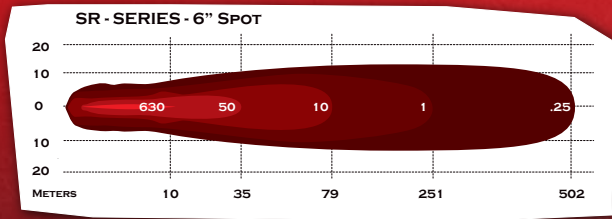

Product Description

Product Description	Part #
SR-Series 6" - Flood	90611
SR-Series 6" - Spot	90621
SR-Series 6" - Combo	90631
SR-Series 6" - Driving	90661

Light Kit Includes...

Plug & Play wiring harness with switch
 Mounting Brackets (4)
 Mounting Hardware



Also Available in...

Driving Optic
 Amber LED



SR-SERIES 10"

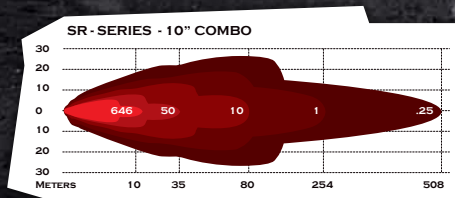
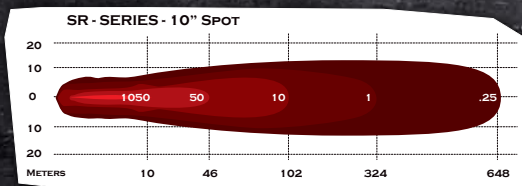

Product Description

Product Description	Part #
SR-Series 10" - Flood	91011
SR-Series 10" - Spot	91021
SR-Series 10" - Combo	91031
SR-Series 10" - Driving	91061

Light Kit Includes...

Plug & Play wiring harness with switch
 Mounting Brackets (4)
 Mounting Hardware



Also Available in...

Driving Optic
 Amber LED



SR-SERIES 20"

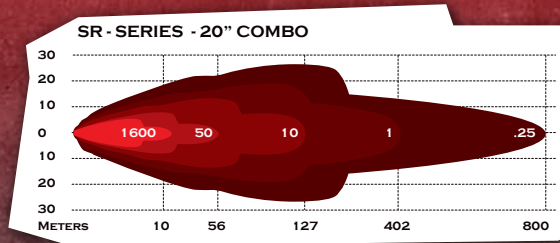

Product Description

SR-Series 20" - Combo

Part

92031

Light Kit Includes...

Plug & Play wiring harness with switch
 Mounting Brackets (4)
 Mounting Hardware



Also Available in...

Amber LED

SR-SERIES 30"

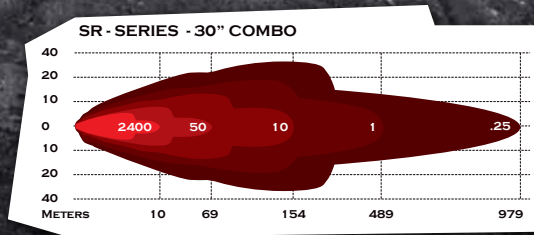

Product Description

SR-Series 30" - Combo

Part

93031

Light Kit Includes...

Plug & Play wiring harness with switch
 Mounting Brackets (4)
 Mounting Hardware



Also Available in...

Amber LED



SR-SERIES 40"

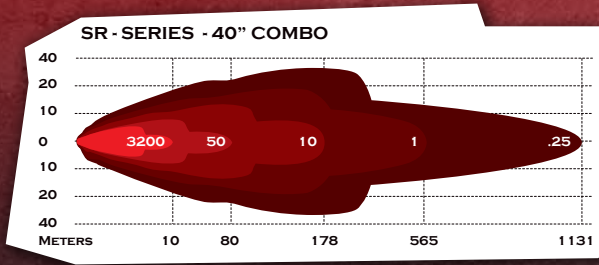

Product Description

SR-Series 40" - Combo

Part

94031

Light Kit Includes...

Plug & Play wiring harness with switch
Mounting Brackets (4)
Mounting Hardware



Also Available in...

Amber LED

SR-SERIES 50"

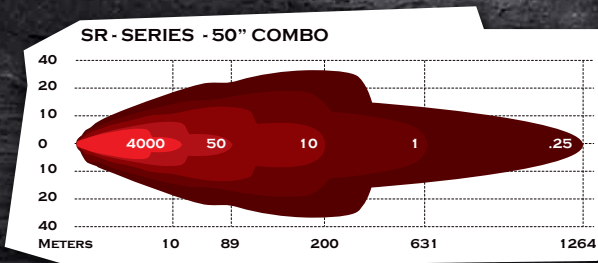

Product Description

SR-Series 50" - Combo

Part

95031

Light Kit Includes...

Plug & Play wiring harness with switch
Mounting Brackets (4)
Mounting Hardware



Also Available in...

Amber LED

SR-SERIES ACCESSORIES

CLAMP KITS



Our 3 piece adjustable clamps are the perfect way to mount your new light bar to virtually any size tubing from .875" to 3.25". The sleek design allows for easy installation and extreme versatility in positioning your light. These clamps are machined from aircraft-grade billet aluminum and hard anodized in black for a durable finish. Hardware included.



Lights Sold Separately

Tubing Size	Part #	Tubing Size	Part #
.875"	40820	2.0"	42020
1.0"	41020	2.25"	42220
1.125"	41120	2.375"	42320
1.25"	42520	2.50"	45220
1.50"	45020	2.625"	42620
1.625"	46220	2.75"	42720
1.70"	47020	2.87"	42820
1.75"	47520	3.0"	43020
1.875"	48720	3.25"	43220

WELD ON TABS



Lights Sold Separately

Your choice of flat surfaced or 1³/₄" radius.

Type	Part #
Flat (pair)	40291
Round (pair)	40292

CRADLES

Cradles are another option for mounting your light. They are powder-coated black for a durable finish. Hardware included.



Lights Sold Separately

Light Size	Part #
6" Light	40690
10" Light	41090
20" Light	42090
30" Light	43090
40" Light	44090



SR-SERIES COVERS



COVERS

SR-SERIES

- Black 50" (5 x 10" covers) - 19591
- Black 40" (4 x 10" covers) - 19491
- Black 30" (3 x 10" covers) - 19391
- Black 20" (2 x 10" covers) - 19291
- Black 10" - 19091
- Clear 10" - 19092
- Amber 10" - 19093
- Blue 10" - 19094
- Red 10" - 19095
- White 10" - 19096
- Green 10" - 19097
- Smoked 10" - 19098

Rigid SR-Series light covers not only give your LED light bars a unique look, they also provide another layer of protection. Available in 10" increments, these covers are made from durable polycarbonate plastic and are designed to snap onto your lights with ease. Our SR-Series LED light covers are available in a variety of colors. The white and black versions are opaque and feature the words 'Rigid Industries' along the bottom. The translucent version comes in red, blue, green, amber, clear, and smoked. Our light covers are often used to improve visibility in harsh environments.

AMBER LED

- Cuts Through Fog, Dust and Other Air Debris
- Patented Hybrid & Specter Optical Systems
- Available in Spot, Flood or Combination
- 50,000+ Hours Average Lifespan
- 93% Optical System Efficiency
- 9-36V DC Input
- 100% Optically Clear, Scratch Resistant Lens
- Instant On / Off - No Warm-up
- Operating Temp: -40° F ~ +145° F
- Shock Proof
- Over / Under Voltage Protection
- Limited Lifetime Warranty
- Oversized Heat Sink
- Low Power Consumption
- IP68 Rating
- Integrated Thermal Management
- Zero UV Emissions

Rigid Industries' amber LED lights are designed to work in rain, snow, fog, smoke and dust. To achieve the best light output, use a narrow beam amber light. By using a dedicated amber LED, all the light produced is between 550 and 590nm wavelength. By only projecting narrow wavelength light, it cuts through the elements better than any other light system. Rigid recommends our Hybrid Spot or Specter Driving as the ideal beam patterns for amber lights.

SPECIFICATIONS

* Based on LED manufacturer specifications

** Tested using ANSI/NEMA FL standards

Product Description	Part #	Weight (lbs)	Watts	AMP Draw	LED's	Raw Lumens*	Beam Distance (m)**
Amber SR-Series 6" - Flood	90612	1.4	13.2	.96	6	840	193.2
Amber SR-Series 6" - Spot	90622	1.4	18	1.3	6	900	335.4
Amber SR-Series 10" - Flood	91012	2.1	30	2.17	10	1500	258.2
Amber SR-Series 10" - Spot	91022	2.1	30	2.17	10	1500	433
Amber SR-Series 6" - Driving	90662	1.4	19.8	1.43	9	1260	185.2
Amber SR-Series 10" - Driving	91062	2.1	33	2.39	15	2100	239
Amber SR-Series 6" - Combo	90632	1.4	18	1.3	6	900	263.1
Amber SR-Series 10" - Combo	91032	2.1	30	2.17	10	1500	339.7
Amber SR-Series 20" - Combo	92032	3.65	60	4.35	20	3000	534.5
Amber SR-Series 30" - Combo	93032	5.2	90	6.52	30	4500	654.7
Amber SR-Series 40" - Combo	94032	6.75	120	8.7	40	6000	755.9
Amber SR-Series 50" - Combo	95032	8.3	150	10.87	50	7500	845.2



SR-M SERIES

The new SR-M Series (Single Row Mini) is housed in one of our smallest and lightest fixtures ever produced. This compact LED light can be mounted in virtually any location and can project almost 1,000 feet with Hybrid Spot optics or produce an unbelievable 1,125 raw lumens with Specter Driving optics. Limited lifetime warranty.

STANDARD

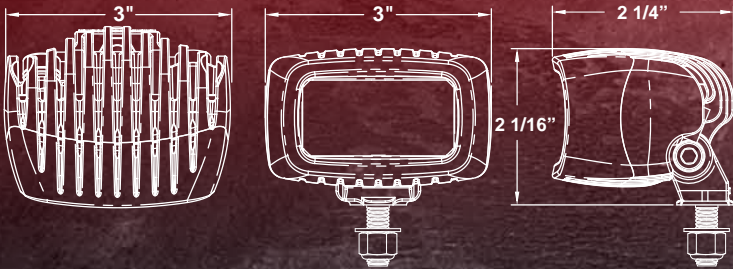

FLUSHMOUNT

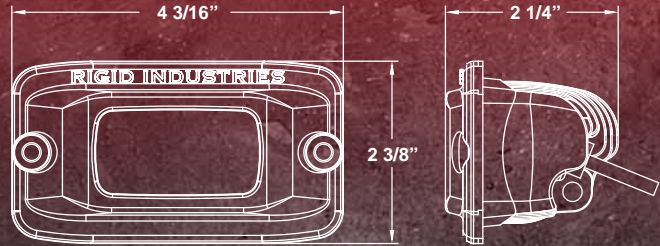

SPECIFICATIONS

* Based on LED manufacturer specifications
** Tested using ANSI/NEMA FL standards

Product Description	Part #	Weight (lbs)	Watts	AMP Draw	LED's	Raw Lumens*	Lux @ 10m	Beam Distance (m)**	Peak Beam Intensity (cd)**
SR-M - Flood	90211	1	10	.72	2	784	87.1	186.7	8711
SR-M - Spot	90221	1	10	.72	2	784	245	313.0	24500
SR-M - Diffused	90251	1	10	.72	2	784	9.7	62.1	966
SR-M2 - Wide	91211	1	11.25	.82	3	1125	66.2	162.7	6618
SR-M2 - Driving	91231	1	11.25	.82	3	1125	76.5	175	7653
SR-M2 - Diffused	91251	1	11.25	.82	3	1125	13.9	74.4	1385

FACTS

- Available in Hybrid or Specter Optics
- GORE® Pressure Equalizing Vent
- Unbreakable Polycarbonate Lens
- Durable UV 3800 Polyester Powder-coat
- Runs on 9 to 36V DC
- Sealed Deutsch Connector
- 50,000+ Hour Lifespan
- IP68 Certified
- MIL810-STDG Vibration Certified
- ROHS Compliant
- Patented Optics (6,986,593 b2, 7,114,832 b2)



SR-M SERIES COVERS NOW AVAILABLE



COVERS

SR-M SERIES

- Black - 30191
- Clear - 30192
- Amber - 30193
- Blue - 30194
- Red - 30195
- White - 30196
- Green - 30197
- Smoked - 30198



EACH STANDARD SR-M SERIES KIT INCLUDES A BLACK COVER

SR-Q SERIES

With the successful release of the SR-M Series (Single Row Mini) line of LED products, Rigid Industries has taken this slimline product concept to the next level with the new SR-Q Series (Single Row Quad). Utilizing the same compact aluminum design as the SR-M Series, but with lumen output equivalent to the D-Series, the SR-Q Series offers another option for your lighting needs. Limited lifetime warranty.

STANDARD

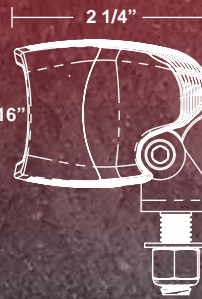
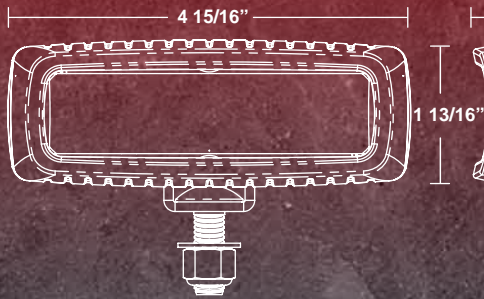

FLUSHMOUNT

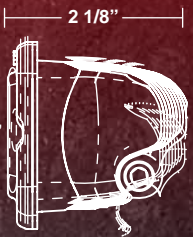
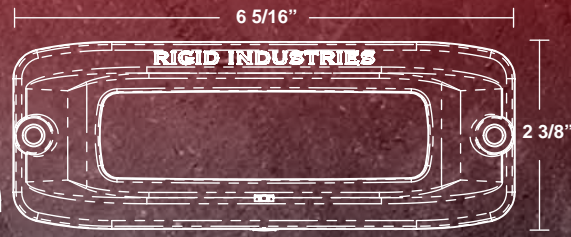

SPECIFICATIONS

* Based on LED manufacturer specifications
** Tested using ANSI/NEMA FL standards

Product Description	Part #	Weight (lbs)	Watts	AMP Draw	LED's	Raw Lumens*	Lux @ 10m	Beam Distance (m)**	Peak Beam Intensity (cd)**
SR-Q - Spot	90421	1	20	1.45	4	1568	174.2	264.0	17422
SR-Q - Flood	90411	1	20	1.45	4	1568	490	442.7	49000
SR-Q - Diffused	90451	1	20	1.45	4	1568	19.3	87.9	1931
SR-Q2 - Wide	91411	1	34.5	2.50	6	3030	206.1	287.1	20612
SR-Q2 - Driving	91431	1	34.5	2.50	6	3030	178.2	267.0	17824
SR-Q2 - Diffused	91451	1	34.5	2.50	6	3030	37.3	122.2	3732

FACTS

- Available in Hybrid or Specter Optics
- GORE® Pressure Equalizing Vent
- Unbreakable Polycarbonate Lens
- Durable UV 3800 Polyester Powder-coat
- Runs on 9 to 36V DC
- Sealed Deutsch Connector
- 50,000+ Hour Lifespan
- IP68 Certified
- MIL810-STDG Vibration Certified
- ROHS Compliant
- Patented Optics (6,986,593 b2, 7,114,832 b2)



SR-Q SERIES COVERS NOW AVAILABLE



COVERS

SR-Q SERIES

- Black - 31191
- Clear - 31192
- Amber - 31193
- Blue - 31194
- Red - 31195
- White - 31196
- Green - 31197
- Smoked - 31198

EACH STANDARD SR-Q SERIES KIT INCLUDES A BLACK COVER

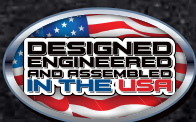

SR-M SERIES

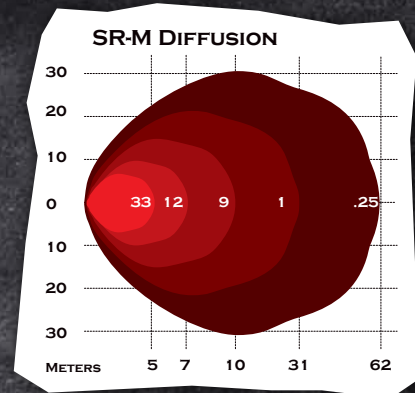

Product Description	Part #
SR-M Series - Diffused	90251
SR-M Series - Amber Diffused	90252

Light Kit Includes...

Plug & Play wiring harness with switch
Mounting Bracket & Hardware
Black Cover

Also Available in...

Marine Grade

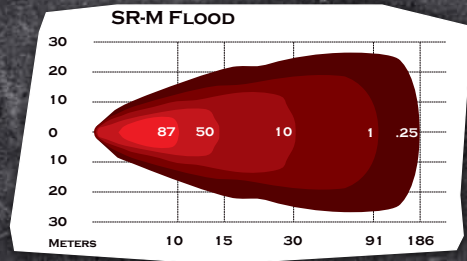

Product Description	Part #
SR-M Series - Flood	90211
SR-M Series - Amber Flood	90212

Light Kit Includes...

Plug & Play wiring harness with switch
Mounting Bracket & Hardware
Black Cover

Also Available in...

Marine Grade

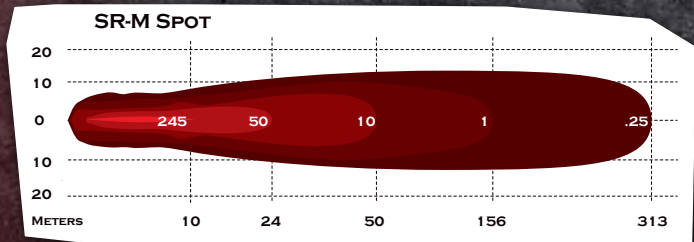

Also Available in...

Marine Grade

Product Description	Part #
SR-M Series - Spot	90221
SR-M Series - Amber Spot	90222

Light Kit Includes...

Plug & Play wiring harness with switch
Mounting Bracket & Hardware
Black Cover



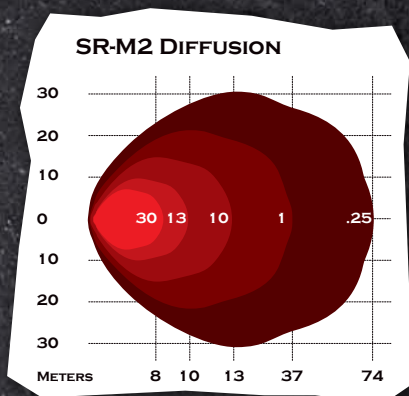

Product Description	Part #
SR-M2 Series - Diffused	91251
SR-M2 Series - Amber Diffused	91252

Light Kit Includes...

Plug & Play wiring harness with switch
 Mounting Bracket & Hardware
 Black Cover

Also Available in...

Marine Grade

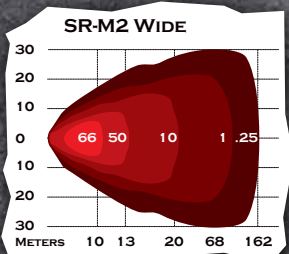

Product Description	Part #
SR-M2 Series - Wide	91211
SR-M2 Series - Amber Wide	91212

Light Kit Includes...

Plug & Play wiring harness with switch
 Mounting Bracket & Hardware
 Black Cover

Also Available in...

Marine Grade

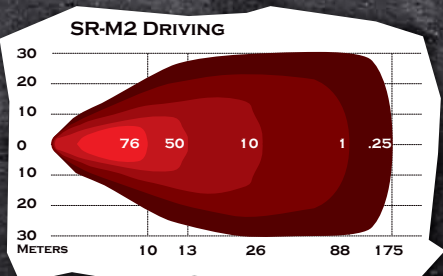

Also Available in...	Product Description	Part #
Marine Grade	SR-M2 Series - Driving	91231
	SR-M2 Series - Amber Driving	91232



Light Kit Includes...

Plug & Play wiring harness with switch
 Mounting Bracket & Hardware
 Black Cover



SR-M2 SERIES

SR-Q SERIES

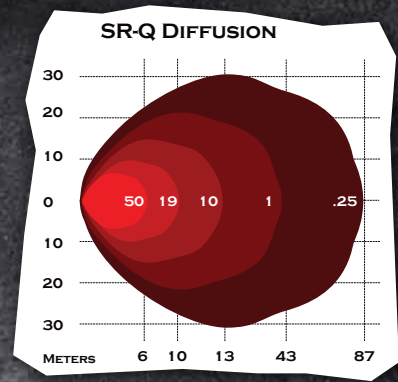

Product Description **Part #**

SR-Q Series - Diffused 90451
 SR-Q Series - Diffused - Set of 2 90551

Light Kit Includes...

Plug & Play wiring harness with switch
 Mounting Bracket & Hardware
 Black Cover

Also Available in...

Marine Grade
 Amber LED

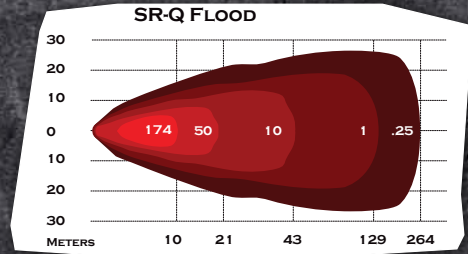

Product Description **Part #**

SR-Q Series - Flood 90411
 SR-Q Series - Flood - Set of 2 90511

Light Kit Includes...

Plug & Play wiring harness with switch
 Mounting Bracket & Hardware
 Black Cover

Also Available in...

Marine Grade
 Amber LED

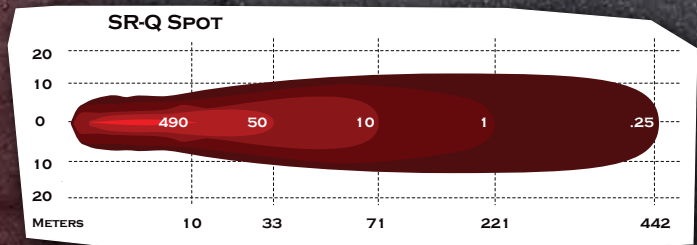

Product Description **Part #**

SR-Q Series - Spot 90421
 SR-Q Series - Spot - Set of 2 90521

Light Kit Includes...

Plug & Play wiring harness with switch
 Mounting Bracket & Hardware
 Black Cover

Also Available in...

Marine Grade
 Amber LED



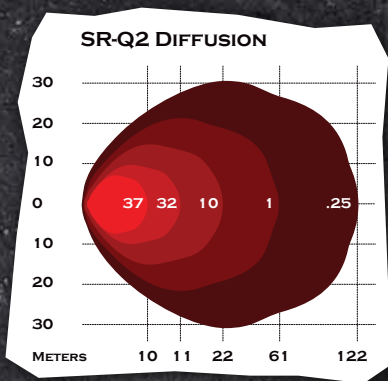

Product Description **Part #**

SR-Q2 Series - Diffused 91451
 SR-Q2 Series - Diffused - Set of 2 91551

Light Kit Includes...

Plug & Play wiring harness with switch
 Mounting Bracket & Hardware
 Black Cover

Also Available in...

Marine Grade
 Amber LED

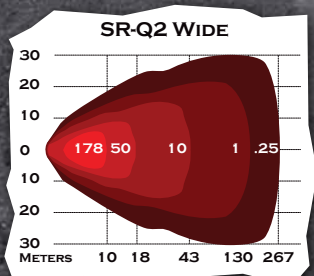

Product Description **Part #**

SR-Q2 Series - Wide 91411
 SR-Q2 Series - Wide - Set of 2 91511

Light Kit Includes...

Plug & Play wiring harness with switch
 Mounting Bracket & Hardware
 Black Cover

Also Available in...

Marine Grade
 Amber LED

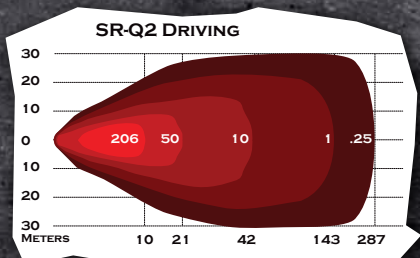

Product Description **Part #**

SR-Q2 Series - Driving 91431
 SR-Q2 Series - Driving - Set of 2 91531

Light Kit Includes...

Plug & Play wiring harness with switch
 Mounting Bracket & Hardware
 Black Cover

Also Available in...

Marine Grade
 Amber LED



SR-Q2 SERIES

FLUSH MOUNTS



Product Description	Part #	Product Description	Part #	Product Description	Part #
SR-M FM - Flood	92211	SR-M FM - Spot	92221	SR-M FM - Diffused	92251
SR-M FM - Amber Flood	92212	SR-M FM - Amber Spot	92222	SR-M FM - Amber Diffused	92252



Product Description	Part #	Product Description	Part #	Product Description	Part #
SR-M2 FM - Wide	93211	SR-M2 FM - Driving	93231	SR-M2 FM - Diffused	93251
SR-M2 FM - Amber Wide	93212	SR-M2 FM - Amber Driving	93232	SR-M2 FM - Amber Diffused	93252

SPECIFICATIONS

* Based on LED manufacturer specifications
 ** Tested using ANSI/NEMA FL Standards

Product Description	Part #	Weight (lbs)	Watts	AMP Draw	LED's	Raw Lumens*	Lux @ 10m	Beam Distance (m)**	Peak Beam Intensity (cd)**
SR-M Flush Mount - Flood	92211	1	10	.72	2	784	87.1	186.7	8711
SR-M Flush Mount - Spot	92221	1	10	.72	2	784	245	313.0	24500
SR-M Flush Mount - Diffused	92251	1	10	.72	2	784	9.7	62.1	966
SR-M2 Flush Mount - Wide	93211	1	11.25	.82	3	1125	66.2	162.7	6618
SR-M2 Flush Mount - Driving	93231	1	11.25	.82	3	1125	76.5	175	7653
SR-M2 Flush Mount - Diffused	93251	1	11.25	.82	3	1125	13.9	74.4	1385

Each SR-M and SR-M2 light kit includes plug and play wiring harness and switch.



These models are designed to be recessed into a bumper, a utility bed, on a boat or any application where you need the light to look clean and out of the way. Once installed, the light is only 1/4" exposed, which means you can have all the benefits of our surface mount lights in an OEM quality, flush installation. Limited lifetime warranty.



Product Description **Part #**
 SR-Q FM - Flood 92411
 SR-Q FM - Flood - Set of 2 92511

Product Description **Part #**
 SR-Q FM - Spot 92421
 SR-Q FM - Spot - Set of 2 92521

Product Description **Part #**
 SR-Q FM - Diffused 92451
 SR-Q FM - Diffused - Set of 2 92551



Product Description **Part #**
 SR-Q2 FM - Wide 93411
 SR-Q2 FM - Set of 2 93511

Product Description **Part #**
 SR-Q2 FM - Driving 93431
 SR-Q2 FM - Driving - Set of 2 93531

Product Description **Part #**
 SR-Q2 FM - Diffused 93451
 SR-Q2 FM - Diffused - Set of 2 93551

SPECIFICATIONS

* Based on LED manufacturer specifications
 ** Tested using ANSI/NEMA FL Standards

Product Description	Part #	Weight (lbs)	Watts	AMP Draw	LED's	Raw Lumens*	Lux @ 10m	Beam Distance (m)**	Peak Beam Intensity (cd)**
SR-Q Flush Mount - Spot	92421	1	20	1.45	4	1568	174.2	264.0	17422
SR-Q Flush Mount - Flood	92411	1	20	1.45	4	1568	490	442.7	49000
SR-Q Flush Mount - Diffused	92451	1	20	1.45	4	1568	19.3	87.9	1931
SR-Q2 Flush Mount - Wide	93411	1	34.5	2.50	6	3030	206.1	287.1	20612
SR-Q2 Flush Mount - Driving	93431	1	34.5	2.50	6	3030	178.2	267.0	17824
SR-Q2 Flush Mount - Diffused	93451	1	34.5	2.50	6	3030	37.3	122.2	3732



Each SR-Q and SR-Q2 light kit comes with plug and play wiring harness and switch.



M-SERIES



ENHANCING YOUR BOATING EXPERIENCE

Whether you're lighting up your deck, the water, or heading back to the dock, the M-Series lighting solution makes your boating experience more fun and enjoyable.

Marine Grade - Rigid marine lighting products are given special attention due to the elements they will be exposed to in a marine environment. First, the aluminum housing receives a chromate conversion coating. This acts as a corrosion inhibitor against elements such as salt. The housing then receives a UV-resistant powder-coat. Second, our marine products use 316 marine-grade stainless steel hardware. All hardware receives a coating that's been tested for over 1,000 hours of corrosion resistance. Mounting hardware for the marine products is also 316 marine-grade stainless steel. Marine products do not include a wire harness or switch, due to the fact that most installs on marine equipment are custom and require smaller holes and unique components. Limited lifetime warranty.





FACTS

- Available in Hybrid Optics
- GORE® Pressure Equalizing Vent
- Unbreakable Polycarbonate Lens
- 6063 Aluminum Extrusion
- Durable UV 3800 Polyester Powder-coat
- Runs on 9 to 36V DC
- 50,000+ Hour Lifespan
- IP68 Certified
- MIL810-STDG Vibration Certified
- ROHS Compliant
- Over / Under Voltage Protection
- Operating Temp -40° F ~ +145° F
- Protected Against RFI / EMI
- Integrated Thermal Management System
- Updated Hybrid Optic System
- Patented Optics (6,986,593 b2, 7,114,832 b2)

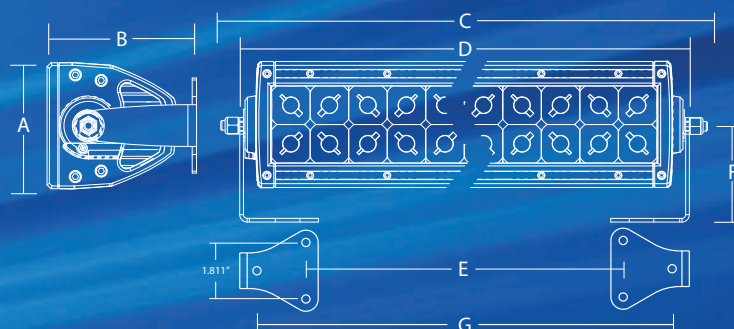

SIZING

Light Bar	A	B	C	D	E	F	G
M-Series 4"	3¼	3¾	6⅞	5⅜	-	2⅝	-
M-Series 6"	3¼	3¾	8⅞	7⅜	-	2⅝	-
M-Series 10"	3¼	3¾	12⅞	11⅜	-	2⅝	-
M-Series 20"	3¼	3¾	22⅞	21⅜	17⅝ ₂₅	2⅝	2⅝
M-Series 30"	3¼	3¾	32⅞	31⅜	27⅝ ₂₅	2⅝	2⅝
M-Series 40"	3¼	3¾	42⅞	41⅜	37⅝ ₂₅	2⅝	2⅝
M-Series 50"	3¼	3¾	52⅞	51⅜	47⅝ ₂₅	2⅝	2⅝

SPECIFICATIONS

* Based on LED manufacturer specifications
 ** Tested using ANSI/NEMA FL Standards

Product Description	Part #	Weight (lbs)	Watts	AMP Draw	LED's	Raw Lumens*	Lux @ 10m	Beam Distance (m)**	Peak Beam Intensity (cd)**
M-Series 4" - Flood	80411	1.9	16	1.16	8	1680	186	273.3	18667
M-Series 4" - Spot	80421	1.9	16	1.16	8	1680	525	458.3	52500
M-Series 4" - Diffused	80451	1.9	16	1.16	8	1680	20	91.0	2069
M-Series 6" - Flood	80611	2.35	24	1.74	12	2520	280	334.7	27000
M-Series 6" - Spot	80621	2.35	24	1.74	12	2520	787	561.2	78750
M-Series 6" - Combo	80631	2.35	24	1.74	12	2520	484	440.3	48462
M-Series 6" - Diffused	80651	2.35	24	1.74	12	2520	31	114.4	3103
M-Series 10" - Flood	81011	3.45	40	2.9	20	4200	466	432	46667
M-Series 10" - Spot	81021	3.45	40	2.9	20	4200	1312	724	131250
M-Series 10" - Combo	81031	3.45	40	2.9	20	4200	807	568	80769
M-Series 20" - Combo	82031	6.15	80	5.8	40	8400	2240	946.6	224000
M-Series 30" - Combo	83031	8.85	120	8.7	60	12600	3600	1200	360000
M-Series 40" - Combo	84031	11.55	160	11.59	80	16800	4800	1385.6	480000
M-Series 50" - Combo	85031	14.25	200	14.49	100	21000	6000	1549.2	600000

M-SERIES 4"



Flood

Diffused

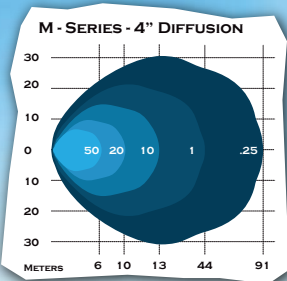
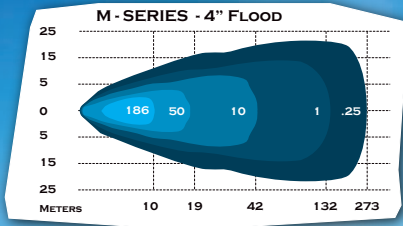
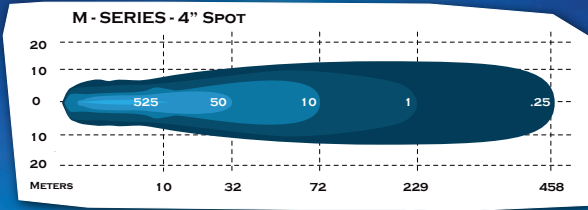

Product Description

Part

M-Series 4" - Flood	80411
M-Series 4" - Spot	80421
M-Series 4" - Diffused	80451

Light Kit Includes...

- Mounting Cradle
- Mounting Hardware

Also Available in...

- Amber LED



M-SERIES 6"



Diffused

Combo

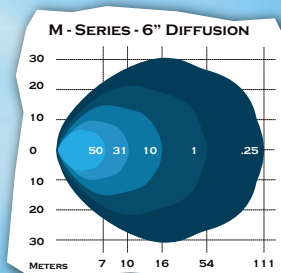
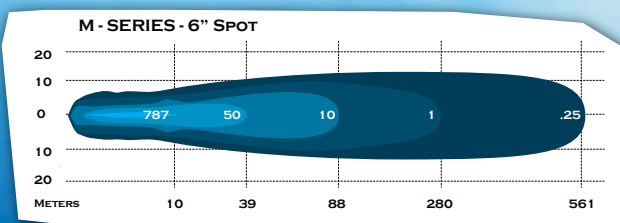
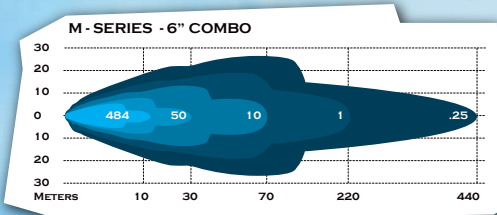
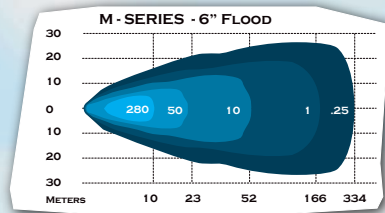

Product Description

Part

M-Series 6" - Flood	80611
M-Series 6" - Spot	80621
M-Series 6" - Combo	80631
M-Series 6" - Diffused	80651

Light Kit Includes...

- Mounting Cradle
- Mounting Hardware

Also Available in...

- Amber LED



M-SERIES 10"

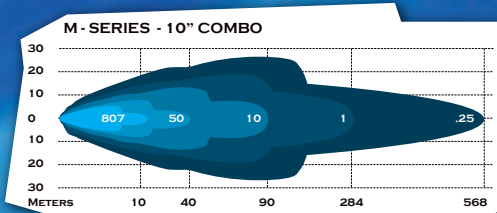
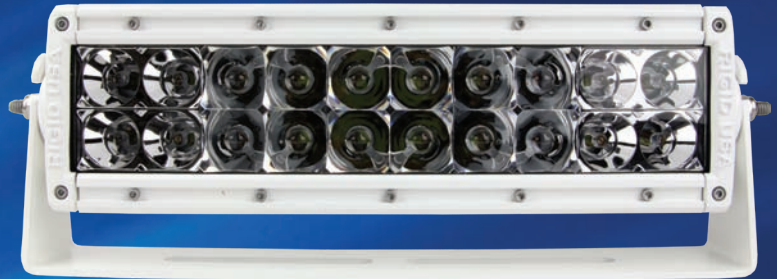
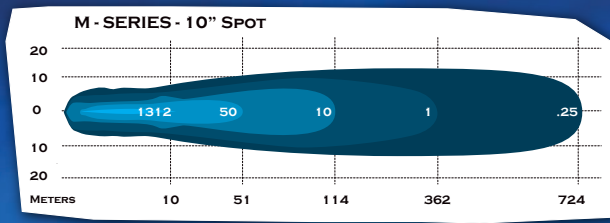

Product Description Part

M-Series 10" - Flood	81011
M-Series 10" - Spot	81021
M-Series 10" - Combo	81031

Light Kit Includes...

Mounting Cradle
Mounting Hardware

Also Available in...

Amber LED

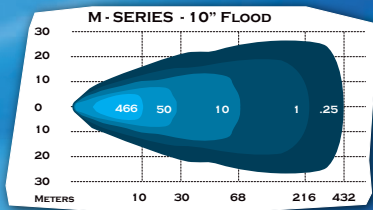

M-SERIES 20"

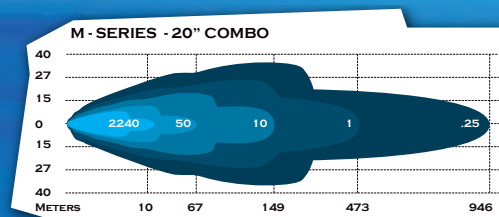

Product Description Part

M-Series 20" - Combo	82031
----------------------	-------

Light Kit Includes...

Mounting Brackets (2)
Mounting Hardware

Also Available in...

Amber LED



M-SERIES 30"

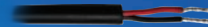
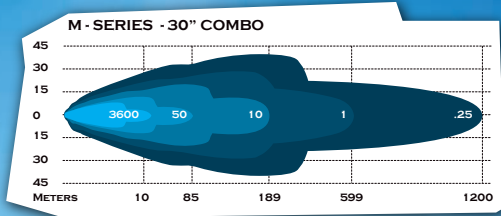

Product Description	Part #
M-Series 30" - Combo	83031

Light Kit Includes...

- Mounting Brackets (2)
- Mounting Hardware

Also Available in...

Amber LED



M-SERIES 40"

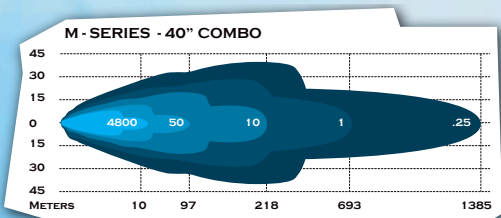

Product Description	Part #
M-Series 40" - Combo	84031

Light Kit Includes...

- Mounting Brackets (2)
- Mounting Hardware

Also Available in...

Amber LED



M-SERIES 50"

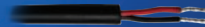
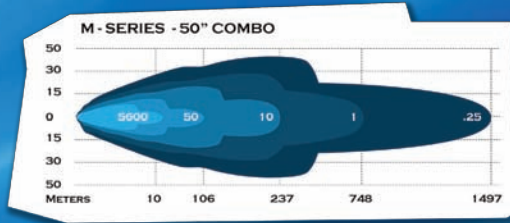

Product Description	Part #
M-Series 50" - Combo	85031

Light Kit Includes...

- Mounting Brackets (2)
- Mounting Hardware

Also Available in...

Amber LED



M-SERIES ACCESSORIES

CLAMP KITS



Our 3 piece adjustable clamps are the perfect way to mount your new lightbar to virtually any size tubing from .875" to 3.25".

Designed for fresh water applications, these clamps are not treated to protect against salt or fog. Hardware is included.



Tubing Size	Part #	Tubing Size	Part #
.875"	40820	2.0"	42020
1.0"	41020	2.25"	42220
1.125"	41120	2.375"	42320
1.25"	42520	2.50"	45220
1.50"	45020	2.625"	42620
1.625"	46220	2.75"	42720
1.70"	47020	2.87"	42820
1.75"	47520	3.0"	43020
1.875"	48720	3.25"	43220

Lights Sold Separately

CRADLES



Light Size	Part #
4" Light	40411
6" Light	40611
10" Light	41011

M-Series cradles are powder-coated over stainless steel to resist rusting.

Lights Sold Separately



M-SERIES COVERS



COVERS

M-SERIES

- Black 50" (5 x 10" covers) - 15091
- Black 40" (4 x 10" covers) - 14091
- Black 30" (3 x 10" covers) - 13091
- Black 20" (2 x 10" covers) - 12091
- Black 10" - 11091
- Clear 10" - 11092
- Amber 10" - 11093
- Blue 10" - 11094
- Red 10" - 11095
- White 10" - 11096
- Green 10" - 11097
- Smoked 10" - 11098

Rigid M-Series light covers not only give your LED light bars a unique look, they also provide another layer of protection. Available in 10" increments, these covers are made from durable polycarbonate plastic and are designed to snap onto your lights with ease. Our M-Series LED light covers are available in a variety of colors. The white and black versions are opaque and feature the Rigid Industries star logo. The translucent version comes in red, blue, green, amber, clear, and smoked. Our light covers are often used to improve visibility in harsh environments.



CILOWAY III

MARINE DUALLY

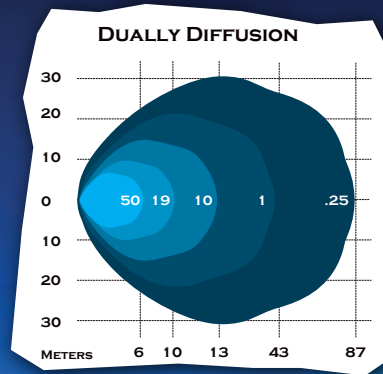

Product Description **Part #**

Marine Dually - Diffused 60151
 Marine Dually - Diffused Set of 2 60251

Light Kit Includes...

Mounting Bracket
 Mounting Hardware

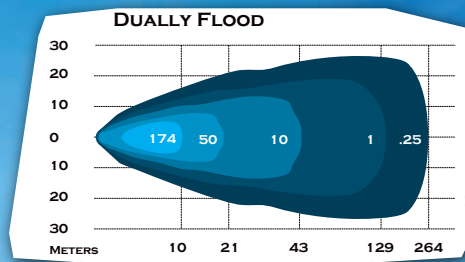

Product Description **Part #**

Marine Dually - Flood 60111
 Marine Dually - Flood Set of 2 60211

Light Kit Includes...

Mounting Bracket
 Mounting Hardware

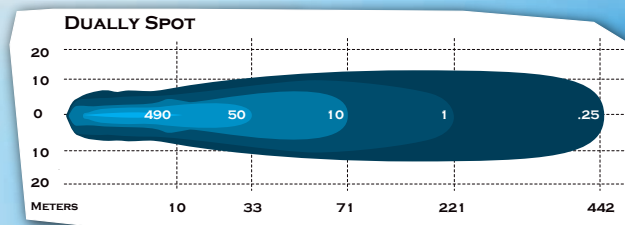

Product Description **Part #**

Marine Dually - Spot 60121
 Marine Dually - Spot Set of 2 60221

Light Kit Includes...

Mounting Bracket
 Mounting Hardware

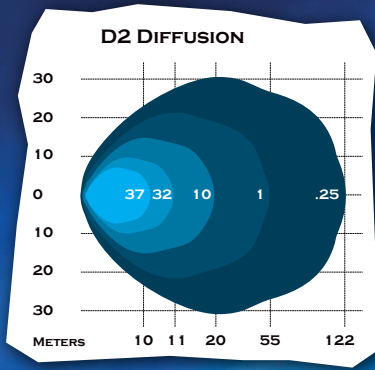

Product Description

Part #

Marine D2 - Diffused 70151
 Marine D2 - Diffused Set of 2 70251

Light Kit Includes...

Mounting Bracket
 Mounting Hardware

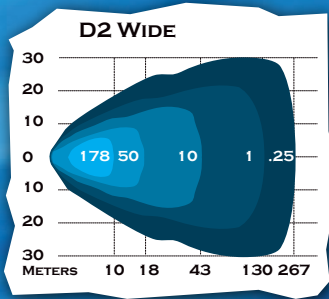

Product Description

Part #

Marine D2 - Wide 70111
 Marine D2 - Wide Set of 2 70211

Light Kit Includes...

Mounting Bracket
 Mounting Hardware

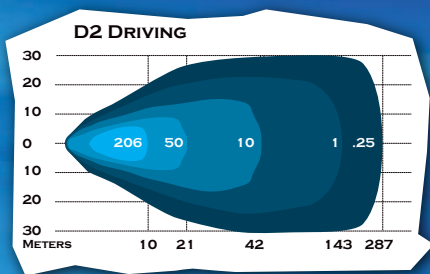

Product Description

Part #

Marine D2 - Driving 70131
 Marine D2 - Driving Set of 2 70231

Light Kit Includes...

Mounting Bracket
 Mounting Hardware



MARINE D2



MARINE D-SERIES COVERS



COVERS

MARINE D-SERIES

- Black - 20191
- Clear - 20192
- Amber - 20193
- Blue - 20194
- Red - 20195
- White - 20196
- Green - 20197
- Smoked - 20198

Rigid snap-on light covers are perfect for the Marine D-Series line of products. Made of polycarbonate plastic, these covers are tough and snap easily into place to protect your light. The black and white covers are opaque and show the Rigid star logo. Also available in clear, amber, blue, red, green, and smoked for different colored tinting applications. The amber cover provides instant improvements in harsh environments.

FLUSH MOUNTS

These models are designed to be recessed into a bumper, a utility bed, on a boat or any application where you need the light to look clean and out of the way. Once installed, the light is only 1/4" exposed, which means you can have all the benefits of our surface mount lights in an OEM quality, flush installation.



Product Description **Part #**
 MDually FM - Flood 61111
 MDually FM - Flood Set of 2 61211



Product Description **Part #**
 MDually FM - Spot 61121
 MDually FM - Spot Set of 2 61221



Product Description **Part #**
 MDually FM - Diffused 61151
 MDually FM - Diffused Set of 2 61251



Product Description **Part #**
 MD2 FM - Wide 71111
 MD2 FM - Wide Set of 2 71211



Product Description **Part #**
 MD2 FM - Driving 71131
 MD2 FM - Driving Set of 2 71231



Product Description **Part #**
 MD2 FM - Diffused 71151
 MD2 FM - Diffused Set of 2 71251

SPECIFICATIONS

* Based on LED manufacturer specifications
 ** Tested using ANSI/NEMA FL Standards

Product Description	Part #	Weight (lbs)	Watts	AMP Draw	LED's	Raw Lumens*	Lux @ 10m	Beam Distance (m)**	Peak Beam Intensity (cd)**
Marine Dually Flush Mount - Flood	61111	1.25	20	1.45	4	1568	174.2	264.0	17422
Marine Dually Flush Mount - Spot	61121	1.25	20	1.45	4	1568	490	442.7	49000
Marine Dually Flush Mount - Diffused	61151	1.25	20	1.45	4	1568	19.3	87.9	1931
Marine D2 Flush Mount - Wide	71111	1.25	34.5	2.50	6	3030	178.2	267.0	17824
Marine D2 Flush Mount - Driving	71131	1.25	34.5	2.50	6	3030	206.1	287.1	20612
Marine D2 Flush Mount - Diffused	71151	1.25	34.5	2.50	6	3030	37.3	122.2	3732

Each Marine Dually Flush Mount and Marine D2 Flush Mount light comes with a pigtail wire end.



MARINE SR-M SERIES

The new Marine SR-M Series (Single Row Mini) is housed in one of the smallest and lightest fixtures ever produced. This compact LED light can be mounted in virtually any location and can project almost 1,000 feet with a Hybrid Spot or produce an unbelievable 1,125 raw lumens with our Specter Driving optics. Limited lifetime warranty.

STANDARD

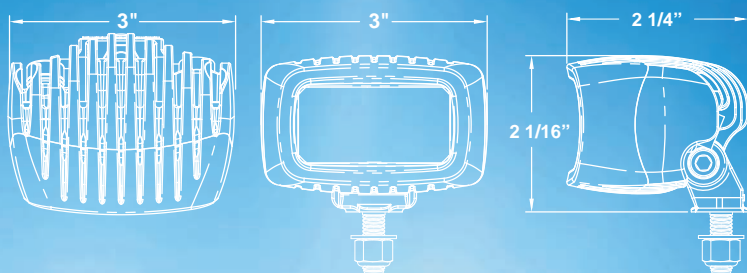

FLUSHMOUNT

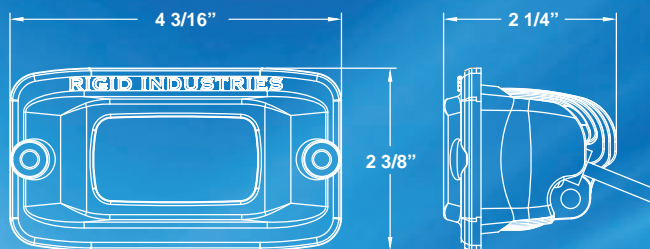

SPECIFICATIONS

* Based on LED manufacturer specifications
** Tested using ANSI/NEMA FL standards

Product Description	Part #	Weight (lbs)	Watts	AMP Draw	LED's	Raw Lumens*	Lux @ 10m	Beam Distance (m)**	Peak Beam Intensity (cd)**
Marine SR-M - Flood	94211	1	10	.72	2	784	87.1	186.7	8711
Marine SR-M - Spot	94221	1	10	.72	2	784	245	313.0	24500
Marine SR-M - Diffused	94251	1	10	.72	2	784	9.7	62.1	966
Marine SR-M2 - Wide	95211	1	11.25	.82	3	1125	66.2	162.7	6618
Marine SR-M2 - Driving	95231	1	11.25	.82	3	1125	76.5	175	7653
Marine SR-M2 - Diffused	95251	1	11.25	.82	3	1125	13.9	74.4	1385

FACTS

- Available in Hybrid or Specter Optics
- GORE® Pressure Equalizing Vent
- Unbreakable Polycarbonate Lens
- Durable UV 3800 Polyester Powder-coat
- Runs on 9 to 36V DC
- 50,000+ Hour Lifespan
- IP68 Certified
- MIL810-STDG Vibration Certified
- ROHS Compliant
- Patented Optics (6,986,593 b2, 7,114,832 b2)



MARINE SR-M SERIES COVERS NOW AVAILABLE



COVERS

MARINE SR-M SERIES

- Black - 30191
- Clear - 30192
- Amber - 30193
- Blue - 30194
- Red - 30195
- White - 30196
- Green - 30197
- Smoked - 30198



EACH MARINE SR-M SERIES KIT INCLUDES A WHITE COVER



The Marine Series products do not include a wire harness or switch, due to the fact that most installs on marine equipment are custom and require smaller holes and unique components.



MARINE SR-Q SERIES

With the successful release of the Marine SR-M Series (Single Row Mini) line of LED products, Rigid Industries has taken this slimline product concept to the next level with the new Marine SR-Q Series (Single Row Quad). Utilizing the same compact aluminum design as the Marine SR-M Series, but with lumen output equivalent to the Marine D-Series, the Marine SR-Q Series offers another option for your lighting needs. Limited lifetime warranty.

STANDARD

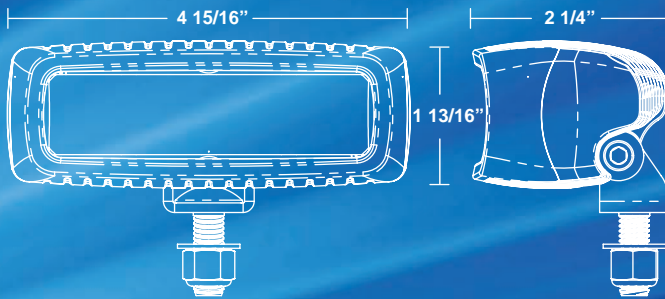

FLUSHMOUNT

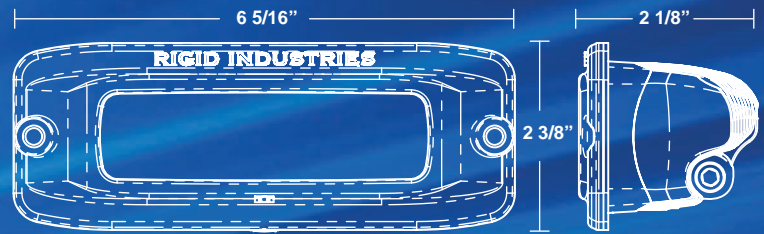

SPECIFICATIONS

* Based on LED manufacturer specifications
 ** Tested using ANSI/NEMA FL standards

Product Description	Part #	Weight (lbs)	Watts	AMP Draw	LED's	Raw Lumens*	Lux @ 10m	Beam Distance (m)**	Peak Beam Intensity (cd)**
Marine SR-Q - Spot	94421	1	20	1.45	4	1568	174.2	264.0	17422
Marine SR-Q - Flood	94411	1	20	1.45	4	1568	490	442.7	49000
Marine SR-Q - Diffused	94451	1	20	1.45	4	1568	19.3	87.9	1931
Marine SR-Q2 - Wide	95411	1	34.5	2.50	6	3030	206.1	287.1	20612
Marine SR-Q2 - Driving	95431	1	34.5	2.50	6	3030	178.2	267.0	17824
Marine SR-Q2 - Diffused	95451	1	34.5	2.50	6	3030	37.3	122.2	3732

FACTS

- Available in Hybrid or Specter Optics
- GORE® Pressure Equalizing Vent
- Unbreakable Polycarbonate Lens
- Durable UV 3800 Polyester Powder-coat
- Runs on 9 to 36V DC
- 50,000+ Hour Lifespan
- IP68 Certified
- MIL810-STDG Vibration Certified
- ROHS Compliant
- Patented Optics (6,986,593 b2, 7,114,832 b2)



MARINE SR-Q SERIES COVERS NOW AVAILABLE

COVERS

MARINE SR-Q SERIES

- Black - 31191
- Clear - 31192
- Amber - 31193
- Blue - 31194
- Red - 31195
- White - 31196
- Green - 31197
- Smoked - 31198



EACH MARINE SR-Q SERIES KIT INCLUDES A WHITE COVER



The Marine Series products do not include a wire harness or switch, due to the fact that most installs on marine equipment are custom and require smaller holes and unique components.



MARINE SR-M

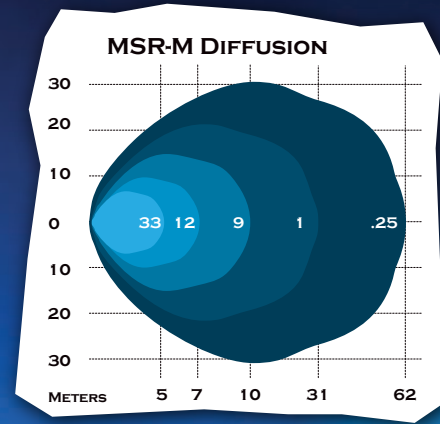

Product Description **Part #**

MSR-M - Diffused 94251
 MSR-M - Amber Diffused 94252

Light Kit Includes...

Mounting Bracket & Hardware
 White Cover

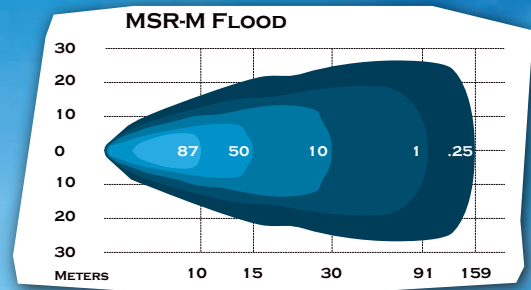

Product Description **Part #**

MSR-M - Flood 94211
 MSR-M - Amber Flood 94212

Light Kit Includes...

Mounting Bracket & Hardware
 White Cover

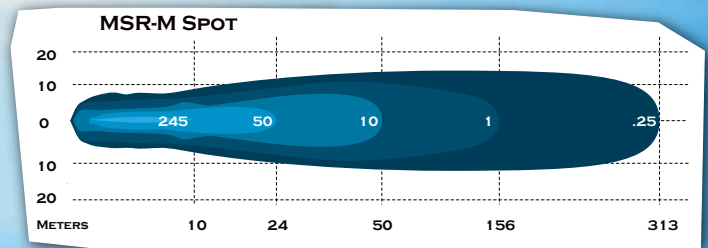

Product Description **Part #**

MSR-M - Spot 94221
 MSR-M - Amber Spot 94222

Light Kit Includes...

Mounting Bracket & Hardware
 White Cover

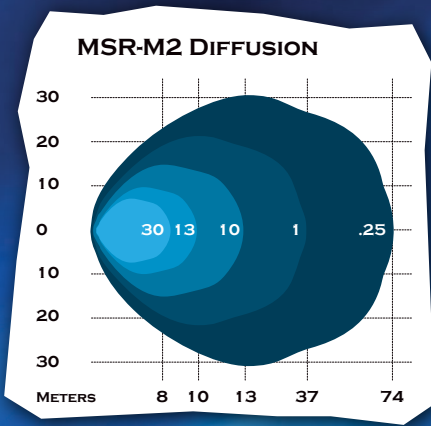

Product Description

Part #

MSR-M2 - Diffused 95251
 MSR-M2 - Amber Diffused 95252

Light Kit Includes...

Mounting Bracket & Hardware
 White Cover

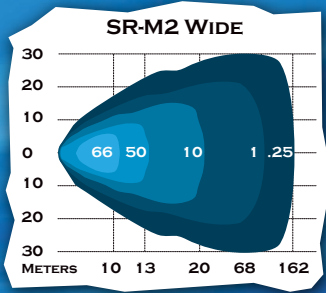

Product Description

Part #

MSR-M2 - Wide 95211
 MSR-M2 - Amber Wide 95212

Light Kit Includes...

Mounting Bracket & Hardware
 White Cover

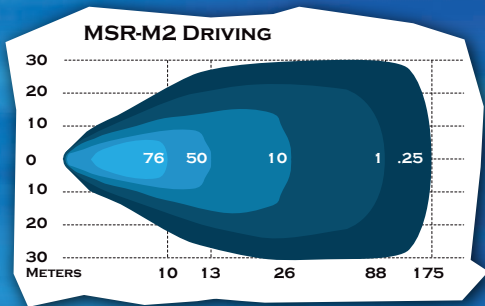

Product Description

Part #

MSR-M2 - Driving 95231
 MSR-M2 - Amber Driving 95232

Light Kit Includes...

Mounting Bracket & Hardware
 White Cover



MARINE SR-M2



MARINE SR-Q

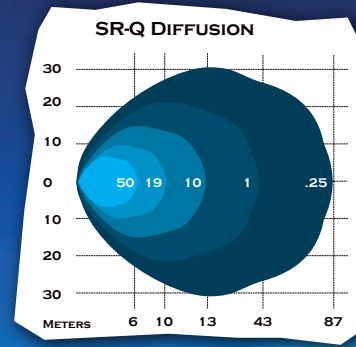

Product Description **Part #**

MSRO - Diffused 94451
 MSRO - Diffused - Set of 2 94551

Light Kit Includes...

Mounting Bracket & Hardware
 White Cover

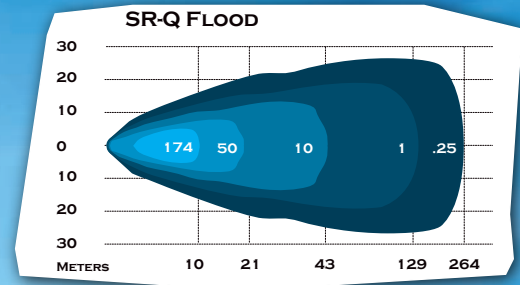

Product Description **Part #**

MSRO - Flood 94411
 MSRO - Flood - Set of 2 94511

Light Kit Includes...

Mounting Bracket & Hardware
 White Cover

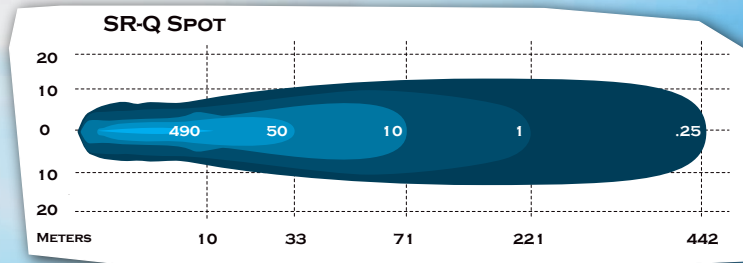

Product Description **Part #**

MSRO - Spot 94421
 MSRO - Spot - Set of 2 94521

Light Kit Includes...

Mounting Bracket & Hardware
 White Cover

MARINE SR-Q2

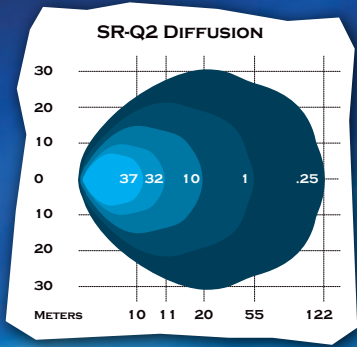

Product Description

Part #

MSRQ2 - Diffused 95451
MSRQ2 - Diffused - Set of 2 95551

Light Kit Includes...

Mounting Bracket & Hardware
White Cover

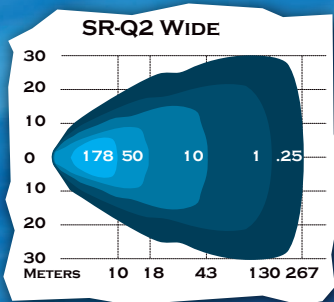

Product Description

Part #

MSRQ2 - Wide 95411
MSRQ2 - Wide - Set of 2 95511

Light Kit Includes...

Mounting Bracket & Hardware
White Cover

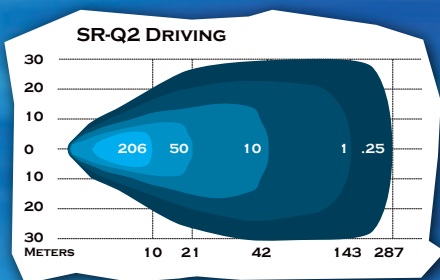
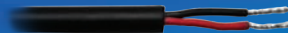

Product Description

Part #

MSRQ2 - Driving 95431
MSRQ2 - Driving - Set of 2 95531

Light Kit Includes...

Mounting Bracket & Hardware
White Cover

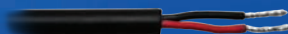

FLUSH MOUNTS



Product Description	Part #	Product Description	Part #	Product Description	Part #
MSR-M FM - Flood	96211	MSR-M FM - Spot	96221	MSR-M FM - Diffused	96251
MSR-M FM - Amber Flood	96212	MSR-M FM - Amber Spot	96222	MSR-M FM - Amber Diffused	96252



Product Description	Part #	Product Description	Part #	Product Description	Part #
MSR-M2 FM - Wide	97211	MSR-M2 FM - Driving	97231	MSR-M2 FM - Diffused	97251
MSR-M2 FM - Amber Wide	97212	MSR-M2 FM - Amber Driving	97232	MSR-M2 FM - Amber Diffused	97252

SPECIFICATIONS

* Based on LED manufacturer specifications
 ** Tested using ANSI/NEMA FL Standards

Product Description	Part #	Weight (lbs)	Watts	AMP Draw	LED's	Raw Lumens*	Lux @ 10m	Beam Distance (m)**	Peak Beam Intensity (cd)**
Marine SR-M Flush Mount - Flood	96211	1	10	.72	2	784	87.1	186.7	8711
Marine SR-M Flush Mount - Spot	96221	1	10	.72	2	784	245	313.0	24500
Marine SR-M Flush Mount - Diffused	96251	1	10	.72	2	784	9.7	62.1	966
Marine SR-M2 Flush Mount - Wide	97211	1	11.25	.82	3	1125	66.2	162.7	6618
Marine SR-M2 Flush Mount - Driving	97231	1	11.25	.82	3	1125	76.5	175	7653
Marine SR-M2 Flush Mount - Diffused	97251	1	11.25	.82	3	1125	13.9	74.4	1385

The Marine Series products do not include a wire harness or switch, due to the fact that most installs on marine equipment are custom and require smaller holes and unique components.



These models are designed to be recessed into a bumper, a utility bed, on a boat or any application where you need the light to look clean and out of the way. Once installed, the light is only 1/4" exposed, which means you can have all the benefits of our surface mount lights in an OEM quality, flush installation. Limited lifetime warranty.



Product Description	Part #	Product Description	Part #	Product Description	Part #
MSR-Q Flush Mount - Flood	96411	MSR-Q Flush Mount - Spot	96421	MSR-Q Flush Mount - Diffused	96451
MSR-Q FM - Flood - Set of 2	96511	MSR-Q FM - Spot - Set of 2	96521	MSR-Q FM - Diffused - Set of 2	96551



Product Description	Part #	Product Description	Part #	Product Description	Part #
MSR-Q2 Flush Mount - Wide	97411	MSR-Q2 Flush Mount - Driving	97431	MSR-Q2 Flush Mount - Diffused	97451
MSR-Q2 FM - Wide - Set of 2	97511	MSR-Q2 FM - Driving - Set of 2	97531	MSR-Q2 FM - Diffused - Set of 2	97551

SPECIFICATIONS

* Based on LED manufacturer specifications
 ** Tested using ANSI/NEMA FL Standards

Product Description	Part #	Weight (lbs)	Watts	AMP Draw	LED's	Raw Lumens*	Lux @ 10m	Beam Distance (m)**	Peak Beam Intensity (cd)**
Marine SR-Q Flush Mount - Spot	96421	1	20	1.45	4	1568	174.2	264.0	17422
Marine SR-Q Flush Mount - Flood	96411	1	20	1.45	4	1568	490	442.7	49000
Marine SR-Q Flush Mount - Diffused	96451	1	20	1.45	4	1568	19.3	87.9	1931
Marine SR-Q2 Flush Mount - Wide	97411	1	34.5	2.50	6	3030	206.1	287.1	20612
Marine SR-Q2 Flush Mount - Driving	97431	1	34.5	2.50	6	3030	178.2	267.0	17824
Marine SR-Q2 Flush Mount - Diffused	97451	1	34.5	2.50	6	3030	37.3	122.2	3732

The Marine Series products do not include a wire harness or switch, due to the fact that most installs on marine equipment are custom and require smaller holes and unique components.



M-SERIES UNDERWATER LIGHT



FACTS

- Produces up to 9000 Lumens
- Runs on 12-28V DC
- EN 55015:2006 EMC Complaint
- MIL810-STDG Vibration Certified
- ROHS Compliant
- Over / Under Voltage Protection
- Operating Temp -40° F ~ +145° F
- 50,000+ Hour Lifespan
- Protected Against RFI / EMI
- Instant On; Flashing won't damage bulb or circuitry.
- Scratch Resistant Lens Coating
- 15' Marine Rated Connection Wire

LED COLORS



Rigid Industries is proud to introduce the newest addition to the Rigid marine lighting family, the Under Water Light (UWL). It utilizes a Triplex coating process that is up to 5 times stronger than any military spec anodized coating. The coating allows the use of aluminum in a salt water environment. After rigorous testing for over 9,000 hours, the light had zero pitting or corrosion. Using lightweight, heat-dissipating aluminum, the UWL can operate longer and will keep the LED's cooler. The UWL provides up to 9,000 lumens using the latest generation of US made LED's available. The virtually unbreakable polycarbonate lens is coated with a proprietary sealant that protects and makes it easy to clean; this includes algae and other organisms. The UWL is available in a surface mount with exposed mounting hardware, or stealth mount with concealed mounting hardware.

SPECIFICATIONS

Product Description	Part #	Min/Max Voltage (V)	AMP Draw	LED's	Fixed Lumens
UWL 2X3 Surface Mount White	89111	12 - 28	7	18	9000
UWL 2x3 Stealth Mount White	89121	12 - 28	7	18	9000
UWL 2X3 Surface Mount Blue	89112	12 - 28	5	18	1440
UWL 2x3 Stealth Mount Blue	89122	12 - 28	5	18	1440
UWL 2X3 Surface Mount Green	89113	12 - 28	5	18	3400
UWL 2x3 Stealth Mount Green	89123	12 - 28	5	18	3400
UWL 2X3 Surface Mount RGBW	89114	12 - 28	5	6	1200~4000
UWL 2x3 Stealth Mount RGBW	89124	12 - 28	5	6	1200~4000

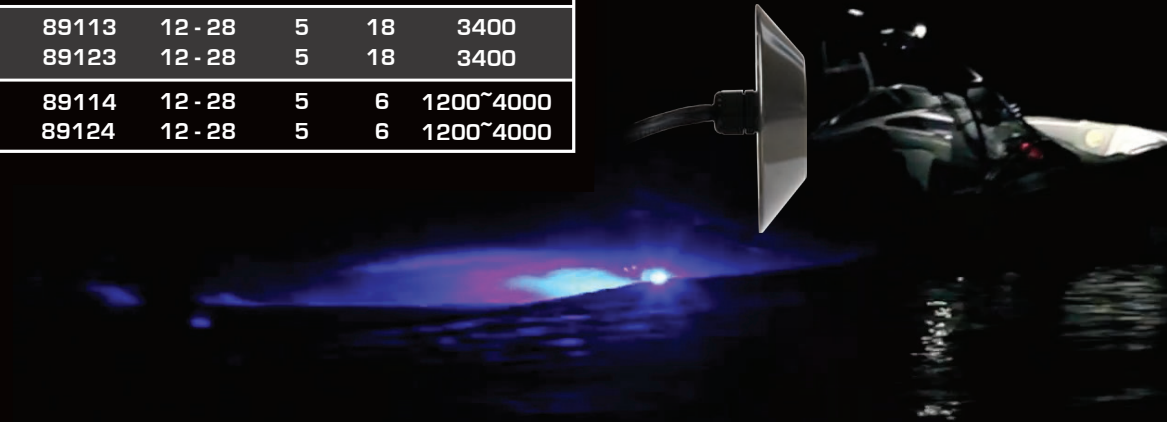
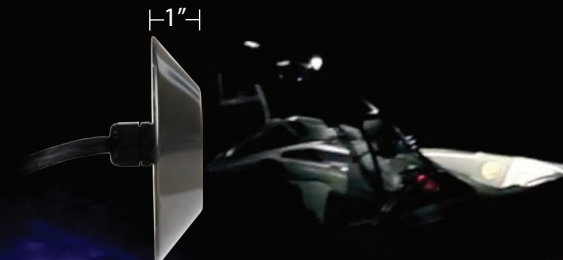
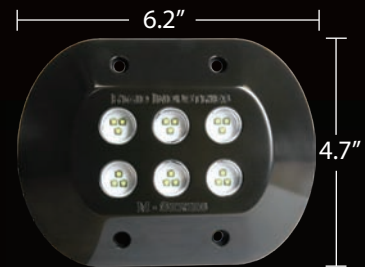

SURFACE

The Surface mounted UWL provides a quick and easy installation.



STEALTH

The Stealth mounted UWL provides a sleek look that is characteristic to the marine world.

▼ ACTUAL SIZE ▲





Q4

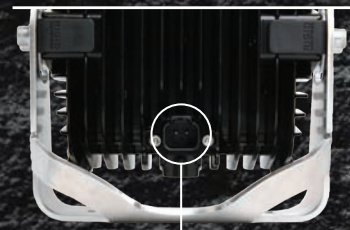

Integrated Sealed Deutsch Connector

When facing the challenge of severe darkness, the new Rigid Q4 light will illuminate the path. Designed specifically to function in harsh working environments and made of the toughest and most durable materials, this light can withstand abuse. The new Q4 is available in a 4,000 lumen Hybrid model or 9,000 lumen Specter model with a Diffused lens option. The Q4 is a big, bright, heavy duty light developed especially for mining operations, agriculture, oil and gas industry, and construction. Mounting locations include a bracket or threaded eyelets on the bottom of the light housing. Limited lifetime warranty.

SPECIFICATIONS

* Based on LED manufacturer specifications
 ** Tested using ANSI/NEMA FL Standards

Product Description	Part #	Weight (lbs)	Watts	AMP Draw	LED's	Raw Lumens*	Lux @ 10m	Beam Distance (m)**	Peak Beam Intensity (cd)**
Q4 - Flood	24411	4	80	5.8	16	6272	696.9	528.0	69689
Q4 - Spot	24421	4	80	5.8	16	6272	1960	885.4	196000
Q4 - Diffused Flood	24451	4	80	5.8	16	6272	77.2	175.8	7724
Q4 - Wide	54411	4	90	6.52	24	9000	529.4	460.2	52941
Q4 - Driving	54431	4	90	6.52	24	9000	612.2	494.9	61224
Q4 - Diffused Driving	54451	4	90	6.52	24	9000	110.8	210.6	11084

FACTS

- Available in Hybrid & Specter Optics
- GORE® Pressure Equalizing Vent
- Unbreakable Polycarbonate Lens
- Durable UV 3800 Polyester Powder-coat
- Integrated Deutsch Plug on All Housings
- IP68 Certified
- MIL810-STDG Vibration Certified
- ROHS Compliant
- Over / Under Voltage Protection
- Operating Temp -40° F ~ +145° F
- 50,000+ Hour Lifespan
- Protected Against RFI / EMI
- Integrated Thermal Management



Our patented Hybrid and Specter optic systems and state of the art technology makes our LED products second to none. We continue to lead the industry in innovation with our new Q4 – an extra heavy duty, multi-purpose light, with multiple diffusion options. Q4 Driving light with Downward Diffused lenses shown above.

DIFFUSION KIT



This all new diffusion kit is specially designed for the Q4 to provide a wide array of diffusion options. You have the choice of a regular diffusion lens to spread the light in a 60 degree angle in all directions, or only downward with the downward diffusion lenses. The unique screw-on diffusion plate and lenses also allow for a combination of diffusion that is ideal for any heavy duty task. Diffusion plate measures 5 1/2" x 5 1/2".

Diffusion Kit Sold Separately (Part Number 49003)

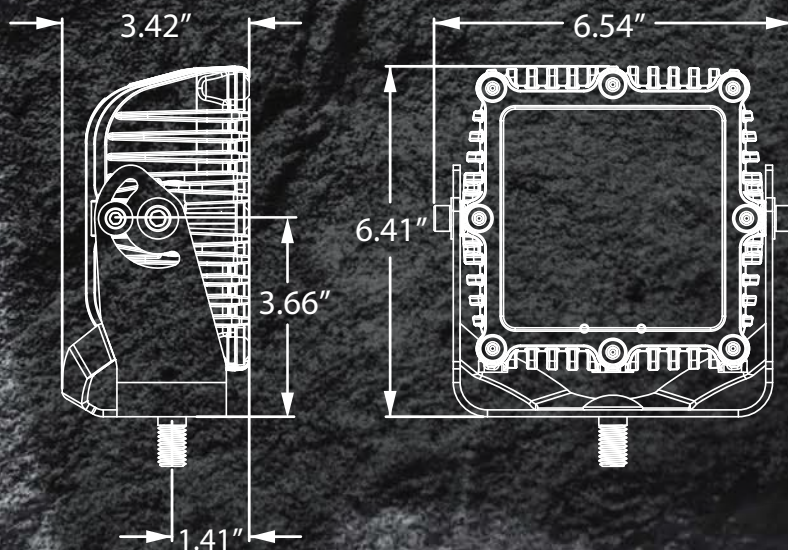

All Q4 lights feature a vibration isolator to reduce internal component failure and to extend the lifespan of the light.

(JDQ53.3 Agriculture Heavy Equipment Vibration Spec)

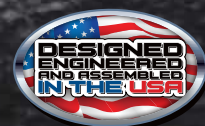

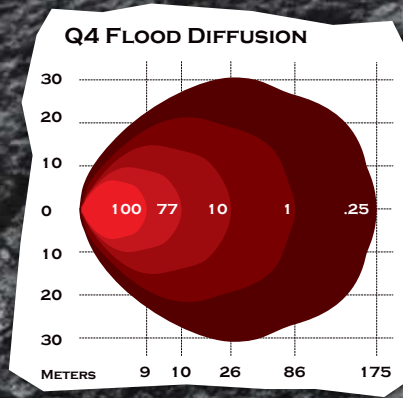

Product Description	Part #
Q4 - Flood Diffused	24451
Q4 - Amber Flood Diff.	24452

Light Kit Includes...

- Plug & Play wiring harness with switch
- Mounting Bracket
- Mounting Hardware

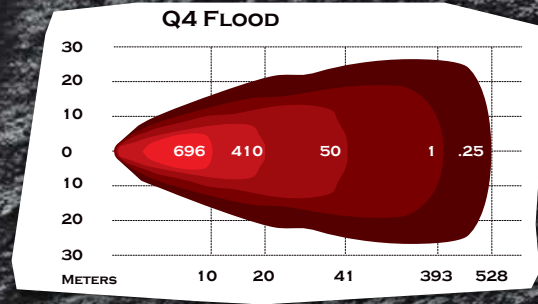

Product Description	Part #
Q4 - Flood	24411
Q4 - Amber Flood	24412

Light Kit Includes...

- Plug & Play wiring harness with switch
- Mounting Bracket
- Mounting Hardware

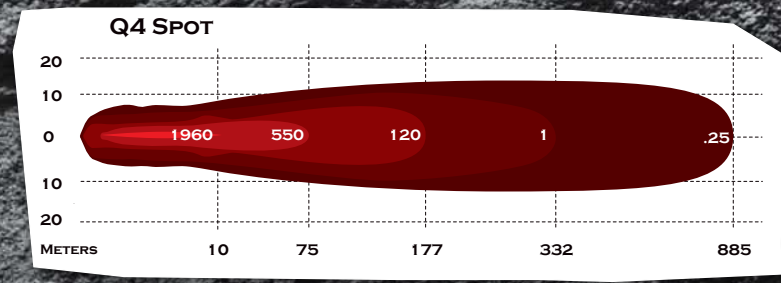

Product Description	Part #
Q4 - Spot	24421
Q4 - Amber Spot	24422

Light Kit Includes...

- Plug & Play wiring harness with switch
- Mounting Bracket
- Mounting Hardware



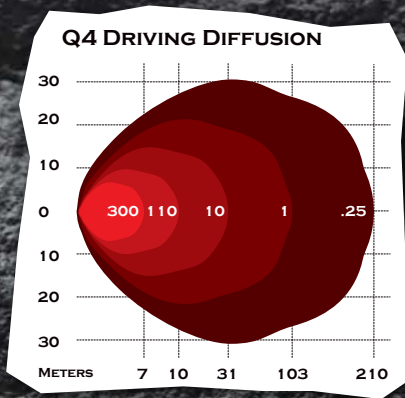

Product Description

Part #

Q4 - Driving Diffused 54451
 Q4 - Amber Driving Diff. 54452

Light Kit Includes...

Plug & Play wiring harness with switch
 Mounting Bracket
 Mounting Hardware

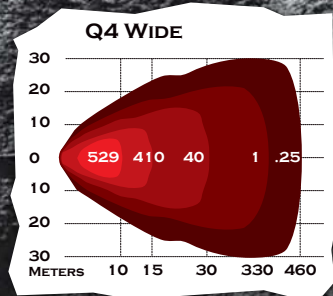

Product Description

Part #

Q4 - Wide 54411
 Q4 - Amber Wide 54412

Light Kit Includes...

Plug & Play wiring harness with switch
 Mounting Bracket
 Mounting Hardware

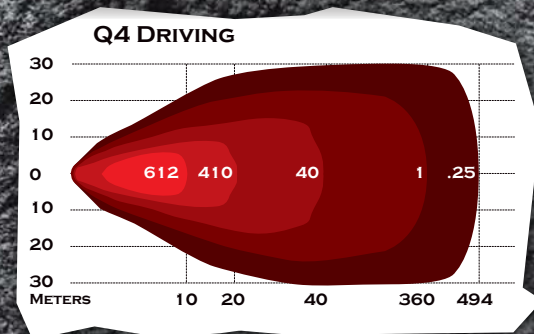

Product Description

Part #

Q4 - Driving 54431
 Q4 - Amber Driving 54432

Light Kit Includes...

Plug & Play wiring harness with switch
 Mounting Bracket
 Mounting Hardware



HD D-SERIES



SPECIFICATIONS

* Based on LED manufacturer specifications
 ** Tested using ANSI/NEMA FL Standards

Product Description	Part #	Weight (lbs)	Watts	AMP Draw	LED's	Raw Lumens*	Lux @ 10m	Beam Distance (m)**	Peak Beam Intensity (cd)**
HD Dually - Flood	22111	1.25	20	1.45	4	1568	174.2	264.0	17422
HD Dually - Spot	22121	1.25	20	1.45	4	1568	490	442.7	49000
HD Dually - Diffused	22151	1.25	20	1.45	4	1568	19.3	87.9	1931
HD D2 - Wide	52111	1.25	34.5	2.50	6	3030	178.2	267.0	17824
HD D2 - Driving	52131	1.25	34.5	2.50	6	3030	206.1	287.1	20612
HD D2 - Diffused	52151	1.25	34.5	2.50	6	3030	37.3	122.2	3732

The all new HD D-Series is the perfect compliment to our Heavy Duty line of lights is the unbelievable lighting power that comes from Rigid D-Series. The combination is a super bright, compact light paired with superior dependability of the HD bracketry and hardware. All HD D-Series lights feature a vibration isolator to reduce internal component failure and to extend the lifespan of the light. This allows the HD D-Series light to be ready for the rigorous abuse of mining operations, agriculture, construction and other heavy duty applications. Limited lifetime warranty.

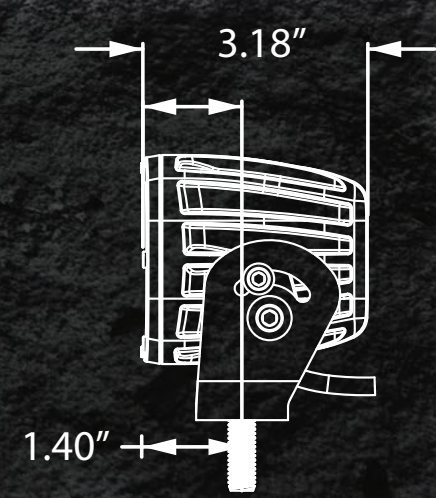
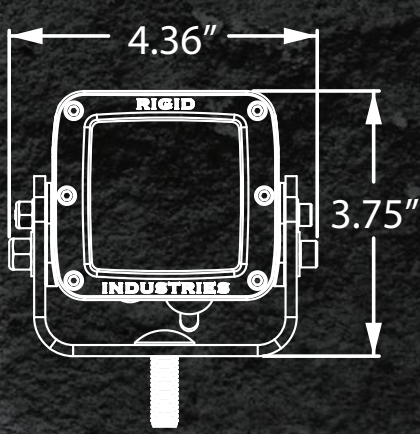

FACTS

- GORE® Pressure Equalizing Vent
- Unbreakable Polycarbonate Lens
- Durable UV 3800 Polyester Powdercoat
- Sealed Deutsch Connector
- Runs on 9 to 36V DC
- 50,000+ Hour Lifespan
- Available in Hybrid & Specter Optics
- IP68 Certified
- MIL810-STDG Vibration Certified
- ROHS Compliant
- Over / Under Voltage Protection
- Operating temp -40° F ~ +145° F
- Protected Against RFI / EMI
- Integrated Thermal Management System
- Patented Optics (6,986,593 b2, 7,114,832 b2)



HD DUALLY

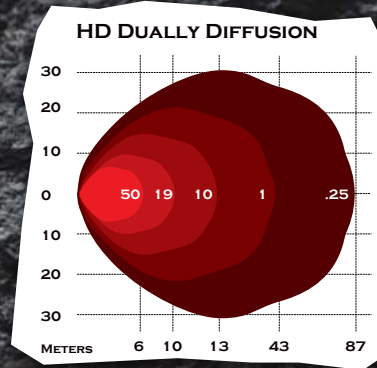

Also Available in...

Yellow Bezel
Amber LED



Product Description

Product Description	Part #
HD Dually - Diffused	22151
HD Dually - Diffused Set of 2	22251
HD Dually - Diff Yellow Bezel	23151

Light Kit Includes...

Plug & Play wiring harness with switch
Mounting Bracket
Mounting Hardware

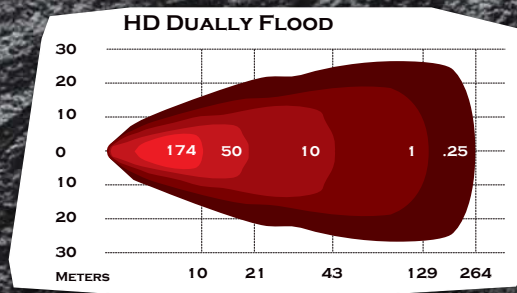

Also Available in...

Yellow Bezel
Amber LED



Product Description

Product Description	Part #
HD Dually - Flood	22111
HD Dually - Flood Set of 2	22211
HD Dually - Flood Yellow Bezel	23111

Light Kit Includes...

Plug & Play wiring harness with switch
Mounting Bracket
Mounting Hardware

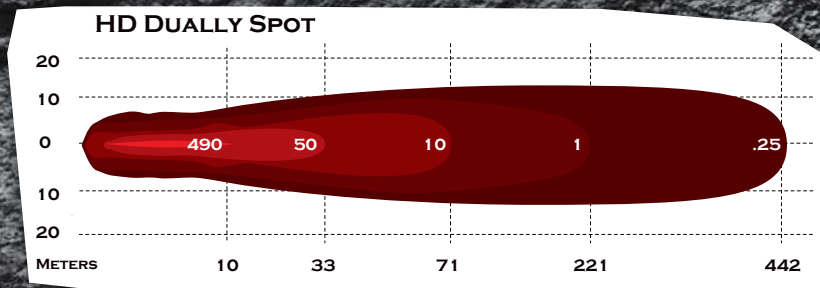
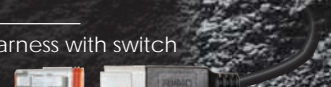

Also Available in...

Yellow Bezel
Amber LED



Product Description

Product Description	Part #
HD Dually - Spot	22121
HD Dually - Spot Set of 2	22221
HD Dually - Spot Yellow Bezel	23121

Light Kit Includes...

Plug & Play wiring harness with switch
Mounting Bracket
Mounting Hardware

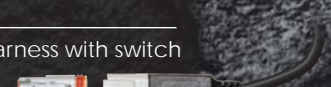

HD D2

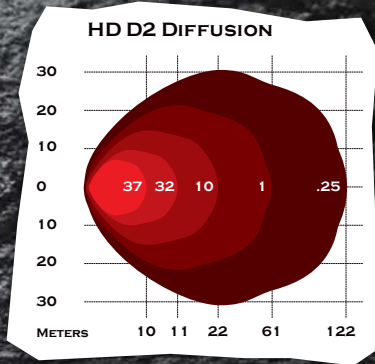

Also Available in...

Yellow Bezel
Amber LED



Product Description

Product Description	Part #
HD D2 - Diffused	52151
HD D2 - Diffused Set of 2	52251
HD D2 - Diffused Yellow Bezel	53151

Light Kit Includes...

Plug & Play wiring harness with switch
Mounting Bracket
Mounting Hardware

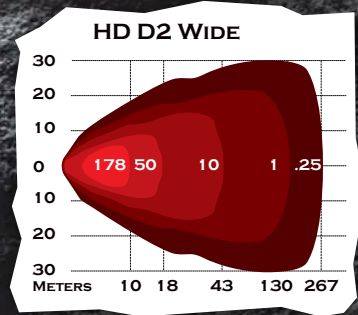

Also Available in...

Yellow Bezel
Amber LED



Product Description

Product Description	Part #
HD D2 - Wide	52111
HD D2 - Wide Set of 2	52211
HD D2 - Wide Yellow Bezel	53111

Light Kit Includes...

Plug & Play wiring harness with switch
Mounting Bracket
Mounting Hardware

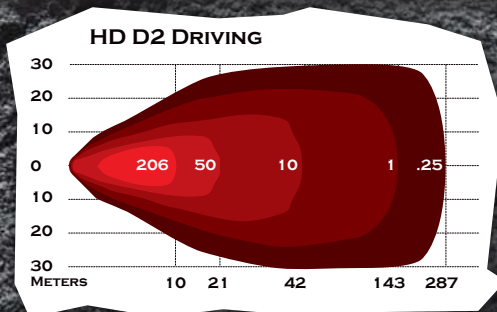

Also Available in...

Yellow Bezel
Amber LED



Product Description

Product Description	Part #
HD D2 - Driving	52131
HD D2 - Driving Set of 2	52231
HD D2 - Driving Yellow Bezel	53131

Light Kit Includes...

Plug & Play wiring harness with switch
Mounting Bracket
Mounting Hardware



R-SERIES

PAR-36 RETROFIT



Diffused Lens (RD, RD+)

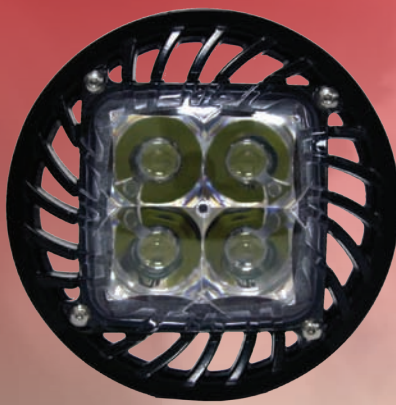

Hybrid Optic (R+, RS)



Back



Side

The Rigid R-Series Par-36 Retrofit fits into any standard Par-36 bulb application, offering clear, white LED auxiliary illumination. Using Rigid Industries patented optics paired with either 10 watt or 5 watt LEDs gives the ultimate versatility to choose the right light. The R+ is the best choice as an all around light. Using 10 watt LEDs paired with our Hybrid Spot optic give the ultimate in width and distance. If lower power draw and long range lighting is what you need, the RS will give over 500 meters of light in a very narrow pattern. Offering both 10 watt and 5 watt versions of wide diffused will fill the need for wide area lighting. Using Rigid Industries 9-36V DC input driver these lights will work with almost all vehicle and aviation electrical systems. This Rigid retrofit light uses a polarity insensitive stainless screw terminal wiring identical to the outdated sealed beams, just attach your wires and go. Limited lifetime warranty.



- 25,000 Hour Lifespan
- Runs on 9 to 36V DC
- Non Polarity Sensitive
- IP68 Certified
- Extremely Durable
- DO-160 Compliant
- Lightweight Cast Aluminum Housing
- Over / Under Voltage Protection
- Integrated Thermal Management



SPECIFICATIONS

* Based on LED manufacturer specifications
 ** Tested using ANSI/NEMA FL standards

Product Description	Part #	Weight (lbs)	Watts	AMP Draw	LED's	Raw Lumens*	Lux @ 10m	Beam Distance (m)**	Peak Beam Intensity (cd)**
R-Series - RS	62110	11 oz	23	1.6	4	1800	460	428	46000
R-Series - R+	62010	11 oz	40	2.7	4	3400	390	400	39000
R-Series - Diffused - RD	62120	11 oz	23	1.6	4	1800	14	75	1400
R-Series - Diffused - RD+	62020	11 oz	40	2.7	4	3400	40	126	4000

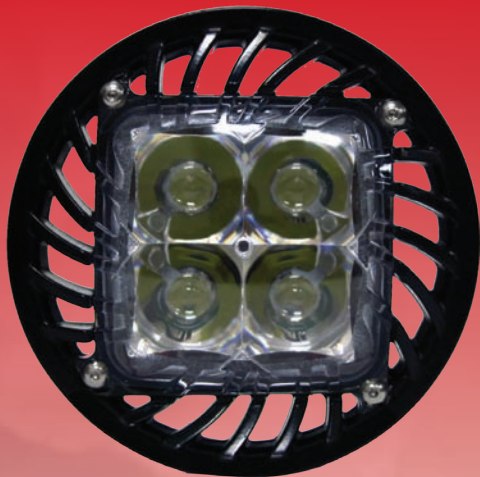

Product Description **Part #**

R-Series - RS 62110

Light Kit Includes...

Installation Instructions

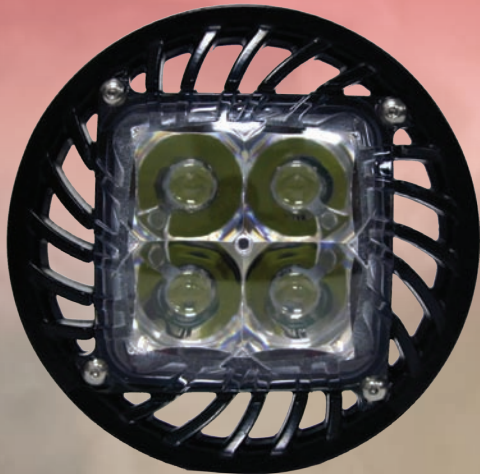
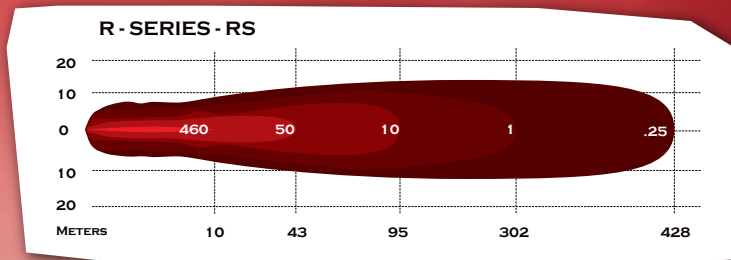

Product Description **Part #**

R-Series - R+ 62010

Light Kit Includes...

Installation Instructions

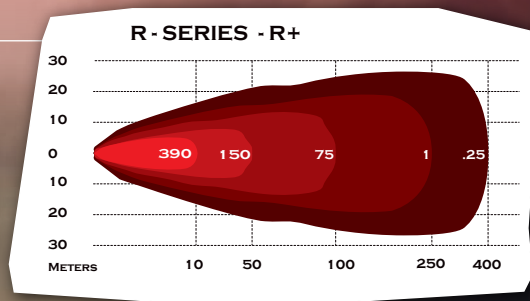

Product Description **Part #**

R-Series - RD 62120

Light Kit Includes...

Installation Instructions

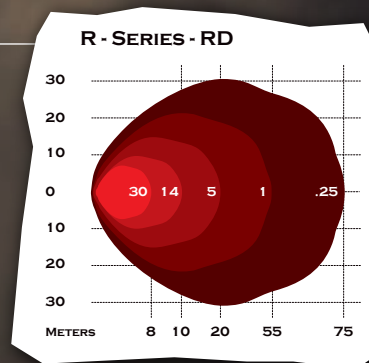

Product Description **Part #**

R-Series - RD+ 62020

Light Kit Includes...

Installation Instructions

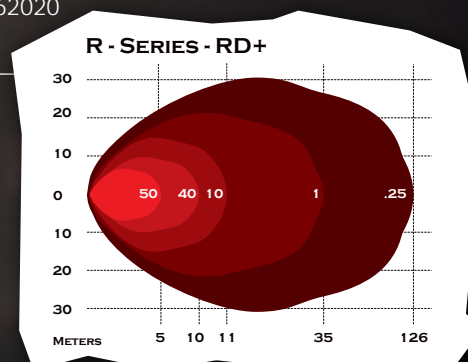

A-SERIES

LED ACCESSORY LIGHT



Rigid Industries introduces the new A-Series LED Accessory Light. It's a small light with a large projection – 200 lumens interior and 400 lumens exterior. All A-Series lights are waterproof and come in a black, white or Triplex™ housing. The Triplex™ housing is designed for extreme salt water applications. This LED Accessory Light uses a polycarbonate lens with UV anti-scratch coating. Typical uses for the A-Series LED Accessory Light are used for interior vehicle lighting, or to illuminate a boat. Limited lifetime warranty.

FACTS

- Fully Submersible Cast Aluminum Housing
- .2 amps / 10 - 28V / 3W Total Draw - 200 Lumen
- .3 amps / 10 - 28V / 4W Total Draw - 400 Lumen
- Polycarbonate Lens with UV /Anti-Scratch Coating
- Reverse Voltage Protected
- Triplex™ is for Extreme Salt Water Conditions
- 38 Series Polyester Powder-coat
- Includes Adapters for Radius Tube or Flat Surface Mounts
- Includes Internal or External Wiring Options
- VHB Adhesive Pad Included for Stick-on Surface Mounting

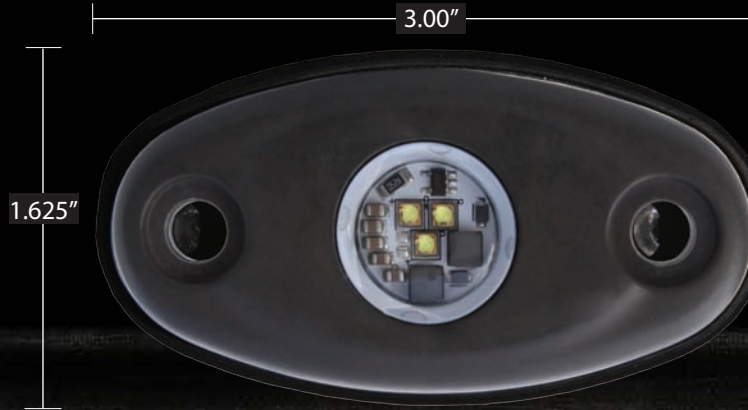

TRIPLEX



WHITE



BLACK

BLACK

LOW POWER Pair Part #

Warm White - 48001	48201
Natural White - 48002	48202
Cool White - 48003	48203
Red - 48004	48204
Blue - 48005	48205
Green - 48006	48206
Amber - 48034	48234

HIGH POWER Pair Part #

Warm White - 48007	48207
Natural White - 48008	48208
Cool White - 48009	48209
Red - 48010	48210
Blue - 48011	48211
Green - 48012	48212
Amber - 48033	48233

WHITE

LOW POWER Pair Part #

Warm White - 48013	48213
Natural White - 48014	48214
Cool White - 48015	48215
Red - 48016	48216
Blue - 48017	48217
Green - 48018	48218
Amber - 48032	48232

HIGH POWER Pair Part #

Warm White - 48019	48219
Natural White - 48020	48220
Cool White - 48021	48221
Red - 48022	48222
Blue - 48023	48223
Green - 48024	48224
Amber - 48031	48231

TRIPLEX

HIGH POWER Pair Part #

Warm White - 48025	48225
Natural White - 48026	48226
Cool White - 48027	48227
Red - 48028	48228
Blue - 48029	48229
Green - 48030	48230
Amber - 48035	48235

Cool white matches the color of light from all other non-amber LED lights. Warm white is comparable to a 60 watt incandescent light bulb, while Natural white is similar to being outside on a sunny day.

INCLUDED RUBBER ADAPTER MOUNTS



FLAT MOUNT
SIDE OR BOTTOM
WIRE EXIT



TUBE MOUNT
SIDE OR BOTTOM
WIRE EXIT



FLAT MOUNT
SIDE OR BOTTOM
WIRE EXIT

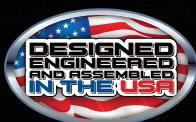

HALO TORCH

Halo
800 Lumens

The Rigid Industries Halo Torch is the best all-around flashlight you'll ever find. It combines the latest in US made LEDs with a machined aluminum reflector, making this an extremely versatile flashlight. The Halo Torch has a nice wide beam for area illumination. The focused center projects 1,000 feet at the highest setting. At about the same length as a Mini Maglite®, the Halo Torch has almost 10x more light output. Dual AC and car charger included. Limited lifetime warranty.



Part # 30120

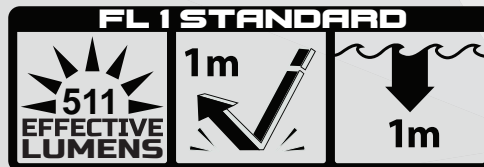
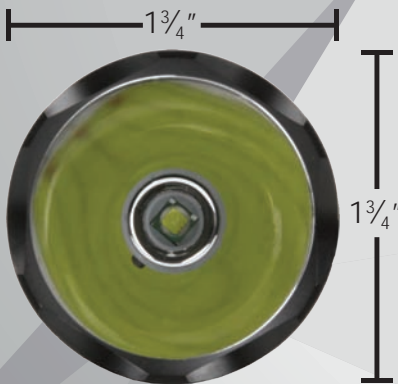

Light Output

A measurement of the total quantity of emitted overall light energy.

Impact Resistance

The degree to which a portable light resists damage when dropped on a solid surface.

Water Resistance

Resistance to temporary immersion in water, continuous immersion in water, and splashing water.



Beam Distance

The distance from the device at which the light beam is .25 lux.

Peak Beam Intensity

The maximum luminous intensity typically along the central axis of a cone light. This is the brightest part of the beam.

Run Time

The duration of time from the initial light output value (30 seconds after the light has been turned on with fresh batteries) until the light output drops to 10% of the initial value



LIGHT KIT INCLUDES

- 1 - 800 Raw Lumen Halo Flashlight
- 1 - 110V Wall Charger (Part # 30112)
- 1 - AC/DC Cigarette Charger Adapter (Part # 30112)
- 1 - 18650 Rechargeable Li-Ion Battery (Part # 30111)

RV LEDS

The Rigid RV LED retrofit kit comes with your choice of bulb adapters to adapt to most bulb styles. It provides thermal and over voltage protection -- and uses 80% less power than stock RV lights and still provides more light. Now you can remove your existing 20 watt bulbs and replace them with super-efficient 4 or 6 watt LEDs. Great for extending times between charges in your RV/Travel Trailer. Available in Natural and Cool white.

RV LED 3 350 Lumens

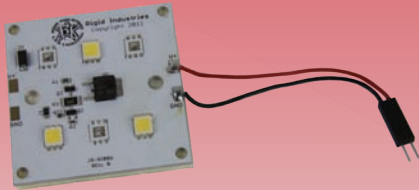

RV LED 6 450 Lumens

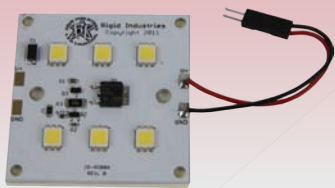

Light	Connector	Part #
RV LED 3	1141/1156	40103
RV LED 3	3156	40203
RV LED 3	921	40303
RV LED 3	T10	40403
RV LED 3	Festoon	40503
RV LED 6	1141/1156	40106
RV LED 6	3156	40206
RV LED 6	921	40306
RV LED 6	T10	40406
RV LED 6	Festoon	40506



921 Connector

1141/1156 Connector



Festoon Connector T10 Connector 3156 Connector

OTHER ACCESSORIES



Flat Radius

LED DOME LIGHT

Billet housing with our warm white 12 LED board. Produces 300 lumens. Available in white, red, blue, green, and amber LEDs. Coped for tube mounting option, and comes with installation hardware.

Mount	Color	Part #
Radius	White	40101
Radius	Amber	40111
Radius	Blue	40121
Radius	Green	40141
Radius	Red	40151
Flat	White	40102
Flat	Amber	40112
Flat	Blue	40122
Flat	Green	40142
Flat	Red	40152



12V Relay

24V Relay

RELAY

Part # 49012 12V Relay
Part # 49024 24V Relay

Relay replacement for 12 and 24V DC systems. Works with all Rigid Industries wiring harnesses.



ROCKER SWITCH

Part # 40191

This water resistant switch with an IP56 rating features a lit 12V rocker with protective rubber boot and is a great addition to any Rigid Industries lighting system. This switch will fit all Rigid Industries wiring harnesses.



LED FLASHER

Part # 40312 3 amp - 12 Volt
Part # 40324 3 amp - 24 Volt
Part # 40612 6 amp - 12 Volt

This 12V and 24V flasher will flash up to a 10 inch LED light and features a waterproof housing. Available in the following 7 patterns:

- Double alternating
- Double simultaneous
- Quad alternating
- Quad simultaneous
- Quint alternating
- Random
- Mega Alternating



SECURITY KIT

Part # 40281

Extra protection for your light bars; Spanner nuts and driver with washers for E-Series, SR-Series, and M-Series mount bolts.



OE APPLICATIONS

Rigid OE application mounts are specifically designed to fit your vehicle's requirements. Superior LED technology and specifically designed mounts mean easy installation and unmatched lighting for your vehicle. Follow installation instructions carefully or consult a professional installer for proper installation.

FORD RAPTOR



RAPTOR ROOF MOUNT KIT 50"

Part # 40236 **Roof Mount Brackets**
The Rigid Raptor Roof Mount Kit is your choice for adding our largest light bar onto your Ford Raptor. Drill holes will need to be made for installation. Mounting brackets and all necessary hardware included for installation. Your choice of white or amber color LEDs.



Light Sold Separately

RAPTOR FOG KIT

Part # 40235
These Rigid brackets mount in the existing fog openings in the lower corners of the bumper utilizing aluminum mounting plates. Two lights per side. Wire harness, mounting brackets and all necessary hardware included for installation. Your choice of white or amber color, with Dually or D2 optics.



Lights Sold Separately

RAPTOR UPPER GRILLE KIT 40"

Part # 40236 **Light Sold Separately**

Rigid Upper Grille Kits mount a 40" light bar behind upper grill to existing mounting holes on both sides of the inner frame assembly. Wire harness, mounting brackets and all necessary hardware included for installation. Your choice of white or amber color LEDs.

40" Upper Grill Brackets



RAPTOR LOWER GRILLE KIT 20"

Part # 40133 **Light Sold Separately**

Rigid Lower Grille Kits mount in the existing lower grill opening. Simply remove the lower grill and install our bracket/light kit and securely mount one single 20" light bar. Mounting bracket and all necessary hardware included for installation.

20" Lower Grill Kit



4"x2 Alternative Lower Grill Kit



RAPTOR LOWER GRILLE KIT 4"x 2

Part # 40134 **Lights Sold Separately**

Rigid Raptor Lower Grille 4" E-Series x 2 kits are perfect for states requiring a front license plate. This system mounts a 4" E-Series LED light on both sides of the license plate in the lower grill area. Your choice of white or amber color, and either spot or flood reflector patterns with an optional diffused lens. Mounting bracket and all necessary hardware included for installation.

FORD SUPERDUTY

SUPERDUTY LOWER GRILLE KIT 20"

Rigid Ford Superduty Lower Grille Kits use existing real estate on the front of your F-250 & F-350 truck. This mount system calls for a 20" E-Series LED light, fitting right into the stock lower bumper opening. This black powder-coated steel bracket bolts into place by drilling 2 small holes that are out of sight if the light is removed.



Part # 40136

Light Sold Separately

DODGE

DODGE BUMPER MOUNT KIT

Part # 40240

The sleek add-on for your Dodge Ram truck is the Rigid Dodge Bumper Mount Kit that securely fits a SR-Series 20" light bar without any major interruption to the radiator. The black powder-coated brackets mount directly onto the bolt holes on the tow hooks.

Fits 2004 - 2013 Dodge Ram 2500-3500

Light Sold Separately



TOYOTA

Part # 40132 TOYOTA FJ ROOF RACK

Light up your FJ with 16,000+ lumens of the latest LED lights available from Rigid Industries. Bolting directly to the vehicle utilizing existing bolt holes in the roof rack, the FJ Roof Rack carries a 20" E-Series in the center and one 10" E-Series on each side. Textured black powder-coat (matches stock roof rack). **Lights Sold Separately**



TOYOTA TUNDRA FOG LIGHT KIT

Part # 40155 **Lights Sold Separately**

With so many requests for such an OE mount, we are happy to introduce the Toyota Tundra Fog Light Kit. These brackets are powder-coated and firmly mount a set of D-Series lights in your fog light fixtures.

Amber LEDs are optional when choosing the correct D-Series light to include with this very effective kit.

Fits 2008 - 2013 Toyota Tundra



TOYOTA TACOMA BUMPER MOUNT KIT

Part # 40156 **Lights Sold Separately**

To show our continuous innovation to our OE line of LED lighting, we introduce the Toyota Tacoma Bumper Mount Kit. These powder-coated brackets make a SR-Series 30" light bar a part of your Tacoma's front bumper, bringing thousands of lumens to your Tacoma's front bumper.

Fits 2012 - 2013 Toyota Tacoma



ATV MOUNTS

Universal 6", 10" E-Series, SR-Series and D-Series handlebar mounts fit most ATV's. All Rigid Industries lights require DC voltage. If your ATV has this power source - bolt it up and go!



Light Size	Part #
D-Series	40230

Lights Sold Separately

Light Size	Part #
6" Light	40630
10" Light	41030

Lights Sold Separately

JEEP

MOUNTING ACCESSORIES

UPPER WINDSHIELD 50" LIGHT BAR MOUNT

Now you can securely mount a 50" E-Series or SR-Series LED light bar at the top of your Jeep's windshield. It easily attaches to the top of the A-pillars, into the existing bolt holes. If you do a lot of off-roading after sunset or just want more light, adding a light bar is the way to go. Made from powder-coated stainless steel. Limited lifetime warranty.

<i>Product Description</i>	<i>Part #</i>
----------------------------	---------------

Jeep JK Brackets	40131
Jeep TJ Brackets	40137

<i>Kit Includes...</i>

Mounting Brackets (2)
Rubber Washer (2)



A-PILLAR D-SERIES MOUNTING BRACKETS

The Rigid Jeep A-Pillar brackets give you another place on your Jeep to add a couple of Rigid Duallys. Just take out the screws on the A Pillar and replace them with Rigid A-Pillar brackets. They look great and give you more light. Made from powder-coated stainless steel. Limited lifetime warranty.

*If pairing with upper windshield bracket, longer bolts may be required.

Product Description	Part #
Jeep JK A-Pillar Brackets	40331
Jeep JK A-Pillar Dual Brackets	40335
Jeep JK A-Pillar Swivel Brackets	40139

Kit Includes...

Mounting Brackets (2)

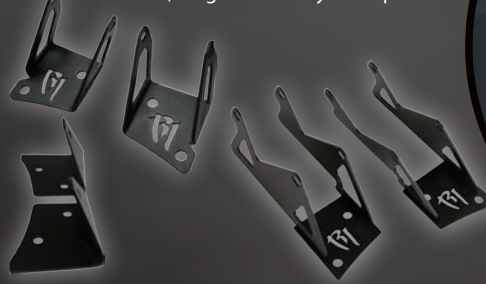

10" OR 20" LIGHT BAR HOOD BRACKETS

If you ever wanted to place a light bar directly on your Jeep's hood – without punching through the hood itself, now you can. Rigid's one of a kind hood bracket lets you secure a 10 or 20 inch light bar directly on your hood. The bracket is made of powder-coated stainless steel and attaches securely to the hinges on your Jeep's hood. Installation is simple and easy. Limited lifetime warranty.

*Fits SR-Series, E-Series or M-Series

Product Description	Part #
10" Light Bar Hood Brackets	40332
20" Light Bar Hood Brackets	40333

Kit Includes...

Mounting Brackets (2)



D-SERIES FOG LIGHT REPLACEMENT KIT

When you want something different for your Jeep, the Rigid Duallly LED Fog light kit make your Jeep look terrific and they work perfect in extremely foggy conditions. It's a rare look for your Jeep and you can now fit a Rigid D-Series light in a round hole with this bracket. Installation is quick, with a clean finish. Made from powder-coated stainless steel. Limited lifetime warranty.

*Includes brackets for both lights

*Should not be used with factory switch.

Product Description	Part #
D-Series Fog Light Brackets	40138

Kit Includes...

Mounting Brackets (2)

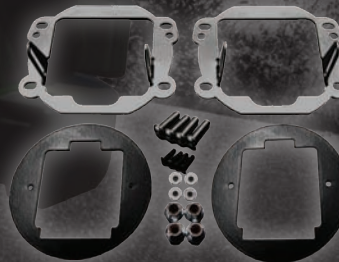

TAIL LIGHT SR-M MOUNTING BRACKETS

Now you can quickly secure a SR-M or SR-Q on top of either of the existing brake lights (Driver or Passenger) by using these Rigid Tail Light Mounting Brackets. Limited lifetime warranty.

Product Description	Part #
Drivers Side Bracket	40311
Passenger Side Bracket	40322

Kit Includes...

Mounting Brackets (1)



LED GRILLES

BY RIGID INDUSTRIES

LED Grilles by Rigid Industries are the new way to customize your rig with high output Rigid lights. Not only does this new accessory mount Rigid LEDs in your grille but it gives your vehicle a whole new Rigid look. Each LED Grille by Rigid Industries consists of two parts laser cut out of 304 Stainless Steel. There's zero welding.

LED Grilles by Rigid Industries receive the same Satin Black powder-coat treatment as our lights for a seamless look then bolted together with stainless steel button socket head bolts and nyloc nuts. All mounting hardware is included. Cutting and drilling of OE grille shell is required for select grilles. Installation instructions included for specific details.

Professional installation is recommended for your LED Grille by Rigid Industries to be properly installed. May not fit all body styles for recommended make and model. Some select LED Grilles may be sold in separate pieces. Limited Lifetime Warranty.

2005 - 2013 TOYOTA FJ

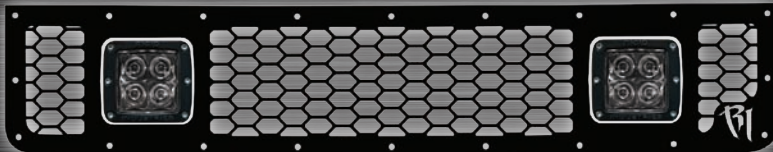

TOYOTA FJ UPPER Part # 40560

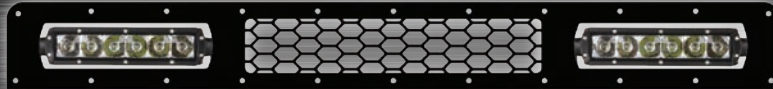

TOYOTA FJ LOWER Part # 40561 Combined Set Part # 40551



2012 - 2013 TOYOTA TACOMA

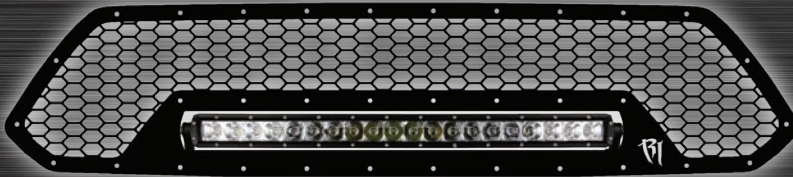

(1) SA-20"

Part # 40552



2005 - 2010 TOYOTA TACOMA

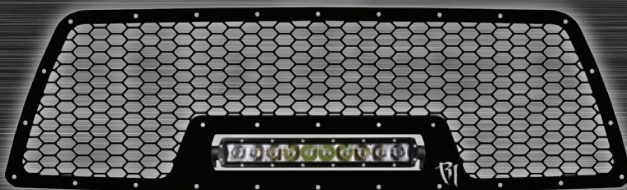

(1) SA-10"

Part # 40553



2010 - 2013 TOYOTA TUNDRA

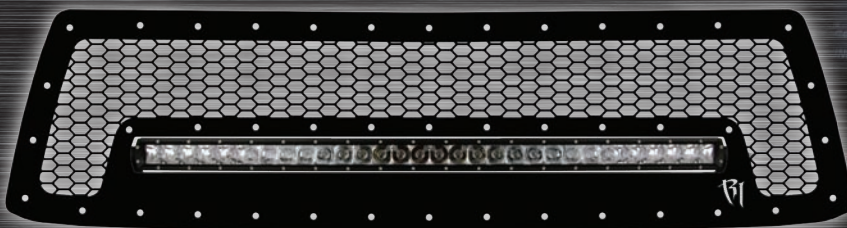

(1) SA-30"

Part # 40554





Shown Above

TOYOTA 4-RUNNER UPPER Part # 40562

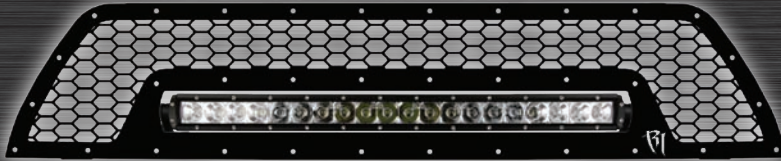

TOYOTA 4-RUNNER LOWER Part # 40563

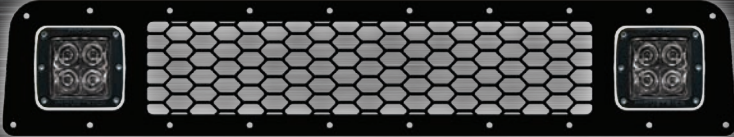

Combined Set Part # 40556

TOYOTA 4-RUNNER 2010 - 2013
(1) SR-20" (2) DUALLY'S



2010 - 2013 TOYOTA TUNDRA

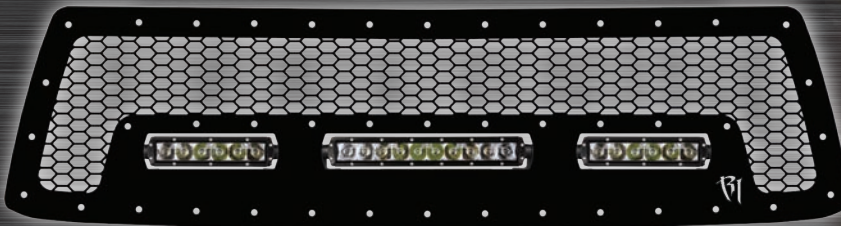

(1) SR-10" (2) SR-6" Part # 40555



2012 - 2013 POLARIS RZR



(1) SR-10" Part # 40557



2010 - 2012 FORD F-150



(1) SR-10" (2) SR-6" Part # 40558



Lights Sold Separately

OFF-ROAD LED LIGHTS