

MOUNT UP. MOVE OUT.™



POWERSPORTS 2018



SCOSCHE®



Dear Powersports Dealer,

Scosche® is excited to introduce our completely new line of Powersports products and accessories for 2018.

Since developing the first car stereo installation kits in 1980 Scosche continues our 38-year tradition of providing comprehensive installation and accessory solutions for aftermarket dealers. By strategically developing a sleek and flexible line of products we've proven again that we are a dominate force in the industry.

We have drawn upon a combine 100 years of experience from our designers and engineers to develop for you, the most innovative and exciting products on the market today. This experience along with a passion for the Powersports industry makes Scosche the clear choice for customers to deliver maximum quality and innovation, after all we design – Accessories For Life!

Scosche has developed a line of products that even in the roughest, toughest, bumpiest terrain, you can count on to ensure your phone, GoPro®, wireless speakers, fire extinguishers and other essential items stay securely in place. With powerful mounts designed specifically for ATV/UTV/SxS vehicles, motorcycle handlebars, PWCs, boats and more, you can head out on your next adventure with total confidence that your prized electronics and safety gear remain mounted, visible, accessible and secure.

**Sincerely,
The Alves Family**

BASECLAMP

BASECLAMP – is the most advanced clamping system the industry. BaseClamp premium mounts are designed with the goal of achieving the most flexible and low profile mounting solutions that even the most critical powersports enthusiasts will appreciate.

TERRACLAMP

TERRACLAMP – has been designed as a versatile mounting solution for many scenarios. TerraClamp builds upon the success of previous designs and features multiple mounting options that allows for a wide range of configurations.

SCOSCHE INSTALLATION SOLUTIONS

SCOSCHE – offers a wide range of products that allow for aftermarket stereo installation in unconventional vehicles, our weatherproof wiring and accessories are designed for great performance at a great value, are extremely reliable and a great solution for your everyday install.





POWERSPORTS SOLUTIONS

BASECLAMP	1-8
TERRACLAMP	9-12
HARLEY DAVIDSON SOLUTIONS	13-14
OFC POWERSPORTS AMPLIFIER KITS	15
POLARIS SLINGSHOT SOLUTIONS	15
ACCESSORIES	15
MARINE SOLUTIONS	16
BATTERY JUMPERS	16

BASECLAMP

Through creative design and stringent testing we have developed a system with many unique features. Performance and ergonomics were considered throughout every step of development. All BaseClamps feature the highest grade materials, high performance resin coating and stainless steel hardware. BaseClamp is the most advanced accessory mounting system in the industry.

-  **1. BaseClamp Fixed Whip / Flag Mount Base Pg.7**
-  **2. BaseClamp Fire Extinguisher Mount Base Pg.6**
-  **3. BaseClamp Large Strap Base Pg.6**
-  **4. TerraClamp Heavy Duty 3-in-1 Mount Large Pg.10**
-  **5. TerraClamp MagicMount Pro Large Pg.10**







- 6. **TerraClamp Heavy Duty Fire Extinguisher and BoomBottle Mount** **Large** Pg.10
- 7. **BaseClamp 6" Grab Handle Base** Pg.7
- 8. **BaseClamp MagicMount Pro Base** Pg.5
- 9. **BaseClamp 9" Panoramic Mirror Base** Pg.8
- 10. **BaseClamp 5" Round Convex Mirror Base** Pg.8



CLAMPS

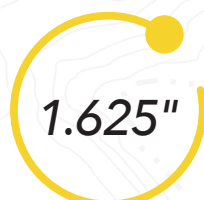

CHOOSE YOUR CLAMP SIZE

 1.5" #PSC21006	 1.625" #PSC21007	 1.75" #PSC21009
 1.85" #PSC21010	 1.875" #PSC21011	 2.0" #PSC21012

All clamps are made with Aerospace Grade 6061-T6 Aluminum and are a UV Resin Finish in Black.

APPLICATION GUIDE

MAKE/MODEL	YEAR	MAIN CAGE	TOP CROSSBARS	REAR HARNESS BAR	REAR BUMPER CROSSBARS
ARCTIC CAT					
Wildcat	All	1.75	1.75	1.75	1.75
CAN-AM					
Maverick	All	2	2	2	2
Maverick 4	All	2	2	2	2
Maverick X3	All	1.85	1.85	1.85	1.85
Commander	All	2	2	2	2
KAWASAKI					
Teryx	All	1.875	1.7	1.875	1.875
Teryx 4	All	1.875	1.7	1.875	1.875
HONDA					
Pioneer 1000	All	1.75	1.75	1.75	1.75
Pioneer 700	All	1.625	1.625	1.625	1.625
Pioneer 500	All	1.625	1.625	1.625	1.625
Big Red	All	1.625	1.625	1.625	1.625
POLARIS					
RZR 900	2015 and Up	1.75	1.75	1.75	1.75
RZR 1000	2015 and Up	1.75	1.75	1.75	1.75
RZR	2014 and Older	1.75	1.75	1.5	1.5
RZR S	2014 and Older	1.75	1.75	1.5	1.5
XP	2014 and Older	1.75	1.75	1.5	1.5
RZR 170	All	1.25	1.75	1.75	1.25
REDLINE					
Revolt	All	1.25	1.25	1.25	1.25
Riot	All	1.5	1.5	1.5	1.5
TEXTON OFFROAD					
Wildcat	All	1.75	1.75	1.75	1.75
Wildcat 4	All	1.75	1.75	1.75	1.75
Prowler	All	1.75	1.75	1.75	1.75
Speedcat 77	All	1.75	1.75	1.75	1.75
Wildcat XX	All	1.75	1.75	1.75	1.75
Wildcat XX 4	All	1.75	1.75	1.75	1.75
YAMAHA					
YZX 1000	All	1.75	1.5	1.75	1.75
Rhino	All	1.75	1.5	1.75	1.75
Viking	All	2	2	2	2
Viking VI	All	2	2	2	2
Wolverine	All	2	1.5	2	2
Wolverine X4	All	2	1.5	2	2

HOW IT WORKS:

USING THE 2-PIECE MODULAR BASECLAMP SYSTEM IS AS EASY AS...



The self locking clamp design allows for easy 1 person installation. Simply slip the clamp over your tube and lock in your base, secure using the stainless mounting hardware and you are ready to **Mount Up and Move Out!**

BASES

BaseClamp Phone Holder Base

- Aerospace Grade 6061-T6 Aluminum Base
- Weatherproof Phone Bag
- Fits Most Smartphones
- UV Resin Finish - Black
- Requires BaseClamp Tube Clamp
PSM31000



BaseClamp MagicMount Pro Base

- Aerospace Grade 6061-T6 Aluminum Base
- 360 Degree Adjustable Turn and Rotate
- High Power Neodymium Magnets
- Includes Large and Small Device Plate
- UV Resin Finish - Black
- Requires BaseClamp Tube Clamp
PSM31002



BaseClamp Small Strap Base

- Aerospace Grade 6061-T6 Aluminum Base
- EPDM Rubber
- Fits up to 1.5" Stock
- UV Resin Finish - Black
- Requires BaseClamp Tube Clamp
PSM21004



BaseClamp
Action Camera Mount Base

- Aerospace Grade 6061-T6 Aluminum Base
- Includes 1/4" -20 Screw Mount
- Includes GoPro Mount
- UV Resin Finish - Black
- Requires BaseClamp Tube Clamp
PSM31001



BaseClamp
Fire Extinguisher Mount Base

- Aerospace Grade 6061-T6 Aluminum Base
- Safe and Easy One-Handed Use
- Maintenance Free O-Ring Connection
- Push Button Quick Release Pin
- UV Resin Finish - Black
- Fits any 3.25" Diameter Extinguisher
- Requires BaseClamp Tube Clamp
PSM21000



BaseClamp
Large Strap Base

- Aerospace Grade 6061-T6 Aluminum Base
- EPDM Rubber
- Fits up to 2.5" stock
- UV Resin Finish - Black
- Requires BaseClamp Tube Clamp
PSM21005



BaseClamp
Whip / Flag Mount Base

- Aerospace Grade 6061-T6 Aluminum Base
- 360 Degree Adjustable
- 18 Adjustment Positions
- 1/2" Mounting Hole
- UV Resin Finish - Black
- Requires BaseClamp Tube Clamp

PSM21006



BaseClamp
Fixed Whip / Flag Mount Base

- Aerospace Grade 6061-T6 Aluminum Base
- Fixed 90 Degree
- 1/2" Mounting Hole
- UV Resin Finish - Black
- Requires BaseClamp Tube Clamp

PSM21007



BaseClamp
6" Grab Handle Base

- Aerospace Grade 6061-T6 Aluminum Base
- EPDM Rubber Molded
- Tactile Contoured Grip
- UV Resin Finish - Black
- Requires BaseClamp Tube Clamp

PSM21011



BaseClamp
5" Round Convex Mirror Base

- Aerospace Grade 6061-T6 Aluminum Base
- Fold Away Design
- Fully Adjustable While Mounted
- UV Resin Finish – Black
- Requires BaseClamp Tube Clamp

PSM21008

SOLD IN PAIRS



BaseClamp
9" Panoramic Mirror Base

- Aerospace Grade 6061-T6 Aluminum Base
- Fully Adjustable While Mounted
- UV Resin Finish – Black
- Requires BaseClamp Tube Clamp

PSM21009



BaseClamp
18" Panoramic Mirror Base

- Aerospace Grade 6061-T6 Aluminum Base
- Fully Adjustable While Mounted
- UV Resin Finish – Black
- Requires BaseClamp Tube Clamp

PSM21010

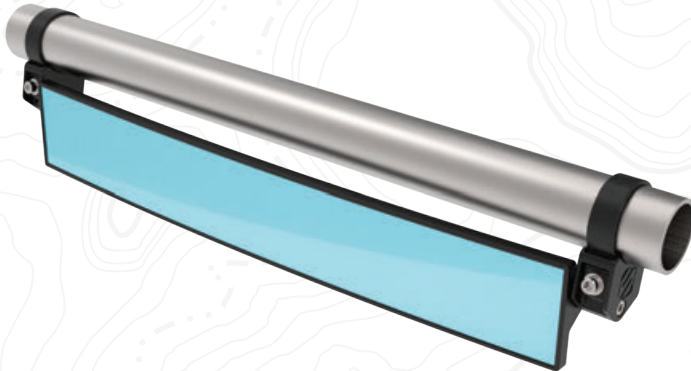

TERRA CLAMP

TERRACLAMP – When it comes to a utility clamp with the ultimate versatility, TerraClamp reigns supreme. TerraClamps are designed for maximum performance while allowing multiple configurations and securely mounting many devices on the market today. TerraClamps are extremely reliable and a great solution for your everyday enthusiast.

TerraClamp *Heavy Duty 3-in-1 Mount Small*

- Weatherproof Smartphone Case
- GoPro Mount
- 1/4"-20 Screw Mount
- 360 Degree Adjustable Turn and Rotate
- Fits Square or Round Tubes .75" to 1.25"
- Stainless Steel Mounting Hardware

PSM11000



TerraClamp *Heavy Duty Fire Extinguisher and BoomBottle Mount Small*

- Holds up to 3.5" Diameter Extinguisher
- Holds Scosche BoomBottle Speaker
- Fits Square or Round Tubes .75" to 1.25"
- Stainless Steel Mounting Hardware

PSM11003

SOLD IN PAIRS



TerraClamp *MagicMount Pro Small*

- High Power Neodymium Magnets
- Includes Large and Small Device Plate
- 360 Degree Adjustable Turn and Rotate
- Fits Square or Round Tubes .75" to 1.25"
- Stainless Steel Mounting Hardware

PSM11017



TerraClamp
Heavy Duty 3-in-1 Mount Large

- Weatherproof Smartphone Case
- GoPro Mount
- 1/4"-20 Screw Mount
- 360 Degree Adjustable Turn and Rotate
- Fits Square or Round Tubes 1.5" to 2"
- Stainless Steel Mounting Hardware

PSM11001



TerraClamp
**Heavy Duty Fire Extinguisher
 and BoomBottle Mount Large**

- Holds up to 3.5" Diameter Extinguisher
- Holds Scosche BoomBottle Speaker
- Fits Square or Round Tubes 1.5" to 2"
- Stainless Steel Mounting Hardware

PSM11004

SOLD IN PAIRS



TerraClamp
MagicMount Pro Large

- High Power Neodymium Magnets
- Includes Large and Small Device Plate
- 360 Degree Adjustable Turn and Rotate
- Fits Square or Round Tubes 1.5" to 2"
- Stainless Steel Mounting Hardware

PSM11018



MagicMount Handlebar

- High Power Neodymium Magnets
- Includes Large and Small Device Plate
- Fits Handlebars .875" to 1.25"
- Elastic Bands for Added Security

PSM11006



TerraClamp Quick Release Phone Mount

- IP67 Weatherproof Smartphone Case
- 360 Degree Adjustable Turn and Rotate
- Fits Round Tubes up to 1.75"
- Stainless Steel Mounting Hardware

PSM11005



MagicMount Pro Universal

- Mounts to Triple Clamp or any Semi Flat Surface
- Includes Elastic Bands for Added Security
- High Power Neodymium Magnets
- Includes Large and Small Device Plate
- Includes 2 Bases for Versatility

PSM11007



TerraClamp Quick Release 3-in-1 Mount

- Weatherproof Smartphone Case
- GoPro Mount
- 1/4"-20 Screw Mount
- 360 Degree Adjustable Turn and Rotate
- Fits Round Tubes up to 1.75"
- Stainless Steel Mounting Hardware

PSM11002



MagicMount Pro Surface

- High Power Neodymium Magnets
- Includes Large and Small Device Plate
- Mounts to any Flat Surface

PSM11008



TerraClamp MagicMount Pro

- High Power Neodymium Magnets
- Includes Large and Small Device Plate
- 360 Degree Adjustable Turn and Rotate
- Mounts Using Screws to any Flat Surface
- Includes Elastic Bands for Added Security
- 6" from Bottom of Base to Mount Surface

PSM11010



TerraClamp Extension Bar

- 4.5" Extension

PSM11019

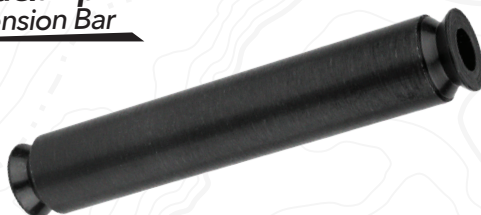

TerraClamp
MagicMount Pro Handlebar

- Aerospace Grade 6061-T6 Aluminum Base
- Fits Handlebars .875" to 1.25"
- High Power Neodymium Magnets
- Includes Large and Small Device Plate
- 360 Degree Adjustable Turn and Rotate
- Includes Elastic Bands for Added Security
- Stainless Steel Mounting Hardware

PSM11011



TerraClamp
MagicMount Pro Bolt

- Aerospace Grade 6061-T6 Aluminum Base
- 45 Degree Mount with Bolt Head Adapter
- High Power Neodymium Magnets
- Includes Large and Small Device Plate
- 360 Degree Adjustable Turn and Rotate
- 10mm Mounting Hole
- Includes Elastic Bands for Added Security
- Stainless Steel Mounting Hardware

PSM11012



TerraClamp
MagicMount Pro Fork Stem

- Center Fork Stem Hole Mount
- High Power Neodymium Magnets
- Includes Large and Small Device Plate
- 360 Degree Adjustable Turn and Rotate
- Includes Elastic Bands for Added Security

PSM11013



TerraClamp
MagicMount Brake / Clutch

- Aerospace Grade 6061-T6 Aluminum Base
- Brake / Clutch Reservoir Mount
- High Power Neodymium Magnets
- Includes Large and Small Device Plate
- 360 Degree Adjustable Turn and Rotate
- Includes Elastic Bands for Added Security
- Stainless Steel Mounting Hardware

PSM11014



TerraClamp
MagicMount Triple Clamp

- Triple Clamp Bolt Mount
- High Power Neodymium Magnets
- Includes Large and Small Device Plate
- 360 Degree Adjustable Turn and Rotate
- Includes Elastic Bands for Added Security
- Stainless Steel Mounting Hardware

PSM11015



TerraClamp
Add a Knuckle

- 360 Degree Adjustable Turn and Rotate
- Adds Additional Pivot Joint
- Includes 1.5" Extension

PSM11016



Scosche has been an innovator in the aftermarket stereo installation market for 38 years, the powersports market is no different. We utilized our knowledge of vehicle integration to develop seamless installation products for your customers weekend toys. Our Powersports amp kits are some of the last kits available to use true gauge wire that strictly follows the American Wire Gauge standard. The UV protected Power and Ground wire included in the amp kits is made with high strand count pure oxygen free copper that ensures your amps are getting the power they need to perform at their best. Pre-terminated with a ring terminals for ease of installation while but durable nylon over braid provides extra protection.



HARLEY-DAVIDSON

2014-Up Harley-Davidson Touring Single Din Kit

- Includes all parts and interfaces necessary for aftermarket stereo installation
- Hi Temp factory grade ASA material
- 16 Gauge galvanized Metal brackets
- Includes HDSWC2 Handle Bar Interface
- Includes Antenna Adapter

HD14UBN

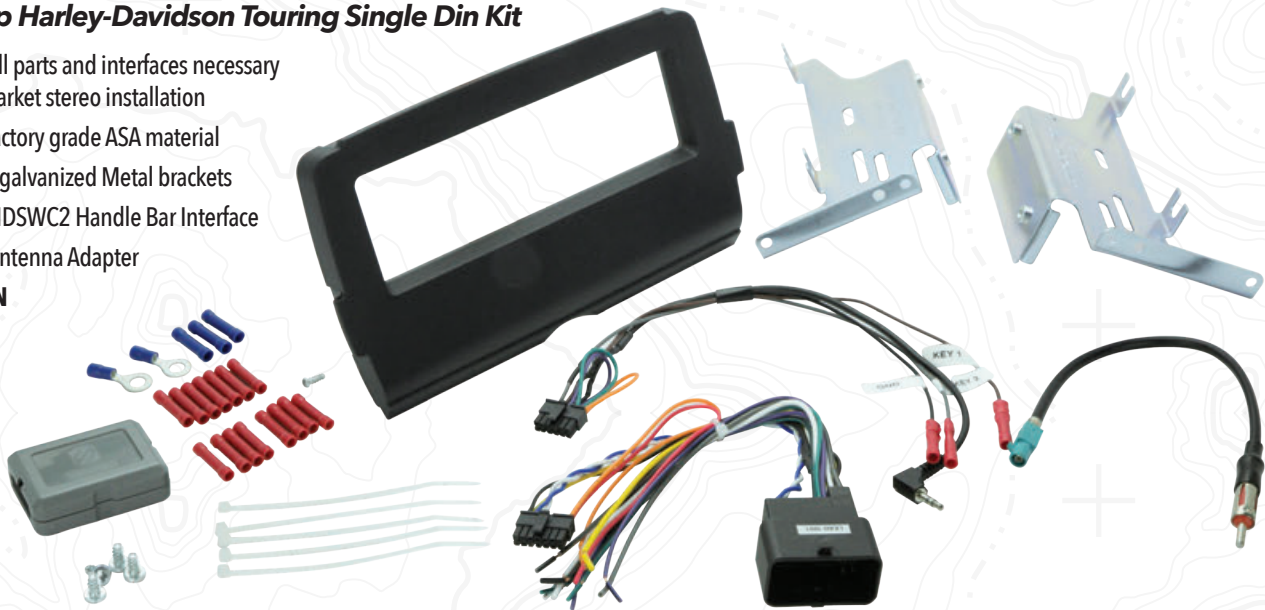

2014-Up Harley-Davidson Touring Double Din Kit

- Includes all parts and interfaces necessary for aftermarket stereo installation
- Hi Temp factory grade ASA material
- 16 Gauge galvanized Metal brackets
- Includes HDSWC2 Handle Bar Interface
- Includes Antenna Adapter

HD14UDBN



1996-2013 Harley-Davidson Touring Single Din Kit

- Includes 1996-13 Harley Davidson Weather shield
- Hi Temp factory grade ASA material
- Stainless steel hardware with brass inserts
- Neoprene sealing gasket
- Made in USA

HD9613BN



2014-Up Front Speaker Harness

- Plugs into factory harness
- Use with aftermarket speakers
- Oxygen free copper

SHHD01B



1996-2013 6 3/4" Fairing Speaker Adapter

- Fits most 6.75" aftermarket speakers
- Shallow design for oversized depth
- Weatherproof gasket

SAHD675

SOLD IN PAIRS



Amplified Under Fairing Antenna

- Universal amplified AM/FM antennar

PSUFA



Hydrophobic Speaker Grill Cloth

- 2-13" x 13" Sheets
- Acoustically Transparent
- Repels Moisture

SGCWP



1998-2013 Saddlebag Lid 5x7" to 6x9" Speaker Adapter

- For Boom Audio Lids
- Converts 5x7 to 6x9

SAHD6901

SOLD IN PAIRS



OFC POWERSPORTS AMPLIFIER KITS

10 AWG Single Amp Power Kit

- 6' 10 AWG Power and Ground
- Two 4' 16 AWG Speaker Wires

EFXV10PS6

8 AWG Single Amp Power Kit

- 6' 8 AWG Power and Ground
- Two 4' 16 AWG Speaker Wires

EFXV8PS6

8 AWG Single Amp Power Kit

- 16' 8 AWG Power and Ground
- Two 8' 16 AWG Speaker Wires

EFXV8PS16

4 AWG Single Amp Power Kit

- 16' 4 AWG Power and Ground
- Two 8' 16 AWG Speaker Wires
- Two 16' 16 AWG Speaker Wires

EFXV4PS16

4 AWG Single Amp Power Kit

- 26' 4 AWG Power and Ground

EFXV4PS26

FEATURES:

- Nylon Mesh Cover
- 16 AWG Remote Turn On Wire
- Weatherproof Mini ANL Fuse Holder



POLARIS SLINGSHOT

2015-17 Polaris Slingshot Double DIN Installation Kit

- Includes all parts and interfaces necessary for aftermarket stereo installation
- Includes Power and Camera Retention Harness
- Hi Temp factory grade ASA material

PL15UDBN

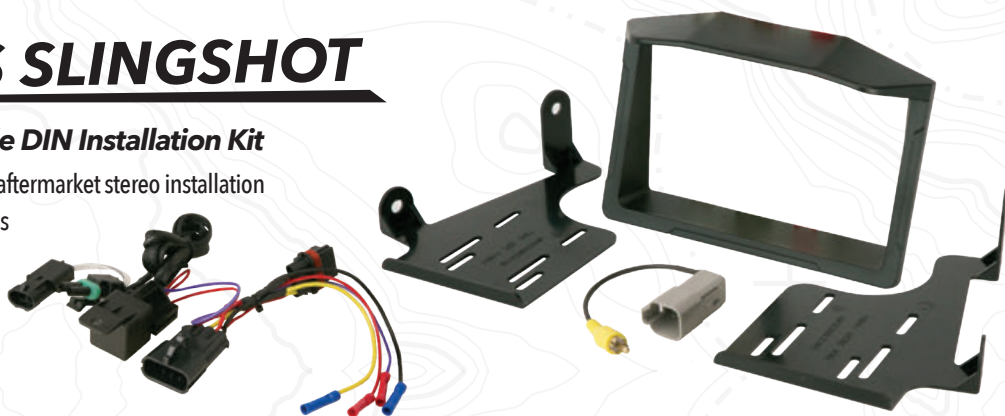

ACCESSORIES

Weatherproof 3.5 AUX and USB Input

- Charge your device or play music through your stereo
- Relocates AUX & USB from rear of aftermarket radio
- Can mount in cigarette lighter socket
- Includes White and Black Cover
- 1 inch diameter mounting hole

USBAUXRLK



Mini 4 Channel 400 Watt Amplifier

- Signal sensing turn on circuit
- 50 x 4 RMS @ 4 OHM
- 100 x 4 max @ 2 OHM
- Compact Class D design

HDMA504I

Dimensions:
5.5"(L) x 3.6"(W) x 1.5" (H)



8 Pin Universal 36" Weatherproof Harness

- 2 - 12 gauge power & ground wires
- 4 - 16 gauge speaker wires
- 2 - 18 gauge accessory wires
- Oxygen free copper

WPAH836



2 Pin Universal 10" Weatherproof Harness

- 2-16 gauge speaker wires

WPAH110B

SOLD IN PAIRS



4 Pin Universal 10" Weatherproof Harness

- 4-16 gauge speaker wires

WPAH210B

SOLD IN PAIRS



MARINE SOLUTIONS

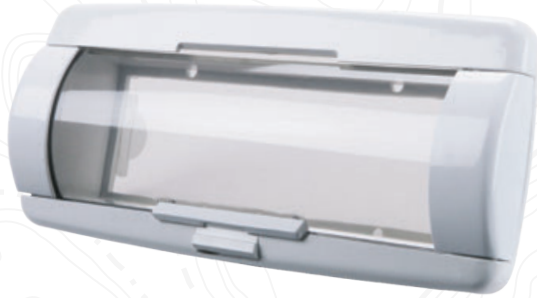

ACM1 (Black)

ACM1W (White) shown

- Retractable Tinted Door
- Auto Spring Open
- Stainless Mounting Hardware

ACM3 (Black)

ACM3W (White)

- Hinged Tinted Door
- Stainless Mounting Hardware

ACM5 (Black)

- Retractable Tinted Door
- Stainless Mounting Hardware

Underdash Enclosure

- Fully Enclosed
- Universal Mounting

UDEB

BATTERY JUMPERS

400 AMP PowerBank Jump Starter and LED Flashlight

- High capacity 5,100mAh Lithium-ion with a peak jumpstart peak current of 400 Amps
- SAFETY PROTECTION against short circuit, reverse connection, reverse charge, overheating and overcurrent
- Remarkable, Spark-Free 6-Point safety protection system Provides maximum peace of mind
- Jump starts a wide array of vehicles (4 to 6 cylinder engines up to 3.5 liters)
- 5V / 2.1A USB port for charging your smartphones, tablets, GPS, and other electronic devices
- Ultra-bright LED flashlight rated at 1,000 lumens
- Dependable design: holds a charge for up to 6 months at a time
- 1000+ charge / discharge cycle

PBJF400

SPECIFICATIONS: Input 5V : 2A, Output 5V : 2A
Jumpstart Current: 12V / 200-400A Battery Standby time: Up to 6 months



300 AMP PowerBank Jump Starter

- Multifunctional USB port for charging your smartphones, tablets, GPS, and other electronic devices
- CIRCUIT SAFETY PROTECTION: No over-heating, over-current, overcharging and short circuit risk.
- High Capacity 5,400 mAh Lithium-ion battery with a Peak current of 300 Amps.
- Ultra-bright LED flash light with; Strobe and SOS lighting options.
- Portable and Durable Design
- 1000+ Battery Life Cycle

PBJ300-1

SPECIFICATIONS: Input 5V : 2A, Output 5V : 2A,
Jump Start Current: 12V / 150 - 300 A, Battery Standby time: Up to 6 months



700 AMP PowerBank Jump Starter

- Dual Multifunctional USB port for charging your Smartphones, Tablets, GPS, and other Electronic devices
- CIRCUIT SAFETY PROTECTION: No over-heating, over-current, overcharging and short circuit risk.
- High Capacity 15,000 mAh Lithium-ion battery with a Peak current of 700 Amps.
- Ultra-bright LED flash light with; Strobe and SOS lighting options.
- Portable and Durable Design
- 1000+ Battery Life Cycle

PBJ700-1

SPECIFICATIONS: Input 14V / 1A, Output 5V / 2A; 5V / 1A,
Jump Start Current : 12V / 350 - 700 A, Battery Standby Time: Up to 12 months





Check out the collection of powersports installation components we offer.