

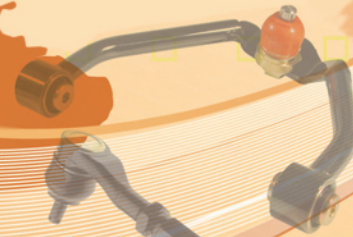

**World  
Applications**



**Wheel Alignment  
Parts and Tools**



**Specialty  
Products  
Company®**



**SPC**  
**PERFORMANCE.**

Entire contents © 2010  
Niwot Corporation  
dba  
Specialty Products Co.®



**TOOL ICON**

When you see our  
"wrench" next to a part it  
means there is a special  
tool available to assist you  
in the installation.



**TABLE OF  
CONTENTS**

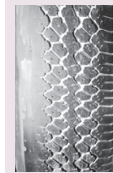

**Problems  
and  
Solutions**

**Page**

**2**

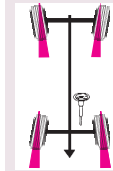
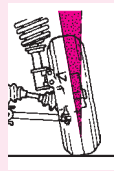
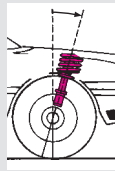

**Alignment  
Terms**

**3**



**Benefits**

**3**



**Application  
Guide**

**5**



**Parts**

**42**



**Tools**

**58**



**Index**

**65**

**Because of space constraints, the photos and illustrations of the parts and tools may vary slightly from the actual part.**

The design, shape, format and arrangement of this catalog constitutes a trademark of Specialty Products Company.  
Printed in U.S.A.

All rights reserved, reproduction in whole or in part without permission is prohibited.

Total Wheel Alignment Sourcebook is a trademark of Niwot Corporation.

## WORN ON ONE SHOULDER

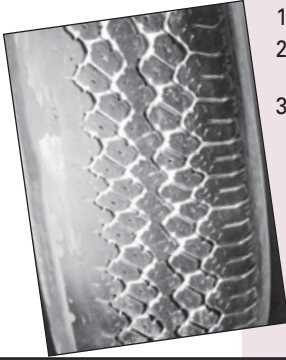

### PROBLEM:

1. Excessive Camber (High or Low)
2. Excessive Toe In or Toe Out
3. Lack of proper rotation

### SOLUTION:

1. Total 4 Wheel Alignment
2. Replace or relocate worn tires
3. Rotate tires at regular intervals

## CENTER OR OUTSIDE WEAR



### PROBLEM:

1. Running tires underinflated (both shoulders)
2. Running tires over inflated (center wear)
3. Overloading vehicle
4. Possible combination of camber and toe problems
5. Lack of proper rotation
6. Improper tire & wheel fitment

### SOLUTION:

1. Check tire pressure weekly
2. Rotate tires at regular intervals
3. Total 4 Wheel Alignment
4. Check loading of vehicle

## FEATHER EDGE OR CUPPING

### PROBLEM:

1. Worn suspension parts
2. Wheel balance
3. Worn out shock absorbers
4. Internal tire problem
5. Combination of worn parts and alignment problems

## BORDES ESCAMOSOS



### SOLUTION:

1. Inspect and replace worn parts
2. Check wheel balance
3. Replace tires
4. Total 4 Wheel Alignment

**Toe In** - Front of tires are shorter distance than rear tires across the axle  
**Toe Out** - Rear of tires are shorter distance than front tires across the axle  
**Effects** -  
**Most important angle for tire wear**  
 Excessive toe will wear tires quickly

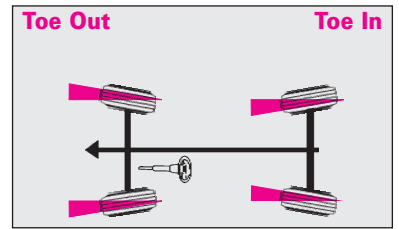

CAMBER

Tilt of tire inward or outward  
**Effects** - Can cause uneven tire wear  
**Cross Camber** - The difference in camber from side to side  
**Effects** - Can cause the vehicle to pull to the greater side

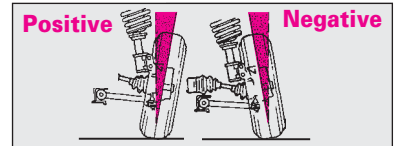

CASTER

Tilt of the steering axis to the front or back  
**Effects** - Helps with directional stability  
**Cross Caster** - The difference in caster from side to side  
**Effects** - Can cause the vehicle to pull to the lesser side

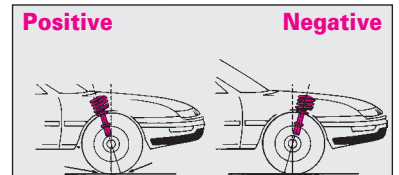

THRUST

Path or track of the rear axle compared to the centerline of the vehicle  
**Effects** -  
 May cause a pull or lead to one side  
 May cause a crooked steering wheel

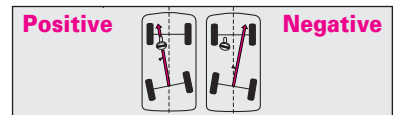

**Prolong Tire Life**  
 Get the most from your tires  
**Improve Handling**  
 Increase stability in severe weather and on bad roads  
 Eliminate vehicle 'Pull'  
**Increase Gas Mileage**  
 Save fuel dollars and the earth  
**Reduce Suspension Parts Wear**  
 Minimize future repair costs

**Benefits**

*A Total 4 Wheel Alignment will pay for itself in these four important areas*

EUROPE			CENTRAL/SOUTH AMERICA			ASIA/AUSTRALIA			REAR			FRONT		
Make	Year	Drive	Make An	Year	Drive	Make	Year	Drive	Rear Camber	Rear Toe	Page	Front Caster	Front Camber	Page
<b>ACURA</b>														
CL - 3.2	01-04	FWD	CL - 3.2	01-04	FWD	CL - 3.2	01-04	FWD	67090	OEMA	42	N/A - S/O	<b>67125</b> 67320(8)	53
Integra	94-01	FWD	Integra	94-01	FWD	Integra	94-01	FWD	<b>67030</b> 69200 <i>(exc. Type R)</i>	OEMA 69250, <b>67450</b>	42 43,42	N/A - S/O	<b>67135</b> 67330(8)	53
Integra	90-93	FWD	Integra	90-93	FWD	Integra	90-93	FWD	<b>67030</b> 69200	OEMA <b>67450</b>	42 43,42	N/A - S/O	<b>67135</b> 67330(8)	53
Integra	86-89	FWD	Integra	86-89	FWD	Integra	86-89	FWD	N/A - S/O	N/A - S/O		N/A - S/O	N/A - S/O	
Legend	91-96	FWD	Legend	91-96	FWD	Legend	91-96	FWD	N/A - S/O	OEMA		N/A - S/O	<b>67135</b> 67330(8)	53
Legend	86-90	FWD	Legend	86-90	FWD	Legend	86-90	FWD	N/A - S/O	OEMA		OEMA	N/A - S/O	
MD-X	07-10	AWD	MD-X	07-10	AWD	MD-X	07-10	AWD	67570	OEMA	42	N/A - S/O	81290	46
MD-X	01-06	AWD	MD-X	01-06	AWD	MD-X	01-06	AWD	67290	OEMA	42	N/A - S/O	81280	46
NSX	91-06	RWD	NSX	91-06	RWD	NSX	91-06	RWD	OEMA	OEMA		OEMA	OEMA	
RDX	07-10	AWD	RDX	07-10	AWD	RDX	07-10	AWD	N/A - S/O	OEMA		N/A - S/O	81280	46
RL - 3.5	09-10	AWD	RL - 3.5	09-10	AWD	RL - 3.5	09-10	AWD	N/A - S/O	OEMA		N/A - S/O	N/A - S/O	
RL - 3.5	96-04	FWD	RL - 3.5	96-04	FWD	RL - 3.5	96-04	FWD	67090	OEMA	42	N/A - S/O	<b>67135</b> 67330(8)	53
RSX / RSX Type start VIN2C003184	02-07	FWD	RSX / RSX Type start VIN2C003184	02-07	FWD	RSX / RSX Type start VIN2C003184	02-07	FWD	<b>67230</b> 69400	OEMA	42 43	N/A - S/O	81280	46
RSX S-Type VIN2C003183 end	02-02	FWD	RSX S-Type end VIN2C003183 end	02-02	FWD	RSX S-Type VIN2C003183 end	02-02	FWD	<b>67230</b> 69400	OEMA	42 43	N/A - S/O	81260	46
SLX - 4x4	96-00	RWD	SLX	96-00	RWD	SLX	96-00	RWD	N/A - S/O	N/A - S/O		OEMA(5)	OEMA(5)	
TL - 3.2	11-09	FWD/ AWD	TL - 3.2	09-11	FWD/ AWD	TL - 3.2	09-11	FWD/ AWD	<b>67540</b> 67545(12)	OEMA 67540	43 42	N/A - S/O	<b>67135</b> 67330(8)	53
TL - 3.2	04-08	FWD	TL - 3.2	04-08	FWD	TL - 3.2	04-08	FWD	67095	OEMA	42	N/A - S/O	<b>67125</b> 67320(8)	53
TL - 3.2	99-03	FWD	TL - 3.2	99-03	FWD	TL - 3.2	99-03	FWD	67090	OEMA	42	84690, 84695	<b>67125</b> 67320(8)	54,53
TL - 3.2	96-98	FWD	TL - 3.2	96-98	FWD	TL - 3.2	96-98	FWD	<b>67065</b> 67265(8)	OEMA	42 42	84690, 84695	<b>67135</b> 67330(8)	54,53
TSX	09-09	FWD	TSX	09-11	FWD	TSX	09-11	FWD	<b>67540</b> 67545(12)	OEMA 67540	43 42	N/A - S/O	<b>67135</b> 67330(8)	53
TSX	04-08	FWD	TSX	04-08	FWD	TSX	04-08	FWD	67290	OEMA	42	N/A - S/O	<b>67125</b> 67320(8)	53
ZDX	10-10	AWD	ZDX	10-10	AWD	ZDX	10-10	AWD	N/A - S/O	OEMA		N/A - S/O	81290	46
<b>ALFA ROMEO</b>														
Alfa 6	80-89	RWD	Alfa 6	80-89	RWD	Alfa 6	80-89	RWD	81250	OEMA	46	47150-47764	47150-47764	48
Alfa 33	90-94	FWD/ AWD	Alfa 33	90-94	FWD/ AWD	Alfa 33	90-94	FWD/ AWD	N/A - S/O	OEMA		N/A - S/O	N/A - S/O	
Alfa 75	85-93	RWD	Alfa 75	85-93	RWD	Alfa 75	85-93	RWD	N/A - S/O	N/A - S/O		47150-47764	47150-47764	48
Alfa 90	84-87	RWD	Alfa 90	84-87	RWD	Alfa 90	84-87	RWD	N/A - S/O	N/A - S/O		N/A - S/O	47150-47764	48
Alfa 145/146	94-01	FWD	Alfa 145/146	94-01	FWD	Alfa 145/146	94-01	FWD	N/A - S/O	N/A - S/O		N/A - S/O	81240-10MM 81250-12MM	46
Alfa 147	01-08	FWD	Alfa 147	01-08	FWD	Alfa 147	01-08	FWD	N/A - S/O	N/A - S/O		N/A - S/O	N/A - S/O	
Alfa 155	91-97	FWD/ AWD	Alfa 155	91-97	FWD/ AWD	Alfa 155	91-97	FWD/ AWD	N/A - S/O	N/A - S/O		N/A - S/O	81240	46
Alfa 156	98-06	FWD/ AWD	Alfa 156	98-06	FWD/ AWD	Alfa 156	98-06	FWD/ AWD	N/A - S/O	OEMA		N/A - S/O	N/A - S/O	
Alfa 159	05-09	FWD/ AWD	Alfa 159	05-09	FWD/ AWD	Alfa 159	05-09	FWD/ AWD	OEMA	OEMA		N/A - S/O	N/A - S/O	
Alfa 164	93-99	FWD/ AWD	Alfa 164	93-99	FWD/ AWD	Alfa 164	93-99	FWD/ AWD	N/A - S/O	OEMA		N/A - S/O	N/A - S/O	
Alfa166	99-09	FWD	Alfa166	99-09	FWD	Alfa166	99-09	FWD	N/A - S/O	OEMA		N/A - S/O	N/A - S/O	
GT	04-09	FWD	GT	04-09	FWD	GT	04-09	FWD	N/A - S/O	OEMA		N/A - S/O	N/A - S/O	46
GTV	95-05	FWD	GTV	95-05	FWD	GTV	95-05	FWD	N/A - S/O	OEMA		N/A - S/O	81250	
MiTo	08-09	FWD	MiTo	08-09	FWD	MiTo	08-09	FWD	N/A - S/O	N/A - S/O		N/A - S/O	N/A - S/O	
Spider	68-89	RWD	Spider	68-89	RWD	Spider	68-89	RWD	N/A - S/O	OEMA		47150-47764	47150-47764	48
Spider (916)	95-05	RWD	Spider (916)	95-05	RWD	Spider (916)	98-05	RWD	N/A - S/O	OEMA		N/A - S/O	81250	46
Spider (939) Brera	05-09	FWD	Spider (939) Brera	05-09	FWD	Spider (939) Brera	05-09	FWD	OEMA	OEMA		N/A - S/O	N/A - S/O	

APPLICATIONS

EUROPE			CENTRAL/SOUTH AMERICA			ASIA/AUSTRALIA			REAR			FRONT		
Make	Year	Drive	Make	Year	Drive	Make An	Year	Drive	Rear Camber	Rear Toe	Page	Front Caster	Front Camber	Page
<b>AUDI</b>														
80, 90 Quattro	88-96	AWD	80, 90 Quattro	88-96	AWD	80, 90 Quattro	88-96	AWD	OEMA	OEMA		N/A - S/O	OEMA	
80, 90 2WD	88-93	FWD	80, 90 2WD	88-93	FWD	80, 90 2WD	88-93	FWD	N/A - S/O	N/A - S/O		N/A - S/O	OEMA	
100, 200 2WD	87-96	FWD	100, 200 2WD	87-96	FWD	100, 200 2WD	87-96	FWD	N/A - S/O	N/A - S/O		N/A - S/O	OEMA	
100, 200 Quattro	87-96	AWD	100, 200 Quattro	87-96	AWD	100, 200 Quattro	87-96	AWD	OEMA	OEMA		N/A - S/O	OEMA	
4000 2WD	80-87	FWD	4000 2WD	80-87	FWD	4000 2WD	80-87	FWD	75200(1) +10408	75200(1) +10408	45 45	N/A - S/O	OEMA	
4000 Quattro	80-87	AWD	4000 Quattro	80-87	AWD	4000 Quattro	80-87	AWD	OEMA	OEMA		N/A - S/O	OEMA	
5000 2WD	80-86	FWD	5000 2WD	80-86	FWD	5000 2WD	80-86	FWD	75400(1) +10408	75400(1) +10408	45 45	N/A - S/O	OEMA	
5000 Quattro	86-88	AWD	5000 Quattro	86-88	AWD	5000 Quattro	86-88	AWD	OEMA	OEMA		N/A - S/O	OEMA	
A2	00-06		A2	00-06		A2	00-06		N/A - S/O	N/A - S/O		N/A - S/O	N/A - S/O	
A3	06-10	FWD	A3	06-10	FWD	A3	06-10	FWD	OEMA	OEMA		N/A - S/O	N/A - S/O	
A4 & A6	96-09	FWD	A4 & A6 FWD	96-09	FWD	A4 & A6 FWD	96-09	FWD	N/A - S/O	N/A - S/O		N/A - S/O	OEMA	
A4, A6, A8 Allroad, S4, S6, S8 (IRS,All)	96-10	FWD	A4, A6, A8 Allroad, S4, S6, S8 (IRS,All)	96-10	FWD	A4, A6, A8 Allroad, S4, S6, S8 (IRS,All)	96-10	FWD	OEMA	OEMA		N/A - S/O	OEMA	
A5, S5	08-10	FWD	A5, S5	08-10	FWD	A5, S5	08-10	FWD	OEMA	OEMA		N/A - S/O	N/A - S/O	
Cabriolet	94-98	FWD	Cabriolet	94-98	FWD	Cabriolet	94-98	FWD	N/A - S/O	N/A - S/O		N/A - S/O	OEMA 81260	46
Fox	75-79	FWD	Fox	75-79	FWD	Fox	75-79	FWD	75200(1) +10408	75200(1) +10408	45 45	N/A - S/O	OEMA	
Q7 - 4x4	07-10	AWD	Q7 - 4x4	07-10	AWD	Q7 - 4x4	07-10	AWD	N/A - S/O	N/A - S/O		N/A - S/O	N/A - S/O	
Quattro	82-86	AWD	Quattro	82-86	AWD	Quattro	82-86	AWD	OEMA	OEMA		N/A - S/O	OEMA	
RS4	07-08	FWD/ AWD	RS4	07-08	FWD/ AWD	RS4	07-08	FWD/ AWD	OEMA	OEMA		N/A - S/O	N/A - S/O	
TT	07-10	FWD	TT	07-10	FWD	TT	07-10	FWD	OEMA	OEMA		N/A - S/O	N/A - S/O	
TT AWD-Quattro	00-06	AWD	TT AWD-Quattro	00-06	AWD	TT AWD-Quattro	00-06	AWD	N/A - S/O	OEMA		81340	81340	54
TT, FWD	00-06	FWD	TT, FWD	00-06	FWD	TT, FWD	00-06	FWD	71530*	71520*	44	81340	81340	54
<b>BMW</b>														
Vehicles w/ 12mm bolt	63-88	RWD	Vehicles w/ 12mm bolt	63-88	RWD	Vehicles w/ 12mm bolt	63-88	RWD	N/A - S/O	N/A - S/O		N/A - S/O	N/A - S/O	
Vehicles w/ 14mm bolt	63-88	RWD	Vehicles w/ 14mm bolt	63-88	RWD	Vehicles w/ 14mm bolt	63-88	RWD	N/A - S/O	N/A - S/O		N/A - S/O	83115	
1 Series (E81,E82,E87,E88)	08-10	AWD	1 Series (E81,E82,E87,E88)	08-10	AWD	1 Series (E81,E82,E87,E88)	08-10	AWD	OEMA	OEMA		72070	OEMA 72070	54 54
1 Series (E81,E82,E87,E88)	08-10	RWD	1 Series (E81,E82,E87,E88)	08-10	AWD	1 Series (E81,E82,E87,E88)	08-10	AWD	OEMA	OEMA		72190	OEMA 72190	54 54
3 Series (E90,E91,E92,E93)	07-10	AWD	3 Series	07-10	AWD	3 Series	07-10	AWD	OEMA	OEMA		72070	OEMA 72070	54 54
3 Series (E90,E91,E92,E93)	07-10	RWD	3 Series (E90,E91,E92,E93)	07-10	RWD	3 Series (E90,E91,E92,E93)	07-10	RWD	OEMA	OEMA		72190	OEMA 72190	54 54
3 Series M3	07-10	RWD	3 Series M3	07-10	RWD	3 Series M3	07-10	RWD	OEMA	OEMA		N/A - S/O	OEMA	
3 Series (46) Cpe. and Conv.	05-06	RWD/ AWD	3 Series (46) Cpe. and Conv.	05-06	RWD/ AWD	3 Series (46) Cpe. and Conv.	05-06	RWD/ AWD	OEMA 67110 <b>72110</b>	OEMA	42 42	72090	OEMA 72090	54 54
3 Series (46) Cpe. and Conv.	00-04	RWD/ AWD	3 Series (46) Cpe. and Conv.	00-04	RWD/ AWD	3 Series (46) Cpe. and Conv.	00-04	RWD/ AWD	OEMA 67110 <b>72110</b>	OEMA	42 42	72080	OEMA 72080	54 54
3 Series (E46) Sedan and Wagon	04-05	RWD/ AWD	3 Series (E46) Sedan and Wagon	04-05	RWD/ AWD	3 Series (E46) Sedan and Wagon	04-05	RWD/ AWD	OEMA 67110 <b>72110</b>	OEMA	42 42	72090	OEMA 72090	54 54

### ALIGNMENT FOOTNOTES

**BOLD PART NUMBER INDICATES PREFERRED CORRECTION METHOD**

(1), (2), (3), (4), (5), (6), (7), (8), (9), (10), (11), (12) See page 41

N/A = No Available Adjuster

OEMA = Original Equipment Manufacturer Adjustment

(\*) = Series P/N, for correct size •  = Go to Website for more

**All products available from Specialty Products Company are intended for use by professional installers only.**

EUROPE			CENTRAL/SOUTH AMERICA			ASIA/AUSTRALIA			REAR			FRONT		
Make	Year	Drive	Make An	Year	Drive	Make	Year	Drive	Rear Camber	Rear Toe	Page	Front Caster	Front Camber	Page

**BMW - CONTINUED**

3 Series (E46) Sedan and Wagon	99-03	RWD/ AWD	3 Series (E46) Sedan and Wagon	99-03	RWD/ AWD	3 Series (E46) Sedan and Wagon	99-03	RWD/ AWD	OEMA 67110 <b>72110</b>	OEMA	42 42	72080	OEMA 72080	54 54
3 Series(E46)M3	00-06	RWD	3 Series(E46)M3	00-06	RWD	3 Series(E46)M3	00-06	RWD	OEMA	OEMA		N/A - S/O	OEMA	
3 Series (E36) 318, 323, M3	92-99	RWD	3 Series (E36) 318, 323, M3	92-99	RWD	3 Series (E36) 318, 323, M3	92-99	RWD	OEMA 67110 <b>72110</b>	OEMA	42 42	72070(10)	72070(10)	54
3 Series (E36) Z3 & M Cpe./Rdstr.	96-02	RWD	3 Series (E36) Z3 & M Cpe./Rdstr.	96-02	RWD	3 Series (E36) Z3 & M Cpe./Rdstr.	96-02	RWD	N/A - S/O	N/A - S/O		72070(10)	72070(10)	54
3 Series (E30) 318Ti	92-99	RWD	3 Series (E30) 318Ti	92-99	RWD	3 Series (E30) 318Ti	92-99	RWD	N/A - S/O	N/A - S/O		72090	72090	54
3 Series (E30)	84-91	RWD/ AWD	3 Series (E30)	84-91	RWD/ AWD	3 Series (E30)	84-91	RWD/ AWD	N/A - S/O	N/A - S/O		72065	72065	54
3 Series(E89)Z4	09-10	RWD	3 Series(E89)Z4	09-10	RWD	3 Series(E89)Z4	09-10	RWD	OEMA	OEMA		N/A - S/O	N/A - S/O	
3 Series(E85)Z4	03-08	RWD	3 Series(E85)Z4	03-08	RWD	3 Series(E85)Z4	03-08	RWD	OEMA 67110 <b>72110</b>	OEMA	42 42	72090	OEMA 72090	54 54
5 Series(E60,61)	04-10	RWD	5 Series(E60,61)	04-10	RWD	5 Series(E60,61)	04-10	RWD	OEMA	OEMA		N/A - S/O	OEMA	
5 Series (E39) 525i, 528i w/o EDC, 528iT, 530i	96-03	RWD	5 Series (E39) 525i, 528i w/o EDC, 528iT, 530i	96-03	RWD	5 Series (E39) 525i, 528i w/o EDC, 528iT, 530i	96-03	RWD	OEMA 72185	OEMA 72185	46	72080	72080	54
5 Series (E39) 528i w/EDC, 540i, 540iT, M5	96-04	RWD	5 Series (E39) 528i w/EDC, 540i, 540iT, M5	96-04	RWD	5 Series (E39) 528i w/EDC, 540i, 540iT, M5	96-04	RWD	OEMA 72185	OEMA 72185	46	72180	72180	54
5 Series (E23, E34)	87-95	RWD	5 Series (E23, E34)	87-95	RWD	5 Series (E23, E34)	87-95	RWD	N/A - S/O	N/A - S/O		N/A - S/O	N/A - S/O	
6 Series (E63,E64) M6	04-10	RWD	6 Series (E63,E64) M6	04-10	RWD	6 Series (E63,E64) M6	04-10	RWD	72185	72185	46	N/A - S/O	N/A - S/O	
6 Series (E24)	80-89	RWD	6 Series (E24)	80-89	RWD	6 Series (E24)	80-89	RWD	N/A - S/O	N/A - S/O		N/A - S/O	N/A - S/O	
7 Series (E65, E66) 745, B7	02-10	RWD	7 Series (E65, E66) 745, B7	02-10	RWD	7 Series (E65, E66) 745, B7	02-10	RWD	72185	72185	46	N/A - S/O	OEMA	
7 Series (E38) 740, 750	95-01	RWD	7 Series (E38) 740, 750	95-01	RWD	7 Series (E38) 740, 750	95-01	RWD	OEMA	OEMA		N/A - S/O	N/A - S/O	
7 Series (E23, E32) 733, 735, 740, 750	87-94	RWD	7 Series (E23, E32) 733, 735, 740, 750	87-94	RWD	7 Series (E23, E32) 733, 735, 740, 750	87-94	RWD	N/A - S/O	N/A - S/O		N/A - S/O	N/A - S/O	
8 Series(E31)	90-99	RWD	8 Series(E31)	90-99	RWD	8 Series(E31)	90-99	RWD	N/A - S/O	N/A - S/O		N/A - S/O	N/A - S/O	
8 Series (E52) Z8 Rdstr.	00-04	RWD	8 Series (E52) . Z8 Rdstr.	00-04	RWD	8 Series (E52) Z8 Rdstr.	00-04	RWD	OEMA	OEMA		N/A - S/O	N/A - S/O	
X-3 (E83)	05-10	AWD	X-3 (E83)	05-10	AWD	X-3 (E83) - 4x4	05-10	AWD	N/A - S/O	N/A - S/O		N/A - S/O	N/A - S/O	
X-5 (E70)	07-10	AWD	X-5 (E70)	07-10	AWD	X-5 (E70) - 4x4	07-10	AWD	OEMA	OEMA		N/A - S/O	N/A - S/O	
X-5 (E53)	00-06	AWD	X-5 (E53)	00-06	AWD	X-5 (E53) - 4x4	00-06	AWD	OEMA	OEMA		N/A - S/O	81280 82120	46 
X-6 (E71)	08-10	AWD	X-6 (E71)	08-10	AWD	X-6 (E71)	08-10	AWD	OEMA	OEMA		N/A - S/O	N/A - S/O	

**BUICK**

			Apollo - 'X' Body	73-74	RWD				N/A - S/O	N/A - S/O		OEMA(5) 94305, 94374	OEMA(5) 94305	57
			Century	97-05	FWD				81260	OEMA		N/A - S/O	81260	46
			Century	82-96	FWD				75800(1)	75800(1)	45	N/A - S/O	82110	47
			Century - 'A' Body	73-77	RWD				N/A - S/O	N/A - S/O		OEMA(5) 94340, 94378	OEMA(5) 94340	57
			Electra	85-96	FWD				81280	OEMA	46	OEMA	81280	46
			Enclave	08-10	FWD/ AWD	Enclave	08-10	FWD/ AWD	OEMA	OEMA		N/A - S/O	81280	46
			Estate SW	80-90	RWD				N/A - S/O	N/A - S/O		OEMA(5)	OEMA(5)	
						Excelle	03-08	FWD	81250	OEMA	46	N/A - S/O	81250	46
			Grand National - 'G' Body	78-87	RWD				N/A - S/O	N/A - S/O		OEMA(5) 94330, 94331 94332(8) 95336 (Lower)	OEMA(5) 94330, 94331 94332 (8)	57 57 57

EUROPE			CENTRAL/SOUTH AMERICA			ASIA/AUSTRALIA			REAR			FRONT		
Make	Year	Drive	Make	Year	Drive	Make An	Year	Drive	Rear Camber	Rear Toe	Page	Front Caster	Front Camber	Page
			Grand National - 'A' Body	73-77	RWD				N/A - S/O	N/A - S/O		OEMA(5) 94340 94378 (Lower)	OEMA(5) 94340	57 57
			GS - 'A' Body	64-72	RWD				N/A - S/O	N/A - S/O		OEMA(5) 94324, 94325 94320(8) 94344 (Lower)	OEMA(5) 94324, 94325 94320(8)	57 57 57
			LaCrosse/Allure	10-10	FWD	LaCrosse/Allure	10-10	FWD	OEMA	OEMA		N/A - S/O	81260	46
			LaCrosse/Allure	05-09	FWD				81260	OEMA	46	N/A - S/O	81260	46
			LeSabre	00-06	FWD				75800(1)	OEMA 75800(1)	45 45	OEMA	81280	46
			LeSabre	86-99	FWD				81280	OEMA	46	OEMA	81280	46
			LeSabre-'B' Body	77-93	RWD				81280	OEMA	46	OEMA(5)	OEMA(5)	
			LeSabre-'B' Body	71-76	RWD				N/A - S/O	N/A - S/O		OEMA(5) 94340 94378 (Lower)	OEMA(5) 94340	57 57
			Lucerne	06-10	FWD	Lucerne	06-10	FWD	75800(1)	OEMA 75800(1)	45 45	N/A - S/O	81280	46
			Park Ave., Park Ave. Ultra	97-07 97-07	FWD FWD				75800(1)	OEMA 75800(1)	45 45	OEMA	81280	46
			Park Avenue	85-96	FWD				81280	OEMA	46	OEMA	81280	46
			Rainier	04-07	RWD/ 4WD				N/A - S/O	N/A - S/O		N/A - S/O	OEMA	
			Reatta	89-91	FWD				75800(1)	OEMA 75800(1)	45 45	OEMA	81280	46
			Regal	97-04	FWD				81260	OEMA	46	N/A - S/O	81260	46
			Regal	95-96	FWD				81280	OEMA	46	N/A - S/O	N/A - S/O	
			Regal	88-94	FWD				81280	OEMA	46	N/A - S/O		
			Regal - 'G' Body	78-87	RWD				N/A - S/O	N/A - S/O		OEMA(5) 94330, 94331 94332(8) 95336 (Lower)	OEMA(5) 94330, 94331 94332(8)	57 57 57
			Regal - 'A' Body	73-77	RWD				N/A - S/O	N/A - S/O		OEMA(5) 94340 94378 (Lower)	OEMA(5) 94340	57 57
			Rendezvous	02-07	AWD				OEMA 75800(1)	OEMA 75800(1)	45	N/A - S/O	81260	46
			Riviera	95-99	FWD				75800(1)	OEMA 75800(1)	45 45	OEMA	81280	46
			Riviera	86-92	FWD				75800(1)	OEMA 75800(1)	45 45	OEMA	OEMA 81280	46
			Riviera	78-85	FWD				75800(1)	OEMA 75800(1)	45 45	OEMA	OEMA	
			Roadmaster / SW	91-96	RWD				N/A - S/O	N/A - S/O		OEMA(5)	OEMA(5)	
			Skyhawk	82-89	FWD				75400(1)	75400(1)	45	N/A - S/O	81280	46
			Skylark	96-98	FWD				75400(1)	75400(1)	45	N/A - S/O	81260	46
			Skylark	86-95	FWD				75400(1)	75400(1)	45	N/A - S/O	81280	46
			Skylark	80-85	FWD				75400(1)	75400(1)	45	N/A - S/O	82110	47
			Skylark-'X' Body	75-79	RWD				N/A - S/O	N/A - S/O		OEMA(5) 94340 94378 (Lower)	OEMA(5) 94340	57 57

APPLICATIONS

**ALIGNMENT FOOTNOTES**

**BOLD PART NUMBER INDICATES PREFERRED CORRECTION METHOD**

(1), (2), (3), (4), (5), (6), (7), (8), (9), (10), (11), (12) See page 41

N/A = No Available Adjuster

OEMA = Original Equipment Manufacturer Adjustment

(\*) = Series P/N, for correct size • Go to Website for more

**All products available from Specialty Products Company are intended for use by professional installers only.**



EUROPE			CENTRAL/SOUTH AMERICA			ASIA/AUSTRALIA			REAR			FRONT		
Make	Year	Drive	Make	Year	Drive	Make An	Year	Drive	Rear Camber	Rear Toe	Page	Front Caster	Front Camber	Page
<b>BUICK - CONTINUED</b>														
			Skylark-'A' Body	64-72	RWD				N/A - S/O	N/A - S/O		OEMA(5) 94324, 94325 94320(8), 94344 (Lower)	OEMA(5) 94324, 94325 94320(8)	57 57 57
			Special-'A' Body	64-72	RWD				N/A - S/O	N/A - S/O		OEMA(5) 94324, 94325 94320(8) 94344 (Lower)	OEMA(5) 94324, 94325 94320(8)	57 57 57
			Somerset	85-89	FWD				75400(1)	75400(1)	45	N/A - S/O	81280	46
			Terraza	05-07	FWD				75800 (1)	75800 (1)	45	N/A - S/O	81260	46
			Terraza	05-07	AWD				OEMA	OEMA		N/A - S/O	81260	46
<b>CADILLAC</b>														
			Allante	93-93					OEMA	OEMA		OEMA	81280	46
			Allante	87-92					N/A - S/O	OEMA		OEMA	81280	46
BLS	06-09	FWD	BLS	06-09	FWD	BLS	06-09	FWD	OEMA	OEMA		N/A - S/O	81250	46
			Brougham	85-96	RWD				N/A - S/O	N/A - S/O		OEMA(5)	OEMA(5)	
			Catera	97-01	RWD				N/A - S/O	OEMA		N/A - S/O	81250	46
			Cimarron	82-88	FWD				75400(1)	75400(1)	45	N/A - S/O	81280	46
CTS/CTS-V	03-10	RWD/ AWD	CTS/CTS-V	03-10	RWD/ AWD				OEMA	OEMA		OEMA	OEMA	
			Deville	00-05	FWD				75800(1)	OEMA 75800(1)	45 45	OEMA	81280	46
			Deville & Concours (94)	94-99	FWD				OEMA	OEMA		OEMA	81280	46
			Deville	85-93	FWD				OEMA	OEMA		OEMA	OEMA	
			DTS	06-10	FWD				75800(1)	OEMA 75800(1)	45 45	OEMA	81280	46
			Eldorado	93-03	FWD				OEMA	OEMA		OEMA	81280	46
			Eldorado & Seville	86-92	FWD				75800(1)	OEMA 75800(1)	45 45	OEMA	OEMA 81280	46
			Eldorado & Seville	80-85	FWD				75800(1)	OEMA 75800(1)	45 45	OEMA	OEMA	
			Escalade	99-01	RWD/ 4WD				N/A - S/O	N/A - S/O		OEMA 87400	OEMA 87400	47
			Escalade/ ESV/EXT	02-10	RWD/ 4WD				N/A - S/O	N/A - S/O		OEMA 86375, 86325	OEMA 86350 86375, 86325	55, 55
STS	05-10	RWD/ AWD	Fleetwood	85-93	FWD				OEMA	OEMA		OEMA	OEMA	
			STS	05-10	RWD/ AWD				OEMA	OEMA		OEMA	OEMA	
			Seville STS/SLS	98-04	FWD				75800(1)	OEMA 75800(1)	45 45	OEMA	81280	46
			Seville STS/SLS	93-97	FWD				OEMA	OEMA		N/A - S/O	81280	46
			SRX	10-10	FWD/ AWD				OEMA	OEMA		N/A - S/O	81280	46
			SRX	04-09	AWD				OEMA	OEMA		OEMA	OEMA	
XLR	04-10	RWD	Allante	04-10	RWD				OEMA	OEMA		OEMA	OEMA	
<b>CHEVROLET/GMC</b>														
			1500, Silverado, Sierra	99-10	RWD/ 4WD				N/A - S/O	N/A - S/O		OEMA 86375, 86325	OEMA 86350 86375, 86325	55, 55
			1500HD, Crew Cab Long Bed	01-10	4WD				N/A - S/O	N/A - S/O		OEMA 86375, 86325	OEMA 86330 86375, 86325	55, 55
			1500,2500,2500	88-98	RWD/ 4WD				N/A - S/O	N/A - S/O		OEMA 87400	OEMA 86350(2) 87400	 47
			2500,3500, Silverado, Sierra	99-10	RWD/ 4WD				N/A - S/O	N/A - S/O		OEMA 86375, 86325	OEMA 86330 86375, 86325	55, 55

APPLICATIONS

EUROPE			CENTRAL/SOUTH AMERICA			ASIA/AUSTRALIA			REAR			FRONT		
Make	Year	Drive	Make	Year	Drive	Make An	Year	Drive	Rear Camber	Rear Toe	Page	Front Caster	Front Camber	Page
			4500, 5500, Kodiak, Topkick	05-10	4WD				N/A - S/O	N/A - S/O		23230*	23230*	50
			Acadia	07-10	FWD/AWD				OEMA	OEMA		N/A - S/O	81280	46
			Astro, Safari	85-06	RWD				N/A - S/O	N/A - S/O		OEMA(5)	OEMA(5)	
			Astro, Safari	88-06	AWD				N/A - S/O	N/A - S/O		OEMA	OEMA	47
			Avalanche 1500	02-10	RWD/4WD				N/A - S/O	N/A - S/O		OEMA	OEMA	55,
			Avalanche 1500	02-10	RWD/4WD				N/A - S/O	N/A - S/O		86375, 86325	86350	55
			Avalanche 2500	02-07	4WD				N/A - S/O	N/A - S/O		OEMA	OEMA	55,
			Avalanche 2500	02-07	4WD				N/A - S/O	N/A - S/O		86375, 86325	86330	55
Aveo	04-10	FWD	Aveo	04-10	FWD				75200(1)	75200(1)	45	N/A - S/O	81250	46
			Blazer/S10	82-04	RWD/4WD				N/A - S/O	N/A - S/O		OEMA	OEMA	
			Blazer	92-99	RWD/4WD				N/A - S/O	N/A - S/O		OEMA	OEMA	47
			Blazer/C & R	65-87	RWD				N/A - S/O	N/A - S/O		OEMA(5)	OEMA(5)	
			Blazer/K	70-87	4WD				N/A - S/O	N/A - S/O		23000*	23000*	50
			Beretta	96-97	FWD				75400(1)	75400(1)	45	N/A - S/O	81260	46
			Beretta	87-95	FWD				75400(1)	75400(1)	45	N/A - S/O	81280	46
			C10, C20 C30, C1500, C2500, C3500	65-87	RWD				N/A - S/O	N/A - S/O		OEMA(5)	OEMA(5)	
			Camaro	10-10	RWD				OEMA	OEMA		N/A - S/O	81280	46
			Camaro	93-02	RWD				N/A - S/O	N/A - S/O		OEMA	OEMA	
			Camaro	82-92	RWD				N/A - S/O	N/A - S/O		OEMA	OEMA	46
			Camaro-'F' Body	70-81	RWD				N/A - S/O	N/A - S/O		OEMA(5)	OEMA(5)	57
			Camaro-'F' Body	70-81	RWD				N/A - S/O	N/A - S/O		94340	94340	57
			Camaro-'F' Body	70-81	RWD				N/A - S/O	N/A - S/O		94378 (Lower)	94340	57
			Camaro-'F' Body	67-69	RWD				N/A - S/O	N/A - S/O		OEMA(5)	OEMA(5)	57
			Camaro-'F' Body	67-69	RWD				N/A - S/O	N/A - S/O		94305	94305	57
			Camaro-'F' Body	67-69	RWD				N/A - S/O	N/A - S/O		94374 (Lower)	94305	57
			Canyon-See Colorado											
			Caprice & SW (See Impala)	80-96	RWD				N/A - S/O	N/A - S/O		OEMA(5)	OEMA(5)	
			Cavalier	95-05	FWD				75400(1)	75400(1)	45	N/A - S/O	81260	46
			Cavalier	82-94	FWD				75400(1)	75400(1)	45	N/A - S/O	81280	46
			Celebrity	82-90	FWD				75800(1)	75800(1)	45	N/A - S/O	82110	47
			Chevellé - 'G' Body	78-88	RWD				N/A - S/O	N/A - S/O		OEMA(5)	OEMA(5)	57
			Chevellé - 'G' Body	78-88	RWD				N/A - S/O	N/A - S/O		94330, 94331	94330, 94331	57
			Chevellé - 'G' Body	78-88	RWD				N/A - S/O	N/A - S/O		94332 (8)	94332 (8)	57
			Chevellé - 'G' Body	78-88	RWD				N/A - S/O	N/A - S/O		95336 (Lower)	94332 (8)	57
			Chevellé - 'A' Body	73-77	RWD				N/A - S/O	N/A - S/O		OEMA(5)	OEMA(5)	57
			Chevellé - 'A' Body	73-77	RWD				N/A - S/O	N/A - S/O		94340	94340	57
			Chevellé - 'A' Body	73-77	RWD				N/A - S/O	N/A - S/O		94378 (Lower)	94340	57
			Chevellé - 'A' Body	64-72	RWD				N/A - S/O	N/A - S/O		OEMA(5)	OEMA(5)	57
			Chevellé - 'A' Body	64-72	RWD				N/A - S/O	N/A - S/O		94324, 94325	94324, 94325	57
			Chevellé - 'A' Body	64-72	RWD				N/A - S/O	N/A - S/O		94320 (8)	94320 (8)	57
			Chevellé - 'A' Body	64-72	RWD				N/A - S/O	N/A - S/O		94344 (Lower)	94320 (8)	57
			Chevette	76-87	RWD				N/A - S/O	N/A - S/O		OEMA	OEMA	

APPLICATIONS

**ALIGNMENT FOOTNOTES**

**BOLD PART NUMBER INDICATES PREFERRED CORRECTION METHOD**

(1), (2), (3), (4), (5), (6), (7), (8), (9), (10), (11), (12) See page 41

N/A = No Available Adjuster

OEMA = Original Equipment Manufacturer Adjustment

(\*) = Series P/N, for correct size • = Go to Website for more

**All products available from Specialty Products Company are intended for use by professional installers only.**

EUROPE			CENTRAL/SOUTH AMERICA			ASIA/AUSTRALIA			REAR			FRONT		
Make	Year	Drive	Make	Year	Drive	Make An	Year	Drive	Rear Camber	Rear Toe	Page	Front Caster	Front Camber	Page
<b>CHEVROLET/GMC - CONTINUED</b>														
			Citation	80-85	FWD				75400(1)	75400(1)	45	N/A - S/O	82110	47
			Cobalt	05-10	FWD				75400(1)	75400(1)	45	N/A - S/O	81250	46
			Colorado, Canyon	04-10	RWD/ 4WD				N/A - S/O	N/A - S/O		OEMA 86360 86375, 86325	OEMA 86360 86375, 86325	55 55
			Corsica	96-96	FWD				75400(1)	75400(1)	45	N/A - S/O	81260	46
			Corsica	87-95	FWD				75400(1)	75400(1)	45	N/A - S/O	81280	46
			Corvette C5, C6	97-10	RWD				OEMA	OEMA		OEMA	OEMA	
			Corvette Late C4	88-96	RWD				OEMA	OEMA		OEMA(5) 94370, 94371	OEMA(5) 94370, 94371	57
			Corvette Early C4	84-87	RWD				OEMA	OEMA		OEMA(5) 94368, 94369	OEMA(5) 94368, 94369	57
			Corvette C3	63-82	RWD				OEMA 83160	OEMA 47170*	47,	OEMA(5) 94360	OEMA(5) 94360	57
			Denali-See Yukon											
			El Camino - 'G' Body	78-88	RWD				N/A - S/O	N/A - S/O		OEMA(5) 94330, 94331 94332 (8) 95336 (Lower)	OEMA(5) 94330, 94331 94332 (8)	57 57 57
			El Camino - 'A' Body	73-77	RWD				N/A - S/O	N/A - S/O		OEMA(5) 94340 94378 (Lower)	OEMA(5) 94340	57 57
			El Camino - 'A' Body	64-72	RWD				N/A - S/O	N/A - S/O		OEMA(5) 94324, 94325 94320(8) 94344 (Lower)	OEMA(5) 94324, 94325 94320(8)	57 57 57
			Envoy	02-09	RWD/ 4WD				N/A - S/O	N/A - S/O		N/A - S/O	OEMA	
			Equinox, Terrain	05-10	FWD/ AWD				OEMA 87420	OEMA 87420		N/A - S/O	81260	46
			Express, Savana Van	03-10	RWD/ 4WD				N/A - S/O	N/A - S/O		OEMA 86370 86375, 86325	OEMA 86370 86375, 86325	55 55
			Express, Savana Van	96-02	RWD				N/A - S/O	N/A - S/O		OEMA 87400	OEMA 87400	47
			G10,G20,G30	71-96	RWD				N/A - S/O	N/A - S/O		OEMA(5)	OEMA(5)	
			HHR	06-10	FWD				75400(1)	75400(1)	45	N/A - S/O	81250	46
			Impala	99-10	FWD				81260	OEMA		N/A - S/O	81260	46
			Impala/Caprice - 'B' Body	78-96	RWD				N/A - S/O	N/A - S/O		OEMA(5) 94378 (Lower)	OEMA(5)	57
			Impala/Caprice - 'B' Body	73-77	RWD				N/A - S/O	N/A - S/O		OEMA(5) 94340 94378 (Lower)	OEMA(5) 94340	57 57
			Impala	58-64	RWD				N/A - S/O	N/A - S/O		OEMA(5) 94360	OEMA(5) 94360	57
			Jimmy/R	88-91	RWD				N/A - S/O	N/A - S/O		OEMA(5)	OEMA(5)	
			Jimmy/ S10 & S15	82-04	RWD/ 4WD				N/A - S/O	N/A - S/O		OEMA	OEMA	
			K-5, K-10, K-20, Blazer	70-87	4WD				N/A - S/O	N/A - S/O		23000*	23000*	50
			K30, V30 (Dana 60)	88-94	4WD				N/A - S/O	N/A - S/O		88940 88950	88940 88950	56 56
			K30, V30	58-87	4WD				N/A - S/O	N/A - S/O		N/A - S/O	23000*	50
			Kodiak-See 4500	5500										
			Lumina APV Van	90-96	FWD				75800(1)	75800(1)	45	N/A - S/O	82110	47
			Lumina Sedan	97-01	FWD				81260	OEMA	46	N/A - S/O	N/A - S/O	
			Lumina Sedan	95-96	FWD				81280	OEMA	46	N/A - S/O	N/A - S/O	
			Lumina Sedan	88-94	FWD				81280	OEMA	46	N/A - S/O	N/A - S/O	
			Luv	80-82	RWD/ 4WD				N/A - S/O	N/A - S/O		OEMA(5)	OEMA(5)	

EUROPE			CENTRAL/SOUTH AMERICA			ASIA/AUSTRALIA			REAR			FRONT		
Make	Year	Drive	Make	Year	Drive	Make An	Year	Drive	Rear Camber	Rear Toe	Page	Front Caster	Front Camber	Page
			Maibu, Malibu Maxx	04-10	FWD				OEMA	OEMA		N/A - S/O	81250	46
			Malibu	97-03	FWD				81250	OEMA	46	N/A - S/O	81260	46
			Malibu - 'G' Body	78-88	RWD				N/A - S/O	N/A - S/O		OEMA(5) 94330, 94331 94332(8) 95336 (Lower)	OEMA(5) 94330, 94331 94332(8)	57 57 57
			Malibu - 'A' Body	73-77	RWD				N/A - S/O	N/A - S/O		OEMA(5) 94340 94378 (Lower)	OEMA(5) 94340	57 57
			Malibu - 'A' Body	64-72	RWD				N/A - S/O	N/A - S/O		OEMA(5) 94324, 94325 94320(8) 94344 (Lower)	OEMA(5) 94324, 94325 94320(8)	57 57 57
			Metro	98-01	FWD				N/A - S/O	OEMA		N/A - S/O	81250	46
			Monte Carlo	00-07	FWD				81260	OEMA	46	N/A - S/O	81260	46
			Monte Carlo	95-99	FWD				81280	OEMA	46	N/A - S/O	N/A - S/O	
			Monte Carlo - 'G' Body	78-88	RWD				N/A - S/O	N/A - S/O		OEMA(5) 94330, 94331 94332(8) 95336 (Lower)	OEMA(5) 94330, 94331 94332(8)	57 57 57
			Monte Carlo - 'A' Body	73-77	RWD				N/A - S/O	N/A - S/O		OEMA(5) 94340 94378 (Lower)	OEMA(5) 94340	57 57
			Monte Carlo - 'A' Body	68-72	RWD				N/A - S/O	N/A - S/O		OEMA(5) 94324, 94325 94320(8) 94344 (Lower)	OEMA(5) 94324, 94325 94320(8)	57 57 57
			Nova	85-88	FWD				81250	OEMA	46	N/A - S/O	OEMA 81250	46
			Nova - 'X' Body	75-79	RWD				N/A - S/O	N/A - S/O		OEMA(5) 94340 94378 (Lower)	OEMA(5) 94340	57 57
			Nova - 'X' Body	68-74	RWD				N/A - S/O	N/A - S/O		OEMA(5) 94305 94374 (Lower)	OEMA(5) 94305	57 57
			Prizm	98-02	FWD				81250 75800(1)	OEMA 75800(1)	46 45	N/A - S/O	OEMA 81260	46
			R10, R20, R30, R1500, R2500, R3500	88-91	RWD				N/A - S/O	N/A - S/O		OEMA(5)	OEMA(5)	
			S10 Blazer, S15 Pickup, Jimmy, Sonoma Safari- See Astro	82-04	RWD/ 4WD				N/A - S/O	N/A - S/O		OEMA	OEMA	
			Savana Van-See Express Van											
			Sierra-See 1500 and 2500 -											
			Silverado-See 1500 and 2500											
			Sonoma/S15	82-04	RWD/ 4WD				N/A - S/O	N/A - S/O		OEMA	OEMA	
			Spectrum	85-88	FWD				75200(1)	75200(1)	45	N/A - S/O	81250	46
			Sprint	87-88	FWD				N/A - S/O	N/A - S/O		N/A - S/O	OEMA 81250	46
			Sprint	85-86	FWD				N/A - S/O	N/A - S/O		N/A - S/O	81250	46

APPLICATIONS

**ALIGNMENT FOOTNOTES**

**BOLD PART NUMBER INDICATES PREFERRED CORRECTION METHOD**

(1), (2), (3), (4), (5), (6), (7), (8), (9), (10), (11), (12) See page 41

N/A = No Available Adjuster

OEMA = Original Equipment Manufacturer Adjustment

(\*) = Series P/N, for correct size • Go to Website for more

**All products available from Specialty Products Company are intended for use by professional installers only.**

EUROPE			CENTRAL/SOUTH AMERICA			ASIA/AUSTRALIA			REAR			FRONT		
Make	Year	Drive	Make	Year	Drive	Make An	Year	Drive	Rear Camber	Rear Toe	Page	Front Caster	Front Camber	Page

**CHEVROLET/GMC - CONTINUED**

			SSR	04-06	RWD				N/A - S/O	N/A - S/O		N/A - S/O	OEMA	
			Suburban 1500	00-10	RWD/ 4WD				N/A - S/O	N/A - S/O		OEMA 86375, 86325	OEMA 86350 86375, 86325	55,
			Suburban 2500	00-10	RWD/ 4WD				N/A - S/O	N/A - S/O		OEMA 86375, 86325	OEMA 86330 86375, 86325	55,
			Suburban	92-99	RWD/ 4WD				N/A - S/O	N/A - S/O		OEMA 87400	OEMA 86350(2) 87400	
			Suburban	70-91	4WD				N/A - S/O	N/A - S/O		23000*	23000*	50
			Suburban	65-91	RWD				N/A - S/O	N/A - S/O		OEMA(5)	OEMA(5)	
			Tahoe 1500	00-10	RWD/ 4WD				N/A - S/O	N/A - S/O		OEMA 86375, 86325	OEMA 86350 86375, 86325	55,
			Tahoe	92-99	RWD/ 4WD				N/A - S/O	N/A - S/O		OEMA 87400	OEMA 86350(2) 87400	
			Terrain-See Equinox											
			Topkick-See 4500, 5500											
			Tracker	98-04	4WD				N/A - S/O	N/A - S/O		N/A - S/O	81250	46
			Trailblazer	02-09	RWD/ 4WD				N/A - S/O	N/A - S/O		N/A - S/O	OEMA	
			Traverse	09-10	FWD/ AWD				OEMA	OEMA		N/A - S/O	81280	46
			'Tri-5' Body	55-57	RWD				N/A - S/O	N/A - S/O		94350	94350	57
			Uplander	05-08	AWD				OEMA	OEMA		N/A - S/O	81260	46
			Uplander	05-08	FWD				75800 (1)	75800 (1)	45	N/A - S/O	81260	46
			V10, V20, V1500, V2500	88-91	4WD				N/A - S/O	N/A - S/O		23000*	23000*	50
			Venture	97-05	FWD				75800(1)	75800(1)	45	N/A - S/O	81260	46
			Venture	02-05	AWD				OEMA	OEMA		N/A - S/O	81260	46
			Yukon, Denali 1500	00-10	RWD/ 4WD				N/A - S/O	N/A - S/O		OEMA 86375, 86325	OEMA 86350 86375, 86325	55,
			Yukon, Denali 2500	00-10	RWD/ 4WD				N/A - S/O	N/A - S/O		OEMA 86375, 86325	OEMA 86330 86375, 86325	55,
			Yukon	92-99	RWD/ 4WD				N/A - S/O	N/A - S/O		OEMA 87400	OEMA 86350(2) 87400	

**CHRYSLER**

300/C	06-10	RWD	300	06-10	RWD	300/C	06-10	RWD	66080, 66085	OEMA	44	OEMA 66030, 66035	OEMA 66030, 66035	52
300/C	05-05	RWD	300	05-05	RWD	300/C	05-05	RWD	66010, 66020(3) 66080, 66085(3)	OEMA	44 44 44 44	OEMA 66030, 66035	OEMA 66030, 66035	52
300/C	06-10	AWD	300	06-10	AWD	300/C	06-10	AWD	66080, 66085	OEMA	44	OEMA	OEMA	
300/C	05-05	AWD	300	05-05	AWD	300/C	05-05	AWD	66010, 66020(3) 66080, 66085(3)	OEMA	44 44 44 44	OEMA	OEMA	
			300M (6)	99-04	FWD				67080	OEMA	42	N/A - S/O	81280	46
			Cirrus	95-00	FWD				OEMA	OEMA		N/A - S/O	67180	53
			Concord (6)	98-04	FWD				67080	OEMA	42	N/A - S/O	81280	46
			Concord (6)	93-97	FWD				67020	OEMA	42	N/A - S/O	81280	46
Crossfire	04-09	RWD							OEMA	OEMA		OEMA	OEMA	
			LHS (6)	98-02	FWD				67080	OEMA	42	N/A - S/O	81280	46
			LHS (6)	94-97	FWD				67020	OEMA	42	N/A - S/O	81280	46

APPLICATIONS

EUROPE			CENTRAL/SOUTH AMERICA			ASIA/AUSTRALIA			REAR			FRONT		
Make	Year	Drive	Make	Year	Drive	Make An	Year	Drive	Rear Camber	Rear Toe	Page	Front Caster	Front Camber	Page

### CHRYSLER - CONTINUED

			New Yorker (6)	94-97	RWD				67020	OEMA	42	N/A - S/O	81280	46
			New Yorker	88-93	FWD				75200(1)	75200(1)	45	N/A - S/O	OEMA 83170	47
PT Cruiser	01-09	FWD	PT Cruiser	01-09	FWD	PT Cruiser	01-09	FWD	75200(1)	75200(1)	45	N/A - S/O	81260	46
			Sebring Sedan & Conv.	07-08	FWD				67015	OEMA	42	N/A - S/O	81260	46
			Sebring Sedan & Conv.	04-06	FWD				67025	OEMA	42	N/A - S/O	67180	53
			Sebring Sedan & Conv.	01-03	FWD				OEMA	OEMA		N/A - S/O	67180	53
			Sebring 2Dr. Coupe	01-06	FWD				73600 73620(8) 73400+ 73415(7)	OEMA	47 47 44 44	N/A - S/O	81280	46
			Sebring	95-00	FWD				73600 73620(8) 73400+ 73415(7)	OEMA	47 47 44 44	N/A - S/O	67170 67370(8)	56 56
			Sebring Conv.	96-00					OEMA	OEMA		N/A - S/O	67180	56
Voyager/ Grand Voyager	91-10	FWD	Town & Country	96-10	FWD	Voyager/ Grand Voyager	91-10	FWD	71730*(1)	71720*(1)	44	N/A - S/O	OEMA 81260	46
Voyager/ Grand Voyager	91-10	AWD	Town & Country	97-10	AWD	Voyager/ Grand Voyager	91-10	AWD	N/A - S/O	N/A - S/O		N/A - S/O	81260	46
			Voyager	02-04	FWD				71730*	71720*	44	N/A - S/O	OEMA 81260	46
			Voyager	02-04	AWD				N/A - S/O	N/A - S/O		N/A - S/O	81260	46

### CITROËN

Berlingo	96-10	FWD	Berlingo	96-10	FWD				N/A - S/O	N/A - S/O		N/A - S/O	N/A - S/O	
C1	05-10	FWD	C1	05-10	FWD				N/A - S/O	N/A - S/O		N/A - S/O	N/A - S/O	
C2	03-09	FWD	C2	03-09	FWD				N/A - S/O	N/A - S/O		N/A - S/O	N/A - S/O	
C3	02-10	FWD	C3	02-10	FWD				N/A - S/O	N/A - S/O		N/A - S/O	N/A - S/O	
C4	04-10	FWD	C4	04-10	FWD				N/A - S/O	N/A - S/O		N/A - S/O	N/A - S/O	
C5	01-10	FWD	C5	01-10	FWD				N/A - S/O	N/A - S/O		N/A - S/O	N/A - S/O	
C6	05-10	FWD	C6	05-10	FWD				N/A - S/O	N/A - S/O		N/A - S/O	N/A - S/O	
C8	02-10	FWD	C8	02-10	FWD				N/A - S/O	N/A - S/O		N/A - S/O	N/A - S/O	
C15E	88-98	FWD	C15E	88-98	FWD				N/A - S/O	N/A - S/O		N/A - S/O	N/A - S/O	
Nemo	07-10	FWD	Nemo	07-10	FWD				N/A - S/O	N/A - S/O		N/A - S/O	N/A - S/O	
Relay/Jumper	94-10	FWD	Relay/Jumper	94-10	FWD				N/A - S/O	N/A - S/O		N/A - S/O	N/A - S/O	
Saxo	96-03	FWD	Saxo	96-03	FWD				N/A - S/O	N/A - S/O		N/A - S/O	N/A - S/O	
Xantia	93-01	FWD	Xantia	93-01	FWD				N/A - S/O	N/A - S/O		N/A - S/O	N/A - S/O	
Xsara	97-08	FWD	Xsara	97-08	FWD				N/A - S/O	N/A - S/O		N/A - S/O	N/A - S/O	

### DAEWOO (CHEVROLET)

Captiva/ Winstorm	06-10	AWD	Captiva/ Winstorm	06-10	FWD	Captiva/ Winstorm	06-10	FWD	OEMA 87420	OEMA 87420		N/A - S/O	81260	46
Epica/Evanda/ Magnus	00-06	FWD	Epica/Evanda/ Magnus	00-06	FWD	Epica/Evanda/ Magnus	00-06	FWD	N/A - S/O	OEMA		N/A - S/O	81250	46
Espero/Aranos	90-97	FWD				Espero/Aranos	90-97	FWD	75400(1)	75400(1)	45	N/A - S/O	81260	46
Kalos/Aveo/ Gentra	00-10	FWD	Kalos/Aveo/ Gentra	00-10	FWD	Kalos/Aveo/ Gentra	00-10	FWD	75200(1)	75200(1)	45	N/A - S/O	81250	46
Lacetti	03-10	FWD	Optra	06-10	FWD				81250	OEMA		N/A - S/O	81250	46
Lanos	97-10	FWD	Lanos	97-10	FWD	Lanos	97-10	FWD	N/A - S/O	N/A - S/O		N/A - S/O	N/A - S/O	
Leganza	97-02	FWD							81250	OEMA		N/A - S/O	81250	46

### ALIGNMENT FOOTNOTES

**BOLD PART NUMBER INDICATES PREFERRED CORRECTION METHOD**

(1), (2), (3), (4), (5), (6), (7), (8), (9), (10), (11), (12) See page 41

N/A = No Available Adjuster

OEMA = Original Equipment Manufacturer Adjustment

(\*) = Series P/N, for correct size •  = Go to Website for more

**All products available from Specialty Products Company are intended for use by professional installers only.**

EUROPE			CENTRAL/SOUTH AMERICA			ASIA/AUSTRALIA			REAR			FRONT		
Make	Year	Drive	Make	Year	Drive	Make An	Year	Drive	Rear Camber	Rear Toe	Page	Front Caster	Front Camber	Page

### DAEWOO (CHEVROLET) - CONTINUED

Matiz/Spark/Joy	98-10	FWD	Matiz/Spark/Joy	98-10	FWD	Matiz/Spark/Joy	98-10	FWD	N/A - S/O	N/A - S/O		N/A - S/O	N/A - S/O	
Musso	99-03	FWD	Musso	99-03	FWD	Musso	99-03	FWD	N/A - S/O	N/A - S/O		47150-47764	47150-47764	48
Nubira	97-09	FWD	Nubira	97-09	FWD	Nubira	97-09	FWD	81250	OEMA	46	N/A - S/O	81250	46
Tacuma/Rezzo	00-08	FWD	Tacuma/Rezzo	00-08	FWD	Tacuma/Rezzo	00-08	FWD	N/A - S/O	N/A - S/O		N/A - S/O	N/A - S/O	
Tosca/Epica	06-10	FWD	Tosca	06-10	FWD	Tosca	06-10	FWD	N/A - S/O	OEMA		N/A - S/O	81250	46

### DAIHATSU

Applause	98-02	FWD	Applause	98-02	FWD	Applause	98-02	FWD	N/A - S/O	OEMA		N/A - S/O	N/A - S/O	
Charade	01-07	FWD	Charade	01-07	FWD	Charade	01-07	FWD	N/A - S/O	N/A - S/O		N/A - S/O	N/A - S/O	
Charade	93-00	FWD	Charade	93-00	FWD	Charade	93-00	FWD	81250	OEMA	46	N/A - S/O	81250	46
Charade	87-93	FWD	Charade	87-93	FWD	Charade	87-93	FWD	81250	OEMA	46	N/A - S/O	81250	46
Copen	03-10	FWD	Copen	03-10	FWD	Copen	03-10	FWD	N/A - S/O	N/A - S/O		N/A - S/O	N/A - S/O	
Cuore	98-07	FWD	Cuore	98-07	FWD	Cuore	98-07	FWD	N/A - S/O	N/A - S/O		N/A - S/O	N/A - S/O	
Cuore	96-98	FWD	Cuore	96-98	FWD	Cuore	96-98	FWD	N/A - S/O	OEMA		N/A - S/O	N/A - S/O	
Fourtrak/Rocky	93-99	RWD/ 4WD	Fourtrak/Rocky	93-99	4WD	Fourtrak/Rocky	93-99	4WD	N/A - S/O	N/A - S/O		47150-47764	47150-47764	48
GranMove/Move	97-02	FWD	GranMove/Move	97-02	FWD	GranMove/Move	97-02	FWD	N/A - S/O	OEMA		N/A - S/O	N/A - S/O	
Materia	06-08	FWD	Materia	06-08	FWD	Materia	06-08	FWD	N/A - S/O	OEMA		N/A - S/O	81290	46
Sirion	98-10	FWD	Sirion	98-10	FWD	Sirion	98-10	FWD	N/A - S/O	N/A - S/O		N/A - S/O	N/A - S/O	
Terios	06-10	RWD/ 4WD	Terios	06-10	FWD	Terios	06-10	FWD	N/A - S/O	N/A - S/O		N/A - S/O	N/A - S/O	
YRV	01-07	FWD	YRV	01-07	FWD	YRV	01-07	FWD	N/A - S/O	N/A - S/O		N/A - S/O	81250	46

### DODGE

			All Passenger Car Models	60-73	RWD				N/A - S/O	N/A - S/O		OEMA 83160	OEMA 83160	47
			All Passenger B & E (Except 880)	62-65	RWD				N/A - S/O	N/A - S/O		94450, 94451	94450, 94451	57
1500 Ram Excpt Mega Cab	06-10	RWD/ 4WD	1500 Ram Excpt Mega Cab	06-10	RWD/ 4WD				N/A - S/O	N/A - S/O		OEMA	OEMA	
			1500 Ram Mega Cab	06-10	4WD				N/A - S/O	N/A - S/O		23800-23830	23800-23830	51
			1500 Ram	02-05	4WD				N/A - S/O	N/A - S/O		OEMA 23755	OEMA 23755	47
			1500 Ram	02-05	RWD				N/A - S/O	N/A - S/O		OEMA 23765	OEMA 23765	47
			1500, 2500 LD Ram	94-01	4WD				N/A - S/O	N/A - S/O		23510-23540	23510-23540	51
			1500, 2500 Ram	94-01	RWD				N/A - S/O	N/A - S/O		OEMA	OEMA	
			2500 HD, 3500 Ram	03-10	4WD				N/A - S/O	N/A - S/O		23800-23830	23800-23830	51
			2500, 3500 Ram	03-10	RWD				N/A - S/O	N/A - S/O		OEMA	OEMA	
			2500 HD, 3500 Ram-Solid	00-02	RWD/ 4WD				N/A - S/O	N/A - S/O		23710-23730	23710-23730	51
			2500 HD, 3500 Ram	94-99	4WD				N/A - S/O	N/A - S/O		23130* 24130	23130* 24130	50 51
			3500 Ram w/mono beam	94-99	RWD				N/A - S/O	N/A - S/O		23130* 24130	23130* 24130	50 51
			400	83-84	FWD				75200(1)	75200(1)	45	N/A - S/O	OEMA 83170(2)	47
			600	83-88	FWD				75200(1)	75200(1)	45	N/A - S/O	OEMA 83170(2)	47
			AD150 Ramcharger	90-96	RWD				N/A - S/O	N/A - S/O		OEMA	OEMA	
			AD150 Ramcharger	72-89	RWD				N/A - S/O	N/A - S/O		OEMA 83160	OEMA 83160	47
			Aries	81-89	FWD				75200(1)	75200(1)	45	N/A - S/O	OEMA 83170(2)	47
Avenger	08-10	FWD/ AWD	Avenger	08-10	FWD/ AWD	Avenger	08-10	FWD/ AWD	67015	OEMA	42	N/A - S/O	81260	64

EUROPE			CENTRAL/SOUTH AMERICA			ASIA/AUSTRALIA			REAR			FRONT		
Make	Year	Drive	Make	Year	Drive	Make An	Year	Drive	Rear Camber	Rear Toe	Page	Front Caster	Front Camber	Page
			Avenger	95-00	FWD				<b>73600</b> 73620(8) 73400+ 73415(7)	OEMA	47 47 44 44	N/A - S/O	<b>67170</b> 67370(8)	53 53
			B100, B200, B300 Ram Van	70-80	RWD				N/A - S/O	N/A - S/O		OEMA 83160	OEMA 83160	47
			B150, B250, B350 Ram Van	81-01	RWD				N/A - S/O	N/A - S/O		OEMA	OEMA	
Caliber	07-10	FWD/ AWD	Caliber	07-10	FWD/ AWD	Caliber	07-10	FWD/ AWD	N/A - S/O	OEMA		N/A - S/O	81260	46
			Caravan/ Grand Caravan	01-10	FWD				71730*(1)	71720*(1)	44	N/A - S/O	OEMA 81260	46
			Caravan/ Grand Caravan	01-10	AWD				N/A - S/O	N/A - S/O		N/A - S/O	81260	46
			Caravan w/ABS	96-00	FWD/ AWD				N/A - S/O	N/A - S/O		N/A - S/O	OEMA 83170	47
			Caravan w/o ABS	96-00	FWD FWD				71730*	71720*	44	N/A - S/O	OEMA 83170	47
			Caravan	84-95	FWD				75400(1)	75400(1)	45		OEMA 83170	47
Challenger	09-10	RWD	Challenger	09-10	RWD	Challenger	09-10	RWD	66080, 66085	OEMA	44	OEMA 66030, 66035	OEMA 66030, 66035	52
			Challenger	80-83	RWD				N/A - S/O	N/A - S/O		OEMA	N/A - S/O	
			Challenger	70-74	RWD				N/A - S/O	N/A - S/O		OEMA 94450, 94451	OEMA 94450, 94451	57
Charger	06-10	RWD	Charger	06-10	RWD	Charger	06-10	RWD	66080, 66085	OEMA	44	OEMA 66030, 66035	OEMA 66030, 66035	52
Charger	06-10	AWD	Charger	06-10	AWD	Charger	06-10	AWD	66080, 66085	OEMA	44	OEMA	OEMA	
			Charger	82-87	FWD				75200(1)	75200(1)	45	N/A - S/O	OEMA 83170	47
			Charger	66-72	RWD				N/A - S/O	N/A - S/O		OEMA 94450, 94451	OEMA 94450, 94451	57
			Colt	93-94	FWD				OEMA	OEMA		N/A - S/O	81250	46
			Colt	80-93	FWD				N/A - S/O	N/A - S/O		N/A - S/O	81250	46
			Colt	80-87	RWD				N/A - S/O	N/A - S/O		OEMA	81250	46
			Colt Vista	92-94	FWD/ AWD				N/A - S/O	OEMA		N/A - S/O	OEMA	
Space Wagon	84-91	2WD	Colt Vista	84-91	FWD/ AWD				N/A - S/O	OEMA		OEMA	81250	46
			Colt Vista	84-94	4WD				N/A - S/O	OEMA		N/A - S/O	81250	46
			Conquest	84-86	RWD				N/A - S/O	OEMA		OEMA	N/A - S/O	
			Coronet	65-72	RWD				N/A - S/O	N/A - S/O		OEMA 94450, 94451	OEMA 94450, 94451	57
			D150, D250, D350 Truck	88-93	RWD				N/A - S/O	N/A - S/O		OEMA	OEMA	
			D100,D150,D200, D250 Truck	72-87	RWD				N/A - S/O	N/A - S/O		OEMA	OEMA	
			D300,D350,D400, D450 Truck	72-87	RWD				N/A - S/O	N/A - S/O		83160	83160	
			Dakota	87-10	RWD/ AWD				N/A - S/O	N/A - S/O		OEMA	OEMA	
			Dart	72-76	RWD				N/A - S/O	N/A - S/O		OEMA 94460, 94461	OEMA 94460, 94461	57

### ALIGNMENT FOOTNOTES

**BOLD PART NUMBER INDICATES PREFERRED CORRECTION METHOD**

(1), (2), (3), (4), (5), (6), (7), (8), (9), (10), (11), (12) See page 41

N/A = No Available Adjuster

OEMA = Original Equipment Manufacturer Adjustment

(\*) = Series P/N, for correct size • Go to Website for more

**All products available from Specialty Products Company are intended for use by professional installers only.**



EUROPE			CENTRAL/SOUTH AMERICA			ASIA/AUSTRALIA			REAR			FRONT		
Make	Year	Drive	Make	Year	Drive	Make An	Year	Drive	Rear Camber	Rear Toe	Page	Front Caster	Front Camber	Page
<b>DODGE - CONTINUED</b>														
			Daytona	84-94	FWD				75200(1)	75200(1)	45	N/A - S/O	OEMA 83170	47
			Durango	98-03	RWD/ AWD				N/A - S/O	N/A - S/O		OEMA	OEMA	
			Dynasty	88-94	FWD				75200(1)	75200(1)	45	N/A - S/O	OEMA 83170	47
			Intrepid (6)	98-04	FWD				67080	OEMA		N/A - S/O	81280 82120	46 📄
			Intrepid (6)	93-97	FWD				67020	OEMA		N/A - S/O	81280 82120	46 📄
Journey	09-10	FWD/ AWD	Journey	09-10	FWD/ AWD	Journey	09-10	FWD/ AWD	67015	OEMA		N/A - S/O	81260	46
			Lancer	85-89	FWD				75200(1)	75200(1)	45	N/A - S/O	OEMA 83170	47
Magnum	05-08	RWD	Magnum	05-08	RWD	Magnum	05-08	RWD	66010, 66020(3) 66080, 66085(3)	OEMA	44 44 44 44	OEMA 66030, 66035	OEMA 66030, 66035	52
Magnum	05-08	AWD	Magnum	05-08	AWD	Magnum	05-08	AWD	66010, 66020(3) 66080, 66085(3)	OEMA	44 44 44 44	OEMA	OEMA	
			Monaco/X58	90-92	FWD				75200(1)	75200(1)	45	N/A - S/O	81280	46
Neon, R/T, SRT	94-06	FWD	Neon, R/T, SRT	94-06	FWD	Neon, R/T, SRT	94-06	FWD	81250 67210	OEMA 67210	46 42	N/A - S/O	81260	46
Nitro	07-10	RWD/ AWD	Nitro	07-10	RWD/ AWD				N/A - S/O	N/A - S/O		OEMA	OEMA	
			O24	80-82	FWD				75200(1)	75200(1)	45	N/A - S/O	OEMA 83170	47
			Omni	80-90	FWD				75200(1)	75200(1)	45	N/A - S/O	OEMA 83170	47
			R/T	67-70	RWD				N/A - S/O	N/A - S/O		OEMA 94450, 94451	OEMA 94450, 94451	57
			Raider	87-89	RWD/ AWD				N/A - S/O	N/A - S/O		OEMA	OEMA	
			Rampage	82-84	FWD				75200(1)	75200(1)	45	N/A - S/O	OEMA 83170	47
			Shadow	87-94	FWD				75200(1)	75200(1)	45	N/A - S/O	OEMA 83170	47
			Spirit	89-96	FWD				75200(1)	75200(1)	45	N/A - S/O	OEMA 83170	47
Sprinter Van	07-10	RWD	Sprinter Van	07-10	RWD	Sprinter Van	07-10		N/A - S/O	N/A - S/O		N/A - S/O	81280	46
Sprinter Van	00-06	RWD	Sprinter Van	03-06	RWD	Sprinter Van	03-06		N/A - S/O	N/A - S/O		35075, 35076	35075, 35076	📄
			Stratus 2Dr.	01-06	FWD				73600 73620(8) 73400+ 73415(7)	OEMA	47 47 44 44	N/A - S/O	81280	46
			Stratus 4Dr.	04-06	FWD				67025	OEMA	42	N/A - S/O	67180	53
			Stratus 4Dr.	95-03	FWD				OEMA	OEMA		N/A - S/O	67180	53
			Stealth	91-96	FWD/ AWD				OEMA	OEMA		N/A - S/O	OEMA	
			Super Bee	68-70	RWD				N/A - S/O	N/A - S/O		OEMA 94450, 94451	OEMA 94450, 94451	57
Viper	94-09	RWD	Viper	94-09	RWD	Viper	94-09	RWD	OEMA	OEMA		OEMA	OEMA	
			W100, W150, AW150 Truck	72-93	4WD				N/A - S/O	N/A - S/O		23000*	23000*	50
			W200,W250 Truck	72-93	4WD				N/A - S/O	N/A - S/O		23000*	23000*	50
			W300,W350 Truck	60-93	4WD				N/A - S/O	N/A - S/O		N/A - S/O	N/A - S/O	
			W300,W350 Truck w/ Dana 60	75-93	4WD				N/A - S/O	N/A - S/O		88940 88950	88940 88950	56 56

APPLICATIONS

EUROPE			CENTRAL/SOUTH AMERICA			ASIA/AUSTRALIA			REAR			FRONT		
Make	Year	Drive	Make	Year	Drive	Make An	Year	Drive	Rear Camber	Rear Toe	Page	Front Caster	Front Camber	Page
<b>FIAT</b>														
500	07-10	RWD	500	07-10	RWD	500	07-10	RWD	N/A - S/O	N/A - S/O		N/A - S/O	N/A - S/O	
Barchetta	95-06	FWD	Barchetta	95-06	FWD	Barchetta	95-06	FWD	N/A - S/O	N/A - S/O		N/A - S/O	81240	46
Bravo	07-09	FWD	Bravo	07-09	FWD	Bravo	07-09	FWD	N/A - S/O	N/A - S/O		N/A - S/O	N/A - S/O	
Bravo/Brava	95-01	FWD	Bravo/Brava	95-01	FWD	Bravo/Brava	95-01	FWD	N/A - S/O	N/A - S/O		N/A - S/O	81250	46
Cinquecento	91-98	FWD	Cinquecento	91-98	FWD	Cinquecento	91-98	FWD	N/A - S/O	N/A - S/O		N/A - S/O	81250	46
Coupe	96-01	FWD	Coupe	96-01	FWD	Coupe	96-01	FWD	N/A - S/O	N/A - S/O		N/A - S/O	81250	46
Croma	86-96	FWD	Croma	86-96	FWD	Croma	86-96	FWD	N/A - S/O	OEMA		N/A - S/O	81250	46
Croma II	05-10	FWD	Croma II	05-10	FWD	Croma II	05-10	FWD	OEMA	OEMA		N/A - S/O	81250	46
Doblo	02-10	FWD	Doblo	02-10	FWD	Doblo	02-10	FWD	N/A - S/O	N/A - S/O		N/A - S/O	N/A - S/O	
Ducato	94-10	FWD	Ducato	94-10	FWD	Ducato	94-10	FWD	N/A - S/O	N/A - S/O		N/A - S/O	N/A - S/O	
Fiorino	08-10	FWD	Fiorino	08-10	FWD	Fiorino	08-10	FWD	N/A - S/O	N/A - S/O		N/A - S/O	N/A - S/O	
Fiorino	94-01	FWD	Fiorino	94-01	FWD	Fiorino	94-01	FWD	N/A - S/O	N/A - S/O		N/A - S/O	81250	46
Idea	04-10	FWD	Idea	04-10	FWD	Idea	04-10	FWD	N/A - S/O	N/A - S/O		N/A - S/O	N/A - S/O	
Marea	96-03	FWD	Marea	96-03	FWD	Marea	96-03	FWD	N/A - S/O	N/A - S/O		N/A - S/O	81240	46
Multipla	99-10	FWD	Multipla	99-10	FWD	Multipla	99-10	FWD	N/A - S/O	N/A - S/O		N/A - S/O	81250	46
Palio	99-10	FWD	Palio	99-10	FWD	Palio	99-10	FWD	N/A - S/O	N/A - S/O		N/A - S/O	81240	46
Panda	05-10	FWD	Panda	05-10	FWD	Panda	05-10	FWD	N/A - S/O	N/A - S/O		N/A - S/O	N/A - S/O	
Panda	80-03	FWD	Panda	80-03	FWD	Panda	80-03	FWD	N/A - S/O	N/A - S/O		N/A - S/O	N/A - S/O	
Punto/ Grande Punto	03-10	FWD	Punto/ Grande Punto	03-10	FWD	Punto/ Grande Punto	03-10	FWD	N/A - S/O	N/A - S/O		N/A - S/O	N/A - S/O	
Punto	99-02	FWD	Punto	99-02	FWD	Punto	99-02	FWD	N/A - S/O	N/A - S/O		N/A - S/O	N/A - S/O	
Punto	93-99	FWD	Punto	93-99	FWD	Punto	93-99	FWD	N/A - S/O	N/A - S/O		N/A - S/O	81240	46
Regata	85-90	FWD	Regata	85-90	FWD	Regata	85-90	FWD	N/A - S/O	N/A - S/O		N/A - S/O	N/A - S/O	
Ritmo	85-90	FWD	Ritmo	85-90	FWD	Ritmo	85-90	FWD	N/A - S/O	N/A - S/O		N/A - S/O	N/A - S/O	
Scudo	95-10	FWD	Scudo	95-10	FWD	Scudo	95-10	FWD	N/A - S/O	N/A - S/O		N/A - S/O	N/A - S/O	
Sedici	06-10	FWD/ AWD	Sedici	06-10	FWD/ AWD	Sedici	06-10	FWD/ AWD	N/A - S/O	N/A - S/O		N/A - S/O	N/A - S/O	
Seicento	98-10	FWD	Seicento	98-10	FWD	Seicento	98-10	FWD	N/A - S/O	N/A - S/O		N/A - S/O	81250	46
Stilo	01-07	FWD	Stilo	01-07	FWD	Stilo	01-07	FWD	N/A - S/O	N/A - S/O		N/A - S/O	N/A - S/O	
Strada	99-10	FWD	Strada	99-10	FWD	Strada	99-10	FWD	N/A - S/O	N/A - S/O		N/A - S/O	81250	46
Tipo/Temptra/ Marenga	91-96	FWD	Tipo/Temptra/ Marenga	91-96	FWD	Tipo/Temptra/ Marenga	91-96	FWD	N/A - S/O	N/A - S/O		N/A - S/O	N/A - S/O	
Ulysse/Ulysse II	02-06	FWD	Ulysse/Ulysse II	02-06	FWD	Ulysse/Ulysse II	02-06	FWD	N/A - S/O	N/A - S/O		N/A - S/O	N/A - S/O	
Ulysse	95-02	FWD	Ulysse	95-02	FWD	Ulysse	95-02	FWD	N/A - S/O	N/A - S/O		N/A - S/O	81250	46
Uno	82-96	FWD	Uno	82-96	FWD	Uno	82-96	FWD	N/A - S/O	N/A - S/O		N/A - S/O	81240	46
<b>FORD</b>														
			Bronco	87-96	4WD				N/A - S/O	N/A - S/O		23100*	23100*	50
			Bronco	80-86	4WD				N/A - S/O	N/A - S/O		24130	24130	51
			Bronco	80-86	4WD				N/A - S/O	N/A - S/O		23100*	23100*	50
			Bronco	80-86	4WD				N/A - S/O	N/A - S/O		24130	24130	51
			F100, F150, Bronco	66-79	4WD				N/A - S/O	N/A - S/O		23000*	23000*	50
			Bronco II (Late 1990)	90-90	4WD				N/A - S/O	N/A - S/O		23180*	23180*	50
			Bronco II (Late 1990)	90-90	4WD				N/A - S/O	N/A - S/O		24180	24180	51
			Bronco II (Early 1990)	83-89	4WD				N/A - S/O	N/A - S/O		23120*	23120*	50
			Bronco II (Early 1990)	83-89	4WD				N/A - S/O	N/A - S/O		24120	24120	51
			Bronco II	89-90	RWD				N/A - S/O	N/A - S/O		23180*	23180*	50
			Bronco II	89-90	RWD				N/A - S/O	N/A - S/O		24180	24180	51
			Bronco II	83-88	RWD				N/A - S/O	N/A - S/O			23160*	50
			Bronco II	83-88	RWD				N/A - S/O	N/A - S/O		24160	24160	51
C-Max	03-10	FWD							67420	OEMA	42	N/A - S/O	N/A - S/O	
Cougar	98-02	FWD	Cougar	98-02	FWD	Cougar	98-02	FWD	N/A - S/O	OEMA		89675	89675	54

### ALIGNMENT FOOTNOTES

**BOLD PART NUMBER INDICATES PREFERRED**

**CORRECTION METHOD**



(1), (2), (3), (4), (5), (6), (7), (8), (9), (10), (11), (12) See page 41

N/A = No Available Adjuster





OEMA = Original Equipment Manufacturer Adjustment

(\*) = Series P/N, for correct size • □ = Go to Website for more

**All products available from Specialty Products Company  
are intended for use by professional installers only.**

EUROPE			CENTRAL/SOUTH AMERICA			ASIA/AUSTRALIA			REAR			FRONT		
Make	Year	Drive	Make	Year	Drive	Make An	Year	Drive	Rear Camber	Rear Toe	Page	Front Caster	Front Camber	Page
			E150, E250, E350, E450	92-09	RWD				N/A - S/O	N/A - S/O		23180* 24180	23180* 24180	50 51
			E150, E250, E350 - w/king pins	65-90	RWD				N/A - S/O	N/A - S/O		N/A - S/O	N/A - S/O	
			E250, E350, E450 (with ball joints)	80-03	4WD				N/A - S/O	N/A - S/O		23100* 24130	23100* 24130	50 51
			Edge	07-09	FWD/ AWD				OEMA	OEMA		N/A - S/O	81280	46
			Escape	09-10	FWD/ AWD				N/A - S/O	OEMA		OEMA	OEMA 81250	46
			Escape	01-09	FWD/ AWD				67280	OEMA	42	OEMA	OEMA 81250	46
Escort	90-96	FWD	Escort	90-96	FWD	Escort	90-96	FWD	75400(1)	75400(1)	45	N/A - S/O	N/A - S/O	
Escort	81-90	FWD							81250	OEMA	46	N/A - S/O	N/A - S/O	
			Excursion	00-05	4WD				N/A - S/O	N/A - S/O		23130* 24130	23130* 24130	50 51
			Excursion	00-05	RWD				N/A - S/O	N/A - S/O		23180* 24180	23180* 24180	50 51
			Expedition	07-09	RWD/ 4WD				OEMA	OEMA		OEMA 86250	OEMA 86250	47
			Expedition	03-06	RWD/ 4WD				86680	OEMA	47	86640	86640	
			Expedition	97-02	RWD/ 4WD				N/A - S/O	N/A - S/O		87385	87385	47
			Explorer	06-09	RWD/ 4WD				OEMA	OEMA		OEMA	OEMA	
			Explorer	02-05	RWD/ 4WD				86180	OEMA	47	86140	86140	47
			Explorer	95-01	RWD/ 4WD				N/A - S/O	N/A - S/O		87310 87500	87310 87500	 47
			Explorer	91-94	RWD/ 4WD				N/A - S/O	N/A - S/O		23180* 24180	23180* 24180	50 51
			Explorer Sport Trac	07-09	RWD/ 4WD				OEMA	OEMA		OEMA	OEMA	
			Explorer Sport Trac	03-06	RWD/ 4WD				N/A - S/O	N/A - S/O		87500	87500	47
			Explorer Sport Trac	01-02	RWD/ 4WD				N/A - S/O	N/A - S/O		87310 87500	87310 87500	 47
			F100, F150, Bronco	66-79	4WD				N/A - S/O	N/A - S/O		23000*	23000*	50
			F100, F150, F250, F350 King Pin	82-90	RWD				N/A - S/O	N/A - S/O		N/A - S/O	N/A - S/O	
			F100, F150, F250, F350 King Pin	65-82	RWD				N/A - S/O	N/A - S/O		N/A - S/O	N/A - S/O	
			F150	09-09	RWD/ 4WD				N/A - S/O	N/A - S/O		OEMA 86250	OEMA 86250	47
			F150 Heritage	04-05	RWD/ 4WD				N/A - S/O	N/A - S/O		87385	87385	47
			F150	97-03	RWD/ 4WD				N/A - S/O	N/A - S/O		87385	87385	47
			F150	87-96	4WD				N/A - S/O	N/A - S/O		23100* 24130	23100* 24130	50 51
			F150, F250	89-96	RWD				N/A - S/O	N/A - S/O		23180* 24180	23180* 24180	50 51
			F150	82-86	RWD				N/A - S/O	N/A - S/O		87225	23160* 24160	50 51
			F150	80-86	4WD				N/A - S/O	N/A - S/O		23100* 24130	23100* 24130	50 51
			F250, F350, Super Duty- Coil	05-09	RWD/ Spring 4WD				N/A - S/O	N/A - S/O		23220* 24220	23220* 24220	50 51

APPLICATIONS

EUROPE			CENTRAL/SOUTH AMERICA			ASIA/AUSTRALIA			REAR			FRONT		
Make	Year	Drive	Make	Year	Drive	Make An	Year	Drive	Rear Camber	Rear Toe	Page	Front Caster	Front Camber	Page
			F250, F350, Twin I-Beam	98-09	RWD				N/A - S/O	N/A - S/O		23180*	23180*	50
			F250, F350, F450, F550-Leaf Spring	99-04	RWD/ 4WD				N/A - S/O	N/A - S/O		23130*	23130*	50
			F250 (L/D)	97-99	RWD/ 4WD				N/A - S/O	N/A - S/O		87385	87385	47
			F250, F350	84-98	4WD				N/A - S/O	N/A - S/O		23100*	23100*	50
												24130	24130	51
			F250, F350	80-83	4WD				N/A - S/O	N/A - S/O		23100*	23100*	50
												24130	24130	51
			F250	73-79	4WD				N/A - S/O	N/A - S/O		23000*	23000*	50
			F250, F350	87-98	RWD				N/A - S/O	N/A - S/O		23180*	23180*	50
												24180	24180	51
			F250, F350	82-86	RWD				N/A - S/O	N/A - S/O		87225	N/A - S/O	
			F250 (Dana 60), F350 (Dana 60)	76-98	4WD				N/A - S/O	N/A - S/O		88940	88940	56
												88950	88950	56
			F350 Crew Cab	92-98	4WD				N/A - S/O	N/A - S/O		23130*	23130*	50
												24130	24130	51
			F350	73-79	4WD				N/A - S/O	N/A - S/O		N/A - S/O	N/A - S/O	
			F450, F550, Super Duty-Coil Spring	05-09	RWD/ 4WD				N/A - S/O	N/A - S/O		23230*	23230*	50
									N/A - S/O	N/A - S/O		24230	24230	51
Fiesta/Fusion	09-10	FWD	Fiesta/Fusion	09-10	FWD	Fiesta/Fusion	09-10	FWD	N/A - S/O	N/A - S/O		N/A - S/O	N/A - S/O	
Fiesta/Fusion	03-08	FWD	Fiesta/Fusion	03-08	FWD	Fiesta/Fusion	03-08	FWD	N/A - S/O	N/A - S/O		N/A - S/O	N/A - S/O	
Fiesta	95-02	FWD	Fiesta	95-02	FWD	Fiesta	95-02	FWD	N/A - S/O	N/A - S/O		N/A - S/O	N/A - S/O	
Fiesta	89-94	FWD	Fiesta	89-94	FWD	Fiesta	89-94	FWD	N/A - S/O	N/A - S/O		N/A - S/O	N/A - S/O	
Fiesta	76-89	FWD	Fiesta	76-89	FWD	Fiesta	76-89	FWD	N/A - S/O	N/A - S/O		N/A - S/O	N/A - S/O	
Focus/SVT	97-10	FWD	Focus/SVT	97-10	FWD	Focus/SVT	97-10	FWD	81310	OEMA		81320	81320	46
									<b>67420</b>		42			
Galaxy	07-10	FWD	Galaxy	07-10	FWD				N/A - S/O	N/A - S/O		N/A - S/O	N/A - S/O	
Galaxy	01-06	FWD	Galaxy	01-06	FWD				N/A - S/O	N/A - S/O		N/A - S/O	N/A - S/O	
Galaxy	95-00	FWD	Galaxy	95-00	FWD				N/A - S/O	N/A - S/O		N/A - S/O	N/A - S/O	
Ka/Streetka	96-10	FWD	Ka/Streetka	97-10	FWD	Ka/Streetka	96-10	FWD	75400(1)	75400(1)	45	N/A - S/O	N/A - S/O	
Kuga	08-10	FWD							N/A - S/O	OEMA		N/A - S/O	N/A - S/O	
Maverick	01-04	FWD/ AWD							67280	OEMA		OEMA	OEMA	46
												81250	81250	46
Mondeo	07-10	FWD	Mondeo	07-10	FWD	Mondeo	07-10	FWD	N/A - S/O	OEMA		N/A - S/O	81260	46
Mondeo	01-06	FWD	Mondeo	01-06	FWD	Mondeo	01-06	FWD	N/A - S/O	N/A - S/O		N/A - S/O	N/A - S/O	
Mondeo	93-00	FWD	Mondeo	93-00	FWD	Mondeo	93-00	FWD	N/A - S/O	OEMA		89675	89675	54
			Mustang	05-10	RWD				N/A - S/O	72045			<b>81260</b>	46
										72345		72040	72040	54
			Mustang Cobra	99-04	RWD				OEMA	OEMA		OEMA	OEMA	46
												72060	<b>81280</b>	54
			Mustang	94-04	RWD				N/A - S/O	N/A - S/O			OEMA	46
												72060	72060	54
			Mustang	79-93	RWD				N/A - S/O	N/A - S/O		N/A - S/O	OEMA	46
												81280	OEMA	
			Mustang	75-78	RWD				N/A - S/O	N/A - S/O		OEMA	OEMA	
			Mustang	67-73	RWD				N/A - S/O	N/A - S/O		OEMA	OEMA	
												83160		46
Probe	89-97	FWD	Probe	89-97	FWD	Probe	89-97	FWD	81250	OEMA	46	OEMA	OEMA	46
												81250		46

### ALIGNMENT FOOTNOTES

**BOLD PART NUMBER INDICATES PREFERRED CORRECTION METHOD**

(1), (2), (3), (4), (5), (6), (7), (8), (9), (10), (11), (12) See page 41

N/A = No Available Adjuster

OEMA = Original Equipment Manufacturer Adjustment

(\*) = Series P/N, for correct size •  = Go to Website for more

**All products available from Specialty Products Company are intended for use by professional installers only.**

EUROPE			CENTRAL/SOUTH AMERICA			ASIA/AUSTRALIA			REAR			FRONT		
Make	Year	Drive	Make	Year	Drive	Make An	Year	Drive	Rear Camber	Rear Toe	Page	Front Caster	Front Camber	Page
<b>FORD - CONTINUED</b>														
Puma	97-02	FWD							N/A - S/O	N/A - S/O		N/A - S/O	N/A - S/O	
Ranger	01-09	RWD/ 4WD	Ranger	01-09	RWD/ 4WD				N/A - S/O	N/A - S/O		87500	87500	47
			Ranger	98-00	RWD/ 4WD				N/A - S/O	N/A - S/O		87310 87500	87310 87500	47
			Ranger	90-97	RWD/ 4WD				N/A - S/O	N/A - S/O		23180*	23180	50
												24180	24180	51
			Ranger	83-89	4WD				N/A - S/O	N/A - S/O		23120*	23120*	50
												24120	24120	51
			Ranger	83-88	RWD				N/A - S/O	N/A - S/O		N/A - S/O	23160*	50
												24160	24160	51
S-Max	06-10	FWD				S-Max	06-10	FWD	N/A - S/O	OEMA		N/A - S/O	81260	46
Scorpio	85-98	RWD							N/A - S/O	N/A - S/O		N/A - S/O	N/A - S/O	
			Taurus Sedan	96-06	FWD	Taurus Sedan	96-06		87330	OEMA 87330	44 44	OEMA	OEMA	
												89635	89635	
			Taurus Sedan	86-95	FWD	Taurus Sedan	86-95		87330	OEMA 87330	44 44	OEMA	OEMA	
			Taurus Wagon	96-05	FWD	Taurus Wagon	96-05		87350	OEMA		OEMA	OEMA	
												89635	89635	
			Taurus Wagon	86-95	FWD	Taurus Wagon	86-95		87350	OEMA		OEMA	OEMA	
Tourneo/ Transit Connect	02-10	FWD							N/A - S/O	N/A - S/O		N/A - S/O	N/A - S/O	
Transit	00-10	FWD/ AWD							N/A - S/O	N/A - S/O		N/A - S/O	N/A - S/O	
Windstar	94-03	FWD	Windstar	94-03	FWD	Windstar	94-03	FWD	75400(1)	75400(1)	45	OEMA	OEMA	
												89685	89685	
<b>GMC - SEE VOYEZ VEA - CHEVROLET/GMC</b>														
<b>HOLDEN</b>														
						Barina	05-10	FWD	N/A - S/O	N/A - S/O		N/A - S/O	81250	46
						Colorado	07-10	RWD/ 4WD	N/A - S/O	N/A - S/O		OEMA 86360 86375, 86325	OEMA 86360 86375, 86325	55
												86375, 86325	86375, 86325	55
						Commodore	06-10	RWD	OEMA	OEMA		OEMA	81260	46
						Commodore	97-05	RWD	N/A - S/O	OEMA		N/A - S/O	81250	46
						Captiva Maxx	07-10	FWD/ AWD	OEMA 87420	OEMA 87420		N/A - S/O	81260	46
						Cruze	02-10	FWD	N/A - S/O	N/A - S/O		N/A - S/O	81250	46
						Epica	07-10	FWD	N/A - S/O	OEMA		N/A - S/O	81250	46
						Monaro	01-05	FWD	N/A - S/O	OEMA		N/A - S/O	81260	46
						Statesman	08-10	RWD	OEMA	OEMA		OEMA	81260	46
						Statesman	06-07	RWD	75800(1)	OEMA 75800(1)	45 45	OEMA	81280	46
						Statesman	97-05	RWD	81280	OEMA	46	OEMA	81280	46
						Tigra	04-06	FWD	N/A - S/O	N/A - S/O		N/A - S/O	81250	46
						Vectra-C	02-06	FWD	N/A - S/O	N/A - S/O		N/A - S/O	81250	46
						Vectra-B	95-01	FWD	75400(1)	75400(1)	45	N/A - S/O	81250	46
						Vectra-A	88-94	FWD	75400(1)	75400(1)	45	N/A - S/O	N/A - S/O	
						Viva	05-08	FWD	81250	OEMA	46	N/A - S/O	81250	46
						Zafira	01-04	FWD	75400(1)	75400(1)	45	N/A - S/O	81250	46
<b>HONDA</b>														
Accord	08-11	FWD	Accord	08-11	FWD	Accord/Inspire	08-11	FWD	<b>67540</b> 67545(12)	OEMA 67540	43 43	N/A - S/O	<b>67135</b> 67330(8)	53
														53
Accord/Tourer	03-07	FWD	Accord	03-07	FWD	Accord/Inspire CL7, CL9	03-07	FWD	67290	OEMA	42	N/A - S/O	<b>67135</b> 67330(8)	53
														53
Accord TypeR	99-03	FWD							67290	OEMA	42	N/A - S/O	<b>67135</b> 67330(8)	53
														53
Accord	98-02	FWD	Accord	98-02	FWD	Accord	98-02	FWD	67090	OEMA	42	84690, 84695	<b>67125</b> 67320(8)	54,53
														53
Accord	90-97	FWD	Accord	90-97	FWD	Accord	90-97	FWD	<b>67065</b> 67265(8)	OEMA	42 42	84690, 84695	<b>67145</b> 67340(8)	54,53
														53

EUROPE			CENTRAL/SOUTH AMERICA			ASIA/AUSTRALIA			REAR			FRONT		
Make	Year	Drive	Make	Year	Drive	Make An	Year	Drive	Rear Camber	Rear Toe	Page	Front Caster	Front Camber	Page
Accord	86-89	FWD	Accord	86-89	FWD	Accord	86-89	FWD	67395	OEMA	☐	OEMA	N/A - S/O	
Accord	80-85	FWD	Accord	80-85	FWD	Accord	80-85	FWD	N/A - S/O	OEMA		N/A - S/O	N/A - S/O	
			Civic/ Civic Hybrid	06-10	FWD	Civic/ Civic Hybrid	06-10	FWD	<b>67470</b> 67465	OEMA	42 47	N/A - S/O	81260	46
Civic/ Civic Hybrid	06-10	FWD							N/A - S/O	OEMA		N/A - S/O	81260	46
Civic Type R	07-08	FWD				Civic Type R	07-08	FWD	71640*	71640*	44	N/A - S/O	81260	46
Civic	03-05	FWD	Civic	03-05	FWD	Civic	03-05	FWD	<b>67230</b> 69300	OEMA	42 43	N/A - S/O	81280	46
Civic	01-02	FWD	Civic	01-02	FWD	Civic	01-02	FWD	<b>67230</b> 69300	OEMA	42 43	N/A - S/O	81260	46
Civic	96-00	FWD	Civic	96-00	FWD	Civic	96-00	FWD	<b>67030</b> 69100	OEMA 69250, <b>69450</b>	42 43,42	62010	62010 <b>67135</b> 67330(8)	☐ 53 53
Civic	92-95	FWD	Civic	92-95	FWD	Civic	92-95	FWD	<b>67030</b> 69200	OEMA 69250, <b>69450</b>	42 43,42		<b>67135</b> 67330(8)	53 53
Civic	88-91	FWD	Civic	88-91	FWD	Civic	88-91	FWD	<b>67030</b> 69200	OEMA 69250, <b>69460</b>	42 42,43	N/A - S/O	<b>67125</b> 67320(8)	53 53
Civic	80-87	FWD	Civic	80-87	FWD	Civic	80-87	FWD	N/A - S/O	N/A - S/O		N/A - S/O	N/A - S/O	
Civic SW	88-91	FWD/ 4WD	Civic SW	88-91	FWD/ 4WD	Civic SW	88-91	FWD/ 4WD	<b>67030</b> 69200	OEMA	42 43	N/A - S/O	<b>67125</b> 67320(8)	53 53
						Crossroad	08-10	FWD/ AWD	N/A - S/O	OEMA		N/A - S/O	N/A - S/O	
CRV	07-10	FWD/ AWD	CRV	07-10	FWD/ AWD	CRV	07-10	FWD/ AWD	67580	OEMA	42	N/A - S/O	81280	46
CRV	02-06	FWD/ AWD	CRV	02-06	FWD/ AWD	CRV	02-06	FWD/ AWD	<b>67430</b> 69400	OEMA	42 43	N/A - S/O	81280	46
CRV	97-01	FWD/ AWD	CRV	97-01	FWD/ AWD	CRV	97-01	FWD/ AWD	67030	OEMA	42	N/A - S/O	<b>67135</b> 67330(8)	53 53
CRX	88-92	FWD	CRX	88-92	FWD	CRX	88-92	FWD	<b>67030</b> 69200	OEMA 69250, <b>69460</b>	42 43,42	N/A - S/O	<b>67125</b> 67320(8)	53 53
CRX	84-86	FWD	CRX	84-86	FWD	CRX	84-86	FWD	N/A - S/O	N/A - S/O		N/A - S/O	N/A - S/O	
CR-Z	10-10	FWD							N/A - S/O	OEMA		N/A - S/O	N/A - S/O	
Element (Except SC)	03-09	FWD/ AWD							<b>67430</b> 69400	OEMA	42 43	N/A - S/O	81280	46
FR-V	05-09	FWD				EDIX (BE1-4)	05-09	FWD	67430	OEMA	42	N/A - S/O	OEMA 81280	46
Jazz	09-10	FWD	City	09-10	FWD	Fit/City	09-10	FWD	N/A - S/O	N/A - S/O		N/A - S/O	81260	46
Jazz	01-08	FWD	City	02-08	FWD	Fit/City	02-08	FWD	75800(1)	75800(1)	45	N/A - S/O	81260	46
Insight	10-10	FWD				Insight	10-10	FWD	N/A - S/O	N/A - S/O		N/A - S/O	81260	46
						Insight	01-06	FWD	N/A - S/O	N/A - S/O		N/A - S/O	81260	46
Integra Type R	98-01	FWD							67030	OEMA 69250, <b>69450</b>	42 42	N/A - S/O	<b>67135</b> 67330(8)	53 53
						Legend	09-10	AWD	N/A - S/O	OEMA		N/A - S/O	N/A - S/O	
						Legend	96-04	FWD	67090	OEMA	42	N/A - S/O	<b>67135</b> 67330(8)	53 53
Legend	91-96	FWD							N/A - S/O	OEMA		N/A - S/O	<b>67135</b> 67330(8)	53 53
			Odyssey	05-10	FWD				67590	OEMA	42	N/A - S/O	81280	46
						Odyssey RB	03-08	FWD	67430	OEMA	42	N/A - S/O	<b>67135</b> 67330(8)	53 53
			Odyssey	99-04	FWD				67290	OEMA	42	N/A - S/O	81280	46
Shuttle	95-98	FWD				Odyssey RA	95-98	FWD	67155	OEMA	53	OEMA 84690, 84695	<b>67125</b> 67320(8)	53 54,53

### ALIGNMENT FOOTNOTES

**BOLD PART NUMBER INDICATES PREFERRED CORRECTION METHOD**

(1), (2), (3), (4), (5), (6), (7), (8), (9), (10), (11), (12) See page 41

N/A = No Available Adjuster

OEMA = Original Equipment Manufacturer Adjustment

(\*) = Series P/N, for correct size • ☐ = Go to Website for more

**All products available from Specialty Products Company are intended for use by professional installers only.**

EUROPE			CENTRAL/SOUTH AMERICA			ASIA/AUSTRALIA			REAR			FRONT		
Make	Year	Drive	Make	Year	Drive	Make An	Year	Drive	Rear Camber	Rear Toe	Page	Front Caster	Front Camber	Page

### HONDA - CONTINUED

			Pilot	09-11	FWD/AWD				67570	OEMA	42	N/A - S/O	81290	46
	03-08		Pilot	03-08	FWD/AWD				67290	OEMA	42	N/A - S/O	81280	46
Prelude	97-02	FWD	Prelude	97-02	FWD	Prelude	97-02	FWD	<b>67165</b> 67360(8)	OEMA	53 53	N/A - S/O	<b>67165</b> 67330(8)	53 53
Prelude SH	97-02	FWD	Prelude SH	97-02	FWD	Prelude SH	97-02	FWD	<b>67165</b> 67360(8)	OEMA	53 53	N/A - S/O	<b>67155</b> 67350(8)	53 53
Prelude	92-96	FWD	Prelude	92-96	FWD	Prelude	92-96	FWD	<b>67165</b> 67360(8)	OEMA	53 53	N/A - S/O	67165	53
Prelude	83-91	FWD	Prelude	83-91	FWD	Prelude	83-91	FWD	N/A - S/O	OEMA		OEMA	OEMA	
Prelude	79-82	FWD	Prelude	79-82	FWD	Prelude	79-82	FWD	N/A - S/O	N/A - S/O		OEMA	N/A - S/O	
Prelude 4WS	92-94	FWD	Prelude 4WS	92-94	FWD	Prelude 4WS	92-94	FWD	OEMA	OEMA		OEMA	<b>67165</b> 67360(8)	53 53
Prelude 4WS	88-91	FWD	Prelude 4WS	88-91	FWD	Prelude 4WS	88-91	FWD	OEMA	OEMA		OEMA	OEMA	
			Ridgeline	06-01	FWD/AWD				67490	OEMA	42	N/A - S/O	81280	46
S2000	00-09	RWD	S2000	00-09	RWD	S2000	00-09	RWD	OEMA 67220	OEMA	53	OEMA	OEMA 67220	53
Stream	07-10	FWD/AWD				Stream	07-10	FWD/AWD	N/A - S/O	OEMA		N/A - S/O	N/A - S/O	
Stream up to VIN 1300000	01-06	FWD				Stream up to VIN 1300000	01-06	FWD	N/A - S/O 69400	OEMA	43	N/A - S/O	81260	46
Stream after VIN 1300001	01-06	FWD				Stream after VIN 1300001	01-06	FWD	N/A - S/O 69400	OEMA	43	N/A - S/O	81280	46

### HUMMER

			H1	92-06	4WD				OEMA	OEMA		OEMA	OEMA	
			H2	02-09	AWD				N/A - S/O	N/A - S/O		OEMA 86375, 86325	OEMA 86330 86375, 86325	55,  55
			H3, H3T	06-09	AWD				N/A - S/O	N/A - S/O		OEMA 86360 86375, 86325	OEMA 86360 86375, 86325	55 55

### HYUNDAI

Accent	06-10	FWD	Accent	06-10	FWD	Accent/Verna	06-10	FWD	75800(1)	75800(1)	45	N/A - S/O	81250	46
Accent	95-05	FWD	Accent/Verna	95-05	FWD	Accent/Verna	95-05	FWD	81250	OEMA	46	N/A - S/O	81250	46
Atos/Atoz/Amica	98-10	FWD	Atos/Atoz/Amica	98-10	FWD	Atos/Atoz/Amica	98-10	FWD	N/A - S/O	N/A - S/O		N/A - S/O	N/A - S/O	
Azera/Grandeur	06-10	FWD	Azera/Grandeur	06-10	FWD	Azera/Grandeur	06-10	FWD	OEMA	OEMA		N/A - S/O	67195	53
Coupe	03-09	FWD	Coupe	03-09	FWD	Coupe	03-09	FWD	81250	OEMA	46	N/A - S/O	81260	46
Coupe	96-02	FWD	Coupe	96-02	FWD	Coupe	96-02	FWD	81250	OEMA	46	OEMA	81250	46
Elantra	07-10	FWD	Elantra	07-10	FWD	Elantra/Avante	07-10	FWD	67410	OEMA 67410	42 42	N/A - S/O	81260	46
Elantra	97-06	FWD	Elantra	97-06	FWD	Elantra/Avante	97-06	FWD	81250	OEMA	46	N/A - S/O	81250	46
						Equus	09-11	RWD	N/A - S/O	N/A - S/O		N/A - S/O	N/A - S/O	
						Equus	00-08	FWD	N/A - S/O	N/A - S/O		N/A - S/O	N/A - S/O	
Excel	90-94	FWD	Excel	90-94	FWD	Excel	90-94	FWD	N/A - S/O	N/A - S/O		N/A - S/O	81250	46
Excel	86-89	FWD	Excel	86-89	FWD	Excel	86-89	FWD	N/A - S/O	N/A - S/O		OEMA	81250	46
Genesis	09-10	RWD/AWD	Genesis	09-10	RWD/AWD	Genesis	07-10	RWD/AWD	OEMA	OEMA		N/A - S/O	N/A - S/O	
						Genesis Coupe	10-11	RWD	OEMA	OEMA		N/A - S/O	81260	46
Getz/Click	02-09	FWD	Getz/Click	02-09	FWD	Getz/Click	02-09	FWD	N/A - S/O	N/A - S/O		N/A - S/O	N/A - S/O	
			Grandeur	02-06	FWD	Grandeur	02-06	FWD	N/A - S/O	OEMA		N/A - S/O	67190	53
Lantra	96-01	FWD	Lantra	96-01	FWD	Lantra	96-01	FWD	81250	OEMA	46	N/A - S/O	81250	46
Lantra	91-95	FWD	Lantra	91-95	FWD	Lantra	91-95	FWD	N/A - S/O	N/A - S/O		N/A - S/O	N/A - S/O	
i10	08-10	FWD	i10	08-10	FWD	i10	08-10	FWD	N/A - S/O	N/A - S/O		N/A - S/O	N/A - S/O	
						i10	07-08	FWD	N/A - S/O	N/A - S/O		N/A - S/O	N/A - S/O	
i20	09-10	FWD	i20	09-10	FWD	i20	09-10	FWD	N/A - S/O	N/A - S/O		N/A - S/O	81260	46
i30	07-10	FWD	i30	07-10	FWD	i30	07-10	FWD	N/A - S/O	OEMA		N/A - S/O	N/A - S/O	
Matrix/Levita	01-10	FWD	Matrix/Levita	01-10	FWD	Matrix/Levita	01-10	FWD	N/A - S/O	OEMA		N/A - S/O	N/A - S/O	
Pony	83-87	RWD	Pony	83-87	RWD	Pony	83-87	RWD	N/A - S/O	N/A - S/O		OEMA	N/A - S/O	
Sante Fe	01-10	AWD	Sante Fe	01-10	AWD	Sante Fe	01-10	AWD	OEMA	OEMA		N/A - S/O	81260	46

EUROPE			CENTRAL/SOUTH AMERICA			ASIA/AUSTRALIA			REAR			FRONT		
Make	Year	Drive	Make	Year	Drive	Make An	Year	Drive	Rear Camber	Rear Toe	Page	Front Caster	Front Camber	Page
<b>HYUNDAI - CONTINUED</b>														
Sonata	06-10	FWD	Sonata	06-10	FWD	Sonata	06-10	FWD	OEMA	OEMA		N/A - S/O	67195	53
Sonata	99-05	FWD	Sonata	99-05	FWD	Sonata	99-05	FWD	N/A - S/O	OEMA		N/A - S/O	67190	53
Sonata	95-98	FWD	Sonata	95-98	FWD	Sonata	95-98	FWD	N/A - S/O	OEMA		N/A - S/O	81260	46
Sonata	89-94	FWD	Sonata	89-94	FWD	Sonata	89-94	FWD	N/A - S/O	N/A - S/O		N/A - S/O	81260	46
Starex/H-1	97-08	FWD	Starex/H-1	97-08	FWD	Starex/H-1	97-08	FWD	N/A - S/O	N/A - S/O		OEMA	OEMA	
Trajet	00-07	FWD	Trajet	00-07	FWD	Trajet	00-07	FWD	N/A - S/O	OEMA		N/A - S/O	N/A - S/O	
Tuscon	05-10	FWD/AWD	Tuscon	05-10	FWD/AWD	Tuscon	05-10	FWD/AWD	81260	OEMA	46	N/A - S/O	81260	46
Veracruz	07-10	AWD	Veracruz	07-10	AWD	Veracruz	07-10	AWD	OEMA	OEMA		N/A - S/O	81260	46

<b>INFINITI</b>														
EX35	08-10	FWD/AWD	EX35	08-10	FWD/AWD	EX35	08-10	FWD/AWD	OEMA	OEMA		72130	72130	52
FX35/FX50	09-10	FWD/AWD	FX35/FX50	09-10	FWD/AWD	FX35/FX50	09-10	FWD/AWD	OEMA	OEMA		N/A - S/O	N/A - S/O	
FX35/FX45	03-08	FWD/AWD	FX35/FX45	03-08	FWD/AWD	FX35/FX45	03-08	FWD/AWD	OEMA	OEMA		N/A - S/O	81260	46
			G20	97-02	FWD				N/A - S/O	N/A - S/O		N/A - S/O	N/A - S/O	
			G20	91-96	FWD				81250	OEMA	46	N/A - S/O	N/A - S/O	
			G35 Coupe w/o rear active steer	03-07	RWD/AWD				OEMA 72050 <b>72055</b>	OEMA 72050 <b>72055</b>	42 47	72125	72125	52
			G35 Coupe w/ rear active steer	06-07	RWD/AWD				OEMA 72260 <b>72265</b>	OEMA 72260 <b>72265</b>	42 47	72125	72125	52
			G35/G35x Sedan incl. active steer	07-08	RWD/AWD				OEMA 72260 <b>72265</b>	OEMA 72260 <b>72265</b>	42 47	72130	72130	52
			G35 Sedan	03-06	RWD/AWD				OEMA 72050 <b>72055</b>	OEMA 72050 <b>72055</b>	42 47	72125	72125	52
G37 Coupe incl. active steer	08-10	RWD/AWD	G37 Coupe incl. active steer	08-10	RWD/AWD	G37 Coupe incl. active steer	08-10	RWD/AWD	OEMA 72280 <b>72265</b>	OEMA 72280 <b>72265</b>	42	72130	72130	52
G37 Sedan	09-10	RWD/AWD	G37 Sedan	09-10	RWD/AWD	G37 Sedan	09-10	RWD/AWD	OEMA 72280 <b>72265</b>	OEMA 72280 <b>72265</b>	42 47	72130	72130	52
			J30	92-97	RWD				N/A - S/O	OEMA		N/A - S/O	N/A - S/O	
			I35	02-05	FWD				N/A - S/O	OEMA		N/A - S/O	81260	46
			I30	00-01	FWD				N/A - S/O	OEMA		N/A - S/O	81260	46
			I30	95-99	FWD				N/A - S/O	OEMA		N/A - S/O	81260	46
			M35/M45	06-10	RWD/AWD	M35/M45	06-10	RWD/AWD	OEMA 72280 <b>72265</b>	OEMA 72280 <b>72265</b>	42 47	72130	72130	52
			M35/M45	03-05	RWD/AWD	M35/M45	03-05	RWD/AWD	OEMA	OEMA		N/A - S/O	N/A - S/O	
			M30	90-92	RWD				N/A - S/O	OEMA		N/A - S/O	N/A - S/O	
			Q45	90-07	RWD				OEMA	OEMA		N/A - S/O	N/A - S/O	
QX4	97-03	RWD/4WD	QX4	97-03	RWD/4WD	QX4	97-03	RWD/4WD	N/A - S/O	N/A - S/O		N/A - S/O	81260	46
QX56	05-10	FWD/AWD	QX56	05-10	FWD/AWD	QX56	05-10	FWD/AWD	N/A - S/O	N/A - S/O		OEMA 87520	OEMA 87520	47

APPLICATIONS

**ALIGNMENT FOOTNOTES**

**BOLD PART NUMBER INDICATES PREFERRED CORRECTION METHOD**

(1), (2), (3), (4), (5), (6), (7), (8), (9), (10), (11), (12) See page 41

N/A = No Available Adjuster

OEMA = Original Equipment Manufacturer Adjustment

(\*) = Series P/N, for correct size • = Go to Website for more

**All products available from Specialty Products Company are intended for use by professional installers only.**



EUROPE			CENTRAL/SOUTH AMERICA			ASIA/AUSTRALIA			REAR			FRONT		
Make	Year	Drive	Make	Year	Drive	Make An	Year	Drive	Rear Camber	Rear Toe	Page	Front Caster	Front Camber	Page
<b>ISUZU</b>														
			Amigo	90-00	RWD/ 4WD				N/A - S/O	N/A - S/O		OEMA(5)	OEMA(5)	
			Rodeo	91-03	RWD/ 4WD				N/A - S/O	N/A - S/O		OEMA(5)	OEMA(5)	
			Rodeo Sport	01-03	RWD/ 4WD				N/A - S/O	N/A - S/O		OEMA(5)	OEMA(5)	
			Trooper	81-02	RWD/ 4WD				N/A - S/O	N/A - S/O		OEMA(5)	OEMA(5)	
<b>JAGUAR</b>														
S Type	00-08								N/A - S/O	OEMA		OEMA	OEMA	
X-Type	02-10								N/A - S/O	OEMA		N/A - S/O	N/A - S/O	
XF	09-10								N/A - S/O	N/A - S/O		N/A - S/O	N/A - S/O	
XK8, XKR	02-10								N/A - S/O	OEMA		N/A - S/O	N/A - S/O	
XJR, XJB	97-10								N/A - S/O	OEMA		N/A - S/O	N/A - S/O	
<b>JEEP</b>														
Cherokee	97-01	RWD/ 4WD	Cherokee	97-01	RWD/ 4WD	Cherokee	97-01	RWD/ 4WD	N/A - S/O	N/A - S/O		47240-47242 23510-23540	23510-23540	51 51
Commander	06-10	RWD/ 4WD	Commander	06-10	RWD/ 4WD	Commander	06-10	RWD/ 4WD	N/A - S/O	N/A - S/O		OEMA	OEMA 23410	53
Compass	07-10	FWD/ AWD	Compass	07-10	FWD/ AWD	Compass	07-10	FWD/ AWD	N/A - S/O	OEMA		N/A - S/O	81260	46
Grand Cherokee	05-10	RWD/ 4WD	Grand Cherokee	05-10	RWD/ 4WD	Grand Cherokee	05-10	RWD/ 4WD	N/A - S/O	N/A - S/O		OEMA	OEMA 23410	53
Grand Cherokee	93-04	RWD/ 4WD	Grand Cherokee	93-04	RWD/ 4WD	Grand Cherokee	93-04	RWD/ 4WD	N/A - S/O	N/A - S/O		47240-47242 23510-23540	23510-23540	51 51
Grand Wagoneer	93-04	RWD/ 4WD	Grand Wagoneer	93-04	RWD/ 4WD	Grand Wagoneer	93-04	RWD/ 4WD	N/A - S/O	N/A - S/O		47240-47242 23510-23540	23510-23540	51 51
Liberty	02-10	FWD/ AWD	Liberty	02-10	FWD/ AWD	Liberty	02-10	FWD/ AWD	N/A - S/O	N/A - S/O		OEMA	OEMA	
Patriot	07-10	FWD/ AWD	Patriot	07-10	FWD/ AWD	Patriot	07-10	FWD/ AWD	N/A - S/O	OEMA		N/A - S/O	81260	46
Wrangler(JK)	07-10	RWD/ 4WD	Wrangler(JK)	07-10	RWD/ 4WD	Wrangler(JK)	07-10	RWD/ 4WD	N/A - S/O 82390-Pinion	N/A - S/O Angle	47	23510-23540	23510-23540 82390	51 47
Wrangler(TJ)(11)	97-06	4WD	Wrangler(TJ)(11)	97-06	4WD	Wrangler(TJ)(11)	97-06	4WD	N/A - S/O 82370-Pinion	N/A - S/O Angle	47	23510-23540	23510-23540 82380	51 47
Wrangler & Renegade (YJ)	90-96	4WD	Wrangler & Renegade (YJ)	90-96	4WD	Wrangler & Renegade (YJ)	90-96	4WD	N/A - S/O	N/A - S/O		23510-23540	23510-23540	51
Wrangler	89-89	4WD	Wrangler	89-89	4WD	Wrangler	89-89	4WD	N/A - S/O	N/A - S/O		23510-23540	23510-23540	51
<b>KIA</b>														
Amica	00-04	FWD				Visto	00-10	FWD	N/A - S/O	N/A - S/O		N/A - S/O	N/A - S/O	
			Opirus	07-10	FWD	Opirus	07-10	FWD	OEMA	OEMA		N/A - S/O	67195	53
			Opirus	04-06	FWD	Opirus	04-06	FWD	N/A - S/O	OEMA		N/A - S/O	67190	53
Cadenza	10-10	FWD				Cadenza/K7	10-10	FWD	N/A - S/O	OEMA		N/A - S/O	N/A - S/O	
Carens	07-10	FWD	Carens	07-10	FWD	Carens	07-10	FWD	67410	OEMA 67410	42 42	N/A - S/O	81260	46
Carens	99-06	FWD	Carens	99-06	FWD	Carens	99-06	FWD	N/A - S/O	OEMA		N/A - S/O	OEMA 81250	46
cee'd	07-10	FWD							N/A - S/O	OEMA		N/A - S/O	N/A - S/O	
Cerato	04-08	FWD							N/A - S/O	OEMA		N/A - S/O	81260	46
Clarus/Credos	97-01	???	Clarus/Credos	97-01		Clarus/Credos	97-01		N/A - S/O	OEMA		N/A - S/O	81260	46
Forte	10-11	FWD	Forte	10-11	FWD	Forte/Cerato	10-11	FWD	75800(1)	75800(1)	45	N/A - S/O	81260	46
Magentis	07-10	FWD	Magentis	07-10	FWD	Magentis	07-10	FWD	67410	OEMA 67410	42 42	N/A - S/O	81260	46
Mentor/Sephia	94-02	FWD	Mentor/Sephia	94-02	FWD	Mentor/Sephia	94-02	FWD	81250	OEMA	46	N/A - S/O	OEMA 81250	46
Mohave	09-10	FWD/ AWD	Borrego	09-10	FWD/ AWD	Mohave	09-10	FWD/ AWD	OEMA	OEMA		OEMA	OEMA	
Optima/Magentis	01-06	FWD	Optima/Magentis	01-06	FWD	Optima/Magentis	01-06	FWD	N/A - S/O	OEMA		N/A - S/O	67190	53
Picanto/Morning	04-10	FWD	Picanto/Morning	04-10	FWD	Picanto/Morning	04-10	FWD	N/A - S/O	N/A - S/O		N/A - S/O	N/A - S/O	
Pride	90-99	FWD	Pride	90-99	FWD	Pride	90-99	FWD	N/A - S/O	N/A - S/O		N/A - S/O	OEMA	

APPLICATIONS

EUROPE			CENTRAL/SOUTH AMERICA			ASIA/AUSTRALIA			REAR			FRONT		
Make	Year	Drive	Make	Year	Drive	Make An	Year	Drive	Rear Camber	Rear Toe	Page	Front Caster	Front Camber	Page
<b>KIA - CONTINUED</b>														
Rio/Rio Cinco	01-10	FWD	Rio/Rio Cinco	01-10	FWD	Rio/Rio Cinco	01-10	FWD	75800(1)	75800(1)	45	N/A - S/O	81250	46
Sedona	06-10	FWD	Carnival	06-10	FWD	Carnival	06-10	FWD	N/A - S/O	OEMA		N/A - S/O	81260	46
Sedona	02-05	FWD	Carnival	02-05	FWD	Carnival	02-05	FWD	N/A - S/O	N/A - S/O		N/A - S/O	81260	46
Sorento	03-10	FWD/AWD	Sorento	03-10	FWD/AWD	Sorento	03-10	FWD/AWD	N/A - S/O	N/A - S/O		OEMA	OEMA	
Soul	10-10	FWD	Soul	10-10	FWD	Soul	10-10	FWD	N/A - S/O	N/A - S/O		N/A - S/O	81260	46
Sportage	95-03	FWD/AWD	Sportage	95-03	FWD/AWD	Sportage	95-03	FWD/AWD	N/A - S/O	N/A - S/O		OEMA	OEMA	
Sportage	05-10	FWD/AWD	Sportage	05-10	FWD/AWD	Sportage	05-10	FWD/AWD	81260	OEMA	46	N/A - S/O	81260	46
Venga	09-10	FWD				Venga	09-10	FWD	N/A - S/O	N/A - S/O		N/A - S/O	81260	46
<b>LANCIA</b>														
Delta	93-99	FWD							N/A - S/O	N/A - S/O		N/A - S/O	N/A - S/O	
Kappa	95-22	FWD							N/A - S/O	OEMA		N/A - S/O	N/A - S/O	
Lybra	99-06	FWD							N/A - S/O	N/A - S/O		N/A - S/O	N/A - S/O	
Musa	04-09	FWD							N/A - S/O	N/A - S/O		N/A - S/O	N/A - S/O	
Phedra	02-08	FWD							N/A - S/O	N/A - S/O		N/A - S/O	N/A - S/O	
Thesis	02-09	FWD							OEMA	OEMA		N/A - S/O	N/A - S/O	
Zeta	95-02	FWD							N/A - S/O	N/A - S/O		N/A - S/O	N/A - S/O	
Ypsilon	95-09	FWD							N/A - S/O	N/A - S/O		N/A - S/O	N/A - S/O	
<b>LANDROVER</b>														
Discovery	99-04	4WD	Discovery	99-04	4WD	Discovery	99-04	4WD	N/A - S/O	N/A - S/O		N/A - S/O	N/A - S/O	
Freelander	02-06	4WD	Freelander	02-06	4WD	Freelander	02-06	4WD	81260	OEMA	46	N/A - S/O	81260	46
LR2	05-09	4WD	LR2	05-09	4WD	LR2	05-09	4WD	N/A - S/O	OEMA		N/A - S/O	N/A - S/O	
LR3	05-09	4WD	LR3	05-09	4WD	LR3	05-09	4WD	N/A - S/O	OEMA		OEMA	OEMA	
Range Rover	03-09	4WD	Range Rover	03-09	4WD	Range Rover	03-09	4WD	N/A - S/O	OEMA		N/A - S/O	81280	46
Range Rover	95-02	4WD	Range Rover	95-02	4WD	Range Rover	95-02	4WD	N/A - S/O	N/A - S/O		N/A - S/O	N/A - S/O	
<b>LEXUS</b>														
ES	92-10	FWD	ES	92-10	FWD	ES	92-10	FWD	81270	OEMA	46	N/A - S/O	81290	46
ES	90-91	FWD	ES	90-91	FWD	ES	90-91	FWD	81270	OEMA	46	85690, 85695	81290	54,46
GS	06-10	RWD/AWD	GS	06-10	RWD/AWD	GS	06-10	RWD/AWD	OEMA	OEMA		N/A - S/O	OEMA	
GS	98-05	RWD	GS	98-05	RWD	GS	98-05	RWD	OEMA 67510	OEMA	47	72270	OEMA 72270	52 52
GS	93-97	RWD	GS	93-97	RWD	GS	93-97	RWD	OEMA	OEMA		72270	OEMA 72270	52 52
GX	03-10	AWD	GX	03-10	AWD	GX	03-10	AWD	N/A - S/O	N/A - S/O		OEMA 25480	OEMA 25480	52
HS-Hybrid	10-10	FWD	HS-Hybrid	10-10	FWD	HS-Hybrid	10-10	FWD	OEMA	OEMA		N/A - S/O	81290	46
IS	06-10	RWD/AWD	IS	06-10	RWD/AWD	IS	06-10	RWD/AWD	N/A - S/O	OEMA		N/A - S/O	N/A - S/O	
IS	01-05	RWD	IS	01-05	RWD	IS	01-05	RWD	OEMA 67515	OEMA	47	N/A - S/O	OEMA 67525	53
IS-F	08-10	RWD	IS-F	08-10	RWD	IS-F	08-10	RWD	N/A - S/O	OEMA		N/A - S/O	N/A - S/O	
LS	90-09	RWD/AWD	LS	90-09	RWD/AWD	LS	90-09	RWD/AWD	N/A - S/O	OEMA		OEMA	OEMA	
LX	08-10	AWD	LX	08-10	AWD	LX	08-10	AWD	N/A - S/O	N/A - S/O		OEMA	OEMA	
LX-470	98-07	AWD	LX-470	98-07	AWD	LX-470	98-07	AWD	N/A - S/O	N/A - S/O		OEMA	OEMA	
LX-450	96-97	AWD	LX-450	96-97	AWD	LX-450	96-97	AWD	N/A - S/O	N/A - S/O		N/A - S/O	N/A - S/O	
RX	10-10	FWD/AWD	RX	10-10	FWD/AWD	RX	10-10	FWD/AWD	N/A - S/O	OEMA		N/A - S/O	81290	46

APPLICATIONS

**ALIGNMENT FOOTNOTES**

**BOLD PART NUMBER INDICATES PREFERRED**

**CORRECTION METHOD**

(1), (2), (3), (4), (5), (6), (7), (8), (9), (10), (11), (12) See page 41

N/A = No Available Adjuster

OEMA = Original Equipment Manufacturer Adjustment

(\*) = Series P/N, for correct size • □ = Go to Website for more

**All products available from Specialty Products Company are intended for use by professional installers only.**

EUROPE			CENTRAL/SOUTH AMERICA			ASIA/AUSTRALIA			REAR			FRONT		
Make	Year	Drive	Make	Year	Drive	Make An	Year	Drive	Rear Camber	Rear Toe	Page	Front Caster	Front Camber	Page

**LEXUS - CONTINUED**

RX	99-09	FWD/ AWD	RX	99-09	FWD/ AWD	RX	99-09	FWD/ AWD	81270	OEMA	46	N/A - S/O	81290	46
SC	02-10	RWD	SC	02-10	RWD	SC	02-10	RWD	OEMA	OEMA		OEMA	OEMA	
SC	92-01	RWD	SC	92-01	RWD	SC	92-01	RWD	OEMA	OEMA		OEMA	OEMA	

**LINCOLN**

			Aviator	03-05	RWD/ 4WD				86180	OEMA	47	86140	86140	47
			Blackwood/ EXT	02-03	RWD/ 4WD				N/A - S/O	N/A - S/O		OEMA 86250	OEMA 86250	47
			Continental	95-02	FWD				OEMA	OEMA		OEMA	OEMA	
			Continental	88-94	FWD				N/A - S/O	OEMA		OEMA	OEMA	
			Continental	82-87	RWD				N/A - S/O	N/A - S/O		N/A - S/O	OEMA 81280	46
			LS	00-06	RWD				N/A - S/O	OEMA		OEMA 87545	OEMA 87545	47
			MKS	09-10	FWD/ AWD				OEMA	OEMA		N/A - S/O	OEMA	
			Mark LT	06-09	RWD/ 4WD				N/A - S/O	N/A - S/O		OEMA 86250	OEMA 86250	47
			Mark VII	84-92	RWD				N/A - S/O	N/A - S/O		N/A - S/O	OEMA 81280	46
			Mark VIII	93-98	RWD				OEMA	OEMA		OEMA	OEMA	
			MKX	07-10	FWD/ AWD				OEMA	OEMA		N/A - S/O	81280	46
			MKZ	07-10	FWD/ AWD				OEMA	OEMA		N/A - S/O	67115	53
			Navigator	07-10	RWD/ 4WD				OEMA	OEMA		OEMA 86250	OEMA 86250	47
			Navigator	03-06	RWD/ 4WD				86680	OEMA	47	86640	86640	47
			Navigator	98-02	RWD/ 4WD				N/A - S/O	N/A - S/O		87385	87385	47
			Town Car	03-10	RWD				N/A - S/O	N/A - S/O		OEMA	OEMA	
			Town Car	91-02	RWD				N/A - S/O	N/A - S/O		OEMA	OEMA	
			Town Car	80-90	RWD				N/A - S/O	N/A - S/O		OEMA	OEMA	
			Zephyr	06-06	FWD/ AWD				OEMA	OEMA		N/A - S/O	67115	53

**MAZDA**

323	98-02		323	98-02		323	98-02		81250	OEMA	46	N/A - S/O	OEMA 81250	46
323	95-97		323	95-97		323	95-97		81250	OEMA	46	N/A - S/O	OEMA 81250	46
323	86-94	FWD/ AWD	323	86-94	FWD/ AWD	323	86-94	FWD/ AWD	81250	OEMA	46	N/A - S/O	OEMA 81250	46
626	83-02	FWD	626	83-02	FWD	626	83-02	FWD	81250	OEMA	46	OEMA	OEMA 81250	46
626	79-82	RWD	626	79-82	RWD	626	79-82	RWD	N/A - S/O	N/A - S/O		N/A - S/O	N/A - S/O	
929	88-91	RWD	929	88-91	RWD	929	88-91	RWD	N/A - S/O	OEMA		OEMA	OEMA 81250	46
B-Series Pickup	98-09	RWD/ 4WD	B-Series Pickup	98-09	RWD/ 4WD	B-Series Pickup	98-09	RWD/ 4WD	N/A - S/O	N/A - S/O		87310 87500	87310 87500	47
B-Series Pickup	94-97	RWD/ 4WD	B-Series Pickup	94-97	RWD/ 4WD	B-Series Pickup	94-97	RWD/ 4WD	N/A - S/O	N/A - S/O		23180* 24180	23180* 24180	50 51
CX-7	07-10	FWD/ AWD	CX-7	07-10	FWD/ AWD	CX-7	07-10	FWD/ AWD	N/A - S/O	OEMA		OEMA	OEMA 81260	46
CX-9	07-10	FWD/ AWD	CX-9	07-10	FWD/ AWD	CX-9	07-10	FWD/ AWD	OEMA	OEMA		N/A - S/O	81260	46
Mazda2/ 121/Demio	07-09	FWD	Mazda2/ 121/Demio	07-09	FWD	Mazda2/ 121/Demio	07-09	FWD	75800(1)	75800(1)	45	N/A - S/O	81250	46

APPLICATIONS

EUROPE			CENTRAL/SOUTH AMERICA			ASIA/AUSTRALIA			REAR			FRONT		
Make	Year	Drive	Make	Year	Drive	Make An	Year	Drive	Rear Camber	Rear Toe	Page	Front Caster	Front Camber	Page

**MAZDA - CONTINUED**

Mazda2/121/Demio	02-06	FWD	Mazda2/121/Demio	02-06	FWD	Mazda2/121/Demio	02-06	FWD	75400(1)	75400(1)	45	N/A - S/O	OEMA	
Mazda2/121/Demio	96-01	FWD	Mazda2/121/Demio	96-01	FWD	Mazda2/121/Demio	96-01	FWD	N/A - S/O	N/A - S/O		N/A - S/O	OEMA	
Mazda2/121/Demio	92-95	FWD	Mazda2/121/Demio	92-95	FWD	Mazda2/121/Demio	92-95	FWD	N/A - S/O	N/A - S/O		N/A - S/O	OEMA	
Mazda2/121/Demio	88-91	FWD	Mazda2/121/Demio	88-91	FWD	Mazda2/121/Demio	88-91	FWD	N/A - S/O	N/A - S/O		N/A - S/O	N/A - S/O	
Mazda3	04-10	FWD	Mazda3	04-10	FWD	Mazda3	04-10	FWD	67420	OEMA	42	N/A - S/O	N/A - S/O	
Mazda5	06-10	FWD	Mazda5	06-10	FWD	Mazda5	06-10	FWD	67420	OEMA	42	N/A - S/O	N/A - S/O	
Mazda6	09-10	FWD/AWD	Mazda6	09-10	FWD/AWD	Mazda6	09-10	FWD/AWD	N/A - S/O	OEMA		N/A - S/O	N/A - S/O	
Mazda6	03-08	FWD/AWD	Mazda6	03-08	FWD/AWD	Mazda6/Atenza	03-08	FWD/AWD	OEMA	OEMA		N/A - S/O	67115	53
MX-5	90-10	RWD	MX-5	90-10	RWD	MX-5	90-10	RWD	OEMA	OEMA		OEMA	OEMA	
Millenia	95-02	FWD	Millenia	95-02	FWD	Millenia	95-02	FWD	OEMA	OEMA		N/A - S/O	OEMA	
						MPV,Mazda8	07-10	FWD	N/A - S/O	OEMA		N/A - S/O	OEMA	
MPV	89-07	2WD/AWD	MPV	89-07	2WD/AWD	MPV	89-07	2WD/AWD	N/A - S/O	N/A - S/O		OEMA	OEMA	46
													81250	
MX-6	88-97	FWD	MX-6	88-97	FWD	MX-6	88-97	FWD	81250	OEMA	46	OEMA	OEMA	46
													81250	
Navajo	91-94	RWD/4WD	Navajo	91-94	RWD/4WD	Navajo	91-94	RWD/4WD	N/A - S/O	N/A - S/O		23180*	23180*	50
												24180	24180	51
Pickup	86-93	RWD/4WD	Pickup	86-93	RWD/4WD	Pickup	86-93	RWD/4WD	N/A - S/O	N/A - S/O		OEMA(5)	OEMA(5)	
Protégé/Protégé 5	90-04	FWD/AWD	Protégé/Protégé 5	90-04	FWD/AWD	Protégé/Protégé 5	90-04	FWD/AWD	81250	OEMA	46	OEMA	OEMA	46
													81250	
RX7	93-96	RWD	RX7	93-96	RWD	RX7	93-96	RWD	OEMA	OEMA		OEMA	OEMA	
RX7	86-92	RWD	RX7	86-92	RWD	RX7	86-92	RWD	N/A - S/O	OEMA		OEMA	OEMA	46
													81250	
RX7	80-85	RWD	RX7	80-85	RWD	RX7	80-85	RWD	N/A - S/O	N/A - S/O		OEMA	OEMA	
RX8	04-10	RWD	RX8	04-10	RWD	RX8	04-10	RWD	OEMA	OEMA		OEMA	OEMA	
						Spiano	02-10	FWD/AWD	N/A - S/O	N/A - S/O		N/A - S/O	81250	46
Tribute	01-10	FWD/AWD	Tribute	01-10	FWD/AWD	Tribute	01-10	FWD/AWD	N/A - S/O	OEMA		OEMA	OEMA	46
													81250	
Tribute	01-08	FWD/AWD	Tribute	01-08	FWD/AWD	Tribute	01-08	FWD/AWD	67280	OEMA		OEMA	OEMA	46
													81250	
						Verisa	04-10	FWD	N/A - S/O	N/A - S/O		N/A - S/O	N/A - S/O	

**MERCEDES-BENZ**

A-Class	98-10	FWD	A-Class	98-10	FWD	A-Class	98-10	FWD	N/A - S/O	N/A - S/O		OEMA	OEMA	
C-Class-C300, C350	08-10	RWD/AWD	C-Class-C300, C350	08-10	RWD/AWD	C-Class-C300, C350	08-10	RWD/AWD	N/A - S/O	N/A - S/O		N/A - S/O	N/A - S/O	
C-Class-C220, C230, C280	01-07	RWD/AWD	C-Class-C220, C230, C280	01-07	RWD/AWD	C-Class-C220, C220,C230,C280	01-07	RWD/AWD	28840	OEMA	44	N/A - S/O	81260	46
C-Class-C220, C230, C280	94-00	RWD/AWD	C-Class-C220, C230, C280	94-00	RWD/AWD	C-Class-C220, C230, C280	94-00	RWD/AWD	28840	OEMA	44	OEMA	OEMA	
C-Class	82-93	RWD/AWD	C-Class	82-93	RWD/AWD	C-Class	82-93	RWD/AWD	N/A - S/O	OEMA		OEMA	OEMA	
CL-500 Coupe	00-10	RWD	CL-500 Coupe	00-10	RWD	CL-500 Coupe	00-10	RWD	N/A - S/O	OEMA		OEMA	OEMA	
CLK Series-320,430,Cabrio	94-09	RWD	CLK Series-320,430,Cabrio	94-09	RWD	CLK Series-320,430,Cabrio	94-09	RWD	28840	OEMA	44	OEMA	OEMA	
CLS	06-10	RWD	CLS	06-10	RWD	CLS	06-10	RWD	N/A - S/O	OEMA		OEMA	OEMA	

**ALIGNMENT FOOTNOTES**

**BOLD PART NUMBER INDICATES PREFERRED**

**CORRECTION METHOD**

(1), (2), (3), (4), (5), (6), (7), (8), (9), (10), (11), (12) See page 41

N/A = No Available Adjuster

OEMA = Original Equipment Manufacturer Adjustment

(\*) = Series P/N, for correct size •  = Go to Website for more

**All products available from Specialty Products Company are intended for use by professional installers only.**

EUROPE			CENTRAL/SOUTH AMERICA			ASIA/AUSTRALIA			REAR			FRONT		
Make	Year	Drive	Make	Year	Drive	Make An	Year	Drive	Rear Camber	Rear Toe	Page	Front Caster	Front Camber	Page

**MERCEDES-BENZ - CONTINUED**

E-Class-320, 300, 430, 420	03-09	RWD/AWD	E-Class-320, 300, 430, 420	03-09	RWD/AWD	E-Class-320, 300, 430, 420	03-09	RWD/AWD	N/A - S/O	N/A - S/O		N/A - S/O	N/A - S/O	
E-Class-320, 300, 430, 420	96-02	RWD/AWD	E-Class-320, 300, 430, 420	96-02	RWD/AWD	E-Class-320, 300, 430, 420	96-02	RWD/AWD	28840	OEMA	44	OEMA	OEMA	
E-Class	86-95	RWD/AWD	E-Class	86-95	RWD/AWD	E-Class	86-95	RWD/AWD	28840	OEMA	44	OEMA	OEMA	
G-Class	02-10	AWD	G-Class	02-10	AWD	G-Class	02-10	AWD	N/A - S/O	OEMA		OEMA	OEMA	
ML320-ML430	98-10	AWD	ML320-ML430	98-10	AWD	ML320-ML430	98-10	AWD	N/A - S/O	N/A - S/O		N/A - S/O	N/A - S/O	
R-Class	06-10		R-Class	06-10		R-Class	06-10		OEMA	OEMA		N/A - S/O	OEMA	
S-Class-S430, S500	99-10		S-Class-S430, S500	99-10		S-Class-S430, S500	99-10		N/A - S/O	OEMA		N/A - S/O	N/A - S/O	
SL-Class-SL-500, SL-600	03-10		SL-Class-SL-500, SL-600	03-10		SL-Class-SL-500, SL-600	03-10		N/A - S/O	OEMA		OEMA	OEMA	
SL-Class	99-02		SL-Class	99-02		SL-Class	99-02		28840	OEMA	44	OEMA	OEMA	
SL-Class	89-98		SL-Class	89-98		SL-Class	89-98		N/A - S/O	OEMA		OEMA	OEMA	
SLK	06-10		SLK	06-10		SLK	06-10		28840	OEMA	44	OEMA	OEMA	
SLK	98-05		SLK	98-05		SLK	98-05		28840	OEMA	44	OEMA	OEMA	
Sprinter Van	07-10	RWD							N/A - S/O	N/A - S/O		N/A - S/O	81280	46
Sprinter Van	03-06	RWD							N/A - S/O	N/A - S/O		35075, 35076	35075, 35076	

**MERCURY**

			Capri	91-94	RWD				81250	OEMA	46	OEMA	OEMA 81250	46
			Capri	79-86	RWD				N/A - S/O	N/A - S/O		N/A - S/O	OEMA 81280	46
			Comet	69-77	RWD				N/A - S/O	N/A - S/O		OEMA	OEMA 83160	47
			Cougar	99-02	FWD				N/A - S/O	OEMA		89675	89675	54
			Cougar	89-97	RWD				OEMA	OEMA		OEMA	OEMA	
			Cougar	80-88	RWD				N/A - S/O	N/A - S/O		N/A - S/O	OEMA 81280	46
			Cougar	67-79	RWD				N/A - S/O	N/A - S/O		OEMA	OEMA 83160	47
			Grand Marquis & SW	83-10	RWD				N/A - S/O	N/A - S/O		OEMA	OEMA	
			LN-7	82-85	FWD				81250	OEMA	46	N/A - S/O	N/A - S/O	
			Lynx	86-87	FWD				81250	OEMA	46	N/A - S/O	N/A - S/O	
			Lynx	81-85	FWD				81250	OEMA	46	N/A - S/O	N/A - S/O	
			Marauder	03-04	RWD				N/A - S/O	N/A - S/O		OEMA	OEMA	
			Mariner	09-10	FWD/AWD				N/A - S/O	OEMA		OEMA	OEMA 81250	46
			Mariner	05-08	FWD/AWD				67280	OEMA	42	OEMA	OEMA 81250	46
			Marquis	83-86	RWD				N/A - S/O	N/A - S/O		N/A - S/O	OEMA 81280	46
			Milan	06-10	FWD/AWD				OEMA	OEMA		N/A - S/O	67115	53
			Monarch	75-80	RWD				N/A - S/O	N/A - S/O		OEMA	OEMA 83160	47
			Montego	05-07	FWD/AWD				N/A - S/O	OEMA		N/A - S/O	OEMA	
			Montego	66-71	RWD				N/A - S/O	N/A - S/O		OEMA	OEMA 83160	47
			Monterey	04-07	FWD				N/A - S/O	N/A - S/O		OEMA	OEMA 89685	
			Mountaineer	06-10	RWD/4WD				OEMA	OEMA		OEMA	OEMA	
			Mountaineer	02-05	RWD/4WD				86180	OEMA	47	86140	86140	47
			Mountaineer	96-01	RWD/4WD				N/A - S/O	N/A - S/O		87310 87500	87310 87500	47
			Mystique	95-00	FWD				N/A - S/O	OEMA		89675	89675	54

APPLICATIONS

EUROPE			CENTRAL/SOUTH AMERICA			ASIA/AUSTRALIA			REAR			FRONT		
Make	Year	Drive	Make	Year	Drive	Make An	Year	Drive	Rear Camber	Rear Toe	Page	Front Caster	Front Camber	Page

### MERCURY - CONTINUED

			Sable	08-09	FWD/AWD				N/A - S/O	OEMA		N/A - S/O	OEMA	
			Sable Sedan	96-06	FWD				87330	OEMA 87330		OEMA	OEMA 89635	
			Sable Sedan	86-95	FWD				87330	OEMA 87330		OEMA	OEMA	
			Sable Wagon	96-05	FWD				87350	OEMA		OEMA	OEMA 89635	
			Sable Wagon	86-95	FWD				87350	OEMA 87340		OEMA	OEMA	
			Topaz	86-94	FWD/AWD				81250	OEMA	46	N/A - S/O	N/A - S/O	
			Topaz	84-85	FWD/AWD				81250	N/A - S/O	46	N/A - S/O	N/A - S/O	
			Tracer	97-99	FWD				81250	N/A - S/O	46	N/A - S/O	OEMA 81250	46
			Tracer	95-96	FWD				81250	OEMA	46	OEMA	OEMA 81250	46
			Tracer	91-94	FWD				81250	OEMA 67070	46	OEMA	OEMA 81250	46
			Tracer	87-90	FWD				81250	OEMA	46	N/A - S/O	OEMA 81250	46
			Villager	93-02	FWD				75400(1)	75400(1)	45	N/A - S/O	81250	46
			Zephyr	78-83	RWD				N/A - S/O	N/A - S/O		N/A - S/O	OEMA 81280	46

### MINI

Cooper/Cooper S/Conv.	07-10	FWD	Cooper/Cooper S/Conv.	07-10	FWD	R55/R56	07-10	FWD	67610	N/A - S/O	42	67630	67630	54
Cooper/Cooper S/Conv.	03-06	FWD	Cooper/Cooper S/Conv.	03-06	FWD	R50/R52/R53	03-06	FWD	67610	N/A - S/O	42	67620	67620	54

### MITSUBISHI

3000 GT	91-99	FWD/AWD				3000 GT	91-99	FWD/AWD	OEMA	OEMA		N/A - S/O	OEMA 81250	46
Carisma	96-04	FWD							OEMA	OEMA		N/A - S/O	81250	46
Colt	04-10	FWD				Colt	04-10	FWD	N/A - S/O	N/A - S/O		N/A - S/O	N/A - S/O	
						Diamante	97-04	FWD	<b>73600</b> 73620(8) 73400+ 73415(7)	OEMA	47 47 44 44	N/A - S/O	81250	46
						Diamante	92-96	FWD/AWD	OEMA	OEMA		N/A - S/O	81250	46
Eclipse	00-05	2WD	Eclipse	00-05	2WD	Eclipse	06-10	FWD	OEMA	OEMA		N/A - S/O	81280	46
Eclipse			Eclipse			Eclipse	00-05	FWD	<b>73600</b> 73620(8) 73400+ 73415(7)	OEMA	47 47 44 44	N/A - S/O	81280	46
Eclipse	95-99	FWD/AWD	Eclipse	95-99	FWD/AWD	Eclipse	95-99	FWD/AWD	<b>73600</b> 73620(8) 73400+ 73415(7)	OEMA	47 47 44 44	N/A - S/O	<b>67170</b> 67370(8)	53 53
Eclipse	90-94	FWD	Eclipse	90-94	FWD	Eclipse	90-94	FWD	N/A - S/O	N/A - S/O		N/A - S/O	81250	46
Eclipse	90-94	AWD	Eclipse	90-94	AWD	Eclipse	90-94	AWD	OEMA	OEMA		N/A - S/O	81250	46

### ALIGNMENT FOOTNOTES

**BOLD PART NUMBER INDICATES PREFERRED CORRECTION METHOD**

(1), (2), (3), (4), (5), (6), (7), (8), (9), (10), (11), (12) See page 41

N/A = No Available Adjuster

OEMA = Original Equipment Manufacturer Adjustment

(\*) = Series P/N, for correct size • = Go to Website for more

**All products available from Specialty Products Company are intended for use by professional installers only.**

EUROPE			CENTRAL/SOUTH AMERICA			ASIA/AUSTRALIA			REAR			FRONT		
Make	Year	Drive	Make	Year	Drive	Make An	Year	Drive	Rear Camber	Rear Toe	Page	Front Caster	Front Camber	Page

**MITSUBISHI - CONTINUED**

						Endeavor	04-10	FWD/AWD	OEMA	OEMA		N/A - S/O	81280	46
						Expo	92-96	FWD/AWD	N/A - S/O	OEMA		N/A - S/O	81250	46
Galant	04-10	FWD	Galant	04-10	FWD	Galant	04-10	FWD	OEMA	OEMA		N/A - S/O	81280	46
Galant	99-03	FWD/AWD	Galant	99-03	FWD/AWD	Galant	99-03	FWD/AWD	<b>73600</b> 73620(8) 73400+ 73415(7)	OEMA	47 44 44	N/A - S/O	81280	46
Galant	94-98	FWD/AWD	Galant	94-98	FWD/AWD	Galant	94-98	FWD/AWD	<b>73600</b> 73620(8) 73400+ 73415(7)	OEMA	47 47 44 44	N/A - S/O	<b>67170</b> 67370(8)	53 53
Galant	85-93	FWD	Galant	85-93	FWD	Galant	85-93	FWD	N/A - S/O	N/A - S/O		N/A - S/O	81250	46
Grandis	04-10	FWD	Grandis	04-10	FWD	Grandis	04-10	FWD	N/A - S/O	OEMA		N/A - S/O	N/A - S/O	
Lancer	08-10	FWD/AWD	Lancer	08-10	FWD/AWD	Lancer/Fortis	08-10	FWD/AWD	N/A - S/O	OEMA		N/A - S/O	81260	46
Lancer Evolution	08-10	AWD	Lancer Evolution	08-10	AWD	Lancer Evolution	08-10	AWD	OEMA	OEMA		N/A - S/O	81260	46
Lancer/EVO/Sportback	02-06	AWD	Lancer/EVO/Sportback	02-06	AWD	Lancer/EVO/Sportback	02-06	AWD	OEMA	OEMA		N/A - S/O	81260	46
Lancer	92-01	FWD/AWD				Lancer	92-01	FWD/AWD	N/A - S/O	N/A - S/O		N/A - S/O	81250	46
						Mirage/Coupe	94-03	FWD	OEMA	OEMA		N/A - S/O	81250	46
						Mirage	85-93	FWD/AWD	N/A - S/O	N/A - S/O		N/A - S/O	81250	46
Shogun/Pajero	01-09	RWD/4WD	Shogun/Pajero	01-09	RWD/4WD	Shogun/Pajero	01-09	RWD/4WD	OEMA	OEMA		OEMA(5)	OEMA(5)	
Shogun/Pajero Sport	01-08	RWD/4WD	Shogun/Pajero Sport	01-08	RWD/4WD	Shogun/Pajero Sport	01-08	RWD/4WD	N/A - S/O	N/A - S/O		OEMA	OEMA	
Sigma	91-96	FWD							OEMA	OEMA		N/A - S/O	81250	46
Space Runner	91-02	FWD/AWD							N/A - S/O	OEMA		N/A - S/O	81250	46
Space Star	98-05	FWD	Space Star	98-05	FWD				OEMA	OEMA		N/A - S/O	81250	46

**OPAL - SEE VOYEZ VEA - VAUXHALL/OPAL**

**NISSAN**

1600	78-81	RWD	1600	78-81	RWD	1600	78-81	RWD	N/A - S/O	N/A - S/O		N/A - S/O	N/A - S/O	
240 Z	71-73	RWD	240 Z	71-73	RWD	240 Z	71-73	RWD	N/A - S/O	N/A - S/O		N/A - S/O	83115	
260 Z	74-74	RWD	260 Z	74-74	RWD	260 Z	74-74	RWD	N/A - S/O	N/A - S/O		N/A - S/O	83115	
280 Z	75-78	RWD	280 Z	75-78	RWD	280 Z	75-78	RWD	N/A - S/O	N/A - S/O		N/A - S/O	83115	
280 ZX	79-83	RWD	280 ZX	79-83	RWD	280 ZX	79-83	RWD	N/A - S/O	N/A - S/O		N/A - S/O	83115	
300 ZX	90-96	RWD	300 ZX	90-96	RWD	300 ZX	90-96	RWD	OEMA 67765	OEMA 67765	43	N/A - S/O	83115	
300 ZX	84-89	RWD	300 ZX	84-89	RWD	300 ZX	84-89	RWD	N/A - S/O	OEMA		N/A - S/O	83115	
350Z	03-09	RWD	350Z	03-09	RWD	350Z/Skyline	03-09	RWD	OEMA 72050 <b>72055</b>	OEMA 72050 <b>72055</b>	42 47	72125	72125	52
370Z	09-10	RWD	370Z	09-10	RWD	370Z	09-10	RWD	OEMA 72260 <b>72265</b>	OEMA 72260 <b>72265</b>	42 47	72130	72130	52
810	77-83	RWD	810	77-83	RWD	810	77-83	RWD	N/A - S/O	N/A - S/O		N/A - S/O	83115	
Aprio	04-08	FWD							71860*	OEMA	44	N/A - S/O	N/A - S/O	
			Armada	04-10	RWD/4WD				OEMA	OEMA		87520	87520	47
Cabstar/Atlas	87-10	RWD							N/A - S/O	N/A - S/O		OEMA(5)	OEMA(5)	
			Lucino	94-98	RWD				N/A - S/O	N/A - S/O		N/A - S/O	81250	46
						Fuga	06-10	RWD/AWD	OEMA 72280 <b>72265</b>	OEMA 72280 <b>72265</b>	42 47	72130	72130	52
						Fuga	03-05	RWD/AWD	OEMA	OEMA		N/A - S/O	N/A - S/O	

APPLICATIONS

EUROPE			CENTRAL/SOUTH AMERICA			ASIA/AUSTRALIA			REAR			FRONT		
Make	Year	Drive	Make	Year	Drive	Make An	Year	Drive	Rear Camber	Rear Toe	Page	Front Caster	Front Camber	Page
<b>NISSAN - CONTINUED</b>														
Maxima	04-10	FWD	Maxima	04-10	FWD	Maxima/Cefiro	04-10	FWD	OEMA	OEMA		N/A - S/O	81260	46
Maxima	95-03	FWD	Maxima	95-03	FWD	Maxima/Cefiro	95-03	FWD	N/A - S/O	N/A - S/O		N/A - S/O	81260	46
Maxima	85-94	FWD	Maxima	85-94	FWD	Maxima/Bluebird	85-94	FWD	67010	OEMA	42	N/A - S/O	81250	46
Maxima	82-84	RWD	Maxima	82-84	RWD	Maxima	82-84	RWD	N/A - S/O	N/A - S/O		N/A - S/O	83115	46
Micra/March	03-10	FWD	Micra/March	03-10	FWD	Micra/March	03-10	FWD	75200(1)	75200(1)	45	N/A - S/O	81250	46
Micra/March	93-02	FWD	Micra/March	93-02	FWD	Micra/March	93-02	FWD	N/A - S/O	N/A - S/O		N/A - S/O	81250	46
Micra/March	88-92	FWD	Micra/March	88-92	FWD	Micra/March	88-92	FWD	N/A - S/O	N/A - S/O		N/A - S/O	N/A - S/O	
Murano	03-10	FWD/AWD	Murano	03-10	FWD/AWD	Murano	03-10	FWD/AWD	OEMA	OEMA		N/A - S/O	81260	46
Navara	05-10	RWD/4WD	Frontier	05-10	RWD/4WD	Frontier	05-10	RWD/4WD	N/A - S/O	N/A - S/O		87520	87520	47
Navara	98-04	RWD/4WD	Frontier	98-04	RWD/4WD	Frontier	98-04	RWD/4WD	N/A - S/O	N/A - S/O		OEMA	OEMA	
Note/Tiida	06-10	FWD	Tiida	06-10	FWD	Tiida/Latio	06-10	FWD	75800 +73415(7)	75800 +73415(7)	45 44	N/A - S/O	81260	46
Patrol (Y61)	98-10	4WD	Patrol (Y61)	98-10	4WD	Patrol (Y61)	98-10	4WD	N/A - S/O	N/A - S/O		N/A - S/O	N/A - S/O	
Patrol (Y60)	92-99	4WD	Patrol (Y60)	92-99	4WD	Patrol (Y60)	92-99	4WD	N/A - S/O	N/A - S/O		N/A - S/O	N/A - S/O	
Pickup	86-97	RWD/4WD	Pickup	86-97	RWD/4WD	Pickup	86-97	RWD/4WD	N/A - S/O	N/A - S/O		35080*	35080*	49
Platina	01-10	FWD				Platina	01-10	FWD	71860*	OEMA	44	N/A - S/O	N/A - S/O	
Primera	03-08	FWD				Primera	03-08	FWD	N/A - S/O	N/A - S/O		N/A - S/O	N/A - S/O	
Primera	97-02	FWD				Primera	97-02	FWD	N/A - S/O	N/A - S/O		N/A - S/O	N/A - S/O	
Primera	91-96	FWD				Primera	91-96	FWD	81250	OEMA	46	N/A - S/O	N/A - S/O	
Qashqui	07-10	FWD/AWD				Dualis	07-10	FWD/AWD	OEMA	OEMA		N/A - S/O	N/A - S/O	
						Silvia (S15)	99-02	RWD	OEMA 67775, 67776	OEMA 67740	43,42	67720	OEMA 81250	43 46
Silvia/ 200SX (S14)	95-00	RWD	240 SX	95-98	RW	Silvia/ 200SX (S14)	95-00	RWD	OEMA 67775, 67776	OEMA 67740	43,42	67720	OEMA 81250	43 46
Silvia/ 200SX (S13)	89-94	RWD	240 SX	89-94	RWD	Silvia (S13)	89-94	RWD	OEMA 67765	OEMA 67740	43,42	67720	OEMA 81250	43 46
Silvia/200SX	84-88	RWD	200 SX	84-88	RWD	Silvia/200SX	84-88	RWD	N/A - S/O	OEMA		N/A - S/O	83115	46
Silvia/200SX	80-83	RWD	200 SX	80-83	RWD	Silvia/200SX	80-83	RWD	N/A - S/O	N/A - S/O		N/A - S/O	N/A - S/O	
Sunny/ Almera/100NX	07-10	FWD	Tsuru/Sunny	07-10	FWD	Sunny	07-10	FWD	71730*	71720*	44	N/A - S/O	81260	46
Sunny/ Almera/100NX	95-06	FWD	Tsuru/Sunny	95-06	FWD	Sunny	95-06	FWD	N/A - S/O	N/A - S/O		N/A - S/O	81250	46
Sunny/ Almera/100NX	87-94	FWD	Tsuru/Sunny	87-94	FWD	Sunny	87-94	FWD	81250	OEMA	46	N/A - S/O	OEMA 81250	46
Sunny/ Almera/100NX	83-86	FWD	Tsuru/Sunny	83-86	FWD	Sunny	83-86	FWD	N/A - S/O	N/A - S/O		N/A - S/O	81250	46
Sunny	78-82	RWD	Sunny	78-82	RWD	Sunny	78-82	RWD	N/A - S/O	N/A - S/O		N/A - S/O	N/A - S/O	
Sunny	71-73	RWD	Sunny	71-73	RWD	Sunny	71-73	RWD	N/A - S/O	N/A - S/O		N/A - S/O	N/A - S/O	
Terrano	05-10	RWD/4WD	Terrano	05-10	RWD/4WD	Terrano	05-10	RWD/4WD	OEMA	OEMA		87520	87520	47
Terrano	96-04	RWD/4WD	Terrano	96-04	RWD/4WD	Terrano	96-04	RWD/4WD	N/A - S/O	N/A - S/O		N/A - S/O	81260	46
Terrano	87-95	RWD/4WD	Terrano	87-95	RWD/4WD	Terrano	87-95	RWD/4WD	N/A - S/O	N/A - S/O		35080*	35080*	49
			Titan	04-10	RWD/4WD				N/A - S/O	N/A - S/O		87520	87520	47
Vanette	86-01								N/A - S/O	N/A - S/O		N/A - S/O	N/A - S/O	
X-Trail	08-10	FWD/AWD	X-Trail	08-10	FWD/AWD	X-Trail	08-10	FWD/AWD	N/A - S/O	OEMA		N/A - S/O	81260	46

**ALIGNMENT FOOTNOTES****BOLD PART NUMBER INDICATES PREFERRED CORRECTION METHOD**

(1), (2), (3), (4), (5), (6), (7), (8), (9), (10), (11), (12) See page 41

N/A = No Available Adjuster

OEMA = Original Equipment Manufacturer Adjustment

(\*) = Series P/N, for correct size • □ = Go to Website for more

**All products available from Specialty Products Company are intended for use by professional installers only.**



EUROPE			CENTRAL/SOUTH AMERICA			ASIA/AUSTRALIA			REAR			FRONT		
Make	Year	Drive	Make	Year	Drive	Make An	Year	Drive	Rear Camber	Rear Toe	Page	Front Caster	Front Camber	Page
<b>OLDSMOBILE</b>														
			442 - 'A' Body	64-72	RWD				N/A - S/O	N/A - S/O		OEMA(5) 94324, 94325 94320 (8) 94344 (Lower)	OEMA(5) 94324, 94325 94320 (8)	57 57 57
			88	86-99	FWD				81280	OEMA	46	OEMA	81280	46
			88,98	80-96	RWD				N/A - S/O	N/A - S/O		OEMA(5)	OEMA(5)	
			88 'B' Body	78-82	RWD				N/A - S/O	N/A - S/O		OEMA(5) 94378	OEMA(5)	57
			88 'B' Body	71-77	RWD							94340 94378 (Lower)	94340	57 57
			98	85-99	FWD				81280	OEMA	46	OEMA	81280	46
			Achieva	96-98	FWD				75400(1)	75400(1)	45	N/A - S/O	81260	46
			Achieva	92-95	FWD				75400(1)	75400(1)	45	N/A - S/O	81280	46
			Alero	99-04	FWD				81250	OEMA	46	N/A - S/O	81260	46
			Aurora	95-03	FWD				75800(1)	OEMA 75800(1)	45 45	OEMA	81280	46
			Bravada	02-04	FWD/ AWD				N/A - S/O	N/A - S/O		N/A - S/O	OEMA	
			Bravada	95-01	FWD/ AWD				N/A - S/O	N/A - S/O		OEMA(5)	OEMA(5)	
			Calais	85-91	FWD				75400(1)	75400(1)	45	N/A - S/O	81280	46
			Ciera	82-96	FWD				75800(1)	75800(1)	45	N/A - S/O	82110	47
			Custom Cruiser	80-96	RWD				N/A - S/O	N/A - S/O		OEMA(5)	OEMA(5)	
			Custom Cruiser	82-96	FWD				75800(1)	75800(1)	45	N/A - S/O	82110	47
			Cutlass	97-99	FWD				81250	OEMA	46	N/A - S/O	81260	46
			Cutlass	82-96	FWD				75800(1)	75800(1)	45	N/A - S/O	82110	47
			Cutlass Supreme	88-97	FWD				81280	OEMA	46	N/A - S/O	N/A - S/O	
			Cutlass & Cutless Sprme -'G' Body	78-88	RWD				N/A - S/O	N/A - S/O		OEMA(5) 94330, 94331 94332 (8) 95336 (Lower)	OEMA(5) 94330, 94331 94332 (8)	57 57 57
			Cutlass & Cutless Sprme -'A' Body	73-77	RWD				N/A - S/O	N/A - S/O		OEMA(5) 94340 94378 (Lower)	OEMA(5) 94340	57 57
			Cutlass & Cutless Sprme -'A' Body	64-72	RWD				N/A - S/O	N/A - S/O		OEMA(5) 94324, 94325 94320 (8) 94344 (Lower)	OEMA(5) 94324, 94325 94320 (8)	57 57 57
			Firenza	82-89	FWD				75400(1)	75400(1)	45	N/A - S/O	81280	46
			Intrigue	97-02	FWD				81260	OEMA	46	N/A - S/O	81260	46
			LSS	96-99	FWD				81280	OEMA	46	OEMA	81280	46
			Omega	80-85	FWD				75400(1)	75400(1)	45	N/A - S/O	82110	47
			Omega 'X' Body	75-79	RWD				N/A - S/O	N/A - S/O		OEMA(5) 94340 94378 (Lower)	OEMA(5) 94340	57 57
			Omega 'X' Body	75-79	RWD									
			Regency	97-99	FWD				81280	OEMA	46	OEMA	81280	46
			Silhouette	02-03	AWD				OEMA	OEMA		N/A - S/O	81260	46
			Silhouette	97-04	FWD				75800(1)	75800(1)	45	N/A - S/O	81260	46
			Silhouette	90-96	FWD				75800(1)	75800(1)	45	N/A - S/O	82110	47
			Toronado	86-92	FWD				75800(1)	OEMA 75800(1)	45 45	OEMA	OEMA 81280	46
			Toronado	78-85	FWD				75800(1)	OEMA 75800(1)	45 45	OEMA	OEMA	
			Trofeo	88-92	FWD				75800(1)	OEMA 75800(1)	45 45	OEMA	81280	46
<b>PEUGEOT</b>														
106	96-03	FWD	106	96-03	FWD	106	96-03	FWD	N/A - S/O	N/A - S/O		N/A - S/O	N/A - S/O	
107	05-10	FWD	107	05-10	FWD	107	05-10	FWD	N/A - S/O	N/A - S/O		N/A - S/O	N/A - S/O	
1007	05-09	FWD	1007	05-09	FWD	1007	05-09	FWD	N/A - S/O	N/A - S/O		N/A - S/O	N/A - S/O	
206	98-06	FWD	206	98-06	FWD	206	98-06	FWD	N/A - S/O	N/A - S/O		N/A - S/O	N/A - S/O	
207	06-10	FWD	207	06-10	FWD	207	06-10	FWD	N/A - S/O	N/A - S/O		N/A - S/O	N/A - S/O	

APPLICATIONS

EUROPE			CENTRAL/SOUTH AMERICA			ASIA/AUSTRALIA			REAR			FRONT		
Make	Year	Drive	Make	Year	Drive	Make An	Year	Drive	Rear Camber	Rear Toe	Page	Front Caster	Front Camber	Page
<b>PEUGEOT - CONTINUED</b>														
306	97-02	FWD	306	97-02	FWD	306	97-02	FWD	N/A - S/O	N/A - S/O		N/A - S/O	N/A - S/O	
307	01-08	FWD	307	01-08	FWD	307	01-08	FWD	71850*	71850*	44	N/A - S/O	N/A - S/O	
407	04-10	FWD	407	04-10	FWD	407	04-10	FWD	N/A - S/O	N/A - S/O		N/A - S/O	N/A - S/O	
4007	08-10	FWD/AWD	4007	08-10	FWD/AWD	4007	08-10	FWD/AWD	N/A - S/O	N/A - S/O		N/A - S/O	N/A - S/O	
406	96-04	FWD	406	96-04	FWD	406	96-04	FWD	N/A - S/O	N/A - S/O		N/A - S/O	N/A - S/O	
605	90-99	FWD	605	90-99	FWD	605	90-99	FWD	N/A - S/O	N/A - S/O		N/A - S/O	N/A - S/O	
607	00-10	FWD	607	00-10	FWD	607	00-10	FWD	N/A - S/O	N/A - S/O		N/A - S/O	N/A - S/O	
806	94-01	FWD	806	94-01	FWD	806	94-01	FWD	N/A - S/O	N/A - S/O		N/A - S/O	81250	464
807	02-10	FWD	807	02-10	FWD	807	02-10	FWD	N/A - S/O	N/A - S/O		N/A - S/O	N/A - S/O	
Expert	95-10	FWD	Expert	95-10	FWD	Expert	95-10	FWD	N/A - S/O	N/A - S/O		N/A - S/O	N/A - S/O	
Boxer	94-10	FWD	Boxer	94-10	FWD	Boxer	94-10	FWD	N/A - S/O	N/A - S/O		N/A - S/O	N/A - S/O	
Partner	97-10	FWD	Partner	97-10	FWD	Partner	97-10	FWD	N/A - S/O	N/A - S/O		N/A - S/O	N/A - S/O	
<b>PLYMOUTH</b>														
			All Passenger Car Models	60-73	RWD				N/A - S/O	N/A - S/O		OEMA 83160	OEMA 83160	47
			All Passenger B & E Bodies	62-64	RWD				N/A - S/O	N/A - S/O		94450, 94451	94450, 94451	57
			Acclaim	89-94	FWD				75200(1)	75200(1)	45	N/A - S/O	OEMA 83170	47
			Barracuda	70-74	RWD				N/A - S/O	N/A - S/O		OEMA 94450, 94451	OEMA 94450, 94451	57
			Belvedere	65-70	RWD				N/A - S/O	N/A - S/O		OEMA 94450, 94451	OEMA 94450, 94451	57
			Breeze	96-00	FWD				OEMA	OEMA		N/A - S/O	67180 87470	42
			Caravelle	84-88	FWD				75200(1)	75200(1)	45	N/A - S/O	OEMA 83170	47
			Colt Vista	85-96	4WD				N/A - S/O	OEMA		OEMA	81250	46
			Colt Vista	92-94	FWD				N/A - S/O	OEMA		N/A - S/O	81250	46
			Colt Vista	84-91	FWD				N/A - S/O	N/A - S/O		N/A - S/O	81250	46
			Conquest	88-89	RWD				N/A - S/O	N/A - S/O		N/A - S/O	N/A - S/O	
			Grand Fury	65-89	RWD				N/A - S/O	N/A - S/O		OEMA	OEMA	
			GTX	67-71	RWD				N/A - S/O	N/A - S/O		OEMA 94450, 94451	OEMA 94450, 94451	57
			Horizon	78-90	FWD				75200(1)	75200(1)	45	N/A - S/O	OEMA 83170	47
			Laser	92-94	AWD				OEMA	OEMA		N/A - S/O	81250	46
			Laser	89-94	FWD				N/A - S/O	N/A - S/O		N/A - S/O	81250	46
			Neon, Neon R/T	94-01	FWD				<b>81250</b>	OEMA 67210	46 42	N/A - S/O	81260	46
			Prowler	97-01	RWD				N/A - S/O	N/A - S/O		OEMA	OEMA	
			Road Runner	68-72	RWD				N/A - S/O	N/A - S/O		OEMA 94450, 94451	OEMA 94450, 94451	57
			Reliant	81-89	FWD				75200(1)	75200(1)	45	N/A - S/O	OEMA 83170	47
			Sapporo	80-83	RWD				N/A - S/O	N/A - S/O		N/A - S/O	N/A - S/O	
			Satellite	65-72	RWD				N/A - S/O	N/A - S/O		OEMA 94450, 94451	OEMA 94450, 94451	57
			Scamp	82-85	FWD				75200(1)	75200(1)	45	N/A - S/O	OEMA 83170	47
			Sundance	87-94	FWD				75200(1)	75200(1)	45	N/A - S/O	OEMA 83170	47

### ALIGNMENT FOOTNOTES

**BOLD PART NUMBER INDICATES PREFERRED CORRECTION METHOD**

(1), (2), (3), (4), (5), (6), (7), (8), (9), (10), (11), (12) See page 41

N/A = No Available Adjuster

OEMA = Original Equipment Manufacturer Adjustment

(\*) = Series P/N, for correct size •  = Go to Website for more

**All products available from Specialty Products Company are intended for use by professional installers only.**

EUROPE			CENTRAL/SOUTH AMERICA			ASIA/AUSTRALIA			REAR			FRONT		
Make	Year	Drive	Make	Year	Drive	Make An	Year	Drive	Rear Camber	Rear Toe	Page	Front Caster	Front Camber	Page
<b>PLYMOUTH - CONTINUED</b>														
			TC3, Turismo	79-87	FWD				75200(1)	75200(1)	45	N/A - S/O	OEMA 83170	47
			Valiant	72-76	RWD				N/A - S/O	N/A - S/O		OEMA 94460, 94461	OEMA 94460, 94461	57
			Voyager w/ABS	96-01	FWD/ AWD				N/A - S/O	N/A - S/O		N/A - S/O	OEMA 83170	47
			Voyager w/o ABS	96-01	FWD				71730*	71720*	44	N/A - S/O	OEMA 81260	56
			Voyager	84-95	FWD				75400(1)	75400(1)	45	N/A - S/O	OEMA 83170	47
<b>PONTIAC</b>														
			1000	76-87	RWD				N/A - S/O	N/A - S/O		OEMA	OEMA	
			2000 Sunbird	82-94	FWD				75400(1)	75400(1)	45	N/A - S/O	81280	46
			6000/A	82-91	FWD				75800(1)	75800(1)	45	N/A - S/O	82110	47
			Aztec	01-06	AWD				OEMA	OEMA		N/A - S/O	81260	46
			Aztec	01-06	FWD				75800(1)	75800(1)	45	N/A - S/O	81260	46
			Bonneville	00-06	FWD				75800(1)	75800(1)	45 45	N/A - S/O	81280	46
			Bonneville	87-99	FWD				81280	OEMA	46	OEMA	81280	46
			Bonneville - 'B' Body	82-86	RWD				N/A - S/O	N/A - S/O		OEMA(5) 94330, 94331 94332 (8) 95336 (Lower)	OEMA(5) 94330, 94331 94332 (8)	57 57 57
			Bonneville - 'B' Body	77-81	RWD				N/A - S/O	N/A - S/O		OEMA(5) 94378 (Lower)	OEMA(5)	57
			Bonneville - 'B' Body	71-76	RWD				N/A - S/O	N/A - S/O		OEMA(5) 94340 94378 (Lower)	OEMA(5) 94340	57 57
			Catalina	65-86	RWD				N/A - S/O	N/A - S/O		OEMA(5)	OEMA(5)	
			Fiero	84-88	RWD				82110	OEMA	47	OEMA	OEMA	
			Firebird	93-02	RWD				N/A - S/O	N/A - S/O		OEMA	OEMA	
			Firebird	82-92	RWD				N/A - S/O	N/A - S/O		OEMA	OEMA 81280	46
			Firebird - 'F' Body	70-81	RWD				N/A - S/O	N/A - S/O		OEMA(5) 94340 94378 (Lower)	OEMA(5) 94340	57 57
			Firebird - 'F' Body	67-69	RWD				N/A - S/O	N/A - S/O		OEMA(5) 94305 94374 (Lower)	OEMA(5) 94305	57 57
			G3/Wave	05-10	FWD				75200(1)	75200(1)	45	N/A - S/O	81250	46
			G5	07-09	FWD				75400(1)	75400(1)	45	N/A - S/O	81250	46
			G6	05-09	FWD				OEMA	OEMA		N/A - S/O	81250	46
			G8	08-09	RWD				OEMA	OEMA		N/A - S/O	81260	46
			Firefly	85-92	FWD				N/A - S/O	N/A - S/O		N/A - S/O	81250	46
			Grand Am	04-05	FWD				81250	OEMA	46	N/A - S/O	81260	46
			Grand Am	99-03	FWD				81250	OEMA	46	N/A - S/O	81250	46
			Grand Am	96-98	FWD				75400(1)	75400(1)	45	N/A - S/O	81260	46
			Grand Am	88-95	FWD				75400(1)	75400(1)	45	N/A - S/O	81280	46
			Grand Am- 'G' Body	78-80	RWD				N/A - S/O	N/A - S/O		OEMA(5) 94330, 94331 94332 (8) 95336 (Lower)	OEMA(5) 94330, 94331 94332 (8)	57 57 57
			Grand Am- 'A' Body	73-75	RWD				N/A - S/O	N/A - S/O		OEMA(5) 94340 94378 (Lower)	OEMA(5) 94340	57 57
			Grand Prix	97-08	FWD				81260	OEMA	46	N/A - S/O	81260	46
			Grand Prix	95-96	FWD				81280	OEMA	46	N/A - S/O	N/A - S/O	
			Grand Prix	88-94	FWD				81280	OEMA	46	N/A - S/O	N/A - S/O	
			Grand Prix - 'G' Body	78-87	RWD				N/A - S/O	N/A - S/O		OEMA(5) 94330, 94331 94332 (8) 95336 (Lower)	OEMA(5) 94330, 94331 94332 (8)	57 57 57

APPLICATIONS

EUROPE			CENTRAL/SOUTH AMERICA			ASIA/AUSTRALIA			REAR			FRONT		
Make	Year	Drive	Make	Year	Drive	Make An	Year	Drive	Rear Camber	Rear Toe	Page	Front Caster	Front Camber	Page

**PONTIAC - CONTINUED**

			Grand Prix - 'A' Body	73-77	RWD				N/A - S/O	N/A - S/O		OEMA(5) 94340 94378 (Lower)	OEMA(5) 94340	57 57
			Grand Prix	65-72	RWD				N/A - S/O	N/A - S/O		OEMA(5)	OEMA(5)	
			GTO	04-06	RWD				N/A - S/O	OEMA		OEMA	OEMA 81260	46
			GTO - 'A' Body	64-72	RWD				N/A - S/O	N/A - S/O		OEMA(5) 94324, 94325 94320 (8) 94344 (Lower)	OEMA(5) 94324, 94325 94320 (8)	57 57 57
			LeMans	88-94	FWD				N/A - S/O	N/A - S/O		N/A - S/O	N/A - S/O	
			LeMans - 'G' Body	78-81	RWD				N/A - S/O	N/A - S/O		OEMA(5) 94330, 94331 94332 (8) 95336 (Lower)	OEMA(5) 94330, 94331 94332(8)	57 57 57
			LeMans - 'A' Body	73-77	RWD				N/A - S/O	N/A - S/O		OEMA(5) 94340 94378 (Lower)	OEMA(5) 94340	57 57
			LeMans - 'A' Body	64-72	RWD				N/A - S/O	N/A - S/O		OEMA(5) 94324, 94325 94320 (8) 94344 (Lower)	OEMA(5) 94324, 94325 94320 (8)	57 57 57
			Montana/SV6	97-07	FWD				75800(1)	75800(1)	45	N/A - S/O	81260	46
			Montana/SV6	02-07	AWD				OEMA	OEMA		N/A - S/O	81260	46
			Phoenix	80-85	FWD				75400(1)	75400(1)	45	N/A - S/O	82110	47
			Safari SW	80-89	RWD				N/A - S/O	N/A - S/O		OEMA(5)	OEMA(5)	
			Soltice	06-09	RWD				OEMA	OEMA		OEMA	OEMA	
			Sunfire & Tempest	95-06	FWD				75400(1)	75400(1)	45	N/A - S/O	81260	46
			Tempest - 'A' Body	64-70	RWD				N/A - S/O	N/A - S/O		OEMA(5) 94324, 94325 94320 (8) 94344 (Lower)	OEMA(5) 94324, 94325 94320 (8)	57 57 57
			Torrent	06-09	FWD/ AWD				OEMA 87420	OEMA 87420		N/A - S/O	81260	46
			Transport	97-01	FWD				75800(1)	75800(1)	45	N/A - S/O	81260	46
			Transport	90-96	FWD				75800(1)	75800(1)	45	N/A - S/O	82110	47
			Vibe	03-10	FWD				75800(1) +73415	75800(1) +73415	45 44	N/A - S/O	81290	46
			Vibe	03-10	AWD				OEMA	OEMA		N/A - S/O	81290	46

**PORSCHE**

911	80-10	RWD/ AWD	911	80-10	RWD/ AWD	911	80-10	RWD/ AWD	OEMA	OEMA		N/A - S/O	OEMA	
924	80-82	RWD	924	80-82	RWD	924	80-82	RWD	OEMA	OEMA		OEMA	81250	46
924S	87-88	RWD	924S	87-88	RWD	924S	87-88	RWD	OEMA	OEMA		OEMA	81250	46
928	80-96	RWD	928	80-96	RWD	928	80-96	RWD	OEMA	OEMA		OEMA	OEMA	
944	82-91	RWD	944	82-91	RWD	944	82-91	RWD	OEMA	OEMA		OEMA	OEMA 81250	46
968	92-95	RWD	968	92-95	RWD	968	92-95	RWD	OEMA	OEMA		OEMA	OEMA	
Boxster	97-10	RWD	Boxster	97-10	RWD	Boxster	97-10	RWD	OEMA	OEMA		N/A - S/O	OEMA	
Cayenne	04-10	AWD	Cayenne	04-10	AWD	Cayenne	04-10	AWD	OEMA	OEMA		OEMA	OEMA	
Cayman	06-10	RWD	Cayman	06-10	RWD	Cayman	06-10	RWD	OEMA	OEMA		N/A - S/O	OEMA	
Panamera	10-10	RWD/ AWD	Panamera	10-10	RWD/ AWD	Panamera	10-10	RWD/ AWD	OEMA	OEMA		N/A - S/O	OEMA	

**ALIGNMENT FOOTNOTES**

**BOLD PART NUMBER INDICATES PREFERRED**

**CORRECTION METHOD**

(1), (2), (3), (4), (5), (6), (7), (8), (9), (10), (11), (12) See page 41

N/A = No Available Adjuster

OEMA = Original Equipment Manufacturer Adjustment

(\*) = Series P/N, for correct size •  = Go to Website for more

**All products available from Specialty Products Company are intended for use by professional installers only.**

EUROPE			CENTRAL/SOUTH AMERICA			ASIA/AUSTRALIA			REAR			FRONT		
Make	Year	Drive	Make	Year	Drive	Make An	Year	Drive	Rear Camber	Rear Toe	Page	Front Caster	Front Camber	Page
<b>PROTON</b>														
Coupe	95-00	FWD	Coupe	95-00	FWD	Coupe	95-00	FWD	N/A - S/O	N/A - S/O		N/A - S/O	N/A - S/O	
Gen-2	04-10	FWD	Gen-2	04-10	FWD	Gen-2	04-10	FWD	OEMA	OEMA		N/A - S/O	N/A - S/O	
Impian	01-08	FWD	Impian	01-08	FWD	Impian	01-08	FWD	OEMA	OEMA		N/A - S/O	N/A - S/O	
Persona	94-06	FWD	Persona	94-06	FWD	Persona	94-06	FWD	OEMA	OEMA		N/A - S/O	N/A - S/O	
Savvy	05-10	FWD	Savvy	05-10	FWD	Savvy	05-10	FWD	N/A - S/O	N/A - S/O		N/A - S/O	N/A - S/O	
Satria	00-10	FWD	Satria	00-10	FWD	Satria	00-10	FWD	OEMA	OEMA		N/A - S/O	N/A - S/O	
Wira	00-07	FWD	Wira	00-07	FWD	Wira	00-07	FWD	OEMA	OEMA		N/A - S/O	N/A - S/O	
<b>RENAULT</b>														
Clio III	05-10	FWD	Clio III	05-10	FWD	Clio III	05-10	FWD	71860*	N/A - S/O	44	N/A - S/O	N/A - S/O	
Clio II/Thalia	98-04	FWD	Clio II/Thalia	98-04	FWD	Clio II/Thalia	98-04	FWD	71860*	N/A - S/O	44	N/A - S/O	81260	46
Clio I	90-98	FWD	Clio I	90-98	FWD	Clio I	90-98	FWD	N/A - S/O	N/A - S/O		N/A - S/O	81250	46
Espace	03-10	FWD	Espace	03-10	FWD	Espace	03-10	FWD	N/A - S/O	N/A - S/O		N/A - S/O	N/A - S/O	
Espace	97-02	FWD	Espace	97-02	FWD	Espace	97-02	FWD	N/A - S/O	N/A - S/O		N/A - S/O	N/A - S/O	
Espace	91-96	FWD	Espace	91-96	FWD	Espace	91-96	FWD	75400(1)	75400(1)	45	N/A - S/O	N/A - S/O	
Kangoo	98-10	FWD	Kangoo	98-10	FWD	Kangoo	98-10	FWD	N/A - S/O	N/A - S/O		N/A - S/O	81260	46
Koleos	08-10	FWD/AWD	Koleos	08-10	FWD/AWD	Koleos	08-10	FWD/AWD	OEMA	OEMA		N/A - S/O	N/A - S/O	
Logan	04-10	FWD							N/A - S/O	N/A - S/O		N/A - S/O	N/A - S/O	
Laguna II	01-10	FWD	Laguna II	01-10	FWD	Laguna II	01-10	FWD	N/A - S/O	N/A - S/O		N/A - S/O	N/A - S/O	
Laguna	94-00	FWD	Laguna	94-00	FWD	Laguna	94-00	FWD	75200(1)	75200(1)	45	N/A - S/O	81250	46
Megane II	02-10	FWD	Megane II	02-10	FWD	Megane II	02-10	FWD	N/A - S/O	N/A - S/O		N/A - S/O	81260	46
Megane I	95-02	FWD	Megane I	95-02	FWD	Megane I	95-02	FWD	N/A - S/O	N/A - S/O		N/A - S/O	81250	46
Modus	04-10	FWD	Modus	04-10	FWD	Modus	04-10	FWD	N/A - S/O	N/A - S/O		N/A - S/O	N/A - S/O	
R5	85-95	FWD	R5	85-95	FWD	R5	85-95	FWD	N/A - S/O	N/A - S/O		N/A - S/O	81250	46
R9/11	82-89	FWD	R9/11	82-89	FWD	R9/11	82-89	FWD	N/A - S/O	N/A - S/O		N/A - S/O	81250	46
R19	91-00	FWD	R19	91-00	FWD	R19	91-00	FWD	N/A - S/O	N/A - S/O		N/A - S/O	81250	46
R21	89-94	FWD/AWD	R21	89-94	FWD/AWD	R21	89-94	FWD/AWD	N/A - S/O	N/A - S/O		N/A - S/O	81260	46
R25	83-92	FWD	R25	83-92	FWD	R25	83-92	FWD	N/A - S/O	OEMA		N/A - S/O	N/A - S/O	
Safrane	92-01	FWD/AWD	Safrane	92-01	FWD/AWD	Safrane	92-01	FWD/AWD	N/A - S/O	OEMA		N/A - S/O	81280	46
Scenic II/III	03-10	FWD/AWD	Scenic II/III	03-10	FWD/AWD	Scenic II/III	03-10	FWD/AWD	N/A - S/O	N/A - S/O		N/A - S/O	N/A - S/O	
Scenic	97-02	FWD/AWD	Scenic	97-02	FWD/AWD	Scenic	97-02	FWD/AWD	75200(1)	75200(1)	45	N/A - S/O	81260	46
Trafic	01-10	???	Trafic	01-10		Trafic	01-10		N/A - S/O	N/A - S/O		N/A - S/O	N/A - S/O	
Twingo	93-10	FWD	Twingo	93-10	FWD	Twingo	93-10	FWD	75200(1)	75200(1)	45	N/A - S/O	81250	46
Vel Satis	01-10	FWD	Vel Satis	01-10	FWD	Vel Satis	01-10	FWD	OEMA	OEMA		N/A - S/O	N/A - S/O	
<b>ROVER</b>														
25	99-05	FWD	25	99-05	FWD	25	99-05	FWD	75200(1)	75200(1)	45	N/A - S/O	N/A - S/O	
45	99-05	FWD	45	99-05	FWD	45	99-05	FWD	67030 69200	OEMA 69250,69450	42 43,42	N/A - S/O	67135 67330(8)	53 53
75	99-05	FWD	75	99-05	FWD	75	99-05	FWD	N/A - S/O	OEMA		N/A - S/O	N/A - S/O	
200/400	89-94	FWD	200/400	89-94	FWD	200/400	89-94	FWD	67030	OEMA	42	N/A - S/O	N/A - S/O	
200	95-99	FWD	200	95-99	FWD	200	95-99	FWD	75400(1)	75400(1)	45	N/A - S/O	N/A - S/O	
400	95-99	FWD	400	95-99	FWD	400	95-99	FWD	67030 69200	OEMA 69250,69450	42 43,42	N/A - S/O	67135 67330(8)	53 53
600	93-99	FWD	600	93-99	FWD	600	93-99	FWD	67065 67265(8)	OEMA	53 53	84690, 84695	67145 67340(8)	54,53 53
800	91-99	FWD	800	91-99	FWD	800	91-99	FWD	N/A - S/O	OEMA		N/A - S/O	N/A - S/O	
City Rover	03-05	FWD	City Rover	03-05	FWD	City Rover	03-05	FWD	N/A - S/O	N/A - S/O		N/A - S/O	81250	46
MG TF	07-10	RWD	MG TF	07-10	RWD	MG TF	07-10	RWD	N/A - S/O	OEMA		N/A - S/O	N/A - S/O	
MG TF	01-05	RWD	MG TF	01-05	RWD	MG TF	01-05	RWD	N/A - S/O	OEMA		N/A - S/O	N/A - S/O	
MG ZR	01-05	FWD	MG ZR	01-05	FWD	MG ZR	01-05	FWD	N/A - S/O	OEMA		N/A - S/O	N/A - S/O	
MG ZT	01-05	FWD	MG ZT	01-05	FWD	MG ZT	01-05	FWD	N/A - S/O	OEMA		N/A - S/O	N/A - S/O	
Maestro	89-98	FWD	Maestro	89-98	FWD	Maestro	89-98	FWD	N/A - S/O	N/A - S/O		N/A - S/O	81250	46
Montego	89-94	FWD	Montego	89-94	FWD	Montego	89-94	FWD	N/A - S/O	N/A - S/O		N/A - S/O	81250	46
Streetwise	03-05	FWD	Streetwise	03-05	FWD	Streetwise	03-05	FWD	N/A - S/O	OEMA		N/A - S/O	N/A - S/O	

APPLICATIONS

EUROPE			CENTRAL/SOUTH AMERICA			ASIA/AUSTRALIA			REAR			FRONT		
Make	Year	Drive	Make	Year	Drive	Make An	Year	Drive	Rear Camber	Rear Toe	Page	Front Caster	Front Camber	Page
<b>SAAB</b>														
9-2X	05-07	4WD	9-2X	05-07	4WD	9-2X	05-07	4WD	81260 67640	OEMA 67640	46 42	N/A - S/O	81260	46
9(3)	08-10	FWD/ AWD	9(3)	08-10	FWD/ AWD	9(3)	08-10	FWD/ AWD	OEMA	OEMA		N/A - S/O	81250	46
9(3)	03-09	FWD	9(3)	03-09	FWD	9(3)	03-09	FWD	OEMA	OEMA		N/A - S/O	81250	46
9(3)	99-02	FWD	9(3)	99-02	FWD	9(3)	99-02	FWD	N/A - S/O	N/A - S/O		N/A - S/O	N/A - S/O	
9(5)	00-10	FWD	9(5)	00-10	FWD	9(5)	00-10	FWD	N/A - S/O	OEMA		N/A - S/O	81250	46
9-7X	05-09	AWD	9-7X	05-09	AWD	9-7X	05-09	AWD	N/A - S/O	N/A - S/O		N/A - S/O	OEMA	
99	80-80	FWD	99	80-80	FWD	99	80-80	FWD	N/A - S/O	N/A - S/O		OEMA	OEMA	
900	94-99	FWD	900	94-99	FWD	900	94-99	FWD	N/A - S/O	N/A - S/O		N/A - S/O	N/A - S/O	
900	80-93	FWD	900	80-93	FWD	900	80-93	FWD	N/A - S/O	N/A - S/O		OEMA(5)	OEMA(5)	
9000	86-98	FWD	9000	86-98	FWD	9000	86-98	FWD	N/A - S/O	N/A - S/O		N/A - S/O	81250	46
<b>SEAT</b>														
Alhambra	97-10	FWD/ AWD	Alhambra	97-10	FWD/ AWD				N/A - S/O	N/A - S/O		N/A - S/O	N/A - S/O	
Altea(A5)	04-10	FWD	Altea(A5)	04-10	FWD				OEMA	OEMA		N/A - S/O	N/A - S/O	
Arosa	97-05	FWD	Arosa	97-05	FWD				75200(1)	75200(1)	45	N/A - S/O	81250	46
Exeo	09-10	FWD	Exeo	09-10	FWD				N/A - S/O	N/A - S/O		N/A - S/O	N/A - S/O	
Ibiza III/Cordoba II	02-10	FWD	Ibiza III/Cordoba II	02-10	FWD				N/A - S/O	N/A - S/O		N/A - S/O	N/A - S/O	
Ibiza III/Cordoba I	93-01	FWD	Ibiza III/Cordoba I	93-01	FWD				75200(1)	75200(1)	45	N/A - S/O	81250	46
Inca	96-03	FWD	Inca	96-03	FWD				75200(1)	75200(1)	45	N/A - S/O	81250	46
Loen II	05-10	FWD	Loen II	05-10	FWD				N/A - S/O	N/A - S/O		N/A - S/O	N/A - S/O	
Leon I/Toledo II	99-04	FWD	Leon I/Toledo II	99-04	FWD				71530*	71520*	44	81340	81340	46
Toledo III	05-09	FWD	Toledo III	05-09	FWD				N/A - S/O	N/A - S/O		N/A - S/O	N/A - S/O	
Toledo I	91-98	FWD	Toledo I	91-98	FWD				75200(1)	75200(1)	45	N/A - S/O	81250	46
<b>SKODA</b>														
Fabia II	07-10	FWD				Fabia II	07-10	FWD	N/A - S/O	N/A - S/O		N/A - S/O	N/A - S/O	
Fabia	00-06	FWD				Fabia	00-06	FWD	N/A - S/O	N/A - S/O		N/A - S/O	N/A - S/O	
Favorit	89-93	FWD				Favorit	89-93	FWD	75200(1)	75200(1)	45	N/A - S/O	N/A - S/O	
Felicia	94-99	FWD				Felicia	94-99	FWD	75200(1)	75200(1)	45	N/A - S/O	N/A - S/O	
Octavia II	04-10	FWD				Octavia II	04-10	FWD	OEMA	OEMA		N/A - S/O	N/A - S/O	
Octavia	96-03	FWD				Octavia	96-03	FWD	71530*	71520*	44	81340	81340	54
Roomster	06-10	FWD				Roomster	06-10	FWD	N/A - S/O	N/A - S/O		N/A - S/O	N/A - S/O	
Superb	02-10	FWD/ AWD				Superb	02-10	FWD/ AWD	N/A - S/O	N/A - S/O		N/A - S/O	N/A - S/O	
Yeti	10-10	FWD/ AWD				Yeti	10-10	FWD/ AWD	N/A - S/O	N/A - S/O		N/A - S/O	N/A - S/O	
<b>SMART</b>														
Smart	99-01	RWD	Smart	99-01	RWD				N/A - S/O	N/A - S/O		N/A - S/O	N/A - S/O	
Cabrio/Fortwo	01-10	RWD	Cabrio/Fortwo	01-10	RWD				N/A - S/O	N/A - S/O		N/A - S/O	N/A - S/O	
City/Coupe	01-10	RWD	City/Coupe	01-10	RWD				N/A - S/O	N/A - S/O		N/A - S/O	N/A - S/O	
Forfour	04-06	FWD	Forfour	04-06	FWD				N/A - S/O	N/A - S/O		N/A - S/O	N/A - S/O	
Roadster/Coupe	03-06	RWD	Roadster/Coupe	03-06	RWD				N/A - S/O	N/A - S/O		N/A - S/O	N/A - S/O	
<b>SUBARU</b>														
All (except below)	80-94	AWD	All (except below)	80-94	AWD	All (except below)	80-94	AWD	N/A - S/O	OEMA		N/A - S/O	N/A - S/O	
Baja	03-07	AWD	Baja	03-07	AWD	Baja	03-07	AWD	N/A - S/O	OEMA		N/A - S/O	81260	46
Forester	09-10	AWD	Forester	09-10	AWD	Forester	09-10	AWD	N/A - S/O	OEMA		N/A - S/O	81260	46
Forester	98-08	AWD	Forester	98-08	AWD	Forester	98-08	AWD	81260	OEMA	46	N/A - S/O	OEMA 81260	46
Justy	87-94	FWD/ AWD	Justy	87-94	FWD/ AWD	Justy	87-94	FWD/ AWD	N/A - S/O	OEMA		N/A - S/O	N/A - S/O	

### ALIGNMENT FOOTNOTES

**BOLD PART NUMBER INDICATES PREFERRED CORRECTION METHOD**

(1), (2), (3), (4), (5), (6), (7), (8), (9), (10), (11), (12) See page 41

N/A = No Available Adjuster

OEMA = Original Equipment Manufacturer Adjustment

(\*) = Series P/N, for correct size • = Go to Website for more

**All products available from Specialty Products Company are intended for use by professional installers only.**

EUROPE			CENTRAL/SOUTH AMERICA			ASIA/AUSTRALIA			REAR			FRONT		
Make	Year	Drive	Make	Year	Drive	Make An	Year	Drive	Rear Camber	Rear Toe	Page	Front Caster	Front Camber	Page
<b>SUBARU - CONTINUED</b>														
Impreza, WRX	08-10	AWD	Impreza, WRX	08-10	AWD	Impreza, WRX	08-10	AWD	N/A - S/O	OEMA		N/A - S/O	81260	46
Impreza, WRX	93-07	AWD	Impreza, WRX	93-07	AWD	Impreza, WRX	93-07	AWD	81260 67640 (except STI)	OEMA 67640 (except STI)	46 42	N/A - S/O	OEMA 81260	46
Legacy/ Outback/GT	00-10	AWD	Legacy/ Outback/GT	00-10	AWD	Legacy/ Outback/GT	00-10	AWD	N/A - S/O	OEMA		N/A - S/O	81260	46
Legacy/ Outback/SVX	89-99	AWD	Legacy/ Outback/SVX	89-99	AWD	Legacy/	89-99	AWD	81260	OEMA	46	N/A - S/O	OEMA 81260	46
Tribeca	06-10	AWD	Tribeca	06-10	AWD	Tribeca	06-10	AWD	N/A - S/O	OEMA		N/A - S/O	81260	46
<b>SUZUKI</b>														
Aerio/Liana	03-07	FWD/ AWD	Aerio/Liana	03-07	FWD/ AWD	Aerio/Liana	03-07	FWD/ AWD	81250	OEMA	46	N/A - S/O	81250	46
Alto	96-10	FWD	Alto	96-10	FWD	Alto	96-10	FWD	N/A - S/O	N/A - S/O		N/A - S/O	81250	46
Esteem/Baleno	95-07	FWD/ AWD	Esteem/Baleno	95-07	FWD/ AWD	Esteem/Baleno	95-07	FWD/ AWD	81250	OEMA	46	OEMA	81250	46
Forenza/Wagon	04-08	FWD	Forenza/Wagon	04-08	FWD	Forenza/Wagon	04-08	FWD	81250	OEMA	46	N/A - S/O	81250	46
Jimny	98-10	AWD	Jimny	98-10	AWD	Jimny	98-10	AWD	N/A - S/O	N/A - S/O		N/A - S/O	N/A - S/O	
Kizashi	10-10	FWD/ AWD	Kizashi	10-10	FWD/ AWD	Kizashi	10-10	FWD/ AWD	OEMA	OEMA		N/A - S/O	N/A - S/O	
Reno	05-08	FWD	Reno	05-08	FWD	Reno	05-08	FWD	81250	OEMA	46	N/A - S/O	81250	46
Splash	08-10	FWD				Ritz	08-10	FWD	N/A - S/O			OEMA	OEMA	
Swift/Ignis	04-10	FWD	Swift/Ignis	04-10	FWD	Swift/Ignis	04-10	FWD	75200(1)	75200(1)	45	N/A - S/O	81250	46
Swift	89-01	FWD	Swift	89-01	FWD	Swift	89-01	FWD	N/A - S/O	OEMA		OEMA	81250	46
SX4	07-10	FWD/ AWD	SX4	07-10	FWD/ AWD	SX4	07-10	FWD/ AWD	N/A - S/O	OEMA		N/A - S/O	81250	46
Verona	04-08	FWD	Verona	04-08	FWD	Verona	04-08	FWD	N/A - S/O	OEMA		OEMA	81250	46
<b>TATA</b>														
Loadbeta	95-07	RWD							N/A - S/O	N/A - S/O		OEMA	OEMA	
Safari	99-10	FWD/ AWD							N/A - S/O	N/A - S/O		OEMA	OEMA	
<b>TOYOTA</b>														
						Aristo	97-05	RWD	OEMA 67510	OEMA	47	72270	OEMA 72270	52 52
Avensis	03-10	FWD			FWD	Avensis	03-10	FWD	OEMA 67485	OEMA	42	N/A - S/O	81290	46
Avensis	97-02	FWD			FWD	Avensis	97-02	FWD	N/A - S/O	OEMA		N/A - S/O	OEMA	
Avensis Verso /Picnic	03-08	FWD	Avensis Verso/ /Picnic	03-08	FWD	Avensis Verso /Picnic	03-08	FWD	N/A - S/O	N/A - S/O		N/A - S/O	OEMA	
Aygo	06-10	FWD							N/A - S/O	N/A - S/O		N/A - S/O	N/A - S/O	
Camry, Solara Camry Hybrid	92-10	FWD	Camry, Solara Camry Hybrid	92-10	FWD	Camry, Solara Camry Hybrid	92-10	FWD	81270	OEMA	46	N/A - S/O	81290	46
Camry	88-91	FWD/ AWD	Camry	88-91	FWD/ AWD	Camry	88-91	FWD/ AWD	81270	OEMA	46	85690, 85695	81290	54,46
Camry	83-87	FWD/ AWD	Camry	83-87	FWD/ AWD	Camry	83-87	FWD/ AWD	81270	OEMA	46	OEMA 85690, 85695	OEMA 81290	54,46
Carina	96-01	FWD/ AWD							N/A - S/O	OEMA		N/A - S/O	OEMA	
Carina	92-95	FWD/ AWD							N/A - S/O	OEMA		N/A - S/O	N/A - S/O	
Carina	85-91	FWD							81270	OEMA	46	N/A - S/O	81270	46
Celica	00-05	FWD	Celica	00-05	FWD	Celica	00-05	FWD	OEMA 67440	OEMA	42	N/A - S/O	81270	
Celica	86-99	FWD	Celica	86-99	FWD	Celica	86-99	FWD	81270	OEMA	46	N/A - S/O	81270	46
Celica	71-85	RWD	Celica	71-85	RWD	Celica	71-85	RWD	N/A - S/O	N/A - S/O		N/A - S/O	N/A - S/O	

APPLICATIONS

EUROPE			CENTRAL/SOUTH AMERICA			ASIA/AUSTRALIA			REAR			FRONT		
Make	Year	Drive	Make	Year	Drive	Make An	Year	Drive	Rear Camber	Rear Toe	Page	Front Caster	Front Camber	Page
<b>TOYOTA - CONTINUED</b>														
Corolla/Auris	09-10	FWD	Corolla	09-10	FWD	Corolla/Altis	09-10	FWD	N/A - S/O	N/A - S/O		OEMA	81290	46
Corolla/Auris	03-08	FWD	Corolla	03-09	FWD	Corolla/Altis	03-08	FWD	75800(1)+ 73415	75800(1)+ 73415	45 44	OEMA	81270	46
Corolla	88-02	FWD	Corolla	88-02	FWD	Corolla	88-02	FWD	81250	OEMA	46	N/A - S/O	81270	46
Corolla All-Trac	89-92	FWD	Corolla All-Trac	89-92	FWD	Corolla All-Trac	89-92	FWD	N/A - S/O	N/A - S/O		N/A - S/O	81270	46
Hiace	96-10	FWD							N/A - S/O	OEMA		OEMA	OEMA	
iQ	09-10	FWD							N/A - S/O	N/A - S/O		N/A - S/O	81270	46
Landcruiser SW	91-10	4WD	Landcruiser SW	91-10	4WD	Landcruiser SW	91-10	4WD	N/A - S/O	N/A - S/O		OEMA	OEMA	
Landcruiser, Landcruiser SW	65-90	4WD	Landcruiser, Landcruiser SW	65-90	4WD	Landcruiser, Landcruiser SW	65-90	4WD	N/A - S/O	N/A - S/O		88901-88904	88901-88904	56
						Voltz	02-04	FWD	OEMA 75800(1)+ 73415	OEMA 75800(1)+ 73415	45 44	N/A - S/O	81290	46
MR2 Spyder	00-06	RWD	MR2 Spyder	00-06	RWD	MR2 Spyder	00-06	RWD	81270	OEMA	46	OEMA	81270	46
MR2	91-97	RWD	MR2	91-97	RWD	MR2	91-97	RWD	81270	OEMA	46	OEMA	81270	46
MR2	85-90	RWD	MR2	85-90	RWD	MR2	85-90	RWD	OEMA 81250	OEMA	46	OEMA	OEMA 81250	46
Paseo	92-97	FWD	Paseo	92-97	FWD	Paseo	92-97	FWD	N/A - S/O	N/A - S/O		N/A - S/O	81270	46
Previa	00-06	FWD				Previa	00-06		N/A - S/O	N/A - S/O		N/A - S/O	OEMA	
Previa	90-97	RWD/ AWD	Previa	90-97	RWD/ AWD	Previa	90-97	RWD/ AWD	N/A - S/O	N/A - S/O		N/A - S/O	81290	46
Prius	10-10	FWD							75800(1)	75800(1)	45	N/A - S/O	81290	46
Prius	01-09	FWD							75800(1)	75800(1)	45	N/A - S/O	81270	46
RAV4	06-10	FWD/ AWD	RAV4	06-10	FWD/ AWD	RAV4	06-10	FWD/ AWD	N/A - S/O	OEMA		N/A - S/O	81290	46
RAV4	96-05	FWD/ AWD	RAV4	96-05	FWD/ AWD	RAV4	96-05	FWD/ AWD	OEMA	OEMA		N/A - S/O	81270	46
Starlet	96-99	RWD							N/A - S/O	N/A - S/O		N/A - S/O	OEMA	
Starlet	90-95	RWD							N/A - S/O	N/A - S/O		N/A - S/O	N/A - S/O	
Tacoma/Hilux	05-10	4WD	Tacoma/Hilux	05-10	4WD	Tacoma/Hilux	05-10	4WD	N/A - S/O	N/A - S/O		OEMA 25470	OEMA 25470	52
Tacoma/Hilux	86-04	RWD/ 4WD	Tacoma/Hilux	86-04	RWD/ 4WD	Tacoma/Hilux	86-04	RWD/ 4WD	N/A - S/O	N/A - S/O		OEMA	OEMA	
Verso	10-10	FWD							N/A - S/O	N/A - S/O		N/A - S/O	81290	46
Yaris	07-10	FWD	Yaris	07-10	FWD	Yaris/Vitz	07-10	FWD	75800(1)	75800(1)	45	N/A - S/O	81270	46
<b>VAUXHALL-OPEL</b>														
Agila	00-10	FWD	Agila	00-10	FWD				N/A - S/O	N/A - S/O		OEMA	OEMA	
Antara	07-10	AWD	Antara	07-10	AWD				OEMA 87420	OEMA 87420		N/A - S/O	81260	46
Astra-G/H	99-10	FWD	Astra-G/H	99-10	FWD				75400(1)	75400(1)	45	N/A - S/O	81250	46
Astra-F	91-98	FWD	Astra-F	91-98	FWD				75400(1)	75400(1)	45	N/A - S/O	N/A - S/O	
Brava/Midi	98-03	RWD/ 4WD	Brava/Midi	98-03	RWD/ 4WD				N/A - S/O	N/A - S/O		OEMA(5)	OEMA(5)	
Combo-B	02-10	FWD	Combo-B	02-10	FWD				N/A - S/O	N/A - S/O		N/A - S/O	81250	46
Calibra	90-97	FWD/ AWD	Calibra	90-97	FWD/ AWD				N/A - S/O	N/A - S/O		N/A - S/O	81250	46
Corsa D/VXR	06-10	FWD	Corsa D/VXR	06-10	FWD				N/A - S/O	N/A - S/O		N/A - S/O	81250	46
Corsa C	00-07	FWD	Corsa C	00-07	FWD				75200(1)	75200(1)	45	N/A - S/O	81250	46
Corsa B	93-99	FWD	Corsa B	93-99	FWD				N/A - S/O	N/A - S/O		N/A - S/O	81250	46
Corsa A	84-93	FWD	Corsa A	84-93	FWD				75200(1)	75200(1)	45	N/A - S/O	81250	46
Frontera	91-04	RWD/ 4WD	Frontera	91-04	RWD/ 4WD				N/A - S/O	N/A - S/O		OEMA(5)	OEMA(5)	

### ALIGNMENT FOOTNOTES

**BOLD PART NUMBER INDICATES PREFERRED CORRECTION METHOD**

(1), (2), (3), (4), (5), (6), (7), (8), (9), (10), (11), (12) See page 41  
N/A = No Available Adjuster

OEMA = Original Equipment Manufacturer Adjustment

(\*) = Series P/N, for correct size •  = Go to Website for more

**All products available from Specialty Products Company are intended for use by professional installers only.**



EUROPE			CENTRAL/SOUTH AMERICA			ASIA/AUSTRALIA			REAR			FRONT		
Make	Year	Drive	Make	Year	Drive	Make An	Year	Drive	Rear Camber	Rear Toe	Page	Front Caster	Front Camber	Page

**VAUXHALL-OPEL - CONTINUED**

Insignia	08-10	FWD/AWD	Insignia	08-10	FWD/AWD				OEMA	OEMA		N/A - S/O	81250	46
Meriva	02-10	FWD	Meriva	02-10	FWD				N/A - S/O	N/A - S/O		N/A - S/O	81250	46
Monterey	94-98	RWD/4WD	Monterey	94-98	RWD/4WD				N/A - S/O	N/A - S/O		OEMA(5)	OEMA(5)	
Omega	99-03	RWD	Omega	99-03	RWD				N/A - S/O	OEMA		N/A - S/O	81250	46
Omega/Carlton	87-94	RWD	Omega/Carlton	87-94	RWD				N/A - S/O	N/A - S/O		N/A - S/O	81250	46
Sintra	96-99	FWD	Sintra	96-99	FWD				75800(1)	75800(1)	45	N/A - S/O	81260	46
Signum	03-08	FWD	Signum	03-08	FWD				OEMA	OEMA		N/A - S/O	81250	46
Speedster VX220	00-06	RWD	Speedster VX220	00-06	RWD				OEMA	OEMA		OEMA	OEMA	
Tigra	97-10	FWD	Tigra	97-10	FWD				N/A - S/O	N/A - S/O		N/A - S/O	81250	46
Vectra-C	02-09	FWD	Vectra-C	02-09	FWD				N/A - S/O	N/A - S/O		N/A - S/O	81250	46
Vectra-B	95-01	FWD	Vectra-B	95-01	FWD				75400(1)	75400(1)	45	N/A - S/O	81250	46
Vectra-A	88-94	FWD/AWD	Vectra-A	88-94	FWD/AWD				75400(1)	75400(1)	45	N/A - S/O	N/A - S/O	
VXR8	08-10	RWD	VXR8	08-10	RWD				OEMA	OEMA		N/A - S/O	81280	46
Zafira	99-10	FWD	Zafira	99-10	FWD				75400(1)	75400(1)	45	N/A - S/O	81250	46

**VOLKSWAGEN**

Beetle/Conv.	99-10	FWD	Beetle/Conv.	99-10	FWD	Beetle/Conv.	99-10	FWD	71530*	71520*	44	81340	81340	54
Corrado	90-94	FWD	Corrado	90-94	FWD	Corrado	90-94	FWD	75200(1)+ 10408	75200(1)+ 10408	45 45	N/A - S/O	81250	46
Eos(A5)	07-10	FWD	Eos(A5)	07-10	FWD	Eos(A5)	07-10	FWD	OEMA	OEMA		N/A - S/O	N/A - S/O	
EuroVan	93-09	FWD/AWD	EuroVan	93-09	FWD/AWD	EuroVan	93-09	FWD/AWD	N/A - S/O	OEMA		N/A - S/O	OEMA	
Fox	06-10	FWD	Fox	06-10	FWD	Fox	06-10	FWD	N/A - S/O	N/A - S/O		N/A - S/O	81250	46
Golf/Bora	99-06	FWD	Golf/Bora	99-06	FWD	Golf/Bora	99-06	FWD	71530*	71520*	44	81340	81340	54
Golf/Bora	04-06	FWD	Golf/Bora	04-06	FWD	Golf/Bora	04-06	FWD	N/A - S/O	N/A - S/O		81340	81340	54
Golf/Bora/GTI	84-98	FWD	Golf/Bora/GTI	84-98	FWD	Golf/Bora/GTI	84-98	FWD	75200(1)+ 10408	75200(1)+ 10408	45 45	N/A - S/O	81250	46
GTI/Golf/R32(A5)	06-10	FWD	GTI/Golf/R32(A5)	06-10	FWD	GTI/Golf/R32(A5)	06-10	FWD	OEMA	OEMA		N/A - S/O	N/A - S/O	
Jetta/Vento/GLI(A5)	05-10	FWD	Jetta/Vento/GLI(A5)	05-10	FWD	Jetta/Vento/GLI(A5)	05-10	FWD	OEMA	OEMA		N/A - S/O	N/A - S/O	
Jetta/Vento(A4)	99-05	FWD	Jetta/Vento(A4)	99-05	FWD	Jetta/Vento(A4)	99-05	FWD	71530*	71520*	44	81340	81340	54
Jetta/Vento	80-98	FWD	Jetta/Vento	80-98	FWD	Jetta/Vento	80-98	FWD	75200(1)+ 10408	75200(1)+ 10408	45 45	N/A - S/O	81250	46
Lupo	98-05	FWD	Lupo	98-05	FWD	Lupo	98-05	FWD	75200(1)+ 10408	75200(1)+ 10408	45 45	N/A - S/O	81250	46
Passat(B6)	06-10	FWD/AWD	Passat(B6)	06-10	FWD/AWD	Passat(B6)	06-10	FWD/AWD	OEMA	OEMA		N/A - S/O	N/A - S/O	
Passat	01-05	AWD	Passat	01-05	AWD	Passat	01-05	AWD	OEMA	OEMA		N/A - S/O	N/A - S/O	
Passat	98-05	2WD	Passat	98-05	2WD	Passat	98-05	2WD	75800(1)+ 10408	75800(1)+ 10408	45 45	N/A - S/O	N/A - S/O	
Passat	90-97	FWD	Passat	90-97	FWD	Passat	90-97	FWD	75200(1)+ 10408	75200(1)+ 10408	45 45	N/A - S/O	81250	46
Polo III & IV	94-10	FWD	Polo III & IV	94-10	FWD	Polo III & IV	94-10	FWD	75200(1)+ 10408	75200(1)+ 10408	45 45	N/A - S/O	81250	46
Polo I & II	82-93	FWD	Polo I & II	82-93	FWD	Polo I & II	82-93	FWD	75200(1)+ 10408	75200(1)+ 10408	45 45	N/A - S/O	N/A - S/O	
Rabbit(A5)	06-09	FWD	Rabbit(A5)	06-09	FWD	Rabbit(A5)	06-09	FWD	OEMA	OEMA		N/A - S/O	N/A - S/O	
Scirocco	09-10	FWD	Scirocco	09-10	FWD	Scirocco	09-10	FWD	OEMA	OEMA		N/A - S/O	N/A - S/O	
Sharan	95-10	FWD/AWD	Sharan	95-10	FWD/AWD	Sharan	95-10	FWD/AWD	OEMA	OEMA		N/A - S/O	N/A - S/O	
Tiguan (A5)	09-10	AWD	Tiguan (A5)	09-10	AWD	Tiguan (A5)	09-10	AWD	OEMA	OEMA		N/A - S/O	N/A - S/O	
Touran	03-10	FWD	Touran	03-10	FWD	Touran	03-10	FWD	N/A - S/O	OEMA		N/A - S/O	N/A - S/O	
Toureaq/Toureaq 2	04-10	AWD	Toureaq/Toureaq 2	04-10	AWD	Toureaq/Toureaq 2	04-10	AWD	OEMA	OEMA		OEMA	OEMA	

EUROPE			CENTRAL/SOUTH AMERICA			ASIA/AUSTRALIA			REAR			FRONT		
Make	Year	Drive	Make	Year	Drive	Make An	Year	Drive	Rear Camber	Rear Toe	Page	Front Caster	Front Camber	Page
<b>VOLVO</b>														
90 Series	98-00	RWD	90 Series	98-00	RWD	90 Series	98-00	RWD	N/A - S/O	OEMA		OEMA	81250	46
240	80-91	RWD	240	80-91	RWD	240	80-91	RWD	N/A - S/O	N/A - S/O		N/A - S/O	OEMA	
740	85-93	RWD	740	85-93	RWD	740	85-93	RWD	N/A - S/O	N/A - S/O		OEMA	N/A - S/O	
940	85-95	RWD	940	85-95	RWD	940	85-95	RWD	N/A - S/O	N/A - S/O		OEMA	N/A - S/O	
760	83-94	RWD	760	83-94	RWD	760	83-94	RWD	OEMA	OEMA		OEMA	N/A - S/O	
850 GLT	93-97	FWD	850 GLT	93-97	FWD	850 GLT	93-97	FWD	N/A - S/O	OEMA		N/A - S/O	81250	46
960	95-97	RWD	960	95-97	RWD	960	95-97	RWD	OEMA	OEMA		N/A - S/O	81250	46
C30	08-10	FWD	C30	08-10	FWD	C30	08-10	FWD	81310 <b>67420</b>	OEMA	42	N/A - S/O	N/A - S/O	
C70	06-10	FWD	C70	06-10	FWD	C70	06-10	FWD	N/A - S/O	OEMA		N/A - S/O	N/A - S/O	
C70	97-05	FWD	C70	97-05	FWD	C70	97-05	FWD	N/A - S/O	N/A - S/O		N/A - S/O	81250	46
GV Series	87-89	RWD	GV Series	87-89	RWD	GV Series	87-89	RWD	OEMA	OEMA		N/A - S/O	81250	46
S40, V50	04-10	FWD/ AWD	S40, V50	04-10	FWD/ AWD	S40, V50	04-10	FWD/ AWD	81310 <b>67420</b>	OEMA	42	N/A - S/O	N/A - S/O	
S40, V40	00-03	FWD	S40, V40	00-03	FWD	S40, V40	00-03	FWD	OEMA	OEMA		N/A - S/O	81250	46
S60	01-10	RWD/ AWD	S60	01-10	RWD/ AWD	S60	01-10	RWD/ AWD	N/A - S/O	OEMA		N/A - S/O	81260	46
S70, V70	98-00	FWD/ AWD	S70, V70	98-00	FWD/ AWD	S70, V70	98-00	FWD/ AWD	N/A - S/O	OEMA		N/A - S/O	81260	46
S80 Sedan	99-10	RWD/ AWD	S80 Sedan	99-10	RWD/ AWD	S80 Sedan	99-10	RWD/ AWD	N/A - S/O	OEMA		N/A - S/O	81260	46
V70, XC70	08-10	FWD/ AWD	V70, XC70	08-10	FWD/ AWD	V70, XC70	08-10	FWD/ AWD	N/A - S/O	OEMA		N/A - S/O	N/A - S/O	
V70, XC70	02-07	FWD/ AWD	V70, XC70	02-07	FWD/ AWD	V70, XC70	02-07	FWD/ AWD	N/A - S/O	OEMA		N/A - S/O	81260	46
XC-60	09-10	AWD	XC-60	09-10	AWD	XC-60	09-10	AWD	N/A - S/O	OEMA		N/A - S/O	N/A - S/O	
XC-90	03-10	AWD	XC-90	03-10	AWD	XC-90	03-10	AWD	N/A - S/O	OEMA		N/A - S/O	81260	46

**ALIGNMENT FOOTNOTES BOLD PART NUMBER INDICATES PREFERRED CORRECTION METHOD**

(1) = CAUTION: Check for caliper to rotor clearance with disc brakes. Use spacer pak 75970 (pg.45) as necessary to keep caliper centered on rotor • (2) = All EXCEPT RWD 1500  
 (3) = 66010, 66020, 66080, 66085 You will need to measure outer bushing diameter on the most forward arm on the rear suspension • (4) = Check Bolt Length BEFORE Cutting Hole  
 (5) = Shims (pg.48) • (6) = LH Toe Tool for front toe adjustment (pg.60) • (7) = Bolts, 73415, are necessary for changes greater than 3/4" (pg.44) • (8) = Recommended for vehicles lowered more than 1.5"  
 (9) = Will not work on 1988-89 models with welded-in ball joint • (10) = M3 Only, caster will decrease by 2 degrees • (11) = Pinion Angle Adj. Part No. 82370 (pg.47) • (12) = Limited camber range of ±1.0°  
 N/A = No Available Adjuster • OEMA = Original Equipment Manufacturer Adjustment • (\*) = Series P/N, for correct size • SW = Station Wagon • 42 = Go to Website for more • © 2010 Niwot Corp. dba Specialty Products Co.®

**All products available from Specialty Products Company are intended for use by professional installers only.**

## REAR

## EZ ARM™ ADJUSTABLE REAR ARMS

By removing the stock rear control arm and replacing it with the adjustable arm you can adjust alignment angles either positive or negative with the turnbuckle adjuster. These arms can be used on vehicles with stock ride height or vehicles that have been altered for performance.

67010  
67020  
67080  
67210  
67640

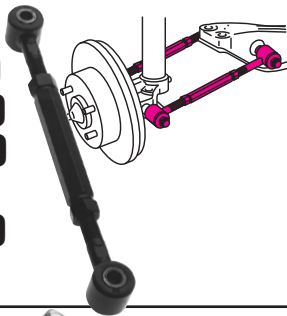

67090  
67095  
67290  
67490  
67570  
67590

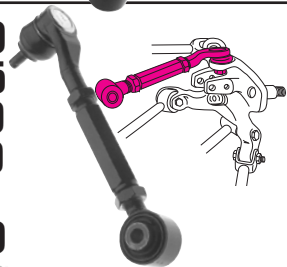

67110  
67270

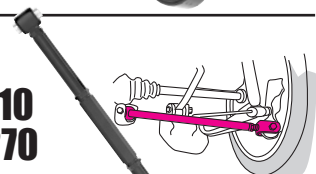

67610  
72110

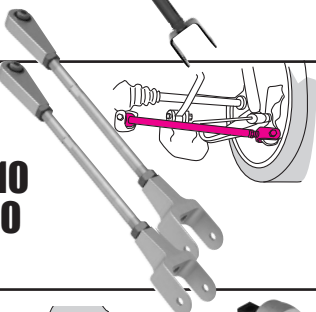

67420  
67440  
67470  
67485

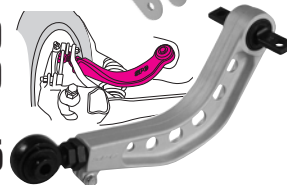

67740  
72050  
72260  
72280

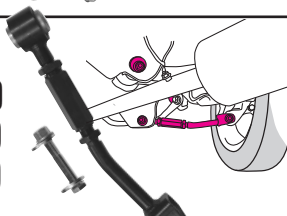

67230  
67430  
67580

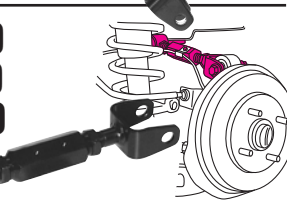

69450  
69460

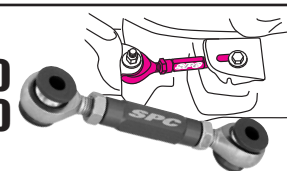

Part #	Required	Rear		Time	Notes
		Camber	Toe		
67010	1/wheel	-2.00° to +2.75°		.8 hr/side	1
67015	1/wheel	±2.50°		.5 hr/side	
67020	1/wheel	-2.00° to +1.00°		.8 hr/side	1
67025	1/wheel	±3.50°		.8 hr/side	
67030	1/wheel	-2.00° to +5.00°		.5 hr/side	
67065	1/wheel	-2.00° to +3.50°		.5 hr/side	2 (67265)
67080	1/wheel	-2.00° to +1.00°		.8 hr/side	1
67090	1/wheel	-2.00° to +4.00°		.5 hr/side	
67095	1/wheel	-2.00° to +4.00°		.5 hr/side	
67110	1/wheel	-1.00° to +3.00°		1.3 hr/side	2 (72110)
67210	1/axle 2/axle	±1.50° ±3.50°	±3.50°	.4 hr/side .4 hr/side	
67230	1/wheel	-4.00° to +6.00°		.5 hr/side	
67265	1/wheel	-2.00° to +3.50°		.5 hr/side	2 (67065)
67270	1/wheel	±4.00°		.8 hr/side	
67280	1/wheel	±4.00°		.5 hr/side	
67290	1/wheel	-2.00° to +4.00°		.5 hr/side	
67395	1/wheel	-2.00° to +4.00°		.5 hr/side	
67410	1/wheel	±2.00°	±2.00	.5 hr/side	
67420	1/wheel	-1.50° to +5.00°		.5 hr/side	
67440	1/wheel	±3.00°		.5 hr/side	
67430	1/wheel	-2.00° to +4.00°		.5 hr/side	
67470	1/wheel	±3.00°		.5 hr/side	
67485	1/wheel	±3.25°		.5 hr/side	3
67490	1/wheel	±2.00°		.5 hr/side	
67545	1/wheel	±1.00°		.3 hr/side	4
67550	1/wheel			.3 hr/side	4
67555	1/wheel	±1.00°		.3 hr/side	4
67570	1/wheel	-2.00° to +4.00°		.5 hr/side	
67580	1/wheel	-2.00° to +4.00°		.5 hr/side	
67590	1/wheel	-2.00° to +4.00°		.5 hr/side	
67610	1/axle	±4.00°		.6 hr/side	
67640	1/wheel	±1.50°	±1.50°	.8 hr/side	
67740	1/wheel	±2.00		.3 hr/side	
67765	1/wheel	±3.00°		1.0 hr/side	4
67775	1/wheel	±3.00°		1.0 hr/side	4
67776	1/wheel	±3.00°		1.0 hr/side	4
69250	1/axle		±2.00	.6 hr/side	
69450	1/axle		±2.00	.5 hr/side	
67460	1/axle		±2.00	.5 hr/side	
72050	1/wheel	±4.00°	±3.00	.6 hr/side	
72110	1/axle	-1.00° to +3.00°		1.3 hr/side	2 (67110)
72260	1/wheel	±4.00°	±3.00	.6 hr/side	
72280	1/wheel	±4.00°	±3.00	.6 hr/side	

1 For greater positive camber install two (2) EZ Arms™ on each side

2 Alternate EZ Arms available

3 Includes factory adjustment

4 Part of multi link set on page 43

## MULTI-LINK ARMS AND SETS

These rear arms provide an increased amount of alignment change on multi-link suspensions. You may need to make several links adjustable to maximize chassis set-up including camber, toe, set-back and tracking. Whether you need alignment changes to adjust for ride height changes, prepare for a weekend of road racing or correct suspension damage, these multi arm sets will provide maximum adjustability.

### REAR

## 67540 SET GROUPE GRUPO

67550 Rear Lateral

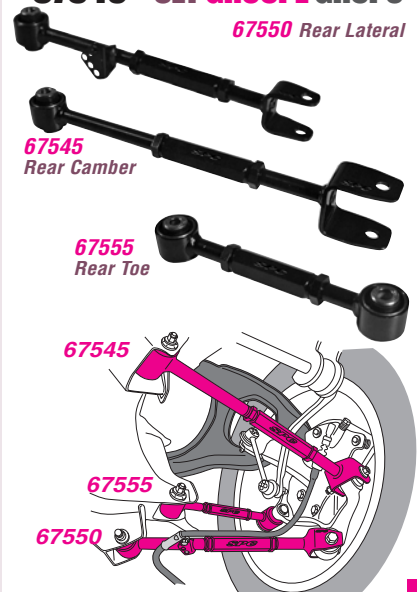

67545 Rear Camber

67555 Rear Toe

67545

67555

67550

Part #	Required	Rear		Time	Notes
		Camber	Toe		
<b>67540</b> Includes	1/wheel	±3.00°	±1.00°	.8 hr/side	1/2
<b>67545</b>	1/wheel	±1.00°		.3 hr/side	
<b>67550</b>	1/wheel			.3 hr/side	2
<b>67555</b>	1/wheel		±1.00°	.3 hr/side	
<b>60765 / 60775</b> Includes	1/axle	±3.00°	±2.00°	1.5 hr/side	3
<b>67720</b>	1/axle			.3 hr/side	3
<b>67740</b>	1/wheel		±2.00°	.3 hr/side	
<b>67765 (60765)</b>	1/wheel	±3.00°		1.0 hr/side	
<b>67775 &amp; 67776 (60775)</b>	1/wheel	±3.00°		1.0 hr/side	

1 See SPC-TV on how to adjust multi link suspensions.

2 Rear Setback ±1.0"

3 Front Caster ±1.50°

## 240SX SET GROUPE GRUPO

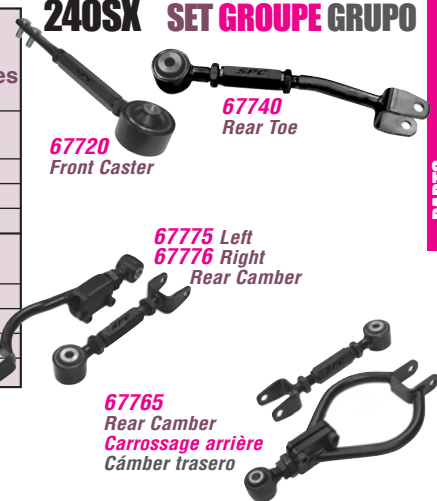

67720 Front Caster

67740 Rear Toe

67775 Left  
67776 Right  
Rear Camber

67765 Rear Camber  
Carrossage arrière  
Cámbier trasero

## REAR LOWER ARMS

These extreme lower control arms are for Honda Civics and Acura Integras and RSXs. Made from aircraft aluminum alloy, these arms are available in a silver finish.

Combined with front and rear camber and toe arms SPC Performance provides the complete alignment solution for lowering your Civic, Del Sol, RSX, or Integra.

## 69100, 69200 69300, 69400

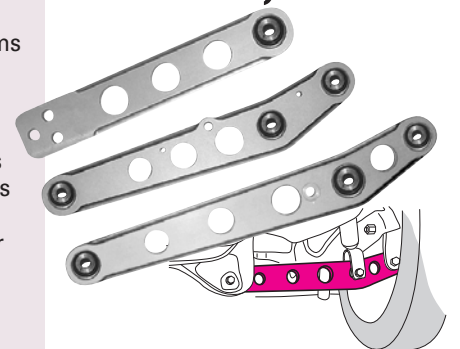

Part #	Required	Time	Notes
<b>69100, 69200</b>	1/axle	.3 hr/side	1
<b>69300, 69400</b>	1/axle	.3 hr/side	2

1 Arm is shorter and affects camber. Must be used with 67030 Arms (page 42)

2 Appearance Only Includes special installation socket

## REAR

**28840**

 **72509** - Press P. 62

**75990** - Sleeves P. 63



## ADJUSTABLE REAR BUSHINGS

These bushings make rear alignment change possible, by replacing the bushings in the rear upper control arms. Stock bushings are easily removed without removing the control arm by using bushing press adapters and a ball joint press.

**66010, 66020**  
**66080, 66085**

**40920**-Press

 P. 62

**66025**-Sleeves

 P. 63



**72185**

 **72509**-Press  
**Presse**

**Prensa** P. 62



Part #	Required	Rear adjustment range	Time	Notes
<b>28840</b>	1/wheel	±1.25° Camber	.6 hr/side	
<b>66010 &amp; 66080</b>	1/wheel	±0.75° Camber	.6 hr/side	<b>1</b>
<b>66020 &amp; 66085</b>	1/wheel	±1.50° Camber	.6 hr/side	<b>1</b>
<b>72185</b>	1/wheel	±1.25° Camber & Toe	.6 hr/side	
<b>87330</b>	1/axle 1	±1.00° Camber & Toe	.5 hr/side	

**1** Bushing Measurement Required - see website.

**71520**

**71530**

**Volkswagen**

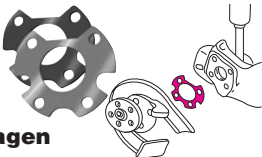

## REAR SHIMS





Correct rear toe and camber with these solid axle shims. One series will affect toe and the other will affect camber, stack the two and you will be able get numerous combinations to bring your angles back into specification.

**73400**

**Chrysler/  
Mitsubishi**

 **73415**  
\* Changes over .75° need #  
73415 Bolts



	Part #	Required	Rear		Time
			Camber	Toe	
<b>Toyota Van Series</b> <b>71020</b> 	<b>71020</b>	1/wheel	±0.06°	±0.06°	.5 hr/side
	<b>71021</b>	1/wheel	±0.13°	±0.13°	.5 hr/side
	<b>71022</b>	1/wheel	±0.25°	±0.25°	.5 hr/side
	<b>71023</b>	1/wheel	±0.38°	±0.38°	.5 hr/side
	<b>71024</b>	1/wheel	±0.50°	±0.50°	.5 hr/side
<b>Volkswagen Series</b> <b>71520</b> <b>71530</b>  <b>87530</b> - Wrench P. 63		1/wheel	±0.13° <b>#71520</b>	+0.50° <b>#71530</b> -0.50° <b>#71532</b>	.5 hr/side
		1/wheel	±0.25° <b>#71521</b>	+1.00° <b>#71531</b> -1.00° <b>#71533</b>	.5 hr/side
		1/wheel	±0.38° <b>#71522</b>		.5 hr/side
		1/wheel	±0.50° <b>#71523</b>		.5 hr/side
		1/wheel			.5 hr/side
<b>Honda Civic Series</b> <b>71640</b> 		1/wheel		+0.13° <b>#71641</b> -0.13° <b>#71645</b>	.5 hr/side
		1/wheel		+0.25° <b>#71642</b> -0.25° <b>#71646</b>	.5 hr/side
		1/wheel		+0.38° <b>#71643</b> -0.38° <b>#71647</b>	.5 hr/side
		1/wheel		+0.50° <b>#71644</b> -0.50° <b>#71648</b>	.5 hr/side
<b>Chrysler Van Series</b> <b>71720</b> <b>71730</b> 		1/wheel	±0.25° <b>#71730</b>	±0.10° <b>#71720</b>	.5 hr/side
		1/wheel	±0.50° <b>#71731</b>	±0.20° <b>#71721</b>	.5 hr/side
		1/wheel	±0.75° <b>#71732</b>	±0.30° <b>#71722</b>	.5 hr/side
		1/wheel	±1.00° <b>#71733</b>	±0.40° <b>#71723</b>	.5 hr/side
		1/wheel		±0.50° <b>#71724</b>	.5 hr/side
<b>Peugeot Series</b> <b>71850</b> 	<b>71851</b>	1/wheel	±0.06°	±0.06°	.5 hr/side
	<b>71852</b>	1/wheel	±0.13°	±0.13°	.5 hr/side
	<b>71853</b>	1/wheel	±0.25°	±0.25°	.5 hr/side
	<b>71854</b>	1/wheel	±0.50°	±0.50°	.5 hr/side
	<b>71855</b>	1/wheel	±0.75°	±0.75°	.5 hr/side
	<b>71856</b>	1/wheel	±1.00°	±1.00°	.5 hr/side
<b>71860</b> <b>Renault Cleo Series</b>	<b>71861</b>	1/wheel	±0.50°	±0.50°	.5 hr/side
	<b>71862</b>	1/wheel	±1.00°	±1.00°	.5 hr/side
<b>73400</b> <b>Chrysler/Mitsubishi*</b>	<b>73400</b>	1/wheel	+0.25° to +0.75°		.3 hr/side

**EZ SHIM™  
FULL CONTACT /  
DUAL ANGLE SHIM**

TÜV approved, this patented Full Contact Dual Angle Shim will correct Toe and Camber with just one shim. There are 3 sizes available to cover many makes and models of front wheel drive cars with solid rear axles. The durable two-piece construction provides  $\pm 1.5^\circ$  of change, accurate to  $.03^\circ$  of toe and  $.10^\circ$  of camber.

**CAUTION:** Check for caliper to rotor clearance when installing this part on vehicles equipped with rear disc brakes. Some vehicles may require the use of longer bolts (#10408-below) or brake caliper spacers (#75970-below).

**REAR**

**75200 - Blue  
75400 - Grey  
75800 - Red**

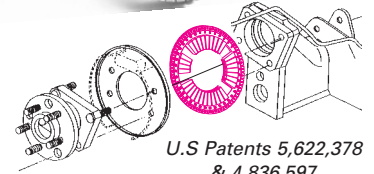

U.S. Patents 5,622,378  
& 4,836,597  
EPO 0695255

**Rear** Adjustment range:  
Camber  $\pm 1.75^\circ$   
Required: 1 per wheel  
Installation time: .4 hr/side

**EZ SHIM™ ACCESSORIES**

**BOLTS**

M10 X 1.5 X 40 Set of 8 Bolts



**10408**

**DIAL CHART**

Dial in the desired change needed for simple shim adjustment. Chart lists changes in decimal degrees only.



**75910**

**CUTTER**

This cutter is a necessary tool for cutting the EZ Shim™. Its thin cutting blades minimize shim breakage.



**75915**

**MARKER**

This will mark the areas to be removed. Marks will not rub off, and are easy to see.



**75920**

**SPACER SET (8)**

This set (4 different sizes – 2 of each) aligns caliper (disc brakes) to rotor after installation of a camber shim.



**75970**

PARTS

**FRONT  
REAR**

Pair	Single	Size
<b>81240</b>	<b>81241</b>	<b>10mm</b>
<b>81250</b>	<b>81251</b>	<b>12mm</b>
<b>81260</b>	<b>81261</b>	<b>14mm</b>
<b>81270</b>	<b>81271</b>	<b>15mm</b>
<b>81280</b>	<b>81281</b>	<b>16mm</b>
<b>81290</b>	<b>81291</b>	<b>17mm</b>

**EZ CAM™ XR -  
CAMBER KITS FOR  
DOMESTIC/ IMPORT  
TWO BOLT STRUTS**

EZ Cam™ XRs are designed for non-slotted struts. They allow both positive and negative camber changes up to approximately 1.75° (depending on vehicle) by replacing the upper O.E. strut/spindle bolt. This easy to use adjuster provides built-in adjustment over the life of a vehicle just by rotating the head of the bolt. Each kit contains two cam bolt assemblies, enough for both sides of the vehicle.

**Front** Adjustment range:  
Camber ±1.75°  
Pair Req. 1 per axle  
Single Req. 1 per wheel  
Installation time: .4 hr/side

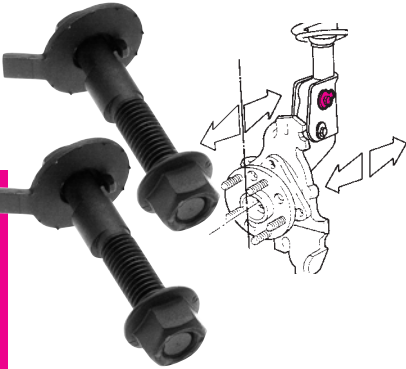

**63020, 63030**



U.S. Patent #5,401,054  
Canadian Patent #2,138,439

**THRUST  
ALIGNMENT PLATE**

Our patented thrust alignment plate will allow for corrections of setback and thrust angle on most vehicles with rear leaf springs. Installation is made by loosening the U-bolts holding the leaf spring to the axle, installing the alignment plate between the axle and leaf spring and re-tightening the U-bolts. Widths are available in 2-3/8" and 3", and each kit comes with multiple parts to provide coverage of most vehicles with rear leaf springs, including all early model passenger cars. **NOTE:** Allow extra time for rusted bolts. New, longer U-Bolts may be required.

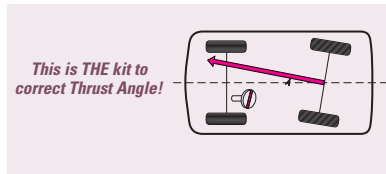

This is THE kit to correct Thrust Angle!

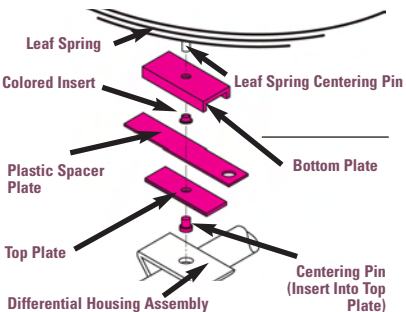

**63020** - 2-3/8" Leaf Spring  
Width 2-3/8" to 2-3/4"  
60mm, 65mm and 70mm  
Small trucks. All passenger vehicles with rear leaf springs.

**63030** - 3" Leaf Spring  
Width 3", 3-1/2" and 3-5/8"  
80mm, 90mm, and 100mm  
Larger Trucks  
Required: 1 kit per axle  
Installation Time: .5 hr/side

PARTS

## CAMBER, CASTER AND TOE ADJUSTING CAMS AND BOLTS

Cams in combination with bolts and cam guides provide easy change and positive lock for alignment angle changes in the front and rear of many passenger vehicles and trucks.

The eccentric design of SPC cams maximize the change available. In order to maximize change on some kits, elongating the O.E. slots by removing O.E. slugs with a punch (SPC No. 74910) or rotary file (SPC No. 85127) may be necessary.

### DELANTERA TRASERA

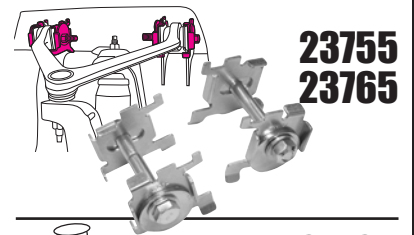

**23755**  
**23765**

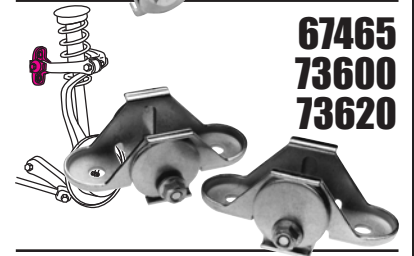

**67465**  
**73600**  
**73620**

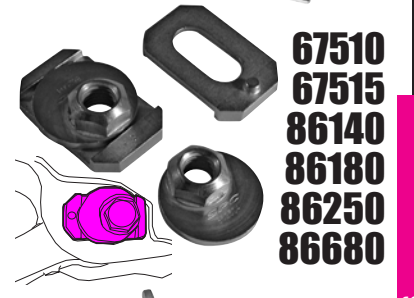

**67510**  
**67515**  
**86140**  
**86180**  
**86250**  
**86680**

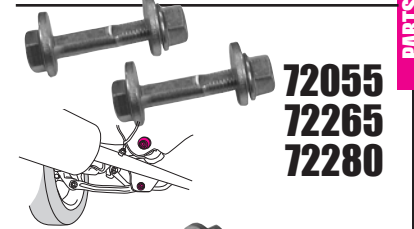

**72055**  
**72265**  
**72280**

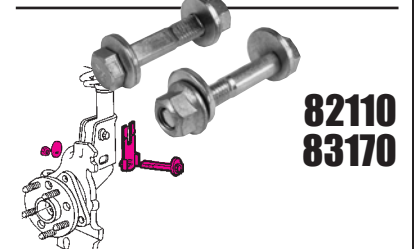

**82110**  
**83170**

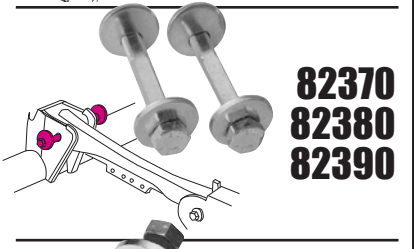

**82370**  
**82380**  
**82390**

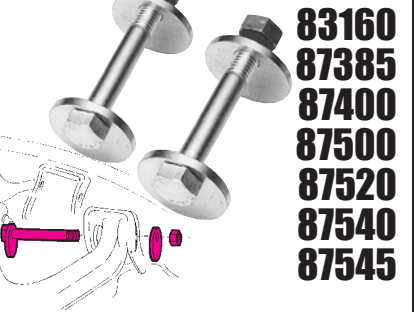

**83160**  
**87385**  
**87400**  
**87500**  
**87520**  
**87540**  
**87545**

Part #	Required	Rear		Front		Time	Notes
		Camber	Toe	Camber	Caster		
23755	1/wheel			±1.00°	±1.50°	.3 hr/side	
23765	1/wheel			±1.00°	±1.50°	.3 hr/side	
67465	1/wheel	±1.25°				.5 hr/side	4/5
67510	1/wheel	±1.00°				.8 hr/side	1/6
67515	1/wheel	±1.00°				.8 hr/side	1/6
72055	1/wheel	±3.00°	±3.00°			.6 hr/side	6
72265	1/wheel	±3.00°	±3.00°			.6 hr/side	6
73600	1/wheel	-0.75° to +1.50°				.5 hr/side	
73620	1/wheel	-0.75° to +3.00°				.5 hr/side	2
82110	1/axle			±2.50°		.4 hr/side	
82370	1/axle					.3 hr/side	7/10
82380	1/axle			±1.50°		.4 hr/side	7/8/9
82390	1/axle			±1.50°		.4 hr/side	7/8/9
83160	1/wheel	±2.00°		±2.00°	±2.00°	.4 hr/side	3
83170	1/axle			±2.50°		.4 hr/side	6
86140	1/axle			±0.75°	±1.25°	.4 hr/side	
86180	1/axle	±0.50°				.2 hr/side	
86250	1/wheel			±1.00°	±1.50°	.3 hr/side	
86640	1/wheel			±1.00°	±1.50°	.4 hr/side	
86680	1/wheel	±1.00°				.3 hr/side	
87310	1/axle			±1.75°	±1.75°	.3 hr/side	
87350	1/axle	±2.50°				.5 hr/side	
87385	1/axle			±2.00°	±2.00°	.5 hr/side	
87400	1/axle			±2.00°	±2.00°	.4 hr/side	8
87500	1/axle			±2.00°	±2.00°	.7 hr/side	
87520	1/wheel			±2.00°	±2.00°	.3 hr/side	
87540	1/axle			±1.00°	±2.00°	.4 hr/side	
87545	1/axle			±1.00°	±2.00°	.4 hr/side	

- 1 Additional camber range
- 2 Includes spacers
- 3 For adjustment type see applications
- 4 72509 Press - page 62
- 5 75980 Sleeves - page 63
- 6 85125 Rotary File - page 61
- 7 64225 Angle Gauge - page 59
- 8 74910 Punch - page 60
- 9 Pinion Angle ±1.50°
- 10 Pinion Angle ±2.00°

PARTS



**FRONT**

**37100-37107**

*Shims shown actual size*

**CAMBER/CASTER DUO-FIT SHIMS**

Special tapered opening gives greater coverage with fewer shims.

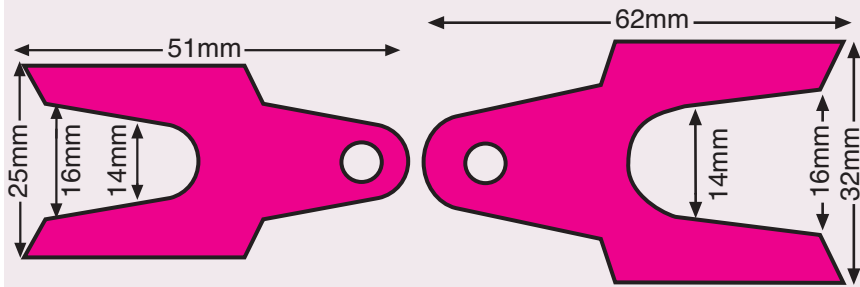

Part #	Thick.	Opening	Qty
<b>37100</b>	1/64"	7/16" - 1/2"	25
<b>37101</b>	1/32"	7/16" - 1/2"	25
<b>37102</b>	1/16"	7/16" - 1/2"	25
<b>37103</b>	1/8"	7/16" - 1/2"	25
<b>37104</b>	1/64"	9/16" - 5/8"	25
<b>37105</b>	1/32"	9/16" - 5/8"	25
<b>37106</b>	1/16"	9/16" - 5/8"	25
<b>37107</b>	1/8"	9/16" - 5/8"	25

**CAMBER/CASTER SHIMS**

**47142-47143**

**"BS"** Universal - 13mm slot shim

Part #	Thick.	Qty
<b>47142</b>	1.6mm	25
<b>47143</b>	3.2mm	25

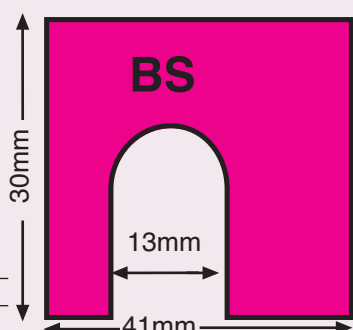

**47150-47153**

**"US"** 16mm opening

Part #	Thick.	Qty
<b>47150</b>	0.4mm	50
<b>47151</b>	0.8mm	50
<b>47152</b>	1.6mm	50
<b>47153</b>	3.2mm	50

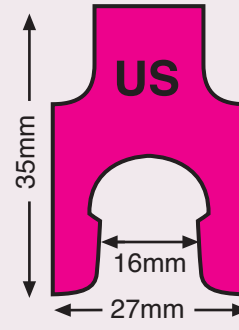

**47180-47184**

**"N"** Universal - 13mm slot shim

Part #	Thick.	Qty
<b>47180</b>	0.4mm	50
<b>47181</b>	0.8mm	50
<b>47182</b>	1.6mm	50
<b>47183</b>	3.2mm	50
<b>47184</b>	4.8mm	50

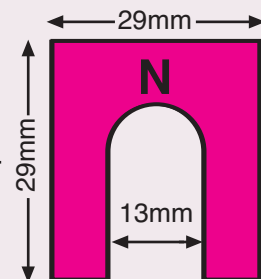

**47760-47764**

**"X"** 11mm opening

Part #	Thick.	Qty
<b>47760</b>	0.4mm	50
<b>47761</b>	0.8mm	50
<b>47762</b>	1.6mm	50
<b>47763</b>	3.2mm	50
<b>47764</b>	4.8mm	50

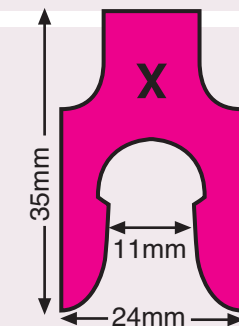

**47765-47769**

**"CT"** 14mm opening

Part #	Thick.	Qty
<b>47765</b>	0.4mm	50
<b>47766</b>	0.8mm	50
<b>47767</b>	1.6mm	50
<b>47768</b>	3.2mm	50
<b>47769</b>	4.8mm	50

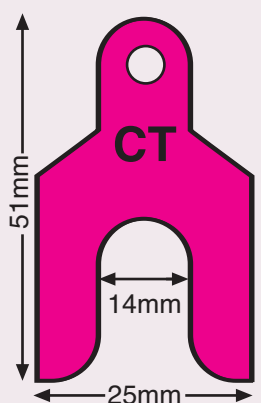

**47775-47778**

**"CC"** 14mm opening

Part #	Thick.	Qty
<b>47775</b>	0.4mm	50
<b>47776</b>	0.8mm	50
<b>47777</b>	1.6mm	50
<b>47778</b>	3.2mm	25

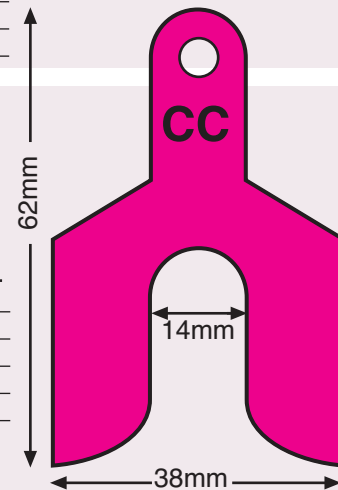

PARTS

## DUO-FIT ASSORTMENT

Filled with 200 shims - 25 each of all Duo-Fit styles and sizes above (37100 through 37107). Handy organizational chart inside lid makes reordering & organization simple. Packaged in a durable plastic case.



FRONT

**37150**

## SHIM SET

Our Shim Dispenser holds a select assortment of shims. The metal dispenser can be mounted on a bench or hung on a wall.

### Set Contains:

**47769, 47774** (6 ea.)

**47775, 47776, 47777, 47778**  
(8 ea.)

**47760, 47763, 47765, 47768,  
47770, 47773** (12 ea.)

**47761, 47762, 47766, 47767,  
47771, 47772** (24 ea.)



**37790**

## SLA SHIM ASSORTMENT

These camber/caster shims are now available in a corrugated box set to help you organize all of your shims. Covering both cars and trucks this set is perfect for inventory control.

### Set Contains 50 Each:

**37105, 37106, 37107, 47151,  
47152, 47153, 47181, 47182,  
47183, 47766, 47767, 47768,  
47775, 47776, 47777**



**47700**

## NISSAN CAMBER/CASTER SHIMS

These shims install between the upper control arm mount and shaft to adjust Pathfinders and Pickups. 6 Shims per package



**35080  
35081  
35082**

**35080** 1mm Thick  
**35081** 2mm Thick  
**35082** 4mm Thick

# FRONT

**23100**  
**23120**

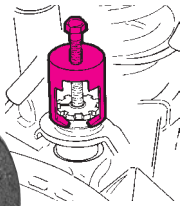
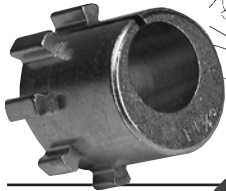

**23160**

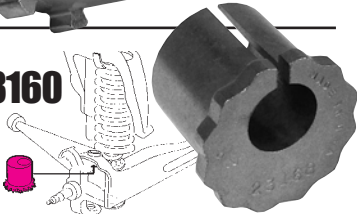

**23130**  
**23180**  
**23220**  
**23230**

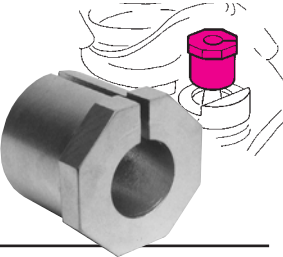

## TRUCK SLEEVES

Change camber, caster or both at the same time with these sleeves. Simply remove the tire cotter pin and upper ball joint stud nut then break the taper free between the stud and sleeve. Using a sleeve puller, remove the existing sleeve. Install a 0° sleeve to determine the change needed, then install the correct sleeve. To adjust, the sleeve may be lifted and rotated 1/8 turn.

**Front** adjustment range:  
See chart  
Required: 1 per wheel  
Installation time: .5 hr/side

**77880, 88830 - Pullers - Page 60**

### DEGREE OF CAMBER/CASTER CHANGE BY SERIES/PART NUMBER

	23000	23100	23120	23130	23160	23180 RWD	23180 4WD	23200	23230
0.00°		23109	23129	23139	23169	23199		23229	23239
±.20°							23181		
±.25°	23002	23101	23121	23131	23161	23181		23221	23231
±.40°							23182		
±.50°	23004	23102	23122	23132	23162	23182		23222	23232
±.60°							23183		
±.75°	23006	23103	23123	23133	23163	23183	23184	23223	23233
±.90°							23185		
±1.00°	23008	23104	23124	23134	23164	23184		23224	23234
±1.10°							23186		
±1.25°	23010	23105	23125	23135	23165	23185	23187	23225	23235
±1.40°							23188		
±1.50°	23012	23106	23126	23136	23166	23186		23226	23236
±1.60°							23189		
±1.75°		23107	23127	23137	23167	23187		23227	23237
±1.80°							23190		
±2.00°		23108	23128	23138	23168	23188	23191	23228	23238
±2.25°		23111			23160	23189	23192	23211	
±2.50°		23112			<b>CAMBER ONLY</b>	23190	23193	23212	
±2.75°		23113				23191	23194		
±3.00°						23192			
±3.25°						23193			
±3.50°						23194			

*We have Adjustable Sleeves – see next page for more.*

FOR 23160 - FOR 23160 - FOR 23160

#### LEFT/RIGHT WHEEL



(-) CAMBER



(+) CAMBER

#### FRONT

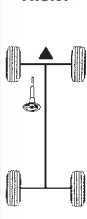

#### FOR NUMBERS

23000  
23100  
23120  
23130  
23180  
23220  
23230

*1, 2, 3 and 4 will change camber/caster the amount stamped on the sleeve.*

LEFT/RIGHT WHEEL		FRONT	LEFT/RIGHT WHEEL	

*5, 6, 7 and 8 will change the camber/ caster by the following amounts:*

MARKED	5, 6, 7, 8	MARKED	5, 6, 7, 8
1/4°	3/16°	1-1/4°	7/8°
1/2°	11/32°	1-1/2°	1-1/16°
3/4°	17/32°	1-3/4°	1-7/32°
1°	11/16°	2°	1-13/32°

*Installation Charts – Slot in sleeve shows direction top of wheel will move*

## OFFSET BALL JOINTS

These offset ball joints replace the upper ball joint and come in 1/2° increments, providing for caster and/or camber changes. Use installation sleeve sets in conjunction with ball joint press 72509 for quick removal and installation of the ball joints.

**Front** Adjustment range:  
See Chart  
Installation time:  
1.0 hr/side  
Required: 1 per wheel  
72509 Press - Page 62  
23780 Sleeves - Page 63

**FRONT**  
**23510-23540**  
**23710-23730**  
**23800-23830**

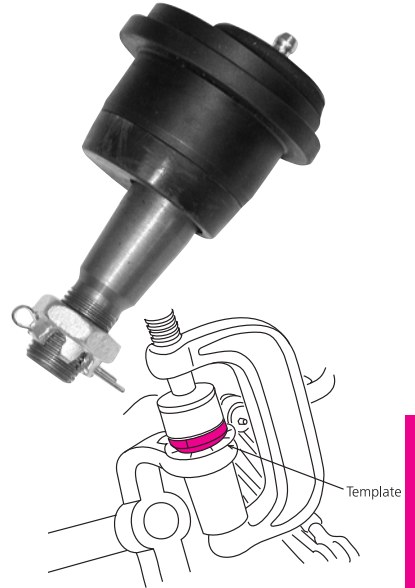

Part Number		<b>23510</b>	<b>23520</b>	<b>23530</b>	<b>23540</b>
		<b>23710</b>	<b>23720</b>	<b>23730</b>	
		<b>23800</b>	<b>23810</b>	<b>23820</b>	<b>23830</b>
Camber and/or Caster	0°	±.50	±1.00°	±1.50°	±2.00°

## ADJUSTABLE TRUCK SLEEVES

Inventory getting out of hand? Just need to fill in a few odd sizes? An Adjustable Sleeve may be just what you need. This sleeve can adjust camber and/or caster in a large variety of combinations. A great solution for saving money and keeping sales.

**Front** adjustment range:  
See chart  
Required: 1 per wheel  
Installation time: .5 hr/side

74550, 74500  
Wrenches - Page 60

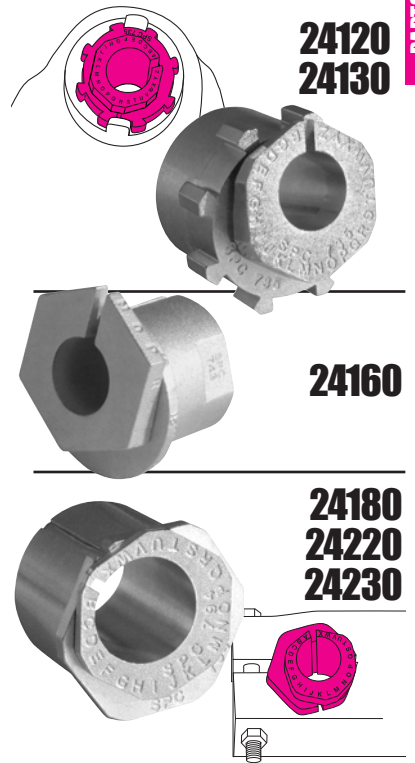

**24120**  
**24130**

**24160**

**24180**  
**24220**  
**24230**

	Part Number					
	<b>24120</b>	<b>24130</b>	<b>24160</b>	<b>24180</b>	<b>24220</b>	<b>24230</b>
Minimum Adjustment	±1.00°	±.75		±.50°		
Camber and/or Caster	±1.00° -	±.75° -	0.0° -	±.50° -	0.0° -	0.0° -
	±2.75°	±2.75°	±2.25°	±2.25°	±2.50°	±2.75°

*We have Adjustable Sleeves – see next page for more.*

**FRONT**

- 25460** Pair
- 25470** Pair
- 25480** Pair
- 25490** Pair



- 66030** Right
- 66035** Left



- 72125** Pair



- 72130** Pair



- 72270** Pair



All Arms - Patent No.  
US 7,513,514 B

**ADJUSTABLE FRONT UPPER CONTROL ARMS**

These adjustable upper control arms will give you caster and camber change. Simply replace the OE front upper control arms and dial in your suspension angles with our patented sliding ball joint and caster plate. Whether you want to tune your suspension for the ultimate in handling performance, minimize tire wear or easily move back and forth between two settings, these are the arms to get the job done.

Front Adjustment range:

- 25460** Pair\*
- 25462** Right\*\*
- 25463** Left\*\*
- 25470** Pair\*
- 25472** Right\*\*
- 25473** Left\*\*
- 25480** Pair\*
- 25482** Right\*\*
- 25483** Left\*\*
- 25490** Pair\*
- 25492** Right\*\*
- 25493** Left\*\*

Camber  $\pm 2.00^\circ$   
Caster  $0.0^\circ$  to  $+4.00^\circ$   
Installation time: .8 hr/side

- 66030** Right\*\*
- 66035** Left\*\*

Camber  $\pm 2.00^\circ$   
Caster  $\pm 1.50^\circ$   
Installation time: .6 hr/side  
**Not for AWD Vehicles**

- 72125** Pair\*
- Camber  $-1.50^\circ$  to  $+3.50^\circ$   
Caster  $\pm 1.0^\circ$   
Installation time: 1.8 hr/side  
**Includes ABS shims**

- 72130** Pair\*
- Camber  $\pm 2.50^\circ$   
Caster  $\pm 1.0^\circ$   
Installation time: .6 hr/side

- 72270** Pair\*
- Camber  $\pm 2.00^\circ$   
Caster  $\pm 1.0^\circ$   
Installation time: .6 hr/side

**Note:**  
\* **Pair - 1 per axle**  
\*\* **Left / Right**  
**1 per wheel**

PARTS

## ADJUSTABLE BALL JOINT

These adjustable upper ball joints make front camber adjustments possible for many vehicles with upper control arms. By replacing the factory ball joint, this sliding ball joint allows for greater changes than previously available. With an OE quality replacement ball joint, this sliding plate assembly is perfect for vehicles that need a simple camber adjustment and for those being dialed-in at the track.

- **Best clearance in the industry**
- **Exclusive 'low-profile' design**
- **OEM strength built-in**
- **Preferred by professional installers**

**Front/Rear** Adjustment range: Camber  $\pm 1.50^\circ$   
Required: 1 per wheel  
Installation time: .6 hr/side  
**\*67220 Rear:** only for vehicles with 17" rims or larger

 **40920 Press**  
Page 62

DELANTERA

**23410, 67115**  
**67125, 67135**  
**67145, 67155**  
**67165, 67170**  
**67180, 67190**  
**67195, 67220\***  
**67525**

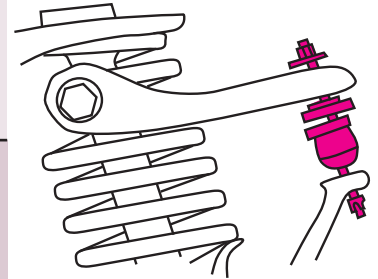

PARTS

## EXTENDED RANGE ADJUSTABLE BALL JOINT

Change camber from  $+1.50^\circ$  up to  $+3.0^\circ$  with these ball joints. They are designed to return camber to  $0^\circ$  on vehicles lowered by more than 1.5".

**Front/Rear** Adjustment range: Camber  $+1.50^\circ$  to  $+3.00^\circ$   
Required: 1 per wheel  
Installation time: .6 hr/side

 **40920 Press**  
Page 62

**67320, 67330**  
**67340, 67350**  
**67360, 67370**

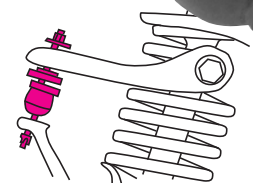
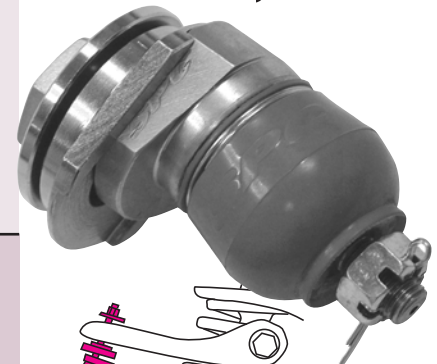

## FRONT

**67620**  
**67630**

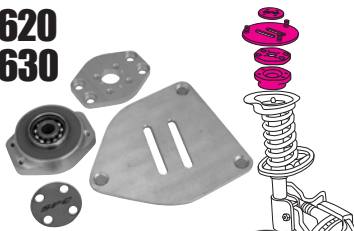

**72040**  
**72060**

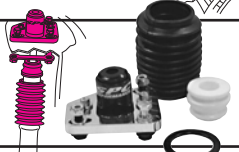

**72065, 72070**  
**72080, 72090**  
**72180, 72190**

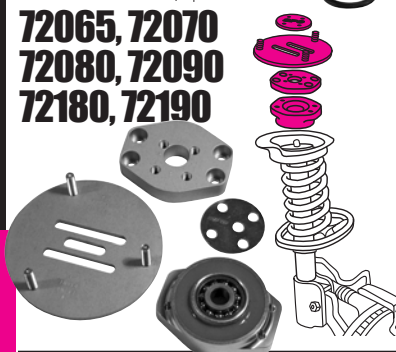

**81320, 89675**

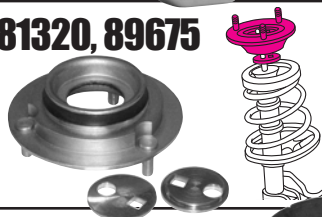

**81340**



## ADJUSTABLE FRONT STRUT MOUNTS

Engineered utilizing a unique, multi-adjustable design, these strut mounts fit a wide variety of vehicles. Tuners will find these kits' ability to change both camber and caster, perfect for street and racing applications alike.

Part #	Required	Front		Time	Notes
		Camber	Caster		
<b>67620</b>	1/axle	±2.00°	±0.75°	1.2 hr/side	
<b>67630</b>	1/axle	±2.00°	±0.75°	1.2 hr/side	
<b>72040</b>	1/axle	±2.00°	±2.00°	1.0 hr/side	
<b>72060</b>	1/axle	-0.50° to +1.50°	0.00° to +1.50°	1.0 hr/side	
<b>72065</b>	1/axle	-1.00° to +3.00°	±0.50°	1.2 hr/side	
<b>72070</b>	1/axle	-1.00° to +3.00°	±0.50°	1.2 hr/side	1
<b>72080</b>	1/axle	-1.00° to +3.00°	±0.50°	1.2 hr/side	
<b>72090</b>	1/axle	-1.00° to +3.00°	±0.50°	1.2 hr/side	
<b>72180</b>	1/axle	-1.00° to +3.00°	±0.50°	1.2 hr/side	
<b>72190</b>	1/axle	-1.00° to +3.00°	±0.50°	1.2 hr/side	
<b>81320</b>	1/wheel	±1.00°	±1.00°	1.0 hr/side	
<b>81340</b>	1/wheel	+1.00°	±1.00°	.9 hr/side	
<b>89675</b>	1/wheel	±1.00°	±1.00°	1.2 hr/side	

1 M3 Only, caster will decrease by 2 degrees

 **72095 Tool - Page 63**

## CASTER SPACERS

These spacers change caster by repositioning the lower front control arms. Each part number comes in a package of ten.

**84690**

1/16" Thick



**84695**

1/8" Thick

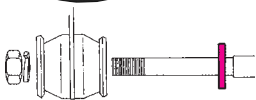

**85690**

1/16" Thick



**85695**

1/8" Thick

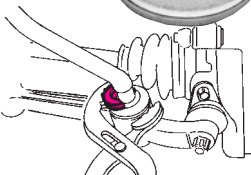

**Front** Adjustment range:  
**84690, 85690** Caster -.125°  
**84695, 85695** Caster -.25°  
 Installation time:  
**84690, 84695** .2 hr/side  
**85690, 85695** .5 hr/side

## GMC ALIGNMENT CAM PLATES

These specially designed adjusters replace the OE adjusters, allowing fast and easy "on-the-vehicle" adjustments. The unique design saves time by installing onto the OE bolt – no need to replace the bolt – and allows for future adjustments. #86375 includes the bolts to make a complete OE replacement assembly.

**Front Adjustment range:**

**86320**  
Locks in OEMA Adjustment  
Required: 1 per wheel  
Installation time: .3 hr/side

**86360**  
Camber  $\pm 1.50^\circ$   
Caster  $\pm 1.50^\circ$   
Required: 1 per wheel  
Installation time: .5 hr/side

**86370**  
Camber  $\pm 1.50$   
Caster  $\pm 1.50^\circ$   
Required: 1 per wheel  
Installation time: .3 hr/side

**86375**  
Complete Plate and Cam Assembly  
Camber  $\pm 1.50^\circ$   
Caster  $\pm 1.50^\circ$   
Required: 1 per wheel  
Installation time: .3 hr/side

**FRONT**

**86320**

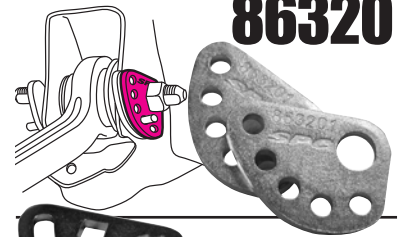

**86360**

**86370**

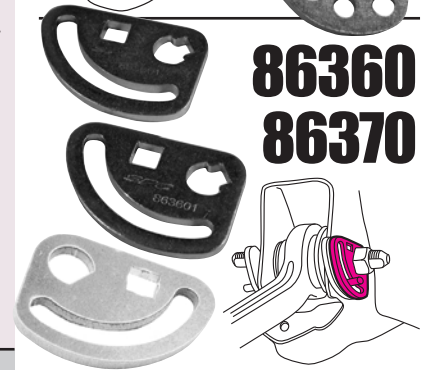

**86375**

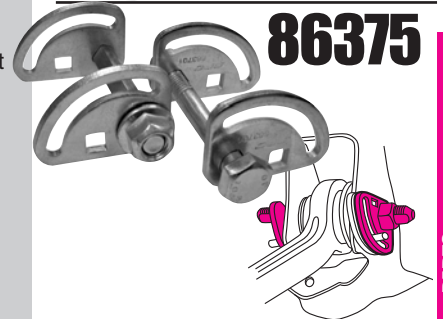

*We have parts for most Light Trucks and SUVs - check our our website for more!*

**PARTS**

## GMC ALIGNMENT PINS

These pins replace the alignment pins in the GM vehicles listed. The pins make it easier to align the vehicle and often become bent or crushed and need to be replaced. 8 pins

**Replacement Part**  
8 pins per package  
Installation time: .3 hr/side

**86325**

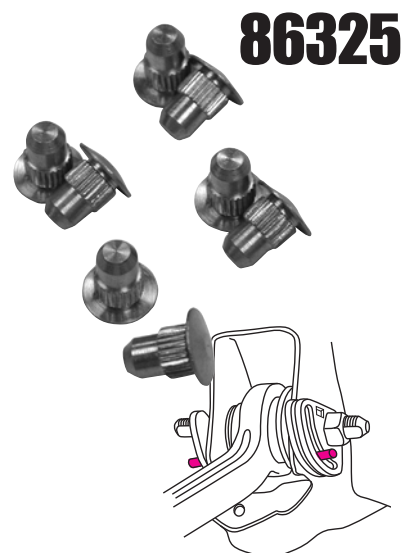



## FRONT

**88901**  
**88902**  
**88903**  
**88904**

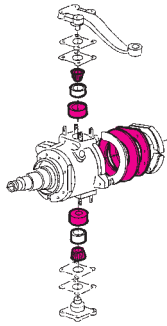

## ALIGNMENT SLEEVES

These combination sleeves come in various sizes to change camber, caster or both on monobeam axles without causing a binding in the steering.

**Front Adjustment range:**

- 88901** Camber  $\pm 1.20^\circ$   
Caster  $\pm 1.20^\circ$
- 88902** Camber  $\pm 1.50^\circ$   
Caster  $\pm 1.50^\circ$
- 88903** Camber  $\pm 1.80^\circ$   
Caster  $\pm 1.80^\circ$
- 88904** Camber  $\pm 2.20^\circ$   
Caster  $\pm 2.20^\circ$
- 88905** Camber  $\pm 1.00^\circ$   
Caster  $\pm 1.00^\circ$
- 88906** Camber  $\pm 1.50^\circ$   
Caster  $\pm 1.50^\circ$

Required: 1 per wheel  
Installation time: 1.4 hr/side

**88905**  
**88906**

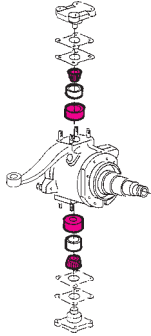

**88940**  
**88950**

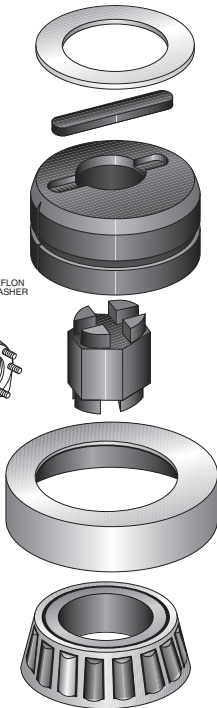
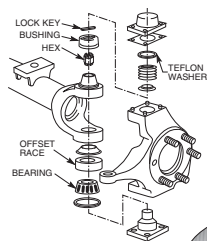

## DANA 60 AXLE CAMBER/CASTER KITS

These exclusive kits provide a camber and caster change for Dana 60 Axles. Replace the O.E. bushing with the correct eccentric bushing, rotate to adjust caster/camber and lock in place. These kits provide full adjustment for future alignments.

**Front Adjustment range:**

- 88940** Camber  $\pm 1.00^\circ$   
Caster  $\pm 1.00^\circ$
- 88950** Camber  $\pm 1.50^\circ$   
Caster  $\pm 1.50^\circ$

Required: 1 per wheel  
Installation time:  
**88940** - .4 hr/side  
**88950** - 1.4 hr/side

## SPC KNOWS PERFORMANCE

SPC Performance is the world leader when it comes to performance suspension tuning. With cutting edge designs and over 35 years experience, SPC alignment kits are recognized for top quality and largest adjustment ranges.



## FRONT ADJUSTABLE UPPER CONTROL ARMS

These fully adjustable Upper Control Arms (each) transform your classic American Muscle Car from sluggish, non-responsive handling to high performance FUN! Dial in additional positive caster, adjust your camber, and enjoy the feel of up to 6 degrees adjustment! **Sold as individual arms.**

FRONT

94305



94320, 94324

94325

94330

94331

94332



94340, 94360

94368

94369

94370

94371



**Front** Adjustment range:  
Camber  $\pm 3.00^\circ$   
Caster  $\pm 3.00^\circ$   
Required: 1 per wheel  
Installation time: .7 hr/side



94050

Part Number	Right	Left	Either
94305, 94320, 94330, 94340, 94350, 94360, 94450, 94451, 94460, 94461			x
94324, 94331, 94368, 94370	x		
94325, 94332, 94369, 94371		x	

## TUBULAR FRONT LOWER CONTROL ARMS

Improve your handling and tracking with these new tubular arms (pair) and lower your front end by 1" and add 1° positive caster for an aggressive, ready-to-run stance. Optional Ride Height Tuning Kits are available to raise the ride height if desired. If you have coilovers use our Coilover Mount and Spacer Plate, To complete your arm you can also add an OEM style bump stop (#95339). **Sold as pairs.**

95339 OEM style bump stop



94344



94374, 94378



95336



**Front** fixed change:  
Caster +1.00°  
Required: 1 per Axle  
Installation time: 1,2 hr/side

# 91000



## FASTRAX™ CAMBER / CASTER GAUGE

This great tool is a must for your garage. Portable, hands-free alignment can be done quickly and easily with the FasTrax™ Adjustable Camber/Caster Gauge.

- Includes gauge and wheel mount.
- Displays Camber  $\pm 4^\circ$  / Caster  $-4^\circ$  to  $+12^\circ$ .
- Saves time and tires.
- Accurate, rugged and easy-to-use
- For easy toe measurement use our 91100 Optional Toe Adapter (next page) on all of our FasTrax.

# 91000



**#91000**  
Fits wheels 13" to 18"

**#91010**  
Fits wheels 17" - 22"

# 91010



**#91025**  
**Off-Road FasTrax™**  
Wheels 13" to 18"  
Align off-road wheels with tire sizes up to 44" Includes longer toe arms, bungee cord and tape measure.

# 91025



**#91040**  
**Heavy Duty FasTrax™**  
Includes gauge and wheel mount (fits most wheels from 21" to 26"). Complete with extra length toe arms, heavy duty tape measure and our No Lip Adapters.

# 91040



**If you do any of these jobs in your garage - you need the FasTrax Camber/Caster Gauge!**

- Install adjustable control arms
- Replacing struts
- Install adjustable bushings
- Replace idler arms / tie rod ends

## OPTIONAL TOE ADAPTER KIT

Simply lower toe arms and insert tape measure into slot. Then measure to opposite tire reference point for accurate and fast toe readings. Includes 2 arms and reinforcement blocks that install easily onto either the 91000 or the 91010.



**91100**

## NO LIP ADAPTER

A quick adapter to attach the FaxTrax to wheels without an outer "lip". Fits on the 91000, 91010 and 91025.



**91030**

## MAGNETIC ADJUSTABLE CAMBER GAUGE

The 81139 is inexpensive, portable, and very accurate. It has a simple leveling adjustment of  $\pm 3^\circ$ . Housed in a durable, non-magnetic casing with a magnetic head that attaches firmly to rotors or spindles.



**81139**

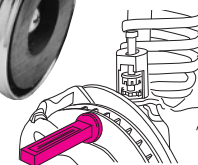

**#81134** - Replacement Bubble Vial  
**#81133** - Replacement Magnet

## MAGNETIC ANGLE GAUGE

This angle gauge is an easy, accurate way for measuring frame and drive shaft angles. An ideal tool to ensure the drive line angle is still within specification for raised and lowered vehicles.

*Alignment equipment manufacturers are using frame angle input with their software for completing Caster specifications.*



**64225**

# 74910

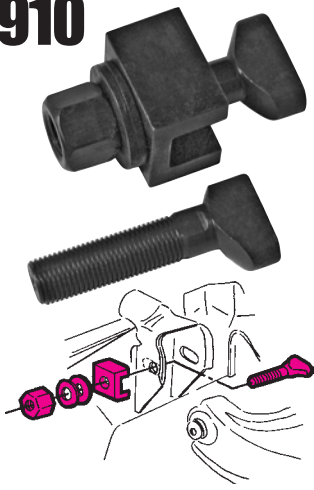

## CAM KNOCK OUT PUNCH

A necessary tool for removing the alignment control inserts on the upper control arm alignment brackets without damaging the bracket. Includes a center punch for the older GM vehicles and newer Jeep JKs and an offset punch for GM's newer models.

**74914** - Replacement Offset Punch.

# 77880

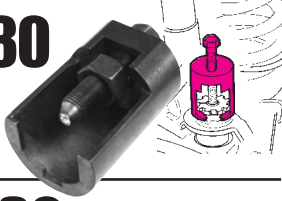

## SLEEVE PULLERS

Sleeve pullers will pull both O.E. and most aftermarket camber/caster sleeves quickly and efficiently, usually without damaging the ears of the sleeve.

**CAUTION: Not for use with impact wrenches (air tools).**

# 88830

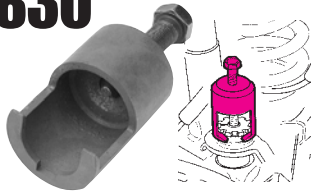

# 74400



## ADJUSTABLE SLEEVE WRENCHES

These wrenches make presetting our adjustable truck sleeves (pages 50 and 51) easier for the installer. When using the 74400 wrench it is recommended that the opening be equally positioned over the slot opening of the sleeve body.

# 74500



# 55600



## LH TOE TOOLS

These tool kits provide a much easier method for the technician to adjust toe on popular Chrysler LH body vehicles such as the Concord, New Yorker, and Intrepid.

# 55700

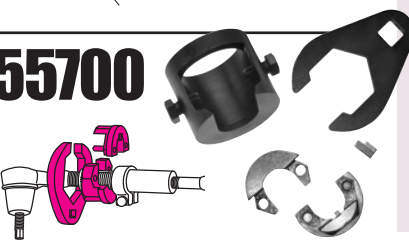

TOOLS

**31010**

### 10" POWER GRIP JAWS

Power Grip Jaws outperform pliers, channel locks, pipe wrenches and vise-type tools. Full 360° rotating/self adjusting ratcheting head operates at any angle on pipes, fittings, bolts and nuts of all kinds. This tool is one of the best tools to adjust toe on Hondas, Nissans and Toyotas, along with other vehicles that use a knurled grip for adjustment.



**40310**

### TIE ROD/BALL JOINT/PITMAN ARM TOOL

Five tools in one, this handy kit consists of three drop forged forks and two handles. One handle is for use with a hammer and one is designed to fit an air hammer. All forks are threaded to interchange with either handle. Comes with 3 forks of 11/16", 15/16" and 1-1/8" openings.



**85125**

### ROTARY FILE SET

High quality carbide rotary files, ideal for elongating strut holes on many vehicles. May be used with 1/4" or 3/8" drills at high speeds. Available individually. Use with 85774 Cool Tool cutting fluid (below).

**CAUTION:** Always wear safety glasses when using cutting or grinding tools and equipment.



### 85774 Cool Tool Fluid

Recommended to prolong the life of all cutting bits.



- #85126 - 1/4" Rotary File (Max. Operating Speed 9,000 RPM)
- #85127 - 3/8" Rotary File (Max. Operating Speed 9,000 RPM)
- #85128 - 5/8" Rotary File (Max. Operating Speed 7,000 RPM)

TOOLS

# 72509



## RWD/4WD BALL JOINT PRESS

Remove and replace universal joints without "brute force" methods that can cause costly damage. Now you can take on 4WD ball joint service in

addition to servicing most cars. A forcing screw-powered press, used with proper adapters, easily removes and installs all press-fit ball joints (inc. GM plastic pin "U" type joints). Comes in a durable plastic case.

### Package Includes

<b>4437</b>	Press
<b>4438</b>	Forcing Screw
<b>29503</b>	Receiver Tube, 3" OD x 2-3/4" ID
<b>29504</b>	Receiver Tube, 2-1/2" OD x 2-1/4" ID
<b>29505</b>	Receiver Tube, 2" OD x 1-3/4" ID
<b>38354</b>	4WD Receiving Cup
<b>38355</b>	Installing Cup
<b>204508</b>	4WD Installing Adapter
<b>305227</b>	Installing Adapter
<b>305228</b>	Removing Adapter

# 40920



## PERFORMANCE BALL JOINT PRESS

This tool was specifically designed to remove the original equipment ball joints on smaller cars when installing SPC Performance's sliding ball joints (page 53). With this revolutionary design you can remove the ball joint from the front upper control arm without removing the arm from the vehicle, saving time and costs.

Packaged in a convenient blow-molded plastic case this set comes complete with adapters for removing and installing stock or Specialty Product's sliding ball joints.

### Package Includes

<b>40923</b>	Adapter
<b>40927</b>	Adapter
<b>40929</b>	C-Clamp w/Screw
<b>40925</b>	Adapter
<b>4433</b>	Screw Only

TOOLS

## BUSHING PRESS SLEEVES

These sleeve sets are designed to make the removal of the OEM part fast and efficient, and to facilitate the installation of the new, adjustable SPC part. The 75990 Mercedes Rear Bushing Press Adapter Set also includes a wrench for easy adjustment of the 28840 rear bushing (page 44).



## UNIVERSAL SPRING COMPRESSOR

This two-piece internally threaded spring compressor is a great option for MacPherson strut, coilover, and other accessible springs. With 7" of travel and a 6,000 lbf max working load with a 3x safety factor, this is an ideal tool for almost any spring. Vinyl coated ends protect the spring from damage, safety jaws keep the compressor stabilized on the spring, and the ball bearing load surface makes compression easy using simple hand tools. Use of both hooks per spring is required.

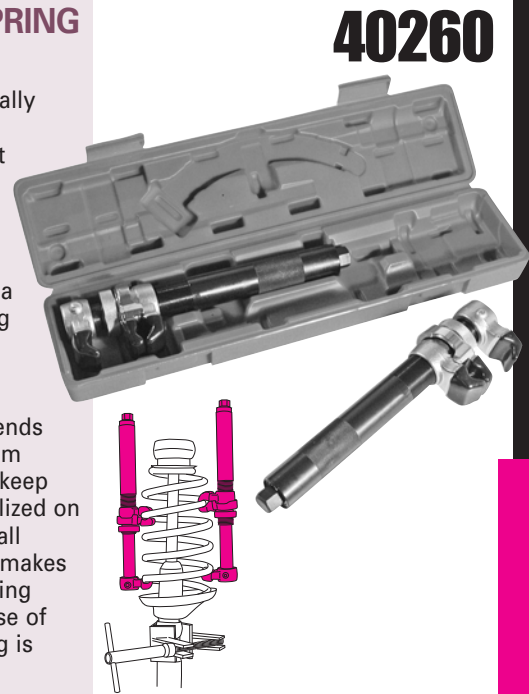

## FRONT STRUT TOOL

This tool was designed for turning the valves on adjustable damping struts when installing our SPC Adjustable Strut Mounts (pg. 54).



## VW SHIM WRENCH

Designed to remove the rear hub when installing our 71520 and 71530 Series Volkswagen shim (page 44). This wrench is a must in assisting the installer when using these camber and toe shims.





# 37000



## WHEEL WEIGHT TOOL

The best tool for removing or installing passenger car and light truck wheel weights. Incorporates hooks for removal of wheel weights on many different types of wheels. Not for use on aluminum or decorative wheels.

# 10010



## HOSE CUTTER

This high quality hose cutter provides a straight, even, clean cut on heater, air conditioning, braided rubber or plastic hose up to 1-1/8" dia.

**10011** – Replacement blades. Blades are High Grade Carbon steel, 2 per pkg.

# 33173

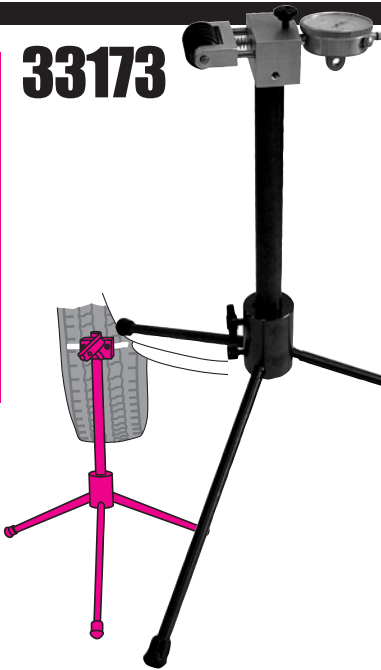

## RADIAL RUN-OUT GAUGE

Radial run-out is an out of round condition in which the radius of the wheel or tire is not consistent from the wheel center to any point on the rim or the tread. Tire and wheel radial run-out are often factors in troubleshooting ride and handling and in maintaining correct wheel balancing to reduce vibration.

- Measures vehicle vibration sensitivity
- Measures out of round condition
- Easy to use - only 2 adjustments
- Pinpoints high or low spots in the tire
- Determines accurate centering of tire and wheel mounting

# 33174

Replacement Radial Run-Out Gauge



## TURNTABLES, SLIP PLATES AND STANDS

### 99750 - Turntables (Pair)

Full floating turntables with enclosed ball bearings. Large, easy to read dial is quickly adjusted to zero.



### 99884

### Front & Rear Stands (Pairs)

Made of heavy gauge steel, these portable stands will enable the wheel alignment mechanic to perform alignments without an alignment rack. All legs have leveling adjustments.



### 99884 - Front

### 99886 - Rear Wheel Stands with Slip Plates

### 91851 - Rear Slip Plates (Pair)

With a total height of only 3/8", these low-profile slip plates allow a 2 inch total movement of the rear wheel while adjusting camber and toe.



### 91851

## Index

Part #	Page	Part #	Page	Part #	Page	Part #	Page	Part #	Page	Part #	Page	Part #	Page	Part #	Page
10010	64	25460	52	47143	48	66025	63	67370	53	69400	43	72509	62	83160	47
10408	45	25462	52	47150	48	66030	52	67420	42	69450	42	73400	44	83170	47
23100	50	25463	52	47151	48	66035	52	67430	42	69460	42	73400	44	84690	54
23120	50	25470	52	47152	48	66080	44	67440	42	71020	44	73600	47	84695	54
23130	50	25472	52	47153	48	66085	44	67465	47	71520	44	73620	47	85125	61
23160	50	25473	52	47180	48	67010	42	67470	42	71530	44	74400	60	85126	61
23180	50	25480	52	47181	48	67020	42	67485	42	71640	44	74500	60	85127	61
23220	50	25482	52	47182	48	67080	42	67490	42	71720	44	74910	60	85128	61
23230	50	25483	52	47183	48	67090	42	67510	47	71730	44	75200	45	85690	54
23410	53	25490	52	47700	49	67095	42	67515	47	71850	44	75800	45	85695	54
23510	51	25492	52	47760	48	67110	42	67525	53	71860	44	75910	45	86140	47
23520	51	25493	52	47761	48	67115	53	67540	43	72040	54	75915	45	86180	47
23530	51	28840	44	47762	48	67125	53	67545	43	72050	42	75920	45	86250	47
23540	51	31010	61	47763	48	67135	53	67550	43	72055	47	75970	45	86320	55
23580	63	33173	64	47764	48	67145	53	67555	43	72060	54	75980	63	86325	55
23710	51	35080	49	47765	48	67155	53	67570	42	72065	54	75990	63	86360	55
23720	51	37000	64	47766	48	67165	53	67580	42	72070	54	77880	60	86370	55
23730	50	37100	48	47767	48	67171	53	67590	42	72080	54	79500	63	86375	55
23755	47	37101	48	47768	48	67180	53	67610	42	72090	54	81139	59	86680	47
23765	47	37102	48	47769	48	67190	53	67620	54	72095	63	81240	46	87330	44
23780	63	37103	48	47775	48	67195	53	67630	54	72110	42	81250	46	87385	47
23800	51	37104	48	47776	48	67210	42	67640	42	72125	52	81260	46	87400	47
23810	50	37105	48	47777	48	67220	53	67720	43	72130	52	81280	46	87500	47
23820	51	37106	48	47778	48	67230	42	67740	42	72180	54	81290	46	87520	47
23830	51	37107	48	55600	60	67270	42	67740	43	72185	44	81290	46	87530	63
24120	51	37150	49	55700	60	67290	42	67765	43	72190	54	81320	54	87540	47
24130	50	37790	49	63020	46	67320	53	67775	43	72260	42	81340	54	87545	47
24160	51	40260	63	63030	46	67330	53	67776	43	72265	47	82110	47	88830	60
24180	51	40310	61	64225	59	67340	53	69100	43	72270	52	82370	47	88901	56
24220	51	40920	62	66010	44	67350	53	69200	43	72280	42	82380	47	88902	56
24230	51	47142	48	66020	44	67360	53	69300	43	72280	47	82390	47	88903	56