

2021

STANDARD[®]

Diesel

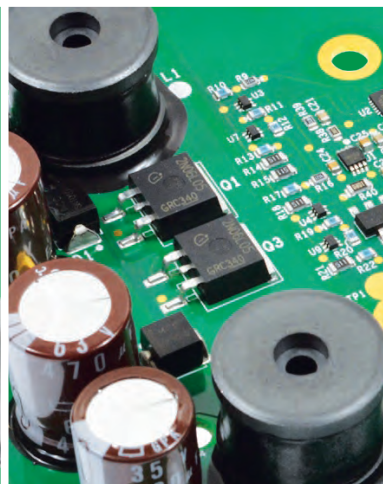
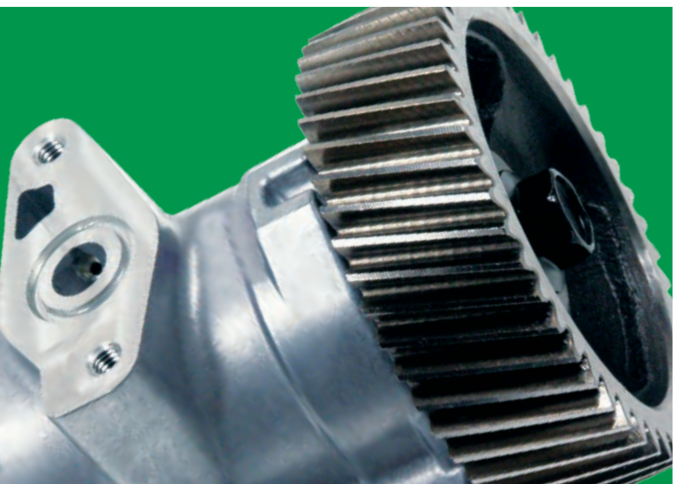
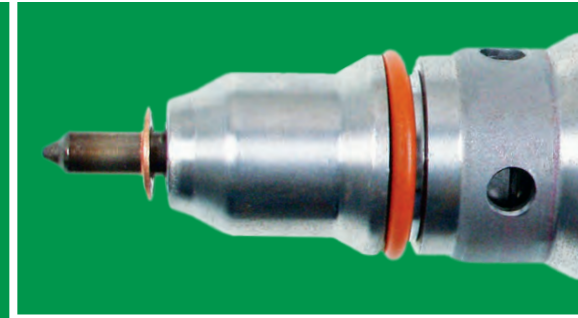

Diesel Automotive Products

Application and Illustrated Parts Guide

Domestic and Import Passenger Cars and Light/Medium Duty Trucks



CATALOG TABLE OF CONTENTS

Content	Page
Standard Warranty	Inside Front Cover
EGR Coolers Kits	Front Section
Fuel Transfer Pump – New	Front Section
Turbochargers	Front Section
Fuel Injection Control Module (FICM) Power Board	Front Section
Application Table of Contents	i - xx
Illustrated Part Number Index	xxi – xxviii
Make to Engine Part Number Index	xxix - xxxi
Application Guide	1 - 344
Illustrated Parts Guide	345 - 553
Make to Engine Part Guide	C1 – C151
Hydraulic Electric Unit Injectors (HEUI)	Rear Section

EGR Coolers

Not All EGR Coolers Are Designed the Same

EGR coolers use engine coolant to reduce exhaust gas temperatures before the gas is recirculated through the intake system. Reducing exhaust gas temperatures is critical for reducing NOx emissions. Plus, engines that run with higher EGR temperature don't adequately cool the combustion, which can reduce the life expectancy of the EGR valve, engine valves, and head gaskets.

But not all EGR coolers are the same. The original equipment EGR cooler's fin-and-tube-style design is prone to clogging and leaking. Additionally, many aftermarket EGR coolers feature various tube designs that do not provide the necessary cooling. Providing a superior alternative to both designs, Standard® is proud to offer an EGR cooler with an upgraded 20 spiral tube design. Take a look at our ECK1, for example:

ECK1

Ford F Series & Excursion
w/6.0L (2007-04)

Ford E-Series w/6.0L
(2010-04)

Navistar VT 365 Engines
(2007-04)

Upgraded 20 spiral tube design provides
OE-matching cooling efficiency while
preventing clogging and leaking

100% new, not remanufactured,
so there are no core charges or
core returns

Stainless steel
construction maximizes
corrosion resistance and
dimensional stability

Comes with intake
manifold gaskets,
seals, and hardware
for a complete EGR
cooler install

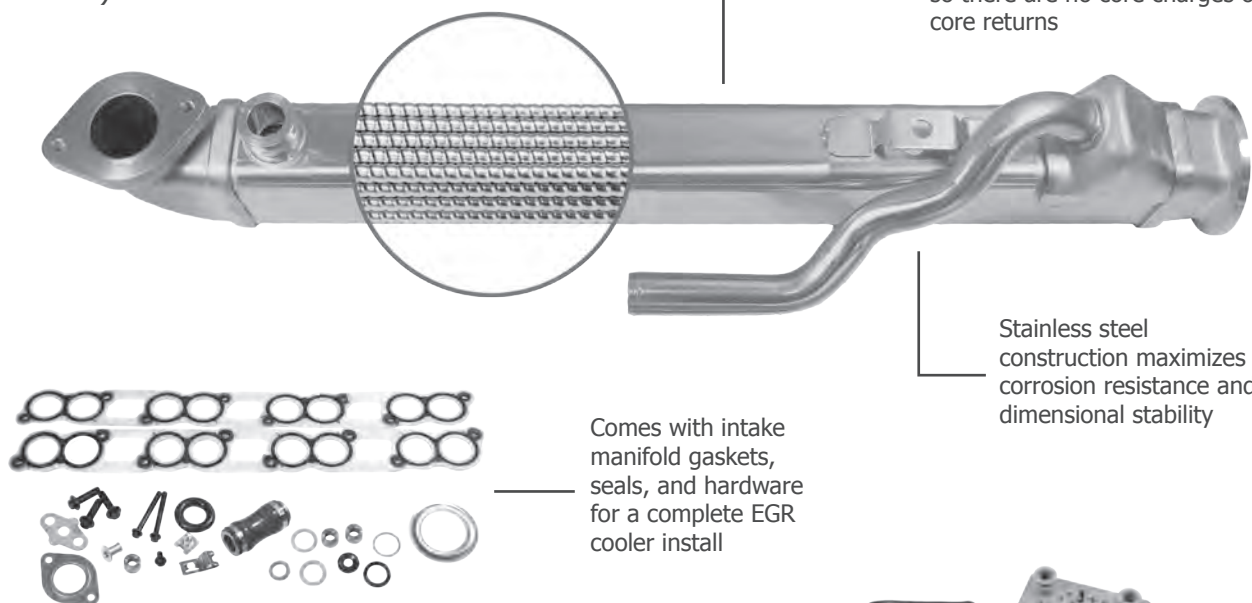

Tech Tip: When replacing an EGR cooler, experts recommend inspecting and servicing the oil cooler, too.

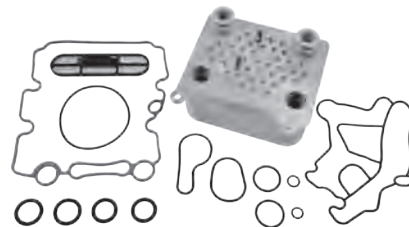

OCK1 - Diesel Oil Cooler Kit

DIESEL

The Benefits of a 20 Spiral Tube Design

The OE EGR cooler features a tube-and-fin-style design that is prone to clogging from soot and to internal leaks from fractures caused by overheating. To address the design flaw, our EGR cooler features a 20 spiral tube construction that resists soot clogging and prevents leaks to maintain proper system flow and pressure. Plus, our design provides the same cooling efficiency as the OE design.



Standard® ECK1
Design: 20 spiral tubes
Effect: Provides OE-matching cooling efficiency while resisting soot clogging and maintaining necessary system flow and pressure



OE
Design: Fin-and-tube
Effect: Although this design is efficient, it's prone to soot clogging and internal leaks from fractures caused by overheating



Competitor A
Design: 6 spiral tubes
Effect: Exhaust gas temperatures that are hundreds of degrees hotter than OE specs, which can reduce the life expectancy of the EGR valve, engine valves, and head gaskets



Competitor B
Design: 6 straight tubes
Effect: The straight tubes are less efficient than spiral tubes, which creates even hotter exhaust gas temperatures than Competitor A

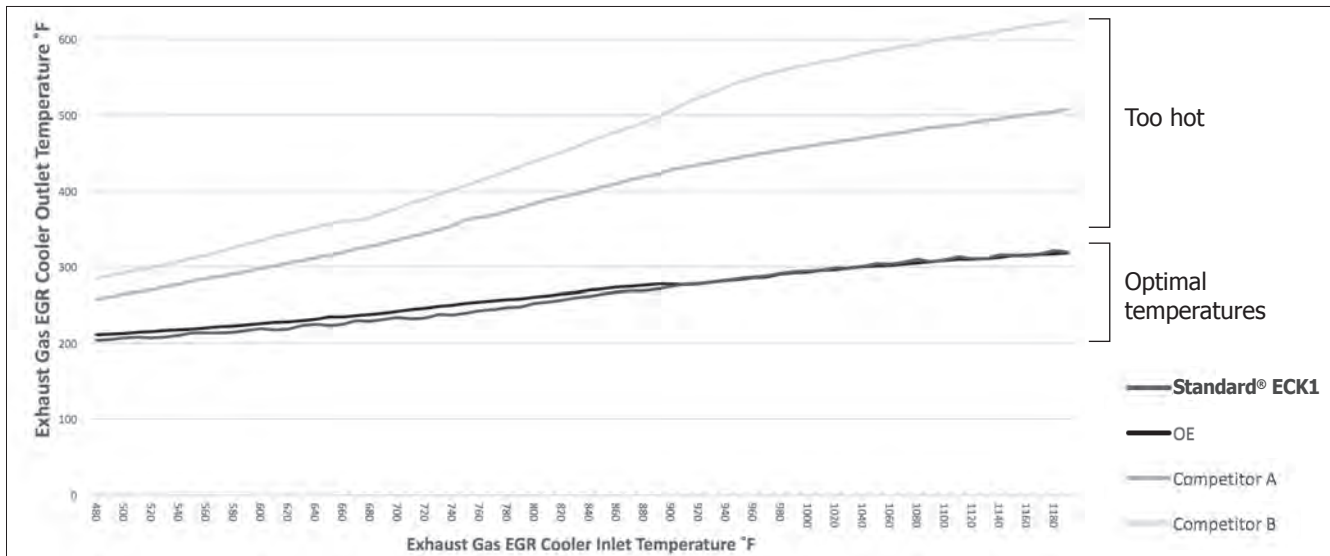

Tested to Ensure OE Cooling Efficiency

Most aftermarket suppliers fail to adequately test their EGR coolers for proper performance. We subject our EGR Coolers to 100% factory testing for air and water leaks. To see how our ECK1 EGR Cooler performs against both the OE and our aftermarket competitors, see the results of our heat exchange test above. Note that vehicles with exhaust gas temperatures not in the optimal temperature range are at risk of failing NOx emissions inspections.

Diesel Fuel Transfer Pump – New

Don't Let a Faulty Fuel Transfer Pump Ruin Your New Fuel Injection Pump

The fuel injection pump can fail if the fuel transfer pump (a.k.a. lift pump) doesn't supply enough fuel pressure. To protect the longevity of your replacement fuel injection pump, it is highly recommended that you also replace the fuel transfer pump.

As a high-quality replacement part, Standard's 100% new Diesel Fuel Transfer Pump is designed to keep constant fuel flow from the vehicle fuel tank to the injection pump. The constant flow allows peak performance to remain consistent during vehicle operation.

FTP1 - NEW

Dodge Ram 2500, 3500
(02-98)

VIO over 384,000



Tech Tip: Fuel transfer pump pressure should be 8-10 PSI during cranking and more than 5 PSI during vehicle operation.

Related Parts

If you also need a high-quality fuel injection pump for the job, Standard® offers two options: the IP19 and IP20. Both injection pumps are remanufactured at a TS16949, ISO9001, and ISO14001 certified facility to ensure quality. Both parts also include O-ring seals for proper installation.

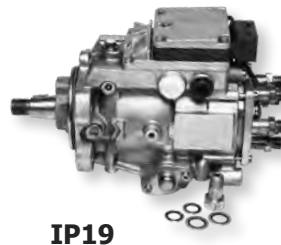

IP19



IP20

Turbochargers

Turbochargers

Demonstrating our commitment to the turbocharger category, we continue to expand our turbocharger line. The expansion increases coverage to an array of applications, from domestic to import, passenger car to truck. Here are a few highlights:



TBC521 (Reman)
Dodge Pickups (2010-07)
Ram Trucks (2012-11)
VIO Over 426,000



TBC576 (Reman)
Ford F Pickups (2010-08)
VIO Over 300,000



TBC563 (Reman)
Ford F Pickups, E-Vans,
Excursion (2003-99)
VIO Over 175,000

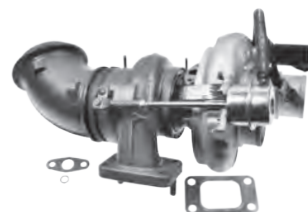

TBC567 (Reman)
Dodge Ram 2500,
3500 (2009-04)
VIO Over 475,000

Turbocharger Hoses

The bulk of our new additions are turbochargers. But we also introduced two Turbocharger Hoses to help technicians with their turbocharger repairs. For example, our new TIH1 and TIH2 Turbocharger Hoses complement our new TBC524 Turbocharger, among others.



TIH1
Ford F Pickups,
Excursion (2004-03)
VIO Over 325,000



TIH2
Ford F Pickups,
Excursion (2004-03)
VIO Over 700,000



TBC524 (New)
Ford F Pickups, E-Vans,
Excursion (2005-04)
VIO Over 400,000

Fuel Injection Control Module (FICM) Power Board

The Problem

On select Ford trucks, the low-quality electronics on the OE and competition's Fuel Injection Control Module Power Board can overheat and lead to failure.

Our Response

Designed from the ground up at our state-of-the-art manufacturing facility in Orlando, FL, our Fuel Injection Control Module Power Board surpasses its counterparts in quality.

- Re-engineered power circuit board layout
- Higher-quality electronics cut down excess heat
- Four large coils on the circuit board that exceed OE specifications
- Gold-plated contacts for greater energy transfer
- Built-in load dump protection for reduced high-voltage interference
- No programming necessary
- New, NOT Remanufactured
- Designed and manufactured in the U.S.A.

Featuring a re-engineered layout, the power board is wired with higher-quality electronics that can protect critical components from excess heat. For proof, look at these thermal images. They were taken 1 minute after the power boards were loaded during a cold-start simulation.

As you can see, our Fuel Injection Control Module Power Board distributes heat more evenly, keeping critical components cooler and preventing the failure that can occur in competitors' units.

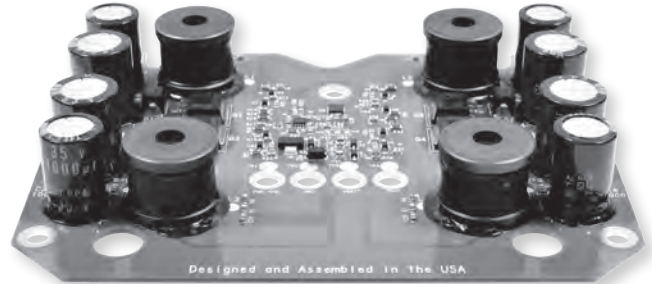

R76001

Ford 6.0L Diesel Trucks (2010-01)

VIO over 800,000

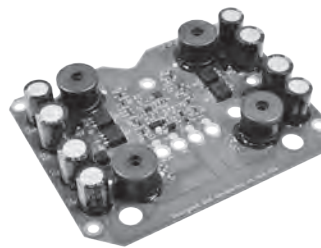

Our Power Board

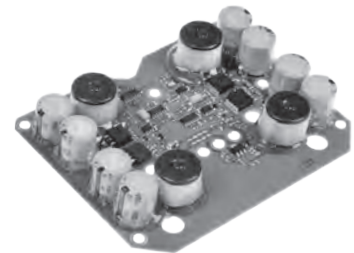

Competitor's Power Board

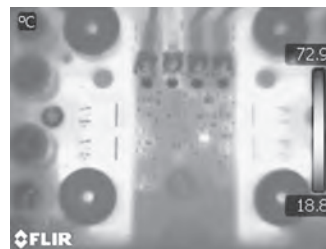

Our Power Board

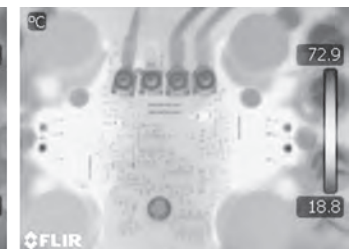

Competitor's Power Board

Table of Contents

AM General	
Circuit Breaker.....	1
Crankshaft Sensor	1
Diesel Fuel Injection Pump - Remanufactured .	1
Diesel Glow Plug	1
Diesel Injector Pump Driver Relocation Kit	1
Diesel Injector Pump Module	1
Diesel Injector Pump Module Resistor	1
Fuel Injector - Diesel - New.....	1
Fuel Pump Relay	1
Fuel Shut-Off Solenoid.....	1
MAP Sensor	1
Oil Pressure Light Switch.....	1
Turbocharger Boost Sensor	1

Audi	
A/C Evaporator Temperature Sensor.....	5
ABS Speed Sensor.....	3
ABS Speed Sensor Wire Harness	3
Accelerator Pedal Sensor	4
Air Pump Relay	1
Ambient Air Temperature Sensor	5
Automatic Transmission Output Sensor.....	3
Auxiliary Air Valve	2
Battery Current / Volt Sensor	4
Camshaft Sensor.....	4
Canister Purge Solenoid.....	2
Clock Spring	6
Coolant Temperature Sensor	5
Crankshaft Sensor	4
Defroster Relay	1
Diesel Emission Fluid Injection Nozzle	2
Diesel Glow Plug	3
Direct Injection High Pressure Fuel Pump.....	3
Diverter Valve.....	2
EGR Control Solenoid.....	2
EGR Valve	2
EGR Valve Mounting Gasket	2
Engine Oil Level Sensor	3
Engine Oil Separator.....	2
Exhaust Gas Temperature Sensor.....	5
Fuel Injection Throttle Body	2
Fuel Injector - Diesel - New.....	3
Fuel Injector - Diesel - Remfd.....	3
Fuel Injector Seal Kit.....	3
Fuel Pressure Regulator.....	3
Fuel Pressure Sensor	4
Fuel Pump Camshaft Follower.....	3
Fuel Pump Fitting	3
Fuel Pump O-Ring	3
Fuel Pump Relay	1
Fuel Vapor Leak Detection Pump	3
Headlight Washer Relay.....	1
Ignition Starter Switch	6
Intake Air Temperature Sensor	6

Audi	
Intake Manifold Actuator.....	2
Knock Sensor	4
MAP Sensor	5
Mass Air Flow	4
Neutral Safety Switch.....	6
Oil Pressure Light Switch.....	6
Oxygen Sensor	4
Power Seat Relay	1
Secondary Air Injection Sensor	5
Starter Relay	1
Starter Solenoid.....	1
Stoplight Switch	6
Temperature Sender - With Gauge.....	6
Turbocharger - New.....	2
Turbocharger Boost Sensor	5
Turbocharger Boost Solenoid	2
Vacuum Pump.....	2
Variable Valve Timing Solenoid.....	6
Voltage Regulator	1
Windshield Washer Relay	1

Bering	
Air Inlet Pressure Sensor	7

Blue Bird	
Crankcase Ventilation Filter	7
Diesel Particulate Filter (DPF) Pressure Sensor	7
EGR Valve Pressure Feedback Sensor	7
Fuel Pressure Sensor	7
Injection Actuation Pressure Sensor	7
Oil Pressure Gauge Switch	7

BMW	
ABS Speed Sensor.....	8
Accelerator Pedal Sensor.....	9
Ambient Air Temperature Sensor	12
Battery Current / Volt Sensor	9
Blower Motor Resistor	14
Brake Fluid Level Sensor	8
Brake Pad Wear Sensor.....	9
Camshaft Sensor.....	9
Canister Purge Solenoid.....	8
Canister Vent Solenoid	8
Clock Spring	13
Coolant Fan Switch	15
Coolant Level Sensor.....	8
Coolant Temperature Sensor	12
Crankshaft Sensor	9
Cruise Control Switch.....	13
Diesel Emission Fluid Injection Nozzle	8
Direct Injection High Pressure Fuel Pump.....	8
EGR Valve	8
EGR Valve Mounting Gasket	8
Engine Oil Level Sensor	8

Table of Contents

BMW	BMW
Engine Variable Valve Lift Eccentric Shaft Sensor	Voltage Regulator
9	7
Engine Variable Valve Timing Sprocket	Windshield Washer Level Sensor
15	8
Exhaust Gas Temperature Sensor	Windshield Wiper Switch.....
12	14
Fuel Injection Throttle Body	
7	Buick
Fuel Injector - Diesel - New.....	A/C and Heater Blower Motor Switch
8	20
Fuel Injector Seal Kit.....	A/C and Heater Selector Switch.....
8	20
Fuel Pressure Sensor	A/C Compressor Clutch Cut-Off Relay
9	15
Fuel Pump Cut-Off Switch	A/C Compressor Throttle Cut-Off Relay.....
13	15
Fuel Pump Driver Module	A/C Control Relay
7	15
Fuel Pump Relay	Air Cleaner Inlet Hose
7	16
Fuel Vapor Canister.....	Air Control Valve Relay
8	15
Hazard Warning Relay.....	Automatic Transmission Output Sensor.....
7	18
Headlight Dimmer Switch	Automatic Transmission Vacuum Modulator ...
13	19
Headlight Switch.....	Blower Motor Relay
13	15
Heater Core Temperature Sensor	Blower Motor Resistor
12	20
Horn Relay	Coolant Fan Relay
7	15
HVAC Temperature Blend Door Actuator.....	Coolant Temperature Sensor
15	19
Ignition Push Button Switch.....	Crankcase Ventilation Filter
13	16
Ignition Starter Switch	Cruise Control Release Switch
13	19
Intake Air Temperature Sensor	Cruise Control Switch.....
12	19
Knock Sensor	Diesel Glow Plug
8	18
Manifold Differential Pressure Sensor	Diesel Glow Plug Control Sensor
9	19
MAP Sensor	Diesel Glow Plug Indicator Relay
9	15
Mass Air Flow	Diesel Glow Plug Relay.....
8	15
Oil Pressure Light Switch.....	Diesel Wait Lamp Relay
14	15
Park Assist Camera.....	Door Lock Kit.....
13	20
Parking Assist Sensor	EGR Valve
13	17
Power Door Lock Actuator	EGR Valve Mounting Gasket
15	17
Power Window Switch	Fast Idle Relay
14	15
Starter Solenoid.....	Fast Idle Solenoid Relay
7	15
Stoplight Switch	Fuel Injection Pump Relay.....
13	16
Sunroof Relay	Fuel Injector - Diesel - New.....
7	18
Temperature Sender - With Gauge.....	Fuel Pump Relay
15	16
Tire Pressure Monitoring System OE Design Sensor	Fuel Rail O-Ring Kit.....
9	18
Tire Pressure Monitoring System OE Design Sensor Service Kit.....	Fuel Vapor Canister.....
10	18
Tire Pressure Monitoring System OE Design Valve	Fuel Vapor Canister Filter
10	18
Tire Pressure Monitoring System QWIK-Sensor	Headlight Dimmer Switch
11	19
Tire Pressure Monitoring System QWIK-Sensor Service Kit.....	Headlight Switch.....
11	19
Tire Pressure Monitoring System QWIK-Sensor Valve	Horn Relay
11	16
Turbocharger - New.....	Idle Stop Solenoid
7	16
Turbocharger Boost Sensor	Ignition Lock Cylinder Housing Repair Kit
12	20
Turbocharger Boost Solenoid	Manifold Air Tube
7	16
Turn Signal Flasher	Manual Transmission Output Sensor
7	18
Turn Signal Switch	MAP Sensor
13	19
Vacuum Control Valve.....	Oil Pressure Gauge Switch
7	20
Vacuum Pump.....	Oil Pressure Light Switch
7	20
Variable Valve Timing Solenoid.....	Overdrive Relay
15	16
	PCV Grommet
	17
	PCV Valve
	18
	Ported Vacuum Switch.....
	20
	Power Door Lock Actuator
	20
	Power Seat Relay
	16
	Starter Solenoid.....
	16

Table of Contents

Buick		Cadillac	
Stereo Wiring Relay.....	16	Transmission Control Solenoid	24
Temperature Sender - With Gauge.....	20	Trunk Release Switch	24
Temperature Sender - With Light	20	Vacuum Pump.....	22
Theft Deterrent Relay	16	Windshield Washer Relay	21
Transmission Control Solenoid	19		
Trunk Release Switch	19	Checker	
Turn Signal Switch	19	PCV Grommet	25
Vacuum Motor.....	16	Starter Solenoid.....	25
Vacuum Pump.....	16		
Vehicle Speed Sensor	18	Chevrolet	
		A/C and Heater Blower Motor Switch	79
Cadillac		A/C and Heater Selector Switch	79
A/C Control Relay	21	A/C Compressor Time Delay Relay.....	26
A/C Speed-Up Solenoid Relay	21	ABS Speed Sensor	61
Air Cleaner Check Valve	22	Accelerator Pedal Sensor	64
Air Cleaner Inlet Hose	22	Accelerator Pedal Sensor Repair Kit	64
Automatic Transmission Vacuum Modulator ...	24	Accessory Delay Relay	26
Coolant Fan Relay	21	Accessory Relay.....	26
Coolant Temperature Sensor	24	Air Bag Relay	27
Crankcase Ventilation Filter	22	Air Cleaner Check Valve	34
Cruise Control Release Switch	24	Air Cleaner Inlet Hose	36
Diesel Glow Plug	23	Air Intake Heater Relay	27
Diesel Glow Plug Control Sensor	24	Ambient Air Temperature Sensor	68
Diesel Glow Plug Relay.....	21	Ambient Light Sensor	64
Diesel Wait Lamp Relay	21	Automatic Headlight Relay	27
EGR Valve	22	Automatic Transmission Input Sensor.....	61
EGR Valve Mounting Gasket	22	Automatic Transmission Vacuum Modulator ...	73
Fast Idle Relay	21	Auxiliary Battery Relay	27
Fuel Injection Pump Relay.....	21	Auxiliary Engine Cooling Fan Relay	27
Fuel Injection Relay.....	21	Auxiliary Heater and A/C Control Relay	27
Fuel Injector - Diesel - New.....	23	Back-Up Light Switch.....	71
Fuel Pressure Regulator	23	Barometric Pressure Sensor	66
Fuel Pump Relay	21	Blower Motor Cut-Off Relay.....	27
Fuel Rail O-Ring Kit.....	23	Blower Motor Relay	27
Fuel Vapor Canister.....	23	Blower Motor Resistor	80
Idle Speed Control Motor.....	22	Blower Motor Resistor Kit	80
Idle Speed Control Motor Repair Kit.....	22	Brake Fluid Level Sensor	61
Idle Stop Solenoid	22	Camshaft Sensor.....	64
Instrument Cluster Relay	21	Canister Purge Solenoid.....	46
Intake Air Temperature Sensor	24	Canister Purge Valve.....	46
MAP Sensor	24	Canister Vent Solenoid	46
Neutral Safety Switch.....	24	Center High Mount Stop Light Assembly.....	83
Neutral Safety Switch Relay	21	Choke Heater Control Relay	28
Oil Pressure Light Switch.....	24	Clock Spring	75
Oxygen Sensor	24	Coolant Fan Relay	28
Parking Brake Switch.....	24	Coolant Fan Switch	80
PCV Grommet	22	Coolant Level Sensor.....	61
PCV Valve.....	23	Coolant Temperature Sensor	68
Ported Vacuum Switch.....	25	Crankcase Ventilation Filter	36
Power Window Relay	21	Crankshaft Sensor	65
Starter Solenoid.....	21	Cruise Control Release Switch	75
Temperature Sender - With Light	25	Cruise Control Switch	75
Throttle Position Sensor.....	24	Diesel Air Intake Heater	32
Trailer Towing Package Relay	21	Diesel EGR Cooler.....	36
		Diesel Emission Fluid Injection Nozzle	40

Table of Contents

Chevrolet	Chevrolet		
Diesel Emissions Fluid Pump	40	Fuel Shut-Off Solenoid.....	47
Diesel Emissions Fluid Temperature Sensor....	40	Fuel Tank Selector Switch	76
Diesel Exhaust Fluid (DEF) Heater	41	Fuel Tank Selector Valve.....	47
Diesel Exhaust Particulate Sensor	62	Fuel Temperature Sensor	70
Diesel Fast Idle Temperature Switch	80	Fuel Vapor Canister.....	46
Diesel Fuel Heater	51	Fuel Vapor Canister Filter	47
Diesel Fuel Injection Harness	52	Glow Plug Conductor.....	61
Diesel Fuel Injection Pump - New	52	Glow Plug Controller.....	26
Diesel Fuel Injection Pump - Remanufactured .	52	Hazard Warning Switch.....	71
Diesel Fuel Injector Line	55	Headlight Dimmer Switch	72
Diesel Fuel Injector Rail.....	55	Headlight Relay	29
Diesel Glow Plug	55	Headlight Switch.....	72
Diesel Glow Plug Control Sensor	69	Heater Core Temperature Sensor	70
Diesel Glow Plug Indicator Relay	28	HVAC Temperature Blend Door Actuator.....	83
Diesel Glow Plug Relay.....	28	Idle Air Control Valve	35
Diesel Glow Plug Temperature Sensor.....	69	Idle Stop Solenoid	35
Diesel Injector Pump Driver Relocation Kit	56	Ignition Lock Cylinder.....	83
Diesel Injector Pump Module	57	Ignition Relay	29
Diesel Injector Pump Module Resistor.....	25	Ignition Starter Switch	74
Diesel Nitrogen Oxide (NOx) Sensor	62	Ignition Switch with Lock Cylinder.....	75
Diesel Oil Cooler Kit.....	57	Injection Actuation Pressure Sensor	67
Diesel Particulate Filter (DPF) Pressure		Instrument Panel Dimmer Switch	72
Sensor	66	Instrument Panel Wiring Harness Module	26
Diesel Valve Cover Gasket	58	Intake Air Temperature Sensor	70
Diesel Wait Lamp Relay	28	Interior Light Switch.....	72
Diverter Valve.....	34	Knock Sensor	64
EGR Control Solenoid.....	37	Low Fuel Relay	29
EGR Valve	38	Manifold Air Tube	32
EGR Valve Mounting Gasket	39	Manifold Differential Pressure Sensor	67
EGR Valve Relay	28	MAP Sensor	67
Emission Control Relay	28	Mass Air Flow	64
Engine Oil Level Sensor	62	Neutral Safety Switch.....	74
Exhaust Gas Temperature Sensor	70	Oil Pressure Gauge Switch	76
Fast Idle Relay	28	Oil Pressure Light Switch.....	78
Fog Lamp Relay.....	28	Oxygen Sensor.....	64
Fog Lamp Switch.....	71	Parking Brake Switch.....	76
Four Wheel Drive Indicator Lamp Switch.....	74	Parking Lamp Relay	29
Fuel / Water Separator Sensor	63	PCV Grommet	41
Fuel / Water Separator Valve	47	PCV Valve.....	44
Fuel Filter Housing Seal Kit.....	58	Ported Vacuum Switch.....	78
Fuel Injection Cold Advance Solenoid Relay ...	28	Power Antenna Relay.....	29
Fuel Injection Pump Relay.....	28	Power Door Lock Actuator	83
Fuel Injection Throttle Body	32	Power Door Lock Relay	29
Fuel Injector - Diesel - New.....	49	Power Steering Pressure Switch	79
Fuel Injector - Diesel - Remfd	50	Power Window Relay	29
Fuel Injector Installation Kit	58	Starter Relay	29
Fuel Injector Seal Kit.....	59	Starter Solenoid.....	30
Fuel Level Sensor.....	62	Steering Wheel Audio Control Switch.....	76
Fuel Pressure Regulator.....	60	Stoplight Relay	30
Fuel Pressure Relief Valve.....	47	Stoplight Switch	72
Fuel Pressure Sensor	67	Tailgate Lock Cylinder	83
Fuel Pump Driver Module	25	Temperature Sender - With Gauge.....	81
Fuel Pump Relay	29	Temperature Sender - With Light.....	82
Fuel Rail O-Ring Kit.....	60	Throttle Body Injection Flange Gasket.....	61

Table of Contents

Chevrolet	Dodge		
Throttle Position Sensor.....	65	Brake Pad Wear Sensor.....	92
Transfer Case Relay.....	30	Cabin Air Temperature Sensor.....	96
Transmission Control Solenoid.....	74	Camshaft Sensor.....	92
Trunk Lock Kit.....	83	Center High Mount Stop Light Assembly.....	101
Turbocharger - New.....	32	Clock Spring.....	99
Turbocharger - Remfd.....	33	Clutch Starter Safety Switch.....	98
Turbocharger Actuator.....	35	Computer Control Relay.....	84
Turbocharger Boost Sensor.....	68	Coolant Level Sensor.....	91
Turbocharger Boost Solenoid.....	36	Coolant Temperature Sensor.....	96
Turn Signal Lever.....	73	Crankcase Ventilation Filter.....	87
Turn Signal Switch.....	73	Crankshaft Sensor.....	93
Turn Signal Switch Repair Kit.....	73	Cruise Control Switch.....	99
Vacuum Delay Valve.....	35	Diesel Air Intake Heater.....	85
Vacuum Motor.....	34	Diesel EGR Cooler.....	87
Vacuum Pump.....	34	Diesel Fuel Injection Pump - New.....	89
Vehicle Speed Sensor.....	61	Diesel Fuel Injection Pump - Remanufactured.....	89
Voltage Regulator.....	31	Diesel Fuel Injector Line.....	90
Water In Fuel Indicator Relay.....	30	Diesel Fuel Injector Rail.....	90
Windshield Washer Relay.....	30	Diesel Fuel Injector Sleeve.....	90
Windshield Wiper Switch.....	76	Diesel Fuel Transfer Pump.....	90
Wiper Relay.....	30	Diesel Glow Plug.....	90
YAW Rate Sensor.....	61	Diesel Oil Cooler Kit.....	90
		Diesel Valve Cover Gasket.....	90
		EGR Tube.....	87
Crane Carrier		EGR Tube Gasket.....	87
Diesel Particulate Filter (DPF) Pressure Sensor.....	83	EGR Valve.....	87
Injection Actuation Pressure Sensor.....	83	EGR Valve Mounting Gasket.....	88
Oil Pressure Gauge Switch.....	84	EGR Valve Pressure Feedback Sensor.....	93
		Electronic Brake Control Relay.....	84
Dodge		Electronic Throttle Body (ETB) Gasket.....	85
A/C and Heater Blower Motor Switch.....	100	Engine Block Heater.....	90
A/C and Heater Selector Switch.....	101	Engine Oil Level Sensor.....	91
A/C Compressor Clutch Relay.....	84	Exhaust Back Pressure Sensor.....	94
A/C Evaporator Temperature Sensor.....	96	Exhaust Gas Temperature Sensor.....	96
A/C Relay.....	84	Fog Lamp Switch.....	97
ABS Speed Sensor.....	91	Four Wheel Drive Actuator.....	101
ABS Warning Lamp Relay.....	84	Four Wheel Drive Selector Switch.....	98
Accelerator Pedal Sensor.....	92	Fuel / Water Separator Sensor.....	92
Accessory Relay.....	84	Fuel Injection Throttle Body.....	86
Air Cleaner Check Valve.....	87	Fuel Injector - Diesel - New.....	88
Air Intake Heater Relay.....	84	Fuel Injector - Diesel - Remfd.....	89
Air Pump Relay.....	84	Fuel Injector Seal Kit.....	91
Ambient Air Temperature Sensor.....	96	Fuel Pressure Regulator.....	91
Automatic Shutdown Relay.....	84	Fuel Pressure Relief Valve.....	88
Automatic Transmission Governor Repair Kit.....	98	Fuel Pressure Sensor.....	94
Automatic Transmission Input Sensor.....	91	Fuel Pressure Warning Light Kit.....	101
Automatic Transmission Oil Temperature Sensor.....	96	Fuel Pump Relay.....	84
Automatic Transmission Output Sensor.....	91	Fuel Shut-Off Solenoid.....	88
Back-Up Light Switch.....	97	Fuel Temperature Sensor.....	97
Barometric Pressure Sensor.....	93	Fuel Vapor Canister.....	88
Battery Temperature Sensor.....	96	Fuel Vapor Canister Seal.....	88
Blower Motor Resistor.....	101	Fuel Vapor Leak Detection Pump.....	88
Bowl Vent Solenoid.....	87	Fuel Vapor Leak Detection Pump Filter.....	88
Brake Fluid Pressure Sensor.....	93	Glove Box Lamp Switch.....	97

Table of Contents

Dodge		Dodge	
Glow Plug Controller.....	84	Tire Pressure Monitoring System OE Design Sensor Service Kit.....	94
Governor Pressure Sensor.....	92	Tire Pressure Monitoring System OE Design Valve	94
Hazard Flasher.....	84	Tire Pressure Monitoring System QWIK-Sensor	95
Hazard Warning Switch.....	97	Tire Pressure Monitoring System QWIK-Sensor Service Kit.....	95
Headlight Dimmer Switch	97	Tire Pressure Monitoring System QWIK-Sensor Valve	95
Headlight Switch.....	98	Traction Control Switch	100
Heated Seat Switch	99	Trailer Towing Package Relay	85
Horn Relay	84	Transfer Case Switch	98
HVAC Defrost Mode Door Actuator	101	Transmission Control Solenoid	99
HVAC Recirculation Mode Door Actuator	101	Transmission Oil Pressure Sensor.....	95
HVAC Temperature Blend Door Actuator.....	101	Transmission Oil Pressure Switch	100
HVAC Temperature Control Panel.....	101	Turbocharger - New.....	86
Idle Air Control Valve	87	Turbocharger - Remfd	86
Idle Speed Control Motor.....	87	Turbocharger Boost Sensor	95
Ignition Lock Cylinder.....	101	Turbocharger Speed Sensor	91
Ignition Starter Switch	99	Turbocharger Wastegate Solenoid	87
Ignition Time Delay Relay	85	Turn Signal Relay	85
Intake Air Temperature Sensor	97	Turn Signal Switch	98
Intake Manifold Actuator.....	87	Vacuum Pump.....	87
Interior Light Switch.....	98	Vehicle Speed Sensor	91
Manifold Differential Pressure Sensor	94	Voltage Regulator	85
MAP Sensor	94	Windshield Washer Level Sensor	91
Mass Air Flow	92	Windshield Wiper Switch.....	100
Neutral Safety Switch.....	98	YAW Rate Sensor.....	91
Oil Pressure Gauge Switch	100		
Oil Pressure Light Switch.....	100	El Dorado	
Overdrive Kick-Down Switch	98	Oil Pressure Gauge Switch	102
Oxygen Sensor.....	92		
Oxygen Sensor Relay	85	Fiat	
Parking Assist Sensor	97	Coolant Temperature Sensor	102
Parking Brake Switch.....	99	Oil Pressure Light Switch.....	102
Parking Lamp Relay	85		
PCV Grommet	88	Ford	
PCV Valve.....	88	A/C and Heater Blower Motor Switch	154
Pedal Height Adjustment Switch	99	A/C and Heater Selector Switch.....	155
Ported Vacuum Switch.....	100	A/C Compressor Clutch Cut-Off Relay.....	102
Power Door Lock Actuator	101	A/C Cut-Off Switch	155
Power Door Lock Switch	99	ABS Speed Sensor	136
Power Seat Memory Switch.....	99	ABS Warning Lamp Relay	102
Power Sunroof Switch	99	Accelerator Pedal Sensor.....	140
Power Window Switch	99	Accelerator Pedal Sensor Repair Kit.....	140
Rear Window Defogger Switch	100	Accessory Relay.....	102
Remote Mirror Switch	100	Air Cleaner Check Valve	112
Secondary Air Injection Solenoid	87	Air Filter Indicator.....	108
Starter Relay	85	Air Intake Heater Relay	102
Starter Solenoid.....	85	Ambient Air Temperature Sensor	146
Steering Angle Sensor.....	100	Automatic Transmission Output Sensor.....	137
Stoplight Switch	98	Automatic Transmission Vacuum Modulator ...	151
Temperature Sender - With Gauge.....	101	Auxiliary Air Valve	112
Throttle Control Actuator.....	101	Axle Shift Motor.....	156
Throttle Position Sensor.....	93		
Tire Pressure Monitoring System OE Design Sensor	94		

Table of Contents

Ford	Ford		
Axle Shift Switch - H/D Truck	151	Diesel High Pressure Oil Rail Ball Tube	131
Axle Shift Switch Terminal Block.....	151	Diesel High Pressure Oil Rail Seal Kit.....	131
Back-Up Light Switch.....	148	Diesel Injection Control Pressure Sensor.....	137
Barometric Pressure Sensor	142	Diesel Injection High Pressure Oil Pump.....	131
Blower Motor Relay	102	Diesel Injection Pump Installation Kit	132
Blower Motor Resistor	155	Diesel Injection Pump Supply Line.....	132
Blower Motor Resistor Kit	155	Diesel Injector Connector Removal Tool.....	132
Bowl Vent Solenoid	113	Diesel Injector Retaining Bracket Socket	132
Camshaft Sensor.....	141	Diesel Nitrogen Oxide (NOx) Sensor	140
Canister Purge Solenoid.....	117	Diesel Oil Cooler Gasket Kit.....	132
Canister Purge Valve.....	117	Diesel Oil Cooler Kit.....	133
Canister Vent Solenoid	117	Diesel Particulate Filter (DPF) Pressure	
Charge Air Cooler.....	108	Sensor	143
Circuit Breaker.....	103	Diesel Valve Cover Gasket	133
Computer Control Relay	103	Diverter Valve.....	112
Coolant Fan Relay	103	Door Jamb Switch	149
Coolant Fan Switch	155	Door Lock Kit.....	156
Coolant Level Sensor.....	137	Dual Battery Solenoid Relay	104
Coolant Temperature Sensor	146	EGR Control Solenoid.....	114
Crankcase Ventilation Filter	113	EGR Tube	114
Crankshaft Sensor	142	EGR Valve	115
Cruise Control Release Switch	152	EGR Valve Control Solenoid Filter.....	115
Diesel EGR Cooler.....	113	EGR Valve Mounting Gasket	115
Diesel EGR Cooler Gasket Kit.....	114	EGR Valve Position Sensor	142
Diesel Emission Fluid Injection Nozzle	116	EGR Valve Pressure Feedback Sensor	143
Diesel Emissions Fluid Pump	116	EGR Valve Spacer Plate.....	116
Diesel Engine Belt Tensioner	122	Electronic Throttle Body (ETB) Gasket	108
Diesel Exhaust Fluid (DEF) Heater	116	Engine Control Relay	104
Diesel Exhaust Fluid (DEF) Pump Wiring		Engine Oil Separator.....	112
Harness	116	Engine Oil Stand Pipe and Dummy Plug Kit.....	133
Diesel Exhaust Fluid (DEF) Tank.....	116	Engine Oil Temperature Sensor	147
Diesel Exhaust Particulate Sensor	137	Exhaust Back Pressure Sensor	144
Diesel Fuel Filter Housing	123	Exhaust Gas Temperature Sensor.....	147
Diesel Fuel Heater	123	Fog Lamp Relay.....	104
Diesel Fuel Injection Harness	123	Fog Lamp Switch.....	149
Diesel Fuel Injection Pump - New	124	Fuel / Water Separator Sensor	140
Diesel Fuel Injection Pump - Remanufactured .	124	Fuel / Water Separator Valve	117
Diesel Fuel Injector Control Module (FICM).....	126	Fuel Injection Relay.....	104
Diesel Fuel Injector Driver Module (IDM)	126	Fuel Injection Throttle Body.....	108
Diesel Fuel Injector Installation Kit.....	126	Fuel Injector - Diesel - New.....	119
Diesel Fuel Injector Rail.....	127	Fuel Injector - Diesel - Remfd.....	120
Diesel Fuel Injector Return Hose	127	Fuel Injector Installation Kit	134
Diesel Fuel Injector Sleeve	127	Fuel Injector Retaining Bracket	134
Diesel Fuel Rail Supply Line	127	Fuel Injector Seal Kit.....	134
Diesel Fuel Transfer Pump	128	Fuel Line Retainer	134
Diesel Glow Plug	128	Fuel Pressure Regulator	135
Diesel Glow Plug Control Sensor	146	Fuel Pressure Regulator O-Ring.....	135
Diesel Glow Plug Indicator Relay	103	Fuel Pressure Regulator Upgrade Kit	136
Diesel Glow Plug Relay.....	103	Fuel Pressure Sensor	144
Diesel Glow Plug Wiring Harness.....	129	Fuel Pump Driver Module	102
Diesel High Pressure Oil Pump Hose.....	129	Fuel Pump Relay	104
Diesel High Pressure Oil Pump Seal Kit	130	Fuel Pump Strainer	136
Diesel High Pressure Oil Rail Ball Installation		Fuel Tank Selector Switch	152
Tool	130	Fuel Tank Selector Valve.....	118

Table of Contents

Ford	Ford		
Fuel Tank Vent Valve	118	Throttle Body Injection Gasket Pack.....	136
Fuel Temperature Sensor	147	Throttle Position Sensor.....	142
Fuel Vapor Canister.....	117	Tire Pressure Monitoring System OE Design	
Glow Plug Controller.....	102	Sensor	145
Hazard Flasher.....	104	Tire Pressure Monitoring System OE Design	
Hazard Warning Switch.....	149	Sensor Service Kit.....	145
Headlight Dimmer Switch	149	Tire Pressure Monitoring System OE Design	
Headlight Dimmer Switch Relay	104	Valve	145
Headlight Switch.....	150	Tire Pressure Monitoring System	
Headlight Switch Knob	152	QWIK-Sensor	145
Heater Core Temperature Sensor	147	Tire Pressure Monitoring System	
Horizontal Fuel Conditioning Module.....	136	QWIK-Sensor Service Kit.....	145
Horizontal Fuel Conditioning Module Cover		Tire Pressure Monitoring System	
Gasket Kit.....	136	QWIK-Sensor Valve	145
Horn Relay	104	Trailer Towing Package Relay	105
HVAC Binary Switch.....	155	Transmission Control Solenoid	151
HVAC Temperature Blend Door Actuator.....	156	Transmission Kick-Down Solenoid Switch.....	151
Idle Air Control Valve	112	Turbocharger - New.....	108
Idle Stop Solenoid	113	Turbocharger - Remfd	109
Ignition Lock Cylinder.....	157	Turbocharger Actuator.....	112
Ignition Relay	105	Turbocharger Boost Solenoid	113
Ignition Starter Switch	151	Turbocharger Gasket Set.....	110
Injection Actuation Pressure Sensor	144	Turbocharger Hose.....	110
Instrument Panel Dimmer Switch	150	Turbocharger Oil Drain Tube	110
Intake Air Temperature Sensor	147	Turn Signal Flasher	105
Load Leveling Relay.....	105	Turn Signal Switch	150
Manual Transmission Output Sensor	137	Vacuum Delay Valve	113
MAP Sensor	144	Vacuum Motor.....	111
Mass Air Flow	140	Vacuum Pump.....	111
Neutral Safety Switch.....	151	Vehicle Ride Height Switch	153
Neutral Safety Switch Relay	105	Vehicle Speed Sensor	137
Oil Level Indicator Relay.....	105	Vertical Fuel Conditioning Module.....	136
Oil Pressure Gauge Switch	153	Voltage Regulator	107
Oil Pressure Light Switch.....	153	Windshield Wiper Switch.....	153
Park Assist Camera.....	148		
PCV Grommet	116	Freightliner	
PCV Valve.....	117	A/C and Heater Blower Motor Switch	164
Plenum Gasket	136	A/C and Heater Selector Switch.....	164
Ported Vacuum Switch.....	154	ABS Speed Sensor.....	158
Power Door Lock Actuator	156	Accelerator Pedal Sensor.....	159
Power Door Lock Relay	105	Accessory Relay.....	157
Power Seat Switch	152	Air Inlet Pressure Sensor	159
Power Steering Pressure Switch	154	Ambient Air Temperature Sensor	162
Power Window Relay	105	Automatic Transmission Output Sensor.....	159
Power Window Switch	152	Blower Motor Resistor	164
Powertrain Control Module Relay.....	105	Brake Fluid Pressure Sensor	159
Remote Mirror Switch	153	Brake Pad Wear Sensor.....	159
Shift Interlock Actuator.....	156	Cabin Air Temperature Sensor.....	162
Starter Relay	105	Camshaft Sensor.....	159
Starter Solenoid.....	105	Clock Spring	163
Stoplight Switch	150	Clutch Starter Safety Switch	163
Temperature Sender - With Gauge.....	155	Coolant Level Sensor.....	159
Temperature Sender - With Light.....	156	Coolant Temperature Sensor	162
Theft Deterrent Relay	105	Crankcase Ventilation Filter	157

Table of Contents

Freightliner	Freightliner
Crankshaft Sensor	Turn Signal Switch
Cruise Control Switch	Vacuum Pump.....
Diesel EGR Cooler.....	Vehicle Speed Sensor
Diesel Emission Fluid Injection Nozzle	Voltage Regulator
Diesel Fuel Injection Pump - Remanufactured .	Windshield Wiper Switch.....
Diesel Glow Plug	YAW Rate Sensor.....
Diesel Particulate Filter (DPF) Pressure Sensor	Gillig
EGR Tube	Oil Pressure Gauge Switch
EGR Tube Gasket	GMC
EGR Valve	A/C and Heater Blower Motor Switch
EGR Valve Pressure Feedback Sensor	A/C and Heater Selector Switch
Exhaust Gas Temperature Sensor.....	A/C Control Relay
Fog Lamp Switch.....	ABS Speed Sensor.....
Fuel / Water Separator Sensor	ABS Warning Lamp Relay
Fuel Injector - Diesel - Remfd	Accelerator Pedal Sensor.....
Fuel Pressure Regulator	Accelerator Pedal Sensor Repair Kit.....
Fuel Pressure Sensor	Accessory Delay Relay
Hazard Warning Switch.....	Accessory Relay.....
Headlight Dimmer Switch	Air Bag Relay
Headlight Switch.....	Air Cleaner Check Valve
Ignition Starter Switch	Air Intake Heater Relay
Injection Actuation Pressure Sensor	Air Pump Relay
Interior Light Switch.....	Ambient Air Temperature Sensor
MAP Sensor	Automatic Headlight Relay.....
Mass Air Flow	Automatic Transmission Input Sensor.....
Oil Pressure Gauge Switch	Automatic Transmission Vacuum Modulator ...
Parking Brake Switch.....	Auxiliary Battery Relay
PCV Valve.....	Auxiliary Heater and A/C Control Relay
Power Door Lock Actuator	Back-Up Light Switch.....
Power Door Lock Switch	Barometric Pressure Sensor
Power Window Switch	Blower Motor Cut-Off Relay.....
Rear Window Defogger Switch	Blower Motor Relay
Remote Mirror Switch	Blower Motor Resistor
Secondary Air Injection Solenoid	Blower Motor Resistor Kit
Starter Solenoid.....	Camshaft Sensor.....
Steering Angle Sensor.....	Center High Mount Stop Light Assembly.....
Stoplight Switch	Clock Spring
Tire Pressure Monitoring System OE Design Sensor	Coolant Fan Relay
Tire Pressure Monitoring System OE Design Sensor Service Kit.....	Coolant Fan Switch
Tire Pressure Monitoring System OE Design Valve	Coolant Level Sensor.....
Tire Pressure Monitoring System QWIK-Sensor	Coolant Temperature Sensor
Tire Pressure Monitoring System QWIK-Sensor Service Kit.....	Cornering Lamp Relay
Tire Pressure Monitoring System QWIK-Sensor Valve	Crankcase Ventilation Filter
Traction Control Switch	Crankshaft Sensor
Transmission Control Solenoid	Cruise Control Release Switch
Turbocharger - New.....	Cruise Control Switch.....
Turbocharger Boost Sensor.....	Daytime Running Lamp Relay.....
	Diesel Air Intake Heater
	Diesel EGR Cooler.....
	Diesel Emission Fluid Injection Nozzle
	Diesel Emissions Fluid Pump
	Diesel Emissions Fluid Temperature Sensor....
	Diesel Exhaust Fluid (DEF) Heater

Table of Contents

GMC	GMC	
Diesel Exhaust Particulate Sensor	Hazard Flasher	194
Diesel Fuel Heater	Hazard Warning Switch.....	185
Diesel Fuel Injection Harness	Headlight Dimmer Switch	185
Diesel Fuel Injection Pump - New	Headlight Relay	185
Diesel Fuel Injection Pump - Remanufactured .	Headlight Switch.....	186
Diesel Fuel Injector Line	Heater Core Temperature Sensor	188
Diesel Fuel Injector Rail	Idle Air Control Valve	188
Diesel Glow Plug	Idle Stop Solenoid	188
Diesel Glow Plug Control Sensor	Ignition Lock Cylinder Housing Repair Kit	200
Diesel Glow Plug Relay.....	Ignition Relay	167
Diesel Glow Plug Temperature Sensor.....	Ignition Starter Switch	200
Diesel Injector Pump Driver Relocation Kit	Ignition Switch with Lock Cylinder.....	189
Diesel Injector Pump Module	Injection Actuation Pressure Sensor	190
Diesel Injector Pump Module Resistor	Instrument Panel Dimmer Switch	164
Diesel Nitrogen Oxide (NOx) Sensor	Instrument Panel Wiring Harness Module	194
Diesel Oil Cooler Kit	Intake Air Temperature Sensor	190
Diesel Particulate Filter (DPF) Pressure	Knock Sensor	
Sensor	Low Fuel Relay	198
Diesel Valve Cover Gasket	Manifold Air Tube	190
Diverter Valve.....	MAP Sensor	172
EGR Control Solenoid.....	Mass Air Flow	174
EGR Valve	Neutral Safety Switch.....	175
EGR Valve Mounting Gasket	Oil Pressure Gauge Switch	176
EGR Valve Relay	Oil Pressure Light Switch.....	167
Emission Control Relay	Parking Brake Switch.....	167
Engine Oil Level Sensor	Parking Lamp Relay	194
Exhaust Gas Temperature Sensor	PCV Grommet	201
Fog Lamp Relay.....	PCV Valve.....	167
Fog Lamp Switch.....	Power Door Lock Actuator	202
Four Wheel Drive Indicator Lamp Switch.....	Power Door Lock Relay	204
Fuel / Water Separator Sensor	Power Steering Pressure Switch	194
Fuel / Water Separator Valve	Power Window Relay	181
Fuel Filter Housing Seal Kit.....	Starter Relay	191
Fuel Injection Cold Advance Solenoid Relay ...	Starter Solenoid.....	167
Fuel Injection Pump Relay.....	Steering Wheel Audio Control Switch.....	167
Fuel Injection Throttle Body	Stoplight Switch	170
Fuel Injector - Diesel - New.....	Temperature Sender - With Gauge.....	182
Fuel Injector - Diesel - Remfd	Temperature Sender - With Light.....	183
Fuel Injector Installation Kit	Theft Deterrent Relay	191
Fuel Injector Seal Kit.....	Throttle Body Injection Flange Gasket.....	192
Fuel Level Sensor.....	Throttle Position Sensor.....	194
Fuel Pressure Regulator	Transfer Case Relay	192
Fuel Pressure Relief Valve.....	Turbocharger - New.....	181
Fuel Pressure Sensor	Turbocharger - Remfd	198
Fuel Pump Relay	Turbocharger Actuator.....	167
Fuel Rail O-Ring Kit.....	Turbocharger Boost Sensor	193
Fuel Shut-Off Solenoid.....	Turbocharger Boost Solenoid	181
Fuel Tank Selector Switch	Turn Signal Lever	206
Fuel Tank Selector Valve.....	Turn Signal Switch	181
Fuel Temperature Sensor	Turn Signal Switch Repair Kit	201
Fuel Vapor Canister.....	Vacuum Delay Valve	181
Fuel Vapor Canister Filter	Vacuum Motor.....	181
Glow Plug Conductor.....	Vacuum Pump.....	193
Glow Plug Controller.....	Vehicle Speed Sensor	165

Table of Contents

GMC		Indiana Phoenix	
Water In Fuel Indicator Relay	168	Fuel Injector - Diesel - New.....	221
Windshield Wiper Switch.....	207	International	
Hummer		A/C and Heater Blower Motor Switch	267
Ambient Air Temperature Sensor	212	Air Inlet Pressure Sensor	266
Automatic Transmission Output Sensor.....	212	Automatic Transmission Vacuum Modulator ...	267
Cruise Control Switch	212	Camshaft Sensor.....	265
Diesel Fuel Injection Pump - Remanufactured .	212	Crankcase Ventilation Filter	226
Diesel Glow Plug	212	Diesel EGR Cooler.....	226
Diesel Injector Pump Driver Relocation Kit	212	Diesel EGR Cooler Gasket Kit.....	227
Diesel Injector Pump Module	212	Diesel Fuel Heater	247
Diesel Injector Pump Module Resistor	212	Diesel Fuel Injection Harness	248
Diesel Valve Cover Gasket	212	Diesel Fuel Injection Pump - New	249
Engine Oil Level Sensor	212	Diesel Fuel Injection Pump - Remanufactured .	249
Fuel Injector - Diesel - New.....	212	Diesel Fuel Injector Control Module (FICM).....	249
Fuel Injector - Diesel - Remfd.....	212	Diesel Fuel Injector Sleeve	249
Fuel Injector Installation Kit	212	Diesel Fuel Transfer Pump	250
Fuel Pressure Regulator.....	212	Diesel Glow Plug	251
Fuel Pressure Sensor	212	Diesel Glow Plug Relay.....	221
Fuel Shut-Off Solenoid.....	212	Diesel High Pressure Oil Pump Hose	251
Fuel Vapor / Vent Pressure Sensor.....	212	Diesel High Pressure Oil Pump Seal Kit	251
Hazard Warning Switch.....	212	Diesel High Pressure Oil Rail Seal Kit.....	251
Ignition Starter Switch	212	Diesel Injection Control Pressure Sensor.....	263
Neutral Safety Switch.....	212	Diesel Injection High Pressure Oil Pump.....	251
Parking Brake Switch.....	212	Diesel Injection Pump Installation Kit	255
Power Seat Switch	212	Diesel Oil Cooler Gasket Kit.....	255
Vehicle Speed Sensor	212	Diesel Oil Cooler Kit.....	256
Windshield Wiper Switch.....	212	Diesel Particulate Filter (DPF) Pressure Sensor	266
IC Corporation		Diesel Valve Cover Gasket	256
Diesel EGR Cooler.....	213	EGR Valve	227
Diesel Fuel Heater	216	EGR Valve Pressure Feedback Sensor	266
Diesel Fuel Injection Harness	216	Engine Oil Stand Pipe and Dummy Plug Kit.....	257
Diesel Fuel Injection Pump - Remanufactured .	216	Exhaust Back Pressure Sensor	266
Diesel Fuel Injector Control Module (FICM).....	217	Exhaust Gas Temperature Sensor.....	267
Diesel Fuel Injector Sleeve	217	Fuel Injector - Diesel - New.....	227
Diesel Glow Plug	217	Fuel Injector - Diesel - Remfd.....	242
Diesel Glow Plug Relay.....	213	Fuel Injector Seal Kit.....	257
Diesel Injection Control Pressure Sensor.....	220	Fuel Pressure Regulator	260
Diesel Injection High Pressure Oil Pump.....	217	Fuel Pressure Regulator O-Ring.....	261
Diesel Injection Pump Installation Kit	218	Fuel Rail O-Ring Kit.....	262
Diesel Oil Cooler Kit.....	219	Headlight Switch.....	267
Diesel Particulate Filter (DPF) Pressure Sensor	221	HVAC Floor Mode Door Actuator	267
EGR Valve	213	HVAC Temperature Blend Door Actuator.....	268
Engine Oil Stand Pipe and Dummy Plug Kit.....	219	Intake Air Temperature Sensor	267
Fuel Injector - Diesel - New.....	213	MAP Sensor	266
Fuel Injector - Diesel - Remfd.....	215	PCV Valve	227
Fuel Injector Seal Kit.....	219	Starter Solenoid.....	221
Fuel Pressure Regulator.....	219	Stoplight Switch	267
Fuel Pressure Regulator O-Ring.....	220	Turbocharger - New.....	225
Fuel Rail O-Ring Kit.....	220	Turbocharger Gasket Set.....	226
Intake Air Temperature Sensor	221	Voltage Regulator	223
Turbocharger - New.....	213	Isuzu	
Turbocharger Gasket Set.....	213	A/C Auto Temperature Control Relay	268

Table of Contents

Isuzu	Jeep
Air Cleaner Check Valve	Diesel Glow Plug
269	272
Automatic Transmission Output Sensor.....	Diesel Particulate Filter (DPF) Pressure
270	Sensor
Blower Motor Relay	273
269	EGR Control Solenoid.....
Blower Motor Resistor	272
270	EGR Tube Gasket
Coolant Fan Switch	272
270	EGR Valve
Coolant Temperature Sensor	272
270	EGR Valve Mounting Gasket
Diesel Glow Plug Relay.....	272
269	EGR Valve Pressure Feedback Sensor
EGR Valve Mounting Gasket	273
269	EGR Valve Vacuum Modulator
Fuel Injector - Diesel - Remfd	272
269	Engine Oil Filter Housing.....
Fuel Pump Relay	272
269	Engine Oil Level Sensor
Glow Plug Controller.....	273
268	Engine Oil Temperature Sensor
Headlight Relay	273
269	Exhaust Back Pressure Sensor
Ignition Lock Cylinder.....	273
271	Exhaust Gas Temperature Sensor
Ignition Starter Switch	273
270	Fog Lamp Relay.....
Ignition Switch with Lock Cylinder	271
270	Fuel / Water Separator Sensor
MAP Sensor	273
270	Fuel Injector - Diesel - New.....
Oil Pressure Gauge Switch	272
270	Fuel Injector - Diesel - Remfd
Oil Pressure Light Switch.....	272
270	Fuel Pressure Regulator.....
PCV Valve.....	273
269	Fuel Pressure Sensor
Starter Relay	273
269	Fuel Pump Relay
Starter Solenoid.....	271
269	Fuel Vapor Leak Detection Pump Filter.....
Temperature Sender - With Gauge.....	272
271	Glow Plug Controller.....
Vehicle Speed Sensor	271
270	Hazard Warning Switch.....
Voltage Regulator	274
269	Idle Stop Solenoid
	272
Jaguar	Intake Air Temperature Sensor
Camshaft Sensor.....	274
271	Intake Manifold Actuator.....
Crankshaft Sensor	272
271	Knock Sensor
Direct Injection High Pressure Fuel Pump.....	273
271	MAP Sensor
Fuel Pump Camshaft Follower.....	273
271	Mass Air Flow
Fuel Pump O-Ring	273
271	Neutral Safety Switch Relay
Intake Air Temperature Sensor	271
271	Oil Pressure Gauge Switch
MAP Sensor	274
271	Oil Pressure Light Switch.....
Mass Air Flow	274
271	Oil Pump Solenoid.....
Oil Pressure Light Switch.....	274
271	Parking Brake Switch.....
Variable Valve Timing Solenoid.....	274
271	Parking Lamp Relay
	272
Jeep	PCV Valve.....
A/C and Heater Blower Motor Switch	272
274	Power Door Lock Relay
A/C Relay.....	272
271	Power Steering Pressure Switch
ABS Speed Sensor	274
273	Power Window Switch
Accelerator Pedal Sensor	274
273	Starter Relay
Ambient Air Temperature Sensor	272
273	Starter Solenoid.....
Auto Transaxle Relay	272
271	Temperature Sender - With Gauge.....
Battery Current / Volt Sensor	274
273	Tire Pressure Monitoring System OE Design
Blower Motor Relay	Sensor
271	273
Brake Fluid Level Sensor	Trailer Towing Package Relay
273	272
Camshaft Sensor	Turbocharger - New.....
273	272
Canister Purge Valve.....	Turbocharger Boost Sensor
272	273
Clock Spring	Vacuum Pump.....
274	272
Coolant Fan Relay	Voltage Regulator
271	272
Coolant Temperature Sensor	Wiper Relay
273	272
Crankshaft Sensor	
273	Kenworth
Diesel Emission Fluid Injection Nozzle	Air Inlet Pressure Sensor
272	274
Diesel Exhaust Particulate Sensor	
273	

Table of Contents

Kenworth	Mazda		
Coolant Level Sensor.....	274	Ignition Switch with Lock Cylinder.....	279
Diesel Particulate Filter (DPF) Pressure Sensor	274	Oil Pressure Light Switch.....	279
Exhaust Gas Temperature Sensor.....	275	PCV Grommet.....	279
Fuel Pressure Sensor	275	PCV Valve.....	279
Injection Actuation Pressure Sensor	275	Pre Heater Hose.....	279
MAP Sensor	275	Starter Solenoid.....	278
Oil Pressure Gauge Switch	275	Stoplight Switch	279
Turbocharger Boost Sensor.....	275	Temperature Sender - With Gauge.....	279
		Temperature Sender - With Light.....	279
		Turn Signal Switch	279
		Voltage Regulator	278
		Windshield Wiper Switch.....	279
Land Rover		Mercedes-Benz	
Battery Current / Volt Sensor	275	A/C and Heater Blower Motor Switch	298
Blower Motor Resistor	276	A/C Auto Temperature Control Relay	279
Brake Pad Wear Sensor.....	275	A/C Control Relay	279
Camshaft Sensor.....	276	ABS Relay	279
Crankshaft Sensor	276	ABS Speed Sensor.....	285
Direct Injection High Pressure Fuel Pump.....	275	Accelerator Pedal Sensor.....	287
Exhaust Gas Temperature Sensor.....	276	Accessory Relay.....	279
Fuel Pump Camshaft Follower.....	275	Air Pump Relay.....	280
Fuel Pump O-Ring	275	Ambient Air Temperature Sensor	293
Fuel Vapor Leak Detection Pump	275	Automatic Transmission Conductor Plate.....	285
Intake Air Temperature Sensor	276	Auxiliary Battery Relay	280
Tire Pressure Monitoring System OE Design Sensor	276	Back-Up Light Switch.....	295
		Battery Current / Volt Sensor	286
		Blind Spot Detection Sensor.....	295
		Blower Motor Relay.....	280
		Blower Motor Resistor	298
		Brake Pad Wear Sensor.....	286
		Brake Pedal Travel Sensor	287
		Cabin Air Temperature Sensor.....	293
		Camshaft Sensor.....	287
		Canister Purge Solenoid.....	283
		Canister Vent Solenoid	283
		Clutch Starter Safety Switch	296
		Computer Control Relay	280
		Coolant Fan Relay	280
		Coolant Fan Switch	298
		Coolant Level Sensor.....	286
		Coolant Temperature Sensor	293
		Crankshaft Sensor	287
		Cruise Control Distance Sensor	295
		Daytime Running Lamp Relay.....	280
		Diesel Emission Fluid Injection Nozzle	283
		Diesel Emissions Fluid Pump	283
		Diesel Fuel Injection Pump - Remanufactured	284
		Diesel Fuel Injector Heat Shield.....	284
		Diesel Glow Plug	284
		Diesel Glow Plug Relay.....	280
		Diesel Nitrogen Oxide (NOx) Sensor	286
		Diesel Particulate Filter (DPF) Pressure Sensor	288
Lincoln			
Air Cleaner Check Valve	276		
Coolant Temperature Sensor	276		
Fuel Injector - Diesel - Remfd.....	276		
Fuel Line Retainer	276		
Headlight Relay	276		
Ignition Relay.....	276		
PCV Grommet.....	276		
Ported Vacuum Switch.....	276		
Starter Solenoid.....	276		
Mack			
A/C and Heater Blower Motor Switch	278		
Diesel Particulate Filter (DPF) Pressure Sensor	278		
Starter Solenoid.....	276		
Voltage Regulator.....	277		
Mazda			
Air Cleaner Check Valve	278		
Automatic Transmission Vacuum Modulator ...	279		
Back-Up Light Switch.....	279		
Blower Motor Resistor	279		
Coolant Fan Relay	278		
Coolant Temperature Sensor	279		
Door Lock Kit.....	279		
Fuel Pump Cut-Off Switch	279		
Headlight Dimmer Switch	279		
Headlight Switch.....	279		
Ignition Starter Switch	279		

Table of Contents

Mercedes-Benz

EGR Valve	282
EGR Valve Mounting Gasket	283
Exhaust Gas Temperature Sensor	293
Fog Lamp Relay	280
Fog Lamp Switch	295
Fuel Injection Relay	280
Fuel Injection Throttle Body	282
Fuel Injector - Diesel - New	284
Fuel Injector - Diesel - Remfd	284
Fuel Pressure Regulator	284
Fuel Pressure Sensor	288
Fuel Pump Cut-Off Switch	296
Fuel Pump Relay	280
Fuel Shut-Off Relay	281
Fuel Vapor Canister	283
Glow Plug Controller	279
Hazard Flasher	281
Headlight Dimmer Switch	295
Headlight Level Sensor	287
Headlight Relay	281
Headlight Switch	295
Heater Core Temperature Sensor	294
Horn Relay	281
Ignition Lock Cylinder	299
Ignition Push Button Switch	297
Ignition Starter Switch	297
Instrument Cluster Relay	281
Intake Air Temperature Sensor	294
Intake Manifold Actuator	282
Knock Sensor	286
MAP Sensor	288
Mass Air Flow	286
Oil Pressure Gauge Switch	298
Oxygen Sensor	286
Parking Assist Sensor	295
PCV Valve	283
Power Brake Booster Sensor	288
Power Door Lock Actuator	299
Power Seat Relay	281
Power Window Relay	281
Power Window Switch	297
Rear Window Defogger Relay	281
Remote Mirror Switch	297
Starter Relay	281
Starter Solenoid	281
Steering Angle Sensor	298
Stoplight Switch	295
Temperature Sender - With Gauge	299
Temperature Sender - With Light	299
Tire Pressure Monitoring System OE Design Sensor	289
Tire Pressure Monitoring System OE Design Sensor Service Kit	289

Mercedes-Benz

Tire Pressure Monitoring System OE Design Valve	290
Tire Pressure Monitoring System QWIK-Sensor	290
Tire Pressure Monitoring System QWIK-Sensor Service Kit	291
Tire Pressure Monitoring System QWIK-Sensor Valve	291
Transmission Control Solenoid	296
Turbocharger - New	282
Turbocharger Boost Sensor	292
Turn Signal Relay	281
Turn Signal Switch	296
Vacuum Pump	282
Vehicle Speed Sensor	285
Voltage Regulator	281
Windshield Washer Level Sensor	286
Windshield Washer Relay	281
Windshield Wiper Switch	298
Wiper Relay	281

Mercury

Air Cleaner Check Valve	300
Bowl Vent Solenoid	300
Coolant Fan Relay	299
Coolant Fan Switch	300
Coolant Temperature Sensor	300
Crankcase Ventilation Filter	300
EGR Valve Control Solenoid Filter	300
Engine Control Relay	299
Fuel Injection Relay	299
Fuel Injector - Diesel - Remfd	300
Fuel Line Retainer	300
Headlight Dimmer Switch Relay	299
Ignition Control Module Relay	299
Ignition Relay	299
Keyless Entry System Relay	299
Neutral Safety Switch	300
Neutral Safety Switch Relay	299
Oil Pressure Light Switch	300
PCV Grommet	300
Ported Vacuum Switch	300
Starter Solenoid	299
Theft Deterrent Relay	299
Throttle Position Sensor	300
Vacuum Motor	299
Voltage Regulator	299

Mitsubishi

Headlight Switch	300
Neutral Safety Switch	300
PCV Valve	300
Temperature Sender - With Gauge	300
Turn Signal Switch	300
Voltage Regulator	300

Table of Contents

Nissan	Oldsmobile		
A/C Control Relay	301	Diesel Glow Plug Control Sensor	307
Back-Up Light Switch.....	302	Diesel Glow Plug Indicator Relay	303
Camshaft Sensor.....	302	Diesel Glow Plug Relay	303
Coolant Temperature Sensor	302	Diesel Wait Lamp Relay	303
Crankshaft Sensor	302	Door Jamb Switch	308
Diesel Glow Plug Relay.....	301	EGR Valve	305
Diesel Particulate Filter (DPF) Pressure Sensor	302	EGR Valve Mounting Gasket	305
Diverter Valve.....	301	Fast Idle Relay	303
EGR Tube Gasket	301	Fast Idle Solenoid Relay	303
EGR Valve	301	Fuel Injection Pump Relay.....	303
EGR Valve Mounting Gasket	301	Fuel Injector - Diesel - New.....	307
Exhaust Gas Temperature Sensor.....	302	Fuel Pump Relay	303
Fog Lamp Switch.....	302	Fuel Rail O-Ring Kit.....	307
Fuel Injection Relay.....	301	Fuel Vapor Canister.....	307
Fuel Injector - Diesel - New.....	301	Headlight Switch.....	308
Fuel Injector - Diesel - Remfd.....	301	Idle Stop Solenoid	304
Fuel Pressure Regulator	302	Intake Air Temperature Sensor	308
Fuel Vapor Canister.....	301	Knock Sensor	307
Headlight Dimmer Switch	302	Manifold Air Tube	304
Headlight Switch.....	302	Manual Transmission Output Sensor.....	307
Ignition Starter Switch	302	MAP Sensor	307
Knock Sensor	302	Neutral Safety Switch.....	308
MAP Sensor	302	Oil Pressure Gauge Switch	309
Mass Air Flow	302	Oil Pressure Light Switch.....	309
Oil Pressure Gauge Switch	302	Parking Brake Switch.....	309
Oil Pressure Light Switch.....	302	PCV Grommet	305
Overdrive Relay	301	PCV Valve.....	306
PCV Valve.....	301	Ported Vacuum Switch.....	309
Ported Vacuum Switch.....	302	Power Antenna Relay.....	303
Starter Solenoid.....	301	Power Door Lock Actuator	310
Stoplight Switch	302	Power Seat Relay	303
Theft Deterrent Relay	301	Starter Solenoid.....	303
Throttle Position Sensor.....	302	Temperature Sender - With Gauge.....	309
Turn Signal Switch	302	Temperature Sender - With Light	310
Voltage Regulator	301	Throttle Position Sensor.....	307
Windshield Wiper Switch.....	302	Transmission Control Solenoid	308
		Trunk Release Switch	309
		Turn Signal Switch Repair Kit	308
		Vacuum Motor.....	304
		Vacuum Pump.....	304
		Vehicle Speed Sensor	307
		Wiper Relay	303
		Oshkosh Motor Truck Co.	
		Air Inlet Pressure Sensor	310
		Diesel Particulate Filter (DPF) Pressure Sensor	310
		Exhaust Gas Temperature Sensor.....	310
		Peterbilt	
		A/C and Heater Blower Motor Switch	312
		Air Inlet Pressure Sensor	310
		Coolant Level Sensor.....	310
		Diesel Particulate Filter (DPF) Pressure Sensor	311

Table of Contents

Peterbilt		Pontiac	
Exhaust Gas Temperature Sensor	311	Diverter Valve	313
Fuel Pressure Sensor	311	EGR Valve	314
Headlight Dimmer Switch	311	EGR Valve Mounting Gasket	314
Injection Actuation Pressure Sensor	311	Fast Idle Solenoid Relay	313
MAP Sensor	311	Fuel Injector - Diesel - New	315
Oil Pressure Gauge Switch	311	Fuel Pump Relay	313
Turbocharger Boost Sensor	311	Fuel Rail O-Ring Kit	315
Voltage Regulator	310	Fuel Vapor Canister	315
Peugeot		Idle Air Control Valve	313
ABS Speed Sensor	312	Idle Stop Solenoid	314
Air Cleaner Check Valve	312	Intake Air Temperature Sensor	316
Auxiliary Air Valve	312	MAP Sensor	316
Back-Up Light Switch	312	Neutral Safety Switch	316
Coolant Fan Switch	312	Oil Pressure Gauge Switch	317
Diesel Glow Plug	312	Oil Pressure Light Switch	317
Fuel Pump Cut-Off Switch	312	PCV Grommet	314
Knock Sensor	312	PCV Valve	315
Oil Pressure Light Switch	312	Ported Vacuum Switch	317
Stoplight Switch	312	Power Door Lock Actuator	318
Temperature Sender - With Gauge	312	Starter Solenoid	313
Temperature Sender - With Light	312	Stoplight Switch	316
Turn Signal Switch	312	Temperature Sender - With Gauge	317
Voltage Regulator	312	Temperature Sender - With Light	317
Pierce Mfg. Inc.		Throttle Position Sensor	316
Diesel Particulate Filter (DPF) Pressure		Trunk Release Switch	317
Sensor	312	Vacuum Motor	313
Pontiac		Vacuum Pump	313
A/C and Heater Blower Motor Switch	317	Vehicle Speed Sensor	315
A/C and Heater Selector Switch	317	Porsche	
A/C Blower Delay Switch	317	Camshaft Sensor	318
A/C Compressor Clutch Cut-Off Relay	312	Coolant Temperature Sensor	318
Air Cleaner Check Valve	313	Crankshaft Sensor	318
Air Cleaner Inlet Hose	314	Diesel Emission Fluid Injection Nozzle	318
Air Control Valve Relay	313	Exhaust Gas Temperature Sensor	318
Anti-Dieseling Relay	313	Fuel Pressure Sensor	318
Automatic Choke Relay	313	Fuel Vapor Leak Detection Pump	318
Automatic Transmission Output Sensor	315	Ignition Push Button Switch	318
Automatic Transmission Vacuum Modulator ...	316	Knock Sensor	318
Auxiliary Air Valve	313	MAP Sensor	318
Blower Motor Cut-Off Relay	313	Mass Air Flow	318
Blower Motor Relay	313	Oil Pressure Gauge Switch	318
Coolant Fan Relay	313	Oil Pressure Light Switch	318
Coolant Fan Switch	317	Turbocharger - New	318
Coolant Temperature Sensor	316	Variable Valve Timing Solenoid	318
Crankcase Ventilation Filter	314	Ram	
Crankshaft Sensor Bracket	316	A/C Cut-Off Switch	326
Cruise Control Switch	316	A/C Evaporator Temperature Sensor	323
Diesel Glow Plug	315	ABS Speed Sensor	321
Diesel Glow Plug Control Sensor	316	Accelerator Pedal Sensor	322
Diesel Glow Plug Indicator Relay	313	Air Intake Heater Relay	318
Diesel Glow Plug Relay	313	Ambient Air Temperature Sensor	323
Diesel Wait Lamp Relay	313	Automatic Transmission Input Sensor	321

Table of Contents

Ram	Ram
Automatic Transmission Oil Temperature Sensor	MAP Sensor
323	323
Barometric Pressure Sensor	Mass Air Flow
323	322
Blower Motor Resistor	Neutral Safety Switch.....
326	325
Camshaft Sensor.....	Oil Pressure Gauge Switch
322	326
Center High Mount Stop Light Assembly.....	Oil Pressure Light Switch
327	326
Clutch Starter Safety Switch	Park Assist Camera.....
325	324
Coolant Level Sensor.....	Pedal Height Adjustment Switch
322	325
Coolant Temperature Sensor	Power Door Lock Actuator
323	327
Crankcase Ventilation Filter	Power Door Lock Switch
319	325
Crankshaft Sensor	Power Seat Lumbar Switch
322	326
Diesel Air Intake Heater	Power Seat Memory Switch.....
319	326
Diesel EGR Cooler.....	Power Seat Switch
319	326
Diesel Emission Fluid Injection Nozzle	Power Window Switch
320	326
Diesel Fuel Injection Pump - New	Radiator Active Grille Shutter Assembly
320	319
Diesel Fuel Injection Pump - Remanufactured ..	Remote Mirror Switch
321	326
Diesel Fuel Injector Line	Starter Relay
321	318
Diesel Fuel Injector Rail.....	Steering Wheel Audio Control Switch.....
321	326
Diesel Fuel Injector Sleeve	Stoplight Switch
321	325
Diesel Glow Plug Relay.....	Transfer Case Switch
318	325
Diesel Nitrogen Oxide (NOx) Sensor	Transmission Control Solenoid
322	325
Diesel Oil Cooler Kit.....	Transmission Oil Pressure Switch
321	326
Diesel Particulate Filter (DPF) Pressure Sensor	Turbocharger - New.....
323	319
Diesel Valve Cover Gasket	Turbocharger - Remfd.....
321	319
EGR Control Solenoid.....	Turbocharger Speed Sensor
319	321
EGR Tube	Vacuum Pump.....
319	319
EGR Tube Gasket	Vacuum Regulator Valve.....
319	319
EGR Valve	Vehicle Speed Sensor
319	322
EGR Valve Mounting Gasket	Windshield Washer Level Sensor
320	322
EGR Valve Pressure Feedback Sensor	
323	Renault
EGR Valve Vacuum Modulator	Back-Up Light Switch.....
320	327
Electronic Throttle Body (ETB) Gasket	Camshaft Sensor.....
319	327
Engine Oil Temperature Sensor	Cruise Control Release Switch
324	327
Exhaust Gas Temperature Sensor.....	MAP Sensor
324	327
Fog Lamp Switch.....	Oil Pressure Light Switch.....
324	327
Four Wheel Drive Actuator	Stoplight Switch
327	327
Four Wheel Drive Selector Switch	
325	Smart
Fuel / Water Separator Sensor	Crankshaft Sensor
322	327
Fuel Injection Throttle Body.....	
319	Sterling Truck
Fuel Injector - Diesel - New.....	Air Inlet Pressure Sensor
320	327
Fuel Injector - Diesel - Remfd.....	Crankcase Ventilation Filter
320	327
Fuel Injector Seal Kit.....	Diesel Particulate Filter (DPF) Pressure Sensor
321	328
Fuel Pressure Regulator	EGR Valve Pressure Feedback Sensor
321	328
Fuel Pressure Relief Valve.....	Injection Actuation Pressure Sensor
320	328
Fuel Pressure Sensor	Oil Pressure Gauge Switch
323	328
Headlight Switch.....	Turbocharger Boost Sensor
324	328
Heated Seat Switch	
325	Thomas
HVAC Floor Mode Door Actuator.....	Crankcase Ventilation Filter
327	328
HVAC Recirculation Mode Door Actuator	EGR Valve Pressure Feedback Sensor
327	328
HVAC Temperature Blend Door Actuator.....	Oil Pressure Gauge Switch
327	328
Instrument Panel Dimmer Switch	
325	
Intake Air Temperature Sensor	
324	
Manifold Differential Pressure Sensor	
323	

Table of Contents

Toyota

A/C Relay	328
Air Cleaner Check Valve	329
Automatic Transmission Output Sensor.....	329
Charge Lamp Relay	328
Cold Start Valve	329
Coolant Fan Relay	328
Coolant Fan Switch	329
Diesel Glow Plug Relay.....	328
EGR Valve Mounting Gasket	329
Exhaust Gas Temperature Sensor	329
Fuel Pressure Regulator.....	329
Idle Air Control Valve	329
Idle Stop Solenoid	329
Multi-Port Fuel Injection Tune-Up Kit	329
Neutral Safety Switch.....	329
PCV Grommet	329
PCV Valve.....	329
Plenum Gasket	329
Ported Vacuum Switch.....	329
Starter Solenoid.....	328
Throttle Position Sensor.....	329
Turn Signal Flasher	328
Vehicle Speed Sensor	329
Voltage Regulator	328

Volkswagen

A/C Compressor Clutch Cut-Off Relay	330
A/C Relay.....	330
ABS Speed Sensor	335
Accelerator Pedal Sensor	336
Air Pump Relay	330
Ambient Air Temperature Sensor	338
Automatic Transmission Output Sensor.....	335
Auxiliary Air Valve	332
Back-Up Light Switch.....	339
Blind Spot Detection Sensor	339
Blower Motor Relay	330
Brake Pad Wear Sensor	336
Camshaft Sensor	336
Center High Mount Stop Light Assembly.....	342
Clutch Starter Safety Switch	340
Cold Start Valve	334
Computer Control Relay	330
Coolant Fan Relay	330
Coolant Fan Switch	341
Coolant Level Relay	330
Coolant Level Sensor.....	336
Coolant Temperature Sensor	338
Crankshaft Sensor	336
Cruise Control Switch.....	340
Defroster Relay	330
Diesel Emission Fluid Injection Nozzle	333
Diesel Emissions Fluid Pump	333
Diesel Fuel Injection Pump - Remanufactured .	334

Volkswagen

Diesel Fuel Injector Heat Shield	334
Diesel Glow Plug	334
Diesel Glow Plug Relay.....	330
Diesel Particulate Filter (DPF) Pressure Sensor	337
Direct Injection High Pressure Fuel Pump.....	335
Diverter Valve.....	332
EGR Control Solenoid.....	332
EGR Valve	333
EGR Valve Mounting Gasket	333
Electronic Throttle Body (ETB) Gasket	331
Engine Control Relay	330
Engine Crankcase Breather Hose.....	333
Engine Oil Level Sensor	336
Engine Oil Separator	332
Engine Oil Temperature Switch.....	341
Engine Variable Valve Timing Sprocket	342
Exhaust Gas Temperature Sensor	338
Fuel Injection Relay.....	330
Fuel Injection Throttle Body	331
Fuel Injector - Diesel - New.....	334
Fuel Injector - Diesel - Remfd	334
Fuel Injector Seal Kit.....	335
Fuel Pressure Regulator.....	335
Fuel Pressure Sensor	337
Fuel Pump Camshaft Follower.....	335
Fuel Pump Cut-Off Switch	340
Fuel Pump Fitting	335
Fuel Pump Relay	330
Fuel Vapor Canister.....	334
Fuel Vapor Leak Detection Pump	334
Hazard Flasher.....	330
Headlight Dimmer Switch	340
Headlight Relay	330
Headlight Switch.....	340
Headlight Washer Relay.....	330
Heater Core Temperature Sensor	339
Horn Relay	330
Idle Air Control Valve	332
Ignition Lock Cylinder.....	342
Ignition Starter Switch	340
Intake Air Temperature Sensor	339
Knock Sensor	336
Lambda Heater Relay	330
Manual Transmission Output Sensor	335
MAP Sensor	337
Mass Air Flow	336
Neutral Safety Switch.....	340
Neutral Safety Switch Relay	330
Oil Pressure Gauge Switch	341
Oil Pressure Light Switch	341
Oxygen Sensor	336
PCV Valve	333
Ported Vacuum Switch.....	341

Table of Contents

Volkswagen	
Power Door Lock Actuator	342
Power Door Lock Relay	331
Power Window Switch	340
Pre Heater Hose.....	332
Pulse Wiper Relay	331
Rear Window Defogger Relay	331
Starter Solenoid.....	331
Stoplight Switch	340
Temperature Sender - With Gauge.....	341
Turbocharger - New.....	331
Turbocharger Boost Sensor	337
Turbocharger Boost Solenoid	332
Turbocharger Oil Line	332
Turn Signal Flasher	331
Turn Signal Switch	340
Vacuum Pump.....	332
Variable Valve Timing Solenoid.....	342
Vehicle Speed Sensor	335
Voltage Regulator	331
Wiper Relay	331
X-Contact Relay	331

Volvo	
A/C Low Pressure Cut-Out Switch.....	343
Back-Up Light Switch.....	342
Coolant Fan Relay	342
Coolant Fan Switch	343
Diesel Glow Plug	342
Diesel Glow Plug Relay.....	342
Diesel Particulate Filter (DPF) Pressure Sensor	342
Exhaust Gas Temperature Sensor	342
Fuel Injection Relay.....	342
Fuel Injector - Diesel - Remfd	342
Fuel Pressure Regulator	342
Headlight Dimmer Switch	342
Ignition Starter Switch	343
MAP Sensor	342
Oil Pressure Light Switch.....	343
Starter Solenoid.....	342
Temperature Sender - With Gauge.....	343
Turbocharger Boost Sensor	342
Turn Signal Switch	343
Windshield Wiper Switch.....	343

Western Star	
Air Inlet Pressure Sensor	343
Diesel Particulate Filter (DPF) Pressure Sensor	343
Injection Actuation Pressure Sensor	343
Turbocharger Boost Sensor	343

Workhorse	
Crankcase Ventilation Filter	343
Diesel EGR Cooler.....	343

Workhorse	
Diesel Fuel Injector Control Module (FICM)	343
Diesel Oil Cooler Kit.....	343
EGR Valve Pressure Feedback Sensor	343
Fuel Injector - Diesel - New.....	343
Fuel Injector - Diesel - Remfd	343

Workhorse Custom Chassis	
Diesel EGR Cooler.....	343
Diesel Fuel Injector Control Module (FICM)	344
Diesel Oil Cooler Kit.....	344
Fuel Injector - Diesel - New.....	343
Fuel Injector - Diesel - Remfd	343

Part No.	Page	Part No.	Page	Part No.	Page	Part No.	Page	Part No.	Page
2006	345	ALS2160	350	AS13	355	AT165	360	AX517	365
2054	345	ALS2238	350	AS17	355	AT187	360	AX520	365
AC1	345	ALS2239	350	AS59	355	ATS45	360	BF11	366
AC2	345	ALS2352	350	AS88	355	AV1	360	BF17	366
AC6	345	ALS2397	350	AS90	355	AV5	360	BF19	366
AC23	345	ALS2409	350	AS119	356	AV7	360	BF41	366
ADR160	345	ALS2683	350	AS169	356	AV9	360	BF43	366
ADR4200	345	ALS2686	351	AS194	356	AV12	361	BR-34	366
ADR4201	345	ALS2690	351	AS195	356	AV18	361	BR-120	366
ADR4209	345	ALS2715	351	AS223	356	AV22	361	BR-207	366
ADR4304	345	ALS2719	351	AS302	356	AV23	361	BR-208	366
AFI100	345	ALS2721	351	AS306	356	AV30	361	BR-220	366
AGS1003	345	ALS2722	351	AS334	356	AV32	361	BR-230	366
AIP23	346	ALS2724	351	AS337	356	AV35	361	BSC16	366
ALH290	346	ALS2746	351	AS349	356	AV56	361	BSC55	367
ALS177	346	ALS2761	351	AS356	356	AW-1023	361	BSC62	367
ALS197	346	ALS2815	351	AS359	356	AW-1024	361	BSC68	367
ALS258	346	ALS2818	351	AS364	357	AX1	361	BSC75	367
ALS365	346	ALS2903	351	AS365	357	AX3	361	BSC84	367
ALS367	346	ALS3082	351	AS366	357	AX8	361	BSC86	367
ALS371	346	ALS3083	351	AS367	357	AX24	361	BSC90	367
ALS375	346	ALS3085	352	AS370	357	AX25	362	BSC102	367
ALS376	346	ALS3086	352	AS370K	357	AX31	362	BSC104	367
ALS390	346	ALS3097	352	AS371	357	AX32	362	BSD86	367
ALS395	346	ALS3105	352	AS405	357	AX35	362	BSD87	367
ALS411	347	APK102	352	AS413	357	AX36	362	BSD124	367
ALS430	347	APS101	352	AS414	357	AX68	362	BSD125	367
ALS463	347	APS102	352	AS415	357	AX69	362	BST107	368
ALS465	347	APS103	352	AS422	357	AX75	362	BST119	368
ALS467	347	APS104	352	AS428	358	AX78	362	BTL123	368
ALS468	347	APS105	352	AS434	358	AX102	362	BTL127	368
ALS469	347	APS108	352	AS435	358	AX103	362	BTL128	368
ALS470	347	APS109	352	AS441	358	AX104	362	CAC1	368
ALS522	347	APS113	352	AS447	358	AX115	363	CBH100	368
ALS545	347	APS115	352	AS448	358	AX116	363	CBS2352	368
ALS546	347	APS116	352	AS452	358	AX118	363	CBS2357	368
ALS1161	347	APS117	353	AS454	358	AX129	363	CBS2387	368
ALS1162	347	APS130	353	AS461	358	AX142	363	CBS2418	368
ALS1163	348	APS163	353	AS493	358	AX154	363	CBS-1002	368
ALS1164	348	APS165	353	AS495	358	AX158	363	CBS-1003	368
ALS1165	348	APS187	353	AS532	358	AX181	363	CBS-1065	368
ALS1166	348	APS188	353	AS534	358	AX203	363	CBS-1085	368
ALS1184	348	APS194	353	AS535	358	AX214	363	CBS-1149	368
ALS1187	348	APS195	353	AS602	359	AX215	363	CBS-1155	368
ALS1448	348	APS222	353	AS622	359	AX229	363	CBS-1158	369
ALS1527	348	APS265	353	AS628	359	AX234	364	CBS-1181	369
ALS1528	348	APS269	353	AS639	359	AX254	364	CBS-1261	369
ALS1842	348	APS273	353	AS645	359	AX264	364	CBS-1338	369
ALS1856	348	APS295	353	AS650	359	AX288	364	CBS-1352	369
ALS1866	348	APS332	354	AS653	359	AX293	364	CBS-1372	369
ALS1885	349	APS333	354	AS658	359	AX303	364	CBS-1392	369
ALS1889	349	APS335	354	AS663	359	AX328	364	CBS-1403	369
ALS1890	349	APS347	354	AS670	359	AX355	364	CBS-1422	369
ALS1892	349	APS353	354	AS677	359	AX377	364	CBS-1427	369
ALS1893	349	APS356	354	AS679	359	AX381	364	CBS-1446	369
ALS1894	349	APS373	354	AS680	359	AX382	364	CBS-1452	369
ALS1899	349	APS399	354	AS686	359	AX402	364	CBS-1573	369
ALS1901	349	APS402	354	ASM101	359	AX403	364	CBS-1584	369
ALS1902	349	APS412	354	AT101	359	AX412	365	CBS-1588	369
ALS1904	349	APS444	354	AT103	360	AX417	365	CBS-1773	370
ALS1905	349	APS461	354	AT104	360	AX420	365	CBS-1877	370
ALS1924	349	APS611	354	AT111	360	AX422	365	CBS-1891	370
ALS1925	349	AS1	355	AT123	360	AX431	365	CBS-1899	370
ALS1958	350	AS4	355	AT126	360	AX441	365	CBS-1916	370
ALS1971	350	AS5	355	AT132	360	AX451	365	CBS-1917	370
ALS2059	350	AS6	355	AT142	360	AX454	365	CBS-1925	370
ALS2157	350	AS10	355	AT146	360	AX461	365	CBS-1945	370
ALS2158	350	AS11	355	AT148	360	AX506	365	CBS-1975	370

Part No.	Page	Part No.	Page	Part No.	Page	Part No.	Page	Part No.	Page
CBS-2016	370	DFH105	375	DLA1435	380	DS-905	386	DWS-583	392
CBS-2071	370	DFH106	375	DLA-1	380	DS-932	386	DWS-593	392
CBS-2081	370	DFH107	375	DLA-131	380	DS-936	386	DWS-599	392
CBS-2106	370	DFI1	375	DLA-144	380	DS-957	386	DWS-612	392
CBS-2107	370	DFI2	375	DLA-463	381	DS-1109	386	DWS-631	392
CBS-2110	370	DFI3	375	DLA-479	381	DS-1142	386	DWS-645	392
CBS-2112	370	DFI4	375	DLA-523	381	DS-1170	387	DWS-646	392
CBS-2145	370	DFI5	376	DLA-525	381	DS-1185	387	DWS-659	392
CBS-2146	371	DFI6	376	DLA-526	381	DS-1243	387	DWS-753	392
CBS-2147	371	DFI7	376	DLA-527	381	DS-1362	387	DWS-772	392
CBS-2148	371	DFI8	376	DLA-630	381	DS-1385	387	DWS-856	393
CCA1026	371	DFIP1	376	DLA-631	381	DS-1506	387	DWS-860	393
CCA1097	371	DFIP2	376	DLA-632	381	DS-1534	387	DWS-879	393
CCA1168	371	DFIP3	376	DLA-633	381	DS-1750	387	DWS-896	393
CCA1291	371	DFIP6	376	DLA-634	382	DS-1807	387	DWS-901	393
CCD72	371	DFS1	376	DLA-635	382	DS-2153	387	DWS-972	393
CCR-1	371	DH1	376	DLA-636	382	DS-2156	387	DWS-1326	393
CCR-5	371	DH2	376	DLA-643	382	DS-2219	387	DWS-1335	393
CF-1	371	DH3	376	DLA-647	382	DS-2243	388	DWS-1347	393
CP109	371	DH4	377	DPS100	382	DS-2298	388	DWS-1349	393
CP208	371	DH6	377	DPS101	382	DS-2301	388	DWS-1350	393
CP225	372	DIH1	377	DPS102	382	DS-2326	388	DWS-1351	394
CP403	372	DIH2	377	DPS103	382	DS-2358	388	DWS-1385	394
CP408	372	DIH3	377	DPS104	382	DS-2359	388	DWS-1386	394
CP417	372	DIH4	377	DPS105	382	DS-2360	388	DWS-1390	394
CP440	372	DIH5	377	DPS106	382	DS-2362	388	ECG1	394
CP492	372	DIH6	377	DPS107	383	DS-2363	388	ECK1	394
CP569	372	DIH7	377	DPS108	383	DS-2404	388	ECK2	394
CP604	372	DIH8	377	DPS109	383	DS-3035	388	ECK3	394
CP796	372	DIH9	377	DPS110	383	DS-3072	388	ECK4	394
CP806	372	DIH11	377	DPS111	383	DS-3102	389	ECK5	394
CP838	372	DIH12	378	DPS112	383	DS-3126	389	ECK6	394
CP863	372	DIL1	378	DPS113	383	DS-3357	389	ECK7	394
CP884	372	DIL2	378	DPS114	383	DS-3364	389	ECK8	394
CP1022	373	DIL3	378	DPS115	383	DS-5748	389	ECK9	394
CP2000	373	DIL4	378	DPS116	383	DTL1	389	ECK10	394
CP3051	373	DIL5	378	DRL-1	383	DV108	389	ECK11	395
CP3287	373	DIL6	378	DS1099	383	DV130	389	ECK12	395
CP3319	373	DIL7	378	DS2476	383	DV146	389	ECK13	395
CP3375	373	DIL8	378	DS3500	383	DV165	389	EFH201	395
CP3454	373	DIL9	378	DS-68	384	DV169	389	EFH202	395
CP3543	373	DIL10	378	DS-70	384	DV172	389	EFL172	395
CSP100	373	DIL11	378	DS-72	384	DV173	390	EFL-4	395
CSP123	373	DIL12	378	DS-79	384	DV180	390	EFL-6	395
CSP127	373	DIL13	378	DS-168	384	DWS1642	390	EFL-8	395
CSP131	373	DIL14	378	DS-169A	384	DWS1645	390	EFL-9	395
CSP164	373	DL275	378	DS-177	384	DWS1649	390	EGV330	395
CSP247	373	DL-3	378	DS-199	384	DWS1711	390	EGV335	396
CSP311	374	DL-6	379	DS-205	384	DWS1837	390	EGV339	396
CVS46	374	DL-14	379	DS-213	384	DWS1899	390	EGV340	396
CVS47	374	DL-54	379	DS-240	385	DWS1994	390	EGV344	396
CVS60	374	DL-140	379	DS-268	385	DWS2007	390	EGV434	396
CVS80	374	DLA824	379	DS-278	385	DWS2010	390	EGV435	396
CVS129	374	DLA987	379	DS-290	385	DWS2012	390	EGV483	396
CVS134	374	DLA997	379	DS-293	385	DWS2013	391	EGV545	396
CVS153	374	DLA998	379	DS-374	385	DWS2014	391	EGV635	396
DBT1	374	DLA1002	379	DS-453	385	DWS2015	391	EGV653	396
DEP100	374	DLA1007	379	DS-533	385	DWS2017	391	EGV677	397
DEP118	374	DLA1034	379	DS-550	385	DWS2018	391	EGV679	397
DEP119	374	DLA1035	379	DS-576	385	DWS2020	391	EGV718	397
DEP120	374	DLA1036	380	DS-647	385	DWS2022	391	EGV726	397
DEP122	374	DLA1037	380	DS-658	386	DWS2023	391	EGV764	397
DEP123	375	DLA1038	380	DS-698	386	DWS2078	391	EGV801	397
DEP125	375	DLA1063	380	DS-749	386	DWS-184	391	EGV802	397
DFH101	375	DLA1065	380	DS-796	386	DWS-187	391	EGV803	397
DFH102	375	DLA1066	380	DS-833	386	DWS-489	391	EGV1031	397
DFH103	375	DLA1139	380	DS-876	386	DWS-498	392	EGV1034	397
DFH104	375	DLA1434	380	DS-890	386	DWS-523	392	EGV1072	397

Part No.	Page	Part No.	Page	Part No.	Page	Part No.	Page	Part No.	Page
EGV1076	397	ETS81	403	ETS168	408	FJ174	413	FJ1243	418
EGV1079	398	ETS82	403	ETS169	408	FJ251	413	FJ1243NX	418
EGV1081	398	ETS83	403	ETS170	408	FJ252	413	FJ1244	418
EGV1093	398	ETS84	403	ETS171	409	FJ253	414	FJ1256	418
EGV1094	398	ETS85	403	ETS172	409	FJ254	414	FJ1256NX	418
EGV1096	398	ETS90	403	ETS173	409	FJ255	414	FJ1257	418
EGV1105	398	ETS92	403	ETS174	409	FJ256	414	FJ1258	418
EGV1106	398	ETS93	403	ETS175	409	FJ258	414	FJ1258NX	419
EGV1139	398	ETS95	403	ETS176	409	FJ330	414	FJ1259	419
EGV1142	398	ETS96	403	ETS177	409	FJ489	414	FJ1260	419
EGV1151	398	ETS97	403	ETS178	409	FJ495	414	FJ1261	419
EGV1188	398	ETS98	404	ETS180	409	FJ593	414	FJ1262	419
EGV1190	399	ETS99	404	ETS181	409	FJ595	414	FJ1262NX	419
EGV1191	399	ETS100	404	ETS183	409	FJ595NX	414	FJ1268	419
EGV1218	399	ETS103	404	ETS184	409	FJ596	414	FJ1269	419
EGV1219	399	ETS104	404	ETS185	410	FJ596NX	414	FJ1277	419
EGV1238	399	ETS105	404	ETS187	410	FJ607	414	FJ1278	419
EGV1239	399	ETS106	404	ETS188	410	FJ619	414	FJ1279	419
EGV1240	399	ETS107	404	ETS189	410	FJ622	414	FJ1289	419
EGV1241	399	ETS110	404	ETS190	410	FJ623	415	FJ1290	419
EGV1242	399	ETS111	404	ETS191	410	FJ642	415	FJ1292NX	419
EGV1243	399	ETS114	404	ETS192	410	FJ643	415	FJ1300	419
EGV1247	399	ETS115	404	ETS194	410	FJ738	415	FJ1300NX	420
EGV1249	399	ETS117	405	ETS195	410	FJ738NX	415	FJ1301	420
EGV1254	399	ETS118	405	ETS196	410	FJ842	415	FJ1301NX	420
EGV1255	400	ETS119	405	ETS197	410	FJ908	415	FJ1302	420
EGV1262	400	ETS120	405	ETS198	410	FJ909	415	FJ1302NX	420
EGV1264	400	ETS121	405	ETS199	411	FJ912	415	FJ1303	420
EGV1267	400	ETS122	405	ETS200	411	FJ918	415	FJ1303NX	420
EGV1268	400	ETS123	405	ETS201	411	FJ921	415	FJ1304	420
EGV1272	400	ETS124	405	ETS202	411	FJ922	415	FJ1304NX	420
EGV1278	400	ETS125	405	ETS203	411	FJ923	415	FJ1305	420
EGV1282	400	ETS126	405	ETS204	411	FJ926	415	FJ1305NX	420
EGV1284	400	ETS127	405	ETS205	411	FJ926NX	415	FJ1306	420
EGV1285	400	ETS129	405	ETS206	411	FJ927	416	FJ1306NX	420
EGV1288	400	ETS130	406	ETS211	411	FJ927NX	416	FJ1307	420
EGV1289	400	ETS131	406	ETS213	411	FJ928	416	FJ1307NX	420
EGV1290	400	ETS132	406	ETS215	411	FJ928NX	416	FJ1308	421
EGV1293	401	ETS133	406	ETS216	411	FJ932	416	FJ1308NX	421
EGV1294	401	ETS134	406	ETS217	412	FJ933	416	FJ1309	421
EOS1	401	ETS135	406	ETS218	412	FJ935	416	FJ1309NX	421
EOS2	401	ETS136	406	ETS219	412	FJ960	416	FJ1310	421
EOS3	401	ETS137	406	ETS221	412	FJ960NX	416	FJ1310NX	421
ES9	401	ETS138	406	ETS222	412	FJ961	416	FJ1348	421
ES110	401	ETS139	406	ETS223	412	FJ962	416	FJ1378	421
ES146	401	ETS140	406	ETS229	412	FJ976	416	FJ1379	421
ETB17	401	ETS141	406	ETS300	412	FJ1009	417	FJ1381NX	421
ETB18	401	ETS142	407	EVCS01	412	FJ1010	417	FJ1382NX	421
ETB27	401	ETS143	407	FFH1	412	FJ1168	417	FJ4958PCK	421
ETB62	401	ETS145	407	FFH2	412	FJ1173	417	FJ7388PCK	421
ETB73	401	ETS146	407	FICM1	412	FJ1174	417	FJ9278PCK	421
ETB74	401	ETS147	407	FICM2	412	FJ1216	417	FJ9288PCK	421
ETB78	401	ETS148	407	FICM3	413	FJ1217	417	FLA1010	422
ETB79	401	ETS149	407	FIDM1	413	FJ1221	417	FLA1027	422
ETB82	401	ETS150	407	FIDM2	413	FJ1222	417	FLS278	422
ETB91	402	ETS151	407	FIR1	413	FJ1223	417	FLS283	422
ETS3	402	ETS152	407	FIR2	413	FJ1224	417	FLS284	422
ETS66	402	ETS153	407	FIR3	413	FJ1225NX	417	FLS309	422
ETS67	402	ETS154	407	FIR4	413	FJ1226	417	FLS-1	422
ETS72	402	ETS155	408	FIR5	413	FJ1227	417	FLS-3	422
ETS73	402	ETS157	408	FIR6	413	FJ1229	417	FLS-12	422
ETS74	402	ETS158	408	FIR7	413	FJ1230	418	FLS-14	422
ETS75	402	ETS160	408	FIR9	413	FJ1232	418	FLS-33	422
ETS76	402	ETS162	408	FIT1	413	FJ1239	418	FLS-56	422
ETS77	402	ETS163	408	FIT2	413	FJ1240	418	FLS-61	423
ETS78	402	ETS164	408	FJ171	413	FJ1240NX	418	FLS-72	423
ETS79	402	ETS165	408	FJ172	413	FJ1241	418	FLS-75	423
ETS80	403	ETS166	408	FJ173	413	FJ1242	418	FLS-84	423

Part No.	Page	Part No.	Page	Part No.	Page	Part No.	Page	Part No.	Page
FLS-116	423	FWSS112	428	HLS1686	433	HSS120	438	IP51	443
FLS-125	423	FWSS113	428	HLS1719	433	HSS122	438	IP52	443
FLS-126	423	FWSS114	428	HLS1720	433	HSS124	438	IPK1	443
FLS-162	423	FWSS115	428	HLS1738	433	HSS125	438	IPK2	443
FLS-164	423	FWSS116	429	HLS1757	433	HZS149	438	IPK3	443
FLS-172	423	FWSV101	429	HLS-1051	433	ICP101K	439	IPL1	444
FLS-175	423	FWSV102	429	HLS-1053	433	ICP102K	439	IPL2	444
FLS-179	423	FWSV103	429	HLS-1225	433	ICP103K	439	IPLM1	444
FLS-187	424	GDF604	429	HLS-1226	433	ICP105	439	IPR1	444
FPC1	424	GDF901	429	HLS-1345	433	ICP106	439	IPR2	444
FPF603	424	GDP608	429	HLS-1349	433	IFH1	439	IRL1	444
FPF604	424	GDP609	429	HLS-1369	433	IFH2	439	IRL2	444
FPM105	424	GDP610	429	HLS-1391	433	IFH3	439	IRL3	444
FPM113	424	GDP612	429	HLS-1456	434	IFH4	439	KS2	444
FPM120	424	GDP613	429	HLS-1457	434	IFH5	439	KS18	444
FPS1	424	GDP902	429	HLS-1487	434	IFH6	439	KS50	444
FPS2	424	GDP905	429	HLS-1488	434	IFH7	439	KS171	444
FPS11	424	GDR601	430	HLS-1504	434	IFH8	439	KS214	444
FPS13	424	GP101	430	HLS-1505	434	IFH9	439	KS234	444
FPS15	424	GP102	430	HLS-1520	434	IFS1	439	KS235	445
FPS16	424	GP103	430	HLS-1620	434	IFS2	439	KS260	445
FPS20	424	GP104	430	HLS-1621	434	IFS3	440	KS312	445
FPS28	425	GP105	430	HLS-1630	434	IMA110	440	KS328	445
FPS29	425	GP106	430	HLS-1631	434	IMA111	440	KS356	445
FPS30	425	GP107	430	HLS-1632	435	IP1	440	KS397	445
FPS31	425	GP108	430	HLS-1633	435	IP2	440	KS418	445
FPS43	425	GP109	430	HLS-1647	435	IP4	440	KS424	445
FPS44	425	GP110	430	HLS-1648	435	IP10	440	KS436	445
FPS45	425	GP111	430	HPI1	435	IP12	440	KS445	445
FPS46	425	GP112	430	HPI2	435	IP17	440	KS448	445
FPS55	425	GP113	430	HPI3	435	IP18	440	KS450	445
FPS58	425	GP114	430	HPI4	435	IP19	440	KS466	445
FPS61	425	GP115	430	HPI6	435	IP20	440	KS467	445
FPS62	425	GP116	430	HPI7	435	IP21	441	KS480	446
FPS63	426	GP117	430	HPI8	435	IP22	441	LDP14	446
FPS68	426	GP119	430	HPI9	435	IP23	441	LDP18	446
FPS69	426	GP120	430	HPI10	436	IP24	441	LDP25	446
FPS73	426	GP121	430	HPI11	436	IP25	441	LDP26	446
FPS89	426	GP122	430	HPI12	436	IP26	441	LDP28	446
FPS94	426	GP123	430	HPI13	436	IP27	441	LDP39	446
FPS103	426	GP124	431	HPI14	436	IP28	441	LDP45	446
FPS112	426	GPC101	431	HPI16	436	IP30	441	LDP50	446
FPS113	426	GPH101	431	HPI17	436	IP31	441	LDP74	446
FPW1	426	GPH102	431	HPI18	436	IP32	441	LDP75	446
FSS101	426	GPH103	431	HPI19	436	IP33	441	LR-35	446
FSS102	426	GPH104	431	HPI20	436	IP34	441	LS388	446
FSS103	427	GPH105	431	HR-127	436	IP35	442	LS-200	447
FTP1	427	GPH106	431	HR-151	436	IP36	442	LS-201	447
FTP2	427	GPH107	431	HS569	437	IP37	442	LS-202	447
FTP3	427	GV1	431	HS570	437	IP38	442	LS-221	447
FTP4	427	GV4	431	HS-204	437	IP38NX	442	LS-222	447
FTP5	427	GV5	431	HS-205	437	IP39	442	LS-256	447
FTP6	427	GV6	431	HS-206	437	IP39NX	442	LS-263	447
FTP7	427	GV9	431	HS-210	437	IP40NX	442	LS-265	447
FTP8	427	GV13	431	HS-214	437	IP41	442	LS-273	447
FTS104	427	GV16	432	HS-224	437	IP41NX	442	LS-285	447
FTS110	427	GV18	432	HS-229	437	IP42	442	LS-291	447
FV11	427	GV21	432	HS-242	437	IP42NX	442	LS-304	447
FV12	427	GV22	432	HS-292	437	IP43NX	442	LS-307	447
FV-5	427	GV27	432	HS-316	437	IP44NX	443	LS-317	447
FV-5K	428	GV28	432	HS-321	438	IP45NX	443	LS-338	448
FV-7	428	GV29	432	HS-333	438	IP46NX	443	LS-344	448
FWSS101	428	HFG101	432	HS-348	438	IP47	443	LS-376	448
FWSS102	428	HK12	432	HS-388	438	IP47NX	443	LSH102	448
FWSS104	428	HK9330	432	HS-424	438	IP48	443	LX-756	448
FWSS106	428	HK9331	432	HS-482	438	IP48NX	443	MAK100	448
FWSS109	428	HLS1667	432	HS-527	438	IP49	443	MAS0164	448
FWSS110	428	HLS1685	432	HS-531	438	IP50	443	MAS0279	448

Part Number Index

MAS0280 - PVS50

Part No.	Page	Part No.	Page	Part No.	Page	Part No.	Page	Part No.	Page
MAS0280	448	NS-314	454	PC660	459	PCS213	463	PS-15	468
MAS0288	448	NS-319	454	PC673	459	PDS-124	463	PS-57	468
MAS0290	448	NS-334	454	PC700	459	PG1	463	PS-120	468
MAS0308	448	NS-335	454	PC705	459	PG72	463	PS-121	469
MAS0323	449	NS-344	454	PC707	459	PHS1	464	PS-126	469
MAS0338	449	NS-379	454	PC708	459	PMR1	464	PS-138	469
MAS0354	449	NS-485	454	PC716	459	PMR2	464	PS-140	469
MAS0357	449	NS-518	454	PC725	459	PMS12	464	PS-144	469
MAS0374	449	NS-520	455	PC738	459	PPS9	464	PS-154	469
MAS0379	449	NS-523	455	PC756	459	PPS11	464	PS-155	469
MAS0386	449	NS-527	455	PC758	459	PPS45	464	PS-163	469
MAS0388	449	NS-561	455	PC765	460	PPS55	464	PS-165	469
MAS0411	449	NS-574	455	PC766	460	PR23	464	PS-167	469
MAS0421	449	OCG1	455	PC779	460	PR37	464	PS-168	470
MAS0422	450	OCG2	455	PC781	460	PR41	464	PS-189	470
MAS0427	450	OCK1	455	PC792	460	PR71	464	PS-221	470
MAS0428	450	OCK2	455	PC810	460	PR73	464	PS-230	470
MAS0450	450	OCK3	455	PC828	460	PR315	464	PS-233	470
MAS0469	450	OCK4	455	PC836	460	PR429	465	PS-240	470
MAS0473	450	OCK5	455	PC837	460	PR430	465	PS-243	470
MAS0475	450	OCK6	455	PC839	460	PR437	465	PS-245	470
MAS0480	450	OCK7	455	PC843	460	PR439	465	PS-248	470
MAS0483	450	OCK8	456	PC865	460	PR444	465	PS-256	470
MAS0509	450	OCK9	456	PC873	460	PR460	465	PS-264	471
MRS1	450	OCK10	456	PC878	460	PR462	465	PS-272	471
NOX001	450	OCK11	456	PC883	460	PR500	465	PS-291	471
NOX002	451	OCK12	456	PC891	460	PR509	465	PS-292	471
NOX003	451	OCK13	456	PC900	461	PR511	465	PS-296	471
NOX004	451	OCK14	456	PC912	461	PR516	465	PS-297	471
NOX005	451	OCK16	456	PC919	461	PR542	465	PS-304	471
NOX006	451	OCK17	456	PC927	461	PR544	466	PS-305	471
NOX007	451	OCK19	456	PC933	461	PR553	466	PS-308	471
NOX008	451	OFH101	456	PC950	461	PR555	466	PS-314	471
NOX009	451	OPH1	456	PC977	461	PR560	466	PS-317	471
NOX010	451	OPH2	456	PC981	461	PR561	466	PS-323	471
NOX011	451	OPH3	456	PC983	461	PR562	466	PS-329	471
NOX012	451	OPH4	456	PC984	461	PR563	466	PS-331	472
NOX013	451	PAC22	456	PC989	461	PR564	466	PS-362	472
NOX014	451	PAC237	456	PC997	461	PR594	466	PS-400	472
NOX015	452	PC125	457	PC998	461	PR604	466	PS-405	472
NOX016	452	PC139	457	PC1003	461	PR607	466	PS-406	472
NOX017	452	PC164	457	PC1004	461	PRU1	467	PS-407	472
NOX018	452	PC260	457	PC1006	462	PRV1	467	PS-414	472
NOX021	452	PC292	457	PC1022	462	PRV2	467	PS-437	472
NOX022	452	PC358	457	PC1029	462	PRV3	467	PS-461	472
NS659	452	PC396	457	PC1030	462	PS539	467	PS-479	472
NS689	452	PC398	457	PC1032	462	PS605	467	PS-488	472
NS691	452	PC399	457	PC1040	462	PS622	467	PS-490	472
NS692	452	PC410	457	PC1041	462	PS623	467	PS-491	472
NS718	452	PC436	457	PC1046	462	PS639	467	PS-492	472
NS744	452	PC456	457	PC1047	462	PS647	467	PS-528	472
NS755	453	PC460	457	PC1048	462	PS651	467	PS-531	473
NS763	453	PC464	458	PC1058	462	PS656	467	PSS1	473
NS766	453	PC480	458	PC1064	462	PS662	467	PSS4	473
NS-11	453	PC497	458	PC1068	462	PS663	467	PSS12	473
NS-21	453	PC498	458	PC1088	462	PS666	467	PSS33	473
NS-25	453	PC504	458	PC1095	462	PS667	467	PSW106	473
NS-35	453	PC575	458	PC1097	462	PS668	467	PSW126	473
NS-41	453	PC590	458	PC1103	463	PS671	467	PSW165	473
NS-66	453	PC593	458	PC1126	463	PS675	467	PVS1	473
NS-72	453	PC594	458	PC1127	463	PS679	468	PVS16	473
NS-85	453	PC603	458	PC1138	463	PS690	468	PVS18	473
NS-120	453	PC617	458	PC1146	463	PS711	468	PVS19	473
NS-126	454	PC625	458	PC1147	463	PS713	468	PVS20	474
NS-127	454	PC628	459	PC1179	463	PS715	468	PVS27	474
NS-193	454	PC641	459	PC1191	463	PS716	468	PVS43	474
NS-223	454	PC644	459	PC1195	463	PS726	468	PVS48	474
NS-240	454	PC645	459	PCB1	463	PS-12	468	PVS50	474

Part No.	Page	Part No.	Page	Part No.	Page	Part No.	Page	Part No.	Page
PVS59	474	RU-562	479	RY-121	488	RY-923	496	SK38	503
PVS67	474	RU-564	479	RY-127	488	RY-975	496	SK39	503
PVS71	474	RU-566	479	RY-132	488	RY-976	496	SK50	503
PVS82	474	RU-569	479	RY-137	488	RY-1084	496	SK54	503
PVS85	474	RU-570	479	RY-138	488	RY-1086	497	SK55	503
PVS87	474	RU-571	480	RY-139	488	RY-1088	497	SK64	503
PVS90	474	RU-620	480	RY-143	488	RY-1093	497	SK66	503
PVS91	474	RU-630	480	RY-144	489	RY-1094	497	SK67	503
PVS126	475	RU-631	480	RY-145	489	RY-1095	497	SK68	503
PVS133	475	RU-661	480	RY-175	489	RY-1103	497	SK80	503
PVS135	475	RU-669	480	RY-178	489	RY-1108	497	SK85	503
PVS148	475	RU-685	480	RY-191	489	RY-1111	497	SK104	503
PVS149	475	RU-686	480	RY-193	489	RY-1113	497	SK105	503
PVS160	475	RU-710	480	RY-194	489	RY-1116	498	SK106	504
PVS166	475	RU-729	480	RY-203	489	RY-1117	498	SK107	504
PVS167	475	RU-730	480	RY-214	489	RY-1118	498	SK108	504
PWS105	475	RU-775	480	RY-230	490	RY-1132	498	SK115	504
PWS108	475	RU-778	481	RY-232	490	RY-1188	498	SK120	504
PWS144	475	RU-812	481	RY-233	490	RY-1330	498	SK121	504
PWS145	475	RU-818	481	RY-238	490	RY-1340	498	SK122	504
PWS173	476	RU-825	481	RY-242	490	RY-1483	498	SK125	504
PWS176	476	RU-839	481	RY-255	490	RY-1528	499	SK136	504
PWS177	476	RU-879	481	RY-256	491	RY-1552	499	SK138	504
PWS182	476	RU-884	481	RY-265	491	RY-1556	499	SK139	504
PWS217	476	RY467	481	RY-273	491	RY-1567	499	SK140	504
PWS234	476	RY1420	481	RY-280	491	RY-1616	499	SK141	505
PWS235	476	RY1724	481	RY-282	491	RY-1625	499	SK142	505
PWS236	476	RY1736	481	RY-289	491	RY-1627	499	SK145	505
PWS260	476	RY1811	482	RY-292	492	RY-1667	499	SK146	505
PWS262	476	RY1832	482	RY-300	492	RY-1678	499	SK157	505
PWS290	476	RY1848	482	RY-304	492	RY-1697	500	SK168	505
PWS291	476	RY1854	482	RY-316	492	RY-1723	500	SK170	505
PWS304	476	RY1866	482	RY-341	492	RY-1726	500	SLS531	505
PWS332	477	RY1868	482	RY-345	492	RY-1731	500	SLS532	505
PWS339	477	RY1869	482	RY-347	492	RY-1733	500	SLS541	505
QS101M	477	RY1952	482	RY-383	492	RY-1757	500	SLS556	505
QS101R	477	RY-8	482	RY-429	492	RY-1772	500	SLS577	505
QS102M	477	RY-20	482	RY-439	493	RY-1779	500	SLS-34	505
QS102R	477	RY-22	483	RY-441	493	RY-1801	500	SLS-66	505
QS104M	477	RY-23	483	RY-489	493	SA4	501	SLS-82	506
QS104R	477	RY-27	483	RY-494	493	SA100	501	SLS-87	506
QS105M	477	RY-32	483	RY-525	493	SC34	501	SLS-93	506
QS105R	477	RY-33	483	RY-528	493	SC37	501	SLS-101	506
RL-2	477	RY-34	483	RY-531	493	SC46	501	SLS-102	506
RTL1	477	RY-39	483	RY-536	493	SC163	501	SLS-104	506
RTL2	477	RY-43	484	RY-553	493	SC168	501	SLS-106	506
RU51HTK	478	RY-44	484	RY-568	493	SC226	501	SLS-126	506
RU318HTK	478	RY-46	484	RY-573	494	SC303	501	SLS-127	506
RU445HTK	478	RY-47	484	RY-575	494	SC317	501	SLS-159	506
RU932	478	RY-48	484	RY-577	494	SC318	501	SLS-170	506
RU968	478	RY-49	484	RY-583	494	SC333	501	SLS-173	506
RU969	478	RY-51	485	RY-585	494	SC335	502	SLS-174	506
RU987	478	RY-53	485	RY-601	494	SC346	502	SLS-179	506
RU-51	478	RY-54	485	RY-603	494	SC352	502	SLS-204	506
RU-56	478	RY-55	485	RY-604	494	SC354	502	SLS-208	507
RU-57	478	RY-63	485	RY-610	495	SC390	502	SLS-214	507
RU-59	478	RY-65	485	RY-612	495	SC403	502	SLS-234	507
RU-62	478	RY-69	486	RY-698	495	SC466	502	SLS-237	507
RU-67	478	RY-70	486	RY-738	495	SC528	502	SLS-247	507
RU-268	478	RY-71	486	RY-777	495	SC602	502	SLS-276	507
RU-318	479	RY-85	486	RY-790	495	SC668	502	SLS-282	507
RU-371	479	RY-90	486	RY-869	495	SC669	502	SLS-303	507
RU-373	479	RY-95	487	RY-884	496	SC695	502	SLS-316	507
RU-432	479	RY-100	487	RY-889	496	SC761	502	SLS-323	507
RU-440	479	RY-109	487	RY-892	496	SK13	502	SLS-331	507
RU-445	479	RY-115	487	RY-915	496	SK18	503	SLS-336	507
RU-538	479	RY-116	487	RY-921	496	SK26	503	SLS-345	508
RU-561	479	RY-117	488	RY-922	496	SK27	503	SLS-385	508

Part No.	Page	Part No.	Page	Part No.	Page	Part No.	Page	Part No.	Page	
SLS-386	508	TBC546	513	TCA-64	519	TPM97A	524	TS-67	529	
SLS-450	508	TBC547	513	TCBS1	519	TPM102	524	TS-71	529	
SLS-466	508	TBC548	513	TCP01	519	TPM104	524	TS-76	529	
SLS-467	508	TBC549	513	TCPA01	519	TPM104A	524	TS-81	529	
SLS-501	508	TBC553	514	TCS20	519	TPM109A	524	TS-83	529	
SLS-502	508	TBC554	514	TCS78	519	TPM116A	525	TS-93	529	
SLS-513	508	TBC555	514	TCS93	520	TPM116RA	525	TS-105	529	
SLS-521	508	TBC559	514	TCS108	520	TPM141	525	TS-145	529	
SPK101	508	TBC560	514	TCS114	520	TPM155	525	TS-151	529	
SR-113	508	TBC561	514	TCS208	520	TPM155A	525	TS-155	529	
SR-121	508	TBC562	514	TCS209	520	TPM196	525	TS-168	529	
SS853	508	TBC563	514	TCS221	520	TPM197RA	525	TS-169	529	
SS868	509	TBC564	514	TCS234	520	TPM209	525	TS-198	529	
SS869	509	TBC566	514	TCS257	520	TPM210	525	TS-206	529	
SS874	509	TBC567	514	TCS260	520	TPM222	525	TS-222	529	
SS-200	509	TBC568	514	TCS273	520	TPM298	525	TS-232	529	
SS-213	509	TBC569	515	TCS331	520	TPM327	525	TS-241	530	
SS-215	509	TBC570	515	TGS1	520	TPM930K	525	TS-247	530	
SS-216	509	TBC573	515	TGS2	521	TPM930K4	525	TS-253	530	
SS-230	509	TBC574	515	TGS3	521	TPM1040K	525	TS-262	530	
SS-233	509	TBC575	515	TH1	521	TPM1040K4	525	TS-268	530	
SS-251	509	TBC576	515	TH4	521	TPM1090K	526	TS-286	530	
SS-255	509	TBC577	515	TH5	521	TPM1090K4	526	TS-288	530	
SS-262	510	TBC579	515	TH35	521	TPM2000K	526	TS-299	530	
SS-265	510	TBC580	515	TH41	521	TPM2000K4	526	TS-339	530	
SS-268	510	TBC584	515	TH43	521	TPM2011VK	526	TS-355	530	
SS-277	510	TBC585	515	TH44	521	TPM2011VK4PK	526	TS-362	530	
SS-279	510	TBC586	515	TH140	521	526	TPM2011VK25PK	530	TS-372	530
SS-296	510	TBC587	516	TH149	521	526	TPM2011VK25PK	530	TS-374	530
SS-299	510	TBC591	516	TH150	521	526	526	TS-375	530	
SS-300	510	TBC592	516	TH157	521	TPM2012VBK	526	TS-377	530	
SS-306	510	TBC593	516	TH160	522	TPM2012VBK4	526	TS-380	530	
SS-318	510	TBC594	516	TH175	522	TPM2012VCK	526	TS-406	530	
SS-331	510	TBC602	516	TH218	522	TPM2012VCK4	526	TS-409	531	
SS-332	510	TBC603	516	TH232	522	TPM2012VK	526	TS-414	531	
SS-336	510	TBC607	516	TH245	522	TPM2012VK4PK	526	TS-440	531	
SS-337	510	TBC613	516	TH303	522	526	526	TS-451	531	
SS-348	511	TBC622	516	TH371	522	TPM2012VK25PK	526	TS-471	531	
SS-357	511	TBC658	516	TH383	522	526	526	TS-477	531	
SS-367	511	TBC664	517	TH394	522	TPM2013VK	527	TS-496	531	
SS-369	511	TBC665	517	TH420	522	TPM2014VK	527	TS-500	531	
SS-388	511	TBC666	517	TH454	522	TPM2018VK	527	TS-504	531	
SS-401	511	TBC668	517	TH456	522	TPM2020K	527	TS-507	531	
SS-404	511	TBC669	517	TH463	522	TPM2020K4	527	TS-513	531	
SS-448	511	TBC-511	517	TIH1	523	TPM2026VK	527	TS-518	531	
SS-581	511	TBC-512	517	TIH2	523	TPM2030K	527	TS-519	531	
SS-588	511	TBC-513	517	TL-163	523	TPM2030K4	527	TS-521	531	
SS-590	511	TBC-514	517	TL-232	523	TPM2080K	527	TS-529	531	
SS-591	512	TBC-515	517	TM-23	523	TPM2080K4	527	TS-550	531	
SS-598	512	TBC-516	517	TM-33	523	TPM2100VK	527	TS-552	531	
SS-613	512	TBC-517	518	TM-34	523	TPM2104VK	527	TS-555	531	
SS-750	512	TBC-518	518	TM-36	523	TPM2104VK4	527	TS-556	532	
SS-762	512	TBC-519	518	TM-37	523	TPM2107VK	527	TS-557	532	
SS-843	512	TBC-521	518	TM-41	523	TPM2107VK4	528	TS-568	532	
SWS46	512	TBC-523	518	TM-44	523	TPM4012SK	528	TS-603	532	
SWS116	512	TBG110	518	TM-45	523	TPM4012SK4PK	528	TS-604	532	
TBA2	512	TBG111	518	TM-50	523	528	528	TS-608	532	
TBC3	512	TBS1004	518	TM-54	524	TPM4012SK25PK	528	TS-612	532	
TBC4	512	TCA14	518	TM-58	524	528	528	TS-613	532	
TBC522	512	TCA111	518	TM-63	524	TS-6	528	TS-615	532	
TBC524	513	TCA-4	518	TPM5	524	TS-17	528	TS-621	532	
TBC529	513	TCA-5	518	TPM9	524	TS-24	528	TS-633	532	
TBC535	513	TCA-25	518	TPM10	524	TS-36	528	TS-650	532	
TBC541	513	TCA-26	519	TPM11	524	TS-43	528	TW-8	532	
TBC542	513	TCA-27	519	TPM66	524	TS-50	528	TW-20	532	
TBC543	513	TCA-52	519	TPM66A	524	TS-58	528	TW-73	532	
TBC544	513	TCA-58	519	TPM67	524	TS-59	528	TW-83C	533	
TBC545	513	TCA-59	519	TPM67A	524	TS-66	528	TW-86	533	

Part No.	Page	Part No.	Page	Part No.	Page	Part No.	Page
TW-96	533	US-285L	538	VCP132	543	VP29	548
TW-97	533	US-289L	538	VCP139	543	VP30	548
TW-98	533	US-294L	538	VCP142	543	VP31	548
TX1	533	US-322L	538	VCP143	543	VP32	548
TX3	533	US-331	538	VCP144	543	VP34	548
TX6	533	US-351	539	VCP150	543	VP35	548
TX12	533	US-362	539	VCP155	543	VP36	548
TX13	533	US-398	539	VCP169	543	VP37	548
TX18	534	US-431	539	VCP173	544	VP38	549
TX34	534	US-432	539	VCP174	544	VR842	549
TX36	534	US-514	539	VCP177	544	VR859	549
TX41	534	US-556L	539	VG6	544	VR-111	549
TX42	534	US-559L	539	VG7	544	VR-125	549
TX49	534	US-583	539	VG8	544	VR-134	549
TX51	534	US-603	539	VG19	544	VR-144	549
TX55	534	US-672	539	VG44	544	VR-155	549
TX57	534	US-700	539	VG88	544	VR-160	549
TX61	534	US-714	539	VG113	544	VR-162	549
TX71	534	US-747	540	VG120	544	VR-166	550
TX78	534	US-895	540	VG121	544	VR-169	550
TX89	535	US-980	540	VG122	544	VR-175	550
TX104	535	US-982	540	VG123	544	VR-179	550
TX121	535	US-988	540	VG124	545	VR-185	550
TX133	535	US-989	540	VG125	545	VR-405	550
TX141	535	US-990	540	VG126	545	VR-424	550
TX155	535	US-1017	540	VG127	545	VR-432	550
TX174	535	US-1021	540	VG164	545	VR-435	550
TX186	535	US-1195	540	VG169	545	VR-439	550
TX195	535	V112	540	VG175	545	VR-455	550
TX209	535	V165	540	VG177	545	VR-471	551
TX229	535	V168	541	VG182	545	VR-472	551
TX239	535	V178	541	VG183	545	VR-485	551
TX247	535	V184	541	VG184	545	VR-506	551
TX260	535	V188	541	VG185	545	VR-788	551
TX262	536	V206	541	VG186	545	VR-789	551
TX265	536	V210	541	VG236	545	VR-831	551
TX266	536	V223	541	VG238	545	VR-850	551
TX267	536	V226	541	VG239	546	VRV109	551
TX268	536	V227	541	VG240	546	VS36	551
TX270	536	V237	541	VG241	546	VS37	551
TX272	536	V246	541	VG242	546	VS52	551
TX275	536	V247	541	VG246	546	VS62	552
TX282	536	V276	541	VG247	546	VS76	552
TX283	536	V335	541	VG248	546	VS146	552
TX284	536	V353	541	VG249	546	VS153	552
TX294	536	V422	542	VG251	546	VS154	552
TX305	536	V425	542	VG253	546	VS198	552
TX316	536	V489	542	VG257	546	VS234	552
US1127	536	V520	542	VG263	546	VS237	552
US1149	537	V566	542	VG265	546	VS239	552
US1324	537	V581	542	VG266	546	VS244	552
US1336	537	VCG1	542	VG267	547	VS245	552
US1456	537	VCG2	542	VG270	547	VTS20	552
US1458	537	VCG3	542	VG273	547	VVT136	552
US1479	537	VCG4	542	VG274	547	VVT137	552
US-70L	537	VCG5	542	VG275	547	VVT138	553
US-84	537	VCG6	542	VG279	547	VVT214	553
US-89	537	VCG7	542	VG281	547	VVT353	553
US-109L	537	VCG8	542	VG282	547	VVT369	553
US-110	537	VCG9	542	VP1	547	VVT393	553
US-112	537	VCP108	542	VP2	547	VVT405	553
US-117L	538	VCP112	543	VP16	547	VVT408	553
US-165L	538	VCP113	543	VP18	547	VVT666	553
US-214L	538	VCP119	543	VP22	548	VVT711	553
US-216	538	VCP120	543	VP24	548	WGS1	553
US-274	538	VCP125	543	VP25	548	WP-236	553
US-275	538	VCP126	543	VP26	548	YA132	553
US-280L	538	VCP131	543	VP27	548	YA161	553

Make to Engine Part Number Index

**B42001
to
FJ1309NX**

Part No.	Page	Part No.	Page	Part No.	Page	Part No.	Page
B42001	C25	ECK7	C58	FJ258	C20, C21	FJ1241NX	C107
CAC1	C60	ECK8	C58	FJ330	C3	FJ1242	C135
DBT1	C50, C57	ECK9	C13	FJ489	C89	FJ1242NX	C136
DFH101	C26, C118	ECK10	C2	FJ495	C89	FJ1243	C116
DFH102	C72	ECK11	C13	FJ593	C28	FJ1243NX	C116
DFH103	C27	ECK12	C42, C127	FJ595	C28, C120	FJ1244	C113
DFH104	C27, C118	ECK13	C60	FJ595NX	C29, C120	FJ1244NX	C113
DFH105	C27	EGV801	C87	FJ596	C29, C120	FJ1256	C108
DFI1	C62, C66	EGV802	C87	FJ596NX	C29, C121	FJ1256NX	C108
DFI2	C88	EGV803	C87	FJ607	C3	FJ1257	C136
DFI3	C14	EGV1031	C43	FJ642	C4	FJ1257NX	C136
DFI5	C1	EGV1034	C43	FJ643	C4	FJ1258	C107
DFI6	C100	EGV1139	C145	FJ738	C30, C121	FJ1258NX	C107
DFI8	C151	EGV1142	C87	FJ738NX	C30, C121	FJ1259	C112
DFIP1	C62, C66	EGV1151	C58	FJ921	C145	FJ1259NX	C112
DFIP3	C61, C66	EGV1218	C102	FJ922	C147	FJ1262	C137
DFS1	C88	EGV1219	C88	FJ926	C31, C122	FJ1262NX	C137
DIH1	C1	EGV1238	C61	FJ926NX	C31, C122	FJ1268	C103
DIH2	C1	EGV1239	C62	FJ927	C44, C128	FJ1269	C103
DIH3	C2	EGV1240	C88	FJ927NX	C45, C128	FJ1277	C116
DIH4	C82	EGV1241	C14	FJ928	C45, C56, C132	FJ1277NX	C117
DIH5	C82	EGV1249	C43	FJ928NX	C45, C56, C133	FJ1278	C114
DIH6	C82	EGV1254	C103, C144	FJ932	C4	FJ1278NX	C114
DIH7	C82	EOS3	C62	FJ933	C4	FJ1279	C117
DIH8	C83	F08001	C33	FJ960	C59, C112	FJ1279NX	C117
DIH9	C12	F81003	C89	FJ960NX	C59, C112	FJ1291NX	C115
DIH11	C12	FFH1	C26	FJ961	C90	FJ1292NX	C105
DIH12	C83	FFH2	C26	FJ962	C90	FJ1300	C122
DIL1	C91	FICM1	C46	FJ976	C4	FJ1300NX	C123
DIL2	C91	FICM2	C46	FJ1009	C14	FJ1301	C140
DIL3	C91	FICM3	C46	FJ1010	C14	FJ1301NX	C141
DIL4	C92	FIDM1	C32	FJ1216	C100	FJ1302	C141
DPS101	C13, C19, C115, C134	FIDM2	C32	FJ1221	C63	FJ1302NX	C141
DPS104	C149	FIR1	C63	FJ1222	C63	FJ1303	C142
DPS105	C85, C101	FIR2	C64	FJ1223	C63	FJ1303NX	C142
DPS106	C100, C101, C102	FIR3	C83	FJ1224	C63	FJ1304	C108
DPS107	C85	FIR4	C83	FJ1225NX	C66	FJ1304NX	C109
DPS108	C19	FJ171	C67	FJ1226	C90	FJ1305	C142
DPS109	C19	FJ172	C68	FJ1227	C91	FJ1305NX	C142
DPS114	C102	FJ173	C73	FJ1229	C15	FJ1306	C109
DTL1	C49, C56	FJ174	C73	FJ1230	C15	FJ1306NX	C109
ECK1	C42, C127	FJ251	C68	FJ1232	C31	FJ1307	C143
ECK2	C85	FJ252	C2	FJ1239	C107	FJ1307NX	C143
ECK3	C86	FJ253	C3	FJ1239NX	C108	FJ1308	C109
ECK4	C86	FJ254	C3	FJ1240	C135	FJ1308NX	C110
ECK5	C86	FJ255	C3	FJ1240NX	C135	FJ1309	C105
ECK6	C86	FJ256	C3	FJ1241	C106	FJ1309NX	C106

**FJ1310
to
SK145**

Make to Engine Part Number Index (Cont'd)

Part No.	Page	Part No.	Page	Part No.	Page	Part No.	Page
FJ1310	C15	HPI1	C37, C124	IP25	C75	OCK6	C61
FJ1310NX	C15	HPI2	C38, C124	IP26	C8	OCK7	C144
FJ9288PCK.C45,C63,C126,C128		HPI3	C38, C125	IP27	C8	OCK8	C84
FSS101	C5	HPI4	C38, C125	IP28	C76	OCK9	C84
FSS102	C5	HPI6	C51	IP30	C60	OCK10	C85
FSS103	C74	HPI7	C51, C130	IP31	C146	OCK11	C101
FTP1	C5	HPI8	C110	IP32	C148	OCK12	C101
FTP2	C5	HPI9	C113	IP33	C16	OCK13	C72
FTP3	C33	HPI10	C117	IP34	C112	OCK14	C72
FTP4	C34	HPI11	C57, C110	IP35	C113	OCK15	C100
FTP5	C6	HPI12	C137	IP36	C96	OCK16	C2
FTP6	C59	HPI13	C118	IP37	C65	OCK17	C145
FTP7	C65	HPI14	C114	IP38	C20	OCK18	C20, C21, C105, C114
FTP8	C65	HPI15	C115	IP38NX	C21	OPH1	C36
FWSS101	C93	HPI16	C57, C127	IP39	C22	OPH2	C36
FWSS102	C74	HPI17	C107	IP39NX	C23	OPH3	C36
FWSS103	C69	HPI18	C139	IP40NX	C23	OPH4	C37
FWSS104	C103, C145	HPI19	C138	IP41	C23	PR315	C33, C123
FWSS106	C6	HPI20	C106	IP41NX	C24	PRV2	C4
FWSS107	C6	ICP101	C50, C129	IP42	C24	R75002	C52
FWSS108	C146	ICP102	C51, C124	IP42NX	C24	RTL1	C64
FWSS109	C102	ICP103	C51, C129	IP43NX	C125	RY1832	C95
FWSS110	C22	ICP105	C22	IP44NX	C125	RY-175	C20
FWSS112	C6	ICP106	C138	IP45NX	C24	RY-316	C35
FWSS113	C34	IFH1	C119	IP46NX	C76	RY-525	C35
FWSS114	C47	IFH2	C44	IP47	C76	RY-553	C36
FWSV101	C74	IFH3	C44	IP47NX	C76	RY-1528	C146
FWSV102	C34	IFH4	C44	IP48	C70	RY-1697	C95
GP104	C75	IFH5	C28, C119	IP48NX	C71	S39001	C78
GP105	C22	IFH6	C28	IPK1	C58	S39002	C79
GP107	C35	IFH7	C89, C119	IPK2	C111	SK38	C21
GP109	C35	IFH8	C58, C111	IPK3	C111	SK54	C67, C71
GP110	C93	IFH9	C59, C111	IPL1	C61	SK55	C32, C123
GP111	C146	IFS1	C47, C131	IPL2	C65	SK64	C59
GP113	C47	IFS2	C143	IPM1	C77	SK66	C92
GP114	C94	IFS3	C8	IRL1	C64	SK67	C92
GP115	C94	IP1	C75	K07020	C92	SK68	C92
GP116	C104, C147	IP10	C69	K07025	C93	SK85	C46, C56, C131
GP119	C149, C151	IP12	C70	L17001	C42	SK108	C37
GPC101	C94	IP17	C7	L25001	C2	SK115	C84
GPH101	C47	IP18	C7	L86001	C11, C16	SK125	C49
GPH102	C48	IP19	C7	OCG1	C52, C57, C133	SK138	C64
GPH103	C48	IP20	C7	OCG2	C38	SK139	C64
GPH104	C48	IP21	C8	OCK1	C52, C57, C134	SK140	C139
GPH105	C48	IP22	C95	OCK2	C39	SK141	C140
GPH106	C48	IP23	C95	OCK3	C115, C134	SK142	C49, C129
GPH107	C49	IP24	C96	OCK4	C13	SK145	C42, C127

Make to Engine Part Number Index (Cont'd)

Part No.	Page	Part No.	Page	Part No.	Page	Part No.	Page
SK146	C15	TBC-515	C41				
TBC522	C52	TBC-516	C80				
TBC524	C53	TBC-517	C81				
TBC529	C150	TBC-518	C149				
TBC535	C39	TBC-519	C149				
TBC541	C9	TBC-521	C16				
TBC542	C148	TBC-523	C54				
TBC543	C100	TIH1	C54				
TBC544	C9	TIH2	C55				
TBC545	C9	U43001	C79				
TBC546	C147	VCG1	C144				
TBC547	C104	VCG3	C99				
TBC548	C39	VCG4	C41, C126				
TBC549	C40	VCG5	C99				
TBC553	C9	VCG6	C41, C126				
TBC554	C147	VCG7	C16				
TBC555	C10	VCG8	C12				
TBC559	C60	VCG9	C12				
TBC560	C103	VCP108	C81				
TBC561	C97	VCP112	C12, C41, C55				
TBC562	C97	VCP113	C99				
TBC563	C97	VCP114	C71				
TBC564	C150	VCP119	C55				
TBC566	C40	VCP120	C55				
TBC567	C10	Z76002	C50				
TBC568	C10	Z76003	C56				
TBC569	C10	Z98001	C25				
TBC570	C10	Z98002	C25				
TBC573	C98						
TBC574	C98						
TBC575	C11						
TBC576	C60						
TBC577	C98						
TBC579	C11						
TBC580	C150						
TBC584	C11						
TBC585	C151						
TBC586	C151						
TBC587	C148						
TBC591	C126						
TBC592	C40						
TBC593	C53, C130						
TBC594	C53, C130						
TBC-511	C53						
TBC-512	C54						
TBC-513	C40						
TBC-514	C54						

NOTES PAGE

Modules

		Part No.
AM General		
Modules		
Diesel Injector Pump Module Resistor		
Hummer		
2001-1996	8 Cyl. 6.5L; Resistor No. 5	PMR1
2001-1996	8 Cyl. 6.5L; Resistor No. 9	PMR2
Relays and Fuses		
Circuit Breaker		
Hummer		
1998-1997		BR-34
1994-1992		BR-34
Fuel Pump Relay		
Hummer		
2001-2000	8 Cyl. 6.5L	RY-232
1996-1995	8 Cyl. 6.5L	RY-109
Fuel Valves and Solenoids		
Fuel Shut-Off Solenoid		
Hummer		
2001-1997		FSS103
Injectors		
Fuel Injector - Diesel - New		
Hummer		
2001-1999	8 Cyl. 6.5L	FJ173
1998-1996	8 Cyl. 6.5L; Turbocharged	FJ173
1998-1996	8 Cyl. 6.5L; Naturally Aspirated	FJ174
1995-1994	8 Cyl. 6.5L	FJ174
1993-1992	8 Cyl. 6.2L	FJ174
Injection Components		
Diesel Fuel Injection Pump - Remanufactured		
Hummer		
2001-1996	8 Cyl. 6.5L; Complete Assembly	IP1
2001-1996	8 Cyl. 6.5L; Pump Only	IP25
Diesel Glow Plug		
Hummer		
2001-1994	8 Cyl. 6.5L	GP104
1993-1992	8 Cyl. 6.2L	GP104
Diesel Injector Pump Driver Relocation Kit		
Hummer		
2001-1996	8 Cyl. 6.5L; w/ Module	IPR1
2001-1996	8 Cyl. 6.5L; w/o Module	IPR2
Diesel Injector Pump Module		
Hummer		
2001-1996	8 Cyl. 6.5L	IPM1
Position Sensors		
Crankshaft Sensor		
Hummer		
1997-1996	8 Cyl. 6.5L	PC125
Pressure Sensors		
MAP Sensor		
Hummer		
2001-1995	8 Cyl. 6.5L; Diesel	AS4
Turbocharger Boost Sensor		
Hummer		
2001-1996	8 Cyl. 6.5L; Diesel; Turbocharged	AS4
Pressure and Vacuum Sending Switches		
Oil Pressure Light Switch		
Hummer		
1997		PS-221

		Part No.
Audi		
Relays and Fuses		
Air Pump Relay		
Q7		
2008	8 Cyl. 4.2L; Exhaust stock and reorder	RY-265
2008	8 Cyl. 4.2L; Alternate Number	RY-273
Defroster Relay		
Q7		
2008	6 Cyl. 3.0L; Exhaust stock and reorder	RY-265
2008	8 Cyl. 4.2L; Exhaust stock and reorder	RY-265
2008	6 Cyl. 3.0L; Alternate Number	RY-273
2008	8 Cyl. 4.2L; Alternate Number	RY-273
Fuel Pump Relay		
5000		
1985	5 Cyl. 2.0L; Exhaust stock and reorder	RY253
1985	5 Cyl. 2.0L; Alternate Number	RY-494
Headlight Washer Relay		
Q7		
2008	6 Cyl. 3.0L; Exhaust stock and reorder	RY-265
2008	8 Cyl. 4.2L; Exhaust stock and reorder	RY-265
2008	6 Cyl. 3.0L; Alternate Number	RY-273
2008	8 Cyl. 4.2L; Alternate Number	RY-273
Power Seat Relay		
4000		
1983-1982	4 Cyl. 1.6L; Exhaust stock and reorder	RY-265
1983-1982	4 Cyl. 1.6L; Alternate Number	RY-273
Starter Relay		
Q7		
2010	6 Cyl. 3.0L	RY-573
2010	8 Cyl. 4.2L	RY-573
2009-2008	6 Cyl. 3.0L; Exhaust stock and reorder	RY-265
2009-2008	8 Cyl. 4.2L; Exhaust stock and reorder	RY-265
2009-2008	6 Cyl. 3.0L; Alternate Number	RY-273
2009-2008	8 Cyl. 4.2L; Alternate Number	RY-273
Windshield Washer Relay		
5000		
1985-1984	5 Cyl. 2.0L	RY-203
Starting and Charging System Parts		
Starter Solenoid		
4000		
1983-1982	4 Cyl.; Str. No. 049 911 023D, G, H	SS-262
5000		
1984	5 Cyl.; Bosch	SS-255
1983	5 Cyl.; Bosch; OE No. 035911023, 035911023L, 035911023N	SS-255
1983-1982	5 Cyl.; Bosch; OE No. 035911023J	SS-262
1982	5 Cyl.; Bosch; OE No. 035911023, 035911023L	SS-255
1981	5 Cyl.; Bosch; OE No. 035911023, 035911023L, 035911023N	SS-255
1981	5 Cyl.; Bosch; OE No. 035911023J, 035911023K	SS-262
1980	5 Cyl.; Bosch; OE No. 0001362077, 035911023	SS-255
1980	5 Cyl.; Bosch; OE No. 035911023J	SS-262
Voltage Regulator		
4000		
1983-1982	4 Cyl.; Motorola	VR-169
1983-1982	4 Cyl.; Bosch	VR-179

Air Injection and Induction Parts

		Part No.
Air Injection and Induction Parts		
Fuel Injection Throttle Body		
A3		
2013-2010	4 Cyl. 2.0L; Diesel	S20118
2010	4 Cyl. 2.0L	S20070
A6 Quattro		
2013-2012	6 Cyl. 3.0L	S20116
Q3		
2016-2015	4 Cyl.	S20070
Q3 Quattro		
2017	4 Cyl.	S20070
Q7		
2014-2013	6 Cyl. 3.0L; Diesel	S20117
2012-2010	6 Cyl. 3.0L; Diesel	S20115
Turbocharger - New		
A3		
2013-2010	4 Cyl. 2.0L; Diesel; Turbocharged	TBC529
Q3		
2016-2015	4 Cyl. 2.0L; Turbocharged	TBC622
Q7		
2012-2011	6 Cyl. 3.0L; Diesel; Turbocharged	TBC585
2010-2009	6 Cyl. 3.0L; Turbocharged	TBC585
Vacuum Pump		
A3		
2013-2010	4 Cyl. 2.0L	VCP169
Air Management Valves		
Auxiliary Air Valve		
4000		
1983-1982	4 Cyl. 1.6L	AV50
Diverter Valve		
A3		
2013-2010	4 Cyl. 2.0L	DV180
2010	4 Cyl. 2.0L; Turbocharged	G62001
A6 Quattro		
2014-2012	6 Cyl. 3.0L; Left	DV169
2013-2012	6 Cyl. 3.0L; Right	DV172
A8 Quattro		
2014	6 Cyl. 3.0L; Left	DV169
2014	6 Cyl. 3.0L; Right	DV172
Q5		
2014	6 Cyl. 3.0L; Left	DV169
2014-2013	6 Cyl. 3.0L; Right	DV172
Q7		
2014-2011	6 Cyl. 3.0L; Right	DV172
Engine Oil Separator		
A3		
2013-2010	4 Cyl. 2.0L	Z27003
Air Management Regulators and Solenoids		
Intake Manifold Actuator		
Q7		
2009-2008	8 Cyl. 4.2L	R56003
Turbocharger Boost Solenoid		
A3		
2013-2010	4 Cyl. 2.0L; Diesel	VS198
EGR Components		
EGR Control Solenoid		
A6 Quattro		
2014	6 Cyl. 3.0L; Diesel	VS153
A7 Quattro		
2016-2014	Turbocharged	VS153

		Part No.
EGR Control Solenoid		
A8 Quattro		
2014	6 Cyl. 3.0L; Diesel	VS153
Q5		
2014	6 Cyl. 3.0L; Diesel	VS153
Q7		
2014-2011	6 Cyl. 3.0L; Diesel	VS153
EGR Valve		
A3		
2016-2015	4 Cyl. 2.0L; Regulates EGR Control	EGV1272
2016-2015	4 Cyl. 2.0L; EGR Valve Assembly	EGV1278
2013-2010	4 Cyl. 2.0L; Diesel	EGV1247
A6 Quattro		
2016-2015	6 Cyl. 3.0L	EGV1268
2014	6 Cyl. 3.0L; Diesel	EGV1268
A7 Quattro		
2016-2015	6 Cyl. 3.0L	EGV1268
2014	6 Cyl. 3.0L; Diesel; To 5/11/14	EGV1264
2014	6 Cyl. 3.0L; Diesel; From 5/12/14	EGV1268
A8 Quattro		
2016-2015	6 Cyl. 3.0L; Diesel	EGV1268
2014	6 Cyl. 3.0L; Diesel	EGV1250
Q5		
2016	6 Cyl. 3.0L	EGV1268
2015	6 Cyl. 3.0L; Diesel	EGV1268
2014-2013	6 Cyl. 3.0L; Diesel; Turbocharged	EGV1250
Q7		
2015	6 Cyl. 3.0L; Diesel	EGV1264
2014-2013	6 Cyl. 3.0L; Diesel	EGV1250
2012-2011	6 Cyl. 3.0L; Diesel	EGV1242
2010-2009	6 Cyl. 3.0L	EGV1242
EGR Valve Mounting Gasket		
A3		
2013-2012	4 Cyl. 2.0L; Diesel; At Outlet	VG253
2011	4 Cyl. 2.0L; TDI; Diesel; At Outlet	VG253
2010	4 Cyl. 2.0L; Diesel; At Outlet	VG253
A6 Quattro		
2014	6 Cyl. 3.0L; Diesel	VG251
A7 Quattro		
2014	6 Cyl. 3.0L; Diesel	VG251
Q5		
2015-2014	6 Cyl. 3.0L; Diesel	VG251
Exhaust Components		
Diesel Emission Fluid Injection Nozzle		
A7 Quattro		
2015-2014	6 Cyl. 3.0L; Diesel	DFI8
Q7		
2015-2011	6 Cyl. 3.0L; Diesel	DFI8
2010	6 Cyl. 3.0L	DFI8
Vapor and Purge Components		
Canister Purge Solenoid		
A6 Quattro		
2015-2012	6 Cyl. 3.0L	CP838
A7 Quattro		
2016-2014	6 Cyl. 3.0L	CP838
A8 Quattro		
2016	6 Cyl. 3.0L	CP838
2015-2014	6 Cyl. 3.0L; By Air Cleaner	CP604
Q3		
2016-2015	4 Cyl. 2.0L; Turbocharged	CP863
Q5		
2017	6 Cyl. 3.0L	CP838

Vapor and Purge Components

		Part No.
Canister Purge Solenoid		
Q5		
2013	6 Cyl. 3.0L	CP838
Q7		
2009-2008	8 Cyl. 4.2L	CP569
Fuel Vapor Leak Detection Pump		
A3		
2013-2010	4 Cyl. 2.0L	LDP50
Q3		
2016-2013	4 Cyl. 2.0L	LDP26
Q7		
2015-2009	6 Cyl. 3.0L	LDP45
2010-2008	8 Cyl. 4.2L	LDP45
Injectors		
Fuel Injector - Diesel - New		
A3		
2013-2010	4 Cyl. 2.0L; Diesel	FJ1168
A6 Quattro		
2014	6 Cyl. 3.0L; Diesel	FJ1173
A7 Quattro		
2014	6 Cyl. 3.0L; Diesel	FJ1173
A8 Quattro		
2015-2014	6 Cyl. 3.0L; Diesel	FJ1260
Q5		
2016-2014	6 Cyl. 3.0L; Diesel	FJ1173
Q7		
2015-2013	6 Cyl. 3.0L; Diesel	FJ1173
2012-2011	6 Cyl. 3.0L; Diesel	FJ1174
2010-2009	6 Cyl. 3.0L	FJ1174
Fuel Injector - Diesel - Remfd		
4000		
1983-1982	4 Cyl. 1.6L; Turbocharged	FJ622
1983-1982	4 Cyl. 1.6L; Naturally Aspirated	FJ624
5000		
1983-1982	5 Cyl. 2.0L	FJ622
1981-1980	5 Cyl. 2.0L	FJ120
Injection Components		
Diesel Glow Plug		
A3		
2011-2010	4 Cyl. 2.0L; TDI	GP119
A6 Quattro		
2015-2014	6 Cyl. 3.0L; Cyl. 2	GP119
A7 Quattro		
2016-2014	6 Cyl. 3.0L; Diesel; Cyl. 2	GP119
Q7		
2015	6 Cyl. 3.0L; Diesel; Cyl. 2	GP119
2014	6 Cyl. 3.0L; Diesel; Cyl. 2	GP119
Direct Injection High Pressure Fuel Pump		
A3		
2013-2010	4 Cyl. 2.0L	GDP905
A6 Quattro		
2013-2012	6 Cyl. 3.0L	GDP608
Q5		
2017	6 Cyl. 3.0L	GDP608
2013	6 Cyl. 3.0L	GDP608
Q7		
2010	8 Cyl. 4.2L; Left	GDP609
2010	8 Cyl. 4.2L; Right	GDP610
2009-2008	8 Cyl. 4.2L; Left	GDP612
2009-2008	8 Cyl. 4.2L; Right	GDP613

		Part No.
Fuel Injector Seal Kit		
A3		
2013-2010	4 Cyl. 2.0L ²	SK106
A7 Quattro		
2014	6 Cyl. 3.0L	SK157
Q3		
2016-2015	4 Cyl. 2.0L ²	SK106
Q7		
2010-2008	8 Cyl. 4.2L ²	SK105
Fuel Pressure Regulator		
A3		
2010	4 Cyl. 2.0L; Diesel	PR509
A8 Quattro		
2015	6 Cyl. 3.0L	PR594
Q7		
2009	8 Cyl. 4.2L	PR500
Fuel Pump Camshaft Follower		
A3		
2013-2010	4 Cyl. 2.0L	FPC1
Q7		
2010-2008	8 Cyl. 4.2L	GDF604
Fuel Pump Fitting		
A6 Quattro		
2013-2012	6 Cyl. 3.0L; Low Pressure; At Pump Inlet	FPF604
Q5		
2017	6 Cyl. 3.0L; Low Pressure; At Pump Inlet	FPF604
2013	6 Cyl. 3.0L; Low Pressure; At Pump Inlet	FPF604
Q7		
2017	6 Cyl. 3.0L; Low Pressure; At Pump Inlet	FPF604
Fuel Pump O-Ring		
A6 Quattro		
2013-2012	6 Cyl. 3.0L; On Pump	GDR601
Q3		
2015	4 Cyl. 2.0L; On Pump	GDR601
Q5		
2017	6 Cyl. 3.0L; On Pump	GDR601
2013	6 Cyl. 3.0L; On Pump	GDR601
Q7		
2015-2011	6 Cyl. 3.0L; On Pump	GDR601
2010-2008	8 Cyl. 4.2L; On Pump	GDR601
Chassis and Drivetrain Sensors		
ABS Speed Sensor		
A3		
2013-2012	4 Cyl. 2.0L; Left Front	ALS430
2013-2012	4 Cyl. 2.0L; Right Front	ALS467
2013-2012	4 Cyl. 2.0L; FWD; Right Rear	ALS468
2013-2012	4 Cyl. 2.0L; FWD; Left Rear	ALS469
2010	4 Cyl. 2.0L; Left Front	ALS430
2010	4 Cyl. 2.0L; Right Front	ALS467
2010	4 Cyl. 2.0L; FWD; Right Rear	ALS468
2010	4 Cyl. 2.0L; FWD; Left Rear	ALS469
ABS Speed Sensor Wire Harness		
A7 Quattro		
2015-2014	Turbocharged; Left Front	ALH290
Automatic Transmission Output Sensor		
A3		
2012-2010	4 Cyl. 2.0L	SC602
Fluid Level Sensors		
Engine Oil Level Sensor		
A3		
2013-2010	4 Cyl. 2.0L; Diesel	FLS284

² Seal Kit Services One Injector

Fluid Level Sensors

		Part No.
Engine Oil Level Sensor		
A6 Quattro		
2016-2012	6 Cyl. 3.0L; Diesel	FLS311
A7 Quattro		
2016	6 Cyl. 3.0L	FLS311
2015	6 Cyl. 3.0L; Diesel	FLS311
2014	6 Cyl. 3.0L	FLS311
A8 Quattro		
2016-2014	6 Cyl. 3.0L; Diesel	FLS311
Q5		
2016-2014	6 Cyl. 3.0L; Diesel	FLS311
Q7		
2015-2013	6 Cyl. 3.0L; Diesel	FLS311
2010-2008	6 Cyl.	FLS284
Fuel Sensors		
Knock Sensor		
A6 Quattro		
2016	6 Cyl. 3.0L; Cyl. 1-3	KS466
2016	6 Cyl. 3.0L; Cyl. 4-6	KS467
2016-2015	6 Cyl. 3.0L	KS480
2015	6 Cyl. 3.0L; Cyl. 1-3	KS312
2015	6 Cyl. 3.0L; Cyl. 4-6	KS356
A7 Quattro		
2016	6 Cyl. 3.0L; Cyl. 1-3	KS466
2016	6 Cyl. 3.0L; Cyl. 4-6	KS467
2015	6 Cyl. 3.0L; Cyl. 1-3	KS312
2015	6 Cyl. 3.0L; Cyl. 4-6	KS356
2015	6 Cyl. 3.0L	KS480
A8 Quattro		
2015	6 Cyl. 3.0L	KS480
Q5		
2017-2015	6 Cyl. 3.0L	KS480
Q7		
2015	6 Cyl. 3.0L	KS480
2010-2009	8 Cyl. 4.2L; Brown; Cyl. 3-4, 7-8	KS234
2010-2009	8 Cyl. 4.2L; 3 Term.; Black Finish; Cyl. 1-2, 5-6	KS235
2008	8 Cyl. 4.2L; 345mm Wire	KS234
Mass Air Flow		
A6 Quattro		
2012	6 Cyl. 3.0L	MAS0379
A8 Quattro		
2016-2014	6 Cyl. 3.0L	MAS0516
Q7		
2010-2008	8 Cyl. 4.2L	MAS0411
Oxygen Sensor		
Q7		
2009-2008	8 Cyl. 4.2L; Left;Upstream Sensor	SG1208
2009-2008	8 Cyl. 4.2L; Right;Upstream Sensor	SG1208
Miscellaneous Sensors		
Battery Current / Volt Sensor		
A3		
2016-2015	4 Cyl.	BSC102
Position Sensors		
Accelerator Pedal Sensor		
A3		
2013	4 Cyl. 2.0L; FWD; Twin Clutch Trans.	APS222
A6 Quattro		
2013-2012	6 Cyl. 3.0L; Black Finish	APS353
2013-2012	6 Cyl. 3.0L; Silver	APS356
Q7		
2014-2011	6 Cyl. 3.0L	APS188

		Part No.
Camshaft Sensor		
A3		
2013-2010	4 Cyl. 2.0L; Diesel	PC839
A6 Quattro		
2013-2012	6 Cyl. 3.0L; Alternate Number	PC781
2013-2012	6 Cyl. 3.0L; Exhaust stock and reorder	PC911
A8 Quattro		
2016	6 Cyl. 3.0L	PC984
2016-2014	6 Cyl. 3.0L	PC781
Q3		
2016-2015	4 Cyl. 2.0L	PC781
Q3 Quattro		
2017	4 Cyl. 2.0L	PC781
Q5		
2017-2014	6 Cyl. 3.0L	PC781
2013	6 Cyl. 3.0L; Alternate Number	PC781
2013	6 Cyl. 3.0L; Exhaust stock and reorder	PC911
Q7		
2019-2017	6 Cyl. 3.0L	PC984
2015-2014	6 Cyl. 3.0L	PC781
2013-2011	6 Cyl. 3.0L; Alternate Number	PC781
2013-2011	6 Cyl. 3.0L; Exhaust stock and reorder	PC911
2010-2009	6 Cyl. 3.0L	PC781
2010-2008	8 Cyl. 4.2L	PC781
Crankshaft Sensor		
A3		
2016-2015	4 Cyl. 2.0L; Diesel; FWD	PC1029
2013-2010	4 Cyl. 2.0L; Diesel	PC843
A6 Quattro		
2016	6 Cyl. 3.0L	PC919
2013-2012	6 Cyl. 3.0L	PC919
A8 Quattro		
2016-2014	6 Cyl. 3.0L	PC919
Q3		
2016-2015	4 Cyl. 2.0L	PC837
Q3 Quattro		
2017	4 Cyl. 2.0L	PC837
Q5		
2017-2013	6 Cyl. 3.0L	PC919
2012-2010	6 Cyl.	PC878
Q7		
2019-2017	6 Cyl. 3.0L; Diesel	PC919
2015-2013	6 Cyl. 3.0L; Diesel	PC919
2012-2008	6 Cyl. 3.0L; Diesel	PC792
Pressure Sensors		
Fuel Pressure Sensor		
A3		
2013-2010	4 Cyl. 2.0L; Diesel	FPS68
A6 Quattro		
2016	6 Cyl. 3.0L; Located at Fuel Rail	FPS69
2015-2014	6 Cyl. 3.0L; Diesel; Located at Fuel Rail	FPS69
2012	6 Cyl. 3.0L; Located at Fuel Rail	FPS58
A7 Quattro		
2015-2014	6 Cyl. 3.0L; Diesel; Located at Fuel Rail	FPS69
Q5		
2016	6 Cyl. 3.0L; Located at Fuel Rail	FPS69
2015-2014	6 Cyl. 3.0L; Diesel; Located at Fuel Rail	FPS69
2013	6 Cyl. 3.0L; Located at Fuel Rail	FPS58
Q7		
2015-2013	6 Cyl. 3.0L; Located at Fuel Rail	FPS58
2010	8 Cyl. 4.2L	FPS15
2009-2008	8 Cyl. 4.2L; Rear	FPS15

Pressure Sensors

		Part No.
MAP Sensor		
A3		
2013-2010	4 Cyl. 2.0L; Diesel	AS441
A6 Quattro		
2016	6 Cyl. 3.0L	AS663
2014	6 Cyl. 3.0L; Alternate Number; Diesel; Location-Intercooler Piping	AS364
2014	6 Cyl. 3.0L; Diesel; Exhaust stock and reorder; Location-Intercooler Piping	AS438
A7 Quattro		
2016	6 Cyl. 3.0L	AS663
A8 Quattro		
2014	6 Cyl. 3.0L; Inlet	AS367
2014	6 Cyl. 3.0L; Outlet	AS448
Q3		
2016-2015	4 Cyl. 2.0L	AS645
Q5		
2017	6 Cyl. 3.0L	AS367
2015-2013	6 Cyl. 3.0L	AS367
Q7		
2019-2017	6 Cyl. 3.0L	AS663
2014-2011	6 Cyl. 3.0L; Alternate Number; Diesel	AS364
2014-2011	6 Cyl. 3.0L; Diesel; Exhaust stock and reorder	AS377
2010-2009	6 Cyl. 3.0L; Alternate Number	AS364
2010-2009	6 Cyl. 3.0L; Exhaust stock and reorder	AS377
Secondary Air Injection Sensor		
A3		
2010	4 Cyl. 2.0L	AS447
A6 Quattro		
2015-2013	6 Cyl. 3.0L	AS447
Q7		
2009-2008	8 Cyl. 4.2L	AS447
Turbocharger Boost Sensor		
A3		
2012-2010	4 Cyl. 2.0L; Diesel; Turbocharged	AS441
Q7		
2012-2011	6 Cyl. 3.0L; Alternate Number; Diesel; Turbocharged	AS364
2012-2011	6 Cyl. 3.0L; Diesel; Exhaust stock and reorder; Turbocharged	AS377
2010-2009	6 Cyl. 3.0L; Alternate Number; Turbocharged	AS364
2010-2009	6 Cyl. 3.0L; Exhaust stock and reorder; Turbocharged	AS377
Temperature Sensors		
A/C Evaporator Temperature Sensor		
Q7		
2008	8 Cyl. 4.2L	AX303
Ambient Air Temperature Sensor		
A3		
2016-2015	4 Cyl. 2.0L	AX377
Coolant Temperature Sensor		
5000		
1983	5 Cyl. 2.0L	TX57
A3		
2013-2011	4 Cyl. 2.0L; Located On Thermostat Housing	TS-608
A6 Quattro		
2015-2014	6 Cyl. 3.0L	TS-608
2013	6 Cyl. 3.0L; Located On Cylinder Head	AX522
A8 Quattro		
2016-2014	6 Cyl. 3.0L; Located On Radiator Hose	TS-608

		Part No.
Coolant Temperature Sensor		
Q7		
2013	6 Cyl.; Located On Radiator Hose	TS-608
2013	6 Cyl.; Located On Cylinder Head	TX305
Exhaust Gas Temperature Sensor		
A3		
2016-2015	4 Cyl. 2.0L; Turbocharged; Location-Before Catalyst	ETS130
2016-2015	4 Cyl. 2.0L; Turbocharged; Located After Particulate Filter	ETS139
2016-2015	4 Cyl. 2.0L; Turbocharged; Located Before Particulate Filter	ETS140
2016-2015	4 Cyl. 2.0L; Turbocharged; Located Before Turbocharger	ETS185
2012-2011	4 Cyl. 2.0L; Black Finish; Diesel; Located Before Turbocharger	ETS126
2012-2011	4 Cyl. 2.0L; Diesel; Orange; Located Before Catalytic Converter	ETS66
2012-2011	4 Cyl. 2.0L; Diesel; Orange; Located After Particulate Filter	ETS77
2012-2011	4 Cyl. 2.0L; Brown; Diesel; Located Before Particulate Filter	ETS83
2010	4 Cyl. 2.0L; Diesel; Located Before Catalytic Converter	ETS66
2010	4 Cyl. 2.0L; 1 Term.; Diesel; Located After Particulate Filter	ETS77
2010	4 Cyl. 2.0L; Diesel; Located Before Particulate Filter	ETS83
2010	4 Cyl. 2.0L; 2 Term.; Diesel; Located After Particulate Filter	ETS84
A6 Quattro		
2016-2015	6 Cyl. 3.0L; Turbocharged; Located Before Turbocharger	ETS134
2016-2014	6 Cyl. 3.0L; Turbocharged; Located After Particulate Filter	ETS141
2016-2014	6 Cyl. 3.0L; Turbocharged; Located Before Particulate Filter	ETS148
2014	6 Cyl. 3.0L; Turbocharged; Located Before Turbocharger	ETS135
A7 Quattro		
2016-2015	6 Cyl. 3.0L; Turbocharged; Located Before Turbocharger	ETS134
2016-2014	6 Cyl. 3.0L; Turbocharged; Located After Particulate Filter	ETS141
2016-2014	6 Cyl. 3.0L; Turbocharged; Located Before Particulate Filter	ETS148
2014	6 Cyl. 3.0L; Turbocharged; Located in Catalytic Converter	ETS134
2014	6 Cyl. 3.0L; Turbocharged; Located Before Turbocharger	ETS135
A8 Quattro		
2016-2015	6 Cyl. 3.0L; Turbocharged; Located Before Turbocharger	ETS134
2016-2014	6 Cyl. 3.0L; Turbocharged; Located After Particulate Filter	ETS141
2016-2014	6 Cyl. 3.0L; Turbocharged; Located Before Particulate Filter	ETS148
2014	6 Cyl. 3.0L; Turbocharged; Located in Catalytic Converter	ETS134
2014	6 Cyl. 3.0L; Turbocharged; Located Before Turbocharger	ETS135
2014	6 Cyl. 3.0L; Turbocharged; Located on EGR Cooler	ETS138
Q5		
2016-2015	6 Cyl. 3.0L; Turbocharged; Located Before Turbocharger	ETS134
2016-2014	6 Cyl. 3.0L; Turbocharged; Located After Particulate Filter	ETS141
2016-2014	6 Cyl. 3.0L; Turbocharged; Located Before Particulate Filter	ETS148

Temperature Sensors

		Part No.
Exhaust Gas Temperature Sensor		
Q5		
2014	6 Cyl. 3.0L; Turbocharged; Located in Catalytic Converter	ETS134
2014	6 Cyl. 3.0L; Turbocharged; Located Before Turbocharger	ETS135
2014	6 Cyl. 3.0L; Turbocharged; Located Before Catalytic Converter	ETS187
Q7		
2015	6 Cyl. 3.0L; Located After Particulate Filter	ETS169
2015-2013	6 Cyl. 3.0L; Located Before Turbocharger	ETS135
2015-2013	6 Cyl. 3.0L; Located on EGR Cooler	ETS138
2015-2013	6 Cyl. 3.0L; Located Before Catalytic Converter	ETS164
2012-2011	6 Cyl. 3.0L; Located After Particulate Filter	ETS78
2012-2011	6 Cyl. 3.0L; Located Before Particulate Filter	ETS80
2012-2009	6 Cyl. 3.0L; Located Before Catalytic Converter	ETS79
2012-2009	6 Cyl. 3.0L; Located Before Pre-Catalyst	ETS81
2012-2009	6 Cyl. 3.0L; Located Before Turbocharger	ETS82
2010-2009	6 Cyl. 3.0L; Back of EGR valve	ETS110
Intake Air Temperature Sensor		
A3		
2016-2015	4 Cyl. 2.0L; Diesel	AX381
A8 Quattro		
2016-2015	6 Cyl.	AX382
Body Light Switches		
Stoptlight Switch		
5000		
1981-1980	5 Cyl. 2.0L	SLS-126
Chassis and Drivetrain Switches		
Neutral Safety Switch		
Q7		
2014-2013	6 Cyl. 3.0L	NS689
Ignition Switches		
Ignition Starter Switch		
Q5		
2013	6 Cyl. 3.0L	US-990
2012-2011	6 Cyl. 3.0L	US-989
Q7		
2014-2011	6 Cyl. 3.0L	US-988
Interior Power Switches		
Clock Spring		
A3		
2010	4 Cyl. 2.0L	CSP164
Pressure and Vacuum Sending Switches		
Oil Pressure Light Switch		
A3		
2016-2015	4 Cyl. 2.0L; 2 Blade Term.; Brown; Diesel	PS668
2016-2015	4 Cyl. 2.0L; 2 Blade Term.; Diesel; Light Green	PS671
2015	4 Cyl. 2.0L; 1 Blade Term.; Brown; Diesel	PS-400
2013	4 Cyl. 2.0L; 1 Blade Term.; Black	PS-297
2013	4 Cyl. 2.0L; 1 Blade Term.; Brown	PS-400
2013	4 Cyl. 2.0L; 2 Blade Term.; Brown	PS668
2013	4 Cyl. 2.0L; 2 Blade Term.; Light Green	PS671
2012-2010	4 Cyl. 2.0L; w/ Black Connector	PS-297
2012-2010	4 Cyl. 2.0L; w/ Brown Connector	PS-400
A6 Quattro		
2016	6 Cyl.; 1 Blade; Gray	PS666

		Part No.
Oil Pressure Light Switch		
A6 Quattro		
2016-2015	6 Cyl.; 1 Blade; Purple	PS662
2016-2012	6 Cyl.; 2 Blade Term.; Purple	PS663
2016-2012	6 Cyl.; 2 Blade Term.; Gray	PS667
2015-2014	6 Cyl. 3.0L; 1 Pin Term.	PS-490
A8 Quattro		
2016-2015	6 Cyl.; 1 Blade; Purple	PS662
2016-2015	6 Cyl.; 1 Blade; Gray	PS666
2016-2014	6 Cyl.; 2 Blade Term.; Purple	PS663
2016-2014	6 Cyl.; 2 Blade Term.; Gray	PS667
Q5		
2017	6 Cyl.; 2 Blade Term.; Purple	PS663
2017	6 Cyl.; 2 Blade Term.; Gray	PS667
2016	6 Cyl.; 2 Blade Term.; Diesel; Gray	PS667
2015-2014	6 Cyl.; 1 Blade Term.; Gray	PS-490
2015-2014	6 Cyl.; 2 Blade Term.; Gray	PS667
2015-2013	6 Cyl.; 2 Blade Term.; Purple	PS663
2012-2010	6 Cyl. 3.0L; 2 Blade Term.; Purple	PS663
2010	6 Cyl.; 1 Blade Term.; Gray	PS-490
Q7		
2017	6 Cyl.; 1 Blade; Gray	PS666
2015-2014	6 Cyl.; 2 Blade Term.; Purple	PS663
2015-2014	6 Cyl.; 2 Blade Term.; Gray	PS667
2013-2011	6 Cyl.; 1 Blade Term.; Diesel; w/ Black Insulator	PS-165
2013-2011	6 Cyl.; 2 Pin; Diesel; Green	PS-492
2013-2011	6 Cyl.; 2 Blade Term.; Diesel; Gray	PS667
2010	6 Cyl. 3.0L; 1 Blade Term.	PS-165
2010	6 Cyl. 3.0L; 2 Pin	PS-492
2010-2008	6 Cyl. 3.0L; 2 Blade Term.; Purple	PS663
2010-2008	6 Cyl. 3.0L; 2 Blade Term.; Gray	PS667
2009-2008	8 Cyl. 4.2L; 1 Blade Term.; Black	PS-488
Temperature Switches and Senders		
Temperature Sender - With Gauge		
4000		
1983-1982	4 Cyl.	TS-59
5000		
1983-1980	5 Cyl. 2.0L	TS-59
Actuators		
Variable Valve Timing Solenoid		
A3		
2015	4 Cyl. 2.0L; Diesel	VVT369
2011-2010	4 Cyl. 2.0L	VVT137
A6 Quattro		
2016	6 Cyl. 3.0L; Intake	VVT136
2016	6 Cyl. 3.0L; Alternate Number; Exhaust	VVT214
2016	6 Cyl. 3.0L; Exhaust stock and reorder; Exhaust	VVT295
A7 Quattro		
2016	6 Cyl. 3.0L; Intake	VVT136
2016	6 Cyl. 3.0L; Alternate Number; Exhaust	VVT214
2016	6 Cyl. 3.0L; Exhaust stock and reorder; Exhaust	VVT295
A8 Quattro		
2016	6 Cyl. 3.0L; Intake	VVT136
2016	6 Cyl. 3.0L; Alternate Number; Exhaust	VVT214
2016	6 Cyl. 3.0L; Exhaust stock and reorder; Exhaust	VVT295
Q7		
2012-2011	6 Cyl. 3.0L; Diesel	VVT138
2010-2009	6 Cyl. 3.0L	VVT138

Pressure Sensors

		Part No.
Bering		
Pressure Sensors		
Air Inlet Pressure Sensor		
HD67MX		
2000	6 Cyl. 12.0L	PS711
Blue Bird		
Early Fuel Emission Control		
Crankcase Ventilation Filter		
All American FE		
2018-2008	6 Cyl. 6.7L	BF43
All American RE		
2018-2008	6 Cyl. 6.7L	BF43
SHL All American		
2017	6 Cyl. 6.7L	BF43
Vision School Bus		
2018-2008	6 Cyl. 6.7L	BF43
Pressure Sensors		
Diesel Particulate Filter (DPF) Pressure Sensor		
All American FE		
2018-2010	6 Cyl. 6.7L	DPS101
All American RE		
2018-2014	6 Cyl. 8.9L	DPS101
2018-2010	6 Cyl. 6.7L	DPS101
SHL All American		
2017	6 Cyl. 6.7L	DPS101
Vision School Bus		
2018-2017	6 Cyl. 6.7L	DPS101
EGR Valve Pressure Feedback Sensor		
All American FE		
2018-2008	6 Cyl. 6.7L; Diesel	VP34
All American RE		
2018-2008	6 Cyl. 6.7L; Diesel	VP34
SHL All American		
2017	6 Cyl. 6.7L; Diesel	VP34
Vision School Bus		
2019-2008	6 Cyl. 6.7L; Diesel	VP34
Fuel Pressure Sensor		
All American FE		
2007-2005		FPS63
Injection Actuation Pressure Sensor		
All American FE		
2000-1999	6 Cyl. 7.2L	PS713
All American RE		
2000-1999	6 Cyl. 7.2L	PS713
TC2000		
2000-1999	6 Cyl. 7.2L	PS713
Pressure and Vacuum Sending Switches		
Oil Pressure Gauge Switch		
All American RE		
2017-2014	6 Cyl. 8.9L	PS-407
BMW		
Modules		
Fuel Pump Driver Module		
335d		
2009		FPM105
X5		
2009	6 Cyl. 3.0L; Diesel	FPM105

		Part No.
Relays and Fuses		
Fuel Pump Relay		
524td		
1986-1985		RY-489
Hazard Warning Relay		
524td		
1986-1985		RY-975
Horn Relay		
524td		
1986-1985		RY-777
Sunroof Relay		
524td		
1986-1985		RY-976
Turn Signal Flasher		
524td		
1986-1985		EFL-9
Starting and Charging System Parts		
Starter Solenoid		
524td		
1986-1985		SS-348
X5		
2012-2009	6 Cyl. 3.0L; Diesel	SS853
Voltage Regulator		
524td		
1986-1985		VR-471
X5		
2009	6 Cyl. 3.0L; Turbocharged	VR859
Air Injection and Induction Parts		
Fuel Injection Throttle Body		
335d		
2011-2009		S20107
X5		
2018-2014	6 Cyl. 3.0L	S20228
2013-2009	6 Cyl. 3.0L; Diesel	S20107
Turbocharger - New		
335d		
2011-2009	6 Cyl. 3.0L; Diesel; Turbocharged	TBC660
X5		
2013-2010	6 Cyl. 3.0L; Diesel; High Pressure; Turbocharged	TBC659
2013-2009	6 Cyl. 3.0L; Diesel; Low Pressure; Turbocharged	TBC652
2009	6 Cyl. 3.0L; Diesel; High Pressure; Turbocharged	TBC653
Vacuum Pump		
X5		
2012-2011	6 Cyl. 3.0L	VCP174
Air Management Valves		
Vacuum Control Valve		
335d		
2011-2009		VS237
535d		
2016-2014		VS237
535d xDrive		
2016-2014		VS237
X5		
2014-2011	6 Cyl. 3.0L	VS237
Air Management Regulators and Solenoids		
Turbocharger Boost Solenoid		
X3		
2016-2015	4 Cyl. 2.0L	TBS1004

Air Management Regulators and Solenoids

		Part No.
Turbocharger Boost Solenoid		
X5		
2012-2011	6 Cyl. 3.0L	TBS1004
EGR Components		
EGR Valve		
328d		
2018-2014		EGV1252
328d xDrive		
2018-2014		EGV1252
335d		
2011-2009	6 Cyl. 3.0L; Diesel	EGV1243
535d		
2016-2014		EGV1252
535d xDrive		
2016-2014		EGV1252
X5		
2013-2009	6 Cyl. 3.0L; Diesel	EGV1243
EGR Valve Mounting Gasket		
335d		
2011-2009	6 Cyl. 3.0L; At Outlet	VG248
2011-2009	6 Cyl. 3.0L; At Inlet	VG249
X5		
2013-2009	6 Cyl. 3.0L; Diesel; At Outlet	VG248
2013-2009	6 Cyl. 3.0L; Diesel; At Inlet	VG249
Exhaust Components		
Diesel Emission Fluid Injection Nozzle		
335d		
2011-2010	6 Cyl. 3.0L	DFI5
X5		
2013-2010	6 Cyl. 3.0L; Diesel	DFI5
Vapor and Purge Components		
Canister Purge Solenoid		
X5		
2018-2016	6 Cyl.	CP884
2014	6 Cyl. 3.0L	CP884
2013	6 Cyl.	CP884
Canister Vent Solenoid		
X3		
2015	4 Cyl.	CVS129
X5		
2012-2011	6 Cyl. 3.0L	CVS134
2009	6 Cyl. 3.0L	CVS60
Fuel Vapor Canister		
335d		
2011-2009	w/o SULEV	CP3287
2011-2009	w/ SULEV	CP3319
Injectors		
Fuel Injector - Diesel - New		
524td		
1986-1985		FJ843
Injection Components		
Direct Injection High Pressure Fuel Pump		
X3		
2017-2015	4 Cyl. 2.0L; w/ SULEV	GDP703
X5		
2018-2015	6 Cyl. 3.0L	GDP702
2014	6 Cyl. 3.0L; From 3/01	GDP702
Fuel Injector Seal Kit		
X3		
2017-2015	4 Cyl. 2.0L; O-Ring Only	SK170

		Part No.
Fuel Injector Seal Kit		
X5		
2017-2011	6 Cyl. 3.0L; O-Ring Only	SK170
Chassis and Drivetrain Sensors		
ABS Speed Sensor		
328d		
2018-2014	Exc.Adaptive Cruise Control; Front	ALS2721
2018-2014	w/o Adaptive Cruise Control; Rear	ALS2724
328d xDrive		
2018-2014	w/o Adaptive Cruise Control; Rear	ALS2724
2018-2014	w/o Adaptive Cruise Control; Front	ALS3105
335d		
2011	Includes ABS Wheel Speed Sensor Wire Harness; Rear	ALS1842
2011	Includes ABS Wheel Speed Sensor Wire Harness; Front	ALS463
2010-2009	Rear	ALS1842
2010-2009	Front	ALS463
524td		
1986-1985	Front	ALS1431
1986-1985	Rear	ALS1448
535d		
2016-2014	Front	ALS2722
535d xDrive		
2016-2014	Front	ALS2719
740Ld xDrive		
2015	Includes ABS Wheel Speed Sensor Wire Harness; Rear	ALS2715
2015	Front	ALS2719
Fluid Level Sensors		
Brake Fluid Level Sensor		
535d		
2016-2014	6 Cyl. 3.0L; Diesel	FLS94
535d xDrive		
2016-2014	6 Cyl. 3.0L; Diesel	FLS94
740Ld xDrive		
2015	6 Cyl. 3.0L; Diesel	FLS94
Coolant Level Sensor		
335d		
2011-2009		FLS-125
Engine Oil Level Sensor		
335d		
2010-2009		L26001
Windshield Washer Level Sensor		
335d		
2011-2009		FLS-125
Fuel Sensors		
Knock Sensor		
524td		
1986-1985		KS328
X3		
2017	4 Cyl. 2.0L	KS397
2015	4 Cyl. 2.0L	KS397
Mass Air Flow		
328d		
2015-2014	4 Cyl. 2.0L	MAS0509
328d xDrive		
2015-2014	4 Cyl. 2.0L	MAS0509
335d		
2011-2009	6 Cyl. 3.0L	MAS0422
535d		
2016-2014	6 Cyl. 3.0L	MAS0483

Fuel Sensors

		Part No.
Mass Air Flow		
X3		
2017	4 Cyl. 2.0L	MAS0338
X5		
2017-2014	6 Cyl. 3.0L	MAS0288
2013-2009	6 Cyl. 3.0L; Diesel	MAS0422
Miscellaneous Sensors		
Battery Current / Volt Sensor		
328d		
2018-2014	4 Cyl.	BSC84
335d		
2011-2009	Negative Side	BSC86
535d		
2016		BSC90
535d xDrive		
2016		BSC90
Brake Pad Wear Sensor		
328d		
2014	Front	PWS290
2014	Rear	PWS291
328d xDrive		
2014	Front	PWS290
2014	Rear	PWS291
335d		
2011	Front	PWS260
2009	Rear	PWS105
2009	Front	PWS108
524td		
1986-1985	Rear	PWS144
1986-1985	Front	PWS145
540d xDrive		
2018	Rear	PWS339
X5		
2013-2011	6 Cyl.; Front	PWS262
Engine Variable Valve Lift Eccentric Shaft Sensor		
X5		
2018-2014	6 Cyl. 3.0L	VTS20
Position Sensors		
Accelerator Pedal Sensor		
328d		
2018-2014		APS332
328d xDrive		
2018-2014		APS332
335d		
2011-2010		APS347
535d		
2016-2014		APS347
535d xDrive		
2016-2014		APS347
Camshaft Sensor		
328d		
2018		PC1088
328d xDrive		
2018-2016		PC1088
335d		
2011-2009	6 Cyl. 3.0L	PC883
535d		
2016		PC1088
535d xDrive		
2016		PC1088

		Part No.
Camshaft Sensor		
740Ld xDrive		
2015	6 Cyl. 3.0L	PC1088
X3		
2017-2015	4 Cyl. 2.0L; Diesel	PC1088
X5		
2018-2014	6 Cyl. 3.0L; Diesel	PC1088
2013-2009	6 Cyl. 3.0L; Diesel	PC883
Crankshaft Sensor		
328d		
2018-2014		PC1068
328d xDrive		
2018-2014		PC1068
335d		
2011-2009	6 Cyl. 3.0L	PC891
524td		
1986-1985	6 Cyl. 2.4L	PC436
535d		
2016-2014		PC983
535d xDrive		
2016-2014		PC983
740Ld xDrive		
2015		PC983
X5		
2017-2016	6 Cyl. 3.0L; Diesel	PC983
2015-2014	6 Cyl.; Diesel	PC983
2013-2009	6 Cyl.; Diesel	PC891
Pressure Sensors		
Fuel Pressure Sensor		
335d		
2011-2009	6 Cyl. 3.0L	FPS43
X5		
2013-2009	6 Cyl. 3.0L; Diesel	FPS43
Manifold Differential Pressure Sensor		
X5		
2010-2009	6 Cyl. 3.0L; Diesel	AS639
MAP Sensor		
328d		
2018-2014		AS495
328d xDrive		
2018-2014		AS495
335d		
2011-2009		AS454
535d		
2016-2014		AS495
535d xDrive		
2016-2014		AS495
X5		
2018	6 Cyl. 3.0L	AS461
2015-2014	6 Cyl. 3.0L; Diesel	AS495
2013-2009	6 Cyl. 3.0L; Diesel	AS454
Tire Pressure Monitoring System OE Design Sensor		
328d		
2017-2015	433 Mhz Sensor; OE Style; w/ Aluminum Valve; w/ Aluminum Valve	TPM222
2014	433 Mhz Sensor; OE Style; To 3/14	TPM196
2014	433 Mhz Sensor; From 3/14; OE Style; w/ Aluminum Valve; w/ Aluminum Valve	TPM222
328d xDrive		
2018	433 Mhz Sensor; OE Style/ID Clone-able; w/ Aluminum Valve; w/ Aluminum Valve	TPM222
2017-2015	433 Mhz Sensor; OE Style; w/ Aluminum Valve; w/ Aluminum Valve	TPM222

Pressure Sensors

		Part No.
Tire Pressure Monitoring System OE Design Sensor		
328d xDrive		
2014	433 Mhz Sensor; OE Style/ID Clone-able; To 3/14	TPM196
2014	433 Mhz Sensor; From 3/14; OE Style/ID Clone-able; w/ Aluminum Valve; w/ Aluminum Valve	TPM222
335d		
2011-2010	433 Mhz Sensor; OE Style; w/ Aluminum Valve; w/ Aluminum Valve	TPM141
2009	433 Mhz Sensor; OE Style/ID Clone-able	TPM109A
2009	433 Mhz Sensor; From 9/09; OE Style; w/ Aluminum Valve	TPM141
535d		
2016-2015	433 Mhz Sensor; OE Style	TPM196
2014	433 Mhz Sensor; OE Style; To 3/14; w/ Aluminum Valve; w/ Aluminum Valve	TPM141
2014	433 Mhz Sensor; From 3/14; OE Style	TPM196
535d xDrive		
2016-2015	433 Mhz Sensor; OE Style	TPM196
2014	433 Mhz Sensor; OE Style; To 3/14; w/ Aluminum Valve; w/ Aluminum Valve	TPM141
2014	433 Mhz Sensor; From 3/14; OE Style	TPM196
540d xDrive		
2018	433 Mhz Sensor; w/ Aluminum Valve	TPM327
740Ld xDrive		
2015	433 Mhz Sensor	TPM196
Tire Pressure Monitoring System OE Design Sensor Service Kit		
328d		
2017-2015	25 Per Box; OE Style; w/o Valve	TPM2080K
2017-2015	4 Per Box; OE Style; w/o Valve	TPM2080K4
2014	25 Per Box; OE Style; To 3/14; w/o Valve	TPM2000K
2014	4 Per Box; OE Style; To 3/14; w/o Valve	TPM2000K4
2014	25 Per Box; From 3/14; OE Style; w/o Valve	TPM2080K
2014	4 Per Box; From 3/14; OE Style; w/o Valve	TPM2080K4
328d xDrive		
2018	25 Per Box; From 3/14; OE Style; w/o Valve	TPM2080K
2018	4 Per Box; From 3/14; OE Style; w/o Valve	TPM2080K4
2017-2015	25 Per Box; OE Style; w/o Valve	TPM2080K
2017-2015	4 Per Box; OE Style; w/o Valve	TPM2080K4
2014	25 Per Box; OE Style; To 3/14; w/o Valve	TPM2000K
2014	4 Per Box; OE Style; To 3/14; w/o Valve	TPM2000K4
2014	25 Per Box; From 3/14; OE Style; w/o Valve	TPM2080K
2014	4 Per Box; From 3/14; OE Style; w/o Valve	TPM2080K4
335d		
2011-2009	25 Per Box; OE Style; w/o Valve	TPM1090K
2011-2009	4 Per Box; OE Style; w/o Valve	TPM1090K4
535d		
2016-2015	25 Per Box; OE Style; w/o Valve	TPM2000K
2016-2015	4 Per Box; OE Style; w/o Valve	TPM2000K4
2014	25 Per Box; OE Style; To 3/14; w/o Valve	TPM1090K
2014	4 Per Box; OE Style; To 3/14; w/o Valve	TPM1090K4
2014	25 Per Box; From 3/14; OE Style; w/o Valve	TPM2000K
2014	4 Per Box; From 3/14; OE Style; w/o Valve	TPM2000K4
535d xDrive		
2016-2015	25 Per Box; OE Style; w/o Valve	TPM2000K
2016-2015	4 Per Box; OE Style; w/o Valve	TPM2000K4
2014	25 Per Box; OE Style; To 3/14; w/o Valve	TPM1090K
2014	4 Per Box; OE Style; To 3/14; w/o Valve	TPM1090K4

		Part No.
Tire Pressure Monitoring System OE Design Sensor Service Kit		
535d xDrive		
2014	4 Per Box; OE Style; To 3/14; w/o Valve	TPM1090K4
2014	25 Per Box; From 3/14; OE Style; w/o Valve	TPM2000K
2014	4 Per Box; From 3/14; OE Style; w/o Valve	TPM2000K4
Tire Pressure Monitoring System OE Design Valve		
328d		
2017-2015	433 Mhz Sensor; OE Style; w/ Aluminum Valve	TPM2026VK
2014	433 Mhz Sensor; From 3/14; OE Style; w/ Aluminum Valve	TPM2026VK
328d xDrive		
2018	433 Mhz Sensor; From 3/14; OE Style; w/ Aluminum Valve	TPM2026VK
2017-2015	433 Mhz Sensor; OE Style; w/ Aluminum Valve	TPM2026VK
2014	433 Mhz Sensor; From 3/14; OE Style; w/ Aluminum Valve	TPM2026VK
335d		
2011-2009	Black; OE Style; Overall Length of 49mm; w/ Aluminum Valve; w/ Washers	TPM10
2011-2009	OE Style; Overall Length of 52mm; Silver; w/ Aluminum Valve; w/ Washers	TPM102
2011-2009	Green; OE Style; Overall Length of 51mm; w/ Aluminum Valve; w/ Washers	TPM11
2011-2009	OE Style; Overall Length of 56.5mm; w/ Aluminum Valve; w/ Washers; Yellow	TPM2013VK
2011-2009	OE Style; Overall Length of 43mm; Silver; w/ Aluminum Valve; w/ Washers	TPM5
2011-2009	OE Style; Orange; Overall Length of 48mm; w/ Aluminum Valve; w/ Washers	TPM9
535d		
2016-2015	Green; OE Style; Overall Length of 51mm; w/ Aluminum Valve; w/ Washers	TPM11
2016-2015	OE Style; Overall Length of 56.5mm; w/ Aluminum Valve; w/ Washers; Yellow	TPM2013VK
2016-2015	OE Style; Overall Length of 43mm; Silver; w/ Aluminum Valve; w/ Washers	TPM5
2014	Black; OE Style; Overall Length of 49mm; To 3/14; w/ Aluminum Valve; w/ Washers	TPM10
2014	OE Style; Overall Length of 52mm; Silver; To 3/14; w/ Aluminum Valve; w/ Washers	TPM102
2014	Green; OE Style; Overall Length of 51mm; To 3/14; w/ Aluminum Valve; w/ Washers	TPM11
2014	OE Style; Overall Length of 56.5mm; To 3/14; w/ Aluminum Valve; w/ Washers; Yellow	TPM2013VK
2014	OE Style; Overall Length of 43mm; Silver; To 3/14; w/ Aluminum Valve; w/ Washers	TPM5
2014	OE Style; Orange; Overall Length of 48mm; To 3/14; w/ Aluminum Valve; w/ Washers	TPM9
535d xDrive		
2016-2015	Green; OE Style; Overall Length of 51mm; w/ Aluminum Valve; w/ Washers	TPM11
2016-2015	OE Style; Overall Length of 56.5mm; w/ Aluminum Valve; w/ Washers; Yellow	TPM2013VK
2016-2015	OE Style; Overall Length of 43mm; Silver; w/ Aluminum Valve; w/ Washers	TPM5
2014	Black; OE Style; Overall Length of 49mm; To 3/14; w/ Aluminum Valve; w/ Washers	TPM10
2014	OE Style; Overall Length of 52mm; Silver; To 3/14; w/ Aluminum Valve; w/ Washers	TPM102
2014	Green; OE Style; Overall Length of 51mm; To 3/14; w/ Aluminum Valve; w/ Washers	TPM11

Pressure Sensors

		Part No.
Tire Pressure Monitoring System OE Design Valve		
535d xDrive		
2014	OE Style; Overall Length of 56.5mm; To 3/14; w/ Aluminum Valve; w/ Washers; Yellow	TPM2013VK
2014	OE Style; Overall Length of 43mm; Silver; To 3/14; w/ Aluminum Valve; w/ Washers	TPM5
2014	OE Style; Orange; Overall Length of 48mm; To 3/14; w/ Aluminum Valve; w/ Washers	TPM9
Tire Pressure Monitoring System QWIK-Sensor		
328d		
2017-2015	433 Mhz Sensor; Black; w/ Aluminum Valve	QS104M
2017-2015	433 Mhz Sensor; Black; w/ Rubber Valve	QS104R
2014	433 Mhz Sensor; Black; From 3/14; w/ Aluminum Valve	QS104M
2014	433 Mhz Sensor; Alternate Number; Black; To 3/14; w/ Aluminum Valve	QS104M
2014	433 Mhz Sensor; Black; From 3/14; w/ Rubber Valve	QS104R
2014	433 Mhz Sensor; Alternate Number; Black; To 3/14; w/ Rubber Valve	QS104R
328d xDrive		
2018	433 Mhz Sensor; Black; From 3/14; w/ Aluminum Valve	QS104M
2018	433 Mhz Sensor; Black; From 3/14; w/ Rubber Valve	QS104R
2017-2015	433 Mhz Sensor; Black; w/ Aluminum Valve	QS104M
2017-2015	433 Mhz Sensor; Black; w/ Rubber Valve	QS104R
2014	433 Mhz Sensor; Black; From 3/14; w/ Aluminum Valve	QS104M
2014	433 Mhz Sensor; Alternate Number; Black; To 3/14; w/ Aluminum Valve	QS104M
2014	433 Mhz Sensor; Black; From 3/14; w/ Rubber Valve	QS104R
2014	433 Mhz Sensor; Alternate Number; Black; To 3/14; w/ Rubber Valve	QS104R
335d		
2011-2009	433 Mhz Sensor; Exhaust stock and reorder; Red; w/ Aluminum Valve	QS102M
2011-2009	433 Mhz Sensor; Exhaust stock and reorder; Red; w/ Rubber Valve	QS102R
2011-2009	433 Mhz Sensor; Alternate Number; Black; w/ Aluminum Valve	QS104M
2011-2009	433 Mhz Sensor; Alternate Number; Black; w/ Rubber Valve	QS104R
535d		
2016-2014	433 Mhz Sensor; Alternate Number; Black; w/ Aluminum Valve	QS104M
2016-2014	433 Mhz Sensor; Alternate Number; Black; w/ Rubber Valve	QS104R
2014	433 Mhz Sensor; Exhaust stock and reorder; Red; w/ Aluminum Valve	QS102M
2014	433 Mhz Sensor; Exhaust stock and reorder; Red; w/ Rubber Valve	QS102R
535d xDrive		
2016-2014	433 Mhz Sensor; Alternate Number; Black; w/ Aluminum Valve	QS104M
2016-2014	433 Mhz Sensor; Alternate Number; Black; w/ Rubber Valve	QS104R
2014	433 Mhz Sensor; Exhaust stock and reorder; Red; w/ Aluminum Valve	QS102M
2014	433 Mhz Sensor; Exhaust stock and reorder; Red; w/ Rubber Valve	QS102R
740Ld xDrive		
2015	433 Mhz Sensor; Alternate Number; Black; w/ Aluminum Valve	QS104M

		Part No.
Tire Pressure Monitoring System QWIK-Sensor		
740Ld xDrive		
2015	433 Mhz Sensor; Alternate Number; Black; w/ Rubber Valve	QS104R
Tire Pressure Monitoring System QWIK-Sensor Service Kit		
328d		
2017-2014	1 Per Box; 433 Mhz Sensor; w/ Aluminum Valve	TPM4012SK
2017-2014	25 Per Box; 433 Mhz Sensor; w/ Aluminum Valve	TPM4012SK25PK
2017-2014	4 Per Box; 433 Mhz Sensor; w/ Aluminum Valve	TPM4012SK4PK
328d xDrive		
2018-2014	1 Per Box; 433 Mhz Sensor; w/ Aluminum Valve	TPM4012SK
2018-2014	25 Per Box; 433 Mhz Sensor; w/ Aluminum Valve	TPM4012SK25PK
2018-2014	4 Per Box; 433 Mhz Sensor; w/ Aluminum Valve	TPM4012SK4PK
335d		
2011-2009	1 Per Box; 433 Mhz Sensor; w/ Aluminum Valve	TPM4012SK
2011-2009	25 Per Box; 433 Mhz Sensor; w/ Aluminum Valve	TPM4012SK25PK
2011-2009	4 Per Box; 433 Mhz Sensor; w/ Aluminum Valve	TPM4012SK4PK
535d		
2016-2014	1 Per Box; 433 Mhz Sensor; w/ Aluminum Valve	TPM4012SK
2016-2014	25 Per Box; 433 Mhz Sensor; w/ Aluminum Valve	TPM4012SK25PK
2016-2014	4 Per Box; 433 Mhz Sensor; w/ Aluminum Valve	TPM4012SK4PK
535d xDrive		
2014	1 Per Box; 433 Mhz Sensor; w/ Aluminum Valve	TPM4012SK
2014	25 Per Box; 433 Mhz Sensor; w/ Aluminum Valve	TPM4012SK25PK
2014	4 Per Box; 433 Mhz Sensor; w/ Aluminum Valve	TPM4012SK4PK
740Ld xDrive		
2015	1 Per Box; 433 Mhz Sensor; Black; w/ Aluminum Valve	TPM4012SK
2015	25 Per Box; 433 Mhz Sensor; Black; w/ Aluminum Valve	TPM4012SK25PK
2015	4 Per Box; 433 Mhz Sensor; Black; w/ Aluminum Valve	TPM4012SK4PK
Tire Pressure Monitoring System QWIK-Sensor Valve		
328d		
2017-2014	1 Per Box; 433 Mhz Sensor; w/ Rubber Valve	TPM2011VK
2017-2014	25 Per Box; 433 Mhz Sensor; w/ Rubber Valve	TPM2011VK25PK
2017-2014	4 Per Box; 433 Mhz Sensor; w/ Rubber Valve	TPM2011VK4PK
2017-2014	1 Per Box; 433 Mhz Sensor; w/ Aluminum Valve	TPM2012VK
2017-2014	25 Per Box; 433 Mhz Sensor; w/ Aluminum Valve	TPM2012VK25PK
2017-2014	4 Per Box; 433 Mhz Sensor; w/ Aluminum Valve	TPM2012VK4PK
328d xDrive		
2018-2014	1 Per Box; 433 Mhz Sensor; w/ Rubber Valve	TPM2011VK
2018-2014	25 Per Box; 433 Mhz Sensor; w/ Rubber Valve	TPM2011VK25PK
2018-2014	4 Per Box; 433 Mhz Sensor; w/ Rubber Valve	TPM2011VK4PK

Pressure Sensors

		Part No.
Tire Pressure Monitoring System QWIK-Sensor Valve		
328d xDrive		
2018-2014	1 Per Box; 433 Mhz Sensor; w/ Aluminum Valve	TPM2012VK
2018-2014	25 Per Box; 433 Mhz Sensor; w/ Aluminum Valve	TPM2012VK25PK
2018-2014	4 Per Box; 433 Mhz Sensor; w/ Aluminum Valve	TPM2012VK4PK
335d		
2011-2009	1 Per Box; 433 Mhz Sensor; w/ Rubber Valve	TPM2011VK
2011-2009	25 Per Box; 433 Mhz Sensor; w/ Rubber Valve	TPM2011VK25PK
2011-2009	4 Per Box; 433 Mhz Sensor; w/ Rubber Valve	TPM2011VK4PK
2011-2009	1 Per Box; 433 Mhz Sensor; w/ Aluminum Valve	TPM2012VK
2011-2009	25 Per Box; 433 Mhz Sensor; w/ Aluminum Valve	TPM2012VK25PK
2011-2009	4 Per Box; 433 Mhz Sensor; w/ Aluminum Valve	TPM2012VK4PK
535d		
2016-2014	1 Per Box; 433 Mhz Sensor; w/ Rubber Valve	TPM2011VK
2016-2014	25 Per Box; 433 Mhz Sensor; w/ Rubber Valve	TPM2011VK25PK
2016-2014	4 Per Box; 433 Mhz Sensor; w/ Rubber Valve	TPM2011VK4PK
2016-2014	1 Per Box; 433 Mhz Sensor; w/ Aluminum Valve	TPM2012VK
2016-2014	25 Per Box; 433 Mhz Sensor; w/ Aluminum Valve	TPM2012VK25PK
2016-2014	4 Per Box; 433 Mhz Sensor; w/ Aluminum Valve	TPM2012VK4PK
740Ld xDrive		
2015	1 Per Box; 433 Mhz Sensor; Black; w/ Rubber Valve	TPM2011VK
2015	25 Per Box; 433 Mhz Sensor; Black; w/ Rubber Valve	TPM2011VK25PK
2015	4 Per Box; 433 Mhz Sensor; Black; w/ Rubber Valve	TPM2011VK4PK
2015	1 Per Box; 433 Mhz Sensor; Black; w/ Aluminum Valve	TPM2012VK
2015	25 Per Box; 433 Mhz Sensor; Black; w/ Aluminum Valve	TPM2012VK25PK
2015	4 Per Box; 433 Mhz Sensor; Black; w/ Aluminum Valve	TPM2012VK4PK
Turbocharger Boost Sensor		
335d		
2011-2009	Turbocharged	AS639
Temperature Sensors		
Ambient Air Temperature Sensor		
335d		
2011-2009		AX203
Coolant Temperature Sensor		
328d		
2018-2014		TX294
328d xDrive		
2018-2014		TX294
335d		
2011-2009		TS-471
524td		
1986-1985		TX51
535d		
2016-2014		TX294
535d xDrive		
2016-2014		TX294

		Part No.
Coolant Temperature Sensor		
X5		
2013	6 Cyl.; Located On Cylinder Head	TS-471
2012-2011	6 Cyl.	TS-471
Exhaust Gas Temperature Sensor		
328d		
2017-2014	4 Cyl. 2.0L; Front; Located in Particulate Filter	ETS152
2016-2014	4 Cyl. 2.0L; Located on EGR Cooler	ETS219
328d xDrive		
2017-2014	4 Cyl. 2.0L; Front; Located in Particulate Filter	ETS152
2016-2014	4 Cyl. 2.0L; Located on EGR Cooler	ETS219
335d		
2011-2009	6 Cyl. 3.0L; Diesel; Upstream	ETS73
2010-2009	6 Cyl. 3.0L; Diesel; Downstream	ETS74
535d		
2016-2015	6 Cyl.; Located on EGR Cooler	ETS127
2016-2014	6 Cyl. 3.0L; Front; Located in Particulate Filter	ETS143
2016-2014	6 Cyl. 3.0L; Located Before Particulate Filter	ETS149
2016-2014	6 Cyl. 3.0L; Downstream	ETS174
2014	6 Cyl. 3.0L; Located on EGR Cooler	ETS127
535d xDrive		
2016-2014	6 Cyl. 3.0L; Front; Located in Particulate Filter	ETS143
2016-2014	6 Cyl. 3.0L; Downstream	ETS174
2014	6 Cyl.; Located on EGR Cooler	ETS127
740Ld xDrive		
2015	6 Cyl. 3.0L; Front; Located in Particulate Filter	ETS143
X3		
2016-2015	4 Cyl. 2.0L; Located on EGR Cooler	ETS219
X5		
2017-2014	6 Cyl. 3.0L; Diesel; Located After Particulate Filter	ETS221
2016-2014	6 Cyl. 3.0L; Diesel; Front; Located in Particulate Filter	ETS143
2016-2014	6 Cyl. 3.0L; Diesel; Downstream	ETS174
2013	6 Cyl.; Diesel; EGR Pipe	ETS104
2013	6 Cyl.; Diesel; On Exhaust Manifold	ETS105
2012-2009	6 Cyl. 3.0L; Diesel; EGR Pipe	ETS104
2012-2009	6 Cyl. 3.0L; Diesel; On Exhaust Manifold	ETS105
Heater Core Temperature Sensor		
328d		
2018-2014		AX420
328d xDrive		
2018-2014		AX420
335d		
2011-2009		AX506
535d		
2016-2014		AX451
535d xDrive		
2016-2014		AX451
740Ld xDrive		
2015		AX451
Intake Air Temperature Sensor		
328d		
2018-2014		AX454
328d xDrive		
2018-2014		AX454
335d		
2011-2009		AX453

Temperature Sensors

		Part No.
Intake Air Temperature Sensor		
535d		
2016-2014		AX454
535d xDrive		
2016-2014		AX454
740Ld xDrive		
2015		AX454
X3		
2017-2015	4 Cyl. 2.0L; Diesel	AX454
X5		
2017-2014	6 Cyl. 3.0L	AX454
2013	6 Cyl.; Diesel	AX453
2012	xDrive35d	AX453
2011	6 Cyl. 3.0L; xDrive35d	AX453
Telematics Sensors		
Park Assist Camera		
328d		
2018-2014	Rear	PAC237
328d xDrive		
2018-2014	Rear	PAC237
740Ld xDrive		
2015	Rear	PAC237
Parking Assist Sensor		
335d		
2009	To 3/09; Rear	PPS55
Body Light Switches		
Headlight Dimmer Switch		
328d		
2017-2015	w/ Automatic High Beam; w/o Heated Steering Wheel	CBS2352
2017-2015	w/ Automatic High Beam; w/ Heated Steering Wheel	CBS2357
328d xDrive		
2017-2015	w/ Automatic High Beam; w/o Heated Steering Wheel	CBS2352
2017-2015	w/ Automatic High Beam; w/ Heated Steering Wheel	CBS2357
X5		
2013-2010	6 Cyl. 3.0L; w/ Heated Steering Wheel	CBS-2110
2013-2010	6 Cyl. 3.0L; w/o Heated Steering Wheel	CBS-2112
Headlight Switch		
328d		
2017-2016	w/ Fog Lights; w/ Rain Sensitive Wipers	HLS1738
2015-2014	w/ Rain Sensitive Wipers	HLS1738
328d xDrive		
2017-2016	w/ Fog Lights; w/ Rain Sensitive Wipers	HLS1738
2015-2014	w/ Rain Sensitive Wipers	HLS1738
335d		
2011-2009	w/o Rain Sensitive Wipers	HLS1719
2011-2009	w/ Rain Sensitive Wipers	HLS1720
X5		
2013-2010	6 Cyl. 3.0L; w/o Head-Up Display	HLS-1487
2013-2010	6 Cyl. 3.0L; w/ Head-Up Display	HLS-1488
Stoplight Switch		
328d		
2018-2014		SLS541
328d xDrive		
2018-2014		SLS541
335d		
2011-2009	6 Cyl. 3.0L	SLS-323
524td		
1986-1985	6 Cyl. 2.4L	SLS-127

		Part No.
Stoplight Switch		
535d		
2016-2014		SLS-323
535d xDrive		
2016-2014		SLS-323
Turn Signal Switch		
328d		
2017-2015	w/ Automatic High Beam; w/o Heated Steering Wheel	CBS2352
2017-2015	w/ Automatic High Beam; w/ Heated Steering Wheel	CBS2357
328d xDrive		
2017-2015	w/ Automatic High Beam; w/o Heated Steering Wheel	CBS2352
2017-2015	w/ Automatic High Beam; w/ Heated Steering Wheel	CBS2357
X5		
2010-2009	6 Cyl. 3.0L; w/ Heated Steering Wheel	CBS-2110
2010-2009	6 Cyl. 3.0L; w/o Heated Steering Wheel	CBS-2112
Chassis and Drivetrain Switches		
Fuel Pump Cut-Off Switch		
524td		
1986-1985	Universal; w/ Electric Fuel Pump	FV-7
Ignition Switches		
Ignition Push Button Switch		
328d		
2018-2014	Dash Mounted	US1324
328d xDrive		
2018-2014	Dash Mounted	US1324
335d		
2011-2009	Dash Mounted	US-1017
535d		
2016-2014	Dash Mounted	US-1195
535d xDrive		
2016-2014	Dash Mounted	US-1195
740Ld xDrive		
2015	Dash Mounted	US-1021
Ignition Starter Switch		
524td		
1986-1985		US1149
Interior Power Switches		
Clock Spring		
328d		
2017-2015	w/ Automatic High Beam; w/o Heated Steering Wheel	CBS2352
2017-2015	w/ Automatic High Beam; w/ Heated Steering Wheel	CBS2357
328d xDrive		
2017-2015	w/ Automatic High Beam; w/o Heated Steering Wheel	CBS2352
2017-2015	w/ Automatic High Beam; w/ Heated Steering Wheel	CBS2357
Cruise Control Switch		
328d		
2017-2015	w/ Automatic High Beam; w/o Heated Steering Wheel	CBS2352
2017-2015	w/ Automatic High Beam; w/ Heated Steering Wheel	CBS2357
328d xDrive		
2017-2015	w/ Automatic High Beam; w/o Heated Steering Wheel	CBS2352
2017-2015	w/ Automatic High Beam; w/ Heated Steering Wheel	CBS2357

Interior Power Switches

		Part No.
Power Window Switch		
328d		
2018-2015	Rear	DWS2010
2018-2014	Right	DWS2007
2018-2014	w/ Power Folding Mirrors; w/o Rear Window Sunshade; Front Left	DWS2014
2018-2014	9 Pin; w/o Power Folding Mirrors; Front Left	DWS2015
2018-2014	6 Pin; w/o Power Folding Mirrors; Front Left	DWS2020
2018-2014	w/ Power Folding Mirrors; w/ Rear Window Sunshade; Front Left	DWS2022
2015-2014	Black; Rear	DWS2012
328d xDrive		
2018-2015	Rear	DWS2010
2018-2014	Right	DWS2007
2018-2014	w/ Power Folding Mirrors; w/o Rear Window Sunshade; Front Left	DWS2014
2018-2014	9 Pin; w/o Power Folding Mirrors; Front Left	DWS2015
2018-2014	6 Pin; w/o Power Folding Mirrors; Front Left	DWS2020
2018-2014	w/ Power Folding Mirrors; w/ Rear Window Sunshade; Front Left	DWS2022
2015-2014	Black; Rear	DWS2012
335d		
2011	Black Finish; Front Right	DWS-612
2011	Black Finish; Rear	DWS-612
2011	Gray; Front Right	DWS-631
2011	Gray; Rear	DWS-631
2011	Beige; Front Right	DWS654
2011	Beige; Rear	DWS654
2011-2009	Gray; w/ Power Folding Mirrors; Front Left	DWS1645
2010-2009	Beige; w/ Memory Seats; w/o Power Folding Mirrors; Front Left	DWS-1326
2010-2009	Black Finish; w/o Memory Seats; w/o Power Folding Mirrors; Front Left	DWS-1347
2010-2009	Beige; w/ Power Folding Mirrors; Front Left	DWS-1349
2010-2009	Beige; w/o Memory Seats; w/o Power Folding Mirrors; Front Left	DWS-1350
2010-2009	Black Finish; w/ Memory Seats; w/o Power Folding Mirrors; Front Left	DWS-1351
2010-2009	6 Cyl. 3.0L; Black Finish; Front Right	DWS-612
2010-2009	6 Cyl. 3.0L; Black Finish; Rear	DWS-612
2010-2009	6 Cyl. 3.0L; Gray; Front Right	DWS-631
2010-2009	6 Cyl. 3.0L; Gray; Rear	DWS-631
2010-2009	Gray; w/o Memory Seats; w/o Power Folding Mirrors; Front Left	DWS-645
2010-2009	Gray; w/ Memory Seats; w/o Power Folding Mirrors; Front Left	DWS-646
2010-2009	6 Cyl. 3.0L; Beige; Front Right	DWS654
2010-2009	6 Cyl. 3.0L; Beige; Rear	DWS654
2010-2009	Black Finish; w/ Power Folding Mirrors; Front Left	DWS-856
535d		
2016-2014	Front Right	DWS2013
2016-2014	w/ Power Folding Mirrors; w/o Rear Window Sunshade; Front Left	DWS2014
2016-2014	9 Pin; w/o Power Folding Mirrors; Front Left	DWS2015
2016-2014	w/o Power Folding Mirrors; w/o Rear Window Sunshade; Front Left	DWS2017
2016-2014	w/ Power Folding Mirrors; w/ Rear Window Sunshade; Front Left	DWS2018
2016-2014	6 Pin; w/o Power Folding Mirrors; Front Left	DWS2020
2016-2014	w/ Power Folding Mirrors; Front Left	DWS2023

		Part No.
Power Window Switch		
535d xDrive		
2016-2015	w/ Power Folding Mirrors; w/o Rear Window Sunshade; Front Left	DWS2014
2016-2015	9 Pin; w/o Power Folding Mirrors; Front Left	DWS2015
2016-2015	6 Pin; w/o Power Folding Mirrors; Front Left	DWS2020
2016-2014	Front Right	DWS2013
2016-2014	w/o Power Folding Mirrors; w/o Rear Window Sunshade; Front Left	DWS2017
2016-2014	w/ Power Folding Mirrors; w/ Rear Window Sunshade; Front Left	DWS2018
2016-2014	w/ Power Folding Mirrors; Front Left	DWS2023
X5		
2013	6 Cyl.; Black Finish; Front Right	DWS-612
2013	6 Cyl.; Black Finish; Rear	DWS-612
2013	6 Cyl.; Gray; Front Right	DWS-631
2013	6 Cyl.; Gray; Rear	DWS-631
2013	6 Cyl.; Beige; Front Right	DWS654
2013	6 Cyl.; Beige; Rear	DWS654
2013	6 Cyl.; Tobacco; Front Right	DWS-753
2013	6 Cyl.; Tobacco; Rear	DWS-753
2013	6 Cyl.; w/o Auto Dimming Mirrors; Front Left	DWS-896
2013	6 Cyl.; w/ Auto Dimming Mirrors; Front Left	DWS-901
2009	6 Cyl. 3.0L; Black Finish; Front Right	DWS-612
2009	6 Cyl. 3.0L; Black Finish; Rear	DWS-612
2009	6 Cyl. 3.0L; Gray; Front Right	DWS-631
2009	6 Cyl. 3.0L; Gray; Rear	DWS-631
2009	6 Cyl. 3.0L; Beige; Front Right	DWS654
2009	6 Cyl. 3.0L; Beige; Rear	DWS654
2009	6 Cyl. 3.0L; Tobacco; Front Right	DWS-753
2009	6 Cyl. 3.0L; Tobacco; Rear	DWS-753
2009	6 Cyl. 3.0L; w/o Auto Dimming Mirrors; Front Left	DWS-896
2009	6 Cyl. 3.0L; w/ Auto Dimming Mirrors; Front Left	DWS-901
Windshield Wiper Switch		
328d		
2017-2015	w/ Automatic High Beam; w/o Heated Steering Wheel	CBS2352
2017-2015	w/ Automatic High Beam; w/ Heated Steering Wheel	CBS2357
328d xDrive		
2017-2015	w/ Automatic High Beam; w/o Heated Steering Wheel	CBS2352
2017-2015	w/ Automatic High Beam; w/ Heated Steering Wheel	CBS2357
Pressure and Vacuum Sending Switches		
Oil Pressure Light Switch		
335d		
2010-2009	6 Cyl. 3.0L	PS-292
524td		
1986-1985		PS-272
X3		
2017-2015	4 Cyl.	PS539
X5		
2011	6 Cyl. 3.0L; Diesel	PS-292
Temperature Switches and Senders		
Blower Motor Resistor		
328d		
2018-2014	Alternate Number	RU-818
2018-2014	Exhaust stock and reorder	RU869

Temperature Switches and Senders

		Part No.
Blower Motor Resistor		
328d xDrive		
2018-2014	Alternate Number	RU-818
2018-2014	Exhaust stock and reorder	RU869
335d		
2011-2009		RU-729
524td		
1986-1985	3 Blade Term.	RU-620
1986-1985	7 Term.	RU-669
535d		
2016-2014		RU-812
535d xDrive		
2016-2014		RU-812
740Ld xDrive		
2015	Front	RU-812
2015	Rear	RU-812
Coolant Fan Switch		
524td		
1986	108 Deg. C	TS-550
1986-1985	99 Deg. C	TS-247
1986-1985	91 Deg. C	TS-288
Temperature Sender - With Gauge		
524td		
1986-1985		TS-440
Actuators		
Engine Variable Valve Timing Sprocket		
X5		
2018-2009	6 Cyl. 3.0L; Exhaust	VVT666
HVAC Temperature Blend Door Actuator		
328d		
2014		J04082
328d xDrive		
2014		J04082
335d		
2009		J04082
Power Door Lock Actuator		
335d		
2011-2009	Left Front	DLA1002
Variable Valve Timing Solenoid		
X3		
2016-2015	4 Cyl. 2.0L; Magnet Sensor	VVT353
Buick		
Relays and Fuses		
A/C Compressor Clutch Cut-Off Relay		
Century		
1983-1982	6 Cyl. 4.3L	RY-85
A/C Compressor Throttle Cut-Off Relay		
Estate Wagon		
1983-1982	8 Cyl. 5.7L; Compressor Cut-Off; Wagon	RY-85
A/C Control Relay		
Century		
1984-1983	6 Cyl. 4.3L; 4 Blade Term.	RY-85
Electra		
1985	8 Cyl.	RY-27
1985	6 Cyl. 4.3L	RY-85
Riviera		
1984	8 Cyl.	RY-85
Air Control Valve Relay		
Century		
1984	6 Cyl. 4.3L; Diesel	RY-85

		Part No.
Blower Motor Relay		
Regal		
1981	8 Cyl. 5.7L	RY-242
Coolant Fan Relay		
Century		
1985	6 Cyl. 4.3L	RY-242
Electra		
1985	6 Cyl. 4.3L	RY496
Diesel Glow Plug Indicator Relay		
Century		
1983-1982	6 Cyl. 4.3L; Diesel	RY-138
Electra		
1983-1980	8 Cyl. 5.7L; Diesel	RY-138
Estate Wagon		
1982-1980	8 Cyl. 5.7L; Diesel	RY-138
LeSabre		
1983-1980	8 Cyl. 5.7L; Diesel	RY-138
Riviera		
1983-1980	8 Cyl. 5.7L; Diesel	RY-138
Diesel Glow Plug Relay		
Century		
1982	6 Cyl. 4.3L; Diesel	SS-591
1981	8 Cyl. 5.7L; Diesel	SS-591
LeSabre		
1985	8 Cyl. 5.7L	RY204
Regal		
1985	6 Cyl. 4.3L	SS-591
Riviera		
1985	8 Cyl. 5.7L	RY204
Diesel Wait Lamp Relay		
Century		
1983-1982	6 Cyl. 4.3L; Diesel	RY-138
1981	8 Cyl. 5.7L; Diesel	RY-138
Electra		
1983-1980	8 Cyl. 5.7L; Diesel	RY-138
Estate Wagon		
1983-1980	8 Cyl. 5.7L; Diesel	RY-138
LeSabre		
1983-1980	8 Cyl. 5.7L; Diesel	RY-138
Regal		
1983-1981	8 Cyl. 5.7L; Diesel	RY-138
Riviera		
1983-1981	8 Cyl. 5.7L; Diesel	RY-138
Fast Idle Relay		
Estate Wagon		
1982-1980	8 Cyl. 5.7L; Diesel	RY-8
Regal		
1984-1983	6 Cyl. 4.3L; Diesel	RY-34
1982	6 Cyl. 4.3L; Diesel; OE No. 22515682	RY-34
1982	6 Cyl. 4.3L; Diesel; OE No. 391948, 412687, 1116992, 1365166, 12339254	RY-8
1982-1981	8 Cyl. 5.7L; Diesel	RY-8
Riviera		
1982-1981	8 Cyl. 5.7L; Diesel	RY-8
Fast Idle Solenoid Relay		
Century		
1981	8 Cyl. 5.7L; Diesel	RY-8
Electra		
1982-1980	8 Cyl. 5.7L; Canada; Export	RY-8
LeSabre		
1982-1980	8 Cyl. 5.7L	RY-8

Relays and Fuses

		Part No.
Fuel Injection Pump Relay		
Electra		
1985	6 Cyl. 4.3L	RY-85
Fuel Pump Relay		
Century		
1985	6 Cyl. 4.3L	RY-121
Electra		
1985	8 Cyl.; Wagon	RY-27
1985	6 Cyl. 4.3L; Exc. Wagon	RY-85
Horn Relay		
Electra		
1983	8 Cyl.	HR-151
Estate Wagon		
1983	8 Cyl. 5.7L	HR-151
Overdrive Relay		
Riviera		
1985-1982	8 Cyl. 5.7L; Alternate Number	RY-116
1985-1982	8 Cyl. 5.7L; Exhaust stock and reorder	RY30
Power Seat Relay		
Century		
1985-1984	6 Cyl. 4.3L	RY-116
LeSabre		
1985-1982	8 Cyl. 5.7L	RY-116
Regal		
1983-1982	6 Cyl. 4.3L	RY-116
1983-1982	8 Cyl. 5.7L	RY-116
Stereo Wiring Relay		
LeSabre		
1985	8 Cyl. 5.7L; w/ Bose Stereo System; w/o Skirt	RY-115
1985	8 Cyl. 5.7L; w/ Bose Stereo System; w/ Skirt	RY-242
Riviera		
1985-1983	8 Cyl. 5.7L	RY-100
Theft Deterrent Relay		
Estate Wagon		
1980	8 Cyl. 5.7L	RY-49
Starting and Charging System Parts		
Starter Solenoid		
Century		
1985-1984	6 Cyl. 4.3L; Delco Equipped	SS-251
1985-1984	6 Cyl. 4.3L; Mitsubishi	SS-306
1983	6 Cyl. 4.3L ⁶	SS-251
1981	8 Cyl. 5.7L ^{5,6}	SS-200
Electra		
1984-1982	8 Cyl. 5.7L ⁶	SS-251
Estate Wagon		
1983	8 Cyl. 5.7L; Delco Equipped	SS-251
1982	8 Cyl. 5.7L	SS-251
1981-1980	8 Cyl. 5.7L	SS-200
LeSabre		
1985	8 Cyl. 5.7L	SS-306
1984-1982	8 Cyl. 5.7L ⁶	SS-251
1981	8 Cyl. 5.7L ^{5,6}	SS-200
1980	8 Cyl. 5.7L ⁵	SS-200
Regal		
1985	6 Cyl. 4.3L	SS-251
1985	8 Cyl. 5.7L	SS-306
1984-1982	6 Cyl. 4.3L ⁶	SS-251
1983-1982	8 Cyl. 5.7L ⁶	SS-251
1981	8 Cyl. 5.7L	SS-200

		Part No.
Starter Solenoid		
Riviera		
1985-1984	8 Cyl. 5.7L ⁶	SS-251
1982	8 Cyl. 5.7L ⁶	SS-251
1981	8 Cyl. 5.7L ^{5,6}	SS-200
1980	8 Cyl. 5.7L ⁵	SS-200
Air Injection and Induction Parts		
Manifold Air Tube		
Electra		
1980	8 Cyl. 5.7L; Left	AT104
Vacuum Motor		
Riviera		
1980	8 Cyl. 5.7L	VA6
Vacuum Pump		
Century		
1985-1982	6 Cyl. 4.3L; Diesel; w/ AC	VCP100
Electra		
1985	6 Cyl. 4.3L; Diesel; w/ AC	VCP100
Air Management Regulators and Solenoids		
Idle Stop Solenoid		
Century		
1981	8 Cyl. 5.7L; Diesel	ES118
Electra		
1983-1982	8 Cyl. 5.7L; Diesel	ES118
1981	8 Cyl. 5.7L; N; Diesel	ES118
1980	8 Cyl.; Diesel; Stamping No. 2507441, 22511974	ES118
LeSabre		
1983-1981	8 Cyl. 5.7L; Diesel	ES118
1980	8 Cyl.; Diesel; Stamping No. 2507441, 22511974	ES118
Regal		
1983-1981	8 Cyl.; Diesel	ES118
Riviera		
1983-1981	8 Cyl.; Diesel	ES118
Early Fuel Emission Control		
Air Cleaner Inlet Hose		
Century		
1983	6 Cyl. 4.3L	DH34
1982	6 Cyl. 4.3L	DH40
Electra		
1985-1982	8 Cyl. 5.7L	DH40
LeSabre		
1985-1982	8 Cyl. 5.7L	DH40
Regal		
1985	8 Cyl. 5.7L	DH40
1983-1982	8 Cyl. 5.7L	DH40
Riviera		
1985-1983	8 Cyl. 5.7L	DH40
1982-1981	8 Cyl. 5.7L	DH34
Crankcase Ventilation Filter		
Century		
1984-1983	6 Cyl.	BF11
1981	8 Cyl. 5.7L; Crankcase Vent	BF19
Electra		
1984	8 Cyl.	BF19
1983	8 Cyl.; Diesel	BF19
1982-1981	8 Cyl.; In Air Cleaner	BF11
1982-1981	8 Cyl.; On Valve Cover	BF19
1980	8 Cyl. 5.7L; PCV Breather	BF11
1980	8 Cyl. 5.7L; Crankcase Vent	BF19

Early Fuel Emission Control

		Part No.
Crankcase Ventilation Filter		
LeSabre		
1982	8 Cyl. 5.7L	BF19
1980	8 Cyl. 5.7L; PCV Breather	BF11
1980	8 Cyl. 5.7L; Crankcase Vent	BF19
Regal		
1983	8 Cyl.	BF11
1982	8 Cyl.; In Air Cleaner	BF11
1982	6 Cyl.; On Valve Cover	BF19
1982	8 Cyl.; On Valve Cover	BF19
1981	8 Cyl. 5.7L; Crankcase Vent	BF19
Riviera		
1985-1984	8 Cyl.	BF19
1983	8 Cyl.; Diesel	BF19
EGR Components		
EGR Valve		
Electra		
1983	8 Cyl. 5.7L	EGV330
LeSabre		
1983	8 Cyl. 5.7L	EGV330
Regal		
1983	8 Cyl. 5.7L	EGV330
Riviera		
1984-1982	8 Cyl. 5.7L; Diesel	EGV545
EGR Valve Mounting Gasket		
Century		
1983	6 Cyl.	VG8
Electra		
1983	8 Cyl. 5.7L; Diesel	VG6
1981	8 Cyl. 5.7L	VG6
LeSabre		
1983	8 Cyl. 5.7L	VG6
Regal		
1985	8 Cyl.	VG7
1983	8 Cyl. 5.7L	VG6
PCV Systems		
PCV Grommet		
Century		
1985	6 Cyl. 4.3L	GV9
1981	8 Cyl. 5.7L; 23/32 Inch Inner Dia. x 1 1/4 Inch Outer Dia.	GV13
1981	8 Cyl. 5.7L; 7/16 Inch Inner Dia. x 1 1/4 Inch Outer Dia.	GV16
1981	8 Cyl. 5.7L; 11/16 Inch Inner Dia. x 1 3/4 Inch Outer Dia.	GV18
1981	8 Cyl. 5.7L; 11/16 Inch Inner Dia. x 1 3/16 Inch Outer Dia.	GV5
1981	8 Cyl. 5.7L; 1 Inch Inner Dia. x 1 1/2 Inch Outer Dia.	GV6
1981	8 Cyl. 5.7L; 23/32 Inch Inner Dia. x 1 Inch Outer Dia.	GV9
Electra		
1985	6 Cyl. 4.3L	GV9
1985-1982	8 Cyl. 5.7L; 23/32 Inch Inner Dia. x 1 1/4 Inch Outer Dia.	GV13
1985-1982	8 Cyl. 5.7L; 7/16 Inch Inner Dia. x 1 1/4 Inch Outer Dia.	GV16
1985-1982	8 Cyl. 5.7L; 7/16 Inch Inner Dia. x 1 3/4 Inch Outer Dia.	GV18
1985-1982	8 Cyl. 5.7L; 11/16 Inch Inner Dia. x 1 3/16 Inch Outer Dia.	GV5
1985-1982	8 Cyl. 5.7L; 1 Inch Inner Dia. x 1 1/2 Inch Outer Dia.	GV6
1985-1982	8 Cyl. 5.7L; 23/32 Inch Inner Dia. x 1 Inch Outer Dia.	GV9

		Part No.
PCV Grommet		
Electra		
1981	8 Cyl. 5.7L	GV5
1980	8 Cyl. 5.7L	GV18
Estate Wagon		
1983-1980	8 Cyl. 5.7L; 23/32 Inch Inner Dia. x 1 1/4 Inch Outer Dia.	GV13
1983-1980	8 Cyl. 5.7L; 7/16 Inch Inner Dia. x 1 1/4 Inch Outer Dia.	GV16
1983-1980	8 Cyl. 5.7L; 7/16 Inch Inner Dia. x 1 3/4 Inch Outer Dia.	GV18
1983-1980	8 Cyl. 5.7L; 11/16 Inch Inner Dia. x 1 3/16 Inch Outer Dia.	GV5
1983-1980	8 Cyl. 5.7L; 1 Inch Inner Dia. x 1 1/2 Inch Outer Dia.	GV6
1983-1980	8 Cyl. 5.7L; 23/32 Inch Inner Dia. x 1 Inch Outer Dia.	GV9
LeSabre		
1985-1981	8 Cyl. 5.7L; 23/32 Inch Inner Dia. x 1 1/4 Inch Outer Dia.	GV13
1985-1981	8 Cyl. 5.7L; 7/16 Inch Inner Dia. x 1 1/4 Inch Outer Dia.	GV16
1985-1981	8 Cyl. 5.7L; 7/16 Inch Inner Dia. x 1 3/4 Inch Outer Dia.	GV18
1985-1981	8 Cyl. 5.7L; 11/16 Inch Inner Dia. x 1 3/16 Inch Outer Dia.	GV5
1985-1981	8 Cyl. 5.7L; 1 Inch Inner Dia. x 1 1/2 Inch Outer Dia.	GV6
1985-1981	8 Cyl. 5.7L; 23/32 Inch Inner Dia. x 1 Inch Outer Dia.	GV9
Regal		
1985	8 Cyl. 5.7L; 23/32 Inch Inner Dia. x 1 1/4 Inch Outer Dia.	GV13
1985	8 Cyl. 5.7L; 7/16 Inch Inner Dia. x 1 1/4 Inch Outer Dia.	GV16
1985	8 Cyl. 5.7L; 7/16 Inch Inner Dia. x 1 3/4 Inch Outer Dia.	GV18
1985	8 Cyl. 5.7L; 11/16 Inch Inner Dia. x 1 3/16 Inch Outer Dia.	GV5
1985	8 Cyl. 5.7L; 1 Inch Inner Dia. x 1 1/2 Inch Outer Dia.	GV6
1985	8 Cyl. 5.7L; 23/32 Inch Inner Dia. x 1 Inch Outer Dia.	GV9
1985	6 Cyl. 4.3L; 23/32 Inch Inner Dia. x 1 1/4 Inch Outer Dia.	GV13
1985	6 Cyl. 4.3L; 7/16 Inch Inner Dia. x 1 1/4 Inch Outer Dia.	GV16
1985	6 Cyl. 4.3L; 7/16 Inch Inner Dia. x 1 3/4 Inch Outer Dia.	GV18
1985	6 Cyl. 4.3L; 11/16 Inch Inner Dia. x 1 3/16 Inch Outer Dia.	GV5
1985	6 Cyl. 4.3L; 1 Inch Inner Dia. x 1 1/2 Inch Outer Dia.	GV6
1985	6 Cyl. 4.3L; 23/32 Inch Inner Dia. x 1 Inch Outer Dia.	GV9
1983-1982	6 Cyl. 4.3L; 23/32 Inch Inner Dia. x 1 1/4 Inch Outer Dia.	GV13
1983-1982	6 Cyl. 4.3L; 7/16 Inch Inner Dia. x 1 1/4 Inch Outer Dia.	GV16
1983-1982	6 Cyl. 4.3L; 7/16 Inch Inner Dia. x 1 3/4 Inch Outer Dia.	GV18
1983-1982	6 Cyl. 4.3L; 11/16 Inch Inner Dia. x 1 3/16 Inch Outer Dia.	GV5
1983-1982	6 Cyl. 4.3L; 1 Inch Inner Dia. x 1 1/2 Inch Outer Dia.	GV6
1983-1982	6 Cyl. 4.3L; 23/32 Inch Inner Dia. x 1 Inch Outer Dia.	GV9
1983-1981	8 Cyl. 5.7L; 23/32 Inch Inner Dia. x 1 1/4 Inch Outer Dia.	GV13

PCV Systems

		Part No.
PCV Grommet		
Regal		
1983-1981	8 Cyl. 5.7L; 7/16 Inch Inner Dia. x 1 1/4 Inch Outer Dia.	GV16
1983-1981	8 Cyl. 5.7L; 7/16 Inch Inner Dia. x 1 3/4 Inch Outer Dia.	GV18
1983-1981	8 Cyl. 5.7L; 11/16 Inch Inner Dia. x 1 3/16 Inch Outer Dia.	GV5
1983-1981	8 Cyl. 5.7L; 1 Inch Inner Dia. x 1 1/2 Inch Outer Dia.	GV6
1983-1981	8 Cyl. 5.7L; 23/32 Inch Inner Dia. x 1 Inch Outer Dia.	GV9
Riviera		
1984-1980	8 Cyl. 5.7L; 23/32 Inch Inner Dia. x 1 1/4 Inch Outer Dia.	GV13
1984-1980	8 Cyl. 5.7L; 7/16 Inch Inner Dia. x 1 1/4 Inch Outer Dia.	GV16
1984-1980	8 Cyl. 5.7L; 7/16 Inch Inner Dia. x 1 3/4 Inch Outer Dia.	GV18
1984-1980	8 Cyl. 5.7L; 11/16 Inch Inner Dia. x 1 3/16 Inch Outer Dia.	GV5
1984-1980	8 Cyl. 5.7L; 1 Inch Inner Dia. x 1 1/2 Inch Outer Dia.	GV6
1984-1980	8 Cyl. 5.7L; 23/32 Inch Inner Dia. x 1 Inch Outer Dia.	GV9
PCV Valve		
Century		
1985	6 Cyl. 4.3L	V188
1981	8 Cyl. 5.7L	V353
Electra		
1985	6 Cyl. 4.3L	V188
1981	8 Cyl. 5.7L; Diesel	V353
1980	8 Cyl. 5.7L; N	V353
Estate Wagon		
1981	8 Cyl. 5.7L	V353
LeSabre		
1981	8 Cyl. 5.7L; Diesel	V353
1980	8 Cyl. 5.7L; N	V353
Riviera		
1981	8 Cyl. 5.7L	V353
Vapor and Purge Components		
Fuel Vapor Canister		
Riviera		
1980	8 Cyl. 5.7L	CP1010
Fuel Vapor Canister Filter		
Estate Wagon		
1983-1980	8 Cyl. 5.7L	CF-1
Injectors		
Fuel Injector - Diesel - New		
Century		
1985-1984	6 Cyl. 4.3L	FJ698
Electra		
1985	6 Cyl. 4.3L	FJ698
1985-1984	8 Cyl. 5.7L	FJ698
LeSabre		
1985-1984	8 Cyl. 5.7L	FJ698
Regal		
1985	8 Cyl. 5.7L	FJ698
1984	6 Cyl. 4.3L	FJ698
Riviera		
1985-1984	8 Cyl. 5.7L	FJ698

		Part No.
Injection Components		
Diesel Glow Plug		
Century		
1985-1984	6 Cyl. 4.3L	GP108
1983-1982	6 Cyl. 4.3L	GP103
1981	8 Cyl. 5.7L	GP103
Electra		
1985	6 Cyl. 4.3L	GP108
1985-1980	8 Cyl. 5.7L	GP108
Regal		
1985	8 Cyl. 5.7L	GP108
1985-1982	6 Cyl. 4.3L	GP108
1983-1981	8 Cyl. 5.7L	GP108
Fuel Rail O-Ring Kit		
Century		
1985-1982	6 Cyl. 4.3L; Inlet and Outlet	SK18
1981	8 Cyl. 5.7L; Inlet and Outlet	SK18
Electra		
1985	6 Cyl. 4.3L; Inlet and Outlet	SK18
1984-1981	8 Cyl. 5.7L; Inlet and Outlet	SK18
Estate Wagon		
1983-1981	8 Cyl. 5.7L; Inlet and Outlet	SK18
LeSabre		
1985-1981	8 Cyl. 5.7L; Inlet and Outlet	SK18
Regal		
1985-1982	6 Cyl. 4.3L; Inlet and Outlet	SK18
1983-1981	8 Cyl. 5.7L; Inlet and Outlet	SK18
Riviera		
1985-1981	8 Cyl. 5.7L; Inlet and Outlet	SK18
Chassis and Drivetrain Sensors		
Automatic Transmission Output Sensor		
Electra		
1985	6 Cyl. 4.3L; w/o Digital Dash	SC25
1985	6 Cyl. 4.3L; w/ Digital Dash	SC27
1985-1984	8 Cyl.	SC82
Regal		
1985	6 Cyl.; w/o Digital Instrument Panel	SC25
1985	6 Cyl.; w/ Digital Instrument Panel	SC27
Manual Transmission Output Sensor		
Electra		
1985	6 Cyl. 4.3L; w/o Digital Dash	SC25
1985	6 Cyl. 4.3L; w/ Digital Dash	SC27
1985-1984	8 Cyl.	SC25
Regal		
1985	6 Cyl.; w/o Digital Instrument Panel	SC25
1985	8 Cyl. 5.7L	SC25
1985	6 Cyl.; w/ Digital Instrument Panel	SC27
Vehicle Speed Sensor		
Electra		
1985	6 Cyl. 4.3L; w/o Digital Dash; Dash Mounted	SC25
1985	6 Cyl. 4.3L; w/ Digital Dash; Dash Mounted	SC27
1985-1984	8 Cyl.; Cluster Mounted	SC25
1985-1984	8 Cyl.; Transmission Mounted	SC82
Regal		
1985	6 Cyl.; w/o Digital Instrument Panel; Cluster Mounted	SC25
1985	8 Cyl. 5.7L; Cluster Mounted	SC25
1985	6 Cyl.; w/ Digital Instrument Panel; Cluster Mounted	SC27
1985	8 Cyl.; Transmission Mounted	SC82

Pressure Sensors

		Part No.
Pressure Sensors		
MAP Sensor		
Century		
1984	6 Cyl. 4.3L; Calif.	AS5
Electra		
1985	6 Cyl. 4.3L	AS5
LeSabre		
1985	8 Cyl. 5.7L	AS5
Regal		
1985	8 Cyl. 5.7L	AS5
1985-1982	6 Cyl. 4.3L	AS6
1983-1982	8 Cyl. 5.7L	AS6
Riviera		
1985	8 Cyl. 5.7L	AS5
Temperature Sensors		
Coolant Temperature Sensor		
Electra		
1980	8 Cyl. 5.7L; Calif.	TX3
LeSabre		
1980	8 Cyl. 5.7L	TX3
Riviera		
1980	8 Cyl. 5.7L; w/o Connector	TX3
1980	8 Cyl. 5.7L; w/ Connector	TX4
Diesel Glow Plug Control Sensor		
Century		
1983-1982	6 Cyl. 4.3L	TX34
1981	8 Cyl. 5.7L; 6 Terminals	TX34
1981	8 Cyl. 5.7L; 5 Terminals	TX36
Electra		
1983-1982	8 Cyl. 5.7L; 6 Terminals	TX34
1983-1982	8 Cyl. 5.7L; 5 Terminals	TX36
1981	8 Cyl. 5.7L; N; 6 Terminals	TX34
1981	8 Cyl. 5.7L; N; 5 Terminals	TX36
LeSabre		
1983-1981	8 Cyl. 5.7L; 6 Terminals	TX34
1983-1981	8 Cyl. 5.7L; 5 Terminals	TX36
Regal		
1983-1982	8 Cyl. 5.7L; 6 Terminals	TX34
1983-1982	6 Cyl. 4.3L; 5 Terminals	TX36
1983-1982	8 Cyl. 5.7L; 5 Terminals	TX36
Riviera		
1983-1981	8 Cyl. 5.7L; 6 Terminals	TX34
1983-1981	8 Cyl. 5.7L; 5 Terminals	TX36
Body Light Switches		
Headlight Dimmer Switch		
Estate Wagon		
1980	8 Cyl. 5.7L; w/ Column Mounted	DS-79
Headlight Switch		
Estate Wagon		
1981	8 Cyl. 5.7L; w/o Twilight Sentinel	DS-213
1981	8 Cyl. 5.7L; w/ Twilight Sentinel	DS223
Turn Signal Switch		
Estate Wagon		
1983	8 Cyl. 5.7L; w/o Cornering Lights	TW-20
1983	8 Cyl. 5.7L; w/ Cornering Lights	TW-8
Chassis and Drivetrain Switches		
Automatic Transmission Vacuum Modulator		
Century		
1985	6 Cyl. 4.3L; MV4, MX2, MX3, MX5	TM-63
1984	6 Cyl. 4.3L; w/ 4 Speed TH440 Trans.	TM-58

		Part No.
Automatic Transmission Vacuum Modulator		
Century		
1981	8 Cyl. 5.7L; w/ External EGR; w/ TH250, TH350 Trans.	TM-33
1981	8 Cyl. 5.7L; w/ Int. EGR; w/ TH250, TH350 Trans.	TM-45
Electra		
1985	6 Cyl. 4.3L; w/ 4 Speed TH4T60 Trans.	TM-58
1983-1982	8 Cyl. 5.7L; w/ 3 Speed TH250, TH350 Trans.	TM-37
1981	8 Cyl. 5.7L; N; w/ External EGR; w/ TH250, TH350 Trans.	TM-33
1981	8 Cyl. 5.7L; N; w/ Int. EGR; w/ TH250, TH350 Trans.	TM-45
1980	8 Cyl. 5.7L; N; w/ TH250, TH350 Trans.	TM-33
Estate Wagon		
1981	8 Cyl. 5.7L; Diesel; Exc. Calif.; OE Style; w/ 3 Speed TH250 Trans.	TM-45
LeSabre		
1983-1982	8 Cyl. 5.7L; Diesel; w/ 3 Speed TH250, TH350 Trans.	TM-37
1981	8 Cyl. 5.7L; Fed.; w/ External EGR; w/ TH250, TH350 Trans.	TM-33
1981	8 Cyl. 5.7L; Fed.; w/ Int. EGR; w/ TH250, TH350 Trans.	TM-45
1980	8 Cyl. 5.7L; N; w/ TH250, TH350 Trans.	TM-33
Regal		
1983-1982	8 Cyl. 5.7L; Diesel; w/ 3 Speed TH250, TH350 Trans.	TM-37
Riviera		
1983	8 Cyl.	TM40
1980	8 Cyl.; Screw Type Cap; w/ Brown Dot	TM-23
1980	8 Cyl.; No Color Mark	TM-33
1980	8 Cyl.; w/ Black Stripe	TM40
1980	8 Cyl.; w/ Brown Stripe	TM-45
Transmission Control Solenoid		
Riviera		
1980	8 Cyl. 5.7L	TCS20
Interior Power Switches		
Cruise Control Release Switch		
LeSabre		
1984-1982	8 Cyl. 5.7L; Exc. Canada	SLS-234
Cruise Control Switch		
Century		
1985	6 Cyl. 4.3L; w/ Intermittent Wipers	DS-1534
Electra		
1984	8 Cyl. 5.7L; w/ Intermittent Wipers	DS-1534
LeSabre		
1985	8 Cyl. 5.7L; w/ Intermittent Wipers	DS-1534
Regal		
1985	8 Cyl. 5.7L; w/ Intermittent Wipers	DS-1534
1985-1984	6 Cyl. 4.3L; w/ Intermittent Wipers	DS-1534
Riviera		
1985-1984	8 Cyl. 5.7L; w/ Intermittent Wipers	DS-1534
Trunk Release Switch		
Century		
1981	8 Cyl. 5.7L	DS-2153
Regal		
1981	8 Cyl. 5.7L	DS-2153
Riviera		
1981-1980	8 Cyl. 5.7L	DS-2153

Buick

Pressure and Vacuum Sending Switches

		Part No.
Pressure and Vacuum Sending Switches		
Oil Pressure Gauge Switch		
Century		
1983	6 Cyl. 4.3L	PS-155
Oil Pressure Light Switch		
Century		
1985-1982	6 Cyl. 4.3L	PS-12
1981	8 Cyl. 5.7L	PS-12
Electra		
1985	6 Cyl. 4.3L	PS-12
1984-1981	8 Cyl. 5.7L	PS-12
1980	8 Cyl. 5.7L; 1/8 Inch x 27 Thread	PS-12
1980	8 Cyl. 5.7L; w/ 1/4 Inch x 18 Thread	PS-57
Estate Wagon		
1982-1981	8 Cyl. 5.7L	PS-12
LeSabre		
1985-1982	8 Cyl. 5.7L	PS-12
1981	8 Cyl. 5.7L; Diesel	PS-12
1980	8 Cyl. 5.7L; 1/8 Inch x 27 Thread	PS-12
1980	8 Cyl. 5.7L; w/ 1/4 Inch x 18 Thread	PS-57
Regal		
1984	6 Cyl. 4.3L	PS-12
1983-1981	8 Cyl. 5.7L	PS-12
Riviera		
1985-1980	8 Cyl. 5.7L	PS-12
Ported Vacuum Switch		
Century		
1984	6 Cyl. 4.3L; 3 Ports; Black w/ Blue Top	PVS135
Electra		
1981-1980	8 Cyl. 5.7L; 2 Ports; Dark Blue	PVS77
1980	8 Cyl. 5.7L; 3 Ports; Green	PVS133
1980	8 Cyl. 5.7L; 2 Ports; Orange	PVS146
1980	8 Cyl. 5.7L; 4 Ports; Black Finish	PVS167
1980	8 Cyl. 5.7L; 2 Ports; Black Finish; OE No. 22514776, 22536551	PVS42
1980	8 Cyl. 5.7L; 3 Ports; Blue	PVS50
1980	8 Cyl. 5.7L; 4 Ports; Blue	PVS76
LeSabre		
1980	8 Cyl. 5.7L; 3 Ports; Green	PVS133
1980	8 Cyl. 5.7L; 2 Ports; Orange	PVS146
1980	8 Cyl. 5.7L; 4 Ports; Black Finish	PVS167
1980	8 Cyl. 5.7L; 2 Ports; Black Finish	PVS42
1980	8 Cyl. 5.7L; 3 Ports; Blue	PVS50
1980	8 Cyl. 5.7L; 4 Ports; Blue	PVS76
1980	8 Cyl. 5.7L; 2 Ports; Dark Blue	PVS77
Riviera		
1980	8 Cyl. 5.7L; 6 Ports; 7 Term.; Black Finish	PVS104
1980	8 Cyl. 5.7L; 3 Ports; Green	PVS133
1980	8 Cyl. 5.7L; 2 Ports; Orange	PVS146
1980	8 Cyl. 5.7L; 4 Ports; Black Finish	PVS167
1980	8 Cyl. 5.7L; 2 Ports; 162 Deg.; Black Finish; OE No. 22514776, 22536551	PVS42
1980	8 Cyl. 5.7L; 3 Ports; Blue	PVS50
Temperature Switches and Senders		
A/C and Heater Blower Motor Switch		
Regal		
1985	8 Cyl. 5.7L; w/o AC	HS-205
1985	8 Cyl. 5.7L; w/ AC	HS-206
1985-1984	6 Cyl. 4.3L; w/o AC	HS-205
1985-1984	6 Cyl. 4.3L; w/ AC	HS-206
1983-1982	6 Cyl. 4.3L; w/o Climate Control	HS-204
1983-1982	8 Cyl. 5.7L; w/o Climate Control	HS-204
1983-1982	6 Cyl. 4.3L; Lever	HS-206

		Part No.
A/C and Heater Blower Motor Switch		
Regal		
1983-1982	8 Cyl. 5.7L; Lever	HS-206
A/C and Heater Selector Switch		
Estate Wagon		
1983-1981	8 Cyl. 5.7L	HS-316
LeSabre		
1984-1980	8 Cyl. 5.7L	HS-316
Regal		
1981	8 Cyl. 5.7L	HS-316
Blower Motor Resistor		
Estate Wagon		
1983	8 Cyl. 5.7L; w/ AC Manual Control	RU-62
Temperature Sender - With Gauge		
Century		
1985-1984	6 Cyl. 4.3L	TS-168
1983	6 Cyl. 4.3L	TS-76
Electra		
1984	8 Cyl. 5.7L	TS-168
1983-1982	8 Cyl. 5.7L	TS-76
Estate Wagon		
1983-1982	8 Cyl. 5.7L	TS-76
LeSabre		
1983-1982	8 Cyl. 5.7L; w/ Gauge	TS-76
Riviera		
1985-1984	8 Cyl. 5.7L	TS-168
1983	8 Cyl. 5.7L	TS-76
1981-1980	8 Cyl. 5.7L	TS-76
Temperature Sender - With Light		
Century		
1985-1984	6 Cyl. 4.3L; 3/8 Inch x 18 Thread	TS-169
1983	6 Cyl. 4.3L; 3/8 Inch x 18 Thread	TS-66
Electra		
1983-1982	8 Cyl. 5.7L; 3/8 Inch x 18 Thread	TS-66
1981	8 Cyl. 5.7L; 3/8 Inch x 18 Thread; Diesel	TS-66
1980	8 Cyl. 5.7L; 1/2 Inch x 14 Thread	TS-43
Estate Wagon		
1983-1981	8 Cyl. 5.7L; 3/8 Inch x 18 Thread	TS-66
1980	8 Cyl. 5.7L; 3/8 Inch x 18 Thread; Diesel	TS-66
LeSabre		
1985-1984	8 Cyl.; 3/8 Inch x 18 Thread	TS-169
1983-1982	8 Cyl. 5.7L; 3/8 Inch x 18 Thread	TS-66
Regal		
1985-1984	6 Cyl. 4.3L; 3/8 Inch x 18 Thread	TS-169
1983-1982	8 Cyl. 5.7L; 3/8 Inch x 18 Thread	TS-66
Riviera		
1983	8 Cyl. 5.7L; 3/8 Inch x 18 Thread	TS-66
1981	8 Cyl. 5.7L; 3/8 Inch x 18 Thread	TS-66
1980	8 Cyl.; 1/2 Inch x 14 Thread	TS-43
Actuators		
Power Door Lock Actuator		
Century		
1985	6 Cyl. 4.3L	DLA-1
1982	6 Cyl. 4.3L	DLA-1
Locks		
Door Lock Kit		
Riviera		
1982	8 Cyl. 5.7L	DL-6
Ignition Lock Cylinder Housing Repair Kit		
Estate Wagon		
1982	8 Cyl. 5.7L; w/ Tilt Steering	US-165L

Relays and Fuses

		Part No.
Cadillac		
Relays and Fuses		
A/C Control Relay		
DeVille		
1985	6 Cyl.	RY-116
Fleetwood		
1985	8 Cyl. 5.7L; Diesel	RY-116
A/C Speed-Up Solenoid Relay		
DeVille		
1985	6 Cyl. 4.3L; Diesel	RY-116
1980	8 Cyl. 5.7L; Diesel	RY-8
Eldorado		
1980	8 Cyl. 5.7L; Diesel	RY-8
Fleetwood		
1985	6 Cyl. 4.3L; Diesel	RY-116
1980	8 Cyl. 5.7L; Diesel	RY-8
Seville		
1980	8 Cyl. 5.7L; Diesel	RY-8
Coolant Fan Relay		
Fleetwood		
1985	6 Cyl.	RY-242
Diesel Glow Plug Relay		
Eldorado		
1980	8 Cyl. 5.7L; Diesel; Solenoid Type	SS-591
Diesel Wait Lamp Relay		
DeVille		
1983-1982	8 Cyl. 5.7L; Diesel	RY-116
1981-1980	8 Cyl. 5.7L; Alternate Number; Diesel	RY-116
1981-1980	8 Cyl. 5.7L; Diesel; Exhaust stock and reorder	RY30
Eldorado		
1983-1982	8 Cyl. 5.7L; Diesel	RY-116
1981-1980	8 Cyl. 5.7L; Alternate Number; Diesel	RY-116
1981-1980	8 Cyl. 5.7L; Diesel; Exhaust stock and reorder	RY30
Fleetwood		
1983-1982	8 Cyl. 5.7L; Diesel	RY-116
1981-1980	8 Cyl. 5.7L; Alternate Number; Diesel	RY-116
1981-1980	8 Cyl. 5.7L; Diesel; Exhaust stock and reorder	RY30
Seville		
1983-1982	8 Cyl. 5.7L; Diesel	RY-116
1981-1980	8 Cyl. 5.7L; Alternate Number; Diesel	RY-116
1981-1980	8 Cyl. 5.7L; Diesel; Exhaust stock and reorder	RY30
Fast Idle Relay		
DeVille		
1985	6 Cyl. 4.3L; Diesel	RY-116
1981	8 Cyl. 5.7L; Alternate Number; Diesel	RY-116
1981	8 Cyl. 5.7L; Diesel; Exhaust stock and reorder	RY30
1980	8 Cyl. 5.7L; Diesel	RY-8
Eldorado		
1981	8 Cyl. 5.7L	RY-116
1980	8 Cyl. 5.7L; Diesel	RY-8
Fleetwood		
1985	6 Cyl. 4.3L; Diesel	RY-116
1981	8 Cyl. 5.7L; Alternate Number; Diesel	RY-116
1981	8 Cyl. 5.7L; Diesel; Exhaust stock and reorder	RY30
1980	8 Cyl. 5.7L; Diesel	RY-8
Seville		
1981	8 Cyl. 5.7L; Alternate Number; Diesel	RY-116

		Part No.
Fast Idle Relay		
Seville		
1981	8 Cyl. 5.7L; Diesel; Exhaust stock and reorder	RY30
1980	8 Cyl. 5.7L; Diesel	RY-8
Fuel Injection Pump Relay		
DeVille		
1984	8 Cyl.	RY-85
Fleetwood		
1985	6 Cyl.	RY-85
1984-1983	8 Cyl. 5.7L	RY-116
Fuel Injection Relay		
DeVille		
1985	6 Cyl.	RY-85
Fuel Pump Relay		
DeVille		
1984-1983	8 Cyl. 5.7L	RY-116
1982	8 Cyl.	RY-116
Instrument Cluster Relay		
DeVille		
1984-1982	8 Cyl. 5.7L	RY-116
Eldorado		
1984	8 Cyl. 5.7L	RY-116
Seville		
1984-1982	8 Cyl. 5.7L	RY-116
Neutral Safety Switch Relay		
DeVille		
1981-1980	8 Cyl. 5.7L; Alternate Number	RY-116
1981-1980	8 Cyl. 5.7L; Exhaust stock and reorder	RY30
Eldorado		
1981-1980	8 Cyl. 5.7L; Alternate Number	RY-116
1981-1980	8 Cyl. 5.7L; Exhaust stock and reorder	RY30
Fleetwood		
1981-1980	8 Cyl. 5.7L; 5 Blade Term.; Alternate Number	RY-116
1981-1980	8 Cyl. 5.7L; 5 Blade Term.; Exhaust stock and reorder	RY30
Seville		
1981-1980	8 Cyl. 5.7L; Alternate Number	RY-116
1981-1980	8 Cyl. 5.7L; Exhaust stock and reorder	RY30
Power Window Relay		
Eldorado		
1984	8 Cyl. 5.7L	RY-116
Trailer Towing Package Relay		
Eldorado		
1982-1981	8 Cyl. 5.7L; Alternate Number	RY-116
1982-1981	8 Cyl. 5.7L; Exhaust stock and reorder	RY30
Fleetwood		
1982	8 Cyl. 5.7L; Alternate Number	RY-116
1982	8 Cyl. 5.7L; Exhaust stock and reorder	RY30
Windshield Washer Relay		
Eldorado		
1984	8 Cyl. 5.7L	RY-44
Starting and Charging System Parts		
Starter Solenoid		
Commercial Chassis		
1985	6 Cyl. 4.3L; Diesel; Mitsubishi; Str. No. 22523207	SS-306
DeVille		
1985	6 Cyl. 4.3L; Str. No. 1998553 ⁶	SS-251
1985	6 Cyl. 4.3L; OE No. 25523207	SS-306
1984-1983	8 Cyl. 5.7L	SS-251

⁶ Use Heavy Duty Version Only

Starting and Charging System Parts

		Part No.
Starter Solenoid		
DeVille		
1981-1980	8 Cyl. 5.7L ^{5, 6}	SS-200
Eldorado		
1985-1984	8 Cyl. 5.7L ⁶	SS-251
1983	8 Cyl. 5.7L	SS-251
1981	8 Cyl. 5.7L ^{5, 6}	SS-200
Fleetwood		
1985	6 Cyl. 4.3L ⁶	SS-251
1985	8 Cyl. 5.7L; Delco Starter	SS-251
1985	8 Cyl. 5.7L; Mitsubishi Starter	SS-306
1984	8 Cyl. 5.7L ⁶	SS-251
1983-1982	8 Cyl. 5.7L	SS-251
1981-1980	8 Cyl. 5.7L ^{5, 6}	SS-200
Seville		
1985-1984	8 Cyl. 5.7L ⁶	SS-251
1983	8 Cyl. 5.7L	SS-251
1981	8 Cyl. 5.7L ^{5, 6}	SS-200
1980	8 Cyl. 5.7L ⁵	SS-200
Air Injection and Induction Parts		
Vacuum Pump		
Commercial Chassis		
1985	6 Cyl. 4.3L; Diesel; w/ AC	VCP100
DeVille		
1985	6 Cyl. 4.3L; Diesel; w/ AC	VCP100
Fleetwood		
1985	6 Cyl. 4.3L; Diesel; w/ AC	VCP100
Air Management Valves		
Air Cleaner Check Valve		
Fleetwood		
1980	8 Cyl.	AV7
Idle Speed Control Motor		
Eldorado		
1980	8 Cyl. 5.7L	SA4
Seville		
1980	8 Cyl. 5.7L	SA4
Idle Speed Control Motor Repair Kit		
Eldorado		
1980	8 Cyl. 5.7L	SA100
Seville		
1980	8 Cyl. 5.7L	SA100
Air Management Regulators and Solenoids		
Idle Stop Solenoid		
Fleetwood		
1981-1980	8 Cyl. 5.7L; Diesel	ES118
Early Fuel Emission Control		
Air Cleaner Inlet Hose		
DeVille		
1981	8 Cyl.	DH22
Fleetwood		
1981-1980	8 Cyl.	DH22
Seville		
1985-1984	8 Cyl. 5.7L; On Grille	DH40
1985-1982	8 Cyl. 5.7L; On Silencer	DH24
1983-1982	8 Cyl. 5.7L; At Front of Car	DH40
1981-1980	8 Cyl. 5.7L	DH34
Crankcase Ventilation Filter		
DeVille		
1981-1980	8 Cyl. 5.7L	BF19

		Part No.
Crankcase Ventilation Filter		
Eldorado		
1981-1980	8 Cyl. 5.7L	BF19
Fleetwood		
1981-1980	8 Cyl. 5.7L	BF19
Seville		
1981-1980	8 Cyl. 5.7L	BF19
EGR Components		
EGR Valve		
Eldorado		
1985-1982	8 Cyl. 5.7L	EGV434
1981	8 Cyl. 5.7L	EGV787
Fleetwood		
1985	8 Cyl. 5.7L	EGV434
1984-1983	8 Cyl. 5.7L; Calif., Fed.	EGV434
1984-1983	8 Cyl. 5.7L; High Altitude	EGV726
1981	8 Cyl. 5.7L	EGV434
EGR Valve Mounting Gasket		
DeVille		
1980	8 Cyl. 5.7L	VG8
Eldorado		
1985-1982	8 Cyl. 5.7L	VG8
1980	8 Cyl. 5.7L	VG8
Fleetwood		
1980	8 Cyl. 5.7L	VG8
Seville		
1980	8 Cyl. 5.7L	VG8
PCV Systems		
PCV Grommet		
Commercial Chassis		
1985	6 Cyl. 4.3L; 23/32 Inch Inner Dia. x 1 1/4 Inch Outer Dia.	GV13
1985	6 Cyl. 4.3L; 7/16 Inch Inner Dia. x 1 1/4 Inch Outer Dia.	GV16
1985	6 Cyl. 4.3L; 7/16 Inch Inner Dia. x 1 3/4 Inch Outer Dia.	GV18
1985	6 Cyl. 4.3L; 11/16 Inch Inner Dia. x 1 3/16 Inch Outer Dia.	GV5
1985	6 Cyl. 4.3L; 1 Inch Inner Dia. x 1 1/2 Inch Outer Dia.	GV6
1985	6 Cyl. 4.3L; 23/32 Inch Inner Dia. x 1 Inch Outer Dia.	GV9
DeVille		
1985	6 Cyl. 4.3L; 23/32 Inch Inner Dia. x 1 1/4 Inch Outer Dia.	GV13
1985	6 Cyl. 4.3L; 7/16 Inch Inner Dia. x 1 1/4 Inch Outer Dia.	GV16
1985	6 Cyl. 4.3L; 7/16 Inch Inner Dia. x 1 3/4 Inch Outer Dia.	GV18
1985	6 Cyl. 4.3L; 11/16 Inch Inner Dia. x 1 3/16 Inch Outer Dia.	GV5
1985	6 Cyl. 4.3L; 1 Inch Inner Dia. x 1 1/2 Inch Outer Dia.	GV6
1985	6 Cyl. 4.3L; 23/32 Inch Inner Dia. x 1 Inch Outer Dia.	GV9
1984-1980	8 Cyl. 5.7L; 23/32 Inch Inner Dia. x 1 1/4 Inch Outer Dia.	GV13
1984-1980	8 Cyl. 5.7L; 7/16 Inch Inner Dia. x 1 1/4 Inch Outer Dia.	GV16
1984-1980	8 Cyl. 5.7L; 7/16 Inch Inner Dia. x 1 3/4 Inch Outer Dia.	GV18
1984-1980	8 Cyl. 5.7L; 11/16 Inch Inner Dia. x 1 3/16 Inch Outer Dia.	GV5
1984-1980	8 Cyl. 5.7L; 1 Inch Inner Dia. x 1 1/2 Inch Outer Dia.	GV6

PCV Systems

PCV Grommet		Part No.
DeVille		
1984-1980	8 Cyl. 5.7L; 23/32 Inch Inner Dia. x 1 Inch Outer Dia.	GV9
Eldorado		
1984	8 Cyl. 5.7L; 23/32 Inch Inner Dia. x 1 1/4 Inch Outer Dia.	GV13
1984	8 Cyl. 5.7L; 7/16 Inch Inner Dia. x 1 3/4 Inch Outer Dia.	GV18
1984	8 Cyl. 5.7L; 1 Inch Inner Dia. x 1 1/2 Inch Outer Dia.	GV6
1984	8 Cyl. 5.7L; 23/32 Inch Inner Dia. x 1 Inch Outer Dia.	GV9
1984-1983	8 Cyl. 5.7L; 7/16 Inch Inner Dia. x 1 1/4 Inch Outer Dia.	GV16
1984-1983	8 Cyl. 5.7L; 11/16 Inch Inner Dia. x 1 3/16 Inch Outer Dia.	GV5
1981	8 Cyl. 5.7L; 23/32 Inch Inner Dia. x 1 1/4 Inch Outer Dia.	GV13
1981	8 Cyl. 5.7L; 7/16 Inch Inner Dia. x 1 1/4 Inch Outer Dia.	GV16
1981	8 Cyl. 5.7L; 7/16 Inch Inner Dia. x 1 3/4 Inch Outer Dia.	GV18
1981	8 Cyl. 5.7L; 11/16 Inch Inner Dia. x 1 3/16 Inch Outer Dia.	GV5
1981	8 Cyl. 5.7L; 1 Inch Inner Dia. x 1 1/2 Inch Outer Dia.	GV6
1981	8 Cyl. 5.7L; 23/32 Inch Inner Dia. x 1 Inch Outer Dia.	GV9
Fleetwood		
1985	6 Cyl. 4.3L; 23/32 Inch Inner Dia. x 1 1/4 Inch Outer Dia.	GV13
1985	6 Cyl. 4.3L; 7/16 Inch Inner Dia. x 1 1/4 Inch Outer Dia.	GV16
1985	6 Cyl. 4.3L; 7/16 Inch Inner Dia. x 1 3/4 Inch Outer Dia.	GV18
1985	6 Cyl. 4.3L; 11/16 Inch Inner Dia. x 1 3/16 Inch Outer Dia.	GV5
1985	6 Cyl. 4.3L; 1 Inch Inner Dia. x 1 1/2 Inch Outer Dia.	GV6
1985	6 Cyl. 4.3L; 23/32 Inch Inner Dia. x 1 Inch Outer Dia.	GV9
1983-1982	8 Cyl. 5.7L; 23/32 Inch Inner Dia. x 1 1/4 Inch Outer Dia.	GV13
1983-1982	8 Cyl. 5.7L; 7/16 Inch Inner Dia. x 1 1/4 Inch Outer Dia.	GV16
1983-1982	8 Cyl. 5.7L; 7/16 Inch Inner Dia. x 1 3/4 Inch Outer Dia.	GV18
1983-1982	8 Cyl. 5.7L; 11/16 Inch Inner Dia. x 1 3/16 Inch Outer Dia.	GV5
1983-1982	8 Cyl. 5.7L; 1 Inch Inner Dia. x 1 1/2 Inch Outer Dia.	GV6
1983-1982	8 Cyl. 5.7L; 23/32 Inch Inner Dia. x 1 Inch Outer Dia.	GV9
Seville		
1985-1981	8 Cyl. 5.7L; 23/32 Inch Inner Dia. x 1 1/4 Inch Outer Dia.	GV13
1985-1981	8 Cyl. 5.7L; 7/16 Inch Inner Dia. x 1 1/4 Inch Outer Dia.	GV16
1985-1981	8 Cyl. 5.7L; 7/16 Inch Inner Dia. x 1 3/4 Inch Outer Dia.	GV18
1985-1981	8 Cyl. 5.7L; 11/16 Inch Inner Dia. x 1 3/16 Inch Outer Dia.	GV5
1985-1981	8 Cyl. 5.7L; 1 Inch Inner Dia. x 1 1/2 Inch Outer Dia.	GV6
1985-1981	8 Cyl. 5.7L; 23/32 Inch Inner Dia. x 1 Inch Outer Dia.	GV9
PCV Valve		
DeVille		
1981-1980	8 Cyl. 5.7L; Diesel	V353

PCV Valve		Part No.
Eldorado		
1985	8 Cyl.	V178
1981-1980	8 Cyl. 5.7L; Diesel	V353
Fleetwood		
1981-1980	8 Cyl. 5.7L; Diesel	V353
Seville		
1985	8 Cyl. 5.7L; Diesel	V178
1981-1980	8 Cyl. 5.7L; Diesel	V353
Vapor and Purge Components		
Fuel Vapor Canister		
Eldorado		
1980	8 Cyl. 5.7L	CP1022
Seville		
1980	8 Cyl. 5.7L	CP1022
Injectors		
Fuel Injector - Diesel - New		
DeVille		
1985	6 Cyl. 4.3L	FJ698
Fleetwood		
1985	6 Cyl. 4.3L	FJ698
Injection Components		
Diesel Glow Plug		
DeVille		
1985	6 Cyl. 4.3L	GP108
1984	8 Cyl. 5.7L	GP108
1983-1980	8 Cyl. 5.7L	GP103
Eldorado		
1985-1984	8 Cyl. 5.7L	GP108
1983-1980	8 Cyl. 5.7L	GP103
Fleetwood		
1985-1980	8 Cyl. 5.7L	GP103
Seville		
1985-1980	8 Cyl. 5.7L	GP103
Fuel Pressure Regulator		
Eldorado		
1980	8 Cyl. 5.7L	PR23
Seville		
1980	8 Cyl. 5.7L	PR23
Fuel Rail O-Ring Kit		
Commercial Chassis		
1985	6 Cyl. 4.3L; Inlet and Outlet	SK18
1985	6 Cyl. 4.3L; Inlet; Multi-Pack	SK26
1985	6 Cyl. 4.3L; Multi-Pack; Outlet	SK27
DeVille		
1985	6 Cyl. 4.3L; Inlet and Outlet	SK18
1985	6 Cyl. 4.3L; Inlet; Multi-Pack	SK26
1985	6 Cyl. 4.3L; Multi-Pack; Outlet	SK27
1984-1981	8 Cyl. 5.7L; Inlet and Outlet	SK18
Eldorado		
1985	8 Cyl. 5.7L; Inlet; Multi-Pack	SK26
1985	8 Cyl. 5.7L; Multi-Pack; Outlet	SK27
1985-1981	8 Cyl. 5.7L; Inlet and Outlet	SK18
Fleetwood		
1985	6 Cyl. 4.3L; Inlet and Outlet	SK18
1985	6 Cyl. 4.3L; Inlet; Multi-Pack	SK26
1985	8 Cyl. 5.7L; Inlet; Multi-Pack	SK26
1985	6 Cyl. 4.3L; Multi-Pack; Outlet	SK27
1985	8 Cyl. 5.7L; Multi-Pack; Outlet	SK27
1985-1981	8 Cyl. 5.7L; Inlet and Outlet	SK18
Seville		
1985	8 Cyl. 5.7L; Inlet; Multi-Pack	SK26

Injection Components

		Part No.
Fuel Rail O-Ring Kit		
Seville		
1985	8 Cyl. 5.7L; Multi-Pack; Outlet	SK27
1985-1981	8 Cyl. 5.7L; Inlet and Outlet	SK18
Fuel Sensors		
Oxygen Sensor		
Eldorado		
1982	8 Cyl.; Upstream Sensor	SG3
1982	8 Cyl.; Universal Upstream	SG306
Fleetwood		
1985	8 Cyl.; Universal Upstream	SG12
1985	8 Cyl.; Upstream Sensor	SG5
1982	8 Cyl.; Upstream Sensor	SG3
1982	8 Cyl.; Universal Upstream	SG306
Seville		
1982	8 Cyl.; Upstream Sensor	SG3
1982	8 Cyl.; Universal Upstream	SG306
Position Sensors		
Throttle Position Sensor		
Seville		
1980	8 Cyl. 5.7L	TH154
Pressure Sensors		
MAP Sensor		
DeVille		
1985	6 Cyl. 4.3L	AS5
Fleetwood		
1985	6 Cyl. 4.3L	AS5
1985	8 Cyl. 5.7L	AS5
Temperature Sensors		
Coolant Temperature Sensor		
Eldorado		
1981	8 Cyl. 5.7L	TX3
Diesel Glow Plug Control Sensor		
DeVille		
1983-1981	8 Cyl. 5.7L; 6 Terminals	TX34
1983-1981	8 Cyl. 5.7L; 5 Terminals	TX36
Eldorado		
1983-1981	8 Cyl. 5.7L; 6 Terminals	TX34
1983-1981	8 Cyl. 5.7L; 5 Terminals	TX36
Fleetwood		
1983-1981	8 Cyl. 5.7L; 6 Terminals	TX34
1983-1981	8 Cyl. 5.7L; 5 Terminals	TX36
Seville		
1983-1981	8 Cyl. 5.7L; 6 Terminals	TX34
1983-1981	8 Cyl. 5.7L; 5 Terminals	TX36
Intake Air Temperature Sensor		
DeVille		
1982	8 Cyl. 5.7L; On Air Cleaner	ATS14
1980	8 Cyl. 5.7L	AX35
Eldorado		
1982	8 Cyl. 5.7L; On Air Cleaner	ATS14
1980	8 Cyl. 5.7L; On Air Cleaner	ATS14
Fleetwood		
1982	8 Cyl. 5.7L; On Air Cleaner	ATS14
1980	8 Cyl. 5.7L	AX35
Seville		
1982	8 Cyl. 5.7L; On Air Cleaner	ATS14
1980	8 Cyl. 5.7L	AX35

		Part No.
Chassis and Drivetrain Switches		
Automatic Transmission Vacuum Modulator		
Commercial Chassis		
1985	6 Cyl. 4.3L; Diesel; w/ 4 Speed TH4T60 Trans.	TM-58
DeVille		
1985	6 Cyl. 4.3L; No Stripe	TM-58
1985	6 Cyl. 4.3L; Green	TM-63
1982	8 Cyl. 5.7L; w/ 3 Speed TH350 Trans.	TM-37
1981	8 Cyl. 5.7L; Diesel; w/ 3 Speed TH400, TH425 Trans.	TM62
Eldorado		
1985	8 Cyl. 5.7L; MV4, MX2, MX3, MX5	TM-63
Fleetwood		
1985	6 Cyl. 4.3L; w/ 4 Speed TH440 Trans.	TM-58
1985	8 Cyl. 5.7L; MV4, MX2, MX3, MX5	TM-63
1984	8 Cyl. 5.7L	TM62
Seville		
1985	8 Cyl. 5.7L; MV4, MX2, MX3, MX5	TM-63
Neutral Safety Switch		
DeVille		
1984-1981	8 Cyl. 5.7L	NS81
Eldorado		
1985-1981	8 Cyl. 5.7L	NS81
Fleetwood		
1981	8 Cyl. 5.7L	NS81
Transmission Control Solenoid		
Eldorado		
1981	8 Cyl. 5.7L	TCS20
1980	8 Cyl. 5.7L; TCC Solenoid	TCS20
Seville		
1981	8 Cyl. 5.7L	TCS20
1980	8 Cyl. 5.7L; TCC Solenoid	TCS20
Interior Power Switches		
Cruise Control Release Switch		
Fleetwood		
1985	6 Cyl. 4.3L	SLS-234
1985-1982	8 Cyl. 5.7L	SLS-234
Parking Brake Switch		
Eldorado		
1984	8 Cyl. 5.7L	DS-905
Trunk Release Switch		
Eldorado		
1981-1980	8 Cyl. 5.7L	DS-2153
Seville		
1981-1980	8 Cyl. 5.7L	DS-2153
Pressure and Vacuum Sending Switches		
Oil Pressure Light Switch		
Commercial Chassis		
1985	6 Cyl. 4.3L; Diesel	PS-12
DeVille		
1985	6 Cyl. 4.3L	PS-12
1984-1982	8 Cyl. 5.7L	PS-12
Eldorado		
1985-1982	8 Cyl. 5.7L	PS-12
1980	8 Cyl. 5.7L	PS-12
Fleetwood		
1985	6 Cyl. 4.3L	PS-12
1985-1982	8 Cyl. 5.7L	PS-12
Seville		
1985-1982	8 Cyl. 5.7L	PS-12

Pressure and Vacuum Sending Switches

		Part No.
Ported Vacuum Switch		
Eldorado		
1980	8 Cyl. 5.7L; 3 Ports; Black Finish	PVS1
Seville		
1980	8 Cyl. 5.7L; 3 Ports; Black Finish	PVS1
Temperature Switches and Senders		
Temperature Sender - With Light		
Commercial Chassis		
1985	6 Cyl. 4.3L; Diesel; Water Temp Sensor	TS234
1985	6 Cyl. 4.3L; Diesel; Metal Temp	TS312
DeVille		
1985	6 Cyl. 4.3L; Coolant Temp	TS234
1985	6 Cyl. 4.3L; Metal Temp	TS312
1984	8 Cyl. 5.7L; 3/8 Inch x 18 Thread; Coolant Temp	TS-169
1984	8 Cyl. 5.7L; Metal Temp	TS264
1983	8 Cyl. 5.7L; 3/8 Inch x 18 Thread	TS-66
1981-1980	8 Cyl. 5.7L; Metal Temp	TS314
1981-1980	8 Cyl. 5.7L; 1/2 Inch x 14 Thread; Coolant Temp	TS-43
Eldorado		
1985	8 Cyl. 5.7L; Metal Temp	TS264
1985	8 Cyl. 5.7L; 3/8 Inch x 18 Thread; Coolant Temp	TS-169
1984	8 Cyl. 5.7L; 2 Blade Term.; 3/8 Inch x 18 Thread	TS-169
1984	8 Cyl. 5.7L; 1 Term.	TS264
1983	8 Cyl. 5.7L	TS264
1982	8 Cyl. 5.7L; Metal Temp	TS264
1981	8 Cyl. 5.7L; Metal Temp	TS314
1981	8 Cyl. 5.7L; 1/2 Inch x 14 Thread; Coolant Temp	TS-43
Fleetwood		
1985	6 Cyl. 4.3L; Water Temp Sensor	TS234
1985	6 Cyl. 4.3L; Metal Temp	TS312
1985-1984	8 Cyl. 5.7L; 2 Blade Term.; 3/8 Inch x 18 Thread	TS-169
1985-1984	8 Cyl. 5.7L; 1 Term.	TS264
1983-1982	8 Cyl. 5.7L; 3/8 Inch x 18 Thread; Water Temp Sensor	TS-66
1982-1980	8 Cyl. 5.7L; Metal Temp	TS314
1981-1980	8 Cyl. 5.7L; 1/2 Inch x 14 Thread; Coolant Temp	TS-43
Seville		
1985-1984	8 Cyl. 5.7L; 2 Blade Term.; 3/8 Inch x 18 Thread	TS-169
1985-1984	8 Cyl. 5.7L; 1 Term.	TS264
1983	8 Cyl. 5.7L; 3/8 Inch x 18 Thread; Coolant Temp; Diesel	TS-66
1983-1982	8 Cyl. 5.7L; Diesel; Metal Temp; Right Side	TS264
1983-1982	8 Cyl. 5.7L; Diesel; Metal Temp; Left Side	TS314
1981	8 Cyl. 5.7L; Metal Temp	TS314
1981	8 Cyl. 5.7L; 1/2 Inch x 14 Thread; Coolant Temp	TS-43
1980	8 Cyl. 5.7L; Diesel; Metal Temp	TS314
1980	8 Cyl. 5.7L; 1/2 Inch x 14 Thread; Diesel; At Cylinder Head	TS-43
1980	8 Cyl. 5.7L; Diesel; Top of Engine	TS-50
Checker		
Starting and Charging System Parts		
Starter Solenoid		
Marathon		
1982-1980	8 Cyl. 5.7L	SS-200

		Part No.
PCV Systems		
PCV Grommet		
Marathon		
1982-1980	8 Cyl. 5.7L	GV6
Chevrolet		
Modules		
Diesel Injector Pump Module Resistor		
Blazer		
1994	8 Cyl. 6.5L; OE No. 17800077, ID Tag No. 5521; Resistor No. 5	PMR1
1994	8 Cyl. 6.5L; OE No. 17800077, ID Tag No. 5521; Resistor No. 9	PMR2
C1500		
1998-1994	8 Cyl. 6.5L; Resistor No. 5	PMR1
1998-1994	8 Cyl. 6.5L; Resistor No. 9	PMR2
C1500 Suburban		
1999-1998	8 Cyl. 6.5L; Resistor No. 5	PMR1
1999-1998	8 Cyl. 6.5L; Resistor No. 9	PMR2
C2500		
2000-1994	8 Cyl. 6.5L; Resistor No. 5	PMR1
2000-1994	8 Cyl. 6.5L; Resistor No. 9	PMR2
C3500		
2000-1994	8 Cyl. 6.5L; Resistor No. 5	PMR1
2000-1994	8 Cyl. 6.5L; Resistor No. 9	PMR2
C3500HD		
2002-1995	8 Cyl. 6.5L; Resistor No. 5	PMR1
2002-1995	8 Cyl. 6.5L; Resistor No. 9	PMR2
1994	8 Cyl. 6.5L; F; Resistor No. 5	PMR1
1994	8 Cyl. 6.5L; F; Resistor No. 9	PMR2
Express 2500		
2002-1996	8 Cyl. 6.5L; Resistor No. 5	PMR1
2002-1996	8 Cyl. 6.5L; Resistor No. 9	PMR2
Express 3500		
2002-1996	8 Cyl. 6.5L; Resistor No. 5	PMR1
2002-1996	8 Cyl. 6.5L; Resistor No. 9	PMR2
G20		
1995-1994	8 Cyl. 6.5L; Resistor No. 5	PMR1
1995-1994	8 Cyl. 6.5L; Resistor No. 9	PMR2
K1500		
1998-1994	8 Cyl. 6.5L; Resistor No. 5	PMR1
1998-1994	8 Cyl. 6.5L; Resistor No. 9	PMR2
K1500 Suburban		
1999-1995	8 Cyl. 6.5L; Resistor No. 5	PMR1
1999-1995	8 Cyl. 6.5L; Resistor No. 9	PMR2
K2500		
2000-1994	8 Cyl. 6.5L; Resistor No. 5	PMR1
2000-1994	8 Cyl. 6.5L; Resistor No. 9	PMR2
K3500		
2000-1994	8 Cyl. 6.5L; Resistor No. 5	PMR1
2000-1994	8 Cyl. 6.5L; Resistor No. 9	PMR2
P30		
1999-1995	8 Cyl. 6.5L; Resistor No. 5; Turbocharged	PMR1
1999-1995	8 Cyl. 6.5L; Resistor No. 9; Turbocharged	PMR2
1994	8 Cyl. 6.5L; OE No. 17800077, ID Tag No. 5521; Resistor No. 5; Turbocharged	PMR1
1994	8 Cyl. 6.5L; OE No. 17800077, ID Tag No. 5521; Resistor No. 9; Turbocharged	PMR2
Tahoe		
1997-1995	8 Cyl. 6.5L; Resistor No. 5	PMR1
1997-1995	8 Cyl. 6.5L; Resistor No. 9	PMR2
Fuel Pump Driver Module		
Cruze		
2014	4 Cyl. 2.0L	FPM113

Chevrolet

Modules

		Part No.
Glow Plug Controller		
C10		
1986-1985	8 Cyl. 6.2L	RY-139
C20		
1986-1985	8 Cyl. 6.2L	RY-139
C30		
1986-1985	8 Cyl. 6.2L	RY-139
C1500		
1993-1989	8 Cyl. 6.2L	RY-139
C2500		
2000	8 Cyl. 6.5L	RY-915
1993-1992	8 Cyl. 6.5L	RY-139
1993-1989	8 Cyl. 6.2L	RY-139
C3500		
2000	8 Cyl. 6.5L	RY-915
1993-1992	8 Cyl. 6.5L	RY-139
1993-1989	8 Cyl. 6.2L	RY-139
C3500HD		
2000	8 Cyl. 6.5L	RY-915
1993-1992	8 Cyl. 6.5L	RY-139
C4500 Kodiak		
2007-2006	8 Cyl. 6.6L	RY-1697
2003	8 Cyl. 6.6L	RY-1731
C5500 Kodiak		
2007-2006	8 Cyl. 6.6L	RY-1697
Express 2500		
2012-2011	8 Cyl. 6.6L	RY1866
2010	8 Cyl. 6.6L; L	RY1866
2007-2006	8 Cyl. 6.6L	RY-1697
Express 3500		
2012-2011	8 Cyl. 6.6L	RY1866
2010	8 Cyl. 6.6L; L	RY1866
Express 4500		
2012-2011	8 Cyl. 6.6L	RY1866
2010	8 Cyl. 6.6L; L	RY1866
G20		
1993-1985	8 Cyl. 6.2L	RY-139
G30		
1993-1991	8 Cyl. 6.2L	RY-139
1989-1985	8 Cyl. 6.2L	RY-139
K10		
1986-1985	8 Cyl. 6.2L	RY-139
K20		
1986-1985	8 Cyl. 6.2L	RY-139
K30		
1986-1985	8 Cyl. 6.2L	RY-139
K1500		
1993-1989	8 Cyl. 6.2L	RY-139
K2500		
2000	8 Cyl. 6.5L	RY-915
1993-1992	8 Cyl. 6.5L	RY-139
1993-1989	8 Cyl. 6.2L	RY-139
K3500		
2000	8 Cyl. 6.5L	RY-915
1993-1992	8 Cyl. 6.5L	RY-139
1993-1989	8 Cyl. 6.2L	RY-139
R2500		
1989	8 Cyl. 6.2L	RY-139
R3500		
1991-1989	8 Cyl. 6.2L	RY-139
Silverado 2500 HD		
2012-2011	8 Cyl. 6.6L	RY1866
2005-2001	8 Cyl. 6.6L; w/o ULEV	RY-1556

		Part No.
Glow Plug Controller		
Silverado 2500 HD		
2004-2001	8 Cyl. 6.6L; w/ ULEV	RY-1731
2004-2001	8 Cyl. 6.6L	RY-585
Silverado 3500		
2005-2004	8 Cyl. 6.6L; w/o ULEV	RY-1556
2004-2001	8 Cyl. 6.6L; w/ ULEV	RY-1731
2004-2001	8 Cyl. 6.6L	RY-585
Silverado 3500 HD		
2012-2011	8 Cyl. 6.6L	RY1866
T7500		
2009-2004	6 Cyl. 7.8L	RY1952
T8500		
2009-2008	6 Cyl. 7.8L	RY1952
2006-2004	6 Cyl. 7.8L	RY1952
V3500		
1991-1989	8 Cyl. 6.2L	RY-139
W3500 Tiltmaster		
2009-2007	4 Cyl. 5.2L	RY1952
W4500 Tiltmaster		
2009-2007	4 Cyl. 5.2L	RY1952
W5500 Tiltmaster		
2010-2007	4 Cyl. 5.2L	RY1952
W5500HD Tiltmaster		
2009-2007	4 Cyl. 5.2L	RY1952
Instrument Panel Wiring Harness Module		
C10		
1986	8 Cyl. 6.2L; w/ M.T.	RY-536
1985	8 Cyl. 6.2L; C; w/ M.T.	RY-536
C20		
1986-1985	8 Cyl. 6.2L; C; w/ M.T.	RY-536
K5 Blazer		
1986-1985	8 Cyl. 6.2L; w/ M.T.	RY-536
K10		
1986-1985	8 Cyl. 6.2L; w/ M.T.	RY-536
K20		
1986-1985	8 Cyl. 6.2L; C; w/ M.T.	RY-536
Relays and Fuses		
A/C Compressor Time Delay Relay		
Impala		
1983	8 Cyl. 5.7L	RY35
Accessory Delay Relay		
Express 2500		
2011-2008	8 Cyl. 6.6L	RY-280
2007	8 Cyl. 6.6L	RY-604
Express 3500		
2011-2008	8 Cyl. 6.6L	RY-280
2007	8 Cyl. 6.6L	RY-604
Silverado 2500 HD		
2012-2011	8 Cyl. 6.6L	RY-601
Silverado 3500 HD		
2012-2011	8 Cyl. 6.6L	RY-601
Accessory Relay		
G20		
1995	8 Cyl. 6.5L; Alternate Number	RY-116
1995	8 Cyl. 6.5L; Exhaust stock and reorder	RY30
G30		
1995	8 Cyl. 6.5L; Alternate Number	RY-116
1995	8 Cyl. 6.5L; Exhaust stock and reorder	RY30
P30		
1995	8 Cyl. 6.5L; Alternate Number	RY-116
1995	8 Cyl. 6.5L; Exhaust stock and reorder	RY30

Relays and Fuses

		Part No.
Air Bag Relay		
Express 2500		
2000	8 Cyl.	RY-280
Express 3500		
2000	8 Cyl.	RY-280
Air Intake Heater Relay		
Silverado 2500 HD		
2004-2001	8 Cyl. 6.6L	RY-1567
Silverado 3500		
2004-2001	8 Cyl. 6.6L	RY-1567
Automatic Headlight Relay		
Express 2500		
2002-2001	8 Cyl. 6.5L; w/ Off Road Lights	RY331
Express 3500		
2002-2001	8 Cyl. 6.5L; w/ Off Road Lights	RY331
Auxiliary Battery Relay		
G30		
1990	8 Cyl. 6.2L; 4 Term.	RY-139
1990	8 Cyl. 6.2L; 2 Screw, 2 Blade Term.	RY-238
Auxiliary Engine Cooling Fan Relay		
C1500 Suburban		
1999-1996	8 Cyl.; Exhaust stock and reorder	RY-282
1999-1996	8 Cyl.; Alternate Number	RY-531
C2500 Suburban		
1998-1996	8 Cyl.; Exhaust stock and reorder	RY-282
1998-1996	8 Cyl.; Alternate Number	RY-531
Chevette		
1986	4 Cyl. 1.8L	RY-145
K1500 Suburban		
1998-1996	8 Cyl.; Exhaust stock and reorder	RY-282
1998-1996	8 Cyl.; Alternate Number	RY-531
K2500 Suburban		
1998-1996	8 Cyl.; Exhaust stock and reorder	RY-282
1998-1996	8 Cyl.; Alternate Number	RY-531
Tahoe		
1998-1996	8 Cyl.; Exhaust stock and reorder	RY-282
1998-1996	8 Cyl.; Alternate Number	RY-531
Auxiliary Heater and A/C Control Relay		
Blazer		
1994	8 Cyl. 6.5L; w/o Skirt	RY-115
1994	8 Cyl. 6.5L; w/ Skirt	RY-242
C1500		
1994	8 Cyl. 6.5L; w/o Skirt	RY-115
1994	8 Cyl. 6.5L; w/ Skirt	RY-242
C2500		
1994	8 Cyl. 6.5L; w/o Skirt	RY-115
1994	8 Cyl. 6.5L; w/ Skirt	RY-242
C2500 Suburban		
1994	8 Cyl. 6.5L; w/o Skirt	RY-115
1994	8 Cyl. 6.5L; w/ Skirt	RY-242
C3500		
1994	8 Cyl. 6.5L; w/o Skirt	RY-115
1994	8 Cyl. 6.5L; w/ Skirt	RY-242
C3500HD		
1994	8 Cyl. 6.5L; w/o Skirt	RY-115
1994	8 Cyl. 6.5L; w/ Skirt	RY-242
K1500		
1994	8 Cyl. 6.5L; w/o Skirt	RY-115
1994	8 Cyl. 6.5L; w/ Skirt	RY-242
K2500		
1994	8 Cyl. 6.5L; w/o Skirt	RY-115
1994	8 Cyl. 6.5L; w/ Skirt	RY-242

		Part No.
Auxiliary Heater and A/C Control Relay		
K2500 Suburban		
1994	8 Cyl. 6.5L; w/o Skirt	RY-115
1994	8 Cyl. 6.5L; w/ Skirt	RY-242
K3500		
1994	8 Cyl. 6.5L; w/o Skirt	RY-115
1994	8 Cyl. 6.5L; w/ Skirt	RY-242
Blower Motor Cut-Off Relay		
P20		
1989-1984	8 Cyl. 6.2L	RY-117
P30		
1990	4 Cyl. 3.9L	RY-117
1990-1984	8 Cyl. 6.2L	RY-117
R20		
1987	8 Cyl. 6.2L	RY-117
Blower Motor Relay		
Blazer		
1994	8 Cyl.	RY-242
C10		
1982	8 Cyl. 6.2L	RY-23
C10 Suburban		
1982	8 Cyl. 6.2L	RY-23
C20		
1982	8 Cyl. 6.2L	RY-23
C20 Suburban		
1982	8 Cyl. 6.2L	RY-23
C30		
1982	8 Cyl. 6.2L	RY-23
C1500 Suburban		
1994	8 Cyl.; Exhaust stock and reorder	RY-282
1994	8 Cyl.; Alternate Number	RY-531
C2500 Suburban		
1994	8 Cyl.; Exhaust stock and reorder	RY-282
1994	8 Cyl.; Alternate Number	RY-531
Express 2500		
2012	8 Cyl. 6.6L; Exhaust stock and reorder; w/ Auxiliary Blower	RY-282
2012	8 Cyl. 6.6L; Alternate Number; w/ Auxiliary Blower	RY-531
2010-2008	8 Cyl. 6.6L; Exhaust stock and reorder; w/ Auxiliary Blower	RY-282
2010-2008	8 Cyl. 6.6L; Alternate Number; w/ Auxiliary Blower	RY-531
Express 3500		
2012	8 Cyl. 6.6L; Exhaust stock and reorder; w/ Auxiliary Blower	RY-282
2012	8 Cyl. 6.6L; Alternate Number; w/ Auxiliary Blower	RY-531
2010-2008	8 Cyl. 6.6L; Exhaust stock and reorder; w/ Auxiliary Blower	RY-282
2010-2008	8 Cyl. 6.6L; Alternate Number; w/ Auxiliary Blower	RY-531
K5 Blazer		
1982	8 Cyl. 6.2L	RY-23
K10		
1982	8 Cyl. 6.2L	RY-23
K10 Suburban		
1982	8 Cyl. 6.2L	RY-23
K20		
1982	8 Cyl. 6.2L	RY-23
K20 Suburban		
1982	8 Cyl. 6.2L	RY-23
K30		
1982	8 Cyl. 6.2L	RY-23

Chevrolet

Relays and Fuses

		Part No.
Blower Motor Relay		
K1500 Suburban		
1994	8 Cyl.; Exhaust stock and reorder	RY-282
1994	8 Cyl.; Alternate Number	RY-531
K2500 Suburban		
1994	8 Cyl.; Exhaust stock and reorder	RY-282
1994	8 Cyl.; Alternate Number	RY-531
P20		
1982	8 Cyl. 6.2L	RY-23
P30		
1982	8 Cyl. 6.2L	RY-23
Choke Heater Control Relay		
Impala		
1984	8 Cyl. 5.7L	RY-144
Coolant Fan Relay		
Silverado 2500 HD		
2010-2008	8 Cyl. 6.6L; 4 Blade Term.	RY-280
2010-2008	8 Cyl. 6.6L; 5 Term.	RY-604
2004	8 Cyl. 6.6L; 4 Blade Term.; Black Finish	RY-280
2004	8 Cyl. 6.6L; 5 Term.; Black Finish	RY-604
Silverado 3500 HD		
2009-2008	8 Cyl. 6.6L; 4 Blade Term.	RY-280
2009-2008	8 Cyl. 6.6L; 5 Term.	RY-604
Diesel Glow Plug Indicator Relay		
Caprice		
1983-1982	8 Cyl. 5.7L; Diesel	RY-138
Celebrity		
1983-1982	6 Cyl. 4.3L; Diesel	RY-138
Impala		
1983-1982	8 Cyl. 5.7L; Diesel	RY-138
Diesel Glow Plug Relay		
C10 Suburban		
1984	8 Cyl. 6.2L; Diesel	SS-591
C20 Suburban		
1984	8 Cyl. 6.2L; Diesel	SS-591
C1500		
1996	8 Cyl. 6.5L; Exhaust stock and reorder	RY-383
1996	8 Cyl. 6.5L	RY391
El Camino		
1984-1983	8 Cyl. 5.7L; Diesel	SS-591
G20		
1985-1983	8 Cyl. 6.2L; Diesel	SS-591
G30		
1985-1983	8 Cyl. 6.2L; Diesel	SS-591
K5 Blazer		
1984-1982	8 Cyl. 6.2L; Diesel	SS-591
K20 Suburban		
1984	8 Cyl. 6.2L; Diesel	SS-591
LUV		
1982	4 Cyl. 2.2L; Diesel; Exhaust stock and reorder	RY-54
Malibu		
1983	8 Cyl. 5.7L; N	SS-591
1983-1982	6 Cyl. 4.3L; Diesel	SS-591
1982	8 Cyl. 5.7L; Diesel	SS-591
Monte Carlo		
1983-1982	6 Cyl. 4.3L; Diesel	SS-591
1983-1982	8 Cyl. 5.7L; Diesel	SS-591
S10		
1983	4 Cyl. 2.2L; Exhaust stock and reorder	RY-54
Silverado 2500 HD		
2006	8 Cyl. 6.6L	RY1832

		Part No.
Diesel Glow Plug Relay		
Silverado 2500 HD Classic		
2007	8 Cyl. 6.6L	RY1832
Silverado 3500		
2006	8 Cyl. 6.6L	RY1832
Silverado 3500 Classic		
2007	8 Cyl. 6.6L	RY1832
Diesel Wait Lamp Relay		
Caprice		
1983-1980	8 Cyl. 5.7L	RY-138
Celebrity		
1983-1982	6 Cyl. 4.3L	RY-138
Impala		
1983-1980	8 Cyl. 5.7L	RY-138
Malibu		
1983-1982	8 Cyl. 5.7L	RY-138
Monte Carlo		
1983-1982	8 Cyl. 5.7L	RY-138
EGR Valve Relay		
El Camino		
1983	8 Cyl. 5.7L	RY-27
Emission Control Relay		
G20		
1984-1983	8 Cyl. 6.2L	RY35
G30		
1984-1983	8 Cyl. 6.2L	RY35
Fast Idle Relay		
Celebrity		
1984	6 Cyl. 4.3L	RY35
Impala		
1981-1980	8 Cyl. 5.7L	RY-8
Malibu		
1983-1982	6 Cyl. 4.3L	RY-34
Monte Carlo		
1983-1982	6 Cyl. 4.3L	RY-34
Fog Lamp Relay		
C10		
1981-1980	8 Cyl. 5.7L; w/ Sport Package; w/o Skirt	RY-115
1981-1980	8 Cyl. 5.7L; w/ Skirt; w/ Sport Package	RY-242
Fuel Injection Cold Advance Solenoid Relay		
R1500 Suburban		
1990-1989	8 Cyl. 6.2L	RY-109
V1500 Suburban		
1990-1989	8 Cyl. 6.2L	RY-109
Fuel Injection Pump Relay		
C1500		
1993-1992	8 Cyl. 6.2L	RY-109
C2500		
2000	8 Cyl. 6.5L; 5 Pin; Exhaust stock and reorder	RY-282
2000	8 Cyl. 6.5L; 4 Pin; Alternate Number	RY-531
1993-1992	8 Cyl. 6.2L	RY-109
1993-1992	8 Cyl. 6.5L	RY-109
C3500		
2000	8 Cyl. 6.5L; 5 Pin; Exhaust stock and reorder	RY-282
2000	8 Cyl. 6.5L; 4 Pin; Alternate Number	RY-531
1993-1992	8 Cyl. 6.2L	RY-109
1993-1992	8 Cyl. 6.5L	RY-109
C3500HD		
2002-2000	8 Cyl. 6.5L; 5 Pin; Exhaust stock and reorder	RY-282
2002-2000	8 Cyl. 6.5L; 4 Pin; Alternate Number	RY-531

Relays and Fuses

		Part No.
Fuel Injection Pump Relay		
C3500HD		
1993-1992	8 Cyl. 6.5L	RY-109
K1500		
1993-1992	8 Cyl. 6.2L	RY-109
K2500		
2000	8 Cyl. 6.5L; 5 Pin; Exhaust stock and reorder	RY-282
2000	8 Cyl. 6.5L; 4 Pin; Alternate Number	RY-531
1993-1992	8 Cyl. 6.2L	RY-109
1993-1992	8 Cyl. 6.5L	RY-109
K3500		
2000	8 Cyl. 6.5L; 5 Pin; Exhaust stock and reorder	RY-282
2000	8 Cyl. 6.5L; 4 Pin; Alternate Number	RY-531
1993-1992	8 Cyl. 6.2L	RY-109
1993-1992	8 Cyl. 6.5L	RY-109
S10		
1985	4 Cyl. 2.2L	HR-151
Silverado 2500 HD		
2002-2001	8 Cyl. 6.6L; 5 Pin; Exhaust stock and reorder	RY-282
2002-2001	8 Cyl. 6.6L; 4 Pin; Alternate Number	RY-531
Silverado 3500		
2002-2001	8 Cyl. 6.6L; 5 Pin; Exhaust stock and reorder	RY-282
2002-2001	8 Cyl. 6.6L; 4 Pin; Alternate Number	RY-531
Fuel Pump Relay		
C2500		
2000-1999	8 Cyl. 6.5L	RY-604
C3500		
2000-1999	8 Cyl. 6.5L	RY-604
C3500HD		
2002-1999	8 Cyl. 6.5L	RY-604
Caprice		
1984	8 Cyl. 5.7L; Diesel	RY-85
Celebrity		
1985	6 Cyl. 4.3L	RY-85
1984	6 Cyl.	RY-85
El Camino		
1984	8 Cyl. 5.7L	RY-85
K2500		
2000-1999	8 Cyl. 6.5L	RY-604
K3500		
2000-1999	8 Cyl. 6.5L	RY-604
Malibu		
1983-1982	6 Cyl. 4.3L	RY-34
Monte Carlo		
1983-1982	6 Cyl. 4.3L	RY-34
Silverado 2500 HD		
2002-2001	8 Cyl. 6.6L	RY-604
Silverado 3500		
2002-2001	8 Cyl. 6.6L	RY-604
Silverado 3500 Classic		
2007	8 Cyl. 6.6L	RY-601
Silverado 3500 HD		
2007	8 Cyl. 6.6L	RY-601
Headlight Relay		
Silverado 2500 HD		
2008	8 Cyl. 6.6L; Black Finish; Low Beam	RY-280
2008	8 Cyl. 6.6L; Gray; Low Beam	RY-601
Silverado 3500 HD		
2008	8 Cyl. 6.6L; Black Finish; Low Beam	RY-280

		Part No.
Headlight Relay		
Silverado 3500 HD		
2008	8 Cyl. 6.6L; Gray; Low Beam	RY-601
Ignition Relay		
Silverado 2500 HD		
2011-2008	8 Cyl. 6.6L	RY-280
Silverado 3500 HD		
2011-2008	8 Cyl. 6.6L	RY-280
Low Fuel Relay		
S10 Blazer		
1984	4 Cyl. 2.2L; OE No. 25523703	HR-151
Parking Lamp Relay		
Express 2500		
2011-2008	8 Cyl. 6.6L	RY-280
2007	8 Cyl. 6.6L	RY-232
2002	8 Cyl. 6.5L	RY-232
Express 3500		
2011-2008	8 Cyl. 6.6L	RY-280
2007	8 Cyl. 6.6L	RY-232
2002	8 Cyl. 6.5L	RY-232
Silverado 2500 HD		
2011-2008	8 Cyl. 6.6L	RY-280
2007	8 Cyl. 6.6L; Black Finish	RY-280
2007	8 Cyl. 6.6L; Gray	RY-601
2005-2003	8 Cyl. 6.6L	RY-280
Silverado 3500		
2005-2003	8 Cyl. 6.6L	RY-280
Silverado 3500 HD		
2011-2008	8 Cyl. 6.6L	RY-280
2007	8 Cyl. 6.6L; Black Finish	RY-280
2007	8 Cyl. 6.6L; Gray	RY-601
Power Antenna Relay		
Impala		
1985	8 Cyl. 5.7L	RY-603
Power Door Lock Relay		
Express 2500		
2008	8 Cyl. 6.6L	RY-612
Express 3500		
2008	8 Cyl. 6.6L	RY-612
Power Window Relay		
Silverado 2500 HD		
2012-2011	8 Cyl. 6.6L; 5 Pin; Exhaust stock and reorder; For Power Rear Sliding Window	RY-282
2012-2011	8 Cyl. 6.6L; 4 Pin; Alternate Number; For Power Rear Sliding Window	RY-531
Silverado 3500 HD		
2012-2011	8 Cyl. 6.6L; 5 Pin; Exhaust stock and reorder; For Power Rear Sliding Window	RY-282
2012-2011	8 Cyl. 6.6L; 4 Pin; Alternate Number; For Power Rear Sliding Window	RY-531
Starter Relay		
Express 2500		
2011-2010	8 Cyl. 6.6L	RY-601
Express 3500		
2011-2010	8 Cyl. 6.6L	RY-601
P30		
1995-1994	8 Cyl. 6.5L	RY-109
1993-1991	8 Cyl. 6.2L	RY-109
Silverado 2500 HD		
2008	8 Cyl. 6.6L	RY-601
Silverado 3500 HD		
2008	8 Cyl. 6.6L	RY-601

Chevrolet

Relays and Fuses

		Part No.
Stoplight Relay		
C1500		
1994	8 Cyl. 6.5L; 5 Pin; Exhaust stock and reorder; w/o Bracket	RY-282
1994	8 Cyl. 6.5L; 4 Pin; Alternate Number; w/o Bracket	RY-531
C2500		
1994	8 Cyl. 6.5L; 5 Pin; Exhaust stock and reorder; w/o Bracket	RY-282
1994	8 Cyl. 6.5L; 4 Pin; Alternate Number; w/o Bracket	RY-531
C3500		
1994	8 Cyl. 6.5L; 5 Pin; Exhaust stock and reorder; w/o Bracket	RY-282
1994	8 Cyl. 6.5L; 4 Pin; Alternate Number; w/o Bracket	RY-531
C3500HD		
1994	8 Cyl. 6.5L; 5 Pin; Exhaust stock and reorder; w/o Bracket	RY-282
1994	8 Cyl. 6.5L; 4 Pin; Alternate Number; w/o Bracket	RY-531
K1500		
1994	8 Cyl. 6.5L; 5 Pin; Exhaust stock and reorder; w/o Bracket	RY-282
1994	8 Cyl. 6.5L; 4 Pin; Alternate Number; w/o Bracket	RY-531
K2500		
1994	8 Cyl. 6.5L; 5 Pin; Exhaust stock and reorder; w/o Bracket	RY-282
1994	8 Cyl. 6.5L; 4 Pin; Alternate Number; w/o Bracket	RY-531
K3500		
1994	8 Cyl. 6.5L; 5 Pin; Exhaust stock and reorder; w/o Bracket	RY-282
1994	8 Cyl. 6.5L; 4 Pin; Alternate Number; w/o Bracket	RY-531
Transfer Case Relay		
K3500		
2000-1998	8 Cyl. 6.5L	RY-1625
1996	8 Cyl. 6.5L	RY-1625
Water In Fuel Indicator Relay		
C10		
1980	8 Cyl. 5.7L; Diesel	RY-43
S10		
1985-1984	4 Cyl. 2.2L; Diesel	HR-151
Windshield Washer Relay		
Silverado 2500 HD		
2007-2006	8 Cyl. 6.6L	RY-280
Silverado 3500		
2006	8 Cyl. 6.6L	RY-280
Silverado 3500 Classic		
2007	8 Cyl. 6.6L	RY-280
Silverado 3500 HD		
2007	8 Cyl. 6.6L	RY-280
Wiper Relay		
Celebrity		
1984	6 Cyl. 4.3L; w/ Intermittent Wipers	RY-44
Starting and Charging System Parts		
Starter Solenoid		
B7		
1998-1994	6 Cyl. 6.6L	SS-404
B60		
1989-1983	8 Cyl. 8.2L	SS-216
Blazer		
1994	8 Cyl. 6.5L	SS-337

		Part No.
Starter Solenoid		
Blazer		
1989-1988	8 Cyl. 6.2L; 4 Term.	SS-200
C10		
1982	8 Cyl. 6.2L; 4 Term.	SS-200
C10 Suburban		
1986	8 Cyl. 6.2L; 4 Term.; 12 Volt	SS-200
1985	8 Cyl. 6.2L; 12 Volt	SS-200
1984	8 Cyl. 6.2L; 24 Volt; OE No. 1113591, 1998454	SS-367
1984-1982	8 Cyl. 6.2L; 4 Term.; 12 Volt	SS-200
C20		
1982	8 Cyl. 6.2L; 4 Term.	SS-200
C20 Suburban		
1986-1982	8 Cyl. 6.2L; 4 Term.	SS-200
1985-1984	8 Cyl. 6.2L; 24 Volt; OE No. 1113591, 1998454	SS-367
C30		
1982	8 Cyl. 6.2L; 4 Term.	SS-200
C70		
1985-1983	8 Cyl.	SS-318
C1500		
1998-1994	8 Cyl. 6.5L; Diesel	SS-337
1993-1992	8 Cyl. 6.2L; Diesel	SS-337
1991-1990	8 Cyl. 6.2L; 4 Term.	SS-200
C1500 Suburban		
1999-1995	8 Cyl. 6.5L; Diesel	SS-337
C2500		
2000-1992	8 Cyl. 6.5L; Diesel	SS-337
1993-1992	8 Cyl. 6.2L; Diesel	SS-337
1991-1990	8 Cyl. 6.2L; 4 Term.	SS-200
C2500 Suburban		
1999-1994	8 Cyl. 6.5L; Diesel	SS-337
C3500		
2000-1992	8 Cyl. 6.5L; Diesel	SS-337
1993-1992	8 Cyl. 6.2L; Diesel	SS-337
1991-1990	8 Cyl. 6.2L; 4 Term.	SS-200
C3500HD		
2002-1992	8 Cyl. 6.5L	SS-337
Celebrity		
1985-1983	6 Cyl. 4.3L	SS-306
1982	6 Cyl. 4.3L	SS-251
Chevette		
1986-1983	4 Cyl. 1.8L; Diesel	SS-300
1982	4 Cyl. 1.8L	SS-300
1981	4 Cyl. 1.8L; Diesel	SS-300
Express 2500		
2010-2008	8 Cyl. 6.6L	SS868
2007-2006	8 Cyl. 6.6L	SS874
2002-1996	8 Cyl. 6.5L	SS-337
Express 3500		
2010-2008	8 Cyl. 6.6L	SS868
2007-2006	8 Cyl. 6.6L	SS874
2002-1996	8 Cyl. 6.5L	SS-337
G20		
1995-1994	8 Cyl. 6.5L	SS-337
1993-1992	8 Cyl. 6.2L	SS-337
1991-1983	8 Cyl. 6.2L; 4 Term.; 12 Volt	SS-200
1985-1984	8 Cyl. 6.2L; 24 Volt; OE No. 1113591, 1998454	SS-367
G30		
1996-1994	8 Cyl. 6.5L	SS-337
1993-1992	8 Cyl. 6.2L	SS-337
1991	8 Cyl. 6.2L; 4 Term.; 12 Volt	SS-200

Starting and Charging System Parts

		Part No.
Starter Solenoid		
G30		
1990	8 Cyl. 6.2L; 12 Volt	SS-200
1989-1983	8 Cyl. 6.2L; 4 Term.; 12 Volt	SS-200
1985-1984	8 Cyl. 6.2L; 24 Volt; OE No. 1113591, 1998454	SS-367
K5 Blazer		
1985-1984	8 Cyl. 6.2L; 24 Volt; OE No. 1113591, 1998454	SS-367
K10		
1982	8 Cyl. 6.2L; 4 Term.	SS-200
K10 Suburban		
1986-1982	8 Cyl. 6.2L; 4 Term.; 12 Volt	SS-200
1985-1984	8 Cyl. 6.2L; 24 Volt; OE No. 1113591, 1998454	SS-367
K20		
1982	8 Cyl. 6.2L; 4 Term.	SS-200
K20 Suburban		
1985-1984	8 Cyl. 6.2L; 24 Volt; OE No. 1113591, 1998454	SS-367
1985-1982	8 Cyl. 6.2L; 4 Term.; 12 Volt	SS-200
K30		
1982	8 Cyl. 6.2L; 4 Term.	SS-200
K1500		
1998-1994	8 Cyl. 6.5L; Diesel	SS-337
1993-1992	8 Cyl. 6.2L; Diesel	SS-337
1991-1990	8 Cyl. 6.2L; 4 Term.	SS-200
K1500 Suburban		
1999-1995	8 Cyl. 6.5L; Diesel	SS-337
K2500		
2000-1992	8 Cyl. 6.5L	SS-337
1993-1992	8 Cyl. 6.2L	SS-337
1991-1990	8 Cyl. 6.2L; 4 Term.	SS-200
K2500 Suburban		
1999	8 Cyl. 6.5L	SS-337
1998	8 Cyl. 6.5L; Diesel	SS-337
1997	8 Cyl. 6.5L	SS-337
1996-1994	8 Cyl. 6.5L; Diesel	SS-337
K3500		
2000-1992	8 Cyl. 6.5L	SS-337
1993-1992	8 Cyl. 6.2L	SS-337
1991-1990	8 Cyl. 6.2L; 4 Term.	SS-200
P20		
1989-1982	8 Cyl. 6.2L; 4 Term.; 12 Volt	SS-200
1985-1984	8 Cyl. 6.2L; 24 Volt; OE No. 1113591, 1998454	SS-367
P30		
1999-1994	8 Cyl. 6.5L	SS-337
1993-1982	8 Cyl. 6.2L; 4 Term.; 12 Volt	SS-200
1985-1984	8 Cyl. 6.2L; 24 Volt; OE No. 1113591, 1998454	SS-367
R20 Suburban		
1988-1987	8 Cyl. 6.2L; 4 Term.	SS-200
R1500 Suburban		
1991-1989	8 Cyl. 6.2L; 4 Term.	SS-200
R2500 Suburban		
1991	8 Cyl. 6.2L; 4 Term.	SS-200
R3500		
1991-1990	8 Cyl. 6.2L; 4 Term.	SS-200
Silverado 3500		
2006-2005	8 Cyl. 6.6L	SS868
2004-2001	8 Cyl. 6.6L	SS869
Silverado 3500 Classic		
2007	8 Cyl. 6.6L	SS868

		Part No.
Starter Solenoid		
Silverado 3500 HD		
2010-2007	8 Cyl. 6.6L	SS868
T6500		
2001-1999	Starter Mounted	SS-357
T7500		
2001-1999	Starter Mounted	SS-357
Tahoe		
1999-1995	8 Cyl. 6.5L; Diesel	SS-337
V10 Suburban		
1988-1987	8 Cyl. 6.2L; 4 Term.	SS-200
V20 Suburban		
1988	8 Cyl. 6.2L; 4 Term.	SS-200
V1500 Suburban		
1991-1989	8 Cyl. 6.2L; 4 Term.	SS-200
V2500 Suburban		
1991-1990	8 Cyl. 6.2L; 4 Term.	SS-200
V3500		
1991-1990	8 Cyl. 6.2L; 4 Term.	SS-200
Voltage Regulator		
Blazer		
1994	8 Cyl. 6.5L	VR-472
C10		
1984-1982	8 Cyl. 6.2L	VR-111
1981-1980	8 Cyl. 5.7L	VR-111
C10 Suburban		
1984	8 Cyl. 6.2L	VR-111
1982	8 Cyl. 6.2L	VR-111
C20		
1984-1982	8 Cyl. 6.2L	VR-111
C20 Suburban		
1982	8 Cyl. 6.2L	VR-111
C30		
1984-1982	8 Cyl. 6.2L	VR-111
C1500		
1998-1996	8 Cyl. 6.5L	VR-472
C1500 Suburban		
1999-1998	8 Cyl. 6.5L	VR-472
1995	8 Cyl. 6.5L	VR-472
C2500		
2000-1994	8 Cyl. 6.5L	VR-472
C2500 Suburban		
1999-1994	8 Cyl. 6.5L	VR-472
C3500		
2000-1994	8 Cyl. 6.5L	VR-472
C3500HD		
2000-1994	8 Cyl. 6.5L	VR-472
K5 Blazer		
1984-1982	8 Cyl. 6.2L	VR-111
K10		
1984-1982	8 Cyl. 6.2L	VR-111
K10 Suburban		
1984	8 Cyl. 6.2L	VR-111
1982	8 Cyl. 6.2L	VR-111
K20		
1984-1982	8 Cyl. 6.2L	VR-111
K20 Suburban		
1982	8 Cyl. 6.2L	VR-111
K30		
1984-1982	8 Cyl. 6.2L	VR-111
K1500		
1998-1996	8 Cyl. 6.5L	VR-472

Chevrolet

Starting and Charging System Parts

		Part No.
Voltage Regulator		
K1500 Suburban		
1999-1995	8 Cyl. 6.5L	VR-472
K2500		
2000-1994	8 Cyl. 6.5L	VR-472
K2500 Suburban		
1999-1994	8 Cyl. 6.5L	VR-472
K3500		
2000-1994	8 Cyl. 6.5L	VR-472
P20		
1984-1982	8 Cyl. 6.2L	VR-111
P30		
1997-1994	8 Cyl. 6.5L	VR-472
1984-1982	8 Cyl. 6.2L	VR-111
S10		
1984-1983	4 Cyl. 2.2L	VR-111
S10 Blazer		
1984	4 Cyl. 2.2L	VR-111
Tahoe		
1999-1995	8 Cyl. 6.5L	VR-472
Air Injection and Induction Parts		
Diesel Air Intake Heater		
C4500 Kodiak		
2009-2006	8 Cyl. 6.6L	DIH12
2004-2003	8 Cyl. 6.6L	DIH4
C5500 Kodiak		
2009-2006	8 Cyl. 6.6L	DIH12
2004-2003	8 Cyl. 6.6L	DIH4
Express 2500		
2016-2011	8 Cyl. 6.6L	DIH6
2010	8 Cyl. 6.6L; 6	DIH12
2010	8 Cyl. 6.6L; L	DIH6
2009-2006	8 Cyl. 6.6L	DIH12
Express 3500		
2016-2011	8 Cyl. 6.6L	DIH6
2010	8 Cyl. 6.6L; 6	DIH12
2010	8 Cyl. 6.6L; L	DIH6
2009-2006	8 Cyl. 6.6L	DIH12
Express 4500		
2009	8 Cyl. 6.6L	DIH12
Silverado 2500 HD		
2016-2011	8 Cyl. 6.6L	DIH5
2010-2007	8 Cyl. 6.6L	DIH7
2006	8 Cyl. 6.6L	DIH8
2004-2001	8 Cyl. 6.6L	DIH4
Silverado 3500		
2006	8 Cyl. 6.6L	DIH8
2004-2001	8 Cyl. 6.6L	DIH4
Silverado 3500 Classic		
2007	8 Cyl. 6.6L	DIH8
Silverado 3500 HD		
2016-2011	8 Cyl. 6.6L	DIH5
2010-2007	8 Cyl. 6.6L	DIH7
Fuel Injection Throttle Body		
Cruze		
2015-2014	4 Cyl. 2.0L; Diesel	S20091
Express 2500		
2016-2009	8 Cyl. 6.6L	S20063
Express 3500		
2016-2009	8 Cyl. 6.6L	S20063
Silverado 2500 HD		
2013-2011	8 Cyl. 6.6L; Diesel	S20084

		Part No.
Fuel Injection Throttle Body		
Silverado 2500 HD		
2010-2007	8 Cyl. 6.6L	S20430
Silverado 3500 HD		
2013-2011	8 Cyl. 6.6L; Diesel	S20084
2010-2007	8 Cyl. 6.6L	S20430
Manifold Air Tube		
C10		
1985-1984	8 Cyl. 6.2L; Left	AT132
1981	8 Cyl. 5.7L; Right	AT126
1981	8 Cyl. 5.7L; Left	AT132
1980	8 Cyl. 5.7L; Right	AT123
1980	8 Cyl. 5.7L; Left	AT148
C10 Suburban		
1985-1984	8 Cyl. 6.2L; Left	AT132
C20		
1985	8 Cyl. 6.2L; Left	AT178
1984	8 Cyl. 6.2L; Diesel	AT132
1983	8 Cyl. 6.2L; J; Right	AT142
1983	8 Cyl. 6.2L; J; Left	AT178
C20 Suburban		
1985	8 Cyl. 6.2L; Left	AT178
1984	8 Cyl. 6.2L; Left	AT132
C30		
1985-1984	8 Cyl. 6.2L; Left	AT132
C60		
1990	8 Cyl. 8.2L; Right	AT146
Caprice		
1982	8 Cyl.; Left	AT101
1982	8 Cyl.; Right	AT111
1981	8 Cyl. 5.7L; Left	AT101
1981	8 Cyl. 5.7L; U.S. Models; Right	AT111
1981	8 Cyl. 5.7L; Export; Right	AT187
1980	8 Cyl. 5.7L; Right	AT126
Impala		
1982-1981	8 Cyl.; Left	AT101
1981	8 Cyl.; Right	AT111
K5 Blazer		
1985-1984	8 Cyl. 6.2L; Left	AT132
K10		
1985-1984	8 Cyl. 6.2L; Left	AT132
K10 Suburban		
1985-1984	8 Cyl. 6.2L; Left	AT132
K20		
1985-1984	8 Cyl. 6.2L; Left	AT132
K20 Suburban		
1985-1984	8 Cyl. 6.2L; Left	AT132
K30		
1985-1984	8 Cyl. 6.2L; Left	AT132
K3500		
1990	8 Cyl. 6.2L; Right	AT165
Malibu		
1982	8 Cyl. 5.7L; Left	AT101
Monte Carlo		
1984	8 Cyl.; Left	AT101
1984	8 Cyl.; Right	AT111
1982	8 Cyl.; Left	AT101
1982	8 Cyl.; Right	AT111
Turbocharger - New		
Blazer		
1994	8 Cyl. 6.5L; Turbocharged	TBC689
C1500		
1998-1996	8 Cyl. 6.5L; Turbocharged	TBC690

Air Injection and Induction Parts

		Part No.
Turbocharger - New		
C1500		
1995-1994	8 Cyl. 6.5L; S; Turbocharged	TBC689
C1500 Suburban		
1999-1997	8 Cyl. 6.5L; Turbocharged	TBC690
1995	8 Cyl. 6.5L; Turbocharged	TBC689
C2500		
2000-1996	8 Cyl. 6.5L; Turbocharged	TBC690
1995-1994	8 Cyl. 6.5L; S; Turbocharged	TBC689
C2500 Suburban		
1999-1997	8 Cyl. 6.5L; Turbocharged	TBC690
1995-1994	8 Cyl. 6.5L; Turbocharged	TBC689
C3500		
2000-1996	8 Cyl. 6.5L; Turbocharged	TBC690
1995-1994	8 Cyl. 6.5L; Turbocharged	TBC689
C3500HD		
2002-1996	8 Cyl. 6.5L; Turbocharged	TBC690
1995	8 Cyl. 6.5L; F; Turbocharged	TBC689
Cruze		
2015-2014	4 Cyl. 2.0L	TBC543
Express 2500		
2002-1996	8 Cyl. 6.5L; Turbocharged	TBC689
Express 3500		
2002-1996	8 Cyl. 6.5L; Turbocharged	TBC689
K1500		
1998-1996	8 Cyl. 6.5L; Turbocharged	TBC690
1995-1994	8 Cyl. 6.5L; S; Turbocharged	TBC689
K1500 Suburban		
1999-1997	8 Cyl. 6.5L; Turbocharged	TBC690
1995	8 Cyl. 6.5L; Turbocharged	TBC689
K2500		
2000-1996	8 Cyl. 6.5L; Turbocharged	TBC690
1995-1994	8 Cyl. 6.5L; S; Turbocharged	TBC689
K2500 Suburban		
1999-1997	8 Cyl. 6.5L; Turbocharged	TBC690
1995-1994	8 Cyl. 6.5L; Turbocharged	TBC689
K3500		
2000-1996	8 Cyl. 6.5L; Turbocharged	TBC690
1995-1994	8 Cyl. 6.5L; Turbocharged	TBC689
P30		
1999-1994	8 Cyl. 6.5L; Turbocharged	TBC689
Silverado 2500 HD		
2004	8 Cyl. 6.6L; 1; Fed.; Turbocharged	TBC705
2003-2002	8 Cyl. 6.6L; Fed.; Turbocharged	TBC705
Silverado 3500		
2004	8 Cyl. 6.6L; 1; Fed.; Turbocharged	TBC705
2003-2002	8 Cyl. 6.6L; Fed.; Turbocharged	TBC705
Tahoe		
1995	8 Cyl. 6.5L; Turbocharged	TBC689
Turbocharger - Remfd		
Blazer		
1994	8 Cyl. 6.5L; Turbocharged	TBC-516
C1500		
1998-1996	8 Cyl. 6.5L; Turbocharged	TBC-517
1995-1994	8 Cyl. 6.5L; S; Turbocharged	TBC-516
C1500 Suburban		
1999-1997	8 Cyl. 6.5L; Turbocharged	TBC-517
1995	8 Cyl. 6.5L; Turbocharged	TBC-516
C2500		
2000-1996	8 Cyl. 6.5L; Turbocharged	TBC-517
1995-1994	8 Cyl. 6.5L; S; Turbocharged	TBC-516
C2500 Suburban		
1999-1997	8 Cyl. 6.5L; Turbocharged	TBC-517

		Part No.
Turbocharger - Remfd		
C2500 Suburban		
1995-1994	8 Cyl. 6.5L; Turbocharged	TBC-516
C3500		
2000-1996	8 Cyl. 6.5L; Turbocharged	TBC-517
1995-1994	8 Cyl. 6.5L; Turbocharged	TBC-516
C3500HD		
2002-1996	8 Cyl. 6.5L; Turbocharged	TBC-517
1995	8 Cyl. 6.5L; F; Turbocharged	TBC-516
Express 2500		
2011	8 Cyl. 6.6L; Turbocharged	TBC577
2010	8 Cyl. 6.6L; 6; Turbocharged	TBC563
2010	8 Cyl. 6.6L; L; Turbocharged	TBC577
2009-2008	8 Cyl. 6.6L; Turbocharged	TBC563
2007	8 Cyl. 6.6L; 2; Turbocharged	TBC561
2007	8 Cyl. 6.6L; 6; Turbocharged	TBC563
2006	8 Cyl. 6.6L; Turbocharged	TBC561
2002-1996	8 Cyl. 6.5L; Turbocharged	TBC-516
Express 3500		
2011	8 Cyl. 6.6L; Turbocharged	TBC577
2010	8 Cyl. 6.6L; 6; Turbocharged	TBC563
2010	8 Cyl. 6.6L; L; Turbocharged	TBC577
2009-2008	8 Cyl. 6.6L; Turbocharged	TBC563
2007	8 Cyl. 6.6L; 2; Turbocharged	TBC561
2007	8 Cyl. 6.6L; 6; Turbocharged	TBC563
2006	8 Cyl. 6.6L; Turbocharged	TBC561
2002-1996	8 Cyl. 6.5L; Turbocharged	TBC-516
Express 4500		
2011	8 Cyl. 6.6L; Turbocharged	TBC577
2010	8 Cyl. 6.6L; 6; Turbocharged	TBC563
2010	8 Cyl. 6.6L; L; Turbocharged	TBC577
2009	8 Cyl. 6.6L; Turbocharged	TBC563
K1500		
1998-1996	8 Cyl. 6.5L; Turbocharged	TBC-517
1995-1994	8 Cyl. 6.5L; S; Turbocharged	TBC-516
K1500 Suburban		
1999-1997	8 Cyl. 6.5L; Turbocharged	TBC-517
1995	8 Cyl. 6.5L; Turbocharged	TBC-516
K2500		
2000-1996	8 Cyl. 6.5L; Turbocharged	TBC-517
1995-1994	8 Cyl. 6.5L; S; Turbocharged	TBC-516
K2500 Suburban		
1999-1997	8 Cyl. 6.5L; Turbocharged	TBC-517
1995-1994	8 Cyl. 6.5L; Turbocharged	TBC-516
K3500		
2000-1996	8 Cyl. 6.5L; Turbocharged	TBC-517
1995-1994	8 Cyl. 6.5L; Turbocharged	TBC-516
P30		
1999-1994	8 Cyl. 6.5L; Turbocharged	TBC-516
Silverado 2500 HD		
2016-2013	8 Cyl. 6.6L; Turbocharged	TBC603
2012-2011	8 Cyl. 6.6L; 8; Turbocharged	TBC603
2010-2007	8 Cyl. 6.6L; Turbocharged	TBC563
2006	8 Cyl. 6.6L; Turbocharged	TBC561
2005	8 Cyl. 6.6L; Turbocharged	TBC562
2004	8 Cyl. 6.6L; 1; Calif.; Turbocharged	TBC573
2004	8 Cyl. 6.6L; 1; Fed.; Turbocharged	TBC574
2004	8 Cyl. 6.6L; 2; Turbocharged	TBC562
2003-2002	8 Cyl. 6.6L; Calif.; Turbocharged	TBC573
2003-2002	8 Cyl. 6.6L; Fed.; Turbocharged	TBC574
Silverado 2500 HD Classic		
2007	8 Cyl. 6.6L; Turbocharged	TBC561
Silverado 3500		
2006	8 Cyl. 6.6L; Turbocharged	TBC561

Chevrolet

Air Injection and Induction Parts

		Part No.
Turbocharger - Remfd		
Silverado 3500		
2005	8 Cyl. 6.6L; Turbocharged	TBC562
2004	8 Cyl. 6.6L; 1; Calif.; Turbocharged	TBC573
2004	8 Cyl. 6.6L; 1; Fed.; Turbocharged	TBC574
2004	8 Cyl. 6.6L; 2; Turbocharged	TBC562
2003-2002	8 Cyl. 6.6L; Calif.; Turbocharged	TBC573
2003-2002	8 Cyl. 6.6L; Fed.; Turbocharged	TBC574
Silverado 3500 Classic		
2007	8 Cyl. 6.6L; Turbocharged	TBC561
Silverado 3500 HD		
2016-2013	8 Cyl. 6.6L; Turbocharged	TBC603
2012-2011	8 Cyl. 6.6L; 8; Turbocharged	TBC603
2010-2007	8 Cyl. 6.6L; Turbocharged	TBC563
Tahoe		
1995	8 Cyl. 6.5L; Turbocharged	TBC-516
Vacuum Motor		
Blazer		
1988	8 Cyl.	VA5
C10		
1981-1980	8 Cyl. 5.7L	VA5
C10 Suburban		
1980	8 Cyl. 5.7L	VA5
Caprice		
1981	8 Cyl. 5.7L	VA5
El Camino		
1984	8 Cyl. 5.7L	VA6
1983	8 Cyl. 5.7L	VA5
Impala		
1981	8 Cyl. 5.7L	VA5
P20		
1988	8 Cyl.	VA5
1985	8 Cyl.	VA5
P30		
1988	8 Cyl.	VA5
R20		
1988	8 Cyl.	VA5
R30		
1988	8 Cyl.	VA5
V30		
1988	8 Cyl.	VA5
Vacuum Pump		
C4500 Kodiak		
2009-2008	8 Cyl. 6.6L	VCP113
C5500 Kodiak		
2009-2008	8 Cyl. 6.6L	VCP113
Celebrity		
1985-1984	6 Cyl. 4.3L; Coupe or Sedan; w/ AC	VCP100
1983-1982	6 Cyl. 4.3L; w/ AC	VCP100
Cruze		
2015-2014	4 Cyl. 2.0L	VCP150
Express 2500		
2016-2006	8 Cyl. 6.6L	VCP113
Express 3500		
2016-2006	8 Cyl. 6.6L	VCP113
K1500		
1991-1988	8 Cyl. 6.2L; w/o Speed Sensor; Rear of Engine	VCP101
1991-1988	8 Cyl. 6.2L; w/ Manual AC; Front of Engine	VCP108
1991-1988	8 Cyl. 6.2L; w/ Auto. AC; Front of Engine	VCP114

		Part No.
Air Management Valves		
Air Cleaner Check Valve		
C1500		
1998	8 Cyl. 6.5L	AV7
C1500 Suburban		
1998	8 Cyl. 6.5L	AV7
C3500HD		
2000	8 Cyl. 6.5L; Mounted on Air Tube	AV56
K10 Suburban		
1985	8 Cyl. 6.2L	AV7
K20 Suburban		
1985	8 Cyl. 6.2L	AV7
K1500		
1998	8 Cyl. 6.5L	AV7
K2500		
1989-1988	8 Cyl. 6.2L	AV7
K3500		
1999-1998	8 Cyl. 6.5L	AV7
Malibu		
1983-1982	8 Cyl.	AV7
P30		
1984-1982	8 Cyl. 6.2L	AV7
Diverter Valve		
C10		
1986	8 Cyl. 6.2L; Diesel; w/o Deceleration Valve	DV32
1985-1983	8 Cyl.; w/ Deceleration Valve	DV28
1984-1983	8 Cyl.; w/o Deceleration Valve	DV33
1982-1980	8 Cyl.	DV66
C20		
1985-1983	8 Cyl.; w/ Deceleration Valve	DV28
1984-1983	8 Cyl.; w/o Deceleration Valve	DV33
1982	8 Cyl.	DV66
C30		
1986	8 Cyl. 6.2L; Diesel; w/ Deceleration Valve	DV28
1985-1983	8 Cyl.; w/ Deceleration Valve	DV28
1984-1983	8 Cyl.; w/o Deceleration Valve	DV33
1982	8 Cyl.	DV66
Express 2500		
2001	8 Cyl. 6.5L	DV130
Express 3500		
2001	8 Cyl. 6.5L	DV130
G20		
1984	8 Cyl. 6.2L	DV33
G30		
1984	8 Cyl. 6.2L	DV33
K5 Blazer		
1985	8 Cyl.; w/o Deceleration Valve	DV32
1985-1983	8 Cyl.; w/ Deceleration Valve	DV28
1984	8 Cyl.; w/o Deceleration Valve	DV33
1982	8 Cyl.	DV66
K10		
1986	8 Cyl. 6.2L; Diesel; w/o Deceleration Valve	DV32
1985-1983	8 Cyl.; w/ Deceleration Valve	DV28
1984-1983	8 Cyl.; w/o Deceleration Valve	DV33
1982	8 Cyl.	DV66
K20		
1985-1983	8 Cyl.; w/ Deceleration Valve	DV28
1984-1983	8 Cyl.; w/o Deceleration Valve	DV33
1982	8 Cyl.	DV66
K30		
1986	8 Cyl. 6.2L; Diesel	DV28

Air Management Valves

		Part No.
Diverter Valve		
K30		
1985-1983	8 Cyl.; w/ Deceleration Valve	DV28
1984-1983	8 Cyl.; w/o Deceleration Valve	DV33
1982	8 Cyl.	DV66
Idle Air Control Valve		
Caprice		
1985	8 Cyl. 5.7L	AC1
1984-1982	8 Cyl. 5.7L	AC2
El Camino		
1984	8 Cyl. 5.7L	AC2
Impala		
1985	8 Cyl. 5.7L	AC1
1984-1982	8 Cyl. 5.7L	AC2
Malibu		
1983-1982	8 Cyl. 5.7L	AC2
Monte Carlo		
1984-1982	8 Cyl. 5.7L	AC2
Turbocharger Actuator		
C4500 Kodiak		
2009-2006	8 Cyl. 6.6L; Turbocharged	TBA2
C5500 Kodiak		
2009-2006	8 Cyl. 6.6L; Turbocharged	TBA2
Express 2500		
2016-2006	8 Cyl. 6.6L; Turbocharged	TBA2
Express 3500		
2016-2006	8 Cyl. 6.6L; Turbocharged	TBA2
Express 4500		
2016-2009	8 Cyl. 6.6L; Turbocharged	TBA2
Silverado 2500 HD		
2016-2006	8 Cyl. 6.6L; Turbocharged	TBA2
Silverado 3500		
2006	8 Cyl. 6.6L; Turbocharged	TBA2
Silverado 3500 HD		
2016-2007	8 Cyl. 6.6L; Turbocharged	TBA2
Vacuum Delay Valve		
C10		
1981-1980	8 Cyl. 5.7L; 4 Ports; Black and Red	DSV11
1981-1980	8 Cyl. 5.7L; 4 Ports; Black and White	DSV16
1981-1980	8 Cyl. 5.7L; 2 Ports; Black and Yellow	DSV19
C10 Suburban		
1980	8 Cyl. 5.7L; 4 Ports; Black and Red	DSV11
1980	8 Cyl. 5.7L; 4 Ports; Black and White	DSV16
1980	8 Cyl. 5.7L; 2 Ports; Black and Yellow	DSV19
Caprice		
1981	8 Cyl. 5.7L; 2 Ports; Black and White	DSV15
1981-1980	8 Cyl. 5.7L; Black and Green	DSV6
1980	8 Cyl. 5.7L; Black and White	DSV15
El Camino		
1984	8 Cyl. 5.7L; Black and Gray; Diesel	DSV14
1984-1983	8 Cyl. 5.7L; Black and Yellow; Diesel	DSV19
1983	8 Cyl. 5.7L; 4 Ports; Black and White; Diesel	DSV16
Impala		
1981	8 Cyl. 5.7L; 2 Ports; Black and White	DSV15
1981-1980	8 Cyl. 5.7L; Black and Green	DSV6
1980	8 Cyl. 5.7L; Black and White	DSV15
Air Management Regulators and Solenoids		
Idle Stop Solenoid		
Blazer		
1991-1987	8 Cyl. 6.2L; Diesel	ES155

		Part No.
Idle Stop Solenoid		
C10		
1981	8 Cyl. 5.7L; Diesel	ES118
1981-1980	8 Cyl. 5.7L; Spade Term., w/o Bracket	ES9
1980	8 Cyl. 5.7L; Spade Term. Connector; w/ Bracket	ES110
C10 Suburban		
1980	8 Cyl. 5.7L; Diesel	ES118
C20		
1986-1982	8 Cyl. 6.2L; Diesel	ES155
C30		
1986-1982	8 Cyl. 6.2L; Diesel	ES155
C1500		
1988	8 Cyl. 6.2L; Diesel	ES155
C2500		
1988	8 Cyl. 6.2L; Diesel	ES155
C3500		
1989-1988	8 Cyl. 6.2L; Diesel	ES155
Caprice		
1985	8 Cyl. 5.7L	ES110
1983-1982	8 Cyl. 5.7L	ES118
1981	8 Cyl. 5.7L; Diesel	ES118
1980	8 Cyl. 5.7L; Diesel; Stamping No. 22507441, 22511974	ES118
Chevette		
1986-1985	4 Cyl.; Secondary	ES56
1986-1985	4 Cyl.; Primary	ES62
El Camino		
1983	8 Cyl. 5.7L	ES118
G20		
1988-1986	8 Cyl. 6.2L; Diesel	ES155
1985	8 Cyl. 6.2L; Control	ES155
1984-1983	8 Cyl. 6.2L; Diesel	ES155
G30		
1989-1983	8 Cyl. 6.2L; Diesel	ES155
Impala		
1985-1984	8 Cyl. 5.7L	ES110
1983-1980	8 Cyl. 5.7L; Diesel	ES118
K5 Blazer		
1986-1982	8 Cyl. 6.2L; Diesel	ES155
K10		
1986-1982	8 Cyl. 6.2L; Diesel	ES155
K10 Suburban		
1986	8 Cyl. 6.2L; Diesel	ES155
K20		
1986-1982	8 Cyl. 6.2L; Diesel	ES155
K30		
1986-1982	8 Cyl. 6.2L; Diesel	ES155
K1500		
1988	8 Cyl. 6.2L; Diesel	ES155
K2500		
1988	8 Cyl. 6.2L; Diesel	ES155
K3500		
1989-1988	8 Cyl. 6.2L; Diesel	ES155
LUV		
1982	4 Cyl.; Calif.	ES58
1982	4 Cyl.; Fed.	ES59
Malibu		
1983	8 Cyl. 5.7L	ES118
1982	8 Cyl. 5.7L; Diesel	ES118
Monte Carlo		
1983-1982	8 Cyl. 5.7L; Diesel	ES118

Chevrolet

Air Management Regulators and Solenoids

		Part No.
Idle Stop Solenoid		
P20		
1989-1982	8 Cyl. 6.2L; Diesel	ES155
P30		
1989-1982	8 Cyl. 6.2L; Diesel	ES155
R10		
1987	8 Cyl. 6.2L; Diesel	ES155
R20		
1988-1987	8 Cyl. 6.2L; Diesel	ES155
R2500		
1989	8 Cyl. 6.2L	ES155
Turbocharger Boost Solenoid		
Blazer		
1994	8 Cyl. 6.5L; Diesel; w/ Vent Filter	U43001
1994	8 Cyl. 6.5L; w/o Vent Filter	VS62
C1500		
1997-1994	8 Cyl. 6.5L; Diesel; w/ Vent Filter	U43001
1997-1994	8 Cyl. 6.5L; w/o Vent Filter	VS62
C1500 Suburban		
1997	8 Cyl. 6.5L; 1st Design	VS62
1996-1995	8 Cyl. 6.5L	VS62
C2500		
1997-1994	8 Cyl. 6.5L; Diesel; w/ Vent Filter	U43001
1997-1994	8 Cyl. 6.5L; w/o Vent Filter	VS62
C2500 Suburban		
1997-1994	8 Cyl. 6.5L	VS62
C3500		
1997-1994	8 Cyl. 6.5L; Diesel; w/ Vent Filter	U43001
1997-1994	8 Cyl. 6.5L; w/o Vent Filter	VS62
C3500HD		
1997-1994	8 Cyl. 6.5L; Diesel; w/ Vent Filter	U43001
1997-1994	8 Cyl. 6.5L; w/o Vent Filter	VS62
Express 2500		
1997-1996	8 Cyl. 6.5L; Diesel; w/ Vent Filter	U43001
1997-1996	8 Cyl. 6.5L; w/o Vent Filter	VS62
Express 3500		
1997-1996	8 Cyl. 6.5L; Diesel; w/ Vent Filter	U43001
1997-1996	8 Cyl. 6.5L; w/o Vent Filter	VS62
G30		
1996	8 Cyl. 6.5L; Diesel; w/ Vent Filter	U43001
1996	8 Cyl. 6.5L	VS62
K1500		
1997-1994	8 Cyl. 6.5L; Diesel; w/ Vent Filter	U43001
1997-1994	8 Cyl. 6.5L; w/o Vent Filter	VS62
K1500 Suburban		
1997-1995	8 Cyl. 6.5L; Diesel; w/ Vent Filter	U43001
1997-1995	8 Cyl. 6.5L	VS62
K2500		
1997-1994	8 Cyl. 6.5L; Diesel; w/ Vent Filter	U43001
1997-1994	8 Cyl. 6.5L; w/o Vent Filter	VS62
K2500 Suburban		
1997-1994	8 Cyl. 6.5L	VS62
K3500		
1997-1994	8 Cyl. 6.5L; Diesel; w/ Vent Filter	U43001
1997-1994	8 Cyl. 6.5L; w/o Vent Filter	VS62
P30		
1997-1994	8 Cyl. 6.5L; Diesel; w/ Vent Filter	U43001
1997-1994	8 Cyl. 6.5L; w/o Vent Filter	VS62
Tahoe		
1997-1995	8 Cyl. 6.5L; Diesel; w/ Vent Filter	U43001
1997-1995	8 Cyl. 6.5L; w/o Vent Filter	VS62

		Part No.
Early Fuel Emission Control		
Air Cleaner Inlet Hose		
Caprice		
1985	8 Cyl. 5.7L	DH40
1984-1983	8 Cyl. 5.7L; N	DH40
1982	8 Cyl. 5.7L	DH40
Celebrity		
1983	6 Cyl. 4.3L; 1st Design	DH34
1982	6 Cyl. 4.3L	DH34
Chevette		
1986-1981	4 Cyl.	DH24
Impala		
1985-1983	8 Cyl. 5.7L	DH40
1982	8 Cyl. 5.7L; N	DH40
Crankcase Ventilation Filter		
C1500		
1990-1988	8 Cyl.	BF11
C2500		
1990	8 Cyl.	BF11
C3500		
1990	8 Cyl.	BF11
Caprice		
1981-1980	8 Cyl. 5.7L	BF11
El Camino		
1984	8 Cyl.	BF11
Impala		
1981-1980	8 Cyl. 5.7L	BF11
K1500		
1990	8 Cyl.	BF11
K2500		
1990	8 Cyl.	BF11
K3500		
1990	8 Cyl.	BF11
R10		
1987	8 Cyl.	BF11
R20		
1987	8 Cyl.	BF11
R30		
1987	8 Cyl.	BF11
V10		
1987	8 Cyl.	BF11
V20		
1987	8 Cyl.	BF11
V30		
1987	8 Cyl.	BF11
EGR Components		
Diesel EGR Cooler		
C4500 Kodiak		
2009-2008	8 Cyl. 6.6L	ECK6
2007	8 Cyl. 6.6L; 2	ECK4
2007	8 Cyl. 6.6L; 9	ECK6
2006	8 Cyl. 6.6L	ECK4
2005-2004	8 Cyl. 6.6L	ECK5
C5500 Kodiak		
2009-2008	8 Cyl. 6.6L	ECK6
2007	8 Cyl. 6.6L; 2	ECK4
2007	8 Cyl. 6.6L; 9	ECK6
2006	8 Cyl. 6.6L	ECK4
2005-2004	8 Cyl. 6.6L	ECK5
Express 2500		
2010	8 Cyl. 6.6L; 6	ECK3
2009-2008	8 Cyl. 6.6L	ECK3

EGR Components

		Part No.
Diesel EGR Cooler		
Express 2500		
2007	8 Cyl. 6.6L; 6	ECK3
Express 3500		
2010	8 Cyl. 6.6L; 6	ECK3
2009-2008	8 Cyl. 6.6L	ECK3
2007	8 Cyl. 6.6L; 6	ECK3
Express 4500		
2010	8 Cyl. 6.6L; 6	ECK3
2009	8 Cyl. 6.6L	ECK3
Silverado 2500 HD		
2010-2007	8 Cyl. 6.6L	ECK2
2006	8 Cyl. 6.6L	ECK4
2005-2004	8 Cyl. 6.6L	ECK5
Silverado 2500 HD Classic		
2007	8 Cyl. 6.6L	ECK4
Silverado 3500		
2006	8 Cyl. 6.6L	ECK4
2005-2004	8 Cyl. 6.6L	ECK5
Silverado 3500 Classic		
2007	8 Cyl. 6.6L	ECK4
Silverado 3500 HD		
2010-2007	8 Cyl. 6.6L	ECK2
EGR Control Solenoid		
Blazer		
1994	8 Cyl. 6.5L; w/ White Dot	VS36
1994	8 Cyl. 6.5L; w/ Red Dot	VS37
1991-1988	8 Cyl. 6.2L	VS39
C1500		
1998	8 Cyl. 6.5L; Exc. Calif.	VS76
1997	8 Cyl. 6.5L; Exc. Vent Filter Cover; w/ Red Dot	VS37
1997	8 Cyl. 6.5L; w/ Vent Filter Cover	VS76
1996-1994	8 Cyl. 6.5L; w/ White Dot	VS36
1996-1994	8 Cyl. 6.5L; w/ Red Dot	VS37
1993-1988	8 Cyl. 6.2L	VS39
C1500 Suburban		
1999-1998	8 Cyl. 6.5L	VS64
1997	8 Cyl. 6.5L; 2nd Design; Exc. Calif.; w/ Vent Filter Cover	VS76
1996	8 Cyl. 6.5L; w/ Red Dot	VS37
1996-1995	8 Cyl. 6.5L; w/ White Dot	VS36
C2500		
2000	8 Cyl. 6.5L	VS64
1998	8 Cyl. 6.5L; w/ White Dot	VS76
1997	8 Cyl. 6.5L	VS37
1996-1994	8 Cyl. 6.5L; w/ White Dot	VS36
1996-1994	8 Cyl. 6.5L; w/ Red Dot	VS37
1993-1988	8 Cyl. 6.2L	VS39
C2500 Suburban		
1998	8 Cyl. 6.5L; Exc. Calif.	VS76
1997	8 Cyl. 6.5L; 2nd Design; Exc. Calif.; w/ Vent Filter Cover	VS76
1996	8 Cyl. 6.5L; w/ Red Dot	VS37
1996-1995	8 Cyl. 6.5L; w/ White Dot	VS36
C3500		
2000	8 Cyl. 6.5L	VS64
1998	8 Cyl. 6.5L; Exc. Calif.	VS76
1997	8 Cyl. 6.5L; 2nd Design; Exc. Calif.; w/ Vent Filter Cover	VS76
C3500HD		
2000	8 Cyl. 6.5L	VS64
1998	8 Cyl. 6.5L; Exc. Calif.	VS76

		Part No.
EGR Control Solenoid		
C3500HD		
1997	8 Cyl. 6.5L; 2nd Design; Exc. Calif.; w/ Vent Filter Cover	VS76
Express 2500		
2010-2007	8 Cyl. 6.6L	VS154
1998	8 Cyl. 6.5L; Exc. Calif.	VS76
1997	8 Cyl. 6.5L; 2nd Design; Exc. Calif.; w/ Vent Filter Cover	VS76
Express 3500		
2010-2007	8 Cyl. 6.6L	VS154
1998	8 Cyl. 6.5L; Exc. Calif.	VS76
1997	8 Cyl. 6.5L; 2nd Design; Exc. Calif.; w/ Vent Filter Cover	VS76
G20		
1995-1994	8 Cyl. 6.5L; w/ White Dot	VS36
1995-1994	8 Cyl. 6.5L; w/ Red Dot	VS37
K1500		
1998-1997	8 Cyl. 6.5L; OE No. 1997254; w/ White Dot	VS76
1997-1996	8 Cyl. 6.5L; OE No. 1997226; w/ White Dot	VS36
1997-1994	8 Cyl. 6.5L; w/ Red Dot	VS37
1995-1994	8 Cyl. 6.5L; w/ White Dot	VS36
1993-1988	8 Cyl. 6.2L	VS39
K1500 Suburban		
1999-1998	8 Cyl. 6.5L	VS64
1997	8 Cyl. 6.5L; 2nd Design; Exc. Calif.; w/ Vent Filter Cover	VS76
1996	8 Cyl. 6.5L; w/ Red Dot	VS37
1996-1995	8 Cyl. 6.5L; w/ White Dot	VS36
K2500		
2000	8 Cyl. 6.5L	VS64
1999-1997	8 Cyl. 6.5L; OE No. 1997254; w/ White Dot	VS76
1997-1996	8 Cyl. 6.5L; OE No. 1997226; w/ White Dot	VS36
1997-1994	8 Cyl. 6.5L; w/ Red Dot	VS37
1995-1994	8 Cyl. 6.5L; w/ White Dot	VS36
1993-1988	8 Cyl. 6.2L	VS39
K2500 Suburban		
1998	8 Cyl. 6.5L; Exc. Calif.	VS76
1997	8 Cyl. 6.5L; 2nd Design; Exc. Calif.; w/ Vent Filter Cover	VS76
1996	8 Cyl. 6.5L; w/ Red Dot	VS37
1996-1995	8 Cyl. 6.5L; w/ White Dot	VS36
K3500		
2000	8 Cyl. 6.5L	VS64
1998	8 Cyl. 6.5L; Exc. Calif.	VS76
1997	8 Cyl. 6.5L; 2nd Design; Exc. Calif.; w/ Vent Filter Cover	VS76
P30		
1998	8 Cyl. 6.5L; Exc. Calif.	VS76
1997	8 Cyl. 6.5L; 2nd Design; Exc. Calif.; w/ Vent Filter Cover	VS76
1994	8 Cyl. 6.5L; F	VS37
Silverado 2500 HD		
2007-2006	8 Cyl. 6.6L	VS154
2004-2002	8 Cyl. 6.6L	VS76
Silverado 3500		
2006	8 Cyl. 6.6L	VS154
2004-2002	8 Cyl. 6.6L	VS76
Silverado 3500 Classic		
2007	8 Cyl. 6.6L	VS154
Silverado 3500 HD		
2007	8 Cyl. 6.6L	VS154

Chevrolet

EGR Components

		Part No.
EGR Control Solenoid		
Tahoe		
1999	8 Cyl. 6.5L; w/ Red Dot	VS64
1999-1998	8 Cyl. 6.5L; w/ White Dot	VS76
1998-1997	8 Cyl. 6.5L; OE No. 1997225; w/ Red Dot	VS37
1998-1997	8 Cyl. 6.5L; OE No. 1997253; w/ Red Dot	VS64
1997	8 Cyl. 6.5L; OE No. 1997254; w/ White Dot	VS76
1996-1995	8 Cyl. 6.5L; w/ White Dot	VS36
1996-1995	8 Cyl. 6.5L; w/ Red Dot	VS37
EGR Valve		
Blazer		
1994	8 Cyl. 6.5L; w/ A.T.	EGV512
1991-1987	8 Cyl. 6.2L	EGV511
C10		
1986	8 Cyl. 6.2L; Federal	EGV511
1985-1983	8 Cyl. 6.2L	EGV511
1982	8 Cyl. 6.2L; C	EGV511
1980	8 Cyl. 5.7L; Calif.; OE No. 17063337, 338	EGV635
1980	8 Cyl. 5.7L; Fed.; OE No. 17063366, 367	EGV677
C10 Suburban		
1986-1985	8 Cyl. 6.2L	EGV511
1980	8 Cyl. 5.7L; OE No. 17063338	EGV635
C20		
1985-1982	8 Cyl. 6.2L	EGV511
C20 Suburban		
1986-1985	8 Cyl. 6.2L	EGV511
C1500		
1996	8 Cyl. 6.5L	EGV512
1995-1994	8 Cyl. 6.5L; P	EGV511
1995-1994	8 Cyl. 6.5L; S	EGV512
1993-1988	8 Cyl. 6.2L	EGV511
C2500		
1998-1994	8 Cyl. 6.5L; S	EGV512
1995-1994	8 Cyl. 6.5L; P	EGV511
1993-1988	8 Cyl. 6.2L	EGV511
Caprice		
1985-1982	8 Cyl. 5.7L	EGV435
1980	8 Cyl. 5.7L; N; OE No. 17064141	EGV653
Colorado		
2020-2016	4 Cyl. 2.8L; Kit; w/ Plastic Housing	EGV1294
2019-2016	4 Cyl. 2.8L; w/o Plastic Housing	EGV1282
Cruze		
2019-2017	4 Cyl. 1.6L	EGV1288
2015-2014	4 Cyl. 2.0L	EGV1280
Express 2500		
2019-2017	4 Cyl. 2.8L; Kit; w/ Plastic Housing	EGV1294
2013-2011	8 Cyl. 6.6L	EGV1219
2010	8 Cyl. 6.6L; 6; Exhaust stock and reorder	EGV1200
2010	8 Cyl. 6.6L; 6; Alternate Number	EGV803
2009-2006	8 Cyl. 6.6L	EGV803
Express 3500		
2019-2017	4 Cyl. 2.8L; Kit; w/ Plastic Housing	EGV1294
2016	8 Cyl. 6.6L	EGV1219
2014-2011	8 Cyl. 6.6L	EGV1219
2010	8 Cyl. 6.6L; 6; Exhaust stock and reorder	EGV1200
2010	8 Cyl. 6.6L; 6; Alternate Number	EGV803
2010	8 Cyl. 6.6L; L	EGV1219
2009-2006	8 Cyl. 6.6L	EGV803
Express 4500		
2016	8 Cyl. 6.6L	EGV1219
2014-2011	8 Cyl. 6.6L	EGV1219
2010	8 Cyl. 6.6L; 6; Exhaust stock and reorder	EGV1200
2010	8 Cyl. 6.6L; 6; Alternate Number	EGV803

		Part No.
EGR Valve		
Express 4500		
2010	8 Cyl. 6.6L; L	EGV1219
2009	8 Cyl. 6.6L; Exhaust stock and reorder	EGV1200
2009	8 Cyl. 6.6L; Alternate Number	EGV803
G20		
1995-1994	8 Cyl. 6.5L	EGV511
1993-1983	8 Cyl. 6.2L	EGV511
G30		
1984	8 Cyl. 6.2L; C	EGV511
Impala		
1985-1983	8 Cyl. 5.7L	EGV435
1982	8 Cyl. 5.7L; Calif.	EGV435
1982	8 Cyl. 5.7L; Fed.	EGV679
1981	8 Cyl. 5.7L; OE No. 17062705, 17075615	EGV435
1980	8 Cyl. 5.7L; OE No. 17064141	EGV653
K5 Blazer		
1986-1982	8 Cyl. 6.2L	EGV511
K10		
1986-1982	8 Cyl. 6.2L	EGV511
K10 Suburban		
1986	8 Cyl. 6.2L	EGV511
K20		
1986-1985	8 Cyl. 6.2L	EGV511
1984-1982	8 Cyl. 6.2L; C	EGV511
K1500		
1998-1997	8 Cyl. 6.5L; S	EGV512
1996	8 Cyl. 6.5L	EGV512
1995-1994	8 Cyl. 6.5L; P	EGV511
1995-1994	8 Cyl. 6.5L; S	EGV512
1993-1988	8 Cyl. 6.2L	EGV511
K2500		
1998	8 Cyl. 6.5L	EGV512
1997	8 Cyl. 6.5L; S	EGV512
1995-1994	8 Cyl. 6.5L; P	EGV511
1995-1994	8 Cyl. 6.5L; S	EGV512
1993-1991	8 Cyl. 6.2L; C	EGV511
1990-1988	8 Cyl. 6.2L	EGV511
R10		
1987	8 Cyl. 6.2L	EGV511
R10 Suburban		
1988-1987	8 Cyl. 6.2L	EGV511
R20		
1988-1987	8 Cyl. 6.2L	EGV511
R20 Suburban		
1988-1987	8 Cyl. 6.2L	EGV511
R30		
1988-1987	8 Cyl. 6.2L	EGV511
R1500 Suburban		
1991-1989	8 Cyl. 6.2L	EGV511
R2500		
1989	8 Cyl. 6.2L	EGV511
R2500 Suburban		
1991-1989	8 Cyl. 6.2L	EGV511
R3500		
1991-1989	8 Cyl. 6.2L	EGV511
Silverado 2500 HD		
2019-2017	8 Cyl. 6.6L	EGV1289
2016-2011	8 Cyl. 6.6L	EGV1240
2010-2006	8 Cyl. 6.6L	EGV1142
2005	8 Cyl. 6.6L	EGV801
2004	8 Cyl. 6.6L; 1	EGV802
2004	8 Cyl. 6.6L; 2	EGV801

EGR Components

		Part No.
EGR Valve		
Silverado 2500 HD		
2003-2002	8 Cyl. 6.6L	EGV802
Silverado 3500		
2006	8 Cyl. 6.6L	EGV1142
2005	8 Cyl. 6.6L	EGV801
2004-2002	8 Cyl. 6.6L	EGV802
Silverado 3500 Classic		
2007	8 Cyl. 6.6L	EGV1142
Silverado 3500 HD		
2019-2017	8 Cyl. 6.6L	EGV1289
2016-2011	8 Cyl. 6.6L	EGV1240
2010-2007	8 Cyl. 6.6L	EGV1142
Tahoe		
1999-1996	8 Cyl. 6.5L	EGV512
1995	8 Cyl. 6.5L; w/ A.T.	EGV512
V10		
1987	8 Cyl. 6.2L	EGV511
V10 Suburban		
1988-1987	8 Cyl. 6.2L	EGV511
V20		
1987	8 Cyl. 6.2L; C	EGV511
V20 Suburban		
1988	8 Cyl. 6.2L	EGV511
V1500 Suburban		
1991-1989	8 Cyl. 6.2L	EGV511
V2500 Suburban		
1991-1989	8 Cyl. 6.2L	EGV511
EGR Valve Mounting Gasket		
Blazer		
1994	8 Cyl. 6.5L; EGR Valve	VG44
1994	8 Cyl. 6.5L; EGR Pipe	VG61
1991-1987	8 Cyl. 6.2L	VG44
C10		
1986-1982	8 Cyl. 6.2L	VG44
1981-1980	8 Cyl. 5.7L	VG7
C10 Suburban		
1986-1985	8 Cyl. 6.2L	VG7
1980	8 Cyl. 5.7L	VG7
C20		
1986-1982	8 Cyl. 6.2L	VG44
C20 Suburban		
1986-1985	8 Cyl. 6.2L	VG7
C30		
1986-1982	8 Cyl. 6.2L	VG44
C1500		
1996	8 Cyl. 6.5L; EGR Valve	VG44
1996	8 Cyl. 6.5L; EGR Pipe	VG61
1995-1994	8 Cyl. 6.5L; P	VG44
1995-1994	8 Cyl. 6.5L; S; EGR Valve	VG44
1995-1994	8 Cyl. 6.5L; S; EGR Pipe	VG61
1993-1988	8 Cyl. 6.2L	VG44
C2500		
1998-1994	8 Cyl. 6.5L; S; EGR Valve	VG44
1998-1994	8 Cyl. 6.5L; S; EGR Pipe	VG61
1995-1994	8 Cyl. 6.5L; P	VG44
1993-1988	8 Cyl. 6.2L	VG44
C2500 Suburban		
1997-1996	8 Cyl. 6.5L	VG44
C3500		
1993-1988	8 Cyl. 6.2L	VG44
Caprice		
1985	8 Cyl. 5.7L	VG7

		Part No.
EGR Valve Mounting Gasket		
Caprice		
1984	8 Cyl. 5.7L; Federal	VG7
1983-1982	8 Cyl. 5.7L	VG7
1980	8 Cyl. 5.7L	VG7
El Camino		
1984-1983	8 Cyl. 5.7L	VG7
Express 2500		
2016-2011	8 Cyl. 6.6L; Intake	VG246
2016-2011	8 Cyl. 6.6L; EGR to Cooler	VG247
2010	8 Cyl. 6.6L; 6	VG257
2009	8 Cyl. 6.6L; Diesel	VG257
2008-2006	8 Cyl. 6.6L; EGR to Cooler	VG123
2008-2006	8 Cyl. 6.6L; By Middle of EGR	VG125
2008-2006	8 Cyl. 6.6L; EGR To Intake Pipe	VG126
Express 3500		
2016-2011	8 Cyl. 6.6L; Intake	VG246
2016-2011	8 Cyl. 6.6L; EGR to Cooler	VG247
2010	8 Cyl. 6.6L; 6	VG257
2009	8 Cyl. 6.6L; Diesel	VG257
2008-2006	8 Cyl. 6.6L; EGR to Cooler	VG123
2008-2006	8 Cyl. 6.6L; By Middle of EGR	VG125
2008-2006	8 Cyl. 6.6L; EGR To Intake Pipe	VG126
Express 4500		
2016-2011	8 Cyl. 6.6L; Intake	VG246
2016-2011	8 Cyl. 6.6L; EGR to Cooler	VG247
2010	8 Cyl. 6.6L; 6	VG257
2009	8 Cyl. 6.6L	VG257
G20		
1995-1994	8 Cyl. 6.5L	VG44
1993-1983	8 Cyl. 6.2L	VG44
G30		
1987-1983	8 Cyl. 6.2L	VG44
Impala		
1985-1980	8 Cyl. 5.7L	VG7
K5 Blazer		
1986-1982	8 Cyl. 6.2L	VG44
K10		
1986-1982	8 Cyl. 6.2L	VG44
K10 Suburban		
1986	8 Cyl. 6.2L	VG44
1985	8 Cyl. 6.2L	VG7
K20		
1986-1982	8 Cyl. 6.2L	VG44
K20 Suburban		
1986	8 Cyl. 6.2L; Federal	VG7
1985	8 Cyl. 6.2L	VG7
K30		
1986-1982	8 Cyl. 6.2L	VG44
K1500		
1998-1997	8 Cyl. 6.5L; S; EGR Valve	VG44
1998-1997	8 Cyl. 6.5L; S; EGR Pipe	VG61
1996	8 Cyl. 6.5L; EGR Valve	VG44
1996	8 Cyl. 6.5L; EGR Pipe	VG61
1995-1994	8 Cyl. 6.5L; P; At EGR	VG44
1995-1994	8 Cyl. 6.5L; S; At EGR	VG44
1995-1994	8 Cyl. 6.5L; S; EGR Pipe	VG61
1993-1988	8 Cyl. 6.2L	VG44
K2500		
1998	8 Cyl. 6.5L; EGR Valve	VG44
1998	8 Cyl. 6.5L; EGR Pipe	VG61
1997	8 Cyl. 6.5L; S; EGR Valve	VG44
1997	8 Cyl. 6.5L; S; EGR Pipe	VG61
1995-1994	8 Cyl. 6.5L; P	VG44

Chevrolet

EGR Components

		Part No.
EGR Valve Mounting Gasket		
K2500		
1995-1994	8 Cyl. 6.5L; S; EGR Valve	VG44
1995-1994	8 Cyl. 6.5L; S; EGR Pipe	VG61
1993-1988	8 Cyl. 6.2L	VG44
K2500 Suburban		
1997-1996	8 Cyl. 6.5L	VG44
K3500		
1993-1988	8 Cyl. 6.2L	VG44
R10		
1987	8 Cyl. 6.2L	VG44
R10 Suburban		
1988	8 Cyl. 6.2L	VG7
R20		
1988-1987	8 Cyl. 6.2L	VG44
R20 Suburban		
1988	8 Cyl. 6.2L	VG7
R30		
1988-1987	8 Cyl. 6.2L	VG44
R1500 Suburban		
1991-1989	8 Cyl. 6.2L	VG7
R2500		
1989	8 Cyl. 6.2L	VG44
R2500 Suburban		
1991-1989	8 Cyl. 6.2L	VG7
R3500		
1991-1989	8 Cyl. 6.2L	VG44
Silverado 2500 HD		
2016-2011	8 Cyl. 6.6L; Intake	VG246
2016-2011	8 Cyl. 6.6L; EGR to Cooler	VG247
2010-2009	8 Cyl. 6.6L	VG257
2008-2006	8 Cyl. 6.6L; EGR to Cooler	VG123
2008-2006	8 Cyl. 6.6L; By Middle of EGR	VG125
2008-2006	8 Cyl. 6.6L; EGR To Intake Pipe	VG126
2005	8 Cyl. 6.6L; EGR Pipe; By Middle of EGR	VG121
2005	8 Cyl. 6.6L; w/ EGR Valve	VG123
2005	8 Cyl. 6.6L; EGR Pipe; At EGR	VG124
2004	8 Cyl. 6.6L; 1; Back of EGR valve	VG120
2004	8 Cyl. 6.6L; 1; Bottom of EGR Valve	VG122
2004	8 Cyl. 6.6L; 2; EGR Pipe; By Middle of EGR	VG121
2004	8 Cyl. 6.6L; 2; w/ EGR Valve	VG123
2004	8 Cyl. 6.6L; 2; EGR Pipe; At EGR	VG124
2003-2002	8 Cyl. 6.6L; Back of EGR valve	VG120
2003-2002	8 Cyl. 6.6L; Bottom of EGR Valve	VG122
Silverado 3500		
2006	8 Cyl. 6.6L; EGR to Cooler	VG123
2006	8 Cyl. 6.6L; By Middle of EGR	VG125
2006	8 Cyl. 6.6L; EGR To Intake Pipe	VG126
2005	8 Cyl. 6.6L; EGR Pipe; By Middle of EGR	VG121
2005	8 Cyl. 6.6L; w/ EGR Valve	VG123
2005	8 Cyl. 6.6L; EGR Pipe; At EGR	VG124
2004-2002	8 Cyl. 6.6L; Back of EGR valve	VG120
2004-2002	8 Cyl. 6.6L; Bottom of EGR Valve	VG122
Silverado 3500 Classic		
2007	8 Cyl. 6.6L; EGR to Cooler	VG123
2007	8 Cyl. 6.6L; By Middle of EGR	VG125
2007	8 Cyl. 6.6L; EGR To Intake Pipe	VG126
Silverado 3500 HD		
2016-2011	8 Cyl. 6.6L; Intake	VG246
2016-2011	8 Cyl. 6.6L; EGR to Cooler	VG247
2010-2009	8 Cyl. 6.6L	VG257
2008-2007	8 Cyl. 6.6L; EGR to Cooler	VG123
2008-2007	8 Cyl. 6.6L; By Middle of EGR	VG125

		Part No.
EGR Valve Mounting Gasket		
Silverado 3500 HD		
2008-2007	8 Cyl. 6.6L; EGR To Intake Pipe	VG126
Tahoe		
1999-1995	8 Cyl. 6.5L; EGR Valve	VG44
1999-1995	8 Cyl. 6.5L; EGR Pipe	VG61
V10		
1987	8 Cyl. 6.2L	VG44
V10 Suburban		
1988	8 Cyl. 6.2L	VG7
V20		
1987	8 Cyl. 6.2L	VG44
V20 Suburban		
1988	8 Cyl. 6.2L	VG7
V30		
1988-1987	8 Cyl. 6.2L	VG44
V1500 Suburban		
1991-1989	8 Cyl. 6.2L	VG7
V2500 Suburban		
1991-1989	8 Cyl. 6.2L	VG7
V3500		
1991-1989	8 Cyl. 6.2L	VG44
Exhaust Components		
Diesel Emission Fluid Injection Nozzle		
Cruze		
2015-2014	4 Cyl. 2.0L	DFI6
Express 2500		
2016-2011	8 Cyl. 6.6L	DFI2
2010	8 Cyl. 6.6L; L	DFI2
Express 3500		
2016-2011	8 Cyl. 6.6L	DFI2
2010	8 Cyl. 6.6L; L	DFI2
Express 4500		
2016-2011	8 Cyl. 6.6L	DFI2
2010	8 Cyl. 6.6L; L	DFI2
Silverado 2500 HD		
2016-2011	8 Cyl. 6.6L	DFI2
Silverado 3500 HD		
2016-2011	8 Cyl. 6.6L	DFI2
Diesel Emissions Fluid Pump		
Cruze		
2015-2014	4 Cyl. 2.0L; Diesel	DFIP2
Express 2500		
2016-2010	8 Cyl. 6.6L	DFIP2
Express 3500		
2016-2010	8 Cyl. 6.6L	DFIP2
Express 4500		
2016-2010	8 Cyl. 6.6L	DFIP2
Silverado 2500 HD		
2016-2011	8 Cyl. 6.6L	DFIP2
Silverado 3500 HD		
2016-2011	8 Cyl. 6.6L	DFIP2
Diesel Emissions Fluid Temperature Sensor		
Cruze		
2015-2014	4 Cyl. 2.0L	DFS1
Express 2500		
2016-2010	8 Cyl. 6.6L	DFS1
Express 3500		
2016-2010	8 Cyl. 6.6L	DFS1
Express 4500		
2016-2010	8 Cyl. 6.6L	DFS1

Exhaust Components

		Part No.
Diesel Emissions Fluid Temperature Sensor		
Silverado 2500 HD		
2016-2011	8 Cyl. 6.6L	DFS1
Silverado 3500 HD		
2016-2011	8 Cyl. 6.6L	DFS1
Diesel Exhaust Fluid (DEF) Heater		
Express 2500		
2016-2012	8 Cyl. 6.6L	DFH107
Express 3500		
2016-2012	8 Cyl. 6.6L	DFH107
Express 4500		
2016-2012	8 Cyl. 6.6L	DFH107
Silverado 2500 HD		
2016-2012	8 Cyl. 6.6L	DFH106
Silverado 3500 HD		
2016-2012	8 Cyl. 6.6L	DFH106
PCV Systems		
PCV Grommet		
C10		
1986-1982	8 Cyl. 6.2L; 23/32 Inch Inner Dia. x 1 1/4 Inch Outer Dia.	GV13
1986-1982	8 Cyl. 6.2L; 7/16 Inch Inner Dia. x 1 1/4 Inch Outer Dia.	GV16
1986-1982	8 Cyl. 6.2L; 7/16 Inch Inner Dia. x 1 3/4 Inch Outer Dia.	GV18
1986-1982	8 Cyl. 6.2L; 11/16 Inch Inner Dia. x 1 3/16 Inch Outer Dia.	GV5
1986-1982	8 Cyl. 6.2L; 1 Inch Inner Dia. x 1 1/2 Inch Outer Dia.	GV6
1986-1982	8 Cyl. 6.2L; 23/32 Inch Inner Dia. x 1 Inch Outer Dia.	GV9
1980	8 Cyl. 5.7L	GV9
C10 Suburban		
1986-1982	8 Cyl. 6.2L; 23/32 Inch Inner Dia. x 1 1/4 Inch Outer Dia.	GV13
1986-1982	8 Cyl. 6.2L; 7/16 Inch Inner Dia. x 1 1/4 Inch Outer Dia.	GV16
1986-1982	8 Cyl. 6.2L; 7/16 Inch Inner Dia. x 1 3/4 Inch Outer Dia.	GV18
1986-1982	8 Cyl. 6.2L; 11/16 Inch Inner Dia. x 1 3/16 Inch Outer Dia.	GV5
1986-1982	8 Cyl. 6.2L; 1 Inch Inner Dia. x 1 1/2 Inch Outer Dia.	GV6
1986-1982	8 Cyl. 6.2L; 23/32 Inch Inner Dia. x 1 Inch Outer Dia.	GV9
1980	8 Cyl. 5.7L	GV9
C20		
1986-1982	8 Cyl. 6.2L; 23/32 Inch Inner Dia. x 1 1/4 Inch Outer Dia.	GV13
1986-1982	8 Cyl. 6.2L; 7/16 Inch Inner Dia. x 1 1/4 Inch Outer Dia.	GV16
1986-1982	8 Cyl. 6.2L; 7/16 Inch Inner Dia. x 1 3/4 Inch Outer Dia.	GV18
1986-1982	8 Cyl. 6.2L; 11/16 Inch Inner Dia. x 1 3/16 Inch Outer Dia.	GV5
1986-1982	8 Cyl. 6.2L; 1 Inch Inner Dia. x 1 1/2 Inch Outer Dia.	GV6
1986-1982	8 Cyl. 6.2L; 23/32 Inch Inner Dia. x 1 Inch Outer Dia.	GV9
C20 Suburban		
1986-1982	8 Cyl. 6.2L; 23/32 Inch Inner Dia. x 1 1/4 Inch Outer Dia.	GV13
1986-1982	8 Cyl. 6.2L; 7/16 Inch Inner Dia. x 1 1/4 Inch Outer Dia.	GV16
1986-1982	8 Cyl. 6.2L; 7/16 Inch Inner Dia. x 1 3/4 Inch Outer Dia.	GV18

		Part No.
PCV Grommet		
C20 Suburban		
1986-1982	8 Cyl. 6.2L; 11/16 Inch Inner Dia. x 1 3/16 Inch Outer Dia.	GV5
1986-1982	8 Cyl. 6.2L; 1 Inch Inner Dia. x 1 1/2 Inch Outer Dia.	GV6
1986-1982	8 Cyl. 6.2L; 23/32 Inch Inner Dia. x 1 Inch Outer Dia.	GV9
C30		
1986-1982	8 Cyl. 6.2L; 23/32 Inch Inner Dia. x 1 1/4 Inch Outer Dia.	GV13
1986-1982	8 Cyl. 6.2L; 7/16 Inch Inner Dia. x 1 1/4 Inch Outer Dia.	GV16
1986-1982	8 Cyl. 6.2L; 7/16 Inch Inner Dia. x 1 3/4 Inch Outer Dia.	GV18
1986-1982	8 Cyl. 6.2L; 11/16 Inch Inner Dia. x 1 3/16 Inch Outer Dia.	GV5
1986-1982	8 Cyl. 6.2L; 1 Inch Inner Dia. x 1 1/2 Inch Outer Dia.	GV6
1986-1982	8 Cyl. 6.2L; 23/32 Inch Inner Dia. x 1 Inch Outer Dia.	GV9
C60		
1989-1988	8 Cyl. 8.2L; 23/32 Inch Inner Dia. x 1 1/4 Inch Outer Dia.	GV13
1989-1988	8 Cyl. 8.2L; 7/16 Inch Inner Dia. x 1 1/4 Inch Outer Dia.	GV16
1989-1988	8 Cyl. 8.2L; 7/16 Inch Inner Dia. x 1 3/4 Inch Outer Dia.	GV18
1989-1988	8 Cyl. 8.2L; 11/16 Inch Inner Dia. x 1 3/16 Inch Outer Dia.	GV5
1989-1988	8 Cyl. 8.2L; 1 Inch Inner Dia. x 1 1/2 Inch Outer Dia.	GV6
1989-1988	8 Cyl. 8.2L; 23/32 Inch Inner Dia. x 1 Inch Outer Dia.	GV9
C70		
1989-1988	8 Cyl. 10.4L; 23/32 Inch Inner Dia. x 1 1/4 Inch Outer Dia.	GV13
1989-1988	8 Cyl. 8.2L; 23/32 Inch Inner Dia. x 1 1/4 Inch Outer Dia.	GV13
1989-1988	8 Cyl. 10.4L; 7/16 Inch Inner Dia. x 1 1/4 Inch Outer Dia.	GV16
1989-1988	8 Cyl. 8.2L; 7/16 Inch Inner Dia. x 1 1/4 Inch Outer Dia.	GV16
1989-1988	8 Cyl. 10.4L; 7/16 Inch Inner Dia. x 1 3/4 Inch Outer Dia.	GV18
1989-1988	8 Cyl. 8.2L; 7/16 Inch Inner Dia. x 1 3/4 Inch Outer Dia.	GV18
1989-1988	8 Cyl. 10.4L; 11/16 Inch Inner Dia. x 1 3/16 Inch Outer Dia.	GV5
1989-1988	8 Cyl. 8.2L; 11/16 Inch Inner Dia. x 1 3/16 Inch Outer Dia.	GV5
1989-1988	8 Cyl. 10.4L; 1 Inch Inner Dia. x 1 1/2 Inch Outer Dia.	GV6
1989-1988	8 Cyl. 8.2L; 1 Inch Inner Dia. x 1 1/2 Inch Outer Dia.	GV6
1989-1988	8 Cyl. 10.4L; 23/32 Inch Inner Dia. x 1 Inch Outer Dia.	GV9
1989-1988	8 Cyl. 8.2L; 23/32 Inch Inner Dia. x 1 Inch Outer Dia.	GV9
C1500		
1990	8 Cyl. 6.2L; 11/16 Inch Inner Dia. x 1 3/16 Inch Outer Dia.	GV5
1990	8 Cyl. 6.2L; 1 Inch Inner Dia. x 1 1/2 Inch Outer Dia.	GV6
1990	8 Cyl. 6.2L; 23/32 Inch Inner Dia. x 1 Inch Outer Dia.	GV9
C2500		
1990	8 Cyl. 6.2L; 11/16 Inch Inner Dia. x 1 3/16 Inch Outer Dia.	GV5

Chevrolet

PCV Systems

		Part No.
PCV Grommet		
C2500		
1990	8 Cyl. 6.2L; 1 Inch Inner Dia. x 1 1/2 Inch Outer Dia.	GV6
1990	8 Cyl. 6.2L; 23/32 Inch Inner Dia. x 1 Inch Outer Dia.	GV9
C3500		
1990	8 Cyl. 6.2L; 11/16 Inch Inner Dia. x 1 3/16 Inch Outer Dia.	GV5
1990	8 Cyl. 6.2L; 1 Inch Inner Dia. x 1 1/2 Inch Outer Dia.	GV6
1990	8 Cyl. 6.2L; 23/32 Inch Inner Dia. x 1 Inch Outer Dia.	GV9
Caprice		
1984-1981	8 Cyl. 5.7L; 23/32 Inch Inner Dia. x 1 1/4 Inch Outer Dia.	GV13
1984-1981	8 Cyl. 5.7L; 7/16 Inch Inner Dia. x 1 1/4 Inch Outer Dia.	GV16
1984-1981	8 Cyl. 5.7L; 7/16 Inch Inner Dia. x 1 3/4 Inch Outer Dia.	GV18
1984-1981	8 Cyl. 5.7L; 11/16 Inch Inner Dia. x 1 3/16 Inch Outer Dia.	GV5
1984-1981	8 Cyl. 5.7L; 1 Inch Inner Dia. x 1 1/2 Inch Outer Dia.	GV6
1984-1981	8 Cyl. 5.7L; 23/32 Inch Inner Dia. x 1 Inch Outer Dia.	GV9
Celebrity		
1985	6 Cyl. 4.3L; 23/32 Inch Inner Dia. x 1 1/4 Inch Outer Dia.	GV13
1985	6 Cyl. 4.3L; 7/16 Inch Inner Dia. x 1 1/4 Inch Outer Dia.	GV16
1985	6 Cyl. 4.3L; 7/16 Inch Inner Dia. x 1 3/4 Inch Outer Dia.	GV18
1985	6 Cyl. 4.3L; 11/16 Inch Inner Dia. x 1 3/16 Inch Outer Dia.	GV5
1985	6 Cyl. 4.3L; 1 Inch Inner Dia. x 1 1/2 Inch Outer Dia.	GV6
1985	6 Cyl. 4.3L; 23/32 Inch Inner Dia. x 1 Inch Outer Dia.	GV9
1984-1982	6 Cyl.	GV9
Chevette		
1986-1981	4 Cyl. 1.8L; 23/32 Inch Inner Dia. x 1 1/4 Inch Outer Dia.	GV13
1986-1981	4 Cyl. 1.8L; 7/16 Inch Inner Dia. x 1 1/4 Inch Outer Dia.	GV16
1986-1981	4 Cyl. 1.8L; 7/16 Inch Inner Dia. x 1 3/4 Inch Outer Dia.	GV18
1986-1981	4 Cyl. 1.8L; 11/16 Inch Inner Dia. x 1 3/16 Inch Outer Dia.	GV5
1986-1981	4 Cyl. 1.8L; 1 Inch Inner Dia. x 1 1/2 Inch Outer Dia.	GV6
1986-1981	4 Cyl. 1.8L; 23/32 Inch Inner Dia. x 1 Inch Outer Dia.	GV9
El Camino		
1984-1983	8 Cyl. 5.7L; 23/32 Inch Inner Dia. x 1 1/4 Inch Outer Dia.	GV13
1984-1983	8 Cyl. 5.7L; 7/16 Inch Inner Dia. x 1 1/4 Inch Outer Dia.	GV16
1984-1983	8 Cyl. 5.7L; 7/16 Inch Inner Dia. x 1 3/4 Inch Outer Dia.	GV18
1984-1983	8 Cyl. 5.7L; 11/16 Inch Inner Dia. x 1 3/16 Inch Outer Dia.	GV5
1984-1983	8 Cyl. 5.7L; 1 Inch Inner Dia. x 1 1/2 Inch Outer Dia.	GV6
1984-1983	8 Cyl. 5.7L; 23/32 Inch Inner Dia. x 1 Inch Outer Dia.	GV9
G20		
1986-1983	8 Cyl. 6.2L; 23/32 Inch Inner Dia. x 1 1/4 Inch Outer Dia.	GV13

		Part No.
PCV Grommet		
G20		
1986-1983	8 Cyl. 6.2L; 7/16 Inch Inner Dia. x 1 1/4 Inch Outer Dia.	GV16
1986-1983	8 Cyl. 6.2L; 7/16 Inch Inner Dia. x 1 3/4 Inch Outer Dia.	GV18
1986-1983	8 Cyl. 6.2L; 11/16 Inch Inner Dia. x 1 3/16 Inch Outer Dia.	GV5
1986-1983	8 Cyl. 6.2L; 1 Inch Inner Dia. x 1 1/2 Inch Outer Dia.	GV6
1986-1983	8 Cyl. 6.2L; 23/32 Inch Inner Dia. x 1 Inch Outer Dia.	GV9
G30		
1986-1983	8 Cyl. 6.2L; 23/32 Inch Inner Dia. x 1 1/4 Inch Outer Dia.	GV13
1986-1983	8 Cyl. 6.2L; 7/16 Inch Inner Dia. x 1 1/4 Inch Outer Dia.	GV16
1986-1983	8 Cyl. 6.2L; 7/16 Inch Inner Dia. x 1 3/4 Inch Outer Dia.	GV18
1986-1983	8 Cyl. 6.2L; 11/16 Inch Inner Dia. x 1 3/16 Inch Outer Dia.	GV5
1986-1983	8 Cyl. 6.2L; 1 Inch Inner Dia. x 1 1/2 Inch Outer Dia.	GV6
1986-1983	8 Cyl. 6.2L; 23/32 Inch Inner Dia. x 1 Inch Outer Dia.	GV9
Impala		
1984	8 Cyl.	GV9
1982	8 Cyl.	GV9
1981	8 Cyl. 5.7L	GV9
1980	8 Cyl. 5.7L; 23/32 Inch Inner Dia. x 1 1/4 Inch Outer Dia.	GV13
1980	8 Cyl. 5.7L; 7/16 Inch Inner Dia. x 1 1/4 Inch Outer Dia.	GV16
1980	8 Cyl. 5.7L; 7/16 Inch Inner Dia. x 1 3/4 Inch Outer Dia.	GV18
1980	8 Cyl. 5.7L; 11/16 Inch Inner Dia. x 1 3/16 Inch Outer Dia.	GV5
1980	8 Cyl. 5.7L; 1 Inch Inner Dia. x 1 1/2 Inch Outer Dia.	GV6
1980	8 Cyl. 5.7L; 23/32 Inch Inner Dia. x 1 Inch Outer Dia.	GV9
K5 Blazer		
1986-1982	8 Cyl. 6.2L; 23/32 Inch Inner Dia. x 1 1/4 Inch Outer Dia.	GV13
1986-1982	8 Cyl. 6.2L; 7/16 Inch Inner Dia. x 1 1/4 Inch Outer Dia.	GV16
1986-1982	8 Cyl. 6.2L; 7/16 Inch Inner Dia. x 1 3/4 Inch Outer Dia.	GV18
1986-1982	8 Cyl. 6.2L; 11/16 Inch Inner Dia. x 1 3/16 Inch Outer Dia.	GV5
1986-1982	8 Cyl. 6.2L; 1 Inch Inner Dia. x 1 1/2 Inch Outer Dia.	GV6
1986-1982	8 Cyl. 6.2L; 23/32 Inch Inner Dia. x 1 Inch Outer Dia.	GV9
K10		
1986-1982	8 Cyl. 6.2L; 23/32 Inch Inner Dia. x 1 1/4 Inch Outer Dia.	GV13
1986-1982	8 Cyl. 6.2L; 7/16 Inch Inner Dia. x 1 1/4 Inch Outer Dia.	GV16
1986-1982	8 Cyl. 6.2L; 7/16 Inch Inner Dia. x 1 3/4 Inch Outer Dia.	GV18
1986-1982	8 Cyl. 6.2L; 11/16 Inch Inner Dia. x 1 3/16 Inch Outer Dia.	GV5
1986-1982	8 Cyl. 6.2L; 1 Inch Inner Dia. x 1 1/2 Inch Outer Dia.	GV6
1986-1982	8 Cyl. 6.2L; 23/32 Inch Inner Dia. x 1 Inch Outer Dia.	GV9
K10 Suburban		
1986-1982	8 Cyl. 6.2L; 23/32 Inch Inner Dia. x 1 1/4 Inch Outer Dia.	GV13

Chevrolet

PCV Systems

		Part No.
PCV Grommet		
P20		
1986-1982	8 Cyl. 6.2L; 7/16 Inch Inner Dia. x 1 1/4 Inch Outer Dia.	GV16
1986-1982	8 Cyl. 6.2L; 7/16 Inch Inner Dia. x 1 3/4 Inch Outer Dia.	GV18
1986-1982	8 Cyl. 6.2L; 11/16 Inch Inner Dia. x 1 3/16 Inch Outer Dia.	GV5
1986-1982	8 Cyl. 6.2L; 1 Inch Inner Dia. x 1 1/2 Inch Outer Dia.	GV6
1986-1982	8 Cyl. 6.2L; 23/32 Inch Inner Dia. x 1 Inch Outer Dia.	GV9
P30		
1991-1990	4 Cyl. 3.9L; 11/16 Inch Inner Dia. x 1 3/16 Inch Outer Dia.	GV5
1991-1990	4 Cyl. 3.9L; 1 Inch Inner Dia. x 1 1/2 Inch Outer Dia.	GV6
1991-1990	4 Cyl. 3.9L; 23/32 Inch Inner Dia. x 1 Inch Outer Dia.	GV9
1986-1982	8 Cyl. 6.2L; 23/32 Inch Inner Dia. x 1 1/4 Inch Outer Dia.	GV13
1986-1982	8 Cyl. 6.2L; 7/16 Inch Inner Dia. x 1 1/4 Inch Outer Dia.	GV16
1986-1982	8 Cyl. 6.2L; 7/16 Inch Inner Dia. x 1 3/4 Inch Outer Dia.	GV18
1986-1982	8 Cyl. 6.2L; 11/16 Inch Inner Dia. x 1 3/16 Inch Outer Dia.	GV5
1986-1982	8 Cyl. 6.2L; 1 Inch Inner Dia. x 1 1/2 Inch Outer Dia.	GV6
1986-1982	8 Cyl. 6.2L; 23/32 Inch Inner Dia. x 1 Inch Outer Dia.	GV9
R3500		
1991-1989	8 Cyl. 6.2L; 11/16 Inch Inner Dia. x 1 3/16 Inch Outer Dia.	GV5
1991-1989	8 Cyl. 6.2L; 1 Inch Inner Dia. x 1 1/2 Inch Outer Dia.	GV6
1991-1989	8 Cyl. 6.2L; 23/32 Inch Inner Dia. x 1 Inch Outer Dia.	GV9
1989	8 Cyl. 6.2L; 23/32 Inch Inner Dia. x 1 1/4 Inch Outer Dia.	GV13
1989	8 Cyl. 6.2L; 7/16 Inch Inner Dia. x 1 1/4 Inch Outer Dia.	GV16
1989	8 Cyl. 6.2L; 7/16 Inch Inner Dia. x 1 3/4 Inch Outer Dia.	GV18
S10		
1985-1983	4 Cyl. 2.2L; 23/32 Inch Inner Dia. x 1 1/4 Inch Outer Dia.	GV13
1985-1983	4 Cyl. 2.2L; 7/16 Inch Inner Dia. x 1 1/4 Inch Outer Dia.	GV16
1985-1983	4 Cyl. 2.2L; 7/16 Inch Inner Dia. x 1 3/4 Inch Outer Dia.	GV18
1985-1983	4 Cyl. 2.2L; 11/16 Inch Inner Dia. x 1 3/16 Inch Outer Dia.	GV5
1985-1983	4 Cyl. 2.2L; 1 Inch Inner Dia. x 1 1/2 Inch Outer Dia.	GV6
1985-1983	4 Cyl. 2.2L; 23/32 Inch Inner Dia. x 1 Inch Outer Dia.	GV9
S10 Blazer		
1984	4 Cyl. 2.2L; 23/32 Inch Inner Dia. x 1 1/4 Inch Outer Dia.	GV13
1984	4 Cyl. 2.2L; 7/16 Inch Inner Dia. x 1 1/4 Inch Outer Dia.	GV16
1984	4 Cyl. 2.2L; 7/16 Inch Inner Dia. x 1 3/4 Inch Outer Dia.	GV18
1984	4 Cyl. 2.2L; 11/16 Inch Inner Dia. x 1 3/16 Inch Outer Dia.	GV5
1984	4 Cyl. 2.2L; 1 Inch Inner Dia. x 1 1/2 Inch Outer Dia.	GV6
1984	4 Cyl. 2.2L; 23/32 Inch Inner Dia. x 1 Inch Outer Dia.	GV9

		Part No.
PCV Valve		
Blazer		
1994	8 Cyl. 6.5L; 3 1/2 Inch Dia. Canister Type; Crankcase Depression Regulator Valve	V335
1991-1987	8 Cyl. 6.2L; 3 1/2 Inch Dia. Canister Type; Crankcase Depression Regulator Valve	V335
C10		
1986-1985	8 Cyl. 6.2L; Crankcase Depression Regulator Valve	V335
1981	8 Cyl. 5.7L; 1 Hose	V178
1981	8 Cyl. 5.7L; Dual Hose	V227
C10 Suburban		
1986-1985	8 Cyl. 6.2L; Crankcase Depression Regulator Valve	V335
C20		
1986-1985	8 Cyl. 6.2L; Crankcase Depression Regulator Valve	V335
C20 Suburban		
1986-1985	8 Cyl. 6.2L; Crankcase Depression Regulator Valve	V335
C30		
1986-1985	8 Cyl. 6.2L; Crankcase Depression Regulator Valve	V335
C1500		
1998-1996	8 Cyl. 6.5L	BF41
1995-1994	8 Cyl. 6.5L; 3 1/2 Inch Dia. Canister Type; Crankcase Depression Regulator Valve	V335
1993-1991	8 Cyl. 6.2L; 3 1/2 Inch Dia. Canister Type; Crankcase Depression Regulator Valve	V335
1990	8 Cyl. 6.2L	V335
1989	8 Cyl. 6.2L; 3 1/2 Inch Dia. Canister Type; Crankcase Depression Regulator Valve	V335
1988	8 Cyl. 6.2L	V335
C1500 Suburban		
1999-1996	8 Cyl. 6.5L	BF41
1995	8 Cyl. 6.5L; 3 1/2 Inch Dia. Canister Type; Crankcase Depression Regulator Valve	V335
C2500		
2000	8 Cyl. 6.5L; 3 1/2 Inch Dia. Canister Type; Crankcase Depression Regulator Valve	V335
1999	8 Cyl. 6.5L; Diesel	BF41
1998-1996	8 Cyl. 6.5L	BF41
1995-1994	8 Cyl. 6.5L; 3 1/2 Inch Dia. Canister Type; Crankcase Depression Regulator Valve	V335
1993	8 Cyl. 6.5L	V335
1993-1991	8 Cyl. 6.2L; 3 1/2 Inch Dia. Canister Type; Crankcase Depression Regulator Valve	V335
1992	8 Cyl. 6.5L; 3 1/2 Inch Dia. Canister Type; Crankcase Depression Regulator Valve	V335
1990	8 Cyl. 6.2L	V335
1989	8 Cyl. 6.2L; 3 1/2 Inch Dia. Canister Type; Crankcase Depression Regulator Valve	V335
1988	8 Cyl. 6.2L; Diesel	V335
C2500 Suburban		
1999-1996	8 Cyl. 6.5L	BF41
1995-1994	8 Cyl. 6.5L; 3 1/2 Inch Dia. Canister Type; Crankcase Depression Regulator Valve	V335
C3500		
2000	8 Cyl. 6.5L; 3 1/2 Inch Dia. Canister Type; Crankcase Depression Regulator Valve	V335
1999	8 Cyl. 6.5L; Diesel	BF41
1998-1996	8 Cyl. 6.5L	BF41
1995-1994	8 Cyl. 6.5L; 3 1/2 Inch Dia. Canister Type; Crankcase Depression Regulator Valve	V335
1993	8 Cyl. 6.5L	V335
1993-1991	8 Cyl. 6.2L; 3 1/2 Inch Dia. Canister Type; Crankcase Depression Regulator Valve	V335

PCV Systems

PCV Valve		Part No.
C3500		
1992	8 Cyl. 6.5L; 3 1/2 Inch Dia. Canister Type; Crankcase Depression Regulator Valve	V335
1990	8 Cyl. 6.2L	V335
1989-1988	8 Cyl. 6.2L; 3 1/2 Inch Dia. Canister Type; Crankcase Depression Regulator Valve	V335
C3500HD		
2001	8 Cyl. 6.5L	V335
2000	8 Cyl. 6.5L; 3 1/2 Inch Dia. Canister Type; Crankcase Depression Regulator Valve	V335
1999	8 Cyl. 6.5L; Diesel	BF41
1998-1996	8 Cyl. 6.5L	BF41
1995-1994	8 Cyl. 6.5L; 3 1/2 Inch Dia. Canister Type; Crankcase Depression Regulator Valve	V335
1993	8 Cyl. 6.5L	V335
1992	8 Cyl. 6.5L; 3 1/2 Inch Dia. Canister Type; Crankcase Depression Regulator Valve	V335
Caprice		
1984	8 Cyl. 5.7L; Police Package; U.S. Models	V178
1981-1980	8 Cyl. 5.7L; Diesel	V353
Celebrity		
1984-1982	6 Cyl.	V188
Express 2500		
2001	8 Cyl. 6.5L; Crankcase Depression Regulator Valve	V335
2000-1997	8 Cyl. 6.5L	BF41
1996	8 Cyl. 6.5L; 3 1/2 Inch Dia. Canister Type; Crankcase Depression Regulator Valve	V335
Express 3500		
2001	8 Cyl. 6.5L; Crankcase Depression Regulator Valve	V335
2000-1997	8 Cyl. 6.5L	BF41
1996	8 Cyl. 6.5L; 3 1/2 Inch Dia. Canister Type; Crankcase Depression Regulator Valve	V335
G20		
1995-1994	8 Cyl. 6.5L; 3 1/2 Inch Dia. Canister Type; Crankcase Depression Regulator Valve	V335
1993-1988	8 Cyl. 6.2L; 3 1/2 Inch Dia. Canister Type; Crankcase Depression Regulator Valve	V335
1987	8 Cyl. 6.2L	V335
1986	8 Cyl. 6.2L; Crankcase Depression Regulator Valve	V335
1985-1983	8 Cyl. 6.2L	V389
G30		
1996-1994	8 Cyl. 6.5L; 3 1/2 Inch Dia. Canister Type; Crankcase Depression Regulator Valve	V335
1993-1987	8 Cyl. 6.2L; 3 1/2 Inch Dia. Canister Type; Crankcase Depression Regulator Valve	V335
1986	8 Cyl. 6.2L; Crankcase Depression Regulator Valve	V335
1985-1983	8 Cyl. 6.2L	V389
Impala		
1981-1980	8 Cyl. 5.7L; Diesel	V353
K5 Blazer		
1986-1985	8 Cyl. 6.2L; Crankcase Depression Regulator Valve	V335
K10		
1986-1985	8 Cyl. 6.2L; Crankcase Depression Regulator Valve	V335
K10 Suburban		
1986-1985	8 Cyl. 6.2L; Crankcase Depression Regulator Valve	V335
K20		
1986-1985	8 Cyl. 6.2L; Crankcase Depression Regulator Valve	V335

PCV Valve		Part No.
K20 Suburban		
1986-1985	8 Cyl. 6.2L; Crankcase Depression Regulator Valve	V335
K30		
1986-1985	8 Cyl. 6.2L; Crankcase Depression Regulator Valve	V335
K1500		
1998-1996	8 Cyl. 6.5L	BF41
1995-1994	8 Cyl. 6.5L; 3 1/2 Inch Dia. Canister Type; Crankcase Depression Regulator Valve	V335
1993-1991	8 Cyl. 6.2L; 3 1/2 Inch Dia. Canister Type; Crankcase Depression Regulator Valve	V335
1990	8 Cyl. 6.2L	V335
1989	8 Cyl. 6.2L; 3 1/2 Inch Dia. Canister Type; Crankcase Depression Regulator Valve	V335
1988	8 Cyl. 6.2L	V335
K1500 Suburban		
1999-1996	8 Cyl. 6.5L	BF41
1995	8 Cyl. 6.5L; 3 1/2 Inch Dia. Canister Type; Crankcase Depression Regulator Valve	V335
K2500		
2000	8 Cyl. 6.5L; 3 1/2 Inch Dia. Canister Type; Crankcase Depression Regulator Valve	V335
1999	8 Cyl. 6.5L; Diesel	BF41
1998-1996	8 Cyl. 6.5L	BF41
1995-1994	8 Cyl. 6.5L; 3 1/2 Inch Dia. Canister Type; Crankcase Depression Regulator Valve	V335
1993	8 Cyl. 6.5L	V335
1993-1991	8 Cyl. 6.2L; 3 1/2 Inch Dia. Canister Type; Crankcase Depression Regulator Valve	V335
1992	8 Cyl. 6.5L; 3 1/2 Inch Dia. Canister Type; Crankcase Depression Regulator Valve	V335
1990	8 Cyl. 6.2L	V335
1989	8 Cyl. 6.2L; 3 1/2 Inch Dia. Canister Type; Crankcase Depression Regulator Valve	V335
1988	8 Cyl. 6.2L	V335
K2500 Suburban		
1999-1996	8 Cyl. 6.5L	BF41
1995-1994	8 Cyl. 6.5L; 3 1/2 Inch Dia. Canister Type; Crankcase Depression Regulator Valve	V335
K3500		
2000	8 Cyl. 6.5L; 3 1/2 Inch Dia. Canister Type; Crankcase Depression Regulator Valve	V335
1999	8 Cyl. 6.5L; Diesel	BF41
1998-1996	8 Cyl. 6.5L	BF41
1995-1994	8 Cyl. 6.5L; 3 1/2 Inch Dia. Canister Type; Crankcase Depression Regulator Valve	V335
1993	8 Cyl. 6.5L	V335
1993-1991	8 Cyl. 6.2L; 3 1/2 Inch Dia. Canister Type; Crankcase Depression Regulator Valve	V335
1992	8 Cyl. 6.5L; 3 1/2 Inch Dia. Canister Type; Crankcase Depression Regulator Valve	V335
1990	8 Cyl. 6.2L	V335
1989-1988	8 Cyl. 6.2L; 3 1/2 Inch Dia. Canister Type; Crankcase Depression Regulator Valve	V335
P20		
1989-1987	8 Cyl. 6.2L; 3 1/2 Inch Dia. Canister Type; Crankcase Depression Regulator Valve	V335
1986	8 Cyl. 6.2L; Crankcase Depression Regulator Valve	V335
1985-1983	8 Cyl. 6.2L	V389
P30		
1999-1994	8 Cyl. 6.5L; 3 1/2 Inch Dia. Canister Type; Crankcase Depression Regulator Valve	V335
1993-1987	8 Cyl. 6.2L; 3 1/2 Inch Dia. Canister Type; Crankcase Depression Regulator Valve	V335

Chevrolet

PCV Systems

PCV Valve		Part No.
P30		
1986	8 Cyl. 6.2L; Crankcase Depression Regulator Valve	V335
1985-1983	8 Cyl. 6.2L	V389
R10		
1987	8 Cyl. 6.2L; 3 1/2 Inch Dia. Canister Type; Crankcase Depression Regulator Valve	V335
R10 Suburban		
1988-1987	8 Cyl. 6.2L; 3 1/2 Inch Dia. Canister Type; Crankcase Depression Regulator Valve	V335
R20		
1988	8 Cyl. 6.2L; 3 1/2 Inch Dia. Canister Type; Crankcase Depression Regulator Valve; Diesel	V335
1987	8 Cyl. 6.2L; 3 1/2 Inch Dia. Canister Type; Crankcase Depression Regulator Valve	V335
R20 Suburban		
1988-1987	8 Cyl. 6.2L; 3 1/2 Inch Dia. Canister Type; Crankcase Depression Regulator Valve	V335
R30		
1988-1987	8 Cyl. 6.2L; 3 1/2 Inch Dia. Canister Type; Crankcase Depression Regulator Valve	V335
R1500 Suburban		
1991-1989	8 Cyl. 6.2L; 3 1/2 Inch Dia. Canister Type; Crankcase Depression Regulator Valve	V335
R2500		
1989	8 Cyl. 6.2L; 3 1/2 Inch Dia. Canister Type; Crankcase Depression Regulator Valve	V335
R2500 Suburban		
1991-1989	8 Cyl. 6.2L; 3 1/2 Inch Dia. Canister Type; Crankcase Depression Regulator Valve	V335
R3500		
1991-1990	8 Cyl. 6.2L; Crankcase Depression Regulator Valve	V335
1989	8 Cyl. 6.2L; 3 1/2 Inch Dia. Canister Type; Crankcase Depression Regulator Valve	V335
Silverado 2500 HD		
2004-2002	8 Cyl. 6.6L	V425
Silverado 3500		
2004-2002	8 Cyl. 6.6L	V425
Tahoe		
1999-1996	8 Cyl. 6.5L	BF41
1995	8 Cyl. 6.5L; 3 1/2 Inch Dia. Canister Type; Crankcase Depression Regulator Valve	V335
V10		
1987	8 Cyl. 6.2L; 3 1/2 Inch Dia. Canister Type; Crankcase Depression Regulator Valve	V335
V10 Suburban		
1988-1987	8 Cyl. 6.2L; 3 1/2 Inch Dia. Canister Type; Crankcase Depression Regulator Valve	V335
V20		
1987	8 Cyl. 6.2L; 3 1/2 Inch Dia. Canister Type; Crankcase Depression Regulator Valve	V335
V20 Suburban		
1988-1987	8 Cyl. 6.2L; 3 1/2 Inch Dia. Canister Type; Crankcase Depression Regulator Valve	V335
V30		
1988-1987	8 Cyl. 6.2L; 3 1/2 Inch Dia. Canister Type; Crankcase Depression Regulator Valve	V335
V1500 Suburban		
1991-1989	8 Cyl. 6.2L; 3 1/2 Inch Dia. Canister Type; Crankcase Depression Regulator Valve	V335
V2500 Suburban		
1991-1989	8 Cyl. 6.2L; 3 1/2 Inch Dia. Canister Type; Crankcase Depression Regulator Valve	V335

PCV Valve		Part No.
V3500		
1991-1989	8 Cyl. 6.2L; 3 1/2 Inch Dia. Canister Type; Crankcase Depression Regulator Valve	V335
Vapor and Purge Components		
Canister Purge Solenoid		
Blazer		
1994	8 Cyl.	CP208
C1500 Suburban		
1994	8 Cyl.	CP208
C2500 Suburban		
1994	8 Cyl.	CP208
C3500		
1994	8 Cyl.	CP208
C3500HD		
1998-1996	8 Cyl.	CP225
1995-1994	8 Cyl.	CP208
Express 2500		
1996	8 Cyl.	CP225
K1500		
1996	8 Cyl.	CP225
1995-1994	8 Cyl.	CP208
K1500 Suburban		
1994	8 Cyl.	CP208
K2500		
1994	8 Cyl.	CP208
K2500 Suburban		
1997-1996	8 Cyl.	CP225
1994	8 Cyl.	CP208
K3500		
1994	8 Cyl.	CP208
Canister Purge Valve		
Caprice		
1980	8 Cyl. 5.7L	CP417
Impala		
1980	8 Cyl. 5.7L	CP417
R10		
1987	8 Cyl.	CP109
R20		
1987	8 Cyl.	CP109
R30		
1987	8 Cyl.	CP109
V10		
1987	8 Cyl.	CP109
V20		
1987	8 Cyl.	CP109
V30		
1987	8 Cyl.	CP109
Canister Vent Solenoid		
Cruze		
2015-2014	4 Cyl.	CVS153
Fuel Vapor Canister		
C10 Suburban		
1980	8 Cyl. 5.7L; Calif.	CP1004
1980	8 Cyl. 5.7L; Fed.	CP1014
Caprice		
1985	8 Cyl. 5.7L; 2 Ports	CP1001
1985	8 Cyl. 5.7L; 5 Ports	CP1014
1984-1982	8 Cyl. 5.7L	CP1001
1981-1980	8 Cyl. 5.7L	CP1014
Chevette		
1986-1985	4 Cyl.; Export	CP1022

Vapor and Purge Components

		Part No.
Fuel Vapor Canister		
El Camino		
1984	8 Cyl. 5.7L	CP1001
1983	8 Cyl. 5.7L	CP1004
Impala		
1985-1983	8 Cyl. 5.7L	CP1001
1981-1980	8 Cyl. 5.7L	CP1014
Malibu		
1983-1982	8 Cyl. 5.7L	CP1001
Monte Carlo		
1983-1982	8 Cyl. 5.7L	CP1001
P30		
1996-1995	8 Cyl. 6.5L	CP1028
Silverado 2500 HD		
2016-2013	8 Cyl.	CP3543
Fuel Vapor Canister Filter		
C60		
1983	6 Cyl. 6.1L; w/ 4 1/2 Inch Dia.	CF-1
C70		
1985-1982	6 Cyl. 6.1L; w/ 4 1/2 Inch Dia.	CF-1
Fuel Valves and Solenoids		
Fuel / Water Separator Valve		
Express 2500		
2002-1996	8 Cyl. 6.5L	FWSV101
Express 3500		
2002-1996	8 Cyl. 6.5L	FWSV101
G30		
1996	8 Cyl. 6.5L	FWSV101
Fuel Pressure Relief Valve		
Express 2500		
2010-2006	8 Cyl. 6.6L	PRV1
Express 3500		
2010-2006	8 Cyl. 6.6L	PRV1
Express 4500		
2010-2009	8 Cyl. 6.6L	PRV1
Silverado 2500 HD		
2010-2006	8 Cyl. 6.6L	PRV1
2005	8 Cyl. 6.6L	PRV3
2004	8 Cyl. 6.6L; 2	PRV3
Silverado 2500 HD Classic		
2007	8 Cyl. 6.6L	PRV1
Silverado 3500		
2006	8 Cyl. 6.6L	PRV1
2005	8 Cyl. 6.6L	PRV3
2004	8 Cyl. 6.6L; 2	PRV3
Silverado 3500 Classic		
2007	8 Cyl. 6.6L	PRV1
Fuel Shut-Off Solenoid		
Blazer		
1994	8 Cyl. 6.5L	FSS103
C1500		
1998-1994	8 Cyl. 6.5L	FSS103
C1500 Suburban		
1999-1998	8 Cyl. 6.5L	FSS103
C2500		
2000-1994	8 Cyl. 6.5L	FSS103
C2500 Suburban		
1999-1994	8 Cyl. 6.5L	FSS103
C3500		
2000-1994	8 Cyl. 6.5L	FSS103
C3500HD		
2002-1994	8 Cyl. 6.5L	FSS103

		Part No.
Fuel Shut-Off Solenoid		
Express 2500		
2002-1996	8 Cyl. 6.5L	FSS103
Express 3500		
2002-1996	8 Cyl. 6.5L	FSS103
G20		
1995-1994	8 Cyl. 6.5L	FSS103
K1500		
1998-1994	8 Cyl. 6.5L	FSS103
K1500 Suburban		
1999-1995	8 Cyl. 6.5L	FSS103
K2500		
2000-1994	8 Cyl. 6.5L	FSS103
K2500 Suburban		
1998-1994	8 Cyl. 6.5L	FSS103
K3500		
2000-1994	8 Cyl. 6.5L	FSS103
P30		
1999-1994	8 Cyl. 6.5L	FSS103
Tahoe		
1999-1995	8 Cyl. 6.5L	FSS103
Fuel Tank Selector Valve		
C10		
1981-1980	8 Cyl. 5.7L; Connector Required; w/ 6 Port; w/ Pin Term.	FV-5
1981-1980	8 Cyl. 5.7L; Kit; w/ 6 Port; w/ Pin Term.	FV-5K
C10 Suburban		
1980	8 Cyl. 5.7L; Connector Required; w/ 6 Port; w/ Pin Term.	FV-5
1980	8 Cyl. 5.7L; Kit; w/ 6 Port; w/ Pin Term.	FV-5K
C60		
1989-1988	8 Cyl. 8.2L; Connector Required; w/ 6 Port; w/ Pin Term.	FV-5
1989-1988	8 Cyl. 8.2L; Kit; w/ 6 Port; w/ Pin Term.	FV-5K
C70		
1989-1988	8 Cyl. 10.4L; Connector Required; w/ 6 Port; w/ Pin Term.	FV-5
1989-1988	8 Cyl. 8.2L; Connector Required; w/ 6 Port; w/ Pin Term.	FV-5
1989-1988	8 Cyl. 10.4L; Kit; w/ 6 Port; w/ Pin Term.	FV-5K
1989-1988	8 Cyl. 8.2L; Kit; w/ 6 Port; w/ Pin Term.	FV-5K
C1500		
1995-1994	8 Cyl. 6.5L; Connector Required; w/ 6 Port; w/ Pin Term.	FV-5
1995-1994	8 Cyl. 6.5L; Kit; w/ 6 Port; w/ Pin Term.	FV-5K
1993-1988	8 Cyl. 6.2L; Connector Required; w/ 6 Port; w/ Pin Term.	FV-5
1993-1988	8 Cyl. 6.2L; Kit; w/ 6 Port; w/ Pin Term.	FV-5K
C1500 Suburban		
1995	8 Cyl. 6.5L; Connector Required; w/ 6 Port; w/ Pin Term.	FV-5
1995	8 Cyl. 6.5L; Kit; w/ 6 Port; w/ Pin Term.	FV-5K
C2500		
1995-1992	8 Cyl. 6.5L; Connector Required; w/ 6 Port; w/ Pin Term.	FV-5
1995-1992	8 Cyl. 6.5L; Kit; w/ 6 Port; w/ Pin Term.	FV-5K
1993-1988	8 Cyl. 6.2L; Connector Required; w/ 6 Port; w/ Pin Term.	FV-5
1993-1988	8 Cyl. 6.2L; Kit; w/ 6 Port; w/ Pin Term.	FV-5K
C2500 Suburban		
1995-1994	8 Cyl. 6.5L; Connector Required; w/ 6 Port; w/ Pin Term.	FV-5
1995-1994	8 Cyl. 6.5L; Kit; w/ 6 Port; w/ Pin Term.	FV-5K

Chevrolet

Fuel Valves and Solenoids

		Part No.
Fuel Tank Selector Valve		
C3500		
1995-1992	8 Cyl. 6.5L; Connector Required; w/ 6 Port; w/ Pin Term.	FV-5
1995-1992	8 Cyl. 6.5L; Kit; w/ 6 Port; w/ Pin Term.	FV-5K
1993-1988	8 Cyl. 6.2L; Connector Required; w/ 6 Port; w/ Pin Term.	FV-5
1993-1988	8 Cyl. 6.2L; Kit; w/ 6 Port; w/ Pin Term.	FV-5K
C3500HD		
1995-1992	8 Cyl. 6.5L; Connector Required; w/ 6 Port; w/ Pin Term.	FV-5
1995-1992	8 Cyl. 6.5L; Kit; w/ 6 Port; w/ Pin Term.	FV-5K
El Camino		
1984-1983	8 Cyl. 5.7L; Connector Required; w/ 6 Port; w/ Pin Term.	FV-5
1984-1983	8 Cyl. 5.7L; Kit; w/ 6 Port; w/ Pin Term.	FV-5K
G20		
1995-1994	8 Cyl. 6.5L; Connector Required; w/ 6 Port; w/ Pin Term.	FV-5
1995-1994	8 Cyl. 6.5L; Kit; w/ 6 Port; w/ Pin Term.	FV-5K
1993-1983	8 Cyl. 6.2L; Connector Required; w/ 6 Port; w/ Pin Term.	FV-5
1993-1983	8 Cyl. 6.2L; Kit; w/ 6 Port; w/ Pin Term.	FV-5K
G30		
1995-1994	8 Cyl. 6.5L; Connector Required; w/ 6 Port; w/ Pin Term.	FV-5
1995-1994	8 Cyl. 6.5L; Kit; w/ 6 Port; w/ Pin Term.	FV-5K
1993-1983	8 Cyl. 6.2L; Connector Required; w/ 6 Port; w/ Pin Term.	FV-5
1993-1983	8 Cyl. 6.2L; Kit; w/ 6 Port; w/ Pin Term.	FV-5K
K1500		
1995-1994	8 Cyl. 6.5L; Connector Required; w/ 6 Port; w/ Pin Term.	FV-5
1995-1994	8 Cyl. 6.5L; Kit; w/ 6 Port; w/ Pin Term.	FV-5K
1993-1988	8 Cyl. 6.2L; Connector Required; w/ 6 Port; w/ Pin Term.	FV-5
1993-1988	8 Cyl. 6.2L; Kit; w/ 6 Port; w/ Pin Term.	FV-5K
K2500		
1995-1992	8 Cyl. 6.5L; Connector Required; w/ 6 Port; w/ Pin Term.	FV-5
1995-1992	8 Cyl. 6.5L; Kit; w/ 6 Port; w/ Pin Term.	FV-5K
1993-1988	8 Cyl. 6.2L; Connector Required; w/ 6 Port; w/ Pin Term.	FV-5
1993-1988	8 Cyl. 6.2L; Kit; w/ 6 Port; w/ Pin Term.	FV-5K
K2500 Suburban		
1995-1994	8 Cyl. 6.5L; Connector Required; w/ 6 Port; w/ Pin Term.	FV-5
1995-1994	8 Cyl. 6.5L; Kit; w/ 6 Port; w/ Pin Term.	FV-5K
K3500		
1995-1992	8 Cyl. 6.5L; Connector Required; w/ 6 Port; w/ Pin Term.	FV-5
1995-1992	8 Cyl. 6.5L; Kit; w/ 6 Port; w/ Pin Term.	FV-5K
1993-1988	8 Cyl. 6.2L; Connector Required; w/ 6 Port; w/ Pin Term.	FV-5
1993-1988	8 Cyl. 6.2L; Kit; w/ 6 Port; w/ Pin Term.	FV-5K
Monte Carlo		
1984	8 Cyl. 5.7L; Connector Required; w/ 6 Port; w/ Pin Term.	FV-5
1984	8 Cyl. 5.7L; Kit; w/ 6 Port; w/ Pin Term.	FV-5K
P20		
1989-1982	8 Cyl. 6.2L; Connector Required; w/ 6 Port; w/ Pin Term.	FV-5
1989-1982	8 Cyl. 6.2L; Kit; w/ 6 Port; w/ Pin Term.	FV-5K
P30		
1995-1994	8 Cyl. 6.5L; Connector Required; w/ 6 Port; w/ Pin Term.	FV-5
1995-1994	8 Cyl. 6.5L; Kit; w/ 6 Port; w/ Pin Term.	FV-5K

		Part No.
Fuel Tank Selector Valve		
P30		
1993-1982	8 Cyl. 6.2L; Connector Required; w/ 6 Port; w/ Pin Term.	FV-5
1993-1982	8 Cyl. 6.2L; Kit; w/ 6 Port; w/ Pin Term.	FV-5K
1991-1990	4 Cyl. 3.9L; Connector Required; w/ 6 Port; w/ Pin Term.	FV-5
1991-1990	4 Cyl. 3.9L; Kit; w/ 6 Port; w/ Pin Term.	FV-5K
R10 Suburban		
1988-1987	8 Cyl. 6.2L; Connector Required; w/ 6 Port; w/ Pin Term.	FV-5
1988-1987	8 Cyl. 6.2L; Kit; w/ 6 Port; w/ Pin Term.	FV-5K
R20 Suburban		
1988-1987	8 Cyl. 6.2L; Connector Required; w/ 6 Port; w/ Pin Term.	FV-5
1988-1987	8 Cyl. 6.2L; Kit; w/ 6 Port; w/ Pin Term.	FV-5K
R1500 Suburban		
1991-1989	8 Cyl. 6.2L; Connector Required; w/ 6 Port; w/ Pin Term.	FV-5
1991-1989	8 Cyl. 6.2L; Kit; w/ 6 Port; w/ Pin Term.	FV-5K
R2500		
1989	8 Cyl. 6.2L; Connector Required; w/ 6 Port; w/ Pin Term.	FV-5
1989	8 Cyl. 6.2L; Kit; w/ 6 Port; w/ Pin Term.	FV-5K
R2500 Suburban		
1991-1989	8 Cyl. 6.2L; Connector Required; w/ 6 Port; w/ Pin Term.	FV-5
1991-1989	8 Cyl. 6.2L; Kit; w/ 6 Port; w/ Pin Term.	FV-5K
R3500		
1991-1989	8 Cyl. 6.2L; Connector Required; w/ 6 Port; w/ Pin Term.	FV-5
1991-1989	8 Cyl. 6.2L; Kit; w/ 6 Port; w/ Pin Term.	FV-5K
S10		
1985-1983	4 Cyl. 2.2L; Connector Required; w/ 6 Port; w/ Pin Term.	FV-5
1985-1983	4 Cyl. 2.2L; Kit; w/ 6 Port; w/ Pin Term.	FV-5K
S10 Blazer		
1984	4 Cyl. 2.2L; Connector Required; w/ 6 Port; w/ Pin Term.	FV-5
1984	4 Cyl. 2.2L; Kit; w/ 6 Port; w/ Pin Term.	FV-5K
Tahoe		
1995	8 Cyl. 6.5L; Connector Required; w/ 6 Port; w/ Pin Term.	FV-5
1995	8 Cyl. 6.5L; Kit; w/ 6 Port; w/ Pin Term.	FV-5K
V10 Suburban		
1988-1987	8 Cyl. 6.2L; Connector Required; w/ 6 Port; w/ Pin Term.	FV-5
1988-1987	8 Cyl. 6.2L; Kit; w/ 6 Port; w/ Pin Term.	FV-5K
V20 Suburban		
1988-1987	8 Cyl. 6.2L; Connector Required; w/ 6 Port; w/ Pin Term.	FV-5
1988-1987	8 Cyl. 6.2L; Kit; w/ 6 Port; w/ Pin Term.	FV-5K
V1500 Suburban		
1991-1989	8 Cyl. 6.2L; Connector Required; w/ 6 Port; w/ Pin Term.	FV-5
1991-1989	8 Cyl. 6.2L; Kit; w/ 6 Port; w/ Pin Term.	FV-5K
V2500 Suburban		
1991-1989	8 Cyl. 6.2L; Connector Required; w/ 6 Port; w/ Pin Term.	FV-5
1991-1989	8 Cyl. 6.2L; Kit; w/ 6 Port; w/ Pin Term.	FV-5K
V3500		
1991-1990	8 Cyl. 6.2L; Connector Required; w/ 6 Port; w/ Pin Term.	FV-5
1991-1990	8 Cyl. 6.2L; Kit; w/ 6 Port; w/ Pin Term.	FV-5K

Injectors

		Part No.
Injectors		
Fuel Injector - Diesel - New		
Blazer		
1994	8 Cyl. 6.5L	FJ173
1991-1987	8 Cyl. 6.2L; 83.7mm Long	FJ171
C10		
1986-1983	8 Cyl. 6.2L; 83.7mm Long	FJ171
1982	8 Cyl. 6.2L	FJ172
C10 Suburban		
1986-1983	8 Cyl. 6.2L	FJ171
1982	8 Cyl. 6.2L	FJ172
C20		
1986	8 Cyl. 6.2L; 83.7mm Long	FJ171
1984-1983	8 Cyl. 6.2L; 83.7mm Long	FJ171
1982	8 Cyl. 6.2L	FJ172
C20 Suburban		
1986-1983	8 Cyl. 6.2L	FJ171
1982	8 Cyl. 6.2L	FJ172
C30		
1986-1983	8 Cyl. 6.2L; 83.7mm Long	FJ171
1982	8 Cyl. 6.2L	FJ172
C1500		
1998-1996	8 Cyl. 6.5L	FJ173
1995-1994	8 Cyl. 6.5L; P	FJ174
1995-1994	8 Cyl. 6.5L; S	FJ173
1993-1992	8 Cyl. 6.2L	FJ174
1991-1988	8 Cyl. 6.2L; 83.7mm Long	FJ171
C1500 Suburban		
1999-1995	8 Cyl. 6.5L	FJ173
C2500		
2000-1996	8 Cyl. 6.5L	FJ173
1995-1994	8 Cyl. 6.5L; F	FJ173
1995-1994	8 Cyl. 6.5L; P	FJ174
1995-1994	8 Cyl. 6.5L; S	FJ173
1993-1992	8 Cyl. 6.5L	FJ173
1993-1992	8 Cyl. 6.2L	FJ174
1991-1988	8 Cyl. 6.2L; 83.7mm Long	FJ171
C2500 Suburban		
1999-1994	8 Cyl. 6.5L	FJ173
C3500		
2000-1992	8 Cyl. 6.5L	FJ173
1993-1992	8 Cyl. 6.2L	FJ174
1991-1988	8 Cyl. 6.2L; 83.7mm Long	FJ171
C3500HD		
2002-1992	8 Cyl. 6.5L	FJ173
Colorado		
2019-2017	4 Cyl. 2.8L; Indirect Injector	FJ1379
2018-2017	4 Cyl. 2.8L; Direct Injector	FJ1381NX
2016	4 Cyl. 2.8L	FJ1381NX
Cruze		
2019-2017	4 Cyl. 1.6L	FJ1382NX
2015-2014	4 Cyl. 2.0L	FJ1216
Equinox		
2019-2018	4 Cyl. 1.6L	FJ1382NX
Express 2500		
2019	4 Cyl. 2.8L; Direct Injector	FJ1381NX
2019-2017	4 Cyl. 2.8L; Indirect Injector	FJ1379
2018-2017	4 Cyl. 2.8L	FJ1381NX
2016-2010	8 Cyl. 6.6L; Indirect Injector	FJ1378
2002-1996	8 Cyl. 6.5L	FJ173
Express 3500		
2019-2017	4 Cyl. 2.8L; Indirect Injector	FJ1379
2019-2017	4 Cyl. 2.8L	FJ1381NX

		Part No.
Fuel Injector - Diesel - New		
Express 3500		
2016-2010	8 Cyl. 6.6L; Indirect Injector	FJ1378
2002-1996	8 Cyl. 6.5L	FJ173
G20		
1995-1994	8 Cyl. 6.5L	FJ174
1993-1992	8 Cyl. 6.2L	FJ174
1991-1987	8 Cyl. 6.2L; 83.7mm Long	FJ171
G30		
1996	8 Cyl. 6.5L	FJ173
1995-1994	8 Cyl. 6.5L	FJ174
1993-1992	8 Cyl. 6.2L	FJ174
1991-1987	8 Cyl. 6.2L; 83.7mm Long	FJ171
K5 Blazer		
1986-1983	8 Cyl. 6.2L	FJ171
1982	8 Cyl. 6.2L	FJ172
K10		
1986-1983	8 Cyl. 6.2L; 83.7mm Long	FJ171
1982	8 Cyl. 6.2L	FJ172
K10 Suburban		
1986-1983	8 Cyl. 6.2L	FJ171
1982	8 Cyl. 6.2L	FJ172
K20		
1986-1983	8 Cyl. 6.2L; 83.7mm Long	FJ171
1982	8 Cyl. 6.2L	FJ172
K20 Suburban		
1986-1983	8 Cyl. 6.2L	FJ171
1982	8 Cyl. 6.2L	FJ172
K30		
1986-1983	8 Cyl. 6.2L; 83.7mm Long	FJ171
1982	8 Cyl. 6.2L	FJ172
K1500		
1998-1996	8 Cyl. 6.5L	FJ173
1995-1994	8 Cyl. 6.5L; P	FJ174
1995-1994	8 Cyl. 6.5L; S	FJ173
1993-1992	8 Cyl. 6.2L	FJ174
1991-1988	8 Cyl. 6.2L; 83.7mm Long	FJ171
K1500 Suburban		
1999-1995	8 Cyl. 6.5L	FJ173
K2500		
2000-1996	8 Cyl. 6.5L	FJ173
1995-1994	8 Cyl. 6.5L; F	FJ173
1995-1994	8 Cyl. 6.5L; P	FJ174
1995-1994	8 Cyl. 6.5L; S	FJ173
1993-1992	8 Cyl. 6.5L	FJ173
1993-1992	8 Cyl. 6.2L	FJ174
1991-1988	8 Cyl. 6.2L; 83.7mm Long	FJ171
K2500 Suburban		
1999-1994	8 Cyl. 6.5L	FJ173
K3500		
2000-1992	8 Cyl. 6.5L	FJ173
1993-1992	8 Cyl. 6.2L	FJ174
1991-1988	8 Cyl. 6.2L; 83.7mm Long	FJ171
P20		
1989-1987	8 Cyl. 6.2L; 83.7mm Long	FJ171
P30		
1999-1994	8 Cyl. 6.5L; Turbocharged	FJ173
1999-1994	8 Cyl. 6.5L; Naturally Aspirated	FJ174
1993-1991	8 Cyl. 6.2L	FJ174
1991	4 Cyl. 3.9L	FJ173
1990-1987	8 Cyl. 6.2L; 83.7mm Long	FJ171
R10		
1987	8 Cyl. 6.2L; 83.7mm Long	FJ171

Chevrolet

Injectors

		Part No.
Fuel Injector - Diesel - New		
R10 Suburban		
1988-1987	8 Cyl. 6.2L; 83.7mm Long	FJ171
R20		
1988-1987	8 Cyl. 6.2L; 83.7mm Long	FJ171
R20 Suburban		
1988-1987	8 Cyl. 6.2L; 83.7mm Long	FJ171
R30		
1988-1987	8 Cyl. 6.2L; 83.7mm Long	FJ171
R1500 Suburban		
1991-1989	8 Cyl. 6.2L; 83.7mm Long	FJ171
R2500		
1989	8 Cyl. 6.2L; 83.7mm Long	FJ171
R2500 Suburban		
1991-1989	8 Cyl. 6.2L; 83.7mm Long	FJ171
R3500		
1991-1989	8 Cyl. 6.2L; 83.7mm Long	FJ171
Silverado 2500 HD		
2019-2017	8 Cyl. 6.6L; Indirect Injector	FJ1379
2016-2011	8 Cyl. 6.6L; Indirect Injector	FJ1378
Silverado 3500 HD		
2019-2017	8 Cyl. 6.6L; Indirect Injector	FJ1379
2016-2011	8 Cyl. 6.6L; Indirect Injector	FJ1378
Tahoe		
1999-1995	8 Cyl. 6.5L	FJ173
V10		
1987	8 Cyl. 6.2L; 83.7mm Long	FJ171
V10 Suburban		
1988-1987	8 Cyl. 6.2L; 83.7mm Long	FJ171
V20		
1987	8 Cyl. 6.2L; 83.7mm Long	FJ171
V20 Suburban		
1988-1987	8 Cyl. 6.2L; 83.7mm Long	FJ171
V30		
1988-1987	8 Cyl. 6.2L; 83.7mm Long	FJ171
V1500 Suburban		
1991-1989	8 Cyl. 6.2L; 83.7mm Long	FJ171
V2500 Suburban		
1991-1989	8 Cyl. 6.2L; 83.7mm Long	FJ171
V3500		
1991-1989	8 Cyl. 6.2L; 83.7mm Long	FJ171
Fuel Injector - Diesel - Remfd		
Blazer		
1991-1987	8 Cyl. 6.2L; 73.8mm Long	FJ251
C1500		
1991-1988	8 Cyl. 6.2L; 73.8mm Long	FJ251
C2500		
1991-1988	8 Cyl. 6.2L; 73.8mm Long	FJ251
C3500		
1991-1988	8 Cyl. 6.2L; 73.8mm Long	FJ251
C4500 Kodiak		
2009-2008	8 Cyl. 6.6L	FJ961
2007-2006	8 Cyl. 6.6L	FJ962
2005	8 Cyl. 6.6L; Injector Only	FJ489
2004	8 Cyl. 6.6L; 1; Injector Only	FJ495
2004	8 Cyl. 6.6L; 1; Complete Kit	FJ4958PCK
2004	8 Cyl. 6.6L; 2; Injector Only	FJ489
2003	8 Cyl. 6.6L; Injector Only	FJ495
2003	8 Cyl. 6.6L; Complete Kit	FJ4958PCK
C5500 Kodiak		
2009-2008	8 Cyl. 6.6L	FJ961
2007-2006	8 Cyl. 6.6L	FJ962

		Part No.
Fuel Injector - Diesel - Remfd		
C5500 Kodiak		
2005	8 Cyl. 6.6L; Injector Only	FJ489
2004	8 Cyl. 6.6L; 1; Injector Only	FJ495
2004	8 Cyl. 6.6L; 1; Complete Kit	FJ4958PCK
2004	8 Cyl. 6.6L; 2; Injector Only	FJ489
2003	8 Cyl. 6.6L; Injector Only	FJ495
2003	8 Cyl. 6.6L; Complete Kit	FJ4958PCK
C6500 Kodiak		
2009-2007	6 Cyl. 7.8L; OE No. 2901233200, 8976097904, 97780454, 97609790, 095000-6384	FJ56907
C7500 Kodiak		
2009-2007	6 Cyl. 7.8L; OE No. 2901233200, 8976097904, 97780454, 97609790, 095000-6384	FJ56907
Express 2500		
2016-2011	8 Cyl. 6.6L; Direct Injector	FJ1227
2010	8 Cyl. 6.6L; 6; Direct Injector	FJ961
2010	8 Cyl. 6.6L; L; Direct Injector	FJ1227
2009-2008	8 Cyl. 6.6L	FJ961
2007	8 Cyl. 6.6L; 2	FJ962
2007	8 Cyl. 6.6L; 6	FJ961
2006	8 Cyl. 6.6L	FJ962
Express 3500		
2016-2011	8 Cyl. 6.6L; Direct Injector	FJ1227
2010	8 Cyl. 6.6L; 6; Direct Injector	FJ961
2010	8 Cyl. 6.6L; L; Direct Injector	FJ1227
2009-2008	8 Cyl. 6.6L	FJ961
2007	8 Cyl. 6.6L; 2	FJ962
2007	8 Cyl. 6.6L; 6	FJ961
2006	8 Cyl. 6.6L	FJ962
Express 4500		
2016-2011	8 Cyl. 6.6L	FJ1227
2010	8 Cyl. 6.6L; 6	FJ961
2010	8 Cyl. 6.6L; L	FJ1227
2009	8 Cyl. 6.6L	FJ961
G20		
1991-1983	8 Cyl. 6.2L; 73.8mm Long	FJ251
G30		
1991-1983	8 Cyl. 6.2L; 73.8mm Long	FJ251
K1500		
1991-1988	8 Cyl. 6.2L; 73.8mm Long	FJ251
K2500		
1991-1988	8 Cyl. 6.2L; 73.8mm Long	FJ251
K3500		
1991-1988	8 Cyl. 6.2L; 73.8mm Long	FJ251
P20		
1989-1982	8 Cyl. 6.2L; 73.8mm Long	FJ251
P30		
1990-1982	8 Cyl. 6.2L; 73.8mm Long	FJ251
R10		
1987	8 Cyl. 6.2L; 73.8mm Long	FJ251
R10 Suburban		
1988-1987	8 Cyl. 6.2L; 73.8mm Long	FJ251
R20		
1988-1987	8 Cyl. 6.2L; 73.8mm Long	FJ251
R20 Suburban		
1988-1987	8 Cyl. 6.2L; 73.8mm Long	FJ251
R30		
1988-1987	8 Cyl. 6.2L; 73.8mm Long	FJ251
R1500 Suburban		
1991-1989	8 Cyl. 6.2L; 73.8mm Long	FJ251

Injectors

		Part No.
Fuel Injector - Diesel - Remfd		
R2500		
1989	8 Cyl. 6.2L; 73.8mm Long	FJ251
R2500 Suburban		
1991-1989	8 Cyl. 6.2L; 73.8mm Long	FJ251
R3500		
1991-1989	8 Cyl. 6.2L; 73.8mm Long	FJ251
Silverado 2500 HD		
2019-2017	8 Cyl. 6.6L	FJ1383
2016-2013	8 Cyl. 6.6L; Direct Injector	FJ1226
2012-2011	8 Cyl. 6.6L; 8; Direct Injector	FJ1226
2012-2011	8 Cyl. 6.6L; L; Direct Injector	FJ1227
2010-2007	8 Cyl. 6.6L	FJ961
2006	8 Cyl. 6.6L	FJ962
2005	8 Cyl. 6.6L; Injector Only	FJ489
2004	8 Cyl. 6.6L; 1; Injector Only	FJ495
2004	8 Cyl. 6.6L; 1; Complete Kit	FJ4958PCK
2004	8 Cyl. 6.6L; 2; Injector Only	FJ489
2003-2001	8 Cyl. 6.6L; Injector Only	FJ495
2003-2001	8 Cyl. 6.6L; Complete Kit	FJ4958PCK
Silverado 2500 HD Classic		
2007	8 Cyl. 6.6L	FJ962
Silverado 3500		
2006	8 Cyl. 6.6L	FJ962
2005	8 Cyl. 6.6L; Injector Only	FJ489
2004	8 Cyl. 6.6L; 1; Injector Only	FJ495
2004	8 Cyl. 6.6L; 1; Complete Kit	FJ4958PCK
2004	8 Cyl. 6.6L; 2; Injector Only	FJ489
2003-2001	8 Cyl. 6.6L; Injector Only	FJ495
2003-2001	8 Cyl. 6.6L; Complete Kit	FJ4958PCK
Silverado 3500 Classic		
2007	8 Cyl. 6.6L	FJ962
Silverado 3500 HD		
2019-2017	8 Cyl. 6.6L	FJ1383
2016-2013	8 Cyl. 6.6L; Direct Injector	FJ1226
2012-2011	8 Cyl. 6.6L; 8; Direct Injector	FJ1226
2012-2011	8 Cyl. 6.6L; L; Direct Injector	FJ1227
2010-2007	8 Cyl. 6.6L	FJ961
T6500		
2009-2007	6 Cyl. 7.8L; OE No. 2901233200, 8976097904, 97780454, 97609790, 095000-6384	FJ56907
2007-2004	6 Cyl. 7.8L; OE No. 2901233000, 8976028032, 97780452, 97602803, 095000-5360	FJ56905
2007-2004	6 Cyl. 7.8L; OE No. 2901233100, 8976011562, 97780453, 97601156, 095000-5351	FJ56906
T7500		
2009-2007	6 Cyl. 7.8L; OE No. 2901233200, 8976097904, 97780454, 97609790, 095000-6384	FJ56907
2007-2004	6 Cyl. 7.8L; OE No. 2901233000, 8976028032, 97780452, 97602803, 095000-5360	FJ56905
2007-2004	6 Cyl. 7.8L; OE No. 2901233100, 8976011562, 97780453, 97601156, 095000-5351	FJ56906
T8500		
2009-2007	6 Cyl. 7.8L; OE No. 2901233200, 8976097904, 97780454, 97609790, 095000-6384	FJ56907
2007-2004	6 Cyl. 7.8L; OE No. 2901233100, 8976011562, 97780453, 97601156, 095000-5351	FJ56906

		Part No.
Fuel Injector - Diesel - Remfd		
T8500		
2006-2004	6 Cyl. 7.8L; OE No. 2901233000, 8976028032, 97780452, 97602803, 095000-5360	FJ56905
V10		
1987	8 Cyl. 6.2L; 73.8mm Long	FJ251
V10 Suburban		
1988-1987	8 Cyl. 6.2L; 73.8mm Long	FJ251
V20		
1987	8 Cyl. 6.2L; 73.8mm Long	FJ251
V20 Suburban		
1988-1987	8 Cyl. 6.2L; 73.8mm Long	FJ251
V30		
1988-1987	8 Cyl. 6.2L; 73.8mm Long	FJ251
V1500 Suburban		
1991-1989	8 Cyl. 6.2L; 73.8mm Long	FJ251
V2500 Suburban		
1991-1989	8 Cyl. 6.2L; 73.8mm Long	FJ251
V3500		
1991-1989	8 Cyl. 6.2L; 73.8mm Long	FJ251
W3500 Tiltmaster		
2009-2007	4 Cyl. 5.2L; OE No. 2901233300, 8976097915, 97780455, 97609791, 095000-6395	FJ56908
2009-2005	4 Cyl. 5.2L; OE No. 2901231000, 8973297035, 97780100, 095000-5471	FJ56909
2004-1999	4 Cyl. 4.8L	FJ56909
W4500 Tiltmaster		
2010-2005	4 Cyl. 5.2L; OE No. 2901231000, 8973297035, 97780100, 095000-5471	FJ56909
2009-2007	4 Cyl. 5.2L; OE No. 2901233300, 8976097915, 97780455, 97609791, 095000-6395	FJ56908
2004-1999	4 Cyl. 4.8L	FJ56909
W5500 Tiltmaster		
2010-2005	4 Cyl. 5.2L; OE No. 2901231000, 8973297035, 97780100, 095000-5471	FJ56909
2009-2007	4 Cyl. 5.2L; OE No. 2901233300, 8976097915, 97780455, 97609791, 095000-6395	FJ56908
2004-2000	4 Cyl. 4.8L	FJ56909
W5500HD Tiltmaster		
2009-2007	4 Cyl. 5.2L; OE No. 2901233300, 8976097915, 97780455, 97609791, 095000-6395	FJ56908
2008-2005	4 Cyl. 5.2L	FJ56909
2004	4 Cyl. 4.8L	FJ56909
Injection Components		
Diesel Fuel Heater		
Blazer		
1994	8 Cyl. 6.5L	DFH102
C1500		
1998-1994	8 Cyl. 6.5L	DFH102
C1500 Suburban		
1999-1998	8 Cyl. 6.5L	DFH102
C2500		
2000-1994	8 Cyl. 6.5L	DFH102
C3500		
2000-1994	8 Cyl. 6.5L	DFH102
C3500HD		
2002-1994	8 Cyl. 6.5L	DFH102
Express 2500		
1996	8 Cyl. 6.5L	DFH102

Chevrolet

Injection Components

		Part No.
Diesel Fuel Heater		
Express 3500		
1996	8 Cyl. 6.5L	DFH102
G20		
1995-1994	8 Cyl. 6.5L	DFH102
G30		
1996-1994	8 Cyl. 6.5L	DFH102
K1500		
1998-1994	8 Cyl. 6.5L	DFH102
K1500 Suburban		
1999-1995	8 Cyl. 6.5L	DFH102
K2500		
2000-1994	8 Cyl. 6.5L	DFH102
K3500		
2000-1994	8 Cyl. 6.5L	DFH102
P30		
1999-1994	8 Cyl. 6.5L	DFH102
Tahoe		
1997-1995	8 Cyl. 6.5L	DFH102
Diesel Fuel Injection Harness		
C4500 Kodiak		
2004	8 Cyl. 6.6L; 1	IFH7
2003	8 Cyl. 6.6L	IFH7
C5500 Kodiak		
2004	8 Cyl. 6.6L; 1	IFH7
2003	8 Cyl. 6.6L	IFH7
Silverado 2500 HD		
2004	8 Cyl. 6.6L; 1	IFH7
2003-2001	8 Cyl. 6.6L	IFH7
Silverado 3500		
2004	8 Cyl. 6.6L; 1	IFH7
2003-2001	8 Cyl. 6.6L	IFH7
Diesel Fuel Injection Pump - New		
Blazer		
1989-1988	8 Cyl. 6.2L	IP48NX
C1500		
1989-1988	8 Cyl. 6.2L	IP48NX
C2500		
1993-1992	8 Cyl. 6.5L; GVW Under 15,000 Lbs.; w/o Cold Climate Package	IP47NX
1989	8 Cyl. 6.2L; C	IP48NX
1988	8 Cyl. 6.2L	IP48NX
C3500		
1993-1992	8 Cyl. 6.5L; GVW Under 15,000 Lbs.; w/o Cold Climate Package	IP47NX
C3500HD		
1993-1992	8 Cyl. 6.5L; GVW Under 15,000 Lbs.; w/o Cold Climate Package	IP47NX
Express 2500		
2016-2011	8 Cyl. 6.6L	IP36
2010	8 Cyl. 6.6L; L	IP36
Express 3500		
2016-2011	8 Cyl. 6.6L	IP36
2010	8 Cyl. 6.6L; L	IP36
Express 4500		
2016-2011	8 Cyl. 6.6L	IP36
2010	8 Cyl. 6.6L; L	IP36
G20		
1994	8 Cyl. 6.5L; 170 HP	IP46NX
1989-1988	8 Cyl. 6.2L	IP48NX
G30		
1994	8 Cyl. 6.5L; 170 HP	IP46NX

		Part No.
Diesel Fuel Injection Pump - New		
K1500		
1989-1988	8 Cyl. 6.2L	IP48NX
K2500		
1993-1992	8 Cyl. 6.5L; w/o Cold Climate Package	IP47NX
1989	8 Cyl. 6.2L; C	IP48NX
1988	8 Cyl. 6.2L	IP48NX
K3500		
1993	8 Cyl. 6.5L; Alternate Number; GVW Under 15,000 Lbs.; w/o Cold Climate Package	IP47NX
1992	8 Cyl. 6.5L; GVW Under 15,000 Lbs.; w/o Cold Climate Package	IP47NX
P30		
1994	8 Cyl. 6.5L; Motor Home; Turbocharged	IP46NX
R10 Suburban		
1988	8 Cyl. 6.2L	IP48NX
R1500 Suburban		
1989	8 Cyl. 6.2L	IP48NX
Silverado 2500 HD		
2016-2011	8 Cyl. 6.6L	IP36
Silverado 3500 HD		
2016-2011	8 Cyl. 6.6L	IP36
V10 Suburban		
1988	8 Cyl. 6.2L	IP48NX
V1500 Suburban		
1989	8 Cyl. 6.2L	IP48NX
Diesel Fuel Injection Pump - Remanufactured		
Blazer		
1994	8 Cyl. 6.5L; Complete Assembly	IP1
1994	8 Cyl. 6.5L; Pump Only	IP25
1991	8 Cyl. 6.2L	IP9
1990	8 Cyl. 6.2L	IP11
1989-1988	8 Cyl. 6.2L; Alternate Number	IP48
1989-1988	8 Cyl. 6.2L; Exhaust stock and reorder	IP7
C20		
1986-1985	8 Cyl. 6.2L; J	IP10
C20 Suburban		
1986-1985	8 Cyl. 6.2L	IP10
C30		
1986-1985	8 Cyl. 6.2L	IP10
C1500		
1998-1994	8 Cyl. 6.5L; Complete Assembly	IP1
1998-1994	8 Cyl. 6.5L; Pump Only	IP25
1993	8 Cyl. 6.2L; w/o High Altitude	IP16
1992	8 Cyl. 6.2L; w/o High Altitude	IP14
1991	8 Cyl. 6.2L	IP9
1990	8 Cyl. 6.2L	IP11
1989-1988	8 Cyl. 6.2L; Alternate Number	IP48
1989-1988	8 Cyl. 6.2L; Exhaust stock and reorder	IP7
C1500 Suburban		
1999-1995	8 Cyl. 6.5L; Complete Assembly	IP1
1999-1995	8 Cyl. 6.5L; Pump Only	IP25
C2500		
2000-1995	8 Cyl. 6.5L; Complete Assembly	IP1
2000-1995	8 Cyl. 6.5L; Pump Only	IP25
1994	8 Cyl. 6.5L; Complete Assembly; OE No. 17800077, ID Tag No. 5521	IP1
1994	8 Cyl. 6.5L; OE No. 17800077, ID Tag No. 5521; Pump Only	IP25
1994	8 Cyl. 6.5L; OE No. 10225929, ID Tag No. 5068	IP28
1993	8 Cyl. 6.2L; C; w/o High Altitude	IP16

Injection Components

		Part No.
Diesel Fuel Injection Pump - Remanufactured		
C2500		
1993-1992	8 Cyl. 6.5L; Exhaust stock and reorder; GVW Under 15,000 Lbs.; w/o Cold Climate Package	IP29
1993-1992	8 Cyl. 6.5L; Alternate Number; GVW Under 15,000 Lbs.; w/o Cold Climate Package	IP47
1993-1992	8 Cyl. 6.2L; J; w/o Cold Climate Package; w/o High Altitude	IP15
1992-1991	8 Cyl. 6.2L; J; w/ Cold Climate Package; w/o High Altitude	IP13
1991-1990	8 Cyl. 6.2L; J; w/o Cold Climate Package; w/o High Altitude	IP12
1989	8 Cyl. 6.2L; C; Alternate Number	IP48
1989	8 Cyl. 6.2L; C; Exhaust stock and reorder	IP7
1989	8 Cyl. 6.2L; J	IP10
1988	8 Cyl. 6.2L	IP48
C2500 Suburban		
1999-1995	8 Cyl. 6.5L; Complete Assembly	IP1
1999-1995	8 Cyl. 6.5L; Pump Only	IP25
1994	8 Cyl. 6.5L; Complete Assembly; OE No. 17800077, ID Tag No. 5521	IP1
1994	8 Cyl. 6.5L; OE No. 17800077, ID Tag No. 5521; Pump Only	IP25
1994	8 Cyl. 6.5L; OE No. 10225929, ID Tag No. 5068; Pump Only	IP28
C3500		
2000-1995	8 Cyl. 6.5L; Complete Assembly	IP1
2000-1995	8 Cyl. 6.5L; Pump Only	IP25
1994	8 Cyl. 6.5L; Complete Assembly; OE No. 17800077, ID Tag No. 5521	IP1
1994	8 Cyl. 6.5L; OE No. 17800077, ID Tag No. 5521; Pump Only	IP25
1994	8 Cyl. 6.5L; OE No. 10225929, ID Tag No. 5068	IP28
1993-1992	8 Cyl. 6.2L; w/o Cold Climate Package; w/o High Altitude	IP15
1993-1992	8 Cyl. 6.5L; Exhaust stock and reorder; GVW Under 15,000 Lbs.; w/o Cold Climate Package	IP29
1993-1992	8 Cyl. 6.5L; Alternate Number; GVW Under 15,000 Lbs.; w/o Cold Climate Package	IP47
1992-1991	8 Cyl. 6.2L; w/ Cold Climate Package; w/o High Altitude	IP13
1991-1990	8 Cyl. 6.2L; w/o Cold Climate Package; w/o High Altitude	IP12
1989-1988	8 Cyl. 6.2L	IP10
C3500HD		
2002-1995	8 Cyl. 6.5L; Complete Assembly	IP1
2002-1995	8 Cyl. 6.5L; Pump Only	IP25
1994	8 Cyl. 6.5L; Complete Assembly; OE No. 17800077, ID Tag No. 5521	IP1
1994	8 Cyl. 6.5L; OE No. 17800077, ID Tag No. 5521; Pump Only	IP25
1994	8 Cyl. 6.5L; OE No. 10225929, ID Tag No. 5068	IP28
1993-1992	8 Cyl. 6.5L; Exhaust stock and reorder; GVW Under 15,000 Lbs.; w/o Cold Climate Package	IP29
1993-1992	8 Cyl. 6.5L; Alternate Number; GVW Under 15,000 Lbs.; w/o Cold Climate Package	IP47
C4500 Kodiak		
2009-2006	8 Cyl. 6.6L	IP24
2005	8 Cyl. 6.6L	IP23
2004	8 Cyl. 6.6L; 1	IP22
2004	8 Cyl. 6.6L; 2	IP23

		Part No.
Diesel Fuel Injection Pump - Remanufactured		
C4500 Kodiak		
2003	8 Cyl. 6.6L	IP22
C5500 Kodiak		
2009-2006	8 Cyl. 6.6L	IP24
2005	8 Cyl. 6.6L	IP23
2004	8 Cyl. 6.6L; 1	IP22
2004	8 Cyl. 6.6L; 2	IP23
2003	8 Cyl. 6.6L	IP22
Express 2500		
2016-2011	8 Cyl. 6.6L	IP52
2010	8 Cyl. 6.6L; 6	IP24
2010	8 Cyl. 6.6L; L	IP52
2009-2006	8 Cyl. 6.6L	IP24
2002-1996	8 Cyl. 6.5L; Complete Assembly	IP1
2002-1996	8 Cyl. 6.5L; Pump Only	IP25
Express 3500		
2016-2011	8 Cyl. 6.6L	IP52
2010	8 Cyl. 6.6L; 6	IP24
2010	8 Cyl. 6.6L; L	IP52
2009-2006	8 Cyl. 6.6L	IP24
2002-1996	8 Cyl. 6.5L; Complete Assembly	IP1
2002-1996	8 Cyl. 6.5L; Pump Only	IP25
Express 4500		
2016-2011	8 Cyl. 6.6L	IP52
2010	8 Cyl. 6.6L; 6	IP24
2010	8 Cyl. 6.6L; L	IP52
2009	8 Cyl. 6.6L	IP24
G20		
1995-1994	8 Cyl. 6.5L; Complete Assembly	IP1
1995-1994	8 Cyl. 6.5L; Pump Only	IP25
1993	8 Cyl. 6.2L; w/o High Altitude	IP16
1992	8 Cyl. 6.2L; w/o High Altitude	IP14
1991	8 Cyl. 6.2L	IP9
1990	8 Cyl. 6.2L	IP11
1989-1988	8 Cyl. 6.2L; Alternate Number	IP48
1989-1988	8 Cyl. 6.2L; Exhaust stock and reorder	IP7
1987-1986	8 Cyl. 6.2L; w/ High Altitude	IP8
1985-1984	8 Cyl. 6.2L; C; w/ High Altitude	IP8
1985-1984	8 Cyl. 6.2L; J	IP10
G30		
1993-1992	8 Cyl. 6.2L; w/o Cold Climate Package; w/o High Altitude	IP15
1991-1990	8 Cyl. 6.2L; w/ A.T.; w/o Cold Climate Package; w/o High Altitude	IP12
1989-1985	8 Cyl. 6.2L; w/ A.T.	IP10
1984	8 Cyl. 6.2L; C; w/ High Altitude	IP8
1984	8 Cyl. 6.2L; J	IP10
K20		
1986-1985	8 Cyl. 6.2L; J	IP10
K20 Suburban		
1986	8 Cyl. 6.2L	IP10
1985	8 Cyl. 6.2L; J	IP10
K30		
1986-1985	8 Cyl. 6.2L	IP10
K1500		
1998-1994	8 Cyl. 6.5L; Complete Assembly	IP1
1998-1994	8 Cyl. 6.5L; Pump Only	IP25
1993	8 Cyl. 6.2L; w/o High Altitude	IP16
1992	8 Cyl. 6.2L; w/o High Altitude	IP14
1991	8 Cyl. 6.2L	IP9
1990	8 Cyl. 6.2L	IP11
1989-1988	8 Cyl. 6.2L; Alternate Number	IP48
1989-1988	8 Cyl. 6.2L; Exhaust stock and reorder	IP7

Injection Components

		Part No.
Diesel Fuel Injection Pump - Remanufactured		
K1500 Suburban		
1999-1995	8 Cyl. 6.5L; Complete Assembly	IP1
1999-1995	8 Cyl. 6.5L; Pump Only	IP25
K2500		
2000-1995	8 Cyl. 6.5L; Complete Assembly	IP1
2000-1995	8 Cyl. 6.5L; Pump Only	IP25
1994	8 Cyl. 6.5L; Complete Assembly; OE No. 17800077, ID Tag No. 5521	IP1
1994	8 Cyl. 6.5L; OE No. 17800077, ID Tag No. 5521; Pump Only	IP25
1994	8 Cyl. 6.5L; OE No. 10225929, ID Tag No. 5068	IP28
1993	8 Cyl. 6.2L; C; w/o High Altitude	IP16
1993-1992	8 Cyl. 6.5L; Exhaust stock and reorder; w/o Cold Climate Package	IP29
1993-1992	8 Cyl. 6.5L; Alternate Number; w/o Cold Climate Package	IP47
1993-1992	8 Cyl. 6.2L; J; w/o Cold Climate Package; w/o High Altitude	IP15
1992	8 Cyl. 6.2L; C; w/o High Altitude	IP14
1992-1991	8 Cyl. 6.2L; J; w/ Cold Climate Package; w/o High Altitude	IP13
1991-1990	8 Cyl. 6.2L; J; w/o Cold Climate Package; w/o High Altitude	IP12
1990	8 Cyl. 6.2L; C	IP11
1989	8 Cyl. 6.2L; C; Alternate Number	IP48
1989	8 Cyl. 6.2L; C; Exhaust stock and reorder	IP7
1989	8 Cyl. 6.2L; J	IP10
1988	8 Cyl. 6.2L; Alternate Number	IP48
1988	8 Cyl. 6.2L; Exhaust stock and reorder	IP7
K2500 Suburban		
1999-1995	8 Cyl. 6.5L; Complete Assembly	IP1
1999-1995	8 Cyl. 6.5L; Pump Only	IP25
1994	8 Cyl. 6.5L; Complete Assembly; OE No. 17800077, ID Tag No. 5521	IP1
1994	8 Cyl. 6.5L; OE No. 17800077, ID Tag No. 5521; Pump Only	IP25
1994	8 Cyl. 6.5L; OE No. 10225929, ID Tag No. 5068	IP28
K3500		
2000-1995	8 Cyl. 6.5L; Complete Assembly	IP1
2000-1995	8 Cyl. 6.5L; Pump Only	IP25
1994	8 Cyl. 6.5L; Complete Assembly; OE No. 17800077, ID Tag No. 5521	IP1
1994	8 Cyl. 6.5L; OE No. 17800077, ID Tag No. 5521; Pump Only	IP25
1994	8 Cyl. 6.5L; OE No. 10225929, ID Tag No. 5068	IP28
1993-1992	8 Cyl. 6.2L; w/o Cold Climate Package; w/o High Altitude	IP15
1993-1992	8 Cyl. 6.5L; Exhaust stock and reorder; GVW Under 15,000 Lbs.; w/o Cold Climate Package	IP29
1993-1992	8 Cyl. 6.5L; Alternate Number; GVW Under 15,000 Lbs.; w/o Cold Climate Package	IP47
1992-1991	8 Cyl. 6.2L; w/ Cold Climate Package; w/o High Altitude	IP13
1991-1990	8 Cyl. 6.2L; w/o Cold Climate Package; w/o High Altitude	IP12
1989-1988	8 Cyl. 6.2L	IP10
P20		
1989-1984	8 Cyl. 6.2L	IP10
P30		
1999-1995	8 Cyl. 6.5L; Complete Assembly; Turbocharged	IP1
1999-1995	8 Cyl. 6.5L; Pump Only; Turbocharged	IP25

		Part No.
Diesel Fuel Injection Pump - Remanufactured		
P30		
1993-1992	8 Cyl. 6.2L; w/ Stripped Chassis; w/o Cold Climate Package; w/o High Altitude	IP15
1991-1990	8 Cyl. 6.2L; w/o Cold Climate Package; w/o High Altitude	IP12
1989-1984	8 Cyl. 6.2L	IP10
R10 Suburban		
1988	8 Cyl. 6.2L; Alternate Number	IP48
1988	8 Cyl. 6.2L; Exhaust stock and reorder	IP7
R20		
1988	8 Cyl. 6.2L	IP10
1987	8 Cyl. 6.2L; J	IP10
R20 Suburban		
1988-1987	8 Cyl. 6.2L; J	IP10
R30		
1988-1987	8 Cyl. 6.2L	IP10
R1500 Suburban		
1991	8 Cyl. 6.2L	IP9
1990	8 Cyl. 6.2L	IP11
1989	8 Cyl. 6.2L; Alternate Number	IP48
1989	8 Cyl. 6.2L; Exhaust stock and reorder	IP7
R2500		
1989	8 Cyl. 6.2L	IP10
R2500 Suburban		
1991	8 Cyl. 6.2L; w/o Cold Climate Package; w/o High Altitude	IP12
1991	8 Cyl. 6.2L; w/ Cold Climate Package; w/o High Altitude	IP13
1990	8 Cyl. 6.2L; J; w/o Cold Climate Package; w/o High Altitude	IP12
1989	8 Cyl. 6.2L	IP10
R3500		
1991	8 Cyl. 6.2L; w/ Cold Climate Package; w/o High Altitude	IP13
1991-1990	8 Cyl. 6.2L; w/o Cold Climate Package; w/o High Altitude	IP12
1989	8 Cyl. 6.2L	IP10
Silverado 2500 HD		
2016-2011	8 Cyl. 6.6L	IP52
2010-2006	8 Cyl. 6.6L	IP24
2005	8 Cyl. 6.6L	IP23
2004	8 Cyl. 6.6L; 1	IP22
2004	8 Cyl. 6.6L; 2	IP23
2003-2001	8 Cyl. 6.6L	IP22
Silverado 2500 HD Classic		
2007	8 Cyl. 6.6L	IP24
Silverado 3500		
2006	8 Cyl. 6.6L	IP24
2005	8 Cyl. 6.6L	IP23
2004	8 Cyl. 6.6L; 1	IP22
2004	8 Cyl. 6.6L; 2	IP23
2003-2001	8 Cyl. 6.6L	IP22
Silverado 3500 Classic		
2007	8 Cyl. 6.6L	IP24
Silverado 3500 HD		
2016-2011	8 Cyl. 6.6L	IP52
2010-2007	8 Cyl. 6.6L	IP24
Tahoe		
1999-1995	8 Cyl. 6.5L; Complete Assembly	IP1
1999-1995	8 Cyl. 6.5L; Pump Only	IP25
V10 Suburban		
1988	8 Cyl. 6.2L; Alternate Number	IP48
1988	8 Cyl. 6.2L; Exhaust stock and reorder	IP7

Injection Components

		Part No.
Diesel Fuel Injection Pump - Remanufactured		
V20		
1987	8 Cyl. 6.2L; J	IP10
V20 Suburban		
1988-1987	8 Cyl. 6.2L; J	IP10
V30		
1988-1987	8 Cyl. 6.2L	IP10
V1500 Suburban		
1991	8 Cyl. 6.2L	IP9
1990	8 Cyl. 6.2L; w/o Cold Climate Package; w/o High Altitude	IP12
1989	8 Cyl. 6.2L; Alternate Number	IP48
1989	8 Cyl. 6.2L; Exhaust stock and reorder	IP7
V2500 Suburban		
1991	8 Cyl. 6.2L; w/o Cold Climate Package; w/o High Altitude	IP12
1991	8 Cyl. 6.2L; w/ Cold Climate Package; w/o High Altitude	IP13
1990	8 Cyl. 6.2L; J; w/o Cold Climate Package; w/o High Altitude	IP12
1989	8 Cyl. 6.2L; J	IP10
V3500		
1991	8 Cyl. 6.2L; w/ Cold Climate Package; w/o High Altitude	IP13
1991-1990	8 Cyl. 6.2L; w/o Cold Climate Package; w/o High Altitude	IP12
1989	8 Cyl. 6.2L	IP10
Diesel Fuel Injector Line		
C4500 Kodiak		
2004	8 Cyl. 6.6L; 1; Cyl. 1 and 8	DIL1
2004	8 Cyl. 6.6L; 1; Cyl. 3 and 6	DIL2
2004	8 Cyl. 6.6L; 1; Cyl. 4 and 5	DIL3
2004	8 Cyl. 6.6L; 1; Cyl. 2 and 7	DIL4
2004-2003	8 Cyl. 6.6L; Complete Kit	DIL1000K
2003	8 Cyl. 6.6L; Cyl. 1 and 8	DIL1
2003	8 Cyl. 6.6L; Cyl. 3 and 6	DIL2
2003	8 Cyl. 6.6L; Cyl. 4 and 5	DIL3
2003	8 Cyl. 6.6L; Cyl. 2 and 7	DIL4
C5500 Kodiak		
2004	8 Cyl. 6.6L; 1; Cyl. 1 and 8	DIL1
2004	8 Cyl. 6.6L; 1; Cyl. 3 and 6	DIL2
2004	8 Cyl. 6.6L; 1; Cyl. 4 and 5	DIL3
2004	8 Cyl. 6.6L; 1; Cyl. 2 and 7	DIL4
2004-2003	8 Cyl. 6.6L; Complete Kit	DIL1000K
2003	8 Cyl. 6.6L; Cyl. 1 and 8	DIL1
2003	8 Cyl. 6.6L; Cyl. 3 and 6	DIL2
2003	8 Cyl. 6.6L; Cyl. 4 and 5	DIL3
2003	8 Cyl. 6.6L; Cyl. 2 and 7	DIL4
Silverado 2500 HD		
2004	8 Cyl. 6.6L; 1; Cyl. 1 and 8	DIL1
2004	8 Cyl. 6.6L; 1; Cyl. 3 and 6	DIL2
2004	8 Cyl. 6.6L; 1; Cyl. 4 and 5	DIL3
2004	8 Cyl. 6.6L; 1; Cyl. 2 and 7	DIL4
2004-2001	8 Cyl. 6.6L; Complete Kit	DIL1000K
2003-2001	8 Cyl. 6.6L; Cyl. 1 and 8	DIL1
2003-2001	8 Cyl. 6.6L; Cyl. 3 and 6	DIL2
2003-2001	8 Cyl. 6.6L; Cyl. 4 and 5	DIL3
2003-2001	8 Cyl. 6.6L; Cyl. 2 and 7	DIL4
Silverado 3500		
2004	8 Cyl. 6.6L; 1; Cyl. 1 and 8	DIL1
2004	8 Cyl. 6.6L; 1; Cyl. 3 and 6	DIL2
2004	8 Cyl. 6.6L; 1; Cyl. 4 and 5	DIL3
2004	8 Cyl. 6.6L; 1; Cyl. 2 and 7	DIL4
2004-2001	8 Cyl. 6.6L; Complete Kit	DIL1000K
2003-2001	8 Cyl. 6.6L; Cyl. 1 and 8	DIL1

		Part No.
Diesel Fuel Injector Line		
Silverado 3500		
2003-2001	8 Cyl. 6.6L; Cyl. 3 and 6	DIL2
2003-2001	8 Cyl. 6.6L; Cyl. 4 and 5	DIL3
2003-2001	8 Cyl. 6.6L; Cyl. 2 and 7	DIL4
Diesel Fuel Injector Rail		
Express 2500		
2016-2010	8 Cyl. 6.6L; Right	FIR3
2016-2010	8 Cyl. 6.6L; Left	FIR4
Express 3500		
2016-2010	8 Cyl. 6.6L; Right	FIR3
2016-2010	8 Cyl. 6.6L; Left	FIR4
Silverado 2500 HD		
2016-2011	8 Cyl. 6.6L; Right	FIR3
2016-2011	8 Cyl. 6.6L; Left	FIR4
Silverado 3500 HD		
2016-2011	8 Cyl. 6.6L; Right	FIR3
2016-2011	8 Cyl. 6.6L; Left	FIR4
Diesel Glow Plug		
Blazer		
1994	8 Cyl. 6.5L	GP104
1991-1987	8 Cyl. 6.2L	GP104
C10		
1986-1982	8 Cyl. 6.2L	GP104
1981-1980	8 Cyl. 5.7L	GP103
C20		
1986-1982	8 Cyl. 6.2L	GP104
C30		
1986-1982	8 Cyl. 6.2L	GP104
C1500		
1998-1994	8 Cyl. 6.5L	GP104
1993-1988	8 Cyl. 6.2L	GP104
C1500 Suburban		
1999-1995	8 Cyl. 6.5L	GP104
C2500		
2000-1992	8 Cyl. 6.5L	GP104
1993-1988	8 Cyl. 6.2L	GP104
C2500 Suburban		
1999-1994	8 Cyl. 6.5L	GP104
C3500		
2000-1992	8 Cyl. 6.5L	GP104
1993-1988	8 Cyl. 6.2L	GP104
C3500HD		
2002-1992	8 Cyl. 6.5L	GP104
C4500 Kodiak		
2009-2008	8 Cyl. 6.6L	GP114
2007	8 Cyl. 6.6L; 2	GP114
2006	8 Cyl. 6.6L	GP114
2005	8 Cyl. 6.6L	GP115
2004	8 Cyl. 6.6L; 1	GP110
2004	8 Cyl. 6.6L; 2	GP115
2003	8 Cyl. 6.6L	GP110
C5500 Kodiak		
2009-2008	8 Cyl. 6.6L	GP114
2007	8 Cyl. 6.6L; 2	GP114
2007	8 Cyl. 6.6L; 9	GP115
2006	8 Cyl. 6.6L	GP114
2005	8 Cyl. 6.6L	GP115
2004	8 Cyl. 6.6L; 1	GP110
2004	8 Cyl. 6.6L; 2	GP115
2003	8 Cyl. 6.6L	GP110
Caprice		
1985-1984	8 Cyl. 5.7L	GP108

Chevrolet

Injection Components

		Part No.
Diesel Glow Plug		
Caprice		
1983-1980	8 Cyl. 5.7L	GP103
Celebrity		
1985-1984	6 Cyl. 4.3L	GP108
1983-1982	6 Cyl. 4.3L	GP103
El Camino		
1984	8 Cyl. 5.7L	GP108
1983	8 Cyl. 5.7L	GP103
Express 2500		
2016-2006	8 Cyl. 6.6L	GP114
2002-1996	8 Cyl. 6.5L	GP104
Express 3500		
2016-2006	8 Cyl. 6.6L	GP114
2002-1996	8 Cyl. 6.5L	GP104
Express 4500		
2016-2009	8 Cyl. 6.6L	GP114
G20		
1995-1994	8 Cyl. 6.5L	GP104
1993-1983	8 Cyl. 6.2L	GP104
G30		
1996-1994	8 Cyl. 6.5L	GP104
1993-1983	8 Cyl. 6.2L	GP104
Impala		
1985-1984	8 Cyl. 5.7L	GP108
1983-1980	8 Cyl. 5.7L	GP103
K5 Blazer		
1986-1982	8 Cyl. 6.2L	GP104
K10		
1986-1982	8 Cyl. 6.2L	GP104
K10 Suburban		
1986-1985	8 Cyl. 6.2L	GP104
K20		
1986-1982	8 Cyl. 6.2L	GP104
K30		
1986-1982	8 Cyl. 6.2L	GP104
K1500		
1998-1994	8 Cyl. 6.5L	GP104
1993-1988	8 Cyl. 6.2L	GP104
K1500 Suburban		
1999-1995	8 Cyl. 6.5L	GP104
K2500		
2000-1992	8 Cyl. 6.5L	GP104
1993-1988	8 Cyl. 6.2L	GP104
K2500 Suburban		
1999-1994	8 Cyl. 6.5L	GP104
K3500		
2000-1992	8 Cyl. 6.5L	GP104
1993-1988	8 Cyl. 6.2L	GP104
Malibu		
1983-1982	6 Cyl. 4.3L	GP103
1983-1982	8 Cyl. 5.7L	GP103
Monte Carlo		
1984	8 Cyl. 5.7L	GP108
1983-1982	6 Cyl. 4.3L	GP103
1983-1982	8 Cyl. 5.7L	GP103
P20		
1989-1982	8 Cyl. 6.2L	GP104
P30		
1999	8 Cyl. 6.5L	GP104
1998-1994	8 Cyl. 6.5L	GP104
1993-1982	8 Cyl. 6.2L	GP104

		Part No.
Diesel Glow Plug		
R10		
1987	8 Cyl. 6.2L	GP104
R20		
1988-1987	8 Cyl. 6.2L	GP104
R30		
1988-1987	8 Cyl. 6.2L	GP104
R2500		
1989	8 Cyl. 6.2L	GP104
R3500		
1991-1989	8 Cyl. 6.2L	GP104
Silverado 2500 HD		
2020-2017	8 Cyl. 6.6L	GP124
2016-2006	8 Cyl. 6.6L	GP114
2005	8 Cyl. 6.6L	GP115
2004	8 Cyl. 6.6L; 1	GP110
2004	8 Cyl. 6.6L; 2	GP115
2003-2001	8 Cyl. 6.6L	GP110
Silverado 2500 HD Classic		
2007	8 Cyl. 6.6L	GP114
Silverado 3500		
2006	8 Cyl. 6.6L	GP114
2005	8 Cyl. 6.6L	GP115
2004	8 Cyl. 6.6L; 1	GP110
2004	8 Cyl. 6.6L; 2	GP115
2003-2001	8 Cyl. 6.6L	GP110
Silverado 3500 Classic		
2007	8 Cyl. 6.6L	GP114
Silverado 3500 HD		
2020-2017	8 Cyl. 6.6L	GP124
2016-2007	8 Cyl. 6.6L	GP114
Tahoe		
1999-1995	8 Cyl. 6.5L	GP104
V10		
1987	8 Cyl. 6.2L	GP104
V20		
1987	8 Cyl. 6.2L	GP104
V30		
1988-1987	8 Cyl. 6.2L	GP104
V3500		
1991-1989	8 Cyl. 6.2L	GP104
Diesel Injector Pump Driver Relocation Kit		
Blazer		
1994	8 Cyl. 6.5L; OE No. 17800077, ID Tag No. 5521; w/ Module	IPR1
1994	8 Cyl. 6.5L; OE No. 17800077, ID Tag No. 5521; w/o Module	IPR2
C1500		
1998-1995	8 Cyl. 6.5L; w/ Module	IPR1
1998-1995	8 Cyl. 6.5L; w/o Module	IPR2
1994	8 Cyl. 6.5L; OE No. 17800077, ID Tag No. 5521; w/ Module	IPR1
1994	8 Cyl. 6.5L; OE No. 17800077, ID Tag No. 5521; w/o Module	IPR2
C1500 Suburban		
1999-1998	8 Cyl. 6.5L; w/ Module	IPR1
1999-1998	8 Cyl. 6.5L; w/o Module	IPR2
C2500		
2000-1995	8 Cyl. 6.5L; w/ Module	IPR1
2000-1995	8 Cyl. 6.5L; w/o Module	IPR2
1994	8 Cyl. 6.5L; OE No. 17800077, ID Tag No. 5521; w/ Module	IPR1
1994	8 Cyl. 6.5L; OE No. 17800077, ID Tag No. 5521; w/o Module	IPR2

Injection Components

		Part No.
Diesel Injector Pump Driver Relocation Kit		
C3500		
2000-1995	8 Cyl. 6.5L; w/ Module	IPR1
2000-1995	8 Cyl. 6.5L; w/o Module	IPR2
1994	8 Cyl. 6.5L; OE No. 17800077, ID Tag No. 5521; w/ Module	IPR1
1994	8 Cyl. 6.5L; OE No. 17800077, ID Tag No. 5521; w/o Module	IPR2
C3500HD		
2002-1995	8 Cyl. 6.5L; w/ Module	IPR1
2002-1995	8 Cyl. 6.5L; w/o Module	IPR2
1994	8 Cyl. 6.5L; OE No. 17800077, ID Tag No. 5521; w/ Module	IPR1
1994	8 Cyl. 6.5L; OE No. 17800077, ID Tag No. 5521; w/o Module	IPR2
Express 2500		
2002-1996	8 Cyl. 6.5L; w/ Module	IPR1
2002-1996	8 Cyl. 6.5L; w/o Module	IPR2
Express 3500		
2002-1996	8 Cyl. 6.5L; w/ Module	IPR1
2002-1996	8 Cyl. 6.5L; w/o Module	IPR2
G20		
1995	8 Cyl. 6.5L; w/ Module	IPR1
1995	8 Cyl. 6.5L; w/o Module	IPR2
1994	8 Cyl. 6.5L; OE No. 17800077, ID Tag No. 5521; w/ Module	IPR1
1994	8 Cyl. 6.5L; OE No. 17800077, ID Tag No. 5521; w/o Module	IPR2
K1500		
1998-1995	8 Cyl. 6.5L; w/ Module	IPR1
1998-1995	8 Cyl. 6.5L; w/o Module	IPR2
1994	8 Cyl. 6.5L; OE No. 17800077, ID Tag No. 5521; w/ Module	IPR1
1994	8 Cyl. 6.5L; OE No. 17800077, ID Tag No. 5521; w/o Module	IPR2
K1500 Suburban		
1999-1995	8 Cyl. 6.5L; w/ Module	IPR1
1999-1995	8 Cyl. 6.5L; w/o Module	IPR2
K2500		
2000-1995	8 Cyl. 6.5L; w/ Module	IPR1
2000-1995	8 Cyl. 6.5L; w/o Module	IPR2
1994	8 Cyl. 6.5L; OE No. 17800077, ID Tag No. 5521; w/ Module	IPR1
1994	8 Cyl. 6.5L; OE No. 17800077, ID Tag No. 5521; w/o Module	IPR2
K3500		
2000-1995	8 Cyl. 6.5L; w/ Module	IPR1
2000-1995	8 Cyl. 6.5L; w/o Module	IPR2
1994	8 Cyl. 6.5L; OE No. 17800077, ID Tag No. 5521; w/ Module	IPR1
1994	8 Cyl. 6.5L; OE No. 17800077, ID Tag No. 5521; w/o Module	IPR2
P30		
1999-1995	8 Cyl. 6.5L; Turbocharged; w/ Module	IPR1
1999-1995	8 Cyl. 6.5L; Turbocharged; w/o Module	IPR2
1994	8 Cyl. 6.5L; OE No. 17800077, ID Tag No. 5521; Turbocharged; w/ Module	IPR1
1994	8 Cyl. 6.5L; OE No. 17800077, ID Tag No. 5521; Turbocharged; w/o Module	IPR2
Tahoe		
1997-1995	8 Cyl. 6.5L; w/ Module	IPR1
1997-1995	8 Cyl. 6.5L; w/o Module	IPR2
Diesel Injector Pump Module		
Blazer		
1994	8 Cyl. 6.5L; OE No. 17800077, ID Tag No. 5521	IPM1

		Part No.
Diesel Injector Pump Module		
C1500		
1998-1994	8 Cyl. 6.5L	IPM1
C1500 Suburban		
1999-1998	8 Cyl. 6.5L	IPM1
C2500		
2000-1995	8 Cyl. 6.5L	IPM1
1994	8 Cyl. 6.5L; OE No. 17800077, ID Tag No. 5521	IPM1
C3500		
2000-1995	8 Cyl. 6.5L	IPM1
1994	8 Cyl. 6.5L; OE No. 17800077, ID Tag No. 5521	IPM1
C3500HD		
2002-1995	8 Cyl. 6.5L	IPM1
1994	8 Cyl. 6.5L; F; OE No. 17800077, ID Tag No. 5521	IPM1
Express 2500		
2002-1996	8 Cyl. 6.5L	IPM1
Express 3500		
2002-1996	8 Cyl. 6.5L	IPM1
G20		
1995-1994	8 Cyl. 6.5L	IPM1
K1500		
1998-1994	8 Cyl. 6.5L	IPM1
K1500 Suburban		
1999-1995	8 Cyl. 6.5L	IPM1
K2500		
2000-1995	8 Cyl. 6.5L	IPM1
1994	8 Cyl. 6.5L; OE No. 17800077, ID Tag No. 5521	IPM1
K3500		
2000-1994	8 Cyl. 6.5L	IPM1
P30		
1999-1995	8 Cyl. 6.5L	IPM1
1994	8 Cyl. 6.5L; OE No. 17800077, ID Tag No. 5521	IPM1
Tahoe		
1997-1995	8 Cyl. 6.5L	IPM1
Diesel Oil Cooler Kit		
C2500		
1998-1996	8 Cyl. 6.5L	OCK14
1995-1994	8 Cyl. 6.5L	OCK13
C3500		
1998-1996	8 Cyl. 6.5L	OCK14
1995-1994	8 Cyl. 6.5L	OCK13
Colorado		
2019-2016	4 Cyl. 2.8L	OCK12
Express 2500		
2019-2017	4 Cyl. 2.8L	OCK11
2016-2010	8 Cyl. 6.6L	OCK8
2002-2000	8 Cyl. 6.5L	OCK19
1998-1996	8 Cyl. 6.5L	OCK19
Express 3500		
2019-2017	4 Cyl. 2.8L	OCK11
2016-2010	8 Cyl. 6.6L	OCK8
2009-2006	8 Cyl. 6.6L	OCK9
2002-1996	8 Cyl. 6.5L	OCK19
Express 4500		
2016-2010	8 Cyl. 6.6L	OCK8
Silverado 2500 HD		
2019-2017	8 Cyl. 6.6L	OCK10
2016-2011	8 Cyl. 6.6L	OCK8
2010-2004	8 Cyl. 6.6L	OCK9

Chevrolet

Injection Components

		Part No.
Diesel Oil Cooler Kit		
Silverado 3500		
2006-2004	8 Cyl. 6.6L	OCK9
Silverado 3500 HD		
2019-2017	8 Cyl. 6.6L	OCK10
2016-2011	8 Cyl. 6.6L	OCK8
2010-2007	8 Cyl. 6.6L	OCK9
Diesel Valve Cover Gasket		
C4500 Kodiak		
2009-2005	8 Cyl. 6.6L	VCG3
2004	8 Cyl. 6.6L; 1	VCG5
2004	8 Cyl. 6.6L; 2	VCG3
2003	8 Cyl. 6.6L	VCG5
C5500 Kodiak		
2009-2005	8 Cyl. 6.6L	VCG3
2004	8 Cyl. 6.6L; 1	VCG5
2004	8 Cyl. 6.6L; 2	VCG3
2003	8 Cyl. 6.6L	VCG5
Express 2500		
2010-2006	8 Cyl. 6.6L	VCG3
Express 3500		
2010-2006	8 Cyl. 6.6L	VCG3
Express 4500		
2010	8 Cyl. 6.6L; 6	VCG3
2009	8 Cyl. 6.6L	VCG3
Silverado 2500 HD		
2010-2005	8 Cyl. 6.6L	VCG3
2004	8 Cyl. 6.6L; 1	VCG5
2004	8 Cyl. 6.6L; 2	VCG3
2003-2001	8 Cyl. 6.6L	VCG5
Silverado 2500 HD Classic		
2007	8 Cyl. 6.6L	VCG3
Silverado 3500		
2006-2005	8 Cyl. 6.6L	VCG3
2004	8 Cyl. 6.6L; 1	VCG5
2004	8 Cyl. 6.6L; 2	VCG3
2003-2001	8 Cyl. 6.6L	VCG5
Silverado 3500 Classic		
2007	8 Cyl. 6.6L	VCG3
Silverado 3500 HD		
2010-2007	8 Cyl. 6.6L	VCG3
Fuel Filter Housing Seal Kit		
Silverado 2500 HD		
2010-2001	8 Cyl. 6.6L	PHS1
Silverado 3500		
2006-2001	8 Cyl. 6.6L	PHS1
Silverado 3500 HD		
2010-2007	8 Cyl. 6.6L	PHS1
Fuel Injector Installation Kit		
Blazer		
1994	8 Cyl. 6.5L	SK54
1991-1987	8 Cyl. 6.2L	SK54
C10		
1986-1982	8 Cyl. 6.2L	SK54
C10 Suburban		
1986-1982	8 Cyl. 6.2L	SK54
C20		
1986-1982	8 Cyl. 6.2L	SK54
C20 Suburban		
1986-1982	8 Cyl. 6.2L	SK54
C30		
1986-1982	8 Cyl. 6.2L	SK54

		Part No.
Fuel Injector Installation Kit		
C1500		
1998-1994	8 Cyl. 6.5L	SK54
1993-1988	8 Cyl. 6.2L	SK54
C1500 Suburban		
1999-1995	8 Cyl. 6.5L	SK54
C2500		
2000-1994	8 Cyl. 6.5L	SK54
1993-1988	8 Cyl. 6.2L	SK54
C2500 Suburban		
1999-1994	8 Cyl. 6.5L	SK54
C3500		
2000-1994	8 Cyl. 6.5L	SK54
1993-1988	8 Cyl. 6.2L	SK54
C3500HD		
2002-1994	8 Cyl. 6.5L	SK54
C4500 Kodiak		
2009-2005	8 Cyl. 6.6L	SK115
2004	8 Cyl. 6.6L; 2	SK115
C5500 Kodiak		
2009-2005	8 Cyl. 6.6L	SK115
2004	8 Cyl. 6.6L; 2	SK115
Express 2500		
2010-2006	8 Cyl. 6.6L	SK115
2002-1996	8 Cyl. 6.5L	SK54
Express 3500		
2010-2006	8 Cyl. 6.6L	SK115
2002-1996	8 Cyl. 6.5L	SK54
Express 4500		
2010-2009	8 Cyl. 6.6L	SK115
G20		
1995-1994	8 Cyl. 6.5L	SK54
1993-1983	8 Cyl. 6.2L	SK54
G30		
1996-1994	8 Cyl. 6.5L	SK54
1993-1983	8 Cyl. 6.2L	SK54
K5 Blazer		
1986-1982	8 Cyl. 6.2L	SK54
K10		
1986-1982	8 Cyl. 6.2L	SK54
K10 Suburban		
1986-1982	8 Cyl. 6.2L	SK54
K20		
1986-1982	8 Cyl. 6.2L	SK54
K20 Suburban		
1986	8 Cyl. 6.2L	SK54
1985-1984	8 Cyl. 6.2L; J	SK54
1983-1982	8 Cyl. 6.2L	SK54
K30		
1986-1982	8 Cyl. 6.2L	SK54
K1500		
1998-1994	8 Cyl. 6.5L	SK54
1993-1988	8 Cyl. 6.2L	SK54
K1500 Suburban		
1999-1995	8 Cyl. 6.5L	SK54
K2500		
2000-1994	8 Cyl. 6.5L	SK54
1993-1988	8 Cyl. 6.2L	SK54
K2500 Suburban		
1999-1994	8 Cyl. 6.5L	SK54
K3500		
2000-1994	8 Cyl. 6.5L	SK54
1993-1988	8 Cyl. 6.2L	SK54

Injection Components

		Part No.
Fuel Injector Installation Kit		
P20		
1989-1983	8 Cyl. 6.2L	SK54
P30		
1999-1994	8 Cyl. 6.5L	SK54
1993-1983	8 Cyl. 6.2L	SK54
R10		
1987	8 Cyl. 6.2L	SK54
R10 Suburban		
1988-1987	8 Cyl. 6.2L	SK54
R20		
1988-1987	8 Cyl. 6.2L	SK54
R20 Suburban		
1988-1987	8 Cyl. 6.2L; J	SK54
R30		
1988-1987	8 Cyl. 6.2L	SK54
R1500 Suburban		
1991-1989	8 Cyl. 6.2L	SK54
R2500		
1989	8 Cyl. 6.2L	SK54
R2500 Suburban		
1991-1989	8 Cyl. 6.2L	SK54
R3500		
1991-1989	8 Cyl. 6.2L	SK54
Silverado 2500 HD		
2010-2005	8 Cyl. 6.6L	SK115
2004	8 Cyl. 6.6L; 2	SK115
Silverado 3500		
2006-2005	8 Cyl. 6.6L	SK115
2004	8 Cyl. 6.6L; 2	SK115
Silverado 3500 Classic		
2007	8 Cyl. 6.6L	SK115
Silverado 3500 HD		
2010-2007	8 Cyl. 6.6L	SK115
Tahoe		
1999-1995	8 Cyl. 6.5L	SK54
V10		
1987	8 Cyl. 6.2L	SK54
V10 Suburban		
1988-1987	8 Cyl. 6.2L	SK54
V20		
1987	8 Cyl. 6.2L	SK54
V20 Suburban		
1988-1987	8 Cyl. 6.2L	SK54
V30		
1988-1987	8 Cyl. 6.2L	SK54
V1500 Suburban		
1991-1989	8 Cyl. 6.2L	SK54
V2500 Suburban		
1991-1989	8 Cyl. 6.2L	SK54
V3500		
1991-1989	8 Cyl. 6.2L	SK54
Fuel Injector Seal Kit		
Blazer		
1994	8 Cyl. 6.5L; Seal	SK13
1991-1987	8 Cyl. 6.2L; Seal	SK13
C10		
1986-1982	8 Cyl. 6.2L; Seal	SK13
C10 Suburban		
1986-1982	8 Cyl. 6.2L; Seal	SK13
C20		
1986-1982	8 Cyl. 6.2L; Seal	SK13

		Part No.
Fuel Injector Seal Kit		
C20 Suburban		
1986-1982	8 Cyl. 6.2L; Seal	SK13
C30		
1986-1982	8 Cyl. 6.2L; Seal	SK13
C1500		
1998-1994	8 Cyl. 6.5L; Seal	SK13
1993-1988	8 Cyl. 6.2L; Seal	SK13
C1500 Suburban		
1999-1995	8 Cyl. 6.5L; Seal	SK13
C2500		
2000-1994	8 Cyl. 6.5L; Seal	SK13
1993-1988	8 Cyl. 6.2L; Seal	SK13
C2500 Suburban		
1999-1994	8 Cyl. 6.5L; Seal	SK13
C3500		
2000-1994	8 Cyl. 6.5L; Seal	SK13
1993-1988	8 Cyl. 6.2L; Seal	SK13
C3500HD		
2002-1994	8 Cyl. 6.5L; Seal	SK13
Cruze		
2014	4 Cyl. 2.0L; Upper	SK121
2014	4 Cyl. 2.0L; Lower	SK122
Express 2500		
2002-1999	8 Cyl. 6.5L; Seal	SK13
1997-1996	8 Cyl. 6.5L; Seal	SK13
Express 3500		
2002-1999	8 Cyl. 6.5L; Seal	SK13
1997-1996	8 Cyl. 6.5L; Seal	SK13
G20		
1995-1994	8 Cyl. 6.5L; Seal	SK13
1993-1983	8 Cyl. 6.2L; Seal	SK13
G30		
1996-1994	8 Cyl. 6.5L; Seal	SK13
1993-1983	8 Cyl. 6.2L; Seal	SK13
K5 Blazer		
1986-1982	8 Cyl. 6.2L; Seal	SK13
K10		
1986-1982	8 Cyl. 6.2L; Seal	SK13
K10 Suburban		
1986-1982	8 Cyl. 6.2L; Seal	SK13
K20		
1986-1982	8 Cyl. 6.2L; Seal	SK13
K20 Suburban		
1986-1982	8 Cyl. 6.2L; Seal	SK13
K30		
1986-1982	8 Cyl. 6.2L; Seal	SK13
K1500		
1998-1994	8 Cyl. 6.5L; Seal	SK13
1993-1988	8 Cyl. 6.2L; Seal	SK13
K1500 Suburban		
1999-1995	8 Cyl. 6.5L; Seal	SK13
K2500		
2000-1994	8 Cyl. 6.5L; Seal	SK13
1993-1992	8 Cyl. 6.5L; Diesel	SK13
1993-1988	8 Cyl. 6.2L; Seal	SK13
K2500 Suburban		
1999-1994	8 Cyl. 6.5L; Seal	SK13
K3500		
2000-1994	8 Cyl. 6.5L; Seal	SK13
1993-1992	8 Cyl. 6.5L; Diesel	SK13
1993-1988	8 Cyl. 6.2L; Seal	SK13

Chevrolet

Injection Components

		Part No.
Fuel Injector Seal Kit		
P20		
1988-1983	8 Cyl. 6.2L; Seal	SK13
1982	8 Cyl. 6.2L; Diesel	SK13
P30		
1999-1994	8 Cyl. 6.5L; Seal	SK13
1993-1990	8 Cyl. 6.2L; Seal	SK13
1988-1983	8 Cyl. 6.2L; Seal	SK13
1982	8 Cyl. 6.2L; Diesel	SK13
R10		
1987	8 Cyl. 6.2L; Seal	SK13
R10 Suburban		
1988-1987	8 Cyl. 6.2L; Seal	SK13
R20		
1988-1987	8 Cyl. 6.2L; Seal	SK13
R20 Suburban		
1988-1987	8 Cyl. 6.2L; Seal	SK13
R30		
1988-1987	8 Cyl. 6.2L; Seal	SK13
R1500 Suburban		
1991-1989	8 Cyl. 6.2L; Seal	SK13
R2500		
1989	8 Cyl. 6.2L; Seal	SK13
R2500 Suburban		
1991-1989	8 Cyl. 6.2L; Seal	SK13
R3500		
1991-1989	8 Cyl. 6.2L; Seal	SK13
Silverado 1500		
2019	6 Cyl. ⁹	SK120
Silverado 2500 HD		
2004	8 Cyl. 6.6L; 1; O-Ring Only; Single Injector ²	SK66
2004	8 Cyl. 6.6L; 1; Rail Service Kit w/o Valve Cover Gasket ⁹	SK67
2004	8 Cyl. 6.6L; 1; Rail Service Kit w/ Valve Cover Gasket ⁹	SK68
2003-2001	8 Cyl. 6.6L; O-Ring Only; Single Injector ²	SK66
2003-2001	8 Cyl. 6.6L; Rail Service Kit w/o Valve Cover Gasket ⁹	SK67
2003-2001	8 Cyl. 6.6L; Rail Service Kit w/ Valve Cover Gasket ⁹	SK68
Silverado 3500		
2004	8 Cyl. 6.6L; 1; O-Ring Only; Single Injector ²	SK66
2004	8 Cyl. 6.6L; 1; Rail Service Kit w/o Valve Cover Gasket ⁹	SK67
2004	8 Cyl. 6.6L; 1; Rail Service Kit w/ Valve Cover Gasket ⁹	SK68
2003-2001	8 Cyl. 6.6L; O-Ring Only; Single Injector ²	SK66
2003-2001	8 Cyl. 6.6L; Rail Service Kit w/o Valve Cover Gasket ⁹	SK67
2003-2001	8 Cyl. 6.6L; Rail Service Kit w/ Valve Cover Gasket ⁹	SK68
Tahoe		
1999-1995	8 Cyl. 6.5L; Seal	SK13
V10		
1987	8 Cyl. 6.2L; Seal	SK13
V10 Suburban		
1988-1987	8 Cyl. 6.2L; Seal	SK13
V20		
1987	8 Cyl. 6.2L; Seal	SK13
V20 Suburban		
1988-1987	8 Cyl. 6.2L; Seal	SK13

		Part No.
Fuel Injector Seal Kit		
V30		
1988-1987	8 Cyl. 6.2L; Seal	SK13
V1500 Suburban		
1991-1989	8 Cyl. 6.2L; Seal	SK13
V2500 Suburban		
1991-1989	8 Cyl. 6.2L; Seal	SK13
V3500		
1991-1989	8 Cyl. 6.2L; Seal	SK13
Fuel Pressure Regulator		
C4500 Kodiak		
2009-2006	8 Cyl. 6.6L	PR444
2005	8 Cyl. 6.6L	PR439
2004	8 Cyl. 6.6L; 1	PR437
2004	8 Cyl. 6.6L; 2	PR439
2003	8 Cyl. 6.6L	PR437
C5500 Kodiak		
2009-2006	8 Cyl. 6.6L	PR444
2005	8 Cyl. 6.6L	PR439
2004	8 Cyl. 6.6L; 1	PR437
2004	8 Cyl. 6.6L; 2	PR439
2003	8 Cyl. 6.6L	PR437
Express 2500		
2010	8 Cyl. 6.6L; 6	PR444
2010	8 Cyl. 6.6L; L; Located On Fuel Pump	PR544
2010	8 Cyl. 6.6L; L; Located On Fuel Rail	PR553
Express 3500		
2010	8 Cyl. 6.6L; 6	PR444
2010	8 Cyl. 6.6L; L; Located On Fuel Pump	PR544
2010	8 Cyl. 6.6L; L; Located On Fuel Rail	PR553
Express 4500		
2016-2011	8 Cyl. 6.6L; Located On Fuel Rail	PR553
2014-2011	8 Cyl. 6.6L; Located On Fuel Pump	PR544
2010	8 Cyl. 6.6L; 6	PR444
2010	8 Cyl. 6.6L; L; Located On Fuel Pump	PR544
2010	8 Cyl. 6.6L; L; Located On Fuel Rail	PR553
2009	8 Cyl. 6.6L	PR444
Silverado 2500 HD		
2016-2013	8 Cyl. 6.6L; Located On Fuel Pump	PR544
2016-2013	8 Cyl. 6.6L; Located On Fuel Rail	PR553
2012-2011	8 Cyl. 6.6L; 8; Located On Fuel Pump	PR544
2012-2011	8 Cyl. 6.6L; 8; Located On Fuel Rail	PR553
2012-2011	8 Cyl. 6.6L; L	PR444
2005	8 Cyl. 6.6L	PR439
2004	8 Cyl. 6.6L; 1	PR437
2004	8 Cyl. 6.6L; 2	PR439
2003-2001	8 Cyl. 6.6L	PR437
Silverado 3500		
2005	8 Cyl. 6.6L	PR439
2004	8 Cyl. 6.6L; 1	PR437
2004	8 Cyl. 6.6L; 2	PR439
2003-2001	8 Cyl. 6.6L	PR437
Silverado 3500 Classic		
2007	8 Cyl. 6.6L	PR444
Silverado 3500 HD		
2016-2013	8 Cyl. 6.6L; Located On Fuel Pump	PR544
2016-2013	8 Cyl. 6.6L; Located On Fuel Rail	PR553
2012-2011	8 Cyl. 6.6L; 8; Located On Fuel Pump	PR544
2012-2011	8 Cyl. 6.6L; 8; Located On Fuel Rail	PR553
2012-2011	8 Cyl. 6.6L; L	PR444
Fuel Rail O-Ring Kit		
Blazer		
1994	8 Cyl. 6.5L; Inlet and Outlet	SK18
1991-1987	8 Cyl. 6.2L; Inlet and Outlet	SK18

Injection Components

		Part No.
Fuel Rail O-Ring Kit		
C2500 Suburban		
1999-1994	8 Cyl.; Inlet and Outlet	SK18
Caprice		
1985-1981	8 Cyl. 5.7L; Inlet and Outlet	SK18
Celebrity		
1985-1982	6 Cyl. 4.3L; Inlet and Outlet	SK18
Chevette		
1986-1981	4 Cyl. 1.8L; Inlet and Outlet	SK18
Express 2500		
2006	8 Cyl.; Fuel Line Feed Kit	SK80
1999-1996	8 Cyl. 6.5L; Inlet and Outlet	SK18
1998-1996	8 Cyl. 6.5L; Inlet; Multi-Pack	SK26
Express 3500		
1999-1996	8 Cyl. 6.5L; Inlet and Outlet	SK18
G20		
1995-1994	8 Cyl. 6.5L; Inlet and Outlet	SK18
1993-1986	8 Cyl. 6.2L; Inlet and Outlet	SK18
G30		
1996-1994	8 Cyl. 6.5L; Inlet and Outlet	SK18
1993-1991	8 Cyl. 6.2L; Inlet and Outlet	SK18
1989-1986	8 Cyl. 6.2L; Inlet and Outlet	SK18
Impala		
1985-1981	8 Cyl. 5.7L; Inlet and Outlet	SK18
K5 Blazer		
1986	8 Cyl. 6.2L; Inlet and Outlet	SK18
K10		
1986	8 Cyl. 6.2L; Inlet and Outlet	SK18
K30		
1986	8 Cyl. 6.2L; Inlet and Outlet	SK18
K1500 Suburban		
1999-1996	8 Cyl. 6.5L; Inlet and Outlet	SK18
Malibu		
1983-1982	6 Cyl. 4.3L; Inlet and Outlet	SK18
1983-1982	8 Cyl. 5.7L; Inlet and Outlet	SK18
Monte Carlo		
1984-1982	8 Cyl. 5.7L; Inlet and Outlet	SK18
1983-1982	6 Cyl. 4.3L; Inlet and Outlet	SK18
P20		
1988-1986	8 Cyl. 6.2L; Inlet and Outlet	SK18
P30		
1999-1994	8 Cyl. 6.5L; Inlet and Outlet	SK18
1993-1986	8 Cyl. 6.2L; Inlet and Outlet	SK18
1991-1990	4 Cyl. 3.9L; Inlet and Outlet	SK18
Tahoe		
1999-1996	8 Cyl. 6.5L; Inlet and Outlet	SK18
Glow Plug Conductor		
C4500 Kodiak		
2004-2003	8 Cyl. 6.6L	GPC101
C5500 Kodiak		
2004-2003	8 Cyl. 6.6L	GPC101
Silverado 2500 HD		
2004	8 Cyl. 6.6L; 1	GPC101
2003-2001	8 Cyl. 6.6L	GPC101
Silverado 3500		
2004	8 Cyl. 6.6L; 1	GPC101
2003-2001	8 Cyl. 6.6L	GPC101
Throttle Body Injection Flange Gasket		
Silverado 2500 HD		
2010-2007	8 Cyl. 6.6L	TBG144
Silverado 3500 HD		
2009-2007	8 Cyl. 6.6L	TBG144

		Part No.
Chassis and Drivetrain Sensors		
ABS Speed Sensor		
K1500 Suburban		
1999-1998	8 Cyl. 6.5L; Right Front	ALS1184
1999-1998	8 Cyl. 6.5L; Left Front	ALS1187
1996	8 Cyl. 6.5L; Right Front	ALS1184
1996	8 Cyl. 6.5L; Left Front	ALS1187
T6500		
2009	w/ Hydraulic Brakes; Rear	ALS2683
2009-2004	w/ Hydraulic Brakes; Front	ALS2397
2007-2004	w/ Hydraulic Brakes; Rear	ALS2683
2002-1999	Straight End; Front	ALS2394
2002-1999	Straight End; Rear	ALS2394
2002-1999	90 Deg. Angle; Front	ALS2409
2002-1999	90 Deg. Angle; Rear	ALS2409
T7500		
2009	w/ Hydraulic Brakes; Rear	ALS2683
2009-2004	w/ Hydraulic Brakes; Front	ALS2397
2007-2004	w/ Hydraulic Brakes; Rear	ALS2683
2002-1999	Straight End; Front	ALS2394
2002-1999	Straight End; Rear	ALS2394
2002-1999	90 Deg. Angle; Front	ALS2409
2002-1999	90 Deg. Angle; Rear	ALS2409
Automatic Transmission Input Sensor		
Silverado 2500 HD		
2015	8 Cyl. 6.6L	SC695
Vehicle Speed Sensor		
Silverado 2500 HD		
2015	8 Cyl. 6.6L	SC695
Silverado 3500 Classic		
2007	8 Cyl. 6.6L; RWD; w/ A.T.	SC163
Silverado 3500 HD		
2019-2015	8 Cyl. 6.6L	SC695
2008	8 Cyl. 6.6L; RWD	SC163
2007	8 Cyl. 6.6L; RWD; w/ A.T.	SC163
YAW Rate Sensor		
Express 2500		
2007	8 Cyl. 6.6L	YA132
Fluid Level Sensors		
Brake Fluid Level Sensor		
Express 2500		
2007	8 Cyl. 6.6L	FLS-12
Express 3500		
2007	8 Cyl. 6.6L	FLS-12
Silverado 2500 HD		
2004-2003	8 Cyl. 6.6L	FLS-12
Silverado 3500		
2006-2003	8 Cyl. 6.6L	FLS-12
Coolant Level Sensor		
Blazer		
1991-1987	8 Cyl. 6.2L	FLS-3
C10 Suburban		
1986	8 Cyl. 6.2L	FLS-3
1984-1982	8 Cyl. 6.2L	FLS-3
C20 Suburban		
1986-1982	8 Cyl. 6.2L	FLS-3
G20		
1994	8 Cyl. 6.5L	FLS-1
1993-1992	8 Cyl. 6.2L	FLS-1
1991-1983	8 Cyl. 6.2L	FLS-3
G30		
1994	8 Cyl. 6.5L	FLS-1

Chevrolet

Fluid Level Sensors

		Part No.
Coolant Level Sensor		
G30		
1993-1992	8 Cyl. 6.2L	FLS-1
1991	8 Cyl. 6.2L	FLS-3
1989-1983	8 Cyl. 6.2L	FLS-3
K5 Blazer		
1986-1982	8 Cyl. 6.2L	FLS-3
K10 Suburban		
1986	8 Cyl. 6.2L	FLS-3
1984-1982	8 Cyl. 6.2L	FLS-3
K20 Suburban		
1986-1982	8 Cyl. 6.2L	FLS-3
R10 Suburban		
1988-1987	8 Cyl. 6.2L	FLS-3
R20 Suburban		
1988-1987	8 Cyl. 6.2L	FLS-3
R1500 Suburban		
1991-1989	8 Cyl. 6.2L	FLS-3
R2500 Suburban		
1991-1989	8 Cyl. 6.2L	FLS-3
V10 Suburban		
1988-1987	8 Cyl. 6.2L	FLS-3
V20 Suburban		
1988-1987	8 Cyl. 6.2L	FLS-3
V1500 Suburban		
1991-1989	8 Cyl. 6.2L	FLS-3
V2500 Suburban		
1991-1989	8 Cyl. 6.2L	FLS-3
Engine Oil Level Sensor		
Express 2500		
2016-2006	8 Cyl. 6.6L	FLS-61
Express 3500		
2016-2006	8 Cyl. 6.6L	FLS-61
Silverado 2500 HD		
2016-2001	8 Cyl. 6.6L	FLS-61
Silverado 2500 HD Classic		
2007	8 Cyl. 6.6L	FLS-61
Silverado 3500		
2006-2001	8 Cyl. 6.6L	FLS-61
Silverado 3500 Classic		
2007	8 Cyl. 6.6L	FLS-61
Silverado 3500 HD		
2016-2007	8 Cyl. 6.6L	FLS-61
Fuel Level Sensor		
Colorado		
2020-2016	4 Cyl.	LSF135
Express 2500		
2009-2006	8 Cyl.	LSF136
Express 3500		
2009-2007	8 Cyl.	LSF136
Silverado 2500 HD		
2008-2004	8 Cyl. 6.6L	K07025
Silverado 2500 HD Classic		
2007	8 Cyl. 6.6L	K07025
Silverado 3500		
2006-2004	8 Cyl. 6.6L	K07025
Silverado 3500 Classic		
2007	8 Cyl. 6.6L	K07025
Silverado 3500 HD		
2015-2011	8 Cyl. 6.6L; Diesel	K07020

		Part No.
Fuel Sensors		
Diesel Exhaust Particulate Sensor		
Colorado		
2019-2016	4 Cyl. 2.8L	DEP118
Cruze		
2019	4 Cyl. 1.6L	DEP124
2018-2017	4 Cyl. 1.6L	DEP123
2015-2014	4 Cyl. 2.0L	DEP125
Equinox		
2019-2018	4 Cyl. 1.6L	DEP122
Express 2500		
2019-2018	4 Cyl. 2.8L	DEP121
2017	4 Cyl. 2.8L	DEP125
2016	8 Cyl. 6.6L	DEP120
Express 3500		
2019-2018	4 Cyl. 2.8L	DEP121
2017	4 Cyl. 2.8L	DEP125
2016	8 Cyl. 6.6L	DEP120
Silverado 2500 HD		
2019-2017	8 Cyl. 6.6L	DEP119
2016	8 Cyl. 6.6L	DEP120
Silverado 3500 HD		
2019-2017	8 Cyl. 6.6L	DEP119
2016	8 Cyl. 6.6L	DEP120
Diesel Nitrogen Oxide (NOx) Sensor		
Express 2500		
2016	8 Cyl. 6.6L; Downstream	NOX021
2016	8 Cyl. 6.6L; Upstream	NOX022
2015	8 Cyl. 6.6L; Downstream	NOX003
2015	8 Cyl. 6.6L; Upstream	NOX004
2014-2010	8 Cyl. 6.6L; Downstream	NOX001
2014-2010	8 Cyl. 6.6L; Upstream	NOX002
Express 3500		
2016	8 Cyl. 6.6L; Downstream	NOX021
2016	8 Cyl. 6.6L; Upstream	NOX022
2015	8 Cyl. 6.6L; Downstream	NOX003
2015	8 Cyl. 6.6L; Upstream	NOX004
2014-2010	8 Cyl. 6.6L; Downstream	NOX001
2014-2010	8 Cyl. 6.6L; Upstream	NOX002
Express 4500		
2016	8 Cyl. 6.6L; Downstream	NOX021
2015	8 Cyl. 6.6L; Downstream	NOX003
2015	8 Cyl. 6.6L; Upstream	NOX004
2014-2010	8 Cyl. 6.6L; Downstream	NOX001
2014-2010	8 Cyl. 6.6L; Upstream	NOX002
Silverado 2500 HD		
2019-2018	8 Cyl. 6.6L; Upstream	NOX007
2018-2017	8 Cyl. 6.6L; Downstream	NOX005
2017	8 Cyl. 6.6L; Upstream	NOX006
2016	8 Cyl. 6.6L; Downstream	NOX021
2016	8 Cyl. 6.6L; Upstream	NOX022
2015	8 Cyl. 6.6L; Downstream	NOX003
2015	8 Cyl. 6.6L; Upstream	NOX004
2014-2011	8 Cyl. 6.6L; Downstream	NOX001
2014-2011	8 Cyl. 6.6L; Upstream	NOX002
Silverado 3500 HD		
2019-2018	8 Cyl. 6.6L; Upstream	NOX007
2018-2017	8 Cyl. 6.6L; Downstream	NOX005
2017	8 Cyl. 6.6L; Upstream	NOX006
2016	8 Cyl. 6.6L; Downstream	NOX021
2016	8 Cyl. 6.6L; Upstream	NOX022
2015	8 Cyl. 6.6L; Downstream	NOX003
2015	8 Cyl. 6.6L; Upstream	NOX004
2014-2011	8 Cyl. 6.6L; Downstream	NOX001

Fuel Sensors

		Part No.
Diesel Nitrogen Oxide (NOx) Sensor		
Silverado 3500 HD		
2014-2011	8 Cyl. 6.6L; Upstream	NOX002
Fuel / Water Separator Sensor		
Blazer		
1994	8 Cyl. 6.5L	FWSS102
1991-1987	8 Cyl. 6.2L	FWSS103
C10		
1986-1985	8 Cyl. 6.2L	FWSS103
C10 Suburban		
1986-1985	8 Cyl. 6.2L	FWSS103
C20		
1986-1985	8 Cyl. 6.2L	FWSS103
C20 Suburban		
1986-1985	8 Cyl. 6.2L	FWSS103
C30		
1986-1985	8 Cyl. 6.2L	FWSS103
C1500		
1998-1994	8 Cyl. 6.5L	FWSS102
1993-1988	8 Cyl. 6.2L	FWSS103
C1500 Suburban		
1999-1995	8 Cyl. 6.5L	FWSS102
C2500		
2000-1994	8 Cyl. 6.5L	FWSS102
1993-1988	8 Cyl. 6.2L	FWSS103
C2500 Suburban		
1999-1994	8 Cyl. 6.5L	FWSS102
C3500		
2000-1994	8 Cyl. 6.5L	FWSS102
1993-1988	8 Cyl. 6.2L	FWSS103
C3500HD		
2001	8 Cyl. 6.5L; F	FWSS102
2000-1994	8 Cyl. 6.5L	FWSS102
C4500 Kodiak		
2009-2003	8 Cyl. 6.6L; Diesel	FWSS101
C5500 Kodiak		
2009-2003	8 Cyl. 6.6L; Diesel	FWSS101
Express 2500		
2016-2012	8 Cyl. 6.6L	FWSS116
2006	8 Cyl. 6.6L	FWSS101
2001-1996	8 Cyl. 6.5L	FWSS102
Express 3500		
2016-2012	8 Cyl. 6.6L	FWSS116
2006	8 Cyl. 6.6L	FWSS101
2001-1996	8 Cyl. 6.5L	FWSS102
Express 4500		
2016-2012	8 Cyl. 6.6L	FWSS116
G20		
1995-1994	8 Cyl. 6.5L	FWSS102
1993-1985	8 Cyl. 6.2L	FWSS103
G30		
1996-1994	8 Cyl. 6.5L	FWSS102
1993-1985	8 Cyl. 6.2L	FWSS103
K5 Blazer		
1986-1985	8 Cyl. 6.2L	FWSS103
K10		
1986-1985	8 Cyl. 6.2L	FWSS103
K10 Suburban		
1986-1985	8 Cyl. 6.2L	FWSS103
K20		
1986-1985	8 Cyl. 6.2L	FWSS103

		Part No.
Fuel / Water Separator Sensor		
K20 Suburban		
1986	8 Cyl. 6.2L	FWSS103
1985	8 Cyl. 6.2L; J	FWSS103
K30		
1986-1985	8 Cyl. 6.2L	FWSS103
K1500		
1998-1994	8 Cyl. 6.5L	FWSS102
1993-1988	8 Cyl. 6.2L	FWSS103
K1500 Suburban		
1999-1995	8 Cyl. 6.5L	FWSS102
K2500		
2000-1994	8 Cyl. 6.5L	FWSS102
1993-1988	8 Cyl. 6.2L	FWSS103
K2500 Suburban		
1999-1994	8 Cyl. 6.5L	FWSS102
K3500		
2000-1994	8 Cyl. 6.5L	FWSS102
1993-1988	8 Cyl. 6.2L	FWSS103
P20		
1989-1985	8 Cyl. 6.2L	FWSS103
P30		
1999-1994	8 Cyl. 6.5L	FWSS102
1993-1985	8 Cyl. 6.2L	FWSS103
R10		
1987	8 Cyl. 6.2L	FWSS103
R10 Suburban		
1988-1987	8 Cyl. 6.2L	FWSS103
R20		
1988-1987	8 Cyl. 6.2L	FWSS103
R20 Suburban		
1988-1987	8 Cyl. 6.2L; J	FWSS103
R30		
1988-1987	8 Cyl. 6.2L	FWSS103
R1500 Suburban		
1991-1989	8 Cyl. 6.2L	FWSS103
R2500		
1989	8 Cyl. 6.2L	FWSS103
R2500 Suburban		
1991	8 Cyl. 6.2L	FWSS103
1990	8 Cyl. 6.2L; J	FWSS103
1989	8 Cyl. 6.2L	FWSS103
R3500		
1991-1989	8 Cyl. 6.2L	FWSS103
Silverado 2500 HD		
2016-2012	8 Cyl. 6.6L	FWSS116
2011-2001	8 Cyl. 6.6L	FWSS101
Silverado 2500 HD Classic		
2007	8 Cyl. 6.6L	FWSS101
Silverado 3500		
2006-2001	8 Cyl. 6.6L	FWSS101
Silverado 3500 Classic		
2007	8 Cyl. 6.6L	FWSS101
Silverado 3500 HD		
2016-2012	8 Cyl. 6.6L	FWSS116
2011-2007	8 Cyl. 6.6L	FWSS101
Tahoe		
1999-1995	8 Cyl. 6.5L	FWSS102
V10		
1987	8 Cyl. 6.2L	FWSS103
V10 Suburban		
1988-1987	8 Cyl. 6.2L	FWSS103

Chevrolet

Fuel Sensors

		Part No.
Fuel / Water Separator Sensor		
V20		
1987	8 Cyl. 6.2L	FWSS103
V20 Suburban		
1988-1987	8 Cyl. 6.2L; J	FWSS103
V30		
1988-1987	8 Cyl. 6.2L	FWSS103
V1500 Suburban		
1991-1989	8 Cyl. 6.2L	FWSS103
V2500 Suburban		
1991	8 Cyl. 6.2L	FWSS103
1990-1989	8 Cyl. 6.2L; J	FWSS103
V3500		
1991-1989	8 Cyl. 6.2L	FWSS103
Knock Sensor		
C1500 Suburban		
1997	8 Cyl. 6.5L	KS50
C2500 Suburban		
1997	8 Cyl. 6.5L	KS50
K2500 Suburban		
1997	8 Cyl. 6.5L	KS50
Mass Air Flow		
C4500 Kodiak		
2007-2003	8 Cyl. 6.6L; Sensor Only	MAS0280
C5500 Kodiak		
2007-2003	8 Cyl. 6.6L; Sensor Only	MAS0280
Colorado		
2016	4 Cyl. 2.8L	MAS0450
Cruze		
2015-2014	4 Cyl. 2.0L	MAS0357
Express 2500		
2015-2011	8 Cyl. 6.6L	MAS0279
2010-2007	8 Cyl. 6.6L	MAS0354
2006	8 Cyl. 6.6L; Sensor Only	MAS0280
Express 3500		
2015-2011	8 Cyl. 6.6L	MAS0279
2010-2007	8 Cyl. 6.6L	MAS0354
2006	8 Cyl. 6.6L; Sensor Only	MAS0280
Express 4500		
2010-2009	8 Cyl. 6.6L	MAS0354
Silverado 2500 HD		
2010-2009	8 Cyl. 6.6L; Turbocharged	MAS0354
2008-2007	8 Cyl. 6.6L; Diesel	MAS0354
Silverado 3500 HD		
2010-2007	8 Cyl. 6.6L; Diesel	MAS0354
Oxygen Sensor		
Impala		
1985	8 Cyl.; Universal Upstream	SG12
1985	8 Cyl.; Upstream Sensor	SG5
Miscellaneous Sensors		
Accelerator Pedal Sensor Repair Kit		
Silverado 2500 HD		
2005-2003	8 Cyl. 6.6L; Sensor Only; w/ Fixed Pedals	G92003
Silverado 3500		
2005-2003	8 Cyl. 6.6L; Sensor Only; w/ Fixed Pedals	G92003
Ambient Light Sensor		
Silverado 2500 HD		
2011-2008	8 Cyl.	EFL172
2006-2003	8 Cyl.	EFL172
Silverado 3500		
2006	8 Cyl.	EFL172
2004-2003	8 Cyl.	EFL172

		Part No.
Ambient Light Sensor		
Silverado 3500 HD		
2011-2010	8 Cyl.	EFL172
Position Sensors		
Accelerator Pedal Sensor		
C1500 Suburban		
1998-1996	8 Cyl. 6.5L	APS130
Express 2500		
1999-1996	8 Cyl. 6.5L	APS129
Express 3500		
1999-1996	8 Cyl. 6.5L	APS129
G30		
1996	8 Cyl. 6.5L	APS129
K1500 Suburban		
1998-1996	8 Cyl. 6.5L	APS130
Silverado 2500 HD		
2006	8 Cyl. 6.6L	APS194
2005-2003	8 Cyl. 6.6L; Complete Assembly	APS105
Silverado 2500 HD Classic		
2007	8 Cyl. 6.6L	APS194
Silverado 3500		
2006	8 Cyl. 6.6L	APS194
2005-2003	8 Cyl. 6.6L; Complete Assembly	APS105
Silverado 3500 HD		
2019-2014	8 Cyl. 6.6L; Exhaust stock and reorder	APS413
2017-2014	8 Cyl. 6.6L; Alternate Number	APS265
T6500		
2002-1999		TH371
T7500		
2002-1999		TH371
Camshaft Sensor		
C3500HD		
2002-2001	8 Cyl. 6.5L	PC398
C4500 Kodiak		
2005-2004	8 Cyl. 6.6L	PC617
2003	8 Cyl. 6.6L	PC398
C5500 Kodiak		
2005-2004	8 Cyl. 6.6L	PC617
2003	8 Cyl. 6.6L	PC398
Colorado		
2019-2016	4 Cyl. 2.8L	PC1103
2016	4 Cyl.	PC1006
Cruze		
2019-2017	4 Cyl. 1.6L	PC1191
2015-2014	4 Cyl. 2.0L; Diesel	PC1022
Equinox		
2019-2018	4 Cyl. 1.6L	PC1191
Express 2500		
2019-2017	4 Cyl. 2.8L	PC1103
2016-2006	8 Cyl. 6.6L	PC660
2001	8 Cyl. 6.5L	LX-756
Express 3500		
2019-2017	4 Cyl. 2.8L	PC1103
2016-2006	8 Cyl. 6.6L	PC660
2001	8 Cyl. 6.5L	LX-756
Express 4500		
2016-2009	8 Cyl. 6.6L	PC660
Silverado 2500 HD		
2019-2017	8 Cyl. 6.6L	PC1138
2016-2006	8 Cyl. 6.6L	PC660
2005	8 Cyl. 6.6L	PC617
2004-2001	8 Cyl. 6.6L	PC398

Position Sensors

		Part No.
Camshaft Sensor		
Silverado 2500 HD Classic		
2007	8 Cyl. 6.6L	PC660
Silverado 3500		
2006	8 Cyl. 6.6L	PC660
2005	8 Cyl. 6.6L	PC617
2004	8 Cyl. 6.6L; 1	PC398
2004	8 Cyl. 6.6L; 2	PC617
2003-2001	8 Cyl. 6.6L	PC398
Silverado 3500 Classic		
2007	8 Cyl. 6.6L	PC660
Silverado 3500 HD		
2019-2017	8 Cyl. 6.6L	PC1138
2016-2007	8 Cyl. 6.6L	PC660
Crankshaft Sensor		
B7		
1998-1997	8 Cyl. 6.5L	PC125
C3500		
2000-1996	8 Cyl. 6.5L	PC125
C3500HD		
2002-1996	8 Cyl. 6.5L	PC125
C4500 Kodiak		
2009-2004	8 Cyl. 6.6L	PC593
2003	8 Cyl. 6.6L	PC399
C5500 Kodiak		
2009-2004	8 Cyl. 6.6L	PC593
2003	8 Cyl. 6.6L	PC399
Cruze		
2019-2017	4 Cyl. 1.6L	PC1194
2015-2014	4 Cyl. 2.0L	PC1179
Equinox		
2019-2018	4 Cyl. 1.6L	PC1194
Express 2500		
2016-2011	8 Cyl. 6.6L	PC593
2010	8 Cyl. 6.6L; M12 x 1.5 Thread	PC593
2009-2006	8 Cyl. 6.6L	PC593
2002-2001	8 Cyl. 6.5L	PC125
Express 3500		
2016-2014	8 Cyl. 6.6L	PC593
2013	8 Cyl. 6.6L; Diesel	PC593
2012-2006	8 Cyl. 6.6L	PC593
2002-2001	8 Cyl. 6.5L	PC125
Express 4500		
2013-2012	8 Cyl. 6.6L; Diesel	PC593
2011-2009	8 Cyl. 6.6L	PC593
G30		
1996	8 Cyl. 6.5L; Diesel	PC125
K2500		
2000-1999	8 Cyl. 6.5L	PC125
K3500		
2000-1999	8 Cyl. 6.5L	PC125
P30		
1999-1998	8 Cyl. 6.5L	PC125
Silverado 2500 HD		
2020-2017	8 Cyl. 6.6L	PC1195
2016-2006	8 Cyl. 6.6L	PC593
2005	8 Cyl. 6.6L	PC594
2004	8 Cyl. 6.6L; 1	PC399
2004	8 Cyl. 6.6L; 2	PC594
2003-2001	8 Cyl. 6.6L	PC399
Silverado 2500 HD Classic		
2007	8 Cyl. 6.6L	PC593

		Part No.
Crankshaft Sensor		
Silverado 3500		
2006-2005	8 Cyl. 6.6L	PC594
2004-2001	8 Cyl. 6.6L	PC399
Silverado 3500 Classic		
2007	8 Cyl. 6.6L	PC593
Silverado 3500 HD		
2020-2017	8 Cyl. 6.6L	PC1195
2016-2014	8 Cyl. 6.6L	PC593
2013	8 Cyl. 6.6L; Diesel	PC593
2012-2007	8 Cyl. 6.6L	PC593
Throttle Position Sensor		
Blazer		
1991-1989	8 Cyl. 6.2L	TH150
1988	8 Cyl. 6.2L; Calif.	TH150
1988	8 Cyl. 6.2L; Fed.	TH322
1987	8 Cyl. 6.2L	TH150
C10		
1986	8 Cyl. 6.2L	TH322
1985	8 Cyl. 6.2L; C; Calif.	TH150
1985	8 Cyl. 6.2L; C; Fed.; High Altitude	TH322
1984-1983	8 Cyl. 6.2L; Fed.; High Altitude; w/ A.T.	TH322
1982	8 Cyl. 6.2L; C; Fed.; High Altitude; w/ A.T.	TH322
C20		
1986	8 Cyl. 6.2L	TH322
1985-1983	8 Cyl. 6.2L; J; w/ A.T.	TH304
1985-1982	8 Cyl. 6.2L; C; Fed.; High Altitude; w/ A.T.	TH322
C30		
1986	8 Cyl. 6.2L	TH322
1985	8 Cyl. 6.2L; J; w/ A.T.	TH304
1984-1983	8 Cyl. 6.2L; w/ A.T.	TH304
C1500		
1997	8 Cyl. 6.5L	TH149
1995	8 Cyl. 6.5L	TH160
1993-1991	8 Cyl. 6.2L; w/ M.T.	TH150
1993-1991	8 Cyl. 6.2L; w/ A.T.	TH160
1990-1988	8 Cyl. 6.2L	TH150
C2500		
1997	8 Cyl. 6.5L	TH149
1993-1992	8 Cyl. 6.5L	TH160
1993-1991	8 Cyl. 6.2L; w/ M.T.	TH150
1993-1991	8 Cyl. 6.2L; w/ A.T.	TH160
1990-1988	8 Cyl. 6.2L	TH150
C3500		
1998-1996	8 Cyl. 6.5L	TH149
1993-1992	8 Cyl. 6.5L	TH160
1993-1991	8 Cyl. 6.2L; w/ M.T.	TH150
1993-1991	8 Cyl. 6.2L; w/ A.T.	TH160
1990-1988	8 Cyl. 6.2L	TH150
C3500HD		
1998-1996	8 Cyl. 6.5L	TH149
1993-1992	8 Cyl. 6.5L	TH160
Caprice		
1985-1983	8 Cyl. 5.7L	TH1
1982	8 Cyl. 5.7L	TH4
1981-1980	8 Cyl. 5.7L	TH1
Celebrity		
1985	6 Cyl. 4.3L	TH43
Express 2500		
1997-1996	8 Cyl. 6.5L	TH160
Express 3500		
1997-1996	8 Cyl. 6.5L	TH160

Chevrolet

Position Sensors

		Part No.
Throttle Position Sensor		
G20		
1993	8 Cyl. 6.2L	TH160
1992-1989	8 Cyl. 6.2L	TH150
1988	8 Cyl. 6.2L; Calif.	TH150
1988-1983	8 Cyl. 6.2L; Fed.; High Altitude	TH322
1985	8 Cyl. 6.2L; Calif.	TH150
G30		
1996-1994	8 Cyl. 6.5L	TH160
1993-1991	8 Cyl. 6.2L	TH160
1989	8 Cyl. 6.2L	TH150
1988	8 Cyl. 6.2L; Calif.	TH150
1988-1986	8 Cyl. 6.2L; Fed.; High Altitude	TH322
1985-1983	8 Cyl. 6.2L	TH304
Impala		
1985	8 Cyl. 5.7L	TH1
1982	8 Cyl. 5.7L	TH1
1980	8 Cyl. 5.7L	TH1
K5 Blazer		
1986	8 Cyl. 6.2L; Fed.; High Altitude	TH303
1986-1985	8 Cyl. 6.2L; Calif.	TH150
1985-1982	8 Cyl. 6.2L; Fed.; High Altitude	TH322
K10		
1986	8 Cyl. 6.2L	TH322
1985	8 Cyl. 6.2L; Calif.	TH150
1985	8 Cyl. 6.2L; Fed.; High Altitude	TH322
1984-1982	8 Cyl. 6.2L; Fed.; High Altitude; w/ A.T.	TH322
K10 Suburban		
1986	8 Cyl. 6.2L; Calif.	TH150
1986	8 Cyl. 6.2L; Fed.; High Altitude	TH303
K20		
1986	8 Cyl. 6.2L	TH322
1985-1984	8 Cyl. 6.2L; Fed.; High Altitude	TH322
1983	8 Cyl. 6.2L; J; w/ A.T.	TH304
1983-1982	8 Cyl. 6.2L; C; Fed.; High Altitude; w/ A.T.	TH322
K30		
1986	8 Cyl. 6.2L	TH322
1985	8 Cyl. 6.2L; J; w/ A.T.	TH304
1984-1983	8 Cyl. 6.2L; w/ A.T.	TH304
K1500		
1997	8 Cyl. 6.5L	TH149
1993-1991	8 Cyl. 6.2L; w/ M.T.	TH150
1993-1991	8 Cyl. 6.2L; w/ A.T.	TH160
1990-1988	8 Cyl. 6.2L	TH150
K1500 Suburban		
1996	8 Cyl. 6.5L	TH149
K2500		
1993-1992	8 Cyl. 6.5L	TH160
1993-1991	8 Cyl. 6.2L; w/ M.T.	TH150
1993-1991	8 Cyl. 6.2L; w/ A.T.	TH160
1990-1988	8 Cyl. 6.2L	TH150
K3500		
1998	8 Cyl. 6.5L; Diesel	TH149
1997	8 Cyl. 6.5L	TH149
1996	8 Cyl. 6.5L; Diesel	TH149
1993-1992	8 Cyl. 6.5L	TH160
1993-1991	8 Cyl. 6.2L; w/ M.T.	TH150
1993-1991	8 Cyl. 6.2L; w/ A.T.	TH160
1990-1988	8 Cyl. 6.2L	TH150
Malibu		
1982	8 Cyl. 5.7L; FI	TH4
Monte Carlo		
1982	8 Cyl. 5.7L	TH4

		Part No.
Throttle Position Sensor		
P30		
1999-1994	8 Cyl. 6.5L	TH160
1993-1991	8 Cyl. 6.2L	TH160
R10		
1987	8 Cyl. 6.2L; Fed.	TH322
R20		
1988	8 Cyl. 6.2L	TH150
1987	8 Cyl. 6.2L; Fed.	TH322
R20 Suburban		
1988-1987	8 Cyl. 6.2L	TH160
R30		
1988	8 Cyl. 6.2L	TH150
1987	8 Cyl. 6.2L; Fed.	TH322
R2500		
1989	8 Cyl. 6.2L	TH150
R2500 Suburban		
1991-1989	8 Cyl. 6.2L	TH160
R3500		
1991	8 Cyl. 6.2L	TH160
1990-1989	8 Cyl. 6.2L	TH150
Tahoe		
1996	8 Cyl. 6.5L	TH149
V10		
1987	8 Cyl. 6.2L; Fed.	TH322
V20		
1987	8 Cyl. 6.2L; Fed.	TH322
V20 Suburban		
1988-1987	8 Cyl. 6.2L; J	TH160
V30		
1988	8 Cyl. 6.2L	TH150
1987	8 Cyl. 6.2L; Fed.	TH322
V2500 Suburban		
1991-1989	8 Cyl. 6.2L	TH160
V3500		
1991	8 Cyl. 6.2L	TH160
1990-1989	8 Cyl. 6.2L	TH150
Pressure Sensors		
Barometric Pressure Sensor		
G30		
1996-1995	8 Cyl. 6.5L	AS11
1992-1991	8 Cyl. 6.2L	AS11
Silverado 2500 HD		
2005	8 Cyl. 6.6L	AS371
2004	8 Cyl. 6.6L; 1	AS195
2004	8 Cyl. 6.6L; 2	AS371
2003-2002	8 Cyl. 6.6L	AS195
2001	8 Cyl. 6.6L	AS371
Silverado 3500		
2005	8 Cyl. 6.6L	AS371
2004	8 Cyl. 6.6L; 1	AS195
2004	8 Cyl. 6.6L; 2	AS371
2003-2002	8 Cyl. 6.6L	AS195
2001	8 Cyl. 6.6L	AS371
Diesel Particulate Filter (DPF) Pressure Sensor		
Colorado		
2019	4 Cyl. 2.8L	DPS114
2018-2016	4 Cyl. 2.8L	DPS106
Cruze		
2015-2014	4 Cyl. 2.0L	DPS106
Equinox		
2018	4 Cyl. 1.6L	DPS106

Pressure Sensors

		Part No.
Diesel Particulate Filter (DPF) Pressure Sensor		
Express 2500		
2019-2018	4 Cyl. 2.8L	DPS114
2017	4 Cyl. 2.8L	DPS105
2016-2011	8 Cyl. 6.6L	DPS107
2010	8 Cyl. 6.6L; 6; M12 x 1.5 Thread	VP27
2010	8 Cyl. 6.6L; L	DPS107
2009-2007	8 Cyl. 6.6L	VP27
Express 3500		
2019-2018	4 Cyl. 2.8L	DPS114
2017	4 Cyl. 2.8L	DPS105
2016-2011	8 Cyl. 6.6L	DPS107
2010	8 Cyl. 6.6L; 6	VP27
2010	8 Cyl. 6.6L; L	DPS107
2009-2007	8 Cyl. 6.6L	VP27
Express 4500		
2012-2011	8 Cyl. 6.6L	DPS107
2010	8 Cyl. 6.6L; L	DPS107
Silverado 2500 HD		
2019-2017	8 Cyl. 6.6L	DPS105
2016-2011	8 Cyl. 6.6L	DPS107
Silverado 3500 HD		
2019-2017	8 Cyl. 6.6L	DPS105
2016-2011	8 Cyl. 6.6L	DPS107
Fuel Pressure Sensor		
C4500 Kodiak		
2009-2006	8 Cyl. 6.6L	FPS11
2005	8 Cyl. 6.6L; To 12/04	FPS29
2005	8 Cyl. 6.6L; From 1/05	FPS46
2004	8 Cyl. 6.6L; 1	FPS28
2004	8 Cyl. 6.6L; 2	FPS29
2003	8 Cyl. 6.6L	FPS28
C5500 Kodiak		
2009-2006	8 Cyl. 6.6L	FPS11
2005	8 Cyl. 6.6L; To 12/04	FPS29
2005	8 Cyl. 6.6L; From 1/05	FPS46
2004	8 Cyl. 6.6L; 1	FPS28
2004	8 Cyl. 6.6L; 2	FPS29
2003	8 Cyl. 6.6L	FPS28
Cruze		
2015-2014	4 Cyl. 2.0L	FPS35
Express 2500		
2016-2013	8 Cyl. 6.6L	FPS45
2012-2011	8 Cyl. 6.6L	FPS44
2010	8 Cyl. 6.6L; 6	FPS11
2010	8 Cyl. 6.6L; L	FPS44
Express 3500		
2016-2013	8 Cyl. 6.6L	FPS45
2012-2011	8 Cyl. 6.6L	FPS44
2010	8 Cyl. 6.6L; 6	FPS11
2010	8 Cyl. 6.6L; L	FPS44
Express 4500		
2016-2013	8 Cyl. 6.6L	FPS45
2012-2011	8 Cyl. 6.6L	FPS44
2010	8 Cyl. 6.6L; 6	FPS11
2010	8 Cyl. 6.6L; L	FPS44
Silverado 2500 HD		
2016-2013	8 Cyl. 6.6L	FPS45
2012-2011	8 Cyl. 6.6L	FPS44
2010-2006	8 Cyl. 6.6L	FPS11
2005	8 Cyl. 6.6L; To 12/04	FPS29
2005	8 Cyl. 6.6L; From 1/05	FPS46
2004	8 Cyl. 6.6L; 1	FPS28
2004	8 Cyl. 6.6L; 2	FPS29

		Part No.
Fuel Pressure Sensor		
Silverado 2500 HD		
2003-2001	8 Cyl. 6.6L	FPS28
Silverado 2500 HD Classic		
2007	8 Cyl. 6.6L	FPS11
Silverado 3500		
2006	8 Cyl. 6.6L	FPS11
2005	8 Cyl. 6.6L; To 12/04	FPS29
2005	8 Cyl. 6.6L; From 1/05	FPS46
2004	8 Cyl. 6.6L; 1	FPS28
2004	8 Cyl. 6.6L; 2	FPS29
2003-2001	8 Cyl. 6.6L	FPS28
Silverado 3500 Classic		
2007	8 Cyl. 6.6L	FPS11
Silverado 3500 HD		
2016-2013	8 Cyl. 6.6L	FPS45
2012-2011	8 Cyl. 6.6L	FPS44
2010-2007	8 Cyl. 6.6L	FPS11
Injection Actuation Pressure Sensor		
B7		
2000-1999	6 Cyl. 7.2L	PS713
C6500 Kodiak		
2000-1999	6 Cyl. 7.2L	PS713
C7500 Kodiak		
2000-1999	6 Cyl. 7.2L	PS713
T6500		
2000-1999	6 Cyl. 7.2L	PS713
T7500		
2000-1999	6 Cyl. 7.2L	PS713
Manifold Differential Pressure Sensor		
EI Camino		
1983	8 Cyl.	AS10
MAP Sensor		
C20		
1984	8 Cyl. 6.2L	AS5
C30		
1985-1984	8 Cyl. 6.2L	AS5
C1500 Suburban		
1999-1996	8 Cyl. 6.5L	AS4
C2500		
1998-1996	8 Cyl. 6.5L	AS4
1993-1989	8 Cyl. 6.2L	AS5
C4500 Kodiak		
2009-2003	8 Cyl. 6.6L	AS194
C5500 Kodiak		
2009-2003	8 Cyl. 6.6L	AS194
C7500 Kodiak		
2008-2005	6 Cyl. 7.8L	AS194
Caprice		
1985	8 Cyl. 5.7L	AS6
Celebrity		
1985	6 Cyl. 4.3L	AS5
Express 2500		
2002-2000	8 Cyl. 6.5L	AS4
1999	8 Cyl. 6.5L; Diesel	AS4
1996	8 Cyl. 6.5L	AS4
Express 3500		
2016-2011	8 Cyl. 6.6L	AS428
2010	8 Cyl. 6.6L; L; Alternate Number	AS428
2010	8 Cyl. 6.6L; L; Exhaust stock and reorder	AS433
2002-2000	8 Cyl. 6.5L	AS4
1999	8 Cyl. 6.5L; Diesel	AS4

Chevrolet

Pressure Sensors

		Part No.
MAP Sensor		
Express 3500		
1996	8 Cyl. 6.5L	AS4
Express 4500		
2016-2014	8 Cyl. 6.6L	AS428
2012-2011	8 Cyl. 6.6L	AS428
G20		
1991	8 Cyl. 6.2L	AS5
1986	8 Cyl. 6.2L	AS5
G30		
1996	8 Cyl. 6.5L	AS6
1991	8 Cyl. 6.2L	AS5
1984	8 Cyl. 6.2L	AS5
Impala		
1985	8 Cyl. 5.7L; Diesel	AS5
K5 Blazer		
1984	8 Cyl. 6.2L	AS5
K10		
1984	8 Cyl. 6.2L	AS5
K20		
1984	8 Cyl. 6.2L	AS5
K1500		
1997	8 Cyl. 6.5L; Turbocharged	AS4
1989	8 Cyl. 6.2L	AS5
P20		
1989	8 Cyl.	AS5
P30		
1999-1994	8 Cyl. 6.5L; Turbocharged	AS4
1999-1994	8 Cyl. 6.5L; Naturally Aspirated	AS6
1993-1991	8 Cyl. 6.2L	AS6
1990	8 Cyl.	AS5
R10 Suburban		
1988	8 Cyl. 6.2L	AS5
1987	8 Cyl. 6.2L	AS17
R20		
1988-1987	8 Cyl. 6.2L	AS5
R30		
1988	8 Cyl. 6.2L	AS5
Silverado 2500 HD		
2016-2011	8 Cyl. 6.6L	AS428
2010-2008	8 Cyl. 6.6L	AS194
Silverado 3500		
2005-2001	8 Cyl. 6.6L	AS194
Silverado 3500 HD		
2016-2011	8 Cyl. 6.6L	AS428
V20		
1987	8 Cyl. 6.2L	AS5
Turbocharger Boost Sensor		
Blazer		
1994	8 Cyl. 6.5L; Diesel; Turbocharged	AS4
C1500		
1998-1994	8 Cyl. 6.5L; Diesel; Turbocharged	AS4
C1500 Suburban		
1999-1995	8 Cyl. 6.5L; Diesel; Turbocharged	AS4
C2500		
2000-1994	8 Cyl. 6.5L; Diesel; Turbocharged	AS4
C2500 Suburban		
1999-1994	8 Cyl. 6.5L; Diesel; Turbocharged	AS4
C3500		
2000-1994	8 Cyl. 6.5L; Diesel; Turbocharged	AS4
Colorado		
2019-2016	4 Cyl. 2.8L; Turbocharged	AS493

		Part No.
Turbocharger Boost Sensor		
Cruze		
2015-2014	4 Cyl. 2.0L; Turbocharged	AS493
Express 2500		
2019-2017	4 Cyl. 2.8L; Turbocharged	AS493
2010	8 Cyl. 6.6L; 6; Turbocharged	AS194
2009-2006	8 Cyl. 6.6L; Turbocharged	AS194
2002-1997	8 Cyl. 6.5L; Diesel; Turbocharged	AS4
Express 3500		
2019-2017	4 Cyl. 2.8L; Turbocharged	AS493
2010	8 Cyl. 6.6L; 6; Turbocharged	AS194
2009-2006	8 Cyl. 6.6L; Turbocharged	AS194
2002-1997	8 Cyl. 6.5L; Diesel; Turbocharged	AS4
Express 4500		
2010	8 Cyl. 6.6L; 6; Turbocharged	AS194
2009	8 Cyl. 6.6L; Turbocharged	AS194
K1500		
1998-1994	8 Cyl. 6.5L; Diesel; Turbocharged	AS4
K1500 Suburban		
1999-1995	8 Cyl. 6.5L; Diesel; Turbocharged	AS4
K2500		
2000-1994	8 Cyl. 6.5L; Diesel; Turbocharged	AS4
K2500 Suburban		
1999-1994	8 Cyl. 6.5L; Diesel; Turbocharged	AS4
K3500		
2000-1994	8 Cyl. 6.5L; Diesel; Turbocharged	AS4
P30		
1999-1994	8 Cyl. 6.5L; Diesel; Turbocharged	AS4
Silverado 2500 HD		
2010-2001	8 Cyl. 6.6L; Turbocharged	AS194
Silverado 3500		
2006-2001	8 Cyl. 6.6L; Turbocharged	AS194
Silverado 3500 Classic		
2007	8 Cyl. 6.6L; Turbocharged	AS194
Silverado 3500 HD		
2010-2007	8 Cyl. 6.6L; Turbocharged	AS194
Tahoe		
1999-1995	8 Cyl. 6.5L; Diesel; Turbocharged	AS4
Temperature Sensors		
Ambient Air Temperature Sensor		
Express 2500		
2017	4 Cyl. 2.8L; w/o Chrome Grille	AX355
Express 3500		
2017	4 Cyl. 2.8L; w/o Chrome Grille	AX355
Coolant Temperature Sensor		
C2500		
2000-1999	8 Cyl. 6.5L	TX3
C3500		
1996-1994	8 Cyl. 6.5L	TX3
1992	8 Cyl. 6.2L	TX3
1992	8 Cyl. 6.5L	TX3
C3500HD		
2002-2001	8 Cyl. 6.5L	TX3
1996-1994	8 Cyl. 6.5L	TX3
1992	8 Cyl. 6.5L	TX3
Caprice		
1980	8 Cyl. 5.7L; w/o Connector	TX3
1980	8 Cyl. 5.7L; w/ Connector	TX4
Colorado		
2019-2016	4 Cyl.; On Water Outlet	TX268
2018-2016	4 Cyl.; Alternate Number; Located On Radiator	TX229

Temperature Sensors

		Part No.
Coolant Temperature Sensor		
Colorado		
2018-2016	4 Cyl.; Exhaust stock and reorder; Located On Radiator	TX271
Cruze		
2019	4 Cyl. 1.6L; Alternate Number	TX229
2019	4 Cyl. 1.6L; Exhaust stock and reorder	TX271
2018-2017	4 Cyl. 1.6L	TX247
Equinox		
2019-2018	4 Cyl. 1.6L; Diesel	TX247
Express 2500		
2009-2006	8 Cyl. 6.6L	TX3
2002-1998	8 Cyl. 6.5L	TX94
Express 3500		
2009	8 Cyl. 6.6L	TX3
2002-1998	8 Cyl. 6.5L	TX94
Impala		
1980	8 Cyl. 5.7L; w/o Connector	TX3
1980	8 Cyl. 5.7L; w/ Connector	TX4
K3500		
2000	8 Cyl. 6.5L; Located In Water Pump Crossover Pipe	TX3
1999	8 Cyl. 6.5L	TX3
LUV		
1982	4 Cyl. 2.2L	TX1
P20		
1987	8 Cyl. 6.2L; Glow Plug Inhibit Switch	TX47
Silverado 2500 HD		
2010	8 Cyl. 6.6L	TX133
2009-2001	8 Cyl. 6.6L	TX3
Silverado 2500 HD Classic		
2007	8 Cyl. 6.6L	TX3
Silverado 3500		
2006-2001	8 Cyl. 6.6L	TX3
Silverado 3500 Classic		
2007	8 Cyl. 6.6L	TX3
Silverado 3500 HD		
2010	8 Cyl. 6.6L	TX133
2009-2007	8 Cyl. 6.6L	TX3
Diesel Glow Plug Control Sensor		
C10		
1984-1982	8 Cyl. 6.2L	TX42
1980	8 Cyl. 5.7L	TX36
C20		
1984-1982	8 Cyl. 6.2L	TX42
C20 Suburban		
1984-1982	8 Cyl. 6.2L	TX42
C30		
1984-1982	8 Cyl. 6.2L	TX42
Caprice		
1983	8 Cyl. 5.7L; N; 6 Terminals	TX34
1983	8 Cyl. 5.7L; N; 5 Terminals	TX36
1982-1981	8 Cyl. 5.7L; 6 Terminals	TX34
1982-1981	8 Cyl. 5.7L; 5 Terminals	TX36
Celebrity		
1983-1982	6 Cyl. 4.3L	TX34
El Camino		
1983	8 Cyl. 5.7L; 6 Terminals	TX34
1983	8 Cyl. 5.7L; 5 Terminals	TX36
G20		
1984	8 Cyl. 6.2L; J	TX42
G30		
1984	8 Cyl. 6.2L; J	TX42

		Part No.
Diesel Glow Plug Control Sensor		
G30		
1983	8 Cyl. 6.2L	TX42
Impala		
1983-1981	8 Cyl. 5.7L; N; 6 Terminals	TX34
1983-1981	8 Cyl. 5.7L; N; 5 Terminals	TX36
K5 Blazer		
1984-1982	8 Cyl. 6.2L	TX42
K10		
1984-1983	8 Cyl. 6.2L	TX42
K20		
1984-1982	8 Cyl. 6.2L	TX42
K20 Suburban		
1984	8 Cyl. 6.2L; J	TX42
1983-1982	8 Cyl. 6.2L	TX42
K30		
1984-1982	8 Cyl. 6.2L	TX42
Malibu		
1983	8 Cyl. 5.7L; N; 6 Terminals	TX34
1983	8 Cyl. 5.7L; N; 5 Terminals	TX36
1983-1982	6 Cyl. 4.3L; 5 Terminals	TX36
1982	8 Cyl. 5.7L; 6 Terminals	TX34
1982	8 Cyl. 5.7L; 5 Terminals	TX36
Monte Carlo		
1983	8 Cyl. 5.7L; N; 6 Terminals	TX34
1983	8 Cyl. 5.7L; N; 5 Terminals	TX36
1983-1982	6 Cyl. 4.3L; 5 Terminals	TX36
1982	8 Cyl. 5.7L; 6 Terminals	TX34
1982	8 Cyl. 5.7L; 5 Terminals	TX36
Diesel Glow Plug Temperature Sensor		
Blazer		
1990-1988	8 Cyl. 6.2L; Diesel	TS243
C1500		
1990-1988	8 Cyl. 6.2L	TS243
C2500		
1990-1988	8 Cyl. 6.2L	TS243
C3500		
1990-1988	8 Cyl. 6.2L	TS243
G20		
1990-1988	8 Cyl. 6.2L	TS243
G30		
1989-1988	8 Cyl. 6.2L	TS243
K1500		
1990-1988	8 Cyl. 6.2L	TS243
K2500		
1990-1988	8 Cyl. 6.2L	TS243
K3500		
1990-1988	8 Cyl. 6.2L	TS243
R10 Suburban		
1988	8 Cyl. 6.2L; Diesel	TS243
R20		
1988	8 Cyl. 6.2L	TS243
R20 Suburban		
1988	8 Cyl. 6.2L; Diesel	TS243
R30		
1988	8 Cyl. 6.2L	TS243
R1500 Suburban		
1990-1989	8 Cyl. 6.2L; Diesel	TS243
R2500		
1989	8 Cyl. 6.2L	TS243
R2500 Suburban		
1990-1989	8 Cyl. 6.2L; Diesel	TS243

Chevrolet

Temperature Sensors

		Part No.
Diesel Glow Plug Temperature Sensor		
R3500		
1990-1989	8 Cyl. 6.2L	TS243
V10 Suburban		
1988	8 Cyl. 6.2L; Diesel	TS243
V20 Suburban		
1988	8 Cyl. 6.2L; Diesel	TS243
V30		
1988	8 Cyl. 6.2L	TS243
V1500 Suburban		
1990-1989	8 Cyl. 6.2L; Diesel	TS243
V2500 Suburban		
1990-1989	8 Cyl. 6.2L; Diesel	TS243
V3500		
1990-1989	8 Cyl. 6.2L	TS243
Exhaust Gas Temperature Sensor		
Cruze		
2015	4 Cyl. 2.0L; Upstream	ETS168
2015	4 Cyl. 2.0L; Downstream	ETS172
2014	4 Cyl. 2.0L; Diesel; Upstream	ETS168
2014	4 Cyl. 2.0L; Diesel; Downstream	ETS172
Express 2500		
2016-2014	8 Cyl. 6.6L; Located on EGR Cooler	ETS125
2016-2013	8 Cyl. 6.6L; Downstream	ETS171
2016-2010	8 Cyl. 6.6L; Located on EGR Crossover Tube	ETS119
2015-2011	8 Cyl. 6.6L; Center	ETS170
2014-2011	8 Cyl. 6.6L; Front	ETS155
2009-2007	8 Cyl. 6.6L	ETS72
Express 3500		
2016-2014	8 Cyl. 6.6L; Located on EGR Cooler	ETS125
2016-2013	8 Cyl. 6.6L; Downstream	ETS171
2015-2011	8 Cyl. 6.6L; Center	ETS170
2014-2011	8 Cyl. 6.6L; Front	ETS155
2010	8 Cyl. 6.6L; Located on EGR Crossover Tube	ETS119
2009-2007	8 Cyl. 6.6L	ETS72
Express 4500		
2016-2013	8 Cyl. 6.6L; Front	ETS155
2015-2011	8 Cyl. 6.6L; Center	ETS170
2011	8 Cyl. 6.6L; Front	ETS155
2010	8 Cyl. 6.6L; 6	ETS72
2010	8 Cyl. 6.6L; L; Front	ETS155
2010	8 Cyl. 6.6L; L; Center	ETS170
2009	8 Cyl. 6.6L	ETS72
Silverado 2500 HD		
2016-2015	8 Cyl. 6.6L; Located on EGR Cooler	ETS125
2016-2015	8 Cyl. 6.6L; Front of Muffler	ETS229
2016-2013	8 Cyl. 6.6L; Located on EGR Crossover Tube	ETS119
2016-2012	8 Cyl. 6.6L; Front	ETS145
2016-2011	8 Cyl. 6.6L; Rear	ETS146
2016-2011	8 Cyl. 6.6L; Center	ETS173
2012-2011	8 Cyl. 6.6L; 8; Located on EGR Crossover Tube	ETS119
2010-2008	8 Cyl. 6.6L; Center	ETS121
2010-2007	8 Cyl. 6.6L; Front	ETS72
2010-2007	8 Cyl. 6.6L; Rear	ETS75
Silverado 3500 Classic		
2007	8 Cyl. 6.6L; Front	ETS72
2007	8 Cyl. 6.6L; Rear	ETS75
Silverado 3500 HD		
2016-2015	8 Cyl. 6.6L; Located on EGR Cooler	ETS125
2016-2015	8 Cyl. 6.6L; Front of Muffler	ETS229

		Part No.
Exhaust Gas Temperature Sensor		
Silverado 3500 HD		
2016-2013	8 Cyl. 6.6L; Located on EGR Crossover Tube	ETS119
2016-2011	8 Cyl. 6.6L; Front	ETS145
2016-2011	8 Cyl. 6.6L; Rear	ETS146
2016-2011	8 Cyl. 6.6L; Center	ETS173
2012-2011	8 Cyl. 6.6L; 8; Located on EGR Crossover Tube	ETS119
2010-2008	8 Cyl. 6.6L; Center	ETS121
2010-2007	8 Cyl. 6.6L; Front	ETS72
2010-2007	8 Cyl. 6.6L; Rear	ETS75
Fuel Temperature Sensor		
Express 2500		
2016-2010	8 Cyl. 6.6L	FTS110
2009-2006	8 Cyl. 6.6L	FTS104
Express 3500		
2016-2010	8 Cyl. 6.6L	FTS110
2009-2006	8 Cyl. 6.6L	FTS104
Silverado 2500 HD		
2016-2011	8 Cyl. 6.6L	FTS110
2010-2006	8 Cyl. 6.6L	FTS104
Silverado 3500		
2006	8 Cyl. 6.6L	FTS104
Silverado 3500 Classic		
2007	8 Cyl. 6.6L	FTS104
Silverado 3500 HD		
2016-2011	8 Cyl. 6.6L	FTS110
2010-2007	8 Cyl. 6.6L	FTS104
Heater Core Temperature Sensor		
Express 2500		
2011-2006	8 Cyl. 6.6L	AX293
Express 3500		
2011-2006	8 Cyl. 6.6L	AX293
Intake Air Temperature Sensor		
Blazer		
1987	8 Cyl.; On Air Cleaner	ATS18
C10		
1980	8 Cyl. 5.7L; Green; On Air Cleaner	ATS3
1980	8 Cyl. 5.7L; White; On Air Cleaner	ATS4
C10 Suburban		
1986	8 Cyl.; On Air Cleaner	ATS18
1980	8 Cyl. 5.7L; Green; On Air Cleaner	ATS3
1980	8 Cyl. 5.7L; White; On Air Cleaner	ATS4
C20 Suburban		
1986	8 Cyl.; Green; On Air Cleaner	ATS18
C1500		
1998-1996	8 Cyl. 6.5L	AX1
1995-1994	8 Cyl. 6.5L; Turbocharged	AX1
1995-1994	8 Cyl. 6.5L; Naturally Aspirated	AX32
1988	8 Cyl.; Green; On Air Cleaner	ATS18
C1500 Suburban		
1999-1998	8 Cyl. 6.5L	AX1
1997-1995	8 Cyl. 6.5L; Diesel	AX1
C2500		
2000-1996	8 Cyl. 6.5L; Diesel	AX1
1995-1994	8 Cyl. 6.5L; Turbocharged	AX1
1995-1994	8 Cyl. 6.5L; Naturally Aspirated	AX32
C2500 Suburban		
1999-1996	8 Cyl. 6.5L; Diesel	AX1
1995-1994	8 Cyl. 6.5L	AX1
C3500		
2000-1996	8 Cyl. 6.5L	AX1

Temperature Sensors

		Part No.
Intake Air Temperature Sensor		
C3500		
1995-1994	8 Cyl. 6.5L; Turbocharged	AX1
C3500HD		
2002-1996	8 Cyl. 6.5L	AX1
1995-1994	8 Cyl. 6.5L; Turbocharged	AX1
Caprice		
1985-1982	8 Cyl.; On Air Cleaner	ATS13
1981-1980	8 Cyl. 5.7L; On Air Cleaner	ATS7
Chevette		
1982	4 Cyl. 1.8L; Built In U.S.; Diesel; On Air Cleaner	ATS14
1981	4 Cyl. 1.8L; Diesel; OE No. 8997574; U.S. Models; On Air Cleaner	ATS14
1981	4 Cyl. 1.8L; Canada; Diesel; Export; OE No. 8995654; On Air Cleaner	ATS5
Colorado		
2019-2016	4 Cyl. 2.8L; Between Intercooler and Throttle Body	TX267
Cruze		
2015-2014	4 Cyl. 2.0L; Between Intercooler and Throttle Body	TX267
El Camino		
1984	8 Cyl.; Blue; On Air Cleaner	ATS13
Express 2500		
2016-2014	8 Cyl. 6.6L; On Throttle Body	TX266
2016-2010	8 Cyl. 6.6L; Between Intercooler and Throttle Body	TX267
2011	8 Cyl. 6.6L; On Throttle Body	TX266
2010	8 Cyl. 6.6L; On Intake Manifold	AX229
2002-1996	8 Cyl. 6.5L	AX1
Express 3500		
2016-2011	8 Cyl. 6.6L; On Throttle Body	TX266
2016-2010	8 Cyl. 6.6L; Between Intercooler and Throttle Body	TX267
2010	8 Cyl. 6.6L; On Intake Manifold	AX229
2002-1996	8 Cyl. 6.5L	AX1
G20		
1995-1994	8 Cyl. 6.5L	AX32
G30		
1996	8 Cyl. 6.5L	AX1
1995-1994	8 Cyl. 6.5L	AX32
Impala		
1985-1982	8 Cyl.; On Air Cleaner	ATS13
1981-1980	8 Cyl.; Canada; On Air Cleaner	ATS3
1980	8 Cyl. 5.7L; Exc. Canada; On Air Cleaner	ATS7
K5 Blazer		
1986-1985	8 Cyl.; On Air Cleaner	ATS18
K10 Suburban		
1986	8 Cyl.; On Air Cleaner	ATS18
K20 Suburban		
1986	8 Cyl.; On Air Cleaner	ATS18
K1500		
1998-1996	8 Cyl. 6.5L; Diesel	AX1
1995-1994	8 Cyl. 6.5L; Turbocharged	AX1
1995-1994	8 Cyl. 6.5L; Naturally Aspirated	AX32
K1500 Suburban		
1999-1996	8 Cyl. 6.5L; Diesel	AX1
1995	8 Cyl. 6.5L	AX1
K2500		
2000-1996	8 Cyl. 6.5L; Diesel	AX1
1995-1994	8 Cyl. 6.5L; Turbocharged	AX1
1995-1994	8 Cyl. 6.5L; Naturally Aspirated	AX32

		Part No.
Intake Air Temperature Sensor		
K2500 Suburban		
1999-1996	8 Cyl. 6.5L; Diesel	AX1
1995-1994	8 Cyl. 6.5L	AX1
K3500		
2000-1994	8 Cyl. 6.5L	AX1
Malibu		
1983-1982	8 Cyl.; On Air Cleaner	ATS13
Monte Carlo		
1984-1982	8 Cyl.; On Air Cleaner	ATS13
P30		
1999-1996	8 Cyl. 6.5L; Turbocharged	AX1
1999-1996	8 Cyl. 6.5L; Naturally Aspirated	AX32
1995-1994	8 Cyl. 6.5L	AX1
Silverado 2500 HD		
2019-2017	8 Cyl. 6.6L; On Intake Manifold	AX461
2018-2011	8 Cyl. 6.6L; Between Intercooler and Throttle Body	TX267
2016-2011	8 Cyl. 6.6L; On Throttle Body	TX266
Silverado 3500 HD		
2019-2017	8 Cyl. 6.6L; On Intake Manifold	AX461
2018-2011	8 Cyl. 6.6L; Between Intercooler and Throttle Body	TX267
2016-2011	8 Cyl. 6.6L; On Throttle Body	TX266
Tahoe		
1999-1995	8 Cyl. 6.5L	AX1
Body Light Switches		
Back-Up Light Switch		
C6500 Kodiak		
1998-1997	6 Cyl. 6.6L	LS-307
K10		
1983	8 Cyl. 6.2L; w/ 4 Speed M.T.	LS-202
K20		
1983	8 Cyl. 6.2L; w/ 4 Speed M.T.	LS-202
K30		
1983	8 Cyl. 6.2L; w/ 4 Speed M.T.	LS-202
Silverado 2500 HD		
2006-2003	8 Cyl. 6.6L; w/ M.T.	LS-304
Silverado 3500		
2006-2003	8 Cyl. 6.6L; w/ M.T.	LS-304
Silverado 3500 Classic		
2007	8 Cyl. 6.6L; w/ M.T.	NS-561
Fog Lamp Switch		
C1500		
1998-1996	8 Cyl. 6.5L; w/ Sport Package	DS938
Silverado 2500 HD		
2011-2010	8 Cyl. 6.6L	CBS-1427
Silverado 3500 HD		
2011-2010	8 Cyl. 6.6L	CBS-1427
Hazard Warning Switch		
C4500 Kodiak		
2009-2003	8 Cyl. 6.6L; w/ Cruise Control	CBS-1452
Silverado 2500 HD		
2011	8 Cyl. 6.6L	CBS-1422
Silverado 3500 HD		
2011	8 Cyl. 6.6L	CBS-1422
T6500		
2009-2004	Canada; w/ Cruise Control	CBS-2145
2009-2004	U.S. Models; w/o Cruise Control	CBS-2146
2009-2004	Canada; w/o Cruise Control	CBS-2147
2009-2004	U.S. Models; w/ Cruise Control	CBS-2148

Chevrolet

Body Light Switches

		Part No.
Hazard Warning Switch		
T7500		
2009-2004	Canada; w/ Cruise Control	CBS-2145
2009-2004	U.S. Models; w/o Cruise Control	CBS-2146
2009-2004	Canada; w/o Cruise Control	CBS-2147
2009-2004	U.S. Models; w/ Cruise Control	CBS-2148
Headlight Dimmer Switch		
C70		
1990-1980	8 Cyl.; Floor Mounted	DS-72
C3500HD		
2002	8 Cyl.; w/ Tilt Steering	DS-698
2002	8 Cyl.; w/o Tilt Wheel	DS-796
T6500		
2009-2004	Canada; w/ Cruise Control	CBS-2145
2009-2004	U.S. Models; w/o Cruise Control	CBS-2146
2009-2004	Canada; w/o Cruise Control	CBS-2147
2009-2004	U.S. Models; w/ Cruise Control	CBS-2148
T7500		
2009-2004	Canada; w/ Cruise Control	CBS-2145
2009-2004	U.S. Models; w/o Cruise Control	CBS-2146
2009-2004	Canada; w/o Cruise Control	CBS-2147
2009-2004	U.S. Models; w/ Cruise Control	CBS-2148
Headlight Switch		
B7		
2002-1998	6 Cyl. 7.2L	DS-658
1998-1997	8 Cyl. 6.5L	DS-658
1998-1993	6 Cyl. 6.6L	DS-658
C60 Kodiak		
1996-1995	6 Cyl. 6.6L	DS-647
1994-1990	6 Cyl. 6.6L	DS-290
C70 Kodiak		
1996-1995	6 Cyl. 6.6L	DS-647
1994-1990	6 Cyl. 6.6L	DS-290
C4500 Kodiak		
2009-2003	8 Cyl. 6.6L	DS-876
C5500 Kodiak		
2009-2003	8 Cyl. 6.6L	DS-876
C6500 Kodiak		
2009-2003	6 Cyl. 7.2L	DS-876
2009-2003	6 Cyl. 7.8L	DS-876
2002-1999	6 Cyl. 7.2L	DS-647
1998-1997	6 Cyl. 6.6L	DS-647
C7500 Kodiak		
2009-2003	6 Cyl. 7.2L	DS-876
2009-2003	6 Cyl. 7.8L	DS-876
2002-1999	6 Cyl. 7.2L	DS-647
1998-1997	6 Cyl. 6.6L	DS-647
Silverado 2500 HD		
2011	8 Cyl. 6.6L; w/ Fog Lights	CBS-1427
2011	8 Cyl. 6.6L; w/o Fog Lights	HLS-1520
Silverado 3500 HD		
2011	8 Cyl. 6.6L; w/ Fog Lights	CBS-1427
2011	8 Cyl. 6.6L; w/o Fog Lights	HLS-1520
T6500		
2009-2004	Canada; w/ Cruise Control	CBS-2145
2009-2004	U.S. Models; w/o Cruise Control	CBS-2146
2009-2004	Canada; w/o Cruise Control	CBS-2147
2009-2004	U.S. Models; w/ Cruise Control	CBS-2148
T7500		
2009-2004	Canada; w/ Cruise Control	CBS-2145
2009-2004	U.S. Models; w/o Cruise Control	CBS-2146
2009-2004	Canada; w/o Cruise Control	CBS-2147
2009-2004	U.S. Models; w/ Cruise Control	CBS-2148

		Part No.
Instrument Panel Dimmer Switch		
B7		
2002-1998	6 Cyl. 7.2L	DS-453
1998-1997	8 Cyl. 6.5L	DS-453
1998-1994	6 Cyl. 6.6L	DS-453
C60 Kodiak		
1994-1990	6 Cyl. 6.6L	DS-374
C70 Kodiak		
1994-1990	6 Cyl. 6.6L	DS-374
C4500 Kodiak		
2009-2003	8 Cyl. 6.6L	DS-876
C5500 Kodiak		
2009-2003	8 Cyl. 6.6L	DS-876
C6500 Kodiak		
2009-2003	6 Cyl. 7.2L	DS-876
2009-2003	6 Cyl. 7.8L	DS-876
C7500 Kodiak		
2009-2003	6 Cyl. 7.2L	DS-876
2009-2003	6 Cyl. 7.8L	DS-876
Express 2500		
2011	8 Cyl. 6.6L	CBS-1446
Express 3500		
2011	8 Cyl. 6.6L	CBS-1446
Express 4500		
2016-2014	8 Cyl. 6.6L	CBS-1446
2011-2009	8 Cyl. 6.6L	CBS-1446
R1500 Suburban		
1990	8 Cyl. 6.2L; Instrument Panel	DS-833
R2500 Suburban		
1990	8 Cyl. 6.2L; Instrument Panel	DS-833
Silverado 2500 HD		
2011	8 Cyl. 6.6L; Chrome Finish; w/ Fog Lights	CBS-1427
2011	8 Cyl. 6.6L; Chrome Finish; w/o Fog Lights	CBS-1446
Silverado 3500 HD		
2011	8 Cyl. 6.6L; Chrome Finish; w/ Fog Lights	CBS-1427
2011	8 Cyl. 6.6L; Chrome Finish; w/o Fog Lights	CBS-1446
V1500 Suburban		
1990	8 Cyl. 6.2L; Instrument Panel	DS-833
V2500 Suburban		
1990	8 Cyl. 6.2L; Instrument Panel	DS-833
Interior Light Switch		
C2500 Suburban		
1994	8 Cyl. 6.5L; Courtesy Lights; Dash Mounted Switch	DS1494
K2500 Suburban		
1994	8 Cyl. 6.5L; Courtesy Lights; Dash Mounted Switch	DS1494
Stoplight Switch		
B7		
2002-1998	6 Cyl. 7.2L; w/ Hydraulic Brakes	SLS-214
1998-1997	8 Cyl. 6.5L; w/ Hydraulic Brakes	SLS-214
1998-1993	6 Cyl. 6.6L; w/ Hydraulic Brakes	SLS-214
P30		
1996	8 Cyl. 6.5L; 4 Term.	SLS-173
1996	8 Cyl. 6.5L; 5 Term.	SLS-174
1996	8 Cyl. 6.5L; 6 Term.	SLS-179
Silverado 2500 HD		
2011	8 Cyl. 6.6L; w/ Fixed Pedals	SLS-450
Silverado 3500		
2001	8 Cyl. 6.6L	SLS-303

Body Light Switches

		Part No.
Stoplight Switch		
Silverado 3500 HD		
2011	8 Cyl. 6.6L; w/ Fixed Pedals	SLS-450
Turn Signal Lever		
T6500		
2009-2004	Canada; w/ Cruise Control	CBS-2145
2009-2004	USA Production; w/o Cruise Control	CBS-2146
2009-2004	Canada; w/o Cruise Control	CBS-2147
2009-2004	USA Production; w/ Cruise Control	CBS-2148
T7500		
2009-2004	Canada; w/ Cruise Control	CBS-2145
2009-2004	USA Production; w/o Cruise Control	CBS-2146
2009-2004	Canada; w/o Cruise Control	CBS-2147
2009-2004	USA Production; w/ Cruise Control	CBS-2148
Turn Signal Switch		
B7		
2000-1998	6 Cyl. 7.2L; w/o Tilt Wheel	TW-20
1998-1997	8 Cyl. 6.5L; w/o Tilt Wheel	TW-20
1998-1993	6 Cyl. 6.6L; w/o Tilt Wheel	TW-20
C4500 Kodiak		
2009-2003	8 Cyl. 6.6L; w/o Cruise Control	CBS-1181
2009-2003	8 Cyl. 6.6L; w/ Cruise Control	CBS-1452
Express 2500		
2011	8 Cyl. 6.6L	CBS-1945
Express 3500		
2011	8 Cyl. 6.6L	CBS-1945
Express 4500		
2016-2009	8 Cyl. 6.6L	CBS-1945
K2500		
2000	8 Cyl. 6.5L; w/ Cruise Control	DS-698
2000	8 Cyl. 6.5L; w/o Cruise Control	DS-796
K3500		
2000	8 Cyl. 6.5L; w/ Cruise Control	DS-698
2000	8 Cyl. 6.5L; w/o Cruise Control	DS-796
Silverado 2500 HD		
2011	8 Cyl. 6.6L	CBS-1422
Silverado 3500 HD		
2011	8 Cyl. 6.6L	CBS-1422
T6500		
2009-2004	Canada; w/ Cruise Control	CBS-2145
2009-2004	U.S. Models; w/o Cruise Control	CBS-2146
2009-2004	Canada; w/o Cruise Control	CBS-2147
2009-2004	U.S. Models; w/ Cruise Control	CBS-2148
T7500		
2009-2004	Canada; w/ Cruise Control	CBS-2145
2009-2004	U.S. Models; w/o Cruise Control	CBS-2146
2009-2004	Canada; w/o Cruise Control	CBS-2147
2009-2004	U.S. Models; w/ Cruise Control	CBS-2148
Turn Signal Switch Repair Kit		
C10		
1986	8 Cyl. 6.2L	TW-83C
C20		
1986	8 Cyl. 6.2L	TW-83C
C30		
1986	8 Cyl. 6.2L	TW-83C
K10		
1986	8 Cyl. 6.2L	TW-83C
K20		
1986	8 Cyl. 6.2L	TW-83C
K30		
1986	8 Cyl. 6.2L	TW-83C

		Part No.
Chassis and Drivetrain Switches		
Automatic Transmission Vacuum Modulator		
C10		
1985	8 Cyl. 6.2L	TM-63
1981	8 Cyl. 5.7L; Diesel; w/ TH350 Trans.	TM-33
1980	8 Cyl. 5.7L; Calif.; Diesel	TM-33
1980	8 Cyl. 5.7L; Diesel; Fed.	TM-50
C10 Suburban		
1980	8 Cyl. 5.7L; Diesel; w/ TH350 Trans.	TM-33
C20		
1985-1982	8 Cyl. 6.2L; J	TM-50
C20 Suburban		
1986-1982	8 Cyl. 6.2L	TM-50
C30		
1986-1982	8 Cyl. 6.2L	TM-63
C3500		
1990-1988	8 Cyl. 6.2L; w/ 3 Speed TH400 Trans.	TM-50
Caprice		
1983-1982	8 Cyl. 5.7L; w/ TH250, TH350 Trans.	TM-37
1981	8 Cyl. 5.7L; Calif.; Diesel; w/ External EGR; w/ TH250, TH350 Trans.	TM-33
1981	8 Cyl. 5.7L; Calif.; Diesel; w/ Int. EGR; w/ TH250, TH350 Trans.	TM-45
1980	8 Cyl. 5.7L; Diesel; w/ External EGR; w/ TH250, TH350 Trans.	TM-33
1980	8 Cyl. 5.7L; Diesel; w/ Int. EGR; w/ TH250, TH350 Trans.	TM-37
El Camino		
1983	8 Cyl. 5.7L; w/ TH250, TH350 Trans.	TM-37
G20		
1990	8 Cyl. 6.2L; Diesel; w/ 3 Speed TH400 Trans.	TM-50
1985	8 Cyl. 6.2L; J; Diesel; w/ 3 Speed TH400 Trans.	TM-50
1984	8 Cyl. 6.2L; w/ TH400 Trans.	TM-50
1984	8 Cyl. 6.2L; w/ TH350 Trans.	TM-63
1983	8 Cyl. 6.2L	TM-63
G30		
1987-1983	8 Cyl. 6.2L; Diesel; w/ 3 Speed TH400 Trans.	TM-50
Impala		
1983	8 Cyl. 5.7L; w/ TH250, TH350 Trans.	TM-37
1982	8 Cyl. 5.7L; Diesel; w/ TH250, TH350 Trans.	TM-37
1981	8 Cyl. 5.7L; Diesel; w/ External EGR; w/ TH250, TH350 Trans.	TM-33
1981	8 Cyl. 5.7L; Diesel; w/ Int. EGR; w/ TH250, TH350 Trans.	TM-45
1980	8 Cyl. 5.7L; Diesel; w/ TH250, TH350 Trans.	TM-33
K5 Blazer		
1984-1983	8 Cyl. 6.2L	TM-63
1982	8 Cyl. 6.2L; Green	TM-63
K10		
1984-1982	8 Cyl. 6.2L	TM-63
K10 Suburban		
1984-1982	8 Cyl. 6.2L	TM-63
K20		
1986-1985	8 Cyl. 6.2L	TM-63
1984	8 Cyl. 6.2L; Green	TM-63
1983-1982	8 Cyl. 6.2L	TM-63
K20 Suburban		
1984	8 Cyl. 6.2L	TM-63
1983	8 Cyl. 6.2L; Green	TM-63
1982	8 Cyl. 6.2L	TM-63

Chevrolet

Chassis and Drivetrain Switches

		Part No.
Automatic Transmission Vacuum Modulator		
K30		
1986-1982	8 Cyl. 6.2L	TM-63
K3500		
1988	8 Cyl. 6.2L; w/ 3 Speed TH400 Trans.	TM-50
Malibu		
1983-1982	8 Cyl. 5.7L; w/ TH250, TH350 Trans.	TM-37
Monte Carlo		
1983-1982	8 Cyl. 5.7L; w/ TH250, TH350 Trans.	TM-37
P20		
1988-1982	8 Cyl. 6.2L	TM-63
P30		
1988-1982	8 Cyl. 6.2L	TM-63
R20		
1988-1987	8 Cyl. 6.2L; w/ 3 Speed TH400 Trans.	TM-50
R20 Suburban		
1988-1987	8 Cyl. 6.2L; Diesel; w/ 3 Speed TH400 Trans.	TM-50
R30		
1988	8 Cyl. 6.2L; w/ 3 Speed TH400 Trans.	TM-50
1987	8 Cyl. 6.2L	TM-63
R2500		
1989	8 Cyl. 6.2L; w/ 3 Speed TH400 Trans.	TM-50
R2500 Suburban		
1990-1989	8 Cyl. 6.2L; Diesel; w/ 3 Speed TH400 Trans.	TM-50
R3500		
1990-1989	8 Cyl. 6.2L; w/ 3 Speed TH400 Trans.	TM-50
V20		
1987	8 Cyl. 6.2L	TM-63
V20 Suburban		
1988	8 Cyl. 6.2L; Diesel; w/ 3 Speed TH400 Trans.	TM-50
V30		
1988	8 Cyl. 6.2L; w/ 3 Speed TH400 Trans.	TM-50
1987	8 Cyl. 6.2L	TM-63
V2500 Suburban		
1989	8 Cyl. 6.2L; Diesel; w/ 3 Speed TH400 Trans.	TM-50
V3500		
1989	8 Cyl. 6.2L; w/ 3 Speed TH400 Trans.	TM-50
Four Wheel Drive Indicator Lamp Switch		
Blazer		
1994	8 Cyl. 6.5L; 2 Pin; On Transfer Case	TCA-26
1994	8 Cyl. 6.5L; 3 Pin; On Transfer Case	TCA-4
1991-1988	8 Cyl. 6.2L; On Transfer Case	TCA-25
K1500 Suburban		
1999	8 Cyl. 6.5L; On Transfer Case	TCA-4
K2500		
1990	8 Cyl. 6.2L; 2 Pin; On Transfer Case	TCA-26
1990	8 Cyl. 6.2L; 3 Pin; On Transfer Case	TCA-4
K2500 Suburban		
1999	8 Cyl. 6.5L; On Transfer Case	TCA-4
K3500		
1990	8 Cyl. 6.2L; 2 Pin; White; On Transfer Case	TCA-26
1990	8 Cyl. 6.2L; 3 Pin; On Transfer Case	TCA-4
Silverado 2500 HD		
2007-2003	8 Cyl. 6.6L; w/ Manual Shift Transfer Case	TCA-4
2001	8 Cyl. 6.6L; w/ Manual Shift Transfer Case	TCA-4

		Part No.
Four Wheel Drive Indicator Lamp Switch		
Silverado 3500		
2006-2001	8 Cyl. 6.6L; w/ Manual Shift Transfer Case	TCA-4
Silverado 3500 Classic		
2007	8 Cyl. 6.6L; w/ Manual Shift Transfer Case	TCA-4
Silverado 3500 HD		
2007	8 Cyl. 6.6L; w/ Manual Shift Transfer Case	TCA-4
Tahoe		
1999	8 Cyl. 6.5L; On Transfer Case	TCA-4
1998-1995	8 Cyl. 6.5L; 2 Pin; On Transfer Case	TCA-26
1998-1995	8 Cyl. 6.5L; 3 Pin; On Transfer Case	TCA-4
1997	8 Cyl. 6.5L; 2 Pin Term.; Front Axle	TCA-5
V10 Suburban		
1988	8 Cyl. 6.2L; On Transfer Case	TCA-25
V1500 Suburban		
1991-1989	8 Cyl. 6.2L; On Transfer Case	TCA-25
Neutral Safety Switch		
C3500HD		
2002-2001	8 Cyl. 6.5L; w/ A.T.	NS-85
Colorado		
2018-2016	4 Cyl.; w/ M.T.	NS763
Express 4500		
2009	8 Cyl. 6.6L	NS-319
LUV		
1982	4 Cyl. 2.2L; w/ M.T.; On Transmission	NS-72
Silverado 2500 HD		
2019-2007	8 Cyl. 6.6L; Allison Trans	NS691
Silverado 2500 HD Classic		
2007	8 Cyl. 6.6L; Allison Trans	NS691
Silverado 3500 Classic		
2007	8 Cyl. 6.6L; Allison Trans	NS691
Silverado 3500 HD		
2019-2007	8 Cyl. 6.6L; Allison Trans	NS691
Transmission Control Solenoid		
Cruze		
2015-2014	4 Cyl. 2.0L	TCS234
Ignition Switches		
Ignition Starter Switch		
B7		
2002-1998	6 Cyl. 7.2L; w/o Tilt Wheel	US-514
1998-1997	8 Cyl. 6.5L; w/o Tilt Wheel	US-514
1998-1993	6 Cyl. 6.6L; w/o Tilt Wheel	US-514
B60		
1991-1983	8 Cyl. 8.2L	US-84
C60		
1989-1985	8 Cyl. 8.2L	US-84
1985	8 Cyl. 10.4L	US-84
C70		
1989-1985	8 Cyl. 10.4L	US-84
1989-1985	8 Cyl. 8.2L	US-84
1985-1982	6 Cyl. 6.1L	US-84
C4500 Kodiak		
2009-2003	8 Cyl. 6.6L	US-275
C6500 Kodiak		
2009-2003	6 Cyl. 7.2L	US-275
2009-2003	6 Cyl. 7.8L	US-275
C7500 Kodiak		
2009-2003	6 Cyl. 7.2L	US-275
2009-2003	6 Cyl. 7.8L	US-275

Ignition Switches

		Part No.
Ignition Starter Switch		
Express 2500		
2012	8 Cyl. 6.6L	US-747
Express 3500		
2012	8 Cyl. 6.6L	US-747
Express 4500		
2016-2009	8 Cyl. 6.6L	US-747
Silverado 2500 HD		
2012	8 Cyl. 6.6L	US-747
Silverado 3500 HD		
2012	8 Cyl. 6.6L	US-747
Ignition Switch with Lock Cylinder		
T6500		
2009-2004		US-603
T7500		
2009-2004		US-603
Interior Power Switches		
Clock Spring		
C1500		
1998	8 Cyl. 6.5L	CSP100
C1500 Suburban		
1999-1998	8 Cyl. 6.5L	CSP100
C2500		
2000-1998	8 Cyl. 6.5L	CSP100
C2500 Suburban		
1999-1998	8 Cyl. 6.5L	CSP100
C3500		
2000-1998	8 Cyl. 6.5L	CSP100
C3500HD		
2000-1998	8 Cyl. 6.5L	CSP100
Express 2500		
2000-1998	8 Cyl. 6.5L	CSP100
Express 3500		
2000-1998	8 Cyl. 6.5L	CSP100
K1500		
1998	8 Cyl. 6.5L	CSP100
K1500 Suburban		
1999-1998	8 Cyl. 6.5L	CSP100
K2500		
2000-1998	8 Cyl. 6.5L	CSP100
K2500 Suburban		
1999-1998	8 Cyl. 6.5L	CSP100
K3500		
2000-1998	8 Cyl. 6.5L	CSP100
Cruise Control Release Switch		
C10 Suburban		
1986-1982	8 Cyl. 6.2L	SLS-234
C20 Suburban		
1986-1982	8 Cyl. 6.2L	SLS-234
C1500		
1996-1994	8 Cyl. 6.5L; Lock Out Switch	NS-35
1993-1988	8 Cyl. 6.2L; Lock Out Switch	NS-35
C1500 Suburban		
1996-1995	8 Cyl. 6.5L; Lock Out Switch	NS-35
C2500		
1996-1992	8 Cyl. 6.5L; Lock Out Switch	NS-35
1993-1988	8 Cyl. 6.2L; Lock Out Switch	NS-35
C2500 Suburban		
1996-1994	8 Cyl. 6.5L; Lock Out Switch	NS-35
C3500		
1996-1992	8 Cyl. 6.5L; Lock Out Switch	NS-35
1993-1988	8 Cyl. 6.2L; Lock Out Switch	NS-35

		Part No.
Cruise Control Release Switch		
El Camino		
1984	8 Cyl. 5.7L	SLS-234
K5 Blazer		
1986-1982	8 Cyl. 6.2L	SLS-234
K10 Suburban		
1986-1982	8 Cyl. 6.2L	SLS-234
K20 Suburban		
1986-1982	8 Cyl. 6.2L	SLS-234
K1500		
1996-1994	8 Cyl. 6.5L; Lock Out Switch	NS-35
1993-1988	8 Cyl. 6.2L; Lock Out Switch	NS-35
K1500 Suburban		
1996-1995	8 Cyl. 6.5L; Lock Out Switch	NS-35
K2500		
1996-1992	8 Cyl. 6.5L; Lock Out Switch	NS-35
1993-1988	8 Cyl. 6.2L; Lock Out Switch	NS-35
K2500 Suburban		
1996-1994	8 Cyl. 6.5L; Lock Out Switch	NS-35
K3500		
1996-1992	8 Cyl. 6.5L; Lock Out Switch	NS-35
1993-1988	8 Cyl. 6.2L; Lock Out Switch	NS-35
Monte Carlo		
1984	8 Cyl. 5.7L	SLS-234
R10 Suburban		
1988	8 Cyl. 6.2L	NS-120
1987	8 Cyl. 6.2L	SLS-234
R20		
1987	8 Cyl. 6.2L	SLS-234
R20 Suburban		
1988	8 Cyl. 6.2L	NS-120
1987	8 Cyl. 6.2L	SLS-234
R30		
1987	8 Cyl. 6.2L	SLS-234
R1500 Suburban		
1991-1989	8 Cyl. 6.2L	NS-120
R2500 Suburban		
1991-1989	8 Cyl. 6.2L	NS-120
Tahoe		
1996-1995	8 Cyl. 6.5L; Lock Out Switch	NS-35
V10		
1987	8 Cyl. 6.2L	SLS-234
V10 Suburban		
1987	8 Cyl. 6.2L	SLS-234
V20		
1987	8 Cyl. 6.2L	SLS-234
V20 Suburban		
1987	8 Cyl. 6.2L	SLS-234
V30		
1987	8 Cyl. 6.2L	SLS-234
Cruise Control Switch		
C10		
1986-1984	8 Cyl. 6.2L; w/ Intermittent Wipers	DS-1534
C10 Suburban		
1986-1984	8 Cyl. 6.2L; w/ Intermittent Wipers	DS-1534
C20		
1986-1984	8 Cyl. 6.2L; w/ Intermittent Wipers	DS-1534
C20 Suburban		
1986-1984	8 Cyl. 6.2L; w/ Intermittent Wipers	DS-1534
C30		
1986-1984	8 Cyl. 6.2L; w/ Intermittent Wipers	DS-1534

Chevrolet

Interior Power Switches

		Part No.
Cruise Control Switch		
C1500		
1997-1995	8 Cyl. 6.5L	DS-698
C2500		
1997-1995	8 Cyl. 6.5L	DS-698
C3500		
1997-1995	8 Cyl. 6.5L	DS-698
C3500HD		
1997-1995	8 Cyl. 6.5L	DS-698
C4500 Kodiak		
2009-2003	8 Cyl. 6.6L	CBS-1452
Celebrity		
1985-1984	6 Cyl. 4.3L; w/ Intermittent Wipers	DS-1534
El Camino		
1984	8 Cyl. 5.7L; w/ Intermittent Wipers	DS-1534
Express 2500		
2000-1997	8 Cyl. 6.5L; w/ Tilt Steering	DS-698
Express 3500		
2011	8 Cyl. 6.6L	DS-2156
2000-1997	8 Cyl. 6.5L; w/ Tilt Steering	DS-698
Express 4500		
2016-2014	8 Cyl. 6.6L	DS-2156
2011-2009	8 Cyl. 6.6L	DS-2156
G20		
1991-1983	8 Cyl. 6.2L; w/ Intermittent Wipers	DS-1534
G30		
1991-1983	8 Cyl. 6.2L; w/ Intermittent Wipers	DS-1534
Impala		
1985-1984	8 Cyl. 5.7L; w/ Intermittent Wipers	DS-1534
K5 Blazer		
1986-1984	8 Cyl. 6.2L; w/ Intermittent Wipers	DS-1534
K10		
1986-1984	8 Cyl. 6.2L; w/ Intermittent Wipers	DS-1534
K10 Suburban		
1986-1984	8 Cyl. 6.2L; w/ Intermittent Wipers	DS-1534
K20		
1986-1984	8 Cyl. 6.2L; w/ Intermittent Wipers	DS-1534
K20 Suburban		
1986-1984	8 Cyl. 6.2L; w/ Intermittent Wipers	DS-1534
K30		
1986-1984	8 Cyl. 6.2L; w/ Intermittent Wipers	DS-1534
K1500		
1997-1995	8 Cyl. 6.5L	DS-698
K2500		
1997-1995	8 Cyl. 6.5L	DS-698
K3500		
1997-1995	8 Cyl. 6.5L	DS-698
Monte Carlo		
1984	8 Cyl. 5.7L; w/ Intermittent Wipers	DS-1534
P30		
1997-1996	8 Cyl. 6.5L; Motorhome; w/ Air Bag; w/ Tilt Steering	DS-698
R10		
1987	8 Cyl. 6.2L; w/ Intermittent Wipers	DS-1534
R20		
1987	8 Cyl. 6.2L; w/ Intermittent Wipers	DS-1534
R30		
1987	8 Cyl. 6.2L; w/ Intermittent Wipers	DS-1534
S10		
1984	4 Cyl. 2.2L; w/ Intermittent Wipers	DS-1534
Silverado 3500 HD		
2011-2008	8 Cyl. 6.6L; Cashmere	CCA1097

		Part No.
Cruise Control Switch		
Silverado 3500 HD		
2011-2008	8 Cyl. 6.6L; Black Finish	DS-2156
T6500		
2009-2004	U.S. Models	CBS-2148
T7500		
2009-2004	U.S. Models	CBS-2148
V10		
1987	8 Cyl. 6.2L; w/ Intermittent Wipers	DS-1534
Fuel Tank Selector Switch		
R10		
1987	8 Cyl. 6.2L	DS-293
R20		
1988-1987	8 Cyl. 6.2L	DS-293
R30		
1988-1987	8 Cyl. 6.2L	DS-293
R3500		
1990	8 Cyl. 6.2L	DS-1807
V10		
1987	8 Cyl. 6.2L	DS-293
V20		
1987	8 Cyl. 6.2L	DS-293
V30		
1988-1987	8 Cyl. 6.2L	DS-293
V3500		
1991-1989	8 Cyl. 6.2L	DS-293
Parking Brake Switch		
G20		
1995-1994	8 Cyl. 6.5L	DS-905
1993-1991	8 Cyl. 6.2L	DS-905
1984-1983	8 Cyl. 6.2L	DS-905
G30		
1995-1994	8 Cyl. 6.5L	DS-905
1993-1991	8 Cyl. 6.2L	DS-905
1984-1983	8 Cyl. 6.2L	DS-905
Steering Wheel Audio Control Switch		
Express 2500		
2010-2008	8 Cyl.	SAS113
Express 3500		
2010-2008	8 Cyl.	SAS113
Express 4500		
2010-2009	8 Cyl.	SAS113
Silverado 3500		
2002-2001	8 Cyl.	SAS115
Silverado 3500 HD		
2011-2009	8 Cyl.	SAS114
2008	8 Cyl.	SAS113
Windshield Wiper Switch		
T6500		
2009-2004	Canada; w/ Cruise Control	CBS-2145
2009-2004	U.S. Models; w/o Cruise Control	CBS-2146
2009-2004	Canada; w/o Cruise Control	CBS-2147
2009-2004	U.S. Models; w/ Cruise Control	CBS-2148
T7500		
2009-2004	Canada; w/ Cruise Control	CBS-2145
2009-2004	U.S. Models; w/o Cruise Control	CBS-2146
2009-2004	Canada; w/o Cruise Control	CBS-2147
2009-2004	U.S. Models; w/ Cruise Control	CBS-2148
Pressure and Vacuum Sending Switches		
Oil Pressure Gauge Switch		
Blazer		
1991-1987	8 Cyl. 6.2L	PS-155

Pressure and Vacuum Sending Switches

		Part No.
Oil Pressure Gauge Switch		
C10 Suburban		
1984-1982	8 Cyl. 6.2L; Diesel	PS-154
C1500		
1998	8 Cyl. 6.5L	PS-245
1991-1988	8 Cyl. 6.2L	PS-256
C2500		
2000	8 Cyl. 6.5L	PS-245
1999	8 Cyl. 6.5L; 3 Blade Term.	PS-245
1998	8 Cyl. 6.5L; Diesel	PS-245
1991-1988	8 Cyl. 6.2L	PS-256
C3500		
2000	8 Cyl. 6.5L	PS-245
1994-1992	8 Cyl. 6.5L	PS-245
1993-1992	8 Cyl. 6.2L	PS-245
1991-1988	8 Cyl. 6.2L	PS-256
C3500HD		
2002-2001	8 Cyl. 6.5L; Diesel	PS-245
2000	8 Cyl. 6.5L	PS-245
1998	8 Cyl. 6.5L	PS-245
1994-1992	8 Cyl. 6.5L	PS-245
C4500 Kodiak		
2009-2003	8 Cyl. 6.6L	PS-414
C5500 Kodiak		
2009-2003	8 Cyl. 6.6L	PS-414
Caprice		
1982	8 Cyl. 5.7L	PS-154
Equinox		
2019	4 Cyl. 1.6L	PS635
Express 2500		
2010	8 Cyl. 6.6L; M12 x 1.5 Thread	PS-414
2009-2006	8 Cyl. 6.6L	PS-414
2002-1999	8 Cyl. 6.5L	PS419
1998	8 Cyl. 6.5L; 3 Blade Term.	PS-245
1998	8 Cyl. 6.5L; 1 Term.	PS419
1997	8 Cyl. 6.5L	PS-245
Express 3500		
2010-2006	8 Cyl. 6.6L	PS-414
2002-1999	8 Cyl. 6.5L	PS419
1998	8 Cyl. 6.5L; 3 Blade Term.	PS-245
1998	8 Cyl. 6.5L; 1 Term.	PS419
1997	8 Cyl. 6.5L	PS-245
G20		
1989-1987	8 Cyl. 6.2L	PS-155
G30		
1996	8 Cyl. 6.5L; Old Body Style	PS-245
1988-1987	8 Cyl. 6.2L	PS-155
K5 Blazer		
1986-1985	8 Cyl. 6.2L	PS-155
1984-1982	8 Cyl. 6.2L; Diesel; w/ Tachometer	PS-154
1984-1982	8 Cyl. 6.2L; Diesel; w/o Tachometer	PS-155
K10 Suburban		
1986	8 Cyl. 6.2L	PS-155
K1500		
1998	8 Cyl. 6.5L	PS-245
1991-1988	8 Cyl. 6.2L	PS-256
K2500		
2000	8 Cyl. 6.5L	PS-245
1998	8 Cyl. 6.5L	PS-245
1991-1988	8 Cyl. 6.2L	PS-256
K3500		
2000	8 Cyl. 6.5L	PS-245
1998	8 Cyl. 6.5L	PS-245

		Part No.
Oil Pressure Gauge Switch		
K3500		
1991-1988	8 Cyl. 6.2L	PS-256
P20		
1986-1985	8 Cyl. 6.2L	PS-155
P30		
1999-1996	8 Cyl. 6.5L	PS-245
1993-1991	8 Cyl. 6.2L; 1 Term.	PS-155
1993-1991	8 Cyl. 6.2L; 3 Blade Term.	PS-245
1991-1990	4 Cyl. 3.9L	PS-154
1990	8 Cyl. 6.2L	PS-155
1986-1985	8 Cyl. 6.2L	PS-155
R10		
1987	8 Cyl. 6.2L	PS-155
R10 Suburban		
1988-1987	8 Cyl. 6.2L	PS-155
R20		
1988-1987	8 Cyl. 6.2L	PS-155
R20 Suburban		
1988-1987	8 Cyl. 6.2L	PS-155
R30		
1988-1987	8 Cyl. 6.2L	PS-155
R1500 Suburban		
1991-1989	8 Cyl. 6.2L	PS-155
R2500		
1989	8 Cyl. 6.2L	PS-155
R2500 Suburban		
1991-1989	8 Cyl. 6.2L	PS-155
R3500		
1991-1989	8 Cyl. 6.2L	PS-155
S10		
1985	4 Cyl. 2.2L	PS-155
Silverado 2500 HD		
2010-2003	8 Cyl. 6.6L	PS-414
2002-2001	8 Cyl. 6.6L	PS-230
Silverado 2500 HD Classic		
2007	8 Cyl. 6.6L	PS-414
Silverado 3500		
2006-2003	8 Cyl. 6.6L	PS-414
2002-2001	8 Cyl. 6.6L	PS-230
Silverado 3500 Classic		
2007	8 Cyl. 6.6L	PS-414
Silverado 3500 HD		
2010-2007	8 Cyl. 6.6L	PS-414
Tahoe		
1999	8 Cyl. 6.5L; 3 Blade Term.	PS-245
V10		
1987	8 Cyl. 6.2L	PS-155
V10 Suburban		
1988-1987	8 Cyl. 6.2L	PS-155
V20		
1987	8 Cyl. 6.2L	PS-155
V20 Suburban		
1988-1987	8 Cyl. 6.2L	PS-155
V30		
1988-1987	8 Cyl. 6.2L	PS-155
V1500 Suburban		
1991-1989	8 Cyl. 6.2L	PS-155
V2500 Suburban		
1991-1989	8 Cyl. 6.2L	PS-155
V3500		
1991-1989	8 Cyl. 6.2L	PS-155

Chevrolet

Pressure and Vacuum Sending Switches

		Part No.
Oil Pressure Light Switch		
Blazer		
1987	8 Cyl. 6.2L	PS-12
C10		
1986-1985	8 Cyl. 6.2L	PS-140
C10 Suburban		
1980	8 Cyl.	PS-12
C20		
1986-1985	8 Cyl. 6.2L	PS-140
C30		
1986-1985	8 Cyl. 6.2L	PS-140
C1500		
1992-1988	8 Cyl. 6.2L	PS-140
C2500		
1992-1988	8 Cyl. 6.2L	PS-140
C3500		
1992-1988	8 Cyl. 6.2L	PS-140
Caprice		
1985	8 Cyl. 5.7L; 1 Blade Term.	PS-12
1985	8 Cyl. 5.7L; 2 Blade Term.	PS-144
1984-1982	8 Cyl. 5.7L	PS-12
1981-1980	8 Cyl. 5.7L; 1 Blade Term.	PS-12
1981-1980	8 Cyl. 5.7L; 2 Blade Term.	PS-126
Celebrity		
1985-1982	6 Cyl. 4.3L	PS-12
Colorado		
2020-2018	4 Cyl. 2.8L	PS623
2016	4 Cyl. 2.8L	PS623
El Camino		
1984-1983	8 Cyl. 5.7L; 1/8 Inch x 27 Thread	PS-12
Express 2500		
2002-1999	8 Cyl. 6.5L	PS-304
Express 3500		
2002-1999	8 Cyl. 6.5L	PS-304
G20		
1988	8 Cyl. 6.2L	PS-57
1986-1983	8 Cyl. 6.2L	PS-57
G30		
1988-1985	8 Cyl. 6.2L	PS-57
1984-1983	8 Cyl. 6.2L; w/ 1/4 Inch x 18 Thread	PS-57
Impala		
1985	8 Cyl. 5.7L; 1 Blade Term.	PS-12
1985	8 Cyl. 5.7L; 2 Blade Term.	PS-144
1984-1983	8 Cyl. 5.7L; Diesel	PS-12
1982	8 Cyl. 5.7L; 1/8 Inch x 27 Thread; Diesel	PS-12
1981	8 Cyl. 5.7L; 1 Blade Term.; 1/8 Inch x 27 Thread; Diesel	PS-12
1980	8 Cyl. 5.7L; 1 Blade Term.	PS-12
1980	8 Cyl. 5.7L; 2 Blade Term.	PS-126
K5 Blazer		
1986-1985	8 Cyl. 6.2L	PS-140
K10		
1986-1985	8 Cyl. 6.2L	PS-140
K10 Suburban		
1986	8 Cyl. 6.2L	PS-140
1985	8 Cyl.	PS-12
K20		
1986-1985	8 Cyl. 6.2L	PS-140
K30		
1986-1985	8 Cyl. 6.2L	PS-140
K1500		
1992-1988	8 Cyl. 6.2L	PS-140

		Part No.
Oil Pressure Light Switch		
K2500		
1992-1988	8 Cyl. 6.2L	PS-140
K3500		
1992-1988	8 Cyl. 6.2L	PS-140
Malibu		
1983	6 Cyl. 4.3L; 1 Blade Term.; Diesel	PS-12
1983	8 Cyl. 5.7L; 1 Blade Term.; 2.75 Inch Overall Length; Diesel	PS-12
1982	6 Cyl. 4.3L; 1 Blade Term.	PS-12
1982	8 Cyl. 5.7L; 1 Blade Term.	PS-12
Monte Carlo		
1984-1982	8 Cyl. 5.7L	PS-12
1983-1982	6 Cyl. 4.3L	PS-12
P30		
1999	8 Cyl. 6.5L; Diesel	PS-304
R10		
1987	8 Cyl. 6.2L	PS-12
R10 Suburban		
1987	8 Cyl. 6.2L	PS-12
R20		
1988	8 Cyl. 6.2L	PS-140
1987	8 Cyl. 6.2L	PS-12
R20 Suburban		
1987	8 Cyl. 6.2L	PS-12
R30		
1988	8 Cyl. 6.2L	PS-140
1987	8 Cyl. 6.2L	PS-12
S10		
1985	4 Cyl. 2.2L	PS-15
Silverado 2500 HD		
2002-2001	8 Cyl. 6.6L	PS622
Silverado 3500		
2002-2001	8 Cyl. 6.6L	PS622
V10 Suburban		
1987	8 Cyl. 6.2L	PS-12
V20		
1987	8 Cyl. 6.2L	PS-12
V20 Suburban		
1987	8 Cyl. 6.2L	PS-12
V30		
1988	8 Cyl. 6.2L	PS-140
1987	8 Cyl. 6.2L	PS-12
Ported Vacuum Switch		
C10		
1981	8 Cyl. 5.7L; 2 Ports; Green	PVS24
1981	8 Cyl. 5.7L; 3 Ports; Brown	PVS44
1981	8 Cyl. 5.7L; 5 Ports; Black Finish	PVS47
1981	8 Cyl. 5.7L; 4 Ports; Black w/ Red Plug	PVS53
1981	8 Cyl. 5.7L; 4 Ports; Black Finish; Canada; Export	PVS81
1981	8 Cyl. 5.7L; 4 Ports; Black Finish; Fed.	PVS82
1981	8 Cyl. 5.7L; 2 Ports; Natural	PVS92
1981	8 Cyl. 5.7L; 4 Ports; Black w/ Green Plug	PVS94
1981-1980	8 Cyl. 5.7L; 4 Ports; Black Finish	PVS53
1981-1980	8 Cyl. 5.7L; 2 Ports; Dark Blue	PVS67
1980	8 Cyl. 5.7L; 3 Ports; Blue	PVS118
1980	8 Cyl. 5.7L; 2 Ports; Purple	PVS27
1980	8 Cyl. 5.7L; 2 Ports; Brown	PVS45
1980	8 Cyl. 5.7L; 4 Ports	PVS82
C10 Suburban		
1980	8 Cyl.; 3 Ports; Blue	PVS118
1980	8 Cyl.; 2 Ports; Purple	PVS27

Pressure and Vacuum Sending Switches

		Part No.
Ported Vacuum Switch		
C10 Suburban		
1980	8 Cyl.; 2 Ports; Brown	PVS45
1980	8 Cyl.; 2 Ports; Black Finish	PVS48
1980	8 Cyl.; 4 Ports; Black Finish	PVS53
1980	8 Cyl.; 4 Ports	PVS82
Caprice		
1985	8 Cyl. 5.7L; 2 Ports; Purple	PVS27
1985	8 Cyl. 5.7L; 2 Ports; Black Finish; OE No. 3043015	PVS48
1985	8 Cyl. 5.7L; 2 Ports; Dark Blue	PVS67
1985	8 Cyl. 5.7L; 2 Ports; 7 Term.; Black Finish; OE No. 3030951, 370721	PVS13
1984-1983	8 Cyl. 5.7L; 2 Ports; Black Finish	PVS48
1982	8 Cyl. 5.7L; 2 Ports; 7 Term.; Black Finish; OE No. 3033397	PVS13
1982	8 Cyl. 5.7L; 2 Ports; Black Finish; OE No. 3043015	PVS48
1982	8 Cyl. 5.7L; 2 Ports; Black w/ Green Top	PVS55
1982	8 Cyl. 5.7L; 2 Ports; Dark Blue	PVS67
1981	8 Cyl. 5.7L; 2 Ports; Light Green	PVS43
1981-1980	8 Cyl. 5.7L; 2 Ports; Blue	PVS16
1981-1980	8 Cyl. 5.7L; 2 Ports; Purple	PVS27
1981-1980	8 Cyl. 5.7L; 2 Ports; Black Finish	PVS48
1980	8 Cyl. 5.7L; 3 Ports; Black Finish	PVS54
1980	8 Cyl. 5.7L; 2 Ports; White	PVS71
Celebrity		
1985	6 Cyl.; 2 Ports; Green	PVS24
1985	6 Cyl.; 3 Ports; Gray	PVS41
1984	6 Cyl. 4.3L	PVS135
1983	6 Cyl.; 2 Ports; Canada; Green	PVS24
1983	6 Cyl.; 2 Ports; Canada; Purple	PVS27
1982	6 Cyl.; 2 Ports; Green	PVS24
1982	6 Cyl.; 2 Ports; Purple	PVS27
El Camino		
1984	8 Cyl. 5.7L; 5 Ports; Black Finish; Calif.	PVS47
1984	8 Cyl. 5.7L; 3 Ports; Black Finish; w/ High Altitude	PVS54
1984-1983	8 Cyl. 5.7L; 2 Ports; Black Finish; OE No. 3043015	PVS48
1984-1983	8 Cyl. 5.7L; 4 Ports; Black w/ Green Plug	PVS94
1983	8 Cyl. 5.7L; 5 Ports; Black Finish	PVS47
1983	8 Cyl. 5.7L; 3 Ports; Black Finish	PVS54
Impala		
1985-1983	8 Cyl. 5.7L; 2 Ports; Purple	PVS27
1985-1982	8 Cyl. 5.7L; 2 Ports; 7 Term.; Black Finish; OE No. 3030951, 370721	PVS13
1985-1982	8 Cyl. 5.7L; 2 Ports; Black Finish; OE No. 3043015	PVS48
1985-1982	8 Cyl. 5.7L; 2 Ports; Dark Blue	PVS67
1984-1982	8 Cyl. 5.7L; 2 Ports; Black w/ Green Top	PVS55
1981	8 Cyl. 5.7L; 2 Ports; Light Green	PVS43
1981-1980	8 Cyl. 5.7L; 2 Ports; Blue	PVS16
1981-1980	8 Cyl. 5.7L; 2 Ports; Purple	PVS27
1981-1980	8 Cyl. 5.7L; 2 Ports; Black Finish	PVS48
1980	8 Cyl. 5.7L; 3 Ports; Black Finish	PVS54
1980	8 Cyl. 5.7L; 2 Ports; White	PVS71
Malibu		
1983-1982	8 Cyl. 5.7L; 2 Ports; Black Finish; OE No. 3043015	PVS48
Monte Carlo		
1984	8 Cyl. 5.7L; 2 Ports; Black Finish; OE No. 3043015	PVS48
1983-1982	8 Cyl. 5.7L; 2 Ports; Black Finish	PVS48

		Part No.
Power Steering Pressure Switch		
C1500		
1998-1997	8 Cyl. 6.5L	PSS12
C1500 Suburban		
1999	8 Cyl. 6.5L	PSS12
C2500		
1998-1997	8 Cyl. 6.5L	PSS12
C2500 Suburban		
1999	8 Cyl. 6.5L	PSS12
C3500		
1998-1997	8 Cyl. 6.5L	PSS12
C3500HD		
1998-1997	8 Cyl. 6.5L	PSS12
K1500		
1998-1997	8 Cyl. 6.5L	PSS12
K1500 Suburban		
1999	8 Cyl. 6.5L	PSS12
K2500		
1998-1997	8 Cyl. 6.5L	PSS12
K2500 Suburban		
1999	8 Cyl. 6.5L	PSS12
K3500		
1998-1997	8 Cyl. 6.5L	PSS12
P30		
1999-1994	8 Cyl. 6.5L	PSS12
Tahoe		
1999-1996	8 Cyl. 6.5L	PSS12
Temperature Switches and Senders		
A/C and Heater Blower Motor Switch		
Celebrity		
1982	6 Cyl. 4.3L	HS-206
Chevette		
1981	4 Cyl. 1.8L	HS-321
P20		
1983	8 Cyl. 6.2L; Front	HS-204
P30		
1983	8 Cyl. 6.2L; Front	HS-204
S10		
1985-1983	4 Cyl. 2.2L	HS-242
S10 Blazer		
1984	4 Cyl. 2.2L	HS-242
A/C and Heater Selector Switch		
C10		
1986-1984	8 Cyl. 6.2L	HS-316
C10 Suburban		
1986	8 Cyl. 6.2L	HS-316
1984	8 Cyl. 6.2L	HS-316
C20		
1986-1984	8 Cyl. 6.2L	HS-316
C20 Suburban		
1986	8 Cyl. 6.2L	HS-316
1984	8 Cyl. 6.2L	HS-316
C30		
1986-1984	8 Cyl. 6.2L	HS-316
Caprice		
1985-1983	8 Cyl. 5.7L	HS-316
1981-1980	8 Cyl. 5.7L	HS-316
El Camino		
1983	8 Cyl. 5.7L	HS-316
K10		
1986-1984	8 Cyl. 6.2L	HS-316

Chevrolet

Temperature Switches and Senders

		Part No.
A/C and Heater Selector Switch		
K10 Suburban		
1986	8 Cyl. 6.2L	HS-316
1984	8 Cyl. 6.2L	HS-316
K20		
1986-1984	8 Cyl. 6.2L	HS-316
K20 Suburban		
1986	8 Cyl. 6.2L	HS-316
1984	8 Cyl. 6.2L	HS-316
K30		
1986-1984	8 Cyl. 6.2L	HS-316
Malibu		
1983-1982	6 Cyl. 4.3L	HS-316
1983-1982	8 Cyl. 5.7L	HS-316
R10		
1987	8 Cyl. 6.2L	HS-316
R10 Suburban		
1988-1987	8 Cyl. 6.2L	HS-316
R20		
1988-1987	8 Cyl. 6.2L	HS-316
R20 Suburban		
1988-1987	8 Cyl. 6.2L	HS-316
R30		
1988-1987	8 Cyl. 6.2L	HS-316
R2500		
1989	8 Cyl. 6.2L	HS-316
R3500		
1991-1989	8 Cyl. 6.2L	HS-316
S10		
1985-1983	4 Cyl. 2.2L	HS-316
S10 Blazer		
1984	4 Cyl. 2.2L	HS-316
V10		
1987	8 Cyl. 6.2L	HS-316
V10 Suburban		
1988-1987	8 Cyl. 6.2L	HS-316
V20		
1987	8 Cyl. 6.2L	HS-316
V20 Suburban		
1988-1987	8 Cyl. 6.2L	HS-316
V30		
1988-1987	8 Cyl. 6.2L	HS-316
V3500		
1991-1989	8 Cyl. 6.2L	HS-316
Blower Motor Resistor		
Blazer		
1994	8 Cyl.; w/ AC	RU-57
1994	8 Cyl.; w/o AC	RU-59
C70 Kodiak		
1996-1991	6 Cyl. 6.6L	RU-57
C6500 Kodiak		
2009-2003	6 Cyl. 7.2L; w/ Auxiliary Heater; Rear	RU-373
2009-2003	6 Cyl. 7.8L; w/ Auxiliary Heater; Rear	RU-373
2009-2003	6 Cyl. 7.2L; Main; Resistor; Front	RU-51
2009-2003	6 Cyl. 7.8L; Main; Resistor; Front	RU-51
2002-1999	6 Cyl. 7.2L	RU-57
1998-1997	6 Cyl. 6.6L	RU-57
C7500 Kodiak		
2009-2003	6 Cyl. 7.2L; w/ Auxiliary Heater; Rear	RU-373
2009-2003	6 Cyl. 7.8L; w/ Auxiliary Heater; Rear	RU-373
2009-2003	6 Cyl. 7.2L; Main; Resistor; Front	RU-51
2009-2003	6 Cyl. 7.8L; Main; Resistor; Front	RU-51
2002-1999	6 Cyl. 7.2L	RU-57

		Part No.
Blower Motor Resistor		
C7500 Kodiak		
1998-1997	6 Cyl. 6.6L	RU-57
P30		
1994	8 Cyl. 6.5L; Main Unit; w/ AC; Front	RU-56
1993	8 Cyl. 6.2L; Main Unit; w/ AC; Front	RU-56
1991	4 Cyl. 3.9L	RU-62
1991	8 Cyl. 6.2L	RU-62
T6500		
2009-2004		RU987
T7500		
2009-2004		RU987
T8500		
2009-2004		RU987
Blower Motor Resistor Kit		
C6500 Kodiak		
2009-2003	6 Cyl. 7.2L; Main; w/ Connector; w/ High Temperature Connector; Front	RU51HTK
2009-2003	6 Cyl. 7.8L; Main; w/ Connector; w/ High Temperature Connector; Front	RU51HTK
C7500 Kodiak		
2009-2003	6 Cyl. 7.2L; Main; w/ Connector; w/ High Temperature Connector; Front	RU51HTK
2009-2003	6 Cyl. 7.8L; Main; w/ Connector; w/ High Temperature Connector; Front	RU51HTK
Coolant Fan Switch		
Celebrity		
1983-1982	6 Cyl. 4.3L	TS240
K5 Blazer		
1986	8 Cyl. 6.2L	TS272
K10 Suburban		
1986	8 Cyl. 6.2L	TS272
P30		
1997-1994	8 Cyl. 6.5L	TS-241
Diesel Fast Idle Temperature Switch		
C10 Suburban		
1986-1985	8 Cyl. 6.2L; Diesel	TS-621
C20 Suburban		
1986-1985	8 Cyl. 6.2L; Diesel	TS-621
K5 Blazer		
1986-1985	8 Cyl. 6.2L; Diesel	TS-621
K10 Suburban		
1986-1985	8 Cyl. 6.2L; Diesel	TS-621
K20 Suburban		
1985	8 Cyl. 6.2L; Diesel	TS-621
R10 Suburban		
1988-1987	8 Cyl. 6.2L; Diesel	TS-621
R20 Suburban		
1988-1987	8 Cyl. 6.2L; Diesel	TS-621
R1500 Suburban		
1991-1989	8 Cyl. 6.2L; Diesel	TS-621
R2500 Suburban		
1991-1989	8 Cyl. 6.2L; Diesel	TS-621
V10 Suburban		
1987	8 Cyl. 6.2L; Diesel	TS-621
V20 Suburban		
1988-1987	8 Cyl. 6.2L; Diesel	TS-621
V1500 Suburban		
1991-1989	8 Cyl. 6.2L; Diesel	TS-621
V2500 Suburban		
1991-1989	8 Cyl. 6.2L; Diesel	TS-621

Temperature Switches and Senders

		Part No.
Temperature Sender - With Gauge		
C10		
1986-1985	8 Cyl. 6.2L	TS-76
1984	8 Cyl. 6.2L; 1/2 Inch x 14 Thread	TS-71
1984	8 Cyl. 6.2L; 3/8 Inch x 18 Thread	TS-76
1983-1982	8 Cyl. 6.2L	TS-76
1981	8 Cyl. 5.7L	TS-76
1980	8 Cyl. 5.7L; 1/2 Inch x 14 Thread; w/ Gauge	TS-71
1980	8 Cyl. 5.7L; 3/8 Inch x 18 Thread; w/ Gauge	TS-76
C10 Suburban		
1985	8 Cyl. 6.2L; Diesel	TS-76
1980	8 Cyl. 5.7L	TS-76
C20		
1986	8 Cyl. 6.2L; Diesel	TS-76
1985	8 Cyl. 6.2L	TS-76
1984	8 Cyl. 6.2L; 1/2 Inch x 14 Thread	TS-71
1984	8 Cyl. 6.2L; 3/8 Inch x 18 Thread	TS-76
1983-1982	8 Cyl. 6.2L	TS-76
C30		
1986-1985	8 Cyl. 6.2L	TS-76
1984	8 Cyl. 6.2L; 1/2 Inch x 14 Thread	TS-71
1984	8 Cyl. 6.2L; 3/8 Inch x 18 Thread	TS-76
1983-1982	8 Cyl. 6.2L	TS-76
C70		
1980	8 Cyl.	TS-6
C1500		
1998-1996	8 Cyl. 6.5L; w/ Oval Connector	TS-253
1995-1994	8 Cyl. 6.5L	TS-253
1993	8 Cyl. 6.2L; w/ Oval Connector	TS-253
1992-1988	8 Cyl. 6.2L	TS-76
C1500 Suburban		
1999-1996	8 Cyl. 6.5L; w/ Oval Connector	TS-253
1995	8 Cyl. 6.5L	TS-253
C2500		
2000-1992	8 Cyl. 6.5L; w/ Oval Connector	TS-253
1993	8 Cyl. 6.2L; w/ Oval Connector	TS-253
1992-1988	8 Cyl. 6.2L	TS-76
C2500 Suburban		
1999-1997	8 Cyl. 6.5L; w/ Oval Connector	TS-253
1995-1994	8 Cyl. 6.5L; w/ Oval Connector	TS-253
C3500		
2000-1992	8 Cyl. 6.5L; w/ Oval Connector	TS-253
1993	8 Cyl. 6.2L; w/ Oval Connector	TS-253
1992-1988	8 Cyl. 6.2L	TS-76
C3500HD		
2002-2001	8 Cyl. 6.5L	TS-253
2000-1992	8 Cyl. 6.5L; w/ Oval Connector	TS-253
Chevette		
1985	4 Cyl. 1.8L	TS-76
El Camino		
1983	8 Cyl. 5.7L	TS-105
Express 2500		
2002	8 Cyl. 6.5L; w/ Oval Connector	TS-253
2000-1997	8 Cyl. 6.5L; w/ Oval Connector	TS-253
Express 3500		
2002	8 Cyl. 6.5L; w/ Oval Connector	TS-253
2000-1996	8 Cyl. 6.5L; w/ Oval Connector	TS-253
G20		
1995	8 Cyl. 6.5L; w/o Wire	TS-253
1994	8 Cyl. 6.5L	TS-253
1993-1992	8 Cyl. 6.2L	TS-253
1991	8 Cyl. 6.2L; Diesel	TS-76

		Part No.
Temperature Sender - With Gauge		
G30		
1996-1994	8 Cyl. 6.5L; w/ Oval Connector	TS-253
1993-1992	8 Cyl. 6.2L; w/ Oval Connector	TS-253
1991-1988	8 Cyl. 6.2L; Diesel	TS-76
Impala		
1985-1984	8 Cyl. 5.7L	TS-168
K10		
1986-1985	8 Cyl. 6.2L	TS-76
1984	8 Cyl. 6.2L; 1/2 Inch x 14 Thread	TS-71
1984	8 Cyl. 6.2L; 3/8 Inch x 18 Thread	TS-76
1983-1982	8 Cyl. 6.2L	TS-76
K20		
1986-1985	8 Cyl. 6.2L; Diesel	TS-76
1984	8 Cyl. 6.2L; 1/2 Inch x 14 Thread	TS-71
1984	8 Cyl. 6.2L; 3/8 Inch x 18 Thread	TS-76
1983-1982	8 Cyl. 6.2L; Diesel	TS-76
K30		
1986-1985	8 Cyl. 6.2L; Diesel	TS-76
1984	8 Cyl. 6.2L; 1/2 Inch x 14 Thread	TS-71
1984	8 Cyl. 6.2L; 3/8 Inch x 18 Thread	TS-76
1983-1982	8 Cyl. 6.2L; Diesel	TS-76
K1500		
1998-1996	8 Cyl. 6.5L; w/ Oval Connector	TS-253
1995-1994	8 Cyl. 6.5L	TS-253
1993	8 Cyl. 6.2L	TS-253
1992-1988	8 Cyl. 6.2L	TS-76
K1500 Suburban		
1999-1997	8 Cyl. 6.5L; Diesel; w/ Oval Connector	TS-253
1996	8 Cyl. 6.5L; w/ Oval Connector	TS-253
1995	8 Cyl. 6.5L	TS-253
K2500		
2000-1992	8 Cyl. 6.5L; w/ Oval Connector	TS-253
1993	8 Cyl. 6.2L; w/ Oval Connector	TS-253
1992	8 Cyl. 6.2L; Diesel	TS-76
1991	8 Cyl. 6.2L	TS-76
1990-1989	8 Cyl. 6.2L; Diesel	TS-76
1988	8 Cyl. 6.2L	TS-76
K2500 Suburban		
1999-1997	8 Cyl. 6.5L; w/ Oval Connector	TS-253
1995-1994	8 Cyl. 6.5L; w/ Oval Connector	TS-253
K3500		
2000-1992	8 Cyl. 6.5L; w/ Oval Connector	TS-253
1993	8 Cyl. 6.2L; w/ Oval Connector	TS-253
1992	8 Cyl. 6.2L; Diesel	TS-76
1991	8 Cyl. 6.2L	TS-76
1990-1989	8 Cyl. 6.2L; Diesel	TS-76
1988	8 Cyl. 6.2L	TS-76
Malibu		
1983-1982	6 Cyl. 4.3L	TS-76
1983-1982	8 Cyl. 5.7L	TS-76
P20		
1989-1985	8 Cyl. 6.2L	TS-76
P30		
1999-1994	8 Cyl. 6.5L; w/ Oval Connector	TS-253
1993-1992	8 Cyl. 6.2L; w/ Oval Connector	TS-253
1991	4 Cyl. 3.9L; Diesel	TS-71
1991	8 Cyl. 6.2L; Diesel	TS-76
1989-1986	8 Cyl. 6.2L	TS-76
R10		
1987	8 Cyl. 6.2L	TS-76
R20		
1988	8 Cyl. 6.2L	TS-76
1987	8 Cyl. 6.2L; 1 Blade Term.	TS-76

Chevrolet

Temperature Switches and Senders

		Part No.
Temperature Sender - With Gauge		
R20 Suburban		
1987	8 Cyl. 6.2L; Diesel	TS-76
R30		
1988	8 Cyl. 6.2L	TS-76
1987	8 Cyl. 6.2L; 1 Blade Term.	TS-76
R1500 Suburban		
1991	8 Cyl. 6.2L; Diesel	TS-76
R2500 Suburban		
1991	8 Cyl. 6.2L; Diesel	TS-76
R3500		
1991	8 Cyl. 6.2L; Diesel	TS-76
Tahoe		
1999-1996	8 Cyl. 6.5L; w/ Oval Connector	TS-253
V10		
1987	8 Cyl. 6.2L	TS-76
V20		
1987	8 Cyl. 6.2L	TS-76
V30		
1988	8 Cyl. 6.2L	TS-76
1987	8 Cyl. 6.2L; 1 Blade Term.	TS-76
V1500 Suburban		
1991	8 Cyl. 6.2L; Diesel	TS-76
V2500 Suburban		
1991	8 Cyl. 6.2L; Diesel	TS-76
V3500		
1991-1989	8 Cyl. 6.2L; Diesel	TS-76
Temperature Sender - With Light		
Blazer		
1987	8 Cyl. 6.2L	TS-81
C10		
1986-1982	8 Cyl. 6.2L	TS-81
1981	8 Cyl. 5.7L; 3/8 Inch x 18 Thread	TS-66
1980	8 Cyl.; 3/8 Inch x 18 Thread; Diesel	TS-66
C10 Suburban		
1985-1984	8 Cyl. 6.2L	TS-81
1982	8 Cyl. 6.2L	TS-81
C20		
1986-1982	8 Cyl. 6.2L	TS-81
C20 Suburban		
1983-1982	8 Cyl. 6.2L; Diesel	TS-81
C30		
1986-1982	8 Cyl. 6.2L	TS-81
C1500		
1998-1994	8 Cyl. 6.5L	TS-253
1993	8 Cyl. 6.2L	TS-253
1990-1988	8 Cyl. 6.2L	TS-81
C1500 Suburban		
1999-1995	8 Cyl. 6.5L	TS-253
C2500		
2000-1993	8 Cyl. 6.5L	TS-253
1993	8 Cyl. 6.2L	TS-253
1990-1988	8 Cyl. 6.2L	TS-81
C2500 Suburban		
1996	8 Cyl. 6.5L	TS-253
1994	8 Cyl. 6.5L	TS-253
C3500		
2000-1993	8 Cyl. 6.5L	TS-253
1993	8 Cyl. 6.2L	TS-253
1990-1988	8 Cyl. 6.2L	TS-81
C3500HD		
2000-1993	8 Cyl. 6.5L	TS-253

		Part No.
Temperature Sender - With Light		
Caprice		
1984	8 Cyl. 5.7L; 3/8 Inch x 18 Thread	TS-169
1980	8 Cyl. 5.7L; 3/8 Inch x 18 Thread; Diesel	TS-66
Celebrity		
1985	6 Cyl. 4.3L; 3/8 Inch x 18 Thread	TS-169
1984	6 Cyl. 4.3L; 2 Blade Term.; 3/8 Inch x 18 Thread	TS-169
1983-1982	6 Cyl. 4.3L; 1 Blade Term.; 3/8 Inch x 18 Thread	TS-66
Express 2500		
2002	8 Cyl. 6.5L	TS-253
2000-1996	8 Cyl. 6.5L	TS-253
Express 3500		
2002	8 Cyl. 6.5L	TS-253
2000-1996	8 Cyl. 6.5L	TS-253
G20		
1995-1994	8 Cyl. 6.5L	TS-253
1993-1992	8 Cyl. 6.2L	TS-253
1989-1988	8 Cyl. 6.2L	TS-81
1984-1983	8 Cyl. 6.2L	TS-81
G30		
1996-1994	8 Cyl. 6.5L	TS-253
1993-1992	8 Cyl. 6.2L	TS-253
1989-1988	8 Cyl. 6.2L	TS-81
1984-1983	8 Cyl. 6.2L	TS-81
Impala		
1985-1984	8 Cyl. 5.7L; 3/8 Inch x 18 Thread	TS-169
1983	8 Cyl. 5.7L	TS-66
1980	8 Cyl. 5.7L; 3/8 Inch x 18 Thread; Diesel	TS-66
K5 Blazer		
1986-1982	8 Cyl. 6.2L	TS-81
K10		
1986-1982	8 Cyl. 6.2L	TS-81
K10 Suburban		
1986	8 Cyl. 6.2L	TS-81
1982	8 Cyl. 6.2L; Diesel	TS-81
K20		
1986-1982	8 Cyl. 6.2L	TS-81
K20 Suburban		
1982	8 Cyl. 6.2L; Diesel	TS-81
K30		
1986-1982	8 Cyl. 6.2L	TS-81
K1500		
1998-1994	8 Cyl. 6.5L	TS-253
1993	8 Cyl. 6.2L	TS-253
1990-1988	8 Cyl. 6.2L	TS-81
K1500 Suburban		
1999-1995	8 Cyl. 6.5L	TS-253
K2500		
2000-1995	8 Cyl. 6.5L	TS-253
1993	8 Cyl. 6.2L	TS-253
1993	8 Cyl. 6.5L	TS-253
1990-1988	8 Cyl. 6.2L	TS-81
K2500 Suburban		
1996	8 Cyl. 6.5L	TS-253
1994	8 Cyl. 6.5L	TS-253
K3500		
2000-1993	8 Cyl. 6.5L	TS-253
1993	8 Cyl. 6.2L	TS-253
1990-1988	8 Cyl. 6.2L	TS-81
P30		
1999-1998	8 Cyl. 6.5L	TS-253
1996-1994	8 Cyl. 6.5L	TS-253

Temperature Switches and Senders

		Part No.
Temperature Sender - With Light		
P30		
1993-1992	8 Cyl. 6.2L	TS-253
R10		
1987	8 Cyl. 6.2L	TS-81
R20		
1988-1987	8 Cyl. 6.2L	TS-81
R30		
1988-1987	8 Cyl. 6.2L	TS-81
R2500		
1989	8 Cyl. 6.2L	TS-81
R3500		
1990-1989	8 Cyl. 6.2L	TS-81
S10		
1985	4 Cyl.	TS-145
Tahoe		
1999-1996	8 Cyl. 6.5L	TS-253
V10		
1987	8 Cyl. 6.2L	TS-81
V20		
1987	8 Cyl. 6.2L	TS-81
V30		
1988-1987	8 Cyl. 6.2L	TS-81
V3500		
1990-1989	8 Cyl. 6.2L	TS-81
Universal Switches		
Center High Mount Stop Light Assembly		
Silverado 3500 Classic		
2007	8 Cyl.	BTL128
Actuators		
HVAC Temperature Blend Door Actuator		
Silverado 3500		
2006-2004	8 Cyl. 6.6L; Front	ADR160
Power Door Lock Actuator		
C10 Suburban		
1986-1982	8 Cyl. 6.2L	DLA-1
C20 Suburban		
1986-1982	8 Cyl. 6.2L	DLA-1
Celebrity		
1984-1982	6 Cyl. 4.3L	DLA-1
K10 Suburban		
1986-1982	8 Cyl. 6.2L	DLA-1
K20 Suburban		
1986-1982	8 Cyl. 6.2L	DLA-1
R10		
1987	8 Cyl. 6.2L	DLA-1
R10 Suburban		
1988-1987	8 Cyl. 6.2L	DLA-1
R20 Suburban		
1988-1987	8 Cyl. 6.2L	DLA-1
S10		
1985-1983	4 Cyl. 2.2L	DLA-1
S10 Blazer		
1984	4 Cyl. 2.2L	DLA-1
V10		
1987	8 Cyl. 6.2L	DLA-1
V10 Suburban		
1988-1987	8 Cyl. 6.2L	DLA-1
V20		
1987	8 Cyl. 6.2L	DLA-1

		Part No.
Power Door Lock Actuator		
V20 Suburban		
1988-1987	8 Cyl. 6.2L	DLA-1
Locks		
Ignition Lock Cylinder		
C10		
1985	8 Cyl.; Black Finish ⁸	US-117L
1983	8 Cyl.; Black Finish ⁸	US-117L
C1500 Suburban		
1997-1995	8 Cyl. 6.5L	US-214L
Tailgate Lock Cylinder		
Blazer		
1990-1987	8 Cyl. 6.2L; w/o Power Tailgate Window	TL-232
K5 Blazer		
1986-1983	8 Cyl. 6.2L; Rear Window; Rear Hatch	TL-163
R10 Suburban		
1988-1987	8 Cyl. 6.2L; w/o Power Tailgate Window	TL-232
R20 Suburban		
1988-1987	8 Cyl. 6.2L; w/o Power Tailgate Window	TL-232
R1500 Suburban		
1990-1989	8 Cyl. 6.2L; w/o Power Tailgate Window	TL-232
R2500 Suburban		
1990-1989	8 Cyl. 6.2L; w/o Power Tailgate Window	TL-232
V10 Suburban		
1988-1987	8 Cyl. 6.2L; w/o Power Tailgate Window	TL-232
V20 Suburban		
1988-1987	8 Cyl. 6.2L; w/o Power Tailgate Window	TL-232
V1500 Suburban		
1990-1989	8 Cyl. 6.2L; w/o Power Tailgate Window	TL-232
V2500 Suburban		
1990-1989	8 Cyl. 6.2L; w/o Power Tailgate Window	TL-232
Trunk Lock Kit		
Blazer		
1990-1987	8 Cyl. 6.2L; w/o Power Tailgate Window	TL-232
K5 Blazer		
1986-1983	8 Cyl. 6.2L; Rear Window; Rear Hatch	TL-163
R10 Suburban		
1988-1987	8 Cyl. 6.2L; w/o Power Tailgate Window	TL-232
R20 Suburban		
1988-1987	8 Cyl. 6.2L; w/o Power Tailgate Window	TL-232
R1500 Suburban		
1990-1989	8 Cyl. 6.2L; w/o Power Tailgate Window	TL-232
R2500 Suburban		
1990-1989	8 Cyl. 6.2L; w/o Power Tailgate Window	TL-232
V10 Suburban		
1988-1987	8 Cyl. 6.2L; w/o Power Tailgate Window	TL-232
V20 Suburban		
1988-1987	8 Cyl. 6.2L; w/o Power Tailgate Window	TL-232
V1500 Suburban		
1990-1989	8 Cyl. 6.2L; w/o Power Tailgate Window	TL-232
V2500 Suburban		
1990-1989	8 Cyl. 6.2L; w/o Power Tailgate Window	TL-232
Crane Carrier		
Pressure Sensors		
Diesel Particulate Filter (DPF) Pressure Sensor		
Low Entry		
2017-2010	6 Cyl. 8.9L	DPS101
Injection Actuation Pressure Sensor		
Centurion		
2000-1999	6 Cyl. 7.2L	PS713

⁸ Square Key

Crane Carrier

Pressure Sensors

		Part No.
Injection Actuation Pressure Sensor		
Equipment Carrier		
1999	6 Cyl. 7.2L	PS713
IRL		
2000-1999	6 Cyl. 7.2L	PS713
Low Entry		
2000-1999	6 Cyl. 7.2L	PS713
Pressure and Vacuum Sending Switches		
Oil Pressure Gauge Switch		
Low Entry		
2013-2012	6 Cyl. 8.9L	PS-407
2009-2008	6 Cyl. 8.9L	PS-407
Dodge		
Modules		
Glow Plug Controller		
Sprinter 2500		
2009-2007	6 Cyl. 3.0L	RY1724
Sprinter 3500		
2009-2007	6 Cyl. 3.0L	RY1724
Relays and Fuses		
A/C Compressor Clutch Relay		
Ram 3500		
2010		RY-1627
A/C Relay		
Ram 3500		
2006	6 Cyl. 5.9L	RY-273
ABS Warning Lamp Relay		
Ram 2500		
1995-1994	6 Cyl. 5.9L	RY-116
Ram 3500		
1995-1994	6 Cyl. 5.9L	RY-116
Accessory Relay		
Sprinter 2500		
2006-2003	Instrument Panel Mounted	RY1420
2006-2003	Near Battery Tray	RY-1723
2006-2003	5 Term.; Under Seat	RY-1726
2006-2003	4 Term.; Under Seat	RY1811
Sprinter 3500		
2006-2003	Instrument Panel Mounted	RY1420
2006-2003	Near Battery Tray	RY-1723
2006-2003	5 Term.; Under Seat	RY-1726
2006-2003	4 Term.; Under Seat	RY1811
Air Intake Heater Relay		
Ram 2500		
2010-2007	6 Cyl. 6.7L	RY-1779
2009-2007	6 Cyl. 5.9L	RY-1779
2002-1994	6 Cyl. 5.9L	RY-441
Ram 3500		
2010-2007	6 Cyl. 6.7L	RY-1779
2007-2006	6 Cyl. 5.9L	RY-1779
2005-2003	6 Cyl. 5.9L; Diesel	RY-1552
2002-1994	6 Cyl. 5.9L	RY-441
Ram 4500		
2010-2008	6 Cyl. 6.7L; Diesel	RY-1779
Ram 5500		
2010-2008	6 Cyl. 6.7L; Diesel	RY-1779
Air Pump Relay		
Ram 2500		
2003	6 Cyl. 5.9L; Alternate Number	RY-1552
2003	6 Cyl. 5.9L; Exhaust stock and reorder	RY693

		Part No.
Air Pump Relay		
Ram 3500		
2003	6 Cyl. 5.9L; Alternate Number	RY-1552
2003	6 Cyl. 5.9L; Exhaust stock and reorder	RY693
Automatic Shutdown Relay		
Ram 2500		
2009	6 Cyl. 5.9L	RY-116
2009	6 Cyl. 6.7L	RY-116
1995-1994	6 Cyl. 5.9L	RY-116
Ram 3500		
2009	6 Cyl. 6.7L	RY-116
1995-1994	6 Cyl. 5.9L	RY-116
Computer Control Relay		
Ram 2500		
2004	6 Cyl. 5.9L; Alternate Number	RY-429
2004	6 Cyl. 5.9L; Exhaust stock and reorder	RY431
Electronic Brake Control Relay		
Ram 2500		
2007	6 Cyl. 5.9L; OE No. 56006709	RY-116
2007	6 Cyl. 6.7L; OE No. 56006709	RY-116
2006	6 Cyl. 5.9L	RY-116
2005	6 Cyl.	RY-116
2004-2003	6 Cyl. 5.9L	RY-116
Ram 3500		
2007	6 Cyl. 5.9L; OE No. 56006709	RY-116
2007	6 Cyl. 6.7L; OE No. 56006709	RY-116
2006	6 Cyl. 5.9L	RY-116
2005	6 Cyl.	RY-116
2004-2003	6 Cyl. 5.9L	RY-116
Fuel Pump Relay		
D250		
1992	6 Cyl. 5.9L	RY-193
D350		
1992	6 Cyl. 5.9L	RY-193
Power Ram 50		
1985	4 Cyl. 2.3L	RY-65
Ram 50		
1985	4 Cyl. 2.3L	RY-65
1984	FI	RY-65
Ram 2500		
2009-2008	6 Cyl. 5.9L	RY-116
2009-2008	6 Cyl. 6.7L	RY-116
Ram 3500		
2010	6 Cyl. 6.7L; Stamping No. VFM-15F71-S01	RY-1667
2009-2008	6 Cyl. 6.7L	RY-116
Sprinter 2500		
2009		RY-1726
W250		
1992	6 Cyl. 5.9L	RY-193
W350		
1992	6 Cyl. 5.9L	RY-193
Hazard Flasher		
Ram 2500		
2002-1998	6 Cyl. 5.9L	EFL-4
Ram 3500		
2002-1998	6 Cyl. 5.9L	EFL-4
Horn Relay		
Ram 2500		
2000-1999	6 Cyl. 5.9L	RY-612
Ram 3500		
2000-1999	6 Cyl. 5.9L	RY-612

Relays and Fuses

		Part No.
Ignition Time Delay Relay		
Ram 2500		
1997	6 Cyl. 5.9L	RY-300
Ram 3500		
1997-1995	6 Cyl. 5.9L	RY-300
Oxygen Sensor Relay		
Ram 2500		
2009	6 Cyl. 5.9L; Calif.	RY-116
2009	6 Cyl. 6.7L; Calif.	RY-116
2006	6 Cyl. 5.9L; Exc. Calif.	RY-116
2005	6 Cyl.	RY-116
2004	6 Cyl. 5.9L	RY-116
Ram 3500		
2009	6 Cyl. 6.7L; Calif.	RY-116
2006	6 Cyl. 5.9L; Exc. Calif.	RY-116
2005	6 Cyl.	RY-116
2004	6 Cyl. 5.9L	RY-116
Parking Lamp Relay		
Ram 2500		
2002-2000	6 Cyl. 5.9L	RY-116
Ram 3500		
2010-2009	6 Cyl. 6.7L	RY-1801
2002-2000	6 Cyl. 5.9L	RY-116
Ram 4500		
2010		RY-1627
Ram 5500		
2010	4 Term.	RY-1627
2010	5 Term.	RY-1801
Starter Relay		
Ram 2500		
2010	6 Cyl. 6.7L; L	RY-1483
2009	6 Cyl. 5.9L	RY-1483
2009	6 Cyl. 6.7L	RY-1483
1996	6 Cyl. 5.9L	SR-121
Ram 3500		
2010-2009	6 Cyl. 6.7L	RY-1801
1996	6 Cyl. 5.9L	SR-121
Ram 4500		
2010		RY-1801
Ram 5500		
2010		RY-1801
Trailer Towing Package Relay		
Ram 2500		
1995-1994	6 Cyl. 5.9L	RY-116
Ram 3500		
1995-1994	6 Cyl. 5.9L	RY-116
Turn Signal Relay		
Ram 2500		
2002-2001	6 Cyl. 5.9L	EFL-4
Ram 3500		
2002	6 Cyl. 5.9L	EFL-4
Starting and Charging System Parts		
Starter Solenoid		
D250		
1990	6 Cyl. 5.9L; Nippondenso	SS327
D350		
1990	6 Cyl. 5.9L; Nippondenso	SS327
Power Ram 50		
1984-1983	4 Cyl. 2.3L	SS-279
Ram 50		
1985	4 Cyl. 2.3L; Diesel	SS-279
1984-1983	4 Cyl. 2.3L	SS-279

		Part No.
Starter Solenoid		
W250		
1990	6 Cyl. 5.9L; Nippondenso	SS327
W350		
1990	6 Cyl. 5.9L; Nippondenso	SS327
Voltage Regulator		
D250		
1992-1990	6 Cyl. 5.9L	VR-125
D350		
1992-1990	6 Cyl. 5.9L	VR-125
Power Ram 50		
1984-1983	4 Cyl. 2.3L	VR-185
Ram 50		
1985-1983	4 Cyl. 2.3L	VR-185
W250		
1992-1990	6 Cyl. 5.9L	VR-125
W350		
1992-1990	6 Cyl. 5.9L	VR-125
Air Injection and Induction Parts		
Diesel Air Intake Heater		
D250		
1993-1989	6 Cyl. 5.9L	DIH2
D350		
1993-1989	6 Cyl. 5.9L	DIH2
Ram 2500		
2010-2007	6 Cyl. 6.7L	DIH11
2008-2006	6 Cyl. 5.9L	DIH3
2005	6 Cyl.	DIH1
2004-1999	6 Cyl. 5.9L	DIH1
1998	6 Cyl. 5.9L; 6	DIH1
1998	6 Cyl. 5.9L; D	DIH10
1997-1995	6 Cyl. 5.9L	DIH10
1994	6 Cyl. 5.9L	DIH1
Ram 3500		
2010-2007	6 Cyl. 6.7L; w/ Pickup Bed	DIH11
2010-2007	6 Cyl. 6.7L; w/o Pickup Bed	DIH9
2007-2006	6 Cyl. 5.9L	DIH3
2005	6 Cyl.	DIH1
2004-1999	6 Cyl. 5.9L	DIH1
1998	6 Cyl. 5.9L; 6	DIH1
1998	6 Cyl. 5.9L; D	DIH10
1997-1995	6 Cyl. 5.9L	DIH10
1994	6 Cyl. 5.9L	DIH1
Ram 4500		
2010-2008		DIH9
Ram 5500		
2010-2008		DIH9
W250		
1993-1989	6 Cyl. 5.9L	DIH2
W350		
1993-1989	6 Cyl. 5.9L	DIH2
Electronic Throttle Body (ETB) Gasket		
Ram 2500		
2010-2007	6 Cyl. 6.7L	TBG130
Ram 3500		
2010-2007	6 Cyl. 6.7L	TBG130
Ram 4500		
2010-2008	6 Cyl. 6.7L	TBG130
Ram 5500		
2008	6 Cyl. 6.7L	TBG130

Air Injection and Induction Parts

		Part No.
Fuel Injection Throttle Body		
Ram 2500		
2010-2007	6 Cyl. 6.7L	S20401
Ram 3500		
2010-2007	6 Cyl. 6.7L	S20401
Ram 4500		
2010-2008	6 Cyl. 6.7L	S20401
Ram 5500		
2010-2008	6 Cyl. 6.7L	S20401
Turbocharger - New		
Ram 2500		
2009-2007	6 Cyl. 5.9L; Turbocharged	TBC694
2006-2005	6 Cyl.; Turbocharged	TBC694
2004	6 Cyl. 5.9L; C; Turbocharged; w/ 600 HP Engine	TBC694
2002	6 Cyl. 5.9L; Turbocharged; w/ M.T.	TBC696
2001	6 Cyl. 5.9L; 6; Turbocharged	TBC696
2000	6 Cyl. 5.9L; Turbocharged; w/ A.T.	TBC695
2000	6 Cyl.; Turbocharged; w/ M.T.	TBC696
1999	6 Cyl. 5.9L; Turbocharged	TBC695
1998	6 Cyl. 5.9L; 6; Turbocharged	TBC691
1998	6 Cyl. 5.9L; D; Calif.; Turbocharged	TBC692
1998	6 Cyl. 5.9L; D; Fed.; Turbocharged; w/ A.T.	TBC697
1997-1996	6 Cyl.; Calif.; Turbocharged	TBC692
1997-1996	6 Cyl.; Fed.; Turbocharged; w/ A.T.	TBC697
1995	6 Cyl.; To 1/15/95; Turbocharged	TBC584
1995	6 Cyl.; From 1/16/95; Turbocharged	TBC697
1994	6 Cyl. 5.9L; Turbocharged	TBC584
Ram 3500		
2007	6 Cyl. 5.9L; Turbocharged	TBC694
2006-2005	6 Cyl.; Turbocharged	TBC694
2004	6 Cyl. 5.9L; C; Turbocharged; w/ 600 HP Engine	TBC694
2002	6 Cyl. 5.9L; Turbocharged; w/ M.T.	TBC696
2001	6 Cyl. 5.9L; 6; Turbocharged	TBC696
2000	6 Cyl. 5.9L; Turbocharged; w/ A.T.	TBC695
2000	6 Cyl.; Turbocharged; w/ M.T.	TBC696
1999	6 Cyl. 5.9L; Turbocharged	TBC695
1998	6 Cyl. 5.9L; 6; Turbocharged	TBC691
1998	6 Cyl. 5.9L; D; Calif.; Turbocharged	TBC692
1998	6 Cyl. 5.9L; D; Fed.; Turbocharged; w/ A.T.	TBC697
1997-1996	6 Cyl.; Calif.; Turbocharged	TBC692
1997-1996	6 Cyl.; Fed.; Turbocharged; w/ A.T.	TBC697
1995	6 Cyl.; To 1/15/95; Turbocharged	TBC584
1995	6 Cyl.; From 1/16/95; Turbocharged	TBC697
1994	6 Cyl. 5.9L; Turbocharged	TBC584
Sprinter 2500		
2009-2007	6 Cyl. 3.0L; Turbocharged	TBC547
2006-2004	Turbocharged	TBC546
2003	Turbocharged	TBC554
Sprinter 3500		
2009-2007	6 Cyl. 3.0L; Turbocharged	TBC547
2006-2004	Turbocharged	TBC546
2003	Turbocharged	TBC554
Turbocharger - Remfd		
D250		
1993-1992	6 Cyl. 5.9L; Turbocharged	TBC579
1991	6 Cyl. 5.9L; 8; Turbocharged	TBC544
1991	6 Cyl. 5.9L; C; Turbocharged	TBC579
1990-1989	Turbocharged	TBC544
D350		
1993-1992	6 Cyl. 5.9L; Turbocharged	TBC579
1991	6 Cyl. 5.9L; 8; Turbocharged	TBC544

		Part No.
Turbocharger - Remfd		
D350		
1991	6 Cyl. 5.9L; C; Turbocharged	TBC579
1990-1989	Turbocharged	TBC544
Ram 2500		
2010-2007	6 Cyl. 6.7L; Turbocharged	TBC-521
2009-2007	6 Cyl. 5.9L; Turbocharged	TBC567
2006-2005	6 Cyl.; Turbocharged	TBC567
2004	6 Cyl. 5.9L; 6; Turbocharged	TBC569
2004	6 Cyl. 5.9L; C; Turbocharged; w/ 600 HP Engine	TBC567
2004	6 Cyl. 5.9L; C; Turbocharged; w/o 600 HP Engine	TBC569
2003	Turbocharged	TBC569
2002	6 Cyl. 5.9L; Turbocharged; w/ A.T.	TBC553
2002	6 Cyl. 5.9L; Turbocharged; w/ M.T.	TBC570
2001	6 Cyl. 5.9L; 6; Turbocharged	TBC570
2001	6 Cyl. 5.9L; 7; Turbocharged	TBC553
2000	6 Cyl. 5.9L; Turbocharged; w/ A.T.	TBC568
2000	6 Cyl.; Turbocharged; w/ M.T.	TBC570
1999	6 Cyl. 5.9L; Turbocharged	TBC568
1998	6 Cyl. 5.9L; 6; Turbocharged	TBC541
1998	6 Cyl. 5.9L; D; Fed.; Turbocharged; w/ M.T.	TBC545
1998	6 Cyl. 5.9L; D; Calif.; Turbocharged	TBC555
1998	6 Cyl. 5.9L; D; Fed.; Turbocharged; w/ A.T.	TBC575
1997-1996	6 Cyl.; Fed.; Turbocharged; w/ M.T.	TBC545
1997-1996	6 Cyl.; Calif.; Turbocharged	TBC555
1997-1996	6 Cyl.; Fed.; Turbocharged; w/ A.T.	TBC575
1995	6 Cyl.; From 1/16/95; Turbocharged	TBC575
Ram 3500		
2010-2007	6 Cyl. 6.7L; Turbocharged	TBC-521
2007	6 Cyl. 5.9L; Turbocharged	TBC567
2006-2005	6 Cyl.; Turbocharged	TBC567
2004	6 Cyl. 5.9L; 6; Turbocharged	TBC569
2004	6 Cyl. 5.9L; C; Turbocharged; w/ 600 HP Engine	TBC567
2004	6 Cyl. 5.9L; C; Turbocharged; w/o 600 HP Engine	TBC569
2003	Turbocharged	TBC569
2002	6 Cyl. 5.9L; Turbocharged; w/ A.T.	TBC553
2002	6 Cyl. 5.9L; Turbocharged; w/ M.T.	TBC570
2001	6 Cyl. 5.9L; 6; Turbocharged	TBC570
2001	6 Cyl. 5.9L; 7; Turbocharged	TBC553
2000	6 Cyl. 5.9L; Turbocharged; w/ A.T.	TBC568
2000	6 Cyl.; Turbocharged; w/ M.T.	TBC570
1999	6 Cyl. 5.9L; Turbocharged	TBC568
1998	6 Cyl. 5.9L; 6; Turbocharged	TBC541
1998	6 Cyl. 5.9L; D; Fed.; Turbocharged; w/ M.T.	TBC545
1998	6 Cyl. 5.9L; D; Calif.; Turbocharged	TBC555
1998	6 Cyl. 5.9L; D; Fed.; Turbocharged; w/ A.T.	TBC575
1997-1996	6 Cyl.; Fed.; Turbocharged; w/ M.T.	TBC545
1997-1996	6 Cyl.; Calif.; Turbocharged	TBC555
1997-1996	6 Cyl.; Fed.; Turbocharged; w/ A.T.	TBC575
1995	6 Cyl.; From 1/16/95; Turbocharged	TBC575
Ram 4500		
2010-2008	Turbocharged	TBC-521
Ram 5500		
2010-2008	Turbocharged	TBC-521
W250		
1993-1992	6 Cyl. 5.9L; Turbocharged	TBC579
1991	6 Cyl. 5.9L; 8; Turbocharged	TBC544
1991	6 Cyl. 5.9L; C; Turbocharged	TBC579

Air Injection and Induction Parts

		Part No.
Turbocharger - Remfd		
W250		
1990-1989	Turbocharged	TBC544
W350		
1993-1992	6 Cyl. 5.9L; Turbocharged	TBC579
1991-1989	Turbocharged	TBC544
Turbocharger Wastegate Solenoid		
Ram 2500		
2009-2007	6 Cyl. 5.9L; Turbocharged	WGS1
2006-2005	6 Cyl.; Turbocharged	WGS1
2004	6 Cyl. 5.9L; C; Turbocharged	WGS1
Ram 3500		
2007	6 Cyl. 5.9L; Turbocharged	WGS1
2006-2005	6 Cyl.; Turbocharged	WGS1
2004	6 Cyl. 5.9L; C; Turbocharged	WGS1
Vacuum Pump		
Ram 2500		
2009-2005	6 Cyl. 5.9L	VCP142
2004-2003	6 Cyl. 5.9L; Electronic	VCP112
2004-2003	6 Cyl. 5.9L; Mechanical	VCP142
Ram 3500		
2007-2005	6 Cyl. 5.9L	VCP142
2004-2003	6 Cyl. 5.9L; Electronic	VCP112
2004-2003	6 Cyl. 5.9L; Mechanical	VCP142
Sprinter 2500		
2009-2007	6 Cyl. 3.0L	VCP125
2003		VCP177
Sprinter 3500		
2009-2007	6 Cyl. 3.0L	VCP125
2003		VCP177
Air Management Valves		
Air Cleaner Check Valve		
D250		
1993-1990	6 Cyl. 5.9L; w/ External Threads; w/ Tube	AV22
1993-1990	6 Cyl. 5.9L; w/ Internal Threads; w/o Tube	AV7
D350		
1993-1990	6 Cyl. 5.9L; w/ External Threads; w/ Tube	AV22
1993-1990	6 Cyl. 5.9L; w/ Internal Threads; w/o Tube	AV7
W250		
1993-1990	6 Cyl. 5.9L; w/ External Threads; w/ Tube	AV22
1993-1990	6 Cyl. 5.9L; w/ Internal Threads; w/o Tube	AV7
W350		
1993-1990	6 Cyl. 5.9L; w/ External Threads; w/ Tube	AV22
1993-1990	6 Cyl. 5.9L; w/ Internal Threads; w/o Tube	AV7
Idle Air Control Valve		
Ram 2500		
2004	6 Cyl. 5.9L	AC529
Ram 3500		
2004	6 Cyl. 5.9L	AC529
Idle Speed Control Motor		
D250		
1993-1992	6 Cyl. 5.9L	SA4
D350		
1993-1992	6 Cyl. 5.9L	SA4
W250		
1993-1992	6 Cyl. 5.9L	SA4
W350		
1993-1992	6 Cyl. 5.9L	SA4
Air Management Regulators and Solenoids		
Intake Manifold Actuator		
Sprinter 2500		
2009-2007	6 Cyl. 3.0L	IMA111

		Part No.
Intake Manifold Actuator		
Sprinter 3500		
2009-2007	6 Cyl. 3.0L	IMA111
Secondary Air Injection Solenoid		
Sprinter 2500		
2009		VS146
Sprinter 3500		
2009		VS146
Early Fuel Emission Control		
Bowl Vent Solenoid		
D150		
1980	6 Cyl.	BV4
Crankcase Ventilation Filter		
D150		
1980	6 Cyl. 4.0L; Crankcase Vent	BF28
D200		
1980	6 Cyl. 4.0L; Crankcase Vent	BF28
D250		
1989	6 Cyl. 5.9L; Crankcase Vent	BF28
D350		
1989	6 Cyl. 5.9L; Crankcase Vent	BF28
Ram 2500		
2010-2007	6 Cyl. 6.7L	BF43
Ram 3500		
2010-2007	6 Cyl. 6.7L	BF43
Ram 4500		
2010-2008	6 Cyl. 6.7L	BF43
Ram 5500		
2010-2008	6 Cyl. 6.7L	BF43
W250		
1989	6 Cyl. 5.9L; Crankcase Vent	BF28
W350		
1989	6 Cyl. 5.9L; Crankcase Vent	BF28
EGR Components		
Diesel EGR Cooler		
Ram 2500		
2010-2007	6 Cyl. 6.7L	ECK11
Ram 3500		
2010-2007	6 Cyl. 6.7L	ECK11
EGR Tube		
Ram 2500		
2010-2008	6 Cyl. 6.7L	ETB91
Ram 3500		
2010-2008	6 Cyl. 6.7L	ETB91
Ram 4500		
2010-2008	6 Cyl. 6.7L	ETB91
Ram 5500		
2010-2008	6 Cyl. 6.7L	ETB91
Sprinter 2500		
2009-2007	6 Cyl. 3.0L; Rear	ETB62
Sprinter 3500		
2009-2007	6 Cyl. 3.0L; Rear	ETB62
EGR Tube Gasket		
Sprinter 2500		
2009-2007	6 Cyl. 3.0L	VG274
Sprinter 3500		
2009-2007	6 Cyl. 3.0L	VG274
EGR Valve		
Ram 2500		
2010-2007	6 Cyl. 6.7L	EGV1241
1998-1994	6 Cyl. 5.9L	EGV808

EGR Components

		Part No.
EGR Valve		
Ram 3500		
2010-2007	6 Cyl. 6.7L	EGV1241
1998-1994	6 Cyl. 5.9L	EGV808
Ram 4500		
2010-2008		EGV1241
Ram 5500		
2010-2008		EGV1241
Sprinter 2500		
2009-2007	6 Cyl.; EGR to Cooler	EGV1255
2006-2004	5 Cyl. 2.7L	EGV1160
2003	5 Cyl. 2.7L	EGV1139
Sprinter 3500		
2009-2007	6 Cyl.; EGR to Cooler	EGV1255
2006-2004	5 Cyl. 2.7L	EGV1160
2003	5 Cyl. 2.7L	EGV1139
EGR Valve Mounting Gasket		
Ram 2500		
2010-2007	6 Cyl. 6.7L; EGR Pipe	VG270
1998-1994	6 Cyl. 5.9L; EGR Pipe	VG127
1998-1994	6 Cyl. 5.9L; w/ EGR Valve	VG128
1998-1994	6 Cyl. 5.9L; Seal; EGR Pipe	VG136
Ram 3500		
2010-2007	6 Cyl. 6.7L; EGR Pipe	VG270
1998-1994	6 Cyl. 5.9L; EGR Pipe	VG127
1998-1994	6 Cyl. 5.9L; w/ EGR Valve	VG128
1998-1994	6 Cyl. 5.9L; Seal; EGR Pipe	VG136
Ram 4500		
2010-2008	6 Cyl. 6.7L; EGR Pipe	VG270
Ram 5500		
2010-2008	6 Cyl. 6.7L; EGR Pipe	VG270
PCV Systems		
PCV Grommet		
W350		
1991-1989	6 Cyl. 5.9L	GV1
PCV Valve		
Ram 3500		
2004	6 Cyl. 5.9L	V165
Sprinter 2500		
2009-2007	6 Cyl. 3.0L	V520
Sprinter 3500		
2009-2007	6 Cyl. 3.0L	V520
Vapor and Purge Components		
Fuel Vapor Canister		
Ram 2500		
2003-2000	6 Cyl. 5.9L; Round Body	CP3212
2003-2000	6 Cyl. 5.9L; Square Canister	CP440
1999-1998	6 Cyl. 5.9L	CP3212
Ram 3500		
2003-2000	6 Cyl. 5.9L; Round Body	CP3212
2003-2000	6 Cyl. 5.9L; Square Canister	CP440
Fuel Vapor Canister Seal		
Ram 3500		
2007	6 Cyl. 6.7L; Pump to Canister	EVCS01
Fuel Vapor Leak Detection Pump		
Ram 3500		
2007	6 Cyl. 6.7L ¹⁰	LDP14
Fuel Vapor Leak Detection Pump Filter		
Ram 2500		
2002-1998	6 Cyl. 5.9L	LDP75
Ram 3500		
2010		LDP74

		Part No.
Fuel Vapor Leak Detection Pump Filter		
Ram 3500		
2002-1998	6 Cyl. 5.9L	LDP75
Fuel Valves and Solenoids		
Fuel Pressure Relief Valve		
Ram 2500		
2009-2007	6 Cyl. 6.7L	PRV1
2009-2003	6 Cyl. 5.9L	PRV2
Ram 3500		
2010-2007	6 Cyl. 6.7L	PRV1
2007-2003	6 Cyl. 5.9L	PRV2
Ram 4500		
2010-2009	6 Cyl.	PRV1
Ram 5500		
2010-2009	6 Cyl.	PRV1
Fuel Shut-Off Solenoid		
D250		
1993-1989	6 Cyl. 5.9L	FSS101
D350		
1993-1989	6 Cyl. 5.9L	FSS101
Ram 2500		
1998	6 Cyl. 5.9L; w/ Mechanical Pump	FSS102
1997-1994	6 Cyl. 5.9L	FSS102
Ram 3500		
1998	6 Cyl. 5.9L; w/ Mechanical Pump	FSS102
1997-1994	6 Cyl. 5.9L	FSS102
W250		
1993-1989	6 Cyl. 5.9L	FSS101
W350		
1993-1989	6 Cyl. 5.9L	FSS101
Injectors		
Fuel Injector - Diesel - New		
D250		
1993-1992	6 Cyl. 5.9L	FJ256
1991	6 Cyl. 5.9L; 8	FJ253
1991	6 Cyl. 5.9L; C	FJ256
1990-1989	6 Cyl. 5.9L	FJ253
D350		
1993-1992	6 Cyl. 5.9L	FJ256
1991	6 Cyl. 5.9L; 8	FJ253
1991	6 Cyl. 5.9L; C	FJ256
1990-1989	6 Cyl. 5.9L	FJ253
Ram 2500		
2002	6 Cyl. 5.9L; C; w/ M.T.	FJ976
2002-2001	6 Cyl. 5.9L; 6; w/ M.T.	FJ642
2002-2001	6 Cyl. 5.9L; 6; w/ A.T.	FJ643
2001	6 Cyl. 5.9L; 7; w/ M.T.	FJ976
2000-1999	6 Cyl. 5.9L; w/ M.T.	FJ642
2000-1999	6 Cyl. 5.9L; w/ A.T.	FJ643
1998	6 Cyl. 5.9L; 6; w/ M.T.	FJ642
1998	6 Cyl. 5.9L; 6; w/ A.T.	FJ643
1998	6 Cyl. 5.9L; D; w/ M.T.	FJ330
1998	6 Cyl. 5.9L; D; w/ A.T.	FJ607
1997-1996	6 Cyl. 5.9L; w/ M.T.	FJ330
1997-1996	6 Cyl. 5.9L; w/ A.T.	FJ607
1995-1994	6 Cyl. 5.9L; w/ M.T.	FJ607
Ram 3500		
2002	6 Cyl. 5.9L; C; w/ M.T.	FJ976
2002-2001	6 Cyl. 5.9L; 6; w/ M.T.	FJ642
2002-2001	6 Cyl. 5.9L; 6; w/ A.T.	FJ643
2002-2001	6 Cyl. 5.9L; 7; w/ M.T.	FJ976
2000-1999	6 Cyl. 5.9L; w/ M.T.	FJ642
2000-1999	6 Cyl. 5.9L; w/ A.T.	FJ643

Injectors

		Part No.
Fuel Injector - Diesel - New		
Ram 3500		
1998	6 Cyl. 5.9L; 6; w/ M.T.	FJ642
1998	6 Cyl. 5.9L; 6; w/ A.T.	FJ643
1998	6 Cyl. 5.9L; D; w/ M.T.	FJ330
1998	6 Cyl. 5.9L; D; w/ A.T.	FJ607
1997-1996	6 Cyl. 5.9L; w/ M.T.	FJ330
1997-1996	6 Cyl. 5.9L; w/ A.T.	FJ607
1995-1994	6 Cyl. 5.9L; w/ M.T.	FJ607
W250		
1993-1992	6 Cyl. 5.9L	FJ256
1991	6 Cyl. 5.9L; 8	FJ253
1991	6 Cyl. 5.9L; C	FJ256
1990-1989	6 Cyl. 5.9L	FJ253
W350		
1993-1992	6 Cyl. 5.9L	FJ256
1991-1989	6 Cyl. 5.9L	FJ253
Fuel Injector - Diesel - Remfd		
Ram 2500		
2010-2008	6 Cyl. 6.7L; Injector Only	FJ1009
2010-2008	6 Cyl. 6.7L; Kit	FJ1009K
2009-2006	6 Cyl. 5.9L; Injector Only	FJ933
2009-2006	6 Cyl. 5.9L; Kit	FJ933K
2007	6 Cyl. 6.7L; Injector Only	FJ1010
2007	6 Cyl. 6.7L; Kit	FJ1010K
2005	6 Cyl.; Injector Only	FJ933
2005	6 Cyl.; Kit	FJ933K
2004	6 Cyl. 5.9L; Injector Only; Stamping No. 0986435503; w/ 8 Hole Injector Nozzle	FJ932
2004	6 Cyl. 5.9L; Kit; Stamping No. 0986435503; w/ 8 Hole Injector Nozzle	FJ932K
2004	6 Cyl. 5.9L; Injector Only; Stamping No. 0986435505; w/ 5 Hole Injector Nozzle	FJ933
2004	6 Cyl. 5.9L; Kit; Stamping No. 0986435505; w/ 5 Hole Injector Nozzle	FJ933K
2003	6 Cyl. 5.9L; Kit	FJ932K
2003-2002	6 Cyl. 5.9L; Injector Only	FJ932
2002	6 Cyl. 5.9L; Kit; Stamping No. 0986435503	FJ932K
1998	6 Cyl. 5.9L; D; w/ M.T.	FJ254
1998	6 Cyl. 5.9L; D; w/ A.T.	FJ255
1997-1996	6 Cyl. 5.9L; w/ M.T.	FJ254
1997-1996	6 Cyl. 5.9L; w/ A.T.	FJ255
1995-1994	6 Cyl. 5.9L; w/ A.T.	FJ252
1995-1994	6 Cyl. 5.9L; w/ M.T.	FJ255
Ram 3500		
2010-2007	6 Cyl. 6.7L; Injector Only; w/ Pickup Bed	FJ1009
2010-2007	6 Cyl. 6.7L; Kit; w/ Pickup Bed	FJ1009K
2010-2007	6 Cyl. 6.7L; Injector Only; w/o Pickup Bed	FJ1010
2010-2007	6 Cyl. 6.7L; Kit; w/o Pickup Bed	FJ1010K
2007-2006	6 Cyl. 5.9L; Injector Only	FJ933
2007-2006	6 Cyl. 5.9L; Kit	FJ933K
2005	6 Cyl.; Injector Only	FJ933
2005	6 Cyl.; Kit	FJ933K
2004	6 Cyl. 5.9L; Injector Only; Stamping No. 0986435503; w/ 8 Hole Injector Nozzle	FJ932
2004	6 Cyl. 5.9L; Kit; Stamping No. 0986435503; w/ 8 Hole Injector Nozzle	FJ932K
2004	6 Cyl. 5.9L; Injector Only; Stamping No. 0986435505; w/ 5 Hole Injector Nozzle	FJ933
2004	6 Cyl. 5.9L; Kit; Stamping No. 0986435505; w/ 5 Hole Injector Nozzle	FJ933K
2003	6 Cyl. 5.9L; Kit	FJ932K
2003-2002	6 Cyl. 5.9L; Injector Only	FJ932
2002	6 Cyl. 5.9L; Kit; Stamping No. 0986435503	FJ932K

		Part No.
Fuel Injector - Diesel - Remfd		
Ram 3500		
1998	6 Cyl. 5.9L; D; w/ M.T.	FJ254
1998	6 Cyl. 5.9L; D; w/ A.T.	FJ255
1997-1996	6 Cyl. 5.9L; w/ M.T.	FJ254
1997-1996	6 Cyl. 5.9L; w/ A.T.	FJ255
1995-1994	6 Cyl. 5.9L; w/ A.T.	FJ252
1995-1994	6 Cyl. 5.9L; w/ M.T.	FJ255
Ram 4500		
2010-2008	6 Cyl. 6.7L; Cab and Chassis; Injector Only	FJ1010
2010-2008	6 Cyl. 6.7L; Cab and Chassis; Kit	FJ1010K
Ram 5500		
2010-2008	6 Cyl. 6.7L; Cab and Chassis; Injector Only	FJ1010
2010-2008	6 Cyl. 6.7L; Cab and Chassis; Kit	FJ1010K
Sprinter 2500		
2009-2007	6 Cyl. 3.0L	FJ1348
2006-2004	5 Cyl. 2.7L	FJ922
2003	5 Cyl. 2.7L	FJ921
Sprinter 3500		
2009-2007	6 Cyl. 3.0L	FJ1348
2006-2004	5 Cyl. 2.7L	FJ922
2003	5 Cyl. 2.7L	FJ921
Injection Components		
Diesel Fuel Injection Pump - New		
Ram 2500		
2010-2007	6 Cyl. 6.7L	IP33
Ram 3500		
2010-2007	6 Cyl. 6.7L	IP33
Ram 4500		
2010-2008		IP33
Ram 5500		
2010-2008		IP33
Diesel Fuel Injection Pump - Remanufactured		
D250		
1993-1990	6 Cyl. 5.9L; Diesel; w/o Intercooler	IP26
1993-1990	6 Cyl. 5.9L; Diesel; w/ Intercooler	IP27
1989	6 Cyl. 5.9L; Diesel	IP26
D350		
1993-1990	6 Cyl. 5.9L; Diesel; w/o Intercooler	IP26
1993-1990	6 Cyl. 5.9L; Diesel; w/ Intercooler	IP27
1989	6 Cyl. 5.9L; Diesel	IP26
Ram 2500		
2010-2007	6 Cyl. 6.7L	IP54
2007	6 Cyl. 5.9L	IP21
2006-2003	6 Cyl. 5.9L; Diesel	IP21
2002-2000	6 Cyl. 5.9L; Diesel; Exc. High Output	IP19
2002-2000	6 Cyl. 5.9L; Diesel; High Output	IP20
1999	6 Cyl. 5.9L; Diesel	IP19
1998	6 Cyl. 5.9L; 6; Electrical	IP19
1998	6 Cyl. 5.9L; D; Mechanical Type; w/ M.T.	IP17
1998	6 Cyl. 5.9L; D; Mechanical Type; w/ A.T.	IP18
1997-1994	6 Cyl. 5.9L; Diesel; w/ M.T.	IP17
1997-1994	6 Cyl. 5.9L; Diesel; w/ A.T.	IP18
Ram 3500		
2010-2007	6 Cyl. 6.7L	IP54
2007	6 Cyl. 5.9L	IP21
2006	6 Cyl. 5.9L; Diesel	IP21
2005	6 Cyl.; Diesel	IP21
2004-2003	6 Cyl. 5.9L; Diesel	IP21
2002-2000	6 Cyl. 5.9L; Diesel; Exc. High Output	IP19
2002-2000	6 Cyl. 5.9L; Diesel; High Output	IP20
1999	6 Cyl. 5.9L; Diesel	IP19

Injection Components

		Part No.
Diesel Fuel Injection Pump - Remanufactured		
Ram 3500		
1998	6 Cyl. 5.9L; 6; Electrical	IP19
1998	6 Cyl. 5.9L; D; Mechanical Type; w/ M.T.	IP17
1998	6 Cyl. 5.9L; D; Mechanical Type; w/ A.T.	IP18
1997-1994	6 Cyl. 5.9L; Diesel; w/ M.T.	IP17
1997-1994	6 Cyl. 5.9L; Diesel; w/ A.T.	IP18
Ram 4500		
2010-2008	6 Cyl. 6.7L	IP54
Ram 5500		
2010-2008	6 Cyl. 6.7L	IP54
Sprinter 2500		
2009-2007	6 Cyl. 3.0L	IP32
2006-2004	5 Cyl. 2.7L	IP31
Sprinter 3500		
2009-2007	6 Cyl. 3.0L	IP32
2006-2004	5 Cyl. 2.7L	IP31
W250		
1993-1990	6 Cyl. 5.9L; Diesel; w/o Intercooler	IP26
1993-1990	6 Cyl. 5.9L; Diesel; w/ Intercooler	IP27
1989	6 Cyl. 5.9L; Diesel	IP26
W350		
1993-1990	6 Cyl. 5.9L; Diesel; w/o Intercooler	IP26
1993-1990	6 Cyl. 5.9L; Diesel; w/ Intercooler	IP27
1989	6 Cyl. 5.9L; Diesel	IP26
Diesel Fuel Injector Line		
Ram 2500		
2010-2007	6 Cyl. 6.7L; Cyl. 1	DIL11
2010-2007	6 Cyl. 6.7L; Cyl. 2 and 4	DIL12
2010-2007	6 Cyl. 6.7L; Cyl. 3 and 5	DIL13
2010-2007	6 Cyl. 6.7L; Cyl. 6	DIL14
2006-2003	6 Cyl. 5.9L; Cyl. 6	DIL10
2006-2003	6 Cyl. 5.9L; Cyl. 1	DIL5
2006-2003	6 Cyl. 5.9L; Cyl. 2	DIL6
2006-2003	6 Cyl. 5.9L; Cyl. 3	DIL7
2006-2003	6 Cyl. 5.9L; Cyl. 4	DIL8
2006-2003	6 Cyl. 5.9L; Cyl. 5	DIL9
Ram 3500		
2010-2007	6 Cyl. 6.7L; Cyl. 1	DIL11
2010-2007	6 Cyl. 6.7L; Cyl. 2 and 4	DIL12
2010-2007	6 Cyl. 6.7L; Cyl. 3 and 5	DIL13
2010-2007	6 Cyl. 6.7L; Cyl. 6	DIL14
2006-2003	6 Cyl. 5.9L; Cyl. 6	DIL10
2006-2003	6 Cyl. 5.9L; Cyl. 1	DIL5
2006-2003	6 Cyl. 5.9L; Cyl. 2	DIL6
2006-2003	6 Cyl. 5.9L; Cyl. 3	DIL7
2006-2003	6 Cyl. 5.9L; Cyl. 4	DIL8
2006-2003	6 Cyl. 5.9L; Cyl. 5	DIL9
Ram 4500		
2010-2008	6 Cyl. 6.7L; Cyl. 1	DIL11
2010-2008	6 Cyl. 6.7L; Cyl. 2 and 4	DIL12
2010-2008	6 Cyl. 6.7L; Cyl. 3 and 5	DIL13
2010-2008	6 Cyl. 6.7L; Cyl. 6	DIL14
Ram 5500		
2010-2008	6 Cyl. 6.7L; Cyl. 1	DIL11
2010-2008	6 Cyl. 6.7L; Cyl. 2 and 4	DIL12
2010-2008	6 Cyl. 6.7L; Cyl. 3 and 5	DIL13
2010-2008	6 Cyl. 6.7L; Cyl. 6	DIL14
Diesel Fuel Injector Rail		
Ram 2500		
2010-2007	6 Cyl. 6.7L	FIR5
2009-2003	6 Cyl. 5.9L	FIR7
Ram 3500		
2010-2007	6 Cyl. 6.7L	FIR5

		Part No.
Diesel Fuel Injector Rail		
Ram 4500		
2010-2008	6 Cyl. 6.7L	FIR5
Ram 5500		
2010-2008	6 Cyl. 6.7L	FIR5
Diesel Fuel Injector Sleeve		
Ram 2500		
2010-2007	6 Cyl. 6.7L	IFS3
2007-2003	6 Cyl. 5.9L	IFS3
Ram 3500		
2010-2007	6 Cyl. 6.7L	IFS3
2007-2003	6 Cyl. 5.9L	IFS3
Ram 4000		
2009-2005	6 Cyl. 5.9L	IFS3
Ram 4500		
2010-2008	6 Cyl. 6.7L	IFS3
Ram 5500		
2010-2008	6 Cyl. 6.7L	IFS3
Diesel Fuel Transfer Pump		
Ram 2500		
2004-2003	6 Cyl. 5.9L	FTP2
2002-1998	6 Cyl. 5.9L; Original Design	FTP1
2002-1998	6 Cyl. 5.9L; Improved Design	FTP5
Ram 3500		
2004-2003	6 Cyl. 5.9L	FTP2
2002-1998	6 Cyl. 5.9L; Original Design	FTP1
2002-1998	6 Cyl. 5.9L; Improved Design	FTP5
Diesel Glow Plug		
Sprinter 2500		
2009-2007	6 Cyl. 3.0L	GP116
2006-2003	5 Cyl. 2.7L	GP111
Sprinter 3500		
2009-2007	6 Cyl. 3.0L	GP116
2006-2003	5 Cyl. 2.7L	GP111
Diesel Oil Cooler Kit		
Ram 2500		
2010-2007	6 Cyl. 6.7L	OCK4
2008-2005	6 Cyl. 5.9L	OCK16
Ram 3500		
2010-2007	6 Cyl. 6.7L	OCK4
2007-2005	6 Cyl. 5.9L	OCK16
Sprinter 2500		
2009		OCK17
2006-2003		OCK7
Sprinter 3500		
2009		OCK17
2006-2003		OCK7
Diesel Valve Cover Gasket		
Ram 2500		
2010-2006	6 Cyl.	VCG7
2005-2003	6 Cyl.	VCG8
2002-1999	6 Cyl.	VCG9
1998	6 Cyl. 5.9L; 6	VCG9
Ram 3500		
2010-2006	6 Cyl.	VCG7
2005-2003	6 Cyl.	VCG8
2002-1999	6 Cyl. 5.9L	VCG9
1998	6 Cyl. 5.9L; 6	VCG9
Engine Block Heater		
Ram 2500		
2007-2003	6 Cyl. 5.9L	L25001

Injection Components

		Part No.
Engine Block Heater		
Ram 3500		
2007-2003	6 Cyl. 5.9L	L25001
Fuel Injector Seal Kit		
Ram 2500		
2010-2007	6 Cyl. 6.7L	SK146
Ram 3500		
2010-2007	6 Cyl. 6.7L	SK146
Fuel Pressure Regulator		
Ram 2500		
2010-2007	6 Cyl. 6.7L	PR555
2010-2003	6 Cyl. 5.9L	PR511
Ram 3500		
2010-2007	6 Cyl. 6.7L	PR555
2007-2003	6 Cyl. 5.9L	PR511
Ram 4500		
2010-2008		PR555
Ram 5500		
2010-2008		PR555
Sprinter 2500		
2009-2007	6 Cyl. 3.0L	PR562
2006-2005	5 Cyl. 2.7L	PR564
2004	5 Cyl. 2.7L	PR563
2003	5 Cyl. 2.7L	PR462
Sprinter 3500		
2009-2007	6 Cyl. 3.0L	PR562
2006-2005	5 Cyl. 2.7L	PR564
2004	5 Cyl. 2.7L	PR563
2003	5 Cyl. 2.7L	PR462
Chassis and Drivetrain Sensors		
ABS Speed Sensor		
Ram 3500		
2010	RWD; Front	ALS1958
2010	4WD; Front	ALS1971
2010	4WD; In Differential	ALS258
2010	RWD; In Differential	ALS258
Ram 4500		
2010-2008	Includes ABS Wheel Speed Sensor Wire Harness; Front	ALS2686
2010-2008	Rear	SC466
Ram 5500		
2010-2008	Includes ABS Wheel Speed Sensor Wire Harness; Front	ALS2686
2010-2008	Rear	SC466
Sprinter 2500		
2009	Front	ALS2157
2009	Right Rear	ALS2158
2009	Exhaust stock and reorder; Left Rear	ALS2159
2009	Alternate Number; Left Rear	ALS3097
2006-2003	Rear	ALS1924
2006-2003	Front	ALS1925
Sprinter 3500		
2009	Front	ALS2157
2009	Right Rear	ALS2158
2009	Left Rear	ALS2160
2006-2003	Rear	ALS1924
2006-2003	Front	ALS1925
Automatic Transmission Input Sensor		
Ram 4500		
2010-2008		SC668
Ram 5500		
2010-2008		SC668

		Part No.
Automatic Transmission Output Sensor		
Ram 3500		
2010	6 Cyl. 6.7L	SC226
Sprinter 2500		
2006-2003		SC335
Sprinter 3500		
2006-2003		SC335
Turbocharger Speed Sensor		
Ram 2500		
2010-2007	6 Cyl. 5.9L; Turbocharged	TCBS1
2010-2007	6 Cyl. 6.7L; Turbocharged	TCBS1
Ram 3500		
2010-2007	6 Cyl. 6.7L; Turbocharged	TCBS1
2007	6 Cyl. 5.9L; Turbocharged	TCBS1
Ram 4500		
2010-2008	6 Cyl. 6.7L; Turbocharged	TCBS1
Ram 5500		
2010-2008	6 Cyl. 6.7L; Turbocharged	TCBS1
Vehicle Speed Sensor		
Ram 3500		
2010		SC226
Ram 4500		
2010-2008		SC333
Ram 5500		
2010-2008		SC333
Sprinter 2500		
2006		SC761
2006-2003	Stamping No. A0145429717	SC335
2006-2003	Stamping No. A0145429817	SC528
Sprinter 3500		
2006-2003	Stamping No. A0145429717	SC335
2006-2003	Stamping No. A0145429817	SC528
YAW Rate Sensor		
Sprinter 2500		
2006-2004		YA161
Sprinter 3500		
2006-2004		YA161
Fluid Level Sensors		
Coolant Level Sensor		
Sprinter 2500		
2009		FLS-179
2006-2003		FLS-126
Sprinter 3500		
2009		FLS-179
2005-2003		FLS-126
Engine Oil Level Sensor		
Sprinter 2500		
2006-2003	5 Cyl. 2.7L; Diesel	FLS-84
Windshield Washer Level Sensor		
Ram 2500		
2003	6 Cyl. 5.9L; Diesel	FLS-33
2002	6 Cyl. 5.9L	FLS25
Ram 3500		
2010		FLS-116
2003	6 Cyl. 5.9L; Diesel	FLS-33
2002	6 Cyl. 5.9L	FLS25
Ram 4500		
2010-2008		FLS-116
Ram 5500		
2010-2008		FLS-116

Fuel Sensors

		Part No.
Fuel Sensors		
Fuel / Water Separator Sensor		
D250		
1993-1989	6 Cyl. 5.9L	FWSS115
D350		
1993-1989	6 Cyl. 5.9L	FWSS115
Ram 2500		
2010-2007	6 Cyl. 6.7L	FWSS118
2009-2003	6 Cyl. 5.9L	FWSS112
2002-2000	6 Cyl. 5.9L	FWSS106
1999-1998	6 Cyl. 5.9L	FWSS107
1997	6 Cyl. 5.9L	FWSS105
1996-1994	6 Cyl. 5.9L	FWSS115
Ram 3500		
2010-2007	6 Cyl. 6.7L	FWSS118
2007-2003	6 Cyl. 5.9L	FWSS112
2002-2000	6 Cyl. 5.9L	FWSS106
1999-1998	6 Cyl. 5.9L	FWSS107
1997	6 Cyl. 5.9L	FWSS105
1996-1994	6 Cyl. 5.9L	FWSS115
Ram 4500		
2009-2008	6 Cyl. 6.7L	FWSS118
Ram 5500		
2009-2008	6 Cyl. 6.7L	FWSS118
Sprinter 2500		
2009		FWSS104
2008-2007	6 Cyl. 3.0L	FWSS104
2006-2004		FWSS104
2003		FWSS108
Sprinter 3500		
2009		FWSS104
2008-2007	6 Cyl. 3.0L	FWSS104
2006-2004		FWSS104
2003		FWSS108
W250		
1993-1989	6 Cyl. 5.9L	FWSS115
W350		
1993-1989	6 Cyl. 5.9L	FWSS115
Mass Air Flow		
Ram 2500		
2009-2008	6 Cyl. 6.7L; Diesel	MAS0388
2007	6 Cyl.; Diesel	MAS0388
Ram 3500		
2009-2007	6 Cyl. 6.7L; Diesel	MAS0388
Sprinter 2500		
2009		MAS0386
2006-2005		MAS0386
2004-2003	Complete Assembly	MAS0308
2004-2003	Sensor Only	MAK100
Sprinter 3500		
2009		MAS0386
2006-2005		MAS0386
2004-2003	Complete Assembly	MAS0308
2004-2003	Sensor Only	MAK100
Oxygen Sensor		
Ram 50		
1985-1984	4 Cyl.; Universal Upstream	SG12
1985-1984	4 Cyl.; Upstream Sensor	SG287
Ram 2500		
2001	6 Cyl.; To 2/21/01; Downstream Sensor	SG1816
2001	6 Cyl.; Calif.; Upstream Sensor	SG1816
2001	6 Cyl.; From 2/22/01; Downstream Sensor	SG1852

		Part No.
Oxygen Sensor		
Ram 2500		
2001	6 Cyl.; Fed.; Upstream Sensor	SG1852
2001	6 Cyl.; Universal Upstream	SG300
Ram 3500		
2001	6 Cyl.; To 2/21/01; Downstream Sensor	SG1816
2001	6 Cyl.; Calif.; Upstream Sensor	SG1816
2001	6 Cyl.; From 2/22/01; Downstream Sensor	SG1852
2001	6 Cyl.; Fed.; Upstream Sensor	SG1852
2001	6 Cyl.; Universal Upstream	SG300
Miscellaneous Sensors		
Brake Pad Wear Sensor		
Sprinter 2500		
2009	Alternate Number; w/ Single Rear Wheels; Rear	PWS177
2009	w/ Single Rear Wheels; Rear	PWS177
2009	Front	PWS235
2009	w/ Dual Rear Wheels; Rear	PWS236
2009	Exhaust stock and reorder; w/ Single Rear Wheels; Rear	PWS316
2006-2003	w/ Push-In Sensor; Front	PWS217
2006-2003	w/ Push-In Sensor; Rear	PWS217
2006-2003	w/ Clip on Sensor; Front	PWS234
2006-2003	w/ Clip on Sensor; Rear	PWS234
Sprinter 3500		
2009	Front	PWS235
2009	w/ Dual Rear Wheels; Rear	PWS236
2006-2003	w/ Push-In Sensor; Front	PWS217
2006-2003	w/ Push-In Sensor; Rear	PWS217
2006-2003	w/ Clip on Sensor; Front	PWS234
2006-2003	w/ Clip on Sensor; Rear	PWS234
Governor Pressure Sensor		
Ram 2500		
2008-2006	6 Cyl. 5.9L; w/ 4 Speed A.T.	T51001
2005-2003	6 Cyl. 5.9L; w/ A.T.	T51001
Ram 3500		
2007-2006	6 Cyl. 5.9L; w/ 4 Speed A.T.	T51001
2005-2003	6 Cyl. 5.9L; w/ A.T.	T51001
Position Sensors		
Accelerator Pedal Sensor		
Ram 3500		
2010	w/ Adjustable Pedals	APS399
2010	w/ Fixed Pedals	APS611
Ram 4500		
2010-2009	w/ Adjustable Pedals	APS399
2010-2009	w/ Fixed Pedals	APS611
2008	w/ Bracket	APS613
Ram 5500		
2010-2009	w/ Adjustable Pedals	APS399
2010-2009	w/ Fixed Pedals	APS611
2008	w/ Bracket	APS613
Sprinter 2500		
2006-2004		APS163
2003		APS273
Sprinter 3500		
2006-2004		APS163
2003		APS273
Camshaft Sensor		
Ram 2500		
2005-2003	6 Cyl. 5.9L	PC716
2002-1998	6 Cyl. 5.9L	PC396

Position Sensors

		Part No.
Camshaft Sensor		
Ram 3500		
2007	6 Cyl. 6.7L	PC590
2007-2006	6 Cyl. 5.9L	PC590
2005-2003	6 Cyl. 5.9L	PC716
2002	6 Cyl. 5.9L; 6	PC396
2002	6 Cyl. 5.9L; 7	PC396
2002	6 Cyl. 5.9L; C	PC716
2001-1998	6 Cyl. 5.9L	PC396
Ram 4500		
2010-2008		PC590
Ram 5500		
2010-2008		PC590
Sprinter 2500		
2009		PC810
2006		PC810
2005-2003		PC625
Sprinter 3500		
2009		PC810
2006		PC810
2005-2003		PC625
Crankshaft Sensor		
D250		
1993	6 Cyl. 5.9L; w/ A.T.	PC164
1993	6 Cyl. 5.9L; w/ M.T.	PC480
1992-1991	6 Cyl. 5.9L	PC756
D350		
1993-1991	6 Cyl. 5.9L	PC756
Ram 2500		
2005-2002	6 Cyl. 5.9L	PC716
2001-1999	6 Cyl. 5.9L	PC292
1998	6 Cyl. 5.9L; 6	PC292
1998	6 Cyl. 5.9L; D	PC260
1997	6 Cyl. 5.9L	PC260
1996-1994	6 Cyl. 5.9L	PC756
Ram 3500		
2005-2002	6 Cyl. 5.9L	PC716
2001-1999	6 Cyl. 5.9L	PC292
1998	6 Cyl. 5.9L; 12 Valve	PC260
1998	6 Cyl. 5.9L; 24 Valve	PC292
1997	6 Cyl. 5.9L	PC260
1996	6 Cyl. 5.9L	PC758
1995-1994	6 Cyl. 5.9L	PC756
Ram 5500		
2010-2008		PC590
Sprinter 2500		
2009		PC738
2006-2003		PC497
Sprinter 3500		
2009		PC738
2006-2003		PC497
W250		
1993	6 Cyl. 5.9L	PC756
1992	6 Cyl. 5.9L; Diesel	PC756
1991	6 Cyl. 5.9L	PC756
W350		
1993-1992	6 Cyl. 5.9L; Diesel	PC756
1991	6 Cyl. 5.9L	PC756
Throttle Position Sensor		
D250		
1993-1990	6 Cyl. 5.9L; Diesel	TH245
D350		
1993-1990	6 Cyl. 5.9L	TH245

		Part No.
Throttle Position Sensor		
Ram 2500		
2004	6 Cyl. 5.9L; Full Bellcrank Assembly; w/ A.T.	TH420
2004	6 Cyl. 5.9L; Full Bellcrank Assembly; w/ M.T.	TH456
2003	6 Cyl. 5.9L; Diesel; From 1/1/03; Full Bellcrank Assembly; w/ M.T.	TH456
2003-1999	6 Cyl. 5.9L; Diesel; Full Bellcrank Assembly; w/ A.T.	TH420
2002-1999	6 Cyl. 5.9L; Diesel; Full Bellcrank Assembly; w/ M.T.	TH383
1998	6 Cyl. 5.9L; 6; Full Bellcrank Assembly; w/ M.T.	TH383
1998	6 Cyl. 5.9L; 6; Full Bellcrank Assembly; w/ A.T.	TH420
1998	6 Cyl. 5.9L; D	TH175
1997	6 Cyl. 5.9L; Diesel	TH175
1996-1995	6 Cyl. 5.9L	TH175
1994	6 Cyl. 5.9L; Diesel	TH175
Ram 3500		
2004-2003	6 Cyl. 5.9L; Full Bellcrank Assembly; w/ M.T.	TH456
2004-1999	6 Cyl. 5.9L; Full Bellcrank Assembly; w/ A.T.	TH420
2002-1999	6 Cyl. 5.9L; Full Bellcrank Assembly; w/ M.T.	TH383
1998	6 Cyl. 5.9L; 6; Full Bellcrank Assembly; w/ M.T.	TH383
1998	6 Cyl. 5.9L; 6; Full Bellcrank Assembly; w/ A.T.	TH420
1998	6 Cyl. 5.9L; D	TH175
1997-1994	6 Cyl. 5.9L	TH175
W250		
1993-1990	6 Cyl. 5.9L; Diesel	TH245
W350		
1993-1990	6 Cyl. 5.9L; Diesel	TH245
Pressure Sensors		
Barometric Pressure Sensor		
Ram 2500		
2010	6 Cyl. 6.7L	AS414
2009-2008	6 Cyl. 6.7L; Mounted on Compressor	AS414
2009-2008	6 Cyl. 6.7L; Mounted on Intake Manifold	AS415
Ram 3500		
2010	6 Cyl. 6.7L	AS414
2009-2008	6 Cyl. 6.7L; Mounted on Compressor	AS414
2009-2008	6 Cyl. 6.7L; Mounted on Intake Manifold	AS415
Ram 4500		
2010-2008		AS414
Ram 5500		
2010-2008		AS414
Brake Fluid Pressure Sensor		
Sprinter 2500		
2006-2003		BST119
Sprinter 3500		
2006-2003		BST119
EGR Valve Pressure Feedback Sensor		
Ram 2500		
2010-2007	6 Cyl. 6.7L; Diesel	VP34
2008	6 Cyl. 5.9L; Diesel	VP34
Ram 3500		
2010	6 Cyl.; Diesel	VP34
2009-2007	6 Cyl. 6.7L; Diesel	VP34
Ram 4500		
2010-2008	6 Cyl. 6.7L; Diesel	VP34

Pressure Sensors

		Part No.
EGR Valve Pressure Feedback Sensor		
Ram 5500		
2010-2008	6 Cyl. 6.7L; Diesel	VP34
Sprinter 2500		
2009-2007	6 Cyl. 3.0L	VP29
Sprinter 3500		
2009-2007	6 Cyl. 3.0L	VP29
Exhaust Back Pressure Sensor		
Sprinter 2500		
2004-2003	5 Cyl. 2.7L	VP35
Sprinter 3500		
2004-2003	5 Cyl. 2.7L	VP35
Fuel Pressure Sensor		
Ram 2500		
2010-2007	6 Cyl. 6.7L	FPS2
2008	6 Cyl. 5.9L	FPS20
2007	6 Cyl. 5.9L; OE No. 0 281 002 534	FPS1
2007	6 Cyl. 5.9L; OE No. 68039886AA	FPS20
2006-2003	6 Cyl. 5.9L	FPS1
Ram 3500		
2010-2007	6 Cyl. 6.7L	FPS2
2007	6 Cyl. 5.9L; OE No. 0 281 002 534	FPS1
2007	6 Cyl. 5.9L; OE No. 68039886AA	FPS20
2006-2003	6 Cyl. 5.9L	FPS1
Sprinter 2500		
2009-2007	6 Cyl. 3.0L	FPS30
2006-2004	5 Cyl. 2.7L	FPS30
2003	5 Cyl. 2.7L	FPS31
Sprinter 3500		
2009-2007	6 Cyl. 3.0L	FPS30
2006-2004	5 Cyl. 2.7L	FPS30
2003	5 Cyl. 2.7L	FPS31
Manifold Differential Pressure Sensor		
Ram 2500		
2010-2009	6 Cyl. 6.7L	AS628
Ram 3500		
2010-2009	6 Cyl. 6.7L	AS628
MAP Sensor		
Ram 2500		
2010-2008	6 Cyl. 6.7L	AS413
2009-2003	6 Cyl. 5.9L	AS349
2007	6 Cyl. 6.7L; Location-Intercooler Piping	AS414
2007	6 Cyl. 6.7L; On Intake Manifold	AS415
2002	6 Cyl. 5.9L	AS88
2001	6 Cyl. 5.9L; Sensor Only	AS370
2001	6 Cyl. 5.9L; Sensor Kit	AS370K
2000	6 Cyl. 5.9L; Sensor Only; To 4/4/00	AS334
2000	6 Cyl. 5.9L; From 4/4/00; Sensor Only	AS370
2000	6 Cyl. 5.9L; From 4/4/00; Sensor Kit	AS370K
1999	6 Cyl. 5.9L; Diesel	AS334
1998	6 Cyl. 5.9L	AS334
Ram 3500		
2010	6 Cyl. 6.7L; On Intake Manifold	AS415
2009-2008	6 Cyl. 6.7L	AS413
2007	6 Cyl. 6.7L; Location-Intercooler Piping	AS414
2007	6 Cyl. 6.7L; On Intake Manifold	AS415
2007-2003	6 Cyl. 5.9L	AS349
2002	6 Cyl. 5.9L	AS88
2001	6 Cyl. 5.9L; Sensor Only	AS370
2001	6 Cyl. 5.9L; Sensor Kit	AS370K
2000	6 Cyl. 5.9L; Sensor Only; To 6/26/00	AS334
2000	6 Cyl. 5.9L; From 6/26/00; Sensor Only	AS370
1999	6 Cyl. 5.9L; Sensor Only	AS334

		Part No.
MAP Sensor		
Ram 3500		
1998	6 Cyl. 5.9L	AS334
Ram 4500		
2010-2008		AS413
Ram 5500		
2010-2008		AS413
Sprinter 2500		
2009-2007	6 Cyl. 3.0L	AS356
2006-2004	5 Cyl. 2.7L	AS356
2003	5 Cyl. 2.7L	AS337
Sprinter 3500		
2009-2007	6 Cyl. 3.0L	AS356
2006-2004	5 Cyl. 2.7L	AS356
2003	5 Cyl. 2.7L	AS337
Tire Pressure Monitoring System OE Design Sensor		
Ram 3500		
2010	433 Mhz Sensor; OE Style/ID Clone-able; w/ Rubber Valve	TPM197RA
2010	433 Mhz Sensor; OE Style/ID Clone-able; w/ Aluminum Valve	TPM97A
Ram 4500		
2010	433 Mhz Sensor; OE Style/ID Clone-able; w/ Rubber Valve	TPM197RA
2010	433 Mhz Sensor; OE Style/ID Clone-able; w/ Aluminum Valve	TPM97A
Ram 5500		
2010	433 Mhz Sensor; OE Style/ID Clone-able; w/ Rubber Valve	TPM197RA
2010	433 Mhz Sensor; OE Style/ID Clone-able; w/ Aluminum Valve	TPM97A
Sprinter 2500		
2009	315 Mhz Sensor; OE Style/ID Clone-able; w/ Aluminum Valve	TPM104 TPM104A
Sprinter 3500		
2009	315 Mhz Sensor; OE Style/ID Clone-able; w/ Aluminum Valve	TPM104 TPM104A
Tire Pressure Monitoring System OE Design Sensor Service Kit		
Sprinter 2500		
2009	25 Per Box; OE Style; w/o Valve	TPM2000K
2009	4 Per Box; OE Style; w/o Valve	TPM2000K4
Sprinter 3500		
2009	25 Per Box; OE Style; w/o Valve	TPM2000K
2009	4 Per Box; OE Style; w/o Valve	TPM2000K4
Tire Pressure Monitoring System OE Design Valve		
Ram 3500		
2010	25 Per Box; 433 Mhz Sensor; OE Style/ID Clone-able; w/ Aluminum Valve	TPM2107VK
2010	4 Per Box; 433 Mhz Sensor; OE Style/ID Clone-able; w/ Aluminum Valve	TPM2107VK4
2010	25 Per Box; 433 Mhz Sensor; OE Style; w/ Rubber Valve	TPM930K
2010	4 Per Box; 433 Mhz Sensor; OE Style; w/ Rubber Valve	TPM930K4
Ram 4500		
2010	25 Per Box; 433 Mhz Sensor; OE Style/ID Clone-able; w/ Aluminum Valve	TPM2107VK
2010	4 Per Box; 433 Mhz Sensor; OE Style/ID Clone-able; w/ Aluminum Valve	TPM2107VK4
Ram 5500		
2010	25 Per Box; 433 Mhz Sensor; OE Style/ID Clone-able; w/ Aluminum Valve	TPM2107VK
2010	4 Per Box; 433 Mhz Sensor; OE Style/ID Clone-able; w/ Aluminum Valve	TPM2107VK4

Pressure Sensors

		Part No.
Tire Pressure Monitoring System OE Design Valve		
Sprinter 2500		
2009	315 Mhz Sensor; OE Style; w/ Aluminum Valve	TPM2018VK
2009	25 Per Box; 315 Mhz Sensor; OE Style; w/ Metal Valve	TPM2104VK
2009	4 Per Box; 315 Mhz Sensor; OE Style; w/ Metal Valve	TPM2104VK4
Sprinter 3500		
2009	315 Mhz Sensor; OE Style; w/ Aluminum Valve	TPM2018VK
2009	25 Per Box; 315 Mhz Sensor; OE Style; w/ Metal Valve	TPM2104VK
2009	4 Per Box; 315 Mhz Sensor; OE Style; w/ Metal Valve	TPM2104VK4
Tire Pressure Monitoring System QWIK-Sensor		
Ram 3500		
2010	433 Mhz Sensor; Alternate Number; Black; w/ Aluminum Valve	QS104M
2010	433 Mhz Sensor; Alternate Number; Black; w/ Rubber Valve	QS104R
Ram 4500		
2010	433 Mhz Sensor; Black; w/ Aluminum Valve	QS104M
2010	433 Mhz Sensor; Black; w/ Rubber Valve	QS104R
Ram 5500		
2010	433 Mhz Sensor; Black; w/ Aluminum Valve	QS104M
2010	433 Mhz Sensor; Black; w/ Rubber Valve	QS104R
Sprinter 2500		
2009	315 Mhz Sensor; Blue; Exhaust stock and reorder; w/ Aluminum Valve	QS101M
2009	315 Mhz Sensor; Blue; Exhaust stock and reorder; w/ Rubber Valve	QS101R
2009	315 Mhz Sensor; Alternate Number; Black; w/ Aluminum Valve	QS105M
2009	315 Mhz Sensor; Alternate Number; Black; w/ Rubber Valve	QS105R
Sprinter 3500		
2009	315 Mhz Sensor; Blue; Exhaust stock and reorder; w/ Aluminum Valve	QS101M
2009	315 Mhz Sensor; Blue; Exhaust stock and reorder; w/ Rubber Valve	QS101R
2009	315 Mhz Sensor; Alternate Number; Black; w/ Aluminum Valve	QS105M
2009	315 Mhz Sensor; Alternate Number; Black; w/ Rubber Valve	QS105R
Tire Pressure Monitoring System QWIK-Sensor Service Kit		
Ram 3500		
2010	1 Per Box; 433 Mhz Sensor; w/ Aluminum Valve	TPM4012SK
2010	25 Per Box; 433 Mhz Sensor; w/ Aluminum Valve	TPM4012SK25PK
2010	4 Per Box; 433 Mhz Sensor; w/ Aluminum Valve	TPM4012SK4PK
Sprinter 2500		
2009	1 Per Box; 315 Mhz Sensor; w/ Aluminum Valve	TPM4012SK
2009	25 Per Box; 315 Mhz Sensor; w/ Aluminum Valve	TPM4012SK25PK
2009	4 Per Box; 315 Mhz Sensor; w/ Aluminum Valve	TPM4012SK4PK
Sprinter 3500		
2009	1 Per Box; 315 Mhz Sensor; w/ Aluminum Valve	TPM4012SK
2009	25 Per Box; 315 Mhz Sensor; w/ Aluminum Valve	TPM4012SK25PK
2009	4 Per Box; 315 Mhz Sensor; w/ Aluminum Valve	TPM4012SK4PK

		Part No.
Tire Pressure Monitoring System QWIK-Sensor Valve		
Ram 3500		
2010	1 Per Box; 433 Mhz Sensor; w/ Rubber Valve	TPM2011VK
2010	25 Per Box; 433 Mhz Sensor; w/ Rubber Valve	TPM2011VK25PK
2010	4 Per Box; 433 Mhz Sensor; w/ Rubber Valve	TPM2011VK4PK
2010	25 Per Box; 433 Mhz Sensor; Black; OE Style; w/ Aluminum Valve	TPM2012VBK
2010	4 Per Box; 433 Mhz Sensor; Black; OE Style; w/ Aluminum Valve	TPM2012VBK4
2010	25 Per Box; 433 Mhz Sensor; Chrome Finish; OE Style; w/ Aluminum Valve	TPM2012VCK
2010	4 Per Box; 433 Mhz Sensor; Chrome Finish; OE Style; w/ Aluminum Valve	TPM2012VCK4
2010	1 Per Box; 433 Mhz Sensor; w/ Aluminum Valve	TPM2012VK
2010	25 Per Box; 433 Mhz Sensor; w/ Aluminum Valve	TPM2012VK25PK
2010	4 Per Box; 433 Mhz Sensor; w/ Aluminum Valve	TPM2012VK4PK
Sprinter 2500		
2009	1 Per Box; 315 Mhz Sensor; w/ Rubber Valve	TPM2011VK
2009	25 Per Box; 315 Mhz Sensor; w/ Rubber Valve	TPM2011VK25PK
2009	4 Per Box; 315 Mhz Sensor; w/ Rubber Valve	TPM2011VK4PK
2009	1 Per Box; 315 Mhz Sensor; w/ Aluminum Valve	TPM2012VK
2009	25 Per Box; 315 Mhz Sensor; w/ Aluminum Valve	TPM2012VK25PK
2009	4 Per Box; 315 Mhz Sensor; w/ Aluminum Valve	TPM2012VK4PK
Sprinter 3500		
2009	1 Per Box; 315 Mhz Sensor; w/ Rubber Valve	TPM2011VK
2009	25 Per Box; 315 Mhz Sensor; w/ Rubber Valve	TPM2011VK25PK
2009	4 Per Box; 315 Mhz Sensor; w/ Rubber Valve	TPM2011VK4PK
2009	1 Per Box; 315 Mhz Sensor; w/ Aluminum Valve	TPM2012VK
2009	25 Per Box; 315 Mhz Sensor; w/ Aluminum Valve	TPM2012VK25PK
2009	4 Per Box; 315 Mhz Sensor; w/ Aluminum Valve	TPM2012VK4PK
Transmission Oil Pressure Sensor		
Ram 3500		
2010	w/ 5 Speed A.T.	TCS78
Turbocharger Boost Sensor		
Ram 2500		
2010	6 Cyl. 6.7L; Turbocharged	AS415
2007-2003	6 Cyl. 5.9L; Diesel; Turbocharged; Location-Air Cleaner Housing	AS349
2002	6 Cyl. 5.9L; Sensor Kit; Turbocharged	AS370K
2001-1999	6 Cyl. 5.9L; Sensor Only; Turbocharged; w/ Round Connector	AS334
2001-1999	6 Cyl. 5.9L; Sensor Only; Turbocharged; w/ Oval Connector	AS370
2001-1999	6 Cyl. 5.9L; Sensor Kit; Turbocharged; w/ Oval Connector	AS370K
1998	6 Cyl. 5.9L; Turbocharged	AS334
Ram 3500		
2007-2003	6 Cyl. 5.9L; Diesel; Turbocharged; Location-Air Cleaner Housing	AS349
2002	6 Cyl. 5.9L; Sensor Kit; Turbocharged	AS370K

Pressure Sensors

		Part No.
Turbocharger Boost Sensor		
Ram 3500		
2001-1999	6 Cyl. 5.9L; Sensor Only; Turbocharged; w/ Round Connector	AS334
2001-1999	6 Cyl. 5.9L; Sensor Only; Turbocharged; w/ Oval Connector	AS370
2001-1999	6 Cyl. 5.9L; Sensor Kit; Turbocharged; w/ Oval Connector	AS370K
1998	6 Cyl. 5.9L; Turbocharged	AS334
Sprinter 2500		
2009-2007	6 Cyl. 3.0L; Turbocharged	AS356
2006-2005	5 Cyl. 2.7L; Turbocharged	AS356
Sprinter 3500		
2009-2007	6 Cyl. 3.0L; Turbocharged	AS356
2006-2005	5 Cyl. 2.7L; Turbocharged	AS356
Temperature Sensors		
A/C Evaporator Temperature Sensor		
Ram 3500		
2010		AX412
Ram 4500		
2010-2008		AX412
Ram 5500		
2010-2008		AX412
Ambient Air Temperature Sensor		
Ram 2500		
2005-2004	6 Cyl. 5.9L	AX75
2002-1999	6 Cyl. 5.9L	TX49
Ram 3500		
2010		AX75
2005-2004	6 Cyl. 5.9L	AX75
2002-1999	6 Cyl. 5.9L	TX49
Ram 4500		
2010-2009		AX75
Ram 5500		
2010-2009		AX75
Sprinter 2500		
2009		AX118
2006-2003		AX158
Sprinter 3500		
2009		AX118
2006-2003		AX158
Automatic Transmission Oil Temperature Sensor		
Ram 3500		
2010	w/ 6 Speed A.T.	TX262
Ram 4500		
2010-2008		TX262
Ram 5500		
2010-2008		TX262
Battery Temperature Sensor		
Ram 2500		
2006	6 Cyl. 5.9L	TS-406
2005	6 Cyl.	TS-406
2004	6 Cyl. 5.9L	TS-406
Ram 3500		
2006	6 Cyl. 5.9L	TS-406
2005	6 Cyl.	TS-406
2004	6 Cyl. 5.9L	TS-406
Cabin Air Temperature Sensor		
Sprinter 2500		
2009		AX215
2006-2004	w/ Flat Connector	AX215
2006-2004	w/ Round Connector	AX234
2003		AX234

		Part No.
Cabin Air Temperature Sensor		
Sprinter 3500		
2009		AX215
2006-2004	w/ Flat Connector	AX215
2006-2004	w/ Round Connector	AX234
2003		AX234
Coolant Temperature Sensor		
D250		
1993-1991	6 Cyl.	TX13
1990-1989	6 Cyl. 5.9L	TX13
D350		
1992-1991	6 Cyl.	TX13
1990	6 Cyl. 5.9L	TX13
Ram 2500		
2010-2008	6 Cyl. 6.7L	TX195
2000-1998	6 Cyl. 5.9L; Exhaust stock and reorder	TS420
Ram 3500		
2002-1998	6 Cyl. 5.9L; Exhaust stock and reorder	TS420
1997	6 Cyl. 5.9L; Diesel; Exhaust stock and reorder	TS420
Sprinter 2500		
2009		TX155
2006-2003		TS-615
Sprinter 3500		
2009		TX155
2006-2003		TS-615
W250		
1992-1991	6 Cyl. 5.9L	TX71
1990-1989	6 Cyl. 5.9L	TX13
W350		
1992-1991	6 Cyl. 5.9L	TX71
1990-1989	6 Cyl. 5.9L	TX13
Exhaust Gas Temperature Sensor		
Ram 2500		
2010	6 Cyl. 6.7L; Located on EGR Crossover Tube	ETS117
2010-2007	6 Cyl. 6.7L; Located After Catalytic Converter	ETS67
2009-2007	6 Cyl. 6.7L; Back of EGR valve	ETS103
2009-2007	6 Cyl. 6.7L; Located Before Catalytic Converter	ETS67
2009-2007	6 Cyl. 6.7L; Located Before Particulate Filter	ETS67
2008	6 Cyl. 5.9L; Back of EGR valve	ETS103
Ram 3500		
2010	Located on EGR Crossover Tube	ETS117
2010	Located After Catalytic Converter	ETS67
2009-2007	6 Cyl. 6.7L; w/ Pickup Bed; Back of EGR valve	ETS103
2009-2007	6 Cyl. 6.7L; Cab and Chassis; Located After Catalytic Converter	ETS67
2008	6 Cyl. 6.7L; w/ Pickup Bed; Located Before Particulate Filter	ETS67
2008-2007	6 Cyl. 6.7L; Cab and Chassis; EGR Pipe	ETS103
2008-2007	6 Cyl. 6.7L; w/ Pickup Bed; Located After Catalytic Converter	ETS67
2008-2007	6 Cyl. 6.7L; w/ Pickup Bed; Located Before Catalytic Converter	ETS67
Ram 4500		
2010	Located on EGR Crossover Tube	ETS117
2010	Located After Catalytic Converter	ETS67
2009-2008	6 Cyl. 6.7L; Located After Catalytic Converter	ETS67
2008	6 Cyl. 6.7L; EGR Pipe	ETS103
Ram 5500		
2010	Located on EGR Crossover Tube	ETS117

Temperature Sensors

		Part No.
Exhaust Gas Temperature Sensor		
Ram 5500		
2010	Located After Catalytic Converter	ETS67
2009-2008	6 Cyl. 6.7L; Located After Catalytic Converter	ETS67
2008	6 Cyl. 6.7L; EGR Pipe	ETS103
Sprinter 2500		
2009-2007	6 Cyl. 3.0L; Exhaust stock and reorder	ETS102
2009-2007	6 Cyl. 3.0L; Alternate Number	ETS107
Sprinter 3500		
2009-2007	6 Cyl. 3.0L; Exhaust stock and reorder	ETS102
2009-2007	6 Cyl. 3.0L; Alternate Number	ETS107
Fuel Temperature Sensor		
Sprinter 2500		
2009		TS-604
2006-2003		TS-604
Sprinter 3500		
2009		TS-604
2006-2003		TS-604
Intake Air Temperature Sensor		
D250		
1993-1990	6 Cyl. 5.9L; On Intake Manifold	AX36
D350		
1993-1990	6 Cyl. 5.9L	AX36
Ram 2500		
2010-2009	6 Cyl. 6.7L	AS415
2007-2003	6 Cyl. 5.9L	AX116
2002-1998	6 Cyl. 5.9L	AX68
1997-1994	6 Cyl. 5.9L	AX36
Ram 3500		
2010-2009	6 Cyl. 6.7L	AS415
2007-2003	6 Cyl. 5.9L	AX116
2002-1998	6 Cyl. 5.9L	AX68
1997-1994	6 Cyl. 5.9L	AX36
Sprinter 2500		
2009		AX129
2006-2003		AX129
Sprinter 3500		
2009		AX129
2006-2003		AX129
W250		
1993-1992	6 Cyl. 5.9L	AX36
W350		
1993-1991	6 Cyl. 5.9L	AX36
1990	6 Cyl. 5.9L; Diesel	AX36
1989	6 Cyl.; 2 Term.	AX8
Telematics Sensors		
Parking Assist Sensor		
Ram 3500		
2010	Rear	PPS45
Body Light Switches		
Back-Up Light Switch		
D250		
1993	6 Cyl. 5.9L; Diesel; w/ 5 Speed M.T.	LS-201
D350		
1993-1992	6 Cyl. 5.9L; Diesel; Getrag; w/ 5 Speed M.T.	LS-201
1991	6 Cyl. 5.9L; w/ M.T.	LS-201
Ram 2500		
2010-2007	6 Cyl. 6.7L; w/ M.T.	NS-485
2009-2006	6 Cyl. 5.9L; w/ M.T.	NS-485
2005	6 Cyl.; Trans Code NV4500, NV5600; w/ M.T.	LS-285

		Part No.
Back-Up Light Switch		
Ram 2500		
2005	6 Cyl.; Trans Code G56; w/ M.T.	NS-485
Ram 3500		
2010-2007	6 Cyl. 6.7L; w/ M.T.	NS-485
2007-2006	6 Cyl. 5.9L; w/ M.T.	NS-485
2005	6 Cyl.; Trans Code NV4500, NV5600; w/ M.T.	LS-285
2005	6 Cyl.; Trans Code G56; w/ M.T.	NS-485
Ram 4500		
2010	w/ M.T.	NS-485
2009	w/ A.T.	NS-485
Ram 5500		
2010	w/ M.T.	NS-485
2009	w/ A.T.	NS-485
W250		
1993-1992	6 Cyl. 5.9L; Diesel; Getrag; w/ 5 Speed M.T.	LS-201
1991	6 Cyl. 5.9L; 8; w/ M.T.	LS-201
W350		
1993-1992	6 Cyl. 5.9L; Diesel; Getrag; w/ 5 Speed M.T.	LS-201
1991	6 Cyl. 5.9L; w/ M.T.	LS-201
Fog Lamp Switch		
Ram 2500		
2003-2000	6 Cyl. 5.9L	FLA1010
1999	6 Cyl. 5.9L	FLA1018
Ram 3500		
2003-2000	6 Cyl. 5.9L	FLA1010
1999	6 Cyl. 5.9L	FLA1018
Sprinter 2500		
2006-2005		FLA1027
2004-2003		DS-5748
Sprinter 3500		
2006-2005		FLA1027
2004-2003		DS-5748
Glove Box Lamp Switch		
Ram 2500		
2004-2001	6 Cyl. 5.9L	DS-1142
Ram 3500		
2004-2001	6 Cyl. 5.9L	DS-1142
Hazard Warning Switch		
Ram 4500		
2010-2008		CBS-1338
Ram 5500		
2010-2008		CBS-1338
Sprinter 2500		
2006-2003	w/ Parking Light Control	CBS-1261
2006-2003	w/o Parking Light Control	CBS-1392
Sprinter 3500		
2006-2003	w/ Parking Light Control	CBS-1261
2006-2003	w/o Parking Light Control	CBS-1392
Headlight Dimmer Switch		
Ram 4500		
2010-2008		CBS-1338
Ram 5500		
2010-2008		CBS-1338
Sprinter 2500		
2009	w/o Rear Wiper	CBS-1773
2009	w/ Rear Wiper	CBS-1916
2006-2003	w/ Parking Light Control	CBS-1261
2006-2003	w/o Parking Light Control	CBS-1392

Body Light Switches

		Part No.
Headlight Dimmer Switch		
Sprinter 3500		
2009	w/o Rear Wiper	CBS-1773
2009	w/ Rear Wiper	CBS-1916
2006-2003	w/ Parking Light Control	CBS-1261
2006-2003	w/o Parking Light Control	CBS-1392
Headlight Switch		
Ram 3500		
2010	w/o Fog Lights	HLS-1456
2010	w/ Fog Lights	HLS-1457
Ram 4500		
2010-2008	w/ Cargo Light; w/o Fog Lights	HLS-1345
2010-2008	w/ Cargo Light; w/ Fog Lights	HLS-1349
Ram 5500		
2010-2008	w/ Cargo Light; w/o Fog Lights	HLS-1345
2010-2008	w/ Cargo Light; w/ Fog Lights	HLS-1349
Sprinter 2500		
2009	w/o Rear Wiper	CBS-1773
2009	w/ Rear Wiper	CBS-1916
2006-2003	w/ Parking Light Control	CBS-1261
2006-2003	w/o Parking Light Control	CBS-1392
Sprinter 3500		
2009	w/o Rear Wiper	CBS-1773
2009	w/ Rear Wiper	CBS-1916
2006-2003	w/ Parking Light Control	CBS-1261
2006-2003	w/o Parking Light Control	CBS-1392
Interior Light Switch		
Sprinter 2500		
2006-2005	Cargo Light; Cargo Van	DS-3035
2005	Cab and Chassis; Cargo Light	DS-2404
2004-2003	Cargo Light	DS-3035
Sprinter 3500		
2006-2005	Cab and Chassis; Cargo Light	DS-2404
2006-2003	Cargo Light; Cargo Van	DS-3035
Stoplight Switch		
Ram 4500		
2010-2008		SLS-237
Ram 5500		
2010-2008		SLS-237
Sprinter 2500		
2009		SLS-467
2006-2003	w/ Stability Control	SLS-466
Sprinter 3500		
2009		SLS-467
2006-2003	w/ Stability Control	SLS-466
Turn Signal Switch		
Ram 3500		
2010		CBS-1925
Ram 4500		
2010-2008		CBS-1338
Ram 5500		
2010-2008		CBS-1338
Sprinter 2500		
2009-2007	6 Cyl. 3.0L; w/o Rear Wiper	CBS-1773
2009-2007	6 Cyl. 3.0L; Rear Wiper	CBS-1916
2006-2003	w/ Parking Light Control	CBS-1261
2006-2003	w/o Parking Light Control	CBS-1392
Sprinter 3500		
2009-2007	6 Cyl. 3.0L; w/o Rear Wiper	CBS-1773
2009-2007	6 Cyl. 3.0L; Rear Wiper	CBS-1916
2006-2003	w/ Parking Light Control	CBS-1261
2006-2003	w/o Parking Light Control	CBS-1392

		Part No.
Chassis and Drivetrain Switches		
Automatic Transmission Governor Repair Kit		
Ram 2500		
2008-2003	6 Cyl. 5.9L; Governor Pressure Sensor and Solenoid Kit; w/ 4 Speed A.T.	B51002
Ram 3500		
2007-2006	6 Cyl. 5.9L; Governor Pressure Sensor and Solenoid Kit; w/ 4 Speed A.T.	B51002
2005	6 Cyl.; Governor Pressure Sensor and Solenoid Kit	B51002
2004-2003	6 Cyl. 5.9L; Governor Pressure Sensor and Solenoid Kit	B51002
Clutch Starter Safety Switch		
D250		
1989	6 Cyl. 5.9L	NS382
D350		
1989	6 Cyl. 5.9L	NS382
Ram 4500		
2010-2008		NS-193
Ram 5500		
2010-2008		NS-193
Sprinter 2500		
2006-2003		SLS-385
Sprinter 3500		
2006-2003		SLS-385
W250		
1989	6 Cyl. 5.9L	NS382
W350		
1989	6 Cyl. 5.9L	NS382
Four Wheel Drive Selector Switch		
Ram 3500		
2010	w/ Electronic Shift	TCA-58
Ram 4500		
2009-2008		TCA-52
Ram 5500		
2009-2008		TCA-52
Neutral Safety Switch		
Power Ram 50		
1985-1983	4 Cyl. 2.3L; w/ A.T.	NS-11
Ram 50		
1985-1983	4 Cyl. 2.3L; w/ A.T.	NS-11
Ram 2500		
2009-2006	6 Cyl. 5.9L	NS-223
2005	6 Cyl.	NS-223
Ram 3500		
2010	6 Cyl. 6.7L; Mounted on Transmission	NS718
2007-2006	6 Cyl. 5.9L	NS-223
2005	6 Cyl.	NS-223
Ram 4500		
2010-2009		NS718
Ram 5500		
2010-2009		NS718
Overdrive Kick-Down Switch		
Ram 2500		
2002-2000	6 Cyl. 5.9L	DS-1170
1994	6 Cyl. 5.9L	DS1169
Ram 3500		
2002-2000	6 Cyl. 5.9L	DS-1170
1994	6 Cyl. 5.9L	DS1169
Transfer Case Switch		
Ram 3500		
2010	w/ Manual Shift	TCA-59

Chassis and Drivetrain Switches

		Part No.
Transfer Case Switch		
Ram 5500		
2009	On Transfer Case	TCA-64
Transmission Control Solenoid		
Ram 3500		
2010	Solenoid Pack; w/ White Connector	TCS108
2010	Shift Solenoid	TCS221
Ram 4500		
2010-2008		TCS221
Ram 5500		
2010-2008		TCS221
Sprinter 2500		
2009	Shift Solenoid	TCS208
2009	TCC Solenoid	TCS331
2009	On-Off Shift	TCS209
2006-2003	Shift Solenoid	TCS208
2006-2003	TCC Solenoid	TCS331
Sprinter 3500		
2009	Shift Solenoid	TCS208
2009	On-Off Shift	TCS209
2006-2003		TCS208
Ignition Switches		
Ignition Starter Switch		
Ram 3500		
2010		US-895
2005	6 Cyl.	US-351
2004	6 Cyl. 5.9L	US-351
Ram 4500		
2010-2008		US-895
Ram 5500		
2010-2008		US-895
Sprinter 2500		
2006-2003		US-980
Sprinter 3500		
2006-2003		US-980
Interior Power Switches		
Clock Spring		
Ram 3500		
2010	Cab and Chassis	CSP127
2010	Quad Cab; w/o Heated Steering Wheel	CSP247
Sprinter 2500		
2009		CSP131
2006-2003		CSP123
Sprinter 3500		
2009		CSP131
2006-2003		CSP123
Cruise Control Switch		
Ram 2500		
2009-2007	6 Cyl. 5.9L; Left	CCA1026
2009-2007	6 Cyl. 6.7L; Left	CCA1026
2006	6 Cyl. 5.9L; On-Off	CCA1026
2005	6 Cyl.; On-Off	CCA1026
2004	6 Cyl. 5.9L; On-Off	CCA1026
Ram 3500		
2010		CCA1168
2009-2007	6 Cyl. 6.7L; Left	CCA1026
2007	6 Cyl. 5.9L; Left	CCA1026
2006	6 Cyl. 5.9L; On-Off	CCA1026
2005	6 Cyl.; On-Off	CCA1026
2004	6 Cyl. 5.9L; On-Off	CCA1026
Ram 5500		
2010-2008	6 Cyl. 6.7L; Left	CCA1026

		Part No.
Cruise Control Switch		
Sprinter 2500		
2009		DS-2363
2006-2004		CCA1291
Sprinter 3500		
2009		DS-2363
2006-2004		CCA1291
Heated Seat Switch		
Ram 2500		
2006	6 Cyl. 5.9L; Right	DS-3072
2006	6 Cyl. 5.9L; Left	DS-3102
2004	6 Cyl. 5.9L; Right	DS3074
2004	6 Cyl. 5.9L; Left	DS3114
Ram 3500		
2010	Right	DS-3072
2010	Left Rear	HSS122
2006	6 Cyl. 5.9L; Right	DS-3072
2006	6 Cyl. 5.9L; Left	DS-3102
2004	6 Cyl. 5.9L; Right	DS3074
2004	6 Cyl. 5.9L; Left	DS3114
Sprinter 2500		
2006-2003	Left and Right	DS-2358
Sprinter 3500		
2006-2003	Left and Right	DS-2358
Parking Brake Switch		
Ram 2500		
2005-2004	6 Cyl. 5.9L	DS-890
2003	6 Cyl. 5.9L	DS-1243
Ram 3500		
2005-2004	6 Cyl. 5.9L	DS-890
2003	6 Cyl. 5.9L	DS-1243
Sprinter 2500		
2006-2003		DS-3364
Sprinter 3500		
2004		DS-3364
Pedal Height Adjustment Switch		
Ram 3500		
2010		DS1099
Power Door Lock Switch		
Sprinter 2500		
2006-2003	Dash Mounted Switch	PDS-124
Sprinter 3500		
2006-2003	Dash Mounted Switch	PDS-124
Power Seat Memory Switch		
Ram 3500		
2010		PMS12
Power Sunroof Switch		
Ram 2500		
2006	6 Cyl. 5.9L	DS3100
Ram 3500		
2010		DS3500
2006	6 Cyl. 5.9L	DS3100
Power Window Switch		
Ram 2500		
2010	6 Cyl. 6.7L; 2 Door; Front Right	DWS-1390
2010	6 Cyl. 6.7L; 4 Door; Front Right	DWS-523
2008	6 Cyl. 5.9L; Front Right	DS-1185
2008	6 Cyl. 6.7L; Front Right	DS-1185
2008	6 Cyl. 5.9L; Rear	DS-1185
2008	6 Cyl. 6.7L; Rear	DS-1185
Ram 3500		
2010	4 Door; Front Left	DWS-1386
2010	6 Cyl. 6.7L; 2 Door; Front Right	DWS-1390

Interior Power Switches

		Part No.
Power Window Switch		
Ram 3500		
2010	Rear	DWS-498
2010	6 Cyl. 6.7L; 4 Door; Front Right	DWS-523
2010	2 Door; Front Left	DWS-879
2008	6 Cyl. 6.7L; Front Right	DS-1185
2008	6 Cyl. 6.7L; Rear	DS-1185
Ram 4500		
2010	Rear	DS-1185
2010-2008	Front Left	DWS-1385
2010-2008	2 Door; Front Right	DWS-1390
2010-2008	4 Door; Front Right	DWS-523
2008	Rear	DS-1185
Ram 5500		
2010-2009	2 Door; Front Right	DWS-1390
2010-2009	4 Door; Front Right	DWS-523
2010-2008	Rear	DS-1185
2010-2008	Front Left	DWS-1385
Sprinter 2500		
2009	w/ Power Mirrors; Front Right	DS-2362
2009	w/o Power Mirrors; Front Left	DWS1642
2009	w/ Power Mirrors; Front Left	DWS-184
2006	5 Cyl. 2.7L; Front Left	DWS-187
2005	5 Cyl. 2.7L	DWS-187
2004		DWS-187
2003	Front Left	DWS-187
Sprinter 3500		
2009	w/ Power Mirrors; Front Right	DS-2362
2009	w/o Power Mirrors; Front Left	DWS1642
2009	w/ Power Mirrors; Front Left	DWS-184
2006-2005	5 Cyl. 2.7L	DWS-187
2004-2003		DWS-187
Rear Window Defogger Switch		
Sprinter 2500		
2006-2003		DS-2359
Sprinter 3500		
2006-2003		DS-2359
Remote Mirror Switch		
Ram 3500		
2010	4 Door	DWS-1385
Ram 4500		
2010-2008		DWS-1385
Ram 5500		
2010-2008		DWS-1385
Sprinter 2500		
2006-2003	w/ Heated Mirror	MRS1
Sprinter 3500		
2006-2003	w/ Heated Mirror	MRS1
Steering Angle Sensor		
Ram 3500		
2010	w/o Heated Steering Wheel	CSP247
Sprinter 2500		
2006-2004		SWS46
Sprinter 3500		
2006-2004		SWS46
Traction Control Switch		
Sprinter 2500		
2006-2003		DS-2360
Sprinter 3500		
2006-2003		DS-2360
Windshield Wiper Switch		
Ram 3500		
2010		CBS-1925

		Part No.
Windshield Wiper Switch		
Ram 4500		
2010-2008		CBS-1338
Ram 5500		
2010-2008		CBS-1338
Sprinter 2500		
2009-2007	6 Cyl. 3.0L; w/o Rear Wiper	CBS-1773
2009-2007	6 Cyl. 3.0L; Rear Wiper	CBS-1916
2006-2003	w/ Parking Light Control	CBS-1261
2006-2003	w/o Parking Light Control	CBS-1392
Sprinter 3500		
2009-2007	6 Cyl. 3.0L; w/o Rear Wiper	CBS-1773
2009-2007	6 Cyl. 3.0L; Rear Wiper	CBS-1916
2006-2003	w/ Parking Light Control	CBS-1261
2006-2003	w/o Parking Light Control	CBS-1392
Pressure and Vacuum Sending Switches		
Oil Pressure Gauge Switch		
Ram 2500		
2009-2007	6 Cyl. 6.7L	PS-406
2009-2003	6 Cyl. 5.9L	PS-406
2002	6 Cyl. 5.9L; Diesel	PS-406
2001-1999	6 Cyl. 5.9L	PS-407
1998	6 Cyl. 5.9L	PS-291
Ram 3500		
2010-2007	6 Cyl. 6.7L	PS-406
2007-2004	6 Cyl. 5.9L	PS-406
2002	6 Cyl. 5.9L; Diesel	PS-406
2001-1998	6 Cyl. 5.9L	PS-407
W250		
1989	6 Cyl. 5.9L	PS-233
Oil Pressure Light Switch		
Ram 2500		
2010-2007	6 Cyl. 6.7L	PS-406
2009-2004	6 Cyl. 5.9L	PS-406
Ram 3500		
2010-2007	6 Cyl. 6.7L	PS-406
2007-2004	6 Cyl. 5.9L	PS-406
Ported Vacuum Switch		
D150		
1980	6 Cyl.; 3 Ports; Blue	PVS40
1980	6 Cyl.; 2 Ports; Black Finish	PVS85
Transmission Oil Pressure Switch		
Ram 3500		
2010	w/ 1/4 Inch Pipe Thread	PS679
2010	1/8 Inch x 28 British Standard Pipe Thread	PS690
Ram 4500		
2010-2008	w/ 1/4 Inch Pipe Thread	PS679
2010-2008	1/8 Inch x 28 British Standard Pipe Thread	PS690
Ram 5500		
2010-2008		PS679
Temperature Switches and Senders		
A/C and Heater Blower Motor Switch		
Sprinter 2500		
2006-2004	Rear	DS-2219
2006-2004	w/ Heat Booster; w/o Auto. Temp Control; Front	HS-424
2006-2004	w/ Auto. Temp Control; w/ Heat Booster; Front	HS-482
2006-2004	w/ Auto. Temp Control; w/o Heat Booster; Front	HS570
2003	5 Cyl. 2.7L; Rear	DS-2219

Temperature Switches and Senders

		Part No.
A/C and Heater Blower Motor Switch		
Sprinter 3500		
2006-2004	Rear	DS-2219
2006-2004	w/ Heat Booster; w/o Auto. Temp Control; Front	HS-424
2006-2004	w/ Auto. Temp Control; w/ Heat Booster; Front	HS-482
2006-2004	w/ Auto. Temp Control; w/o Heat Booster; Front	HS570
2003	5 Cyl. 2.7L; Rear	DS-2219
A/C and Heater Selector Switch		
Sprinter 2500		
2006-2003	w/ Heat Booster; w/o Auto. Temp Control	HS-424
2006-2003	w/ Auto. Temp Control; w/ Heat Booster	HS-482
2006-2003	w/ Auto. Temp Control; w/o Heat Booster	HS570
Sprinter 3500		
2006-2003	w/ Heat Booster; w/o Auto. Temp Control	HS-424
2006-2003	w/ Auto. Temp Control; w/ Heat Booster	HS-482
2006-2003	w/ Auto. Temp Control; w/o Heat Booster	HS570
Blower Motor Resistor		
Ram 3500		
2010	w/o Auto. Temp Control	RU-710
2010	w/ Auto. Temp Control	RU932
Ram 4500		
2010-2008		RU-661
Ram 5500		
2010-2008		RU-661
Sprinter 2500		
2009	Front and Rear	RU-778
2006-2003	Front and Rear	RU-686
2004-2003	Front	RU-685
Sprinter 3500		
2009-2007	6 Cyl. 3.0L; Front and Rear	RU-778
2006-2005	5 Cyl. 2.7L; Front and Rear	RU-686
2004-2003	Front	RU-685
2004-2003	Front and Rear	RU-686
HVAC Temperature Control Panel		
Sprinter 2500		
2006-2003	w/ Heat Booster; w/o Auto. Temp Control	HS-424
2006-2003	w/ Auto. Temp Control; w/ Heat Booster	HS-482
2006-2003	w/ Auto. Temp Control; w/o Heat Booster	HS570
Sprinter 3500		
2006-2003	w/ Heat Booster; w/o Auto. Temp Control	HS-424
2006-2003	w/ Auto. Temp Control; w/ Heat Booster	HS-482
2006-2003	w/ Auto. Temp Control; w/o Heat Booster	HS570
Temperature Sender - With Gauge		
Ram 2500		
2003	6 Cyl. 5.9L	TX174
2001-2000	6 Cyl. 5.9L	TX174
Ram 3500		
2003	6 Cyl. 5.9L	TX174
2001-2000	6 Cyl. 5.9L	TX174
Universal Switches		
Center High Mount Stop Light Assembly		
Ram 3500		
2010		BTL123
Fuel Pressure Warning Light Kit		
Ram 2500		
2007-1998	6 Cyl. 5.9L	FPW1
Ram 3500		
2007-1998	6 Cyl. 5.9L	FPW1

		Part No.
Actuators		
Four Wheel Drive Actuator		
Ram 3500		
1996	6 Cyl. 5.9L; 4WD	TCA-27
HVAC Defrost Mode Door Actuator		
Ram 3500		
2010	6 Cyl. 6.7L	ADR4201
Ram 4500		
2010-2008		ADR4201
Ram 5500		
2010-2008		ADR4201
HVAC Recirculation Mode Door Actuator		
Ram 3500		
2010	Front	ADR4209
HVAC Temperature Blend Door Actuator		
Ram 3500		
2010	Front	ADR4209
Power Door Lock Actuator		
Ram 3500		
2010	Crew Cab; Left Rear	DLA1066
2010	Regular Cab; w/o Keyless Entry; Right Front	DLA-630
2010	Regular Cab; w/ Keyless Entry; Right Front	DLA-631
2010	Regular Cab; Left Front	DLA-632
2010	Quad Cab; w/o Keyless Entry; Right Front	DLA-633
2010	Quad Cab; w/ Keyless Entry; Right Front	DLA-634
2010	Quad Cab; Left Front	DLA-635
2010	Quad Cab; Right Rear	DLA-636
2010	Quad Cab; w/ Manual Locks; Left Rear	DLA824
2010	Crew Cab; w/o Keyless Entry; Right Front	DLA987
Ram 4500		
2010-2008	4 Door; Left Rear	DLA824
Ram 5500		
2010-2008	4 Door; Left Rear	DLA824
Sprinter 2500		
2009	Left Front	DLA1434
2009	Right Front	DLA1435
2006-2003	Right Rear	DLA-463
2006-2003	Cargo Compartment	DLA-479
2006-2003	w/o Auto Door Lock; Left Front	DLA-525
2006-2003	w/ Auto. Door Lock; Right Front	DLA-526
2006-2003	w/ Auto. Door Lock; Left Front	DLA-527
2005-2003	w/o Auto Door Lock; Right Front	DLA-523
Sprinter 3500		
2009	Left Front	DLA1434
2009	Right Front	DLA1435
2006-2003	Right Rear	DLA-463
2006-2003	Cargo Compartment	DLA-479
2006-2003	w/o Auto Door Lock; Right Front	DLA-523
2006-2003	w/o Auto Door Lock; Left Front	DLA-525
2006-2003	w/ Auto. Door Lock; Right Front	DLA-526
2006-2003	w/ Auto. Door Lock; Left Front	DLA-527
Throttle Control Actuator		
Ram 2500		
2009	6 Cyl. 5.9L; Transmission Mounted	TH463
2009-2005	6 Cyl. 5.9L	TH463
Ram 3500		
2007-2005	6 Cyl. 5.9L	TH463
Locks		
Ignition Lock Cylinder		
Ram 3500		
2010		US-285L

El Dorado

Pressure and Vacuum Sending Switches

		Part No.
El Dorado		
Pressure and Vacuum Sending Switches		
Oil Pressure Gauge Switch		
Axess		
2017	6 Cyl. 8.9L	PS-407
E-Z Rider II Max		
2017	6 Cyl. 8.9L	PS-407
Fiat		
Temperature Sensors		
Coolant Temperature Sensor		
Ducato		
2008		TX239
Pressure and Vacuum Sending Switches		
Oil Pressure Light Switch		
Ducato		
2014	4 Cyl. 2.3L	PS726
Ford		
Modules		
Fuel Pump Driver Module		
Transit-250		
2019-2016	5 Cyl. 3.2L	FPM120
Transit-350		
2019-2016	5 Cyl. 3.2L	FPM120
Transit-350 HD		
2019-2016	5 Cyl. 3.2L	FPM120
Glow Plug Controller		
E-350 Club Wagon		
2004-2003	8 Cyl. 7.3L	RY467
E-350 Econoline Club Wagon		
2002-2000	8 Cyl. 7.3L	RY467
Excursion		
2005-2003	8 Cyl. 6.0L	RY467
2002-2000	8 Cyl. 7.3L	RY467
F-250 Super Duty		
2017-2011	8 Cyl. 6.7L	RY1869
2010-2008	8 Cyl. 6.4L	RY467
2007-2004	8 Cyl. 6.0L	RY467
2003-1999	8 Cyl. 7.3L; Calif.	RY467
F-350 Super Duty		
2017-2011	8 Cyl. 6.7L	RY1869
2010-2008	8 Cyl. 6.4L	RY467
2007-2004	8 Cyl. 6.0L	RY467
2003-2000	8 Cyl. 7.3L; Calif.; Diesel	RY467
F-450 Super Duty		
2017-2011	8 Cyl. 6.7L	RY1869
2010-2008	8 Cyl. 6.4L	RY467
2007-2004	8 Cyl. 6.0L	RY467
2003-1999	8 Cyl. 7.3L; Calif.	RY467
F-550 Super Duty		
2017-2011	8 Cyl. 6.7L	RY1869
2010-2008	8 Cyl. 6.4L	RY467
2007-2004	8 Cyl. 6.0L	RY467
Relays and Fuses		
A/C Compressor Clutch Cut-Off Relay		
E-350 Club Wagon		
2005-2004	8 Cyl. 6.0L	RY-345
E-350 Super Duty		
2005-2004	8 Cyl. 6.0L	RY-345

		Part No.
A/C Compressor Clutch Cut-Off Relay		
Excursion		
2005-2003	8 Cyl. 6.0L	RY-345
ABS Warning Lamp Relay		
E-350 Club Wagon		
2003	8 Cyl. 7.3L	RY-116
E-350 Econoline		
1998-1997	8 Cyl. 7.3L	RY-116
1994	8 Cyl. 7.3L	RY-116
E-350 Econoline Club Wagon		
2002-1997	8 Cyl. 7.3L	RY-116
1994	8 Cyl. 7.3L	RY-116
E-450 Econoline Super Duty		
2002-2000	8 Cyl. 7.3L	RY-116
E-550 Econoline Super Duty		
2002	8 Cyl. 7.3L	RY-116
Econoline Super Duty		
1999-1997	8 Cyl. 7.3L	RY-116
Accessory Relay		
CF6000		
1990	25 Amp	RL-2
1990	20 Amp	RY-47
CF7000		
1997-1990	w/ 2 Mounting Holes	RL-2
1997-1990	1 Hole Mounting	RY-47
CF8000		
1997-1990	w/ 2 Mounting Holes	RL-2
1997-1990	1 Hole Mounting	RY-47
E-450 Super Duty		
2007-2005	8 Cyl. 6.0L	RY-790
F800		
1999		RY-1772
1996-1992		RY-1772
F-250 Super Duty		
2003	8 Cyl. 6.0L	RY-612
2003-2000	8 Cyl. 7.3L	RY-612
F-350 Super Duty		
2010	8 Cyl. 6.4L	RY-790
2003	8 Cyl. 6.0L	RY-612
2003-2000	8 Cyl. 7.3L	RY-612
F-450 Super Duty		
2010-2008	8 Cyl. 6.4L	RY-790
2007-2005	8 Cyl. 6.0L	RY-790
F-550 Super Duty		
2010-2008	8 Cyl. 6.4L	RY-790
2007-2005	8 Cyl. 6.0L	RY-790
F Super Duty		
1997	8 Cyl. 7.3L; Exhaust stock and reorder; OE No.8956002958	RY30
Air Intake Heater Relay		
F-250 Super Duty		
2003-1999	8 Cyl. 7.3L	RY-698
F-350 Super Duty		
2003-1999	8 Cyl. 7.3L	RY-698
F-450 Super Duty		
2003-2002	8 Cyl. 7.3L	RY-698
2000-1999	8 Cyl. 7.3L	RY-698
F-550 Super Duty		
2003-1999	8 Cyl. 7.3L	RY-698
Blower Motor Relay		
E-450 Econoline Super Duty		
2002-2000	8 Cyl. 7.3L	RY-214

Relays and Fuses

		Part No.
Blower Motor Relay		
E-550 Econoline Super Duty		
2002	8 Cyl. 7.3L	RY-214
F-450 Super Duty		
2001-2000	8 Cyl. 7.3L	RY-116
F-550 Super Duty		
2001-2000	8 Cyl. 7.3L	RY-116
Circuit Breaker		
CF6000		
1990	6 Amp	BR-207
1990	25 Amp	BR-208
1990-1986	30 Amp	BR-230
1989-1986	20 Amp	BR-220
CF7000		
1991-1990	20 Amp	BR-120
1991-1990	6 Amp	BR-207
1991-1990	8 Amp	BR-208
1991-1986	30 Amp	BR-230
1989-1986	20 Amp	BR-220
CF8000		
1991-1990	20 Amp	BR-120
1991-1990	6 Amp	BR-207
1991-1990	8 Amp	BR-208
1991-1987	30 Amp	BR-230
1989-1987	20 Amp	BR-220
LN7000		
1991-1990	6 Amp	BR-207
LN8000		
1991-1990	6 Amp	BR-207
Computer Control Relay		
F-250		
1989-1988	8 Cyl. 7.3L; Diesel	RY-71
F-350		
1989-1988	8 Cyl. 7.3L; Diesel	RY-71
F Super Duty		
1988	8 Cyl. 7.3L; Diesel	RY-71
Coolant Fan Relay		
Escort		
1984	4 Cyl. 2.0L	RY-143
Diesel Glow Plug Indicator Relay		
F-550 Super Duty		
2003-1999	8 Cyl. 7.3L	RY-525
Diesel Glow Plug Relay		
E-250 Econoline Club Wagon		
1991-1990	8 Cyl. 7.3L; Diesel; w/o Wire	RY-175
1991-1990	8 Cyl. 7.3L; w/ Connector	RY-553
1989-1988	8 Cyl. 7.3L; Diesel; Solenoid Only	RY-175
1989-1988	8 Cyl. 7.3L; Complete Assembly; Diesel	RY-316
1987	8 Cyl. 6.9L; Diesel; Solenoid Only	RY-175
1987	8 Cyl. 6.9L; Complete Assembly; Diesel	RY-316
1986-1983	8 Cyl. 6.9L; Diesel	RY-175
E-350 Club Wagon		
2003	8 Cyl. 7.3L	RY-525
E-350 Econoline		
1998-1997	8 Cyl. 7.3L	RY-525
1996-1995	8 Cyl. 7.3L; w/o Connector	RY-525
1996-1990	8 Cyl. 7.3L; w/ Connector	RY-553
1994-1990	8 Cyl. 7.3L; Diesel; w/o Wire	RY-175
1989-1988	8 Cyl. 7.3L; Diesel; Solenoid Only	RY-175
1989-1988	8 Cyl. 7.3L; Complete Assembly; Diesel	RY-316
1987	8 Cyl. 6.9L; Diesel; Solenoid Only	RY-175
1987	8 Cyl. 6.9L; Complete Assembly; Diesel	RY-316
1986-1983	8 Cyl. 6.9L; Diesel	RY-175

		Part No.
Diesel Glow Plug Relay		
E-350 Econoline Club Wagon		
2002-1995	8 Cyl. 7.3L; w/o Connector	RY-525
1996-1990	8 Cyl. 7.3L; w/ Connector	RY-553
1994-1990	8 Cyl. 7.3L; Diesel; w/o Wire	RY-175
1989-1988	8 Cyl. 7.3L; Diesel; Solenoid Only	RY-175
1989-1988	8 Cyl. 7.3L; Complete Assembly; Diesel	RY-316
1987	8 Cyl. 6.9L; Diesel; Solenoid Only	RY-175
1987	8 Cyl. 6.9L; Complete Assembly; Diesel	RY-316
1986-1983	8 Cyl. 6.9L; Diesel	RY-175
E-350 Super Duty		
2003-1999	8 Cyl. 7.3L	RY-525
E-450 Super Duty		
2003	8 Cyl. 7.3L	RY-525
E-550 Econoline Super Duty		
2002	8 Cyl. 7.3L	RY-525
E-550 Super Duty		
2003	8 Cyl. 7.3L	RY-525
Econoline Super Duty		
1999-1997	8 Cyl. 7.3L	RY-525
1996	8 Cyl. 7.3L; w/o Connector	RY-175
1996	8 Cyl. 7.3L; w/ Connector	RY-553
Excursion		
2000	8 Cyl. 7.3L	RY-525
F59		
1994	8 Cyl. 7.3L	RY-525
F650		
2009-2008	6 Cyl. 6.7L	RY1868
2009-2002	6 Cyl. 7.2L	RY1868
2007-2004	8 Cyl. 6.0L	RY1868
2007-2002	6 Cyl. 5.9L	RY1868
2003-2002	8 Cyl. 7.3L	RY1868
F750		
2009-2008	6 Cyl. 6.7L	RY1868
2009-2002	6 Cyl. 7.2L	RY1868
2007-2004	8 Cyl. 6.0L	RY1868
2007-2002	6 Cyl. 5.9L	RY1868
2003-2002	8 Cyl. 7.3L	RY1868
F-150		
1984	8 Cyl. 6.9L; Diesel	RY-175
F-250		
1996-1995	8 Cyl. 7.3L; w/o Connector	RY-525
1996-1995	8 Cyl. 7.3L; w/ Connector	RY-553
1994-1990	8 Cyl. 7.3L; w/ Module	RY-316
1994-1988	8 Cyl. 7.3L; Solenoid Only	RY-175
1989-1988	8 Cyl. 7.3L; Complete Assembly	RY-316
1987	8 Cyl. 6.9L; Solenoid Only	RY-175
1987	8 Cyl. 6.9L; Complete Assembly	RY-316
1986-1983	8 Cyl. 6.9L	RY-175
F-250 HD		
1997	8 Cyl. 7.3L	RY-525
F-250 Super Duty		
2003-1999	8 Cyl. 7.3L	RY-525
F-350		
1997-1995	8 Cyl. 7.3L; w/o Connector	RY-525
1996-1995	8 Cyl. 7.3L; w/ Connector	RY-553
1994	8 Cyl. 7.3L; Naturally Aspirated; w/ Module	RY-316
1993-1990	8 Cyl. 7.3L; Solenoid Only	RY-175
1993-1990	8 Cyl. 7.3L; w/ Module	RY-316
1989-1988	8 Cyl. 7.3L; Diesel; Solenoid Only	RY-175
1989-1988	8 Cyl. 7.3L; Complete Assembly; Diesel	RY-316
1987	8 Cyl. 6.9L; Diesel; Solenoid Only	RY-175
1987	8 Cyl. 6.9L; Complete Assembly; Diesel	RY-316

Ford

Relays and Fuses

		Part No.
Diesel Glow Plug Relay		
F-350		
1986-1983	8 Cyl. 6.9L; Diesel	RY-175
F-350 Super Duty		
2003-1999	8 Cyl. 7.3L	RY-525
F-450 Super Duty		
2003-1999	8 Cyl. 7.3L	RY-525
F-550 Super Duty		
2003-1999	8 Cyl. 7.3L	RY-525
F Super Duty		
1997-1990	8 Cyl. 7.3L; w/o Connector	RY-525
1997-1990	8 Cyl. 7.3L; w/ Connector	RY-553
LCF		
2009-2006	6 Cyl. 4.5L	RY1868
Transit-150		
2019-2015	5 Cyl. 3.2L	RY1854
Transit-250		
2019-2015	5 Cyl. 3.2L	RY1854
Transit-350		
2019-2015	5 Cyl. 3.2L	RY1854
Transit-350 HD		
2019-2015	5 Cyl. 3.2L	RY1854
Dual Battery Solenoid Relay		
E-250 Econoline Club Wagon		
1983	8 Cyl. 6.9L; Diesel; w/ Dual Battery	SS-750
E-350 Econoline		
1990-1988	8 Cyl. 7.3L; Diesel; w/ Dual Battery	SS-750
1987-1983	8 Cyl. 6.9L; Diesel; w/ Dual Battery	SS-750
E-350 Econoline Club Wagon		
1990-1988	8 Cyl. 7.3L; Diesel; w/ Dual Battery	SS-750
1987-1983	8 Cyl. 6.9L; Diesel; w/ Dual Battery	SS-750
Engine Control Relay		
E-350 Econoline		
1996-1993	8 Cyl. 7.3L	RY-116
E-350 Econoline Club Wagon		
1996-1993	8 Cyl. 7.3L	RY-116
Econoline Super Duty		
1996	8 Cyl. 7.3L	RY-116
F-250		
1996-1993	8 Cyl. 7.3L	RY-116
F-350		
1996-1993	8 Cyl. 7.3L	RY-116
Fog Lamp Relay		
F59		
1994-1992	8 Cyl. 7.3L	RY-214
Fuel Injection Relay		
F650		
2003-2000		RY1168
F750		
2003-2000		RY1168
Fuel Pump Relay		
E-350 Econoline		
1987-1986	8 Cyl. 6.9L	RY-610
E-350 Econoline Club Wagon		
1987-1986	8 Cyl. 6.9L	RY-610
E-450 Econoline Super Duty		
2002-2000	8 Cyl. 7.3L	RY-116
E-450 Super Duty		
2004	8 Cyl. 6.0L	RY-116
2003	8 Cyl. 7.3L	RY-116
E-550 Econoline Super Duty		
2002	8 Cyl. 7.3L	RY-116

		Part No.
Fuel Pump Relay		
E-550 Super Duty		
2003	8 Cyl. 7.3L	RY-116
F-250		
1993	8 Cyl. 7.3L	RY-70
1992-1990	8 Cyl. 7.3L	RY-71
F-450 Super Duty		
2004-2003	8 Cyl. 6.0L	RY-612
2003-2000	8 Cyl. 7.3L	RY-612
F-550 Super Duty		
2004-2003	8 Cyl. 6.0L	RY-612
2003-2000	8 Cyl. 7.3L	RY-612
Hazard Flasher		
F650		
2009-2000		EFL-4
F750		
2009-2000		EFL-4
F800		
1999		EFL-4
Headlight Dimmer Switch Relay		
E-250 Econoline Club Wagon		
1991	8 Cyl. 7.3L	RY-70
1989-1988	8 Cyl. 7.3L	RY-70
1987-1983	8 Cyl. 6.9L	RY-70
E-350 Econoline		
1992-1991	8 Cyl. 7.3L	RY-70
1989-1988	8 Cyl. 7.3L	RY-70
1987-1983	8 Cyl. 6.9L	RY-70
E-350 Econoline Club Wagon		
1992-1991	8 Cyl. 7.3L	RY-70
1989-1988	8 Cyl. 7.3L	RY-70
1987-1983	8 Cyl. 6.9L	RY-70
Escort		
1985-1984	4 Cyl. 2.0L	RY-70
F-150		
1984	8 Cyl. 6.9L	RY-70
F-250		
1992-1988	8 Cyl. 7.3L	RY-70
1987-1983	8 Cyl. 6.9L	RY-70
F-350		
1992-1988	8 Cyl. 7.3L	RY-70
1987-1983	8 Cyl. 6.9L	RY-70
Ranger		
1987-1985	4 Cyl. 2.3L	RY-70
1984-1983	4 Cyl. 2.2L	RY-70
Tempo		
1986	4 Cyl. 2.0L	RY-70
Horn Relay		
CF6000		
1989-1986		HR-127
CF7000		
1989-1986		HR-127
CF8000		
1989-1987		HR-127
E-450 Econoline Super Duty		
2002-2000	8 Cyl. 7.3L	RY-214
E-550 Econoline Super Duty		
2002	8 Cyl. 7.3L	RY-214
Econoline Super Duty		
1999-1996	8 Cyl. 7.3L	RY-214

Relays and Fuses

		Part No.
Ignition Relay		
E-350 Econoline		
1984-1983	8 Cyl. 6.9L	RY-71
E-350 Econoline Club Wagon		
1984-1983	8 Cyl. 6.9L	RY-71
Escort		
1984	4 Cyl. 2.0L	RY-71
F-150		
1984	8 Cyl. 6.9L	RY-71
F-250		
1984-1983	8 Cyl. 6.9L	RY-71
F-350		
1984-1983	8 Cyl. 6.9L	RY-71
Load Leveling Relay		
Ranger		
1986	4 Cyl. 2.3L	RY-194
Neutral Safety Switch Relay		
Escort		
1987-1984	4 Cyl. 2.0L; Alternate Number	RY-116
1987-1984	4 Cyl. 2.0L; Exhaust stock and reorder	RY30
Tempo		
1986-1984	4 Cyl. 2.0L; Alternate Number	RY-116
1986-1984	4 Cyl. 2.0L; Exhaust stock and reorder	RY30
Oil Level Indicator Relay		
Ranger		
1987-1986	4 Cyl. 2.3L	RY453
Power Door Lock Relay		
F-450 Super Duty		
2004-2003	8 Cyl. 6.0L	RY-612
2003-1999	8 Cyl. 7.3L	RY-612
F-550 Super Duty		
2004-2003	8 Cyl. 6.0L	RY-612
2003-1999	8 Cyl. 7.3L	RY-612
Power Window Relay		
F-250 Super Duty		
2004	8 Cyl.	RY-612
2003	8 Cyl. 6.0L	RY-612
2003-2002	8 Cyl. 7.3L	RY-612
F-350 Super Duty		
2004	8 Cyl.	RY-612
2003	8 Cyl. 6.0L	RY-612
2003-2002	8 Cyl. 7.3L	RY-612
Powertrain Control Module Relay		
E-350 Econoline Club Wagon		
2002	8 Cyl. 7.3L; Alternate Number	RY-116
2002	8 Cyl. 7.3L; Exhaust stock and reorder	RY30
E-450 Econoline Super Duty		
2002	8 Cyl. 7.3L; Alternate Number	RY-116
2002	8 Cyl. 7.3L; Exhaust stock and reorder	RY30
Excursion		
2002-2000	8 Cyl. 7.3L; Alternate Number	RY-116
2002-2000	8 Cyl. 7.3L; Exhaust stock and reorder	RY30
F-250 Super Duty		
2003	8 Cyl. 6.0L; Alternate Number	RY-116
2003	8 Cyl. 6.0L; Exhaust stock and reorder	RY30
2003-2002	8 Cyl. 7.3L; Alternate Number	RY-116
2003-2002	8 Cyl. 7.3L; Exhaust stock and reorder	RY30
F-350 Super Duty		
2003	8 Cyl. 6.0L; Alternate Number	RY-116
2003	8 Cyl. 6.0L; Exhaust stock and reorder	RY30
2003-2002	8 Cyl. 7.3L; Alternate Number	RY-116
2003-2002	8 Cyl. 7.3L; Exhaust stock and reorder	RY30

		Part No.
Powertrain Control Module Relay		
F-450 Super Duty		
2003	8 Cyl. 6.0L; Alternate Number	RY-116
2003	8 Cyl. 6.0L; Exhaust stock and reorder	RY30
2003-2002	8 Cyl. 7.3L; Alternate Number	RY-116
2003-2002	8 Cyl. 7.3L; Exhaust stock and reorder	RY30
F-550 Super Duty		
2003	8 Cyl. 6.0L; Alternate Number	RY-116
2003	8 Cyl. 6.0L; Exhaust stock and reorder	RY30
2003-2002	8 Cyl. 7.3L; Alternate Number	RY-116
2003-2002	8 Cyl. 7.3L; Exhaust stock and reorder	RY30
Starter Relay		
F59		
1994-1992		RY-116
Theft Deterrent Relay		
Escort		
1984	4 Cyl. 2.0L	RY-69
F-450 Super Duty		
2001-1999	8 Cyl. 7.3L; Alternate Number	RY-116
2001-1999	8 Cyl. 7.3L; Exhaust stock and reorder	RY30
F-550 Super Duty		
2001-1999	8 Cyl. 7.3L; Alternate Number	RY-116
2001-1999	8 Cyl. 7.3L; Exhaust stock and reorder	RY30
Trailer Towing Package Relay		
E-450 Econoline Super Duty		
2002-2000	8 Cyl. 7.3L	RY-214
E-550 Econoline Super Duty		
2002	8 Cyl. 7.3L	RY-214
F59		
1994-1992	Alternate Number	RY-116
1994-1992	Exhaust stock and reorder	RY30
F-350 Super Duty		
2004-2003	8 Cyl. 6.0L	RY-116
2001-1999	8 Cyl. 7.3L	RY-116
F-450 Super Duty		
2004-2003	8 Cyl. 6.0L	RY-116
2003-1999	8 Cyl. 7.3L	RY-116
F-550 Super Duty		
2004-2003	8 Cyl. 6.0L	RY-116
2003-1999	8 Cyl. 7.3L	RY-116
Turn Signal Flasher		
E-350 Econoline		
1994-1993	8 Cyl. 7.3L	EFL-8
E-350 Econoline Club Wagon		
1994-1993	8 Cyl. 7.3L	EFL-8
F59		
1994		EFL-8
F-250		
1996-1994	8 Cyl. 7.3L	EFL-8
F-350		
1996-1994	8 Cyl. 7.3L	EFL-8
Starting and Charging System Parts		
Starter Solenoid		
CF6000		
1990	6 Cyl. 6.6L	SS-598
1989-1986	w/ Fender Mounted Solenoid	SS-581
CF7000		
1993	6 Cyl. 5.9L	SS-598
1992-1990	6 Cyl. 6.6L	SS-598
1989-1986	w/ Fender Mounted Solenoid	SS-581
CF8000		
1992-1990	6 Cyl. 7.8L	SS-598

Starting and Charging System Parts

		Part No.
Starter Solenoid		
CF8000		
1989-1987	w/ Fender Mounted Solenoid	SS-581
E-250 Econoline Club Wagon		
1991-1990	8 Cyl. 7.3L; Exhaust stock and reorder; Gold; Mitsubishi; Starter Mounted	SS-331
1991-1990	8 Cyl. 7.3L; Mitsubishi; Fender Mounted	SS-598
1991-1990	8 Cyl. 7.3L; Alternate Number; Mitsubishi; Silver; Starter Mounted	SS-762
1987-1986	8 Cyl. 6.9L	SS-588
1985	8 Cyl. 6.9L; Diesel; Starter Mounted	SS-331
1984-1983	8 Cyl. 6.9L; Starter Mounted	SS-251
1984-1983	8 Cyl. 6.9L; Fender Mounted	SS-598
E-350 Econoline		
1998-1997	8 Cyl. 7.3L; Mitsubishi; Fender Mounted	SS-613
1998-1992	8 Cyl. 7.3L; Exhaust stock and reorder; Gold; Mitsubishi; Starter Mounted	SS-331
1998-1992	8 Cyl. 7.3L; Alternate Number; Mitsubishi; Silver; Starter Mounted	SS-762
1996-1992	8 Cyl. 7.3L; Mitsubishi; Fender Mounted	SS-598
1991	8 Cyl. 7.3L; Diesel; Exhaust stock and reorder; Gold; Mitsubishi; Starter Mounted	SS-331
1991	8 Cyl. 7.3L; Diesel; Mitsubishi; Fender Mounted	SS-598
1991	8 Cyl. 7.3L; Alternate Number; Diesel; Mitsubishi; Silver; Starter Mounted	SS-762
1990	8 Cyl. 7.3L; Exhaust stock and reorder; Gold; Mitsubishi; Starter Mounted	SS-331
1990	8 Cyl. 7.3L; Mitsubishi; Fender Mounted	SS-598
1990	8 Cyl. 7.3L; Alternate Number; Mitsubishi; Silver; Starter Mounted	SS-762
1987-1986	8 Cyl. 6.9L	SS-588
1985	8 Cyl. 6.9L; Diesel; Exhaust stock and reorder; Gold; Starter Mounted	SS-331
1985	8 Cyl. 6.9L; Alternate Number; Diesel; Silver; Starter Mounted	SS-762
1984	8 Cyl. 6.9L; Starter Mounted	SS-251
1984	8 Cyl. 6.9L; Fender Mounted	SS-598
1983	8 Cyl. 6.9L; Diesel; Starter Mounted	SS-251
1983	8 Cyl. 6.9L; Diesel; Fender Mounted	SS-598
E-350 Econoline Club Wagon		
2001	8 Cyl. 7.3L; Diesel; Exhaust stock and reorder; Gold; Mitsubishi; Starter Mounted	SS-331
2001	8 Cyl. 7.3L; Alternate Number; Diesel; Mitsubishi; Silver; Starter Mounted	SS-762
2001	8 Cyl. 7.3L; Diesel; Mitsubishi; Fender Mounted	SS-613
2000	8 Cyl. 7.3L; Fender Mounted	SS-613
1999	8 Cyl. 7.3L; Diesel; Exhaust stock and reorder; Gold; Mitsubishi; Starter Mounted	SS-331
1999	8 Cyl. 7.3L; Alternate Number; Diesel; Mitsubishi; Silver; Starter Mounted	SS-762
1999	8 Cyl. 7.3L; Diesel; Mitsubishi; Fender Mounted	SS-613
1998-1997	8 Cyl. 7.3L; Mitsubishi; Fender Mounted	SS-613
1998-1993	8 Cyl. 7.3L; Exhaust stock and reorder; Gold; Mitsubishi; Starter Mounted	SS-331
1998-1993	8 Cyl. 7.3L; Alternate Number; Mitsubishi; Silver; Starter Mounted	SS-762
1996-1993	8 Cyl. 7.3L; Mitsubishi; Fender Mounted	SS-598
1992-1990	8 Cyl. 7.3L; Diesel; Exhaust stock and reorder; Gold; Mitsubishi; Starter Mounted	SS-331
1992-1990	8 Cyl. 7.3L; Diesel; Mitsubishi; Fender Mounted	SS-598

		Part No.
Starter Solenoid		
E-350 Econoline Club Wagon		
1992-1990	8 Cyl. 7.3L; Alternate Number; Diesel; Mitsubishi; Silver; Starter Mounted	SS-762
1987-1986	8 Cyl. 6.9L; Diesel	SS-588
1985	8 Cyl. 6.9L; Diesel; Exhaust stock and reorder; Gold; Starter Mounted	SS-331
1985	8 Cyl. 6.9L; Alternate Number; Diesel; Silver; Starter Mounted	SS-762
1984-1983	8 Cyl. 6.9L; Diesel; Starter Mounted	SS-251
1984-1983	8 Cyl. 6.9L; Diesel; Fender Mounted	SS-598
E-450 Econoline Super Duty		
2001-2000	8 Cyl. 7.3L; Exhaust stock and reorder; Gold; Starter Mounted	SS-331
2001-2000	8 Cyl. 7.3L; Alternate Number; Silver; Starter Mounted	SS-762
Econoline Super Duty		
1999-1996	8 Cyl. 7.3L; Exhaust stock and reorder; Gold; Starter Mounted	SS-331
1999-1996	8 Cyl. 7.3L; Alternate Number; Silver; Starter Mounted	SS-762
Escort		
1987-1984	4 Cyl. 2.0L; Starter Mounted	SS343
1987-1984	4 Cyl. 2.0L; Fender Mounted	SS-598
Excursion		
2001-2000	8 Cyl. 7.3L; Exhaust stock and reorder; Gold; Starter Mounted	SS-331
2001-2000	8 Cyl. 7.3L; Fender Mounted	SS-598
2001-2000	8 Cyl. 7.3L; Alternate Number; Silver; Starter Mounted	SS-762
F59		
1995-1994		SS-762
1993-1992		SS-598
1991-1990		SS-613
1989		SS-598
F800		
1999-1993	6 Cyl. 5.9L	SS-598
1992-1990	6 Cyl. 7.8L	SS-598
F-150		
1984	8 Cyl. 6.9L; Diesel; Starter Mounted	SS-251
1984	8 Cyl. 6.9L; Diesel; Fender Mounted	SS-598
F-250		
1991-1990	8 Cyl. 7.3L; Exhaust stock and reorder; Gold; Starter Mounted	SS-331
1991-1990	8 Cyl. 7.3L; Fender Mounted	SS-613
1991-1990	8 Cyl. 7.3L; Alternate Number; Silver; Starter Mounted	SS-762
1988	8 Cyl. 7.3L; 3 Term.	SS-598
1988	8 Cyl. 7.3L; 4 Term.	SS-613
1987-1986	8 Cyl. 6.9L; Exhaust stock and reorder; Gold; Starter Mounted	SS-331
1987-1986	8 Cyl. 6.9L; Fender Mounted	SS-588
1987-1986	8 Cyl. 6.9L; Alternate Number; Silver; Starter Mounted	SS-762
1985	8 Cyl. 6.9L; Mitsubishi Starter	SS-588
1984	8 Cyl. 6.9L; Starter Mounted	SS-251
1984	8 Cyl. 6.9L; Fender Mounted	SS-598
1983	8 Cyl. 6.9L; Delco Starter; Starter Mounted	SS-251
1983	8 Cyl. 6.9L; Delco Starter; Fender Mounted	SS-598
F-250 HD		
1997	8 Cyl. 7.3L; Fender Mounted	SS-598
1997	8 Cyl. 7.3L; Starter Mounted	SS-762
F-250 Super Duty		
2001-1999	8 Cyl. 7.3L; Fender Mounted	SS-598
2000-1999	8 Cyl. 7.3L; Starter Mounted	SS-762

Starting and Charging System Parts

		Part No.
Starter Solenoid		
F-350		
1997	8 Cyl. 7.3L; Fender Mounted	SS-598
1997	8 Cyl. 7.3L; Starter Mounted	SS-762
1991-1990	8 Cyl. 7.3L; Exhaust stock and reorder; Gold; Starter Mounted	SS-331
1991-1990	8 Cyl. 7.3L; Alternate Number; Silver; Starter Mounted	SS-762
1991-1990	8 Cyl. 7.3L; Fender Mounted	SS-613
1988	8 Cyl. 7.3L; Exhaust stock and reorder; Gold; Starter Mounted	SS-331
1988	8 Cyl. 7.3L; Alternate Number; Silver; Starter Mounted	SS-762
1987-1986	8 Cyl. 6.9L; Exhaust stock and reorder; Gold; Starter Mounted	SS-331
1987-1986	8 Cyl. 6.9L; Fender Mounted	SS-588
1987-1986	8 Cyl. 6.9L; Alternate Number; Silver; Starter Mounted	SS-762
1985	8 Cyl. 6.9L; Mitsubishi Starter	SS-588
1984	8 Cyl. 6.9L; Starter Mounted	SS-251
1984	8 Cyl. 6.9L; Fender Mounted	SS-598
1983	8 Cyl. 6.9L; Delco Starter; Starter Mounted	SS-251
1983	8 Cyl. 6.9L; Delco Starter; Fender Mounted	SS-598
F-350 Super Duty		
2001-1999	8 Cyl. 7.3L; Fender Mounted	SS-598
2000-1999	8 Cyl. 7.3L; Starter Mounted	SS-762
F-450 Super Duty		
2000-1999	8 Cyl. 7.3L	SS-762
F-550 Super Duty		
2003-1999	8 Cyl. 7.3L; Fender Mounted	SS-598
F Super Duty		
1995	8 Cyl. 7.3L; Exhaust stock and reorder; Gold; Starter Mounted	SS-331
1995	8 Cyl. 7.3L; Alternate Number; Silver; Starter Mounted	SS-762
1995	8 Cyl. 7.3L; Fender Mounted	SS-598
1991-1990	8 Cyl. 7.3L; Exhaust stock and reorder; Gold; Starter Mounted	SS-331
1991-1990	8 Cyl. 7.3L; Fender Mounted	SS-613
1991-1990	8 Cyl. 7.3L; Alternate Number; Silver; Starter Mounted	SS-762
Ranger		
1987	4 Cyl. 2.3L; Diesel; Starter Mounted	SS-369
1987	4 Cyl. 2.3L; Diesel; Fender Mounted	SS-598
1986-1985	4 Cyl. 2.3L; Starter Mounted	SS-369
1986-1985	4 Cyl. 2.3L; Fender Mounted	SS-598
1984-1983	4 Cyl. 2.2L; Starter Mounted	SS-279
1984-1983	4 Cyl. 2.2L; Fender Mounted	SS619
Tempo		
1984	4 Cyl. 2.0L; Starter Mounted	SS343
1984	4 Cyl. 2.0L; Fender Mounted	SS-598
Voltage Regulator		
B7000		
1987-1983	Internal	VR-144
1987-1983	External	VR-166
C7000		
1986-1980	Internal	VR-144
1986-1980	External	VR-166
C8000		
1989-1980	w/ External Regulator	VR-166
CF6000		
1990	90 Amp Alternator; Leece Neville Alternator	VR-166

		Part No.
Voltage Regulator		
CF6000		
1990-1986	Delco Alternator; w/ 90, 100, 105, 115 Amp Alternator	VR-144
1989-1986	75 or 90 Amp; Motorcraft Alternator; w/ External Regulator	VR-166
CF7000		
1992-1986	Delco; w/ 90, 100, 105, 115 Amp Alternator	VR-144
1991-1990	90 Amp; Leece Neville; w/ External Regulator	VR-166
1989-1986	70 Amp; 75 or 90 Amp; Motorcraft; w/ External Regulator	VR-166
CF8000		
1992-1987	Delco; w/ 90, 100, 105, 115 Amp Alternator	VR-144
1991-1990	90 Amp; Leece Neville; w/ External Regulator	VR-166
1989-1987	70 Amp; 75 or 90 Amp; Motorcraft; w/ External Regulator	VR-166
E-450 Econoline Super Duty		
2002	8 Cyl. 7.3L	VR-455
E-450 Super Duty		
2003	8 Cyl. 7.3L; 95, 130 Amp; Diesel	VR-455
E-550 Econoline Super Duty		
2002	8 Cyl. 7.3L; 95, 130 Amp	VR-455
E-550 Super Duty		
2003	8 Cyl. 7.3L; 95, 130 Amp	VR-455
F59		
1992-1988	8 Cyl. 7.3L	VR-166
F600		
1994	6 Cyl. 5.9L	VR-432
F650		
2003	8 Cyl. 7.3L; 165 Amp	VR-432
2003	8 Cyl. 7.3L; 130 Amp	VR-455
2002-2000	8 Cyl.; 165 Amp	VR-432
2002-2000	8 Cyl.; 130 Amp	VR-455
F750		
2003	8 Cyl. 7.3L; 165 Amp	VR-432
2003	8 Cyl. 7.3L; 130 Amp	VR-455
2002-2000	8 Cyl.; 165 Amp	VR-432
2002-2000	8 Cyl.; 130 Amp	VR-455
F7000		
1986-1983	Internal	VR-144
1986-1983	External	VR-166
F8000		
1987-1983	Internal	VR-144
1987-1983	External	VR-166
F-250 Super Duty		
2003	8 Cyl. 6.0L; 130 Amp; Diesel	VR-455
2003-1999	8 Cyl. 7.3L; 165 Amp; Diesel	VR-432
2003-1999	8 Cyl. 7.3L; 130 Amp; Diesel	VR-455
F-350 Super Duty		
2003	8 Cyl. 6.0L; 130 Amp; Diesel	VR-455
2003-1999	8 Cyl. 7.3L; 165 Amp; Diesel	VR-432
2003-1999	8 Cyl. 7.3L; 130 Amp; Diesel	VR-455
F-450 Super Duty		
2003	8 Cyl. 6.0L; 130 Amp; Diesel	VR-455
2003-1999	8 Cyl. 7.3L; 165 Amp	VR-432
2003-1999	8 Cyl. 7.3L; 130 Amp	VR-455
F-550 Super Duty		
2003	8 Cyl. 6.0L; 130 Amp	VR-455
2003-1999	8 Cyl. 7.3L; 165 Amp	VR-432
2003-1999	8 Cyl. 7.3L; 130 Amp	VR-455

Starting and Charging System Parts

		Part No.
Voltage Regulator		
LN7000		
1991-1981	Internal	VR-144
1991-1981	External	VR-166
LN8000		
1991-1990	Internal	VR-144
1991-1990	External	VR-166
1989-1988	6 Cyl. 7.8L; Internal	VR-144
1989-1988	6 Cyl. 7.8L; External	VR-166
1987-1986	Internal	VR-144
1987-1986	External	VR-166
1981	Internal	VR-144
1981	External	VR-166
Tempo		
1985-1984	4 Cyl. 2.0L; External	VR-166
Air Filters		
Air Filter Indicator		
F-250 Super Duty		
2007-2005	8 Cyl. 6.0L	AFI100
F-350 Super Duty		
2007-2005	8 Cyl. 6.0L	AFI100
F-450 Super Duty		
2007-2005	8 Cyl. 6.0L	AFI100
F-550 Super Duty		
2007-2005	8 Cyl. 6.0L	AFI100
Air Injection and Induction Parts		
Charge Air Cooler		
F-250 Super Duty		
2016-2011	8 Cyl. 6.7L	CAC1
F-350 Super Duty		
2016-2011	8 Cyl. 6.7L	CAC1
F-450 Super Duty		
2016-2011	8 Cyl. 6.7L	CAC1
F-550 Super Duty		
2016-2011	8 Cyl. 6.7L	CAC1
Electronic Throttle Body (ETB) Gasket		
F-250 Super Duty		
2010-2008	8 Cyl. 6.4L	TBG127
F-350 Super Duty		
2010-2008	8 Cyl. 6.4L	TBG127
Fuel Injection Throttle Body		
F-250 Super Duty		
2017-2011	8 Cyl. 6.7L; Diesel	S20142
2010-2008	8 Cyl. 6.4L	S20225
F-350 Super Duty		
2019-2011	8 Cyl. 6.7L; Diesel	S20142
2010-2008	8 Cyl. 6.4L	S20225
F-450 Super Duty		
2019-2011	8 Cyl. 6.7L; Diesel	S20142
F-550 Super Duty		
2019-2011	8 Cyl. 6.7L; Diesel	S20142
Turbocharger - New		
E-350 Club Wagon		
2005	8 Cyl. 6.0L; Turbocharged	TBC-523
2004	8 Cyl. 6.0L; Turbocharged	TBC524
E-350 Super Duty		
2010-2005	8 Cyl. 6.0L; Turbocharged	TBC-523
2004	8 Cyl. 6.0L; Turbocharged	TBC524
E-450 Super Duty		
2010-2005	8 Cyl. 6.0L; Turbocharged	TBC-523
2004	8 Cyl. 6.0L; Turbocharged	TBC524

		Part No.
Turbocharger - New		
Excursion		
2005	8 Cyl. 6.0L; From 2/05; Turbocharged	TBC-523
2005	8 Cyl. 6.0L; To 1/05; Turbocharged	TBC524
2004	8 Cyl. 6.0L; To 9/03; Turbocharged	TBC522
2004	8 Cyl. 6.0L; From 10/03; Turbocharged	TBC524
2003	8 Cyl. 6.0L; Turbocharged	TBC522
2003-2000	8 Cyl. 7.3L; Turbocharged	TBC702
F650		
2007-2005	8 Cyl.; Turbocharged	TBC593
2004	8 Cyl. 6.0L; Turbocharged	TBC594
F750		
2007-2005	8 Cyl.; Turbocharged	TBC593
2004	8 Cyl. 6.0L; Turbocharged	TBC594
F-250 Super Duty		
2010-2008	8 Cyl. 6.4L; Low Pressure; Turbocharged	TBC693
2010-2008	8 Cyl. 6.4L; Turbocharged; w/ High and Low Pressure	TBC698
2010-2008	8 Cyl. 6.4L; High Pressure; Turbocharged; w/o Actuator	TBC701
2007-2006	8 Cyl. 6.0L; Turbocharged	TBC-523
2005	8 Cyl. 6.0L; From 11/4/04; Turbocharged	TBC-523
2005	8 Cyl. 6.0L; To 11/3/04; Turbocharged	TBC524
2004	8 Cyl. 6.0L; To 9/03; Turbocharged	TBC522
2004	8 Cyl. 6.0L; From 10/03; Turbocharged	TBC524
2003	8 Cyl. 6.0L; Turbocharged	TBC522
2003-2000	8 Cyl. 7.3L; Turbocharged	TBC702
1999	8 Cyl. 7.3L; From Engine No. 896813; Turbocharged; w/ EBP Actuator	TBC702
F-350 Super Duty		
2010-2008	8 Cyl. 6.4L; Low Pressure; Turbocharged	TBC693
2010-2008	8 Cyl. 6.4L; Turbocharged; w/ High and Low Pressure	TBC698
2010-2008	8 Cyl. 6.4L; High Pressure; Turbocharged; w/o Actuator	TBC701
2007-2006	8 Cyl. 6.0L; Turbocharged	TBC-523
2005	8 Cyl. 6.0L; From 11/4/04; Turbocharged	TBC-523
2005	8 Cyl. 6.0L; To 11/3/04; Turbocharged	TBC524
2004	8 Cyl. 6.0L; To 9/03; Turbocharged	TBC522
2004	8 Cyl. 6.0L; From 10/03; Turbocharged	TBC524
2003	8 Cyl. 6.0L; Turbocharged	TBC522
2003-2000	8 Cyl. 7.3L; Turbocharged	TBC702
1999	8 Cyl. 7.3L; From Engine No. 896813; Turbocharged; w/ EBP Actuator	TBC702
F-450 Super Duty		
2010-2008	8 Cyl. 6.4L; Low Pressure; Turbocharged	TBC693
2010-2008	8 Cyl. 6.4L; Turbocharged; w/ High and Low Pressure	TBC698
2010-2008	8 Cyl. 6.4L; High Pressure; Turbocharged; w/o Actuator	TBC701
2007-2006	8 Cyl. 6.0L; Turbocharged	TBC-523
2005	8 Cyl. 6.0L; From 11/4/04; Turbocharged	TBC-523
2005	8 Cyl. 6.0L; To 11/3/04; Turbocharged	TBC524
2004	8 Cyl. 6.0L; To 9/03; Turbocharged	TBC522
2004	8 Cyl. 6.0L; From 10/03; Turbocharged	TBC524
2003	8 Cyl. 6.0L; Turbocharged	TBC522
2003-2000	8 Cyl. 7.3L; Turbocharged	TBC702
1999	8 Cyl. 7.3L; From Engine No. 896813; Turbocharged; w/ EBP Actuator	TBC702
F-550 Super Duty		
2010-2008	8 Cyl. 6.4L; Low Pressure; Turbocharged	TBC693
2010-2008	8 Cyl. 6.4L; Turbocharged; w/ High and Low Pressure	TBC698
2010-2008	8 Cyl. 6.4L; High Pressure; Turbocharged; w/o Actuator	TBC701
2007-2006	8 Cyl. 6.0L; Turbocharged	TBC-523

Air Injection and Induction Parts

		Part No.
Turbocharger - New		
F-550 Super Duty		
2005	8 Cyl. 6.0L; From 11/4/04; Turbocharged	TBC-523
2005	8 Cyl. 6.0L; To 11/3/04; Turbocharged	TBC524
2004	8 Cyl. 6.0L; To 9/03; Turbocharged	TBC522
2004	8 Cyl. 6.0L; From 10/03; Turbocharged	TBC524
2003	8 Cyl. 6.0L; Turbocharged	TBC522
2003-2000	8 Cyl. 7.3L; Turbocharged	TBC702
1999	8 Cyl. 7.3L; From Engine No. 896813; Turbocharged; w/ EBP Actuator	TBC702
Turbocharger - Remfd		
E-350 Club Wagon		
2005	8 Cyl. 6.0L; Turbocharged; w/o Drain Tube	TBC-512
2005	8 Cyl. 6.0L; Turbocharged; w/ Drain Tube	TRB225RK
2004	8 Cyl. 6.0L; Turbocharged	TBC-514
2003	8 Cyl. 7.3L; Turbocharged	TBC-515
E-350 Econoline		
1998	8 Cyl. 7.3L; From Engine No. 661974; Turbocharged	TBC548
1998	8 Cyl. 7.3L; To Engine No. 661973; Turbocharged	TBC566
1997-1996	Turbocharged	TBC566
1995	8 Cyl. 7.3L; Turbocharged	TBC566
E-350 Econoline Club Wagon		
2002-2000	Turbocharged	TBC-515
1999	8 Cyl. 7.3L; From Engine No. 896812; Turbocharged	TBC-515
1999	8 Cyl. 7.3L; To Engine No. 896811; Turbocharged	TBC548
1998	8 Cyl. 7.3L; From Engine No. 661974; Turbocharged	TBC548
1998	8 Cyl. 7.3L; To Engine No. 661973; Turbocharged	TBC566
1997-1996	Turbocharged	TBC566
1995	8 Cyl. 7.3L; Turbocharged	TBC566
E-350 Super Duty		
2010-2005	8 Cyl. 6.0L; Turbocharged; w/o Drain Tube	TBC-512
2010-2005	8 Cyl. 6.0L; Turbocharged; w/ Drain Tube	TRB225RK
2004	8 Cyl. 6.0L; Turbocharged	TBC-514
2003-1999	8 Cyl. 7.3L; Turbocharged	TBC-515
E-450 Econoline Super Duty		
2002-2000	8 Cyl. 7.3L; Turbocharged	TBC-515
E-450 Super Duty		
2010-2005	8 Cyl. 6.0L; Turbocharged; w/o Drain Tube	TBC-512
2010-2005	8 Cyl. 6.0L; Turbocharged; w/ Drain Tube	TRB225RK
2004	8 Cyl. 6.0L; Turbocharged	TBC-514
2003	8 Cyl. 7.3L; Turbocharged	TBC-515
E-550 Econoline Super Duty		
2002	8 Cyl. 7.3L; Turbocharged	TBC-515
E-550 Super Duty		
2003	8 Cyl. 7.3L; Turbocharged	TBC-515
Econoline Super Duty		
1999-1998	8 Cyl. 7.3L; From Engine No. 661974; Turbocharged	TBC548
1998	8 Cyl. 7.3L; To Engine No. 661973; Turbocharged	TBC566
1997-1996	Turbocharged	TBC566
Excursion		
2005	8 Cyl. 6.0L; From 2/05; Turbocharged; w/o Drain Tube	TBC-512
2005	8 Cyl. 6.0L; To 1/05; Turbocharged	TBC-514
2005	8 Cyl. 6.0L; From 2/05; Turbocharged; w/ Drain Tube	TRB225RK

		Part No.
Turbocharger - Remfd		
Excursion		
2004	8 Cyl. 6.0L; To 9/03; Turbocharged	TBC-511
2004	8 Cyl. 6.0L; From 10/03; Turbocharged	TBC-514
2003	8 Cyl. 6.0L; Turbocharged	TBC-511
2003-2000	8 Cyl. 7.3L; Turbocharged	TBC-513
F650		
2003	8 Cyl. 7.3L; Turbocharged	TBC592
2002-2000	8 Cyl.; Turbocharged	TBC592
F750		
2003	8 Cyl. 7.3L; Turbocharged	TBC592
2002-2000	8 Cyl.; Turbocharged	TBC592
F-250		
1996-1995	Turbocharged	TBC566
1994	8 Cyl. 7.3L; F; Turbocharged	TBC566
1994	8 Cyl. 7.3L; K; Turbocharged	TBC535
1993	8 Cyl. 7.3L; Turbocharged	TBC535
F-250 Super Duty		
2010-2008	8 Cyl. 6.4L; Low Pressure; Turbocharged	TBC559
2010-2008	8 Cyl. 6.4L; Turbocharged; w/ Actuator; w/ High and Low Pressure	TBC576
2010-2008	8 Cyl. 6.4L; High Pressure; Turbocharged; w/ Actuator	TBC664
2010-2008	8 Cyl. 6.4L; High Pressure; Turbocharged; w/o Actuator	TBC665
2010-2008	8 Cyl. 6.4L; Turbocharged; w/ High and Low Pressure; w/o Actuator	TBC666
2007-2006	8 Cyl. 6.0L; Turbocharged; w/o Drain Tube	TBC-512
2007-2006	8 Cyl. 6.0L; Turbocharged; w/ Drain Tube	TRB225RK
2005	8 Cyl. 6.0L; From 11/4/04; Turbocharged; w/o Drain Tube	TBC-512
2005	8 Cyl. 6.0L; To 11/3/04; Turbocharged	TBC-514
2005	8 Cyl. 6.0L; From 11/4/04; Turbocharged; w/ Drain Tube	TRB225RK
2004	8 Cyl. 6.0L; To 9/03; Turbocharged	TBC-511
2004	8 Cyl. 6.0L; From 10/03; Turbocharged	TBC-514
2003	8 Cyl. 6.0L; Turbocharged	TBC-511
2003-2000	8 Cyl. 7.3L; Turbocharged	TBC-513
1999	8 Cyl. 7.3L; From Engine No. 896813; Turbocharged	TBC-513
1999	8 Cyl. 7.3L; To Engine No. 896812; Turbocharged	TBC549
F-350		
1997-1995	Turbocharged	TBC566
1994	8 Cyl. 7.3L; F; Turbocharged	TBC566
1994	8 Cyl. 7.3L; K; Turbocharged	TBC535
1993	8 Cyl. 7.3L; Turbocharged	TBC535
F-350 Super Duty		
2010-2008	8 Cyl. 6.4L; Low Pressure; Turbocharged	TBC559
2010-2008	8 Cyl. 6.4L; Turbocharged; w/ Actuator; w/ High and Low Pressure	TBC576
2010-2008	8 Cyl. 6.4L; High Pressure; Turbocharged; w/ Actuator	TBC664
2010-2008	8 Cyl. 6.4L; High Pressure; Turbocharged; w/o Actuator	TBC665
2010-2008	8 Cyl. 6.4L; Turbocharged; w/ High and Low Pressure; w/o Actuator	TBC666
2007-2006	8 Cyl. 6.0L; Turbocharged; w/o Drain Tube	TBC-512
2007-2006	8 Cyl. 6.0L; Turbocharged; w/ Drain Tube	TRB225RK
2005	8 Cyl. 6.0L; From 11/4/04; Turbocharged; w/o Drain Tube	TBC-512
2005	8 Cyl. 6.0L; To 11/3/04; Turbocharged	TBC-514
2005	8 Cyl. 6.0L; From 11/4/04; Turbocharged; w/ Drain Tube	TRB225RK
2004	8 Cyl. 6.0L; To 9/03; Turbocharged	TBC-511

Air Injection and Induction Parts

		Part No.
Turbocharger - Remfd		
F-350 Super Duty		
2004	8 Cyl. 6.0L; From 10/03; Turbocharged	TBC-514
2003	8 Cyl. 6.0L; Turbocharged	TBC-511
2003-2000	8 Cyl. 7.3L; Turbocharged	TBC-513
1999	8 Cyl. 7.3L; From Engine No. 896813; Turbocharged	TBC-513
1999	8 Cyl. 7.3L; To Engine No. 896812; Turbocharged	TBC549
F-450 Super Duty		
2010-2008	8 Cyl. 6.4L; Low Pressure; Turbocharged	TBC559
2010-2008	8 Cyl. 6.4L; Turbocharged; w/ Actuator; w/ High and Low Pressure	TBC576
2010-2008	8 Cyl. 6.4L; High Pressure; Turbocharged; w/ Actuator	TBC664
2010-2008	8 Cyl. 6.4L; High Pressure; Turbocharged; w/o Actuator	TBC665
2010-2008	8 Cyl. 6.4L; Turbocharged; w/ High and Low Pressure; w/o Actuator	TBC666
2007-2006	8 Cyl. 6.0L; Turbocharged; w/o Drain Tube	TBC-512
2007-2006	8 Cyl. 6.0L; Turbocharged; w/ Drain Tube	TRB225RK
2005	8 Cyl. 6.0L; From 11/4/04; Turbocharged; w/o Drain Tube	TBC-512
2005	8 Cyl. 6.0L; To 11/3/04; Turbocharged	TBC-514
2005	8 Cyl. 6.0L; From 11/4/04; Turbocharged; w/ Drain Tube	TRB225RK
2004	8 Cyl. 6.0L; To 9/03; Turbocharged	TBC-511
2004	8 Cyl. 6.0L; From 10/03; Turbocharged	TBC-514
2003	8 Cyl. 6.0L; Turbocharged	TBC-511
2003-2000	8 Cyl. 7.3L; Turbocharged	TBC-513
1999	8 Cyl. 7.3L; From Engine No. 896813; Turbocharged	TBC-513
1999	8 Cyl. 7.3L; To Engine No. 896812; Turbocharged	TBC549
F-550 Super Duty		
2010-2008	8 Cyl. 6.4L; Low Pressure; Turbocharged	TBC559
2010-2008	8 Cyl. 6.4L; Turbocharged; w/ Actuator; w/ High and Low Pressure	TBC576
2010-2008	8 Cyl. 6.4L; High Pressure; Turbocharged; w/ Actuator	TBC664
2010-2008	8 Cyl. 6.4L; High Pressure; Turbocharged; w/o Actuator	TBC665
2010-2008	8 Cyl. 6.4L; Turbocharged; w/ High and Low Pressure; w/o Actuator	TBC666
2007-2006	8 Cyl. 6.0L; Turbocharged; w/o Drain Tube	TBC-512
2007-2006	8 Cyl. 6.0L; Turbocharged; w/ Drain Tube	TRB225RK
2005	8 Cyl. 6.0L; From 11/4/04; Turbocharged; w/o Drain Tube	TBC-512
2005	8 Cyl. 6.0L; To 11/3/04; Turbocharged	TBC-514
2005	8 Cyl. 6.0L; From 11/4/04; Turbocharged; w/ Drain Tube	TRB225RK
2004	8 Cyl. 6.0L; To 9/03; Turbocharged	TBC-511
2004	8 Cyl. 6.0L; From 10/03; Turbocharged	TBC-514
2003	8 Cyl. 6.0L; Turbocharged	TBC-511
2003-2000	8 Cyl. 7.3L; Turbocharged	TBC-513
1999	8 Cyl. 7.3L; From Engine No. 896813; Turbocharged	TBC-513
1999	8 Cyl. 7.3L; To Engine No. 896812; Turbocharged	TBC549
F Super Duty		
1997-1995	Turbocharged	TBC566
1994	8 Cyl. 7.3L; Turbocharged	TBC535
Turbocharger Gasket Set		
E-350 Club Wagon		
2005-2004	8 Cyl. 6.0L; Turbocharged	TGS2

		Part No.
Turbocharger Gasket Set		
E-350 Super Duty		
2010-2004	8 Cyl. 6.0L; Turbocharged	TGS2
E-450 Super Duty		
2010-2004	8 Cyl. 6.0L; Turbocharged	TGS2
Excursion		
2005-2003	8 Cyl. 6.0L; Turbocharged	TGS2
2002-2000	8 Cyl. 7.3L; Turbocharged	TGS3
F650		
2007-2004	8 Cyl. 6.0L; Turbocharged	TGS2
F750		
2007-2004	8 Cyl. 6.0L; Turbocharged	TGS2
F-250 Super Duty		
2010-2008	8 Cyl. 6.4L; Turbocharged	TGS1
2007-2003	8 Cyl. 6.0L; Turbocharged	TGS2
2003-1999	8 Cyl. 7.3L; Turbocharged	TGS3
F-350 Super Duty		
2010-2008	8 Cyl. 6.4L; Turbocharged	TGS1
2007-2003	8 Cyl. 6.0L; Turbocharged	TGS2
2003-1999	8 Cyl. 7.3L; Turbocharged	TGS3
F-450 Super Duty		
2010-2008	8 Cyl. 6.4L; Turbocharged	TGS1
2007-2003	8 Cyl. 6.0L; Turbocharged	TGS2
2003-1999	8 Cyl. 7.3L; Turbocharged	TGS3
F-550 Super Duty		
2010-2008	8 Cyl. 6.4L; Turbocharged	TGS1
2007-2003	8 Cyl. 6.0L; Turbocharged	TGS2
2003-1999	8 Cyl. 7.3L; Turbocharged	TGS3
Turbocharger Hose		
Excursion		
2005	8 Cyl. 6.0L; Turbocharged	TIH2
2004	8 Cyl. 6.0L; To Engine No. 6,155,636; Turbocharged	TIH1
2004	8 Cyl. 6.0L; From Engine No. 6,155,637; Turbocharged	TIH2
2003	8 Cyl. 6.0L; Turbocharged	TIH1
F-250 Super Duty		
2007-2005	8 Cyl. 6.0L; Turbocharged	TIH2
2004	8 Cyl. 6.0L; To Engine No. 6,155,636; Turbocharged	TIH1
2003	8 Cyl. 6.0L; Turbocharged	TIH1
F-350 Super Duty		
2007-2005	8 Cyl. 6.0L; Turbocharged	TIH2
2004	8 Cyl. 6.0L; To Engine No. 6,155,636; Turbocharged	TIH1
2003	8 Cyl. 6.0L; Turbocharged	TIH1
F-450 Super Duty		
2007-2005	8 Cyl. 6.0L; Turbocharged	TIH2
2004	8 Cyl. 6.0L; To Engine No. 6,155,636; Turbocharged	TIH1
2003	8 Cyl. 6.0L; Turbocharged	TIH1
F-550 Super Duty		
2007-2005	8 Cyl. 6.0L; Turbocharged	TIH2
2004	8 Cyl. 6.0L; To Engine No. 6,155,636; Turbocharged	TIH1
Turbocharger Oil Drain Tube		
E-350 Club Wagon		
2005-2004	8 Cyl. 6.0L; Turbocharged	TBC4
E-350 Super Duty		
2010-2005	8 Cyl. 6.0L; Turbocharged	TBC4
E-450 Super Duty		
2010-2004	8 Cyl. 6.0L; Turbocharged	TBC4
Excursion		
2005-2003	8 Cyl. 6.0L; Turbocharged	TBC4

Air Injection and Induction Parts

		Part No.
Turbocharger Oil Drain Tube		
F650		
2007-2005	8 Cyl. 6.0L; Turbocharged	TBC4
F750		
2007-2005	8 Cyl. 6.0L; Turbocharged	TBC4
F-250 Super Duty		
2007-2003	8 Cyl. 6.0L; Turbocharged	TBC4
F-350 Super Duty		
2007-2003	8 Cyl. 6.0L; Turbocharged	TBC4
F-450 Super Duty		
2007-2003	8 Cyl. 6.0L; Turbocharged	TBC4
F-550 Super Duty		
2007-2003	8 Cyl. 6.0L; Turbocharged	TBC4
Vacuum Motor		
E-250 Econoline Club Wagon		
1987	8 Cyl. 6.9L; Diesel; w/ Blue Stripe	VA11
E-350 Econoline		
1987	8 Cyl. 6.9L; Diesel; w/ Blue Stripe	VA11
E-350 Econoline Club Wagon		
1987	8 Cyl. 6.9L; Diesel; w/ Blue Stripe	VA11
Escort		
1984	4 Cyl. 2.0L	VA19
F-250		
1987	8 Cyl. 6.9L; Diesel; w/ Blue Stripe	VA11
F-350		
1987	8 Cyl. 6.9L; Diesel; w/ Blue Stripe	VA11
Ranger		
1987-1985	4 Cyl. 2.3L	VA7
Tempo		
1984	4 Cyl. 2.0L	VA19
Vacuum Pump		
B600		
1994-1990		VCP133
B700		
1994-1990		VCP133
E-350 Club Wagon		
2005-2004	8 Cyl. 6.0L	VCP119
2003	8 Cyl. 7.3L; Electrical	VCP112
2003	8 Cyl. 7.3L; Mechanical	VCP120
E-350 Econoline		
1998-1996	8 Cyl. 7.3L	VCP120
1995-1994	8 Cyl. 7.3L	VCP131
E-350 Econoline Club Wagon		
2002-2000	8 Cyl. 7.3L; Electrical	VCP112
2002-2000	8 Cyl. 7.3L; Mechanical	VCP120
1999-1996	8 Cyl. 7.3L	VCP120
1995-1994	8 Cyl. 7.3L	VCP131
E-350 Super Duty		
2010-2008	8 Cyl. 6.0L	VCP119
2007-2004	8 Cyl. 6.0L; w/ Electric Pump	VCP112
2007-2004	8 Cyl. 6.0L; w/ Belt Driven Pump	VCP119
E-450 Econoline Super Duty		
2002-2000	8 Cyl. 7.3L; w/ Electric Pump	VCP112
2002-2000	8 Cyl. 7.3L; w/ Belt Driven Pump	VCP120
E-450 Super Duty		
2010-2008	8 Cyl. 6.0L	VCP119
2007-2004	8 Cyl. 6.0L; w/ Electric Pump	VCP112
2007-2004	8 Cyl. 6.0L; w/ Belt Driven Pump	VCP119
2003	8 Cyl. 7.3L; w/ Electric Pump	VCP112
2003	8 Cyl. 7.3L; w/ Belt Driven Pump	VCP120
E-550 Econoline Super Duty		
2002	8 Cyl. 7.3L; w/ Electric Pump	VCP112

		Part No.
Vacuum Pump		
E-550 Econoline Super Duty		
2002	8 Cyl. 7.3L; w/ Belt Driven Pump	VCP120
E-550 Super Duty		
2003	8 Cyl. 7.3L	VCP112
Econoline Super Duty		
1999-1996	8 Cyl. 7.3L	VCP120
Excursion		
2005-2004	8 Cyl. 6.0L	VCP112
2003-2000	8 Cyl. 7.3L	VCP112
F650		
2010-2009	6 Cyl. 6.7L; w/ Electric Pump	VCP112
2008-2004	8 Cyl. 6.0L; w/ Electric Pump	VCP112
2003-2000	8 Cyl. 7.3L; w/ Electric Pump	VCP112
F750		
2010-2009	6 Cyl. 6.7L; w/ Electric Pump	VCP112
2008-2004	8 Cyl. 6.0L; w/ Electric Pump	VCP112
2003-2000	8 Cyl. 7.3L; w/ Electric Pump	VCP112
F800		
1994-1992		VCP133
F-250		
1996	8 Cyl. 7.3L	VCP120
1995-1994	8 Cyl. 7.3L	VCP131
F-250 Super Duty		
2017-2011	8 Cyl. 6.7L	VCP126
2010-2008	8 Cyl. 6.4L	VCP132
2007-2003	8 Cyl. 6.0L	VCP112
2003	8 Cyl. 7.3L	VCP112
2002-1999	8 Cyl. 7.3L; w/ Electric Pump	VCP112
2002-1999	8 Cyl. 7.3L; w/ Belt Driven Pump	VCP120
F-350		
1997-1996	8 Cyl. 7.3L	VCP120
1995-1994	8 Cyl. 7.3L	VCP131
F-350 Super Duty		
2017-2011	8 Cyl. 6.7L	VCP126
2010-2008	8 Cyl. 6.4L	VCP132
2007-2003	8 Cyl. 6.0L	VCP112
2003-1999	8 Cyl. 7.3L	VCP112
F-450 Super Duty		
2017-2011	8 Cyl. 6.7L	VCP126
2010-2008	8 Cyl. 6.4L	VCP132
2007-2003	8 Cyl. 6.0L	VCP112
2003-1999	8 Cyl. 7.3L; w/ Electric Pump	VCP112
2003-1999	8 Cyl. 7.3L; w/ Belt Driven Pump	VCP120
F-550 Super Duty		
2017-2011	8 Cyl. 6.7L	VCP126
2010-2008	8 Cyl. 6.4L	VCP112
2007-2004	8 Cyl. 6.0L	VCP112
2003-1999	8 Cyl. 7.3L; w/ Electric Pump	VCP112
2003-1999	8 Cyl. 7.3L; w/ Belt Driven Pump	VCP120
F Super Duty		
1997-1996	8 Cyl. 7.3L	VCP120
1995-1994	8 Cyl. 7.3L	VCP131
FT900		
1998-1986		VCP133
Transit-150		
2019-2016	5 Cyl. 3.2L	VCP144
Transit-250		
2019-2016	5 Cyl. 3.2L	VCP144
Transit-350		
2019-2016	5 Cyl. 3.2L	VCP144
Transit-350 HD		
2019-2016	5 Cyl. 3.2L	VCP144

Air Management Valves

		Part No.
Air Management Valves		
Air Cleaner Check Valve		
E-250 Econoline Club Wagon		
1990-1988	8 Cyl. 7.3L; w/ External Threads; w/o Tube	AV1
1990-1988	8 Cyl. 7.3L; w/ Internal Threads	AV12
1990-1988	8 Cyl. 7.3L; w/ External Threads; w/ Tube	AV26
1990-1988	8 Cyl. 7.3L; Non-Threaded	AV30
1987-1984	8 Cyl. 6.9L; w/ External Threads; w/ Tube	AV26
1987-1983	8 Cyl. 6.9L; w/ External Threads; w/o Tube	AV1
1987-1983	8 Cyl. 6.9L; w/ Internal Threads	AV12
1983	8 Cyl. 6.9L; w/ External Threads; w/ Straight Tube	AV26
E-350 Econoline		
1987-1983	8 Cyl. 6.9L; w/ External Threads; w/o Tube	AV1
1987-1983	8 Cyl. 6.9L; w/ Internal Threads	AV12
1987-1983	8 Cyl. 6.9L; w/ External Thread; w/ Tube	AV26
E-350 Econoline Club Wagon		
1990-1988	8 Cyl. 7.3L; w/ External Thread; w/o Tube	AV1
1990-1988	8 Cyl. 7.3L; w/ External Threads; w/ Tube	AV26
1990-1988	8 Cyl. 7.3L; Non-Threaded	AV30
1987-1983	8 Cyl. 6.9L; w/ External Threads; w/o Tube	AV1
1987-1983	8 Cyl. 6.9L; w/ Internal Threads	AV12
1987-1983	8 Cyl. 6.9L; w/ External Thread; w/ Tube	AV26
1984	8 Cyl. 6.9L; w/ Straight Tube	AV27
Escort		
1985	4 Cyl. 2.0L	AV18
F-250		
1990	8 Cyl. 7.3L; w/ External Thread; w/o Tube	AV1
1990	8 Cyl. 7.3L; w/ Internal Threads	AV12
1990	8 Cyl. 7.3L; Non-Threaded	AV30
1989-1988	8 Cyl. 7.3L; w/ External Threads; w/o Tube	AV30
1987	8 Cyl. 6.9L	AV26
1985	8 Cyl. 6.9L; w/ External Threads	AV27
F-350		
1990-1988	8 Cyl. 7.3L; w/ External Thread; w/o Tube	AV1
1990-1988	8 Cyl. 7.3L; w/ External Threads; w/ Tube	AV26
1990-1988	8 Cyl. 7.3L; Non-Threaded	AV30
1987	8 Cyl. 6.9L; w/ External Threads	AV26
1987-1985	8 Cyl. 6.9L; w/ Internal Threads; w/o Tube	AV12
1985-1983	8 Cyl. 6.9L; w/ External Threads; w/ Tube	AV27
1983	8 Cyl. 6.9L; w/ External Threads; w/o Tube	AV1
Ranger		
1985	4 Cyl. 2.3L	AV5
1984-1983	4 Cyl.; 2 Ports; Non-Threaded	AV23
1984-1983	4 Cyl. 2.2L; 3 Ports; Non-Threaded	AV32
1984-1983	4 Cyl.; 2 Ports; Threaded	AV5
Tempo		
1985	4 Cyl. 2.0L	AV18
Auxiliary Air Valve		
E-350 Econoline		
1989	8 Cyl. 7.3L	AC23
Diverter Valve		
CF6000		
1990	Stamping No. E5TE-9B289-CA	DV107
1990	Stamping No. E9HE-9B289-BA	DV108
1990	Stamping No. E1TE-9B289-GA	DV58
CF7000		
1997-1990	1 Port	DV107
1997-1990	3 Ports	DV108

		Part No.
Diverter Valve		
CF7000		
1997-1990	1 Vacuum and 2 Exhaust Ports	DV58
CF8000		
1997-1990	1 Port	DV107
1997-1990	3 Ports	DV108
1997-1990	1 Vacuum and 2 Exhaust Ports	DV58
E-250 Econoline Club Wagon		
1983	8 Cyl.; w/ 2 Exhaust Ports; w/ 2 Vacuum Ports	DV6
1983	8 Cyl. 6.9L; 2 Vacuum and 1 Exhaust Ports	DV8
E-350 Econoline		
1996	8 Cyl.; OE No. F5TE-HA	DV106
1983	8 Cyl.; w/ 2 Exhaust Ports; w/ 2 Vacuum Ports	DV6
1983	8 Cyl.; 2 Vacuum and 1 Exhaust Ports	DV8
E-350 Econoline Club Wagon		
1996	8 Cyl.; OE No. F5TE-HA	DV106
1983	8 Cyl.; w/ 2 Exhaust Ports; w/ 2 Vacuum Ports	DV6
1983	8 Cyl.; 2 Vacuum and 1 Exhaust Ports	DV8
F-250		
1996	8 Cyl.; OE No. F5TE-HA	DV106
F-350		
1996	8 Cyl.; OE No. F5TE-HA	DV106
F Super Duty		
1996	8 Cyl.; OE No. F5TE-HA	DV106
Ranger		
1986	4 Cyl. 2.3L	DV8
1983	4 Cyl.; 3 Ports	DV50
1983	4 Cyl.; 2 Ports	DV6
Tempo		
1984	4 Cyl.; 2 Vacuum and 1 Exhaust Ports	DV3
1984	4 Cyl.; w/ 2 Exhaust Ports; w/ 2 Vacuum Ports	DV54
Engine Oil Separator		
F-250 Super Duty		
2019-2017	8 Cyl. 6.7L; w/ Dual Rear Wheels	EOS3
2019-2017	8 Cyl. 6.7L; w/ Single Rear Wheels	EOS4
2016	8 Cyl. 6.7L; To 01/07/2016	EOS2
2016	8 Cyl. 6.7L; From 01/08/2016	EOS4
2015	8 Cyl. 6.7L; w/o Cab Chassis	EOS2
F-350 Super Duty		
2019-2017	8 Cyl. 6.7L; w/ Dual Rear Wheels	EOS3
2019-2017	8 Cyl. 6.7L; w/ Single Rear Wheels	EOS4
2016-2015	8 Cyl. 6.7L; w/o Cab Chassis	EOS2
2016-2011	8 Cyl. 6.7L; Cab and Chassis	EOS1
F-450 Super Duty		
2019-2017	8 Cyl. 6.7L; w/ Dual Rear Wheels	EOS3
2019-2017	8 Cyl. 6.7L; w/ Single Rear Wheels	EOS4
2016-2015	8 Cyl. 6.7L; w/o Cab Chassis	EOS2
2016-2011	8 Cyl. 6.7L; Cab and Chassis	EOS1
F-550 Super Duty		
2019-2017	8 Cyl. 6.7L; w/ Dual Rear Wheels	EOS3
2019-2017	8 Cyl. 6.7L; w/ Single Rear Wheels	EOS4
2016-2011	8 Cyl. 6.7L; Cab and Chassis	EOS1
2015	8 Cyl. 6.7L	EOS1
Idle Air Control Valve		
Ranger		
1987-1985	4 Cyl. 2.3L	AC13
Turbocharger Actuator		
E-350 Super Duty		
2010-2004	8 Cyl. 6.0L; Diesel; Turbocharged	R75002

Air Management Valves

		Part No.
Turbocharger Actuator		
E-450 Super Duty		
2010-2004	8 Cyl. 6.0L; Diesel; Turbocharged	R75002
F650		
2007-2004	8 Cyl. 6.0L; Diesel; Turbocharged	R75002
F750		
2007-2004	8 Cyl. 6.0L; Diesel; Turbocharged	R75002
F-250 Super Duty		
2007-2003	8 Cyl. 6.0L; Diesel; Turbocharged	R75002
F-350 Super Duty		
2007-2003	8 Cyl. 6.0L; Diesel; Turbocharged	R75002
F-450 Super Duty		
2007-2003	8 Cyl. 6.0L; Diesel; Turbocharged	R75002
F-550 Super Duty		
2007-2004	8 Cyl. 6.0L; Diesel; Turbocharged	R75002
2003	8 Cyl. 6.0L; Turbocharged	R75002
Vacuum Delay Valve		
E-250 Econoline Club Wagon		
1985	8 Cyl.; 2 Ports; OE No. D3DE-AB	DSV8
1984	8 Cyl.; 2 Ports; Brown and White; OE No. E3AE-DA	DSV24
1984-1983	8 Cyl.; 2 Ports; Black and Brown; OE No. D3DE-AB	DSV8
1983	8 Cyl.; 2 Ports; Black and Brown; OE No. D3DE-AA	DSV8
E-350 Econoline		
1985	8 Cyl.; 2 Ports; OE No. D3DE-AB	DSV8
1984	8 Cyl.; 2 Ports; Brown and White; OE No. E3AE-DA	DSV24
1984-1983	8 Cyl.; 2 Ports; Black and Brown; OE No. D3DE-AB	DSV8
1983	8 Cyl.; 2 Ports; Black and Brown; OE No. D3DE-AA	DSV8
E-350 Econoline Club Wagon		
1985	8 Cyl.; 2 Ports; OE No. D3DE-AB	DSV8
1984	8 Cyl.; 2 Ports; Brown and White; OE No. E3AE-DA	DSV24
1984-1983	8 Cyl.; 2 Ports; Black and Brown; OE No. D3DE-AB	DSV8
1983	8 Cyl.; 2 Ports; Black and Brown; OE No. D3DE-AA	DSV8
F-150		
1984	8 Cyl.; 2 Ports; Black and Brown; OE No. D3DE-AB	DSV8
F-250		
1985	8 Cyl.; 2 Ports; OE No. D3DE-AB	DSV8
1984	8 Cyl.; 2 Ports; Black and Brown; OE No. D3DE-AB	DSV8
F-350		
1985-1984	8 Cyl.; 2 Ports; OE No. D3DE-AB	DSV8
Air Management Regulators and Solenoids		
Idle Stop Solenoid		
B700		
1991-1990		ES146
Turbocharger Boost Solenoid		
E-350 Econoline		
1998	8 Cyl. 7.3L	TBS1005
E-350 Econoline Club Wagon		
1998	8 Cyl. 7.3L	TBS1005
E-350 Super Duty		
2003-1999	8 Cyl. 7.3L	TBS1005
Excursion		
2003-2000	8 Cyl. 7.3L	TBS1005

		Part No.
Turbocharger Boost Solenoid		
F-250 Super Duty		
2003-1999	8 Cyl. 7.3L	TBS1005
F-350 Super Duty		
2003-1999	8 Cyl. 7.3L	TBS1005
F-450 Super Duty		
2003-1999	8 Cyl. 7.3L	TBS1005
F-550 Super Duty		
2003-1999	8 Cyl. 7.3L	TBS1005
Early Fuel Emission Control		
Bowl Vent Solenoid		
E-250 Econoline Club Wagon		
1989	8 Cyl.	BV1
1987-1983	8 Cyl.	BV1
E-350 Econoline		
1989	8 Cyl.	BV1
1987-1983	8 Cyl.	BV1
E-350 Econoline Club Wagon		
1989	8 Cyl.	BV1
1987-1983	8 Cyl.	BV1
Escort		
1987-1984	4 Cyl.	BV1
F-150		
1984	8 Cyl.	BV1
F-250		
1989-1983	8 Cyl.	BV1
F-350		
1989-1983	8 Cyl.	BV1
Tempo		
1986-1984	4 Cyl.	BV1
Crankcase Ventilation Filter		
E-250 Econoline Club Wagon		
1986-1983	8 Cyl.	BF17
E-350 Econoline		
1986-1983	8 Cyl.	BF17
E-350 Econoline Club Wagon		
1986-1983	8 Cyl.	BF17
Escort		
1987-1984	4 Cyl.	BF20
F650		
2015	6 Cyl. 6.7L	BF43
2013-2008	6 Cyl. 6.7L	BF43
F750		
2015	6 Cyl. 6.7L	BF43
2013-2008	6 Cyl. 6.7L	BF43
F-150		
1984	8 Cyl.	BF17
F-250		
1986-1983	8 Cyl.	BF17
F-350		
1986-1983	8 Cyl.	BF17
Tempo		
1986-1984	4 Cyl.	BF20
EGR Components		
Diesel EGR Cooler		
E-350 Club Wagon		
2005-2004	8 Cyl. 6.0L	ECK1
E-350 Super Duty		
2010-2004	8 Cyl. 6.0L	ECK1
E-450 Super Duty		
2010-2004	8 Cyl. 6.0L	ECK1

Ford

EGR Components

		Part No.
Diesel EGR Cooler		
Excursion		
2005	8 Cyl. 6.0L	ECK1
2004	8 Cyl. 6.0L; From Engine No. 6,155,637	ECK1
2004	8 Cyl. 6.0L; To Engine No. 6,155,636	ECK12
2003	8 Cyl. 6.0L	ECK12
F650		
2010-2008	6 Cyl. 6.7L	ECK9
2008-2003	6 Cyl. 5.9L	ECK10
2007-2005	8 Cyl.	ECK1
2004	8 Cyl.; From Engine No. 137745	ECK1
2004	8 Cyl.; To Engine No. 137744	ECK12
F750		
2010-2008	6 Cyl. 6.7L	ECK9
2008-2003	6 Cyl. 5.9L	ECK10
2007-2005	8 Cyl.	ECK1
2004	8 Cyl.; From Engine No. 137745	ECK1
2004	8 Cyl.; To Engine No. 137744	ECK12
F-250 Super Duty		
2016-2011	8 Cyl. 6.7L	ECK13
2010-2008	8 Cyl. 6.4L; Mounted Vertically	ECK7
2010-2008	8 Cyl. 6.4L; Mounted Horizontally	ECK8
2007-2005	8 Cyl. 6.0L	ECK1
2004	8 Cyl. 6.0L; From Engine No. 6,155,637	ECK1
2004	8 Cyl. 6.0L; To Engine No. 6,155,636	ECK12
2003	8 Cyl. 6.0L	ECK12
F-350 Super Duty		
2016-2011	8 Cyl. 6.7L	ECK13
2010-2008	8 Cyl. 6.4L; Mounted Vertically	ECK7
2010-2008	8 Cyl. 6.4L; Mounted Horizontally	ECK8
2007-2005	8 Cyl. 6.0L	ECK1
2004	8 Cyl. 6.0L; From Engine No. 6,155,637	ECK1
2004	8 Cyl. 6.0L; To Engine No. 6,155,636	ECK12
2003	8 Cyl. 6.0L	ECK12
F-450 Super Duty		
2016-2011	8 Cyl. 6.7L	ECK13
2010-2008	8 Cyl. 6.4L; Mounted Vertically	ECK7
2010-2008	8 Cyl. 6.4L; Mounted Horizontally	ECK8
2007-2005	8 Cyl. 6.0L	ECK1
2004	8 Cyl. 6.0L; From Engine No. 6,155,637	ECK1
2004	8 Cyl. 6.0L; To Engine No. 6,155,636	ECK12
2003	8 Cyl. 6.0L	ECK12
F-550 Super Duty		
2016-2011	8 Cyl. 6.7L	ECK13
2010-2008	8 Cyl. 6.4L; Mounted Vertically	ECK7
2010-2008	8 Cyl. 6.4L; Mounted Horizontally	ECK8
2007-2005	8 Cyl. 6.0L	ECK1
2004	8 Cyl. 6.0L; From Engine No. 6,155,637	ECK1
2004	8 Cyl. 6.0L; To Engine No. 6,155,636	ECK12
2003	8 Cyl. 6.0L	ECK12
Diesel EGR Cooler Gasket Kit		
E-350 Club Wagon		
2005-2004	8 Cyl. 6.0L	ECG1
E-350 Super Duty		
2010-2004	8 Cyl. 6.0L	ECG1
E-450 Super Duty		
2010-2004	8 Cyl. 6.0L	ECG1
Excursion		
2005-2003	8 Cyl. 6.0L	ECG1
F650		
2008-2004	8 Cyl.	ECG1
F750		
2008-2004	8 Cyl.	ECG1

		Part No.
Diesel EGR Cooler Gasket Kit		
F-250 Super Duty		
2007-2003	8 Cyl. 6.0L	ECG1
F-350 Super Duty		
2007-2003	8 Cyl. 6.0L	ECG1
F-450 Super Duty		
2007-2003	8 Cyl. 6.0L	ECG1
F-550 Super Duty		
2007-2003	8 Cyl. 6.0L	ECG1
EGR Control Solenoid		
E-350 Econoline		
1996-1994	8 Cyl.	VS52
E-350 Econoline Club Wagon		
1996-1994	8 Cyl.	VS52
Econoline Super Duty		
1996	8 Cyl. 7.3L	VS52
F-250 Super Duty		
2016-2011	8 Cyl. 6.7L	VS249
F-350		
1997	8 Cyl. 7.3L	VS52
F-350 Super Duty		
2016-2011	8 Cyl. 6.7L	VS249
F-450 Super Duty		
2016-2011	8 Cyl. 6.7L	VS249
F Super Duty		
1997	8 Cyl. 7.3L	VS52
Ranger		
1987	4 Cyl. 2.3L; OE No. E67E-A1A	VS44
1987	4 Cyl. 2.3L; OE No. E77E-C1A	VS48
1986-1985	4 Cyl. 2.3L	VS44
EGR Tube		
E-350 Club Wagon		
2005-2004	8 Cyl. 6.0L	ETB74
2003	8 Cyl. 7.3L	ETB27
E-350 Econoline		
1998	8 Cyl. 7.3L; From 1/12/98	ETB27
1997	8 Cyl. 7.3L; To 5/12/97	ETB17
1996-1995	8 Cyl. 7.3L	ETB17
E-350 Econoline Club Wagon		
2002-1999	8 Cyl. 7.3L	ETB27
1998	8 Cyl. 7.3L; From 1/12/98	ETB27
1997	8 Cyl. 7.3L; To 5/12/97	ETB17
1996-1995	8 Cyl. 7.3L	ETB17
E-350 Super Duty		
2010-2006	8 Cyl. 6.0L	ETB74
E-450 Super Duty		
2010-2004	8 Cyl. 6.0L	ETB74
Excursion		
2005	8 Cyl. 6.0L	ETB73
2004	8 Cyl. 6.0L	ETB18
2003	8 Cyl. 6.0L; Diesel	ETB18
2003-2000	8 Cyl. 7.3L	ETB27
F-250		
1996	8 Cyl. 7.3L	ETB17
1994	8 Cyl. 7.3L	ETB17
F-250 Super Duty		
2019-2011	8 Cyl. 6.7L; Exhaust Side	ETB79
2013-2011	8 Cyl. 6.7L; Intake Manifold to EGR Tube	ETB78
2010-2008	8 Cyl. 6.4L	ETB82
2007-2005	8 Cyl. 6.0L	ETB73
2004-2003	8 Cyl. 6.0L	ETB18
2003-1999	8 Cyl. 7.3L	ETB27

EGR Components

		Part No.
EGR Tube		
F-350		
1997	8 Cyl. 7.3L; To 5/12/97	ETB17
1996	8 Cyl. 7.3L	ETB17
1994	8 Cyl. 7.3L	ETB17
F-350 Super Duty		
2019-2011	8 Cyl. 6.7L; Exhaust Side	ETB79
2013-2011	8 Cyl. 6.7L; Intake Manifold to EGR Tube	ETB78
2010-2008	8 Cyl. 6.4L	ETB82
2007-2005	8 Cyl. 6.0L	ETB73
2004-2003	8 Cyl. 6.0L	ETB18
2003-1999	8 Cyl. 7.3L	ETB27
F-450 Super Duty		
2019-2011	8 Cyl. 6.7L; Exhaust Side	ETB79
2013-2011	8 Cyl. 6.7L; Intake Manifold to EGR Tube	ETB78
2010-2008	8 Cyl. 6.4L	ETB82
2007-2005	8 Cyl. 6.0L	ETB73
2003	8 Cyl. 6.0L; Diesel	ETB18
F-550 Super Duty		
2019-2011	8 Cyl. 6.7L; Exhaust Side	ETB79
2013-2011	8 Cyl. 6.7L; Intake Manifold to EGR Tube	ETB78
2010-2008	8 Cyl. 6.4L	ETB82
2007-2005	8 Cyl. 6.0L	ETB73
2003	8 Cyl. 6.0L	ETB18
F Super Duty		
1997	8 Cyl. 7.3L; To 5/12/97	ETB17
1996	8 Cyl. 7.3L	ETB17
1994	8 Cyl. 7.3L	ETB17
EGR Valve		
E-350 Club Wagon		
2005	8 Cyl. 6.0L	EGV1031
2004	8 Cyl. 6.0L	EGV1034
E-350 Super Duty		
2010-2006	8 Cyl. 6.0L; EGR Valve Modulator Assy	EGV1031
2005	8 Cyl. 6.0L	EGV1031
2004	8 Cyl. 6.0L	EGV1034
E-450 Super Duty		
2010-2005	8 Cyl. 6.0L; EGR Valve Modulator Assy	EGV1031
2004	8 Cyl. 6.0L; EGR Valve Modulator Assy	EGV1034
Excursion		
2005	8 Cyl. 6.0L	EGV1031
2004-2003	8 Cyl. 6.0L	EGV1034
F650		
2007-2004	8 Cyl. 6.0L	EGV1249
F750		
2007-2004	8 Cyl. 6.0L	EGV1249
F-250 Super Duty		
2017-2011	8 Cyl. 6.7L	EGV1238
2010-2008	8 Cyl. 6.4L	EGV1151
2007-2006	8 Cyl. 6.0L; EGR Valve Modulator Assy	EGV1031
2005	8 Cyl. 6.0L	EGV1031
2004-2003	8 Cyl. 6.0L	EGV1034
F-350 Super Duty		
2019-2018	8 Cyl. 6.7L; Cab and Chassis	EGV1290
2017-2011	8 Cyl. 6.7L; w/ Pickup Bed	EGV1238
2017-2011	8 Cyl. 6.7L; Cab and Chassis	EGV1239
2010-2008	8 Cyl. 6.4L	EGV1151
2007-2006	8 Cyl. 6.0L; EGR Valve Modulator Assy	EGV1031
2005	8 Cyl. 6.0L	EGV1031
2004-2003	8 Cyl. 6.0L	EGV1034
F-450 Super Duty		
2017-2011	8 Cyl. 6.7L; w/ Pickup Bed	EGV1238
2017-2011	8 Cyl. 6.7L; Cab and Chassis	EGV1239
2010-2008	8 Cyl. 6.4L	EGV1151

		Part No.
EGR Valve		
F-450 Super Duty		
2007-2005	8 Cyl. 6.0L; EGR Valve Modulator Assy	EGV1031
2004-2003	8 Cyl. 6.0L; EGR Valve Modulator Assy	EGV1034
F-550 Super Duty		
2017-2011	8 Cyl. 6.7L; Cab and Chassis	EGV1239
2010-2008	8 Cyl. 6.4L	EGV1151
2007-2005	8 Cyl. 6.0L; EGR Valve Modulator Assy	EGV1031
2004-2003	8 Cyl. 6.0L; EGR Valve Modulator Assy	EGV1034
LCF		
2009-2008	6 Cyl. 4.5L	EGV1251
2007-2006	6 Cyl. 4.5L	EGV1246
Transit-150		
2019-2015	5 Cyl. 3.2L	EGV1284
Transit-250		
2019-2015	5 Cyl. 3.2L	EGV1284
Transit-350		
2019-2015	5 Cyl. 3.2L	EGV1284
Transit-350 HD		
2019-2015	5 Cyl. 3.2L	EGV1284
EGR Valve Control Solenoid Filter		
Ranger		
1987	4 Cyl. 2.3L; SOHC	BLF1
1986-1985	4 Cyl. 2.3L	BLF1
1984-1983	4 Cyl. 2.2L; Diesel	BLF1
EGR Valve Mounting Gasket		
E-350 Club Wagon		
2005-2004	8 Cyl. 6.0L	VG169
E-350 Super Duty		
2010	8 Cyl. 6.0L	VG169
2007-2004	8 Cyl. 6.0L	VG169
E-450 Super Duty		
2010	8 Cyl. 6.0L	VG169
2007-2004	8 Cyl. 6.0L	VG169
Excursion		
2005-2003	8 Cyl. 6.0L	VG169
F-250 Super Duty		
2019-2011	8 Cyl. 6.7L; Outlet	VG242
2017-2011	8 Cyl. 6.7L; Inlet	VG241
2010-2008	8 Cyl. 6.4L	VG267
2007-2003	8 Cyl. 6.0L	VG169
F-350 Super Duty		
2019-2011	8 Cyl. 6.7L; Outlet	VG242
2017-2011	8 Cyl. 6.7L; Inlet	VG241
2010-2008	8 Cyl. 6.4L	VG267
2007-2003	8 Cyl. 6.0L	VG169
F-450 Super Duty		
2019-2011	8 Cyl. 6.7L; Outlet	VG242
2017-2011	8 Cyl. 6.7L; Inlet	VG241
2010-2008	8 Cyl. 6.4L	VG267
2007-2003	8 Cyl. 6.0L	VG169
F-550 Super Duty		
2019-2011	8 Cyl. 6.7L; Outlet	VG242
2017-2011	8 Cyl. 6.7L; Inlet	VG241
2010-2008	8 Cyl. 6.4L	VG267
2007-2003	8 Cyl. 6.0L	VG169
Transit-150		
2019-2015	5 Cyl. 3.2L; EGR Pipe	VG281
2018-2015	5 Cyl. 3.2L; Bottom of EGR Valve	VG282
Transit-250		
2019-2015	5 Cyl. 3.2L; EGR Pipe	VG281
2018-2015	5 Cyl. 3.2L; Bottom of EGR Valve	VG282

EGR Components

		Part No.
EGR Valve Mounting Gasket		
Transit-350		
2019-2015	5 Cyl. 3.2L; EGR Pipe	VG281
2018-2015	5 Cyl. 3.2L; Bottom of EGR Valve	VG282
Transit-350 HD		
2019-2015	5 Cyl. 3.2L; EGR Pipe	VG281
2018-2015	5 Cyl. 3.2L; Bottom of EGR Valve	VG282
EGR Valve Spacer Plate		
E-350 Super Duty		
2010-2006	8 Cyl. 6.0L; EGR Valve Assembly	EGV1293
E-450 Super Duty		
2010-2004	8 Cyl. 6.0L; EGR Valve Assembly	EGV1293
F650		
2016	8 Cyl. 6.7L	VG113
F750		
2016	8 Cyl. 6.7L	VG113
F-250 Super Duty		
2016-2011	8 Cyl. 6.7L; Diesel	VG113
2007-2006	8 Cyl. 6.0L; EGR Valve Assembly	EGV1293
F-350 Super Duty		
2016-2011	8 Cyl. 6.7L; Diesel	VG113
2007-2006	8 Cyl. 6.0L; EGR Valve Assembly	EGV1293
F-450 Super Duty		
2016-2011	8 Cyl. 6.7L; Diesel	VG113
2007-2003	8 Cyl. 6.0L; EGR Valve Assembly	EGV1293
F-550 Super Duty		
2007-2003	8 Cyl. 6.0L; EGR Valve Assembly	EGV1293
Exhaust Components		
Diesel Emission Fluid Injection Nozzle		
F-250 Super Duty		
2016-2011	8 Cyl. 6.7L	DFI1
F-350 Super Duty		
2016-2011	8 Cyl. 6.7L	DFI1
F-450 Super Duty		
2016-2013	8 Cyl. 6.7L	DFI1
2011	8 Cyl. 6.7L	DFI1
F-550 Super Duty		
2016-2011	8 Cyl. 6.7L	DFI1
Transit-150		
2018-2015	5 Cyl. 3.2L	DFI1
Transit-250		
2018-2015	5 Cyl. 3.2L	DFI1
Transit-350		
2018-2015	5 Cyl. 3.2L	DFI1
Transit-350 HD		
2018-2015	5 Cyl. 3.2L	DFI1
Diesel Emissions Fluid Pump		
F-150		
2020-2018	6 Cyl. 3.0L	DFIP3
F-250 Super Duty		
2019-2017	8 Cyl. 6.7L	DFIP3
2016-2011	8 Cyl. 6.7L	DFIP1
F-350 Super Duty		
2019-2017	8 Cyl. 6.7L	DFIP3
2016-2011	8 Cyl. 6.7L	DFIP1
F-450 Super Duty		
2019-2017	8 Cyl. 6.7L	DFIP3
2016-2011	8 Cyl. 6.7L	DFIP1
F-550 Super Duty		
2019-2017	8 Cyl. 6.7L	DFIP3
2016-2011	8 Cyl. 6.7L	DFIP1

		Part No.
Diesel Emissions Fluid Pump		
Transit-150		
2019-2015	5 Cyl. 3.2L	DFIP1
Transit-250		
2019-2015	5 Cyl. 3.2L	DFIP1
Transit-350		
2019-2015	5 Cyl. 3.2L	DFIP1
Transit-350 HD		
2019-2015	5 Cyl. 3.2L	DFIP1
Diesel Exhaust Fluid (DEF) Heater		
F-250 Super Duty		
2016-2011	8 Cyl. 6.7L	EFH201
F-350 Super Duty		
2016-2011	8 Cyl. 6.7L; w/ Pickup Bed	EFH201
2016-2011	8 Cyl. 6.7L; Cab and Chassis	EFH202
F-450 Super Duty		
2016-2011	8 Cyl. 6.7L; Cab and Chassis	EFH202
F-550 Super Duty		
2016-2011	8 Cyl. 6.7L; Cab and Chassis	EFH202
Diesel Exhaust Fluid (DEF) Pump Wiring Harness		
F-250 Super Duty		
2019-2017	8 Cyl. 6.7L; w/ Pickup Bed	FWH103
F-350 Super Duty		
2019-2017	8 Cyl. 6.7L; Cab and Chassis	FWH102
2019-2017	8 Cyl. 6.7L; w/ Pickup Bed	FWH103
F-450 Super Duty		
2019-2017	8 Cyl. 6.7L; Cab and Chassis	FWH102
2019-2017	8 Cyl. 6.7L; w/ Pickup Bed	FWH103
F-550 Super Duty		
2019-2017	8 Cyl. 6.7L; Cab and Chassis	FWH102
Diesel Exhaust Fluid (DEF) Tank		
F-250 Super Duty		
2011	8 Cyl. 6.7L	DEFT100
F-350 Super Duty		
2011	8 Cyl. 6.7L; w/ Pickup Bed	DEFT100
F-450 Super Duty		
2011	8 Cyl. 6.7L; w/ Pickup Bed	DEFT100
PCV Systems		
PCV Grommet		
E-250 Econoline Club Wagon		
1990-1988	8 Cyl. 7.3L; 1/2 Inch Inner Dia.; Grommet	GV4
1989-1988	8 Cyl. 7.3L; 3/4 Inch Inner Dia. x 1 1/2 Inch Outer Dia. X 1/2 Inch Long	GV27
1989-1988	8 Cyl. 7.3L; 3/4 Inch Inner Dia. x 1 1/2 Inch Outer Dia. X 1 Inch Long	GV28
1987-1983	8 Cyl. 6.9L; 3/4 Inch Inner Dia. x 1 1/2 Inch Outer Dia. X 1/2 Inch Long	GV27
1987-1983	8 Cyl. 6.9L; 3/4 Inch Inner Dia. x 1 1/2 Inch Outer Dia. X 1 Inch Long	GV28
1987-1983	8 Cyl. 6.9L; 1/2 Inch Inner Dia.; Grommet	GV4
E-350 Econoline		
1990-1988	8 Cyl. 7.3L; 1/2 Inch Inner Dia.; Grommet	GV4
1989-1988	8 Cyl. 7.3L; 3/4 Inch Inner Dia. x 1 1/2 Inch Outer Dia. X 1/2 Inch Long	GV27
1989-1988	8 Cyl. 7.3L; 3/4 Inch Inner Dia. x 1 1/2 Inch Outer Dia. X 1 Inch Long	GV28
1987-1983	8 Cyl. 6.9L; 3/4 Inch Inner Dia. x 1 1/2 Inch Outer Dia. X 1/2 Inch Long	GV27
1987-1983	8 Cyl. 6.9L; 3/4 Inch Inner Dia. x 1 1/2 Inch Outer Dia. X 1 Inch Long	GV28
1987-1983	8 Cyl. 6.9L; 1/2 Inch Inner Dia.; Grommet	GV4
E-350 Econoline Club Wagon		
1990-1988	8 Cyl. 7.3L; 1/2 Inch Inner Dia.; Grommet	GV4

PCV Systems

		Part No.
PCV Grommet		
E-350 Econoline Club Wagon		
1989-1988	8 Cyl. 7.3L; 3/4 Inch Inner Dia. x 1 1/2 Inch Outer Dia. X 1/2 Inch Long	GV27
1989-1988	8 Cyl. 7.3L; 3/4 Inch Inner Dia. x 1 1/2 Inch Outer Dia. X 1 Inch Long	GV28
1987-1983	8 Cyl. 6.9L; 3/4 Inch Inner Dia. x 1 1/2 Inch Outer Dia. X 1/2 Inch Long	GV27
1987-1983	8 Cyl. 6.9L; 3/4 Inch Inner Dia. x 1 1/2 Inch Outer Dia. X 1 Inch Long	GV28
1987-1983	8 Cyl. 6.9L; 1/2 Inch Inner Dia.; Grommet	GV4
Escort		
1985	4 Cyl. 2.0L; 3/4 Inch Inner Dia. x 1 1/2 Inch Outer Dia. X 1/2 Inch Long	GV27
1985	4 Cyl. 2.0L; 3/4 Inch Inner Dia. x 1 1/2 Inch Outer Dia. X 1 Inch Long	GV28
1985	4 Cyl. 2.0L; 1/2 Inch Inner Dia. x 1 Inch Outer Dia.	GV29
1985	4 Cyl. 2.0L; 1/2 Inch Inner Dia.; Grommet	GV4
F59		
1991-1990	8 Cyl. 7.3L	GV4
1989-1988	8 Cyl. 7.3L; 3/4 Inch Inner Dia. x 1 1/2 Inch Outer Dia. X 1/2 Inch Long	GV27
1989-1988	8 Cyl. 7.3L; 3/4 Inch Inner Dia. x 1 1/2 Inch Outer Dia. X 1 Inch Long	GV28
1989-1988	8 Cyl. 7.3L; 1/2 Inch Inner Dia.; Grommet	GV4
F-150		
1984	8 Cyl. 6.9L; 3/4 Inch Inner Dia. x 1 1/2 Inch Outer Dia. X 1/2 Inch Long	GV27
1984	8 Cyl. 6.9L; 3/4 Inch Inner Dia. x 1 1/2 Inch Outer Dia. X 1 Inch Long	GV28
1984	8 Cyl. 6.9L; 1/2 Inch Inner Dia.; Grommet	GV4
F-250		
1990-1988	8 Cyl. 7.3L; 1/2 Inch Inner Dia.; Grommet	GV4
1989-1988	8 Cyl. 7.3L; 3/4 Inch Inner Dia. x 1 1/2 Inch Outer Dia. X 1/2 Inch Long	GV27
1989-1988	8 Cyl. 7.3L; 3/4 Inch Inner Dia. x 1 1/2 Inch Outer Dia. X 1 Inch Long	GV28
1987-1983	8 Cyl. 6.9L; 3/4 Inch Inner Dia. x 1 1/2 Inch Outer Dia. X 1/2 Inch Long	GV27
1987-1983	8 Cyl. 6.9L; 3/4 Inch Inner Dia. x 1 1/2 Inch Outer Dia. X 1 Inch Long	GV28
1987-1983	8 Cyl. 6.9L; 1/2 Inch Inner Dia.; Grommet	GV4
F-350		
1990-1988	8 Cyl. 7.3L; 1/2 Inch Inner Dia.; Grommet	GV4
1989-1988	8 Cyl. 7.3L; 3/4 Inch Inner Dia. x 1 1/2 Inch Outer Dia. X 1/2 Inch Long	GV27
1989-1988	8 Cyl. 7.3L; 3/4 Inch Inner Dia. x 1 1/2 Inch Outer Dia. X 1 Inch Long	GV28
1987-1983	8 Cyl. 6.9L; 3/4 Inch Inner Dia. x 1 1/2 Inch Outer Dia. X 1/2 Inch Long	GV27
1987-1983	8 Cyl. 6.9L; 3/4 Inch Inner Dia. x 1 1/2 Inch Outer Dia. X 1 Inch Long	GV28
1987-1983	8 Cyl. 6.9L; 1/2 Inch Inner Dia.; Grommet	GV4
F Super Duty		
1990	8 Cyl. 7.3L; 1/2 Inch Inner Dia.; Grommet	GV4
Ranger		
1984-1983	4 Cyl. 2.2L; 3/4 Inch Inner Dia. x 1 1/2 Inch Outer Dia. X 1/2 Inch Long	GV27
1984-1983	4 Cyl. 2.2L; 3/4 Inch Inner Dia. x 1 1/2 Inch Outer Dia. X 1 Inch Long	GV28
1984-1983	4 Cyl. 2.2L; 1/2 Inch Inner Dia.; Grommet	GV4
Tempo		
1986-1985	4 Cyl. 2.0L; 3/4 Inch Inner Dia. x 1 1/2 Inch Outer Dia. X 1/2 Inch Long	GV27
1986-1985	4 Cyl. 2.0L; 3/4 Inch Inner Dia. x 1 1/2 Inch Outer Dia. X 1 Inch Long	GV28

		Part No.
PCV Grommet		
Tempo		
1986-1985	4 Cyl. 2.0L; 1/2 Inch Inner Dia. x 1 Inch Outer Dia.	GV29
1986-1985	4 Cyl. 2.0L; 1/2 Inch Inner Dia.; Grommet	GV4
PCV Valve		
Ranger		
1987-1985	4 Cyl. 2.3L	V237
Vapor and Purge Components		
Canister Purge Solenoid		
E-350 Econoline		
1989	8 Cyl. 7.3L; w/o High Altitude	CP402
1989	8 Cyl. 7.3L; High Altitude	CP408
E-350 Econoline Club Wagon		
1989	8 Cyl. 7.3L; w/o High Altitude	CP402
1989	8 Cyl. 7.3L; High Altitude	CP408
F-250		
1995-1990	8 Cyl. 7.3L	CP403
F-350		
1995-1990	8 Cyl. 7.3L	CP403
Ranger		
1987-1985	4 Cyl. 2.3L	CP400
Canister Purge Valve		
E-250 Econoline Club Wagon		
1983	8 Cyl. 6.9L; OE No. E3TE-9B963-AA	CP302
E-350 Econoline		
1988	8 Cyl. 7.3L; OE No. E3TE-9B963-AA	CP302
1987-1983	8 Cyl. 6.9L; OE No. E3TE-9B963-AA	CP302
E-350 Econoline Club Wagon		
1988	8 Cyl. 7.3L; OE No. E3TE-9B963-AA	CP302
1987-1983	8 Cyl. 6.9L; OE No. E3TE-9B963-AA	CP302
F-250		
1988	8 Cyl. 7.3L; OE No. E3TE-9B963-AA	CP302
1987-1983	8 Cyl. 6.9L; OE No. E3TE-9B963-AA	CP302
F-350		
1988	8 Cyl. 7.3L; OE No. E3TE-9B963-AA	CP302
1987-1983	8 Cyl. 6.9L; OE No. E3TE-9B963-AA	CP302
Ranger		
1987-1985	4 Cyl. 2.3L	CP311
1984-1983	4 Cyl. 2.2L; High Altitude	CP311
Canister Vent Solenoid		
Transit		
2014		CP806
Fuel Vapor Canister		
Ranger		
1987-1986	4 Cyl. 2.3L	CP2000
Fuel Valves and Solenoids		
Fuel / Water Separator Valve		
E-350 Club Wagon		
2003	8 Cyl. 7.3L; Diesel	FWSV102
E-350 Econoline		
1998	8 Cyl. 7.3L; Diesel; From 1/12/98	FWSV102
1998	8 Cyl. 7.3L; Diesel; To 1/12/98	FWSV103
1997-1996	8 Cyl. 7.3L; Diesel	FWSV103
1994	8 Cyl. 7.3L; Diesel	FWSV103
E-350 Econoline Club Wagon		
2002-1999	8 Cyl. 7.3L; Diesel	FWSV102
1998	8 Cyl. 7.3L; Diesel; From 1/12/98	FWSV102
1998	8 Cyl. 7.3L; Diesel; To 1/12/98	FWSV103
1997-1994	8 Cyl. 7.3L; Diesel	FWSV103
E-350 Super Duty		
2003	8 Cyl. 7.3L; Diesel	FWSV102

Fuel Valves and Solenoids

		Part No.
Fuel / Water Separator Valve		
E-350 Super Duty		
1999	8 Cyl. 7.3L; Diesel	FWSV102
E-450 Econoline Super Duty		
2002-1999	8 Cyl. 7.3L; Diesel	FWSV102
E-450 Super Duty		
2003	8 Cyl. 7.3L; Diesel	FWSV102
E-550 Econoline Super Duty		
2002	8 Cyl. 7.3L	FWSV102
E-550 Super Duty		
2003	8 Cyl. 7.3L	FWSV102
Econoline Super Duty		
1998-1996	8 Cyl. 7.3L	FWSV103
Excursion		
2003-2000	8 Cyl. 7.3L; Diesel	FWSV102
F59		
1994	8 Cyl. 7.3L; Diesel	FWSV103
F-250		
1996-1994	8 Cyl. 7.3L; Diesel	FWSV103
F-250 HD		
1997	8 Cyl. 7.3L; Diesel	FWSV103
F-250 Super Duty		
2003-1999	8 Cyl. 7.3L; Diesel	FWSV102
F-350		
1997-1994	8 Cyl. 7.3L; Diesel	FWSV103
F-350 Super Duty		
2003-1999	8 Cyl. 7.3L; Diesel	FWSV102
F-450 Super Duty		
2003-1999	8 Cyl. 7.3L	FWSV102
F-550 Super Duty		
2003-1999	8 Cyl. 7.3L	FWSV102
F Super Duty		
1997-1994	8 Cyl. 7.3L	FWSV103
Fuel Tank Selector Valve		
E-250 Econoline Club Wagon		
1991-1988	8 Cyl. 7.3L; Connector Required; w/ 6 Port; w/ Pin Term.	FV-5
1991-1988	8 Cyl. 7.3L; Kit; w/ 6 Port; w/ Pin Term.	FV-5K
1987-1983	8 Cyl. 6.9L; Connector Required; w/ 6 Port; w/ Pin Term.	FV-5
1987-1983	8 Cyl. 6.9L; Kit; w/ 6 Port; w/ Pin Term.	FV-5K
E-350 Econoline		
1994-1988	8 Cyl. 7.3L; Connector Required; w/ 6 Port; w/ Pin Term.	FV-5
1994-1988	8 Cyl. 7.3L; Kit; w/ 6 Port; w/ Pin Term.	FV-5K
1989-1988	8 Cyl. 7.3L; w/ 6 Port; w/ Blade Term.	FV11
1987-1983	8 Cyl. 6.9L; w/ 6 Port; w/ Blade Term.	FV11
1987-1983	8 Cyl. 6.9L; Connector Required; w/ 6 Port; w/ Pin Term.	FV-5
1987-1983	8 Cyl. 6.9L; Kit; w/ 6 Port; w/ Pin Term.	FV-5K
E-350 Econoline Club Wagon		
1994-1988	8 Cyl. 7.3L; Connector Required; w/ 6 Port; w/ Pin Term.	FV-5
1994-1988	8 Cyl. 7.3L; Kit; w/ 6 Port; w/ Pin Term.	FV-5K
1989-1988	8 Cyl. 7.3L; w/ 6 Port; w/ Blade Term.	FV11
1987-1983	8 Cyl. 6.9L; w/ 6 Port; w/ Blade Term.	FV11
1987-1983	8 Cyl. 6.9L; Connector Required; w/ 6 Port; w/ Pin Term.	FV-5
1987-1983	8 Cyl. 6.9L; Kit; w/ 6 Port; w/ Pin Term.	FV-5K
F59		
1994-1988	Connector Required; w/ 6 Port	FV-5
1994-1988	Kit; w/ 6 Port	FV-5K

		Part No.
Fuel Tank Selector Valve		
F-150		
1984	8 Cyl. 6.9L; Connector Required; w/ 6 Port; w/ Pin Term.	FV-5
1984	8 Cyl. 6.9L; Kit; w/ 6 Port; w/ Pin Term.	FV-5K
F-250		
1996-1995	8 Cyl. 7.3L; w/ 6 Port	FV12
1994	8 Cyl. 7.3L; 5 Blade Term.; w/ 6 Port	FV12
1994-1988	8 Cyl. 7.3L; Connector Required; w/ 6 Port; w/ Pin Term.	FV-5
1994-1988	8 Cyl. 7.3L; Kit; w/ 6 Port; w/ Pin Term.	FV-5K
1989-1988	8 Cyl. 7.3L; w/ 6 Port; w/ Blade Term.	FV11
1987-1983	8 Cyl. 6.9L; w/ 6 Port; w/ Blade Term.	FV11
F-250 HD		
1997	8 Cyl. 7.3L; w/ 6 Port	FV12
F-250 Super Duty		
2016-2011	8 Cyl. 6.7L; w/ 6 Port	FV12
2010-2008	8 Cyl. 6.4L; w/ 6 Port	FV12
2007-2003	8 Cyl. 6.0L; w/ 6 Port	FV12
2003-2000	8 Cyl. 7.3L; w/ 6 Port	FV12
F-350		
1997-1995	8 Cyl. 7.3L; w/ 6 Port	FV12
1994	8 Cyl. 7.3L; 5 Blade Term.; w/ 6 Port	FV12
1994-1988	8 Cyl. 7.3L; Connector Required; w/ 6 Port; w/ Pin Term.	FV-5
1994-1988	8 Cyl. 7.3L; Kit; w/ 6 Port; w/ Pin Term.	FV-5K
1993	8 Cyl. 7.3L; w/ 6 Port; w/ Blade Term.	FV11
1989-1988	8 Cyl. 7.3L; w/ 6 Port; w/ Blade Term.	FV11
1987-1983	8 Cyl. 6.9L; w/ 6 Port; w/ Blade Term.	FV11
1987-1983	8 Cyl. 6.9L; Connector Required; w/ 6 Port; w/ Pin Term.	FV-5
1987-1983	8 Cyl. 6.9L; Kit; w/ 6 Port; w/ Pin Term.	FV-5K
F-350 Super Duty		
2016-2011	8 Cyl. 6.7L; w/ 6 Port	FV12
2010-2008	8 Cyl. 6.4L; w/ 6 Port	FV12
2007-2003	8 Cyl. 6.0L; w/ 6 Port	FV12
2003-2000	8 Cyl. 7.3L; w/ 6 Port	FV12
F-450 Super Duty		
2016-2011	8 Cyl. 6.7L; w/ 6 Port	FV12
2010-2008	8 Cyl. 6.4L; w/ 6 Port	FV12
2007-2003	8 Cyl. 6.0L; w/ 6 Port	FV12
2003-2000	8 Cyl. 7.3L; w/ 6 Port	FV12
F-550 Super Duty		
2016-2011	8 Cyl. 6.7L; w/ 6 Port	FV12
2010-2008	8 Cyl. 6.4L; w/ 6 Port	FV12
2007-2003	8 Cyl. 6.0L; w/ 6 Port	FV12
2003-2000	8 Cyl. 7.3L; w/ 6 Port	FV12
F Super Duty		
1997-1995	8 Cyl. 7.3L; w/ 6 Port	FV12
1994	8 Cyl. 7.3L; 5 Blade Term.; w/ 6 Port	FV12
1994-1990	8 Cyl. 7.3L; Connector Required; w/ 6 Port; w/ Pin Term.	FV-5
1994-1990	8 Cyl. 7.3L; Kit; w/ 6 Port; w/ Pin Term.	FV-5K
1989-1988	8 Cyl. 7.3L; w/ 6 Port	FV11
Ranger		
1987-1985	4 Cyl. 2.3L; Connector Required; w/ 6 Port; w/ Pin Term.	FV-5
1987-1985	4 Cyl. 2.3L; Kit; w/ 6 Port; w/ Pin Term.	FV-5K
1984-1983	4 Cyl. 2.2L; Connector Required; w/ 6 Port; w/ Pin Term.	FV-5
1984-1983	4 Cyl. 2.2L; Kit; w/ 6 Port; w/ Pin Term.	FV-5K
Fuel Tank Vent Valve		
F650		
2015	6 Cyl. 6.7L	VRV109
2013-2011	6 Cyl. 6.7L	VRV109

Injectors

		Part No.
Injectors		
Fuel Injector - Diesel - New		
E-250 Econoline Club Wagon		
1991-1988	8 Cyl. 7.3L	FJ258
1987-1983	8 Cyl. 6.9L	FJ258
E-350 Club Wagon		
2005-2004	8 Cyl. 6.0L; Injector Only	FJ928NX
2003	8 Cyl. 7.3L; Cyl. 1 to 7	FJ738NX
2003	8 Cyl. 7.3L; Cyl. 8	FJ926NX
E-350 Econoline		
1998-1995	8 Cyl. 7.3L; Stamping No. AA	FJ595NX
1998-1995	8 Cyl. 7.3L; Stamping No. AB	FJ596NX
1994-1993	8 Cyl. 7.3L	FJ593
1992	8 Cyl. 7.3L; To 2/28/92	FJ258
1992	8 Cyl. 7.3L; From 3/92	FJ593
1991-1988	8 Cyl. 7.3L	FJ258
1987-1983	8 Cyl. 6.9L	FJ258
E-350 Econoline Club Wagon		
2002-2000	8 Cyl. 7.3L; Cyl. 1 to 7	FJ738NX
2002-1999	8 Cyl. 7.3L; Cyl. 8	FJ926NX
1999	8 Cyl. 7.3L; To 12/6/98; Cyl. 1 to 7	FJ596NX
1999	8 Cyl. 7.3L; From 12/7/98; Cyl. 1 to 7	FJ738NX
1998-1995	8 Cyl. 7.3L; Stamping No. AA	FJ595NX
1998-1995	8 Cyl. 7.3L; Stamping No. AB	FJ596NX
1994-1993	8 Cyl. 7.3L	FJ593
1992	8 Cyl. 7.3L; To 2/28/92	FJ258
1992	8 Cyl. 7.3L; From 3/92	FJ593
1991-1988	8 Cyl. 7.3L	FJ258
1987-1983	8 Cyl. 6.9L	FJ258
E-350 Super Duty		
2010-2004	8 Cyl. 6.0L; Injector Only	FJ928NX
2003-2000	8 Cyl. 7.3L; Cyl. 1 to 7	FJ738NX
2003-1999	8 Cyl. 7.3L; Cyl. 8	FJ926NX
1999	8 Cyl. 7.3L; To 12/6/98; Cyl. 1 to 7	FJ596NX
1999	8 Cyl. 7.3L; From 12/7/98; Cyl. 1 to 7	FJ738NX
E-450 Econoline Super Duty		
2002-2000	8 Cyl. 7.3L; Cyl. 1 to 7	FJ738NX
2002-2000	8 Cyl. 7.3L; Cyl. 8	FJ926NX
E-450 Super Duty		
2010-2004	8 Cyl. 6.0L; Injector Only	FJ928NX
2003	8 Cyl. 7.3L; Cyl. 1 to 7	FJ738NX
2003	8 Cyl. 7.3L; Cyl. 8	FJ926NX
E-550 Econoline Super Duty		
2002	8 Cyl. 7.3L; Cyl. 1 to 7	FJ738NX
2002	8 Cyl. 7.3L; Cyl. 8	FJ926NX
E-550 Super Duty		
2003	8 Cyl. 7.3L; Cyl. 1 to 7	FJ738NX
2003	8 Cyl. 7.3L; Cyl. 8	FJ926NX
Econoline Super Duty		
1999	8 Cyl. 7.3L; To 12/6/98; Cyl. 1 to 7	FJ596NX
1999	8 Cyl. 7.3L; From 12/7/98; Cyl. 1 to 7	FJ738NX
1999	8 Cyl. 7.3L; Cyl. 8	FJ926NX
1998-1996	8 Cyl. 7.3L; Stamping No. AA	FJ595NX
1998-1996	8 Cyl. 7.3L; Stamping No. AB	FJ596NX
Excursion		
2005	8 Cyl. 6.0L; Injector Only	FJ928NX
2004	8 Cyl. 6.0L; ID No. 1843089-C95	FJ927NX
2004	8 Cyl. 6.0L; ID No. 5010120-R91; Injector Only	FJ928NX
2003	8 Cyl. 6.0L; Injector Only	FJ927NX
2003-2000	8 Cyl. 7.3L; Cyl. 1 to 7	FJ738NX
2003-2000	8 Cyl. 7.3L; Cyl. 8	FJ926NX
F59		
1997-1995	8 Cyl. 7.3L; F; Stamping No. AA	FJ595NX

		Part No.
Fuel Injector - Diesel - New		
F59		
1997-1995	8 Cyl. 7.3L; F; Stamping No. AB	FJ596NX
1997-1994	8 Cyl. 7.3L; K	FJ1232
1997-1994	8 Cyl. 7.3L; M	FJ593
1994	8 Cyl. 7.3L; F	FJ595NX
1993	8 Cyl. 7.3L	FJ593
1992	8 Cyl. 7.3L; To 2/28/92	FJ258
1992	8 Cyl. 7.3L; From 3/92	FJ593
1991-1990	8 Cyl. 7.3L	FJ258
F650		
2008-2005	8 Cyl. 6.0L	FJ928NX
2004	8 Cyl.; ID No. 1843089-C95; Injector Only	FJ927NX
2004	8 Cyl. 6.0L; ID No. 5010120-R91; Injector Only	FJ928NX
2003	8 Cyl. 7.3L; Cyl. 1 to 7	FJ738NX
2003	8 Cyl. 7.3L; Cyl. 8	FJ926NX
2002-2000	8 Cyl.; Cyl. 1 to 7	FJ738NX
2002-2000	8 Cyl.; Cyl. 8	FJ926NX
F750		
2008-2005	8 Cyl. 6.0L	FJ928NX
2004	8 Cyl.; ID No. 1843089-C95; Injector Only	FJ927NX
2004	8 Cyl. 6.0L; ID No. 5010120-R91; Injector Only	FJ928NX
2003	8 Cyl. 7.3L; Cyl. 1 to 7	FJ738NX
2003	8 Cyl. 7.3L; Cyl. 8	FJ926NX
2002-2000	8 Cyl.; Cyl. 1 to 7	FJ738NX
2002-2000	8 Cyl.; Cyl. 8	FJ926NX
F7000		
1983		FJ1263
F-150		
1984	8 Cyl. 6.9L	FJ258
F-250		
1996-1995	8 Cyl. 7.3L; Stamping No. AA	FJ595NX
1996-1995	8 Cyl. 7.3L; Stamping No. AB	FJ596NX
1994	8 Cyl. 7.3L; F	FJ595NX
1994	8 Cyl. 7.3L; K	FJ1232
1994-1993	8 Cyl. 7.3L; M	FJ593
1993	8 Cyl. 7.3L; C	FJ1232
1992	8 Cyl. 7.3L; To 2/28/92	FJ258
1992	8 Cyl. 7.3L; From 3/92	FJ593
1991-1988	8 Cyl. 7.3L	FJ258
1987-1983	8 Cyl. 6.9L	FJ258
F-250 Super Duty		
2010-2008	8 Cyl. 6.4L; Injector Only	FJ960NX
2007-2005	8 Cyl. 6.0L; Injector Only	FJ928NX
2004	8 Cyl. 6.0L; ID No. 1843089-C95	FJ927NX
2004	8 Cyl. 6.0L; ID No. 5010120-R91	FJ928NX
2003	8 Cyl. 6.0L; Injector Only	FJ927NX
2003-2000	8 Cyl. 7.3L; Cyl. 1 to 7	FJ738NX
2003-1999	8 Cyl. 7.3L; Cyl. 8	FJ926NX
1999	8 Cyl. 7.3L; To 12/6/98; Cyl. 1 to 7	FJ596NX
1999	8 Cyl. 7.3L; From 12/7/98; Cyl. 1 to 7	FJ738NX
F-350		
1997-1995	8 Cyl. 7.3L; Stamping No. AA	FJ595NX
1997-1995	8 Cyl. 7.3L; Stamping No. AB	FJ596NX
1994	8 Cyl. 7.3L; F	FJ595NX
1994	8 Cyl. 7.3L; K	FJ1232
1994-1993	8 Cyl. 7.3L; M	FJ593
1993	8 Cyl. 7.3L; C	FJ1232
1992	8 Cyl. 7.3L; To 2/28/92	FJ258
1992	8 Cyl. 7.3L; From 3/92	FJ593
1991-1988	8 Cyl. 7.3L	FJ258
1987-1983	8 Cyl. 6.9L	FJ258

Injectors

		Part No.
Fuel Injector - Diesel - New		
F-350 Super Duty		
2010-2008	8 Cyl. 6.4L; Injector Only	FJ960NX
2007-2005	8 Cyl. 6.0L; Injector Only	FJ928NX
2004	8 Cyl. 6.0L; ID No. 1843089-C95; Injector Only	FJ927NX
2004	8 Cyl. 6.0L; ID No. 5010120-R91; Injector Only	FJ928NX
2003	8 Cyl. 6.0L; Injector Only	FJ927NX
2003-2000	8 Cyl. 7.3L; Cyl. 1 to 7	FJ738NX
2003-1999	8 Cyl. 7.3L; Cyl. 8	FJ926NX
1999	8 Cyl. 7.3L; To 12/6/98; Cyl. 1 to 7	FJ596NX
1999	8 Cyl. 7.3L; From 12/7/98; Cyl. 1 to 7	FJ738NX
F-450 Super Duty		
2010-2008	8 Cyl. 6.4L; Injector Only	FJ960NX
2007-2005	8 Cyl. 6.0L; Injector Only	FJ928NX
2004	8 Cyl. 6.0L; ID No. 1843089-C95; Injector Only	FJ927NX
2004	8 Cyl. 6.0L; ID No. 5010120-R91; Injector Only	FJ928NX
2003	8 Cyl. 6.0L; Injector Only	FJ927NX
2003-2000	8 Cyl. 7.3L; Cyl. 1 to 7	FJ738NX
2003-1999	8 Cyl. 7.3L; Cyl. 8	FJ926NX
1999	8 Cyl. 7.3L; To 12/6/98; Cyl. 1 to 7	FJ596NX
1999	8 Cyl. 7.3L; From 12/7/98; Cyl. 1 to 7	FJ738NX
F-550 Super Duty		
2010-2008	8 Cyl. 6.4L; Injector Only	FJ960NX
2007-2005	8 Cyl. 6.0L; Injector Only	FJ928NX
2004	8 Cyl. 6.0L; ID No. 1843089-C95; Injector Only	FJ927NX
2004	8 Cyl. 6.0L; ID No. 5010120-R91; Injector Only	FJ928NX
2003	8 Cyl. 6.0L; Injector Only	FJ927NX
2003-2000	8 Cyl. 7.3L; Cyl. 1 to 7	FJ738NX
2003-1999	8 Cyl. 7.3L; Cyl. 8	FJ926NX
1999	8 Cyl. 7.3L; To 12/6/98; Cyl. 1 to 7	FJ596NX
1999	8 Cyl. 7.3L; From 12/7/98; Cyl. 1 to 7	FJ738NX
F Super Duty		
1997-1996	8 Cyl. 7.3L; Stamping No. AB	FJ596NX
1997-1995	8 Cyl. 7.3L; Stamping No. AA	FJ595NX
1994	8 Cyl. 7.3L; K	FJ1232
1994-1993	8 Cyl. 7.3L; M	FJ593
1993	8 Cyl. 7.3L; C	FJ1232
1992	8 Cyl. 7.3L; To 2/28/92	FJ258
1992	8 Cyl. 7.3L; From 3/92	FJ593
1991-1988	8 Cyl. 7.3L	FJ258
LCF		
2010-2006	Injector Only	FJ928NX
Transit-150		
2019-2015	5 Cyl. 3.2L; Exhaust stock and reorder	FJ1225
2017-2015	5 Cyl. 3.2L; Alternate Number	FJ1225NX
Transit-250		
2019-2015	5 Cyl. 3.2L; Exhaust stock and reorder	FJ1225
2017-2015	5 Cyl. 3.2L; Alternate Number	FJ1225NX
Transit-350		
2019-2015	5 Cyl. 3.2L; Exhaust stock and reorder	FJ1225
2017-2015	5 Cyl. 3.2L; Alternate Number	FJ1225NX
Transit-350 HD		
2019-2015	5 Cyl. 3.2L; Exhaust stock and reorder	FJ1225
2017-2015	5 Cyl. 3.2L; Alternate Number	FJ1225NX
Fuel Injector - Diesel - Remfd		
E-350 Club Wagon		
2005-2004	8 Cyl. 6.0L; Injector Only	FJ928
2005-2004	8 Cyl. 6.0L; Complete Kit	FJ9288PCK
2003	8 Cyl. 7.3L; Cyl. 1 to 7	FJ738

		Part No.
Fuel Injector - Diesel - Remfd		
E-350 Club Wagon		
2003	8 Cyl. 7.3L; Complete Kit; Cyl. 1 to 8	FJ7388PCK
2003	8 Cyl. 7.3L; Cyl. 8	FJ926
E-350 Econoline		
1998-1995	8 Cyl. 7.3L; Stamping No. AA	FJ595
1998-1995	8 Cyl. 7.3L; Stamping No. AB	FJ596
E-350 Econoline Club Wagon		
2002-2000	8 Cyl. 7.3L; Cyl. 1 to 7	FJ738
2002-2000	8 Cyl. 7.3L; Complete Kit; Cyl. 1 to 8	FJ7388PCK
2002-1999	8 Cyl. 7.3L; Cyl. 8	FJ926
1999	8 Cyl. 7.3L; To 12/6/98; Cyl. 1 to 7	FJ596
1999	8 Cyl. 7.3L; From 12/7/98; Cyl. 1 to 7	FJ738
1999	8 Cyl. 7.3L; Complete Kit; From 12/7/98; Cyl. 1 to 8	FJ7388PCK
1998-1995	8 Cyl. 7.3L; Stamping No. AA	FJ595
1998-1995	8 Cyl. 7.3L; Stamping No. AB	FJ596
E-350 Super Duty		
2010-2004	8 Cyl. 6.0L; Injector Only	FJ928
2010-2004	8 Cyl. 6.0L; Complete Kit	FJ9288PCK
2003-2000	8 Cyl. 7.3L; Cyl. 1 to 7	FJ738
2003-2000	8 Cyl. 7.3L; Complete Kit; Cyl. 1 to 8	FJ7388PCK
2003-1999	8 Cyl. 7.3L; Cyl. 8	FJ926
1999	8 Cyl. 7.3L; To 12/6/98; Cyl. 1 to 7	FJ596
1999	8 Cyl. 7.3L; From 12/7/98; Cyl. 1 to 7	FJ738
1999	8 Cyl. 7.3L; Complete Kit; From 12/7/98; Cyl. 1 to 8	FJ7388PCK
E-450 Econoline Super Duty		
2002-1999	8 Cyl. 7.3L; Cyl. 1 to 7	FJ738
2002-1999	8 Cyl. 7.3L; Complete Kit; Cyl. 1 to 8	FJ7388PCK
2002-1999	8 Cyl. 7.3L; Cyl. 8	FJ926
E-450 Super Duty		
2010-2004	8 Cyl. 6.0L; Injector Only	FJ928
2010-2004	8 Cyl. 6.0L; Complete Kit	FJ9288PCK
2003	8 Cyl. 7.3L; Cyl. 1 to 7	FJ738
2003	8 Cyl. 7.3L; Complete Kit; Cyl. 1 to 8	FJ7388PCK
2003	8 Cyl. 7.3L; Cyl. 8	FJ926
E-550 Econoline Super Duty		
2002	8 Cyl. 7.3L; Cyl. 1 to 7	FJ738
2002	8 Cyl. 7.3L; Complete Kit; Cyl. 1 to 8	FJ7388PCK
2002	8 Cyl. 7.3L; Cyl. 8	FJ926
E-550 Super Duty		
2003	8 Cyl. 7.3L; Cyl. 1 to 7	FJ738
2003	8 Cyl. 7.3L; Complete Kit; Cyl. 1 to 8	FJ7388PCK
2003	8 Cyl. 7.3L; Cyl. 8	FJ926
Econoline Super Duty		
1999	8 Cyl. 7.3L; To 12/6/98; Cyl. 1 to 7	FJ596
1999	8 Cyl. 7.3L; From 12/7/98; Cyl. 1 to 7	FJ738
1999	8 Cyl. 7.3L; Complete Kit; From 12/7/98; Cyl. 1 to 8	FJ7388PCK
1999	8 Cyl. 7.3L; Cyl. 8	FJ926
1998-1996	8 Cyl. 7.3L; Stamping No. AA	FJ595
1998-1996	8 Cyl. 7.3L; Stamping No. AB	FJ596
Escort		
1987-1984	4 Cyl. 2.0L	FJ588
Excursion		
2005	8 Cyl. 6.0L; Injector Only	FJ928
2005	8 Cyl. 6.0L; Complete Kit	FJ9288PCK
2004	8 Cyl. 6.0L; ID No. 1843089-C95; Injector Only	FJ927
2004	8 Cyl. 6.0L; Complete Kit; ID No. 1843089-C95	FJ9278PCK
2004	8 Cyl. 6.0L; ID No. 5010120-R91; Injector Only	FJ928

Injectors

		Part No.
Fuel Injector - Diesel - Remfd		
Excursion		
2004	8 Cyl. 6.0L; Complete Kit; ID No. 5010120-R91	FJ9288PCK
2003	8 Cyl. 6.0L; Injector Only	FJ927
2003	8 Cyl. 6.0L; Complete Kit	FJ9278PCK
2003-2000	8 Cyl. 7.3L; Cyl. 1 to 7	FJ738
2003-2000	8 Cyl. 7.3L; Complete Kit; Cyl. 1 to 8	FJ7388PCK
2003-2000	8 Cyl. 7.3L; Cyl. 8	FJ926
F59		
1997-1995	8 Cyl. 7.3L; F; Stamping No. AA	FJ595
1997-1995	8 Cyl. 7.3L; F; Stamping No. AB	FJ596
1994	8 Cyl. 7.3L; F	FJ595
F650		
2017-2016	8 Cyl. 6.7L; Cyl. 3 to 6	FJ1223
2017-2016	8 Cyl. 6.7L; Cyl. 1, 2, 7, 8	FJ1224
2008-2005	8 Cyl. 6.0L; Injector Only	FJ928
2008-2005	8 Cyl. 6.0L; Complete Kit	FJ9288PCK
2004	8 Cyl.; ID No. 1843089-C95; Injector Only	FJ927
2004	8 Cyl.; Complete Kit; ID No. 1843089-C95	FJ9278PCK
2004	8 Cyl. 6.0L; ID No. 5010120-R91; Injector Only	FJ928
2004	8 Cyl. 6.0L; Complete Kit; ID No. 5010120-R91	FJ9288PCK
2003	8 Cyl. 7.3L; Cyl. 1 to 7	FJ738
2003	8 Cyl. 7.3L; Complete Kit; Cyl. 1 to 8	FJ7388PCK
2003	8 Cyl. 7.3L; Cyl. 8	FJ926
2002-2000	8 Cyl.; Cyl. 1 to 7	FJ738
2002-2000	8 Cyl.; Complete Kit; Cyl. 1 to 8	FJ7388PCK
2002-2000	8 Cyl.; Cyl. 8	FJ926
F750		
2017-2016	8 Cyl. 6.7L; Cyl. 3 to 6	FJ1223
2017-2016	8 Cyl. 6.7L; Cyl. 1, 2, 7, 8	FJ1224
2008-2005	8 Cyl. 6.0L; Injector Only	FJ928
2008-2005	8 Cyl. 6.0L; Complete Kit	FJ9288PCK
2004	8 Cyl.; ID No. 1843089-C95; Injector Only	FJ927
2004	8 Cyl.; Complete Kit; ID No. 1843089-C95	FJ9278PCK
2004	8 Cyl. 6.0L; ID No. 5010120-R91; Injector Only	FJ928
2004	8 Cyl. 6.0L; Complete Kit; ID No. 5010120-R91	FJ9288PCK
2003	8 Cyl. 7.3L; Cyl. 1 to 7	FJ738
2003	8 Cyl. 7.3L; Complete Kit; Cyl. 1 to 8	FJ7388PCK
2003	8 Cyl. 7.3L; Cyl. 8	FJ926
2002-2000	8 Cyl.; Cyl. 1 to 7	FJ738
2002-2000	8 Cyl.; Complete Kit; Cyl. 1 to 8	FJ7388PCK
2002-2000	8 Cyl.; Cyl. 8	FJ926
F-250		
1996-1995	8 Cyl. 7.3L; Stamping No. AA	FJ595
1996-1995	8 Cyl. 7.3L; Stamping No. AB	FJ596
1994	8 Cyl. 7.3L; F	FJ595
F-250 Super Duty		
2019-2016	8 Cyl. 6.7L; Cyl. 3 to 6	FJ1223
2019-2016	8 Cyl. 6.7L; Cyl. 1, 2, 7, 8	FJ1224
2015-2014	8 Cyl. 6.7L; w/ Pickup Bed; Cyl. 3 to 6	FJ1223
2015-2014	8 Cyl. 6.7L; w/ Pickup Bed; Cyl. 1, 2, 7, 8	FJ1224
2013-2011	8 Cyl. 6.7L; Cyl. 3 to 6	FJ1221
2013-2011	8 Cyl. 6.7L; Cyl. 1, 2, 7, 8	FJ1222
2010-2008	8 Cyl. 6.4L; Injector Only	FJ960
2007-2005	8 Cyl. 6.0L; Injector Only	FJ928
2007-2005	8 Cyl. 6.0L; Complete Kit	FJ9288PCK
2004	8 Cyl. 6.0L; ID No. 1843089-C95; Injector Only	FJ927
2004	8 Cyl. 6.0L; Complete Kit; ID No. 1843089-C95	FJ9278PCK
2004	8 Cyl. 6.0L; ID No. 5010120-R91; Injector Only	FJ928
2004	8 Cyl. 6.0L; Complete Kit; ID No. 5010120-R91	FJ9288PCK
2003	8 Cyl. 6.0L; Injector Only	FJ927
2003	8 Cyl. 6.0L; Complete Kit	FJ9278PCK
2003-2000	8 Cyl. 7.3L; Cyl. 1 to 7	FJ738
2003-2000	8 Cyl. 7.3L; Complete Kit; Cyl. 1 to 8	FJ7388PCK
2003-1999	8 Cyl. 7.3L; Cyl. 8	FJ926
1999	8 Cyl. 7.3L; To 12/6/98; Cyl. 1 to 7	FJ596
1999	8 Cyl. 7.3L; From 12/7/98; Cyl. 1 to 7	FJ738
1999	8 Cyl. 7.3L; Complete Kit; From 12/7/98; Cyl. 1 to 8	FJ7388PCK
F-450 Super Duty		
2019-2017	8 Cyl. 6.7L; Cyl. 3 to 6	FJ1223
2019-2017	8 Cyl. 6.7L; Cyl. 1, 2, 7, 8	FJ1224
2016-2015	8 Cyl. 6.7L; Cab and Chassis; Cyl. 3 to 6	FJ1221
2016-2015	8 Cyl. 6.7L; Cab and Chassis; Cyl. 1, 2, 7, 8	FJ1222
2016-2015	8 Cyl. 6.7L; w/ Pickup Bed; Cyl. 3 to 6	FJ1223
2016-2015	8 Cyl. 6.7L; w/ Pickup Bed; Cyl. 1, 2, 7, 8	FJ1224
2014	8 Cyl. 6.7L; To 3/17/14; Cyl. 3 to 6	FJ1221

		Part No.
Fuel Injector - Diesel - Remfd		
F-250 Super Duty		
2004	8 Cyl. 6.0L; ID No. 5010120-R91; Injector Only	FJ928
2004	8 Cyl. 6.0L; Complete Kit; ID No. 5010120-R91	FJ9288PCK
2003	8 Cyl. 6.0L; Injector Only	FJ927
2003	8 Cyl. 6.0L; Complete Kit	FJ9278PCK
2003-2000	8 Cyl. 7.3L; Cyl. 1 to 7	FJ738
2003-1999	8 Cyl. 7.3L; Complete Kit; Cyl. 1 to 8	FJ7388PCK
2003-1999	8 Cyl. 7.3L; Cyl. 8	FJ926
1999	8 Cyl. 7.3L; To 12/6/98; Cyl. 1 to 7	FJ596
1999	8 Cyl. 7.3L; From 12/7/98; Cyl. 1 to 7	FJ738
F-350		
1997-1995	8 Cyl. 7.3L; Stamping No. AA	FJ595
1997-1995	8 Cyl. 7.3L; Stamping No. AB	FJ596
1994	8 Cyl. 7.3L; F	FJ595
F-350 Super Duty		
2019-2017	8 Cyl. 6.7L; Cyl. 3 to 6	FJ1223
2019-2017	8 Cyl. 6.7L; Cyl. 1, 2, 7, 8	FJ1224
2016-2015	8 Cyl. 6.7L; Cab and Chassis; Cyl. 3 to 6	FJ1221
2016-2015	8 Cyl. 6.7L; Cab and Chassis; Cyl. 1, 2, 7, 8	FJ1222
2016-2015	8 Cyl. 6.7L; w/ Pickup Bed; Cyl. 3 to 6	FJ1223
2016-2015	8 Cyl. 6.7L; w/ Pickup Bed; Cyl. 1, 2, 7, 8	FJ1224
2014	8 Cyl. 6.7L; To 3/17/14; Cyl. 3 to 6	FJ1221
2014	8 Cyl. 6.7L; Cab and Chassis; From 3/18/14; Cyl. 3 to 6	FJ1221
2014	8 Cyl. 6.7L; To 3/17/14; Cyl. 1, 2, 7, 8	FJ1222
2014	8 Cyl. 6.7L; Cab and Chassis; From 3/18/14; Cyl. 1, 2, 7, 8	FJ1222
2014	8 Cyl. 6.7L; From 3/18/14; w/ Pickup Bed; Cyl. 3 to 6	FJ1223
2014	8 Cyl. 6.7L; From 3/18/14; w/ Pickup Bed; Cyl. 1, 2, 7, 8	FJ1224
2013-2011	8 Cyl. 6.7L; Cyl. 3 to 6	FJ1221
2013-2011	8 Cyl. 6.7L; Cyl. 1, 2, 7, 8	FJ1222
2010-2008	8 Cyl. 6.4L; Injector Only	FJ960
2007-2005	8 Cyl. 6.0L; Injector Only	FJ928
2007-2005	8 Cyl. 6.0L; Complete Kit	FJ9288PCK
2004	8 Cyl. 6.0L; ID No. 1843089-C95; Injector Only	FJ927
2004	8 Cyl. 6.0L; Complete Kit; ID No. 1843089-C95	FJ9278PCK
2004	8 Cyl. 6.0L; ID No. 5010120-R91; Injector Only	FJ928
2004	8 Cyl. 6.0L; Complete Kit; ID No. 5010120-R91	FJ9288PCK
2003	8 Cyl. 6.0L; Injector Only	FJ927
2003	8 Cyl. 6.0L; Complete Kit	FJ9278PCK
2003-2000	8 Cyl. 7.3L; Cyl. 1 to 7	FJ738
2003-2000	8 Cyl. 7.3L; Complete Kit; Cyl. 1 to 8	FJ7388PCK
2003-1999	8 Cyl. 7.3L; Cyl. 8	FJ926
1999	8 Cyl. 7.3L; To 12/6/98; Cyl. 1 to 7	FJ596
1999	8 Cyl. 7.3L; From 12/7/98; Cyl. 1 to 7	FJ738
1999	8 Cyl. 7.3L; Complete Kit; From 12/7/98; Cyl. 1 to 8	FJ7388PCK
F-450 Super Duty		
2019-2017	8 Cyl. 6.7L; Cyl. 3 to 6	FJ1223
2019-2017	8 Cyl. 6.7L; Cyl. 1, 2, 7, 8	FJ1224
2016-2015	8 Cyl. 6.7L; Cab and Chassis; Cyl. 3 to 6	FJ1221
2016-2015	8 Cyl. 6.7L; Cab and Chassis; Cyl. 1, 2, 7, 8	FJ1222
2016-2015	8 Cyl. 6.7L; w/ Pickup Bed; Cyl. 3 to 6	FJ1223
2016-2015	8 Cyl. 6.7L; w/ Pickup Bed; Cyl. 1, 2, 7, 8	FJ1224
2014	8 Cyl. 6.7L; To 3/17/14; Cyl. 3 to 6	FJ1221

Ford

Injectors

		Part No.
Fuel Injector - Diesel - Remfd		
F-450 Super Duty		
2014	8 Cyl. 6.7L; Cab and Chassis; From 3/18/14; Cyl. 3 to 6	FJ1221
2014	8 Cyl. 6.7L; To 3/17/14; Cyl. 1, 2, 7, 8	FJ1222
2014	8 Cyl. 6.7L; Cab and Chassis; From 3/18/14; Cyl. 1, 2, 7, 8	FJ1222
2014	8 Cyl. 6.7L; From 3/18/14; w/ Pickup Bed; Cyl. 3 to 6	FJ1223
2014	8 Cyl. 6.7L; From 3/18/14; w/ Pickup Bed; Cyl. 1, 2, 7, 8	FJ1224
2013-2011	8 Cyl. 6.7L; Cyl. 3 to 6	FJ1221
2013-2011	8 Cyl. 6.7L; Cyl. 1, 2, 7, 8	FJ1222
2010-2008	8 Cyl. 6.4L; Injector Only	FJ960
2007-2005	8 Cyl. 6.0L; Injector Only	FJ928
2007-2005	8 Cyl. 6.0L; Complete Kit	FJ9288PCK
2004	8 Cyl. 6.0L; ID No. 1843089-C95; Injector Only	FJ927
2004	8 Cyl. 6.0L; Complete Kit; ID No. 1843089-C95	FJ9278PCK
2004	8 Cyl. 6.0L; ID No. 5010120-R91; Injector Only	FJ928
2004	8 Cyl. 6.0L; Complete Kit; ID No. 5010120-R91	FJ9288PCK
2003	8 Cyl. 6.0L; Injector Only	FJ927
2003	8 Cyl. 6.0L; Complete Kit	FJ9278PCK
2003-2000	8 Cyl. 7.3L; Cyl. 1 to 7	FJ738
2003-2000	8 Cyl. 7.3L; Complete Kit; Cyl. 1 to 8	FJ7388PCK
2003-1999	8 Cyl. 7.3L; Cyl. 8	FJ926
1999	8 Cyl. 7.3L; To 12/6/98; Cyl. 1 to 7	FJ596
1999	8 Cyl. 7.3L; From 12/7/98; Cyl. 1 to 7	FJ738
1999	8 Cyl. 7.3L; Complete Kit; From 12/7/98; Cyl. 1 to 8	FJ7388PCK
F-550 Super Duty		
2019-2017	8 Cyl. 6.7L; Cyl. 3 to 6	FJ1223
2019-2017	8 Cyl. 6.7L; Cyl. 1, 2, 7, 8	FJ1224
2016-2015	8 Cyl. 6.7L; Cab and Chassis; Cyl. 3 to 6	FJ1221
2016-2015	8 Cyl. 6.7L; Cab and Chassis; Cyl. 1, 2, 7, 8	FJ1222
2014	8 Cyl. 6.7L; To 3/17/14; Cyl. 3 to 6	FJ1221
2014	8 Cyl. 6.7L; Cab and Chassis; From 3/18/14; Cyl. 3 to 6	FJ1221
2014	8 Cyl. 6.7L; To 3/17/14; Cyl. 1, 2, 7, 8	FJ1222
2014	8 Cyl. 6.7L; Cab and Chassis; From 3/18/14; Cyl. 1, 2, 7, 8	FJ1222
2013-2011	8 Cyl. 6.7L; Cyl. 3 to 6	FJ1221
2013-2011	8 Cyl. 6.7L; Cyl. 1, 2, 7, 8	FJ1222
2010-2008	8 Cyl. 6.4L; Injector Only	FJ960
2007-2005	8 Cyl. 6.0L; Injector Only	FJ928
2007-2005	8 Cyl. 6.0L; Complete Kit	FJ9288PCK
2004	8 Cyl. 6.0L; ID No. 1843089-C95; Injector Only	FJ927
2004	8 Cyl. 6.0L; Complete Kit; ID No. 1843089-C95	FJ9278PCK
2004	8 Cyl. 6.0L; ID No. 5010120-R91; Injector Only	FJ928
2004	8 Cyl. 6.0L; Complete Kit; ID No. 5010120-R91	FJ9288PCK
2003	8 Cyl. 6.0L; Injector Only	FJ927
2003	8 Cyl. 6.0L; Complete Kit	FJ9278PCK
2003-2000	8 Cyl. 7.3L; Cyl. 1 to 7	FJ738
2003-2000	8 Cyl. 7.3L; Complete Kit; Cyl. 1 to 8	FJ7388PCK
2003-1999	8 Cyl. 7.3L; Cyl. 8	FJ926
1999	8 Cyl. 7.3L; To 12/6/98; Cyl. 1 to 7	FJ596
1999	8 Cyl. 7.3L; From 12/7/98; Cyl. 1 to 7	FJ738
1999	8 Cyl. 7.3L; Complete Kit; From 12/7/98; Cyl. 1 to 8	FJ7388PCK

		Part No.
Fuel Injector - Diesel - Remfd		
F Super Duty		
1997-1996	8 Cyl. 7.3L; Stamping No. AB	FJ596
1997-1995	8 Cyl. 7.3L; Stamping No. AA	FJ595
LCF		
2010-2006	Injector Only	FJ928
2010-2006	Complete Kit	FJ9288PCK
Ranger		
1987	4 Cyl. 2.3L; Diesel	FJ591
1986	4 Cyl. 2.3L; Diesel; To 5/86	FJ590
1986	4 Cyl. 2.3L; Diesel; From 6/86	FJ591
1985	4 Cyl. 2.3L; Diesel	FJ590
1984-1983	4 Cyl. 2.2L	FJ587
Tempo		
1986-1984	4 Cyl. 2.0L	FJ588
Injection Components		
Diesel Engine Belt Tensioner		
E-350 Club Wagon		
2005-2004	8 Cyl. 6.0L; Dual Alternator System	EBT1
2005-2004	8 Cyl. 6.0L; Single Alternator System	EBT3
2003	8 Cyl. 7.3L	EBT2
E-350 Econoline		
1998-1997	8 Cyl. 7.3L	EBT2
E-350 Econoline Club Wagon		
2002-1997	8 Cyl. 7.3L	EBT2
E-350 Super Duty		
2010-2004	8 Cyl. 6.0L; Dual Alternator System	EBT1
2010-2004	8 Cyl. 6.0L; Single Alternator System	EBT3
2003-1999	8 Cyl. 7.3L	EBT2
E-450 Econoline Super Duty		
2002-2000	8 Cyl. 7.3L	EBT2
E-450 Super Duty		
2010-2004	8 Cyl. 6.0L; Dual Alternator System	EBT1
2010-2004	8 Cyl. 6.0L; Single Alternator System	EBT3
E-550 Econoline Super Duty		
2002	8 Cyl. 7.3L	EBT2
Econoline Super Duty		
1999-1997	8 Cyl. 7.3L	EBT2
Excursion		
2005-2003	8 Cyl. 6.0L; Single Alternator System	EBT3
2003-2000	8 Cyl. 7.3L	EBT2
F750		
2007-2004	8 Cyl.; Dual Alternator System	EBT1
2007-2004	8 Cyl.; Single Alternator System	EBT3
2003-2000	8 Cyl.	EBT2
F-250 Super Duty		
2007-2003	8 Cyl. 6.0L; Dual Alternator System	EBT1
2007-2003	8 Cyl. 6.0L; Single Alternator System	EBT3
2003-1999	8 Cyl. 7.3L	EBT2
F-350 Super Duty		
2007-2003	8 Cyl. 6.0L; Dual Alternator System	EBT1
2007-2003	8 Cyl. 6.0L; Single Alternator System	EBT3
2003-1999	8 Cyl. 7.3L	EBT2
F-450 Super Duty		
2007-2003	8 Cyl. 6.0L; Dual Alternator System	EBT1
2007-2003	8 Cyl. 6.0L; Single Alternator System	EBT3
2003-1999	8 Cyl. 7.3L	EBT2
F-550 Super Duty		
2007-2003	8 Cyl. 6.0L; Dual Alternator System	EBT1
2007-2003	8 Cyl. 6.0L; Single Alternator System	EBT3
2003-1999	8 Cyl. 7.3L	EBT2

Injection Components

		Part No.
Diesel Fuel Filter Housing		
E-350 Econoline		
1996	8 Cyl. 7.3L	FFH2
E-350 Econoline Club Wagon		
2002-1999	8 Cyl. 7.3L	FFH1
1996	8 Cyl. 7.3L	FFH2
E-350 Super Duty		
2000-1999	8 Cyl. 7.3L	FFH1
E-450 Econoline Super Duty		
2002-2000	8 Cyl. 7.3L	FFH1
E-550 Econoline Super Duty		
2002	8 Cyl. 7.3L	FFH1
Econoline Super Duty		
1999	8 Cyl. 7.3L	FFH1
1996	8 Cyl. 7.3L	FFH2
Excursion		
2002-2000	8 Cyl. 7.3L	FFH1
F-250 Super Duty		
2003-1999	8 Cyl. 7.3L	FFH1
F-350		
1997	8 Cyl. 7.3L	FFH2
F-350 Super Duty		
2002-1999	8 Cyl. 7.3L	FFH1
Diesel Fuel Heater		
E-350 Club Wagon		
2004	8 Cyl. 7.3L; Mounted in Filter Housing	DFH101
2003	8 Cyl. 7.3L; Heater; Mounted in Filter Housing	DFH101
2003	8 Cyl. 7.3L; Mounted on Filter Housing	DFH103
E-350 Econoline		
1998	8 Cyl. 7.3L; Heater; Mounted in Filter Housing	DFH101
1998	8 Cyl. 7.3L; Mounted on Filter Housing	DFH103
1997-1994	8 Cyl. 7.3L; Mounted in Filter Housing	DFH104
1997-1994	8 Cyl. 7.3L; Mounted on Filter Housing	DFH105
E-350 Econoline Club Wagon		
2002-1998	8 Cyl. 7.3L; Heater; Mounted in Filter Housing	DFH101
2002-1998	8 Cyl. 7.3L; Mounted on Filter Housing	DFH103
1997-1994	8 Cyl. 7.3L; Mounted in Filter Housing	DFH104
1997-1994	8 Cyl. 7.3L; Mounted on Filter Housing	DFH105
E-350 Super Duty		
2003	8 Cyl. 7.3L; Heater; Mounted in Filter Housing	DFH101
2003	8 Cyl. 7.3L; Mounted on Filter Housing	DFH103
2002-2001	8 Cyl. 7.3L; Mounted in Filter Housing	DFH101
2000-1999	8 Cyl. 7.3L; Heater; Mounted in Filter Housing	DFH101
2000-1999	8 Cyl. 7.3L; Mounted on Filter Housing	DFH103
E-450 Econoline Super Duty		
2002-1999	8 Cyl. 7.3L; Heater; Mounted in Filter Housing	DFH101
2002-1999	8 Cyl. 7.3L; Mounted on Filter Housing	DFH103
E-450 Super Duty		
2003	8 Cyl. 7.3L; Mounted in Filter Housing	DFH101
E-550 Econoline Super Duty		
2002	8 Cyl. 7.3L; Heater; Mounted in Filter Housing	DFH101
2002	8 Cyl. 7.3L; Mounted on Filter Housing	DFH103
E-550 Super Duty		
2003	8 Cyl. 7.3L; Heater; Mounted in Filter Housing	DFH101
2003	8 Cyl. 7.3L; Mounted on Filter Housing	DFH103

		Part No.
Diesel Fuel Heater		
Econoline Super Duty		
1999-1998	8 Cyl. 7.3L; Heater; Mounted in Filter Housing	DFH101
1999-1998	8 Cyl. 7.3L; Mounted on Filter Housing	DFH103
1997-1996	8 Cyl. 7.3L; Mounted in Filter Housing	DFH104
1997-1996	8 Cyl. 7.3L; Mounted on Filter Housing	DFH105
Excursion		
2003-2000	8 Cyl. 7.3L; Heater; Mounted in Filter Housing	DFH101
2003-2000	8 Cyl. 7.3L; Mounted on Filter Housing	DFH103
F59		
1997-1995	8 Cyl. 7.3L; F; Mounted in Filter Housing	DFH104
1997-1994	8 Cyl. 7.3L; F; Mounted on Filter Housing	DFH105
F650		
2003-2000	8 Cyl. 7.3L; Mounted in Filter Housing	DFH101
F750		
2003-2000	8 Cyl. 7.3L; Mounted in Filter Housing	DFH101
F-250		
1996-1995	8 Cyl. 7.3L; Mounted in Filter Housing	DFH104
1996-1995	8 Cyl. 7.3L; Mounted on Filter Housing	DFH105
1994	8 Cyl. 7.3L; F; Mounted in Filter Housing	DFH104
1994	8 Cyl. 7.3L; F; Mounted on Filter Housing	DFH105
F-250 HD		
1997	8 Cyl. 7.3L; Mounted in Filter Housing	DFH104
F-250 Super Duty		
2003-1999	8 Cyl. 7.3L; Heater; Mounted in Filter Housing	DFH101
2003-1999	8 Cyl. 7.3L; Mounted on Filter Housing	DFH103
F-350		
1997-1995	8 Cyl. 7.3L; Mounted in Filter Housing	DFH104
1997-1995	8 Cyl. 7.3L; Mounted on Filter Housing	DFH105
1994	8 Cyl. 7.3L; F; Mounted in Filter Housing	DFH104
1994	8 Cyl. 7.3L; F; Mounted on Filter Housing	DFH105
F-350 Super Duty		
2003-1999	8 Cyl. 7.3L; Heater; Mounted in Filter Housing	DFH101
2003-1999	8 Cyl. 7.3L; Mounted on Filter Housing	DFH103
F-450 Super Duty		
2003-1999	8 Cyl. 7.3L; Heater; Mounted in Filter Housing	DFH101
2003-1999	8 Cyl. 7.3L; Mounted on Filter Housing	DFH103
F-550 Super Duty		
2003-1999	8 Cyl. 7.3L; Heater; Mounted in Filter Housing	DFH101
2003-1999	8 Cyl. 7.3L; Mounted on Filter Housing	DFH103
F Super Duty		
1997-1995	8 Cyl. 7.3L; Mounted on Filter Housing	DFH105
1997-1994	8 Cyl. 7.3L; Mounted in Filter Housing	DFH104
Diesel Fuel Injection Harness		
E-350 Econoline		
1998	8 Cyl. 7.3L	IFH6
1997-1995	8 Cyl. 7.3L	IFH5
E-350 Econoline Club Wagon		
2002	8 Cyl. 7.3L	IFH6
2001	8 Cyl. 7.3L	IFH6
2000-1998	8 Cyl. 7.3L	IFH6
1997-1995	8 Cyl. 7.3L	IFH5
E-450 Econoline Super Duty		
2002	8 Cyl. 7.3L	IFH6
E-450 Super Duty		
2003	8 Cyl. 7.3L	IFH6
Econoline Super Duty		
1999-1998	8 Cyl. 7.3L	IFH6

Ford

Injection Components

		Part No.
Diesel Fuel Injection Harness		
Econoline Super Duty		
1997-1996	8 Cyl. 7.3L	IFH5
Excursion		
2005	8 Cyl. 6.0L	IFH4
2004	8 Cyl. 6.0L	IFH3
2003	8 Cyl. 6.0L	IFH2
2003-2002	8 Cyl. 7.3L	IFH6
2001	8 Cyl. 7.3L	IFH6
2000	8 Cyl. 7.3L	IFH6
F59		
1997-1994	8 Cyl. 7.3L	IFH5
F650		
2008-2005	8 Cyl.	IFH4
2004	8 Cyl.	IFH3
F750		
2008-2005	8 Cyl.	IFH4
2004	8 Cyl.	IFH3
F-250		
1996-1994	8 Cyl. 7.3L	IFH5
F-250 Super Duty		
2010-2008	8 Cyl. 6.4L; Right	IFH8
2010-2008	8 Cyl. 6.4L; Left	IFH9
2007-2005	8 Cyl. 6.0L	IFH4
2004	8 Cyl. 6.0L	IFH3
2003	8 Cyl. 6.0L	IFH2
2003-2002	8 Cyl. 7.3L	IFH6
2001	8 Cyl. 7.3L	IFH6
2000-1999	8 Cyl. 7.3L	IFH6
F-350		
1997-1995	8 Cyl. 7.3L	IFH5
1994	8 Cyl. 7.3L; F	IFH5
F-350 Super Duty		
2010-2008	8 Cyl. 6.4L; Right	IFH8
2010-2008	8 Cyl. 6.4L; Left	IFH9
2007-2005	8 Cyl. 6.0L	IFH4
2004	8 Cyl. 6.0L	IFH3
2003	8 Cyl. 6.0L	IFH2
2003-2002	8 Cyl. 7.3L	IFH6
2001	8 Cyl. 7.3L	IFH6
2000	8 Cyl. 7.3L	IFH6
F-450 Super Duty		
2010-2008	8 Cyl. 6.4L; Right	IFH8
2010-2008	8 Cyl. 6.4L; Left	IFH9
2007-2005	8 Cyl. 6.0L	IFH4
2004	8 Cyl. 6.0L	IFH3
2003	8 Cyl. 6.0L	IFH2
2003-2002	8 Cyl. 7.3L	IFH6
2001	8 Cyl. 7.3L	IFH6
2000-1999	8 Cyl. 7.3L	IFH6
F-550 Super Duty		
2010-2008	8 Cyl. 6.4L; Right	IFH8
2010-2008	8 Cyl. 6.4L; Left	IFH9
2007-2005	8 Cyl. 6.0L	IFH4
2004	8 Cyl. 6.0L	IFH3
2003	8 Cyl. 6.0L	IFH2
2003-2002	8 Cyl. 7.3L	IFH6
2001	8 Cyl. 7.3L	IFH6
1999	8 Cyl. 7.3L	IFH6
F Super Duty		
1997-1995	8 Cyl. 7.3L	IFH5
Diesel Fuel Injection Pump - New		
E-250 Econoline Club Wagon		
1991-1990	8 Cyl. 7.3L	IP40NX

		Part No.
Diesel Fuel Injection Pump - New		
E-250 Econoline Club Wagon		
1989-1988	8 Cyl. 7.3L	IP39NX
1987-1983	8 Cyl. 6.9L	IP38NX
E-350 Econoline		
1994-1993	8 Cyl. 7.3L; Naturally Aspirated; w/ A.T.	IP41NX
1992	8 Cyl. 7.3L; To 2/92	IP40NX
1992	8 Cyl. 7.3L; From 3/92; w/ A.T.	IP41NX
1991-1990	8 Cyl. 7.3L	IP40NX
1989-1988	8 Cyl. 7.3L	IP39NX
1987-1983	8 Cyl. 6.9L	IP38NX
E-350 Econoline Club Wagon		
1994-1993	8 Cyl. 7.3L; Naturally Aspirated; w/ A.T.	IP41NX
1992	8 Cyl. 7.3L; To 2/92	IP40NX
1992	8 Cyl. 7.3L; From 3/92; w/ A.T.	IP41NX
1991-1990	8 Cyl. 7.3L	IP40NX
1989-1988	8 Cyl. 7.3L	IP39NX
1987-1983	8 Cyl. 6.9L	IP38NX
F59		
1994-1993	8 Cyl. 7.3L; Naturally Aspirated; w/ A.T.	IP41NX
1994-1993	8 Cyl. 7.3L; Naturally Aspirated; w/ M.T.	IP42NX
1994-1993	8 Cyl. 7.3L; Turbocharged; w/ M.T.	IP45NX
1992	8 Cyl. 7.3L; To 2/92	IP40NX
1992	8 Cyl. 7.3L; From 3/92; w/ A.T.	IP41NX
1992	8 Cyl. 7.3L; From 3/92; w/ M.T.	IP42NX
1991-1990	8 Cyl. 7.3L	IP40NX
1989-1988	8 Cyl. 7.3L	IP39NX
F-250		
1994-1993	8 Cyl. 7.3L; Naturally Aspirated; w/ A.T.	IP41NX
1994-1993	8 Cyl. 7.3L; Naturally Aspirated; w/ M.T.	IP42NX
1994-1993	8 Cyl. 7.3L; Turbocharged; w/ M.T.	IP45NX
1992	8 Cyl. 7.3L; To 2/92	IP40NX
1992	8 Cyl. 7.3L; From 3/92; w/ A.T.	IP41NX
1992	8 Cyl. 7.3L; From 3/92; w/ M.T.	IP42NX
1991-1990	8 Cyl. 7.3L	IP40NX
1989-1988	8 Cyl. 7.3L	IP39NX
1987-1983	8 Cyl. 6.9L	IP38NX
F-350		
1994-1993	8 Cyl. 7.3L; Naturally Aspirated; w/ A.T.	IP41NX
1994-1993	8 Cyl. 7.3L; Naturally Aspirated; w/ M.T.	IP42NX
1994-1993	8 Cyl. 7.3L; Turbocharged; w/ M.T.	IP45NX
1992	8 Cyl. 7.3L; To 2/92	IP40NX
1992	8 Cyl. 7.3L; From 3/92; w/ A.T.	IP41NX
1992	8 Cyl. 7.3L; From 3/92; w/ M.T.	IP42NX
1991-1990	8 Cyl. 7.3L	IP40NX
1989-1988	8 Cyl. 7.3L	IP39NX
1987-1983	8 Cyl. 6.9L	IP38NX
F-450 Super Duty		
1994-1993	8 Cyl. 7.3L; Naturally Aspirated; w/ A.T.	IP41NX
1994-1993	8 Cyl. 7.3L; Naturally Aspirated; w/ M.T.	IP42NX
1994-1993	8 Cyl. 7.3L; Turbocharged; w/ M.T.	IP45NX
1992	8 Cyl. 7.3L; To 2/92	IP40NX
1992	8 Cyl. 7.3L; From 3/92; w/ A.T.	IP41NX
1992	8 Cyl. 7.3L; From 3/92; w/ M.T.	IP42NX
1991-1990	8 Cyl. 7.3L	IP40NX
1989-1988	8 Cyl. 7.3L	IP39NX
1987-1983	8 Cyl. 6.9L	IP38NX
F Super Duty		
1994	8 Cyl. 7.3L; Naturally Aspirated; w/ M.T.	IP42NX
1994	8 Cyl. 7.3L; Turbocharged; w/ M.T.	IP45NX
1994-1993	8 Cyl. 7.3L; Naturally Aspirated; w/ A.T.	IP41NX
1992	8 Cyl. 7.3L; To 2/92	IP40NX
1992	8 Cyl. 7.3L; From 3/92; w/ A.T.	IP41NX
1991-1990	8 Cyl. 7.3L	IP40NX
1989-1988	8 Cyl. 7.3L	IP39NX
Diesel Fuel Injection Pump - Remanufactured		
E-250 Econoline Club Wagon		
1991-1990	8 Cyl. 7.3L; Exhaust stock and reorder	IP4
1991-1990	8 Cyl. 7.3L; Alternate Number	IP40
1989-1988	8 Cyl. 7.3L; Exhaust stock and reorder	IP3
1989-1988	8 Cyl. 7.3L; Alternate Number	IP39
1987-1983	8 Cyl. 6.9L; Exhaust stock and reorder	IP2
1987-1983	8 Cyl. 6.9L; Alternate Number	IP38

Injection Components

		Part No.
Diesel Fuel Injection Pump - Remanufactured		
F-550 Super Duty		
2019-2017	8 Cyl. 6.7L	IP53
2016-2015	8 Cyl. 6.7L; Cab and Chassis	IP37
2014-2011	8 Cyl. 6.7L	IP37
2010-2008	8 Cyl. 6.4L	IP30
F Super Duty		
1994	8 Cyl. 7.3L; Alternate Number; Naturally Aspirated; w/ M.T.	IP42
1994	8 Cyl. 7.3L; Exhaust stock and reorder; Naturally Aspirated; w/ M.T.	IP6
1994-1993	8 Cyl. 7.3L; Alternate Number; Naturally Aspirated; w/ A.T.	IP41
1994-1993	8 Cyl. 7.3L; Exhaust stock and reorder; Naturally Aspirated; w/ A.T.	IP5
1992	8 Cyl. 7.3L; Exhaust stock and reorder; To 2/92	IP4
1992	8 Cyl. 7.3L; Alternate Number; To 2/92	IP40
1992	8 Cyl. 7.3L; Alternate Number; From 3/92; Naturally Aspirated; w/ A.T.	IP41
1992	8 Cyl. 7.3L; Exhaust stock and reorder; From 3/92; Naturally Aspirated; w/ A.T.	IP5
1991-1990	8 Cyl. 7.3L; Exhaust stock and reorder	IP4
1991-1990	8 Cyl. 7.3L; Alternate Number	IP40
1989-1988	8 Cyl. 7.3L; Exhaust stock and reorder	IP3
1989-1988	8 Cyl. 7.3L; Alternate Number	IP39
Diesel Fuel Injector Control Module (FICM)		
E-350 Club Wagon		
2005-2004	8 Cyl. 6.0L; Complete Assembly	FICM3
2005-2004	8 Cyl. 6.0L; Power Supply	R76001
E-350 Super Duty		
2010-2004	8 Cyl. 6.0L; Complete Assembly	FICM3
2010-2004	8 Cyl. 6.0L; Power Supply	R76001
E-450 Super Duty		
2010-2004	8 Cyl. 6.0L; Complete Assembly	FICM3
2010-2004	8 Cyl. 6.0L; Power Supply	R76001
Excursion		
2005-2004	8 Cyl. 6.0L; Complete Assembly; From Engine No. 6,344,943 To Engine No. 6,429,301; From Engine No. 131,587 To Engine No. 181,447	FICM2
2005-2003	8 Cyl. 6.0L; Power Supply	R76001
2003	8 Cyl. 6.0L; Complete Assembly	FICM1
F-250 Super Duty		
2007-2005	8 Cyl. 6.0L; Complete Assembly	FICM3
2007-2003	8 Cyl. 6.0L; Power Supply	R76001
2004	8 Cyl. 6.0L; Complete Assembly; To Engine No. 6,155,636	FICM1
2004	8 Cyl. 6.0L; Complete Assembly; From Engine No. 6,155,637	FICM2
2003	8 Cyl. 6.0L; Complete Assembly	FICM1
F-350 Super Duty		
2007-2005	8 Cyl. 6.0L; Complete Assembly	FICM3
2007-2003	8 Cyl. 6.0L; Power Supply	R76001
2004	8 Cyl. 6.0L; Complete Assembly; To Engine No. 6,155,636	FICM1
2004	8 Cyl. 6.0L; Complete Assembly; From Engine No. 6,155,637	FICM2
2003	8 Cyl. 6.0L; Complete Assembly	FICM1
F-450 Super Duty		
2007-2005	8 Cyl. 6.0L; Complete Assembly	FICM3
2007-2003	8 Cyl. 6.0L; Power Supply	R76001
2004	8 Cyl. 6.0L; Complete Assembly; To Engine No. 6,155,636	FICM1
2004	8 Cyl. 6.0L; Complete Assembly; From Engine No. 6,155,637	FICM2
2003	8 Cyl. 6.0L; Complete Assembly	FICM1

		Part No.
Diesel Fuel Injector Control Module (FICM)		
F-550 Super Duty		
2007-2005	8 Cyl. 6.0L; Complete Assembly	FICM3
2007-2003	8 Cyl. 6.0L; Power Supply	R76001
2004	8 Cyl. 6.0L; Complete Assembly; To Engine No. 6,155,636	FICM1
2004	8 Cyl. 6.0L; Complete Assembly; From Engine No. 6,155,637	FICM2
2003	8 Cyl. 6.0L; Complete Assembly	FICM1
Diesel Fuel Injector Driver Module (IDM)		
E-350 Club Wagon		
2003	8 Cyl. 7.3L	FIDM2
E-350 Econoline		
1998-1995	8 Cyl. 7.3L	FIDM1
E-350 Econoline Club Wagon		
2002-1999	8 Cyl. 7.3L	FIDM2
1998-1995	8 Cyl. 7.3L	FIDM1
E-350 Super Duty		
2003-1999	8 Cyl. 7.3L	FIDM2
E-450 Econoline Super Duty		
2002-2000	8 Cyl. 7.3L	FIDM2
E-450 Super Duty		
2003	8 Cyl. 7.3L	FIDM2
E-550 Econoline Super Duty		
2002	8 Cyl. 7.3L	FIDM2
E-550 Super Duty		
2003	8 Cyl. 7.3L	FIDM2
Econoline Super Duty		
1999	8 Cyl. 7.3L	FIDM2
1998-1996	8 Cyl. 7.3L	FIDM1
Excursion		
2003-2000	8 Cyl. 7.3L	FIDM2
F59		
1997-1994	8 Cyl. 7.3L	FIDM1
F-250		
1996-1995	8 Cyl. 7.3L	FIDM1
1994	8 Cyl. 7.3L; F	FIDM1
F-250 Super Duty		
2003-1999	8 Cyl. 7.3L	FIDM2
F-350		
1997-1994	8 Cyl. 7.3L	FIDM1
F-350 Super Duty		
2003-1999	8 Cyl. 7.3L	FIDM2
F-450 Super Duty		
2003-1999	8 Cyl. 7.3L	FIDM2
F-550 Super Duty		
2003-1999	8 Cyl. 7.3L	FIDM2
F Super Duty		
1997-1995	8 Cyl. 7.3L	FIDM1
Diesel Fuel Injector Installation Kit		
E-350 Super Duty		
2010-2004	8 Cyl. 6.0L	SK171
E-450 Super Duty		
2010-2004	8 Cyl. 6.0L	SK171
Excursion		
2005-2004	8 Cyl. 6.0L	SK171
F650		
2019-2016	8 Cyl. 6.7L; Cyl. 1, 2, 7, 8	SK138
2019-2016	8 Cyl. 6.7L; Cyl. 3, 4, 5, 6	SK139
F750		
2019-2016	8 Cyl. 6.7L; Cyl. 1, 2, 7, 8	SK138
2019-2016	8 Cyl. 6.7L; Cyl. 3, 4, 5, 6	SK139

Injection Components

		Part No.
Diesel Fuel Injector Installation Kit		
F-250 Super Duty		
2019-2011	8 Cyl. 6.7L; Cyl. 1, 2, 7, 8	SK138
2019-2011	8 Cyl. 6.7L; Cyl. 3, 4, 5, 6	SK139
2010-2008	8 Cyl. 6.4L	SK64
2007-2004	8 Cyl. 6.0L	SK171
F-350 Super Duty		
2019-2011	8 Cyl. 6.7L; Cyl. 1, 2, 7, 8	SK138
2019-2011	8 Cyl. 6.7L; Cyl. 3, 4, 5, 6	SK139
2010-2008	8 Cyl. 6.4L	SK64
2007-2004	8 Cyl. 6.0L	SK171
F-450 Super Duty		
2019-2011	8 Cyl. 6.7L; Cyl. 1, 2, 7, 8	SK138
2019-2011	8 Cyl. 6.7L; Cyl. 3, 4, 5, 6	SK139
2010-2008	8 Cyl. 6.4L	SK64
2007-2004	8 Cyl. 6.0L	SK171
F-550 Super Duty		
2019-2011	8 Cyl. 6.7L; Cyl. 1, 2, 7, 8	SK138
2019-2011	8 Cyl. 6.7L; Cyl. 3, 4, 5, 6	SK139
2010-2008	8 Cyl. 6.4L	SK64
2007-2004	8 Cyl. 6.0L	SK171
Diesel Fuel Injector Rail		
F-150		
2019-2018	6 Cyl. 3.0L; Diesel; Left	FIR8
2019-2018	6 Cyl. 3.0L; Right	FIR9
F-250 Super Duty		
2019-2011	8 Cyl. 6.7L; Right	FIR1
2019-2011	8 Cyl. 6.7L; Left	FIR2
F-350 Super Duty		
2019-2011	8 Cyl. 6.7L; Right	FIR1
2019-2011	8 Cyl. 6.7L; Left	FIR2
F-450 Super Duty		
2019-2011	8 Cyl. 6.7L; Right	FIR1
2019-2011	8 Cyl. 6.7L; Left	FIR2
F-550 Super Duty		
2019-2011	8 Cyl. 6.7L; Right	FIR1
2019-2011	8 Cyl. 6.7L; Left	FIR2
Diesel Fuel Injector Return Hose		
F-250 Super Duty		
2019-2017	8 Cyl. 6.7L	RTL2
2016-2011	8 Cyl. 6.7L	RTL1
F-350 Super Duty		
2019-2017	8 Cyl. 6.7L	RTL2
2016-2011	8 Cyl. 6.7L	RTL1
F-450 Super Duty		
2019-2017	8 Cyl. 6.7L	RTL2
2016-2011	8 Cyl. 6.7L	RTL1
F-550 Super Duty		
2019-2017	8 Cyl. 6.7L	RTL2
2016-2011	8 Cyl. 6.7L	RTL1
Diesel Fuel Injector Sleeve		
E-350 Club Wagon		
2003	8 Cyl. 7.3L; Diesel	B42001
E-350 Econoline		
1998-1995	8 Cyl. 7.3L; Diesel	B42001
E-350 Econoline Club Wagon		
2002-1995	8 Cyl. 7.3L; Diesel	B42001
E-350 Super Duty		
2010-2004	8 Cyl. 6.0L	IFS1
2003-1999	8 Cyl. 7.3L; Diesel	B42001
E-450 Econoline Super Duty		
2002-2000	8 Cyl. 7.3L; Diesel	B42001

		Part No.
Diesel Fuel Injector Sleeve		
E-450 Super Duty		
2010-2004	8 Cyl. 6.0L	IFS1
2003	8 Cyl. 7.3L; Diesel	B42001
E-550 Econoline Super Duty		
2002	8 Cyl. 7.3L	B42001
E-550 Super Duty		
2003	8 Cyl. 7.3L	B42001
Econoline Super Duty		
1999	8 Cyl. 7.3L; Diesel	B42001
1998-1996	8 Cyl. 7.3L	B42001
Excursion		
2005	8 Cyl. 6.0L	IFS1
2004	8 Cyl. 6.0L	IFS1
2003	8 Cyl. 6.0L	IFS1
2003-2000	8 Cyl. 7.3L; Diesel	B42001
F650		
2007-2004	8 Cyl. 6.0L	IFS1
F750		
2008-2004	8 Cyl. 6.0L	IFS1
F-250		
1996-1994	8 Cyl. 7.3L; Diesel	B42001
F-250 Super Duty		
2007-2003	8 Cyl. 6.0L	IFS1
2003-1999	8 Cyl. 7.3L; Diesel	B42001
F-350		
1997-1994	8 Cyl. 7.3L; Diesel	B42001
F-350 Super Duty		
2007-2003	8 Cyl. 6.0L	IFS1
2003-1999	8 Cyl. 7.3L; Diesel	B42001
F-450 Super Duty		
2007-2003	8 Cyl. 6.0L	IFS1
2003-1999	8 Cyl. 7.3L	B42001
F-550 Super Duty		
2007-2003	8 Cyl. 6.0L	IFS1
2003-1999	8 Cyl. 7.3L	B42001
F Super Duty		
1997-1995	8 Cyl. 7.3L	B42001
LCF		
2010-2006	6 Cyl. 4.5L	IFS1
Diesel Fuel Rail Supply Line		
Excursion		
2004-2003	8 Cyl. 6.0L; Right	IRL2
2004-2003	8 Cyl. 6.0L; Left	IRL3
F650		
2017-2016	8 Cyl. 6.7L	IRL1
2007-2004	8 Cyl. 6.0L; Right	IRL2
2007-2004	8 Cyl. 6.0L; Left	IRL3
F750		
2017-2016	8 Cyl. 6.7L	IRL1
2007-2004	8 Cyl. 6.0L; Right	IRL2
2007-2004	8 Cyl. 6.0L; Left	IRL3
F-250 Super Duty		
2017-2011	8 Cyl. 6.7L	IRL1
2004-2003	8 Cyl. 6.0L; Right	IRL2
2004-2003	8 Cyl. 6.0L; Left	IRL3
F-350 Super Duty		
2017-2011	8 Cyl. 6.7L	IRL1
2004-2003	8 Cyl. 6.0L; Right	IRL2
2004-2003	8 Cyl. 6.0L; Left	IRL3
F-450 Super Duty		
2017-2011	8 Cyl. 6.7L	IRL1
2004-2003	8 Cyl. 6.0L; Right	IRL2

Ford

Injection Components

		Part No.
Diesel Fuel Rail Supply Line		
F-450 Super Duty		
2004-2003	8 Cyl. 6.0L; Left	IRL3
F-550 Super Duty		
2017-2011	8 Cyl. 6.7L	IRL1
2004-2003	8 Cyl. 6.0L; Right	IRL2
2004-2003	8 Cyl. 6.0L; Left	IRL3
Diesel Fuel Transfer Pump		
E-350 Econoline		
1998	8 Cyl. 7.3L; To 1/12/98	FTP3
1998	8 Cyl. 7.3L; From 1/12/98	FTP4
1997-1995	8 Cyl. 7.3L	FTP3
E-350 Econoline Club Wagon		
2002-1999	8 Cyl. 7.3L	FTP4
1998	8 Cyl. 7.3L; To 1/12/98	FTP3
1998	8 Cyl. 7.3L; From 1/12/98	FTP4
1997-1995	8 Cyl. 7.3L	FTP3
E-350 Super Duty		
2000-1999	8 Cyl. 7.3L	FTP4
E-450 Econoline Super Duty		
2002-2000	8 Cyl. 7.3L	FTP4
E-550 Econoline Super Duty		
2002	8 Cyl. 7.3L	FTP4
Econoline Super Duty		
1999	8 Cyl. 7.3L	FTP4
1998	8 Cyl. 7.3L; To 1/12/98	FTP3
1998	8 Cyl. 7.3L; From 1/12/98	FTP4
1997-1996	8 Cyl. 7.3L	FTP3
Excursion		
2003-2000	8 Cyl. 7.3L	FTP4
F-250		
1996-1994	8 Cyl. 7.3L	FTP3
F-250 Super Duty		
2016	8 Cyl. 6.7L	FTP8
2015-2011	8 Cyl. 6.7L	FTP7
2010-2008	8 Cyl. 6.4L	FTP6
2003-1999	8 Cyl. 7.3L	FTP4
F-350		
1997-1994	8 Cyl. 7.3L	FTP3
F-350 Super Duty		
2016	8 Cyl. 6.7L	FTP8
2015-2011	8 Cyl. 6.7L	FTP7
2010-2008	8 Cyl. 6.4L	FTP6
2003-1999	8 Cyl. 7.3L	FTP4
F-450 Super Duty		
2016	8 Cyl. 6.7L	FTP8
2015-2011	8 Cyl. 6.7L	FTP7
2010-2008	8 Cyl. 6.4L	FTP6
F-550 Super Duty		
2016	8 Cyl. 6.7L	FTP8
2015-2011	8 Cyl. 6.7L	FTP7
2010-2008	8 Cyl. 6.4L	FTP6
Diesel Glow Plug		
E-250 Econoline Club Wagon		
1991-1988	8 Cyl. 7.3L	GP105
1987	8 Cyl. 6.9L	GP105
1986-1983	8 Cyl. 6.9L	GP103
E-350 Club Wagon		
2005	8 Cyl. 6.0L	GP113
2004	8 Cyl. 6.0L; 22mm Length; To 9/21/03; To Engine No. 6,155,636	GP109
2004	8 Cyl. 6.0L; 20mm Length; From 9/22/03; From Engine No. 6,155,637	GP113
2004-2003	8 Cyl. 7.3L	GP107

		Part No.
Diesel Glow Plug		
E-350 Econoline		
1998-1995	8 Cyl. 7.3L	GP107
1994-1988	8 Cyl. 7.3L	GP105
1987	8 Cyl. 6.9L	GP105
1986-1983	8 Cyl. 6.9L	GP103
E-350 Econoline Club Wagon		
2002-1995	8 Cyl. 7.3L	GP107
1994-1988	8 Cyl. 7.3L	GP105
1987	8 Cyl. 6.9L	GP105
1986-1983	8 Cyl. 6.9L	GP103
E-350 Super Duty		
2010-2005	8 Cyl. 6.0L	GP113
2004	8 Cyl. 6.0L; 22mm Length; To 9/21/03; To Engine No. 6,155,636	GP109
2004	8 Cyl. 6.0L; 20mm Length; From 9/22/03; From Engine No. 6,155,637	GP113
2003-1999	8 Cyl. 7.3L	GP107
E-450 Econoline Super Duty		
2002-2000	8 Cyl. 7.3L	GP107
E-450 Super Duty		
2010-2005	8 Cyl. 6.0L	GP113
2004	8 Cyl. 6.0L; 22mm Length; To 9/21/03; To Engine No. 6,155,636	GP109
2004	8 Cyl. 6.0L; 20mm Length; From 9/22/03; From Engine No. 6,155,637	GP113
2003	8 Cyl. 7.3L	GP107
E-550 Econoline Super Duty		
2002	8 Cyl. 7.3L	GP107
E-550 Super Duty		
2003	8 Cyl. 7.3L	GP107
Econoline Super Duty		
1999-1996	8 Cyl. 7.3L	GP107
Excursion		
2005	8 Cyl. 6.0L	GP113
2004	8 Cyl. 6.0L; 22mm Length; To 9/21/03; To Engine No. 6,155,636	GP109
2004	8 Cyl. 6.0L; 20mm Length; From 9/22/03; From Engine No. 6,155,637	GP113
2003	8 Cyl. 6.0L	GP109
2003-2000	8 Cyl. 7.3L	GP107
F-150		
1984	8 Cyl. 6.9L	GP103
F-250		
1996-1995	8 Cyl. 7.3L	GP107
1994-1988	8 Cyl. 7.3L	GP105
1987	8 Cyl. 6.9L	GP105
1986-1983	8 Cyl. 6.9L	GP103
F-250 Super Duty		
2019-2013	8 Cyl. 6.7L	GP121
2012	8 Cyl. 6.7L; To 2/12	GP120
2012	8 Cyl. 6.7L; From 3/12	GP121
2011	8 Cyl. 6.7L	GP120
2010-2008	8 Cyl. 6.4L	GP122
2007-2005	8 Cyl. 6.0L	GP113
2004	8 Cyl. 6.0L; 22mm Length; To 9/21/03; To Engine No. 6,155,636	GP109
2004	8 Cyl. 6.0L; 20mm Length; From 9/22/03; From Engine No. 6,155,637	GP113
2003	8 Cyl. 6.0L	GP109
2003-1999	8 Cyl. 7.3L	GP107
F-350		
1997-1995	8 Cyl. 7.3L	GP107
1994-1988	8 Cyl. 7.3L	GP105
1987	8 Cyl. 6.9L	GP105

Injection Components

		Part No.
Diesel Glow Plug		
F-350		
1986-1983	8 Cyl. 6.9L	GP103
F-350 Super Duty		
2019-2013	8 Cyl. 6.7L	GP121
2012	8 Cyl. 6.7L; To 2/12	GP120
2012	8 Cyl. 6.7L; From 3/12	GP121
2011	8 Cyl. 6.7L	GP120
2010-2008	8 Cyl. 6.4L	GP122
2007-2005	8 Cyl. 6.0L	GP113
2004	8 Cyl. 6.0L; 22mm Length; To 9/21/03; To Engine No. 6,155,636	GP109
2004	8 Cyl. 6.0L; 20mm Length; From 9/22/03; From Engine No. 6,155,637	GP113
2003	8 Cyl. 6.0L	GP109
2003-1999	8 Cyl. 7.3L	GP107
F-450 Super Duty		
2019-2013	8 Cyl. 6.7L	GP121
2012	8 Cyl. 6.7L; To 2/12	GP120
2012	8 Cyl. 6.7L; From 3/12	GP121
2011	8 Cyl. 6.7L	GP120
2010-2008	8 Cyl. 6.4L	GP122
2007-2005	8 Cyl. 6.0L	GP113
2004	8 Cyl. 6.0L; 22mm Length; To 9/21/03; To Engine No. 6,155,636	GP109
2004	8 Cyl. 6.0L; 20mm Length; From 9/22/03; From Engine No. 6,155,637	GP113
2003	8 Cyl. 6.0L	GP109
2003-1999	8 Cyl. 7.3L	GP107
F-550 Super Duty		
2019-2013	8 Cyl. 6.7L	GP121
2012	8 Cyl. 6.7L; To 2/12	GP120
2012	8 Cyl. 6.7L; From 3/12	GP121
2011	8 Cyl. 6.7L	GP120
2010-2008	8 Cyl. 6.4L	GP122
2007-2005	8 Cyl. 6.0L	GP113
2004	8 Cyl. 6.0L; 22mm Length; To 9/21/03; To Engine No. 6,155,636	GP109
2004	8 Cyl. 6.0L; 20mm Length; From 9/22/03; From Engine No. 6,155,637	GP113
2003	8 Cyl. 6.0L	GP109
2003-1999	8 Cyl. 7.3L	GP107
F Super Duty		
1997-1995	8 Cyl. 7.3L	GP107
1994-1988	8 Cyl. 7.3L	GP105
Transit-150		
2019-2015	5 Cyl. 3.2L	GP123
Transit-250		
2019-2015	5 Cyl. 3.2L	GP123
Transit-350		
2019-2015	5 Cyl. 3.2L	GP123
Transit-350 HD		
2019-2015	5 Cyl. 3.2L	GP123
Diesel Glow Plug Wiring Harness		
E-350 Club Wagon		
2005-2004	8 Cyl. 6.0L; Right	GPH103
2005-2004	8 Cyl. 6.0L; Left	GPH107
E-350 Super Duty		
2010-2004	8 Cyl. 6.0L; Right	GPH103
2010-2004	8 Cyl. 6.0L; Left	GPH107
E-450 Super Duty		
2010	8 Cyl. 6.0L; Right	GPH103
2010	8 Cyl. 6.0L; Left	GPH107
2008-2004	8 Cyl. 6.0L; Right	GPH103
2008-2004	8 Cyl. 6.0L; Left	GPH107

		Part No.
Diesel Glow Plug Wiring Harness		
Excursion		
2005	8 Cyl. 6.0L; Right	GPH103
2005	8 Cyl. 6.0L; Left	GPH104
2004	8 Cyl. 6.0L; From 8/17/03 to 1/15/04; Right	GPH101
2004	8 Cyl. 6.0L; From 8/17/03 to 1/15/04; Left	GPH102
2004	8 Cyl. 6.0L; From 1/16/04; Right	GPH103
2004	8 Cyl. 6.0L; To 9/23/03; Left	GPH105
2004	8 Cyl. 6.0L; To 9/23/03; Right	GPH106
2004	8 Cyl. 6.0L; From 1/16/04; Left	GPH107
2003	8 Cyl. 6.0L; Left	GPH105
2003	8 Cyl. 6.0L; Right	GPH106
F-250 Super Duty		
2007-2005	8 Cyl. 6.0L; Right	GPH103
2007-2005	8 Cyl. 6.0L; Left	GPH104
2004	8 Cyl. 6.0L; From 8/17/03 to 1/15/04; Right	GPH101
2004	8 Cyl. 6.0L; From 8/17/03 to 1/15/04; Left	GPH102
2004	8 Cyl. 6.0L; From 1/16/04; Right	GPH103
2004	8 Cyl. 6.0L; To 9/23/03; Left	GPH105
2004	8 Cyl. 6.0L; To 9/23/03; Right	GPH106
2004	8 Cyl. 6.0L; From 1/16/04; Left	GPH107
2003	8 Cyl. 6.0L; Left	GPH105
2003	8 Cyl. 6.0L; Right	GPH106
F-350 Super Duty		
2007-2005	8 Cyl. 6.0L; Right	GPH103
2007-2005	8 Cyl. 6.0L; Left	GPH104
2004	8 Cyl. 6.0L; From 8/17/03 to 1/15/04; Right	GPH101
2004	8 Cyl. 6.0L; From 8/17/03 to 1/15/04; Left	GPH102
2004	8 Cyl. 6.0L; From 1/16/04; Right	GPH103
2004	8 Cyl. 6.0L; To 9/23/03; Left	GPH105
2004	8 Cyl. 6.0L; To 9/23/03; Right	GPH106
2004	8 Cyl. 6.0L; From 1/16/04; Left	GPH107
2003	8 Cyl. 6.0L; Left	GPH105
2003	8 Cyl. 6.0L; Right	GPH106
F-450 Super Duty		
2007-2005	8 Cyl. 6.0L; Right	GPH103
2007-2005	8 Cyl. 6.0L; Left	GPH104
2004	8 Cyl. 6.0L; From 8/17/03 to 1/15/04; Right	GPH101
2004	8 Cyl. 6.0L; From 8/17/03 to 1/15/04; Left	GPH102
2004	8 Cyl. 6.0L; From 1/16/04; Right	GPH103
2004	8 Cyl. 6.0L; To 9/23/03; Left	GPH105
2004	8 Cyl. 6.0L; To 9/23/03; Right	GPH106
2004	8 Cyl. 6.0L; From 1/16/04; Left	GPH107
2003	8 Cyl. 6.0L; Left	GPH105
2003	8 Cyl. 6.0L; Right	GPH106
F-550 Super Duty		
2007-2005	8 Cyl. 6.0L; Right	GPH103
2007-2005	8 Cyl. 6.0L; Left	GPH104
2004	8 Cyl. 6.0L; From 8/17/03 to 1/15/04; Right	GPH101
2004	8 Cyl. 6.0L; From 8/17/03 to 1/15/04; Left	GPH102
2004	8 Cyl. 6.0L; From 1/16/04; Right	GPH103
2004	8 Cyl. 6.0L; To 9/23/03; Left	GPH105
2004	8 Cyl. 6.0L; To 9/23/03; Right	GPH106
2004	8 Cyl. 6.0L; From 1/16/04; Left	GPH107
2003	8 Cyl. 6.0L; Left	GPH105
2003	8 Cyl. 6.0L; Right	GPH106
Diesel High Pressure Oil Pump Hose		
E-350 Club Wagon		
2003	8 Cyl. 7.3L; 90 Degree End and Straight End; Passenger Side	OPH1

Injection Components

		Part No.
Diesel High Pressure Oil Pump Hose		
E-350 Club Wagon		
2003	8 Cyl. 7.3L; 90 Degree Both Ends; Passenger Side	OPH3
E-350 Econoline		
1997-1995	8 Cyl. 7.3L	OPH4
E-350 Econoline Club Wagon		
2002-2000	8 Cyl. 7.3L; 90 Degree Both Ends; Passenger Side	OPH3
2002-1999	8 Cyl. 7.3L; 90 Degree End and Straight End; Passenger Side	OPH1
2002-1999	8 Cyl. 7.3L; Driver Side	OPH2
1997-1995	8 Cyl. 7.3L	OPH4
E-350 Super Duty		
2003	8 Cyl. 7.3L; 90 Degree Both Ends; Passenger Side	OPH3
E-450 Econoline Super Duty		
2002-2000	8 Cyl. 7.3L; 90 Degree End and Straight End; Passenger Side	OPH1
2002-2000	8 Cyl. 7.3L; 90 Degree Both Ends; Passenger Side	OPH3
2002-1999	8 Cyl. 7.3L; Driver Side	OPH2
E-450 Super Duty		
2003	8 Cyl. 7.3L; 90 Degree Both Ends; Passenger Side	OPH3
E-550 Econoline Super Duty		
2002	8 Cyl. 7.3L; 90 Degree End and Straight End; Passenger Side	OPH1
Econoline Super Duty		
1999	8 Cyl. 7.3L; 90 Degree End and Straight End; Passenger Side	OPH1
1999	8 Cyl. 7.3L; Driver Side	OPH2
Excursion		
2003-2000	8 Cyl. 7.3L; 90 Degree End and Straight End; Passenger Side	OPH1
2003-2000	8 Cyl. 7.3L; Driver Side	OPH2
2003-2000	8 Cyl. 7.3L; 90 Degree Both Ends; Passenger Side	OPH3
F59		
1997-1995	8 Cyl. 7.3L	OPH4
F-250		
1996-1994	8 Cyl. 7.3L	OPH4
F-250 Super Duty		
2003-2000	8 Cyl. 7.3L; 90 Degree Both Ends; Passenger Side	OPH3
2003-1999	8 Cyl. 7.3L; 90 Degree End and Straight End; Passenger Side	OPH1
2003-1999	8 Cyl. 7.3L; Driver Side	OPH2
F-350		
1997-1994	8 Cyl. 7.3L	OPH4
F-350 Super Duty		
2003-2000	8 Cyl. 7.3L; 90 Degree Both Ends; Passenger Side	OPH3
2003-1999	8 Cyl. 7.3L; 90 Degree End and Straight End; Passenger Side	OPH1
2003-1999	8 Cyl. 7.3L; Driver Side	OPH2
F-450 Super Duty		
2003-2000	8 Cyl. 7.3L; 90 Degree End and Straight End; Passenger Side	OPH1
2003-2000	8 Cyl. 7.3L; 90 Degree Both Ends; Passenger Side	OPH3
2003-1999	8 Cyl. 7.3L; Driver Side	OPH2
F-550 Super Duty		
2003-2000	8 Cyl. 7.3L; 90 Degree End and Straight End; Passenger Side	OPH1
2003-2000	8 Cyl. 7.3L; 90 Degree Both Ends; Passenger Side	OPH3

		Part No.
Diesel High Pressure Oil Pump Hose		
F-550 Super Duty		
2003-1999	8 Cyl. 7.3L; Driver Side	OPH2
F Super Duty		
1997-1995	8 Cyl. 7.3L	OPH4
Diesel High Pressure Oil Pump Seal Kit		
E-350 Club Wagon		
2005	8 Cyl. 6.0L	SK142
2004	8 Cyl. 6.0L	SK125
2003	8 Cyl. 7.3L	SK108
E-350 Econoline		
1998-1994	8 Cyl. 7.3L	SK108
E-350 Econoline Club Wagon		
2002-1994	8 Cyl. 7.3L	SK108
E-350 Super Duty		
2010-2005	8 Cyl. 6.0L	SK142
2004	8 Cyl. 6.0L	SK125
E-450 Econoline Super Duty		
2002-2000	8 Cyl. 7.3L	SK108
E-450 Super Duty		
2010-2005	8 Cyl. 6.0L	SK142
2003	8 Cyl. 7.3L	SK108
E-550 Econoline Super Duty		
2002	8 Cyl. 7.3L	SK108
E-550 Super Duty		
2003	8 Cyl. 7.3L	SK108
Econoline Super Duty		
1999-1996	8 Cyl. 7.3L	SK108
Excursion		
2005	8 Cyl. 6.0L	SK142
2004-2003	8 Cyl. 6.0L	SK125
2003-2000	8 Cyl. 7.3L	SK108
F650		
2004	8 Cyl.	SK125
F750		
2004-2003		SK125
F-250		
1996-1994	8 Cyl. 7.3L	SK108
F-250 Super Duty		
2007-2005	8 Cyl. 6.0L	SK142
2004-2003	8 Cyl. 6.0L	SK125
2003-1999	8 Cyl. 7.3L	SK108
F-350		
1997-1994	8 Cyl. 7.3L	SK108
F-350 Super Duty		
2007-2005	8 Cyl. 6.0L	SK142
2004-2003	8 Cyl. 6.0L	SK125
2003-1999	8 Cyl. 7.3L	SK108
F-450 Super Duty		
2007-2005	8 Cyl. 6.0L	SK142
2004-2003	8 Cyl. 6.0L	SK125
2003-1999	8 Cyl. 7.3L	SK108
F-550 Super Duty		
2007-2005	8 Cyl. 6.0L	SK142
2004-2003	8 Cyl. 6.0L	SK125
2003-1999	8 Cyl. 7.3L	SK108
F Super Duty		
1997-1994	8 Cyl. 7.3L	SK108
Diesel High Pressure Oil Rail Ball Installation Tool		
E-350 Super Duty		
2010-2004	8 Cyl. 6.0L	DTL1
E-450 Super Duty		
2010	8 Cyl. 6.0L	DTL1

Injection Components

		Part No.
Diesel High Pressure Oil Rail Ball Installation Tool		
E-450 Super Duty		
2008-2004	8 Cyl. 6.0L	DTL1
Excursion		
2005-2004	8 Cyl. 6.0L	DTL1
F650		
2006-2004	8 Cyl. 6.0L	DTL1
F750		
2006-2005	8 Cyl. 6.0L	DTL1
F-250 Super Duty		
2007-2004	8 Cyl. 6.0L	DTL1
F-350 Super Duty		
2007-2003	8 Cyl. 6.0L	DTL1
F-450 Super Duty		
2006-2004	8 Cyl. 6.0L	DTL1
F-550 Super Duty		
2007-2004	8 Cyl. 6.0L	DTL1
Diesel High Pressure Oil Rail Ball Tube		
E-350 Super Duty		
2010-2004	8 Cyl. 6.0L	DBT1
E-450 Super Duty		
2010-2004	8 Cyl. 6.0L	DBT1
Excursion		
2005-2004	8 Cyl. 6.0L	DBT1
F-250 Super Duty		
2007-2004	8 Cyl. 6.0L	DBT1
F-350 Super Duty		
2007-2004	8 Cyl. 6.0L	DBT1
F-450 Super Duty		
2007-2004	8 Cyl. 6.0L	DBT1
F-550 Super Duty		
2007-2004	8 Cyl. 6.0L	DBT1
Diesel High Pressure Oil Rail Seal Kit		
F-250 Super Duty		
2007-2003	8 Cyl. 6.0L	SK145
F-350 Super Duty		
2007-2003	8 Cyl. 6.0L	SK145
F-450 Super Duty		
2007-2003	8 Cyl. 6.0L	SK145
F-550 Super Duty		
2007-2003	8 Cyl. 6.0L	SK145
Diesel Injection High Pressure Oil Pump		
E-350 Club Wagon		
2005	8 Cyl. 6.0L; Remanufactured	HPI7
2004	8 Cyl. 6.0L; Exhaust stock and reorder; From Engine No. 6,155,637; Remanufactured	HPI5
2004	8 Cyl. 6.0L; Alternate Number; From Engine No. 6,155,637; Remanufactured	HPI6
2004	8 Cyl. 6.0L; Remanufactured; To Engine No. 6,155,636	HPI6
2003	8 Cyl. 7.3L; Remanufactured	HPI2
E-350 Econoline		
1998	8 Cyl. 7.3L; Remanufactured	HPI3
1997-1996	8 Cyl. 7.3L; Remanufactured	HPI1
1995	8 Cyl. 7.3L; Remanufactured	HPI4
E-350 Econoline Club Wagon		
2002-1999	8 Cyl. 7.3L; Remanufactured	HPI2
1998	8 Cyl. 7.3L; Remanufactured	HPI3
1997-1996	8 Cyl. 7.3L; Remanufactured	HPI1
1995	8 Cyl. 7.3L; Remanufactured	HPI4
E-350 Super Duty		
2010-2005	8 Cyl. 6.0L; Remanufactured	HPI7

		Part No.
Diesel Injection High Pressure Oil Pump		
E-350 Super Duty		
2004	8 Cyl. 6.0L; Exhaust stock and reorder; Remanufactured	HPI5
2004	8 Cyl. 6.0L; Alternate Number; Remanufactured	HPI6
2003-1999	8 Cyl. 7.3L	HPI2
E-450 Econoline Super Duty		
2002-2000	8 Cyl. 7.3L	HPI2
E-450 Super Duty		
2010	8 Cyl. 6.0L; Remanufactured	HPI7
2009	8 Cyl. 6.0L; Exhaust stock and reorder	HPI5
2009	8 Cyl. 6.0L; Alternate Number	HPI6
2008-2005	8 Cyl. 6.0L; Remanufactured	HPI7
2004	8 Cyl. 6.0L; Exhaust stock and reorder	HPI5
2004	8 Cyl. 6.0L; Alternate Number	HPI6
2003	8 Cyl. 7.3L	HPI2
E-550 Econoline Super Duty		
2002	8 Cyl. 7.3L	HPI2
E-550 Super Duty		
2003	8 Cyl. 7.3L	HPI2
Econoline Super Duty		
1999	8 Cyl. 7.3L	HPI2
1998	8 Cyl. 7.3L	HPI3
1997-1996	8 Cyl. 7.3L	HPI1
Excursion		
2005	8 Cyl. 6.0L; Remanufactured	HPI7
2004	8 Cyl. 6.0L; Exhaust stock and reorder; From Engine No. 6,155,637; Remanufactured	HPI5
2004	8 Cyl. 6.0L; Alternate Number; From Engine No. 6,155,637; Remanufactured	HPI6
2004	8 Cyl. 6.0L; Remanufactured; To Engine No. 6,155,636	HPI6
2003	8 Cyl. 6.0L; Remanufactured	HPI6
2003-2000	8 Cyl. 7.3L; Remanufactured	HPI2
F59		
1997-1996	8 Cyl. 7.3L; Remanufactured	HPI1
1995-1994	8 Cyl. 7.3L; F; Remanufactured	HPI4
F650		
2004	8 Cyl. 6.0L; Remanufactured	HPI6
2003	8 Cyl. 7.3L	HPI2
2002-2000	8 Cyl.	HPI2
F750		
2004	8 Cyl. 6.0L; Remanufactured	HPI6
2003	8 Cyl. 7.3L	HPI2
2002-2000	8 Cyl.	HPI2
F-250		
1996	8 Cyl. 7.3L; Remanufactured	HPI1
1995	8 Cyl. 7.3L; Remanufactured	HPI4
1994	8 Cyl. 7.3L; F; Remanufactured	HPI4
F-250 Super Duty		
2007-2005	8 Cyl. 6.0L; Remanufactured	HPI7
2004	8 Cyl. 6.0L; Exhaust stock and reorder; From Engine No. 6,155,637; Remanufactured	HPI5
2004	8 Cyl. 6.0L; Alternate Number; From Engine No. 6,155,637; Remanufactured	HPI6
2004	8 Cyl. 6.0L; Remanufactured; To Engine No. 6,155,636	HPI6
2003	8 Cyl. 6.0L; Remanufactured	HPI6
2003-2000	8 Cyl. 7.3L; Remanufactured	HPI2
1999	8 Cyl. 7.3L; From Engine No. 896813; Remanufactured	HPI2
1999	8 Cyl. 7.3L; Remanufactured; To Engine No. 896812	HPI3

Ford

Injection Components

		Part No.
Diesel Injection High Pressure Oil Pump		
F-350		
1997-1996	8 Cyl. 7.3L; Remanufactured	HPI1
1995	8 Cyl. 7.3L; Remanufactured	HPI4
1994	8 Cyl. 7.3L; F; Remanufactured	HPI4
F-350 Super Duty		
2007-2005	8 Cyl. 6.0L; Remanufactured	HPI7
2004	8 Cyl. 6.0L; Exhaust stock and reorder; From Engine No. 6,155,637; Remanufactured	HPI5
2004	8 Cyl. 6.0L; Alternate Number; From Engine No. 6,155,637; Remanufactured	HPI6
2004	8 Cyl. 6.0L; Remanufactured; To Engine No. 6,155,636	HPI6
2003	8 Cyl. 6.0L; Remanufactured	HPI6
2003-2000	8 Cyl. 7.3L; Remanufactured	HPI2
1999	8 Cyl. 7.3L; From Engine No. 896813; Remanufactured	HPI2
1999	8 Cyl. 7.3L; Remanufactured; To Engine No. 896812	HPI3
F-450 Super Duty		
2007-2005	8 Cyl. 6.0L; Remanufactured	HPI7
2004	8 Cyl. 6.0L; Exhaust stock and reorder; From Engine No. 6,155,637; Remanufactured	HPI5
2004	8 Cyl. 6.0L; Alternate Number; From Engine No. 6,155,637; Remanufactured	HPI6
2004	8 Cyl. 6.0L; Remanufactured; To Engine No. 6,155,636	HPI6
2003	8 Cyl. 6.0L; Remanufactured	HPI6
2003-2000	8 Cyl. 7.3L; Remanufactured	HPI2
1999	8 Cyl. 7.3L; From Engine No. 896813; Remanufactured	HPI2
1999	8 Cyl. 7.3L; Remanufactured; To Engine No. 896812	HPI3
F-550 Super Duty		
2007-2005	8 Cyl. 6.0L; Remanufactured	HPI7
2004	8 Cyl. 6.0L; Exhaust stock and reorder; From Engine No. 6,155,637; Remanufactured	HPI5
2004	8 Cyl. 6.0L; Alternate Number; From Engine No. 6,155,637; Remanufactured	HPI6
2004	8 Cyl. 6.0L; Remanufactured; To Engine No. 6,155,636	HPI6
2003	8 Cyl. 6.0L; Remanufactured	HPI6
2003-2000	8 Cyl. 7.3L; Remanufactured	HPI2
1999	8 Cyl. 7.3L; From Engine No. 896813; Remanufactured	HPI2
1999	8 Cyl. 7.3L; Remanufactured; To Engine No. 896812	HPI3
F Super Duty		
1997-1996	8 Cyl. 7.3L; Remanufactured	HPI1
1995	8 Cyl. 7.3L; Remanufactured	HPI4
LCF		
2010-2008		HPI11
2007-2006		HPI16
Diesel Injection Pump Installation Kit		
F-250 Super Duty		
2010-2008	8 Cyl. 6.4L	IPK1
F-350 Super Duty		
2010-2008	8 Cyl. 6.4L	IPK1
F-450 Super Duty		
2010-2008	8 Cyl. 6.4L	IPK1
F-550 Super Duty		
2010-2008	8 Cyl. 6.4L	IPK1

		Part No.
Diesel Injection Pump Supply Line		
F-250 Super Duty		
2019-2017	8 Cyl. 6.7L	IPL3
2016-2015	8 Cyl. 6.7L	IPL2
2014-2011	8 Cyl. 6.7L	IPL1
F-350 Super Duty		
2019-2017	8 Cyl. 6.7L	IPL3
2016-2015	8 Cyl. 6.7L	IPL2
2014-2011	8 Cyl. 6.7L	IPL1
F-450 Super Duty		
2019-2017	8 Cyl. 6.7L	IPL3
2016-2015	8 Cyl. 6.7L	IPL2
2014-2011	8 Cyl. 6.7L	IPL1
F-550 Super Duty		
2019-2017	8 Cyl. 6.7L	IPL3
2016-2015	8 Cyl. 6.7L	IPL2
2014-2011	8 Cyl. 6.7L	IPL1
Diesel Injector Connector Removal Tool		
F-250 Super Duty		
2007-2003	8 Cyl. 6.0L	FIT1
F-350 Super Duty		
2007-2003	8 Cyl. 6.0L	FIT1
F-450 Super Duty		
2007-2003	8 Cyl. 6.0L	FIT1
F-550 Super Duty		
2007-2003	8 Cyl. 6.0L	FIT1
Diesel Injector Retaining Bracket Socket		
F-250 Super Duty		
2007-2003	8 Cyl. 6.0L	FIT2
F-350 Super Duty		
2007-2003	8 Cyl. 6.0L	FIT2
F-450 Super Duty		
2007-2003	8 Cyl. 6.0L	FIT2
F-550 Super Duty		
2007-2003	8 Cyl. 6.0L	FIT2
Diesel Oil Cooler Gasket Kit		
E-350 Club Wagon		
2005-2004	8 Cyl. 6.0L	OCG1
E-350 Super Duty		
2010-2004	8 Cyl. 6.0L	OCG1
E-450 Super Duty		
2010-2004	8 Cyl. 6.0L	OCG1
Excursion		
2005-2003	8 Cyl. 6.0L	OCG1
2003-2000	8 Cyl. 7.3L	OCG2
F650		
2008-2004	8 Cyl.	OCG1
F750		
2008-2004	8 Cyl.	OCG1
F-250		
1996-1994	8 Cyl. 7.3L	OCG2
F-250 Super Duty		
2007-2003	8 Cyl. 6.0L	OCG1
2003-1999	8 Cyl. 7.3L	OCG2
F-350		
1997-1994	8 Cyl. 7.3L	OCG2
F-350 Super Duty		
2007-2003	8 Cyl. 6.0L	OCG1
2003-1999	8 Cyl. 7.3L	OCG2
F-450 Super Duty		
2007-2003	8 Cyl. 6.0L	OCG1
2003-1999	8 Cyl. 7.3L	OCG2

Injection Components

		Part No.
Diesel Oil Cooler Gasket Kit		
F-550 Super Duty		
2007-2003	8 Cyl. 6.0L	OCG1
2003-1999	8 Cyl. 7.3L	OCG2
LCF		
2010-2006		OCG1
Diesel Oil Cooler Kit		
E-250 Econoline Club Wagon		
1989-1988	8 Cyl. 7.3L	OCK18
1987-1984	8 Cyl. 6.9L	OCK18
E-350 Club Wagon		
2005-2004	8 Cyl. 6.0L	OCK1
E-350 Econoline		
1998-1995	8 Cyl. 7.3L	OCK2
1989-1988	8 Cyl. 7.3L	OCK18
1987-1984	8 Cyl. 6.9L	OCK18
E-350 Econoline Club Wagon		
2002-1995	8 Cyl. 7.3L	OCK2
1989-1988	8 Cyl. 7.3L	OCK18
1987-1984	8 Cyl. 6.9L	OCK18
E-350 Super Duty		
2010-2004	8 Cyl. 6.0L	OCK1
E-450 Econoline Super Duty		
2001-2000	8 Cyl. 7.3L	OCK2
E-450 Super Duty		
2010-2004	8 Cyl. 6.0L	OCK1
E-550 Econoline Super Duty		
2002	8 Cyl. 7.3L	OCK2
Econoline Super Duty		
1999-1996	8 Cyl. 7.3L	OCK2
Excursion		
2005-2003	8 Cyl. 6.0L	OCK1
2003-2000	8 Cyl. 7.3L	OCK2
F650		
2008-2004	8 Cyl. 6.0L	OCK1
F750		
2008-2004	8 Cyl.	OCK1
F-250		
1996-1994	8 Cyl. 7.3L	OCK2
1993-1988	8 Cyl. 7.3L	OCK18
1987-1984	8 Cyl. 6.9L	OCK18
F-250 Super Duty		
2019-2011	8 Cyl. 6.7L	OCK6
2010-2008	8 Cyl. 6.4L	OCK5
2007-2003	8 Cyl. 6.0L	OCK1
2003-1999	8 Cyl. 7.3L	OCK2
F-350		
1997-1994	8 Cyl. 7.3L	OCK2
1993-1988	8 Cyl. 7.3L	OCK18
1987-1984	8 Cyl. 6.9L	OCK18
F-350 Super Duty		
2019-2011	8 Cyl. 6.7L	OCK6
2010-2008	8 Cyl. 6.4L	OCK5
2007-2003	8 Cyl. 6.0L	OCK1
2003-1999	8 Cyl. 7.3L	OCK2
F-450 Super Duty		
2019-2011	8 Cyl. 6.7L	OCK6
2010-2008	8 Cyl. 6.4L	OCK5
2007-2003	8 Cyl. 6.0L	OCK1
2003-1999	8 Cyl. 7.3L	OCK2
F-550 Super Duty		
2019-2011	8 Cyl. 6.7L	OCK6
2010-2008	8 Cyl. 6.4L	OCK5

		Part No.
Diesel Oil Cooler Kit		
F-550 Super Duty		
2007-2003	8 Cyl. 6.0L	OCK1
2003-1999	8 Cyl. 7.3L	OCK2
F Super Duty		
1994-1988	8 Cyl. 7.3L	OCK18
LCF		
2010-2006	6 Cyl. 4.5L	OCK1
Diesel Valve Cover Gasket		
E-350 Club Wagon		
2005-2004	8 Cyl. 6.0L	VCG2
E-350 Econoline		
1998	8 Cyl. 7.3L	VCG4
1997-1994	8 Cyl. 7.3L	VCG6
E-350 Econoline Club Wagon		
2002-1998	8 Cyl. 7.3L	VCG4
1997-1994	8 Cyl. 7.3L	VCG6
E-350 Super Duty		
2010-2004	8 Cyl. 6.0L	VCG2
E-450 Econoline Super Duty		
2002	8 Cyl. 7.3L	VCG4
E-450 Super Duty		
2003	8 Cyl. 7.3L	VCG4
Econoline Super Duty		
1999-1998	8 Cyl. 7.3L	VCG4
1997-1996	8 Cyl. 7.3L	VCG6
Excursion		
2005-2003	8 Cyl. 6.0L	VCG2
2003-2000	8 Cyl. 7.3L	VCG4
F59		
1997-1994	8 Cyl. 7.3L; F	VCG6
F-250		
1996-1995	8 Cyl. 7.3L	VCG6
1994	8 Cyl. 7.3L; F	VCG6
F-250 Super Duty		
2007-2003	8 Cyl. 6.0L	VCG2
2003-1999	8 Cyl. 7.3L	VCG4
F-350		
1997-1995	8 Cyl. 7.3L	VCG6
1994	8 Cyl. 7.3L; F	VCG6
F-350 Super Duty		
2007-2003	8 Cyl. 6.0L	VCG2
2003-1999	8 Cyl. 7.3L	VCG4
F-450 Super Duty		
2005-2003	8 Cyl. 6.0L	VCG2
2003-1999	8 Cyl. 7.3L	VCG4
F-550 Super Duty		
2005-2003	8 Cyl. 6.0L	VCG2
2003-1999	8 Cyl. 7.3L	VCG4
F Super Duty		
1997-1994	8 Cyl. 7.3L	VCG6
Engine Oil Stand Pipe and Dummy Plug Kit		
E-350 Super Duty		
2010-2004	8 Cyl. 6.0L	SPK101
E-450 Super Duty		
2010-2004	8 Cyl. 6.0L	SPK101
Excursion		
2005-2004	8 Cyl. 6.0L	SPK101
F-250 Super Duty		
2007-2004	8 Cyl. 6.0L	SPK101
F-350 Super Duty		
2007-2003	8 Cyl. 6.0L	SPK101

Injection Components

		Part No.
Engine Oil Stand Pipe and Dummy Plug Kit		
F-450 Super Duty		
2007-2004	8 Cyl. 6.0L	SPK101
F-550 Super Duty		
2007-2004	8 Cyl. 6.0L	SPK101
Fuel Injector Installation Kit		
E-250 Econoline Club Wagon		
1991-1989	8 Cyl. 7.3L	SK38
1988	8 Cyl. 7.3L; w/ Fuel Return Line	SK38
1988	8 Cyl. 7.3L; w/o Fuel Return Line	SK39
1987-1983	8 Cyl. 6.9L	SK39
E-350 Econoline		
1994-1989	8 Cyl. 7.3L	SK38
1988	8 Cyl. 7.3L; w/ Fuel Return Line	SK38
1988	8 Cyl. 7.3L; w/o Fuel Return Line	SK39
1987-1983	8 Cyl. 6.9L	SK39
E-350 Econoline Club Wagon		
1994-1989	8 Cyl. 7.3L	SK38
1988	8 Cyl. 7.3L; w/ Fuel Return Line	SK38
1988	8 Cyl. 7.3L; w/o Fuel Return Line	SK39
1987-1983	8 Cyl. 6.9L	SK39
F-150		
1984	8 Cyl. 6.9L	SK39
F-250		
1994-1989	8 Cyl. 7.3L	SK38
1988	8 Cyl. 7.3L; w/ Fuel Return Line	SK38
1988	8 Cyl. 7.3L; w/o Fuel Return Line	SK39
1987-1983	8 Cyl. 6.9L	SK39
F-350		
1994	8 Cyl. 7.3L; K	SK38
1994	8 Cyl. 7.3L; M	SK38
1993-1989	8 Cyl. 7.3L	SK38
1988	8 Cyl. 7.3L; w/ Fuel Return Line	SK38
1988	8 Cyl. 7.3L; w/o Fuel Return Line	SK39
1987-1983	8 Cyl. 6.9L	SK39
F Super Duty		
1994-1989	8 Cyl. 7.3L	SK38
1988	8 Cyl. 7.3L; w/ Fuel Return Line	SK38
1988	8 Cyl. 7.3L; w/o Fuel Return Line	SK39
Ranger		
1984-1983	4 Cyl. 2.2L	SK39
Fuel Injector Retaining Bracket		
E-350 Super Duty		
2005-2004	8 Cyl. 6.0L	HK12
E-450 Super Duty		
2005-2004	8 Cyl. 6.0L	HK12
Excursion		
2005-2003	8 Cyl. 6.0L	HK12
F650		
2007-2004	8 Cyl. 6.0L	HK12
F750		
2007-2004	8 Cyl. 6.0L	HK12
F-250 Super Duty		
2005-2003	8 Cyl. 6.0L	HK12
F-350 Super Duty		
2005-2003	8 Cyl. 6.0L	HK12
F-450 Super Duty		
2005-2003	8 Cyl. 6.0L	HK12
F-550 Super Duty		
2005-2003	8 Cyl. 6.0L	HK12
Fuel Injector Seal Kit		
E-350 Club Wagon		
2005-2004	8 Cyl. 6.0L	SK85

		Part No.
Fuel Injector Seal Kit		
E-350 Club Wagon		
2003	8 Cyl. 7.3L; Diesel ²	SK55
E-350 Econoline		
1998-1995	8 Cyl. 7.3L ²	SK55
E-350 Econoline Club Wagon		
2002-1995	8 Cyl. 7.3L ²	SK55
E-350 Super Duty		
2010-2004	8 Cyl. 6.0L	SK85
E-450 Econoline Super Duty		
2002-2000	8 Cyl. 7.3L ²	SK55
E-450 Super Duty		
2010	8 Cyl. 6.0L	SK85
2007-2004	8 Cyl. 6.0L	SK85
2003	8 Cyl. 7.3L	SK55
E-550 Super Duty		
2003	8 Cyl. 7.3L	SK55
Econoline Super Duty		
1999-1996	8 Cyl. 7.3L ²	SK55
Excursion		
2005-2003	8 Cyl. 6.0L	SK85
2003-2000	8 Cyl. 7.3L ²	SK55
F59		
1995-1993	8 Cyl. 7.3L	SK55
F650		
2007-2004	8 Cyl.	SK85
F750		
2007-2004	8 Cyl.	SK85
F-250		
1996-1994	8 Cyl. 7.3L ²	SK55
F-250 Super Duty		
2007-2003	8 Cyl. 6.0L	SK85
2003-1999	8 Cyl. 7.3L ²	SK55
F-350		
1997-1994	8 Cyl. 7.3L ²	SK55
F-350 Super Duty		
2007-2003	8 Cyl. 6.0L	SK85
2003-1999	8 Cyl. 7.3L ²	SK55
F-450 Super Duty		
2007-2003	8 Cyl. 6.0L	SK85
2003-1999	8 Cyl. 7.3L ²	SK55
F-550 Super Duty		
2007-2003	8 Cyl. 6.0L	SK85
2003-1999	8 Cyl. 7.3L ²	SK55
F Super Duty		
1997-1995	8 Cyl. 7.3L ²	SK55
LCF		
2010-2006		SK85
Fuel Line Retainer		
E-250 Econoline Club Wagon		
1986	8 Cyl. 6.9L; w/ 3/8 Inch Fuel Line	HK9330
1986	8 Cyl. 6.9L; w/ 5/16 Inch Fuel Line	HK9331
1984-1983	8 Cyl. 6.9L; w/ 3/8 Inch Fuel Line	HK9330
1984-1983	8 Cyl. 6.9L; w/ 5/16 Inch Fuel Line	HK9331
E-350 Econoline		
1986	8 Cyl. 6.9L; w/ 3/8 Inch Fuel Line	HK9330
1986	8 Cyl. 6.9L; w/ 5/16 Inch Fuel Line	HK9331
1984-1983	8 Cyl. 6.9L; w/ 3/8 Inch Fuel Line	HK9330
1984-1983	8 Cyl. 6.9L; w/ 5/16 Inch Fuel Line	HK9331
E-350 Econoline Club Wagon		
1986	8 Cyl. 6.9L; w/ 3/8 Inch Fuel Line	HK9330
1986	8 Cyl. 6.9L; w/ 5/16 Inch Fuel Line	HK9331

Injection Components

		Part No.
Fuel Line Retainer		
E-350 Econoline Club Wagon		
1984-1983	8 Cyl. 6.9L; w/ 3/8 Inch Fuel Line	HK9330
1984-1983	8 Cyl. 6.9L; w/ 5/16 Inch Fuel Line	HK9331
Escort		
1987-1984	4 Cyl. 2.0L; w/ 3/8 Inch Fuel Line	HK9330
1987-1984	4 Cyl. 2.0L; w/ 5/16 Inch Fuel Line	HK9331
F-250		
1986	8 Cyl. 6.9L; w/ 3/8 Inch Fuel Line	HK9330
1986	8 Cyl. 6.9L; w/ 5/16 Inch Fuel Line	HK9331
1984-1983	8 Cyl. 6.9L; w/ 3/8 Inch Fuel Line	HK9330
1984-1983	8 Cyl. 6.9L; w/ 5/16 Inch Fuel Line	HK9331
F-350		
1986	8 Cyl. 6.9L; w/ 3/8 Inch Fuel Line	HK9330
1986	8 Cyl. 6.9L; w/ 5/16 Inch Fuel Line	HK9331
1984-1983	8 Cyl. 6.9L; w/ 3/8 Inch Fuel Line	HK9330
1984-1983	8 Cyl. 6.9L; w/ 5/16 Inch Fuel Line	HK9331
Ranger		
1985	4 Cyl. 2.3L; w/ 3/8 Inch Fuel Line	HK9330
1985	4 Cyl. 2.3L; w/ 5/16 Inch Fuel Line	HK9331
1984-1983	4 Cyl. 2.2L; w/ 3/8 Inch Fuel Line	HK9330
1984-1983	4 Cyl. 2.2L; w/ 5/16 Inch Fuel Line	HK9331
Tempo		
1986-1984	4 Cyl. 2.0L; SOHC; w/ 3/8 Inch Fuel Line	HK9330
1986-1984	4 Cyl. 2.0L; SOHC; w/ 5/16 Inch Fuel Line	HK9331
Fuel Pressure Regulator		
E-350 Club Wagon		
2005	8 Cyl. 6.0L	PR429
2004	8 Cyl. 6.0L	PR430
2003	8 Cyl. 7.3L; Diesel	PR315
E-350 Econoline		
1998-1996	8 Cyl. 7.3L	PR315
1995	8 Cyl. 7.3L; w/o Edge Filter	PR315
1995	8 Cyl. 7.3L; w/ Edge Filter	PR516
E-350 Econoline Club Wagon		
2002-2000	8 Cyl. 7.3L; Diesel	PR315
1999-1996	8 Cyl. 7.3L	PR315
1995	8 Cyl. 7.3L; w/o Edge Filter	PR315
1995	8 Cyl. 7.3L; w/ Edge Filter	PR516
E-350 Super Duty		
2010-2005	8 Cyl. 6.0L	PR429
2004	8 Cyl. 6.0L	PR430
2003-1999	8 Cyl. 7.3L	PR315
E-450 Econoline Super Duty		
2002-2000	8 Cyl. 7.3L; Diesel	PR315
E-450 Super Duty		
2008-2005	8 Cyl. 6.0L	PR429
2004	8 Cyl. 6.0L	PR430
2003	8 Cyl. 7.3L	PR315
E-550 Econoline Super Duty		
2002	8 Cyl. 7.3L	PR315
E-550 Super Duty		
2003	8 Cyl. 7.3L	PR315
Econoline Super Duty		
1999-1996	8 Cyl. 7.3L	PR315
Excursion		
2005	8 Cyl. 6.0L	PR429
2004-2003	8 Cyl. 6.0L	PR430
2003-2000	8 Cyl. 7.3L	PR315
F59		
1997-1996	8 Cyl. 7.3L	PR315
1995	8 Cyl. 7.3L; w/o Dust Filter	PR315
1995	8 Cyl. 7.3L; w/ Edge Filter	PR516

		Part No.
Fuel Pressure Regulator		
F59		
1994	8 Cyl. 7.3L	PR516
F650		
2017-2016	8 Cyl. 6.7L; Located On Fuel Rail	PR542
2017-2016	8 Cyl. 6.7L; Located On Fuel Pump	PR560
2007-2005	8 Cyl.	PR429
2004	8 Cyl.	PR430
2003-2000	8 Cyl.	PR315
F750		
2018-2016	8 Cyl. 6.7L; Located On Fuel Rail	PR542
2018-2016	8 Cyl. 6.7L; Located On Fuel Pump	PR560
2007-2005	8 Cyl.	PR429
2004	8 Cyl.	PR430
2003-2000	8 Cyl.	PR315
F-250		
1996	8 Cyl. 7.3L	PR315
1995	8 Cyl. 7.3L; w/o Edge Filter	PR315
1995	8 Cyl. 7.3L; w/ Edge Filter	PR516
1994	8 Cyl. 7.3L; F	PR516
F-250 HD		
1997	8 Cyl. 7.3L	PR315
F-250 Super Duty		
2019-2011	8 Cyl. 6.7L; Located On Fuel Rail	PR542
2018-2015	8 Cyl. 6.7L; Located On Fuel Pump	PR560
2014	8 Cyl. 6.7L; On Injection Pump	PR560
2013	8 Cyl. 6.7L; Located On Fuel Pump	PR560
2012-2011	8 Cyl. 6.7L; On Injection Pump	PR560
2007-2005	8 Cyl. 6.0L	PR429
2004-2003	8 Cyl. 6.0L	PR430
2003-1999	8 Cyl. 7.3L	PR315
F-350		
1997-1996	8 Cyl. 7.3L	PR315
1995	8 Cyl. 7.3L; w/o Edge Filter	PR315
1995	8 Cyl. 7.3L; w/ Edge Filter	PR516
1994	8 Cyl. 7.3L	PR315
F-350 Super Duty		
2019-2011	8 Cyl. 6.7L; Located On Fuel Rail	PR542
2018-2011	8 Cyl. 6.7L; Located On Fuel Pump	PR560
2007-2005	8 Cyl. 6.0L	PR429
2004-2003	8 Cyl. 6.0L	PR430
2003-1999	8 Cyl. 7.3L	PR315
F-450 Super Duty		
2019-2011	8 Cyl. 6.7L; Located On Fuel Rail	PR542
2017-2011	8 Cyl. 6.7L; Located On Fuel Pump	PR560
2007-2005	8 Cyl. 6.0L	PR429
2004-2003	8 Cyl. 6.0L	PR430
2003-1999	8 Cyl. 7.3L	PR315
F-550 Super Duty		
2019-2011	8 Cyl. 6.7L; Located On Fuel Rail	PR542
2017-2011	8 Cyl. 6.7L; Located On Fuel Pump	PR560
2007-2005	8 Cyl. 6.0L	PR429
2004-2003	8 Cyl. 6.0L	PR430
2003-1999	8 Cyl. 7.3L	PR315
F Super Duty		
1997-1996	8 Cyl. 7.3L	PR315
1995	8 Cyl. 7.3L; w/o Edge Filter	PR315
1995	8 Cyl. 7.3L; w/ Edge Filter	PR516
LCF		
2010-2006		PR429
Fuel Pressure Regulator O-Ring		
E-350 Club Wagon		
2005-2004	8 Cyl. 6.0L; Kit	SK107
2003	8 Cyl. 7.3L	SK104

Injection Components

		Part No.
Fuel Pressure Regulator O-Ring		
E-350 Econoline		
1998-1995	8 Cyl. 7.3L	SK104
E-350 Econoline Club Wagon		
2002-1995	8 Cyl. 7.3L	SK104
E-350 Super Duty		
2010-2004	8 Cyl. 6.0L; Kit	SK107
2003-1999	8 Cyl. 7.3L	SK104
E-450 Super Duty		
2008-2004	8 Cyl. 6.0L; Kit	SK107
2003	8 Cyl. 7.3L	SK104
E-550 Super Duty		
2003	8 Cyl. 7.3L	SK104
Excursion		
2005-2003	8 Cyl. 6.0L; Kit	SK107
2003-2000	8 Cyl. 7.3L	SK104
F59		
1997	8 Cyl. 7.3L	SK104
1995-1993	8 Cyl. 7.3L	SK104
F650		
2007-2004	8 Cyl.; Kit	SK107
2003-2000	8 Cyl.; Diesel	SK104
F750		
2007-2004	8 Cyl.; Kit	SK107
2003-2000	8 Cyl.; Diesel	SK104
F-250		
1996-1993	8 Cyl. 7.3L	SK104
F-250 Super Duty		
2007-2003	8 Cyl. 6.0L; Kit	SK107
2003-1999	8 Cyl. 7.3L; Diesel	SK104
F-350		
1997-1993	8 Cyl. 7.3L	SK104
F-350 Super Duty		
2007-2003	8 Cyl. 6.0L; Kit	SK107
2003-1999	8 Cyl. 7.3L	SK104
F-450 Super Duty		
2007-2003	8 Cyl. 6.0L; Kit	SK107
2003-1999	8 Cyl. 7.3L	SK104
F-550 Super Duty		
2007-2003	8 Cyl. 6.0L; Kit	SK107
2003-1999	8 Cyl. 7.3L	SK104
F Super Duty		
1997-1995	8 Cyl. 7.3L	SK104
LCF		
2010-2006	Kit	SK107
Fuel Pressure Regulator Upgrade Kit		
Excursion		
2004-2003	8 Cyl. 6.0L; Upgrade Kit	PRU1
F-250 Super Duty		
2007-2003	8 Cyl. 6.0L; Upgrade Kit	PRU1
F-350 Super Duty		
2007-2003	8 Cyl. 6.0L; Upgrade Kit	PRU1
F-450 Super Duty		
2007-2003	8 Cyl. 6.0L	PRU1
Fuel Pump Strainer		
E-350 Econoline		
1995-1990	8 Cyl. 7.3L	F08001
E-350 Super Duty		
2008-2004	8 Cyl. 6.0L	F08001
E-450 Econoline Super Duty		
2002	8 Cyl. 7.3L	F08001

		Part No.
Fuel Pump Strainer		
E-550 Econoline Super Duty		
2002	8 Cyl. 7.3L	F08001
Excursion		
2003-2000	8 Cyl. 7.3L	F08001
F-250		
1994-1990	8 Cyl. 7.3L	F08001
F-250 Super Duty		
2007-2003	8 Cyl. 6.0L	F08001
2003-1999	8 Cyl. 7.3L	F08001
F-350		
1994-1990	8 Cyl. 7.3L	F08001
F-350 Super Duty		
2007-2003	8 Cyl. 6.0L	F08001
2003-1999	8 Cyl. 7.3L	F08001
Horizontal Fuel Conditioning Module		
Excursion		
2005-2003	8 Cyl. 6.0L; Diesel	Z76002
F-250 Super Duty		
2007-2003	8 Cyl. 6.0L; Diesel	Z76002
F-350 Super Duty		
2007-2003	8 Cyl. 6.0L; Diesel	Z76002
F-450 Super Duty		
2007-2003	8 Cyl. 6.0L; Diesel	Z76002
F-550 Super Duty		
2007-2004	8 Cyl. 6.0L; Diesel	Z76002
2003	8 Cyl. 6.0L	Z76002
Horizontal Fuel Conditioning Module Cover Gasket Kit		
Excursion		
2005-2003	8 Cyl. 6.0L	HFG101
F-250 Super Duty		
2007-2003	8 Cyl. 6.0L	HFG101
F-350 Super Duty		
2007-2003	8 Cyl. 6.0L	HFG101
F-450 Super Duty		
2007-2003	8 Cyl. 6.0L	HFG101
F-550 Super Duty		
2007-2003	8 Cyl. 6.0L	HFG101
Plenum Gasket		
Ranger		
1987-1985	4 Cyl. 2.3L	PG1
Throttle Body Injection Gasket Pack		
Ranger		
1987-1985	4 Cyl. 2.3L	2006
Vertical Fuel Conditioning Module		
E-350 Super Duty		
2010-2004	8 Cyl. 6.0L; Diesel	Z76003
Chassis and Drivetrain Sensors		
ABS Speed Sensor		
F650		
2007-2005	In Differential	ALS1889
2007-2004	Rear	ALS2239
2004	In Differential	ALS177
2004	Front	ALS197
2003-2001	Left Front	ALS2690
2003-2000	w/ Hydraulic Brakes; In Differential	ALS2238
F750		
2007-2005	In Differential	ALS1889
2004	In Differential	ALS177
2004	Front	ALS197
2003-2001	Left Front	ALS2690
2003-2000	w/ Hydraulic Brakes; In Differential	ALS2238

Chassis and Drivetrain Sensors

		Part No.
ABS Speed Sensor		
F800		
1999	In Differential	ALS177
1999	Front	ALS197
Transit		
2010	4 Cyl. 2.2L; Front	ALS1866
2010	4 Cyl. 2.2L; Rear	ALS1885
Automatic Transmission Output Sensor		
E-350 Econoline Club Wagon		
2002-2000	8 Cyl. 7.3L	SC37
E-450 Econoline Super Duty		
2002-2001	8 Cyl. 7.3L	SC37
E-550 Econoline Super Duty		
2002	8 Cyl. 7.3L	SC37
Escort		
1987-1985	4 Cyl. 2.0L; Diesel; w/ Dealer Installed Cruise Control	SC31
1987-1985	4 Cyl. 2.0L; Diesel; w/ Factory Installed Cruise Control	SC34
1984	4 Cyl. 2.0L; w/ Dealer Installed Cruise Control	SC31
1984	4 Cyl. 2.0L; w/ Factory Installed Cruise Control	SC34
Ranger		
1983	4 Cyl. 2.2L	SC46
Manual Transmission Output Sensor		
Escort		
1987-1985	4 Cyl. 2.0L; Diesel; w/ Factory Installed Cruise Control	SC34
1984	4 Cyl. 2.0L; w/ Factory Installed Cruise Control	SC34
Ranger		
1983	4 Cyl. 2.2L	SC46
Vehicle Speed Sensor		
E-350 Econoline Club Wagon		
2002-2000	8 Cyl. 7.3L	SC37
E-450 Econoline Super Duty		
2002-2001	8 Cyl. 7.3L	SC37
E-550 Econoline Super Duty		
2002	8 Cyl. 7.3L	SC37
Escort		
1985-1984	4 Cyl. 2.0L; w/ Dealer Installed Cruise Control	SC31
1985-1984	4 Cyl. 2.0L; w/ Factory Installed Cruise Control	SC34
Ranger		
1983	4 Cyl. 2.2L	SC46
Fluid Level Sensors		
Coolant Level Sensor		
F650		
2003-2000		FLS165
F750		
2003-2000		FLS165
F800		
1999		FLS-164
1996-1995		FLS-164
Fuel Sensors		
Diesel Exhaust Particulate Sensor		
F650		
2019	8 Cyl. 6.7L	DEP109
2018-2016	8 Cyl. 6.7L	DEP108
F750		
2019	8 Cyl. 6.7L	DEP109

		Part No.
Diesel Exhaust Particulate Sensor		
F750		
2018-2016	8 Cyl. 6.7L	DEP108
F-150		
2018	6 Cyl. 3.0L	DEP105
F-250 Super Duty		
2019	8 Cyl. 6.7L	DEP107
2018-2017	8 Cyl. 6.7L; w/ 203 Inch Wheel Base	DEP101
2018-2017	8 Cyl. 6.7L; w/ 169, 193, 205 Inch Wheel Base	DEP103
2016-2015	8 Cyl. 6.7L	DEP100
F-350 Super Duty		
2019	8 Cyl. 6.7L	DEP107
2018-2017	8 Cyl. 6.7L; w/ 203 Inch Wheel Base	DEP101
2018-2017	8 Cyl. 6.7L; w/ 169, 193, 205 Inch Wheel Base	DEP103
F-450 Super Duty		
2019	8 Cyl. 6.7L	DEP107
2018-2017	8 Cyl. 6.7L; w/ 203 Inch Wheel Base	DEP101
2018-2017	8 Cyl. 6.7L; w/ 169, 193, 205 Inch Wheel Base	DEP103
F-550 Super Duty		
2019	8 Cyl. 6.7L	DEP107
2018-2017	8 Cyl. 6.7L; w/ 203 Inch Wheel Base	DEP101
2018-2017	8 Cyl. 6.7L; w/ 169, 193, 205 Inch Wheel Base	DEP103
Transit-250		
2017-2016	5 Cyl. 3.2L	DEP102
Transit-350		
2017-2016	5 Cyl. 3.2L	DEP102
Transit-350 HD		
2017-2016	5 Cyl. 3.2L	DEP102
Diesel Injection Control Pressure Sensor		
E-250 Econoline Club Wagon		
1991-1988	8 Cyl. 7.3L	ICP105
E-350 Club Wagon		
2005-2004	8 Cyl. 6.0L; Exhaust stock and reorder; Sensor Only	ICP101
2005-2004	8 Cyl. 6.0L; Sensor Kit	ICP101K
2005-2004	8 Cyl. 6.0L; Alternate Number; Sensor Kit	ICP101K
2003	8 Cyl. 7.3L; Exhaust stock and reorder; Sensor Only	ICP102
2003	8 Cyl. 7.3L; Sensor Kit	ICP102K
2003	8 Cyl. 7.3L; Alternate Number; Sensor Kit	ICP102K
E-350 Econoline		
1998-1997	8 Cyl. 7.3L; Exhaust stock and reorder; Sensor Only	ICP102
1998-1997	8 Cyl. 7.3L; Sensor Kit	ICP102K
1998-1995	8 Cyl. 7.3L; Alternate Number; Sensor Kit	ICP102K
1996-1995	8 Cyl. 7.3L; Exhaust stock and reorder	ICP102
1996-1995	8 Cyl. 7.3L; Exhaust stock and reorder	ICP104
1994-1988	8 Cyl. 7.3L	ICP105
E-350 Econoline Club Wagon		
2002-1997	8 Cyl. 7.3L; Exhaust stock and reorder; Sensor Only	ICP102
2002-1997	8 Cyl. 7.3L; Sensor Kit	ICP102K
2002-1995	8 Cyl. 7.3L; Alternate Number; Sensor Kit	ICP102K
1996-1995	8 Cyl. 7.3L; Exhaust stock and reorder	ICP102
1996-1995	8 Cyl. 7.3L; Exhaust stock and reorder	ICP104
1994-1988	8 Cyl. 7.3L	ICP105
E-350 Super Duty		
2010-2004	8 Cyl. 6.0L; Exhaust stock and reorder; Sensor Only	ICP101
2010-2004	8 Cyl. 6.0L; Sensor Kit	ICP101K
2010-2004	8 Cyl. 6.0L; Alternate Number; Sensor Kit	ICP101K

Ford

Fuel Sensors

		Part No.
Diesel Injection Control Pressure Sensor		
E-450 Econoline Super Duty		
2002-2000	8 Cyl. 7.3L; Exhaust stock and reorder; Sensor Only	ICP102
2002-2000	8 Cyl. 7.3L; Sensor Kit	ICP102K
2002-2000	8 Cyl. 7.3L; Alternate Number; Sensor Kit	ICP102K
E-450 Super Duty		
2010-2004	8 Cyl. 6.0L; Exhaust stock and reorder; Sensor Only	ICP101
2010-2004	8 Cyl. 6.0L; Sensor Kit	ICP101K
2010-2004	8 Cyl. 6.0L; Alternate Number; Sensor Kit	ICP101K
2003	8 Cyl. 7.3L; Exhaust stock and reorder; Sensor Only	ICP102
2003	8 Cyl. 7.3L; Sensor Kit	ICP102K
2003	8 Cyl. 7.3L; Alternate Number; Sensor Kit	ICP102K
E-550 Econoline Super Duty		
2002	8 Cyl. 7.3L; Exhaust stock and reorder; Sensor Only	ICP102
2002	8 Cyl. 7.3L; Sensor Kit	ICP102K
2002	8 Cyl. 7.3L; Alternate Number; Sensor Kit	ICP102K
E-550 Super Duty		
2003	8 Cyl. 7.3L; Exhaust stock and reorder; Sensor Only	ICP102
2003	8 Cyl. 7.3L; Sensor Kit	ICP102K
2003	8 Cyl. 7.3L; Alternate Number; Sensor Kit	ICP102K
Econoline Super Duty		
1999-1997	8 Cyl. 7.3L; Exhaust stock and reorder; Sensor Only	ICP102
1999-1997	8 Cyl. 7.3L; Sensor Kit	ICP102K
1999-1996	8 Cyl. 7.3L; Alternate Number; Sensor Kit	ICP102K
1996	8 Cyl. 7.3L; Exhaust stock and reorder	ICP102
1996	8 Cyl. 7.3L; Exhaust stock and reorder	ICP104
Excursion		
2005	8 Cyl. 6.0L; Exhaust stock and reorder; Sensor Only	ICP101
2005	8 Cyl. 6.0L; Sensor Kit	ICP101K
2005	8 Cyl. 6.0L; Alternate Number; Sensor Kit	ICP101K
2004	8 Cyl. 6.0L; Exhaust stock and reorder; Sensor Only; Mounts On Passenger Side Valve Cover	ICP101
2004	8 Cyl. 6.0L; Sensor Kit; Mounts On Passenger Side Valve Cover	ICP101K
2004	8 Cyl. 6.0L; Alternate Number; Sensor Kit; Mounts On Passenger Side Valve Cover	ICP101K
2004	8 Cyl. 6.0L; Exhaust stock and reorder; Sensor Only; Mounts Below Turbocharger	ICP103
2004	8 Cyl. 6.0L; Sensor Kit; Mounts Below Turbocharger	ICP103K
2004	8 Cyl. 6.0L; Alternate Number; Sensor Kit; Mounts Below Turbocharger	ICP103K
2003	8 Cyl. 6.0L; Exhaust stock and reorder; Sensor Only	ICP103
2003	8 Cyl. 6.0L; Sensor Kit	ICP103K
2003	8 Cyl. 6.0L; Alternate Number; Sensor Kit	ICP103K
2003-2000	8 Cyl. 7.3L; Exhaust stock and reorder; Sensor Only	ICP102
2003-2000	8 Cyl. 7.3L; Sensor Kit	ICP102K
2003-2000	8 Cyl. 7.3L; Alternate Number; Sensor Kit	ICP102K
F59		
1997-1994	8 Cyl. 7.3L; F; Exhaust stock and reorder	ICP102
1997-1994	8 Cyl. 7.3L; F; Alternate Number; Sensor Kit	ICP102K
1997-1994	8 Cyl. 7.3L; F; Exhaust stock and reorder	ICP104
1997-1994	8 Cyl. 7.3L; K	ICP105
1997-1994	8 Cyl. 7.3L; M	ICP105

		Part No.
Diesel Injection Control Pressure Sensor		
F650		
2008-2005	8 Cyl.; Exhaust stock and reorder; Sensor Only	ICP101
2008-2005	8 Cyl.; Sensor Kit	ICP101K
2008-2005	8 Cyl.; Alternate Number; Sensor Kit	ICP101K
2004	8 Cyl.; Exhaust stock and reorder; Sensor Only; Mounts On Passenger Side Valve Cover	ICP101
2004	8 Cyl.; Sensor Kit; Mounts On Passenger Side Valve Cover	ICP101K
2004	8 Cyl.; Alternate Number; Sensor Kit; Mounts On Passenger Side Valve Cover	ICP101K
2004	8 Cyl.; Exhaust stock and reorder; Sensor Only; Mounts Below Turbocharger	ICP103
2004	8 Cyl.; Sensor Kit; Mounts Below Turbocharger	ICP103K
2004	8 Cyl.; Alternate Number; Sensor Kit; Mounts Below Turbocharger	ICP103K
2003	8 Cyl. 7.3L; Exhaust stock and reorder; Sensor Only	ICP102
2003	8 Cyl. 7.3L; Sensor Kit	ICP102K
2003	8 Cyl. 7.3L; Alternate Number; Sensor Kit	ICP102K
2002-2000	8 Cyl.; Exhaust stock and reorder; Sensor Only	ICP102
2002-2000	8 Cyl.; Sensor Kit	ICP102K
2002-2000	8 Cyl.; Alternate Number; Sensor Kit	ICP102K
F750		
2008-2005	8 Cyl.; Exhaust stock and reorder; Sensor Only	ICP101
2008-2005	8 Cyl.; Sensor Kit	ICP101K
2008-2005	8 Cyl.; Alternate Number; Sensor Kit	ICP101K
2004	8 Cyl.; Exhaust stock and reorder; Sensor Only; Mounts On Passenger Side Valve Cover	ICP101
2004	8 Cyl.; Sensor Kit; Mounts On Passenger Side Valve Cover	ICP101K
2004	8 Cyl.; Alternate Number; Sensor Kit; Mounts On Passenger Side Valve Cover	ICP101K
2004	8 Cyl.; Exhaust stock and reorder; Sensor Only; Mounts Below Turbocharger	ICP103
2004	8 Cyl.; Sensor Kit; Mounts Below Turbocharger	ICP103K
2004	8 Cyl.; Alternate Number; Sensor Kit; Mounts Below Turbocharger	ICP103K
2003	8 Cyl. 7.3L; Exhaust stock and reorder; Sensor Only	ICP102
2003	8 Cyl. 7.3L; Sensor Kit	ICP102K
2003	8 Cyl. 7.3L; Alternate Number; Sensor Kit	ICP102K
2002-2000	8 Cyl.; Exhaust stock and reorder; Sensor Only	ICP102
2002-2000	8 Cyl.; Sensor Kit	ICP102K
2002-2000	8 Cyl.; Alternate Number; Sensor Kit	ICP102K
F-250		
1996-1995	8 Cyl. 7.3L; Exhaust stock and reorder	ICP102
1996-1995	8 Cyl. 7.3L; Alternate Number; Sensor Kit	ICP102K
1996-1995	8 Cyl. 7.3L; Exhaust stock and reorder	ICP104
1994	8 Cyl. 7.3L; F; Exhaust stock and reorder	ICP102
1994	8 Cyl. 7.3L; F; Alternate Number; Sensor Kit	ICP102K
1994	8 Cyl. 7.3L; F; Exhaust stock and reorder	ICP104
1994	8 Cyl. 7.3L; K	ICP105
1994	8 Cyl. 7.3L; M	ICP105
1993-1988	8 Cyl. 7.3L	ICP105
F-250 HD		
1997	8 Cyl. 7.3L; Sensor Kit	ICP102K
F-250 Super Duty		
2007-2005	8 Cyl. 6.0L; Exhaust stock and reorder; Sensor Only	ICP101

Fuel Sensors

		Part No.
Diesel Nitrogen Oxide (NOx) Sensor		
F-250 Super Duty		
2019-2017	8 Cyl. 6.7L	NOX018
2016-2013	8 Cyl. 6.7L; Upstream	NOX009
2016-2013	8 Cyl. 6.7L; Downstream	NOX010
2012-2011	8 Cyl. 6.7L	NOX008
F-350 Super Duty		
2019-2017	8 Cyl. 6.7L	NOX018
2016-2013	8 Cyl. 6.7L; Upstream	NOX009
2016-2013	8 Cyl. 6.7L; Downstream	NOX010
2012-2011	8 Cyl. 6.7L	NOX008
Fuel / Water Separator Sensor		
E-250 Econoline Club Wagon		
1991-1988	8 Cyl. 7.3L	FWSS110
E-350 Club Wagon		
2005-2004	8 Cyl. 6.0L	FWSS114
E-350 Econoline		
1998-1995	8 Cyl. 7.3L	FWSS113
1994-1988	8 Cyl. 7.3L	FWSS110
E-350 Econoline Club Wagon		
1998-1995	8 Cyl. 7.3L	FWSS113
1994-1988	8 Cyl. 7.3L	FWSS110
E-350 Super Duty		
2010-2004	8 Cyl. 6.0L	FWSS114
E-450 Super Duty		
2010	8 Cyl. 6.0L	FWSS114
2008-2004	8 Cyl. 6.0L	FWSS114
Excursion		
2005-2003	8 Cyl. 6.0L	FWSS114
F650		
2019-2016	8 Cyl. 6.7L	FPS113
F750		
2019-2016	8 Cyl. 6.7L	FPS113
F-250		
1996-1995	8 Cyl. 7.3L	FWSS113
1994	8 Cyl. 7.3L; F	FWSS113
1994	8 Cyl. 7.3L; K	FWSS110
1994	8 Cyl. 7.3L; M	FWSS110
1993-1988	8 Cyl. 7.3L	FWSS110
F-250 Super Duty		
2016-2011	8 Cyl. 6.7L	FPS113
2010-2008	8 Cyl. 6.4L	FWSS114
2007-2003	8 Cyl. 6.0L	FWSS114
F-350		
1997-1995	8 Cyl. 7.3L	FWSS113
1994	8 Cyl. 7.3L; F	FWSS113
1994	8 Cyl. 7.3L; K	FWSS110
1994	8 Cyl. 7.3L; M	FWSS110
1993-1988	8 Cyl. 7.3L	FWSS110
F-350 Super Duty		
2016-2011	8 Cyl. 6.7L	FPS113
2010-2008	8 Cyl. 6.4L	FWSS114
2007-2003	8 Cyl. 6.0L	FWSS114
F-450 Super Duty		
2016-2011	8 Cyl. 6.7L	FPS113
2010-2008	8 Cyl. 6.4L	FWSS114
2007-2003	8 Cyl. 6.0L	FWSS114
F-550 Super Duty		
2016-2011	8 Cyl. 6.7L	FPS113
2010-2008	8 Cyl. 6.4L	FWSS114
2007-2003	8 Cyl. 6.0L	FWSS114
F Super Duty		
1997-1995	8 Cyl. 7.3L	FWSS113

		Part No.
Fuel / Water Separator Sensor		
F Super Duty		
1994	8 Cyl. 7.3L; K	FWSS110
1994	8 Cyl. 7.3L; M	FWSS110
1993-1990	8 Cyl. 7.3L	FWSS110
1988	8 Cyl. 7.3L	FWSS110
Mass Air Flow		
E-350 Super Duty		
2010-2004	8 Cyl. 6.0L	MAS0164
E-450 Super Duty		
2010-2004	8 Cyl. 6.0L	MAS0164
Miscellaneous Sensors		
Accelerator Pedal Sensor Repair Kit		
F-250		
1996	8 Cyl. 7.3L; Diesel; Sensor Only	APK103
F-250 Super Duty		
2001	8 Cyl. 7.3L; Diesel; Sensor Only; To 10/2/00	APK103
2000-1999	8 Cyl. 7.3L; Diesel; Sensor Only	APK103
F-350		
1997-1996	8 Cyl. 7.3L; Diesel; Sensor Only	APK103
F-350 Super Duty		
2001	8 Cyl. 7.3L; Diesel; Sensor Only; To 10/2/00	APK103
2000-1999	8 Cyl. 7.3L; Diesel; Sensor Only	APK103
F-450 Super Duty		
2001	8 Cyl. 7.3L; Sensor Only; To 10/2/00	APK103
2000-1999	8 Cyl. 7.3L; Sensor Only	APK103
F-550 Super Duty		
2001	8 Cyl. 7.3L; Sensor Only; To 10/2/00	APK103
2000-1999	8 Cyl. 7.3L; Sensor Only	APK103
F Super Duty		
1997-1996	8 Cyl. 7.3L; Sensor Only	APK103
Position Sensors		
Accelerator Pedal Sensor		
E-350 Club Wagon		
2005	8 Cyl. 6.0L; w/o Stripped Chassis	APS115
2004	8 Cyl. 6.0L	APS115
2003	8 Cyl. 7.3L	APS113
E-350 Econoline		
1998-1997	8 Cyl. 7.3L	APS113
E-350 Econoline Club Wagon		
2002-1997	8 Cyl. 7.3L	APS113
E-350 Super Duty		
2005	8 Cyl. 6.0L; w/o Stripped Chassis	APS115
2004	8 Cyl. 6.0L	APS115
E-450 Super Duty		
2010-2009	8 Cyl. 6.0L	APS115
Excursion		
2005-2003	8 Cyl. 6.0L; w/ Fixed Pedals	APS104
2005-2003	8 Cyl. 6.0L; w/ Adjustable Pedals	APS109
2003-2002	8 Cyl. 7.3L; w/ Fixed Pedals	APS103
2002	8 Cyl. 7.3L; w/ Adjustable Pedals	APS108
2001	8 Cyl. 7.3L	APS103
2000	8 Cyl. 7.3L; w/ Fixed Pedals	APS102
F-250		
1996	8 Cyl. 7.3L; Complete Assembly	APS101
F-250 Super Duty		
2011	8 Cyl. 6.7L; Turbocharged; w/ Adjustable Pedals	APS335
2011	8 Cyl. 6.7L; Turbocharged; w/ Fixed Pedals	APS373
2007	8 Cyl. 6.0L; w/ Fixed Pedals	APS116

Position Sensors

		Part No.
Accelerator Pedal Sensor		
F-250 Super Duty		
2007	8 Cyl. 6.0L; w/ Adjustable Pedals	APS117
2005	8 Cyl. 6.0L; w/ Fixed Pedals	APS116
2005	8 Cyl. 6.0L; w/ Adjustable Pedals	APS117
2004-2003	8 Cyl. 6.0L; w/ Fixed Pedals	APS104
2004-2003	8 Cyl. 6.0L; w/ Adjustable Pedals	APS109
2003-2002	8 Cyl. 7.3L; w/ Adjustable Pedals	APS108
2002	8 Cyl. 7.3L; w/ Fixed Pedals	APS103
2001	8 Cyl. 7.3L; To 10/2/00; w/ Fixed Pedals	APS102
2000-1999	8 Cyl. 7.3L; w/ Fixed Pedals	APS102
F-350		
1997-1996	8 Cyl. 7.3L; Complete Assembly	APS101
F-350 Super Duty		
2011	8 Cyl. 6.7L; Turbocharged; w/ Adjustable Pedals	APS335
2011	8 Cyl. 6.7L; Turbocharged; w/ Fixed Pedals	APS373
2007-2005	8 Cyl. 6.0L; w/ Fixed Pedals	APS116
2007-2005	8 Cyl. 6.0L; w/ Adjustable Pedals	APS117
2004-2003	8 Cyl. 6.0L; w/ Fixed Pedals	APS104
2004-2003	8 Cyl. 6.0L; w/ Adjustable Pedals	APS109
2003	8 Cyl. 7.3L; w/ Fixed Pedals	APS102
2003-2002	8 Cyl. 7.3L; w/ Adjustable Pedals	APS108
2002	8 Cyl. 7.3L; w/ Fixed Pedals	APS103
2001-1999	8 Cyl. 7.3L; w/ Fixed Pedals	APS102
F-450 Super Duty		
2011	8 Cyl. 6.7L; Turbocharged; w/ Adjustable Pedals	APS335
2011	8 Cyl. 6.7L; Turbocharged; w/ Fixed Pedals	APS373
2004-2003	8 Cyl. 6.0L; w/ Adjustable Pedal	APS109
2003-2002	8 Cyl. 7.3L; w/ Adjustable Pedal	APS108
F-550 Super Duty		
2012-2011	8 Cyl. 6.7L; Turbocharged; w/ Adjustable Pedals	APS335
2012-2011	8 Cyl. 6.7L; Turbocharged; w/ Fixed Pedals	APS373
2004-2003	8 Cyl. 6.0L; w/ Adjustable Pedal	APS109
2003-2002	8 Cyl. 7.3L; w/ Adjustable Pedal	APS108
F Super Duty		
1997-1996	8 Cyl. 7.3L; Complete Assembly	APS101
Camshaft Sensor		
E-350 Club Wagon		
2005-2004	8 Cyl. 6.0L	PC645
2003	8 Cyl. 7.3L	PC603
E-350 Econoline		
1998-1997	8 Cyl. 7.3L	PC603
1996-1995	8 Cyl. 7.3L	PC139
1994-1990	8 Cyl. 7.3L	PC933
E-350 Econoline Club Wagon		
2002-1997	8 Cyl. 7.3L	PC603
1996-1995	8 Cyl. 7.3L	PC139
1994-1990	8 Cyl. 7.3L	PC933
E-350 Super Duty		
2010-2004	8 Cyl. 6.0L	PC645
2003-1999	8 Cyl. 7.3L	PC603
E-450 Econoline Super Duty		
2002-2000	8 Cyl. 7.3L	PC603
E-450 Super Duty		
2010-2009	8 Cyl. 6.0L	PC645
2007-2004	8 Cyl. 6.0L	PC645
2003	8 Cyl. 7.3L	PC603
E-550 Econoline Super Duty		
2002	8 Cyl. 7.3L	PC603

		Part No.
Camshaft Sensor		
E-550 Super Duty		
2003	8 Cyl. 7.3L	PC603
Econoline Super Duty		
1999-1997	8 Cyl. 7.3L	PC603
1996	8 Cyl. 7.3L	PC139
Excursion		
2005-2003	8 Cyl. 6.0L	PC645
2003-2000	8 Cyl. 7.3L	PC603
F59		
1997	8 Cyl. 7.3L	PC603
1996-1995	Turbocharged	PC139
1994-1990		PC933
F650		
2007-2004	8 Cyl.	PC645
2003-2000	8 Cyl.	PC603
F750		
2007-2004	8 Cyl.	PC645
2003-2000	8 Cyl.	PC603
F-150		
2020-2018	6 Cyl. 3.0L	PC1190
F-250		
1996-1995	8 Cyl. 7.3L	PC139
1994	8 Cyl. 7.3L; Turbocharged	PC139
1994	8 Cyl. 7.3L; Naturally Aspirated	PC933
1993-1990	8 Cyl. 7.3L	PC933
F-250 HD		
1997	8 Cyl. 7.3L	PC603
F-250 Super Duty		
2020	8 Cyl. 6.7L	PC1189
2019-2011	8 Cyl. 6.7L	PC912
2010-2008	8 Cyl. 6.4L	PC645
2007-2003	8 Cyl. 6.0L	PC645
2003-1999	8 Cyl. 7.3L	PC603
F-350		
1997	8 Cyl. 7.3L	PC603
1996-1995	8 Cyl. 7.3L	PC139
1994	8 Cyl. 7.3L; Turbocharged	PC139
1994	8 Cyl. 7.3L; Naturally Aspirated	PC933
1993-1990	8 Cyl. 7.3L	PC933
F-350 Super Duty		
2020	8 Cyl. 6.7L	PC1189
2019-2011	8 Cyl. 6.7L	PC912
2010-2008	8 Cyl. 6.4L	PC645
2007-2003	8 Cyl. 6.0L	PC645
2003-1999	8 Cyl. 7.3L	PC603
F-450 Super Duty		
2019-2011	8 Cyl. 6.7L	PC912
2010-2008	8 Cyl. 6.4L	PC645
2007-2003	8 Cyl. 6.0L	PC645
2003-1999	8 Cyl. 7.3L	PC603
F-550 Super Duty		
2019-2011	8 Cyl. 6.7L	PC912
2010-2008	8 Cyl. 6.4L	PC645
2007-2003	8 Cyl. 6.0L	PC645
2003-1999	8 Cyl. 7.3L	PC603
F Super Duty		
1997	8 Cyl. 7.3L	PC603
1996	8 Cyl. 7.3L	PC139
1995-1994	8 Cyl. 7.3L; Turbocharged	PC139
1994	8 Cyl. 7.3L; Naturally Aspirated	PC933
LCF		
2009-2006		PC645

Position Sensors

		Part No.
Camshaft Sensor		
Transit		
2013-2007	4 Cyl. 2.2L; Alternate Number; Diesel	PC1048
2013-2007	4 Cyl. 2.2L; Diesel; Exhaust stock and reorder	PC1149
Transit-150		
2019-2015	5 Cyl. 3.2L	PC1048
Transit-250		
2019-2015	5 Cyl. 3.2L	PC1048
Transit-350		
2019-2015	5 Cyl. 3.2L	PC1048
Transit-350 HD		
2019-2015	5 Cyl. 3.2L	PC1048
Crankshaft Sensor		
E-350 Club Wagon		
2005-2004	8 Cyl. 6.0L	PC498
E-350 Super Duty		
2010-2004	8 Cyl. 6.0L	PC498
E-450 Super Duty		
2010-2004	8 Cyl. 6.0L	PC498
Excursion		
2005	8 Cyl.; Diesel	PC498
F650		
2008-2004		PC498
2003	8 Cyl.	PC498
F750		
2008-2004		PC498
2003	8 Cyl.	PC498
F-150		
2020-2018	6 Cyl. 3.0L	PC1193
F-250 Super Duty		
2019-2011	8 Cyl. 6.7L	PC865
2010-2008	8 Cyl. 6.4L	PC498
2007-2003	8 Cyl. 6.0L	PC498
F-350 Super Duty		
2019-2011	8 Cyl. 6.7L	PC865
2010-2008	8 Cyl. 6.4L	PC498
2007-2003	8 Cyl. 6.0L	PC498
F-450 Super Duty		
2019-2011	8 Cyl. 6.7L	PC865
2010-2008	8 Cyl. 6.4L	PC498
2007-2003	8 Cyl. 6.0L	PC498
2003	8 Cyl. 7.3L	PC498
F-550 Super Duty		
2019-2011	8 Cyl. 6.7L	PC865
2010-2008	8 Cyl. 6.4L	PC498
2007-2003	8 Cyl. 6.0L	PC498
2003	8 Cyl. 7.3L	PC498
Transit		
2015-2007	4 Cyl. 2.2L; Diesel	PC1147
Transit-150		
2019-2015	5 Cyl. 3.2L	PC1004
Transit-250		
2016-2015	5 Cyl. 3.2L	PC1004
Transit-350		
2016-2015	5 Cyl. 3.2L	PC1004
Transit-350 HD		
2016-2015	5 Cyl. 3.2L	PC998
EGR Valve Position Sensor		
Ranger		
1987	4 Cyl. 2.3L	VP1
1986-1985	4 Cyl. 2.3L; White	VP1
1986-1985	4 Cyl. 2.3L; Black	VP2

		Part No.
Throttle Position Sensor		
E-250 Econoline Club Wagon		
1991-1988	8 Cyl. 7.3L	TH35
E-350 Club Wagon		
2004	8 Cyl. 6.0L; 6 Pin	TH394
2004	8 Cyl. 6.0L; 3 Pin Term.	TH454
E-350 Econoline		
1997-1988	8 Cyl. 7.3L	TH35
E-350 Econoline Club Wagon		
1997-1988	8 Cyl. 7.3L	TH35
E-350 Super Duty		
2004	8 Cyl. 6.0L; 6 Pin	TH394
E-450 Super Duty		
2004	8 Cyl. 6.0L; 6 Pin	TH394
2004	8 Cyl. 6.0L; 3 Pin Term.	TH454
Escort		
1987	4 Cyl. 2.0L	TH35
Excursion		
2005	8 Cyl. 6.0L	TH394
2004	8 Cyl. 6.0L; 6 Pin	TH394
2004	8 Cyl. 6.0L; 3 Pin Term.	TH454
2003	8 Cyl. 6.0L	TH157
F-250		
1996-1990	8 Cyl. 7.3L	TH35
1986	8 Cyl. 6.9L	TH44
F-250 Super Duty		
2004	8 Cyl. 6.0L; 6 Pin	TH394
2004	8 Cyl. 6.0L; 3 Pin Term.	TH454
F-350		
1997-1988	8 Cyl. 7.3L	TH35
1987-1986	8 Cyl. 6.9L	TH44
F-350 Super Duty		
2004	8 Cyl. 6.0L; 6 Pin	TH394
2004	8 Cyl. 6.0L; 3 Pin Term.	TH454
F-450 Super Duty		
2004	8 Cyl. 6.0L; 6 Pin	TH394
2004	8 Cyl. 6.0L; 3 Pin Term.	TH454
F-550 Super Duty		
2004	8 Cyl. 6.0L; 6 Pin	TH394
2004	8 Cyl. 6.0L; 3 Pin Term.	TH454
F Super Duty		
1997-1990	8 Cyl. 7.3L	TH35
1988	8 Cyl. 7.3L	TH35
Ranger		
1987-1985	4 Cyl. 2.3L	TH16
Pressure Sensors		
Barometric Pressure Sensor		
E-350 Club Wagon		
2005-2004	8 Cyl. 6.0L	AS306
2004	8 Cyl. 7.3L	AS306
2003	8 Cyl. 7.3L	AS169
E-350 Econoline		
1998-1995	8 Cyl. 7.3L	AS169
E-350 Econoline Club Wagon		
2002-1995	8 Cyl. 7.3L	AS169
E-350 Super Duty		
2010-2008	8 Cyl. 6.0L	AS405
2007-2004	8 Cyl. 6.0L	AS306
E-450 Econoline Super Duty		
2002-2000	8 Cyl. 7.3L	AS169
E-450 Super Duty		
2010-2009	8 Cyl. 6.0L	AS405

Pressure Sensors

		Part No.
Barometric Pressure Sensor		
E-450 Super Duty		
2007-2005	8 Cyl. 6.0L	AS405
2004	8 Cyl. 6.0L	AS306
2003	8 Cyl. 7.3L	AS169
E-550 Econoline Super Duty		
2002	8 Cyl. 7.3L	AS169
E-550 Super Duty		
2003	8 Cyl. 7.3L	AS169
Econoline Super Duty		
1999-1996	8 Cyl. 7.3L	AS169
Excursion		
2005-2004	8 Cyl. 6.0L	AS306
2003	8 Cyl. 6.0L; To 9/30/03	AS169
2003	8 Cyl. 6.0L; From 9/30/03	AS306
F59		
1995	8 Cyl. 7.3L; Naturally Aspirated	AS13
1995-1994	8 Cyl. 7.3L; Turbocharged	AS169
1993	8 Cyl. 7.3L	AS13
F650		
2004	8 Cyl.	AS405
2003-2000	8 Cyl. 7.3L	AS169
F750		
2004	8 Cyl.	AS405
2003-2000	8 Cyl.	AS169
F-250		
1996-1995	8 Cyl. 7.3L	AS169
F-250 Super Duty		
2004	8 Cyl. 6.0L	AS405
2003	8 Cyl. 6.0L; To 9/30/03	AS169
2003	8 Cyl. 7.3L; To 9/30/03	AS169
2003	8 Cyl. 6.0L; From 9/30/03	AS405
2002-1999	8 Cyl. 7.3L	AS169
F-350		
1997-1995	8 Cyl. 7.3L	AS169
1994	8 Cyl. 7.3L; Turbocharged	AS169
F-350 Super Duty		
2004	8 Cyl. 6.0L	AS405
2003	8 Cyl. 6.0L; To 9/30/03	AS169
2003	8 Cyl. 6.0L; From 9/30/03	AS405
2003-1999	8 Cyl. 7.3L	AS169
F-450 Super Duty		
2004	8 Cyl. 6.0L	AS405
2003	8 Cyl. 6.0L; To 9/30/03	AS169
2003	8 Cyl. 6.0L; From 9/30/03	AS405
2003-1999	8 Cyl. 7.3L	AS169
F-550 Super Duty		
2004	8 Cyl. 6.0L	AS405
2003	8 Cyl. 6.0L; To 9/30/03	AS169
2003	8 Cyl. 6.0L; From 9/30/03	AS405
2003-1999	8 Cyl. 7.3L	AS169
F Super Duty		
1997-1995	8 Cyl. 7.3L	AS169
Diesel Particulate Filter (DPF) Pressure Sensor		
F-150		
2020-2018	6 Cyl. 3.0L	DPS121
F-250 Super Duty		
2019	8 Cyl. 6.7L; w/ 142, 148, 164 Inch Wheel Base	DPS115
2019	8 Cyl. 6.7L; w/ 160, 176 Inch Wheel Base	DPS116
2018-2017	8 Cyl. 6.7L	DPS111
2016	8 Cyl. 6.7L	VP36
2015	8 Cyl. 6.7L; 1 Hose; Bolt-On Mounting	VP31
2015	8 Cyl. 6.7L; Bolt-On Mounting; Dual Hose	VP36

		Part No.
Diesel Particulate Filter (DPF) Pressure Sensor		
F-250 Super Duty		
2014-2013	8 Cyl. 6.7L; Front	VP31
2014-2013	8 Cyl. 6.7L; Rear	VP36
2012-2011	8 Cyl. 6.7L	VP31
2010-2008	8 Cyl. 6.4L	VP24
F-350 Super Duty		
2019	8 Cyl. 6.7L; w/o Pickup Bed	DPS111
2019	8 Cyl. 6.7L; w/ 142, 148, 164 Inch Wheel Base; w/ Pickup Bed	DPS115
2019	8 Cyl. 6.7L; w/ 160, 176 Inch Wheel Base; w/ Pickup Bed	DPS116
2017	8 Cyl. 6.7L	DPS111
2016-2015	8 Cyl. 6.7L	VP36
2014-2013	8 Cyl. 6.7L; w/o Pickup Bed; Front	VP30
2014-2013	8 Cyl. 6.7L; w/ Pickup Bed; Front	VP31
2014-2013	8 Cyl. 6.7L; w/ Pickup Bed; Rear	VP36
2010-2008	8 Cyl. 6.4L	VP24
F-450 Super Duty		
2019	8 Cyl. 6.7L; w/ 142, 148, 164 Inch Wheel Base; w/ Pickup Bed	DPS115
2019	8 Cyl. 6.7L; w/ 160, 176 Inch Wheel Base; w/ Pickup Bed	DPS116
2018-2017	8 Cyl. 6.7L	DPS111
2015	8 Cyl. 6.7L	VP31
2014-2013	8 Cyl. 6.7L; w/o Pickup Bed; Front	VP30
2014-2013	8 Cyl. 6.7L; w/ Pickup Bed; Front	VP31
2012-2011	8 Cyl. 6.7L	VP31
2010-2008	8 Cyl. 6.4L	VP24
F-550 Super Duty		
2019-2017	8 Cyl. 6.7L	DPS111
2014-2013	8 Cyl. 6.7L; Front	VP30
2010-2008	8 Cyl. 6.4L	VP24
Transit-250		
2015	5 Cyl. 3.2L	DPS110
Transit-350		
2015	5 Cyl. 3.2L	DPS110
Transit-350 HD		
2015	5 Cyl. 3.2L	DPS110
EGR Valve Pressure Feedback Sensor		
E-350 Club Wagon		
2003	8 Cyl.	VP16
E-350 Econoline		
1998-1997	8 Cyl. 7.3L	VP16
1996-1995	8 Cyl. 7.3L	VP18
E-350 Econoline Club Wagon		
2002-1996	8 Cyl. 7.3L	VP16
1995	8 Cyl. 7.3L	VP18
E-350 Super Duty		
2010-2006	8 Cyl. 6.0L	VP22
E-450 Econoline Super Duty		
2002-1999	8 Cyl. 7.3L	VP16
E-450 Super Duty		
2010-2004	8 Cyl. 6.0L	VP22
2003	8 Cyl.	VP16
E-550 Super Duty		
2003	8 Cyl.	VP16
Econoline Super Duty		
1999-1996	8 Cyl. 7.3L	VP16
Excursion		
2005	8 Cyl. 6.0L	VP22
2004-2003	8 Cyl.	VP16
2002-2000	8 Cyl. 7.3L	VP16

Ford

Pressure Sensors

		Part No.
EGR Valve Pressure Feedback Sensor		
F59		
1994	8 Cyl. 7.3L	VP16
F-250		
1996-1995	8 Cyl. 7.3L	VP18
F-250 Super Duty		
2018-2011	8 Cyl. 6.7L; Screw Type Mounting	VP32
2007-2004	8 Cyl. 6.0L	VP22
2004-2003	8 Cyl.	VP16
2002-1999	8 Cyl. 7.3L	VP16
F-350		
1997	8 Cyl. 7.3L	VP16
1996-1995	8 Cyl. 7.3L	VP18
F-350 Super Duty		
2018-2013	8 Cyl. 6.7L; Screw Type Mounting	VP32
2012-2011	8 Cyl. 6.7L	VP32
2007-2005	8 Cyl. 6.0L	VP22
2004-2003	8 Cyl.	VP16
2002-1999	8 Cyl. 7.3L	VP16
F-450 Super Duty		
2018-2015	8 Cyl. 6.7L	VP32
2014-2011	8 Cyl. 6.7L; Screw Type Mounting	VP32
2007-2004	8 Cyl. 6.0L	VP22
2003	8 Cyl.	VP16
2002-1999	8 Cyl. 7.3L	VP16
F-550 Super Duty		
2018-2011	8 Cyl. 6.7L	VP32
2007-2005	8 Cyl. 6.0L	VP22
2004-2003	8 Cyl.	VP16
2002-1999	8 Cyl. 7.3L	VP16
F Super Duty		
1997	8 Cyl. 7.3L	VP22
1996-1995	8 Cyl. 7.3L	VP18
Exhaust Back Pressure Sensor		
E-350 Econoline		
1998	8 Cyl. 7.3L	VP16
1997	8 Cyl.	VP16
E-350 Econoline Club Wagon		
2002-1997	8 Cyl. 7.3L	VP16
1996-1995	8 Cyl. 7.3L	VP18
E-550 Super Duty		
2003	8 Cyl.	VP16
Excursion		
2004-2003	8 Cyl.	VP16
2002-2000	8 Cyl. 7.3L	VP16
F-250		
1995	8 Cyl. 7.3L	VP18
F-250 Super Duty		
2010-2008	8 Cyl. 6.4L; w/ Tube; At EGR	VP26
2008	8 Cyl. 6.4L; Sensor Only; At EGR	VP25
2003	8 Cyl.	VP16
1999	8 Cyl. 7.3L	VP16
F-350		
1997	8 Cyl. 7.3L	VP16
1996-1995	8 Cyl. 7.3L	VP18
F-350 Super Duty		
2015-2013	8 Cyl. 6.7L; Front	VP30
2012-2011	8 Cyl. 6.7L	VP30
2010-2008	8 Cyl. 6.4L; w/ Tube; At EGR	VP26
2008	8 Cyl. 6.4L; Sensor Only; At EGR	VP25
2004-2003	8 Cyl.	VP16
2002-1999	8 Cyl. 7.3L	VP16

		Part No.
Exhaust Back Pressure Sensor		
F-450 Super Duty		
2010-2008	8 Cyl. 6.4L; w/ Tube; At EGR	VP26
F-550 Super Duty		
2015-2013	8 Cyl. 6.7L; Front	VP30
2012-2011	8 Cyl. 6.7L	VP30
2010-2008	8 Cyl. 6.4L; w/ Tube; At EGR	VP26
Fuel Pressure Sensor		
E-350 Econoline		
1998-1988	8 Cyl. 7.3L	FPS55
Econoline Super Duty		
1997	8 Cyl. 7.3L	FPS55
F650		
2017-2016	8 Cyl. 6.7L; Located at Fuel Rail	FPS112
2007		FPS63
F750		
2017-2016	8 Cyl. 6.7L; Located at Fuel Rail	FPS112
2007		FPS63
F-250		
1996-1988	8 Cyl. 7.3L	FPS55
F-250 Super Duty		
2019-2013	8 Cyl. 6.7L	FPS73
2017-2011	8 Cyl. 6.7L; Located at Fuel Rail	FPS112
2010-2008	8 Cyl. 6.4L	FPS13
F-350		
1997-1995	8 Cyl. 7.3L	FPS55
1993-1988	8 Cyl. 7.3L	FPS55
F-350 Super Duty		
2018-2013	8 Cyl. 6.7L	FPS73
2017-2011	8 Cyl. 6.7L; Located at Fuel Rail	FPS112
2010-2008	8 Cyl. 6.4L	FPS13
F-450 Super Duty		
2018-2013	8 Cyl. 6.7L	FPS73
2017-2011	8 Cyl. 6.7L; Located at Fuel Rail	FPS112
2010-2008	8 Cyl. 6.4L	FPS13
F-550 Super Duty		
2018-2013	8 Cyl. 6.7L	FPS73
2017-2011	8 Cyl. 6.7L; Located at Fuel Rail	FPS112
2010-2008	8 Cyl. 6.4L	FPS13
F Super Duty		
1997-1988	8 Cyl. 7.3L	FPS55
Injection Actuation Pressure Sensor		
F650		
2000	6 Cyl. 7.2L	PS713
F750		
2000	6 Cyl. 7.2L	PS713
MAP Sensor		
E-350 Club Wagon		
2005-2004	8 Cyl. 6.0L	AS223
2003	8 Cyl. 7.3L	AS223
E-350 Econoline		
1998	8 Cyl. 7.3L; From 1/12/98	AS119
1998	8 Cyl. 7.3L; To 1/5/98	AS90
1997-1995	8 Cyl. 7.3L	AS90
E-350 Econoline Club Wagon		
2002-1999	8 Cyl. 7.3L	AS119
1998	8 Cyl. 7.3L; From 1/12/98	AS119
1998	8 Cyl. 7.3L; To 1/5/98	AS90
1997-1995	8 Cyl. 7.3L	AS90
E-350 Super Duty		
2010-2004	8 Cyl. 6.0L	AS223
E-450 Econoline Super Duty		
2002-2000	8 Cyl. 7.3L	AS119

Pressure Sensors

		Part No.
MAP Sensor		
E-450 Super Duty		
2010-2009	8 Cyl. 6.0L	AS223
2007-2004	8 Cyl. 6.0L	AS223
2003	8 Cyl. 7.3L	AS119
E-550 Econoline Super Duty		
2002	8 Cyl. 7.3L	AS119
Econoline Super Duty		
1999	8 Cyl. 7.3L	AS119
1998	8 Cyl. 7.3L; From 1/12/98	AS119
1997-1996	8 Cyl. 7.3L	AS90
Excursion		
2005-2003	8 Cyl. 6.0L	AS223
2003-2000	8 Cyl. 7.3L	AS119
F650		
2007-2004	8 Cyl.	AS223
2003-2000	8 Cyl.	AS119
F750		
2007-2004	8 Cyl.	AS223
2003-2000	8 Cyl.	AS119
F-250		
1996-1995	8 Cyl. 7.3L	AS90
1994	8 Cyl. 7.3L; Turbocharged	AS90
1988	8 Cyl. 7.3L	AS1
F-250 HD		
1997	8 Cyl. 7.3L	AS90
F-250 Super Duty		
2019-2011	8 Cyl. 6.7L	AS434
2010-2008	8 Cyl. 6.4L	AS422
2007-2003	8 Cyl. 6.0L	AS223
2003-1999	8 Cyl. 7.3L	AS119
F-350		
1997-1995	8 Cyl. 7.3L	AS90
1994	8 Cyl. 7.3L; Turbocharged	AS90
1988	8 Cyl. 7.3L	AS1
F-350 Super Duty		
2019-2011	8 Cyl. 6.7L	AS434
2010-2008	8 Cyl. 6.4L	AS422
2007-2003	8 Cyl. 6.0L	AS223
2003-1999	8 Cyl. 7.3L	AS119
F-450 Super Duty		
2019-2011	8 Cyl. 6.7L	AS434
2010-2008	8 Cyl. 6.4L	AS422
2007-2003	8 Cyl. 6.0L	AS223
2003-1999	8 Cyl. 7.3L	AS119
F-550 Super Duty		
2019-2011	8 Cyl. 6.7L	AS434
2010-2008	8 Cyl. 6.4L	AS422
2007-2003	8 Cyl. 6.0L	AS223
2003-1999	8 Cyl. 7.3L	AS119
F Super Duty		
1997-1995	8 Cyl. 7.3L	AS90
1994	8 Cyl. 7.3L; Turbocharged	AS90
Ranger		
1987-1986	4 Cyl. 2.3L	AS1
1985	4 Cyl. 2.3L; OE No. E43Z-B, E57F-A1A, A2A	AS1
Transit-150		
2019-2015	5 Cyl. 3.2L	AS435
Transit-250		
2019-2015	5 Cyl. 3.2L	AS435
Transit-350		
2019-2015	5 Cyl. 3.2L	AS435

		Part No.
MAP Sensor		
Transit-350 HD		
2019-2015	5 Cyl. 3.2L	AS435
Tire Pressure Monitoring System OE Design Sensor		
Transit		
2014-2010	315 Mhz Sensor; OE Style/ID Clone-able; w/ Aluminum Valve; w/ Aluminum Valve	TPM116A
2014-2010	315 Mhz Sensor; OE Style/ID Clone-able; w/ Rubber Valve	TPM116RA
Tire Pressure Monitoring System OE Design Sensor Service Kit		
Transit		
2010	25 Per Box; OE Style; w/o Valve	TPM2020K
2010	4 Per Box; OE Style; w/o Valve	TPM2020K4
Tire Pressure Monitoring System OE Design Valve		
Transit		
2010	25 Per Box; 315 Mhz Sensor; OE Style; w/ Rubber Valve	TPM930K
2010	4 Per Box; 315 Mhz Sensor; OE Style; w/ Rubber Valve	TPM930K4
Tire Pressure Monitoring System QWIK-Sensor		
Transit		
2014-2011	315 Mhz Sensor; OE Style/ID Clone-able; w/ Aluminum Valve	QS105M
2014-2011	315 Mhz Sensor; OE Style/ID Clone-able; w/ Rubber Valve	QS105R
2010	315 Mhz Sensor; Blue; Exhaust stock and reorder; w/ Aluminum Valve	QS101M
2010	315 Mhz Sensor; Blue; Exhaust stock and reorder; w/ Rubber Valve	QS101R
2010	315 Mhz Sensor; Alternate Number; Black; w/ Aluminum Valve	QS105M
2010	315 Mhz Sensor; Alternate Number; Black; w/ Rubber Valve	QS105R
Tire Pressure Monitoring System QWIK-Sensor Service Kit		
Transit		
2010	1 Per Box; 315 Mhz Sensor; w/ Aluminum Valve	TPM4012SK
2010	25 Per Box; 315 Mhz Sensor; w/ Aluminum Valve	TPM4012SK25PK
2010	4 Per Box; 315 Mhz Sensor; w/ Aluminum Valve	TPM4012SK4PK
Tire Pressure Monitoring System QWIK-Sensor Valve		
Transit		
2010	1 Per Box; 315 Mhz Sensor; w/ Rubber Valve	TPM2011VK
2010	25 Per Box; 315 Mhz Sensor; w/ Rubber Valve	TPM2011VK25PK
2010	4 Per Box; 315 Mhz Sensor; w/ Rubber Valve	TPM2011VK4PK
2010	25 Per Box; 315 Mhz Sensor; Black; OE Style; w/ Aluminum Valve	TPM2012VBK
2010	4 Per Box; 315 Mhz Sensor; Black; OE Style; w/ Aluminum Valve	TPM2012VBK4
2010	25 Per Box; 315 Mhz Sensor; Chrome Finish; OE Style; w/ Aluminum Valve	TPM2012VCK
2010	4 Per Box; 315 Mhz Sensor; Chrome Finish; OE Style; w/ Aluminum Valve	TPM2012VCK4
2010	1 Per Box; 315 Mhz Sensor; w/ Aluminum Valve	TPM2012VK
2010	25 Per Box; 315 Mhz Sensor; w/ Aluminum Valve	TPM2012VK25PK
2010	4 Per Box; 315 Mhz Sensor; w/ Aluminum Valve	TPM2012VK4PK

Ford

Temperature Sensors

		Part No.
Temperature Sensors		
Ambient Air Temperature Sensor		
E-350 Club Wagon		
2005	8 Cyl. 6.0L; Exhaust stock and reorder	TX12
2005	8 Cyl. 6.0L; Alternate Number	TX6
E-350 Econoline Club Wagon		
1999	8 Cyl. 7.3L; Exhaust stock and reorder	TX12
1999	8 Cyl. 7.3L; Alternate Number	TX6
E-350 Super Duty		
2010-2005	8 Cyl. 6.0L; Exhaust stock and reorder	TX12
2010-2005	8 Cyl. 6.0L; Alternate Number	TX6
E-450 Super Duty		
2006-2005	8 Cyl. 6.0L; Exhaust stock and reorder	TX12
2006-2005	8 Cyl. 6.0L; Alternate Number	TX6
Econoline Super Duty		
1999	8 Cyl. 7.3L; Exhaust stock and reorder	TX12
1999	8 Cyl. 7.3L; Alternate Number	TX6
F59		
1996	8 Cyl. 7.3L; Alternate Number	TX6
1996-1994	8 Cyl. 7.3L; Exhaust stock and reorder	TX12
1994	8 Cyl. 7.3L; Alternate Number	TX6
F650		
2009-2005	Exhaust stock and reorder	TX12
2009-2005	Alternate Number	TX6
F750		
2009-2005	Exhaust stock and reorder	TX12
2009-2005	Alternate Number	TX6
F-250		
1996	8 Cyl. 7.3L; Exhaust stock and reorder	TX12
1996	8 Cyl. 7.3L; Alternate Number	TX6
1994-1990	8 Cyl. 7.3L; Exhaust stock and reorder	TX12
1994-1990	8 Cyl. 7.3L; Alternate Number	TX6
F-350		
1997-1996	8 Cyl. 7.3L; Exhaust stock and reorder	TX12
1997-1996	8 Cyl. 7.3L; Alternate Number	TX6
1994-1990	8 Cyl. 7.3L; Exhaust stock and reorder	TX12
1994-1990	8 Cyl. 7.3L; Alternate Number	TX6
F Super Duty		
1997-1990	8 Cyl. 7.3L; Exhaust stock and reorder	TX12
1997-1990	8 Cyl. 7.3L; Alternate Number	TX6
Tempo		
1986-1984	4 Cyl.	TX12
Coolant Temperature Sensor		
E-350 Club Wagon		
2004	8 Cyl. 6.0L	TS-603
2004	8 Cyl. 7.3L	TX61
E-350 Econoline Club Wagon		
1999	8 Cyl. 7.3L	TX61
E-350 Super Duty		
2010-2004	8 Cyl. 6.0L	TS-603
E-450 Super Duty		
2003	8 Cyl. 7.3L	TX61
E-550 Econoline Super Duty		
2002	8 Cyl. 7.3L	TX61
E-550 Super Duty		
2003	8 Cyl. 7.3L	TX61
Escort		
1987-1985	4 Cyl. 2.0L	TX309
Excursion		
2005-2003	8 Cyl. 6.0L	TS-603
2003-2000	8 Cyl. 7.3L	TX61
F59		
1997-1996	w/ Rectangular Connector	TX61

		Part No.
Coolant Temperature Sensor		
F59		
1995-1988		TX6
F-150		
2018	6 Cyl.; To 06/30/2018	TX272
2018	6 Cyl.; From 07/01/2018	TX316
F-250		
1995-1990	8 Cyl. 7.3L	TX309
F-250 Super Duty		
2020	8 Cyl. 6.7L; From 07/01/2018	TX316
2019-2017	8 Cyl. 6.7L; Located in Cylinder Head	TX272
2016-2011	8 Cyl. 6.7L	TX61
2010-2008	8 Cyl. 6.4L	TS-603
2007-2005	8 Cyl. 6.0L	TS-603
2003	8 Cyl. 6.0L	TS-603
2003	8 Cyl. 7.3L	TX61
F-350 Super Duty		
2020	8 Cyl. 6.7L; From 07/01/2018	TX316
2019-2017	8 Cyl. 6.7L; Located in Cylinder Head	TX272
2016-2011	8 Cyl. 6.7L	TX61
2010-2008	8 Cyl. 6.4L	TS-603
2007-2005	8 Cyl. 6.0L	TS-603
2003	8 Cyl. 6.0L	TS-603
2003	8 Cyl. 7.3L	TX61
F-450 Super Duty		
2019-2017	8 Cyl. 6.7L; Located in Cylinder Head	TX272
2016-2011	8 Cyl. 6.7L	TX61
2010-2008	8 Cyl. 6.4L	TS-603
2007-2005	8 Cyl. 6.0L	TS-603
2004	8 Cyl.; Diesel	TS-603
F-550 Super Duty		
2019-2017	8 Cyl. 6.7L; Located in Cylinder Head	TX272
2016-2011	8 Cyl. 6.7L	TX61
2010-2008	8 Cyl. 6.4L	TS-603
2007-2005	8 Cyl. 6.0L	TS-603
2004	8 Cyl.; Diesel	TS-603
F Super Duty		
1997	8 Cyl. 7.3L	TX61
Ranger		
2018-2017	5 Cyl. 3.2L; Alternate Number	TX104
2018-2017	5 Cyl. 3.2L; Exhaust stock and reorder	TX90
2017-2015	4 Cyl. 2.2L; Alternate Number	TX104
2017-2015	4 Cyl. 2.2L; Exhaust stock and reorder	TX90
Tempo		
1986-1985	4 Cyl. 2.0L	TX309
Diesel Glow Plug Control Sensor		
E-250 Econoline Club Wagon		
1987-1983	8 Cyl. 6.9L	TX41
E-350 Econoline		
1987-1983	8 Cyl. 6.9L	TX41
E-350 Econoline Club Wagon		
1987-1983	8 Cyl. 6.9L	TX41
F-150		
1984	8 Cyl. 6.9L	TX41
F-250		
1988	8 Cyl. 7.3L	TX41
1987-1983	8 Cyl. 6.9L	TX41
F-350		
1988	8 Cyl. 7.3L	TX41
1987-1983	8 Cyl. 6.9L	TX41
F Super Duty		
1988	8 Cyl. 7.3L	TX41

Temperature Sensors

		Part No.
Engine Oil Temperature Sensor		
F-250 Super Duty		
2016	8 Cyl. 6.7L	TX61
2010-2008	8 Cyl. 6.4L	TS-603
F-350 Super Duty		
2010-2008	8 Cyl. 6.4L	TS-603
2003	8 Cyl. 7.3L	TX61
F-450 Super Duty		
2010-2008	8 Cyl. 6.4L	TS-603
F-550 Super Duty		
2010-2008	8 Cyl. 6.4L	TS-603
Exhaust Gas Temperature Sensor		
F650		
2019-2018	8 Cyl. 6.7L	ETS300
2017-2016	8 Cyl. 6.7L; Located Before Turbocharger	ETS158
2017-2016	8 Cyl. 6.7L; Back of EGR valve	ETS300
F750		
2019-2017	8 Cyl. 6.7L	ETS300
2016	8 Cyl. 6.7L; Located Before Turbocharger	ETS158
2016	8 Cyl. 6.7L; Back of EGR valve	ETS300
F-250 Super Duty		
2020-2017	8 Cyl. 6.7L	ETS300
2016-2015	8 Cyl. 6.7L; Located Before Turbocharger	ETS158
2016-2015	8 Cyl. 6.7L; Located on EGR Cooler	ETS300
2015	8 Cyl. 6.7L; Located After Particulate Filter	ETS115
2014-2011	8 Cyl. 6.7L	ETS115
2014-2011	8 Cyl. 6.7L	ETS300
2010-2008	8 Cyl. 6.4L; Located Before Catalytic Converter	ETS106
2010-2008	8 Cyl. 6.4L; Located on EGR Cooler	ETS114
2010-2008	8 Cyl. 6.4L; Located on EGR Crossover Tube	ETS123
2010-2008	8 Cyl. 6.4L; Rear	ETS124
F-350 Super Duty		
2020-2011	8 Cyl. 6.7L	ETS300
2015	8 Cyl. 6.7L; Located Before Turbocharger	ETS158
2015-2011	8 Cyl. 6.7L	ETS115
2010-2008	8 Cyl. 6.4L; Located Before Catalytic Converter	ETS106
2010-2008	8 Cyl. 6.4L; Located on EGR Cooler	ETS114
2010-2008	8 Cyl. 6.4L; Located on EGR Crossover Tube	ETS123
2010-2008	8 Cyl. 6.4L; Rear	ETS124
2009	8 Cyl. 6.4L; Located After Particulate Filter	ETS124
F-450 Super Duty		
2016-2011	8 Cyl. 6.7L	ETS115
2010-2008	8 Cyl. 6.4L; Located Before Catalytic Converter	ETS106
2010-2008	8 Cyl. 6.4L; Located on EGR Crossover Tube	ETS123
2009-2008	8 Cyl. 6.4L; Located on EGR Cooler	ETS114
F-550 Super Duty		
2016-2011	8 Cyl. 6.7L	ETS115
2010-2008	8 Cyl. 6.4L; Located Before Catalytic Converter	ETS106
2010-2008	8 Cyl. 6.4L; Located on EGR Cooler	ETS114
2010-2008	8 Cyl. 6.4L; Located on EGR Crossover Tube	ETS123
Transit-150		
2019-2017	5 Cyl. 3.2L; Upstream	ETS115
2019-2015	5 Cyl. 3.2L; Located in Catalytic Converter	ETS157
2019-2015	5 Cyl. 3.2L; Located After Particulate Filter	ETS160

		Part No.
Exhaust Gas Temperature Sensor		
Transit-150		
2015	5 Cyl. 3.2L; Upstream	ETS115
Transit-250		
2019-2017	5 Cyl. 3.2L; Upstream	ETS115
2019-2015	5 Cyl. 3.2L; Located in Catalytic Converter	ETS157
2019-2015	5 Cyl. 3.2L; Located After Particulate Filter	ETS160
2015	5 Cyl. 3.2L; Upstream	ETS115
Transit-350		
2019-2017	5 Cyl. 3.2L; Upstream	ETS115
2019-2015	5 Cyl. 3.2L; Located in Catalytic Converter	ETS157
2019-2015	5 Cyl. 3.2L; Located After Particulate Filter	ETS160
2015	5 Cyl. 3.2L; Upstream	ETS115
Transit-350 HD		
2019-2017	5 Cyl. 3.2L; Upstream	ETS115
2019-2015	5 Cyl. 3.2L; Located in Catalytic Converter	ETS157
2015	5 Cyl. 3.2L; Upstream	ETS115
Fuel Temperature Sensor		
F-250 Super Duty		
2010-2008	8 Cyl. 6.4L	TS-603
F-350 Super Duty		
2013-2011	8 Cyl. 6.7L	FTS109
2010-2008	8 Cyl. 6.4L	TS-603
F-450 Super Duty		
2013-2011	8 Cyl. 6.7L	FTS109
2010-2008	8 Cyl. 6.4L	TS-603
F-550 Super Duty		
2013-2011	8 Cyl. 6.7L	FTS109
2010-2008	8 Cyl. 6.4L	TS-603
Heater Core Temperature Sensor		
F-250 Super Duty		
2006-2005	8 Cyl. 6.0L	AX288
F-350 Super Duty		
2007-2005	8 Cyl. 6.0L	AX288
F-450 Super Duty		
2007-2005	8 Cyl. 6.0L	AX288
F-550 Super Duty		
2007-2005	8 Cyl. 6.0L	AX288
Intake Air Temperature Sensor		
E-350 Club Wagon		
2005-2004	8 Cyl. 6.0L	ATS51
2003	8 Cyl. 7.3L; On Air Cleaner	AX25
2003	8 Cyl. 7.3L; On Intake Manifold	AX31
E-350 Econoline		
1998	8 Cyl. 7.3L; To 1/12/98; On Air Cleaner	AX25
1998	8 Cyl. 7.3L; From 1/12/98; On Intake Manifold	AX35
1997	8 Cyl. 7.3L; w/ Square Connector	AX35
1997	8 Cyl. 7.3L; Exhaust stock and reorder; w/ Round Connector	TX12
1995	8 Cyl. 7.3L; Exhaust stock and reorder	TX12
E-350 Econoline Club Wagon		
2002	8 Cyl. 7.3L; Mounted to Intercooler	AX35
2002-1999	8 Cyl. 7.3L; On Air Cleaner	AX25
2001-2000	8 Cyl. 7.3L; On Intake Manifold	AX35
1999	8 Cyl. 7.3L; Mounted to Intercooler	AX35
1998	8 Cyl. 7.3L; To 1/12/98; On Air Cleaner	AX25
1998	8 Cyl. 7.3L; To 1/12/98; On Intake Manifold	AX31

Temperature Sensors

		Part No.
Intake Air Temperature Sensor		
E-350 Econoline Club Wagon		
1998	8 Cyl. 7.3L; From 1/12/98; On Intake Manifold	AX35
1997	8 Cyl. 7.3L; w/ Square Connector	AX35
1997	8 Cyl. 7.3L; Exhaust stock and reorder; w/ Round Connector	TX12
1995	8 Cyl. 7.3L; Exhaust stock and reorder	TX12
E-350 Super Duty		
2010-2004	8 Cyl. 6.0L	TX265
E-450 Econoline Super Duty		
2002-2000	8 Cyl. 7.3L; On Air Cleaner	AX25
E-450 Super Duty		
2010-2004	8 Cyl. 6.0L	TX265
2003	8 Cyl. 7.3L; On Air Cleaner	AX25
2003	8 Cyl. 7.3L; Mounted to Intercooler	AX35
E-550 Econoline Super Duty		
2002	8 Cyl. 7.3L; On Air Cleaner	AX25
E-550 Super Duty		
2003	8 Cyl. 7.3L; On Air Cleaner	AX25
2003	8 Cyl. 7.3L; Mounted to Intercooler	AX35
Econoline Super Duty		
1999-1998	8 Cyl. 7.3L; On Air Cleaner	AX25
1997-1996	8 Cyl. 7.3L; Exhaust stock and reorder	TX12
Excursion		
2005-2003	8 Cyl. 6.0L	TX265
2003-2000	8 Cyl. 7.3L	AX35
F59		
1997-1995	8 Cyl. 7.3L	AX25
F650		
2008	8 Cyl. 6.0L	AX214
2007-2004	8 Cyl. 6.0L	ATS51
2003	8 Cyl. 7.3L; On Air Cleaner	AX25
2003	8 Cyl. 7.3L; Mounted to Intercooler	AX35
2002-2000	8 Cyl.; On Air Cleaner	AX25
2002-2000	8 Cyl.; Mounted to Intercooler	AX35
F750		
2008	8 Cyl. 6.0L	AX214
2007-2004	8 Cyl. 6.0L	ATS51
2003	8 Cyl. 7.3L; On Air Cleaner	AX25
2003	8 Cyl. 7.3L; Mounted to Intercooler	AX35
2002-2000	8 Cyl.; On Air Cleaner	AX25
2002-2000	8 Cyl.; Mounted to Intercooler	AX35
F-150		
2020-2018	6 Cyl.	AX422
F-250		
1996-1995	8 Cyl. 7.3L; Push-In Type	AX25
1996-1995	8 Cyl. 7.3L; Exhaust stock and reorder; Screw-In Type	TX12
F-250 Super Duty		
2019-2011	8 Cyl. 6.7L	AX254
2010-2009	8 Cyl. 6.4L	AX214
2008	8 Cyl. 6.4L; On Intake Manifold	AX214
2007	8 Cyl. 6.0L; On Intake Manifold	TX265
2006-2003	8 Cyl. 6.0L	TX265
2003	8 Cyl. 7.3L; On Air Cleaner	AX25
2003	8 Cyl. 7.3L; Mounted to Intercooler	AX35
2002	8 Cyl. 7.3L	AX25
2001-1999	8 Cyl. 7.3L; Plastic Sensor	AX25
2001-1999	8 Cyl. 7.3L; Metal Sensor	AX35
F-350		
1997-1995	8 Cyl. 7.3L; Push-In Type	AX25
1997-1995	8 Cyl. 7.3L; Exhaust stock and reorder; Screw-In Type	TX12

		Part No.
Intake Air Temperature Sensor		
F-350		
1994	8 Cyl. 7.3L; Exhaust stock and reorder	TX12
F-350 Super Duty		
2019-2011	8 Cyl. 6.7L	AX254
2010-2009	8 Cyl. 6.4L	AX214
2008	8 Cyl. 6.4L; On Intake Manifold	AX214
2007	8 Cyl. 6.0L; On Intake Manifold	TX265
2006-2003	8 Cyl. 6.0L	TX265
2003	8 Cyl. 7.3L; On Air Cleaner	AX25
2003	8 Cyl. 7.3L; Mounted to Intercooler	AX35
2002	8 Cyl. 7.3L	AX25
2001-1999	8 Cyl. 7.3L; Plastic Sensor	AX25
2001-1999	8 Cyl. 7.3L; Metal Sensor	AX35
F-450 Super Duty		
2019-2011	8 Cyl. 6.7L	AX254
2010-2008	8 Cyl. 6.4L	AX214
2007-2003	8 Cyl. 6.0L	TX265
2003-1999	8 Cyl. 7.3L; On Air Cleaner	AX25
2003-1999	8 Cyl. 7.3L; Mounted to Intercooler	AX35
F-550 Super Duty		
2019-2011	8 Cyl. 6.7L	AX254
2010-2008	8 Cyl. 6.4L	AX214
2007-2003	8 Cyl. 6.0L	TX265
2003-1999	8 Cyl. 7.3L; On Air Cleaner	AX25
2003-1999	8 Cyl. 7.3L; Mounted to Intercooler	AX35
F Super Duty		
1997	8 Cyl. 7.3L; Push-In Type	AX25
1997	8 Cyl. 7.3L; Exhaust stock and reorder; Screw-In Type	TX12
1996	8 Cyl. 7.3L; Exhaust stock and reorder	TX12
1995	8 Cyl. 7.3L; Push-In Type	AX25
1995	8 Cyl. 7.3L; Exhaust stock and reorder; Screw-In Type	TX12
1994	8 Cyl. 7.3L; Exhaust stock and reorder	TX12
LCF		
2010-2008	6 Cyl. 4.5L	AX214
2007-2006	6 Cyl. 4.5L	ATS51
Ranger		
1987	4 Cyl. 2.3L	AX3
1986-1985	4 Cyl. 2.3L; On Air Cleaner	ATS10
1983	4 Cyl.; On Air Cleaner	ATS10
1983	4 Cyl.; Blue, Red and Green/Yellow; On Air Cleaner	ATS21
Transit-150		
2019-2015	5 Cyl. 3.2L; Diesel; Turbocharged	AX517
Transit-250		
2019-2015	5 Cyl. 3.2L; Diesel; Turbocharged	AX517
Transit-350		
2019-2015	5 Cyl. 3.2L; Diesel; Turbocharged	AX517
Telematics Sensors		
Park Assist Camera		
Transit Custom		
2018	Rear	PAC111
Body Light Switches		
Back-Up Light Switch		
B7000		
1987-1983	w/ A.T.	LS-256
E-250 Econoline Club Wagon		
1991-1988	8 Cyl. 7.3L	LS-200
E-350 Club Wagon		
2005-2004	8 Cyl. 6.0L	LS-200
2003	8 Cyl. 7.3L	LS-200

Body Light Switches

		Part No.
Back-Up Light Switch		
E-350 Econoline		
1992-1988	8 Cyl. 7.3L	LS-200
E-350 Econoline Club Wagon		
2002-1999	8 Cyl. 7.3L	LS-200
1992-1988	8 Cyl. 7.3L	LS-200
E-350 Super Duty		
2005-2004	8 Cyl. 6.0L	LS-200
E-450 Econoline Super Duty		
2002-2000	8 Cyl. 7.3L	LS-200
Excursion		
2005	8 Cyl. 6.0L	LS-200
2003	8 Cyl. 6.0L	LS-200
2003	8 Cyl. 7.3L	LS-200
F59		
1994-1988	8 Cyl. 7.3L	LS-200
F650		
2007-2004	8 Cyl.; w/ M.T.	LS-200
2003-2000	w/ A.T.	LS-256
2003-2000	1 Blade Term.; w/ M.T.	LS-317
2003-2000	2 Bullet Term.; w/ M.T.	LS388
F750		
2007-2004	8 Cyl.; w/ M.T.	LS-200
2003-2000	w/ A.T.	LS-256
2003-2000	1 Blade Term.; w/ M.T.	LS-317
2003-2000	2 Bullet Term.; w/ M.T.	LS388
F8000		
1987-1983	w/ A.T.	LS-256
F-250 Super Duty		
2008	8 Cyl. 6.4L; w/ M.T.	LS-200
2007-2004	8 Cyl. 6.0L; w/ M.T.	LS-200
F-350 Super Duty		
2008	8 Cyl. 6.4L; w/ M.T.	LS-200
2007-2004	8 Cyl. 6.0L; w/ M.T.	LS-200
F-450 Super Duty		
2010	8 Cyl. 6.4L	LS-200
2009-2008	8 Cyl. 6.4L; w/ M.T.	LS-200
2007-2003	8 Cyl. 6.0L; w/ M.T.	LS-200
2003-1999	8 Cyl. 7.3L; w/ M.T.	LS-200
F-550 Super Duty		
2010	8 Cyl. 6.4L	LS-200
2009-2008	8 Cyl. 6.4L; w/ M.T.	LS-200
2007-2003	8 Cyl. 6.0L; w/ M.T.	LS-200
2003-1999	8 Cyl. 7.3L; w/ M.T.	LS-200
Door Jamb Switch		
F59		
1994-1992	8 Cyl. 7.3L	DS-278
1991-1988	Front	DS-278
F650		
2006-2004	Right	AW-1023
2006-2004	Left	AW-1024
2003-2002	Right	DS-957
2003-2000	Left	DS-1506
F750		
2006-2004	Right	AW-1023
2006-2004	Left	AW-1024
2003-2002	Left	DS-1506
2003-2002	Right	DS-957
2000	Left	DS-1506
F800		
1999	Front	DS-278
1996-1992	Front	DS-278

		Part No.
Fog Lamp Switch		
LCF		
2009-2007		CBS2387
2006	Dual Lever Multifunction Switch Assembly	CBS2387
2006	Single Lever Multifunction Switch Assembly	CBS2418
Hazard Warning Switch		
E-350 Super Duty		
2010	8 Cyl. 6.0L; Column Mounted	CBS-1403
E-450 Super Duty		
2007-2005	8 Cyl. 6.0L; Column Mounted	CBS-1403
F650		
2011-2000		CBS-1155
F750		
2015		CBS-1155
2013-2000		CBS-1155
F800		
1999		DS-749
F-250 Super Duty		
2007-2005	8 Cyl. 6.0L	CBS-1158
2001	8 Cyl. 7.3L	CBS-1155
F-350 Super Duty		
2007-2005	8 Cyl. 6.0L	CBS-1158
2001	8 Cyl. 7.3L	CBS-1155
F-450 Super Duty		
2007-2003	8 Cyl. 6.0L	CBS-1158
2003-2002	8 Cyl. 7.3L	CBS-1158
2001	8 Cyl. 7.3L	CBS-1155
F-550 Super Duty		
2007-2003	8 Cyl. 6.0L	CBS-1158
2003-2002	8 Cyl. 7.3L	CBS-1158
2001	8 Cyl. 7.3L	CBS-1155
Headlight Dimmer Switch		
B700		
1991		DS-70
CF6000		
1990-1986	Floor Mounted	DS-68
CF7000		
1993-1986	w/ Floor Mounted Switch	DS-68
CF8000		
1993-1987	w/ Floor Mounted Switch	DS-68
E-450 Econoline Super Duty		
2002-2000	8 Cyl. 7.3L	DS-936
E-550 Econoline Super Duty		
2002	8 Cyl. 7.3L	DS-936
F59		
1994-1992	8 Cyl. 7.3L	DS-533
F650		
2011-2000		CBS-1155
F750		
2015		CBS-1155
2013-2000		CBS-1155
F800		
1999		DS-749
F-250		
1993	8 Cyl. 7.3L; w/ A.T.	DS-533
1993	8 Cyl. 7.3L; w/ M.T.	DS-70
F-350		
1993-1992	8 Cyl. 7.3L; w/ A.T.	DS-533
1993-1992	8 Cyl. 7.3L; w/ M.T.	DS-70
F-450 Super Duty		
2009-2008	8 Cyl. 6.4L	CBS-1899
2007-2003	8 Cyl. 6.0L	CBS-1158

Ford

Body Light Switches

		Part No.
Headlight Dimmer Switch		
F-450 Super Duty		
2003-2002	8 Cyl. 7.3L	CBS-1158
2001	8 Cyl. 7.3L	CBS-1155
2000-1999	8 Cyl. 7.3L	DS-749
F-550 Super Duty		
2003	8 Cyl. 6.0L	CBS-1158
2003-2002	8 Cyl. 7.3L	CBS-1158
2001	8 Cyl. 7.3L	CBS-1155
2000-1999	8 Cyl. 7.3L	DS-749
L8000F		
1997-1990		DS-70
LCF		
2009-2007		CBS2387
2006	Dual Lever Multifunction Switch Assembly	CBS2387
2006	Single Lever Multifunction Switch Assembly	CBS2418
Headlight Switch		
B600		
1994-1990		DS-199
B700		
1994-1990		DS-199
C7000		
1981-1980		DS-199
C8000		
1981-1980		DS-199
E-450 Econoline Super Duty		
2002-2000	8 Cyl. 7.3L	DS-268
E-550 Econoline Super Duty		
2002	8 Cyl. 7.3L	DS-268
E-550 Super Duty		
2003	8 Cyl. 7.3L	DS-268
F59		
1994-1989	8 Cyl. 7.3L	DS-268
F650		
2009-2006		DS-1362
2005-2000		DS-1385
F700		
1997-1995	6 Cyl. 5.9L	DS-199
F750		
2009-2006		DS-1362
2005-2000		DS-1385
F800		
1999		DS-1385
LCF		
2009-2007		CBS2387
2006	Dual Lever Multifunction Switch Assembly	CBS2387
2006	Single Lever Multifunction Switch Assembly	CBS2418
LN7000		
1987-1986		DS-199
1981		DS-199
LN8000		
1987-1986		DS-199
1981		DS-199
Instrument Panel Dimmer Switch		
E-450 Econoline Super Duty		
2002-2000	8 Cyl. 7.3L	DS-268
E-550 Econoline Super Duty		
2002	8 Cyl. 7.3L	DS-268
E-550 Super Duty		
2003	8 Cyl. 7.3L	DS-268

		Part No.
Stoplight Switch		
B600		
1989	6 Cyl.; w/ Hydraulic Brakes	SLS-66
1987-1980	8 Cyl.; w/ Air Brake	SLS-102
1987-1980	8 Cyl.; w/ Hydraulic Brakes	SLS-66
B700		
1989-1987	6 Cyl.; w/ Air Brake	SLS-102
1989-1987	6 Cyl.; w/ Hydraulic Brakes	SLS-66
1987-1981	8 Cyl.; w/ Air Brake	SLS-102
1987-1980	8 Cyl.; w/ Hydraulic Brakes	SLS-66
B7000		
1987-1983		SLS-66
C7000		
1986-1980		SLS-66
C8000		
1989-1980		SLS-66
E-450 Econoline Super Duty		
2002-2000	8 Cyl. 7.3L	SLS-82
E-450 Super Duty		
2007	8 Cyl. 6.0L	SLS-82
E-550 Econoline Super Duty		
2002	8 Cyl. 7.3L	SLS-82
F59		
1997-1995		SLS-93
F650		
2009-2004		SLS-247
2003	8 Cyl. 7.3L; w/ Hydraulic Brakes	SLS-247
2003	8 Cyl. 7.3L; w/ Air Brake	SLS-345
2003-2000	6 Cyl. 5.9L; w/ Hydraulic Brakes	SLS-247
2003-2000	6 Cyl. 7.2L; w/ Hydraulic Brakes	SLS-247
2003-2000	6 Cyl. 5.9L; w/ Air Brake	SLS-331
2002-2000	8 Cyl.; w/ Hydraulic Brakes	SLS-247
2002-2000	8 Cyl.; w/ Air Brake	SLS-345
F750		
2009-2004		SLS-247
2003	8 Cyl. 7.3L; w/ Hydraulic Brakes	SLS-247
2003	8 Cyl. 7.3L; w/ Air Brake	SLS-345
2003-2000	6 Cyl. 5.9L; w/ Hydraulic Brakes	SLS-247
2003-2000	6 Cyl. 7.2L; w/ Hydraulic Brakes	SLS-247
2003-2000	6 Cyl. 5.9L; w/ Air Brake	SLS-331
2002-2000	8 Cyl.; w/ Hydraulic Brakes	SLS-247
2002-2000	8 Cyl.; w/ Air Brake	SLS-345
F800		
1999	w/ Hydraulic Brakes	SLS-66
1999	w/ Air Brake	SLS395
1996-1992	w/ Air Brake	SLS-102
1996-1992	w/ Hydraulic Brakes	SLS-66
F7000		
1987-1983		SLS-66
F8000		
1987-1983		SLS-66
LN7000		
1989-1986		SLS-66
1981		SLS-66
LN8000		
1989-1986		SLS-66
1981		SLS-66
Turn Signal Switch		
B600		
1994-1993		CBS-1917
1990	w/o Tilt Wheel	TW-73
B700		
1994-1993		CBS-1917

Body Light Switches

		Part No.
Turn Signal Switch		
B700		
1990	w/o Tilt Wheel	TW-73
B7000		
1987-1983	w/o Tilt Wheel	TW-73
E-450 Econoline Super Duty		
2002-2000	8 Cyl. 7.3L; w/ Electronic Flasher	DS-936
F59		
1994-1992		DS-533
F650		
2011-2000		CBS-1155
F750		
2015		CBS-1155
2013-2000		CBS-1155
F800		
1999		DS-749
1996-1993		CBS-1917
1992	w/ Allison MD3000 SRS A.T.; w/ Ford M.T.	TW-96
1992	w/o Signal Stat Option	TW-97
1992	w/ Allison AT545 A.T.; w/ Ford A.T.	TW-98
LCF		
2006	Single Lever Multifunction Switch Assembly	CBS2418
Chassis and Drivetrain Switches		
Automatic Transmission Vacuum Modulator		
E-350 Econoline		
1987-1985	8 Cyl. 6.9L	TM-36
1984-1983	8 Cyl. 6.9L; w/ Green Stripe	TM-44
E-350 Econoline Club Wagon		
1987-1985	8 Cyl. 6.9L	TM-36
1984-1983	8 Cyl. 6.9L; w/ Green Stripe	TM-44
F-150		
1984	8 Cyl. 6.9L; Diesel; Model XPL Trans.; w/ C6 Trans.; w/ Green Stripe	TM-44
F-250		
1987-1985	8 Cyl. 6.9L	TM-36
1984-1983	8 Cyl. 6.9L; w/ Green Stripe	TM-44
F-350		
1987	8 Cyl. 6.9L	TM-36
1985	8 Cyl. 6.9L	TM-36
1984-1983	8 Cyl. 6.9L; w/ Green Stripe	TM-44
Ranger		
1987	4 Cyl. 2.3L	TM-54
1985	4 Cyl. 2.3L	TM-54
1984-1983	4 Cyl. 2.2L; w/ Green Stripe	TM-41
Axle Shift Switch - H/D Truck		
CF6000		
1990-1986		DS-168
CF7000		
1990-1986	w/ Dash Mounted Switch	DS-168
CF8000		
1990-1987	w/ Dash Mounted Switch	DS-168
1987	Transmission Mounted	DS-169A
Axle Shift Switch Terminal Block		
CF6000		
1990-1986	Terminal Block	DS-169A
CF7000		
1990-1986	Transmission Mounted	DS-169A
CF8000		
1990-1988	Transmission Mounted	DS-169A

		Part No.
Neutral Safety Switch		
E-350 Super Duty		
2010	8 Cyl. 6.0L	NS-379
E-450 Super Duty		
2007-2004	8 Cyl. 6.0L	NS-379
2003	8 Cyl. 7.3L	NS-379
E-550 Econoline Super Duty		
2002	8 Cyl. 7.3L	NS-126
E-550 Super Duty		
2003	8 Cyl. 7.3L	NS-379
F-450 Super Duty		
2019-2013	8 Cyl. 6.7L	NS659
2011	8 Cyl. 6.7L	NS659
2010-2008	8 Cyl. 6.4L	NS-379
2007-2003	8 Cyl. 6.0L	NS-379
2003	8 Cyl. 7.3L	NS-379
2002-1999	8 Cyl. 7.3L	NS-126
F-550 Super Duty		
2019-2011	8 Cyl. 6.7L	NS659
2010-2009	8 Cyl. 6.4L	NS-379
2007-2003	8 Cyl. 6.0L	NS-379
2003	8 Cyl. 7.3L	NS-379
2002-2000	8 Cyl. 7.3L	NS-126
Transmission Control Solenoid		
F650		
2011-2004	Shift Control Solenoid	TCS400
2009-2005	w/ 20 Bolt Transmission Pan	TCS93
2004-2000	w/ 20 Bolt Transmission Pan	TCS114
F750		
2015	Shift Control Solenoid	TCS400
2013-2004	Shift Control Solenoid	TCS400
2009-2005	w/ 20 Bolt Transmission Pan	TCS93
2004-2000	w/ 20 Bolt Transmission Pan	TCS114
Transmission Kick-Down Solenoid Switch		
F59		
1997-1992		DS-3126
F-250 Super Duty		
2001-1999	8 Cyl. 7.3L	DS-3126
F-350		
1997-1993	8 Cyl. 7.3L	DS-3126
Ignition Switches		
Ignition Starter Switch		
B600		
1994-1990		US-89
B700		
1994-1990		US-89
E-450 Econoline Super Duty		
2002-2000	8 Cyl. 7.3L	US-112
E-450 Super Duty		
2004	8 Cyl. 6.0L	US-274
E-550 Econoline Super Duty		
2002	8 Cyl. 7.3L	US-112
F59		
1996-1991		US-112
F650		
2009-2005		US-583
2004		US-714
2003-2000		US-216
F750		
2009-2005		US-583
2004		US-714
2003-2000		US-216

Ignition Switches

		Part No.
Ignition Starter Switch		
F800		
1999		US-89
1996-1992		US-89
F-250 Super Duty		
2014-2013	8 Cyl. 6.7L	US-431
2006	8 Cyl. 6.0L	US-714
F-350 Super Duty		
2014-2013	8 Cyl. 6.7L	US-431
2006	8 Cyl. 6.0L	US-714
F-450 Super Duty		
2019-2013	8 Cyl. 6.7L	US-431
2011	8 Cyl. 6.7L	US-431
F-550 Super Duty		
2019-2011	8 Cyl. 6.7L	US-431
Transit		
2012-2009		US-431
Interior Power Switches		
Cruise Control Release Switch		
E-250 Econoline Club Wagon		
1991-1988	8 Cyl. 7.3L	NS-127
E-350 Econoline		
1992-1988	8 Cyl. 7.3L	NS-127
E-350 Econoline Club Wagon		
2002	8 Cyl. 7.3L; Located On Brake Line Or Master Cylinder	CCR-1
2002	8 Cyl. 7.3L; Located On Brake Pedal	CCR-5
1992-1988	8 Cyl. 7.3L	NS-127
F59		
1994-1989	8 Cyl. 7.3L	NS-127
F-250		
1992-1988	8 Cyl. 7.3L	NS-127
F-350		
1992-1988	8 Cyl. 7.3L	NS-127
F-450 Super Duty		
2002-1999	8 Cyl. 7.3L	CCR-1
F-550 Super Duty		
2002-1999	8 Cyl. 7.3L	CCR-1
F Super Duty		
1992-1990	8 Cyl. 7.3L	NS-127
Fuel Tank Selector Switch		
E-350 Econoline		
1995-1988	8 Cyl. 7.3L	DS-2301
1987-1986	8 Cyl. 6.9L	DS-2301
E-350 Econoline Club Wagon		
1995-1988	8 Cyl. 7.3L	DS-2301
1987-1986	8 Cyl. 6.9L	DS-2301
F-250		
1991-1990	8 Cyl. 7.3L	DS2476
F-250 Super Duty		
2010-2008	8 Cyl. 6.4L	DS-2298
F-350		
1991-1990	8 Cyl. 7.3L	DS2476
F-350 Super Duty		
2010-2008	8 Cyl. 6.4L	DS-2298
F-450 Super Duty		
2010-2008	8 Cyl. 6.4L	DS-2298
2007	8 Cyl. 6.0L	DS-2298
2004-2003	8 Cyl. 6.0L	DS-2298
2003-2002	8 Cyl. 7.3L	DS-2298
2001-1999	8 Cyl. 7.3L	DS2293

		Part No.
Fuel Tank Selector Switch		
F-550 Super Duty		
2010-2008	8 Cyl. 6.4L	DS-2298
2007	8 Cyl. 6.0L	DS-2298
2004-2003	8 Cyl. 6.0L	DS-2298
2003-2002	8 Cyl. 7.3L	DS-2298
2001-1999	8 Cyl. 7.3L	DS2293
F Super Duty		
1991-1990	8 Cyl. 7.3L	DS2476
Headlight Switch Knob		
F650		
2004		HLS1757
F750		
2004		HLS1757
Power Seat Switch		
E-350 Super Duty		
2010-2007	8 Cyl. 6.0L; 4 Way; 6 Way; Dual Captains Chairs; Front Left	PSW106
E-450 Super Duty		
2008-2004	8 Cyl. 6.0L; 4 Way; 6 Way; Dual Captains Chairs; Front Left	PSW106
F650		
2011-2001	4 Way; 6 Way; w/ Heated Seats; w/ Leather Seat; Front	PSW106
F750		
2013-2001	4 Way; 6 Way; w/ Heated Seats; w/ Leather Seat; Front	PSW106
F-250 Super Duty		
2010-2008	8 Cyl. 6.4L; 4 Way; 6 Way; w/o Integral Seat Restraints; Front	PSW106
2007	8 Cyl. 6.0L; 4 Way; 6 Way; w/o Integral Seat Restraints; Front	PSW106
2004-2003	8 Cyl. 6.0L; 4 Way; 6 Way; Regular Cab; w/ Integral Seat Restraints	PSW106
2003-1999	8 Cyl. 7.3L; 4 Way; 6 Way; Regular Cab; w/ Integral Seat Restraints	PSW106
F-350 Super Duty		
2010-2008	8 Cyl. 6.4L; 4 Way; 6 Way; w/o Integral Seat Restraints; Front	PSW106
2007	8 Cyl. 6.0L; 4 Way; 6 Way; w/o Integral Seat Restraints; Front	PSW106
2004-2003	8 Cyl. 6.0L; 4 Way; 6 Way; Regular Cab; w/ Integral Seat Restraints	PSW106
2003-2000	8 Cyl. 7.3L; 4 Way; 6 Way; Regular Cab; w/ Integral Seat Restraints	PSW106
F-450 Super Duty		
2010-2008	8 Cyl. 6.4L; 4 Way; 6 Way; w/o Integral Seat Restraints; Front	PSW106
2007	8 Cyl. 6.0L; 4 Way; 6 Way; w/o Integral Seat Restraints; Front	PSW106
2004-2003	8 Cyl. 6.0L; 4 Way; 6 Way; w/ Integral Seat Restraints	PSW106
2003-2000	8 Cyl. 7.3L; 4 Way; 6 Way; w/ Integral Seat Restraints	PSW106
F-550 Super Duty		
2010-2008	8 Cyl. 6.4L; 4 Way; 6 Way; w/o Integral Seat Restraints; Front	PSW106
2007	8 Cyl. 6.0L; 4 Way; 6 Way; w/o Integral Seat Restraints; Front	PSW106
2004-2003	8 Cyl. 6.0L; 4 Way; 6 Way; w/ Integral Seat Restraints	PSW106
2003-2000	8 Cyl. 7.3L; 4 Way; 6 Way; w/ Integral Seat Restraints	PSW106
Power Window Switch		
F650		
2010-2000	2 Door; Front Left	DWS-772
2003-2000	Front Right	DWS-593

Interior Power Switches

		Part No.
Power Window Switch		
F650		
2003-2000	Rear	DWS-593
F750		
2010-2000	2 Door; Front Left	DWS-772
2003-2000	Front Right	DWS-593
2003-2000	Rear	DWS-593
Remote Mirror Switch		
F650		
2003-2001		DS-1750
F750		
2003-2001		DS-1750
Vehicle Ride Height Switch		
F-550 Super Duty		
2002	8 Cyl. 7.3L	DS-2243
Windshield Wiper Switch		
F59		
1994-1992		DS-533
F650		
2009-2006		WP628
2005-2000		CBS-1155
F750		
2015		CBS-1155
2013-2006		CBS-1155
2004-2000		CBS-1155
F800		
1999		DS-749
1996-1992		DS-576
F-450 Super Duty		
2009-2008	8 Cyl. 6.4L	CBS-1899
2007-2003	8 Cyl. 6.0L	CBS-1158
2003-2002	8 Cyl. 7.3L	CBS-1158
2001	8 Cyl. 7.3L	CBS-1155
2000-1999	8 Cyl. 7.3L	DS-749
F-550 Super Duty		
2003	8 Cyl. 6.0L	CBS-1158
2003-2002	8 Cyl. 7.3L	CBS-1158
2001	8 Cyl. 7.3L	CBS-1155
2000-1999	8 Cyl. 7.3L	DS-749
LCF		
2009-2006		CBS2387
Pressure and Vacuum Sending Switches		
Oil Pressure Gauge Switch		
E-250 Econoline Club Wagon		
1991-1989	8 Cyl. 7.3L	PS-243
E-350 Club Wagon		
2005-2004	8 Cyl. 6.0L	PS-314
2003	8 Cyl. 7.3L	PS-314
E-350 Econoline		
1998-1996	8 Cyl. 7.3L	PS-405
1995-1992	8 Cyl. 7.3L	PS-240
1991-1989	8 Cyl. 7.3L	PS-243
E-350 Econoline Club Wagon		
2001-1999	8 Cyl. 7.3L	PS-314
1998-1996	8 Cyl. 7.3L	PS-405
1995-1992	8 Cyl. 7.3L	PS-240
1991-1989	8 Cyl. 7.3L	PS-243
E-350 Super Duty		
2010-2006	8 Cyl. 6.0L	PS-314
2004	8 Cyl. 6.0L	PS-314
2003-1999	8 Cyl. 7.3L	PS-314
E-450 Super Duty		
2010-2004	8 Cyl. 6.0L	PS-314

		Part No.
Oil Pressure Gauge Switch		
E-450 Super Duty		
2003	8 Cyl. 7.3L	PS-314
E-550 Super Duty		
2003	8 Cyl. 7.3L	PS-314
Econoline Super Duty		
1998-1996	8 Cyl. 7.3L	PS-405
Excursion		
2005	8 Cyl. 6.0L	PS-314
2000	8 Cyl. 7.3L	PS-314
F650		
2007-2004	8 Cyl.	PS-314
2003	8 Cyl. 7.3L	PS-314
2002-2000	8 Cyl.	PS-314
F750		
2007-2004	8 Cyl.	PS-314
2003	8 Cyl. 7.3L	PS-314
2002-2000	8 Cyl.	PS-314
F-250		
1996	8 Cyl. 7.3L	PS-405
1995-1988	8 Cyl.	PS-240
F-250 HD		
1997	8 Cyl. 7.3L	PS-405
F-250 Super Duty		
2010-2008	8 Cyl. 6.4L	PS-314
2007-2003	8 Cyl. 6.0L	PS-314
2003-1999	8 Cyl. 7.3L	PS-314
F-350		
1997-1996	8 Cyl. 7.3L	PS-405
1995-1988	8 Cyl.	PS-240
F-350 Super Duty		
2010-2008	8 Cyl. 6.4L	PS-314
2007-2003	8 Cyl. 6.0L	PS-314
2003-1999	8 Cyl. 7.3L	PS-314
F-450 Super Duty		
2010-2008	8 Cyl. 6.4L	PS-314
2007-2003	8 Cyl. 6.0L	PS-314
2003-1999	8 Cyl. 7.3L	PS-314
F-550 Super Duty		
2010-2008	8 Cyl. 6.4L	PS-314
2007-2003	8 Cyl. 6.0L	PS-314
2003-1999	8 Cyl. 7.3L	PS-314
F Super Duty		
1997-1996	8 Cyl. 7.3L	PS-405
1995-1991	8 Cyl.	PS-240
Oil Pressure Light Switch		
E-250 Econoline Club Wagon		
1988	8 Cyl. 7.3L	PS-461
E-350 Club Wagon		
2004	8 Cyl. 6.0L	PS-314
2003	8 Cyl. 7.3L	PS-314
E-350 Econoline		
1988	8 Cyl. 7.3L	PS-461
E-350 Econoline Club Wagon		
2002-2000	8 Cyl. 7.3L	PS-314
1988	8 Cyl. 7.3L	PS-461
E-350 Super Duty		
2010-2004	8 Cyl. 6.0L	PS-314
Escort		
1986-1984	4 Cyl. 2.0L	PS-120
Excursion		
2004-2003	8 Cyl. 6.0L	PS-314
2003-2000	8 Cyl. 7.3L	PS-314

Ford

Pressure and Vacuum Sending Switches

		Part No.
Oil Pressure Light Switch		
F-250 Super Duty		
2006-2003	8 Cyl. 6.0L	PS-314
2003-1999	8 Cyl. 7.3L	PS-314
F-350 Super Duty		
2006-2003	8 Cyl. 6.0L	PS-314
2003-2000	8 Cyl. 7.3L	PS-314
Tempo		
1986-1984	4 Cyl. 2.0L	PS-120
Transit-150		
2019-2015	5 Cyl. 3.2L	PS656
Ported Vacuum Switch		
E-250 Econoline Club Wagon		
1988	8 Cyl. 7.3L; 3 Ports; Gray w/ Blue Cap	PVS112
1988	8 Cyl. 7.3L; 3 Ports; Brown	PVS18
1988	8 Cyl. 7.3L; 3 Ports; Green; w/o Solenoid	PVS19
1988	8 Cyl. 7.3L; 3 Ports; Yellow	PVS20
1988	8 Cyl. 7.3L; 3 Ports; Green; w/ Solenoid	PVS22
1988	8 Cyl. 7.3L; 3 Ports; Red; w/ Solenoid	PVS29
1985-1983	8 Cyl. 6.9L; 3 Ports; Gray w/ Blue Cap	PVS112
1985-1983	8 Cyl. 6.9L; 3 Ports; Brown	PVS18
1985-1983	8 Cyl. 6.9L; 3 Ports; Green; w/o Solenoid	PVS19
1985-1983	8 Cyl. 6.9L; 3 Ports; Yellow	PVS20
1985-1983	8 Cyl. 6.9L; 3 Ports; Green; w/ Solenoid	PVS22
1985-1983	8 Cyl. 6.9L; 3 Ports; Red; w/ Solenoid	PVS29
E-350 Econoline		
1988	8 Cyl. 7.3L; 3 Ports; Gray w/ Blue Cap	PVS112
1988	8 Cyl. 7.3L; 3 Ports; Brown	PVS18
1988	8 Cyl. 7.3L; 3 Ports; Green; w/o Solenoid	PVS19
1988	8 Cyl. 7.3L; 3 Ports; Yellow	PVS20
1988	8 Cyl. 7.3L; 3 Ports; Green; w/ Solenoid	PVS22
1988	8 Cyl. 7.3L; 3 Ports; Red; w/ Solenoid	PVS29
1985-1983	8 Cyl. 6.9L; 3 Ports; Gray w/ Blue Cap	PVS112
1985-1983	8 Cyl. 6.9L; 3 Ports; Brown	PVS18
1985-1983	8 Cyl. 6.9L; 3 Ports; Green; w/o Solenoid	PVS19
1985-1983	8 Cyl. 6.9L; 3 Ports; Yellow	PVS20
1985-1983	8 Cyl. 6.9L; 3 Ports; Green; w/ Solenoid	PVS22
1985-1983	8 Cyl. 6.9L; 3 Ports; Red; w/ Solenoid	PVS29
E-350 Econoline Club Wagon		
1988	8 Cyl. 7.3L; 3 Ports; Gray w/ Blue Cap	PVS112
1988	8 Cyl. 7.3L; 3 Ports; Brown	PVS18
1988	8 Cyl. 7.3L; 3 Ports; Green; w/o Solenoid	PVS19
1988	8 Cyl. 7.3L; 3 Ports; Yellow	PVS20
1988	8 Cyl. 7.3L; 3 Ports; Green; w/ Solenoid	PVS22
1988	8 Cyl. 7.3L; 3 Ports; Red; w/ Solenoid	PVS29
1985-1983	8 Cyl. 6.9L; 3 Ports; Gray w/ Blue Cap	PVS112
1985-1983	8 Cyl. 6.9L; 3 Ports; Brown	PVS18
1985-1983	8 Cyl. 6.9L; 3 Ports; Green; w/o Solenoid	PVS19
1985-1983	8 Cyl. 6.9L; 3 Ports; Yellow	PVS20
1985-1983	8 Cyl. 6.9L; 3 Ports; Green; w/ Solenoid	PVS22
1985-1983	8 Cyl. 6.9L; 3 Ports; Red; w/ Solenoid	PVS29
Escort		
1987-1984	4 Cyl. 2.0L; 3 Ports; Orange	PVS150
F-250		
1988	8 Cyl. 7.3L; 3 Ports; Gray w/ Blue Cap	PVS112
1988	8 Cyl. 7.3L; 3 Ports; Brown	PVS18
1988	8 Cyl. 7.3L; 3 Ports; Green; w/o Solenoid	PVS19
1988	8 Cyl. 7.3L; 3 Ports; Yellow	PVS20
1988	8 Cyl. 7.3L; 3 Ports; Green; w/ Solenoid	PVS22
1988	8 Cyl. 7.3L; 3 Ports; Red; w/ Solenoid	PVS29
1985-1983	8 Cyl. 6.9L; 3 Ports; Gray w/ Blue Cap	PVS112
1985-1983	8 Cyl. 6.9L; 3 Ports; Brown	PVS18
1985-1983	8 Cyl. 6.9L; 3 Ports; Green; w/o Solenoid	PVS19
1985-1983	8 Cyl. 6.9L; 3 Ports; Yellow	PVS20

		Part No.
Ported Vacuum Switch		
F-250		
1985-1983	8 Cyl. 6.9L; 3 Ports; Green; w/ Solenoid	PVS22
1985-1983	8 Cyl. 6.9L; 3 Ports; Red; w/ Solenoid	PVS29
F-350		
1988	8 Cyl. 7.3L; 3 Ports; Gray w/ Blue Cap	PVS112
1988	8 Cyl. 7.3L; 3 Ports; Brown	PVS18
1988	8 Cyl. 7.3L; 3 Ports; Green; w/o Solenoid	PVS19
1988	8 Cyl. 7.3L; 3 Ports; Yellow	PVS20
1988	8 Cyl. 7.3L; 3 Ports; Green; w/ Solenoid	PVS22
1988	8 Cyl. 7.3L; 3 Ports; Red; w/ Solenoid	PVS29
1985-1983	8 Cyl. 6.9L; 3 Ports; Gray w/ Blue Cap	PVS112
1985-1983	8 Cyl. 6.9L; 3 Ports; Brown	PVS18
1985-1983	8 Cyl. 6.9L; 3 Ports; Green; w/o Solenoid	PVS19
1985-1983	8 Cyl. 6.9L; 3 Ports; Yellow	PVS20
1985-1983	8 Cyl. 6.9L; 3 Ports; Green; w/ Solenoid	PVS22
1985-1983	8 Cyl. 6.9L; 3 Ports; Red; w/ Solenoid	PVS29
Ranger		
1987-1985	4 Cyl. 2.3L; 3 Ports; Gray w/ Blue Cap	PVS112
1987-1985	4 Cyl. 2.3L; 3 Ports; Brown	PVS18
1987-1985	4 Cyl. 2.3L; 3 Ports; Green; w/o Solenoid	PVS19
1987-1985	4 Cyl. 2.3L; 3 Ports; Yellow	PVS20
1987-1985	4 Cyl. 2.3L; 3 Ports; Green; w/ Solenoid	PVS22
1987-1985	4 Cyl. 2.3L; 3 Ports; Red	PVS29
1984-1983	4 Cyl. 2.2L; 3 Ports; Gray w/ Blue Cap	PVS112
1984-1983	4 Cyl. 2.2L; 3 Ports; Brown	PVS18
1984-1983	4 Cyl. 2.2L; 3 Ports; Green; w/o Solenoid	PVS19
1984-1983	4 Cyl. 2.2L; 3 Ports; Yellow	PVS20
1984-1983	4 Cyl. 2.2L; 3 Ports; Green; w/ Solenoid	PVS22
1984-1983	4 Cyl. 2.2L; 3 Ports; Red	PVS29
Tempo		
1986-1984	4 Cyl. 2.0L; 3 Ports; Orange	PVS150
Power Steering Pressure Switch		
E-350 Club Wagon		
2004	8 Cyl. 6.0L	PSS4
2003	8 Cyl. 7.3L	PSS4
E-350 Econoline Club Wagon		
2002	8 Cyl. 7.3L	PSS4
E-350 Super Duty		
2004	8 Cyl. 6.0L	PSS4
2002	8 Cyl. 7.3L; Diesel	PSS4
E-450 Econoline Super Duty		
2002-2000	8 Cyl. 7.3L	PSS4
E-450 Super Duty		
2004	8 Cyl. 6.0L	PSS4
2003	8 Cyl. 7.3L	PSS4
E-550 Econoline Super Duty		
2002	8 Cyl. 7.3L	PSS4
E-550 Super Duty		
2003	8 Cyl. 7.3L	PSS4
Temperature Switches and Senders		
A/C and Heater Blower Motor Switch		
E-450 Super Duty		
2003	8 Cyl. 7.3L; Main	HS-214
Excursion		
2003	8 Cyl. 6.0L; w/ Auxiliary Fan	HS286
2003	8 Cyl. 6.0L; w/o Auxiliary Fan	HS-333
2003-2002	8 Cyl. 7.3L; w/ Auxiliary Fan	HS286
2003-2002	8 Cyl. 7.3L; w/o Auxiliary Fan	HS-333
F59		
1997		HS-229
1996-1992	w/ Manual AC	HS-229
1991-1988	Lever Type	HS-210

Temperature Switches and Senders

		Part No.
A/C and Heater Blower Motor Switch		
F650		
2009-2007	w/ Manual Control	HS-527
2006-2000		HS-333
F750		
2009-2007	w/ Manual Control	HS-527
2006-2000		HS-333
F800		
1996		HS-210
Ranger		
1987-1985	4 Cyl. 2.3L; w/ AC	HS213
A/C and Heater Selector Switch		
F650		
2006-2005	w/ Manual Control	HS-388
F750		
2006-2005	w/ Manual Control	HS-388
A/C Cut-Off Switch		
F650		
2006-2004	8 Cyl.	PCS123
2003	8 Cyl. 7.3L; 4 Door	PCS123
2003	8 Cyl. 7.3L; 2 Door	PCS124
2003-2000	6 Cyl. 5.9L; 4 Door	PCS123
2003-2000	6 Cyl. 7.2L; 4 Door	PCS123
2003-2000	6 Cyl. 5.9L; 2 Door	PCS124
2003-2000	6 Cyl. 7.2L; 2 Door	PCS124
2002-2000	8 Cyl.; 4 Door	PCS123
2002-2000	8 Cyl.; 2 Door	PCS124
F750		
2006-2004	8 Cyl.	PCS123
2003	8 Cyl. 7.3L	PCS124
2003-2000	6 Cyl. 5.9L	PCS124
2003-2000	6 Cyl. 7.2L	PCS124
2002-2000	8 Cyl.	PCS124
F-250 Super Duty		
2007-2003	8 Cyl. 6.0L	PCS123
F-350 Super Duty		
2007-2003	8 Cyl. 6.0L	PCS123
F-450 Super Duty		
2007-2004	8 Cyl. 6.0L	PCS123
F-550 Super Duty		
2007-2004	8 Cyl. 6.0L	PCS123
Blower Motor Resistor		
E-550 Econoline Super Duty		
2002	8 Cyl. 7.3L; 4 Blade Term.; Rear	RU-318
2002	8 Cyl. 7.3L; 2 Term.; Rear	RU-432
2002	8 Cyl. 7.3L; 4 Term.; Front	RU-445
E-550 Super Duty		
2003	8 Cyl. 7.3L; Main Unit; Front	RU-445
F59		
1997	w/ Auto. Temp Control	RU-538
1996-1995	Angled; w/ Factory Installed AC	RU-318
1994-1988		RU-318
F650		
2011		RU-825
2010-2008	w/o Auto. Temp Control	RU-440
2010-2008	w/ Auto. Temp Control	RU872
2007-2005	w/o Auto. Temp Control	RU-445
2007-2005	w/ Auto. Temp Control	RU-775
2004-2000		RU-445
F750		
2015		RU-825
2013-2011		RU-825
2010-2008	w/o Auto. Temp Control	RU-440

		Part No.
Blower Motor Resistor		
F750		
2010-2008	w/ Auto. Temp Control	RU872
2007-2005	w/o Auto. Temp Control	RU-445
2007-2005	w/ Auto. Temp Control	RU-775
2004-2000		RU-445
F800		
1999		RU-445
LNT9000		
1994		RU-318
Ranger		
1987-1985	4 Cyl. 2.3L	RU-318
1984-1983	4 Cyl. 2.2L	RU-318
Blower Motor Resistor Kit		
E-550 Econoline Super Duty		
2002	8 Cyl. 7.3L; 4 Blade Term.; w/ High Temperature Connector; Rear	RU318HTK
2002	8 Cyl. 7.3L; 4 Term.; w/ High Temperature Connector; Front	RU445HTK
E-550 Super Duty		
2003	8 Cyl. 7.3L; Main Unit; w/ High Temperature Connector; Front	RU445HTK
F59		
1994-1988	w/ High Temperature Connector	RU318HTK
F650		
2008-2000	w/ High Temperature Connector	RU445HTK
F750		
2007-2000	w/ High Temperature Connector	RU445HTK
F800		
1999	w/ High Temperature Connector	RU445HTK
Ranger		
1987-1985	4 Cyl. 2.3L; w/ High Temperature Connector	RU318HTK
1984-1983	4 Cyl. 2.2L; w/ High Temperature Connector	RU318HTK
Coolant Fan Switch		
Tempo		
1986-1984	4 Cyl. 2.0L	TS-155
HVAC Binary Switch		
E-350 Super Duty		
2010-2005	8 Cyl. 6.0L	PCS123
Excursion		
2005-2003	8 Cyl. 6.0L	PCS123
F-250 Super Duty		
2010-2008	8 Cyl. 6.4L	PCS123
2003	8 Cyl. 7.3L	PCS123
F-350 Super Duty		
2010-2008	8 Cyl. 6.4L	PCS123
2003	8 Cyl. 7.3L	PCS123
Temperature Sender - With Gauge		
B600		
1987-1983	8 Cyl. 8.2L	TS-17
B700		
1987-1983	8 Cyl. 8.2L	TS-17
B7000		
1987-1983		TS-58
E-250 Econoline Club Wagon		
1986-1985	8 Cyl. 6.9L	TS-58
E-350 Econoline		
1986-1984	8 Cyl. 6.9L	TS-58
E-350 Econoline Club Wagon		
1986-1985	8 Cyl. 6.9L	TS-58

Ford

Temperature Switches and Senders

		Part No.
Temperature Sender - With Gauge		
E-450 Econoline Super Duty		
2002-2000	8 Cyl. 7.3L	TS-380
E-450 Super Duty		
2003	8 Cyl. 7.3L	TS-380
E-550 Econoline Super Duty		
2002	8 Cyl. 7.3L	TS-380
E-550 Super Duty		
2003	8 Cyl. 7.3L	TS-380
Excursion		
2003	8 Cyl. 7.3L	TS-380
F600		
1994	6 Cyl. 5.9L	TS323
1987-1983	8 Cyl. 8.2L	TS-17
F650		
2003-2000		TS-380
F700		
1987	8 Cyl. 10.4L	TS-58
1987-1983	8 Cyl. 8.2L	TS-17
1983	8 Cyl. 10.4L	TS-58
F750		
2003-2000		TS-380
F800		
1999-1993	6 Cyl. 5.9L	TS323
1993-1992	6 Cyl. 7.8L	TS-24
1987-1983	8 Cyl. 8.2L	TS-17
F7000		
1987	8 Cyl.	TS-58
1986-1983		TS-58
F8000		
1987-1983		TS-58
F-250		
1996-1994	8 Cyl. 7.3L; Left Front of Engine	TS-355
1996-1994	8 Cyl. 7.3L; 1 1/2 Inch Long; On Water Pump	TS-58
F-250 Super Duty		
2003	8 Cyl. 7.3L	TS-380
F-350		
1997	8 Cyl. 7.3L; On Water Pump	TS-58
1997-1994	8 Cyl. 7.3L; Left Front of Engine	TS-355
1996-1994	8 Cyl. 7.3L; 1 1/2 Inch Long; On Water Pump	TS-58
F-350 Super Duty		
2003	8 Cyl. 7.3L	TS-380
F-550 Super Duty		
2003	8 Cyl. 6.0L	TS-380
2003	8 Cyl. 7.3L	TS-380
F Super Duty		
1996-1994	8 Cyl. 7.3L; Left Front of Engine	TS-355
1996-1994	8 Cyl. 7.3L; 1 1/2 Inch Long; On Water Pump	TS-58
1994	8 Cyl. 7.3L; 1 9/16 Inch Long; On Water Pump	TS-374
Ranger		
1987-1986	4 Cyl.	TS-374
Temperature Sender - With Light		
E-250 Econoline Club Wagon		
1986-1983	8 Cyl. 6.9L	TS-232
E-350 Econoline		
1986-1983	8 Cyl. 6.9L	TS-232
F600		
1994-1993	6 Cyl. 5.9L	TS-414
1993-1990	6 Cyl. 6.6L	TS-414

		Part No.
Temperature Sender - With Light		
F650		
2003-2000	6 Cyl. 5.9L	TS-650
F700		
1993-1990	6 Cyl. 6.6L	TS-414
1991-1990	6 Cyl. 7.8L	TS-414
F800		
1999-1993	6 Cyl. 5.9L	TS-414
Ranger		
1987	4 Cyl. 2.3L; SOHC	TS-36
Actuators		
Axle Shift Motor		
FT900		
1987-1986	Kit	ASM101
HVAC Temperature Blend Door Actuator		
F650		
2003-2000		J04012
F750		
2003-2000		J04012
Power Door Lock Actuator		
F-450 Super Duty		
2006-2005	8 Cyl. 6.0L; Left Front	DLA-131
2006-2005	8 Cyl. 6.0L; Right Front	DLA-144
2002-2000	8 Cyl. 7.3L; Left Front	DLA-131
2002-2000	8 Cyl. 7.3L; Right Front	DLA-144
F-550 Super Duty		
2006-2005	8 Cyl. 6.0L; Left Front	DLA-131
2006-2005	8 Cyl. 6.0L; Right Front	DLA-144
2002-2001	8 Cyl. 7.3L; Left Front	DLA-131
2002-2001	8 Cyl. 7.3L; Right Front	DLA-144
Shift Interlock Actuator		
F650		
2007-2000		B05001
F750		
2007-2000		B05001
F800		
1999		B05001
Locks		
Door Lock Kit		
F650		
2009-2005	Lock Mounted on Door Handle	DL275
2004-2000	Chrome Finish; Lock Mounted on Door Handle	DL275
2004-2000	Black Finish; Lock Mounted on Door Near Handle	DL-54
F750		
2009-2005	Lock Mounted on Door Handle	DL275
2004-2000	Chrome Finish; Lock Mounted on Door Handle	DL275
2004-2000	Black Finish; Lock Mounted on Door Near Handle	DL-54
F800		
1999	Chrome Finish; Lock Mounted on Door Handle	DL275
1999	Black Finish; Lock Mounted on Door Near Handle	DL-54
1996	Lock Mounted on Door Near Handle	DL-140
F7000		
1986-1983		DL-3
F8000		
1986-1983		DL-3

Locks

		Part No.
Ignition Lock Cylinder		
B600		
1994-1990		US-294L
B700		
1994-1990		US-294L
F59		
1994-1988	8 Cyl. 7.3L	US-70L
F600		
1988	6 Cyl. 6.6L	US-294L
1988	6 Cyl. 7.8L	US-294L
F650		
2007-2000	w/ Transponder Key	US-280L
2007-2000	w/o Transponder Key	US-322L
F750		
2007-2000	w/ Transponder Key	US-280L
2007-2000	w/o Transponder Key	US-322L
F800		
1999	w/ Transponder Key	US-280L
1999	w/o Transponder Key	US-322L
1996-1992		US-294L
Freightliner		
Relays and Fuses		
Accessory Relay		
Sprinter 2500		
2006-2003	Instrument Panel Mounted	RY1420
2006-2003	Near Battery Tray	RY-1723
2006-2003	5 Term.; Under Seat	RY-1726
2006-2003	4 Term.; Under Seat	RY1811
Sprinter 3500		
2006-2003	Instrument Panel Mounted	RY1420
2006-2003	Near Battery Tray	RY-1723
2006-2003	5 Term.; Under Seat	RY-1726
2006-2003	4 Term.; Under Seat	RY1811
Starting and Charging System Parts		
Starter Solenoid		
FL60		
1992	6 Cyl. 8.3L; 24 Volt; Str. No. 1990231, 1990248, 1990269, 1990270	SS-215
1992	6 Cyl. 8.3L; 12 Volt; OE No. 1990261	SS-216
1992-1991	6 Cyl. 5.9L; 24 Volt; Str. No. 1990231, 1990248, 1990269, 1990270	SS-215
1992-1991	6 Cyl. 5.9L; 12 Volt; OE No. 1990261	SS-216
FL70		
1992	6 Cyl. 8.3L; 24 Volt; Str. No. 1990231, 1990248, 1990269, 1990270	SS-215
1992	6 Cyl. 8.3L; 12 Volt; OE No. 1990261	SS-216
1992-1991	6 Cyl. 5.9L; 24 Volt; Str. No. 1990231, 1990248, 1990269, 1990270	SS-215
1992-1991	6 Cyl. 5.9L; 12 Volt; OE No. 1990261	SS-216
FL80		
1992	6 Cyl. 8.3L; 24 Volt; Str. No. 1990231, 1990248, 1990269, 1990270	SS-215
1992	6 Cyl. 8.3L; 12 Volt; OE No. 1990261	SS-216
1992-1991	6 Cyl. 5.9L; 24 Volt; Str. No. 1990231, 1990248, 1990269, 1990270	SS-215
1992-1991	6 Cyl. 5.9L; 12 Volt; OE No. 1990261	SS-216
Voltage Regulator		
FL60		
1992	6 Cyl. 8.3L	VR-144
1992-1991	6 Cyl. 5.9L	VR-144
FL70		
1992	6 Cyl. 8.3L	VR-144
1992-1991	6 Cyl. 5.9L	VR-144

		Part No.
Voltage Regulator		
FL80		
1992	6 Cyl. 8.3L	VR-144
1992-1991	6 Cyl. 5.9L	VR-144
MB60		
1992		VR-144
MB70		
1992		VR-144
Air Injection and Induction Parts		
Turbocharger - New		
Sprinter 2500		
2017-2010	6 Cyl.; Diesel; Turbocharged	TBC602
2009-2007	6 Cyl. 3.0L; Turbocharged	TBC547
2006-2004	Turbocharged	TBC546
2003-2002	Turbocharged	TBC554
Sprinter 3500		
2017-2010	6 Cyl.; Diesel; Turbocharged	TBC602
2009-2007	6 Cyl. 3.0L; Turbocharged	TBC547
2006-2004	Turbocharged	TBC546
2003-2002	Turbocharged	TBC554
Vacuum Pump		
Sprinter 2500		
2009-2007	6 Cyl. 3.0L	VCP125
2003-2002		VCP177
Sprinter 3500		
2009-2007	6 Cyl. 3.0L	VCP125
2003-2002		VCP177
Air Management Regulators and Solenoids		
Secondary Air Injection Solenoid		
Sprinter 2500		
2009		VS146
Sprinter 3500		
2009		VS146
Early Fuel Emission Control		
Crankcase Ventilation Filter		
108SD		
2018-2012	6 Cyl. 6.7L	BF43
B2		
2019-2008	6 Cyl. 6.7L	BF43
M2 106		
2018-2008	6 Cyl. 6.7L	BF43
MB Line		
2017-2008	6 Cyl. 6.7L	BF43
MC Line		
2017-2008	6 Cyl. 6.7L	BF43
MCL		
2014	6 Cyl. 6.7L	BF43
2011	6 Cyl. 6.7L	BF43
MT45		
2018-2008	6 Cyl. 6.7L	BF43
MT55		
2017-2008	6 Cyl. 6.7L	BF43
S2		
2011	6 Cyl. 6.7L	BF43
2009-2008	6 Cyl. 6.7L	BF43
S2C		
2017-2013	6 Cyl. 6.7L	BF43
XB Line		
2015-2013	6 Cyl.	BF43
2012	6 Cyl. 6.7L	BF43
2011-2010	6 Cyl.	BF43
2009	6 Cyl. 6.7L	BF43

Early Fuel Emission Control

		Part No.
Crankcase Ventilation Filter		
XB Raised Rail		
2008	6 Cyl. 6.7L	BF43
XB Straight Rail		
2018-2008	6 Cyl. 6.7L	BF43
XBA		
2016-2015	6 Cyl. 6.7L	BF43
XC Lowered Rail		
2017-2011	6 Cyl. 6.7L	BF43
XC Modular Rail		
2017-2008	6 Cyl. 6.7L	BF43
XC Raised Rail		
2018-2008	6 Cyl. 6.7L	BF43
XC Straight Rail		
2017-2008	6 Cyl. 6.7L	BF43
EGR Components		
Diesel EGR Cooler		
FC70		
2004-2002	6 Cyl. 5.9L	ECK10
FC80		
2005-2003	6 Cyl. 5.9L	ECK10
FL50		
2003-2002	6 Cyl. 5.9L	ECK10
M2 106		
2010-2008	6 Cyl. 6.7L	ECK9
MT35		
2006-2004	6 Cyl. 5.9L	ECK10
MT45		
2006-2003	6 Cyl. 5.9L	ECK10
MT55		
2006-2003	6 Cyl. 5.9L	ECK10
XC		
2005-2002	6 Cyl. 5.9L	ECK10
EGR Tube		
Sprinter 2500		
2009-2007	6 Cyl. 3.0L; Rear	ETB62
Sprinter 3500		
2009-2007	6 Cyl. 3.0L; Rear	ETB62
EGR Tube Gasket		
Sprinter 2500		
2009-2007	6 Cyl. 3.0L	VG274
Sprinter 3500		
2009-2007	6 Cyl. 3.0L	VG274
EGR Valve		
Sprinter 2500		
2009-2007	6 Cyl. 3.0L; Turbocharged	EGV1262
2006	5 Cyl. 2.7L; Diesel	EGV1160
2003-2002	5 Cyl. 2.7L; Diesel	EGV1139
Sprinter 3500		
2009-2007	6 Cyl. 3.0L; Turbocharged	EGV1262
2006	5 Cyl. 2.7L; Diesel	EGV1160
2003-2002	5 Cyl. 2.7L; Diesel	EGV1139
Exhaust Components		
Diesel Emission Fluid Injection Nozzle		
Sprinter 2500		
2015-2010	6 Cyl. 3.0L	DFI7
Sprinter 3500		
2015-2010	6 Cyl. 3.0L	DFI7

		Part No.
PCV Systems		
PCV Valve		
Sprinter 2500		
2009-2007	6 Cyl. 3.0L; Diesel	V520
Sprinter 3500		
2009-2007	6 Cyl. 3.0L; Diesel	V520
Injectors		
Fuel Injector - Diesel - Remfd		
Sprinter 2500		
2016-2014	4 Cyl. 2.1L	FJ1289
2016-2010	6 Cyl. 3.0L	FJ1290
2009-2007	6 Cyl. 3.0L	FJ1348
2006-2004	5 Cyl. 2.7L	FJ922
2003-2002	5 Cyl. 2.7L	FJ921
Sprinter 3500		
2016-2014	4 Cyl. 2.1L	FJ1289
2016-2010	6 Cyl. 3.0L	FJ1290
2009-2007	6 Cyl. 3.0L	FJ1348
2006-2004	5 Cyl. 2.7L	FJ922
2003-2002	5 Cyl. 2.7L	FJ921
Injection Components		
Diesel Fuel Injection Pump - Remanufactured		
Sprinter 2500		
2009-2007	6 Cyl. 3.0L	IP32
2006-2004	5 Cyl. 2.7L	IP31
Sprinter 3500		
2009-2007	6 Cyl. 3.0L	IP32
2006-2004	5 Cyl. 2.7L	IP31
Diesel Glow Plug		
Sprinter 2500		
2009-2007	6 Cyl. 3.0L	GP116
2006-2003	5 Cyl. 2.7L	GP111
Sprinter 3500		
2009-2007	6 Cyl. 3.0L	GP116
2006-2003	5 Cyl. 2.7L	GP111
Fuel Pressure Regulator		
Sprinter 2500		
2009-2007	6 Cyl. 3.0L	PR562
2006-2005	5 Cyl. 2.7L	PR564
2004	5 Cyl. 2.7L	PR563
Sprinter 3500		
2009-2007	6 Cyl. 3.0L	PR562
2006-2005	5 Cyl. 2.7L	PR564
2004	5 Cyl. 2.7L	PR563
Chassis and Drivetrain Sensors		
ABS Speed Sensor		
Sprinter 2500		
2018-2011	Right Rear	ALS2746
2018-2010	Front	ALS3082
2006	Left Rear	ALS1924
2005	Right Rear	ALS1924
2004-2003	Rear	ALS1924
2003	Front	ALS1925
Sprinter 3500		
2018-2010	Right Rear	ALS2746
2018-2010	Front	ALS3082
2018-2010	Rear	ALS3083
2017-2016	Left Rear	ALS3085
2003	Rear	ALS1924
2003	Front	ALS1925

Chassis and Drivetrain Sensors

		Part No.
Automatic Transmission Output Sensor		
Sprinter 2500		
2006-2003		SC335
Sprinter 3500		
2006-2003		SC335
Vehicle Speed Sensor		
Sprinter 2500		
2006-2003	Stamping No. A0145429717	SC335
2006-2003	Stamping No. A0145429817	SC528
Sprinter 3500		
2006-2003	Stamping No. A0145429717	SC335
2006-2003	Stamping No. A0145429817	SC528
YAW Rate Sensor		
Sprinter 2500		
2006-2004		YA161
Sprinter 3500		
2006-2004		YA161
Fluid Level Sensors		
Coolant Level Sensor		
Sprinter 2500		
2009		FLS-179
2006-2003		FLS-126
Sprinter 3500		
2009		FLS-179
2005-2003		FLS-126
Fuel Sensors		
Fuel / Water Separator Sensor		
Sprinter 2500		
2002		FWSS108
Sprinter 3500		
2002		FWSS108
Mass Air Flow		
Sprinter 2500		
2015-2010		MAS0421
2009		MAS0386
2006-2005		MAS0386
2004-2002	Complete Assembly	MAS0308
2004-2002	Sensor Only	MAK100
Sprinter 3500		
2015-2010		MAS0421
2009		MAS0386
2008-2007	6 Cyl. 3.0L	MAS0386
2006-2005		MAS0386
2004-2003	Sensor Only	MAK100
2004-2002	Complete Assembly	MAS0308
Miscellaneous Sensors		
Brake Pad Wear Sensor		
Sprinter 2500		
2014-2009	Front	PWS235
2009	Alternate Number; w/ Single Rear Wheels; Rear	PWS177
2009	w/ Single Rear Wheels; Rear	PWS177
2009	w/ Dual Rear Wheels; Rear	PWS236
2009	Exhaust stock and reorder; w/ Single Rear Wheels; Rear	PWS316
2006-2002	w/ Push-In Sensor; Front	PWS217
2006-2002	w/ Push-In Sensor; Rear	PWS217
2006-2002	w/ Clip on Sensor; Front	PWS234
2006-2002	w/ Clip on Sensor; Rear	PWS234
Sprinter 3500		
2014-2009	Front	PWS235
2009	w/o Dual Rear Wheels; Rear	PWS177

		Part No.
Brake Pad Wear Sensor		
Sprinter 3500		
2009	w/ Dual Rear Wheels; Rear	PWS236
2006-2002	w/ Push-In Sensor; Front	PWS217
2006-2002	w/ Push-In Sensor; Rear	PWS217
2006-2002	w/ Clip on Sensor; Front	PWS234
2006-2002	w/ Clip on Sensor; Rear	PWS234
Position Sensors		
Accelerator Pedal Sensor		
Sprinter 2500		
2014	4 Cyl. 2.1L	APS461
2014	6 Cyl. 3.0L	APS461
2013-2011		APS461
2006-2004		APS163
2003		APS273
Sprinter 3500		
2015		APS461
2010		APS461
2003		APS273
Camshaft Sensor		
Sprinter 2500		
2017-2014	4 Cyl. 2.1L	PC1064
2017-2014	6 Cyl. 3.0L	PC810
2013-2009		PC810
2006		PC810
2003		PC625
Sprinter 3500		
2005		PC625
2003		PC625
Crankshaft Sensor		
Sprinter 2500		
2017-2014	4 Cyl. 2.1L	PC1003
2014-2008	6 Cyl. 3.0L	PC738
2006-2003		PC497
Sprinter 3500		
2017-2014	4 Cyl. 2.1L	PC1003
2014-2008	6 Cyl. 3.0L	PC738
2006-2003		PC497
Pressure Sensors		
Air Inlet Pressure Sensor		
Argosy		
2001-1999	6 Cyl. 12.0L	PS711
Condor		
2001	6 Cyl. 12.0L	PS711
FLC112		
2001-2000	6 Cyl. 12.0L	PS711
Brake Fluid Pressure Sensor		
Sprinter 2500		
2006-2003		BST119
Sprinter 3500		
2006-2003		BST119
Diesel Particulate Filter (DPF) Pressure Sensor		
108SD		
2018-2017	6 Cyl. 8.9L	DPS101
2017-2012	6 Cyl. 6.7L	DPS101
2015-2014	6 Cyl. 8.9L	DPS101
114SD		
2018-2012	6 Cyl. 8.9L	DPS101
Argosy		
2012	ISX 15.0 Eng.	DPS101
B2		
2018-2010	6 Cyl. 6.7L	DPS101

Pressure Sensors

		Part No.
Diesel Particulate Filter (DPF) Pressure Sensor		
Cascadia		
2017-2012	6 Cyl. 11.9L	DPS101
2017-2010	ISX 15.0 Eng.	DPS101
Columbia		
2017	6 Cyl.	DPS101
2014	ISX 15.0 Eng.	DPS101
2012	ISX 15.0 Eng.	DPS101
Coronado		
2016-2011	ISX 15.0 Eng.	DPS101
FLD132		
2011	ISX 15.0 Eng.	DPS101
M2 106		
2018-2013	6 Cyl. 8.9L	DPS101
2018-2010	6 Cyl. 6.7L	DPS101
M2 112		
2018-2012	6 Cyl. 8.9L	DPS101
MB Line		
2017	6 Cyl. 6.7L	DPS101
MC Line		
2017	6 Cyl. 6.7L	DPS101
MT45		
2018-2010	6 Cyl. 6.7L	DPS101
MT55		
2017-2010	6 Cyl. 6.7L	DPS101
S2C		
2017	6 Cyl. 6.7L	DPS101
XB Line		
2015-2012	6 Cyl. 6.7L	DPS101
2014	6 Cyl. 8.9L	DPS101
XB Straight Rail		
2018-2010	6 Cyl. 6.7L	DPS101
XC Lowered Rail		
2017	6 Cyl. 6.7L	DPS101
2017-2010	6 Cyl. 8.9L	DPS101
2015-2011	6 Cyl. 6.7L	DPS101
XC Modular Rail		
2017-2013	ISX 15.0 Eng.	DPS101
2017-2012	6 Cyl. 8.9L	DPS101
2017-2010	6 Cyl. 6.7L	DPS101
XC Raised Rail		
2018-2010	6 Cyl. 6.7L	DPS101
2018-2010	6 Cyl. 8.9L	DPS101
2017-2015	ISX 15.0 Eng.	DPS101
XC Straight Rail		
2017-2010	6 Cyl. 6.7L	DPS101
EGR Valve Pressure Feedback Sensor		
108SD		
2019	6 Cyl. 6.7L; Diesel	VP34
2017-2012	6 Cyl. 6.7L; Diesel	VP34
B2		
2019-2008	6 Cyl. 6.7L; Diesel	VP34
M2 106		
2019-2007	6 Cyl. 6.7L; Diesel	VP34
MB Line		
2019	6 Cyl. 6.7L; Diesel	VP34
2017-2016	6 Cyl. 6.7L; Diesel	VP34
2014-2007	6 Cyl. 6.7L; Diesel	VP34
MC Line		
2016-2007	6 Cyl. 6.7L; Diesel	VP34
MCL		
2014	6 Cyl. 6.7L; Diesel	VP34
2011	6 Cyl. 6.7L; Diesel	VP34

		Part No.
EGR Valve Pressure Feedback Sensor		
MT45		
2019-2008	6 Cyl. 6.7L; Diesel	VP34
MT55		
2019-2008	6 Cyl. 6.7L; Diesel	VP34
S2		
2011	6 Cyl. 6.7L; Diesel	VP34
2009-2008	6 Cyl. 6.7L; Diesel	VP34
S2C		
2019	6 Cyl. 6.7L; Diesel	VP34
2017-2013	6 Cyl. 6.7L; Diesel	VP34
S2RV		
2019	6 Cyl. 6.7L; Diesel	VP34
XB Line		
2015-2012	6 Cyl. 6.7L; Diesel	VP34
2009	6 Cyl. 6.7L; Diesel	VP34
XB Raised Rail		
2008	6 Cyl. 6.7L; Diesel	VP34
XB Straight Rail		
2019-2008	6 Cyl. 6.7L; Diesel	VP34
XBA		
2016-2015	6 Cyl. 6.7L; Diesel	VP34
XC Lowered Rail		
2017-2011	6 Cyl. 6.7L; Diesel	VP34
XC Modular Rail		
2019-2008	6 Cyl. 6.7L; Diesel	VP34
XC Raised Rail		
2019-2007	6 Cyl. 6.7L; Diesel	VP34
XC Straight Rail		
2019	6 Cyl. 6.7L; Diesel	VP34
2017-2007	6 Cyl. 6.7L; Diesel	VP34
Fuel Pressure Sensor		
Argosy		
2008-2006		FPS62
Cascadia		
2009	ISX 15.0 Eng.	FPS62
2008	6 Cyl. 14.0L	FPS62
Sprinter 2500		
2009-2007	6 Cyl. 3.0L	FPS30
2006-2004	5 Cyl. 2.7L	FPS30
Sprinter 3500		
2009-2007	6 Cyl. 3.0L	FPS30
2006-2004	5 Cyl. 2.7L	FPS30
Injection Actuation Pressure Sensor		
Argosy		
2000	6 Cyl. 7.2L	PS713
FL50		
2000-1999	6 Cyl. 7.2L	PS713
FL60		
2000-1999	6 Cyl. 7.2L	PS713
FL70		
2000-1999	6 Cyl. 7.2L	PS713
FLD112		
2000-1999	6 Cyl. 7.2L	PS713
FS65		
2000-1999	6 Cyl. 7.2L	PS713
XB Line		
2000-1999	6 Cyl. 7.2L	PS713
MAP Sensor		
Argosy		
2002-1999	6 Cyl. 10.8L; On Intake Manifold	AS680

Pressure Sensors

		Part No.
MAP Sensor		
Century Class		
2002-1998	6 Cyl. 10.3L; On Intake Manifold	AS680
Condor		
2002-2001	6 Cyl. 10.3L; On Intake Manifold	AS680
Sprinter 2500		
2014-2010	6 Cyl. 3.0L	AS356
Sprinter 3500		
2014-2010	6 Cyl. 3.0L	AS356
Tire Pressure Monitoring System OE Design Sensor		
Sprinter 2500		
2016-2014	433 Mhz Sensor; OE Style/ID Clone-able; w/ Aluminum Valve	TPM155 TPM155A
2013-2009	315 Mhz Sensor; OE Style/ID Clone-able; w/ Aluminum Valve	TPM104 TPM104A
Sprinter 3500		
2018-2014	433 Mhz Sensor; OE Style/ID Clone-able; w/ Aluminum Valve	TPM155 TPM155A
2013-2009	315 Mhz Sensor; OE Style/ID Clone-able; w/ Aluminum Valve	TPM104 TPM104A
Tire Pressure Monitoring System OE Design Sensor Service Kit		
Sprinter 2500		
2016-2014	w/ Aluminum Valve	TPM2014VK
2016-2014	25 Per Box; 433 Mhz Sensor; OE Style/ID Clone-able; w/ Aluminum Valve	TPM3000K
2016-2014	4 Per Box; 433 Mhz Sensor; OE Style/ID Clone-able; w/ Aluminum Valve	TPM3000K4
2013-2009	25 Per Box; OE Style; w/o Valve	TPM2000K
2013-2009	4 Per Box; OE Style; w/o Valve	TPM2000K4
Sprinter 3500		
2016-2014	w/ Aluminum Valve	TPM2014VK
2016-2014	25 Per Box; 433 Mhz Sensor; OE Style/ID Clone-able; w/ Aluminum Valve	TPM3000K
2016-2014	4 Per Box; 433 Mhz Sensor; OE Style/ID Clone-able; w/ Aluminum Valve	TPM3000K4
2013-2009	25 Per Box; OE Style; w/o Valve	TPM2000K
2013-2009	4 Per Box; OE Style; w/o Valve	TPM2000K4
Tire Pressure Monitoring System OE Design Valve		
Sprinter 2500		
2016-2014	433 Mhz Sensor; OE Style; w/ Aluminum Valve	TPM2014VK
2016-2014	25 Per Box; 433 Mhz Sensor; OE Style/ID Clone-able; w/ Aluminum Valve	TPM2107VK
2016-2014	4 Per Box; 433 Mhz Sensor; OE Style/ID Clone-able; w/ Aluminum Valve	TPM2107VK4
2016-2009	25 Per Box; 315 Mhz Sensor; OE Style; w/ Metal Valve	TPM2104VK
2016-2009	4 Per Box; 315 Mhz Sensor; OE Style; w/ Metal Valve	TPM2104VK4
2013-2009	315 Mhz Sensor; OE Style; w/ Aluminum Valve	TPM2018VK
Sprinter 3500		
2016-2014	433 Mhz Sensor; OE Style; w/ Aluminum Valve	TPM2014VK
2016-2014	25 Per Box; 433 Mhz Sensor; OE Style/ID Clone-able; w/ Aluminum Valve	TPM2107VK
2016-2014	4 Per Box; 433 Mhz Sensor; OE Style/ID Clone-able; w/ Aluminum Valve	TPM2107VK4
2016-2009	25 Per Box; 315 Mhz Sensor; OE Style; w/ Metal Valve	TPM2104VK
2016-2009	4 Per Box; 315 Mhz Sensor; OE Style; w/ Metal Valve	TPM2104VK4
2013-2009	315 Mhz Sensor; OE Style; w/ Aluminum Valve	TPM2018VK

		Part No.
Tire Pressure Monitoring System QWIK-Sensor		
Sprinter 2500		
2016-2014	433 Mhz Sensor; Alternate Number; Black; w/ Aluminum Valve	QS104M
2016-2014	433 Mhz Sensor; Alternate Number; Black; w/ Rubber Valve	QS104R
2013-2009	315 Mhz Sensor; Blue; Exhaust stock and reorder; w/ Aluminum Valve	QS101M
2013-2009	315 Mhz Sensor; Blue; Exhaust stock and reorder; w/ Rubber Valve	QS101R
2013-2009	315 Mhz Sensor; Alternate Number; Black; w/ Aluminum Valve	QS105M
2013-2009	315 Mhz Sensor; Alternate Number; Black; w/ Rubber Valve	QS105R
Sprinter 3500		
2018-2017	433 Mhz Sensor; OE Style/ID Clone-able; w/ Aluminum Valve	QS104M
2018-2017	433 Mhz Sensor; OE Style/ID Clone-able; w/ Rubber Valve	QS104R
2016-2014	433 Mhz Sensor; Alternate Number; Black; w/ Aluminum Valve	QS104M
2016-2014	433 Mhz Sensor; Alternate Number; Black; w/ Rubber Valve	QS104R
2013-2009	315 Mhz Sensor; Blue; Exhaust stock and reorder; w/ Aluminum Valve	QS101M
2013-2009	315 Mhz Sensor; Blue; Exhaust stock and reorder; w/ Rubber Valve	QS101R
2013-2009	315 Mhz Sensor; Alternate Number; Black; w/ Aluminum Valve	QS105M
2013-2009	315 Mhz Sensor; Alternate Number; Black; w/ Rubber Valve	QS105R
Tire Pressure Monitoring System QWIK-Sensor Service Kit		
Sprinter 2500		
2016-2014	1 Per Box; 433 Mhz Sensor; w/ Aluminum Valve	TPM4012SK
2016-2014	25 Per Box; 433 Mhz Sensor; w/ Aluminum Valve	TPM4012SK25PK
2016-2014	4 Per Box; 433 Mhz Sensor; w/ Aluminum Valve	TPM4012SK4PK
2013-2009	1 Per Box; 315 Mhz Sensor; w/ Aluminum Valve	TPM4012SK
2013-2009	25 Per Box; 315 Mhz Sensor; w/ Aluminum Valve	TPM4012SK25PK
2013-2009	4 Per Box; 315 Mhz Sensor; w/ Aluminum Valve	TPM4012SK4PK
Sprinter 3500		
2016-2014	1 Per Box; 433 Mhz Sensor; w/ Aluminum Valve	TPM4012SK
2016-2014	25 Per Box; 433 Mhz Sensor; w/ Aluminum Valve	TPM4012SK25PK
2016-2014	4 Per Box; 433 Mhz Sensor; w/ Aluminum Valve	TPM4012SK4PK
2013-2009	1 Per Box; 315 Mhz Sensor; w/ Aluminum Valve	TPM4012SK
2013-2009	25 Per Box; 315 Mhz Sensor; w/ Aluminum Valve	TPM4012SK25PK
2013-2009	4 Per Box; 315 Mhz Sensor; w/ Aluminum Valve	TPM4012SK4PK
Tire Pressure Monitoring System QWIK-Sensor Valve		
Sprinter 2500		
2016-2014	1 Per Box; 433 Mhz Sensor; w/ Rubber Valve	TPM2011VK
2016-2014	25 Per Box; 433 Mhz Sensor; w/ Rubber Valve	TPM2011VK25PK
2016-2014	4 Per Box; 433 Mhz Sensor; w/ Rubber Valve	TPM2011VK4PK
2016-2014	1 Per Box; 433 Mhz Sensor; w/ Aluminum Valve	TPM2012VK
2016-2014	25 Per Box; 433 Mhz Sensor; w/ Aluminum Valve	TPM2012VK25PK

Pressure Sensors

		Part No.
Tire Pressure Monitoring System QWIK-Sensor Valve		
Sprinter 2500		
2016-2014	4 Per Box; 433 Mhz Sensor; w/ Aluminum Valve	TPM2012VK4PK
2013-2009	1 Per Box; 315 Mhz Sensor; w/ Rubber Valve	TPM2011VK
2013-2009	25 Per Box; 315 Mhz Sensor; w/ Rubber Valve	TPM2011VK25PK
2013-2009	4 Per Box; 315 Mhz Sensor; w/ Rubber Valve	TPM2011VK4PK
2013-2009	1 Per Box; 315 Mhz Sensor; w/ Aluminum Valve	TPM2012VK
2013-2009	25 Per Box; 315 Mhz Sensor; w/ Aluminum Valve	TPM2012VK25PK
2013-2009	4 Per Box; 315 Mhz Sensor; w/ Aluminum Valve	TPM2012VK4PK
Sprinter 3500		
2016-2014	1 Per Box; 433 Mhz Sensor; w/ Rubber Valve	TPM2011VK
2016-2014	25 Per Box; 433 Mhz Sensor; w/ Rubber Valve	TPM2011VK25PK
2016-2014	4 Per Box; 433 Mhz Sensor; w/ Rubber Valve	TPM2011VK4PK
2016-2014	1 Per Box; 433 Mhz Sensor; w/ Aluminum Valve	TPM2012VK
2016-2014	25 Per Box; 433 Mhz Sensor; w/ Aluminum Valve	TPM2012VK25PK
2016-2014	4 Per Box; 433 Mhz Sensor; w/ Aluminum Valve	TPM2012VK4PK
2013-2009	1 Per Box; 315 Mhz Sensor; w/ Rubber Valve	TPM2011VK
2013-2009	25 Per Box; 315 Mhz Sensor; w/ Rubber Valve	TPM2011VK25PK
2013-2009	4 Per Box; 315 Mhz Sensor; w/ Rubber Valve	TPM2011VK4PK
2013-2009	1 Per Box; 315 Mhz Sensor; w/ Aluminum Valve	TPM2012VK
2013-2009	25 Per Box; 315 Mhz Sensor; w/ Aluminum Valve	TPM2012VK25PK
2013-2009	4 Per Box; 315 Mhz Sensor; w/ Aluminum Valve	TPM2012VK4PK
Turbocharger Boost Sensor		
Argosy		
2002-1999	6 Cyl. 14.0L; Turbocharged	AS677
Century Class		
2003-1997	6 Cyl. 14.6L; Turbocharged	AS677
Columbia		
2003-2002	ISX 15.0 Eng.; Turbocharged	AS677
Sprinter 2500		
2015-2007	6 Cyl. 3.0L; Turbocharged	AS356
2006-2004	5 Cyl. 2.7L; Turbocharged	AS356
Sprinter 3500		
2015-2007	6 Cyl. 3.0L; Turbocharged	AS356
2006-2004	5 Cyl. 2.7L; Turbocharged	AS356
Temperature Sensors		
Ambient Air Temperature Sensor		
Sprinter 2500		
2017-2011		AX181
2010	To 7/30/10	AX181
2009		AX118
2006-2003		AX158
Sprinter 3500		
2017-2011		AX181
2010	To 7/30/10	AX181
2009		AX118
2006-2003		AX158

		Part No.
Cabin Air Temperature Sensor		
Sprinter 2500		
2009		AX215
2006-2004	w/ Flat Connector	AX215
2006-2004	w/ Round Connector	AX234
2003		AX234
Sprinter 3500		
2009		AX215
2006-2004	w/ Flat Connector	AX215
2006-2004	w/ Round Connector	AX234
2003		AX234
Coolant Temperature Sensor		
Sprinter 2500		
2016-2009		TX155
2006-2003		TS-615
Sprinter 3500		
2016-2009		TX155
2006-2003		TS-615
Exhaust Gas Temperature Sensor		
Argosy		
2008	ISX 15.0 Eng.	ETS223
Cascadia		
2011-2009	ISX 15.0 Eng.	ETS223
Columbia		
2009-2008	ISX 15.0 Eng.	ETS223
Coronado		
2011	ISX 15.0 Eng.	ETS223
Sprinter 2500		
2013	6 Cyl. 3.0L	ETS111
2010-2007	6 Cyl. 3.0L	ETS111
Sprinter 3500		
2013		ETS111
2010		ETS111
2008-2007	6 Cyl. 3.0L	ETS111
Body Light Switches		
Fog Lamp Switch		
Sprinter 2500		
2006-2005		FLA1027
2004-2003		DS-5748
Sprinter 3500		
2006-2005		FLA1027
2004-2003		DS-5748
Hazard Warning Switch		
Sprinter 2500		
2006-2002	w/ Parking Light Control	CBS-1261
2006-2002	w/o Parking Light Control	CBS-1392
Sprinter 3500		
2006-2002	w/ Parking Light Control	CBS-1261
2006-2002	w/o Parking Light Control	CBS-1392
Headlight Dimmer Switch		
Sprinter 2500		
2009	w/o Rear Wiper	CBS-1773
2009	w/ Rear Wiper	CBS-1916
2002	w/ Parking Light Control	CBS-1261
2002	w/o Parking Light Control	CBS-1392
Sprinter 3500		
2009	w/o Rear Wiper	CBS-1773
2009	w/ Rear Wiper	CBS-1916
2006-2002	w/ Parking Light Control	CBS-1261
2006-2002	w/o Parking Light Control	CBS-1392

Body Light Switches

		Part No.
Headlight Switch		
Sprinter 2500		
2014-2011	w/ Auto Headlights; w/ Rain Sensitive Wipers; w/o Rear Fog Lights	HLS-1630
2014-2011	w/o Auto Headlights; w/o Rain Sensitive Wipers; w/ Rear Fog Lights	HLS-1631
2014-2011	w/ Rear Fog Lights; w/o Auto Headlights; w/o Rain Sensitive Wipers	HLS-1632
2014-2011	w/ Auto Headlights; w/ Rain Sensitive Wipers; w/ Rear Fog Lights	HLS-1633
2002	w/ Parking Light Control	CBS-1261
2002	w/o Parking Light Control	CBS-1392
Sprinter 3500		
2014-2011	w/ Auto Headlights; w/ Rain Sensitive Wipers; w/o Rear Fog Lights	HLS-1630
2014-2011	w/o Auto Headlights; w/ Rain Sensitive Wipers; w/o Rear Fog Lights	HLS-1631
2014-2011	w/ Rear Fog Lights; w/o Auto Headlights; w/o Rain Sensitive Wipers	HLS-1632
2014-2011	w/ Auto Headlights; w/ Rain Sensitive Wipers; w/ Rear Fog Lights	HLS-1633
2009	w/o Rear Wiper	CBS-1773
2009	w/ Rear Wiper	CBS-1916
2006-2002	w/ Parking Light Control	CBS-1261
2006-2002	w/o Parking Light Control	CBS-1392
Interior Light Switch		
Sprinter 2500		
2006-2005	Cargo Light; Cargo Van	DS-3035
Sprinter 3500		
2006-2005	Cargo Light; Cargo Van	DS-3035
Stoplight Switch		
Sprinter 2500		
2017-2013		SLS-502
2012-2011	6 Cyl. 3.0L	SLS-467
2010		SLS-502
2006-2003	w/ Stability Control	SLS-466
Sprinter 3500		
2017-2013		SLS-502
2012-2011	6 Cyl. 3.0L	SLS-467
2010		SLS-502
2009		SLS-467
2006-2003	w/ Stability Control	SLS-466
Turn Signal Switch		
Sprinter 2500		
2009	6 Cyl. 3.0L; Rear Wiper	CBS-1916
2009-2007	6 Cyl. 3.0L; w/o Rear Wiper	CBS-1773
2008-2007	6 Cyl. 3.0L; w/ Rear Wiper	CBS-1916
2006-2002	w/ Parking Light Control	CBS-1261
2006-2002	w/o Parking Light Control	CBS-1392
Sprinter 3500		
2009	6 Cyl. 3.0L; Rear Wiper	CBS-1916
2009-2007	6 Cyl. 3.0L; w/o Rear Wiper	CBS-1773
2008-2007	6 Cyl. 3.0L; w/ Rear Wiper	CBS-1916
2006-2002	5 Cyl. 2.7L; w/ Parking Light Control	CBS-1261
2006-2002	5 Cyl. 2.7L; w/o Parking Light Control	CBS-1392
Chassis and Drivetrain Switches		
Clutch Starter Safety Switch		
Sprinter 2500		
2006-2003		SLS-385
Sprinter 3500		
2006-2003		SLS-385
Transmission Control Solenoid		
Sprinter 2500		
2016-2014	TCC Solenoid	TCS273
2009	Shift Solenoid	TCS208

		Part No.
Transmission Control Solenoid		
Sprinter 2500		
2009	TCC Solenoid	TCS331
2009	On-Off Shift	TCS209
2006-2003	Shift Solenoid	TCS208
2006-2003	TCC Solenoid	TCS331
Sprinter 3500		
2016-2014	TCC Solenoid	TCS273
2009	Shift Solenoid	TCS208
2009	On-Off Shift	TCS209
2006-2003		TCS208
Ignition Switches		
Ignition Starter Switch		
Sprinter 2500		
2006-2002		US-980
Sprinter 3500		
2006-2002		US-980
Interior Power Switches		
Clock Spring		
Sprinter 2500		
2009		CSP131
2006-2003		CSP123
Sprinter 3500		
2009		CSP131
2006-2003		CSP123
Cruise Control Switch		
Sprinter 2500		
2009		DS-2363
2006-2004		CCA1291
Sprinter 3500		
2009		DS-2363
2006-2004		CCA1291
Parking Brake Switch		
Sprinter 2500		
2006-2003		DS-3364
Sprinter 3500		
2004		DS-3364
Power Door Lock Switch		
Sprinter 2500		
2006-2003	Dash Mounted Switch	PDS-124
Sprinter 3500		
2006-2003	Dash Mounted Switch	PDS-124
Power Window Switch		
Sprinter 2500		
2018-2015	w/ Heated Mirrors; w/o Rear Power Vent Windows; Front Left	DWS-184
2017-2015	Exc. Passenger Van; w/o Heated Mirrors; w/o Rear Power Vent Windows; Front Left	DWS1642
2013	Exc. Passenger Van; w/o Heated Mirrors; w/o Rear Power Vent Windows; Front Left	DWS1642
2013	w/ Heated Mirrors; w/o Rear Power Vent Windows; Front Left	DWS-184
2012-2009	w/ Power Mirrors; Front Left	DWS-184
2009	w/ Power Mirrors; Front Right	DS-2362
2009	w/o Power Mirrors; Front Left	DWS1642
2006-2003	Front Left	DWS-187
Sprinter 3500		
2017-2015	Exc. Passenger Van; w/o Heated Mirrors; w/o Rear Power Vent Windows; Front Left	DWS1642
2017-2015	w/ Heated Mirrors; w/o Rear Power Vent Windows; Front Left	DWS-184
2013	Exc. Passenger Van; w/o Heated Mirrors; w/o Rear Power Vent Windows; Front Left	DWS1642

Interior Power Switches

		Part No.
Power Window Switch		
Sprinter 3500		
2013	w/ Heated Mirrors; w/o Rear Power Vent Windows; Front Left	DWS-184
2009	w/o Power Mirrors; Front Left	DWS1642
2009	w/ Power Mirrors; Front Left	DWS-184
2009-2008	6 Cyl. 3.0L; Right	DS-2362
2006-2003	Front Left	DWS-187
Rear Window Defogger Switch		
Sprinter 2500		
2006-2003		DS-2359
Sprinter 3500		
2006-2003		DS-2359
Remote Mirror Switch		
Sprinter 2500		
2006-2003	w/ Heated Mirror	MRS1
Sprinter 3500		
2006-2003	w/ Heated Mirror	MRS1
Steering Angle Sensor		
Sprinter 2500		
2006-2004		SWS46
Sprinter 3500		
2006-2004		SWS46
Traction Control Switch		
Sprinter 2500		
2006-2003		DS-2360
Sprinter 3500		
2006-2003		DS-2360
Windshield Wiper Switch		
Sprinter 2500		
2009	6 Cyl. 3.0L; Rear Wiper	CBS-1916
2009-2007	6 Cyl. 3.0L; w/o Rear Wiper	CBS-1773
2008-2007	6 Cyl. 3.0L; w/ Rear Wiper	CBS-1916
2006-2002	w/ Parking Light Control	CBS-1261
2006-2002	w/o Parking Light Control	CBS-1392
Sprinter 3500		
2009	6 Cyl. 3.0L; Rear Wiper	CBS-1916
2009-2007	6 Cyl. 3.0L; w/o Rear Wiper	CBS-1773
2008-2007	6 Cyl. 3.0L; w/ Rear Wiper	CBS-1916
2006-2002	w/ Parking Light Control	CBS-1261
2006-2002	w/o Parking Light Control	CBS-1392
Pressure and Vacuum Sending Switches		
Oil Pressure Gauge Switch		
114SD		
2016-2013	6 Cyl. 8.9L	PS-407
Temperature Switches and Senders		
A/C and Heater Blower Motor Switch		
Sprinter 2500		
2006-2004	Rear	DS-2219
2006-2004	w/ Heat Booster; w/o Auto. Temp Control; Front	HS-424
2006-2004	w/ Auto. Temp Control; w/ Heat Booster; Front	HS-482
2006-2004	w/ Auto. Temp Control; w/o Heat Booster; Front	HS570
2003	5 Cyl. 2.7L; Rear	DS-2219
Sprinter 3500		
2006-2004	Rear	DS-2219
2006-2004	w/ Heat Booster; w/o Auto. Temp Control; Front	HS-424
2006-2004	w/ Auto. Temp Control; w/ Heat Booster; Front	HS-482

		Part No.
A/C and Heater Blower Motor Switch		
Sprinter 3500		
2006-2004	w/ Auto. Temp Control; w/o Heat Booster; Front	HS570
2003	5 Cyl. 2.7L; Rear	DS-2219
A/C and Heater Selector Switch		
Sprinter 2500		
2006-2003	w/ Heat Booster; w/o Auto. Temp Control	HS-424
2006-2003	w/ Auto. Temp Control; w/ Heat Booster	HS-482
2006-2003	w/ Auto. Temp Control; w/o Heat Booster	HS570
Sprinter 3500		
2006-2003	w/ Heat Booster; w/o Auto. Temp Control	HS-424
2006-2003	w/ Auto. Temp Control; w/ Heat Booster	HS-482
2006-2003	w/ Auto. Temp Control; w/o Heat Booster	HS570
Blower Motor Resistor		
Sprinter 2500		
2017-2010	Alternate Number; w/ Auto. Temp Control	RU-778
2017-2010	w/o Auto. Temp Control	RU-879
2017-2010	Exhaust stock and reorder; w/ Auto. Temp Control	RU880
2009	Front and Rear	RU-778
2006-2003	Front and Rear	RU-686
2004-2003	Front	RU-685
Sprinter 3500		
2017-2010	Alternate Number; w/ Auto. Temp Control	RU-778
2017-2010	w/o Auto. Temp Control	RU-879
2017-2010	Exhaust stock and reorder; w/ Auto. Temp Control	RU880
2009-2007	6 Cyl. 3.0L; Front and Rear	RU-778
2006-2005	5 Cyl. 2.7L; Front and Rear	RU-686
2004-2003	Front	RU-685
2004-2003	Front and Rear	RU-686
Actuators		
Power Door Lock Actuator		
Sprinter 2500		
2006-2003	Right Rear	DLA-463
2006-2003	Cargo Compartment	DLA-479
2006-2003	w/o Auto Door Lock; Left Front	DLA-525
2006-2003	w/ Auto. Door Lock; Right Front	DLA-526
2006-2003	w/ Auto. Door Lock; Left Front	DLA-527
2005-2003	w/o Auto Door Lock; Right Front	DLA-523
Sprinter 3500		
2006-2003	Right Rear	DLA-463
2006-2003	Cargo Compartment	DLA-479
2006-2003	w/o Auto Door Lock; Right Front	DLA-523
2006-2003	w/o Auto Door Lock; Left Front	DLA-525
2006-2003	w/ Auto. Door Lock; Right Front	DLA-526
2006-2003	w/ Auto. Door Lock; Left Front	DLA-527
Gillig		
Pressure and Vacuum Sending Switches		
Oil Pressure Gauge Switch		
Low Floor		
2017	6 Cyl. 8.9L	PS-407
GMC		
Modules		
Diesel Injector Pump Module Resistor		
C1500		
1997-1995	8 Cyl. 6.5L; Resistor No. 5	PMR1
1997-1995	8 Cyl. 6.5L; Resistor No. 9	PMR2
1994	8 Cyl. 6.5L; P; Resistor No. 5	PMR1
1994	8 Cyl. 6.5L; P; Resistor No. 9	PMR2
1994	8 Cyl. 6.5L; S; Resistor No. 5	PMR1

Modules

		Part No.
Diesel Injector Pump Module Resistor		
C1500		
1994	8 Cyl. 6.5L; S; Resistor No. 9	PMR2
C1500 Suburban		
1999-1998	8 Cyl. 6.5L; Resistor No. 5	PMR1
1999-1998	8 Cyl. 6.5L; Resistor No. 9	PMR2
C2500		
2000-1995	8 Cyl. 6.5L; Resistor No. 5	PMR1
2000-1995	8 Cyl. 6.5L; Resistor No. 9	PMR2
1994	8 Cyl. 6.5L; F; Resistor No. 5	PMR1
1994	8 Cyl. 6.5L; F; Resistor No. 9	PMR2
1994	8 Cyl. 6.5L; P; Resistor No. 5	PMR1
1994	8 Cyl. 6.5L; P; Resistor No. 9	PMR2
1994	8 Cyl. 6.5L; S; Resistor No. 5	PMR1
1994	8 Cyl. 6.5L; S; Resistor No. 9	PMR2
C3500		
2000-1994	8 Cyl. 6.5L; Resistor No. 5	PMR1
2000-1994	8 Cyl. 6.5L; Resistor No. 9	PMR2
C3500HD		
2002-1994	8 Cyl. 6.5L; Resistor No. 5	PMR1
2002-1994	8 Cyl. 6.5L; Resistor No. 9	PMR2
G2500		
1995-1994	8 Cyl. 6.5L; Resistor No. 5	PMR1
1995-1994	8 Cyl. 6.5L; Resistor No. 9	PMR2
K1500		
1998-1995	8 Cyl. 6.5L; Resistor No. 5	PMR1
1998-1995	8 Cyl. 6.5L; Resistor No. 9	PMR2
1994	8 Cyl. 6.5L; P; Resistor No. 5	PMR1
1994	8 Cyl. 6.5L; P; Resistor No. 9	PMR2
1994	8 Cyl. 6.5L; S; Resistor No. 5	PMR1
1994	8 Cyl. 6.5L; S; Resistor No. 9	PMR2
K2500		
2000-1995	8 Cyl. 6.5L; Resistor No. 5	PMR1
2000-1995	8 Cyl. 6.5L; Resistor No. 9	PMR2
1994	8 Cyl. 6.5L; F; Resistor No. 5	PMR1
1994	8 Cyl. 6.5L; F; Resistor No. 9	PMR2
1994	8 Cyl. 6.5L; P; Resistor No. 5	PMR1
1994	8 Cyl. 6.5L; P; Resistor No. 9	PMR2
1994	8 Cyl. 6.5L; S; Resistor No. 5	PMR1
1994	8 Cyl. 6.5L; S; Resistor No. 9	PMR2
K3500		
2000-1994	8 Cyl. 6.5L; Resistor No. 5	PMR1
2000-1994	8 Cyl. 6.5L; Resistor No. 9	PMR2
P3500		
1999-1997	8 Cyl. 6.5L; Resistor No. 5; Turbocharged	PMR1
1999-1997	8 Cyl. 6.5L; Resistor No. 9; Turbocharged	PMR2
Savana 2500		
2002-1996	8 Cyl. 6.5L; Resistor No. 5	PMR1
2002-1996	8 Cyl. 6.5L; Resistor No. 9	PMR2
Savana 3500		
2002-1996	8 Cyl. 6.5L; Resistor No. 5	PMR1
2002-1996	8 Cyl. 6.5L; Resistor No. 9	PMR2
Yukon		
1997-1995	8 Cyl. 6.5L; Resistor No. 5	PMR1
1997-1995	8 Cyl. 6.5L; Resistor No. 9	PMR2
1994	8 Cyl. 6.5L; OE No. 17800077, ID Tag No. 5521; Resistor No. 5	PMR1
1994	8 Cyl. 6.5L; OE No. 17800077, ID Tag No. 5521; Resistor No. 9	PMR2
Glow Plug Controller		
C4500 Topkick		
2007-2006	8 Cyl. 6.6L	RY-1697
2003	8 Cyl. 6.6L	RY-1731

		Part No.
Glow Plug Controller		
C5500 Topkick		
2007-2006	8 Cyl. 6.6L	RY-1697
Savana 2500		
2012-2011	8 Cyl. 6.6L	RY1866
2010	8 Cyl. 6.6L; L	RY1866
2007-2006	8 Cyl. 6.6L	RY-1697
Savana 3500		
2012-2011	8 Cyl. 6.6L	RY1866
2010	8 Cyl. 6.6L; L	RY1866
2007-2006	8 Cyl. 6.6L	RY-1697
Savana 4500		
2012-2011	8 Cyl. 6.6L	RY1866
2010	8 Cyl. 6.6L; L	RY1866
Sierra 2500 HD		
2012-2011	8 Cyl. 6.6L	RY1866
2005-2001	8 Cyl. 6.6L; w/o ULEV	RY-1556
2004-2001	8 Cyl. 6.6L; w/ ULEV	RY-1731
2004-2001	8 Cyl. 6.6L	RY-585
Sierra 3500		
2004	8 Cyl. 6.6L; 1; w/ ULEV	RY-1731
2004-2001	8 Cyl. 6.6L	RY-585
2003-2001	8 Cyl. 6.6L; w/ ULEV	RY-1731
Sierra 3500 HD		
2012-2011	8 Cyl. 6.6L	RY1866
T7500		
2009-2004	6 Cyl. 7.8L	RY1952
W3500 Forward		
2008-2007	4 Cyl. 5.2L	RY1952
W4500 Forward		
2010-2008	4 Cyl. 5.2L	RY1952
W5500 Forward		
2010-2008	4 Cyl. 5.2L	RY1952
W5500HD Forward		
2009-2008	4 Cyl. 5.2L	RY1952
Instrument Panel Wiring Harness Module		
C1500		
1986-1985	8 Cyl. 6.2L; C; w/ M.T.	RY-536
C2500		
1986-1985	8 Cyl. 6.2L; C; w/ M.T.	RY-536
Jimmy		
1986-1985	8 Cyl. 6.2L; w/ M.T.	RY-536
K1500		
1986-1985	8 Cyl. 6.2L; C; w/ M.T.	RY-536
K2500		
1986-1985	8 Cyl. 6.2L; C; w/ M.T.	RY-536
Relays and Fuses		
A/C Control Relay		
Caballero		
1984-1983	8 Cyl. 5.7L; N; Compressor Cut-Off	RY-85
ABS Warning Lamp Relay		
C2500		
1998	8 Cyl. 6.5L; 5 Pin; Exhaust stock and reorder	RY-282
1998	8 Cyl. 6.5L; 4 Pin; Alternate Number	RY-531
C3500		
1998	8 Cyl. 6.5L; 5 Pin; Exhaust stock and reorder	RY-282
1998	8 Cyl. 6.5L; 4 Pin; Alternate Number	RY-531
C3500HD		
1998	8 Cyl. 6.5L; 5 Pin; Exhaust stock and reorder	RY-282
1998	8 Cyl. 6.5L; 4 Pin; Alternate Number	RY-531

Relays and Fuses

		Part No.
ABS Warning Lamp Relay		
Yukon		
1994	8 Cyl. 6.5L; 5 Pin; Exhaust stock and reorder	RY-282
1994	8 Cyl. 6.5L; 4 Pin; Alternate Number	RY-531
Accessory Delay Relay		
Savana 2500		
2011-2008	8 Cyl. 6.6L; Black Finish	RY-280
2011-2008	8 Cyl. 6.6L; Gray	RY-601
2007-2006	8 Cyl. 6.6L	RY-604
Savana 3500		
2011-2008	8 Cyl. 6.6L; Black Finish	RY-280
2011-2008	8 Cyl. 6.6L; Gray	RY-601
2007-2006	8 Cyl. 6.6L	RY-604
Sierra 2500 HD		
2012-2011	8 Cyl. 6.6L	RY-601
Sierra 3500 HD		
2012-2011	8 Cyl. 6.6L	RY-601
Accessory Relay		
G2500		
1995	8 Cyl. 6.5L; Alternate Number	RY-116
1995	8 Cyl. 6.5L; Exhaust stock and reorder	RY30
G3500		
1995	8 Cyl. 6.5L; Alternate Number; OE No.8956002958	RY-116
1995	8 Cyl. 6.5L; Exhaust stock and reorder; OE No.8956002958	RY30
P3500		
1995	8 Cyl. 6.5L; Alternate Number; OE No.8956002958	RY-116
1995	8 Cyl. 6.5L; Exhaust stock and reorder; OE No.8956002958	RY30
Air Bag Relay		
Savana 2500		
2000	8 Cyl.	RY-280
Savana 3500		
2000	8 Cyl.	RY-280
Air Intake Heater Relay		
Sierra 2500 HD		
2004-2001	8 Cyl. 6.6L	RY-1567
Sierra 3500		
2004-2001	8 Cyl. 6.6L	RY-1567
Air Pump Relay		
C3500HD		
1998	8 Cyl.; 5 Pin; Exhaust stock and reorder	RY-282
1998	8 Cyl.; 4 Pin; Alternate Number	RY-531
Automatic Headlight Relay		
Savana 2500		
2002-2001	8 Cyl. 6.5L; w/ Off Road Lights	RY331
Savana 3500		
2002-2001	8 Cyl. 6.5L; w/ Off Road Lights	RY331
Auxiliary Battery Relay		
C1500 Suburban		
1996-1995	8 Cyl.	RY-238
C2500 Suburban		
1996-1994	8 Cyl.	RY-238
K1500 Suburban		
1996-1995	8 Cyl.	RY-238
K2500 Suburban		
1996-1994	8 Cyl.	RY-238
Yukon		
1996-1994	8 Cyl.	RY-238

		Part No.
Auxiliary Heater and A/C Control Relay		
C2500 Suburban		
1994	8 Cyl. 6.5L; w/o Skirt	RY-115
1994	8 Cyl. 6.5L; w/ Skirt	RY-242
K2500 Suburban		
1994	8 Cyl. 6.5L; w/o Skirt	RY-115
1994	8 Cyl. 6.5L; w/ Skirt	RY-242
Yukon		
1994	8 Cyl. 6.5L; w/o Skirt	RY-115
1994	8 Cyl. 6.5L; w/ Skirt	RY-242
Blower Motor Cut-Off Relay		
P2500		
1989-1984	8 Cyl. 6.2L	RY-117
P3500		
1990	4 Cyl. 3.9L	RY-117
1990-1984	8 Cyl. 6.2L	RY-117
R2500		
1987	8 Cyl. 6.2L	RY-117
Blower Motor Relay		
C1500		
1982	8 Cyl. 6.2L	RY-23
1981-1980	8 Cyl. 5.7L	RY-23
C1500 Suburban		
1982	8 Cyl. 6.2L	RY-23
1981	8 Cyl. 5.7L	RY-23
C2500		
1982	8 Cyl. 6.2L	RY-23
C2500 Suburban		
1982	8 Cyl. 6.2L	RY-23
C3500		
1982	8 Cyl. 6.2L	RY-23
Jimmy		
1982	8 Cyl. 6.2L	RY-23
K1500		
1982	8 Cyl. 6.2L	RY-23
K1500 Suburban		
1982	8 Cyl. 6.2L	RY-23
K2500		
1982	8 Cyl. 6.2L	RY-23
K2500 Suburban		
1982	8 Cyl. 6.2L	RY-23
K3500		
1982	8 Cyl. 6.2L	RY-23
P2500		
1982	8 Cyl. 6.2L	RY-23
P3500		
1982	8 Cyl. 6.2L	RY-23
Savana 2500		
2012	8 Cyl. 6.6L; Exhaust stock and reorder; w/ Auxiliary Blower	RY-282
2012	8 Cyl. 6.6L; Alternate Number; w/ Auxiliary Blower	RY-531
2010-2008	8 Cyl. 6.6L; Exhaust stock and reorder; w/ Auxiliary Blower	RY-282
2010-2008	8 Cyl. 6.6L; Alternate Number; w/ Auxiliary Blower	RY-531
Savana 3500		
2012	8 Cyl. 6.6L; Exhaust stock and reorder; w/ Auxiliary Blower	RY-282
2012	8 Cyl. 6.6L; Alternate Number; w/ Auxiliary Blower	RY-531
2010-2008	8 Cyl. 6.6L; Exhaust stock and reorder; w/ Auxiliary Blower	RY-282

Relays and Fuses

		Part No.
Blower Motor Relay		
Savana 3500		
2010-2008	8 Cyl. 6.6L; Alternate Number; w/ Auxiliary Blower	RY-531
Coolant Fan Relay		
Jimmy		
1985	8 Cyl. 6.2L	RY-109
P3500		
1995	8 Cyl. 6.5L	RY-109
Sierra 2500 HD		
2010-2008	8 Cyl. 6.6L; 4 Blade Term.	RY-280
2010-2008	8 Cyl. 6.6L; 5 Term.; 35 Amp; Daesung	RY-604
Sierra 3500 HD		
2012	8 Cyl. 6.6L; 8; Black Finish	RY-280
2012	8 Cyl. 6.6L; 8; 5 Term.; 35 Amp; Black Finish; Daesung	RY-604
2012	8 Cyl. 6.6L; L; Black Finish	RY-280
2012	8 Cyl. 6.6L; L; 5 Term.; 35 Amp; Black Finish; Daesung	RY-604
2010-2008	8 Cyl. 6.6L; 4 Term.; Black Finish	RY-280
2010-2008	8 Cyl. 6.6L; 5 Term.; 35 Amp; Black Finish; Daesung	RY-604
Cornering Lamp Relay		
Savana 2500		
2002	8 Cyl. 6.5L	RY-232
Savana 3500		
2002	8 Cyl. 6.5L	RY-232
Daytime Running Lamp Relay		
C2500		
2000-1999	8 Cyl. 6.5L	RY-232
C3500		
2000-1999	8 Cyl. 6.5L	RY-232
C3500HD		
2000-1999	8 Cyl. 6.5L	RY-232
K2500		
2000-1999	8 Cyl. 6.5L	RY-232
K3500		
2000-1999	8 Cyl. 6.5L	RY-232
Diesel Glow Plug Relay		
C1500		
1996	8 Cyl. 6.5L; Diesel; Exhaust stock and reorder	RY-383
1996	8 Cyl. 6.5L; Diesel	RY391
Sierra 2500 HD		
2006	8 Cyl. 6.6L	RY1832
Sierra 2500 HD Classic		
2007	8 Cyl. 6.6L	RY1832
Sierra 3500		
2006	8 Cyl. 6.6L	RY1832
2001	8 Cyl. 6.6L; Diesel	RY-585
Sierra 3500 Classic		
2007	8 Cyl. 6.6L	RY1832
EGR Valve Relay		
Caballero		
1983	8 Cyl. 5.7L	RY-27
Emission Control Relay		
G2500		
1984-1983	8 Cyl. 6.2L	RY35
G3500		
1984-1983	8 Cyl. 6.2L	RY35

		Part No.
Fog Lamp Relay		
C1500		
1981-1980	8 Cyl. 5.7L; Diesel; w/ Sport Package; w/o Skirt	RY-115
1981-1980	8 Cyl. 5.7L; Diesel; w/ Skirt; w/ Sport Package	RY-242
Fuel Injection Cold Advance Solenoid Relay		
Jimmy		
1990	8 Cyl. 6.2L	RY-109
R1500 Suburban		
1990-1989	8 Cyl. 6.2L	RY-109
R2500 Suburban		
1990-1989	8 Cyl. 6.2L	RY-109
V1500 Suburban		
1990-1989	8 Cyl. 6.2L	RY-109
V2500 Suburban		
1990-1989	8 Cyl. 6.2L	RY-109
Fuel Injection Pump Relay		
C2500		
2000	8 Cyl. 6.5L; 5 Pin; Exhaust stock and reorder	RY-282
2000	8 Cyl. 6.5L; 4 Pin; Alternate Number	RY-531
C3500		
2000	8 Cyl. 6.5L; 5 Pin; Exhaust stock and reorder	RY-282
2000	8 Cyl. 6.5L; 4 Pin; Alternate Number	RY-531
C3500HD		
2002-2000	8 Cyl. 6.5L; 5 Pin; Exhaust stock and reorder	RY-282
2002-2000	8 Cyl. 6.5L; 4 Pin; Alternate Number	RY-531
K2500		
2000	8 Cyl. 6.5L; 5 Pin; Exhaust stock and reorder	RY-282
2000	8 Cyl. 6.5L; 4 Pin; Alternate Number	RY-531
K3500		
2000	8 Cyl. 6.5L; 5 Pin; Exhaust stock and reorder	RY-282
2000	8 Cyl. 6.5L; 4 Pin; Alternate Number	RY-531
S15		
1985	4 Cyl. 2.2L	HR-151
Sierra 2500 HD		
2002-2001	8 Cyl. 6.6L; 5 Pin; Exhaust stock and reorder	RY-282
2002-2001	8 Cyl. 6.6L; 4 Pin; Alternate Number	RY-531
Sierra 3500		
2002-2001	8 Cyl. 6.6L; 5 Pin; Exhaust stock and reorder	RY-282
2002-2001	8 Cyl. 6.6L; 4 Pin; Alternate Number	RY-531
Fuel Pump Relay		
C2500		
2000-1999	8 Cyl. 6.5L	RY-604
C3500		
2000-1999	8 Cyl. 6.5L	RY-604
C3500HD		
2002-1999	8 Cyl. 6.5L	RY-604
Caballero		
1984	8 Cyl. 5.7L; N	RY-85
K2500		
2000-1999	8 Cyl. 6.5L	RY-604
K3500		
2000-1999	8 Cyl. 6.5L	RY-604
Sierra 2500 HD		
2007	8 Cyl. 6.6L	RY-601
2002-2001	8 Cyl. 6.6L	RY-604

Relays and Fuses

		Part No.
Fuel Pump Relay		
Sierra 3500		
2002-2001	8 Cyl. 6.6L	RY-604
Sierra 3500 Classic		
2007	8 Cyl. 6.6L	RY-601
Sierra 3500 HD		
2007	8 Cyl. 6.6L	RY-601
Hazard Flasher		
C2500		
2000-1999	8 Cyl. 6.5L	EFL-6
C3500		
2000-1999	8 Cyl. 6.5L	EFL-6
C3500HD		
2000-1999	8 Cyl. 6.5L	EFL-6
K2500		
2000-1999	8 Cyl. 6.5L	EFL-6
K3500		
2000-1999	8 Cyl. 6.5L	EFL-6
Headlight Relay		
Sierra 2500 HD		
2008	8 Cyl. 6.6L; Black Finish; Low Beam	RY-280
2008	8 Cyl. 6.6L; Gray; Low Beam	RY-601
Sierra 3500 HD		
2008	8 Cyl. 6.6L; Black Finish; Low Beam	RY-280
2008	8 Cyl. 6.6L; Gray; Low Beam	RY-601
Ignition Relay		
Sierra 2500 HD		
2011-2008	8 Cyl. 6.6L	RY-280
2007	8 Cyl.; Square Relay	RY-280
2007	8 Cyl.; Rectangular Relay	RY-601
2005-2004	8 Cyl. 6.6L	RY-280
Sierra 3500		
2005-2004	8 Cyl. 6.6L	RY-280
Sierra 3500 HD		
2011-2008	8 Cyl. 6.6L	RY-280
Low Fuel Relay		
S15		
1985-1984	4 Cyl. 2.2L; S	HR-151
Parking Lamp Relay		
Sierra 2500 HD		
2011-2008	8 Cyl. 6.6L	RY-280
2007	8 Cyl. 6.6L; Black Finish	RY-280
2007	8 Cyl. 6.6L; Gray	RY-601
2005-2003	8 Cyl. 6.6L	RY-280
Sierra 3500		
2005-2003	8 Cyl. 6.6L	RY-280
Sierra 3500 HD		
2011-2008	8 Cyl. 6.6L	RY-280
2007	8 Cyl. 6.6L; Black Finish	RY-280
2007	8 Cyl. 6.6L; Gray	RY-601
Power Door Lock Relay		
Savana 2500		
2008	8 Cyl. 6.6L	RY-612
Savana 3500		
2008	8 Cyl. 6.6L	RY-612
Power Window Relay		
Sierra 2500 HD		
2012-2011	8 Cyl. 6.6L; 5 Pin; Exhaust stock and reorder; For Power Rear Sliding Window	RY-282
2012-2011	8 Cyl. 6.6L; 4 Pin; Alternate Number; For Power Rear Sliding Window	RY-531

		Part No.
Power Window Relay		
Sierra 3500 HD		
2012-2011	8 Cyl. 6.6L; 5 Pin; Exhaust stock and reorder; For Power Rear Sliding Window	RY-282
2012-2011	8 Cyl. 6.6L; 4 Pin; Alternate Number; For Power Rear Sliding Window	RY-531
Starter Relay		
P3500		
1995-1994	8 Cyl. 6.5L	RY-109
1993-1991	8 Cyl. 6.2L	RY-109
Savana 2500		
2011-2010	8 Cyl. 6.6L	RY-601
Savana 3500		
2011-2010	8 Cyl. 6.6L	RY-601
Theft Deterrent Relay		
Savana 2500		
2001-2000	8 Cyl. 6.5L; 5 Pin; Exhaust stock and reorder	RY-282
2001-2000	8 Cyl. 6.5L; 4 Pin; Alternate Number	RY-531
Savana 3500		
2001-2000	8 Cyl. 6.5L; 5 Pin; Exhaust stock and reorder	RY-282
2001-2000	8 Cyl. 6.5L; 4 Pin; Alternate Number	RY-531
Sierra 2500 HD		
2002-2001	8 Cyl. 6.6L; 5 Pin; Exhaust stock and reorder	RY-282
2002-2001	8 Cyl. 6.6L; 4 Pin; Alternate Number	RY-531
Sierra 3500		
2002	8 Cyl. 6.6L; 5 Pin; Exhaust stock and reorder	RY-282
2002	8 Cyl. 6.6L; 4 Pin; Alternate Number	RY-531
Transfer Case Relay		
K3500		
2000-1998	8 Cyl. 6.5L	RY-1625
1996	8 Cyl. 6.5L	RY-1625
Water In Fuel Indicator Relay		
C1500		
1980	8 Cyl. 5.7L; Diesel	RY-43
S15		
1985-1984	4 Cyl. 2.2L; Diesel	HR-151
Starting and Charging System Parts		
Starter Solenoid		
C1500		
1997-1994	8 Cyl. 6.5L; Diesel	SS-337
1993-1992	8 Cyl. 6.2L; Diesel	SS-337
1991-1988	8 Cyl. 6.2L; 4 Term.; 12 Volt	SS-200
1986-1983	8 Cyl. 6.2L; 24 Volt; OE No. 1113591, 1998454	SS-367
1986-1982	8 Cyl. 6.2L; 4 Term.; 12 Volt	SS-200
1981-1980	8 Cyl.	SS-200
C1500 Suburban		
1999-1995	8 Cyl. 6.5L; Diesel	SS-337
1986-1982	8 Cyl. 6.2L; 4 Term.; 12 Volt	SS-200
1985-1984	8 Cyl. 6.2L; 24 Volt; OE No. 1113591, 1998454	SS-367
1981-1980	8 Cyl.	SS-200
C2500		
2000-1993	8 Cyl. 6.5L; Diesel	SS-337
1993	8 Cyl. 6.2L; Diesel	SS-337
1992	8 Cyl. 6.5L	SS-337
1991-1988	8 Cyl. 6.2L; 4 Term.; 12 Volt	SS-200
1986-1983	8 Cyl. 6.2L; 24 Volt; OE No. 1113591, 1998454	SS-367
1986-1982	8 Cyl. 6.2L; 4 Term.; 12 Volt	SS-200

Starting and Charging System Parts

		Part No.
Starter Solenoid		
C2500 Suburban		
1984-1982	8 Cyl. 6.2L; 4 Term.; 12 Volt	SS-200
1980	8 Cyl. 5.7L	SS-200
C3500		
2000-1992	8 Cyl. 6.5L; Diesel	SS-337
1993-1992	8 Cyl. 6.2L; Diesel	SS-337
1991-1988	8 Cyl. 6.2L; 4 Term.; 12 Volt	SS-200
1986-1983	8 Cyl. 6.2L; 24 Volt; OE No. 1113591, 1998454	SS-367
1986-1982	8 Cyl. 6.2L; 4 Term.; 12 Volt	SS-200
C3500HD		
2001-1992	8 Cyl. 6.5L; Diesel	SS-337
Caballero		
1984	8 Cyl. 5.7L ⁶	SS-251
G2500		
1995-1994	8 Cyl. 6.5L; Diesel	SS-337
1993-1992	8 Cyl. 6.2L; Diesel	SS-337
1991-1983	8 Cyl. 6.2L; 4 Term.; 12 Volt	SS-200
1985-1984	8 Cyl. 6.2L; 24 Volt; OE No. 1113591, 1998454	SS-367
G3500		
1996-1994	8 Cyl. 6.5L; Diesel	SS-337
1993-1992	8 Cyl. 6.2L; Diesel	SS-337
1991-1990	8 Cyl. 6.2L; 4 Term.; 12 Volt	SS-200
1988-1983	8 Cyl. 6.2L; 4 Term.; 12 Volt	SS-200
1985-1984	8 Cyl. 6.2L; 24 Volt; OE No. 1113591, 1998454	SS-367
Jimmy		
1991-1982	8 Cyl. 6.2L; 4 Term.; 12 Volt	SS-200
1985-1984	8 Cyl. 6.2L; 24 Volt; OE No. 1113591, 1998454	SS-367
K1500		
1998-1994	8 Cyl. 6.5L; Diesel	SS-337
1993-1992	8 Cyl. 6.2L; Diesel	SS-337
1991-1988	8 Cyl. 6.2L; 4 Term.; 12 Volt	SS-200
1986-1983	8 Cyl. 6.2L; 24 Volt; OE No. 1113591, 1998454	SS-367
1986-1982	8 Cyl. 6.2L; 4 Term.; 12 Volt	SS-200
K1500 Suburban		
1999-1995	8 Cyl. 6.5L; Diesel	SS-337
1984-1982	8 Cyl. 6.2L; 4 Term.; 12 Volt	SS-200
K2500		
2000-1992	8 Cyl. 6.5L; Diesel	SS-337
1993-1992	8 Cyl. 6.2L; Diesel	SS-337
1991-1988	8 Cyl. 6.2L; 4 Term.; 12 Volt	SS-200
1986-1983	8 Cyl. 6.2L; 24 Volt; OE No. 1113591, 1998454	SS-367
1986-1982	8 Cyl. 6.2L; 4 Term.; 12 Volt	SS-200
K2500 Suburban		
1999-1994	8 Cyl. 6.5L; Diesel	SS-337
1984-1982	8 Cyl. 6.2L; 4 Term.; 12 Volt	SS-200
K3500		
2000-1992	8 Cyl. 6.5L; Diesel	SS-337
1993-1992	8 Cyl. 6.2L; Diesel	SS-337
1991-1988	8 Cyl. 6.2L; 4 Term.; 12 Volt	SS-200
1986-1983	8 Cyl. 6.2L; 24 Volt; OE No. 1113591, 1998454	SS-367
1986-1982	8 Cyl. 6.2L; 4 Term.; 12 Volt	SS-200
P2500		
1989-1983	8 Cyl. 6.2L; 4 Term.; 12 Volt	SS-200
1985-1984	8 Cyl. 6.2L; 24 Volt; OE No. 1113591, 1998454	SS-367
P3500		
1999-1994	8 Cyl. 6.5L; Diesel	SS-337

		Part No.
Starter Solenoid		
P3500		
1993	8 Cyl. 6.2L; Diesel	SS-337
1991	8 Cyl. 6.2L; Diesel	SS-337
1988-1983	8 Cyl. 6.2L; 4 Term.; 12 Volt	SS-200
1985-1984	8 Cyl. 6.2L; 24 Volt; OE No. 1113591, 1998454	SS-367
R1500		
1987	8 Cyl. 6.2L; 4 Term.; 12 Volt	SS-200
R1500 Suburban		
1989-1987	8 Cyl. 6.2L; 4 Term.; 12 Volt	SS-200
R2500		
1988-1987	8 Cyl. 6.2L; 4 Term.; 12 Volt	SS-200
R2500 Suburban		
1988-1987	8 Cyl. 6.2L; 4 Term.; 12 Volt	SS-200
R3500		
1988-1987	8 Cyl. 6.2L; 4 Term.; 12 Volt	SS-200
S15		
1985-1984	4 Cyl. 2.2L; 4 Term.	SS-200
Savana 2500		
2010-2007	8 Cyl. 6.6L	SS868
2006	8 Cyl. 6.6L	SS874
2000-1996	8 Cyl. 6.5L; Diesel	SS-337
Savana 3500		
2010-2008	8 Cyl. 6.6L	SS868
2007-2006	8 Cyl. 6.6L	SS874
2000-1996	8 Cyl. 6.5L; Diesel	SS-337
Sierra 2500 HD		
2010-2004	8 Cyl. 6.6L	SS868
Sierra 3500		
2002-2001	8 Cyl. 6.6L	SS869
Sierra 3500 HD		
2010-2007	8 Cyl. 6.6L	SS868
T6500		
2001-1999	Starter Mounted	SS-357
T7500		
2001-1999	Starter Mounted	SS-357
V1500		
1987	8 Cyl. 6.2L; 4 Term.; 12 Volt	SS-200
V1500 Suburban		
1989-1987	8 Cyl. 6.2L; 4 Term.; 12 Volt	SS-200
V2500		
1987	8 Cyl. 6.2L; 4 Term.; 12 Volt	SS-200
V2500 Suburban		
1988-1987	8 Cyl. 6.2L; 4 Term.; 12 Volt	SS-200
V3500		
1988-1987	8 Cyl. 6.2L; 4 Term.; 12 Volt	SS-200
Yukon		
1997-1994	8 Cyl. 6.5L; Diesel	SS-337
Air Injection and Induction Parts		
Diesel Air Intake Heater		
C4500 Topkick		
2009-2006	8 Cyl. 6.6L	DIH12
2004-2003	8 Cyl. 6.6L	DIH4
C5500 Topkick		
2009-2006	8 Cyl. 6.6L	DIH12
2004-2003	8 Cyl. 6.6L	DIH4
Savana 2500		
2016-2011	8 Cyl. 6.6L	DIH6
2010	8 Cyl. 6.6L; 6	DIH12
2010	8 Cyl. 6.6L; L	DIH6
2009-2006	8 Cyl. 6.6L	DIH12

⁶ Use Heavy Duty Version Only

Air Injection and Induction Parts

		Part No.
Diesel Air Intake Heater		
Savana 3500		
2016-2011	8 Cyl. 6.6L	DIH6
2010	8 Cyl. 6.6L; 6	DIH12
2010	8 Cyl. 6.6L; L	DIH6
2009-2006	8 Cyl. 6.6L	DIH12
Savana 4500		
2009	8 Cyl. 6.6L	DIH12
Sierra 2500 HD		
2016-2011	8 Cyl. 6.6L	DIH5
2010-2007	8 Cyl. 6.6L	DIH7
2006	8 Cyl. 6.6L	DIH8
2004-2001	8 Cyl. 6.6L	DIH4
Sierra 3500		
2006	8 Cyl. 6.6L	DIH8
2004-2001	8 Cyl. 6.6L	DIH4
Sierra 3500 Classic		
2007	8 Cyl. 6.6L	DIH8
Sierra 3500 HD		
2016-2011	8 Cyl. 6.6L	DIH5
2010-2007	8 Cyl. 6.6L	DIH7
Fuel Injection Throttle Body		
Savana 2500		
2016-2009	8 Cyl. 6.6L	S20063
Savana 3500		
2016-2009	8 Cyl. 6.6L	S20063
Sierra 2500 HD		
2013-2011	8 Cyl. 6.6L; Diesel	S20084
2010-2007	8 Cyl. 6.6L	S20430
Sierra 3500 HD		
2013-2011	8 Cyl. 6.6L; Diesel	S20084
2010-2007	8 Cyl. 6.6L	S20430
Manifold Air Tube		
C1500		
1985	8 Cyl. 6.2L; Fed.; High Altitude; Left	AT132
1984	8 Cyl. 6.2L; Left	AT132
1981	8 Cyl. 5.7L; Right	AT126
1981	8 Cyl. 5.7L; Left	AT132
1980	8 Cyl. 5.7L; Right	AT123
1980	8 Cyl. 5.7L; Left	AT148
C1500 Suburban		
1985-1984	8 Cyl. 6.2L; Left	AT132
1981	8 Cyl. 5.7L; Right	AT126
1981	8 Cyl. 5.7L; Left	AT132
1980	8 Cyl. 5.7L; Right	AT123
1980	8 Cyl. 5.7L; Left	AT148
C2500		
1992	8 Cyl. 6.2L; Calif.; Left	AT132
1985-1984	8 Cyl. 6.2L; Left	AT132
C2500 Suburban		
1985-1984	8 Cyl. 6.2L; Left	AT132
1980	8 Cyl. 5.7L; Right	AT123
1980	8 Cyl. 5.7L; Left	AT148
C3500		
1985-1984	8 Cyl. 6.2L; Left	AT132
Jimmy		
1985-1984	8 Cyl. 6.2L; Left	AT132
K1500		
1985-1984	8 Cyl. 6.2L; Left	AT132
K1500 Suburban		
1985-1984	8 Cyl. 6.2L; Left	AT132
K2500		
1985-1984	8 Cyl. 6.2L; Left	AT132

		Part No.
Manifold Air Tube		
K2500 Suburban		
1985-1984	8 Cyl. 6.2L; Left	AT132
K3500		
1985-1984	8 Cyl. 6.2L; Left	AT132
Turbocharger - New		
C1500		
1997-1996	8 Cyl. 6.5L; Turbocharged	TBC690
1995-1994	8 Cyl. 6.5L; S; Turbocharged	TBC689
C1500 Suburban		
1995	8 Cyl. 6.5L; F; Turbocharged	TBC689
C2500		
2000-1996	8 Cyl. 6.5L; Turbocharged	TBC690
1995	8 Cyl. 6.5L; Turbocharged	TBC689
1994	8 Cyl. 6.5L; S; Turbocharged	TBC689
C2500 Suburban		
1995	8 Cyl. 6.5L; F; Turbocharged	TBC689
1994	8 Cyl. 6.5L; Turbocharged	TBC689
C3500		
2000-1996	8 Cyl. 6.5L; Turbocharged	TBC690
1995-1994	8 Cyl. 6.5L; Turbocharged	TBC689
C3500HD		
2002-1995	8 Cyl. 6.5L; Turbocharged	TBC690
K1500		
1998-1996	8 Cyl. 6.5L; Turbocharged	TBC690
1995-1994	8 Cyl. 6.5L; S; Turbocharged	TBC689
K1500 Suburban		
1995	8 Cyl. 6.5L; F; Turbocharged	TBC689
K2500		
2000-1996	8 Cyl. 6.5L; Turbocharged	TBC690
1995	8 Cyl. 6.5L; Turbocharged	TBC689
1994	8 Cyl. 6.5L; S; Turbocharged	TBC689
K2500 Suburban		
1995	8 Cyl. 6.5L; F; Turbocharged	TBC689
1994	8 Cyl. 6.5L; Turbocharged	TBC689
K3500		
2000-1996	8 Cyl. 6.5L; Turbocharged	TBC690
1995-1994	8 Cyl. 6.5L; Turbocharged	TBC689
P3500		
1999-1997	8 Cyl. 6.5L; Turbocharged	TBC689
Savana 2500		
2002-1996	8 Cyl. 6.5L; Turbocharged	TBC689
Savana 3500		
2002-1996	8 Cyl. 6.5L; Turbocharged	TBC689
Sierra 2500 HD		
2004	8 Cyl. 6.6L; 1; Fed.; Turbocharged	TBC705
2003-2002	8 Cyl. 6.6L; Fed.; Turbocharged	TBC705
Sierra 3500		
2004	8 Cyl. 6.6L; 1; Fed.; Turbocharged	TBC705
2003-2002	8 Cyl. 6.6L; Fed.; Turbocharged	TBC705
Yukon		
1995	8 Cyl. 6.5L; S; Turbocharged	TBC689
1994	8 Cyl. 6.5L; Turbocharged	TBC689
Turbocharger - Remfd		
C1500		
1997-1996	8 Cyl. 6.5L; Turbocharged	TBC-517
1995-1994	8 Cyl. 6.5L; S; Turbocharged	TBC-516
C1500 Suburban		
1995	8 Cyl. 6.5L; F; Turbocharged	TBC-516
C2500		
2000-1996	8 Cyl. 6.5L; Turbocharged	TBC-517
1995	8 Cyl. 6.5L; Turbocharged	TBC-516
1994	8 Cyl. 6.5L; S; Turbocharged	TBC-516

Air Injection and Induction Parts

		Part No.
Turbocharger - Remfd		
C2500 Suburban		
1995	8 Cyl. 6.5L; F; Turbocharged	TBC-516
1994	8 Cyl. 6.5L; Turbocharged	TBC-516
C3500		
2000-1996	8 Cyl. 6.5L; Turbocharged	TBC-517
1995-1994	8 Cyl. 6.5L; Turbocharged	TBC-516
C3500HD		
2002-1995	8 Cyl. 6.5L; Turbocharged	TBC-517
K1500		
1998-1996	8 Cyl. 6.5L; Turbocharged	TBC-517
1995-1994	8 Cyl. 6.5L; S; Turbocharged	TBC-516
K1500 Suburban		
1995	8 Cyl. 6.5L; F; Turbocharged	TBC-516
K2500		
2000-1996	8 Cyl. 6.5L; Turbocharged	TBC-517
1995	8 Cyl. 6.5L; Turbocharged	TBC-516
1994	8 Cyl. 6.5L; S; Turbocharged	TBC-516
K2500 Suburban		
1995	8 Cyl. 6.5L; F; Turbocharged	TBC-516
1994	8 Cyl. 6.5L; Turbocharged	TBC-516
K3500		
2000-1996	8 Cyl. 6.5L; Turbocharged	TBC-517
1995-1994	8 Cyl. 6.5L; Turbocharged	TBC-516
P3500		
1999-1997	8 Cyl. 6.5L; Turbocharged	TBC-516
Savana 2500		
2011	8 Cyl. 6.6L; Turbocharged	TBC577
2010	8 Cyl. 6.6L; 6; Turbocharged	TBC563
2009-2008	8 Cyl. 6.6L; Turbocharged	TBC563
2007	8 Cyl. 6.6L; 2; Turbocharged	TBC561
2007	8 Cyl. 6.6L; 6; Turbocharged	TBC563
2006	8 Cyl. 6.6L; Turbocharged	TBC561
2002-1996	8 Cyl. 6.5L; Turbocharged	TBC-516
Savana 3500		
2011	8 Cyl. 6.6L; Turbocharged	TBC577
2010	8 Cyl. 6.6L; 6; Turbocharged	TBC563
2009-2008	8 Cyl. 6.6L; Turbocharged	TBC563
2007	8 Cyl. 6.6L; 2; Turbocharged	TBC561
2007	8 Cyl. 6.6L; 6; Turbocharged	TBC563
2006	8 Cyl. 6.6L; Turbocharged	TBC561
2002-1996	8 Cyl. 6.5L; Turbocharged	TBC-516
Savana 4500		
2011	8 Cyl. 6.6L; Turbocharged	TBC577
2010	8 Cyl. 6.6L; 6; Turbocharged	TBC563
2009	8 Cyl. 6.6L; Turbocharged	TBC563
Sierra 2500 HD		
2016-2013	8 Cyl. 6.6L; Turbocharged	TBC603
2012-2011	8 Cyl. 6.6L; 8; Turbocharged	TBC603
2010-2007	8 Cyl. 6.6L; Turbocharged	TBC563
2006	8 Cyl. 6.6L; Turbocharged	TBC561
2005	8 Cyl. 6.6L; Turbocharged	TBC562
2004	8 Cyl. 6.6L; 1; Calif.; Turbocharged	TBC573
2004	8 Cyl. 6.6L; 1; Fed.; Turbocharged	TBC574
2004	8 Cyl. 6.6L; 2; Turbocharged	TBC562
2003-2002	8 Cyl. 6.6L; Calif.; Turbocharged	TBC573
2003-2002	8 Cyl. 6.6L; Fed.; Turbocharged	TBC574
Sierra 2500 HD Classic		
2007	8 Cyl. 6.6L; Turbocharged	TBC561
Sierra 3500		
2006	8 Cyl. 6.6L; Turbocharged	TBC561
2005	8 Cyl. 6.6L; Turbocharged	TBC562
2004	8 Cyl. 6.6L; 1; Calif.; Turbocharged	TBC573
2004	8 Cyl. 6.6L; 1; Fed.; Turbocharged	TBC574

		Part No.
Turbocharger - Remfd		
Sierra 3500		
2004	8 Cyl. 6.6L; 2; Turbocharged	TBC562
2003-2002	8 Cyl. 6.6L; Calif.; Turbocharged	TBC573
2003-2002	8 Cyl. 6.6L; Fed.; Turbocharged	TBC574
Sierra 3500 Classic		
2007	8 Cyl. 6.6L; Turbocharged	TBC561
Sierra 3500 HD		
2016-2013	8 Cyl. 6.6L; Turbocharged	TBC603
2012-2011	8 Cyl. 6.6L; 8; Turbocharged	TBC603
2010-2007	8 Cyl. 6.6L; Turbocharged	TBC563
Yukon		
1995	8 Cyl. 6.5L; S; Turbocharged	TBC-516
1994	8 Cyl. 6.5L; Turbocharged	TBC-516
Vacuum Motor		
C1500		
1988	8 Cyl.	VA5
1985	8 Cyl.	VA5
1981-1980	8 Cyl. 5.7L	VA5
C1500 Suburban		
1985	8 Cyl.	VA5
1981-1980	8 Cyl. 5.7L	VA5
Caballero		
1984-1983	8 Cyl. 5.7L	VA5
G2500		
1988	8 Cyl.	VA5
1985	8 Cyl.	VA5
G3500		
1988	8 Cyl.	VA5
1985	8 Cyl.	VA5
Jimmy		
1988	8 Cyl.	VA5
1985	8 Cyl.	VA5
P2500		
1988	8 Cyl.	VA5
1985	8 Cyl.	VA5
P3500		
1988	8 Cyl.	VA5
1985	8 Cyl.	VA5
R1500 Suburban		
1988	8 Cyl.	VA5
R2500		
1988	8 Cyl.	VA5
R3500		
1988	8 Cyl.	VA5
V3500		
1988	8 Cyl.	VA5
Vacuum Pump		
C1500		
1991-1988	8 Cyl. 6.2L; Rear of Engine	VCP101
1991-1988	8 Cyl. 6.2L; w/ Manual AC; Front of Engine	VCP108
1991-1988	8 Cyl. 6.2L; w/ Auto. AC; Front of Engine	VCP114
C2500		
1991	8 Cyl. 6.2L; Rear of Engine	VCP101
1991	8 Cyl. 6.2L; w/ Manual AC; Front of Engine	VCP108
1991	8 Cyl. 6.2L; w/ Auto. AC; Front of Engine	VCP114
1989-1988	8 Cyl. 6.2L; Rear of Engine	VCP101
1989-1988	8 Cyl. 6.2L; w/ Manual AC; Front of Engine	VCP108
1989-1988	8 Cyl. 6.2L; w/ Auto. AC; Front of Engine	VCP114

Air Injection and Induction Parts

		Part No.
Vacuum Pump		
C3500		
1991-1990	8 Cyl. 6.2L; Diesel; Rear of Engine	VCP101
1991-1990	8 Cyl. 6.2L; Diesel; w/ Manual AC; Front of Engine	VCP108
1991-1990	8 Cyl. 6.2L; Diesel; w/ Auto. AC; Front of Engine	VCP114
1989-1988	8 Cyl. 6.2L; Rear of Engine	VCP101
1989-1988	8 Cyl. 6.2L; w/ Manual AC; Front of Engine	VCP108
1989-1988	8 Cyl. 6.2L; w/ Auto. AC; Front of Engine	VCP114
C4500 Topkick		
2009-2008	8 Cyl. 6.6L	VCP113
C5500 Topkick		
2009-2008	8 Cyl. 6.6L	VCP113
K1500		
1991-1988	8 Cyl. 6.2L; Diesel; Rear of Engine	VCP101
1991-1988	8 Cyl. 6.2L; Diesel; w/ Manual AC; Front of Engine	VCP108
1991-1988	8 Cyl. 6.2L; Diesel; w/ Auto. AC; Front of Engine	VCP114
K2500		
1991-1988	8 Cyl. 6.2L; Rear of Engine	VCP101
1991-1988	8 Cyl. 6.2L; w/ Manual AC; Front of Engine	VCP108
1991-1988	8 Cyl. 6.2L; w/ Auto. AC; Front of Engine	VCP114
K3500		
1991-1988	8 Cyl. 6.2L; Rear of Engine	VCP101
1991-1988	8 Cyl. 6.2L; w/ Manual AC; Front of Engine	VCP108
1991-1988	8 Cyl. 6.2L; w/ Auto. AC; Front of Engine	VCP114
R2500		
1989-1988	8 Cyl. 6.2L; Rear of Engine	VCP101
1989-1988	8 Cyl. 6.2L; w/ Manual AC; Front of Engine	VCP108
1989-1988	8 Cyl. 6.2L; w/ Auto. AC; Front of Engine	VCP114
R3500		
1991-1988	8 Cyl. 6.2L; Rear of Engine	VCP101
1991-1988	8 Cyl. 6.2L; w/ Manual AC; Front of Engine	VCP108
1991-1988	8 Cyl. 6.2L; w/ Auto. AC; Front of Engine	VCP114
Savana 2500		
2016-2006	8 Cyl. 6.6L	VCP113
Savana 3500		
2016-2006	8 Cyl. 6.6L	VCP113
V3500		
1991-1988	8 Cyl. 6.2L; Rear of Engine	VCP101
1991-1988	8 Cyl. 6.2L; w/ Manual AC; Front of Engine	VCP108
1991-1988	8 Cyl. 6.2L; w/ Auto. AC; Front of Engine	VCP114
Air Management Valves		
Air Cleaner Check Valve		
C1500		
1986-1985	8 Cyl. 6.2L	AV7
C1500 Suburban		
1998	8 Cyl. 6.5L	AV7
C2500		
1998	8 Cyl. 6.5L	AV7
1986-1985	8 Cyl. 6.2L	AV7
C3500		
1986-1985	8 Cyl. 6.2L	AV7
C3500HD		
2000	8 Cyl. 6.5L; Mounted on Air Tube	AV56
G2500		
1989-1988	8 Cyl.	AV7

		Part No.
Air Cleaner Check Valve		
G3500		
1989	8 Cyl.	AV7
1988	8 Cyl.	AV34
K1500		
1998	8 Cyl. 6.5L	AV7
1986-1985	8 Cyl. 6.2L	AV7
K2500		
1998	8 Cyl. 6.5L	AV7
1986-1985	8 Cyl. 6.2L	AV7
K2500 Suburban		
1985	8 Cyl. 6.2L	AV7
K3500		
1998	8 Cyl. 6.5L	AV7
1986	8 Cyl. 6.2L	AV7
P2500		
1989-1988	8 Cyl.	AV7
1985-1982	8 Cyl.	AV7
P3500		
1989-1988	8 Cyl.	AV7
1987-1982	8 Cyl. 6.2L	AV7
S15		
1985-1984	4 Cyl. 2.2L	AV7
Diverter Valve		
C1500		
1981-1980	8 Cyl. 5.7L	DV66
Caballero		
1984	8 Cyl. 5.7L; w/ Deceleration Valve	DV28
1984	8 Cyl. 5.7L; w/o Deceleration Valve	DV32
1983	8 Cyl. 5.7L; w/ Deceleration Valve	DV121
1983	8 Cyl. 5.7L; w/o Deceleration Valve	DV18
G2500		
1984	8 Cyl. 6.2L	DV33
G3500		
1984	8 Cyl. 6.2L; Diesel	DV33
Savana 2500		
2001	8 Cyl. 6.5L	DV130
Savana 3500		
2001	8 Cyl. 6.5L	DV130
Idle Air Control Valve		
K2500 Suburban		
1998-1997	8 Cyl. 6.5L; 10mm Dia. Pintle	AC6
Turbocharger Actuator		
C4500 Topkick		
2009-2006	8 Cyl. 6.6L; Turbocharged	TBA2
Savana 2500		
2016-2006	8 Cyl. 6.6L; Turbocharged	TBA2
Savana 3500		
2016-2006	8 Cyl. 6.6L; Turbocharged	TBA2
Savana 4500		
2016-2009	8 Cyl. 6.6L; Turbocharged	TBA2
Sierra 2500 HD		
2016-2006	8 Cyl. 6.6L; Turbocharged	TBA2
Sierra 3500		
2006	8 Cyl. 6.6L; Turbocharged	TBA2
Sierra 3500 Classic		
2007	8 Cyl. 6.6L; Turbocharged	TBA2
Sierra 3500 HD		
2016-2007	8 Cyl. 6.6L; Turbocharged	TBA2
Vacuum Delay Valve		
C1500		
1981-1980	8 Cyl. 5.7L; 4 Ports; Black and Red	DSV11

Air Management Valves

		Part No.
Vacuum Delay Valve		
C1500		
1981-1980	8 Cyl. 5.7L; Black and White	DSV16
1981-1980	8 Cyl. 5.7L; 2 Ports; Black and Yellow	DSV19
C1500 Suburban		
1981	8 Cyl. 5.7L; Black and White	DSV16
1981-1980	8 Cyl. 5.7L; 4 Ports; Black and Red	DSV11
1981-1980	8 Cyl. 5.7L; 2 Ports; Black and Yellow	DSV19
Caballero		
1984	8 Cyl. 5.7L; Black and Gray	DSV14
1984-1983	8 Cyl. 5.7L; Black and Yellow	DSV19
1983	8 Cyl. 5.7L; Black and White	DSV16
Air Management Regulators and Solenoids		
Idle Stop Solenoid		
C1500		
1989	8 Cyl. 6.2L	ES155
1988	8 Cyl. 6.2L; Diesel; OE No. 14066255	ES155
1986-1982	8 Cyl. 6.2L; OE No. 14066255	ES155
1981	8 Cyl. 5.7L; Spade Term., w/o Bracket	ES9
1980	8 Cyl. 5.7L	ES110
C1500 Suburban		
1986-1982	8 Cyl. 6.2L; OE No. 14066255	ES155
1981-1980	8 Cyl. 5.7L; Spade Term., w/o Bracket	ES9
C2500		
1995-1994	8 Cyl. 6.5L; Diesel; OE No. 14066255	ES155
1989	8 Cyl. 6.2L	ES155
1988	8 Cyl. 6.2L; Diesel; OE No. 14066255	ES155
1986-1982	8 Cyl. 6.2L; OE No. 14066255	ES155
C2500 Suburban		
1995-1994	8 Cyl. 6.5L; Diesel; OE No. 14066255	ES155
1983-1982	8 Cyl. 6.2L; OE No. 14066255	ES155
1980	8 Cyl. 5.7L; Spade Term., w/o Bracket	ES9
C3500		
1995-1994	8 Cyl. 6.5L; Diesel; OE No. 14066255	ES155
1989	8 Cyl. 6.2L	ES155
1988	8 Cyl. 6.2L; Diesel; OE No. 14066255	ES155
1986-1982	8 Cyl. 6.2L; OE No. 14066255	ES155
C3500HD		
1995-1994	8 Cyl. 6.5L; Diesel; OE No. 14066255	ES155
Caballero		
1983	8 Cyl. 5.7L; Diesel; Spade Term., w/o Bracket	ES155
G2500		
1988-1986	8 Cyl. 6.2L; Diesel	ES155
G3500		
1989-1983	8 Cyl. 6.2L; Diesel	ES155
Jimmy		
1986-1983	8 Cyl. 6.2L	ES155
1982	8 Cyl. 6.2L; Diesel	ES155
K1500		
1989	8 Cyl. 6.2L	ES155
1988	8 Cyl. 6.2L; Diesel; OE No. 14066255	ES155
1986-1982	8 Cyl. 6.2L; OE No. 14066255	ES155
K1500 Suburban		
1983-1982	8 Cyl. 6.2L; OE No. 14066255	ES155
K2500		
1995-1994	8 Cyl. 6.5L; Diesel; OE No. 14066255	ES155
1989	8 Cyl. 6.2L	ES155
1988	8 Cyl. 6.2L; Diesel; OE No. 14066255	ES155
1986-1982	8 Cyl. 6.2L; OE No. 14066255	ES155
K2500 Suburban		
1983-1982	8 Cyl. 6.2L; OE No. 14066255	ES155

		Part No.
Idle Stop Solenoid		
K3500		
1995-1994	8 Cyl. 6.5L; Diesel; OE No. 14066255	ES155
1989	8 Cyl. 6.2L	ES155
1988	8 Cyl. 6.2L; Diesel; OE No. 14066255	ES155
1986-1982	8 Cyl. 6.2L; OE No. 14066255	ES155
P2500		
1988-1982	8 Cyl. 6.2L; Diesel	ES155
P3500		
1989-1982	8 Cyl. 6.2L; Diesel	ES155
R1500		
1987	8 Cyl. 6.2L; OE No. 14066255	ES155
R1500 Suburban		
1988-1987	8 Cyl. 6.2L; Diesel; OE No. 14066255	ES155
R2500		
1989	8 Cyl. 6.2L	ES155
1987	8 Cyl. 6.2L; OE No. 14066255	ES155
R2500 Suburban		
1989-1987	8 Cyl. 6.2L; Diesel; OE No. 14066255	ES155
R3500		
1989	8 Cyl. 6.2L; Diesel	ES155
1987	8 Cyl. 6.2L; Diesel; OE No. 14066255	ES155
V1500		
1987	8 Cyl. 6.2L; OE No. 14066255	ES155
V1500 Suburban		
1988-1987	8 Cyl. 6.2L; Diesel; OE No. 14066255	ES155
V2500		
1987	8 Cyl. 6.2L; OE No. 14066255	ES155
V2500 Suburban		
1988-1987	8 Cyl. 6.2L; Diesel; OE No. 14066255	ES155
V3500		
1989	8 Cyl. 6.2L	ES155
1987	8 Cyl. 6.2L; OE No. 14066255	ES155
Turbocharger Boost Solenoid		
C1500		
1997-1994	8 Cyl. 6.5L; Diesel; w/ Vent Filter	U43001
1997-1994	8 Cyl. 6.5L; w/o Vent Filter	VS62
C1500 Suburban		
1997	8 Cyl. 6.5L; 1st Design	VS62
1996-1995	8 Cyl. 6.5L	VS62
C2500		
1997-1994	8 Cyl. 6.5L; Diesel; w/ Vent Filter	U43001
1997-1994	8 Cyl. 6.5L; w/o Vent Filter	VS62
C2500 Suburban		
1997	8 Cyl. 6.5L; 1st Design	VS62
1996-1994	8 Cyl. 6.5L	VS62
C3500		
1997-1994	8 Cyl. 6.5L; Diesel; w/ Vent Filter	U43001
1997-1994	8 Cyl. 6.5L; w/o Vent Filter	VS62
C3500HD		
1997-1994	8 Cyl. 6.5L; Diesel; w/ Vent Filter	U43001
1997-1994	8 Cyl. 6.5L; w/o Vent Filter	VS62
G3500		
1996	8 Cyl. 6.5L; Diesel; w/ Vent Filter	U43001
1996	8 Cyl. 6.5L	VS62
K1500		
1997-1994	8 Cyl. 6.5L; Diesel; w/ Vent Filter	U43001
1997-1994	8 Cyl. 6.5L; w/o Vent Filter	VS62
K1500 Suburban		
1997	8 Cyl. 6.5L; 1st Design	VS62
1996-1995	8 Cyl. 6.5L	VS62
K2500		
1997-1994	8 Cyl. 6.5L; Diesel; w/ Vent Filter	U43001

Air Management Regulators and Solenoids

		Part No.
Turbocharger Boost Solenoid		
K2500		
1997-1994	8 Cyl. 6.5L; w/o Vent Filter	VS62
K2500 Suburban		
1997	8 Cyl. 6.5L; 1st Design	VS62
1996-1994	8 Cyl. 6.5L	VS62
K3500		
1997-1994	8 Cyl. 6.5L; Diesel; w/ Vent Filter	U43001
1997-1994	8 Cyl. 6.5L; w/o Vent Filter	VS62
P3500		
1997-1994	8 Cyl. 6.5L; Diesel; w/ Vent Filter	U43001
1997-1994	8 Cyl. 6.5L	VS62
Savana 2500		
1997-1996	8 Cyl. 6.5L; Diesel; w/ Vent Filter	U43001
1997-1996	8 Cyl. 6.5L; w/o Vent Filter	VS62
Savana 3500		
1997-1996	8 Cyl. 6.5L; Diesel; w/ Vent Filter	U43001
1997-1996	8 Cyl. 6.5L; w/o Vent Filter	VS62
Yukon		
1997	8 Cyl. 6.5L; Exc. Vent Filter Cover	VS62
1996-1994	8 Cyl. 6.5L	VS62
Early Fuel Emission Control		
Crankcase Ventilation Filter		
Caballero		
1984-1983	8 Cyl.	BF11
G2500		
1988	8 Cyl.	BF11
G3500		
1988	8 Cyl.	BF11
R1500		
1987	8 Cyl.	BF11
R2500		
1988	8 Cyl.	BF11
R3500		
1988	8 Cyl.	BF11
V3500		
1988	8 Cyl.	BF11
EGR Components		
Diesel EGR Cooler		
C4500 Topkick		
2009-2008	8 Cyl. 6.6L	ECK6
2007	8 Cyl. 6.6L; 2	ECK4
2007	8 Cyl. 6.6L; 9	ECK6
2006	8 Cyl. 6.6L	ECK4
2005	8 Cyl. 6.6L	ECK5
2004	8 Cyl. 6.6L; 2	ECK5
C5500 Topkick		
2009-2008	8 Cyl. 6.6L	ECK6
2007	8 Cyl. 6.6L; 2	ECK4
2007	8 Cyl. 6.6L; 9	ECK6
2006	8 Cyl. 6.6L	ECK4
2005	8 Cyl. 6.6L	ECK5
2004	8 Cyl. 6.6L; 2	ECK5
Savana 2500		
2010	8 Cyl. 6.6L; 6	ECK3
2009-2008	8 Cyl. 6.6L	ECK3
2007	8 Cyl. 6.6L; 6	ECK3
Savana 3500		
2010	8 Cyl. 6.6L; 6	ECK3
2009-2008	8 Cyl. 6.6L	ECK3
2007	8 Cyl. 6.6L; 6	ECK3

		Part No.
Diesel EGR Cooler		
Savana 4500		
2010	8 Cyl. 6.6L; 6	ECK3
2009	8 Cyl. 6.6L	ECK3
Sierra 2500 HD		
2010-2007	8 Cyl. 6.6L	ECK2
2006	8 Cyl. 6.6L	ECK4
2005	8 Cyl. 6.6L	ECK5
2004	8 Cyl. 6.6L; 2	ECK5
Sierra 2500 HD Classic		
2007	8 Cyl. 6.6L	ECK4
Sierra 3500		
2006	8 Cyl. 6.6L	ECK4
2005	8 Cyl. 6.6L	ECK5
2004	8 Cyl. 6.6L; 2	ECK5
Sierra 3500 Classic		
2007	8 Cyl. 6.6L	ECK4
Sierra 3500 HD		
2010-2007	8 Cyl. 6.6L	ECK2
EGR Control Solenoid		
C1500		
1997	8 Cyl. 6.5L; Exc. Vent Filter Cover	VS37
1997	8 Cyl. 6.5L; w/ Vent Filter Cover	VS76
1996-1994	8 Cyl. 6.5L; w/ White Dot	VS36
1996-1994	8 Cyl. 6.5L; w/ Red Dot	VS37
1993-1988	8 Cyl. 6.2L	VS39
C1500 Suburban		
1999-1998	8 Cyl. 6.5L	VS64
1997	8 Cyl. 6.5L; 2nd Design; Exc. Calif.; w/ Vent Filter Cover	VS76
1996	8 Cyl. 6.5L; w/ Red Dot	VS37
1996-1995	8 Cyl. 6.5L; w/ White Dot	VS36
C2500		
2000	8 Cyl. 6.5L	VS64
1999-1997	8 Cyl. 6.5L; OE No. 1997254; w/ White Dot	VS76
1997	8 Cyl. 6.5L; OE No. 1997226; w/ White Dot	VS36
1997-1994	8 Cyl. 6.5L; w/ Red Dot	VS37
1996-1994	8 Cyl. 6.5L; w/ White Dot	VS36
1993-1988	8 Cyl. 6.2L	VS39
C2500 Suburban		
1998	8 Cyl. 6.5L; Exc. Calif.	VS76
1997	8 Cyl. 6.5L; 2nd Design; Exc. Calif.; w/ Vent Filter Cover	VS76
1996	8 Cyl. 6.5L; w/ Red Dot	VS37
1996-1995	8 Cyl. 6.5L; w/ White Dot	VS36
C3500		
2000	8 Cyl. 6.5L	VS64
1998	8 Cyl. 6.5L; Exc. Calif.	VS76
1997	8 Cyl. 6.5L; 2nd Design; Exc. Calif.; w/ Vent Filter Cover	VS76
C3500HD		
2000	8 Cyl. 6.5L	VS64
1998	8 Cyl. 6.5L; Exc. Calif.	VS76
1997	8 Cyl. 6.5L; 2nd Design; Exc. Calif.; w/ Vent Filter Cover	VS76
G2500		
1995-1994	8 Cyl. 6.5L; w/ White Dot	VS36
1995-1994	8 Cyl. 6.5L; w/ Red Dot	VS37
Jimmy		
1991-1988	8 Cyl. 6.2L	VS39
1986-1984	8 Cyl.	VS33
K1500		
1998-1997	8 Cyl. 6.5L; w/ White Dot	VS76

EGR Components

		Part No.
EGR Control Solenoid		
K1500		
1997-1994	8 Cyl. 6.5L; w/ Red Dot	VS37
1996-1994	8 Cyl. 6.5L; w/ White Dot	VS36
1993-1989	8 Cyl. 6.2L	VS39
K1500 Suburban		
1998	8 Cyl. 6.5L; Exc. Calif.	VS76
1997	8 Cyl. 6.5L; 2nd Design; Exc. Calif.; w/ Vent Filter Cover	VS76
1996	8 Cyl. 6.5L; w/ Red Dot	VS37
1996-1995	8 Cyl. 6.5L; w/ White Dot	VS36
K2500		
2000	8 Cyl. 6.5L	VS64
1999-1997	8 Cyl. 6.5L; w/ White Dot	VS76
1997-1994	8 Cyl. 6.5L; w/ Red Dot	VS37
1996-1994	8 Cyl. 6.5L; w/ White Dot	VS36
1993-1989	8 Cyl. 6.2L	VS39
K2500 Suburban		
1998	8 Cyl. 6.5L; Exc. Calif.	VS76
1997	8 Cyl. 6.5L; 2nd Design; Exc. Calif.; w/ Vent Filter Cover	VS76
1996	8 Cyl. 6.5L; w/ Red Dot	VS37
1996-1995	8 Cyl. 6.5L; w/ White Dot	VS36
K3500		
2000	8 Cyl. 6.5L	VS64
1998	8 Cyl. 6.5L; Exc. Calif.	VS76
1997	8 Cyl. 6.5L; 2nd Design; Exc. Calif.; w/ Vent Filter Cover	VS76
P3500		
1998	8 Cyl. 6.5L; Exc. Calif.	VS76
1997	8 Cyl. 6.5L; 2nd Design; Exc. Calif.; w/ Vent Filter Cover	VS76
Savana 2500		
2010-2007	8 Cyl. 6.6L	VS154
1998	8 Cyl. 6.5L; Exc. Calif.	VS76
1997	8 Cyl. 6.5L; 2nd Design; Exc. Calif.; w/ Vent Filter Cover	VS76
Savana 3500		
2010-2007	8 Cyl. 6.6L	VS154
1998	8 Cyl. 6.5L; Exc. Calif.	VS76
1997	8 Cyl. 6.5L; 2nd Design; Exc. Calif.; w/ Vent Filter Cover	VS76
Sierra 2500 HD		
2007-2006	8 Cyl. 6.6L	VS154
2004-2002	8 Cyl. 6.6L	VS76
Sierra 3500		
2006	8 Cyl. 6.6L	VS154
2004-2002	8 Cyl. 6.6L	VS76
Sierra 3500 Classic		
2007	8 Cyl. 6.6L	VS154
Sierra 3500 HD		
2007	8 Cyl. 6.6L	VS154
Yukon		
1997	8 Cyl. 6.5L; OE No. 1997226; w/ White Dot	VS36
1997	8 Cyl. 6.5L; OE No. 1997225; w/ Red Dot	VS37
1997	8 Cyl. 6.5L; OE No. 1997253; w/ Red Dot	VS64
1997	8 Cyl. 6.5L; OE No. 1997254; w/ White Dot	VS76
1996-1994	8 Cyl. 6.5L; w/ White Dot	VS36
1996-1994	8 Cyl. 6.5L; w/ Red Dot	VS37
EGR Valve		
C1500		
1997-1996	8 Cyl. 6.5L	EGV512
1995-1994	8 Cyl. 6.5L; P	EGV511

		Part No.
EGR Valve		
C1500		
1995-1994	8 Cyl. 6.5L; S	EGV512
1993-1988	8 Cyl. 6.2L	EGV511
1986-1984	8 Cyl. 6.2L	EGV511
1983-1982	8 Cyl. 6.2L; C	EGV511
1980	8 Cyl. 5.7L; Calif.; OE No. 17063337, 338	EGV635
1980	8 Cyl. 5.7L; Fed.; OE No. 17063366, 367	EGV677
C1500 Suburban		
1980	8 Cyl. 5.7L; Diesel; OE No. 17063338	EGV635
C2500		
1998-1996	8 Cyl. 6.5L	EGV512
1995-1994	8 Cyl. 6.5L; S	EGV512
1994	8 Cyl. 6.5L; P	EGV511
1993-1989	8 Cyl. 6.2L; C	EGV511
1988	8 Cyl. 6.2L	EGV511
1986-1982	8 Cyl. 6.2L; C	EGV511
C2500 Suburban		
1980	8 Cyl. 5.7L; OE No. 17063339	EGV764
C3500		
1998-1997	8 Cyl. 6.5L	EGV512
C3500HD		
1998-1997	8 Cyl. 6.5L	EGV512
Canyon		
2020-2016	4 Cyl. 2.8L; Kit; w/ Plastic Housing	EGV1294
2017-2016	4 Cyl. 2.8L; w/o Plastic Housing	EGV1282
G2500		
1995-1994	8 Cyl. 6.5L	EGV511
1993-1983	8 Cyl. 6.2L	EGV511
Jimmy		
1991-1982	8 Cyl. 6.2L	EGV511
K1500		
1998-1996	8 Cyl. 6.5L	EGV512
1995-1994	8 Cyl. 6.5L; P	EGV511
1995-1994	8 Cyl. 6.5L; S	EGV512
1993-1989	8 Cyl. 6.2L	EGV511
1986-1982	8 Cyl. 6.2L	EGV511
K2500		
1998-1996	8 Cyl. 6.5L	EGV512
1995-1994	8 Cyl. 6.5L; S	EGV512
1994	8 Cyl. 6.5L; P	EGV511
1993-1989	8 Cyl. 6.2L; C	EGV511
1986-1982	8 Cyl. 6.2L; C	EGV511
K3500		
1998-1997	8 Cyl. 6.5L	EGV512
R1500		
1987	8 Cyl. 6.2L; C	EGV511
R1500 Suburban		
1991-1990	8 Cyl. 6.2L	EGV511
R2500		
1987	8 Cyl. 6.2L; C	EGV511
R2500 Suburban		
1991-1990	8 Cyl. 6.2L	EGV511
Savana 2500		
2019-2017	4 Cyl. 2.8L; Kit; w/ Plastic Housing	EGV1294
2016-2011	8 Cyl. 6.6L	EGV1219
2010	8 Cyl. 6.6L; 6; Exhaust stock and reorder	EGV1200
2010	8 Cyl. 6.6L; 6; Alternate Number	EGV803
2009-2006	8 Cyl. 6.6L	EGV803
Savana 3500		
2019-2017	4 Cyl. 2.8L; Kit; w/ Plastic Housing	EGV1294
2016-2011	8 Cyl. 6.6L	EGV1219
2010	8 Cyl. 6.6L; 6; Exhaust stock and reorder	EGV1200

EGR Components

		Part No.
EGR Valve		
Savana 3500		
2010	8 Cyl. 6.6L; 6; Alternate Number	EGV803
2009-2006	8 Cyl. 6.6L	EGV803
Savana 4500		
2016-2011	8 Cyl. 6.6L	EGV1219
2010	8 Cyl. 6.6L; 6; Exhaust stock and reorder	EGV1200
2010	8 Cyl. 6.6L; 6; Alternate Number	EGV803
2010	8 Cyl. 6.6L; L	EGV1219
2009	8 Cyl. 6.6L; Exhaust stock and reorder	EGV1200
2009	8 Cyl. 6.6L; Alternate Number	EGV803
Sierra 2500 HD		
2019-2017	8 Cyl. 6.6L	EGV1289
2016-2011	8 Cyl. 6.6L	EGV1240
2010-2006	8 Cyl. 6.6L	EGV1142
2005	8 Cyl. 6.6L	EGV801
2004	8 Cyl. 6.6L; 1	EGV802
2004	8 Cyl. 6.6L; 2	EGV801
2003-2002	8 Cyl. 6.6L	EGV802
Sierra 2500 HD Classic		
2007	8 Cyl. 6.6L	EGV1142
Sierra 3500		
2006	8 Cyl. 6.6L	EGV1142
2005	8 Cyl. 6.6L	EGV801
2004	8 Cyl. 6.6L; 1	EGV802
2004	8 Cyl. 6.6L; 2	EGV801
2003-2002	8 Cyl. 6.6L	EGV802
Sierra 3500 Classic		
2007	8 Cyl. 6.6L	EGV1142
Sierra 3500 HD		
2019-2017	8 Cyl. 6.6L	EGV1289
2016-2011	8 Cyl. 6.6L	EGV1240
2010-2007	8 Cyl. 6.6L	EGV1142
Terrain		
2019-2018	4 Cyl. 1.6L	EGV1288
V1500		
1987	8 Cyl. 6.2L; C	EGV511
V1500 Suburban		
1991-1990	8 Cyl. 6.2L	EGV511
V2500		
1987	8 Cyl. 6.2L; C	EGV511
V2500 Suburban		
1991-1990	8 Cyl. 6.2L	EGV511
Yukon		
1997-1996	8 Cyl. 6.5L	EGV512
1995-1994	8 Cyl. 6.5L; w/ A.T.	EGV512
EGR Valve Mounting Gasket		
C1500		
1997-1996	8 Cyl. 6.5L; EGR Valve	VG44
1997-1996	8 Cyl. 6.5L; EGR Pipe	VG61
1995-1994	8 Cyl. 6.5L; P	VG44
1995-1994	8 Cyl. 6.5L; S; EGR Valve	VG44
1995-1994	8 Cyl. 6.5L; S; EGR Pipe	VG61
1993-1988	8 Cyl. 6.2L	VG44
1986-1982	8 Cyl. 6.2L	VG44
1981-1980	8 Cyl. 5.7L	VG7
C1500 Suburban		
1997-1996	8 Cyl. 6.5L	VG44
1986-1985	8 Cyl. 6.2L	VG7
1980	8 Cyl. 5.7L	VG7
C2500		
1999	8 Cyl. 6.5L	VG7
1998-1996	8 Cyl. 6.5L; EGR Valve	VG44

		Part No.
EGR Valve Mounting Gasket		
C2500		
1998-1996	8 Cyl. 6.5L; EGR Pipe	VG61
1995-1994	8 Cyl. 6.5L; S; EGR Valve	VG44
1995-1994	8 Cyl. 6.5L; S; EGR Pipe	VG61
1994	8 Cyl. 6.5L; P	VG44
1993-1989	8 Cyl. 6.2L; C	VG44
1988	8 Cyl. 6.2L	VG44
1986-1982	8 Cyl. 6.2L; C	VG44
C2500 Suburban		
1997-1996	8 Cyl. 6.5L	VG44
1986	8 Cyl. 6.2L; Federal	VG7
1985	8 Cyl. 6.2L	VG7
1980	8 Cyl. 5.7L	VG7
C3500		
1999	8 Cyl. 6.5L	VG7
1998-1996	8 Cyl. 6.5L; EGR Valve	VG44
1998-1996	8 Cyl. 6.5L; EGR Pipe	VG61
1995	8 Cyl. 6.5L	VG44
C3500HD		
1999	8 Cyl. 6.5L	VG7
1998-1996	8 Cyl. 6.5L; EGR Valve	VG44
1998-1996	8 Cyl. 6.5L; EGR Pipe	VG61
1995	8 Cyl. 6.5L	VG44
Caballero		
1984-1983	8 Cyl. 5.7L	VG7
G2500		
1995-1994	8 Cyl. 6.5L	VG44
1993-1983	8 Cyl. 6.2L	VG44
G3500		
1992	8 Cyl. 6.2L	VG44
1983	8 Cyl. 6.2L	VG7
Jimmy		
1991-1982	8 Cyl. 6.2L	VG44
K1500		
1998-1996	8 Cyl. 6.5L; EGR Valve	VG44
1998-1996	8 Cyl. 6.5L; EGR Pipe	VG61
1995-1994	8 Cyl. 6.5L; P	VG44
1995-1994	8 Cyl. 6.5L; S; EGR Valve	VG44
1995-1994	8 Cyl. 6.5L; S; EGR Pipe	VG61
1993-1988	8 Cyl. 6.2L	VG44
1986-1985	8 Cyl. 6.2L; C	VG44
1984-1982	8 Cyl. 6.2L	VG44
K1500 Suburban		
1997-1996	8 Cyl. 6.5L	VG44
1986	8 Cyl. 6.2L; Federal	VG7
1985	8 Cyl. 6.2L	VG7
K2500		
1998-1996	8 Cyl. 6.5L; EGR Valve	VG44
1998-1996	8 Cyl. 6.5L; EGR Pipe	VG61
1995-1994	8 Cyl. 6.5L; S; EGR Valve	VG44
1995-1994	8 Cyl. 6.5L; S; EGR Pipe	VG61
1994	8 Cyl. 6.5L; P	VG44
1993-1988	8 Cyl. 6.2L; C	VG44
1986-1982	8 Cyl. 6.2L; C	VG44
K2500 Suburban		
1997-1996	8 Cyl. 6.5L	VG44
1986	8 Cyl. 6.2L; Federal	VG7
1985	8 Cyl. 6.2L	VG7
K3500		
1998-1996	8 Cyl. 6.5L; EGR Valve	VG44
1998-1996	8 Cyl. 6.5L; EGR Pipe	VG61
1995	8 Cyl. 6.5L	VG44

EGR Components

		Part No.
EGR Valve Mounting Gasket		
R1500		
1987	8 Cyl. 6.2L	VG44
R1500 Suburban		
1991-1990	8 Cyl. 6.2L	VG44
1989-1988	8 Cyl. 6.2L	VG7
R2500		
1987	8 Cyl. 6.2L; C	VG44
R2500 Suburban		
1991-1988	8 Cyl. 6.2L	VG7
Savana 2500		
2016-2011	8 Cyl. 6.6L; Intake	VG246
2016-2011	8 Cyl. 6.6L; EGR to Cooler	VG247
2010	8 Cyl. 6.6L; 6	VG257
2009-2008	8 Cyl. 6.6L; Diesel	VG257
2007-2006	8 Cyl. 6.6L; EGR to Cooler	VG123
2007-2006	8 Cyl. 6.6L; By Middle of EGR	VG125
2007-2006	8 Cyl. 6.6L; EGR To Intake Pipe	VG126
Savana 3500		
2016-2011	8 Cyl. 6.6L; Intake	VG246
2016-2011	8 Cyl. 6.6L; EGR to Cooler	VG247
2010	8 Cyl. 6.6L; 6	VG257
2009-2008	8 Cyl. 6.6L; Diesel	VG257
2007-2006	8 Cyl. 6.6L; EGR to Cooler	VG123
2007-2006	8 Cyl. 6.6L; By Middle of EGR	VG125
2007-2006	8 Cyl. 6.6L; EGR To Intake Pipe	VG126
Sierra 2500 HD		
2016-2011	8 Cyl. 6.6L; Intake	VG246
2016-2011	8 Cyl. 6.6L; EGR to Cooler	VG247
2010-2007	8 Cyl. 6.6L	VG257
2005	8 Cyl. 6.6L; EGR Pipe; By Middle of EGR	VG121
2005	8 Cyl. 6.6L; w/ EGR Valve	VG123
2005	8 Cyl. 6.6L; EGR Pipe; At EGR	VG124
2004	8 Cyl. 6.6L; 1; Back of EGR valve	VG120
2004	8 Cyl. 6.6L; 1; Bottom of EGR Valve	VG122
2004	8 Cyl. 6.6L; 2; EGR Pipe; By Middle of EGR	VG121
2004	8 Cyl. 6.6L; 2; w/ EGR Valve	VG123
2004	8 Cyl. 6.6L; 2; EGR Pipe; At EGR	VG124
2003-2002	8 Cyl. 6.6L; Back of EGR valve	VG120
2003-2002	8 Cyl. 6.6L; Bottom of EGR Valve	VG122
Sierra 3500		
2005	8 Cyl. 6.6L; EGR Pipe; By Middle of EGR	VG121
2005	8 Cyl. 6.6L; w/ EGR Valve	VG123
2005	8 Cyl. 6.6L; EGR Pipe; At EGR	VG124
2004	8 Cyl. 6.6L; 1; Back of EGR valve	VG120
2004	8 Cyl. 6.6L; 1; Bottom of EGR Valve	VG122
2004	8 Cyl. 6.6L; 2; EGR Pipe; By Middle of EGR	VG121
2004	8 Cyl. 6.6L; 2; w/ EGR Valve	VG123
2004	8 Cyl. 6.6L; 2; EGR Pipe; At EGR	VG124
2003-2002	8 Cyl. 6.6L; Back of EGR valve	VG120
2003-2002	8 Cyl. 6.6L; Bottom of EGR Valve	VG122
Sierra 3500 HD		
2016-2011	8 Cyl. 6.6L; Intake	VG246
2016-2011	8 Cyl. 6.6L; EGR to Cooler	VG247
2010-2007	8 Cyl. 6.6L	VG257
V1500		
1987	8 Cyl. 6.2L	VG44
V1500 Suburban		
1991-1990	8 Cyl. 6.2L	VG44
1989-1988	8 Cyl. 6.2L	VG7
V2500		
1987	8 Cyl. 6.2L; C	VG44

		Part No.
EGR Valve Mounting Gasket		
V2500 Suburban		
1991-1988	8 Cyl. 6.2L	VG7
Yukon		
1997-1994	8 Cyl. 6.5L; EGR Valve	VG44
1997-1994	8 Cyl. 6.5L; EGR Pipe	VG61
Exhaust Components		
Diesel Emission Fluid Injection Nozzle		
Savana 2500		
2016-2010	8 Cyl. 6.6L	DFI2
Savana 3500		
2016-2010	8 Cyl. 6.6L	DFI2
Savana 4500		
2016-2010	8 Cyl. 6.6L	DFI2
Sierra 2500 HD		
2014-2011	8 Cyl. 6.6L	DFI2
Sierra 3500 HD		
2014-2011	8 Cyl. 6.6L	DFI2
Diesel Emissions Fluid Pump		
Savana 2500		
2016-2010	8 Cyl. 6.6L	DFIP2
Savana 3500		
2016-2010	8 Cyl. 6.6L	DFIP2
Savana 4500		
2015-2010	8 Cyl. 6.6L	DFIP2
Sierra 2500 HD		
2016-2011	8 Cyl. 6.6L	DFIP2
Sierra 3500 HD		
2016-2011	8 Cyl. 6.6L	DFIP2
Diesel Emissions Fluid Temperature Sensor		
Savana 2500		
2016-2010	8 Cyl. 6.6L	DFS1
Savana 3500		
2016-2010	8 Cyl. 6.6L	DFS1
Savana 4500		
2016-2010	8 Cyl. 6.6L	DFS1
Sierra 2500 HD		
2016-2011	8 Cyl. 6.6L	DFS1
Sierra 3500 HD		
2016-2011	8 Cyl. 6.6L	DFS1
Diesel Exhaust Fluid (DEF) Heater		
Savana 2500		
2016-2012	8 Cyl. 6.6L	DFH107
Savana 3500		
2016-2012	8 Cyl. 6.6L	DFH107
Savana 4500		
2016-2012	8 Cyl. 6.6L	DFH107
Sierra 2500 HD		
2016-2012	8 Cyl. 6.6L	DFH106
Sierra 3500 HD		
2016-2012	8 Cyl. 6.6L	DFH106
PCV Systems		
PCV Grommet		
C1500		
1986-1982	8 Cyl. 6.2L; 23/32 Inch Inner Dia. x 1 1/4 Inch Outer Dia.	GV13
1986-1982	8 Cyl. 6.2L; 7/16 Inch Inner Dia. x 1 1/4 Inch Outer Dia.	GV16
1986-1982	8 Cyl. 6.2L; 7/16 Inch Inner Dia. x 1 3/4 Inch Outer Dia.	GV18
1986-1982	8 Cyl. 6.2L; 11/16 Inch Inner Dia. x 1 3/16 Inch Outer Dia.	GV5

PCV Systems

		Part No.
PCV Grommet		
K1500 Suburban		
1986-1982	8 Cyl. 6.2L; 7/16 Inch Inner Dia. x 1 3/4 Inch Outer Dia.	GV18
1986-1982	8 Cyl. 6.2L; 11/16 Inch Inner Dia. x 1 3/16 Inch Outer Dia.	GV5
1986-1982	8 Cyl. 6.2L; 1 Inch Inner Dia. x 1 1/2 Inch Outer Dia.	GV6
1986-1982	8 Cyl. 6.2L; 23/32 Inch Inner Dia. x 1 Inch Outer Dia.	GV9
K2500		
1993-1992	8 Cyl. 6.5L; 23/32 Inch Inner Dia. x 1 Inch Outer Dia.	GV9
1986-1982	8 Cyl. 6.2L; 23/32 Inch Inner Dia. x 1 1/4 Inch Outer Dia.	GV13
1986-1982	8 Cyl. 6.2L; 7/16 Inch Inner Dia. x 1 1/4 Inch Outer Dia.	GV16
1986-1982	8 Cyl. 6.2L; 7/16 Inch Inner Dia. x 1 3/4 Inch Outer Dia.	GV18
1986-1982	8 Cyl. 6.2L; 11/16 Inch Inner Dia. x 1 3/16 Inch Outer Dia.	GV5
1986-1982	8 Cyl. 6.2L; 1 Inch Inner Dia. x 1 1/2 Inch Outer Dia.	GV6
1986-1982	8 Cyl. 6.2L; 23/32 Inch Inner Dia. x 1 Inch Outer Dia.	GV9
K2500 Suburban		
1986-1982	8 Cyl. 6.2L; 23/32 Inch Inner Dia. x 1 1/4 Inch Outer Dia.	GV13
1986-1982	8 Cyl. 6.2L; 7/16 Inch Inner Dia. x 1 1/4 Inch Outer Dia.	GV16
1986-1982	8 Cyl. 6.2L; 7/16 Inch Inner Dia. x 1 3/4 Inch Outer Dia.	GV18
1986-1982	8 Cyl. 6.2L; 11/16 Inch Inner Dia. x 1 3/16 Inch Outer Dia.	GV5
1986-1982	8 Cyl. 6.2L; 1 Inch Inner Dia. x 1 1/2 Inch Outer Dia.	GV6
1986-1982	8 Cyl. 6.2L; 23/32 Inch Inner Dia. x 1 Inch Outer Dia.	GV9
K3500		
1993-1992	8 Cyl. 6.5L; 23/32 Inch Inner Dia. x 1 Inch Outer Dia.	GV9
1986-1982	8 Cyl. 6.2L; 23/32 Inch Inner Dia. x 1 1/4 Inch Outer Dia.	GV13
1986-1982	8 Cyl. 6.2L; 7/16 Inch Inner Dia. x 1 1/4 Inch Outer Dia.	GV16
1986-1982	8 Cyl. 6.2L; 7/16 Inch Inner Dia. x 1 3/4 Inch Outer Dia.	GV18
1986-1982	8 Cyl. 6.2L; 11/16 Inch Inner Dia. x 1 3/16 Inch Outer Dia.	GV5
1986-1982	8 Cyl. 6.2L; 1 Inch Inner Dia. x 1 1/2 Inch Outer Dia.	GV6
1986-1982	8 Cyl. 6.2L; 23/32 Inch Inner Dia. x 1 Inch Outer Dia.	GV9
P2500		
1986-1982	8 Cyl. 6.2L; 23/32 Inch Inner Dia. x 1 1/4 Inch Outer Dia.	GV13
1986-1982	8 Cyl. 6.2L; 7/16 Inch Inner Dia. x 1 1/4 Inch Outer Dia.	GV16
1986-1982	8 Cyl. 6.2L; 7/16 Inch Inner Dia. x 1 3/4 Inch Outer Dia.	GV18
1986-1982	8 Cyl. 6.2L; 11/16 Inch Inner Dia. x 1 3/16 Inch Outer Dia.	GV5
1986-1982	8 Cyl. 6.2L; 1 Inch Inner Dia. x 1 1/2 Inch Outer Dia.	GV6
1986-1982	8 Cyl. 6.2L; 23/32 Inch Inner Dia. x 1 Inch Outer Dia.	GV9
P3500		
1995-1994	8 Cyl. 6.5L	GV9
1991-1990	4 Cyl. 3.9L; 11/16 Inch Inner Dia. x 1 3/16 Inch Outer Dia.	GV5

		Part No.
PCV Grommet		
P3500		
1991-1990	4 Cyl. 3.9L; 1 Inch Inner Dia. x 1 1/2 Inch Outer Dia.	GV6
1991-1990	4 Cyl. 3.9L; 23/32 Inch Inner Dia. x 1 Inch Outer Dia.	GV9
1986-1982	8 Cyl. 6.2L; 23/32 Inch Inner Dia. x 1 1/4 Inch Outer Dia.	GV13
1986-1982	8 Cyl. 6.2L; 7/16 Inch Inner Dia. x 1 1/4 Inch Outer Dia.	GV16
1986-1982	8 Cyl. 6.2L; 7/16 Inch Inner Dia. x 1 3/4 Inch Outer Dia.	GV18
1986-1982	8 Cyl. 6.2L; 11/16 Inch Inner Dia. x 1 3/16 Inch Outer Dia.	GV5
1986-1982	8 Cyl. 6.2L; 1 Inch Inner Dia. x 1 1/2 Inch Outer Dia.	GV6
1986-1982	8 Cyl. 6.2L; 23/32 Inch Inner Dia. x 1 Inch Outer Dia.	GV9
S15		
1985-1984	4 Cyl. 2.2L; 23/32 Inch Inner Dia. x 1 1/4 Inch Outer Dia.	GV13
1985-1984	4 Cyl. 2.2L; 7/16 Inch Inner Dia. x 1 1/4 Inch Outer Dia.	GV16
1985-1984	4 Cyl. 2.2L; 7/16 Inch Inner Dia. x 1 3/4 Inch Outer Dia.	GV18
1985-1984	4 Cyl. 2.2L; 11/16 Inch Inner Dia. x 1 3/16 Inch Outer Dia.	GV5
1985-1984	4 Cyl. 2.2L; 1 Inch Inner Dia. x 1 1/2 Inch Outer Dia.	GV6
1985-1984	4 Cyl. 2.2L; 23/32 Inch Inner Dia. x 1 Inch Outer Dia.	GV9
PCV Valve		
C1500		
1997-1996	8 Cyl. 6.5L	BF41
1995-1994	8 Cyl. 6.5L; 3 1/2 Inch Dia. Canister Type; Crankcase Depression Regulator Valve	V335
1993-1989	8 Cyl. 6.2L; 3 1/2 Inch Dia. Canister Type; Crankcase Depression Regulator Valve	V335
1988	8 Cyl. 6.2L	V335
1986-1985	8 Cyl. 6.2L; C; Crankcase Depression Regulator Valve	V335
1981	8 Cyl. 5.7L; 1 Hose	V178
1981	8 Cyl. 5.7L; Dual Hose	V227
1980	8 Cyl. 5.7L; Diesel	V353
C1500 Suburban		
1999-1996	8 Cyl. 6.5L	BF41
1995	8 Cyl. 6.5L	V335
1986-1985	8 Cyl. 6.2L; Crankcase Depression Regulator Valve	V335
1981	8 Cyl. 5.7L; 1 Hose	V178
1981	8 Cyl. 5.7L; Dual Hose	V227
1980	8 Cyl. 5.7L; Diesel	V353
C2500		
2000-1996	8 Cyl. 6.5L	BF41
1995-1994	8 Cyl. 6.5L; 3 1/2 Inch Dia. Canister Type; Crankcase Depression Regulator Valve	V335
1993-1992	8 Cyl. 6.2L; Crankcase Depression Regulator Valve	V335
1993-1992	8 Cyl. 6.5L	BF41
1991-1989	8 Cyl. 6.2L; 3 1/2 Inch Dia. Canister Type; Crankcase Depression Regulator Valve	V335
1988	8 Cyl. 6.2L	V335
1986-1985	8 Cyl. 6.2L; Crankcase Depression Regulator Valve	V335
C2500 Suburban		
1999-1996	8 Cyl. 6.5L	BF41
1995-1994	8 Cyl. 6.5L	V335
1986-1985	8 Cyl. 6.2L; Crankcase Depression Regulator Valve	V335

PCV Systems

PCV Valve		Part No.
C2500 Suburban		
1980	8 Cyl. 5.7L; Diesel	V353
C3500		
2000-1996	8 Cyl. 6.5L	BF41
1995-1994	8 Cyl. 6.5L; 3 1/2 Inch Dia. Canister Type; Crankcase Depression Regulator Valve	V335
1993-1992	8 Cyl. 6.2L; Crankcase Depression Regulator Valve	V335
1993-1992	8 Cyl. 6.5L	BF41
1991-1988	8 Cyl. 6.2L; 3 1/2 Inch Dia. Canister Type; Crankcase Depression Regulator Valve	V335
1986-1985	8 Cyl. 6.2L; Crankcase Depression Regulator Valve	V335
C3500HD		
2001	8 Cyl. 6.5L	V335
2000-1996	8 Cyl. 6.5L	BF41
1995-1994	8 Cyl. 6.5L; 3 1/2 Inch Dia. Canister Type; Crankcase Depression Regulator Valve	V335
1993-1992	8 Cyl. 6.5L	BF41
Canyon		
2016	4 Cyl.; Side Of Valve Cover; Front	V566
G2500		
1995-1994	8 Cyl. 6.5L	V335
1993-1987	8 Cyl. 6.2L	V335
1986-1985	8 Cyl. 6.2L; Crankcase Depression Regulator Valve	V335
G3500		
1996-1994	8 Cyl. 6.5L	V335
1993-1987	8 Cyl. 6.2L	V335
1986-1985	8 Cyl. 6.2L; Crankcase Depression Regulator Valve	V335
Jimmy		
1991-1987	8 Cyl. 6.2L	V335
1986-1985	8 Cyl. 6.2L; Crankcase Depression Regulator Valve	V335
K1500		
1998-1996	8 Cyl. 6.5L	BF41
1995-1994	8 Cyl. 6.5L; 3 1/2 Inch Dia. Canister Type; Crankcase Depression Regulator Valve	V335
1993-1988	8 Cyl. 6.2L; 3 1/2 Inch Dia. Canister Type; Crankcase Depression Regulator Valve	V335
1986-1985	8 Cyl. 6.2L; C; Crankcase Depression Regulator Valve	V335
K1500 Suburban		
1999-1996	8 Cyl. 6.5L	BF41
1995	8 Cyl. 6.5L	V335
1986-1985	8 Cyl. 6.2L; Crankcase Depression Regulator Valve	V335
K2500		
2000-1996	8 Cyl. 6.5L	BF41
1995-1994	8 Cyl. 6.5L; 3 1/2 Inch Dia. Canister Type; Crankcase Depression Regulator Valve	V335
1993-1992	8 Cyl. 6.2L; Crankcase Depression Regulator Valve	V335
1993-1992	8 Cyl. 6.5L	BF41
1991-1989	8 Cyl. 6.2L; 3 1/2 Inch Dia. Canister Type; Crankcase Depression Regulator Valve	V335
1988	8 Cyl. 6.2L	V335
1986-1985	8 Cyl. 6.2L; Crankcase Depression Regulator Valve	V335
K2500 Suburban		
1999-1996	8 Cyl. 6.5L	BF41
1995-1994	8 Cyl. 6.5L	V335
1986-1985	8 Cyl. 6.2L; Crankcase Depression Regulator Valve	V335

PCV Valve		Part No.
K3500		
2000-1996	8 Cyl. 6.5L	BF41
1995-1994	8 Cyl. 6.5L; 3 1/2 Inch Dia. Canister Type; Crankcase Depression Regulator Valve	V335
1993-1992	8 Cyl. 6.2L; Crankcase Depression Regulator Valve	V335
1993-1992	8 Cyl. 6.5L	BF41
1991-1988	8 Cyl. 6.2L; 3 1/2 Inch Dia. Canister Type; Crankcase Depression Regulator Valve	V335
1986-1985	8 Cyl. 6.2L; Crankcase Depression Regulator Valve	V335
P2500		
1989-1987	8 Cyl. 6.2L	V335
1986-1985	8 Cyl. 6.2L; Crankcase Depression Regulator Valve	V335
P3500		
1999-1997	8 Cyl. 6.5L	V335
1996	8 Cyl. 6.5L; Crankcase Depression Regulator Valve	V335
1995-1994	8 Cyl. 6.5L	V335
1993-1987	8 Cyl. 6.2L	V335
1986-1985	8 Cyl. 6.2L; Crankcase Depression Regulator Valve	V335
R1500		
1987	8 Cyl. 6.2L; 3 1/2 Inch Dia. Canister Type; Crankcase Depression Regulator Valve	V335
R1500 Suburban		
1991-1987	8 Cyl. 6.2L	V335
R2500		
1989-1987	8 Cyl. 6.2L; 3 1/2 Inch Dia. Canister Type; Crankcase Depression Regulator Valve	V335
R2500 Suburban		
1991-1987	8 Cyl. 6.2L; Diesel	V335
R3500		
1991-1987	8 Cyl. 6.2L; 3 1/2 Inch Dia. Canister Type; Crankcase Depression Regulator Valve	V335
S15		
1985-1984	4 Cyl. 2.2L	V360
Savana 2500		
2000-1996	8 Cyl. 6.5L	BF41
Savana 3500		
2000-1996	8 Cyl. 6.5L	BF41
Sierra 2500 HD		
2004-2002	8 Cyl. 6.6L	V425
Sierra 3500		
2004-2002	8 Cyl. 6.6L	V425
V1500		
1987	8 Cyl. 6.2L; 3 1/2 Inch Dia. Canister Type; Crankcase Depression Regulator Valve	V335
V1500 Suburban		
1991-1987	8 Cyl. 6.2L	V335
V2500		
1987	8 Cyl. 6.2L; 3 1/2 Inch Dia. Canister Type; Crankcase Depression Regulator Valve	V335
V2500 Suburban		
1991-1987	8 Cyl. 6.2L	V335
V3500		
1991-1987	8 Cyl. 6.2L; 3 1/2 Inch Dia. Canister Type; Crankcase Depression Regulator Valve	V335
Yukon		
1997-1996	8 Cyl. 6.5L	BF41
1995-1994	8 Cyl. 6.5L	V335

Vapor and Purge Components

		Part No.
Vapor and Purge Components		
Fuel Vapor Canister		
C1500		
1981	8 Cyl. 5.7L	CP1004
1980	8 Cyl. 5.7L; Fed.	CP1014
C1500 Suburban		
1981	8 Cyl. 5.7L	CP1004
Caballero		
1984-1983	8 Cyl. 5.7L	CP1004
P2500		
1986-1985	8 Cyl. 6.2L	CP1004
P3500		
1986-1985	8 Cyl. 6.2L	CP1004
Sierra 2500 HD		
2016-2013	8 Cyl.	CP3543
Fuel Vapor Canister Filter		
C7000		
1985-1982	6 Cyl. 6.1L; w/ 4 1/2 Inch Dia.	CF-1
Fuel Valves and Solenoids		
Fuel / Water Separator Valve		
G3500		
1996	8 Cyl. 6.5L	FWSV101
Savana 2500		
2002-1996	8 Cyl. 6.5L	FWSV101
Savana 3500		
2002-1996	8 Cyl. 6.5L	FWSV101
Fuel Pressure Relief Valve		
Savana 2500		
2010-2006	8 Cyl. 6.6L	PRV1
Savana 3500		
2010-2006	8 Cyl. 6.6L	PRV1
Sierra 2500 HD		
2010-2006	8 Cyl. 6.6L	PRV1
2005	8 Cyl. 6.6L	PRV3
2004	8 Cyl. 6.6L; 2	PRV3
Sierra 2500 HD Classic		
2007	8 Cyl. 6.6L	PRV1
Sierra 3500		
2006	8 Cyl. 6.6L	PRV1
2005	8 Cyl. 6.6L	PRV3
2004	8 Cyl. 6.6L; 2	PRV3
Sierra 3500 Classic		
2007	8 Cyl. 6.6L	PRV1
Sierra 3500 HD		
2010-2007	8 Cyl. 6.6L	PRV1
Fuel Shut-Off Solenoid		
C1500		
1997-1995	8 Cyl. 6.5L	FSS103
1994	8 Cyl. 6.5L; OE No. 17800077, ID Tag No. 5521	FSS103
C1500 Suburban		
1999-1995	8 Cyl. 6.5L	FSS103
C2500		
2000-1995	8 Cyl. 6.5L	FSS103
1994	8 Cyl. 6.5L; OE No. 17800077, ID Tag No. 5521	FSS103
C2500 Suburban		
1999-1994	8 Cyl. 6.5L	FSS103
C3500		
2000-1995	8 Cyl. 6.5L	FSS103
1994	8 Cyl. 6.5L; OE No. 17800077, ID Tag No. 5521	FSS103

		Part No.
Fuel Shut-Off Solenoid		
C3500HD		
2002-1995	8 Cyl. 6.5L	FSS103
1994	8 Cyl. 6.5L; OE No. 17800077, ID Tag No. 5521	FSS103
G2500		
1995-1994	8 Cyl. 6.5L	FSS103
K1500		
1998-1995	8 Cyl. 6.5L	FSS103
1994	8 Cyl. 6.5L; OE No. 17800077, ID Tag No. 5521	FSS103
K2500		
2000-1995	8 Cyl. 6.5L	FSS103
1994	8 Cyl. 6.5L; OE No. 17800077, ID Tag No. 5521	FSS103
K2500 Suburban		
1999-1994	8 Cyl. 6.5L	FSS103
K3500		
2000-1995	8 Cyl. 6.5L	FSS103
1994	8 Cyl. 6.5L; OE No. 17800077, ID Tag No. 5521	FSS103
P3500		
1999-1997	8 Cyl. 6.5L	FSS103
Savana 2500		
2002-1996	8 Cyl. 6.5L	FSS103
Savana 3500		
2002-1996	8 Cyl. 6.5L	FSS103
Yukon		
1997-1995	8 Cyl. 6.5L	FSS103
Fuel Tank Selector Valve		
C1500		
1995-1994	8 Cyl. 6.5L; Connector Required; w/ 6 Port; w/ Pin Term.	FV-5
1995-1994	8 Cyl. 6.5L; Kit; w/ 6 Port; w/ Pin Term.	FV-5K
1993-1988	8 Cyl. 6.2L; Connector Required; w/ 6 Port; w/ Pin Term.	FV-5
1993-1988	8 Cyl. 6.2L; Kit; w/ 6 Port; w/ Pin Term.	FV-5K
1981-1980	8 Cyl. 5.7L; Connector Required; w/ 6 Port; w/ Pin Term.	FV-5
1981-1980	8 Cyl. 5.7L; Kit; w/ 6 Port; w/ Pin Term.	FV-5K
C1500 Suburban		
1995	8 Cyl. 6.5L; Connector Required; w/ 6 Port; w/ Pin Term.	FV-5
1995	8 Cyl. 6.5L; Kit; w/ 6 Port; w/ Pin Term.	FV-5K
1981-1980	8 Cyl. 5.7L; Connector Required; w/ 6 Port; w/ Pin Term.	FV-5
1981-1980	8 Cyl. 5.7L; Kit; w/ 6 Port; w/ Pin Term.	FV-5K
C2500		
1995-1992	8 Cyl. 6.5L; Connector Required; w/ 6 Port; w/ Pin Term.	FV-5
1995-1992	8 Cyl. 6.5L; Kit; w/ 6 Port; w/ Pin Term.	FV-5K
1993-1988	8 Cyl. 6.2L; Connector Required; w/ 6 Port; w/ Pin Term.	FV-5
1993-1988	8 Cyl. 6.2L; Kit; w/ 6 Port; w/ Pin Term.	FV-5K
C2500 Suburban		
1995-1994	8 Cyl. 6.5L; Connector Required; w/ 6 Port; w/ Pin Term.	FV-5
1995-1994	8 Cyl. 6.5L; Kit; w/ 6 Port; w/ Pin Term.	FV-5K
1980	8 Cyl. 5.7L; Connector Required; w/ 6 Port; w/ Pin Term.	FV-5
1980	8 Cyl. 5.7L; Kit; w/ 6 Port; w/ Pin Term.	FV-5K
C3500		
1995-1992	8 Cyl. 6.5L; Connector Required; w/ 6 Port; w/ Pin Term.	FV-5
1995-1992	8 Cyl. 6.5L; Kit; w/ 6 Port; w/ Pin Term.	FV-5K

Fuel Valves and Solenoids

		Part No.
Fuel Tank Selector Valve		
C3500		
1993-1988	8 Cyl. 6.2L; Connector Required; w/ 6 Port; w/ Pin Term.	FV-5
1993-1988	8 Cyl. 6.2L; Kit; w/ 6 Port; w/ Pin Term.	FV-5K
C3500HD		
1995-1992	8 Cyl. 6.5L; Connector Required; w/ 6 Port; w/ Pin Term.	FV-5
1995-1992	8 Cyl. 6.5L; Kit; w/ 6 Port; w/ Pin Term.	FV-5K
Caballero		
1984-1983	8 Cyl. 5.7L; Connector Required; w/ 6 Port; w/ Pin Term.	FV-5
1984-1983	8 Cyl. 5.7L; Kit; w/ 6 Port; w/ Pin Term.	FV-5K
G2500		
1995-1994	8 Cyl. 6.5L; Connector Required; w/ 6 Port; w/ Pin Term.	FV-5
1995-1994	8 Cyl. 6.5L; Kit; w/ 6 Port; w/ Pin Term.	FV-5K
1993-1983	8 Cyl. 6.2L; Connector Required; w/ 6 Port; w/ Pin Term.	FV-5
1993-1983	8 Cyl. 6.2L; Kit; w/ 6 Port; w/ Pin Term.	FV-5K
G3500		
1995-1994	8 Cyl. 6.5L; Connector Required; w/ 6 Port; w/ Pin Term.	FV-5
1995-1994	8 Cyl. 6.5L; Kit; w/ 6 Port; w/ Pin Term.	FV-5K
1993-1983	8 Cyl. 6.2L; Connector Required; w/ 6 Port; w/ Pin Term.	FV-5
1993-1983	8 Cyl. 6.2L; Kit; w/ 6 Port; w/ Pin Term.	FV-5K
Jimmy		
1991-1987	8 Cyl. 6.2L; Connector Required; w/ 6 Port; w/ Pin Term.	FV-5
1991-1987	8 Cyl. 6.2L; Kit; w/ 6 Port; w/ Pin Term.	FV-5K
K1500		
1995-1994	8 Cyl. 6.5L; Connector Required; w/ 6 Port; w/ Pin Term.	FV-5
1995-1994	8 Cyl. 6.5L; Kit; w/ 6 Port; w/ Pin Term.	FV-5K
1993-1988	8 Cyl. 6.2L; Connector Required; w/ 6 Port; w/ Pin Term.	FV-5
1993-1988	8 Cyl. 6.2L; Kit; w/ 6 Port; w/ Pin Term.	FV-5K
K1500 Suburban		
1995	8 Cyl. 6.5L; Connector Required; w/ 6 Port; w/ Pin Term.	FV-5
1995	8 Cyl. 6.5L; Kit; w/ 6 Port; w/ Pin Term.	FV-5K
1983	8 Cyl. 6.2L; Connector Required; w/ 6 Port; w/ Pin Term.	FV-5
1983	8 Cyl. 6.2L; Kit; w/ 6 Port; w/ Pin Term.	FV-5K
K2500		
1995-1992	8 Cyl. 6.5L; Connector Required; w/ 6 Port; w/ Pin Term.	FV-5
1995-1992	8 Cyl. 6.5L; Kit; w/ 6 Port; w/ Pin Term.	FV-5K
1993-1988	8 Cyl. 6.2L; Connector Required; w/ 6 Port; w/ Pin Term.	FV-5
1993-1988	8 Cyl. 6.2L; Kit; w/ 6 Port; w/ Pin Term.	FV-5K
K2500 Suburban		
1995-1994	8 Cyl. 6.5L; Connector Required; w/ 6 Port; w/ Pin Term.	FV-5
1995-1994	8 Cyl. 6.5L; Kit; w/ 6 Port; w/ Pin Term.	FV-5K
K3500		
1995-1992	8 Cyl. 6.5L; Connector Required; w/ 6 Port; w/ Pin Term.	FV-5
1995-1992	8 Cyl. 6.5L; Kit; w/ 6 Port; w/ Pin Term.	FV-5K
1993-1988	8 Cyl. 6.2L; Connector Required; w/ 6 Port; w/ Pin Term.	FV-5
1993-1988	8 Cyl. 6.2L; Kit; w/ 6 Port; w/ Pin Term.	FV-5K
P2500		
1989-1982	8 Cyl. 6.2L; Connector Required; w/ 6 Port; w/ Pin Term.	FV-5
1989-1982	8 Cyl. 6.2L; Kit; w/ 6 Port; w/ Pin Term.	FV-5K

		Part No.
Fuel Tank Selector Valve		
P3500		
1995-1994	8 Cyl. 6.5L; Connector Required; w/ 6 Port; w/ Pin Term.	FV-5
1995-1994	8 Cyl. 6.5L; Kit; w/ 6 Port; w/ Pin Term.	FV-5K
1993-1982	8 Cyl. 6.2L; Connector Required; w/ 6 Port; w/ Pin Term.	FV-5
1993-1982	8 Cyl. 6.2L; Kit; w/ 6 Port; w/ Pin Term.	FV-5K
1991-1990	4 Cyl. 3.9L; Connector Required; w/ 6 Port; w/ Pin Term.	FV-5
1991-1990	4 Cyl. 3.9L; Kit; w/ 6 Port; w/ Pin Term.	FV-5K
R1500 Suburban		
1991-1988	8 Cyl. 6.2L; Connector Required; w/ 6 Port; w/ Pin Term.	FV-5
1991-1988	8 Cyl. 6.2L; Kit; w/ 6 Port; w/ Pin Term.	FV-5K
R2500		
1989	8 Cyl. 6.2L; Connector Required; w/ 6 Port; w/ Pin Term.	FV-5
1989	8 Cyl. 6.2L; Kit; w/ 6 Port; w/ Pin Term.	FV-5K
R2500 Suburban		
1991-1988	8 Cyl. 6.2L; Connector Required; w/ 6 Port; w/ Pin Term.	FV-5
1991-1988	8 Cyl. 6.2L; Kit; w/ 6 Port; w/ Pin Term.	FV-5K
R3500		
1991-1989	8 Cyl. 6.2L; Connector Required; w/ 6 Port; w/ Pin Term.	FV-5
1991-1989	8 Cyl. 6.2L; Kit; w/ 6 Port; w/ Pin Term.	FV-5K
1987	8 Cyl. 6.2L; Connector Required; w/ 6 Port; w/ Pin Term.	FV-5
1987	8 Cyl. 6.2L; Kit; w/ 6 Port; w/ Pin Term.	FV-5K
S15		
1985-1984	4 Cyl. 2.2L; Connector Required; w/ 6 Port; w/ Pin Term.	FV-5
1985-1984	4 Cyl. 2.2L; Kit; w/ 6 Port; w/ Pin Term.	FV-5K
V1500 Suburban		
1991-1988	8 Cyl. 6.2L; Connector Required; w/ 6 Port; w/ Pin Term.	FV-5
1991-1988	8 Cyl. 6.2L; Kit; w/ 6 Port; w/ Pin Term.	FV-5K
V2500 Suburban		
1991-1988	8 Cyl. 6.2L; Connector Required; w/ 6 Port; w/ Pin Term.	FV-5
1991-1988	8 Cyl. 6.2L; Kit; w/ 6 Port; w/ Pin Term.	FV-5K
V3500		
1991-1989	8 Cyl. 6.2L; Connector Required; w/ 6 Port; w/ Pin Term.	FV-5
1991-1989	8 Cyl. 6.2L; Kit; w/ 6 Port; w/ Pin Term.	FV-5K
Yukon		
1995-1994	8 Cyl. 6.5L; Connector Required; w/ 6 Port; w/ Pin Term.	FV-5
1995-1994	8 Cyl. 6.5L; Kit; w/ 6 Port; w/ Pin Term.	FV-5K
Injectors		
Fuel Injector - Diesel - New		
C1500		
1997-1996	8 Cyl. 6.5L	FJ173
1995-1994	8 Cyl. 6.5L; P	FJ174
1995-1994	8 Cyl. 6.5L; S	FJ173
1993-1992	8 Cyl. 6.2L	FJ174
1991-1988	8 Cyl. 6.2L; 83.7mm Long	FJ171
1986-1983	8 Cyl. 6.2L	FJ171
1982	8 Cyl. 6.2L	FJ172
C1500 Suburban		
1999-1995	8 Cyl. 6.5L	FJ173
1986-1983	8 Cyl. 6.2L	FJ171
1982	8 Cyl. 6.2L	FJ172
C2500		
2000-1996	8 Cyl. 6.5L	FJ173

Injectors

		Part No.
Fuel Injector - Diesel - New		
C2500		
1995-1994	8 Cyl. 6.5L; F	FJ173
1995-1994	8 Cyl. 6.5L; S	FJ173
1994	8 Cyl. 6.5L; P	FJ174
1993-1992	8 Cyl. 6.5L	FJ173
1993-1992	8 Cyl. 6.2L	FJ174
1991-1988	8 Cyl. 6.2L; 83.7mm Long	FJ171
1986-1983	8 Cyl. 6.2L	FJ171
1982	8 Cyl. 6.2L	FJ172
C2500 Suburban		
1999-1994	8 Cyl. 6.5L	FJ173
1986-1983	8 Cyl. 6.2L	FJ171
1982	8 Cyl. 6.2L	FJ172
C3500		
2000-1992	8 Cyl. 6.5L	FJ173
1993-1992	8 Cyl. 6.2L	FJ174
1991-1988	8 Cyl. 6.2L; 83.7mm Long	FJ171
1986-1983	8 Cyl. 6.2L	FJ171
1982	8 Cyl. 6.2L	FJ172
C3500HD		
2002-1992	8 Cyl. 6.5L	FJ173
Canyon		
2019-2017	4 Cyl. 2.8L; Indirect Injector	FJ1379
2019-2017	4 Cyl. 2.8L; Direct Injector	FJ1381NX
2016	4 Cyl. 2.8L	FJ1381NX
G2500		
1995-1994	8 Cyl. 6.5L	FJ174
1993-1992	8 Cyl. 6.2L	FJ174
1991-1987	8 Cyl. 6.2L; 83.7mm Long	FJ171
G3500		
1996-1994	8 Cyl. 6.5L	FJ174
1993-1992	8 Cyl. 6.2L	FJ174
1991-1987	8 Cyl. 6.2L; 83.7mm Long	FJ171
Jimmy		
1991-1987	8 Cyl. 6.2L; 83.7mm Long	FJ171
1986-1983	8 Cyl. 6.2L	FJ171
1982	8 Cyl. 6.2L	FJ172
K1500		
1998-1996	8 Cyl. 6.5L	FJ173
1995	8 Cyl. 6.5L; Turbocharged	FJ173
1995	8 Cyl. 6.5L; Naturally Aspirated	FJ174
1994	8 Cyl. 6.5L; P	FJ174
1994	8 Cyl. 6.5L; S	FJ173
1993-1992	8 Cyl. 6.2L	FJ174
1991-1988	8 Cyl. 6.2L; 83.7mm Long	FJ171
1986-1983	8 Cyl. 6.2L	FJ171
1982	8 Cyl. 6.2L	FJ172
K1500 Suburban		
1999-1995	8 Cyl. 6.5L	FJ173
1986-1983	8 Cyl. 6.2L	FJ171
1982	8 Cyl. 6.2L	FJ172
K2500		
2000-1996	8 Cyl. 6.5L	FJ173
1995-1994	8 Cyl. 6.5L; F	FJ173
1995-1994	8 Cyl. 6.5L; S	FJ173
1994	8 Cyl. 6.5L; P	FJ174
1993-1992	8 Cyl. 6.5L	FJ173
1993-1992	8 Cyl. 6.2L	FJ174
1991-1988	8 Cyl. 6.2L; 83.7mm Long	FJ171
1986-1983	8 Cyl. 6.2L	FJ171
1982	8 Cyl. 6.2L	FJ172
K2500 Suburban		
1999-1994	8 Cyl. 6.5L	FJ173

		Part No.
Fuel Injector - Diesel - New		
K2500 Suburban		
1986-1983	8 Cyl. 6.2L	FJ171
1982	8 Cyl. 6.2L	FJ172
K3500		
2000-1992	8 Cyl. 6.5L	FJ173
1993-1992	8 Cyl. 6.2L	FJ174
1991-1988	8 Cyl. 6.2L; 83.7mm Long	FJ171
1986-1983	8 Cyl. 6.2L	FJ171
1982	8 Cyl. 6.2L	FJ172
P2500		
1989-1987	8 Cyl. 6.2L; 83.7mm Long	FJ171
P3500		
1999-1997	8 Cyl. 6.5L; Turbocharged	FJ173
1999-1997	8 Cyl. 6.5L; Naturally Aspirated	FJ174
1996-1994	8 Cyl. 6.5L	FJ174
1993-1987	8 Cyl. 6.2L; 83.7mm Long	FJ171
R1500		
1987	8 Cyl. 6.2L; 83.7mm Long	FJ171
R1500 Suburban		
1991-1987	8 Cyl. 6.2L; 83.7mm Long	FJ171
R2500		
1989-1987	8 Cyl. 6.2L; 83.7mm Long	FJ171
R2500 Suburban		
1991-1987	8 Cyl. 6.2L; 83.7mm Long	FJ171
R3500		
1991-1987	8 Cyl. 6.2L; 83.7mm Long	FJ171
Savana 2500		
2019	4 Cyl. 2.8L; Direct Injector	FJ1381NX
2019-2017	4 Cyl. 2.8L; Indirect Injector	FJ1379
2018-2017	4 Cyl. 2.8L	FJ1381NX
2016-2010	8 Cyl. 6.6L; Indirect Injector	FJ1378
2002-1996	8 Cyl. 6.5L	FJ173
Savana 3500		
2019	4 Cyl. 2.8L; Direct Injector	FJ1381NX
2019-2017	4 Cyl. 2.8L; Indirect Injector	FJ1379
2018-2017	4 Cyl. 2.8L	FJ1381NX
2016-2010	8 Cyl. 6.6L; Indirect Injector	FJ1378
2002-1996	8 Cyl. 6.5L	FJ173
Sierra 2500 HD		
2019-2017	8 Cyl. 6.6L; Indirect Injector	FJ1379
2016-2011	8 Cyl. 6.6L; Indirect Injector	FJ1378
Sierra 3500 HD		
2019-2017	8 Cyl. 6.6L; Indirect Injector	FJ1379
2016-2011	8 Cyl. 6.6L; Indirect Injector	FJ1378
Terrain		
2019-2018	4 Cyl. 1.6L	FJ1382NX
V1500		
1987	8 Cyl. 6.2L; 83.7mm Long	FJ171
V1500 Suburban		
1991-1987	8 Cyl. 6.2L; 83.7mm Long	FJ171
V2500		
1987	8 Cyl. 6.2L; 83.7mm Long	FJ171
V2500 Suburban		
1991-1987	8 Cyl. 6.2L; 83.7mm Long	FJ171
V3500		
1991-1987	8 Cyl. 6.2L; 83.7mm Long	FJ171
Yukon		
1997-1994	8 Cyl. 6.5L	FJ173
Fuel Injector - Diesel - Remfd		
C1500		
1991-1988	8 Cyl. 6.2L; 73.8mm Long	FJ251

Injectors

		Part No.
Fuel Injector - Diesel - Remfd		
C2500		
1991-1988	8 Cyl. 6.2L; 73.8mm Long	FJ251
C3500		
1991-1988	8 Cyl. 6.2L; 73.8mm Long	FJ251
C4500 Topkick		
2009-2008	8 Cyl. 6.6L	FJ961
2007-2006	8 Cyl. 6.6L	FJ962
2005	8 Cyl. 6.6L; Injector Only	FJ489
2004	8 Cyl. 6.6L; 1; Injector Only	FJ495
2004	8 Cyl. 6.6L; 1; Complete Kit	FJ4958PCK
2004	8 Cyl. 6.6L; 2; Injector Only	FJ489
2003	8 Cyl. 6.6L; Injector Only	FJ495
2003	8 Cyl. 6.6L; Complete Kit	FJ4958PCK
C5500 Topkick		
2008	8 Cyl. 6.6L	FJ961
2007-2006	8 Cyl. 6.6L	FJ962
2005	8 Cyl. 6.6L; Injector Only	FJ489
2004	8 Cyl. 6.6L; 1; Injector Only	FJ495
2004	8 Cyl. 6.6L; 1; Complete Kit	FJ4958PCK
2004	8 Cyl. 6.6L; 2; Injector Only	FJ489
2003	8 Cyl. 6.6L; Injector Only	FJ495
2003	8 Cyl. 6.6L; Complete Kit	FJ4958PCK
C6500 Topkick		
2009-2007	6 Cyl. 7.8L; OE No. 2901233200, 8976097904, 97780454, 97609790, 095000-6384	FJ56907
C7500 Topkick		
2009-2007	6 Cyl. 7.8L; OE No. 2901233200, 8976097904, 97780454, 97609790, 095000-6384	FJ56907
G2500		
1991-1983	8 Cyl. 6.2L; 73.8mm Long	FJ251
G3500		
1991-1983	8 Cyl. 6.2L; 73.8mm Long	FJ251
Jimmy		
1991-1987	8 Cyl. 6.2L; 73.8mm Long	FJ251
K1500		
1991-1988	8 Cyl. 6.2L; 73.8mm Long	FJ251
K2500		
1991-1988	8 Cyl. 6.2L; 73.8mm Long	FJ251
K3500		
1991-1988	8 Cyl. 6.2L; 73.8mm Long	FJ251
P2500		
1989-1982	8 Cyl. 6.2L; 73.8mm Long	FJ251
P3500		
1993-1982	8 Cyl. 6.2L; 73.8mm Long	FJ251
R1500		
1987	8 Cyl. 6.2L; 73.8mm Long	FJ251
R1500 Suburban		
1991-1987	8 Cyl. 6.2L; 73.8mm Long	FJ251
R2500		
1989-1987	8 Cyl. 6.2L; 73.8mm Long	FJ251
R2500 Suburban		
1991-1987	8 Cyl. 6.2L; 73.8mm Long	FJ251
R3500		
1991-1987	8 Cyl. 6.2L; 73.8mm Long	FJ251
Savana 2500		
2016-2011	8 Cyl. 6.6L; Direct Injector	FJ1227
2010	8 Cyl. 6.6L; 6; Direct Injector	FJ961
2010	8 Cyl. 6.6L; L; Direct Injector	FJ1227
2009-2008	8 Cyl. 6.6L	FJ961
2007	8 Cyl. 6.6L; 2	FJ962
2007	8 Cyl. 6.6L; 6	FJ961
2007	8 Cyl. 6.6L; 6	FJ961

		Part No.
Fuel Injector - Diesel - Remfd		
Savana 2500		
2006	8 Cyl. 6.6L	FJ962
Savana 3500		
2016-2011	8 Cyl. 6.6L; Direct Injector	FJ1227
2010	8 Cyl. 6.6L; 6; Direct Injector	FJ961
2010	8 Cyl. 6.6L; L; Direct Injector	FJ1227
2009-2008	8 Cyl. 6.6L	FJ961
2007	8 Cyl. 6.6L; 2	FJ962
2007	8 Cyl. 6.6L; 6	FJ961
2006	8 Cyl. 6.6L	FJ962
Savana 4500		
2016-2011	8 Cyl. 6.6L	FJ1227
2010	8 Cyl. 6.6L; 6	FJ961
2010	8 Cyl. 6.6L; L	FJ1227
2009	8 Cyl. 6.6L	FJ961
Sierra 2500 HD		
2019-2017	8 Cyl. 6.6L	FJ1383
2016-2013	8 Cyl. 6.6L; Direct Injector	FJ1226
2012-2011	8 Cyl. 6.6L; 8; Direct Injector	FJ1226
2012-2011	8 Cyl. 6.6L; L; Direct Injector	FJ1227
2010-2007	8 Cyl. 6.6L	FJ961
2006	8 Cyl. 6.6L	FJ962
2005	8 Cyl. 6.6L; Injector Only	FJ489
2004	8 Cyl. 6.6L; 1; Injector Only	FJ495
2004	8 Cyl. 6.6L; 1; Complete Kit	FJ4958PCK
2004	8 Cyl. 6.6L; 2; Injector Only	FJ489
2003-2001	8 Cyl. 6.6L; Injector Only	FJ495
2003-2001	8 Cyl. 6.6L; Complete Kit	FJ4958PCK
Sierra 2500 HD Classic		
2007	8 Cyl. 6.6L	FJ962
Sierra 3500		
2006	8 Cyl. 6.6L	FJ962
2005	8 Cyl. 6.6L; Injector Only	FJ489
2004	8 Cyl. 6.6L; 1; Injector Only	FJ495
2004	8 Cyl. 6.6L; 1; Complete Kit	FJ4958PCK
2004	8 Cyl. 6.6L; 2; Injector Only	FJ489
2003-2001	8 Cyl. 6.6L; Injector Only	FJ495
2003-2001	8 Cyl. 6.6L; Complete Kit	FJ4958PCK
Sierra 3500 Classic		
2007	8 Cyl. 6.6L	FJ962
Sierra 3500 HD		
2019-2017	8 Cyl. 6.6L	FJ1383
2016-2013	8 Cyl. 6.6L; Direct Injector	FJ1226
2012-2011	8 Cyl. 6.6L; 8; Direct Injector	FJ1226
2012-2011	8 Cyl. 6.6L; L; Direct Injector	FJ1227
2010-2007	8 Cyl. 6.6L	FJ961
T6500		
2007-2004	6 Cyl. 7.8L; OE No. 2901233000, 8976028032, 97780452, 97602803, 095000-5360	FJ56905
2007-2004	6 Cyl. 7.8L; OE No. 2901233100, 8976011562, 97780453, 97601156, 095000-5351	FJ56906
T7500		
2007-2004	6 Cyl. 7.8L; OE No. 2901233000, 8976028032, 97780452, 97602803, 095000-5360	FJ56905
2007-2004	6 Cyl. 7.8L; OE No. 2901233100, 8976011562, 97780453, 97601156, 095000-5351	FJ56906
V1500		
1987	8 Cyl. 6.2L; 73.8mm Long	FJ251
V1500 Suburban		
1991-1987	8 Cyl. 6.2L; 73.8mm Long	FJ251

Injectors

		Part No.
Fuel Injector - Diesel - Remfd		
V2500		
1987	8 Cyl. 6.2L; 73.8mm Long	FJ251
V2500 Suburban		
1991-1987	8 Cyl. 6.2L; 73.8mm Long	FJ251
V3500		
1991-1987	8 Cyl. 6.2L; 73.8mm Long	FJ251
W3500 Forward		
2008-2007	4 Cyl. 5.2L; OE No. 2901233300, 8976097915, 97780455, 97609791, 095000-6395	FJ56908
2008-2005	4 Cyl. 5.2L; OE No. 2901231000, 8973297035, 97780100, 095000-5471	FJ56909
2004-1999	4 Cyl. 4.8L	FJ56909
W4500 Forward		
2010-2007	4 Cyl. 5.2L; OE No. 2901233300, 8976097915, 97780455, 97609791, 095000-6395	FJ56908
2010-2005	4 Cyl. 5.2L; OE No. 2901231000, 8973297035, 97780100, 095000-5471	FJ56909
2004-1999	4 Cyl. 4.8L	FJ56909
W5500 Forward		
2010-2007	4 Cyl. 5.2L; OE No. 2901233300, 8976097915, 97780455, 97609791, 095000-6395	FJ56908
2010-2005	4 Cyl. 5.2L; OE No. 2901231000, 8973297035, 97780100, 095000-5471	FJ56909
2004-2000	4 Cyl. 4.8L	FJ56909
W5500HD Forward		
2009-2007	4 Cyl. 5.2L; OE No. 2901233300, 8976097915, 97780455, 97609791, 095000-6395	FJ56908
2008-2005	4 Cyl. 5.2L	FJ56909
2004	4 Cyl. 4.8L	FJ56909
Injection Components		
Diesel Fuel Heater		
C1500		
1997-1994	8 Cyl. 6.5L	DFH102
C1500 Suburban		
1999-1998	8 Cyl. 6.5L	DFH102
C2500		
2000-1994	8 Cyl. 6.5L	DFH102
C3500		
2000-1994	8 Cyl. 6.5L	DFH102
C3500HD		
2002-1994	8 Cyl. 6.5L	DFH102
G2500		
1995-1994	8 Cyl. 6.5L	DFH102
G3500		
1996-1994	8 Cyl. 6.5L	DFH102
K1500		
1998-1994	8 Cyl. 6.5L	DFH102
K2500		
2000-1994	8 Cyl. 6.5L	DFH102
K3500		
2000-1994	8 Cyl. 6.5L	DFH102
P3500		
1999-1994	8 Cyl. 6.5L	DFH102
Savana 2500		
1996	8 Cyl. 6.5L	DFH102
Savana 3500		
1996	8 Cyl. 6.5L	DFH102
Yukon		
1997-1994	8 Cyl. 6.5L	DFH102

		Part No.
Diesel Fuel Injection Harness		
C4500 Topkick		
2004-2003	8 Cyl. 6.6L	IFH7
C5500 Topkick		
2004-2003	8 Cyl. 6.6L	IFH7
Sierra 2500 HD		
2004	8 Cyl. 6.6L; 1	IFH7
2003-2001	8 Cyl. 6.6L	IFH7
Sierra 3500		
2004	8 Cyl. 6.6L; 1	IFH7
2003-2001	8 Cyl. 6.6L	IFH7
Diesel Fuel Injection Pump - New		
C1500		
1989-1988	8 Cyl. 6.2L	IP48NX
C2500		
1993-1992	8 Cyl. 6.5L; GVW Under 15,000 Lbs.; w/o Cold Climate Package	IP47NX
1989	8 Cyl. 6.2L; C	IP48NX
1988	8 Cyl. 6.2L	IP48NX
C3500		
1993-1992	8 Cyl. 6.5L; GVW Under 15,000 Lbs.; w/o Cold Climate Package	IP47NX
C3500HD		
1993-1992	8 Cyl. 6.5L; GVW Under 15,000 Lbs.; w/o Cold Climate Package	IP47NX
G2500		
1994	8 Cyl. 6.5L; 170 HP	IP46NX
1989	8 Cyl. 6.2L; C	IP48NX
G3500		
1994	8 Cyl. 6.5L; 170 HP	IP46NX
Jimmy		
1989-1988	8 Cyl. 6.2L	IP48NX
K1500		
1989-1988	8 Cyl. 6.2L	IP48NX
K2500		
1993-1992	8 Cyl. 6.5L; w/o Cold Climate Package	IP47NX
1989	8 Cyl. 6.2L; C	IP48NX
1988	8 Cyl. 6.2L	IP48NX
K3500		
1993	8 Cyl. 6.5L; Alternate Number; GVW Under 15,000 Lbs.; w/o Cold Climate Package	IP47NX
1992	8 Cyl. 6.5L; GVW Under 15,000 Lbs.; w/o Cold Climate Package	IP47NX
R1500 Suburban		
1989-1988	8 Cyl. 6.2L	IP48NX
Savana 2500		
2016-2011	8 Cyl. 6.6L	IP36
2010	8 Cyl. 6.6L; L	IP36
Savana 3500		
2016-2011	8 Cyl. 6.6L	IP36
2010	8 Cyl. 6.6L; L	IP36
Savana 4500		
2016-2011	8 Cyl. 6.6L	IP36
2010	8 Cyl. 6.6L; L	IP36
Sierra 2500 HD		
2016-2011	8 Cyl. 6.6L	IP36
Sierra 3500 HD		
2016-2011	8 Cyl. 6.6L	IP36
V1500 Suburban		
1989-1988	8 Cyl. 6.2L	IP48NX

Injection Components

		Part No.
Diesel Fuel Injection Pump - Remanufactured		
C1500		
1997-1994	8 Cyl. 6.5L; Complete Assembly	IP1
1997-1994	8 Cyl. 6.5L; Pump Only	IP25
1993	8 Cyl. 6.2L; w/o High Altitude	IP16
1992	8 Cyl. 6.2L; w/o High Altitude	IP14
1991	8 Cyl. 6.2L	IP9
1990	8 Cyl. 6.2L	IP11
1989-1988	8 Cyl. 6.2L; Alternate Number	IP48
1989-1988	8 Cyl. 6.2L; Exhaust stock and reorder	IP7
1986	8 Cyl. 6.2L; J	IP10
C1500 Suburban		
1999-1995	8 Cyl. 6.5L; Complete Assembly	IP1
1999-1995	8 Cyl. 6.5L; Pump Only	IP25
C2500		
2000-1995	8 Cyl. 6.5L; Complete Assembly	IP1
2000-1995	8 Cyl. 6.5L; Pump Only	IP25
1994	8 Cyl. 6.5L; Complete Assembly; OE No. 17800077, ID Tag No. 5521	IP1
1994	8 Cyl. 6.5L; OE No. 17800077, ID Tag No. 5521; Pump Only	IP25
1994	8 Cyl. 6.5L; OE No. 10225929, ID Tag No. 5068	IP28
1993	8 Cyl. 6.2L; C; w/o High Altitude	IP16
1993-1992	8 Cyl. 6.5L; Exhaust stock and reorder; GVW Under 15,000 Lbs.; w/o Cold Climate Package	IP29
1993-1992	8 Cyl. 6.5L; Alternate Number; GVW Under 15,000 Lbs.; w/o Cold Climate Package	IP47
1993-1992	8 Cyl. 6.2L; J; w/o Cold Climate Package; w/o High Altitude	IP15
1992	8 Cyl. 6.2L; C; w/o High Altitude	IP14
1992-1991	8 Cyl. 6.2L; J; w/ Cold Climate Package; w/o High Altitude	IP13
1991-1990	8 Cyl. 6.2L; J; w/o Cold Climate Package; w/o High Altitude	IP12
1989	8 Cyl. 6.2L; C; Alternate Number	IP48
1989	8 Cyl. 6.2L; C; Exhaust stock and reorder	IP7
1989	8 Cyl. 6.2L; J	IP10
1988	8 Cyl. 6.2L; Alternate Number	IP48
1988	8 Cyl. 6.2L; Exhaust stock and reorder	IP7
1986-1985	8 Cyl. 6.2L; J	IP10
C2500 Suburban		
1999-1995	8 Cyl. 6.5L; Complete Assembly	IP1
1999-1995	8 Cyl. 6.5L; Pump Only	IP25
1994	8 Cyl. 6.5L; Complete Assembly; OE No. 17800077, ID Tag No. 5521	IP1
1994	8 Cyl. 6.5L; OE No. 17800077, ID Tag No. 5521; Pump Only	IP25
1994	8 Cyl. 6.5L; OE No. 10225929, ID Tag No. 5068	IP28
1986-1985	8 Cyl. 6.2L	IP10
C3500		
2000-1995	8 Cyl. 6.5L; Complete Assembly	IP1
2000-1995	8 Cyl. 6.5L; Pump Only	IP25
1994	8 Cyl. 6.5L; Complete Assembly; OE No. 17800077, ID Tag No. 5521	IP1
1994	8 Cyl. 6.5L; OE No. 17800077, ID Tag No. 5521; Pump Only	IP25
1994	8 Cyl. 6.5L; OE No. 10225929, ID Tag No. 5068	IP28
1993-1992	8 Cyl. 6.2L; w/o Cold Climate Package; w/o High Altitude	IP15
1993-1992	8 Cyl. 6.5L; Exhaust stock and reorder; GVW Under 15,000 Lbs.; w/o Cold Climate Package	IP29

		Part No.
Diesel Fuel Injection Pump - Remanufactured		
C3500		
1993-1992	8 Cyl. 6.5L; Alternate Number; GVW Under 15,000 Lbs.; w/o Cold Climate Package	IP47
1992-1991	8 Cyl. 6.2L; w/ Cold Climate Package; w/o High Altitude	IP13
1991-1990	8 Cyl. 6.2L; w/o Cold Climate Package; w/o High Altitude	IP12
1989-1988	8 Cyl. 6.2L	IP10
1986-1985	8 Cyl. 6.2L	IP10
C3500HD		
2002-1995	8 Cyl. 6.5L; Complete Assembly	IP1
2002-1995	8 Cyl. 6.5L; Pump Only	IP25
1994	8 Cyl. 6.5L; Complete Assembly; OE No. 17800077, ID Tag No. 5521	IP1
1994	8 Cyl. 6.5L; OE No. 17800077, ID Tag No. 5521; Pump Only	IP25
1994	8 Cyl. 6.5L; OE No. 10225929, ID Tag No. 5068	IP28
1993-1992	8 Cyl. 6.5L; Exhaust stock and reorder; GVW Under 15,000 Lbs.; w/o Cold Climate Package	IP29
1993-1992	8 Cyl. 6.5L; Alternate Number; GVW Under 15,000 Lbs.; w/o Cold Climate Package	IP47
C4500 Topkick		
2009-2006	8 Cyl. 6.6L	IP24
2005	8 Cyl. 6.6L	IP23
2004	8 Cyl. 6.6L; 1	IP22
2004	8 Cyl. 6.6L; 2	IP23
2003	8 Cyl. 6.6L	IP22
C5500 Topkick		
2009-2006	8 Cyl. 6.6L	IP24
2005	8 Cyl. 6.6L	IP23
2004	8 Cyl. 6.6L; 1	IP22
2004	8 Cyl. 6.6L; 2	IP23
2003	8 Cyl. 6.6L	IP22
G2500		
1995-1994	8 Cyl. 6.5L; Complete Assembly	IP1
1995-1994	8 Cyl. 6.5L; Pump Only	IP25
1993	8 Cyl. 6.2L; C; w/o High Altitude	IP16
1992	8 Cyl. 6.2L; C; w/o High Altitude	IP14
1991	8 Cyl. 6.2L; C	IP9
1990	8 Cyl. 6.2L; C; w/ A.T.; w/o Cold Climate Package; w/o High Altitude	IP12
1989	8 Cyl. 6.2L; C	IP48
1988	8 Cyl. 6.2L; C; Alternate Number	IP48
1988	8 Cyl. 6.2L; C; Exhaust stock and reorder	IP7
1987-1985	8 Cyl. 6.2L; C; w/ High Altitude	IP8
1984	8 Cyl. 6.2L; w/o High Altitude	IP10
1984	8 Cyl. 6.2L; w/ High Altitude	IP8
G3500		
1993-1992	8 Cyl. 6.2L; w/o Cold Climate Package; w/o High Altitude	IP15
1991-1990	8 Cyl. 6.2L; w/ A.T.; w/o Cold Climate Package; w/o High Altitude	IP12
1989-1985	8 Cyl. 6.2L; w/ A.T.	IP10
1984	8 Cyl. 6.2L	IP10
Jimmy		
1991	8 Cyl. 6.2L	IP9
1990	8 Cyl. 6.2L; w/o Cold Climate Package; w/o High Altitude	IP12
1989-1988	8 Cyl. 6.2L; Alternate Number	IP48
1989-1988	8 Cyl. 6.2L; Exhaust stock and reorder	IP7
K1500		
1998-1994	8 Cyl. 6.5L; Complete Assembly	IP1

Injection Components

		Part No.
Diesel Fuel Injection Pump - Remanufactured		
K1500		
1998-1994	8 Cyl. 6.5L; Pump Only	IP25
1993	8 Cyl. 6.2L; w/o High Altitude	IP16
1992	8 Cyl. 6.2L; w/o High Altitude	IP14
1991	8 Cyl. 6.2L	IP9
1990	8 Cyl. 6.2L	IP11
1989-1988	8 Cyl. 6.2L; Alternate Number	IP48
1989-1988	8 Cyl. 6.2L; Exhaust stock and reorder	IP7
1986-1985	8 Cyl. 6.2L; J	IP10
K1500 Suburban		
1999-1995	8 Cyl. 6.5L; Complete Assembly	IP1
1999-1995	8 Cyl. 6.5L; Pump Only	IP25
K2500		
2000-1995	8 Cyl. 6.5L; Complete Assembly	IP1
2000-1995	8 Cyl. 6.5L; Pump Only	IP25
1994	8 Cyl. 6.5L; Complete Assembly; OE No. 17800077, ID Tag No. 5521	IP1
1994	8 Cyl. 6.5L; OE No. 17800077, ID Tag No. 5521; Pump Only	IP25
1994	8 Cyl. 6.5L; OE No. 10225929, ID Tag No. 5068	IP28
1993	8 Cyl. 6.2L; C; w/o High Altitude	IP16
1993-1992	8 Cyl. 6.5L; Exhaust stock and reorder; w/o Cold Climate Package	IP29
1993-1992	8 Cyl. 6.5L; Alternate Number; w/o Cold Climate Package	IP47
1993-1992	8 Cyl. 6.2L; J; w/o Cold Climate Package; w/o High Altitude	IP15
1992	8 Cyl. 6.2L; C; w/o High Altitude	IP14
1992-1991	8 Cyl. 6.2L; J; w/ Cold Climate Package; w/o High Altitude	IP13
1991-1990	8 Cyl. 6.2L; J; w/o Cold Climate Package; w/o High Altitude	IP12
1989	8 Cyl. 6.2L; C; Alternate Number	IP48
1989	8 Cyl. 6.2L; C; Exhaust stock and reorder	IP7
1989	8 Cyl. 6.2L; J	IP10
1988	8 Cyl. 6.2L; Alternate Number	IP48
1988	8 Cyl. 6.2L; Exhaust stock and reorder	IP7
1986-1985	8 Cyl. 6.2L; J	IP10
K2500 Suburban		
1999-1995	8 Cyl. 6.5L; Complete Assembly	IP1
1999-1995	8 Cyl. 6.5L; Pump Only	IP25
1994	8 Cyl. 6.5L; Complete Assembly; OE No. 17800077, ID Tag No. 5521	IP1
1994	8 Cyl. 6.5L; OE No. 17800077, ID Tag No. 5521; Pump Only	IP25
1994	8 Cyl. 6.5L; OE No. 10225929, ID Tag No. 5068	IP28
1986-1985	8 Cyl. 6.2L	IP10
K3500		
2000-1995	8 Cyl. 6.5L; Complete Assembly	IP1
2000-1995	8 Cyl. 6.5L; Pump Only	IP25
1994	8 Cyl. 6.5L; Complete Assembly; OE No. 17800077, ID Tag No. 5521	IP1
1994	8 Cyl. 6.5L; OE No. 17800077, ID Tag No. 5521; Pump Only	IP25
1994	8 Cyl. 6.5L; OE No. 10225929, ID Tag No. 5068	IP28
1993-1992	8 Cyl. 6.2L; w/o Cold Climate Package; w/o High Altitude	IP15
1993-1992	8 Cyl. 6.5L; Exhaust stock and reorder; GVW Under 15,000 Lbs.; w/o Cold Climate Package	IP29
1993-1992	8 Cyl. 6.5L; Alternate Number; GVW Under 15,000 Lbs.; w/o Cold Climate Package	IP47

		Part No.
Diesel Fuel Injection Pump - Remanufactured		
K3500		
1992	8 Cyl. 6.2L; w/ Cold Climate Package; w/o High Altitude	IP13
1991-1990	8 Cyl. 6.2L; w/o Cold Climate Package; w/o High Altitude	IP12
1989-1988	8 Cyl. 6.2L	IP10
1986-1985	8 Cyl. 6.2L	IP10
P2500		
1989-1984	8 Cyl. 6.2L	IP10
P3500		
1999-1997	8 Cyl. 6.5L; Complete Assembly; Turbocharged	IP1
1999-1997	8 Cyl. 6.5L; Pump Only; Turbocharged	IP25
1993-1992	8 Cyl. 6.2L; Step Van; w/o Cold Climate Package; w/o High Altitude	IP15
1991-1990	8 Cyl. 6.2L; w/o Cold Climate Package; w/o High Altitude	IP12
1989-1984	8 Cyl. 6.2L	IP10
R1500 Suburban		
1991	8 Cyl. 6.2L	IP9
1990	8 Cyl. 6.2L; w/o Cold Climate Package; w/o High Altitude	IP12
1989-1988	8 Cyl. 6.2L; Alternate Number	IP48
1989-1988	8 Cyl. 6.2L; Exhaust stock and reorder	IP7
R2500		
1989-1988	8 Cyl. 6.2L	IP10
1987	8 Cyl. 6.2L; J	IP10
R2500 Suburban		
1991	8 Cyl. 6.2L; w/ Cold Climate Package; w/o High Altitude	IP13
1991-1990	8 Cyl. 6.2L; w/o Cold Climate Package; w/o High Altitude	IP12
1989-1987	8 Cyl. 6.2L	IP10
R3500		
1991	8 Cyl. 6.2L; w/ Cold Climate Package; w/o High Altitude	IP13
1991-1990	8 Cyl. 6.2L; w/o Cold Climate Package; w/o High Altitude	IP12
1989-1987	8 Cyl. 6.2L	IP10
Savana 2500		
2016-2011	8 Cyl. 6.6L	IP52
2010	8 Cyl. 6.6L; 6	IP24
2010	8 Cyl. 6.6L; L	IP52
2009-2006	8 Cyl. 6.6L	IP24
2002-1996	8 Cyl. 6.5L; Complete Assembly	IP1
2002-1996	8 Cyl. 6.5L; Pump Only	IP25
Savana 3500		
2016-2011	8 Cyl. 6.6L	IP52
2010	8 Cyl. 6.6L; 6	IP24
2010	8 Cyl. 6.6L; L	IP52
2009-2006	8 Cyl. 6.6L	IP24
2002-1996	8 Cyl. 6.5L; Complete Assembly	IP1
2002-1996	8 Cyl. 6.5L; Pump Only	IP25
Savana 4500		
2016-2011	8 Cyl. 6.6L	IP52
2010	8 Cyl. 6.6L; 6	IP24
2010	8 Cyl. 6.6L; L	IP52
2009	8 Cyl. 6.6L	IP24
Sierra 2500 HD		
2016-2011	8 Cyl. 6.6L	IP52
2010-2006	8 Cyl. 6.6L	IP24
2005	8 Cyl. 6.6L	IP23
2004	8 Cyl. 6.6L; 1	IP22
2004	8 Cyl. 6.6L; 2	IP23
2003-2001	8 Cyl. 6.6L	IP22

Injection Components

		Part No.
Diesel Fuel Injection Pump - Remanufactured		
Sierra 2500 HD Classic		
2007	8 Cyl. 6.6L	IP24
Sierra 3500		
2006	8 Cyl. 6.6L	IP24
2005	8 Cyl. 6.6L	IP23
2004	8 Cyl. 6.6L; 1	IP22
2004	8 Cyl. 6.6L; 2	IP23
2003-2001	8 Cyl. 6.6L	IP22
Sierra 3500 Classic		
2007	8 Cyl. 6.6L	IP24
Sierra 3500 HD		
2016-2011	8 Cyl. 6.6L	IP52
2010-2007	8 Cyl. 6.6L	IP24
V1500 Suburban		
1991	8 Cyl. 6.2L	IP9
1990	8 Cyl. 6.2L; w/o Cold Climate Package; w/o High Altitude	IP12
1989-1988	8 Cyl. 6.2L; Alternate Number	IP48
1989-1988	8 Cyl. 6.2L; Exhaust stock and reorder	IP7
V2500		
1987	8 Cyl. 6.2L; J	IP10
V2500 Suburban		
1991	8 Cyl. 6.2L; w/ Cold Climate Package; w/o High Altitude	IP13
1991-1990	8 Cyl. 6.2L; w/o Cold Climate Package; w/o High Altitude	IP12
1989-1987	8 Cyl. 6.2L	IP10
V3500		
1990	8 Cyl. 6.2L; w/o Cold Climate Package; w/o High Altitude	IP12
1989-1987	8 Cyl. 6.2L	IP10
Yukon		
1997-1994	8 Cyl. 6.5L; Complete Assembly	IP1
1997-1994	8 Cyl. 6.5L; Pump Only	IP25
Diesel Fuel Injector Line		
C4500 Topkick		
2004	8 Cyl. 6.6L; 1; Cyl. 1 and 8	DIL1
2004	8 Cyl. 6.6L; 1; Cyl. 3 and 6	DIL2
2004	8 Cyl. 6.6L; 1; Cyl. 4 and 5	DIL3
2004	8 Cyl. 6.6L; 1; Cyl. 2 and 7	DIL4
2004-2003	8 Cyl. 6.6L; Complete Kit	DIL1000K
2003	8 Cyl. 6.6L; Cyl. 1 and 8	DIL1
2003	8 Cyl. 6.6L; Cyl. 3 and 6	DIL2
2003	8 Cyl. 6.6L; Cyl. 4 and 5	DIL3
2003	8 Cyl. 6.6L; Cyl. 2 and 7	DIL4
C5500 Topkick		
2004	8 Cyl. 6.6L; 1; Cyl. 1 and 8	DIL1
2004	8 Cyl. 6.6L; 1; Cyl. 3 and 6	DIL2
2004	8 Cyl. 6.6L; 1; Cyl. 4 and 5	DIL3
2004	8 Cyl. 6.6L; 1; Cyl. 2 and 7	DIL4
2004-2003	8 Cyl. 6.6L; Complete Kit	DIL1000K
2003	8 Cyl. 6.6L; Cyl. 1 and 8	DIL1
2003	8 Cyl. 6.6L; Cyl. 3 and 6	DIL2
2003	8 Cyl. 6.6L; Cyl. 4 and 5	DIL3
2003	8 Cyl. 6.6L; Cyl. 2 and 7	DIL4
Sierra 2500 HD		
2004	8 Cyl. 6.6L; 1; Cyl. 1 and 8	DIL1
2004	8 Cyl. 6.6L; 1; Cyl. 3 and 6	DIL2
2004	8 Cyl. 6.6L; 1; Cyl. 4 and 5	DIL3
2004	8 Cyl. 6.6L; 1; Cyl. 2 and 7	DIL4
2004-2001	8 Cyl. 6.6L; Complete Kit	DIL1000K
2003-2001	8 Cyl. 6.6L; Cyl. 1 and 8	DIL1
2003-2001	8 Cyl. 6.6L; Cyl. 3 and 6	DIL2
2003-2001	8 Cyl. 6.6L; Cyl. 4 and 5	DIL3

		Part No.
Diesel Fuel Injector Line		
Sierra 2500 HD		
2003-2001	8 Cyl. 6.6L; Cyl. 2 and 7	DIL4
Sierra 3500		
2004	8 Cyl. 6.6L; 1; Cyl. 1 and 8	DIL1
2004	8 Cyl. 6.6L; 1; Cyl. 3 and 6	DIL2
2004	8 Cyl. 6.6L; 1; Cyl. 4 and 5	DIL3
2004	8 Cyl. 6.6L; 1; Cyl. 2 and 7	DIL4
2004-2001	8 Cyl. 6.6L; Complete Kit	DIL1000K
2003-2001	8 Cyl. 6.6L; Cyl. 1 and 8	DIL1
2003-2001	8 Cyl. 6.6L; Cyl. 3 and 6	DIL2
2003-2001	8 Cyl. 6.6L; Cyl. 4 and 5	DIL3
2003-2001	8 Cyl. 6.6L; Cyl. 2 and 7	DIL4
Diesel Fuel Injector Rail		
Savana 2500		
2016-2010	8 Cyl. 6.6L; Right	FIR3
2016-2010	8 Cyl. 6.6L; Left	FIR4
Savana 3500		
2016-2010	8 Cyl. 6.6L; Right	FIR3
2016-2010	8 Cyl. 6.6L; Left	FIR4
Sierra 2500 HD		
2016-2011	8 Cyl. 6.6L; Right	FIR3
2016-2011	8 Cyl. 6.6L; Left	FIR4
Sierra 3500 HD		
2016-2011	8 Cyl. 6.6L; Right	FIR3
2016-2011	8 Cyl. 6.6L; Left	FIR4
Diesel Glow Plug		
C1500		
1997-1994	8 Cyl. 6.5L	GP104
1993-1988	8 Cyl. 6.2L	GP104
1986-1982	8 Cyl. 6.2L	GP104
1981-1980	8 Cyl. 5.7L	GP103
C1500 Suburban		
1999-1995	8 Cyl. 6.5L	GP104
C2500		
2000-1994	8 Cyl. 6.5L	GP104
1993-1988	8 Cyl. 6.2L	GP104
1986	8 Cyl. 6.2L; Fuel Line Feed Kit	GP104
1985-1982	8 Cyl. 6.2L	GP104
C2500 Suburban		
1999-1994	8 Cyl. 6.5L	GP104
C3500		
2000-1994	8 Cyl. 6.5L	GP104
1993-1988	8 Cyl. 6.2L	GP104
1986-1982	8 Cyl. 6.2L	GP104
C3500HD		
2002-1994	8 Cyl. 6.5L	GP104
C4500 Topkick		
2009-2007	8 Cyl. 6.6L	GP114
2006	8 Cyl. 6.6L; w/ Hex Threads Located Middle of Glow Plug	GP114
2006	8 Cyl. 6.6L; w/ Hex Threads Located Near Top of Glow Plug	GP115
2005	8 Cyl. 6.6L	GP115
2004	8 Cyl. 6.6L; 1	GP110
2004	8 Cyl. 6.6L; 2	GP115
2003	8 Cyl. 6.6L	GP110
C5500 Topkick		
2009-2007	8 Cyl. 6.6L	GP114
2006	8 Cyl. 6.6L; w/ Hex Threads Located Middle of Glow Plug	GP114
2006	8 Cyl. 6.6L; w/ Hex Threads Located Near Top of Glow Plug	GP115
2005	8 Cyl. 6.6L	GP115

Injection Components

		Part No.
Diesel Glow Plug		
C5500 Topkick		
2004	8 Cyl. 6.6L; 1	GP110
2004	8 Cyl. 6.6L; 2	GP115
2003	8 Cyl. 6.6L	GP110
Caballero		
1984	8 Cyl. 5.7L	GP108
1983	8 Cyl. 5.7L	GP103
G2500		
1995-1994	8 Cyl. 6.5L	GP104
1993-1983	8 Cyl. 6.2L	GP104
G3500		
1996-1994	8 Cyl. 6.5L	GP104
1993-1983	8 Cyl. 6.2L	GP104
Jimmy		
1991-1982	8 Cyl. 6.2L	GP104
K1500		
1998-1994	8 Cyl. 6.5L	GP104
1993-1988	8 Cyl. 6.2L	GP104
1986-1982	8 Cyl. 6.2L	GP104
K1500 Suburban		
1999-1995	8 Cyl. 6.5L	GP104
K2500		
2000-1994	8 Cyl. 6.5L	GP104
1993-1988	8 Cyl. 6.2L	GP104
1986-1982	8 Cyl. 6.2L	GP104
K2500 Suburban		
1999-1994	8 Cyl. 6.5L	GP104
K3500		
2000-1994	8 Cyl. 6.5L	GP104
1993-1988	8 Cyl. 6.2L	GP104
1986-1982	8 Cyl. 6.2L	GP104
P2500		
1989-1982	8 Cyl. 6.2L	GP104
P3500		
1999-1994	8 Cyl. 6.5L	GP104
1993-1982	8 Cyl. 6.2L	GP104
R1500		
1987	8 Cyl. 6.2L	GP104
R1500 Suburban		
1991-1987	8 Cyl. 6.2L	GP104
R2500		
1989-1987	8 Cyl. 6.2L	GP104
R2500 Suburban		
1991-1987	8 Cyl. 6.2L	GP104
R3500		
1991-1987	8 Cyl. 6.2L	GP104
Savana 2500		
2016-2006	8 Cyl. 6.6L	GP114
2002-1996	8 Cyl. 6.5L	GP104
Savana 3500		
2016-2006	8 Cyl. 6.6L	GP114
2002-1996	8 Cyl. 6.5L	GP104
Savana 4500		
2016-2009	8 Cyl. 6.6L	GP114
Sierra 2500 HD		
2020-2017	8 Cyl. 6.6L	GP124
2016-2006	8 Cyl. 6.6L	GP114
2005	8 Cyl. 6.6L	GP115
2004	8 Cyl. 6.6L; 1	GP110
2004	8 Cyl. 6.6L; 2	GP115
2003-2001	8 Cyl. 6.6L	GP110

		Part No.
Diesel Glow Plug		
Sierra 2500 HD Classic		
2007	8 Cyl. 6.6L	GP114
Sierra 3500		
2006	8 Cyl. 6.6L	GP114
2005	8 Cyl. 6.6L	GP115
2004	8 Cyl. 6.6L; 1	GP110
2004	8 Cyl. 6.6L; 2	GP115
2003-2001	8 Cyl. 6.6L	GP110
Sierra 3500 Classic		
2007	8 Cyl. 6.6L	GP114
Sierra 3500 HD		
2020-2017	8 Cyl. 6.6L	GP124
2016-2007	8 Cyl. 6.6L	GP114
V1500		
1987	8 Cyl. 6.2L	GP104
V1500 Suburban		
1991-1987	8 Cyl. 6.2L	GP104
V2500		
1987	8 Cyl. 6.2L	GP104
V2500 Suburban		
1991-1987	8 Cyl. 6.2L	GP104
V3500		
1991-1987	8 Cyl. 6.2L	GP104
Yukon		
1997-1994	8 Cyl. 6.5L	GP104
Diesel Injector Pump Driver Relocation Kit		
C1500		
1997-1995	8 Cyl. 6.5L; w/ Module	IPR1
1997-1995	8 Cyl. 6.5L; w/o Module	IPR2
1994	8 Cyl. 6.5L; OE No. 17800077, ID Tag No. 5521; w/ Module	IPR1
1994	8 Cyl. 6.5L; OE No. 17800077, ID Tag No. 5521; w/o Module	IPR2
C1500 Suburban		
1999-1998	8 Cyl. 6.5L; w/ Module	IPR1
1999-1998	8 Cyl. 6.5L; w/o Module	IPR2
C2500		
2000-1995	8 Cyl. 6.5L; w/ Module	IPR1
2000-1995	8 Cyl. 6.5L; w/o Module	IPR2
1994	8 Cyl. 6.5L; OE No. 17800077, ID Tag No. 5521; w/ Module	IPR1
1994	8 Cyl. 6.5L; OE No. 17800077, ID Tag No. 5521; w/o Module	IPR2
C3500		
2000-1995	8 Cyl. 6.5L; w/ Module	IPR1
2000-1995	8 Cyl. 6.5L; w/o Module	IPR2
1994	8 Cyl. 6.5L; OE No. 17800077, ID Tag No. 5521; w/ Module	IPR1
1994	8 Cyl. 6.5L; OE No. 17800077, ID Tag No. 5521; w/o Module	IPR2
C3500HD		
2002-1995	8 Cyl. 6.5L; w/ Module	IPR1
2002-1995	8 Cyl. 6.5L; w/o Module	IPR2
1994	8 Cyl. 6.5L; OE No. 17800077, ID Tag No. 5521; w/ Module	IPR1
1994	8 Cyl. 6.5L; OE No. 17800077, ID Tag No. 5521; w/o Module	IPR2
G2500		
1995	8 Cyl. 6.5L; w/ Module	IPR1
1995	8 Cyl. 6.5L; w/o Module	IPR2
1994	8 Cyl. 6.5L; OE No. 17800077, ID Tag No. 5521; w/ Module	IPR1
1994	8 Cyl. 6.5L; OE No. 17800077, ID Tag No. 5521; w/o Module	IPR2

Injection Components

		Part No.
Diesel Injector Pump Driver Relocation Kit		
K1500		
1998-1995	8 Cyl. 6.5L; w/ Module	IPR1
1998-1995	8 Cyl. 6.5L; w/o Module	IPR2
1994	8 Cyl. 6.5L; OE No. 17800077, ID Tag No. 5521; w/ Module	IPR1
1994	8 Cyl. 6.5L; OE No. 17800077, ID Tag No. 5521; w/o Module	IPR2
K2500		
2000-1995	8 Cyl. 6.5L; w/ Module	IPR1
2000-1995	8 Cyl. 6.5L; w/o Module	IPR2
1994	8 Cyl. 6.5L; OE No. 17800077, ID Tag No. 5521; w/ Module	IPR1
1994	8 Cyl. 6.5L; OE No. 17800077, ID Tag No. 5521; w/o Module	IPR2
K3500		
2000-1995	8 Cyl. 6.5L; w/ Module	IPR1
2000-1995	8 Cyl. 6.5L; w/o Module	IPR2
1994	8 Cyl. 6.5L; OE No. 17800077, ID Tag No. 5521; w/ Module	IPR1
1994	8 Cyl. 6.5L; OE No. 17800077, ID Tag No. 5521; w/o Module	IPR2
P3500		
1999-1997	8 Cyl. 6.5L; Turbocharged; w/ Module	IPR1
1999-1997	8 Cyl. 6.5L; Turbocharged; w/o Module	IPR2
Savana 2500		
2002-1996	8 Cyl. 6.5L; w/ Module	IPR1
2002-1996	8 Cyl. 6.5L; w/o Module	IPR2
Savana 3500		
2002-1996	8 Cyl. 6.5L; w/ Module	IPR1
2002-1996	8 Cyl. 6.5L; w/o Module	IPR2
Yukon		
1997-1995	8 Cyl. 6.5L; w/ Module	IPR1
1997-1995	8 Cyl. 6.5L; w/o Module	IPR2
1994	8 Cyl. 6.5L; OE No. 17800077, ID Tag No. 5521; w/ Module	IPR1
1994	8 Cyl. 6.5L; OE No. 17800077, ID Tag No. 5521; w/o Module	IPR2
Diesel Injector Pump Module		
C1500		
1997-1994	8 Cyl. 6.5L	IPM1
C1500 Suburban		
1999-1998	8 Cyl. 6.5L	IPM1
C2500		
2000-1995	8 Cyl. 6.5L	IPM1
1994	8 Cyl. 6.5L; OE No. 17800077, ID Tag No. 5521	IPM1
C3500		
2000-1995	8 Cyl. 6.5L	IPM1
1994	8 Cyl. 6.5L; OE No. 17800077, ID Tag No. 5521	IPM1
C3500HD		
2002-1995	8 Cyl. 6.5L	IPM1
1994	8 Cyl. 6.5L; OE No. 17800077, ID Tag No. 5521	IPM1
G2500		
1995-1994	8 Cyl. 6.5L	IPM1
K1500		
1998-1995	8 Cyl. 6.5L	IPM1
1994	8 Cyl. 6.5L; P	IPM1
1994	8 Cyl. 6.5L; S	IPM1
K2500		
2000-1995	8 Cyl. 6.5L	IPM1
1994	8 Cyl. 6.5L; OE No. 17800077, ID Tag No. 5521	IPM1

		Part No.
Diesel Injector Pump Module		
K3500		
2000-1995	8 Cyl. 6.5L	IPM1
1994	8 Cyl. 6.5L; OE No. 17800077, ID Tag No. 5521	IPM1
P3500		
1999-1995	8 Cyl. 6.5L	IPM1
1994	8 Cyl. 6.5L; OE No. 17800077, ID Tag No. 5521	IPM1
Savana 2500		
2002-1996	8 Cyl. 6.5L	IPM1
Savana 3500		
2002-1996	8 Cyl. 6.5L	IPM1
Yukon		
1997-1995	8 Cyl. 6.5L	IPM1
1994	8 Cyl. 6.5L; OE No. 17800077, ID Tag No. 5521	IPM1
Diesel Oil Cooler Kit		
C2500		
1998-1996	8 Cyl. 6.5L	OCK14
1995-1994	8 Cyl. 6.5L	OCK13
C3500		
1998-1996	8 Cyl. 6.5L	OCK14
1995-1994	8 Cyl. 6.5L	OCK13
Canyon		
2019-2016	4 Cyl. 2.8L	OCK12
Savana 2500		
2016-2010	8 Cyl. 6.6L	OCK8
2002-1996	8 Cyl. 6.5L	OCK19
Savana 3500		
2016-2010	8 Cyl. 6.6L	OCK8
2009-2006	8 Cyl. 6.6L	OCK9
2002-1996	8 Cyl. 6.5L	OCK19
Savana 4500		
2016-2010	8 Cyl. 6.6L	OCK8
Sierra 2500 HD		
2019-2017	8 Cyl. 6.6L	OCK10
2016-2011	8 Cyl. 6.6L	OCK8
2010-2004	8 Cyl. 6.6L	OCK9
Sierra 3500		
2006-2004	8 Cyl. 6.6L	OCK9
Sierra 3500 HD		
2019-2017	8 Cyl. 6.6L	OCK10
2016-2011	8 Cyl. 6.6L	OCK8
2010-2007	8 Cyl. 6.6L	OCK9
Diesel Valve Cover Gasket		
C4500 Topkick		
2009-2005	8 Cyl. 6.6L	VCG3
2004	8 Cyl. 6.6L; 1	VCG5
2004	8 Cyl. 6.6L; 2	VCG3
2003	8 Cyl. 6.6L	VCG5
C5500 Topkick		
2009-2005	8 Cyl. 6.6L	VCG3
2004	8 Cyl. 6.6L; 1	VCG5
2004	8 Cyl. 6.6L; 2	VCG3
2003	8 Cyl. 6.6L	VCG5
Savana 2500		
2010-2006	8 Cyl. 6.6L	VCG3
Savana 3500		
2010-2006	8 Cyl. 6.6L	VCG3
Savana 4500		
2010	8 Cyl. 6.6L; 6	VCG3
2009	8 Cyl. 6.6L	VCG3

Injection Components

		Part No.
Diesel Valve Cover Gasket		
Sierra 2500 HD		
2010-2005	8 Cyl. 6.6L	VCG3
2004	8 Cyl. 6.6L; 1	VCG5
2004	8 Cyl. 6.6L; 2	VCG3
2003-2001	8 Cyl. 6.6L	VCG5
Sierra 2500 HD Classic		
2007	8 Cyl. 6.6L	VCG3
Sierra 3500		
2006-2005	8 Cyl. 6.6L	VCG3
2004	8 Cyl. 6.6L; 1	VCG5
2004	8 Cyl. 6.6L; 2	VCG3
2003-2001	8 Cyl. 6.6L	VCG5
Sierra 3500 Classic		
2007	8 Cyl. 6.6L	VCG3
Sierra 3500 HD		
2010-2007	8 Cyl. 6.6L	VCG3
Fuel Filter Housing Seal Kit		
Sierra 2500 HD		
2010-2001	8 Cyl. 6.6L	PHS1
Sierra 3500		
2006-2001	8 Cyl. 6.6L	PHS1
Sierra 3500 Classic		
2007	8 Cyl. 6.6L	PHS1
Sierra 3500 HD		
2010-2007	8 Cyl. 6.6L	PHS1
Fuel Injector Installation Kit		
C1500		
1997-1994	8 Cyl. 6.5L	SK54
1993-1988	8 Cyl. 6.2L	SK54
1986-1982	8 Cyl. 6.2L	SK54
C1500 Suburban		
1999-1995	8 Cyl. 6.5L	SK54
1986-1982	8 Cyl. 6.2L	SK54
C2500		
2000-1992	8 Cyl. 6.5L	SK54
1993-1988	8 Cyl. 6.2L	SK54
1986	8 Cyl. 6.2L; Fuel Line Feed Kit	SK54
1985-1982	8 Cyl. 6.2L	SK54
C2500 Suburban		
1999-1994	8 Cyl. 6.5L	SK54
1986-1982	8 Cyl. 6.2L	SK54
C3500		
2000-1992	8 Cyl. 6.5L	SK54
1993-1988	8 Cyl. 6.2L	SK54
1986-1982	8 Cyl. 6.2L	SK54
C3500HD		
2001-1992	8 Cyl. 6.5L	SK54
C4500 Topkick		
2009-2005	8 Cyl. 6.6L	SK115
2004	8 Cyl. 6.6L; 2	SK115
C5500 Topkick		
2009-2005	8 Cyl. 6.6L	SK115
2004	8 Cyl. 6.6L; 2	SK115
G2500		
1995-1994	8 Cyl. 6.5L	SK54
1993-1983	8 Cyl. 6.2L	SK54
G3500		
1996-1994	8 Cyl. 6.5L	SK54
1993-1983	8 Cyl. 6.2L	SK54
Jimmy		
1991-1982	8 Cyl. 6.2L	SK54

		Part No.
Fuel Injector Installation Kit		
K1500		
1998-1994	8 Cyl. 6.5L	SK54
1993-1988	8 Cyl. 6.2L	SK54
1986-1982	8 Cyl. 6.2L	SK54
K1500 Suburban		
1999-1995	8 Cyl. 6.5L	SK54
1986-1982	8 Cyl. 6.2L	SK54
K2500		
2000-1992	8 Cyl. 6.5L	SK54
1993-1988	8 Cyl. 6.2L	SK54
1986-1982	8 Cyl. 6.2L	SK54
K2500 Suburban		
1999-1994	8 Cyl. 6.5L	SK54
1986-1982	8 Cyl. 6.2L	SK54
K3500		
2000-1992	8 Cyl. 6.5L	SK54
1993-1988	8 Cyl. 6.2L	SK54
1986-1982	8 Cyl. 6.2L	SK54
P2500		
1989-1983	8 Cyl. 6.2L	SK54
P3500		
1998-1994	8 Cyl. 6.5L	SK54
1993-1983	8 Cyl. 6.2L	SK54
R1500		
1987	8 Cyl. 6.2L	SK54
R1500 Suburban		
1991-1987	8 Cyl. 6.2L	SK54
R2500		
1989-1987	8 Cyl. 6.2L	SK54
R2500 Suburban		
1991-1987	8 Cyl. 6.2L	SK54
R3500		
1991-1987	8 Cyl. 6.2L	SK54
Savana 2500		
2010-2006	8 Cyl. 6.6L	SK115
2002-1996	8 Cyl. 6.5L	SK54
Savana 3500		
2010-2006	8 Cyl. 6.6L	SK115
2002-1996	8 Cyl. 6.5L	SK54
Savana 4500		
2010-2009	8 Cyl. 6.6L	SK115
Sierra 2500 HD		
2010-2004	8 Cyl. 6.6L	SK115
Sierra 3500		
2006-2004	8 Cyl. 6.6L	SK115
Sierra 3500 Classic		
2007	8 Cyl. 6.6L	SK115
Sierra 3500 HD		
2010-2007	8 Cyl. 6.6L	SK115
V1500		
1987	8 Cyl. 6.2L	SK54
V1500 Suburban		
1991-1987	8 Cyl. 6.2L	SK54
V2500		
1987	8 Cyl. 6.2L	SK54
V2500 Suburban		
1991-1987	8 Cyl. 6.2L	SK54
V3500		
1991-1987	8 Cyl. 6.2L	SK54
Yukon		
1997-1994	8 Cyl. 6.5L	SK54

Injection Components

		Part No.
Fuel Injector Seal Kit		
C1500		
1997-1994	8 Cyl. 6.5L; Seal	SK13
1993-1988	8 Cyl. 6.2L; Seal	SK13
1986-1982	8 Cyl. 6.2L; Seal	SK13
C1500 Suburban		
1999-1995	8 Cyl. 6.5L; Seal	SK13
1986-1982	8 Cyl. 6.2L; Seal	SK13
C2500		
2000-1992	8 Cyl. 6.5L; Seal	SK13
1993-1988	8 Cyl. 6.2L; Seal	SK13
1986-1982	8 Cyl. 6.2L; Seal	SK13
C2500 Suburban		
1999-1994	8 Cyl. 6.5L; Seal	SK13
1986-1982	8 Cyl. 6.2L; Seal	SK13
C3500		
2000-1992	8 Cyl. 6.5L; Seal	SK13
1993-1988	8 Cyl. 6.2L; Seal	SK13
1986-1982	8 Cyl. 6.2L; Seal	SK13
C3500HD		
2002-1992	8 Cyl. 6.5L; Seal	SK13
G2500		
1995-1994	8 Cyl. 6.5L; Seal	SK13
1993-1983	8 Cyl. 6.2L; Seal	SK13
G3500		
1996-1994	8 Cyl. 6.5L; Seal	SK13
1993-1983	8 Cyl. 6.2L; Seal	SK13
Jimmy		
1991-1982	8 Cyl. 6.2L; Seal	SK13
K1500		
1998-1994	8 Cyl. 6.5L; Seal	SK13
1993-1988	8 Cyl. 6.2L; Seal	SK13
1986-1982	8 Cyl. 6.2L; Seal	SK13
K1500 Suburban		
1999-1995	8 Cyl. 6.5L; Seal	SK13
1986-1982	8 Cyl. 6.2L; Seal	SK13
K2500		
2000-1992	8 Cyl. 6.5L; Seal	SK13
1993-1988	8 Cyl. 6.2L; Seal	SK13
1986-1982	8 Cyl. 6.2L; Seal	SK13
K2500 Suburban		
1999-1994	8 Cyl. 6.5L; Seal	SK13
1986-1982	8 Cyl. 6.2L; Seal	SK13
K3500		
2000-1992	8 Cyl. 6.5L; Seal	SK13
1993-1988	8 Cyl. 6.2L; Seal	SK13
1986-1982	8 Cyl. 6.2L; Seal	SK13
P2500		
1989-1982	8 Cyl. 6.2L; Seal	SK13
P3500		
1999-1994	8 Cyl. 6.5L; Seal	SK13
1993-1982	8 Cyl. 6.2L; Seal	SK13
R1500		
1987	8 Cyl. 6.2L; Seal	SK13
R1500 Suburban		
1991-1987	8 Cyl. 6.2L; Seal	SK13
R2500		
1989-1987	8 Cyl. 6.2L; Seal	SK13
R2500 Suburban		
1991-1987	8 Cyl. 6.2L; Seal	SK13
R3500		
1991-1987	8 Cyl. 6.2L; Seal	SK13

		Part No.
Fuel Injector Seal Kit		
Savana 2500		
2002-1996	8 Cyl. 6.5L; Seal	SK13
Savana 3500		
2002-1996	8 Cyl. 6.5L; Seal	SK13
Sierra 1500		
2019	6 Cyl. ⁹	SK120
Sierra 2500 HD		
2004-2001	8 Cyl. 6.6L; O-Ring Only; Single Injector ²	SK66
2004-2001	8 Cyl. 6.6L; Rail Service Kit w/o Valve Cover Gasket ⁹	SK67
2004-2001	8 Cyl. 6.6L; Rail Service Kit w/ Valve Cover Gasket ⁹	SK68
Sierra 3500		
2004-2001	8 Cyl. 6.6L; O-Ring Only; Single Injector ²	SK66
2004-2001	8 Cyl. 6.6L; Rail Service Kit w/o Valve Cover Gasket ⁹	SK67
2004-2001	8 Cyl. 6.6L; Rail Service Kit w/ Valve Cover Gasket ⁹	SK68
V1500		
1987	8 Cyl. 6.2L; Seal	SK13
V1500 Suburban		
1991-1987	8 Cyl. 6.2L; Seal	SK13
V2500		
1987	8 Cyl. 6.2L; Seal	SK13
V2500 Suburban		
1991-1987	8 Cyl. 6.2L; Seal	SK13
V3500		
1991-1987	8 Cyl. 6.2L; Seal	SK13
Yukon		
1997-1994	8 Cyl. 6.5L; Seal	SK13
Fuel Pressure Regulator		
C4500 Topkick		
2009-2006	8 Cyl. 6.6L	PR444
2005	8 Cyl. 6.6L	PR439
2004	8 Cyl. 6.6L; 1	PR437
2004	8 Cyl. 6.6L; 2	PR439
2003	8 Cyl. 6.6L	PR437
C5500 Topkick		
2009-2006	8 Cyl. 6.6L	PR444
2005	8 Cyl. 6.6L	PR439
2004	8 Cyl. 6.6L; 1	PR437
2004	8 Cyl. 6.6L; 2	PR439
2003	8 Cyl. 6.6L	PR437
Savana 2500		
2010	8 Cyl. 6.6L; 6	PR444
2010	8 Cyl. 6.6L; L; Located On Fuel Pump	PR544
2010	8 Cyl. 6.6L; L; Located On Fuel Rail	PR553
Savana 3500		
2010	8 Cyl. 6.6L; 6	PR444
2010	8 Cyl. 6.6L; L; Located On Fuel Pump	PR544
2010	8 Cyl. 6.6L; L; Located On Fuel Rail	PR553
Savana 4500		
2010	8 Cyl. 6.6L; 6	PR444
2010	8 Cyl. 6.6L; L; Located On Fuel Pump	PR544
2010	8 Cyl. 6.6L; L; Located On Fuel Rail	PR553
Sierra 2500 HD		
2016-2013	8 Cyl. 6.6L; Located On Fuel Pump	PR544
2016-2013	8 Cyl. 6.6L; Located On Fuel Rail	PR553
2012-2011	8 Cyl. 6.6L; 8; Located On Fuel Pump	PR544
2012-2011	8 Cyl. 6.6L; 8; Located On Fuel Rail	PR553
2012-2011	8 Cyl. 6.6L; L	PR444
2005	8 Cyl. 6.6L	PR439
2004	8 Cyl. 6.6L; 1	PR437

Injection Components

		Part No.
Fuel Pressure Regulator		
Sierra 2500 HD		
2004	8 Cyl. 6.6L; 2	PR439
2003-2001	8 Cyl. 6.6L	PR437
Sierra 3500		
2005	8 Cyl. 6.6L	PR439
2004	8 Cyl. 6.6L; 1	PR437
2004	8 Cyl. 6.6L; 2	PR439
2003-2001	8 Cyl. 6.6L	PR437
Sierra 3500 HD		
2016-2013	8 Cyl. 6.6L; Located On Fuel Pump	PR544
2016-2013	8 Cyl. 6.6L; Located On Fuel Rail	PR553
2012-2011	8 Cyl. 6.6L; 8; Located On Fuel Pump	PR544
2012-2011	8 Cyl. 6.6L; 8; Located On Fuel Rail	PR553
2012-2011	8 Cyl. 6.6L; L	PR444
Fuel Rail O-Ring Kit		
C1500		
1997-1996	8 Cyl. 6.5L; Inlet and Outlet	SK18
C1500 Suburban		
1999-1996	8 Cyl. 6.5L; Inlet and Outlet	SK18
C2500		
1999-1996	8 Cyl. 6.5L; Inlet and Outlet	SK18
C3500		
1999-1992	8 Cyl. 6.5L; Inlet and Outlet	SK18
1993-1989	8 Cyl. 6.2L; Inlet and Outlet	SK18
C3500HD		
1999-1992	8 Cyl. 6.5L; Inlet and Outlet	SK18
G2500		
1995-1994	8 Cyl. 6.5L; Inlet and Outlet	SK18
1993-1987	8 Cyl. 6.2L; Inlet and Outlet	SK18
G3500		
1996-1994	8 Cyl. 6.5L; Inlet and Outlet	SK18
1993-1986	8 Cyl. 6.2L; Inlet and Outlet	SK18
Jimmy		
1991-1987	8 Cyl. 6.2L; Inlet and Outlet	SK18
K1500		
1998-1996	8 Cyl. 6.5L; Inlet and Outlet	SK18
K2500		
1999-1996	8 Cyl. 6.5L; Inlet and Outlet	SK18
K3500		
1999-1992	8 Cyl. 6.5L; Inlet and Outlet	SK18
1993-1988	8 Cyl. 6.2L; Inlet and Outlet	SK18
P3500		
1999-1996	8 Cyl. 6.5L; Inlet and Outlet	SK18
Savana 2500		
1999-1996	8 Cyl. 6.5L; Inlet and Outlet	SK18
Savana 3500		
1999-1996	8 Cyl. 6.5L; Inlet and Outlet	SK18
Yukon		
1997-1994	8 Cyl. 6.5L; Inlet and Outlet	SK18
Glow Plug Conductor		
C4500 Topkick		
2004-2003	8 Cyl. 6.6L	GPC101
C5500 Topkick		
2004-2003	8 Cyl. 6.6L	GPC101
Sierra 2500 HD		
2004-2001	8 Cyl. 6.6L	GPC101
Sierra 3500		
2004-2001	8 Cyl. 6.6L	GPC101
Throttle Body Injection Flange Gasket		
Sierra 2500 HD		
2010-2007	8 Cyl. 6.6L	TBG144

		Part No.
Throttle Body Injection Flange Gasket		
Sierra 3500 HD		
2010-2007	8 Cyl. 6.6L	TBG144
Chassis and Drivetrain Sensors		
ABS Speed Sensor		
C1500 Suburban		
1996-1995	8 Cyl. 6.5L; Left Front	ALS545
1996-1995	8 Cyl. 6.5L; Right Front	ALS546
C2500 Suburban		
1996-1995	8 Cyl. 6.5L; Left Front	ALS545
1996-1995	8 Cyl. 6.5L; Right Front	ALS546
K1500 Suburban		
1999-1997	8 Cyl. 6.5L; Right Front	ALS1184
1999-1997	8 Cyl. 6.5L; Left Front	ALS1187
Savana 4500		
2011	8 Cyl. 6.6L; Rear	ALS2352
T6500		
2009	w/ Hydraulic Brakes; Rear	ALS2683
2009-2004	w/ Hydraulic Brakes; Front	ALS2397
2007-2004	w/ Hydraulic Brakes; Rear	ALS2683
2002-1999	Straight End; Front	ALS2394
2002-1999	Straight End; Rear	ALS2394
2002-1999	90 Deg. Angle; Front	ALS2409
2002-1999	90 Deg. Angle; Rear	ALS2409
T7500		
2009-2004	w/ Hydraulic Brakes; Front	ALS2397
2009-2004	w/ Hydraulic Brakes; Rear	ALS2683
2002-1999	Straight End; Front	ALS2394
2002-1999	Straight End; Rear	ALS2394
2002-1999	90 Deg. Angle; Front	ALS2409
2002-1999	90 Deg. Angle; Rear	ALS2409
Yukon		
1997	8 Cyl. 6.5L; 4WD; Right Front	ALS1184
1997-1996	8 Cyl. 6.5L; 4WD; Left Front	ALS1187
1997-1996	8 Cyl. 6.5L; RWD; Left Front	ALS545
1997-1996	8 Cyl. 6.5L; RWD; Right Front	ALS546
1996	8 Cyl. 6.5L; 4WD; Right Front	ALS2264
Automatic Transmission Input Sensor		
Sierra 2500 HD		
2014	8 Cyl. 6.6L	SC163
Sierra 3500 HD		
2014	8 Cyl. 6.6L	SC163
Vehicle Speed Sensor		
Savana 3500		
2010	8 Cyl. 6.6L	SC317
Sierra 2500 HD		
2019-2015	8 Cyl. 6.6L	SC695
2008	8 Cyl. 6.6L	SC163
2007-2006	8 Cyl. 6.6L; RWD; w/ A.T.	SC163
Sierra 3500		
2006	8 Cyl. 6.6L; RWD; w/ A.T.	SC163
Sierra 3500 HD		
2019-2015	8 Cyl. 6.6L	SC695
2008-2007	8 Cyl. 6.6L; RWD	SC163
Fluid Level Sensors		
Coolant Level Sensor		
G2500		
1994	8 Cyl. 6.5L	FLS-1
1993-1992	8 Cyl. 6.2L	FLS-1
1991-1983	8 Cyl. 6.2L	FLS-3
G3500		
1994	8 Cyl. 6.5L	FLS-1

Fluid Level Sensors

		Part No.
Coolant Level Sensor		
G3500		
1993-1992	8 Cyl. 6.2L	FLS-1
1991-1983	8 Cyl. 6.2L	FLS-3
Engine Oil Level Sensor		
Savana 2500		
2016-2006	8 Cyl. 6.6L	FLS-61
Savana 3500		
2016-2006	8 Cyl. 6.6L	FLS-61
Sierra 2500 HD		
2016-2001	8 Cyl. 6.6L	FLS-61
Sierra 2500 HD Classic		
2007	8 Cyl. 6.6L	FLS-61
Sierra 3500		
2006-2001	8 Cyl. 6.6L	FLS-61
Sierra 3500 Classic		
2007	8 Cyl. 6.6L	FLS-61
Sierra 3500 HD		
2016-2007	8 Cyl. 6.6L	FLS-61
Fuel Level Sensor		
Canyon		
2020-2016	4 Cyl.	LSF135
Savana 2500		
2009-2007	8 Cyl.	LSF136
Savana 3500		
2009-2007	8 Cyl.	LSF136
Sierra 2500 HD		
2008-2004	8 Cyl. 6.6L	K07025
Sierra 3500		
2006-2004	8 Cyl. 6.6L	K07025
Sierra 3500 Classic		
2007	8 Cyl. 6.6L	K07025
Sierra 3500 HD		
2015-2011	8 Cyl. 6.6L; Diesel	K07020
Fuel Sensors		
Diesel Exhaust Particulate Sensor		
Canyon		
2019-2016	4 Cyl. 2.8L	DEP118
Savana 2500		
2019-2018	4 Cyl. 2.8L	DEP121
2017	4 Cyl. 2.8L	DEP125
2016	8 Cyl. 6.6L	DEP120
Savana 3500		
2019-2018	4 Cyl. 2.8L	DEP121
2017	4 Cyl. 2.8L	DEP125
2016	8 Cyl. 6.6L	DEP120
Sierra 2500 HD		
2019-2017	8 Cyl. 6.6L	DEP119
2016	8 Cyl. 6.6L	DEP120
Sierra 3500 HD		
2019-2017	8 Cyl. 6.6L	DEP119
2016	8 Cyl. 6.6L	DEP120
Terrain		
2019-2018	4 Cyl. 1.6L	DEP122
Diesel Nitrogen Oxide (NOx) Sensor		
Savana 2500		
2016	8 Cyl. 6.6L; Downstream	NOX021
2016	8 Cyl. 6.6L; Upstream	NOX022
2015	8 Cyl. 6.6L; Downstream	NOX003
2015	8 Cyl. 6.6L; Upstream	NOX004
2014-2010	8 Cyl. 6.6L; Downstream	NOX001
2014-2010	8 Cyl. 6.6L; Upstream	NOX002

		Part No.
Diesel Nitrogen Oxide (NOx) Sensor		
Savana 3500		
2016	8 Cyl. 6.6L; Downstream	NOX021
2016	8 Cyl. 6.6L; Upstream	NOX022
2015	8 Cyl. 6.6L; Downstream	NOX003
2015	8 Cyl. 6.6L; Upstream	NOX004
2014-2010	8 Cyl. 6.6L; Downstream	NOX001
2014-2010	8 Cyl. 6.6L; Upstream	NOX002
Savana 4500		
2016	8 Cyl. 6.6L; Downstream	NOX021
2015	8 Cyl. 6.6L; Downstream	NOX003
2015	8 Cyl. 6.6L; Upstream	NOX004
2014-2010	8 Cyl. 6.6L; Downstream	NOX001
2014-2010	8 Cyl. 6.6L; Upstream	NOX002
Sierra 2500 HD		
2019-2018	8 Cyl. 6.6L; Upstream	NOX007
2018-2017	8 Cyl. 6.6L; Downstream	NOX005
2017	8 Cyl. 6.6L; Upstream	NOX006
2016	8 Cyl. 6.6L; Downstream	NOX021
2016	8 Cyl. 6.6L; Upstream	NOX022
2015	8 Cyl. 6.6L; Downstream	NOX003
2015	8 Cyl. 6.6L; Upstream	NOX004
2014-2011	8 Cyl. 6.6L; Downstream	NOX001
2014-2011	8 Cyl. 6.6L; Upstream	NOX002
Sierra 3500 HD		
2019-2018	8 Cyl. 6.6L; Upstream	NOX007
2018-2017	8 Cyl. 6.6L; Downstream	NOX005
2017	8 Cyl. 6.6L; Upstream	NOX006
2016	8 Cyl. 6.6L; Downstream	NOX021
2016	8 Cyl. 6.6L; Upstream	NOX022
2015	8 Cyl. 6.6L; Downstream	NOX003
2015	8 Cyl. 6.6L; Upstream	NOX004
2014-2011	8 Cyl. 6.6L; Downstream	NOX001
2014-2011	8 Cyl. 6.6L; Upstream	NOX002
Fuel / Water Separator Sensor		
C1500		
1997-1994	8 Cyl. 6.5L	FWSS102
1993-1988	8 Cyl. 6.2L	FWSS103
1986-1985	8 Cyl. 6.2L	FWSS103
C1500 Suburban		
1999-1995	8 Cyl. 6.5L	FWSS102
1986-1985	8 Cyl. 6.2L	FWSS103
C2500		
2000-1994	8 Cyl. 6.5L	FWSS102
1993-1988	8 Cyl. 6.2L	FWSS103
1986	8 Cyl. 6.2L; Fuel Line Feed Kit	FWSS103
1985	8 Cyl. 6.2L	FWSS103
C2500 Suburban		
1999-1994	8 Cyl. 6.5L	FWSS102
1986-1985	8 Cyl. 6.2L	FWSS103
C3500		
2000-1994	8 Cyl. 6.5L	FWSS102
1993-1988	8 Cyl. 6.2L	FWSS103
1986-1985	8 Cyl. 6.2L	FWSS103
C3500HD		
2001-1994	8 Cyl. 6.5L	FWSS102
G2500		
1995-1994	8 Cyl. 6.5L	FWSS102
1993-1985	8 Cyl. 6.2L	FWSS103
G3500		
1996-1994	8 Cyl. 6.5L	FWSS102
1993-1985	8 Cyl. 6.2L	FWSS103
Jimmy		
1991-1985	8 Cyl. 6.2L	FWSS103

Fuel Sensors

		Part No.
Fuel / Water Separator Sensor		
K1500		
1998-1994	8 Cyl. 6.5L	FWSS102
1993-1988	8 Cyl. 6.2L	FWSS103
1986-1985	8 Cyl. 6.2L	FWSS103
K1500 Suburban		
1999-1995	8 Cyl. 6.5L	FWSS102
1986-1985	8 Cyl. 6.2L	FWSS103
K2500		
2000-1994	8 Cyl. 6.5L	FWSS102
1993-1988	8 Cyl. 6.2L	FWSS103
1986-1985	8 Cyl. 6.2L	FWSS103
K2500 Suburban		
1999-1994	8 Cyl. 6.5L	FWSS102
1986-1985	8 Cyl. 6.2L	FWSS103
K3500		
2000-1994	8 Cyl. 6.5L	FWSS102
1993-1988	8 Cyl. 6.2L	FWSS103
1986-1985	8 Cyl. 6.2L	FWSS103
P2500		
1989-1985	8 Cyl. 6.2L	FWSS103
P3500		
1999-1994	8 Cyl. 6.5L	FWSS102
1993-1985	8 Cyl. 6.2L	FWSS103
R1500		
1987	8 Cyl. 6.2L	FWSS103
R1500 Suburban		
1991-1987	8 Cyl. 6.2L	FWSS103
R2500		
1989-1987	8 Cyl. 6.2L	FWSS103
R2500 Suburban		
1991-1987	8 Cyl. 6.2L	FWSS103
R3500		
1991-1987	8 Cyl. 6.2L	FWSS103
Savana 2500		
2016-2012	8 Cyl. 6.6L	FWSS116
2006	8 Cyl. 6.6L	FWSS101
2001-1996	8 Cyl. 6.5L	FWSS102
Savana 3500		
2016-2012	8 Cyl. 6.6L	FWSS116
2006	8 Cyl. 6.6L	FWSS101
2001-1996	8 Cyl. 6.5L	FWSS102
Savana 4500		
2016-2012	8 Cyl. 6.6L	FWSS116
Sierra 2500 HD		
2016-2012	8 Cyl. 6.6L	FWSS116
2011-2001	8 Cyl. 6.6L	FWSS101
Sierra 2500 HD Classic		
2007	8 Cyl. 6.6L	FWSS101
Sierra 3500		
2006-2001	8 Cyl. 6.6L	FWSS101
Sierra 3500 Classic		
2007	8 Cyl. 6.6L	FWSS101
Sierra 3500 HD		
2016-2012	8 Cyl. 6.6L	FWSS116
2011-2007	8 Cyl. 6.6L	FWSS101
V1500		
1987	8 Cyl. 6.2L	FWSS103
V1500 Suburban		
1991-1987	8 Cyl. 6.2L	FWSS103
V2500		
1987	8 Cyl. 6.2L	FWSS103

		Part No.
Fuel / Water Separator Sensor		
V2500 Suburban		
1991-1987	8 Cyl. 6.2L	FWSS103
V3500		
1991-1987	8 Cyl. 6.2L	FWSS103
Yukon		
1997-1994	8 Cyl. 6.5L	FWSS102
Knock Sensor		
C1500 Suburban		
1997	8 Cyl. 6.5L	KS50
C2500 Suburban		
1997	8 Cyl. 6.5L	KS50
K1500 Suburban		
1997	8 Cyl. 6.5L	KS50
K2500 Suburban		
1997	8 Cyl. 6.5L	KS50
Mass Air Flow		
C4500 Topkick		
2007-2003	8 Cyl. 6.6L; Sensor Only	MAS0280
C5500 Topkick		
2007-2003	8 Cyl. 6.6L; Sensor Only	MAS0280
Canyon		
2017	4 Cyl.	MAS0323
2016	4 Cyl. 2.8L	MAS0450
Savana 2500		
2019-2017	4 Cyl.; Turbocharged	MAS0450
2015-2011	8 Cyl. 6.6L	MAS0279
2010-2008	8 Cyl. 6.6L	MAS0354
2007	8 Cyl. 6.6L; Diesel; w/o High Output Engine	MAS0354
Savana 3500		
2019-2017	4 Cyl.; Turbocharged	MAS0450
2015-2011	8 Cyl. 6.6L	MAS0279
2010-2008	8 Cyl. 6.6L	MAS0354
Savana 4500		
2010-2009	8 Cyl. 6.6L	MAS0354
Sierra 2500 HD		
2010-2007	8 Cyl. 6.6L; Diesel	MAS0354
Sierra 3500 HD		
2010-2007	8 Cyl. 6.6L; Diesel	MAS0354
Miscellaneous Sensors		
Accelerator Pedal Sensor Repair Kit		
C1500		
1997-1994	8 Cyl. 6.5L; Sensor Only	APK102
C1500 Suburban		
1999-1995	8 Cyl. 6.5L; Sensor Only	APK102
C2500		
2000-1994	8 Cyl. 6.5L; Sensor Only	APK102
C2500 Suburban		
1999-1994	8 Cyl. 6.5L; Sensor Only	APK102
C3500		
2000-1994	8 Cyl. 6.5L; Sensor Only	APK102
C3500HD		
2002-1994	8 Cyl. 6.5L; Sensor Only	APK102
K1500		
1998-1994	8 Cyl. 6.5L; Sensor Only	APK102
K1500 Suburban		
1997-1995	8 Cyl. 6.5L; Sensor Only	APK102
K2500		
2000-1994	8 Cyl. 6.5L; Sensor Only	APK102
K2500 Suburban		
1999-1994	8 Cyl. 6.5L; Sensor Only	APK102

Miscellaneous Sensors

		Part No.
Accelerator Pedal Sensor Repair Kit		
K3500		
2000-1994	8 Cyl. 6.5L; Sensor Only	APK102
Sierra 2500 HD		
2005-2001	8 Cyl. 6.6L; Sensor Only	G92003
Sierra 3500		
2005-2001	8 Cyl. 6.6L; Sensor Only	G92003
Yukon		
1997-1994	8 Cyl. 6.5L; Sensor Only	APK102
Position Sensors		
Accelerator Pedal Sensor		
C1500		
1997-1994	8 Cyl. 6.5L	APS130
C1500 Suburban		
1999-1995	8 Cyl. 6.5L	APS130
C2500		
2000-1994	8 Cyl. 6.5L	APS130
C2500 Suburban		
1999-1994	8 Cyl. 6.5L	APS130
C3500		
2000-1994	8 Cyl. 6.5L	APS130
C3500HD		
2002-1994	8 Cyl. 6.5L	APS130
G3500		
1996	8 Cyl. 6.5L	APS129
K1500		
1998-1994	8 Cyl. 6.5L	APS130
K1500 Suburban		
1997-1995	8 Cyl. 6.5L	APS130
K2500		
2000-1994	8 Cyl. 6.5L	APS130
K2500 Suburban		
1999-1994	8 Cyl. 6.5L	APS130
K3500		
2000-1994	8 Cyl. 6.5L	APS130
Savana 2500		
2002-1996	8 Cyl. 6.5L	APS129
Savana 3500		
2002-1996	8 Cyl. 6.5L	APS129
Sierra 2500 HD		
2019-2014	8 Cyl. 6.6L; Exhaust stock and reorder	APS413
2017-2014	8 Cyl. 6.6L; Alternate Number	APS265
2006	8 Cyl. 6.6L	APS194
2005-2001	8 Cyl. 6.6L; Complete Assembly	APS105
Sierra 2500 HD Classic		
2007	8 Cyl. 6.6L	APS194
Sierra 3500		
2006	8 Cyl. 6.6L	APS194
2005-2003	8 Cyl. 6.6L; Complete Assembly	APS105
2001	8 Cyl. 6.6L; Complete Assembly	APS105
Sierra 3500 HD		
2019-2014	8 Cyl. 6.6L; Exhaust stock and reorder	APS413
2017-2014	8 Cyl. 6.6L; Alternate Number	APS265
T6500		
2002-1999		TH371
T7500		
2002-1999		TH371
Yukon		
1997-1994	8 Cyl. 6.5L	APS130
Camshaft Sensor		
Canyon		
2019-2016	4 Cyl. 2.8L	PC1103

		Part No.
Camshaft Sensor		
Savana 2500		
2019-2017	4 Cyl. 2.8L	PC1103
2016-2011	8 Cyl. 6.6L	PC660
2009-2006	8 Cyl. 6.6L	PC660
Savana 3500		
2019-2017	4 Cyl. 2.8L	PC1103
2016-2006	8 Cyl. 6.6L	PC660
Savana 4500		
2016-2009	8 Cyl. 6.6L	PC660
Sierra 2500 HD		
2019-2017	8 Cyl. 6.6L	PC1138
2016-2010	8 Cyl. 6.6L	PC660
2009	8 Cyl. 6.6L; Diesel	PC660
2008-2006	8 Cyl. 6.6L	PC660
2005-2004	8 Cyl. 6.6L	PC617
2003-2001	8 Cyl. 6.6L	PC398
Sierra 2500 HD Classic		
2007	8 Cyl. 6.6L	PC660
Sierra 3500		
2006	8 Cyl. 6.6L	PC660
2005-2004	8 Cyl. 6.6L	PC617
2003-2001	8 Cyl. 6.6L	PC398
Sierra 3500 Classic		
2007	8 Cyl. 6.6L	PC660
Sierra 3500 HD		
2019-2017	8 Cyl. 6.6L	PC1138
2016-2011	8 Cyl. 6.6L	PC660
2009-2007	8 Cyl. 6.6L	PC660
Terrain		
2019-2018	4 Cyl. 1.6L	PC1191
Crankshaft Sensor		
B7		
1998-1997	8 Cyl. 6.5L	PC125
C2500		
2000-1999	8 Cyl. 6.5L	PC125
C3500		
2000-1996	8 Cyl. 6.5L	PC125
C3500HD		
2002	8 Cyl. 6.5L	PC125
2001	8 Cyl. 6.5L	PC399
2000-1996	8 Cyl. 6.5L	PC125
C4500 Topkick		
2009-2006	8 Cyl. 6.6L	PC593
2005-2003	8 Cyl. 6.6L	PC399
C5500 Topkick		
2009-2005	8 Cyl. 6.6L	PC593
2004-2003	8 Cyl. 6.6L	PC399
Canyon		
2019-2018	4 Cyl.	PC977
2016	4 Cyl.	PC977
P3500		
1999-1998	8 Cyl. 6.5L	PC125
Savana 2500		
2016-2006	8 Cyl. 6.6L	PC593
2002-2001	8 Cyl. 6.5L	PC125
Savana 3500		
2016-2006	8 Cyl. 6.6L	PC593
2002-2001	8 Cyl. 6.5L	PC125
Savana 4500		
2016-2009	8 Cyl. 6.6L	PC593
Sierra 2500 HD		
2020-2017	8 Cyl. 6.6L	PC1195

Position Sensors

		Part No.
Crankshaft Sensor		
Sierra 2500 HD		
2016-2006	8 Cyl. 6.6L	PC593
2005	8 Cyl. 6.6L	PC594
2004	8 Cyl. 6.6L; 1	PC399
2004	8 Cyl. 6.6L; 2	PC594
2003-2001	8 Cyl. 6.6L	PC399
Sierra 2500 HD Classic		
2007	8 Cyl. 6.6L	PC593
Sierra 3500		
2006	8 Cyl. 6.6L	PC593
2005	8 Cyl. 6.6L	PC594
2004	8 Cyl. 6.6L; 1	PC399
2004	8 Cyl. 6.6L; 2	PC594
2003-2001	8 Cyl. 6.6L	PC399
Sierra 3500 Classic		
2007	8 Cyl. 6.6L	PC593
Sierra 3500 HD		
2020-2017	8 Cyl. 6.6L	PC1195
2016-2007	8 Cyl. 6.6L	PC593
Terrain		
2019-2018	4 Cyl. 1.6L	PC1194
Throttle Position Sensor		
C1500		
1997-1996	8 Cyl. 6.5L	TH149
1993	8 Cyl. 6.2L; w/ A.T.	TH160
1993-1991	8 Cyl. 6.2L; w/ M.T.	TH150
1991	8 Cyl. 6.2L; w/ A.T.	TH160
1990-1988	8 Cyl. 6.2L	TH150
1986	8 Cyl. 6.2L; Fed.; High Altitude	TH322
1985	8 Cyl. 6.2L; C; Calif.	TH150
1985	8 Cyl. 6.2L; C; Fed.; High Altitude	TH322
1984-1983	8 Cyl. 6.2L; Fed.; High Altitude	TH322
1982	8 Cyl. 6.2L	TH322
C1500 Suburban		
1999-1998	8 Cyl. 6.5L	TH149
C2500		
1999-1996	8 Cyl. 6.5L	TH149
1993	8 Cyl. 6.2L; w/ M.T.	TH150
1993	8 Cyl. 6.2L; w/ A.T.	TH160
1993-1992	8 Cyl. 6.5L	TH160
1992	8 Cyl. 6.2L; C; w/ M.T.	TH150
1992	8 Cyl. 6.2L; J; w/ A.T.	TH160
1991	8 Cyl. 6.2L; w/ M.T.	TH150
1991	8 Cyl. 6.2L; w/ A.T.	TH160
1990-1989	8 Cyl. 6.2L; C	TH150
1990-1989	8 Cyl. 6.2L; J	TH160
1988	8 Cyl. 6.2L	TH150
1986-1983	8 Cyl. 6.2L; C; Fed.; High Altitude	TH322
1985	8 Cyl. 6.2L; C; Calif.	TH150
1985-1983	8 Cyl. 6.2L; J	TH304
1982	8 Cyl. 6.2L; C	TH322
C2500 Suburban		
1999-1996	8 Cyl. 6.5L	TH149
1985	8 Cyl. 6.2L; J	TH304
1984	8 Cyl. 6.2L	TH304
1983	8 Cyl. 6.2L; J	TH304
C3500		
1999-1996	8 Cyl. 6.5L	TH149
1993-1992	8 Cyl. 6.5L	TH160
1993-1991	8 Cyl. 6.2L; w/ M.T.	TH150
1993-1991	8 Cyl. 6.2L; w/ A.T.	TH160
1990	8 Cyl. 6.2L	TH160
1985-1983	8 Cyl. 6.2L; J	TH304

		Part No.
Throttle Position Sensor		
C3500HD		
1999-1996	8 Cyl. 6.5L	TH149
1993-1992	8 Cyl. 6.5L	TH160
Caballero		
1984	8 Cyl. 5.7L	TH4
G2500		
1993	8 Cyl. 6.2L	TH160
1992-1989	8 Cyl. 6.2L	TH150
1988	8 Cyl. 6.2L; Calif.	TH150
1988	8 Cyl. 6.2L; Fed.	TH322
1987-1985	8 Cyl. 6.2L; C; Fed.; High Altitude; w/ A.T.	TH322
1984	8 Cyl. 6.2L; Fed.; High Altitude; w/ A.T.	TH322
1983	8 Cyl. 6.2L; C; Fed.; High Altitude; w/ A.T.	TH322
G3500		
1996-1994	8 Cyl. 6.5L	TH160
1993	8 Cyl. 6.2L	TH160
1991	8 Cyl. 6.2L	TH160
1989	8 Cyl. 6.2L	TH150
1985	8 Cyl. 6.2L; w/ A.T.	TH304
1984-1983	8 Cyl. 6.2L; J; w/ A.T.	TH304
Jimmy		
1991-1988	8 Cyl. 6.2L	TH150
1987	8 Cyl. 6.2L; w/ M.T.	TH303
1987	8 Cyl. 6.2L; w/ A.T.	TH322
1986-1983	8 Cyl. 6.2L; Fed.	TH322
1985	8 Cyl. 6.2L; Calif.	TH150
1982	8 Cyl. 6.2L	TH322
K1500		
1998-1996	8 Cyl. 6.5L	TH149
1993	8 Cyl. 6.2L; w/ A.T.	TH160
1993-1991	8 Cyl. 6.2L; w/ M.T.	TH150
1991	8 Cyl. 6.2L; w/ A.T.	TH160
1990-1988	8 Cyl. 6.2L	TH150
1986-1985	8 Cyl. 6.2L; C; Fed.; High Altitude	TH322
1985	8 Cyl. 6.2L; C; Calif.	TH150
1985	8 Cyl. 6.2L; J	TH304
1984-1983	8 Cyl. 6.2L; Fed.; High Altitude	TH322
1982	8 Cyl. 6.2L	TH322
K1500 Suburban		
1997-1996	8 Cyl. 6.5L	TH149
K2500		
1999-1996	8 Cyl. 6.5L	TH149
1993-1992	8 Cyl. 6.5L	TH160
1993-1991	8 Cyl. 6.2L; w/ M.T.	TH150
1993-1991	8 Cyl. 6.2L; w/ A.T.	TH160
1990	8 Cyl. 6.2L	TH160
1989-1988	8 Cyl. 6.2L	TH150
1986-1983	8 Cyl. 6.2L; C; Fed.; High Altitude	TH322
1985	8 Cyl. 6.2L; C; Calif.	TH150
1985-1983	8 Cyl. 6.2L; J	TH304
1982	8 Cyl. 6.2L; C	TH322
K2500 Suburban		
1999-1996	8 Cyl. 6.5L	TH149
1985-1983	8 Cyl. 6.2L; J	TH304
K3500		
1999-1996	8 Cyl. 6.5L	TH149
1993	8 Cyl. 6.2L; w/ M.T.	TH150
1993-1992	8 Cyl. 6.5L	TH160
1993-1991	8 Cyl. 6.2L; w/ A.T.	TH160
1991	8 Cyl. 6.2L; w/ M.T.	TH150
1990	8 Cyl. 6.2L	TH160
1985-1983	8 Cyl. 6.2L	TH304

Position Sensors

		Part No.
Throttle Position Sensor		
P2500		
1989-1988	8 Cyl. 6.2L	TH41
P3500		
1999-1994	8 Cyl. 6.5L	TH160
1993-1991	8 Cyl. 6.2L	TH160
1989-1988	8 Cyl. 6.2L	TH41
R1500		
1987	8 Cyl. 6.2L	TH322
R1500 Suburban		
1991-1990	8 Cyl. 6.2L	TH150
R2500		
1989-1988	8 Cyl. 6.2L	TH160
1987	8 Cyl. 6.2L	TH322
R2500 Suburban		
1991-1988	8 Cyl. 6.2L	TH160
R3500		
1991-1988	8 Cyl. 6.2L	TH160
V1500		
1987	8 Cyl. 6.2L	TH322
V1500 Suburban		
1991-1990	8 Cyl. 6.2L	TH150
V2500		
1987	8 Cyl. 6.2L; C	TH322
V2500 Suburban		
1991-1988	8 Cyl. 6.2L	TH160
V3500		
1991-1988	8 Cyl. 6.2L	TH160
Yukon		
1996	8 Cyl. 6.5L	TH149
Pressure Sensors		
Barometric Pressure Sensor		
C4500 Topkick		
2007-2004	8 Cyl. 6.6L	AS371
P3500		
1998	8 Cyl. 6.5L; Naturally Aspirated	AS11
1997	8 Cyl. 6.5L; Diesel; Naturally Aspirated	AS11
1996	8 Cyl. 6.5L	AS11
Sierra 2500 HD		
2005	8 Cyl. 6.6L	AS371
2004	8 Cyl. 6.6L; 1	AS195
2004	8 Cyl. 6.6L; 2	AS371
2003-2002	8 Cyl. 6.6L	AS195
2001	8 Cyl. 6.6L	AS371
Sierra 3500		
2005	8 Cyl. 6.6L	AS371
2004	8 Cyl. 6.6L; 1	AS195
2004	8 Cyl. 6.6L; 2	AS371
2003-2002	8 Cyl. 6.6L	AS195
2001	8 Cyl. 6.6L	AS371
Diesel Particulate Filter (DPF) Pressure Sensor		
Canyon		
2019	4 Cyl. 2.8L	DPS114
2018-2016	4 Cyl. 2.8L	DPS106
Savana 2500		
2019-2018	4 Cyl. 2.8L	DPS114
2017	4 Cyl. 2.8L	DPS105
2016-2011	8 Cyl. 6.6L	DPS107
2010	8 Cyl. 6.6L; L	DPS107
2010-2007	8 Cyl. 6.6L	VP27
Savana 3500		
2019-2018	4 Cyl. 2.8L	DPS114
2017	4 Cyl. 2.8L	DPS105

		Part No.
Diesel Particulate Filter (DPF) Pressure Sensor		
Savana 3500		
2015-2011	8 Cyl. 6.6L	DPS107
2010	8 Cyl. 6.6L; L	DPS107
2010-2007	8 Cyl. 6.6L	VP27
Savana 4500		
2012-2011	8 Cyl. 6.6L	DPS107
2010	8 Cyl. 6.6L; L	DPS107
Sierra 2500 HD		
2019-2017	8 Cyl. 6.6L	DPS105
2015-2011	8 Cyl. 6.6L	DPS107
Sierra 3500 HD		
2019-2017	8 Cyl. 6.6L	DPS105
2016-2011	8 Cyl. 6.6L	DPS107
Terrain		
2018	4 Cyl. 1.6L	DPS106
Fuel Pressure Sensor		
C4500 Topkick		
2009-2006	8 Cyl. 6.6L	FPS11
2005	8 Cyl. 6.6L; To 12/04	FPS29
2005	8 Cyl. 6.6L; From 1/05	FPS46
2004	8 Cyl. 6.6L; 1	FPS28
2004	8 Cyl. 6.6L; 2	FPS29
2003	8 Cyl. 6.6L	FPS28
C5500 Topkick		
2009-2006	8 Cyl. 6.6L	FPS11
2005	8 Cyl. 6.6L; To 12/04	FPS29
2005	8 Cyl. 6.6L; From 1/05	FPS46
2004	8 Cyl. 6.6L; 1	FPS28
2004	8 Cyl. 6.6L; 2	FPS29
2003	8 Cyl. 6.6L	FPS28
Savana 2500		
2016-2013	8 Cyl. 6.6L	FPS45
2012-2011	8 Cyl. 6.6L	FPS44
2010	8 Cyl. 6.6L; 6	FPS11
2010	8 Cyl. 6.6L; L	FPS44
Savana 3500		
2016-2013	8 Cyl. 6.6L	FPS45
2012-2011	8 Cyl. 6.6L	FPS44
2010	8 Cyl. 6.6L; 6	FPS11
2010	8 Cyl. 6.6L; L	FPS44
Savana 4500		
2016-2013	8 Cyl. 6.6L	FPS45
2012-2011	8 Cyl. 6.6L	FPS44
2010	8 Cyl. 6.6L; 6	FPS11
2010	8 Cyl. 6.6L; L	FPS44
Sierra 2500 HD		
2015-2013	8 Cyl. 6.6L	FPS45
2012-2011	8 Cyl. 6.6L	FPS44
2010-2006	8 Cyl. 6.6L	FPS11
2005	8 Cyl. 6.6L	FPS46
2004	8 Cyl. 6.6L; 1	FPS28
2004	8 Cyl. 6.6L; 2	FPS29
2003-2001	8 Cyl. 6.6L	FPS28
Sierra 2500 HD Classic		
2007	8 Cyl. 6.6L	FPS11
Sierra 3500		
2006	8 Cyl. 6.6L	FPS11
2005	8 Cyl. 6.6L; To 12/04	FPS29
2005	8 Cyl. 6.6L; From 1/05	FPS46
2004	8 Cyl. 6.6L; 1	FPS28
2004	8 Cyl. 6.6L; 2	FPS29
2003-2001	8 Cyl. 6.6L	FPS28

Pressure Sensors

		Part No.
Fuel Pressure Sensor		
Sierra 3500 Classic		
2007	8 Cyl. 6.6L	FPS11
Sierra 3500 HD		
2016-2013	8 Cyl. 6.6L	FPS45
2012-2011	8 Cyl. 6.6L	FPS44
2010-2007	8 Cyl. 6.6L	FPS11
Injection Actuation Pressure Sensor		
B7		
2000-1999	6 Cyl. 7.2L	PS713
C6500 Topkick		
2000-1999	6 Cyl. 7.2L	PS713
C7500 Topkick		
2000-1999	6 Cyl. 7.2L	PS713
T6500		
2000-1999	6 Cyl. 7.2L	PS713
T7500		
2000-1999	6 Cyl. 7.2L	PS713
MAP Sensor		
C1500 Suburban		
1998	8 Cyl. 6.5L; Diesel	AS4
1997-1996	8 Cyl. 6.5L	AS4
C2500		
1998-1996	8 Cyl. 6.5L; F	AS4
1998-1996	8 Cyl. 6.5L; S	AS5
1993-1989	8 Cyl. 6.2L	AS5
1984	8 Cyl. 6.2L	AS5
C2500 Suburban		
1999-1996	8 Cyl. 6.5L	AS4
C3500		
1998	8 Cyl. 6.5L; F	AS4
1998	8 Cyl. 6.5L; S	AS5
C4500 Topkick		
2009-2003	8 Cyl. 6.6L	AS194
C5500 Topkick		
2009-2003	8 Cyl. 6.6L	AS194
C7500 Topkick		
2007-2005	6 Cyl. 7.8L	AS194
2004	6 Cyl. 7.2L	AS59
G2500		
1986-1984	8 Cyl. 6.2L	AS5
G3500		
1996	8 Cyl. 6.5L	AS6
Jimmy		
1987	8 Cyl. 6.2L	AS5
1985-1984	8 Cyl. 6.2L	AS5
K1500		
1998	8 Cyl. 6.5L	AS5
1996	8 Cyl. 6.5L	AS4
1984	8 Cyl. 6.2L	AS5
K1500 Suburban		
1999-1996	8 Cyl. 6.5L	AS4
K2500		
2000	8 Cyl. 6.5L	AS4
1993-1992	8 Cyl. 6.2L	AS5
1990-1988	8 Cyl. 6.2L	AS5
1984	8 Cyl. 6.2L	AS5
K2500 Suburban		
1999-1994	8 Cyl. 6.5L	AS4
K3500		
2000-1994	8 Cyl. 6.5L	AS4

		Part No.
MAP Sensor		
P2500		
1989	8 Cyl.	AS5
P3500		
1999	8 Cyl. 6.5L; Turbocharged	AS4
1999	8 Cyl. 6.5L; Naturally Aspirated	AS6
1998-1997	8 Cyl. 6.5L; Naturally Aspirated	AS4
1998-1997	8 Cyl. 6.5L; Turbocharged	AS5
1991	8 Cyl. 6.2L	AS6
1990-1989	8 Cyl.	AS5
R1500		
1987	8 Cyl. 6.2L	AS5
R2500		
1987	8 Cyl. 6.2L	AS5
Savana 2500		
2016-2011	8 Cyl. 6.6L	AS428
2010	8 Cyl. 6.6L; Alternate Number	AS428
2010	8 Cyl. 6.6L; Exhaust stock and reorder	AS433
2002-1997	8 Cyl. 6.5L	AS4
Savana 3500		
2016-2011	8 Cyl. 6.6L	AS428
2010	8 Cyl. 6.6L; Alternate Number	AS428
2010	8 Cyl. 6.6L; Exhaust stock and reorder	AS433
2002-1998	8 Cyl. 6.5L	AS4
Savana 4500		
2016-2014	8 Cyl. 6.6L	AS428
2013	8 Cyl.	AS413
2012-2011	8 Cyl. 6.6L	AS428
2010	8 Cyl. 6.6L; Alternate Number	AS428
2010	8 Cyl. 6.6L; Exhaust stock and reorder	AS433
Sierra 2500 HD		
2016-2011	8 Cyl. 6.6L	AS428
2006-2001	8 Cyl. 6.6L	AS194
Sierra 3500		
2006-2001	8 Cyl. 6.6L	AS194
Sierra 3500 HD		
2016-2011	8 Cyl. 6.6L	AS428
V1500		
1987	8 Cyl. 6.2L	AS5
V2500		
1987	8 Cyl.	AS5
Yukon		
1997-1994	Turbocharged	AS4
Turbocharger Boost Sensor		
C1500		
1997-1994	8 Cyl. 6.5L; Diesel; Turbocharged	AS4
C1500 Suburban		
1999-1995	8 Cyl. 6.5L; Diesel; Turbocharged	AS4
C2500		
2000-1994	8 Cyl. 6.5L; Diesel; Turbocharged	AS4
C2500 Suburban		
1999-1994	8 Cyl. 6.5L; Diesel; Turbocharged	AS4
C3500		
2000-1994	8 Cyl. 6.5L; Diesel; Turbocharged	AS4
Canyon		
2019-2016	4 Cyl. 2.8L; Turbocharged	AS493
K1500		
1998-1994	8 Cyl. 6.5L; Diesel; Turbocharged	AS4
K1500 Suburban		
1999-1995	8 Cyl. 6.5L; Diesel; Turbocharged	AS4
K2500		
2000-1994	8 Cyl. 6.5L; Diesel; Turbocharged	AS4

Pressure Sensors

		Part No.
Turbocharger Boost Sensor		
K2500 Suburban		
1999-1994	8 Cyl. 6.5L; Diesel; Turbocharged	AS4
K3500		
2000-1994	8 Cyl. 6.5L; Diesel; Turbocharged	AS4
P3500		
1999-1997	8 Cyl. 6.5L; Diesel; Turbocharged	AS4
Savana 2500		
2019-2017	4 Cyl. 2.8L; Turbocharged	AS493
2010	8 Cyl. 6.6L; 6; Turbocharged	AS194
2009-2006	8 Cyl. 6.6L; Turbocharged	AS194
2002-1996	8 Cyl. 6.5L; Diesel; Turbocharged	AS4
Savana 3500		
2019-2017	4 Cyl. 2.8L; Turbocharged	AS493
2010	8 Cyl. 6.6L; 6; Turbocharged	AS194
2009-2006	8 Cyl. 6.6L; Turbocharged	AS194
2002-1996	8 Cyl. 6.5L; Diesel; Turbocharged	AS4
Savana 4500		
2010	8 Cyl. 6.6L; 6; Turbocharged	AS194
2009	8 Cyl. 6.6L; Turbocharged	AS194
Sierra 2500 HD		
2010-2001	8 Cyl. 6.6L; Turbocharged	AS194
Sierra 3500		
2006-2001	8 Cyl. 6.6L; Turbocharged	AS194
Sierra 3500 Classic		
2007	8 Cyl. 6.6L; Turbocharged	AS194
Sierra 3500 HD		
2010-2007	8 Cyl. 6.6L; Turbocharged	AS194
Yukon		
1997-1994	8 Cyl. 6.5L; Diesel; Turbocharged	AS4
Temperature Sensors		
Ambient Air Temperature Sensor		
C2500		
2000	8 Cyl. 6.5L; w/ Bracket	AX78
C3500		
2000	8 Cyl. 6.5L; w/ Bracket	AX78
K3500		
2000	8 Cyl. 6.5L; w/ Bracket	AX78
Savana 2500		
2017	4 Cyl. 2.8L; w/o Chrome Grille	AX355
2002-2001	8 Cyl. 6.5L; w/ Bracket	AX78
Savana 3500		
2017	4 Cyl. 2.8L; w/o Chrome Grille	AX355
2002-2001	8 Cyl. 6.5L; w/ Bracket	AX78
Sierra 3500		
2006-2005	8 Cyl. 6.6L; w/ Bracket	AX78
2003-2001	8 Cyl. 6.6L; w/ Bracket	AX78
Coolant Temperature Sensor		
C3500		
2000-1994	8 Cyl. 6.5L	TX3
1992	8 Cyl. 6.2L	TX3
1992	8 Cyl. 6.5L	TX3
C3500HD		
2002	8 Cyl. 6.5L; Located On Water Pump Crossover Pipe	TX3
2002	8 Cyl. 6.5L; Located On Coolant Outlet	TX94
2001	8 Cyl. 6.5L; Located In Water Pump Crossover Pipe	TX3
2000-1994	8 Cyl. 6.5L	TX3
1992	8 Cyl. 6.5L	TX3
Canyon		
2020-2016	4 Cyl.; Alternate Number; Located On Radiator	TX229

		Part No.
Coolant Temperature Sensor		
Canyon		
2020-2016	4 Cyl.; On Water Outlet	TX268
2020-2016	4 Cyl.; Exhaust stock and reorder; Located On Radiator	TX271
Jimmy		
1988-1987	8 Cyl. 6.2L	TX3
K3500		
2000	8 Cyl. 6.5L; Located In Water Pump Crossover Pipe	TX3
1999	8 Cyl. 6.5L	TX3
P3500		
1999	8 Cyl. 6.5L	TX3
R1500 Suburban		
1988	8 Cyl. 6.2L	TX3
Savana 2500		
2009-2006	8 Cyl. 6.6L	TX3
2002-1998	8 Cyl. 6.5L	TX94
Savana 3500		
2016-2015	8 Cyl. 6.6L	TX89
2014-2011	8 Cyl.	TX89
2010-2006	8 Cyl. 6.6L	TX3
2002-1998	8 Cyl. 6.5L	TX94
1996	8 Cyl. 6.5L	TX3
Sierra 2500 HD		
2010	8 Cyl. 6.6L	TX133
2009-2001	8 Cyl. 6.6L	TX3
Sierra 2500 HD Classic		
2007	8 Cyl. 6.6L	TX3
Sierra 3500		
2006-2001	8 Cyl. 6.6L	TX3
Sierra 3500 Classic		
2007	8 Cyl. 6.6L	TX3
Sierra 3500 HD		
2010	8 Cyl. 6.6L	TX133
2009-2007	8 Cyl. 6.6L	TX3
Terrain		
2019	4 Cyl. 1.6L; Alternate Number	TX229
2019	4 Cyl. 1.6L; Exhaust stock and reorder	TX271
2018	4 Cyl. 1.6L	TX247
Diesel Glow Plug Control Sensor		
C1500		
1982	8 Cyl. 6.2L	TX42
C2500		
1984-1982	8 Cyl. 6.2L	TX42
C2500 Suburban		
1984-1982	8 Cyl. 6.2L	TX42
C3500		
1984-1982	8 Cyl. 6.2L	TX42
G3500		
1984-1983	8 Cyl. 6.2L	TX42
K2500		
1984-1982	8 Cyl. 6.2L	TX42
K2500 Suburban		
1984-1982	8 Cyl. 6.2L	TX42
K3500		
1984-1982	8 Cyl. 6.2L	TX42
Diesel Glow Plug Temperature Sensor		
C1500		
1990-1988	8 Cyl. 6.2L	TS243
C2500		
1990-1988	8 Cyl. 6.2L	TS243

Temperature Sensors

		Part No.
Diesel Glow Plug Temperature Sensor		
C3500		
1990-1988	8 Cyl. 6.2L	TS243
G2500		
1990-1988	8 Cyl. 6.2L	TS243
G3500		
1990-1988	8 Cyl. 6.2L	TS243
Jimmy		
1990-1988	8 Cyl. 6.2L	TS243
K1500		
1990-1988	8 Cyl. 6.2L	TS243
K2500		
1990-1988	8 Cyl. 6.2L	TS243
K3500		
1990-1988	8 Cyl. 6.2L	TS243
P2500		
1989-1988	8 Cyl. 6.2L	TS243
1987	8 Cyl. 6.2L; Diesel; w/ Light	TX47
P3500		
1989-1988	8 Cyl. 6.2L	TS243
1987	8 Cyl. 6.2L; Diesel; w/ Light	TX47
R1500 Suburban		
1990-1988	8 Cyl. 6.2L	TS243
R2500		
1989-1988	8 Cyl. 6.2L	TS243
R2500 Suburban		
1990	8 Cyl. 6.2L	TS243
1988	8 Cyl. 6.2L	TS243
R3500		
1990	8 Cyl. 6.2L	TS243
1988	8 Cyl. 6.2L	TS243
V1500 Suburban		
1990	8 Cyl. 6.2L	TS243
1988	8 Cyl. 6.2L	TS243
V2500 Suburban		
1990	8 Cyl. 6.2L	TS243
1988	8 Cyl. 6.2L	TS243
V3500		
1990	8 Cyl. 6.2L	TS243
1988	8 Cyl. 6.2L	TS243
Exhaust Gas Temperature Sensor		
Savana 2500		
2016-2014	8 Cyl. 6.6L; Located on EGR Cooler	ETS125
2016-2013	8 Cyl. 6.6L; Downstream	ETS171
2016-2011	8 Cyl. 6.6L; Front	ETS155
2015-2011	8 Cyl. 6.6L; Located on EGR Crossover Tube	ETS119
2015-2011	8 Cyl. 6.6L; Center	ETS170
2010	8 Cyl. 6.6L; L; Center	ETS170
2009-2007	8 Cyl. 6.6L	ETS72
Savana 3500		
2016-2014	8 Cyl. 6.6L; Located on EGR Cooler	ETS125
2016-2012	8 Cyl. 6.6L; Downstream	ETS171
2016-2011	8 Cyl. 6.6L; Front	ETS155
2015-2010	8 Cyl. 6.6L; Center	ETS170
2009-2007	8 Cyl. 6.6L	ETS72
Savana 4500		
2016	8 Cyl. 6.6L; Front	ETS155
2016-2013	8 Cyl. 6.6L	ETS72
2015-2010	8 Cyl. 6.6L; Center	ETS170
2014-2010	8 Cyl. 6.6L; Front	ETS155
2011-2009	8 Cyl. 6.6L	ETS72

		Part No.
Exhaust Gas Temperature Sensor		
Sierra 2500 HD		
2016-2015	8 Cyl. 6.6L; Located on EGR Cooler	ETS125
2016-2015	8 Cyl. 6.6L; Front of Muffler	ETS229
2016-2012	8 Cyl. 6.6L; Located on EGR Crossover Tube	ETS119
2016-2011	8 Cyl. 6.6L; Front	ETS145
2016-2011	8 Cyl. 6.6L; Rear	ETS146
2016-2011	8 Cyl. 6.6L; Center	ETS173
2011	8 Cyl. 6.6L; 8; Located on EGR Crossover Tube	ETS119
2010-2008	8 Cyl. 6.6L; Center	ETS121
2010-2007	8 Cyl. 6.6L; Front	ETS72
2010-2007	8 Cyl. 6.6L; Rear	ETS75
Sierra 3500 Classic		
2007	8 Cyl. 6.6L; Front	ETS72
2007	8 Cyl. 6.6L; Rear	ETS75
Sierra 3500 HD		
2016-2015	8 Cyl. 6.6L; Located on EGR Cooler	ETS125
2016-2015	8 Cyl. 6.6L; Front of Muffler	ETS229
2016-2011	8 Cyl. 6.6L; Front	ETS145
2016-2011	8 Cyl. 6.6L; Rear	ETS146
2016-2011	8 Cyl. 6.6L; Center	ETS173
2010-2008	8 Cyl. 6.6L; Center	ETS121
2010-2007	8 Cyl. 6.6L; Front	ETS72
2010-2007	8 Cyl. 6.6L; Rear	ETS75
Fuel Temperature Sensor		
Savana 2500		
2016-2010	8 Cyl. 6.6L	FTS110
2009-2006	8 Cyl. 6.6L	FTS104
Savana 3500		
2016-2010	8 Cyl. 6.6L	FTS110
2009-2006	8 Cyl. 6.6L	FTS104
Sierra 2500 HD		
2016-2011	8 Cyl. 6.6L	FTS110
2010-2006	8 Cyl. 6.6L	FTS104
Sierra 3500		
2006	8 Cyl. 6.6L	FTS104
Sierra 3500 Classic		
2007	8 Cyl. 6.6L	FTS104
Sierra 3500 HD		
2016-2011	8 Cyl. 6.6L	FTS110
2010-2007	8 Cyl. 6.6L	FTS104
Heater Core Temperature Sensor		
Savana 2500		
2011-2006	8 Cyl. 6.6L	AX293
Savana 3500		
2011-2006	8 Cyl. 6.6L	AX293
Intake Air Temperature Sensor		
C1500		
1997-1996	8 Cyl. 6.5L	AX1
1995-1994	8 Cyl. 6.5L; Turbocharged	AX1
1995-1994	8 Cyl. 6.5L; Naturally Aspirated	AX32
1980	8 Cyl. 5.7L; Green; On Air Cleaner	ATS3
1980	8 Cyl. 5.7L; White; On Air Cleaner	ATS4
C1500 Suburban		
1999-1995	8 Cyl. 6.5L	AX1
1980	8 Cyl. 5.7L; OE No. 6484244; On Air Cleaner	ATS3
C2500		
2000-1996	8 Cyl. 6.5L	AX1
1995-1994	8 Cyl. 6.5L; Turbocharged	AX1
1995-1994	8 Cyl. 6.5L; Naturally Aspirated	AX32

Temperature Sensors

		Part No.
Intake Air Temperature Sensor		
C2500 Suburban		
1999-1994	8 Cyl. 6.5L	AX1
1980	8 Cyl. 5.7L; OE No. 6484244; On Air Cleaner	ATS3
C3500		
2000-1994	8 Cyl. 6.5L	AX1
C3500HD		
2002-1994	8 Cyl. 6.5L	AX1
Canyon		
2019-2016	4 Cyl. 2.8L; Between Intercooler and Throttle Body	TX267
G2500		
1995-1994	8 Cyl. 6.5L	AX32
G3500		
1996	8 Cyl. 6.5L	AX1
1995-1994	8 Cyl. 6.5L	AX32
K1500		
1998-1996	8 Cyl. 6.5L	AX1
1995-1994	8 Cyl. 6.5L; Turbocharged	AX1
1995-1994	8 Cyl. 6.5L; Naturally Aspirated	AX32
K1500 Suburban		
1999-1995	8 Cyl. 6.5L	AX1
K2500		
2000-1996	8 Cyl. 6.5L	AX1
1995-1994	8 Cyl. 6.5L; Turbocharged	AX1
1995-1994	8 Cyl. 6.5L; Naturally Aspirated	AX32
K2500 Suburban		
1999-1994	8 Cyl. 6.5L	AX1
K3500		
2000-1994	8 Cyl. 6.5L	AX1
P3500		
1999-1998	8 Cyl. 6.5L; Turbocharged	AX1
1999-1998	8 Cyl. 6.5L; Naturally Aspirated	AX32
1995-1994	8 Cyl. 6.5L	AX1
Savana 2500		
2016-2010	8 Cyl. 6.6L; Between Intercooler and Throttle Body	TX267
2010	8 Cyl. 6.6L; On Intake Manifold	AX229
2002-1996	8 Cyl. 6.5L	AX1
Savana 3500		
2016-2011	8 Cyl. 6.6L; On Throttle Body	TX266
2016-2010	8 Cyl. 6.6L; Between Intercooler and Throttle Body	TX267
2010	8 Cyl. 6.6L; On Intake Manifold	AX229
2002-1996	8 Cyl. 6.5L	AX1
Savana 4500		
2010	8 Cyl. 6.6L	AX229
Sierra 2500 HD		
2019-2017	8 Cyl. 6.6L; On Intake Manifold	AX461
2018-2011	8 Cyl. 6.6L; Between Intercooler and Throttle Body	TX267
2016-2011	8 Cyl. 6.6L; On Throttle Body	TX266
Sierra 3500 HD		
2019-2017	8 Cyl. 6.6L; On Intake Manifold	AX461
2018-2011	8 Cyl. 6.6L; Between Intercooler and Throttle Body	TX267
2016-2011	8 Cyl. 6.6L; On Throttle Body	TX266
Yukon		
1997-1994	8 Cyl. 6.5L	AX1
Body Light Switches		
Back-Up Light Switch		
C6500 Topkick		
1998-1997	6 Cyl. 6.6L	LS-307

		Part No.
Back-Up Light Switch		
Sierra 2500 HD		
2006-2003	8 Cyl. 6.6L; w/ M.T.	LS-304
Sierra 3500		
2006-2003	8 Cyl. 6.6L; w/ M.T.	LS-304
Sierra 3500 Classic		
2007	8 Cyl. 6.6L; w/ M.T.	NS-561
Fog Lamp Switch		
C1500		
1997-1996	8 Cyl. 6.5L; w/ Sport Package	DS938
Sierra 2500 HD		
2011-2010	8 Cyl. 6.6L	CBS-1427
Sierra 3500 HD		
2011-2010	8 Cyl. 6.6L	CBS-1427
Hazard Warning Switch		
C4500 Topkick		
2009-2003	8 Cyl. 6.6L; w/ Cruise Control	CBS-1452
Sierra 2500 HD		
2011	8 Cyl. 6.6L	CBS-1422
Sierra 3500 HD		
2011	8 Cyl. 6.6L	CBS-1422
T6500		
2009-2004	Canada; w/ Cruise Control	CBS-2145
2009-2004	U.S. Models; w/o Cruise Control	CBS-2146
2009-2004	Canada; w/o Cruise Control	CBS-2147
2009-2004	U.S. Models; w/ Cruise Control	CBS-2148
T7500		
2009-2004	Canada; w/ Cruise Control	CBS-2145
2009-2004	U.S. Models; w/o Cruise Control	CBS-2146
2009-2004	U.S. Models; w/ Cruise Control	CBS-2148
2008-2004	Canada; w/o Cruise Control	CBS-2147
Headlight Dimmer Switch		
T6500		
2009-2004	Canada; w/ Cruise Control	CBS-2145
2009-2004	U.S. Models; w/o Cruise Control	CBS-2146
2009-2004	Canada; w/o Cruise Control	CBS-2147
2009-2004	U.S. Models; w/ Cruise Control	CBS-2148
T7500		
2009-2004	Canada; w/ Cruise Control	CBS-2145
2009-2004	U.S. Models; w/o Cruise Control	CBS-2146
2009-2004	U.S. Models; w/ Cruise Control	CBS-2148
2008-2004	Canada; w/o Cruise Control	CBS-2147
Headlight Switch		
C4500 Topkick		
2009-2003	8 Cyl. 6.6L	DS-876
C5500 Topkick		
2009-2003	8 Cyl. 6.6L	DS-876
C6000 Topkick		
1996-1995	6 Cyl. 6.6L	DS-647
1994-1992	6 Cyl. 6.6L	DS-290
1990	6 Cyl. 6.6L	DS-290
C6500 Topkick		
2009-2005	6 Cyl. 7.2L	DS-876
2009-2005	6 Cyl. 7.8L	DS-876
2002-1999	6 Cyl. 7.2L	DS-647
1998-1997	6 Cyl. 6.6L	DS-647
C7000 Topkick		
1996-1995	6 Cyl. 6.6L	DS-647
1994-1990	6 Cyl. 6.6L	DS-290
C7500 Topkick		
2009-2003	6 Cyl. 7.2L	DS-876
2009-2003	6 Cyl. 7.8L	DS-876
2002-1999	6 Cyl. 7.2L	DS-647

Body Light Switches

		Part No.
Headlight Switch		
C7500 Topkick		
1998-1997	6 Cyl. 6.6L	DS-647
G3500		
1996	8 Cyl. 6.5L	DS-177
T6500		
2009-2004	Canada; w/ Cruise Control	CBS-2145
2009-2004	U.S. Models; w/o Cruise Control	CBS-2146
2009-2004	Canada; w/o Cruise Control	CBS-2147
2009-2004	U.S. Models; w/ Cruise Control	CBS-2148
T7500		
2009-2004	Canada; w/ Cruise Control	CBS-2145
2009-2004	U.S. Models; w/o Cruise Control	CBS-2146
2009-2004	U.S. Models; w/ Cruise Control	CBS-2148
2008-2004	Canada; w/o Cruise Control	CBS-2147
Instrument Panel Dimmer Switch		
C4500 Topkick		
2009-2003	8 Cyl. 6.6L	DS-876
C5500 Topkick		
2009-2003	8 Cyl. 6.6L	DS-876
C6000 Topkick		
1994-1990	6 Cyl. 6.6L	DS-374
C6500 Topkick		
2009-2003	6 Cyl. 7.2L	DS-876
2009-2003	6 Cyl. 7.8L	DS-876
C7000 Topkick		
1994-1990	6 Cyl. 6.6L	DS-374
C7500 Topkick		
2009-2003	6 Cyl. 7.2L	DS-876
2009-2003	6 Cyl. 7.8L	DS-876
Sierra 2500 HD		
2011	8 Cyl. 6.6L; Chrome Finish; w/ Fog Lights	CBS-1427
2011	8 Cyl. 6.6L; Chrome Finish; w/o Fog Lights	CBS-1446
Sierra 3500 HD		
2011	8 Cyl. 6.6L; Chrome Finish; w/ Fog Lights	CBS-1427
2011	8 Cyl. 6.6L; Chrome Finish; w/o Fog Lights	CBS-1446
Stoplight Switch		
Savana 2500		
2012	8 Cyl. 6.6L	SLS556
2011	8 Cyl. 6.6L	SLS-336
2007	8 Cyl. 6.6L	SLS-303
Savana 3500		
2012	8 Cyl. 6.6L	SLS556
2011	8 Cyl. 6.6L	SLS-336
2007	8 Cyl. 6.6L	SLS-303
Sierra 2500 HD		
2011	8 Cyl. 6.6L; w/ Fixed Pedals	SLS-450
Sierra 3500 HD		
2011	8 Cyl. 6.6L; w/ Fixed Pedals	SLS-450
Turn Signal Lever		
T6500		
2009-2004	Canada; w/ Cruise Control	CBS-2145
2009-2004	USA Production; w/o Cruise Control	CBS-2146
2009-2004	Canada; w/o Cruise Control	CBS-2147
2009-2004	USA Production; w/ Cruise Control	CBS-2148
T7500		
2009-2004	Canada; w/ Cruise Control	CBS-2145
2009-2004	USA Production; w/o Cruise Control	CBS-2146
2009-2004	Canada; w/o Cruise Control	CBS-2147
2009-2004	USA Production; w/ Cruise Control	CBS-2148

		Part No.
Turn Signal Switch		
C1500		
1995	8 Cyl. 6.5L; w/ Tilt Steering	DS-698
1995	8 Cyl. 6.5L; w/o Tilt Wheel	DS-796
C4500 Topkick		
2009-2003	8 Cyl. 6.6L; w/o Cruise Control	CBS-1181
2009-2003	8 Cyl. 6.6L; w/ Cruise Control	CBS-1452
C6000 Topkick		
1992-1990	6 Cyl. 6.6L	TW-20
C7000 Topkick		
1992-1990	6 Cyl. 6.6L	TW-20
Savana 2500		
2015-2008	8 Cyl. 6.6L	CBS-1945
Savana 3500		
2015-2008	8 Cyl. 6.6L	CBS-1945
Sierra 2500 HD		
2011	8 Cyl. 6.6L	CBS-1422
Sierra 3500 HD		
2011	8 Cyl. 6.6L	CBS-1422
T6500		
2009-2004	Canada; w/ Cruise Control	CBS-2145
2009-2004	U.S. Models; w/o Cruise Control	CBS-2146
2009-2004	Canada; w/o Cruise Control	CBS-2147
2009-2004	U.S. Models; w/ Cruise Control	CBS-2148
T7500		
2009-2004	Canada; w/ Cruise Control	CBS-2145
2009-2004	U.S. Models; w/o Cruise Control	CBS-2146
2009-2004	Canada; w/o Cruise Control	CBS-2147
2009-2004	U.S. Models; w/ Cruise Control	CBS-2148
Turn Signal Switch Repair Kit		
C1500		
1986	8 Cyl. 6.2L	TW-83C
C2500		
1986	8 Cyl. 6.2L	TW-83C
C3500		
1986	8 Cyl. 6.2L	TW-83C
K1500		
1986	8 Cyl. 6.2L	TW-83C
K2500		
1986	8 Cyl. 6.2L	TW-83C
K3500		
1986	8 Cyl. 6.2L	TW-83C
Chassis and Drivetrain Switches		
Automatic Transmission Vacuum Modulator		
C1500		
1985	8 Cyl. 6.2L	TM-63
1984-1982	8 Cyl. 6.2L; Green	TM-63
1981	8 Cyl. 5.7L; Z; Calif.; w/ TH350 Trans.	TM-33
1980	8 Cyl. 5.7L; Diesel; w/ TH350 Trans.	TM-33
1980	8 Cyl. 5.7L; Diesel; w/ TH400 Trans.	TM-33
C1500 Suburban		
1984	8 Cyl. 6.2L; w/ A.T.	TM-50
1983	8 Cyl. 6.2L	TM-63
1982	8 Cyl. 6.2L; Green	TM-63
1981	8 Cyl. 5.7L; Calif.; Diesel; w/ TH350 Trans.	TM-33
1980	8 Cyl. 5.7L; Diesel; w/ TH350 Trans.	TM-33
C2500		
1989	8 Cyl. 6.2L; w/ 3 Speed TH400 Trans.	TM-50
1985	8 Cyl. 6.2L; w/ 3 Speed TH400 Trans.	TM-50
1982	8 Cyl. 6.2L; w/ TH400 Trans.	TM-50
1982	8 Cyl. 6.2L; w/ TH350 Trans.	TM-63

Chassis and Drivetrain Switches

		Part No.
Automatic Transmission Vacuum Modulator		
C2500 Suburban		
1985	8 Cyl. 6.2L; w/ 3 Speed TH400 Trans.	TM-50
1982	8 Cyl. 6.2L; w/ TH350 Trans.	TM-63
1980	8 Cyl. 5.7L	TM-63
C3500		
1990-1989	8 Cyl. 6.2L; Diesel; w/ 3 Speed TH400 Trans.	TM-50
1988	8 Cyl. 6.2L; w/ 3 Speed TH400 Trans.	TM-50
1986	8 Cyl. 6.2L; w/ TH350 Trans.	TM-63
1984-1983	8 Cyl. 6.2L; w/ TH400 Trans.	TM-50
1984-1982	8 Cyl. 6.2L; w/ TH350 Trans.	TM-63
G2500		
1990	8 Cyl. 6.2L; Diesel; w/ 3 Speed TH400 Trans.	TM-50
1984	8 Cyl. 6.2L; w/ TH400 Trans.	TM-50
1984	8 Cyl. 6.2L; w/ TH350 Trans.	TM-63
1983	8 Cyl. 6.2L; C; w/ 3 Speed TH400 Trans.	TM-50
G3500		
1990-1989	8 Cyl. 6.2L; Diesel; w/ 3 Speed TH400 Trans.	TM-50
1987	8 Cyl. 6.2L; w/ 3 Speed TH400 Trans.	TM-50
1986-1983	8 Cyl. 6.2L; w/ TH400 Trans.	TM-50
1985-1984	8 Cyl. 6.2L; w/ TH350 Trans.	TM-63
Jimmy		
1985-1984	8 Cyl. 6.2L; Green	TM-63
1983	8 Cyl. 6.2L	TM-63
1982	8 Cyl. 6.2L; Green	TM-63
K1500		
1984-1982	8 Cyl. 6.2L	TM-63
K1500 Suburban		
1984-1983	8 Cyl. 6.2L	TM-63
1982	8 Cyl. 6.2L; Green	TM-63
K2500		
1989	8 Cyl. 6.2L; w/ 3 Speed TH400 Trans.	TM-50
1986-1985	8 Cyl. 6.2L	TM-63
1984	8 Cyl. 6.2L; w/ TH400 Trans.	TM-50
1983-1982	8 Cyl. 6.2L; Green	TM-63
K2500 Suburban		
1986-1985	8 Cyl. 6.2L; w/ 3 Speed TH400 Trans.	TM-50
1984-1983	8 Cyl. 6.2L; w/ TH400 Trans.	TM-50
K3500		
1989	8 Cyl. 6.2L; Diesel; w/ 3 Speed TH400 Trans.	TM-50
1988	8 Cyl. 6.2L; w/ 3 Speed TH400 Trans.	TM-50
1986-1985	8 Cyl. 6.2L	TM-63
1983	8 Cyl. 6.2L	TM-63
1982	8 Cyl. 6.2L; Green	TM-63
P2500		
1988-1982	8 Cyl. 6.2L	TM-63
P3500		
1988-1982	8 Cyl. 6.2L	TM-63
R2500		
1989-1987	8 Cyl. 6.2L; w/ 3 Speed TH400 Trans.	TM-50
R2500 Suburban		
1990-1987	8 Cyl. 6.2L; w/ 3 Speed TH400 Trans.	TM-50
R3500		
1990-1989	8 Cyl. 6.2L; Diesel; w/ 3 Speed TH400 Trans.	TM-50
1988	8 Cyl. 6.2L; w/ TH400 Trans.	TM-50
1987	8 Cyl. 6.2L	TM-63
V2500		
1987	8 Cyl. 6.2L	TM-63

		Part No.
Automatic Transmission Vacuum Modulator		
V2500 Suburban		
1989-1988	8 Cyl. 6.2L; Diesel; w/ 3 Speed TH400 Trans.	TM-50
1987	8 Cyl. 6.2L; w/ 3 Speed TH400 Trans.	TM-50
V3500		
1989	8 Cyl. 6.2L; Diesel; w/ 3 Speed TH400 Trans.	TM-50
1988	8 Cyl. 6.2L; w/ 3 Speed TH400 Trans.	TM-50
1988	8 Cyl. 6.2L; w/ A.T.	TM-63
1987	8 Cyl. 6.2L	TM-63
Four Wheel Drive Indicator Lamp Switch		
Jimmy		
1991-1988	8 Cyl. 6.2L; On Transfer Case	TCA-25
K1500 Suburban		
1999	8 Cyl. 6.5L; On Transfer Case	TCA-4
K2500		
1999	8 Cyl. 6.5L; On Transfer Case	TCA-4
1998-1997	8 Cyl. 6.5L; 2 Pin; On Transfer Case	TCA-26
1998-1997	8 Cyl. 6.5L; 3 Pin; On Transfer Case	TCA-4
1997	8 Cyl. 6.5L; 2 Pin Term.; Front Axle	TCA-5
1995-1992	8 Cyl. 6.5L; 2 Pin; On Transfer Case	TCA-26
1995-1992	8 Cyl. 6.5L; 3 Pin; On Transfer Case	TCA-4
1993-1992	8 Cyl. 6.2L; 2 Pin; On Transfer Case	TCA-26
1993-1992	8 Cyl. 6.2L; 3 Pin; On Transfer Case	TCA-4
K2500 Suburban		
1999	8 Cyl. 6.5L; On Transfer Case	TCA-4
K3500		
2000-1999	8 Cyl. 6.5L; On Transfer Case	TCA-4
1998-1997	8 Cyl. 6.5L; 3 Pin; On Transfer Case	TCA-4
1998-1997	8 Cyl. 6.5L; 2 Pin; On Transfer Case	TCA-26
1997	8 Cyl. 6.5L; 2 Pin Term.; Front Axle	TCA-5
1995-1994	8 Cyl. 6.5L; 2 Pin; On Transfer Case	TCA-26
1995-1992	8 Cyl. 6.5L; 3 Pin; On Transfer Case	TCA-4
1993-1992	8 Cyl. 6.2L; 3 Pin; On Transfer Case	TCA-4
1993-1992	8 Cyl. 6.2L; 2 Pin; White; On Transfer Case	TCA-26
1993-1992	8 Cyl. 6.5L; 2 Pin; White; On Transfer Case	TCA-26
1989	8 Cyl. 6.2L; 2 Pin; On Transfer Case	TCA-26
1989-1988	8 Cyl. 6.2L; 3 Pin; On Transfer Case	TCA-4
Sierra 2500 HD		
2007-2001	8 Cyl. 6.6L; w/ Manual Shift Transfer Case	TCA-4
Sierra 3500		
2006-2001	8 Cyl. 6.6L; w/ Manual Shift Transfer Case	TCA-4
Sierra 3500 Classic		
2007	8 Cyl. 6.6L; w/ Manual Shift Transfer Case	TCA-4
Sierra 3500 HD		
2007	8 Cyl. 6.6L; w/ Manual Shift Transfer Case	TCA-4
V1500 Suburban		
1991	8 Cyl. 6.2L; On Transfer Case	TCA-25
1988	8 Cyl. 6.2L; On Transfer Case	TCA-25
Yukon		
1997	8 Cyl. 6.5L; 2 Pin Term.; Front Axle	TCA-5
1997-1994	8 Cyl. 6.5L; 2 Pin; On Transfer Case	TCA-26
1997-1994	8 Cyl. 6.5L; 3 Pin; On Transfer Case	TCA-4
Neutral Safety Switch		
C3500HD		
2002	8 Cyl. 6.5L; w/ A.T.	NS-85
Savana 2500		
2009-2006	8 Cyl. 6.6L	NS-319

Chassis and Drivetrain Switches

		Part No.
Neutral Safety Switch		
Savana 3500		
2009-2006	8 Cyl. 6.6L	NS-319
Savana 4500		
2009	8 Cyl. 6.6L	NS-319
Sierra 2500 HD		
2019-2007	8 Cyl. 6.6L; Allison Trans	NS691
2006	8 Cyl. 6.6L	NS-319
Sierra 2500 HD Classic		
2007	8 Cyl. 6.6L; Allison Trans	NS691
Sierra 3500		
2006	8 Cyl. 6.6L	NS-319
Sierra 3500 Classic		
2007	8 Cyl. 6.6L	NS691
Sierra 3500 HD		
2019-2007	8 Cyl. 6.6L; Allison Trans	NS691
Ignition Switches		
Ignition Starter Switch		
B7		
2002-1999	6 Cyl. 7.2L; w/o Tilt Wheel	US-514
1998-1997	8 Cyl. 6.5L; w/o Tilt Wheel	US-514
1998-1993	6 Cyl. 6.6L; w/o Tilt Wheel	US-514
B6000		
1991-1983	8 Cyl. 8.2L	US-84
C4500 Topkick		
2009-2003	8 Cyl. 6.6L	US-275
C5500 Topkick		
2009-2003	8 Cyl. 6.6L	US-275
C6000		
1989-1985	8 Cyl. 8.2L	US-84
C6000 Topkick		
1996-1991	6 Cyl. 6.6L; w/ Tilt Steering	US-432
1996-1991	6 Cyl. 6.6L; w/o Tilt Wheel	US-514
C6500 Topkick		
2009-2003	6 Cyl. 7.2L	US-275
2009-2003	6 Cyl. 7.8L	US-275
2002-1999	6 Cyl. 7.2L; w/ Tilt Steering	US-432
2002-1999	6 Cyl. 7.2L; w/o Tilt Wheel	US-514
1998-1997	6 Cyl. 6.6L; w/ Tilt Steering	US-432
1998-1997	6 Cyl. 6.6L; w/o Tilt Wheel	US-514
C7000		
1990-1989	8 Cyl. 10.4L	US-84
1990-1989	8 Cyl. 8.2L	US-84
1985	6 Cyl. 6.1L	US-84
1985	8 Cyl. 10.4L	US-84
1985	8 Cyl. 8.2L	US-84
C7000 Topkick		
1996-1991	6 Cyl. 6.6L; w/ Tilt Steering	US-432
1996-1991	6 Cyl. 6.6L; w/o Tilt Wheel	US-514
1990	6 Cyl. 6.6L	US-514
C7500 Topkick		
2009-2003	6 Cyl. 7.2L	US-275
2009-2003	6 Cyl. 7.8L	US-275
2002-1999	6 Cyl. 7.2L; w/ Tilt Steering	US-432
2002-1999	6 Cyl. 7.2L; w/o Tilt Wheel	US-514
1998-1997	6 Cyl. 6.6L; w/ Tilt Steering	US-432
1998-1997	6 Cyl. 6.6L; w/o Tilt Wheel	US-514
P2500		
1987	8 Cyl. 6.2L; Dash Mounted	US-84
P3500		
1987	8 Cyl. 6.2L; Dash Mounted	US-84
Savana 2500		
2013-2012	8 Cyl. 6.6L	US-747

		Part No.
Ignition Starter Switch		
Savana 3500		
2013-2012	8 Cyl. 6.6L	US-747
Sierra 2500 HD		
2012	8 Cyl. 6.6L	US-747
Sierra 3500		
2006	8 Cyl. 6.6L	US-331
Sierra 3500 Classic		
2007	8 Cyl. 6.6L	US-331
Sierra 3500 HD		
2012	8 Cyl. 6.6L	US-747
2007	8 Cyl. 6.6L	US-331
Ignition Switch with Lock Cylinder		
T6500		
2009-2004		US-603
T7500		
2009-2004		US-603
Interior Power Switches		
Clock Spring		
C1500 Suburban		
1999-1998	8 Cyl. 6.5L	CSP100
C2500		
2000-1998	8 Cyl. 6.5L	CSP100
C2500 Suburban		
1999-1998	8 Cyl. 6.5L	CSP100
C3500		
2000-1998	8 Cyl. 6.5L	CSP100
C3500HD		
2000-1998	8 Cyl. 6.5L	CSP100
K1500		
1998	8 Cyl. 6.5L	CSP100
K1500 Suburban		
1999-1998	8 Cyl. 6.5L	CSP100
K2500		
2000-1998	8 Cyl. 6.5L	CSP100
K2500 Suburban		
1999-1998	8 Cyl. 6.5L	CSP100
K3500		
2000-1998	8 Cyl. 6.5L	CSP100
Savana 2500		
2000-1998	8 Cyl. 6.5L	CSP100
Savana 3500		
2000-1998	8 Cyl. 6.5L	CSP100
Cruise Control Release Switch		
C1500		
1996-1994	8 Cyl. 6.5L; Lock Out Switch	NS-35
1993-1988	8 Cyl. 6.2L; Lock Out Switch	NS-35
C1500 Suburban		
1996-1995	8 Cyl. 6.5L; Lock Out Switch	NS-35
1986-1982	8 Cyl. 6.2L	SLS-234
1981	8 Cyl. 5.7L	SLS-234
C2500		
1996-1992	8 Cyl. 6.5L; Lock Out Switch	NS-35
1993-1988	8 Cyl. 6.2L; Lock Out Switch	NS-35
C2500 Suburban		
1996-1994	8 Cyl. 6.5L; Lock Out Switch	NS-35
1986-1982	8 Cyl. 6.2L	SLS-234
C3500		
1996-1992	8 Cyl. 6.5L; Lock Out Switch	NS-35
1993-1988	8 Cyl. 6.2L; Lock Out Switch	NS-35
G2500		
1993-1990	8 Cyl. 6.2L	DS1514

Interior Power Switches

		Part No.
Cruise Control Release Switch		
G3500		
1993-1990	8 Cyl. 6.2L	DS1514
Jimmy		
1987-1982	8 Cyl. 6.2L	SLS-234
K1500		
1996-1994	8 Cyl. 6.5L; Lock Out Switch	NS-35
1993-1988	8 Cyl. 6.2L; Lock Out Switch	NS-35
K1500 Suburban		
1996-1995	8 Cyl. 6.5L; Lock Out Switch	NS-35
1986-1982	8 Cyl. 6.2L	SLS-234
K2500		
1996-1992	8 Cyl. 6.5L; Lock Out Switch	NS-35
1993-1988	8 Cyl. 6.2L; Lock Out Switch	NS-35
K2500 Suburban		
1996-1994	8 Cyl. 6.5L; Lock Out Switch	NS-35
1986-1982	8 Cyl. 6.2L	SLS-234
K3500		
1996-1992	8 Cyl. 6.5L; Lock Out Switch	NS-35
1993-1988	8 Cyl. 6.2L; Lock Out Switch	NS-35
R1500 Suburban		
1987	8 Cyl. 6.2L	SLS-234
R2500 Suburban		
1989-1988	8 Cyl. 6.2L	NS-120
1987	8 Cyl. 6.2L	SLS-234
R3500		
1991-1990	8 Cyl. 6.2L	DS1514
V1500		
1987	8 Cyl. 6.2L	SLS-234
V1500 Suburban		
1987	8 Cyl. 6.2L	SLS-234
V2500 Suburban		
1987	8 Cyl. 6.2L	SLS-234
V3500		
1991-1990	8 Cyl. 6.2L	DS1514
Yukon		
1996-1994	8 Cyl. 6.5L; Lock Out Switch	NS-35
Cruise Control Switch		
C1500		
1997-1995	8 Cyl. 6.5L	DS-698
1986-1984	8 Cyl. 6.2L; w/ Intermittent Wipers	DS-1534
C1500 Suburban		
1999	8 Cyl. 6.5L	DS-698
1986	8 Cyl. 6.2L; w/ Intermittent Wipers	DS-1534
C2500		
1998-1995	8 Cyl. 6.5L	DS-698
1986-1984	8 Cyl. 6.2L; w/ Intermittent Wipers	DS-1534
C2500 Suburban		
1999	8 Cyl. 6.5L	DS-698
1986	8 Cyl. 6.2L; w/ Intermittent Wipers	DS-1534
C3500		
1998-1995	8 Cyl. 6.5L	DS-698
1986-1984	8 Cyl. 6.2L; w/ Intermittent Wipers	DS-1534
C3500HD		
1998-1995	8 Cyl. 6.5L	DS-698
C4500 Topkick		
2009-2003	8 Cyl. 6.6L	CBS-1452
C7500 Topkick		
2009-2003	6 Cyl. 7.2L	CBS-1452
2009-2003	6 Cyl. 7.8L	CBS-1452
Caballero		
1984	8 Cyl. 5.7L; w/ Intermittent Wipers	DS-1534

		Part No.
Cruise Control Switch		
G2500		
1991-1983	8 Cyl. 6.2L; w/ Intermittent Wipers	DS-1534
G3500		
1991-1983	8 Cyl. 6.2L; w/ Intermittent Wipers	DS-1534
Jimmy		
1986	8 Cyl. 6.2L; w/ Intermittent Wipers	DS-1534
K1500		
1998-1995	8 Cyl. 6.5L	DS-698
1986-1984	8 Cyl. 6.2L; w/ Intermittent Wipers	DS-1534
K1500 Suburban		
1999	8 Cyl. 6.5L	DS-698
1986	8 Cyl. 6.2L; w/ Intermittent Wipers	DS-1534
K2500		
1998-1995	8 Cyl. 6.5L	DS-698
1986-1984	8 Cyl. 6.2L; w/ Intermittent Wipers	DS-1534
K2500 Suburban		
1999	8 Cyl. 6.5L	DS-698
1986	8 Cyl. 6.2L; w/ Intermittent Wipers	DS-1534
K3500		
1998-1995	8 Cyl. 6.5L	DS-698
1986-1984	8 Cyl. 6.2L; w/ Intermittent Wipers	DS-1534
R1500		
1987	8 Cyl. 6.2L; w/ Intermittent Wipers	DS-1534
R2500		
1987	8 Cyl. 6.2L; w/ Intermittent Wipers	DS-1534
R3500		
1987	8 Cyl. 6.2L; w/ Intermittent Wipers	DS-1534
Sierra 2500 HD		
2011-2008	8 Cyl. 6.6L; Cashmere	CCA1097
2011-2008	8 Cyl. 6.6L; Black Finish	DS-2156
Sierra 3500 HD		
2010-2008	8 Cyl. 6.6L; Cashmere	CCA1097
2010-2008	8 Cyl. 6.6L; Black Finish	DS-2156
T6500		
2009-2004	U.S. Models	CBS-2148
T7500		
2009-2004	U.S. Models	CBS-2148
V1500		
1987	8 Cyl. 6.2L; w/ Intermittent Wipers	DS-1534
Fuel Tank Selector Switch		
R1500		
1987	8 Cyl. 6.2L	DS-293
R2500		
1989-1987	8 Cyl. 6.2L	DS-293
R3500		
1991-1987	8 Cyl. 6.2L	DS-293
V1500		
1987	8 Cyl. 6.2L	DS-293
V2500		
1987	8 Cyl. 6.2L	DS-293
V3500		
1991-1987	8 Cyl. 6.2L	DS-293
Parking Brake Switch		
Caballero		
1984-1983	8 Cyl. 5.7L	DS-905
G2500		
1995-1994	8 Cyl. 6.5L	DS-905
1993-1991	8 Cyl. 6.2L	DS-905
1984-1983	8 Cyl. 6.2L	DS-905
G3500		
1995-1994	8 Cyl. 6.5L	DS-905

Interior Power Switches

		Part No.
Parking Brake Switch		
G3500		
1993-1991	8 Cyl. 6.2L	DS-905
1984-1983	8 Cyl. 6.2L	DS-905
Steering Wheel Audio Control Switch		
Savana 2500		
2010-2008	8 Cyl.	SAS113
Savana 3500		
2010-2008	8 Cyl.	SAS113
Savana 4500		
2010-2009	8 Cyl.	SAS113
Windshield Wiper Switch		
T6500		
2009-2004	Canada; w/ Cruise Control	CBS-2145
2009-2004	U.S. Models; w/o Cruise Control	CBS-2146
2009-2004	Canada; w/o Cruise Control	CBS-2147
2009-2004	U.S. Models; w/ Cruise Control	CBS-2148
T7500		
2009-2004	Canada; w/ Cruise Control	CBS-2145
2009-2004	U.S. Models; w/o Cruise Control	CBS-2146
2009-2004	U.S. Models; w/ Cruise Control	CBS-2148
2008-2004	Canada; w/o Cruise Control	CBS-2147
Pressure and Vacuum Sending Switches		
Oil Pressure Gauge Switch		
C1500		
1997-1994	8 Cyl. 6.5L	PS-245
1993-1992	8 Cyl. 6.2L	PS-245
1991-1988	8 Cyl. 6.2L	PS-256
1986-1984	8 Cyl. 6.2L	PS-155
C1500 Suburban		
1995	8 Cyl. 6.5L	PS-245
1986-1982	8 Cyl. 6.2L	PS-155
C2500		
2000-1992	8 Cyl. 6.5L	PS-245
1993-1992	8 Cyl. 6.2L	PS-245
1991-1988	8 Cyl. 6.2L	PS-256
1986	8 Cyl. 6.2L; Fuel Line Feed Kit	PS-155
1985-1984	8 Cyl. 6.2L	PS-155
C2500 Suburban		
1994	8 Cyl. 6.5L	PS-245
1983-1982	8 Cyl. 6.2L	PS-155
C3500		
2000-1992	8 Cyl. 6.5L	PS-245
1993-1992	8 Cyl. 6.2L	PS-245
1991-1988	8 Cyl. 6.2L	PS-256
1986-1984	8 Cyl. 6.2L	PS-155
C3500HD		
2002-1992	8 Cyl. 6.5L	PS-245
C4500 Topkick		
2009-2003	8 Cyl. 6.6L	PS-414
C5500 Topkick		
2009-2003	8 Cyl. 6.6L	PS-414
G2500		
1993-1992	8 Cyl. 6.2L	PS-245
1991-1983	8 Cyl. 6.2L	PS-155
G3500		
1993-1992	8 Cyl. 6.2L	PS-245
1991-1983	8 Cyl. 6.2L	PS-155
Jimmy		
1991-1987	8 Cyl. 6.2L	PS-155
1986-1982	8 Cyl. 6.2L	PS-154
K1500		
1998-1994	8 Cyl. 6.5L	PS-245

		Part No.
Oil Pressure Gauge Switch		
K1500		
1993-1992	8 Cyl. 6.2L	PS-245
1991-1988	8 Cyl. 6.2L	PS-256
1986-1984	8 Cyl. 6.2L	PS-155
K1500 Suburban		
1985	8 Cyl. 6.2L	PS-155
1983-1982	8 Cyl. 6.2L	PS-155
K2500		
2000-1992	8 Cyl. 6.5L	PS-245
1993-1992	8 Cyl. 6.2L	PS-245
1991-1988	8 Cyl. 6.2L	PS-256
1986-1984	8 Cyl. 6.2L	PS-155
K2500 Suburban		
1994	8 Cyl. 6.5L	PS-245
1985	8 Cyl. 6.2L	PS-155
1983-1982	8 Cyl. 6.2L	PS-155
K3500		
2000-1992	8 Cyl. 6.5L	PS-245
1993-1992	8 Cyl. 6.2L	PS-245
1991-1988	8 Cyl. 6.2L	PS-256
1986-1984	8 Cyl. 6.2L	PS-155
P2500		
1989-1983	8 Cyl. 6.2L	PS-155
P3500		
1999-1998	8 Cyl. 6.5L; 3 Blade Term.	PS-245
1999-1998	8 Cyl. 6.5L; 1 Term.	PS419
1992-1991	8 Cyl. 6.2L	PS-245
1991	4 Cyl. 3.9L	PS-245
1990	4 Cyl. 3.9L	PS-154
1990-1983	8 Cyl. 6.2L	PS-155
R1500		
1987	8 Cyl. 6.2L	PS-155
R1500 Suburban		
1991-1987	8 Cyl. 6.2L	PS-155
R2500		
1988-1987	8 Cyl. 6.2L	PS-155
R2500 Suburban		
1990	8 Cyl. 6.2L	PS-155
1988-1987	8 Cyl. 6.2L	PS-155
R3500		
1991-1990	8 Cyl. 6.2L	PS-155
1988-1987	8 Cyl. 6.2L	PS-155
Savana 2500		
2010-2006	8 Cyl. 6.6L	PS-414
1999	8 Cyl. 6.5L	PS419
1998	8 Cyl. 6.5L; 3 Blade Term.	PS-245
1997-1996	8 Cyl. 6.5L	PS-245
Savana 3500		
2010-2006	8 Cyl. 6.6L	PS-414
1999	8 Cyl. 6.5L	PS419
1998	8 Cyl. 6.5L; 3 Blade Term.	PS-245
1998	8 Cyl. 6.5L; 1 Term.	PS419
1997	8 Cyl. 6.5L	PS-245
Sierra 2500 HD		
2010-2005	8 Cyl. 6.6L	PS-414
2004-2003	8 Cyl. 6.6L; 1 Term.	PS-230
2004-2003	8 Cyl. 6.6L; 3 Term.	PS-414
2002-2001	8 Cyl. 6.6L	PS-230
Sierra 2500 HD Classic		
2007	8 Cyl. 6.6L	PS-414
Sierra 3500		
2006-2003	8 Cyl. 6.6L	PS-414

Pressure and Vacuum Sending Switches

		Part No.
Oil Pressure Gauge Switch		
Sierra 3500		
2002-2001	8 Cyl. 6.6L	PS-230
Sierra 3500 Classic		
2007	8 Cyl. 6.6L	PS-414
Sierra 3500 HD		
2010-2007	8 Cyl. 6.6L	PS-414
V1500		
1987	8 Cyl. 6.2L	PS-155
V1500 Suburban		
1991-1990	8 Cyl. 6.2L	PS-155
1988-1987	8 Cyl. 6.2L	PS-155
V2500		
1987	8 Cyl. 6.2L	PS-155
V2500 Suburban		
1991-1990	8 Cyl. 6.2L	PS-155
1988-1987	8 Cyl. 6.2L	PS-155
V3500		
1991-1990	8 Cyl. 6.2L	PS-155
1988-1987	8 Cyl. 6.2L	PS-155
Oil Pressure Light Switch		
B6000		
1990-1983	8 Cyl.	PS188
C1500		
1992-1988	8 Cyl. 6.2L	PS-140
1986-1985	8 Cyl. 6.2L	PS-140
1984-1982	8 Cyl.; 1 Blade Term.	PS-12
1984-1982	8 Cyl.; 2 Blade Term.	PS-144
1980	8 Cyl.	PS-12
C1500 Suburban		
1986-1985	8 Cyl. 6.2L	PS-140
1984	8 Cyl.; 1 Blade Term.	PS-12
1984	8 Cyl.; 2 Blade Term.	PS-144
1982	8 Cyl. 6.2L	PS-57
C2500		
1992-1988	8 Cyl. 6.2L	PS-140
1986	8 Cyl. 6.2L; Fuel Line Feed Kit	PS-140
1985	8 Cyl. 6.2L	PS-140
1984-1982	8 Cyl.; 1 Blade Term.	PS-12
1984-1982	8 Cyl.; 2 Blade Term.	PS-144
C2500 Suburban		
1982	8 Cyl. 6.2L	PS-57
C3500		
1992-1988	8 Cyl. 6.2L	PS-140
1986-1985	8 Cyl. 6.2L	PS-140
1984-1982	8 Cyl.; 1 Blade Term.	PS-12
1984-1982	8 Cyl.; 2 Blade Term.	PS-144
Canyon		
2020	4 Cyl. 2.8L	PS623
G2500		
1988-1983	8 Cyl. 6.2L	PS-57
G3500		
1988	8 Cyl. 6.2L	PS-140
1986-1983	8 Cyl. 6.2L	PS-57
Jimmy		
1991-1988	8 Cyl. 6.2L	PS-140
1987	8 Cyl. 6.2L; 1/8 Inch x 27 Thread	PS-12
1986-1985	8 Cyl. 6.2L	PS-140
1982	8 Cyl. 6.2L	PS-57
K1500		
1992-1988	8 Cyl. 6.2L	PS-140
1986-1985	8 Cyl. 6.2L	PS-140
1984-1982	8 Cyl.; 1 Blade Term.	PS-12

		Part No.
Oil Pressure Light Switch		
K1500		
1984-1982	8 Cyl.; 2 Blade Term.	PS-144
K1500 Suburban		
1982	8 Cyl. 6.2L	PS-57
K2500		
1992-1988	8 Cyl. 6.2L	PS-140
1986-1985	8 Cyl. 6.2L	PS-140
1984-1982	8 Cyl.; 1 Blade Term.	PS-12
1984-1982	8 Cyl.; 2 Blade Term.	PS-144
K2500 Suburban		
1982	8 Cyl. 6.2L	PS-57
K3500		
1992-1988	8 Cyl. 6.2L	PS-140
1986-1985	8 Cyl. 6.2L	PS-140
1984-1982	8 Cyl.; 1 Blade Term.	PS-12
1984-1982	8 Cyl.; 2 Blade Term.	PS-144
R1500		
1987	8 Cyl. 6.2L	PS-12
R1500 Suburban		
1987	8 Cyl. 6.2L	PS-12
R2500		
1987	8 Cyl. 6.2L	PS-12
R2500 Suburban		
1987	8 Cyl. 6.2L	PS-12
R3500		
1987	8 Cyl. 6.2L	PS-12
S15		
1985	4 Cyl. 2.2L	PS-15
Savana 2500		
2002-1999	8 Cyl. 6.5L	PS-304
Savana 3500		
2002-1999	8 Cyl. 6.5L	PS-304
Sierra 2500 HD		
2002-2001	8 Cyl. 6.6L	PS622
Sierra 3500		
2002-2001	8 Cyl. 6.6L	PS622
V1500 Suburban		
1987	8 Cyl. 6.2L; 1 Term.; w/ 1/8 Inch -27 Thread	PS-12
V2500		
1987	8 Cyl. 6.2L	PS-12
V2500 Suburban		
1987	8 Cyl. 6.2L	PS-12
V3500		
1987	8 Cyl. 6.2L	PS-12
Power Steering Pressure Switch		
C1500		
1997	8 Cyl. 6.5L	PSS12
C1500 Suburban		
1999	8 Cyl. 6.5L	PSS12
C2500		
1998-1997	8 Cyl. 6.5L	PSS12
C2500 Suburban		
1999	8 Cyl. 6.5L	PSS12
C3500		
1998-1997	8 Cyl. 6.5L	PSS12
C3500HD		
1998-1997	8 Cyl. 6.5L	PSS12
G3500		
1984-1983	8 Cyl. 6.2L	PSS1

Pressure and Vacuum Sending Switches

		Part No.
Power Steering Pressure Switch		
K1500		
1998-1997	8 Cyl. 6.5L	PSS12
K2500		
1998-1997	8 Cyl. 6.5L	PSS12
K2500 Suburban		
1999	8 Cyl. 6.5L	PSS12
K3500		
1998-1997	8 Cyl. 6.5L	PSS12
P3500		
1999-1994	8 Cyl. 6.5L	PSS12
Temperature Switches and Senders		
A/C and Heater Blower Motor Switch		
P2500		
1989-1985	8 Cyl. 6.2L	HS-204
1984	8 Cyl. 6.2L	HS-205
1983	8 Cyl. 6.2L; Front	HS-204
P3500		
1996-1995	8 Cyl. 6.5L; w/ Auto. AC	HS-205
1996-1995	8 Cyl. 6.5L; w/ Manual AC	HS-224
1990	4 Cyl. 3.9L	HS-204
1990-1985	8 Cyl. 6.2L	HS-204
1984	8 Cyl. 6.2L	HS-205
1983	8 Cyl. 6.2L; Front	HS-204
S15		
1985-1984	4 Cyl. 2.2L	HS-242
A/C and Heater Selector Switch		
C1500		
1986-1984	8 Cyl. 6.2L	HS-316
C1500 Suburban		
1986-1984	8 Cyl. 6.2L	HS-316
C2500		
1986-1984	8 Cyl. 6.2L	HS-316
C2500 Suburban		
1999	8 Cyl. 6.5L; w/ AC and Auxiliary Heater	HS-348
1986-1984	8 Cyl. 6.2L	HS-316
C3500		
1986-1984	8 Cyl. 6.2L	HS-316
Caballero		
1984-1983	8 Cyl. 5.7L	HS-316
K1500		
1986-1984	8 Cyl. 6.2L	HS-316
K1500 Suburban		
1999	8 Cyl. 6.5L; w/ AC and Auxiliary Heater	HS-348
1986-1984	8 Cyl. 6.2L	HS-316
K2500		
1986-1984	8 Cyl. 6.2L	HS-316
K2500 Suburban		
1999	8 Cyl. 6.5L; w/ AC and Auxiliary Heater	HS-348
1986-1984	8 Cyl. 6.2L	HS-316
K3500		
1986-1984	8 Cyl. 6.2L	HS-316
R1500		
1987	8 Cyl. 6.2L	HS-316
R1500 Suburban		
1988-1987	8 Cyl. 6.2L	HS-316
R2500		
1989-1987	8 Cyl. 6.2L	HS-316
R2500 Suburban		
1988-1987	8 Cyl. 6.2L	HS-316
R3500		
1991-1987	8 Cyl. 6.2L	HS-316

		Part No.
A/C and Heater Selector Switch		
S15		
1985-1984	4 Cyl. 2.2L	HS-316
V1500		
1987	8 Cyl. 6.2L	HS-316
V1500 Suburban		
1988-1987	8 Cyl. 6.2L	HS-316
V2500		
1987	8 Cyl. 6.2L	HS-316
V2500 Suburban		
1988-1987	8 Cyl. 6.2L	HS-316
V3500		
1991-1987	8 Cyl. 6.2L	HS-316
Blower Motor Resistor		
C4500 Topkick		
2009-2003	8 Cyl. 6.6L; w/ Auxiliary Heater; Rear	RU-373
2009-2003	8 Cyl. 6.6L; Main; Resistor; Front	RU-51
C5500 Topkick		
2009-2003	8 Cyl. 6.6L; w/ Auxiliary Heater; Rear	RU-373
2009-2003	8 Cyl. 6.6L; Main; Resistor; Front	RU-51
C6500 Topkick		
2009-2003	6 Cyl. 7.2L; w/ Auxiliary Heater; Rear	RU-373
2009-2003	6 Cyl. 7.8L; w/ Auxiliary Heater; Rear	RU-373
2009-2003	6 Cyl. 7.2L; Main; Resistor; Front	RU-51
2009-2003	6 Cyl. 7.8L; Main; Resistor; Front	RU-51
2002-1999	6 Cyl. 7.2L	RU-57
1998-1997	6 Cyl. 6.6L	RU-57
C7000 Topkick		
1996-1991	6 Cyl. 6.6L	RU-57
C7500 Topkick		
2009-2003	6 Cyl. 7.2L; w/ Auxiliary Heater; Rear	RU-373
2009-2003	6 Cyl. 7.8L; w/ Auxiliary Heater; Rear	RU-373
2009-2003	6 Cyl. 7.2L; Main; Resistor; Front	RU-51
2009-2003	6 Cyl. 7.8L; Main; Resistor; Front	RU-51
2002-1999	6 Cyl. 7.2L	RU-57
1998-1997	6 Cyl. 6.6L	RU-57
Jimmy		
1991	8 Cyl.; w/o AC	RU-630
1991	8 Cyl.; w/ AC	RU-67
P3500		
1996-1994	8 Cyl. 6.5L; Main Unit; w/ AC; Front	RU-56
1993	8 Cyl. 6.2L; Main Unit; w/ AC; Front	RU-56
1992-1991	8 Cyl. 6.2L	RU-62
1991	4 Cyl. 3.9L	RU-62
Sierra 2500 HD		
2009-2008	8 Cyl. 6.6L	RU-730
Sierra 3500 HD		
2009-2008	8 Cyl. 6.6L	RU-730
W3500 Forward		
2004-2003	4 Cyl. 4.8L; 2 Hole Mounting; Resistor; Front	RU-371
2004-2003	4 Cyl. 4.8L; 4 Hole Mounting; Resistor; Front	RU-571
2004-2003	4 Cyl. 4.8L; Module	RU-631
2002	4 Cyl. 4.8L; 2 Hole Mounting; Front	RU-371
2002	4 Cyl. 4.8L; 4 Hole Mounting; Front	RU-571
Blower Motor Resistor Kit		
C4500 Topkick		
2009-2003	8 Cyl. 6.6L; Main; w/ Connector; w/ High Temperature Connector; Front	RU51HTK
C5500 Topkick		
2009-2003	8 Cyl. 6.6L; Main; w/ Connector; w/ High Temperature Connector; Front	RU51HTK

Temperature Switches and Senders

		Part No.
Blower Motor Resistor Kit		
C6500 Topkick		
2009-2003	6 Cyl. 7.2L; Main; w/ Connector; w/ High Temperature Connector; Front	RU51HTK
2009-2003	6 Cyl. 7.8L; Main; w/ Connector; w/ High Temperature Connector; Front	RU51HTK
C7500 Topkick		
2009-2003	6 Cyl. 7.2L; Main; w/ Connector; w/ High Temperature Connector; Front	RU51HTK
2009-2003	6 Cyl. 7.8L; Main; w/ Connector; w/ High Temperature Connector; Front	RU51HTK
Coolant Fan Switch		
P3500		
1996-1994	8 Cyl. 6.5L; Auxiliary Fan Control	TS-241
Temperature Sender - With Gauge		
C1500		
1997-1996	8 Cyl. 6.5L; w/ Oval Connector	TS-253
1995-1994	8 Cyl. 6.5L	TS-253
1993	8 Cyl. 6.2L	TS-253
1992	8 Cyl. 6.2L; 2 Term.	TS-253
1992	8 Cyl. 6.2L; 1 Blade Term.	TS-76
1991-1988	8 Cyl. 6.2L	TS-76
1986-1982	8 Cyl. 6.2L	TS-76
1981	8 Cyl. 5.7L	TS-76
1980	8 Cyl. 5.7L	TS-71
C1500 Suburban		
1999-1996	8 Cyl. 6.5L; w/ Oval Connector	TS-253
1995	8 Cyl. 6.5L	TS-253
1986-1982	8 Cyl. 6.2L	TS-76
1981	8 Cyl. 5.7L	TS-76
C2500		
2000-1993	8 Cyl. 6.5L; w/ Oval Connector	TS-253
1993	8 Cyl. 6.2L; w/ Oval Connector	TS-253
1992	8 Cyl. 6.2L; 2 Term.	TS-253
1992	8 Cyl. 6.5L; 2 Term.	TS-253
1992	8 Cyl. 6.2L; 1 Blade Term.	TS-76
1991-1988	8 Cyl. 6.2L	TS-76
1986	8 Cyl. 6.2L; Fuel Line Feed Kit	TS-76
1985-1982	8 Cyl. 6.2L	TS-76
C2500 Suburban		
1999	8 Cyl. 6.5L; w/ Oval Connector	TS-253
1998	8 Cyl. 6.5L; w/ Oval Connector; Located On Left Hand Cylinder Head	TS-253
1997-1994	8 Cyl. 6.5L; w/ Oval Connector	TS-253
1984-1982	8 Cyl. 6.2L	TS-76
1980	8 Cyl. 5.7L	TS-76
C3500		
2000-1993	8 Cyl. 6.5L; w/ Oval Connector	TS-253
1993	8 Cyl. 6.2L; w/ Oval Connector	TS-253
1992	8 Cyl. 6.2L; 2 Term.	TS-253
1992	8 Cyl. 6.5L; 2 Term.	TS-253
1992	8 Cyl. 6.2L; 1 Blade Term.	TS-76
1991-1988	8 Cyl. 6.2L	TS-76
1986-1982	8 Cyl. 6.2L	TS-76
C3500HD		
2002-2001	8 Cyl. 6.5L	TS-253
2000-1993	8 Cyl. 6.5L; w/ Oval Connector	TS-253
1992	8 Cyl. 6.5L; 2 Term.	TS-253
G2500		
1995-1994	8 Cyl. 6.5L	TS-253
1993-1992	8 Cyl. 6.2L	TS-253
1991-1990	8 Cyl. 6.2L	TS-76
G3500		
1996-1994	8 Cyl. 6.5L; w/ Oval Connector	TS-253
1993	8 Cyl. 6.2L; w/ Oval Connector	TS-253

		Part No.
Temperature Sender - With Gauge		
G3500		
1992	8 Cyl. 6.2L; 2 Term.	TS-253
1991-1988	8 Cyl. 6.2L	TS-76
K1500		
1998-1996	8 Cyl. 6.5L; w/ Oval Connector	TS-253
1995-1994	8 Cyl. 6.5L	TS-253
1993	8 Cyl. 6.2L	TS-253
1992	8 Cyl. 6.2L; 2 Term.	TS-253
1992	8 Cyl. 6.2L; 1 Blade Term.	TS-76
1991-1988	8 Cyl. 6.2L	TS-76
1986-1982	8 Cyl. 6.2L	TS-76
K1500 Suburban		
1999	8 Cyl. 6.5L; w/ Oval Connector	TS-253
1998	8 Cyl. 6.5L; w/ Oval Connector; Located On Left Hand Cylinder Head	TS-253
1997	8 Cyl. 6.5L; w/ Oval Connector	TS-253
1995	8 Cyl. 6.5L	TS-253
1984-1982	8 Cyl. 6.2L	TS-76
K2500		
2000-1993	8 Cyl. 6.5L; w/ Oval Connector	TS-253
1993	8 Cyl. 6.2L; w/ Oval Connector	TS-253
1992	8 Cyl. 6.2L; 2 Term.	TS-253
1992	8 Cyl. 6.5L; 2 Term.	TS-253
1992	8 Cyl. 6.2L; 1 Blade Term.	TS-76
1991-1988	8 Cyl. 6.2L	TS-76
1986-1982	8 Cyl. 6.2L	TS-76
K2500 Suburban		
1999-1997	8 Cyl. 6.5L; w/ Oval Connector	TS-253
1995-1994	8 Cyl. 6.5L; w/ Oval Connector	TS-253
1984-1982	8 Cyl. 6.2L	TS-76
K3500		
2000-1993	8 Cyl. 6.5L; w/ Oval Connector	TS-253
1993	8 Cyl. 6.2L; w/ Oval Connector	TS-253
1992	8 Cyl. 6.2L; 2 Term.	TS-253
1992	8 Cyl. 6.5L; 2 Term.	TS-253
1992	8 Cyl. 6.2L; 1 Blade Term.	TS-76
1991-1988	8 Cyl. 6.2L	TS-76
1986-1982	8 Cyl. 6.2L	TS-76
P2500		
1988-1982	8 Cyl. 6.2L	TS-76
P3500		
1999-1994	8 Cyl. 6.5L; w/ Oval Connector	TS-253
1997-1994	8 Cyl. 6.5L; w/ Pigtail Connector	TS-375
1993	8 Cyl. 6.2L; w/ Oval Connector	TS-253
1992	8 Cyl. 6.2L; 2 Term.	TS-253
1991	4 Cyl. 3.9L	TS-71
1991-1990	8 Cyl. 6.2L	TS-76
1990	4 Cyl. 3.9L	TS-76
1988-1982	8 Cyl. 6.2L	TS-76
R1500		
1987	8 Cyl. 6.2L	TS-76
R1500 Suburban		
1991-1990	8 Cyl. 6.2L	TS-76
1988-1987	8 Cyl. 6.2L	TS-76
R2500		
1988-1987	8 Cyl. 6.2L	TS-76
R2500 Suburban		
1991-1990	8 Cyl. 6.2L	TS-76
1988-1987	8 Cyl. 6.2L	TS-76
R3500		
1991-1990	8 Cyl. 6.2L	TS-76
1988-1987	8 Cyl. 6.2L	TS-76

Temperature Switches and Senders

		Part No.
Temperature Sender - With Gauge		
Savana 2500		
2000-1996	8 Cyl. 6.5L; w/ Oval Connector	TS-253
Savana 3500		
2000-1996	8 Cyl. 6.5L; w/ Oval Connector	TS-253
V1500		
1987	8 Cyl. 6.2L	TS-76
V1500 Suburban		
1991-1990	8 Cyl. 6.2L	TS-76
1988-1987	8 Cyl. 6.2L	TS-76
V2500		
1987	8 Cyl. 6.2L	TS-76
V2500 Suburban		
1991-1990	8 Cyl. 6.2L	TS-76
1988-1987	8 Cyl. 6.2L	TS-76
V3500		
1991-1990	8 Cyl. 6.2L	TS-76
1988-1987	8 Cyl. 6.2L	TS-76
Yukon		
1997-1996	8 Cyl. 6.5L; w/ Oval Connector	TS-253
1995	8 Cyl. 6.5L	TS-253
Temperature Sender - With Light		
C1500		
1997-1994	8 Cyl. 6.5L	TS-253
1993	8 Cyl. 6.2L	TS-253
1990-1988	8 Cyl. 6.2L	TS-81
1986-1982	8 Cyl. 6.2L	TS-81
1981	8 Cyl. 5.7L; 3/8 Inch x 18 Thread	TS-66
1980	8 Cyl. 5.7L; 3/8 Inch x 18 Thread; Diesel	TS-66
C1500 Suburban		
1999-1995	8 Cyl. 6.5L	TS-253
1984-1982	8 Cyl. 6.2L	TS-81
1980	8 Cyl. 5.7L; Diesel	TS-66
C2500		
2000-1993	8 Cyl. 6.5L	TS-253
1993	8 Cyl. 6.2L	TS-253
1990-1988	8 Cyl. 6.2L	TS-81
1986	8 Cyl. 6.2L; Fuel Line Feed Kit	TS-81
1985-1982	8 Cyl. 6.2L	TS-81
C2500 Suburban		
1999-1994	8 Cyl. 6.5L	TS-253
1983-1982	8 Cyl. 6.2L	TS-81
1980	8 Cyl. 5.7L; Diesel	TS-66
C3500		
1990-1988	8 Cyl. 6.2L	TS-81
1986-1982	8 Cyl. 6.2L	TS-81
C3500HD		
2002-2001	8 Cyl.	TS-253
G2500		
1994	8 Cyl. 6.5L	TS-253
1993-1992	8 Cyl. 6.2L	TS-253
1989-1988	8 Cyl. 6.2L	TS-81
1985	8 Cyl. 6.2L	TS-81
G3500		
1995-1994	8 Cyl. 6.5L	TS-253
1993-1992	8 Cyl. 6.2L	TS-253
1989-1988	8 Cyl. 6.2L	TS-81
1985-1983	8 Cyl. 6.2L	TS-81
Jimmy		
1989	8 Cyl. 6.2L	TS-81
1987-1982	8 Cyl. 6.2L	TS-81
K1500		
1998-1994	8 Cyl. 6.5L	TS-253

		Part No.
Temperature Sender - With Light		
K1500		
1993	8 Cyl. 6.2L	TS-253
1990-1988	8 Cyl. 6.2L	TS-81
1986-1982	8 Cyl. 6.2L	TS-81
K1500 Suburban		
1997-1996	8 Cyl. 6.5L	TS-253
1983-1982	8 Cyl. 6.2L	TS-81
K2500		
2000-1993	8 Cyl. 6.5L	TS-253
1993	8 Cyl. 6.2L	TS-253
1990-1988	8 Cyl. 6.2L	TS-81
1986-1982	8 Cyl. 6.2L	TS-81
K2500 Suburban		
1999-1994	8 Cyl. 6.5L	TS-253
1983-1982	8 Cyl. 6.2L	TS-81
K3500		
2000-1993	8 Cyl. 6.5L	TS-253
1993	8 Cyl. 6.2L	TS-253
1990-1988	8 Cyl. 6.2L	TS-81
1986-1982	8 Cyl. 6.2L	TS-81
P3500		
1993-1992	8 Cyl. 6.2L	TS-253
R1500		
1987	8 Cyl. 6.2L	TS-81
R2500		
1989-1987	8 Cyl. 6.2L	TS-81
R3500		
1990-1987	8 Cyl. 6.2L	TS-81
Savana 2500		
2000-1996	8 Cyl. 6.5L	TS-253
Savana 3500		
2000-1996	8 Cyl. 6.5L	TS-253
V1500		
1987	8 Cyl. 6.2L	TS-81
V2500		
1987	8 Cyl. 6.2L	TS-81
V3500		
1990-1987	8 Cyl. 6.2L	TS-81
Yukon		
1997-1995	8 Cyl. 6.5L	TS-253
Universal Switches		
Center High Mount Stop Light Assembly		
Sierra 3500		
2006-2001	8 Cyl.	BTL128
Actuators		
Power Door Lock Actuator		
C1500		
1986-1982	8 Cyl. 6.2L	DLA-1
C1500 Suburban		
1986-1982	8 Cyl. 6.2L	DLA-1
C2500		
1986-1982	8 Cyl. 6.2L	DLA-1
C2500 Suburban		
1986-1982	8 Cyl. 6.2L	DLA-1
C3500		
1986-1982	8 Cyl. 6.2L	DLA-1
Caballero		
1984-1983	8 Cyl. 5.7L	DLA-1
G2500		
1991-1985	8 Cyl. 6.2L	DLA-1

Actuators

		Part No.
Power Door Lock Actuator		
G3500		
1991-1985	8 Cyl. 6.2L	DLA-1
Jimmy		
1982	8 Cyl. 6.2L	DLA-1
K1500		
1986-1982	8 Cyl. 6.2L	DLA-1
K1500 Suburban		
1986-1982	8 Cyl. 6.2L	DLA-1
K2500		
1986-1982	8 Cyl. 6.2L	DLA-1
K2500 Suburban		
1986-1982	8 Cyl. 6.2L	DLA-1
K3500		
1986-1982	8 Cyl. 6.2L	DLA-1
Locks		
Ignition Lock Cylinder Housing Repair Kit		
G2500		
1985	8 Cyl. 6.2L; w/ Tilt Steering	US-165L
G3500		
1985	8 Cyl. 6.2L; w/ Tilt Steering	US-165L
Hummer		
Modules		
Diesel Injector Pump Module Resistor		
H1		
2004-2002	8 Cyl. 6.5L; Resistor No. 5	PMR1
2004-2002	8 Cyl. 6.5L; Resistor No. 9	PMR2
Fuel Valves and Solenoids		
Fuel Shut-Off Solenoid		
H1		
2004-2002		FSS103
Injectors		
Fuel Injector - Diesel - New		
H1		
2004-2002	8 Cyl. 6.5L	FJ173
Fuel Injector - Diesel - Remfd		
H1		
2006	8 Cyl. 6.6L	FJ962
Injection Components		
Diesel Fuel Injection Pump - Remanufactured		
H1		
2006	8 Cyl. 6.6L	IP24
2004-2002	8 Cyl. 6.5L; Complete Assembly	IP1
2004-2002	8 Cyl. 6.5L; Pump Only	IP25
Diesel Glow Plug		
H1		
2006	8 Cyl. 6.6L	GP104
2004-2002	8 Cyl. 6.5L	GP104
Diesel Injector Pump Driver Relocation Kit		
H1		
2004-2002	8 Cyl. 6.5L; w/ Module	IPR1
2004-2002	8 Cyl. 6.5L; w/o Module	IPR2
Diesel Injector Pump Module		
H1		
2004-2002	8 Cyl. 6.5L	IPM1
Diesel Valve Cover Gasket		
H1		
2006	8 Cyl. 6.6L	VCG3

		Part No.
Fuel Injector Installation Kit		
H1		
2006	8 Cyl. 6.6L	SK115
Fuel Pressure Regulator		
H1		
2006	8 Cyl. 6.6L	PR444
Chassis and Drivetrain Sensors		
Automatic Transmission Output Sensor		
H1		
2003		SC168
Vehicle Speed Sensor		
H1		
2003		SC168
Fluid Level Sensors		
Engine Oil Level Sensor		
H1		
2003	Calif.	FLS-14
Pressure Sensors		
Fuel Pressure Sensor		
H1		
2006	8 Cyl. 6.6L	FPS11
Fuel Vapor / Vent Pressure Sensor		
H1		
2004-2003	Vapor Pressure	AS302
Temperature Sensors		
Ambient Air Temperature Sensor		
H1		
2003	w/ Bracket	AX78
Body Light Switches		
Hazard Warning Switch		
H1		
2003	Combo Switch Assembly; w/ Cruise Control	CBS-1149
Chassis and Drivetrain Switches		
Neutral Safety Switch		
H1		
2003	w/ A.T.	NS-85
Ignition Switches		
Ignition Starter Switch		
H1		
2006		US-331
2004-2003		US-331
Interior Power Switches		
Cruise Control Switch		
H1		
2003	w/ Cruise Control	CBS-1149
Parking Brake Switch		
H1		
2003		DS-3357
Power Seat Switch		
H1		
2003	8 Cyl. 6.5L	PSW141
Windshield Wiper Switch		
H1		
2003	w/ Cruise Control	CBS-1149

Relays and Fuses

		Part No.
IC Corporation		
Relays and Fuses		
Diesel Glow Plug Relay		
1652 SC		
2007-2005	8 Cyl. 6.0L	RY1868
3200		
2007	8 Cyl. 6.0L	RY1868
3300 Chassis		
2005	8 Cyl. 6.0L	RY1868
HC Integrated Commercial		
2007	8 Cyl. 6.0L	RY1868
RE Integrated		
2005	8 Cyl. 6.0L	RY1868
RE School Bus		
2007-2006	8 Cyl. 6.0L	RY1868
Air Injection and Induction Parts		
Turbocharger - New		
1652 SC		
2007-2005	Turbocharged	TBC594
3000 Chassis		
2007	Turbocharged	TBC594
2006-2005	8 Cyl. 6.0L; Turbocharged	TBC594
3000 IC		
2007-2006	8 Cyl. 6.0L; Turbocharged	TBC594
3200		
2007	Turbocharged	TBC594
3300 Chassis		
2005	8 Cyl. 6.0L; Turbocharged	TBC594
BE Commercial Bus		
2008	8 Cyl. 6.0L; Turbocharged	TBC594
BE School Bus		
2008	8 Cyl. 6.0L; Turbocharged	TBC594
CE Commercial		
2008-2005	8 Cyl. 6.0L; Turbocharged	TBC594
CE Integrated		
2008-2005	8 Cyl. 6.0L; Turbocharged	TBC594
HC Integrated Commercial		
2008	8 Cyl. 6.0L; Turbocharged	TBC594
2007	Turbocharged	TBC594
RE Commercial		
2007	8 Cyl. 6.0L; Turbocharged	TBC594
RE Integrated		
2005	8 Cyl. 6.0L; Turbocharged	TBC594
RE School Bus		
2008-2006	8 Cyl. 6.0L; Turbocharged	TBC594
2005	Turbocharged	TBC594
Turbocharger Gasket Set		
1652 SC		
2007-2005	8 Cyl. 6.0L; Turbocharged	TGS2
3000 Chassis		
2007-2005	8 Cyl. 6.0L; Turbocharged	TGS2
3000 IC		
2007-2006	8 Cyl. 6.0L; Turbocharged	TGS2
2002	8 Cyl. 7.3L; Turbocharged	TGS3
3200		
2007	8 Cyl. 6.0L; Turbocharged	TGS2
3300 Chassis		
2005	8 Cyl. 6.0L; Turbocharged	TGS2
BE Commercial Bus		
2008	8 Cyl. 6.0L; Turbocharged	TGS2

		Part No.
Turbocharger Gasket Set		
BE School Bus		
2008	8 Cyl. 6.0L; Turbocharged	TGS2
CE Commercial		
2008-2005	8 Cyl. 6.0L; Turbocharged	TGS2
CE Integrated		
2008-2005	8 Cyl. 6.0L; Turbocharged	TGS2
HC Integrated Commercial		
2008-2007	8 Cyl. 6.0L; Turbocharged	TGS2
RE Commercial		
2007	8 Cyl. 6.0L; Turbocharged	TGS2
RE Integrated		
2005	8 Cyl. 6.0L; Turbocharged	TGS2
RE School Bus		
2008-2005	8 Cyl. 6.0L; Turbocharged	TGS2
EGR Components		
Diesel EGR Cooler		
1652 SC		
2007-2006	8 Cyl. 6.0L	ECK1
3000 Chassis		
2007-2006	8 Cyl. 6.0L	ECK1
3000 IC		
2007-2006	8 Cyl. 6.0L	ECK1
3200		
2007	8 Cyl. 6.0L	ECK1
BE Commercial Bus		
2008	8 Cyl. 6.0L	ECK1
BE School Bus		
2008	8 Cyl. 6.0L	ECK1
CE Commercial		
2008-2006	8 Cyl. 6.0L	ECK1
CE Integrated		
2008-2006	8 Cyl. 6.0L	ECK1
HC Integrated Commercial		
2008	8 Cyl. 6.0L	ECK1
RE School Bus		
2008-2006	8 Cyl. 6.0L	ECK1
EGR Valve		
BE School Bus		
2010-2008	8 Cyl. 6.4L	EGV1151
CE Commercial		
2010	8 Cyl. 6.4L	EGV1151
2008	8 Cyl. 6.4L	EGV1151
CE Integrated		
2009-2008	8 Cyl. 6.4L	EGV1151
CE School Bus		
2010	8 Cyl. 6.4L	EGV1151
HC Integrated Commercial		
2010-2008	8 Cyl. 6.4L	EGV1151
Injectors		
Fuel Injector - Diesel - New		
1000 SC		
2004-2003	8 Cyl. 7.3L; Cyl. 1 to 7	FJ738NX
2004-2003	8 Cyl. 7.3L; Cyl. 8	FJ926NX
1300 FBC		
2014-2011	6 Cyl. 7.6L; 215-300 HP	FJ1277NX
2014-2011	6 Cyl. 7.6L; 210-225 HP	FJ1279NX
2010-2007	6 Cyl. 7.6L	FJ1243NX
2006	6 Cyl. 7.6L	FJ1257NX
1652 SC		
2007-2005	8 Cyl. 6.0L	FJ928NX

Injectors

		Part No.
Fuel Injector - Diesel - New		
1652 SC		
2004-2003	8 Cyl. 7.3L; Cyl. 1 to 7	FJ738NX
2004-2003	8 Cyl. 7.3L; Cyl. 8	FJ926NX
3000 Chassis		
2007-2005	8 Cyl. 6.0L	FJ928NX
2006	6 Cyl. 7.6L	FJ1257NX
2005	6 Cyl. 7.6L	FJ1242NX
3000 IC		
2007-2006	8 Cyl. 6.0L	FJ928NX
2004	6 Cyl. 7.6L; 210-225 HP	FJ1240NX
2004	6 Cyl. 7.6L; 245-285 HP	FJ1242NX
2002	6 Cyl. 7.6L; Exhaust stock and reorder	FJ1254
2002	6 Cyl. 7.6L; Exhaust stock and reorder	FJ1254NX
2002	6 Cyl. 7.6L; Alternate Number	FJ1307NX
2002	8 Cyl. 7.3L; Cyl. 1 to 7	FJ738NX
2002	8 Cyl. 7.3L; Cyl. 8	FJ926NX
3200		
2007	8 Cyl. 6.0L	FJ928NX
3300 Chassis		
2005	6 Cyl. 7.6L	FJ1242NX
2005	8 Cyl. 6.0L	FJ928NX
3800		
2003	6 Cyl. 7.6L; Exhaust stock and reorder	FJ1254
2003	6 Cyl. 7.6L; Exhaust stock and reorder	FJ1254NX
2003	6 Cyl. 7.6L; Alternate Number	FJ1307NX
2003	8 Cyl. 7.3L; Cyl. 1 to 7	FJ738NX
2003	8 Cyl. 7.3L; Cyl. 8	FJ926NX
AC Commercial Bus		
2015-2012	8 Cyl. 6.4L	FJ1259NX
AE School Bus		
2015	8 Cyl. 6.4L	FJ1259NX
AR School Bus		
2015-2013	8 Cyl. 6.4L	FJ1259NX
BE Commercial Bus		
2008	8 Cyl. 6.0L	FJ928NX
BE School Bus		
2015-2011	8 Cyl. 6.4L	FJ1259NX
2010	8 Cyl. 6.4L; From Engine No. 5300002	FJ1259NX
2010	8 Cyl. 6.4L; To Engine No. 5300001	FJ960NX
2009-2008	8 Cyl. 6.4L	FJ960NX
2008	8 Cyl. 6.0L	FJ928NX
CE Commercial		
2015-2011	8 Cyl. 6.4L	FJ1259NX
2014-2011	6 Cyl. 7.6L; 215-300 HP	FJ1277NX
2014-2011	6 Cyl. 7.6L; 210-225 HP	FJ1279NX
2010	6 Cyl. 7.6L	FJ1243NX
2010	8 Cyl. 6.4L; From Engine No. 5300002	FJ1259NX
2010	8 Cyl. 6.4L; To Engine No. 5300001	FJ960NX
2008	6 Cyl. 7.6L	FJ1243NX
2008	8 Cyl. 6.4L	FJ960NX
2008-2005	8 Cyl. 6.0L	FJ928NX
2006	6 Cyl. 7.6L	FJ1257NX
2005	6 Cyl. 7.6L	FJ1242NX
2004	6 Cyl. 7.6L; 210-225 HP	FJ1240NX
2004	6 Cyl. 7.6L; 245-285 HP	FJ1242NX
2004-2003	8 Cyl. 7.3L; Cyl. 1 to 7	FJ738NX
2004-2003	8 Cyl. 7.3L; Cyl. 8	FJ926NX
2003	6 Cyl. 7.6L; Exhaust stock and reorder	FJ1254
2003	6 Cyl. 7.6L; Exhaust stock and reorder	FJ1254NX
2003	6 Cyl. 7.6L; Alternate Number	FJ1307NX
CE Integrated		
2014-2011	6 Cyl. 7.6L; 215-300 HP	FJ1277NX
2014-2011	6 Cyl. 7.6L; 210-225 HP	FJ1279NX

		Part No.
Fuel Injector - Diesel - New		
CE Integrated		
2010-2007	6 Cyl. 7.6L	FJ1243NX
2009-2008	8 Cyl. 6.4L	FJ960NX
2008-2005	8 Cyl. 6.0L	FJ928NX
2006	6 Cyl. 7.6L	FJ1257NX
2005	6 Cyl. 7.6L	FJ1242NX
CE School Bus		
2015-2011	8 Cyl. 6.4L	FJ1259NX
2014-2011	6 Cyl. 7.6L; 215-300 HP	FJ1277NX
2014-2011	6 Cyl. 7.6L; 210-225 HP	FJ1279NX
2010	6 Cyl. 7.6L	FJ1243NX
2010	8 Cyl. 6.4L; From Engine No. 5300002	FJ1259NX
2010	8 Cyl. 6.4L; To Engine No. 5300001	FJ960NX
2004	6 Cyl. 7.6L; 210-225 HP	FJ1240NX
2004	6 Cyl. 7.6L; 245-285 HP	FJ1242NX
2004-2003	8 Cyl. 7.3L; Cyl. 1 to 7	FJ738NX
2004-2003	8 Cyl. 7.3L; Cyl. 8	FJ926NX
2003	6 Cyl. 7.6L; Exhaust stock and reorder	FJ1254
2003	6 Cyl. 7.6L; Exhaust stock and reorder	FJ1254NX
2003	6 Cyl. 7.6L; Alternate Number	FJ1307NX
FE Commercial		
2011	6 Cyl. 7.6L; 215-300 HP	FJ1277NX
2011	6 Cyl. 7.6L; 210-225 HP	FJ1279NX
2010-2008	6 Cyl. 7.6L	FJ1243NX
2004	6 Cyl. 7.6L; 210-225 HP	FJ1240NX
2004	6 Cyl. 7.6L; 245-285 HP	FJ1242NX
2003	6 Cyl. 7.6L; Exhaust stock and reorder	FJ1254
2003	6 Cyl. 7.6L; Exhaust stock and reorder	FJ1254NX
2003	6 Cyl. 7.6L; Alternate Number	FJ1307NX
FE Integrated		
2008-2007	6 Cyl. 7.6L	FJ1243NX
2005	6 Cyl. 7.6L	FJ1242NX
FE School Bus		
2011	6 Cyl. 7.6L; 215-300 HP	FJ1277NX
2011	6 Cyl. 7.6L; 210-225 HP	FJ1279NX
2010-2007	6 Cyl. 7.6L	FJ1243NX
2006	6 Cyl. 7.6L	FJ1257NX
2004	6 Cyl. 7.6L; 210-225 HP	FJ1240NX
2004	6 Cyl. 7.6L; 245-285 HP	FJ1242NX
2003	6 Cyl. 7.6L; Exhaust stock and reorder	FJ1254
2003	6 Cyl. 7.6L; Exhaust stock and reorder	FJ1254NX
2003	6 Cyl. 7.6L; Alternate Number	FJ1307NX
HC Integrated Commercial		
2015-2011	8 Cyl. 6.4L	FJ1259NX
2014-2011	6 Cyl. 7.6L; 215-300 HP	FJ1277NX
2014-2011	6 Cyl. 7.6L; 210-225 HP	FJ1279NX
2010	8 Cyl. 6.4L; From Engine No. 5300002	FJ1259NX
2010	8 Cyl. 6.4L; To Engine No. 5300001	FJ960NX
2010-2008	6 Cyl. 7.6L	FJ1243NX
2009-2008	8 Cyl. 6.4L	FJ960NX
2008-2007	8 Cyl. 6.0L	FJ928NX
RE Commercial		
2014-2011	6 Cyl. 7.6L; 215-300 HP	FJ1277NX
2014-2011	6 Cyl. 7.6L; 210-225 HP	FJ1279NX
2010-2007	6 Cyl. 7.6L	FJ1243NX
2007	8 Cyl. 6.0L	FJ928NX
2006	6 Cyl. 7.6L	FJ1257NX
2005	6 Cyl. 7.6L	FJ1242NX
2004	6 Cyl. 7.6L; 210-225 HP	FJ1240NX
2004	6 Cyl. 7.6L; 245-285 HP	FJ1242NX
2004-2003	8 Cyl. 7.3L; Cyl. 1 to 7	FJ738NX
2004-2003	8 Cyl. 7.3L; Cyl. 8	FJ926NX
2003	6 Cyl. 7.6L; Exhaust stock and reorder	FJ1254
2003	6 Cyl. 7.6L; Exhaust stock and reorder	FJ1254NX

Injectors

		Part No.
Fuel Injector - Diesel - New		
RE Commercial		
2003	6 Cyl. 7.6L; Alternate Number	FJ1307NX
RE Integrated		
2005	6 Cyl. 7.6L	FJ1242NX
2005	8 Cyl. 6.0L	FJ928NX
RE School Bus		
2014-2011	6 Cyl. 7.6L; 215-300 HP	FJ1277NX
2014-2011	6 Cyl. 7.6L; 210-225 HP	FJ1279NX
2010-2007	6 Cyl. 7.6L	FJ1243NX
2008-2005	8 Cyl. 6.0L	FJ928NX
2006	6 Cyl. 7.6L	FJ1257NX
2004	6 Cyl. 7.6L; 210-225 HP	FJ1240NX
2004	6 Cyl. 7.6L; 245-285 HP	FJ1242NX
2004-2003	8 Cyl. 7.3L; Cyl. 1 to 7	FJ738NX
2004-2003	8 Cyl. 7.3L; Cyl. 8	FJ926NX
2003	6 Cyl. 7.6L; Exhaust stock and reorder	FJ1254
2003	6 Cyl. 7.6L; Exhaust stock and reorder	FJ1254NX
2003	6 Cyl. 7.6L; Alternate Number	FJ1307NX
Fuel Injector - Diesel - Remfd		
1000 SC		
2004-2003	8 Cyl. 7.3L; Cyl. 1 to 7	FJ738
2004-2003	8 Cyl. 7.3L; Complete Kit; Cyl. 1 to 8	FJ7388PCK
2004-2003	8 Cyl. 7.3L; Cyl. 8	FJ926
1300 FBC		
2014-2011	6 Cyl. 7.6L; 215-300 HP	FJ1277
2014-2011	6 Cyl. 7.6L; 210-225 HP	FJ1279
2010-2007	6 Cyl. 7.6L	FJ1243
2006	6 Cyl. 7.6L	FJ1257
1652 SC		
2007-2005	8 Cyl. 6.0L; Injector Only	FJ928
2007-2005	8 Cyl. 6.0L; Complete Kit	FJ9288PCK
2004-2003	8 Cyl. 7.3L; Cyl. 1 to 7	FJ738
2004-2003	8 Cyl. 7.3L; Complete Kit; Cyl. 1 to 8	FJ7388PCK
2004-2003	8 Cyl. 7.3L; Cyl. 8	FJ926
3000 Chassis		
2007-2005	8 Cyl. 6.0L; Injector Only	FJ928
2007-2005	8 Cyl. 6.0L; Complete Kit	FJ9288PCK
2006	6 Cyl. 7.6L	FJ1257
2005	6 Cyl. 7.6L	FJ1242
3000 IC		
2007-2006	8 Cyl. 6.0L; Injector Only	FJ928
2007-2006	8 Cyl. 6.0L; Complete Kit	FJ9288PCK
2004	6 Cyl. 7.6L; 210-225 HP	FJ1240
2004	6 Cyl. 7.6L; 245-285 HP	FJ1242
2002	6 Cyl. 7.6L	FJ1307
2002	8 Cyl. 7.3L; Cyl. 1 to 7	FJ738
2002	8 Cyl. 7.3L; Complete Kit; Cyl. 1 to 8	FJ7388PCK
2002	8 Cyl. 7.3L; Cyl. 8	FJ926
3200		
2007	8 Cyl. 6.0L; Injector Only	FJ928
2007	8 Cyl. 6.0L; Complete Kit	FJ9288PCK
3300 Chassis		
2005	6 Cyl. 7.6L	FJ1242
2005	8 Cyl. 6.0L; Injector Only	FJ928
2005	8 Cyl. 6.0L; Complete Kit	FJ9288PCK
3800		
2003	6 Cyl. 7.6L	FJ1307
2003	8 Cyl. 7.3L; Cyl. 1 to 7	FJ738
2003	8 Cyl. 7.3L; Complete Kit; Cyl. 1 to 8	FJ7388PCK
2003	8 Cyl. 7.3L; Cyl. 8	FJ926
AC Commercial Bus		
2015-2012	8 Cyl. 6.4L	FJ1259

		Part No.
Fuel Injector - Diesel - Remfd		
AE School Bus		
2015	8 Cyl. 6.4L	FJ1259
AR School Bus		
2015-2013	8 Cyl. 6.4L	FJ1259
BE Commercial Bus		
2008	8 Cyl. 6.0L; Injector Only	FJ928
2008	8 Cyl. 6.0L; Complete Kit	FJ9288PCK
BE School Bus		
2015-2011	8 Cyl. 6.4L	FJ1259
2010	8 Cyl. 6.4L; From Engine No. 5300002	FJ1259
2010	8 Cyl. 6.4L; To Engine No. 5300001	FJ960
2009-2008	8 Cyl. 6.4L	FJ960
2008	8 Cyl. 6.0L; Injector Only	FJ928
2008	8 Cyl. 6.0L; Complete Kit	FJ9288PCK
CE Commercial		
2015-2011	8 Cyl. 6.4L	FJ1259
2014-2011	6 Cyl. 7.6L; 215-300 HP	FJ1277
2014-2011	6 Cyl. 7.6L; 210-225 HP	FJ1279
2010	6 Cyl. 7.6L	FJ1243
2010	8 Cyl. 6.4L; From Engine No. 5300002	FJ1259
2010	8 Cyl. 6.4L; To Engine No. 5300001	FJ960
2008	6 Cyl. 7.6L	FJ1243
2008	8 Cyl. 6.4L	FJ960
2008-2005	8 Cyl. 6.0L; Injector Only	FJ928
2008-2005	8 Cyl. 6.0L; Complete Kit	FJ9288PCK
2006	6 Cyl. 7.6L	FJ1257
2005	6 Cyl. 7.6L	FJ1242
2004	6 Cyl. 7.6L; 210-225 HP	FJ1240
2004	6 Cyl. 7.6L; 245-285 HP	FJ1242
2004-2003	8 Cyl. 7.3L; Cyl. 1 to 7	FJ738
2004-2003	8 Cyl. 7.3L; Complete Kit; Cyl. 1 to 8	FJ7388PCK
2004-2003	8 Cyl. 7.3L; Cyl. 8	FJ926
2003	6 Cyl. 7.6L	FJ1307
CE Integrated		
2014-2011	6 Cyl. 7.6L; 215-300 HP	FJ1277
2014-2011	6 Cyl. 7.6L; 210-225 HP	FJ1279
2010-2007	6 Cyl. 7.6L	FJ1243
2009-2008	8 Cyl. 6.4L	FJ960
2008-2005	8 Cyl. 6.0L; Injector Only	FJ928
2008-2005	8 Cyl. 6.0L; Complete Kit	FJ9288PCK
2006	6 Cyl. 7.6L	FJ1257
2005	6 Cyl. 7.6L	FJ1242
CE School Bus		
2015-2011	8 Cyl. 6.4L	FJ1259
2014-2011	6 Cyl. 7.6L; 215-300 HP	FJ1277
2014-2011	6 Cyl. 7.6L; 210-225 HP	FJ1279
2010	6 Cyl. 7.6L	FJ1243
2010	8 Cyl. 6.4L; From Engine No. 5300002	FJ1259
2010	8 Cyl. 6.4L; To Engine No. 5300001	FJ960
2004	6 Cyl. 7.6L; 210-225 HP	FJ1240
2004	6 Cyl. 7.6L; 245-285 HP	FJ1242
2004-2003	8 Cyl. 7.3L; Cyl. 1 to 7	FJ738
2004-2003	8 Cyl. 7.3L; Complete Kit; Cyl. 1 to 8	FJ7388PCK
2004-2003	8 Cyl. 7.3L; Cyl. 8	FJ926
2003	6 Cyl. 7.6L	FJ1307
FE Commercial		
2011	6 Cyl. 7.6L; 215-300 HP	FJ1277
2011	6 Cyl. 7.6L; 210-225 HP	FJ1279
2010-2008	6 Cyl. 7.6L	FJ1243
2004	6 Cyl. 7.6L; 210-225 HP	FJ1240
2004	6 Cyl. 7.6L; 245-285 HP	FJ1242
2003	6 Cyl. 7.6L	FJ1307

Injectors

		Part No.
Fuel Injector - Diesel - Remfd		
FE Integrated		
2008-2007	6 Cyl. 7.6L	FJ1243
2005	6 Cyl. 7.6L	FJ1242
FE School Bus		
2011	6 Cyl. 7.6L; 215-300 HP	FJ1277
2011	6 Cyl. 7.6L; 210-225 HP	FJ1279
2010-2007	6 Cyl. 7.6L	FJ1243
2006	6 Cyl. 7.6L	FJ1257
2004	6 Cyl. 7.6L; 210-225 HP	FJ1240
2004	6 Cyl. 7.6L; 245-285 HP	FJ1242
2003	6 Cyl. 7.6L	FJ1307
HC Integrated Commercial		
2015-2011	8 Cyl. 6.4L	FJ1259
2014-2011	6 Cyl. 7.6L; 215-300 HP	FJ1277
2014-2011	6 Cyl. 7.6L; 210-225 HP	FJ1279
2010	8 Cyl. 6.4L; From Engine No. 5300002	FJ1259
2010	8 Cyl. 6.4L; To Engine No. 5300001	FJ960
2010-2008	6 Cyl. 7.6L	FJ1243
2009-2008	8 Cyl. 6.4L	FJ960
2008-2007	8 Cyl. 6.0L; Injector Only	FJ928
2008-2007	8 Cyl. 6.0L; Complete Kit	FJ9288PCK
RE Commercial		
2015	6 Cyl. 7.6L; 210-225 HP	FJ1279
2014-2011	6 Cyl. 7.6L; 215-300 HP	FJ1277
2013-2011	6 Cyl. 7.6L; 210-225 HP	FJ1279
2010-2007	6 Cyl. 7.6L	FJ1243
2007	8 Cyl. 6.0L; Injector Only	FJ928
2007	8 Cyl. 6.0L; Complete Kit	FJ9288PCK
2006	6 Cyl. 7.6L	FJ1257
2005	6 Cyl. 7.6L	FJ1242
2004	6 Cyl. 7.6L; 210-225 HP	FJ1240
2004	6 Cyl. 7.6L; 245-285 HP	FJ1242
2004-2003	8 Cyl. 7.3L; Cyl. 1 to 7	FJ738
2004-2003	8 Cyl. 7.3L; Complete Kit; Cyl. 1 to 8	FJ7388PCK
2004-2003	8 Cyl. 7.3L; Cyl. 8	FJ926
2003	6 Cyl. 7.6L	FJ1307
RE Integrated		
2005	6 Cyl. 7.6L	FJ1242
2005	8 Cyl. 6.0L; Injector Only	FJ928
2005	8 Cyl. 6.0L; Complete Kit	FJ9288PCK
RE School Bus		
2014-2011	6 Cyl. 7.6L; 215-300 HP	FJ1277
2014-2011	6 Cyl. 7.6L; 210-225 HP	FJ1279
2010-2007	6 Cyl. 7.6L	FJ1243
2008-2005	8 Cyl. 6.0L; Injector Only	FJ928
2008-2005	8 Cyl. 6.0L; Complete Kit	FJ9288PCK
2006	6 Cyl. 7.6L	FJ1257
2004	6 Cyl. 7.6L; 210-225 HP	FJ1240
2004	6 Cyl. 7.6L; 245-285 HP	FJ1242
2004-2003	8 Cyl. 7.3L; Cyl. 1 to 7	FJ738
2004-2003	8 Cyl. 7.3L; Complete Kit; Cyl. 1 to 8	FJ7388PCK
2004-2003	8 Cyl. 7.3L; Cyl. 8	FJ926
2003	6 Cyl. 7.6L	FJ1307
Injection Components		
Diesel Fuel Heater		
1000 SC		
2004-2003	8 Cyl. 7.3L	DFH101
1652 SC		
2007-2005	8 Cyl. 6.0L	DFH101
2004-2003	8 Cyl. 7.3L	DFH101
3000 Chassis		
2007-2005	8 Cyl. 6.0L	DFH101

		Part No.
Diesel Fuel Heater		
3000 IC		
2007-2006	8 Cyl. 6.0L	DFH101
2002	8 Cyl. 7.3L	DFH101
3200		
2007	8 Cyl. 6.0L	DFH101
3300 Chassis		
2005	8 Cyl. 6.0L	DFH101
3800		
2003	8 Cyl. 7.3L	DFH101
CE Commercial		
2007-2005	8 Cyl. 6.0L	DFH101
2004-2003	8 Cyl. 7.3L	DFH101
CE Integrated		
2007-2005	8 Cyl. 6.0L	DFH101
CE School Bus		
2004-2003	8 Cyl. 7.3L	DFH101
HC Integrated Commercial		
2007	8 Cyl. 6.0L	DFH101
RE Commercial		
2007	8 Cyl. 6.0L	DFH101
2004-2003	8 Cyl. 7.3L	DFH101
RE Integrated		
2005	8 Cyl. 6.0L	DFH101
RE School Bus		
2007-2005	8 Cyl. 6.0L	DFH101
2004-2003	8 Cyl. 7.3L	DFH101
Diesel Fuel Injection Harness		
BE School Bus		
2013	8 Cyl. 6.4L; Left	IFH9
2010-2008	8 Cyl. 6.4L; Right	IFH8
2010-2008	8 Cyl. 6.4L; Left	IFH9
CE Commercial		
2010	8 Cyl. 6.4L; Right	IFH8
2010	8 Cyl. 6.4L; Left	IFH9
2008	8 Cyl. 6.4L; Right	IFH8
2008	8 Cyl. 6.4L; Left	IFH9
CE Integrated		
2009-2008	8 Cyl. 6.4L; Right	IFH8
2009-2008	8 Cyl. 6.4L; Left	IFH9
CE School Bus		
2010	8 Cyl. 6.4L; Right	IFH8
2010	8 Cyl. 6.4L; Left	IFH9
HC Integrated Commercial		
2010-2008	8 Cyl. 6.4L; Right	IFH8
2010-2008	8 Cyl. 6.4L; Left	IFH9
Diesel Fuel Injection Pump - Remanufactured		
AC Commercial Bus		
2015-2012	8 Cyl. 6.4L	IP35
AE School Bus		
2015	8 Cyl. 6.4L	IP35
AR School Bus		
2015-2013	8 Cyl. 6.4L	IP35
BE School Bus		
2015-2011	8 Cyl. 6.4L	IP35
2010	8 Cyl. 6.4L; To Engine No. 5300001	IP34
2010	8 Cyl. 6.4L; From Engine No. 5300002	IP35
2009-2008	8 Cyl. 6.4L	IP34
CE Commercial		
2015-2011	8 Cyl. 6.4L	IP35
2010	8 Cyl. 6.4L; To Engine No. 5300001	IP34
2010	8 Cyl. 6.4L; From Engine No. 5300002	IP35
2008	8 Cyl. 6.4L	IP34

Injection Components

		Part No.
Diesel Fuel Injection Pump - Remanufactured		
CE Integrated		
2009-2008	8 Cyl. 6.4L	IP34
CE School Bus		
2015-2011	8 Cyl. 6.4L	IP35
2010	8 Cyl. 6.4L; To Engine No. 5300001	IP34
2010	8 Cyl. 6.4L; From Engine No. 5300002	IP35
HC Integrated Commercial		
2015-2011	8 Cyl. 6.4L	IP35
2010	8 Cyl. 6.4L; To Engine No. 5300001	IP34
2010	8 Cyl. 6.4L; From Engine No. 5300002	IP35
2009-2008	8 Cyl. 6.4L	IP34
Diesel Fuel Injector Control Module (FICM)		
1300 FBC		
2008-2006	6 Cyl. 7.6L; Power Supply	R76001
1652 SC		
2007-2005	8 Cyl. 6.0L; Power Supply	R76001
3000 IC		
2006	8 Cyl. 6.0L; Power Supply	R76001
3200		
2007	8 Cyl. 6.0L; Power Supply	R76001
3300 Chassis		
2005	6 Cyl. 7.6L; Power Supply	R76001
2005	8 Cyl. 6.0L; Power Supply	R76001
BE Commercial Bus		
2008	8 Cyl. 6.0L; Power Supply	R76001
BE School Bus		
2008	8 Cyl. 6.0L; Power Supply	R76001
CE Commercial		
2008	6 Cyl. 7.6L; Power Supply	R76001
2008-2005	8 Cyl. 6.0L; Power Supply	R76001
2006-2005	6 Cyl. 7.6L; Power Supply	R76001
CE Integrated		
2008-2005	6 Cyl. 7.6L; Power Supply	R76001
2008-2005	8 Cyl. 6.0L; Power Supply	R76001
FE Commercial		
2008	6 Cyl. 7.6L; Power Supply	R76001
FE Integrated		
2008-2007	6 Cyl. 7.6L; Power Supply	R76001
2005	6 Cyl. 7.6L; Power Supply	R76001
FE School Bus		
2008-2006	6 Cyl. 7.6L; Power Supply	R76001
HC Integrated Commercial		
2008	6 Cyl. 7.6L; Power Supply	R76001
2008-2007	8 Cyl. 6.0L; Power Supply	R76001
RE Commercial		
2008-2005	6 Cyl. 7.6L; Power Supply	R76001
2007	8 Cyl. 6.0L; Power Supply	R76001
RE Integrated		
2005	6 Cyl. 7.6L; Power Supply	R76001
2005	8 Cyl. 6.0L; Power Supply	R76001
RE School Bus		
2008-2006	6 Cyl. 7.6L; Power Supply	R76001
2007-2005	8 Cyl. 6.0L; Power Supply	R76001
Diesel Fuel Injector Sleeve		
1652 SC		
2007-2005	8 Cyl. 6.0L	IFS1
3000 Chassis		
2007-2005	8 Cyl. 6.0L	IFS1
3000 IC		
2007-2006	8 Cyl. 6.0L	IFS1

		Part No.
Diesel Fuel Injector Sleeve		
3200		
2007	8 Cyl. 6.0L	IFS1
3300 Chassis		
2005	8 Cyl. 6.0L	IFS1
BE Commercial Bus		
2008	8 Cyl. 6.0L	IFS1
BE School Bus		
2008	8 Cyl. 6.0L	IFS1
CE Commercial		
2008-2005	8 Cyl. 6.0L	IFS1
CE Integrated		
2008-2005	8 Cyl. 6.0L	IFS1
HC Integrated Commercial		
2008	8 Cyl. 6.0L	IFS1
RE Commercial		
2007	8 Cyl. 6.0L	IFS1
RE Integrated		
2005	8 Cyl. 6.0L	IFS1
RE School Bus		
2008-2005	8 Cyl. 6.0L	IFS1
Diesel Glow Plug		
BE School Bus		
2010-2008	8 Cyl. 6.4L	GP122
CE Commercial		
2010	8 Cyl. 6.4L	GP122
2008	8 Cyl. 6.4L	GP122
CE Integrated		
2009-2008	8 Cyl. 6.4L	GP122
CE School Bus		
2010	8 Cyl. 6.4L	GP122
HC Integrated Commercial		
2010-2008	8 Cyl. 6.4L	GP122
Diesel Injection High Pressure Oil Pump		
1000 SC		
2004-2003	8 Cyl. 7.3L	HPI2
1300 FBC		
2014-2011	6 Cyl. 7.6L	HPI10
2010	6 Cyl. 7.6L; From Engine No. 3,300,001	HPI10
2010	6 Cyl. 7.6L; From Engine No. 3,040,001 to Engine No. 3,300,000	HPI13
2010-2007	6 Cyl. 7.6L; To Engine No. 3040000	HPI8
2009-2007	6 Cyl. 7.6L; From Engine No. 3,040,001	HPI13
2006	6 Cyl. 7.6L	HPI12
1652 SC		
2007-2005	8 Cyl. 6.0L	HPI7
2004-2003	8 Cyl. 7.3L	HPI2
3000 Chassis		
2007-2005	8 Cyl. 6.0L	HPI7
2006-2005	6 Cyl. 7.6L	HPI12
3000 IC		
2007	6 Cyl. 7.6L; From Engine No. 3,040,001	HPI13
2007	6 Cyl. 7.6L; To Engine No. 3040000	HPI8
2007-2006	8 Cyl. 6.0L	HPI7
2006	6 Cyl. 7.6L	HPI12
2004	6 Cyl. 7.6L	HPI12
2002	6 Cyl. 7.6L; 230-300 HP	HPI18
2002	6 Cyl. 8.7L; 230-300 HP	HPI18
2002	6 Cyl. 7.6L; 175-230 HP	HPI19
2002	8 Cyl. 7.3L	HPI2
2002	6 Cyl. 8.7L; 300-330 HP	HPI20
3200		
2007	8 Cyl. 6.0L	HPI7

Injection Components

		Part No.
Diesel Injection High Pressure Oil Pump		
3300 Chassis		
2005	6 Cyl. 7.6L	HPI12
2005	8 Cyl. 6.0L	HPI7
3800		
2003	6 Cyl. 7.6L; 230-300 HP	HPI18
2003	6 Cyl. 7.6L; 175-230 HP	HPI19
2003	8 Cyl. 7.3L	HPI2
BE Commercial Bus		
2008	8 Cyl. 6.0L	HPI7
BE School Bus		
2008	8 Cyl. 6.0L	HPI7
CE Commercial		
2014-2011	6 Cyl. 7.6L	HPI10
2010	6 Cyl. 7.6L; To Engine No. 3040000	HPI8
2010	6 Cyl. 7.6L; From Engine No. 3,300,001	HPI10
2010	6 Cyl. 7.6L; From Engine No. 3,040,001 to Engine No. 3,300,000	HPI13
2008	6 Cyl. 7.6L; From Engine No. 3,040,001	HPI13
2008	6 Cyl. 7.6L; To Engine No. 3040000	HPI8
2008-2005	8 Cyl. 6.0L	HPI7
2006-2004	6 Cyl. 7.6L	HPI12
2004-2003	8 Cyl. 7.3L	HPI2
2003	6 Cyl. 7.6L; 230-300 HP	HPI18
2003	6 Cyl. 7.6L; 175-230 HP	HPI19
CE Integrated		
2014-2011	6 Cyl. 7.6L	HPI10
2010	6 Cyl. 7.6L; From Engine No. 3,300,001	HPI10
2010	6 Cyl. 7.6L; From Engine No. 3,040,001 to Engine No. 3,300,000	HPI13
2010-2007	6 Cyl. 7.6L; To Engine No. 3040000	HPI8
2009-2007	6 Cyl. 7.6L; From Engine No. 3,040,001	HPI13
2008-2005	8 Cyl. 6.0L	HPI7
2006-2005	6 Cyl. 7.6L	HPI12
CE School Bus		
2014-2011	6 Cyl. 7.6L	HPI10
2010	6 Cyl. 7.6L; From Engine No. 3,300,001	HPI10
2010	6 Cyl. 7.6L; From Engine No. 3,040,001 to Engine No. 3,300,000	HPI13
2010	6 Cyl. 7.6L; To Engine No. 3040000	HPI8
2004	6 Cyl. 7.6L	HPI12
2004-2003	8 Cyl. 7.3L	HPI2
2003	6 Cyl. 7.6L; 230-300 HP	HPI18
2003	6 Cyl. 7.6L; 175-230 HP	HPI19
FE Commercial		
2011	6 Cyl. 7.6L	HPI10
2010	6 Cyl. 7.6L; From Engine No. 3,300,001	HPI10
2010	6 Cyl. 7.6L; From Engine No. 3,040,001 to Engine No. 3,300,000	HPI13
2010-2008	6 Cyl. 7.6L; To Engine No. 3040000	HPI8
2009-2008	6 Cyl. 7.6L; From Engine No. 3,040,001	HPI13
2004	6 Cyl. 7.6L	HPI12
2003	6 Cyl. 7.6L; 230-300 HP	HPI18
2003	6 Cyl. 7.6L; 175-230 HP	HPI19
FE Integrated		
2008-2007	6 Cyl. 7.6L; From Engine No. 3,040,001	HPI13
2008-2007	6 Cyl. 7.6L; To Engine No. 3040000	HPI8
2005	6 Cyl. 7.6L	HPI12
FE School Bus		
2011	6 Cyl. 7.6L	HPI10
2010	6 Cyl. 7.6L; From Engine No. 3,300,001	HPI10
2010	6 Cyl. 7.6L; From Engine No. 3,040,001 to Engine No. 3,300,000	HPI13
2010-2007	6 Cyl. 7.6L; To Engine No. 3040000	HPI8
2009-2007	6 Cyl. 7.6L; From Engine No. 3,040,001	HPI13

		Part No.
Diesel Injection High Pressure Oil Pump		
FE School Bus		
2006	6 Cyl. 7.6L	HPI12
2004	6 Cyl. 7.6L	HPI12
2003	6 Cyl. 7.6L; 230-300 HP	HPI18
2003	6 Cyl. 7.6L; 175-230 HP	HPI19
HC Integrated Commercial		
2014-2011	6 Cyl. 7.6L	HPI10
2010	6 Cyl. 7.6L; From Engine No. 3,300,001	HPI10
2010	6 Cyl. 7.6L; From Engine No. 3,040,001 to Engine No. 3,300,000	HPI13
2010-2008	6 Cyl. 7.6L; To Engine No. 3040000	HPI8
2009-2008	6 Cyl. 7.6L; From Engine No. 3,040,001	HPI13
2008-2007	8 Cyl. 6.0L	HPI7
RE Commercial		
2014-2011	6 Cyl. 7.6L	HPI10
2010	6 Cyl. 7.6L; From Engine No. 3,300,001	HPI10
2010	6 Cyl. 7.6L; From Engine No. 3,040,001 to Engine No. 3,300,000	HPI13
2010-2007	6 Cyl. 7.6L; To Engine No. 3040000	HPI8
2009-2007	6 Cyl. 7.6L; From Engine No. 3,040,001	HPI13
2007	8 Cyl. 6.0L	HPI7
2006-2004	6 Cyl. 7.6L	HPI12
2004-2003	6 Cyl. 8.7L; 230-300 HP	HPI18
2004-2003	8 Cyl. 7.3L	HPI2
2004-2003	6 Cyl. 8.7L; 300-330 HP	HPI20
2003	6 Cyl. 7.6L; 230-300 HP	HPI18
2003	6 Cyl. 7.6L; 175-230 HP	HPI19
RE Integrated		
2005	6 Cyl. 7.6L	HPI12
2005	8 Cyl. 6.0L	HPI7
RE School Bus		
2014-2011	6 Cyl. 7.6L	HPI10
2010	6 Cyl. 7.6L; From Engine No. 3,300,001	HPI10
2010	6 Cyl. 7.6L; From Engine No. 3,040,001 to Engine No. 3,300,000	HPI13
2010-2007	6 Cyl. 7.6L; To Engine No. 3040000	HPI8
2009-2007	6 Cyl. 7.6L; From Engine No. 3,040,001	HPI13
2008-2005	8 Cyl. 6.0L	HPI7
2006	6 Cyl. 7.6L	HPI12
2004	6 Cyl. 7.6L	HPI12
2004-2003	6 Cyl. 8.7L; 230-300 HP	HPI18
2004-2003	8 Cyl. 7.3L	HPI2
2004-2003	6 Cyl. 8.7L; 300-330 HP	HPI20
2003	6 Cyl. 7.6L; 230-300 HP	HPI18
2003	6 Cyl. 7.6L; 175-230 HP	HPI19
Diesel Injection Pump Installation Kit		
AC Commercial Bus		
2015-2012	8 Cyl. 6.4L	IPK3
AE School Bus		
2015	8 Cyl. 6.4L	IPK3
AR School Bus		
2015-2013	8 Cyl. 6.4L	IPK3
BE School Bus		
2015-2011	8 Cyl. 6.4L	IPK3
2010	8 Cyl. 6.4L; To Engine No. 5300001	IPK2
2010	8 Cyl. 6.4L; From Engine No. 5300002	IPK3
2009-2008	8 Cyl. 6.4L	IPK2
CE Commercial		
2015-2011	8 Cyl. 6.4L	IPK3
2010	8 Cyl. 6.4L; To Engine No. 5300001	IPK2
2010	8 Cyl. 6.4L; From Engine No. 5300002	IPK3
2008	8 Cyl. 6.4L	IPK2
CE Integrated		
2009-2008	8 Cyl. 6.4L	IPK2

Injection Components

		Part No.
Diesel Injection Pump Installation Kit		
CE School Bus		
2015-2011	8 Cyl. 6.4L	IPK3
2010	8 Cyl. 6.4L; To Engine No. 5300001	IPK2
2010	8 Cyl. 6.4L; From Engine No. 5300002	IPK3
HC Integrated Commercial		
2015-2011	8 Cyl. 6.4L	IPK3
2010	8 Cyl. 6.4L; To Engine No. 5300001	IPK2
2010	8 Cyl. 6.4L; From Engine No. 5300002	IPK3
2009-2008	8 Cyl. 6.4L	IPK2
Diesel Oil Cooler Kit		
1300 FBC		
2008-2006	6 Cyl. 7.6L	OCK3
3000 Chassis		
2006	6 Cyl. 7.6L	OCK3
3000 IC		
2007-2006	6 Cyl. 7.6L	OCK3
CE Commercial		
2008	6 Cyl. 7.6L	OCK3
2006	6 Cyl. 7.6L	OCK3
CE Integrated		
2008-2006	6 Cyl. 7.6L	OCK3
FE Commercial		
2008	6 Cyl. 7.6L	OCK3
FE Integrated		
2008-2007	6 Cyl. 7.6L	OCK3
FE School Bus		
2008-2006	6 Cyl. 7.6L	OCK3
RE Commercial		
2009-2006	6 Cyl. 7.6L	OCK3
RE School Bus		
2009-2006	6 Cyl. 7.6L	OCK3
Engine Oil Stand Pipe and Dummy Plug Kit		
1652 SC		
2006-2005	8 Cyl. 6.0L	SPK101
3000 Chassis		
2007-2005	8 Cyl. 6.0L	SPK101
3000 IC		
2007-2006	8 Cyl. 6.0L	SPK101
3200		
2007	8 Cyl. 6.0L	SPK101
3300 Chassis		
2005	8 Cyl. 6.0L	SPK101
BE Commercial Bus		
2008	8 Cyl. 6.0L	SPK101
BE School Bus		
2008	8 Cyl. 6.0L	SPK101
CE Commercial		
2008-2005	8 Cyl. 6.0L	SPK101
CE Integrated		
2008-2005	8 Cyl. 6.0L	SPK101
HC Integrated Commercial		
2008-2007	8 Cyl. 6.0L	SPK101
RE Commercial		
2007	8 Cyl. 6.0L	SPK101
RE Integrated		
2005	8 Cyl. 6.0L	SPK101
RE School Bus		
2008-2005	8 Cyl. 6.0L	SPK101
Fuel Injector Seal Kit		
1000 SC		
2004-2003	8 Cyl. 7.3L	SK55

		Part No.
Fuel Injector Seal Kit		
1652 SC		
2007-2005	8 Cyl. 6.0L	SK85
2004-2003	8 Cyl. 7.3L	SK55
3000 Chassis		
2007-2005	8 Cyl. 6.0L	SK85
3000 IC		
2007-2006	8 Cyl. 6.0L	SK85
2002	8 Cyl. 7.3L	SK55
3200		
2007	8 Cyl. 6.0L	SK85
3300 Chassis		
2005	8 Cyl. 6.0L	SK85
3800		
2003	8 Cyl. 7.3L	SK55
BE Commercial Bus		
2008	8 Cyl. 6.0L	SK85
BE School Bus		
2008	8 Cyl. 6.0L	SK85
CE Commercial		
2008-2005	8 Cyl. 6.0L	SK85
2004-2003	8 Cyl. 7.3L	SK55
CE Integrated		
2008-2005	8 Cyl. 6.0L	SK85
CE School Bus		
2004-2003	8 Cyl. 7.3L	SK55
HC Integrated Commercial		
2008-2007	8 Cyl. 6.0L	SK85
RE Commercial		
2007	8 Cyl. 6.0L	SK85
2004-2003	8 Cyl. 7.3L	SK55
RE Integrated		
2005	8 Cyl. 6.0L	SK85
RE School Bus		
2008-2005	8 Cyl. 6.0L	SK85
2004-2003	8 Cyl. 7.3L	SK55
Fuel Pressure Regulator		
1652 SC		
2007-2005	8 Cyl. 6.0L	PR429
3000 Chassis		
2007-2005	8 Cyl. 6.0L	PR429
3000 IC		
2007-2006	8 Cyl. 6.0L	PR429
3200		
2007	8 Cyl. 6.0L	PR429
3300 Chassis		
2005	8 Cyl. 6.0L	PR429
BE Commercial Bus		
2008	8 Cyl. 6.0L	PR429
BE School Bus		
2008	8 Cyl. 6.0L	PR429
CE Commercial		
2008-2005	8 Cyl. 6.0L	PR429
CE Integrated		
2008-2005	8 Cyl. 6.0L	PR429
2007	6 Cyl. 7.6L; Diesel; w/o Edge Filter	PR315
FE Integrated		
2007	6 Cyl. 7.6L; Diesel; w/o Edge Filter	PR315
FE School Bus		
2007	6 Cyl. 7.6L; Diesel; w/o Edge Filter	PR315
HC Integrated Commercial		
2008-2007	8 Cyl. 6.0L	PR429

Injection Components

		Part No.
Fuel Pressure Regulator		
RE Commercial		
2007	6 Cyl. 7.6L; Diesel; w/o Edge Filter	PR315
2007	8 Cyl. 6.0L	PR429
RE Integrated		
2005	8 Cyl. 6.0L	PR429
RE School Bus		
2008-2005	8 Cyl. 6.0L	PR429
2007	6 Cyl. 7.6L; Diesel; w/o Edge Filter	PR315
Fuel Pressure Regulator O-Ring		
1652 SC		
2007-2005	8 Cyl. 6.0L; Kit	SK107
3000 Chassis		
2007-2005	8 Cyl. 6.0L; Kit	SK107
3000 IC		
2007-2006	8 Cyl. 6.0L; Kit	SK107
2004	6 Cyl. 7.6L	SK104
2002	6 Cyl. 7.6L	SK104
3200		
2007	8 Cyl. 6.0L; Kit	SK107
3300 Chassis		
2005	8 Cyl. 6.0L; Kit	SK107
3800		
2003	6 Cyl. 7.6L	SK104
BE Commercial Bus		
2008	8 Cyl. 6.0L; Kit	SK107
BE School Bus		
2008	8 Cyl. 6.0L; Kit	SK107
CE Commercial		
2008-2005	8 Cyl. 6.0L; Kit	SK107
2004-2003	6 Cyl. 7.6L	SK104
CE Integrated		
2008-2005	8 Cyl. 6.0L; Kit	SK107
CE School Bus		
2004-2003	6 Cyl. 7.6L	SK104
FE Commercial		
2004-2003	6 Cyl. 7.6L	SK104
FE School Bus		
2004-2003	6 Cyl. 7.6L	SK104
HC Integrated Commercial		
2008-2007	8 Cyl. 6.0L; Kit	SK107
RE Commercial		
2007	8 Cyl. 6.0L; Kit	SK107
2004-2003	6 Cyl.	SK104
RE Integrated		
2005	8 Cyl. 6.0L; Kit	SK107
RE School Bus		
2008-2005	8 Cyl. 6.0L; Kit	SK107
2004-2003	6 Cyl.	SK104
Fuel Rail O-Ring Kit		
1300 FBC		
2015-2008	6 Cyl. 7.6L	SK168
2006	6 Cyl. 7.6L	SK168
3000 Chassis		
2006-2005	6 Cyl. 7.6L	SK168
3000 IC		
2007-2006	6 Cyl. 7.6L	SK168
3300 Chassis		
2005	6 Cyl. 7.6L	SK168
CE Commercial		
2016-2010	6 Cyl. 7.6L	SK168
2008	6 Cyl. 7.6L	SK168

		Part No.
Fuel Rail O-Ring Kit		
CE Commercial		
2006-2005	6 Cyl. 7.6L	SK168
CE Integrated		
2015-2005	6 Cyl. 7.6L	SK168
CE School Bus		
2016-2010	6 Cyl. 7.6L	SK168
FE Commercial		
2011-2008	6 Cyl. 7.6L	SK168
FE Integrated		
2008-2007	6 Cyl. 7.6L	SK168
2005	6 Cyl. 7.6L	SK168
FE School Bus		
2011-2006	6 Cyl. 7.6L	SK168
HC Integrated Commercial		
2016-2008	6 Cyl. 7.6L	SK168
RE Commercial		
2016-2015	6 Cyl. 7.6L	SK168
2013-2005	6 Cyl. 7.6L	SK168
RE Integrated		
2005	6 Cyl. 7.6L	SK168
RE School Bus		
2016-2006	6 Cyl. 7.6L	SK168
Fuel Sensors		
Diesel Injection Control Pressure Sensor		
1652 SC		
2007-2005	8 Cyl. 6.0L; Exhaust stock and reorder; Sensor Only	ICP101
2007-2005	8 Cyl. 6.0L; Sensor Kit	ICP101K
2007-2005	8 Cyl. 6.0L; Alternate Number; Sensor Kit	ICP101K
3000 Chassis		
2007-2005	8 Cyl. 6.0L; Exhaust stock and reorder; Sensor Only	ICP101
2007-2005	8 Cyl. 6.0L; Sensor Kit	ICP101K
2007-2005	8 Cyl. 6.0L; Alternate Number; Sensor Kit	ICP101K
3000 IC		
2007-2006	8 Cyl. 6.0L; Exhaust stock and reorder; Sensor Only	ICP101
2007-2006	8 Cyl. 6.0L; Sensor Kit	ICP101K
2007-2006	8 Cyl. 6.0L; Alternate Number; Sensor Kit	ICP101K
3200		
2007	8 Cyl. 6.0L; Exhaust stock and reorder; Sensor Only	ICP101
2007	8 Cyl. 6.0L; Sensor Kit	ICP101K
2007	8 Cyl. 6.0L; Alternate Number; Sensor Kit	ICP101K
3300 Chassis		
2005	8 Cyl. 6.0L; Exhaust stock and reorder; Sensor Only	ICP101
2005	8 Cyl. 6.0L; Sensor Kit	ICP101K
2005	8 Cyl. 6.0L; Alternate Number; Sensor Kit	ICP101K
BE Commercial Bus		
2008	8 Cyl. 6.0L; Exhaust stock and reorder; Sensor Only	ICP101
2008	8 Cyl. 6.0L; Sensor Kit	ICP101K
2008	8 Cyl. 6.0L; Alternate Number; Sensor Kit	ICP101K
BE School Bus		
2008	8 Cyl. 6.0L; Exhaust stock and reorder; Sensor Only	ICP101
2008	8 Cyl. 6.0L; Sensor Kit	ICP101K
2008	8 Cyl. 6.0L; Alternate Number; Sensor Kit	ICP101K
CE Commercial		
2008-2005	8 Cyl. 6.0L; Exhaust stock and reorder; Sensor Only	ICP101
2008-2005	8 Cyl. 6.0L; Sensor Kit	ICP101K

Fuel Sensors

		Part No.
Diesel Injection Control Pressure Sensor		
CE Commercial		
2008-2005	8 Cyl. 6.0L; Alternate Number; Sensor Kit	ICP101K
CE Integrated		
2008-2005	8 Cyl. 6.0L; Exhaust stock and reorder; Sensor Only	ICP101
2008-2005	8 Cyl. 6.0L; Sensor Kit	ICP101K
2008-2005	8 Cyl. 6.0L; Alternate Number; Sensor Kit	ICP101K
HC Integrated Commercial		
2008-2007	8 Cyl. 6.0L; Exhaust stock and reorder; Sensor Only	ICP101
2008-2007	8 Cyl. 6.0L; Sensor Kit	ICP101K
2008-2007	8 Cyl. 6.0L; Alternate Number; Sensor Kit	ICP101K
RE Commercial		
2007	8 Cyl. 6.0L; Exhaust stock and reorder; Sensor Only	ICP101
2007	8 Cyl. 6.0L; Sensor Kit	ICP101K
2007	8 Cyl. 6.0L; Alternate Number; Sensor Kit	ICP101K
RE Integrated		
2005	8 Cyl. 6.0L; Exhaust stock and reorder; Sensor Only	ICP101
2005	8 Cyl. 6.0L; Sensor Kit	ICP101K
2005	8 Cyl. 6.0L; Alternate Number; Sensor Kit	ICP101K
RE School Bus		
2008-2005	8 Cyl. 6.0L; Exhaust stock and reorder; Sensor Only	ICP101
2008-2005	8 Cyl. 6.0L; Sensor Kit	ICP101K
2008-2005	8 Cyl. 6.0L; Alternate Number; Sensor Kit	ICP101K
Pressure Sensors		
Diesel Particulate Filter (DPF) Pressure Sensor		
CE School Bus		
2018-2017	6 Cyl. 7.6L	DPS101
HC Integrated Commercial		
2017	6 Cyl. 7.6L	DPS101
Temperature Sensors		
Intake Air Temperature Sensor		
1652 SC		
2006-2005	8 Cyl. 6.0L	ATS51
3000 Chassis		
2007	8 Cyl. 6.0L	ATS51
2005	8 Cyl. 6.0L	ATS51
3000 IC		
2007-2006	8 Cyl. 6.0L	ATS51
3200		
2007	8 Cyl. 6.0L	ATS51
3300 Chassis		
2005	8 Cyl. 6.0L	ATS51
CE Commercial		
2007-2005	8 Cyl. 6.0L	ATS51
CE Integrated		
2007-2005	8 Cyl. 6.0L	ATS51
HC Integrated Commercial		
2007	8 Cyl. 6.0L	ATS51
RE Commercial		
2007	8 Cyl. 6.0L	ATS51
RE Integrated		
2005	8 Cyl. 6.0L	ATS51
RE School Bus		
2007-2005	8 Cyl. 6.0L	ATS51

		Part No.
Indiana Phoenix		
Injectors		
Fuel Injector - Diesel - New		
11 Yard		
2002	6 Cyl. 12.0L	FJ1266
International		
Relays and Fuses		
Diesel Glow Plug Relay		
1652SC		
2007-2004	8 Cyl. 6.0L; VT365 Eng.	RY1868
3200		
2007-2003	8 Cyl. 6.0L; VT365 Eng.	RY1868
4100		
2007-2006	8 Cyl. 6.0L; VT365 Eng.	RY1868
4100 SBA		
2007-2006	8 Cyl. 6.0L; VT365 Eng.	RY1868
4200		
2007-2003	8 Cyl. 6.0L; VT365 Eng.	RY1868
4200LP		
2007-2003	8 Cyl. 6.0L; VT365 Eng.	RY1868
CF500		
2006	6 Cyl. 4.5L; VT275 Eng.	RY1868
CF600		
2006	6 Cyl. 4.5L; VT275 Eng.	RY1868
MXT		
2007	8 Cyl. 6.0L; VT365 Eng.	RY1868
RXT		
2007-2006	8 Cyl. 6.0L; VT365 Eng.	RY1868
Starting and Charging System Parts		
Starter Solenoid		
F1954		
1986	6 Cyl. 7.6L; 24 Volt; OE No. 1990276	SS-215
1986	6 Cyl. 9.0L; 24 Volt; OE No. 1990276	SS-215
1986	8 Cyl. 6.8L; 24 Volt; OE No. 1990276	SS-215
S1654		
1986	8 Cyl. 6.8L; 24 Volt; OE No. 1990276	SS-215
1984	8 Cyl. 6.8L; 24 Volt	SS-215
1984	8 Cyl. 6.8L; 12 Volt	SS-216
S1753		
1986	8 Cyl. 6.8L; 24 Volt; OE No. 1990276	SS-215
1984	8 Cyl. 6.8L; 24 Volt	SS-215
1984	8 Cyl. 6.8L; 12 Volt	SS-216
S1754		
1986	6 Cyl. 7.6L; 24 Volt; OE No. 1990276	SS-215
1986	6 Cyl. 9.0L; 24 Volt; OE No. 1990276	SS-215
1984	6 Cyl. 7.6L; 24 Volt	SS-215
1984	6 Cyl. 7.6L; 12 Volt	SS-216
1984-1983	6 Cyl. 9.0L; 12 Volt	SS-216
1984-1981	6 Cyl. 9.0L; 24 Volt	SS-215
1982-1981	6 Cyl. 9.0L; 12 Volt; OE No. 1113183	SS-213
1982-1981	6 Cyl. 9.0L; 12 Volt; Str. No. 1114052, 1114129, 1114142, 1114175, 1114177, 1114714, 1114734	SS-216
1982-1981	6 Cyl. 9.0L; 12 Volt; Str. No. 1114890, 1114895, 1114896	SS-216
1982-1981	6 Cyl. 9.0L; 12 Volt; Str. No. 114836, 1114884, 1114886, 1114889, 1114892, 1114895, 1114896	SS-216
S1853		
1986	6 Cyl. 7.6L; 24 Volt; OE No. 1990276	SS-215
1986	6 Cyl. 9.0L; 24 Volt; OE No. 1990276	SS-215
1984	6 Cyl. 7.6L; 24 Volt	SS-215

International

Starting and Charging System Parts

		Part No.
Starter Solenoid		
S1853		
1984	6 Cyl. 7.6L; 12 Volt	SS-216
1984	6 Cyl. 9.0L; 12 Volt	SS-216
1984-1981	6 Cyl. 9.0L; 24 Volt	SS-215
1983-1981	6 Cyl. 9.0L; 12 Volt; Str. No. 114836, 1114884, 1114886, 1114889, 1114892, 1114895, 1114896	SS-216
1982-1981	6 Cyl. 9.0L; 12 Volt; OE No. 1113183	SS-213
1982-1981	6 Cyl. 9.0L; 12 Volt; Str. No. 1114052, 1114129, 1114142, 1114175, 1114177, 1114714, 1114734	SS-216
1982-1981	6 Cyl. 9.0L; 12 Volt; Str. No. 1114890, 1114895, 1114896	SS-216
S1854		
1986	6 Cyl. 7.6L; 24 Volt; OE No. 1990276	SS-215
1986	6 Cyl. 9.0L; 24 Volt; OE No. 1990276	SS-215
1984	6 Cyl. 7.6L; 24 Volt; Str. No. 1113846, 1113887, 1113900, 1113914, 1113952	SS-215
1984	6 Cyl. 7.6L; 12 Volt	SS-216
1984-1983	6 Cyl. 9.0L; 12 Volt	SS-216
1984-1981	6 Cyl. 9.0L; 24 Volt	SS-215
1982-1981	6 Cyl. 9.0L; 12 Volt; OE No. 1113183	SS-213
1982-1981	6 Cyl. 9.0L; 12 Volt; Str. No. 1114052, 1114129, 1114142, 1114175, 1114177, 1114714, 1114734	SS-216
1982-1981	6 Cyl. 9.0L; 12 Volt; Str. No. 1114890, 1114895, 1114896	SS-216
1982-1981	6 Cyl. 9.0L; 12 Volt; Str. No. 114836, 1114884, 1114886, 1114889, 1114892, 1114895, 1114896	SS-216
S1924		
1982-1981	12 Volt; OE No. 1113183	SS-213
1982-1981	24 Volt	SS-215
1982-1981	12 Volt; Str. No. 1114052, 1114129, 1114142, 1114175, 1114177, 1114714, 1114734	SS-216
1982-1981	12 Volt; Str. No. 1114890, 1114895, 1114896	SS-216
1982-1981	12 Volt; Str. No. 114836, 1114884, 1114886, 1114889, 1114892, 1114895, 1114896	SS-216
1980	6 Cyl. 7.6L; 12 Volt; OE No. 1113183	SS-213
1980	6 Cyl. 7.6L; 24 Volt	SS-215
1980	6 Cyl. 7.6L; 12 Volt; Str. No. 1114052, 1114129, 1114142, 1114175, 1114177, 1114714, 1114734	SS-216
1980	6 Cyl. 7.6L; 12 Volt; Str. No. 1114890, 1114895, 1114896	SS-216
1980	6 Cyl. 7.6L; 12 Volt; Str. No. 114836, 1114884, 1114886, 1114889, 1114892, 1114895, 1114896	SS-216
S1925		
1982-1981	12 Volt; OE No. 1113183	SS-213
1982-1981	24 Volt	SS-215
1982-1981	12 Volt; Str. No. 1114052, 1114129, 1114142, 1114175, 1114177, 1114714, 1114734	SS-216
1982-1981	12 Volt; Str. No. 1114890, 1114895, 1114896	SS-216
1982-1981	12 Volt; Str. No. 114836, 1114884, 1114886, 1114889, 1114892, 1114895, 1114896	SS-216
1980	6 Cyl. 7.6L; 12 Volt; OE No. 1113183	SS-213
1980	6 Cyl. 7.6L; 24 Volt	SS-215
1980	6 Cyl. 7.6L; 12 Volt; Str. No. 1114052, 1114129, 1114142, 1114175, 1114177, 1114714, 1114734	SS-216
1980	6 Cyl. 7.6L; 12 Volt; Str. No. 1114890, 1114895, 1114896	SS-216

		Part No.
Starter Solenoid		
S1925		
1980	6 Cyl. 7.6L; 12 Volt; Str. No. 114836, 1114884, 1114886, 1114889, 1114892, 1114895, 1114896	SS-216
S1954		
1986	6 Cyl. 7.6L; 24 Volt; OE No. 1990276	SS-215
1986	6 Cyl. 9.0L; 24 Volt; OE No. 1990276	SS-215
1984-1983	6 Cyl. 7.6L; 12 Volt; Str. No. 114836, 1114884, 1114886, 1114889, 1114892, 1114895, 1114896	SS-216
1984-1981	6 Cyl. 7.6L; 24 Volt	SS-215
1982	6 Cyl. 7.6L; 12 Volt; Str. No. 114836, 1114884, 1114886, 1114889, 1114892, 1114895, 1114896; Str. No. 1114890, 1114895, 1114896	SS-216
1982-1981	6 Cyl. 7.6L; 12 Volt; OE No. 1113183	SS-213
1982-1981	6 Cyl. 7.6L; 12 Volt; Str. No. 1114052, 1114129, 1114142, 1114175, 1114177, 1114714, 1114734	SS-216
1981	6 Cyl. 7.6L; 12 Volt; Str. No. 1114890, 1114895, 1114896	SS-216
1981	6 Cyl. 7.6L; 12 Volt; Str. No. 114836, 1114884, 1114886, 1114889, 1114892, 1114895, 1114896	SS-216
S1955		
1986	6 Cyl. 7.6L; 24 Volt; OE No. 1990276	SS-215
1984-1983	6 Cyl. 7.6L; 12 Volt	SS-216
1984-1981	6 Cyl. 7.6L; 24 Volt	SS-215
1982	6 Cyl. 7.6L; 12 Volt; Str. No. 114836, 1114884, 1114886, 1114889, 1114892, 1114895, 1114896; Str. No. 1114052, 1114129, 1114142, 1114175, 1114177, 1114714, 1114734; Str. No. 1114890, 1114895, 1114896	SS-216
1982-1981	6 Cyl. 7.6L; 12 Volt; OE No. 1113183	SS-213
1981	6 Cyl. 7.6L; 12 Volt; Str. No. 1114890, 1114895, 1114896	SS-216
1981	6 Cyl. 7.6L; 12 Volt; Str. No. 114836, 1114884, 1114886, 1114889, 1114892, 1114895, 1114896; Str. No. 1114052, 1114129, 1114142, 1114175, 1114177, 1114714, 1114734	SS-216
S2125		
1981	6 Cyl. 7.6L; 12 Volt; OE No. 1113183	SS-213
1981	6 Cyl. 7.6L; 12 Volt; Str. No. 1114052, 1114129, 1114142, 1114175, 1114177, 1114714, 1114734	SS-216
1981	6 Cyl. 7.6L; 12 Volt; Str. No. 1114890, 1114895, 1114896	SS-216
1981	6 Cyl. 7.6L; 12 Volt; Str. No. 114836, 1114884, 1114886, 1114889, 1114892, 1114895, 1114896	SS-216
S2155		
1986	6 Cyl. 7.6L; 24 Volt; OE No. 1990276	SS-215
1984	6 Cyl. 7.6L; 24 Volt	SS-215
1984	6 Cyl. 7.6L; 12 Volt	SS-216
S2375		
1986	6 Cyl. 9.0L; 24 Volt; OE No. 1990276	SS-215
1984	6 Cyl. 9.0L; 24 Volt	SS-215
1984	6 Cyl. 9.0L; 12 Volt	SS-216
S2524		
1982-1980	6 Cyl. 7.6L; 12 Volt; OE No. 1113183	SS-213
1982-1980	6 Cyl. 7.6L; 24 Volt	SS-215
1982-1980	6 Cyl. 7.6L; 12 Volt; Str. No. 1114052, 1114129, 1114142, 1114175, 1114177, 1114714, 1114734	SS-216
1982-1980	6 Cyl. 7.6L; 12 Volt; Str. No. 1114890, 1114895, 1114896	SS-216

Starting and Charging System Parts

		Part No.
Starter Solenoid		
S2524		
1982-1980	6 Cyl. 7.6L; 12 Volt; Str. No. 114836, 1114884, 1114886, 1114889, 1114892, 1114895, 1114896	SS-216
S2554		
1986	6 Cyl. 7.6L; 24 Volt; OE No. 1990276	SS-215
1984-1983	6 Cyl. 7.6L; 12 Volt	SS-216
1984-1981	6 Cyl. 7.6L; 24 Volt	SS-215
1982	6 Cyl. 7.6L; 12 Volt; Str. No. 114836, 1114884, 1114886, 1114889, 1114892, 1114895, 1114896; Str. No. 1114052, 1114129, 1114142, 1114175, 1114177, 1114714, 1114734	SS-216
1982-1981	6 Cyl. 7.6L; 12 Volt; OE No. 1113183	SS-213
1982-1981	6 Cyl. 7.6L; 12 Volt; Str. No. 1114890, 1114895, 1114896	SS-216
1981	6 Cyl. 7.6L; 12 Volt; Str. No. 1114052, 1114129, 1114142, 1114175, 1114177, 1114714, 1114734	SS-216
1981	6 Cyl. 7.6L; 12 Volt; Str. No. 114836, 1114884, 1114886, 1114889, 1114892, 1114895, 1114896	SS-216
Scout II		
1980	6 Cyl. ⁵	SS-200
Voltage Regulator		
F1954		
1986	42 Amp; Alt. No. 1103175	VR-111
1986	42 Amp; Alt. No. 1105162, 1105514	VR-111
1986	63 Amp; Alt. No. 1103182	VR-111
1986	63 Amp; Alt. No. 1105170	VR-111
1986	65 Amp; Alt. No. 1100177	VR-111
1986	72 Amp; Alt. No. 1103174	VR-111
1986	105 Amp; Alt. No. 1117141, 1117147	VR-144
1986	145 Amp; Alt. No. 1117142, 1117143, 1117148, 1117149	VR-144
1986	65 Amp; Alt. No. 1100081, 1105177, 1105460, 1105482	VR-144
1986	80 Amp; Alt. No. 1100080, 1105465	VR-144
1986	80 Amp; Alt. No. 1100083	VR-144
1986	90 Amp; Alt. No. 1117160	VR-144
1986	90 Amp; Alt. No. 1117481, 1117482	VR-144
S1654		
1986	42 Amp; 63 Amp; 65 Amp; 72 Amp; Alt No. 1100177; Alt No. 1103182; Alt No. 1105170; Alt. No. 1100081; Alt. No. 1103175; Alt. No. 1105162, 1105514	VR-111
1986	65 Amp; 80 Amp; 90 Amp; 105 Amp; 145 Amp; Alt. No. 1100083; Alt. No. 1117160; Alt. No. 1100081, 1105177, 1105460, 1105482; Alt. No. 1100080, 1105465; Alt. No. 1117141, 1117147; Alt. No. 1117142, 1117143, 1117148, 1117149; Alt. No. 1117481, 1117482	VR-144
1984	42 Amp; 63 Amp; 65 Amp; Alt. No. 1100177; Alt. No. 1103182; Alt. No. 1105170; Alt. No. 1103175; Alt. No. 1105162, 1105514	VR-111
1984	65 Amp; 80 Amp; 90 Amp; 105 Amp; 145 Amp; Alt. No. 1117160; Alt. No. 1100081, 1105177, 1105460, 1105482; Alt. No. 1100080, 1105465; Alt. No. 1117141, 1117147; Alt. No. 1117142, 1117143, 1117148, 1117149; Alt. No. 1117481, 1117482	VR-144

		Part No.
Voltage Regulator		
S1753		
1986	65 Amp; 80 Amp; 90 Amp; 105 Amp; 145 Amp; Alt. No. 1100083; Alt. No. 1117160; Alt. No. 1100081, 1105177, 1105460, 1105482; Alt. No. 1100080, 1105465; Alt. No. 1117141, 1117147; Alt. No. 1117142, 1117143, 1117148, 1117149; Alt. No. 1117481, 1117482	VR-144
1986	42 Amp; 63 Amp; 65 Amp; 72 Amp; Alt. No. 1100177; Alt. No. 1103182; Alt. No. 1105170; Alt. No. 1103175; Alt. No. 1105162, 1105514	VR-111
1984	42 Amp; 63 Amp; 65 Amp; 72 Amp; Alt. No. 1100177; Alt. No. 1103182; Alt. No. 1105170; Alt. No. 1103174; Alt. No. 1103175; Alt. No. 1105162, 1105514	VR-111
1984	65 Amp; 80 Amp; 90 Amp; 105 Amp; 145 Amp; Alt. No. 1100083; Alt. No. 1117160; Alt. No. 1100081, 1105177, 1105460, 1105482; Alt. No. 1100080, 1105465; Alt. No. 1117141, 1117147; Alt. No. 1117142, 1117143, 1117148, 1117149; Alt. No. 1117481, 1117482	VR-144
S1754		
1986	42 Amp; 63 Amp; 65 Amp; 72 Amp; Alt. No. 1100177; Alt. No. 1103182; Alt. No. 1105170; Alt. No. 1103174; Alt. No. 1103175; Alt. No. 1105162, 1105514	VR-111
1986	65 Amp; 80 Amp; 90 Amp; 105 Amp; 145 Amp; Alt. No. 1100083; Alt. No. 1117160; Alt. No. 1100081, 1105177, 1105460, 1105482; Alt. No. 1100080, 1105465; Alt. No. 1117141, 1117147; Alt. No. 1117142, 1117143, 1117148, 1117149; Alt. No. 1117481, 1117482	VR-144
1984	42 Amp; 63 Amp; 65 Amp; 72 Amp; Alt. No. 1100177; Alt. No. 1103182; Alt. No. 1105170; Alt. No. 1103174; Alt. No. 1103175; Alt. No. 1105162, 1105514	VR-111
1984	65 Amp; 80 Amp; 90 Amp; 105 Amp; 145 Amp; Alt. No. 1100083; Alt. No. 1117160; Alt. No. 1100081, 1105177, 1105460, 1105482; Alt. No. 1100080, 1105465; Alt. No. 1117141, 1117147; Alt. No. 1117142, 1117143, 1117148, 1117149; Alt. No. 1117481, 1117482	VR-144
1983	65 Amp; 80 Amp; 90 Amp; 105 Amp; 145 Amp; Alt. No. 1117160; Alt. No. 1100081, 1105177, 1105460, 1105482; Alt. No. 1100080, 1105465; Alt. No. 1117141, 1117147; Alt. No. 1117142, 1117143, 1117148, 1117149	VR-144
1983	42 Amp; 61 Amp; 70 Amp; Alt. No. 1101450; Alt. No. 1101040; Alt. No. 1103172, 1103174; Alt. No. 1103175	VR-111
1982	42 Amp; 61 Amp; 70 Amp; 80 Amp; Alt. No. 1101040; Alt. No. 1101450; Alt. No. 1103172, 1103174; Alt. No. 1103175	VR-111
1982	65 Amp; 80 Amp; 90 Amp; 105 Amp; 145 Amp; Alt. No. 1100081, 1105177, 1105460, 1105482; Alt. No. 1100080, 1105465; Alt. No. 1117141, 1117147; Alt. No. 1117142, 1117143, 1117148, 1117149	VR-144
1981	42 Amp; 61 Amp; 70 Amp; 80 Amp; Alt. No. 1101450; Alt. No. 1101040; Alt. No. 1103172, 1103174; Alt. No. 1103175	VR-111
1981	65 Amp; 80 Amp; 90 Amp; 105 Amp; 145 Amp; Alt. No. 1117160; Alt. No. 1100081, 1105177, 1105460, 1105482; Alt. No. 1100080, 1105465; Alt. No. 1117141, 1117147; Alt. No. 1117142, 1117143, 1117148, 1117149	VR-144

⁵ Standard Unit

Starting and Charging System Parts

		Part No.
Voltage Regulator		
S1955		
1984	65 Amp; 80 Amp; 90 Amp; 105 Amp; 145 Amp; Alt No. 1100083; Alt No. 1117160; Alt. No.1100081, 1105177, 1105460, 1105482; Alt. No. 1100080, 1105465; Alt. No. 1117141, 1117147; Alt. No. 1117142, 1117143, 1117148, 1117149; Alt. No. 1117481, 1117482	VR-144
1983-1982	65 Amp; 80 Amp; 90 Amp; 105 Amp; 145 Amp; Alt No. 1117160; Alt. No.1100081, 1105177, 1105460, 1105482; Alt. No. 1100080, 1105465; Alt. No. 1117141, 1117147; Alt. No. 1117142, 1117143, 1117148, 1117149	VR-144
1983-1981	42 Amp; 61 Amp; 70 Amp; 80 Amp; Alt No. 1101450; Alt. No. 1101040; Alt. No. 1103172, 1103174; Alt. No. 1103175	VR-111
1981	65 Amp; 80 Amp; 105 Amp; 145 Amp; Alt No. 1117160; Alt. No.1100081, 1105177, 1105460, 1105482; Alt. No. 1100080, 1105465; Alt. No. 1117141, 1117147; Alt. No. 1117142, 1117143, 1117148, 1117149	VR-144
S2125		
1981	42 Amp; Alt. No. 1103175	VR-111
1981	61 Amp; Alt. No. 1103172, 1103174	VR-111
1981	70 Amp; Alt. No. 1101040	VR-111
1981	80 Amp; Alt. No. 1101450	VR-111
1981	105 Amp; Alt. No. 1117141, 1117147	VR-144
1981	145 Amp; Alt. No. 1117142, 1117143, 1117148, 1117149	VR-144
1981	65 Amp; Alt. No.1100081, 1105177, 1105460, 1105482	VR-144
1981	80 Amp; Alt. No. 1100080, 1105465	VR-144
1981	90 Amp; Alt. No. 1117160	VR-144
S2155		
1986	42 Amp; 63 Amp; 65 Amp; 72 Amp; Alt No. 1100177; Alt No. 1103182; Alt No. 1105170; Alt. No. 1103174; Alt. No. 1103175; Alt. No. 1105162, 1105514	VR-111
1986	65 Amp; 80 Amp; 90 Amp; 105 Amp; 145 Amp; Alt No. 1100083; Alt No. 1117160; Alt. No.1100081, 1105177, 1105460, 1105482; Alt. No. 1100080, 1105465; Alt. No. 1117141, 1117147; Alt. No. 1117142, 1117143, 1117148, 1117149; Alt. No. 1117481, 1117482	VR-144
1984	42 Amp; 63 Amp; 65 Amp; 72 Amp; Alt No. 1100177; Alt No. 1103182; Alt No. 1105170; Alt. No. 1103174; Alt. No. 1103175; Alt. No. 1105162, 1105514	VR-111
1984	65 Amp; 80 Amp; 90 Amp; 105 Amp; 145 Amp; Alt No. 1100083; Alt No. 1117160; Alt. No.1100081, 1105177, 1105460, 1105482; Alt. No. 1100080, 1105465; Alt. No. 1117141, 1117147; Alt. No. 1117142, 1117143, 1117148, 1117149	VR-144
S2375		
1986	42 Amp; 63 Amp; 65 Amp; 72 Amp; 80 Amp; 90 Amp; 105 Amp; 145 Amp; Alt No. 1100083; Alt No. 1100177; Alt No. 1103182; Alt No. 1105170; Alt. No. 1103174; Alt. No. 1117160; Alt. No.; Alt. No.1100081, 1105177, 1105460, 1105482; Alt. No. 1100080, 1105465; Alt. No. 1103174; Alt. No. 1103175; Alt. No. 1105162, 1105514; Alt. No. 1117141, 1117147	VR-111
1984	42 Amp; 63 Amp; 65 Amp; 72 Amp; Alt No. 1100177; Alt No. 1103182; Alt No. 1105170; Alt. No. 1103174; Alt. No. 1103175; Alt. No. 1105162, 1105514	VR-111

		Part No.
Voltage Regulator		
S2375		
1984	65 Amp; 80 Amp; 90 Amp; 105 Amp; 145 Amp; Alt No. 1100083; Alt No. 1117160; Alt. No.1100081, 1105177, 1105460, 1105482; Alt. No. 1100080, 1105465; Alt. No. 1117141, 1117147; Alt. No. 1117142, 1117143, 1117148, 1117149; Alt. No. 1117481, 1117482	VR-144
S2524		
1982-1981	42 Amp; Alt. No. 1103175	VR-111
1982-1981	61 Amp; Alt. No. 1103172, 1103174	VR-111
1982-1981	70 Amp; Alt. No. 1101040	VR-111
1982-1981	80 Amp; Alt. No. 1101450	VR-111
1982-1981	105 Amp; Alt. No. 1117141, 1117147	VR-144
1982-1981	145 Amp; Alt. No. 1117142, 1117143, 1117148, 1117149	VR-144
1982-1981	65 Amp; Alt. No.1100081, 1105177, 1105460, 1105482	VR-144
1982-1981	80 Amp; Alt. No. 1100080, 1105465	VR-144
1982-1981	90 Amp; Alt. No. 1117160	VR-144
S2554		
1986	42 Amp; 63 Amp; 65 Amp; 72 Amp; Alt No. 1100177; Alt No. 1103182; Alt No. 1105170; Alt. No. 1103174; Alt. No. 1103175; Alt. No. 1105162, 1105514	VR-111
1986	65 Amp; 80 Amp; 90 Amp; 105 Amp; 145 Amp; Alt No. 1100083; Alt No. 1117160; Alt. No.1100081, 1105177, 1105460, 1105482; Alt. No. 1100080, 1105465; Alt. No. 1117141, 1117147; Alt. No. 1117142, 1117143, 1117148, 1117149; Alt. No. 1117481, 1117482	VR-144
1984	42 Amp; 63 Amp; 65 Amp; 72 Amp; Alt No. 1100177; Alt No. 1103182; Alt No. 1105170; Alt. No. 1103174; Alt. No. 1103175; Alt. No. 1105162, 1105514	VR-111
1984	65 Amp; 80 Amp; 90 Amp; 105 Amp; 145 Amp; Alt No. 1100083; Alt No. 1117160; Alt. No.1100081, 1105177, 1105460, 1105482; Alt. No. 1100080, 1105465; Alt. No. 1117141, 1117147; Alt. No. 1117142, 1117143, 1117148, 1117149; Alt. No. 1117481, 1117482	VR-144
1983-1981	42 Amp; 61 Amp; 70 Amp; 80 Amp; Alt No. 1101450; Alt. No. 1101040; Alt. No. 1103172, 1103174; Alt. No. 1103175	VR-111
1983-1981	65 Amp; 80 Amp; 90 Amp; 105 Amp; 145 Amp; Alt No. 1117160; Alt. No.1100081, 1105177, 1105460, 1105482; Alt. No. 1100080, 1105465; Alt. No. 1117141, 1117147; Alt. No. 1117142, 1117143, 1117148, 1117149	VR-144
Air Injection and Induction Parts		
Turbocharger - New		
1652SC		
2010-2004	8 Cyl. 6.0L; VT365 Eng.; Turbocharged	TBC594
2554		
2002-1999	6 Cyl. 7.6L; DT466 Eng.; Turbocharged	TBC591
2574		
2002-2001	6 Cyl. 7.6L; DT466 Eng.; Turbocharged	TBC591
2654		
2002-1999	6 Cyl. 7.6L; DT466 Eng.; Turbocharged	TBC591
3000		
2002-2001	Turbocharged	TBC591
2000-1999	6 Cyl. 7.6L; DT466 Eng.; Turbocharged	TBC591
3200		
2010-2004	8 Cyl. 6.0L; VT365 Eng.; Turbocharged	TBC594
2003-2002	6 Cyl. 7.6L; DT466 Eng.; Turbocharged	TBC591

International

Air Injection and Induction Parts

		Part No.
Turbocharger - New		
3300		
2010-2005	8 Cyl. 6.0L; VT365 Eng.; Turbocharged	TBC594
3600		
1999	6 Cyl. 7.6L; DT466 Eng.; Turbocharged	TBC591
3800		
2003-1999	6 Cyl. 7.6L; DT466 Eng.; Turbocharged	TBC591
4100		
2010-2006	8 Cyl. 6.0L; VT365 Eng.; Turbocharged	TBC593
4100 SBA		
2008-2006	8 Cyl. 6.0L; VT365 Eng.; Turbocharged	TBC593
4200		
2010-2004	8 Cyl. 6.0L; VT365 Eng.; Turbocharged	TBC593
4200LP		
2008-2004	8 Cyl. 6.0L; VT365 Eng.; Turbocharged	TBC593
4300		
2008-2002	Turbocharged	TBC591
4400		
2003-2002	6 Cyl. 7.6L; DT466 Eng.; Turbocharged	TBC591
4700		
2002-2001	6 Cyl. 7.6L; DT466 Eng.; Turbocharged	TBC591
1999	6 Cyl. 7.6L; DT466 Eng.; Turbocharged	TBC591
4800		
2003-1999	6 Cyl. 7.6L; DT466 Eng.; Turbocharged	TBC591
4900		
2002-1999	6 Cyl. 7.6L; DT466 Eng.; Turbocharged	TBC591
7300		
2003-2002	Turbocharged	TBC591
7400		
2003-2002	6 Cyl. 7.6L; DT466 Eng.; Turbocharged	TBC591
7500		
2002	6 Cyl. 7.6L; DT466 Eng.; Turbocharged	TBC591
8100		
2002-1999	6 Cyl. 7.6L; DT466 Eng.; Turbocharged	TBC591
CXT		
2008-2006	8 Cyl. 6.0L; VT365 Eng.; Turbocharged	TBC593
MXT		
2009-2007	8 Cyl. 6.0L; VT365 Eng.; Turbocharged	TBC593
RXT		
2008-2005	8 Cyl. 6.0L; VT365 Eng.; Turbocharged	TBC593
Turbocharger Gasket Set		
1652SC		
2010-2004	8 Cyl. 6.0L; VT365 Eng.; Turbocharged	TGS2
2002-2001	8 Cyl. 7.3L; T444E Eng.; Turbocharged	TGS3
3000IC		
2002-2001	8 Cyl. 7.3L; T444E Eng.; Turbocharged	TGS3
3000RE		
2000	8 Cyl. 7.3L; T444E Eng.; Turbocharged	TGS3
3200		
2010-2004	8 Cyl. 6.0L; VT365 Eng.; Turbocharged	TGS2
3300		
2010-2005	8 Cyl. 6.0L; VT365 Eng.; Turbocharged	TGS2
3400		
2002-1999	8 Cyl. 7.3L; T444E Eng.; Turbocharged	TGS3
3800		
2002-1999	8 Cyl. 7.3L; T444E Eng.; Turbocharged	TGS3
4100		
2010-2006	8 Cyl. 6.0L; VT365 Eng.; Turbocharged	TGS2
4100 SBA		
2008-2006	8 Cyl. 6.0L; VT365 Eng.; Turbocharged	TGS2
4200		
2010-2004	8 Cyl. 6.0L; VT365 Eng.; Turbocharged	TGS2

		Part No.
Turbocharger Gasket Set		
4200LP		
2008-2004	8 Cyl. 6.0L; VT365 Eng.; Turbocharged	TGS2
4700		
2002-1999	8 Cyl. 7.3L; T444E Eng.; Turbocharged	TGS3
4700LP		
2002-1999	8 Cyl. 7.3L; T444E Eng.; Turbocharged	TGS3
4700LPX		
2002-1999	8 Cyl. 7.3L; T444E Eng.; Turbocharged	TGS3
CXT		
2008-2006	8 Cyl. 6.0L; VT365 Eng.; Turbocharged	TGS2
MXT		
2009-2007	8 Cyl. 6.0L; VT365 Eng.; Turbocharged	TGS2
RXT		
2008-2005	8 Cyl. 6.0L; VT365 Eng.; Turbocharged	TGS2
Early Fuel Emission Control		
Crankcase Ventilation Filter		
4300		
2019-2017	6 Cyl. 6.7L	BF43
2016-2014	6 Cyl. 6.7L; ISB 6.7 Eng.	BF43
4300LP		
2019-2016	6 Cyl. 6.7L	BF43
7300		
2019-2016	6 Cyl. 6.7L	BF43
MV607		
2020-2019	6 Cyl. 6.7L	BF43
EGR Components		
Diesel EGR Cooler		
1652SC		
2012-2005	8 Cyl. 6.0L; VT365 Eng.	ECK1
2004	8 Cyl. 6.0L; VT365 Eng.; From Engine No. 137745	ECK1
2004	8 Cyl. 6.0L; VT365 Eng.; To Engine No. 137744	ECK12
3200		
2011-2008		ECK1
2007-2005	8 Cyl. 6.0L; VT365 Eng.	ECK1
2004	8 Cyl. 6.0L; VT365 Eng.; From Engine No. 137745	ECK1
2004	8 Cyl. 6.0L; VT365 Eng.; To Engine No. 137744	ECK12
2003-2002	8 Cyl. 6.0L; VT365 Eng.	ECK12
3300		
2011-2005		ECK1
4100		
2012		ECK1
2011-2008	8 Cyl. 6.0L; VT365 Eng.	ECK1
2007-2006		ECK1
4100 SBA		
2008	8 Cyl. 6.0L; VT365 Eng.	ECK1
2007-2006		ECK1
4200		
2008-2005		ECK1
2004	From Engine No. 137745	ECK1
2004	To Engine No. 137744	ECK12
2003-2002		ECK12
4200LP		
2007-2005		ECK1
2004	From Engine No. 137745	ECK1
2004	To Engine No. 137744	ECK12
2003		ECK12
4300		
2003	8 Cyl. 6.0L; VT365 Eng.	ECK12

EGR Components

		Part No.
Diesel EGR Cooler		
4400		
2003	8 Cyl. 6.0L; VT365 Eng.	ECK12
CXT		
2008-2006	8 Cyl. 6.0L; VT365 Eng.	ECK1
MXT		
2009-2007		ECK1
RXT		
2008-2006	8 Cyl. 6.0L; VT365 Eng.	ECK1
2005		ECK1
Diesel EGR Cooler Gasket Kit		
1652SC		
2012-2006		ECG1
2005-2004	8 Cyl. 6.0L; VT365 Eng.	ECG1
3200		
2011-2007		ECG1
2006-2002	8 Cyl. 6.0L; VT365 Eng.	ECG1
3300		
2011-2005		ECG1
4100		
2012		ECG1
2011-2008	8 Cyl. 6.0L; VT365 Eng.	ECG1
2007-2006		ECG1
4100 SBA		
2008	8 Cyl. 6.0L; VT365 Eng.	ECG1
2007-2006		ECG1
4200		
2008-2002		ECG1
4200LP		
2007-2003		ECG1
4300		
2003	8 Cyl. 6.0L; VT365 Eng.	ECG1
4400		
2003	8 Cyl. 6.0L; VT365 Eng.	ECG1
CXT		
2008-2006	8 Cyl. 6.0L; VT365 Eng.	ECG1
MXT		
2009-2007		ECG1
RXT		
2008-2006	8 Cyl. 6.0L; VT365 Eng.	ECG1
2005		ECG1
EGR Valve		
3200		
2006-2004	8 Cyl. 6.0L; VT365 Eng.	EGV1249
4100		
2010-2008	8 Cyl. 6.4L; MaxxFORCE 7 Eng.	EGV1151
2006	8 Cyl. 6.0L; VT365 Eng.	EGV1249
4100 SBA		
2006	8 Cyl. 6.0L; VT365 Eng.	EGV1249
4200		
2006-2004	8 Cyl. 6.0L; VT365 Eng.	EGV1249
4200LP		
2006-2004	8 Cyl. 6.0L; VT365 Eng.	EGV1249
4300		
2010-2008	8 Cyl. 6.4L; MaxxFORCE 7 Eng.	EGV1151
4300LP		
2010-2008	8 Cyl. 6.4L; MaxxFORCE 7 Eng.	EGV1151
RXT		
2006	8 Cyl. 6.0L; VT365 Eng.	EGV1249
TerraStar		
2010	8 Cyl. 6.4L; MaxxFORCE 7 Eng.	EGV1151

		Part No.
PCV Systems		
PCV Valve		
Scout II		
1980	6 Cyl.	V112
Injectors		
Fuel Injector - Diesel - New		
1552SC		
1998-1997	8 Cyl. 7.3L; T444E Eng.	FJ596NX
1996	8 Cyl. 7.3L; T444E Eng.; Exhaust stock and reorder; High Output	FJ1252
1996	8 Cyl. 7.3L; T444E Eng.; Exhaust stock and reorder; High Output	FJ1252NX
1996	8 Cyl. 7.3L; T444E Eng.; Alternate Number; High Output	FJ1300NX
1996	8 Cyl. 7.3L; T444E Eng.; Exc. High Output	FJ595NX
1652SC		
2012-2006		FJ928NX
2005-2004	8 Cyl. 6.0L; VT365 Eng.	FJ928NX
2005-2000	8 Cyl. 7.3L; T444E Eng.; Cyl. 1 to 7	FJ738NX
2005-2000	8 Cyl. 7.3L; T444E Eng.; Cyl. 8	FJ926NX
1999	8 Cyl. 7.3L; T444E Eng.; To Engine No. 843989	FJ596NX
1999	8 Cyl. 7.3L; T444E Eng.; From Engine No. 843,990; Cyl. 1 to 7	FJ738NX
1999	8 Cyl. 7.3L; T444E Eng.; From Engine No. 843,990; Cyl. 8	FJ926NX
1998-1997	8 Cyl. 7.3L; T444E Eng.	FJ596NX
1996-1994	8 Cyl. 7.3L; T444E Eng.; Exhaust stock and reorder; High Output	FJ1252
1996-1994	8 Cyl. 7.3L; T444E Eng.; Exhaust stock and reorder; High Output	FJ1252NX
1996-1994	8 Cyl. 7.3L; T444E Eng.; Alternate Number; High Output	FJ1300NX
1995-1994	8 Cyl. 7.3L; T444E Eng.; Exc. High Output	FJ595NX
1652UPS		
1997	8 Cyl. 7.3L; T444E Eng.	FJ596NX
1996-1995	8 Cyl. 7.3L; T444E Eng.; Exhaust stock and reorder; High Output	FJ1252
1996-1995	8 Cyl. 7.3L; T444E Eng.; Exhaust stock and reorder; High Output	FJ1252NX
1996-1995	8 Cyl. 7.3L; T444E Eng.; Alternate Number; High Output	FJ1300NX
1996-1995	8 Cyl. 7.3L; T444E Eng.; Exc. High Output	FJ595NX
2554		
2002-2000	6 Cyl. 8.7L; Exhaust stock and reorder	FJ1245
2002-2000	6 Cyl. 8.7L; Exhaust stock and reorder	FJ1245NX
2002-2000	6 Cyl. 7.6L; DT466 Eng.; Exhaust stock and reorder	FJ1254
2002-2000	6 Cyl. 7.6L; DT466 Eng.; Exhaust stock and reorder	FJ1254NX
2002-2000	6 Cyl. 7.6L; DT466 Eng.; Alternate Number	FJ1307NX
2002-2000	6 Cyl. 8.7L; Alternate Number	FJ1309NX
1999	6 Cyl. 8.7L; Exhaust stock and reorder; To Engine No. 1134350	FJ1251
1999	6 Cyl. 8.7L; Exhaust stock and reorder; To Engine No. 1134350	FJ1251NX
1999	6 Cyl. 7.6L; DT466 Eng.; 175-190 HP; Exhaust stock and reorder; To Engine No. 1194038	FJ1253
1999	6 Cyl. 7.6L; DT466 Eng.; 175-190 HP; Exhaust stock and reorder; To Engine No. 1194038	FJ1253NX

Injectors

Fuel Injector - Diesel - New		Part No.
2554		
1999	6 Cyl. 7.6L; DT466 Eng.; 175-250 HP; Exhaust stock and reorder; From Engine No. 1125228	FJ1254
1999	6 Cyl. 7.6L; DT466 Eng.; 175-250 HP; Exhaust stock and reorder; From Engine No. 1125228	FJ1254NX
1999	6 Cyl. 7.6L; DT466 Eng.; 230-250 HP; Exhaust stock and reorder; To Engine No. 1125227	FJ1255
1999	6 Cyl. 8.7L; Exhaust stock and reorder; From Engine No. 1134351	FJ1255
1999	6 Cyl. 7.6L; DT466 Eng.; 230-250 HP; Exhaust stock and reorder; To Engine No. 1125227	FJ1255NX
1999	6 Cyl. 8.7L; Exhaust stock and reorder; From Engine No. 1134351	FJ1255NX
1999	6 Cyl. 7.6L; DT466 Eng.; 175-190 HP; To Engine No. 1194038	FJ1305NX
1999	6 Cyl. 8.7L; Alternate Number; To Engine No. 1134350	FJ1306NX
1999	6 Cyl. 7.6L; DT466 Eng.; 175-250 HP; Alternate Number; From Engine No. 1125228	FJ1307NX
1999	6 Cyl. 7.6L; DT466 Eng.; 230-250 HP; To Engine No. 1125227	FJ1308NX
1999	6 Cyl. 8.7L; From Engine No. 1134351	FJ1308NX
1998	6 Cyl. 8.7L; Exhaust stock and reorder	FJ1251
1998	6 Cyl. 8.7L; Exhaust stock and reorder	FJ1251NX
1998	6 Cyl. 7.6L; DT466 Eng.; 175-190 HP; Exhaust stock and reorder	FJ1253
1998	6 Cyl. 7.6L; DT466 Eng.; 175-190 HP; Exhaust stock and reorder	FJ1253NX
1998	6 Cyl. 7.6L; DT466 Eng.; 230-250 HP; Exhaust stock and reorder	FJ1255
1998	6 Cyl. 7.6L; DT466 Eng.; 230-250 HP; Exhaust stock and reorder	FJ1255NX
1998	6 Cyl. 7.6L; DT466 Eng.; 175-190 HP	FJ1305NX
1998	6 Cyl. 8.7L; Alternate Number	FJ1306NX
1998	6 Cyl. 7.6L; DT466 Eng.; 230-250 HP	FJ1308NX
1997	6 Cyl. 7.6L; DT466 Eng.; 195-230 HP; Exhaust stock and reorder; To Engine No. 1028710	FJ1248
1997	6 Cyl. 7.6L; DT466 Eng.; 195-230 HP; Exhaust stock and reorder; To Engine No. 1028710	FJ1248NX
1997	6 Cyl. 7.6L; DT466 Eng.; 175-190 HP; Exhaust stock and reorder; To Engine No. 1028710	FJ1249
1997	6 Cyl. 7.6L; DT466 Eng.; 175-190 HP; Exhaust stock and reorder; To Engine No. 1028710	FJ1249NX
1997	6 Cyl. 7.6L; DT466 Eng.; 230-250 HP; Exhaust stock and reorder; To Engine No. 1084867	FJ1250
1997	6 Cyl. 7.6L; DT466 Eng.; 230-250 HP; Exhaust stock and reorder; To Engine No. 1084867	FJ1250NX
1997	6 Cyl. 7.6L; DT466 Eng.; 175-190 HP; Exhaust stock and reorder; From Engine No. 1028711	FJ1253
1997	6 Cyl. 7.6L; DT466 Eng.; 175-190 HP; Exhaust stock and reorder; From Engine No. 1028711	FJ1253NX
1997	6 Cyl. 7.6L; DT466 Eng.; 230-250 HP; Exhaust stock and reorder; From Engine No. 1084868	FJ1255
1997	6 Cyl. 7.6L; DT466 Eng.; 230-250 HP; Exhaust stock and reorder; From Engine No. 1084868	FJ1255NX

Fuel Injector - Diesel - New		Part No.
2554		
1997	6 Cyl. 7.6L; DT466 Eng.; 230-250 HP; Alternate Number; To Engine No. 1084867	FJ1301NX
1997	6 Cyl. 7.6L; DT466 Eng.; 175-190 HP; To Engine No. 1028710	FJ1302NX
1997	6 Cyl. 7.6L; DT466 Eng.; 195-230 HP; Alternate Number; To Engine No. 1028710	FJ1303NX
1997	6 Cyl. 7.6L; DT466 Eng.; 175-190 HP; From Engine No. 1028711	FJ1305NX
1997	6 Cyl. 7.6L; DT466 Eng.; 230-250 HP; From Engine No. 1084868	FJ1308NX
1997-1995	6 Cyl. 8.7L; Exhaust stock and reorder	FJ1247
1997-1995	6 Cyl. 8.7L; Alternate Number	FJ1247NX
1997-1995	6 Cyl. 8.7L; Alternate Number	FJ1304NX
1996	6 Cyl. 7.6L; DT466 Eng.; 175-190 HP	FJ1302NX
1996-1995	6 Cyl. 7.6L; DT466 Eng.; 195-230 HP; Exhaust stock and reorder	FJ1248
1996-1995	6 Cyl. 7.6L; DT466 Eng.; 195-230 HP; Exhaust stock and reorder	FJ1248NX
1996-1995	6 Cyl. 7.6L; DT466 Eng.; 175-190 HP; Exhaust stock and reorder	FJ1249
1996-1995	6 Cyl. 7.6L; DT466 Eng.; 175-190 HP; Exhaust stock and reorder	FJ1249NX
1996-1995	6 Cyl. 7.6L; DT466 Eng.; 230-250 HP; Exhaust stock and reorder	FJ1250
1996-1995	6 Cyl. 7.6L; DT466 Eng.; 230-250 HP; Exhaust stock and reorder	FJ1250NX
1996-1995	6 Cyl. 7.6L; DT466 Eng.; 230-250 HP; Alternate Number	FJ1301NX
1996-1995	6 Cyl. 7.6L; DT466 Eng.; 195-230 HP; Alternate Number	FJ1303NX
1995	6 Cyl. 7.6L; DT466 Eng.; 175-190 HP; Alternate Number	FJ1302NX
2574		
2003-2001	6 Cyl. 7.6L; DT466 Eng.; Exhaust stock and reorder	FJ1254
2003-2001	6 Cyl. 7.6L; DT466 Eng.; Exhaust stock and reorder	FJ1254NX
2003-2001	6 Cyl. 7.6L; DT466 Eng.; Alternate Number	FJ1307NX
2003-2000	6 Cyl. 8.7L; Exhaust stock and reorder	FJ1245
2003-2000	6 Cyl. 8.7L; Exhaust stock and reorder	FJ1245NX
2003-2000	6 Cyl. 8.7L; Alternate Number	FJ1309NX
1999	6 Cyl. 8.7L; Exhaust stock and reorder; To Engine No. 1134350	FJ1251
1999	6 Cyl. 8.7L; Exhaust stock and reorder; To Engine No. 1134350	FJ1251NX
1999	6 Cyl. 8.7L; Exhaust stock and reorder; From Engine No. 1134351	FJ1255
1999	6 Cyl. 8.7L; Exhaust stock and reorder; From Engine No. 1134351	FJ1255NX
1999	6 Cyl. 8.7L; Alternate Number; To Engine No. 1134350	FJ1306NX
1999	6 Cyl. 8.7L; From Engine No. 1134351	FJ1308NX
1998	6 Cyl. 8.7L; Exhaust stock and reorder	FJ1251
1998	6 Cyl. 8.7L; Exhaust stock and reorder	FJ1251NX
1998	6 Cyl. 8.7L; Alternate Number	FJ1306NX
1997-1995	6 Cyl. 8.7L; Exhaust stock and reorder	FJ1247
1997-1995	6 Cyl. 8.7L; Alternate Number	FJ1247NX
1997-1995	6 Cyl. 8.7L	FJ1304NX
2654		
2002-2000	6 Cyl. 8.7L; Exhaust stock and reorder	FJ1245
2002-2000	6 Cyl. 8.7L; Exhaust stock and reorder	FJ1245NX
2002-2000	6 Cyl. 7.6L; DT466 Eng.; Exhaust stock and reorder	FJ1254
2002-2000	6 Cyl. 7.6L; DT466 Eng.; Exhaust stock and reorder	FJ1254NX

Injectors

		Part No.
Fuel Injector - Diesel - New		
2654		
2002-2000	6 Cyl. 7.6L; DT466 Eng.; Alternate Number	FJ1307NX
2002-2000	6 Cyl. 8.7L; Alternate Number	FJ1309NX
1999	6 Cyl. 8.7L; Exhaust stock and reorder; To Engine No. 1134350	FJ1251
1999	6 Cyl. 8.7L; Exhaust stock and reorder; To Engine No. 1134350	FJ1251NX
1999	6 Cyl. 7.6L; DT466 Eng.; 175-190 HP; Exhaust stock and reorder; To Engine No. 1194038	FJ1253
1999	6 Cyl. 7.6L; DT466 Eng.; 175-190 HP; Exhaust stock and reorder; To Engine No. 1194038	FJ1253NX
1999	6 Cyl. 7.6L; DT466 Eng.; 175-250 HP; Exhaust stock and reorder; From Engine No. 1125228	FJ1254
1999	6 Cyl. 7.6L; DT466 Eng.; 175-250 HP; Exhaust stock and reorder; From Engine No. 1125228	FJ1254NX
1999	6 Cyl. 7.6L; DT466 Eng.; 230-250 HP; Exhaust stock and reorder; To Engine No. 1125227	FJ1255
1999	6 Cyl. 8.7L; Exhaust stock and reorder; From Engine No. 1134351	FJ1255
1999	6 Cyl. 7.6L; DT466 Eng.; 230-250 HP; Exhaust stock and reorder; To Engine No. 1125227	FJ1255NX
1999	6 Cyl. 8.7L; Exhaust stock and reorder; From Engine No. 1134351	FJ1255NX
1999	6 Cyl. 7.6L; DT466 Eng.; 175-190 HP; To Engine No. 1194038	FJ1305NX
1999	6 Cyl. 8.7L; Alternate Number; To Engine No. 1134350	FJ1306NX
1999	6 Cyl. 7.6L; DT466 Eng.; 175-250 HP; Alternate Number; From Engine No. 1125228	FJ1307NX
1999	6 Cyl. 7.6L; DT466 Eng.; 230-250 HP; To Engine No. 1125227	FJ1308NX
1999	6 Cyl. 8.7L; From Engine No. 1134351	FJ1308NX
1998	6 Cyl. 8.7L; Exhaust stock and reorder	FJ1251
1998	6 Cyl. 8.7L; Exhaust stock and reorder	FJ1251NX
1998	6 Cyl. 7.6L; DT466 Eng.; 175-190 HP; Exhaust stock and reorder	FJ1253
1998	6 Cyl. 7.6L; DT466 Eng.; 175-190 HP; Exhaust stock and reorder	FJ1253NX
1998	6 Cyl. 7.6L; DT466 Eng.; 230-250 HP; Exhaust stock and reorder	FJ1255
1998	6 Cyl. 7.6L; DT466 Eng.; 230-250 HP; Exhaust stock and reorder	FJ1255NX
1998	6 Cyl. 7.6L; DT466 Eng.; 175-190 HP	FJ1305NX
1998	6 Cyl. 8.7L; Alternate Number	FJ1306NX
1998	6 Cyl. 7.6L; DT466 Eng.; 230-250 HP	FJ1308NX
1997	6 Cyl. 7.6L; DT466 Eng.; 195-230 HP; Exhaust stock and reorder; To Engine No. 1028710	FJ1248
1997	6 Cyl. 7.6L; DT466 Eng.; 195-230 HP; Exhaust stock and reorder; To Engine No. 1028710	FJ1248NX
1997	6 Cyl. 7.6L; DT466 Eng.; 175-190 HP; Exhaust stock and reorder; To Engine No. 1028710	FJ1249
1997	6 Cyl. 7.6L; DT466 Eng.; 175-190 HP; Exhaust stock and reorder; To Engine No. 1028710	FJ1249NX
1997	6 Cyl. 7.6L; DT466 Eng.; 230-250 HP; Exhaust stock and reorder; To Engine No. 1084867	FJ1250
1997	6 Cyl. 7.6L; DT466 Eng.; 230-250 HP; Exhaust stock and reorder; To Engine No. 1084867	FJ1250NX

		Part No.
Fuel Injector - Diesel - New		
2654		
1997	6 Cyl. 7.6L; DT466 Eng.; 175-190 HP; Exhaust stock and reorder; From Engine No. 1028711	FJ1253
1997	6 Cyl. 7.6L; DT466 Eng.; 175-190 HP; Exhaust stock and reorder; From Engine No. 1028711	FJ1253NX
1997	6 Cyl. 7.6L; DT466 Eng.; 230-250 HP; Exhaust stock and reorder; From Engine No. 1084868	FJ1255
1997	6 Cyl. 7.6L; DT466 Eng.; 230-250 HP; Exhaust stock and reorder; From Engine No. 1084868	FJ1255NX
1997	6 Cyl. 7.6L; DT466 Eng.; 230-250 HP; Alternate Number; To Engine No. 1084867	FJ1301NX
1997	6 Cyl. 7.6L; DT466 Eng.; 175-190 HP; To Engine No. 1028710	FJ1302NX
1997	6 Cyl. 7.6L; DT466 Eng.; 195-230 HP; Alternate Number; To Engine No. 1028710	FJ1303NX
1997	6 Cyl. 7.6L; DT466 Eng.; 175-190 HP; From Engine No. 1028711	FJ1305NX
1997	6 Cyl. 7.6L; DT466 Eng.; 230-250 HP; From Engine No. 1084868	FJ1308NX
1997-1995	6 Cyl. 8.7L; Exhaust stock and reorder	FJ1247
1997-1995	6 Cyl. 8.7L; Alternate Number	FJ1247NX
1997-1995	6 Cyl. 8.7L	FJ1304NX
1996-1995	6 Cyl. 7.6L; DT466 Eng.; 195-230 HP; Exhaust stock and reorder	FJ1248
1996-1995	6 Cyl. 7.6L; DT466 Eng.; 195-230 HP; Exhaust stock and reorder	FJ1248NX
1996-1995	6 Cyl. 7.6L; DT466 Eng.; 175-190 HP; Exhaust stock and reorder	FJ1249
1996-1995	6 Cyl. 7.6L; DT466 Eng.; 175-190 HP; Exhaust stock and reorder	FJ1249NX
1996-1995	6 Cyl. 7.6L; DT466 Eng.; 230-250 HP; Exhaust stock and reorder	FJ1250
1996-1995	6 Cyl. 7.6L; DT466 Eng.; 230-250 HP; Exhaust stock and reorder	FJ1250NX
1996-1995	6 Cyl. 7.6L; DT466 Eng.; 230-250 HP; Alternate Number	FJ1301NX
1996-1995	6 Cyl. 7.6L; DT466 Eng.; 175-190 HP	FJ1302NX
1996-1995	6 Cyl. 7.6L; DT466 Eng.; 195-230 HP; Alternate Number	FJ1303NX
2674		
2003-2001	6 Cyl. 7.6L; DT466 Eng.; Exhaust stock and reorder	FJ1254
2003-2001	6 Cyl. 7.6L; DT466 Eng.; Exhaust stock and reorder	FJ1254NX
2003-2001	6 Cyl. 7.6L; DT466 Eng.; Alternate Number	FJ1307NX
2003-2000	6 Cyl. 8.7L; Exhaust stock and reorder	FJ1245
2003-2000	6 Cyl. 8.7L; Exhaust stock and reorder	FJ1245NX
2003-2000	6 Cyl. 8.7L; Alternate Number	FJ1309NX
1999	6 Cyl. 8.7L; Exhaust stock and reorder; To Engine No. 1134350	FJ1251
1999	6 Cyl. 8.7L; Exhaust stock and reorder; To Engine No. 1134350	FJ1251NX
1999	6 Cyl. 8.7L; Exhaust stock and reorder; From Engine No. 1134351	FJ1255
1999	6 Cyl. 8.7L; Exhaust stock and reorder; From Engine No. 1134351	FJ1255NX
1999	6 Cyl. 8.7L; Alternate Number; To Engine No. 1134350	FJ1306NX
1999	6 Cyl. 8.7L; From Engine No. 1134351	FJ1308NX
1998	6 Cyl. 8.7L; Exhaust stock and reorder	FJ1251
1998	6 Cyl. 8.7L; Exhaust stock and reorder	FJ1251NX
1998	6 Cyl. 8.7L; Exhaust stock and reorder	FJ1306NX

Injectors

		Part No.
Fuel Injector - Diesel - New		
2674		
1997-1995	6 Cyl. 8.7L; Exhaust stock and reorder	FJ1247
1997-1995	6 Cyl. 8.7L; Alternate Number	FJ1247NX
1997-1995	6 Cyl. 8.7L	FJ1304NX
3000		
2002-2000	6 Cyl. 7.6L; DT466 Eng.; Exhaust stock and reorder	FJ1254
2002-2000	6 Cyl. 7.6L; DT466 Eng.; Exhaust stock and reorder	FJ1254NX
2002-2000	6 Cyl. 7.6L; DT466 Eng.; Alternate Number	FJ1307NX
2000	8 Cyl. 7.3L; T444E Eng.; Cyl. 1 to 7	FJ738NX
2000	8 Cyl. 7.3L; T444E Eng.; Cyl. 8	FJ926NX
1999	6 Cyl. 7.6L; DT466 Eng.; 175-190 HP; Exhaust stock and reorder; To Engine No. 1194038	FJ1253
1999	6 Cyl. 7.6L; DT466 Eng.; 175-190 HP; Exhaust stock and reorder; To Engine No. 1194038	FJ1253NX
1999	6 Cyl. 7.6L; DT466 Eng.; 175-250 HP; Exhaust stock and reorder; From Engine No. 1125228	FJ1254
1999	6 Cyl. 7.6L; DT466 Eng.; 175-250 HP; Exhaust stock and reorder; From Engine No. 1125228	FJ1254NX
1999	6 Cyl. 7.6L; DT466 Eng.; 230-250 HP; Exhaust stock and reorder; To Engine No. 1125227	FJ1255
1999	6 Cyl. 7.6L; DT466 Eng.; 230-250 HP; Exhaust stock and reorder; To Engine No. 1125227	FJ1255NX
1999	6 Cyl. 7.6L; DT466 Eng.; 175-190 HP; To Engine No. 1194038	FJ1305NX
1999	6 Cyl. 7.6L; DT466 Eng.; 175-250 HP; Alternate Number; From Engine No. 1125228	FJ1307NX
1999	6 Cyl. 7.6L; DT466 Eng.; 230-250 HP; To Engine No. 1125227	FJ1308NX
1999	8 Cyl. 7.3L; T444E Eng.; To Engine No. 843989	FJ596NX
1999	8 Cyl. 7.3L; T444E Eng.; From Engine No. 843,990; Cyl. 1 to 7	FJ738NX
1999	8 Cyl. 7.3L; T444E Eng.; From Engine No. 843,990; Cyl. 8	FJ926NX
1998	6 Cyl. 7.6L; DT466 Eng.; 175-190 HP; Exhaust stock and reorder	FJ1253
1998	6 Cyl. 7.6L; DT466 Eng.; 175-190 HP; Exhaust stock and reorder	FJ1253NX
1998	6 Cyl. 7.6L; DT466 Eng.; 230-250 HP; Exhaust stock and reorder	FJ1255
1998	6 Cyl. 7.6L; DT466 Eng.; 230-250 HP; Exhaust stock and reorder	FJ1255NX
1998	6 Cyl. 7.6L; DT466 Eng.; 175-190 HP	FJ1305NX
1998	6 Cyl. 7.6L; DT466 Eng.; 230-250 HP	FJ1308NX
1998-1997	8 Cyl. 7.3L; T444E Eng.	FJ596NX
1997	6 Cyl. 7.6L; DT466 Eng.; 195-230 HP; Exhaust stock and reorder; To Engine No. 1028710	FJ1248
1997	6 Cyl. 7.6L; DT466 Eng.; 195-230 HP; Exhaust stock and reorder; To Engine No. 1028710	FJ1248NX
1997	6 Cyl. 7.6L; DT466 Eng.; 175-190 HP; Exhaust stock and reorder; To Engine No. 1028710	FJ1249
1997	6 Cyl. 7.6L; DT466 Eng.; 175-190 HP; Exhaust stock and reorder; To Engine No. 1028710	FJ1249NX
1997	6 Cyl. 7.6L; DT466 Eng.; 230-250 HP; Exhaust stock and reorder; To Engine No. 1084867	FJ1250

		Part No.
Fuel Injector - Diesel - New		
3000		
1997	6 Cyl. 7.6L; DT466 Eng.; 230-250 HP; Exhaust stock and reorder; To Engine No. 1084867	FJ1250NX
1997	6 Cyl. 7.6L; DT466 Eng.; 175-190 HP; Exhaust stock and reorder; From Engine No. 1028711	FJ1253
1997	6 Cyl. 7.6L; DT466 Eng.; 175-190 HP; Exhaust stock and reorder; From Engine No. 1028711	FJ1253NX
1997	6 Cyl. 7.6L; DT466 Eng.; 230-250 HP; Exhaust stock and reorder; From Engine No. 1084868	FJ1255
1997	6 Cyl. 7.6L; DT466 Eng.; 230-250 HP; Exhaust stock and reorder; From Engine No. 1084868	FJ1255NX
1997	6 Cyl. 7.6L; DT466 Eng.; 230-250 HP; Alternate Number; To Engine No. 1084867	FJ1301NX
1997	6 Cyl. 7.6L; DT466 Eng.; 175-190 HP; To Engine No. 1028710	FJ1302NX
1997	6 Cyl. 7.6L; DT466 Eng.; 195-230 HP; Alternate Number; To Engine No. 1028710	FJ1303NX
1997	6 Cyl. 7.6L; DT466 Eng.; 175-190 HP; From Engine No. 1028711	FJ1305NX
1997	6 Cyl. 7.6L; DT466 Eng.; 230-250 HP; From Engine No. 1084868	FJ1308NX
1996	6 Cyl. 7.6L; DT466 Eng.; 195-230 HP; Exhaust stock and reorder	FJ1248
1996	6 Cyl. 7.6L; DT466 Eng.; 195-230 HP; Exhaust stock and reorder	FJ1248NX
1996	6 Cyl. 7.6L; DT466 Eng.; 175-190 HP; Exhaust stock and reorder	FJ1249
1996	6 Cyl. 7.6L; DT466 Eng.; 175-190 HP; Exhaust stock and reorder	FJ1249NX
1996	6 Cyl. 7.6L; DT466 Eng.; 230-250 HP; Exhaust stock and reorder	FJ1250
1996	6 Cyl. 7.6L; DT466 Eng.; 230-250 HP; Exhaust stock and reorder	FJ1250NX
1996	6 Cyl. 7.6L; DT466 Eng.; 230-250 HP; Alternate Number	FJ1301NX
1996	6 Cyl. 7.6L; DT466 Eng.; 175-190 HP; Alternate Number	FJ1302NX
1996	6 Cyl. 7.6L; DT466 Eng.; 195-230 HP; Alternate Number	FJ1303NX
3000FE		
1999	6 Cyl. 7.6L; DT466 Eng.; 175-190 HP; Exhaust stock and reorder; To Engine No. 1194038	FJ1253NX
1999	6 Cyl. 7.6L; DT466 Eng.; 175-250 HP; Exhaust stock and reorder; From Engine No. 1125228	FJ1254NX
1999	6 Cyl. 7.6L; DT466 Eng.; 230-250 HP; Exhaust stock and reorder; To Engine No. 1125227	FJ1255NX
1999	6 Cyl. 7.6L; DT466 Eng.; 175-190 HP; Alternate Number; To Engine No. 1194038	FJ1305NX
1999	6 Cyl. 7.6L; DT466 Eng.; 175-250 HP; Alternate Number; From Engine No. 1125228	FJ1307NX
1999	6 Cyl. 7.6L; DT466 Eng.; 230-250 HP; Alternate Number; To Engine No. 1125227	FJ1308NX
1998	6 Cyl. 7.6L; DT466 Eng.; 175-190 HP; Exhaust stock and reorder	FJ1253NX
1998	6 Cyl. 7.6L; DT466 Eng.; 230-250 HP; Exhaust stock and reorder	FJ1255NX
1998	6 Cyl. 7.6L; DT466 Eng.; 175-190 HP; Alternate Number	FJ1305NX

Injectors

		Part No.
Fuel Injector - Diesel - New		
3000FE		
1998	6 Cyl. 7.6L; DT466 Eng.; 230-250 HP; Alternate Number	FJ1308NX
1997	6 Cyl. 7.6L; DT466 Eng.; 195-230 HP; Exhaust stock and reorder; To Engine No. 1028710	FJ1248
1997	6 Cyl. 7.6L; DT466 Eng.; 195-230 HP; Exhaust stock and reorder; To Engine No. 1028710	FJ1248NX
1997	6 Cyl. 7.6L; DT466 Eng.; 175-190 HP; Exhaust stock and reorder; To Engine No. 1028710	FJ1249
1997	6 Cyl. 7.6L; DT466 Eng.; 175-190 HP; Exhaust stock and reorder; To Engine No. 1028710	FJ1249NX
1997	6 Cyl. 7.6L; DT466 Eng.; 230-250 HP; Exhaust stock and reorder; To Engine No. 1084867	FJ1250
1997	6 Cyl. 7.6L; DT466 Eng.; 230-250 HP; Exhaust stock and reorder; To Engine No. 1084867	FJ1250NX
1997	6 Cyl. 7.6L; DT466 Eng.; 175-190 HP; Exhaust stock and reorder; From Engine No. 1028711	FJ1253
1997	6 Cyl. 7.6L; DT466 Eng.; 175-190 HP; Exhaust stock and reorder; From Engine No. 1028711	FJ1253NX
1997	6 Cyl. 7.6L; DT466 Eng.; 230-250 HP; Exhaust stock and reorder; From Engine No. 1084868	FJ1255
1997	6 Cyl. 7.6L; DT466 Eng.; 230-250 HP; Exhaust stock and reorder; From Engine No. 1084868	FJ1255NX
1997	6 Cyl. 7.6L; DT466 Eng.; 230-250 HP; Alternate Number; To Engine No. 1084867	FJ1301NX
1997	6 Cyl. 7.6L; DT466 Eng.; 175-190 HP; Alternate Number; To Engine No. 1028710	FJ1302NX
1997	6 Cyl. 7.6L; DT466 Eng.; 195-230 HP; Alternate Number; To Engine No. 1028710	FJ1303NX
1997	6 Cyl. 7.6L; DT466 Eng.; 175-190 HP; Alternate Number; From Engine No. 1028711	FJ1305NX
1997	6 Cyl. 7.6L; DT466 Eng.; 230-250 HP; Alternate Number; From Engine No. 1084868	FJ1308NX
3000IC		
2002-2000	6 Cyl. 7.6L; DT466 Eng.; Exhaust stock and reorder	FJ1254
2002-2000	6 Cyl. 7.6L; DT466 Eng.; Exhaust stock and reorder	FJ1254NX
2002-2000	6 Cyl. 7.6L; DT466 Eng.; Alternate Number	FJ1307NX
2002-2000	8 Cyl. 7.3L; T444E Eng.; Cyl. 1 to 7	FJ738NX
2002-2000	8 Cyl. 7.3L; T444E Eng.; Cyl. 8	FJ926NX
3000RE		
2005		FJ1242NX
2002	6 Cyl. 8.7L; Exhaust stock and reorder	FJ1245
2002	6 Cyl. 8.7L; Exhaust stock and reorder	FJ1245NX
2002	6 Cyl. 8.7L; Alternate Number	FJ1309NX
3200		
2011-2008	8 Cyl.	FJ928NX
2007-2004	8 Cyl. 6.0L; VT365 Eng.	FJ928NX
2006	6 Cyl. 7.6L; DT466 Eng.	FJ1257NX
2005	6 Cyl. 7.6L; DT466 Eng.	FJ1242NX
2004	6 Cyl. 7.6L; DT466 Eng.; 210-225 HP	FJ1240NX
2004	6 Cyl. 7.6L; DT466 Eng.; 245-285 HP	FJ1242NX
2004-2003	6 Cyl. 8.7L; Exhaust stock and reorder	FJ1245

		Part No.
Fuel Injector - Diesel - New		
3200		
2004-2003	6 Cyl. 8.7L; Exhaust stock and reorder	FJ1245NX
2004-2003	6 Cyl. 8.7L; Alternate Number	FJ1309NX
2003-2002	6 Cyl. 7.6L; DT466 Eng.; Exhaust stock and reorder	FJ1254
2003-2002	6 Cyl. 7.6L; DT466 Eng.; Exhaust stock and reorder	FJ1254NX
2003-2002	6 Cyl. 7.6L; DT466 Eng.; Alternate Number	FJ1307NX
2003-2002	8 Cyl. 6.0L; VT365 Eng.	FJ927NX
3300		
2011-2005	8 Cyl. 6.0L; VT365 Eng.	FJ928NX
3400		
2002-2000	8 Cyl. 7.3L; T444E Eng.; Cyl. 1 to 7	FJ738NX
2002-2000	8 Cyl. 7.3L; T444E Eng.; Cyl. 8	FJ926NX
1999	8 Cyl. 7.3L; T444E Eng.; To Engine No. 843989	FJ596NX
1999	8 Cyl. 7.3L; T444E Eng.; From Engine No. 843,990; Cyl. 1 to 7	FJ738NX
1999	8 Cyl. 7.3L; T444E Eng.; From Engine No. 843,990; Cyl. 8	FJ926NX
1998-1997	8 Cyl. 7.3L; T444E Eng.	FJ596NX
1996	8 Cyl. 7.3L; T444E Eng.; Exhaust stock and reorder; High Output	FJ1252
1996	8 Cyl. 7.3L; T444E Eng.; Exhaust stock and reorder; High Output	FJ1252NX
1996	8 Cyl. 7.3L; T444E Eng.; Alternate Number; High Output	FJ1300NX
1996	8 Cyl. 7.3L; T444E Eng.; Exc. High Output	FJ595NX
3600		
2001	6 Cyl. 7.6L; DT466 Eng.; Exhaust stock and reorder	FJ1254
2001	6 Cyl. 7.6L; DT466 Eng.; Exhaust stock and reorder	FJ1254NX
2001	6 Cyl. 7.6L; DT466 Eng.; Alternate Number	FJ1307NX
1999	6 Cyl. 7.6L; DT466 Eng.; 175-190 HP; Exhaust stock and reorder; To Engine No. 1194038	FJ1253
1999	6 Cyl. 7.6L; DT466 Eng.; 175-190 HP; Exhaust stock and reorder; To Engine No. 1194038	FJ1253NX
1999	6 Cyl. 7.6L; DT466 Eng.; 175-250 HP; Exhaust stock and reorder; From Engine No. 1125228	FJ1254
1999	6 Cyl. 7.6L; DT466 Eng.; 175-250 HP; Exhaust stock and reorder; From Engine No. 1125228	FJ1254NX
1999	6 Cyl. 7.6L; DT466 Eng.; 230-250 HP; Exhaust stock and reorder; To Engine No. 1125227	FJ1255
1999	6 Cyl. 7.6L; DT466 Eng.; 230-250 HP; Exhaust stock and reorder; To Engine No. 1125227	FJ1255NX
1999	6 Cyl. 7.6L; DT466 Eng.; 175-190 HP; To Engine No. 1194038	FJ1305NX
1999	6 Cyl. 7.6L; DT466 Eng.; 175-250 HP; Alternate Number; From Engine No. 1125228	FJ1307NX
1999	6 Cyl. 7.6L; DT466 Eng.; 230-250 HP; To Engine No. 1125227	FJ1308NX
1999	8 Cyl. 7.3L; T444E Eng.; To Engine No. 843989	FJ596NX
1999	8 Cyl. 7.3L; T444E Eng.; From Engine No. 843,990; Cyl. 1 to 7	FJ738NX
1999	8 Cyl. 7.3L; T444E Eng.; From Engine No. 843,990; Cyl. 8	FJ926NX
1998	6 Cyl. 7.6L; DT466 Eng.; 175-190 HP; Exhaust stock and reorder	FJ1253

International

Injectors

		Part No.
Fuel Injector - Diesel - New		
3600		
1998	6 Cyl. 7.6L; DT466 Eng.; 175-190 HP; Exhaust stock and reorder	FJ1253NX
1998	6 Cyl. 7.6L; DT466 Eng.; 230-250 HP; Exhaust stock and reorder	FJ1255
1998	6 Cyl. 7.6L; DT466 Eng.; 230-250 HP; Exhaust stock and reorder	FJ1255NX
1998	6 Cyl. 7.6L; DT466 Eng.; 175-190 HP	FJ1305NX
1998	6 Cyl. 7.6L; DT466 Eng.; 230-250 HP	FJ1308NX
1998-1997	8 Cyl. 7.3L; T444E Eng.	FJ596NX
1997	6 Cyl. 7.6L; DT466 Eng.; 195-230 HP; Exhaust stock and reorder; To Engine No. 1028710	FJ1248
1997	6 Cyl. 7.6L; DT466 Eng.; 195-230 HP; Exhaust stock and reorder; To Engine No. 1028710	FJ1248NX
1997	6 Cyl. 7.6L; DT466 Eng.; 175-190 HP; Exhaust stock and reorder; To Engine No. 1028710	FJ1249
1997	6 Cyl. 7.6L; DT466 Eng.; 175-190 HP; Exhaust stock and reorder; To Engine No. 1028710	FJ1249NX
1997	6 Cyl. 7.6L; DT466 Eng.; 230-250 HP; Exhaust stock and reorder; To Engine No. 1084867	FJ1250
1997	6 Cyl. 7.6L; DT466 Eng.; 230-250 HP; Exhaust stock and reorder; To Engine No. 1084867	FJ1250NX
1997	6 Cyl. 7.6L; DT466 Eng.; 175-190 HP; Exhaust stock and reorder; From Engine No. 1028711	FJ1253
1997	6 Cyl. 7.6L; DT466 Eng.; 175-190 HP; Exhaust stock and reorder; From Engine No. 1028711	FJ1253NX
1997	6 Cyl. 7.6L; DT466 Eng.; 230-250 HP; Exhaust stock and reorder; From Engine No. 1084868	FJ1255
1997	6 Cyl. 7.6L; DT466 Eng.; 230-250 HP; Exhaust stock and reorder; From Engine No. 1084868	FJ1255NX
1997	6 Cyl. 7.6L; DT466 Eng.; 230-250 HP; Alternate Number; To Engine No. 1084867	FJ1301NX
1997	6 Cyl. 7.6L; DT466 Eng.; 175-190 HP; To Engine No. 1028710	FJ1302NX
1997	6 Cyl. 7.6L; DT466 Eng.; 195-230 HP; Alternate Number; To Engine No. 1028710	FJ1303NX
1997	6 Cyl. 7.6L; DT466 Eng.; 175-190 HP; From Engine No. 1028711	FJ1305NX
1997	6 Cyl. 7.6L; DT466 Eng.; 230-250 HP; From Engine No. 1084868	FJ1308NX
1996-1995	6 Cyl. 7.6L; DT466 Eng.; 195-230 HP; Exhaust stock and reorder	FJ1248
1996-1995	6 Cyl. 7.6L; DT466 Eng.; 195-230 HP; Exhaust stock and reorder	FJ1248NX
1996-1995	6 Cyl. 7.6L; DT466 Eng.; 175-190 HP; Exhaust stock and reorder	FJ1249
1996-1995	6 Cyl. 7.6L; DT466 Eng.; 175-190 HP; Exhaust stock and reorder	FJ1249NX
1996-1995	6 Cyl. 7.6L; DT466 Eng.; 230-250 HP; Exhaust stock and reorder	FJ1250
1996-1995	6 Cyl. 7.6L; DT466 Eng.; 230-250 HP; Exhaust stock and reorder	FJ1250NX
1996-1995	6 Cyl. 7.6L; DT466 Eng.; 230-250 HP; Alternate Number	FJ1301NX
1996-1995	6 Cyl. 7.6L; DT466 Eng.; 175-190 HP	FJ1302NX
1996-1995	6 Cyl. 7.6L; DT466 Eng.; 195-230 HP; Alternate Number	FJ1303NX
1996-1994	8 Cyl. 7.3L; T444E Eng.; Exhaust stock and reorder; High Output	FJ1252

		Part No.
Fuel Injector - Diesel - New		
3600		
1996-1994	8 Cyl. 7.3L; T444E Eng.; Exhaust stock and reorder; High Output	FJ1252NX
1996-1994	8 Cyl. 7.3L; T444E Eng.; Alternate Number; High Output	FJ1300NX
1996-1994	8 Cyl. 7.3L; T444E Eng.; Exc. High Output	FJ595NX
3700		
1994	8 Cyl. 7.3L; T444E Eng.; Exhaust stock and reorder; High Output	FJ1252
1994	8 Cyl. 7.3L; T444E Eng.; Exhaust stock and reorder; High Output	FJ1252NX
1994	8 Cyl. 7.3L; T444E Eng.; Alternate Number; High Output	FJ1300NX
1994	8 Cyl. 7.3L; T444E Eng.; Exc. High Output	FJ595NX
3800		
2004	6 Cyl. 7.6L; DT466 Eng.; 210-225 HP	FJ1240NX
2004	6 Cyl. 7.6L; DT466 Eng.; 245-285 HP	FJ1242NX
2004-2000	8 Cyl. 7.3L; T444E Eng.; Cyl. 1 to 7	FJ738NX
2004-2000	8 Cyl. 7.3L; T444E Eng.; Cyl. 8	FJ926NX
2003-2000	6 Cyl. 7.6L; DT466 Eng.; Exhaust stock and reorder	FJ1254
2003-2000	6 Cyl. 7.6L; DT466 Eng.; Exhaust stock and reorder	FJ1254NX
2003-2000	6 Cyl. 7.6L; DT466 Eng.; Alternate Number	FJ1307NX
1999	6 Cyl. 7.6L; DT466 Eng.; 175-190 HP; Exhaust stock and reorder; To Engine No. 1194038	FJ1253
1999	6 Cyl. 7.6L; DT466 Eng.; 175-190 HP; Exhaust stock and reorder; To Engine No. 1194038	FJ1253NX
1999	6 Cyl. 7.6L; DT466 Eng.; 175-250 HP; Exhaust stock and reorder; From Engine No. 1125228	FJ1254
1999	6 Cyl. 7.6L; DT466 Eng.; 175-250 HP; Exhaust stock and reorder; From Engine No. 1125228	FJ1254NX
1999	6 Cyl. 7.6L; DT466 Eng.; 230-250 HP; Exhaust stock and reorder; To Engine No. 1125227	FJ1255
1999	6 Cyl. 7.6L; DT466 Eng.; 230-250 HP; Exhaust stock and reorder; To Engine No. 1125227	FJ1255NX
1999	6 Cyl. 7.6L; DT466 Eng.; 175-190 HP; To Engine No. 1194038	FJ1305NX
1999	6 Cyl. 7.6L; DT466 Eng.; 175-250 HP; Alternate Number; From Engine No. 1125228	FJ1307NX
1999	6 Cyl. 7.6L; DT466 Eng.; 230-250 HP; To Engine No. 1125227	FJ1308NX
1999	8 Cyl. 7.3L; T444E Eng.; To Engine No. 843989	FJ596NX
1999	8 Cyl. 7.3L; T444E Eng.; From Engine No. 843,990; Cyl. 1 to 7	FJ738NX
1999	8 Cyl. 7.3L; T444E Eng.; From Engine No. 843,990; Cyl. 8	FJ926NX
1998	6 Cyl. 7.6L; DT466 Eng.; 175-190 HP; Exhaust stock and reorder	FJ1253
1998	6 Cyl. 7.6L; DT466 Eng.; 175-190 HP; Exhaust stock and reorder	FJ1253NX
1998	6 Cyl. 7.6L; DT466 Eng.; 230-250 HP; Exhaust stock and reorder	FJ1255
1998	6 Cyl. 7.6L; DT466 Eng.; 230-250 HP; Exhaust stock and reorder	FJ1255NX
1998	6 Cyl. 7.6L; DT466 Eng.; 175-190 HP	FJ1305NX
1998	6 Cyl. 7.6L; DT466 Eng.; 230-250 HP	FJ1308NX
1998-1997	8 Cyl. 7.3L; T444E Eng.	FJ596NX

Injectors

		Part No.
Fuel Injector - Diesel - New		
3800		
1997	6 Cyl. 7.6L; DT466 Eng.; 195-230 HP; Exhaust stock and reorder; To Engine No. 1028710	FJ1248
1997	6 Cyl. 7.6L; DT466 Eng.; 195-230 HP; Exhaust stock and reorder; To Engine No. 1028710	FJ1248NX
1997	6 Cyl. 7.6L; DT466 Eng.; 175-190 HP; Exhaust stock and reorder; To Engine No. 1028710	FJ1249
1997	6 Cyl. 7.6L; DT466 Eng.; 175-190 HP; Exhaust stock and reorder; To Engine No. 1028710	FJ1249NX
1997	6 Cyl. 7.6L; DT466 Eng.; 230-250 HP; Exhaust stock and reorder; To Engine No. 1084867	FJ1250
1997	6 Cyl. 7.6L; DT466 Eng.; 230-250 HP; Exhaust stock and reorder; To Engine No. 1084867	FJ1250NX
1997	6 Cyl. 7.6L; DT466 Eng.; 175-190 HP; Exhaust stock and reorder; From Engine No. 1028711	FJ1253
1997	6 Cyl. 7.6L; DT466 Eng.; 175-190 HP; Exhaust stock and reorder; From Engine No. 1028711	FJ1253NX
1997	6 Cyl. 7.6L; DT466 Eng.; 230-250 HP; Exhaust stock and reorder; From Engine No. 1084868	FJ1255
1997	6 Cyl. 7.6L; DT466 Eng.; 230-250 HP; Exhaust stock and reorder; From Engine No. 1084868	FJ1255NX
1997	6 Cyl. 7.6L; DT466 Eng.; 230-250 HP; Alternate Number; To Engine No. 1084867	FJ1301NX
1997	6 Cyl. 7.6L; DT466 Eng.; 175-190 HP; To Engine No. 1028710	FJ1302NX
1997	6 Cyl. 7.6L; DT466 Eng.; 195-230 HP; Alternate Number; To Engine No. 1028710	FJ1303NX
1997	6 Cyl. 7.6L; DT466 Eng.; 175-190 HP; From Engine No. 1028711	FJ1305NX
1997	6 Cyl. 7.6L; DT466 Eng.; 230-250 HP; From Engine No. 1084868	FJ1308NX
1996-1995	6 Cyl. 7.6L; DT466 Eng.; 195-230 HP; Exhaust stock and reorder	FJ1248
1996-1995	6 Cyl. 7.6L; DT466 Eng.; 195-230 HP; Exhaust stock and reorder	FJ1248NX
1996-1995	6 Cyl. 7.6L; DT466 Eng.; 175-190 HP; Exhaust stock and reorder	FJ1249
1996-1995	6 Cyl. 7.6L; DT466 Eng.; 175-190 HP; Exhaust stock and reorder	FJ1249NX
1996-1995	6 Cyl. 7.6L; DT466 Eng.; 230-250 HP; Exhaust stock and reorder	FJ1250
1996-1995	6 Cyl. 7.6L; DT466 Eng.; 230-250 HP; Exhaust stock and reorder	FJ1250NX
1996-1995	6 Cyl. 7.6L; DT466 Eng.; 230-250 HP; Alternate Number	FJ1301NX
1996-1995	6 Cyl. 7.6L; DT466 Eng.; 175-190 HP	FJ1302NX
1996-1995	6 Cyl. 7.6L; DT466 Eng.; 195-230 HP; Alternate Number	FJ1303NX
1996-1994	8 Cyl. 7.3L; T444E Eng.; Exhaust stock and reorder; High Output	FJ1252
1996-1994	8 Cyl. 7.3L; T444E Eng.; Exhaust stock and reorder; High Output	FJ1252NX
1996-1994	8 Cyl. 7.3L; T444E Eng.; Alternate Number; High Output	FJ1300NX
1996-1994	8 Cyl. 7.3L; T444E Eng.; Exc. High Output	FJ595NX
3900FC		
1996	6 Cyl. 7.6L; DT466 Eng.; 195-230 HP; Exhaust stock and reorder	FJ1248

		Part No.
Fuel Injector - Diesel - New		
3900FC		
1996	6 Cyl. 7.6L; DT466 Eng.; 195-230 HP; Exhaust stock and reorder	FJ1248NX
1996	6 Cyl. 7.6L; DT466 Eng.; 175-190 HP; Exhaust stock and reorder	FJ1249
1996	6 Cyl. 7.6L; DT466 Eng.; 175-190 HP; Exhaust stock and reorder	FJ1249NX
1996	6 Cyl. 7.6L; DT466 Eng.; 230-250 HP; Exhaust stock and reorder	FJ1250
1996	6 Cyl. 7.6L; DT466 Eng.; 230-250 HP; Exhaust stock and reorder	FJ1250NX
1996	6 Cyl. 7.6L; DT466 Eng.; 230-250 HP; Alternate Number	FJ1301NX
1996	6 Cyl. 7.6L; DT466 Eng.; 175-190 HP; Alternate Number	FJ1302NX
1996	6 Cyl. 7.6L; DT466 Eng.; 195-230 HP; Alternate Number	FJ1303NX
4100		
2012		FJ928NX
2011	8 Cyl. 6.4L; MaxxForce 7 Eng.	FJ1259NX
2011-2008	8 Cyl. 6.0L; VT365 Eng.	FJ928NX
2010	8 Cyl. 6.4L; MaxxForce 7 Eng.; From Engine No. 5300002	FJ1259NX
2010	8 Cyl. 6.4L; MaxxForce 7 Eng.; To Engine No. 5300001	FJ960NX
2009-2008	8 Cyl. 6.4L; MaxxForce 7 Eng.	FJ960NX
2007-2006		FJ928NX
4100 SBA		
2008	8 Cyl. 6.0L; VT365 Eng.	FJ928NX
2007-2006		FJ928NX
4200		
2008-2004		FJ928NX
2003-2002		FJ927NX
4200LP		
2007-2004		FJ928NX
2003		FJ927NX
4300		
2015-2011	8 Cyl. 6.4L; MaxxForce 7 Eng.	FJ1259NX
2013-2011	6 Cyl. 7.6L; MaxxForce DT Eng.; 215-300 HP	FJ1277NX
2012-2011	6 Cyl. 7.6L; MaxxForce DT Eng.; 210-225 HP	FJ1279NX
2010	8 Cyl. 6.4L; MaxxForce 7 Eng.; From Engine No. 5300002	FJ1259NX
2010	8 Cyl. 6.4L; MaxxForce 7 Eng.; To Engine No. 5300001	FJ960NX
2010-2008	6 Cyl. 7.6L; MaxxForce DT Eng.	FJ1243NX
2009-2008	8 Cyl. 6.4L; MaxxForce 7 Eng.	FJ960NX
2007	6 Cyl. 7.6L; DT466 Eng.	FJ1243NX
2006	6 Cyl. 7.6L; DT466 Eng.	FJ1257NX
2005	6 Cyl. 7.6L; DT466 Eng.	FJ1242NX
2004	6 Cyl. 7.6L; DT466 Eng.; 210-225 HP	FJ1240NX
2004	6 Cyl. 7.6L; DT466 Eng.; 245-285 HP	FJ1242NX
2003	8 Cyl. 6.0L; VT365 Eng.	FJ927NX
2003-2002	6 Cyl. 7.6L; DT466 Eng.; Exhaust stock and reorder	FJ1254
2003-2002	6 Cyl. 7.6L; DT466 Eng.; Exhaust stock and reorder	FJ1254NX
2003-2002	6 Cyl. 7.6L; DT466 Eng.; Alternate Number	FJ1307NX
4300LP		
2015-2011	8 Cyl. 6.4L; MaxxForce 7 Eng.	FJ1259NX
2012-2011	6 Cyl. 7.6L; MaxxForce DT Eng.; 215-300 HP	FJ1277NX
2012-2011	6 Cyl. 7.6L; MaxxForce DT Eng.; 210-225 HP	FJ1279NX

Injectors

		Part No.
Fuel Injector - Diesel - New		
4300LP		
2010	8 Cyl. 6.4L; MaxxFORCE 7 Eng.; From Engine No. 5300002	FJ1259NX
2010	8 Cyl. 6.4L; MaxxFORCE 7 Eng.; To Engine No. 5300001	FJ960NX
2010-2009	6 Cyl. 7.6L; MaxxFORCE DT Eng.	FJ1243NX
2009-2008	8 Cyl. 6.4L; MaxxFORCE 7 Eng.	FJ960NX
2008	6 Cyl. 7.6L; DT466 Eng.	FJ1243NX
2007		FJ1243NX
2006		FJ1257NX
2005		FJ1242NX
2004	210-225 HP	FJ1240NX
2004	245-285 HP	FJ1242NX
2003-2002	6 Cyl. 7.6L; DT466 Eng.; Exhaust stock and reorder	FJ1254
2003-2002	6 Cyl. 7.6L; DT466 Eng.; Exhaust stock and reorder	FJ1254NX
2003-2002	6 Cyl. 7.6L; DT466 Eng.; Alternate Number	FJ1307NX
4400		
2016	6 Cyl. 9.3L; N9 Eng.	FJ1291NX
2015	6 Cyl. 9.3L; N9 Eng.	FJ1278NX
2012-2011	6 Cyl. 7.6L; MaxxFORCE DT Eng.; 215-300 HP	FJ1277NX
2012-2011	6 Cyl. 7.6L; MaxxFORCE DT Eng.; 210-225 HP	FJ1279NX
2010-2008	6 Cyl. 7.6L; MaxxFORCE DT Eng.	FJ1243NX
2008-2007	6 Cyl. 9.3L; DT570 Eng.	FJ1244NX
2007	6 Cyl. 7.6L; DT466 Eng.	FJ1243NX
2006	6 Cyl. 7.6L; DT466 Eng.	FJ1257NX
2006	6 Cyl. 9.3L; DT570 Eng.	FJ1258NX
2005	6 Cyl. 7.6L; DT466 Eng.	FJ1242NX
2005-2004	6 Cyl. 9.3L; DT570 Eng.	FJ1241NX
2005-2002	6 Cyl. 8.7L; Exhaust stock and reorder	FJ1245
2005-2002	6 Cyl. 8.7L; Exhaust stock and reorder	FJ1245NX
2005-2002	6 Cyl. 8.7L; Alternate Number	FJ1309NX
2004	6 Cyl. 7.6L; DT466 Eng.; 210-225 HP	FJ1240NX
2004	6 Cyl. 7.6L; DT466 Eng.; 245-285 HP	FJ1242NX
2003	8 Cyl. 6.0L; VT365 Eng.	FJ927NX
2003-2002	6 Cyl. 7.6L; DT466 Eng.; Exhaust stock and reorder	FJ1254
2003-2002	6 Cyl. 7.6L; DT466 Eng.; Exhaust stock and reorder	FJ1254NX
2003-2002	6 Cyl. 7.6L; DT466 Eng.; Alternate Number	FJ1307NX
4400LP		
2012-2011	6 Cyl. 7.6L; MaxxFORCE DT Eng.; 215-300 HP	FJ1277NX
2012-2011	6 Cyl. 7.6L; MaxxFORCE DT Eng.; 210-225 HP	FJ1279NX
2010-2008	6 Cyl. 7.6L; MaxxFORCE DT Eng.	FJ1243NX
2007	6 Cyl. 7.6L; DT466 Eng.	FJ1243NX
2007	6 Cyl. 9.3L; DT570 Eng.	FJ1244NX
2006	6 Cyl. 7.6L; DT466 Eng.	FJ1257NX
2006	6 Cyl. 9.3L; DT570 Eng.	FJ1258NX
2005	6 Cyl. 9.3L; DT570 Eng.	FJ1241NX
2005	6 Cyl. 7.6L; DT466 Eng.	FJ1242NX
2005-2002	6 Cyl. 8.7L; Exhaust stock and reorder	FJ1245
2005-2002	6 Cyl. 8.7L; Exhaust stock and reorder	FJ1245NX
2005-2002	6 Cyl. 8.7L; Alternate Number	FJ1309NX
2004	6 Cyl. 7.6L; DT466 Eng.; 210-225 HP	FJ1240NX
2004	6 Cyl. 7.6L; DT466 Eng.; 245-285 HP	FJ1242NX
2003-2002	6 Cyl. 7.6L; DT466 Eng.; Exhaust stock and reorder	FJ1254
2003-2002	6 Cyl. 7.6L; DT466 Eng.; Exhaust stock and reorder	FJ1254NX

		Part No.
Fuel Injector - Diesel - New		
4400LP		
2003-2002	6 Cyl. 7.6L; DT466 Eng.; Alternate Number	FJ1307NX
4600		
1995-1994	8 Cyl. 7.3L; T444E Eng.; Exhaust stock and reorder; High Output	FJ1252
1995-1994	8 Cyl. 7.3L; T444E Eng.; Exhaust stock and reorder; High Output	FJ1252NX
1995-1994	8 Cyl. 7.3L; T444E Eng.; Alternate Number; High Output	FJ1300NX
1995-1994	8 Cyl. 7.3L; T444E Eng.; Exc. High Output	FJ595NX
4600LP		
1994	8 Cyl. 7.3L; T444E Eng.; Exhaust stock and reorder; High Output	FJ1252
1994	8 Cyl. 7.3L; T444E Eng.; Exhaust stock and reorder; High Output	FJ1252NX
1994	8 Cyl. 7.3L; T444E Eng.; Alternate Number; High Output	FJ1300NX
1994	8 Cyl. 7.3L; T444E Eng.; Exc. High Output	FJ595NX
4700		
2003-2001	6 Cyl. 7.6L; DT466 Eng.; Exhaust stock and reorder	FJ1254
2003-2001	6 Cyl. 7.6L; DT466 Eng.; Exhaust stock and reorder	FJ1254NX
2003-2001	6 Cyl. 7.6L; DT466 Eng.; Alternate Number	FJ1307NX
2003-2000	6 Cyl. 8.7L; Exhaust stock and reorder	FJ1245
2003-2000	6 Cyl. 8.7L; Exhaust stock and reorder	FJ1245NX
2003-2000	6 Cyl. 8.7L; Alternate Number	FJ1309NX
2002-2000	8 Cyl. 7.3L; T444E Eng.; Cyl. 1 to 7	FJ738NX
2002-2000	8 Cyl. 7.3L; T444E Eng.; Cyl. 8	FJ926NX
2000	6 Cyl. 7.6L; MaxxFORCE DT Eng.; Exhaust stock and reorder	FJ1254
2000	6 Cyl. 7.6L; MaxxFORCE DT Eng.; Exhaust stock and reorder	FJ1254NX
2000	6 Cyl. 7.6L; MaxxFORCE DT Eng.; Alternate Number	FJ1307NX
1999	6 Cyl. 8.7L; Exhaust stock and reorder; To Engine No. 1134350	FJ1251
1999	6 Cyl. 8.7L; Exhaust stock and reorder; To Engine No. 1134350	FJ1251NX
1999	6 Cyl. 7.6L; DT466 Eng.; 175-190 HP; Exhaust stock and reorder; To Engine No. 1194038	FJ1253
1999	6 Cyl. 7.6L; DT466 Eng.; 175-190 HP; Exhaust stock and reorder; To Engine No. 1194038	FJ1253NX
1999	6 Cyl. 7.6L; DT466 Eng.; 175-250 HP; Exhaust stock and reorder; From Engine No. 1125228	FJ1254
1999	6 Cyl. 7.6L; DT466 Eng.; 175-250 HP; Exhaust stock and reorder; From Engine No. 1125228	FJ1254NX
1999	6 Cyl. 7.6L; DT466 Eng.; 230-250 HP; Exhaust stock and reorder; To Engine No. 1125227	FJ1255
1999	6 Cyl. 8.7L; Exhaust stock and reorder; From Engine No. 1133755	FJ1255
1999	6 Cyl. 7.6L; DT466 Eng.; 230-250 HP; Exhaust stock and reorder; To Engine No. 1125227	FJ1255NX
1999	6 Cyl. 8.7L; Exhaust stock and reorder; From Engine No. 1133755	FJ1255NX
1999	6 Cyl. 7.6L; DT466 Eng.; 175-190 HP; To Engine No. 1194038	FJ1305NX
1999	6 Cyl. 7.6L; DT466 Eng.; 175-190 HP; Alternate Number; To Engine No. 1194038	FJ1305NX

Injectors

		Part No.
Fuel Injector - Diesel - New		
4700		
1999	6 Cyl. 8.7L; Alternate Number; To Engine No. 1134350	FJ1306NX
1999	6 Cyl. 7.6L; DT466 Eng.; 175-250 HP; Alternate Number; From Engine No. 1125228	FJ1307NX
1999	6 Cyl. 7.6L; DT466 Eng.; 230-250 HP; To Engine No. 1125227	FJ1308NX
1999	6 Cyl. 8.7L; From Engine No. 1133755	FJ1308NX
1999	8 Cyl. 7.3L; T444E Eng.; To Engine No. 843989	FJ596NX
1999	8 Cyl. 7.3L; T444E Eng.; From Engine No. 843,990; Cyl. 1 to 7	FJ738NX
1999	8 Cyl. 7.3L; T444E Eng.; From Engine No. 843,990; Cyl. 8	FJ926NX
1998	6 Cyl. 8.7L; Exhaust stock and reorder	FJ1251
1998	6 Cyl. 8.7L; Exhaust stock and reorder	FJ1251NX
1998	6 Cyl. 7.6L; DT466 Eng.; 175-190 HP; Exhaust stock and reorder	FJ1253
1998	6 Cyl. 7.6L; DT466 Eng.; 175-190 HP; Exhaust stock and reorder	FJ1253NX
1998	6 Cyl. 7.6L; DT466 Eng.; 230-250 HP; Exhaust stock and reorder	FJ1255
1998	6 Cyl. 7.6L; DT466 Eng.; 230-250 HP; Exhaust stock and reorder	FJ1255NX
1998	6 Cyl. 7.6L; DT466 Eng.; 175-190 HP	FJ1305NX
1998	6 Cyl. 8.7L; Alternate Number	FJ1306NX
1998	6 Cyl. 7.6L; DT466 Eng.; 230-250 HP	FJ1308NX
1998-1997	8 Cyl. 7.3L; T444E Eng.	FJ596NX
1997	6 Cyl. 7.6L; DT466 Eng.; 195-230 HP; Exhaust stock and reorder; To Engine No. 1028710	FJ1248
1997	6 Cyl. 7.6L; DT466 Eng.; 195-230 HP; Exhaust stock and reorder; To Engine No. 1028710	FJ1248NX
1997	6 Cyl. 7.6L; DT466 Eng.; 175-190 HP; Exhaust stock and reorder; To Engine No. 1028710	FJ1249
1997	6 Cyl. 7.6L; DT466 Eng.; 175-190 HP; Exhaust stock and reorder; To Engine No. 1028710	FJ1249NX
1997	6 Cyl. 7.6L; DT466 Eng.; 230-250 HP; Exhaust stock and reorder; To Engine No. 1084867	FJ1250
1997	6 Cyl. 7.6L; DT466 Eng.; 230-250 HP; Exhaust stock and reorder; To Engine No. 1084867	FJ1250NX
1997	6 Cyl. 7.6L; DT466 Eng.; 175-190 HP; Exhaust stock and reorder; From Engine No. 1028711	FJ1253
1997	6 Cyl. 7.6L; DT466 Eng.; 175-190 HP; Exhaust stock and reorder; From Engine No. 1028711	FJ1253NX
1997	6 Cyl. 7.6L; DT466 Eng.; 230-250 HP; Exhaust stock and reorder; From Engine No. 1084868	FJ1255
1997	6 Cyl. 7.6L; DT466 Eng.; 230-250 HP; Exhaust stock and reorder; From Engine No. 1084868	FJ1255NX
1997	6 Cyl. 7.6L; DT466 Eng.; 230-250 HP; Alternate Number; To Engine No. 1084867	FJ1301NX
1997	6 Cyl. 7.6L; DT466 Eng.; 175-190 HP; To Engine No. 1028710	FJ1302NX
1997	6 Cyl. 7.6L; DT466 Eng.; 195-230 HP; Alternate Number; To Engine No. 1028710	FJ1303NX
1997	6 Cyl. 7.6L; DT466 Eng.; 175-190 HP; From Engine No. 1028711	FJ1305NX
1997	6 Cyl. 7.6L; DT466 Eng.; 230-250 HP; From Engine No. 1084868	FJ1308NX

		Part No.
Fuel Injector - Diesel - New		
4700		
1997-1996	6 Cyl. 8.7L; Exhaust stock and reorder	FJ1247
1997-1996	6 Cyl. 8.7L; Alternate Number	FJ1247NX
1997-1996	6 Cyl. 8.7L	FJ1304NX
1996-1995	6 Cyl. 7.6L; DT466 Eng.; 195-230 HP; Exhaust stock and reorder	FJ1248
1996-1995	6 Cyl. 7.6L; DT466 Eng.; 195-230 HP; Exhaust stock and reorder	FJ1248NX
1996-1995	6 Cyl. 7.6L; DT466 Eng.; 175-190 HP; Exhaust stock and reorder	FJ1249
1996-1995	6 Cyl. 7.6L; DT466 Eng.; 175-190 HP; Exhaust stock and reorder	FJ1249NX
1996-1995	6 Cyl. 7.6L; DT466 Eng.; 230-250 HP; Exhaust stock and reorder	FJ1250
1996-1995	6 Cyl. 7.6L; DT466 Eng.; 230-250 HP; Exhaust stock and reorder	FJ1250NX
1996-1995	6 Cyl. 7.6L; DT466 Eng.; 230-250 HP; Alternate Number	FJ1301NX
1996-1995	6 Cyl. 7.6L; DT466 Eng.; 175-190 HP	FJ1302NX
1996-1995	6 Cyl. 7.6L; DT466 Eng.; 195-230 HP; Alternate Number	FJ1303NX
1996-1994	8 Cyl. 7.3L; T444E Eng.; Exhaust stock and reorder; High Output	FJ1252
1996-1994	8 Cyl. 7.3L; T444E Eng.; Exhaust stock and reorder; High Output	FJ1252NX
1996-1994	8 Cyl. 7.3L; T444E Eng.; Alternate Number; High Output	FJ1300NX
1996-1994	8 Cyl. 7.3L; T444E Eng.; Exc. High Output	FJ595NX
4700LP		
2002-2000	6 Cyl. 8.7L; Exhaust stock and reorder	FJ1245
2002-2000	6 Cyl. 8.7L; Exhaust stock and reorder	FJ1245NX
2002-2000	6 Cyl. 7.6L; DT466 Eng.; Exhaust stock and reorder	FJ1254
2002-2000	6 Cyl. 7.6L; DT466 Eng.; Exhaust stock and reorder	FJ1254NX
2002-2000	6 Cyl. 7.6L; DT466 Eng.; Alternate Number	FJ1307NX
2002-2000	6 Cyl. 8.7L; Alternate Number	FJ1309NX
2002-2000	8 Cyl. 7.3L; T444E Eng.; Cyl. 1 to 7	FJ738NX
2002-2000	8 Cyl. 7.3L; T444E Eng.; Cyl. 8	FJ926NX
1999	6 Cyl. 8.7L; Exhaust stock and reorder; To Engine No. 1134350	FJ1251
1999	6 Cyl. 8.7L; Exhaust stock and reorder; To Engine No. 1134350	FJ1251NX
1999	6 Cyl. 7.6L; DT466 Eng.; 175-190 HP; Exhaust stock and reorder; To Engine No. 1194038	FJ1253
1999	6 Cyl. 7.6L; DT466 Eng.; 175-190 HP; Exhaust stock and reorder; To Engine No. 1194038	FJ1253NX
1999	6 Cyl. 7.6L; DT466 Eng.; 175-250 HP; Exhaust stock and reorder; From Engine No. 1125228	FJ1254
1999	6 Cyl. 7.6L; DT466 Eng.; 175-250 HP; Exhaust stock and reorder; From Engine No. 1125228	FJ1254NX
1999	6 Cyl. 7.6L; DT466 Eng.; 230-250 HP; Exhaust stock and reorder; To Engine No. 1125227	FJ1255
1999	6 Cyl. 8.7L; Exhaust stock and reorder; From Engine No. 1134351	FJ1255
1999	6 Cyl. 7.6L; DT466 Eng.; 230-250 HP; Exhaust stock and reorder; To Engine No. 1125227	FJ1255NX
1999	6 Cyl. 8.7L; Exhaust stock and reorder; From Engine No. 1134351	FJ1255NX
1999	6 Cyl. 7.6L; DT466 Eng.; 175-190 HP; To Engine No. 1194038	FJ1305NX

International

Injectors

		Part No.
Fuel Injector - Diesel - New		
4700LP		
1999	6 Cyl. 7.6L; DT466 Eng.; 175-190 HP; Alternate Number; To Engine No. 1194038	FJ1305NX
1999	6 Cyl. 8.7L; Alternate Number; To Engine No. 1134350	FJ1306NX
1999	6 Cyl. 7.6L; DT466 Eng.; 175-250 HP; Alternate Number; From Engine No. 1125228	FJ1307NX
1999	6 Cyl. 7.6L; DT466 Eng.; 230-250 HP; To Engine No. 1125227	FJ1308NX
1999	6 Cyl. 7.6L; DT466 Eng.; 230-250 HP; Alternate Number; To Engine No. 1125227	FJ1308NX
1999	6 Cyl. 8.7L; From Engine No. 1134351	FJ1308NX
1999	6 Cyl. 8.7L; Alternate Number; From Engine No. 1134351	FJ1308NX
1999	8 Cyl. 7.3L; T444E Eng.; To Engine No. 843989	FJ596NX
1999	8 Cyl. 7.3L; T444E Eng.; From Engine No. 843,990; Cyl. 1 to 7	FJ738NX
1999	8 Cyl. 7.3L; T444E Eng.; From Engine No. 843,990; Cyl. 8	FJ926NX
1998	6 Cyl. 8.7L; Exhaust stock and reorder	FJ1251
1998	6 Cyl. 8.7L; Exhaust stock and reorder	FJ1251NX
1998	6 Cyl. 7.6L; DT466 Eng.; 175-190 HP; Exhaust stock and reorder	FJ1253
1998	6 Cyl. 7.6L; DT466 Eng.; 175-190 HP; Exhaust stock and reorder	FJ1253NX
1998	6 Cyl. 7.6L; DT466 Eng.; 230-250 HP; Exhaust stock and reorder	FJ1255
1998	6 Cyl. 7.6L; DT466 Eng.; 230-250 HP; Exhaust stock and reorder	FJ1255NX
1998	6 Cyl. 7.6L; DT466 Eng.; 175-190 HP	FJ1305NX
1998	6 Cyl. 7.6L; DT466 Eng.; 175-190 HP; Alternate Number	FJ1305NX
1998	6 Cyl. 8.7L; Alternate Number	FJ1306NX
1998	6 Cyl. 7.6L; DT466 Eng.; 230-250 HP	FJ1308NX
1998	6 Cyl. 7.6L; DT466 Eng.; 230-250 HP; Alternate Number	FJ1308NX
1998-1997	8 Cyl. 7.3L; T444E Eng.	FJ596NX
1997	6 Cyl. 8.7L; Exhaust stock and reorder	FJ1247
1997	6 Cyl. 8.7L; Alternate Number	FJ1247NX
1997	6 Cyl. 7.6L; DT466 Eng.; 195-230 HP; Exhaust stock and reorder; To Engine No. 1028710	FJ1248
1997	6 Cyl. 7.6L; DT466 Eng.; 195-230 HP; Exhaust stock and reorder; To Engine No. 1028710	FJ1248NX
1997	6 Cyl. 7.6L; DT466 Eng.; 175-190 HP; Exhaust stock and reorder; To Engine No. 1028710	FJ1249
1997	6 Cyl. 7.6L; DT466 Eng.; 175-190 HP; Exhaust stock and reorder; To Engine No. 1028710	FJ1249NX
1997	6 Cyl. 7.6L; DT466 Eng.; 230-250 HP; Exhaust stock and reorder; To Engine No. 1084867	FJ1250
1997	6 Cyl. 7.6L; DT466 Eng.; 230-250 HP; Exhaust stock and reorder; To Engine No. 1084867	FJ1250NX
1997	6 Cyl. 7.6L; DT466 Eng.; 175-190 HP; Exhaust stock and reorder; From Engine No. 1028711	FJ1253
1997	6 Cyl. 7.6L; DT466 Eng.; 175-190 HP; Exhaust stock and reorder; From Engine No. 1028711	FJ1253NX
1997	6 Cyl. 7.6L; DT466 Eng.; 230-250 HP; Exhaust stock and reorder; From Engine No. 1084868	FJ1255

		Part No.
Fuel Injector - Diesel - New		
4700LP		
1997	6 Cyl. 7.6L; DT466 Eng.; 230-250 HP; Exhaust stock and reorder; From Engine No. 1084868	FJ1255NX
1997	6 Cyl. 7.6L; DT466 Eng.; 230-250 HP; Alternate Number; To Engine No. 1084867	FJ1301NX
1997	6 Cyl. 7.6L; DT466 Eng.; 175-190 HP; To Engine No. 1028710	FJ1302NX
1997	6 Cyl. 7.6L; DT466 Eng.; 195-230 HP; Alternate Number; To Engine No. 1028710	FJ1303NX
1997	6 Cyl. 8.7L	FJ1304NX
1997	6 Cyl. 7.6L; DT466 Eng.; 175-190 HP; From Engine No. 1028711	FJ1305NX
1997	6 Cyl. 7.6L; DT466 Eng.; 175-190 HP; Alternate Number; From Engine No. 1028711	FJ1305NX
1997	6 Cyl. 7.6L; DT466 Eng.; 230-250 HP; From Engine No. 1084868	FJ1308NX
1996-1995	6 Cyl. 7.6L; DT466 Eng.; 195-230 HP; Exhaust stock and reorder	FJ1248
1996-1995	6 Cyl. 7.6L; DT466 Eng.; 195-230 HP; Exhaust stock and reorder	FJ1248NX
1996-1995	6 Cyl. 7.6L; DT466 Eng.; 175-190 HP; Exhaust stock and reorder	FJ1249
1996-1995	6 Cyl. 7.6L; DT466 Eng.; 175-190 HP; Exhaust stock and reorder	FJ1249NX
1996-1995	6 Cyl. 7.6L; DT466 Eng.; 230-250 HP; Exhaust stock and reorder	FJ1250
1996-1995	6 Cyl. 7.6L; DT466 Eng.; 230-250 HP; Exhaust stock and reorder	FJ1250NX
1996-1995	6 Cyl. 7.6L; DT466 Eng.; 230-250 HP; Alternate Number	FJ1301NX
1996-1995	6 Cyl. 7.6L; DT466 Eng.; 175-190 HP	FJ1302NX
1996-1995	6 Cyl. 7.6L; DT466 Eng.; 195-230 HP; Alternate Number	FJ1303NX
1996-1994	8 Cyl. 7.3L; T444E Eng.; Exhaust stock and reorder; High Output	FJ1252
1996-1994	8 Cyl. 7.3L; T444E Eng.; Exhaust stock and reorder; High Output	FJ1252NX
1996-1994	8 Cyl. 7.3L; T444E Eng.; Alternate Number; High Output	FJ1300NX
1996-1994	8 Cyl. 7.3L; T444E Eng.; Exc. High Output	FJ595NX
4700LPX		
2002-2000	8 Cyl. 7.3L; T444E Eng.; Cyl. 1 to 7	FJ738NX
2002-2000	8 Cyl. 7.3L; T444E Eng.; Cyl. 8	FJ926NX
1999	8 Cyl. 7.3L; T444E Eng.; To Engine No. 843989	FJ596NX
1999	8 Cyl. 7.3L; T444E Eng.; From Engine No. 843,990; Cyl. 1 to 7	FJ738NX
1999	8 Cyl. 7.3L; T444E Eng.; From Engine No. 843,990; Cyl. 8	FJ926NX
1998-1997	8 Cyl. 7.3L; T444E Eng.	FJ596NX
1996-1995	8 Cyl. 7.3L; T444E Eng.; Exhaust stock and reorder; High Output	FJ1252
1996-1995	8 Cyl. 7.3L; T444E Eng.; Exhaust stock and reorder; High Output	FJ1252NX
1996-1995	8 Cyl. 7.3L; T444E Eng.; Alternate Number; High Output	FJ1300NX
1996-1995	8 Cyl. 7.3L; T444E Eng.; Exc. High Output	FJ595NX
4800		
2003-2000	6 Cyl. 8.7L; Exhaust stock and reorder	FJ1245
2003-2000	6 Cyl. 8.7L; Exhaust stock and reorder	FJ1245NX
2003-2000	6 Cyl. 7.6L; DT466 Eng.; Exhaust stock and reorder	FJ1254
2003-2000	6 Cyl. 7.6L; DT466 Eng.; Exhaust stock and reorder	FJ1254NX

Injectors

		Part No.
Fuel Injector - Diesel - New		
4800		
2003-2000	6 Cyl. 7.6L; DT466 Eng.; Alternate Number	FJ1307NX
2003-2000	6 Cyl. 8.7L; Alternate Number	FJ1309NX
1999	6 Cyl. 8.7L; Exhaust stock and reorder; To Engine No. 1134350	FJ1251
1999	6 Cyl. 8.7L; Exhaust stock and reorder; To Engine No. 1134350	FJ1251NX
1999	6 Cyl. 7.6L; DT466 Eng.; 175-190 HP; Exhaust stock and reorder; To Engine No. 1194038	FJ1253
1999	6 Cyl. 7.6L; DT466 Eng.; 175-190 HP; Exhaust stock and reorder; To Engine No. 1194038	FJ1253NX
1999	6 Cyl. 7.6L; DT466 Eng.; 175-250 HP; Exhaust stock and reorder; From Engine No. 1125228	FJ1254
1999	6 Cyl. 7.6L; DT466 Eng.; 175-250 HP; Exhaust stock and reorder; From Engine No. 1125228	FJ1254NX
1999	6 Cyl. 7.6L; DT466 Eng.; 230-250 HP; Exhaust stock and reorder; To Engine No. 1125227	FJ1255
1999	6 Cyl. 8.7L; Exhaust stock and reorder; From Engine No. 1134351	FJ1255
1999	6 Cyl. 7.6L; DT466 Eng.; 230-250 HP; Exhaust stock and reorder; To Engine No. 1125227	FJ1255NX
1999	6 Cyl. 8.7L; Exhaust stock and reorder; From Engine No. 1134351	FJ1255NX
1999	6 Cyl. 7.6L; DT466 Eng.; 175-190 HP; To Engine No. 1194038	FJ1305NX
1999	6 Cyl. 8.7L; Alternate Number; To Engine No. 1134350	FJ1306NX
1999	6 Cyl. 7.6L; DT466 Eng.; 175-250 HP; Alternate Number; From Engine No. 1125228	FJ1307NX
1999	6 Cyl. 7.6L; DT466 Eng.; 230-250 HP; To Engine No. 1125227	FJ1308NX
1999	6 Cyl. 8.7L; From Engine No. 1134351	FJ1308NX
1998	6 Cyl. 8.7L; Exhaust stock and reorder	FJ1251
1998	6 Cyl. 8.7L; Exhaust stock and reorder	FJ1251NX
1998	6 Cyl. 7.6L; DT466 Eng.; 175-190 HP; Exhaust stock and reorder	FJ1253
1998	6 Cyl. 7.6L; DT466 Eng.; 175-190 HP; Exhaust stock and reorder	FJ1253NX
1998	6 Cyl. 7.6L; DT466 Eng.; 230-250 HP; Exhaust stock and reorder	FJ1255
1998	6 Cyl. 7.6L; DT466 Eng.; 230-250 HP; Exhaust stock and reorder	FJ1255NX
1998	6 Cyl. 7.6L; DT466 Eng.; 175-190 HP	FJ1305NX
1998	6 Cyl. 8.7L; Alternate Number	FJ1306NX
1998	6 Cyl. 7.6L; DT466 Eng.; 230-250 HP	FJ1308NX
1997	6 Cyl. 7.6L; DT466 Eng.; 195-230 HP; Exhaust stock and reorder; To Engine No. 1028710	FJ1248
1997	6 Cyl. 7.6L; DT466 Eng.; 195-230 HP; Exhaust stock and reorder; To Engine No. 1028710	FJ1248NX
1997	6 Cyl. 7.6L; DT466 Eng.; 175-190 HP; Exhaust stock and reorder; To Engine No. 1028710	FJ1249
1997	6 Cyl. 7.6L; DT466 Eng.; 175-190 HP; Exhaust stock and reorder; To Engine No. 1028710	FJ1249NX
1997	6 Cyl. 7.6L; DT466 Eng.; 230-250 HP; Exhaust stock and reorder; To Engine No. 1084867	FJ1250
1997	6 Cyl. 7.6L; DT466 Eng.; 230-250 HP; Exhaust stock and reorder; To Engine No. 1084867	FJ1250NX

		Part No.
Fuel Injector - Diesel - New		
4800		
1997	6 Cyl. 7.6L; DT466 Eng.; 175-190 HP; Exhaust stock and reorder; From Engine No. 1028711	FJ1253
1997	6 Cyl. 7.6L; DT466 Eng.; 175-190 HP; Exhaust stock and reorder; From Engine No. 1028711	FJ1253NX
1997	6 Cyl. 7.6L; DT466 Eng.; 230-250 HP; Exhaust stock and reorder; From Engine No. 1084868	FJ1255
1997	6 Cyl. 7.6L; DT466 Eng.; 230-250 HP; Exhaust stock and reorder; From Engine No. 1084868	FJ1255NX
1997	6 Cyl. 7.6L; DT466 Eng.; 230-250 HP; Alternate Number; To Engine No. 1084867	FJ1301NX
1997	6 Cyl. 7.6L; DT466 Eng.; 175-190 HP; To Engine No. 1028710	FJ1302NX
1997	6 Cyl. 7.6L; DT466 Eng.; 195-230 HP; Alternate Number; To Engine No. 1028710	FJ1303NX
1997	6 Cyl. 7.6L; DT466 Eng.; 175-190 HP; From Engine No. 1028711	FJ1305NX
1997	6 Cyl. 7.6L; DT466 Eng.; 230-250 HP; From Engine No. 1084868	FJ1308NX
1997	8 Cyl. 7.3L; T444E Eng.	FJ596NX
1997-1996	6 Cyl. 8.7L; Exhaust stock and reorder	FJ1247
1997-1996	6 Cyl. 8.7L; Alternate Number	FJ1247NX
1997-1996	6 Cyl. 8.7L	FJ1304NX
1996-1995	6 Cyl. 7.6L; DT466 Eng.; 195-230 HP; Exhaust stock and reorder	FJ1248
1996-1995	6 Cyl. 7.6L; DT466 Eng.; 195-230 HP; Exhaust stock and reorder	FJ1248NX
1996-1995	6 Cyl. 7.6L; DT466 Eng.; 175-190 HP; Exhaust stock and reorder	FJ1249
1996-1995	6 Cyl. 7.6L; DT466 Eng.; 175-190 HP; Exhaust stock and reorder	FJ1249NX
1996-1995	6 Cyl. 7.6L; DT466 Eng.; 230-250 HP; Exhaust stock and reorder	FJ1250
1996-1995	6 Cyl. 7.6L; DT466 Eng.; 230-250 HP; Exhaust stock and reorder	FJ1250NX
1996-1995	8 Cyl. 7.3L; T444E Eng.; Exhaust stock and reorder; High Output	FJ1252
1996-1995	8 Cyl. 7.3L; T444E Eng.; Exhaust stock and reorder; High Output	FJ1252NX
1996-1995	8 Cyl. 7.3L; T444E Eng.; Alternate Number; High Output	FJ1300NX
1996-1995	6 Cyl. 7.6L; DT466 Eng.; 230-250 HP; Alternate Number	FJ1301NX
1996-1995	6 Cyl. 7.6L; DT466 Eng.; 175-190 HP	FJ1302NX
1996-1995	6 Cyl. 7.6L; DT466 Eng.; 195-230 HP; Alternate Number	FJ1303NX
1996-1995	8 Cyl. 7.3L; T444E Eng.; Exc. High Output	FJ595NX
4900		
2003-2000	6 Cyl. 8.7L; Exhaust stock and reorder	FJ1245
2003-2000	6 Cyl. 8.7L; Exhaust stock and reorder	FJ1245NX
2003-2000	6 Cyl. 7.6L; DT466 Eng.; Exhaust stock and reorder	FJ1254
2003-2000	6 Cyl. 7.6L; DT466 Eng.; Exhaust stock and reorder	FJ1254NX
2003-2000	6 Cyl. 7.6L; DT466 Eng.; Alternate Number	FJ1307NX
2003-2000	6 Cyl. 8.7L; Alternate Number	FJ1309NX
1999	6 Cyl. 8.7L; Exhaust stock and reorder; To Engine No. 1134350	FJ1251
1999	6 Cyl. 8.7L; Exhaust stock and reorder; To Engine No. 1134350	FJ1251NX

Injectors

Fuel Injector - Diesel - New		Part No.
4900		
1999	6 Cyl. 7.6L; DT466 Eng.; 175-190 HP; Exhaust stock and reorder; To Engine No. 1194038	FJ1253
1999	6 Cyl. 7.6L; DT466 Eng.; 175-190 HP; Exhaust stock and reorder; To Engine No. 1194038	FJ1253NX
1999	6 Cyl. 7.6L; DT466 Eng.; 175-250 HP; Exhaust stock and reorder; From Engine No. 1125228	FJ1254
1999	6 Cyl. 7.6L; DT466 Eng.; 175-250 HP; Exhaust stock and reorder; From Engine No. 1125228	FJ1254NX
1999	6 Cyl. 7.6L; DT466 Eng.; 230-250 HP; Exhaust stock and reorder; To Engine No. 1125227	FJ1255
1999	6 Cyl. 8.7L; Exhaust stock and reorder; From Engine No. 1134351	FJ1255
1999	6 Cyl. 7.6L; DT466 Eng.; 230-250 HP; Exhaust stock and reorder; To Engine No. 1125227	FJ1255NX
1999	6 Cyl. 8.7L; Exhaust stock and reorder; From Engine No. 1134351	FJ1255NX
1999	6 Cyl. 7.6L; DT466 Eng.; 175-190 HP; To Engine No. 1194038	FJ1305NX
1999	6 Cyl. 8.7L; Alternate Number; To Engine No. 1134350	FJ1306NX
1999	6 Cyl. 7.6L; DT466 Eng.; 175-250 HP; Alternate Number; From Engine No. 1125228	FJ1307NX
1999	6 Cyl. 7.6L; DT466 Eng.; 230-250 HP; To Engine No. 1125227	FJ1308NX
1999	6 Cyl. 8.7L; From Engine No. 1134351	FJ1308NX
1998	6 Cyl. 8.7L; Exhaust stock and reorder	FJ1251
1998	6 Cyl. 8.7L; Exhaust stock and reorder	FJ1251NX
1998	6 Cyl. 7.6L; DT466 Eng.; 175-190 HP; Exhaust stock and reorder	FJ1253
1998	6 Cyl. 7.6L; DT466 Eng.; 175-190 HP; Exhaust stock and reorder	FJ1253NX
1998	6 Cyl. 7.6L; DT466 Eng.; 230-250 HP; Exhaust stock and reorder	FJ1255
1998	6 Cyl. 7.6L; DT466 Eng.; 230-250 HP; Exhaust stock and reorder	FJ1255NX
1998	6 Cyl. 7.6L; DT466 Eng.; 175-190 HP	FJ1305NX
1998	6 Cyl. 8.7L; Alternate Number	FJ1306NX
1998	6 Cyl. 7.6L; DT466 Eng.; 230-250 HP	FJ1308NX
1997	6 Cyl. 7.6L; DT466 Eng.; 195-230 HP; Exhaust stock and reorder; To Engine No. 1028710	FJ1248
1997	6 Cyl. 7.6L; DT466 Eng.; 195-230 HP; Exhaust stock and reorder; To Engine No. 1028710	FJ1248NX
1997	6 Cyl. 7.6L; DT466 Eng.; 175-190 HP; Exhaust stock and reorder; To Engine No. 1028710	FJ1249
1997	6 Cyl. 7.6L; DT466 Eng.; 175-190 HP; Exhaust stock and reorder; To Engine No. 1028710	FJ1249NX
1997	6 Cyl. 7.6L; DT466 Eng.; 230-250 HP; Exhaust stock and reorder; To Engine No. 1084867	FJ1250
1997	6 Cyl. 7.6L; DT466 Eng.; 230-250 HP; Exhaust stock and reorder; To Engine No. 1084867	FJ1250NX
1997	6 Cyl. 7.6L; DT466 Eng.; 175-190 HP; Exhaust stock and reorder; From Engine No. 1028711	FJ1253
1997	6 Cyl. 7.6L; DT466 Eng.; 175-190 HP; Exhaust stock and reorder; From Engine No. 1028711	FJ1253NX

Fuel Injector - Diesel - New		Part No.
4900		
1997	6 Cyl. 7.6L; DT466 Eng.; 230-250 HP; Exhaust stock and reorder; From Engine No. 1084868	FJ1255
1997	6 Cyl. 7.6L; DT466 Eng.; 230-250 HP; Exhaust stock and reorder; From Engine No. 1084868	FJ1255NX
1997	6 Cyl. 7.6L; DT466 Eng.; 230-250 HP; Alternate Number; To Engine No. 1084867	FJ1301NX
1997	6 Cyl. 7.6L; DT466 Eng.; 175-190 HP; To Engine No. 1028710	FJ1302NX
1997	6 Cyl. 7.6L; DT466 Eng.; 195-230 HP; Alternate Number; To Engine No. 1028710	FJ1303NX
1997	6 Cyl. 7.6L; DT466 Eng.; 175-190 HP; From Engine No. 1028711	FJ1305NX
1997	6 Cyl. 7.6L; DT466 Eng.; 230-250 HP; From Engine No. 1084868	FJ1308NX
1997	8 Cyl. 7.3L; T444E Eng.	FJ596NX
1997-1995	6 Cyl. 8.7L; Exhaust stock and reorder	FJ1247
1997-1995	6 Cyl. 8.7L; Alternate Number	FJ1247NX
1997-1995	6 Cyl. 8.7L	FJ1304NX
1996-1995	6 Cyl. 7.6L; DT466 Eng.; 195-230 HP; Exhaust stock and reorder	FJ1248
1996-1995	6 Cyl. 7.6L; DT466 Eng.; 195-230 HP; Exhaust stock and reorder	FJ1248NX
1996-1995	6 Cyl. 7.6L; DT466 Eng.; 175-190 HP; Exhaust stock and reorder	FJ1249
1996-1995	6 Cyl. 7.6L; DT466 Eng.; 175-190 HP; Exhaust stock and reorder	FJ1249NX
1996-1995	6 Cyl. 7.6L; DT466 Eng.; 230-250 HP; Exhaust stock and reorder	FJ1250
1996-1995	6 Cyl. 7.6L; DT466 Eng.; 230-250 HP; Exhaust stock and reorder	FJ1250NX
1996-1995	8 Cyl. 7.3L; T444E Eng.; Exhaust stock and reorder; High Output	FJ1252
1996-1995	8 Cyl. 7.3L; T444E Eng.; Exhaust stock and reorder; High Output	FJ1252NX
1996-1995	8 Cyl. 7.3L; T444E Eng.; Alternate Number; High Output	FJ1300NX
1996-1995	6 Cyl. 7.6L; DT466 Eng.; 230-250 HP; Alternate Number	FJ1301NX
1996-1995	6 Cyl. 7.6L; DT466 Eng.; 175-190 HP	FJ1302NX
1996-1995	6 Cyl. 7.6L; DT466 Eng.; 195-230 HP; Alternate Number	FJ1303NX
1996-1995	8 Cyl. 7.3L; T444E Eng.; Exc. High Output	FJ595NX
5000		
1999	6 Cyl. 8.7L; Exhaust stock and reorder; To Engine No. 1134350	FJ1251
1999	6 Cyl. 8.7L; Exhaust stock and reorder; To Engine No. 1134350	FJ1251NX
1999	6 Cyl. 8.7L; Exhaust stock and reorder; From Engine No. 1134351	FJ1255
1999	6 Cyl. 8.7L; Exhaust stock and reorder; From Engine No. 1134351	FJ1255NX
1999	6 Cyl. 8.7L; Alternate Number; To Engine No. 1134350	FJ1306NX
1999	6 Cyl. 8.7L; From Engine No. 1134351	FJ1308NX
1998	6 Cyl. 8.7L; Exhaust stock and reorder	FJ1251
1998	6 Cyl. 8.7L; Exhaust stock and reorder	FJ1251NX
1998	6 Cyl. 8.7L; Alternate Number	FJ1306NX
1997-1995	6 Cyl. 8.7L; Exhaust stock and reorder	FJ1247
1997-1995	6 Cyl. 8.7L; Alternate Number	FJ1247NX
1997-1995	6 Cyl. 8.7L	FJ1304NX
5500i		
2005-2000	6 Cyl. 8.7L; Exhaust stock and reorder	FJ1245
2005-2000	6 Cyl. 8.7L; Exhaust stock and reorder	FJ1245NX

Injectors

		Part No.
Fuel Injector - Diesel - New		
5500i		
2005-2000	6 Cyl. 8.7L; Alternate Number	FJ1309NX
2002-2001	6 Cyl. 7.6L; DT466 Eng.; Exhaust stock and reorder	FJ1254
2002-2001	6 Cyl. 7.6L; DT466 Eng.; Exhaust stock and reorder	FJ1254NX
2002-2001	6 Cyl. 7.6L; DT466 Eng.; Alternate Number	FJ1307NX
5600i		
2005-2000	6 Cyl. 8.7L; Exhaust stock and reorder	FJ1245
2005-2000	6 Cyl. 8.7L; Exhaust stock and reorder	FJ1245NX
2005-2000	6 Cyl. 8.7L; Alternate Number	FJ1309NX
2002-2001	6 Cyl. 7.6L; DT466 Eng.; Exhaust stock and reorder	FJ1254
2002-2001	6 Cyl. 7.6L; DT466 Eng.; Exhaust stock and reorder	FJ1254NX
2002-2001	6 Cyl. 7.6L; DT466 Eng.; Alternate Number	FJ1307NX
7100		
1995	6 Cyl. 8.7L; Exhaust stock and reorder	FJ1247
1995	6 Cyl. 8.7L; Alternate Number	FJ1247NX
1995	6 Cyl. 7.6L; DT466 Eng.; 195-230 HP; Exhaust stock and reorder	FJ1248
1995	6 Cyl. 7.6L; DT466 Eng.; 195-230 HP; Exhaust stock and reorder	FJ1248NX
1995	6 Cyl. 7.6L; DT466 Eng.; 175-190 HP; Exhaust stock and reorder	FJ1249
1995	6 Cyl. 7.6L; DT466 Eng.; 175-190 HP; Exhaust stock and reorder	FJ1249NX
1995	6 Cyl. 7.6L; DT466 Eng.; 230-250 HP; Exhaust stock and reorder	FJ1250
1995	6 Cyl. 7.6L; DT466 Eng.; 230-250 HP; Exhaust stock and reorder	FJ1250NX
1995	6 Cyl. 7.6L; DT466 Eng.; 230-250 HP; Alternate Number	FJ1301NX
1995	6 Cyl. 7.6L; DT466 Eng.; 175-190 HP	FJ1302NX
1995	6 Cyl. 7.6L; DT466 Eng.; 195-230 HP; Alternate Number	FJ1303NX
1995	6 Cyl. 8.7L	FJ1304NX
1995-1994	8 Cyl. 7.3L; T444E Eng.; Exhaust stock and reorder; High Output	FJ1252
1995-1994	8 Cyl. 7.3L; T444E Eng.; Exhaust stock and reorder; High Output	FJ1252NX
1995-1994	8 Cyl. 7.3L; T444E Eng.; Alternate Number; High Output	FJ1300NX
1995-1994	8 Cyl. 7.3L; T444E Eng.; Exc. High Output	FJ595NX
7300		
2006		FJ1257NX
2005		FJ1242NX
2004	210-225 HP	FJ1240NX
2004	245-285 HP	FJ1242NX
2003-2002	6 Cyl. 7.6L; DT466 Eng.; Exhaust stock and reorder	FJ1254
2003-2002	6 Cyl. 7.6L; DT466 Eng.; Exhaust stock and reorder	FJ1254NX
2003-2002	6 Cyl. 7.6L; DT466 Eng.; Alternate Number	FJ1307NX
7400		
2016	6 Cyl. 9.3L; N9 Eng.	FJ1291NX
2015	6 Cyl. 9.3L; N9 Eng.	FJ1278NX
2007	6 Cyl. 7.6L; DT466 Eng.	FJ1243NX
2007	6 Cyl. 9.3L; DT570 Eng.	FJ1244NX
2006	6 Cyl. 7.6L; DT466 Eng.	FJ1257NX
2006	6 Cyl. 9.3L; DT570 Eng.	FJ1258NX
2005	6 Cyl. 9.3L; DT570 Eng.	FJ1241NX
2005	6 Cyl. 7.6L; DT466 Eng.	FJ1242NX

		Part No.
Fuel Injector - Diesel - New		
7400		
2005-2002	6 Cyl. 8.7L; Exhaust stock and reorder	FJ1245
2005-2002	6 Cyl. 8.7L; Exhaust stock and reorder	FJ1245NX
2005-2002	6 Cyl. 8.7L; Alternate Number	FJ1309NX
2004	6 Cyl. 7.6L; DT466 Eng.; 210-225 HP	FJ1240NX
2004	6 Cyl. 7.6L; DT466 Eng.; 245-285 HP	FJ1242NX
2003-2002	6 Cyl. 7.6L; DT466 Eng.; Exhaust stock and reorder	FJ1254
2003-2002	6 Cyl. 7.6L; DT466 Eng.; Exhaust stock and reorder	FJ1254NX
2003-2002	6 Cyl. 7.6L; DT466 Eng.; Alternate Number	FJ1307NX
7500		
2016-2015	6 Cyl. 9.3L	FJ1291NX
2007		FJ1244NX
2006	6 Cyl. 9.3L; HT570 Eng.	FJ1256NX
2005		FJ1239NX
2004	6 Cyl. 9.3L; HT570 Eng.	FJ1239NX
2004	6 Cyl. 8.7L; HT530 Eng.; Exhaust stock and reorder	FJ1245
2004	6 Cyl. 8.7L; HT530 Eng.; Exhaust stock and reorder	FJ1245NX
2004	6 Cyl. 8.7L; HT530 Eng.; Alternate Number	FJ1309NX
2003-2002	6 Cyl. 8.7L; Exhaust stock and reorder	FJ1245
2003-2002	6 Cyl. 8.7L; Exhaust stock and reorder	FJ1245NX
2003-2002	6 Cyl. 8.7L; Alternate Number	FJ1309NX
2002	6 Cyl. 7.6L; DT466 Eng.; Exhaust stock and reorder	FJ1254
2002	6 Cyl. 7.6L; DT466 Eng.; Exhaust stock and reorder	FJ1254NX
2002	6 Cyl. 7.6L; DT466 Eng.; Alternate Number	FJ1307NX
7600		
2007	6 Cyl. 9.3L; DT570 Eng.	FJ1244NX
7700		
2007	6 Cyl. 9.3L	FJ1244NX
8100		
2002-2000	6 Cyl. 8.7L; Exhaust stock and reorder	FJ1245
2002-2000	6 Cyl. 8.7L; Exhaust stock and reorder	FJ1245NX
2002-2000	6 Cyl. 7.6L; DT466 Eng.; Exhaust stock and reorder	FJ1254
2002-2000	6 Cyl. 7.6L; DT466 Eng.; Exhaust stock and reorder	FJ1254NX
2002-2000	6 Cyl. 7.6L; DT466 Eng.; Alternate Number	FJ1307NX
2002-2000	6 Cyl. 8.7L; Alternate Number	FJ1309NX
1999	6 Cyl. 8.7L; Exhaust stock and reorder; To Engine No. 1134350	FJ1251
1999	6 Cyl. 8.7L; Exhaust stock and reorder; To Engine No. 1134350	FJ1251NX
1999	6 Cyl. 7.6L; DT466 Eng.; 175-190 HP; Exhaust stock and reorder; To Engine No. 1194038	FJ1253
1999	6 Cyl. 7.6L; DT466 Eng.; 175-190 HP; Exhaust stock and reorder; To Engine No. 1194038	FJ1253NX
1999	6 Cyl. 7.6L; DT466 Eng.; 175-250 HP; Exhaust stock and reorder; From Engine No. 1125228	FJ1254
1999	6 Cyl. 7.6L; DT466 Eng.; 175-250 HP; Exhaust stock and reorder; From Engine No. 1125228	FJ1254NX
1999	6 Cyl. 7.6L; DT466 Eng.; 230-250 HP; Exhaust stock and reorder; To Engine No. 1125227	FJ1255
1999	6 Cyl. 8.7L; Exhaust stock and reorder; From Engine No. 1134351	FJ1255

Injectors

		Part No.
Fuel Injector - Diesel - New		
8200		
1996	6 Cyl. 7.6L; DT466 Eng.; 195-230 HP; Exhaust stock and reorder	FJ1248NX
1996	6 Cyl. 7.6L; DT466 Eng.; 175-190 HP; Exhaust stock and reorder	FJ1249
1996	6 Cyl. 7.6L; DT466 Eng.; 175-190 HP; Exhaust stock and reorder	FJ1249NX
1996	6 Cyl. 7.6L; DT466 Eng.; 230-250 HP; Exhaust stock and reorder	FJ1250
1996	6 Cyl. 7.6L; DT466 Eng.; 230-250 HP; Exhaust stock and reorder	FJ1250NX
1996	6 Cyl. 7.6L; DT466 Eng.; 230-250 HP; Alternate Number	FJ1301NX
1996	6 Cyl. 7.6L; DT466 Eng.; 175-190 HP	FJ1302NX
1996	6 Cyl. 7.6L; DT466 Eng.; 195-230 HP; Alternate Number	FJ1303NX
8500		
2007		FJ1244NX
2006		FJ1258NX
2005-2004	6 Cyl. 9.3L; HT570 Eng.	FJ1239NX
2005-2002	6 Cyl. 8.7L; Exhaust stock and reorder	FJ1245
2005-2002	6 Cyl. 8.7L; Exhaust stock and reorder	FJ1245NX
2005-2002	6 Cyl. 8.7L; Alternate Number	FJ1309NX
2002	6 Cyl. 7.6L; DT466 Eng.; Exhaust stock and reorder	FJ1254
2002	6 Cyl. 7.6L; DT466 Eng.; Exhaust stock and reorder	FJ1254NX
2002	6 Cyl. 7.6L; DT466 Eng.; Alternate Number	FJ1307NX
8500 TranStar		
2009-2008	6 Cyl. 9.3L; DT570 Eng.	FJ1244NX
8600 SBA		
2007	6 Cyl. 9.3L; HT570 Eng.	FJ1244NX
2006	6 Cyl. 9.3L; HT570 Eng.	FJ1256NX
2005-2004	6 Cyl. 9.3L; HT570 Eng.	FJ1239NX
CF500		
2010-2005		FJ928NX
CF600		
2010-2005		FJ928NX
CXT		
2008-2007	6 Cyl. 7.6L; DT466 Eng.	FJ1243NX
2008-2007	6 Cyl. 9.3L; DT570 Eng.	FJ1244NX
2008-2006	8 Cyl. 6.0L; VT365 Eng.	FJ928NX
2006	6 Cyl. 7.6L; DT466 Eng.	FJ1257NX
2006	6 Cyl. 9.3L; DT570 Eng.	FJ1258NX
2005		FJ1242NX
Durastar		
2013	6 Cyl. 7.6L; DT466 Eng.	FJ1243NX
Genesis RE		
2002-2001	6 Cyl. 8.7L; Exhaust stock and reorder	FJ1245
2002-2001	6 Cyl. 8.7L; Exhaust stock and reorder	FJ1245NX
2002-2001	6 Cyl. 8.7L; Alternate Number	FJ1309NX
2002-2000	6 Cyl. 7.6L; DT466 Eng.	FJ1262NX
2002-2000	8 Cyl. 7.3L; T444E Eng.; Cyl. 1 to 7	FJ738NX
2002-2000	8 Cyl. 7.3L; T444E Eng.; Cyl. 8	FJ926NX
1999	6 Cyl. 8.7L; DT530 Eng.; Exhaust stock and reorder; To Engine No. 1134350	FJ1251
1999	6 Cyl. 8.7L; DT530 Eng.; Exhaust stock and reorder; To Engine No. 1134350	FJ1251NX
1999	6 Cyl. 7.6L; DT466 Eng.; 175-190 HP; Exhaust stock and reorder; To Engine No. 1194038	FJ1253
1999	6 Cyl. 7.6L; DT466 Eng.; 175-190 HP; Exhaust stock and reorder; To Engine No. 1194038	FJ1253NX

		Part No.
Fuel Injector - Diesel - New		
Genesis RE		
1999	6 Cyl. 7.6L; DT466 Eng.; 175-250 HP; Exhaust stock and reorder; From Engine No. 1125228	FJ1254
1999	6 Cyl. 7.6L; DT466 Eng.; 175-250 HP; Exhaust stock and reorder; From Engine No. 1125228	FJ1254NX
1999	6 Cyl. 7.6L; DT466 Eng.; 230-250 HP; Exhaust stock and reorder; To Engine No. 1125227	FJ1255
1999	6 Cyl. 8.7L; DT530 Eng.; Exhaust stock and reorder; From Engine No. 1133755	FJ1255
1999	6 Cyl. 7.6L; DT466 Eng.; 230-250 HP; Exhaust stock and reorder; To Engine No. 1125227	FJ1255NX
1999	6 Cyl. 8.7L; DT530 Eng.; Exhaust stock and reorder; From Engine No. 1133755	FJ1255NX
1999	6 Cyl. 7.6L; DT466 Eng.; 175-190 HP; To Engine No. 1194038	FJ1305NX
1999	6 Cyl. 8.7L; DT530 Eng.; Alternate Number; To Engine No. 1134350	FJ1306NX
1999	6 Cyl. 7.6L; DT466 Eng.; 175-250 HP; Alternate Number; From Engine No. 1125228	FJ1307NX
1999	6 Cyl. 7.6L; DT466 Eng.; 230-250 HP; To Engine No. 1125227	FJ1308NX
1999	6 Cyl. 8.7L; DT530 Eng.; From Engine No. 1133755	FJ1308NX
1999	8 Cyl. 7.3L; T444E Eng.; To Engine No. 843989	FJ596NX
1999	8 Cyl. 7.3L; T444E Eng.; From Engine No. 843,990; Cyl. 1 to 7	FJ738NX
1999	8 Cyl. 7.3L; T444E Eng.; From Engine No. 843,990; Cyl. 8	FJ926NX
1998	6 Cyl. 8.7L; DT530 Eng.; Exhaust stock and reorder	FJ1251
1998	6 Cyl. 8.7L; DT530 Eng.; Exhaust stock and reorder	FJ1251NX
1998	6 Cyl. 7.6L; DT466 Eng.; 175-190 HP; Exhaust stock and reorder	FJ1253
1998	6 Cyl. 7.6L; DT466 Eng.; 175-190 HP; Exhaust stock and reorder	FJ1253NX
1998	6 Cyl. 7.6L; DT466 Eng.; 230-250 HP; Exhaust stock and reorder	FJ1255
1998	6 Cyl. 7.6L; DT466 Eng.; 230-250 HP; Exhaust stock and reorder	FJ1255NX
1998	6 Cyl. 7.6L; DT466 Eng.; 175-190 HP	FJ1305NX
1998	6 Cyl. 8.7L; DT530 Eng.; Alternate Number	FJ1306NX
1998	6 Cyl. 7.6L; DT466 Eng.; 230-250 HP	FJ1308NX
1998-1997	8 Cyl. 7.3L; T444E Eng.	FJ596NX
1997	6 Cyl. 8.7L; DT530 Eng.; Exhaust stock and reorder	FJ1247
1997	6 Cyl. 8.7L; DT530 Eng.; Alternate Number	FJ1247NX
1997	6 Cyl. 8.7L; DT530 Eng.	FJ1304NX
1996	8 Cyl. 7.3L; T444E Eng.; Exhaust stock and reorder; High Output	FJ1252
1996	8 Cyl. 7.3L; T444E Eng.; Exhaust stock and reorder; High Output	FJ1252NX
1996	8 Cyl. 7.3L; T444E Eng.; Alternate Number; High Output	FJ1300NX
1996	8 Cyl. 7.3L; T444E Eng.; Exc. High Output	FJ595NX
MXT		
2009-2007		FJ928NX
RXT		
2008-2006	8 Cyl. 6.0L; VT365 Eng.	FJ928NX
2007-2006	6 Cyl. 9.3L; DT570 Eng.	FJ1258NX

Injectors

		Part No.
Fuel Injector - Diesel - New		
RXT		
2005		FJ928NX
TerraStar		
2013-2011	8 Cyl. 6.4L; MaxxFORCE 7 Eng.	FJ1259NX
2010	8 Cyl. 6.4L; MaxxFORCE 7 Eng.; From Engine No. 5300002	FJ1259NX
2010	8 Cyl. 6.4L; MaxxFORCE 7 Eng.; To Engine No. 5300001	FJ960NX
Fuel Injector - Diesel - Remfd		
1552SC		
1998-1997	8 Cyl. 7.3L; T444E Eng.	FJ596
1996	8 Cyl. 7.3L; T444E Eng.; High Output	FJ1300
1996	8 Cyl. 7.3L; T444E Eng.; Exc. High Output	FJ595
1652SC		
2012-2006	Injector Only	FJ928
2012-2006	Complete Kit	FJ9288PCK
2005-2004	8 Cyl. 6.0L; VT365 Eng.; Injector Only	FJ928
2005-2004	8 Cyl. 6.0L; VT365 Eng.; Complete Kit	FJ9288PCK
2005-2000	8 Cyl. 7.3L; T444E Eng.; Cyl. 1 to 7	FJ738
2005-2000	8 Cyl. 7.3L; T444E Eng.; Complete Kit; Cyl. 1 to 8	FJ7388PCK
2005-2000	8 Cyl. 7.3L; T444E Eng.; Cyl. 8	FJ926
1999	8 Cyl. 7.3L; T444E Eng.; To Engine No. 843989	FJ596
1999	8 Cyl. 7.3L; T444E Eng.; From Engine No. 843,990; Cyl. 1 to 7	FJ738
1999	8 Cyl. 7.3L; T444E Eng.; Complete Kit; From Engine No. 843,990; Cyl. 1 to 8	FJ7388PCK
1999	8 Cyl. 7.3L; T444E Eng.; From Engine No. 843,990; Cyl. 8	FJ926
1998-1997	8 Cyl. 7.3L; T444E Eng.	FJ596
1996-1994	8 Cyl. 7.3L; T444E Eng.; High Output	FJ1300
1996-1994	8 Cyl. 7.3L; T444E Eng.; Exc. High Output	FJ595
1652UPS		
1997	8 Cyl. 7.3L; T444E Eng.	FJ596
1996-1995	8 Cyl. 7.3L; T444E Eng.; High Output	FJ1300
1996-1995	8 Cyl. 7.3L; T444E Eng.; Exc. High Output	FJ595
2554		
2002-2000	6 Cyl. 7.6L; DT466 Eng.	FJ1307
2002-2000	6 Cyl. 8.7L	FJ1309
1999	6 Cyl. 7.6L; DT466 Eng.; 175-190 HP; To Engine No. 1194038	FJ1305
1999	6 Cyl. 8.7L; To Engine No. 1134350	FJ1306
1999	6 Cyl. 7.6L; DT466 Eng.; 175-250 HP; From Engine No. 1125228	FJ1307
1999	6 Cyl. 7.6L; DT466 Eng.; 230-250 HP; To Engine No. 1125227	FJ1308
1999	6 Cyl. 8.7L; From Engine No. 1134351	FJ1308
1998	6 Cyl. 7.6L; DT466 Eng.; 175-190 HP	FJ1305
1998	6 Cyl. 8.7L	FJ1306
1998	6 Cyl. 7.6L; DT466 Eng.; 230-250 HP	FJ1308
1997	6 Cyl. 7.6L; DT466 Eng.; 230-250 HP; To Engine No. 1084867	FJ1301
1997	6 Cyl. 7.6L; DT466 Eng.; 175-190 HP; To Engine No. 1028710	FJ1302
1997	6 Cyl. 7.6L; DT466 Eng.; 195-230 HP; To Engine No. 1028710	FJ1303
1997	6 Cyl. 7.6L; DT466 Eng.; 175-190 HP; From Engine No. 1028711	FJ1305
1997	6 Cyl. 7.6L; DT466 Eng.; 230-250 HP; From Engine No. 1084868	FJ1308
1997-1995	6 Cyl. 8.7L	FJ1304
1996-1995	6 Cyl. 7.6L; DT466 Eng.; 230-250 HP	FJ1301
1996-1995	6 Cyl. 7.6L; DT466 Eng.; 175-190 HP	FJ1302
1996-1995	6 Cyl. 7.6L; DT466 Eng.; 195-230 HP	FJ1303

		Part No.
Fuel Injector - Diesel - Remfd		
2554		
1996-1995	6 Cyl. 7.6L; DT466 Eng.; 195-230 HP	FJ1303
2574		
2003-2001	6 Cyl. 7.6L; DT466 Eng.	FJ1307
2003-2000	6 Cyl. 8.7L	FJ1309
1999	6 Cyl. 8.7L; To Engine No. 1134350	FJ1306
1999	6 Cyl. 8.7L; From Engine No. 1134351	FJ1308
1998	6 Cyl. 8.7L	FJ1306
1997-1995	6 Cyl. 8.7L	FJ1304
2654		
2002-2000	6 Cyl. 7.6L; DT466 Eng.	FJ1307
2002-2000	6 Cyl. 8.7L	FJ1309
1999	6 Cyl. 7.6L; DT466 Eng.; 175-190 HP; To Engine No. 1194038	FJ1305
1999	6 Cyl. 8.7L; To Engine No. 1134350	FJ1306
1999	6 Cyl. 7.6L; DT466 Eng.; 175-250 HP; From Engine No. 1125228	FJ1307
1999	6 Cyl. 7.6L; DT466 Eng.; 230-250 HP; To Engine No. 1125227	FJ1308
1999	6 Cyl. 8.7L; From Engine No. 1134351	FJ1308
1998	6 Cyl. 7.6L; DT466 Eng.; 175-190 HP	FJ1305
1998	6 Cyl. 8.7L	FJ1306
1998	6 Cyl. 7.6L; DT466 Eng.; 230-250 HP	FJ1308
1997	6 Cyl. 7.6L; DT466 Eng.; 230-250 HP; To Engine No. 1084867	FJ1301
1997	6 Cyl. 7.6L; DT466 Eng.; 175-190 HP; To Engine No. 1028710	FJ1302
1997	6 Cyl. 7.6L; DT466 Eng.; 195-230 HP; To Engine No. 1028710	FJ1303
1997	6 Cyl. 7.6L; DT466 Eng.; 175-190 HP; From Engine No. 1028711	FJ1305
1997	6 Cyl. 7.6L; DT466 Eng.; 230-250 HP; From Engine No. 1084868	FJ1308
1997-1995	6 Cyl. 8.7L	FJ1304
1996-1995	6 Cyl. 7.6L; DT466 Eng.; 230-250 HP	FJ1301
1996-1995	6 Cyl. 7.6L; DT466 Eng.; 175-190 HP	FJ1302
1996-1995	6 Cyl. 7.6L; DT466 Eng.; 195-230 HP	FJ1303
2674		
2003-2001	6 Cyl. 7.6L; DT466 Eng.	FJ1307
2003-2000	6 Cyl. 8.7L	FJ1309
1999	6 Cyl. 8.7L; To Engine No. 1134350	FJ1306
1999	6 Cyl. 8.7L; From Engine No. 1134351	FJ1308
1998	6 Cyl. 8.7L	FJ1306
1997-1995	6 Cyl. 8.7L	FJ1304
3000		
2002-2000	6 Cyl. 7.6L; DT466 Eng.	FJ1307
2000	8 Cyl. 7.3L; T444E Eng.; Cyl. 1 to 7	FJ738
2000	8 Cyl. 7.3L; T444E Eng.; Complete Kit; Cyl. 1 to 8	FJ7388PCK
2000	8 Cyl. 7.3L; T444E Eng.; Cyl. 8	FJ926
1999	6 Cyl. 7.6L; DT466 Eng.; 175-190 HP; To Engine No. 1194038	FJ1305
1999	6 Cyl. 7.6L; DT466 Eng.; 175-250 HP; From Engine No. 1125228	FJ1307
1999	6 Cyl. 7.6L; DT466 Eng.; 230-250 HP; To Engine No. 1125227	FJ1308
1999	8 Cyl. 7.3L; T444E Eng.; To Engine No. 843989	FJ596
1999	8 Cyl. 7.3L; T444E Eng.; From Engine No. 843,990; Cyl. 1 to 7	FJ738
1999	8 Cyl. 7.3L; T444E Eng.; Complete Kit; From Engine No. 843,990; Cyl. 1 to 8	FJ7388PCK
1999	8 Cyl. 7.3L; T444E Eng.; From Engine No. 843,990; Cyl. 8	FJ926
1998	6 Cyl. 7.6L; DT466 Eng.; 175-190 HP	FJ1305
1998	6 Cyl. 7.6L; DT466 Eng.; 230-250 HP	FJ1308
1998-1997	8 Cyl. 7.3L; T444E Eng.	FJ596

Injectors

		Part No.
Fuel Injector - Diesel - Remfd		
3000		
1997	6 Cyl. 7.6L; DT466 Eng.; 230-250 HP; To Engine No. 1084867	FJ1301
1997	6 Cyl. 7.6L; DT466 Eng.; 175-190 HP; To Engine No. 1028710	FJ1302
1997	6 Cyl. 7.6L; DT466 Eng.; 195-230 HP; To Engine No. 1028710	FJ1303
1997	6 Cyl. 7.6L; DT466 Eng.; 175-190 HP; From Engine No. 1028711	FJ1305
1997	6 Cyl. 7.6L; DT466 Eng.; 230-250 HP; From Engine No. 1084868	FJ1308
1996	6 Cyl. 7.6L; DT466 Eng.; 230-250 HP	FJ1301
1996	6 Cyl. 7.6L; DT466 Eng.; 175-190 HP	FJ1302
1996	6 Cyl. 7.6L; DT466 Eng.; 195-230 HP	FJ1303
3000FE		
1999	6 Cyl. 7.6L; DT466 Eng.; 175-190 HP; To Engine No. 1194038	FJ1305
1999	6 Cyl. 7.6L; DT466 Eng.; 175-250 HP; From Engine No. 1125228	FJ1307
1999	6 Cyl. 7.6L; DT466 Eng.; 230-250 HP; To Engine No. 1125227	FJ1308
1998	6 Cyl. 7.6L; DT466 Eng.; 175-190 HP	FJ1305
1998	6 Cyl. 7.6L; DT466 Eng.; 230-250 HP	FJ1308
1997	6 Cyl. 7.6L; DT466 Eng.; 230-250 HP; To Engine No. 1084867	FJ1301
1997	6 Cyl. 7.6L; DT466 Eng.; 175-190 HP; To Engine No. 1028710	FJ1302
1997	6 Cyl. 7.6L; DT466 Eng.; 195-230 HP; To Engine No. 1028710	FJ1303
1997	6 Cyl. 7.6L; DT466 Eng.; 175-190 HP; From Engine No. 1028711	FJ1305
1997	6 Cyl. 7.6L; DT466 Eng.; 230-250 HP; From Engine No. 1084868	FJ1308
3000IC		
2002-2000	6 Cyl. 7.6L; DT466 Eng.	FJ1307
2002-2000	8 Cyl. 7.3L; T444E Eng.; Cyl. 1 to 7	FJ738
2002-2000	8 Cyl. 7.3L; T444E Eng.; Complete Kit; Cyl. 1 to 8	FJ7388PCK
2002-2000	8 Cyl. 7.3L; T444E Eng.; Cyl. 8	FJ926
3000RE		
2005		FJ1242
2002	6 Cyl. 8.7L	FJ1309
3200		
2011-2008	8 Cyl.; Injector Only	FJ928
2011-2008	8 Cyl.; Complete Kit	FJ9288PCK
2007-2004	8 Cyl. 6.0L; VT365 Eng.; Injector Only	FJ928
2007-2004	8 Cyl. 6.0L; VT365 Eng.; Complete Kit	FJ9288PCK
2006	6 Cyl. 7.6L; DT466 Eng.	FJ1257
2005	6 Cyl. 7.6L; DT466 Eng.	FJ1242
2004	6 Cyl. 7.6L; DT466 Eng.; 210-225 HP	FJ1240
2004	6 Cyl. 7.6L; DT466 Eng.; 245-285 HP	FJ1242
2004-2003	6 Cyl. 8.7L	FJ1309
2003-2002	6 Cyl. 7.6L; DT466 Eng.	FJ1307
2003-2002	8 Cyl. 6.0L; VT365 Eng.; Injector Only	FJ927
2003-2002	8 Cyl. 6.0L; VT365 Eng.; Complete Kit	FJ9278PCK
3300		
2011-2005	8 Cyl. 6.0L; VT365 Eng.; Injector Only	FJ928
2011-2005	8 Cyl. 6.0L; VT365 Eng.; Complete Kit	FJ9288PCK
3400		
2002-2000	8 Cyl. 7.3L; T444E Eng.; Cyl. 1 to 7	FJ738
2002-2000	8 Cyl. 7.3L; T444E Eng.; Complete Kit; Cyl. 1 to 8	FJ7388PCK
2002-2000	8 Cyl. 7.3L; T444E Eng.; Cyl. 8	FJ926
1999	8 Cyl. 7.3L; T444E Eng.; To Engine No. 843989	FJ596
1999	8 Cyl. 7.3L; T444E Eng.; From Engine No. 843,990; Cyl. 1 to 7	FJ738

		Part No.
Fuel Injector - Diesel - Remfd		
3400		
1999	8 Cyl. 7.3L; T444E Eng.; Complete Kit; From Engine No. 843,990; Cyl. 1 to 8	FJ7388PCK
1999	8 Cyl. 7.3L; T444E Eng.; From Engine No. 843,990; Cyl. 8	FJ926
1998-1997	8 Cyl. 7.3L; T444E Eng.	FJ596
1996	8 Cyl. 7.3L; T444E Eng.; High Output	FJ1300
1996	8 Cyl. 7.3L; T444E Eng.; Exc. High Output	FJ595
3600		
2001	6 Cyl. 7.6L; DT466 Eng.	FJ1307
1999	6 Cyl. 7.6L; DT466 Eng.; 175-190 HP; To Engine No. 1194038	FJ1305
1999	6 Cyl. 7.6L; DT466 Eng.; 175-250 HP; From Engine No. 1125228	FJ1307
1999	6 Cyl. 7.6L; DT466 Eng.; 230-250 HP; To Engine No. 1125227	FJ1308
1999	8 Cyl. 7.3L; T444E Eng.; To Engine No. 843989	FJ596
1999	8 Cyl. 7.3L; T444E Eng.; From Engine No. 843,990; Cyl. 1 to 7	FJ738
1999	8 Cyl. 7.3L; T444E Eng.; Complete Kit; From Engine No. 843,990; Cyl. 1 to 8	FJ7388PCK
1999	8 Cyl. 7.3L; T444E Eng.; From Engine No. 843,990; Cyl. 8	FJ926
1998	6 Cyl. 7.6L; DT466 Eng.; 175-190 HP	FJ1305
1998	6 Cyl. 7.6L; DT466 Eng.; 230-250 HP	FJ1308
1998-1997	8 Cyl. 7.3L; T444E Eng.	FJ596
1997	6 Cyl. 7.6L; DT466 Eng.; 230-250 HP; To Engine No. 1084867	FJ1301
1997	6 Cyl. 7.6L; DT466 Eng.; 175-190 HP; To Engine No. 1028710	FJ1302
1997	6 Cyl. 7.6L; DT466 Eng.; 195-230 HP; To Engine No. 1028710	FJ1303
1997	6 Cyl. 7.6L; DT466 Eng.; 175-190 HP; From Engine No. 1028711	FJ1305
1997	6 Cyl. 7.6L; DT466 Eng.; 230-250 HP; From Engine No. 1084868	FJ1308
1996-1995	6 Cyl. 7.6L; DT466 Eng.; 230-250 HP	FJ1301
1996-1995	6 Cyl. 7.6L; DT466 Eng.; 175-190 HP	FJ1302
1996-1995	6 Cyl. 7.6L; DT466 Eng.; 195-230 HP	FJ1303
1996-1994	8 Cyl. 7.3L; T444E Eng.; High Output	FJ1300
1996-1994	8 Cyl. 7.3L; T444E Eng.; Exc. High Output	FJ595
3700		
1994	8 Cyl. 7.3L; T444E Eng.; High Output	FJ1300
1994	8 Cyl. 7.3L; T444E Eng.; Exc. High Output	FJ595
3800		
2004	6 Cyl. 7.6L; DT466 Eng.; 210-225 HP	FJ1240
2004	6 Cyl. 7.6L; DT466 Eng.; 245-285 HP	FJ1242
2004-2000	8 Cyl. 7.3L; T444E Eng.; Cyl. 1 to 7	FJ738
2004-2000	8 Cyl. 7.3L; T444E Eng.; Complete Kit; Cyl. 1 to 8	FJ7388PCK
2004-2000	8 Cyl. 7.3L; T444E Eng.; Cyl. 8	FJ926
2003-2000	6 Cyl. 7.6L; DT466 Eng.	FJ1307
1999	6 Cyl. 7.6L; DT466 Eng.; 175-190 HP; To Engine No. 1194038	FJ1305
1999	6 Cyl. 7.6L; DT466 Eng.; 175-250 HP; From Engine No. 1125228	FJ1307
1999	6 Cyl. 7.6L; DT466 Eng.; 230-250 HP; To Engine No. 1125227	FJ1308
1999	8 Cyl. 7.3L; T444E Eng.; To Engine No. 843989	FJ596
1999	8 Cyl. 7.3L; T444E Eng.; From Engine No. 843,990; Cyl. 1 to 7	FJ738
1999	8 Cyl. 7.3L; T444E Eng.; Complete Kit; From Engine No. 843,990; Cyl. 1 to 8	FJ7388PCK

International

Injectors

		Part No.
Fuel Injector - Diesel - Remfd		
3800		
1999	8 Cyl. 7.3L; T444E Eng.; From Engine No. 843,990; Cyl. 8	FJ926
1998	6 Cyl. 7.6L; DT466 Eng.; 175-190 HP	FJ1305
1998	6 Cyl. 7.6L; DT466 Eng.; 230-250 HP	FJ1308
1998-1997	8 Cyl. 7.3L; T444E Eng.	FJ596
1997	6 Cyl. 7.6L; DT466 Eng.; 230-250 HP; To Engine No. 1084867	FJ1301
1997	6 Cyl. 7.6L; DT466 Eng.; 175-190 HP; To Engine No. 1028710	FJ1302
1997	6 Cyl. 7.6L; DT466 Eng.; 195-230 HP; To Engine No. 1028710	FJ1303
1997	6 Cyl. 7.6L; DT466 Eng.; 175-190 HP; From Engine No. 1028711	FJ1305
1997	6 Cyl. 7.6L; DT466 Eng.; 230-250 HP; From Engine No. 1084868	FJ1308
1996-1995	6 Cyl. 7.6L; DT466 Eng.; 230-250 HP	FJ1301
1996-1995	6 Cyl. 7.6L; DT466 Eng.; 175-190 HP	FJ1302
1996-1995	6 Cyl. 7.6L; DT466 Eng.; 195-230 HP	FJ1303
1996-1994	8 Cyl. 7.3L; T444E Eng.; High Output	FJ1300
1996-1994	8 Cyl. 7.3L; T444E Eng.; Exc. High Output	FJ595
3900FC		
1996	6 Cyl. 7.6L; DT466 Eng.; 230-250 HP	FJ1301
1996	6 Cyl. 7.6L; DT466 Eng.; 175-190 HP	FJ1302
1996	6 Cyl. 7.6L; DT466 Eng.; 195-230 HP	FJ1303
4100		
2012	Injector Only	FJ928
2012	Complete Kit	FJ9288PCK
2011	8 Cyl. 6.4L; MaxxForce 7 Eng.	FJ1259
2011-2008	8 Cyl. 6.0L; VT365 Eng.; Injector Only	FJ928
2011-2008	8 Cyl. 6.0L; VT365 Eng.; Complete Kit	FJ9288PCK
2010	8 Cyl. 6.4L; MaxxForce 7 Eng.; From Engine No. 5300002	FJ1259
2010	8 Cyl. 6.4L; MaxxForce 7 Eng.; To Engine No. 5300001	FJ960
2009-2008	8 Cyl. 6.4L; MaxxForce 7 Eng.	FJ960
2007-2006	Injector Only	FJ928
2007-2006	Complete Kit	FJ9288PCK
4100 SBA		
2008	8 Cyl. 6.0L; VT365 Eng.; Injector Only	FJ928
2008	8 Cyl. 6.0L; VT365 Eng.; Complete Kit	FJ9288PCK
2007-2006	Injector Only	FJ928
2007-2006	Complete Kit	FJ9288PCK
4200		
2008-2004	Injector Only	FJ928
2008-2004	Complete Kit	FJ9288PCK
2003-2002	Injector Only	FJ927
2003-2002	Complete Kit	FJ9278PCK
4200LP		
2007-2004	Injector Only	FJ928
2007-2004	Complete Kit	FJ9288PCK
2003	Injector Only	FJ927
2003	Complete Kit	FJ9278PCK
4300		
2015-2011	8 Cyl. 6.4L; MaxxForce 7 Eng.	FJ1259
2012-2011	6 Cyl. 7.6L; MaxxForce DT Eng.; 215-300 HP	FJ1277
2012-2011	6 Cyl. 7.6L; MaxxForce DT Eng.; 210-225 HP	FJ1279
2010	8 Cyl. 6.4L; MaxxForce 7 Eng.; From Engine No. 5300002	FJ1259
2010	8 Cyl. 6.4L; MaxxForce 7 Eng.; To Engine No. 5300001	FJ960
2010-2008	6 Cyl. 7.6L; MaxxForce DT Eng.	FJ1243
2009-2008	8 Cyl. 6.4L; MaxxForce 7 Eng.	FJ960

		Part No.
Fuel Injector - Diesel - Remfd		
4300		
2007	6 Cyl. 7.6L; DT466 Eng.	FJ1243
2006	6 Cyl. 7.6L; DT466 Eng.	FJ1257
2005	6 Cyl. 7.6L; DT466 Eng.	FJ1242
2004	6 Cyl. 7.6L; DT466 Eng.; 210-225 HP	FJ1240
2004	6 Cyl. 7.6L; DT466 Eng.; 245-285 HP	FJ1242
2003	8 Cyl. 6.0L; VT365 Eng.; Injector Only	FJ927
2003	8 Cyl. 6.0L; VT365 Eng.; Complete Kit	FJ9278PCK
2003-2002	6 Cyl. 7.6L; DT466 Eng.	FJ1307
4300LP		
2015-2011	8 Cyl. 6.4L; MaxxForce 7 Eng.	FJ1259
2012-2011	6 Cyl. 7.6L; MaxxForce DT Eng.; 215-300 HP	FJ1277
2012-2011	6 Cyl. 7.6L; MaxxForce DT Eng.; 210-225 HP	FJ1279
2010	8 Cyl. 6.4L; MaxxForce 7 Eng.; From Engine No. 5300002	FJ1259
2010	8 Cyl. 6.4L; MaxxForce 7 Eng.; To Engine No. 5300001	FJ960
2010-2009	6 Cyl. 7.6L; MaxxForce DT Eng.	FJ1243
2009-2008	8 Cyl. 6.4L; MaxxForce 7 Eng.	FJ960
2008	6 Cyl. 7.6L; DT466 Eng.	FJ1243
2007		FJ1243
2006		FJ1257
2005		FJ1242
2004	210-225 HP	FJ1240
2004	245-285 HP	FJ1242
2003-2002	6 Cyl. 7.6L; DT466 Eng.	FJ1307
4400		
2015	6 Cyl. 9.3L; N9 Eng.	FJ1278
2012-2011	6 Cyl. 7.6L; MaxxForce DT Eng.; 215-300 HP	FJ1277
2012-2011	6 Cyl. 7.6L; MaxxForce DT Eng.; 210-225 HP	FJ1279
2010-2008	6 Cyl. 7.6L; MaxxForce DT Eng.	FJ1243
2008-2007	6 Cyl. 9.3L; DT570 Eng.	FJ1244
2007	6 Cyl. 7.6L; DT466 Eng.	FJ1243
2006	6 Cyl. 7.6L; DT466 Eng.	FJ1257
2006	6 Cyl. 9.3L; DT570 Eng.	FJ1258
2005	6 Cyl. 7.6L; DT466 Eng.	FJ1242
2005-2004	6 Cyl. 9.3L; DT570 Eng.	FJ1241
2005-2002	6 Cyl. 8.7L	FJ1309
2004	6 Cyl. 7.6L; DT466 Eng.; 210-225 HP	FJ1240
2004	6 Cyl. 7.6L; DT466 Eng.; 245-285 HP	FJ1242
2003	8 Cyl. 6.0L; VT365 Eng.; Injector Only	FJ927
2003	8 Cyl. 6.0L; VT365 Eng.; Complete Kit	FJ9278PCK
2003-2002	6 Cyl. 7.6L; DT466 Eng.	FJ1307
4400LP		
2012-2011	6 Cyl. 7.6L; MaxxForce DT Eng.; 215-300 HP	FJ1277
2012-2011	6 Cyl. 7.6L; MaxxForce DT Eng.; 210-225 HP	FJ1279
2010-2008	6 Cyl. 7.6L; MaxxForce DT Eng.	FJ1243
2007	6 Cyl. 7.6L; DT466 Eng.	FJ1243
2007	6 Cyl. 9.3L; DT570 Eng.	FJ1244
2006	6 Cyl. 7.6L; DT466 Eng.	FJ1257
2006	6 Cyl. 9.3L; DT570 Eng.	FJ1258
2005	6 Cyl. 9.3L; DT570 Eng.	FJ1241
2005	6 Cyl. 7.6L; DT466 Eng.	FJ1242
2005-2002	6 Cyl. 8.7L	FJ1309
2004	6 Cyl. 7.6L; DT466 Eng.; 210-225 HP	FJ1240
2004	6 Cyl. 7.6L; DT466 Eng.; 245-285 HP	FJ1242
2003-2002	6 Cyl. 7.6L; DT466 Eng.	FJ1307
4600		
1995-1994	8 Cyl. 7.3L; T444E Eng.; High Output	FJ1300

Injectors

		Part No.
Fuel Injector - Diesel - Remfd		
4600		
1995-1994	8 Cyl. 7.3L; T444E Eng.; Exc. High Output	FJ595
4600LP		
1994	8 Cyl. 7.3L; T444E Eng.; High Output	FJ1300
1994	8 Cyl. 7.3L; T444E Eng.; Exc. High Output	FJ595
4700		
2003-2001	6 Cyl. 7.6L; DT466 Eng.	FJ1307
2003-2000	6 Cyl. 8.7L	FJ1309
2002-2000	8 Cyl. 7.3L; T444E Eng.; Cyl. 1 to 7	FJ738
2002-2000	8 Cyl. 7.3L; T444E Eng.; Complete Kit; Cyl. 1 to 8	FJ7388PCK
2002-2000	8 Cyl. 7.3L; T444E Eng.; Cyl. 8	FJ926
2000	6 Cyl. 7.6L; MaxxFORCE DT Eng.	FJ1307
1999	6 Cyl. 7.6L; DT466 Eng.; 175-190 HP; To Engine No. 1194038	FJ1305
1999	6 Cyl. 8.7L; To Engine No. 1134350	FJ1306
1999	6 Cyl. 7.6L; DT466 Eng.; 175-250 HP; From Engine No. 1125228	FJ1307
1999	6 Cyl. 7.6L; DT466 Eng.; 230-250 HP; To Engine No. 1125227	FJ1308
1999	6 Cyl. 8.7L; From Engine No. 1133755	FJ1308
1999	8 Cyl. 7.3L; T444E Eng.; To Engine No. 843989	FJ596
1999	8 Cyl. 7.3L; T444E Eng.; From Engine No. 843,990; Cyl. 1 to 7	FJ738
1999	8 Cyl. 7.3L; T444E Eng.; Complete Kit; From Engine No. 843,990; Cyl. 1 to 8	FJ7388PCK
1999	8 Cyl. 7.3L; T444E Eng.; From Engine No. 843,990; Cyl. 8	FJ926
1998	6 Cyl. 7.6L; DT466 Eng.; 175-190 HP	FJ1305
1998	6 Cyl. 8.7L	FJ1306
1998	6 Cyl. 7.6L; DT466 Eng.; 230-250 HP	FJ1308
1998-1997	8 Cyl. 7.3L; T444E Eng.	FJ596
1997	6 Cyl. 7.6L; DT466 Eng.; 230-250 HP; To Engine No. 1084867	FJ1301
1997	6 Cyl. 7.6L; DT466 Eng.; 175-190 HP; To Engine No. 1028710	FJ1302
1997	6 Cyl. 7.6L; DT466 Eng.; 195-230 HP; To Engine No. 1028710	FJ1303
1997	6 Cyl. 7.6L; DT466 Eng.; 175-190 HP; From Engine No. 1028711	FJ1305
1997	6 Cyl. 7.6L; DT466 Eng.; 230-250 HP; From Engine No. 1084868	FJ1308
1997-1996	6 Cyl. 8.7L	FJ1304
1996-1995	6 Cyl. 7.6L; DT466 Eng.; 230-250 HP	FJ1301
1996-1995	6 Cyl. 7.6L; DT466 Eng.; 175-190 HP	FJ1302
1996-1995	6 Cyl. 7.6L; DT466 Eng.; 195-230 HP	FJ1303
1996-1994	8 Cyl. 7.3L; T444E Eng.; High Output	FJ1300
1996-1994	8 Cyl. 7.3L; T444E Eng.; Exc. High Output	FJ595
4700LP		
2002-2000	6 Cyl. 7.6L; DT466 Eng.	FJ1307
2002-2000	6 Cyl. 8.7L	FJ1309
2002-2000	8 Cyl. 7.3L; T444E Eng.; Cyl. 1 to 7	FJ738
2002-2000	8 Cyl. 7.3L; T444E Eng.; Complete Kit; Cyl. 1 to 8	FJ7388PCK
2002-2000	8 Cyl. 7.3L; T444E Eng.; Cyl. 8	FJ926
1999	6 Cyl. 7.6L; DT466 Eng.; 175-190 HP; To Engine No. 1194038	FJ1305
1999	6 Cyl. 8.7L; To Engine No. 1134350	FJ1306
1999	6 Cyl. 7.6L; DT466 Eng.; 175-250 HP; From Engine No. 1125228	FJ1307
1999	6 Cyl. 7.6L; DT466 Eng.; 230-250 HP; To Engine No. 1125227	FJ1308
1999	6 Cyl. 8.7L; From Engine No. 1134351	FJ1308

		Part No.
Fuel Injector - Diesel - Remfd		
4700LP		
1999	8 Cyl. 7.3L; T444E Eng.; To Engine No. 843989	FJ596
1999	8 Cyl. 7.3L; T444E Eng.; From Engine No. 843,990; Cyl. 1 to 7	FJ738
1999	8 Cyl. 7.3L; T444E Eng.; Complete Kit; From Engine No. 843,990; Cyl. 1 to 8	FJ7388PCK
1999	8 Cyl. 7.3L; T444E Eng.; From Engine No. 843,990; Cyl. 8	FJ926
1998	6 Cyl. 7.6L; DT466 Eng.; 175-190 HP	FJ1305
1998	6 Cyl. 8.7L	FJ1306
1998	6 Cyl. 7.6L; DT466 Eng.; 230-250 HP	FJ1308
1998-1997	8 Cyl. 7.3L; T444E Eng.	FJ596
1997	6 Cyl. 7.6L; DT466 Eng.; 230-250 HP; To Engine No. 1084867	FJ1301
1997	6 Cyl. 7.6L; DT466 Eng.; 175-190 HP; To Engine No. 1028710	FJ1302
1997	6 Cyl. 7.6L; DT466 Eng.; 195-230 HP; To Engine No. 1028710	FJ1303
1997	6 Cyl. 8.7L	FJ1304
1997	6 Cyl. 7.6L; DT466 Eng.; 175-190 HP; From Engine No. 1028711	FJ1305
1997	6 Cyl. 7.6L; DT466 Eng.; 230-250 HP; From Engine No. 1084868	FJ1308
1996-1995	6 Cyl. 7.6L; DT466 Eng.; 230-250 HP	FJ1301
1996-1995	6 Cyl. 7.6L; DT466 Eng.; 175-190 HP	FJ1302
1996-1995	6 Cyl. 7.6L; DT466 Eng.; 195-230 HP	FJ1303
1996-1994	8 Cyl. 7.3L; T444E Eng.; High Output	FJ1300
1996-1994	8 Cyl. 7.3L; T444E Eng.; Exc. High Output	FJ595
4700LPX		
2002-2000	8 Cyl. 7.3L; T444E Eng.; Cyl. 1 to 7	FJ738
2002-2000	8 Cyl. 7.3L; T444E Eng.; Complete Kit; Cyl. 1 to 8	FJ7388PCK
2002-2000	8 Cyl. 7.3L; T444E Eng.; Cyl. 8	FJ926
1999	8 Cyl. 7.3L; T444E Eng.; To Engine No. 843989	FJ596
1999	8 Cyl. 7.3L; T444E Eng.; From Engine No. 843,990; Cyl. 1 to 7	FJ738
1999	8 Cyl. 7.3L; T444E Eng.; Complete Kit; From Engine No. 843,990; Cyl. 1 to 8	FJ7388PCK
1999	8 Cyl. 7.3L; T444E Eng.; From Engine No. 843,990; Cyl. 8	FJ926
1998-1997	8 Cyl. 7.3L; T444E Eng.	FJ596
1996-1995	8 Cyl. 7.3L; T444E Eng.; High Output	FJ1300
1996-1995	8 Cyl. 7.3L; T444E Eng.; Exc. High Output	FJ595
4800		
2003-2000	6 Cyl. 7.6L; DT466 Eng.	FJ1307
2003-2000	6 Cyl. 8.7L	FJ1309
1999	6 Cyl. 7.6L; DT466 Eng.; 175-190 HP; To Engine No. 1194038	FJ1305
1999	6 Cyl. 8.7L; To Engine No. 1134350	FJ1306
1999	6 Cyl. 7.6L; DT466 Eng.; 175-250 HP; From Engine No. 1125228	FJ1307
1999	6 Cyl. 7.6L; DT466 Eng.; 230-250 HP; To Engine No. 1125227	FJ1308
1999	6 Cyl. 8.7L; From Engine No. 1134351	FJ1308
1998	6 Cyl. 7.6L; DT466 Eng.; 175-190 HP	FJ1305
1998	6 Cyl. 8.7L	FJ1306
1998	6 Cyl. 7.6L; DT466 Eng.; 230-250 HP	FJ1308
1997	6 Cyl. 7.6L; DT466 Eng.; 230-250 HP; To Engine No. 1084867	FJ1301
1997	6 Cyl. 7.6L; DT466 Eng.; 175-190 HP; To Engine No. 1028710	FJ1302
1997	6 Cyl. 7.6L; DT466 Eng.; 195-230 HP; To Engine No. 1028710	FJ1303

Injectors

		Part No.
Fuel Injector - Diesel - Remfd		
4800		
1997	6 Cyl. 7.6L; DT466 Eng.; 175-190 HP; From Engine No. 1028711	FJ1305
1997	6 Cyl. 7.6L; DT466 Eng.; 230-250 HP; From Engine No. 1084868	FJ1308
1997	8 Cyl. 7.3L; T444E Eng.	FJ596
1997-1996	6 Cyl. 8.7L	FJ1304
1996-1995	8 Cyl. 7.3L; T444E Eng.; High Output	FJ1300
1996-1995	6 Cyl. 7.6L; DT466 Eng.; 230-250 HP	FJ1301
1996-1995	6 Cyl. 7.6L; DT466 Eng.; 175-190 HP	FJ1302
1996-1995	6 Cyl. 7.6L; DT466 Eng.; 195-230 HP	FJ1303
1996-1995	8 Cyl. 7.3L; T444E Eng.; Exc. High Output	FJ595
4900		
2003-2000	6 Cyl. 7.6L; DT466 Eng.	FJ1307
2003-2000	6 Cyl. 8.7L	FJ1309
1999	6 Cyl. 7.6L; DT466 Eng.; 175-190 HP; To Engine No. 1194038	FJ1305
1999	6 Cyl. 8.7L; To Engine No. 1134350	FJ1306
1999	6 Cyl. 7.6L; DT466 Eng.; 175-250 HP; From Engine No. 1125228	FJ1307
1999	6 Cyl. 7.6L; DT466 Eng.; 230-250 HP; To Engine No. 1125227	FJ1308
1999	6 Cyl. 8.7L; From Engine No. 1134351	FJ1308
1998	6 Cyl. 7.6L; DT466 Eng.; 175-190 HP	FJ1305
1998	6 Cyl. 8.7L	FJ1306
1998	6 Cyl. 7.6L; DT466 Eng.; 230-250 HP	FJ1308
1997	6 Cyl. 7.6L; DT466 Eng.; 230-250 HP; To Engine No. 1084867	FJ1301
1997	6 Cyl. 7.6L; DT466 Eng.; 175-190 HP; To Engine No. 1028710	FJ1302
1997	6 Cyl. 7.6L; DT466 Eng.; 195-230 HP; To Engine No. 1028710	FJ1303
1997	6 Cyl. 7.6L; DT466 Eng.; 175-190 HP; From Engine No. 1028711	FJ1305
1997	6 Cyl. 7.6L; DT466 Eng.; 230-250 HP; From Engine No. 1084868	FJ1308
1997	8 Cyl. 7.3L; T444E Eng.	FJ596
1997-1995	6 Cyl. 8.7L	FJ1304
1996-1995	8 Cyl. 7.3L; T444E Eng.; High Output	FJ1300
1996-1995	6 Cyl. 7.6L; DT466 Eng.; 230-250 HP	FJ1301
1996-1995	6 Cyl. 7.6L; DT466 Eng.; 175-190 HP	FJ1302
1996-1995	6 Cyl. 7.6L; DT466 Eng.; 195-230 HP	FJ1303
1996-1995	8 Cyl. 7.3L; T444E Eng.; Exc. High Output	FJ595
5000		
1999	6 Cyl. 8.7L; To Engine No. 1134350	FJ1306
1999	6 Cyl. 8.7L; From Engine No. 1134351	FJ1308
1998	6 Cyl. 8.7L	FJ1306
1997-1995	6 Cyl. 8.7L	FJ1304
5500i		
2005-2000	6 Cyl. 8.7L	FJ1309
2002-2001	6 Cyl. 7.6L; DT466 Eng.	FJ1307
5600i		
2005-2000	6 Cyl. 8.7L	FJ1309
2002-2001	6 Cyl. 7.6L; DT466 Eng.	FJ1307
7100		
1995	6 Cyl. 7.6L; DT466 Eng.; 230-250 HP	FJ1301
1995	6 Cyl. 7.6L; DT466 Eng.; 175-190 HP	FJ1302
1995	6 Cyl. 7.6L; DT466 Eng.; 195-230 HP	FJ1303
1995	6 Cyl. 8.7L	FJ1304
1995-1994	8 Cyl. 7.3L; T444E Eng.; High Output	FJ1300
1995-1994	8 Cyl. 7.3L; T444E Eng.; Exc. High Output	FJ595
7300		
2006		FJ1257

		Part No.
Fuel Injector - Diesel - Remfd		
7300		
2005		FJ1242
2004	210-225 HP	FJ1240
2004	245-285 HP	FJ1242
2003-2002	6 Cyl. 7.6L; DT466 Eng.	FJ1307
7400		
2015	6 Cyl. 9.3L; N9 Eng.	FJ1278
2007	6 Cyl. 7.6L; DT466 Eng.	FJ1243
2007	6 Cyl. 9.3L; DT570 Eng.	FJ1244
2006	6 Cyl. 7.6L; DT466 Eng.	FJ1257
2006	6 Cyl. 9.3L; DT570 Eng.	FJ1258
2005	6 Cyl. 9.3L; DT570 Eng.	FJ1241
2005	6 Cyl. 7.6L; DT466 Eng.	FJ1242
2005-2002	6 Cyl. 8.7L	FJ1309
2004	6 Cyl. 7.6L; DT466 Eng.; 210-225 HP	FJ1240
2004	6 Cyl. 7.6L; DT466 Eng.; 245-285 HP	FJ1242
2003-2002	6 Cyl. 7.6L; DT466 Eng.	FJ1307
7500		
2007		FJ1244
2006	6 Cyl. 9.3L; HT570 Eng.	FJ1256
2005		FJ1239
2004	6 Cyl. 9.3L; HT570 Eng.	FJ1239
2004	6 Cyl. 8.7L; HT530 Eng.	FJ1309
2003-2002	6 Cyl. 8.7L	FJ1309
2002	6 Cyl. 7.6L; DT466 Eng.	FJ1307
7600		
2007	6 Cyl. 9.3L; DT570 Eng.	FJ1244
7700		
2007	6 Cyl. 9.3L	FJ1244
8100		
2002-2000	6 Cyl. 7.6L; DT466 Eng.	FJ1307
2002-2000	6 Cyl. 8.7L	FJ1309
1999	6 Cyl. 7.6L; DT466 Eng.; 175-190 HP; To Engine No. 1194038	FJ1305
1999	6 Cyl. 8.7L; To Engine No. 1134350	FJ1306
1999	6 Cyl. 7.6L; DT466 Eng.; 175-250 HP; From Engine No. 1125228	FJ1307
1999	6 Cyl. 7.6L; DT466 Eng.; 230-250 HP; To Engine No. 1125227	FJ1308
1999	6 Cyl. 8.7L; From Engine No. 1134351	FJ1308
1998	6 Cyl. 7.6L; DT466 Eng.; 175-190 HP	FJ1305
1998	6 Cyl. 8.7L	FJ1306
1998	6 Cyl. 7.6L; DT466 Eng.; 230-250 HP	FJ1308
1997	6 Cyl. 7.6L; DT466 Eng.; 230-250 HP; To Engine No. 1084867	FJ1301
1997	6 Cyl. 7.6L; DT466 Eng.; 175-190 HP; To Engine No. 1028710	FJ1302
1997	6 Cyl. 7.6L; DT466 Eng.; 195-230 HP; To Engine No. 1028710	FJ1303
1997	6 Cyl. 7.6L; DT466 Eng.; 175-190 HP; From Engine No. 1028711	FJ1305
1997	6 Cyl. 7.6L; DT466 Eng.; 230-250 HP; From Engine No. 1084868	FJ1308
1997-1995	6 Cyl. 8.7L	FJ1304
1996-1995	6 Cyl. 7.6L; DT466 Eng.; 230-250 HP	FJ1301
1996-1995	6 Cyl. 7.6L; DT466 Eng.; 175-190 HP	FJ1302
1996-1995	6 Cyl. 7.6L; DT466 Eng.; 195-230 HP	FJ1303
8200		
1997	6 Cyl. 7.6L; DT466 Eng.; 230-250 HP; To Engine No. 1084867	FJ1301
1997	6 Cyl. 7.6L; DT466 Eng.; 175-190 HP; To Engine No. 1028710	FJ1302
1997	6 Cyl. 7.6L; DT466 Eng.; 195-230 HP; To Engine No. 1028710	FJ1303
1997	6 Cyl. 7.6L; DT466 Eng.; 175-190 HP; From Engine No. 1028711	FJ1305

Injectors

		Part No.
Fuel Injector - Diesel - Remfd		
8200		
1997	6 Cyl. 7.6L; DT466 Eng.; 230-250 HP; From Engine No. 1084868	FJ1308
1997-1996	6 Cyl. 8.7L	FJ1304
1996	6 Cyl. 7.6L; DT466 Eng.; 230-250 HP	FJ1301
1996	6 Cyl. 7.6L; DT466 Eng.; 175-190 HP	FJ1302
1996	6 Cyl. 7.6L; DT466 Eng.; 195-230 HP	FJ1303
8500		
2007		FJ1244
2006		FJ1258
2005-2004	6 Cyl. 9.3L; HT570 Eng.	FJ1239
2005-2002	6 Cyl. 8.7L	FJ1309
2002	6 Cyl. 7.6L; DT466 Eng.	FJ1307
8500 TranStar		
2009-2008	6 Cyl. 9.3L; DT570 Eng.	FJ1244
8600 SBA		
2007	6 Cyl. 9.3L; HT570 Eng.	FJ1244
2006	6 Cyl. 9.3L; HT570 Eng.	FJ1256
2005-2004	6 Cyl. 9.3L; HT570 Eng.	FJ1239
CF500		
2010-2005	Injector Only	FJ928
2010-2005	Complete Kit	FJ9288PCK
CF600		
2010-2005	Injector Only	FJ928
2010-2005	Complete Kit	FJ9288PCK
CXT		
2008-2007	6 Cyl. 7.6L; DT466 Eng.	FJ1243
2008-2007	6 Cyl. 9.3L; DT570 Eng.	FJ1244
2008-2006	8 Cyl. 6.0L; VT365 Eng.; Injector Only	FJ928
2008-2006	8 Cyl. 6.0L; VT365 Eng.; Complete Kit	FJ9288PCK
2006	6 Cyl. 7.6L; DT466 Eng.	FJ1257
2006	6 Cyl. 9.3L; DT570 Eng.	FJ1258
2005		FJ1242
Durastar		
2013	6 Cyl. 7.6L; DT466 Eng.	FJ1243
Genesis RE		
2002	6 Cyl. 7.6L; DT466 Eng.; Exhaust stock and reorder	FJ1246
2002-2001	6 Cyl. 8.7L	FJ1309
2002-2000	8 Cyl. 7.3L; T444E Eng.; Cyl. 1 to 7	FJ738
2002-2000	8 Cyl. 7.3L; T444E Eng.; Complete Kit; Cyl. 1 to 8	FJ7388PCK
2002-2000	8 Cyl. 7.3L; T444E Eng.; Cyl. 8	FJ926
2001-2000	6 Cyl. 7.6L; DT466 Eng.	FJ1262
1999	6 Cyl. 7.6L; DT466 Eng.; 175-190 HP; To Engine No. 1194038	FJ1305
1999	6 Cyl. 8.7L; DT530 Eng.; To Engine No. 1134350	FJ1306
1999	6 Cyl. 7.6L; DT466 Eng.; 175-250 HP; From Engine No. 1125228	FJ1307
1999	6 Cyl. 7.6L; DT466 Eng.; 230-250 HP; To Engine No. 1125227	FJ1308
1999	6 Cyl. 8.7L; DT530 Eng.; From Engine No. 1133755	FJ1308
1999	8 Cyl. 7.3L; T444E Eng.; To Engine No. 843989	FJ596
1999	8 Cyl. 7.3L; T444E Eng.; From Engine No. 843,990; Cyl. 1 to 7	FJ738
1999	8 Cyl. 7.3L; T444E Eng.; Complete Kit; From Engine No. 843,990; Cyl. 1 to 8	FJ7388PCK
1999	8 Cyl. 7.3L; T444E Eng.; From Engine No. 843,990; Cyl. 8	FJ926
1998	6 Cyl. 7.6L; DT466 Eng.; 175-190 HP	FJ1305
1998	6 Cyl. 8.7L; DT530 Eng.	FJ1306
1998	6 Cyl. 7.6L; DT466 Eng.; 230-250 HP	FJ1308

		Part No.
Fuel Injector - Diesel - Remfd		
Genesis RE		
1998-1997	8 Cyl. 7.3L; T444E Eng.	FJ596
1997	6 Cyl. 8.7L; DT530 Eng.	FJ1304
1996	8 Cyl. 7.3L; T444E Eng.; High Output	FJ1300
1996	8 Cyl. 7.3L; T444E Eng.; Exc. High Output	FJ595
MXT		
2009-2007	Injector Only	FJ928
2009-2007	Complete Kit	FJ9288PCK
RXT		
2008-2006	8 Cyl. 6.0L; VT365 Eng.; Injector Only	FJ928
2008-2006	8 Cyl. 6.0L; VT365 Eng.; Complete Kit	FJ9288PCK
2007-2006	6 Cyl. 9.3L; DT570 Eng.	FJ1258
2005	Injector Only	FJ928
2005	Complete Kit	FJ9288PCK
TerraStar		
2013-2011	8 Cyl. 6.4L; MaxxFORCE 7 Eng.	FJ1259
2010	8 Cyl. 6.4L; MaxxFORCE 7 Eng.; From Engine No. 5300002	FJ1259
2010	8 Cyl. 6.4L; MaxxFORCE 7 Eng.; To Engine No. 5300001	FJ960
Injection Components		
Diesel Fuel Heater		
1552SC		
1998-1996	8 Cyl. 7.3L; T444E Eng.	DFH104
1652SC		
2007-2004		DFH101
2003-1999	8 Cyl. 7.3L; T444E Eng.	DFH101
1998-1994	8 Cyl. 7.3L; T444E Eng.	DFH104
1652UPS		
1997-1995	8 Cyl. 7.3L; T444E Eng.	DFH104
3000		
2000-1999	8 Cyl. 7.3L; T444E Eng.	DFH101
1998-1997	8 Cyl. 7.3L; T444E Eng.	DFH104
3000IC		
2002-2000	8 Cyl. 7.3L; T444E Eng.	DFH101
3200		
2007		DFH101
2006-2002	8 Cyl. 6.0L; VT365 Eng.	DFH101
3300		
2007-2005		DFH101
3400		
2002-1999		DFH101
1998-1996		DFH104
3600		
1999	8 Cyl. 7.3L; T444E Eng.	DFH101
1998-1994	8 Cyl. 7.3L; T444E Eng.	DFH104
3700		
1994	8 Cyl. 7.3L; T444E Eng.	DFH104
3800		
2004-1999	8 Cyl. 7.3L; T444E Eng.	DFH101
1998-1994	8 Cyl. 7.3L; T444E Eng.	DFH104
4100		
2007-2006		DFH101
4100 SBA		
2007-2006		DFH101
4200		
2007-2002		DFH101
4200LP		
2007-2003		DFH101
4300		
2003	8 Cyl. 6.0L; VT365 Eng.	DFH101

International

Injection Components

		Part No.
Diesel Fuel Heater		
4400		
2003	8 Cyl. 6.0L; VT365 Eng.	DFH101
4600		
1995-1994		DFH104
4600LP		
1994		DFH104
4700		
2002-1999	8 Cyl. 7.3L; T444E Eng.	DFH101
1998-1994	8 Cyl. 7.3L; T444E Eng.	DFH104
4700LP		
2002-1999	8 Cyl. 7.3L; T444E Eng.	DFH101
1998-1994	8 Cyl. 7.3L; T444E Eng.	DFH104
4700LPX		
2002-1999		DFH101
1998-1995		DFH104
4800		
1997-1995	8 Cyl. 7.3L; T444E Eng.	DFH104
4900		
1997-1995	8 Cyl. 7.3L; T444E Eng.	DFH104
7100		
1995-1994	8 Cyl. 7.3L; T444E Eng.	DFH104
CXT		
2007-2006	8 Cyl. 6.0L; VT365 Eng.	DFH101
Genesis RE		
2002-1999	8 Cyl. 7.3L; T444E Eng.	DFH101
1998	8 Cyl. 7.3L	DFH104
1997	8 Cyl. 7.3L; T444E Eng.	DFH104
1996		DFH104
MXT		
2007		DFH101
RXT		
2007	8 Cyl. 6.0L; VT365 Eng.	DFH101
2006-2005		DFH101
Diesel Fuel Injection Harness		
1552SC		
1998		IFH6
1997-1996		IFH5
1652SC		
2005-2004	8 Cyl. 7.3L; T444E Eng.	IFH6
2003-1998		IFH6
1997-1995		IFH5
1994	8 Cyl. 7.3L; T444E Eng.	IFH5
1652UPS		
1997-1995		IFH5
2554		
2002-1994	6 Cyl. 7.6L; DT466 Eng.	IFH1
2574		
2003-2001	6 Cyl. 7.6L; DT466 Eng.	IFH1
2003-1994	6 Cyl. 8.7L; DT530 Eng.	IFH1
2654		
2002-1999	6 Cyl. 7.6L; DT466 Eng.	IFH1
2002-1999	6 Cyl. 8.7L; DT530 Eng.	IFH1
1998-1994		IFH1
2674		
2003-2001	6 Cyl. 7.6L; DT466 Eng.	IFH1
2003-1994	6 Cyl. 8.7L; DT530 Eng.	IFH1
3000		
2002-2001		IFH1
2000-1998	8 Cyl. 7.3L; T444E Eng.	IFH6
2000-1997	6 Cyl. 7.6L; DT466 Eng.	IFH1
1996		IFH1

		Part No.
Diesel Fuel Injection Harness		
3000FE		
1999-1997		IFH1
3000IC		
2002-2000	6 Cyl. 7.6L; DT466 Eng.	IFH1
2002-2000	8 Cyl. 7.3L; T444E Eng.	IFH6
3000RE		
2002		IFH1
3200		
2003	6 Cyl. 8.7L; DT530 Eng.	IFH1
2003-2002	6 Cyl. 7.6L; DT466 Eng.	IFH1
3400		
2002-1998		IFH6
1997-1996		IFH5
3600		
1999-1998	8 Cyl. 7.3L; T444E Eng.	IFH6
1999-1995	6 Cyl. 7.6L; DT466 Eng.	IFH1
1997-1994	8 Cyl. 7.3L; T444E Eng.	IFH5
3700		
1994		IFH5
3800		
2004-1998	8 Cyl. 7.3L; T444E Eng.	IFH6
2003-1994	6 Cyl. 7.6L; DT466 Eng.	IFH1
1997-1994	8 Cyl. 7.3L; T444E Eng.	IFH5
3900FC		
1996		IFH1
1994	6 Cyl. 7.6L; DT466 Eng.	IFH1
4100		
2010-2008	8 Cyl. 6.4L; MaxxForce 7 Eng.; Right	IFH8
2010-2008	8 Cyl. 6.4L; MaxxForce 7 Eng.; Left	IFH9
4300		
2010-2008	8 Cyl. 6.4L; MaxxForce 7 Eng.; Right	IFH8
2010-2008	8 Cyl. 6.4L; MaxxForce 7 Eng.; Left	IFH9
2003-2002	6 Cyl. 7.6L; DT466 Eng.	IFH1
4300LP		
2010-2008	8 Cyl. 6.4L; MaxxForce 7 Eng.; Right	IFH8
2010-2008	8 Cyl. 6.4L; MaxxForce 7 Eng.; Left	IFH9
2003-2002		IFH1
4400		
2003-2002	6 Cyl.	IFH1
4400LP		
2003-2002		IFH1
4600		
1995-1994		IFH5
4600LP		
1994		IFH5
4700		
2003-2001	6 Cyl. 7.6L; DT466 Eng.	IFH1
2003-1997	6 Cyl. 8.7L; DT530 Eng.	IFH1
2002-1998	8 Cyl. 7.3L; T444E Eng.	IFH6
2000	6 Cyl. 7.6L; MaxxForce DT Eng.	IFH1
1999-1994	6 Cyl. 7.6L; DT466 Eng.	IFH1
1997-1994	8 Cyl. 7.3L; T444E Eng.	IFH5
4700LP		
2002-1998	8 Cyl. 7.3L; T444E Eng.	IFH6
2002-1997	6 Cyl.	IFH1
1997-1994	8 Cyl. 7.3L; T444E Eng.	IFH5
1996-1994	6 Cyl. 7.6L; DT466 Eng.	IFH1
4700LPX		
2002-1998		IFH6
1997-1995		IFH5
4800		
2003-1998		IFH1

Injection Components

		Part No.
Diesel Fuel Injection Harness		
4800		
1997	6 Cyl. 8.7L; DT530 Eng.	IFH1
1997-1995	8 Cyl. 7.3L; T444E Eng.	IFH5
1997-1994	6 Cyl. 7.6L; DT466 Eng.	IFH1
4900		
2003-1994	6 Cyl. 7.6L; DT466 Eng.	IFH1
1997-1995	8 Cyl. 7.3L; T444E Eng.	IFH5
5000		
1999-1996	6 Cyl. 8.7L; DT530 Eng.	IFH1
5500i		
2003-2000	6 Cyl. 8.7L; DT530 Eng.	IFH1
2002-2001	6 Cyl. 7.6L; DT466 Eng.	IFH1
5600i		
2003-2000	6 Cyl. 8.7L; DT530 Eng.	IFH1
2002-2001	6 Cyl. 7.6L; DT466 Eng.	IFH1
7100		
1995-1994	6 Cyl.	IFH1
1995-1994	8 Cyl. 7.3L; T444E Eng.	IFH5
7400		
2003-2002		IFH1
7500		
2003-2002		IFH1
8100		
2002-1994	6 Cyl. 7.6L; DT466 Eng.	IFH1
2002-1994	6 Cyl. 8.7L; DT530 Eng.	IFH1
8500		
2003-2002		IFH1
Genesis RE		
2002-2000	6 Cyl.	IFH1
2002-1999	8 Cyl. 7.3L; T444E Eng.	IFH6
1999-1998	6 Cyl. 7.6L; DT466 Eng.	IFH1
1999-1997	6 Cyl. 8.7L; DT530 Eng.	IFH1
1998	8 Cyl. 7.3L	IFH6
1997	8 Cyl. 7.3L; T444E Eng.	IFH5
1996	w/ 6 Bar	IFH1
1996	w/ 4 Bar	IFH5
TerraStar		
2010	8 Cyl. 6.4L; MaxxFORCE 7 Eng.; Right	IFH8
2010	8 Cyl. 6.4L; MaxxFORCE 7 Eng.; Left	IFH9
Diesel Fuel Injection Pump - New		
1452SC		
1992	8 Cyl. 7.3L; 170 HP	IP43NX
1992	8 Cyl. 7.3L; 155 HP	IP44NX
1652SC		
1992	8 Cyl. 7.3L; 170 HP	IP43NX
1992	8 Cyl. 7.3L; 155 HP	IP44NX
Diesel Fuel Injection Pump - Remanufactured		
4100		
2011	8 Cyl. 6.4L; MaxxFORCE 7 Eng.	IP35
2010	8 Cyl. 6.4L; MaxxFORCE 7 Eng.; To Engine No. 5300001	IP34
2010	8 Cyl. 6.4L; MaxxFORCE 7 Eng.; From Engine No. 5300002	IP35
2009-2008	8 Cyl. 6.4L; MaxxFORCE 7 Eng.	IP34
4300		
2015-2011	8 Cyl. 6.4L; MaxxFORCE 7 Eng.	IP35
2010	8 Cyl. 6.4L; MaxxFORCE 7 Eng.; To Engine No. 5300001	IP34
2010	8 Cyl. 6.4L; MaxxFORCE 7 Eng.; From Engine No. 5300002	IP35
2009-2008	8 Cyl. 6.4L; MaxxFORCE 7 Eng.	IP34
4300LP		
2015-2011	8 Cyl. 6.4L; MaxxFORCE 7 Eng.	IP35

		Part No.
Diesel Fuel Injection Pump - Remanufactured		
4300LP		
2010	8 Cyl. 6.4L; MaxxFORCE 7 Eng.; To Engine No. 5300001	IP34
2010	8 Cyl. 6.4L; MaxxFORCE 7 Eng.; From Engine No. 5300002	IP35
2009-2008	8 Cyl. 6.4L; MaxxFORCE 7 Eng.	IP34
4700LP		
1998-1994	6 Cyl. 7.6L; DT466 Eng.	HPI19
1997	8 Cyl. 7.3L; T444E Eng.; From Serial No. 216544 To 661894	HPI1
1997	8 Cyl. 7.3L; T444E Eng.; From Serial No. 005500 To 216543	HPI4
CF500		
2009		HPI11
CF600		
2009		HPI11
TerraStar		
2013-2011	8 Cyl. 6.4L; MaxxFORCE 7 Eng.	IP35
2010	8 Cyl. 6.4L; MaxxFORCE 7 Eng.; To Engine No. 5300001	IP34
2010	8 Cyl. 6.4L; MaxxFORCE 7 Eng.; From Engine No. 5300002	IP35
Diesel Fuel Injector Control Module (FICM)		
3200		
2008-2007	6 Cyl. 7.6L; Power Supply	R76001
2008-2004	8 Cyl. 6.0L; VT365 Eng.; Power Supply	R76001
2006-2005	6 Cyl. 7.6L; DT466 Eng.; Power Supply	R76001
3300		
2005	8 Cyl. 6.0L; VT365 Eng.; Power Supply	R76001
4100		
2008-2006	8 Cyl. 6.0L; VT365 Eng.; Power Supply	R76001
4200		
2009-2005	8 Cyl. 6.0L; VT365 Eng.; Power Supply	R76001
4300		
2008	6 Cyl. 7.6L; MaxxFORCE DT Eng.; Power Supply	R76001
2007-2005	6 Cyl. 7.6L; DT466 Eng.; Power Supply	R76001
CF500		
2008-2006	6 Cyl. 4.5L; VT275 Eng.; Power Supply	R76001
CF600		
2008-2006	6 Cyl. 4.5L; VT275 Eng.; Power Supply	R76001
CXT		
2008-2006	8 Cyl. 6.0L; VT365 Eng.; Power Supply	R76001
MXT		
2008-2007	8 Cyl. 6.0L; VT365 Eng.; Power Supply	R76001
RXT		
2008-2005	8 Cyl. 6.0L; VT365 Eng.; Power Supply	R76001
Diesel Fuel Injector Sleeve		
1652SC		
2010-2004	8 Cyl. 6.0L; VT365 Eng.	IFS1
2003-1994	8 Cyl. 7.3L; T444E Eng.; Diesel	B42001
2554		
2002-2000		IFS2
1999	6 Cyl. 7.6L; DT466 Eng.	IFS2
1999	6 Cyl. 8.7L; DT530 Eng.	IFS2
1998-1996		IFS2
2574		
2003-2001	6 Cyl. 7.6L; DT466 Eng.	IFS2
2003-1996	6 Cyl. 8.7L; DT530 Eng.	IFS2
2654		
2002-2001		IFS2
2000-1999	6 Cyl. 7.6L; DT466 Eng.	IFS2
2000-1999	6 Cyl. 8.7L; DT530 Eng.	IFS2

International

Injection Components

		Part No.
Diesel Fuel Injector Sleeve		
2654		
1998-1996		IFS2
2674		
2003-2001	6 Cyl. 7.6L; DT466 Eng.	IFS2
2003-1996	6 Cyl. 8.7L; DT530 Eng.	IFS2
3000		
2002-2001		IFS2
2000-1997	8 Cyl. 7.3L; T444E Eng.; Diesel	B42001
2000-1997	6 Cyl. 7.6L; DT466 Eng.	IFS2
1996		IFS2
3000FE		
1999-1997		IFS2
3000IC		
2002-2000	8 Cyl. 7.3L; T444E Eng.; Diesel	B42001
2002-2000	6 Cyl. 7.6L; DT466 Eng.	IFS2
3000RE		
2002		IFS2
3200		
2010-2003	8 Cyl. 6.0L; VT365 Eng.	IFS1
2003	6 Cyl.	IFS2
2002	6 Cyl. 7.6L; DT466 Eng.	IFS2
3300		
2010-2005	8 Cyl. 6.0L; VT365 Eng.	IFS1
3600		
2001		IFS2
1999-1996	6 Cyl. 7.6L; DT466 Eng.	IFS2
1999-1994	8 Cyl. 7.3L; T444E Eng.; Diesel	B42001
3700		
1994	8 Cyl. 7.3L; T444E Eng.; Diesel	B42001
3800		
2003-1996	6 Cyl. 7.6L; DT466 Eng.	IFS2
2003-1994	8 Cyl. 7.3L; T444E Eng.; Diesel	B42001
3900FC		
1996		IFS2
4100		
2010-2006	8 Cyl. 6.0L; VT365 Eng.	IFS1
4100 SBA		
2008-2006	8 Cyl. 6.0L; VT365 Eng.	IFS1
4200		
2010-2003	8 Cyl. 6.0L; VT365 Eng.	IFS1
4200LP		
2008-2003	8 Cyl. 6.0L; VT365 Eng.	IFS1
4300		
2003	8 Cyl. 6.0L; VT365 Eng.	IFS1
2003	6 Cyl. 7.6L; DT466 Eng.	IFS2
2002		IFS2
4300LP		
2003-2002		IFS2
4400		
2003	8 Cyl. 6.0L; VT365 Eng.	IFS1
2003	6 Cyl.	IFS2
2002		IFS2
4400LP		
2003-2002		IFS2
4700		
2003		IFS2
2002	6 Cyl.	IFS2
2002-1994	8 Cyl. 7.3L; T444E Eng.; Diesel	B42001
2001	6 Cyl. 7.6L; DT466 Eng.	IFS2
2001-2000	6 Cyl. 8.7L; DT530 Eng.	IFS2
2000	6 Cyl. 7.6L; MaxxForce DT Eng.	IFS2
1999-1998	6 Cyl.	IFS2

		Part No.
Diesel Fuel Injector Sleeve		
4700		
1997-1996	6 Cyl. 7.6L; DT466 Eng.	IFS2
1997-1996	6 Cyl. 8.7L; DT530 Eng.	IFS2
4700LP		
2002-1996	6 Cyl.	IFS2
2002-1994	8 Cyl. 7.3L; T444E Eng.; Diesel	B42001
4800		
2003-2002		IFS2
2000-1998		IFS2
1997	6 Cyl. 7.6L; DT466 Eng.	IFS2
1997-1996	6 Cyl. 8.7L; DT530 Eng.	IFS2
1995	8 Cyl. 7.3L; T444E Eng.; Diesel	B42001
4900		
2003-1998		IFS2
1997-1996	6 Cyl. 7.6L; DT466 Eng.	IFS2
1997-1996	6 Cyl. 8.7L; DT530 Eng.	IFS2
5000		
1999-1996	6 Cyl. 8.7L; DT530 Eng.	IFS2
5500i		
2002-2001	6 Cyl. 7.6L; DT466 Eng.	IFS2
2002-2000	6 Cyl. 8.7L; DT530 Eng.	IFS2
5600i		
2003-2000	6 Cyl. 8.7L; DT530 Eng.	IFS2
2002-2001	6 Cyl. 7.6L; DT466 Eng.	IFS2
7300		
2003-2002		IFS2
7400		
2003-2002		IFS2
7500		
2003	6 Cyl. 8.7L; DT530 Eng.	IFS2
2002		IFS2
8100		
2002-1996	6 Cyl. 7.6L; DT466 Eng.	IFS2
2002-1996	6 Cyl. 8.7L; DT530 Eng.	IFS2
8200		
1997-1996	6 Cyl. 7.6L; DT466 Eng.	IFS2
1997-1996	6 Cyl. 8.7L; DT530 Eng.	IFS2
8500		
2003-2002		IFS2
CF500		
2010	6 Cyl. 4.5L	IFS1
2009-2006	6 Cyl. 4.5L; VT275 Eng.	IFS1
CF600		
2010	6 Cyl. 4.5L	IFS1
2009-2006	6 Cyl. 4.5L; VT275 Eng.	IFS1
CXT		
2008-2006	8 Cyl. 6.0L; VT365 Eng.	IFS1
Genesis RE		
2002-1997	6 Cyl.	IFS2
1996		IFS2
MXT		
2009-2007	8 Cyl. 6.0L; VT365 Eng.	IFS1
RXT		
2008-2005	8 Cyl. 6.0L; VT365 Eng.	IFS1
Diesel Fuel Transfer Pump		
1652SC		
2002-1998	8 Cyl. 7.3L; T444E Eng.	FTP3
3000IC		
2002-2000	8 Cyl. 7.3L; T444E Eng.	FTP3
3000RE		
2000-1998	8 Cyl. 7.3L; T444E Eng.	FTP3

Injection Components

		Part No.
Diesel Fuel Transfer Pump		
3600		
1999-1997	8 Cyl. 7.3L; T444E Eng.	FTP3
3800		
2003-1997	8 Cyl. 7.3L; T444E Eng.	FTP3
4700		
2002-1995	8 Cyl. 7.3L; T444E Eng.	FTP3
4900		
1997-1995	8 Cyl. 7.3L; T444E Eng.	FTP3
Diesel Glow Plug		
4100		
2010-2008	8 Cyl. 6.4L; MaxxForce 7 Eng.	GP122
4300		
2010-2008	8 Cyl. 6.4L; MaxxForce 7 Eng.	GP122
4300LP		
2010-2008	8 Cyl. 6.4L; MaxxForce 7 Eng.	GP122
TerraStar		
2010	8 Cyl. 6.4L; MaxxForce 7 Eng.	GP122
Diesel High Pressure Oil Pump Hose		
1552SC		
1998-1996	8 Cyl. 7.3L; T444E Eng.	OPH4
1652SC		
1998-1994	8 Cyl. 7.3L; T444E Eng.	OPH4
1652UPS		
1997-1995	8 Cyl. 7.3L; T444E Eng.	OPH4
3000		
1998-1997	8 Cyl. 7.3L; T444E Eng.	OPH4
3000RE		
1998-1996	8 Cyl. 7.3L; T444E Eng.	OPH4
3400		
1998-1996	8 Cyl. 7.3L; T444E Eng.	OPH4
3600		
1998-1994	8 Cyl. 7.3L; T444E Eng.	OPH4
3700		
1994	8 Cyl. 7.3L; T444E Eng.	OPH4
3800		
1998-1994	8 Cyl. 7.3L; T444E Eng.	OPH4
4600		
1995-1994	8 Cyl. 7.3L; T444E Eng.	OPH4
4600LP		
1994	8 Cyl. 7.3L; T444E Eng.	OPH4
4700		
1998-1994	8 Cyl. 7.3L; T444E Eng.	OPH4
4700LP		
1998-1994	8 Cyl. 7.3L; T444E Eng.	OPH4
4700LPX		
1998-1995	8 Cyl. 7.3L; T444E Eng.	OPH4
7100		
1995-1994	8 Cyl. 7.3L; T444E Eng.	OPH4
Genesis RE		
1998-1996	8 Cyl. 7.3L; T444E Eng.	OPH4
Diesel High Pressure Oil Pump Seal Kit		
1652SC		
2007-2006		SK142
2005	8 Cyl. 6.0L; VT365 Eng.	SK142
3200		
2007		SK142
2006-2005	8 Cyl. 6.0L; VT365 Eng.	SK142
3300		
2007-2005		SK142
4100		
2007-2006		SK142

		Part No.
Diesel High Pressure Oil Pump Seal Kit		
4100 SBA		
2007-2006		SK142
4200		
2007-2005		SK142
4200LP		
2007-2005		SK142
CXT		
2007-2006	8 Cyl. 6.0L; VT365 Eng.	SK142
MXT		
2007		SK142
RXT		
2007-2006	8 Cyl. 6.0L; VT365 Eng.	SK142
2005		SK142
Diesel High Pressure Oil Rail Seal Kit		
1652SC		
2007-2006		SK145
2005-2004	8 Cyl. 6.0L; VT365 Eng.	SK145
3200		
2007		SK145
2006-2003	8 Cyl. 6.0L; VT365 Eng.	SK145
3300		
2007-2005		SK145
4100		
2007-2006		SK145
4100 SBA		
2007-2006		SK145
4200		
2007-2003		SK145
4200LP		
2007-2003		SK145
4300		
2003	8 Cyl. 6.0L; VT365 Eng.	SK145
4400		
2003	8 Cyl. 6.0L; VT365 Eng.	SK145
CF500		
2007-2005		SK145
CXT		
2007-2006	8 Cyl. 6.0L; VT365 Eng.	SK145
MXT		
2007	8 Cyl. 6.0L; VT365 Eng.	SK145
RXT		
2007-2005	8 Cyl. 6.0L; VT365 Eng.	SK145
Diesel Injection High Pressure Oil Pump		
1552SC		
1998		HPI3
1997-1996	From Engine No. 216544 to Engine No. 661894	HPI1
1997-1996	From Engine No. 5500 to Engine No. 216543	HPI4
1652SC		
2007-2006		HPI7
2005	8 Cyl. 6.0L; VT365 Eng.	HPI7
2005-2004	8 Cyl. 7.3L; T444E Eng.	HPI2
2004	8 Cyl. 6.0L; VT365 Eng.; Exhaust stock and reorder; w/o Snap to Connect (STC) Fitting	HPI5
2004	8 Cyl. 6.0L; VT365 Eng.; Alternate Number; w/o Snap to Connect (STC) Fitting	HPI6
2004	8 Cyl. 6.0L; VT365 Eng.; w/ Snap to Connect (STC) Fitting	HPI7
2003-2000		HPI2
1999	From Engine No. 843,990	HPI2

Injection Components

		Part No.
Diesel Injection High Pressure Oil Pump		
1652SC		
1999	To Engine No. 843989	HPI3
1998		HPI3
1997-1996		HPI1
1995	From Engine No. 216544 to Engine No. 661894	HPI1
1995	From Engine No. 5500 to Engine No. 216543	HPI4
1994	8 Cyl. 7.3L; T444E Eng.	HPI4
1652UPS		
1997-1996		HPI1
1995	From Engine No. 216544 to Engine No. 661894	HPI1
1995	From Engine No. 5500 to Engine No. 216543	HPI4
2554		
2002-2000	6 Cyl. 7.6L; DT466 Eng.; 230-300 HP	HPI18
2002-2000	6 Cyl. 7.6L; DT466 Eng.; 175-230 HP	HPI19
2002-1995	6 Cyl. 8.7L; DT530 Eng.; 230-300 HP	HPI18
2002-1995	6 Cyl. 8.7L; DT530 Eng.; 300-330 HP	HPI20
1999-1994	6 Cyl. 7.6L; DT466 Eng.	HPI19
2574		
2003-2001	6 Cyl. 7.6L; DT466 Eng.; 230-300 HP	HPI18
2003-2001	6 Cyl. 7.6L; DT466 Eng.; 175-230 HP	HPI19
2003-1994	6 Cyl. 8.7L; DT530 Eng.; 230-300 HP	HPI18
2003-1994	6 Cyl. 8.7L; DT530 Eng.; 300-330 HP	HPI20
2654		
2002-2000	6 Cyl. 7.6L; DT466 Eng.; 230-300 HP	HPI18
2002-2000	6 Cyl. 7.6L; DT466 Eng.; 175-230 HP	HPI19
2002-1995	6 Cyl. 8.7L; DT530 Eng.; 230-300 HP	HPI18
2002-1995	6 Cyl. 8.7L; DT530 Eng.; 300-330 HP	HPI20
1999-1995	6 Cyl. 7.6L; DT466 Eng.	HPI19
1994		HPI19
2674		
2003-2001	6 Cyl. 7.6L; DT466 Eng.; 230-300 HP	HPI18
2003-2001	6 Cyl. 7.6L; DT466 Eng.; 175-230 HP	HPI19
2003-1994	6 Cyl. 8.7L; DT530 Eng.; 230-300 HP	HPI18
2003-1994	6 Cyl. 8.7L; DT530 Eng.; 300-330 HP	HPI20
3000		
2002-2001	230-300 HP	HPI18
2002-2001	175-230 HP	HPI19
2000	6 Cyl. 7.6L; DT466 Eng.; 230-300 HP	HPI18
2000	6 Cyl. 7.6L; DT466 Eng.; 175-230 HP	HPI19
2000	8 Cyl. 7.3L; T444E Eng.	HPI2
1999	8 Cyl. 7.3L; T444E Eng.; From Engine No. 843,990	HPI2
1999	8 Cyl. 7.3L; T444E Eng.; To Engine No. 843989	HPI3
1999-1996	6 Cyl. 7.6L; DT466 Eng.	HPI19
1998	8 Cyl. 7.3L; T444E Eng.	HPI3
1997	8 Cyl. 7.3L; T444E Eng.; From Engine No. 216544 to Engine No. 661894	HPI1
1997	8 Cyl. 7.3L; T444E Eng.; From Engine No. 5500 to Engine No. 216543	HPI4
3000FE		
1999-1997		HPI19
3000IC		
2002-2000	6 Cyl. 7.6L; DT466 Eng.; 230-300 HP	HPI18
2002-2000	6 Cyl. 7.6L; DT466 Eng.; 175-230 HP	HPI19
2002-2000	8 Cyl. 7.3L; T444E Eng.	HPI2
3000RE		
2005		HPI12
2002	230-300 HP	HPI18
2002	300-330 HP	HPI20

		Part No.
Diesel Injection High Pressure Oil Pump		
3200		
2007		HPI7
2006-2005	8 Cyl. 6.0L; VT365 Eng.	HPI7
2006-2004	6 Cyl. 7.6L; DT466 Eng.	HPI12
2004	8 Cyl. 6.0L; VT365 Eng.; Exhaust stock and reorder; w/o Snap to Connect (STC) Fitting	HPI5
2004	8 Cyl. 6.0L; VT365 Eng.; Alternate Number; w/o Snap to Connect (STC) Fitting	HPI6
2004	8 Cyl. 6.0L; VT365 Eng.; w/ Snap to Connect (STC) Fitting	HPI7
2003	6 Cyl. 8.7L; DT530 Eng.; 230-300 HP	HPI18
2003	6 Cyl. 8.7L; DT530 Eng.; 300-330 HP	HPI20
2003-2002	6 Cyl. 7.6L; DT466 Eng.; 230-300 HP	HPI18
2003-2002	6 Cyl. 7.6L; DT466 Eng.; 175-230 HP	HPI19
2003-2002	8 Cyl. 6.0L; VT365 Eng.; Exhaust stock and reorder	HPI5
2003-2002	8 Cyl. 6.0L; VT365 Eng.; Alternate Number	HPI6
3300		
2007-2005		HPI7
3400		
2002-2000		HPI2
1999	From Engine No. 843,990	HPI2
1999	To Engine No. 843989	HPI3
1998		HPI3
1997-1996	From Engine No. 216544 to Engine No. 661894	HPI1
1997-1996	From Engine No. 5500 to Engine No. 216543	HPI4
3600		
2001	230-300 HP	HPI18
2001	175-230 HP	HPI19
1999	8 Cyl. 7.3L; T444E Eng.; From Engine No. 843,990	HPI2
1999	8 Cyl. 7.3L; T444E Eng.; To Engine No. 843989	HPI3
1999-1995	6 Cyl. 7.6L; DT466 Eng.	HPI19
1998	8 Cyl. 7.3L; T444E Eng.	HPI3
1997-1996	8 Cyl. 7.3L; T444E Eng.	HPI1
1995	8 Cyl. 7.3L; T444E Eng.; From Engine No. 216544 to Engine No. 661894	HPI1
1995	8 Cyl. 7.3L; T444E Eng.; From Engine No. 5500 to Engine No. 216543	HPI4
1994	8 Cyl. 7.3L; T444E Eng.	HPI4
3700		
1994	From Engine No. 216544 to Engine No. 661894	HPI1
1994	From Engine No. 5500 to Engine No. 216543	HPI4
3800		
2004	6 Cyl. 7.6L; DT466 Eng.	HPI12
2004-2000	8 Cyl. 7.3L; T444E Eng.	HPI2
2003-2000	6 Cyl. 7.6L; DT466 Eng.; 230-300 HP	HPI18
2003-2000	6 Cyl. 7.6L; DT466 Eng.; 175-230 HP	HPI19
1999	8 Cyl. 7.3L; T444E Eng.; From Engine No. 843,990	HPI2
1999	8 Cyl. 7.3L; T444E Eng.; To Engine No. 843989	HPI3
1999-1994	6 Cyl. 7.6L; DT466 Eng.	HPI19
1998	8 Cyl. 7.3L; T444E Eng.	HPI3
1997-1996	8 Cyl. 7.3L; T444E Eng.	HPI1
1995	8 Cyl. 7.3L; T444E Eng.; From Engine No. 216544 to Engine No. 661894	HPI1
1995	8 Cyl. 7.3L; T444E Eng.; From Engine No. 5500 to Engine No. 216543	HPI4

Injection Components

		Part No.
Diesel Injection High Pressure Oil Pump		
3800		
1994	8 Cyl. 7.3L; T444E Eng.	HPI4
3900FC		
1996		HPI19
1994	6 Cyl. 7.6L; DT466 Eng.	HPI19
4100		
2007-2006		HPI7
4100 SBA		
2007-2006		HPI7
4200		
2007-2005		HPI7
2004	8 Cyl. 6.0L; VT365 Eng.; Exhaust stock and reorder; w/o Snap to Connect (STC) Fitting	HPI5
2004	8 Cyl. 6.0L; VT365 Eng.; Alternate Number; w/o Snap to Connect (STC) Fitting	HPI6
2004	8 Cyl. 6.0L; VT365 Eng.; w/ Snap to Connect (STC) Fitting	HPI7
2003-2002	8 Cyl. 6.0L; VT365 Eng.; Exhaust stock and reorder	HPI5
2003-2002	8 Cyl. 6.0L; VT365 Eng.; Alternate Number	HPI6
4200LP		
2007-2005		HPI7
2004	w/ Snap to Connect (STC) Fitting	HPI7
2003	8 Cyl. 6.0L; VT365 Eng.; Exhaust stock and reorder	HPI5
2003	8 Cyl. 6.0L; VT365 Eng.; Alternate Number	HPI6
4300		
2011		HPI10
2010	From Engine No. 3,300,001	HPI10
2010	From Engine No. 3,040,001 to Engine No. 3,300,000	HPI13
2010-2007	To Engine No. 3040000	HPI8
2009-2007	From Engine No. 3,040,001	HPI13
2006-2004		HPI12
2003	6 Cyl. 7.6L; DT466 Eng.; 230-300 HP	HPI18
2003	6 Cyl. 7.6L; DT466 Eng.; 175-230 HP	HPI19
2003	8 Cyl. 6.0L; VT365 Eng.; Exhaust stock and reorder	HPI5
2003	8 Cyl. 6.0L; VT365 Eng.; Alternate Number	HPI6
2002	230-300 HP	HPI18
2002	175-230 HP	HPI19
4300LP		
2012		HPI10
2011	6 Cyl. 7.6L; MaxxFORCE DT Eng.	HPI10
2010	From Engine No. 3,300,001	HPI10
2010	From Engine No. 3,040,001 to Engine No. 3,300,000	HPI13
2010-2007	To Engine No. 3040000	HPI8
2009-2007	From Engine No. 3,040,001	HPI13
2006-2004		HPI12
2003-2002	230-300 HP	HPI18
2003-2002	175-230 HP	HPI19
4400		
2011		HPI10
2010	From Engine No. 3,300,001	HPI10
2010	From Engine No. 3,040,001 to Engine No. 3,300,000	HPI13
2010-2009	To Engine No. 3040000	HPI8
2009	From Engine No. 3,040,001	HPI13
2008	6 Cyl. 7.6L; MaxxFORCE DT Eng.; From Engine No. 3,040,001	HPI13

		Part No.
Diesel Injection High Pressure Oil Pump		
4400		
2008	6 Cyl. 7.6L; MaxxFORCE DT Eng.; To Engine No. 3040000	HPI8
2008-2007	6 Cyl. 9.3L; DT570 Eng.; From Engine No. 3,040,001	HPI14
2008-2007	6 Cyl. 9.3L; DT570 Eng.; To Engine No. 3040000	HPI9
2007	6 Cyl. 7.6L; DT466 Eng.; From Engine No. 3,040,001	HPI13
2007	6 Cyl. 7.6L; DT466 Eng.; To Engine No. 3040000	HPI8
2006-2004	6 Cyl. 7.6L; DT466 Eng.	HPI12
2006-2004	6 Cyl. 9.3L; DT570 Eng.	HPI17
2003	8 Cyl. 6.0L; VT365 Eng.; Exhaust stock and reorder	HPI5
2003	8 Cyl. 6.0L; VT365 Eng.; Alternate Number	HPI6
2003-2002	6 Cyl. 7.6L; DT466 Eng.; 230-300 HP	HPI18
2003-2002	6 Cyl. 8.7L; DT530 Eng.; 230-300 HP	HPI18
2003-2002	6 Cyl. 7.6L; DT466 Eng.; 175-230 HP	HPI19
2003-2002	6 Cyl. 8.7L; DT530 Eng.; 300-330 HP	HPI20
4400LP		
2012-2011		HPI10
2010	From Engine No. 3,300,001	HPI10
2010	From Engine No. 3,040,001 to Engine No. 3,300,000	HPI13
2010-2008	To Engine No. 3040000	HPI8
2009-2008	From Engine No. 3,040,001	HPI13
2007	6 Cyl. 7.6L; DT466 Eng.; From Engine No. 3,040,001	HPI13
2007	6 Cyl. 9.3L; DT570 Eng.; From Engine No. 3,040,001	HPI14
2007	6 Cyl. 7.6L; DT466 Eng.; To Engine No. 3040000	HPI8
2007	6 Cyl. 9.3L; DT570 Eng.; To Engine No. 3040000	HPI9
2006-2005	6 Cyl. 9.3L; DT570 Eng.	HPI17
2006-2004	6 Cyl. 7.6L; DT466 Eng.	HPI12
2003-2002	6 Cyl. 7.6L; DT466 Eng.; 230-300 HP	HPI18
2003-2002	6 Cyl. 8.7L; DT530 Eng.; 230-300 HP	HPI18
2003-2002	6 Cyl. 7.6L; DT466 Eng.; 175-230 HP	HPI19
2003-2002	6 Cyl. 8.7L; DT530 Eng.; 300-330 HP	HPI20
4600		
1995-1994	From Engine No. 216544 to Engine No. 661894	HPI1
1995-1994	From Engine No. 5500 to Engine No. 216543	HPI4
4600LP		
1994	From Engine No. 216544 to Engine No. 661894	HPI1
1994	From Engine No. 5500 to Engine No. 216543	HPI4
4700		
2003-2001	6 Cyl. 7.6L; DT466 Eng.; 230-300 HP	HPI18
2003-2001	6 Cyl. 7.6L; DT466 Eng.; 175-230 HP	HPI19
2003-1996	6 Cyl. 8.7L; DT530 Eng.; 230-300 HP	HPI18
2003-1996	6 Cyl. 8.7L; DT530 Eng.; 300-330 HP	HPI20
2002-2000	8 Cyl. 7.3L; T444E Eng.	HPI2
2000	6 Cyl. 7.6L; MaxxFORCE DT Eng.; 230-300 HP	HPI18
2000	6 Cyl. 7.6L; MaxxFORCE DT Eng.; 175-230 HP	HPI19
1999	8 Cyl. 7.3L; T444E Eng.; From Engine No. 843,990	HPI2
1999	8 Cyl. 7.3L; T444E Eng.; To Engine No. 843,989	HPI3
1999-1994	6 Cyl. 7.6L; DT466 Eng.	HPI19

Injection Components

		Part No.
Diesel Injection High Pressure Oil Pump		
4700		
1998	8 Cyl. 7.3L; T444E Eng.	HPI3
1997-1996	8 Cyl. 7.3L; T444E Eng.	HPI1
1995	8 Cyl. 7.3L; T444E Eng.; From Engine No. 216544 to Engine No. 661894	HPI1
1995	8 Cyl. 7.3L; T444E Eng.; From Engine No. 5500 to Engine No. 216543	HPI4
1994	8 Cyl. 7.3L; T444E Eng.	HPI4
4700LP		
2002-2000	6 Cyl. 7.6L; DT466 Eng.; 230-300 HP	HPI18
2002-1997	6 Cyl. 8.7L; DT530 Eng.; 230-300 HP	HPI18
2002-1997	6 Cyl. 8.7L; DT530 Eng.; 300-330 HP	HPI20
2000	6 Cyl. 7.6L; DT466 Eng.; 175-230 HP	HPI19
1999	6 Cyl. 7.6L; DT466 Eng.	HPI19
1999	8 Cyl. 7.3L; T444E Eng.; From Engine No. 843,990	HPI2
1999	8 Cyl. 7.3L; T444E Eng.; To Engine No. 843989	HPI3
1995	8 Cyl. 7.3L; T444E Eng.; From Engine No. 216544 to Engine No. 661894	HPI1
1995	8 Cyl. 7.3L; T444E Eng.; From Engine No. 5500 to Engine No. 216543	HPI4
1994	8 Cyl. 7.3L; T444E Eng.	HPI4
4700LPX		
2002-2000		HPI2
1999	From Engine No. 843,990	HPI2
1999	To Engine No. 843989	HPI3
1998		HPI3
1997-1996		HPI1
1995	From Engine No. 216544 to Engine No. 661894	HPI1
1995	From Engine No. 5500 to Engine No. 216543	HPI4
4800		
2003-2001	6 Cyl. 8.7L; DT530 Eng.; 230-300 HP	HPI18
2003-2001	6 Cyl. 8.7L; DT530 Eng.; 300-330 HP	HPI20
2003-2000	6 Cyl. 7.6L; DT466 Eng.; 230-300 HP	HPI18
2003-2000	6 Cyl. 7.6L; DT466 Eng.; 175-230 HP	HPI19
2000	6 Cyl. 8.7L; 230-300 HP	HPI18
2000	6 Cyl. 8.7L; 300-330 HP	HPI20
1999-1996	6 Cyl. 8.7L; DT530 Eng.; 230-300 HP	HPI18
1999-1996	6 Cyl. 8.7L; DT530 Eng.; 300-330 HP	HPI20
1999-1994	6 Cyl. 7.6L; DT466 Eng.	HPI19
1997-1995	8 Cyl. 7.3L; T444E Eng.; From Engine No. 216544 to Engine No. 661894	HPI1
1997-1995	8 Cyl. 7.3L; T444E Eng.; From Engine No. 5500 to Engine No. 216543	HPI4
4900		
2003-2000	6 Cyl. 7.6L; DT466 Eng.; 230-300 HP	HPI18
2003-2000	6 Cyl. 7.6L; DT466 Eng.; 175-230 HP	HPI19
2003-1994	6 Cyl. 8.7L; DT530 Eng.; 230-300 HP	HPI18
2003-1994	6 Cyl. 8.7L; DT530 Eng.; 300-330 HP	HPI20
1999-1994	6 Cyl. 7.6L; DT466 Eng.	HPI19
1997-1995	8 Cyl. 7.3L; T444E Eng.; From Engine No. 216544 to Engine No. 661894	HPI1
1997-1995	8 Cyl. 7.3L; T444E Eng.; From Engine No. 5500 to Engine No. 216543	HPI4
5000		
1999-1995	6 Cyl. 8.7L; DT530 Eng.; 230-300 HP	HPI18
1999-1995	6 Cyl. 8.7L; DT530 Eng.; 300-330 HP	HPI20
5500i		
2003-2000	6 Cyl. 8.7L; DT530 Eng.; 230-300 HP	HPI18
2003-2000	6 Cyl. 8.7L; DT530 Eng.; 300-330 HP	HPI20
2002-2001	6 Cyl. 7.6L; DT466 Eng.; 230-300 HP	HPI18
2002-2001	6 Cyl. 7.6L; DT466 Eng.; 175-230 HP	HPI19

		Part No.
Diesel Injection High Pressure Oil Pump		
5600i		
2003-2000	6 Cyl. 8.7L; DT530 Eng.; 230-300 HP	HPI18
2003-2000	6 Cyl. 8.7L; DT530 Eng.; 300-330 HP	HPI20
2002-2001	6 Cyl. 7.6L; DT466 Eng.; 230-300 HP	HPI18
2002-2001	6 Cyl. 7.6L; DT466 Eng.; 175-230 HP	HPI19
7100		
1995-1994	8 Cyl. 7.3L; T444E Eng.; From Engine No. 216544 to Engine No. 661894	HPI1
1995-1994	6 Cyl. 8.7L; DT530 Eng.; 230-300 HP	HPI18
1995-1994	6 Cyl. 7.6L; DT466 Eng.	HPI19
1995-1994	6 Cyl. 8.7L; DT530 Eng.; 300-330 HP	HPI20
1995-1994	8 Cyl. 7.3L; T444E Eng.; From Engine No. 5500 to Engine No. 216543	HPI4
7300		
2006-2004		HPI12
2003-2002	230-300 HP	HPI18
2003-2002	175-230 HP	HPI19
7400		
2007	6 Cyl. 7.6L; DT466 Eng.; From Engine No. 3,040,001	HPI13
2007	6 Cyl. 9.3L; DT570 Eng.; From Engine No. 3,040,001	HPI14
2007	6 Cyl. 7.6L; DT466 Eng.; To Engine No. 3040000	HPI8
2007	6 Cyl. 9.3L; DT570 Eng.; To Engine No. 3040000	HPI9
2006-2005	6 Cyl. 9.3L; DT570 Eng.	HPI17
2006-2004	6 Cyl. 7.6L; DT466 Eng.	HPI12
2003-2002	6 Cyl. 7.6L; DT466 Eng.; 230-300 HP	HPI18
2003-2002	6 Cyl. 8.7L; DT530 Eng.; 230-300 HP	HPI18
2003-2002	6 Cyl. 7.6L; DT466 Eng.; 175-230 HP	HPI19
2003-2002	6 Cyl. 8.7L; DT530 Eng.; 300-330 HP	HPI20
7500		
2007	From Engine No. 3,040,001	HPI14
2007	To Engine No. 3040000	HPI9
2006-2005		HPI17
2004	6 Cyl. 9.3L; HT570 Eng.	HPI17
2003	230-300 HP	HPI18
2003	300-330 HP	HPI20
2002	6 Cyl. 7.6L; DT466 Eng.; 230-300 HP	HPI18
2002	6 Cyl. 8.7L; DT530 Eng.; 230-300 HP	HPI18
2002	6 Cyl. 7.6L; DT466 Eng.; 175-230 HP	HPI19
2002	6 Cyl. 8.7L; DT530 Eng.; 300-330 HP	HPI20
7600		
2007	6 Cyl. 9.3L; DT570 Eng.; From Engine No. 3,040,001	HPI14
2007	6 Cyl. 9.3L; DT570 Eng.; To Engine No. 3040000	HPI9
7700		
2007	6 Cyl. 9.3L; From Engine No. 3,040,001	HPI14
2007	6 Cyl. 9.3L; To Engine No. 3040000	HPI9
8100		
2002-2000	6 Cyl. 7.6L; DT466 Eng.; 230-300 HP	HPI18
2002-2000	6 Cyl. 7.6L; DT466 Eng.; 175-230 HP	HPI19
2002-1994	6 Cyl. 8.7L; DT530 Eng.; 230-300 HP	HPI18
2002-1994	6 Cyl. 8.7L; DT530 Eng.; 300-330 HP	HPI20
1999-1994	6 Cyl. 7.6L; DT466 Eng.	HPI19
8200		
1997-1996	6 Cyl. 8.7L; DT530 Eng.; 230-300 HP	HPI18
1997-1996	6 Cyl. 7.6L; DT466 Eng.	HPI19
1997-1996	6 Cyl. 8.7L; DT530 Eng.; 300-330 HP	HPI20
8500		
2007	From Engine No. 3,040,001	HPI14
2007	To Engine No. 3040000	HPI9
2006		HPI17

Injection Components

		Part No.
Diesel Injection High Pressure Oil Pump		
8500		
2005-2004	6 Cyl. 9.3L; HT570 Eng.	HPI17
2003-2002	6 Cyl. 8.7L; DT530 Eng.; 230-300 HP	HPI18
2003-2002	6 Cyl. 8.7L; DT530 Eng.; 300-330 HP	HPI20
2002	6 Cyl. 7.6L; DT466 Eng.; 230-300 HP	HPI18
2002	6 Cyl. 7.6L; DT466 Eng.; 175-230 HP	HPI19
8500 TranStar		
2009-2008	6 Cyl. 9.3L; DT570 Eng.; From Engine No. 3,040,001	HPI14
2009-2008	6 Cyl. 9.3L; DT570 Eng.; To Engine No. 3040000	HPI9
8600 SBA		
2007	6 Cyl. 9.3L; HT570 Eng.; From Engine No. 3,040,001	HPI14
2007	6 Cyl. 9.3L; HT570 Eng.; To Engine No. 3040000	HPI9
2006-2004	6 Cyl. 9.3L; HT570 Eng.	HPI17
CF500		
2009-2007		HPI11
2006-2005		HPI16
CF600		
2009-2007		HPI11
2006-2005		HPI16
CXT		
2008-2007	6 Cyl. 7.6L; DT466 Eng.; From Engine No. 3,040,001	HPI13
2008-2007	6 Cyl. 9.3L; DT570 Eng.; From Engine No. 3,040,001	HPI14
2008-2007	6 Cyl. 7.6L; DT466 Eng.; To Engine No. 3040000	HPI8
2008-2007	6 Cyl. 9.3L; DT570 Eng.; To Engine No. 3040000	HPI9
2007-2006	8 Cyl. 6.0L; VT365 Eng.	HPI7
2006	6 Cyl. 9.3L; DT570 Eng.	HPI17
2006-2005	6 Cyl. 7.6L; DT466 Eng.	HPI12
Durastar		
2013		HPI10
Genesis RE		
2002-2001	6 Cyl. 8.7L; DT530 Eng.; 230-300 HP	HPI18
2002-2001	6 Cyl. 8.7L; DT530 Eng.; 300-330 HP	HPI20
2002-2000	6 Cyl. 7.6L; DT466 Eng.; 230-300 HP	HPI18
2002-2000	6 Cyl. 7.6L; DT466 Eng.; 175-230 HP	HPI19
2002-2000	8 Cyl. 7.3L; T444E Eng.	HPI2
1999	8 Cyl. 7.3L; T444E Eng.; To Engine No. 843989	HPI3
1999-1998	6 Cyl. 7.6L; DT466 Eng.	HPI19
1999-1997	6 Cyl. 8.7L; DT530 Eng.; 230-300 HP	HPI18
1999-1997	6 Cyl. 8.7L; DT530 Eng.; 300-330 HP	HPI20
1998	8 Cyl. 7.3L	HPI3
1997	8 Cyl. 7.3L; T444E Eng.; From Engine No. 216544 to Engine No. 661894	HPI1
1997	8 Cyl. 7.3L; T444E Eng.; From Engine No. 5500 to Engine No. 216543	HPI4
1996	From Engine No. 216544 to Engine No. 661894	HPI1
1996	From Engine No. 5500 to Engine No. 216543	HPI4
MXT		
2007	8 Cyl. 6.0L; VT365 Eng.	HPI7
RXT		
2007	6 Cyl. 9.3L; DT570 Eng.; From Engine No. 3,040,001	HPI14
2007	6 Cyl. 9.3L; DT570 Eng.; To Engine No. 3040000	HPI9
2007-2006	8 Cyl. 6.0L; VT365 Eng.	HPI7
2006	6 Cyl. 9.3L; DT570 Eng.	HPI17

		Part No.
Diesel Injection High Pressure Oil Pump		
RXT		
2005		HPI7
Diesel Injection Pump Installation Kit		
4100		
2011	8 Cyl. 6.4L; MaxxFORCE 7 Eng.	IPK3
2010	8 Cyl. 6.4L; MaxxFORCE 7 Eng.; To Engine No. 5300001	IPK2
2010	8 Cyl. 6.4L; MaxxFORCE 7 Eng.; From Engine No. 5300002	IPK3
2009-2008	8 Cyl. 6.4L; MaxxFORCE 7 Eng.	IPK2
4300		
2015-2011	8 Cyl. 6.4L; MaxxFORCE 7 Eng.	IPK3
2010	8 Cyl. 6.4L; MaxxFORCE 7 Eng.; To Engine No. 5300001	IPK2
2010	8 Cyl. 6.4L; MaxxFORCE 7 Eng.; From Engine No. 5300002	IPK3
2009-2008	8 Cyl. 6.4L; MaxxFORCE 7 Eng.	IPK2
4300LP		
2015-2011	8 Cyl. 6.4L; MaxxFORCE 7 Eng.	IPK3
2010	8 Cyl. 6.4L; MaxxFORCE 7 Eng.; To Engine No. 5300001	IPK2
2010	8 Cyl. 6.4L; MaxxFORCE 7 Eng.; From Engine No. 5300002	IPK3
2009-2008	8 Cyl. 6.4L; MaxxFORCE 7 Eng.	IPK2
TerraStar		
2013-2011	8 Cyl. 6.4L; MaxxFORCE 7 Eng.	IPK3
2010	8 Cyl. 6.4L; MaxxFORCE 7 Eng.; To Engine No. 5300001	IPK2
2010	8 Cyl. 6.4L; MaxxFORCE 7 Eng.; From Engine No. 5300002	IPK3
Diesel Oil Cooler Gasket Kit		
1652SC		
2012-2006		OCG1
2005-2004	8 Cyl. 6.0L; VT365 Eng.	OCG1
3200		
2011-2007		OCG1
2006-2004	8 Cyl. 6.0L; VT365 Eng.	OCG1
3300		
2011-2005		OCG1
4100		
2012-2011		OCG1
2010-2008	8 Cyl. 6.0L; VT365 Eng.	OCG1
2007-2006		OCG1
4100 SBA		
2008	8 Cyl. 6.0L; VT365 Eng.	OCG1
2007-2006		OCG1
4200		
2008-2002		OCG1
4200LP		
2007-2003		OCG1
4300		
2003	8 Cyl. 6.0L; VT365 Eng.	OCG1
4400		
2003	8 Cyl. 6.0L; VT365 Eng.	OCG1
CF500		
2009-2005		OCG1
CF600		
2009-2005		OCG1
CXT		
2008-2006	8 Cyl. 6.0L; VT365 Eng.	OCG1
MXT		
2009-2007		OCG1

International

Injection Components

		Part No.
Diesel Oil Cooler Gasket Kit		
RXT		
2008-2006	8 Cyl. 6.0L; VT365 Eng.	OCG1
2005		OCG1
Diesel Oil Cooler Kit		
400		
1991	8 Cyl. 7.3L	OCK18
500		
1991	8 Cyl. 7.3L	OCK18
1452SC		
1992-1988	8 Cyl. 7.3L	OCK18
1988-1987	8 Cyl. 6.9L	OCK18
1652SC		
2012-2006		OCK1
2005-2004	8 Cyl. 6.0L; VT365 Eng.	OCK1
1993-1988	8 Cyl. 7.3L	OCK18
1988-1986	8 Cyl. 6.9L	OCK18
1652UPS		
1993	8 Cyl. 7.3L	OCK18
1991-1990	8 Cyl. 7.3L	OCK18
1654		
1989-1984		OCK18
3200		
2011-2007		OCK1
2006	6 Cyl. 7.6L; DT466 Eng.	OCK3
2006-2004	8 Cyl. 6.0L; VT365 Eng.	OCK1
3300		
2011-2005		OCK1
3600		
1993-1992	8 Cyl. 7.3L	OCK18
3700		
1993-1990	8 Cyl. 7.3L	OCK18
3800		
1990	8 Cyl. 7.3L	OCK18
4100		
2012-2011		OCK1
2010-2008	8 Cyl. 6.0L; VT365 Eng.	OCK1
2007-2006		OCK1
4100 SBA		
2008	8 Cyl. 6.0L; VT365 Eng.	OCK1
2007-2006		OCK1
4200		
2008-2002		OCK1
4200LP		
2007-2003		OCK1
4300		
2009-2008	6 Cyl. 7.6L; MaxxForce DT Eng.	OCK3
2007-2006	6 Cyl. 7.6L; DT466 Eng.	OCK3
2003	8 Cyl. 6.0L; VT365 Eng.	OCK1
4300LP		
2009	6 Cyl. 7.6L; MaxxForce DT Eng.	OCK3
2008-2006	6 Cyl. 7.6L; DT466 Eng.	OCK3
4400		
2009-2008	6 Cyl. 7.6L; MaxxForce DT Eng.	OCK3
2007-2006	6 Cyl. 7.6L; DT466 Eng.	OCK3
2003	8 Cyl. 6.0L; VT365 Eng.	OCK1
4400LP		
2009-2008	6 Cyl. 7.6L; MaxxForce DT Eng.	OCK3
2007-2006	6 Cyl. 7.6L; DT466 Eng.	OCK3
4600		
1993-1990	8 Cyl. 7.3L	OCK18
4600LP		
1993-1990	8 Cyl. 7.3L	OCK18

		Part No.
Diesel Oil Cooler Kit		
4600UH		
1990	8 Cyl. 7.3L	OCK18
4900		
1991	8 Cyl. 7.3L	OCK18
7300		
2007-2006	6 Cyl. 7.6L; DT466 Eng.	OCK3
7400		
2007-2006	6 Cyl. 7.6L; DT466 Eng.	OCK3
CF500		
2010	6 Cyl. 4.5L	OCK1
2009-2005	6 Cyl. 4.5L; VT275 Eng.	OCK1
CF600		
2010	6 Cyl. 4.5L	OCK1
2009-2005	6 Cyl. 4.5L; VT275 Eng.	OCK1
CXT		
2008-2006	8 Cyl. 6.0L; VT365 Eng.	OCK1
2008-2006	6 Cyl. 7.6L; DT466 Eng.	OCK3
M1400 Metro II		
1990-1988	8 Cyl. 7.3L	OCK18
M1600 Metro II		
1990-1988	8 Cyl. 7.3L	OCK18
MXT		
2009-2007		OCK1
RXT		
2008-2006	8 Cyl. 6.0L; VT365 Eng.	OCK1
2005		OCK1
S1654		
1989-1988	8 Cyl. 7.3L	OCK18
S1654LP		
1989-1988	8 Cyl. 7.3L	OCK18
S1753		
1989-1988	8 Cyl. 7.3L	OCK18
S1754		
1988	8 Cyl. 7.3L	OCK18
Diesel Valve Cover Gasket		
1552SC		
1998-1996	8 Cyl. 7.3L; T444E Eng.	VCG6
1652SC		
2005-2004	8 Cyl. 7.3L; T444E Eng.	VCG4
2003-1998		VCG4
1997-1994	8 Cyl. 7.3L; T444E Eng.	VCG6
1652UPS		
1997-1995	8 Cyl. 7.3L; T444E Eng.	VCG6
2554		
2002-2001		VCG1
1999	6 Cyl. 7.6L; DT466 Eng.	VCG1
1999	6 Cyl. 8.7L; DT530 Eng.	VCG1
1998-1996		VCG1
2574		
2003-2001	6 Cyl. 7.6L; DT466 Eng.	VCG1
2003-1996	6 Cyl. 8.7L; DT530 Eng.	VCG1
2654		
2002		VCG1
2000-1999	6 Cyl. 7.6L; DT466 Eng.	VCG1
2000-1999	6 Cyl. 8.7L; DT530 Eng.	VCG1
1998-1996		VCG1
2674		
2003-2001	6 Cyl. 7.6L; DT466 Eng.	VCG1
2003-1996	6 Cyl. 8.7L; DT530 Eng.	VCG1
3000		
2002-2001		VCG1
2000-1998	8 Cyl. 7.3L; T444E Eng.	VCG4

Injection Components

		Part No.
Diesel Valve Cover Gasket		
3000		
2000-1997	6 Cyl. 7.6L; DT466 Eng.	VCG1
1996		VCG1
3000FE		
1999-1997		VCG1
3000IC		
2002-2000	6 Cyl. 7.6L; DT466 Eng.	VCG1
2002-2000	8 Cyl. 7.3L; T444E Eng.	VCG4
3000RE		
2002		VCG1
3200		
2003-2002	6 Cyl.	VCG1
3400		
2002-1998		VCG4
1997-1996	8 Cyl. 7.3L; T444E Eng.	VCG6
3600		
1999-1998	8 Cyl. 7.3L; T444E Eng.	VCG4
1999-1996	6 Cyl. 7.6L; DT466 Eng.	VCG1
1997-1994	8 Cyl. 7.3L; T444E Eng.	VCG6
3700		
1994	8 Cyl. 7.3L; T444E Eng.	VCG6
3800		
2004-1998	8 Cyl. 7.3L; T444E Eng.	VCG4
2003-1996	6 Cyl. 7.6L; DT466 Eng.	VCG1
1997-1994	8 Cyl. 7.3L; T444E Eng.	VCG6
3900FC		
1996		VCG1
4300		
2003-2002	6 Cyl. 7.6L; DT466 Eng.	VCG1
4300LP		
2003-2002		VCG1
4400		
2003	6 Cyl.	VCG1
2002		VCG1
4400LP		
2003-2002		VCG1
4600		
1995-1994	8 Cyl. 7.3L; T444E Eng.	VCG6
4600LP		
1994	8 Cyl. 7.3L; T444E Eng.	VCG6
4700		
2003		VCG1
2002	6 Cyl.	VCG1
2002-1998	8 Cyl. 7.3L; T444E Eng.	VCG4
2001	6 Cyl. 7.6L; DT466 Eng.	VCG1
2001-1996	6 Cyl. 8.7L; DT530 Eng.	VCG1
2000	6 Cyl. 7.6L; MaxForce DT Eng.	VCG1
1999-1996	6 Cyl. 7.6L; DT466 Eng.	VCG1
1997-1994	8 Cyl. 7.3L; T444E Eng.	VCG6
4700LP		
2002-1998	8 Cyl. 7.3L; T444E Eng.	VCG4
2002-1997	6 Cyl.	VCG1
1997-1994	8 Cyl. 7.3L; T444E Eng.	VCG6
1996	6 Cyl. 7.6L; DT466 Eng.	VCG1
4700LPX		
2002-1998		VCG4
1997-1995	8 Cyl. 7.3L; T444E Eng.	VCG6
4800		
2003-1998		VCG1
1997-1996	6 Cyl. 7.6L; DT466 Eng.	VCG1
1997-1996	6 Cyl. 8.7L; DT530 Eng.	VCG1
1997-1995	8 Cyl. 7.3L; T444E Eng.	VCG6

		Part No.
Diesel Valve Cover Gasket		
4900		
2003-1998		VCG1
1997-1996	6 Cyl. 7.6L; DT466 Eng.	VCG1
1997-1996	6 Cyl. 8.7L; DT530 Eng.	VCG1
1997-1995	8 Cyl. 7.3L; T444E Eng.	VCG6
5000		
1999-1996	6 Cyl. 8.7L; DT530 Eng.	VCG1
5500i		
2003-2000	6 Cyl. 8.7L; DT530 Eng.	VCG1
2002-2001	6 Cyl. 7.6L; DT466 Eng.	VCG1
5600i		
2003-2000	6 Cyl. 8.7L; DT530 Eng.	VCG1
2002-2001	6 Cyl. 7.6L; DT466 Eng.	VCG1
7100		
1995-1994	8 Cyl. 7.3L; T444E Eng.	VCG6
7300		
2003-2002		VCG1
7400		
2003-2002		VCG1
7500		
2003-2002		VCG1
8100		
2002-1996	6 Cyl. 7.6L; DT466 Eng.	VCG1
2002-1996	6 Cyl. 8.7L; DT530 Eng.	VCG1
8200		
1997-1996	6 Cyl. 7.6L; DT466 Eng.	VCG1
1997-1996	6 Cyl. 8.7L; DT530 Eng.	VCG1
8500		
2003	6 Cyl. 8.7L; DT530 Eng.	VCG1
2002		VCG1
Genesis RE		
2002-1998	6 Cyl. 7.6L; DT466 Eng.	VCG1
2002-1998	8 Cyl. 7.3L; T444E Eng.	VCG4
2002-1997	6 Cyl. 8.7L; DT530 Eng.	VCG1
1997	8 Cyl. 7.3L; T444E Eng.	VCG6
1996	8 Cyl. 7.3L; T444E Eng.	VCG6
Engine Oil Stand Pipe and Dummy Plug Kit		
1652SC		
2012-2004	8 Cyl. 6.0L; VT365 Eng.	SPK101
3200		
2011-2002	8 Cyl. 6.0L; VT365 Eng.	SPK101
3300		
2011-2005	8 Cyl. 6.0L; VT365 Eng.	SPK101
4100		
2012-2006	8 Cyl. 6.0L; VT365 Eng.	SPK101
4100 SBA		
2008-2006	8 Cyl. 6.0L; VT365 Eng.	SPK101
4200		
2010-2002	8 Cyl. 6.0L; VT365 Eng.	SPK101
4200LP		
2008-2003	8 Cyl. 6.0L; VT365 Eng.	SPK101
CXT		
2008-2006	8 Cyl. 6.0L; VT365 Eng.	SPK101
MXT		
2009-2007	8 Cyl. 6.0L; VT365 Eng.	SPK101
RXT		
2008-2005	8 Cyl. 6.0L; VT365 Eng.	SPK101
Fuel Injector Seal Kit		
1652SC		
2012-2006		SK85
2005-2004	8 Cyl. 6.0L; VT365 Eng.	SK85

Injection Components

		Part No.
Fuel Injector Seal Kit		
2554		
2002-1995	w/ Stainless Steel Sleeve	SK141
2002-1995	w/ Brass Sleeve	SK55
2574		
2003-2001	6 Cyl. 7.6L; DT466 Eng.; w/ Stainless Steel Sleeve	SK141
2003-2001	6 Cyl. 7.6L; DT466 Eng.; w/ Brass Sleeve	SK55
2003-1995	6 Cyl. 8.7L; DT530 Eng.; w/ Stainless Steel Sleeve	SK141
2003-1995	6 Cyl. 8.7L; DT530 Eng.; w/ Brass Sleeve	SK55
2654		
2002-2001	w/ Stainless Steel Sleeve	SK141
2002-2001	w/ Brass Sleeve	SK55
2000-1999	6 Cyl. 7.6L; DT466 Eng.; w/ Stainless Steel Sleeve	SK141
2000-1999	6 Cyl. 8.7L; DT530 Eng.; w/ Stainless Steel Sleeve	SK141
2000-1999	6 Cyl. 7.6L; DT466 Eng.; w/ Brass Sleeve	SK55
2000-1999	6 Cyl. 8.7L; DT530 Eng.; w/ Brass Sleeve	SK55
1998-1995	w/ Stainless Steel Sleeve	SK141
1998-1995	w/ Brass Sleeve	SK55
2674		
2003-2001	6 Cyl. 7.6L; DT466 Eng.; w/ Stainless Steel Sleeve	SK141
2003-2001	6 Cyl. 7.6L; DT466 Eng.; w/ Brass Sleeve	SK55
2003-1995	6 Cyl. 8.7L; DT530 Eng.; w/ Stainless Steel Sleeve	SK141
2003-1995	6 Cyl. 8.7L; DT530 Eng.; w/ Brass Sleeve	SK55
3000		
2002-2001	w/ Stainless Steel Sleeve	SK141
2002-2001	w/ Brass Sleeve	SK55
2000-1997	6 Cyl.; w/ Stainless Steel Sleeve	SK141
2000-1997	6 Cyl.; w/ Brass Sleeve	SK55
1996	w/ Stainless Steel Sleeve	SK141
1996	w/ Brass Sleeve	SK55
3000FE		
1999-1997	w/ Stainless Steel Sleeve	SK141
1999-1997	w/ Brass Sleeve	SK55
3000IC		
2002-2000	6 Cyl.; w/ Stainless Steel Sleeve	SK141
2002-2000	6 Cyl.; w/ Brass Sleeve	SK55
2002-2000	8 Cyl.	SK55
3000RE		
2005	w/ O-Ring and Chamber Gasket	SK140
2005	Chamber Gasket Only	SK141
2002	w/ Stainless Steel Sleeve	SK141
2002	w/ Brass Sleeve	SK55
2000		SK55
1998-1996		SK55
3200		
2011-2007		SK85
2006-2005	6 Cyl.; w/ O-Ring and Chamber Gasket	SK140
2006-2005	6 Cyl.; Chamber Gasket Only	SK141
2006-2002	8 Cyl. 6.0L; VT365 Eng.	SK85
2004	6 Cyl. 7.6L; DT466 Eng.; w/ O-Ring and Chamber Gasket	SK140
2004	6 Cyl. 7.6L; DT466 Eng.; Chamber Gasket Only	SK141
2004	6 Cyl. 8.7L; DT530 Eng.; w/ Stainless Steel Sleeve	SK141
2004	6 Cyl. 8.7L; DT530 Eng.; w/ Brass Sleeve	SK55
2003-2002	6 Cyl.; w/ Stainless Steel Sleeve	SK141
2003-2002	6 Cyl.; w/ Brass Sleeve	SK55
3300		
2011-2005		SK85

		Part No.
Fuel Injector Seal Kit		
3400		
1996		SK55
3600		
2001	w/ Stainless Steel Sleeve	SK141
2001	w/ Brass Sleeve	SK55
1999-1995	6 Cyl. 7.6L; DT466 Eng.; w/ Stainless Steel Sleeve	SK141
1999-1995	6 Cyl. 7.6L; DT466 Eng.; w/ Brass Sleeve	SK55
1996-1994	8 Cyl. 7.3L; T444E Eng.	SK55
3700		
1994		SK55
3800		
2004	6 Cyl. 7.6L; DT466 Eng.; w/ O-Ring and Chamber Gasket	SK140
2004	6 Cyl. 7.6L; DT466 Eng.; Chamber Gasket Only	SK141
2003-1995	6 Cyl. 7.6L; DT466 Eng.; w/ Stainless Steel Sleeve	SK141
2003-1995	6 Cyl. 7.6L; DT466 Eng.; w/ Brass Sleeve	SK55
1996-1994	8 Cyl.	SK55
3900FC		
1996	w/ Stainless Steel Sleeve	SK141
1996	w/ Brass Sleeve	SK55
4100		
2012		SK85
2011-2008	8 Cyl. 6.0L; VT365 Eng.	SK85
2007-2006		SK85
4100 SBA		
2008-2006		SK85
4200		
2008-2002		SK85
4200LP		
2007-2003		SK85
4300		
2010-2008	6 Cyl. 7.6L; MaxxForce DT Eng.; w/ O-Ring and Chamber Gasket	SK140
2010-2008	6 Cyl. 7.6L; MaxxForce DT Eng.; Chamber Gasket Only	SK141
2007-2004	6 Cyl. 7.6L; DT466 Eng.; w/ O-Ring and Chamber Gasket	SK140
2007-2004	6 Cyl. 7.6L; DT466 Eng.; Chamber Gasket Only	SK141
2003	8 Cyl. 6.0L; VT365 Eng.	SK85
2003-2002	6 Cyl. 7.6L; DT466 Eng.; w/ Stainless Steel Sleeve	SK141
2003-2002	6 Cyl. 7.6L; DT466 Eng.; w/ Brass Sleeve	SK55
4300LP		
2010-2008	6 Cyl.; w/ O-Ring and Chamber Gasket	SK140
2010-2008	6 Cyl.; Chamber Gasket Only	SK141
2007-2004	w/ O-Ring and Chamber Gasket	SK140
2007-2004	Chamber Gasket Only	SK141
2003-2002	w/ Stainless Steel Sleeve	SK141
2003-2002	w/ Brass Sleeve	SK55
4400		
2010-2008	6 Cyl. 7.6L; MaxxForce DT Eng.; w/ O-Ring and Chamber Gasket	SK140
2010-2008	6 Cyl. 7.6L; MaxxForce DT Eng.; Chamber Gasket Only	SK141
2008-2004	6 Cyl. 9.3L; DT570 Eng.; w/ O-Ring and Chamber Gasket	SK140
2008-2004	6 Cyl. 9.3L; DT570 Eng.; Chamber Gasket Only	SK141
2007-2004	6 Cyl. 7.6L; DT466 Eng.; w/ O-Ring and Chamber Gasket	SK140
2007-2004	6 Cyl. 7.6L; DT466 Eng.; Chamber Gasket Only	SK141

Injection Components

		Part No.
Fuel Injector Seal Kit		
4400		
2005-2002	6 Cyl. 8.7L; DT530 Eng.; w/ Stainless Steel Sleeve	SK141
2005-2002	6 Cyl. 8.7L; DT530 Eng.; w/ Brass Sleeve	SK55
2003	8 Cyl. 6.0L; VT365 Eng.	SK85
2003-2002	6 Cyl. 7.6L; DT466 Eng.; w/ Stainless Steel Sleeve	SK141
2003-2002	6 Cyl. 7.6L; DT466 Eng.; w/ Brass Sleeve	SK55
4400LP		
2010-2008	6 Cyl. 7.6L; MaxxFORCE DT Eng.; w/ O-Ring and Chamber Gasket	SK140
2010-2008	6 Cyl. 7.6L; MaxxFORCE DT Eng.; Chamber Gasket Only	SK141
2007-2005	6 Cyl. 9.3L; DT570 Eng.; w/ O-Ring and Chamber Gasket	SK140
2007-2005	6 Cyl. 9.3L; DT570 Eng.; Chamber Gasket Only	SK141
2007-2004	6 Cyl. 7.6L; DT466 Eng.; w/ O-Ring and Chamber Gasket	SK140
2007-2004	6 Cyl. 7.6L; DT466 Eng.; Chamber Gasket Only	SK141
2005-2004	6 Cyl. 8.7L; DT530 Eng.; w/ Stainless Steel Sleeve	SK141
2005-2004	6 Cyl. 8.7L; DT530 Eng.; w/ Brass Sleeve	SK55
2003-2002	w/ Stainless Steel Sleeve	SK141
2003-2002	w/ Brass Sleeve	SK55
4600		
1995-1994		SK55
4700		
2003	w/ Stainless Steel Sleeve	SK141
2003	w/ Brass Sleeve	SK55
2002	6 Cyl.; w/ Stainless Steel Sleeve	SK141
2002	6 Cyl.; w/ Brass Sleeve	SK55
2001	6 Cyl. 7.6L; DT466 Eng.; w/ Stainless Steel Sleeve	SK141
2001	6 Cyl. 7.6L; DT466 Eng.; w/ Brass Sleeve	SK55
2001-1996	6 Cyl. 8.7L; DT530 Eng.; w/ Stainless Steel Sleeve	SK141
2001-1996	6 Cyl. 8.7L; DT530 Eng.; w/ Brass Sleeve	SK55
2000	6 Cyl. 7.6L; MaxxFORCE DT Eng.; w/ Stainless Steel Sleeve	SK141
2000	6 Cyl. 7.6L; MaxxFORCE DT Eng.; w/ Brass Sleeve	SK55
1999-1995	6 Cyl. 7.6L; DT466 Eng.; w/ Stainless Steel Sleeve	SK141
1999-1995	6 Cyl. 7.6L; DT466 Eng.; w/ Brass Sleeve	SK55
1996-1994	8 Cyl. 7.3L; T444E Eng.	SK55
4700LP		
2002	6 Cyl.; w/ Stainless Steel Sleeve	SK141
2002	6 Cyl.; w/ Brass Sleeve	SK55
2002-1997	8 Cyl.	SK55
2001	6 Cyl. 7.6L; DT466 Eng.; w/ Stainless Steel Sleeve	SK141
2001	6 Cyl. 7.6L; DT466 Eng.; w/ Brass Sleeve	SK55
2001	6 Cyl. 8.7L; DT530 Eng.; w/ Stainless Steel Sleeve	SK141
2001	6 Cyl. 8.7L; DT530 Eng.; w/ Brass Sleeve	SK55
2000-1997	6 Cyl.; w/ Stainless Steel Sleeve	SK141
2000-1997	6 Cyl.; w/ Brass Sleeve	SK55
1996-1995	6 Cyl. 7.6L; DT466 Eng.; w/ Stainless Steel Sleeve	SK141
1996-1995	6 Cyl. 7.6L; DT466 Eng.; w/ Brass Sleeve	SK55
1996-1995	8 Cyl. 7.3L; T444E Eng.	SK55
4800		
2003-2001	6 Cyl. 8.7L; DT530 Eng.; w/ Stainless Steel Sleeve	SK141
2003-2001	6 Cyl. 8.7L; DT530 Eng.; w/ Brass Sleeve	SK55

		Part No.
Fuel Injector Seal Kit		
4800		
2003-1995	6 Cyl. 7.6L; DT466 Eng.; w/ Stainless Steel Sleeve	SK141
2003-1995	6 Cyl. 7.6L; DT466 Eng.; w/ Brass Sleeve	SK55
2000	6 Cyl. 8.7L; w/ Stainless Steel Sleeve	SK141
2000	6 Cyl. 8.7L; w/ Brass Sleeve	SK55
1999-1996	6 Cyl. 8.7L; DT530 Eng.; w/ Stainless Steel Sleeve	SK141
1999-1996	6 Cyl. 8.7L; DT530 Eng.; w/ Brass Sleeve	SK55
4900		
2003-1995	6 Cyl. 7.6L; DT466 Eng.; w/ Stainless Steel Sleeve	SK141
2003-1995	6 Cyl. 8.7L; DT530 Eng.; w/ Stainless Steel Sleeve	SK141
2003-1995	6 Cyl. 7.6L; DT466 Eng.; w/ Brass Sleeve	SK55
2003-1995	6 Cyl. 8.7L; DT530 Eng.; w/ Brass Sleeve	SK55
5000		
1999-1995	6 Cyl. 8.7L; DT530 Eng.; w/ Stainless Steel Sleeve	SK141
1999-1995	6 Cyl. 8.7L; DT530 Eng.; w/ Brass Sleeve	SK55
5500i		
2005	6 Cyl. 8.7L; w/ Stainless Steel Sleeve	SK141
2005	6 Cyl. 8.7L; w/ Brass Sleeve	SK55
2004-2000	6 Cyl. 8.7L; DT530 Eng.; w/ Stainless Steel Sleeve	SK141
2004-2000	6 Cyl. 8.7L; DT530 Eng.; w/ Brass Sleeve	SK55
2002-2001	6 Cyl. 7.6L; DT466 Eng.; w/ Stainless Steel Sleeve	SK141
2002-2001	6 Cyl. 7.6L; DT466 Eng.; w/ Brass Sleeve	SK55
5600i		
2005-2000	6 Cyl. 8.7L; DT530 Eng.; w/ Stainless Steel Sleeve	SK141
2005-2000	6 Cyl. 8.7L; DT530 Eng.; w/ Brass Sleeve	SK55
2002-2001	6 Cyl. 7.6L; DT466 Eng.; w/ Stainless Steel Sleeve	SK141
2002-2001	6 Cyl. 7.6L; DT466 Eng.; w/ Brass Sleeve	SK55
7100		
1995	6 Cyl.; w/ Stainless Steel Sleeve	SK141
1995	6 Cyl.; w/ Brass Sleeve	SK55
7300		
2006-2004	w/ O-Ring and Chamber Gasket	SK140
2006-2004	Chamber Gasket Only	SK141
2003-2002	w/ Stainless Steel Sleeve	SK141
2003-2002	w/ Brass Sleeve	SK55
7400		
2007-2005	6 Cyl. 9.3L; DT570 Eng.; w/ O-Ring and Chamber Gasket	SK140
2007-2005	6 Cyl. 9.3L; DT570 Eng.; Chamber Gasket Only	SK141
2007-2004	6 Cyl. 7.6L; DT466 Eng.; w/ O-Ring and Chamber Gasket	SK140
2007-2004	6 Cyl. 7.6L; DT466 Eng.; Chamber Gasket Only	SK141
2005-2004	6 Cyl. 8.7L; DT530 Eng.; w/ Stainless Steel Sleeve	SK141
2005-2004	6 Cyl. 8.7L; DT530 Eng.; w/ Brass Sleeve	SK55
2003-2002	w/ Stainless Steel Sleeve	SK141
2003-2002	w/ Brass Sleeve	SK55
7500		
2007-2005	w/ O-Ring and Chamber Gasket	SK140
2007-2005	Chamber Gasket Only	SK141
2004	6 Cyl. 9.3L; HT570 Eng.; w/ O-Ring and Chamber Gasket	SK140
2004	6 Cyl. 8.7L; HT530 Eng.; w/ Stainless Steel Sleeve	SK141

International

Injection Components

		Part No.
Fuel Injector Seal Kit		
7500		
2004	6 Cyl. 9.3L; HT570 Eng.; Chamber Gasket Only	SK141
2004	6 Cyl. 8.7L; HT530 Eng.; w/ Brass Sleeve	SK55
2003-2002	w/ Stainless Steel Sleeve	SK141
2003-2002	w/ Brass Sleeve	SK55
7600		
2007	6 Cyl. 9.3L; DT570 Eng.; w/ O-Ring and Chamber Gasket	SK140
2007	6 Cyl. 9.3L; DT570 Eng.; Chamber Gasket Only	SK141
7700		
2007	6 Cyl. 9.3L; w/ O-Ring and Chamber Gasket	SK140
2007	6 Cyl. 9.3L; Chamber Gasket Only	SK141
8100		
2002-1995	6 Cyl. 7.6L; DT466 Eng.; w/ Stainless Steel Sleeve	SK141
2002-1995	6 Cyl. 8.7L; DT530 Eng.; w/ Stainless Steel Sleeve	SK141
2002-1995	6 Cyl. 7.6L; DT466 Eng.; w/ Brass Sleeve	SK55
2002-1995	6 Cyl. 8.7L; DT530 Eng.; w/ Brass Sleeve	SK55
8200		
1997-1996	6 Cyl. 7.6L; DT466 Eng.; w/ Stainless Steel Sleeve	SK141
1997-1996	6 Cyl. 8.7L; DT530 Eng.; w/ Stainless Steel Sleeve	SK141
1997-1996	6 Cyl. 7.6L; DT466 Eng.; w/ Brass Sleeve	SK55
1997-1996	6 Cyl. 8.7L; DT530 Eng.; w/ Brass Sleeve	SK55
8500		
2007-2006	w/ O-Ring and Chamber Gasket	SK140
2007-2006	Chamber Gasket Only	SK141
2005-2004	6 Cyl. 9.3L; HT570 Eng.; w/ O-Ring and Chamber Gasket	SK140
2005-2004	6 Cyl. 8.7L; DT530 Eng.; w/ Stainless Steel Sleeve	SK141
2005-2004	6 Cyl. 9.3L; HT570 Eng.; Chamber Gasket Only	SK141
2005-2004	6 Cyl. 8.7L; DT530 Eng.; w/ Brass Sleeve	SK55
2003-2002	w/ Stainless Steel Sleeve	SK141
2003-2002	w/ Brass Sleeve	SK55
8500 TranStar		
2009-2008	6 Cyl. 9.3L; DT570 Eng.; w/ O-Ring and Chamber Gasket	SK140
2009-2008	6 Cyl. 9.3L; DT570 Eng.; Chamber Gasket Only	SK141
8600 SBA		
2007-2004	6 Cyl. 9.3L; HT570 Eng.; w/ O-Ring and Chamber Gasket	SK140
2007-2004	6 Cyl. 9.3L; HT570 Eng.; Chamber Gasket Only	SK141
CF500		
2009-2005		SK85
CF600		
2009-2005		SK85
CXT		
2008-2006	6 Cyl.; w/ O-Ring and Chamber Gasket	SK140
2008-2006	6 Cyl.; Chamber Gasket Only	SK141
2008-2006	8 Cyl. 6.0L; VT365 Eng.	SK85
2005	w/ O-Ring and Chamber Gasket	SK140
2005	Chamber Gasket Only	SK141
Durastar		
2013	w/ O-Ring and Chamber Gasket	SK140
2013	Chamber Gasket Only	SK141

		Part No.
Fuel Injector Seal Kit		
Genesis RE		
2002-1997	6 Cyl.; w/ Stainless Steel Sleeve	SK141
2002-1997	6 Cyl.; w/ Brass Sleeve	SK55
2002-1997	8 Cyl.	SK55
1996		SK55
MXT		
2009-2007		SK85
RXT		
2008		SK85
2007-2006	6 Cyl.; w/ O-Ring and Chamber Gasket	SK140
2007-2006	6 Cyl.; Chamber Gasket Only	SK141
2007-2006	8 Cyl. 6.0L; VT365 Eng.	SK85
2005		SK85
Fuel Pressure Regulator		
1652SC		
2012-2006		PR429
2005	8 Cyl. 6.0L; VT365 Eng.	PR429
2004	8 Cyl. 6.0L; VT365 Eng.	PR430
2002-1996	8 Cyl. 7.3L; T444E Eng.; Diesel; w/o Edge Filter	PR315
1652UPS		
1997	8 Cyl. 7.3L; T444E Eng.; Diesel; w/o Edge Filter	PR315
1995	8 Cyl. 7.3L; T444E Eng.; Diesel; w/o Edge Filter	PR315
2574		
2002-2001	6 Cyl. 7.6L; DT466 Eng.; Diesel; w/o Edge Filter	PR315
2002-1995	6 Cyl. 8.7L; DT530 Eng.; Diesel; w/o Edge Filter	PR315
2674		
2002-1995	6 Cyl. 8.7L; DT530 Eng.; Diesel; w/o Edge Filter	PR315
3000		
2002-1996	6 Cyl. 7.6L; DT466 Eng.; Diesel; w/o Edge Filter	PR315
1998	8 Cyl. 7.3L; T444E Eng.; Diesel; w/o Edge Filter	PR315
3000FE		
1999-1997	6 Cyl. 7.6L; DT466 Eng.; Diesel; w/o Edge Filter	PR315
3000RE		
2002	6 Cyl. 8.7L; DT530 Eng.; Diesel; w/o Edge Filter	PR315
2001	6 Cyl. 8.7L; Diesel; w/o Edge Filter	PR315
2000	8 Cyl. 7.3L; T444E Eng.; Diesel; w/o Edge Filter	PR315
1998-1996	8 Cyl. 7.3L; T444E Eng.; Diesel; w/o Edge Filter	PR315
3200		
2011-2008		PR429
2007	6 Cyl. 7.6L; Diesel; w/o Edge Filter	PR315
2007-2005	8 Cyl. 6.0L; VT365 Eng.	PR429
2006-2005	6 Cyl. 7.6L; DT466 Eng.; Diesel; w/o Edge Filter	PR315
2004-2003	6 Cyl.; Diesel; w/o Edge Filter	PR315
2004-2002	8 Cyl. 6.0L; VT365 Eng.	PR430
2002	6 Cyl. 7.6L; DT466 Eng.; Diesel; w/o Edge Filter	PR315
3300		
2011-2010		PR429
2008-2005		PR429
3400		
2002-1996	8 Cyl. 7.3L; T444E Eng.; Diesel; w/o Edge Filter	PR315

Injection Components

		Part No.
Fuel Pressure Regulator		
3600		
1995	6 Cyl. 7.6L; DT466 Eng.; Diesel; w/o Edge Filter	PR315
3800		
2003-1997	6 Cyl. 7.6L; DT466 Eng.; Diesel; w/o Edge Filter	PR315
2003-1997	8 Cyl. 7.3L; T444E Eng.; Diesel; w/o Edge Filter	PR315
1995	6 Cyl. 7.6L; DT466 Eng.; Diesel; w/o Edge Filter	PR315
4100		
2012		PR429
2011-2008	8 Cyl. 6.0L; VT365 Eng.	PR429
2007-2006		PR429
4100 SBA		
2008	8 Cyl. 6.0L; VT365 Eng.	PR429
2007-2006		PR429
4200		
2010-2005		PR429
2003-2002		PR430
4200LP		
2008-2005		PR429
2004-2003		PR430
4300		
2007-2002	6 Cyl. 7.6L; DT466 Eng.; Diesel; w/o Edge Filter	PR315
2003	8 Cyl. 6.0L; VT365 Eng.	PR430
4300LP		
2007-2002	6 Cyl. 7.6L; DT466 Eng.; Diesel; w/o Edge Filter	PR315
4400		
2007-2004	6 Cyl. 7.6L; DT466 Eng.; Diesel; w/o Edge Filter	PR315
2006-2004	6 Cyl. 8.7L; DT530 Eng.; Diesel; w/o Edge Filter	PR315
2003	8 Cyl. 6.0L; VT365 Eng.	PR430
2003-2002	6 Cyl.; Diesel; w/o Edge Filter	PR315
4400LP		
2007-2005	6 Cyl. 7.6L; DT466 Eng.; Diesel; w/o Edge Filter	PR315
2005	6 Cyl. 8.7L; DT530 Eng.; Diesel; w/o Edge Filter	PR315
4700		
2002-2001	6 Cyl. 7.6L; DT466 Eng.; Diesel; w/o Edge Filter	PR315
2002-1995	8 Cyl. 7.3L; T444E Eng.; Diesel; w/o Edge Filter	PR315
2000-1996	6 Cyl. 8.7L; DT530 Eng.; Diesel; w/o Edge Filter	PR315
1999-1995	6 Cyl. 7.6L; DT466 Eng.; Diesel; w/o Edge Filter	PR315
4700LP		
2002-1996	8 Cyl. 7.3L; T444E Eng.; Diesel; w/o Edge Filter	PR315
2002-1995	6 Cyl. 7.6L; DT466 Eng.; Diesel; w/o Edge Filter	PR315
2000-1997	6 Cyl. 8.7L; DT530 Eng.; Diesel; w/o Edge Filter	PR315
4700LPX		
2002-1996	8 Cyl. 7.3L; T444E Eng.; Diesel; w/o Edge Filter	PR315
4800		
2002-2001	6 Cyl. 8.7L; DT530 Eng.; Diesel; w/o Edge Filter	PR315
2002-1995	6 Cyl. 7.6L; DT466 Eng.; Diesel; w/o Edge Filter	PR315

		Part No.
Fuel Pressure Regulator		
4800		
1999-1996	6 Cyl. 8.7L; DT530 Eng.; Diesel; w/o Edge Filter	PR315
1997-1995	8 Cyl. 7.3L; T444E Eng.; Diesel; w/o Edge Filter	PR315
4900		
2002-1996	6 Cyl. 7.6L; DT466 Eng.; Diesel; w/o Edge Filter	PR315
2002-1996	6 Cyl. 8.7L; DT530 Eng.; Diesel; w/o Edge Filter	PR315
2000	6 Cyl. 10.8L; M11 Eng.; Diesel; w/o Edge Filter	PR315
1999	6 Cyl. 10.0L; L10 Eng.; Diesel; w/o Edge Filter	PR315
1997-1996	8 Cyl. 7.3L; T444E Eng.; Diesel; w/o Edge Filter	PR315
1995	6 Cyl. 6.7L; DT408 Eng.; Diesel; w/o Edge Filter	PR315
5500i		
2005	6 Cyl. 8.7L; Diesel; w/o Edge Filter	PR315
2004-2000	6 Cyl. 8.7L; DT530 Eng.; Diesel; w/o Edge Filter	PR315
5600i		
2003-2000	6 Cyl. 8.7L; DT530 Eng.; Diesel; w/o Edge Filter	PR315
7300		
2006-2002	6 Cyl. 7.6L; DT466 Eng.; Diesel; w/o Edge Filter	PR315
7400		
2006	6 Cyl. 8.7L; Diesel; w/o Edge Filter	PR315
2006-2005	6 Cyl. 7.6L; DT466 Eng.; Diesel; w/o Edge Filter	PR315
2005	6 Cyl. 8.7L; DT530 Eng.; Diesel; w/o Edge Filter	PR315
7500		
2005	6 Cyl. 8.7L; Diesel; w/o Edge Filter	PR315
2004	6 Cyl. 8.7L; HT530 Eng.; Diesel; w/o Edge Filter	PR315
8100		
2003-1995	6 Cyl. 7.6L; DT466 Eng.; Diesel; w/o Edge Filter	PR315
2003-1995	6 Cyl. 8.7L; DT530 Eng.; Diesel; w/o Edge Filter	PR315
8500		
2003	6 Cyl. 8.7L; DT530 Eng.; Diesel; w/o Edge Filter	PR315
CF500		
2009-2005		PR429
CF600		
2009-2005		PR429
CXT		
2008-2006	8 Cyl. 6.0L; VT365 Eng.	PR429
MXT		
2009-2007		PR429
RXT		
2008		PR429
2007-2006	8 Cyl. 6.0L; VT365 Eng.	PR429
2005		PR429
Fuel Pressure Regulator O-Ring		
1652SC		
2012-2006	Kit	SK107
2005-2004	8 Cyl. 6.0L; VT365 Eng.; Kit	SK107
2002-1995	8 Cyl. 7.3L; T444E Eng.	SK104
1652UPS		
1997-1995		SK104

International

Injection Components

		Part No.
Fuel Pressure Regulator O-Ring		
2554		
2001	6 Cyl.	SK104
2000-1998	6 Cyl. 7.6L; DT466 Eng.	SK104
2000-1998	6 Cyl. 8.7L; DT530 Eng.	SK104
2654		
2001-1999	6 Cyl. 8.7L; DT530 Eng.	SK104
1999	6 Cyl. 7.6L; DT466 Eng.	SK104
1998		SK104
1997	6 Cyl. 7.6L; DT466 Eng.	SK104
3000		
2002-2001	6 Cyl. 7.6L; DT466 Eng.	SK104
3000IC		
2002-2001	6 Cyl. 7.6L; DT466 Eng.	SK104
2001	8 Cyl. 7.3L; T444E Eng.	SK104
3000RE		
2002	6 Cyl. 8.7L; DT530 Eng.	SK104
2000-1998		SK104
3200		
2011-2007	Kit	SK107
2006-2002	8 Cyl. 6.0L; VT365 Eng.; Kit	SK107
2004	6 Cyl.	SK104
2002	6 Cyl. 7.6L; DT466 Eng.	SK104
3300		
2011-2005	Kit	SK107
3400		
2002-1996	8 Cyl. 7.3L; T444E Eng.	SK104
3600		
1998		SK104
1997-1995	8 Cyl. 7.3L; T444E Eng.	SK104
3800		
2004-2001	6 Cyl. 7.6L; DT466 Eng.	SK104
2002	8 Cyl. 7.3L; T444E Eng.	SK104
2000		SK104
1999-1997	6 Cyl. 7.6L; DT466 Eng.	SK104
1999-1994	8 Cyl. 7.3L; T444E Eng.	SK104
4100		
2012	Kit	SK107
2011-2008	8 Cyl. 6.0L; VT365 Eng.; Kit	SK107
2007-2006	Kit	SK107
4100 SBA		
2008-2006	Kit	SK107
4200		
2010-2002	Kit	SK107
4200LP		
2008-2003	Kit	SK107
4300		
2004-2003	6 Cyl. 7.6L; DT466 Eng.	SK104
2003	8 Cyl. 6.0L; VT365 Eng.; Kit	SK107
4300LP		
2004-2003	6 Cyl. 7.6L; DT466 Eng.	SK104
4400		
2004-2002	6 Cyl.	SK104
2003	8 Cyl. 6.0L; VT365 Eng.; Kit	SK107
4400LP		
2004-2002	6 Cyl.	SK104
4700		
2002		SK104
2001	6 Cyl. 7.6L; DT466 Eng.	SK104
2001-1997	6 Cyl. 8.7L; DT530 Eng.	SK104
2001-1995	8 Cyl. 7.3L; T444E Eng.	SK104
2000	6 Cyl. 7.6L; MaxxForce DT Eng.	SK104
1999-1997	6 Cyl. 7.6L; DT466 Eng.	SK104

		Part No.
Fuel Pressure Regulator O-Ring		
4700LP		
2002-2000	8 Cyl. 7.3L; T444E Eng.	SK104
2002-2000	6 Cyl. 8.7L; DT530 Eng.	SK104
2001-2000	6 Cyl. 7.6L; DT466 Eng.	SK104
1999-1997		SK104
1996-1995	8 Cyl. 7.3L; T444E Eng.	SK104
4700LPX		
2002-1995	8 Cyl. 7.3L; T444E Eng.	SK104
4800		
2002-1998	6 Cyl.	SK104
1997	6 Cyl. 7.6L; DT466 Eng.	SK104
1997	6 Cyl. 8.7L; DT530 Eng.	SK104
4900		
2002	6 Cyl.	SK104
2001-1997	6 Cyl. 7.6L; DT466 Eng.	SK104
2001-1997	6 Cyl. 8.7L; DT530 Eng.	SK104
5000		
2000	6 Cyl. 8.7L	SK104
1999	6 Cyl. 8.7L; DT530 Eng.	SK104
5500i		
2003-2000	6 Cyl. 8.7L; DT530 Eng.	SK104
5600i		
2005-2001	6 Cyl. 8.7L; DT530 Eng.	SK104
7300		
2003-2002	6 Cyl. 7.6L; DT466 Eng.	SK104
7400		
2005-2004	6 Cyl. 8.7L; DT530 Eng.	SK104
2004	6 Cyl. 7.6L; DT466 Eng.	SK104
2003-2002	6 Cyl.	SK104
7500		
2005	6 Cyl. 8.7L	SK104
2004	6 Cyl. 8.7L; HT530 Eng.	SK104
2003-2002	6 Cyl. 8.7L; DT530 Eng.	SK104
8100		
2003-1996	6 Cyl. 7.6L; DT466 Eng.	SK104
2003-1996	6 Cyl. 8.7L; DT530 Eng.	SK104
8500		
2005-2002	6 Cyl. 8.7L; DT530 Eng.	SK104
CF500		
2009-2005	Kit	SK107
CF600		
2009-2005	Kit	SK107
CXT		
2008-2006	8 Cyl. 6.0L; VT365 Eng.; Kit	SK107
Genesis RE		
2002-1998		SK104
1997	6 Cyl. 8.7L; DT530 Eng.	SK104
MXT		
2009-2007	Kit	SK107
RXT		
2008	Kit	SK107
2007-2006	8 Cyl. 6.0L; VT365 Eng.; Kit	SK107
2005	Kit	SK107
Fuel Rail O-Ring Kit		
3000RE		
2005	6 Cyl. 7.6L; DT466 Eng.	SK168
3200		
2011-2007	6 Cyl. 7.6L	SK168
2006-2005	6 Cyl. 7.6L; DT466 Eng.	SK168
4300		
2016-2008	6 Cyl. 7.6L; MaxxForce DT Eng.	SK168
2007-2005	6 Cyl. 7.6L; DT466 Eng.	SK168

Injection Components

		Part No.
Fuel Rail O-Ring Kit		
4300LP		
2016	6 Cyl. 7.6L	SK168
2015-2009	6 Cyl. 7.6L; MaxxForce DT Eng.	SK168
2008-2005	6 Cyl. 7.6L; DT466 Eng.	SK168
4400		
2016-2008	6 Cyl. 7.6L; MaxxForce DT Eng.	SK168
2007-2005	6 Cyl. 7.6L; DT466 Eng.	SK168
4400LP		
2015-2008	6 Cyl. 7.6L; MaxxForce DT Eng.	SK168
2007-2005	6 Cyl. 7.6L; DT466 Eng.	SK168
4900		
2005	6 Cyl.	SK168
7300		
2016-2008	6 Cyl. 7.6L; MaxxForce DT Eng.	SK168
2007-2005	6 Cyl. 7.6L; DT466 Eng.	SK168
7400		
2016-2008	6 Cyl. 7.6L; MaxxForce DT Eng.	SK168
2007-2005	6 Cyl. 7.6L; DT466 Eng.	SK168
7500		
2011-2008	6 Cyl. 7.6L; MaxxForce DT Eng.	SK168
CXT		
2008-2005	6 Cyl. 7.6L; DT466 Eng.	SK168
Durastar		
2013	6 Cyl. 7.6L; DT466 Eng.	SK168
Fuel Sensors		
Diesel Injection Control Pressure Sensor		
1552SC		
1998-1996	Exhaust stock and reorder; Sensor Only	ICP102
1998-1996	Alternate Number	ICP102K
1998-1996	Sensor Kit	ICP102K
1652SC		
2012-2006	Exhaust stock and reorder; Sensor Only	ICP101
2012-2006	Sensor Kit	ICP101K
2012-2006	Alternate Number; Sensor Kit	ICP101K
2005	8 Cyl. 6.0L; VT365 Eng.; Exhaust stock and reorder; Sensor Only	ICP101
2005	8 Cyl. 6.0L; VT365 Eng.; Sensor Kit	ICP101K
2005	8 Cyl. 6.0L; VT365 Eng.; Alternate Number; Sensor Kit	ICP101K
2005-2004	8 Cyl. 7.3L; T444E Eng.; Exhaust stock and reorder; Sensor Only	ICP102
2005-2004	8 Cyl. 7.3L; T444E Eng.; Alternate Number	ICP102K
2005-2004	8 Cyl. 7.3L; T444E Eng.; Sensor Kit	ICP102K
2004	8 Cyl. 6.0L; VT365 Eng.; Exhaust stock and reorder; Sensor Only; Mounts On Passenger Side Valve Cover	ICP101
2004	8 Cyl. 6.0L; VT365 Eng.; Sensor Kit; Mounts On Passenger Side Valve Cover	ICP101K
2004	8 Cyl. 6.0L; VT365 Eng.; Alternate Number; Sensor Kit; Mounts On Passenger Side Valve Cover	ICP101K
2004	8 Cyl. 6.0L; VT365 Eng.; Exhaust stock and reorder; Sensor Only; Mounts Below Turbocharger	ICP103
2004	8 Cyl. 6.0L; VT365 Eng.; Sensor Kit; Mounts Below Turbocharger	ICP103K
2002-1995	Exhaust stock and reorder; Sensor Only	ICP102
2002-1995	Alternate Number	ICP102K
2002-1995	Sensor Kit	ICP102K
1652UPS		
1997-1995	Exhaust stock and reorder; Sensor Only	ICP102
1997-1995	Alternate Number	ICP102K
1997-1995	Sensor Kit	ICP102K

		Part No.
Diesel Injection Control Pressure Sensor		
2554		
2002-2001	6 Cyl.	ICP106
2000-1999	6 Cyl. 7.6L; DT466 Eng.	ICP106
2000-1999	6 Cyl. 8.7L; DT530 Eng.	ICP106
1999	6 Cyl. 7.6L; DT466 Eng.; From Engine No. 1134351	ICP106
1999	6 Cyl. 8.7L; DT530 Eng.; From Engine No. 1134351	ICP106
2574		
2003-2001	6 Cyl. 7.6L; DT466 Eng.	ICP106
2003-1999	6 Cyl. 8.7L; DT530 Eng.	ICP106
1999	6 Cyl. 8.7L; DT530 Eng.; From Engine No. 1134351	ICP106
2654		
2002-2001	6 Cyl.	ICP106
2000-1999	6 Cyl. 7.6L; DT466 Eng.	ICP106
2000-1999	6 Cyl. 8.7L; DT530 Eng.	ICP106
1999	6 Cyl. 7.6L; DT466 Eng.; From Engine No. 1134351	ICP106
1999	6 Cyl. 8.7L; DT530 Eng.; From Engine No. 1134351	ICP106
2674		
2003-2001	6 Cyl. 7.6L; DT466 Eng.	ICP106
2003-1999	6 Cyl. 8.7L; DT530 Eng.	ICP106
1999	6 Cyl. 8.7L; DT530 Eng.; From Engine No. 1134351	ICP106
3000		
2002-2001		ICP106
2000	6 Cyl. 7.6L; DT466 Eng.	ICP106
2000-1997	8 Cyl. 7.3L; T444E Eng.; Exhaust stock and reorder; Sensor Only	ICP102
2000-1997	8 Cyl. 7.3L; T444E Eng.; Alternate Number	ICP102K
2000-1997	8 Cyl. 7.3L; T444E Eng.; Sensor Kit	ICP102K
1999	6 Cyl. 7.6L; DT466 Eng.; From Engine No. 1134351	ICP106
3000FE		
1999	From Engine No. 1134351	ICP106
3000IC		
2002-2000	8 Cyl. 7.3L; T444E Eng.; Exhaust stock and reorder; Sensor Only	ICP102
2002-2000	8 Cyl. 7.3L; T444E Eng.; Alternate Number	ICP102K
2002-2000	8 Cyl. 7.3L; T444E Eng.; Sensor Kit	ICP102K
2002-2000	6 Cyl. 7.6L; DT466 Eng.	ICP106
3000RE		
2002		ICP106
3200		
2011-2007	Exhaust stock and reorder; Sensor Only	ICP101
2011-2007	Sensor Kit	ICP101K
2011-2007	Alternate Number; Sensor Kit	ICP101K
2006-2005	8 Cyl.; Exhaust stock and reorder; Sensor Only	ICP101
2006-2005	8 Cyl.; Sensor Kit	ICP101K
2006-2005	8 Cyl.; Alternate Number; Sensor Kit	ICP101K
2004	8 Cyl.; Exhaust stock and reorder; Sensor Only; Mounts On Passenger Side Valve Cover	ICP101
2004	8 Cyl.; Sensor Kit; Mounts On Passenger Side Valve Cover	ICP101K
2004	8 Cyl.; Alternate Number; Sensor Kit; Mounts On Passenger Side Valve Cover	ICP101K
2004	8 Cyl.; Exhaust stock and reorder; Sensor Only; Mounts Below Turbocharger	ICP103
2004	8 Cyl.; Sensor Kit; Mounts Below Turbocharger	ICP103K

Fuel Sensors

		Part No.
Diesel Injection Control Pressure Sensor		
3200		
2003-2002	8 Cyl.; Exhaust stock and reorder; Sensor Only	ICP103
2003-2002	8 Cyl.; Sensor Kit	ICP103K
2003-2002	6 Cyl.	ICP106
3300		
2011-2005	Exhaust stock and reorder; Sensor Only	ICP101
2011-2005	Sensor Kit	ICP101K
2011-2005	Alternate Number; Sensor Kit	ICP101K
3400		
2002-1996	Exhaust stock and reorder; Sensor Only	ICP102
2002-1996	Alternate Number	ICP102K
2002-1996	Sensor Kit	ICP102K
3600		
2001		ICP106
1999	6 Cyl.; From Engine No. 1134351	ICP106
1999-1994	8 Cyl.; Exhaust stock and reorder; Sensor Only	ICP102
1999-1994	8 Cyl.; Alternate Number	ICP102K
1999-1994	8 Cyl.; Sensor Kit	ICP102K
3700		
1994	Exhaust stock and reorder; Sensor Only	ICP102
1994	Alternate Number	ICP102K
1994	Sensor Kit	ICP102K
3800		
2004-1994	8 Cyl.; Exhaust stock and reorder; Sensor Only	ICP102
2004-1994	8 Cyl.; Alternate Number	ICP102K
2004-1994	8 Cyl.; Sensor Kit	ICP102K
2003-2000	6 Cyl.	ICP106
1999	6 Cyl.; From Engine No. 1134351	ICP106
4100		
2012-2011	Exhaust stock and reorder; Sensor Only	ICP101
2012-2011	Sensor Kit	ICP101K
2012-2011	Alternate Number; Sensor Kit	ICP101K
2010-2008	8 Cyl. 6.0L; VT365 Eng.; Exhaust stock and reorder; Sensor Only	ICP101
2010-2008	8 Cyl. 6.0L; VT365 Eng.; Sensor Kit	ICP101K
2010-2008	8 Cyl. 6.0L; VT365 Eng.; Alternate Number; Sensor Kit	ICP101K
2007-2006	Exhaust stock and reorder; Sensor Only	ICP101
2007-2006	Sensor Kit	ICP101K
2007-2006	Alternate Number; Sensor Kit	ICP101K
4100 SBA		
2008	8 Cyl. 6.0L; VT365 Eng.; Exhaust stock and reorder; Sensor Only	ICP101
2008	8 Cyl. 6.0L; VT365 Eng.; Alternate Number; Sensor Kit	ICP101K
2008-2006	Sensor Kit	ICP101K
2007-2006	Exhaust stock and reorder; Sensor Only	ICP101
2007-2006	Alternate Number; Sensor Kit	ICP101K
4200		
2008-2005	Exhaust stock and reorder; Sensor Only	ICP101
2008-2005	Sensor Kit	ICP101K
2008-2005	Alternate Number; Sensor Kit	ICP101K
2004	Exhaust stock and reorder; Sensor Only; Mounts On Passenger Side Valve Cover	ICP101
2004	Sensor Kit; Mounts On Passenger Side Valve Cover	ICP101K
2004	Alternate Number; Sensor Kit; Mounts On Passenger Side Valve Cover	ICP101K
2004	Exhaust stock and reorder; Sensor Only; Mounts Below Turbocharger	ICP103
2004	Sensor Kit; Mounts Below Turbocharger	ICP103K
2003-2002	Exhaust stock and reorder; Sensor Only	ICP101

		Part No.
Diesel Injection Control Pressure Sensor		
4200		
2003-2002	Sensor Kit	ICP101K
2003-2002	Alternate Number; Sensor Kit	ICP101K
4200LP		
2007-2005	Exhaust stock and reorder; Sensor Only	ICP101
2007-2005	Sensor Kit	ICP101K
2007-2005	Alternate Number; Sensor Kit	ICP101K
2004	Exhaust stock and reorder; Sensor Only; Mounts On Passenger Side Valve Cover	ICP101
2004	Sensor Kit; Mounts On Passenger Side Valve Cover	ICP101K
2004	Alternate Number; Sensor Kit; Mounts On Passenger Side Valve Cover	ICP101K
2004	Exhaust stock and reorder; Sensor Only; Mounts Below Turbocharger	ICP103
2004	Sensor Kit; Mounts Below Turbocharger	ICP103K
2003	Exhaust stock and reorder; Sensor Only	ICP101
2003	Sensor Kit	ICP101K
2003	Alternate Number; Sensor Kit	ICP101K
4300		
2003	8 Cyl.; Exhaust stock and reorder; Sensor Only	ICP103
2003	8 Cyl.; Sensor Kit	ICP103K
2003	6 Cyl.	ICP106
2002		ICP106
4300LP		
2003-2002		ICP106
4400		
2003	8 Cyl.; Exhaust stock and reorder; Sensor Only	ICP103
2003	8 Cyl.; Sensor Kit	ICP103K
2003	6 Cyl.	ICP106
2002		ICP106
4400LP		
2003-2002		ICP106
4600		
1995-1994	Exhaust stock and reorder; Sensor Only	ICP102
1995-1994	Alternate Number	ICP102K
1995-1994	Sensor Kit	ICP102K
4600LP		
1994	Exhaust stock and reorder; Sensor Only	ICP102
1994	Alternate Number	ICP102K
1994	Sensor Kit	ICP102K
4700		
2003		ICP106
2002	6 Cyl.	ICP106
2002-1994	8 Cyl.; Exhaust stock and reorder; Sensor Only	ICP102
2002-1994	8 Cyl.; Alternate Number	ICP102K
2002-1994	8 Cyl.; Sensor Kit	ICP102K
2001	6 Cyl. 7.6L; DT466 Eng.	ICP106
2001-2000	6 Cyl. 8.7L; DT530 Eng.	ICP106
2000	6 Cyl. 7.6L; MaxxForce DT Eng.	ICP106
1999	6 Cyl.; From Engine No. 1134351	ICP106
4700LP		
2002-2000	6 Cyl.	ICP106
2002-1994	8 Cyl.; Exhaust stock and reorder; Sensor Only	ICP102
2002-1994	8 Cyl.; Alternate Number	ICP102K
2002-1994	8 Cyl.; Sensor Kit	ICP102K
1999	6 Cyl.; From Engine No. 1134351	ICP106
4700LPX		
2002-1995	Exhaust stock and reorder; Sensor Only	ICP102
2002-1995	Alternate Number	ICP102K

Fuel Sensors

		Part No.
Diesel Injection Control Pressure Sensor		
4700LPX		
2002-1995	Sensor Kit	ICP102K
4800		
2003-2000		ICP106
1999	From Engine No. 1134351	ICP106
1997-1995	8 Cyl.; Exhaust stock and reorder; Sensor Only	ICP102
1997-1995	8 Cyl.; Alternate Number	ICP102K
1997-1995	8 Cyl.; Sensor Kit	ICP102K
4900		
2003-2000		ICP106
1999	From Engine No. 1134351	ICP106
1997-1995	8 Cyl.; Exhaust stock and reorder; Sensor Only	ICP102
1997-1995	8 Cyl.; Alternate Number	ICP102K
1997-1995	8 Cyl.; Sensor Kit	ICP102K
5000		
1999	6 Cyl. 8.7L; DT530 Eng.	ICP106
1999	6 Cyl. 8.7L; DT530 Eng.; From Engine No. 1134351	ICP106
5500i		
2003-2000	6 Cyl. 8.7L; DT530 Eng.	ICP106
2002-2001	6 Cyl. 7.6L; DT466 Eng.	ICP106
5600i		
2003-2000	6 Cyl. 8.7L; DT530 Eng.	ICP106
2001	6 Cyl. 7.6L; DT466 Eng.	ICP106
7100		
1995-1994	8 Cyl.; Exhaust stock and reorder; Sensor Only	ICP102
1995-1994	8 Cyl.; Alternate Number	ICP102K
1995-1994	8 Cyl.; Sensor Kit	ICP102K
7300		
2003-2002		ICP106
7400		
2003-2002		ICP106
7500		
2003-2002		ICP106
8100		
2002-1999	6 Cyl. 7.6L; DT466 Eng.	ICP106
2002-1999	6 Cyl. 8.7L; DT530 Eng.	ICP106
1999	6 Cyl. 7.6L; DT466 Eng.; From Engine No. 1134351	ICP106
1999	6 Cyl. 8.7L; DT530 Eng.; From Engine No. 1134351	ICP106
8500		
2003-2002		ICP106
CF500		
2010-2005	Exhaust stock and reorder; Sensor Only	ICP101
2010-2005	Alternate Number; Sensor Kit	ICP101K
2009-2005	Sensor Kit	ICP101K
CF600		
2010-2005	Exhaust stock and reorder; Sensor Only	ICP101
2010-2005	Alternate Number; Sensor Kit	ICP101K
2009-2005	Sensor Kit	ICP101K
CXT		
2008	8 Cyl.; Exhaust stock and reorder; Sensor Only	ICP101
2008	8 Cyl.; Sensor Kit	ICP101K
2008	8 Cyl.; Alternate Number; Sensor Kit	ICP101K
2007	8 Cyl. 6.0L; VT365 Eng.; Exhaust stock and reorder; Sensor Only	ICP101
2007	8 Cyl. 6.0L; VT365 Eng.; Sensor Kit	ICP101K
2007	8 Cyl. 6.0L; VT365 Eng.; Alternate Number; Sensor Kit	ICP101K

		Part No.
Diesel Injection Control Pressure Sensor		
CXT		
2006	8 Cyl.; Exhaust stock and reorder; Sensor Only	ICP101
2006	8 Cyl.; Sensor Kit	ICP101K
2006	8 Cyl.; Alternate Number; Sensor Kit	ICP101K
Genesis RE		
2002-2000	6 Cyl.	ICP106
2002-1997	8 Cyl.; Exhaust stock and reorder; Sensor Only	ICP102
2002-1997	8 Cyl.; Alternate Number	ICP102K
2002-1997	8 Cyl.; Sensor Kit	ICP102K
1999	6 Cyl.; From Engine No. 1134351	ICP106
1996	Exhaust stock and reorder; Sensor Only	ICP102
1996	Alternate Number	ICP102K
1996	Sensor Kit	ICP102K
RXT		
2008	Exhaust stock and reorder; Sensor Only	ICP101
2008	Sensor Kit	ICP101K
2008	Alternate Number; Sensor Kit	ICP101K
2007	8 Cyl. 6.0L; VT365 Eng.; Exhaust stock and reorder; Sensor Only	ICP101
2007	8 Cyl. 6.0L; VT365 Eng.; Sensor Kit	ICP101K
2007	8 Cyl. 6.0L; VT365 Eng.; Alternate Number; Sensor Kit	ICP101K
2006	8 Cyl.; Exhaust stock and reorder; Sensor Only	ICP101
2006	8 Cyl.; Sensor Kit	ICP101K
2006	8 Cyl.; Alternate Number; Sensor Kit	ICP101K
2005	Exhaust stock and reorder; Sensor Only	ICP101
2005	Sensor Kit	ICP101K
2005	Alternate Number; Sensor Kit	ICP101K
Position Sensors		
Camshaft Sensor		
1552SC		
1998-1997	8 Cyl. 7.3L; T444E Eng.	PC139
1652SC		
2002-1994	8 Cyl. 7.3L; T444E Eng.	PC139
1652UPS		
1997-1995	8 Cyl. 7.3L; T444E Eng.	PC139
3000		
2000-1997	8 Cyl. 7.3L; T444E Eng.	PC139
3000RE		
2001	8 Cyl. 7.3L	PC139
3400		
2002-1996	8 Cyl. 7.3L; T444E Eng.	PC139
3600		
1999-1994	8 Cyl. 7.3L; T444E Eng.	PC139
3700		
1994	8 Cyl. 7.3L; T444E Eng.	PC139
3800		
2003-1994	8 Cyl. 7.3L; T444E Eng.	PC139
4600		
1995	8 Cyl. 7.3L; T444E Eng.	PC139
4600LP		
1994	8 Cyl. 7.3L; T444E Eng.	PC139
4700		
2002-1994	8 Cyl. 7.3L; T444E Eng.	PC139
4700LP		
2002-1994	8 Cyl. 7.3L; T444E Eng.	PC139
4700LPX		
2002-1995	8 Cyl. 7.3L; T444E Eng.	PC139
4800		
1997-1995	8 Cyl. 7.3L; T444E Eng.	PC139

Position Sensors

		Part No.
Camshaft Sensor		
4900		
1997-1995	8 Cyl. 7.3L; T444E Eng.	PC139
7100		
1995-1994	8 Cyl. 7.3L; T444E Eng.	PC139
Genesis RE		
2002-1996	8 Cyl. 7.3L; T444E Eng.	PC139
Pressure Sensors		
Air Inlet Pressure Sensor		
2574		
2001-1999	6 Cyl. 12.0L; C12 Eng.	PS711
2674		
2001-1999	6 Cyl. 12.0L; C12 Eng.	PS711
4900		
2001	6 Cyl. 12.0L; C12 Eng.	PS711
8100		
2001	6 Cyl. 12.0L; C12 Eng.	PS711
9200 SBA		
2000-1999	6 Cyl. 12.0L; C12 Eng.	PS711
9200i SBA		
2001-2000	6 Cyl. 12.0L; C12 Eng.	PS711
9400i SBA		
2001-2000	6 Cyl. 12.0L; C12 Eng.	PS711
Diesel Particulate Filter (DPF) Pressure Sensor		
4300		
2018-2017	6 Cyl. 6.7L	DPS101
2016-2014	6 Cyl. 6.7L; ISB 6.7 Eng.	DPS101
4300LP		
2018-2017	6 Cyl. 6.7L	DPS101
4400		
2018-2017	6 Cyl. 8.9L	DPS101
5500i		
2011-2010	6 Cyl. 8.9L; ISL 8.9 Eng.	DPS101
5600i		
2011-2010	6 Cyl. 8.9L; ISL 8.9 Eng.	DPS101
5900i		
2012	ISX 15.0 Eng.	DPS101
7300		
2018-2017	6 Cyl. 6.7L	DPS101
7400		
2018-2017	6 Cyl. 8.9L	DPS101
7500		
2018-2017	6 Cyl. 8.9L	DPS101
9900i		
2017	ISX 15.0 Eng.	DPS101
HX620		
2017	ISX 15.0 Eng.	DPS101
LoneStar		
2017	ISX 15.0 Eng.	DPS101
LT625		
2017	ISX 15.0 Eng.	DPS101
ProStar		
2017-2010	ISX 15.0 Eng.	DPS101
EGR Valve Pressure Feedback Sensor		
1652SC		
1997	8 Cyl. 7.3L; T444E Eng.; To 11/97	VP18
1996	8 Cyl. 7.3L; T444E Eng.	VP18
1652UPS		
1996-1995	8 Cyl. 7.3L; T444E Eng.	VP18
2554		
2002-1999	6 Cyl. 7.6L; DT466 Eng.	VP18
2002-1997	6 Cyl. 8.7L; DT530 Eng.	VP18

		Part No.
EGR Valve Pressure Feedback Sensor		
3000FE		
1998	6 Cyl. 7.6L; DT466 Eng.	VP18
3200		
2004	6 Cyl. 7.6L; DT466 Eng.	VP18
3400		
1998	8 Cyl. 7.3L; T444E Eng.; To 11/97	VP18
3600		
1998	6 Cyl. 7.6L; DT466 Eng.	VP18
1998	8 Cyl. 7.3L; T444E Eng.; To 11/97	VP18
1997	6 Cyl. 7.6L; DT466 Eng.; From 6/97	VP18
1997-1995	8 Cyl. 7.3L; T444E Eng.	VP18
3800		
2004-1998	6 Cyl. 7.6L; DT466 Eng.	VP18
1998	8 Cyl. 7.3L; T444E Eng.; To 11/97	VP18
1997	6 Cyl. 7.6L; DT466 Eng.; From 6/97	VP18
1997-1994	8 Cyl. 7.3L; T444E Eng.	VP18
4300		
2019-2017	6 Cyl. 6.7L; Diesel	VP34
2016-2014	6 Cyl. 6.7L; ISB 6.7 Eng.; Diesel	VP34
2005-2002	6 Cyl. 7.6L; DT466 Eng.	VP18
4300LP		
2019-2016	6 Cyl. 6.7L; Diesel	VP34
4400		
2005-2002	6 Cyl. 7.6L; DT466 Eng.	VP18
2005-2002	6 Cyl. 8.7L; DT530 Eng.	VP18
4700		
2002-2001	6 Cyl. 7.6L; DT466 Eng.	VP18
1999	6 Cyl. 8.7L; DT530 Eng.	VP18
1999-1998	6 Cyl. 7.6L; DT466 Eng.	VP18
1998-1997	8 Cyl. 7.3L; T444E Eng.; To 11/97	VP18
1996	8 Cyl. 7.3L; T444E Eng.	VP18
4700LP		
1998	8 Cyl. 7.3L; T444E Eng.; To 11/97	VP18
4700LPX		
1995	8 Cyl. 7.3L; T444E Eng.	VP18
4800		
2002-1999	6 Cyl. 7.6L; DT466 Eng.	VP18
4900		
2002-1998	6 Cyl. 7.6L; DT466 Eng.	VP18
2001-1998	6 Cyl. 8.7L; DT530 Eng.	VP18
7300		
2019-2016	6 Cyl. 6.7L; Diesel	VP34
2005-2002	6 Cyl. 7.6L; DT466 Eng.	VP18
7400		
2005-2002	6 Cyl. 7.6L; DT466 Eng.	VP18
2005-2002	6 Cyl. 8.7L; DT530 Eng.	VP18
8500		
2005-2003	6 Cyl. 8.7L; DT530 Eng.	VP18
MV607		
2020-2019	6 Cyl. 6.7L; Diesel	VP34
Exhaust Back Pressure Sensor		
4400		
2008	6 Cyl. 7.6L; MaxxForce DT Eng.	VP38
2008-2007	6 Cyl. 9.3L; DT570 Eng.	VP38
8500 TranStar		
2009-2008	6 Cyl. 10.8L; ISM 10.8 Eng.	VP38
CXT		
2008-2006		VP38
MAP Sensor		
4100		
2011-2008	8 Cyl. 6.4L; MaxxForce 7 Eng.	AS422

Pressure Sensors

		Part No.
MAP Sensor		
4300		
2014-2008	8 Cyl. 6.4L; MaxxForce 7 Eng.	AS422
4300LP		
2014-2008	8 Cyl. 6.4L; MaxxForce 7 Eng.	AS422
CF500		
2010-2007		AS670
CF600		
2010-2007		AS670
TerraStar		
2014	8 Cyl. 6.4L	AS422
2013-2010	8 Cyl. 6.4L; MaxxForce 7 Eng.	AS422
Temperature Sensors		
Exhaust Gas Temperature Sensor		
5500i		
2011-2008		ETS223
5600i		
2011-2008		ETS223
5900i		
2011-2008		ETS223
9200i SBA		
2008		ETS223
9400i SBA		
2010-2008		ETS223
9900i		
2011-2008		ETS223
9900ix		
2009-2008		ETS223
LoneStar		
2009	ISX 15.0 Eng.	ETS223
ProStar		
2011-2008	ISX 15.0 Eng.	ETS223
Intake Air Temperature Sensor		
1652SC		
2007-2004	8 Cyl. 6.0L; VT365 Eng.	ATS51
3200		
2007-2003	8 Cyl. 6.0L; VT365 Eng.	ATS51
3300		
2007-2005	8 Cyl. 6.0L; VT365 Eng.	ATS51
4100		
2007-2006	8 Cyl. 6.0L; VT365 Eng.	ATS51
4200		
2007-2003	8 Cyl. 6.0L; VT365 Eng.	ATS51
4200LP		
2007-2003	8 Cyl. 6.0L; VT365 Eng.	ATS51
4300		
2003	8 Cyl. 6.0L; VT365 Eng.	ATS51
4400		
2003	8 Cyl. 6.0L; VT365 Eng.	ATS51
CF500		
2010	6 Cyl. 4.5L	AX214
2009-2007	6 Cyl. 4.5L; VT275 Eng.	AX214
2006	6 Cyl. 4.5L; VT275 Eng.	ATS51
CF600		
2010	6 Cyl. 4.5L	AX214
2009-2007	6 Cyl. 4.5L; VT275 Eng.	AX214
2006	6 Cyl. 4.5L; VT275 Eng.	ATS51
CXT		
2007-2006	8 Cyl. 6.0L; VT365 Eng.	ATS51
RXT		
2007-2005	8 Cyl. 6.0L; VT365 Eng.	ATS51

		Part No.
Body Light Switches		
Headlight Switch		
S1754		
1983-1981		DS-205
S1853		
1983-1981		DS-205
S1854		
1983-1981		DS-205
S1924		
1982-1981		DS-205
S1925		
1982-1981		DS-205
S1954		
1983-1981		DS-205
S1955		
1983-1981		DS-205
S2125		
1981		DS-205
S2524		
1982-1981		DS-205
S2554		
1983-1981		DS-205
Stoplight Switch		
S1754		
1983-1981	w/ Hydraulic Brakes	SLS-66
S1853		
1983-1981	w/ Hydraulic Brakes	SLS-66
S1854		
1983-1981	w/ Hydraulic Brakes	SLS-66
S1924		
1982-1981	w/ Hydraulic Brakes	SLS-66
S1925		
1982-1981	w/ Hydraulic Brakes	SLS-66
S1954		
1983-1981	w/ Hydraulic Brakes	SLS-66
S1955		
1983-1981	w/ Hydraulic Brakes	SLS-66
S2125		
1981	w/ Hydraulic Brakes	SLS-66
S2524		
1982-1981	w/ Hydraulic Brakes	SLS-66
S2554		
1983-1981	w/ Hydraulic Brakes	SLS-66
Chassis and Drivetrain Switches		
Automatic Transmission Vacuum Modulator		
Scout II		
1980	6 Cyl. 3.2L; w/ Aluminum Case	TM16
Temperature Switches and Senders		
A/C and Heater Blower Motor Switch		
8300		
1993-1989		HS569
Actuators		
HVAC Floor Mode Door Actuator		
4100		
2011-2006		ADR4200
4100 SBA		
2008-2006		ADR4200
4200		
2010-2002		ADR4200

International

Actuators

		Part No.
HVAC Floor Mode Door Actuator		
4200LP		
2008-2003		ADR4200
4300		
2011-2002		ADR4200
4300LP		
2011-2002		ADR4200
4400		
2011-2002		ADR4200
4400LP		
2011-2002		ADR4200
4700		
2008		ADR4200
2005-2001		ADR4200
4700LP		
2002-2001		ADR4200
4700LPX		
2002-2001		ADR4200
4800		
2003-2001		ADR4200
4900		
2005-2001		ADR4200
7300		
2011-2002		ADR4200
7400		
2011-2002		ADR4200
7500		
2011-2002		ADR4200
7600		
2011-2009		ADR4200
2007-2003		ADR4200
7700		
2007-2005		ADR4200
8100		
2003-2001		ADR4200
8500		
2007-2002		ADR4200
8500 TranStar		
2011-2008		ADR4200
8600 SBA		
2007-2003		ADR4200
8600 TranStar		
2011-2008		ADR4200
LoneStar		
2011-2009		ADR4200
ProStar		
2011-2008		ADR4200
HVAC Temperature Blend Door Actuator		
4100		
2011-2006		ADR4304
4100 SBA		
2008-2006		ADR4304
4200		
2010-2002		ADR4304
4200LP		
2008-2003		ADR4304
4300		
2011-2002		ADR4304
4300LP		
2011-2002		ADR4304
4400		
2011-2002		ADR4304

		Part No.
HVAC Temperature Blend Door Actuator		
4400LP		
2011-2002		ADR4304
4700		
2008		ADR4304
2005-2001		ADR4304
4700LP		
2002-2001		ADR4304
4700LPX		
2002-2001		ADR4304
4800		
2003-2001		ADR4304
4900		
2005-2001		ADR4304
7300		
2011-2002		ADR4304
7400		
2011-2002		ADR4304
7500		
2011-2002		ADR4304
7600		
2011-2009		ADR4304
2007-2003		ADR4304
7700		
2007-2005		ADR4304
8100		
2003-2001		ADR4304
8500		
2007-2002		ADR4304
8500 TranStar		
2011-2008		ADR4304
8600 SBA		
2007-2003		ADR4304
8600 TranStar		
2011-2008		ADR4304
LoneStar		
2011-2009		ADR4304
ProStar		
2011-2008		ADR4304
Isuzu		
Modules		
Glow Plug Controller		
FTR		
2009-2004	6 Cyl. 7.8L	RY1952
FVR		
2009-2004	6 Cyl. 7.8L	RY1952
FXR		
2009	6 Cyl. 7.8L; 3	RY1952
2008-2004	6 Cyl. 7.8L	RY1952
NPR		
2009-2007	4 Cyl. 5.2L	RY1952
NPR-HD		
2010-2008	4 Cyl. 5.2L	RY1952
NQR		
2010-2008	4 Cyl. 5.2L	RY1952
NRR		
2010-2008	4 Cyl. 5.2L	RY1952
Relays and Fuses		
A/C Auto Temperature Control Relay		
Trooper		
1986	4 Cyl. 2.2L	RY-230

Relays and Fuses

		Part No.
Blower Motor Relay		
FRR		
1995		RY-233
FTR		
1995-1988		RY-233
FVR		
1990-1988		RY-233
Diesel Glow Plug Relay		
I-Mark		
1984-1981	4 Cyl. 1.8L; P; Exhaust stock and reorder	RY-54
Pickup		
1987-1981	4 Cyl. 2.2L; Exhaust stock and reorder; w/ Bracket	RY-54
1986-1981	4 Cyl. 2.2L; w/o Bracket	RY-921
Trooper		
1987-1986	4 Cyl. 2.2L; Exhaust stock and reorder	RY-54
1984	4 Cyl. 2.2L; Exhaust stock and reorder	RY-54
Fuel Pump Relay		
NQR		
2008		RY-1678
NRR		
2008		RY-1678
Pickup		
1986-1985	4 Cyl. 2.2L	RY-55
Headlight Relay		
Trooper		
1987	4 Cyl. 2.2L	RY-39
Starter Relay		
FRR		
1997-1995		RY-922
FTR		
1996-1988		RY-922
FVR		
1996-1994		RY-922
1992-1988		RY-922
Starting and Charging System Parts		
Starter Solenoid		
Trooper		
1986	4 Cyl.	SS721
Voltage Regulator		
Trooper		
1984	4 Cyl. 2.2L	VR-424
Air Management Valves		
Air Cleaner Check Valve		
I-Mark		
1984-1981	4 Cyl.	AV14
Trooper		
1987-1986	4 Cyl. 2.2L	AV14
1984	4 Cyl. 2.2L	AV14
EGR Components		
EGR Valve Mounting Gasket		
Pickup		
1987-1982	4 Cyl. 2.2L	VG164
PCV Systems		
PCV Valve		
Pickup		
1987-1984	4 Cyl. 2.2L	V360
Trooper		
1987-1986	4 Cyl. 2.2L	V489

		Part No.
Injectors		
Fuel Injector - Diesel - Remfd		
FRR		
2004-2000	6 Cyl. 7.8L; OE No. 2901233000, 8976028032, 97780452, 97602803, 095000-5360	FJ56905
2004-2000	6 Cyl. 7.8L; OE No. 2901233100, 8976011562, 97780453, 97601156, 095000-5351	FJ56906
2004-2000	6 Cyl. 7.8L; OE No. 2901233200, 8976097904, 97780454, 97609790, 095000-6384	FJ56907
FSR		
2002-1998	6 Cyl. 7.8L; OE No. 2901233000, 8976028032, 97780452, 97602803, 095000-5360	FJ56905
2002-1998	6 Cyl. 7.8L; OE No. 2901233100, 8976011562, 97780453, 97601156, 095000-5351	FJ56906
2002-1998	6 Cyl. 7.8L; OE No. 2901233200, 8976097904, 97780454, 97609790, 095000-6384	FJ56907
FTR		
2019-2018	4 Cyl. 5.2L; OE No. 2901231000, 8973297035, 97780100, 095000-5471	FJ56909
2008-2004	6 Cyl. 7.8L; OE No. 2901233000, 8976028032, 97780452, 97602803, 095000-5360	FJ56905
2008-2004	6 Cyl. 7.8L; OE No. 2901233100, 8976011562, 97780453, 97601156, 095000-5351	FJ56906
2008-2004	6 Cyl. 7.8L; OE No. 2901233200, 8976097904, 97780454, 97609790, 095000-6384	FJ56907
2002-1998	6 Cyl. 7.8L; OE No. 2901233000, 8976028032, 97780452, 97602803, 095000-5360	FJ56905
2002-1998	6 Cyl. 7.8L; OE No. 2901233100, 8976011562, 97780453, 97601156, 095000-5351	FJ56906
2002-1998	6 Cyl. 7.8L; OE No. 2901233200, 8976097904, 97780454, 97609790, 095000-6384	FJ56907
FVR		
2009-2004	6 Cyl. 7.8L; OE No. 2901233000, 8976028032, 97780452, 97602803, 095000-5360	FJ56905
2009-2004	6 Cyl. 7.8L; OE No. 2901233100, 8976011562, 97780453, 97601156, 095000-5351	FJ56906
2009-2004	6 Cyl. 7.8L; OE No. 2901233200, 8976097904, 97780454, 97609790, 095000-6384	FJ56907
2002-1998	6 Cyl. 7.8L; OE No. 2901233000, 8976028032, 97780452, 97602803, 095000-5360	FJ56905
2002-1998	6 Cyl. 7.8L; OE No. 2901233100, 8976011562, 97780453, 97601156, 095000-5351	FJ56906
2002-1998	6 Cyl. 7.8L; OE No. 2901233200, 8976097904, 97780454, 97609790, 095000-6384	FJ56907
FXR		
2008-2004	6 Cyl. 7.8L; OE No. 2901233000, 8976028032, 97780452, 97602803, 095000-5360	FJ56905
2008-2004	6 Cyl. 7.8L; OE No. 2901233100, 8976011562, 97780453, 97601156, 095000-5351	FJ56906
2008-2004	6 Cyl. 7.8L; OE No. 2901233200, 8976097904, 97780454, 97609790, 095000-6384	FJ56907

Injectors

		Part No.
Fuel Injector - Diesel - Remfd		
HTR		
2007-2005	6 Cyl. 7.8L; OE No. 2901233000, 8976028032, 97780452, 97602803, 095000-5360	FJ56905
2007-2005	6 Cyl. 7.8L; OE No. 2901233100, 8976011562, 97780453, 97601156, 095000-5351	FJ56906
2007-2005	6 Cyl. 7.8L; OE No. 2901233200, 8976097904, 97780454, 97609790, 095000-6384	FJ56907
HVR		
2007-2005	6 Cyl. 7.8L; OE No. 2901233000, 8976028032, 97780452, 97602803, 095000-5360	FJ56905
2007-2005	6 Cyl. 7.8L; OE No. 2901233100, 8976011562, 97780453, 97601156, 095000-5351	FJ56906
2007-2005	6 Cyl. 7.8L; OE No. 2901233200, 8976097904, 97780454, 97609790, 095000-6384	FJ56907
HXR		
2006	6 Cyl. 7.8L; OE No. 2901233000, 8976028032, 97780452, 97602803, 095000-5360	FJ56905
2006	6 Cyl. 7.8L; OE No. 2901233100, 8976011562, 97780453, 97601156, 095000-5351	FJ56906
2006	6 Cyl. 7.8L; OE No. 2901233200, 8976097904, 97780454, 97609790, 095000-6384	FJ56907
I-Mark		
1984-1981	4 Cyl. 1.8L; Diesel	FJ600
NPR		
2009-2007	4 Cyl. 5.2L; OE No. 2901233300, 8976097915, 97780455, 97609791, 095000-6395	FJ56908
2009-2005	4 Cyl. 5.2L; OE No. 2901231000, 8973297035, 97780100, 095000-5471	FJ56909
2004	4 Cyl. 4.8L	FJ56909
NPR-HD		
2018-2005	4 Cyl. 5.2L; OE No. 2901231000, 8973297035, 97780100, 095000-5471	FJ56909
2009-2007	4 Cyl. 5.2L; OE No. 2901233300, 8976097915, 97780455, 97609791, 095000-6395	FJ56908
2004	4 Cyl.	FJ56909
NPR-XD		
2019-2015	4 Cyl. 5.2L; OE No. 2901231000, 8973297035, 97780100, 095000-5471	FJ56909
NQR		
2019-2005	4 Cyl. 5.2L; OE No. 2901231000, 8973297035, 97780100, 095000-5471	FJ56909
2010-2007	4 Cyl. 5.2L; OE No. 2901233300, 8976097915, 97780455, 97609791, 095000-6395	FJ56908
2004		FJ56909
NRR		
2018-2007	4 Cyl. 5.2L; OE No. 2901231000, 8973297035, 97780100, 095000-5471	FJ56909
2010-2007	4 Cyl. 5.2L; OE No. 2901233300, 8976097915, 97780455, 97609791, 095000-6395	FJ56908
2006-2005		FJ56909
Pickup		
1987-1986	4 Cyl. 2.2L; Naturally Aspirated	FJ598
1987-1986	4 Cyl. 2.2L; Turbocharged	FJ599
1985-1981	4 Cyl. 2.2L	FJ598

		Part No.
Fuel Injector - Diesel - Remfd		
Trooper		
1987-1986	4 Cyl. 2.2L	FJ599
Chassis and Drivetrain Sensors		
Automatic Transmission Output Sensor		
NPR-HD		
2011-2010		SC303
NPR-XD		
2019-2015		SC303
NQR		
2020-1995		SC303
Vehicle Speed Sensor		
FRR		
2002-2000	w/ M.T.	SC318
1998-1997	w/ M.T.	SC318
FSR		
2002-1997	w/ M.T.	SC318
Pressure Sensors		
MAP Sensor		
NPR-HD		
1999	4 Cyl. 4.8L	AS59
Temperature Sensors		
Coolant Temperature Sensor		
Trooper		
1987-1986	4 Cyl. 2.2L	TX18
Ignition Switches		
Ignition Starter Switch		
I-Mark		
1981	4 Cyl. 1.8L	US564
Ignition Switch with Lock Cylinder		
FRR		
2002-2000		US-603
1998-1997		US-603
FSR		
2002-1997		US-603
FTR		
2002-1997		US-603
FVR		
2002-1997		US-603
Pressure and Vacuum Sending Switches		
Oil Pressure Gauge Switch		
NPR		
2007	4 Cyl. 5.2L	PS-308
Oil Pressure Light Switch		
ELF 200		
2016-2015	4 Cyl. 3.0L	PS-305
FTR		
2020-2018		PS-305
Pickup		
1987	4 Cyl. 2.2L; Alternate Number	PS-138
1987	4 Cyl. 2.2L; Exhaust stock and reorder	PS200
Temperature Switches and Senders		
Blower Motor Resistor		
Pickup		
1987	4 Cyl. 2.2L; w/ AC	RU528
1987	4 Cyl. 2.2L; w/o AC	RU530
Coolant Fan Switch		
Trooper		
1986	4 Cyl.	TS470

Temperature Switches and Senders

		Part No.
Temperature Sender - With Gauge		
NPR		
2002-1998	4 Cyl. 4.8L	TS-375
1997-1996	4 Cyl. 3.9L	TS-375
Pickup		
1987	4 Cyl.	TS-198
1986-1985	4 Cyl. 2.2L	TS-83
Trooper		
1987-1986	4 Cyl. 2.2L	TS-83
1984	4 Cyl. 2.2L	TS-83
Locks		
Ignition Lock Cylinder		
I-Mark		
1984-1982	4 Cyl. 1.8L	US486L
1981	4 Cyl. 1.8L	US-556L
Jaguar		
Injection Components		
Direct Injection High Pressure Fuel Pump		
XE		
2018-2017	4 Cyl. 2.0L	GDP902
Fuel Pump Camshaft Follower		
XE		
2018-2017	4 Cyl. 2.0L	GDF901
XF		
2018	4 Cyl. 2.0L	GDF901
Fuel Pump O-Ring		
XE		
2018-2017	4 Cyl. 2.0L; On Pump	GDR901
Fuel Sensors		
Mass Air Flow		
XE		
2019-2017	4 Cyl. 2.0L	MAS0520
XF		
2019-2018	4 Cyl. 2.0L	MAS0520
Position Sensors		
Camshaft Sensor		
F-Pace		
2019-2018	4 Cyl. 2.0L; Diesel	PC1126
2017	4 Cyl. 2.0L	PC1126
XE		
2019-2017	4 Cyl. 2.0L; Diesel	PC1126
XF		
2019-2017	4 Cyl. 2.0L; Diesel	PC1126
Crankshaft Sensor		
F-Pace		
2019	4 Cyl. 2.0L; Diesel	PC1126
2018-2017	4 Cyl. 2.0L	PC1127
XE		
2019-2018	4 Cyl. 2.0L	PC1127
2017	4 Cyl. 2.0L; Diesel	PC1127
XF		
2019-2017	4 Cyl. 2.0L	PC1127
Pressure Sensors		
MAP Sensor		
XF		
2019-2017	4 Cyl. 2.0L	AS532

		Part No.
Temperature Sensors		
Intake Air Temperature Sensor		
F-Pace		
2019-2017	4 Cyl. 2.0L	AX520
XE		
2019-2017	4 Cyl. 2.0L	AX520
XF		
2019-2017	4 Cyl. 2.0L	AX520
Pressure and Vacuum Sending Switches		
Oil Pressure Light Switch		
XE		
2017	4 Cyl.	PS605
Actuators		
Variable Valve Timing Solenoid		
F-Pace		
2017	4 Cyl. 2.0L; Magnet Sensor	VVT393
XE		
2017	4 Cyl. 2.0L; Magnet Sensor	VVT393
XF		
2019	4 Cyl. 2.0L; Magnet Sensor	VVT393
2017	4 Cyl. 2.0L; Magnet Sensor	VVT393
Jeep		
Modules		
Glow Plug Controller		
Grand Cherokee		
2009-2007	6 Cyl. 3.0L	RY1724
Relays and Fuses		
A/C Relay		
Cherokee		
1986-1985	4 Cyl. 2.1L; OE No. 8933001779	RY-116
1986-1985	4 Cyl. 2.1L; OE No. 8936000400	RY-48
Grand Cherokee		
2010	6 Cyl. 3.0L	RY-612
2007	6 Cyl. 3.0L	RY-116
Liberty		
2006	4 Cyl. 2.8L	RY-612
Auto Transaxle Relay		
Liberty		
2006	4 Cyl. 2.8L	RY-612
Blower Motor Relay		
Liberty		
2006	4 Cyl.; Exhaust stock and reorder	RY-115
2006	4 Cyl.; Alternate Number	RY-242
Coolant Fan Relay		
Grand Cherokee		
2009	6 Cyl. 3.0L	RY-116
Fog Lamp Relay		
Wagoneer		
1985	4 Cyl. 2.1L; w/o Skirt	RY-115
1985	4 Cyl. 2.1L; w/ Skirt	RY-242
Fuel Pump Relay		
Comanche		
1987	4 Cyl. 2.1L	RY-116
Neutral Safety Switch Relay		
Cherokee		
1987	4 Cyl. 2.1L; Alternate Number	RY-116
1987	4 Cyl. 2.1L; Exhaust stock and reorder	RY30
Comanche		
1987	4 Cyl. 2.1L; Alternate Number	RY-116
1987	4 Cyl. 2.1L; Exhaust stock and reorder	RY30

Relays and Fuses

		Part No.
Parking Lamp Relay		
Grand Cherokee		
2010-2007	6 Cyl. 3.0L	RY-612
Power Door Lock Relay		
Comanche		
1987	4 Cyl. 2.1L; w/o Skirt	RY-115
1987	4 Cyl. 2.1L; w/ Skirt	RY-242
Grand Cherokee		
2010	6 Cyl. 3.0L	RY-612
Starter Relay		
Cherokee		
1987	4 Cyl. 2.1L	SR-113
1985	4 Cyl. 2.1L	SR-113
Comanche		
1987-1986	4 Cyl. 2.1L	SR-113
Grand Cherokee		
2009	6 Cyl. 3.0L	RY-612
Trailer Towing Package Relay		
Grand Cherokee		
2010-2009	6 Cyl. 3.0L	RY-612
Wiper Relay		
Comanche		
1987	4 Cyl. 2.1L; w/o Skirt; Rear	RY-115
1987	4 Cyl. 2.1L; w/ Skirt; Rear	RY-242
Grand Cherokee		
2010-2009	6 Cyl. 3.0L	RY-612
Starting and Charging System Parts		
Starter Solenoid		
Comanche		
1986	4 Cyl.; Fender Mounted	SS-590
Voltage Regulator		
Cherokee		
1985	4 Cyl. 2.1L	VR197
Wagoneer		
1985	4 Cyl. 2.1L	VR197
Air Injection and Induction Parts		
Turbocharger - New		
Grand Cherokee		
2009-2007	6 Cyl. 3.0L; Turbocharged	TBC547
Liberty		
2006-2005	4 Cyl. 2.8L; Diesel; Turbocharged	TBC560
Vacuum Pump		
Grand Cherokee		
2019-2014	6 Cyl. 3.0L; Diesel	VCP143
2009-2007	6 Cyl. 3.0L	VCP139
Liberty		
2006-2005	4 Cyl. 2.8L; Valve	AIP23
Air Management Regulators and Solenoids		
Idle Stop Solenoid		
Cherokee		
1985	4 Cyl.	ES44
Wagoneer		
1985	4 Cyl.	ES44
Intake Manifold Actuator		
Grand Cherokee		
2009-2007	6 Cyl. 3.0L	IMA111
EGR Components		
EGR Control Solenoid		
Grand Cherokee		
2020-2014	6 Cyl. 3.0L	VS234

		Part No.
EGR Control Solenoid		
Wrangler		
2020	6 Cyl. 3.0L	VS234
EGR Tube Gasket		
Grand Cherokee		
2019-2014	6 Cyl. 3.0L	VG279
2009-2007	6 Cyl. 3.0L	VG274
EGR Valve		
Grand Cherokee		
2019-2018	6 Cyl. 3.0L	EGV1254
2016-2015	6 Cyl. 3.0L	EGV1254
2009-2007	6 Cyl. 3.0L	EGV1189
Liberty		
2006-2005	4 Cyl. 2.8L	EGV1218
EGR Valve Mounting Gasket		
Grand Cherokee		
2019-2014	6 Cyl. 3.0L; EGR Pipe	VG273
2009-2007	6 Cyl. 3.0L	VG238
EGR Valve Vacuum Modulator		
Grand Cherokee		
2019-2014	6 Cyl. 3.0L	VS239
Exhaust Components		
Diesel Emission Fluid Injection Nozzle		
Grand Cherokee		
2017-2014	6 Cyl. 3.0L	DFI4
PCV Systems		
PCV Valve		
Grand Cherokee		
2009-2007	6 Cyl. 3.0L; Diesel	V581
Vapor and Purge Components		
Canister Purge Valve		
Grand Cherokee		
2020-2017	6 Cyl.	CP796
2015-2014	6 Cyl.	CP796
Fuel Vapor Leak Detection Pump Filter		
Grand Cherokee		
2010-2007	6 Cyl. 3.0L	LDP75
Liberty		
2006-2005	4 Cyl. 2.8L	LDP75
Fuel and Oil Filters		
Engine Oil Filter Housing		
Grand Cherokee		
2016	6 Cyl. 3.0L	OFH101
2015-2014	6 Cyl.	OFH101
Injectors		
Fuel Injector - Diesel - New		
Grand Cherokee		
2019-2014	6 Cyl. 3.0L	FJ1269
2009-2007	6 Cyl. 3.0L	FJ1268
Fuel Injector - Diesel - Remfd		
Cherokee		
1987-1985	4 Cyl. 2.1L; Diesel	FJ586
Comanche		
1987-1986	4 Cyl. 2.1L; Diesel	FJ586
Wagoneer		
1985	4 Cyl. 2.1L; Diesel	FJ586
Injection Components		
Diesel Glow Plug		
Grand Cherokee		
2009-2007	6 Cyl. 3.0L	GP116

Injection Components

		Part No.
Fuel Pressure Regulator		
Grand Cherokee		
2019-2014	6 Cyl. 3.0L	PR607
2008-2007	6 Cyl. 3.0L	PR561
Chassis and Drivetrain Sensors		
ABS Speed Sensor		
Grand Cherokee		
2014	6 Cyl.; Front	ALS2059
Fluid Level Sensors		
Brake Fluid Level Sensor		
Grand Cherokee		
2008-2007	6 Cyl. 3.0L	FLS-56
Engine Oil Level Sensor		
Grand Cherokee		
2009-2007	6 Cyl. 3.0L	FLS-162
Fuel Sensors		
Diesel Exhaust Particulate Sensor		
Grand Cherokee		
2016	6 Cyl. 3.0L	DEP110
Fuel / Water Separator Sensor		
Grand Cherokee		
2009-2007	6 Cyl. 3.0L	FWSS104
Liberty		
2006-2005	4 Cyl. 2.8L	FWSS109
Knock Sensor		
Grand Cherokee		
2017-2014	6 Cyl. 3.0L	KS436
Liberty		
2005	4 Cyl. 2.8L	KS171
Mass Air Flow		
Grand Cherokee		
2009-2007	6 Cyl. 3.0L; Diesel	MAS0503
Miscellaneous Sensors		
Battery Current / Volt Sensor		
Grand Cherokee		
2016	6 Cyl. 3.0L; Turbocharged	BSC16
Position Sensors		
Accelerator Pedal Sensor		
Grand Cherokee		
2019-2017	6 Cyl. 3.0L	APS402
2015-2014	6 Cyl. 3.0L	APS402
2009-2008	6 Cyl. 3.0L	APS270
2007	6 Cyl. 3.0L	APS269
Camshaft Sensor		
Grand Cherokee		
2019	6 Cyl. 3.0L; Diesel	PC644
2018-2014	6 Cyl. 3.0L	PC644
2009	6 Cyl. 3.0L	PC810
2008	6 Cyl. 3.0L	PC625
2007	6 Cyl. 3.0L	PC810
Liberty		
2006-2005	4 Cyl. 2.8L	PC644
Wrangler		
2020	6 Cyl.	PC950
Crankshaft Sensor		
Grand Cherokee		
2019-2014	6 Cyl. 3.0L	PC997
2009-2008	6 Cyl. 3.0L	PC738
Liberty		
2006	4 Cyl. 2.8L; Diesel	PC766

		Part No.
Crankshaft Sensor		
Liberty		
2005	4 Cyl. 2.8L	PC766
Pressure Sensors		
Diesel Particulate Filter (DPF) Pressure Sensor		
Grand Cherokee		
2018-2014	6 Cyl. 3.0L; w/ Bracket; w/ Hose	DPS102
EGR Valve Pressure Feedback Sensor		
Grand Cherokee		
2019-2014	6 Cyl. 3.0L	VP37
Exhaust Back Pressure Sensor		
Grand Cherokee		
2009-2007	6 Cyl. 3.0L	VP35
Fuel Pressure Sensor		
Grand Cherokee		
2017-2014	6 Cyl. 3.0L; Diesel	FPS89
Liberty		
2006-2005	4 Cyl. 2.8L	FPS16
MAP Sensor		
Grand Cherokee		
2019	6 Cyl. 3.0L; Turbocharged	AS622
2018	6 Cyl. 3.0L	AS686
2017	6 Cyl. 3.0L; Turbocharged	AS622
2015-2014	6 Cyl. 3.0L; Turbocharged	AS622
2007	6 Cyl. 3.0L; Turbocharged	AS356
Liberty		
2006-2005	4 Cyl. 2.8L	AS359
Tire Pressure Monitoring System OE Design Sensor		
Grand Cherokee		
2018-2017	6 Cyl. 3.0L; 433 Mhz Sensor; OE Style Sensor; w/ Rubber Valve	TPM298
2016	6 Cyl. 3.0L; 433 Mhz Sensor; OE Style; w/ Rubber Valve	TPM298
Turbocharger Boost Sensor		
Grand Cherokee		
2009-2007	6 Cyl. 3.0L; Turbocharged	AS356
Temperature Sensors		
Ambient Air Temperature Sensor		
Grand Cherokee		
2009-2007	6 Cyl. 3.0L	AX75
Liberty		
2006-2005	4 Cyl. 2.8L	AX75
Coolant Temperature Sensor		
Grand Cherokee		
2009-2007	6 Cyl. 3.0L	TX155
Liberty		
2006-2005	4 Cyl. 2.8L	TS-633
Engine Oil Temperature Sensor		
Grand Cherokee		
2017-2014	6 Cyl. 3.0L	TX260
Exhaust Gas Temperature Sensor		
Grand Cherokee		
2019	6 Cyl. 3.0L; Located Before Turbocharger	ETS162
2019	6 Cyl. 3.0L; Located After Particulate Filter	ETS163
2019	6 Cyl. 3.0L; Center	ETS222
2019-2014	6 Cyl. 3.0L; Located on EGR Cooler	ETS118
2017	6 Cyl. 3.0L; Center	ETS222
2017-2014	6 Cyl. 3.0L; Located Before Turbocharger	ETS162
2017-2014	6 Cyl. 3.0L; Located After Particulate Filter	ETS163
2017-2014	6 Cyl. 3.0L; Upstream	ETS166

Temperature Sensors

		Part No.
Exhaust Gas Temperature Sensor		
Grand Cherokee		
2016-2014	6 Cyl. 3.0L; Exhaust; Center	ETS218
2009-2007	6 Cyl. 3.0L	ETS76
Intake Air Temperature Sensor		
Cherokee		
1985	4 Cyl.; On Air Cleaner	ATS36
Grand Cherokee		
2019-2014	6 Cyl. 3.0L	TX270
2010	6 Cyl.	AX69
2009-2007	6 Cyl. 3.0L	AX129
Liberty		
2006-2005	4 Cyl. 2.8L	AX115
Body Light Switches		
Hazard Warning Switch		
Liberty		
2006	4 Cyl. 2.8L	HZS149
Interior Power Switches		
Clock Spring		
Grand Cherokee		
2009-2008	6 Cyl. 3.0L; w/ Stability Control	CSP311
Parking Brake Switch		
Liberty		
2005	4 Cyl. 2.8L	DS-932
Power Window Switch		
Grand Cherokee		
2009	6 Cyl. 3.0L; Alternate Number; Rear	DWS-1335
2009	6 Cyl. 3.0L; Front Right	DWS-599
2009	6 Cyl. 3.0L; Exhaust stock and reorder; Rear	DWS684
Pressure and Vacuum Sending Switches		
Oil Pressure Gauge Switch		
Cherokee		
1987-1985	4 Cyl. 2.1L	PS-296
Comanche		
1987	4 Cyl. 2.1L	PS197
1986	4 Cyl. 2.1L; Diesel	PS197
Grand Cherokee		
2016	6 Cyl.; w/ Engine Plant Code TPNE8	PS675
2010-2009	6 Cyl. 3.0L	PS-528
Liberty		
2006-2005	4 Cyl. 2.8L	PS-317
Wagoneer		
1985	4 Cyl. 2.1L	PS197
Oil Pressure Light Switch		
Grand Cherokee		
2018-2014	6 Cyl. 3.0L	PS639
2009-2007	6 Cyl. 3.0L	PS-528
Power Steering Pressure Switch		
Cherokee		
1987-1985	4 Cyl. 2.1L	PSS33
Comanche		
1987-1986	4 Cyl. 2.1L	PSS33
Temperature Switches and Senders		
A/C and Heater Blower Motor Switch		
Cherokee		
1987-1986	4 Cyl. 2.1L	HS-292
Comanche		
1987-1986	4 Cyl. 2.1L	HS-292

		Part No.
Oil Pump Solenoid		
Grand Cherokee		
2016-2015	6 Cyl. 3.0L	J53001
Temperature Sender - With Gauge		
Cherokee		
1986-1985	4 Cyl. 2.1L	TS-268
Comanche		
1986	4 Cyl. 2.1L	TS-268
Kenworth		
Fluid Level Sensors		
Coolant Level Sensor		
T660		
2018-2011	6 Cyl. 12.9L	FLS309
2018-2008	ISX 15.0 Eng.	FLS309
2017-2008	6 Cyl. 10.8L	FLS309
2016-2011	6 Cyl. 11.9L	FLS309
2013-2008	6 Cyl. 12.5L	FLS309
T800		
2018-2016	ISX 15.0 Eng.	FLS309
2018-2011	6 Cyl. 11.9L	FLS309
2018-2011	6 Cyl. 12.9L	FLS309
2017-2008	6 Cyl. 10.8L	FLS309
2014	6 Cyl. 8.8L	FLS309
2014	6 Cyl. 8.9L	FLS309
2012-2008	6 Cyl. 12.5L	FLS309
2012-2008	6 Cyl. 8.9L	FLS309
2011-2008	6 Cyl. 11.1L	FLS309
2011-2008	6 Cyl. 14.6L	FLS309
2011-2008	6 Cyl. 15.8L	FLS309
2010	6 Cyl. 10.3L	FLS309
2009-2008	6 Cyl. 8.8L	FLS309
2008	ISX 15.0 Eng.	FLS309
W900		
2018-2012	6 Cyl. 8.9L	FLS309
2018-2012	6 Cyl. 11.9L	FLS309
2018-2011	6 Cyl. 12.9L	FLS309
2018-2008	ISX 15.0 Eng.	FLS309
2017-2016	6 Cyl. 10.8L	FLS309
2013-2008	6 Cyl. 14.6L	FLS309
2013-2008	6 Cyl. 15.8L	FLS309
2011-2008	6 Cyl. 10.8L	FLS309
2011-2008	6 Cyl. 12.5L	FLS309
2010-2008	6 Cyl. 8.9L	FLS309
2008	6 Cyl. 8.8L	FLS309
Pressure Sensors		
Air Inlet Pressure Sensor		
T600A		
1999	6 Cyl. 12.0L	PS711
T800		
2000-1999	ISX 15.0 Eng.	PS711
T2000		
1999	6 Cyl. 12.0L	PS711
W900		
2000-1999	ISX 15.0 Eng.	PS711
Diesel Particulate Filter (DPF) Pressure Sensor		
C500		
2015-2010	ISX 15.0 Eng.	DPS101
T400		
2016-2010	6 Cyl. 8.9L	DPS101
T460		
2017	6 Cyl. 8.9L	DPS101

Pressure Sensors

		Part No.
Diesel Particulate Filter (DPF) Pressure Sensor		
T660		
2017-2010	ISX 15.0 Eng.	DPS101
2015-2011	6 Cyl. 11.9L	DPS101
T680		
2017-2014	6 Cyl. 11.9L	DPS101
2017-2013	ISX 15.0 Eng.	DPS101
T700		
2015-2011	ISX 15.0 Eng.	DPS101
T800		
2017	ISX 15.0 Eng.	DPS101
2017	6 Cyl. 11.9L	DPS101
2015-2011	6 Cyl. 11.9L	DPS101
2015-2010	ISX 15.0 Eng.	DPS101
2014	6 Cyl. 8.9L	DPS101
2012-2010	6 Cyl. 8.9L	DPS101
T880		
2017	ISX 15.0 Eng.	DPS101
2017	6 Cyl. 11.9L	DPS101
2015	ISX 15.0 Eng.	DPS101
2015	6 Cyl. 11.9L	DPS101
T2000		
2011-2010	ISX 15.0 Eng.	DPS101
W900		
2017-2016	6 Cyl. 11.9L	DPS101
2017-2010	ISX 15.0 Eng.	DPS101
2014-2012	6 Cyl. 11.9L	DPS101
2013-2012	6 Cyl. 8.9L	DPS101
2010	6 Cyl. 8.9L	DPS101
Fuel Pressure Sensor		
T800		
2018	6 Cyl. 10.8L	FPS61
2017	ISX 15.0 Eng.	FPS61
2016-2015	6 Cyl. 10.8L	FPS61
Injection Actuation Pressure Sensor		
T300		
1999	6 Cyl. 7.2L	PS713
T800		
1999	6 Cyl. 7.2L	PS713
T2000		
1999	6 Cyl. 7.2L	PS713
W900		
2000	6 Cyl. 7.2L	PS713
MAP Sensor		
W900		
2002	6 Cyl. 8.9L; On Intake Manifold	AS680
2001-2000	6 Cyl. 10.8L; On Intake Manifold	AS680
1999	6 Cyl. 10.5L; On Intake Manifold	AS680
Turbocharger Boost Sensor		
T800		
2008-2006	ISX 15.0 Eng.; Turbocharged	AS539
W900		
2009-2006	ISX 15.0 Eng.; Turbocharged	AS539
2002	ISX 15.0 Eng.; Turbocharged	AS677
1999	ISX 15.0 Eng.; Turbocharged	AS677
Temperature Sensors		
Exhaust Gas Temperature Sensor		
C500		
2011-2008	ISX 15.0 Eng.	ETS223
T660		
2011-2008	ISX 15.0 Eng.	ETS223

		Part No.
Exhaust Gas Temperature Sensor		
T700		
2011	ISX 15.0 Eng.	ETS223
T800		
2008	ISX 15.0 Eng.	ETS223
T2000		
2011-2008	ISX 15.0 Eng.	ETS223
W900		
2011-2008	ISX 15.0 Eng.	ETS223
Pressure and Vacuum Sending Switches		
Oil Pressure Gauge Switch		
T400		
2017-2011	6 Cyl. 8.9L	PS-407
T800		
2011-2009	6 Cyl. 8.9L	PS-407
W900		
2015-2012	6 Cyl. 8.9L	PS-407
2010	6 Cyl. 8.9L	PS-407
Land Rover		
Vapor and Purge Components		
Fuel Vapor Leak Detection Pump		
Range Rover		
2019-2016	6 Cyl. 3.0L	LDP39
Range Rover Sport		
2020-2016	6 Cyl. 3.0L	LDP39
Injection Components		
Direct Injection High Pressure Fuel Pump		
Discovery		
2019-2017	6 Cyl. 3.0L	GDP901
Range Rover		
2019-2016	6 Cyl. 3.0L	GDP901
Range Rover Sport		
2018-2016	6 Cyl. 3.0L	GDP901
Fuel Pump Camshaft Follower		
Discovery		
2017	6 Cyl. 3.0L	GDF901
Range Rover		
2017-2016	6 Cyl. 3.0L	GDF901
Range Rover Sport		
2017-2016	6 Cyl. 3.0L	GDF901
Fuel Pump O-Ring		
Range Rover		
2017-2016	6 Cyl. 3.0L; On Pump	GDR901
Range Rover Sport		
2017-2016	6 Cyl. 3.0L; On Pump	GDR901
Miscellaneous Sensors		
Battery Current / Volt Sensor		
Range Rover		
2017	6 Cyl.	BSC62
Range Rover Sport		
2017	6 Cyl.	BSC62
Brake Pad Wear Sensor		
Range Rover		
2016	6 Cyl. 3.0L; Front	PWS332
Range Rover Sport		
2016	6 Cyl. 3.0L; Front	PWS332

Position Sensors

		Part No.
Position Sensors		
Camshaft Sensor		
Discovery		
2020	6 Cyl. 3.0L; Diesel	PC1097
2019	6 Cyl. 3.0L; Diesel	PC1097
2018-2017	6 Cyl. 3.0L; Diesel	PC1097
Range Rover Sport		
2020-2016	6 Cyl. 3.0L; Diesel	PC1097
Crankshaft Sensor		
Discovery		
2019-2017	6 Cyl. 3.0L	PC1095
Range Rover		
2019-2016	6 Cyl. 3.0L; Diesel	PC1095
Pressure Sensors		
Tire Pressure Monitoring System OE Design Sensor		
Defender		
2015	433 Mhz Sensor; w/ Aluminum Valve	TPM210
Temperature Sensors		
Exhaust Gas Temperature Sensor		
Range Rover		
2017-2016	6 Cyl. 3.0L; Turbocharged; Front; Located Before Particulate Filter	ETS202
2017-2016	6 Cyl. 3.0L; Turbocharged; Front; Located in Particulate Filter	ETS203
2017-2016	6 Cyl. 3.0L; Left; Turbocharged; Located Before Particulate Filter	ETS204
Range Rover Sport		
2017-2016	6 Cyl. 3.0L; Turbocharged; Front; Located Before Particulate Filter	ETS202
2017-2016	6 Cyl. 3.0L; Turbocharged; Front; Located in Particulate Filter	ETS203
2017-2016	6 Cyl. 3.0L; Left; Turbocharged; Located Before Particulate Filter	ETS204
Intake Air Temperature Sensor		
Range Rover		
2019-2016	6 Cyl. 3.0L	AX104
Range Rover Sport		
2019-2016	6 Cyl. 3.0L	AX104
Range Rover Velar		
2018	4 Cyl. 2.0L; 4 Blade Term.	AX102
2018	4 Cyl. 2.0L; 2 Blade Term.	AX103
Temperature Switches and Senders		
Blower Motor Resistor		
Discovery		
2019	6 Cyl. 3.0L; Front	RU969
2017	6 Cyl. 3.0L; Front	RU969
Lincoln		
Relays and Fuses		
Headlight Relay		
Mark VII		
1984	6 Cyl. 2.4L	RY-46
Ignition Relay		
Continental		
1984	6 Cyl. 2.4L	RY-71
Starting and Charging System Parts		
Starter Solenoid		
Continental		
1985-1984	6 Cyl. 2.4L; Fender Mounted	SS-588
Mark VII		
1985-1984	6 Cyl. 2.4L; Fender Mounted	SS-588

		Part No.
Air Management Valves		
Air Cleaner Check Valve		
Mark VII		
1985-1984	6 Cyl. 2.4L; Hose Nipple One End	AV12
1985-1984	6 Cyl. 2.4L; Hose Nipple Both Ends	AV35
PCV Systems		
PCV Grommet		
Continental		
1985-1984	6 Cyl. 2.4L; 1/2 Inch Inner Dia.; Grommet	GV4
Mark VII		
1985-1984	6 Cyl. 2.4L; 1/2 Inch Inner Dia.; Grommet	GV4
Injectors		
Fuel Injector - Diesel - Remfd		
Continental		
1985-1984	6 Cyl. 2.4L; Diesel	FJ589
Mark VII		
1985-1984	6 Cyl. 2.4L; Diesel	FJ589
Injection Components		
Fuel Line Retainer		
Continental		
1985-1984	6 Cyl. 2.4L; w/ 3/8 Inch Fuel Line	HK9330
1985-1984	6 Cyl. 2.4L; w/ 5/16 Inch Fuel Line	HK9331
Mark VII		
1985-1984	6 Cyl. 2.4L; w/ 3/8 Inch Fuel Line	HK9330
1985-1984	6 Cyl. 2.4L; w/ 5/16 Inch Fuel Line	HK9331
Temperature Sensors		
Coolant Temperature Sensor		
Mark VII		
1984	6 Cyl. 2.4L; Diesel	TX6
Pressure and Vacuum Sending Switches		
Ported Vacuum Switch		
Mark VII		
1985-1984	6 Cyl. 2.4L; 3 Ports; Orange	PVS150
Mack		
Starting and Charging System Parts		
Starter Solenoid		
CS200P Mid-Liner		
1990	24 Volt; Delco; OE No. 1990270	SS-215
1989	Delco	SS-215
1988-1986	24 Volt; Delco	SS-215
1988-1986	12 Volt; Delco; Str. No. 1113537, 1114883, 1114897, 1114899	SS-216
1986	12 Volt; Delco; OE No. 1114943	SS-216
CS250P Mid-Liner		
1990	24 Volt; Delco; OE No. 1990270	SS-215
1989	Delco	SS-215
1988-1986	24 Volt; Delco	SS-215
1988-1986	12 Volt; Delco; Str. No. 1113537, 1114883, 1114897, 1114899	SS-216
CS300P Mid-Liner		
1990	24 Volt; Delco; OE No. 1990270	SS-215
1989	Delco	SS-215
1988-1986	24 Volt; Delco	SS-215
1988-1986	12 Volt; Delco; Str. No. 1113537, 1114883, 1114897, 1114899	SS-216
1986	12 Volt; Delco; OE No. 1114943	SS-216
CS300T Mid-Liner		
1990	24 Volt; Delco; OE No. 1990270	SS-215
1989	Delco	SS-215
1988-1986	24 Volt; Delco	SS-215

Starting and Charging System Parts

		Part No.
Starter Solenoid		
CS300T Mid-Liner		
1988-1986	12 Volt; Delco; Str. No. 1113537, 1114883, 1114897, 1114899	SS-216
MS200P Mid-Liner		
1990-1989	Delco	SS-215
1988-1986	24 Volt; Delco	SS-215
1988-1986	12 Volt; Delco; Str. No. 1113537, 1114883, 1114897, 1114899	SS-216
1986	12 Volt; Delco; OE No. 1114943	SS-216
1984	24 Volt; Delco; OE No. 1990267	SS-215
1984	24 Volt; Delco; OE No. 1990270	SS-215
1982-1980	24 Volt; Delco	SS-215
1982-1980	12 Volt; Delco; Str. No. 1113537, 1114150, 1114161, 1114165, 1114169, 1114170, 1113537, 1114897, 1114899	SS-216
MS250P Mid-Liner		
1990-1989	Delco	SS-215
1988-1986	24 Volt; Delco	SS-215
1988-1986	12 Volt; Delco; Str. No. 1113537, 1114883, 1114897, 1114899	SS-216
1986	12 Volt; Delco; OE No. 1114943	SS-216
1984	24 Volt; Delco; OE No. 1990267	SS-215
1984	24 Volt; Delco; OE No. 1990270	SS-215
1983	24 Volt; Delco	SS-215
1983	12 Volt; Delco; Str. No. 1113537, 1114150, 1114161, 1114165, 1114169, 1114170, 1113537, 1114897, 1114899	SS-216
1981	24 Volt; Delco	SS-215
1981	12 Volt; Delco; Str. No. 1113537, 1114150, 1114161, 1114165, 1114169, 1114170, 1113537, 1114897, 1114899	SS-216
MS300P Mid-Liner		
1990	24 Volt; Delco; OE No. 1990270	SS-215
1989	Delco	SS-215
1988-1986	24 Volt; Delco	SS-215
1988-1986	12 Volt; Delco; Str. No. 1113537, 1114883, 1114897, 1114899	SS-216
1986	12 Volt; Delco; OE No. 1114943	SS-216
1984	24 Volt; Delco; OE No. 1990267	SS-215
1984	24 Volt; Delco; OE No. 1990270	SS-215
1983-1981	24 Volt; Delco	SS-215
1983-1981	12 Volt; Delco; Str. No. 1113537, 1114150, 1114161, 1114165, 1114169, 1114170, 1113537, 1114897, 1114899	SS-216
MS300T Mid-Liner		
1990	24 Volt; Delco; OE No. 1990270	SS-215
1989	Delco	SS-215
1988-1986	24 Volt; Delco	SS-215
1988-1986	12 Volt; Delco; Str. No. 1113537, 1114883, 1114897, 1114899	SS-216
1986	12 Volt; Delco; OE No. 1114943	SS-216
1984	24 Volt; Delco; OE No. 1990267	SS-215
1984	24 Volt; Delco; OE No. 1990270	SS-215
1983-1981	24 Volt; Delco	SS-215
1983-1981	12 Volt; Delco; Str. No. 1113537, 1114150, 1114161, 1114165, 1114169, 1114170, 1113537, 1114897, 1114899	SS-216
Voltage Regulator		
CS200P Mid-Liner		
1992-1986		VR-144
CS250P Mid-Liner		
1992-1988	60 Amp; 90 Amp; 100 Amp; 105 Amp; 130 Amp; 145 Amp; Alt. No. 1117921; Alt. No. 1111732, 1117481; Alt. No. 1117611, 1117612; Alt. No. 1117801; Alt. No. 1117905, 1117880; Alt. No. 1117923, 1117909	VR-144

		Part No.
Voltage Regulator		
CS250P Mid-Liner		
1987	60 Amp; 90 Amp; Alt. No. 1111732, 1117481; Alt. No. 1117611, 1117612	VR-144
1986	60 Amp; Alt. No. 1117611, 1117612	VR-144
1986	90 Amp; Alt. No. 1111732, 1117481	VR-144
CS300P Mid-Liner		
1992-1988	60 Amp; 90 Amp; 100 Amp; 105 Amp; 130 Amp; 145 Amp; Alt. No. 1117921; Alt. No. 1111732, 1117481; Alt. No. 1117611, 1117612; Alt. No. 1117801; Alt. No. 1117905, 1117880; Alt. No. 1117923, 1117909	VR-144
1987	60 Amp; 90 Amp; Alt. No. 1111732, 1117481; Alt. No. 1117611, 1117612	VR-144
1986	60 Amp; Alt. No. 1117611, 1117612	VR-144
1986	90 Amp; Alt. No. 1111732, 1117481	VR-144
CS300T Mid-Liner		
1992-1988	60 Amp; 90 Amp; 100 Amp; 105 Amp; 130 Amp; 145 Amp; Alt. No. 1117921; Alt. No. 1111732, 1117481; Alt. No. 1117611, 1117612; Alt. No. 1117801; Alt. No. 1117905, 1117880; Alt. No. 1117923, 1117909	VR-144
1987	60 Amp; 90 Amp; Alt. No. 1111732, 1117481; Alt. No. 1117611, 1117612	VR-144
1986	60 Amp; Alt. No. 1117611, 1117612	VR-144
1986	90 Amp; Alt. No. 1111732, 1117481	VR-144
MS200P Mid-Liner		
1992-1988	60 Amp; 90 Amp; 100 Amp; 105 Amp; 130 Amp; 145 Amp; Alt. No. 1117921; Alt. No. 1111732, 1117481; Alt. No. 1117611, 1117612; Alt. No. 1117801; Alt. No. 1117905, 1117880; Alt. No. 1117923, 1117909	VR-144
1987-1986	60 Amp; 90 Amp; Alt. No. 1111732, 1117481; Alt. No. 1117611, 1117612	VR-144
1984	60 Amp; 90 Amp; Alt. No. 1117481, 1117482, 1117732, 1117735; Alt. No. 1117611, 1117612	VR-144
1982-1981	60 Amp; 90 Amp; Alt. No. 1117481, 1117482, 1117732, 1117735; Alt. No. 1117611, 1117612	VR-144
1980	60 Amp; Alt. No. 1117611, 1117612	VR-144
1980	90 Amp; Alt. No. 1117481, 1117482, 1117732, 1117735	VR-144
MS250P Mid-Liner		
1992-1988	60 Amp; 90 Amp; 100 Amp; 105 Amp; 130 Amp; 145 Amp; Alt. No. 1117921; Alt. No. 1111732, 1117481; Alt. No. 1117611, 1117612; Alt. No. 1117801; Alt. No. 1117905, 1117880; Alt. No. 1117923, 1117909	VR-144
1987-1986	60 Amp; 90 Amp; Alt. No. 1111732, 1117481; Alt. No. 1117611, 1117612	VR-144
1984-1983	60 Amp; Alt. No. 1117611, 1117612	VR-144
1984-1983	90 Amp; Alt. No. 1117481, 1117482, 1117732, 1117735	VR-144
1981	60 Amp; Alt. No. 1117611, 1117612	VR-144
1981	90 Amp; Alt. No. 1117481, 1117482, 1117732, 1117735	VR-144
MS300P Mid-Liner		
1992-1988	60 Amp; 90 Amp; 100 Amp; 105 Amp; 130 Amp; 145 Amp; Alt. No. 1117921; Alt. No. 1111732, 1117481; Alt. No. 1117611, 1117612; Alt. No. 1117801; Alt. No. 1117905, 1117880; Alt. No. 1117923, 1117909	VR-144
1987	60 Amp; 90 Amp; Alt. No. 1111732, 1117481; Alt. No. 1117611, 1117612	VR-144
1986	60 Amp; Alt. No. 1117611, 1117612	VR-144

Starting and Charging System Parts

		Part No.
Voltage Regulator		
MS300P Mid-Liner		
1986	90 Amp; Alt. No. 111732, 1117481	VR-144
1984	60 Amp; Alt. No. 1117611, 1117612	VR-144
1984	90 Amp; Alt. No. 1117481, 1117482, 1117732, 1117735	VR-144
1983-1981	60 Amp; 90 Amp; Alt. No. 1117481, 1117482, 1117732, 1117735; Alt. No. 1117611, 1117612	VR-144
MS300T Mid-Liner		
1992	60 Amp; 90 Amp; 100 Amp; 105 Amp; 130 Amp; 145 Amp; Alt. No. 1117921; Alt. No. 111732, 1117481; Alt. No. 1117611, 1117612; Alt. No. 1117801; Alt. No. 1117905, 1117880; Alt. No. 1117923, 1117909	VR-144
1991	60 Amp; 90 Amp; 100 Amp; 105 Amp; 130 Amp; Alt. No. 1117921; Alt. No. 111732, 1117481; Alt. No. 1117611, 1117612; Alt. No. 1117801; Alt. No. 1117905, 1117880; Alt. No. 1117923, 1117909	VR-144
1990	60 Amp; 90 Amp; 100 Amp; 105 Amp; 130 Amp; 140 Amp; Alt. No. 1117921; Alt. No. 111732, 1117481; Alt. No. 1117611, 1117612; Alt. No. 1117801; Alt. No. 1117905, 1117880; Alt. No. 1117923, 1117909	VR-144
1989	60 Amp; 90 Amp; 100 Amp; 105 Amp; 130 Amp; 145 Amp; Alt. No. 1117921; Alt. No. 111732, 1117481; Alt. No. 1117611, 1117612; Alt. No. 1117801; Alt. No. 1117905, 1117880; Alt. No. 1117923, 1117909	VR-144
1988	60 Amp; 90 Amp; 100 Amp; 130 Amp; 145 Amp; Alt. No. 1117921; Alt. No. 111732, 1117481; Alt. No. 1117611, 1117612; Alt. No. 1117801; Alt. No. 1117905, 1117880; Alt. No. 1117923, 1117909	VR-144
1987	60 Amp; 90 Amp; Alt. No. 111732, 1117481; Alt. No. 1117611, 1117612	VR-144
1986	60 Amp; Alt. No. 1117611, 1117612	VR-144
1986	90 Amp; Alt. No. 111732, 1117481	VR-144
1984	60 Amp; Alt. No. 1117611, 1117612	VR-144
1984	90 Amp; Alt. No. 1117481, 1117482, 1117732, 1117735	VR-144
1983-1981	60 Amp; 90 Amp; Alt. No. 1117481, 1117482, 1117732, 1117735; Alt. No. 1117611, 1117612	VR-144
Pressure Sensors		
Diesel Particulate Filter (DPF) Pressure Sensor		
GU4		
2018-2012	6 Cyl. 8.9L	DPS101
GU5		
2018-2012	6 Cyl. 8.9L	DPS101
Temperature Switches and Senders		
A/C and Heater Blower Motor Switch		
CF		
1991-1986		HS569
CH		
1989		HS569
CL		
1992-1991		HS569
CM		
1991-1988		HS569
CS200P Mid-Liner		
1996-1986		HS569

		Part No.
A/C and Heater Blower Motor Switch		
CS250P Mid-Liner		
1996-1986		HS569
CS300P Mid-Liner		
1996-1986		HS569
CS300T Mid-Liner		
1996-1986		HS569
DMC		
1986		HS569
DMM		
1996-1986		HS569
FDM		
1996-1992		HS569
1990		HS569
LC		
1994		HS569
LE		
1996-1995		HS569
MC		
1991-1986		HS569
MH		
1994-1992		HS569
MS200P Mid-Liner		
1996-1984		HS569
1982-1980		HS569
MS250P Mid-Liner		
1996-1983		HS569
1981		HS569
MS300P Mid-Liner		
1996-1981		HS569
MS300T Mid-Liner		
1996-1981		HS569
RB		
1989		HS569
RL		
1987		HS569
RM		
1993-1986		HS569
RS		
1989-1988		HS569
RW		
1986		HS569
U		
1989-1986		HS569
Mazda		
Relays and Fuses		
Coolant Fan Relay		
626		
1984	4 Cyl. 2.0L	RY-738
Starting and Charging System Parts		
Starter Solenoid		
B2200		
1984-1982		SS-268
Voltage Regulator		
B2200		
1984-1982		VR196
Air Management Valves		
Air Cleaner Check Valve		
B2200		
1984-1982		AV13

Early Fuel Emission Control

		Part No.
Early Fuel Emission Control		
Pre Heater Hose		
B2200		
1984-1982	3/4 Inch x 36 Inch	DH1
1984-1982	2 x 18 Inch	DH2
1984-1982	2 Inch x 21 Inches	DH23
1984-1982	1 Inch x 36 Inches	DH26
1984-1982	2 x 36 Inch	DH28
1984-1982	1 1/2 Inches x 7 Inches, Expandable To 20 Inches	DH3
1984-1982	1 7/8 Inch x 23 1/2 Inch	DH4
1984-1982	1 1/2 Inches x 20 Inches, Cut To Fit	DH6
PCV Systems		
PCV Grommet		
626		
1985-1984	4 Cyl.	GV29
PCV Valve		
626		
1985-1984	4 Cyl.	V246
Temperature Sensors		
Coolant Temperature Sensor		
B2200		
1984-1982		TX63
Body Light Switches		
Back-Up Light Switch		
B2200		
1984-1982	w/ 5 Speed M.T.	LS-222
Headlight Dimmer Switch		
B2200		
1984-1982	Dual Lever Multifunction Switch Assembly	CBS-1372
1984-1982	Switch Only	CBS1583
Headlight Switch		
B2200		
1984-1982	Dual Lever Multifunction Switch Assembly	CBS-1372
1984-1982	Switch Only	CBS1583
Stoplight Switch		
B2200		
1984-1982		SLS-104
Turn Signal Switch		
B2200		
1984-1982	Dual Lever Multifunction Switch Assembly	CBS-1372
1984-1982	Switch Only	CBS1583
Chassis and Drivetrain Switches		
Automatic Transmission Vacuum Modulator		
626		
1985-1984	4 Cyl. 2.0L	TM-34
B2200		
1984-1982	4 Cyl. 2.2L	TM-34
Fuel Pump Cut-Off Switch		
B2200		
1984-1982	Universal; w/ Electric Fuel Pump	FV-7
Ignition Switches		
Ignition Starter Switch		
B2200		
1984		US931
1983		US191
1982		US225
Ignition Switch with Lock Cylinder		
B2200		
1984-1982		US-289L

		Part No.
Interior Power Switches		
Windshield Wiper Switch		
B2200		
1984-1982	Dual Lever Multifunction Switch Assembly	CBS-1372
1984-1982	Switch Only	WP-236
Pressure and Vacuum Sending Switches		
Oil Pressure Light Switch		
B2200		
1984-1982		PS-120
Temperature Switches and Senders		
Blower Motor Resistor		
B2200		
1984-1982		RU-268
Temperature Sender - With Gauge		
B2200		
1984-1982		TS-67
Temperature Sender - With Light		
B2200		
1983-1982		TS95
Locks		
Door Lock Kit		
B2200		
1984-1982	w/o Illuminated Entry	DL-14
Mercedes-Benz		
Modules		
Glow Plug Controller		
E320		
2009-2007	6 Cyl. 3.0L	RY1724
GL320		
2009-2007	6 Cyl. 3.0L	RY1724
ML320		
2009-2007	6 Cyl. 3.0L	RY1724
R320		
2009-2007	6 Cyl. 3.0L	RY1724
Sprinter 2500		
2015-2010	6 Cyl. 3.0L	RY1724
Sprinter 3500		
2015-2010	6 Cyl. 3.0L	RY1724
Relays and Fuses		
A/C Auto Temperature Control Relay		
S350		
1995-1994		RY-1093
A/C Control Relay		
E300		
1995		RY-1088
ABS Relay		
300D		
1993-1990	5 Cyl.	RY-304
350SD		
1991		RY-304
350SDL		
1991-1990		RY-304
E300		
1995		RY-1103
Accessory Relay		
240D		
1983-1980	4 Cyl. 2.4L; Stamping No. 000 15 45 2232	RY190
1983-1980	4 Cyl. 2.4L; Stamping No. 000 15 45 0605	RY-191

Mercedes-Benz

Relays and Fuses

		Part No.
Accessory Relay		
300CD		
1983-1982	Stamping No. 000 15 45 2232	RY190
1983-1982	Stamping No. 000 15 45 0605	RY-191
1981-1980	5 Cyl. 3.0L; Stamping No. 000 15 45 2232	RY190
1981-1980	5 Cyl. 3.0L; Stamping No. 000 15 45 0605	RY-191
300D		
1981-1980	5 Cyl. 3.0L; Stamping No. 000 15 45 0605	RY-191
300SD		
1983	5 Cyl. 3.0L; Stamping No. 000 15 45 0605	RY-191
1983	5 Cyl. 3.0L; Stamping No. 000 15 45 2232	RY190
1982	Stamping No. 000 15 45 2232	RY190
1982	Stamping No. 000 15 45 0605	RY-191
1981-1980	5 Cyl. 3.0L; Stamping No. 000 15 45 0605	RY-191
300TD		
1981-1980	5 Cyl. 3.0L; Stamping No. 000 15 45 0605	RY-191
ML320		
2009-2007	OE No. A 002 542 23 19	RY-1111
2008	OE No. A 002 542 26 19	RY-1086
2008	OE No. A 002 542 11 19	RY-1116
R320		
2009-2007	In Trunk	RY1811
Air Pump Relay		
E320		
2005	6 Cyl.	RY-1084
Auxiliary Battery Relay		
E320		
2007-2006		RY-1113
Blower Motor Relay		
300CD		
1984-1983		RY-1094
300D		
1984-1983		RY-1094
300SD		
1984-1983		RY-1094
300TD		
1984-1983		RY-1094
Computer Control Relay		
300SDL		
1986		RY-1095
E320		
2007-2006		RY-1118
GL320		
2007		RY-1086
ML320		
2007		RY-1086
Coolant Fan Relay		
240D		
1983-1980		RY-1132
300CD		
1985		RY-1132
300D		
1987	6 Cyl. 3.0L	RY-1132
1985		RY-1132
300SD		
1985		RY-1132

		Part No.
Coolant Fan Relay		
300SDL		
1986		RY-1132
300TD		
1987	6 Cyl. 3.0L	RY-1132
1985		RY-1132
ML320		
2009		RY-1116
S350		
1995-1994		RY-1188
Daytime Running Lamp Relay		
190D		
1989-1985	Universal	DRL-1
300CD		
1985-1982	Universal	DRL-1
300D		
1990	Universal	DRL-1
1987	Universal	DRL-1
1985-1982	Universal	DRL-1
300SD		
1985-1982	Universal	DRL-1
300SDL		
1987-1986	Universal	DRL-1
300TD		
1987	Universal	DRL-1
1985-1982	Universal	DRL-1
Diesel Glow Plug Relay		
240D		
1983-1980	To Chassis No. 149291	RY190
300CD		
1980	To Chassis No. 004934	RY190
300D		
1981-1980	To Chassis No. 164520	RY190
300SD		
1985		RY-292
1984	OE No. 001545983	RY-292
1983		RY-292
300TD		
1980	To Chassis No. 011326	RY190
E320		
2006-2005	6 Cyl. 3.2L; Diesel	RY-1528
Fog Lamp Relay		
ML320		
2009		RY-1116
S350		
1995		RY-1116
Fuel Injection Relay		
GL320		
2007		RY-1086
ML320		
2007		RY-1086
Fuel Pump Relay		
E320		
2007-2006		RY-1118
GL320		
2008-2007		RY-1116
ML320		
2009		RY-1116
2007		RY-1116
R320		
2007		RY-1116

Relays and Fuses

		Part No.
Fuel Shut-Off Relay		
S350		
1995-1994		RY-1117
Hazard Flasher		
E300		
1995		EFL113
Headlight Relay		
190D		
1989-1985		RY-923
E320		
2009-2008		RY-1116
Horn Relay		
300D		
1993-1990	5 Cyl.	RY-1188
E300		
1999-1996		RY-1116
E320		
2009-2006		RY-1116
ML320		
2009		RY-1116
S350		
1995		RY-1188
Instrument Cluster Relay		
ML320		
2009		RY-1116
Power Seat Relay		
190D		
1989-1984		RY-1108
300D		
1993-1990		RY-1108
1987		RY-1108
300SD		
1985-1981		RY-1108
300TD		
1987		RY-1108
Power Window Relay		
300D		
1993-1991	5 Cyl.	RY-1088
1990		RY-1088
350SD		
1991		RY-1088
350SDL		
1991-1990		RY-1088
E300		
1995		RY-1088
Rear Window Defogger Relay		
190D		
1989-1985		RY-923
300D		
1993-1990	5 Cyl.	RY-923
Starter Relay		
E300		
1999-1998		RY-1116
E320		
2009-2008		RY-1116
2006		RY-1116
ML320		
2009		RY-1116
Turn Signal Relay		
190D		
1989-1986		RY-923

		Part No.
Turn Signal Relay		
300D		
1993-1992	5 Cyl.	RY-923
1990	5 Cyl.	RY-923
ML320		
2009		RY-1116
S350		
1995		RY-1116
Windshield Washer Relay		
190D		
1987		RY-1132
1985		RY-1132
Wiper Relay		
190D		
1989		RY-923
1988-1987		RY-1132
1986		RY-923
1985		RY-1132
300D		
1993-1990	5 Cyl.	RY-923
Starting and Charging System Parts		
Starter Solenoid		
190D		
1989-1984		SS-401
240D		
1983-1980		SS-277
300CD		
1985-1982	5 Cyl. 3.0L	SS-277
1981-1980		SS-277
300D		
1993-1990	5 Cyl. 2.5L	SS-401
1987	6 Cyl. 3.0L	SS-401
1985-1981	5 Cyl. 3.0L	SS-277
1980		SS-277
300SD		
1985-1981	5 Cyl. 3.0L	SS-277
1980		SS-277
300SDL		
1987-1986	6 Cyl. 3.0L	SS-401
300TD		
1987	6 Cyl. 3.0L	SS-401
1985-1982	5 Cyl. 3.0L	SS-277
1981-1980		SS-277
350SD		
1991		SS-401
350SDL		
1991-1990		SS-401
Voltage Regulator		
190D		
1989-1985		VR-485
240D		
1981-1980		VR-134
300D		
1992-1991		VR-471
1987		VR-485
1985		VR-471
300SD		
1992		VR-471
1985		VR-485
300SDL		
1987-1986		VR-485

Mercedes-Benz

Starting and Charging System Parts

		Part No.
Voltage Regulator		
300TD		
1987		VR-485
1983-1980		VR-134
E300		
1997-1996	6 Cyl. 3.0L; Alt. No. 010 154 54 02, 011 154 00 02	VR842
Air Injection and Induction Parts		
Fuel Injection Throttle Body		
E320		
2009-2007	6 Cyl. 3.0L	S20165
E350		
2013-2011	6 Cyl. 3.0L	S20165
GL320		
2009-2007	6 Cyl. 3.0L	S20165
GL350		
2016-2010	6 Cyl. 3.0L	S20165
GLS350d		
2017	6 Cyl. 3.0L	S20165
ML320		
2009-2007	6 Cyl. 3.0L	S20165
ML350		
2014-2010	6 Cyl. 3.0L	S20165
R320		
2009-2007	6 Cyl. 3.0L	S20165
R350		
2013-2010	6 Cyl. 3.0L	S20165
S350		
2013-2012	6 Cyl. 3.0L; Diesel	S20165
Sprinter 2500		
2019	6 Cyl. 3.0L	S20165
2017-2010	6 Cyl. 3.0L	S20165
Sprinter 3500		
2017-2010	6 Cyl. 3.0L	S20165
Turbocharger - New		
E320		
2009-2007	6 Cyl. 3.0L; Diesel; Turbocharged	TBC602
E350		
2012-2011	6 Cyl. 3.0L; Diesel; Turbocharged	TBC602
GL320		
2009	6 Cyl. 3.0L; Diesel; Turbocharged	TBC602
2008-2007	6 Cyl. 3.0L; Turbocharged	TBC547
GL350		
2012-2010	6 Cyl. 3.0L; Diesel; Turbocharged	TBC602
ML320		
2009	6 Cyl. 3.0L; Diesel; Turbocharged	TBC602
2008-2007	6 Cyl. 3.0L; Turbocharged	TBC547
ML350		
2011-2010	6 Cyl. 3.0L; Diesel; Turbocharged	TBC602
R320		
2009	6 Cyl. 3.0L; Diesel; Turbocharged	TBC602
2008-2007	6 Cyl. 3.0L; Turbocharged	TBC547
R350		
2012-2010	6 Cyl. 3.0L; Diesel; Turbocharged	TBC602
Sprinter		
2016-2014	4 Cyl. 2.1L; Turbocharged	TBC607
2010-2007	4 Cyl. 2.1L; Turbocharged	TBC658
Sprinter 2500		
2017-2010	6 Cyl. 3.0L; Diesel; Turbocharged	TBC602
Sprinter 3500		
2017-2011	6 Cyl. 3.0L; Diesel; Turbocharged	TBC602

		Part No.
Vacuum Pump		
E320		
2009-2007		VCP171
GL320		
2009-2007		VCP171
GL350		
2012-2010		VCP171
ML320		
2009-2007		VCP171
R320		
2009-2007		VCP171
R350		
2012-2011	6 Cyl. 3.0L	VCP139
Sprinter 2500		
2018-2010		VCP173
Sprinter 3500		
2019-2010		VCP173
Air Management Regulators and Solenoids		
Intake Manifold Actuator		
E320		
2009-2007	6 Cyl. 3.0L	IMA111
E350		
2013-2011	6 Cyl. 3.0L	IMA110
GL320		
2009-2007	6 Cyl. 3.0L	IMA111
GL350		
2016-2010	6 Cyl. 3.0L	IMA110
GLE350d		
2016	6 Cyl. 3.0L	IMA110
ML320		
2009	6 Cyl. 3.0L	IMA110
2008-2007	6 Cyl. 3.0L	IMA111
ML350		
2015-2010	6 Cyl. 3.0L	IMA110
R320		
2009	6 Cyl. 3.0L; Exc. Calif.	IMA110
2009	6 Cyl. 3.0L; w/ Calif.	IMA111
2008-2007	6 Cyl. 3.0L	IMA111
R350		
2013-2010	6 Cyl. 3.0L; Exc. Calif.	IMA110
2013-2010	6 Cyl. 3.0L; w/ Calif.	IMA111
S350		
2013-2012	6 Cyl. 3.0L	IMA110
EGR Components		
EGR Valve		
190D		
1989-1988	5 Cyl. 2.5L	EGV1094
1987	Naturally Aspirated	EGV1093
1987	Turbocharged	EGV1094
1986-1985		EGV1093
300D		
1993	5 Cyl. 2.5L	EGV1094
1992		EGV1094
1991-1990	5 Cyl. 2.5L	EGV1094
1987	6 Cyl. 3.0L	EGV1096
300SD		
1993-1992	6 Cyl.	EGV1096
1985	5 Cyl. 3.0L	EGV1094
300SDL		
1987-1986	6 Cyl. 3.0L	EGV1096
350SD		
1991	6 Cyl.	EGV1096

EGR Components

		Part No.
EGR Valve		
350SDL		
1991-1990	6 Cyl.	EGV1096
E250		
2016-2014	4 Cyl. 2.1L	EGV1271
E300		
1997-1996	6 Cyl. 3.0L	EGV1106
1995	6 Cyl. 3.0L	EGV1105
E320		
2009-2007	6 Cyl. 3.0L	EGV1189
2006	6 Cyl. 3.2L	EGV1107
E350		
2013	6 Cyl. 3.0L; Diesel; Turbocharged	EGV1266
GL320		
2009-2007	6 Cyl. 3.0L	EGV1189
GL350		
2016-2013		EGV1266
GLE300d		
2017	4 Cyl. 2.1L	EGV1271
ML320		
2009-2007	6 Cyl. 3.0L	EGV1189
ML350		
2014-2013	6 Cyl. 3.0L; Diesel; Turbocharged	EGV1266
2012	Bluetec 4Matic	EGV1266
R320		
2009-2007	6 Cyl. 3.0L	EGV1189
S350		
2013	6 Cyl. 3.0L; Diesel; Turbocharged	EGV1266
2012	6 Cyl. 3.0L; From 12/5/11	EGV1266
1995-1994	6 Cyl.	EGV1096
EGR Valve Mounting Gasket		
190D		
1989-1984		VG175
300D		
1993-1990		VG175
1987		VG175
1985		VG175
300SD		
1993-1992		VG175
1985		VG177
300SDL		
1987-1986		VG175
350SD		
1991		VG175
350SDL		
1991-1990		VG175
E300		
1997-1995		VG175
E320		
2009-2007	6 Cyl. 3.0L	VG238
GL320		
2009-2007	6 Cyl. 3.0L	VG238
ML320		
2009-2007	6 Cyl. 3.0L	VG238
R320		
2009-2007	6 Cyl. 3.0L	VG238
S350		
1995-1994		VG175
Exhaust Components		
Diesel Emission Fluid Injection Nozzle		
E350		
2013-2011	6 Cyl. 3.0L	DFI7

		Part No.
Diesel Emission Fluid Injection Nozzle		
GLK250		
2015-2013	4 Cyl. 2.1L	DFI7
ML250		
2015	4 Cyl. 2.1L	DFI7
R350		
2012-2010	6 Cyl. 3.0L	DFI7
Sprinter 2500		
2015-2010	6 Cyl. 3.0L	DFI7
Sprinter 3500		
2015-2010	6 Cyl. 3.0L	DFI7
Diesel Emissions Fluid Pump		
E250		
2016-2014	4 Cyl. 2.1L	DFIP6
E350		
2013-2011	6 Cyl. 3.0L	DFIP6
GL350		
2016-2013	6 Cyl. 3.0L	DFIP6
GLE300d		
2016	4 Cyl. 2.1L	DFIP6
GLK250		
2015-2013	4 Cyl. 2.1L	DFIP6
ML250		
2015	4 Cyl. 2.1L	DFIP6
ML350		
2014-2012	6 Cyl. 3.0L	DFIP6
Sprinter 2500		
2018-2010	6 Cyl. 3.0L	DFIP6
Sprinter 3500		
2018-2010	6 Cyl. 3.0L	DFIP6
PCV Systems		
PCV Valve		
E320		
2009-2007	Includes PCV Hose	V581
GL320		
2009-2007	Includes PCV Hose	V581
ML320		
2009	Exhaust stock and reorder; PCV Only	V496
2009-2007	Includes PCV Hose	V581
R320		
2009	Exhaust stock and reorder; PCV Only	V496
2009-2007	Includes PCV Hose	V581
Vapor and Purge Components		
Canister Purge Solenoid		
E320		
2009-2006	Right	CP492
Canister Vent Solenoid		
300D		
1993-1992		CVS46
300SD		
1993-1992		CVS46
E300		
1999-1998		CVS46
E320		
2009-2006	w/ Plastic Housing	CVS47
2009-2006	w/o Plastic Housing	CVS80
S350		
1995-1994		CVS46
Fuel Vapor Canister		
E320		
2006		CP3454

Mercedes-Benz

Injectors

		Part No.
Injectors		
Fuel Injector - Diesel - New		
GL320		
2009-2007	6 Cyl. 3.0L	FJ1268
GL350		
2016-2013	6 Cyl. 3.0L	FJ1292NX
ML320		
2009-2007	6 Cyl. 3.0L	FJ1268
ML350		
2014-2012	6 Cyl. 3.0L	FJ1292NX
R320		
2009-2007	6 Cyl. 3.0L	FJ1268
R350		
2011-2010	6 Cyl. 3.0L	FJ1268
S350		
2013-2012	6 Cyl. 3.0L	FJ1292NX
Fuel Injector - Diesel - Remfd		
190D		
1989		FJ924
1988		FJ923
1987	Turbocharged	FJ918
1987	Naturally Aspirated	FJ923
1986		FJ923
1985-1984		FJ621
240D		
1983-1980	4 Cyl. 2.4L; Diesel	FJ621
300CD		
1985-1982		FJ619
1981-1980		FJ621
300D		
1987	6 Cyl. 3.0L; Diesel	FJ842
1985-1982	5 Cyl. 3.0L; Diesel	FJ619
300SD		
1993-1992		FJ918
1985-1980		FJ619
300SDL		
1987-1986		FJ842
300TD		
1987		FJ842
1985-1981		FJ619
1980		FJ621
350SD		
1991	6 Cyl.	FJ918
350SDL		
1991-1990	6 Cyl.	FJ918
E300		
1999-1998	6 Cyl. 3.0L	FJ846
1997-1995	6 Cyl. 3.0L	FJ925
GLK250		
2014-2013	4 Cyl. 2.1L	FJ1289
S350		
1995-1994	6 Cyl.	FJ918
Sprinter 2500		
2019-2010	6 Cyl. 3.0L	FJ1290
2017-2014	4 Cyl. 2.1L	FJ1289
Sprinter 3500		
2019-2010	6 Cyl. 3.0L	FJ1290
2017-2014	4 Cyl. 2.1L	FJ1289
Injection Components		
Diesel Fuel Injection Pump - Remanufactured		
E350		
2013-2011	6 Cyl. 3.0L; Turbocharged	IP32

		Part No.
Diesel Fuel Injection Pump - Remanufactured		
GL350		
2012-2010		IP32
ML350		
2011	6 Cyl. 3.0L; Turbocharged	IP32
R350		
2012-2011	6 Cyl. 3.0L; Turbocharged	IP32
Diesel Fuel Injector Heat Shield		
190D		
1987-1984		SK51
300CD		
1985-1982		SK51
300D		
1991-1990		SK51
1985-1982		SK51
300SD		
1993-1992		SK51
1985-1981		SK51
350SD		
1991		SK51
350SDL		
1991		SK51
1990	From 3/90	SK51
S350		
1995-1994		SK51
Diesel Glow Plug		
190D		
1989-1986		GP106
1985-1984		GP106
240D		
1983-1981	4 Cyl. 2.4L	GP106
1980	4 Cyl. 2.4L	GP112
300CD		
1985-1981	5 Cyl. 3.0L	GP106
1980	5 Cyl. 3.0L	GP112
300D		
1987	6 Cyl. 3.0L	GP106
1985-1981	5 Cyl. 3.0L	GP106
1980	5 Cyl. 3.0L	GP112
300SD		
1985-1980	5 Cyl. 3.0L	GP106
300SDL		
1986	6 Cyl. 3.0L	GP106
300TD		
1987	6 Cyl. 3.0L	GP106
1985-1981	5 Cyl. 3.0L	GP106
1980	5 Cyl. 3.0L	GP112
E300		
1999-1996	6 Cyl. 3.0L	GP117
E320		
2009-2007		GP116
Fuel Pressure Regulator		
E320		
2009-2007	6 Cyl. 3.0L	PR561
E350		
2013-2011	6 Cyl. 3.0L; Low Pressure	PR561
GL320		
2009-2007	6 Cyl. 3.0L	PR561
GL350		
2015-2013	6 Cyl. 3.0L	PR561
2012-2010	6 Cyl. 3.0L	PR562

Injection Components

		Part No.
Fuel Pressure Regulator		
ML320		
2009-2007	6 Cyl. 3.0L	PR561
ML350		
2014	6 Cyl. 3.0L	PR561
2013-2010	6 Cyl. 3.0L; Low Pressure	PR561
R350		
2012-2010	6 Cyl. 3.0L	PR561
S350		
2013-2012	6 Cyl. 3.0L; Diesel; Turbocharged	PR561
Sprinter 2500		
2013-2010	6 Cyl. 3.0L	PR561
Sprinter 3500		
2013-2010	6 Cyl. 3.0L	PR561
Chassis and Drivetrain Sensors		
ABS Speed Sensor		
190D		
1989	In Differential	ALS1901
1989-1984	Left Front	ALS1162
1989-1984	Right Front	ALS1163
1987-1984	In Differential	ALS1528
300D		
1993-1990	Right Front	ALS1161
1993-1990	Left Front	ALS1166
1993-1990	In Differential	ALS2089
300SD		
1993-1992	Left Rear	ALS1890
1993-1992	Right Front	ALS1893
1993-1992	Left Front	ALS1904
1993-1992	Right Rear	ALS1905
1993-1992	w/o Traction Control; In Differential	ALS2903
1985	Left Front	ALS1164
1985	Right Front	ALS1165
1985-1981	In Differential	ALS1527
1984-1981	Right Front	ALS1161
1984-1981	Left Front	ALS1166
300SDL		
1987-1986	Left Front	ALS1164
1987-1986	Right Front	ALS1165
1987-1986	In Differential	ALS1899
300TD		
1987	Right Front	ALS1161
1987	Left Front	ALS1166
1987	In Differential	ALS2089
350SD		
1991	Left Front	ALS1164
1991	Right Front	ALS1165
1991	In Differential	ALS1899
350SDL		
1991-1990	Left Front	ALS1164
1991-1990	Right Front	ALS1165
1991-1990	In Differential	ALS1899
E300		
1999-1996	Right Front	ALS367
1999-1996	Left Rear	ALS371
1999-1996	Right Rear	ALS375
1999-1996	Left Front	ALS390
1995	Right Front	ALS1161
1995	Left Front	ALS1166
1995	Rear	ALS2089
E320		
2009-2006	Rear	ALS395
2009-2006	Front	ALS411

		Part No.
ABS Speed Sensor		
GL320		
2009-2007	Front	ALS376
2008	Left Rear	ALS365
GL350		
2016-2015	Front	ALS3086
2012-2011	Includes ABS Wheel Speed Sensor Wire Harness; Front	ALS376
2010	Front	ALS376
GLE300d		
2017-2016	Front	ALS3086
GLS350d		
2017	Front	ALS3086
ML250		
2015	Front	ALS3086
ML320		
2009-2007	Rear	ALS365
2009-2007	Front	ALS376
R320		
2009-2007	Front	ALS1856
2009-2007	Rear	ALS365
R350		
2012	Bluetec 4Matic; Includes ABS Wheel Speed Sensor Wire Harness; Rear	ALS365
2012-2011	Bluetec 4Matic; Includes ABS Wheel Speed Sensor Wire Harness; Front	ALS1856
S350		
2012	6 Cyl. 3.0L; Includes ABS Wheel Speed Sensor Wire Harness; Front	ALS1902
2012	6 Cyl. 3.0L; Includes ABS Wheel Speed Sensor Wire Harness; Rear	ALS2761
1995-1994	Left Rear	ALS1892
1995-1994	Right Front	ALS1893
1995-1994	Right Rear	ALS1894
1995-1994	Left Front	ALS1904
Sprinter 2500		
2018-2012	Base; Includes ABS Wheel Speed Sensor Wire Harness; Left Rear	ALS3097
2018-2010	Right Rear	ALS2746
2018-2010	Front	ALS3082
2011-2010	Includes ABS Wheel Speed Sensor Wire Harness; Left Rear	ALS3097
Sprinter 3500		
2018-2017	Left Rear	ALS3085
2018-2010	Right Rear	ALS2746
2018-2010	Front	ALS3082
2018-2010	Rear	ALS3083
2016-2010	Left Rear	ALS2160
Automatic Transmission Conductor Plate		
E300		
1999-1997		TCP01
1999-1996	In Transmission	TCPA01
E320		
2006		TCP01
Vehicle Speed Sensor		
190D		
1987		SC783
300D		
1993-1990		SC783
1987		SC783
300TD		
1987		SC783
E300		
1995		SC783

Fluid Level Sensors

		Part No.
Fluid Level Sensors		
Coolant Level Sensor		
300SD		
1993-1992		FLS-172
E300		
1999-1996		FLS-172
E320		
2006		FLS278
S350		
1995-1994		FLS-172
Windshield Washer Level Sensor		
300SDL		
1987-1986		FLS174
350SD		
1991		FLS174
350SDL		
1991-1990		FLS174
E300		
1999-1996		FLS-175
1995		FLS174
E320		
2008		FLS-187
2006		FLS-187
Fuel Sensors		
Diesel Nitrogen Oxide (NOx) Sensor		
E250		
2016-2014	4 Cyl. 2.1L; Upstream	NOX016
2016-2014	4 Cyl. 2.1L; Downstream	NOX017
GLK250		
2015-2013	4 Cyl. 2.1L; Upstream	NOX016
2015-2013	4 Cyl. 2.1L; Downstream	NOX017
Sprinter 2500		
2018-2017	6 Cyl. 3.0L; Upstream	NOX017
2018-2014	6 Cyl. 3.0L; Downstream	NOX017
2016-2014	4 Cyl. 2.1L; Upstream	NOX016
2016-2014	4 Cyl. 2.1L; Downstream	NOX017
2015-2014	6 Cyl. 3.0L; Upstream	NOX016
Sprinter 3500		
2018-2017	6 Cyl. 3.0L; Upstream	NOX017
2018-2014	6 Cyl. 3.0L; Downstream	NOX017
2016-2014	6 Cyl. 3.0L; Upstream	NOX016
2016-2014	4 Cyl. 2.1L; Downstream	NOX017
2015-2014	4 Cyl. 2.1L; Upstream	NOX016
Knock Sensor		
E250		
2016-2014	4 Cyl. 2.1L	KS450
GLK250		
2015-2013		KS450
Mass Air Flow		
E300		
1999-1998	6 Cyl. 3.0L; Diesel	MAS0428
E320		
2006-2005	6 Cyl. 3.2L; Diesel	MAS0427
Sprinter 2500		
2016-2014	6 Cyl. 3.0L	MAS0421
2013-2010		MAS0421
Sprinter 3500		
2016-2014	6 Cyl. 3.0L	MAS0421
2013-2010		MAS0421
Oxygen Sensor		
300D		
1987	Universal Upstream	SG36

		Part No.
Oxygen Sensor		
300D		
1987	Upstream Sensor	SG78
300SDL		
1987-1986	Universal Upstream	SG36
1987-1986	Upstream Sensor	SG78
300TD		
1987	Universal Upstream	SG36
1987	Upstream Sensor	SG78
E320		
2006	6 Cyl. 3.2L; Upstream Sensor	SG1660
2005	6 Cyl. 3.2L; Diesel; Upstream Sensor	SG1660
Miscellaneous Sensors		
Battery Current / Volt Sensor		
E250		
2016	4 Cyl. 2.1L	BSC104
GL350		
2016		BSC75
2015-2013		BSC55
GLE300d		
2017-2016	4 Cyl.	BSC68
GLS350d		
2017		BSC75
ML250		
2015		BSC75
Brake Pad Wear Sensor		
190D		
1989-1984	Front	PWS182
240D		
1983-1980	Front	PWS173
300CD		
1985-1980	Front	PWS173
300D		
1993-1990	Front	PWS182
1987	Front	PWS173
1985-1980	Front	PWS173
300SD		
1993-1992	Exhaust stock and reorder; Front	PWS172
1993-1992	Exhaust stock and reorder; Rear	PWS172
1993-1992	Alternate Number; Front	PWS173
1993-1992	Alternate Number; Rear	PWS173
1985-1981	Front	PWS173
300SDL		
1987-1986	Front	PWS173
300TD		
1987	Front	PWS182
1985-1980	Front	PWS173
350SD		
1991	Front	PWS173
350SDL		
1991-1990	Front	PWS173
E300		
1998-1996	Front	PWS173
1998-1996	Rear	PWS173
1995	Front	PWS182
E320		
2009-2006	Front	PWS176
2009-2006	Rear	PWS176
GL320		
2009-2007	Front	PWS177
2009-2007	Rear	PWS177

Miscellaneous Sensors

		Part No.
Brake Pad Wear Sensor		
ML320		
2009-2007	Front	PWS177
2009-2007	Rear	PWS177
R320		
2009-2007	Front	PWS177
2009-2007	Rear	PWS177
S350		
1995-1994	Exhaust stock and reorder; Front	PWS172
1995-1994	Exhaust stock and reorder; w/ Traction Control; Rear	PWS172
1995-1994	Alternate Number; Front	PWS173
1995-1994	Alternate Number; w/ Traction Control; Rear	PWS173
Sprinter 2500		
2014-2010	Front	PWS235
Sprinter 3500		
2014-2010	Front	PWS235
Headlight Level Sensor		
E320		
2006		LSH102
Position Sensors		
Accelerator Pedal Sensor		
E250		
2016-2014	4 Cyl. 2.1L	APS614
Sprinter 2500		
2015		APS461
2014	4 Cyl. 2.1L	APS461
2014	6 Cyl. 3.0L	APS461
2013-2010		APS461
Sprinter 3500		
2015		APS461
2014	4 Cyl. 2.1L	APS461
2014	6 Cyl. 3.0L	APS461
2013-2010		APS461
Brake Pedal Travel Sensor		
GL320		
2009-2007	6 Cyl. 3.0L; Alternate Number	BST107
2009-2007	6 Cyl. 3.0L; Exhaust stock and reorder	BST113
GL350		
2010	6 Cyl. 3.0L; Alternate Number	BST107
2010	6 Cyl. 3.0L; Exhaust stock and reorder	BST113
ML320		
2009-2007	6 Cyl. 3.0L; Alternate Number	BST107
2009-2007	6 Cyl. 3.0L; Exhaust stock and reorder	BST113
R320		
2009-2007	6 Cyl. 3.0L; Alternate Number	BST107
2009-2007	6 Cyl. 3.0L; Exhaust stock and reorder	BST113
R350		
2010	6 Cyl. 3.0L; Alternate Number	BST107
2010	6 Cyl. 3.0L; Exhaust stock and reorder	BST113
Camshaft Sensor		
190D		
1989-1984		PC828
E250		
2016-2014	4 Cyl. 2.1L	PC1064
E320		
2009-2007		PC810
E350		
2013	6 Cyl. 3.0L	PC810
2011	6 Cyl. 3.0L; Alternate Number	PC641
2011	6 Cyl. 3.0L; Exhaust stock and reorder	PC921

		Part No.
Camshaft Sensor		
GL320		
2009		PC810
2008-2007		PC779
GL350		
2016-2010		PC810
GLE300d		
2016	4 Cyl. 2.1L	PC1064
GLK250		
2015-2013	4 Cyl. 2.1L	PC1064
ML250		
2015	4 Cyl. 2.1L	PC1064
ML320		
2009		PC810
2008		PC779
2007		PC625
ML350		
2014-2010	6 Cyl. 3.0L	PC810
R320		
2009		PC810
2008-2007		PC779
R350		
2012-2010	6 Cyl. 3.0L	PC810
S350		
2013-2012	6 Cyl. 3.0L	PC810
Sprinter 2500		
2019-2014	6 Cyl. 3.0L	PC810
2017-2014	4 Cyl. 2.1L	PC1064
2013-2010		PC810
Sprinter 3500		
2018-2014	6 Cyl. 3.0L	PC810
2017-2014	4 Cyl. 2.1L	PC1064
2013-2010		PC810
Crankshaft Sensor		
190D		
1989-1986		PC873
300CD		
1985	5 Cyl. 3.0L	PC358
300D		
1993-1990	5 Cyl. 2.5L; Engine Speed Sensor	PC873
1993-1990	5 Cyl. 2.5L; Crank (TDC)	PC900
1985	5 Cyl. 3.0L	PC358
300SD		
1985	5 Cyl. 3.0L	PC358
300TD		
1985	5 Cyl. 3.0L	PC358
E250		
2016-2014	4 Cyl. 2.1L	PC1003
E300		
1999	w/ Two Locking Tabs on Connector	PC456
1999	w/ One Locking Tab on Connector	PC497
E320		
2009-2007		PC738
2006	6 Cyl. 3.2L	PC497
E350		
2013	6 Cyl. 3.0L	PC1003
2011	6 Cyl. 3.0L; From 6/1/11	PC1003
2011	6 Cyl. 3.0L; To 6/1/11	PC738
GL320		
2009-2007		PC738
GL350		
2016-2013		PC1003
2012-2011	6 Cyl. 3.0L	PC1003

Position Sensors

		Part No.
Crankshaft Sensor		
GL350		
2010	6 Cyl. 3.0L	PC738
GLE300d		
2016	4 Cyl. 2.1L	PC1003
GLK250		
2015-2013		PC1003
ML250		
2015	4 Cyl. 2.1L	PC1003
ML320		
2009-2007		PC738
ML350		
2014-2013	6 Cyl. 3.0L; Diesel	PC1003
2012-2011	6 Cyl. 3.0L	PC1003
2010	6 Cyl. 3.0L	PC738
R320		
2009-2007	6 Cyl. 3.0L	PC497
R350		
2012	Bluetec 4Matic	PC1003
2011	6 Cyl. 3.0L	PC1003
2010	6 Cyl. 3.0L	PC738
S350		
2013-2012	6 Cyl. 3.0L	PC1003
Sprinter 2500		
2019-2015	6 Cyl. 3.0L	PC1003
2017-2014	4 Cyl. 2.1L	PC1003
2014	6 Cyl. 3.0L	PC738
2013		PC738
2012-2010	Base	PC738
Sprinter 3500		
2018-2015	6 Cyl. 3.0L	PC1003
2017-2014	4 Cyl. 2.1L	PC1003
2014	6 Cyl. 3.0L	PC738
2013		PC738
2012-2010	Base	PC738
Power Brake Booster Sensor		
GL320		
2009-2007	Alternate Number	BST107
2009-2007	Exhaust stock and reorder	BST113
ML320		
2009-2007	Alternate Number	BST107
2009-2007	Exhaust stock and reorder	BST113
R320		
2009-2007	Alternate Number	BST107
2009-2007	Exhaust stock and reorder	BST113
Pressure Sensors		
Diesel Particulate Filter (DPF) Pressure Sensor		
GL350		
2016-2013	6 Cyl. 3.0L	DPS112
ML250		
2015	4 Cyl. 2.1L	DPS112
ML350		
2014-2012	6 Cyl. 3.0L	DPS112
Sprinter 2500		
2018-2014	6 Cyl. 3.0L	DPS113
2017-2014	4 Cyl. 2.1L	DPS112
Sprinter 3500		
2018-2014	6 Cyl. 3.0L	DPS113
2017-2014	4 Cyl. 2.1L	DPS112
Fuel Pressure Sensor		
E320		
2009-2007	6 Cyl. 3.0L	FPS30

		Part No.
Fuel Pressure Sensor		
E320		
2006-2005	6 Cyl. 3.2L	FPS30
GL320		
2009-2007		FPS30
GL350		
2011-2010		FPS30
ML320		
2009-2007		FPS30
ML350		
2011-2010	6 Cyl. 3.0L	FPS30
R320		
2009-2007	6 Cyl. 3.0L	FPS30
R350		
2011-2010	6 Cyl. 3.0L	FPS30
Sprinter 2500		
2010	6 Cyl. 3.0L	FPS30
Sprinter 3500		
2010	6 Cyl. 3.0L	FPS30
MAP Sensor		
E250		
2015-2014	4 Cyl. 2.1L	AS653
E320		
2009-2007	6 Cyl. 3.0L	AS356
E350		
2013	6 Cyl. 3.0L; Turbocharged; In Air Cleaner	AS359
2012	Bluetec; Location-Air Cleaner Housing	AS359
GL320		
2009-2007	6 Cyl. 3.0L	AS356
GL350		
2016-2010	In Air Cleaner	AS359
2014-2010	Intake Side	AS356
GLE300d		
2016	4 Cyl. 2.1L	AS653
GLK250		
2015-2013	4 Cyl. 2.1L	AS653
ML250		
2015	4 Cyl. 2.1L	AS653
ML320		
2009	6 Cyl. 3.0L	AS359
2008-2007	6 Cyl. 3.0L	AS356
ML350		
2014-2013	6 Cyl. 3.0L; Turbocharged; Intake Side	AS356
2014-2013	6 Cyl. 3.0L; Turbocharged; In Air Cleaner	AS359
R320		
2009-2007	6 Cyl. 3.0L	AS356
S350		
2013-2012	6 Cyl. 3.0L; Turbocharged; Intake Side	AS356
2013-2012	6 Cyl. 3.0L; Turbocharged; In Air Cleaner	AS359
Sprinter 2500		
2017	6 Cyl. 3.0L; On Air Box	AS359
2017	4 Cyl. 2.1L; Location-Air Cleaner Housing	AS653
2016	4 Cyl. 2.1L	AS653
2015	6 Cyl. 3.0L; On Air Box	AS359
2015	4 Cyl. 2.1L; Location-Air Cleaner Housing	AS653
2014	4 Cyl. 2.1L	AS653
2014-2013	6 Cyl. 3.0L; Intake Side	AS356
2014-2013	6 Cyl. 3.0L; In Air Cleaner	AS359
2012-2010	6 Cyl. 3.0L	AS356
Sprinter 3500		
2017	4 Cyl. 2.1L; Location-Air Cleaner Housing	AS653
2017	6 Cyl. 3.0L; On Air Box	AS359
2016	4 Cyl. 2.1L	AS653

Pressure Sensors

		Part No.
MAP Sensor		
Sprinter 3500		
2015	4 Cyl. 2.1L; On Air Box	AS359
2015	4 Cyl. 2.1L; Location-Air Cleaner Housing	AS653
2014	4 Cyl. 2.1L	AS653
2014-2013	6 Cyl. 3.0L; Intake Side	AS356
2014-2013	6 Cyl. 3.0L; In Air Cleaner	AS359
2012-2010	6 Cyl. 3.0L	AS356
Tire Pressure Monitoring System OE Design Sensor		
E320		
2009-2006	433 Mhz Sensor; Black Finish; OE Style/ID Clone-able; w/ Aluminum Valve	TPM66 TPM66A
2009-2006	315 Mhz Sensor; OE Style/ID Clone-able; w/ Aluminum Valve	TPM67 TPM67A
GL320		
2009-2007	433 Mhz Sensor; OE Style/ID Clone-able; w/ Aluminum Valve	TPM66 TPM66A
GL350		
2016-2015	433 Mhz Sensor; OE Style; w/ Aluminum Valve	TPM209
2014	433 Mhz Sensor; OE Style/ID Clone-able; To 3/31/14; w/ Aluminum Valve	TPM155 TPM155A
2014	433 Mhz Sensor; From 4/14; OE Style; w/ Aluminum Valve	TPM209
2013-2010	433 Mhz Sensor; OE Style/ID Clone-able; w/ Aluminum Valve	TPM155 TPM155A
GLE300d		
2016	433 Mhz Sensor; OE Style; w/ Aluminum Valve	TPM209
GLK250		
2015-2014	433 Mhz Sensor; OE Style; w/ Aluminum Valve	TPM209
2014	433 Mhz Sensor; OE Style/ID Clone-able; w/ Aluminum Valve	TPM155 TPM155A
2013	433 Mhz Sensor; OE Style/ID Clone-able; To 12/22/13; w/ Aluminum Valve	TPM155 TPM155A
2013	433 Mhz Sensor; From 12/23/13; OE Style; w/ Aluminum Valve	TPM209
GLS350d		
2017	433 Mhz Sensor; w/ Aluminum Valve	TPM209
ML250		
2015	433 Mhz Sensor; OE Style; w/ Aluminum Valve	TPM209
ML320		
2009-2007	433 Mhz Sensor; OE Style/ID Clone-able; w/ Aluminum Valve	TPM66 TPM66A
2009-2007	315 Mhz Sensor; w/ Aluminum Valve	TPM67 TPM67A
R320		
2009-2007	433 Mhz Sensor; OE Style/ID Clone-able; w/ Aluminum Valve	TPM66 TPM66A
2009-2007	315 Mhz Sensor; Black Finish; OE Style/ID Clone-able; w/ Aluminum Valve	TPM67 TPM67A
Sprinter 2500		
2018-2013	433 Mhz Sensor; OE Style/ID Clone-able; w/ Aluminum Valve	TPM155 TPM155A
2014-2010	315 Mhz Sensor; OE Style/ID Clone-able; w/ Aluminum Valve	TPM104 TPM104A
Sprinter 3500		
2019	433 Mhz Sensor; OE Style/ID Clone-able; w/ Aluminum Valve	TPM209
2018-2013	433 Mhz Sensor; OE Style/ID Clone-able; w/ Aluminum Valve	TPM155 TPM155A
2014-2010	315 Mhz Sensor; OE Style/ID Clone-able; w/ Aluminum Valve	TPM104 TPM104A

		Part No.
Tire Pressure Monitoring System OE Design Sensor Service Kit		
E320		
2009-2006	25 Per Box; OE Style; w/o Valve	TPM1040K
2009-2006	4 Per Box; OE Style; w/o Valve	TPM1040K4
GL320		
2009-2007	25 Per Box; OE Style; w/o Valve	TPM1040K
2009-2007	4 Per Box; OE Style; w/o Valve	TPM1040K4
GL350		
2016-2015	25 Per Box; OE Style; w/o Valve	TPM2030K
2016-2015	4 Per Box; OE Style; w/o Valve	TPM2030K4
2014	25 Per Box; From 4/14; OE Style; w/o Valve	TPM2030K
2014	4 Per Box; From 4/14; OE Style; w/o Valve	TPM2030K4
2014	25 Per Box; 433 Mhz Sensor; OE Style/ID Clone-able; To 3/31/14; w/ Aluminum Valve	TPM3000K
2014	4 Per Box; 433 Mhz Sensor; OE Style/ID Clone-able; To 3/31/14; w/ Aluminum Valve	TPM3000K4
2014-2010	w/ Aluminum Valve	TPM2014VK
2013-2010	25 Per Box; 433 Mhz Sensor; OE Style/ID Clone-able; w/ Aluminum Valve	TPM3000K
2013-2010	4 Per Box; 433 Mhz Sensor; OE Style/ID Clone-able; w/ Aluminum Valve	TPM3000K4
GLE300d		
2016	25 Per Box; OE Style; w/o Valve	TPM2030K
2016	4 Per Box; OE Style; w/o Valve	TPM2030K4
GLK250		
2015-2014	25 Per Box; OE Style; w/o Valve	TPM2030K
2015-2014	4 Per Box; OE Style; w/o Valve	TPM2030K4
2013	w/ Aluminum Valve	TPM2014VK
2013	25 Per Box; From 12/23/13; OE Style; w/o Valve	TPM2030K
2013	4 Per Box; From 12/23/13; OE Style; w/o Valve	TPM2030K4
2013	25 Per Box; 433 Mhz Sensor; OE Style/ID Clone-able; To 12/22/13; w/ Aluminum Valve	TPM3000K
2013	4 Per Box; 433 Mhz Sensor; OE Style/ID Clone-able; To 12/22/13; w/ Aluminum Valve	TPM3000K4
GLS350d		
2017	25 Per Box; OE Style; w/o Valve	TPM2030K
2017	4 Per Box; OE Style; w/o Valve	TPM2030K4
ML250		
2015	25 Per Box; OE Style; w/o Valve	TPM2030K
2015	4 Per Box; OE Style; w/o Valve	TPM2030K4
ML320		
2009-2007	25 Per Box; OE Style; w/o Valve	TPM1040K
2009-2007	4 Per Box; OE Style; w/o Valve	TPM1040K4
R320		
2009-2007	25 Per Box; OE Style; w/o Valve	TPM1040K
2009-2007	4 Per Box; OE Style; w/o Valve	TPM1040K4
Sprinter 2500		
2016-2014	w/ Aluminum Valve	TPM2014VK
2016-2014	25 Per Box; 433 Mhz Sensor; OE Style/ID Clone-able; w/ Aluminum Valve	TPM3000K
2016-2014	4 Per Box; 433 Mhz Sensor; OE Style/ID Clone-able; w/ Aluminum Valve	TPM3000K4
2013-2010	25 Per Box; OE Style; w/o Valve	TPM2000K
2013-2010	4 Per Box; OE Style; w/o Valve	TPM2000K4
Sprinter 3500		
2016-2014	w/ Aluminum Valve	TPM2014VK
2016-2014	25 Per Box; 433 Mhz Sensor; OE Style/ID Clone-able; w/ Aluminum Valve	TPM3000K

Pressure Sensors

		Part No.
Tire Pressure Monitoring System OE Design Sensor Service Kit		
Sprinter 3500		
2016-2014	4 Per Box; 433 Mhz Sensor; OE Style/ID Clone-able; w/ Aluminum Valve	TPM3000K4
2012-2010	25 Per Box; OE Style; w/o Valve	TPM2000K
2012-2010	4 Per Box; OE Style; w/o Valve	TPM2000K4
Tire Pressure Monitoring System OE Design Valve		
GL350		
2014	433 Mhz Sensor; OE Style; To 3/31/14; w/ Aluminum Valve	TPM2014VK
2014	433 Mhz Sensor; From 4/14; OE Style	TPM2100VK
2014	25 Per Box; 433 Mhz Sensor; OE Style/ID Clone-able; To 3/31/14; w/ Aluminum Valve	TPM2107VK
2014	4 Per Box; 433 Mhz Sensor; OE Style/ID Clone-able; To 3/31/14; w/ Aluminum Valve	TPM2107VK4
2013-2010	433 Mhz Sensor; OE Style; w/ Aluminum Valve	TPM2014VK
2013-2010	25 Per Box; 433 Mhz Sensor; OE Style/ID Clone-able; w/ Aluminum Valve	TPM2107VK
2013-2010	4 Per Box; 433 Mhz Sensor; OE Style/ID Clone-able; w/ Aluminum Valve	TPM2107VK4
GLK250		
2013	433 Mhz Sensor; OE Style; To 12/22/13; w/ Aluminum Valve	TPM2014VK
2013	433 Mhz Sensor; From 12/23/13; OE Style	TPM2100VK
2013	25 Per Box; 433 Mhz Sensor; OE Style/ID Clone-able; To 12/22/13; w/ Aluminum Valve	TPM2107VK
2013	4 Per Box; 433 Mhz Sensor; OE Style/ID Clone-able; To 12/22/13; w/ Aluminum Valve	TPM2107VK4
Sprinter 2500		
2018-2010	25 Per Box; 315 Mhz Sensor; OE Style; w/ Metal Valve	TPM2104VK
2018-2010	4 Per Box; 315 Mhz Sensor; OE Style; w/ Metal Valve	TPM2104VK4
2016-2014	433 Mhz Sensor; OE Style; w/ Aluminum Valve	TPM2014VK
2016-2014	25 Per Box; 433 Mhz Sensor; OE Style/ID Clone-able; w/ Aluminum Valve	TPM2107VK
2016-2014	4 Per Box; 433 Mhz Sensor; OE Style/ID Clone-able; w/ Aluminum Valve	TPM2107VK4
2013-2010	315 Mhz Sensor; OE Style; w/ Aluminum Valve	TPM2018VK
Sprinter 3500		
2019-2010	25 Per Box; 315 Mhz Sensor; OE Style; w/ Metal Valve	TPM2104VK
2019-2010	4 Per Box; 315 Mhz Sensor; OE Style; w/ Metal Valve	TPM2104VK4
2016-2014	433 Mhz Sensor; OE Style; w/ Aluminum Valve	TPM2014VK
2016-2014	25 Per Box; 433 Mhz Sensor; OE Style/ID Clone-able; w/ Aluminum Valve	TPM2107VK
2016-2014	4 Per Box; 433 Mhz Sensor; OE Style/ID Clone-able; w/ Aluminum Valve	TPM2107VK4
2012-2010	315 Mhz Sensor; OE Style; w/ Aluminum Valve	TPM2018VK
Tire Pressure Monitoring System QWIK-Sensor		
E320		
2009-2006	315 Mhz Sensor; Black; w/ Aluminum Valve	QS105M
GL320		
2009-2007	433 Mhz Sensor; Exhaust stock and reorder; Red; w/ Aluminum Valve	QS102M
2009-2007	433 Mhz Sensor; Exhaust stock and reorder; Red; w/ Rubber Valve	QS102R

		Part No.
Tire Pressure Monitoring System QWIK-Sensor		
GL320		
2009-2007	433 Mhz Sensor; Alternate Number; Black; w/ Aluminum Valve	QS104M
2009-2007	433 Mhz Sensor; Alternate Number; Black; w/ Rubber Valve	QS104R
GL350		
2016-2010	433 Mhz Sensor; Alternate Number; Black; w/ Aluminum Valve	QS104M
2016-2010	433 Mhz Sensor; Alternate Number; Black; w/ Rubber Valve	QS104R
GLE300d		
2016	433 Mhz Sensor; Alternate Number; Black; w/ Aluminum Valve	QS104M
2016	433 Mhz Sensor; Alternate Number; Black; w/ Rubber Valve	QS104R
GLK250		
2015-2013	433 Mhz Sensor; Alternate Number; Black; w/ Aluminum Valve	QS104M
2015-2013	433 Mhz Sensor; Alternate Number; Black; w/ Rubber Valve	QS104R
GLS350d		
2017	433 Mhz Sensor; Alternate Number; Black; w/ Aluminum Valve	QS104M
2017	433 Mhz Sensor; Alternate Number; Black; w/ Rubber Valve	QS104R
ML250		
2015	433 Mhz Sensor; Alternate Number; Black; w/ Aluminum Valve	QS104M
2015	433 Mhz Sensor; Alternate Number; Black; w/ Rubber Valve	QS104R
ML320		
2009-2007	433 Mhz Sensor; Exhaust stock and reorder; Red; w/ Aluminum Valve	QS102M
2009-2007	433 Mhz Sensor; Exhaust stock and reorder; Red; w/ Rubber Valve	QS102R
2009-2007	433 Mhz Sensor; Alternate Number; Black; w/ Aluminum Valve	QS104M
2009-2007	433 Mhz Sensor; Alternate Number; Black; w/ Rubber Valve	QS104R
R320		
2009-2007	433 Mhz Sensor; Exhaust stock and reorder; Red; w/ Aluminum Valve	QS102M
2009-2007	433 Mhz Sensor; Exhaust stock and reorder; Red; w/ Rubber Valve	QS102R
2009-2007	433 Mhz Sensor; Alternate Number; Black; w/ Aluminum Valve	QS104M
2009-2007	433 Mhz Sensor; Alternate Number; Black; w/ Rubber Valve	QS104R
Sprinter 2500		
2018-2014	433 Mhz Sensor; Alternate Number; Black; w/ Aluminum Valve	QS104M
2016-2014	433 Mhz Sensor; Alternate Number; Black; w/ Rubber Valve	QS104R
2013-2010	315 Mhz Sensor; Blue; Exhaust stock and reorder; w/ Aluminum Valve	QS101M
2013-2010	315 Mhz Sensor; Blue; Exhaust stock and reorder; w/ Rubber Valve	QS101R
2013-2010	315 Mhz Sensor; Alternate Number; Black; w/ Aluminum Valve	QS105M
2013-2010	315 Mhz Sensor; Alternate Number; Black; w/ Rubber Valve	QS105R
Sprinter 3500		
2019	433 Mhz Sensor; OE Style/ID Clone-able; w/ Aluminum Valve	QS104M
2019	433 Mhz Sensor; OE Style/ID Clone-able; w/ Rubber Valve	QS104R
2018-2014	433 Mhz Sensor; Alternate Number; Black; w/ Aluminum Valve	QS104M

Pressure Sensors

		Part No.
Tire Pressure Monitoring System QWIK-Sensor		
Sprinter 3500		
2016-2014	433 Mhz Sensor; Alternate Number; Black; w/ Rubber Valve	QS104R
2013	433 Mhz Sensor; OE Style/ID Clone-able; w/ Aluminum Valve	QS104M
2013	433 Mhz Sensor; OE Style/ID Clone-able; w/ Rubber Valve	QS104R
2013	315 Mhz Sensor; OE Style/ID Clone-able; w/ Aluminum Valve	QS105M
2013	315 Mhz Sensor; OE Style/ID Clone-able; w/ Rubber Valve	QS105R
2012-2010	315 Mhz Sensor; Blue; Exhaust stock and reorder; w/ Aluminum Valve	QS101M
2012-2010	315 Mhz Sensor; Blue; Exhaust stock and reorder; w/ Rubber Valve	QS101R
2012-2010	315 Mhz Sensor; Alternate Number; Black; w/ Aluminum Valve	QS105M
2012-2010	315 Mhz Sensor; Alternate Number; Black; w/ Rubber Valve	QS105R
Tire Pressure Monitoring System QWIK-Sensor Service Kit		
GL320		
2009-2007	1 Per Box; 433 Mhz Sensor; w/ Aluminum Valve	TPM4012SK
2009-2007	25 Per Box; 433 Mhz Sensor; w/ Aluminum Valve	TPM4012SK25PK
2009-2007	4 Per Box; 433 Mhz Sensor; w/ Aluminum Valve	TPM4012SK4PK
GL350		
2016-2010	1 Per Box; 433 Mhz Sensor; w/ Aluminum Valve	TPM4012SK
2016-2010	25 Per Box; 433 Mhz Sensor; w/ Aluminum Valve	TPM4012SK25PK
2016-2010	4 Per Box; 433 Mhz Sensor; w/ Aluminum Valve	TPM4012SK4PK
GLE300d		
2016	1 Per Box; 433 Mhz Sensor; w/ Aluminum Valve	TPM4012SK
2016	25 Per Box; 433 Mhz Sensor; w/ Aluminum Valve	TPM4012SK25PK
2016	4 Per Box; 433 Mhz Sensor; w/ Aluminum Valve	TPM4012SK4PK
GLK250		
2015-2013	1 Per Box; 433 Mhz Sensor; w/ Aluminum Valve	TPM4012SK
2015-2013	25 Per Box; 433 Mhz Sensor; w/ Aluminum Valve	TPM4012SK25PK
2015-2013	4 Per Box; 433 Mhz Sensor; w/ Aluminum Valve	TPM4012SK4PK
GLS350d		
2017	1 Per Box; 433 Mhz Sensor; w/ Aluminum Valve	TPM4012SK
2017	25 Per Box; 433 Mhz Sensor; w/ Aluminum Valve	TPM4012SK25PK
2017	4 Per Box; 433 Mhz Sensor; w/ Aluminum Valve	TPM4012SK4PK
ML250		
2015	1 Per Box; 433 Mhz Sensor; w/ Aluminum Valve	TPM4012SK
2015	25 Per Box; 433 Mhz Sensor; w/ Aluminum Valve	TPM4012SK25PK
2015	4 Per Box; 433 Mhz Sensor; w/ Aluminum Valve	TPM4012SK4PK
ML320		
2009-2007	1 Per Box; 433 Mhz Sensor; w/ Aluminum Valve	TPM4012SK
2009-2007	25 Per Box; 433 Mhz Sensor; w/ Aluminum Valve	TPM4012SK25PK

		Part No.
Tire Pressure Monitoring System QWIK-Sensor Service Kit		
ML320		
2009-2007	4 Per Box; 433 Mhz Sensor; w/ Aluminum Valve	TPM4012SK4PK
R320		
2009-2007	1 Per Box; 433 Mhz Sensor; w/ Aluminum Valve	TPM4012SK
2009-2007	25 Per Box; 433 Mhz Sensor; w/ Aluminum Valve	TPM4012SK25PK
2009-2007	4 Per Box; 433 Mhz Sensor; w/ Aluminum Valve	TPM4012SK4PK
Sprinter 2500		
2016-2014	1 Per Box; 433 Mhz Sensor; w/ Aluminum Valve	TPM4012SK
2016-2014	25 Per Box; 433 Mhz Sensor; w/ Aluminum Valve	TPM4012SK25PK
2016-2014	4 Per Box; 433 Mhz Sensor; w/ Aluminum Valve	TPM4012SK4PK
2013-2010	1 Per Box; 315 Mhz Sensor; w/ Aluminum Valve	TPM4012SK
2013-2010	25 Per Box; 315 Mhz Sensor; w/ Aluminum Valve	TPM4012SK25PK
2013-2010	4 Per Box; 315 Mhz Sensor; w/ Aluminum Valve	TPM4012SK4PK
Sprinter 3500		
2016-2014	1 Per Box; 433 Mhz Sensor; w/ Aluminum Valve	TPM4012SK
2016-2014	25 Per Box; 433 Mhz Sensor; w/ Aluminum Valve	TPM4012SK25PK
2016-2014	4 Per Box; 433 Mhz Sensor; w/ Aluminum Valve	TPM4012SK4PK
2012-2010	1 Per Box; 315 Mhz Sensor; w/ Aluminum Valve	TPM4012SK
2012-2010	25 Per Box; 315 Mhz Sensor; w/ Aluminum Valve	TPM4012SK25PK
2012-2010	4 Per Box; 315 Mhz Sensor; w/ Aluminum Valve	TPM4012SK4PK
Tire Pressure Monitoring System QWIK-Sensor Valve		
GL320		
2009-2007	1 Per Box; 433 Mhz Sensor; w/ Rubber Valve	TPM2011VK
2009-2007	25 Per Box; 433 Mhz Sensor; w/ Rubber Valve	TPM2011VK25PK
2009-2007	4 Per Box; 433 Mhz Sensor; w/ Rubber Valve	TPM2011VK4PK
2009-2007	1 Per Box; 433 Mhz Sensor; w/ Aluminum Valve	TPM2012VK
2009-2007	25 Per Box; 433 Mhz Sensor; w/ Aluminum Valve	TPM2012VK25PK
2009-2007	4 Per Box; 433 Mhz Sensor; w/ Aluminum Valve	TPM2012VK4PK
GL350		
2016-2010	1 Per Box; 433 Mhz Sensor; w/ Rubber Valve	TPM2011VK
2016-2010	25 Per Box; 433 Mhz Sensor; w/ Rubber Valve	TPM2011VK25PK
2016-2010	4 Per Box; 433 Mhz Sensor; w/ Rubber Valve	TPM2011VK4PK
2016-2010	1 Per Box; 433 Mhz Sensor; w/ Aluminum Valve	TPM2012VK
2016-2010	25 Per Box; 433 Mhz Sensor; w/ Aluminum Valve	TPM2012VK25PK
2016-2010	4 Per Box; 433 Mhz Sensor; w/ Aluminum Valve	TPM2012VK4PK
GLE300d		
2016	1 Per Box; 433 Mhz Sensor; w/ Rubber Valve	TPM2011VK
2016	25 Per Box; 433 Mhz Sensor; w/ Rubber Valve	TPM2011VK25PK

Mercedes-Benz

Pressure Sensors

		Part No.
Tire Pressure Monitoring System QWIK-Sensor Valve		
GLE300d		
2016	4 Per Box; 433 Mhz Sensor; w/ Rubber Valve	TPM2011VK4PK
2016	1 Per Box; 433 Mhz Sensor; w/ Aluminum Valve	TPM2012VK
2016	25 Per Box; 433 Mhz Sensor; w/ Aluminum Valve	TPM2012VK25PK
2016	4 Per Box; 433 Mhz Sensor; w/ Aluminum Valve	TPM2012VK4PK
GLK250		
2015-2013	1 Per Box; 433 Mhz Sensor; w/ Rubber Valve	TPM2011VK
2015-2013	25 Per Box; 433 Mhz Sensor; w/ Rubber Valve	TPM2011VK25PK
2015-2013	4 Per Box; 433 Mhz Sensor; w/ Rubber Valve	TPM2011VK4PK
2015-2013	1 Per Box; 433 Mhz Sensor; w/ Aluminum Valve	TPM2012VK
2015-2013	25 Per Box; 433 Mhz Sensor; w/ Aluminum Valve	TPM2012VK25PK
2015-2013	4 Per Box; 433 Mhz Sensor; w/ Aluminum Valve	TPM2012VK4PK
GLS350d		
2017	1 Per Box; 433 Mhz Sensor; w/ Rubber Valve	TPM2011VK
2017	25 Per Box; 433 Mhz Sensor; w/ Rubber Valve	TPM2011VK25PK
2017	4 Per Box; 433 Mhz Sensor; w/ Rubber Valve	TPM2011VK4PK
2017	1 Per Box; 433 Mhz Sensor; w/ Aluminum Valve	TPM2012VK
2017	25 Per Box; 433 Mhz Sensor; w/ Aluminum Valve	TPM2012VK25PK
2017	4 Per Box; 433 Mhz Sensor; w/ Aluminum Valve	TPM2012VK4PK
ML250		
2015	1 Per Box; 433 Mhz Sensor; w/ Rubber Valve	TPM2011VK
2015	25 Per Box; 433 Mhz Sensor; w/ Rubber Valve	TPM2011VK25PK
2015	4 Per Box; 433 Mhz Sensor; w/ Rubber Valve	TPM2011VK4PK
2015	1 Per Box; 433 Mhz Sensor; w/ Aluminum Valve	TPM2012VK
2015	25 Per Box; 433 Mhz Sensor; w/ Aluminum Valve	TPM2012VK25PK
2015	4 Per Box; 433 Mhz Sensor; w/ Aluminum Valve	TPM2012VK4PK
ML320		
2009-2007	1 Per Box; 433 Mhz Sensor; w/ Rubber Valve	TPM2011VK
2009-2007	25 Per Box; 433 Mhz Sensor; w/ Rubber Valve	TPM2011VK25PK
2009-2007	4 Per Box; 433 Mhz Sensor; w/ Rubber Valve	TPM2011VK4PK
2009-2007	1 Per Box; 433 Mhz Sensor; w/ Aluminum Valve	TPM2012VK
2009-2007	25 Per Box; 433 Mhz Sensor; w/ Aluminum Valve	TPM2012VK25PK
2009-2007	4 Per Box; 433 Mhz Sensor; w/ Aluminum Valve	TPM2012VK4PK
R320		
2009-2007	1 Per Box; 433 Mhz Sensor; w/ Rubber Valve	TPM2011VK
2009-2007	25 Per Box; 433 Mhz Sensor; w/ Rubber Valve	TPM2011VK25PK
2009-2007	4 Per Box; 433 Mhz Sensor; w/ Rubber Valve	TPM2011VK4PK

		Part No.
Tire Pressure Monitoring System QWIK-Sensor Valve		
R320		
2009-2007	1 Per Box; 433 Mhz Sensor; w/ Aluminum Valve	TPM2012VK
2009-2007	25 Per Box; 433 Mhz Sensor; w/ Aluminum Valve	TPM2012VK25PK
2009-2007	4 Per Box; 433 Mhz Sensor; w/ Aluminum Valve	TPM2012VK4PK
Sprinter 2500		
2016-2014	1 Per Box; 433 Mhz Sensor; w/ Rubber Valve	TPM2011VK
2016-2014	25 Per Box; 433 Mhz Sensor; w/ Rubber Valve	TPM2011VK25PK
2016-2014	4 Per Box; 433 Mhz Sensor; w/ Rubber Valve	TPM2011VK4PK
2016-2014	1 Per Box; 433 Mhz Sensor; w/ Aluminum Valve	TPM2012VK
2016-2014	25 Per Box; 433 Mhz Sensor; w/ Aluminum Valve	TPM2012VK25PK
2016-2014	4 Per Box; 433 Mhz Sensor; w/ Aluminum Valve	TPM2012VK4PK
2013-2010	1 Per Box; 315 Mhz Sensor; w/ Rubber Valve	TPM2011VK
2013-2010	25 Per Box; 315 Mhz Sensor; w/ Rubber Valve	TPM2011VK25PK
2013-2010	4 Per Box; 315 Mhz Sensor; w/ Rubber Valve	TPM2011VK4PK
2013-2010	1 Per Box; 315 Mhz Sensor; w/ Aluminum Valve	TPM2012VK
2013-2010	25 Per Box; 315 Mhz Sensor; w/ Aluminum Valve	TPM2012VK25PK
2013-2010	4 Per Box; 315 Mhz Sensor; w/ Aluminum Valve	TPM2012VK4PK
Sprinter 3500		
2016-2014	1 Per Box; 433 Mhz Sensor; w/ Rubber Valve	TPM2011VK
2016-2014	25 Per Box; 433 Mhz Sensor; w/ Rubber Valve	TPM2011VK25PK
2016-2014	4 Per Box; 433 Mhz Sensor; w/ Rubber Valve	TPM2011VK4PK
2016-2014	1 Per Box; 433 Mhz Sensor; w/ Aluminum Valve	TPM2012VK
2016-2014	25 Per Box; 433 Mhz Sensor; w/ Aluminum Valve	TPM2012VK25PK
2016-2014	4 Per Box; 433 Mhz Sensor; w/ Aluminum Valve	TPM2012VK4PK
2012-2010	1 Per Box; 315 Mhz Sensor; w/ Rubber Valve	TPM2011VK
2012-2010	25 Per Box; 315 Mhz Sensor; w/ Rubber Valve	TPM2011VK25PK
2012-2010	4 Per Box; 315 Mhz Sensor; w/ Rubber Valve	TPM2011VK4PK
2012-2010	1 Per Box; 315 Mhz Sensor; w/ Aluminum Valve	TPM2012VK
2012-2010	25 Per Box; 315 Mhz Sensor; w/ Aluminum Valve	TPM2012VK25PK
2012-2010	4 Per Box; 315 Mhz Sensor; w/ Aluminum Valve	TPM2012VK4PK
Turbocharger Boost Sensor		
E320		
2009-2007	6 Cyl. 3.0L; Turbocharged; Location-Intake Manifold	AS356
2006-2005	6 Cyl. 3.2L; Turbocharged	AS452
E350		
2013-2011	6 Cyl. 3.0L; Turbocharged; Location-Intake Manifold	AS356
GL320		
2009-2007	6 Cyl. 3.0L; Turbocharged; Location-Intake Manifold	AS356

Pressure Sensors

		Part No.
Turbocharger Boost Sensor		
GL350		
2013-2010	6 Cyl. 3.0L; Turbocharged; Location-Intake Manifold	AS356
2013-2010	6 Cyl. 3.0L; Turbocharged; Location-Air Cleaner Housing	AS359
ML320		
2009-2007	6 Cyl. 3.0L; Turbocharged	VP29
ML350		
2012-2010	6 Cyl. 3.0L; Turbocharged; Location-Intake Manifold	AS356
2012-2010	6 Cyl. 3.0L; Turbocharged; Location-Air Cleaner Housing	AS359
R320		
2009-2007	6 Cyl. 3.0L; Turbocharged; Location-Intake Manifold	AS356
R350		
2012-2010	6 Cyl. 3.0L; Turbocharged; Location-Intake Manifold	AS356
2012-2010	6 Cyl. 3.0L; Turbocharged; Location-Air Cleaner Housing	AS359
S350		
2012	6 Cyl. 3.0L; Turbocharged; Location-Intake Manifold	AS356
2012	6 Cyl. 3.0L; Turbocharged; Location-Air Cleaner Housing	AS359
Sprinter 2500		
2015-2010	6 Cyl. 3.0L; Turbocharged	AS356
Sprinter 3500		
2015-2010	6 Cyl. 3.0L; Turbocharged	AS356
Temperature Sensors		
Ambient Air Temperature Sensor		
190D		
1989-1984	w/ Harness	AX184
300D		
1993-1990	w/ Harness	AX184
1987	w/ Harness	AX184
300SD		
1993-1992	w/ Harness	AX184
1985-1984	w/ Harness	AX184
300SDL		
1987-1986	w/ Harness	AX184
300TD		
1987	w/ Harness	AX184
E300		
1996-1995		AX184
GL350		
2016-2010		AX181
R320		
2009-2007		AX402
S350		
1995-1994		AX184
Sprinter 2500		
2018-2012		AX181
2011-2010	To 7/30/10	AX181
Sprinter 3500		
2019-2012		AX181
2011-2010	To 7/30/10	AX181
Cabin Air Temperature Sensor		
E300		
1999-1996		AX390
1995		AX397
E320		
2009-2006		AX403

		Part No.
Cabin Air Temperature Sensor		
S350		
1995-1994		AX390
Coolant Temperature Sensor		
190D		
1989-1988		TX121
300D		
1993-1990		TX121
300SD		
1993	Located On Thermostat Housing	TS-555
1992		TX121
350SD		
1991	Located On Thermostat Housing	TS-555
350SDL		
1991-1990	Located On Thermostat Housing	TS-555
E300		
1999-1998		TS-604
1997-1996		TX209
E320		
2009-2007		TX155
2006	6 Cyl. 3.2L	TS-615
GL320		
2009-2007		TX155
GL350		
2016-2010		TX155
GLE300d		
2017-2016		TX155
GLK250		
2015-2013		TX155
GLS350d		
2017		TX155
ML320		
2009-2007		TX155
R320		
2009-2007		TX155
R350		
2011-2010	6 Cyl. 3.0L	TX155
S350		
1995-1994		TS-529
Sprinter 2500		
2018-2010		TX155
Sprinter 3500		
2019-2010		TX155
Exhaust Gas Temperature Sensor		
E250		
2016	4 Cyl. 2.1L; Exhaust Manifold	ETS199
2016-2015	4 Cyl. 2.1L; Located Before Pre-Catalyst	ETS200
2016-2015	4 Cyl. 2.1L; Located on Exhaust	ETS201
2016-2015	4 Cyl. 2.1L; Located After Particulate Filter	ETS215
E320		
2009-2007	6 Cyl. 3.0L; Rear	ETS93
E350		
2013-2011	Bluetec; Front	ETS211
2013-2011	Bluetec; Center	ETS216
2012-2011	6 Cyl. 3.0L; Rear	ETS93
GL320		
2009	6 Cyl. 3.0L; Rear	ETS107
2009	6 Cyl. 3.0L; Located After Particulate Filter	ETS195
2009	6 Cyl. 3.0L; Front	ETS197
2009	6 Cyl. 3.0L; Location-Before Catalyst	ETS216
2008-2007	Rear	ETS107

Mercedes-Benz

Temperature Sensors

		Part No.
Exhaust Gas Temperature Sensor		
GL320		
2008-2007	Center	ETS92
GL350		
2016-2015	6 Cyl.; Located Before Particulate Filter	ETS198
2016-2015	6 Cyl. 3.0L; Front; Located in Particulate Filter	ETS205
2012-2011	6 Cyl. 3.0L; Front; Located in Particulate Filter	ETS190
2012-2011	6 Cyl. 3.0L; Center; Located After Particulate Filter	ETS196
2012-2010	6 Cyl. 3.0L; Center; Located in Catalytic Converter	ETS216
GLE300d		
2017-2016	4 Cyl. 2.1L; Located in Catalytic Converter	ETS191
2017-2016	4 Cyl. 2.1L; Center	ETS213
2016	4 Cyl. 2.1L; EGR Pipe	ETS217
GLK250		
2015	4 Cyl. 2.1L; Located on Exhaust	ETS192
2015	4 Cyl. 2.1L; Front; Located in Catalytic Converter	ETS200
2015-2014	4 Cyl. 2.1L; Rear; Located in Catalytic Converter	ETS215
2015-2013	4 Cyl. 2.1L; EGR Pipe	ETS217
ML250		
2015	4 Cyl. 2.1L; Located in Catalytic Converter	ETS191
2015	4 Cyl. 2.1L; Center	ETS213
2015	4 Cyl. 2.1L; EGR Pipe	ETS217
ML320		
2009	6 Cyl. 3.0L; Located After Particulate Filter	ETS195
2009	6 Cyl. 3.0L; Front	ETS197
2009	6 Cyl. 3.0L; Located in Catalytic Converter	ETS216
2009-2007	Rear	ETS107
2008-2007	6 Cyl. 3.0L	ETS107
2008-2007	Center	ETS92
ML350		
2014-2012	Bluetec 4Matic; Rear	ETS198
2014-2012	Bluetec 4Matic; Front	ETS205
2011	Bluetec 4Matic; Front; Located in Particulate Filter	ETS190
2011	Bluetec 4Matic; Center; Located After Particulate Filter	ETS196
2011	Bluetec 4Matic; Center; Located in Catalytic Converter	ETS216
2010	6 Cyl. 3.0L; Front; Located in Particulate Filter	ETS190
2010	6 Cyl. 3.0L; Center; Located After Particulate Filter	ETS196
2010	6 Cyl. 3.0L; Center; Located in Catalytic Converter	ETS216
R320		
2009	6 Cyl. 3.0L; Located Before Particulate Filter	ETS216
R350		
2012-2010	6 Cyl. 3.0L; Center; Located in Catalytic Converter	ETS111
2012-2010	6 Cyl. 3.0L; Front; Located in Particulate Filter	ETS190
2012-2010	6 Cyl. 3.0L; Front; Located Before Particulate Filter	ETS216
S350		
2013	6 Cyl. 3.0L; Diesel; Location-Before Catalyst	ETS194
2013-2012	6 Cyl. 3.0L; Rear	ETS206

		Part No.
Exhaust Gas Temperature Sensor		
S350		
2012	6 Cyl. 3.0L; Diesel; Located Before Catalytic Converter	ETS194
Sprinter 2500		
2018-2013	EGR Pipe	ETS107
2012-2011	6 Cyl. 3.0L; EGR Pipe	ETS107
2012-2011	6 Cyl. 3.0L; Located in Catalytic Converter	ETS111
2012-2011	6 Cyl. 3.0L; Exhaust Manifold	ETS85
2010	EGR Pipe	ETS107
2010	Located Before Catalytic Converter	ETS111
2010	On Exhaust Manifold	ETS85
Sprinter 3500		
2018-2013	EGR Pipe	ETS107
2012-2011	6 Cyl. 3.0L; EGR Pipe	ETS107
2012-2011	6 Cyl. 3.0L; Located in Catalytic Converter	ETS111
2012-2011	6 Cyl. 3.0L; Exhaust Manifold	ETS85
2010	EGR Pipe	ETS107
2010	Located Before Catalytic Converter	ETS111
2010	On Exhaust Manifold	ETS85
Heater Core Temperature Sensor		
GL320		
2009-2007		AX441
GL350		
2012-2010		AX441
GLE300d		
2017-2016		AX417
GLS350d		
2017		AX417
ML250		
2015		AX441
ML320		
2009-2007		AX441
R320		
2009-2007		AX441
Intake Air Temperature Sensor		
E250		
2014	4 Cyl. 2.1L	AX264
E300		
1999-1996		AX129
E320		
2009-2006		AX129
E350		
2013-2011	6 Cyl. 3.0L	AX264
GL320		
2009-2007		AX129
GL350		
2016-2010		AX264
GLK250		
2015-2013		AX264
ML320		
2009-2007		AX129
ML350		
2014-2010	6 Cyl. 3.0L	AX264
R320		
2009-2007		AX129
R350		
2012-2011	6 Cyl. 3.0L	AX264
S350		
2013-2012	6 Cyl. 3.0L	AX264

Temperature Sensors

		Part No.
Intake Air Temperature Sensor		
Sprinter 2500		
2018-2015		AX264
2014	6 Cyl. 3.0L	AX264
2013-2010		AX264
Sprinter 3500		
2018-2015		AX264
2014	6 Cyl. 3.0L	AX264
2013-2010		AX264
Telematics Sensors		
Blind Spot Detection Sensor		
E250		
2014	4 Cyl. 2.1L	BSD87
GL350		
2016-2013	w/ Active Blind Spot Assist	BSD86
2016-2013	w/o Active Blind Spot Assist	BSD87
GLK250		
2015-2014	w/ Active Blind Spot Assist	BSD86
2015-2014	w/o Active Blind Spot Assist	BSD87
ML250		
2015		BSD86
ML350		
2012	6 Cyl.	BSD86
Cruise Control Distance Sensor		
GL350		
2016-2013	w/o Collision Warning System	BSD86
2016-2013	w/ Collision Warning System	CCD72
GLE300d		
2016		CCD72
GLK250		
2015-2014		BSD86
ML250		
2015		BSD86
ML350		
2012	6 Cyl.	BSD86
Parking Assist Sensor		
E300		
1999-1996	Rear	PPS9
E320		
2009-2006		PPS11
GL320		
2008-2007		PPS11
ML320		
2008-2007		PPS11
R320		
2009-2007		PPS11
Body Light Switches		
Back-Up Light Switch		
190D		
1989-1984		LS-344
Fog Lamp Switch		
GL350		
2016-2013		HLS1667
Headlight Dimmer Switch		
E300		
1997-1996	6 Cyl. 3.0L	CBS-2081
E320		
2009-2007	6 Cyl. 3.0L	CBS-2107
2006-2005	6 Cyl. 3.2L	CBS-2071
GL320		
2009-2007		CBS-2016

		Part No.
Headlight Dimmer Switch		
ML320		
2009-2007	6 Cyl. 3.0L	CBS-2106
R320		
2009-2007	6 Cyl. 3.0L	CBS-2016
Headlight Switch		
190D		
1989-1984		HLS-1225
300CD		
1985-1983		HLS-1225
300D		
1993-1990		HLS-1226
1987		HLS-1226
1985-1983		HLS-1225
300SD		
1993-1992		HLS-1226
1985-1983		HLS-1225
300SDL		
1987		HLS-1226
1986		HLS-1225
300TD		
1987		HLS-1226
1985-1983		HLS-1225
350SD		
1991		HLS-1226
350SDL		
1991-1990		HLS-1226
E300		
1999-1996		HLS1616
1995		HLS-1226
GL350		
2016-2013		HLS1667
S350		
1995-1994		HLS-1226
Sprinter 2500		
2014-2011	w/ Auto Headlights; w/ Rain Sensitive Wipers; w/o Rear Fog Lights	HLS-1630
2014-2011	w/o Auto Headlights; w/o Rain Sensitive Wipers; w/o Rear Fog Lights	HLS-1631
2014-2011	w/ Rear Fog Lights; w/o Auto Headlights; w/o Rain Sensitive Wipers	HLS-1632
2014-2011	w/ Auto Headlights; w/ Rain Sensitive Wipers; w/ Rear Fog Lights	HLS-1633
Sprinter 3500		
2014-2011	w/ Auto Headlights; w/ Rain Sensitive Wipers; w/o Rear Fog Lights	HLS-1630
2014-2011	w/o Auto Headlights; w/o Rain Sensitive Wipers; w/o Rear Fog Lights	HLS-1631
2014-2011	w/ Rear Fog Lights; w/o Auto Headlights; w/o Rain Sensitive Wipers	HLS-1632
2014-2011	w/ Auto Headlights; w/ Rain Sensitive Wipers; w/ Rear Fog Lights	HLS-1633
Stoplight Switch		
190D		
1989-1984		SLS-204
240D		
1983-1980		SLS261
300CD		
1985-1984		SLS261
1983-1981		SLS277
1980		SLS261
300D		
1993-1992		SLS-204
1991-1990		SLS-282

Mercedes-Benz

Body Light Switches

		Part No.
Stoplight Switch		
300D		
1987		SLS-204
1985-1984		SLS261
1983-1981		SLS277
1980		SLS261
300SD		
1993-1992		SLS-204
1985-1981		SLS277
1980		SLS261
300SDL		
1987-1986		SLS-204
300TD		
1987		SLS-204
1985-1984		SLS261
1983-1981		SLS277
1980		SLS261
350SD		
1991	6 Cyl.	SLS-204
350SDL		
1991	6 Cyl.	SLS-204
1990	Self Adjustable Plunger	SLS-204
E250		
2014	4 Cyl. 2.1L	SLS-501
E300		
1999-1995	6 Cyl. 3.0L	SLS-204
E320		
2009-2007	6 Cyl. 3.0L	SLS-502
2006-2005	6 Cyl. 3.2L	SLS-386
E350		
2013-2011	6 Cyl. 3.0L	SLS-501
GL350		
2016-2013		SLS-501
GLK250		
2015-2013		SLS-501
ML350		
2014-2012	6 Cyl. 3.0L	SLS-501
S350		
2013-2012	6 Cyl. 3.0L	SLS-501
1995-1994		SLS-204
Sprinter 2500		
2018-2013		SLS-502
2012-2011	6 Cyl. 3.0L	SLS-467
2010		SLS-502
Sprinter 3500		
2019-2013		SLS-502
2012-2011	6 Cyl. 3.0L	SLS-467
2010		SLS-502
Turn Signal Switch		
E300		
1997-1996	6 Cyl. 3.0L	CBS-2081
E320		
2009-2008		CBS-2107
2007	6 Cyl. 3.0L	CBS-2107
2006-2005	6 Cyl. 3.2L	CBS-2071
GL320		
2009-2007		CBS-2016
ML320		
2009-2007	6 Cyl. 3.0L	CBS-2106
R320		
2009-2007	6 Cyl. 3.0L	CBS-2016

		Part No.
Chassis and Drivetrain Switches		
Clutch Starter Safety Switch		
E320		
2009-2006	Alternate Number	SLS-385
Fuel Pump Cut-Off Switch		
190D		
1989-1984	Universal; w/ Electric Fuel Pump	FV-7
240D		
1983-1980	Universal; w/ Electric Fuel Pump	FV-7
300CD		
1981-1980	Universal; w/ Electric Fuel Pump	FV-7
300D		
1993-1990	Universal; w/ Electric Fuel Pump	FV-7
1987	Universal; w/ Electric Fuel Pump	FV-7
1981-1980	Universal; w/ Electric Fuel Pump	FV-7
300SD		
1993-1992	Universal; w/ Electric Fuel Pump	FV-7
1985-1980	Universal; w/ Electric Fuel Pump	FV-7
300SDL		
1987-1986	Universal; w/ Electric Fuel Pump	FV-7
300TD		
1981-1980	Universal; w/ Electric Fuel Pump	FV-7
350SD		
1991	Universal; w/ Electric Fuel Pump	FV-7
350SDL		
1991-1990	Universal; w/ Electric Fuel Pump	FV-7
E300		
1999-1995	Universal; w/ Electric Fuel Pump	FV-7
S350		
1995-1994	Universal; w/ Electric Fuel Pump	FV-7
Transmission Control Solenoid		
190D		
1989-1985		TCS328
300CD		
1985		TCS328
300D		
1993-1990		TCS328
1985		TCS328
300SD		
1993-1992		TCS328
1985		TCS328
300SDL		
1987-1986		TCS328
300TD		
1987		TCS328
1985		TCS328
350SD		
1991		TCS328
350SDL		
1991-1990		TCS328
E300		
1999-1996	Shift Solenoid	TCS260
1996-1995		TCS328
E320		
2009-2007	Pressure Solenoid	TCS257
2009-2007	TCC Solenoid	TCS273
2006	Shift Solenoid	TCS260
GL320		
2009-2007	Pressure Solenoid	TCS257
2009-2007	TCC Solenoid	TCS273
GL350		
2016-2010	Pressure Solenoid	TCS257

Chassis and Drivetrain Switches

		Part No.
Transmission Control Solenoid		
GL350		
2016-2010	TCC Solenoid	TCS273
GLK250		
2015-2013	Pressure Solenoid	TCS257
2015-2013	TCC Solenoid	TCS273
ML250		
2015	Pressure Solenoid	TCS257
2015	TCC Solenoid	TCS273
ML320		
2009-2007	Pressure Solenoid	TCS257
2009-2007	TCC Solenoid	TCS273
R320		
2009-2007	Pressure Solenoid	TCS257
S350		
1995-1994		TCS328
Sprinter 2500		
2016-2014	Pressure Solenoid	TCS257
2016-2014	TCC Solenoid	TCS273
Sprinter 3500		
2016-2014	Pressure Solenoid	TCS257
2016-2014	TCC Solenoid	TCS273
Ignition Switches		
Ignition Push Button Switch		
E320		
2009-2008	Dash Mounted	US1336
GL320		
2009-2007	Dash Mounted	US1336
GL350		
2016-2013	Dash Mounted	US1479
2014-2013	w/ Start/Stop Feature; Dash Mounted	US1456
2012-2010	Dash Mounted	US1336
GLE300d		
2017-2016	Dash Mounted	US1456
GLK250		
2014-2013	Keyless Ignition; w/ Start/Stop Feature; Dash Mounted	US1456
GLS350d		
2017	Dash Mounted	US1479
ML250		
2015	Dash Mounted	US1456
ML350		
2014-2012	6 Cyl. 3.0L; Keyless Ignition; Dash Mounted	US1456
R320		
2009-2007	Dash Mounted	US1336
Ignition Starter Switch		
240D		
1981-1980		US1048
300CD		
1981-1980		US1048
300D		
1981-1980		US1048
300SD		
1981-1980		US1048
300TD		
1981-1980		US1048
S350		
1995		US-982

		Part No.
Interior Power Switches		
Power Window Switch		
E250		
2014	4 Cyl. 2.1L; Front Right	DWS2081
2014	4 Cyl. 2.1L; Rear	DWS2081
GL320		
2009	w/ Power Folding Mirrors; Front Left	DWS-860
2009	w/o Power Folding Mirrors; Front Left	DWS-972
2009-2007	Rear	DWS2080
GL350		
2016	w/ Power Folding Mirrors	DWS2078
2016-2013	Front Right	DWS2081
2016-2013	Rear	DWS2081
2015-2013	w/ Power Folding Mirrors; Front Left	DWS2078
2012-2010	Rear	DWS2080
GLE300d		
2017-2016	w/ Power Folding Mirrors	DWS2078
GLE350d		
2016	w/ Power Folding Mirrors	DWS2078
GLK250		
2015-2013	Front Right	DWS-583
2015-2013	Rear	DWS-583
ML250		
2015	w/ Power Folding Mirrors	DWS2078
ML320		
2009-2007	Rear	DWS2080
ML350		
2014-2013	6 Cyl. 3.0L; Diesel; Turbocharged; Front Right	DWS2081
2014-2013	6 Cyl. 3.0L; Diesel; Turbocharged; Rear	DWS2081
2012	Bluetec 4Matic; Front Right	DWS2081
2012	Bluetec 4Matic; Rear	DWS2081
R320		
2009	w/ Power Folding Mirrors; Front Left	DWS-860
2009	w/o Power Folding Mirrors; Front Left	DWS-972
2009-2007	Rear	DWS2080
S350		
2012	6 Cyl. 3.0L; w/o Panoramic Sunroof; w/o Rear Window Sunshade; Front Right	DWS-659
2012	6 Cyl. 3.0L; w/o Panoramic Sunroof; w/o Rear Window Sunshade; Rear	DWS-659
Sprinter 2500		
2018-2015	w/ Heated Mirrors; w/o Rear Power Vent Windows; Front Left	DWS-184
2018-2015	Exc. Passenger Van; w/o Heated Mirrors; w/o Rear Power Vent Windows; Front Left	DWS1642
2013	Exc. Passenger Van; w/o Heated Mirrors; w/o Rear Power Vent Windows; Front Left	DWS1642
2013-2010	w/ Heated Mirrors; w/o Rear Power Vent Windows; Front Left	DWS-184
Sprinter 3500		
2019-2015	w/ Heated Mirrors; w/o Rear Power Vent Windows; Front Left	DWS-184
2019-2015	Exc. Passenger Van; w/o Heated Mirrors; w/o Rear Power Vent Windows; Front Left	DWS1642
2013	Exc. Passenger Van; w/o Heated Mirrors; w/o Rear Power Vent Windows; Front Left	DWS1642
2013-2010	w/ Heated Mirrors; w/o Rear Power Vent Windows; Front Left	DWS-184
Remote Mirror Switch		
GL350		
2016-2013	w/ Power Folding Mirrors	DWS2078
GLE300d		
2017-2016	w/ Power Folding Mirrors	DWS2078

Mercedes-Benz

Interior Power Switches

		Part No.
Remote Mirror Switch		
GLE350d		
2016	w/ Power Folding Mirrors	DWS2078
ML250		
2015	w/ Power Folding Mirrors	DWS2078
Steering Angle Sensor		
300SD		
1993		SWS116
E300		
1999-1996		SWS116
GL320		
2009-2007		SWS79
GL350		
2012-2010		SWS79
ML320		
2009-2007		SWS79
S350		
1995-1994		SWS116
Windshield Wiper Switch		
E300		
1997-1996	6 Cyl. 3.0L	CBS-2081
E320		
2009-2007		CBS-2107
2006-2005	6 Cyl. 3.2L	CBS-2071
GL320		
2009-2007		CBS-2016
ML320		
2009-2007	6 Cyl. 3.0L	CBS-2106
R320		
2009-2007	6 Cyl. 3.0L	CBS-2016
Pressure and Vacuum Sending Switches		
Oil Pressure Gauge Switch		
300D		
1990		PS-329
1987		PS-329
1985		PS-329
300SDL		
1987-1986		PS-329
S350		
1995		PS-437
Temperature Switches and Senders		
A/C and Heater Blower Motor Switch		
190D		
1989-1984		HS530
300CD		
1985-1982		HS-531
300D		
1985-1982		HS-531
300SD		
1985-1982		HS-531
300TD		
1985-1982		HS-531
Blower Motor Resistor		
190D		
1989-1984		RU-569
300D		
1993-1991	w/o Dust Filter	RU-562
1993-1991	w/ Dust Filter	RU563
1990		RU-562
1987		RU-562

		Part No.
Blower Motor Resistor		
300SD		
1993-1992	w/o Dust Filter	RU-562
1993-1992	w/ Dust Filter	RU563
300SDL		
1987-1986		RU-562
300TD		
1987		RU-562
350SD		
1991	w/o Dust Filter	RU-562
1991	w/ Dust Filter	RU563
350SDL		
1991-1990	w/o Dust Filter	RU-562
1991-1990	w/ Dust Filter	RU563
E300		
1999-1995		RU-564
E320		
2009-2006		RU-566
GL350		
2016-2010		RU968
GLE300d		
2017-2016		RU968
GLK250		
2015-2013		RU-884
ML250		
2015		RU968
ML320		
2007		RU-561
R320		
2007		RU-564
S350		
1995-1994		RU-570
Sprinter		
2018-2010	w/ Auto. Temp Control; Front	RU-778
2018-2010	Rear	RU-778
Sprinter 2500		
2018-2010	w/o Auto. Temp Control	RU-879
Sprinter 3500		
2018-2010	Alternate Number; w/ Auto. Temp Control	RU-778
2018-2010	w/o Auto. Temp Control	RU-879
2018-2010	Exhaust stock and reorder; w/ Auto. Temp Control	RU880
Coolant Fan Switch		
190D		
1989-1987		TS-513
1986	3 Term.	TS-513
1986-1984	1 Term.	TS-451
1985-1984	w/ 3 Term.	TS-513
240D		
1983-1980		TS-451
300CD		
1985-1980		TS-451
300D		
1987	6 Cyl. 3.0L	TS-552
1985-1983		TS-613
1981-1980		TS-451
300SD		
1985-1980		TS-451
300SDL		
1987		TS-507
300TD		
1987	6 Cyl. 3.0L	TS-552
1981-1980		TS-451

Temperature Switches and Senders

		Part No.
Temperature Sender - With Gauge		
190D		
1989-1984		TS-339
240D		
1983-1980		TS-556
300D		
1993-1990		TS-339
1987		TS-339
1985-1983		TS-612
300SDL		
1987-1986		TS-339
350SD		
1991		TS-339
350SDL		
1991-1990		TS-339
E300		
1996-1995		TS-557
Temperature Sender - With Light		
190D		
1989-1984		TS-496
240D		
1983-1980	2 Term.	TS-372
1983-1980	1 Term.	TS-496
300CD		
1985-1982	2 Term.	TS-372
1985-1982	1 Term.	TS-496
1981-1980		TS-496
300D		
1993	2 Term.	TS-372
1993	1 Term.	TS-496
1992-1990		TS-496
1987		TS-496
1981-1980		TS-496
300SD		
1993	2 Term.	TS-372
1993	1 Term.	TS-496
1992		TS-496
1985-1980		TS-496
300SDL		
1987-1986		TS-496
300TD		
1981-1980		TS-496
350SD		
1991		TS-496
350SDL		
1991-1990		TS-496
Actuators		
Power Door Lock Actuator		
E300		
1999-1996	Vacuum Actuated; Rear	DLA839
E320		
2009-2006	Fuel Tank, Door Lock Control	DLA-647
Sprinter 2500		
2010	Left Front	DLA1434
2010	Right Front	DLA1435
Sprinter 3500		
2010	Left Front	DLA1434
2010	Right Front	DLA1435
Locks		
Ignition Lock Cylinder		
190D		
1989-1984		US-559L

		Part No.
Ignition Lock Cylinder		
300D		
1993-1990		US-559L
E300		
1995		US-559L
Mercury		
Relays and Fuses		
Coolant Fan Relay		
Lynx		
1984	4 Cyl. 2.0L; w/ AC	RY-178
1984	4 Cyl. 2.0L; w/o AC	RY-46
Topaz		
1984	4 Cyl. 2.0L; w/ AC	RY-143
1984	4 Cyl. 2.0L; w/o AC	RY-178
Engine Control Relay		
Lynx		
1987-1986	4 Cyl. 2.0L; OE No. E6EF-12A646-B1A	RY-127
Fuel Injection Relay		
Lynx		
1984	4 Cyl. 2.0L	RY-127
Headlight Dimmer Switch Relay		
Lynx		
1985-1984	4 Cyl. 2.0L	RY-70
Ignition Control Module Relay		
Lynx		
1985-1984	4 Cyl. 2.0L; EFI	RY-71
Topaz		
1984	4 Cyl. 2.0L	RY-71
Ignition Relay		
Lynx		
1985-1984	4 Cyl. 2.0L	RY-71
Keyless Entry System Relay		
Topaz		
1984	4 Cyl.	RY-46
Neutral Safety Switch Relay		
Lynx		
1987-1984	4 Cyl. 2.0L; Alternate Number	RY-116
1987-1984	4 Cyl. 2.0L; Exhaust stock and reorder	RY30
Topaz		
1986-1984	4 Cyl. 2.0L; Alternate Number	RY-116
1986-1984	4 Cyl. 2.0L; Exhaust stock and reorder	RY30
Theft Deterrent Relay		
Topaz		
1986	4 Cyl.; Canada; Starter Motor Cut-Off	RY-46
Starting and Charging System Parts		
Starter Solenoid		
Lynx		
1986-1984	4 Cyl. 2.0L	SS-598
Topaz		
1986-1984	4 Cyl. 2.0L	SS-598
Voltage Regulator		
Topaz		
1985-1984	4 Cyl. 2.0L; External	VR-166
Air Injection and Induction Parts		
Vacuum Motor		
Lynx		
1984	4 Cyl. 2.0L	VA19
Topaz		
1984	4 Cyl. 2.0L	VA19

Air Management Valves

		Part No.
Air Management Valves		
Air Cleaner Check Valve		
Topaz		
1985	4 Cyl. 2.0L	AV18
Early Fuel Emission Control		
Bowl Vent Solenoid		
Lynx		
1987-1984	4 Cyl.	BV1
Topaz		
1986-1984	4 Cyl.	BV1
Crankcase Ventilation Filter		
Lynx		
1987-1984	4 Cyl.	BF20
Topaz		
1986-1984	4 Cyl.	BF20
EGR Components		
EGR Valve Control Solenoid Filter		
Lynx		
1984	4 Cyl. 2.0L; SOHC	BLF1
PCV Systems		
PCV Grommet		
Lynx		
1987-1984	4 Cyl. 2.0L; 3/4 Inch Inner Dia. x 1 1/2 Inch Outer Dia. X 1/2 Inch Long	GV27
1987-1984	4 Cyl. 2.0L; 3/4 Inch Inner Dia. x 1 1/2 Inch Outer Dia. X 1 Inch Long	GV28
1987-1984	4 Cyl. 2.0L; 1/2 Inch Inner Dia.; Grommet	GV4
Topaz		
1984	4 Cyl. 2.0L; 3/4 Inch Inner Dia. x 1 1/2 Inch Outer Dia. X 1/2 Inch Long	GV27
1984	4 Cyl. 2.0L; 3/4 Inch Inner Dia. x 1 1/2 Inch Outer Dia. X 1 Inch Long	GV28
1984	4 Cyl. 2.0L; 1/2 Inch Inner Dia.; Grommet	GV4
Injectors		
Fuel Injector - Diesel - Remfd		
Lynx		
1987	4 Cyl. 2.0L	FJ592
1986-1984	4 Cyl. 2.0L	FJ588
Topaz		
1986-1984	4 Cyl. 2.0L	FJ588
Injection Components		
Fuel Line Retainer		
Topaz		
1986-1984	4 Cyl. 2.0L; SOHC; w/ 3/8 Inch Fuel Line	HK9330
1986-1984	4 Cyl. 2.0L; SOHC; w/ 5/16 Inch Fuel Line	HK9331
Position Sensors		
Throttle Position Sensor		
Lynx		
1987	4 Cyl. 2.0L	TH35
Topaz		
1985	4 Cyl. 2.0L	TH7
Temperature Sensors		
Coolant Temperature Sensor		
Lynx		
1987-1985	4 Cyl. 2.0L	TX309
Topaz		
1986-1985	4 Cyl. 2.0L	TX309

		Part No.
Chassis and Drivetrain Switches		
Neutral Safety Switch		
Lynx		
1987	4 Cyl. 2.0L; w/ A.T.	NS-25
1987	4 Cyl. 2.0L; w/ M.T.; Mounted on Transmission	NS-66
Pressure and Vacuum Sending Switches		
Oil Pressure Light Switch		
Lynx		
1986-1984	4 Cyl. 2.0L	PS-120
Topaz		
1986-1984	4 Cyl. 2.0L	PS-120
Ported Vacuum Switch		
Lynx		
1987-1984	4 Cyl. 2.0L; 3 Ports; Orange	PVS150
1984	4 Cyl. 2.0L; 3 Ports; Gray w/ Blue Cap	PVS112
1984	4 Cyl. 2.0L; 3 Ports; Brown	PVS18
1984	4 Cyl. 2.0L; 3 Ports; Green; w/o Solenoid	PVS19
1984	4 Cyl. 2.0L; 3 Ports; Yellow	PVS20
1984	4 Cyl. 2.0L; 3 Ports; Green; w/ Solenoid	PVS22
1984	4 Cyl. 2.0L; 3 Ports; Red	PVS29
Topaz		
1986-1984	4 Cyl. 2.0L; 3 Ports; Orange	PVS150
1984	4 Cyl. 2.0L; 3 Ports; Gray w/ Blue Cap	PVS112
1984	4 Cyl. 2.0L; 3 Ports; Brown	PVS18
1984	4 Cyl. 2.0L; 3 Ports; Green; w/o Solenoid	PVS19
1984	4 Cyl. 2.0L; 3 Ports; Yellow	PVS20
1984	4 Cyl. 2.0L; 3 Ports; Green; w/ Solenoid	PVS22
1984	4 Cyl. 2.0L; 3 Ports; Red	PVS29
Temperature Switches and Senders		
Coolant Fan Switch		
Lynx		
1984	4 Cyl. 2.0L	TS-155
Topaz		
1986-1984	4 Cyl. 2.0L	TS-155
Mitsubishi		
Starting and Charging System Parts		
Voltage Regulator		
Mighty Max		
1983	4 Cyl. 2.3L	VR-185
PCV Systems		
PCV Valve		
Mighty Max		
1985	4 Cyl. 2.3L	V226
Body Light Switches		
Headlight Switch		
Mighty Max		
1985	4 Cyl. 2.3L; w/o Intermittent Wipers	DS-1109
Turn Signal Switch		
Mighty Max		
1985	4 Cyl. 2.3L; w/o Intermittent Wipers	DS-1109
Chassis and Drivetrain Switches		
Neutral Safety Switch		
Mighty Max		
1985-1983	4 Cyl. 2.3L	NS-240
Temperature Switches and Senders		
Temperature Sender - With Gauge		
Mighty Max		
1985-1983	4 Cyl. 2.3L	TS-299

Relays and Fuses

		Part No.
Nissan		
Relays and Fuses		
A/C Control Relay		
720		
1984-1983	4 Cyl. 2.5L; 5 Blade Term.; OE No. 25230-79901, 89966	RY102
1984-1983	4 Cyl. 2.5L; 4 Blade Term.; OE No. 25230-01P00	RY61
1983-1981	4 Cyl. 2.2L; 5 Blade Term.; OE No. 25230-79901, 89966	RY102
1983-1981	4 Cyl. 2.2L; 4 Blade Term.; OE No. 25230-01P00	RY61
810		
1981	6 Cyl. 2.8L; 5 Blade Term.; OE No. 25230-79901, 89966	RY102
1981	6 Cyl. 2.8L; 4 Blade Term.; OE No. 25230-01P00	RY61
Maxima		
1983-1981	6 Cyl. 2.8L; 5 Blade Term.; OE No. 25230-79901, 89966	RY102
1983-1981	6 Cyl. 2.8L; 4 Blade Term.; OE No. 25230-01P00	RY61
Diesel Glow Plug Relay		
720		
1986-1983	4 Cyl. 2.5L; Exhaust stock and reorder	RY-54
1982-1981	4 Cyl. 2.2L; S	RY219
Maxima		
1983-1982	6 Cyl. 2.8L; Diesel; Exhaust stock and reorder	RY-54
Sentra		
1985-1984	4 Cyl. 1.7L	RY391
1983	4 Cyl. 1.7L; Diesel; Exhaust stock and reorder	RY-54
Fuel Injection Relay		
810		
1981	6 Cyl. 2.8L	RY-63
Maxima		
1983-1981	6 Cyl. 2.8L	RY-63
Sentra		
1984-1983	4 Cyl. 1.7L	RY-63
Overdrive Relay		
Sentra		
1986	4 Cyl. 1.7L	RY-132
Theft Deterrent Relay		
720		
1985-1984	4 Cyl. 2.5L; OE No. 25230-C9961, C9971	RY-90
1984	4 Cyl. 2.5L; OE No. 25230-C9970, C9980	RY-63
Maxima		
1983	6 Cyl. 2.8L; OE No. 25230-79910	RY207
Sentra		
1985-1984	4 Cyl. 1.7L; OE No. 25230-C9961, C9971	RY-90
1984	4 Cyl. 1.7L; OE No. 25230-C9970, C9980	RY-63
Starting and Charging System Parts		
Starter Solenoid		
720		
1986	4 Cyl. 2.5L	SS-388
1985-1983	4 Cyl. 2.5L	SS-332
1983	4 Cyl. 2.2L; U.S. Models	SS-265
1983	4 Cyl. 2.2L; Canada	SS-296
Maxima		
1981	6 Cyl. 2.8L; Diesel	SS-233
Sentra		
1986-1983	4 Cyl. 1.7L	SS-299

		Part No.
Voltage Regulator		
720		
1986	4 Cyl. 2.5L	VR-162
1985-1983	4 Cyl. 2.5L	VR-175
1983-1981	4 Cyl. 2.2L; Diesel	VR-175
Sentra		
1985-1983	4 Cyl. 1.7L; Diesel	VR-175
Air Management Valves		
Diverter Valve		
720		
1983	4 Cyl. 2.2L	DV26
EGR Components		
EGR Tube Gasket		
Titan XD		
2019-2016	8 Cyl. 5.0L	VG266
EGR Valve		
810		
1981	6 Cyl. 2.8L	EGV718
Maxima		
1983	6 Cyl. 2.8L	EGV718
1982	6 Cyl. 2.8L; OE No. 14710-W2500	EGV718
Sentra		
1987-1983	4 Cyl. 1.7L	EGV483
EGR Valve Mounting Gasket		
810		
1981	6 Cyl. 2.8L	VG88
Maxima		
1983-1982	6 Cyl. 2.8L	VG88
Sentra		
1987-1983	4 Cyl. 1.7L	VG88
Titan XD		
2019	8 Cyl. 5.0L; Right	VG263
2019-2016	8 Cyl. 5.0L; Left	VG265
2017-2016	8 Cyl. 5.0L; Right	VG263
PCV Systems		
PCV Valve		
720		
1986-1981	4 Cyl.	V184
810		
1981	6 Cyl.	V184
Maxima		
1983-1982	6 Cyl.	V184
Sentra		
1987-1983	4 Cyl.	V184
Vapor and Purge Components		
Fuel Vapor Canister		
720		
1983-1982	4 Cyl. 2.2L; w/o High Altitude	CP3051
1981	4 Cyl. 2.2L	CP3051
Injectors		
Fuel Injector - Diesel - New		
720		
1986-1984	4 Cyl. 2.5L; Fed.	FJ907
1983	4 Cyl. 2.5L	FJ907
1982-1981	4 Cyl. 2.2L	FJ907
Maxima		
1983-1982	6 Cyl. 2.8L; Diesel	FJ914
Fuel Injector - Diesel - Remfd		
810		
1981	6 Cyl. 2.8L; Diesel	FJ910

Injection Components

		Part No.
Injection Components		
Fuel Pressure Regulator		
Titan XD		
2019-2016	8 Cyl. 5.0L	PR604
Fuel Sensors		
Knock Sensor		
NP300		
2015-2009	4 Cyl. 2.5L; Diesel	KS214
Mass Air Flow		
Titan XD		
2019-2016	8 Cyl. 5.0L	MAS0475
Position Sensors		
Camshaft Sensor		
NP300		
2012	4 Cyl. 2.5L	PC460
2011-2009	4 Cyl. 2.5L	PC464
Titan XD		
2019-2016	8 Cyl. 5.0L	PC1040
Crankshaft Sensor		
Titan XD		
2019-2016	8 Cyl. 5.0L	PC1041
Throttle Position Sensor		
810		
1981	6 Cyl. 2.8L	TH114
Maxima		
1983	6 Cyl. 2.8L	TH114
NP300		
2015-2009	4 Cyl. 2.5L	TH232
Pressure Sensors		
Diesel Particulate Filter (DPF) Pressure Sensor		
Titan XD		
2018-2016	8 Cyl. 5.0L; Right	DPS108
2018-2016	8 Cyl. 5.0L; Left	DPS109
MAP Sensor		
Titan XD		
2019-2016	8 Cyl. 5.0L	AS658
Temperature Sensors		
Coolant Temperature Sensor		
NP300		
2019-2009	4 Cyl. 2.5L	TX78
Titan XD		
2017-2016	8 Cyl.	TX186
Exhaust Gas Temperature Sensor		
Titan XD		
2019-2016	8 Cyl. 5.0L	ETS129
Body Light Switches		
Back-Up Light Switch		
720		
1985-1984	4 Cyl. 2.5L; w/ M.T.	LS-221
Fog Lamp Switch		
720		
1986	4 Cyl. 2.5L	DS-550
Headlight Dimmer Switch		
720		
1986	4 Cyl. 2.5L; w/ Cruise Control; w/ Intermittent Wipers	CBS-1002
1986	4 Cyl. 2.5L; w/o Cruise Control; w/o Intermittent Wipers	CBS-1003

		Part No.
Headlight Dimmer Switch		
Sentra		
1986	4 Cyl. 1.7L; Dual Lever Multifunction Switch Assembly	CBS-1065
1984-1983	4 Cyl. 1.7L; Dual Lever Multifunction Switch Assembly	CBS-1065
Headlight Switch		
720		
1986	4 Cyl. 2.5L; w/ Cruise Control; w/ Intermittent Wipers	CBS-1002
1986	4 Cyl. 2.5L; w/o Cruise Control; w/o Intermittent Wipers	CBS-1003
Stoplight Switch		
720		
1986	4 Cyl. 2.5L	SLS-106
Maxima		
1981	6 Cyl. 2.8L	SLS-101
Turn Signal Switch		
720		
1986	4 Cyl. 2.5L; w/ Cruise Control; w/ Intermittent Wipers	CBS-1002
1986	4 Cyl. 2.5L; w/o Cruise Control; w/o Intermittent Wipers	CBS-1003
Sentra		
1986-1983	4 Cyl. 1.7L; Dual Lever Multifunction Switch Assembly	CBS-1065
Ignition Switches		
Ignition Starter Switch		
Cabstar		
2008	Switch Only	US-362
Interior Power Switches		
Windshield Wiper Switch		
Sentra		
1986-1984	4 Cyl. 1.7L; Dual Lever Multifunction Switch Assembly; w/ Intermittent Wipers; Front	CBS-1065
1983	4 Cyl. 1.7L; Dual Lever Multifunction Switch Assembly	CBS-1065
Pressure and Vacuum Sending Switches		
Oil Pressure Gauge Switch		
Maxima		
1983	6 Cyl. 2.8L	PS153
1982	6 Cyl. 2.8L; Diesel	PS153
Oil Pressure Light Switch		
720		
1985	4 Cyl. 2.5L	PS-168
Cabstar		
2008		PS-323
Titan XD		
2019-2018	Turbocharged	PS651
2017-2016	8 Cyl. 5.0L; Diesel	PS651
Ported Vacuum Switch		
720		
1986	4 Cyl.	PVS90
1985-1983	4 Cyl. 2.5L; 2 Ports; Natural	PVS91
1983	4 Cyl. 2.5L; 3 Ports; Brown	PVS52
1983	4 Cyl. 2.2L; 3 Ports; Natural	PVS62
1983-1981	4 Cyl. 2.2L; 3 Ports; Brown	PVS52
1983-1981	4 Cyl. 2.2L; 2 Ports; Black Finish	PVS90
1983-1981	4 Cyl. 2.2L; 2 Ports; Natural	PVS91
1982-1981	4 Cyl. 2.2L; 3 Ports; Black Finish	PVS57
810		
1981	6 Cyl. 2.8L; 2 Ports; Black Finish; OE No.14890-P7910	PVS126

Pressure and Vacuum Sending Switches

		Part No.
Ported Vacuum Switch		
810		
1981	6 Cyl. 2.8L; 2 Ports; Natural; OE No. 14890-W2400	PVS68
1981	6 Cyl. 2.8L; 2 Ports; Neutral; OE No. 14890-U7800	PVS91
Maxima		
1983	6 Cyl.; 3 Ports; 7 Term.; Black Finish	PVS129
1983-1982	6 Cyl.; 2 Ports; Black Finish	PVS126
Sentra		
1987	4 Cyl. 1.7L; 2 Ports; Black Finish	PVS90
1985	4 Cyl.; 3 Ports; Natural	PVS38
1985	4 Cyl.; 3 Ports; Black Finish	PVS64
1985-1983	4 Cyl.; 2 Ports; Black Finish	PVS90
1983	4 Cyl.; 3 Ports; Gray	PVS59
Oldsmobile		
Relays and Fuses		
A/C Compressor Clutch Cut-Off Relay		
98		
1985	6 Cyl. 4.3L; OE No. 10034222	RY-27
1985	6 Cyl. 4.3L; OE No. 10022960, 10039961	RY-85
Cutlass Ciera		
1985-1984	6 Cyl. 4.3L; OE No. 10022960, 10039961	RY-85
A/C Control Relay		
Custom Cruiser		
1984	8 Cyl. 5.7L; Diesel	RY-85
Delta 88		
1985	8 Cyl. 5.7L	RY-85
Anti-Dieseling Relay		
98		
1983-1982	8 Cyl. 5.7L	RY-138
Custom Cruiser		
1983-1982	8 Cyl. 5.7L; Diesel	RY-138
Delta 88		
1983-1982	8 Cyl. 5.7L; Diesel	RY-138
Coolant Fan Relay		
Cutlass Ciera		
1985-1983	6 Cyl. 4.3L	RY-27
Diesel Glow Plug Indicator Relay		
98		
1983-1980	8 Cyl. 5.7L; Diesel	RY-138
Cutlass		
1981	8 Cyl. 5.7L; Diesel	RY-138
Cutlass Ciera		
1982	6 Cyl. 4.3L; Diesel	RY-138
Cutlass Supreme		
1981	8 Cyl. 5.7L; Diesel	RY-138
Delta 88		
1983-1980	8 Cyl. 5.7L; Diesel	RY-138
Toronado		
1983-1980	8 Cyl. 5.7L; Diesel	RY-138
Diesel Glow Plug Relay		
Custom Cruiser		
1981-1980	8 Cyl. 5.7L; N; Diesel	SS-591
Diesel Wait Lamp Relay		
98		
1983-1980	8 Cyl. 5.7L; Diesel	RY-138
Cutlass		
1981-1980	8 Cyl. 5.7L; Diesel	RY-138
Cutlass Calais		
1983-1982	8 Cyl. 5.7L	RY-138

		Part No.
Diesel Wait Lamp Relay		
Cutlass Ciera		
1983-1982	6 Cyl. 4.3L; Diesel	RY-138
Cutlass Supreme		
1981	8 Cyl. 5.7L; Diesel	RY-138
Delta 88		
1983-1980	8 Cyl. 5.7L; Diesel	RY-138
Toronado		
1983-1980	8 Cyl. 5.7L; Diesel	RY-138
Fast Idle Relay		
Cutlass Calais		
1984-1982	6 Cyl. 4.3L; Diesel	RY-34
Fast Idle Solenoid Relay		
Cutlass Cruiser		
1981	8 Cyl. 5.7L; Canada; Diesel; Export	RY-8
Cutlass Supreme		
1984-1982	6 Cyl. 4.3L	RY-34
Fuel Injection Pump Relay		
98		
1985	6 Cyl. 4.3L	RY-85
Cutlass Ciera		
1984	6 Cyl. 4.3L; Diesel; w/ High Altitude	RY-85
Fuel Pump Relay		
98		
1984	8 Cyl. 5.7L; Diesel	RY-85
Cutlass Calais		
1984	8 Cyl. 5.7L; Diesel	RY-85
Cutlass Ciera		
1985-1984	6 Cyl. 4.3L; Diesel	RY-85
Cutlass Salon		
1985	8 Cyl.	RY-232
Cutlass Supreme		
1985	8 Cyl.	RY-232
Delta 88		
1984	8 Cyl. 5.7L; Diesel	RY-85
Toronado		
1984	8 Cyl. 5.7L; Diesel	RY-85
Power Antenna Relay		
98		
1985	6 Cyl. 4.3L	RY-603
1984	8 Cyl. 5.7L	RY-603
Cutlass		
1981-1980	8 Cyl. 5.7L	RY-603
Cutlass Calais		
1984-1982	6 Cyl. 4.3L	RY-603
1984-1982	8 Cyl. 5.7L	RY-603
Toronado		
1985	8 Cyl. 5.7L	RY-603
Power Seat Relay		
Toronado		
1983-1982	8 Cyl. 5.7L	RY-116
Wiper Relay		
Cutlass Calais		
1983-1982	6 Cyl. 4.3L; w/ Intermittent Wipers	RY-44
1983-1982	8 Cyl. 5.7L; w/ Intermittent Wipers	RY-44
Starting and Charging System Parts		
Starter Solenoid		
Custom Cruiser		
1985-1984	8 Cyl. 5.7L	SS-251
Cutlass Calais		
1984	8 Cyl. 5.7L	SS-251

Starting and Charging System Parts

		Part No.
Starter Solenoid		
Cutlass Calais		
1984-1982	6 Cyl. 4.3L	SS-251
1983	8 Cyl. 5.7L ⁶	SS-251
1982	8 Cyl. 5.7L; Diesel ⁶	SS-251
1981	8 Cyl. 5.7L ^{5,6}	SS-200
1980	8 Cyl. 5.7L ⁵	SS-200
Cutlass Ciera		
1985-1983	6 Cyl. 4.3L; Diesel; Mitsubishi	SS-306
Cutlass Cruiser		
1983-1982	8 Cyl. 5.7L ⁶	SS-251
1981	8 Cyl. 5.7L ^{5,6}	SS-200
1980	8 Cyl. 5.7L ⁵	SS-200
Air Injection and Induction Parts		
Manifold Air Tube		
Custom Cruiser		
1980	8 Cyl. 5.7L; Right	AT103
1980	8 Cyl. 5.7L; Left	AT104
Cutlass		
1981	8 Cyl. 5.7L; Right	AT126
1981-1980	8 Cyl. 5.7L; Left	AT104
1980	8 Cyl. 5.7L; Right	AT103
Cutlass Cruiser		
1980	8 Cyl. 5.7L; Right	AT103
1980	8 Cyl. 5.7L; Left	AT104
Delta 88		
1980	8 Cyl. 5.7L; Right	AT103
1980	8 Cyl. 5.7L; Left	AT104
Toronado		
1980	8 Cyl.; Right	AT103
1980	8 Cyl.; Left	AT104
Vacuum Motor		
Custom Cruiser		
1980	8 Cyl. 5.7L	VA6
Cutlass Calais		
1980	8 Cyl. 5.7L	VA6
Cutlass Cruiser		
1980	8 Cyl. 5.7L	VA6
Toronado		
1980	8 Cyl. 5.7L	VA6
Vacuum Pump		
Cutlass Ciera		
1985-1984	6 Cyl. 4.3L; Coupe or Sedan; w/ AC	VCP100
1983	6 Cyl. 4.3L; w/ AC	VCP100
Air Management Valves		
Air Cleaner Check Valve		
98		
1985	6 Cyl. 4.3L; w/ Internal Threads	AV7
1985	6 Cyl. 4.3L; w/ External Thread	AV9
1981-1980	8 Cyl. 5.7L	AV7
Cutlass		
1980	8 Cyl. 5.7L	AV7
Cutlass Calais		
1982	6 Cyl. 4.3L; Diesel	AV7
1981-1980	8 Cyl. 5.7L	AV7
Cutlass Ciera		
1982	6 Cyl. 4.3L	AV7
Cutlass Cruiser		
1981-1980	8 Cyl. 5.7L	AV7

		Part No.
Air Management Regulators and Solenoids		
Idle Stop Solenoid		
98		
1983-1981	8 Cyl. 5.7L; Diesel	ES118
1980	8 Cyl.	ES123
Custom Cruiser		
1985	8 Cyl.	ES123
1983-1981	8 Cyl. 5.7L; Diesel	ES118
1980	8 Cyl.	ES123
Cutlass		
1981	8 Cyl. 5.7L; Diesel	ES118
Cutlass Calais		
1982	8 Cyl. 5.7L; Diesel	ES118
1980	8 Cyl. 5.7L	ES123
Cutlass Cruiser		
1981	8 Cyl. 5.7L; Diesel	ES118
1980	8 Cyl. 5.7L	ES123
Cutlass Supreme		
1983	8 Cyl. 5.7L; Diesel	ES118
Delta 88		
1983-1981	8 Cyl. 5.7L; Diesel	ES118
1980	8 Cyl.	ES123
Toronado		
1981	8 Cyl. 5.7L; Diesel	ES118
1980	8 Cyl. 5.7L; Spade Term. Connector; w/ Bracket	ES110
Early Fuel Emission Control		
Air Cleaner Inlet Hose		
98		
1984-1981	8 Cyl. 5.7L; N	DH40
Custom Cruiser		
1985-1982	8 Cyl. 5.7L; N	DH40
Cutlass Ciera		
1983	6 Cyl. 4.3L; 1st Design	DH34
Delta 88		
1985-1983	8 Cyl. 5.7L; N; Sedan	DH40
Toronado		
1985-1981	8 Cyl. 5.7L; N	DH40
1980	8 Cyl. 5.7L; N	DH34
Crankcase Ventilation Filter		
98		
1982	8 Cyl.; On Valve Cover	BF19
1981	8 Cyl. 5.7L	BF19
1980	8 Cyl.; On Valve Cover	BF19
Custom Cruiser		
1982	8 Cyl.; On Valve Cover	BF19
1981	8 Cyl. 5.7L	BF19
1980	8 Cyl.; On Valve Cover	BF19
Cutlass		
1981	8 Cyl.	BF19
1980	8 Cyl.; On Valve Cover	BF19
Cutlass Calais		
1982	6 Cyl.; In Air Cleaner	BF11
1982	6 Cyl.; On Valve Cover	BF18
1982-1980	8 Cyl.; On Valve Cover	BF19
Cutlass Ciera		
1982	6 Cyl.; In Air Cleaner	BF11
Cutlass Cruiser		
1982	8 Cyl.; On Valve Cover	BF19
1981	8 Cyl. 5.7L; On Valve Cover	BF19
1980	8 Cyl.; On Valve Cover	BF19

Early Fuel Emission Control

		Part No.
Crankcase Ventilation Filter		
Cutlass Salon		
1980	8 Cyl.; On Valve Cover	BF19
Cutlass Supreme		
1982	6 Cyl.; In Air Cleaner	BF11
1982	6 Cyl.; On Valve Cover	BF18
1982-1980	8 Cyl.; On Valve Cover	BF19
Delta 88		
1982	8 Cyl.; Sedan; On Valve Cover	BF19
1981	8 Cyl. 5.7L; Sedan	BF19
1980	8 Cyl.; Sedan; On Valve Cover	BF19
Toronado		
1982	8 Cyl.; On Valve Cover	BF19
1981	8 Cyl. 5.7L; On Valve Cover	BF19
1980	8 Cyl.; On Valve Cover	BF19
EGR Components		
EGR Valve		
Delta 88		
1980	8 Cyl. 5.7L; OE No. 17058338, 17061578	EGV339
1980	8 Cyl. 5.7L; OE No. 17061580	EGV340
Toronado		
1980	8 Cyl. 5.7L; Calif.; OE No. 17058325	EGV339
1980	8 Cyl. 5.7L; Fed.; OE No. 17061580	EGV340
EGR Valve Mounting Gasket		
98		
1980	8 Cyl. 5.7L	VG8
Custom Cruiser		
1980	8 Cyl.	VG8
Cutlass		
1980	8 Cyl. 5.7L	VG8
Cutlass Calais		
1984-1982	6 Cyl.	VG6
1984-1982	8 Cyl.	VG8
1981-1980	8 Cyl. 5.7L	VG8
Cutlass Ciera		
1983-1982	6 Cyl.	VG8
Cutlass Cruiser		
1982	8 Cyl.	VG8
1981	8 Cyl.	VG6
1980	8 Cyl.	VG8
Cutlass Supreme		
1982	8 Cyl.	VG8
Delta 88		
1980	8 Cyl. 5.7L	VG8
Toronado		
1980	8 Cyl. 5.7L	VG8
PCV Systems		
PCV Grommet		
98		
1985	6 Cyl. 4.3L; 23/32 Inch Inner Dia. x 1 1/4 Inch Outer Dia.	GV13
1985	6 Cyl. 4.3L; 7/16 Inch Inner Dia. x 1 1/4 Inch Outer Dia.	GV16
1985	6 Cyl. 4.3L; 7/16 Inch Inner Dia. x 1 3/4 Inch Outer Dia.	GV18
1985	6 Cyl. 4.3L; 11/16 Inch Inner Dia. x 1 3/16 Inch Outer Dia.	GV5
1985	6 Cyl. 4.3L; 1 Inch Inner Dia. x 1 1/2 Inch Outer Dia.	GV6
1985	6 Cyl. 4.3L; 23/32 Inch Inner Dia. x 1 Inch Outer Dia.	GV9
1984	8 Cyl. 5.7L; 23/32 Inch Inner Dia. x 1 1/4 Inch Outer Dia.	GV13

		Part No.
PCV Grommet		
98		
1984	8 Cyl. 5.7L; 7/16 Inch Inner Dia. x 1 1/4 Inch Outer Dia.	GV16
1984	8 Cyl. 5.7L; 7/16 Inch Inner Dia. x 1 3/4 Inch Outer Dia.	GV18
1984	8 Cyl. 5.7L; 11/16 Inch Inner Dia. x 1 3/16 Inch Outer Dia.	GV5
1984	8 Cyl. 5.7L; 1 Inch Inner Dia. x 1 1/2 Inch Outer Dia.	GV6
1984	8 Cyl. 5.7L; 23/32 Inch Inner Dia. x 1 Inch Outer Dia.	GV9
1983-1982	8 Cyl.	GV18
1981	8 Cyl. 5.7L; 23/32 Inch Inner Dia. x 1 1/4 Inch Outer Dia.	GV13
1981	8 Cyl. 5.7L; 7/16 Inch Inner Dia. x 1 1/4 Inch Outer Dia.	GV16
1981	8 Cyl. 5.7L; 7/16 Inch Inner Dia. x 1 3/4 Inch Outer Dia.	GV18
1981	8 Cyl. 5.7L; 7/16 Inch Inner Dia. x 1 3/4 Inch Outer Dia.	GV18
1981	8 Cyl. 5.7L; 11/16 Inch Inner Dia. x 1 3/16 Inch Outer Dia.	GV5
1981	8 Cyl. 5.7L; 1 Inch Inner Dia. x 1 1/2 Inch Outer Dia.	GV6
1981	8 Cyl. 5.7L; 23/32 Inch Inner Dia. x 1 Inch Outer Dia.	GV9
Custom Cruiser		
1985-1980	8 Cyl. 5.7L; 23/32 Inch Inner Dia. x 1 1/4 Inch Outer Dia.	GV13
1985-1980	8 Cyl. 5.7L; 7/16 Inch Inner Dia. x 1 1/4 Inch Outer Dia.	GV16
1985-1980	8 Cyl. 5.7L; 7/16 Inch Inner Dia. x 1 3/4 Inch Outer Dia.	GV18
1985-1980	8 Cyl. 5.7L; 11/16 Inch Inner Dia. x 1 3/16 Inch Outer Dia.	GV5
1985-1980	8 Cyl. 5.7L; 1 Inch Inner Dia. x 1 1/2 Inch Outer Dia.	GV6
1985-1980	8 Cyl. 5.7L; 23/32 Inch Inner Dia. x 1 Inch Outer Dia.	GV9
Cutlass		
1981	8 Cyl. 5.7L; 23/32 Inch Inner Dia. x 1 1/4 Inch Outer Dia.	GV13
1981	8 Cyl. 5.7L; 7/16 Inch Inner Dia. x 1 1/4 Inch Outer Dia.	GV16
1981	8 Cyl. 5.7L; 7/16 Inch Inner Dia. x 1 3/4 Inch Outer Dia.	GV18
1981	8 Cyl. 5.7L; 11/16 Inch Inner Dia. x 1 3/16 Inch Outer Dia.	GV5
1981	8 Cyl. 5.7L; 1 Inch Inner Dia. x 1 1/2 Inch Outer Dia.	GV6
1981	8 Cyl. 5.7L; 23/32 Inch Inner Dia. x 1 Inch Outer Dia.	GV9
1980	8 Cyl. 5.7L	GV18
Cutlass Calais		
1984-1982	6 Cyl. 4.3L; 23/32 Inch Inner Dia. x 1 1/4 Inch Outer Dia.	GV13
1984-1982	6 Cyl. 4.3L; 7/16 Inch Inner Dia. x 1 1/4 Inch Outer Dia.	GV16
1984-1982	6 Cyl. 4.3L; 7/16 Inch Inner Dia. x 1 3/4 Inch Outer Dia.	GV18
1984-1982	6 Cyl. 4.3L; 11/16 Inch Inner Dia. x 1 3/16 Inch Outer Dia.	GV5
1984-1982	6 Cyl. 4.3L; 1 Inch Inner Dia. x 1 1/2 Inch Outer Dia.	GV6
1984-1982	6 Cyl. 4.3L; 23/32 Inch Inner Dia. x 1 Inch Outer Dia.	GV9
1984-1981	8 Cyl. 5.7L; 23/32 Inch Inner Dia. x 1 1/4 Inch Outer Dia.	GV13
1984-1981	8 Cyl. 5.7L; 7/16 Inch Inner Dia. x 1 1/4 Inch Outer Dia.	GV16

PCV Systems

		Part No.
PCV Grommet		
Cutlass Calais		
1984-1981	8 Cyl. 5.7L; 7/16 Inch Inner Dia. x 1 3/4 Inch Outer Dia.	GV18
1984-1981	8 Cyl. 5.7L; 11/16 Inch Inner Dia. x 1 3/16 Inch Outer Dia.	GV5
1984-1981	8 Cyl. 5.7L; 1 Inch Inner Dia. x 1 1/2 Inch Outer Dia.	GV6
1984-1981	8 Cyl. 5.7L; 23/32 Inch Inner Dia. x 1 Inch Outer Dia.	GV9
Cutlass Ciera		
1985-1982	6 Cyl. 4.3L; 23/32 Inch Inner Dia. x 1 1/4 Inch Outer Dia.	GV13
1985-1982	6 Cyl. 4.3L; 7/16 Inch Inner Dia. x 1 1/4 Inch Outer Dia.	GV16
1985-1982	6 Cyl. 4.3L; 7/16 Inch Inner Dia. x 1 3/4 Inch Outer Dia.	GV18
1985-1982	6 Cyl. 4.3L; 11/16 Inch Inner Dia. x 1 3/16 Inch Outer Dia.	GV5
1985-1982	6 Cyl. 4.3L; 1 Inch Inner Dia. x 1 1/2 Inch Outer Dia.	GV6
1985-1982	6 Cyl. 4.3L; 23/32 Inch Inner Dia. x 1 Inch Outer Dia.	GV9
Cutlass Cruiser		
1983-1981	8 Cyl. 5.7L; 23/32 Inch Inner Dia. x 1 1/4 Inch Outer Dia.	GV13
1983-1981	8 Cyl. 5.7L; 7/16 Inch Inner Dia. x 1 1/4 Inch Outer Dia.	GV16
1983-1981	8 Cyl. 5.7L; 7/16 Inch Inner Dia. x 1 3/4 Inch Outer Dia.	GV18
1983-1981	8 Cyl. 5.7L; 11/16 Inch Inner Dia. x 1 3/16 Inch Outer Dia.	GV5
1983-1981	8 Cyl. 5.7L; 1 Inch Inner Dia. x 1 1/2 Inch Outer Dia.	GV6
1983-1981	8 Cyl. 5.7L; 23/32 Inch Inner Dia. x 1 Inch Outer Dia.	GV9
1980	8 Cyl. 5.7L	GV18
Cutlass Salon		
1985	8 Cyl. 5.7L; 23/32 Inch Inner Dia. x 1 1/4 Inch Outer Dia.	GV13
1985	8 Cyl. 5.7L; 7/16 Inch Inner Dia. x 1 1/4 Inch Outer Dia.	GV16
1985	8 Cyl. 5.7L; 7/16 Inch Inner Dia. x 1 3/4 Inch Outer Dia.	GV18
1985	8 Cyl. 5.7L; 11/16 Inch Inner Dia. x 1 3/16 Inch Outer Dia.	GV5
1985	8 Cyl. 5.7L; 1 Inch Inner Dia. x 1 1/2 Inch Outer Dia.	GV6
1985	8 Cyl. 5.7L; 23/32 Inch Inner Dia. x 1 Inch Outer Dia.	GV9
1980	8 Cyl. 5.7L; 23/32 Inch Inner Dia. x 1 1/4 Inch Outer Dia.	GV13
1980	8 Cyl. 5.7L; 7/16 Inch Inner Dia. x 1 1/4 Inch Outer Dia.	GV16
1980	8 Cyl. 5.7L; 7/16 Inch Inner Dia. x 1 3/4 Inch Outer Dia.	GV18
1980	8 Cyl. 5.7L; 11/16 Inch Inner Dia. x 1 3/16 Inch Outer Dia.	GV5
1980	8 Cyl. 5.7L; 1 Inch Inner Dia. x 1 1/2 Inch Outer Dia.	GV6
1980	8 Cyl. 5.7L; 23/32 Inch Inner Dia. x 1 Inch Outer Dia.	GV9
Cutlass Supreme		
1985-1981	8 Cyl. 5.7L; 23/32 Inch Inner Dia. x 1 1/4 Inch Outer Dia.	GV13
1985-1981	8 Cyl. 5.7L; 7/16 Inch Inner Dia. x 1 1/4 Inch Outer Dia.	GV16
1985-1981	8 Cyl. 5.7L; 7/16 Inch Inner Dia. x 1 3/4 Inch Outer Dia.	GV18

		Part No.
PCV Grommet		
Cutlass Supreme		
1985-1981	8 Cyl. 5.7L; 11/16 Inch Inner Dia. x 1 3/16 Inch Outer Dia.	GV5
1985-1981	8 Cyl. 5.7L; 1 Inch Inner Dia. x 1 1/2 Inch Outer Dia.	GV6
1985-1981	8 Cyl. 5.7L; 23/32 Inch Inner Dia. x 1 Inch Outer Dia.	GV9
1984-1982	6 Cyl. 4.3L; 23/32 Inch Inner Dia. x 1 1/4 Inch Outer Dia.	GV13
1984-1982	6 Cyl. 4.3L; 7/16 Inch Inner Dia. x 1 1/4 Inch Outer Dia.	GV16
1984-1982	6 Cyl. 4.3L; 7/16 Inch Inner Dia. x 1 3/4 Inch Outer Dia.	GV18
1984-1982	6 Cyl. 4.3L; 11/16 Inch Inner Dia. x 1 3/16 Inch Outer Dia.	GV5
1984-1982	6 Cyl. 4.3L; 1 Inch Inner Dia. x 1 1/2 Inch Outer Dia.	GV6
1984-1982	6 Cyl. 4.3L; 23/32 Inch Inner Dia. x 1 Inch Outer Dia.	GV9
1980	8 Cyl. 5.7L	GV18
Delta 88		
1985-1983	8 Cyl.	GV18
1982-1981	8 Cyl. 5.7L; 23/32 Inch Inner Dia. x 1 1/4 Inch Outer Dia.	GV13
1982-1981	8 Cyl. 5.7L; 7/16 Inch Inner Dia. x 1 1/4 Inch Outer Dia.	GV16
1982-1981	8 Cyl. 5.7L; 7/16 Inch Inner Dia. x 1 3/4 Inch Outer Dia.	GV18
1982-1981	8 Cyl. 5.7L; 11/16 Inch Inner Dia. x 1 3/16 Inch Outer Dia.	GV5
1982-1981	8 Cyl. 5.7L; 1 Inch Inner Dia. x 1 1/2 Inch Outer Dia.	GV6
1982-1981	8 Cyl. 5.7L; 23/32 Inch Inner Dia. x 1 Inch Outer Dia.	GV9
1980	8 Cyl. 5.7L	GV18
Toronado		
1985-1981	8 Cyl.	GV18
1980	8 Cyl. 5.7L	GV18
PCV Valve		
98		
1983-1982	8 Cyl.	V206
1981	8 Cyl. 5.7L	V353
1980	8 Cyl. 5.7L; N	V353
Custom Cruiser		
1981-1980	8 Cyl. 5.7L; Diesel	V353
Cutlass		
1981-1980	8 Cyl. 5.7L; Diesel	V353
Cutlass Calais		
1984-1983	6 Cyl. 4.3L	V206
1984-1983	8 Cyl. 5.7L	V206
1982-1980	8 Cyl. 5.7L; Diesel	V353
Cutlass Cruiser		
1981-1980	8 Cyl. 5.7L; Diesel	V353
Cutlass Salon		
1985	8 Cyl. 5.7L	V206
1980	8 Cyl. 5.7L; Diesel	V353
Cutlass Supreme		
1981	8 Cyl. 5.7L	V353
1980	8 Cyl. 5.7L; Diesel	V353
Delta 88		
1985-1983	8 Cyl.	V206
1981-1980	8 Cyl. 5.7L; Diesel	V353
Toronado		
1985-1982	8 Cyl.	V206
1981-1980	8 Cyl. 5.7L; Diesel	V353

Vapor and Purge Components

		Part No.
Vapor and Purge Components		
Fuel Vapor Canister		
Custom Cruiser		
1980	8 Cyl. 5.7L	CP1010
Toronado		
1980	8 Cyl. 5.7L	CP1010
Injectors		
Fuel Injector - Diesel - New		
Cutlass Calais		
1984	6 Cyl. 4.3L; V	FJ698
Cutlass Ciera		
1985-1984	6 Cyl. 4.3L	FJ698
Cutlass Supreme		
1984	6 Cyl. 4.3L; V	FJ698
Injection Components		
Diesel Glow Plug		
98		
1985	6 Cyl. 4.3L; Diesel	GP108
1984	8 Cyl. 5.7L; Diesel	GP108
1983-1980	8 Cyl. 5.7L; Diesel	GP103
Custom Cruiser		
1985-1984	8 Cyl. 5.7L	GP108
1983-1980	8 Cyl. 5.7L	GP103
Cutlass		
1981-1980	8 Cyl. 5.7L; N	GP103
Cutlass Calais		
1984	6 Cyl. 4.3L	GP108
1984	8 Cyl. 5.7L	GP108
1983	6 Cyl. 4.3L	GP103
1983	8 Cyl. 5.7L; N	GP103
1982	8 Cyl. 5.7L; Diesel	GP103
1981-1980	8 Cyl. 5.7L; N	GP103
Cutlass Ciera		
1985-1984	6 Cyl. 4.3L	GP108
1983-1982	6 Cyl. 4.3L	GP103
Cutlass Cruiser		
1980	8 Cyl. 5.7L; N	GP103
Cutlass Salon		
1985	8 Cyl. 5.7L	GP108
1980	8 Cyl. 5.7L; N	GP103
Cutlass Supreme		
1985-1984	8 Cyl. 5.7L	GP108
1984	6 Cyl. 4.3L	GP108
1983-1982	6 Cyl. 4.3L	GP103
1983-1982	8 Cyl. 5.7L; N	GP103
1981	8 Cyl. 5.7L; Diesel	GP103
1980	8 Cyl. 5.7L; N	GP103
Toronado		
1985-1984	8 Cyl. 5.7L	GP108
1983-1980	8 Cyl. 5.7L	GP103
Fuel Rail O-Ring Kit		
98		
1985	6 Cyl. 4.3L; Inlet and Outlet	SK18
1984-1981	8 Cyl. 5.7L; Inlet and Outlet	SK18
Custom Cruiser		
1985-1981	8 Cyl. 5.7L; Inlet and Outlet	SK18
Cutlass		
1981	8 Cyl. 5.7L; Inlet and Outlet	SK18
Cutlass Ciera		
1985-1982	6 Cyl. 4.3L; Inlet and Outlet	SK18
Cutlass Salon		
1985	8 Cyl. 5.7L; Inlet and Outlet	SK18

		Part No.
Fuel Rail O-Ring Kit		
Cutlass Supreme		
1985-1981	8 Cyl. 5.7L; Inlet and Outlet	SK18
1984-1982	6 Cyl. 4.3L; Inlet and Outlet	SK18
Delta 88		
1985-1981	8 Cyl. 5.7L; Inlet and Outlet	SK18
Toronado		
1985-1981	8 Cyl. 5.7L; Inlet and Outlet	SK18
Chassis and Drivetrain Sensors		
Automatic Transmission Output Sensor		
Cutlass Salon		
1985	8 Cyl. 5.7L	SC25
Manual Transmission Output Sensor		
Cutlass Salon		
1985	8 Cyl. 5.7L	SC25
Vehicle Speed Sensor		
Cutlass Salon		
1985	8 Cyl. 5.7L; Dash Mounted	SC25
Fuel Sensors		
Knock Sensor		
Cutlass Calais		
1983	6 Cyl.	KS2
Cutlass Ciera		
1985	6 Cyl.	KS2
Position Sensors		
Throttle Position Sensor		
Custom Cruiser		
1980	8 Cyl. 5.7L	TH1
Cutlass		
1980	8 Cyl. 5.7L	TH1
Pressure Sensors		
Barometric Pressure Sensor		
98		
1982	8 Cyl.	AS11
Cutlass Salon		
1980	8 Cyl.	AS11
Cutlass Supreme		
1981-1980	8 Cyl.	AS11
Toronado		
1983	8 Cyl. 5.7L; N; OE No.16006833, 16022790, 16038591	AS11
MAP Sensor		
98		
1985	6 Cyl. 4.3L	AS5
Cutlass Ciera		
1985-1984	6 Cyl. 4.3L; Calif.	AS5
Cutlass Salon		
1985	8 Cyl. 5.7L	AS5
Cutlass Supreme		
1985	8 Cyl. 5.7L	AS5
1984-1982	6 Cyl.	AS6
Toronado		
1985	8 Cyl. 5.7L	AS5
Temperature Sensors		
Diesel Glow Plug Control Sensor		
98		
1983-1981	8 Cyl. 5.7L; 6 Terminals	TX34
1983-1981	8 Cyl. 5.7L; 5 Terminals	TX36
Custom Cruiser		
1983-1981	8 Cyl. 5.7L; 6 Terminals	TX34

Temperature Sensors

		Part No.
Diesel Glow Plug Control Sensor		
Custom Cruiser		
1983-1981	8 Cyl. 5.7L; 5 Terminals	TX36
Cutlass		
1981-1980	8 Cyl.; 5 Terminals; Diesel	TX36
1981-1980	8 Cyl. 5.7L; N; 6 Terminals; Diesel	TX34
Cutlass Calais		
1983	6 Cyl. 4.3L; 5 Terminals	TX36
1983-1981	8 Cyl. 5.7L; 6 Terminals	TX34
1983-1981	8 Cyl. 5.7L; 5 Terminals	TX36
Cutlass Ciera		
1983-1982	6 Cyl. 4.3L	TX34
Cutlass Cruiser		
1983-1981	8 Cyl. 5.7L; 6 Terminals	TX34
1983-1981	8 Cyl. 5.7L; 5 Terminals	TX36
Cutlass Salon		
1980	8 Cyl.; 5 Terminals; Diesel	TX36
1980	8 Cyl. 5.7L; N; 6 Terminals; Diesel	TX34
Cutlass Supreme		
1983-1982	6 Cyl.; Diesel	TX36
1983-1980	8 Cyl.; 6 Terminals; Diesel	TX34
1983-1980	8 Cyl.; 5 Terminals; Diesel	TX36
Delta 88		
1983	8 Cyl. 5.7L; 6 Terminals; Sedan	TX34
1983	8 Cyl. 5.7L; 5 Terminals; Sedan	TX36
1982	8 Cyl. 5.7L; N; 6 Terminals	TX34
1982	8 Cyl. 5.7L; N; 5 Terminals	TX36
1981	8 Cyl. 5.7L; 6 Terminals; Sedan	TX34
1981	8 Cyl. 5.7L; 5 Terminals; Sedan	TX36
Toronado		
1983-1981	8 Cyl. 5.7L; 6 Terminals	TX34
1983-1981	8 Cyl. 5.7L; 5 Terminals	TX36
Intake Air Temperature Sensor		
Custom Cruiser		
1980	8 Cyl. 5.7L; Calif.; On Air Cleaner	ATS14
1980	8 Cyl. 5.7L; Fed.; On Air Cleaner	ATS5
Delta 88		
1980	8 Cyl.; Calif.; On Air Cleaner	ATS14
1980	8 Cyl.; Fed.; On Air Cleaner	ATS5
Body Light Switches		
Door Jamb Switch		
Custom Cruiser		
1985-1982	8 Cyl. 5.7L	DS-240
Headlight Switch		
Cutlass Cruiser		
1980	8 Cyl. 5.7L	TW-20
Turn Signal Switch Repair Kit		
Cutlass Calais		
1984-1982	6 Cyl. 4.3L	TW-83C
1984-1982	8 Cyl. 5.7L	TW-83C
Chassis and Drivetrain Switches		
Automatic Transmission Vacuum Modulator		
98		
1985	6 Cyl. 4.3L; MV4, MX2, MX3, MX5	TM-63
1983	8 Cyl. 5.7L; w/ TH250, TH350 Trans.	TM-37
1980	8 Cyl. 5.7L; N; w/ TH250, TH350 Trans.	TM-33
Custom Cruiser		
1983-1982	8 Cyl. 5.7L; w/ TH250, TH350 Trans.	TM-37
1981	8 Cyl. 5.7L; Calif.; w/ External EGR; w/ TH250, TH350 Trans.	TM-33
1981	8 Cyl. 5.7L; Fed.; w/ Int. EGR; w/ TH250, TH350 Trans.	TM-45
1980	8 Cyl. 5.7L; w/ TH250, TH350 Trans.	TM-33

		Part No.
Automatic Transmission Vacuum Modulator		
Cutlass		
1980	8 Cyl. 5.7L; N; Calif.; w/ TH250, TH350 Trans.	TM40
Cutlass Calais		
1983-1982	8 Cyl. 5.7L; w/ TH250, TH350 Trans.	TM-37
1980	8 Cyl. 5.7L; N; w/ TH250, TH350 Trans.	TM40
Cutlass Ciera		
1985	6 Cyl. 4.3L; MV4, MX2, MX3, MX5	TM-63
1984	6 Cyl. 4.3L; Diesel; w/ 4 Speed TH440 Trans.	TM-58
Cutlass Cruiser		
1983-1982	8 Cyl. 5.7L; w/ TH250, TH350 Trans.	TM-37
1981	8 Cyl. 5.7L; Calif.; w/ External EGR; w/ TH250, TH350 Trans.	TM-33
Cutlass Salon		
1985	8 Cyl. 5.7L; MV4, MX2, MX3, MX5	TM-63
Cutlass Supreme		
1983-1982	8 Cyl. 5.7L; w/ TH250, TH350 Trans.	TM-37
1981	8 Cyl. 5.7L; w/ TH250, TH350 Trans.	TM-33
1980	8 Cyl. 5.7L; N; Calif.; w/ TH250, TH350 Trans.	TM-33
Delta 88		
1985	8 Cyl. 5.7L; MV4, MX2, MX3, MX5	TM-63
1981	8 Cyl. 5.7L; w/ External EGR; w/ TH250, TH350 Trans.	TM-33
1981	8 Cyl. 5.7L; w/ Int. EGR; w/ TH250, TH350 Trans.	TM-45
1980	8 Cyl. 5.7L; N	TM-33
Toronado		
1985	8 Cyl. 5.7L; MV4, MX2, MX3, MX5	TM-63
1983-1982	8 Cyl. 5.7L; w/ TH250, TH350 Trans.	TM-37
1981	8 Cyl.; No Color Mark	TM-33
1981	8 Cyl.; w/ Brown Stripe	TM-45
Neutral Safety Switch		
Custom Cruiser		
1985-1982	8 Cyl. 5.7L	NS-41
1981	8 Cyl. 5.7L	NS-21
Transmission Control Solenoid		
98		
1980	8 Cyl. 5.7L	TCS20
Delta 88		
1980	8 Cyl. 5.7L	TCS20
Toronado		
1981-1980	8 Cyl. 5.7L	TCS20
Interior Power Switches		
Cruise Control Release Switch		
Cutlass Calais		
1983-1982	6 Cyl. 4.3L	SLS-234
1983-1982	8 Cyl. 5.7L	SLS-234
Cutlass Ciera		
1985-1982	6 Cyl. 4.3L	SLS-234
Delta 88		
1984-1982	8 Cyl. 5.7L	SLS-234
Cruise Control Switch		
98		
1984	8 Cyl. 5.7L; w/ Intermittent Wipers	DS-1534
Cutlass Ciera		
1985	6 Cyl. 4.3L; w/ Intermittent Wipers	DS-1534
Delta 88		
1985-1984	8 Cyl. 5.7L; w/ Intermittent Wipers	DS-1534
Toronado		
1985-1984	8 Cyl. 5.7L; w/ Intermittent Wipers	DS-1534

Interior Power Switches

		Part No.
Parking Brake Switch		
Cutlass Calais		
1984-1982	6 Cyl. 4.3L	DS-905
1984-1982	8 Cyl. 5.7L	DS-905
Trunk Release Switch		
Custom Cruiser		
1982-1980	8 Cyl. 5.7L	DS-2153
Cutlass		
1981-1980	8 Cyl. 5.7L	DS-2153
Cutlass Calais		
1983-1982	6 Cyl. 4.3L	DS-2153
1983-1982	8 Cyl. 5.7L	DS-2153
Cutlass Cruiser		
1982-1980	8 Cyl. 5.7L	DS-2153
Toronado		
1981-1980	8 Cyl. 5.7L	DS-2153
Pressure and Vacuum Sending Switches		
Oil Pressure Gauge Switch		
98		
1985	6 Cyl. 4.3L	PS-155
Cutlass Ciera		
1985	6 Cyl.	PS-155
1984-1983	6 Cyl.; w/ 60 PSI Gauge	PS-154
1984-1983	6 Cyl.; w/ 80 PSI Gauge	PS-155
1982	6 Cyl.	PS-154
Oil Pressure Light Switch		
98		
1985	6 Cyl. 4.3L	PS-12
1983-1982	8 Cyl. 5.7L	PS-12
Cutlass		
1981-1980	8 Cyl. 5.7L	PS-12
Cutlass Ciera		
1985-1982	6 Cyl. 4.3L	PS-12
Cutlass Salon		
1985	8 Cyl. 5.7L	PS-12
Cutlass Supreme		
1985-1981	8 Cyl. 5.7L	PS-12
1984-1983	6 Cyl. 4.3L	PS-12
Delta 88		
1985-1984	8 Cyl. 5.7L	PS-12
1982-1981	8 Cyl. 5.7L	PS-12
1980	8 Cyl.	PS-12
Toronado		
1984-1981	8 Cyl. 5.7L	PS-12
Ported Vacuum Switch		
98		
1981	8 Cyl. 5.7L; 3 Ports; Blue; Diesel	PVS50
1980	8 Cyl. 5.7L; 6 Ports; 7 Term.; Black Finish	PVS104
1980	8 Cyl. 5.7L; 3 Ports; Green	PVS133
1980	8 Cyl. 5.7L; 2 Ports; Orange	PVS146
1980	8 Cyl. 5.7L; 4 Ports; Black Finish	PVS167
1980	8 Cyl. 5.7L; 3 Ports; Blue	PVS50
1980	8 Cyl. 5.7L; 3 Ports; Black Finish	PVS54
1980	8 Cyl. 5.7L; 2 Ports; Blue	PVS87
Custom Cruiser		
1981-1980	8 Cyl. 5.7L; 3 Ports; Blue	PVS50
1980	8 Cyl. 5.7L; 6 Ports; 7 Term.; Black Finish	PVS104
1980	8 Cyl. 5.7L; 3 Ports; Green	PVS133
1980	8 Cyl. 5.7L; 2 Ports; Orange	PVS146
1980	8 Cyl. 5.7L; 2 Ports; Black Finish; OE No. 10012354	PVS166
1980	8 Cyl. 5.7L; 4 Ports; Black Finish	PVS167
1980	8 Cyl. 5.7L; 3 Ports; Black Finish	PVS54

		Part No.
Ported Vacuum Switch		
Cutlass		
1981-1980	8 Cyl. 5.7L; 3 Ports; Blue	PVS50
1980	8 Cyl. 5.7L; 6 Ports; 7 Term.; Black Finish	PVS104
1980	8 Cyl. 5.7L; 2 Ports; Orange	PVS146
1980	8 Cyl. 5.7L; 2 Ports; Black Finish; OE No. 10012354	PVS166
1980	8 Cyl. 5.7L; 4 Ports; Black Finish	PVS167
1980	8 Cyl. 5.7L; 3 Ports; Black Finish	PVS54
Cutlass Calais		
1980	8 Cyl. 5.7L; 2 Ports; Black Finish; OE No. 10012354	PVS166
Cutlass Ciera		
1984	6 Cyl. 4.3L; 3 Ports; Black w/ Blue Top; Diesel	PVS135
Cutlass Cruiser		
1980	8 Cyl. 5.7L; 2 Ports; Black Finish; OE No. 10012354	PVS166
Cutlass Salon		
1980	8 Cyl. 5.7L; 2 Ports; Orange	PVS146
1980	8 Cyl. 5.7L; 2 Ports; Black Finish; OE No. 10012354	PVS166
Cutlass Supreme		
1981	8 Cyl. 5.7L; Diesel	PVS50
1980	8 Cyl. 5.7L; 4 Ports; Black Finish; Diesel	PVS167
1980	8 Cyl. 5.7L; 3 Ports; Blue; Diesel	PVS50
1980	8 Cyl. 5.7L; 3 Ports; Black Finish; Diesel	PVS54
Delta 88		
1981	8 Cyl. 5.7L; 3 Ports; Blue; Diesel	PVS50
1980	8 Cyl. 5.7L; 6 Ports; 7 Term.; Black Finish	PVS104
1980	8 Cyl. 5.7L; 3 Ports; Green	PVS133
1980	8 Cyl. 5.7L; 2 Ports; Orange	PVS146
1980	8 Cyl. 5.7L; 4 Ports; Black Finish	PVS167
1980	8 Cyl. 5.7L; 3 Ports; Blue	PVS50
1980	8 Cyl. 5.7L; 3 Ports; Black Finish	PVS54
1980	8 Cyl. 5.7L; 2 Ports; Blue	PVS87
Toronado		
1981	8 Cyl. 5.7L; 3 Ports; Blue; Diesel	PVS50
1980	8 Cyl. 5.7L; 6 Ports; 7 Term.; Black Finish	PVS104
1980	8 Cyl. 5.7L; 3 Ports; Green	PVS133
1980	8 Cyl. 5.7L; 2 Ports; Orange	PVS146
1980	8 Cyl. 5.7L; 4 Ports; Black Finish	PVS167
1980	8 Cyl. 5.7L; 3 Ports; Blue	PVS50
1980	8 Cyl. 5.7L; 3 Ports; Black Finish	PVS54
1980	8 Cyl. 5.7L; 2 Ports; Blue	PVS87
Temperature Switches and Senders		
A/C and Heater Selector Switch		
98		
1981	8 Cyl. 5.7L	HS-316
Coolant Fan Switch		
Cutlass Ciera		
1985	6 Cyl. 4.3L	TS240
1982	6 Cyl. 4.3L	TS240
Temperature Sender - With Gauge		
Custom Cruiser		
1982-1980	8 Cyl.; 1/2 Inch x 14 Thread	TS-71
1982-1980	8 Cyl.; 3/8 Inch x 18 Thread	TS-76
Cutlass Ciera		
1985	6 Cyl. 4.3L; w/ Gauge	TS-168
1984	6 Cyl. 4.3L	TS-168
1982	6 Cyl.; 1/2 Inch x 14 Thread	TS-71
1982	6 Cyl.; 3/8 Inch x 18 Thread	TS-76
Cutlass Cruiser		
1983	8 Cyl.	TS-71

Temperature Switches and Senders

		Part No.
Temperature Sender - With Gauge		
Cutlass Supreme		
1983	8 Cyl.	TS-71
1983	6 Cyl.	TS-76
Delta 88		
1983	8 Cyl.; 1/2 Inch x 14 Thread	TS-71
1983	8 Cyl.; 3/8 Inch x 18 Thread	TS-76
Temperature Sender - With Light		
Custom Cruiser		
1984	8 Cyl.	TS-169
1983-1982	8 Cyl.	TS-66
Cutlass Calais		
1980	8 Cyl. 5.7L; N; 3/8 Inch x 18 Thread; Diesel	TS-66
Cutlass Ciera		
1985-1984	6 Cyl. 4.3L; 3/8 Inch x 18 Thread	TS-169
1983-1982	6 Cyl. 4.3L; 3/8 Inch x 18 Thread	TS-66
Cutlass Supreme		
1985	8 Cyl. 5.7L; 3/8 Inch x 18 Thread; Diesel	TS-169
Delta 88		
1985-1984	8 Cyl. 5.7L; 3/8 Inch x 18 Thread	TS-169
1983	8 Cyl. 5.7L; 3/8 Inch x 18 Thread	TS-66
Toronado		
1982-1981	8 Cyl. 5.7L; 3/8 Inch x 18 Thread	TS-66
Actuators		
Power Door Lock Actuator		
98		
1985	6 Cyl. 4.3L	DLA-1
1984-1980	8 Cyl. 5.7L	DLA-1
Cutlass Calais		
1984-1982	6 Cyl. 4.3L	DLA-1
1984-1982	8 Cyl. 5.7L	DLA-1
Cutlass Ciera		
1985-1982	6 Cyl. 4.3L	DLA-1
Cutlass Supreme		
1985	8 Cyl. 5.7L	DLA-1
1981-1980	8 Cyl. 5.7L	DLA-1
Delta 88		
1985-1980	8 Cyl. 5.7L	DLA-1
Toronado		
1985-1980	8 Cyl. 5.7L	DLA-1
Oshkosh Motor Truck Co.		
Pressure Sensors		
Air Inlet Pressure Sensor		
S		
2001-2000	6 Cyl. 12.0L	PS711
Diesel Particulate Filter (DPF) Pressure Sensor		
H		
2011	ISX 15.0 Eng.	DPS101
S		
2011	ISX 15.0 Eng.	DPS101
Temperature Sensors		
Exhaust Gas Temperature Sensor		
H		
2011	ISX 15.0 Eng.	ETS223
S		
2011	ISX 15.0 Eng.	ETS223

		Part No.
Peterbilt		
Starting and Charging System Parts		
Voltage Regulator		
224		
1991	6 Cyl. 8.3L	VR-144
1990	6 Cyl. 8.3L; 80 Amp; 90 Amp Alternator; Delco Alternator	VR-144
1989-1987	6 Cyl. 8.3L; 80 Amp; Alt. No. 1105465; Delco Alternator	VR-144
1989-1987	6 Cyl. 8.3L; 90 Amp; Alt. No. 1117481, 1117732, 11177801; Delco Alternator	VR-144
227		
1991	6 Cyl. 8.3L	VR-144
1990	6 Cyl. 8.3L; 80 Amp; Delco Alternator	VR-144
1990	6 Cyl. 8.3L; 90 Amp; Delco Alternator	VR-144
265		
1991	6 Cyl. 8.3L	VR-144
1990	6 Cyl. 8.3L; 80 Amp; Delco Alternator	VR-144
1990	6 Cyl. 8.3L; 90 Amp; Delco Alternator	VR-144
1989-1988	6 Cyl. 8.3L; 80 Amp; Alt. No. 1105465; Delco Alternator	VR-144
1989-1988	6 Cyl. 8.3L; 90 Amp; Alt. No. 1117481, 1117732, 11177801; Delco Alternator	VR-144
282		
1980	6 Cyl. 14.0L; 65 Amp; Alt. No. 1100080, 1100081, 1105465; Delco Alternator	VR-144
1980	6 Cyl. 14.0L; 80 Amp; Alt. No. 1100080, 1100081, 1105465; Delco Alternator	VR-144
1980	6 Cyl. 14.0L; 80 Amp; Alt. No. 1105465; Delco Alternator	VR-144
1980	6 Cyl. 14.0L; 90 Amp; Alt. No. 1117481, 1117732, 11177801; Delco Alternator	VR-144
1980	6 Cyl. 18.8L; 65 Amp; Alt. No. 1100080, 1100081, 1105465; Delco Alternator	VR-144
1980	6 Cyl. 18.8L; 80 Amp; Alt. No. 1100080, 1100081, 1105465; Delco Alternator	VR-144
1980	6 Cyl. 18.8L; 80 Amp; Alt. No. 1105465; Delco Alternator	VR-144
1980	6 Cyl. 18.8L; 90 Amp; Alt. No. 1117481, 1117732, 11177801; Delco Alternator	VR-144
Fluid Level Sensors		
Coolant Level Sensor		
335		
2010-2008	6 Cyl. 6.7L	FLS309
2010-2008	6 Cyl. 8.3L	FLS309
388		
2015	ISX 15.0 Eng.	FLS309
2015-2011	6 Cyl. 11.9L	FLS309
2015-2011	6 Cyl. 12.9L	FLS309
2011-2008	ISX 15.0 Eng.	FLS309
2011-2008	6 Cyl. 10.8L	FLS309
2011-2008	6 Cyl. 12.5L	FLS309
2009	6 Cyl. 12.7L	FLS309
389		
2018-2015	6 Cyl. 11.9L	FLS309
2018-2012	6 Cyl. 12.9L	FLS309
2018-2008	ISX 15.0 Eng.	FLS309
2010	6 Cyl. 12.7L	FLS309
Pressure Sensors		
Air Inlet Pressure Sensor		
357		
2001-1999	6 Cyl. 12.0L	PS711
362		
2001-1999	6 Cyl. 12.0L	PS711

Pressure Sensors

		Part No.
Air Inlet Pressure Sensor		
377		
2001-2000	6 Cyl. 12.0L	PS711
378		
2001-1999	6 Cyl. 12.0L	PS711
379		
2001-2000	6 Cyl. 12.0L	PS711
385		
2001-1999	6 Cyl. 12.0L	PS711
387		
2001-2000	6 Cyl. 12.0L	PS711
Diesel Particulate Filter (DPF) Pressure Sensor		
320		
2017	6 Cyl. 11.9L	DPS101
2015-2011	6 Cyl. 11.9L	DPS101
2014-2010	6 Cyl. 8.9L	DPS101
2011	ISX 15.0 Eng.	DPS101
365		
2017	6 Cyl. 11.9L	DPS101
2015-2011	6 Cyl. 11.9L	DPS101
2014-2010	6 Cyl. 8.9L	DPS101
2011	ISX 15.0 Eng.	DPS101
367		
2017	ISX 15.0 Eng.	DPS101
2017	6 Cyl. 11.9L	DPS101
2015-2011	6 Cyl. 11.9L	DPS101
2015-2010	ISX 15.0 Eng.	DPS101
382		
2014-2011	6 Cyl. 8.9L	DPS101
384		
2015-2011	ISX 15.0 Eng.	DPS101
2015-2011	6 Cyl. 11.9L	DPS101
2013-2011	6 Cyl. 8.9L	DPS101
386		
2015-2010	ISX 15.0 Eng.	DPS101
2014-2011	6 Cyl. 11.9L	DPS101
387		
2011-2010	ISX 15.0 Eng.	DPS101
388		
2015-2011	6 Cyl. 11.9L	DPS101
2015-2010	ISX 15.0 Eng.	DPS101
389		
2017	ISX 15.0 Eng.	DPS101
2017	6 Cyl. 11.9L	DPS101
2015	6 Cyl. 11.9L	DPS101
2015-2010	ISX 15.0 Eng.	DPS101
520		
2017	6 Cyl. 11.9L	DPS101
567		
2017	ISX 15.0 Eng.	DPS101
2017	6 Cyl. 11.9L	DPS101
2015-2014	ISX 15.0 Eng.	DPS101
2015-2014	6 Cyl. 11.9L	DPS101
579		
2017	ISX 15.0 Eng.	DPS101
2017	6 Cyl. 11.9L	DPS101
2015-2014	6 Cyl. 11.9L	DPS101
2015-2013	ISX 15.0 Eng.	DPS101
587		
2017	ISX 15.0 Eng.	DPS101
2015-2011	ISX 15.0 Eng.	DPS101

		Part No.
Fuel Pressure Sensor		
379		
2007-2001	ISX 15.0 Eng.	FPS61
Injection Actuation Pressure Sensor		
320		
2000-1999	6 Cyl. 7.2L	PS713
330		
2000-1999	6 Cyl. 7.2L	PS713
378		
1999	6 Cyl. 7.2L	PS713
379		
2000-1999	6 Cyl. 7.2L	PS713
387		
2000	6 Cyl. 7.2L	PS713
MAP Sensor		
587		
2017-2011	ISX 15.0 Eng.	AS534
Turbocharger Boost Sensor		
367		
2009-2008	6 Cyl. 15.8L; Turbocharged	AS539
Temperature Sensors		
Exhaust Gas Temperature Sensor		
365		
2009-2008		ETS223
367		
2011-2008		ETS223
384		
2009		ETS223
385		
2008	6 Cyl.	ETS223
386		
2011-2008	ISX 15.0 Eng.	ETS223
387		
2011-2008	ISX 15.0 Eng.	ETS223
388		
2011-2008	ISX 15.0 Eng.	ETS223
389		
2011-2008	ISX 15.0 Eng.	ETS223
587		
2011	ISX 15.0 Eng.	ETS223
Body Light Switches		
Headlight Dimmer Switch		
282		
1980		DS-72
Pressure and Vacuum Sending Switches		
Oil Pressure Gauge Switch		
320		
2017-2008	6 Cyl. 8.9L	PS-407
337		
2017	6 Cyl. 8.9L	PS-407
348		
2017	6 Cyl. 8.9L	PS-407
365		
2017-2010	6 Cyl. 8.9L	PS-407
382		
2015-2013	6 Cyl. 8.9L	PS-407
384		
2015-2011	6 Cyl. 8.9L	PS-407

Temperature Switches and Senders

		Part No.
Temperature Switches and Senders		
A/C and Heater Blower Motor Switch		
359		
1988-1986		HS569
Peugeot		
Starting and Charging System Parts		
Voltage Regulator		
505		
1983	4 Cyl. 2.3L	VR-471
Air Management Valves		
Air Cleaner Check Valve		
504		
1983		AV7
1980		AV7
Auxiliary Air Valve		
504		
1982-1981	4 Cyl. 2.3L	AV50
Injection Components		
Diesel Glow Plug		
504		
1983-1980	4 Cyl. 2.3L	GP106
505		
1988-1985	4 Cyl. 2.5L	GP106
1986-1980	4 Cyl. 2.3L	GP106
604		
1984-1982	4 Cyl. 2.3L; Diesel	GP106
Chassis and Drivetrain Sensors		
ABS Speed Sensor		
Partner		
2012-2009	4 Cyl. 1.6L; Front	ALS3235
Fuel Sensors		
Knock Sensor		
505		
1984	4 Cyl. 2.3L	KS18
Body Light Switches		
Back-Up Light Switch		
504		
1983-1980	w/ M.T.	LS-344
604		
1984-1982	w/ M.T.	LS-344
Stoplight Switch		
504		
1983-1980		SLS-170
505		
1988	w/ ABS	SLS-276
Turn Signal Switch		
504		
1982		TW-86
604		
1982		TW-86
Chassis and Drivetrain Switches		
Fuel Pump Cut-Off Switch		
504		
1983-1980	Universal; w/ Electric Fuel Pump	FV-7
604		
1984-1982	Universal; w/ Electric Fuel Pump	FV-7

		Part No.
Pressure and Vacuum Sending Switches		
Oil Pressure Light Switch		
504		
1983-1980		PS-331
505		
1987-1986	4 Cyl. 2.5L	PS-362
1985	4 Cyl. 2.5L	PS-331
604		
1984-1982		PS-331
Temperature Switches and Senders		
Coolant Fan Switch		
504		
1983-1981	4 Cyl. 2.3L	TS-504
1980	2 Term.	TS-500
1980	3 Term.	TS-504
505		
1985-1984	4 Cyl. 2.3L	TS514
1982-1980	4 Cyl. 2.3L	TS-500
604		
1984-1982	4 Cyl. 2.3L	TS-262
Temperature Sender - With Gauge		
504		
1983		TS-286
604		
1984-1982		TS-286
Temperature Sender - With Light		
504		
1982		TS-518
1981-1980		TS-521
604		
1984-1982		TS-519
Pierce Mfg. Inc.		
Pressure Sensors		
Diesel Particulate Filter (DPF) Pressure Sensor		
Arrow XT		
2014	6 Cyl. 11.9L	DPS101
2014-2013	6 Cyl. 8.9L	DPS101
2011-2010	6 Cyl. 8.9L	DPS101
Custom		
2012	6 Cyl. 11.9L	DPS101
2012-2010	6 Cyl. 8.9L	DPS101
Dash CF		
2014	6 Cyl. 8.9L	DPS101
Enforcer		
2011-2010	6 Cyl. 8.9L	DPS101
Impel		
2014-2013	6 Cyl. 8.9L	DPS101
2011-2010	6 Cyl. 8.9L	DPS101
Saber		
2014-2013	6 Cyl. 8.9L	DPS101
2011-2010	6 Cyl. 8.9L	DPS101
Velocity		
2014-2013	6 Cyl. 8.9L	DPS101
2014-2013	6 Cyl. 11.9L	DPS101
2011-2010	6 Cyl. 8.9L	DPS101
Pontiac		
Relays and Fuses		
A/C Compressor Clutch Cut-Off Relay		
6000		
1985	6 Cyl. 4.3L; OE No.10019535	RY-32

Relays and Fuses

		Part No.
A/C Compressor Clutch Cut-Off Relay		
6000		
1985-1984	6 Cyl. 4.3L; OE No.10022960	RY-85
Parisienne		
1985	8 Cyl. 5.7L; OE No.10022960	RY-85
Air Control Valve Relay		
Acadian		
1981	4 Cyl. 1.8L	RY-23
Anti-Dieseling Relay		
Bonneville		
1981-1980	8 Cyl. 5.7L; Diesel	RY-138
Catalina		
1981-1980	8 Cyl. 5.7L; Diesel	RY-138
Grand Prix		
1981	8 Cyl. 5.7L; Diesel	RY-138
Laurentian		
1981	8 Cyl. 5.7L; Diesel	RY-138
Parisienne		
1981-1980	8 Cyl. 5.7L; Diesel	RY-138
Automatic Choke Relay		
6000		
1983-1982	6 Cyl. 4.3L	RY-144
Bonneville		
1981-1980	8 Cyl. 5.7L	RY-144
Catalina		
1981-1980	8 Cyl. 5.7L	RY-144
Blower Motor Cut-Off Relay		
6000		
1983	6 Cyl. 4.3L	RY-22
Blower Motor Relay		
Parisienne		
1981	8 Cyl. 5.7L; Stamping No. 10018449	RY-20
Coolant Fan Relay		
6000		
1985-1982	6 Cyl. 4.3L	RY496
Diesel Glow Plug Indicator Relay		
6000		
1983-1982	6 Cyl. 4.3L; Diesel	RY-138
Parisienne		
1983	8 Cyl. 5.7L; Diesel	RY-138
Diesel Glow Plug Relay		
Bonneville		
1984	8 Cyl. 5.7L; N	RY204
1983-1980	8 Cyl. 5.7L; Diesel; Solenoid Type	SS-591
Catalina		
1981-1980	8 Cyl. 5.7L; Diesel; Solenoid Type	SS-591
Grand Prix		
1984	8 Cyl. 5.7L; N	RY204
1983-1981	8 Cyl. 5.7L; Diesel; Solenoid Type	SS-591
Diesel Wait Lamp Relay		
6000		
1983-1982	6 Cyl. 4.3L; Diesel	RY-138
Bonneville		
1981-1980	8 Cyl. 5.7L; Diesel	RY-138
Catalina		
1981-1980	8 Cyl. 5.7L; Diesel	RY-138
Grand Prix		
1981	8 Cyl. 5.7L; Diesel	RY-138
Parisienne		
1983	8 Cyl. 5.7L; Diesel	RY-138
1981-1980	8 Cyl. 5.7L; Diesel	RY-138

		Part No.
Fast Idle Solenoid Relay		
Bonneville		
1982-1980	8 Cyl. 5.7L; Canada; Export	RY-8
Grand LeMans		
1982	8 Cyl. 5.7L; Canada; Export	RY-8
Grand Prix		
1982-1981	8 Cyl. 5.7L; Canada; Export	RY-8
Fuel Pump Relay		
6000		
1984	6 Cyl. 4.3L; Diesel; Fed.; High Altitude	RY-85
Grand Prix		
1984	8 Cyl. 5.7L; Diesel; Fed.; High Altitude	RY-85
Starting and Charging System Parts		
Starter Solenoid		
6000		
1985-1984	6 Cyl. 4.3L; Diesel; Mitsubishi	SS-306
1983	6 Cyl. 4.3L; Delco ⁶	SS-251
1983	6 Cyl. 4.3L; Mitsubishi	SS-306
1982	6 Cyl. 4.3L; Str. No. 1998553 ⁶	SS-251
1982	6 Cyl. 4.3L; Str. No. 22515863	SS-306
Acadian		
1986	4 Cyl. 1.8L; Canada	SS-300
1985-1982	4 Cyl. 1.8L	SS-300
1981	4 Cyl. 1.8L	SS-200
Catalina		
1981-1980	8 Cyl. 5.7L ^{5, 6}	SS-200
Grand LeMans		
1983-1982	8 Cyl. 5.7L ⁶	SS-251
Parisienne		
1985-1984	8 Cyl. 5.7L	SS-251
1983-1982	8 Cyl. 5.7L ⁶	SS-251
1981-1980	8 Cyl. 5.7L ^{5, 6}	SS-200
Air Injection and Induction Parts		
Vacuum Motor		
Acadian		
1986-1982	4 Cyl. 1.8L	VA23
Laurentian		
1980	8 Cyl. 5.7L	VA5
Parisienne		
1985	8 Cyl. 5.7L; Canada; Export	VA5
1980	8 Cyl. 5.7L	VA5
Vacuum Pump		
6000		
1985-1984	6 Cyl. 4.3L; Sedan; w/ AC	VCP100
1983-1982	6 Cyl. 4.3L; w/ AC	VCP100
Air Management Valves		
Air Cleaner Check Valve		
Catalina		
1980	8 Cyl. 5.7L	AV7
Auxiliary Air Valve		
Acadian		
1986-1982	4 Cyl. 1.8L	AC1
Diverter Valve		
Acadian		
1982	4 Cyl. 1.8L; OE No. 17082701	DV90
1982	4 Cyl. 1.8L; OE No. 17082700	DV91
1982	4 Cyl. 1.8L; OE No. 17070639	DV95
Idle Air Control Valve		
6000		
1985	6 Cyl. 4.3L	AC1

⁵ Standard Unit ⁶ Use Heavy Duty Version Only

Air Management Valves

		Part No.
Idle Air Control Valve		
Acadian		
1986-1982	4 Cyl. 1.8L	AC1
Air Management Regulators and Solenoids		
Idle Stop Solenoid		
Bonneville		
1983	8 Cyl.; Diesel	ES118
1981	8 Cyl.; Diesel	ES118
1980	8 Cyl.; Diesel; Stamping No. 22507441, 22511974	ES118
Catalina		
1981	8 Cyl.; Diesel	ES118
1980	8 Cyl.; Diesel; Stamping No. 22507441, 22511974	ES118
Grand LeMans		
1983	8 Cyl.; Diesel	ES118
1982	8 Cyl.	ES110
Grand Prix		
1983	8 Cyl.; Diesel	ES118
1981	8 Cyl.; Diesel	ES118
Laurentian		
1981	8 Cyl.; Diesel	ES118
1980	8 Cyl.; Diesel; Stamping No. 22507441, 22511974	ES118
Parisienne		
1985	8 Cyl.	ES110
1983	8 Cyl.; Diesel	ES118
1982	8 Cyl.	ES110
1981	8 Cyl.; Diesel	ES118
1980	8 Cyl.; Diesel; Stamping No. 22507441, 22511974	ES118
Early Fuel Emission Control		
Air Cleaner Inlet Hose		
6000		
1983	6 Cyl. 4.3L; 1st Design	DH34
1982	6 Cyl. 4.3L	DH34
Bonneville		
1984-1983	8 Cyl. 5.7L; N	DH40
Crankcase Ventilation Filter		
Bonneville		
1981	8 Cyl.; On Valve Cover	BF19
Catalina		
1981-1980	8 Cyl.; On Valve Cover	BF19
Grand Prix		
1981	8 Cyl. 5.7L; N; On Valve Cover	BF19
Laurentian		
1981	8 Cyl. 5.7L; On Valve Cover	BF19
1980	8 Cyl.; On Valve Cover	BF19
Parisienne		
1981	8 Cyl. 5.7L; On Valve Cover	BF19
1980	8 Cyl.; On Valve Cover	BF19
EGR Components		
EGR Valve		
Bonneville		
1980	8 Cyl. 5.7L; OE No. 17062858, 17064437	EGV335
1980	8 Cyl. 5.7L; Calif.; OE No. 17061578; w/o 2.41 Axle Ratio	EGV339
1980	8 Cyl. 5.7L; Calif.; OE No. 17061580; w/ 2.41 Axle Ratio	EGV340
1980	8 Cyl. 5.7L; OE No. 17062873	EGV344
Catalina		
1980	8 Cyl. 5.7L; Calif.; OE No. 17061578; w/o 2.41 Axle Ratio	EGV339

		Part No.
EGR Valve		
Catalina		
1980	8 Cyl. 5.7L; Calif.; OE No. 17061580; w/ 2.41 Axle Ratio	EGV340
1980	8 Cyl. 5.7L; OE No. 17062873	EGV344
Parisienne		
1980	8 Cyl. 5.7L; OE No. 17062858, 17064437; Sedan	EGV335
1980	8 Cyl. 5.7L; OE No. 17062873; Wagon	EGV344
EGR Valve Mounting Gasket		
Laurentian		
1980	8 Cyl. 5.7L	VG6
Parisienne		
1980	8 Cyl. 5.7L	VG6
PCV Systems		
PCV Grommet		
6000		
1984-1982	6 Cyl. 4.3L; 23/32 Inch Inner Dia. x 1 1/4 Inch Outer Dia.	GV13
1984-1982	6 Cyl. 4.3L; 7/16 Inch Inner Dia. x 1 1/4 Inch Outer Dia.	GV16
1984-1982	6 Cyl. 4.3L; 7/16 Inch Inner Dia. x 1 3/4 Inch Outer Dia.	GV18
1984-1982	6 Cyl. 4.3L; 11/16 Inch Inner Dia. x 1 3/16 Inch Outer Dia.	GV5
1984-1982	6 Cyl. 4.3L; 1 Inch Inner Dia. x 1 1/2 Inch Outer Dia.	GV6
1984-1982	6 Cyl. 4.3L; 23/32 Inch Inner Dia. x 1 Inch Outer Dia.	GV9
Acadian		
1986	4 Cyl. 1.8L; 23/32 Inch Inner Dia. x 1 1/4 Inch Outer Dia.	GV13
1986	4 Cyl. 1.8L; 7/16 Inch Inner Dia. x 1 1/4 Inch Outer Dia.	GV16
1986	4 Cyl. 1.8L; 7/16 Inch Inner Dia. x 1 3/4 Inch Outer Dia.	GV18
1986	4 Cyl. 1.8L; 11/16 Inch Inner Dia. x 1 3/16 Inch Outer Dia.	GV5
1986	4 Cyl. 1.8L; 1 Inch Inner Dia. x 1 1/2 Inch Outer Dia.	GV6
1986	4 Cyl. 1.8L; 23/32 Inch Inner Dia. x 1 Inch Outer Dia.	GV9
1984-1981	4 Cyl. 1.8L; 23/32 Inch Inner Dia. x 1 1/4 Inch Outer Dia.	GV13
1984-1981	4 Cyl. 1.8L; 7/16 Inch Inner Dia. x 1 1/4 Inch Outer Dia.	GV16
1984-1981	4 Cyl. 1.8L; 7/16 Inch Inner Dia. x 1 3/4 Inch Outer Dia.	GV18
1984-1981	4 Cyl. 1.8L; 11/16 Inch Inner Dia. x 1 3/16 Inch Outer Dia.	GV5
1984-1981	4 Cyl. 1.8L; 1 Inch Inner Dia. x 1 1/2 Inch Outer Dia.	GV6
1984-1981	4 Cyl. 1.8L; 23/32 Inch Inner Dia. x 1 Inch Outer Dia.	GV9
Bonneville		
1984-1983	8 Cyl.	GV9
1982-1981	8 Cyl. 5.7L; 23/32 Inch Inner Dia. x 1 1/4 Inch Outer Dia.	GV13
1982-1981	8 Cyl. 5.7L; 7/16 Inch Inner Dia. x 1 1/4 Inch Outer Dia.	GV16
1982-1981	8 Cyl. 5.7L; 7/16 Inch Inner Dia. x 1 3/4 Inch Outer Dia.	GV18
1982-1981	8 Cyl. 5.7L; 11/16 Inch Inner Dia. x 1 3/16 Inch Outer Dia.	GV5
1982-1981	8 Cyl. 5.7L; 1 Inch Inner Dia. x 1 1/2 Inch Outer Dia.	GV6
1982-1981	8 Cyl. 5.7L; 23/32 Inch Inner Dia. x 1 Inch Outer Dia.	GV9

PCV Systems

		Part No.
PCV Grommet		
Catalina		
1981	8 Cyl. 5.7L; 23/32 Inch Inner Dia. x 1 1/4 Inch Outer Dia.	GV13
1981	8 Cyl. 5.7L; 7/16 Inch Inner Dia. x 1 1/4 Inch Outer Dia.	GV16
1981	8 Cyl. 5.7L; 7/16 Inch Inner Dia. x 1 3/4 Inch Outer Dia.	GV18
1981	8 Cyl. 5.7L; 11/16 Inch Inner Dia. x 1 3/16 Inch Outer Dia.	GV5
1981	8 Cyl. 5.7L; 1 Inch Inner Dia. x 1 1/2 Inch Outer Dia.	GV6
1981	8 Cyl. 5.7L; 23/32 Inch Inner Dia. x 1 Inch Outer Dia.	GV9
Grand LeMans		
1983-1982	8 Cyl. 5.7L; 23/32 Inch Inner Dia. x 1 1/4 Inch Outer Dia.	GV13
1983-1982	8 Cyl. 5.7L; 7/16 Inch Inner Dia. x 1 1/4 Inch Outer Dia.	GV16
1983-1982	8 Cyl. 5.7L; 7/16 Inch Inner Dia. x 1 3/4 Inch Outer Dia.	GV18
1983-1982	8 Cyl. 5.7L; 11/16 Inch Inner Dia. x 1 3/16 Inch Outer Dia.	GV5
1983-1982	8 Cyl. 5.7L; 1 Inch Inner Dia. x 1 1/2 Inch Outer Dia.	GV6
1983-1982	8 Cyl. 5.7L; 23/32 Inch Inner Dia. x 1 Inch Outer Dia.	GV9
Grand Prix		
1984-1981	8 Cyl. 5.7L; 23/32 Inch Inner Dia. x 1 1/4 Inch Outer Dia.	GV13
1984-1981	8 Cyl. 5.7L; 7/16 Inch Inner Dia. x 1 1/4 Inch Outer Dia.	GV16
1984-1981	8 Cyl. 5.7L; 7/16 Inch Inner Dia. x 1 3/4 Inch Outer Dia.	GV18
1984-1981	8 Cyl. 5.7L; 11/16 Inch Inner Dia. x 1 3/16 Inch Outer Dia.	GV5
1984-1981	8 Cyl. 5.7L; 1 Inch Inner Dia. x 1 1/2 Inch Outer Dia.	GV6
1984-1981	8 Cyl. 5.7L; 23/32 Inch Inner Dia. x 1 Inch Outer Dia.	GV9
Parisienne		
1985	8 Cyl. 5.7L	GV9
1984-1981	8 Cyl. 5.7L; 23/32 Inch Inner Dia. x 1 1/4 Inch Outer Dia.	GV13
1984-1981	8 Cyl. 5.7L; 7/16 Inch Inner Dia. x 1 1/4 Inch Outer Dia.	GV16
1984-1981	8 Cyl. 5.7L; 7/16 Inch Inner Dia. x 1 3/4 Inch Outer Dia.	GV18
1984-1981	8 Cyl. 5.7L; 11/16 Inch Inner Dia. x 1 3/16 Inch Outer Dia.	GV5
1984-1981	8 Cyl. 5.7L; 1 Inch Inner Dia. x 1 1/2 Inch Outer Dia.	GV6
1984-1981	8 Cyl. 5.7L; 23/32 Inch Inner Dia. x 1 Inch Outer Dia.	GV9
1980	8 Cyl. 5.7L	GV5
PCV Valve		
Bonneville		
1984-1983	8 Cyl.	V178
1981-1980	8 Cyl. 5.7L; Diesel	V353
Catalina		
1981-1980	8 Cyl. 5.7L; Diesel	V353
Grand Prix		
1981	8 Cyl. 5.7L; Diesel	V353
Laurentian		
1981-1980	8 Cyl. 5.7L; Diesel	V353
Parisienne		
1985	8 Cyl. 5.7L	V210
1984-1983	8 Cyl. 5.7L	V178

		Part No.
PCV Valve		
Parisienne		
1981-1980	8 Cyl. 5.7L; Diesel	V353
Vapor and Purge Components		
Fuel Vapor Canister		
Laurentian		
1980	8 Cyl. 5.7L	CP1010
Parisienne		
1985	8 Cyl. 5.7L	CP1014
1980	8 Cyl. 5.7L	CP1010
Injectors		
Fuel Injector - Diesel - New		
6000		
1985-1984	6 Cyl. 4.3L	FJ698
Injection Components		
Diesel Glow Plug		
6000		
1985-1984	6 Cyl. 4.3L	GP108
1983-1982	6 Cyl. 4.3L	GP103
Bonneville		
1984	8 Cyl. 5.7L	GP108
1983-1980	8 Cyl. 5.7L	GP103
Catalina		
1981-1980	8 Cyl. 5.7L	GP103
Grand LeMans		
1983-1982	8 Cyl. 5.7L	GP103
Grand Prix		
1984	8 Cyl. 5.7L	GP108
1983-1981	8 Cyl. 5.7L	GP103
Laurentian		
1981-1980	8 Cyl. 5.7L	GP103
Parisienne		
1985-1984	8 Cyl. 5.7L	GP108
1983-1980	8 Cyl. 5.7L	GP103
Fuel Rail O-Ring Kit		
6000		
1985-1982	6 Cyl. 4.3L; Inlet and Outlet	SK18
Acadian		
1985-1981	4 Cyl. 1.8L; Inlet and Outlet	SK18
Bonneville		
1984-1981	8 Cyl. 5.7L; Inlet and Outlet	SK18
Catalina		
1981	8 Cyl. 5.7L; Inlet and Outlet	SK18
Grand LeMans		
1983-1982	8 Cyl. 5.7L; Inlet and Outlet	SK18
Grand Prix		
1984-1981	8 Cyl. 5.7L; Inlet and Outlet	SK18
Laurentian		
1981	8 Cyl. 5.7L; Inlet and Outlet	SK18
Parisienne		
1985-1981	8 Cyl. 5.7L; Inlet and Outlet	SK18
Chassis and Drivetrain Sensors		
Automatic Transmission Output Sensor		
Parisienne		
1985	8 Cyl. 5.7L	SC25
Vehicle Speed Sensor		
Parisienne		
1985	8 Cyl. 5.7L; Cluster Mounted	SC25

Position Sensors

		Part No.
Position Sensors		
Crankshaft Sensor Bracket		
Acadian		
1986	4 Cyl. 1.8L	PCB1
Throttle Position Sensor		
6000		
1985	6 Cyl. 4.3L	TH43
Acadian		
1986-1982	4 Cyl. 1.8L	TH5
Bonneville		
1980	8 Cyl. 5.7L	TH1
Pressure Sensors		
MAP Sensor		
6000		
1984	6 Cyl. 4.3L; Calif.	AS5
Parisienne		
1985	8 Cyl. 5.7L	AS5
Temperature Sensors		
Coolant Temperature Sensor		
Acadian		
1981	4 Cyl.	TX1
Bonneville		
1980	8 Cyl. 5.7L; w/o Connector	TX3
1980	8 Cyl. 5.7L; w/ Connector	TX4
Grand LeMans		
1983-1982	8 Cyl. 5.7L; w/o Connector	TX3
1983-1982	8 Cyl. 5.7L; w/ Connector	TX4
Laurentian		
1980	8 Cyl. 5.7L; w/o Connector	TX3
1980	8 Cyl. 5.7L; w/ Connector	TX4
Parisienne		
1980	8 Cyl. 5.7L; w/o Connector	TX3
1980	8 Cyl. 5.7L; w/ Connector	TX4
Diesel Glow Plug Control Sensor		
6000		
1983-1982	6 Cyl. 4.3L	TX34
Bonneville		
1983	8 Cyl. 5.7L; N; 6 Terminals	TX34
1983-1981	8 Cyl. 5.7L; 5 Terminals	TX36
1982	8 Cyl. 5.7L; 6 Terminals	TX34
1981	8 Cyl. 5.7L; N; 6 Terminals	TX34
Catalina		
1981	8 Cyl. 5.7L; 6 Terminals	TX34
1981	8 Cyl. 5.7L; 5 Terminals	TX36
Grand LeMans		
1983-1982	8 Cyl. 5.7L; 6 Terminals	TX34
1983-1982	8 Cyl. 5.7L; 5 Terminals	TX36
Grand Prix		
1983-1981	8 Cyl. 5.7L; 6 Terminals	TX34
1983-1981	8 Cyl. 5.7L; 5 Terminals	TX36
Laurentian		
1981	8 Cyl. 5.7L; 6 Terminals	TX34
1981	8 Cyl. 5.7L; 5 Terminals	TX36
Parisienne		
1983-1981	8 Cyl. 5.7L; 6 Terminals	TX34
1983-1981	8 Cyl. 5.7L; 5 Terminals	TX36
Intake Air Temperature Sensor		
Acadian		
1986-1984	4 Cyl. 1.8L; On Air Cleaner	ATS13
Bonneville		
1984	8 Cyl. 5.7L; Canada; Export; On Air Cleaner	ATS13

		Part No.
Intake Air Temperature Sensor		
Grand Prix		
1984	8 Cyl. 5.7L; Canada; Export; On Air Cleaner	ATS13
Laurentian		
1980	8 Cyl. 5.7L; On Air Cleaner	ATS3
Parisienne		
1985-1984	8 Cyl. 5.7L; Canada; Export; On Air Cleaner	ATS13
1980	8 Cyl. 5.7L; On Air Cleaner	ATS3
Body Light Switches		
Stoplight Switch		
Grand LeMans		
1983-1982	8 Cyl. 5.7L; w/ Cruise Control	SLS-159
1983-1982	8 Cyl. 5.7L; w/o Cruise Control	SLS-66
Parisienne		
1981	8 Cyl. 5.7L; w/ Cruise Control	SLS-159
1981	8 Cyl. 5.7L; w/o Cruise Control	SLS-66
Chassis and Drivetrain Switches		
Automatic Transmission Vacuum Modulator		
6000		
1985	6 Cyl. 4.3L; MV4, MX2, MX3, MX5	TM-63
1984	6 Cyl. 4.3L; Diesel; w/ 4 Speed TH440 Trans.	TM-58
Bonneville		
1983	8 Cyl. 5.7L; w/ TH250, TH350 Trans.	TM-37
1981	8 Cyl. 5.7L; N; Calif.; w/ TH250, TH350 Trans.	TM-33
1981	8 Cyl. 5.7L; N; Fed.; w/ TH250, TH350 Trans.	TM-45
1980	8 Cyl. 5.7L; N	TM-33
Catalina		
1981	8 Cyl. 5.7L; N; w/ TH250, TH350 Trans.	TM-33
1980	8 Cyl. 5.7L; N	TM-33
Grand LeMans		
1983-1982	8 Cyl. 5.7L; Diesel; w/ TH250, TH350 Trans.	TM-37
Grand Prix		
1983-1982	8 Cyl. 5.7L; N; w/ TH250, TH350 Trans.	TM-37
Laurentian		
1981	8 Cyl. 5.7L; Calif.; w/ TH250, TH350 Trans.	TM-33
1981	8 Cyl. 5.7L; Fed.; w/ TH250, TH350 Trans.	TM-45
1980	8 Cyl. 5.7L; N	TM-33
Parisienne		
1985	8 Cyl. 5.7L; MV4, MX2, MX3, MX5	TM-63
1983-1982	8 Cyl. 5.7L; w/ TH250, TH350 Trans.	TM-37
1981	8 Cyl. 5.7L; Calif.; w/ TH250, TH350 Trans.	TM-33
1981	8 Cyl. 5.7L; Fed.; w/ TH250, TH350 Trans.	TM-45
1980	8 Cyl. 5.7L; N	TM-33
Neutral Safety Switch		
Parisienne		
1982	8 Cyl. 5.7L	NS-41
Interior Power Switches		
Cruise Control Switch		
Bonneville		
1984	8 Cyl. 5.7L; w/ Intermittent Wipers	DS-1534
Grand Prix		
1984	8 Cyl. 5.7L; w/ Intermittent Wipers	DS-1534
Parisienne		
1985-1984	8 Cyl. 5.7L; w/ Intermittent Wipers	DS-1534

Interior Power Switches

		Part No.
Trunk Release Switch		
6000		
1985	6 Cyl. 4.3L	DS-2153
Grand Prix		
1981	8 Cyl. 5.7L	DS-2153
Pressure and Vacuum Sending Switches		
Oil Pressure Gauge Switch		
6000		
1985-1983	6 Cyl. 4.3L	PS-155
1982	6 Cyl. 4.3L	PS-154
Oil Pressure Light Switch		
6000		
1985-1982	6 Cyl. 4.3L	PS-12
Acadian		
1985-1983	4 Cyl. 1.8L; Alternate Number	PS-138
1985-1983	4 Cyl. 1.8L; Exhaust stock and reorder	PS200
Bonneville		
1984-1981	8 Cyl. 5.7L	PS-12
1980	8 Cyl. 5.7L; N	PS-12
Catalina		
1981	8 Cyl. 5.7L	PS-12
1980	8 Cyl. 5.7L; N	PS-12
Grand LeMans		
1982	8 Cyl. 5.7L; Canada	PS-12
Grand Prix		
1984-1981	8 Cyl. 5.7L	PS-12
Laurentian		
1981	8 Cyl. 5.7L	PS-12
1980	8 Cyl. 5.7L; Diesel	PS-12
Parisienne		
1985-1984	8 Cyl. 5.7L	PS-12
1982-1981	8 Cyl. 5.7L	PS-12
1980	8 Cyl. 5.7L; 2.75 Inch Overall Length	PS-12
1980	8 Cyl. 5.7L; Short Design	PS-57
Ported Vacuum Switch		
6000		
1985-1984	6 Cyl.; 2 Ports; Green	PVS24
1985-1984	6 Cyl.; 3 Ports; Gray	PVS41
1984	6 Cyl.; 3 Ports; Black w/ Blue Top	PVS135
1983-1982	6 Cyl.; 3 Ports; Black Finish	PVS56
Acadian		
1983	4 Cyl. 1.8L; 2 Ports; Purple	PVS27
1982	4 Cyl. 1.8L; 2 Ports; Blue	PVS16
Bonneville		
1981-1980	8 Cyl. 5.7L; 2 Ports; Black Finish	PVS48
1980	8 Cyl. 5.7L; 6 Ports; 7 Term.; Black Finish	PVS104
1980	8 Cyl. 5.7L; 3 Ports; Green	PVS133
1980	8 Cyl. 5.7L; 4 Ports; Black Finish	PVS165
1980	8 Cyl. 5.7L; 3 Ports; Blue	PVS50
1980	8 Cyl. 5.7L; 3 Ports; Black Finish	PVS54
1980	8 Cyl. 5.7L; 4 Ports; Green	PVS73
1980	8 Cyl. 5.7L; 4 Ports; Blue	PVS76
1980	8 Cyl. 5.7L; 2 Ports; Dark Blue	PVS77
Catalina		
1981-1980	8 Cyl. 5.7L; 2 Ports; Black Finish	PVS48
1980	8 Cyl. 5.7L; 6 Ports; 7 Term.; Black Finish	PVS104
1980	8 Cyl. 5.7L; 3 Ports; Green	PVS133
1980	8 Cyl. 5.7L; 4 Ports; Black Finish	PVS165
1980	8 Cyl. 5.7L; 3 Ports; Blue	PVS50
1980	8 Cyl. 5.7L; 3 Ports; Black Finish	PVS54
1980	8 Cyl. 5.7L; 4 Ports; Green	PVS73
1980	8 Cyl. 5.7L; 4 Ports; Blue	PVS76
1980	8 Cyl. 5.7L; 2 Ports; Dark Blue	PVS77

		Part No.
Ported Vacuum Switch		
Grand Prix		
1981	8 Cyl. 5.7L; 2 Ports; Canada; Diesel; Purple	PVS27
1981	8 Cyl. 5.7L; 2 Ports; Black Finish; Diesel	PVS48
Laurentian		
1980	8 Cyl. 5.7L; 2 Ports; Dark Blue	PVS77
Parisienne		
1985	8 Cyl. 5.7L; 2 Ports; 7 Term.; Black Finish; OE No. 3030951, 370721	PVS13
1981	8 Cyl. 5.7L; 2 Ports; Purple	PVS27
1981-1980	8 Cyl. 5.7L; 2 Ports; Black Finish	PVS48
1980	8 Cyl. 5.7L; 3 Ports; Black Finish	PVS54
1980	8 Cyl. 5.7L; 4 Ports; Green	PVS73
1980	8 Cyl. 5.7L; 4 Ports; Blue	PVS76
1980	8 Cyl. 5.7L; 2 Ports; Dark Blue	PVS77
Temperature Switches and Senders		
A/C and Heater Blower Motor Switch		
Parisienne		
1985-1984	8 Cyl. 5.7L	HS-205
1983	8 Cyl. 5.7L	HS-204
A/C and Heater Selector Switch		
Bonneville		
1984-1981	8 Cyl. 5.7L	HS-316
Catalina		
1981-1980	8 Cyl. 5.7L	HS-316
Grand Prix		
1984-1981	8 Cyl. 5.7L	HS-316
A/C Blower Delay Switch		
Bonneville		
1981	8 Cyl. 5.7L; N; w/ A.T.; w/ Auto. Temp Control	TS72
1980	8 Cyl. 5.7L; w/ A.T.; w/ Auto. Temp Control	TS72
Catalina		
1981	8 Cyl. 5.7L; N; w/ A.T.; w/ Auto. Temp Control	TS72
Grand Prix		
1981	8 Cyl. 5.7L; N; w/ A.T.; w/ Auto. Temp Control	TS72
Laurentian		
1981-1980	8 Cyl. 5.7L; w/ A.T.; w/ Auto. Temp Control	TS72
Parisienne		
1981-1980	8 Cyl. 5.7L; w/ A.T.; w/ Auto. Temp Control	TS72
Coolant Fan Switch		
6000		
1985-1982	6 Cyl. 4.3L	TS240
Temperature Sender - With Gauge		
Parisienne		
1981-1980	8 Cyl. 5.7L	TS-76
Temperature Sender - With Light		
6000		
1985-1984	6 Cyl. 4.3L; 3/8 Inch x 18 Thread	TS-169
1983-1982	6 Cyl. 4.3L; 3/8 Inch x 18 Thread	TS-66
Bonneville		
1984	8 Cyl. 5.7L; 3/8 Inch x 18 Thread	TS-169
1981	8 Cyl. 5.7L; 3/8 Inch x 18 Thread	TS-66
Catalina		
1981	8 Cyl. 5.7L; 3/8 Inch x 18 Thread	TS-66
Parisienne		
1985-1984	8 Cyl. 5.7L; 3/8 Inch x 18 Thread	TS-169
1981	8 Cyl. 5.7L; 3/8 Inch x 18 Thread	TS-66

Actuators

		Part No.
Actuators		
Power Door Lock Actuator		
6000		
1985-1982	6 Cyl. 4.3L	DLA-1
Catalina		
1981-1980	8 Cyl. 5.7L	DLA-1
Grand Prix		
1984-1981	8 Cyl. 5.7L	DLA-1
Parisienne		
1985-1983	8 Cyl. 5.7L	DLA-1
1981	8 Cyl. 5.7L	DLA-1
Porsche		
Air Injection and Induction Parts		
Turbocharger - New		
Macan		
2018-2015	6 Cyl. 3.0L; Turbocharged; Left	TBC626
2018-2015	6 Cyl. 3.0L; Turbocharged; Right	TBC633
Exhaust Components		
Diesel Emission Fluid Injection Nozzle		
Cayenne		
2015-2013	6 Cyl. 3.0L	DFI8
Vapor and Purge Components		
Fuel Vapor Leak Detection Pump		
Cayenne		
2018-2011	6 Cyl. 3.0L	LDP25
Fuel Sensors		
Knock Sensor		
Cayenne		
2013-2011	6 Cyl. 3.0L; Left	KS418
2013-2011	6 Cyl. 3.0L; Right	KS424
Panamera		
2013-2012	6 Cyl. 3.0L; Left	KS418
2013-2012	6 Cyl. 3.0L; Right	KS424
Mass Air Flow		
Cayenne		
2015-2011	6 Cyl. 3.0L	MAS0379
Position Sensors		
Camshaft Sensor		
Cayenne		
2016-2014	6 Cyl. 3.0L	PC781
2013-2011	6 Cyl. 3.0L; Alternate Number	PC781
2013-2011	6 Cyl. 3.0L; Exhaust stock and reorder	PC911
Panamera		
2016-2014	6 Cyl. 3.0L	PC781
2013-2012	6 Cyl. 3.0L; Alternate Number	PC781
2013-2012	6 Cyl. 3.0L; Exhaust stock and reorder	PC911
Crankshaft Sensor		
Cayenne		
2019	6 Cyl. 3.0L	PC1146
2016	8 Cyl.	PC927
2016-2013	6 Cyl. 3.0L	PC919
Panamera		
2017	8 Cyl. 4.0L	PC1146
2016-2012	6 Cyl. 3.0L	PC919
Pressure Sensors		
Fuel Pressure Sensor		
Cayenne		
2016-2013	6 Cyl. 3.0L	FPS94

		Part No.
MAP Sensor		
Cayenne		
2016-2011	6 Cyl. 3.0L; Diesel; Location-Intercooler Piping	AS535
Temperature Sensors		
Coolant Temperature Sensor		
Cayenne		
2018-2011	6 Cyl. 3.0L	AX522
2016	8 Cyl.	TS-608
Exhaust Gas Temperature Sensor		
Cayenne		
2016-2013	6 Cyl. 3.0L; Turbocharged; Front	ETS181
2016-2013	6 Cyl. 3.0L; Turbocharged; Center	ETS183
2016-2013	6 Cyl. 3.0L; Turbocharged; Rear	ETS184
Ignition Switches		
Ignition Push Button Switch		
Panamera		
2014-2012	6 Cyl. 3.0L	US1458
Pressure and Vacuum Sending Switches		
Oil Pressure Gauge Switch		
Cayenne		
2016	8 Cyl.	PS716
2016-2011	6 Cyl.	PS-488
Oil Pressure Light Switch		
Cayenne		
2012-2011	6 Cyl. 3.0L	PS-531
Panamera		
2013-2012	6 Cyl. 3.0L	PS-491
Actuators		
Variable Valve Timing Solenoid		
Cayenne		
2018-2012	6 Cyl. 3.0L	VVT405
Macan		
2017-2016	6 Cyl. 3.0L	VVT408
Panamera		
2015-2013	6 Cyl. 3.0L	VVT405
Ram		
Relays and Fuses		
Air Intake Heater Relay		
2500		
2017-2011	6 Cyl. 6.7L; Diesel	RY-1779
3500		
2017-2011	6 Cyl. 6.7L; Diesel	RY-1779
4500		
2017-2016	6 Cyl. 6.7L; Diesel	RY-1779
2014-2011	6 Cyl. 6.7L; Diesel	RY-1779
5500		
2017-2011	6 Cyl. 6.7L; Diesel	RY-1779
Diesel Glow Plug Relay		
ProMaster 1500		
2017-2014	4 Cyl. 3.0L	RY1848
ProMaster 2500		
2018-2014	4 Cyl. 3.0L	RY1848
ProMaster 3500		
2018-2014	4 Cyl. 3.0L	RY1848
Starter Relay		
4500		
2012-2011		RY-1757
5500		
2012-2011		RY-1757

Air Injection and Induction Parts

		Part No.
Air Injection and Induction Parts		
Diesel Air Intake Heater		
2500		
2012-2011	6 Cyl. 6.7L	DIH11
3500		
2014-2011	6 Cyl.; w/o Pickup Bed	DIH9
2012-2011	6 Cyl.; U.S. Models; w/ Pickup Bed	DIH11
4500		
2014	6 Cyl. 6.7L	DIH9
2013-2011		DIH9
5500		
2014	6 Cyl. 6.7L	DIH9
2013-2011		DIH9
Electronic Throttle Body (ETB) Gasket		
2500		
2019-2011	6 Cyl. 6.7L	TBG130
3500		
2019-2011	6 Cyl. 6.7L	TBG130
4500		
2018-2011	6 Cyl. 6.7L	TBG130
5500		
2018-2011	6 Cyl. 6.7L	TBG130
Fuel Injection Throttle Body		
2500		
2019-2013	6 Cyl. 6.7L	S20400
3500		
2019-2013	6 Cyl. 6.7L	S20400
4500		
2018-2013	6 Cyl. 6.7L	S20400
5500		
2018-2013	6 Cyl. 6.7L	S20400
Radiator Active Grille Shutter Assembly		
1500		
2017-2014	6 Cyl. 3.0L; Actuator	AGS1003
Turbocharger - New		
2500		
2018	6 Cyl. 6.7L; Turbocharged	TBC709
2017-2015	6 Cyl. 6.7L; Turbocharged; w/ Pickup Bed	TBC709
2014-2013	6 Cyl. 6.7L; Turbocharged	TBC709
3500		
2018-2016	6 Cyl. 6.7L; Turbocharged; w/ Pickup Bed	TBC709
2015-2013	6 Cyl.; Turbocharged; w/ Pickup Bed	TBC709
Turbocharger - Remfd		
2500		
2018	6 Cyl. 6.7L; Turbocharged	TBC669
2017-2015	6 Cyl. 6.7L; Turbocharged; w/ Pickup Bed	TBC669
2014-2013	6 Cyl. 6.7L; Turbocharged	TBC669
2012-2011	6 Cyl. 6.7L; Turbocharged	TBC-521
3500		
2018-2017	6 Cyl.; Turbocharged; w/o Pickup Bed	TBC668
2018-2016	6 Cyl. 6.7L; Turbocharged; w/ Pickup Bed	TBC669
2015-2013	6 Cyl.; Turbocharged; w/o Pickup Bed	TBC668
2015-2013	6 Cyl.; Turbocharged; w/ Pickup Bed	TBC669
2012	6 Cyl.; Turbocharged	TBC-521
2011	6 Cyl. 6.7L; Turbocharged	TBC-521
4500		
2018-2013	6 Cyl. 6.7L; Turbocharged	TBC668
2012-2011	Turbocharged	TBC-521
5500		
2018-2013	6 Cyl. 6.7L; Turbocharged	TBC668
2012-2011	Turbocharged	TBC-521

		Part No.
Vacuum Pump		
1500		
2018-2014	6 Cyl. 3.0L; Diesel	VCP143
Air Management Valves		
Vacuum Regulator Valve		
ProMaster 1500		
2017-2014	4 Cyl. 3.0L	VS245
ProMaster 2500		
2018-2014	4 Cyl. 3.0L	VS245
ProMaster 3500		
2018-2014	4 Cyl. 3.0L	VS245
Early Fuel Emission Control		
Crankcase Ventilation Filter		
2500		
2019-2011	6 Cyl. 6.7L	BF43
3500		
2019-2011	6 Cyl. 6.7L	BF43
4000		
2013-2011	6 Cyl. 6.7L	BF43
4500		
2018-2011	6 Cyl. 6.7L	BF43
5500		
2018-2011	6 Cyl. 6.7L	BF43
EGR Components		
Diesel EGR Cooler		
2500		
2012-2011	6 Cyl. 6.7L	ECK11
3500		
2012-2011	6 Cyl. 6.7L	ECK11
EGR Control Solenoid		
1500		
2018-2014	6 Cyl. 3.0L	VS234
EGR Tube		
2500		
2012-2011	6 Cyl. 6.7L	ETB91
3500		
2012-2011	6 Cyl. 6.7L	ETB91
4500		
2012-2011	6 Cyl. 6.7L	ETB91
5500		
2012-2011	6 Cyl. 6.7L	ETB91
EGR Tube Gasket		
1500		
2018-2014	6 Cyl. 3.0L	VG279
ProMaster 1500		
2017-2014	4 Cyl. 3.0L	VG275
ProMaster 2500		
2018-2014	4 Cyl. 3.0L	VG275
ProMaster 3500		
2018-2014	4 Cyl. 3.0L	VG275
EGR Valve		
1500		
2018-2014	6 Cyl. 3.0L	EGV1254
2500		
2013-2011	6 Cyl. 6.7L	EGV1241
3500		
2018-2017	6 Cyl. 6.7L; Cab and Chassis	EGV1285
2015-2014	6 Cyl. 6.7L; Cab and Chassis	EGV1285
2013	6 Cyl. 6.7L; Diesel	EGV1241
2012-2011	6 Cyl. 6.7L	EGV1241

EGR Components

		Part No.
EGR Valve		
4500		
2018-2015	6 Cyl. 6.7L; Cab and Chassis	EGV1285
2013-2011		EGV1241
5500		
2018-2015	6 Cyl. 6.7L; Cab and Chassis	EGV1285
2013-2011		EGV1241
EGR Valve Mounting Gasket		
1500		
2018-2014	6 Cyl. 3.0L; EGR Pipe	VG273
2500		
2017-2011	6 Cyl. 6.7L; EGR Pipe	VG270
3500		
2017-2011	6 Cyl. 6.7L; EGR Pipe	VG270
4500		
2018-2011	6 Cyl. 6.7L; EGR Pipe	VG270
EGR Valve Vacuum Modulator		
1500		
2018-2014	6 Cyl. 3.0L	VS239
Exhaust Components		
Diesel Emission Fluid Injection Nozzle		
1500		
2018-2014	6 Cyl. 3.0L	DFI4
1500 Classic		
2019	6 Cyl. 3.0L	DFI4
2500		
2019-2013	6 Cyl. 6.7L	DFI3
3500		
2019-2013	6 Cyl. 6.7L	DFI3
4500		
2018-2013	6 Cyl. 6.7L	DFI3
5500		
2019-2013	6 Cyl. 6.7L	DFI3
ProMaster 1500		
2017-2014	4 Cyl. 3.0L	DFI4
ProMaster 2500		
2017-2014	4 Cyl. 3.0L	DFI4
ProMaster 3500		
2017-2014	4 Cyl. 3.0L	DFI4
Fuel Valves and Solenoids		
Fuel Pressure Relief Valve		
2500		
2018-2010	6 Cyl.	PRV1
3500		
2018-2011	6 Cyl.	PRV1
4500		
2018	6 Cyl. 6.7L	PRV1
2017-2016	6 Cyl.	PRV1
2015-2014	6 Cyl. 6.7L	PRV1
2013-2011	6 Cyl.	PRV1
5500		
2018-2017	6 Cyl. 6.7L	PRV1
2016	6 Cyl.	PRV1
2015-2014	6 Cyl. 6.7L	PRV1
2013-2011	6 Cyl.	PRV1
Injectors		
Fuel Injector - Diesel - New		
1500		
2020	6 Cyl. 3.0L	FJ1269
2018-2014	6 Cyl. 3.0L	FJ1269

		Part No.
Fuel Injector - Diesel - New		
1500 Classic		
2019	6 Cyl. 3.0L	FJ1269
2500		
2018	6 Cyl. 6.7L; Exhaust stock and reorder	FJ1231
2018	6 Cyl. 6.7L; Alternate Number	FJ1310NX
2017	6 Cyl. 6.7L	FJ1310NX
2016-2013	6 Cyl. 6.7L; Exhaust stock and reorder	FJ1231
2016-2013	6 Cyl. 6.7L; Alternate Number	FJ1310NX
3500		
2018-2013	6 Cyl. 6.7L; Exhaust stock and reorder; w/ Pickup Bed	FJ1231
2018-2013	6 Cyl. 6.7L; Alternate Number; w/ Pickup Bed	FJ1310NX
ProMaster 2500		
2017-2014	4 Cyl. 3.0L	FJ1380NX
ProMaster 3500		
2017-2014	4 Cyl. 3.0L	FJ1380NX
Fuel Injector - Diesel - Remfd		
2500		
2016-2013	6 Cyl. 6.7L; Injector Only	FJ1310
2016-2013	6 Cyl. 6.7L; Kit	FJ1310K
2012-2011	6 Cyl. 6.7L; Injector Only	FJ1009
2012-2011	6 Cyl. 6.7L; Kit	FJ1009K
3500		
2018	6 Cyl. 6.7L; Injector Only; w/o Pickup Bed	FJ1230
2018	6 Cyl. 6.7L; Kit; w/o Pickup Bed	FJ1230K
2017	6 Cyl. 6.7L; Diesel; Injector Only; w/o Pickup Bed	FJ1230
2017	6 Cyl. 6.7L; Diesel; Kit; w/o Pickup Bed	FJ1230K
2016-2013	6 Cyl. 6.7L; Injector Only; w/ Pickup Bed	FJ1310
2016-2013	6 Cyl. 6.7L; Kit; w/ Pickup Bed	FJ1310K
2015-2013	6 Cyl. 6.7L; Injector Only; w/o Pickup Bed	FJ1230
2015-2013	6 Cyl. 6.7L; Kit; w/o Pickup Bed	FJ1230K
2012-2011	6 Cyl. 6.7L; Injector Only; w/ Pickup Bed	FJ1009
2012-2011	6 Cyl. 6.7L; Kit; w/ Pickup Bed	FJ1009K
2012-2011	6 Cyl. 6.7L; Injector Only; w/o Pickup Bed	FJ1229
2012-2011	6 Cyl. 6.7L; Kit; w/o Pickup Bed	FJ1229K
4500		
2018-2013	6 Cyl. 6.7L; Diesel; Injector Only	FJ1230
2018-2013	6 Cyl. 6.7L; Diesel; Kit	FJ1230K
2012-2011	Injector Only	FJ1229
2012-2011	Kit	FJ1229K
5500		
2018-2016	6 Cyl. 6.7L; Injector Only	FJ1230
2018-2016	6 Cyl. 6.7L; Kit	FJ1230K
2015-2013	6 Cyl. 6.7L; Diesel; Injector Only	FJ1230
2015-2013	6 Cyl. 6.7L; Diesel; Kit	FJ1230K
2012-2011	Injector Only	FJ1229
2012-2011	Kit	FJ1229K
Injection Components		
Diesel Fuel Injection Pump - New		
2500		
2018-2011	6 Cyl. 6.7L	IP33
3500		
2018-2011	6 Cyl. 6.7L	IP33
4500		
2018-2016	6 Cyl. 6.7L	IP33
2014	6 Cyl. 6.7L	IP33
2013-2011		IP33
5500		
2018-2014	6 Cyl. 6.7L	IP33
2013-2011		IP33

Injection Components

		Part No.
Diesel Fuel Injection Pump - Remanufactured		
2500		
2018-2011	6 Cyl. 6.7L	IP54
3500		
2018-2011	6 Cyl. 6.7L	IP54
4500		
2018-2011	6 Cyl. 6.7L	IP54
5500		
2018-2011	6 Cyl. 6.7L	IP54
Diesel Fuel Injector Line		
2500		
2018-2011	6 Cyl. 6.7L; Cyl. 1	DIL11
2018-2011	6 Cyl. 6.7L; Cyl. 2 and 4	DIL12
2018-2011	6 Cyl. 6.7L; Cyl. 3 and 5	DIL13
2018-2011	6 Cyl. 6.7L; Cyl. 6	DIL14
3500		
2018-2011	6 Cyl. 6.7L; Cyl. 1	DIL11
2018-2011	6 Cyl. 6.7L; Cyl. 2 and 4	DIL12
2018-2011	6 Cyl. 6.7L; Cyl. 3 and 5	DIL13
2018-2011	6 Cyl. 6.7L; Cyl. 6	DIL14
4500		
2018-2011	6 Cyl. 6.7L; Cyl. 1	DIL11
2018-2011	6 Cyl. 6.7L; Cyl. 2 and 4	DIL12
2018-2011	6 Cyl. 6.7L; Cyl. 3 and 5	DIL13
2018-2011	6 Cyl. 6.7L; Cyl. 6	DIL14
5500		
2018-2011	6 Cyl. 6.7L; Cyl. 1	DIL11
2018-2011	6 Cyl. 6.7L; Cyl. 2 and 4	DIL12
2018-2011	6 Cyl. 6.7L; Cyl. 3 and 5	DIL13
2018-2011	6 Cyl. 6.7L; Cyl. 6	DIL14
Diesel Fuel Injector Rail		
2500		
2018-2013	6 Cyl. 6.7L	FIR6
2012-2011	6 Cyl. 6.7L	FIR5
3500		
2018-2013	6 Cyl. 6.7L	FIR6
2012-2011	6 Cyl. 6.7L	FIR5
4500		
2018-2013	6 Cyl. 6.7L	FIR6
2012-2011	6 Cyl. 6.7L	FIR5
5500		
2018-2013	6 Cyl. 6.7L	FIR6
2012-2011	6 Cyl. 6.7L	FIR5
Diesel Fuel Injector Sleeve		
2500		
2020-2019	6 Cyl. 6.7L	IFS5
2018-2010	6 Cyl. 6.7L	IFS3
3500		
2020-2019	6 Cyl. 6.7L	IFS5
2018-2011	6 Cyl. 6.7L	IFS3
4500		
2018-2011	6 Cyl. 6.7L	IFS3
5500		
2020-2019	6 Cyl. 6.7L	IFS5
2018-2011	6 Cyl. 6.7L	IFS3
Diesel Oil Cooler Kit		
2500		
2018-2011	6 Cyl. 6.7L	OCK4
3500		
2018-2011	6 Cyl. 6.7L	OCK4
4500		
2018-2011	6 Cyl. 6.7L	OCK4

		Part No.
Diesel Oil Cooler Kit		
5500		
2018-2011	6 Cyl. 6.7L	OCK4
Diesel Valve Cover Gasket		
2500		
2013-2011	6 Cyl.	VCG7
3500		
2013-2011	6 Cyl.	VCG7
4500		
2013-2011		VCG7
5500		
2013-2011		VCG7
Fuel Injector Seal Kit		
2500		
2019-2011	6 Cyl. 6.7L	SK146
3500		
2019-2011	6 Cyl. 6.7L	SK146
4500		
2013-2011		SK146
5500		
2013-2011		SK146
Fuel Pressure Regulator		
1500		
2018-2014	6 Cyl. 3.0L	PR607
2500		
2014-2011	6 Cyl. 6.7L	PR555
3500		
2014-2011	6 Cyl. 6.7L	PR555
4500		
2014	6 Cyl. 6.7L	PR555
2013-2011		PR555
5500		
2014	6 Cyl. 6.7L	PR555
2013-2011		PR555
Chassis and Drivetrain Sensors		
ABS Speed Sensor		
4500		
2014	6 Cyl. 6.7L; Front	ALS2686
2013	Front	ALS2686
2013	Right Rear	ALS2815
2013	Left Rear	ALS2818
2012-2011	Includes ABS Wheel Speed Sensor Wire Harness; Front	ALS2686
2012-2011	In Differential	SC466
5500		
2014	6 Cyl. 6.7L; Front	ALS2686
2013	Front	ALS2686
2013	Right Rear	ALS2815
2013	Left Rear	ALS2818
2012-2011	Includes ABS Wheel Speed Sensor Wire Harness; Front	ALS2686
2012-2011	Rear	SC466
Automatic Transmission Input Sensor		
4500		
2013-2011		SC668
5500		
2013-2011		SC668
Turbocharger Speed Sensor		
2500		
2012-2011	6 Cyl. 6.7L; Turbocharged	TCBS1
3500		
2012-2011	Turbocharged	TCBS1

Ram

Chassis and Drivetrain Sensors

		Part No.
Turbocharger Speed Sensor		
4500		
2012-2011	6 Cyl. 6.7L; Turbocharged	TCBS1
5500		
2012-2011	6 Cyl. 6.7L; Turbocharged	TCBS1
Vehicle Speed Sensor		
3500		
2018	6 Cyl. 6.7L	SC669
2016-2013	6 Cyl. 6.7L	SC669
4500		
2017-2013	6 Cyl. 6.7L	SC669
2012-2011		SC333
5500		
2017-2013	6 Cyl. 6.7L	SC669
2012-2011		SC333
Fluid Level Sensors		
Coolant Level Sensor		
2500		
2018-2013	6 Cyl. 6.7L; Diesel	FLS318
3500		
2018-2013	6 Cyl. 6.7L; Diesel	FLS318
4500		
2018-2013	6 Cyl. 6.7L; Diesel	FLS318
5500		
2018-2013	6 Cyl. 6.7L; Diesel	FLS318
Windshield Washer Level Sensor		
4500		
2013-2011		FLS-116
5500		
2013-2011		FLS-116
Fuel Sensors		
Diesel Nitrogen Oxide (NOx) Sensor		
2500		
2018-2013	6 Cyl. 6.7L; Upstream	NOX011
2017-2014	6 Cyl. 6.7L; SCR Catalyst Outlet	NOX012
2014-2013	6 Cyl. 6.7L; Turbo Outlet Pipe	NOX013
3500		
2018-2013	6 Cyl. 6.7L; Upstream	NOX011
2017-2015	6 Cyl. 6.7L; SCR Catalyst Outlet	NOX012
2015-2013	6 Cyl. 6.7L; Turbo Outlet Pipe	NOX013
2012-2011	6 Cyl. 6.7L; Upstream	NOX014
2012-2011	6 Cyl. 6.7L; Downstream	NOX015
4500		
2018-2013	6 Cyl. 6.7L; Upstream	NOX011
2017-2015	6 Cyl. 6.7L; SCR Catalyst Outlet	NOX012
2015-2013	6 Cyl. 6.7L; Turbo Outlet Pipe	NOX013
2013	6 Cyl. 6.7L; Upstream	NOX011
2012-2011	6 Cyl. 6.7L; Upstream	NOX014
2012-2011	6 Cyl. 6.7L; Downstream	NOX015
5500		
2018-2016	6 Cyl. 6.7L; Upstream	NOX011
2017-2016	6 Cyl. 6.7L; SCR Catalyst Outlet	NOX012
2015-2013	6 Cyl. 6.7L; Turbo Outlet Pipe	NOX013
2013	6 Cyl. 6.7L; Upstream	NOX011
2012-2011	6 Cyl. 6.7L; Upstream	NOX014
2012-2011	6 Cyl. 6.7L; Downstream	NOX015
Fuel / Water Separator Sensor		
2500		
2017-2013	6 Cyl. 6.7L	FWSS117
2015-2011	6 Cyl. 6.7L	FWSS118
3500		
2017-2013	6 Cyl. 6.7L	FWSS117
2017-2011	6 Cyl. 6.7L	FWSS118

		Part No.
Fuel / Water Separator Sensor		
4500		
2017-2013	6 Cyl. 6.7L	FWSS117
2017-2011	6 Cyl. 6.7L	FWSS118
5500		
2017-2013	6 Cyl. 6.7L	FWSS117
2017-2011	6 Cyl. 6.7L	FWSS118
Mass Air Flow		
1500		
2018	6 Cyl. 3.0L	MAS0473
ProMaster 1500		
2017-2014	4 Cyl. 3.0L	MAS0480
ProMaster 2500		
2017-2014	4 Cyl. 3.0L	MAS0480
ProMaster 3500		
2017-2014	4 Cyl. 3.0L	MAS0480
Position Sensors		
Accelerator Pedal Sensor		
4500		
2013-2012	w/ Fixed Pedals; w/o Bracket	APS612
2013-2011	w/ Adjustable Pedals	APS399
2013-2011	w/ Bracket; w/ Fixed Pedals	APS611
5500		
2013-2012	w/ Fixed Pedals; w/o Bracket	APS612
2013-2011	w/ Adjustable Pedals	APS399
2013-2011	w/ Bracket; w/ Fixed Pedals	APS611
Camshaft Sensor		
1500		
2018-2014	6 Cyl. 3.0L	PC644
1500 Classic		
2019	6 Cyl. 3.0L	PC644
2500		
2018-2011	6 Cyl. 6.7L	PC590
3500		
2018-2011	6 Cyl. 6.7L	PC590
4500		
2018-2014	6 Cyl. 6.7L	PC590
2013-2011		PC590
5500		
2013-2011		PC590
ProMaster 1500		
2017-2014	4 Cyl. 3.0L	PC1046
ProMaster 2500		
2017-2014	4 Cyl. 3.0L	PC1046
ProMaster 3500		
2017-2014	4 Cyl. 3.0L	PC1046
Crankshaft Sensor		
1500		
2018-2014	6 Cyl. 3.0L	PC997
1500 Classic		
2019	6 Cyl. 3.0L	PC997
2500		
2018-2011	6 Cyl. 6.7L	PC590
3500		
2018-2011	6 Cyl. 6.7L	PC590
4500		
2018-2014	6 Cyl. 6.7L	PC590
2013-2011		PC590
5500		
2018-2014	6 Cyl. 6.7L	PC590
2013-2011		PC590

Position Sensors

		Part No.
Crankshaft Sensor		
ProMaster 1500		
2017-2014	4 Cyl. 3.0L	PC1047
ProMaster 2500		
2017-2014	4 Cyl. 3.0L	PC1047
ProMaster 3500		
2017-2014	4 Cyl. 3.0L	PC1047
Pressure Sensors		
Barometric Pressure Sensor		
2500		
2018-2011	6 Cyl. 6.7L	AS414
3500		
2018-2011	6 Cyl. 6.7L	AS414
4500		
2018-2011	6 Cyl. 6.7L	AS414
5500		
2018-2011	6 Cyl. 6.7L	AS414
Diesel Particulate Filter (DPF) Pressure Sensor		
1500		
2018-2014	6 Cyl. 3.0L; w/ Hose	DPS100
2500		
2018-2013	6 Cyl. 6.7L; Sensor Only	DPS103
3500		
2018-2013	6 Cyl. 6.7L; Sensor Only	DPS103
4500		
2017-2013	6 Cyl. 6.7L; Sensor Only	DPS103
5500		
2017-2013	6 Cyl. 6.7L; Sensor Only	DPS103
EGR Valve Pressure Feedback Sensor		
1500		
2018-2014	6 Cyl. 3.0L	VP37
2500		
2018-2015	6 Cyl. 6.7L; Diesel	VP34
2014	6 Cyl. 6.7L	VP34
2013-2011	6 Cyl. 6.7L; Diesel	VP34
3500		
2018-2015	6 Cyl. 6.7L; Diesel	VP34
2014	6 Cyl. 6.7L	VP34
2013-2011	6 Cyl. 6.7L; Diesel	VP34
4500		
2019	6 Cyl.; Diesel	VP34
2018	6 Cyl. 6.7L; Diesel	VP34
2017-2016	6 Cyl.; Diesel	VP34
2015	6 Cyl. 6.7L; Diesel	VP34
2014	6 Cyl. 6.7L	VP34
2013-2011	6 Cyl.	VP34
5500		
2020-2017	6 Cyl. 6.7L; Diesel	VP34
2016	6 Cyl.; Diesel	VP34
2015	6 Cyl. 6.7L; Diesel	VP34
2014	6 Cyl. 6.7L	VP34
2013-2011	6 Cyl.	VP34
Fuel Pressure Sensor		
1500		
2018-2014	6 Cyl. 3.0L; Diesel	FPS89
1500 Classic		
2019	6 Cyl. 3.0L; Diesel	FPS89
2500		
2017-2013	6 Cyl. 6.7L	FPS103
2012-2011	6 Cyl. 6.7L	FPS2
3500		
2017-2013	6 Cyl. 6.7L	FPS103

		Part No.
Fuel Pressure Sensor		
3500		
2012-2011	6 Cyl. 6.7L	FPS2
4500		
2018-2013	6 Cyl. 6.7L	FPS103
2012-2011		FPS2
5500		
2018-2013	6 Cyl. 6.7L	FPS103
2012-2011		FPS2
Manifold Differential Pressure Sensor		
4500		
2012-2011	6 Cyl. 6.7L	AS628
5500		
2012-2011	6 Cyl. 6.7L	AS628
MAP Sensor		
1500		
2018-2014	6 Cyl. 3.0L; Turbocharged	AS622
2500		
2018	6 Cyl. 6.7L	AS413
2017-2011	6 Cyl. 6.7L; Diesel	AS413
3500		
2018-2015	6 Cyl. 6.7L	AS413
2014-2013	6 Cyl. 6.7L; Diesel	AS413
2012-2011	6 Cyl. 6.7L	AS413
4500		
2018-2014	6 Cyl. 6.7L	AS413
2013		AS413
2012-2011	Laramie	AS413
2012-2011	SLT	AS413
2012-2011	ST	AS413
5500		
2018-2014	6 Cyl. 6.7L; Diesel	AS413
2013-2011		AS413
ProMaster 1500		
2017-2014	4 Cyl. 3.0L	AS650
ProMaster 2500		
2017-2014	4 Cyl. 3.0L	AS650
ProMaster 3500		
2017-2014	4 Cyl. 3.0L	AS650
Temperature Sensors		
A/C Evaporator Temperature Sensor		
4500		
2013-2011		AX412
5500		
2013-2011		AX412
Ambient Air Temperature Sensor		
4500		
2013		AX354
5500		
2013		AX354
Automatic Transmission Oil Temperature Sensor		
3500		
2017-2013	6 Cyl.	TX262
4500		
2013-2011		TX262
5500		
2013-2011		TX262
Coolant Temperature Sensor		
1500		
2018-2014	6 Cyl. 3.0L	TS-633
2500		
2018-2011	6 Cyl. 6.7L	TX141

Temperature Sensors

		Part No.
Coolant Temperature Sensor		
3500		
2018-2011	6 Cyl. 6.7L	TX141
ProMaster 1500		
2017-2014	4 Cyl. 3.0L	TX284
ProMaster 2500		
2017-2014	4 Cyl. 3.0L	TX284
ProMaster 3500		
2017-2014	4 Cyl. 3.0L	TX284
Engine Oil Temperature Sensor		
1500		
2017-2014	6 Cyl. 3.0L	TX260
Exhaust Gas Temperature Sensor		
1500		
2020	6 Cyl. 3.0L	ETS230
2018	6 Cyl. 3.0L	ETS230
2018-2015	6 Cyl. 3.0L; Front; Located in Particulate Filter	ETS175
2018-2014	6 Cyl. 3.0L; EGR Pipe	ETS118
2018-2014	6 Cyl. 3.0L; Located Before Turbocharger	ETS162
2018-2014	6 Cyl. 3.0L; Located After Particulate Filter	ETS163
2018-2014	6 Cyl. 3.0L; Located Before Particulate Filter	ETS178
2016-2014	6 Cyl. 3.0L; Located on EGR Crossover Tube	ETS120
2015	6 Cyl. 3.0L; Upstream	ETS166
2015-2014	6 Cyl. 3.0L; Center; Located After Particulate Filter	ETS218
1500 Classic		
2019	6 Cyl. 3.0L	ETS230
2500		
2018-2011	6 Cyl. 6.7L; Located on EGR Crossover Tube	ETS117
2016-2013	6 Cyl. 6.7L; Located Before Particulate Filter	ETS122
2012	6 Cyl. 6.7L; Located After Catalytic Converter	ETS67
2011	6 Cyl. 6.7L; Located After Catalytic Converter	ETS67
3500		
2018-2012	6 Cyl.; Located on EGR Crossover Tube	ETS117
2016-2015	6 Cyl. 6.7L; Located on EGR Crossover Tube	ETS117
2016-2013	6 Cyl. 6.7L; Located Before Particulate Filter	ETS122
2011	6 Cyl. 6.7L; Located on EGR Crossover Tube	ETS117
2011	6 Cyl. 6.7L; Located After Catalytic Converter	ETS67
4500		
2013-2011	Located on EGR Crossover Tube	ETS117
5500		
2013-2011	Located on EGR Crossover Tube	ETS117
2011	Located After Catalytic Converter	ETS67
ProMaster 1500		
2017-2014	4 Cyl. 3.0L; Located on EGR Crossover Tube	ETS120
2016-2014	4 Cyl. 3.0L; Front; Located in Particulate Filter	ETS176
2016-2014	4 Cyl. 3.0L; Front; Located in Catalytic Converter	ETS177
2016-2014	4 Cyl. 3.0L; Located After Particulate Filter	ETS180
2016-2014	4 Cyl. 3.0L; Rear; Located in Catalytic Converter	ETS189

		Part No.
Exhaust Gas Temperature Sensor		
ProMaster 2500		
2018-2014	4 Cyl. 3.0L; Located on EGR Crossover Tube	ETS120
2016-2014	4 Cyl. 3.0L; Front; Located in Particulate Filter	ETS176
2016-2014	4 Cyl. 3.0L; Front; Located in Catalytic Converter	ETS177
2016-2014	4 Cyl. 3.0L; Located After Particulate Filter	ETS180
2016-2014	4 Cyl. 3.0L; Rear; Located in Catalytic Converter	ETS189
ProMaster 3500		
2016-2014	4 Cyl. 3.0L; Front; Located in Particulate Filter	ETS176
2016-2014	4 Cyl. 3.0L; Front; Located in Catalytic Converter	ETS177
2016-2014	4 Cyl. 3.0L; Located After Particulate Filter	ETS180
2016-2014	4 Cyl. 3.0L; Rear; Located in Catalytic Converter	ETS189
Intake Air Temperature Sensor		
1500		
2018-2014	6 Cyl. 3.0L	TX270
2500		
2018	6 Cyl. 6.7L; Diesel	AS415
2016-2011	6 Cyl. 6.7L; Diesel	AS415
3500		
2018-2011	6 Cyl.; Diesel	AS415
4500		
2018-2014	6 Cyl. 6.7L; Diesel	AS415
5500		
2018-2014	6 Cyl. 6.7L; Diesel	AS415
ProMaster 1500		
2017-2014	4 Cyl.; Between Intercooler and Throttle Body	TX283
ProMaster 2500		
2017-2014	4 Cyl.; Between Intercooler and Throttle Body	TX283
ProMaster 3500		
2017-2014	4 Cyl.; Between Intercooler and Throttle Body	TX283
Telematics Sensors		
Park Assist Camera		
4500		
2013		PAC22
5500		
2013		PAC22
Body Light Switches		
Fog Lamp Switch		
4500		
2012-2011	w/ Cargo Light	HLS-1457
2012-2011	w/o Cargo Light	HLS-1621
5500		
2012-2011	w/ Cargo Light	HLS-1457
2012-2011	w/o Cargo Light	HLS-1621
Headlight Switch		
1500		
2018-2014	6 Cyl. 3.0L; w/ Fog Lights	HLS1685
2018-2014	6 Cyl. 3.0L; w/o Fog Lights	HLS1686
2500		
2019-2014	6 Cyl. 6.7L; w/ Fog Lights	HLS1685
2019-2014	6 Cyl. 6.7L; w/o Fog Lights	HLS1686
2013	6 Cyl. 6.7L; Diesel; Turbocharged; w/ Fog Lights	HLS1685

Body Light Switches

		Part No.
Headlight Switch		
2500		
2013	6 Cyl. 6.7L; Diesel; Turbocharged; w/o Fog Lights	HLS1686
2012-2011	6 Cyl. 6.7L; Diesel; Turbocharged; w/o Fog Lights	HLS-1456
2012-2011	6 Cyl. 6.7L; Diesel; Turbocharged; w/ Fog Lights	HLS-1457
3500		
2015-2014	6 Cyl.; w/ Fog Lights	HLS1685
2015-2014	6 Cyl.; w/o Fog Lights	HLS1686
2013	6 Cyl.; Diesel; Turbocharged; w/ Fog Lights	HLS1685
2013	6 Cyl.; Diesel; Turbocharged; w/o Fog Lights	HLS1686
2012	6 Cyl.; Diesel; Turbocharged; w/o Fog Lights	HLS-1456
2012	6 Cyl.; Diesel; Turbocharged; w/ Fog Lights	HLS-1457
2011	6 Cyl. 6.7L; Diesel; Turbocharged; w/o Fog Lights	HLS-1456
2011	6 Cyl. 6.7L; Diesel; Turbocharged; w/ Fog Lights	HLS-1457
4500		
2013	w/ Fog Lights	HLS1685
2013	w/o Fog Lights	HLS1686
2012-2011	w/ Cargo Light; w/o Fog Lights	HLS-1456
2012-2011	w/ Cargo Light; w/ Fog Lights	HLS-1457
2012-2011	w/o Cargo Light; w/o Fog Lights	HLS-1620
2012-2011	w/ Fog Lights; w/o Cargo Light	HLS-1621
5500		
2013	w/ Fog Lights	HLS1685
2013	w/o Fog Lights	HLS1686
2012-2011	w/ Cargo Light; w/o Fog Lights	HLS-1456
2012-2011	w/ Cargo Light; w/ Fog Lights	HLS-1457
2012-2011	w/o Cargo Light; w/o Fog Lights	HLS-1620
2012-2011	w/ Fog Lights; w/o Cargo Light	HLS-1621
Instrument Panel Dimmer Switch		
4500		
2013	w/o Fog Lights	HLS1686
2012-2011	w/ Cargo Light; w/o Fog Lights	HLS-1456
2012-2011	w/ Cargo Light; w/ Fog Lights	HLS-1457
2012-2011	w/o Cargo Light; w/o Fog Lights	HLS-1620
2012-2011	w/ Fog Lights; w/o Cargo Light	HLS-1621
5500		
2013	w/o Fog Lights	HLS1686
2012-2011	w/ Cargo Light; w/o Fog Lights	HLS-1456
2012-2011	w/ Cargo Light; w/ Fog Lights	HLS-1457
2012-2011	w/o Cargo Light; w/o Fog Lights	HLS-1620
2012-2011	w/ Fog Lights; w/o Cargo Light	HLS-1621
Stoplight Switch		
2500		
2012-2011	6 Cyl.	SLS-513
4500		
2013		SLS577
2012	w/ Power Take Off	SLS-208
2012	w/o Power Take Off	SLS-513
2011		SLS-513
5500		
2013		SLS577
2012	w/ Power Take Off	SLS-208
2012	w/o Power Take Off	SLS-513
2011		SLS-513

		Part No.
Chassis and Drivetrain Switches		
Clutch Starter Safety Switch		
4500		
2012-2011		NS-193
5500		
2012-2011		NS-193
Four Wheel Drive Selector Switch		
4500		
2012-2011	w/ Electronic Shift	TCA-58
5500		
2012-2011	w/ Electronic Shift	TCA-58
Neutral Safety Switch		
4500		
2013		NS744
2012-2011		NS718
5500		
2013		NS744
2012		NS718
2011	Laramie	NS718
2011	SLT	NS718
2011	ST	NS718
Transfer Case Switch		
4500		
2013		TCA111
Transmission Control Solenoid		
4500		
2012-2011		TCS221
5500		
2012-2011		TCS221
Interior Power Switches		
Heated Seat Switch		
4500		
2013	Right Rear	HSS120
2013	Left Rear	HSS124
2012-2011	Left Rear	HSS122
2012-2011	Right Rear	HSS125
5500		
2013	Right Rear	HSS120
2013	Left Rear	HSS124
2012-2011	Left Rear	HSS122
2012-2011	Right Rear	HSS125
Pedal Height Adjustment Switch		
4500		
2013		DS1099
5500		
2013		DS1099
Power Door Lock Switch		
4500		
2013	4 Door; w/o Power Folding Mirrors; Left Front	DWS1711
2013	4 Door; w/ Luxury Package; w/ One Touch Window Open/Close; Front Right	DWS1837
2013	2 Door; w/ Auto. Down; w/o Power Folding Mirror Switch; Front Left	DWS1899
2013	2 Door; Right	DWS1994
5500		
2013	4 Door; w/o Power Folding Mirrors; Left Front	DWS1711
2013	4 Door; w/ Luxury Package; w/ One Touch Window Open/Close; Front Right	DWS1837
2013	2 Door; w/ Auto. Down; w/o Power Folding Mirror Switch; Front Left	DWS1899
2013	2 Door; Right	DWS1994

Interior Power Switches

		Part No.
Power Seat Lumbar Switch		
4500		
2013-2012		PSW165
5500		
2013-2012		PSW165
Power Seat Memory Switch		
4500		
2013-2011		PMS12
5500		
2013-2011		PMS12
Power Seat Switch		
4500		
2013-2011	Left	PSW126
5500		
2013-2011	Left	PSW126
Power Window Switch		
2500		
2017-2015	6 Cyl. 6.7L	DWS1899
2013	6 Cyl. 6.7L	DWS1899
3500		
2019	6 Cyl.	DWS1899
2017-2015	6 Cyl.	DWS1899
2013	6 Cyl.	DWS1899
2011	6 Cyl. 6.7L; 2 Door; Front Right	DWS-1390
2011	6 Cyl. 6.7L; 4 Door; Front Right	DWS-523
4500		
2013	w/o One Touch Window Open/Close; Rear	DWS1649
2013	4 Door; w/o Power Folding Mirrors; Front Left	DWS1711
2013	4 Door; w/ Luxury Package; w/ One Touch Window Open/Close; Front Right	DWS1837
2013	2 Door; w/ Auto. Down; w/o Power Folding Mirror Switch; Front Left	DWS1899
2013	2 Door; Front Right	DWS1994
2013	2 Door; Right	DWS1994
2012-2011	4 Door; Front Left	DWS-1386
2012-2011	Laramie; 2 Door; Front Right	DWS-1390
2012-2011	SLT; 2 Door; Front Right	DWS-1390
2012-2011	ST; 2 Door; Front Right	DWS-1390
2012-2011	Laramie; 4 Door; Front Right	DWS-523
2012-2011	SLT; 4 Door; Front Right	DWS-523
2012-2011	ST; 4 Door; Front Right	DWS-523
2012-2011	Laramie; 4 Door; Rear	DWS-523
2012-2011	SLT; 4 Door; Rear	DWS-523
2012-2011	ST; 4 Door; Rear	DWS-523
5500		
2013	w/o One Touch Window Open/Close; Rear	DWS1649
2013	4 Door; w/o Power Folding Mirrors; Front Left	DWS1711
2013	4 Door; w/ Luxury Package; w/ One Touch Window Open/Close; Front Right	DWS1837
2013	2 Door; w/ Auto. Down; w/o Power Folding Mirror Switch; Front Left	DWS1899
2013	2 Door; Front Right	DWS1994
2013	2 Door; Right	DWS1994
2012-2011	4 Door; Front Left	DWS-1386
2012-2011	Laramie; 2 Door; Front Right	DWS-1390
2012-2011	SLT; 2 Door; Front Right	DWS-1390
2012-2011	ST; 2 Door; Front Right	DWS-1390
2012-2011	Laramie; 4 Door; Front Right	DWS-523
2012-2011	SLT; 4 Door; Front Right	DWS-523
2012-2011	ST; 4 Door; Front Right	DWS-523
2012-2011	Laramie; 4 Door; Rear	DWS-523

		Part No.
Power Window Switch		
5500		
2012-2011	SLT; 4 Door; Rear	DWS-523
2012-2011	ST; 4 Door; Rear	DWS-523
Remote Mirror Switch		
4500		
2013	4 Door; w/o Power Folding Mirrors	DWS1711
2013	2 Door; w/ Auto. Down; w/o Power Folding Mirror Switch	DWS1899
5500		
2013	4 Door; w/o Power Folding Mirrors	DWS1711
2013	2 Door; w/ Auto. Down; w/o Power Folding Mirror Switch	DWS1899
Steering Wheel Audio Control Switch		
4500		
2013-2012	Right	SAS256
2013-2012	Left	SAS257
5500		
2013-2012	Right	SAS256
2013-2012	Left	SAS257
Pressure and Vacuum Sending Switches		
Oil Pressure Gauge Switch		
2500		
2018-2011	6 Cyl.	PS-406
3500		
2018-2011	6 Cyl.	PS-406
ProMaster 1500		
2017-2014	4 Cyl.	PS647
ProMaster 2500		
2017-2014	4 Cyl.	PS647
ProMaster 3500		
2017-2014	4 Cyl.	PS647
Oil Pressure Light Switch		
1500		
2018-2014	6 Cyl. 3.0L	PS639
Transmission Oil Pressure Switch		
4500		
2013-2011		PS679
5500		
2013-2011		PS679
Temperature Switches and Senders		
A/C Cut-Off Switch		
4500		
2013-2012		PCS160
5500		
2013-2012		PCS160
Blower Motor Resistor		
4000		
2013	6 Cyl. 6.7L; Cab and Chassis; w/o Auto. Temp Control	RU-710
2013	6 Cyl. 6.7L; Cab and Chassis; w/ Auto. Temp Control	RU-839
4500		
2013	Resistor; w/o Auto. Temp Control	RU-710
2013	Module; w/ Auto. Temp Control; w/o Dual Zone Climate Control	RU-839
2013	Module; w/ Auto. Temp Control; w/ Dual Zone Climate Control	RU932
2012-2011	w/o Auto. Temp Control	RU-710
5500		
2013	Resistor; w/o Auto. Temp Control	RU-710
2013	Module; w/ Auto. Temp Control; w/o Dual Zone Climate Control	RU-839

Temperature Switches and Senders

		Part No.
Blower Motor Resistor		
5500		
2013	Module; w/ Auto. Temp Control; w/ Dual Zone Climate Control	RU932
2012-2011	w/o Auto. Temp Control	RU-710
Universal Switches		
Center High Mount Stop Light Assembly		
4500		
2013-2011		BTL123
5500		
2013-2011		BTL123
Actuators		
Four Wheel Drive Actuator		
2500		
2014-2013	6 Cyl. 6.7L; 4WD; Diesel; Turbocharged	TCA14
2012	6 Cyl. 6.7L; Laramie; 4WD	TCA14
2012	6 Cyl. 6.7L; Laramie Longhorn; 4WD	TCA14
2012	6 Cyl. 6.7L; SLT; 4WD	TCA14
2012	6 Cyl. 6.7L; ST; 4WD	TCA14
HVAC Floor Mode Door Actuator		
4500		
2011	Front	ADR4209
5500		
2011	Front	ADR4209
HVAC Recirculation Mode Door Actuator		
4500		
2011	Front	ADR4209
5500		
2011	Front	ADR4209
HVAC Temperature Blend Door Actuator		
4500		
2011	Front	ADR4209
5500		
2011	Front	ADR4209
Power Door Lock Actuator		
4500		
2013	w/ Keyless Entry; Left Front	DLA1007
2013	2 Door; w/ Keyless Entry; Right Front	DLA1037
2013	4 Door; w/ Keyless Entry; Right Front	DLA1038
2013	w/o Keyless Entry; Left Front	DLA1063
2013	4 Door; w/o Keyless Entry; Right Front	DLA987
2013	4 Door; Right Rear	DLA997
2013	4 Door; Left Rear	DLA998
2013-2011	2 Door; w/o Keyless Entry; Right Front	DLA1036
2012-2011	2 Door; w/ Keyless Entry; Right Front	DLA1034
2012-2011	4 Door; Right Front	DLA1035
2012-2011	Left Front	DLA1065
2012-2011	4 Door; Right Rear	DLA1139
5500		
2013	w/ Keyless Entry; Left Front	DLA1007
2013	2 Door; w/ Keyless Entry; Right Front	DLA1037
2013	4 Door; w/ Keyless Entry; Right Front	DLA1038
2013	w/o Keyless Entry; Left Front	DLA1063
2013	4 Door; w/o Keyless Entry; Right Front	DLA987
2013	4 Door; Right Rear	DLA997
2013	4 Door; Left Rear	DLA998
2013-2011	2 Door; w/o Keyless Entry; Right Front	DLA1036
2012-2011	2 Door; w/ Keyless Entry; Right Front	DLA1034
2012-2011	4 Door; Right Front	DLA1035
2012-2011	Left Front	DLA1065
2012-2011	4 Door; Right Rear	DLA1139

		Part No.
Renault		
Position Sensors		
Camshaft Sensor		
Traffic		
2011-2008		PC1032
Pressure Sensors		
MAP Sensor		
Kangoo Express		
2010	4 Cyl. 1.5L	AS602
Traffic		
2011-2008		AS602
Body Light Switches		
Back-Up Light Switch		
Traffic		
2011-2010		LS-376
2008		LS-376
Stoplight Switch		
Traffic		
2011-2008	2 Blade Term.	SLS531
2011-2008	4 Blade Term.	SLS532
Interior Power Switches		
Cruise Control Release Switch		
Traffic		
2011-2010		SLS-521
2008		SLS-521
Pressure and Vacuum Sending Switches		
Oil Pressure Light Switch		
Traffic		
2013-2008	4 Cyl. 1.9L	PS715
Smart		
Position Sensors		
Crankshaft Sensor		
Fortwo		
2007-2005	3 Cyl. 0.8L	PC456
Sterling Truck		
Early Fuel Emission Control		
Crankcase Ventilation Filter		
Acterra		
2010-2009	6 Cyl. 6.7L	BF43
Pressure Sensors		
Air Inlet Pressure Sensor		
A9500		
1999	6 Cyl. 12.0L	PS711
A9513		
2000-1999	6 Cyl. 12.0L	PS711
AT9500		
2001-1999	6 Cyl. 12.0L	PS711
AT9513		
2001-1999	6 Cyl. 12.0L	PS711
AT9522		
2000-1999	6 Cyl. 12.0L	PS711
Condor		
2001	6 Cyl. 12.0L	PS711
L8513		
2000	6 Cyl. 12.0L	PS711
L9500		
2001-2000	6 Cyl. 12.0L	PS711

Sterling Truck

Pressure Sensors

		Part No.
Air Inlet Pressure Sensor		
L9501		
2000-1999	6 Cyl. 12.0L	PS711
L9511		
2001	6 Cyl. 12.0L	PS711
1999	6 Cyl. 12.0L	PS711
L9513		
2000-1999	6 Cyl. 12.0L	PS711
LT9500		
2001-1999	6 Cyl. 12.0L	PS711
LT9501		
2000-1999	6 Cyl. 12.0L	PS711
LT9511		
2001-1999	6 Cyl. 12.0L	PS711
LT9513		
2001-1999	6 Cyl. 12.0L	PS711
LT9522		
2000-1999	6 Cyl. 12.0L	PS711
ST9500		
2001-2000	6 Cyl. 12.0L	PS711
Diesel Particulate Filter (DPF) Pressure Sensor		
Acterra		
2010	6 Cyl. 6.7L	DPS101
L8500		
2010	6 Cyl. 8.9L	DPS101
EGR Valve Pressure Feedback Sensor		
Acterra		
2010-2009	6 Cyl. 6.7L; Diesel	VP34
Bullet 45		
2010-2008	6 Cyl. 6.7L; Diesel	VP34
Bullet 55		
2010-2008	6 Cyl. 6.7L; Diesel	VP34
Injection Actuation Pressure Sensor		
L7500		
2000-1999	6 Cyl. 7.2L	PS713
L7501		
2000-1999	6 Cyl. 7.2L	PS713
L8500		
2000-1999	6 Cyl. 7.2L	PS713
L8501		
1999	6 Cyl. 7.2L	PS713
L8511		
2000-1999	6 Cyl. 7.2L	PS713
L8513		
2000-1999	6 Cyl. 7.2L	PS713
L9522		
1999	6 Cyl. 7.2L	PS713
LT7500		
2000-1999	6 Cyl. 7.2L	PS713
LT7501		
2000-1999	6 Cyl. 7.2L	PS713
LT8500		
2000-1999	6 Cyl. 7.2L	PS713
LT8501		
1999	6 Cyl. 7.2L	PS713
LT8511		
2000-1999	6 Cyl. 7.2L	PS713
LT8513		
2000-1999	6 Cyl. 7.2L	PS713
Turbocharger Boost Sensor		
A9500		
2007	6 Cyl. 14.0L; Turbocharged	AS679

		Part No.
Pressure and Vacuum Sending Switches		
Oil Pressure Gauge Switch		
L8500		
2009	6 Cyl. 8.9L	PS-407
Thomas		
Early Fuel Emission Control		
Crankcase Ventilation Filter		
Saf-T-Liner		
2020-2019	6 Cyl. 6.7L	BF43
Transit Liner		
2020-2019	6 Cyl. 6.7L	BF43
Pressure Sensors		
EGR Valve Pressure Feedback Sensor		
Saf-T-Liner		
2020-2019	6 Cyl. 6.7L; Diesel	VP34
Pressure and Vacuum Sending Switches		
Oil Pressure Gauge Switch		
Saf-T-Liner		
2017	6 Cyl. 8.9L	PS-407
Toyota		
Relays and Fuses		
A/C Relay		
Corolla		
1985	4 Cyl. 1.8L; Diesel; SOHC; Stamping No. 90987-03001	RY-137
Charge Lamp Relay		
Corolla		
1985-1984	4 Cyl. 1.8L	RY455
Coolant Fan Relay		
Camry		
1986	4 Cyl. 2.0L	RY-137
1986-1985	4 Cyl. 1.8L	RY-439
Diesel Glow Plug Relay		
Camry		
1984	4 Cyl. 1.8L; Diesel	RY-51
Turn Signal Flasher		
Pickup		
1987-1985	4 Cyl. 2.4L	EFL-8
Starting and Charging System Parts		
Starter Solenoid		
Corolla		
1985-1984	4 Cyl. 1.8L; 2.5 Kw	SS-448
Voltage Regulator		
Camry		
1986	4 Cyl. 2.0L	VR-405
1986-1984	4 Cyl. 1.8L	VR-439
Corolla		
1985-1984	4 Cyl. 1.8L	VR-405
Land Cruiser		
1987-1986	4 Cyl. 3.4L; Diesel	VR-439
1986	6 Cyl. 4.2L; External	VR-155
1986	6 Cyl. 4.2L; Internal	VR-160
1985	4 Cyl. 3.4L	VR-435
1984	6 Cyl. 4.2L; External	VR-155
1984	6 Cyl. 4.2L; Internal	VR-160
1984-1982	4 Cyl. 3.4L; Diesel	VR-435
1982-1981	6 Cyl. 4.2L; External	VR-155
1982-1981	6 Cyl. 4.2L; Internal	VR-160
1981	4 Cyl. 3.4L	VR-435

Starting and Charging System Parts

		Part No.
Voltage Regulator		
Pickup		
1981	4 Cyl. 2.2L; 3 Blade Term.	VR-439
Air Management Valves		
Air Cleaner Check Valve		
Land Cruiser		
1986	6 Cyl.	AV11
1986	6 Cyl. 4.2L	AV11
1984-1981	6 Cyl.	AV11
1984-1981	6 Cyl. 4.2L	AV11
Pickup		
1986-1985	4 Cyl. 2.4L	AV11
Idle Air Control Valve		
Camry		
1986	4 Cyl. 2.0L	AC449
Air Management Regulators and Solenoids		
Idle Stop Solenoid		
Pickup		
1987-1986	4 Cyl.	ES56
1985-1984	4 Cyl.; Calif.	ES56
1983-1981	4 Cyl.; 4WD; U.S. Models	ES56
EGR Components		
EGR Valve Mounting Gasket		
Camry		
1986	4 Cyl. 2.0L	VG19
Pickup		
1985	4 Cyl. 2.4L; Diesel; Turbocharged; At Inlet	VG236
PCV Systems		
PCV Grommet		
Corolla		
1985	4 Cyl.	GV21
Pickup		
1987-1981	4 Cyl.	GV22
PCV Valve		
Corolla		
1985	4 Cyl.	V247
1984	4 Cyl. 1.8L	V247
Land Cruiser		
1987	4 Cyl. 2.4L	V168
1987-1981	4 Cyl. 3.4L	V168
1986	6 Cyl.	V168
1984-1981	6 Cyl.	V168
Pickup		
1987-1982	4 Cyl.	V276
1981	4 Cyl.	V223
Fuel Valves and Solenoids		
Cold Start Valve		
Camry		
1986	4 Cyl. 2.0L	CJ5
Pickup		
1987-1984	4 Cyl. 2.4L	CJ2
Injection Components		
Fuel Pressure Regulator		
Camry		
1986	4 Cyl. 2.0L	PR37
Pickup		
1987-1986	4 Cyl. 2.4L; FI	PR41
Multi-Port Fuel Injection Tune-Up Kit		
Pickup		
1987-1985	4 Cyl. 2.4L; SOHC	2054

		Part No.
Plenum Gasket		
Camry		
1986	4 Cyl. 2.0L	PG72
Chassis and Drivetrain Sensors		
Automatic Transmission Output Sensor		
Pickup		
1987-1985	4 Cyl. 2.4L; Naturally Aspirated	SC390
1985	4 Cyl. 2.4L; Turbocharged	SC419
Vehicle Speed Sensor		
Camry		
1986	4 Cyl. 2.0L; Electronic Control; w/ A.T.	SC140
Pickup		
1987-1985	4 Cyl. 2.4L; Naturally Aspirated	SC390
1985	4 Cyl. 2.4L; Turbocharged	SC419
Position Sensors		
Throttle Position Sensor		
Camry		
1986	4 Cyl. 2.0L; w/ M.T.	TH140
1986	4 Cyl. 2.0L; w/ A.T.	TH283
Land Cruiser		
1986	6 Cyl. 4.2L	TH218
1984	6 Cyl. 4.2L	TH218
Pickup		
1987-1986	4 Cyl. 2.4L	TH218
Temperature Sensors		
Exhaust Gas Temperature Sensor		
Land Cruiser		
1985	4 Cyl. 3.4L; To 4/85; U.S. Models	ETS58
1984-1981	4 Cyl. 3.4L; U.S. Models	ETS58
Pickup		
1987-1986	4 Cyl.; Calif.	ETS3
1984	4 Cyl.; 4WD	ETS57
1983	4 Cyl.; 4WD	ETS55
1983	4 Cyl.; RWD	ETS56
1982-1981	4 Cyl.; 4WD; Fed.	ETS55
1982-1981	4 Cyl.; Fed.; RWD	ETS56
Chassis and Drivetrain Switches		
Neutral Safety Switch		
Corolla		
1985-1984	4 Cyl. 1.8L; Hatchback; w/ A.T.	NS168
Land Cruiser		
1987-1986	w/ A.T.	NS159
1985	4 Cyl. 3.4L	NS159
Pickup		
1984	4 Cyl. 2.4L	NS138
Pressure and Vacuum Sending Switches		
Ported Vacuum Switch		
Camry		
1986	4 Cyl. 2.0L	PVS160
Pickup		
1987	4 Cyl. 2.4L	PVS148
Temperature Switches and Senders		
Coolant Fan Switch		
Corolla		
1985-1984	4 Cyl. 1.8L	TS-93

Relays and Fuses

		Part No.
Volkswagen		
Relays and Fuses		
A/C Compressor Clutch Cut-Off Relay		
Golf		
1999-1993	4 Cyl. 1.9L; Diesel	RY-1340
Jetta		
1999-1993	4 Cyl. 1.9L; Diesel	RY-1340
A/C Relay		
Dasher		
1981		RY-347
Air Pump Relay		
Crafter Van		
2008		RY-255
Blower Motor Relay		
Dasher		
1981	Exhaust stock and reorder	RY-265
1981	Alternate Number	RY-273
Computer Control Relay		
Jetta		
2011-2009	4 Cyl. 2.0L	RY-884
2005-2000	4 Cyl. 1.9L; Diesel; Exhaust stock and reorder	RY-265
2005-2000	4 Cyl. 1.9L; Alternate Number; Diesel	RY-273
Coolant Fan Relay		
Dasher		
1981	Exhaust stock and reorder	RY-265
1981	Alternate Number	RY-273
Jetta		
2011	4 Cyl. 2.0L; Mexico Models	RY-889
2010-2008	4 Cyl. 1.9L; Mexico Models	RY-889
2009	4 Cyl. 2.0L; Mexico Models	RY-889
1984-1982	4 Cyl. 1.6L; Exhaust stock and reorder	RY-265
1984-1982	4 Cyl. 1.6L; Alternate Number	RY-273
Vanagon		
1982	4 Cyl. 1.6L; Exhaust stock and reorder	RY-265
1982	4 Cyl. 1.6L; Alternate Number	RY-273
Coolant Level Relay		
Rabbit		
1984	4 Cyl. 1.6L	RY-289
1983	4 Cyl. 1.6L; w/ A.T.	RY-289
Rabbit Pickup		
1983	4 Cyl. 1.6L; w/ A.T.	RY-289
Defroster Relay		
Dasher		
1981		RY-95
Diesel Glow Plug Relay		
Beetle		
2003-2002	4 Cyl. 1.9L	RY-575
Dasher		
1981		RY-53
EuroVan		
2009-2006		RY-1733
1997-1993	5 Cyl. 2.4L; Diesel	RY1736
Jetta		
1992-1981	4 Cyl. 1.6L	RY-53
Quantum		
1985-1982	4 Cyl. 1.6L	RY-53
Rabbit		
1984-1981	4 Cyl. 1.6L; Diesel	RY-53
1980	4 Cyl. 1.5L; Diesel	RY-53

		Part No.
Diesel Glow Plug Relay		
Rabbit Pickup		
1983-1981	4 Cyl. 1.6L; Diesel	RY-53
Vanagon		
1984-1982	4 Cyl. 1.6L; Diesel	RY-53
Engine Control Relay		
Jetta		
2011-2010	4 Cyl. 2.0L; Mexico Models	RY-884
2009	4 Cyl. 2.0L; Mexico Models; To VIN 9M-6-099-000	RY-884
Passat		
2005-2004	4 Cyl. 2.0L	RY-528
Fuel Injection Relay		
Dasher		
1981	4 Cyl. 1.6L	RY-33
1980	4 Cyl. 1.5L	RY-33
Jetta		
1984-1981	4 Cyl. 1.6L	RY-33
Quantum		
1984-1982	4 Cyl. 1.6L	RY-33
Rabbit		
1984-1981	4 Cyl. 1.6L	RY-33
1980	4 Cyl. 1.5L	RY-33
Rabbit Pickup		
1983-1981	4 Cyl. 1.6L	RY-33
Vanagon		
1984-1982	4 Cyl. 1.6L	RY-33
Fuel Pump Relay		
Crafter Van		
2008		RY-577
Touareg		
2007-2004	10 Cyl.; Exhaust stock and reorder	RY-265
2007-2004	10 Cyl.; Alternate Number	RY-273
Vanagon		
1982	4 Cyl. 1.6L; Exhaust stock and reorder	RY-265
1982	4 Cyl. 1.6L; Alternate Number	RY-273
Hazard Flasher		
Golf		
1999	4 Cyl. 1.9L	RY-256
Jetta		
1998-1997	4 Cyl. 1.9L	RY-256
Headlight Relay		
Dasher		
1981		LR-35
Headlight Washer Relay		
Touareg		
2006	10 Cyl.; Exhaust stock and reorder	RY-265
2006	10 Cyl.; Alternate Number	RY-273
Horn Relay		
Transporter		
1994		RY-341
Lambda Heater Relay		
Rabbit		
1984-1982	4 Cyl. 1.6L	RY-95
Rabbit Pickup		
1983-1982	4 Cyl. 1.6L	RY-95
Neutral Safety Switch Relay		
Jetta		
2011-2009	4 Cyl. 2.0L; Mexico Models	RY-1616
2010-2007	4 Cyl. 1.9L; Mexico Models	RY-1616

Relays and Fuses

		Part No.
Power Door Lock Relay		
EuroVan		
2009-2006	4 Cyl. 1.9L	RY-583
Pulse Wiper Relay		
Dasher		
1981		RY-203
Rear Window Defogger Relay		
Dasher		
1981		RY-95
Turn Signal Flasher		
Dasher		
1981		EFL-9
Wiper Relay		
Dasher		
1981		RY-95
Jetta		
2014-2009	4 Cyl. 2.0L; Mexico Models; w/o Rain Sensitive Wipers	RY-892
2012-2009	4 Cyl. 2.0L; Mexico Models; w/ Rain Sensitive Wipers	RY-869
2010-2008	4 Cyl. 1.9L; Mexico Models; w/ Rain Sensitive Wipers	RY-869
2010-2008	4 Cyl. 1.9L; Mexico Models; w/o Rain Sensitive Wipers	RY-892
X-Contact Relay		
Crafter Van		
2008	5 Cyl. 2.5L	RY-255
Touareg		
2006	10 Cyl.; Exhaust stock and reorder	RY-265
2006	10 Cyl.; Alternate Number	RY-273
Starting and Charging System Parts		
Starter Solenoid		
Beetle		
2006-1998	4 Cyl. 1.9L; Bosch Starter	SS-843
Dasher		
1981		SS-336
1980	4 Cyl. 1.5L	SS-843
Golf		
2003-2002	4 Cyl. 1.9L; Bosch Starter	SS-843
2001-2000	4 Cyl. 1.9L	SS-843
1999	4 Cyl. 1.9L; GL; Diesel	SS-843
1999	4 Cyl. 1.9L; TDI; Diesel	SS-843
1990	4 Cyl. 1.6L	SS-255
Jetta		
2005-2002	4 Cyl. 1.9L; TDI; Bosch Starter	SS-843
2001-2000	4 Cyl. 1.9L; TDI; w/ A.T.	SS-843
1999	4 Cyl. 1.9L; TDI; From Chassis No. 9MX000001; w/ A.T.	SS-843
Passat		
1994-1993	4 Cyl. 1.9L	SS-230
Quantum		
1983	4 Cyl.; Mitsubishi	SS-262
Voltage Regulator		
Beetle		
2006	4 Cyl. 1.9L; TDI; Valeo Alternator	VR-831
2006	4 Cyl. 1.9L; TDI; Bosch Alternator	VR-850
2005-2000	4 Cyl. 1.9L; Diesel; Valeo Alternator	VR-831
2005-2000	4 Cyl. 1.9L; Bosch Alternator; Diesel	VR-850
1998	4 Cyl.	VR-506
Dasher		
1981	Bosch	VR-134
1981	Motorola	VR-169

		Part No.
Voltage Regulator		
Golf		
2006	4 Cyl. 1.9L; Bosch Alternator	VR-788
2006	4 Cyl. 1.9L; Valeo Alternator	VR-831
2005	4 Cyl. 1.9L; Bosch Alternator; Diesel	VR-788
2005	4 Cyl. 1.9L; Diesel; Valeo Alternator	VR-831
2004	4 Cyl. 1.9L; Bosch Alternator	VR-788
2004	4 Cyl. 1.9L; Valeo Alternator	VR-831
Jetta		
2009	4 Cyl.; Valeo Alternator	VR-831
2009	4 Cyl.; Bosch Alternator	VR-850
2005	4 Cyl. 1.9L; Bosch Alternator	VR-789
2005	4 Cyl. 1.9L; Valeo Alternator	VR-831
2001-2000	4 Cyl. 1.9L; Bosch Alternator; Diesel	VR-789
2001-2000	4 Cyl. 1.9L; Diesel; Valeo Alternator	VR-831
Passat		
2005	4 Cyl. 2.0L; Bosch Alternator	VR-789
2005	4 Cyl. 2.0L; Valeo Alternator	VR-831
2004	4 Cyl. 2.0L; Diesel; Valeo Alternator	VR-789
2004	4 Cyl. 2.0L; Bosch Alternator; Diesel	VR-831
Quantum		
1984-1982	4 Cyl.; Motorola	VR-169
1984-1982	4 Cyl.; Bosch	VR-179
Air Injection and Induction Parts		
Electronic Throttle Body (ETB) Gasket		
Beetle		
2015	4 Cyl.	TBG111
2014	4 Cyl.; Turbocharged	TBG111
2013	4 Cyl. 2.0L	TBG110
Golf		
2015	4 Cyl.	TBG111
Jetta		
2016	4 Cyl.	TBG111
2015-2014	4 Cyl. 2.0L	TBG111
2013-2009	4 Cyl. 2.0L	TBG110
Fuel Injection Throttle Body		
Amarok		
2014-2013	4 Cyl. 2.0L	S20070
Beetle		
2015-2013	4 Cyl. 2.0L	S20070
2014-2013	4 Cyl. 2.0L; Diesel	S20118
Golf		
2014-2010	4 Cyl. 2.0L; Diesel	S20118
Jetta		
2014-2009	4 Cyl. 2.0L; Diesel	S20118
2010-2008	4 Cyl. 1.9L; Diesel	S20113
2006-2005	4 Cyl. 1.9L; Diesel	S20114
Passat		
2005-2004	4 Cyl. 2.0L; Diesel	S20113
Touareg		
2012	6 Cyl. 3.0L; Diesel	S20116
Turbocharger - New		
Beetle		
2014-2013	4 Cyl. 2.0L; Diesel; Turbocharged	TBC529
2006-2004	4 Cyl. 1.9L; Turbocharged	TBC-518
2003-1999	4 Cyl. 1.9L; Turbocharged	TBC-519
Golf		
2014-2010	4 Cyl. 2.0L; Diesel; Turbocharged	TBC529
2006-2005	4 Cyl. 1.9L; Turbocharged	TBC-518
2004	4 Cyl. 1.9L; BEW Eng.; Turbocharged	TBC-518
2004	4 Cyl. 1.9L; ALH Eng.; Turbocharged	TBC-519
2003-1999	4 Cyl. 1.9L; Turbocharged	TBC-519
1997-1993	4 Cyl. 1.9L; Turbocharged	TBC613

Air Injection and Induction Parts

		Part No.
Turbocharger - New		
Jetta		
2014-2010	4 Cyl. 2.0L; Diesel; Turbocharged	TBC529
2009	4 Cyl. 2.0L; Diesel; Turbocharged; Wagon	TBC529
2006	4 Cyl. 1.9L; Turbocharged	TBC587
2005	4 Cyl. 1.9L; BRM Eng.; Turbocharged	TBC587
2005-2004	4 Cyl. 1.9L; BEW Eng.; Turbocharged	TBC-518
2004	4 Cyl. 1.9L; ALH Eng.; Turbocharged	TBC-519
2003-2001	4 Cyl. 1.9L; Turbocharged	TBC-519
2000	4 Cyl. 1.9L; From 10/00; Turbocharged	TBC-519
1999	4 Cyl. 1.9L; AHU Eng.; Turbocharged	TBC542
1998-1997	4 Cyl. 1.9L; Turbocharged	TBC542
1996-1995	4 Cyl. 1.9L; Turbocharged	TBC613
Passat		
2014-2012	4 Cyl. 2.0L; Turbocharged	TBC580
2005-2004	4 Cyl. 2.0L; Turbocharged	TBC564
1997-1996	4 Cyl. 1.9L; Turbocharged	TBC542
1995	4 Cyl. 1.9L; Turbocharged	TBC613
Touareg		
2012-2011	6 Cyl. 3.0L; Diesel; Turbocharged	TBC585
2010-2009	6 Cyl. 3.0L; Turbocharged	TBC585
2008-2006	10 Cyl.; Turbocharged; Left	TBC586
Turbocharger Oil Line		
Beetle		
2005-1999	4 Cyl. 1.9L; Turbocharged; Inlet	TBC3
Golf		
2006-1999	4 Cyl. 1.9L; Turbocharged; Inlet	TBC3
Jetta		
2005-1999	4 Cyl. 1.9L; Turbocharged; Inlet	TBC3
Vacuum Pump		
Beetle		
2014-2013	4 Cyl. 2.0L; Diesel	VCP169
2003-1998	4 Cyl. 1.9L	VCP155
Golf		
2013-2012	4 Cyl. 2.0L	VCP169
2004-1999	4 Cyl. 1.9L	VCP155
Jetta		
2014-2009	4 Cyl. 2.0L; Diesel	VCP169
2004-1999	4 Cyl. 1.9L	VCP155
Passat		
2014-2012	4 Cyl. 2.0L	VCP169
Air Management Valves		
Auxiliary Air Valve		
Jetta		
1988-1982	4 Cyl. 1.6L	AV50
Quantum		
1985-1982	4 Cyl. 1.6L	AV50
Rabbit		
1984-1982	4 Cyl. 1.6L	AV50
Rabbit Pickup		
1983-1981	4 Cyl. 1.6L	AV50
Diverter Valve		
Beetle		
2013	4 Cyl. 2.0L	DV180
Golf		
2010	4 Cyl. 2.0L	DV146
Jetta		
2013-2009	4 Cyl. 2.0L; Diesel; Turbocharged	DV180
1999	4 Cyl.	DV173
Passat		
2005-2004	4 Cyl.	DV165

		Part No.
Diverter Valve		
Touareg		
2010	6 Cyl. 3.0L; Left	DV169
Engine Oil Separator		
Beetle		
2013	4 Cyl. 2.0L; Turbocharged	Z27003
Jetta		
2013-2012	4 Cyl. 2.0L	Z27003
2010-2009	4 Cyl. 2.0L	Z27003
Idle Air Control Valve		
Dasher		
1981	4 Cyl. 1.6L	AC39
Quantum		
1985	4 Cyl. 1.6L	AC39
Air Management Regulators and Solenoids		
Turbocharger Boost Solenoid		
Golf		
2014-2010	4 Cyl. 2.0L; Diesel	VS198
1999-1997	4 Cyl. 1.9L	U43002
Jetta		
2014-2009	4 Cyl. 2.0L; Diesel	VS198
1999-1997	4 Cyl. 1.9L	U43002
Passat		
2014-2012	4 Cyl. 2.0L; Diesel	VS198
1997	4 Cyl. 1.9L; AHU Eng.	U43002
1996	4 Cyl. 1.9L; 1Z	U43002
Early Fuel Emission Control		
Pre Heater Hose		
Dasher		
1981	3/4 Inch x 36 Inch	DH1
1981	2 x 18 Inch	DH2
1981	2 Inch x 21 Inches	DH23
1981	1 Inch x 36 Inches	DH26
1981	2 x 36 Inch	DH28
1981	1 1/2 Inches x 7 Inches, Expandable To 20 Inches	DH3
1981	1 7/8 Inch x 23 1/2 Inch	DH4
1981	1 1/2 Inches x 20 Inches, Cut To Fit	DH6
Transporter		
1994	3/4 Inch x 36 Inch	DH1
1994	2 x 18 Inch	DH2
1994	2 Inch x 21 Inches	DH23
1994	1 Inch x 36 Inches	DH26
1994	2 x 36 Inch	DH28
1994	1 1/2 Inches x 7 Inches, Expandable To 20 Inches	DH3
1994	1 7/8 Inch x 23 1/2 Inch	DH4
1994	1 1/2 Inches x 20 Inches, Cut To Fit	DH6
EGR Components		
EGR Control Solenoid		
Beetle		
2000-1998	4 Cyl. 1.9L	VS219
EuroVan		
1997-1993	5 Cyl. 2.4L; Diesel	VS244
Golf		
1999	4 Cyl. 1.9L	VS219
Jetta		
2000-1999	4 Cyl. 1.9L	VS219
Touareg		
2014-2011	6 Cyl. 3.0L; Turbocharged	VS153
2008-2007	10 Cyl.	VS153

EGR Components

		Part No.
EGR Valve		
Beetle		
2015-2013	4 Cyl. 2.0L; Diesel	EGV1247
2006-2005	4 Cyl. 1.9L	EGV1072
2004	4 Cyl. 1.9L; OE No. 038 131 501AD	EGV1072
2004	4 Cyl. 1.9L; OE No. 045 131 501C	EGV1079
2003-1998	4 Cyl. 1.9L	EGV1079
Golf		
2015	4 Cyl. 2.0L; EGR Valve Assembly	EGV1267
2015	4 Cyl. 2.0L; Regulates EGR Control	EGV1278
2014-2010	4 Cyl. 2.0L; Diesel	EGV1247
2006	4 Cyl. 1.9L; Turbocharged	EGV1072
2005	4 Cyl. 1.9L	EGV1072
2004	4 Cyl. 1.9L; BEW Eng.	EGV1072
2004	4 Cyl. 1.9L; ALH Eng.	EGV1079
2003-1999	4 Cyl. 1.9L	EGV1079
1997-1993	4 Cyl. 1.9L	EGV1076
Jetta		
2014-2013	4 Cyl. 2.0L; Diesel; Turbocharged	EGV1247
2012-2010	4 Cyl. 2.0L; Diesel	EGV1247
2006	4 Cyl. 1.9L	EGV1081
2005	4 Cyl. 1.9L; BRM Eng.	EGV1081
2005-2004	4 Cyl. 1.9L; BEW Eng.	EGV1072
2004	4 Cyl. 1.9L; ALH Eng.	EGV1079
2003	4 Cyl. 1.9L; Sedan	EGV1079
2003	4 Cyl. 1.9L; Wagon	EGV1079
2002-1999	4 Cyl. 1.9L	EGV1079
1996-1993	4 Cyl. 1.9L	EGV1076
Passat		
2005-2004	4 Cyl. 2.0L; Diesel	EGV1072
1997	4 Cyl. 1.9L; AAZ Eng.	EGV1076
1996-1993	4 Cyl. 1.9L	EGV1076
Touareg		
2014-2013	6 Cyl. 3.0L; Diesel; Turbocharged	EGV1250
2012-2010	6 Cyl. 3.0L; Diesel	EGV1242
2008-2006	10 Cyl.; Left	EGV1190
2008-2006	10 Cyl.; Right	EGV1191
2004	10 Cyl.	EGV1188
EGR Valve Mounting Gasket		
Beetle		
2014-2013	4 Cyl. 2.0L; Diesel; At Outlet	VG253
2006-2004	4 Cyl. 1.9L; Seal	VG186
2006-1998	4 Cyl. 1.9L; Gasket	VG183
2003-1998	4 Cyl. 1.9L; Seal	VG182
Bora		
2009-2008	4 Cyl. 1.9L; Diesel	VG183
EuroVan		
2009-2006	4 Cyl. 1.9L	VG183
Golf		
2014	4 Cyl. 2.0L; Diesel; At Outlet	VG253
2012-2010	4 Cyl. 2.0L; Diesel; At Outlet	VG253
2006	4 Cyl. 1.9L; OE No.038 131 501AD	VG183
2005	4 Cyl. 1.9L; Seal	VG186
2005-1999	4 Cyl. 1.9L; Gasket	VG183
2004-1999	4 Cyl. 1.9L; Seal	VG182
1997-1993	4 Cyl. 1.9L; Gasket Comparison Necessary; OE No. 069131547D	VG183
1997-1993	4 Cyl. 1.9L; Gasket Comparison Necessary; OE No. 068131547B	VG184
Jetta		
2014-2009	4 Cyl. 2.0L; Diesel; At Outlet	VG253
2007	4 Cyl. 1.9L; Diesel; Mexico Models	VG183
2006	4 Cyl. 1.9L; Gasket Comparison Necessary; OE No. 905 216 01	VG182

		Part No.
EGR Valve Mounting Gasket		
Jetta		
2006	4 Cyl. 1.9L; Gasket Comparison Necessary; OE No. 909 273 01	VG185
2005	4 Cyl. 1.9L; BRM Eng.; Gasket Comparison Necessary; OE No. 905 216 01	VG182
2005	4 Cyl. 1.9L; BEW Eng.; Gasket	VG183
2005	4 Cyl. 1.9L; BRM Eng.; Gasket Comparison Necessary; OE No. 909 273 01	VG185
2005	4 Cyl. 1.9L; BEW Eng.; Seal	VG186
2004-1999	4 Cyl. 1.9L; Seal	VG182
2004-1999	4 Cyl. 1.9L; Gasket	VG183
1996-1993	4 Cyl. 1.9L; Gasket Comparison Necessary; OE No. 069131547D	VG183
1996-1993	4 Cyl. 1.9L; Gasket Comparison Necessary; OE No. 068131547B	VG184
Passat		
2014-2012	4 Cyl. 2.0L; Diesel; At Outlet	VG253
2005-2004	4 Cyl. 2.0L; Diesel	VG186
1997-1993	4 Cyl. 1.9L; Gasket Comparison Necessary; OE No. 069131547D	VG183
1997-1993	4 Cyl. 1.9L; Gasket Comparison Necessary; OE No. 068131547B	VG184
Quantum		
1985	4 Cyl. 1.6L	VG184
Touareg		
2014-2013	6 Cyl. 3.0L; Diesel	VG251
2008-2004	10 Cyl.; Rear	VG239
2008-2004	10 Cyl.; Front	VG240
Exhaust Components		
Diesel Emission Fluid Injection Nozzle		
Passat		
2014-2012	4 Cyl. 2.0L	DF18
Touareg		
2015-2010	6 Cyl. 3.0L	DF18
Diesel Emissions Fluid Pump		
Passat		
2014-2012	4 Cyl. 2.0L	DFIP6
Touareg		
2016-2009	6 Cyl. 3.0L	DFIP6
PCV Systems		
Engine Crankcase Breather Hose		
Jetta		
2010-2009	4 Cyl. 2.0L; Driver Side	CBH100
Passat		
2005	4 Cyl. 2.0L; Driver Side	CBH100
PCV Valve		
Beetle		
2004-1998	4 Cyl. 1.9L	V422
EuroVan		
1997	5 Cyl. 2.4L	V578
Golf		
2004-1999	4 Cyl. 1.9L	V422
Jetta		
2010-2009	4 Cyl. 2.0L	N16002
2004-2000	4 Cyl. 1.9L	V422
1999	4 Cyl. 1.9L; 2 Ports	V422
1999	4 Cyl. 1.9L; 3 Ports	V578
1998-1997	4 Cyl. 1.9L	V578
Passat		
1997-1996	4 Cyl. 1.9L	V578

Vapor and Purge Components

		Part No.
Vapor and Purge Components		
Fuel Vapor Canister		
Golf		
2006-2005	4 Cyl. 1.9L	CP3375
Fuel Vapor Leak Detection Pump		
Golf		
2013-2012	4 Cyl. 2.0L	LDP18
Jetta		
2010-2009	4 Cyl. 2.0L	LDP18
Touareg		
2006-2005	10 Cyl. 5.0L	LDP28
2004	10 Cyl.	LDP28
Fuel Valves and Solenoids		
Cold Start Valve		
Rabbit		
1980	4 Cyl. 1.5L	CJ48
Injectors		
Fuel Injector - Diesel - New		
Beetle		
2015-2013	4 Cyl. 2.0L; Diesel; Turbocharged	FJ1168
Golf		
2014-2010	4 Cyl. 2.0L; Diesel	FJ1168
Jetta		
2014-2009	4 Cyl. 2.0L; Diesel	FJ1168
Passat		
2014-2013	4 Cyl. 2.0L	FJ1261
2012	4 Cyl. 2.0L; Diesel	FJ1168
Touareg		
2016-2013	6 Cyl. 3.0L; Diesel	FJ1260
2012-2011	6 Cyl. 3.0L; Diesel	FJ1174
2010-2009	6 Cyl. 3.0L	FJ1174
Fuel Injector - Diesel - Remfd		
Beetle		
2005-1998	4 Cyl. 1.9L; w/ M.T.; Cyl. 1, 2, 4	FJ908
2004-1998	4 Cyl. 1.9L; w/ A.T.; Cyl. 1, 2, 4	FJ909
2004-1998	4 Cyl. 1.9L; w/ A.T.; Cyl. 3	FJ935
2002-1998	4 Cyl. 1.9L; w/ M.T.; Cyl. 3	FJ912
Caribe		
1981	4 Cyl. 1.6L	FJ624
Dasher		
1981		FJ624
EuroVan		
1996	5 Cyl. 2.4L	FJ631
1995	5 Cyl. 2.4L; Diesel	FJ631
Golf		
2004-1999	4 Cyl. 1.9L; w/ M.T.; Cyl. 1, 2, 4	FJ908
2004-1999	4 Cyl. 1.9L; w/ A.T.; Cyl. 1, 2, 4	FJ909
2004-1999	4 Cyl. 1.9L; w/ M.T.; Cyl. 3	FJ912
2004-1999	4 Cyl. 1.9L; w/ A.T.; Cyl. 3	FJ935
1998	4 Cyl. 1.9L; Cyl. 1, 2, 4	FJ908
1998	4 Cyl. 1.9L; Cyl. 3	FJ912
1997-1993	4 Cyl. 1.9L	FJ628
1987-1986	4 Cyl. 1.6L	FJ618
1985	4 Cyl. 1.6L	FJ623
Jetta		
2004-1999	4 Cyl. 1.9L; w/ M.T.; Cyl. 1, 2, 4	FJ908
2004-1999	4 Cyl. 1.9L; w/ A.T.; Cyl. 1, 2, 4	FJ909
2004-1999	4 Cyl. 1.9L; w/ A.T.; Cyl. 3	FJ935
2002-1999	4 Cyl. 1.9L; w/ M.T.; Cyl. 3	FJ912
1998	4 Cyl. 1.9L; Cyl. 1, 2, 4	FJ908
1998	4 Cyl. 1.9L; Cyl. 3	FJ912
1997-1993	4 Cyl. 1.9L	FJ628

		Part No.
Fuel Injector - Diesel - Remfd		
Jetta		
1992-1986	4 Cyl. 1.6L	FJ618
1985-1982	4 Cyl. 1.6L	FJ622
1981	4 Cyl. 1.6L	FJ624
Passat		
1997	4 Cyl. 1.9L	FJ630
1996	4 Cyl. 1.9L; AAZ Eng.	FJ628
1996	4 Cyl. 1.9L; 1Z; Cyl. 1, 2, 4	FJ629
1996	4 Cyl. 1.9L; 1Z; Cyl. 3	FJ630
1994-1993	4 Cyl. 1.9L	FJ628
Quantum		
1985	4 Cyl. 1.6L	FJ622
1984-1982	4 Cyl. 1.6L; OE No. 068130201B	FJ622
1984-1982	4 Cyl. 1.6L; OE No. 068130201E	FJ623
1984-1982	4 Cyl. 1.6L; OE No. 068130201C	FJ624
Rabbit		
1984-1982	4 Cyl. 1.6L	FJ623
1981	4 Cyl. 1.6L	FJ624
1980	4 Cyl. 1.5L	FJ120
Rabbit Pickup		
1983-1982	4 Cyl. 1.6L	FJ623
1981	4 Cyl. 1.6L	FJ624
Vanagon		
1984-1982	4 Cyl. 1.6L	FJ623
Injection Components		
Diesel Fuel Injection Pump - Remanufactured		
Beetle		
2004-1998	4 Cyl. 1.9L; w/ A.T.	IP49
2004-1998	4 Cyl. 1.9L; w/ M.T.	IP50
Golf		
2004-1998	4 Cyl. 1.9L; w/ A.T.	IP49
2004-1998	4 Cyl. 1.9L; w/ M.T.	IP50
Jetta		
2004-2000	4 Cyl. 1.9L; w/ A.T.	IP49
2004-2000	4 Cyl. 1.9L; w/ M.T.	IP50
1999	4 Cyl. 1.9L; ALH Eng.; w/ A.T.	IP49
1999	4 Cyl. 1.9L; ALH Eng.; w/ M.T.	IP50
1998-1997	4 Cyl. 1.9L	IP51
Passat		
1997-1996	4 Cyl. 1.9L	IP51
Diesel Fuel Injector Heat Shield		
Caribe		
1983-1981	4 Cyl. 1.6L	SK50
Dasher		
1981	⁹	SK50
EuroVan		
1995	5 Cyl. 2.4L	SK50
Golf		
1999-1993	4 Cyl. 1.9L ⁹	SK50
Jetta		
1999-1993	4 Cyl. 1.9L ⁹	SK50
1982-1981	4 Cyl. 1.6L; Diesel ⁹	SK50
Passat		
1997-1996	4 Cyl. 1.9L ⁹	SK50
Diesel Glow Plug		
Beetle		
2014	4 Cyl. 2.0L	GP119
2013	4 Cyl. 2.0L; TDI	GP119
2006-1998	4 Cyl. 1.9L; Glow Plug for Engine Start-up	GP102
Dasher		
1981	4 Cyl. 1.6L	GP101

Injection Components

		Part No.
Diesel Glow Plug		
Dasher		
1980	4 Cyl. 1.5L	GP101
Golf		
2014	4 Cyl. 2.0L	GP119
2013	4 Cyl. 2.0L; Diesel	GP119
2012	4 Cyl. 2.0L; TDI	GP119
2011	4 Cyl. 2.0L	GP119
2010	4 Cyl. 2.0L; TDI	GP119
2006-1997	4 Cyl. 1.9L; Glow Plug for Engine Start-up	GP102
1996-1993	4 Cyl. 1.9L	GP101
1992-1985	4 Cyl. 1.6L	GP101
Jetta		
2014	4 Cyl. 2.0L; Diesel	GP119
2013-2009	4 Cyl. 2.0L; TDI; Diesel	GP119
2005-2004	4 Cyl. 1.9L; Glow Plug for Engine Start-up; Sedan	GP102
2003-1997	4 Cyl. 1.9L; Glow Plug for Engine Start-up	GP102
1996-1993	4 Cyl. 1.9L	GP101
1992-1981	4 Cyl. 1.6L	GP101
Passat		
2014-2012	4 Cyl. 2.0L	GP119
1997	4 Cyl. 1.9L; Glow Plug for Engine Start-up	GP102
1996-1993	4 Cyl. 1.9L	GP101
Quantum		
1985-1982	4 Cyl. 1.6L	GP101
Rabbit		
1984-1981	4 Cyl. 1.6L	GP101
1980	4 Cyl. 1.5L; Diesel	GP101
Rabbit Pickup		
1983-1981	4 Cyl. 1.6L	GP101
Touareg		
2014-2011	6 Cyl. 3.0L; Cyl. 2	GP119
2010	6 Cyl. 3.0L; TDI; Cyl. 2	GP119
2009	6 Cyl. 3.0L; Cyl. 2	GP119
Vanagon		
1984-1982	4 Cyl. 1.6L	GP101
Direct Injection High Pressure Fuel Pump		
Beetle		
2013	4 Cyl. 2.0L	GDP905
Jetta		
2013-2012	4 Cyl. 2.0L	GDP905
2010-2009	4 Cyl. 2.0L	GDP905
Fuel Injector Seal Kit		
Jetta		
2014-2009	4 Cyl. 2.0L; Diesel; Upper	SK121
2014-2009	4 Cyl. 2.0L; Diesel; Lower	SK136
Fuel Pressure Regulator		
Amarok		
2011		PR509
Beetle		
2014	4 Cyl. 2.0L; Diesel; Turbocharged	PR509
2013	4 Cyl. 2.0L; Diesel	PR509
Bora		
2010	4 Cyl. 1.9L; Turbocharged	PR460
Golf		
2014-2010	4 Cyl. 2.0L; Diesel	PR509
Jetta		
2016-2015	4 Cyl.	PR460
2014-2012	4 Cyl. 2.0L; Diesel; Turbocharged	PR509
2011-2010	4 Cyl. 2.0L; Diesel	PR509
Transporter		
2011-2010		PR509

		Part No.
Fuel Pressure Regulator		
Transporter		
1994	5 Cyl. 2.4L; Exhaust stock and reorder	PR408
1994	5 Cyl. 2.4L; Alternate Number	PR73
Fuel Pump Camshaft Follower		
Jetta		
2013-2009	4 Cyl. 2.0L	FPC1
Passat		
2013-2012	4 Cyl. 2.0L	FPC1
Fuel Pump Fitting		
Beetle		
2015-2014	4 Cyl. 2.0L	FPF603
Jetta		
2016-2014	4 Cyl. 2.0L	FPF603
Chassis and Drivetrain Sensors		
ABS Speed Sensor		
Amarok		
2011	Left Front	ALS430
2011	Right Front	ALS467
Golf		
2006	4 Cyl. 1.9L; Rear	ALS522
2006	4 Cyl. 1.9L; Right Front	ALS465
2006	4 Cyl. 1.9L; Left Front	ALS470
2004	4 Cyl. 1.9L; Rear	ALS522
Jetta		
2012	TDI; Left Front	ALS430
2012	TDI; Right Front	ALS467
2012	TDI; Right Rear	ALS468
2012	TDI; Left Rear	ALS469
Automatic Transmission Output Sensor		
EuroVan		
2006	4 Cyl. 1.9L	SC352
Jetta		
2007	4 Cyl. 1.9L; Mexico Models	SC403
Manual Transmission Output Sensor		
Jetta		
2007	4 Cyl. 1.9L; Mexico Models	SC403
Vehicle Speed Sensor		
Beetle		
2006-2005	4 Cyl. 1.9L; w/ Automatic Dual Clutch Trans	SC602
2006-2002	4 Cyl. 1.9L; w/ M.T.	SC403
2004	4 Cyl. 1.9L; w/ A.T.	SC602
2003-2002	4 Cyl. 1.9L; w/ A.T.	SC354
2001	4 Cyl. 1.9L; w/ A.T.	SC352
2000-1999	4 Cyl. 1.9L; w/ A.T.	SC354
EuroVan		
2006		SC352
Golf		
2010	4 Cyl. 2.0L	SC602
2006	4 Cyl. 1.9L; w/ A.T.	SC354
2006-2004	4 Cyl. 1.9L; w/ M.T.	SC403
2003	4 Cyl. 1.9L; w/ 4 Speed A.T.	SC354
2003	4 Cyl. 1.9L; w/ 5 Speed M.T.	SC403
Jetta		
2012-2009	4 Cyl. 2.0L; w/ Automatic Dual Clutch Trans	SC602
2007	4 Cyl. 1.9L; Mexico Models	SC403
Passat		
2005-2004	4 Cyl. 2.0L; w/ A.T.; Located On Transmission	SC346

Fluid Level Sensors

		Part No.
Fluid Level Sensors		
Coolant Level Sensor		
Quantum		
1985-1982	4 Cyl. 1.6L	FLS-72
Rabbit		
1984-1983	4 Cyl. 1.6L	FLS-72
Engine Oil Level Sensor		
Beetle		
2015-2013	4 Cyl. 2.0L	FLS313
2013	4 Cyl.	FLS283
2005-2002	4 Cyl. 1.9L	FLS-75
Golf		
2015	4 Cyl. 2.0L	FLS313
1999	4 Cyl.	FLS-75
Golf SportWagen		
2015	4 Cyl. 2.0L	FLS313
Jetta		
2016-2014	4 Cyl. 2.0L	FLS313
2013-2009	4 Cyl.; Diesel	FLS284
2008	4 Cyl.	FLS283
2006-2005	4 Cyl. 1.9L; TDI	FLS284
Passat		
2015-2014	4 Cyl. 2.0L	FLS313
Touareg		
2016	6 Cyl. 3.0L	FLS311
2015-2013	6 Cyl. 3.0L; Diesel	FLS311
2008-2007	10 Cyl. 5.0L	FLS283
2006-2004	10 Cyl.	FLS283
Fuel Sensors		
Knock Sensor		
Golf		
2015	4 Cyl. 2.0L; Diesel	KS448
Jetta		
2016-2015	4 Cyl. 2.0L; Diesel	KS445
2016-2015	4 Cyl. 2.0L	KS448
2014	4 Cyl. 2.0L; Turbocharged	KS445
2012	4 Cyl. 2.0L; Diesel; Turbocharged	KS312
2011	4 Cyl. 2.0L; Diesel	KS260
Touareg		
2014-2013	6 Cyl. 3.0L; w/ Green Connector; Cyl. 4-6	KS312
2014-2013	6 Cyl. 3.0L; w/ Gray Connector; Cyl. 1-3	KS356
Vento		
2015-2014	4 Cyl. 1.6L	KS260
Mass Air Flow		
Beetle		
2003-1998	4 Cyl. 1.9L	MAS0469
Golf		
2015-2014	4 Cyl. 2.0L; Diesel	MAS0374
2003-1999	4 Cyl. 1.9L	MAS0469
Jetta		
2016-2009	4 Cyl. 2.0L; Diesel	MAS0374
2003-1999	4 Cyl. 1.9L	MAS0469
Passat		
2005-2004	4 Cyl. 2.0L	MAS0290
Touareg		
2014-2009	6 Cyl. 3.0L	MAS0379
2008-2004	10 Cyl.	MAS0290
Oxygen Sensor		
Dasher		
1981	Universal Upstream	SG12
1981	Upstream Sensor	SG8

		Part No.
Miscellaneous Sensors		
Brake Pad Wear Sensor		
Touareg		
2015-2014	6 Cyl. 3.0L; Front	PWS304
2013-2012	TDI Executive; Front	PWS304
2013-2012	TDI Lux; Front	PWS304
2013-2012	TDI Sport; Front	PWS304
2011	TDI; Front	PWS304
Position Sensors		
Accelerator Pedal Sensor		
Golf		
2014	Black Finish; w/ Automatic Dual Clutch Trans	APS412
2005-2004	4 Cyl. 1.9L; w/ A.T.	APS165
2005-2004	4 Cyl. 1.9L; w/ M.T.	APS195
Jetta		
2014	4 Cyl. 2.0L; Silver; w/ M.T.	APS333
2014	4 Cyl. 2.0L; Black Finish; w/ M.T.	APS444
2006	4 Cyl. 1.9L; w/ Automatic Dual Clutch Trans	APS187
2006	4 Cyl. 1.9L; w/ M.T.	APS295
Touareg		
2005-2004	10 Cyl.	APS188
Camshaft Sensor		
Beetle		
2015	4 Cyl.; Diesel	PC1030
2014	4 Cyl. 2.0L; Diesel	PC839
2013	4 Cyl. 2.0L; CJAA Eng.	PC839
2006-2002	4 Cyl. 1.9L	PC981
Golf		
2015	4 Cyl. 2.0L	PC1030
2014	4 Cyl. 2.0L; Diesel	PC839
2012	4 Cyl. 2.0L; Diesel	PC839
2011-2010	4 Cyl. 2.0L	PC839
2006-2002	4 Cyl. 1.9L	PC981
Golf SportWagen		
2015	4 Cyl. 2.0L	PC1030
Jetta		
2016	4 Cyl. 2.0L	PC1058
2015	4 Cyl. 2.0L; Diesel; Turbocharged	PC1030
2014	4 Cyl. 2.0L; Diesel; Turbocharged	PC839
2013	4 Cyl. 2.0L; Diesel	PC839
2013	4 Cyl. 2.0L; CBPA Eng.	PC628
2012	4 Cyl. 2.0L; Diesel; Turbocharged	PC839
2011-2009	4 Cyl. 2.0L; Diesel	PC839
2010-2005	4 Cyl. 1.9L; Diesel	PC725
2004-2001	4 Cyl. 1.9L; Diesel	PC981
Passat		
2015	4 Cyl. 2.0L	PC1030
2014-2012	4 Cyl. 2.0L	PC836
Touareg		
2016-2012	6 Cyl. 3.0L; Alternate Number	PC781
2016-2012	6 Cyl. 3.0L; Exhaust stock and reorder	PC911
2011	6 Cyl. 3.0L	PC781
2010-2009	6 Cyl. 3.0L	PC781
2008-2004	10 Cyl.	PC673
Vento		
2015-2014	4 Cyl. 1.6L	PC700
Crankshaft Sensor		
Beetle		
2015	4 Cyl. 2.0L; Diesel	PC1029
2013	4 Cyl. 2.0L; Diesel	PC843
2001	4 Cyl. 1.9L; Diesel	PC575

Position Sensors

		Part No.
Crankshaft Sensor		
Bora		
2009-2008	4 Cyl. 1.9L	PC705
Crafter Van		
2008	KACO Type	PC705
2008	Siemens Type	PC843
EuroVan		
2009-2006	4 Cyl. 1.9L; KACO Type	PC705
Golf		
2015	4 Cyl. 2.0L; Diesel	PC1029
2014-2010	4 Cyl. 2.0L; Diesel	PC843
2006-2005	4 Cyl. 1.9L	PC708
2004-2002	4 Cyl. 1.9L	PC575
2001-2000	4 Cyl. 1.9L; Built In Germany	PC504
2001-2000	4 Cyl. 1.9L; Built In Brazil	PC575
1999	4 Cyl. 1.9L	PC504
1998-1997	4 Cyl. 1.9L	PC410
Golf SportWagen		
2015	4 Cyl. 2.0L	PC1029
Jetta		
2016	4 Cyl. 2.0L	PC989
2015	4 Cyl. 2.0L; Exhaust stock and reorder	PC985
2014	4 Cyl. 2.0L; Diesel	PC843
2013	4 Cyl. 2.0L; Diesel; Turbocharged	PC843
2012	4 Cyl. 2.0L; TDI	PC843
2011-2009	4 Cyl. 2.0L; Diesel	PC843
2009-2007	4 Cyl. 1.9L; Diesel; Mexico Models	PC708
2006	4 Cyl. 1.9L; Diesel	PC705
2005	4 Cyl. 1.9L; Diesel; From 11/04	PC705
2005	4 Cyl. 1.9L; Diesel; To 10/31/04	PC708
2004	4 Cyl. 1.9L; Diesel	PC708
2003-2000	4 Cyl. 1.9L; Diesel	PC575
1999-1997	4 Cyl. 1.9L; Diesel	PC504
1996	4 Cyl. 1.9L; Diesel	PC410
Passat		
2015	4 Cyl. 2.0L	PC1029
2014-2012	4 Cyl. 2.0L; Diesel	PC843
2005	4 Cyl. 2.0L; Diesel	PC707
2004	4 Cyl. 2.0L	PC707
1996	4 Cyl. 1.9L	PC410
Touareg		
2016-2011	6 Cyl. 3.0L	PC919
2010-2009	6 Cyl. 3.0L	PC792
2008-2006	10 Cyl. 5.0L	PC765
2008-2004	10 Cyl.	PC765
2004	10 Cyl. 4.9L	PC765
Pressure Sensors		
Diesel Particulate Filter (DPF) Pressure Sensor		
Beetle		
2015-2014	4 Cyl. 2.0L	DPS104
2013	4 Cyl. 2.0L; TDI	DPS104
Golf		
2014-2013	4 Cyl. 2.0L; Diesel	DPS104
2012	4 Cyl. 2.0L; TDI	DPS104
2011	4 Cyl. 2.0L	DPS104
2010	4 Cyl. 2.0L; TDI	DPS104
Jetta		
2015-2014	4 Cyl. 2.0L; Diesel	DPS104
2013-2010	4 Cyl. 2.0L; TDI; Diesel	DPS104
Passat		
2015-2012	4 Cyl. 2.0L	DPS104

		Part No.
Fuel Pressure Sensor		
Beetle		
2015-2013	4 Cyl. 2.0L; Diesel	FPS68
Golf		
2014-2010	4 Cyl. 2.0L; Diesel	FPS68
Jetta		
2015-2009	4 Cyl. 2.0L; Diesel	FPS68
Passat		
2013-2012	4 Cyl. 2.0L; Diesel	FPS68
Touareg		
2016	6 Cyl. 3.0L; Located at Fuel Rail	FPS69
2015-2013	6 Cyl. 3.0L; Diesel; Located at Fuel Rail	FPS69
MAP Sensor		
Beetle		
2014-2013	4 Cyl. 2.0L; Alternate Number; Diesel; Turbocharged	AS364
2014-2013	4 Cyl. 2.0L; Diesel; Exhaust stock and reorder; Turbocharged	AS377
2005	4 Cyl. 1.9L	AS365
2004-1998	4 Cyl. 1.9L	AS366
Golf		
2014-2010	4 Cyl. 2.0L; Diesel; Turbocharged	AS441
2006-2003	4 Cyl. 1.9L	AS365
2002-1999	4 Cyl. 1.9L	AS366
Jetta		
2014	4 Cyl. 2.0L; Diesel; Turbocharged	AS441
2013-2010	4 Cyl. 2.0L; Diesel	AS441
2009	4 Cyl. 2.0L	AS645
2001	4 Cyl. 1.9L	AS366
2000	4 Cyl. 1.9L; Turbocharged	AS366
1999	4 Cyl. 1.9L	AS366
Passat		
2015-2014	4 Cyl. 2.0L; Alternate Number	AS364
2015-2014	4 Cyl. 2.0L; Exhaust stock and reorder	AS438
2005-2004	4 Cyl. 2.0L; Alternate Number; Diesel; Turbocharged	AS364
2005-2004	4 Cyl. 2.0L; Diesel; Exhaust stock and reorder; Turbocharged	AS377
Touareg		
2014-2013	6 Cyl. 3.0L; Alternate Number; Diesel; Location-Intercooler Piping	AS364
2014-2013	6 Cyl. 3.0L; Diesel; Exhaust stock and reorder; Location-Intercooler Piping	AS377
2009	6 Cyl. 3.0L; Alternate Number	AS364
2009	6 Cyl. 3.0L; Exhaust stock and reorder	AS377
2008-2006	10 Cyl. 5.0L; Alternate Number	AS364
2008-2006	10 Cyl. 5.0L; Exhaust stock and reorder	AS377
2004	10 Cyl.; Alternate Number	AS364
2004	10 Cyl.; Exhaust stock and reorder	AS377
Vento		
2015-2014	4 Cyl. 1.6L	AS367
Turbocharger Boost Sensor		
Beetle		
2006-2005	4 Cyl. 1.9L; Turbocharged	AS365
2004	4 Cyl. 1.9L; To VIN 1J4-001-865; Turbocharged	AS365
2004	4 Cyl. 1.9L; From VIN 1J4-001-866; Turbocharged	AS366
2003	4 Cyl. 1.9L; Turbocharged	AS365
2002-1998	4 Cyl. 1.9L; Turbocharged	AS366
Golf		
2013-2012	4 Cyl. 2.0L; Alternate Number; Diesel; Turbocharged	AS364
2013-2012	4 Cyl. 2.0L; Diesel; Exhaust stock and reorder; Turbocharged	AS438

Pressure Sensors

		Part No.
Turbocharger Boost Sensor		
Golf		
2011-2010	4 Cyl. 2.0L; Diesel; Turbocharged	AS441
2006-2003	4 Cyl. 1.9L; Turbocharged	AS365
2002-1999	4 Cyl. 1.9L; Turbocharged	AS366
Jetta		
2012-2009	4 Cyl. 2.0L; Alternate Number; Diesel; Turbocharged	AS364
2012-2009	4 Cyl. 2.0L; Diesel; Exhaust stock and reorder; Turbocharged	AS377
2006	4 Cyl. 1.9L; Alternate Number; Turbocharged	AS364
2006	4 Cyl. 1.9L; Exhaust stock and reorder; Turbocharged	AS377
2005-2002	4 Cyl. 1.9L; Turbocharged	AS365
2001-1999	4 Cyl. 1.9L; Turbocharged	AS366
Passat		
2013-2012	4 Cyl. 2.0L; Alternate Number; Turbocharged	AS364
2013-2012	4 Cyl. 2.0L; Exhaust stock and reorder; Turbocharged	AS438
2005-2004	4 Cyl. 2.0L; Alternate Number; Turbocharged	AS364
2005-2004	4 Cyl. 2.0L; Exhaust stock and reorder; Turbocharged	AS377
Touareg		
2012-2011	6 Cyl. 3.0L; Alternate Number; Diesel; Turbocharged	AS364
2012-2011	6 Cyl. 3.0L; Diesel; Exhaust stock and reorder; Turbocharged	AS377
2010	6 Cyl. 3.0L; Alternate Number; Turbocharged	AS364
2010	6 Cyl. 3.0L; Exhaust stock and reorder; Turbocharged	AS377
2008-2006	10 Cyl.; Alternate Number; Turbocharged	AS364
2008-2006	10 Cyl.; Exhaust stock and reorder; Turbocharged	AS377
2005-2004	10 Cyl.; Alternate Number; Turbocharged	AS364
2005-2004	10 Cyl.; Exhaust stock and reorder; Turbocharged	AS377
Temperature Sensors		
Ambient Air Temperature Sensor		
Beetle		
2001	4 Cyl. 1.9L	AX154
Jetta		
2016-2015	4 Cyl.	AX377
Coolant Temperature Sensor		
Beetle		
2015	4 Cyl. 2.0L; Bolt-On Type; Diesel	TX282
2014-2013	4 Cyl.; 2 Blade Term.; w/ Gray Connector	TS-608
2014-2013	4 Cyl.; 2 Blade Term.; w/ Black Connector	TX275
2013	4 Cyl.; 4 Blade Term.; w/ Green Connector	TS-477
EuroVan		
2006		TS-608
Golf		
2015	4 Cyl. 2.0L; Diesel	TX282
2002-2000	4 Cyl.	TS-477
1992-1991	4 Cyl. 1.6L	TX51
Jetta		
2016-2015	4 Cyl. 2.0L; Bolt-On Type; Diesel	TX282
2014-2013	4 Cyl. 2.0L	TS-608
2007	4 Cyl. 1.9L; Mexico Models	TS-608
1998	4 Cyl.	TS-377
Passat		
2015	4 Cyl. 2.0L; Bolt-On Type; Diesel	TX282

		Part No.
Coolant Temperature Sensor		
Passat		
2014	4 Cyl. 2.0L; Push-In Type	TS-608
2005-2004	4 Cyl.	TS-477
Quantum		
1985	4 Cyl.	TX55
Touareg		
2008-2004	10 Cyl.	TS-608
Exhaust Gas Temperature Sensor		
Beetle		
2015	4 Cyl. 2.0L; Turbocharged; Located Before Turbocharger	ETS132
2015	4 Cyl. 2.0L; Turbocharged; Located After Particulate Filter	ETS142
2015	4 Cyl. 2.0L; Turbocharged; Located Before Particulate Filter	ETS153
Golf		
2015	4 Cyl. 2.0L; Turbocharged; Location-Before Catalyst	ETS130
2015	4 Cyl. 2.0L; Turbocharged; Located After Particulate Filter	ETS139
2015	4 Cyl. 2.0L; Turbocharged; Located Before Particulate Filter	ETS140
2015	4 Cyl. 2.0L; Turbocharged; Located Before Turbocharger	ETS185
2014	4 Cyl. 2.0L; Diesel; Located Before Turbocharger	ETS126
2013-2012	TDI; Black Finish; Located Before Turbocharger	ETS126
2013-2011	TDI; Orange; Located Before Catalytic Converter	ETS66
2013-2011	TDI; Orange; Located After Particulate Filter	ETS77
2013-2011	TDI; Brown; Located Before Particulate Filter	ETS83
2011	TDI; Black Finish; Located Before Turbocharger	ETS84
2010	4 Cyl. 2.0L; Diesel; Located Before Catalytic Converter	ETS66
2010	4 Cyl. 2.0L; Diesel; Located After Particulate Filter	ETS77
2010	4 Cyl. 2.0L; Diesel; Located Before Particulate Filter	ETS83
2010	4 Cyl. 2.0L; Diesel; Located Before Turbocharger	ETS84
Golf SportWagen		
2015	4 Cyl. 2.0L; Turbocharged; Location-Before Catalyst	ETS130
2015	4 Cyl. 2.0L; Turbocharged; Located After Particulate Filter	ETS139
2015	4 Cyl. 2.0L; Turbocharged; Located Before Particulate Filter	ETS140
2015	4 Cyl. 2.0L; Turbocharged; Located Before Turbocharger	ETS185
Jetta		
2016	4 Cyl. 2.0L; Diesel; Located Before Turbocharger	ETS132
2015	4 Cyl. 2.0L; Located Before Turbocharger	ETS132
2015	4 Cyl. 2.0L; Located After Particulate Filter	ETS142
2015	4 Cyl. 2.0L; Located Before Particulate Filter	ETS153
2014	4 Cyl. 2.0L; Diesel; Sedan; Located Before Turbocharger	ETS126
2013	4 Cyl. 2.0L; Located Before Catalytic Converter	ETS66
2013	4 Cyl. 2.0L; Located After Particulate Filter	ETS77

Temperature Sensors

		Part No.
Exhaust Gas Temperature Sensor		
Jetta		
2013	4 Cyl. 2.0L; Located Before Particulate Filter	ETS83
2013-2011	4 Cyl. 2.0L; TDI; Sedan; Located Before Turbocharger	ETS126
2013-2011	4 Cyl. 2.0L; TDI; Wagon; Located Before Turbocharger	ETS84
2012-2011	4 Cyl. 2.0L; TDI; Located Before Catalytic Converter	ETS66
2012-2011	4 Cyl. 2.0L; TDI; Located After Particulate Filter	ETS77
2012-2011	4 Cyl. 2.0L; TDI; Located Before Particulate Filter	ETS83
2010-2009	4 Cyl. 2.0L; Diesel; Located Before Catalytic Converter	ETS66
2010-2009	4 Cyl. 2.0L; Diesel; Located After Particulate Filter	ETS77
2010-2009	4 Cyl. 2.0L; Diesel; Located Before Particulate Filter	ETS83
2010-2009	4 Cyl. 2.0L; Diesel; Located Before Turbocharger	ETS84
2006-2005	4 Cyl. 1.9L; Rear	ETS90
Passat		
2015	4 Cyl. 2.0L; Located Before Particulate Filter	ETS132
2015	4 Cyl. 2.0L; Located After Particulate Filter	ETS142
2015	4 Cyl. 2.0L; Location-Before Catalyst	ETS153
2015	4 Cyl. 2.0L; Located on EGR Crossover Tube	ETS154
2015	4 Cyl. 2.0L; Located Before Turbocharger	ETS185
2014-2012	4 Cyl. 2.0L; Located After Particulate Filter	ETS133
2014-2012	4 Cyl. 2.0L; Located Before Particulate Filter	ETS147
2014-2012	4 Cyl. 2.0L; Located Before Turbocharger	ETS150
2014-2012	4 Cyl. 2.0L; Location-Before Catalyst	ETS151
2014-2012	4 Cyl. 2.0L; Located on Exhaust	ETS154
Touareg		
2016-2015	6 Cyl. 3.0L; Located Before Turbocharger	ETS134
2016-2013	6 Cyl. 3.0L; Located After Particulate Filter	ETS131
2016-2013	6 Cyl. 3.0L; Located Before Particulate Filter	ETS165
2014-2013	6 Cyl. 3.0L; Located Before Turbocharger	ETS135
2012	TDI Executive; Located Before Catalytic Converter	ETS136
2012	TDI Lux; Located Before Catalytic Converter	ETS136
2012	TDI Sport; Located Before Catalytic Converter	ETS136
2012	TDI Executive; Located After Particulate Filter	ETS137
2012	TDI Lux; Located After Particulate Filter	ETS137
2012	TDI Sport; Located After Particulate Filter	ETS137
2012	TDI Executive; Located Before Turbocharger	ETS82
2012	TDI Lux; Located Before Turbocharger	ETS82
2012	TDI Sport; Located Before Turbocharger	ETS82
2011	6 Cyl. 3.0L; Located Before Catalytic Converter	ETS136
2011	6 Cyl. 3.0L; Located After Particulate Filter	ETS137
2011	6 Cyl. 3.0L; Located Before Particulate Filter	ETS188
2011-2009	6 Cyl. 3.0L; Located Before Turbocharger	ETS82
2010-2009	6 Cyl. 3.0L; Located After Particulate Filter	ETS78

		Part No.
Exhaust Gas Temperature Sensor		
Touareg		
2010-2009	6 Cyl. 3.0L; Located Before Catalytic Converter	ETS79
2010-2009	6 Cyl. 3.0L; Located Before Particulate Filter	ETS80
2010-2009	6 Cyl. 3.0L; Located Before Pre-Catalyst	ETS81
2008-2006	10 Cyl.; Front Right	ETS100
2008-2006	10 Cyl.; Right Center	ETS95
2008-2006	10 Cyl.; Left Center	ETS96
2008-2006	10 Cyl.; Front Left	ETS97
2008-2006	10 Cyl.; Right Rear	ETS98
2008-2006	10 Cyl.; Left Rear	ETS99
Heater Core Temperature Sensor		
Golf		
2015	4 Cyl. 2.0L; Diesel	AX431
Jetta		
2016	4 Cyl.	AX328
Touareg		
2016	6 Cyl.	AX328
Intake Air Temperature Sensor		
Beetle		
2015	4 Cyl. 2.0L; Diesel	AX381
2013	4 Cyl. 2.0L; Turbocharged	AX142
Golf		
2015	4 Cyl. 2.0L; Diesel	AX381
1999-1998	4 Cyl. 1.9L; On Air Cleaner	ATS45
1996-1995	4 Cyl. 1.9L; Diesel; On Air Cleaner	ATS45
1994-1993	4 Cyl. 1.9L; On Air Cleaner	ATS45
Golf SportWagen		
2015	4 Cyl. 2.0L; Diesel	AX381
Jetta		
2015	4 Cyl. 2.0L; Diesel	AX381
2013-2012	4 Cyl. 2.0L	AX142
1999-1998	4 Cyl. 1.9L; On Air Cleaner	ATS45
1996-1995	4 Cyl. 1.9L; Diesel; On Air Cleaner	ATS45
1994-1993	4 Cyl. 1.9L; On Air Cleaner	ATS45
Passat		
1997-1996	4 Cyl. 1.9L; Diesel; On Air Cleaner	ATS45
1995	4 Cyl.	AX24
1994-1993	4 Cyl. 1.9L; Diesel; On Air Cleaner	ATS45
Telematics Sensors		
Blind Spot Detection Sensor		
Jetta		
2016	4 Cyl.; Right	BSD124
2016	4 Cyl.; Left	BSD125
Body Light Switches		
Back-Up Light Switch		
Dasher		
1981	4 Cyl. 1.6L; G; w/ M.T.	LS-273
1980	4 Cyl. 1.5L; w/ M.T.	LS-291
Golf		
1998	4 Cyl.; w/ M.T.	LS-338
1997-1996	4 Cyl. 1.9L; w/ M.T.	LS-338
1985	4 Cyl. 1.6L; w/ M.T.	LS-291
Jetta		
1998-1997	4 Cyl.; w/ M.T.	LS-338
1996	4 Cyl.	LS-338
1988	4 Cyl. 1.6L; w/ M.T.	LS-265
1987-1982	4 Cyl. 1.6L; w/ M.T.	NS-574
Passat		
1997-1996	4 Cyl. 1.9L; w/ M.T.	NS-518
1995	4 Cyl. 1.9L; w/ M.T.	LS-338

Body Light Switches

		Part No.
Back-Up Light Switch		
Rabbit		
1980	4 Cyl. 1.5L; w/ M.T.	LS-291
Vanagon		
1982	4 Cyl. 1.6L; w/ M.T.	LS-273
Headlight Dimmer Switch		
Golf		
2010	4 Cyl. 2.0L; Diesel	CBS-1975
2004	4 Cyl.; w/ Cruise Control	CBS-1573
2004	4 Cyl.; w/o Cruise Control	CBS-1588
Jetta		
2007	4 Cyl.; To 12/06	CBS-1891
2007	4 Cyl.; From 12/06	CBS-1975
Touareg		
2008-2007	10 Cyl.; Exc. Adaptive Cruise Control	CBS-1352
2008-2007	10 Cyl.; w/ Adaptive Cruise Control	CBS-1877
Headlight Switch		
Beetle		
2014-2013	4 Cyl. 2.0L; Alternate Number; Diesel; w/o Fog Lights	HLS-1647
2014-2013	4 Cyl. 2.0L; Diesel; w/ Fog Lights	HLS-1648
2014-2013	4 Cyl. 2.0L; Diesel; Exhaust stock and reorder; w/o Fog Lights	HLS1649
Jetta		
2005-2004	4 Cyl. 1.9L; w/ Fog Lights	HLS-1051
2005-2004	4 Cyl. 1.9L; w/o Fog Lights	HLS-1053
1993	4 Cyl. 1.9L	HLS1049
Touareg		
2009	6 Cyl. 3.0L; w/ Coming Home Feature; w/ Fog Lights	HLS-1369
2009	6 Cyl. 3.0L; w/o Coming Home Feature; w/o Fog Lights	HLS-1391
2009	6 Cyl. 3.0L; w/ Fog Lights; w/o Coming Home Feature	HLS-1504
2008	10 Cyl.; w/ Fog Lights	HLS-1391
2006	10 Cyl. 5.0L; w/ Fog Lights	HLS-1369
2006	10 Cyl. 5.0L; w/o Fog Lights	HLS-1505
Stoplight Switch		
Bora		
2009-2008	4 Cyl. 1.9L	SLS-316
Dasher		
1981	2 Term.	SLS-34
1981	3 Blade Term.	SLS-87
Turn Signal Switch		
Jetta		
2007	4 Cyl.; To 12/06	CBS-1891
2007	4 Cyl.; From 12/06	CBS-1975
Touareg		
2008-2007	10 Cyl.; Exc. Adaptive Cruise Control	CBS-1352
2008-2007	10 Cyl.; w/ Adaptive Cruise Control	CBS-1877
Chassis and Drivetrain Switches		
Clutch Starter Safety Switch		
Beetle		
2015	4 Cyl. 2.0L; Diesel	NS755
2014-2013	4 Cyl. 2.0L; Diesel	NS692
1998	4 Cyl. 1.9L	NS-344
Golf		
2015	4 Cyl. 2.0L; Diesel	NS755
2013-2010	4 Cyl. 2.0L; Diesel	NS755
2002	4 Cyl. 1.9L	NS-344
2001	4 Cyl. 1.9L; To 10/00	NS-314
2001	4 Cyl. 1.9L; From 11/00	NS-344
2000	4 Cyl. 1.9L	NS-344
1999	4 Cyl. 1.9L	NS-314

		Part No.
Clutch Starter Safety Switch		
Jetta		
2002-2001	4 Cyl. 1.9L	NS-344
2000	4 Cyl. 1.9L	NS-314
1999	4 Cyl. 1.9L	NS-344
1998-1997	4 Cyl. 1.9L	NS-314
Fuel Pump Cut-Off Switch		
Dasher		
1981	Universal; w/ Electric Fuel Pump	FV-7
Transporter		
1994	Universal; w/ Electric Fuel Pump	FV-7
Neutral Safety Switch		
Beetle		
2014	4 Cyl.; w/ M.T.	NS766
Dasher		
1981	4 Cyl. 1.6L; w/ A.T.	NS-334
1980	4 Cyl. 1.5L; w/ A.T.	NS-334
EuroVan		
1996	5 Cyl. 2.4L; From VIN 060001	NS-335
1996	5 Cyl. 2.4L; To VIN 060000	NS340
Golf		
2015	4 Cyl. 2.0L	NS766
2006	4 Cyl. 1.9L	NS-523
Jetta		
2016-2015	4 Cyl. 2.0L; w/ M.T.	NS766
2013-2011	4 Cyl. 2.0L	NS-520
Passat		
2015	4 Cyl. 2.0L; w/ M.T.	NS766
Quantum		
1983	4 Cyl. 1.6L; w/ A.T.	NS-334
Rabbit		
1984	4 Cyl. 1.6L; w/ A.T.	NS-334
Touareg		
2014-2011	6 Cyl. 3.0L	NS689
2010	6 Cyl. 3.0L	NS-527
2008-2006	10 Cyl.	NS-527
Ignition Switches		
Ignition Starter Switch		
Bora		
2009-2008	4 Cyl. 1.9L	US-672
Dasher		
1981		US-110
Golf		
2011	4 Cyl. 2.0L; w/o Deadlocking System	US1127
2011	4 Cyl. 2.0L; w/ Deadlocking System	US-672
Jetta		
2011	4 Cyl. 2.0L	US-398
Interior Power Switches		
Cruise Control Switch		
Golf		
2010	4 Cyl. 2.0L	CBS-1975
2005	4 Cyl. 1.9L; w/ Cruise Control	CBS-1573
2003	4 Cyl. 1.9L; w/ Cruise Control	CBS-1573
2002	4 Cyl. 1.9L; w/ Cruise Control; w/o Digital Display	CBS-1085
2002	4 Cyl. 1.9L; w/ Cruise Control; w/ Digital Display Cluster	CBS-1584
Power Window Switch		
Jetta		
2005	4 Cyl. 1.9L; To 12/04; Front Right	DS-2326
2005	4 Cyl. 1.9L; To 12/04; Rear	DS-2326
2005	4 Cyl. 1.9L; From 1/05; Front Right	DWS-489

Interior Power Switches

		Part No.
Power Window Switch		
Jetta		
2005	4 Cyl. 1.9L; From 1/05; Rear	DWS-489
Pressure and Vacuum Sending Switches		
Oil Pressure Gauge Switch		
Dasher		
1981		PS252
Golf		
1990	4 Cyl. 1.6L	PS252
Oil Pressure Light Switch		
Beetle		
2006-2003	4 Cyl. 1.9L	PS-400
Bora		
2009-2008	4 Cyl. 1.9L	PS-400
Crafter Van		
2008		PS-400
Dasher		
1981	w/ Brown Insulator	PS-121
Golf		
2010	4 Cyl. 2.0L; Brown	PS-400
2006-2003	4 Cyl. 1.9L	PS-400
1998-1996	4 Cyl. 1.9L; Gray	PS-248
1998-1995	4 Cyl. 1.9L; w/ White Insulator	PS-163
1998-1995	4 Cyl. 1.9L; Exhaust stock and reorder; w/ Blue Insulator	PS-189
1995	4 Cyl. 1.9L; w/ Black Insulator	PS-165
1994-1993	4 Cyl. 1.9L; M10 X 1.0 Thread; w/ White Insulator	PS-163
1994-1993	4 Cyl. 1.9L; M10 X 1.0 Thread; w/ Black Insulator	PS-165
1994-1993	4 Cyl. 1.9L; Exhaust stock and reorder; M10 X 1.0 Thread; w/ Blue Insulator	PS-189
Jetta		
2016-2015	4 Cyl. 2.0L; Brown	PS-400
2015	4 Cyl. 2.0L; Black	PS-297
2014	4 Cyl. 2.0L; Sedan or Wagon	PS-297
2013	4 Cyl. 2.0L; CJAA Eng.	PS-400
2012-2011	4 Cyl. 2.0L; Sedan or Wagon	PS-297
2010	4 Cyl.	PS-297
2009	4 Cyl. 2.0L	PS-297
2008-2005	4 Cyl. 1.9L	PS-400
2004-2002	4 Cyl. 1.9L; w/ Brown Connector	PS-400
2004-2002	4 Cyl. 1.9L; w/ Green Connector	PS-479
2001-2000	4 Cyl.; w/ White Insulator	PS-163
2001-2000	4 Cyl.; Exhaust stock and reorder; w/ Blue Insulator	PS-189
2001-2000	4 Cyl.; w/ Black Connector	PS-297
2001-2000	4 Cyl.; Brown	PS-400
2001-2000	4 Cyl.; w/ Green Connector	PS-479
1993	4 Cyl.; w/ White Insulator	PS-163
1993	4 Cyl.; Exhaust stock and reorder; w/ Blue Insulator	PS-189
1993	4 Cyl.; Gray	PS-248
1992-1987	4 Cyl. 1.6L; w/ White Insulator; On Oil Filter	PS-163
1992-1987	4 Cyl. 1.6L; Gray	PS-248
1992-1985	4 Cyl. 1.6L; w/ Black Insulator	PS-165
1992-1985	4 Cyl. 1.6L; Exhaust stock and reorder; w/ Blue Insulator; On Cylinder Head	PS-189
1986	4 Cyl. 1.6L; M10 X 1.0 Thread; w/ Brown Insulator	PS-121
1986	4 Cyl. 1.6L; M10 X 1.0 Thread; w/ White Insulator; On Oil Filter	PS-163
1986	4 Cyl. 1.6L; w/ Gray Socket	PS-248
1985	4 Cyl. 1.6L; w/ White Insulator; On Oil Filter	PS-163

		Part No.
Oil Pressure Light Switch		
Jetta		
1985	4 Cyl. 1.6L; Gray	PS-248
Passat		
2005	4 Cyl. 2.0L	PS-400
1996	4 Cyl.; w/ Black Insulator	PS-165
1996	4 Cyl.; Exhaust stock and reorder; w/ Blue Insulator	PS-189
1996	4 Cyl.; Gray	PS-248
Quantum		
1985-1984	4 Cyl.; Exhaust stock and reorder; w/ Blue Insulator	PS-189
Rabbit		
1983	4 Cyl.; w/ Brown Insulator	PS-121
1983	4 Cyl.; w/ White Insulator	PS-163
1983	4 Cyl.; Exhaust stock and reorder; w/ Blue Insulator	PS-189
1982	4 Cyl.; w/ White Insulator; Oil Filter Housing	PS-163
1982-1981	4 Cyl.; Exhaust stock and reorder; On Cylinder Head	PS-189
1981	4 Cyl.; w/ White Insulator; On Oil Filter	PS-163
1980	4 Cyl.; w/ Brown Insulator	PS-121
Rabbit Pickup		
1983-1981	4 Cyl. 1.6L; w/ White Insulator; On Oil Filter	PS-163
1983-1981	4 Cyl. 1.6L; Exhaust stock and reorder; On Cylinder Head	PS-189
Touareg		
2010	6 Cyl. 3.0L; 1 Blade Term.	PS-165
2010	6 Cyl. 3.0L; 2 Pin	PS-492
2008	10 Cyl.	PS-297
Vanagon		
1983-1982	4 Cyl.; w/ Brown Insulator	PS-121
1983-1982	4 Cyl.; Exhaust stock and reorder; w/ Blue Insulator	PS-189
Vento		
2015-2014	4 Cyl. 1.6L	PS-479
Ported Vacuum Switch		
Dasher		
1981		PVS149
1980	4 Cyl. 1.5L	PVS149
Golf		
1992-1989	4 Cyl. 1.6L	PVS149
Jetta		
1992-1989	4 Cyl. 1.6L	PVS149
Passat		
1994-1993	4 Cyl. 1.9L	PVS149
Rabbit		
1980	4 Cyl. 1.5L	PVS149
Temperature Switches and Senders		
Coolant Fan Switch		
Dasher		
1981	w/ Locating Tab; Located in Radiator	TS-151
1981	Exhaust stock and reorder; w/o Locating Tab; Located in Radiator	TS-568
Golf		
2003	4 Cyl.	TS-206
Engine Oil Temperature Switch		
Beetle		
1998	4 Cyl. 1.9L	PS-264
Temperature Sender - With Gauge		
Dasher		
1981		TS-59

Temperature Switches and Senders

		Part No.
Temperature Sender - With Gauge		
EuroVan		
1997	5 Cyl.	TS-362
Golf		
1997-1996	4 Cyl. 1.9L	TS-409
1996-1993	4 Cyl.	TS-409
1989-1988	4 Cyl. 1.6L	TS-222
Jetta		
1999-1993	4 Cyl. 1.9L	TS-409
Passat		
1997-1996	4 Cyl. 1.9L	TS-409
1994-1993	4 Cyl. 1.9L	TS-409
Universal Switches		
Center High Mount Stop Light Assembly		
Beetle		
2006	4 Cyl. 1.9L	BTL127
Actuators		
Engine Variable Valve Timing Sprocket		
Golf		
2015-2010	4 Cyl. 2.0L; Intake	VVT711
Power Door Lock Actuator		
Jetta		
2006	Wagon; Right Rear	DLA-643
Variable Valve Timing Solenoid		
Beetle		
2015	4 Cyl. 2.0L; Diesel	VVT369
Golf		
2015	4 Cyl. 2.0L; Turbocharged	VVT369
Golf SportWagen		
2015	4 Cyl. 2.0L; Turbocharged	VVT369
Jetta		
2015	4 Cyl. 2.0L; Turbocharged	VVT369
Passat		
2015	4 Cyl. 2.0L; Turbocharged	VVT369
Touareg		
2010	6 Cyl. 3.0L	VVT138
Locks		
Ignition Lock Cylinder		
Dasher		
1981		US-109L
Volvo		
Relays and Fuses		
Coolant Fan Relay		
760		
1984-1983	6 Cyl. 2.4L; Alternate Number	RY-116
1984-1983	6 Cyl. 2.4L; Exhaust stock and reorder	RY30
Diesel Glow Plug Relay		
245		
1984	6 Cyl. 2.4L; Diesel	RY-1330
1982	6 Cyl. 2.4L; Diesel	RY-1330
740		
1986	6 Cyl.	RY1413
745		
1985	6 Cyl.	RY1413
760		
1985	6 Cyl. 2.4L	RY1413
Fuel Injection Relay		
740		
1986	6 Cyl.	RY-568

		Part No.
Fuel Injection Relay		
745		
1985	6 Cyl.	RY-568
760		
1985	6 Cyl.	RY-568
Starting and Charging System Parts		
Starter Solenoid		
740		
1986	6 Cyl. 2.4L; GLE; Str. No. 1357199, 3523301	SS-348
Injectors		
Fuel Injector - Diesel - Remfd		
740		
1986-1985	6 Cyl. 2.4L	FJ620
745		
1985	6 Cyl. 2.4L	FJ620
760		
1985-1983	6 Cyl. 2.4L	FJ620
Injection Components		
Diesel Glow Plug		
245		
1984	6 Cyl. 2.4L	GP101
740		
1986-1985	6 Cyl. 2.4L	GP101
745		
1985	6 Cyl. 2.4L	GP101
760		
1985-1983	6 Cyl. 2.4L	GP101
Fuel Pressure Regulator		
760		
1985	6 Cyl.	PR71
Pressure Sensors		
Diesel Particulate Filter (DPF) Pressure Sensor		
VNL		
2017-2010	ISX 15.0 Eng.	DPS101
VT		
2010	ISX 15.0 Eng.	DPS101
MAP Sensor		
VNL		
2017-2003	ISX 15.0 Eng.	AS534
VT		
2009-2006	ISX 15.0 Eng.	AS534
Turbocharger Boost Sensor		
ACL		
2000	6 Cyl. 14.0L; Turbocharged	AS677
1999-1996	6 Cyl. 14.6L; Turbocharged	AS677
Temperature Sensors		
Exhaust Gas Temperature Sensor		
VNL		
2011-2008	ISX 15.0 Eng.	ETS223
VT		
2010-2008	ISX 15.0 Eng.	ETS223
Body Light Switches		
Back-Up Light Switch		
760		
1984-1983	6 Cyl. 2.4L	LS-263
Headlight Dimmer Switch		
264		
1981-1980	6 Cyl. 2.4L; w/ Cruise Control	CBS1216
1981-1980	6 Cyl. 2.4L; w/o Cruise Control	CBS1217

Body Light Switches

		Part No.
Headlight Dimmer Switch		
265		
1980	6 Cyl. 2.4L; w/ Cruise Control	CBS1216
1980	6 Cyl. 2.4L; w/o Cruise Control	CBS1217
Turn Signal Switch		
245		
1984	6 Cyl. 2.4L; w/ Cruise Control	CBS1216
1982	6 Cyl. 2.4L; w/ Cruise Control	CBS1216
264		
1981-1980	6 Cyl. 2.4L; w/ Cruise Control	CBS1216
1981-1980	6 Cyl. 2.4L; w/o Cruise Control	CBS1217
265		
1980	6 Cyl. 2.4L; w/ Cruise Control	CBS1216
1980	6 Cyl. 2.4L; w/o Cruise Control	CBS1217
Ignition Switches		
Ignition Starter Switch		
740		
1986	6 Cyl. 2.4L	US-700
Interior Power Switches		
Windshield Wiper Switch		
264		
1981	6 Cyl. 2.4L	DS1899
Pressure and Vacuum Sending Switches		
Oil Pressure Light Switch		
740		
1986	6 Cyl.	PS-167
760		
1983	6 Cyl. 2.4L; Diesel; Exhaust stock and reorder	PS-189
Temperature Switches and Senders		
A/C Low Pressure Cut-Out Switch		
VNL		
2012-2000		PCS213
Coolant Fan Switch		
760		
1983	6 Cyl. 2.4L	TS-507
Temperature Sender - With Gauge		
245		
1984	6 Cyl. 2.4L	TS132
760		
1985-1984	6 Cyl. 2.4L	TS-59
Western Star		
Pressure Sensors		
Air Inlet Pressure Sensor		
4800		
2001-2000	6 Cyl. 12.0L	PS711
4900		
2001-2000	6 Cyl. 12.0L	PS711
5800		
2001-1999	6 Cyl. 12.0L	PS711
5900		
2001-2000	6 Cyl. 12.0L	PS711
Diesel Particulate Filter (DPF) Pressure Sensor		
4900SA		
2014-2010	ISX 15.0 Eng.	DPS101
6900XD		
2013	ISX 15.0 Eng.	DPS101
Injection Actuation Pressure Sensor		
3700		
2000	6 Cyl. 7.2L	PS713

		Part No.
Injection Actuation Pressure Sensor		
4800		
2000	6 Cyl. 7.2L	PS713
4900		
2000	6 Cyl. 7.2L	PS713
Turbocharger Boost Sensor		
4900EX		
2007	6 Cyl. 14.0L; Turbocharged	AS679
4900FA		
2007	6 Cyl. 14.0L; Turbocharged	AS679
4900SA		
2007	6 Cyl. 14.0L; Turbocharged	AS679
6900XD		
2007	6 Cyl. 14.0L; Turbocharged	AS679
Workhorse		
Early Fuel Emission Control		
Crankcase Ventilation Filter		
R26		
2009-2008	6 Cyl. 6.7L	BF43
EGR Components		
Diesel EGR Cooler		
LF72		
2005	8 Cyl. 6.6L	ECK5
P42		
2005	8 Cyl. 6.5L	ECK5
Injectors		
Fuel Injector - Diesel - New		
W42		
2009-2005	6 Cyl. 4.5L; Injector Only	FJ928NX
Fuel Injector - Diesel - Remfd		
W42		
2009-2005	6 Cyl. 4.5L; Injector Only	FJ928
2009-2005	6 Cyl. 4.5L; Complete Kit	FJ9288PCK
Injection Components		
Diesel Fuel Injector Control Module (FICM)		
W42		
2008-2006	6 Cyl. 4.5L; Power Supply	R76001
Diesel Oil Cooler Kit		
W42		
2009-2005	6 Cyl. 4.5L	OCK1
Pressure Sensors		
EGR Valve Pressure Feedback Sensor		
R26		
2009-2007	6 Cyl. 6.7L; Diesel	VP34
Workhorse Custom Chassis		
EGR Components		
Diesel EGR Cooler		
P42		
2005	8 Cyl. 6.6L	ECK5
Injectors		
Fuel Injector - Diesel - New		
W42		
2009-2006	6 Cyl. 4.5L; Injector Only	FJ928NX
Fuel Injector - Diesel - Remfd		
W42		
2009-2006	6 Cyl. 4.5L; Injector Only	FJ928
2009-2006	6 Cyl. 4.5L; Complete Kit	FJ9288PCK

Workhorse Custom Chassis

Injection Components

		Part No.
Injection Components		
Diesel Fuel Injector Control Module (FICM)		
W42		
2008-2006	6 Cyl. 4.5L; Power Supply	R76001
Diesel Oil Cooler Kit		
W42		
2009-2006	6 Cyl. 4.5L	OCK1



2006
Throttle Body Injection Gasket Pack

INDIVIDUALPARTS: F1PZ9F760C; E9PZ9F760F; E9PZ9F760G; E9SZ9E936B; E8PZ9F760A; E9PZ9F760A; E4SZ9F782A; E4SZ9F782ZA; E5TZ9E936A; E3FZ9F670A; E3FZ9H486A; E3PZ9F760A; E0VY9H323A; E3FZ9E936A; E7SZ9F670A; E0VY9H323A; EOAY9C977A; E0AY9C977A; E6PZ9F760A; E4PZ9229A

Assorted Sizes: Yes
Injectors Covered per Kit: 0
Kit/Set Contents: Yes
Material: Paper
Notes: N/A
Pintle Cap Included: No
Seal Type: MFI

Ford 1987 - 1985



2054
Multi-Port Fuel Injection Tune-Up Kit

Toyota 1987 - 1985



AC1
Idle Air Control Valve

8171114600; 8255270770; ERR5199; ETC6660; 17079256; 25527077; 22048226; 1711286; 17111460; 17111461; 17111288; 17111289; 17111286

Gaskets Included: Yes
Hardware Included: N/A
Port Quantity: 1
Terminal Quantity: 4

Chevrolet 1985
Pontiac 1986 - 1982



AC2
Idle Air Control Valve

17078832

Gaskets Included: Yes
Terminal Quantity: 4

Chevrolet 1984 - 1982



AC6
Idle Air Control Valve

3855194; 38551941; 17113078; 17111788

Gaskets Included: Yes
Hardware Included: Yes
Port Quantity: 1
Terminal Quantity: 4

GMC 1998 - 1997



AC23
Idle Air Control Valve

ZZL020660; ZZL020660A; F27E9F715A1B; F27E9F715AA; F27E9F715AB; F2TZ9F715A; E9TE9F715BA; E9TZ9F715B; E9TZ9F715BA; F0TE9F715B1A; E7TE9F715FA; E7TZ9F715A; E7TE9F715F1A; 17119297

Terminal Quantity: 2
Terminal Type: Blade

Ford 1989



ADR160
HVAC Mode Door Actuator

89023358; 89022572

Number Of Mounting Ears: 0
Terminal Quantity: 5

Chevrolet 2006 - 2004



ADR4200
HVAC Floor Mode Door Actuator

MA1715

Number Of Mounting Ears: 3
Terminal Quantity: 2

International 2011 - 2001



ADR4201
HVAC Defrost Mode Door Actuator

4885206AB; 5019631AA; 4885206AA

Number Of Mounting Ears: 3
Terminal Gender: Male
Terminal Quantity: 2

Dodge 2010 - 2008



ADR4209
HVAC Floor Mode Door Actuator

68048902AA; 68048902AB

Number Of Mounting Ears: 3
Terminal Quantity: 2

Dodge 2010
Ram 2011



ADR4304
HVAC Temperature Blend Door Actuator

2597225C91

Number Of Mounting Ears: 0
Terminal Quantity: 0

International 2011 - 2001



AF100
Air Filter Indicator

5C3Z9N622A

Ford 2007 - 2005



AGS1003
Radiator Active Grille Shutter Assembly

68302660AB; 68302660AA; 68234035AC; 68234035AB; 68234035AA; 68192368AG; 68192368AF; 68192368AE; 68192368AD; 68192368AC; 68192368AB; 68192368AA

Ram..... 2017 - 2014



AIP23
Air Pump
5015037AA

Connector Gender: N/A
Terminal Gender: N/A
Terminal Quantity: N/A
Terminal Type: N/A

Jeep..... 2006 - 2005



ALH290
ABS Wheel Speed
Sensor Wire Harness
4G0972251E; 4G0972251D

Connector Gender: Female
Connector Quantity: 2
Contents: Antilock Brake Speed
Sensor Harness
Terminal Gender: Male
Terminal Quantity: 2 + 2
Terminal Type: Alligator

Audi..... 2015 - 2014



ALS177
ABS / Vehicle Speed
Sensor

ZZP043711C; ZZL043711;
ZZL143711; ZZP043711;
ZZP043711A; F3TZ2L373A;
F85Z2L373AC; F85Z9E731AB;
F37Z2L373A; F85Z9E731AA;
ZZP043711B

Connector Gender: Female
Mounting Location: Wheel
Terminal Gender: Female
Terminal Quantity: 2

Ford..... 2004 - 1999



ALS197
ABS Speed Sensor
F81Z2C204BA; F81Z2C204BB

Connector Gender: Female
Mounting Location: Spindle
Terminal Gender: Male
Terminal Quantity: 2

Ford..... 2004 - 1999



ALS258
ABS / Vehicle Speed
Sensor
5032220AC; 5032220AB;
5032220AA

Connector Gender: Female
Mounting Location: Differential
Terminal Gender: Male
Terminal Quantity: 2

Dodge..... 2010



ALS365
ABS Speed Sensor
1649058500; 1645401517;
1649058300; 1644405641;
1645400717; 1644405241

Connector Gender: Female
Mounting Location: Wheel
Terminal Gender: Male
Terminal Quantity: 2

Mercedes-Benz..... 2012 - 2007



ALS367
ABS Speed Sensor
2105409108

Connector Gender: Female
Mounting Location: Wheel
Terminal Gender: Male
Terminal Quantity: 2

Mercedes-Benz..... 1999 - 1996



ALS371
ABS Speed Sensor
2105400617

Connector Gender: Female
Mounting Location: Wheel
Terminal Gender: Male
Terminal Quantity: 2

Mercedes-Benz..... 1999 - 1996



ALS375
ABS Speed Sensor
2105401017; 2105400717

Connector Gender: Female
Mounting Location: Wheel
Terminal Gender: Male
Terminal Quantity: 2

Mercedes-Benz..... 1999 - 1996



ALS376
ABS Speed Sensor
1649058200; 1644405541;
1645400917; 1645401617;
1644405141

Connector Gender: Female
Mounting Location: Wheel
Terminal Gender: Male
Terminal Quantity: 2

Mercedes-Benz..... 2012 - 2007



ALS390
ABS Speed Sensor
2105409008

Connector Gender: Female
Mounting Location: Wheel
Terminal Gender: Male
Terminal Quantity: 2

Mercedes-Benz..... 1999 - 1996



ALS395
ABS Speed Sensor
211540301764; 2115401217;
2115402417; 2115403017

Connector Gender: Female
Mounting Location: Wheel
Terminal Gender: Male
Terminal Quantity: 2

Mercedes-Benz..... 2009 - 2006



ALS411
ABS Speed Sensor
 2115402317; 2115402917
 Connector Gender: Female
 Mounting Location: Wheel
 Terminal Gender: Male
 Terminal Quantity: 2
 Mercedes-Benz 2009 - 2006



ALS430
ABS Speed Sensor
 WHT003857; 7H0927803
 Connector Gender: Female
 Mounting Location: Wheel
 Mounting Type: Bolt Mount
 Terminal Gender: Male
 Terminal Quantity: 2
 Audi 2013 - 2010
 Volkswagen 2012 - 2011



ALS463
ABS Speed Sensor
 34526760424; 34526785020;
 34526870075
 Connector Gender: Female
 Mounting Location: Wheel
 Terminal Gender: Male
 Terminal Quantity: 2
 BMW 2011 - 2009



ALS465
ABS Speed Sensor
 1H0927808; 1J0927804
 Connector Gender: Female
 Mounting Location: Spindle
 Terminal Gender: Male
 Terminal Quantity: 2
 Volkswagen 2006



ALS467
ABS Speed Sensor
 7H0927804; WHT003856
 Connector Gender: Female
 Mounting Location: Wheel
 Mounting Type: Bolt Mount
 Terminal Gender: Male
 Terminal Quantity: 2
 Audi 2013 - 2010
 Volkswagen 2012 - 2011



ALS468
ABS Speed Sensor
 1K0927808; WHT003858
 Connector Gender: Female
 Mounting Location: Wheel
 Terminal Gender: Male
 Terminal Quantity: 2
 Audi 2013 - 2010
 Volkswagen 2012



ALS469
ABS Speed Sensor
 1K0927807; WHT003859
 Connector Gender: Male
 Mounting Location: Wheel
 Mounting Type: Bolt Mount
 Terminal Gender: Male
 Terminal Quantity: 2



Audi 2013 - 2010
 Volkswagen 2012
ALS470
ABS Speed Sensor
 1H0927807; 1J0927803
 Connector Gender: Female
 Mounting Location: Wheel
 Terminal Gender: Male
 Terminal Quantity: 2
 Volkswagen 2006



ALS522
ABS Speed Sensor
 1J0927807B
 Connector Gender: Female
 Mounting Location: Wheel
 Terminal Gender: Male
 Terminal Quantity: 2
 Volkswagen 2006 - 2004



ALS545
ABS Speed Sensor
 19211695; 15715341
 Connector Gender: Female
 Mounting Location: Wheel
 Mounting Type: Flange
 Terminal Gender: Male
 Terminal Quantity: 2
 GMC 1997 - 1995



ALS546
ABS Speed Sensor
 19211696; 15715342
 Connector Gender: Female
 Mounting Location: Wheel
 Terminal Gender: Male
 Terminal Quantity: 2
 GMC 1997 - 1995



ALS1161
ABS Speed Sensor
 1245401717
 Connector Gender: Female
 Mounting Location: Wheel
 Terminal Gender: Female
 Terminal Quantity: 1
 Mercedes-Benz 1995 - 1981



ALS1162
ABS Speed Sensor
 1075400217; 2015401517
 Connector Gender: Female
 Mounting Location: Wheel
 Terminal Gender: Female
 Terminal Quantity: 1
 Mercedes-Benz 1989 - 1984



ALS1163
ABS Speed Sensor
1075400317; 2015401617

Connector Gender: Female
Mounting Location: Wheel
Terminal Gender: Female
Terminal Quantity: 1

Mercedes-Benz 1989 - 1984



ALS1166
ABS Speed Sensor
1245401617

Connector Gender: Female
Mounting Location: Wheel
Terminal Gender: Female
Terminal Quantity: 1

Mercedes-Benz 1995 - 1981



ALS1448
ABS Speed Sensor
34521155041

Connector Gender: Male
Mounting Location: Wheel
Terminal Gender: Female
Terminal Quantity: 2

BMW 1986 - 1985



ALS1842
ABS Speed Sensor
34526870077; 34526785022;
34526762476

Connector Gender: Female
Mounting Location: Spindle
Terminal Gender: Male
Terminal Quantity: 2

BMW 2011 - 2009



ALS1164
ABS Speed Sensor
1265402517

Connector Gender: Female
Mounting Location: Wheel
Terminal Gender: Female
Terminal Quantity: 1

Mercedes-Benz 1991 - 1985



ALS1184
ABS Speed Sensor
15991986

Connector Gender: Female
Mounting Location: Wheel
Mounting Type: Flange
Terminal Gender: Male
Terminal Quantity: 2

Chevrolet 1999 - 1996
GMC 1999 - 1997



ALS1527
ABS Speed Sensor
1265400017

Connector Gender: Male
Mounting Location: Spindle
Terminal Gender: Male
Terminal Quantity: 2

Mercedes-Benz 1985 - 1981



ALS1856
ABS Speed Sensor
2515400817; 2515401117;
2519055700; 2514404937;
2514403737

Connector Gender: Female
Mounting Location: Spindle
Terminal Gender: Male
Terminal Quantity: 2

Mercedes-Benz 2012 - 2007



ALS1165
ABS Speed Sensor
1265402617

Connector Gender: Female
Mounting Location: Wheel
Terminal Gender: Female
Terminal Quantity: 1

Mercedes-Benz 1991 - 1985



ALS1187
ABS Speed Sensor
19181884; 15991985

Connector Gender: Female
Mounting Location: Spindle
Mounting Type: Bolt Mount
Terminal Gender: Male
Terminal Quantity: 2

Chevrolet 1999 - 1996
GMC 1999 - 1996



ALS1528
ABS Speed Sensor
2015400017

Connector Gender: Male
Mounting Location: Spindle
Mounting Type: Bolt Mount
Terminal Gender: Male
Terminal Quantity: 2

Mercedes-Benz 1987 - 1984



ALS1866
ABS Speed Sensor
2T1Z2C204B

Connector Gender: Male
Mounting Location: Spindle
Terminal Gender: Male
Terminal Quantity: 2

Ford 2010



ALS1885
ABS Speed Sensor
 2T1Z2C204A
 Connector Gender: Female
 Terminal Gender: Male
 Terminal Quantity: 2
 Ford 2010



ALS1892
ABS Speed Sensor
 1405401117
 Connector Gender: Male
 Terminal Gender: Female
 Terminal Quantity: 2
 Mercedes-Benz 1995 - 1994



ALS1899
ABS Speed Sensor
 1265403217
 Connector Gender: Female
 Mounting Location: Spindle
 Terminal Gender: Male
 Terminal Quantity: 2
 Mercedes-Benz 1991 - 1986



ALS1904
ABS Speed Sensor
 1405403417
 Connector Gender: Male
 Mounting Location: Spindle
 Terminal Gender: Male
 Terminal Quantity: 2
 Mercedes-Benz 1995 - 1992



ALS1889
ABS Speed Sensor
 6L3Z9E731A; 4L3Z9E731AA
 Connector Gender: Female
 Mounting Location: Differential
 Terminal Gender: Male
 Terminal Quantity: 2
 Ford 2007 - 2005



ALS1893
ABS Speed Sensor
 1405403517
 Connector Gender: Female
 Mounting Location: Wheel
 Terminal Gender: Male
 Terminal Quantity: 2
 Mercedes-Benz 1995 - 1992



ALS1901
ABS Speed Sensor
 2015401317; 2015402217;
 2015400917
 Connector Gender: Male
 Mounting Location: Spindle
 Terminal Gender: Male
 Terminal Quantity: 2
 Mercedes-Benz 1989



ALS1905
ABS Speed Sensor
 1405402117
 Connector Gender: Female
 Mounting Location: Wheel
 Terminal Gender: Male
 Terminal Quantity: 2
 Mercedes-Benz 1993 - 1992



ALS1890
ABS Speed Sensor
 1405402017
 Connector Gender: Female
 Mounting Location: Spindle
 Terminal Gender: Male
 Terminal Quantity: 2
 Mercedes-Benz 1993 - 1992



ALS1894
ABS Speed Sensor
 1405400817
 Connector Gender: Male
 Terminal Gender: Female
 Terminal Quantity: 2
 Mercedes-Benz 1995 - 1994



ALS1902
ABS Speed Sensor
 2215400517; 2219056100;
 2219055800; 2219055500;
 2215401714; 2215401417
 Connector Gender: Male
 Mounting Location: Spindle
 Terminal Gender: Male
 Terminal Quantity: 2
 Mercedes-Benz 2012



ALS1924
ABS Speed Sensor
 9015421117; 5104144AA
 Connector Gender: N/A
 Mounting Location: Spindle
 Terminal Gender: Male
 Terminal Quantity: 2
 Dodge 2006 - 2003
 Freightliner 2006 - 2003



ALS1925
ABS Speed Sensor
 5104145AA
 Connector Gender: N/A
 Mounting Location: Spindle

Terminal Gender: Male
Terminal Quantity: 2
Dodge 2006 - 2003
Freightliner 2003



ALS1958
ABS Speed Sensor
52122425AC; 52122425AB

Connector Gender: Female
Mounting Location: Spindle
Terminal Gender: Male
Terminal Quantity: 2
Dodge 2010



ALS2157
ABS Speed Sensor
68013735AB; 68013735AA

Connector Gender: Female
Mounting Location: Spindle
Mounting Type: Flange
Terminal Gender: Male
Terminal Quantity: 2
Dodge 2009



ALS2238
ABS Speed Sensor
F81Z2C190AA; F81Z2C190AB

Connector Gender: Female
Mounting Location: Spindle
Mounting Type: Direct
Terminal Gender: Female
Terminal Quantity: 2
Ford 2003 - 2000



ALS2397
ABS / Vehicle Speed Sensor
89026857; 15108409; 15917615;
20784543; 20784539

Connector Gender: Male
Mounting Location: Wheel
Mounting Type: Direct
Terminal Gender: Female
Terminal Quantity: 2
Chevrolet 2009 - 2004
GMC 2009 - 2004



ALS1971
ABS Speed Sensor
52122426AD; 52122426AB;
52122426AC; 52122426AA

Connector Gender: Female
Mounting Location: Spindle
Terminal Gender: Male
Terminal Quantity: 2
Dodge 2010



ALS2158
ABS Speed Sensor
68013832AB; 68013832AA

Connector Gender: Female
Mounting Location: Spindle
Mounting Type: Flange
Terminal Gender: Male
Terminal Quantity: 2
Dodge 2009



ALS2239
ABS Speed Sensor
4C4Z2C204AA; 4C4Z2C204BA;
4C4Z2C204CA; 4C4Z7Z101AA;
4C4Z2C190BA

Connector Gender: Female
Mounting Location: Spindle
Mounting Type: Direct
Terminal Gender: Female
Terminal Quantity: 2
Ford 2007 - 2004



ALS2409
ABS Speed Sensor
89026854; 15737201

Connector Gender: Male
Mounting Location: Wheel
Mounting Type: Direct
Terminal Gender: Female
Terminal Quantity: 2
Chevrolet 2002 - 1999
GMC 2002 - 1999



ALS2059
ABS Speed Sensor
56029447AE; 56029447AF

Connector Gender: Female
Mounting Location: Spindle
Mounting Type: Bolt Mount
Terminal Gender: Male
Terminal Quantity: 2
Jeep 2014



ALS2160
ABS Speed Sensor
68013831AB; 9065401117;
68013831AA

Connector Gender: Female
Mounting Location: Spindle
Mounting Type: Flange
Terminal Gender: Male
Terminal Quantity: 2
Dodge 2009
Mercedes-Benz 2016 - 2010



ALS2352
ABS Speed Sensor
22739481; 19256422

Connector Gender: Female
Mounting Location: Axle
Mounting Type: Flange
Terminal Gender: Male
Terminal Quantity: 2
GMC 2011



ALS2683
ABS Speed Sensor
89026858; 89026855; 20784542;
20784538; 15108411; 15108407

Connector Gender: Male
Mounting Location: Wheel
Mounting Type: Direct
Terminal Gender: Female
Terminal Quantity: 4
Chevrolet 2009 - 2004
GMC 2009 - 2004



ALS2686
ABS Speed Sensor
 68034708AA; 68034708AB;
 68034708AC

Connector Gender: Female
 Mounting Location: Wheel
 Mounting Type: Direct
 Terminal Gender: Male
 Terminal Quantity: 2

Dodge 2010 - 2008
 Ram 2014 - 2011



ALS2690
ABS Speed Sensor
 F81Z2C205DA; 1C4Z2C205AA;
 1C4Z2C205AB

Connector Gender: Female
 Mounting Location: Wheel
 Mounting Type: Bolt Mount
 Terminal Gender: Female
 Terminal Quantity: 2

Ford 2003 - 2001



ALS2715
ABS Speed Sensor
 34526775864

Connector Gender: Female
 Mounting Location: Wheel
 Mounting Type: Bolt Mount
 Terminal Gender: Male
 Terminal Quantity: 2

BMW 2015



ALS2719
ABS Speed Sensor
 34526784902

Connector Gender: Female
 Mounting Location: Wheel
 Mounting Type: Bolt Mount
 Terminal Gender: Male
 Terminal Quantity: 2

BMW 2016 - 2014



ALS2721
ABS Speed Sensor
 34526884422; 34526791223

Connector Gender: Female
 Mounting Location: Wheel
 Mounting Type: Bolt Mount
 Terminal Gender: Male
 Terminal Quantity: 2

BMW 2018 - 2014



ALS2722
ABS Speed Sensor
 34526853859

Connector Gender: Female
 Mounting Location: Wheel
 Mounting Type: Bolt Mount
 Terminal Gender: Male
 Terminal Quantity: 2

BMW 2016 - 2014



ALS2724
ABS Speed Sensor
 34526884421; 34526791225

Connector Gender: Female

Mounting Location: Wheel
 Mounting Type: Bolt Mount
 Terminal Gender: Male
 Terminal Quantity: 2

BMW 2018 - 2014



ALS2746
ABS Speed Sensor
 9065401217

Connector Gender: Female
 Mounting Location: On Transimission
 Mounting Type: Bolt Mount
 Terminal Gender: Male
 Terminal Quantity: 2

Freightliner 2018 - 2010
 Mercedes-Benz 2018 - 2010



ALS2761
ABS Speed Sensor
 2215400917; 2219050201

Connector Gender: Female
 Mounting Location: Wheel
 Mounting Type: Bolt Mount
 Terminal Gender: Male
 Terminal Quantity: 2

Mercedes-Benz 2012



ALS2815
ABS Speed Sensor
 68164798AB

Connector Gender: Female
 Mounting Location: Wheel
 Mounting Type: Bolt Mount
 Terminal Gender: Male
 Terminal Quantity: 2

Ram 2013



ALS2818
ABS Speed Sensor
 68164799AB

Connector Gender: Female
 Mounting Location: Wheel
 Mounting Type: Bolt Mount

Terminal Gender: Male
 Terminal Quantity: 2

Ram 2013



ALS2903
ABS Speed Sensor
 1405400217

Connector Gender: Female
 Mounting Location: Wheel
 Mounting Type: Bolt Mount
 Terminal Gender: Male
 Terminal Quantity: 2

Mercedes-Benz 1993 - 1992



ALS3082
ABS Speed Sensor
 9069050601

Connector Gender: Female
 Mounting Location: Wheel
 Mounting Type: Bolt Mount
 Terminal Gender: Male
 Terminal Quantity: 2

Freightliner 2018 - 2010
 Mercedes-Benz 2018 - 2010



ALS3083
ABS Speed Sensor
 9069051101

Connector Gender: Female
 Mounting Location: Wheel
 Mounting Type: Bolt Mount
 Terminal Gender: Male
 Terminal Quantity: 2

Freightliner 2018 - 2010
 Mercedes-Benz 2018 - 2010



ALS3085

ABS Speed Sensor
9069051001

Connector Gender: Female
Mounting Location: Wheel
Mounting Type: Bolt Mount
Terminal Gender: Male
Terminal Quantity: 2

Freightliner 2017 - 2016
Mercedes-Benz 2018 - 2017



ALS3086

ABS Speed Sensor
1669054002

Connector Gender: Female
Mounting Location: Wheel
Mounting Type: Bolt Mount
Terminal Gender: Male
Terminal Quantity: 2

Mercedes-Benz 2017 - 2015



ALS3097

ABS Speed Sensor
906540011764; 9065400117

Connector Gender: Female
Mounting Location: Wheel
Mounting Type: Bolt Mount
Terminal Gender: Male
Terminal Quantity: 2

Dodge 2009
Mercedes-Benz 2018 - 2010



ALS3105

ABS Speed Sensor
34526791748

Connector Gender: Female
Mounting Location: Wheel
Mounting Type: Bolt Mount
Terminal Gender: Male
Terminal Quantity: 2

BMW 2018 - 2014



APK102

Accelerator Pedal Sensor
Repair Kit
15751307RK

GMC 2002 - 1994



APS101

Accelerator Pedal Sensor
F6TZ9F836AA

Terminal Gender: Male
Terminal Quantity: 3 + 2

Ford 1997 - 1996



APS102

Accelerator Pedal Sensor
F81Z9F836AA; F81Z9F836AB

Terminal Gender: Male
Terminal Quantity: 3

Ford 2003 - 1999



APS103

Accelerator Pedal Sensor
1C3Z9F836BA; 1C3Z9F836C

Terminal Gender: Male
Terminal Quantity: 10

Ford 2003 - 2001



APS104

Accelerator Pedal Sensor
3C4Z9F836AA; 3C4Z9F836C

Terminal Gender: Male
Terminal Quantity: 10

Ford 2005 - 2003



APS105

Accelerator Pedal Sensor
15767491; 15177923

Terminal Gender: Male
Terminal Quantity: 9

Chevrolet 2005 - 2003
GMC 2005 - 2001



APS108

Accelerator Pedal Sensor
2C3Z9F836DE; 2C3Z9F836BA;
2C3Z9F836DA

Terminal Gender: Male
Terminal Quantity: 10

Ford 2003 - 2002



APS109

Accelerator Pedal Sensor
3C3Z9F836BA

Terminal Gender: Male
Terminal Quantity: 10

Ford 2005 - 2003



APS113

Accelerator Pedal Sensor
XC2Z9F836AA; 2C2Z9F836AA;
3C2Z9F836AA; F7UZ9F836AD

Terminal Gender: Female + Male
Terminal Quantity: 5

Ford 2003 - 1997



APS115

Accelerator Pedal Sensor
4C2Z9F836AA; 5C2Z9F836AA

Terminal Gender: Male
Terminal Quantity: 7

Ford 2010 - 2004



APS116

Accelerator Pedal Sensor
8C3Z9F836F; 8C3Z9725A;
5C3Z9F836D

Terminal Gender: Male
Terminal Quantity: 7

Ford 2007 - 2005



APS117
Accelerator Pedal Sensor
5C3Z9F836AA
Terminal Gender: Male
Terminal Quantity: 7
Ford 2007 - 2005



APS165
Accelerator Pedal Sensor
6Q1723503F; 6Q1723503H;
6Q1723503N; 6Q1723503D
Terminal Gender: Male
Terminal Quantity: 6
Volkswagen 2005 - 2004



APS194
Accelerator Pedal Sensor
15233970
Terminal Gender: Male
Terminal Quantity: 6
Chevrolet 2007 - 2006
GMC 2007 - 2006



APS269
Accelerator Pedal Sensor
52121953AA; 52121952AA
Terminal Gender: Male
Terminal Quantity: 6
Jeep 2007



APS130
Accelerator Pedal Sensor
15984422; 15751307
Terminal Gender: Male
Terminal Quantity: 9
Chevrolet 1998 - 1996
GMC 2002 - 1994



APS187
Accelerator Pedal Sensor
1K1723503AK; 1K1723503N;
1K1723503AB
Terminal Gender: Male
Terminal Quantity: 6
Volkswagen 2006



APS195
Accelerator Pedal Sensor
6Q1721503H; 6Q1721503L;
1J1721503H; 6Q1721503D
Terminal Gender: Male
Terminal Quantity: 6
Volkswagen 2005 - 2004



APS273
Accelerator Pedal Sensor
5104047AA
Terminal Gender: Male
Terminal Quantity: 8
Dodge 2003
Freightliner 2003



APS163
Accelerator Pedal Sensor
5135510AA
Terminal Gender: Male
Terminal Quantity: 5
Dodge 2006 - 2004
Freightliner 2006 - 2004



APS188
Accelerator Pedal Sensor
7L0723507B; 7L0723507;
7L0723507D
Terminal Gender: Male
Terminal Quantity: 6
Audi 2014 - 2011
Volkswagen 2005 - 2004



APS222
Accelerator Pedal Sensor
1K1723503L; 1Q1723503;
1Q1723503A; 1K1723503AA;
1K1723503AJ; 1K1723503AP
Terminal Gender: Male
Terminal Quantity: 6
Audi 2013



APS295
Accelerator Pedal Sensor
1Q1721503; 1Q1721503A;
1K1721503AL; 1K1721503AS
Terminal Gender: Male
Terminal Quantity: 6
Volkswagen 2006



APS265
Accelerator Pedal Sensor
15101848; 25832864; 15847349
Terminal Gender: Male
Terminal Quantity: 6
Chevrolet 2017 - 2014
GMC 2017 - 2014



APS332
Accelerator Pedal Sensor
 35426853175; 35426793743;
 35426789528; 35426786588;
 35426770936
 Terminal Gender: Male
 Terminal Quantity: 6
 BMW 2018 - 2014



APS333
Accelerator Pedal Sensor
 1K1721503AN
 Terminal Gender: Male
 Terminal Quantity: 6
 Volkswagen 2014



APS335
Accelerator Pedal Sensor
 BC3Z9F836H; BC3Z9F836C;
 BC3Z9F836A
 Terminal Gender: Male
 Terminal Quantity: 6
 Ford 2012 - 2011



APS347
Accelerator Pedal Sensor
 35426788632; 35426786285;
 35416762482; 35426772645;
 35406766930; 35416752614;
 35416759723; 35406762482;
 35426789998; 35426859999;
 35426860784; 35426858574;
 35426852644
 Terminal Gender: Male
 Terminal Quantity: 6
 BMW 2016 - 2010



APS353
Accelerator Pedal Sensor
 8K1723523A; 8K1723523
 Terminal Gender: Male
 Terminal Quantity: 6
 Audi 2013 - 2012



APS356
Accelerator Pedal Sensor
 4H1723523
 Terminal Gender: Male
 Terminal Quantity: 6
 Audi 2013 - 2012



APS373
Accelerator Pedal Sensor
 BC3Z9F836F; BC3Z9F836D
 Terminal Gender: Male
 Terminal Quantity: 6
 Ford 2012 - 2011



APS399
Accelerator Pedal Sensor
 53034160AB; 53034160AC;
 53034160AD; 53034160AE
 Terminal Gender: Male
 Terminal Quantity: 6
 Dodge 2010 - 2009
 Ram 2013 - 2011



APS402
Accelerator Pedal Sensor
 52124785AF; 52124785AE;
 52124785AD
 Terminal Gender: Male
 Terminal Quantity: 6
 Jeep 2019 - 2014



APS412
Accelerator Pedal Sensor
 1K1723503T; 1K1723503S;
 1K1723503AH; 1K1723503AQ
 Terminal Gender: Male
 Terminal Quantity: 6
 Volkswagen 2014



APS444
Accelerator Pedal Sensor
 1K1721503AH; 1K1721503BB
 Terminal Gender: Male
 Terminal Quantity: 6
 Volkswagen 2014



APS461
Accelerator Pedal Sensor
 9073000200; 9063000304
 Terminal Gender: Male
 Terminal Quantity: 6
 Freightliner 2015 - 2010
 Mercedes-Benz 2015 - 2010



APS611
Accelerator Pedal Sensor
 68043161AD; 68043161AC;
 68043161AC; 68043161AB;
 68043161AA
 Terminal Gender: Male
 Terminal Quantity: 6
 Dodge 2010 - 2009
 Ram 2013 - 2011



AS1
MAP Sensor

E7EF9F479AA; E7FZ9F479A;
E7DF9F479AA; E7DZ9F479A;
E7EF9F479A1A; E7EF9F479A2A;
E6PF9F479AA; E6TZ9F479A;
E7DF9F479A1A; E7DF9F479A2A;
E6EF9F479A2A; E6EF9F479AA;
E6FZ9F479A; E6FZ9F479AA;
E67F9F479A1A; E67F9F479A2A;
E67F9F479AA; E6EF9F479A1A;
E5SF9F479A2A; E5SF9F479AA;
E5SZ9F479A; E4OZ9F479B;
E57F9F479A1A; E57F9F479A2A;
E5SF9F479A1A; E43F9F479B2A;
E43F9F479BA; E43Z9F479A;
E43Z9F479B; E43F9F479A1A

****Additional OE Numbers Available Online****

Terminal Gender: Male
Terminal Quantity: 3

Ford 1988 - 1985



AS4
MAP Sensor

16009886; 16038012

AM General 2001 - 1995
Chevrolet 2002 - 1994
GMC 2002 - 1994



AS5
MAP Sensor

16254719; 12569240; 8933000153;
8933000153; 8933000153;
8933000153; 33000273; 33000273;
33000273; 33000273;
F8JL9F428AB; F8JL9F428AA;
8161580550; 8160174600;
8161370390; 33000153; 16017460;
21020103; 81588; 8933000273;
16158055; 16137039; 4723039;
5234313; 17112715; 8125692400

Terminal Gender: Male
Terminal Quantity: 3

Buick 1985 - 1984
Cadillac 1985
Chevrolet 1993 - 1984
GMC 1998 - 1984
Oldsmobile 1985 - 1984
Pontiac 1985 - 1984



AS6
MAP Sensor

16006835; 12219931

Buick 1985 - 1982
Chevrolet 1999 - 1985
GMC 1999 - 1991
Oldsmobile 1984 - 1982



AS10
MAP Sensor

8953000710; 16231141; 16054920;
16006834

Chevrolet 1983



AS11
Barometric Pressure Sensor

16006833; 16038591; 16022790

Terminal Gender: Female
Terminal Quantity: 3

Chevrolet 1996 - 1991
GMC 1998 - 1996
Oldsmobile 1983 - 1980



AS13
Barometric Pressure Sensor

E7EF12A644A2A; E7FZ12A644A;
ZZL018211; E6EF12A644A1A;
E6EF12A644A2A; E6EF12A644AA;
E7EF12A644A1A; E3ZF12A644A1A;
E3ZF12A644A2A; E3ZF12A644B1A;
E3ZZ12A644A; 12364365

Terminal Gender: Male
Terminal Quantity: 3

Ford 1995 - 1993



AS17
MAP Sensor

17112715

Terminal Gender: Female
Terminal Quantity: 3

Chevrolet 1987



AS59
MAP Sensor

9359409; 8093594090; 38613212;
3861321; 8161875560; 8162499390;
8126149730; 16187556; 09359409;
881731; 12614973; 861249A1;
16249939

GMC 2004
Isuzu 1999



AS88
MAP Sensor

56029405

Dodge 2002



AS90
MAP Sensor

F4TF9S480AA; F4TZ9F479A

Ford 1998 - 1994



AS119
MAP Sensor

98AB9F479BA; F8UZ9F479BA

Terminal Gender: Male
Terminal Quantity: 3

Ford 2003 - 1998



AS169
Barometric Pressure Sensor

F5TZ12A644B; F8UZ12A644AA;
F5TF12A644BA; F5TF12B583AA;
F5TZ12A644A; F5TF12A644AA

Terminal Gender: Male
Terminal Quantity: 3

Ford 2003 - 1994



AS194
Turbocharger Boost Sensor

12215049; 9373269; 19138773;
12630402; 12623671; 09373269

Connector Gender: Female
Connector Shape: Oval
Contents: Sensor
Notes: Sensor Only
O.E.M. Replacement: Yes
Terminal Gender: Male
Terminal Quantity: 3
Terminal Type: Blade

Chevrolet 2010 - 2001
GMC 2010 - 2001



AS195
Barometric Pressure Sensor

9350899; 09350899

Terminal Gender: Male
Terminal Quantity: 3

Chevrolet 2004 - 2002
GMC 2004 - 2002



AS223
MAP Sensor

2L1Z9F479AA

Ford 2010 - 2003



AS302
Fuel Vapor / Vent Pressure Sensor

8162572760; 8162117490;
8093776800; 16257276; 16217059;
12219388; 8122067400;
8161960600; 8162383990;
8226788290; 12206740; 22678829;
16238399; 16196060; 9377680;
09377680

Connector Gender: Female
Connector Shape: Oval
Notes: N/A
O.E.M. Replacement: Yes
Terminal Gender: Male
Terminal Quantity: 3
Terminal Type: Blade

Hummer 2004 - 2003



AS306
Barometric Pressure Sensor

4C2Z12A644AA

Terminal Gender: Male
Terminal Quantity: 3

Ford 2007 - 2003



AS334
Turbocharger Boost Sensor

5012801AA; 5012801AB;
5012628AA; 5011435AA

Connector Gender: Female
Connector Shape: Round
Contents: Sensor
Notes: Sensor Only
O.E.M. Replacement: Yes
Terminal Gender: Male
Terminal Quantity: 3
Terminal Type: Blade

Dodge 2001 - 1998



AS337
MAP Sensor

0041533128; 5080345AA;
5080345AC; 5080345AB

Dodge 2003



AS349
Turbocharger Boost Sensor

5139278AA; 5093104AA;
5093103AA

Connector Gender: Female
Connector Shape: Oval
Contents: Sensor

Notes: N/A
O.E.M. Replacement: Yes
Terminal Gender: Male
Terminal Quantity: 4
Terminal Type: Blade

Dodge 2009 - 2003



AS356
MAP Sensor

5117545AA; 0041538428;
0061531528; 5117545AB;
0261230193; 0061539928;
68066040AA

Dodge 2009 - 2004
Freightliner 2015 - 2004
Jeep 2009 - 2007
Mercedes-Benz 2015 - 2007



AS359
MAP Sensor

56044591AA; 0041533228;
0051535028; 5101120AB;
0261230191; 5101120AA

Jeep 2006 - 2005
Mercedes-Benz 2017 - 2009



AS364
Turbocharger Boost Sensor
0281002976; 038906051D

Connector Gender: Female
Contents: Sensor
Notes: N/A
Terminal Gender: Male
Terminal Quantity: 4
Terminal Type: Blade

Audi 2014 - 2009
Volkswagen 2015 - 2004



AS365
Turbocharger Boost Sensor
038906051B

Connector Gender: Female
Contents: Sensor
Terminal Gender: Male
Terminal Quantity: 4
Terminal Type: Blade

Volkswagen 2006 - 2002



AS366
Turbocharger Boost Sensor
038906051; 38906051

Connector Gender: Female
Connector Shape: Oval
Contents: N/A
Notes: N/A
Terminal Gender: Male
Terminal Quantity: 4
Terminal Type: Blade

Volkswagen 2004 - 1998



AS367
MAP Sensor
03C906051F; 03C906051E;
03C906051

Audi 2017 - 2013
Volkswagen 2015 - 2014



AS370
MAP Sensor
5083365AC; 5083365AD;
5083365AA; 5083365AB;
5017791AA

Terminal Gender: Male
Terminal Quantity: 3

Dodge 2001 - 1999



AS370K
MAP Sensor
5083365ADK

Terminal Gender: Male
Terminal Quantity: 3

Dodge 2002 - 1999



AS371
Barometric Pressure Sensor
97180655; 19207559

Terminal Gender: Male
Terminal Quantity: 3

Chevrolet 2005 - 2001
GMC 2007 - 2001



AS405
Barometric Pressure Sensor
4C2Z12A644A

Terminal Gender: Male
Terminal Quantity: 3

Ford 2010 - 2003



AS413
MAP Sensor
68005161AA; 68005161AB

Dodge 2010 - 2008
GMC 2013
Ram 2018 - 2011



AS414
Barometric Pressure Sensor
2897333; 53034091AA;
53034091AB; 68002437AA

Terminal Gender: Male
Terminal Quantity: 3

Dodge 2010 - 2007
Ram 2018 - 2011



AS415
MAP Sensor
68002434AA; 68282012AA

Terminal Gender: Male
Terminal Quantity: 4

Dodge 2010 - 2007
Ram 2018 - 2011



AS422
MAP Sensor
8C3Z9F479A

Ford 2010 - 2008
International 2014 - 2008



AS428
MAP Sensor
12643955

Terminal Gender: Male
Terminal Quantity: 3
Chevrolet 2016 - 2010
GMC 2016 - 2010



AS434
MAP Sensor
BC3Z9F479A; BC3Z9F479B

Ford 2019 - 2011



AS435
MAP Sensor
AG9Z9F479B; AG9Z9F479A

Ford 2019 - 2015



AS441
Turbocharger Boost
Sensor
03G906051F

Connector Gender: Female
Connector Shape: Oval
Contents: Sensor
Notes: N/A
O.E.M. Replacement: Yes
Terminal Gender: Male
Terminal Quantity: 4
Terminal Type: Blade
Audi 2013 - 2010
Volkswagen 2014 - 2010



AS447
Secondary Air Injection
Sensor
06L906052; 06K906052; 06E906052

Audi 2015 - 2008



AS448
MAP Sensor
038906051J

Terminal Gender: Male
Terminal Quantity: 4

Audi 2014



AS452
Turbocharger Boost
Sensor
0061531428; 0061539828

Connector Gender: Male
Connector Shape: Rectangular
Contents: Sensor
Notes: N/A
O.E.M. Replacement: Yes
Terminal Gender: Male
Terminal Quantity: 3
Terminal Type: Pin

Mercedes-Benz 2006 - 2005



AS454
MAP Sensor
13627792260

Terminal Gender: Male
Terminal Quantity: 3
BMW 2013 - 2009



AS461
Turbocharger Boost
Sensor
13628644432; 13627599042

Connector Gender: Female
Connector Shape: Oval
Contents: Sensor
Notes: N/A
O.E.M. Replacement: Yes
Terminal Gender: Male
Terminal Quantity: 4
Terminal Type: Blade

BMW 2018



AS493
Intake Air Temperature
Sensor
55568175

Connector Gender: Female
Connector Shape: Rectangular
Connector Type: Plug In
Terminal Gender: Male
Terminal Quantity: 4
Terminal Type: Blade
Chevrolet 2019 - 2014
GMC 2019 - 2016



AS495
MAP Sensor
13627804742

Terminal Gender: Male
Terminal Quantity: 3
BMW 2018 - 2014



AS532
MAP Sensor
AJ813840

Jaguar 2019 - 2017



AS534
Barometric / Manifold
Absolute Pressure Sensor
2897331

Terminal Gender: Male
Terminal Quantity: 3
Peterbilt 2017 - 2011
Volvo 2017 - 2003



AS535
MAP Sensor
95560618010

Porsche 2016 - 2011



AS602
MAP Sensor
7700111957

Renault 2011 - 2008



AS622
MAP Sensor
68211211AA

Jeep 2019 - 2014
Ram 2018 - 2014



AS628
Manifold Differential Pressure Sensor
5149229AA; 68043725AA;
5149047AA; 5149044AA

Dodge 2010 - 2009
Ram 2012 - 2011



AS639
Manifold Differential Pressure Sensor
13627805758

BMW 2011 - 2009



AS645
MAP Sensor
07L907386A; 07L907386;
07L907386B

Audi 2016 - 2015
Volkswagen 2009



AS650
MAP Sensor
68218615AA

Ram 2017 - 2014



AS653
MAP Sensor
0261230440; 0101537228

Mercedes-Benz 2017 - 2013



AS658
MAP Sensor
22365EZ40A

Nissan 2019 - 2016



AS663
MAP Sensor
06E906051AB; 0261232012;
06E906051Q; 06E906051AA

Audi 2019 - 2016



AS670
Barometric / Manifold Absolute Pressure Sensor
1846481C92

Terminal Gender: Male
Terminal Quantity: 3

International 2010 - 2007



AS677
Turbocharger Boost Sensor
4921501

Connector Gender: Female
Connector Shape: Round
Contents: Sensor
Notes: Sensor Only
O.E.M. Replacement: Yes
Terminal Gender: Male
Terminal Quantity: 3
Terminal Type: Pin

Freightliner 2003 - 1997
Kenworth 2002 - 1999
Volvo 2000 - 1996



AS679
Turbocharger Boost Sensor
23527829

Connector Gender: Female
Connector Shape: Rectangular
Contents: Sensor
Notes: Sensor Only
O.E.M. Replacement: Yes
Terminal Gender: Male
Terminal Quantity: 3
Terminal Type: Blade

Sterling Truck 2007
Western Star 2007



AS680
MAP Sensor
4921493

Connector Gender: Female
Connector Shape: Oval
Contents: Sensor
Notes: Includes O-Ring
O.E.M. Replacement: Yes
Terminal Gender: Male
Terminal Quantity: 3
Terminal Type: Pin

Freightliner 2002 - 1998
Kenworth 2002 - 1999



AS686
MAP Sensor
68153918AA

Jeep 2018



ASM101
Axle Shift Motor

Ford 1987 - 1986



AT101
Manifold Air Tube
14077907

Chevrolet 1984 - 1981



AT103
Manifold Air Tube
22534540
Oldsmobile 1980



AT104
Manifold Air Tube
22534541
Buick 1980
Oldsmobile 1981 - 1980



AT111
Manifold Air Tube
14077908; 14026182
Chevrolet 1984 - 1981



AT123
Manifold Air Tube
14079236
Chevrolet 1980
GMC 1980



AT126
Manifold Air Tube
14055182
Chevrolet 1981 - 1980
GMC 1981
Oldsmobile 1981



AT132
Manifold Air Tube
14077963
Chevrolet 1985 - 1981
GMC 1992 - 1981



AT142
Manifold Air Tube
357106
Chevrolet 1983



AT146
Manifold Air Tube
15520412
Chevrolet 1990



AT148
Manifold Air Tube
343763
Chevrolet 1980
GMC 1980



AT165
Manifold Air Tube
14102112
Chevrolet 1990



AT187
Manifold Air Tube
14020594
Chevrolet 1981



ATS45
Intake Air Temperature Sensor
867129828
Connector Gender: Female
Connector Type: Plug In
Terminal Gender: Male
Terminal Quantity: 2
Terminal Type: 2 Pin
Volkswagen 1999 - 1993



AV1
Air Cleaner Check Valve
F3TE9A487CA; F3TZ9A487A;
F3TZ9A487C; E8TE9A487BA;
E8TZ9A487B; E9EE9A487AA;
E9TE9A487AA; F3PE9A487AA;
D8BZ9A487B; D9BE9A487D3A;
D9BZ9A487A; E3BE9A487AA;
D4AZ9A487A; D8BE9A487B1A;
D8BE9A487B3A; D8BE9A487D3A;
D4AE9A487AA; D4AE9A487AB;
46620796; 12332533
Hose Size - Inches: 1.24
Hose Size - mm: Refer to Inches
Ford 1990 - 1983



AV5
Air Cleaner Check Valve
E77E9A487AA; E7TZ9A487A;
D8EE9A487A1A; D8EE9A487A2A;
D8FZ9A487A; 9792133; 9797798
Hose Size - Inches: 1.24
Hose Size - mm: Refer to Inches
Ford 1985 - 1983



AV7
Air Cleaner Check Valve
3843110; 3843110; 3843110;
3843110; 3238321; 3238321;
3238321; 3238321; 2288311;
2288311; 2288311; 2288311;
8220506420; 4713243; 4360343;
4290442; 162329; 14830N3300;
14830U6700; 11640743195;
1162560; 060131603; 22016902;
5361997; 5354987; 4993435;
3671039; 3671038; 53000944;
33001549
****Additional OE Numbers Available Online****
Hose Size - Inches: 5/8
Hose Size - mm: Refer to Inches
Cadillac 1980
Chevrolet 1999 - 1982
Dodge 1993 - 1990
GMC 1998 - 1982
Oldsmobile 1985 - 1980
Peugeot 1983 - 1980
Pontiac 1980



AV9
Air Cleaner Check Valve
22048578; 22016736; 22034706;
14830H7200; 12332532; 22097055;
22060632; 22060635; 22017158;
22041206; 22008616
Hose Size - Inches: 3/4
Hose Size - mm: Refer to Inches
Oldsmobile 1985



AV12
Air Cleaner Check Valve
D4VE9A487AB; D4VY9A487A;
E9VE9A487AB; E9VZ9A487A;
D4DZ12A170A; D4DZ9A487A;
D4DZ9A487B; D4VE9A487AA;
C6AE9A487D; C6AZ9A487A;
D4DE9A487AA; D4DE9A487AB;
12323876
Hose Size - Inches: 1/2
Ford 1990 - 1983
Lincoln 1985 - 1984



AV18
Air Cleaner Check Valve
E3FZ9A487D; E3FZ9A487G;
E3EE9A487DA; E3EE9A487GA;
12351033
Hose Size - Inches: 3/4
Hose Size - mm: Refer to Inches
Ford 1985
Mercury 1985



AV22
Air Cleaner Check Valve
4227874
Hose Size - Inches: 3/4
Hose Size - mm: Refer to Inches
Dodge 1993 - 1990



AV23
Air Cleaner Check Valve
E8DZ9A487A; F3TZ9A487B;
F4TZ9A487A; E3TZ9A487A
Hose Size - Inches: 3/4
Hose Size - mm: Refer to Inches
Ford 1984 - 1983



AV30
Air Cleaner Check Valve
E7TZ9A487E; E8TE9A487AA
Hose Size - Inches: 3/4
Hose Size - mm: Refer to Inches
Ford 1990 - 1988



AV32
Air Cleaner Check Valve
E3TZ9B449B
Hose Size - Inches: 3/4
Hose Size - mm: Refer to Inches
Ford 1984 - 1983



AV35
Air Cleaner Check Valve
D9AZ9A487A; D9AZ9A487C;
D9AE9A487CA
Hose Size - Inches: 1.24
Hose Size - mm: Refer to Inches
Lincoln 1985 - 1984



AV56
Air Cleaner Check Valve
12567733; 12563476
Hose Size - Inches: N/A
Hose Size - mm: N/A
Chevrolet 2000
GMC 2000



AW-1023
Door Jamb Switch
3L5Z14018AA; 4L3Z14018AA
Connector Gender: Female
Connector Quantity: 1
Connector Shape: N/A
Mounting Type: Direct
Terminal Gender: Male
Terminal Quantity: 2
Ford 2006 - 2004



AW-1024
Door Jamb Switch
3L5Z13713AA; 4L3Z13713AA
Connector Gender: Female
Connector Quantity: 1
Connector Shape: N/A
Mounting Type: Direct
Terminal Gender: Male
Terminal Quantity: 2
Ford 2006 - 2004



AX1
Intake Air Temperature Sensor
8250373340; 8250367510;
38545273; 25095187; 25037334;
25037225; 25037034; 25036950;
25036751; 805223T; 3854527
Attachment Method: Screw-in
Connector Gender: Female
Connector Quantity: 1
Connector Shape: Oval
Connector Type: Plug In
Terminal Gender: Male
Terminal Quantity: 2
Terminal Type: Pin
Thread Size: N/A
Voltage: N/A
Chevrolet 2002 - 1994
GMC 2002 - 1994



AX3
Intake Air Temperature Sensor
ZZM118845; ZL118845;
F3Z212A697C; FS1518845A;
ZZL018845; F1AZ12A697B;
F32DF12A697AA; F2DZ12A697A;
F32F12A697AA; E4AF12A697AA;
E4AF12A697BA; E7AF12A697AA;
EOAZ12A697A; EOAZ12A697A;
E1AF12A697AA; E1AZ12A697A;
E4AF12A697A; 38541587;
D4AF12A697A; EOAE12A697AA
Connector Gender: Female
Connector Type: Plug In
Terminal Gender: Male
Terminal Quantity: 2
Terminal Type: Pin
Ford 1987



AX8
Intake Air Temperature Sensor
5226504; 4300251
Connector Gender: Female
Connector Type: Plug In
Terminal Gender: Male
Terminal Quantity: 2
Terminal Type: Blade Terminals
Dodge 1989



AX24
Intake Air Temperature Sensor
046905379; 046905379; 280130039;
0280130039; 92860614300
Connector Type: Plug In
Terminal Quantity: 2
Terminal Type: Blade
Volkswagen 1995



AX25

Intake Air Temperature Sensor

F5AF12A697AA; F5AZ12A697A

Connector Gender: Female
 Connector Type: Plug In
 Terminal Gender: Male
 Terminal Quantity: 2
 Terminal Type: Blade

Ford 2003 - 1995



AX31

Intake Air Temperature Sensor

F57Z12A697AA; ZZM218845;
 F57F12A697AA; F57Z12A697A

Connector Gender: Female
 Connector Type: Plug In
 Terminal Gender: Male
 Terminal Quantity: 2
 Terminal Type: Blade

Ford 2003 - 1998



AX32

Intake Air Temperature Sensor

8121103190; 8121602440;
 25037352; 12160244; 12110319

Attachment Method: Push On
 Connector Gender: Female
 Connector Quantity: 1
 Connector Shape: Oval
 Connector Type: Plug In
 Terminal Gender: Male
 Terminal Quantity: 2
 Terminal Type: Blade Terminals
 Thread Size: N/A
 Voltage: 12

Chevrolet 1999 - 1994
 GMC 1999 - 1994



AX35

Intake Air Temperature Sensor

F6SZ12A697A; FSB918845;
 ZZM318845; F62Z12A697A;
 F65Z12A697AA; F6SF12A697AA;
 F6SF12A697AB; F62F12A697AA

Connector Gender: Female
 Connector Type: Plug In
 Terminal Gender: Male
 Terminal Quantity: 2
 Terminal Type: Blade

Cadillac 1980
 Ford 2003 - 1997



AX36

Intake Air Temperature Sensor

3918461; 4638643

Connector Gender: Female
 Connector Type: Plug In
 Terminal Gender: Male
 Terminal Quantity: 2
 Terminal Type: Blade

Dodge 1997 - 1990



AX68

Intake Air Temperature Sensor

5014197AA; 5011402AA

Connector Gender: Female
 Connector Type: Plug In
 Terminal Gender: Male
 Terminal Quantity: 2
 Terminal Type: Blade

Dodge 2002 - 1998



AX69

Intake Air Temperature Sensor

56028364AA

Connector Gender: Female
 Connector Type: Plug In
 Terminal Gender: Male
 Terminal Quantity: 2
 Terminal Type: Blade

Jeep 2010



AX75

Ambient Air Temperature Sensor

5149025AA; 5149265AB;
 05149265AB; 05149025AA;
 56042395

Connector Gender: Female
 Connector Quantity: 1
 Connector Shape: Oval
 Contents: Sensor
 Mounting Location: N/A
 Notes: N/A
 Terminal Gender: Male
 Terminal Quantity: 2
 Terminal Type: Blade

Dodge 2010 - 2004
 Jeep 2009 - 2005



AX78

Ambient Air Temperature Sensor

8150479460; 15047946

Connector Gender: Female
 Contents: Sensor
 Notes: N/A
 Terminal Gender: Male
 Terminal Quantity: 2
 Terminal Type: Blade

GMC 2006 - 2000



AX102

Intake Air Temperature Sensor

LR091865

Attachment Method: Bolt On
 Connector Gender: Female
 Connector Quantity: 1
 Connector Shape: Rectangular, Oval
 Connector Type: Plug; Socket
 Terminal Gender: Male
 Terminal Quantity: 4
 Terminal Type: Blade
 Thread Size: N/A
 Voltage: 12

Land Rover 2018



AX103

Intake Air Temperature Sensor

LR071745

Attachment Method: Push-On
 Connector Gender: Female
 Connector Quantity: 1
 Connector Shape: Rectangular, Square
 Connector Type: Plug In
 Terminal Gender: Male
 Terminal Quantity: 2
 Terminal Type: Blade
 Thread Size: N/A
 Voltage: 12

Land Rover 2018



AX104

Intake Air Temperature Sensor

LR035536

Attachment Method: Screw-On
 Connector Gender: Female
 Connector Quantity: 1
 Connector Shape: Oval
 Connector Type: Plug; Socket

Terminal Gender: Male
Terminal Quantity: 2
Terminal Type: Pin
Thread Size: N/A
Voltage: 12
Land Rover 2019 - 2016



AX115
Intake Air Temperature Sensor
68031593AA; 5140331AA

Connector Gender: Female
Connector Quantity: 1
Connector Shape: Oval
Connector Type: Plug In
Terminal Gender: Male
Terminal Quantity: 4
Terminal Type: Blade Terminals
Jeep 2006 - 2005



AX116
Intake Air Temperature Sensor
53034235AA; 5102115AA;
5102115AB; 53032649AA;
68050010AA

Connector Gender: Female
Connector Type: Plug In
Terminal Gender: Male
Terminal Quantity: 4
Terminal Type: Blade Terminals
Dodge 2007 - 2003



AX118
Ambient Air Temperature Sensor
68085242AA; 5101096AA

Connector Gender: Female
Contents: N/A
Notes: N/A
Terminal Gender: Male
Terminal Quantity: 2
Terminal Type: Pins

Dodge 2009
Freightliner 2009



AX129
Intake Air Temperature Sensor

5174042AC; 5174042AB;
5174042AA; 4862635AA;
0005422818; 5149209AA;
5080343AA

Connector Gender: Female
Connector Type: Plug In
Terminal Gender: Male
Terminal Quantity: 2
Terminal Type: Pin

Dodge 2009 - 2003
Jeep 2009 - 2007
Mercedes-Benz 2009 - 1996



AX142
Intake Air Temperature Sensor

06B905379A; 06B905379C;
06B905379D; 06B905379

Connector Gender: Female
Connector Quantity: 1
Connector Shape: Oval
Connector Type: Plug In
Terminal Gender: Male
Terminal Quantity: 2
Terminal Type: Blade

Volkswagen 2013 - 2012



AX154
Ambient Air Temperature Sensor
1J0919379

Connector Gender: Female
Contents: Sensor
Notes: N/A
Terminal Gender: Male
Terminal Quantity: 2
Terminal Type: Blade
Volkswagen 2001



AX158
Ambient Air Temperature Sensor
5103563AA

Connector Gender: Female
Contents: Sensor
Notes: N/A
Terminal Gender: Male
Terminal Quantity: 2
Terminal Type: Blade

Dodge 2006 - 2003
Freightliner 2006 - 2003



AX181
Cabin Air Temperature Sensor
0005428418; 0075421318

Connector Gender: Female
Contents: Sensor
Notes: N/A
Terminal Gender: Male
Terminal Quantity: 2
Terminal Type: Blade

Freightliner 2017 - 2010
Mercedes-Benz 2019 - 2010



AX203
Cabin Air Temperature Sensor

NSC000030; NSC000031;
65816905133; 65816936953;
65810141199

Connector Gender: Female
Contents: Sensor
Notes: N/A
Terminal Gender: Male
Terminal Quantity: 2
Terminal Type: Blade

BMW 2011 - 2009



AX214
Intake Air Temperature Sensor
8C3Z12A697B

Connector Gender: Female
Connector Type: Plug In
Terminal Gender: Male
Terminal Quantity: 2
Terminal Type: Blade

Ford 2010 - 2008
International 2010 - 2007



AX215
Cabin Air Temperature Sensor
5103937AA; 5103937AB

Connector Gender: Female
Connector Quantity: 1
Connector Shape: N/A
Contents: Sensor
Mounting Location: N/A
Notes: N/A
Terminal Gender: Male
Terminal Quantity: 2
Terminal Type: Pin

Dodge 2009 - 2004
Freightliner 2009 - 2004



AX229
Intake Air Temperature Sensor
97381182

Connector Type: Plug In
Terminal Gender: Male
Terminal Quantity: 2
Terminal Type: Blade

Chevrolet 2010
GMC 2010



AX234
Ambient Air Temperature Sensor
0008306872; 5133427AA

Connector Gender: Female
Connector Quantity: 1
Connector Shape: Rectangular
Contents: Sensor
Mounting Location: N/A
Notes: N/A
Terminal Gender: Male
Terminal Quantity: 2
Terminal Type: Blade

Dodge 2006 - 2003
Freightliner 2006 - 2003



AX288
Heater Core Temperature Sensor
E8OY19C734A

Connector Gender: Female
Contents: Sensor
Notes: N/A
Terminal Gender: Male
Terminal Quantity: 2
Terminal Type: Blade

Ford 2007 - 2005



Audi 2008

AX328
Ambient Air Temperature Sensor
1K0907543E; 1K0907543C

Connector Gender: Female
Connector Quantity: 1
Connector Shape: Rectangular
Contents: Sensor
Mounting Location: N/A
Notes: N/A
Terminal Gender: Male
Terminal Quantity: 2
Terminal Type: Blade

Volkswagen 2016



AX381
Air Charge Temperature Sensor
03N906081D; 03N906081A

Terminal Gender: Male
Terminal Quantity: 2

Audi 2016 - 2015
Volkswagen 2015



AX382
Air Charge Temperature Sensor
06K907386B; 06K907386D

Terminal Gender: Male
Terminal Quantity: 3

Audi 2016 - 2015



AX254
Air Cleaner Temperature Sensor
4R8Z12A697A

Terminal Gender: Male
Terminal Quantity: 2

Ford 2019 - 2011



AX293
Intake Air Temperature Sensor
89024894

Terminal Gender: Male
Terminal Quantity: 2
Terminal Type: Pin

Chevrolet 2011 - 2006
GMC 2011 - 2006



AX355
Ambient Air Temperature Sensor
13583411

Connector Gender: Female
Connector Quantity: 1
Connector Shape: Oval
Contents: Sensor
Mounting Location: N/A
Notes: N/A
Terminal Gender: Male
Terminal Quantity: 2
Terminal Type: Blade

Chevrolet 2017
GMC 2017



AX402
Ambient Air Temperature Sensor
2518300072

Connector Gender: Female
Connector Quantity: 1
Connector Shape: Rectangular
Contents: Sensor
Mounting Location: N/A
Notes: N/A
Terminal Gender: Male
Terminal Quantity: 2
Terminal Type: Blade

Mercedes-Benz 2009 - 2007



AX264
Intake Air Temperature Sensor
6511530028

Connector Type: Plug In
Terminal Gender: Male
Terminal Quantity: 2
Terminal Type: Pin

Mercedes-Benz 2018 - 2010



AX303
Ambient Air Temperature Sensor
95557231100; 4B0820539; 8E0820539B; 8E0820539A

Connector Gender: Female
Connector Quantity: 1
Connector Shape: Rectangular
Contents: Sensor
Mounting Location: N/A
Notes: N/A
Terminal Gender: Male
Terminal Quantity: 2
Terminal Type: Blade



AX377
Cabin Air Temperature Sensor
8Z0820535A

Connector Gender: Female
Connector Quantity: 1
Connector Shape: Oval
Contents: Sensor
Mounting Location: N/A
Notes: N/A
Terminal Gender: Male
Terminal Quantity: 2
Terminal Type: Blade

Audi 2016 - 2015
Volkswagen 2016 - 2015



AX403
Ambient Air Temperature Sensor
2118300272

Connector Gender: N/A
Connector Quantity: 1
Connector Shape: N/A
Contents: Sensor

Mounting Location: N/A
Notes: N/A
Terminal Gender: N/A
Terminal Quantity: 6
Terminal Type: Slide
Mercedes-Benz 2009 - 2006



AX412
Heater Core Temperature Sensor
68004239AA
Connector Gender: Female
Contents: Sensor
Notes: N/A
Terminal Gender: Male
Terminal Quantity: 2
Terminal Type: Pins
Dodge 2010 - 2008
Ram 2013 - 2011



AX417
Heater Core Temperature Sensor
1718300272
Connector Gender: Female
Contents: Sensor
Notes: N/A
Terminal Gender: N/A
Terminal Quantity: 2
Terminal Type: Pin
Mercedes-Benz 2017 - 2016



AX420
Heater Core Temperature Sensor
64119238084
Connector Gender: Female
Contents: Sensor
Notes: N/A
Terminal Gender: Male
Terminal Quantity: 2
Terminal Type: Pin

BMW 2018 - 2014



AX422
Air Charge Temperature Sensor
DS7Z12A697A
Terminal Gender: Male
Terminal Quantity: 2
Ford 2020 - 2018



AX431
Heater Core Temperature Sensor
5Q0907543A
Connector Gender: Female
Contents: Sensor
Notes: N/A
Terminal Gender: Male
Terminal Quantity: 2
Terminal Type: Pin
Volkswagen 2015



AX441
Ambient Air Temperature Sensor
1638300272
Connector Gender: Female
Connector Quantity: 1
Connector Shape: Rectangular
Contents: Sensor
Mounting Location: N/A
Notes: N/A
Terminal Gender: Male
Terminal Quantity: 2
Terminal Type: Blade
Mercedes-Benz 2015 - 2007



AX451
Heater Core Temperature Sensor
64116920430
Connector Gender: Female
Contents: Sensor
Notes: N/A
Terminal Gender: Male
Terminal Quantity: 2
Terminal Type: Pins
BMW 2016 - 2014



AX454
Intake Air Temperature Sensor
13628519445
Connector Gender: Female
Connector Quantity: 1
Connector Shape: Oval
Connector Type: Plug In
Terminal Gender: Male
Terminal Quantity: 2
Terminal Type: Blade
BMW 2018 - 2014



AX461
Intake Air Temperature Sensor
12681993
Attachment Method: Direct
Connector Gender: Female
Connector Quantity: 1
Connector Shape: Oval
Connector Type: Plug In
Terminal Gender: Male
Terminal Quantity: 4
Terminal Type: Blade
Chevrolet 2019 - 2017
GMC 2019 - 2017



AX506
Cabin Air Temperature Sensor
64118391372; 64118380673; 64116930015
Connector Gender: Female
Contents: N/A
Notes: N/A
Terminal Gender: Male
Terminal Quantity: 2
Terminal Type: Pin
BMW 2011 - 2009



AX517
Air Charge Temperature Sensor
9C1Z12A697C
Terminal Gender: Male
Terminal Quantity: 2
Ford 2019 - 2015



AX520
Intake Air Temperature Sensor
T2H3651
Connector Gender: Female
Connector Quantity: 1
Connector Shape: Square
Terminal Gender: Male
Terminal Quantity: 2
Terminal Type: Blade
Jaguar 2019 - 2017



BF11

Crankcase Ventilation Filter

31017506; 6484966; 1622759

Buick..... 1984 - 1980
 Chevrolet..... 1990 - 1980
 GMC..... 1988 - 1983
 Oldsmobile..... 1982



BF17

Crankcase Ventilation Filter

D8AZ9D695A

Ford..... 1986 - 1983



BF19

Crankcase Ventilation Filter

557240; 22513584

Buick..... 1985 - 1980
 Cadillac..... 1981 - 1980
 Oldsmobile..... 1982 - 1980
 Pontiac..... 1981 - 1980



BF41

PCV Valve

25098706

Hose Connector Quantity: 2
 Hose Size - Inches: N/A
 Hose Size - mm: N/A
 Nipple Orientation: N/A

Chevrolet..... 2000 - 1996
 GMC..... 2000 - 1992



BF43

Breather Element

68002433AA; 68002433AC;
 68002433AB

Blue Bird..... 2018 - 2008
 Dodge..... 2010 - 2007
 Ford..... 2015 - 2008
 Freightliner..... 2019 - 2008
 International..... 2020 - 2014
 Ram..... 2019 - 2011
 Sterling Truck..... 2010 - 2009
 Thomas..... 2020 - 2019
 Workhorse..... 2009 - 2008

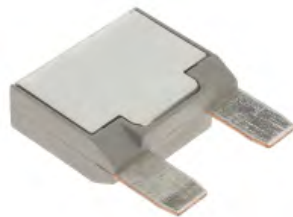

BR-34

Circuit Breaker

12088553

Amperage Rating: 30 A
 Connector Gender: Female
 Terminal Gender: Male
 Terminal Quantity: 2
 Voltage: 12

AM General..... 1998 - 1992



BR-120

Circuit Breaker

D0VY14526B; 19106407

Amperage Rating: 20 A
 Connector Gender: No Connector
 Terminal Gender: Male
 Terminal Quantity: 2

Ford..... 1991 - 1990



BR-207

Circuit Breaker

D9ZZ14526H

Amperage Rating: 6 A
 Connector Gender: Female
 Terminal Gender: Male
 Terminal Quantity: 2

Ford..... 1991 - 1990



BR-208

Circuit Breaker

D3AZ14526B; D9AZ14526C

Amperage Rating: 8
 Connector Gender: Female
 Terminal Gender: Male
 Terminal Quantity: 2

Ford..... 1991 - 1990



BR-220

Circuit Breaker

D9AZ14526B

Amperage Rating: 20 A
 Connector Gender: Male
 Terminal Gender: Male
 Terminal Quantity: 2
 Voltage: 12

Ford..... 1989 - 1986



BR-230

Circuit Breaker

88964825; D9AZ14526A; 14103366;
 14005011; 12040832; 1252240;
 443937105

Amperage Rating: 30 A
 Connector Gender: Female
 Terminal Gender: Male
 Terminal Quantity: 2
 Voltage: 12

Ford..... 1991 - 1986



BSC16

Battery Current / Volt Sensor

56029713AD; 56029713AC;
 56029713AB; 56029713AA

Connector Gender: Female
 Connector Quantity: 1
 Connector Shape: Oval
 Contents: N/A
 Notes: N/A
 Terminal Gender: Male
 Terminal Quantity: 2
 Terminal Type: Bullet

Jeep..... 2016



BSC55
Battery Current / Volt Sensor
1665420518

Connector Gender: Female
Connector Quantity: 1
Connector Shape: Oval
Contents: N/A
Notes: N/A
Terminal Gender: Male
Terminal Quantity: 2
Terminal Type: Bullet

Mercedes-Benz 2015 - 2013



BSC75
Battery Current / Volt Sensor
1669052102

Connector Gender: Female
Connector Quantity: 1
Connector Shape: Oval
Contents: N/A
Notes: N/A
Terminal Gender: Male
Terminal Quantity: 2
Terminal Type: Bullet

Mercedes-Benz 2017 - 2015



BSC90
Battery Current / Volt Sensor
61219302358

Connector Gender: Female
Connector Quantity: 1
Connector Shape: Oval
Contents: N/A
Notes: N/A
Terminal Gender: Male
Terminal Quantity: 3
Terminal Type: Blade

BMW 2016



BSD86
Blind Spot Detection Sensor
000905570128; 000905570127;
0009055701

Mercedes-Benz 2016 - 2012



BSC62
Battery Current / Volt Sensor
LR081460

Connector Gender: Female
Connector Quantity: 1
Connector Shape: Oval
Contents: N/A
Notes: N/A
Terminal Gender: Male
Terminal Quantity: 2
Terminal Type: Blade

Land Rover 2017



BSC84
Battery Current / Volt Sensor
61219117877

Connector Gender: Female
Connector Quantity: 1
Connector Shape: Rectangular
Contents: N/A
Notes: N/A
Terminal Gender: Male
Terminal Quantity: 2
Terminal Type: Blade

BMW 2018 - 2014



BSC102
Battery Current / Volt Sensor
5Q0915181G

Connector Gender: Female
Connector Quantity: 1
Connector Shape: N/A
Connector Shape: Oval
Contents: N/A
Notes: N/A
Terminal Gender: Male
Terminal Quantity: 2
Terminal Type: Blade

Audi 2016 - 2015



BSD87
Blind Spot Detection Sensor
0009057502; 000905450328;
000905450327; 0009054503;
0009053303; 0009052604;
0009050610

Mercedes-Benz 2016 - 2013



BSC68
Battery Current / Volt Sensor
1669055901

Connector Gender: Female
Connector Quantity: 1
Connector Shape: Oval
Contents: N/A
Notes: N/A
Terminal Gender: Male
Terminal Quantity: 2
Terminal Type: Bullet

Mercedes-Benz 2017 - 2016



BSC86
Battery Current / Volt Sensor
61127616200

Connector Gender: Female
Connector Quantity: 1
Connector Shape: Oval
Contents: N/A
Notes: N/A
Terminal Gender: Male
Terminal Quantity: 3
Terminal Type: Blade

BMW 2011 - 2009



BSC104
Battery Current / Volt Sensor
9056702; 0009056702

Connector Gender: Female
Connector Quantity: 2
Connector Shape: Oval
Connector Shape: Round
Contents: N/A
Notes: N/A
Terminal Gender: Male
Terminal Quantity: 3
Terminal Type: Blade

Mercedes-Benz 2016



BSD124
Blind Spot Detection Sensor
5Q0907686B

Volkswagen 2016



BSD125
Blind Spot Detection Sensor
5Q0907685B

Volkswagen 2016



BST107
Brake Pedal Travel Sensor
3W4Z2M113AA

Connector Gender: Female
Contents: Sensor
Terminal Gender: Male
Terminal Quantity: 3
Terminal Type: Blade

Mercedes-Benz 2010 - 2007



BST119
Brake Fluid Pressure Sensor
05133702AA

Connector Gender: Female
Connector Quantity: 1
Contents: Sensor
Terminal Gender: Male
Terminal Quantity: 3
Terminal Type: Pin

Dodge 2006 - 2003
Freightliner 2006 - 2003



BTL123
Center High Mount Stop Light Assembly
55372082AA; 55372082AC;
55372082AB; 55372082AE;
55372082AD; 55372082AF

Dodge 2010
Ram 2013 - 2011



BTL127
Center High Mount Stop Light Assembly
1C0945097A; 1C0945097B;
1C0945097E

Volkswagen 2006



BTL128
Center High Mount Stop Light Assembly
19169016; 5978318; 15884341

Chevrolet 2007

GMC 2006 - 2001



CAC1
Charge Air Cooler
BC3Z6K775B

Hose Connector Quantity: 4
Port Quantity: 2

Ford 2016 - 2011



CBH100
Other PCV Systems
06F103221H

Volkswagen 2010 - 2005



CBS2352
Multi Function Column Switch
61319351145

BMW 2017 - 2015



CBS2357
Multi Function Column Switch
61319351144

BMW 2017 - 2015



CBS2387
Multi Function Column Switch
6E7Z13K359A

Ford 2009 - 2006



CBS2418
Multi Function Column Switch
6E7Z13752AA

Ford 2006



CBS-1002
Multi Function Column Switch
2554003G06

Nissan 1986



CBS-1003
Multi Function Column Switch
25540D4500

Nissan 1986



CBS-1065
Multi Function Column Switch
88923815; 2556004A60

Nissan 1986 - 1983



CBS-1085
Multi Function Column Switch
8L0953513J; 8L0953513B01C;
8L0953513C01C; 8L0953513J01C

Volkswagen 2002



CBS-1149
Multi Function Column Switch
8124500670; 12450067

Hummer 2003



CBS-1155
Multi Function Column Switch
YL3Z13K359AAA; YL3Z13K359ABA;
88924125; XL3Z13K359AAA;
YL3T13K359ABW

Ford 2015 - 2000



CBS-1158
Multi Function Column Switch
2C3Z13K359AAA;
2C3Z13K359ABA; 4C3Z13K359AAA
Ford..... 2007 - 2002



CBS-1338
Multi Function Column Switch
56049823AA; 56045165AB;
56049823AB; 56045515AA
Dodge..... 2010 - 2008



CBS-1403
Multi Function Column Switch
7F1Z13K359AB; 4F1Z13K359AAA;
5F1Z13K359AAA; 7F1Z13K359AA
Ford..... 2010 - 2005



CBS-1452
Multi Function Column Switch
26102159; 26096838; 26090822;
26075065
Chevrolet..... 2016 - 2009
GMC..... 2011



CBS-1181
Multi Function Column Switch
26090823; 26102160; 26096839;
26080823; 26075066
Chevrolet..... 2009 - 2003
GMC..... 2009 - 2003



CBS-1352
Multi Function Column Switch
3D0953513; 3D0953513B41
Volkswagen..... 2008 - 2007



CBS-1422
Multi Function Column Switch
15849313; 15112681
Chevrolet..... 2011
GMC..... 2011



CBS-1573
Multi Function Column Switch
1J095351301C
Volkswagen..... 2005 - 2003



CBS-1261
Multi Function Column Switch
5103745AA
Dodge..... 2006 - 2003
Freightliner..... 2006 - 2002



CBS-1372
Multi Function Column Switch
UA1366120B
Mazda..... 1984 - 1982



CBS-1427
Multi Function Dash Switch
25858705; 15926099; 15096895
Chevrolet..... 2011 - 2010
GMC..... 2011 - 2010



CBS-1584
Multi Function Column Switch
8L0953513S01C
Volkswagen..... 2002



CBS-1392
Multi Function Column Switch
0015404745; 5103539AC;
5103539AB; 5103539AA
Dodge..... 2006 - 2003
Freightliner..... 2006 - 2002



CBS-1446
Multi Function Dash Switch
25858426; 15926098; 15096894



CBS-1588
Multi Function Column Switch
8L0953513G; 8L095351301C;
8L0953513G01C
Volkswagen..... 2004



CBS-1773
Multi Function Column Switch
68026806AA; 9065450310;
68010456AA
Dodge 2009 - 2007
Freightliner 2009 - 2007



CBS-1916
Multi Function Column Switch
68010461AA; 68026805AA
Dodge 2009 - 2007
Freightliner 2009 - 2007



CBS-1975
Multi Function Column Switch
1K0953513G; 1K0953513A9B9;
1K0953513F9B9; 1K0953513G9B9;
1K0953513A
Volkswagen 2010 - 2007



CBS-2106
Multi Function Column Switch
164540014428; 1645400144;
1645403445
Mercedes-Benz 2009 - 2007



CBS-1877
Multi Function Column Switch
7L6953513B41
Volkswagen 2008 - 2007



CBS-1917
Multi Function Column Switch
F3HZ13341A
Ford 1996 - 1993



CBS-2016
Multi Function Column Switch
934102M015; 934102M010
Mercedes-Benz 2009 - 2007



CBS-2107
Multi Function Column Switch
1715400144
Mercedes-Benz 2009 - 2007



CBS-1891
Multi Function Column Switch
8P0953513D9B9; 8P0953513B9B9;
8P09535139B9
Volkswagen 2007



CBS-1925
Multi Function Column Switch
56046114AB; 56046114AC;
56046114AD; 56046114AF;
56046114AE
Dodge 2010



CBS-2071
Multi Function Column Switch
1715402254; 1715402245
Mercedes-Benz 2006 - 2005



CBS-2110
Multi Function Column Switch
61319164423; 61319196280;
61319122378; 61319138210
BMW 2013 - 2009



CBS-1899
Multi Function Column Switch
7C3Z13K359AA
Ford 2009 - 2008



CBS-1945
Multi Function Column Switch
25778641
Chevrolet 2016 - 2009
GMC 2015 - 2008



CBS-2081
Multi Function Column Switch
2105400144
Mercedes-Benz 1997 - 1996



CBS-2112
Multi Function Column Switch
61319138206; 61319164419;
61319196269; 61319122374
BMW 2013 - 2009



CBS-2145
Multi Function Column Switch
8973801672; 8973801670;
8973801671; 97380167
Chevrolet 2009 - 2004
GMC 2009 - 2004



CBS-2146
Multi Function Column Switch
97719290; 97729356

Chevrolet 2009 - 2004
GMC 2009 - 2004



CBS-2147
Multi Function Column Switch
8973801661; 8973801660;
97380166

Chevrolet 2009 - 2004
GMC 2009 - 2004



CBS-2148
Multi Function Column Switch
1823606922; 1823606921;
1823606920; 97730209

Chevrolet 2009 - 2004
GMC 2009 - 2004



CCA1026
Cruise Control Switch
56049379AC

Contents: Switch
Functions: Cruise Control
Terminal Gender: Male
Terminal Quantity: 3
Terminal Type: Blade

Dodge 2010 - 2004



CCA1097
Cruise Control Switch
15276854; 15276857; 15824107

Contents: Switch
Functions: Cruise Control
Terminal Gender: Male
Terminal Quantity: 10
Terminal Type: Pin

Chevrolet 2011 - 2008
GMC 2011 - 2008



CCA1168
Cruise Control Switch
4671929AB; 4671929AC;
68057091AA; 4671929AE;
4671929AA

Contents: Switch
Functions: Cruise Control
Notes: N/A
Terminal Gender: Male
Terminal Quantity: 3
Terminal Type: Pin

Dodge 2010



CCA1291
Cruise Control Switch
5103744AA

Contents: 1 Switch
Functions: Cruise Control
Notes: N/A
Terminal Gender: Male
Terminal Quantity: 6
Terminal Type: Blade

Dodge 2006 - 2004
Freightliner 2006 - 2004



CCD72
Cruise Control Distance Sensor
0009055601; 0009054603;
0009051302

Mercedes-Benz 2016 - 2013



CCR-1
Cruise Control Release Switch
F5TZ2C341A; 1L1Z9F924AA;
F3TZ9F924B; F3TZ9F924BB

Contents: Switch
Notes: N/A
Terminal Gender: Male
Terminal Quantity: 2
Terminal Type: Blade

Ford 2002 - 1999



CCR-5
Cruise Control Release Switch
3L3Z9F924AB; 3L3Z9F924AA

Contents: Switch
Terminal Gender: Male
Terminal Quantity: 2
Terminal Type: Blade

Ford 2002



CF-1
Fuel Vapor Canister Filter
409053C1; 19B10070B; 7026014;
3577586; 3227279; 8120330

Buick 1983 - 1980
Chevrolet 1985 - 1982
GMC 1985 - 1982



CP109
Canister Purge Valve
10105386; 17088122; 17088120;
17087295; 17087293; 17087240;
17087217; 17087230; 17087215;
17087216; 17087179; 17087178

Hose Size - Inches: 5/16, 3/8
Hose Size - mm: 8, 10 mm
Port Quantity: 3

Chevrolet 1987



CP208
Canister Purge Solenoid
8019972010; 8019972290;
01997210; 1997243; 1997210;
1997211; 1997213; 1997201;
1997205; 1997208; 1997170;
1997196

Connector Gender: Female; Male; Male
Connector Quantity: 1
Contents: Sensor
Terminal Gender: Male
Terminal Quantity: 2
Terminal Type: Pin

Chevrolet 1995 - 1994



CP225
Canister Purge Solenoid
1997258; 1997240

Connector Quantity: 2
Terminal Gender: Male
Terminal Quantity: 2
Terminal Type: Pin
Chevrolet 1998 - 1996



CP403
Canister Purge Solenoid
E6ZZ9C915A; FO2Z9C915A;
ZZL013975; E4ZF9C915AA;
12352010

Connector Gender: Female
Connector Quantity: 1
Connector Shape: Oval
Contents: Solenoid
Terminal Gender: Male
Terminal Quantity: 2
Terminal Type: Blade
Ford 1995 - 1990



CP408
Canister Purge Solenoid
E5TE9C915AA; E5TF9C915AA;
E5TZ9C915A; E4TF9C915AA

Connector Gender: Female
Connector Quantity: 1
Contents: Solenoid
Terminal Gender: Male
Terminal Quantity: 2
Terminal Type: Blade
Ford 1989



CP417
Canister Purge Valve
17060514

Hose Size - Inches: 1/4, 5/16
Hose Size - mm: 7, 8 mm
Port Quantity: 3
Chevrolet 1980



CP440
Fuel Vapor Canister
53030837

Terminal Quantity: N/A
Dodge 2003 - 2000



CP492
Canister Purge Solenoid
68028735AA; 68028735AB;
68028735AC; 5098143AA;
5098143AB; 5098145AA;
5140859AA; 0004705593;
0004708893

Mercedes-Benz 2009 - 2006



CP569
Canister Purge Solenoid
06E906517A; 06E906517

Connector Gender: Female
Connector Quantity: 1
Connector Shape: Oval

Terminal Gender: Male
Terminal Quantity: 2
Terminal Type: Pin
Audi 2009 - 2008



CP604
Canister Purge Solenoid
037906283C

Connector Gender: Male
Connector Quantity: 1
Connector Shape: Oval
Contents: Solenoid
Terminal Gender: Male
Terminal Quantity: 2
Terminal Type: Blade
Audi 2015 - 2014



CP796
Canister Purge Valve
4627694AB; 4627694AA

Hose Size - Inches: 1/2
Hose Size - mm: 10 mm
Port Quantity: 2
Jeep 2020 - 2014



CP806
Canister Purge Solenoid
CU5Z9F945A

Connector Gender: Female
Connector Quantity: 1
Connector Shape: Square
Contents: N/A
Terminal Gender: Male
Terminal Quantity: 2
Terminal Type: Blade
Ford 2014



CP838
Fuel Vapor Canister
06E133781E; 06E133781K

Connector Gender: Female
Connector Quantity: 1
Terminal Quantity: 2
Audi 2017 - 2012



CP863
Canister Purge Solenoid
06J133781CE

Connector Gender: Female
Connector Quantity: 1
Connector Shape: Rectangular
Contents: N/A
Terminal Gender: Male
Terminal Quantity: 2
Terminal Type: Bullet
Audi 2016 - 2015



CP884
Canister Purge Solenoid
13902366609; 13907636156

Connector Gender: Female; Female
Connector Quantity: 2
Connector Shape: Rectangular
Terminal Gender: Male; Male
Terminal Quantity: 2; 3
Terminal Type: Blade
BMW 2018 - 2013



CP1022
Fuel Vapor Canister
8171131480; 7028131; 07028131;
07043715; 17092039; 17092110;
17090040; 17086066; 17086007;
17065031; 17063013; 17056539;
17056542; 17052818; 7043715;
17113148
Cadillac..... 1980
Chevrolet..... 1986 - 1985



CP2000
Fuel Vapor Canister
E2ZE9D653AA; E2ZZ9D653A;
ZZL013970; ZZL013970A
Ford..... 1987 - 1986



CP3051
Fuel Vapor Canister
14950W8900; 14950D2100;
14950D210A; 14950S3805
Connector Gender: N/A
Connector Quantity: N/A
Terminal Quantity: N/A
Nissan..... 1983 - 1981



CP3287
Fuel Vapor Canister
16137163596
Connector Quantity: N/A
Terminal Quantity: N/A
BMW..... 2011 - 2009



CP3319
Fuel Vapor Canister
16137194208
BMW..... 2011 - 2009



CP3375
Fuel Vapor Canister
1J0201801L
Connector Quantity: N/A
Terminal Quantity: N/A
Volkswagen..... 2006 - 2005



CP3454
Fuel Vapor Canister
2114700159
Connector Gender: Female
Connector Quantity: 1
Terminal Quantity: 2
Mercedes-Benz..... 2006



CP3543
Fuel Vapor Canister
25937605
Connector Quantity: N/A
Terminal Quantity: N/A
Chevrolet..... 2016 - 2013
GMC..... 2016 - 2013



CSP100
Clock Spring
19330851; 26072085; 26087318
Chevrolet..... 2000 - 1998
GMC..... 2000 - 1998



CSP123
Clock Spring
5104089AA
Dodge..... 2006 - 2003
Freightliner..... 2006 - 2003



CSP127
Clock Spring
56049795AC; 56049795AB;
56049795AA; 56049795AD;
5139286AA; 56049795AE;
56049462AA; 56049461AA
Dodge..... 2010



CSP131
Clock Spring
68010451AA; 68029347AA;
9064640318
Dodge..... 2009
Freightliner..... 2009



CSP164
Clock Spring
1K0959653D
Audi..... 2010



CSP247
Clock Spring
56046116AE
Dodge..... 2010

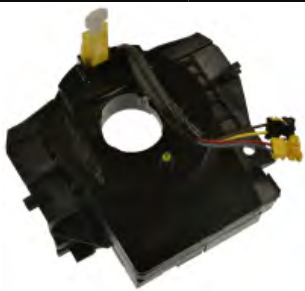

CSP311

Clock Spring

5156106AE; 5156106AG ;
5156106AF

Jeep..... 2009 - 2008



CVS46

Canister Vent Solenoid

0004763032; 0004766732

Hose Connector Quantity: 1

Hose Size - mm: Refer to Inches

Mercedes-Benz 1999 - 1992



CVS47

Canister Vent Solenoid

0004768332; 0004704993;
0004707193

Hose Connector Quantity: 1

Hose Size - mm: Refer to Inches

Mercedes-Benz 2009 - 2006



CVS60

Canister Purge Solenoid

13904588396; 13907572234;
13907618643

Connector Gender: Female

Connector Quantity: 1

Connector Shape: Rectangular

Terminal Gender: Male

Terminal Quantity: 2

Terminal Type: Blade

BMW..... 2009



CVS80

Canister Vent Solenoid

0014701393; 0004742930

Contents: Sensor

Hose Size - mm: N/A

Mercedes-Benz 2009 - 2006



CVS129

Canister Vent Solenoid

13907636145; 13907621107;
13902366606

Contents: Solenoid

Hose Connector Quantity: 1

Hose Size - mm: N/A

BMW..... 2015



CVS134

Canister Vent Solenoid

13907618657; 13907601209;
13904586291; 13907636157

Contents: Solenoid

Hose Connector Quantity: 1

Hose Size - mm: 20 mm

BMW..... 2012 - 2011



CVS153

Fuel Vapor Canister

84802774; 84065747; 22740537

Connector Gender: Female

Connector Quantity: 1

Terminal Quantity: 2

Chevrolet..... 2015 - 2014



DBT1

**Diesel High Pressure Oil
Rail Ball Tube**

522037

Ford..... 2010 - 2004



DEP100

**Diesel Particulate Filter
(DPF) Pressure Sensor**

GC3Z5L239A

Ford..... 2016 - 2015



DEP118

**Diesel Exhaust
Particulate Sensor**

55502921; 55590140

Chevrolet..... 2019 - 2016

GMC..... 2019 - 2016



DEP119

**Diesel Exhaust
Particulate Sensor**

55591380; 12685369

Chevrolet..... 2019 - 2017

GMC..... 2019 - 2017



DEP120

**Diesel Exhaust
Particulate Sensor**

12667010

Chevrolet..... 2016

GMC..... 2016



DEP122

**Diesel Exhaust
Particulate Sensor**

55508293; 55502533; 55504592

Chevrolet..... 2019 - 2018

GMC..... 2019 - 2018



DEP123
Diesel Exhaust Particulate Sensor
55486495

Chevrolet 2018 - 2017



DEP125
Diesel Exhaust Particulate Sensor
12661098; 12662647

Chevrolet 2017 - 2014
GMC 2017



DFH101
Diesel Fuel Heater
F81Z9J294AA; 1831196C92

Notes: N/A

Ford 2004 - 1998
IC Corporation 2007 - 2002
International 2007 - 1999



DFH102
Diesel Fuel Heater
12511964

Material: Steel, Molded Nylon
Notes: N/A

Chevrolet 2002 - 1994
GMC 2002 - 1994



DFH103
Diesel Fuel Heater
1831197C92; 1831197C91;
F81Z9J294BA

Material: Plastic
Notes: Includes O-Ring

Ford 2003 - 1998



DFH104
Diesel Fuel Heater
F5TZ9J294A; 1825186C91

Material: Steel
Notes: Zinc Coated to Prevent Corrosion

Ford 1997 - 1994
International 1998 - 1994



DFH105
Diesel Fuel Heater
F4TZ9J294A

Material: Plastic
Notes: N/A

Ford 1997 - 1994



DFH106
Diesel Exhaust Fluid (DEF) Heater
84412924; 23379348; 22902620;
22872118

Chevrolet 2016 - 2012
GMC 2016 - 2012



DFH107
Diesel Exhaust Fluid (DEF) Heater
84412925; 23379347; 22905128;
22888896; 22872120

Chevrolet 2016 - 2012
GMC 2016 - 2012



DFI1
Diesel Emission Fluid Injection Nozzle
AL3Z5J281A

Connector Gender: Female
Connector Quantity: 1
Terminal Gender: Male
Terminal Quantity: 2

Ford 2018 - 2011



DFI2
Diesel Emission Fluid Injection Nozzle
12647372; 12635928; 12640359

Chevrolet 2016 - 2010
GMC 2016 - 2010



DFI3
Diesel Emission Fluid Injection Nozzle
4627241AF; 4627241AD;
4627241AE; 4627241AB;
4627241AA

Ram 2019 - 2013



DFI4
Diesel Emission Fluid Injection Nozzle
68232842AD; 68232842AB;
68232842AA; 68167878AA;
68186710AC; 68186710AB;
68186710AA; 68155791AC;
68155791AB; 68155791AA;
4627710AC; 4627710AA;
4627710AB

Jeep 2017 - 2014
Ram 2019 - 2014



DFI5
Diesel Emission Fluid
Injection Nozzle
18307807206

BMW 2013 - 2010



DFI6
Diesel Emission Fluid
Injection Nozzle
12656061; 55573939

Connector Gender: Female
Connector Quantity: 1
Terminal Gender: Male
Terminal Quantity: 2

Chevrolet 2015 - 2014



DFI7
Diesel Emission Fluid
Injection Nozzle
1644900213; 1644900413;
1644900513

Connector Gender: Female
Connector Quantity: 1
Terminal Gender: Male
Terminal Quantity: 2

Freightliner 2015 - 2010
Mercedes-Benz 2015 - 2010



DFI8
Diesel Emission Fluid
Injection Nozzle
3C0131113C; 3C0131113D;
3C0131113B

Connector Gender: Female
Connector Quantity: 1
Terminal Gender: Male
Terminal Quantity: 2

Audi 2015 - 2010
Porsche 2015 - 2013
Volkswagen 2015 - 2010



DFIP1
Diesel Emissions Fluid
Pump
BC3Z5L227K; BC3Z5L229L;
BC3Z5J229L; BC3Z5L227D;
BC3Z5J229K; BC3Z5J229A

Ford 2019 - 2011



DFIP2
Diesel Emissions Fluid
Pump
22902634; 22783126; 22872119;
22783123

Chevrolet 2016 - 2010
GMC 2016 - 2010



DFIP3
Diesel Emissions Fluid
Pump
HC345J229AD; HC3Z5J229B

Ford 2020 - 2017



DFIP6
Diesel Emissions Fluid
Pump
561198969; 0024706894

Mercedes-Benz 2018 - 2010
Volkswagen 2016 - 2009



DFS1
Diesel Emissions Fluid
Temperature Sensor
20760381

Terminal Gender: Male; Male
Terminal Quantity: 6; 6

Chevrolet 2016 - 2010
GMC 2016 - 2010



DH1
Pre Heater Hose

Contents: Hose
Inner Diameter (I.D.) - Inches: N/A
Inner Diameter (I.D.) - mm: N/A
Length - Inches: 36
Length - mm: Refer to Inches

Mazda 1984 - 1982
Volkswagen 1994 - 1981



DH2
Pre Heater Hose

Inner Diameter (I.D.) - Inches: N/A
Inner Diameter (I.D.) - mm: N/A
Length - Inches: 18
Length - mm: Refer to Inches

Mazda 1984 - 1982
Volkswagen 1994 - 1981



DH3
Pre Heater Hose

MD005146; MD005135; MD005134;
MD003045; 8933000637; 5214401;
5214119; 473495; 472863; 466302;
460766; 4271913; 4268768;
4241993; 4241992; 4105937;
373525; 373524; 367137; 357016;
25504140; 14054897; 14025296;
14020671; 14009023; 14006706;
14004457; 14001960; 14001196;
1260631

****Additional OE Numbers Available Online****

Inner Diameter (I.D.) - Inches: N/A
Inner Diameter (I.D.) - mm: N/A
Length - Inches: 20

Mazda 1984 - 1982
Volkswagen 1994 - 1981



DH4
Pre Heater Hose

Contents: Hose
 Inner Diameter (I.D.) - Inches: N/A
 Inner Diameter (I.D.) - mm: N/A
 Length - Inches: 18
 Length - mm: Refer to Inches
 Mazda..... 1984 - 1982
 Volkswagen 1994 - 1981



DIH2
Diesel Air Intake Heater
 4856670AB; 4856670; 4429348;
 3913348

Connector Gender: No Connector
 Connector Quantity: 1
 Terminal Gender: Female
 Terminal Quantity: 1
 Terminal Type: Wire Lead
 Dodge..... 1993 - 1989



DIH5
Diesel Air Intake Heater
 12697819; 12601677

Connector Gender: Female
 Connector Quantity: 1
 Hardware Included: No
 Terminal Gender: Male
 Terminal Quantity: 6
 Terminal Type: Pin
 Voltage: 12
 Chevrolet 2016 - 2011
 GMC 2016 - 2011



DIH8
Diesel Air Intake Heater
 98028427; 8980284270

Connector Gender: Female
 Connector Quantity: 1
 Hardware Included: No
 Terminal Gender: Male
 Terminal Quantity: 6
 Terminal Type: Pin
 Voltage: 12
 Chevrolet 2007 - 2006
 GMC 2007 - 2006



DH6
Pre Heater Hose

Contents: Hose
 Inner Diameter (I.D.) - Inches: N/A
 Inner Diameter (I.D.) - mm: N/A
 Length - Inches: 20.5
 Length - mm: Refer to Inches
 Mazda..... 1984 - 1982
 Volkswagen 1994 - 1981



DIH3
Diesel Air Intake Heater
 5175548AA

Connector Gender: No Connector
 Connector Quantity: 1
 Terminal Gender: Male
 Terminal Quantity: 1
 Terminal Type: Stud
 Dodge..... 2008 - 2006



DIH6
Diesel Air Intake Heater
 12621907

Connector Gender: Female
 Connector Quantity: 1
 Hardware Included: No
 Terminal Gender: Male
 Terminal Quantity: 6
 Terminal Type: Pin
 Voltage: 12
 Chevrolet 2016 - 2010
 GMC 2016 - 2010



DIH9
Diesel Air Intake Heater
 68290470AA; 68002431AB;
 68002431AA; 4940345

Connector Gender: No Connector
 Connector Quantity: 1
 Hardware Included: No
 Terminal Gender: Male
 Terminal Quantity: 1
 Terminal Type: Screw
 Voltage: 12
 Dodge 2010 - 2007
 Ram 2014 - 2011



DIH1
Diesel Air Intake Heater
 5086720AC; 4882815; 4762012AB;
 4762012; 5086720AA; 5086720AB;
 4746694

Connector Gender: No Connector
 Connector Quantity: 2
 Hardware Included: No
 Terminal Gender: Male
 Terminal Quantity: 2
 Terminal Type: Stud
 Voltage: 12
 Dodge..... 2005 - 1994



DIH4
Diesel Air Intake Heater
 97251974; 8972519740

Connector Gender: No Connector
 Connector Quantity: 1
 Hardware Included: No
 Terminal Gender: Male
 Terminal Quantity: 1
 Terminal Type: Screw
 Voltage: 12
 Chevrolet 2004 - 2001
 GMC 2004 - 2001



DIH7
Diesel Air Intake Heater
 98050454; 8980504542

Connector Gender: Female
 Connector Quantity: 1
 Hardware Included: No
 Terminal Gender: Male
 Terminal Quantity: 6
 Terminal Type: Pin
 Voltage: 12
 Chevrolet 2010 - 2007
 GMC 2010 - 2007



DIH11
Diesel Air Intake Heater
 68069387AA; 5260965; 68027046AA

Connector Gender: No Connector
 Connector Quantity: 1
 Hardware Included: No
 Terminal Gender: Male
 Terminal Quantity: 1
 Terminal Type: Screw
 Voltage: 12
 Dodge..... 2010 - 2007
 Ram 2012 - 2011



DIH12
Diesel Air Intake Heater
98050441

Connector Gender: Female
Connector Quantity: 1
Hardware Included: No
Terminal Gender: Male
Terminal Quantity: 6
Terminal Type: Blade
Voltage: 12

Chevrolet 2010 - 2006
GMC 2010 - 2006



DIL1
Diesel Fuel Injector Line
97188720

Chevrolet 2004 - 2001
GMC 2004 - 2001



DIL2
Diesel Fuel Injector Line
97188721

Chevrolet 2004 - 2001
GMC 2004 - 2001



DIL3
Diesel Fuel Injector Line
97188722

Chevrolet 2004 - 2001
GMC 2004 - 2001



DIL4
Diesel Fuel Injector Line
97188723

Chevrolet 2004 - 2001
GMC 2004 - 2001



DIL5
Diesel Fuel Injector Line
3957081; 5086871AA

Dodge 2006 - 2003



DIL6
Diesel Fuel Injector Line
4988810; 5086872AB; 5086872AA

Dodge 2006 - 2003



DIL7
Diesel Fuel Injector Line
4988809; 5086873AB; 5086873AA

Dodge 2006 - 2003



DIL8
Diesel Fuel Injector Line
4988808; 5289447; 5086874AC;
5086874AB; 5086874AA



Dodge 2006 - 2003

DIL9
Diesel Fuel Injector Line
4988807; 5086875AB; 5086875AA



Dodge 2006 - 2003

DIL10
Diesel Fuel Injector Line
4988806; 5086876AD; 5086876AB

Dodge 2006 - 2003



DIL11
Diesel Fuel Injector Line
68005437AA

Dodge 2010 - 2007
Ram 2018 - 2011



DIL12
Diesel Fuel Injector Line
68005438AA

Dodge 2010 - 2007
Ram 2018 - 2011



DIL13
Diesel Fuel Injector Line
68005336AA

Dodge 2010 - 2007
Ram 2018 - 2011



DIL14
Diesel Fuel Injector Line
68005435AA

Dodge 2010 - 2007
Ram 2018 - 2011



DL275
Door Lock Kit

F87Z1022050BA; F85Z1521990BB;
F85Z1521990BA; F7UZ1522050EA;
F7UZ1522050DA; F7TZ1522050AA;
F7TZ1521990BA; F6UZ1522050BF;
F6UZ1522050AE; F6TZ1522050AA;
F67Z7822050HB; F67Z7822050GB;
F67Z7822050FB; F67Z7822050EB;
F67Z7822050DB; F67Z1022050DA;
F67Z1022050CA; F67Z1022050BA;
F67Z1022050AA; F65Z1522050BA;
F65Z1522050AA; 8L3Z1521990A;
7C3Z1521990A

Contents: Door Lock Cylinder
Rebuild Kit
Part Finish: Silver

Ford 2009 - 1999



DL-3
Door Lock Kit

E2TZ1021984E; D8BZ5421984A;
D8BZ5422050B; E1DZ5421984C;
E2TZ1021984A

Contents: Complete Kit
Part Finish: Chrome

Ford 1986 - 1983



DL-6
Door Lock Kit
6263178; 6259507; 3996650;
1154619; 1330123; 12505553;
9632762; 9632771; 12398554;
345073; 12330123; 20497701;
20496052; 20495082

Contents: Complete Kit
Part Finish: Chrome
Buick..... 1982



DL-14
Door Lock Kit
E8BZ6121985A; GA1376210;
GA1376220; H04376220;
E27Z1021984A; BE3276220;
BB6276210; BB6276220;
BE3276210; 820875910;
BA0176210; BA0176220;
E6BZ6121984A

Contents: Lock Cylinder & 2 Keys
Mazda..... 1984 - 1982



DL-54
Door Lock Kit
F57Z7822050A; F65Z1522050B;
F65Z1522050D; F3UZ1522050A;
F3UZ1522050C; F3UZ1522050F;
F57Z1022050A; F2UZ1522050A;
F37Z1022050A; F3TZ7822050B;
F3UZ1522050D

Contents: Complete Kit
Part Finish: Black
Ford..... 2004 - 1999



DL-140
Door Lock Kit
XC2Z1521990AA; XL2Z7821990AA;
XL2Z7821990AB; XL2Z7821990AC;
F6UZ1522050AB; F6UZ1522050CB;
F87Z1021990AA; F87Z7821990BA;
F69Z1122050BB

Contents: Complete Kit
Part Finish: Chrome
Ford..... 1996



DLA824
Power Door Lock Actuator
55372857AB; 55372857AA;
55276797AB

Connector Gender: Female
Connector Quantity: 1
Connector Shape: Rectangular
Terminal Gender: Male
Terminal Quantity: 2
Terminal Type: Blade
Dodge..... 2010 - 2008



DLA987
Power Door Lock Actuator
68079094AA; 4589420AD;
4589420AE; 4589420AF;
68079094AC; 68079094AB

Connector Gender: Female
Connector Quantity: 1
Connector Shape: Oval
Terminal Gender: Male
Terminal Quantity: 4
Terminal Type: Blade
Dodge..... 2010
Ram..... 2013



DLA997
Power Door Lock Actuator
4589650AE; 4589650AD;
4589650AC

Connector Gender: Female
Connector Quantity: 1
Connector Shape: Oval
Terminal Gender: Male
Terminal Quantity: 4
Terminal Type: Blade
Ram..... 2013



DLA998
Power Door Lock Actuator
4589651AE; 4589651AD;
4589651AC

Connector Gender: Female
Connector Quantity: 1
Connector Shape: Oval
Terminal Gender: Male
Terminal Quantity: 4
Terminal Type: Blade
Ram..... 2013



DLA1002
Power Door Lock Actuator
51217154619; 51217154621;
51217167065; 51217167071;
51217202143; 51217036167;
51217059967

Connector Gender: Female
Connector Quantity: 1
Connector Shape: Rectangular
Terminal Gender: Male
Terminal Quantity: 7

Terminal Type: Pin
BMW..... 2011 - 2009



DLA1007
Power Door Lock Actuator
4589417AI; 4589417AH;
4589417AG; 4589417AF;
4589417AE; 4589417AD;
4589417AA

Connector Gender: Female
Connector Quantity: 1
Connector Shape: Rectangular
Terminal Gender: Male
Terminal Quantity: 4
Terminal Type: Blade
Ram..... 2013



DLA1034
Power Door Lock Actuator
68071880AC; 68071880AA

Connector Gender: Female
Connector Quantity: 1
Connector Shape: Rectangular
Terminal Gender: Male
Terminal Quantity: 4
Terminal Type: Blade
Ram..... 2012 - 2011



DLA1035
Power Door Lock Actuator
68079092AA

Connector Gender: Female
Connector Quantity: 1
Connector Shape: Oval
Terminal Gender: Male
Terminal Quantity: 4
Terminal Type: Blade

Ram..... 2012 - 2011



DLA1036

Power Door Lock Actuator

68071882AA; 68071882AC; 68071882AB

Connector Gender: Female
 Connector Quantity: 1
 Connector Shape: Rectangular
 Terminal Gender: Male
 Terminal Quantity: 4
 Terminal Type: Blade

Ram..... 2013 - 2011



DLA1037

Power Door Lock Actuator

68071880AB

Connector Gender: Female
 Connector Quantity: 1
 Connector Shape: Rectangular
 Terminal Gender: Male
 Terminal Quantity: 4
 Terminal Type: Blade

Ram..... 2013



DLA1038

Power Door Lock Actuator

4589422AI; 4589422AH; 4589422AG

Connector Gender: Female
 Connector Quantity: 1
 Connector Shape: Rectangular
 Terminal Gender: Male
 Terminal Quantity: 4
 Terminal Type: Blade

Ram..... 2013



DLA1063

Power Door Lock Actuator

68071881AA; 68071881AC; 68071881AB

Connector Gender: Female
 Connector Quantity: 1
 Connector Shape: Rectangular
 Terminal Gender: Male
 Terminal Quantity: 4
 Terminal Type: Blade

Ram..... 2013



DLA1065

Power Door Lock Actuator

68079085AA

Connector Gender: Female
 Connector Quantity: 1
 Connector Shape: Rectangular
 Terminal Gender: Male
 Terminal Quantity: 4
 Terminal Type: Blade

Ram..... 2012 - 2011



DLA1066

Power Door Lock Actuator

04589651AB

Connector Gender: Female
 Connector Quantity: 1
 Connector Shape: Rectangular
 Terminal Gender: Male
 Terminal Quantity: 4
 Terminal Type: Blade

Dodge..... 2010



DLA1139

Power Door Lock Actuator

4589650AB; 68079090AA

Connector Gender: Female
 Connector Quantity: 1
 Connector Shape: Oval
 Terminal Gender: Male
 Terminal Quantity: 4
 Terminal Type: Pin

Ram..... 2012 - 2011



DLA1434

Power Door Lock Actuator

68010012AA; 68017889AA

Connector Gender: Female
 Connector Quantity: 1
 Connector Shape: Oval
 Terminal Gender: Male
 Terminal Quantity: 4
 Terminal Type: Blade

Dodge..... 2009

Mercedes-Benz 2010



DLA1435

Power Door Lock Actuator

A9067201735; 68010100AA; 9067201735; 9067202135; 68017891AA

Connector Gender: Female
 Connector Quantity: 1
 Connector Shape: Oval
 Terminal Gender: Male
 Terminal Quantity: 4
 Terminal Type: Blade

Dodge..... 2009

Mercedes-Benz 2010



DLA-1

Power Door Lock Actuator

22020256; 22062740; 22049686

Connector Gender: No Connector
 Terminal Gender: N/A
 Terminal Quantity: N/A
 Terminal Type: N/A

Buick..... 1985 - 1982

Chevrolet..... 1988 - 1982

GMC 1991 - 1982

Oldsmobile 1985 - 1980

Pontiac 1985 - 1980



DLA-131

Power Door Lock Actuator

3L3Z25218A43AA; 3L3Z25218A43AB; 6L3Z25218A43AA; F81Z25218A43AA

Connector Gender: Female
 Terminal Gender: Male
 Terminal Quantity: 2
 Terminal Type: Blade

Ford..... 2006 - 2000



DLA-144

Power Door Lock Actuator

6L3Z25218A42AA; F81Z25218A42AA; F88Z16219A64BB; 3L3Z25218A42A; 3L3Z25218A42AA

Connector Gender: Female
 Terminal Gender: Male
 Terminal Quantity: 2
 Terminal Type: Blade

Ford..... 2006 - 2000



DLA-463
Power Door Lock Actuator
9018690120; 5103756AA
Connector Gender: Female + Male
Terminal Gender: Female + Male
Terminal Quantity: 2 + 2 + 2
Terminal Type: Blade
Dodge 2006 - 2003
Freightliner 2006 - 2003



DLA-525
Power Door Lock Actuator
5133986AA; 0018003475
Connector Gender: Female; Female
Terminal Gender: Male; Male
Terminal Quantity: 2; 2
Terminal Type: Blade
Dodge 2006 - 2003
Freightliner 2006 - 2003



DLA-630
Power Door Lock Actuator
55276584AD; 55276584AE;
55276584AF; 55372848AB;
55276584AC; 55372848AA;
55276584AA; 55276584AB
Connector Gender: Female
Terminal Gender: Male
Terminal Quantity: 4
Terminal Type: Blade
Dodge 2010



DLA-632
Power Door Lock Actuator
55276585AF; 55276585AE;
55276585AD; 55276585AC;
55372843AA; 55276585AA;
55276585AB
Connector Gender: Female
Terminal Gender: Male
Terminal Quantity: 4
Terminal Type: Blade
Dodge 2010



DLA-479
Power Door Lock Actuator
0018002475; 5133998AA
Connector Gender: Female
Terminal Gender: Male; Male
Terminal Quantity: 2; 2
Terminal Type: Blade
Dodge 2006 - 2003
Freightliner 2006 - 2003



DLA-526
Power Door Lock Actuator
5133510AA; 0018003575
Connector Gender: Female; Female
Terminal Gender: Male; Male
Terminal Quantity: 2; 2
Terminal Type: Blade
Dodge 2006 - 2003
Freightliner 2006 - 2003



DLA-631
Power Door Lock Actuator
55276883AC; 55372844AB;
55372844AA; 55276883AB;
55276883AA
Connector Gender: Female
Terminal Gender: Male
Terminal Quantity: 4
Terminal Type: Blade
Dodge 2010



DLA-633
Power Door Lock Actuator
55372850AB; 55276790AG;
55276790AE; 55276790AF;
55276790AC; 55372850AA;
55276790AB
Connector Gender: Female
Terminal Gender: Male
Terminal Quantity: 4
Terminal Type: Blade
Dodge 2010



DLA-523
Power Door Lock Actuator
5133512AA; 0018003875
Connector Gender: Female; Male;
Male
Terminal Gender: Male; Male;
Female
Terminal Quantity: 3+2+2
Terminal Type: Blade
Dodge 2006 - 2003
Freightliner 2006 - 2003



DLA-527
Power Door Lock Actuator
5133511AA; 0018003975
Connector Gender: Female; Female;
Male
Terminal Gender: Male; Male;
Female
Terminal Quantity: 3; 3; 2
Terminal Type: Blade
Dodge 2006 - 2003
Freightliner 2006 - 2003



DLA-634

Power Door Lock Actuator

55372846AB; 55276888AC;
55276888AD; 55276888AB;
55372846AA; 55276888AA

Connector Gender: Female
Connector Quantity: 1
Terminal Gender: Male
Terminal Quantity: 4
Terminal Type: Blade

Dodge 2010



DLA-635

Power Door Lock Actuator

55372851AB; 55276791AG;
55276791AF; 55276791AE;
55372851AA; 55276791AB;
55276791AC

Connector Gender: Female
Connector Quantity: 1
Terminal Gender: Male
Terminal Quantity: 4
Terminal Type: 4 Blade Terminals

Dodge 2010



DLA-636

Power Door Lock Actuator

55276794AD; 55276794AC;
55372858AA; 55276794AB

Connector Gender: Female
Connector Quantity: 1
Connector Shape: Square
Terminal Gender: Male
Terminal Quantity: 4
Terminal Type: 4 Blade Terminals

Dodge 2010



DLA-643

Power Door Lock Actuator

3B4839016; 3B4839016AJ

Connector Gender: Female
Terminal Gender: Male
Terminal Quantity: 2
Terminal Type: Pin

Volkswagen 2006



DLA-647

Power Door Lock Actuator

2038201997

Connector Gender: Female
Terminal Gender: Male
Terminal Quantity: 2
Terminal Type: Blade Terminals

Mercedes-Benz 2009 - 2006



DPS100

Diesel Particulate Filter (DPF) Pressure Sensor

68229761AA; 68229761AB

Ram 2018 - 2014



DPS101

Diesel Particulate Filter (DPF) Pressure Sensor

2871960

Blue Bird 2018 - 2010
Crane Carrier 2017 - 2010
Freightliner 2018 - 2010
IC Corporation 2018 - 2017
International 2018 - 2010
Kenworth 2017 - 2010
Mack 2018 - 2012
Oshkosh Motor Truck Co. 2011
Peterbilt 2017 - 2010
Pierce Mfg. Inc. 2014 - 2010
Sterling Truck 2010
Volvo 2017 - 2010
Western Star 2014 - 2010



DPS102

Diesel Particulate Filter (DPF) Pressure Sensor

68155263AC; 68155263AB

Jeep 2018 - 2014



DPS103

Diesel Particulate Filter (DPF) Pressure Sensor

68085750AB; 68085750AA

Ram 2018 - 2013



DPS104

Diesel Particulate Filter (DPF) Pressure Sensor

076906051B

Volkswagen 2015 - 2010



DPS105

Diesel Particulate Filter (DPF) Pressure Sensor

12677718

Chevrolet 2019 - 2017
GMC 2019 - 2017



DPS106

Diesel Particulate Filter (DPF) Pressure Sensor

55599659

Chevrolet 2018 - 2014
GMC 2018 - 2016



DPS107
EGR Valve Pressure Feedback Sensor
12630257

Terminal Quantity: 3
Chevrolet 2016 - 2010
GMC 2016 - 2010



DPS108
Diesel Particulate Filter (DPF) Pressure Sensor
22771EZ40A

Nissan 2018 - 2016



DPS109
Diesel Particulate Filter (DPF) Pressure Sensor
22640EZ41A; 22640EZ41B

Nissan 2018 - 2016



DPS110
Diesel Particulate Filter (DPF) Pressure Sensor
CK4Z5L239A

Ford 2015



DPS111
Diesel Particulate Filter (DPF) Pressure Sensor
HC3Z9J460E; HC3Z9J460B

Ford 2019 - 2017



DPS112
Diesel Particulate Filter (DPF) Pressure Sensor
6429050200

Mercedes-Benz 2017 - 2012



DPS113
Diesel Particulate Filter (DPF) Pressure Sensor
6429050100; A6429050100

Mercedes-Benz 2018 - 2014



DPS114
Diesel Particulate Filter (DPF) Pressure Sensor
55506443

Chevrolet 2019 - 2018
GMC 2019 - 2018



DPS115
Diesel Particulate Filter (DPF) Pressure Sensor
HC3Z9J460D

Ford 2019



DPS116
Diesel Particulate Filter (DPF) Pressure Sensor
HC3Z9J460F

Ford 2019



DRL-1
Daytime Running Lamp Relay

Connector Gender: No Connector
Connector Quantity: N/A
Connector Shape: N/A
Functions: Daytime Running Lamp Relay
Mounting Bracket(s) Included: No
Terminal Gender: N/A
Terminal Quantity: N/A
Voltage: 12

Mercedes-Benz 1990 - 1982



DS1099
Pedal Height Adjustment Switch
68025046AA; 56046113AA

Contents: Switch
Notes: N/A

Terminal Gender: Male
Terminal Quantity: 4
Terminal Type: Blade
Dodge 2010
Ram 2013



DS2476
Fuel Tank Selector Switch
E7TZ9A050A

Contents: 1 Switch
Notes: N/A
Terminal Gender: Male
Terminal Quantity: 6
Terminal Type: Blade
Ford 1991 - 1990



DS3500
Power Sunroof Switch
68023666AA

Contents: Switch
Notes: N/A
Terminal Gender: Male
Terminal Quantity: 4
Terminal Type: Pin
Dodge 2010



DS-68

Headlight Dimmer Switch

J3160926; J3160926; J3160926;
 J3160926; J3156124; J3156124;
 J3156124; J3156124; 3488882;
 B9A13532A; 3160926; 3156124;
 2932873; 2701524; 1972149;
 2291202; 1881938; 1841895;
 1547356

Connector Gender: N/A
 Connector Quantity: N/A
 Mounting Location: Floor Mounted
 Terminal Gender: Male
 Terminal Quantity: 3

Ford 1993 - 1986



DS-70

Headlight Dimmer Switch

D2AB13480A2A; D2AB13480AA;
 D2AB13A024A2A; C0TF13A024A;
 C0TZ13480A; C0TZ13A024A;
 C0TZ13A024A; C0TF13480A;
 C0TF13480B; 5U2Z11654A;
 1972161

Connector Gender: N/A
 Connector Quantity: N/A
 Mounting Location: Floor Mounted
 Terminal Gender: Male
 Terminal Quantity: 3

Ford 1997 - 1990



DS-72

Headlight Dimmer Switch

J931201; J931201; J931201;
 J931201; J5487282; J5487282;
 J5487282; J5487282; J5461816;
 J5461816; J5461816; J5461816;
 5487282; 5487282; 5487282;
 5487282; 370677C91; 578005;
 539288; 538446; 5461816; 5457282;
 1480375; 1349787; 931201;
 1987028; 1977043; 12338706;
 3841892; 1859891

****Additional OE Numbers Available Online****

Connector Gender: N/A
 Connector Quantity: N/A
 Mounting Location: Floor Mounted
 Terminal Gender: Male
 Terminal Quantity: 3

Chevrolet 1990 - 1980
 Peterbilt 1980



DS-79

Headlight Dimmer Switch

2586598; 2584927; 1997045;
 7838234; 26035242

Connector Gender: Female
 Connector Quantity: 1
 Mounting Location: Column
 Terminal Gender: Male
 Terminal Quantity: 3

Buick 1980



DS-168

Axle Shift Switch - H/D Truck

8RH4078; 8QH4078; 79348R91;
 2274282; 1685883; 19106694;
 15571155

Ford 1990 - 1986



DS-169A

Axle Shift Switch - H/D Truck

79037R11; B2Q4086A; 2989094

Connector Gender: No Connector
 Terminal Gender: N/A
 Voltage: 12

Ford 1990 - 1986



DS-177

Multi Function Dash Switch

19245092; 12322804; 1995276;
 1995222; 1995217; 1995216;
 1995203; 1995199; 1995198;
 1995195; 1995193; 1995192;
 1995188; 1995183; 1995182;
 1995180; 1995170; 1995159;
 1995155; 1995154; 1116379; 195195

GMC 1996

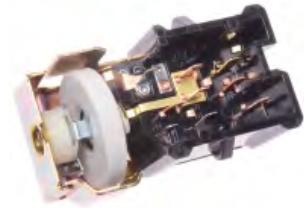

DS-199

Headlight Switch

E1HZ11654A; D3TB11654AA;
 D3TB11654AB; D3TZ11654A;
 EOHZ11654A; D3TB11654A2B;
 88924309; EOHZ11654A; 19106708;
 12336875

Connector Gender: Female
 Connector Quantity: 1
 Terminal Gender: Male
 Terminal Quantity: 9
 Voltage: 12

Ford 1997 - 1980



DS-205

Headlight Switch

393442C1; 1995178

Connector Gender: Female
 Connector Quantity: N/A
 Terminal Gender: Male
 Terminal Quantity: 8
 Voltage: 12

International 1983 - 1981



DS-213

Headlight Switch

1995229; 1995236; 1995226

Connector Gender: Female
 Connector Quantity: 1
 Terminal Gender: Male
 Terminal Quantity: 7
 Voltage: 12

Buick 1981



DS-240
Door Jamb Switch

J3631896; J3631896; J3631896;
J3631896; 4221709; 4373096;
56020477; 391307; 3747289;
3746717; 3631896; 14066671;
5209851; 5209992; 4373086;
8956000137; 8956000136; 9839084;
9662505; 9662504; 2889084;
4221117; 4221387; 1704234;
20421221

Connector Gender: Male
Connector Quantity: 1
Connector Shape: N/A
Mounting Type: Direct
Terminal Gender: Male
Terminal Quantity: 2

Oldsmobile 1985 - 1982



DS-268
Headlight Switch

E7TZ11654D; F4TZ11654A;
E7TB11654AC; E7TZ11654A;
E7TZ11654B; E7TZ11654C;
E77B11654AA; E7TB11654AA;
E7TB11654AB; 19021009

Connector Gender: Female
Connector Quantity: 1
Terminal Gender: Male
Terminal Quantity: 9
Voltage: 12

Ford 2003 - 1989



DS-278
Door Jamb Switch

ZZL066540; ZZL066540A;
8956003541; 8956003541;
8956003541; 8956003541;
E9UZ13713B; E9VZ13713B;
E3SZ13713A; E6DZ13713A;
E7UZ13713A; E8DZ13713A;
D3TZ13713A; E0TZ13713A;
6C2Z13713AA; 36003541; 4373296

Notes: Complete Assembly
Terminal Gender: Male

Terminal Quantity: 3
Ford 1999 - 1988



DS-290
Headlight Switch

19245089; 10496908; 1995359

Connector Gender: No Connector
Connector Quantity: N/A
Terminal Gender: Male
Terminal Quantity: 6
Voltage: 12

Chevrolet 1994 - 1990
GMC 1994 - 1990



DS-293
Fuel Tank Selector Switch

14028811; 15591149

Contents: N/A
Notes: N/A
Terminal Gender: Male
Terminal Quantity: N/A
Terminal Type: Blade

Chevrolet 1991 - 1987
GMC 1991 - 1987



DS-533
Multi Function Column Switch

F3UZ13K359A; F8TZ13K359AB;
F3TA13K359DA; F3TZ13K359B;
F8TZ13K359AA

Ford 1994 - 1992



DS-374
Instrument Panel Dimmer Switch

10497187

Connector Gender: Female
Connector Quantity: 1
Contents: 1 Switch
Functions: Switch
Switch Mounting Type: Snap Fit
Terminal Gender: Male
Terminal Quantity: 4
Terminal Type: 4 Blade Terminals

Chevrolet 1994 - 1990
GMC 1994 - 1990



DS-453
Instrument Panel Dimmer Switch

1995394

Connector Gender: Male
Contents: Switch
Terminal Gender: Male
Terminal Quantity: 4
Terminal Type: Blade

Chevrolet 2002 - 1994



DS-550
Fog Lamp Switch

25370V5000

Connector Gender: Female
Contents: Switch
Functions: Switch
Switch Mounting Type: N/A
Terminal Gender: Male
Terminal Quantity: 4
Terminal Type: Blade Terminals

Nissan 1986



DS-576
Windshield Wiper Switch

E7TZ17A553B; E0TB17A553CB;
E0TZ17A553A; E7TB17A553BA

Connector Gender: Female
Terminal Quantity: 6
Terminal Type: Blade

Ford 1996 - 1992



DS-647
Headlight Switch

19245374; 10470881; 15693548;
15693540

Connector Gender: No Connector
Connector Quantity: N/A
Terminal Gender: Male
Terminal Quantity: 6
Voltage: 12

Chevrolet 2002 - 1995
GMC 2002 - 1995



DS-658
Headlight Switch

19245090; 1995406
Connector Gender: No Connector
Connector Quantity: 1
Terminal Gender: Male
Terminal Quantity: 6
Voltage: 12
Chevrolet..... 2002 - 1993



DS-796
Multi Function Column Switch

26083630; 26097020; 26083628;
26054726; 26036313
Chevrolet..... 2002 - 2000
GMC..... 1995

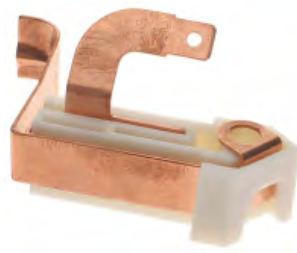

DS-890
Parking Brake Switch

5013819AA; 4883800AA; 4221463
Terminal Gender: Male
Terminal Quantity: 1
Terminal Type: Blade
Dodge..... 2005 - 2004



DS-936
Multi Function Column Switch

YC2Z13K359AA; YC2Z13K359BA;
F7UZ13K359BA
Ford..... 2002 - 2000



DS-698
Multi Function Column Switch

26097019; 26083627; 26083629;
26091769; 26091771; 26100985;
26097021; 26054727; 26047330
Chevrolet..... 2002 - 1995
GMC..... 1999 - 1995



DS-833
Instrument Panel Dimmer Switch

10471139; 15693547
Connector Gender: No Connector
Contents: N/A
Functions: Switch
Terminal Gender: Male
Terminal Quantity: 4
Terminal Type: Blade
Chevrolet..... 1990



DS-905
Parking Brake Switch

1264464; 1257365; 22545055;
22532110; 3521242
Contents: Switch
Notes: N/A
Terminal Gender: Male
Terminal Quantity: 1
Terminal Type: Blade
Cadillac..... 1984
Chevrolet..... 1995 - 1983
GMC..... 1995 - 1983
Oldsmobile..... 1984 - 1982



DS-957
Door Jamb Switch

XF2Z14018AA
Connector Gender: Female
Mounting Type: Direct
Terminal Gender: Male
Terminal Quantity: 2
Ford..... 2003 - 2002



DS-1109
Multi Function Column Switch

MB382800
Mitsubishi..... 1985



DS-749
Multi Function Column Switch

Y85Z13K359CA; YL3Z13K359CA;
F65Z13K359AA; F75Z13K359BA;
F85Z13K359CA; Y85Z13K359AA
Ford..... 2000 - 1999



DS-876
Multi Function Dash Switch

93443101; 93443100; 15992131;
15047634; 15047633; 15741153;
15715272; 15687019; 15013005
Chevrolet..... 2009 - 2003
GMC..... 2009 - 2003



DS-932
Parking Brake Switch

5209922
Notes: N/A
Terminal Gender: Male
Terminal Quantity: 1
Terminal Type: Blade
Jeep..... 2005



DS-1142
Glove Box Lamp Switch

55361341AA; 5134362AA; 4565022
Connector Gender: Female
Terminal Gender: Male
Terminal Quantity: 2
Terminal Type: Blade
Dodge..... 2004 - 2001



DS-1170
Overdrive Kick-Down Switch
56021048

Terminal Gender: Male
Terminal Quantity: 2
Terminal Type: Pin

Dodge..... 2002 - 2000



DS-1185
Power Window Switch
5GS20DX9AA; 56007695;
56007695AB; 56007695AD;
4602465AA; 56007695AC

Contents: 1 Switch
Functions: Power Window Switch
Notes: N/A
Terminal Gender: Male
Terminal Quantity: 3 + 2
Terminal Type: Blade Terminals

Dodge..... 2010 - 2008



DS-1243
Parking Brake Switch
5017047AA

Terminal Gender: Male
Terminal Quantity: 1
Terminal Type: Blade

Dodge..... 2003



DS-1362
Headlight Switch
1C3Z11654AAA; 1C3Z11654AAB;
1C3Z11654AAA

Connector Gender: Female
Connector Quantity: 2
Terminal Gender: Male
Terminal Quantity: 10
Voltage: 12

Ford..... 2009 - 2006



DS-1385
Headlight Switch
F81Z11654AA

Connector Gender: Female; Male
Connector Quantity: 2
Terminal Gender: Male
Terminal Quantity: 12
Voltage: 12

Ford..... 2005 - 1999



DS-1506
Door Jamb Switch
XF2Z14018AC; XF2Z14018AD

Connector Gender: Female
Mounting Type: Direct
Terminal Gender: Male
Terminal Quantity: 2

Ford..... 2003 - 2000



DS-1807
Fuel Tank Selector Switch
19244972; 15599081

Contents: Switch
Notes: N/A
Terminal Gender: Male
Terminal Quantity: 4
Terminal Type: Blade

Chevrolet..... 1990



DS-1534
Multi Function Column Switch
19244690; 25111290; 25111262

Buick.....	1985 - 1984
Chevrolet.....	1991 - 1983
GMC.....	1991 - 1983
Oldsmobile.....	1985 - 1984
Pontiac.....	1985 - 1984



DS-1750
Remote Mirror Switch
F65Z17B676AB

Terminal Gender: Male
Terminal Quantity: 8
Terminal Type: Blade

Ford..... 2003 - 2001



DS-2153
Trunk Release Switch
01620478; 1620478

Terminal Gender: Male
Terminal Quantity: 2
Terminal Type: Blade

Buick.....	1981 - 1980
Cadillac.....	1981 - 1980
Oldsmobile.....	1983 - 1980
Pontiac.....	1985 - 1981



DS-2156
Cruise Control Switch
15276855; 21992517; 15819309

Functions: Cruise Control
Terminal Gender: Male
Terminal Quantity: 10
Terminal Type: Pins

Chevrolet.....	2016 - 2008
GMC.....	2011 - 2008



DS-2219
A/C and Heater Blower Motor Switch
5103853AA

Connector Gender: Female
Terminal Gender: Male
Terminal Quantity: 4

Dodge..... 2006 - 2003

Freightliner 2006 - 2003



DS-2243
Vehicle Ride Height Switch
YC1Z5K761AA

Terminal Gender: Male
Terminal Quantity: 5
Terminal Type: Blade

Ford 2002



DS-2326
Power Window Switch
3B0959855B01C

Functions: Power Window Switch
Terminal Gender: Male
Terminal Quantity: 4
Terminal Type: Blade

Volkswagen 2005



DS-2360
Traction Control Switch
5120472AA

Contents: Switch
Terminal Gender: Male
Terminal Quantity: 4
Terminal Type: Blade

Dodge 2006 - 2003
Freightliner 2006 - 2003



DS-2404
Interior Light Switch
5103854AA

Connector Gender: Female
Terminal Gender: Male
Terminal Quantity: 5
Terminal Type: Blade

Dodge 2006 - 2005



DS-2298
Fuel Tank Selector Switch
2C3Z9A050AA

Contents: Switch
Terminal Gender: Male
Terminal Quantity: 6
Terminal Type: Blade

Ford 2010 - 2002



DS-2358
Heated Seat Switch
5120444AA

Contents: Switch
Terminal Gender: Male
Terminal Quantity: 8
Terminal Type: Blade

Dodge 2006 - 2003



DS-2362
Power Window Switch
68042384AA; 68010117AA

Contents: Switch
Functions: Power Window
Terminal Gender: Male
Terminal Quantity: 3
Terminal Type: Pin

Dodge 2009
Freightliner 2009 - 2008



DS-3035
Interior Light Switch
5103844AA

Connector Gender: Female
Switch Mounting Type: Snap Fit
Terminal Gender: Male
Terminal Quantity: 5
Terminal Type: 5 Blade Terminals

Dodge 2006 - 2003
Freightliner 2006 - 2005



DS-2301
Fuel Tank Selector Switch
E6UZ9A050A

Contents: Switch
Terminal Gender: Male
Terminal Quantity: 6
Terminal Type: Blade

Ford 1995 - 1986



DS-2359
Rear Window Defogger Switch
5120438AA

Contents: Switch
Terminal Gender: Male
Terminal Quantity: 5
Terminal Type: Blade

Dodge 2006 - 2003
Freightliner 2006 - 2003



DS-2363
Cruise Control Switch
68010454AA

Contents: Switch
Functions: Cruise Control
Terminal Gender: Male
Terminal Quantity: 10; 3
Terminal Type: Pin

Dodge 2009
Freightliner 2009



DS-3072
Heated Seat Switch
56040639AB; 56040639AA;
56040639AC; 56040639AD;
56040639AE

Notes: N/A
Terminal Gender: Male
Terminal Quantity: 6
Terminal Type: Blade Terminals

Dodge 2010 - 2006



DS-3102
Heated Seat Switch
 56040688AA; 56040688AB;
 56040688AC; 56040688AE;
 56040688AD

Notes: N/A
 Terminal Gender: Male
 Terminal Quantity: 6
 Terminal Type: Pins
 Dodge 2006



DS-3126
Overdrive Kick-Down Switch
 F58Z7G550AA; F58Z7G550A

Notes: N/A
 Terminal Gender: Male
 Terminal Quantity: 3
 Terminal Type: Pins
 Ford 2001 - 1992



DS-3357
Parking Brake Switch
 15045983; 15010522

Contents: Switch
 Notes: N/A
 Terminal Gender: Male
 Terminal Quantity: 1
 Terminal Type: Blade
 Hummer 2003



DS-3364
Parking Brake Switch
 5103540AA

Contents: Switch
 Notes: N/A
 Terminal Gender: Male
 Terminal Quantity: 1
 Terminal Type: Blade
 Dodge 2006 - 2003
 Freightliner 2006 - 2003



DS-5748
Fog Lamp Switch
 5120484AA

Connector Gender: Female
 Connector Quantity: 1
 Contents: Switch
 Functions: Fog Light Switch Only
 Terminal Gender: Male
 Terminal Quantity: 6
 Terminal Type: Blade
 Dodge 2004 - 2003
 Freightliner 2004 - 2003



DTL1
Diesel High Pressure Oil Rail Ball Installation Tool
 AP0069

Ford 2010 - 2003



DV108
Diverter Valve
 E9HE9B289BA; E9HZ9B289B

Hose Size - Inches: 1/4
 Hose Size - mm: 7 mm, 16 mm, 18 mm
 Ford 1997 - 1990



DV130
Diverter Valve
 12555165

Hose Size - Inches: 1/4
 Hose Size - mm: 7 mm, 16 mm, 18 mm
 Chevrolet 2001
 GMC 2001



DV146
Diverter Valve
 06A131351; 06A131351D

Hose Size - Inches: N/A
 Hose Size - mm: N/A
 Volkswagen 2010



DV165
Diverter Valve
 079131101AR; 06B131101C;
 06B131101G; 06B131101H;
 06B131101K

Hose Size - Inches: 1/2
 Hose Size - mm: Refer to Inches
 Port Quantity: 2
 Volkswagen 2005 - 2004



DV169
Diverter Valve
 06E131101J; 06E131101K;
 06E131101E

Hose Size - Inches: 1/2
 Hose Size - mm: Refer to Inches
 Port Quantity: 1
 Audi 2014 - 2012
 Volkswagen 2010



DV172
Idle Air Control Valve
 06E131102J; 06E131102K;
 06E131102B

Hose Size - Inches: N/A
 Hose Size - mm: N/A
 Port Quantity: 2
 Audi 2014 - 2011



DV173
Diverter Valve
021131101A

Hose Size - Inches: 5/32
Hose Size - mm: Refer to Inches
Port Quantity: 2
Volkswagen 1999



DV180
Idle Air Control Valve
06J131097C; 06J131097D

Port Quantity: 1
Terminal Type: Blade
Audi 2013 - 2010
Volkswagen 2013 - 2009



DWS1642
Power Window Switch
68042380AA; 68010048AA;
9065451013

Contents: Switch
Functions: Power Window Switch
Notes: N/A
Terminal Gender: Male
Terminal Quantity: 4
Terminal Type: Pin
Dodge 2009
Freightliner 2017 - 2009
Mercedes-Benz 2019 - 2013



DWS1645
Power Window Switch
61319217333; 61316948633;
61319132136

Contents: Switch
Functions: Power Window Switch
Notes: N/A
Terminal Gender: Male
Terminal Quantity: 18
Terminal Type: Pin
BMW 2011 - 2009



DWS1649
Power Window Switch
68080842AA

Contents: Switch
Functions: Power Window Switch
Notes: N/A
Terminal Gender: Male
Terminal Quantity: 6
Terminal Type: Blade
Ram 2013



DWS1711
Power Window Switch
68298866AA; 68110866AB;
68110866AA

Contents: Switch
Functions: Power Window Switch
Notes: N/A
Terminal Gender: Male
Terminal Quantity: 12
Terminal Type: Blade & Pin



DWS1837
Power Window Switch
68212782AA

Contents: Switch
Functions: Power Window Switch
Notes: N/A
Terminal Gender: Male
Terminal Quantity: 6
Terminal Type: Pin
Ram 2013



DWS1899
Power Window Switch
68148893AB; 68148893AA

Contents: Switch
Functions: Power Window Switch
Notes: N/A
Terminal Gender: Male
Terminal Quantity: 3
Terminal Type: Pin
Ram 2019 - 2013



DWS1994
Power Window Switch
68148892AB; 68148892AA

Contents: Switch
Functions: N/A
Notes: N/A
Terminal Gender: Male
Terminal Quantity: 6
Terminal Type: Pin
Ram 2013



DWS2007
Power Window Switch
61319208107

Contents: Switch
Functions: N/A
Notes: N/A
Terminal Gender: Male
Terminal Quantity: 3
Terminal Type: Pin
BMW 2018 - 2014



DWS2010
Power Window Switch
61319361936; 61319267078

Contents: Switch
Functions: N/A
Notes: N/A
Terminal Gender: Male
Terminal Quantity: 3
Terminal Type: Pin
BMW 2018 - 2015



DWS2012
Power Window Switch
61319208106

Contents: Switch
Functions: Power Window Switch
Notes: N/A
Terminal Gender: Male
Terminal Quantity: 3
Terminal Type: Pin
BMW 2015 - 2014



DWS2013
Power Window Switch
61319241949; 61319163527

Contents: Switch
Functions: N/A
Notes: N/A
Terminal Gender: Male
Terminal Quantity: 3
Terminal Type: Pin

BMW..... 2016 - 2014



DWS2017
Power Window Switch
61319241953; 61319238237;
61319179909

Contents: Switch
Functions: N/A
Notes: N/A
Terminal Gender: Male
Terminal Quantity: 6
Terminal Type: Pin

BMW..... 2016 - 2014



DWS2022
Power Window Switch
61319362112; 61319218482

Contents: Switch
Functions: N/A
Notes: N/A
Terminal Gender: Male
Terminal Quantity: 6
Terminal Type: Pin

BMW..... 2018 - 2014



DWS-184
Power Window Switch
68010050AA; 68042382AA;
9065451213

Contents: Switch
Functions: Power Window Switch
Terminal Gender: Male: Male: Male
Terminal Quantity: 5 + 4 + 3
Terminal Type: Pin

Dodge..... 2009
Freightliner 2018 - 2009
Mercedes-Benz 2019 - 2010



DWS2014
Power Window Switch
61319362107; 61319208111

Contents: Switch
Functions: N/A
Notes: N/A
Terminal Gender: Male
Terminal Quantity: 6
Terminal Type: Pin

BMW..... 2018 - 2014



DWS2018
Power Window Switch
61319241956; 61319238240;
61319179915

Contents: Screen Filters
Functions: N/A
Notes: N/A
Terminal Gender: Male
Terminal Quantity: 6
Terminal Type: Pin

BMW..... 2016 - 2014



DWS2023
Power Window Switch
61319241955; 61319238239;
61319179913

Contents: Switch
Functions: N/A
Notes: N/A
Terminal Gender: Male
Terminal Quantity: 6
Terminal Type: Pin

BMW..... 2016 - 2014



DWS-187
Power Window Switch
68001799AA; 5103856AA

Contents: Switch
Functions: Power Window Switch
Terminal Gender: Male
Terminal Quantity: 5
Terminal Type: Blade Terminals

Dodge..... 2006 - 2003
Freightliner 2006 - 2003



DWS2015
Power Window Switch
61319208109

Contents: Switch
Functions: N/A
Notes: N/A
Terminal Gender: Male
Terminal Quantity: 9
Terminal Type: Pin

BMW..... 2018 - 2014



DWS2020
Power Window Switch
61319208108

Contents: Switch
Functions: N/A
Notes: N/A
Terminal Gender: Male
Terminal Quantity: 6
Terminal Type: Pin

BMW..... 2018 - 2014



DWS2078
Power Window Switch
29290550009107; 16690544009107

Contents: Switch
Functions: N/A
Notes: N/A
Terminal Gender: Male
Terminal Quantity: 3
Terminal Type: Pin

Mercedes-Benz 2017 - 2013



DWS-489
Power Window Switch
1F0959855REH; 1F09598553X1;
7L6959855B3X1; 7L6959855BREH

Contents: Switch
Functions: Power Window Switch
Notes: N/A
Terminal Gender: Male
Terminal Quantity: 3
Terminal Type: Pin

Volkswagen 2005



DWS-498

Power Window Switch
4602864AB; 4602864AC

Contents: Switch
Functions: Power Window Switch
Terminal Gender: Male
Terminal Quantity: 6
Terminal Type: Blade
Dodge..... 2010



DWS-593

Power Window Switch
XL1Z14529CA

Contents: Switch
Functions: Power Window Switch
Terminal Gender: Male
Terminal Quantity: 7
Terminal Type: Blade
Ford..... 2003 - 2000

BMW..... 2013 - 2009



DWS-631

Power Window Switch
61316945875

Contents: Switch
Functions: Power Window Switch
Terminal Gender: Male
Terminal Quantity: 3
Terminal Type: Pin

BMW..... 2013 - 2009



DWS-659

Power Window Switch
2218704579; 2218704579J22

Contents: Switch
Functions: Power Window Switch
Notes: N/A
Terminal Gender: Male
Terminal Quantity: 6
Terminal Type: Pin
Mercedes-Benz 2012



DWS-523

Power Window Switch
4602870AC; 4602870AB;
4602870AD

Contents: Switch
Functions: Power Window Switch
Terminal Gender: Male
Terminal Quantity: 6
Terminal Type: Pin
Dodge..... 2010 - 2008
Ram..... 2012 - 2011



DWS-599

Power Window Switch
4602652AA; 4602786AA

Contents: Switch
Functions: Power Window Switch
Notes: N/A
Terminal Gender: Male
Terminal Quantity: 6
Terminal Type: Blade Terminals
Jeep..... 2009



DWS-645

Power Window Switch
61316948624; 61319132128;
61319155502; 61319217327

Contents: Switch
Functions: Power Window Switch
Terminal Gender: Male
Terminal Quantity: 18
Terminal Type: Blade

BMW..... 2010 - 2009



DWS-753

Power Window Switch
61316974815

Contents: Switch
Functions: Power Window Switch
Terminal Gender: Male
Terminal Quantity: 3
Terminal Type: Pin

BMW..... 2013 - 2009



DWS-583

Power Window Switch
2048700451; 20490582029107

Contents: Switch
Functions: Power Window Switch
Terminal Gender: Male
Terminal Quantity: 4
Terminal Type: Pin
Mercedes-Benz 2015 - 2013



DWS-612

Power Window Switch
61316945874

Contents: Switch
Functions: Power Window Switch
Terminal Gender: Male
Terminal Quantity: 3
Terminal Type: Pin



DWS-646

Power Window Switch
61316948629; 61319132132;
61319217330

Contents: Switch
Functions: Power Window Switch
Terminal Gender: Male
Terminal Quantity: 18
Terminal Type: Pin

BMW..... 2010 - 2009



DWS-772

Power Window Switch
YC3Z14529AAA

Contents: Switch
Functions: Power Window Switch
Terminal Gender: Male
Terminal Quantity: 9
Terminal Type: Blade

Ford..... 2010 - 2000



DWS-856

Power Window Switch
61319217332; 61316948632;
61319132135

Contents: Switch
Functions: Power Mirror Switch
Terminal Gender: Male
Terminal Quantity: 18
Terminal Type: Pin

BMW..... 2010 - 2009



DWS-896

Power Window Switch
61319218043; 61319122116;
61319122120

Contents: Switch
Functions: Power Window Switch
Terminal Gender: Male
Terminal Quantity: 18
Terminal Type: Pin

BMW..... 2013 - 2009



DWS-972

Power Window Switch
2518300490; 25183004909051

Contents: Switch
Functions: Power Mirror Switch
Terminal Gender: Male
Terminal Quantity: 3
Terminal Type: Pin

Mercedes-Benz 2009



DWS-1347

Power Window Switch
61319155501; 61316948623;
61319132127; 61319217326

Contents: Switch
Functions: Power Window Switch
Notes: N/A
Terminal Gender: Male
Terminal Quantity: 18
Terminal Type: Pin

BMW..... 2010 - 2009



DWS-860

Power Window Switch
2518300590

Contents: Switch
Functions: Power Mirror Switch
Terminal Gender: Male
Terminal Quantity: 3
Terminal Type: Pin

Mercedes-Benz 2009



DWS-1326

Power Window Switch
61319132133; 61316948630;
61319217331

Contents: Switch
Notes: N/A
Terminal Gender: Male
Terminal Quantity: 18
Terminal Type: Pin

BMW..... 2010 - 2009



DWS-1349

Power Window Switch
61316948634; 61319132137;
61319217334

Contents: Switch
Functions: Power Window Switch
Notes: N/A
Terminal Gender: Male
Terminal Quantity: 18
Terminal Type: Pin

BMW..... 2010 - 2009



DWS-879

Multi Function Door
Switch
4602881AC; 4602881AB;
4602881AD

Dodge..... 2010



DWS-901

Power Window Switch
61319218044; 61319122117;
61319122121

Contents: Switch
Functions: Power Window Switch
Terminal Gender: Male
Terminal Quantity: 18
Terminal Type: Blade

BMW..... 2013 - 2009



DWS-1335

Power Window Switch
4602933AA

Contents: Switch
Functions: Power Window Switch
Terminal Gender: Male
Terminal Quantity: 5
Terminal Type: Blade

Jeep..... 2009



DWS-1350

Power Window Switch
61319155503; 61316948625;
61319132129; 61319217328

Contents: Switch
Functions: Power Mirror Switch
Notes: N/A
Terminal Gender: Male
Terminal Quantity: 18
Terminal Type: Pin

BMW..... 2010 - 2009



DWS-1351
Power Window Switch
61316948628; 61319132131;
61319217329

Contents: Switch
Functions: Power Window Switch
Notes: N/A
Terminal Gender: Male
Terminal Quantity: 18
Terminal Type: Pin

BMW..... 2010 - 2009

Terminal Type: Blade Terminals
Dodge..... 2010
Ram..... 2012 - 2011



DWS-1390
Power Window Switch
68021708AC; 68021708AB;
68021708AD

Contents: Switch
Functions: Power Window Switch
Notes: N/A
Terminal Gender: Male
Terminal Quantity: 6
Terminal Type: Blade Terminals

Dodge..... 2010 - 2008
Ram..... 2012 - 2011



DWS-1385
Power Window Switch
5GU34DX9AB; 56049805AB;
5GU34DX9AA; 68171680AB;
68171680AA; 5GU34DX9AC;
56049805AA

Contents: Switch
Functions: Power Mirror Switch
Notes: N/A
Terminal Gender: Male; Male
Terminal Quantity: 12; 8
Terminal Type: Blade

Dodge..... 2010 - 2008



ECG1
Diesel EGR Cooler
Gasket Kit
3C3Z9433BJ; 3C3Z9439AA;
3C3Z9433BH; 3C3Z9433BA;
3C3Z9433BE; 1840702C97

Ford..... 2010 - 2003
International..... 2012 - 2002



DWS-1386
Power Window Switch
4602863AC; 4602863AB;
4602863AD

Contents: Switch
Functions: Power Window Switch
Notes: N/A
Terminal Gender: Male; Male
Terminal Quantity: 9; 3



ECK1
Diesel EGR Cooler Kit
4C3Z9P456AC; 4C3Z9P456AF;
4C3Z9P456AH; 4C3Z9P456AJ;
1845145C99

Ford..... 2010 - 2004
IC Corporation..... 2008 - 2006
International..... 2012 - 2004



ECK2
Diesel EGR Cooler Kit
98034351; 8980343513

Chevrolet..... 2010 - 2007
GMC..... 2010 - 2007



ECK6
Diesel EGR Cooler Kit
98042441; 8980424412

Chevrolet..... 2009 - 2007
GMC..... 2009 - 2007



ECK3
Diesel EGR Cooler Kit
98034354; 8980343543

Chevrolet..... 2010 - 2007
GMC..... 2010 - 2007



ECK7
Diesel EGR Cooler Kit
8C3Z9P464E; 8C3Z9P45BA;
8C3Z9P456C; 8C3Z9P456A;
8C3Z9F464A

Ford..... 2010 - 2008



ECK4
Diesel EGR Cooler Kit
97358507; 8973585071

Chevrolet..... 2007 - 2006
GMC..... 2007 - 2006



ECK8
Diesel EGR Cooler
Gasket Kit
1876888C91; 8C3Z9F464F;
8C3Z9F464E; 8C3Z9F464D;
8C3Z9F464B

Ford..... 2010 - 2008



ECK5
Diesel EGR Cooler Kit
97303654; 8973036540

Chevrolet..... 2005 - 2004
GMC..... 2005 - 2004
Workhorse..... 2005
Workhorse Custom
Chassis..... 2005



ECK9
Diesel EGR Cooler Kit
4955518NX; 4955518; 4946088;
4955518RX; 4946088NX

Ford..... 2010 - 2008
Freightliner..... 2010 - 2008



ECK10
Diesel EGR Cooler Kit
4089256RX; 4089256NX

Ford..... 2008 - 2003



ECK10
Diesel EGR Cooler Kit
4089256RX; 4089256NX

Ford..... 2008 - 2003

Freightliner 2006 - 2002



ECK11
Diesel EGR Cooler Kit
68048991AA; 53041182AA;
68026996AA; 4955922

Dodge 2010 - 2007
Ram 2012 - 2011



ECK12
Diesel EGR Cooler Kit
1840700C99; 1840700C98;
1840700C97; 1840700C95;
1840700C96; 1838093C1;
3C3Z9P456B; 3C3Z9P456AE;
3C3Z9P456AC; 3C3Z9P456AA;
3C3Z9P456A

Ford 2004 - 2003
International 2004 - 2002



ECK13
Diesel EGR Cooler
Gasket Kit
BC3Z9V425A

Ford 2016 - 2011



EFH201
Diesel Exhaust Fluid
(DEF) Heater
BC3Z5J225L; BC3Z5J225KA;
BC3Z5J225A; BC3Z5L227F

Ford 2016 - 2011



EFH202
Diesel Exhaust Fluid
(DEF) Heater
BC3Z5J225M; BC3Z5J225K;
BC3Z5J225C; BC3Z5L227G

Ford 2016 - 2011



EFL172
Other Miscellaneous
Sensors
25718566; 25713063

Chevrolet 2011 - 2003



EFL-4
Hazard Flasher
F65B13350AA; TBB89;
F58Z13350A; F65Z13350AA;
YL3Z13350AA; 5C3T13350AA;
5C3Z13350AA; F4ZZ13350A;
1L5Z13350AA; 2L1T13350AA;
2L1Z13350AA; 1F2066830;
1F0066830; 1F0066830A; 56009711;
56007348

Connector Gender: Male
Functions: Flasher
Terminal Gender: Male
Terminal Quantity: 5

Dodge 2002 - 1998
Ford 2009 - 1999



EFL-6
Hazard Flasher
9306; 11516051; 12450072; 9257

Connector Gender: Male
Functions: Flasher
Terminal Gender: Male
Terminal Quantity: 4

GMC 2000 - 1999



EFL-8
Hazard Flasher
3861076G00; FR3309; 5862028660;
5862070720; 3861084002; FR3302;
3861052D00; 3861078091;
3861078304; 3861084001;
3861050A00; 3861050A01;
38300SV1A01; 38300SV1A11;
38300SE3013; 38300SK7003;
38300SA5013; 38300SB0003;
38300SB2671; 38300SB2672;
38300671672; 38300S5T003;
38300S5T004; 38300S9VA01;
1665000060; 38300671505;
89057136; 96054182; 96053355;
38300SK7004

****Additional OE Numbers Available Online****

Connector Gender: Male
Functions: Flasher
Terminal Gender: Male
Terminal Quantity: 3

Ford 1996 - 1993
Toyota 1987 - 1985



EFL-9
Hazard Flasher
9164; 9165; 3861084011; 54250708;
MR172080; 9230; 9231; 9219; 9205;
9442872; 30003358

Connector Gender: Male
Functions: Flasher
Terminal Gender: Male
Terminal Quantity: 3

BMW 1986 - 1985
Volkswagen 1981



EGV330
EGR Valve
EVK729; EVK7245; EVK7210;
AEY746; AEY7410; 14710P8300;
14710N4311; 14710N4301;
14710M4311; 14710B8000;
BPDQ726; APDQ5432A; APDQ723;
APDQ723A; APDQ726;
8942135710; 858T0712;
APDQ54112; 469997370; 46999745;
469997450; 18710PA6681;
14710U7710; 14710AA320;
14710AA3201; 14710AA250;
14710AA2501; 14710AA251;
14710AA252; 14710AA120

****Additional OE Numbers Available Online****

Digital/Mechanical: Mechanical
Gaskets Included: Yes

Buick 1983



EGV335
EGR Valve

33003184; 33003184; 17112412;
17113455; 17112414; 17111924;
17111850; 17110814; 17110467;
17087249; 17087248; 17087193;
17085939; 17085046; 17084835;
17084721; 17082828; 17082770;
17082704; 17080895; 17078425;
17078424; 17078398; 17075769;
17075667; 17070181; 17067115;
17066868; 17066858; 17066857

****Additional OE Numbers Available Online****

Digital/Mechanical: Mechanical
Gaskets Included: Yes

Pontiac 1980



EGV339
EGR Valve

17113437; 17113431; 17110502;
17110501; 17079370; 17066865;
17066863; 17066149; 17065888;
17065778; 17065099; 17065091;
17055404; 17055380; 7044097

Digital/Mechanical: Mechanical
Gaskets Included: Yes

Oldsmobile 1980

Pontiac 1980



EGV340
EGR Valve

17113489; 17113418; 17110520;
17087145; 17084830; 17084828;
17084794; 17083753; 17083741;
17083732; 17083730; 17083724;
17083720; 17082786; 17082778;
17082731; 17082730; 17079692;
17079676; 17079675; 17079674;
17079672; 17079626; 17079620;
17079616; 17078912; 17078433;
17078415; 17075587; 17065858

****Additional OE Numbers Available Online****

Digital/Mechanical: Mechanical
Gaskets Included: Yes

Oldsmobile 1980

Pontiac 1980



EGV344
EGR Valve

33001798; 17113496; 17113475;
17111855; 17090146; 17085911;
17075713; 17070186; 17067117;
17066878; 17066849; 17066843;
17066232; 17066188; 17066102;
17065806; 17064673; 17064667;
17064432; 17063974; 17063973;
17062876; 17062873; 17062863;
17062862; 17062025; 17060899;
17060898; 17057040; 17056196

****Additional OE Numbers Available Online****

Digital/Mechanical: Mechanical
Gaskets Included: Yes

Pontiac 1980



EGV434
EGR Valve

17113424; 17112440; 17110459;
17110457; 17090204; 17084703;
17084700; 17083824; 17083793;
17082819; 17082705; 17079786;
17079704; 17079563; 17078427;
17078413; 17078411; 17078399;
17068217

Digital/Mechanical: Mechanical
Gaskets Included: Yes

Cadillac 1985 - 1981



EGV435
EGR Valve

19210681; 17113433; 17111299;
17110477; 17110476; 17110475;
17084737; 17079818; 17075627;
17075617; 17068211; 17068196;
17068164; 17068163; 17068159

Digital/Mechanical: Mechanical
Gaskets Included: Yes

Chevrolet 1985 - 1981



EGV483
EGR Valve

AEY7659; 1471017A00

Digital/Mechanical: Mechanical
Gaskets Included: No

Nissan 1987 - 1983



EGV545
EGR Valve

21007027; 21007027; 21008567;
21008567; 21006493

Digital/Mechanical: Mechanical
Gaskets Included: Yes

Buick 1984 - 1982



EGV635
EGR Valve

17113439; 17110513; 17110511;
17110510; 17110506; 17084818;
17078404; 17068195; 17066202;
17066199; 17066198; 17063341;
17063337

Digital/Mechanical: Mechanical
Gaskets Included: Yes

Chevrolet 1980

GMC 1980



EGV653
EGR Valve

17066253; 17066244; 17066243;
17066242; 17064141; 17064140;
17064139; 17064138; 17064137;
17064135

Digital/Mechanical: Mechanical
Gaskets Included: Yes

Chevrolet 1980



EGV677
EGR Valve

17113446; 17113445; 17113442;
17113439; 17113438; 17113422;
17113414; 17110806; 17110805;
17110804; 17110803; 17110802;
17110773; 17110509; 17110508;
17085771; 17085769; 17085768;
17085767; 17085766; 17085765;
17084820; 17084818; 17084816;
17084815; 17084814; 17083847;
17083813; 17083701; 17082807

****Additional OE Numbers Available Online****

Digital/Mechanical: Mechanical
Gaskets Included: Yes

Chevrolet 1980
GMC 1980



EGV679
EGR Valve

17113419; 17086197; 17084738;
17084735; 17082829; 17079710;
17075614; 17075613; 17075517;
17068213; 17068197; 17066862;
17066267; 17064534; 17064059;
17062707; 17062706; 17062705

Digital/Mechanical: Mechanical
Gaskets Included: Yes

Chevrolet 1982



EGV718
EGR Valve

14710W2500; AEY7619

Digital/Mechanical: Mechanical
Gaskets Included: No

Nissan 1983 - 1981



EGV726
EGR Valve

17083764; 17083762; 17079686

Digital/Mechanical: Mechanical
Gaskets Included: Yes

Cadillac 1984 - 1983



EGV764
EGR Valve

17113411; 17066200; 17065865;
17065863; 17065823; 17065080;
17063339; 17061785; 17061783;
17057423; 17056496

Digital/Mechanical: Mechanical
Gaskets Included: Yes

GMC 1980



EGV801
EGR Valve

97303761

Digital/Mechanical: Electronic
Gaskets Included: No

Chevrolet 2005 - 2004
GMC 2005 - 2004



EGV802
EGR Valve

97288827

Digital/Mechanical: Mechanical
Gaskets Included: Yes

Chevrolet 2004 - 2002
GMC 2004 - 2002



EGV803
EGR Valve

97379347

Digital/Mechanical: Electronic
Gaskets Included: Yes

Chevrolet 2010 - 2006
GMC 2010 - 2006



EGV1031
EGR Valve

1846490C91; 5C3Z9F452AA;
5C3Z9F452ARM

Digital/Mechanical: Electronic
Gaskets Included: Yes

Ford 2010 - 2005



EGV1034
EGR Valve

1846491C91; 3C3Z9F452AC;
4C3Z9F452A; 4C3Z9F452ARM;
3C3Z9F452AB

Digital/Mechanical: Electronic
Gaskets Included: No

Ford 2004 - 2003



EGV1072
EGR Valve

038131501BF; 038131501BH;
038131501AD

Digital/Mechanical: Electronic
Gaskets Included: No

Volkswagen 2006 - 2004



EGV1076
EGR Valve

028131501E

Digital/Mechanical: Mechanical
Gaskets Included: No

Volkswagen 1997 - 1993



EGV1079
EGR Valve

045131501L; 038131501E;
045131501C; 038131501A

Digital/Mechanical: Mechanical
Gaskets Included: Yes

Volkswagen 2004 - 1998



EGV1081
EGR Valve

03G131501N; 03G131501D

Digital/Mechanical: Electronic
Gaskets Included: Yes

Volkswagen 2006 - 2005



EGV1093
EGR Valve

0021400760

Digital/Mechanical: Mechanical
Gaskets Included: No

Mercedes-Benz 1987 - 1985



EGV1094
EGR Valve

0021400560

Digital/Mechanical: Mechanical
Gaskets Included: No

Mercedes-Benz 1993 - 1985



EGV1096
EGR Valve

0021401060

Digital/Mechanical: Mechanical
Gaskets Included: No

Mercedes-Benz 1995 - 1986



EGV1105
EGR Valve

0021400060

Digital/Mechanical: Mechanical
Gaskets Included: No

Mercedes-Benz 1995



EGV1106
EGR Valve

0021402960

Digital/Mechanical: Electronic
Gaskets Included: No

Mercedes-Benz 1997 - 1996



EGV1139
EGR Valve

6120980417; 5127718AA;
5104008AA

Digital/Mechanical: Electronic

Gaskets Included: Yes

Dodge 2003

Freightliner 2003 - 2002



EGV1142
EGR Valve

98025695; 97365042

Digital/Mechanical: Electronic
Gaskets Included: No

Chevrolet 2010 - 2006

GMC 2010 - 2006



EGV1151
EGR Valve

8C3Z9D475A; 1885819C92;
9C3Z9D475A; 8C3Z9D475B;
8C3Z9D475C; 8C3Z9D475D

Digital/Mechanical: Electronic
Gaskets Included: Yes

Ford 2010 - 2008

IC Corporation 2010 - 2008

International 2010 - 2008



EGV1188
EGR Valve

07Z131501A

Digital/Mechanical: Mechanical
Gaskets Included: Yes

Volkswagen 2004



EGV1190
EGR Valve
07Z131501E; 07Z131501C
Digital/Mechanical: Electronic
Gaskets Included: Yes
Volkswagen 2008 - 2006



EGV1191
EGR Valve
07Z131502A; 07Z131502C
Digital/Mechanical: Electronic
Gaskets Included: Yes
Volkswagen 2008 - 2006



EGV1218
EGR Valve
5142807AA; 5159971AA;
5166555AB
Digital/Mechanical: Electronic
Gaskets Included: Yes
Jeep 2006 - 2005



EGV1219
EGR Valve
12660270; 12636491; 12639422
Digital/Mechanical: Electronic
Gaskets Included: Yes
Chevrolet 2016 - 2010
GMC 2016 - 2010



EGV1238
EGR Valve
BC3Z9D475G; BC3Z9D475D;
BC3Z9D475E; BC3Z9D475B
Digital/Mechanical: Electronic
Gaskets Included: Yes
Mounting Type: Bolt Mount
Vacuum Port Quantity: N/A
Ford 2017 - 2011



EGV1239
EGR Valve
BC3Z9D475K; BC3Z9D475H;
BC3Z9D475C; BC3Z9D475F;
BC3Z9D475A
Digital/Mechanical: Electronic
Gaskets Included: Yes
Mounting Type: Flange
Vacuum Port Quantity: 1
Ford 2017 - 2011



EGV1240
EGR Valve
12665547; 12643238; 12636492;
XA12643238; 12639423
Digital/Mechanical: Electronic
Gaskets Included: Yes
Mounting Type: Flange
Vacuum Port Quantity: N/A
Chevrolet 2016 - 2011
GMC 2016 - 2011



EGV1241
EGR Valve
68003400AA; 4309085;
R8026995AA; 68026995AA;
68026995AB; 68038088AA;
68002438AA
Digital/Mechanical: Electronic
Gaskets Included: Yes
Mounting Type: Flange
Vacuum Port Quantity: N/A
Dodge 2010 - 2007
Ram 2013 - 2011



EGV1242
EGR Valve
059131502B; 059131502G
Digital/Mechanical: Electronic
Gaskets Included: Yes
Mounting Type: Flange
Vacuum Port Quantity: N/A
Audi 2012 - 2009
Volkswagen 2012 - 2010



EGV1243
EGR Valve
11717807805; 11718517217
Digital/Mechanical: Electronic
Gaskets Included: Yes
Mounting Type: Flange
Vacuum Port Quantity: N/A
BMW 2013 - 2009



EGV1247
EGR Valve
03L131501G; 03L131501D;
03L131501E; 03L131501K
Digital/Mechanical: Electronic
Gaskets Included: Yes
Mounting Type: Bolt Mount
Vacuum Port Quantity: N/A
Audi 2013 - 2010
Volkswagen 2015 - 2010



EGV1249
EGR Valve
5C4Z9F452AA
Digital/Mechanical: Electronic
Gaskets Included: Yes
Mounting Type: Bolt Mount
Vacuum Port Quantity: N/A
Ford 2007 - 2004
International 2006 - 2004



EGV1254
EGR Valve
68211310AA
Digital/Mechanical: Electronic
Gaskets Included: Yes
Mounting Type: Bolt Mount
Vacuum Port Quantity: N/A
Jeep 2019 - 2015
Ram 2018 - 2014



EGV1255
EGR Valve

68021549AA; 68014099AA;
68014100AA; 68026616AA

Digital/Mechanical: Mechanical
Gaskets Included: No
Mounting Type: Bolt Mount
Vacuum Port Quantity: N/A

Dodge 2009 - 2007



EGV1262
EGR Valve

68051514AA; 68021770AA;
68014083AA; 68021770AC;
68021770AB

Digital/Mechanical: Electronic
Gaskets Included: No
Mounting Type: Bolt Mount
Vacuum Port Quantity: 2

Freightliner 2009 - 2007



EGV1264
EGR Valve

059131503AM; 059131503AK

Digital/Mechanical: Electronic
Gaskets Included: No
Mounting Type: Bolt Mount
Vacuum Port Quantity: N/A

Audi 2015 - 2014



EGV1267
EGR Valve
04L131501C

Digital/Mechanical: Electronic
Gaskets Included: No
Mounting Type: Bolt Mount
Vacuum Port Quantity: N/A

Volkswagen 2015



EGV1268
EGR Valve

059131503AL; 059131503AN;
059131503AC

Digital/Mechanical: Electronic
Gaskets Included: No
Mounting Type: Bolt Mount
Vacuum Port Quantity: N/A

Audi 2016 - 2014



EGV1272
EGR Valve
04L131501M

Digital/Mechanical: Electronic
Gaskets Included: No
Mounting Type: Bolt Mount
Vacuum Port Quantity: N/A

Audi 2016 - 2015



EGV1278
EGR Valve

04L131501S; 04L131501N

Digital/Mechanical: Digital
Gaskets Included: Yes
Mounting Type: Bolt Mount
Vacuum Port Quantity: 2

Audi 2016 - 2015
Volkswagen 2015



EGV1282
EGR Valve
55594609

Digital/Mechanical: Digital
Gaskets Included: Yes
Mounting Type: Bolt Mount
Vacuum Port Quantity: N/A

Chevrolet 2019 - 2016
GMC 2017 - 2016



EGV1284
EGR Valve

FB3Z9D475C; BK2Z9D475A

Digital/Mechanical: Digital
Gaskets Included: No
Mounting Type: Bolt Mount
Vacuum Port Quantity: 2

Ford 2019 - 2015



EGV1285
EGR Valve

2881693; 68442472AA;
68228833AA; 68210408AA

Digital/Mechanical: Digital
Gaskets Included: Yes
Mounting Type: Bolt Mount
Vacuum Port Quantity: N/A

Ram 2018 - 2014



EGV1288
EGR Valve
55570005

Digital/Mechanical: Digital
Gaskets Included: No
Mounting Type: Bolt Mount
Vacuum Port Quantity: N/A

Chevrolet 2019 - 2017
GMC 2019 - 2018



EGV1289
EGR Valve

12679965; 12677567; 12674433

Digital/Mechanical: Digital
Gaskets Included: No
Mounting Type: Bolt Mount
Vacuum Port Quantity: 2

Chevrolet 2019 - 2017
GMC 2019 - 2017



EGV1290
EGR Valve

HC3Z9D475D; HC3Z9D475A

Digital/Mechanical: Digital
Gaskets Included: Yes
Mounting Type: Bolt Mount
Vacuum Port Quantity: 1

Ford 2019 - 2018



EGV1293
EGR Valve Spacer Plate
3C3Z9P458AA

Ford 2010 - 2003



EGV1294
EGR Valve
12640017

Digital/Mechanical: N/A
Gaskets Included: N/A
Mounting Type: Bolt Mount
Vacuum Port Quantity: 1

Chevrolet 2020 - 2016
GMC 2020 - 2016



EOS1
Engine Oil Separator
BC3Q6A785FA; DC3Z6A785C

Ford 2016 - 2011



EOS2
Engine Oil Separator
BC3Q6A785FA; FC3Z6A785C

Ford 2016 - 2015



EOS3
Engine Oil Separator
GC4Q6A785CB; GC4Q6A785AE;
GC4Z6A785D; GC4Z6A785C

Ford 2019 - 2017



ES9
Idle Stop Solenoid
E3167; E3164; 6273914; 1114450;
1993403; 1997470; 1997417;
1997420; 1997403; 1997409;
1997416

Chevrolet 1981 - 1980
GMC 1981 - 1980



ES110
Idle Stop Solenoid
17073506; 17071056; 17068272;
17067179; 17061769

Connector Gender: Female
Terminal Gender: Male
Terminal Quantity: 1

Chevrolet 1985 - 1980
GMC 1980
Oldsmobile 1980
Pontiac 1985 - 1982



ES146
Idle Stop Solenoid
F0HZ9S520A

Connector Gender: Female
Terminal Gender: Male
Terminal Quantity: 1

Ford 1991 - 1990



ETB17
EGR Tube
F4TZ9D477A

Ford 1997 - 1994



ETB18
EGR Tube
3C3Z9D477BA

Ford 2004 - 2003



ETB27
EGR Tube
1C3Z9D477AA

Contents: Tube & Seals
Inner Diameter (I.D.) - Inches: N/A
Length - Inches: N/A

Ford 2003 - 1998



ETB62
EGR Tube
68026767AA; 68014094AA

Contents: Tube & Seals
Inner Diameter (I.D.) - Inches: 1
Length - Inches: 16

Dodge 2009 - 2007
Freightliner 2009 - 2007



ETB73
EGR Tube
5C3Z9D477A

Contents: EGR Tube
Inner Diameter (I.D.) - Inches: For 1/4
Length - Inches: 8.5

Ford 2007 - 2005



ETB74
EGR Tube
4C2Z9D477BA

Contents: EGR Tube
Inner Diameter (I.D.) - Inches: For 1/4
Length - Inches: 12

Ford 2010 - 2004



ETB78
EGR Tube
BC3Z9E470A

Contents: EGR Tube
Inner Diameter (I.D.) - Inches: N/A
Length - Inches: 6.5

Ford 2013 - 2011



ETB79
EGR Tube
FC3Z9E469A; BC3Z9E469A

Contents: EGR Tube
Inner Diameter (I.D.) - Inches: N/A
Length - Inches: 15

Ford 2019 - 2011



ETB82
EGR Tube
8C3Z9F459A

Contents: EGR Tube
Inner Diameter (I.D.) - Inches: 1/4
Length - Inches: 11.5

Ford 2010 - 2008



ETB91
EGR Tube
68038087AA

Contents: Bracket
Inner Diameter (I.D.) - Inches: 1/4
Length - Inches: 19

Dodge 2010 - 2008
Ram 2012 - 2011



ETS3
Exhaust Gas Temperature Sensor
8941212010

Connector Gender: Female
Contents: Sensor
Notes: N/A
Terminal Gender: Male
Terminal Quantity: 2
Terminal Type: Blade

Toyota 1987 - 1986



ETS66
Exhaust Gas Temperature Sensor
03L906088T

Connector Gender: Female
Contents: Sensor & Connector
Terminal Gender: Male
Terminal Quantity: 2
Terminal Type: Pin

Audi 2012 - 2010
Volkswagen 2013 - 2009



ETS67
Exhaust Gas Temperature Sensor
5149085AB; 5149085AC

Connector Gender: Female
Contents: Sensor
Terminal Gender: Male
Terminal Quantity: 2
Terminal Type: Blade

Dodge 2010 - 2007
Ram 2012 - 2011



ETS72
Exhaust Gas Temperature Sensor
12633560; 12623114; 12615120; 12598443

Connector Gender: Female
Connector Quantity: 1
Connector Shape: Square
Contents: N/A
Notes: N/A
Terminal Gender: Female
Terminal Quantity: 2
Terminal Type: Pin

Chevrolet 2010 - 2007
GMC 2016 - 2007



ETS73
Exhaust Gas Temperature Sensor
13627805606

Connector Gender: Male
Contents: Sensor
Terminal Gender: Female
Terminal Quantity: 2
Terminal Type: Pin Socket

BMW 2011 - 2009



ETS74
Exhaust Gas Temperature Sensor
13627805607

Connector Gender: Male
Contents: Sensor
Terminal Gender: Male
Terminal Quantity: 2
Terminal Type: Pin Socket

BMW 2010 - 2009



ETS75
Exhaust Gas Temperature Sensor
19418898; 12623113; 12622555; 12598444

Chevrolet 2010 - 2007
GMC 2010 - 2007



ETS76
Exhaust Gas Temperature Sensor
5149103AB; 5149103AA

Connector Gender: Male
Connector Quantity: 1
Terminal Gender: Female
Terminal Quantity: 2
Terminal Type: Pin Socket

Jeep 2009 - 2007



ETS77
Exhaust Gas Temperature Sensor
031906088G; 03L906088G

Connector Gender: Female
Terminal Gender: Male
Terminal Quantity: 1
Terminal Type: Pins

Audi 2012 - 2010
Volkswagen 2013 - 2009



ETS78
Exhaust Gas Temperature Sensor
059906088AC

Connector Gender: Female
Contents: Sensor
Terminal Gender: Male
Terminal Quantity: 2
Terminal Type: Pin

Audi 2012 - 2011
Volkswagen 2010 - 2009



ETS79
Exhaust Gas Temperature Sensor
059906088T

Connector Gender: Female
Contents: Sensor
Terminal Gender: Male
Terminal Quantity: 2
Terminal Type: Pin

Audi 2012 - 2009
Volkswagen 2010 - 2009



ETS80
Exhaust Gas Temperature Sensor
059906088AB

Connector Gender: Female
Contents: Sensor
Terminal Gender: Male
Terminal Quantity: 2
Terminal Type: Pin

Audi 2012 - 2011
Volkswagen 2010 - 2009



ETS83
Exhaust Gas Temperature Sensor
03L906088J

Connector Gender: Female
Contents: Sensor
Terminal Gender: Male
Terminal Quantity: 2
Terminal Type: Pin

Audi 2012 - 2010
Volkswagen 2013 - 2009



ETS90
Exhaust Gas Temperature Sensor
03G906088AN; 03G906088J;
03L906088BS; 03G906088AM

Connector Gender: Female
Contents: Sensor
Terminal Gender: Male
Terminal Quantity: 2
Terminal Type: Pin

Volkswagen 2006 - 2005

Contents: Sensor
Notes: N/A
Terminal Gender: Female
Terminal Quantity: 2
Terminal Type: Pin Plug



ETS95
Exhaust Gas Temperature Sensor
07Z906088

Connector Gender: Female
Contents: Sensor
Terminal Gender: Male
Terminal Quantity: 2
Terminal Type: Pin

Volkswagen 2008 - 2006



ETS81
Exhaust Gas Temperature Sensor
059906088AA

Connector Gender: Female
Contents: Sensor
Terminal Gender: Male
Terminal Quantity: 2
Terminal Type: Pin

Audi 2012 - 2009
Volkswagen 2010 - 2009



ETS84
Exhaust Gas Temperature Sensor
03L906088L

Connector Gender: Female
Contents: Sensor
Terminal Gender: Male
Terminal Quantity: 2
Terminal Type: Pin

Audi 2010
Volkswagen 2013 - 2009



ETS92
Exhaust Gas Temperature Sensor
0051531128

Connector Gender: Male
Contents: Sensor
Terminal Gender: Female
Terminal Quantity: 2
Terminal Type: Pin Socket

Mercedes-Benz 2008 - 2007



ETS96
Exhaust Gas Temperature Sensor
07Z906088A

Connector Gender: Female
Contents: Sensor
Terminal Gender: Male
Terminal Type: Pin

Volkswagen 2008 - 2006



ETS82
Exhaust Gas Temperature Sensor
059906088A

Connector Gender: Female
Contents: Sensor
Terminal Gender: Male
Terminal Quantity: 2
Terminal Type: Pin



ETS85
Exhaust Gas Temperature Sensor
0009051405; 0009053300

Connector Gender: Male
Contents: Sensor
Terminal Gender: Female
Terminal Quantity: 2
Terminal Type: Pin Socket

Mercedes-Benz 2012 - 2010



ETS93
Exhaust Gas Temperature Sensor
0051534528; 0071539828;
0009057901

Connector Gender: Male
Connector Quantity: 1
Connector Shape: N/A



ETS97
Exhaust Gas Temperature Sensor
07Z906088C

Connector Gender: Female
Contents: Sensor
Terminal Gender: Male
Terminal Quantity: 2
Terminal Type: Pin

Volkswagen 2008 - 2006



ETS98
Exhaust Gas Temperature Sensor
07Z906088N

Connector Gender: Female
Contents: Sensor
Terminal Gender: Male
Terminal Quantity: 2
Terminal Type: Pin

Volkswagen 2008 - 2006



ETS99
Exhaust Gas Temperature Sensor
07Z906088P

Connector Gender: Female
Contents: Sensor
Terminal Gender: Male
Terminal Quantity: 2
Terminal Type: Blade Terminals

Volkswagen 2008 - 2006



ETS100
Exhaust Gas Temperature Sensor
07Z906088R; 07Z906088B

Connector Gender: Female
Contents: Sensor
Terminal Gender: Male
Terminal Quantity: 2
Terminal Type: Pin

Volkswagen 2008 - 2006



ETS103
Exhaust Gas Temperature Sensor
68002443AB

Connector Gender: Female
Contents: Sensor
Terminal Gender: Male
Terminal Quantity: 2
Terminal Type: Blade

Dodge 2009 - 2007



ETS104
Exhaust Gas Temperature Sensor
13627811913

Connector Gender: Female
Contents: Sensor
Terminal Gender: Female
Terminal Quantity: 2
Terminal Type: Blade & Bullet

BMW 2013 - 2009



ETS105
Exhaust Gas Temperature Sensor
13628506995

Connector Gender: Female
Contents: Sensor
Terminal Gender: Female
Terminal Quantity: 2
Terminal Type: Blade & Bullet

BMW 2013 - 2009



ETS106
Exhaust Gas Temperature Sensor
7C3Z12B591B; 8C3Z12B591D;
8C3Z5J213D; 7C3Z5J213B

Connector Gender: Female
Connector Quantity: 1

Terminal Quantity: 2
Terminal Type: Bullet
Ford 2010 - 2008



ETS107
Exhaust Gas Temperature Sensor
0009054305; 0071538428;
0051537928

Connector Gender: Male
Connector Quantity: 1
Contents: Sensor & Connector
Terminal Gender: Female
Terminal Quantity: 2
Terminal Type: Pin Socket

Dodge 2009 - 2007
Mercedes-Benz 2018 - 2007



ETS110
Exhaust Gas Temperature Sensor
059906088AP

Connector Gender: Female
Terminal Gender: Female
Terminal Quantity: 4
Terminal Type: Blade

Audi 2010 - 2009



ETS111
Exhaust Gas Temperature Sensor
0009055205; 0071537528;
0081534128

Connector Gender: Male
Connector Quantity: 1
Contents: Sensor Assembly
Terminal Gender: Female
Terminal Quantity: 1
Terminal Type: Pin ; Female Plug

Freightliner 2013 - 2007
Mercedes-Benz 2012 - 2010



ETS114
Exhaust Gas Temperature Sensor
1845988C1; 8C3Z12B591A

Connector Gender: Male
Connector Quantity: 1
Connector Shape: Rectangular
Contents: Sensor
Notes: N/A
Terminal Gender: Male
Terminal Quantity: 2
Terminal Type: Blade

Ford 2010 - 2008



ETS115
Exhaust Gas Temperature Sensor
AC3Z5J213C; AC3Z5J213A;
AC3Z5J213B; AC3Z12B591A

Connector Gender: Female

Connector Quantity: 1
 Connector Shape: Square
 Contents: N/A
 Notes: N/A
 Terminal Gender: Male
 Terminal Quantity: 2
 Terminal Type: Blade
 Ford..... 2019 - 2011



ETS117
 Exhaust Gas Temperature Sensor

68067129AA; 68067129AB;
 68206021AA

Connector Gender: Female
 Connector Quantity: 1
 Connector Shape: Rectangular
 Contents: Sensor
 Notes: N/A
 Terminal Gender: Male
 Terminal Quantity: 2
 Terminal Type: Blade
 Dodge..... 2010
 Ram..... 2018 - 2011



ETS118
 Exhaust Gas Temperature Sensor

68211315AA

Connector Gender: Female
 Connector Quantity: 1
 Connector Shape: N/A
 Contents: N/A
 Notes: N/A
 Terminal Gender: Male
 Terminal Quantity: 2
 Terminal Type: Blade
 Jeep..... 2019 - 2014
 Ram..... 2018 - 2014



ETS119
 Exhaust Gas Temperature Sensor

12636966

Connector Gender: Female
 Connector Quantity: 1
 Contents: N/A
 Notes: N/A

Terminal Gender: Female
 Terminal Quantity: 2
 Terminal Type: Blade
 Chevrolet..... 2016 - 2010
 GMC..... 2016 - 2011



ETS120
 Exhaust Gas Temperature Sensor

68224951AA

Connector Gender: Female
 Connector Quantity: 1
 Contents: Sensor
 Notes: N/A
 Terminal Gender: Male
 Terminal Quantity: 2
 Terminal Type: Blade
 Ram..... 2018 - 2014



ETS121
 Exhaust Gas Temperature Sensor

98070097

Connector Gender: Female
 Connector Quantity: 1
 Contents: Sensor
 Notes: N/A
 Terminal Gender: Male
 Terminal Quantity: 2
 Terminal Type: Blade
 Chevrolet..... 2010 - 2008
 GMC..... 2010 - 2008



ETS122
 Exhaust Gas Temperature Sensor

68085774AB

Connector Gender: Female
 Connector Quantity: 1
 Contents: Sensor
 Notes: N/A
 Terminal Gender: Female
 Terminal Quantity: 2
 Terminal Type: Pin
 Ram..... 2016 - 2013



ETS123

Oxygen Sensor

1888560C1; 8C3Z12B591E;
 8C3Z12B591B

Connector Gender: Female
 Connector Quantity: 1
 Connector Shape: N/A
 Contents: Sensor
 Notes: N/A
 Terminal Gender: Male
 Terminal Quantity: 2
 Terminal Type: Pin
 Ford..... 2010 - 2008



ETS124

Exhaust Gas Temperature Sensor

8C3Z5J213C

Connector Gender: Female
 Connector Quantity: 1
 Contents: Sensor
 Notes: N/A
 Terminal Gender: Male
 Terminal Quantity: 2
 Terminal Type: Pin
 Ford..... 2010 - 2008



ETS125

Exhaust Gas Temperature Sensor

12634536

Connector Gender: Female
 Connector Quantity: 1
 Contents: Sensor
 Notes: N/A
 Terminal Gender: Male
 Terminal Quantity: 2
 Terminal Type: Blade
 Chevrolet..... 2016 - 2014
 GMC..... 2016 - 2014



ETS126

Exhaust Gas Temperature Sensor

03L906088EJ

Connector Gender: Female
 Connector Quantity: 1
 Connector Shape: Oval
 Terminal Gender: Male
 Terminal Quantity: 2
 Terminal Type: Blade
 Audi..... 2012 - 2011
 Volkswagen..... 2014 - 2011



ETS127

Exhaust Gas Temperature Sensor

13628574358

Connector Gender: Male
 Connector Quantity: 1
 Connector Shape: Oval
 Terminal Gender: Female
 Terminal Quantity: 2
 Terminal Type: Pin ; Female Plug
 BMW..... 2016 - 2014



ETS129

Exhaust Gas Temperature Sensor

22640EZ40A

Connector Gender: Male
 Connector Quantity: 1
 Connector Shape: Oval
 Terminal Gender: Male
 Terminal Quantity: 2
 Terminal Type: Blade
 Nissan..... 2019 - 2016



ETS130

Exhaust Gas Temperature Sensor

04L906088BL

Connector Gender: Female
 Connector Quantity: 1
 Connector Shape: Oval
 Terminal Gender: Male
 Terminal Quantity: 2
 Terminal Type: Blade

Audi 2016 - 2015
 Volkswagen 2015



ETS133

Exhaust Gas Temperature Sensor

03L906088ES

Connector Gender: Female
 Connector Quantity: 1
 Connector Shape: Oval
 Terminal Gender: Male
 Terminal Quantity: 2
 Terminal Type: Blade

Volkswagen 2014 - 2012



ETS136

Exhaust Gas Temperature Sensor

059906088BE

Connector Gender: Female
 Connector Quantity: 1
 Connector Shape: Oval
 Terminal Gender: Male
 Terminal Quantity: 2
 Terminal Type: Blade

Volkswagen 2012 - 2011



ETS139

Exhaust Gas Temperature Sensor

04L906088AD

Connector Gender: Female
 Connector Quantity: 1
 Connector Shape: Oval
 Terminal Gender: Male
 Terminal Quantity: 2
 Terminal Type: Blade

Audi 2016 - 2015
 Volkswagen 2015



ETS131

Exhaust Gas Temperature Sensor

059906088BQ

Connector Gender: Female
 Connector Quantity: 1
 Connector Shape: Oval
 Terminal Gender: Male
 Terminal Quantity: 2
 Terminal Type: Blade

Volkswagen 2016 - 2013



ETS134

Exhaust Gas Temperature Sensor

059906088CE

Connector Gender: Female
 Connector Quantity: 1
 Connector Shape: Oval
 Terminal Gender: Male
 Terminal Quantity: 2
 Terminal Type: Blade

Audi 2016 - 2014
 Volkswagen 2016 - 2015



ETS137

Exhaust Gas Temperature Sensor

059906088BG

Connector Gender: Female
 Connector Quantity: 1
 Connector Shape: Oval
 Terminal Gender: Male
 Terminal Quantity: 2
 Terminal Type: Blade

Volkswagen 2012 - 2011



ETS140

Exhaust Gas Temperature Sensor

04L906088BB

Connector Gender: Female
 Connector Quantity: 1
 Connector Shape: Oval
 Terminal Gender: Male
 Terminal Quantity: 2
 Terminal Type: Blade

Audi 2016 - 2015
 Volkswagen 2015



ETS132

Exhaust Gas Temperature Sensor

04L906088EB

Connector Gender: Female
 Connector Quantity: 1
 Connector Shape: Oval
 Terminal Gender: Male
 Terminal Quantity: 2
 Terminal Type: Blade

Volkswagen 2016 - 2015



ETS135

Exhaust Gas Temperature Sensor

059906088CL; 059906088BJ

Connector Gender: Female
 Connector Quantity: 1
 Connector Shape: Oval
 Terminal Gender: Male
 Terminal Quantity: 2
 Terminal Type: Blade

Audi 2015 - 2013
 Volkswagen 2014 - 2013



ETS138

Exhaust Gas Temperature Sensor

059906088CT; 059906088CM;
 059906088BB

Connector Gender: Female
 Connector Quantity: 1
 Connector Shape: Oval
 Terminal Gender: Male
 Terminal Quantity: 2
 Terminal Type: Blade

Audi 2015 - 2013



ETS141

Exhaust Gas Temperature Sensor

8K0906088B

Connector Gender: Female
 Connector Quantity: 1
 Connector Shape: Oval
 Terminal Gender: Male
 Terminal Quantity: 2
 Terminal Type: Blade

Audi 2016 - 2014



ETS142
Exhaust Gas Temperature Sensor
04L906088JN; 04L906088BS
Connector Gender: Female
Connector Quantity: 1
Connector Shape: Oval
Terminal Gender: Male
Terminal Quantity: 2
Terminal Type: Blade
Volkswagen 2015



ETS146
Exhaust Gas Temperature Sensor
12622554
Connector Gender: Female
Connector Quantity: 1
Connector Shape: Oval
Terminal Gender: Male
Terminal Quantity: 2
Terminal Type: Blade
Chevrolet 2016 - 2011
GMC 2016 - 2011



ETS149
Exhaust Gas Temperature Sensor
13628573347; 13628582663
Connector Gender: Female
Connector Quantity: 1
Contents: N/A
Notes: N/A
Terminal Gender: Female
Terminal Quantity: 2
Terminal Type: Pin ; Female Plug
BMW 2016 - 2014



ETS152
Exhaust Gas Temperature Sensor
13628582662
Connector Gender: Male
Connector Quantity: 1
Connector Shape: Oval
Terminal Gender: Female
Terminal Quantity: 2
Terminal Type: Pin ; Female Plug
BMW 2017 - 2014



ETS143
Exhaust Gas Temperature Sensor
13628514730
Connector Gender: Male
Connector Quantity: 1
Connector Shape: N/A
Terminal Gender: Female
Terminal Quantity: 2
Terminal Type: Pin ; Female Plug
BMW 2016 - 2014



ETS147
Exhaust Gas Temperature Sensor
03L906088EF
Connector Gender: Female
Connector Quantity: 1
Connector Shape: Oval
Terminal Gender: Male
Terminal Quantity: 2
Terminal Type: Blade
Volkswagen 2014 - 2012



ETS150
Exhaust Gas Temperature Sensor
03L906088ED
Connector Gender: Female
Connector Quantity: 1
Connector Shape: Oval
Terminal Gender: Male
Terminal Quantity: 2
Terminal Type: Blade
Volkswagen 2014 - 2012



ETS153
Exhaust Gas Temperature Sensor
04L906088EA
Connector Gender: Female
Connector Quantity: 1
Connector Shape: Oval
Terminal Gender: Male
Terminal Quantity: 2
Terminal Type: Blade
Volkswagen 2015



ETS145
Exhaust Gas Temperature Sensor
12636612
Connector Gender: Male
Connector Quantity: 1
Connector Shape: N/A
Terminal Gender: Female
Terminal Quantity: 2
Terminal Type: Pin ; Female Plug
Chevrolet 2016 - 2011
GMC 2016 - 2011



ETS148
Exhaust Gas Temperature Sensor
8K0906088
Connector Gender: Female
Connector Quantity: 1
Connector Shape: Oval
Terminal Gender: Male
Terminal Quantity: 2
Terminal Type: Blade
Audi 2016 - 2014



ETS151
Exhaust Gas Temperature Sensor
03L906088EE
Connector Gender: Female
Connector Quantity: 1
Connector Shape: Oval
Terminal Gender: Male
Terminal Quantity: 2
Terminal Type: Blade
Volkswagen 2014 - 2012



ETS154
Exhaust Gas Temperature Sensor
03L906529B
Connector Gender: Female
Connector Quantity: 1
Connector Shape: Oval
Terminal Gender: Male
Terminal Quantity: 2
Terminal Type: Blade
Volkswagen 2015 - 2012



ETS155

Exhaust Gas Temperature Sensor

19418988; 12642451

Connector Gender: Female
 Connector Quantity: 1
 Connector Shape: Oval
 Terminal Gender: Male
 Terminal Quantity: 2
 Terminal Type: Blade

Chevrolet 2016 - 2010
 GMC 2016 - 2010



ETS157

Exhaust Gas Temperature Sensor

CK4Z12B591A

Connector Gender: Female
 Connector Quantity: 1
 Connector Shape: Square
 Terminal Gender: Male
 Terminal Quantity: 2
 Terminal Type: Blade

Ford 2019 - 2015



ETS158

Exhaust Gas Temperature Sensor

FC3Z12B591A

Connector Gender: Female
 Connector Quantity: 1
 Connector Shape: Square
 Terminal Gender: Male
 Terminal Quantity: 2
 Terminal Type: Blade

Ford 2017 - 2015



ETS160

Exhaust Gas Temperature Sensor

CK4Z12B591B

Connector Gender: Female
 Connector Quantity: 1
 Contents: N/A
 Notes: N/A
 Terminal Gender: Male
 Terminal Quantity: 2
 Terminal Type: Blade

Ford 2019 - 2015



ETS162

Exhaust Gas Temperature Sensor

68211218AA

Connector Gender: Female
 Connector Quantity: 1
 Connector Shape: Oval
 Terminal Gender: Male
 Terminal Quantity: 2
 Terminal Type: Pin

Jeep 2019 - 2014
 Ram 2018 - 2014



ETS163

Exhaust Gas Temperature Sensor

5146663AD

Connector Gender: Female
 Connector Quantity: 1
 Connector Shape: Oval
 Terminal Gender: Male
 Terminal Quantity: 2
 Terminal Type: Blade

Jeep 2019 - 2014
 Ram 2018 - 2014



ETS164

Exhaust Gas Temperature Sensor

4H0906088F

Connector Gender: Female
 Connector Quantity: 1
 Connector Shape: Oval
 Terminal Gender: Male
 Terminal Quantity: 2
 Terminal Type: Blade

Audi 2015 - 2013



ETS165

Exhaust Gas Temperature Sensor

059906088BP

Connector Gender: Female
 Connector Quantity: 1
 Connector Shape: Oval
 Terminal Gender: Male
 Terminal Quantity: 2
 Terminal Type: Blade

Volkswagen 2016 - 2013



ETS166

Exhaust Gas Temperature Sensor

68193645AB

Connector Gender: Female
 Connector Quantity: 1
 Connector Shape: Oval
 Terminal Gender: Male
 Terminal Quantity: 2
 Terminal Type: Blade

Jeep 2017 - 2014
 Ram 2015



ETS168

Exhaust Gas Temperature Sensor

55581035

Connector Gender: Female
 Connector Quantity: 1
 Connector Shape: Oval
 Terminal Gender: Male
 Terminal Quantity: 2
 Terminal Type: Blade

Chevrolet 2015 - 2014



ETS169

Exhaust Gas Temperature Sensor

059906088CC

Connector Gender: Female
 Connector Quantity: 1
 Connector Shape: Oval
 Terminal Gender: Male
 Terminal Quantity: 2
 Terminal Type: Blade

Audi 2015



ETS170

Exhaust Gas Temperature Sensor

12643373; 12637488

Connector Gender: Male
 Connector Quantity: 1
 Connector Shape: Oval
 Terminal Gender: Female
 Terminal Quantity: 2
 Terminal Type: Pin ; Female Plug

Chevrolet 2015 - 2010
 GMC 2015 - 2010



ETS171
Exhaust Gas Temperature Sensor
55583113

Connector Gender: Female
Connector Quantity: 1
Connector Shape: Oval
Terminal Gender: Male
Terminal Quantity: 2
Terminal Type: Blade

Chevrolet 2016 - 2013
GMC 2016 - 2012



ETS174
Exhaust Gas Temperature Sensor
13628508014

Connector Gender: Male
Connector Quantity: 1
Connector Shape: Oval
Terminal Gender: Female
Terminal Quantity: 2
Terminal Type: Pin ; Female Plug

BMW 2016 - 2014



ETS177
Exhaust Gas Temperature Sensor
68224044AB; 68224044AA

Connector Gender: Female
Connector Quantity: 1
Connector Shape: Oval
Contents: N/A
Notes: N/A
Terminal Gender: Male
Terminal Quantity: 2
Terminal Type: Blade

Ram 2016 - 2014



ETS181
Exhaust Gas Temperature Sensor
95860628830

Connector Gender: Female
Connector Quantity: 1
Contents: N/A
Notes: N/A
Terminal Gender: Male
Terminal Quantity: 2
Terminal Type: Blade

Porsche 2016 - 2013



ETS172
Exhaust Gas Temperature Sensor
55581034

Connector Gender: Female
Connector Quantity: 1
Connector Shape: Rectangular
Terminal Gender: Male
Terminal Quantity: 2
Terminal Type: Blade

Chevrolet 2015 - 2014



ETS175
Exhaust Gas Temperature Sensor
5146662AD; 5146662AC

Connector Gender: Female
Connector Quantity: 1
Connector Shape: Rectangular
Contents: N/A
Notes: N/A
Terminal Gender: Male
Terminal Quantity: 2
Terminal Type: Blade

Ram 2018 - 2015



ETS178
Exhaust Gas Temperature Sensor
68231738AB; 68231738AA

Connector Gender: Female
Connector Quantity: 1
Contents: N/A
Notes: N/A
Terminal Gender: Male
Terminal Quantity: 2
Terminal Type: Blade

Ram 2018 - 2014



ETS183
Exhaust Gas Temperature Sensor
95860628820

Connector Gender: Female
Connector Quantity: 1
Connector Shape: Oval
Contents: N/A
Notes: N/A
Terminal Gender: Male
Terminal Quantity: 2
Terminal Type: Blade

Porsche 2016 - 2013



ETS173
Exhaust Gas Temperature Sensor
12643246; 12639455; 12636945

Connector Gender: Female
Connector Quantity: 1
Connector Shape: Oval
Terminal Gender: Female
Terminal Quantity: 2
Terminal Type: Pin Plug

Chevrolet 2016 - 2011
GMC 2016 - 2011



ETS176
Exhaust Gas Temperature Sensor
68224043AB

Connector Gender: Female
Connector Quantity: 1
Connector Shape: Oval
Contents: N/A
Notes: N/A
Terminal Gender: Male
Terminal Quantity: 2
Terminal Type: Blade

Ram 2016 - 2014



ETS180
Exhaust Gas Temperature Sensor
68297577AA; 68167870AB

Connector Gender: Female
Connector Quantity: 1
Contents: N/A
Notes: N/A
Terminal Gender: Male
Terminal Quantity: 2
Terminal Type: Blade

Ram 2016 - 2014



ETS184
Exhaust Gas Temperature Sensor
95860628840

Connector Gender: Female
Connector Quantity: 1
Contents: N/A
Notes: N/A
Terminal Gender: Male
Terminal Quantity: 2
Terminal Type: Blade

Porsche 2016 - 2013



ETS185
Exhaust Gas Temperature Sensor
04L906088AE

Connector Gender: Female
Connector Quantity: 1
Connector Shape: Oval
Contents: N/A
Notes: N/A
Terminal Gender: Male
Terminal Quantity: 2
Terminal Type: Blade

Audi 2016 - 2015
Volkswagen 2015



ETS187
Exhaust Gas Temperature Sensor
4H0906088L

Connector Gender: Female
Connector Quantity: 1
Connector Shape: Oval
Terminal Gender: Male
Terminal Quantity: 2
Terminal Type: Blade

Audi 2014



ETS188
Exhaust Gas Temperature Sensor
059906088BF

Connector Gender: Female
Connector Quantity: 1
Connector Shape: Oval
Terminal Gender: Male
Terminal Quantity: 2
Terminal Type: Blade

Volkswagen 2011



ETS189
Exhaust Gas Temperature Sensor
68224045AB; 68224045AA

Connector Gender: Female
Connector Quantity: 1
Connector Shape: Oval
Terminal Gender: Male
Terminal Quantity: 2
Terminal Type: Blade

Ram 2016 - 2014



ETS190
Exhaust Gas Temperature Sensor
0081533528

Connector Gender: Male
Connector Quantity: 1
Connector Shape: Oval
Contents: N/A
Notes: N/A
Terminal Gender: Female
Terminal Quantity: 2
Terminal Type: N/A

Mercedes-Benz 2012 - 2010



ETS191
Exhaust Gas Temperature Sensor
0009050332; 0009050905

Connector Gender: Male
Connector Quantity: 1
Contents: N/A
Notes: N/A
Terminal Gender: Female
Terminal Quantity: 2
Terminal Type: N/A

Mercedes-Benz 2017 - 2015



ETS192
Exhaust Gas Temperature Sensor
0009052605; 0009058800

Connector Gender: Male
Connector Quantity: 1
Contents: N/A
Notes: N/A
Terminal Gender: Female
Terminal Quantity: 2
Terminal Type: N/A

Mercedes-Benz 2015



ETS194
Exhaust Gas Temperature Sensor
0009050632

Connector Gender: Male
Connector Quantity: 2
Connector Shape: Oval
Contents: N/A
Notes: N/A
Terminal Gender: Female
Terminal Quantity: 2
Terminal Type: Blade

Mercedes-Benz 2013 - 2012



ETS195
Exhaust Gas Temperature Sensor
0071536528

Connector Gender: Male
Connector Quantity: 1
Connector Shape: Oval
Contents: N/A
Notes: N/A
Terminal Gender: Female
Terminal Quantity: 2
Terminal Type: Blade

Mercedes-Benz 2009



ETS196
Exhaust Gas Temperature Sensor
0009058604; 0081533428

Connector Gender: Female
Connector Quantity: 1
Connector Shape: Oval
Contents: N/A
Notes: N/A
Terminal Gender: Female
Terminal Quantity: 1
Terminal Type: Blade

Mercedes-Benz 2012 - 2010



ETS197
Exhaust Gas Temperature Sensor
0071537628

Connector Gender: Female
Connector Quantity: 1
Connector Shape: Oval
Contents: N/A
Notes: N/A
Terminal Gender: Female
Terminal Quantity: 2
Terminal Type: Blade

Mercedes-Benz 2009



ETS198
Exhaust Gas Temperature Sensor
0009057104; 0019052300

Connector Gender: Male
Connector Quantity: 1
Connector Shape: Oval
Contents: N/A
Notes: N/A
Terminal Gender: Female
Terminal Quantity: 2
Terminal Type: Blade

Mercedes-Benz 2016 - 2012



ETS199
Exhaust Gas Temperature Sensor
0081532228; 0009056404
Connector Gender: Female
Connector Quantity: 1
Connector Shape: Oval
Contents: N/A
Notes: N/A
Terminal Gender: Female
Terminal Quantity: 1
Terminal Type: Blade
Mercedes-Benz 2016



ETS202
Exhaust Gas Temperature Sensor
WDN500130
Connector Gender: Female
Connector Quantity: 1
Connector Shape: Square
Terminal Gender: Male
Terminal Quantity: 2
Terminal Type: Blade
Land Rover 2017 - 2016



ETS205
Exhaust Gas Temperature Sensor
0009056904; 0019052200
Connector Gender: Male
Connector Quantity: 1
Connector Shape: N/A
Contents: N/A
Notes: N/A
Terminal Gender: Female
Terminal Quantity: 2
Terminal Type: Pin Socket
Mercedes-Benz 2016 - 2012



ETS213
Exhaust Gas Temperature Sensor
0009056504; 0019050700
Connector Gender: Male
Connector Quantity: 1
Connector Shape: Oval
Contents: N/A
Notes: N/A
Terminal Gender: Female
Terminal Quantity: 2
Terminal Type: Blade
Mercedes-Benz 2017 - 2015



ETS200
Exhaust Gas Temperature Sensor
0009053505
Connector Gender: Male
Connector Quantity: 1
Connector Shape: N/A
Contents: N/A
Notes: N/A
Terminal Gender: Female
Terminal Quantity: 2
Terminal Type: Pin Socket
Mercedes-Benz 2016 - 2015



ETS203
Exhaust Gas Temperature Sensor
LR037787
Connector Gender: Female
Connector Quantity: 1
Connector Shape: Rectangular
Terminal Gender: Male
Terminal Quantity: 2
Terminal Type: Blade
Land Rover 2017 - 2016



ETS206
Exhaust Gas Temperature Sensor
0009050132
Connector Gender: Male
Connector Quantity: 1
Connector Shape: Oval
Terminal Gender: Female
Terminal Quantity: 1
Terminal Type: N/A
Mercedes-Benz 2013 - 2012



ETS215
Exhaust Gas Temperature Sensor
0009056804
Connector Gender: Male
Connector Quantity: 1
Connector Shape: Oval
Contents: N/A
Notes: N/A
Terminal Gender: Female
Terminal Quantity: 1
Terminal Type: Blade
Mercedes-Benz 2016 - 2014



ETS201
Exhaust Gas Temperature Sensor
0009058501; 0009057004
Connector Gender: Female
Connector Quantity: 2
Notes: N/A
Mercedes-Benz 2016 - 2015



ETS204
Exhaust Gas Temperature Sensor
LR062053
Connector Gender: Female
Connector Quantity: 1
Connector Shape: Square
Terminal Gender: Male
Terminal Quantity: 2
Terminal Type: Blade
Land Rover 2017 - 2016



ETS211
Exhaust Gas Temperature Sensor
0009057204; 0071536728
Connector Gender: Male
Connector Quantity: 1
Connector Shape: Oval
Contents: N/A
Notes: N/A
Terminal Gender: Female
Terminal Quantity: 2
Terminal Type: Blade
Mercedes-Benz 2013 - 2011



ETS216
Exhaust Gas Temperature Sensor
0009059000; 0071538828
Connector Gender: Male
Connector Quantity: 1
Connector Shape: Oval
Contents: N/A
Notes: N/A
Terminal Gender: Female
Terminal Quantity: 2
Terminal Type: Blade
Mercedes-Benz 2013 - 2009



ETS217

Exhaust Gas Temperature Sensor

0009059205; 0009058205

Connector Gender: Male
 Connector Quantity: 1
 Connector Shape: Oval
 Contents: Sensor
 Notes: N/A
 Terminal Gender: Female
 Terminal Quantity: 2
 Terminal Type: Blade

Mercedes-Benz 2016 - 2013



ETS218

Exhaust Gas Temperature Sensor

5146662AB

Connector Gender: Female
 Connector Quantity: 1
 Connector Shape: Rectangular
 Contents: N/A
 Notes: N/A
 Terminal Gender: Male
 Terminal Quantity: 2
 Terminal Type: Blade

Jeep 2016 - 2014
 Ram 2015 - 2014



ETS219

Exhaust Gas Temperature Sensor

13628507628

Connector Gender: Female
 Connector Quantity: 1
 Connector Shape: Oval
 Notes: N/A
 Terminal Gender: Female
 Terminal Quantity: 2
 Terminal Type: Pin Socket

BMW 2016 - 2014



ETS221

Exhaust Gas Temperature Sensor

13628514308

Connector Gender: Male
 Connector Quantity: 1
 Connector Shape: Oval
 Contents: N/A
 Notes: N/A
 Terminal Gender: Female
 Terminal Quantity: 2
 Terminal Type: Pin Socket

BMW 2017 - 2014



ETS222

Exhaust Gas Temperature Sensor

68277008AA

Connector Gender: Female
 Connector Quantity: 1
 Connector Shape: Oval
 Contents: N/A
 Notes: N/A
 Terminal Gender: Male
 Terminal Quantity: 2
 Terminal Type: Blade

Jeep 2019 - 2017



ETS223

Exhaust Gas Temperature Sensor

5461596; 2872140

Connector Gender: Female
 Connector Quantity: 1
 Connector Shape: Oval
 Contents: Sensor
 Notes: N/A
 Terminal Gender: Male
 Terminal Quantity: 2
 Terminal Type: Blade

Freightliner 2011 - 2008
 International 2011 - 2008
 Kenworth 2011 - 2008

Oshkosh Motor Truck
 Co 2011
 Peterbilt 2011 - 2008
 Volvo 2011 - 2008



ETS229

Exhaust Gas Temperature Sensor

19418899; 12622554

Connector Gender: Female
 Connector Quantity: 1
 Connector Shape: Oval
 Terminal Gender: Male
 Terminal Quantity: 2
 Terminal Type: Blade

Chevrolet 2016 - 2015
 GMC 2016 - 2015



ETS300

Exhaust Gas Temperature Sensor

BC3Z12B591C; BC3Z12B591B

Connector Gender: Female
 Connector Quantity: 1
 Connector Shape: Square
 Notes: N/A
 Terminal Gender: Male
 Terminal Quantity: 2
 Terminal Type: Blade

Ford 2020 - 2011



EVCS01

Fuel Vapor Canister Seal

52129436AB; 52129436AA;
 4885827AA

Dodge 2007



FFH1

Diesel Fuel Filter Housing

F81Z9155AA; F81Z9155AC

Ford 2003 - 1999



FFH2

Diesel Fuel Filter Housing

F6T29155A; F6T29155AB

Ford 1997 - 1996



FICM1

Diesel Fuel Injector Control Module (FICM)

HC3Z12B599AARM;
 HC3Z12B599ARM;
 4C3Z12B599CRM

Ford 2004 - 2003



FICM2

Diesel Fuel Injector Control Module (FICM)

HC3Z12B599BRM;
 4C3Z12B599DRM

Ford 2005 - 2004

FICM3
Diesel Fuel Injector Control Module (FICM)
HC3Z12B599CRM;
4C3Z12B599ERM
Ford..... 2010 - 2004

FIDM1
Diesel Fuel Injector Driver Module (IDM)
F7TZ12B59AC
Ford..... 1998 - 1994

FIDM2
Diesel Fuel Injector Driver Module (IDM)
XC3Z12B599AA
Ford..... 2003 - 1999

FIR1
Diesel Fuel Injector Rail
BC3Z9D280A
Ford..... 2019 - 2011

FIR2
Diesel Fuel Injector Rail
BC3Z9D280B
Ford..... 2019 - 2011

FIR3
Diesel Fuel Injector Rail
12620532
Chevrolet..... 2016 - 2010
GMC..... 2016 - 2010

FIR4
Diesel Fuel Injector Rail
12651989
Chevrolet..... 2016 - 2010
GMC..... 2016 - 2010

FIR5
Diesel Fuel Injector Rail
68005440AA
Dodge..... 2010 - 2007
Ram..... 2012 - 2011

FIR6
Diesel Fuel Injector Rail
68210146AA
Ram..... 2018 - 2013

FIR7
Diesel Fuel Injector Rail
5086869AB; 5086869AA
Dodge..... 2009 - 2003

FIR9
Diesel Fuel Injector Rail
CK5Z9D280B
Ford..... 2019 - 2018

FIT1
Fuel Injection Tool
Ford..... 2007 - 2003

FIT2
Diesel Injector Retaining Bracket Socket
Ford..... 2007 - 2003

FJ171
Fuel Injector - New
14059057; NA52X
Fuel Injector Type: Direct Injection
System Type: Direct
Terminal Quantity: N/A
Chevrolet..... 1991 - 1983
GMC..... 1993 - 1983

FJ172
Fuel Injector - New
14045021; NA50X
Fuel Injector Type: Direct Injection
Notes: N/A
System Type: Direct
Terminal Quantity: N/A
Chevrolet..... 1982
GMC..... 1982

FJ173
Fuel Injector - New
10183974; 5743223; 05743223;
12458122; 10233973; NA56X
Fuel Injector Type: Direct Injection
System Type: Direct
Terminal Quantity: N/A
AM General..... 2001 - 1996
Chevrolet..... 2002 - 1991
GMC..... 2002 - 1992
Hummer..... 2004 - 2002

FJ174
Fuel Injector - New
10233972; 5743795; 15661825;
12458121; NA55X
Fuel Injector Type: Direct Injection
Notes: N/A
System Type: Direct
Terminal Quantity: N/A
AM General..... 1998 - 1992
Chevrolet..... 1999 - 1991
GMC..... 1999 - 1992

FJ251
Fuel Injector - Remanufactured
NA51X; 0430211054; 0432217092;
14063606
Fuel Injector Type: Direct Injection
System Type: Direct
Terminal Quantity: N/A
Chevrolet..... 1991 - 1982
GMC..... 1993 - 1982

FJ252
Fuel Injector - Remanufactured
NA70X; R4761596; 4761596
Fuel Injector Type: Direct Injection
System Type: Direct
Terminal Quantity: N/A
Dodge..... 1995 - 1994



FJ253
Fuel Injector - New
NA73X; R4720540; R4429238;
4720540; 4429238
Fuel Injector Type: Direct Injection
System Type: Direct
Terminal Quantity: N/A
Dodge 1991 - 1989



FJ254
Fuel Injector - Remanufactured
NA74X; 4864328
Fuel Injector Type: Direct Injection
System Type: Direct
Terminal Quantity: N/A
Dodge 1998 - 1996



FJ255
Fuel Injector - Remanufactured
NA71X; R4761595; 4761595;
R4761365; 4761365
Fuel Injector Type: CIS Injection
System Type: CIS
Terminal Quantity: N/A
Dodge 1998 - 1994



FJ256
Fuel Injector - New
NA72X; R4638651; 4638651
Fuel Injector Type: Direct Injection
Notes: N/A
System Type: Direct
Terminal Quantity: N/A
Dodge 1993 - 1991



FJ258
Fuel Injector - New
2C3Z9VE527ERM;
2C3Z9VE527FRM; E8TZ9E527A
Fuel Injector Type: Direct Injection
Notes: N/A
System Type: Direct
Terminal Quantity: N/A
Ford 1992 - 1983



FJ330
Fuel Injector - New
4882120
Fuel Injector Type: Direct Injection
Notes: N/A
System Type: Direct
Terminal Quantity: N/A
Dodge 1998 - 1996



FJ489
Fuel Injector - Remanufactured
97303657; 97780144
Fuel Injector Type: Direct Injection
Hardware Included: N/A
Notes: N/A
System Type: Direct
Terminal Quantity: 2
Chevrolet 2005 - 2004
GMC 2005 - 2004



FJ495
Fuel Injector - Remanufactured
97720661; 97208074; 97720604;
97729095
Fuel Injector Type: Direct Injection
Hardware Included: N/A
System Type: Direct
Terminal Quantity: 2
Chevrolet 2004 - 2001
GMC 2004 - 2001



FJ593
Fuel Injector - New
1816605C91; 2C3Z9VE527DRM;
F2TZ9D527A; F2TZ9E527A
Fuel Injector Type: Direct Injection
Hardware Included: No
Notes: N/A
O-Rings Included: Yes
System Type: Direct
Terminal Quantity: N/A
Ford 1997 - 1992



FJ595
Fuel Injector - Remanufactured
991931C94; 1822801C92;
1822801C91; 1822801C91;
1822800C95; 1821836C3;
1821836C1; 1821752C1;
1818259C2; 1816187C3;
F4TZ9E527A; F7TZ9E527AA;
F7TZ9E527ARM; F81Z9E527DRM;
1822801C99; F4TZ9VE527AARM
Fuel Injector Type: Direct Injection
Hardware Included: Yes
O-Rings Included: Yes
System Type: Direct
Terminal Quantity: 2
Ford 1998 - 1994
International 1996 - 1994



FJ595NX
Fuel Injector - New
F81Z9E527DRMNX;
F4TZ9VE527AA
Fuel Injector Type: Direct Injection
Hardware Included: No
Notes: Zinc Coated to Prevent Corrosion
O-Rings Included: Yes
System Type: Direct
Terminal Quantity: 2
Ford 1998 - 1994
International 1996 - 1994



FJ596
Fuel Injector - Remanufactured
991931C94; 1825126C1;
1825125C1; 1824583C91;
1824582C94; 1823757RX91;
1823757C91; 1823561C1;
1822803C1; F7TZ9E527BA;
F7TZ9E527BRM; F81Z9E527ARM;
F81Z9E527BRM; F61Z9VE527BRM;
F6TZ9E527A; 1824583C97
Fuel Injector Type: Direct Injection
Hardware Included: Yes
Notes: N/A
O-Rings Included: Yes
System Type: Direct
Terminal Quantity: 2
Ford 1999 - 1995
International 1999 - 1997



FJ596NX
Fuel Injector - New
F81Z9E527BRMNX; F61Z9VE527B
Fuel Injector Type: Direct Injection
Hardware Included: No
Notes: Zinc Coated to Prevent Corrosion
O-Rings Included: Yes
System Type: Direct
Terminal Quantity: 2
Ford 1999 - 1995
International 1999 - 1997



FJ607
Fuel Injector - New
4856671
Fuel Injector Type: Direct Injection
System Type: Direct
Terminal Quantity: N/A
Dodge 1998 - 1994



FJ619
Fuel Injector - Remanufactured
0020172021; 002017202188;
10170121; 0010170121
Fuel Injector Type: Direct Injection
Notes: N/A
System Type: Direct
Terminal Quantity: N/A
Mercedes-Benz 1985 - 1980



FJ622
Fuel Injector - Remanufactured
068133201B; 068133201B;
068130201B
Fuel Injector Type: Direct Injection
System Type: Direct
Terminal Quantity: N/A
Audi 1983 - 1982
Volkswagen 1985 - 1982



FJ623
Fuel Injector - Remanufactured
068130201E; 068130201EX
Fuel Injector Type: Direct Injection
Notes: N/A
System Type: Direct
Terminal Quantity: N/A
Volkswagen 1985 - 1982



FJ642
Fuel Injector - New
5013847AA; 5011038AA
Fuel Injector Type: Direct Injection
System Type: Direct
Terminal Quantity: N/A
Dodge 2002 - 1998



FJ643
Fuel Injector - New
5013848AA
Fuel Injector Type: Direct Injection
System Type: Direct
Terminal Quantity: N/A
Dodge 2002 - 1998



FJ738
Fuel Injector - Remanufactured
5010149R91; 501008R92;
1831551C1; 1831550C1;
1831489C1; 1831488C1;
1831487C92; 1823751RX91;
1823751C91; 5C3Z9VE527BRM;
F81Z9E527CRM; 1831487C93
Fuel Injector Type: Direct Injection
Hardware Included: N/A
Notes: N/A
O-Rings Included: Yes
System Type: Direct
Terminal Quantity: 2
Ford 2003 - 1999
IC Corporation 2004 - 2002
International 2005 - 1999



FJ738NX
Fuel Injector - New
5C3Z9VE527BRMNX;
5C3Z9VE527B
Fuel Injector Type: Direct Injection
Hardware Included: No
Notes: Zinc Coated to Prevent Corrosion
O-Rings Included: Yes
System Type: Direct
Terminal Quantity: 2
Ford 2003 - 1999
IC Corporation 2004 - 2002
International 2005 - 1999



FJ842
Fuel Injector - Remanufactured
0020172821
Fuel Injector Type: Direct Injection
Notes: N/A
System Type: Direct
Terminal Quantity: N/A
Mercedes-Benz 1987 - 1986



FJ908
Fuel Injector - Remanufactured
028130202PX; 028130202P
Fuel Injector Type: Direct Injection
Notes: N/A
System Type: Direct
Terminal Quantity: N/A
Volkswagen 2005 - 1998



FJ909
Fuel Injector - Remanufactured
028130202JX; 028130202J
Fuel Injector Type: Direct Injection
Notes: N/A
System Type: Direct
Terminal Quantity: N/A
Volkswagen 2004 - 1998



FJ912
Fuel Injector - Remanufactured
028130202QX; 028130202Q
Fuel Injector Type: Direct Injection
Notes: N/A
System Type: Direct
Terminal Quantity: 2
Volkswagen 2004 - 1998



FJ918
Fuel Injector - Remanufactured
0030172921; 3017292188;
003017292188
Fuel Injector Type: Direct Injection
Notes: N/A
System Type: Direct
Terminal Quantity: N/A
Mercedes-Benz 1995 - 1987



FJ921
Fuel Injector - Remanufactured
68001712AA; R5135154AB;
445110182; 5140772AA;
5135154AB; 5135154AA;
5103575AA
Fuel Injector Type: Direct Injection
Notes: N/A
System Type: Direct
Terminal Quantity: 2
Dodge 2003
Freightliner 2003 - 2002



FJ922
Fuel Injector - Remanufactured
5137297AB; R5137297AB;
68001837AA; 5137297AA
Fuel Injector Type: Direct Injection
Notes: N/A
O-Rings Included: Yes
System Type: Direct
Terminal Quantity: 2
Dodge 2006 - 2004
Freightliner 2006 - 2004



FJ923
Fuel Injector - Remanufactured
002017372188; 002017372160;
002017372180; 0020173721
Fuel Injector Type: Direct Injection
Notes: N/A
System Type: Direct
Terminal Quantity: N/A
Mercedes-Benz 1988 - 1986



FJ926
Fuel Injector - Remanufactured
5010148R91; 5010052R91;
5010051R92; 1833647C91;
1833646C92; 1833645C1;
1833644C1; 1833640C1;
1833639C1; XC3Z9E527AARM;
5C3Z9VE527ARM;
F61Z9VE527ERM;
F81Z9E527EARM
Fuel Injector Type: Direct Injection
Hardware Included: N/A
Notes: N/A
O-Rings Included: Yes
System Type: Direct
Terminal Quantity: 2
Ford 2003 - 1999
IC Corporation 2004 - 2002
International 2005 - 1999



FJ926NX
Fuel Injector - New
5C3Z9VE527ARMNX;
5C3Z9VE527A
Fuel Injector Type: Direct Injection
Hardware Included: No

Notes: Zinc Coated to Prevent Corrosion
 O-Rings Included: Yes
 System Type: Direct
 Terminal Quantity: 2
 Ford 2003 - 1999
 IC Corporation 2004 - 2002
 International 2005 - 1999



FJ927
 Fuel Injector - Remanufactured

3C3Z9E527EARM;
 3C3Z9E527ABRM; 5010117R91;
 1878282C91; 1845879C91;
 1843481C95; 1843481C94;
 1843089C91; 3C3Z9E527ECRM;
 3C3Z9E527AE; 3C3Z9E527EBRM

Fuel Injector Type: Direct Injection
 Hardware Included: N/A
 Notes: N/A
 O-Rings Included: Yes
 System Type: Direct
 Terminal Quantity: 4
 Ford 2004 - 2003
 International 2003 - 2002



FJ927NX
 Fuel Injector - New

3C3Z9E527AEND; 6901PP
 Fuel Injector Type: Direct Injection
 Hardware Included: N/A
 Notes: N/A
 O-Rings Included: Yes
 System Type: Direct
 Terminal Quantity: 4
 Ford 2004 - 2003
 International 2003 - 2002



FJ928
 Fuel Injector - Remanufactured

5010120R92; 1879998C91;
 1877748C1; 1846692C92;
 1845150C92; 1844751C2;
 1878285C91; 5C4Z9E527A;
 4C3Z9E527AA; 4C3Z9E527BRM;
 CN5019RM
 Fuel Injector Type: Direct Injection
 Hardware Included: N/A
 Notes: N/A

O-Rings Included: Yes
 System Type: Direct
 Terminal Quantity: 4
 Ford 2010 - 2004
 IC Corporation 2008 - 2005
 International 2012 - 2004
 Workhorse 2009 - 2005
 Workhorse Custom
 Chassis 2009 - 2006



FJ928NX
 Fuel Injector - New

4C3Z9E527AAND; 6902PP
 Fuel Injector Type: Direct Injection
 Hardware Included: N/A
 Notes: N/A
 O-Rings Included: Yes
 System Type: Direct
 Terminal Quantity: 4
 Ford 2010 - 2004
 IC Corporation 2008 - 2005
 International 2012 - 2004
 Workhorse 2009 - 2005
 Workhorse Custom
 Chassis 2009 - 2006



FJ932
 Fuel Injector - Remanufactured

X0986435503; 986435503;
 8004082AB; 5254688RX;
 5086894AA; R5086894AA;
 68004082AA; R8004082AC;
 R8004082AB; R8004082AA
 Fuel Injector Type: Direct Injection
 Notes: w/ 8 Hole Injector Nozzle
 System Type: Direct
 Terminal Quantity: 2
 Dodge 2004 - 2002



FJ933
 Fuel Injector - Remanufactured

X0986435505; R5135790AE;
 R5135790AD; R5135790AC;
 5254688RX; 5135790AF;
 5135790AE; 5135790AD;
 5135790AC; 5135790AA;
 R5135790AF
 Fuel Injector Type: Direct Injection
 Notes: w/ 5 Hole Injector Nozzle
 System Type: Direct
 Terminal Quantity: 2
 Dodge 2009 - 2004



FJ935
 Fuel Injector - New

028130202HX; 028130202H
 Fuel Injector Type: Direct Injection
 Hardware Included: N/A
 Notes: N/A
 O-Rings Included: Yes
 System Type: Direct
 Terminal Quantity: 2
 Volkswagen 2004 - 1998



FJ960
 Fuel Injector - Remanufactured

8C3Z9E527DRM; 5010666R91;
 4307369R91; 4307381R91;
 5010359R93; 8C3Z9E527A
 Fuel Injector Type: Direct Injection
 Hardware Included: N/A
 Notes: N/A
 O-Rings Included: Yes
 System Type: Direct
 Terminal Quantity: 2
 Ford 2010 - 2008
 IC Corporation 2010 - 2008
 International 2010 - 2008



FJ960NX
 Fuel Injector - New

8C3Z9E527AND; 8C3Z9E527B;
 1875702C91; 1873422C93; 6903PP
 Fuel Injector Type: Direct Injection
 Hardware Included: N/A
 Notes: N/A
 O-Rings Included: Yes
 System Type: Direct
 Terminal Quantity: 2
 Ford 2010 - 2008
 IC Corporation 2010 - 2008
 International 2010 - 2008



FJ961
 Fuel Injector - Remanufactured

98002368; 97780360
 Fuel Injector Type: Direct Injection
 Hardware Included: N/A
 Notes: Includes O-Ring
 O-Rings Included: Yes
 System Type: Direct
 Terminal Quantity: 2
 Chevrolet 2010 - 2007
 GMC 2010 - 2007



FJ962
 Fuel Injector - Remanufactured

97361355; 97780358; 5745888;
 05745888
 Fuel Injector Type: Direct Injection
 Hardware Included: N/A
 Notes: N/A
 System Type: Direct
 Terminal Quantity: 2
 Chevrolet 2007 - 2006
 GMC 2007 - 2006
 Hummer 2006



FJ976
 Fuel Injector - New

5018177AA
 Fuel Injector Type: Direct Injection
 Notes: N/A
 System Type: Direct
 Terminal Quantity: N/A
 Dodge 2002 - 2001



FJ1009
Fuel Injector - Remanufactured
 R8069384AB; X0986435518; R8069384AA; 986435518; 8069384AA; 5253220NX; 68069384AA; 68027067AB; 68027067AA; R8027067AA

Fuel Injector Type: Direct Injection
 Hardware Included: N/A
 Notes: N/A
 O-Rings Included: Yes
 System Type: Direct
 Terminal Quantity: 2

Dodge 2010 - 2007
 Ram 2012 - 2011



FJ1010
Fuel Injector - Remanufactured
 RL002012AC; RL002012AB; 68002012AC; 68002012AB; 68002012AA

Fuel Injector Type: Direct Injection
 Hardware Included: N/A
 Notes: N/A
 O-Rings Included: Yes
 System Type: Direct
 Terminal Quantity: 2

Dodge 2010 - 2007



FJ1168
Fuel Injector - New
 03L130277A

Fuel Injector Type: Direct Injection
 Hardware Included: No
 Notes: N/A
 O-Rings Included: Yes
 System Type: Direct
 Terminal Quantity: 2

Audi 2013 - 2010
 Volkswagen 2015 - 2009



FJ1173
Fuel Injector - New
 059130277EM; 059130277CP

Fuel Injector Type: Direct Injection
 Hardware Included: No
 Notes: N/A
 O-Rings Included: Yes
 System Type: Direct
 Terminal Quantity: 2

Audi 2016 - 2013



FJ1174
Fuel Injector - New
 057130277AH; 059130277AM

Fuel Injector Type: Direct Injection
 Hardware Included: No
 Notes: N/A
 O-Rings Included: Yes
 System Type: Direct
 Terminal Quantity: 2

Audi 2012 - 2009
 Volkswagen 2012 - 2009



FJ1216
Fuel Injector - New
 55585712

Fuel Injector Type: Direct Injection
 Hardware Included: No
 Notes: N/A
 O-Rings Included: Yes
 System Type: Direct
 Terminal Quantity: 2

Chevrolet 2015 - 2014



FJ1217
Fuel Injector - New
 12684125; 12710481; 12698484; 12687650 ; 12668649; 12672368; 12656932; 12661028

Fuel Injector Type: GDI Injector
 Hardware Included: Yes
 Notes: Includes O-Ring
 O-Rings Included: Yes
 System Type: Direct
 Terminal Quantity: 2

Chevrolet 2019
 GMC 2019



FJ1221
Fuel Injector - New
 BC3Z9H529B; BC3Z9H529D

Fuel Injector Type: Direct Injection
 Hardware Included: Yes
 Notes: N/A
 O-Rings Included: Yes
 System Type: Direct
 Terminal Quantity: 2

Ford 2016 - 2011



FJ1222
Fuel Injector - New
 BC3Z9H529A

Fuel Injector Type: Direct Injection
 Hardware Included: Yes
 Notes: N/A
 O-Rings Included: Yes
 System Type: Direct
 Terminal Quantity: 2

Ford 2016 - 2011



FJ1223
Fuel Injector - New
 FC3Z9H529B

Fuel Injector Type: Direct Injection
 Hardware Included: Yes
 Notes: N/A
 O-Rings Included: Yes
 System Type: Direct
 Terminal Quantity: 2

Ford 2019 - 2014



FJ1224
Fuel Injector - Remanufactured
 FC3Z9H529F; FC3Z9H529C; FC3Z9H529A

Fuel Injector Type: Direct Injection
 Hardware Included: Yes
 Notes: N/A
 O-Rings Included: Yes
 System Type: Direct
 Terminal Quantity: 2

Ford 2019 - 2014



FJ1225NX
Fuel Injector - New
 CK4Z9E527AND

Fuel Injector Type: Direct Injection
 Hardware Included: No
 Notes: Zinc Coated to Prevent Corrosion
 O-Rings Included: Yes
 System Type: Direct
 Terminal Quantity: 2

Ford 2017 - 2015



FJ1226
Fuel Injector - Remanufactured
 19256590

Fuel Injector Type: Direct Injection
 Hardware Included: N/A
 Notes: N/A
 O-Rings Included: Yes
 System Type: Direct
 Terminal Quantity: 2

Chevrolet 2016 - 2011
 GMC 2016 - 2011



FJ1227
Fuel Injector - Remanufactured
 19210900

Fuel Injector Type: Direct Injection
 Hardware Included: N/A
 Notes: N/A
 System Type: Direct
 Terminal Quantity: 2

Chevrolet 2016 - 2010
 GMC 2016 - 2010



FJ1229
Fuel Injector - Remanufactured
 0986435574; 4994928; 68086182AA

Fuel Injector Type: Direct Injection
 Hardware Included: No
 Notes: N/A
 O-Rings Included: Yes
 System Type: Direct
 Terminal Quantity: 2

Ram 2012 - 2011



FJ1230
Fuel Injector - Remanufactured
68210512AA; 0986435573; 5256034
Fuel Injector Type: Direct Injection
Hardware Included: No
Notes: N/A
O-Rings Included: Yes
System Type: Direct
Terminal Quantity: 2
Ram..... 2018 - 2013



FJ1232
Fuel Injector - New
F3TZ9E527B; F3TZ9E527A
Fuel Injector Type: Direct Injection
Hardware Included: No
Notes: Zinc Coated to Prevent Corrosion
O-Rings Included: Yes
System Type: Direct
Terminal Quantity: N/A
Ford..... 1997 - 1993



FJ1239
Fuel Injector - Remanufactured
1842579C94; 1842579C95;
1842579C93; 1842579C92;
1842579C91; 5010659R92;
1842226C91
Fuel Injector Type: Direct Injection
Hardware Included: N/A
Notes: N/A
O-Rings Included: Yes
System Type: Direct
Terminal Quantity: 4
International..... 2005 - 2004



FJ1240
Fuel Injector - Remanufactured
5010656R92; 5010656R91;
1841491C91; 1842223C91
Fuel Injector Type: Direct Injection
Hardware Included: No
Notes: N/A
O-Rings Included: Yes
System Type: Direct
Terminal Quantity: 4
IC Corporation 2004

International..... 2004



FJ1240NX
Fuel Injector - New
1842576C93
Fuel Injector Type: Direct Injection
Hardware Included: N/A
Notes: N/A
O-Rings Included: Yes
System Type: Direct
Terminal Quantity: 4
IC Corporation 2004
International..... 2004



FJ1241
Fuel Injector - Remanufactured
5010658R91; 5010658R92;
1842225C91
Fuel Injector Type: Direct Injection
Hardware Included: No
Notes: Zinc Coated to Prevent Corrosion
O-Rings Included: Yes
System Type: Direct
Terminal Quantity: 4
International..... 2005 - 2004



FJ1242
Fuel Injector - Remanufactured
5010657R91; 1842577C94;
1842577C92; 1842577C91;
5010657R92; 1842224C91
Fuel Injector Type: Direct Injection
Hardware Included: N/A
Notes: N/A
O-Rings Included: Yes
System Type: N/A
Terminal Quantity: 4
IC Corporation 2005 - 2004
International..... 2005 - 2004



FJ1243
Fuel Injector - Remanufactured
1848718C93; 1848718C91;
5010561R93; 5010561R91
Fuel Injector Type: Direct Injection
Hardware Included: No
Notes: Zinc Coated to Prevent Corrosion
O-Rings Included: Yes
System Type: Direct
Terminal Quantity: 4
IC Corporation 2010 - 2007
International..... 2013 - 2007



FJ1243NX
Fuel Injector - New
1848718C92; 5010561R91ND
Fuel Injector Type: Direct Injection
Hardware Included: N/A
Notes: N/A
O-Rings Included: Yes
System Type: Direct
Terminal Quantity: 4
IC Corporation 2010 - 2007
International..... 2013 - 2007



FJ1244
Fuel Injector - Remanufactured
1848721C94; 184721C93;
1848721C91; 4307212R91
Fuel Injector Type: Direct Injection
Hardware Included: N/A
Notes: N/A
O-Rings Included: Yes
System Type: Direct
Terminal Quantity: 4
International..... 2009 - 2007



FJ1256
Fuel Injector - Remanufactured
5010985R91; 1848495C92; 6928PP;
1848495C91
Fuel Injector Type: Direct Injection

Hardware Included: N/A
Notes: N/A
O-Rings Included: Yes
System Type: Direct
Terminal Quantity: 4
International..... 2006



FJ1256NX
Fuel Injector - New
1848495C91
Fuel Injector Type: Direct Injection
Hardware Included: N/A
Notes: N/A
O-Rings Included: Yes
System Type: Direct
Terminal Quantity: 4
International..... 2006



FJ1257
Fuel Injector - Remanufactured
6926PP; 1848489C91
Fuel Injector Type: Direct Injection
Hardware Included: N/A
Notes: N/A
O-Rings Included: Yes
System Type: Direct
Terminal Quantity: 4
IC Corporation 2006
International..... 2006



FJ1258
Fuel Injector - Remanufactured
1848492C92; 6927PP; 1848492C91
Fuel Injector Type: Direct Injection
Hardware Included: N/A
Notes: N/A
O-Rings Included: Yes
System Type: Direct
Terminal Quantity: 4
International..... 2007 - 2006



FJ1258NX
Fuel Injector - New
1848492C91

Fuel Injector Type: Direct Injection
Hardware Included: N/A
Notes: N/A
O-Rings Included: Yes
System Type: Direct
Terminal Quantity: 4

International..... 2007 - 2006



FJ1259
Fuel Injector - Remanufactured
1899239C92; 1883110C1; 1883111C92

Fuel Injector Type: Direct Injection
Hardware Included: N/A
Notes: N/A
O-Rings Included: Yes
System Type: Direct
Terminal Quantity: 2

IC Corporation 2015 - 2010
International..... 2015 - 2010



FJ1260
Fuel Injector - New
059130277CD

Fuel Injector Type: Direct Injection
Hardware Included: No
Notes: Zinc Coated to Prevent Corrosion
O-Rings Included: Yes
System Type: Direct
Terminal Quantity: 2

Audi 2015 - 2014
Volkswagen 2016 - 2013



FJ1261
Fuel Injector - New
03L130277N; 03L130277R

Fuel Injector Type: Direct Injection
Hardware Included: No
Notes: Zinc Coated to Prevent Corrosion
System Type: Direct
Terminal Quantity: 2

Volkswagen 2014 - 2013



FJ1262
Fuel Injector - Remanufactured
1836253C1R

Fuel Injector Type: Direct Injection
Hardware Included: N/A
Notes: N/A
O-Rings Included: Yes
System Type: Direct
Terminal Quantity: 2

International..... 2001 - 2000



FJ1262NX
Fuel Injector - New
1836253C1NX; 1836252C91

Fuel Injector Type: Direct Injection
Hardware Included: N/A
Notes: Zinc Coated to Prevent Corrosion
O-Rings Included: Yes
System Type: Direct
Terminal Quantity: 2

International..... 2002 - 2000



FJ1268
Fuel Injector - New
642070138780; RX028405AA; RX067496AA; 68028405AA; 6420701387; 642070138764; RL028405AA; RL067496AA; 68067496AA; 5175827AB; 5175827AA

Fuel Injector Type: Direct Injection
Hardware Included: No
Notes: Zinc Coated to Prevent Corrosion
O-Rings Included: Yes
System Type: Direct
Terminal Quantity: 2

Jeep 2009 - 2007
Mercedes-Benz 2011 - 2007



FJ1269
Fuel Injector - Remanufactured
68211302AA

Fuel Injector Type: Direct Injection
Hardware Included: No
Notes: Zinc Coated to Prevent Corrosion
O-Rings Included: Yes
System Type: Direct
Terminal Quantity: 2

Jeep 2019 - 2014
Ram 2020 - 2014



FJ1277
Fuel Injector - Remanufactured
5010715R91

Fuel Injector Type: Direct Injection
Hardware Included: N/A
Notes: Product May Differ in Appearance and Finish, but Fit and Function Remain the Same
O-Rings Included: Yes
System Type: Direct
Terminal Quantity: 4

IC Corporation 2014 - 2011
International..... 2012 - 2011



FJ1278
Fuel Injector - Remanufactured
5010717R91

Fuel Injector Type: Direct Injection
Hardware Included: N/A
Notes: N/A
O-Rings Included: Yes
System Type: Direct
Terminal Quantity: 4

International..... 2015



FJ1279
Fuel Injector - Remanufactured
6931PP

Fuel Injector Type: Direct Injection
Hardware Included: N/A
Notes: Product May Differ in Appearance and Finish, but Fit and Function Remain the Same
O-Rings Included: Yes
System Type: Direct
Terminal Quantity: 4

IC Corporation 2015 - 2011
International..... 2012 - 2011



FJ1289
Fuel Injector - Remanufactured
651070498780

Fuel Injector Type: Diesel Injector
Hardware Included: N/A
Notes: N/A
O-Rings Included: Yes
System Type: Direct
Terminal Quantity: 2

Freightliner 2016 - 2014
Mercedes-Benz 2017 - 2013



FJ1290
Fuel Injector - Remanufactured
642070128780; A642070128780; 642070128787; 6420701287

Fuel Injector Type: Diesel Injector
Hardware Included: N/A
Notes: N/A
O-Rings Included: Yes
System Type: Direct
Terminal Quantity: 2

Freightliner 2016 - 2010
Mercedes-Benz 2019 - 2010



FJ1292NX
Fuel Injector - New
6420701187

Fuel Injector Type: Diesel Injector
Hardware Included: N/A
Notes: N/A
O-Rings Included: Yes
System Type: Direct
Terminal Quantity: 2

Mercedes-Benz 2016 - 2012



FJ1300
Fuel Injector - Remanufactured
1824472C1

Fuel Injector Type: Direct Injection
Hardware Included: N/A
Notes: Zinc Coated to Prevent Corrosion
O-Rings Included: Yes
System Type: Direct
Terminal Quantity: 2

International..... 1996 - 1994



FJ1300NX
Fuel Injector - New
 1824456C93; 1824473C2
 Fuel Injector Type: Direct Injection
 Hardware Included: N/A
 Notes: Zinc Coated to Prevent Corrosion
 O-Rings Included: Yes
 System Type: Direct
 Terminal Quantity: 2
 International..... 1996 - 1994



FJ1301
Fuel Injector - Remanufactured
 1824917C3
 Fuel Injector Type: Direct Injection
 Hardware Included: N/A
 Notes: Zinc Coated to Prevent Corrosion
 O-Rings Included: Yes
 System Type: Direct
 Terminal Quantity: 2
 International..... 1997 - 1995



FJ1301NX
Fuel Injector - New
 2593588C91NX; 1824917C2
 Fuel Injector Type: Direct Injection
 Hardware Included: N/A
 Notes: N/A
 O-Rings Included: Yes
 System Type: Direct
 Terminal Quantity: 2
 International..... 1997 - 1995



FJ1302
Fuel Injector - Remanufactured
 1824918C4
 Fuel Injector Type: Direct Injection
 Hardware Included: N/A
 Notes: Zinc Coated to Prevent Corrosion
 O-Rings Included: Yes
 System Type: Direct
 Terminal Quantity: 2



FJ1302NX
Fuel Injector - New
 2593589C91NX; 1824918C2
 Fuel Injector Type: Direct Injection
 Hardware Included: N/A
 Notes: Zinc Coated to Prevent Corrosion
 O-Rings Included: Yes
 System Type: Direct
 Terminal Quantity: 2
 International..... 1997 - 1995



FJ1303
Fuel Injector - Remanufactured
 1824919C4
 Fuel Injector Type: Direct Injection
 Hardware Included: N/A
 Notes: Zinc Coated to Prevent Corrosion
 O-Rings Included: Yes
 System Type: Direct
 Terminal Quantity: 2
 International..... 1997 - 1995



FJ1303NX
Fuel Injector - New
 2593590C91NX; 1824919C2
 Fuel Injector Type: Direct Injection
 Hardware Included: N/A
 Notes: N/A
 O-Rings Included: Yes
 System Type: Direct
 Terminal Quantity: 2
 International..... 1997 - 1995



FJ1304
Fuel Injector - Remanufactured
 1824920C3
 Fuel Injector Type: Direct Injection
 Hardware Included: N/A
 Notes: Zinc Coated to Prevent Corrosion
 O-Rings Included: Yes

System Type: Direct
 Terminal Quantity: 2
 International..... 1997 - 1995



FJ1304NX
Fuel Injector - New
 2593591C91NX; 1824920C2
 Fuel Injector Type: Direct Injection
 Hardware Included: N/A
 Notes: Zinc Coated to Prevent Corrosion
 O-Rings Included: Yes
 System Type: Direct
 Terminal Quantity: 2
 International..... 1997 - 1995



FJ1305
Fuel Injector - Remanufactured
 1829837C4
 Fuel Injector Type: Direct Injection
 Hardware Included: N/A
 Notes: Zinc Coated to Prevent Corrosion
 O-Rings Included: Yes
 System Type: Direct
 Terminal Quantity: 2
 International..... 1999 - 1997



FJ1305NX
Fuel Injector - New
 2593592C91NX; 1829837C2
 Fuel Injector Type: Direct Injection
 Hardware Included: N/A
 Notes: Zinc Coated to Prevent Corrosion
 O-Rings Included: Yes
 System Type: Direct
 Terminal Quantity: 2
 International..... 1999 - 1997



FJ1306
Fuel Injector - Remanufactured
 1830148C3
 Fuel Injector Type: Direct Injection
 Hardware Included: N/A

Notes: Zinc Coated to Prevent Corrosion
 O-Rings Included: Yes
 System Type: Direct
 Terminal Quantity: 2
 International..... 1999 - 1998



FJ1306NX
Fuel Injector - New
 2593593C91NX; 1830147C2
 Fuel Injector Type: Direct Injection
 Hardware Included: N/A
 Notes: Zinc Coated to Prevent Corrosion
 O-Rings Included: Yes
 System Type: Direct
 Terminal Quantity: 2
 International..... 1999 - 1998



FJ1307
Fuel Injector - Remanufactured
 2593594C92; 18305624C4
 Fuel Injector Type: Direct Injection
 Hardware Included: N/A
 Notes: Zinc Coated to Prevent Corrosion
 O-Rings Included: Yes
 System Type: Direct
 Terminal Quantity: 2

IC Corporation 2003 - 2002
 International..... 2003 - 1999



FJ1307NX
Fuel Injector - New
 2593595C91NX; 1830562C2
 Fuel Injector Type: Direct Injection
 Hardware Included: N/A
 Notes: Zinc Coated to Prevent Corrosion
 O-Rings Included: Yes
 System Type: Direct
 Terminal Quantity: 2
 IC Corporation 2003 - 2002
 International..... 2003 - 1999



FJ1308
Fuel Injector - Remanufactured
1830573C3

Fuel Injector Type: Direct Injection
Hardware Included: N/A
Notes: Zinc Coated to Prevent Corrosion
O-Rings Included: Yes
System Type: Direct
Terminal Quantity: 2

International..... 1999 - 1997



FJ1308NX
Fuel Injector - New
2593596C91NX; 1830571C2

Fuel Injector Type: Direct Injection
Hardware Included: N/A
Notes: Zinc Coated to Prevent Corrosion
O-Rings Included: Yes
System Type: Direct
Terminal Quantity: 2

International..... 1999 - 1997



FJ1309
Fuel Injector - Remanufactured
1830693C3

Fuel Injector Type: Direct Injection
Hardware Included: N/A
Notes: Zinc Coated to Prevent Corrosion
O-Rings Included: Yes
System Type: Direct
Terminal Quantity: 2

International..... 2005 - 2000



FJ1309NX
Fuel Injector - New
2593597C91NX; 1830693C1

Fuel Injector Type: Direct Injection
Hardware Included: N/A
Notes: Zinc Coated to Prevent Corrosion
O-Rings Included: Yes
System Type: Direct

Terminal Quantity: 2

International..... 2005 - 2000



FJ1310
Fuel Injector - Remanufactured
RL210105AA

Fuel Injector Type: Direct Injection
Hardware Included: N/A
Notes: N/A
O-Rings Included: Yes
System Type: Direct
Terminal Quantity: 2

Ram..... 2016 - 2013



FJ1310NX
Fuel Injector - New
68210105AA

Fuel Injector Type: Direct Injection
Hardware Included: N/A
Notes: N/A
O-Rings Included: Yes
System Type: Direct
Terminal Quantity: 2

Ram..... 2018 - 2013



FJ1348
Fuel Injector - Remanufactured
RL028404AA

Fuel Injector Type: Diesel Injector
Hardware Included: Yes
Notes: N/A
O-Rings Included: N/A
System Type: Direct
Terminal Quantity: 2

Dodge..... 2009 - 2007
Freightliner..... 2009 - 2007



FJ1378
Fuel Injector - New
12661071

Fuel Injector Type: Diesel Injector
Hardware Included: N/A
Notes: N/A
O-Rings Included: N/A
System Type: N/A
Terminal Quantity: 2

Chevrolet..... 2016 - 2010
GMC..... 2016 - 2010



FJ1379
Fuel Injector - New
12641278

Fuel Injector Type: Diesel Injector
Hardware Included: N/A
Notes: N/A
O-Rings Included: N/A
System Type: N/A
Terminal Quantity: 2

Chevrolet..... 2019 - 2017
GMC..... 2019 - 2017



FJ1381NX
Fuel Injector - New
55594509

Fuel Injector Type: Diesel Injection
Hardware Included: N/A
O-Rings Included: N/A
System Type: Direct
Terminal Quantity: 2

Chevrolet..... 2019 - 2016
GMC..... 2019 - 2016



FJ1382NX
Fuel Injector - New
55596708

Fuel Injector Type: Diesel Injection
Hardware Included: N/A
System Type: Direct
Terminal Quantity: 2

Chevrolet..... 2019 - 2017
GMC..... 2019 - 2018



FJ4958PCK
Fuel Injector - Remanufactured
97729095KIT

Fuel Injector Type: Diesel Injector
Hardware Included: N/A
Notes: N/A
O-Rings Included: N/A

System Type: Direct
Terminal Quantity: 2

Chevrolet..... 2004 - 2001
GMC..... 2004 - 2001



FJ7388PCK
Fuel Injector - Remanufactured
5C3Z9VE527BRMKIT

Fuel Injector Type: Diesel Injector
Hardware Included: N/A
Notes: N/A
O-Rings Included: Yes
System Type: Direct
Terminal Quantity: 2

Ford..... 2003 - 1999
IC Corporation..... 2004 - 2002
International..... 2005 - 1999



FJ9278PCK
Fuel Injector - Remanufactured
3C3Z9E527ECRMKIT

Fuel Injector Type: Direct Injection
Hardware Included: N/A
Notes: N/A
O-Rings Included: Yes
System Type: Direct
Terminal Quantity: 4

Ford..... 2004 - 2003
International..... 2003 - 2002



FJ9288PCK
Fuel Injector - Remanufactured
4C3Z9E527BRMKIT

Fuel Injector Type: Direct Injection
Hardware Included: N/A
Notes: N/A
O-Rings Included: Yes
System Type: Direct
Terminal Quantity: 4

Ford..... 2010 - 2004
IC Corporation..... 2008 - 2005

International..... 2012 - 2004
 Workhorse..... 2009 - 2005
 Workhorse Custom
 Chassis..... 2009 - 2006



FLA1010
 Fog Lamp Switch
 5096300AA

Connector Gender: Male
 Connector Quantity: N/A
 Contents: Switch
 Functions: Fog Light Switch Only
 Terminal Gender: Male
 Terminal Quantity: 3
 Terminal Type: Blade

Dodge..... 2003 - 2000



FLA1027
 Fog Lamp Switch
 0065455207; 5103864AA

Connector Gender: Female
 Connector Quantity: 1
 Connector Shape: Rectangular
 Contents: 1 Switch
 Functions: Fog Light Switch Only
 Hardware Included: N/A
 Labeled: Yes
 Lever Included: No
 Lighted: No
 Multi Function Switch: No
 O.E.M. Replacement: Yes
 Switch Actuation Style: Push Up/Down
 Switch Mounting Type: Snap Fit
 Terminal Gender: Male
 Terminal Quantity: 4
 Terminal Type: Blade

Dodge..... 2006 - 2005
 Freightliner..... 2006 - 2005



FLS278
 Coolant Level Sensor
 2205450024

Connector Gender: Female
 Connector Quantity: 1
 Contents: N/A
 Terminal Gender: Male
 Terminal Quantity: 2
 Terminal Type: Pin

Mercedes-Benz..... 2006



FLS283
 Engine Oil Level Sensor
 94860615000

Connector Gender: Female
 Connector Quantity: 1
 Contents: N/A
 Terminal Gender: Male
 Terminal Quantity: 3
 Terminal Type: Blade

Volkswagen..... 2013 - 2004



FLS284
 Engine Oil Level Sensor
 94860616030; 94860614000

Connector Gender: Female
 Connector Quantity: 1
 Contents: N/A
 Terminal Gender: Male
 Terminal Quantity: 3
 Terminal Type: Blade

Audi..... 2013 - 2008
 Volkswagen..... 2013 - 2005



FLS309
 Coolant Level Sensor
 N9267001

Connector Gender: Female
 Connector Quantity: 1
 Contents: N/A
 Terminal Gender: Male
 Terminal Quantity: 3
 Terminal Type: Blade

Kenworth..... 2018 - 2008
 Peterbilt..... 2018 - 2008



FLS-1
 Coolant Level Sensor
 3055285

Connector Gender: Male
 Contents: N/A
 Terminal Gender: Male
 Terminal Quantity: 1
 Terminal Type: Blade

Chevrolet..... 1994 - 1992
 GMC..... 1994 - 1992



FLS-3
 Coolant Level Sensor
 358375; 82593

Connector Gender: Male
 Connector Quantity: 1
 Contents: N/A
 Terminal Gender: Male
 Terminal Quantity: 1
 Terminal Type: Bullet

Chevrolet..... 1991 - 1982
 GMC..... 1991 - 1983



FLS-12
 Brake Fluid Level Sensor
 21010590; 21010590; 18029973;
 18012741; 5140310AA; 4797655;
 4637625; 18029854

Connector Gender: Female
 Terminal Gender: Male
 Terminal Quantity: 2
 Terminal Type: Blade

Chevrolet..... 2007 - 2003



FLS-14
 Engine Oil Level Sensor
 12579985; 12579983; 12603782;
 24507190; 24501416; 22568381

Connector Gender: Female
 Contents: Sensor
 Terminal Gender: Male
 Terminal Quantity: 2
 Terminal Type: Pin

Hummer..... 2003



FLS-33
 Windshield Washer Level Sensor
 55077351AA

Connector Gender: Female
 Contents: N/A
 Terminal Gender: Male
 Terminal Quantity: 2
 Terminal Type: Blade

Dodge..... 2003



FLS-56
 Brake Fluid Level Sensor
 5013903AA

Connector Gender: Female
 Contents: 1 O-ring
 Terminal Gender: Male
 Terminal Quantity: 2
 Terminal Type: Blade

Jeep..... 2008 - 2007



FLS-61
Engine Oil Level Sensor
 97328879; 97370094; 97219246

Connector Gender: Female
 Connector Quantity: 1
 Contents: Sensor
 Terminal Gender: Male
 Terminal Quantity: 2
 Terminal Type: Blade

Chevrolet 2016 - 2001
 GMC 2016 - 2001



FLS-84
Engine Oil Level Sensor
 5117544AA; 5189422AA;
 5103559AA; 0009050301;
 0061533028

Connector Gender: Female
 Contents: Fluid Level Sensor
 Terminal Gender: Male
 Terminal Quantity: 3
 Terminal Type: Blade

Dodge 2006 - 2003

Terminal Quantity: 2
 Terminal Type: Blade
 BMW 2011 - 2009



FLS-126
Coolant Level Sensor
 5120509AA

Connector Gender: Male
 Connector Quantity: 1
 Contents: Sensor
 Terminal Gender: Male
 Terminal Quantity: 2
 Terminal Type: Bullet

Dodge 2006 - 2003
 Freightliner 2006 - 2003



FLS-172
Coolant Level Sensor
 2105450024

Connector Gender: Male
 Connector Quantity: 2
 Contents: Sensor
 Terminal Gender: N/A
 Terminal Quantity: N/A
 Terminal Type: N/A

Mercedes-Benz 1999 - 1992



FLS-72
Coolant Level Sensor
 251919372

Connector Gender: Female
 Contents: N/A
 Terminal Gender: Male
 Terminal Quantity: 2
 Terminal Type: Blade

Volkswagen 1985 - 1982



FLS-116
Windshield Washer Level Sensor
 5152029AA; 5152029AB

Connector Gender: Female
 Connector Quantity: 1
 Contents: Sensor
 Terminal Gender: Male
 Terminal Quantity: 2
 Terminal Type: Blade

Dodge 2010 - 2008
 Ram 2013 - 2011



FLS-162
Coolant Level Sensor
 5175760AA; 68079192AA;
 5175760AB

Connector Gender: Female
 Connector Quantity: 1
 Contents: Sensor
 Terminal Gender: Male
 Terminal Quantity: 1
 Terminal Type: Blade

Jeep 2009 - 2007



FLS-175
Windshield Washer Level Sensor
 2105400045

Connector Gender: Male
 Connector Quantity: 2
 Contents: Sensor
 Terminal Gender: N/A
 Terminal Quantity: N/A
 Terminal Type: N/A

Mercedes-Benz 1999 - 1996



FLS-75
Engine Oil Level Sensor
 1J0907660B

Connector Gender: Female
 Contents: N/A
 Terminal Gender: Male
 Terminal Quantity: 3
 Terminal Type: Blade

Volkswagen 2005 - 1999



FLS-125
Windshield Washer Level Sensor
 17137524812; 17137553919;
 17117546548; 17137532124;
 17137800097; 17117526845

Connector Gender: Female
 Connector Quantity: 1
 Contents: Fluid Level Sensor
 Terminal Gender: Male



FLS-164
Coolant Level Sensor
 XC4Z10D968AA

Connector Gender: Female
 Connector Quantity: 1
 Contents: Sensor
 Terminal Gender: Male
 Terminal Quantity: 2
 Terminal Type: Blade

Ford 1999 - 1995



FLS-179
Coolant Level Sensor
 68013657AA

Connector Gender: Female
 Connector Quantity: 1
 Contents: Sensor
 Terminal Gender: Male
 Terminal Quantity: 2
 Terminal Type: Pin

Dodge 2009
 Freightliner 2009



FLS-187
Windshield Washer Level Sensor

2205400045; 5099273AA
Connector Gender: Female
Connector Quantity: 1
Contents: Sensor
Terminal Gender: Male
Terminal Quantity: 2
Terminal Type: Pin
Mercedes-Benz 2008 - 2006



FPC1
Fuel Pump Camshaft Follower

06D109309C
Audi 2013 - 2010
Volkswagen 2013 - 2009



FPF603
Fuel Feed Line

06K127065B
Volkswagen 2016 - 2014



FPF604
Fuel Pump Fitting

06E127065F; 06E127065

Audi 2017 - 2012

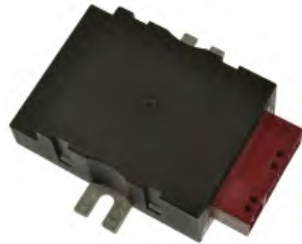

FPM105
Fuel Pump Driver Module

16147229173; 16147218339;
16147209286

BMW 2009



FPM113
Fuel Pump Driver Module

20979890; 22872266

Chevrolet 2014



FPM120
Fuel Pump Driver Module

FU5Z9D370B

Ford 2019 - 2016



FPS1
Fuel Pressure Sensor

5093112AA
Connector Gender: Female
Connector Shape: Rectangular
Mounting Hardware Included: No
Mounting Location: N/A
Notes: N/A
O.E.M. Replacement: Yes
Terminal Gender: Male
Terminal Quantity: 3

Terminal Type: Blade

Dodge 2007 - 2003



FPS2
Fuel Pressure Sensor

68002436AC; 68002436AD;
68002436AA; 68002436AB

Connector Gender: Female
Connector Shape: Rectangular
Mounting Hardware Included: No
Mounting Location: N/A
Notes: N/A
O.E.M. Replacement: Yes
Terminal Gender: Male
Terminal Quantity: 3
Terminal Type: Blade

Dodge 2010 - 2007
Ram 2012 - 2011



FPS11
Fuel Pressure Sensor

98090186; 97371617

Connector Gender: Female
Connector Shape: Rectangular
Mounting Hardware Included: No
Mounting Location: N/A
Notes: N/A
O.E.M. Replacement: Yes
Terminal Gender: Male
Terminal Quantity: 3
Terminal Type: Blade

Chevrolet 2010 - 2006
GMC 2010 - 2006
Hummer 2006



FPS13
Fuel Pressure Sensor

8C3Z9G756B; 1873400C92;
8C3Z9G756A

Connector Gender: Female
Connector Shape: Rectangular
Mounting Hardware Included: No
Mounting Location: N/A
Notes: N/A
O.E.M. Replacement: Yes
Terminal Gender: Female; Female
Terminal Quantity: 3
Terminal Type: Blade

Ford 2010 - 2008



FPS15
Fuel Pressure Sensor

06J906051D; 06E906051E;
06E906051J; 06E906051K

Connector Gender: Female
Connector Shape: Oval
Mounting Hardware Included: No
Mounting Location: N/A
Notes: N/A
O.E.M. Replacement: Yes
Terminal Gender: Male
Terminal Quantity: 3
Terminal Type: Blade

Audi 2010 - 2008



FPS16
Fuel Pressure Sensor

5159963AA; 6802556AA;
68020556AA

Connector Gender: Male
Terminal Gender: Male
Terminal Quantity: 3
Terminal Type: Blade

Jeep 2006 - 2005



FPS20
Fuel Pressure Sensor

68039886AB; 68039886AC;
68039886AA

Connector Gender: Female
Connector Shape: Rectangular
Mounting Hardware Included: No
Mounting Location: N/A
Notes: N/A
O.E.M. Replacement: Yes
Terminal Gender: Male
Terminal Quantity: 3
Terminal Type: Blade

Dodge 2008 - 2007



FPS28
Fuel Pressure Sensor
97329566

Connector Gender: Female
Connector Shape: Rectangular
Mounting Hardware Included: Yes
Mounting Location: On Fuel Rail
O.E.M. Replacement: Yes
Terminal Gender: Male
Terminal Quantity: 3
Terminal Type: Blade & Slide

Chevrolet 2004 - 2001
GMC 2004 - 2001



FPS31
Fuel Pressure Sensor
0041537528; 5080349AA

Connector Gender: Male
Terminal Gender: Male
Terminal Quantity: 3
Terminal Type: Blade

Dodge 2003



FPS45
Fuel Pressure Sensor
12651990

Connector Gender: Female
Connector Shape: Rectangular
Mounting Hardware Included: No
Mounting Location: N/A
Notes: N/A
O.E.M. Replacement: Yes
Terminal Gender: Male
Terminal Quantity: 3
Terminal Type: Blade

Chevrolet 2016 - 2013
GMC 2016 - 2013



FPS58
Fuel Pressure Sensor
03C906051C

Connector Gender: Female
Connector Shape: Rectangular
Mounting Hardware Included: No
Mounting Location: On Fuel Rail
Notes: N/A
O.E.M. Replacement: Yes
Terminal Gender: Male
Terminal Quantity: 3
Terminal Type: Blade

Audi 2015 - 2012



FPS29
Fuel Pressure Sensor
97361561

Connector Gender: Female
Connector Shape: Rectangular
Mounting Hardware Included: No
Mounting Location: N/A
Notes: N/A
O.E.M. Replacement: Yes
Terminal Gender: Male
Terminal Quantity: 3
Terminal Type: Blade

Chevrolet 2005 - 2004
GMC 2005 - 2004



FPS43
Fuel Pressure Sensor
13537787167

Connector Gender: Female
Connector Shape: Oval
Mounting Hardware Included: No
Mounting Location: N/A
Notes: N/A
O.E.M. Replacement: Yes
Terminal Gender: Male
Terminal Quantity: 3
Terminal Type: Blade

BMW 2013 - 2009



FPS46
Fuel Pressure Sensor
8980061011; 98006101

Connector Gender: Female
Connector Shape: Rectangular
Mounting Hardware Included: No
Mounting Location: N/A
Notes: N/A
O.E.M. Replacement: Yes
Terminal Gender: Male
Terminal Quantity: 3
Terminal Type: Blade

Chevrolet 2005
GMC 2005



FPS61
Fuel Pressure Sensor
4921495

Connector Gender: Female
Connector Shape: Round
Mounting Hardware Included: No
Mounting Location: N/A
Notes: N/A
O.E.M. Replacement: Yes
Terminal Quantity: 3
Terminal Type: Blade

Kenworth 2018 - 2015
Peterbilt 2007 - 2001



FPS30
Fuel Pressure Sensor
68032066AA; 0061536528;
5117543AA; 68014067AA

Connector Gender: Male
Connector Shape: Oval
Mounting Hardware Included: No
Mounting Location: N/A
Notes: N/A
O.E.M. Replacement: Yes
Terminal Gender: Male
Terminal Quantity: 3
Terminal Type: Blade

Dodge 2009 - 2004
Freightliner 2009 - 2004
Mercedes-Benz 2011 - 2005



FPS44
Fuel Pressure Sensor
12611873

Connector Gender: Female
Connector Shape: Rectangular
Mounting Hardware Included: No
Mounting Location: N/A
Notes: N/A
O.E.M. Replacement: Yes
Terminal Gender: Male
Terminal Quantity: 3
Terminal Type: Blade

Chevrolet 2012 - 2010
GMC 2012 - 2010



FPS55
Fuel Pressure Sensor
E8TZ9S283A

Connector Gender: Male
Connector Shape: Round
Mounting Hardware Included: No
Mounting Location: N/A
Notes: N/A
O.E.M. Replacement: Yes
Terminal Gender: Male
Terminal Quantity: 1
Terminal Type: Stud

Ford 1998 - 1988



FPS62
Fuel Pressure Sensor
2842728

Connector Gender: Female
Connector Shape: Rectangular
Mounting Hardware Included: No
Mounting Location: On Fuel Rail
Notes: N/A
O.E.M. Replacement: Yes
Terminal Gender: Male
Terminal Quantity: 3
Terminal Type: Pin

Freightliner 2009 - 2006



FPS63

Fuel Pressure Sensor
2482169

Connector Gender: Female
Connector Shape: Rectangular
Mounting Hardware Included: No
Mounting Location: N/A
Notes: N/A
O.E.M. Replacement: Yes
Terminal Gender: Male
Terminal Quantity: 3
Terminal Type: Pin
Blue Bird 2007 - 2005
Ford 2007



FPS73

Fuel Pressure Sensor
FC3Z9G756A

Connector Gender: Female
Connector Shape: Triangle
Mounting Hardware Included: No
Mounting Location: N/A
Notes: N/A
O.E.M. Replacement: Yes
Terminal Gender: Male
Terminal Quantity: 4
Terminal Type: Pin
Ford 2019 - 2013



FPS103

Fuel Pressure Sensor
68210175AA

Connector Gender: Female
Connector Shape: Triangle
Mounting Hardware Included: No
O.E.M. Replacement: Yes
Terminal Gender: Male
Terminal Quantity: 4
Terminal Type: Pin
Ram 2018 - 2013



FPW1

Fuel Pressure Warning
Light Kit
R5019658ADWL

Dodge 2007 - 1998



FSS101

Fuel Shut-Off Solenoid
4429575; 3903575

Connector Gender: No Connector
Connector Shape: N/A
Contents: Solenoid
Functions: Diesel Fuel Cut-Off
Solenoid
Notes: N/A
Terminal Gender: Male
Terminal Quantity: 1
Terminal Type: Stud
Dodge 1993 - 1989



FPS68

Fuel Pressure Sensor
03L906054A; 03L906051

Connector Gender: Female
Connector Shape: Oval
Mounting Hardware Included: No
Mounting Location: On Fuel Rail
Notes: N/A
O.E.M. Replacement: Yes
Terminal Gender: Male
Terminal Quantity: 3
Terminal Type: Blade
Audi 2013 - 2010
Volkswagen 2015 - 2009



FPS89

Fuel Pressure Sensor
68247772AA

Connector Gender: Female
Connector Shape: Oval
Mounting Hardware Included: Yes
Mounting Location: On Fuel Rail
Notes: Sensor Only
O.E.M. Replacement: Yes
Terminal Gender: Male
Terminal Quantity: 3
Terminal Type: Blade
Jeep 2017 - 2014
Ram 2019 - 2014



FPS112

Fuel Pressure Sensor
BC3Z9F838A

Connector Gender: Female
Connector Shape: Oval, Rectangle
Mounting Hardware Included: No
Mounting Location: On Fuel Rail
Notes: Sensor Only
O.E.M. Replacement: Yes
Terminal Gender: Male
Terminal Quantity: 3
Terminal Type: Blade
Ford 2017 - 2011



FSS102

Fuel Shut-Off Solenoid
5016244AB; 4761273; 5015364AA;
4897260AA; 4886531AA

Connector Gender: Female
Connector Quantity: 1
Connector Shape: Oval
Contents: Solenoid
Functions: N/A
Hardware Included: Yes
Notes: N/A
Terminal Gender: Male
Terminal Quantity: 3
Terminal Type: Blade
Dodge 1998 - 1994



FPS69

Fuel Pressure Sensor
05A906051

Connector Gender: Female
Connector Shape: Oval
Mounting Hardware Included: No
Mounting Location: On Fuel Rail
Notes: N/A
O.E.M. Replacement: Yes
Terminal Gender: Male
Terminal Quantity: 3
Terminal Type: Blade
Audi 2016 - 2014
Volkswagen 2016 - 2013



FPS94

Fuel Pressure Sensor
95860623030

Connector Gender: Female
Connector Shape: Rectangular, Oval
Mounting Hardware Included: No
Notes: Sensor Only
O.E.M. Replacement: Yes
Terminal Gender: Female
Terminal Quantity: 3
Terminal Type: Blade
Porsche 2016 - 2013



FPS113

Fuel Pressure Sensor
BC3Z9T321B

Connector Gender: Female
Connector Shape: Square
Mounting Hardware Included: No
Mounting Location: N/A
Notes: Sensor Only
O.E.M. Replacement: Yes
Terminal Gender: Male
Terminal Quantity: 2
Terminal Type: Blade & Pin
Ford 2019 - 2011



FSS103
Fuel Shut-Off Solenoid
12561591; 33072

Connector Gender: Female
Connector Quantity: 1
Connector Shape: Oval
Contents: Solenoid
Functions: Solenoid
Hardware Included: No
Notes: N/A
Terminal Gender: Male
Terminal Quantity: 2
Terminal Type: Blade

AM General 2001 - 1997
Chevrolet 2002 - 1994
GMC 2002 - 1994
Hummer..... 2004 - 2002



FTP1
Diesel Fuel Transfer Pump
4935730; 4932707; 3990105; 3990082

Dodge..... 2002 - 1998



FTP2
Diesel Fuel Transfer Pump
3969705

Dodge..... 2004 - 2003



FTP3
Diesel Fuel Transfer Pump
F6TZ9350A; YC3Z9350AA;
YC3Z9350CA; 1824415C93;
1826794C93

Ford 1998 - 1994
International..... 2003 - 1995



FTP4
Diesel Fuel Transfer Pump
F81Z9C407AC; 0580464074

Ford 2003 - 1998



FTP5
Diesel Fuel Transfer Pump
5015553AA; 5080885AA

Dodge..... 2002 - 1998



FTP6
Diesel Fuel Transfer Pump
8C3Z9G282A

Ford 2010 - 2008



FTP7
Diesel Fuel Transfer Pump
BC3Z9G282E; BC3Z9G282A;
BC3Z9G282B; BC3Z9G282C

Ford 2015 - 2011



FTP8
Diesel Fuel Transfer Pump
FC4Z9G282A

Ford 2016



FTS104
Fuel Temperature Sensor
97224993

Connector Gender: Female
Connector Quantity: 1
Connector Shape: Rectangular
Contents: Sensor
Notes: N/A
Terminal Gender: Male
Terminal Quantity: 2
Terminal Type: Blade
Thread Size - Metric: M12 x 1.25
Thread Size - NPT: N/A

Chevrolet 2010 - 2006
GMC 2010 - 2006



FTS110
Fuel Temperature Sensor
12643002

Connector Shape: Rectangular
Terminal Quantity: 2
Terminal Type: Blade

Thread Size - Metric: M12 x 1.5

Chevrolet 2016 - 2010
GMC 2016 - 2010



FV11
Fuel Tank Selector Valve
E3TZ9189C

Connector Gender: Female
Connector Quantity: 1
Contents: N/A
Notes: N/A
Terminal Gender: Male
Terminal Quantity: 5
Terminal Type: Blade

Ford 1993 - 1983



FV12
Fuel Tank Selector Valve
6C3Z9189A

Connector Gender: Female
Connector Quantity: 1
Contents: N/A
Notes: N/A
Terminal Gender: Male
Terminal Quantity: 5
Terminal Type: Blade

Ford 2016 - 1994



FV-5
Fuel Tank Selector Valve
14029228

Connector Gender: Female
Connector Quantity: 1
Contents: N/A
Notes: Universal Fit will Require Modification for Install
Terminal Gender: Female
Terminal Quantity: 5
Terminal Type: Pin

Chevrolet 1995 - 1980
Ford 1994 - 1983
GMC 1995 - 1980



FV-5K
Fuel Tank Selector Valve

Connector Gender: Male
Connector Quantity: 1
Contents: Includes Bracket
Notes: Universal Fit will Require Modification for Install
Terminal Gender: Male
Terminal Quantity: 5
Terminal Type: Pins

Chevrolet..... 1995 - 1980
Ford..... 1994 - 1983
GMC..... 1995 - 1980



FWSS102
Fuel / Water Separator Sensor

12511965; 12375515

Connector Gender: Female
Connector Quantity: 1
Contents: Sensor
Notes: N/A
Terminal Gender: Male
Terminal Quantity: 3
Terminal Type: Pins
Thread Size - Metric: N/A
Thread Size - NPT: N/A

Chevrolet..... 2001 - 1994
GMC..... 2001 - 1994

Dodge..... 2002 - 2000



FWSS109
Fuel / Water Separator Sensor

5143002AA

Connector Gender: Male
Connector Quantity: 1
Contents: Includes O-Ring Seal
Notes: N/A
Terminal Gender: Male
Terminal Quantity: 2
Terminal Type: Blade
Thread Size - Metric: M12 x 16
Thread Size - NPT: N/A

Jeep..... 2006 - 2005

Thread Size - Metric: N/A
Dodge..... 2009 - 2003



FWSS113
Fuel / Water Separator Sensor

F4T9S281B

Connector Gender: N/A
Connector Quantity: 1
Contents: Sensor
Notes: Includes O-Ring
Terminal Gender: Male
Terminal Quantity: 1
Terminal Type: Stud
Thread Size - Metric: N/A

Ford..... 1998 - 1994



FV-7
Fuel Pump Cut-Off Switch

88922295

Contents: Switch
Functions: Switch
Notes: N/A
Terminal Gender: Male
Terminal Quantity: 3
Terminal Type: Blade

BMW..... 1986 - 1985
Mazda..... 1984 - 1982
Mercedes-Benz..... 1999 - 1980
Peugeot..... 1984 - 1980
Volkswagen..... 1994 - 1981



FWSS104
Fuel / Water Separator Sensor

5117542AA; 0001539513

Connector Gender: Female
Connector Quantity: 1
Contents: Sensor
Notes: N/A
Terminal Gender: Male
Terminal Quantity: 3
Terminal Type: Pins
Thread Size - Metric: N/A
Thread Size - NPT: N/A

Dodge..... 2009 - 2004
Jeep..... 2009 - 2007



FWSS110
Fuel / Water Separator Sensor

E8TZ9J308A

Connector Gender: No Connector
Connector Quantity: 1
Contents: Includes O-Ring Seal
Notes: N/A
Terminal Gender: Male
Terminal Quantity: 1
Terminal Type: Stud
Thread Size - Metric: N/A
Thread Size - NPT: 7/16

Ford..... 1994 - 1988



FWSS114
Fuel / Water Separator Sensor

8C3Z9C264A; 6C3Z9C264A

Connector Gender: Female
Connector Quantity: 1
Contents: Sensor Only
Notes: Includes O-Ring
Terminal Gender: Male
Terminal Quantity: 2
Terminal Type: Blade
Thread Size - Metric: Push On
Thread Size - NPT: Push On

Ford..... 2010 - 2003



FWSS101
Fuel / Water Separator Sensor

12639450; 12639277; 97384931; 97370565

Connector Gender: Male
Connector Quantity: 1
Terminal Gender: Female
Terminal Quantity: 2
Terminal Type: Blade

Chevrolet..... 2011 - 2001
GMC..... 2011 - 2001



FWSS106
Fuel / Water Separator Sensor

5015582AA; 5015582AB

Connector Gender: Female
Connector Quantity: 1
Contents: Includes O-Ring Seal
Notes: N/A
Terminal Gender: Male
Terminal Quantity: 2
Terminal Type: Blade
Thread Size - Metric: M10 x 22
Thread Size - NPT: N/A



FWSS112
Fuel / Water Separator Sensor

5093128AB; 5093128AA

Connector Gender: Female
Connector Quantity: 1
Contents: Includes O-Ring Seal
Notes: N/A
Terminal Gender: Male
Terminal Quantity: 2
Terminal Type: Blade



FWSS115
Fuel / Water Separator Sensor

4429116; 04429116; 3831852S

Connector Gender: Female
Connector Quantity: 1
Contents: N/A
Notes: N/A
Terminal Gender: N/A
Terminal Quantity: 2
Terminal Type: Pin
Thread Size - Metric: N/A
Thread Size - NPT: N/A

Dodge 1996 - 1989



FWSS116
Fuel / Water Separator Sensor
12676436; 12651583; 12637776

Connector Gender: Male
Connector Quantity: 1
Contents: N/A
Notes: N/A
Terminal Gender: Female
Terminal Quantity: 2
Terminal Type: Blade
Thread Size - Metric: N/A
Thread Size - NPT: N/A

Chevrolet 2016 - 2012
GMC 2016 - 2012



FWSV101
Fuel / Water Separator Valve
12532558

Connector Gender: No Connector
Notes: Includes O-Ring
Terminal Gender: Male
Terminal Quantity: 1
Terminal Type: Stud

Chevrolet 2002 - 1996
GMC 2002 - 1996



FWSV102
Fuel / Water Separator Valve
F81Z9A153AA; 1831198C91

Connector Gender: No Connector
Connector Quantity: N/A
Contents: Valve
Notes: N/A
Terminal Gender: N/A
Terminal Quantity: N/A
Terminal Type: N/A

Ford 2003 - 1998



FWSV103
Fuel / Water Separator Valve
F5TZ9A153A; 1823629C91

Connector Gender: No Connector
Connector Quantity: N/A
Contents: Valve
Terminal Gender: N/A
Terminal Quantity: N/A
Terminal Type: N/A

Ford 1998 - 1994



GDF604
Fuel Pump Camshaft Follower
03H127307A

Audi 2010 - 2008



GDF901
Fuel Pump Camshaft Follower
LR038311; LR011208; JDE28731

Jaguar 2018 - 2017
Land Rover 2017 - 2016



GDP608
Direct Injection High Pressure Fuel Pump
07L127026Q; 07L127026K;
07L127026J; 07L127026F;
07L127026AL; 07L127026AK;
07L127026AB

Audi 2017 - 2012



GDP609
Direct Injection High Pressure Fuel Pump
079127025J; 079127025G;
079127025AC

Audi 2010



GDP610
Direct Injection High Pressure Fuel Pump
079127026J; 079127026F;
079127026AC

Audi 2010



GDP612
Direct Injection High Pressure Fuel Pump
079127025C; 079127025AF

Audi 2009 - 2008



GDP613
Direct Injection High Pressure Fuel Pump
079127026C; 079127026AB

Audi 2009 - 2008



GDP902
Direct Injection High Pressure Fuel Pump
LR057504; C2Z21985

Jaguar 2018 - 2017



GDP905
Direct Injection High Pressure Fuel Pump
06H127025P; 06H127025Q;
06H127025N; 06H127025M;
06H127025K; 06H127025G;
06H127025E

Audi 2013 - 2010
Volkswagen 2013 - 2009



GDR601
Fuel Pump O-Ring
06D127248; 03C127311;
WHT005184

Audi 2017 - 2008



GP101
Diesel Glow Plug
N10213002; N10213001; N0191001;
1257889

Volkswagen 1996 - 1980
Volvo 1986 - 1983



GP102
Diesel Glow Plug
N10140104; N10140105

Volkswagen 2006 - 1997



GP103
Diesel Glow Plug
E5TZ12A342B; E5TZ12A342A;
E3TZ12A342A; 5613680;
1804211C2

Buick 1983 - 1981
Cadillac 1985 - 1980
Chevrolet 1983 - 1980
Ford 1986 - 1983
GMC 1983 - 1980
Oldsmobile 1983 - 1980
Pontiac 1983 - 1980



GP104
Diesel Glow Plug
25168651; 25163212; 12563554;
5613738

AM General 2001 - 1992
Chevrolet 2002 - 1982
GMC 2002 - 1982
Hummer 2006 - 2002



GP105
Diesel Glow Plug
F2TZ12A342A; E7TZ12A342A;
5614220; 1819649C1

Ford 1994 - 1987



GP106
Diesel Glow Plug
12231288245; 0011598301;
0011593501; 0001598101;
0011592201; 0001597701

Mercedes-Benz 1989 - 1980
Peugeot 1988 - 1980



GP107
Diesel Glow Plug
F4TZ12A342BA; 1820697C2

Ford 2004 - 1995



GP108
Diesel Glow Plug
5613826

Buick 1985 - 1980
Cadillac 1985 - 1984
Chevrolet 1985 - 1984
GMC 1984
Oldsmobile 1985 - 1984
Pontiac 1985 - 1984



GP109
Diesel Glow Plug
3C3Z12A342AA; 3C3Z12A342AA2;
1836600C1

Ford 2004 - 2003



GP110
Diesel Glow Plug
97226202

Chevrolet 2004 - 2001
GMC 2004 - 2001



GP111
Diesel Glow Plug
5080047AB; 0011594901;
0011594801; 5117592AA

Dodge 2006 - 2003
Freightliner 2006 - 2003



GP112
Diesel Glow Plug
0250001016; 0011599001;
0011596101; 0011596001;
0011592601; 001159260164;
0011592501; 0001599101; 80003

Mercedes-Benz 1980



GP113
Diesel Glow Plug
4C3Z12A342AA; 1843286C2

Ford 2010 - 2004



GP114
Diesel Glow Plug
97364968; 12639701

Chevrolet 2016 - 2006
GMC 2016 - 2006



GP115
Diesel Glow Plug
97326305

Chevrolet 2007 - 2004
GMC 2006 - 2004



GP116
Diesel Glow Plug
5175756AA; 0011595001

Dodge 2009 - 2007
Freightliner 2009 - 2007
Jeep 2009 - 2007
Mercedes-Benz 2009 - 2007



GP117
Diesel Glow Plug
0011592101; 0011592001

Mercedes-Benz 1999 - 1996



GP119
Diesel Glow Plug
03L905061F; 03L905061E;
03L905061D

Audi 2016 - 2010
Volkswagen 2014 - 2009



GP120
Diesel Glow Plug Wiring
Harness
BC3Z12A342B

Ford 2012 - 2011



GP121
Diesel Glow Plug Wiring
Harness
BC3Z12A342C

Ford 2019 - 2012



GP122
Diesel Glow Plug
8C3Z12A342A; 8C3Z12A342A2;
1854421C1

Ford 2010 - 2008
IC Corporation 2010 - 2008
International 2010 - 2008



GP123
Diesel Glow Plug Wiring
Harness
CK4Z12A342A

Ford 2019 - 2015



GP124
Diesel Glow Plug
12679959; 12666880; 12690238

Chevrolet 2020 - 2017
GMC 2020 - 2017



GPC101
Glow Plug Conductor
97209343; 8972093431

Chevrolet 2004 - 2001
GMC 2004 - 2001



GPH101
Diesel Glow Plug Wiring Harness
4C3Z12A690AA; 1845915C93

Ford 2004



GPH102
Diesel Glow Plug Wiring Harness
4C3Z12A690BA; 1845793C93

Ford 2004



GPH103
Diesel Glow Plug Wiring Harness
4C2Z12A690AB; 1845794C93

Ford 2010 - 2004



GPH104
Diesel Glow Plug Wiring Harness
5C3Z12A690A; 1854497C93

Ford 2007 - 2005



GPH105
Diesel Glow Plug Wiring Harness
3C3Z12A690AA; 1840707C91

Ford 2004 - 2003



GPH106
Diesel Glow Plug Wiring Harness
3C3Z12A690BA; 1840708C91

Ford 2004 - 2003



GPH107
Diesel Glow Plug Wiring Harness
4C2Z12A690BA

Ford 2010 - 2004



GV1
PCV Grommet
3751510

Material: Rubber

Dodge 1991 - 1989



GV4
PCV Grommet
C8AZ6A892D

Material: Rubber

Ford 1991 - 1983
Lincoln 1985 - 1984
Mercury 1987 - 1984



GV5
PCV Grommet
1231486

Material: Rubber

Buick 1985 - 1980
Cadillac 1985 - 1980
Chevrolet 1991 - 1980
GMC 1991 - 1982

Oldsmobile	1985 - 1980
Pontiac	1986 - 1980



GV6
PCV Grommet
385204

Material: Rubber

Buick	1985 - 1980
Cadillac	1985 - 1980
Checker	1982 - 1980
Chevrolet	1991 - 1980
GMC	1991 - 1982
Oldsmobile	1985 - 1980
Pontiac	1986 - 1981



GV9
PCV Grommet
3989350; 3989349

Material: Rubber

Buick	1985 - 1980
Cadillac	1985 - 1980
Chevrolet	1991 - 1980
GMC	1995 - 1980
Oldsmobile	1985 - 1980
Pontiac	1986 - 1981



GV13
PCV Grommet
14004477

Material: Rubber

Buick	1985 - 1980
-------------	-------------

Cadillac..... 1985 - 1980
 Chevrolet..... 1989 - 1980
 GMC..... 1986 - 1982
 Oldsmobile..... 1985 - 1980
 Pontiac..... 1986 - 1981



GV16
 PCV Grommet
 1381487

Material: Rubber

Buick..... 1985 - 1980
 Cadillac..... 1985 - 1980
 Chevrolet..... 1989 - 1980
 GMC..... 1986 - 1982
 Oldsmobile..... 1985 - 1980
 Pontiac..... 1986 - 1981



GV18
 PCV Grommet
 385283

Material: Rubber

Buick..... 1985 - 1980
 Cadillac..... 1985 - 1980
 Chevrolet..... 1989 - 1980
 GMC..... 1986 - 1982
 Oldsmobile..... 1985 - 1980
 Pontiac..... 1986 - 1981



GV21
 PCV Grommet

9048018001; 1119858B00;
 MD179909; 96068576; 94843158;
 94123308

Material: Rubber

Toyota..... 1985



GV22
 PCV Grommet
 9048018180

Material: Rubber

Toyota..... 1987 - 1981



GV27
 PCV Grommet
 E7AZ6A892A

Material: Rubber

Ford..... 1989 - 1983
 Mercury..... 1987 - 1984



GV28
 PCV Grommet
 E6AZ6A892A

Material: Rubber

Ford..... 1989 - 1983
 Mercury..... 1987 - 1984



GV29
 PCV Grommet
 E7GZ6A892A; E30113338A;
 19110484

Material: Rubber

Ford..... 1986 - 1985
 Mazda..... 1985 - 1984

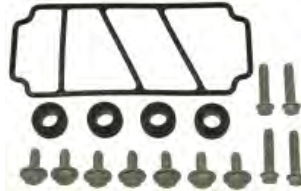

HFG101
 Horizontal Fuel
 Conditioning Module
 Cover Gasket Kit
 6C3Z9276A

Ford..... 2007 - 2003



HK12
 Fuel Injector Retaining
 Bracket
 3C3Z9C995AA

Notes: N/A

Ford..... 2007 - 2003



HK9330
 Retainer Clip
 N802241SAR51

Notes: N/A

Thread Size - Metric: N/A
 Thread Size - NPT: N/A

Ford..... 1987 - 1983
 Lincoln..... 1985 - 1984
 Mercury..... 1986 - 1984



HK9331
 Retainer Clip
 N802239SAR51A

Notes: N/A

Thread Size - Metric: N/A
 Thread Size - NPT: N/A

Ford..... 1987 - 1983
 Lincoln..... 1985 - 1984
 Mercury..... 1986 - 1984



HLS1667
 Headlight Switch
 21290507519107

Connector Gender: Female
 Connector Quantity: 1
 Knob Color: Black
 Terminal Gender: Male
 Terminal Quantity: 8
 Voltage: 12

Mercedes-Benz..... 2016 - 2013



HLS1685
 Headlight Switch
 68269912AA; 68146507AA;
 68189154AA

Connector Gender: Female
 Connector Quantity: 6
 Knob Color: Black
 Terminal Gender: Male
 Terminal Quantity: 6
 Voltage: 12

Ram..... 2019 - 2013



HLS1686
Headlight Switch
68269910AA; 68146503AA;
68189152AA

Connector Gender: Female
Connector Quantity: 1
Knob Color: Black
Terminal Gender: Male
Terminal Quantity: 6
Voltage: 12

Ram..... 2019 - 2013

Terminal Gender: Male
Terminal Quantity: 3
Voltage: 12

BMW..... 2017 - 2014



HLS1757
Other Interior Power
Switches
3L3Z11661AA

Ford..... 2004



HLS-1225
Headlight Switch
0005453704

Connector Gender: Male
Connector Quantity: 1
Terminal Gender: Female
Terminal Quantity: 13
Voltage: 12

Mercedes-Benz 1989 - 1983



HLS-1349
Headlight Switch
68019456AB; 56049637AC;
56049637AD

Connector Gender: Female
Connector Quantity: 1
Terminal Gender: Male
Terminal Quantity: 6
Voltage: 12

Dodge..... 2010 - 2008



HLS1719
Headlight Switch
61319169397

Connector Gender: Female
Connector Quantity: 1
Terminal Gender: Male
Terminal Quantity: 12

BMW..... 2011 - 2009



HLS-1051
Headlight Switch
1C0941531C; 1C0941531C01C;
1C0941531C20H

Connector Gender: Female
Connector Quantity: 1
Terminal Gender: Male
Terminal Quantity: 17
Voltage: 12

Volkswagen 2005 - 2004



HLS-1226
Headlight Switch
0005456204

Connector Gender: Female
Connector Quantity: 1
Terminal Gender: Male
Terminal Quantity: 13
Voltage: 12

Mercedes-Benz 1995 - 1987



HLS-1369
Headlight Switch
7L6941431AG3X1; 7L6941431E3X1;
7L6941431S3X1

Connector Gender: Female
Connector Quantity: 1
Terminal Gender: Male
Terminal Quantity: 10
Voltage: 12

Volkswagen 2009 - 2006



HLS1720
Headlight Switch
61319169398

Connector Gender: Female
Connector Quantity: 1
Terminal Gender: Male
Terminal Quantity: 12

BMW..... 2011 - 2009



HLS-1053
Headlight Switch
1C0941531B20H; 1C0941531B01C

Connector Gender: Female
Connector Quantity: 1
Terminal Gender: Male
Terminal Quantity: 17
Voltage: 12

Volkswagen 2005 - 2004



HLS-1345
Headlight Switch
56049636AD; 56049636AC

Connector Gender: Female
Connector Quantity: 1
Terminal Gender: Male
Terminal Quantity: 6
Voltage: 12

Dodge..... 2010 - 2008



HLS-1391
Headlight Switch
7L6941431T3X1

Connector Gender: Female
Connector Quantity: 1
Terminal Gender: Male
Terminal Quantity: 10
Voltage: 12

Volkswagen 2009 - 2008



HLS1738
Headlight Switch
61319265297; 61316847506

Connector Gender: Female
Connector Quantity: 1



HLS-1456
Headlight Switch
4602880AA

Connector Gender: Female
Connector Quantity: 1
Terminal Gender: Male
Terminal Quantity: 6
Voltage: 12
Dodge..... 2010
Ram..... 2012 - 2011



HLS-1457
Headlight Switch
68189143AA; 4602918AA

Connector Gender: Female
Connector Quantity: 1
Terminal Gender: Male
Terminal Quantity: 6
Voltage: 12
Dodge..... 2010
Ram..... 2012 - 2011



HLS-1487
Headlight Switch
61319134728

Connector Gender: Female
Connector Quantity: 1
Terminal Gender: Male
Terminal Quantity: 12
Voltage: 12
BMW..... 2013 - 2010



HLS-1488
Headlight Switch
61319134729

Connector Gender: Female
Connector Quantity: 1
Terminal Gender: Male
Terminal Quantity: 12
Voltage: 12
BMW..... 2013 - 2010



HLS-1504
Headlight Switch
7L6941431AA3X1

Connector Gender: Female
Connector Quantity: 1
Terminal Gender: Male
Terminal Quantity: 10
Voltage: 12
Volkswagen 2009



HLS-1505
Headlight Switch
7L6941431R3X1

Connector Gender: Female
Connector Quantity: 1
Terminal Gender: Male
Terminal Quantity: 10
Voltage: 12
Volkswagen 2006



HLS-1520
Headlight Switch
25858708; 15926100; 15779718

Connector Gender: Female
Connector Quantity: 1
Terminal Gender: Male
Terminal Quantity: 18
Voltage: 12
Chevrolet..... 2011



HLS-1620
Headlight Switch
4602920AA

Connector Gender: Female
Connector Quantity: 1
Knob Color: Black
Terminal Gender: Male
Terminal Quantity: 6
Voltage: 12
Ram..... 2012 - 2011



HLS-1621
Headlight Switch
68189142AA; 4602889AA

Connector Gender: Female
Connector Quantity: 1
Knob Color: Black
Terminal Gender: Male
Terminal Quantity: 6
Voltage: 12
Ram..... 2012 - 2011



HLS-1630
Headlight Switch
9065450204; 68010507AA

Connector Gender: Female
Connector Quantity: 1
Knob Color: Black
Terminal Gender: Male
Terminal Quantity: 8
Voltage: 12
Freightliner 2014 - 2011
Mercedes-Benz 2014 - 2011



HLS-1631
Headlight Switch
9069052401; 68010510AA;
9065450104

Connector Gender: Female
Connector Quantity: 1
Knob Color: Black
Terminal Gender: Male
Terminal Quantity: 8
Voltage: 12
Freightliner 2014 - 2011
Mercedes-Benz 2014 - 2011



HLS-1632

Headlight Switch

9069052601; 9065450304;
68010505AA

Connector Gender: Female
Connector Quantity: 1
Knob Color: Black
Terminal Gender: Male
Terminal Quantity: 8
Voltage: 12
Freightliner 2014 - 2011
Mercedes-Benz 2014 - 2011



HLS-1633

Headlight Switch

68010503AA; 9065450404

Connector Gender: Female
Connector Quantity: 1
Knob Color: Black
Terminal Gender: Male
Terminal Quantity: 8
Voltage: 12
Freightliner 2014 - 2011
Mercedes-Benz 2014 - 2011



HLS-1647

Headlight Switch

5C6941531EAPW; 5C6941531E20H
Connector Gender: Female
Connector Quantity: 1

Knob Color: Black
Terminal Gender: Male
Terminal Quantity: 17
Voltage: 12
Volkswagen 2014 - 2013



HLS-1648

Headlight Switch

5C6941531FAPW; 5C6941531DAPV
Connector Gender: Female
Connector Quantity: 1
Knob Color: Black
Terminal Gender: Male
Terminal Quantity: 17
Voltage: 12
Volkswagen 2014 - 2013



HPI1

Diesel Injection High Pressure Oil Pump

2503703C91; 991935C94;
1825259C91; 1825248C91;
F6TZ9A543AA; F6TZ9A543ARM;
F6TZ9A543ARM

Contents: Includes Caution Sheet
Notes: N/A
Ford 1997 - 1996
International 1997 - 1994



HPI2

Diesel Injection High Pressure Oil Pump

F81Z9A543CRM

Contents: Includes Caution Sheet
Notes: N/A
Ford 2003 - 1999
IC Corporation 2004 - 2002
International 2005 - 1999



HPI3

Diesel Injection High Pressure Oil Pump

5C3Z9VA543BRM; F81Z9A543AA;
F81Z9A543BRM

Contents: Includes Caution Sheet
Notes: N/A
Ford 1999 - 1998
International 1999 - 1998



HPI4

Diesel Injection High Pressure Oil Pump

2503701C91; 1825371C93;
1825260C91; 1825247C91;
F4TZ9A543BRM;
F4TZ9VA543AARM; F4TZ9A543B

Contents: Includes Caution Sheet
Notes: N/A
Ford 1995 - 1994
International 1997 - 1994



HPI6

Diesel Injection High Pressure Oil Pump

5010106R93; 1838828C91;
3C3Z9A543AARM

Contents: Includes Caution Sheet
Notes: N/A
Ford 2009 - 2003
International 2004 - 2002



HPI7

Diesel Injection High Pressure Oil Pump

4C3Z9H307A; 5C4Z9A543A;
5C4Z9A543AA; 5C4Z9A543B;
5C4Z9A543C

Contents: Includes Caution Sheet
Notes: N/A
Ford 2010 - 2005
IC Corporation 2008 - 2005
International 2007 - 2004



HPI8

Diesel Injection High Pressure Oil Pump

1879743C93; 1879744C2;
1832092C92; 1832093C2;
1876105C95

Contents: High Pressure Oil Pump
Notes: Includes IPR Valve, Oil Line and Line Fittings
IC Corporation 2010 - 2007
International 2010 - 2007



HPI9

Diesel Injection High Pressure Oil Pump

1832094C92; 1832095C2;
1876106C94; 1882259C93

Contents: High Pressure Oil Pump
Notes: Includes IPR Valve, Oil Line and Line Fittings
International 2009 - 2007



HPI10
Diesel Injection High Pressure Oil Pump
1889323C93; 1885043C92; 1885044C2

Contents: High Pressure Oil Pump
Notes: Includes Injection Pressure Regulator

IC Corporation 2014 - 2010
International..... 2013 - 2010

Notes: Includes Injection Pressure Regulator
IC Corporation 2010 - 2007
International..... 2010 - 2007



HPI14
Diesel Injection High Pressure Oil Pump
1879745C93; 1879747C2

Contents: High Pressure Oil Pump
Notes: Includes Injection Pressure Regulator

International..... 2009 - 2007



HPI18
Diesel Injection High Pressure Oil Pump
1842722C91; 1830177C92

Contents: High Pressure Oil Pump
Notes: N/A

IC Corporation 2004 - 2002
International..... 2003 - 1994

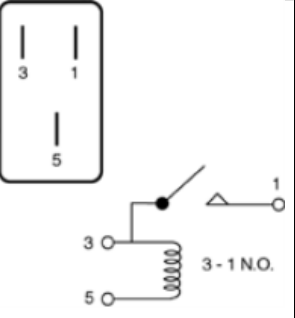

HR-127
Cruise Control Relay
E4TZ9C792A; D3TZ13853A;
D3TZ13853A1A; D6TZ13853A;
E4TA9C792AA; C4AZ13853A;
C4AZ13853B; D3TB13853A1A;
D3TB13853A2A; C4AB13853A;
1972276; 2084423; 1971608

Connector Gender: N/A
Connector Quantity: N/A
Connector Shape: Rectangular
Functions: Relay
Mounting Bracket(s) Included: Yes
Terminal Gender: Male
Terminal Quantity: 3
Voltage: 12

Ford..... 1989 - 1986



HPI11
Diesel Injection High Pressure Oil Pump
8E7Z9A543AA; 8E7Z9A543B;
8E7Z9A543CRM; 4307327R91;
1880313C94

Contents: High Pressure Oil Pump
Notes: Includes Installation Hardware

Ford 2010 - 2008
International..... 2009 - 2007



HPI16
Diesel Injection High Pressure Oil Pump
6E7Z9A543AA; 6E7Z9A543B;
6E7Z9A543BRM; 6E7Z9A543A;
1884357C92; 4307325R91

Contents: High Pressure Oil Pump
Notes: Includes Installation Hardware

Ford 2007 - 2006
International..... 2006 - 2005



HPI19
Diesel Injection High Pressure Oil Pump
1842721C91; 1825681C95

Contents: High Pressure Oil Pump
Notes: N/A

IC Corporation 2003 - 2002
International..... 2003 - 1994



HR-151
Defroster Relay
J5456847; J5456847; J5456847;
J5456847; J5456647; J5456647;
J5456647; J5456647; 5456847;
5456847; 5456847; 5456847;
370113; 344813; 329820; 56001111;
3747299; 3747298; 5456647;
14029600; J5764039; 25523702;
25523703; 25505674; 25513270;
4221658; 4221670; 8956001111;
15679628; 15679676

****Additional OE Numbers Available Online****

Connector Gender: N/A
Connector Quantity: N/A
Connector Shape: Rectangular



HPI12
Diesel Injection High Pressure Oil Pump
1842614C91; 1883888C93;
1842424C2; 1871291C4;
1871292C96; 1842423C97

Contents: High Pressure Oil Pump
Notes: Includes Injection Pressure Regulator

IC Corporation 2006 - 2004
International..... 2006 - 2004



HPI17
Diesel Injection High Pressure Oil Pump
1842617C91; 1842426C2;
1885000C93; 1842425C96

Contents: High Pressure Oil Pump
Notes: Includes Injection Pressure Regulator

International..... 2006 - 2004



HPI20
Diesel Injection High Pressure Oil Pump
1826458C92; 1842723C91

Contents: High Pressure Oil Pump
Notes: N/A

IC Corporation 2004 - 2002
International..... 2003 - 1994



HPI13
Diesel Injection High Pressure Oil Pump
1882258C93

Contents: High Pressure Oil Pump



Functions: Horn
 Mounting Bracket(s) Included: No
 Terminal Gender: Male
 Terminal Quantity: 3
 Voltage: 12
 Buick..... 1983
 Chevrolet..... 1985 - 1984
 GMC..... 1985 - 1984



HS569
 A/C and Heater Blower
 Motor Switch
 4379RD500710; ZGG16596;
 1669348C1

Connector Gender: N/A
 Connector Quantity: N/A
 Number of Switch Positions: 3
 Terminal Gender: Male
 Terminal Quantity: 4
 International..... 1993 - 1989
 Mack..... 1996 - 1980
 Peterbilt..... 1988 - 1986



HS570
 A/C and Heater Blower
 Motor Switch
 9098301500KZ; 5103643AB;
 5103643AA

Connector Gender: Female
 Connector Quantity: 2
 Number of Switch Positions: N/A
 Terminal Gender: Male
 Terminal Quantity: 24
 Dodge..... 2006 - 2003
 Freightliner..... 2006 - 2003



HS-204
 A/C and Heater Blower
 Motor Switch
 16015256; 7895384

Connector Gender: Female
 Number of Switch Positions: 4
 Terminal Gender: Male
 Terminal Quantity: 4
 Buick..... 1983 - 1982
 Chevrolet..... 1983
 GMC..... 1990 - 1983

Pontiac..... 1983



HS-205
 A/C and Heater Blower
 Motor Switch
 16032480

Connector Gender: Male
 Number of Switch Positions: 4
 Terminal Gender: Male
 Terminal Quantity: 4
 Buick..... 1985 - 1984
 GMC..... 1996 - 1984
 Pontiac..... 1985 - 1984



HS-206
 A/C and Heater Blower
 Motor Switch
 16033615

Connector Gender: Male
 Number of Switch Positions: 4
 Terminal Gender: Male
 Terminal Quantity: 4
 Buick..... 1985 - 1982
 Chevrolet..... 1982



HS-210
 A/C and Heater Blower
 Motor Switch
 E0VH19A642AA;
 E0VH19A642D5AH; E8AZ19986A;
 D5OH19986A2A; D5OZ19986A;
 D8AH19A642A1A; D8AZ19986A;
 D5AH19A642A1A;
 D5AH19A642A2A; D5AZ19986A;
 D5OH19986A1A

Connector Gender: Female
 Number of Switch Positions: 4
 Terminal Gender: Male
 Terminal Quantity: 4
 Ford..... 1996 - 1988



HS-214
 A/C and Heater Blower
 Motor Switch
 E6DZ19986A; F49Z19986A

Connector Gender: Female
 Number of Switch Positions: 4
 Terminal Gender: Male
 Terminal Quantity: 4

Ford..... 2003



HS-224
 A/C and Heater Blower
 Motor Switch
 16132816

Connector Gender: Male
 Number of Switch Positions: 4
 Terminal Gender: Male
 Terminal Quantity: 6

GMC..... 1996 - 1995



HS-229
 A/C and Heater Blower
 Motor Switch
 F2DZ19986A; F4DZ19986A

Connector Gender: Female
 Terminal Gender: Male
 Terminal Quantity: 4

Ford..... 1997 - 1992



HS-242
 A/C and Heater Blower
 Motor Switch
 16068777; 16015450

Connector Gender: Male
 Terminal Gender: Male
 Terminal Quantity: 5

Chevrolet..... 1985 - 1983
 GMC..... 1985 - 1984



HS-292
 A/C and Heater Blower
 Motor Switch
 83502719

Connector Gender: Male
 Terminal Gender: Male
 Terminal Quantity: 5

Jeep..... 1987 - 1986



HS-316
 A/C and Heater Selector
 Switch
 16001570

Connector Gender: Male
 Terminal Gender: Male

Buick..... 1984 - 1980
 Chevrolet..... 1991 - 1980
 GMC..... 1991 - 1983
 Oldsmobile..... 1981
 Pontiac..... 1984 - 1980



HS-321

A/C and Heater Blower
Motor Switch
344883

Chevrolet 1981



HS-333

A/C and Heater Blower
Motor Switch
1L2Z18578AA; 1L2Z19986AA;
F65Z19986AA; F65Z19986AB

Connector Gender: Female
Terminal Gender: Male
Terminal Quantity: 4

Ford 2006 - 2000



HS-348

A/C and Heater Selector
Switch
16154598

Connector Gender: Female
Terminal Gender: Male

GMC 1999



HS-388

A/C and Heater Selector
Switch
F6SZ19B888AA

Connector Gender: Female
Number of Switch Positions: 4
Terminal Gender: Male

Ford 2006 - 2005



HS-424

A/C and Heater Selector
Switch
5103690AA; 0008306285

Connector Gender: Female
Number of Switch Positions: N/A
Terminal Gender: Male

Dodge 2006 - 2003
Freightliner 2006 - 2003



HS-482

A/C and Heater Selector
Switch
5103644AA; 5103644AB

Connector Gender: Female; Female
Number of Switch Positions: N/A
Terminal Gender: Male

Dodge 2006 - 2003
Freightliner 2006 - 2003



HS-527

A/C and Heater Blower
Motor Switch
7C3Z19986A

Connector Gender: Female
Number of Switch Positions: N/A
Terminal Gender: Male
Terminal Quantity: 4

Ford 2009 - 2007



HS-531

Blower Motor Resistor
1268202510

Terminal Gender: Female
Terminal Quantity: 4

Mercedes-Benz 1985 - 1982



HSS120

Heated Seat Switch
68059874AB

Contents: Switch
Notes: N/A
Terminal Gender: Male
Terminal Quantity: 6
Terminal Type: Pin

Ram 2013



HSS122

Heated Seat Switch
4602970AB

Contents: Switch
Notes: N/A
Terminal Gender: Male
Terminal Quantity: 6
Terminal Type: Pin

Dodge 2010
Ram 2012 - 2011



HSS124

Heated Seat Switch
68059873AC; 68059873AB

Contents: Switch
Notes: N/A
Terminal Gender: Male
Terminal Quantity: 6
Terminal Type: Pin

Ram 2013



HSS125

Heated Seat Switch
4602872AB; 4602872AA

Contents: Switch
Notes: N/A
Terminal Gender: Male
Terminal Quantity: 6
Terminal Type: Pin

Ram 2012 - 2011



HZS149

Hazard Warning Switch
56010158AD; 56010158AC

Connector Gender: Female
Contents: Switch
Terminal Gender: Male
Terminal Quantity: 10
Terminal Type: Blade

Jeep 2006



ICP101K
Diesel Injection Control Pressure Sensor
4C3Z9F838AK

Ford 2010 - 2004
IC Corporation 2008 - 2005
International 2012 - 2002



ICP102K
Diesel Injection Control Pressure Sensor
F6TZ9F838AK

Ford 2003 - 1994
International 2005 - 1994



ICP103K
Diesel Injection Control Pressure Sensor
3C3Z9F838EAK

Ford 2004 - 2003
International 2004 - 2002



ICP105
Diesel Injection Control Pressure Sensor
E8TZ9F838A; J9TZ9F838A

Ford 1997 - 1988



ICP106
Diesel Injection Control Pressure Sensor
1830669C92

International 2003 - 1999



IFH1
Diesel Fuel Injection Harness
1824908C1; 1889905C91; 30360R1

International 2003 - 1994



IFH2
Diesel Fuel Injection Harness
3C3Z9D930AA

Ford 2003



IFH3
Diesel Fuel Injection Harness
4C3Z9D930AA

Ford 2004



IFH4
Diesel Fuel Injection Harness
5C3Z9D930A

Ford 2008 - 2005



IFH5
Diesel Fuel Injection Harness
1815923C92; F4TZ9D930K

Ford 1997 - 1994
International 1997 - 1994



IFH6
Diesel Fuel Injection Harness
F81Z9D930AB; 1830844C93

Ford 2003 - 1998
International 2005 - 1998



IFH7
Diesel Fuel Injection Harness
97207227; 8972072274

Chevrolet 2004 - 2001
GMC 2004 - 2001



IFH8
Diesel Fuel Injection Harness
8C3Z9D930AA; 1856010C95

Ford 2010 - 2008
IC Corporation 2010 - 2008
International 2010 - 2008



IFH9
Diesel Fuel Injection Harness
8C3Z9D930BA; 1856011C95

Ford 2010 - 2008
IC Corporation 2013 - 2008
International 2010 - 2008



IFS1
Diesel Fuel Injector Sleeve
3C3Z9F538AA

Ford 2010 - 2003
IC Corporation 2008 - 2005
International 2010 - 2003



IFS2
Diesel Fuel Injector Sleeve
1818778C3

International 2003 - 1996



IFS3
Diesel Fuel Injector Sleeve

F00RJ01831; 68005335AA;
4929865; 2873295; 4929864;
5175565AC

Dodge 2010 - 2003
Ram 2018 - 2010



IMA110
Intake Manifold Actuator
6421500694; 6421500594

Connector Gender: Female
Connector Quantity: 1
Terminal Gender: Male
Terminal Quantity: 4
Terminal Type: Blade

Mercedes-Benz 2016 - 2009



IMA111
Intake Manifold Actuator
5175643AB; 5175643AA;
68023872AA; 68065294AA;
6421500194; 6421500294;
6421500394; 6421500494

Connector Gender: Female
Connector Quantity: 1
Terminal Gender: Male
Terminal Quantity: 4
Terminal Type: Blade

Dodge 2009 - 2007
Jeep 2009 - 2007
Mercedes-Benz 2013 - 2007



IP1
Diesel Fuel Injection Pump

17800077; 19209059; 19208315;
12561307

Contents: Includes Instruction Sheet
Notes: N/A

AM General 2001 - 1996
Chevrolet 2002 - 1994
GMC 2002 - 1994
Hummer 2004 - 2002



IP2
Diesel Fuel Injection Pump
E7TZ9A543B

Contents: Pump
Notes: N/A

Ford 1987 - 1983



IP4
Diesel Fuel Injection Pump

F0TZ9A543H; F0TZ9A543H;
F0TZ9A543E; F0TZ9A543F;
F0TZ9A543G

Contents: Pump
Notes: N/A

Ford 1992 - 1990



IP10
Diesel Fuel Injection Pump
23504000

Contents: Pump
Notes: N/A

Chevrolet 1989 - 1984
GMC 1989 - 1984



IP12
Diesel Fuel Injection Pump
10183951

Contents: Pump
Notes: N/A

Chevrolet 1991 - 1990
GMC 1991 - 1990



IP17
Diesel Fuel Injection Pump
R4761367

Contents: Includes Caution Sheet
Notes: N/A

Dodge 1998 - 1994



IP18
Diesel Fuel Injection Pump
R4798548

Contents: Includes O-Ring Seal
Notes: N/A

Dodge 1998 - 1994



IP19
Diesel Fuel Injection Pump
R5019658AD; R5013925AA

Contents: Includes O-Ring Seal
Notes: Includes PSG Module

Dodge 2002 - 1998



IP20
Diesel Fuel Injection Pump
R5019657AD

Contents: 1 Large O-ring, 3 Bolt
Metal Seals, 1 Banjo Bolt
Notes: Includes PSG Module

Dodge 2002 - 2000



IP21
Diesel Fuel Injection Pump

5143425AA; R5191780AD; R5143425AA; R5191780AA; R5191780AB; R5191780AC; 5191780AB; 5191780AC; 5191780AD; R5104877AA; 5191780AA; 5104877AA; 5086765AA

Contents: Pump and Gasket
Notes: Includes Fuel Pressure Regulator

Dodge 2007 - 2003



IP22
Diesel Fuel Injection Pump

97720662

Contents: N/A
Notes: N/A

Chevrolet 2004 - 2001
GMC 2004 - 2001



IP23
Diesel Fuel Injection Pump

97303762; 97780091

Contents: N/A
Notes: Includes Fuel Pressure Regulator

Chevrolet 2005 - 2004
GMC 2005 - 2004



IP24
Diesel Fuel Injection Pump

97361351; 97780161

Contents: Pump
Notes: N/A

Chevrolet 2010 - 2006
GMC 2010 - 2006
Hummer 2006



IP25
Diesel Fuel Injection Pump

IP1

Contents: Includes Caution Sheet
Notes: Includes O-Ring

AM General 2001 - 1996
Chevrolet 2002 - 1994
GMC 2002 - 1994
Hummer 2004 - 2002



IP26
Diesel Fuel Injection Pump

R4429991

Contents: Includes Caution Sheet
Notes: N/A

Dodge 1993 - 1989



IP27
Diesel Fuel Injection Pump

R4638723; R4728745; 4728745; 4638723; 4429570; 3923346

Contents: Includes Caution Sheet
Notes: N/A

Dodge 1993 - 1990



IP28
Diesel Fuel Injection Pump

10225929

Contents: Pump
Notes: N/A

Chevrolet 1994
GMC 1994



IP30
Diesel Fuel Injection Pump

8C3Z9A543B; 8C3Z9A543DRM

Contents: N/A
Notes: N/A

Ford 2010 - 2008



IP31
Diesel Fuel Injection Pump

5142257AA

Contents: Includes Caution Sheet

Notes: Includes O-Ring

Dodge 2006 - 2004
Freightliner 2006 - 2004



IP32
Diesel Fuel Injection Pump

68014060AA; 6420700301

Contents: Includes Caution Sheet
Notes: N/A

Dodge 2009 - 2007
Freightliner 2009 - 2007
Mercedes-Benz 2013 - 2010



IP33
Diesel Fuel Injection Pump

68027022AC; R8027022AC; R8027022AB; R8027022AA; 68027022AA; 68027022AB; 68002013AC; 68002013AB; 68002013AA; 5264247; 0445020146

Contents: N/A
Notes: N/A

Dodge 2010 - 2007
Ram 2018 - 2011



IP34
Diesel Fuel Injection Pump

1855860C94; 1876529C98; 4307291R91

Contents: N/A
Notes: N/A

IC Corporation 2010 - 2008
International 2010 - 2008



IP35

Diesel Fuel Injection Pump
7080839C92

Contents: N/A
Notes: N/A
IC Corporation 2015 - 2010
International..... 2015 - 2010



IP36

Diesel Fuel Injection Pump
12645102; 98077841; 12658095;
12639150; 12638262; 12661059

Contents: N/A
Notes: N/A
Chevrolet 2016 - 2010
GMC 2016 - 2010



IP37

Diesel Fuel Injection Pump
BC3Z9A543B; BC3Z9A543A

Contents: N/A
Notes: N/A
Ford 2016 - 2011



IP38

Diesel Fuel Injection Pump
E7TZ9A543A; E5TZ9A543C

Contents: Pump
Notes: N/A
Ford 1987 - 1983



IP38NX

Diesel Fuel Injection Pump
E7TZ9A543A

Contents: Pump
Notes: N/A
Ford 1987 - 1983



IP39

Diesel Fuel Injection Pump
E9TZ9A543C

Contents: Pump
Notes: N/A
Ford 1989 - 1988



IP39NX

Diesel Fuel Injection Pump
E9TZ9A543C; E9TZ9A543CNEW
Contents: Pump

Notes: N/A
Ford 1989 - 1988



IP40NX
Diesel Fuel Injection Pump
F0TZ9A543C

Contents: Pump
Notes: N/A
Ford 1992 - 1990



IP41
Diesel Fuel Injection Pump
1816521C91; F2TZ9A543A

Contents: Pump
Notes: N/A
Ford 1994 - 1992



IP41NX
Diesel Fuel Injection Pump
F2TZ9A543A

Contents: Pump
Notes: N/A
Ford 1994 - 1992



IP42
Diesel Fuel Injection Pump
F2TZ9A543CRM

Contents: Pump
Notes: N/A
Ford 1994 - 1992



IP42NX
Diesel Fuel Injection Pump
F2TZ9A543C

Contents: Pump
Notes: N/A
Ford 1994 - 1992



IP43NX
Diesel Fuel Injection Pump
1813460C93

Contents: Pump
International..... 1992



IP44NX
Diesel Fuel Injection Pump
1813465C93

Contents: Pump
Notes: N/A

International..... 1992



IP47NX
Diesel Fuel Injection Pump
10183901NEW; 10183901

Contents: Pump
Notes: N/A

Chevrolet..... 1993 - 1992
GMC..... 1993 - 1992



IP49
Diesel Fuel Injection Pump
038130107JX; 038130107H;
038130107HX; 038130107J

Contents: Pump
Notes: Includes Instruction Sheet

Volkswagen..... 2004 - 1998



IP52
Diesel Fuel Injection Pump
12645102; 98077841; 12658095;
12639150; 12638262; 12661059

Contents: Pump

Chevrolet..... 2016 - 2010
GMC..... 2016 - 2010



IP45NX
Diesel Fuel Injection Pump
F3TZ9A543B; F3TZ9A543BNEW

Contents: Pump
Notes: N/A

Ford..... 1994 - 1993



IP48
Diesel Fuel Injection Pump
23500932

Contents: Pump
Notes: N/A

Chevrolet..... 1993 - 1992
GMC..... 1993 - 1992



IP50
Diesel Fuel Injection Pump
038130107KX; 038130107DX;
038130107K; 038130107D

Contents: Pump
Notes: N/A

Volkswagen..... 2004 - 1998



IPK1
Diesel Injection Pump Installation Kit

Ford..... 2010 - 2008



IP46NX
Diesel Fuel Injection Pump
12561383

Contents: Pump
Notes: N/A

Chevrolet..... 1994
GMC..... 1994



IP48NX
Diesel Fuel Injection Pump
23500931

Contents: Pump
Notes: N/A

Chevrolet..... 1989 - 1988
GMC..... 1989 - 1988



IP51
Diesel Fuel Injection Pump
028130115GX; 028130110HX;
028130110N; 028130115G;
028130110NX

Contents: Pump
Notes: N/A

Volkswagen..... 1998 - 1996

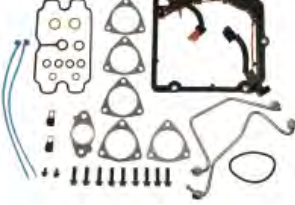

IPK2
Diesel Injection Pump Installation Kit

IC Corporation..... 2010 - 2008
International..... 2010 - 2008



IP47
Diesel Fuel Injection Pump
10183902

Notes: N/A

Chevrolet..... 1989 - 1988
GMC..... 1989 - 1988



IPK3
Diesel Injection Pump Installation Kit

IC Corporation..... 2015 - 2010
International..... 2015 - 2010



IPL1
Diesel Injection Pump
Supply Line
EC3Z9J280B; BC3Z9J280B;
EC3Z9J280A; BC3Z9J280A

Ford 2014 - 2011



IPL2
Diesel Injection Pump
Supply Line
FC3Z9J280B; FC3Z9J280A

Ford 2016 - 2015



IPM1
Diesel Injector Pump
Module
19209057; 12562836

AM General 2001 - 1996
Chevrolet 2002 - 1994
GMC 2002 - 1994
Hummer 2004 - 2002



IPR1
Other Injection
Components
PMDRELOCATIONKIT

AM General 2001 - 1996
Chevrolet 2002 - 1994
GMC 2002 - 1994
Hummer 2004 - 2002



IPR2
Other Injection
Components
PMDRELOCKIT2

AM General 2001 - 1996
Chevrolet 2002 - 1994
GMC 2002 - 1994
Hummer 2004 - 2002



IRL1
Diesel Fuel Rail Supply
Line
BC3Z9E964A

Ford 2017 - 2011



IRL2
Diesel Fuel Rail Supply
Line
4C4Z2A289AA; 3C3Z9324AA;
3C3Z9324A

Ford 2007 - 2003



IRL3
Diesel Fuel Rail Supply
Line
3C3Z9324BA

Ford 2007 - 2003



KS2
Knock Sensor
8019975620; 10456287; 10456205;
10456017; 1997562

Material: Cast Iron
Mounting Type: Screw-in
Terminal Gender: Male
Terminal Quantity: 1
Terminal Type: N/A

Oldsmobile 1985 - 1983



KS18
Knock Sensor
1326658; 0K01C18921; 1367644;
261231046; 0261231046; 9142415

Material: N/A
Mounting Type: Direct
Terminal Gender: Male
Terminal Quantity: 2
Terminal Type: Blade
Peugeot 1984



KS50
Knock Sensor
38574786; 3857478; 10456232

Material: N/A
Mounting Type: Bolt Mount
Terminal Gender: Male
Terminal Quantity: 1
Terminal Type: N/A
Chevrolet 1997
GMC 1997



KS171
Knock Sensor
56041679AD; 56041679AB;
56041679AC

Material: N/A
Mounting Type: Screw-in
Terminal Gender: Male
Terminal Quantity: 4
Terminal Type: Blade
Jeep 2005



KS214
Knock Sensor
22060AU010; 220607S000;
220608Y001

Material: N/A
Mounting Type: Bolt Mount
Terminal Gender: Male
Terminal Quantity: 2
Terminal Type: Blade
Nissan 2015 - 2009



KS234
Knock Sensor
077905377E; 077905377G;
079905376B

Material: N/A
Mounting Type: Bolt Mount
Terminal Gender: Male
Terminal Quantity: 3
Terminal Type: Pin
Audi 2010 - 2008



KS235
Knock Sensor
079905376C; 079905377A;
079905377E

Material: N/A
Mounting Type: Bolt Mount
Terminal Gender: Male
Terminal Quantity: 3
Terminal Type: Pin

Audi 2010 - 2009



KS260
Knock Sensor
95560612500; 030905377C

Material: N/A
Mounting Type: Bolt Mount
Terminal Gender: Male
Terminal Quantity: 2
Terminal Type: Blade

Volkswagen 2015 - 2011



KS312
Knock Sensor
06E905377J; 06E905377A;
06E905376A; 06E905377

Material: N/A
Mounting Type: Bolt Mount
Terminal Gender: Male
Terminal Quantity: 3
Terminal Type: Blade

Audi 2015
Volkswagen 2014 - 2012



KS328
Knock Sensor
12147839167; 12141830788

Material: N/A
Mounting Type: Bolt Mount
Terminal Gender: Male

Terminal Quantity: 2
Terminal Type: Blade
BMW 1986 - 1985



KS356
Knock Sensor
06E905376B; 06E905377B

Material: N/A
Mounting Type: Bolt Mount
Terminal Gender: Male
Terminal Quantity: 3
Terminal Type: Pin

Audi 2015
Volkswagen 2014 - 2013



KS397
Knock Sensor
13627598861

Material: N/A
Mounting Type: Bolt Mount
Terminal Gender: Male
Terminal Quantity: 2
Terminal Type: Blade

BMW 2017 - 2015



KS418
Knock Sensor
95860612121; 95860612120

Material: N/A
Mounting Type: Bolt Mount
Terminal Gender: Male
Terminal Quantity: 3
Terminal Type: Blade

Porsche 2013 - 2011



KS424
Knock Sensor
95860612111; 95860612110

Material: N/A
Mounting Type: Bolt Mount
Terminal Gender: Male
Terminal Quantity: 3
Terminal Type: Blade

Porsche 2013 - 2011



KS436
Knock Sensor
68166540AA

Material: Metal
Mounting Type: Bolt Mount
Terminal Gender: Male
Terminal Quantity: 2
Terminal Type: Blade

Jeep 2017 - 2014



KS445
Knock Sensor
06K905377F; 06K905377A

Material: N/A
Mounting Type: Bolt Mount
Terminal Gender: Male
Terminal Quantity: 2
Terminal Type: Blade

Volkswagen 2016 - 2014



KS448
Knock Sensor
06K905377E; 06K905377E;
06K905377

Material: Aluminum
Mounting Type: Direct
Terminal Gender: Male
Terminal Quantity: 2
Terminal Type: Blade

Volkswagen 2016 - 2015



KS450
Knock Sensor
0071531228

Material: N/A
Mounting Type: Bolt Mount
Terminal Gender: Male
Terminal Quantity: 3
Terminal Type: Blade

Mercedes-Benz 2016 - 2013



KS466
Knock Sensor
06E905377H

Mounting Type: Direct
Terminal Gender: Male
Terminal Quantity: 2
Terminal Type: Blade

Audi 2016



KS467
Knock Sensor
06E905377G

Material: ABS Plastic
Mounting Type: Direct

Terminal Gender: Male
Terminal Quantity: 2
Terminal Type: Blade
Audi 2016



KS480
Knock Sensor
06E905377C

Material: N/A
Mounting Type: Bolt Mount
Terminal Gender: Male
Terminal Quantity: 3
Terminal Type: Blade
Audi 2017 - 2015



LDP14
Fuel Vapor Leak
Detection Pump
4861962AC; 4861962AB;
4891685AA; 4891685AB;
4861962AA

Dodge 2007



LDP18
Fuel Vapor Leak
Detection Pump
1K0906201B; 1K0906201A;
1K0906201D; 1K0906201C;
1K0906201

Volkswagen 2013 - 2009



LDP25
Fuel Vapor Leak
Detection Pump
95860510700; 7L0906243

Porsche 2018 - 2011



LDP26
Fuel Vapor Leak
Detection Pump
3C0906201; 3C0906272;
3C0906201A

Audi 2016 - 2013



LDP28
Fuel Vapor Leak
Detection Pump
7L0906271

Volkswagen 2006 - 2004



LDP39
Fuel Vapor Leak
Detection Pump
307608630; 8683709; LF6618581;
LF6618581A; WTR500030

Land Rover 2020 - 2016



LDP45
Fuel Vapor Leak
Detection Pump
7L8906271; 7L8906271A

Audi 2015 - 2008



LDP50
Fuel Vapor Leak
Detection Pump
8P0906201A; 8P0906201

Audi 2013 - 2010



LDP74
Fuel Vapor Canister Filter
4809607AA; 53013376AA;
53013376AB; 4891561AA

Dodge 2010



LDP75
Fuel Vapor Canister Filter
5085164AA; 4612757; 4612901

Dodge 2002 - 1998
Jeep 2010 - 2005

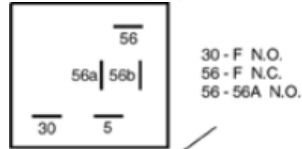

LR-35
Headlight Relay

E7RY14677A; 411941583C;
111941583; 111941583A;
411941583A; 411941583B;
0332515019; 20561554; 20501766

Connector Gender: N/A
Connector Quantity: N/A
Connector Shape: Square
Functions: Relay
Mounting Bracket(s) Included: No
Terminal Gender: Male
Terminal Quantity: 5
Voltage: 12

Volkswagen 1981



LS388
Back-Up Light Switch
F7HZ15520CB

Connector Gender: Female
Connector Quantity: 1
Material: Metal
Terminal Gender: Female
Terminal Quantity: 2

Ford 2003 - 2000



LS-200
Back-Up Light Switch
ZZL017640; ZZL017640A;
E5HZ15520A; F5TZ15520B;
F81Z15520A; F81Z15520AA;
IL2Z15520AA; C9TB15520B;
C9TZ11520C; C9TZ15520C;
E5HT15520BA; 1L2Z15520AA;
1F2017640; 12336287
Connector Gender: Female
Connector Quantity: 1
Terminal Gender: Male
Terminal Quantity: 2
Ford 2010 - 1988



LS-221
Back-Up Light Switch
32005M8002; 32005M8001;
32005M8000; 32005K1002;
32005K1001; 32005K1000;
32005M8004; 32005M8014;
3200521000; 32005K1004;
32005K102A; 32005M0200
Connector Gender: No Connector
Connector Quantity: N/A
Terminal Gender: Male
Terminal Quantity: 2
Nissan 1985 - 1984



LS-263
Back-Up Light Switch
13070867; 1307086; 9442728;
30713679
Connector Gender: Female
Connector Quantity: 1
Terminal Gender: Male
Terminal Quantity: 2
Volvo 1984 - 1983



LS-291
Back-Up Light Switch
020941521A
Connector Gender: Male
Connector Quantity: N/A
Terminal Gender: Male
Terminal Quantity: 2
Volkswagen 1985 - 1980



LS-201
Back-Up Light Switch
4221949; 3488270; 4373814;
4221587; 4221462; 2258404;
4504586
Connector Gender: Male
Connector Quantity: 1
Terminal Gender: Male
Terminal Quantity: 2
Dodge 1993 - 1991



LS-222
Back-Up Light Switch
M50617640A; 139117640;
M50617640
Connector Gender: No Connector
Terminal Gender: Male
Terminal Quantity: 2
Mazda 1984 - 1982



LS-265
Back-Up Light Switch
211941251; 211941521
Connector Gender: No Connector
Connector Quantity: 2
Terminal Gender: Male
Terminal Quantity: 2
Volkswagen 1988



LS-304
Back-Up Light Switch
12479776
Connector Gender: Female
Connector Quantity: 1
Terminal Gender: Male
Terminal Quantity: 2
Chevrolet 2006 - 2003
GMC 2006 - 2003



LS-202
Back-Up Light Switch
14014559
Connector Gender: Female + Male
Connector Quantity: 2
Connector Shape: Round
Terminal Gender: Male
Chevrolet 1983



LS-256
Back-Up Light Switch
E0HZ15520A; E9HZ15520A;
F3HZ15520A
Connector Gender: No Connector
Connector Quantity: 1
Terminal Gender: Male
Terminal Quantity: 2
Ford 2003 - 1983



LS-273
Back-Up Light Switch
3200521U1B; 084941521;
014919361; 0149415211
Connector Gender: Female
Connector Quantity: 1
Terminal Gender: Male
Terminal Quantity: 2
Volkswagen 1982 - 1981



LS-307
Back-Up Light Switch
12470371
Connector Gender: Female
Connector Quantity: 1
Terminal Gender: Male
Terminal Quantity: 2
Chevrolet 1998 - 1997
GMC 1998 - 1997



LS-285
Back-Up Light Switch
56007270; 4741630; 56607270
Connector Gender: Female
Connector Quantity: 1
Terminal Gender: Male
Terminal Quantity: 2
Dodge 2005



LS-317
Back-Up Light Switch
YC3Z15520BA
Connector Gender: Female
Connector Quantity: 1
Terminal Gender: Male
Terminal Quantity: 1
Ford 2003 - 2000



LS-338

Back-Up Light Switch
020945415A

Connector Gender: Female
Connector Quantity: 1
Terminal Gender: Male
Terminal Quantity: 2

Volkswagen 1998 - 1995



LX-756

Hall Effect Switch

19417445; 3863130; 8104926450;
8104854320; 38631305; 10490645;
10485432

Terminal Gender: Male
Terminal Quantity: 3

Chevrolet 2001



MAS0279

Mass Air Flow
10393949; 23259883

Connector Gender: Female
Connector Quantity: 1
Connector Shape: Oval
Housing Included: No
Material: Plastic
Number of Bolt Holes: 2
Terminal Quantity: 5
Terminal Type: Blade

Chevrolet 2015 - 2011
GMC 2015 - 2011



MAS0288

Mass Air Flow
13627593624

Connector Gender: Female
Connector Quantity: 1
Connector Shape: Oval
Housing Included: No
Material: Plastic
Number of Bolt Holes: 2
Terminal Quantity: 4
Terminal Type: Blade

BMW 2017 - 2014



LS-344

Back-Up Light Switch
225712; 817034; 2015450014

Connector Gender: Female
Connector Quantity: 1
Terminal Gender: Male
Terminal Quantity: 2

Mercedes-Benz 1989 - 1984
Peugeot 1984 - 1980



MAK100

Mass Air Flow
A0000941048; 5103615AA

Connector Gender: Female
Connector Quantity: 1
Terminal Quantity: 5
Terminal Type: Blade

Dodge 2004 - 2003
Freightliner 2004 - 2002



MAS0280

Mass Air Flow
97209545

Connector Gender: Female
Connector Quantity: 1
Connector Shape: Rectangular
Housing Included: No
Material: Plastic
Number of Bolt Holes: 2
Terminal Quantity: 5
Terminal Type: Blade

Chevrolet 2007 - 2003
GMC 2007 - 2003



MAS0290

Mass Air Flow
074906461BX; 074906461B

Connector Gender: Female
Connector Quantity: 1
Connector Shape: Oval
Housing Included: Yes
Material: Plastic
Number of Bolt Holes: 2
Terminal Quantity: 5
Terminal Type: Blade

Volkswagen 2008 - 2004



LS-376

Back-Up Light Switch
7700422630; 91167519

Connector Gender: Female
Connector Quantity: 1
Material: Brass
Mounting Type: Screw-in
Terminal Gender: Male
Terminal Quantity: 2

Renault 2011 - 2008



MAS0164

Mass Air Flow
3W4Z12B579AC; 3W4Z12B579AB

Connector Gender: Female
Connector Quantity: 1
Connector Shape: Oval
Housing Included: No
Material: Metal, Plastic
Number of Bolt Holes: 2
Terminal Quantity: 6
Terminal Type: Pin

Ford 2010 - 2004



LSH102

Headlight Level Sensor
0105427617

Mercedes-Benz 2006



MAS0308

Mass Air Flow
0000941048

Connector Gender: Female
Connector Quantity: 1
Connector Shape: Oval
Housing Included: Yes
Material: Plastic
Number of Bolt Holes: 4

Terminal Quantity: 5
Terminal Type: Blade
Dodge 2004 - 2003
Freightliner 2004 - 2002



MAS0323
Mass Air Flow
23118170; 23262343; 20787043

Connector Gender: Female
Connector Quantity: 1
Connector Shape: Rectangular
Housing Included: No
Material: Metal, Plastic
Number of Bolt Holes: 2
Terminal Quantity: 8
Terminal Type: Pin

GMC 2017



MAS0357
Mass Air Flow
22821558

Connector Gender: Female
Connector Quantity: 1
Connector Shape: Rectangular
Housing Included: Yes
Material: Plastic
Number of Bolt Holes: 0
Terminal Quantity: 8
Terminal Type: Pin

Chevrolet 2015 - 2014

Terminal Type: Blade
Audi 2012
Porsche 2015 - 2011
Volkswagen 2014 - 2009



MAS0386
Mass Air Flow
5117501AA; 68017661AA

Connector Gender: Female
Connector Quantity: 1
Connector Shape: Oval
Housing Included: No
Material: Plastic
Number of Bolt Holes: 2
Terminal Quantity: 4
Terminal Type: Blade

Dodge 2009 - 2005
Freightliner 2009 - 2005



MAS0411
Mass Air Flow
06A906461G

Connector Gender: Female
Connector Quantity: 1
Connector Shape: Oval
Housing Included: Yes
Material: Plastic
Number of Bolt Holes: 2
Terminal Quantity: 5
Terminal Type: Blade

Audi 2010 - 2008



MAS0338
Mass Air Flow
13627602038

Connector Gender: Female
Connector Quantity: 1
Connector Shape: Oval
Housing Included: No
Material: Plastic
Number of Bolt Holes: 2
Terminal Quantity: 4
Terminal Type: Blade

BMW 2017



MAS0374
Mass Air Flow
03G906461C

Connector Gender: Female
Connector Quantity: 1
Connector Shape: Oval
Housing Included: Yes
Material: Plastic
Number of Bolt Holes: 2
Terminal Quantity: 5
Terminal Type: Blade

Volkswagen 2016 - 2009



MAS0388
Mass Air Flow
68002441AC; 68002441AA;
68002441AB; 53034068AA

Connector Gender: Female
Connector Quantity: 1
Connector Shape: Rectangular
Housing Included: No
Material: Plastic
Number of Bolt Holes: 2
Terminal Quantity: 4
Terminal Type: Blade

Dodge 2009 - 2007



MAS0421
Mass Air Flow
0000943448

Connector Gender: Female
Connector Quantity: 1
Connector Shape: Oval
Housing Included: Yes
Material: Plastic
Number of Bolt Holes: 2
Terminal Quantity: 4
Terminal Type: Blade

Freightliner 2015 - 2010
Mercedes-Benz 2016 - 2010



MAS0354
Mass Air Flow
98002762

Connector Gender: Female
Connector Quantity: 1
Connector Shape: Oval
Housing Included: No
Material: ABS Plastic
Number of Bolt Holes: 2
Terminal Quantity: 5
Terminal Type: Pin

Chevrolet 2010 - 2007
GMC 2010 - 2007



MAS0379
Mass Air Flow
95560612350; 059906461N

Connector Gender: Female
Connector Quantity: 1
Connector Shape: Oval
Housing Included: Yes
Material: Plastic
Number of Bolt Holes: 4
Terminal Quantity: 5



MAS0422

Mass Air Flow

13627805415; 13628509725

Connector Gender: Female
 Connector Quantity: 1
 Connector Shape: Oval
 Housing Included: Yes
 Material: Metal, Plastic
 Number of Bolt Holes: 2
 Terminal Quantity: 5
 Terminal Type: Blade

BMW 2013 - 2009



MAS0427

Mass Air Flow

6460940048

Connector Gender: Female
 Connector Quantity: 2
 Connector Shape: Rectangular
 Terminal Quantity: 5; 3
 Terminal Type: Blade

Mercedes-Benz 2006 - 2005



MAS0428

Mass Air Flow

0000941248

Connector Gender: Female
 Connector Quantity: 1
 Connector Shape: Oval
 Terminal Quantity: 5
 Terminal Type: Blade

Mercedes-Benz 1999 - 1998



MAS0450

Mass Air Flow

22951817; 23324767

Connector Gender: Female
 Connector Quantity: 1
 Connector Shape: Rectangular
 Housing Included: N/A
 Material: Plastic
 Number of Bolt Holes: 1
 Terminal Quantity: 8
 Terminal Type: Pin

Chevrolet 2016
 GMC 2019 - 2016



MAS0469

Mass Air Flow

06A906461X; 06A906461;
 038906461C

Connector Gender: Female
 Connector Quantity: 1
 Connector Shape: Oval
 Terminal Quantity: 5
 Terminal Type: Pin

Volkswagen 2003 - 1998



MAS0473

Mass Air Flow

68151956AB

Connector Gender: Female
 Connector Quantity: 1
 Connector Shape: Oval
 Terminal Quantity: 8
 Terminal Type: Pin

Ram 2018



MAS0475

Mass Air Flow

22680EZ40A

Connector Gender: Female
 Connector Quantity: 1
 Connector Shape: Oval
 Housing Included: No
 Material: Plastic
 Number of Bolt Holes: 2
 Terminal Quantity: 4
 Terminal Type: Blade

Nissan 2019 - 2016



MAS0480

Mass Air Flow

68167873AA

Connector Gender: Female
 Connector Quantity: 1
 Connector Shape: Oval
 Housing Included: Yes
 Material: Plastic housing
 Number of Bolt Holes: 0
 Terminal Quantity: 8
 Terminal Type: Pin

Ram 2017 - 2014



MAS0483

Mass Air Flow

13627804150

Connector Gender: Female
 Connector Quantity: 1
 Connector Shape: Round
 Housing Included: No
 Material: Polyester Resin
 Number of Bolt Holes: 2
 Terminal Quantity: 5
 Terminal Type: Blade

BMW 2016 - 2014



MAS0509

Mass Air Flow

13628506408

Connector Gender: Female
 Connector Quantity: 1
 Connector Shape: Oval
 Housing Included: No
 Material: ABS Plastic
 Number of Bolt Holes: 2
 Terminal Quantity: 5
 Terminal Type: Blade

BMW 2015 - 2014



MRS1

Remote Mirror Switch

0045459207; 5103845AA

Notes: N/A
 Terminal Gender: Male
 Terminal Quantity: 10
 Terminal Type: Pins

Dodge 2006 - 2003
 Freightliner 2006 - 2003



NOX001

Diesel Nitrogen Oxide (NOx) Sensor

12669595; 12671388; 12622451;
 19256344

Connector Gender: Female
 Connector Quantity: 1
 Terminal Gender: Male
 Terminal Quantity: 6
 Terminal Type: Pin

Chevrolet 2014 - 2010
 GMC 2014 - 2010



NOX002
 Diesel Nitrogen Oxide (NOx) Sensor
 12671387; 19256343

Connector Gender: Female
 Connector Quantity: 1
 Terminal Gender: Male
 Terminal Quantity: 6
 Terminal Type: Pin

Chevrolet 2014 - 2010
 GMC 2014 - 2010



NOX005
 Diesel Nitrogen Oxide (NOx) Sensor
 12673517; 12680469; 12676706

Connector Gender: Female
 Connector Quantity: 1
 Terminal Gender: Male
 Terminal Quantity: 6
 Terminal Type: Blade

Chevrolet 2018 - 2017
 GMC 2018 - 2017



NOX008
 Diesel Nitrogen Oxide (NOx) Sensor
 BC3Z9D378F; BC3Z9D378D;
 BC3Z9D378E; BC3Z9D378C;
 BC3Z9D378G

Connector Gender: Female
 Connector Quantity: 1
 Terminal Gender: Female
 Terminal Quantity: 8
 Terminal Type: Pin

Ford 2012 - 2011



NOX011
 Diesel Nitrogen Oxide (NOx) Sensor
 68210084AA; 4326873

Connector Gender: Female
 Connector Quantity: 1
 Terminal Gender: Male
 Terminal Quantity: 4
 Terminal Type: Blade

Ram 2018 - 2013



NOX003
 Diesel Nitrogen Oxide (NOx) Sensor
 19301329; 19302360

Connector Gender: Female
 Connector Quantity: 1
 Terminal Gender: Male
 Terminal Quantity: 6
 Terminal Type: Pin

Chevrolet 2015
 GMC 2015



NOX006
 Diesel Nitrogen Oxide (NOx) Sensor
 12673516; 12676705

Connector Gender: Female
 Connector Quantity: 1
 Terminal Gender: Male
 Terminal Quantity: 6
 Terminal Type: Blade

Chevrolet 2017
 GMC 2017



NOX009
 Diesel Nitrogen Oxide (NOx) Sensor
 DC3Z9D378A

Connector Gender: Female
 Connector Quantity: 1
 Terminal Gender: Female
 Terminal Quantity: 8
 Terminal Type: Pin

Ford 2016 - 2013



NOX012
 Diesel Nitrogen Oxide (NOx) Sensor
 68227486AA; 68197109AA;
 68227486AA

Connector Gender: Male
 Connector Quantity: 1
 Terminal Gender: Male
 Terminal Quantity: 4
 Terminal Type: Blade

Ram 2017 - 2014



NOX004
 Diesel Nitrogen Oxide (NOx) Sensor
 19301328

Connector Gender: Female
 Connector Quantity: 1
 Terminal Gender: Male
 Terminal Quantity: 6
 Terminal Type: Pin

Chevrolet 2015
 GMC 2015



NOX007
 Diesel Nitrogen Oxide (NOx) Sensor
 12680619; 12680215

Connector Gender: Female
 Connector Quantity: 1
 Terminal Gender: Male
 Terminal Quantity: 6
 Terminal Type: Blade

Chevrolet 2019 - 2018
 GMC 2019 - 2018



NOX010
 Diesel Nitrogen Oxide (NOx) Sensor
 DC3Z9D378B

Connector Gender: Female
 Connector Quantity: 1
 Terminal Gender: Female
 Terminal Quantity: 8
 Terminal Type: Pin

Ford 2016 - 2013



NOX013
 Diesel Nitrogen Oxide (NOx) Sensor
 68085740AA

Connector Gender: Male
 Connector Quantity: 1
 Terminal Gender: Male
 Terminal Quantity: 4
 Terminal Type: Blade

Ram 2015 - 2013



NOX014
 Diesel Nitrogen Oxide (NOx) Sensor
 68067521AA

Connector Gender: Male

Connector Quantity: 1
Terminal Gender: Male
Terminal Quantity: 4
Terminal Type: Blade
Ram 2012 - 2011



NOX015
Diesel Nitrogen Oxide (NOx) Sensor
5149216AB

Connector Gender: Male
Connector Quantity: 1
Terminal Gender: Male
Terminal Quantity: 4
Terminal Type: Blade
Ram 2012 - 2011



NOX016
Diesel Nitrogen Oxide (NOx) Sensor
9053403; A0009053403;
0009053403

Connector Gender: Female
Connector Quantity: 1
Terminal Gender: Male
Terminal Quantity: 5
Terminal Type: Blade
Mercedes-Benz 2016 - 2013



NOX017
Diesel Nitrogen Oxide (NOx) Sensor
A0009053503; 9053503;
0009053503

Connector Gender: Female
Connector Quantity: 1
Terminal Gender: Male
Terminal Quantity: 5
Terminal Type: Blade
Mercedes-Benz 2018 - 2013



NOX018
Diesel Nitrogen Oxide (NOx) Sensor
HC3Z5L248A; HC3A5L248CB

Connector Gender: Female
Connector Quantity: 1
Terminal Gender: Male
Terminal Quantity: 5
Terminal Type: Blade
Ford 2019 - 2017



NOX021
Diesel Nitrogen Oxide (NOx) Sensor
12665216; 19330003

Connector Gender: Female
Connector Quantity: 1
Terminal Gender: Male
Terminal Quantity: 6
Terminal Type: Pin
Chevrolet 2016
GMC 2016



NOX022
Diesel Nitrogen Oxide (NOx) Sensor
12665215; 19330002

Connector Gender: Female
Connector Quantity: 1
Terminal Gender: Male
Terminal Quantity: 6
Terminal Type: Pin
Chevrolet 2016
GMC 2016



NS659
Neutral Safety Switch
CC3Z7H557B; BC3Z7H557C;
CC3Z7H557A

Connector Gender: Female
Connector Quantity: 1
Material: Metal
Mounting Type: Direct
Terminal Gender: Male
Terminal Quantity: 3
Ford 2019 - 2011



NS689
Neutral Safety Switch
0C8919823

Connector Gender: Female
Connector Quantity: 1
Material: Metal
Mounting Type: Bolt Mount
Terminal Gender: Male
Terminal Quantity: 9
Audi 2014 - 2013
Volkswagen 2014 - 2011



NS691
Neutral Safety Switch
29542692

Connector Gender: Female
Connector Quantity: 1
Material: Metal
Mounting Type: Bolt Mount
Terminal Gender: Male
Terminal Quantity: 6
Chevrolet 2019 - 2007
GMC 2019 - 2007



NS692
Clutch Starter Safety Switch
1K0927810E; 1K0927810C

Contents: Clutch Starter Safety Switch
Notes: N/A
Terminal Gender: Male
Terminal Quantity: 4
Terminal Type: Blade
Volkswagen 2014 - 2013



NS718
Neutral Safety Switch
68020005AB; 68020005AA

Connector Gender: Female
Connector Quantity: 1
Material: Metal
Mounting Type: Bolt Mount
Terminal Gender: Male
Terminal Quantity: 10
Dodge 2010 - 2009
Ram 2012 - 2011



NS744
Neutral Safety Switch
68224233AA

Connector Gender: Female
Connector Quantity: 1
Material: Metal
Mounting Type: Bolt Mount
Terminal Gender: Male
Terminal Quantity: 9
Ram 2013



NS755
Clutch Starter Safety Switch
1K0927810D

Contents: Switch
Notes: N/A
Terminal Gender: Male
Terminal Quantity: 4
Terminal Type: Blade

Volkswagen 2015 - 2010



NS763
Neutral Safety Switch
24261926

Connector Gender: Female
Connector Quantity: 1
Material: Aluminum
Mounting Type: Screw-in
Terminal Gender: Male
Terminal Quantity: 2

Chevrolet 2018 - 2016



NS766
Neutral Safety Switch
02T906207D; 02T906207A

Connector Gender: Female
Connector Quantity: 1
Material: Plastic
Mounting Type: Push On
Terminal Gender: Male
Terminal Quantity: 3

Volkswagen 2016 - 2014



NS-11
Neutral Safety Switch
J8121146; J8121146; J8121146;
J8121146; J3218190; J3218190;
J3218190; J3218190; 424705C1;
3218190; 2926495; 2932820;
12336867; 8121146; 1972523

Connector Gender: Male
Connector Quantity: 1
Terminal Gender: Male
Terminal Quantity: 3

Dodge 1985 - 1983



NS-21
Neutral Safety Switch
1994231; 1994230; 1994229;
1994228; 1994226; 1994227;
1994224; 1994225; 1994221;
1994222; 1994201; 1994202;
19107005

Connector Gender: Male
Connector Quantity: 1
Material: N/A
Mounting Type: Bolt Mount
Terminal Gender: Male
Terminal Quantity: 5

Oldsmobile 1981



NS-25
Neutral Safety Switch
E1FZ7A247A; E1FZ7A247AVMR;
F03P7A247AA; E1EP7A247AA;
12337508

Connector Gender: Female
Connector Quantity: 1
Terminal Gender: Male
Terminal Quantity: 4

Mercury 1987



NS-35
Clutch Starter Safety Switch
4814026; 11505514; 14094369;
14094368; 21021083

Contents: N/A
Notes: N/A
Terminal Gender: Male
Terminal Quantity: 2
Terminal Type: Blade

Chevrolet 1996 - 1988
GMC 1996 - 1988



NS-41
Neutral Safety Switch
22509632; 22514861; 15705308;
15685960; 15679679; 15679680

Connector Gender: Male
Connector Quantity: 3
Terminal Gender: Male
Terminal Quantity: 5

Oldsmobile 1985 - 1982
Pontiac 1982



NS-66
Neutral Safety Switch
E4FZ7A247A

Connector Gender: Female
Connector Quantity: 1
Terminal Gender: Male
Terminal Quantity: 2

Mercury 1987



NS-72
Neutral Safety Switch
5824400041; 8971386310;
8981818030; 8824400041;
8980356800; 94024701

Connector Gender: Female
Connector Quantity: 2
Terminal Gender: Male
Terminal Quantity: 2

Chevrolet 1982



NS-85
Neutral Safety Switch
8124500160; 8242294220;
12450016; 24229422

Connector Gender: Female
Connector Quantity: 2
Terminal Gender: Male
Terminal Quantity: 11

Chevrolet 2002 - 2001
GMC 2002
Hummer 2003



NS-120
Clutch Starter Safety Switch
15598491

Terminal Gender: Male
Terminal Quantity: 4
Terminal Type: Blade

Chevrolet 1991 - 1988
GMC 1989 - 1988



NS-126

Neutral Safety Switch
 F5TZ7A247B; F7TZ7A247AA;
 F7TZ7F293AA

Connector Gender: Female
 Connector Quantity: 1
 Terminal Gender: Male
 Terminal Quantity: 6 + 5
 Ford 2002 - 1999



NS-127

Clutch Starter Safety Switch

ZZL067850; ZZL067850B;
 E8TZ11A152A; F57Z11A152A;
 F81Z11A152BA; F81Z11A152BB;
 1C3Z11A152AA; ZZL067850A

Contents: Clutch Starter Safety Switch
 Notes: N/A
 Terminal Gender: Male
 Terminal Quantity: 6
 Terminal Type: Blade
 Ford 1994 - 1988



NS-193

Clutch Starter Safety Switch

53007944AB

Contents: Clutch Starter Safety Switch
 Notes: N/A
 Terminal Gender: Female
 Terminal Quantity: 2
 Terminal Type: Pin
 Dodge 2010 - 2008
 Ram 2012 - 2011



NS-223

Neutral Safety Switch

56045489AB; 56045489AA;
 56045489AC

Connector Gender: Female
 Connector Quantity: 1
 Terminal Gender: Male
 Terminal Quantity: 5
 Dodge 2009 - 2005



NS-240

Neutral Safety Switch

4057750; 3747361; J3232844

Connector Gender: Female
 Connector Quantity: 1
 Terminal Gender: Male
 Terminal Quantity: 3
 Mitsubishi 1985 - 1983



NS-314

Clutch Starter Safety Switch

1H0927189C; 1H0927189D;
 1H0927189A

Terminal Gender: Male
 Terminal Quantity: 2
 Terminal Type: Blade Terminals
 Volkswagen 2001 - 1997



NS-319

Neutral Safety Switch

24221125

Connector Gender: Female

Connector Quantity: 1
 Terminal Gender: Male
 Terminal Quantity: 1
 Chevrolet 2009
 GMC 2009 - 2006

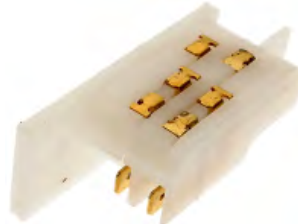

NS-334

Neutral Safety Switch

311927147B

Connector Gender: Female
 Connector Quantity: 2
 Terminal Gender: Male
 Terminal Quantity: 4
 Volkswagen 1984 - 1980



NS-335

Neutral Safety Switch

095919823F

Connector Gender: Female
 Connector Quantity: 1
 Terminal Gender: Male
 Terminal Quantity: 7
 Volkswagen 1996



NS-344

Clutch Starter Safety Switch

1J0927189E; 6Q0927189;
 1J0927189; 1J0927189F

Contents: 1 Switch
 Notes: N/A
 Terminal Gender: Male
 Terminal Quantity: 2
 Terminal Type: Blade Terminals
 Volkswagen 2002 - 1998



NS-379

Neutral Safety Switch

7C3Z7H557A; 5C3Z7H557AA;
 5C3Z7H557B; 3C3Z7H557AA

Connector Gender: Female
 Connector Quantity: 1
 Terminal Gender: Male
 Terminal Quantity: 3
 Ford 2010 - 2003



NS-485

Back-Up Light Switch

5099770AA; 68089074AA

Connector Gender: Female
 Connector Quantity: 1
 Terminal Gender: Male
 Terminal Quantity: 2
 Dodge 2010 - 2005



NS-518

Back-Up Light Switch

02A945413B; 02A945413C

Connector Gender: Female
 Connector Quantity: 1
 Terminal Gender: Male
 Terminal Quantity: 2
 Volkswagen 1997 - 1996



NS-520
Neutral Safety Switch
09G919823

Connector Gender: Female
Connector Quantity: 1
Terminal Gender: Male
Terminal Quantity: 9

Volkswagen 2013 - 2011



NS-561
Neutral Safety Switch
88996556; 19152824

Connector Gender: Female
Connector Quantity: 1
Terminal Gender: Female
Terminal Quantity: 2

Chevrolet 2007
GMC 2007



OCK2
Diesel Oil Cooler Gasket Kit

1C3Z6K649BA; F4TZ6A636A;
F7TZ6A636AAA; 1C3Z6C610BA

Ford 2003 - 1994



OCK4
Diesel High Pressure Oil Pump Hose
68015126AA; 3975818

Dodge 2010 - 2007
Ram 2018 - 2011



NS-523
Neutral Safety Switch
09B919821

Connector Gender: Female
Connector Quantity: 1
Terminal Gender: Male
Terminal Quantity: 7

Volkswagen 2006



NS-574
Back-Up Light Switch
191919823

Connector Gender: Female
Connector Quantity: 1
Terminal Gender: Male
Terminal Quantity: 5

Volkswagen 1987 - 1982



OCK1
Diesel Oil Cooler Kit
3C3Z6A642CA

Ford 2010 - 2003
International 2012 - 2002
Workhorse 2009 - 2005
Workhorse Custom
Chassis 2009 - 2006



OCK5
Diesel High Pressure Oil Pump Hose
8C3Z6A642A

Ford 2010 - 2008



NS-527
Neutral Safety Switch
09D919823; 09D919823A

Connector Gender: Female
Connector Quantity: 1
Terminal Gender: Male
Terminal Quantity: 9

Volkswagen 2010 - 2006



OCK1
Diesel Oil Cooler Gasket Kit
3C3Z6A642CAGK

Ford 2010 - 2003
International 2012 - 2002



OCK2
Diesel Oil Cooler Kit
F8UZ6A642AA; F4TZ6A642B;
1C3Z6A642AA; 1815904C2

Ford 2003 - 1994



OCK6
Diesel Oil Cooler Kit
HC3Z6A642A; BC3Z6A642B;
BC3Z6A642A

Ford 2019 - 2011



OCK3
Diesel Oil Cooler Kit
1842418C3; 1842417C94;
396081600; 1842417C93;
1842417C92; 1842417C91

IC Corporation 2009 - 2006
International 2009 - 2006



OCK7
Diesel Oil Cooler Kit
5080403AA; 5080402AA;
5104010AA; A6461880301;
5183940AA

Dodge 2006 - 2003



OCK8
Diesel Oil Cooler Kit
12649227; 98062847

Chevrolet..... 2016 - 2010
GMC..... 2016 - 2010



OCK9
Diesel Oil Cooler Kit
19210615; 97351829; 97329038;
97262115; 97213653

Chevrolet..... 2010 - 2004
GMC..... 2010 - 2004



OCK10
Diesel Oil Cooler Kit
12678318; 12672505

Chevrolet..... 2019 - 2017
GMC..... 2019 - 2017



OCK11
Diesel Oil Cooler Kit
55484648

Chevrolet..... 2019 - 2017



OCK12
Diesel Oil Cooler Kit
55595793

Chevrolet..... 2019 - 2016
GMC..... 2019 - 2016



OCK13
Diesel Oil Cooler Kit
15557751

Chevrolet..... 1995 - 1994
GMC..... 1995 - 1994



OCK14
Diesel Oil Cooler Kit
15158525

Chevrolet..... 1998 - 1996
GMC..... 1998 - 1996



OCK16
Diesel Oil Cooler Kit
5086837AA; 5114411AA;
5104874AA

Dodge..... 2008 - 2005



OCK17
Diesel Oil Cooler Kit
5179360AB; 5179360AA

Dodge..... 2009



OCK19
Diesel Oil Cooler Kit
15021207

Chevrolet..... 2002 - 1996
GMC..... 2002 - 1996



OFH101
Engine Oil Filter Housing
68105583AE; 68105583AC;
68105583AD; 68105583AB;
68105583AA; 68105583AF

Jeep..... 2016 - 2014



OPH1
Diesel High Pressure Oil
Pump Hose
F81Z9J323E

Ford..... 2003 - 1999

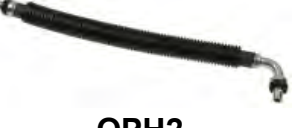

OPH2
Diesel High Pressure Oil
Pump Hose
YC3Z9J323E

Ford..... 2003 - 1999



OPH3
Diesel High Pressure Oil
Pump Hose
YC3Z9J323F

Ford..... 2003 - 2000



OPH4
Diesel High Pressure Oil
Pump Hose
F6TZ95317A; F6TZ9S317A;
1880191C91

Ford..... 1997 - 1994
International..... 1998 - 1994



PAC22
Park Assist Camera
56038978AL; 56038978AK;
56038978AJ; 56038978AI;
56038978AH; 56038978AG;
56038978AF; 56038978AE;
56038978AD; 56038978AC;
56038978AB

Ram..... 2013



PAC237
Park Assist Camera
66539200566; 66539191224;
66539216283; 66539240351

BMW..... 2018 - 2014



PC125
Crankshaft Sensor
05744440; 12557046; 10154687;
5744440
Terminal Gender: Male
Terminal Quantity: 3
AM General 1997 - 1996
Chevrolet 2002 - 1996
GMC 2002 - 1996



PC139
Camshaft Sensor
F4TZ12K073C; F5TZ12K073A;
F6TZ12K073A; 1825899;
4C4Z12K073AB; F4TZ12K073A
Terminal Gender: Male
Terminal Quantity: 3
Ford 1996 - 1994
International 2003 - 1994



PC164
Crankshaft Sensor
70104291; 70104291; 70104291;
70104291; 56026701
Terminal Gender: Male
Terminal Quantity: 3
Dodge 1993



PC260
Crankshaft Sensor
4882763
Terminal Gender: Male
Terminal Quantity: 3
Dodge 1998 - 1997



PC292
Crankshaft Sensor
5015488AB; 5015488AA;
5015184AA; 5011855AA
Terminal Gender: Male
Terminal Quantity: 3
Dodge 2001 - 1998



PC358
Crankshaft Sensor
11538428; 0011538428
Terminal Gender: Female
Terminal Quantity: 3
Mercedes-Benz 1985



PC396
Camshaft Sensor
5014994AA; AACMZUSA; 4002064;
3942816; 5014994AA; 5080577AB;
5080577AA; 5018511AA;
05014994AA; 5011853AA;
05011853AA
Terminal Gender: Male
Terminal Quantity: 3
Dodge 2002 - 1998



PC398
Camshaft Sensor
97226121; 92726121; 25366551;
25339321
Terminal Gender: Male
Terminal Quantity: 3
Chevrolet 2004 - 2001
GMC 2003 - 2001



PC399
Crankshaft Sensor
25366549; 25339320
Terminal Gender: Male
Terminal Quantity: 3
Chevrolet 2004 - 2001
GMC 2005 - 2001



PC410
Crankshaft Sensor
028907319B
Terminal Gender: Male
Terminal Quantity: 3
Volkswagen 1998 - 1996



PC436
Crankshaft Sensor
12141708618; 12141269286;
0261210001; 12141269286
Terminal Gender: Male
Terminal Quantity: 3
BMW 1986 - 1985



PC456
Crankshaft Sensor
0031539528; 31539628;
0031539628
Terminal Gender: Male
Terminal Quantity: 2
Mercedes-Benz 1999
Smart 2007 - 2005



PC460
Camshaft Sensor
237316J90D; 237316J90D;
3322082Z21; 237315M010;
237315M015; 237315M016;
237316J900; 237316J905;
237316J906; 237316J90B
Terminal Gender: Male
Terminal Quantity: 3
Nissan 2012



PC464

Camshaft / Crankshaft
Position Sensor

237316N21A; 237318J005;
237316N206

Terminal Gender: Male
Terminal Quantity: 3

Nissan 2011 - 2009



PC480

Crankshaft Sensor

53006564AB; 53006564

Terminal Gender: Male
Terminal Quantity: 3

Dodge 1993



PC497

Crankshaft Sensor

5080350AA; 31532828;
0031532828; 31532728;
0031532728; DS05080352AA;
5080352AA; 261210170;
0261210170

Terminal Gender: Male
Terminal Quantity: 2

Dodge 2006 - 2003
Freightliner 2006 - 2003
Mercedes-Benz 2009 - 1999



PC498

Crankshaft Sensor

3C3Z6C315AA; 1828345C91

Terminal Gender: Male
Terminal Quantity: 2

Ford 2010 - 2003



PC504

Crankshaft Sensor

038907319

Terminal Gender: Male
Terminal Quantity: 3

Volkswagen 2001 - 1997



PC575

Crankshaft Sensor

038907319A; 038907319F

Terminal Gender: Male
Terminal Quantity: 3

Volkswagen 2004 - 2000



PC590

Camshaft / Crankshaft
Position Sensor

5179099AB; 5179099AA

Terminal Gender: Male
Terminal Quantity: 3

Dodge 2010 - 2006

Ram 2018 - 2011



PC593

Crankshaft Sensor

12672641; 98079567; 97365037

Terminal Gender: Male
Terminal Quantity: 3

Chevrolet 2016 - 2004

GMC 2016 - 2005



PC594

Crankshaft Sensor

97321397

Terminal Gender: Male
Terminal Quantity: 3

Chevrolet 2006 - 2004

GMC 2005 - 2004



PC603

Camshaft Sensor

F7TZ12K073A; 1825899C93;
F7TZ12K073B

Terminal Gender: Male
Terminal Quantity: 3

Ford 2003 - 1997



PC617

Camshaft Sensor

97321398

Terminal Gender: Male
Terminal Quantity: 3

Chevrolet 2005 - 2004

GMC 2005 - 2004



PC625

Camshaft Sensor

0031539728; 5080346AA

Terminal Gender: Male
Terminal Quantity: 3

Dodge 2005 - 2003

Freightliner 2005 - 2003

Jeep 2008

Mercedes-Benz 2007



PC628
Camshaft Sensor
06905161B; 06A905161B;
232101031; 0232101031
Terminal Gender: Male
Terminal Quantity: 3
Volkswagen 2013



PC641
Camshaft Sensor
0041536028; 68430062AA;
0041539628; 41536928;
0041536928; 5137706AA;
5101122AA; 232103037;
0232103037
Terminal Gender: Male
Terminal Quantity: 3
Mercedes-Benz 2011



PC644
Camshaft Sensor
5066856AB; 5140332AA;
5066856AA
Terminal Gender: Male
Terminal Quantity: 3
Jeep 2019 - 2005
Ram 2019 - 2014



PC645
Camshaft Sensor
3C3Z12K073AA; 8C3Z12K073A;
1835985C92
Terminal Gender: Male
Terminal Quantity: 2



Ford 2010 - 2003
PC660
Camshaft Sensor
12672642; 98079566; 97365038
Terminal Gender: Male
Terminal Quantity: 3
Chevrolet 2016 - 2006
GMC 2016 - 2006



PC673
Camshaft / Crankshaft
Position Sensor
070907601A
Terminal Gender: Male
Terminal Quantity: 3
Volkswagen 2008 - 2004



PC700
Camshaft Sensor
030907601E
Terminal Gender: Male
Terminal Quantity: 3
Volkswagen 2015 - 2014



PC705
Crankshaft Sensor
036906433; 036906433A;
045906433A; 036906433E
Terminal Gender: Male
Terminal Quantity: 3
Volkswagen 2009 - 2005



PC707
Crankshaft Sensor
038907319E
Terminal Gender: Male
Terminal Quantity: 3
Volkswagen 2005 - 2004



PC708
Crankshaft Sensor
038907319D; 038957147D;
038957147F
Terminal Gender: Male
Terminal Quantity: 3
Volkswagen 2009 - 2004



PC716
Camshaft / Crankshaft
Position Sensor
5093101AA
Terminal Gender: Male
Terminal Quantity: 3
Dodge 2005 - 2002



PC725
Camshaft Sensor
03G957147B
Terminal Gender: Male
Terminal Quantity: 3



Volkswagen 2010 - 2005
PC738
Crankshaft Sensor
68039478AA; 68039478AB;
68039478AC; 6429050000;
5175763AA; 5175763AB;
0041538728; 6421530728;
2729050000
Terminal Gender: Male
Terminal Quantity: 3
Dodge 2009
Freightliner 2014 - 2008
Jeep 2009 - 2008
Mercedes-Benz 2014 - 2007



PC756
Crankshaft Sensor
4762097; 4720309; 4746691;
3924432
Terminal Gender: Male
Terminal Quantity: 3
Dodge 1996 - 1991



PC758
Crankshaft Sensor
5149009AD; 5149009AB;
5149009AA
Terminal Gender: Male
Terminal Quantity: 3
Dodge 1996



PC765
Crankshaft Sensor
07Z907319

Terminal Gender: Male
Terminal Quantity: 2

Volkswagen 2008 - 2004

Terminal Quantity: 3

Audi 2017 - 2008
Porsche 2016 - 2011
Volkswagen 2016 - 2009



PC792
Crankshaft Sensor
077905381K

Terminal Gender: Male
Terminal Quantity: 3

Audi 2012 - 2008
Volkswagen 2010 - 2009

Terminal Quantity: 3

Volkswagen 2014 - 2012



PC837
Crankshaft Sensor
06H906433

Terminal Gender: Male
Terminal Quantity: 2

Audi 2017 - 2015



PC865
Crankshaft Sensor
BC3Z6C315A

Terminal Gender: Male
Terminal Quantity: 3

Ford 2019 - 2011



PC766
Crankshaft Sensor
5066882AA

Terminal Gender: Male
Terminal Quantity: 3

Jeep 2006 - 2005



PC810
Camshaft Sensor
0051531328; 5175762AA

Terminal Gender: Male
Terminal Quantity: 3

Dodge 2009 - 2006
Freightliner 2017 - 2006
Jeep 2009 - 2007
Mercedes-Benz 2019 - 2007



PC839
Camshaft Sensor
03L957147

Terminal Gender: Male
Terminal Quantity: 3

Audi 2013 - 2010
Volkswagen 2014 - 2009



PC873
Crankshaft Sensor
0105422217

Terminal Gender: Male
Terminal Quantity: 2

Mercedes-Benz 1993 - 1986



PC779
Camshaft Sensor
0051531228

Terminal Gender: Male
Terminal Quantity: 3

Mercedes-Benz 2008 - 2007



PC828
Camshaft Sensor
0021531328

Terminal Gender: Female
Terminal Quantity: 3

Mercedes-Benz 1989 - 1984



PC843
Crankshaft Sensor
03C906433A; 03C906433E

Terminal Gender: Male
Terminal Quantity: 3

Audi 2013 - 2010
Volkswagen 2014 - 2008



PC878
Crankshaft Sensor
059906433C

Terminal Gender: Male
Terminal Quantity: 3

Audi 2012 - 2010



PC781
Camshaft Sensor
07L905163C; 07L905163A

Terminal Gender: Male



PC836
Camshaft Sensor
03L957147A

Terminal Gender: Male



PC883
Camshaft Sensor
13627792256

Terminal Gender: Male
Terminal Quantity: 3

BMW 2013 - 2009



PC891
Crankshaft Sensor
13627809334; 13627787192

Terminal Gender: Male
Terminal Quantity: 3

BMW..... 2013 - 2009



PC900
Camshaft / Crankshaft
Position Sensor
0021534628

Terminal Gender: Female
Terminal Quantity: 3

Mercedes-Benz 1993 - 1990



PC912
Camshaft / Crankshaft
Position Sensor
BC3Z12K073A

Terminal Gender: Male
Terminal Quantity: 3

Ford..... 2019 - 2011



PC919
Camshaft / Crankshaft
Position Sensor
059906433J; 059906433F;
059906433E; 95860643310

Terminal Gender: Male
Terminal Quantity: 3

Audi 2019 - 2012
Porsche 2016 - 2012
Volkswagen 2016 - 2011



PC927
Crankshaft Sensor
7PP905381A; 97060613100;
7PP905381B; 7PP905381

Terminal Gender: Male
Terminal Quantity: 3

Porsche 2016



PC933
Camshaft / Crankshaft
Position Sensor
E5TZ17B384A

Terminal Gender: Male
Terminal Quantity: 2

Ford..... 1994 - 1990



PC950
Camshaft Sensor
5149141AF

Terminal Gender: Male
Terminal Quantity: 4

Jeep..... 2020



PC977
Crankshaft Sensor
12674702; 12627185; 12632872

Terminal Gender: Male
Terminal Quantity: 3

GMC..... 2019 - 2016



PC981
Camshaft / Crankshaft
Position Sensor
045957147A; 045957147B

Terminal Gender: Male
Terminal Quantity: 3

Volkswagen 2006 - 2001



PC983
Crankshaft Sensor
13627806782

Terminal Gender: Male
Terminal Quantity: 3

BMW..... 2017 - 2014



PC984
Camshaft Sensor
04C907601K; 04C907601

Terminal Gender: Male
Terminal Quantity: 3

Audi 2019 - 2016



PC989
Crankshaft Sensor
06K906433B

Terminal Gender: Male
Terminal Quantity: 3

Volkswagen 2016



PC997
Crankshaft Sensor
68490180AA; 68102341AA

Terminal Gender: Male
Terminal Quantity: 3

Jeep..... 2019 - 2014
Ram..... 2019 - 2014



PC998
Crankshaft Sensor
FT4Z6C315C; FT4Z6C315A

Terminal Gender: Male
Terminal Quantity: 3

Ford..... 2016 - 2015



PC1003
Crankshaft Sensor
2769050700; 2769051200;
2761530128

Terminal Gender: Male
Terminal Quantity: 3

Freightliner 2017 - 2014
Mercedes-Benz 2019 - 2011



PC1004
Crankshaft Sensor
BK2Z6C315A

Terminal Gender: Male
Terminal Quantity: 3

Ford..... 2019 - 2015



PC1006
Camshaft Sensor
12638266
Terminal Gender: Male
Terminal Quantity: 3
Chevrolet 2016



PC1032
Camshaft Sensor
8200789528
Terminal Gender: Male
Terminal Quantity: 3
Renault 2011 - 2008



PC1047
Crankshaft Sensor
68098560AA
Terminal Gender: Male
Terminal Quantity: 2
Ram 2017 - 2014



PC1068
Crankshaft Sensor
13627805188
Terminal Gender: Male
Terminal Quantity: 3
BMW 2018 - 2014



PC1022
Camshaft Sensor
55216243
Terminal Gender: Male
Terminal Quantity: 3
Chevrolet 2015 - 2014



PC1040
Camshaft Sensor
23731EZ40A
Terminal Gender: Female; Male
Terminal Quantity: 3
Nissan 2019 - 2016



PC1048
Camshaft Sensor
1811604; 6C1Z6B288A
Terminal Gender: Male
Terminal Quantity: 3
Ford 2019 - 2007



PC1088
Camshaft Sensor
13627803093
Terminal Gender: Male
Terminal Quantity: 3
BMW 2018 - 2014



PC1029
Crankshaft Sensor
04L906433B
Terminal Gender: Male
Terminal Quantity: 3
Audi 2016 - 2015
Volkswagen 2015



PC1041
Crankshaft Sensor
23731EZ40B
Terminal Gender: Male
Terminal Quantity: 3
Nissan 2019 - 2016



PC1058
Camshaft Sensor
04C907601L; 04C907601B
Terminal Gender: Male
Terminal Quantity: 3
Volkswagen 2016



PC1095
Crankshaft Sensor
LR049872
Terminal Gender: Male
Terminal Quantity: 3
Land Rover 2019 - 2016



PC1030
Camshaft Sensor
05E907601D; 04L907601A;
04L907601
Terminal Gender: Male
Terminal Quantity: 3
Volkswagen 2015



PC1046
Camshaft Sensor
68095463AA
Terminal Gender: Male
Terminal Quantity: 3
Ram 2017 - 2014



PC1064
Camshaft Sensor
6519050100
Terminal Gender: Male
Terminal Quantity: 3
Freightliner 2017 - 2014
Mercedes-Benz 2017 - 2013



PC1097
Camshaft Sensor
LR013458
Terminal Gender: Male
Terminal Quantity: 3
Land Rover 2020 - 2016



PC1103
Camshaft Sensor
12637869

Terminal Gender: Male
Terminal Quantity: 3

Chevrolet 2019 - 2016
GMC 2019 - 2016



PC1126
Camshaft Sensor
AJ813216

Terminal Gender: Male
Terminal Quantity: 3

Jaguar 2019 - 2017



PC1127
Crankshaft Sensor
JDE38561; JDE36592

Terminal Gender: Male
Terminal Quantity: 3

Jaguar 2019 - 2017



PC1138
Camshaft Sensor
12636947

Terminal Gender: Male
Terminal Quantity: 3

Chevrolet 2019 - 2017

GMC 2019 - 2017



PC1146
Crankshaft Sensor
057906433B; 9A790643300

Terminal Gender: Male
Terminal Quantity: 3

Porsche 2019 - 2017



PC1147
Camshaft Sensor
1143723

Terminal Gender: Male
Terminal Quantity: 2

Ford 2015 - 2007



PC1179
Crankshaft Sensor
12855170

Terminal Gender: Male
Terminal Quantity: 2

Chevrolet 2015 - 2014



PC1191
Camshaft Sensor
55580466

Terminal Gender: Male
Terminal Quantity: 3

Chevrolet 2019 - 2017
GMC 2019 - 2018



PC1195
Crankshaft Sensor
12641040

Terminal Gender: Male
Terminal Quantity: 3

Chevrolet 2020 - 2017
GMC 2020 - 2017



PCB1
Crankshaft Sensor
Bracket
12537113

Pontiac 1986



PCS213
A/C High Temperature
Cut-Off Switch
3948748; ZGG711076

Volvo 2012 - 2000



PDS-124
Power Door Lock Switch
5103855AA

Contents: Switch
Functions: Power Door Locks
Terminal Gender: Male
Terminal Quantity: 8
Terminal Type: Blade

Dodge 2006 - 2003
Freightliner 2006 - 2003



PG1
Plenum Gasket
E3ZZ9H486A

Assorted Sizes: No
Kit/Set Contents: No
Material: Paper
Notes: N/A
Seal Type: MFI

Ford 1987 - 1985



PG72
Plenum Gasket
1717674011; 1717674012

Assorted Sizes: No
Kit/Set Contents: No
Material: Paper
Notes: N/A
Seal Type: MFI

Toyota 1986



PHS1
Other Injection Components
12642623

Chevrolet 2010 - 2001
GMC 2010 - 2001



PMR1
Other Injection Components
125618905

Terminal Gender: Female
Terminal Quantity: 2
Terminal Type: Button Terminal

AM General 2001 - 1996
Chevrolet 2002 - 1994
GMC 2002 - 1994
Hummer 2004 - 2002



PMR2
Other Injection Components
125618909

AM General 2001 - 1996
Chevrolet 2002 - 1994
GMC 2002 - 1994
Hummer 2004 - 2002



PMS12
Power Seat Memory Switch
4602777AB

Contents: Switch
Notes: N/A
Terminal Gender: Male
Terminal Quantity: 2
Terminal Type: Pin

Dodge 2010
Ram 2013 - 2011



PPS9
Park Assist Sensor
0005425418

Mercedes-Benz 1999 - 1996



PPS11
Park Assist Sensor
0015427418

Mercedes-Benz 2009 - 2006



PPS45
Park Assist Sensor

1EW63ZZAA; 1EW63XWGAA;
1EW63WS2AA; 1EW63TZZAA;
1EW63SW1AA; 1EW63S3XAA;
1EW63RXFAA; 1EW63PZ7AA;
1EW63P79AA; 1EW63P76AA;
1EW63LXTAA; 1EW63LBGAA;
1EW63LAUAA; 1EW63HWLAA;
1EW63HGAA; 1EW63HBVAA;
1EW63HAVAA; 1EW63GSWAA;
1EW63GPLAA; 1EW63GBSAA;
1EW63FLCAA; 1EW63FKGAA;
1EW63FHGAA; 1EW63FHFAAC;
1EW63FHFAA; 1EW63FFGAA;
1EW63FFBAA; 1EW63FDTAA;
1EW63EGJAA; 1EW63EDAAA

****Additional OE Numbers Available Online****

Dodge 2010



PPS55
Park Assist Sensor
66209196705; 66206934308

BMW 2009



PR23
Fuel Pressure Regulator
0280160207; 1612150; 1646763

Cadillac 1980



PR37
Fuel Pressure Regulator
2328074010

Toyota 1986



PR41
Fuel Pressure Regulator
2328035020; 2328035010;
2328035011

Contents: Includes Caution Sheet
Functions: Regulator
Notes: N/A

Toyota 1987 - 1986



PR71
Fuel Pressure Regulator
12711354; 280160215; 0280160215;
1271135; 92811019801; 3517134

Contents: Includes Caution Sheet
Functions: Regulator
Notes: N/A

Volvo 1985



PR73
Fuel Pressure Regulator
280160205; 0280160205

Contents: Includes Caution Sheet
Functions: Regulator
Notes: N/A

Volkswagen 1994



PR315
Fuel Pressure Regulator
1841217C91; 1825249C91;
1824982C91; 1833798C91;
1841279C91; F5TZ9C968A;
F81Z9C968AA; F81Z9C968AB;
1829856C91; 1836412C91;
1841086C91

Automotive Performance Item: No
Contents: Includes Caution Sheet
Functions: Regulator
Material: Steel
Mounting Type: Screw-in
Notes: N/A
Part Finish: Silver
Port Quantity: Not Included
Regulator Finish: Silver

Ford 2003 - 1994
IC Corporation 2007
International 2007 - 1995



PR429

Fuel Pressure Regulator

1846057C1; 5C3Z9C968CA

Automotive Performance Item: No
Contents: Includes Caution Sheet

Functions: Regulator

Material: Steel

Mounting Type: Screw-in

Notes: N/A

Part Finish: Silver

Port Quantity: Not Included

Regulator Finish: Silver

Ford 2010 - 2005

IC Corporation 2008 - 2005

International 2012 - 2005



PR430

Fuel Pressure Regulator

1839437C95; 3C3Z9C968AA

Automotive Performance Item: No
Contents: Includes Caution Sheet

Functions: Regulator

Material: Steel

Mounting Type: Screw-in

Notes: N/A

Part Finish: Silver

Port Quantity: Not Included

Regulator Finish: Silver

Ford 2004 - 2003

International 2004 - 2002



PR437

Fuel Pressure Regulator

97728979

Contents: Includes Caution Sheet

Functions: Regulator

Notes: N/A

Chevrolet 2004 - 2001

GMC 2004 - 2001



PR439

Fuel Pressure Regulator

97369850

Automotive Performance Item: No

Contents: Includes Caution Sheet

Functions: Regulator

Material: Steel

Mounting Type: Bolt Mount

Notes: Includes O-Ring

Part Finish: Silver

Port Quantity: Not Included

Regulator Finish: Silver

Chevrolet 2005 - 2004

GMC 2005 - 2004



PR444

Fuel Pressure Regulator

97384667

Contents: Includes Caution Sheet

Functions: Regulator

Notes: N/A

Chevrolet 2012 - 2006

GMC 2012 - 2006

Hummer 2006



PR460

Fuel Pressure Regulator

1K0201051C; 1K0201051K

Contents: Includes Caution Sheet

Functions: Regulator

Notes: N/A

Volkswagen 2016 - 2010



PR462

Fuel Pressure Regulator

5080462AB; 6652020040;
5080462AA

Contents: Includes Caution Sheet

Functions: Regulator

Notes: N/A

Dodge 2003



PR500

Fuel Pressure Regulator

7L8919679C

Contents: Includes Caution Sheet

Functions: Regulator

Notes: N/A

Audi 2009



PR509

Fuel Pressure Regulator

057130764H

Automotive Performance Item: No

Contents: Includes Caution Sheet

Functions: Regulator

Material: Steel

Mounting Type: Screw-in

Notes: N/A

Part Finish: Silver

Port Quantity: Not Included

Regulator Finish: Silver

Audi 2010

Volkswagen 2014 - 2010



PR511

Fuel Pressure Regulator

5183245AA

Automotive Performance Item: No

Contents: Sensor

Functions: Regulator

Material: Steel

Notes: Includes O-Ring

Dodge 2010 - 2003



PR516

Fuel Pressure Regulator

F4TZ9C968C; F4TZ9C968CA;
F4TZ9C968CB; 2C3Z9C968BA;
1824982C91; 1833798C91;
1841279C91

Automotive Performance Item: No

Contents: Regulator

Functions: Regulator

Material: Steel

Mounting Type: Screw-in

Notes: N/A

Part Finish: Brass

Port Quantity: 1

Regulator Finish: Yellow Dichromium

Ford 1995 - 1994



PR542

Fuel Pressure Regulator

BC3Z9C968A

Automotive Performance Item: No

Contents: Regulator

Functions: Regulator

Material: Steel

Mounting Type: Screw-in

Notes: N/A

Part Finish: Gray

Port Quantity: 1

Regulator Finish: Silver

Ford 2019 - 2011



PR544
Fuel Pressure Regulator
12641035

Automotive Performance Item: No
Contents: Regulator
Functions: Regulator
Material: Steel
Mounting Type: Bolt Mount
Notes: N/A
Part Finish: Silver
Port Quantity: 1
Regulator Finish: Silver

Chevrolet 2016 - 2010
GMC 2016 - 2010



PR555
Fuel Pressure Regulator
68005241AA; 4936097

Automotive Performance Item: No
Contents: Regulator
Functions: Regulator
Material: Steel
Mounting Type: Bolt Mount
Notes: N/A
Part Finish: Gray
Port Quantity: Not Included
Regulator Finish: Silver

Dodge 2010 - 2007
Ram 2014 - 2011

Port Quantity: Not Included
Regulator Finish: Silver

Jeep 2008 - 2007
Mercedes-Benz 2015 - 2007



PR562
Fuel Pressure Regulator
6420740284; 68028268AA

Automotive Performance Item: No
Contents: Regulator
Functions: Regulator
Material: Aluminum
Mounting Type: Bolt Mount
Notes: N/A
Part Finish: Silver
Port Quantity: Not Included
Regulator Finish: Silver

Dodge 2009 - 2007
Freightliner 2009 - 2007
Mercedes-Benz 2012 - 2010

Material: Aluminum
Mounting Type: Bolt Mount
Notes: N/A
Part Finish: Silver
Port Quantity: Not Included
Regulator Finish: Silver

Dodge 2006 - 2005
Freightliner 2006 - 2005



PR594
Fuel Pressure Regulator
4H0201559A; 4H0201559;
4H0201559C

Automotive Performance Item: Yes
Contents: Regulator
Functions: Regulator
Material: Cast Iron
Mounting Type: Direct
Part Finish: Silver
Port Quantity: 2
Regulator Finish: Silver

Audi 2015



PR553
Fuel Pressure Regulator
12611872

Automotive Performance Item: No
Contents: Regulator
Functions: Regulator
Material: Steel
Mounting Type: Screw-in
Notes: N/A
Part Finish: Gray
Port Quantity: 1
Regulator Finish: Silver

Chevrolet 2016 - 2010
GMC 2016 - 2010



PR560
Fuel Pressure Regulator
BC3Z9J307A

Automotive Performance Item: No
Contents: N/A
Functions: N/A
Material: Steel, Molded Nylon
Mounting Type: Bolt Mount
Part Finish: Gray
Port Quantity: Not Included
Regulator Finish: Silver

Ford 2018 - 2011



PR563
Fuel Pressure Regulator
6460740084; 5142115AA;
5142115AB

Automotive Performance Item: No
Contents: Regulator
Functions: Regulator
Material: Aluminum
Mounting Type: Bolt Mount
Notes: N/A
Part Finish: Silver
Port Quantity: Not Included
Regulator Finish: Silver

Dodge 2004
Freightliner 2004



PR604
Fuel Pressure Regulator
22670EZ40A

Automotive Performance Item: No
Contents: Regulator
Functions: Sensor
Material: Steel and Rubber
Mounting Type: Screw-in
Part Finish: Chrome & Black
Port Quantity: Not Included

Nissan 2019 - 2016



PR561
Fuel Pressure Regulator
68014062AA; 6420740184

Automotive Performance Item: No
Contents: Regulator
Functions: Regulator
Material: Aluminum
Mounting Type: Bolt Mount
Notes: N/A
Part Finish: Silver



PR564
Fuel Pressure Regulator
6460740284; 5175767AA

Automotive Performance Item: No
Contents: Regulator
Functions: Regulator



PR607
Fuel Pressure Regulator
68248541AA

Automotive Performance Item: No
Contents: Sensor
Functions: Regulator
Material: Steel and Rubber
Mounting Type: Screw-in
Part Finish: Chrome & Black

Port Quantity: Not Included
 Jeep..... 2019 - 2014
 Ram..... 2018 - 2014



PRU1
 Other Injection Components
 4C2Z9T517AA; 3C3Z9T517AG

Ford..... 2007 - 2003



PRV1
 Fuel Pressure Relief Valve
 97371618; 97361718; 8973716180;
 4938005; 1110010013; 68005441AA

Chevrolet..... 2010 - 2006
 Dodge..... 2010 - 2007
 GMC..... 2010 - 2006
 Ram..... 2018 - 2010



PRV2
 Fuel Pressure Relief Valve
 5093113AA

Dodge..... 2009 - 2003



PRV3
 Fuel Pressure Relief Valve
 1110010024; 97358556

Chevrolet..... 2005 - 2004
 GMC..... 2005 - 2004



PS539
 Oil Pressure Light Switch
 12618613333; 12617595724

Terminal Quantity: 3
 BMW..... 2017 - 2015



PS605
 Oil Pressure Gauge Switch
 LR000633; AJ813129; BE8Z9278A

Terminal Quantity: 1
 Jaguar..... 2017



PS622
 Oil Pressure Light Switch
 97225635

Terminal Quantity: 1
 Chevrolet..... 2002 - 2001
 GMC..... 2002 - 2001



PS623
 Oil Pressure Light Switch
 55488247; 12635397

Terminal Quantity: 3
 Chevrolet..... 2020 - 2016
 GMC..... 2020



PS639
 Oil Pressure Light Switch
 68329323AA; 68148354AA

Terminal Quantity: 1
 Jeep..... 2018 - 2014

Ram..... 2018 - 2014



PS647
 Oil Pressure Gauge Switch
 68095487AA; 68315274AA

Terminal Quantity: 1
 Ram..... 2017 - 2014



PS651
 Oil Pressure Light Switch
 25240EZ40A

Terminal Quantity: 1
 Nissan..... 2019 - 2016



PS656
 Oil Pressure Light Switch
 3S7Z9278A

Terminal Quantity: 1
 Ford..... 2019 - 2015



PS662
 Oil Pressure Light Switch
 06E919081F

Terminal Quantity: 1
 Audi..... 2016 - 2015



PS663
 Oil Pressure Light Switch
 06E919081G

Terminal Quantity: 2
 Audi..... 2017 - 2008



PS666
 Oil Pressure Light Switch
 06E919081D

Terminal Quantity: 1
 Audi..... 2017 - 2015



PS667
 Oil Pressure Light Switch
 059919081H

Terminal Quantity: 2
 Audi..... 2017 - 2008



PS668
 Oil Pressure Light Switch
 04L919081

Terminal Quantity: 2
 Audi..... 2016 - 2013



PS671
 Oil Pressure Light Switch
 04L919081B

Terminal Quantity: 2
 Audi..... 2016 - 2013



PS675
 Oil Pressure Gauge Switch
 68258694AA

Terminal Quantity: 3
 Jeep..... 2016



PS679

Transmission Oil Pressure Switch
68019700AA

Terminal Quantity: 1
Terminal Type: Bullet
Dodge 2010 - 2008
Ram 2013 - 2011



PS690

Oil Pressure Light Switch
68019699AA

Terminal Quantity: 1
Dodge 2010 - 2008



PS711

Air Inlet Pressure Sensor
1946724

Bering 2000
Freightliner 2001 - 1999
International 2001 - 1999
Kenworth 2000 - 1999
Oshkosh Motor Truck Co. 2001 - 2000
Peterbilt 2001 - 1999
Sterling Truck 2001 - 1999
Western Star 2001 - 1999



PS713

Injection Actuation Pressure Sensor
2244536

Blue Bird 2000 - 1999
Chevrolet 2000 - 1999
Crane Carrier 2000 - 1999
Ford 2000
Freightliner 2000 - 1999
GMC 2000 - 1999
Kenworth 2000 - 1999
Peterbilt 2000 - 1999
Sterling Truck 2000 - 1999
Western Star 2000



PS715

Oil Pressure Light Switch
8200671272

Terminal Quantity: 1
Renault 2013 - 2008



PS716

Oil Pressure Gauge Switch
94860621300

Terminal Quantity: 4
Porsche 2016



PS726

Oil Pressure Light Switch
1616996480

Terminal Quantity: 1
Fiat 2014



PS-12

Oil Pressure Light Switch

10045707; 38522157; 379948;
549099; 6460242; 6460391;
5653197; 557458; 3915936;
3815936; 3751700; 3615936;
3852215; 19021012; 2815936;
1998149; 1508425; 1508753;
1508286

Terminal Quantity: 1
Buick 1985 - 1980
Cadillac 1985 - 1980
Chevrolet 1987 - 1980
GMC 1987 - 1980
Oldsmobile 1985 - 1980
Pontiac 1985 - 1980



PS-15

Oil Pressure Light Switch

J806574; J806574; J806574;
J806574; J3200422; J3200422;
J3200422; J3200422; 806574;
806574; 806574; 806574; 3200422;
3200422; 3200422; 3200422;
3142826; 3142826; 3142826;
3142826; 19106700; J3142826;
LHD5642AA; PS530710; C42200;
DORY9278A; 6729107; 214896R91;
280891C91; 292632C91
****Additional OE Numbers Available Online****

Terminal Quantity: 1
Chevrolet 1985
GMC 1985



PS-57

Oil Pressure Light Switch

J1370748; J1370748; J1370748;
J1370748; 1370748; 1370748;
1370748; 1370748; 4379037;
E0ZF9278AA; E0ZZ9278A;
5653462; 551458; 1480667;
1469790; 14103175; 14035122;
1359288; 1350116; 941968;
1619641; 1508767; 1508648

Terminal Quantity: 1
Buick 1980
Chevrolet 1988 - 1983
GMC 1988 - 1982
Pontiac 1980



PS-120

Oil Pressure Gauge Switch

E53Z9278A; E7GZ9278A;
E50318501; R20718501;
9827202090; 9827202091;
9827202092; D27Z9278A;
9827102092; 8353087702000;
8353087703000; 8353036011;
8353060050; 8353087102;
8353087702; 8353030050;
8353030051; 8353030060;
8353036010; 8353030010;
8353030040; 8353030041;
8353030042; 37240P13003;
37240P13004; 37240P13014;
429955500; 081318501;
085518501A; 269118501A

****Additional OE Numbers Available Online****
Terminal Quantity: 1
Ford 1986 - 1984
Mazda 1984 - 1982
Mercury 1986 - 1984



PS-121

Oil Pressure Gauge Switch

113919081C; 113919081C;
113919081A; 113919081A;
311919081A; 113919081;
028919081C; 021919081;
021919081A; 021919081B;
021919081D; 028919081B;
0344101058; 0344101056;
0344101044; 0344101033;
0344101032; 0344101031;
0344101014; 12336868; 19021004;
GPS101

Terminal Quantity: 1

Volkswagen 1986 - 1980

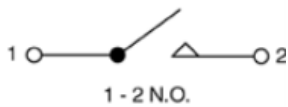
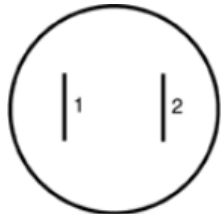

PS-126

Oil Pressure Light Switch

25036001; 457874; 10012967;
10002798

Terminal Quantity: 2

Chevrolet 1981 - 1980



PS-138

Oil Pressure Light Switch

25240KA100; 8353012010;
8353030030; 9475011000;
3782082000; 8353001010;
8353010010; 829956101;
3782073000; 37240PA6004;
37600611154; 37240PA6004;
37200657154; 37240657003;
37240657005; 37240657013;
37240657305; 37200590036;
37200611154; 25240KA020;
022218501A; 086618501A;
12353039; 12336869; 326894

Terminal Quantity: 1

Isuzu 1987

Pontiac 1985 - 1983

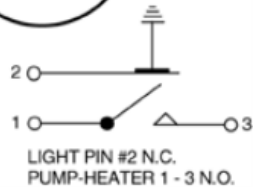
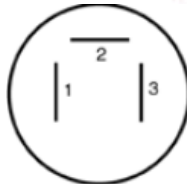

PS-140

Oil Pressure Light Switch

6464144; 10023681; 3241717;
1623576; 1254383; 25036378;
25036276; 1608288

Terminal Quantity: 3

Chevrolet 1992 - 1985

GMC 1992 - 1985

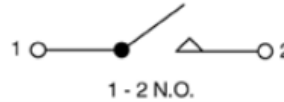
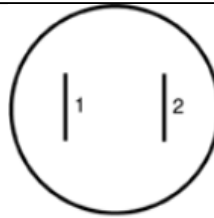

PS-144

Oil Pressure Light Switch

14034354; 1403454; 25036214;
15663139; 15665282

Terminal Quantity: 2

Chevrolet 1985

GMC 1984 - 1982



PS-154

Oil Pressure Gauge Switch

14036243; 459417; 459457;
10007393

Terminal Quantity: 1

Chevrolet 1991 - 1982

GMC 1990 - 1982

Oldsmobile 1984 - 1982

Pontiac 1982



PS-155

Oil Pressure Gauge Switch

53005218; 53005218; 53005218;
53005218; 53000834; 53000834;
53000834; 53000834; 8953004550;
14078917; 10030966; 14078954;
14040816; 8953005218;
8953000834; 22522707; 15591103

Terminal Quantity: 1

Buick 1983

Chevrolet 1993 - 1982
GMC 1991 - 1982
Oldsmobile 1985 - 1983
Pontiac 1985 - 1983



PS-163

Oil Pressure Gauge Switch

056919081; 056919081E; 19021102

Terminal Quantity: 1

Volkswagen 2001 - 1981



PS-165

Oil Pressure Light Switch

068919081D; 068919081E;
038919081B; 038919081G;
068919081; 038919081M

Terminal Quantity: 1

Audi 2013 - 2010

Volkswagen 2010 - 1985



PS-167

Oil Pressure Light Switch

12180287; 1218190; 12181905;
1218028; 113104; 113148; 88924474

Terminal Quantity: 1

Volvo 1986



PS-168
Oil Pressure Light Switch

F3XY9278A; 25240G2400;
2524070J00; F3XY9278B;
2524089920; 252408996E;
2524089915; 2524089960;
19021029

Terminal Quantity: 1

Nissan 1985



PS-189
Oil Pressure Light Switch

3250426; 12571378; 056919081C;
021919081C; 028919081D;
028919081H; 344101082;
0344101082; 12119

Terminal Quantity: 1

Volkswagen 2001 - 1981

Volvo 1983

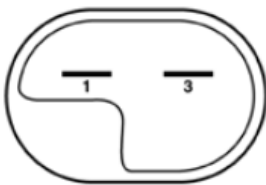

PS-221
Oil Pressure Light Switch

25036938

Terminal Quantity: 2

AM General 1997

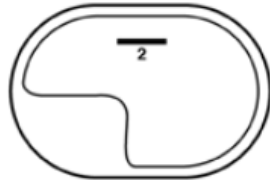

PS-230
Oil Pressure Gauge Switch

8125625710; 8972256350;
10068546; 8125622660; 10036541;
10240133; 12562571; 12562266

Terminal Quantity: 1

Chevrolet 2002 - 2001

GMC 2004 - 2001

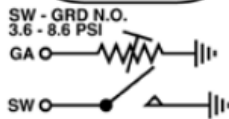
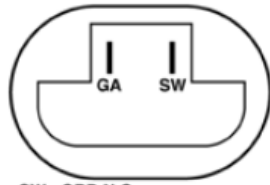

PS-233
Oil Pressure Gauge Switch

8953030493; 8953030493;
8953030493; 8953030493;
53030493; 53030493AB; 4740856;
4741609; 19021107; 4687711;
4713833; 5227913; 4429121

Terminal Quantity: 2

Dodge 1989



PS-240
Oil Pressure Gauge Switch

ZZLO18501; 1816324C1;
E9SF9278AA; E9SZ9278A;
F4TZ9278A; ZZLO18501;
E6SZ9278A

Terminal Quantity: 1

Ford 1995 - 1988



PS-243
Oil Pressure Gauge Switch

E9ZZ9278A; F32F9D290AA;
F3ZZ9278A; E9ZF90290AA;
E9ZF9278A; E9ZF9D290AA;
88924400

Terminal Quantity: 1

Ford 1991 - 1989

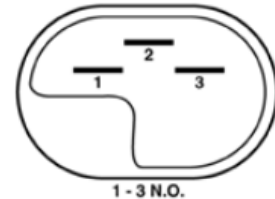

PS-245
Oil Pressure Gauge Switch

12555492; 10243574; 10096169;
8125531750; 24575160; 10207183;
10205676; 10205675; 10201490;
10191433; 10137630; 10096200;
10096178; 8125555340; 19244501;
22578315; 22568444; 1647135;
1643532; 1643552; 1635477

Terminal Quantity: 3

Chevrolet 2002 - 1991

GMC 2002 - 1991



PS-248
Oil Pressure Light Switch

068919081A; 19021111

Terminal Quantity: 1

Volkswagen 1998 - 1985



PS-256
Oil Pressure Gauge Switch

14073454; 14043217; 10137603;
15564999

Terminal Quantity: 3

Chevrolet 1991 - 1988

GMC 1991 - 1988



PS-264
Engine Oil Temperature Switch
140919563; 140919563; 1H0919563
Terminal Quantity: 1
Volkswagen 1998



PS-272
Oil Pressure Light Switch
12611277591
Terminal Quantity: 1
BMW 1986 - 1985



PS-291
Oil Pressure Gauge Switch
56031005AB; 56031005; 5003675AA
Terminal Quantity: 2
Dodge 1998



PS-292
Oil Pressure Light Switch
12617620512; 12618611273;
12612367061; 12611730160;
19021101; 12611710509;
12617568480
Terminal Quantity: 1
BMW 2011 - 2009



PS-296
Oil Pressure Gauge Switch
56026781
Terminal Quantity: 1
Jeep 1987 - 1985



PS-297
Oil Pressure Light Switch
06A919081E; 06A919081A;
06A919081D; 06A919081F;
06A919081J
Terminal Quantity: 1
Audi 2013 - 2010
Volkswagen 2015 - 2000



PS-304
Oil Pressure Light Switch
19244502; 12558074
Terminal Quantity: 1
Chevrolet 2002 - 1999
GMC 2002 - 1999



PS-305
Oil Pressure Gauge Switch
97176230; 8971762300;
8353014060; 8353014070;
8353030090; 8353060020;
835300E010; 8353005010;
94859102; 94854139; 94854295;
88924478
Terminal Quantity: 1
Isuzu 2020 - 2015



PS-308
Oil Pressure Gauge Switch
8126778360; 8126149690;
8125622300; 12556117; 12677836;
8126166460; 8125622300;
12616646; 12614969; 12573107;
12569323; 8125731070; 12562230;
12559780
Terminal Quantity: 3
Isuzu 2007



PS-314
Oil Pressure Gauge Switch
1831259C91; F75F9278CB;
F81Z9278AA
Terminal Quantity: 1
Ford 2010 - 1999



PS-317
Oil Pressure Gauge Switch
7B0919081B; 7B0919081C;
5149062AB; 5149064AA;
56028807AB; 56028807AA;
56028807AB
Terminal Quantity: 3
Jeep 2006 - 2005



PS-323
Oil Pressure Gauge Switch
252404M400; 252404M40E
Terminal Quantity: 1
Nissan 2008



PS-329
Oil Pressure Gauge Switch
818074; SOU403; 65429417;
55421817; 0065429417;
0055421817
Terminal Quantity: 1
Mercedes-Benz 1990 - 1985



PS-331
Oil Pressure Light Switch
113110; 818077; SOB814; 113105;
11311; 88924483
Terminal Quantity: 1
Peugeot 1985 - 1980



PS-362
Oil Pressure Light Switch
818078; SOU400; 113138;
78GB09278AB; 78GB9278AB
Terminal Quantity: 1
Peugeot 1987 - 1986



PS-400
Oil Pressure Gauge Switch
038919081H; 94860620301;
038919081; 038919081C;
038919081K; 94860620300
Terminal Quantity: 1
Audi 2015 - 2010
Volkswagen 2016 - 2000



PS-405
Oil Pressure Gauge Switch
1825263C91; F6TZ9278AA
Terminal Quantity: 1

Ford 1998 - 1996



PS-406
Oil Pressure Gauge Switch
68002994AB; 68002994AA;
5083366AA
Terminal Quantity: 1
Dodge 2010 - 2002
Ram 2018 - 2011



PS-407
Oil Pressure Gauge Switch
5012991AE; 5012991AB;
5012991AC; 5012991AD;
5011434AA; 5012991AA
Terminal Quantity: 3
Blue Bird 2017 - 2014
Crane Carrier 2013 - 2008
Dodge 2001 - 1998
El Dorado 2017
Freightliner 2016 - 2013
Gillig 2017
Kenworth 2017 - 2009
Peterbilt 2017 - 2008
Sterling Truck 2009
Thomas 2017



PS-414
Oil Pressure Gauge Switch
97600434; 98027456
Terminal Quantity: 3
Chevrolet 2010 - 2003
GMC 2010 - 2003



PS-437
Oil Pressure Gauge Switch
95420817; 0095420817
Terminal Quantity: 2
Mercedes-Benz 1995



PS-461
Oil Pressure Gauge Switch
D4AZ9278A
Terminal Quantity: 1
Ford 1988



PS-479
Oil Pressure Light Switch
036919081A; 036919081D;
06A919081C
Terminal Quantity: 1
Volkswagen 2015 - 2000



PS-488
Oil Pressure Gauge Switch
95560609102; 95560609100;
95560609101; 079919081
Terminal Quantity: 1
Audi 2009 - 2008
Porsche 2016 - 2011



PS-490
Oil Pressure Light Switch
038919081P
Terminal Quantity: 1
Audi 2015 - 2010



PS-491
Oil Pressure Light Switch
95860608131; 06E919081C;
95860608130
Terminal Quantity: 2
Porsche 2013 - 2012



PS-492
Oil Pressure Light Switch
059919081G; 059919081D
Terminal Quantity: 2
Audi 2013 - 2010
Volkswagen 2010



PS-528
Oil Pressure Light Switch
5149038AB; 5149065AA
Terminal Quantity: 3
Jeep 2010 - 2007



PS-531
Oil Pressure Light Switch
95860608140
Terminal Quantity: 1
Porsche 2012 - 2011



PSS1
Power Steering Pressure Switch
10035576; 10034239; 10014261; 14032098
Connector Gender: Male
Contents: Switch
Notes: N/A
Switch Mounting Type: Screw-in
Terminal Gender: Male
Terminal Quantity: 2
Terminal Type: Blade
Thread Size - Metric: N/A
GMC 1984 - 1983



PSS4
Power Steering Pressure Switch
E57A3N824AA; E5TZ3N824A; F37A3N824AA; F3TZ3N824A
Connector Gender: Female
Connector Quantity: 1
Contents: Switch
Hardware Included: N/A
Mounting Location: N/A
Notes: N/A
Switch Mounting Type: Screw-in
Terminal Gender: Male
Terminal Quantity: 2
Terminal Type: Blade
Thread Size - Metric: N/A
Ford 2004 - 2000



PSS12
Power Steering Pressure Switch
10218778; 10204101; 10096156
Connector Gender: Female
Contents: Switch
Notes: N/A
Switch Mounting Type: Screw-in
Terminal Gender: Male
Terminal Quantity: 2
Terminal Type: Blade
Thread Size - Metric: N/A
Chevrolet 1999 - 1994
GMC 1999 - 1994



PSS33
Power Steering Pressure Switch
53000970
Connector Gender: Male
Contents: Sensor
Notes: N/A
Switch Mounting Type: Screw-in
Terminal Gender: Male
Terminal Quantity: 2
Terminal Type: Blade
Thread Size - Metric: N/A
Jeep 1987 - 1985



PSW106
Power Seat Switch
F65Z14A701AA; F7UZ14A701AA; F3UZ14A701A
Notes: N/A
Terminal Gender: Male
Terminal Quantity: 8
Terminal Type: Bullet



Ford 2013 - 1999
PSW126
Power Seat Switch
68035043AA; 56049433AE; 56049433AD; 56049429AB
Contents: 1 Switch
Notes: N/A
Terminal Gender: Male
Terminal Quantity: 10
Terminal Type: Blade Terminals
Ram 2013 - 2011



PSW165
Power Seat Lumbar Switch
68157564AA
Contents: Switch
Notes: N/A
Terminal Gender: Female
Terminal Quantity: 4
Terminal Type: Blade
Ram 2013 - 2012



PVS1
Ported Vacuum Switch
E9192; 418457; 419571; 419591; 413473; 3031712; 3030975; 3019022; 3010922; 1238524; 12305001; 1230500
Thread Size - Metric: N/A
Thread Size - NPT: 1/2
Cadillac 1980



PVS16
Ported Vacuum Switch
355961; 357100; 335961; 3031549; 3031549A
Thread Size - Metric: N/A
Thread Size - NPT: 3/8
Chevrolet 1981 - 1980
Pontiac 1982



PVS18
Ported Vacuum Switch
E1AE9A564E1A; E1AE9A564E2A; E1AZ8A564E; E1DE8A564A1A; E1DE8A564A2A; E1AE8A564E2A; E1AE8A564EZA; E1AE8A564G1A; E1AE8A564G2A; D7OE8A564A1A; D7OE8A564A2A; D7OZ8A564AZA; E1AE8A564E1A; D5OE8A564A1A; D5OE8A564A2A; D5OE8A564AZA; D5OZ8A564A; E1AZ8A564D; 12323872
Thread Size - Metric: N/A
Thread Size - NPT: 3/8
Ford 1988 - 1983
Mercury 1984



PVS19
Ported Vacuum Switch
E1BE9A564A2A; D7LE9A564A1A; D7LE9A564A2A; E1BE8A564A1A; E1BE8A564A2A; E1BE9A564A1A; D5Z8A564A; D5Z8A564B; D7LE8A564A1A; D7LE8A564A2A; D4TE8A564AA; D4TZ8A564AA; D5ZE8A564A1A; D5ZE8A564A2A; E4191; E1BE8A564A3A; 12323873
Thread Size - Metric: N/A
Thread Size - NPT: 3/8
Ford 1988 - 1983
Mercury 1984



PVS20
Ported Vacuum Switch
E1AE9A564J2A; D7DE8A564A2A;
E1AE8A564J1A; E1AE8A564J2A;
E1AE9A564J1A; D5AE8A564A2A;
D5AZ8A564A; D5AZ8A564A2A;
D7DE8A564A1A; D4TZ9D473A;
D5AE8A564A1A; E4192; 12323871;
12323866
Thread Size - Metric: N/A
Thread Size - NPT: 3/8
Ford 1988 - 1983
Mercury 1984



PVS27
Ported Vacuum Switch
373510; 3036912
Thread Size - Metric: N/A
Thread Size - NPT: 3/8
Chevrolet 1985 - 1980
Pontiac 1983 - 1981



PVS43
Ported Vacuum Switch
355963; 3031386
Thread Size - Metric: N/A
Thread Size - NPT: 1/2
Chevrolet 1981



PVS48
Ported Vacuum Switch
14007803; 3043015
Thread Size - Metric: N/A
Thread Size - NPT: 1/2

Chevrolet 1985 - 1980
Pontiac 1981 - 1980



PVS50
Ported Vacuum Switch
22505266
Thread Size - Metric: N/A
Thread Size - NPT: N/A
Buick 1980
Oldsmobile 1981 - 1980
Pontiac 1980



PVS59
Ported Vacuum Switch
1489023M00
Thread Size - Metric: N/A
Thread Size - NPT: 3/8
Nissan 1983



PVS67
Ported Vacuum Switch
14009006; 3041769
Thread Size - Metric: N/A
Thread Size - NPT: 3/8
Chevrolet 1985 - 1980



PVS71
Ported Vacuum Switch
353738; 3228288; 3225912;
5003187; 3031385
Thread Size - Metric: N/A
Thread Size - NPT: 3/8
Chevrolet 1980



PVS82
Ported Vacuum Switch
3041970; 3053331; 3041920
Thread Size - Metric: N/A
Thread Size - NPT: 1/2
Chevrolet 1981 - 1980



PVS85
Ported Vacuum Switch
4268708; 12352216; 4049277;
4030351
Thread Size - Metric: N/A
Thread Size - NPT: 3/8
Dodge 1980



PVS87
Ported Vacuum Switch
E1051; 12323827; 3837622
Oldsmobile 1980



PVS90
Ported Vacuum Switch
14890U7800
Thread Size - Metric: N/A
Thread Size - NPT: 3/8
Nissan 1987 - 1981



PVS91
Ported Vacuum Switch
14890U6700; 14890V0500
Thread Size - Metric: N/A
Thread Size - NPT: 3/8
Nissan 1985 - 1981



PVS126
Ported Vacuum Switch
14890P7910
Thread Size - Metric: N/A
Thread Size - NPT: 3/8
Nissan 1983 - 1981



PVS149
Ported Vacuum Switch
058131851A
Thread Size - Metric: N/A
Thread Size - NPT: 3/8
Volkswagen 1994 - 1980



PWS105
Brake Pad Wear Sensor
34356762253; 34356789445
Connector Gender: Female
Connector Quantity: 1
Connector Shape: Round
Functions: Brake Pad Wear Sensor
Mounting Location: Brake Caliper
Terminal Gender: Male; Female
Terminal Quantity: 2
Terminal Type: Pin
BMW 2009



PWS144
Brake Pad Wear Sensor
34351179821; 34351180780;
61311361896; 3421225229
Connector Gender: Female
Connector Quantity: 1
Connector Shape: Round
Functions: Brake Pad Wear Sensor
Mounting Location: Brake Caliper
Terminal Gender: Male; Female
Terminal Quantity: 2
Terminal Type: Pin + Cylindrical
BMW 1986 - 1985



PVS133
Ported Vacuum Switch
22506187
Thread Size - Metric: N/A
Thread Size - NPT: Push On
Buick 1980
Oldsmobile 1980
Pontiac 1980



PVS160
Ported Vacuum Switch
9092505068
Thread Size - Metric: N/A
Thread Size - NPT: 3/8 -19 British
Std. Pipe
Toyota 1986

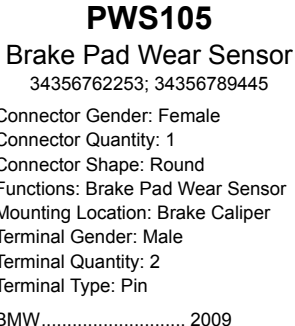

PWS108
Brake Pad Wear Sensor
34356779619; 34356789440
Connector Gender: Female
Connector Quantity: 1
Connector Shape: Round
Functions: Brake Pad Wear Sensor
Mounting Location: Brake Caliper
Terminal Gender: Male
Terminal Quantity: 2
Terminal Type: Pin
BMW 2009



PWS145
Brake Pad Wear Sensor
34351179819; 34351180782;
34111152607
Connector Gender: Female + Male
Connector Quantity: 1
Connector Shape: Round
Functions: Brake Pad Wear Sensor
Mounting Location: Brake Caliper
Terminal Gender: Male; Female
Terminal Quantity: 1 + 1
Terminal Type: Pin
BMW 1986 - 1985



PVS135
Ported Vacuum Switch
22521800
Thread Size - Metric: N/A
Thread Size - NPT: 3/8
Buick 1984
Chevrolet 1984
Oldsmobile 1984
Pontiac 1984



PVS166
Ported Vacuum Switch
10012354
Thread Size - Metric: N/A
Thread Size - NPT: Push On
Oldsmobile 1980



PWS105
Brake Pad Wear Sensor
34356762253; 34356789445
Connector Gender: Female
Connector Quantity: 1
Connector Shape: Round
Functions: Brake Pad Wear Sensor
Mounting Location: Brake Caliper
Terminal Gender: Male; Female
Terminal Quantity: 2
Terminal Type: Pin
BMW 2009



PVS148
Ported Vacuum Switch
9092505073
Thread Size - Metric: N/A
Thread Size - NPT: 1/2
Toyota 1987



PVS167
Ported Vacuum Switch
22525978; 22505978
Thread Size - Metric: N/A
Thread Size - NPT: Push On
Buick 1980
Oldsmobile 1980



PWS173
Brake Pad Wear Sensor
 1265402017; 0005400217;
 1235400017; 5099878AA

Connector Gender: Male
 Connector Quantity: 1
 Connector Shape: Round
 Functions: Brake Pad Wear Sensor
 Mounting Location: Brake Caliper
 Terminal Gender: Female
 Terminal Quantity: 1
 Terminal Type: Bullet

Mercedes-Benz 1998 - 1980



PWS176
Brake Pad Wear Sensor
 2205400617; 2205400717;
 2115401717

Connector Gender: Female
 Connector Quantity: 1
 Connector Shape: Oval
 Functions: Brake Pad Wear Sensor
 Mounting Location: Brake Caliper
 Terminal Gender: Male
 Terminal Quantity: 2
 Terminal Type: Bullet

Mercedes-Benz 2009 - 2006



PWS177
Brake Pad Wear Sensor
 1645401017; 2205401517;
 68013762AA

Connector Gender: Female
 Connector Quantity: 1
 Connector Shape: Oval
 Functions: Brake Pad Wear Sensor
 Mounting Location: Brake Caliper
 Terminal Gender: Male
 Terminal Quantity: 2
 Terminal Type: Bullet

Dodge 2009

Freightliner 2009
 Mercedes-Benz 2009 - 2007

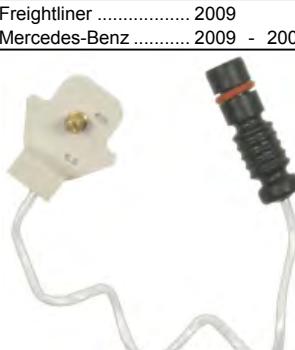

PWS182
Brake Pad Wear Sensor
 2015400317

Connector Gender: Male
 Connector Quantity: 1
 Connector Shape: Round
 Functions: Brake Pad Wear Sensor
 Mounting Location: Brake Caliper
 Terminal Gender: Female
 Terminal Quantity: 1
 Terminal Type: Bullet

Mercedes-Benz 1995 - 1984



PWS217
Brake Pad Wear Sensor
 9015400017; 9015400117;
 5142123AA; 5103583AA

Connector Gender: Male
 Connector Quantity: 1
 Connector Shape: Round
 Functions: Brake Pad Wear Sensor
 Mounting Location: Brake Caliper
 Terminal Gender: Female
 Terminal Quantity: 1
 Terminal Type: Bullet

Dodge 2006 - 2003
 Freightliner 2006 - 2002



PWS234
Brake Pad Wear Sensor
 9015400217; 5170962AA;
 5103583AB

Connector Gender: Male
 Connector Quantity: 1
 Functions: Brake Pad Wear Sensor
 Mounting Location: Brake Caliper
 Terminal Gender: Female
 Terminal Quantity: 1
 Terminal Type: Pin Socket

Dodge 2006 - 2003
 Freightliner 2006 - 2002



PWS235
Brake Pad Wear Sensor
 9065401517; 68006722AA;
 68006717AA

Connector Gender: Male
 Connector Quantity: 2
 Functions: Brake Pad Wear Sensor
 Mounting Location: Brake Caliper
 Terminal Gender: Female
 Terminal Quantity: 1
 Terminal Type: Bullet

Dodge 2009
 Freightliner 2014 - 2009
 Mercedes-Benz 2014 - 2010



PWS236
Brake Pad Wear Sensor
 9065401317; 68019556AA

Connector Gender: Male
 Connector Quantity: 1
 Functions: Brake Pad Wear Sensor
 Mounting Location: Brake Caliper
 Terminal Gender: Female
 Terminal Quantity: 2
 Terminal Type: Bullet

Dodge 2009
 Freightliner 2009



PWS260
Brake Pad Wear Sensor
 34356792560

Connector Gender: Female
 Connector Quantity: 1
 Connector Shape: Round
 Functions: N/A
 Mounting Location: Brake Caliper
 Terminal Gender: Male
 Terminal Quantity: 2
 Terminal Type: Pin

BMW 2011



PWS262
Brake Pad Wear Sensor
 34356792567

Connector Gender: Female
 Connector Quantity: 1

Connector Shape: Oval
 Functions: N/A
 Mounting Location: N/A
 Terminal Gender: Male
 Terminal Quantity: 2
 Terminal Type: Pin

BMW 2013 - 2011



PWS290
Brake Pad Wear Sensor
 34356792289

Connector Gender: Female
 Connector Quantity: 1
 Connector Shape: Oval
 Mounting Location: Brake Caliper
 Terminal Gender: Male
 Terminal Quantity: 2
 Terminal Type: Pin

BMW 2014



PWS291
Brake Pad Wear Sensor
 34356792292

Connector Gender: Female
 Connector Quantity: 1
 Connector Shape: Oval
 Functions: Brake Pad Wear Sensor
 Mounting Location: Brake Caliper
 Terminal Gender: Male
 Terminal Quantity: 2
 Terminal Type: Pin

BMW 2014



PWS304
Brake Pad Wear Sensor
 7P0907637

Connector Gender: Male
 Connector Quantity: 1
 Connector Shape: Oval
 Functions: Brake Pad Wear Sensor
 Mounting Location: Brake Caliper
 Terminal Gender: Female
 Terminal Quantity: 2
 Terminal Type: Alligator

Volkswagen 2015 - 2011



PWS332
Brake Pad Wear Sensor
LR045959

Connector Gender: Female
Connector Quantity: 1
Connector Shape: Oval
Functions: Brake Pad Wear Sensor
Mounting Location: Brake Caliper
Terminal Gender: Male
Terminal Quantity: 2
Terminal Type: Pin
Land Rover 2016



PWS339
Brake Pad Wear Sensor
34356861808; 34356890791

Connector Gender: Female
Connector Quantity: 1
Connector Shape: Oval
Functions: Brake Pad Wear Sensor
Mounting Location: Brake Caliper
Terminal Gender: Male
Terminal Quantity: 2
Terminal Type: Pin
BMW 2018



QS101M
Tire Pressure Monitor Sensor

Must be programmed before installation

Dodge 2009
Ford 2010
Freightliner 2013 - 2009
Mercedes-Benz 2013 - 2010



QS101R
Tire Pressure Monitor Sensor

Must be programmed before installation

Dodge 2009
Ford 2010
Freightliner 2013 - 2009
Mercedes-Benz 2013 - 2010



QS102M
Tire Pressure Monitor Sensor

Must be programmed before installation

BMW 2014 - 2009
Mercedes-Benz 2009 - 2007



QS102R
Tire Pressure Monitor Sensor

Must be programmed before installation

BMW 2014 - 2009
Mercedes-Benz 2009 - 2007



QS104M
Tire Pressure Monitor Sensor

BMW 2018 - 2009
Dodge 2010
Freightliner 2018 - 2014
Mercedes-Benz 2019 - 2007



QS104R
Tire Pressure Monitor Sensor

BMW 2018 - 2009
Dodge 2010
Freightliner 2018 - 2014
Mercedes-Benz 2019 - 2007



QS105M
Tire Pressure Monitor Sensor

Dodge 2009
Ford 2014 - 2010
Freightliner 2013 - 2009
Mercedes-Benz 2013 - 2006





QS105R
Tire Pressure Monitor Sensor

Dodge 2009
Ford 2014 - 2010
Freightliner 2013 - 2009
Mercedes-Benz 2013 - 2010

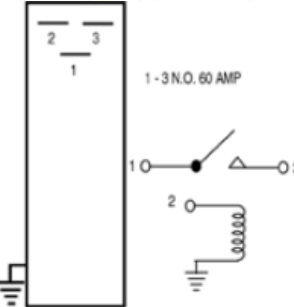

RL-2
A/C Compressor Clutch Relay
D2SZ14677B; D3AB14677AA; D2SB14677AA; 1116882

Connector Gender: N/A
Connector Quantity: N/A
Connector Shape: Rectangular
Functions: Relay
Mounting Bracket(s) Included: Yes
Terminal Gender: Male
Terminal Quantity: 3
Voltage: 12
Ford 1997 - 1990

RTL1
Diesel Fuel Injector Return Hose
BC3Z9A564B; BC3Z9A564A
Ford 2016 - 2011



RTL2
Diesel Fuel Injector Return Hose
HC3Z9A564A
Ford 2019 - 2017



RU51HTK
Blower Motor Resistor Kit
89018537; 12135104
Chevrolet 2009 - 2003
GMC 2009 - 2003



RU318HTK
Blower Motor Resistor Kit
ZZL161D85; E7TZ19A706A;
4C2Z19A706BA; 4C2Z199706BA
Ford 2002 - 1983



RU445HTK
Blower Motor Resistor Kit
F6UZ19A706AA; 4C2Z19A706AA
Ford 2008 - 1999



RU932
Blower Motor Resistor
68048901AA
Terminal Gender: Male
Terminal Quantity: 4
Wire Quantity: N/A
Dodge 2010
Ram 2013



RU968
Blower Motor Resistor
1669064001
Terminal Gender: Male
Terminal Quantity: 6
Wire Quantity: N/A
Mercedes-Benz 2017 - 2010



RU969
Blower Motor Resistor
LR082162
Terminal Gender: Male
Terminal Quantity: 6
Wire Quantity: N/A
Land Rover 2019 - 2017



RU987
Blower Motor Resistor
97500523
Terminal Gender: Male
Terminal Quantity: 4
Wire Quantity: N/A
Chevrolet 2009 - 2004



RU-51
Blower Motor Resistor
89018537; 12135104
Terminal Gender: Male; Female
Terminal Quantity: 8
Wire Quantity: N/A
Chevrolet 2009 - 2003
GMC 2009 - 2003

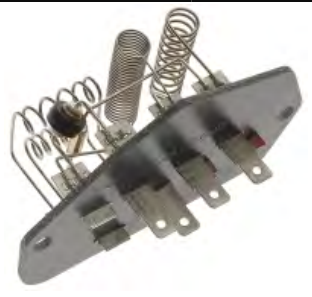

RU-56
Blower Motor Resistor
52472699
Terminal Gender: Male
Terminal Quantity: 4
Wire Quantity: N/A
Chevrolet 1994 - 1993
GMC 1996 - 1993



RU-57
Blower Motor Resistor
15551633
Terminal Gender: Male
Terminal Quantity: 3 + 2
Wire Quantity: N/A
Chevrolet 2002 - 1991
GMC 2002 - 1991



RU-59
Blower Motor Resistor
15991075
Terminal Gender: Male
Terminal Quantity: 5
Wire Quantity: N/A
Chevrolet 1994



RU-62
Blower Motor Resistor
526897; 10039426
Terminal Gender: Male
Terminal Quantity: 4
Wire Quantity: N/A
Buick 1983
Chevrolet 1991
GMC 1992 - 1991



RU-67
Blower Motor Resistor
00336403; 336403
Terminal Gender: Male
Terminal Quantity: 4
Wire Quantity: N/A
GMC 1991



RU-268
Blower Motor Resistor
1468201880; W00176433
Terminal Gender: Male
Terminal Quantity: 3
Wire Quantity: N/A
Mazda 1984 - 1982



RU-318
Blower Motor Resistor
ZZL161D85; E7TZ19A706A;
4C2Z19A706BA; 4C2Z199706BA

Terminal Gender: Male
Terminal Quantity: 4
Wire Quantity: N/A

Ford 2002 - 1983



RU-432
Blower Motor Resistor
D5UZ19A706A

Terminal Gender: Male
Terminal Quantity: 2
Wire Quantity: N/A

Ford 2002



RU-538
Blower Motor Resistor
YL7Z19E624AA; YL7Z19E624A;
F5LY19E624A; F3LY19E624A

Terminal Gender: Male
Terminal Quantity: 5

Ford 1997



RU-564
Blower Motor Resistor
2108214651; 2108211551;
2108212951

Terminal Gender: Male
Terminal Quantity: 4
Wire Quantity: N/A

Mercedes-Benz 2007 - 1995



RU-371
Blower Motor Resistor
22807122; 89019089; 89018597;
15305077

Terminal Gender: Male; Female
Terminal Quantity: 9
Wire Quantity: 2

GMC 2004 - 2002



RU-440
Blower Motor Resistor
3F2Z18591AA; ZZCA61815

Terminal Gender: Male
Terminal Quantity: 4
Wire Quantity: N/A

Ford 2010 - 2008



RU-561
Blower Motor Resistor
2218703858; 2208209210

Terminal Gender: Male
Terminal Quantity: 5
Wire Quantity: N/A

Mercedes-Benz 2007



RU-566
Blower Motor Resistor
1638200597; 2038218651;
2038214058; 203821865164;
230821025164; 2308216351;
2308216451; 2308210251;
2208210951

Terminal Gender: Male
Terminal Quantity: 6
Wire Quantity: 6

Mercedes-Benz 2009 - 2006



RU-373
Blower Motor Resistor
52463893

Terminal Gender: Male
Terminal Quantity: 3
Wire Quantity: N/A

Chevrolet 2009 - 2003
GMC 2009 - 2003



RU-445
Blower Motor Resistor
F6UZ19A706AA; 4C2Z19A706AA

Terminal Gender: Male
Terminal Quantity: 4
Wire Quantity: N/A

Ford 2007 - 1999



RU-562
Blower Motor Resistor
1248205810; 1248202710

Terminal Gender: Male; Female
Terminal Quantity: 5
Wire Quantity: 5

Mercedes-Benz 1993 - 1986



RU-569
Blower Motor Resistor
2018210460

Terminal Gender: Male
Terminal Quantity: 7
Wire Quantity: N/A

Mercedes-Benz 1989 - 1984



RU-570
Blower Motor Resistor
0058205010; 1408218351;
1408218451

Terminal Gender: Male; Female
Terminal Quantity: 6
Wire Quantity: 5

Mercedes-Benz 1995 - 1994



RU-571

Blower Motor Resistor
22807123; 89018596; 89019088;
89018308

Terminal Gender: Male; Female
Terminal Quantity: 9
Wire Quantity: 9

GMC 2004 - 2002



RU-631

Blower Motor Resistor
52413530; 52409643; 89018778;
93803636; 93803635; 89018849;
52497491; 52495874; 19260762;
89019351; 89018964; 22754990

Terminal Gender: Male
Terminal Quantity: 5
Wire Quantity: 5

GMC 2004 - 2003



RU-685

Blower Motor Resistor
5103766AA

Terminal Gender: Male
Terminal Quantity: 7
Wire Quantity: N/A

Dodge 2004 - 2003

Freightliner 2004 - 2003



RU-729

Blower Motor Resistor
64119222072; 64119265892;
64119266185; 64116927090;
64119146765

Terminal Gender: Male
Terminal Quantity: 6
Wire Quantity: N/A

BMW 2011 - 2009



RU-620

Blower Motor Resistor
64111355769; 64111366990;
64111466012

Terminal Gender: Male
Terminal Quantity: 3
Wire Quantity: N/A

BMW 1986 - 1985



RU-661

Blower Motor Resistor
5189134AA; 68004539AA

Terminal Gender: Male
Terminal Quantity: 4
Wire Quantity: N/A

Dodge 2010 - 2008



RU-686

Blower Motor Resistor
5133432AA

Terminal Gender: Male
Terminal Quantity: 4
Wire Quantity: N/A

Dodge 2006 - 2003

Freightliner 2006 - 2003



RU-730

Blower Motor Resistor
13598090; 13598134; 7425178J00;
7425178J01; 13501703; 15141283

Terminal Gender: Male
Terminal Quantity: 5
Wire Quantity: N/A

GMC 2009 - 2008



RU-630

Blower Motor Resistor
500890; 3998401

Terminal Gender: Male
Terminal Quantity: 4
Wire Quantity: N/A

GMC 1991



RU-669

Blower Motor Resistor
64511373277; 64511468409

Terminal Gender: Male
Terminal Quantity: 7
Wire Quantity: N/A

BMW 1986 - 1985



RU-710

Blower Motor Resistor
68048900AB; 68048900AA

Terminal Gender: Male
Terminal Quantity: 4
Wire Quantity: N/A

Dodge 2010

Ram 2013 - 2011



RU-775

Blower Motor Resistor
6C3Z19E624AA; 2C3Z19E624AA

Terminal Gender: Male
Terminal Quantity: 5
Wire Quantity: 5

Ford 2007 - 2005



RU-778

Blower Motor Resistor

68012613AA

Terminal Gender: Male
Terminal Quantity: 4
Wire Quantity: N/A

Dodge 2009 - 2007
Freightliner 2017 - 2007
Mercedes-Benz 2018 - 2010



RU-812

Blower Motor Resistor

64119311938; 64119355981;
64119226780

Terminal Gender: Male
Terminal Quantity: 6
Wire Quantity: N/A

BMW 2016 - 2014



RU-818

Blower Motor Resistor

64119276112; 64119270254

Terminal Gender: Male
Terminal Quantity: 6
Wire Quantity: N/A

BMW 2018 - 2014



RU-825

Blower Motor Resistor

AE9Z19E624B

Terminal Gender: Female
Terminal Quantity: 6
Wire Quantity: N/A

Ford 2015 - 2011



RU-839

Blower Motor Resistor

68018105AA

Terminal Gender: Male
Terminal Quantity: 4
Wire Quantity: N/A

Ram 2013



RU-879

Blower Motor Resistor

0008700089

Terminal Gender: Male
Terminal Quantity: 6
Wire Quantity: N/A

Freightliner 2017 - 2010
Mercedes-Benz 2018 - 2010



RU-884

Blower Motor Resistor

2128702110

Terminal Gender: Male
Terminal Quantity: 6
Wire Quantity: N/A

Mercedes-Benz 2015 - 2013



RY467

Diesel Glow Plug Relay

YC3Z12B533AA; 1828565C1

Connector Gender: Female; Female
Connector Quantity: 2
Connector Shape: Rectangular
Functions: Glow Plug Controller
Mounting Bracket(s) Included: Yes
Terminal Gender: Male; Male
Terminal Quantity: 14
Voltage: 12

Ford 2010 - 1999



RY1420

Multi-Function Relay

0015422923; 5103746AA

Connector Gender: N/A
Connector Quantity: N/A
Connector Shape: Square
Functions: Relay
Mounting Bracket(s) Included: No
Terminal Gender: Male
Terminal Quantity: 2
Voltage: 12

Dodge 2006 - 2003
Freightliner 2006 - 2003



RY1724

Glow Plug Controller

68013182AD; 6429007801;
6421532079; 68013182AC;
5175759AB; 5175759AA;
6429005801

Connector Quantity: 2
Connector Shape: Oval
Mounting Bracket(s) Included: No
Terminal Gender: Male
Terminal Quantity: 12 + 1
Voltage: 12

Dodge 2009 - 2007
Jeep 2009 - 2007
Mercedes-Benz 2015 - 2007



RY1736

Diesel Glow Plug Relay

191911261C

Connector Gender: Male
Connector Quantity: 7
Connector Shape: Square
Functions: Relay
Mounting Bracket(s) Included: No
Terminal Gender: Male
Terminal Quantity: 7
Voltage: 12

Volkswagen 1997 - 1993



RY1811
Multi-Function Relay
5103551AA

Connector Gender: N/A
Connector Quantity: N/A
Connector Shape: Square
Functions: Relay
Mounting Bracket(s) Included: No
Terminal Gender: Male
Terminal Quantity: 4
Voltage: 12
Dodge 2006 - 2003
Freightliner 2006 - 2003
Mercedes-Benz 2009 - 2007



RY1832
Glow Plug Controller
98041624

Mounting Bracket(s) Included: Yes
Terminal Gender: Male
Terminal Quantity: 31
Terminal Type: Blade
Voltage: 12.8
Chevrolet 2007 - 2006
GMC 2007 - 2006



RY1848
Glow Plug Controller
68167867AA

Mounting Bracket(s) Included: Yes
Terminal Gender: Male
Terminal Quantity: 8
Voltage: 12
Ram 2018 - 2014



RY1854
Glow Plug Controller
CK4Z12B533A; CK4Z12B533B

Mounting Bracket(s) Included: Yes
Terminal Gender: Male
Terminal Quantity: 31
Terminal Type: Blade
Voltage: 12
Ford 2019 - 2015



RY1866
Glow Plug Controller
12652113; 12632954; 12652111;
12636451

Mounting Bracket(s) Included: Yes
Terminal Gender: Male
Terminal Quantity: 31
Terminal Type: Blade & Pin
Voltage: 12
Chevrolet 2012 - 2010
GMC 2012 - 2010



RY1868
Diesel Glow Plug Relay
1840861C1; 1840903C91;
4C4Z12B533AA

Amperage Rating: N/A
Connector Gender: Male
Mounting Bracket(s) Included: Yes
Terminal Gender: Male
Terminal Quantity: 4
Voltage: 12
Ford 2009 - 2002
IC Corporation 2007 - 2005
International 2007 - 2003



RY1869
Glow Plug Controller
GC3Z12B533A; GC3A12B533AA;
BC3Z12B533A; FC3Z12B533A;
BC3Z12B533B

Mounting Bracket(s) Included: No
Terminal Gender: Male + Male + Male
Terminal Quantity: 1+12+16
Terminal Type: Blade;Spade
Voltage: 12
Ford 2017 - 2011



RY1952
Glow Plug Controller
8980185121; 98018512;
8980185120

Mounting Bracket(s) Included: No
Terminal Gender: Male
Terminal Quantity: 4
Terminal Type: Blade
Voltage: 12
Chevrolet 2010 - 2004
GMC 2010 - 2004
Isuzu 2010 - 2004

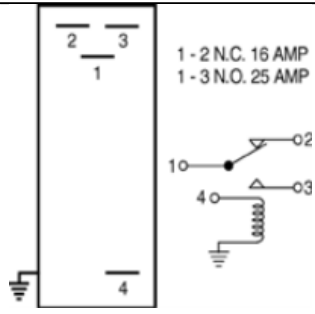

RY-8
A/C Auto Temperature Control Relay

550351; 412687; 413074; 391348;
391948; 412686; 1116992; 1365166;
12339254
Connector Gender: N/A
Connector Quantity: N/A
Connector Shape: Rectangular
Functions: Relay
Mounting Bracket(s) Included: No
Terminal Gender: Male
Terminal Quantity: 4
Voltage: 12

Buick 1982 - 1980
Cadillac 1980
Chevrolet 1981 - 1980
Oldsmobile 1981
Pontiac 1982 - 1980

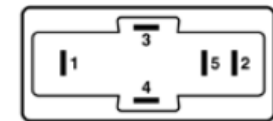

RY-20
A/C Compressor Clutch Relay

526896; 10018449
Connector Gender: Female
Connector Quantity: 1
Connector Shape: Rectangular
Functions: Relay
Mounting Bracket(s) Included: Yes
Terminal Gender: Male
Terminal Quantity: 5
Voltage: 12
Pontiac 1981



RY-22
A/C Condenser Fan Motor Relay
499786; 483694; 10026578;
10018448; 9785034

Connector Gender: Female
Connector Quantity: 1
Connector Shape: Rectangular
Functions: Relay
Mounting Bracket(s) Included: Yes
Terminal Gender: Male
Terminal Quantity: 5
Voltage: 12

Pontiac 1983

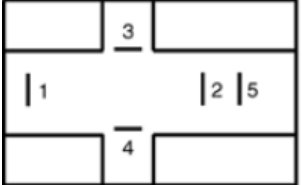
RY-23
Air Control Valve Relay
89057581; 463468

Connector Gender: Female
Connector Quantity: 1
Connector Shape: Rectangular
Functions: Blower Motor
Mounting Bracket(s) Included: Yes
Terminal Gender: Male
Terminal Quantity: 5
Voltage: 12

Chevrolet 1982
GMC 1982 - 1980
Pontiac 1981

RY-27
A/C Auto Temperature Control Relay
10034222; 10024141; 10026663;
10022616; 14081905; 1987312;
20650336

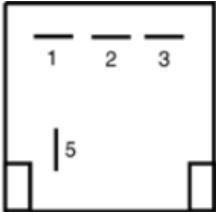
Connector Gender: Female
Connector Quantity: 1
Connector Shape: Square
Functions: Relay
Mounting Bracket(s) Included: No
Terminal Gender: Male
Terminal Quantity: 4
Voltage: 12

Buick 1985
Chevrolet 1983
GMC 1983
Oldsmobile 1985 - 1983

RY-22
A/C Condenser Fan Motor Relay
499786; 483694; 10026578;
10018448; 9785034

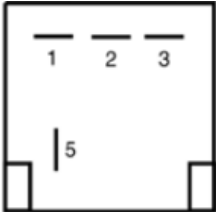
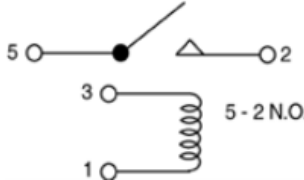
Connector Gender: Female
Connector Quantity: 1
Connector Shape: Rectangular
Functions: Relay
Mounting Bracket(s) Included: Yes
Terminal Gender: Male
Terminal Quantity: 5
Voltage: 12

Pontiac 1983

RY-32
A/C Compressor Clutch Cut-Off Relay
10019535; 10018447

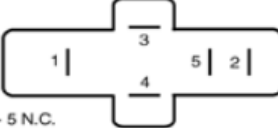
Connector Gender: Female
Connector Quantity: 1
Connector Shape: Rectangular
Functions: Blower Motor
Mounting Bracket(s) Included: No
Terminal Gender: Male
Terminal Quantity: 5
Voltage: 12

Pontiac 1985



RY-33
Fuel Injection Relay
321906059C; 0332204510

Connector Gender: N/A
Connector Quantity: N/A
Connector Shape: Square
Functions: Relay
Mounting Bracket(s) Included: No
Terminal Gender: Male
Terminal Quantity: 5
Voltage: 12

Volkswagen 1984 - 1980

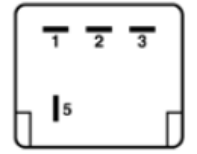
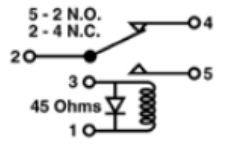
RY-34
Fast Idle Relay
10026187; 10021933; 22515682;
2251682

Connector Gender: Female
Connector Quantity: 1
Connector Shape: Square
Functions: Relay
Mounting Bracket(s) Included: Yes
Terminal Gender: Male
Terminal Quantity: 5
Voltage: 12

Buick 1984 - 1982
Chevrolet 1983 - 1982
Oldsmobile 1984 - 1982

RY-39
A/C Control Relay
5825500360; 8944509710;
942489989; 2523089972;
2523089975; 2523089977; 12322111

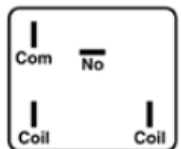
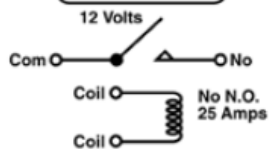
Connector Gender: N/A
Connector Quantity: N/A
Connector Shape: Rectangular
Functions: Relay
Mounting Bracket(s) Included: No
Terminal Gender: Male
Terminal Quantity: 4
Voltage: 12

Isuzu 1987



RY-43

**A/C Compressor Clutch
Cut-Off Relay**
475862; 14080670

Connector Gender: Female
Connector Quantity: 1
Connector Shape: Rectangular
Functions: Coolant Fan Relay
Mounting Bracket(s) Included: Yes
Terminal Gender: Male
Terminal Quantity: 4
Voltage: 12

Chevrolet 1980
GMC 1980



RY-44

Pulse Wiper Relay

22021347; 22039320; 22010011;
22021346

Connector Gender: Male
Functions: Relay
Mounting Bracket(s) Included: Yes
Terminal Gender: Male
Terminal Quantity: 3
Voltage: 12

Cadillac 1984
Chevrolet 1984
Oldsmobile 1983 - 1982

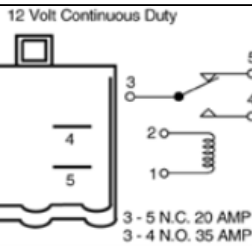
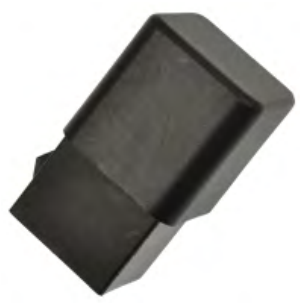

RY-46

**A/C Auto Temperature
Control Relay**

E8DZ13853A; E83Z11433A;
E83B7G080AA; E6ZZ11433B;
E6ZB7G080AA; E6FZ11433A;
E6EB7G080BA; E63Z11433B;
E63Z11433A; E63B7G080AA;
E63B11433AA; F1UZ9345A;
F1ZB9345AA; F8PZ14N135AA;
F19B9345AA; F19Z9345A;
F1TZ9C392B; F1UB9C392A1A;
FOCB11433A2A; FOFZ11433A;
F17B9C392AA; F19B9345A2A;
E9TZ9C392A; E9TZ9C392B;
E9UZ9C392A; FOCB11433A1A;
E8AB13A025A2A; E8AZ13A025A;
E8BZ13A025A; E99Z9C392A

****Additional OE Numbers
Available Online****

Connector Gender: Female
Connector Quantity: 1
Connector Shape: Rectangular
Functions: Relay
Mounting Bracket(s) Included: No
Terminal Gender: Male
Terminal Quantity: 5
Voltage: 12

Lincoln 1984
Mercury 1986 - 1984



RY-47

**A/C Auto Temperature
Control Relay**

D5AB14C609CA; D2LB14C690AA;
D2LY14512A; D5AB14C609AA;
D5AB14C609BA; D2LB14C609AA

Connector Gender: N/A
Connector Quantity: N/A
Connector Shape: Rectangular
Functions: Relay
Mounting Bracket(s) Included: No

Terminal Gender: Male
Terminal Quantity: 3
Voltage: 12

Ford 1997 - 1990

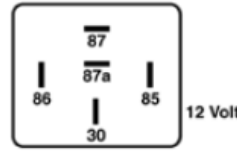

RY-48

**A/C and Heater Delay
Relay**

J3239095; J3239095; J3239095;
J3239095; 8936000401;
8936000401; 8936000401;
8936000401; 36000401; 36000401;
36000401; 36000400; 36000400;
36000400; 36000400; 36000400;
VF415F11S05; 5266147;
0332204166; 0332204158;
33001779; 33001777; 4373677;
4373229; 8936000400; 1623924;
4271149; 4271499; 4271141;
5252672

****Additional OE Numbers
Available Online****

Connector Gender: N/A
Connector Quantity: N/A
Connector Shape: Square
Functions: Relay
Mounting Bracket(s) Included: Yes
Terminal Gender: Male
Terminal Quantity: 5
Voltage: 12

Jeep 1986 - 1985

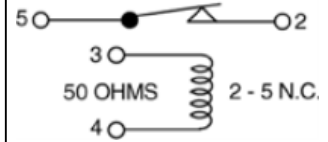
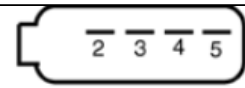

RY-49

Theft Deterrent Relay
1616422

Connector Gender: Female
Connector Quantity: 1
Connector Shape: Rectangular
Functions: Relay
Mounting Bracket(s) Included: No
Terminal Gender: Male
Terminal Quantity: 4
Voltage: 12

Buick 1980

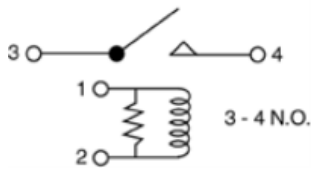
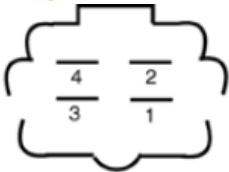

RY-51

A/C and Heater Relay

- MB330024; MB084670;
- E8GY9345A; FE6818811;
- 909870200483; 9098702004B;
- 9098702005; 9098702008;
- 9098705003; 9099999089;
- 9008087003; 9098702001;
- 9098702002; 9098702004;
- 8863004010; 8863022070;
- 8863060020; 8863095702;
- 9008087001; 80490SM4A01;
- 782501081; 82501AA130;
- 82501GA240; 39798SE0003;
- 429557110; 429957110;
- 39798SE0003; 3886060A00;
- 3886060B10; 3886078400

****Additional OE Numbers Available Online****

Connector Gender: Female
 Connector Quantity: 1
 Connector Shape: Round
 Functions: Relay
 Mounting Bracket(s) Included: No
 Terminal Gender: Male
 Terminal Quantity: 4
 Voltage: 12

Toyota 1984



RY-53

Diesel Glow Plug Relay

- 171911261E; 171911261A;
- 171911261B; 321911261;
- 321911261C

Connector Gender: Male
 Functions: Diesel Glow Plug Relay
 Mounting Bracket(s) Included: No
 Terminal Gender: Male
 Terminal Quantity: 7
 Voltage: 12

Volkswagen 1992 - 1980



RY-54

Diesel Glow Plug Relay

- 8942481620; 8944580590;
- 25230W2511; 8941538490;
- 8942369220; 8942382950;
- 8942481610; 25230W0500;
- 25230W2500; 25230W2501;
- 25230W2510; 2523009W00;
- 2523009W01; 94248161; 94248162

Connector Gender: Female
 Connector Quantity: 1
 Connector Shape: Rectangular
 Functions: Relay
 Mounting Bracket(s) Included: Yes
 Terminal Gender: Male
 Terminal Quantity: 4
 Voltage: 12

Chevrolet 1983 - 1982
 Isuzu 1987 - 1981
 Nissan 1986 - 1982

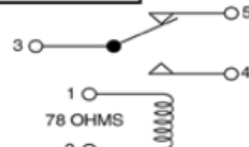
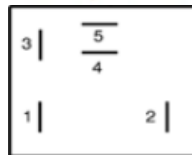

RY-55

A/C Auto Temperature Control Relay

- 8942488260; 8943799210;
- 8944299470; 8944818200;
- 8941635570; 8942075631;
- 8942322220; 8942331340;
- 8942331370; 5822500290;
- 5825500290; 8941291520;
- 8941548020; 1825502940;
- 25230W1300; 8942184970;
- 94218497; 94154802

Connector Gender: Male
 Functions: Fuel Pump Relay
 Mounting Bracket(s) Included: Yes
 Terminal Gender: Male
 Terminal Quantity: 5
 Voltage: 12

Isuzu 1986 - 1985

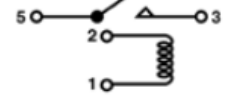
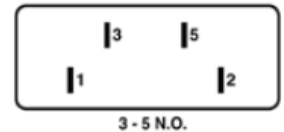

RY-63

A/C Auto Temperature Control Relay

- 3F5Z14N089BA; F3XY9P704A;
- 25230C9965; 25230C9970;
- 25230C9980; 25230C9985;
- 252300B060; 252300B080;
- 2523061A05; 2523061A10;
- 252300B000

Connector Gender: Female
 Connector Quantity: 1
 Connector Shape: Rectangular
 Functions: Relay
 Mounting Bracket(s) Included: No
 Terminal Gender: Male
 Terminal Quantity: 4
 Voltage: 12

Nissan 1984 - 1981

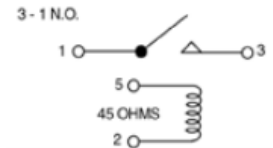
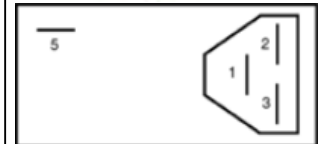

RY-65

Fuel Injection Relay

4221279

Connector Gender: N/A
 Connector Quantity: N/A
 Connector Shape: Rectangular
 Functions: Relay
 Mounting Bracket(s) Included: Yes
 Terminal Gender: Male
 Terminal Quantity: 4
 Voltage: 12

Dodge 1985 - 1984



RY-69

Starter Motor Control Relay

E6EB7G080AA; E3FZ12A598B;
E3SB19A366AA; E3VB19A366AA;
E6EB19A366AA; E3EB12B563AA;
E3EB12B598AA; E3EB12B598BA;
E3FZ12A598A; E3EB12A598B2A;
E3EB12A598B3; E3EB12A598B3A;
E3EB12A598BA; E3EB12A598A1B;
E3EB12A598A2A; E3EB12A598AA;
E3EB12A598B1A; E3EB12A598A1A

Connector Gender: Female
Connector Quantity: 1
Connector Shape: Square
Functions: Starter Relay
Mounting Bracket(s) Included: No
Terminal Gender: Male
Terminal Quantity: 4
Voltage: 12

Ford 1984

Connector Gender: Female
Connector Quantity: 1
Connector Shape: Rectangular
Functions: Relay
Mounting Bracket(s) Included: No
Terminal Gender: Male
Terminal Quantity: 5
Voltage: 12

Ford 1993 - 1983
Mercury 1985 - 1984



12 Volt Continuous Duty

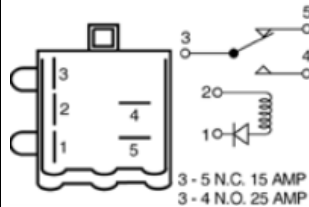

RY-71

Computer Control Relay

F8PZ14N135BA; F8PZ14N135CA;
FOSZ2C013A; E7AZ9C392A;
E7TZ9C392B; E9TZ9C392C;
F1TZ9C392A; E4LB9C392CA;
E4LB9C392DA; E4LY9C392C;
E6AZ9C392D; E43F12A646B2A;
E43F12A646BA; E43Z12A646B;
E3UF12A646B2A; E3UF12A646BA;
E3VF12A646BA; E43F12A646B1A;
E3TF12A646BA; E3UF12A646A1A;
E3UF12A646A2A;
E3UF12A646B1A; E3EF12A646A1A;
E3EF12A646A2A; E3EF12A646B1A;
E3EF12A646B2A; E3AF12A646B1A;
E3AF12A646B2A; E3AF12A646BA;
E3AZ12A646A

****Additional OE Numbers Available Online****

Connector Gender: Female
Connector Quantity: 1
Connector Shape: Square
Functions: Relay
Mounting Bracket(s) Included: No
Terminal Gender: Male
Terminal Quantity: 5
Voltage: 12

Ford 1992 - 1983
Lincoln 1984
Mercury 1985 - 1984

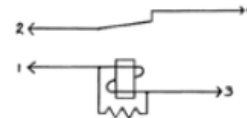
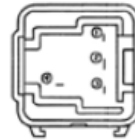

RY-85

A/C Auto Temperature Control Relay

10039961; 10031837; 10028676;
10022960; 10020960; 10020950

Connector Gender: Female
Connector Quantity: 1
Connector Shape: Square
Functions: Headlamp Motor Relay
Mounting Bracket(s) Included: No
Terminal Gender: Male
Terminal Quantity: 4
Voltage: 12

Buick 1985 - 1982
Cadillac 1985 - 1984
Chevrolet 1985 - 1984
GMC 1984 - 1983
Oldsmobile 1985 - 1984
Pontiac 1985 - 1984

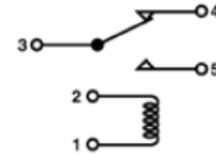
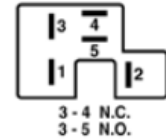

RY-90

Blower Motor Relay

25230B005; F3XY14N089F;
25230C9961; 25230C9971;
788053070; 2523004G00;
2523004G05; 252300B005;
25230C9960; 25230C996A;
3F5Z14N089AA

Connector Gender: Female
Connector Quantity: 1
Connector Shape: Rectangular
Functions: Relay
Mounting Bracket(s) Included: No
Terminal Gender: Male
Terminal Quantity: 5
Voltage: 12

Nissan 1985 - 1984



12 Volt Continuous Duty

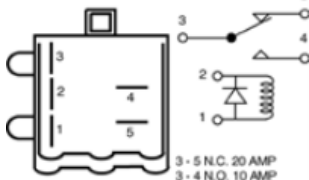

RY-70

A/C Auto Temperature Control Relay

F8PZ14N135DA; F8PZ14N135FA;
E9SB13A025A3A; E9SZ13A025A;
F30Y13A025A; F3OY13A025A;
E93B2C013AA; E93Z8Z658A;
E9SB13A025A1A;
E9SB13A025A2A;
E8OB13A025A1A;
E8OB13A025A2A; E8VB9C392AA;
E8VZ9C392A; E83B2C013AB;
E83B2C013AC; E83B2C013AD;
E83Z8Z658A; E7SB13A025B;
E7SZ13A025A; E80Y13A025A;
E83B2C013AA; E7RY13A025A;
E7RY13A025B; E7SB13A025A1A;
E7SB13A025A2A;
E5VB13A025A2A;
E5VB13A025A3A; E6DZ9345A;
E6VY13A025A

****Additional OE Numbers Available Online****

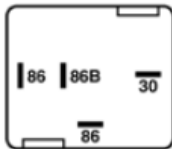
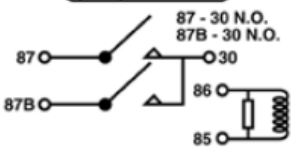
RY-95
A/C Control Relay
431951253C; 171906381;
431951253C; 7M0951253; 60800552

Connector Gender: N/A
Connector Quantity: N/A
Connector Shape: Square
Functions: Relay
Mounting Bracket(s) Included: No
Terminal Gender: Male
Terminal Quantity: 5
Voltage: 12

Volkswagen 1984 - 1981

RY-100
Headlight Actuator Relay
0332019155; 0332014315;
0332014172; 0332014155;
89057565; 20414941

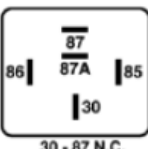
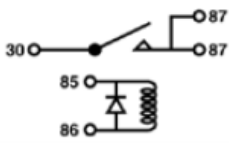
Connector Gender: N/A
Connector Quantity: N/A
Connector Shape: Square
Functions: Relay
Mounting Bracket(s) Included: Yes
Terminal Gender: Male
Terminal Quantity: 5
Voltage: 12

Buick..... 1985 - 1983



RY-109
A/C Compressor Clutch Relay
RX0109; 2013683C1; 14103304;
14089936

Connector Gender: Female
Connector Quantity: 1
Connector Shape: Oval
Functions: Relay
Mounting Bracket(s) Included: Yes
Terminal Gender: Male
Terminal Quantity: 5
Voltage: 12

AM General 1996 - 1995
Chevrolet 1995 - 1989
GMC 1995 - 1985

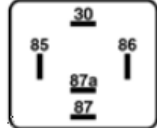
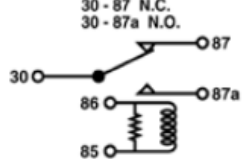



RY-115
A/C and Heater Relay
50732; VF415F11S01;
VF445F11S01; 83504930;
8933001776; 332204171; 25570060;
25525848; 12081388; 12081022;
12070670; 12043552; 12042058;
12040824; 12034722; 12034544;
332209159; 0332209161;
0332209159; 0332204179;
0332204176; 0332204173;
0332204171; 0332204152;
12051153; 12046288; 12046205;
12046005; 56006709; 56003137

****Additional OE Numbers Available Online****

Connector Gender: N/A
Connector Quantity: N/A
Connector Shape: Square
Functions: Multi-Function Relay
Mounting Bracket(s) Included: Yes
Terminal Gender: Male
Terminal Quantity: 5
Voltage: 12

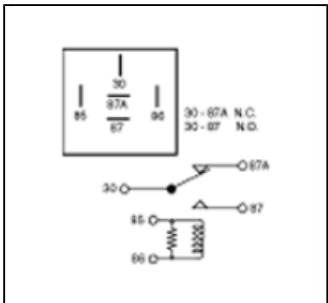
Buick..... 1985
Chevrolet 1994 - 1980
GMC 1994 - 1980
Jeep..... 2006 - 1985





RY-116
A/C and Heater Relay
2012557C1; FOAB14B192AA;
FOAZ14N089A; FOAB14B192AA;
FOAB14N192AA; FOAZ14N089A;
FOZ214N089A; FOAZ14089A;
94580644; 96821098; 86586550012;
F02Z14N089A; 8141004550;
8506545; 8517195; 8522336;
8553901; 391603C200; 0567006707;
0008211063; MR301971; 90191753;
25520198; 20541669; 20499299;
14100455; 13502674; 12088572;
12033862; 1626239

****Additional OE Numbers Available Online****

Connector Gender: N/A
Connector Quantity: N/A
Connector Shape: Square
Functions: Multi-Function Relay
Mounting Bracket(s) Included: No
Terminal Gender: Male
Terminal Quantity: 5
Voltage: 12

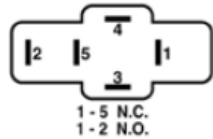
Buick..... 1985 - 1982
Cadillac..... 1985 - 1980
Chevrolet 1995
Dodge 2009 - 1994
Ford 2004 - 1984
GMC 1995
Jeep..... 2009 - 1985
Mercury 1987 - 1984
Oldsmobile 1983 - 1982
Volvo..... 1984 - 1983

RY-117
A/C Auto Temperature Control Relay
14036273

Connector Gender: Female
Connector Quantity: 1
Connector Shape: Rectangular
Functions: Relay
Mounting Bracket(s) Included: Yes
Terminal Gender: Male
Terminal Quantity: 5
Voltage: 12

Chevrolet 1990 - 1984
GMC 1990 - 1984

RY-121
A/C Compressor Clutch Relay
10038792; 14078979; 14078907;
10094701

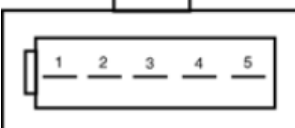
Connector Gender: Female
Connector Quantity: 1
Connector Shape: Rectangular
Functions: Relay
Mounting Bracket(s) Included: Yes
Terminal Gender: Male

Terminal Quantity: 5
Voltage: 12
Buick 1985



RY-127
Computer Control Relay
E3EF12A646BA; E6EF12A646BA;
E6FZ12A646B; F1CZ12A646B

Connector Gender: Female
Connector Quantity: 1
Connector Shape: Square
Functions: Relay
Mounting Bracket(s) Included: No
Terminal Gender: Male
Terminal Quantity: 4
Voltage: 12

Mercury 1987 - 1984



RY-132
Active Suspension Relay
2523089981

Connector Gender: Female
Connector Quantity: 2
Connector Shape: Oval
Functions: Relay
Mounting Bracket(s) Included: No
Terminal Gender: Male
Terminal Quantity: 4
Voltage: 12

Nissan 1986



RY-138
Anti-Dieseling Relay
22505456; 22517700

Connector Gender: Female
Connector Quantity: 1
Connector Shape: Rectangular
Functions: Relay
Mounting Bracket(s) Included: Yes
Terminal Gender: Male
Terminal Quantity: 5
Voltage: 12

Buick 1983 - 1980
Chevrolet 1983 - 1980
Oldsmobile 1983 - 1980
Pontiac 1983 - 1980

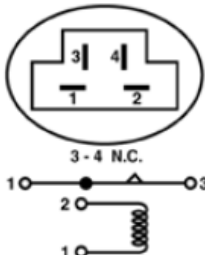

RY-137
A/C Condenser Fan Motor Relay
9098703001B; 8863014030;
9098703001; 909870300183;
25230AA050; 0567005500;
0577004670; 0567004670;
0587000300; 94840297

Connector Gender: Female
Connector Quantity: 1
Connector Shape: Round
Functions: Relay
Mounting Bracket(s) Included: No
Terminal Gender: Male
Terminal Quantity: 4
Voltage: 12

Toyota 1986 - 1985

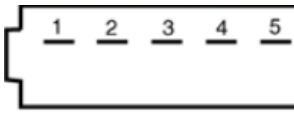
RY-138
Anti-Dieseling Relay
22505456; 22517700

Connector Gender: Female
Connector Quantity: 1
Connector Shape: Rectangular
Functions: Relay
Mounting Bracket(s) Included: Yes
Terminal Gender: Male
Terminal Quantity: 5
Voltage: 12

Buick 1983 - 1980
Chevrolet 1983 - 1980
Oldsmobile 1983 - 1980
Pontiac 1983 - 1980



RY-139
Accessory Relay
12088520; 12052153; 12040822;
12496078; 12182099

Connector Gender: Female
Functions: Relay
Mounting Bracket(s) Included: Yes
Terminal Gender: Male
Terminal Quantity: 4
Voltage: 12

Chevrolet 1993 - 1985



RY-143
Coolant Fan Relay
E73Z8B658A; E73Z8B658B;
E73Z8B658C; E63Z8B658B;
E73B8C609AA; E73B8C609B1A;
E73B8C609BA; E53Z8B658B;
E53Z8B658C; E53Z8B658D;
E63Z8B658A; E53B8C609BB;
E53B8C609D1B; E53B8C609DA;
E53Z8B658A; E4FZ8B658G;
E53B8C609AA; E53B8C609AB;
E53B8C609AC; E53B8C609BA;
E43Z8B658B; E43Z8B658D;
E4FZ8B658C; E4FZ8B658F;
E43Z8B658A

Connector Gender: Female
Connector Quantity: 1
Connector Shape: Rectangular
Functions: Relay
Mounting Bracket(s) Included: Yes
Terminal Gender: Male
Terminal Quantity: 2
Voltage: 12

Ford 1984
Mercury 1984



RY-144
Automatic Choke Relay
14089568; 14039662

Connector Gender: Male
Connector Quantity: 3
Connector Shape: Rectangular
Functions: Running Light Relay
Mounting Bracket(s) Included: No
Terminal Gender: Male
Terminal Quantity: 3
Voltage: 12

Chevrolet 1984
Pontiac 1983 - 1980

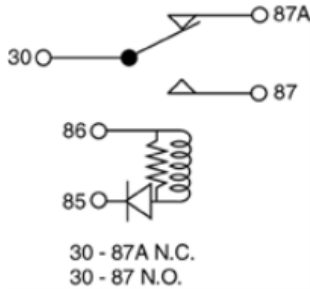

RY-145
A/C and Heater Relay
25526984; 22526984; 12395259;
4373109

Connector Gender: Female
Connector Quantity: 1
Connector Shape: Square
Functions: Coolant Fan Relay
Mounting Bracket(s) Included: Yes
Terminal Gender: Male
Terminal Quantity: 5
Voltage: 12

Chevrolet 1986



RY-175
Diesel Glow Plug Relay
E3TF11450AA; E3TZ12A343C

Connector Gender: Male
Connector Quantity: 4
Connector Shape: Round
Functions: Solenoid
Mounting Bracket(s) Included: Yes
Terminal Gender: Male
Terminal Quantity: 4
Voltage: 12

Ford 1996 - 1983



RY-178
Coolant Fan Relay
E6FZ8B658A; E6FZ8B658C;
E5FZ8B658A; E5FZ8B658C;
E5FZ8B658J; E6EB8C609BA;
E4FZ8B658D; E4FZ8B658E;
E53B8C609CA; E5EB8C609D1A;
E4EB8C609B2C; E4EB8C609C1B;
E4FZ8B658A; E4FZ8B658B;
E43Z8B658E; E43Z8B658H;
E4EB8C609B1B; E4EB8C609B1C;
E3FZ8B658A

Connector Gender: Female
Connector Quantity: 1
Connector Shape: Rectangular
Functions: Relay
Mounting Bracket(s) Included: Yes
Terminal Gender: Male
Terminal Quantity: 2
Voltage: 12

Mercury 1984

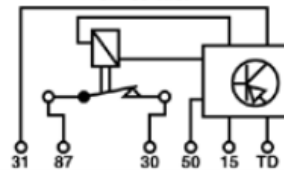
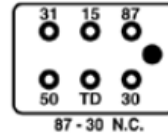

RY-191
Accessory Relay
0015450605; 15450605;
00015450705; 00015450605

Connector Gender: N/A
Connector Quantity: N/A
Connector Shape: Rectangular
Functions: Relay
Mounting Bracket(s) Included: No
Terminal Gender: Male
Terminal Quantity: 6
Voltage: 12

Mercedes-Benz 1983 - 1980

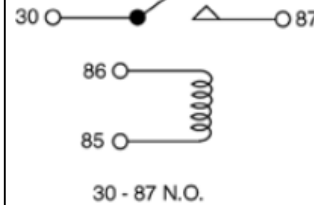

RY-193
A/C Compressor Clutch
Cut-Off Relay
4504206; 5233205; 4443907

Connector Gender: Female

Connector Quantity: 1
Connector Shape: Rectangular
Functions: Relay
Mounting Bracket(s) Included: No
Terminal Gender: Male
Terminal Quantity: 4
Voltage: 12

Dodge 1992



RY-194
Computer Control Relay
E9Z29345A; E9AZ9345A;
F20118811; 0567008031

Connector Gender: Female
Connector Quantity: 1
Connector Shape: Rectangular
Functions: Fuel Pump Relay
Mounting Bracket(s) Included: No
Terminal Gender: Male
Terminal Quantity: 4
Voltage: 12

Ford 1986



RY-203
Pulse Wiper Relay
191955531; 191955531; 2030022;
321955531A; 1HM955531; 8553463

Connector Gender: Male
Functions: Relay
Mounting Bracket(s) Included: No
Terminal Gender: Male
Terminal Quantity: 6
Voltage: 12

Audi 1985 - 1984
Volkswagen 1981





RY-214

A/C Compressor Clutch Relay

F0VY14677B; F0AB14B194DC;
 F0AZ14N089B; FOAZ14N089B;
 F0AB14B193A2A; F0AB14B193A2B;
 F0AB14B193AA; F0AB14B193AB;
 F03B14B193AA; F03B14B194A2A;
 F0AB14B193A1A; F0AB14B193A1B;
 F03B14B193A1A; F03B14B193A2A;
 AU5Z14N089FA

Connector Gender: Female
 Connector Quantity: 1
 Connector Shape: Rectangular
 Functions: Relay
 Mounting Bracket(s) Included: No
 Terminal Gender: Male
 Terminal Quantity: 5
 Voltage: 12

Ford 2002 - 1992

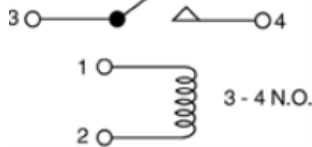
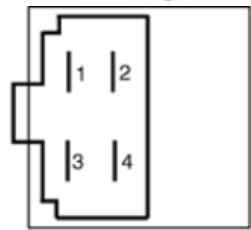

RY-230

A/C and Heater Delay Relay

9761431000; 8941272700;
 8941673831; 8944509700;
 8944509770; 8941129110;
 8941129120; 8941187520;
 8941272680; 8941091481;
 2261431000; 88922846; 94154803;
 94112912; 94038606; 94109148;
 8941548030

Connector Gender: Female

Connector Quantity: 1
 Connector Shape: Rectangular
 Functions: Relay
 Mounting Bracket(s) Included: Yes
 Terminal Gender: Male
 Terminal Quantity: 4
 Voltage: 12

Isuzu 1986

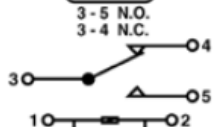
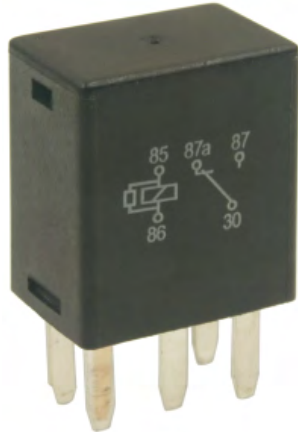

RY-232

A/C Auto Temperature Control Relay

13361778; 8120778660; 12077866;
 13502678; 19115082; 19116364;
 15393413; 21997404; 12135180

Connector Gender: N/A
 Connector Quantity: N/A
 Connector Shape: Rectangular
 Functions: Multi-Function Relay
 Mounting Bracket(s) Included: No
 Terminal Gender: Male
 Terminal Quantity: 5
 Voltage: 12

AM General 2001 - 2000
 Chevrolet 2007 - 2002
 GMC 2002 - 1999
 Oldsmobile 1985



RY-233

Multi-Function Relay

1825501780

Connector Gender: Female

Connector Quantity: 2
 Connector Shape: Rectangular
 Functions: Relay
 Mounting Bracket(s) Included: Yes
 Terminal Gender: Male
 Terminal Quantity: 4
 Voltage: 12

Isuzu 1995 - 1988



RY-238

Accessory Relay

15604900; 15555675

Connector Gender: Female; Female
 Connector Quantity: 4
 Connector Shape: Round
 Functions: Starter Relay
 Mounting Bracket(s) Included: Yes
 Terminal Gender: Male
 Terminal Quantity: 4
 Voltage: 12

Chevrolet 1990
 GMC 1996 - 1994

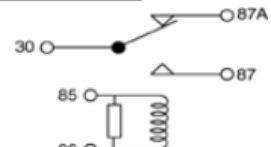
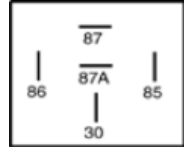

RY-242

A/C Auto Temperature Control Relay

VF425F11S01; 0332204188;
 0332204187; 0332204186;
 0332204177; 0332204175;
 35626344; 3526344; 12088596;
 12088594; 12077876; 1618842;
 12476333; 25609047; 22570060;
 15591178; 30013238

Connector Gender: Female
 Connector Quantity: 1
 Connector Shape: Square
 Functions: Relay
 Mounting Bracket(s) Included: Yes
 Terminal Gender: Male
 Terminal Quantity: 5
 Voltage: 12

Buick 1985 - 1981
 Cadillac 1985
 Chevrolet 1994 - 1980
 GMC 1994 - 1980
 Jeep 2006 - 1985



RY-255
A/C Relay

8D0951253; 191937503;
4H0951253; 7M0951253A; 5246350;
90494959; 12177230; 12177238

Connector Gender: N/A
Connector Quantity: N/A
Connector Shape: Rectangular
Functions: Multi-Function Relay
Mounting Bracket(s) Included: No
Terminal Gender: Male
Terminal Quantity: 4
Voltage: 12

Volkswagen 2008

RY-256
Hazard Flasher

111953227D; 191953227A;
1H0953227; 1363786; 9442468;
176953227

Connector Gender: Male
Functions: Relay
Terminal Gender: Male
Terminal Quantity: 3

Volkswagen 1999 - 1997

RY-265
A/C Compressor Clutch Relay

VF411F11; VF441F11; 853959821;
867906381; 171919505A;
431951253B; 8D0951253A;
0332014156; 0332014134;
36003046; 8K0951253;
4H0951253A; 431951253H;
4320626; 191911251; 171919505A;
8936003046; 8522310; 5234606;
4504215

Connector Gender: N/A
Connector Quantity: N/A
Connector Shape: Square
Functions: Relay
Mounting Bracket(s) Included: No
Terminal Gender: Male
Terminal Quantity: 4
Voltage: 12

Audi 2009 - 1982
Volkswagen 2007 - 1981

RY-273
A/C Compressor Clutch Cut-Off Relay

36002787; 4795068AA; 4672006;
5252260; 4728990; 4728989;
90244312; 5234492; 5234494;
5234294; 5234371; 5234471;
4504214; 4443941; 4443942;
12135197

Connector Gender: N/A

Connector Quantity: N/A
Connector Shape: Square
Functions: Relay
Mounting Bracket(s) Included: No
Terminal Gender: Male
Terminal Quantity: 4
Voltage: 12

Audi 2009 - 1982
Dodge 2006
Volkswagen 2007 - 1981

RY-280
A/C Auto Temperature Control Relay

12193606; 15328864; 13503102;
8121936040; 19116860;
0K2A167740; 8121772360;
12088592; 12088576; 96190189;
12360348; 4692141AA; 12193614;
12193604; 12177236; 12135175;
12135034

Connector Gender: N/A
Connector Quantity: N/A
Connector Shape: Square
Functions: Multi-Function Relay
Mounting Bracket(s) Included: No
Terminal Gender: Male
Terminal Quantity: 4
Voltage: 12

Chevrolet 2011 - 2000
GMC 2012 - 2000

RY-282
A/C Auto Temperature Control Relay

19118886; 3505300C1;
F75Z12B577BA; VF2865F14S01;
8120778670; 8121936010;
8121936030; 8890473890;
8120778640; 15250697; 19259019;
332014175; 12193611; 0332208151;
0332208150; 0332014175;
12088577; 12077864; 94854578;
865202T; 21024065; 12457611;
8121772330; 89047389; 22137260;
12193611; 12193613; 12193601;
12193603; 12193605

****Additional OE Numbers Available Online****

Connector Gender: Female
Connector Quantity: 1
Connector Shape: Square
Functions: Relay
Mounting Bracket(s) Included: Yes
Terminal Gender: Male
Terminal Quantity: 5
Voltage: 12

Chevrolet 2012 - 1994
GMC 2012 - 1994

ELECTRONIC RY-289
Coolant Level Relay

191919376; 17067964; 17067686

Connector Gender: Male
Functions: Relay
Mounting Bracket(s) Included: No
Terminal Gender: Male

Terminal Quantity: 4
Voltage: 12
Volkswagen 1984 - 1983



RY-292

Diesel Glow Plug Relay

0031531728; 0031530728;
25450632; 15459832; 003325391;
0031531928; 0031530628;
0025450632; 0024771301;
0021535028; 0015459832

Connector Gender: N/A
Connector Quantity: N/A
Connector Shape: Rectangular
Functions: Relay
Mounting Bracket(s) Included: Yes
Terminal Gender: Male
Terminal Quantity: 10
Voltage: 12

Mercedes-Benz 1985 - 1983



RY-300

Accessory Delay Relay

2889565

Connector Gender: N/A
Connector Quantity: N/A
Connector Shape: Round
Functions: Relay
Mounting Bracket(s) Included: No
Terminal Gender: Male
Terminal Quantity: 3
Voltage: 12

Dodge 1997 - 1995



RY-304

A/C Control Relay

F3XY2C013A; 91287805;
0332002171; 14105968; 3544130;
12513302; 0015426519

Connector Gender: N/A
Connector Quantity: N/A
Connector Shape: Square
Functions: Relay
Mounting Bracket(s) Included: No
Terminal Gender: Male
Terminal Quantity: 4
Voltage: 12

Mercedes-Benz 1993 - 1990



RY-316

Diesel Glow Plug Relay

1826634C93; 1825898C94;
1825898C93; 1825898C91;
1811059C92; 18072C302;
F6TZ12B533AA; F7TA12B533CA;
F7TZ12B533A; F0TZ12B533A;
E7TZ12B533A; E9TZ12B533A;
F0TZ12B533A; 1825908C2;
1811169C1

Connector Gender: Female
Functions: Diesel Glow Plug Relay
Mounting Bracket(s) Included: Yes
Terminal Gender: Female
Terminal Quantity: 3
Voltage: 12

Ford 1994 - 1987



RY-341

A/C Control Relay

141951253B; 171937503;
443951253K

Connector Gender: N/A
Connector Quantity: N/A
Connector Shape: Square
Functions: Relay
Mounting Bracket(s) Included: No
Terminal Gender: Male
Terminal Quantity: 4
Voltage: 12

Volkswagen 1994



RY-345

A/C Compressor Clutch Relay

3841366; 9008498026; 9008498032;
9098704004; 38413662;
9008087012; 9008087014;
9008087020; 94858551

Connector Gender: N/A
Connector Quantity: N/A
Connector Shape: Rectangular
Functions: Relay
Mounting Bracket(s) Included: No
Terminal Gender: Male
Terminal Quantity: 5
Voltage: 12

Ford 2005 - 2003

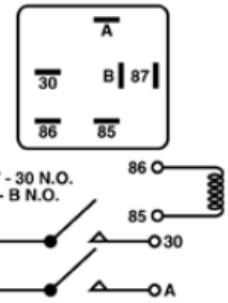

RY-347

A/C Compressor Clutch Relay

171959143A; 90060264

Connector Gender: N/A
Connector Quantity: N/A
Connector Shape: Square
Functions: Blower Motor
Mounting Bracket(s) Included: No
Terminal Gender: Male
Terminal Quantity: 6
Voltage: 12

Volkswagen 1981



RY-383

Diesel Glow Plug Relay

12496472; 12088560; 12182100;
12135176

Connector Gender: N/A
Connector Quantity: N/A
Connector Shape: Rectangular
Functions: Relay
Mounting Bracket(s) Included: Yes
Terminal Gender: Male
Terminal Quantity: 3
Voltage: 12

Chevrolet 1996
GMC 1996

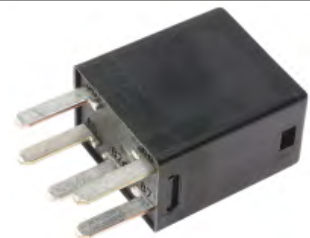

RY-429

A/C Compressor Clutch Cut-Off Relay

5269988AA; 56049018AA

Connector Gender: N/A
Connector Quantity: N/A

Connector Shape: Rectangular
 Functions: Relay
 Mounting Bracket(s) Included: No
 Terminal Gender: Male
 Terminal Quantity: 5
 Voltage: 12
 Dodge..... 2004



RY-439
 Coolant Fan Relay
 8592532020

Connector Gender: Male; Female
 Connector Quantity: 4
 Connector Shape: Round
 Functions: Relay
 Mounting Bracket(s) Included: Yes
 Terminal Gender: Male; Female
 Terminal Quantity: 10
 Voltage: 12
 Toyota..... 1986 - 1985



RY-441
 Air Intake Heater Relay
 68188401AA; 56026842

Connector Gender: Male
 Functions: Relay
 Mounting Bracket(s) Included: No
 Terminal Gender: Male
 Terminal Quantity: 8
 Voltage: 12
 Dodge..... 2002 - 1994



RY-489
 Fuel Pump Relay
 13631276264

Connector Gender: N/A
 Connector Quantity: N/A
 Connector Shape: Square
 Functions: Fuel Pump Relay

Mounting Bracket(s) Included: No
 Terminal Gender: Male
 Terminal Quantity: 7
 Voltage: 12
 BMW..... 1986 - 1985

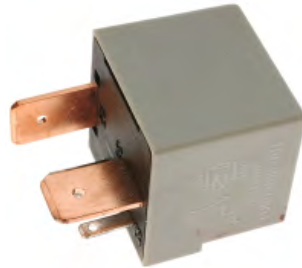

RY-494
 Fuel Injection Relay
 191906383C

Connector Gender: N/A
 Connector Quantity: N/A
 Connector Shape: Square
 Functions: Relay
 Mounting Bracket(s) Included: No
 Terminal Gender: Male
 Terminal Quantity: 4
 Voltage: 12
 Audi..... 1985



RY-525
 Diesel Glow Plug Relay
 1831646C1; 1825931C2;
 1825931C1; 1825908C1;
 F7TZ12B533C; F81Z12B533AA;
 F81Z12B533AC; F4TZ12B533A;
 F5TZ12B533A; F6TZ12B533A;
 F7TZ12B533AA; F7TZ12B533AB

Connector Gender: Male
 Connector Quantity: 4
 Connector Shape: Round
 Functions: Solenoid
 Mounting Bracket(s) Included: Yes
 Terminal Gender: Male
 Terminal Quantity: 4
 Voltage: 12
 Ford..... 2003 - 1990



RY-528
 Computer Control Relay
 165906381

Connector Gender: N/A
 Connector Quantity: N/A
 Connector Shape: Rectangular
 Functions: Computer
 Mounting Bracket(s) Included: No
 Terminal Gender: Male
 Terminal Quantity: 5
 Voltage: 12
 Volkswagen..... 2005 - 2004

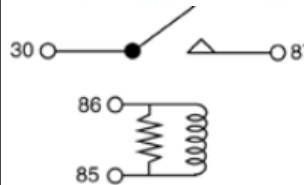

30 - 87 N.O.
RY-531
 A/C Control Relay
 12077867

Connector Gender: Female
 Connector Quantity: 1
 Connector Shape: Square
 Functions: Multi-Function Relay
 Mounting Bracket(s) Included: No
 Terminal Gender: Male
 Terminal Quantity: 4
 Voltage: 12
 Chevrolet..... 2012 - 1994
 GMC..... 2012 - 1994



RY-536
 Brake Indicator Lamp
 Driver Module
 12086553; 12067480; 12060773;
 12067478; 12055405; 12046636;
 12020004; 94853236

Mounting Bracket(s) Included: No
 Terminal Gender: N/A
 Terminal Quantity: N/A
 Terminal Type: N/A
 Voltage: 12
 Chevrolet..... 1986 - 1985
 GMC..... 1986 - 1985



RY-553
 Diesel Glow Plug Relay
 1826634C94; F7TZ12B533CA

Connector Quantity: 1
 Connector Shape: Oval
 Mounting Bracket(s) Included: Yes
 Terminal Gender: Male
 Terminal Quantity: 2
 Voltage: 12
 Ford..... 1997 - 1990



RY-568
 Fuel Injection Relay
 13486006; 35236397; 1348600;
 1324978; 1323152; 1324022;
 1235337

Connector Gender: N/A
 Connector Quantity: N/A
 Connector Shape: Rectangular
 Functions: Fuel Injection Relay

Mounting Bracket(s) Included: No
Terminal Gender: Male
Terminal Quantity: 6
Voltage: 12
Volvo..... 1986 - 1985



RY-573
Computer Control Relay
95561502700; 7N0951253;
3D0951253A

Connector Gender: N/A
Connector Quantity: N/A
Connector Shape: Square
Functions: Starter Relay
Mounting Bracket(s) Included: No
Terminal Gender: Male
Terminal Quantity: 5
Voltage: 12
Audi..... 2010



RY-575
Diesel Glow Plug Relay
038907281A; 038907281C

Connector Gender: Female
Functions: Diesel Glow Plug Relay
Mounting Bracket(s) Included: Yes
Terminal Gender: Male
Terminal Quantity: 9
Voltage: 12
Volkswagen..... 2003 - 2002



RY-577
Fuel Pump Relay
8Z0951253; 7M0951253C;
4H0951253C

Connector Gender: N/A
Connector Quantity: N/A
Connector Shape: Rectangular
Functions: Relay
Mounting Bracket(s) Included: No
Terminal Gender: Male
Terminal Quantity: 5
Voltage: 12
Volkswagen..... 2008

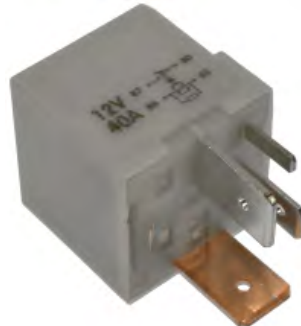

RY-583
Diesel Glow Plug Relay
357911253

Connector Gender: N/A
Connector Quantity: N/A
Connector Shape: Square
Functions: Relay
Mounting Bracket(s) Included: No
Terminal Gender: Male
Terminal Quantity: 4
Voltage: 12
Volkswagen..... 2009 - 2006



RY-585
Diesel Glow Plug Relay
97371491; 97225608

Connector Gender: Female
Connector Quantity: 3
Connector Shape: Rectangular

Functions: Glow Plug Controller
Mounting Bracket(s) Included: Yes
Terminal Gender: Female
Terminal Quantity: 6
Voltage: 12
Chevrolet..... 2004 - 2001
GMC..... 2004 - 2001

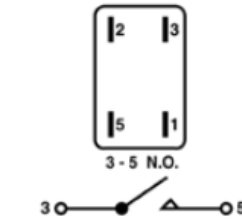
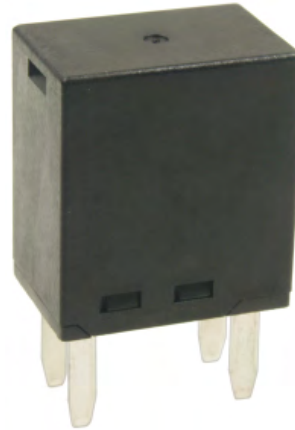

RY-601
A/C and Heater Relay
8191150800; 8191160570;
8153934120; 13500114;
8120885670; 8121936110;
19115083; 19115080; 13502679;
12135170; 12088567

Connector Gender: N/A
Connector Quantity: N/A
Connector Shape: Rectangular
Functions: Relay
Mounting Bracket(s) Included: No
Terminal Gender: Male
Terminal Quantity: 4
Voltage: 12
Chevrolet..... 2012 - 2007
GMC..... 2012 - 2007



RY-603
Coolant Fan Relay
10041257; 10030273; 10028531;
10016638; 14092721; 10059832;
8956000836; 25521721; 25520316;
25515230; 25515229; 22524833;
22535475

Connector Gender: Female
Connector Quantity: 1
Connector Shape: Square
Functions: Relay
Mounting Bracket(s) Included: No
Terminal Gender: Male
Terminal Quantity: 6
Voltage: 12
Chevrolet..... 1985
Oldsmobile..... 1985 - 1980

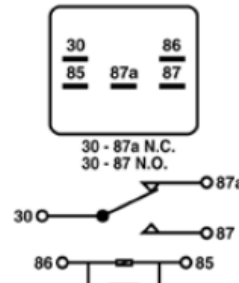

RY-604
A/C Condenser Fan Motor Relay
8192590190; 8153288650;
8135031030; 8121936120;
8121936050; 8121936020;
8121772340; 8121351980;
8219974080; 12077865; 96263403;
19116363; 19115298; 3886078J01;
21997408; 15328865; 12193612;
12177234; 12193602; 12135198

Connector Gender: N/A
Connector Quantity: N/A
Connector Shape: Square
Functions: Relay
Mounting Bracket(s) Included: No
Terminal Gender: Male
Terminal Quantity: 5

Voltage: 12
 Chevrolet 2010 - 1999
 GMC 2012 - 1999



RY-610

A/C Compressor Clutch Relay

E8AB13A025AA; E9EB2C013AA;
 F1SB9345AA; F1SZ9345A;
 E5LB9C392CA; E5VB14A656AA;
 E6AB2C222AA; E6AB9C392BA;
 E6DB13C117AA; E4SB13B401AA;
 E53B9C392AA; E59B13B401AA;
 E5LB2C222AA; E3UZ13A025AA;
 E45B17D736AA; E4DB13B401AA;
 E4LB9C392AA; E3EB9345B3A;
 E3SZ11333A; E3TB9C392DA

Connector Gender: Female
 Connector Quantity: 1
 Connector Shape: Rectangular
 Functions: Relay
 Mounting Bracket(s) Included: No
 Terminal Gender: Male
 Terminal Quantity: 4
 Voltage: 12

Ford 1987 - 1986

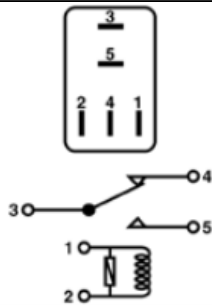
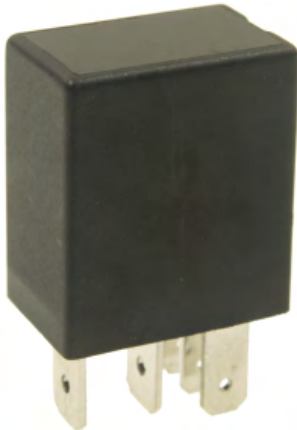

RY-612

A/C and Heater Relay

F5TZ14N089BA; VFM15F21S01;
 F4SB14B192A; F4SZ14N089A;
 F57B14B192AA; F5TZ14N089A;
 93172269; E6LB9C392AA;
 8824332070; 8826332070; 4707212;
 4224200; 1567001400; 90511443;
 13502676; 13266315; 12135084;
 332207109; 0332207307;
 0332207109; 0332207108;
 56021041; 56042677AA; 4671168;
 4671167AB; 4608650; 4608650AB;
 04671168

Connector Gender: N/A
 Connector Quantity: N/A
 Connector Shape: Rectangular
 Functions: Multi-Function Relay
 Mounting Bracket(s) Included: No
 Terminal Gender: Male
 Terminal Quantity: 5
 Voltage: 12

Chevrolet 2008
 Dodge 2000 - 1999
 Ford 2004 - 1999
 GMC 2008
 Jeep 2010 - 2006



RY-698

Air Intake Heater Relay

1831645C1; F81Z6G015AA

Connector Gender: Male
 Functions: Intake Heater Relay
 Mounting Bracket(s) Included: Yes
 Terminal Gender: Male
 Terminal Quantity: 4
 Voltage: 12

Ford 2003 - 1999



RY-738

Coolant Fan Relay

B00267740; B00267740A

Connector Gender: Female
 Connector Quantity: 1
 Connector Shape: Rectangular
 Functions: Relay
 Mounting Bracket(s) Included: Yes
 Terminal Gender: Male
 Terminal Quantity: 4
 Voltage: 12

Mazda 1984



RY-777

A/C Control Relay

61318373700; 61368366600;
 61311350315; 61311378238;
 61311378297; 61311714976;
 12631714976; 12631735424;
 YWB101050; 61368373700;
 61361378238; 61311373585

Connector Gender: N/A
 Connector Quantity: N/A
 Connector Shape: Square
 Functions: Relay
 Mounting Bracket(s) Included: No
 Terminal Gender: Male
 Terminal Quantity: 5
 Voltage: 12

BMW 1986 - 1985



RY-790

A/C Compressor Clutch Relay

F8OZ14N089A; F8OZ14N089AA;
 F80B14B192AA

Connector Gender: N/A
 Connector Quantity: N/A
 Connector Shape: Square
 Functions: Relay
 Mounting Bracket(s) Included: No
 Terminal Gender: Male
 Terminal Quantity: 4
 Voltage: 12

Ford 2010 - 2005



RY-869

Windshield Washer Relay

1J0955531A; 1J0955531

Connector Gender: Male
 Connector Quantity: N/A
 Connector Shape: Rectangular
 Functions: Wiper
 Mounting Bracket(s) Included: No
 Terminal Gender: Male
 Terminal Quantity: 16
 Voltage: 12

Volkswagen 2012 - 2008



RY-884
Computer Control Relay
1J0906381B

Connector Gender: N/A
Connector Quantity: N/A
Connector Shape: Square
Functions: Relay
Mounting Bracket(s) Included: No
Terminal Gender: Male
Terminal Quantity: 4
Voltage: 12
Volkswagen 2011 - 2009



RY-889
Coolant Fan Relay
1J0959485

Connector Gender: N/A
Connector Quantity: N/A
Connector Shape: Square
Functions: Relay
Mounting Bracket(s) Included: No
Terminal Gender: Male
Terminal Quantity: 6
Voltage: 12
Volkswagen 2011 - 2008



RY-892
Windshield Washer Relay
4B0955531A; 4B0955531B;
4B0955531C; 4B0955531E

Connector Gender: No Connector
Functions: Relay
Mounting Bracket(s) Included: Yes
Terminal Gender: Male
Terminal Quantity: 16
Voltage: 12
Volkswagen 2014 - 2008



RY-915
Glow Plug Controller
12568791; 16238701; 9394069

Mounting Bracket(s) Included: Yes
Terminal Gender: Male
Terminal Quantity: 12
Terminal Type: Blade Terminals
Voltage: 12
Chevrolet 2000



RY-921
Diesel Glow Plug Relay
8941538480

Connector Gender: Female
Functions: Relay
Mounting Bracket(s) Included: No
Terminal Gender: Male
Terminal Quantity: 2 + 2
Voltage: 12

ISUZU 1986 - 1981



RY-922
Starter Relay
1811710450; 1811710560

Connector Gender: Female
Connector Quantity: 3
Connector Shape: Round
Functions: Starter Relay
Mounting Bracket(s) Included: Yes
Terminal Gender: Male
Terminal Quantity: 3
Voltage: 12

ISUZU 1997 - 1988

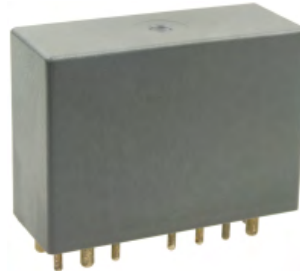

RY-923
Headlight Relay
2018210147

Connector Gender: N/A
Connector Quantity: N/A
Connector Shape: Rectangular
Functions: Relay
Mounting Bracket(s) Included: No
Terminal Gender: Male
Terminal Quantity: 13
Voltage: 12

Mercedes-Benz 1993 - 1985



RY-975
Hazard Warning Relay
61311371909; 61311366727;
61311371907

Connector Gender: No Connector
Functions: Relay
Mounting Bracket(s) Included: Yes

Terminal Gender: Male
Terminal Quantity: 3
Voltage: 12

BMW 1986 - 1985



RY-976
Sunroof Relay
61311362386

Connector Gender: Female
Functions: Relay
Mounting Bracket(s) Included: No
Terminal Gender: Male
Terminal Quantity: 5
Voltage: 12

BMW 1986 - 1985



RY-1084
Air Pump Relay
0025420319

Connector Gender: N/A
Connector Quantity: N/A
Connector Shape: Rectangular
Functions: Relay
Mounting Bracket(s) Included: No
Terminal Gender: Male
Terminal Quantity: 6
Voltage: 12

Mercedes-Benz 2005



RY-1086
A/C Auto Temperature Control Relay
002542261928; 5120360AA;
0025422619

Connector Gender: N/A
Connector Quantity: N/A
Connector Shape: Square
Functions: ABS
Mounting Bracket(s) Included: No
Terminal Gender: Male
Terminal Quantity: 4
Voltage: 12
Mercedes-Benz 2008 - 2007



RY-1088
A/C Auto Temperature Control Relay
0015427819

Connector Gender: N/A
Connector Quantity: N/A
Connector Shape: Rectangular
Functions: Accessory Relay
Mounting Bracket(s) Included: No
Terminal Gender: Male
Terminal Quantity: 6
Voltage: 12
Mercedes-Benz 1995 - 1990



RY-1093
A/C Auto Temperature Control Relay
0015427419

Connector Gender: N/A
Connector Quantity: N/A
Connector Shape: Square
Functions: Relay
Mounting Bracket(s) Included: No
Terminal Gender: Male
Terminal Quantity: 4
Voltage: 12
Mercedes-Benz 1995 - 1994



RY-1094
Blower Motor Relay
0015429619

Connector Gender: N/A
Connector Quantity: N/A
Connector Shape: Square
Functions: Coolant Fan Relay
Mounting Bracket(s) Included: No
Terminal Gender: Male
Terminal Quantity: 4
Voltage: 12
Mercedes-Benz 1984 - 1983



RY-1095
Computer Control Relay
2015400845

Connector Gender: N/A
Connector Quantity: N/A
Connector Shape: Rectangular
Functions: Accessory Relay
Mounting Bracket(s) Included: No
Terminal Gender: Male
Terminal Quantity: 5
Voltage: 12
Mercedes-Benz 1986



RY-1103
ABS Relay
0015426719

Connector Gender: N/A
Connector Quantity: N/A
Connector Shape: Rectangular
Functions: ABS
Mounting Bracket(s) Included: No
Terminal Gender: Male
Terminal Quantity: 6
Voltage: 12
Mercedes-Benz 1995



RY-1108
Power Seat Relay
0008214447

Connector Gender: No Connector
Functions: Accessory Relay
Mounting Bracket(s) Included: No
Terminal Gender: Male
Terminal Quantity: 6
Voltage: 12
Mercedes-Benz 1993 - 1981



RY-1111
Multi-Function Relay
0009828523; 0025422319;
0025427619

Connector Gender: N/A
Connector Quantity: N/A
Connector Shape: Square
Functions: Starter Relay
Mounting Bracket(s) Included: No
Terminal Gender: Male
Terminal Quantity: 5
Voltage: 12
Mercedes-Benz 2009 - 2007



RY-1113
Auxiliary Battery Relay
0025426419

Connector Gender: Female
Functions: Relay
Mounting Bracket(s) Included: Yes
Terminal Gender: Male

Terminal Quantity: 2
Voltage: 12
Mercedes-Benz 2007 - 2006



RY-1116
Coolant Fan Relay
0025429219; 0025428319;
0025421119

Connector Gender: N/A
Connector Quantity: N/A
Connector Shape: Rectangular
Functions: Accessory Relay
Mounting Bracket(s) Included: No
Terminal Gender: Male
Terminal Quantity: 4
Voltage: 12

Mercedes-Benz 2009 - 1995



RY-1117
Fuel Shut-Off Relay
0015429119

Connector Gender: No Connector
Connector Quantity: 4
Functions: Fuel Pump Relay
Mounting Bracket(s) Included: No
Terminal Gender: Male
Terminal Quantity: 4
Voltage: 12
Mercedes-Benz 1995 - 1994

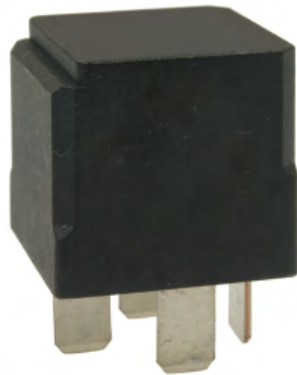

RY-1118
Air Bag Relay
0025427219; 0025421319;
002542131926

Connector Gender: N/A
Connector Quantity: N/A
Connector Shape: Square
Functions: Fuel Pump Relay
Mounting Bracket(s) Included: No
Terminal Gender: Male
Terminal Quantity: 4
Voltage: 12

Mercedes-Benz 2007 - 2006



RY-1132
A/C Auto Temperature
Control Relay
0015420219

Connector Gender: N/A
Connector Quantity: N/A
Connector Shape: Rectangular
Functions: Coolant Fan Relay
Mounting Bracket(s) Included: No
Terminal Gender: Male
Terminal Quantity: 5
Voltage: 12

Mercedes-Benz 1988 - 1980



RY-1188
Coolant Fan Relay
0015429919

Connector Gender: N/A
Connector Quantity: N/A
Connector Shape: Square
Functions: Accessory Relay
Mounting Bracket(s) Included: No
Terminal Gender: Male
Terminal Quantity: 3
Voltage: 12

Mercedes-Benz 1995 - 1990



RY-1330
Multi-Function Relay
1324683

Connector Gender: No Connector
Functions: Diesel Glow Plug Relay
Mounting Bracket(s) Included: Yes
Terminal Gender: Male
Terminal Quantity: 6
Voltage: 12

Volvo 1984 - 1982

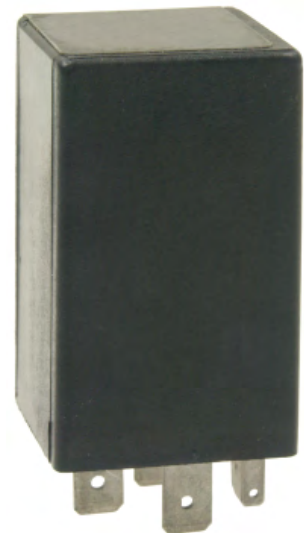

RY-1340
A/C Compressor Clutch
Cut-Off Relay
1H0919577; 1H0919577

Connector Gender: N/A
Connector Quantity: N/A
Connector Shape: Rectangular
Functions: Relay
Mounting Bracket(s) Included: No
Terminal Gender: Male
Terminal Quantity: 6
Voltage: 12

Volkswagen 1999 - 1993



RY-1483
A/C Compressor Clutch
Relay
4692076AC; 4692076AA;
4692076AB

Connector Gender: Female
Connector Quantity: 1
Connector Shape: Square
Functions: Relay
Mounting Bracket(s) Included: Yes
Terminal Gender: Male
Terminal Quantity: 5
Voltage: 12

Dodge 2010 - 2009



RY-1528
Diesel Glow Plug Relay
5170859AA; 0005453616;
68079372AA

Connector Gender: Female
Connector Quantity: 2
Connector Shape: Rectangular
Functions: Diesel Glow Plug Relay
Mounting Bracket(s) Included: Yes
Terminal Gender: Male
Terminal Quantity: 6 + 3
Voltage: 12
Mercedes-Benz 2006 - 2005



RY-1552
Air Intake Heater Relay
56028367AD; 68188370AA;
68188407AA

Connector Gender: Male
Connector Quantity: 4
Connector Shape: Round
Functions: Intake Heater Relay
Mounting Bracket(s) Included: No
Terminal Gender: Male
Terminal Quantity: 4
Voltage: 12
Dodge 2005 - 2003



RY-1556
Glow Plug Controller
97379635; 97304030

Mounting Bracket(s) Included: Yes
Terminal Gender: Male
Terminal Quantity: 13
Terminal Type: Blade Terminals
Voltage: 12

Chevrolet 2005 - 2001
GMC 2005 - 2001



RY-1567
Air Intake Heater Relay
97371489; 97253673

Connector Gender: Female; Female
Functions: Intake Heater Relay
Mounting Bracket(s) Included: Yes
Terminal Gender: Male
Terminal Quantity: 3
Voltage: 12

Chevrolet 2004 - 2001
GMC 2004 - 2001



RY-1616
Neutral Safety Switch
Relay
3A0927181

Connector Gender: Male
Functions: Relay
Mounting Bracket(s) Included: No
Terminal Gender: Male
Terminal Quantity: 9
Voltage: 12
Volkswagen 2011 - 2007



RY-1625
Transfer Case Relay
12182086

Connector Gender: Female
Functions: Transfer Case Relay
Mounting Bracket(s) Included: No
Terminal Gender: Male
Terminal Quantity: 5
Voltage: 12

Chevrolet 2000 - 1996
GMC 2000 - 1996



RY-1627
A/C Compressor Clutch
Relay
68237961AA; 68200229AA;
68055795AA

Connector Gender: N/A
Connector Quantity: N/A
Connector Shape: Rectangular
Functions: Multi-Function Relay
Mounting Bracket(s) Included: No
Terminal Gender: Male
Terminal Quantity: 4
Voltage: 12

Dodge 2010



RY-1667
Fuel Pump Relay
68055796AA

Connector Gender: N/A
Connector Quantity: N/A
Connector Shape: Rectangular
Functions: Fuel Pump Relay
Mounting Bracket(s) Included: No
Terminal Gender: Male
Terminal Quantity: 5
Voltage: 12

Dodge 2010



RY-1678
Fuel Pump Relay
8971739510

Connector Gender: N/A
Connector Quantity: N/A
Connector Shape: Square
Functions: Starter
Mounting Bracket(s) Included: No
Terminal Gender: Male
Terminal Quantity: 5
Voltage: 12

Isuzu 2008



RY-1697

Glow Plug Controller

98041625; 98022490; 98089591;
12604003; 8980416250; 97375411

Mounting Bracket(s) Included: Yes
Terminal Gender: Male
Terminal Quantity: 30
Terminal Type: Pin
Voltage: 12

Chevrolet 2007 - 2006
GMC 2007 - 2006



RY-1723

Multi-Function Relay

5120361AA

Connector Gender: Male; Female
Connector Quantity: 2
Connector Shape: Rectangular
Functions: Relay
Mounting Bracket(s) Included: Yes
Terminal Gender: Male
Terminal Quantity: 4
Voltage: 12

Dodge 2006 - 2003
Freightliner 2006 - 2003



RY-1726

Fuel Pump Relay

5133589AA; 5133590AA;
5103560AA; 6801337AA

Connector Gender: N/A
Connector Quantity: N/A
Connector Shape: Rectangular
Functions: Fuel Injection Relay
Mounting Bracket(s) Included: No
Terminal Gender: Male
Terminal Quantity: 5
Voltage: 12
Dodge 2009 - 2003
Freightliner 2006 - 2003



RY-1731

Glow Plug Controller

97226648

Mounting Bracket(s) Included: Yes
Terminal Gender: Male
Terminal Quantity: 4; 4; 4
Terminal Type: Blade Terminals
Voltage: 12
Chevrolet 2004 - 2001
GMC 2004 - 2001



RY-1733

Diesel Glow Plug Relay

038907281B

Connector Gender: Male
Connector Quantity: 9
Connector Shape: Rectangular
Functions: Diesel Glow Plug Relay
Mounting Bracket(s) Included: No
Terminal Gender: Male
Terminal Quantity: 9
Voltage: 12
Volkswagen 2009 - 2006



RY-1757

Multi-Function Relay

68083380AA

Connector Gender: N/A
Connector Quantity: N/A
Connector Shape: Rectangular
Functions: Relay
Mounting Bracket(s) Included: No
Terminal Gender: Male
Terminal Quantity: 4
Voltage: 12
Ram 2012 - 2011



RY-1772

Accessory Relay

F2HZ2F005A

Connector Gender: Female
Connector Quantity: 1
Connector Shape: Square
Functions: Relay
Mounting Bracket(s) Included: Yes
Terminal Gender: Male
Terminal Quantity: 4
Voltage: 12
Ford 1999 - 1992



RY-1779

Multi-Function Relay

56029173AB; 56029173AA;
5187880AC; 5187880AA

Connector Gender: Male
Connector Quantity: 4
Connector Shape: Round
Functions: Relay
Mounting Bracket(s) Included: Yes
Terminal Gender: Male
Terminal Quantity: 4
Voltage: 12
Dodge 2010 - 2006
Ram 2017 - 2011



RY-1801

Multi-Function Relay

4692224AB; 4692224AA

Connector Gender: Female
Connector Quantity: 2
Connector Shape: Square
Functions: Relay
Mounting Bracket(s) Included: Yes
Terminal Gender: Male
Terminal Quantity: 10
Voltage: 12

Dodge..... 2010 - 2009



SA4
Idle Speed Control Motor
83502376; 83502376; 83502376;
83502376; 33000170; 4288256;
17082688; 17079444; 17079663;
17079204; 17079188; 17079203;
17079136; 17079137; 17079135;
17079134; 17079133; 17079131;
17079132; 17079130; 17079120;
17079129; 83502375; 17068282;
17068106; 17067980; 22020975;
8983502376; 8933000170;
8933002662
****Additional OE Numbers
Available Online****

Connector Gender: Female
Connector Quantity: 1
Terminal Gender: Male
Terminal Quantity: 4
Terminal Type: Bullet

Cadillac..... 1980
Dodge..... 1993 - 1992



SA100
Idle Speed Control Motor
Repair Kit
17079750

Cadillac..... 1980



SC34
Vehicle Speed Sensor
E43F9E731AA; E43Z9E731A

Connector Gender: Female; Male;
Male
Mounting Location: Trans Mount
Terminal Gender: Male
Terminal Quantity: 2

Ford..... 1987 - 1984



SC37
Vehicle Speed Sensor
ZZL243711; ZZM043711;
ZZMO43711; E9LF9E731AA;
E9LZ9E731A; ZZL043701;
ZZL060071; E45Y9E731A;
E6DF9E731DA; E6DZ9E731D;
E8LY9E731A; E45F9E731AA

Connector Gender: Female
Mounting Location: Trans Mount
Terminal Gender: Male
Terminal Quantity: 2

Ford..... 2002 - 2000



SC46
Vehicle Speed Sensor
E9TZ9E731A; F3AF9E731AB;
F3AZ9E731A; E3AZ9E731A;
E6DF9E731CA; E6DZ9E731C;
E9TA9E731AA; E3AF9E731;
E3AF9E731AB

Connector Gender: Female
Mounting Location: Trans Mount
Terminal Gender: Male
Terminal Quantity: 2

Ford..... 1983



SC163
Vehicle Speed Sensor
29536408

Connector Gender: Female
Mounting Location: Trans Mount
Terminal Gender: Male
Terminal Quantity: 2

Chevrolet..... 2008 - 2007
GMC..... 2014 - 2006



SC168
Vehicle Speed Sensor
12376520; 19302667; 8193026670;
97361874; 89048516; 89048421;
88984527

Connector Gender: Female
Mounting Location: On Transmission
Mounting Type: Screw-in
Terminal Gender: Male
Terminal Quantity: 2

Hummer..... 2003



SC226
Vehicle Speed Sensor
4799061; 4799061AB; 04799061

Connector Gender: Female
Mounting Location: Trans Mount
Terminal Gender: Male
Terminal Quantity: 2

Dodge..... 2010



SC303
Vehicle Speed Sensor
8970658340; 8971297040;
8970658340; 8973779200

Connector Gender: Female
Mounting Location: On Transmission
Mounting Type: Screw-in
Terminal Gender: Male
Terminal Quantity: 3

Isuzu..... 2020 - 1995



SC317
Transmission Input /
Output Sensor
24279827; 24276175; 24265507;
24222652; 24238417; 24245141

Connector Gender: Male
Connector Quantity: 1
Contents: Transmission Input &
Output Sensor
Terminal Gender: Female
Terminal Quantity: 3
Terminal Type: Blade

GMC..... 2010



SC318
Vehicle Speed Sensor
88958955

Connector Gender: Female
Mounting Type: Bolt Mount
Terminal Gender: Male
Terminal Quantity: 2

Isuzu..... 2002 - 1997



SC333
Transmission Output
Sensor
68019930AA

Connector Gender: Male
Connector Quantity: 1
Contents: Vehicle Speed Sensor
Terminal Gender: Male
Terminal Quantity: 2
Terminal Type: Blade

Dodge..... 2010 - 2008
Ram..... 2012 - 2011



SC335
Vehicle Speed Sensor
5120317AA; 5170412AA;
0145459717
Connector Gender: Male
Mounting Location: Mounted on Transmission
Mounting Type: Bolt Mount
Terminal Gender: Female
Terminal Quantity: 4
Dodge 2006 - 2003
Freightliner 2006 - 2003



SC346
Vehicle Speed Sensor
01F409191
Connector Gender: Male
Mounting Location: On Transmission
Terminal Gender: Male
Terminal Quantity: 2
Volkswagen 2005 - 2004



SC352
Vehicle Speed Sensor
357919149
Connector Gender: Male
Mounting Location: On Transmission
Mounting Type: Direct
Terminal Gender: Male
Terminal Quantity: 3
Volkswagen 2006 - 2001



SC354
Vehicle Speed Sensor
357919149B
Connector Gender: Female
Mounting Location: Trans Mount
Terminal Gender: Male
Terminal Quantity: 3
Volkswagen 2006 - 1999



SC390
Vehicle Speed Sensor
8941135010
Connector Gender: Male
Mounting Location: On Transmission
Terminal Gender: Male
Terminal Quantity: 2
Toyota 1987 - 1985



SC403
Vehicle Speed Sensor
191919149E
Connector Gender: Female
Mounting Location: On Transmission
Terminal Gender: Male
Terminal Quantity: 3
Volkswagen 2007 - 2002



SC466
Vehicle Speed Sensor
68036479AA
Connector Gender: Female
Mounting Location: Axle
Mounting Type: Flange
Terminal Gender: Male
Terminal Quantity: 2
Dodge 2010 - 2008
Ram 2012 - 2011



SC528
Vehicle Speed Sensor
5120309AA; 5120316AA;
5170419AA; 5170413AA
Connector Gender: Male
Mounting Location: On Transmission
Mounting Type: Bolt Mount
Terminal Gender: Female
Terminal Quantity: 4
Dodge 2006 - 2003
Freightliner 2006 - 2003



SC602
Vehicle Speed Sensor
02E927321A
Connector Gender: Male
Mounting Location: On Transmission
Mounting Type: Bolt Mount
Terminal Gender: Female
Terminal Quantity: 4
Audi 2012 - 2010
Volkswagen 2012 - 2004



SC668
Vehicle Speed Sensor
68020003AA
Connector Gender: Female
Mounting Location: On Transmission
Mounting Type: Bolt Mount
Terminal Gender: Male
Terminal Quantity: 2
Dodge 2010 - 2008
Ram 2013 - 2011



SC669
Vehicle Speed Sensor
68244169AA
Connector Gender: Female
Mounting Location: On Transmission
Mounting Type: Bolt Mount
Terminal Gender: Male
Terminal Quantity: 2
Ram 2018 - 2013



SC695
Vehicle Speed Sensor
24276402; 24262560
Connector Gender: Female
Mounting Location: On Transmission
Mounting Type: Bolt Mount
Terminal Gender: Male
Terminal Quantity: 2
Chevrolet 2019 - 2015
GMC 2019 - 2015



SC761
Vehicle Speed Sensor
5120314AA
Connector Gender: N/A
Mounting Location: On Transmission
Mounting Type: Bolt Mount
Terminal Gender: Male
Terminal Quantity: 2
Dodge 2006



SK13
Fuel Injector Seal Kit
14025557
Chevrolet 2002 - 1982

GMC 2002 - 1982



SK18
Fuel Rail O-Ring Kit
17112834

Notes: N/A

Buick 1985 - 1981
Cadillac 1985 - 1981
Chevrolet 1999 - 1981
GMC 1999 - 1986
Oldsmobile 1985 - 1981
Pontiac 1985 - 1981



SK26
Fuel Line O-Ring Kit
22514722

Notes: N/A

Cadillac 1985
Chevrolet 1998 - 1996



SK27
Fuel Line O-Ring Kit
22516256

Notes: N/A

Cadillac 1985



SK38
Diesel Fuel Injector Installation Kit
E6TZ9229A

Assorted Sizes: Yes
Kit/Set Contents: Yes
Material: N/A
Pintle Cap Included: No

Ford 1994 - 1988

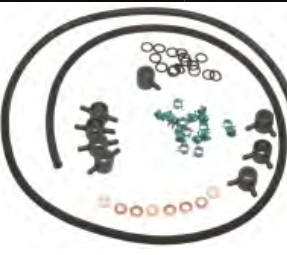

SK39
Diesel Fuel Injector Installation Kit

Ford 1988 - 1983



SK50
Diesel Fuel Injector Heat Shield
1257147

Notes: N/A

Volkswagen 1999 - 1981



SK54
Diesel Fuel Injector Installation Kit

Chevrolet 2002 - 1982
GMC 2002 - 1982



SK55
Fuel Injector Seal Kit
1833564C92; XC3A9229AB;
F8TZ9229AA; F4TZ9229A;
XC3Z9229AA; XC3Z9229AB

Ford 2003 - 1993
IC Corporation 2004 - 2002
International 2005 - 1994



SK64
Diesel Fuel Injector Installation Kit
8C3Z9229A

Injectors Covered per Kit: 1
Kit/Set Contents: Yes
Material: Steel

Ford 2010 - 2008



SK66
Fuel Injector Seal Kit

Assorted Sizes: Yes
Injectors Covered per Kit: 1
Kit/Set Contents: Yes
Material: N/A
Pintle Cap Included: No

Chevrolet 2004 - 2001
GMC 2004 - 2001



SK67
Fuel Injector Seal Kit
97239186; 97216082; 94011699;
94011701

Chevrolet 2004 - 2001
GMC 2004 - 2001

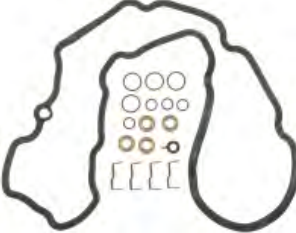

SK68
Fuel Injector Seal Kit

Chevrolet 2004 - 2001
GMC 2004 - 2001



SK80
Fuel Pressure Regulator O-Ring
17113552

Notes: N/A

Chevrolet 2006



SK85
Fuel Injector Seal Kit
3C3Z9229AA

Assorted Sizes: Yes
Injectors Covered per Kit: 1
Kit/Set Contents: Yes
Material: Rubber
Pintle Cap Included: No
Seal Type: MFI

Ford 2010 - 2003
IC Corporation 2008 - 2005
International 2012 - 2002



SK104
Fuel Pressure Regulator O-Ring
F6TZ9C977AN; F6TZ9C977AO;
1825806C92; 1825806C91;
4C3Z9C977AA; F6TZ9C977AA

Ford 2003 - 1993
IC Corporation 2004 - 2002
International 2005 - 1994



SK105
Fuel Injector Seal Kit
06E998907; 06E998907G

Assorted Sizes: Yes
Injectors Covered per Kit: 1
Kit/Set Contents: Yes

Material: Rubber
 Pintle Cap Included: No
 Seal Type: MFI
 Audi 2010 - 2008



SK106
 Fuel Injector Seal Kit
 06J998907D; 06J998907A;
 06J998907B; 06J998907

Assorted Sizes: Yes
 Injectors Covered per Kit: 4
 Kit/Set Contents: Yes
 Material: Rubber
 Pintle Cap Included: No
 Seal Type: MFI
 Audi 2016 - 2010



SK107
 Fuel Pressure Regulator
 O-Ring
 3C3Z9H529A

Kit/Set Contents: No
 Material: Rubber
 Notes: N/A
 Seal Type: MFI
 Ford 2010 - 2003
 IC Corporation 2008 - 2005
 International 2012 - 2002



SK108
 Diesel High Pressure Oil
 Pump Seal Kit
 2C3Z9G804AB; 2C3Z9G804AA

Ford 2003 - 1994



SK115
 Diesel Fuel Injector
 Installation Kit

Material: Rubber
 Notes: N/A
 Chevrolet 2010 - 2004
 GMC 2010 - 2004
 Hummer 2006



SK120
 Fuel Injector Seal Kit
 12672366; 12623119; 12656933;
 12668553

Assorted Sizes: Yes
 Injectors Covered per Kit: 8
 Kit/Set Contents: Yes
 Material: Rubber
 Pintle Cap Included: No
 Seal Type: GDI
 Chevrolet 2019
 GMC 2019



SK121
 Fuel Injector Seal Kit
 12612217; 059130119

Assorted Sizes: No
 Injectors Covered per Kit: 1
 Kit/Set Contents: No
 Material: Rubber
 Pintle Cap Included: No
 Seal Type: MFI
 Chevrolet 2014
 Volkswagen 2014 - 2009



SK122
 Fuel Injector Seal Kit
 12855117

Assorted Sizes: No
 Injectors Covered per Kit: 1
 Kit/Set Contents: No
 Material: Copper
 Pintle Cap Included: No
 Seal Type: MFI
 Chevrolet 2014



SK125
 Diesel High Pressure Oil
 Pump Seal Kit
 3C3Z9G804AA

Ford 2004 - 2003



SK136
 Fuel Injector Seal Kit
 059130519

Assorted Sizes: No
 Injectors Covered per Kit: 1
 Kit/Set Contents: No
 Material: Copper
 Pintle Cap Included: No
 Seal Type: MFI
 Volkswagen 2014 - 2009



SK138
 Diesel Fuel Injector
 Installation Kit
 BC3Z9229C; BC3Z9229E;
 BC3Z9A337A; BC3Z9229A

Ford 2019 - 2011



SK139
 Diesel Fuel Injector
 Installation Kit
 BC3Z9229F; BC3Z9229D;
 BC3Z9A337B; BC3Z9229B

Ford 2019 - 2011



SK140
 Fuel Injector Seal Kit
 1842624C92

Assorted Sizes: Yes
 Injectors Covered per Kit: 1
 Kit/Set Contents: Yes
 Material: Rubber
 Pintle Cap Included: No
 Seal Type: MFI
 International 2013 - 2004



SK141
Fuel Injector Seal Kit
1830317C1

Assorted Sizes: No
Injectors Covered per Kit: 6
Kit/Set Contents: Yes
Material: Stainless Steel
Pintle Cap Included: No
Seal Type: MFI

International..... 2013 - 1995



SK142
Diesel High Pressure Oil Pump Seal Kit
4C3Z9B246F

Ford 2010 - 2005
International..... 2007 - 2005



SK145
Diesel High Pressure Oil Rail Seal Kit
AP0070

Ford 2007 - 2003
International..... 2007 - 2003



SK146
Fuel Injector Seal Kit
68031602AA

Assorted Sizes: Yes
Injectors Covered per Kit: 1
Kit/Set Contents: Yes
Material: Rubber

Pintle Cap Included: No
Seal Type: MFI
Dodge 2010 - 2007
Ram 2019 - 2011



SK157
Fuel Injector O-Ring
06E998907E; 06E998907D;
06E998907B

Assorted Sizes: Yes
Injectors Covered per Kit: 1
Kit/Set Contents: Yes
Material: N/A
Pintle Cap Included: No
Seal Type: GDI

Audi 2014



SK168
Fuel Rail O-Ring Kit
1842626C96; 1842626C95

Assorted Sizes: Yes
Kit/Set Contents: Yes
Material: ABS Plastic
Notes: Includes O-Ring
Seal Type: MFI

IC Corporation 2016 - 2005
International..... 2016 - 2005

SK170
Fuel Injector O-Ring
13537577649

Injectors Covered per Kit: 6
Kit/Set Contents: No
Material: Metal
Pintle Cap Included: No
Seal Type: GDI

BMW..... 2017 - 2011



SLS531
Stoplight Switch
7700414986

Connector Gender: Female
Connector Quantity: 1
Terminal Gender: Male
Terminal Quantity: 2

Renault 2011 - 2008



SLS532
Stoplight Switch
7700414988

Connector Gender: Female
Connector Quantity: 1
Terminal Gender: Male
Terminal Quantity: 4

Renault 2011 - 2008



SLS541
Stoplight Switch
35006876897; 35006876896;
61319240076

Connector Gender: Female
Connector Quantity: 1
Terminal Gender: Male
Terminal Quantity: 2

BMW..... 2018 - 2014



SLS556
Stoplight Switch
13579088

Connector Gender: Female
Connector Quantity: 1
Terminal Gender: Male
Terminal Quantity: 6

GMC 2012



SLS577
Stoplight Switch
68078700AE; 68078700AD;
68078700AB

Connector Gender: Female
Connector Quantity: 1
Terminal Gender: Male
Terminal Quantity: 3

Ram 2013



SLS-34
Stoplight Switch
113945515D; 113945515H;
19106704; 81021; 34542B; 34542A;
31802; 31082; 0344004003

Connector Gender: Female
Connector Quantity: 1
Terminal Gender: Male
Terminal Quantity: 2

Volkswagen 1981



SLS-66
Stoplight Switch
J4488295; J4488295; J4488295;
J4488295; J3194569; J3194569;
J3194569; J3194569; 358560C91;
F6HZ13480EA; F1HT13480BA;
F6HT13480AB; F6HZ13480A;
F6HZ13480B; D7TB13480AA;
D7TB13480BA; D8TB13480A1A;
D8TZ13480A; C8TZ13480B;
C8ZZ13480A; D2TB13480BA;
D2TZ13480B; D3TB13480AA;
C7TA13480B; 312739C91;
358560C1; 175957656A; 675608;
538652; 531281

****Additional OE Numbers Available Online****

Connector Gender: Male
Connector Quantity: 1
Terminal Gender: Male
Terminal Quantity: 2

Ford 1999 - 1980
International..... 1983 - 1981
Pontiac 1983 - 1981



SLS-82
Stoplight Switch
E9TZ13480A; ZZL067210;
E27B13480CA; E3TZ13480C;
E67B13480BA; E6TZ13480A;
D1ZB13480A; D1ZB13480B;
D1ZB13480BA; D1ZZ13480B;
E27B13480AA; 12337507; 12309611
Connector Gender: Male
Connector Quantity: 1
Terminal Gender: Male
Terminal Quantity: 2
Ford 2007 - 2000



SLS-87
Stoplight Switch
113945515E; 113945515G;
12351063
Connector Gender: Male
Connector Quantity: 1
Terminal Gender: Male
Terminal Quantity: 3
Volkswagen 1981



SLS-93
Stoplight Switch
F4TZ13480A; E3UB13480AA;
E3UZ13480A; E6UB13480AA;
E6UZ13480A; D6UA13480A;
D6UB13480AA; D6UZ13480A;
D8TB13480BA; D8TZ13480B;
12323540
Connector Gender: Female
Connector Quantity: 1
Terminal Gender: Male
Terminal Quantity: 2
Ford 1997 - 1995



SLS-101
Stoplight Switch
3532089910; 25320A6900;
682140051; 25320H1000;
25320H5001; MB113081; 12326981;
12321850
Connector Gender: Male
Connector Quantity: 2
Terminal Gender: Male
Terminal Quantity: 2
Nissan 1981



SLS-102
Stoplight Switch
D8HZ13480B; D5TZ13480B;
D8HZ13480A; 2327054; 721461;
2055294; 2008780
Connector Gender: Female
Connector Quantity: 2
Terminal Gender: Male
Terminal Quantity: 2
Ford 1996 - 1980



SLS-104
Stoplight Switch
3774066010; D27Z13480A;
023366790; 072767210;
073067201A; MB113078;
MT138890; 96052137; 12323544
Connector Gender: No Connector
Terminal Gender: Male
Terminal Quantity: 2
Mazda 1984 - 1982



SLS-106
Stoplight Switch
25320H8500; 12326975
Connector Gender: Male
Terminal Gender: Male

Terminal Quantity: 2
Nissan 1986



SLS-126
Stoplight Switch
857945515; 857945515;
811945513A; 811945513A;
857945515A; 811945513; 19021163
Connector Gender: Female
Connector Quantity: 1
Terminal Gender: Male
Terminal Quantity: 2
Audi 1981 - 1980



SLS-127
Stoplight Switch
481945515; 481945515;
61311379830; 6793640;
61311350645; 61311368786;
3544693; 679364; 3544691;
7334642; 88924656
Connector Gender: Male
Connector Quantity: 1
Terminal Gender: Male
Terminal Quantity: 2
BMW 1986 - 1985



SLS-159
Stoplight Switch
25524845; 3902264; 3772117;
9794682; 9789705; 25524847;
25523375; 1608826
Connector Gender: No Connector
Connector Quantity: 1
Terminal Gender: Male
Terminal Quantity: 4
Pontiac 1983 - 1981



SLS-170
Stoplight Switch
453402
Connector Gender: Female
Connector Quantity: 1
Terminal Gender: Male
Terminal Quantity: 2

Peugeot 1983 - 1980



SLS-173
Stoplight Switch
15644318
Connector Gender: Female
Connector Quantity: 2
Terminal Gender: Male
Terminal Quantity: 2; 2
Chevrolet 1996



SLS-174
Stoplight Switch
25523463; 3522540; 3537077
Connector Gender: Female
Connector Quantity: 2
Terminal Gender: Male
Terminal Quantity: 5
Chevrolet 1996



SLS-179
Stoplight Switch
10170430; 10230658; 10230651;
10200426; 10194434
Connector Gender: Female
Connector Quantity: 2
Terminal Gender: Male
Terminal Quantity: 4; 2
Chevrolet 1996



SLS-204
Stoplight Switch
0005459909; 0005457709;
0005458609; 15450109;
0015450109
Connector Gender: Female
Connector Quantity: 1
Terminal Gender: Male
Terminal Quantity: 2 + 2
Mercedes-Benz 1999 - 1984



SLS-208
Stoplight Switch
 7B0945511B; 7B0945511C;
 7B0945511A; 4565238;
 68003916AA; 4671336AD;
 4671336AC; 56042021; 56042051;
 56042691AA; 56042023; 4671340;
 4671341; 4671334; 4671336;
 26042023; 4565239; 4565240;
 88924596; 88923798

Connector Gender: Female
 Connector Quantity: 1
 Terminal Gender: Male
 Terminal Quantity: 6

Ram..... 2012



SLS-214
Stoplight Switch
 15676475; 15038676

Connector Gender: Female
 Connector Quantity: 2
 Terminal Gender: Male
 Terminal Quantity: 6

Chevrolet 2002 - 1993



SLS-234
Cruise Control Release Switch
 25523376; 25509432

Notes: N/A
 Terminal Gender: Male
 Terminal Quantity: 2
 Terminal Type: Blade Terminals

Buick..... 1984 - 1982
 Cadillac..... 1985 - 1982
 Chevrolet 1987 - 1982
 GMC 1987 - 1981
 Oldsmobile 1985 - 1982



SLS-237
Stoplight Switch
 56045043AE; 56045043AG;
 7B0945511; 5016294AC;
 56045043AD; 56045043AB;
 56045043AC; 5083344AA;
 5016294AA; 5016294AB;
 5016294AD; 05083344AA

Connector Gender: Female
 Connector Quantity: 1
 Terminal Gender: Male
 Terminal Quantity: 6

Dodge 2010 - 2008



SLS-247
Stoplight Switch
 F87Z13480AB; ZZP067210;
 ZZPO67210; F87Z13480AA

Connector Gender: Female
 Connector Quantity: 1
 Terminal Gender: Male
 Terminal Quantity: 5

Ford 2009 - 2000



SLS-276
Stoplight Switch
 453409; 88924631

Connector Gender: Female
 Connector Quantity: 1
 Terminal Gender: Male
 Terminal Quantity: 2

Peugeot 1988



SLS-282
Stoplight Switch
 816053; SMU802; 88924701

Connector Gender: Female
 Connector Quantity: 1
 Terminal Gender: Male
 Terminal Quantity: 2 + 2

Mercedes-Benz 1991 - 1990



SLS-303
Stoplight Switch
 15163032; 15158767; 15128874;
 15128874; 15038393; 25771554;
 15161650

Connector Gender: Female
 Connector Quantity: 1
 Terminal Gender: Male
 Terminal Quantity: 6

Chevrolet 2001
 GMC 2007



SLS-316
Stoplight Switch
 1J0945511E; 1J0945511F;
 1J0945511A; 1C0945511ANAR;
 1J0945511C; 1J0945511D;
 1J0945511B; 1C0945511A

Connector Gender: Female
 Connector Quantity: N/A
 Terminal Gender: Male
 Terminal Quantity: 4

Volkswagen 2009 - 2008



SLS-323
Stoplight Switch
 XKB000022; XKD100090L;
 61316908786; 61318372647;
 61316908787; 61310398202;
 61310300846; XKB000021;
 61316967601; 61358360881;
 61314114227; 61316928031;
 61316957151; 61314114226;
 61314105242

Connector Gender: Female
 Connector Quantity: 1
 Terminal Gender: Male
 Terminal Quantity: 4

BMW 2016 - 2009



SLS-331
Stoplight Switch
 YC3Z13480AA

Connector Gender: Female
 Connector Quantity: 1
 Terminal Gender: Male
 Terminal Quantity: 2

Ford 2003 - 2000



SLS-336
Stoplight Switch
 15137492; 15861245; 15839548

Connector Gender: Female
 Connector Quantity: 1
 Terminal Gender: Male
 Terminal Quantity: 4

GMC 2011



SLS-345
Stoplight Switch
YC3Z13480BA

Connector Gender: Female
Connector Quantity: 1
Terminal Gender: Male
Terminal Quantity: 2
Ford 2003 - 2000



SLS-385
Stoplight Switch
0045452114

Connector Gender: Female
Connector Quantity: 1
Terminal Gender: Male
Terminal Quantity: 2
Dodge 2006 - 2003
Freightliner 2006 - 2003
Mercedes-Benz 2009 - 2006



SLS-386
Stoplight Switch
0015454009

Connector Gender: Female
Connector Quantity: 1
Terminal Gender: Male
Terminal Quantity: 2
Mercedes-Benz 2006 - 2005



SLS-450
Stoplight Switch
25981009

Connector Gender: Female
Connector Quantity: 1
Terminal Gender: Male
Terminal Quantity: 4
Chevrolet 2011
GMC 2011



SLS-466
Stoplight Switch
68056230AA; 0015452009;
0015458709

Connector Gender: Female
Connector Quantity: 1
Terminal Gender: Male
Terminal Quantity: 4
Dodge 2006 - 2003
Freightliner 2006 - 2003



SLS-467
Stoplight Switch
68013462AA; 68022569AA

Connector Gender: Female
Connector Quantity: N/A
Terminal Gender: Male
Terminal Quantity: 4
Dodge 2009
Freightliner 2012 - 2009
Mercedes-Benz 2012 - 2011

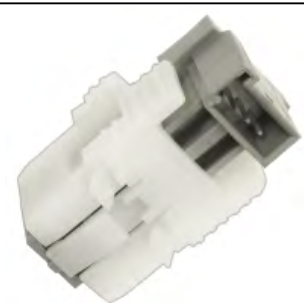

SLS-501
Stoplight Switch
0015456309

Connector Gender: Female
Connector Quantity: 1
Terminal Gender: Male
Terminal Quantity: 4
Mercedes-Benz 2016 - 2011



SLS-502
Stoplight Switch
0015454409; 0015456709

Connector Gender: Female
Connector Quantity: 1

Terminal Gender: Male
Terminal Quantity: 4
Freightliner 2017 - 2010
Mercedes-Benz 2019 - 2007



SLS-513
Stoplight Switch
56038914AB; 56038914AC

Connector Gender: Female
Connector Quantity: 1
Terminal Gender: Male
Terminal Quantity: 6
Ram 2012 - 2011



SLS-521
Cruise Control Release
Switch
8200168240; 4414818

Connector Gender: Female
Connector Quantity: 1
Terminal Gender: Male
Terminal Quantity: 2
Renault 2011 - 2008



SPK101
Engine Oil Stand Pipe
and Dummy Plug Kit
6E7Z9A332A; 1882993C93;
6E7Z9A332B; 6E7Z9E332B

Ford 2010 - 2003
IC Corporation 2008 - 2005
International 2012 - 2002

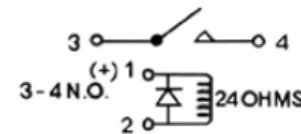
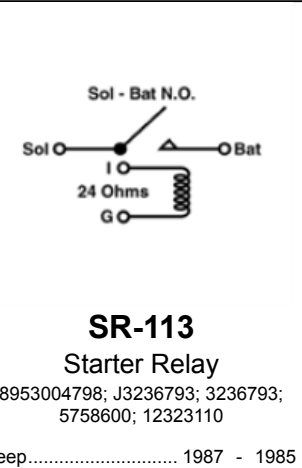

Connector Gender: Female
Connector Quantity: 1
Connector Shape: Rectangular
Functions: Relay
Mounting Bracket(s) Included: Yes
Terminal Gender: Male
Terminal Quantity: 4
Voltage: N/A
Dodge 1996



SS853
Starter Solenoid
12417798034

Connector Gender: N/A
Hardware Included: N/A
Terminal Gender: Male
Terminal Quantity: 3
Voltage: 12
BMW 2012 - 2009



SS868
Starter Solenoid
 97779441; 97729075; 97383133

Connector Gender: N/A
 Hardware Included: Yes
 Terminal Gender: Male
 Terminal Quantity: 1
 Voltage: 12

Chevrolet 2010 - 2005
 GMC 2010 - 2004



SS869
Starter Solenoid
 97365821

Connector Gender: No Connector
 Hardware Included: N/A
 Terminal Gender: Male
 Terminal Quantity: 1
 Voltage: 12

Chevrolet 2004 - 2001
 GMC 2002 - 2001



SS874
Starter Solenoid
 98007758

Connector Gender: No Connector
 Hardware Included: Yes
 Terminal Gender: Male
 Terminal Quantity: 1
 Voltage: 12

Chevrolet 2007 - 2006
 GMC 2007 - 2006



SS-200
Starter Solenoid
 J8130938; J8130938; J8130938;
 J8130938; J3205022; J3205022;
 J3205022; J3205022; J3200939;
 J3200939; J3200939; J3200939;
 3200939; 3200939; 3200939;
 3200939; AR68304; C4TF11390B;
 D6TZ11390A; 49123144; 8733261;
 2735645020; 65478C1; 11869872;
 13064548; 1119998; 1119974;
 1119967; 1119936; 1119946
****Additional OE Numbers Available Online****

Connector Gender: Male
 Hardware Included: Yes
 Terminal Gender: Male
 Terminal Quantity: 4
 Voltage: 12

Buick 1981 - 1980
 Cadillac 1981 - 1980
 Checker 1982 - 1980
 Chevrolet 1993 - 1982
 GMC 1991 - 1980
 International 1980
 Oldsmobile 1981 - 1980
 Pontiac 1981 - 1980



SS-213
Starter Solenoid
 R11292; C5TF11390A; C6TZ11390A;
 2438281; 2692093; 65479C2;
 1119935; 1119890; 1119882;
 1119885; 1119833; 1119818;
 1119778; 1115541; 1115582;
 1115540; 1115530; 1115518;
 1115529; 1115510; 1115501;
 1115508; 2225288; 1028587M91

Connector Gender: Male
 Hardware Included: No
 Terminal Gender: Male
 Terminal Quantity: 4
 Voltage: 12

International 1982 - 1980



SS-215
Starter Solenoid
 AR102766; AR11075; C4TZ11390A;
 E1HZ11390B; 1119878; 1119848;
 1119832; 1115559; 1115607;
 1115557; 1115544; 8L5071; 4M1812;
 4R7057

Connector Gender: Female
 Hardware Included: Yes
 Terminal Gender: Male
 Terminal Quantity: 4
 Voltage: 24

Freightliner 1992 - 1991
 International 1986 - 1980
 Mack 1990 - 1980



SS-216
Starter Solenoid
 303370895; C3TZ11390A;
 E1HZ11390A; SFD221121; 1119879;
 1119853; 1115606; 1115575;
 1115556; 7L6586; AR48337;
 1055740M91; 1022662M91

Connector Gender: Female
 Hardware Included: Yes
 Terminal Gender: Male
 Terminal Quantity: 4
 Voltage: 12

Chevrolet 1989 - 1983
 Freightliner 1992 - 1991
 International 1984 - 1980
 Mack 1988 - 1980



SS-230
Starter Solenoid
 8322315; 2439131

Connector Gender: No Connector
 Hardware Included: No
 Terminal Gender: Male
 Terminal Quantity: 4
 Voltage: 12

Volkswagen 1994 - 1993



SS-233
Starter Solenoid
 23343N3300; 23343N3301;
 12338250; 12323148

Connector Gender: Female
 Hardware Included: No
 Terminal Gender: Male
 Terminal Quantity: 3
 Voltage: 12

Nissan 1981



SS-251
Starter Solenoid
 8011145660; E3PZ11390A;
 8011145310; 8011145840;
 38538690; E3PF11390AA; 1114569;
 1114564; 1114531; 1114557;
 1114518; 1114524; 1114515;
 1114514; 3853869; 8983500937;
 8133925

Connector Gender: Male
 Hardware Included: Yes
 Terminal Gender: Male
 Terminal Quantity: 4
 Voltage: 12

Buick 1985 - 1982
 Cadillac 1985 - 1982
 Chevrolet 1982
 Ford 1984 - 1983
 GMC 1984
 Oldsmobile 1985 - 1982
 Pontiac 1985 - 1982



SS-255
Starter Solenoid
 035911287C; 055911287A;
 055911287B; 073911287;
 026911287; 0331302002

Connector Gender: Female
 Hardware Included: No
 Terminal Gender: Male
 Terminal Quantity: 4
 Voltage: 12/24

Audi 1984 - 1980

Volkswagen 1990



SS-262
Starter Solenoid
 055911287; 0331303004;
 059911287D

Connector Gender: Female
 Hardware Included: No
 Terminal Gender: Male
 Terminal Quantity: 5
 Voltage: 12

Audi 1983 - 1980
 Volkswagen 1983



SS-277
Starter Solenoid
 AL25268; 331402030; 331402001;
 0331402030; 0331402001; 1523010;
 0001523010

Connector Gender: Female
 Hardware Included: Yes
 Terminal Gender: Male
 Terminal Quantity: 2
 Voltage: 12

Mercedes-Benz 1985 - 1980



SS-299
Starter Solenoid
 2334307M00; B334307M00

Connector Gender: Female
 Hardware Included: Yes
 Terminal Gender: Male
 Terminal Quantity: 3
 Voltage: 12

Nissan 1986 - 1983

Voltage: 12

Chevrolet 1985 - 1983



SS-331
Starter Solenoid
 E5PF11390AA; E5PZ11390A;
 F4PU11390AA; F4PU11390AB;
 F4PU11390AC

Connector Gender: Male
 Hardware Included: Yes
 Terminal Gender: Male
 Terminal Quantity: 3
 Voltage: 12

Ford 2001 - 1985



SS-265
Starter Solenoid
 23343U6000

Connector Gender: Female
 Hardware Included: No
 Terminal Gender: Male
 Terminal Quantity: 3
 Voltage: 12

Nissan 1983



SS-279
Starter Solenoid
 E3TZ11390A; R20124736;
 MD607634

Connector Gender: Female
 Hardware Included: No
 Terminal Gender: Male
 Terminal Quantity: 3
 Voltage: 12

Dodge 1985 - 1983
 Ford 1984 - 1983



SS-300
Starter Solenoid
 8942284530; 94228453

Connector Gender: Female
 Hardware Included: No
 Terminal Gender: Male
 Terminal Quantity: 3
 Voltage: 12

Chevrolet 1986 - 1981
 Pontiac 1986 - 1982



SS-332
Starter Solenoid
 23343G7001

Connector Gender: Female
 Hardware Included: Yes
 Terminal Gender: Male
 Terminal Quantity: 3
 Voltage: 12

Nissan 1985 - 1983



SS-268
Starter Solenoid
 859924736

Connector Gender: Female
 Hardware Included: Yes
 Terminal Gender: Male
 Terminal Quantity: 2; 1
 Voltage: 12

Mazda 1984 - 1982



SS-296
Starter Solenoid
 2334307G00; 23343V0700;
 23343W1000; B334307G00

Connector Gender: Female
 Hardware Included: Yes
 Terminal Gender: Male
 Terminal Quantity: 2; 1
 Voltage: 12

Nissan 1983



SS-306
Starter Solenoid
 25516196; 22516196

Connector Gender: Female
 Hardware Included: Yes
 Terminal Gender: Male
 Terminal Quantity: 3
 Voltage: 12

Buick 1985 - 1984
 Cadillac 1985
 Chevrolet 1985 - 1983
 Oldsmobile 1985 - 1983
 Pontiac 1985 - 1982



SS-336
Starter Solenoid
 025911287

Connector Gender: Female
 Hardware Included: No
 Terminal Gender: Male
 Terminal Quantity: 4
 Voltage: 12/24

Volkswagen 1981



SS-318
Starter Solenoid
 1115598

Connector Gender: No Connector
 Hardware Included: No
 Terminal Gender: Male
 Terminal Quantity: 4



SS-337
Starter Solenoid
 F3HZ11390B; 10456454

Connector Gender: Female
 Hardware Included: Yes
 Terminal Gender: Male

Terminal Quantity: 3
Voltage: 12
Chevrolet 2002 - 1992
GMC 2001 - 1991



SS-348
Starter Solenoid
7527856; 13635461; 331303033;
0331303033; 1363546;
12411273228

Connector Gender: Female
Hardware Included: No
Terminal Gender: Male
Terminal Quantity: 4
Voltage: 12
BMW 1986 - 1985
Volvo 1986



SS-357
Starter Solenoid
E7HZ11390B; 1115609

Terminal Quantity: 3
Voltage: 12
Chevrolet 2001 - 1999
GMC 2001 - 1999



SS-367
Starter Solenoid
1114373

Connector Gender: Female
Hardware Included: Yes
Terminal Gender: Male
Terminal Quantity: 4
Voltage: 12/24
Chevrolet 1985 - 1984
GMC 1986 - 1983



SS-369
Starter Solenoid
E5TZ11390A; MD611133

Connector Gender: Female
Hardware Included: No
Terminal Gender: Male
Terminal Quantity: 3
Voltage: 12/24
Ford 1987 - 1985



SS-388
Starter Solenoid
2334310G00

Connector Gender: Female; Male
Hardware Included: Yes
Terminal Gender: Male; Female
Terminal Quantity: 2; 1
Voltage: 12
Nissan 1986



SS-401
Starter Solenoid
1526910; 1527310; 0001526910;
0001527310

Connector Gender: Female
Hardware Included: No
Terminal Gender: Male
Terminal Quantity: 3
Voltage: 12
Mercedes-Benz 1993 - 1984



SS-404
Starter Solenoid
1115618

Connector Gender: No Connector
Hardware Included: No
Terminal Gender: Male
Terminal Quantity: 4

Voltage: 12/24
Chevrolet 1998 - 1994



SS-448
Starter Solenoid
2815064030

Connector Gender: Female
Hardware Included: No
Terminal Gender: Male
Terminal Quantity: 3
Voltage: 12
Toyota 1985 - 1984



SS-581
Starter Solenoid
J3235898; J3235898; J3235898;
J3235898; J3180465; J3180465;
J3180465; J3180465; 980801;
PB9L11450A; D2DF11450AA;
E7HT11450AA; E7HZ11450AA;
FDR11450A; C7AF11450A;
C9AF11450A; C9AZ11450A;
D2AF11450A; D2AF11450AA;
B6A11450A; B6AZ11450A;
C4AF11450A; C4AF11450B;
C6AF11450A; 4921; 1114208;
65057T1; 3225629; 3180465;
2701966

****Additional OE Numbers Available Online****

Amperage Rating: 300 A
Connector Gender: Female
Hardware Included: No
Terminal Gender: Male
Terminal Quantity: 4
Voltage: 12
Ford 1989 - 1986



SS-588
Starter Solenoid
7147371; J3225629; J3225629;
J3225629; J3225629; J3225624;
J3225624; J3225624; J3225624;
545756R1; 3225624; 3225624;
3225624; 3225624; 121316C1;
D8DZ11450A; D8DZ11450B;
D8VF11450AA; E1PF11K185AA;
E7HZ11450A; D2OF11450AB;
D2OZ11450A; D2SF11450AB;
D8DF11450AA; 2C11450A;
121613C1; 1119901; 1114215; 1466;
640035

****Additional OE Numbers Available Online****

Amperage Rating: 250 A
Connector Gender: Male
Mounting Bracket(s) Included: Yes
Terminal Gender: Male
Terminal Quantity: 4
Voltage: 12
Ford 1987 - 1985
Lincoln 1985 - 1984



SS-590
Starter Solenoid
J3235897; J3235897; J3235897;
J3235897; J3234971; J3234971;
J3234971; J3234971; 3234971;
12336882; 235897; 3235897

Connector Gender: Male
Hardware Included: Yes
Terminal Gender: Male
Terminal Quantity: 4
Voltage: 12
Jeep 1986

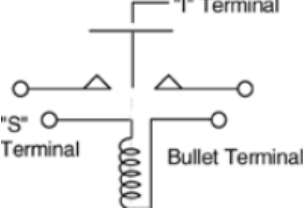

The diagram shows a solenoid with four terminals: 'I' Terminal, 'S' Terminal, and two Bullet Terminals. The 'I' terminal is connected to a coil, and the 'S' terminal is connected to the other end of the coil. The two bullet terminals are connected to the coil's windings.



SS-591

Diesel Glow Plug Relay
560580; D1777; 22514424

Connector Gender: Male
Connector Quantity: 2
Connector Shape: Round
Mounting Bracket(s) Included: Yes
Terminal Gender: Male
Terminal Quantity: 4
Voltage: 12

Buick..... 1985 - 1981
Cadillac..... 1980
Chevrolet..... 1985 - 1982
Oldsmobile..... 1981 - 1980
Pontiac..... 1983 - 1980



SS-598

Starter Solenoid

7146373A; 7146373; SAZ4201R;
E9TZ11450A; E9TZ11450B;
F9TZ11450B; SAZ4201E;
E87F11450BA; E89F11450AA;
E87F11450AA; E99F11450AA;
E97F11450AA; E77F11450BA;
E7TZ11450A; E7VF11450A;
E7VF11450AA; E79F11450AB;
E7EF11450AA; E77F11450AA;
E77F11450AB; E67F11450AA;
E6AF11450AA; E77F11450AA;
E77F11450AB; E79F11450AA;
E59F11450AA; E5AZ11450A;
E5DF11450AA; E5TZ11450B;
E4AF11450AA

****Additional OE Numbers Available Online****

Amperage Rating: 300 A
Connector Gender: Male
Hardware Included: Yes
Mounting Bracket(s) Included: Yes
Terminal Gender: Male
Terminal Quantity: 4
Voltage: 12

Ford..... 2003 - 1983
Mercury..... 1986 - 1984



SS-613

Starter Solenoid

985064; E8TZ11450B;
F7UZ11450AA

Connector Gender: Male
Hardware Included: Yes
Terminal Gender: Male
Terminal Quantity: 4
Voltage: 12
Ford..... 2001 - 1988



SS-750

Dual Battery Solenoid Relay

E5TB14088AA; D3TB14088AA;
D3TB14088AB; D3TB14088AC;
D3TZ14677A

Connector Gender: Male
Connector Quantity: 3
Connector Shape: Rectangular
Functions: Solenoid
Mounting Bracket(s) Included: Yes
Terminal Gender: Male
Terminal Quantity: 3
Voltage: 12

Ford..... 1990 - 1983

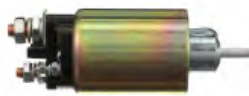

SS-762

Starter Solenoid

F4TZ11390A

Connector Gender: No Connector
Hardware Included: Yes
Terminal Gender: Male
Terminal Quantity: 3
Voltage: 12

Ford..... 2001 - 1985



SS-843

Starter Solenoid

020911287; 02A911287; 085911287

Connector Gender: Female
Hardware Included: No
Terminal Gender: Male
Terminal Quantity: 1; 1; 1
Voltage: 12

Volkswagen..... 2006 - 1980



SWS46

Steering Angle Sensor

5129606AA

Dodge..... 2006 - 2004
Freightliner..... 2006 - 2004



SWS116

Steering Angle Sensor

0005426418

Mercedes-Benz..... 1999 - 1993



TBA2

Turbocharger Actuator

12643471

Chevrolet..... 2016 - 2006
GMC..... 2016 - 2006

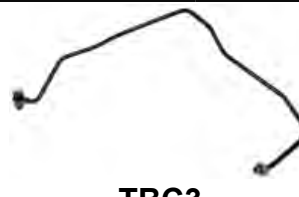

TBC3

Turbocharger Oil Line

038145771AH

Contents: Oil Line
Hardware Included: Yes
Notes: N/A
Thread Size - NPT: 1/2

Volkswagen..... 2006 - 1999



TBC4

Turbocharger Oil Line

6C3Z9T515A

Contents: 2 O-Rings
Hardware Included: N/A
Notes: N/A
Thread Size - NPT: N/A

Ford..... 2010 - 2003



TBC522

Turbocharger - New - Diesel

3C3Z6K682CBRMN

Contents: Turbocharger
Hardware Included: Yes
Hose Connector Quantity: 2
New Or Remanufactured: New

Ford..... 2004 - 2003



TBC524
Turbocharger - New - Diesel
4C3Z6K682CCRMN

Contents: Turbocharger
Hardware Included: Yes
Hose Connector Quantity: 2
New Or Remanufactured: New
Ford 2005 - 2004



TBC541
Turbocharger - Remfd - Diesel
R5010961AA; 5010961AA

Contents: Turbocharger
Hardware Included: Yes
Hose Connector Quantity: 2
Dodge 1998



TBC544
Turbocharger - Remfd - Diesel
4429146; R4728036; R4429146

Contents: Turbocharger
Hardware Included: Yes
Hose Connector Quantity: 2
Dodge 1991 - 1989



TBC547
Turbocharger - New - Diesel
68019589AA; 68043064AA;
68004666AA; 68004663AA;
68037206AA; 6420902380

Contents: Turbocharger
Hardware Included: Yes
Hose Connector Quantity: 2
New Or Remanufactured: New
Dodge 2009 - 2007
Freightliner 2009 - 2007
Jeep 2009 - 2007
Mercedes-Benz 2008 - 2007



TBC529
Turbocharger - New - Diesel
03L253010; 03L253056

Contents: Turbocharger
Hardware Included: Yes
Hose Connector Quantity: 2
New Or Remanufactured: New
Audi 2013 - 2010
Volkswagen 2014 - 2009



TBC542
Turbocharger - New - Diesel
028145701QX

Contents: Turbocharger
Hardware Included: Yes
Hose Connector Quantity: 2
New Or Remanufactured: New
Volkswagen 1999 - 1996



TBC545
Turbocharger - Remfd - Diesel
5010278AA; R5010278AA; 4864283;
4886031AA; R4886031AA;
R4864283; 4882121

Contents: Turbocharger
Hardware Included: Yes
Hose Connector Quantity: 2
Dodge 1998 - 1996



TBC548
Turbocharger - Remfd - Diesel
F8VZ6K682AARM;
5C3Z6V682BRM; F8U26K682AARM

Contents: Turbocharger
Hardware Included: Yes
Hose Connector Quantity: 2
Ford 1999 - 1998



TBC535
Turbocharger - Remfd - Diesel
F4TZ6VK682BARM;
F4TZ6VK682AARM;
F3TZ6K682AAAMR; F3TZ6K682A

Contents: Turbocharger
Hardware Included: Yes
Hose Connector Quantity: 2
Ford 1994 - 1993



TBC543
Turbocharger - New - Diesel
55581063

Contents: Turbocharger
Hardware Included: Yes
Hose Connector Quantity: 2
New Or Remanufactured: New
Chevrolet 2015 - 2014



TBC546
Turbocharger - New - Diesel
5117505AA; 5142494AA;
6470900280; 5142414AA;
5137152AA; RL142494AA

Contents: Includes Actuator
Hardware Included: Yes
Hose Connector Quantity: 2
New Or Remanufactured: New
Dodge 2006 - 2004
Freightliner 2006 - 2004



TBC549
Turbocharger - Remfd - Diesel
1825878C91; 1825878C92;
5C3Z6V682ARM; F81Z6K682AARM

Contents: Turbocharger
Hardware Included: Yes
Hose Connector Quantity: 2

Ford..... 1999



TBC553
Turbocharger - Remfd - Diesel

R5017787AE; 5017787AC;
5017787AA; 5017787AE;
5017787AD; 5017787AB

Contents: Turbocharger
Hardware Included: Yes
Hose Connector Quantity: 2

Dodge..... 2002 - 2001



TBC554
Turbocharger - New - Diesel

612096039980; 612096039960;
612096039964; 612096039987;
612096039988; 5104006AA;
6120960399; R5104006AB;
5104006AB

Contents: Turbocharger
Hardware Included: Yes
Hose Connector Quantity: 2
New Or Remanufactured: New

Dodge..... 2003
Freightliner..... 2003 - 2002



TBC555
Turbocharger - Remfd - Diesel

R5010280AA; 4883755AA;
5010280AA; R4883755AA;
R4886016AA; 4886016AA

Contents: Turbocharger
Hardware Included: Yes
Hose Connector Quantity: 2

Dodge..... 1998 - 1996



TBC559
Turbocharger - Remfd - Diesel

8C3Z6K682A; 8C3Z6K682AARM

Contents: Turbocharger
Hardware Included: Yes
Hose Connector Quantity: 2

Ford..... 2010 - 2008



TBC560
Turbocharger - New - Diesel

5142797AB; 5142797AA;
RL142797AC; 5142653AC;
5142797AC

Contents: Turbocharger
Hardware Included: Yes
Hose Connector Quantity: 2
New Or Remanufactured: New

Jeep..... 2006 - 2005



TBC561
Turbocharger - Remfd - Diesel

98011735; 98003366; 97371105

Contents: Turbocharger
Hardware Included: Yes
Hose Connector Quantity: 2

Chevrolet..... 2007 - 2006
GMC..... 2007 - 2006



TBC564
Turbocharger - New - Diesel

038145702E; 038145702J;
038145702NX; 038145702JX;
038145702N; 038145702G;
038145702GX

Contents: Turbocharger
Hardware Included: No
Hose Connector Quantity: 2



TBC562
Turbocharger - Remfd - Diesel

97387896; 97376376; 97352706;
97352564

Contents: Turbocharger
Hardware Included: Yes
Hose Connector Quantity: 2

Chevrolet..... 2005 - 2004
GMC..... 2005 - 2004



TBC563
Turbocharger - Remfd - Diesel

12639460; 98065854; 98021617;
98002389; 98002388

Contents: Turbocharger
Hardware Included: Yes
Hose Connector Quantity: 2

Chevrolet..... 2010 - 2007
GMC..... 2010 - 2007



TBC564
Turbocharger - New - Diesel

038145702E; 038145702J;
038145702NX; 038145702JX;
038145702N; 038145702G;
038145702GX

Contents: Turbocharger
Hardware Included: No
Hose Connector Quantity: 2

New Or Remanufactured: New

Volkswagen..... 2005 - 2004



TBC566
Turbocharger - Remfd - Diesel

F4TZ6VK682CARM;
F6TZ6K682ARM; F4TZ6K682BRM

Contents: Turbocharger
Hardware Included: Yes
Hose Connector Quantity: 2

Ford..... 1998 - 1994



TBC567
Turbocharger - Remfd - Diesel

R5143256AA; 5135784AB;
5143256AA; R5135784AB;
5135784AA

Contents: Turbocharger
Hardware Included: Yes
Hose Connector Quantity: 2

Dodge..... 2009 - 2004



TBC568
Turbocharger - Remfd - Diesel

R5014203AA; 5014203AA

Contents: Turbocharger
Hardware Included: Yes
Hose Connector Quantity: 2

Dodge..... 2000 - 1999



TBC569
Turbocharger - Remfd - Diesel
R5086863AB; 5086863AA;
5086863AB; R5086863AA
Contents: Turbocharger
Hardware Included: Yes
Hose Connector Quantity: 2
Dodge..... 2004 - 2003



TBC570
Turbocharger - Remfd - Diesel
R5017509AA; 5017509AA
Contents: Turbocharger
Hardware Included: Yes
Hose Connector Quantity: 2
Dodge..... 2002 - 2000



TBC573
Turbocharger - Remfd - Diesel
97720749
Contents: Turbocharger
Hardware Included: Yes
Hose Connector Quantity: 2
Chevrolet..... 2004 - 2002
GMC..... 2004 - 2002



TBC574
Turbocharger - Remfd - Diesel
97720748; 97307711
Contents: Turbocharger
Hardware Included: Yes
Hose Connector Quantity: 2
Chevrolet..... 2004 - 2002
GMC..... 2004 - 2002

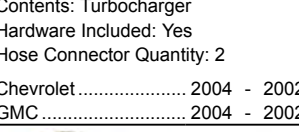

TBC575
Turbocharger - Remfd - Diesel
R5010276AA; 4856400; 5010276AA;
R4886032AA; R4864281; R4856400;
4886032AA
Contents: Turbocharger
Hardware Included: Yes
Hose Connector Quantity: 2
Dodge..... 1998 - 1995



TBC576
Turbocharger - Remfd - Diesel
8C3Z6K682CRM
Contents: Turbocharger
Hardware Included: Yes
Hose Connector Quantity: 4
Ford..... 2010 - 2008



TBC577
Turbocharger - Remfd - Diesel
12640123; 12643547
Contents: Turbocharger
Hardware Included: Yes
Hose Connector Quantity: 2
Chevrolet..... 2011 - 2010
GMC..... 2011



TBC579
Turbocharger - Remfd - Diesel
R4728700; R4638642; 4728700;
4638642
Contents: Turbocharger
Hardware Included: Yes
Hose Connector Quantity: 2
Dodge..... 1993 - 1991



TBC580
Turbocharger - New - Diesel
03L253010J; 03L253056E;
03L253056Q
Contents: Turbocharger
Hardware Included: Yes
Hose Connector Quantity: 2
New Or Remanufactured: New
Volkswagen..... 2014 - 2012



TBC586
Turbocharger - New - Diesel
07Z145873J; 07Z145873B;
07Z145873
Contents: Turbocharger
Hardware Included: Yes
Hose Connector Quantity: 2
New Or Remanufactured: New
Volkswagen..... 2008 - 2006



TBC584
Turbocharger - New - Diesel
R5010960AA; 4761339;
R4897268AA; R4761456; R4761339;
4761358; 4761342
Contents: Turbocharger
Hardware Included: Yes
Hose Connector Quantity: 2
New Or Remanufactured: New
Dodge..... 1995 - 1994



TBC585
Turbocharger - New - Diesel
059145873F
Contents: Turbocharger
Hardware Included: Yes
Hose Connector Quantity: 2
New Or Remanufactured: New
Audi..... 2012 - 2009
Volkswagen..... 2012 - 2009



TBC586
Turbocharger - New - Diesel
07Z145873J; 07Z145873B;
07Z145873
Contents: Turbocharger
Hardware Included: Yes
Hose Connector Quantity: 2
New Or Remanufactured: New
Volkswagen..... 2008 - 2006



TBC587

Turbocharger - New - Diesel

038253014Q; 038253014QX

Contents: Turbocharger
 Hardware Included: Yes
 Hose Connector Quantity: 2
 New Or Remanufactured: New
 Volkswagen 2006 - 2005



TBC591

Turbocharger - New - Diesel

1841839C91

Contents: Turbocharger
 Hardware Included: Yes
 Hose Connector Quantity: 1
 New Or Remanufactured: New
 International..... 2008 - 1999



TBC592

Turbocharger - Remfd - Diesel

YC3Z6K682AARM

Contents: Turbocharger
 Hardware Included: Yes
 Hose Connector Quantity: 2
 Ford 2003 - 2000



TBC593

Turbocharger - New - Diesel

5C4Z6K68CA; 5C4Z9T428A;
 5C4Z9T428AA; 5C4Z6K68BA;
 5C4Z6K682AA; 5C4Z6K68A;
 5010448R92; 5010448R93;
 5010448R91; 5010303R91;
 1845323C94; 1845323C93;
 1845323C92; 1844127C91;
 1845323C91; 1856152C91;
 5C4Z6K682BRM

Contents: Turbocharger
 Hardware Included: Yes
 Hose Connector Quantity: 2
 New Or Remanufactured: New
 Ford 2007 - 2005
 International..... 2010 - 2004



TBC594

Turbocharger - New - Diesel

1832161C91; 4C4Z6K682ARM

Contents: Turbocharger
 Hardware Included: Yes
 Hose Connector Quantity: 2
 New Or Remanufactured: New
 Ford 2004
 IC Corporation 2008 - 2005
 International..... 2010 - 2004



TBC602

Turbocharger - New - Diesel

642090120080; 6420901200;
 6420909480; 6420908980;
 642090898080; 6420908580;
 642090868080; 6420906880;
 6420906280; 6420905880;
 6420905780; 6420905580;
 6420902180; 6420905380;
 6420901486; 6420901680;
 6420900980; 6420900880;
 6420900486; 6420900286;
 6420908680; 6420908780

Freightliner 2017 - 2010
 Mercedes-Benz 2017 - 2007



TBC603

Turbocharger - Remfd

12677684; 12642314; 12642129;
 12637721; 12635167

Chevrolet 2016 - 2011
 GMC 2016 - 2011



TBC607

Turbocharger - Remfd

6510906380

Mercedes-Benz 2016 - 2014



TBC613

Turbocharger - New

028145701R

Volkswagen 1997 - 1993



TBC622

Turbocharger - New - Gas

06J145722BX; 06J145713TX;
 06J145713KX; 06J145702KX;
 06J145722B; 06J145702K;
 06J145701T; 06J145701N;
 06J145713K; 06J145713T

Audi 2016 - 2015



TBC658

Turbocharger - New

6460901880; 6460901180;
 6460900280

Mercedes-Benz 2010 - 2007



TBC664
Turbocharger - Remfd - Diesel
8C3Z6K682BARM

Contents: Turbocharger
Hardware Included: Yes
Hose Connector Quantity: N/A
Ford 2010 - 2008



TBC665
Turbocharger - Remfd
8C3Z6K682DARM;
8C3Z6K682BARM; 8C3Z6K682B

Ford 2010 - 2008



TBC666
Turbocharger - Remfd - Diesel
8C3Z6K682CRMLA

Ford 2010 - 2008



TBC668
Turbocharger - Remfd - Diesel

5326057; 5327046; 3798535;
4309356; 3787608; 3794756;
3779986; 3781633; 3787607;
3775439; 3779987; 3798539;
3775427; 3781755; 3794758;
68210648AA; 68212738AA;
68295438AA; 68321377AA;
68297874AA; 68253983AA;
68240478AA; 68245792AA;
68295348AA

Contents: Turbocharger
Hardware Included: Yes
Hose Connector Quantity: N/A
Ram 2018 - 2013



TBC669
Turbocharger - Remfd - Diesel

3779987; 3798539; 3775427;
3781755; 3794758; 5327045;
5327045HX; 5326058;
532605800HX; 5326058HX;
532605700HX; 5326055HX;
532605700; 5326055; 68321378AA;
68319155AA; 68212379AA;
68212739AA; 68253984AA

Contents: Complete Kit
Hardware Included: Yes
Hose Connector Quantity: N/A
Ram 2018 - 2013

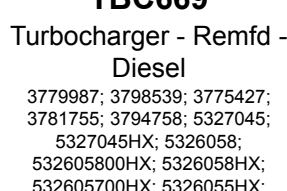

TBC669
Turbocharger - Remfd - Diesel

3779987; 3798539; 3775427;
3781755; 3794758; 5327045;
5327045HX; 5326058;
532605800HX; 5326058HX;
532605700HX; 5326055HX;
532605700; 5326055; 68321378AA;
68319155AA; 68212379AA;
68212739AA; 68253984AA

Contents: Complete Kit
Hardware Included: Yes
Hose Connector Quantity: N/A
Ram 2018 - 2013



TBC-511
Turbocharger - Remfd - Diesel

3C3Z6K682AARM;
3C3Z6K682BARM;
3C3Z6K682CBRM;
3C3Z6K682CCRM; 3C3Z9T428AA

Contents: N/A
Hardware Included: Yes
Hose Connector Quantity: 2
Ford 2004 - 2003



TBC-512
Turbocharger - Remfd - Diesel

5C3Z6K682CARM;
5C3Z6K682CCRM; 5C3Z6K682DA;
5C3Z9T428AA; 5C3Z9T428CARM;
5C3Z6K682BARM; 5C3Z6K682CA;
5C3Z6K682A; 5C3Z6K682AA;
5C3Z6K682BA

Contents: Turbocharger
Hardware Included: Yes
Hose Connector Quantity: 2
Ford 2010 - 2005



TBC-513
Turbocharger - Remfd - Diesel
F81Z6K682BARM

Contents: N/A
Hardware Included: Yes

Hose Connector Quantity: 2
Ford 2003 - 1999



TBC-514
Turbocharger - Remfd - Diesel

4C3Z6K682CDRM;
4C3Z9T428CBRM; 4C3Z6K682A;
4C3Z6K682AARM;
4C3Z6K682ARM; 4C3Z6K682BA;
4C3Z6K682CBRM;
4C3Z6K682CCRM

Contents: N/A
Hardware Included: Yes
Hose Connector Quantity: N/A
Ford 2005 - 2004



TBC-515
Turbocharger - Remfd - Diesel
XC2Z6K682AARM

Contents: Includes O-Ring Seal
Hardware Included: No
Hose Connector Quantity: 2
Ford 2003 - 1999



TBC-516
Turbocharger - Remfd - Diesel
12530339; 12512988

Contents: N/A
Hardware Included: Yes
Hose Connector Quantity: 1
Chevrolet 2002 - 1994
GMC 2002 - 1994



TBC-517
Turbocharger - Remfd - Diesel
12533738

Contents: Turbocharger
Hardware Included: Yes
Hose Connector Quantity: 2

Chevrolet 2002 - 1996
GMC 2002 - 1995



TBC-521
Turbocharger - Remfd - Diesel

R8048234AI; 68002428AA;
R8048234AG; 68048234AF;
R8048234AH; 68048234AC;
68048234AD; R8048234AF;
R8048234AE; 68048234AG;
68048234AE; 68048234AB;
68048234AA; 68032290AC;
68032290AB; 68032290AA;
68031095AA; 68027068AA;
68003401AA

Contents: Turbocharger
Hardware Included: Yes
Hose Connector Quantity: 2

Dodge 2010 - 2007
Ram 2012 - 2011



TBG111
Electronic Throttle Body (ETB) Gasket
06K133073

Volkswagen 2016 - 2014

Terminal Type: Blade
Ram 2013



TCA-4
Four Wheel Drive Indicator Lamp Switch
15693423

Contents: Four Wheel Drive Actuator
Notes: N/A
Terminal Gender: Male
Terminal Quantity: 3
Terminal Type: Blade

Chevrolet 2007 - 1990
GMC 2007 - 1988



TBC-518
Turbocharger - New - Diesel
038253019SX; 038253016P;
038253019S

Contents: Turbocharger
Hardware Included: Yes
Hose Connector Quantity: 2
New Or Remanufactured: New

Volkswagen 2006 - 2004



TBS1004
Turbocharger Boost Solenoid
11747584628; 11747626351

BMW 2016 - 2011



TCA-5
Four Wheel Drive Indicator Lamp Switch
15731299

Contents: Four Wheel Drive Actuator
Notes: N/A
Terminal Gender: Male
Terminal Quantity: 2
Terminal Type: Blade

Chevrolet 1997
GMC 1997



TBC-523
Turbocharger - New - Diesel
5C3Z6K682CARMN

Contents: Turbocharger
Hardware Included: Yes
Hose Connector Quantity: 2
New Or Remanufactured: New

Ford 2010 - 2005



TCA14
Four Wheel Drive Actuator
5175284AC; 5175284AB;
5175284AA

Terminal Gender: Male
Terminal Quantity: 4
Terminal Type: Pins

Ram 2014 - 2012



TCA-25
Four Wheel Drive Indicator Lamp Switch
14037986

Contents: Switch
Terminal Gender: Female
Terminal Quantity: 2
Terminal Type: Bullet

Chevrolet 1991 - 1988
GMC 1991 - 1988



TBC-519
Turbocharger - New - Diesel
038253019C; 03G253014R;
03G253016L

Contents: Turbocharger
Hardware Included: Yes
Hose Connector Quantity: 2
New Or Remanufactured: New

Volkswagen 2004 - 1999



TBG110
Electronic Throttle Body (ETB) Gasket
06F133073D

Volkswagen 2013 - 2009



TCA111
Transfer Case Switch
68211454AA

Contents: Switch
Notes: N/A
Terminal Gender: Male
Terminal Quantity: 2



TCA-26
Four Wheel Drive Indicator Lamp Switch
15582030

Contents: Four Wheel Actuator Switch
Terminal Gender: Female
Terminal Quantity: 2
Terminal Type: Bullet

Chevrolet 1998 - 1990
GMC 1998 - 1989



TCA-27
Four Wheel Drive Actuator
4882682; 4506116

Connector Gender: No Connector
Connector Shape: N/A
Terminal Gender: N/A
Terminal Quantity: N/A
Terminal Type: N/A

Dodge 1996



TCA-52
Four Wheel Drive Selector Switch
56049674AC; 68021674AB;
68021674AA; 56049674AE;
56049674AD; 4602768AA

Contents: 1 Switch
Notes: N/A
Terminal Gender: Male
Terminal Quantity: 7
Terminal Type: Pin

Dodge 2009 - 2008



TCA-58
Four Wheel Drive Selector Switch
4602973AC; 4602973AB;
4602973AA

Contents: 1 Switch
Notes: N/A
Terminal Gender: Male
Terminal Quantity: 6
Terminal Type: Pin

Dodge 2010
Ram 2012 - 2011



TCA-59
Four Wheel Drive Selector Switch
5134375AA

Contents: 1 Switch
Notes: N/A
Terminal Gender: Male
Terminal Quantity: 2
Terminal Type: Bullet

Dodge 2010



TCA-64
Transfer Case Switch
5083138AA

Contents: N/A
Notes: N/A
Terminal Gender: Male
Terminal Quantity: 2
Terminal Type: Blade

Dodge 2009



TCBS1
Turbocharger Speed Sensor
68039104AB; 68039104AA

Dodge 2010 - 2007
Ram 2012 - 2011



TCP01
Automatic Transmission Conductor Plate
1402701161; 68049181AA;
5080451AA; 5097219AA

Mercedes-Benz 2006 - 1997



TCPA01
Automatic Transmission Conductor Plate
68001278AA; 68001279AA;
52108324AB; 52108324AC;
52108323AC; 52108324AA;
52108323AB; 52108322AA;
52108322AB; 52108323AA;
5189122AA; 5166827AA;
5166827AB; 5080285AA;
5073876AA; 5073875AA;
2035400253

Mercedes-Benz 1999 - 1996



TCS20
Transmission Control Solenoid

24235630; 8689901; 8689902;
8685465; 8665356; 8665465;
8665016; 8652379; 8656732;
8664672; 8652376; 8652377;
8652378; 8638931; 8646419;
8637258; 8637858; 8635922;
8635966; 8635980; 8633947;
8635920; 8635921; 8633945;
8633946; 8632950

Contents: Switch
Notes: N/A

Terminal Gender: Female
Terminal Quantity: 2
Terminal Type: Bullet

Buick 1980
Cadillac 1981 - 1980
Oldsmobile 1981 - 1980



TCS78
Transmission Oil Pressure Sensor
4799758AF; 4799758AD; 4799758;
4799758AB; 4799758AC;
5016222AA

Connector Gender: Female
Contents: Transmission Control Solenoid

Terminal Gender: Male
Terminal Quantity: 3
Terminal Type: Blade

Dodge 2010



TCS93

Transmission Control Solenoid

3C3Z7J136BA

Contents: Solenoid
Terminal Gender: Male
Terminal Quantity: 2
Terminal Type: Blade

Ford 2009 - 2005



TCS108

Transmission Control Solenoid

68353383AB; 52119435AA;
5170877AF; 5170877AD;
5170877AC; 5170877AB;
5170877AA; 52119435AF

Contents: Solenoid
Notes: N/A
Terminal Gender: Male
Terminal Quantity: 23
Terminal Type: Blade

Dodge 2010



TCS114

Transmission Control Solenoid

F81Z7G391AB; F81Z7G391CB

Contents: Solenoid
Notes: N/A
Terminal Gender: Male
Terminal Quantity: 9
Terminal Type: Pin

Ford 2004 - 2000



TCS208

Transmission Control Solenoid

5138838AA

Contents: Solenoid
Notes: N/A
Terminal Gender: Male
Terminal Quantity: 2
Terminal Type: Blade

Dodge 2009 - 2003
Freightliner 2009 - 2003



TCS209

Transmission Control Solenoid

5189057AB

Contents: Solenoid
Notes: N/A
Terminal Gender: Male
Terminal Quantity: 2
Terminal Type: Blade

Dodge 2009
Freightliner 2009



TCS221

Transmission Control Solenoid

68019702AA

Contents: Solenoid
Notes: N/A
Terminal Gender: Male
Terminal Quantity: 1
Terminal Type: Blade

Dodge 2010 - 2008
Ram 2012 - 2011



TCS234

Transmission Control Solenoid

55578637

Contents: Solenoid
Notes: N/A
Terminal Gender: Male
Terminal Quantity: 1
Terminal Type: Blade

Chevrolet 2015 - 2014



TCS257

Transmission Control Solenoid

2202771098

Contents: Solenoid
Notes: N/A
Terminal Gender: Male
Terminal Quantity: 2
Terminal Type: Slide

Mercedes-Benz 2016 - 2007



TCS260

Transmission Control Solenoid

2402701600

Contents: Solenoid
Notes: N/A
Terminal Gender: Male
Terminal Quantity: 2
Terminal Type: Blade

Mercedes-Benz 2006 - 1996



TCS273

Transmission Control Solenoid

2202770998

Contents: Solenoid
Notes: N/A
Terminal Gender: Male
Terminal Quantity: 2
Terminal Type: Blade

Freightliner 2016 - 2014
Mercedes-Benz 2016 - 2007



TCS331

Transmission Control Solenoid

52108314AB

Contents: Solenoid
Notes: N/A
Terminal Gender: Male
Terminal Quantity: 2
Terminal Type: Blade

Dodge 2009 - 2003
Freightliner 2009 - 2003



TGS1

Turbocharger Gasket Set

8C3Z9T514C; 1873429C92

Ford 2010 - 2008



TGS2
Turbocharger Gasket Set
3C3Z9T514AG; 3C3Z9T514AD;
3C3Z9T514AA; 3C3Z6N639AB

Ford 2010 - 2003
IC Corporation 2008 - 2005
International 2010 - 2004



TGS3
Turbocharger Gasket Set
F81Z6N653BA; 1831658C91

Ford 2003 - 1999
IC Corporation 2002
International 2002 - 1999



TH1
Throttle Position Sensor
19110521; 17078448; 17067351;
17063708; 14039052; 10065259

Terminal Gender: Female
Terminal Quantity: 3

Chevrolet 1985 - 1980
Oldsmobile 1980
Pontiac 1980



TH4
Throttle Position Sensor
17111262; 17110374; 17080930;
17078828

Terminal Gender: Female
Terminal Quantity: 3

Chevrolet 1982
GMC 1984



TH5
Throttle Position Sensor
17110648; 17110581; 17110632;
17081077; 17078274

Terminal Gender: Female
Terminal Quantity: 3

Pontiac 1986 - 1982



TH35
Throttle Position Sensor
F2TZ9B989C; E7FZ9B989A;
E8EF9B989AA; E8FZ9B989A;
F2TF9B989CA; E7EF9B989AA;
E7EF9B989AB

Terminal Gender: Male
Terminal Quantity: 3
Terminal Type: Blade Terminals

Ford 1997 - 1987
Mercury 1987



TH41
Throttle Position Sensor
19143600; 17111471; 17069532

Terminal Gender: Female
Terminal Quantity: 3

GMC 1989 - 1988



TH43
Throttle Position Sensor
17111162; 17069535

Terminal Gender: Female
Terminal Quantity: 3
Terminal Type: Bullet

Chevrolet 1985
Pontiac 1985



TH44
Throttle Position Sensor
F1TZ9B989A; E7SF9B989BA;
E7TF9B989CA; E7TZ9B989D;
F1TF9B989AA; E6TF9B989AA;
E6TZ9B989A; E6ZF9B989BA;
E6ZF9B989BB; E5TZ9B989B;
E5ZF9B989BA; E5ZF9B989BB;
E5ZF9B989DA; E5AF9B989AA;
E5AZ9B989B; E5PF9B989AA;
E5TF9B989AA; E4AF9B989AA;
12339051; 12339049

Terminal Gender: Female
Terminal Quantity: 3
Terminal Type: Bullet

Ford 1987 - 1986



TH140
Throttle Position Sensor
8945222010; 22633AA040;
22633KA040; 1799500161;
1799500261; 1799500046;
1799500056; 1799500088;
1799500121; 1342060B00;
94851601; 94849310; 94847403

Terminal Gender: Male
Terminal Quantity: 3
Terminal Type: Blade Terminals

Toyota 1986



TH149
Throttle Position Sensor
8171238520; 8171254830;
38574877; 3857487; 853678T;
17123852; 17113578; 17106809

Terminal Gender: Male
Terminal Quantity: 3
Terminal Type: Blade Terminals

Chevrolet 1998 - 1996
GMC 1999 - 1996



TH150
Throttle Position Sensor
14071076

Terminal Gender: Male
Terminal Quantity: 3
Terminal Type: Pin

Chevrolet 1993 - 1985
GMC 1993 - 1985



TH157
Throttle Position Sensor
F8OZ9B989AA; ZMZ318851;
F4SF9N989AA; F4SZ9B989A;
F4SZ9B989AA; F5SF9B989AA;
F8OF9E928AA; F4SF9B989AA

Terminal Gender: Male
Terminal Quantity: 3
Terminal Type: Blade Terminals

Ford 2003



TH160
Throttle Position Sensor
10137417
Terminal Gender: Male
Terminal Quantity: 3
Terminal Type: Bullet
Chevrolet 1999 - 1987
GMC 1999 - 1988



TH232
Throttle Position Sensor
226200S321; 226200S320;
2262031U00; 2262031U01;
2262031U0A; 2262073C00;
2262077C00
Terminal Gender: Male
Terminal Quantity: 3
Terminal Type: Blade Terminals
Nissan 2015 - 2009



TH371
Throttle Position Sensor
8942658200; 94265820
Terminal Gender: Male
Terminal Quantity: 3
Terminal Type: Blade
Chevrolet 2002 - 1999
GMC 2002 - 1999



TH420
Throttle Position Sensor
53031575AH; 53031575AF;
53031575AE; 53031575
Terminal Gender: Male
Terminal Quantity: 6
Terminal Type: Pin
Dodge 2004 - 1998



TH175
Throttle Position Sensor
4877412; 4874412; 4746719
Terminal Gender: Male
Terminal Quantity: 3
Terminal Type: Blade Terminals
Dodge 1998 - 1994



TH245
Throttle Position Sensor
4746966; 4746965; 4746965AB;
4728881; 4638631; 3618837
Terminal Gender: Male
Terminal Quantity: 3
Terminal Type: Blade Terminals
Dodge 1993 - 1990



TH383
Throttle Position Sensor
53031576; 53031576AC;
53031576AD; 53031576AB
Terminal Gender: Male
Terminal Quantity: 6
Terminal Type: Pin
Dodge 2002 - 1998



TH454
Throttle Position Sensor
4C3Z9B989A
Terminal Gender: Male
Terminal Quantity: 3
Terminal Type: Pin
Ford 2004



TH218
Throttle Position Sensor
8945220050; 8945228030;
1985000191
Terminal Gender: Male
Terminal Quantity: 4
Terminal Type: Blade Terminals
Toyota 1987 - 1984



TH303
Throttle Position Sensor
23500164
Terminal Gender: Male
Terminal Quantity: 5
Terminal Type: Blade Terminals
Chevrolet 1986
GMC 1987



TH394
Throttle Position Sensor
1846546C91; 1846544C91;
4C3Z9B989B
Terminal Gender: Male
Terminal Quantity: 6
Terminal Type: Blade Terminals
Ford 2005 - 2004



TH456
Throttle Position Sensor
53032456AE; 53032456AD;
53032456AC; 53032456AB
Terminal Gender: Male
Terminal Quantity: 6
Terminal Type: Pins
Dodge 2004 - 2003



TH463
Throttle Control Actuator
53041140AB

Dodge..... 2009 - 2005



TIH1
Turbocharger Hose
6C3Z6C640C

Ford..... 2004 - 2003



TIH2
Turbocharger Hose
6C3Z6C640A

Ford..... 2007 - 2004



TL-163
Trunk Lock Kit
12540360; 12516382; 12514575;
12507442; 12507441; 12506782;
12500477; 15664890; 15576145;
15537638

Contents: Complete Unit
Notes: N/A

Chevrolet..... 1986 - 1983



TL-232
Trunk Lock Kit
12507408

Contents: Trunk Lock & Keys
Notes: N/A

Chevrolet..... 1990 - 1987



TM-23
Automatic Transmission
Vacuum Modulator
3027843; 8629940

Buick..... 1980



TM-33
Automatic Transmission
Vacuum Modulator
6259799

Hose Connector Quantity: 2
Part Finish: Brass

Buick..... 1981 - 1980
Chevrolet..... 1981 - 1980
GMC..... 1981 - 1980
Oldsmobile..... 1981 - 1980
Pontiac..... 1981 - 1980



TM-34
Automatic Transmission
Vacuum Modulator
D37Z7A377A; D7DZ7A377B;
E7GZ7A377A; 175819823;
31931H0101; 31931X0101;
31931X0102; 033819823

Part Finish: Brass

Mazda..... 1985 - 1982



TM-36
Automatic Transmission
Vacuum Modulator
D2AZ7A377B; D3TZ7A377A;
D4TZ7A377A; D5AZ7A377A

Hose Connector Quantity: 2
Part Finish: Brass

Ford..... 1987 - 1985



TM-37
Automatic Transmission
Vacuum Modulator
458464; 3034884; 3035519;
8629944

Hose Connector Quantity: 2
Part Finish: Brass

Buick..... 1983 - 1982
Cadillac..... 1982
Chevrolet..... 1983 - 1980
Oldsmobile..... 1983 - 1982
Pontiac..... 1983 - 1982



TM-41
Automatic Transmission
Vacuum Modulator
D9AZ7A377A; E2TZ7A377A;
D5AZ7A377B; 19106957

Hose Connector Quantity: 2
Part Finish: Brass

Ford..... 1984 - 1983



TM-44
Automatic Transmission
Vacuum Modulator
D7OZ7A377A; 19106950

Hose Connector Quantity: 2
Part Finish: Brass

Ford..... 1984 - 1983



TM-45
Automatic Transmission
Vacuum Modulator
3033639

Hose Connector Quantity: 2
Part Finish: Brass

Buick..... 1981 - 1980
Chevrolet..... 1981
Oldsmobile..... 1981
Pontiac..... 1981



TM-50
Automatic Transmission
Vacuum Modulator
359917; 3032144; 8629942

Hose Connector Quantity: 1
Part Finish: Brass

Chevrolet..... 1990 - 1980
GMC..... 1990 - 1982



TM-54
Automatic Transmission Vacuum Modulator
E5TZ7A377B; E5TZ7A377C;
E3DZ7A377A; E3TZ7A377A

Hose Connector Quantity: 1
Part Finish: Brass

Ford 1987 - 1985



TM-58
Automatic Transmission Vacuum Modulator
3057720; 3057721; 8662910;
8649636; 8656566; 8649099

Buick 1985 - 1984
Cadillac 1985
Oldsmobile 1984
Pontiac 1984



TM-63
Automatic Transmission Vacuum Modulator
8629945

Hose Connector Quantity: 2
Part Finish: Brass

Buick 1985
Cadillac 1985
Chevrolet 1988 - 1982
GMC 1988 - 1980
Oldsmobile 1985
Pontiac 1985



TPM5
Tire Pressure Monitoring System OE Design Valve
95536105300; 95536166111;
4D0601361B; 4D0601361;
4D0601361; 36111095375;
36146792829

Contents: Valve Stem, Seal, Bolt, Retaining Nut, Cap

BMW 2016 - 2009



TPM9
Tire Pressure Monitoring System OE Design Valve
36111095373; 36146792827

Contents: Tire Pressure Monitor Sensor

BMW 2014 - 2009



TPM10
Tire Pressure Monitoring System OE Design Valve
0014012713; 36146792828;
36111095374

Contents: Valve

BMW 2014 - 2009



TPM11
Tire Pressure Monitoring System OE Design Valve
36146792830; 36111096449

Contents: Valve

BMW 2016 - 2009



TPM66
Tire Pressure Monitor Sensor
0025408017; 0025406917;
25404817; 0025404817

Mercedes-Benz 2009 - 2006



TPM66A
Tire Pressure Monitor Sensor
0025408017; 0025406917;
25404817; 0025404817

Mercedes-Benz 2009 - 2006



TPM67
Tire Pressure Monitor Sensor
0025407917; 0025406817;
0025406617; 25404717;
0025404717

Mercedes-Benz 2009 - 2006



TPM67A
Tire Pressure Monitor Sensor
0025407917; 0025406817;
0025406617; 25404717;
0025404717

Mercedes-Benz 2009 - 2006



TPM97A
Tire Pressure Monitor Sensor
68406531AA; 56029359AA;
56029359AB; 56029359AC;
56029481AB

Dodge 2010



TPM102
Tire Pressure Monitoring System OE Design Valve
4D0601361A

Contents: Valve Stem, Bolt, Washer, O-Ring, Retaining Nut and Cap

BMW 2014 - 2009



TPM104
Tire Pressure Monitor Sensor
68006771AA; 0025409417;
25405417; 0025405417;
68038945AA

Dodge 2009
Freightliner 2013 - 2009
Mercedes-Benz 2014 - 2010



TPM104A
Tire Pressure Monitor Sensor
68006771AA; 0025409417;
25405417; 0025405417;
68038945AA

Dodge 2009
Freightliner 2013 - 2009
Mercedes-Benz 2014 - 2010



TPM109A
Tire Pressure Monitor Sensor
36236781847; 36236798726;
36236779490; 36236771034

BMW..... 2009



TPM116A
Tire Pressure Monitor Sensor
CM5T1A150AA; DE8T1A180AA;
ZZDA37140; 9L3Z1A189A

Ford..... 2014 - 2010



TPM116RA
Tire Pressure Monitor Sensor
9L3Z1A189A

Ford..... 2014 - 2010



TPM141
Tire Pressure Monitor Sensor
36106874829; 36106856227;
36106790054

BMW..... 2014 - 2009



TPM155
Tire Pressure Monitor Sensor
A0009057200; 0009057200;
0025409017; 002540901728;
003540021728; 0009054100;
0035400217; 0025408617

Freightliner 2018 - 2014
Mercedes-Benz 2018 - 2010



TPM155A
Tire Pressure Monitor Sensor
A0009057200; 0009057200;
0025409017; 002540901728;
003540021728; 0009054100;
0035400217; 0025408617

Freightliner 2018 - 2014
Mercedes-Benz 2018 - 2010



TPM196
Tire Pressure Monitor Sensor
36106798872; 36106874830

BMW..... 2016 - 2014



TPM197RA
Tire Pressure Monitoring System OE Design Sensor
7B0907253H; 68406537AA

Dodge..... 2010



TPM209
Tire Pressure Monitor Sensor
0009050030

Mercedes-Benz 2019 - 2013



TPM210
Tire Pressure Monitor Sensor
LR070840; LR058023; LR066378

Land Rover 2015



TPM222
Tire Pressure Monitor Sensor
36106881890; 36106856209

BMW..... 2018 - 2014



TPM298
Tire Pressure Monitor Sensor
68313387AC; 68252493AA;
68313387AB; 68313387AA;
68252493AB

Jeep..... 2018 - 2016



TPM327
Tire Pressure Monitor Sensor
0009052102; 36106887147;
36106872803; 36106876957

BMW..... 2018



TPM930K
Tire Pressure Monitoring System OE Design Valve
13598909; 15263240

Dodge..... 2010
Ford..... 2010



TPM930K4
Tire Pressure Monitoring System OE Design Valve
15263240

Dodge..... 2010
Ford..... 2010



TPM1040K
Tire Pressure Monitoring System OE Design Valve
Contents: Valve Stem, Bolt, Retaining Nut, Cap

Mercedes-Benz 2009 - 2006



TPM1040K4
Tire Pressure Monitoring System OE Design Valve
Contents: Valve Stem, Bolt, Retaining Nut, Cap

Mercedes-Benz 2009 - 2006



TPM1090K
Tire Pressure Monitoring System OE Design Sensor Service Kit

Contents: Valve Core, Seal, Washer, Retaining Nut, Cap

BMW..... 2014 - 2009



TPM2000K4
Tire Pressure Monitoring System OE Design Sensor Service Kit

Contents: Valve Core, Seal, Retaining Nut, Cap

BMW..... 2016 - 2014
Dodge..... 2009
Freightliner..... 2013 - 2009
Mercedes-Benz..... 2013 - 2010

Dodge..... 2010 - 2009
Ford..... 2010
Freightliner..... 2016 - 2009
Mercedes-Benz..... 2017 - 2007



TPM2012VBK
Tire Pressure Monitoring System QWIK-Sensor Valve

Dodge..... 2010
Ford..... 2010



TPM2012VCK4
Tire Pressure Monitoring System QWIK-Sensor Valve

Dodge..... 2010
Ford..... 2010



TPM1090K4
Tire Pressure Monitoring System OE Design Sensor Service Kit

Contents: Valve Core, Seal, Washer, Retaining Nut, Cap

BMW..... 2014 - 2009



TPM2011VK
Tire Pressure Monitoring System OE Design Valve

BMW..... 2018 - 2009
Dodge..... 2010 - 2009
Ford..... 2010
Freightliner..... 2016 - 2009
Mercedes-Benz..... 2017 - 2007



TPM2012VBK4
Tire Pressure Monitoring System QWIK-Sensor Valve

Dodge..... 2010
Ford..... 2010



TPM2012VK
Tire Pressure Monitoring System OE Design Valve

BMW..... 2018 - 2009
Dodge..... 2010 - 2009
Ford..... 2010
Freightliner..... 2016 - 2009
Mercedes-Benz..... 2017 - 2007



TPM2000K
Tire Pressure Monitoring System OE Design Sensor Service Kit

Contents: Valve Core, Seal, Retaining Nut, Cap

BMW..... 2016 - 2014
Dodge..... 2009
Freightliner..... 2013 - 2009
Mercedes-Benz..... 2013 - 2010



TPM2011VK4PK
Tire Pressure Monitoring System QWIK-Sensor Valve

BMW..... 2018 - 2009
Dodge..... 2010 - 2009
Ford..... 2010
Freightliner..... 2016 - 2009
Mercedes-Benz..... 2017 - 2007



TPM2012VCK
Tire Pressure Monitoring System QWIK-Sensor Valve

Dodge..... 2010
Ford..... 2010



TPM2012VK4PK
Tire Pressure Monitoring System QWIK-Sensor Valve

BMW..... 2018 - 2009
Dodge..... 2010 - 2009
Ford..... 2010
Freightliner..... 2016 - 2009
Mercedes-Benz..... 2017 - 2007



TPM2011VK25PK
Tire Pressure Monitoring System QWIK-Sensor Valve

BMW..... 2018 - 2009



TPM2012VK25PK
Tire Pressure Monitoring System QWIK-Sensor Valve

BMW..... 2018 - 2009
 Dodge..... 2010 - 2009
 Ford..... 2010
 Freightliner..... 2016 - 2009
 Mercedes-Benz..... 2017 - 2007



TPM2013VK

Tire Pressure Monitoring System OE Design Valve
 36146759741; 36146792831

Contents: Valve Stem

BMW..... 2016 - 2009



TPM2014VK

Tire Pressure Monitoring System OE Design Valve
 A0004005313; A0004005713

Freightliner..... 2016 - 2014
 Mercedes-Benz..... 2016 - 2010



TPM2018VK

Tire Pressure Monitoring System OE Design Valve

Dodge..... 2009
 Freightliner..... 2013 - 2009
 Mercedes-Benz..... 2013 - 2010



TPM2020K

Tire Pressure Monitoring System OE Design Sensor Service Kit
 TPM2020K

Contents: Valve Core, Seal, Retaining Nut, Cap

Ford..... 2010



TPM2020K4

Tire Pressure Monitoring System OE Design Sensor Service Kit

Contents: Valve Core, Seal, Retaining Nut, Cap

Ford..... 2010



TPM2026VK

Tire Pressure Monitoring System OE Design Valve
 68193587AA

BMW..... 2018 - 2014



TPM2030K

Tire Pressure Monitoring System OE Design Sensor Service Kit

Contents: Valve Core, Seal, Retaining Nut, Cap

Mercedes-Benz..... 2017 - 2013



TPM2030K4

Tire Pressure Monitoring System OE Design Sensor Service Kit

Contents: Valve Core, Seal, Retaining Nut, Cap

Mercedes-Benz..... 2017 - 2013



TPM2080K

Tire Pressure Monitoring System OE Design Sensor Service Kit

BMW..... 2018 - 2014



TPM2080K4

Tire Pressure Monitoring System OE Design Sensor Service Kit

BMW..... 2018 - 2014



TPM2100VK

Tire Pressure Monitoring System OE Design Valve

Mercedes-Benz..... 2014 - 2013



TPM2104VK

Tire Pressure Monitoring System OE Design Valve

Dodge..... 2009
 Freightliner..... 2016 - 2009
 Mercedes-Benz..... 2019 - 2010



TPM2104VK4

Tire Pressure Monitoring System OE Design Valve

Dodge..... 2009
 Freightliner..... 2016 - 2009
 Mercedes-Benz..... 2019 - 2010



TPM2107VK

Tire Pressure Monitoring System OE Design Valve

Dodge..... 2010
 Freightliner..... 2016 - 2014
 Mercedes-Benz..... 2016 - 2010



TPM2107VK4

Tire Pressure Monitoring System OE Design Valve

Dodge 2010
Freightliner 2016 - 2014
Mercedes-Benz 2016 - 2010



TPM4012SK

Tire Pressure Monitoring System QWIK-Sensor Service Kit

BMW 2018 - 2009
Dodge 2010 - 2009
Ford 2010
Freightliner 2016 - 2009
Mercedes-Benz 2017 - 2007



TPM4012SK4PK

Tire Pressure Monitoring System Sensor Service Kit

BMW 2018 - 2009
Dodge 2010 - 2009
Ford 2010
Freightliner 2016 - 2009
Mercedes-Benz 2017 - 2007



TPM4012SK25PK

Tire Pressure Monitoring System QWIK-Sensor Service Kit

BMW 2018 - 2009
Dodge 2010 - 2009
Ford 2010
Freightliner 2016 - 2009
Mercedes-Benz 2017 - 2007



TS-6

Temperature Sender - With Gauge

J914847; J914847; J914847;
J914847; 6489278; 6489277;
6402510; 6402383; 6402382;
6402368; 6402259; 6400759;
546702; 12334870; 12334869;
12326971; 1513462; 1513321;
1513130; 1512678

Chevrolet 1980



TS-17

Coolant Fan Switch

J941841; J941841; J941841;
J941841; J3179955; J3179955;
J3179955; J3179955; J3173363;
J3173363; J3173363; J3173363;
3179955; 3179955; 3179955;
3179955; D2TF10884AA;
D1FZ10884B; D0TZ10884A;
D0TF10884B; C5DZ10884B;
C5DZ10884A; C5DF10884B;
C5DF10884A; C3TZ10884A;
C3TF10884F; C3TF10884E;
C3TF10884A; C3AZ10884B;
C3AZ10884A

****Additional OE Numbers Available Online****

Connector Gender: Male
Terminal Quantity: 1

Ford 1987 - 1983



TS-24

Temperature Sender - With Gauge

D9TZ10884A; D5RY10884A;
D2ZF10884AA; D2WF10884AA;
D2HF10884AA; D0ZF10884B;
D0ZF10884A; D0WF10884B;
D0WF10884A; D0OF10884B;
D0OF10884A; D0HZ10884A;
C9WF10884B; C9WF10884A;
C6TF10884B; C6TF10884A;
C6MF10884B; C6MF10884A;
C6DZ10884B; C6DZ10884A;
C6DZ10884A; C6DF10884A;
1972328; 1972546

Ford 1993 - 1992



TS-36

Temperature Sender - With Light

E8GY10884A; E43Z10884A;
E43Z10884A; E43F10B843AA;
D6AZ10884A; D6AF10B843AA;
D32F10B843AA; D22F10B843AA;
D1FZ10884A; C8GY10884A;
1972435

Ford 1987



TS-43

Temperature Sender - With Light

6490694; 6490970; 6489340;
6489179; 6488708; 25036510;
25036512; 25036506; 25036509;
25036505; 25036310

Buick 1980
Cadillac 1981 - 1980



TS-50

Temperature Sender - With Light

25036982; 6490555; 6490440;
6490469

Cadillac 1980



TS-58

Temperature Sender - With Gauge

F3CF10884BA; F2CZ10884A;
F1SZ10884A; F1SF10884AA;
E1ZZ10884A; E1ZF10884AA;
D9TF10884AA; D0WY10884A;
D0OZ10884A; ZZLO18510;
ZZLO18840; 12321479

Ford 1997 - 1983



TS-59

Temperature Sender - With Light

049919501A; 049919501A;
35175017; 175919501; 12576179;
12572160; 049919501; 028919501A;
049919563B; 12329702; 19021165

Terminal Gender: Male
Terminal Quantity: 1

Audi 1983 - 1980
Volkswagen 1981
Volvo 1985 - 1984



TS-66

Temperature Sender - With Light

33001542; 33001542; 33001542;
8993427; 8992347; 25037176;
25037175; 25036535; 25036452;
25036468; 33001542; 25036371;
25036324; 25036300; 25036136;
25036042; 25036035

Buick 1983 - 1980
Cadillac 1983 - 1982
Chevrolet 1983 - 1980
GMC 1981 - 1980
Oldsmobile 1983 - 1980
Pontiac 1983 - 1981



TS-67
Temperature Sender -
With Gauge
D27Z10884A; 37750611154;
011889181; 011818510; 12323115

Mazda..... 1984 - 1982



TS-71
Temperature Sender -
With Gauge
479758C1; 25037345; 8993372;
8993107; 8993106; 8993105;
8992016

Terminal Gender: Male
Terminal Quantity: 1

Chevrolet 1991 - 1980
GMC 1991 - 1980
Oldsmobile 1983 - 1980



TS-76
Temperature Sender -
With Gauge
8993164; 8993146; 8992508;
8993115; 25037346; 25036135

Buick..... 1983 - 1980
Chevrolet 1992 - 1980
GMC 1992 - 1980
Oldsmobile 1983 - 1980
Pontiac 1981 - 1980



TS-81
Temperature Sender -
With Light
25037178; 25037177; 25036317

Chevrolet 1990 - 1982
GMC 1990 - 1982



TS-83
Temperature Sender -
With Gauge
9831514190; 8942378610;
8942356910; 12326972; 94021116;
94237861

Isuzu..... 1987 - 1984



TS-93
Coolant Fan Switch
8942815030; 19021017

Connector Gender: Female
Terminal Quantity: 2

Toyota..... 1985 - 1984



TS-105
Temperature Sender -
With Gauge
T1348143; T1348143; T1348143;
T1348143; T0245553; T0245553;
T0245553; T0245553; T0245551;
T0245551; T0245551; T0245551;
7910245553; 7910245553;
7910245553; 7910245553;
7910245551; 7910245551;
7910245551; 7910245551; 024220;
7701348143

Chevrolet..... 1983



TS-145
Temperature Sender -
With Light
8933001542; 25036373

Chevrolet..... 1985



TS-151
Coolant Fan Switch
94460948100; 823959481A;
94460648100; 8556003;
823959481F; 823959481G;
175959481; 0268342; 9526518;
024211; 24211; 4086724

Connector Gender: Male
Terminal Quantity: 2

Volkswagen 1981



TS-155
Coolant Fan Switch
E5FZ8B607A; E4EF8B607AA;
E4FZ8B607A; E4FZ8B607B;
19021032

Terminal Quantity: 2

Ford 1986 - 1984
Mercury 1986 - 1984



TS-168
Temperature Sender -
With Gauge
25036809; 25036628

Terminal Quantity: 2

Buick..... 1985 - 1984
Chevrolet 1985 - 1984
Oldsmobile 1985 - 1984



TS-169
Temperature Sender -
With Light
25036629

Buick..... 1985 - 1984
Cadillac..... 1985 - 1984

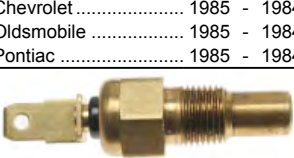

TS-198
Temperature Sender -
With Gauge
KL011851X; KK3701851X;
JE151851X; F42Z10884B;
B5411551X; B5411851X;
9465032520; 9465032510;
9465032500; 8342087703000;
8342016020; 348508294;
3485082912; 3485082012;
3485082011; 3485014F00;
21203AA030; 19532050230000;
91175979; MO4671065; 96067371;
96065787; MO4671065; 19022017;
19022000; 88924783; 94847362

Isuzu..... 1987



TS-206
Coolant Fan Switch
MB356704; MB845063; 19021186

Connector Gender: Male
Terminal Quantity: 2

Volkswagen 2003



TS-222
Temperature Sender -
With Gauge
251919501D; 251919501D;
251919501A

Volkswagen 1989 - 1988



TS-232
Temperature Sender -
With Light
F3TZ10884A; E3TZ10884A;
E3TF10B843AA

Ford..... 1986 - 1983



TS-241
Coolant Fan Switch
10096147

Connector Gender: Female
Terminal Quantity: 1

Chevrolet 1997 - 1994
GMC 1996 - 1994



TS-268
Coolant Fan Switch
J3242662; J3242662; J3242662;
J3242662; 53004981; 53004981;
53004981; 53004981; 8953004981;
8953005056; 53005056; 3242662

Connector Gender: Male
Terminal Quantity: 1

Jeep 1986 - 1985



TS-355
Temperature Sender -
With Light
F4TZ10884B; F4TF10B843AA

Ford 1997 - 1994



TS-375
Temperature Sender -
With Gauge
8125562630; 8125546410;
8125541450; 12556263; 12554641;
12554145

GMC 1997 - 1994
Isuzu 2002 - 1996



TS-247
Coolant Fan Switch
61311364273; 19021184; 1364273

Connector Gender: Male
Terminal Quantity: 2

BMW 1986 - 1985



TS-286
Temperature Sender -
With Gauge
133802; 133772

Peugeot 1984 - 1982



TS-362
Temperature Sender -
With Gauge
701919369C; 701919369B

Volkswagen 1997



TS-377
Coolant Temperature
Sensor
357919501A; 6U0919501B

Terminal Gender: Male
Terminal Quantity: 4

Volkswagen 1998



TS-253
Temperature Sender -
With Gauge
8250373320; 25037332

Chevrolet 2002 - 1992
GMC 2002 - 1992



TS-288
Coolant Fan Switch
61311357073; 61311364272;
1364272

Connector Gender: Male
Terminal Quantity: 2

BMW 1986 - 1985



TS-372
Temperature Sender -
With Light
0065453724; 65453724

Mercedes-Benz 1993 - 1980



TS-380
Temperature Sender -
With Gauge
F65Z10884AA; F65F10884AA

Ford 2003 - 2000



TS-262
Coolant Fan Switch
11600072560200; 126404; 126413;
60506988

Connector Gender: Male
Terminal Quantity: 2

Peugeot 1984 - 1982



TS-299
Temperature Sender -
With Gauge
MD050214

Mitsubishi 1985 - 1983



TS-374
Temperature Sender -
With Gauge
D9HZ10884A; D0ZZ10884A;
C6TZ10884A

Ford 1994 - 1986



TS-406
Battery Temperature
Sensor
56041053

Connector Gender: Female
Connector Quantity: 1
Contents: N/A
Notes: N/A
Terminal Gender: Male
Terminal Quantity: 2
Terminal Type: Blade

Dodge 2006 - 2004



TS-339
Temperature Sender -
With Gauge
55422617; 55421017; 0055422617;
0055421017

Terminal Gender: Male
Terminal Quantity: 1

Mercedes-Benz 1993 - 1984



TS-409
Temperature Sender -
With Gauge
357919501

Volkswagen 1999 - 1993



TS-414
Temperature Sender -
With Light
E7HZ10884A; F7HZ10884A

Terminal Gender: Male
Terminal Quantity: 1

Ford 1999 - 1990



TS-440
Temperature Sender -
With Gauge
1262242282; 1262242282

BMW 1986 - 1985



TS-451
Coolant Fan Switch
0065451424; 0065453924

Connector Gender: Male
Terminal Quantity: 1

Mercedes-Benz 1986 - 1980



TS-471
Cylinder Head
Temperature Sensor
MEK000030L; MEK100170L;
13621433076

Connector Gender: Female

Connector Quantity: 1
Connector Shape: Square
Contents: N/A
Notes: N/A
Terminal Gender: Male
Terminal Quantity: 2
Terminal Type: Blade

BMW 2013 - 2009



TS-477
Coolant Temperature
Sensor
059919501A; 078919501C

Terminal Gender: Male
Terminal Quantity: 4
Thread Type: N/A

Volkswagen 2013 - 2000



TS-496
Temperature Sender -
With Light
0055457024; 0065454424

Mercedes-Benz 1993 - 1980



TS-500
Coolant Fan Switch
024212; 24212; 815051; SNB714

Connector Gender: Male
Terminal Quantity: 2

Peugeot 1982 - 1980



TS-504
Coolant Fan Switch
SNU803; 126406; 126416; 815089

Connector Gender: Male
Terminal Quantity: 3

Peugeot 1983 - 1980



TS-507
Coolant Fan Switch
12762290; 1378504

Connector Gender: Male
Terminal Quantity: 2

Mercedes-Benz 1987
Volvo 1983



TS-513
Coolant Fan Switch
0065456124

Connector Gender: Male
Terminal Quantity: 3

Mercedes-Benz 1989 - 1984



TS-518
Temperature Sender -
With Light
SNU406; 819075; 24241; 024241

Peugeot 1982



TS-519
Temperature Sender -
With Light
SNB150; 24236; 819074; 024236;
24218; 024218; 7701348772;
T1348772

Peugeot 1984 - 1982



TS-521
Temperature Sender -
With Light
819050; SNB707; 24225; 024225

Peugeot 1981 - 1980



TS-529
Coolant Temperature
Sensor
0085424517

Terminal Gender: Male
Terminal Quantity: 2

Mercedes-Benz 1995 - 1994



TS-550
Coolant Fan Switch
12632241341; 12632241342;
12631288130; 2241341

Connector Gender: Male
Terminal Quantity: 2

BMW 1986



TS-552
Coolant Fan Switch
0065456424

Connector Gender: Male
Terminal Quantity: 3

Mercedes-Benz 1987



TS-555
Coolant Temperature
Sensor
85423217; 0085423217

Terminal Gender: Male
Terminal Quantity: 4

Mercedes-Benz 1993 - 1990



TS-556

Temperature Sender -
With Gauge
0055450324

Mercedes-Benz 1983 - 1980



TS-557

Temperature Sender -
With Gauge
0085425617

Terminal Gender: Male
Terminal Quantity: 2

Mercedes-Benz 1996 - 1995



TS-568

Coolant Fan Switch

823959481R; 823959481R;
823959481L; 823959481L;
19021193; 8561367; 8569238;
8330268; 8533226; 4086708

Connector Gender: Female
Terminal Quantity: 2

Volkswagen 1981



TS-603

Temperature Sender -
With Gauge

3C3Z10884AA; 1836537C91

Terminal Gender: Male
Terminal Quantity: 2

Ford 2010 - 2003



TS-604

Coolant Temperature
Sensor

A0051536328; 68057477AA;
5103534AA; 0051532328;
0051536328; 0005426218;
5103534AB

Terminal Gender: Male
Terminal Quantity: 2
Thread Type: N/A

Dodge 2009 - 2003
Mercedes-Benz 1999 - 1998



TS-608

Coolant Temperature
Sensor

95510612500; 95510612501;
06A919501; 06A919501A

Terminal Gender: Male
Terminal Quantity: 2

Audi 2016 - 2011
Porsche 2016
Volkswagen 2014 - 2004



TS-612

Temperature Sender -
With Gauge

65423417; 0065423417

Mercedes-Benz 1985 - 1983



TS-613

Coolant Fan Switch

0055456324

Connector Gender: Female
Terminal Quantity: 1

Mercedes-Benz 1985 - 1983



TS-615

Coolant Temperature
Sensor

A0005425118; 68068746AA;
0005425118; 5080147AA

Terminal Gender: Male
Terminal Quantity: 2

Dodge 2006 - 2003
Freightliner 2006 - 2003
Mercedes-Benz 2006



TS-621

Diesel Fast Idle
Temperature Switch

10154649

Connector Gender: Male
Terminal Quantity: 2

Chevrolet 1991 - 1985



TS-633

Coolant Temperature
Sensor

5066779AA

Terminal Gender: Male
Terminal Quantity: 2

Jeep 2006 - 2005
Ram 2018 - 2014



TS-650

Temperature Sender -
With Light
XC3Z10884AA

Ford 2003 - 2000



TW-8

Turn Signal Switch

1997984

Connector Gender: Male
Terminal Gender: Male
Terminal Quantity: 13
Terminal Type: Blade Terminals

Buick 1983



TW-20

Multi Function Column
Switch

1997988; 1997983; 1995976;
1995975; 322970

Buick 1983
Chevrolet 2000 - 1993
GMC 1992 - 1990
Oldsmobile 1980



TW-73

Turn Signal Switch

E1HZ13341K; E1HZ13B302HA;
E1HZ13341HA

Connector Gender: Male
Terminal Gender: Female
Terminal Quantity: 10

Ford 1990 - 1983



TW-83C

Turn Signal Switch Repair Kit

J8121438; J8121438; J8121438;
 J8121438; J3488805; J3488805;
 J3488805; J3488805; 8121438;
 8121438; 8121438; 8121438;
 3229970; 3747793; 3747794;
 1893582; 1997963; 1997964;
 1997940; 1997047

Connector Gender: No Connector
 Terminal Gender: N/A
 Terminal Quantity: N/A
 Terminal Type: N/A

Chevrolet 1986
 GMC 1986
 Oldsmobile 1984 - 1982



TW-86

Turn Signal Switch

625316; 61310702

Connector Gender: Female
 Terminal Gender: Male
 Terminal Quantity: 6
 Terminal Type: Blade Terminals

Peugeot 1982



TW-96

Turn Signal Switch

E1HZ13B302EA

Connector Gender: Male
 Terminal Gender: Female
 Terminal Quantity: 9
 Terminal Type: Bullet

Ford 1992



TW-97

Turn Signal Switch

E1HZ13341F

Connector Gender: Male
 Terminal Gender: Female
 Terminal Quantity: 9
 Terminal Type: Bullet

Ford 1992



TW-98

Turn Signal Switch

E1HZ13B302GA

Connector Gender: Male
 Terminal Gender: Female
 Terminal Quantity: 10
 Terminal Type: Bullet

Ford 1992



TX1

Coolant Temperature Sensor

25036092; 8983500852;
 8933001793; 3241950

Terminal Gender: Male
 Terminal Quantity: 1

Chevrolet 1982
 Pontiac 1981



TX3

Coolant Temperature Sensor

J3241950; J3241950; J3241950;
 J3241950; 8250369790;
 8250369020; 8153263860;
 8121463121; 38503975;

8121463120; 805218T; 8100458470;
 25037182; 25036979; 25036708;
 15326386; 12146312; 10045847;
 8132906; 8983502327; 8133450;
 3850397

Terminal Gender: Male
 Terminal Quantity: 2

Buick 1980
 Cadillac 1981
 Chevrolet 2009 - 1980
 GMC 2010 - 1987
 Pontiac 1983 - 1980



TX6

Coolant Temperature Sensor

3854159; E1AZ12A648A;
 F1AZ12A648B; F2AZ12A648A;
 F4TZ12A648A; 38541595;
 9U2Z12A648A; E0AZ12A648A;
 250791B020

Terminal Gender: Male
 Terminal Quantity: 2
 Thread Type: N/A

Ford 2010 - 1988
 Lincoln 1984



TX12

Ambient Air Temperature Sensor

F3XY12A648A; F6XZ19E702AB;
 XF5219E702AA; XF5Z19E702AA;
 ZZD061764; F3VY12A647A;
 F3VY12A648A; F3XA12A648AA;
 F50Y19E702A; F5OY19E702A;
 F2VF12A648AA; F2VY12A646A;
 F2VY12A648A; F3VF12A647AA;
 F1AF12A697BA; F1VY19E702A;
 F2AF12A648AA; F2AZ19E702A;
 E8OY19E702A; F0AZ19E702A;
 F0VY19E702A; F1AF12A648AA;
 F1AF12A648BA; E6DF12A648AA;
 E6DZ12A648; E6DZ12A648A;
 E6DZ19E702A; E1AF12A648AA;
 E4AF12A648A; E4AF12A648AA

****Additional OE Numbers Available Online****

Connector Gender: Female

Contents: N/A

Notes: N/A

Terminal Gender: Male

Terminal Quantity: 2

Terminal Type: Pin

Ford 2010 - 1984



TX13

Coolant Temperature Sensor

25174208; T0999029; 5226374

Terminal Gender: Male
 Terminal Quantity: 2

Dodge 1993 - 1989



TX18

Coolant Temperature Sensor

2263070J00; 2263051E02;
2263051E02; 92860612501;
3922022020; 3922022010; 24246;
2263051B00; 2263010G00; 024246;
90410792; F3XY10884A;
F3XY10884B; K857418840;
E8GY12A648A; E8GY10884B;
94460612500; DAC4737;
8942287701000; 87854081;
8770112010; 8942212010;
8942230020; 8942287701;
857418840; 8574188400;
857418880; 7563562; 22630V5010;
1365084101

****Additional OE Numbers Available Online****

Terminal Gender: Male
Terminal Quantity: 2

Isuzu 1987 - 1986



TX34

Diesel Glow Plug Control Sensor
22514724

Connector Gender: Female
Contents: N/A
Functions: Sensor
Notes: N/A
Terminal Gender: Male
Terminal Quantity: 6
Terminal Type: Pin
Thread Size - Metric: N/A
Thread Size - NPT: N/A

Buick 1983 - 1981
Cadillac 1983 - 1981
Chevrolet 1983 - 1981
Oldsmobile 1983 - 1980
Pontiac 1983 - 1981



TX36

Diesel Glow Plug Control Sensor
12015288

Connector Gender: Male
Notes: N/A
Terminal Gender: Female
Terminal Quantity: 5
Terminal Type: Pins
Thread Size - Metric: N/A
Thread Size - NPT: N/A

Buick 1983 - 1981
Cadillac 1983 - 1981
Chevrolet 1983 - 1980
Oldsmobile 1983 - 1980
Pontiac 1983 - 1981



TX41

Diesel Glow Plug Control Sensor

1807444C1; 1803175C1;
F3TZ9A444C; E3TZ9A444A

Connector Gender: Female
Contents: N/A
Functions: Sensor
Notes: N/A
Terminal Gender: Male
Terminal Quantity: 6
Terminal Type: Pin
Thread Size - Metric: N/A
Thread Size - NPT: N/A

Ford 1988 - 1983



TX42

Diesel Glow Plug Control Sensor

14033940; 15575722

Connector Gender: Female
Functions: Glow Plug
Notes: N/A
Terminal Gender: Male
Terminal Quantity: 6

Terminal Type: Pins
Thread Size - NPT: N/A
Chevrolet 1984 - 1982
GMC 1984 - 1982



TX49

Ambient Air Temperature Sensor

25174248; 5266203; 4688204AB;
4688204; 4437691

Connector Gender: Female
Notes: N/A

Terminal Gender: Male
Terminal Quantity: 2
Terminal Type: Pins

Dodge 2002 - 1999



TX51

Coolant Temperature Sensor

12621288159; 035919369M;
280130037; 0280130037;
13621288158; 12621288158

Terminal Gender: Male
Terminal Quantity: 2

BMW 1986 - 1985
Volkswagen 1992 - 1991



TX55

Coolant Temperature Sensor

026906161; 026906161; 280130040;
0280130040

Terminal Gender: Male
Terminal Quantity: 2

Volkswagen 1985



TX57

Coolant Temperature Sensor

034906161; 280130053;
0280130053

Terminal Gender: Male

Terminal Quantity: 2

Thread Type: N/A

Audi 1983



TX61

Coolant Temperature Sensor

1814320C1; ZZM118707;
ZZM118707A; ZZM218707;
F5AZ12A648A; F5AZ12A648AB;
GY0118840; GY0118840A;
3F1Z12A648A

Terminal Gender: Male

Terminal Quantity: 2

Thread Type: N/A

Ford 2016 - 1996



TX71

Coolant Temperature Sensor

5014067AA; 56004815; 4723860

Terminal Gender: Male

Terminal Quantity: 2

Dodge 1992 - 1991



TX78

Coolant Temperature Sensor

F6XA10884AA; F6XZ10884AA;
2263071L00; 226307Y000;
226300M200; 2263043Y00;
2263044B10; 2263044B20;
0280130082

Terminal Gender: Male

Terminal Quantity: 2

Nissan 2019 - 2009



TX89
Coolant Temperature Sensor
8126088140; 8153693050;
8154042800; 8121911700;
12608814; 15326388; 12191170;
19236568; 8153263880; 15369305;
15326388; 12608814
Terminal Gender: Male
Terminal Quantity: 2
GMC 2016 - 2011



TX104
Coolant Temperature Sensor
7M5112A648AA; IL2Z12A648AA;
AJ0318840; AJ0318840A;
3L8Z12A648A; 1F2218840;
1F6018840
Terminal Gender: Male
Terminal Quantity: 2
Ford 2018 - 2015



TX121
Coolant Temperature Sensor
0065454524
Connector Gender: Female
Terminal Quantity: 3
Mercedes-Benz 1993 - 1988



TX133
Coolant Temperature Sensor
12639899; 12566778
Terminal Gender: Male
Terminal Quantity: 2
Thread Type: N/A
Chevrolet 2010
GMC 2010



TX141
Coolant Temperature Sensor
4954905; 5011852AB; 5114413AA
Terminal Gender: Male
Terminal Quantity: 2
Ram 2018 - 2011



TX155
Coolant Temperature Sensor
0009056102; 5175764AA;
68068747AA; 0999053700;
0009050600; 0041539728
Terminal Gender: Male
Terminal Quantity: 2
Thread Type: N/A
Dodge 2009
Freightliner 2016 - 2009
Jeep 2009 - 2007
Mercedes-Benz 2019 - 2007



TX174
Temperature Sender - With Gauge
5093096AA
Terminal Gender: Male
Terminal Quantity: 2
Dodge 2003 - 2000



TX186
Coolant Temperature Sensor
22630JA10A
Terminal Gender: Male
Terminal Quantity: 2
Nissan 2017 - 2016



TX195
Coolant Temperature Sensor
7B0919501B; 68045803AA;
5149096AA; 5149077AB;
5149077AA
Terminal Gender: Male
Terminal Quantity: 2
Thread Type: N/A
Dodge 2010 - 2008



TX209
Coolant Temperature Sensor
0115425117
Terminal Gender: Male
Terminal Quantity: 4
Mercedes-Benz 1997 - 1996



TX229
Coolant Temperature Sensor
55591002; 89019319; 23167457;
55563530
Terminal Gender: Male
Terminal Quantity: 2
Thread Type: N/A
Chevrolet 2019 - 2016
GMC 2020 - 2016



TX239
Coolant Temperature Sensor
9636777280; 1365086CT0;
96310010
Terminal Gender: Male
Terminal Quantity: 3
Thread Type: N/A
Fiat 2008



TX247
Coolant Temperature Sensor
25186240
Terminal Gender: Male
Terminal Quantity: 2
Thread Type: N/A
Chevrolet 2019 - 2017
GMC 2018



TX260
Engine Oil Temperature Sensor
68142898AA

Jeep..... 2017 - 2014
 Ram..... 2017 - 2014



TX262
 Automatic Transmission
 Oil Temperature Sensor
 68020004AA

Connector Gender: Female
 Terminal Quantity: 2
 Terminal Type: Blade

Dodge..... 2010 - 2008
 Ram..... 2017 - 2011



TX265
 Intake Air Temperature
 Sensor
 1836539C91; 3C3412A697AA;
 3C3Z12A697AA

Attachment Method: Direct
 Connector Gender: Female
 Connector Quantity: 1
 Connector Shape: Rectangular
 Connector Type: Plug In
 Terminal Gender: Male
 Terminal Quantity: 2
 Terminal Type: Blade
 Thread Size: N/A
 Voltage: N/A

Ford..... 2010 - 2003



TX266
 Intake Air Temperature
 Sensor
 12643808

Connector Gender: Female
 Connector Quantity: 1
 Connector Shape: Rectangular
 Connector Type: Plug In
 Terminal Gender: Male
 Terminal Quantity: 2
 Terminal Type: Blade

Chevrolet..... 2016 - 2011
 GMC..... 2016 - 2011



TX267
 Intake Air Temperature
 Sensor
 12625041

Connector Gender: Female
 Connector Quantity: 1
 Connector Type: Plug In
 Terminal Gender: Male
 Terminal Quantity: 2
 Terminal Type: Blade

Chevrolet..... 2019 - 2010
 GMC..... 2019 - 2010



TX268
 Coolant Temperature
 Sensor
 12656444; 12636534

Terminal Gender: Male
 Terminal Quantity: 2
 Thread Type: N/A

Chevrolet..... 2019 - 2016
 GMC..... 2020 - 2016



TX270
 Air Charge Temperature
 Sensor
 68211210AA

Terminal Gender: Male
 Terminal Quantity: 2

Jeep..... 2019 - 2014
 Ram..... 2018 - 2014



TX272
 Coolant Temperature
 Sensor
 FT4Z12A648B; FT4Z12A648A

Terminal Gender: Male
 Terminal Quantity: 2
 Thread Type: N/A

Ford..... 2019 - 2017



TX275
 Coolant Temperature
 Sensor
 06K919525A; 06K919523;
 06K919525

Terminal Gender: Male
 Terminal Quantity: 2
 Thread Type: N/A

Volkswagen..... 2014 - 2013



TX282
 Coolant Temperature
 Sensor
 04L919501; 04E919501B

Terminal Gender: Male
 Terminal Quantity: 2
 Thread Type: N/A

Volkswagen..... 2016 - 2015



TX283
 Air Charge Temperature
 Sensor
 68226930AA

Terminal Gender: Male
 Terminal Quantity: 2

Ram..... 2017 - 2014



TX284
 Coolant Temperature
 Sensor
 68098532AA

Terminal Gender: Male
 Terminal Quantity: 2

Ram..... 2017 - 2014



TX294
 Coolant Temperature
 Sensor
 13627797957

Terminal Gender: Male
 Terminal Quantity: 2
 Thread Type: N/A

BMW..... 2018 - 2014



TX305
 Coolant Temperature
 Sensor
 079919523J; 079919523B

Terminal Gender: Male
 Terminal Quantity: 2
 Thread Type: N/A

Audi..... 2013



TX316
 Coolant Temperature
 Sensor
 JL3Z12A648A

Terminal Gender: Male
 Terminal Quantity: 2
 Thread Type: N/A

Ford..... 2020 - 2018



US1127
 Ignition Starter Switch
 1K0905849

Connector Gender: Male
 Connector Quantity: 1
 Mounting Type: Bolt Mount
 Terminal Gender: Female

Terminal Quantity: 6
Volkswagen 2011



US1149

Ignition Starter Switch
61321376322

Connector Gender: Female; Male
Connector Quantity: 2
Mounting Type: Direct
Terminal Gender: Female; Male
Terminal Quantity: 10

BMW 1986 - 1985



US1324

Ignition Push Button
Switch
61319250734

Connector Gender: Female
Connector Quantity: 1
Mounting Type: Direct
Terminal Gender: Male
Terminal Quantity: 7

BMW 2018 - 2014



US1336

Ignition Push Button
Switch
221545071464; 2215450714;
2215450514

Connector Gender: No Connector
Terminal Gender: N/A
Mercedes-Benz 2012 - 2007



US1456

Ignition Push Button
Switch
2215450814

Mercedes-Benz 2017 - 2012



US1458

Ignition Starter Switch
7PP905865F; 7PP905865B;
9A790586500

Connector Gender: Female
Connector Quantity: 1
Mounting Type: Direct
Terminal Gender: Male
Terminal Quantity: 11

Porsche 2014 - 2012



US1479

Ignition Push Button
Switch
221545071464

Mercedes-Benz 2017 - 2013



US-70L

Ignition Lock Cylinder

E4TZ11582B; E5TB1522050AA;
E5TZ11582A; D8FZ11582A;
D8LY11582A; D9EB6222050AA;
E1TZ11582A; D6AZ11582A;
D6LY11582A; D7AB5322050DA;
D7AB5322050DB; 11911050110002;
12321975

Coding: Coded
Keys Included: Yes

Ford 1994 - 1988



US-84

Ignition Starter Switch

01116712; 1116712; 1116711;
1116704; 1116709; 1116695;
1116688; 1116683; 1116504;
12356033; 2234285

Connector Gender: Female
Connector Quantity: 1
Terminal Gender: Male
Terminal Quantity: 8

Chevrolet 1991 - 1982
GMC 1991 - 1983



US-89

Ignition Starter Switch

D7AZ11572A; D7AA11572AA;
12323017

Connector Gender: Female
Connector Quantity: 1
Terminal Gender: Male
Terminal Quantity: 11

Ford 1999 - 1990



US-109L

Ignition Lock Cylinder

4119058511; 113905855B;
191905855

Coding: Coded
Keys Included: Yes

Volkswagen 1981



US-110

Ignition Starter Switch

M505014778; 111905865L;
12336293

Connector Gender: Female
Connector Quantity: 1
Terminal Gender: Male
Terminal Quantity: 7

Volkswagen 1981



US-112

Ignition Starter Switch

E0UZ11572A; E4US11572AA;
E4UZ11572A; F2UZ11572A;
E0TA11572AA; 19021099

Connector Gender: Female
Connector Quantity: 1
Terminal Gender: Male
Terminal Quantity: 11

Ford 2002 - 1991



US-117L

Ignition Lock Cylinder

7840574; 26052796; 26025788;
26005043; 26005718; 16627130

Coding: Coded
Key Programmable: No
Keys Included: Yes

Chevrolet..... 1985 - 1983



US-165L

**Ignition Lock Cylinder
Housing Repair Kit**

7847978; 7827028

Contents: N/A
Notes: N/A

Buick..... 1982
GMC..... 1985



US-214L

Ignition Lock Cylinder

8260495330; 8260502790;
26050280; 25681506; 12369498;
26050278; 26050279; 26047294;
26049498

Coding: Coded
Keys Included: Yes

Chevrolet..... 1997 - 1995



US-216

Ignition Starter Switch

F4DC11572AA; F4DZ11572A;
F4DZ11572B; ZZM066123;
F0DZ11572A; F2DC11572AA;
F2DZ11572A; 487500B000;
19021093

Connector Gender: Female
Connector Quantity: 1
Terminal Gender: Male
Terminal Quantity: 15

Ford..... 2003 - 2000



US-274

Ignition Starter Switch

F5TZ11572A; 88921953

Connector Gender: Female
Connector Quantity: 1
Terminal Gender: Male
Terminal Quantity: 11

Ford..... 2004



US-275

Ignition Starter Switch

26047332

Connector Gender: Male
Connector Quantity: 1
Terminal Gender: Female
Terminal Quantity: 12

Chevrolet..... 2009 - 2003
GMC..... 2009 - 2003



US-280L

Ignition Lock Cylinder

F6HZ11582BA; F85Z11582AA;
F6TZ11582AA; F6DZ11A127AA;
F69Z11582AA

Coding: Coded
Keys Included: Yes

Ford..... 2007 - 1999



US-285L

Ignition Lock Cylinder

68027525AA; 5018702AA

Coding: Coded
Key Programmable: No
Keys Included: Yes

Dodge..... 2010



US-289L

**Ignition Switch with Lock
Cylinder**

BF6776290B; GA9776290A;
GA9776290B; GJ1276290A;
BC4676290B; BF6776290A

Key Quantity: 2
Keys Included: Yes
Notes: N/A
Terminal Gender: N/A
Terminal Quantity: N/A
Terminal Type: N/A

Mazda..... 1984 - 1982



US-294L

Ignition Lock Cylinder

E6HZ11582A

Coding: Coded
Key Programmable: No
Keys Included: Yes

Ford..... 1996 - 1988



US-322L

Ignition Lock Cylinder

1L3Z11582A; 1L3Z11582A1;
1F2009012B; F85Z11582AA

Coding: Coded
Keys Included: Yes

Ford..... 2007 - 1999



US-331

Ignition Starter Switch

15242754; 12450251

Connector Gender: Female
Connector Quantity: 1
Terminal Gender: Male
Terminal Quantity: 7

GMC..... 2007 - 2006
Hummer..... 2006 - 2003



US-351
Ignition Starter Switch
56045112AC; 56045112AD;
56045112AE; 56045112AB;
56045112AA
Connector Gender: Female
Connector Quantity: 1
Terminal Gender: Male
Terminal Quantity: 14
Dodge..... 2005 - 2004



US-431
Ignition Starter Switch
YS4Z11572AC; YS4Z11572AB;
EC0166151; EC0166151D;
98AZ11572A; DG9Z11572A;
ECTT66151; EC0166151B; 4741031
Connector Gender: Female
Connector Quantity: 1
Terminal Gender: Male
Terminal Quantity: 7
Ford..... 2019 - 2009



US-556L
Ignition Lock Cylinder
8942062980; 8942062981
Coding: Coded
Keys Included: Yes
Isuzu..... 1981



US-672
Ignition Starter Switch
1K0905849A; 1K0905865A;
1K0905865; 1K0905849B
Connector Gender: Female
Connector Quantity: 1
Terminal Gender: Male
Terminal Quantity: 6
Volkswagen..... 2011 - 2008



US-362
Ignition Starter Switch
487500M000; 487500M005;
487500M010; 3711150Z00
Connector Gender: Female
Connector Quantity: 1
Terminal Gender: Male
Terminal Quantity: 6
Nissan..... 2008



US-432
Ignition Starter Switch
26009706
Connector Gender: Female
Connector Quantity: 1
Terminal Gender: Male
Terminal Quantity: 9
GMC..... 2002 - 1991



US-559L
Ignition Lock Cylinder
1264600604
Coding: Coded
Keys Included: Yes
Mercedes-Benz..... 1995 - 1984



US-700
Ignition Starter Switch
13246285; 9447805; 94478050
Connector Gender: N/A
Connector Quantity: 1
Terminal Gender: Male
Terminal Quantity: 10
Volvo..... 1986



US-398
Ignition Starter Switch
4B0905849
Connector Gender: Female
Connector Quantity: 1
Mounting Type: Direct
Terminal Gender: Male
Terminal Quantity: 8
Volkswagen..... 2011



US-514
Ignition Starter Switch
26009743
Connector Gender: Female
Connector Quantity: 1
Mounting Type: Bolt Mount
Terminal Gender: Male
Terminal Quantity: 9
Chevrolet..... 2002 - 1993
GMC..... 2002 - 1990



US-583
Ignition Starter Switch
5C3Z11572AA
Connector Gender: Female
Connector Quantity: 1
Terminal Gender: Male
Terminal Quantity: 9
Ford..... 2009 - 2005



US-714
Ignition Starter Switch
1F8066123; 5C3211572AA
Connector Gender: Female
Connector Quantity: 1
Terminal Gender: Male
Terminal Quantity: 9
Ford..... 2006 - 2004



US-603
Ignition Lock Cylinder
8978651330; 97865133;
8978651331
Coding: Coded
Keys Included: Yes
Chevrolet..... 2009 - 2004
GMC..... 2009 - 2004
Isuzu..... 2002 - 1997



US-747

Ignition Starter Switch

22887691; 25733005

Connector Gender: Female
 Connector Quantity: 1
 Mounting Type: Direct
 Terminal Gender: Male
 Terminal Quantity: 5

Chevrolet 2016 - 2009
 GMC 2013 - 2012



US-895

Ignition Starter Switch

56049838AB; 56049838AC

Connector Gender: Female
 Connector Quantity: 1
 Terminal Gender: Male
 Terminal Quantity: 5

Dodge 2010 - 2008



US-980

Ignition Starter Switch

0005458108; 5103664AA

Connector Gender: Male
 Connector Quantity: 1
 Terminal Gender: Female
 Terminal Quantity: 5

Dodge 2006 - 2003
 Freightliner 2006 - 2002



US-982

Ignition Starter Switch

1295450204

Connector Gender: Male
 Connector Quantity: 1
 Terminal Gender: Male
 Terminal Quantity: 14

Mercedes-Benz 1995



US-988

Ignition Starter Switch

4F0910132L; 4F0910131J;
 4F0910131L; 4F0910132J

Connector Gender: Female
 Connector Quantity: 4
 Terminal Gender: Male
 Terminal Quantity: 15

Audi 2014 - 2011



US-989

Ignition Starter Switch

8K0909131C

Connector Gender: Female
 Connector Quantity: 1
 Terminal Gender: Male
 Terminal Quantity: 12

Audi 2012 - 2011



US-990

Ignition Starter Switch

8K0909131D

Connector Gender: Female
 Connector Quantity: 1
 Terminal Gender: Male
 Terminal Quantity: 12

Audi 2013



US-1017

Ignition Push Button Switch

61319154945; 61316949913

BMW 2011 - 2009



US-1021

Ignition Push Button Switch

61319162555; 61319197291;
 61319229563; 61319153832;
 61319263436; 61319225229

BMW 2015



US-1195

Ignition Push Button Switch

61319263438; 61319206645;
 61319225228; 61319229565;
 61319153833

BMW 2016 - 2014



V112

PCV Valve

6422058; 6420876; 6421131;
 6421974; 6418754; 6421972

Hose Connector Quantity: 2
 Hose Size - Inches: 3/8
 Hose Size - mm: 10 mm
 Nipple Orientation: Straight
 International 1980



V165

PCV Valve

5175352AA; 5175351AA; 53031135;
 53030564; 3671076; 3577098;
 3514867; 3420223; 3420224;
 4694335; 6487087

Hose Connector Quantity: 1
 Hose Size - Inches: 5/16, 3/8
 Hose Size - mm: 8, 10 mm
 Nipple Orientation: Angled
 Dodge 2004



V168
PCV Valve
1220442010; 1220451011;
1220451012; 122045101272;
1220461010; 1220440010
Hose Connector Quantity: 1
Hose Size - Inches: N/A
Hose Size - mm: N/A
Nipple Orientation: Straight
Toyota..... 1987 - 1981



V178
PCV Valve
6487779; 6487778; 06487779;
8995940; 8995942; 2540144
Hose Connector Quantity: 1
Hose Size - Inches: 7/16
Hose Size - mm: Refer to Inches
Nipple Orientation: Angled
Cadillac..... 1985
Chevrolet..... 1984 - 1981
GMC..... 1981
Pontiac..... 1984 - 1983



V184
PCV Valve
11810A8501; 1181080W00;
11810A3501; 11810E3000;
11810E3001; 11810F0511;
1181080W00; 11810A3500;
6487692; 11810Y4460;
11810E3001MP; 11810E3000MP;
11810A3501MP; 94020345
Hose Connector Quantity: 1
Nipple Orientation: Straight
Nissan..... 1987 - 1981



V188
PCV Valve
53000960; 53000960; 53000960;
53000960; 8089952840; 8995284;
8996046; 8995091; 8953000960
Hose Connector Quantity: 1
Hose Size - Inches: 7/16
Hose Size - mm: Refer to Inches
Nipple Orientation: Angled
Buick..... 1985
Chevrolet..... 1984 - 1982



V206
PCV Valve
8997683
Hose Connector Quantity: 1
Hose Size - Inches: 3/8
Hose Size - mm: 10 mm
Nipple Orientation: Straight
Oldsmobile..... 1985 - 1982



V210
PCV Valve
25040026
Hose Connector Quantity: 2
Hose Size - Inches: N/A
Hose Size - mm: N/A
Nipple Orientation: Angled
Pontiac..... 1985



V223
PCV Valve
1220435010; 1220441010;
1220445010; 1220412012
Hose Connector Quantity: 1
Hose Size - Inches: 5/16
Hose Size - mm: 7 mm

Nipple Orientation: Straight
Toyota..... 1981



V226
PCV Valve
8941116420; 2674021304;
2674021314; 2674021320;
2674021330; MD024719; MD026613
Hose Connector Quantity: 1
Hose Size - Inches: 3/8
Hose Size - mm: 10 mm
Nipple Orientation: Straight
Mitsubishi..... 1985



V227
PCV Valve
25040733
Hose Connector Quantity: 2
Hose Size - Inches: 3/8
Hose Size - mm: 10 mm
Nipple Orientation: Angled
Chevrolet..... 1981
GMC..... 1981



V237
PCV Valve
E5ZZ6A666A; E43E6A666A1A;
E43Z6A666A
Hose Connector Quantity: 2
Hose Size - Inches: 3/8
Hose Size - mm: 10 mm
Nipple Orientation: Straight
Ford..... 1987 - 1985



V246
PCV Valve
E92Z6A666A; E9JY6A666A;
94123309; 8944195640; E30113890;
E30113890A; 8941233090;
8943109490; 8943244160;
0E30113890; 0943109490;
94419564; 94310949; 94324416
Hose Connector Quantity: 1
Hose Size - Inches: N/A
Hose Size - mm: N/A
Nipple Orientation: Straight
Mazda..... 1985 - 1984



V247
PCV Valve
17130PH1003; MD308787;
94843655; 94845871
Hose Connector Quantity: 1
Hose Size - Inches: 3/8
Hose Size - mm: 8 mm; 16 mm
Nipple Orientation: Straight
Toyota..... 1985 - 1984



V276
PCV Valve
JE1513890; JE9613890;
1220435030; 0K9A013890;
2674038000
Hose Connector Quantity: 1
Hose Size - Inches: 3/8
Hose Size - mm: 10 mm
Nipple Orientation: Straight
Toyota..... 1987 - 1982



V335
PCV Valve
25097699
Hose Connector Quantity: 2
Hose Size - Inches: 3/8
Hose Size - mm: 10 mm
Nipple Orientation: N/A
Chevrolet..... 2001 - 1985
GMC..... 2001 - 1985



V353
PCV Valve
8997446
Hose Connector Quantity: 1

Hose Size - Inches: N/A
 Hose Size - mm: N/A
 Nipple Orientation: Straight
 Buick..... 1981 - 1980
 Cadillac..... 1981 - 1980
 Chevrolet..... 1981 - 1980
 GMC..... 1980
 Oldsmobile..... 1982 - 1980
 Pontiac..... 1981 - 1980



V422
 PCV Valve
 028129101E

Hose Connector Quantity: 2
 Hose Size - Inches: N/A
 Hose Size - mm: N/A
 Nipple Orientation: Straight
 Volkswagen..... 2004 - 1998



V425
 PCV Valve
 97302067

Hose Connector Quantity: 1
 Hose Size - Inches: N/A
 Hose Size - mm: N/A
 Nipple Orientation: Straight
 Chevrolet..... 2004 - 2002
 GMC..... 2004 - 2002



V489
 PCV Valve
 8941554050

Hose Connector Quantity: 2
 Hose Size - Inches: 3/8
 Hose Size - mm: Refer to Inches
 Nipple Orientation: N/A
 Isuzu..... 1987 - 1986



V520
 PCV Valve

68014022AA; 6420100991;
 68048205AA
 Hose Connector Quantity: N/A
 Hose Size - Inches: N/A
 Hose Size - mm: N/A
 Nipple Orientation: N/A
 Dodge..... 2009 - 2007
 Freightliner..... 2009 - 2007



V566
 PCV Valve

12655399; 12637663
 Hose Connector Quantity: 1
 Hose Size - Inches: N/A
 Hose Size - mm: 16
 Nipple Orientation: Straight
 GMC..... 2016



V581
 PCV Valve

68188865AA; 5175514AB;
 68159952AA; 5175514AA
 Hose Connector Quantity: 1
 Nipple Orientation: N/A
 Jeep..... 2009 - 2007
 Mercedes-Benz..... 2009 - 2007

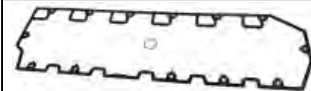

VCG1
 Diesel Valve Cover
 Gasket

1825602C91; 1820909C1
 International..... 2003 - 1996

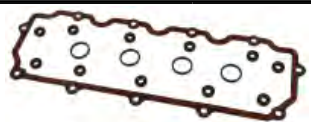

VCG2
 Diesel Valve Cover
 Gasket
 3C3Z6584BA

Ford..... 2010 - 2003

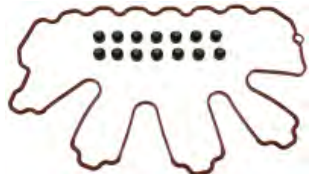

VCG3
 Diesel Valve Cover
 Gasket
 97312341

Chevrolet..... 2010 - 2004
 GMC..... 2010 - 2004
 Hummer..... 2006



VCG4
 Diesel Valve Cover
 Gasket
 F81Z6584AAG

Ford..... 2003 - 1998
 International..... 2005 - 1998

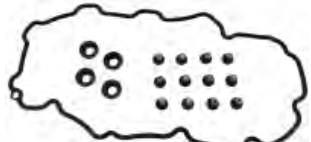

VCG5
 Diesel Valve Cover
 Gasket
 FELPROVS50622R; 97188896

Chevrolet..... 2004 - 2001
 GMC..... 2004 - 2001



VCG6
 Diesel Valve Cover
 Gasket
 F4TZ6584A

Ford..... 1997 - 1994
 International..... 1998 - 1994



VCG7
 Diesel Valve Cover
 Gasket
 5179091AC; 4992982; 3975641;
 5264950; 5179091AB; 5179091AA

Dodge..... 2010 - 2006
 Ram..... 2013 - 2011

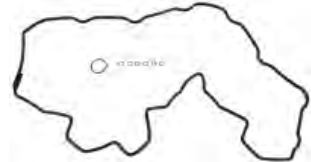

VCG8
 Diesel Valve Cover
 Gasket
 5086954AA

Dodge..... 2005 - 2003

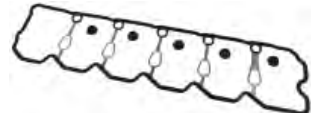

VCG9
 Diesel Valve Cover
 Gasket
 5016356AB

Dodge..... 2002 - 1998



VCP108
 Vacuum Pump
 7849209

Contents: Valve
 Notes: N/A
 Chevrolet..... 1991 - 1988
 GMC..... 1991 - 1988



VCP112
Vacuum Pump
F81Z2A451BA; 6C3Z2A451A;
6C3Z2A451BA; F81Z2A451AA;
53032373AA; 53032373AB;
4C3Z2A451BA; 4C3Z2B925AB;
53032373AC

Contents: Complete Kit
Dodge 2004 - 2003
Ford 2010 - 1999



VCP113
Vacuum Pump
25847999; 94669091

Contents: Vacuum Pump
Hardware Included: No
Notes: N/A
Chevrolet 2016 - 2006
GMC 2016 - 2006



VCP119
Vacuum Pump
4C2Z2A451AA; AC2Z2A451A

Contents: Vacuum Pump
Hardware Included: No
Notes: N/A
Ford 2010 - 2004



VCP120
Vacuum Pump
F6TZ2A451AA

Contents: Puller
Hardware Included: No
Notes: N/A
Ford 2003 - 1996



VCP125
Vacuum Pump
5175907AA

Contents: Pump
Hardware Included: No
Notes: Vacuum
Dodge 2009 - 2007
Freightliner 2009 - 2007



VCP126
Vacuum Pump
BC3Z2A451A; BC3Z2A451B

Contents: Pump
Hardware Included: No
Notes: Vacuum
Ford 2017 - 2011



VCP131
Vacuum Pump
F4TZ2A451A

Contents: Pump
Hardware Included: No

Notes: Vacuum
Ford 1995 - 1994



VCP132
Vacuum Pump
7C3Z2A451B

Contents: Pump
Hardware Included: No
Notes: Vacuum
Ford 2010 - 2008



VCP139
Vacuum Pump
5175850AA

Jeep 2009 - 2007
Mercedes-Benz 2012 - 2011



VCP142
Vacuum Pump
5102084AA

Contents: Pump
Hardware Included: No
Notes: Vacuum
Dodge 2009 - 2003



VCP143
Vacuum Pump
68148184AB; 68148184AA

Contents: Pump
Hardware Included: No
Notes: Vacuum

Jeep 2019 - 2014
Ram 2018 - 2014



VCP144
Vacuum Pump
BK3Z2A451A; BK3Z2A451B;
CK4Z2A451C; CK4Z2A451B

Contents: Pump
Hardware Included: No
Notes: Vacuum
Ford 2019 - 2016



VCP150
Vacuum Pump
55488984; 55205446

Hardware Included: No
Notes: Vacuum
Chevrolet 2015 - 2014



VCP155
Vacuum Pump
038145101B

Contents: Pump
Hardware Included: No
Notes: Vacuum
Volkswagen 2004 - 1998



VCP169
Vacuum Pump
03L145100F

Contents: Vacuum Pump
Hardware Included: No

Notes: N/A
 Audi 2013 - 2010
 Volkswagen 2014 - 2009



VCP173
 Vacuum Pump
 6422300065

Contents: Vacuum Pump
 Hardware Included: No
 Notes: N/A

Mercedes-Benz 2019 - 2010



VCP174
 Vacuum Pump
 11667619350; 11667575325

Contents: Vacuum Pump
 Hardware Included: No
 Notes: N/A

BMW 2012 - 2011



VCP177
 Vacuum Pump
 6112300265; 5117674AA

Contents: Vacuum Pump
 Hardware Included: No
 Notes: N/A

Dodge 2003
 Freightliner 2003 - 2002



VG6
 EGR Valve Mounting
 Gasket

53007919; 53007919; 53007919;
 53007919; 23785V0810;
 14719N3301; EBC1436;
 8943241910; D4AE9E464AA;
 D4AZ9E464A; D4VE9E464AA;
 5161570021; 5862023560;
 8161570021; 461155400;
 18715PA6000; 18715PB2000;
 14719W0401; 14719W0402;
 14719AA010; 147192B500;
 90108224; 14001195; 12337972;
 10078909; 10077546; 10023532;
 10009586; 1254141; 431312
****Additional OE Numbers
 Available Online****

Contents: N/A
 Notes: N/A

Buick 1983 - 1981
 Oldsmobile 1984 - 1981
 Pontiac 1980



VG7
 EGR Valve Mounting
 Gasket

14031369; 12554530; 10140594;
 458616; 374752; 343752

Contents: 1 Gasket

Buick 1985
 Chevrolet 1991 - 1980
 GMC 1999 - 1980



VG8
 EGR Valve Mounting
 Gasket

D3AE9E464AA; D3AZ9E464A;
 D3ZE9E464AA; 8140882620;
 93208809; 14088262; 14047052;
 10147931; 10129596; 10077547;
 10013794; 1646898; 412485; E3121;
 3237589; 21006014; J0854391;
 J3237589; 8132352

Contents: 10 Gaskets

Buick 1983
 Cadillac 1985 - 1980

Oldsmobile 1984 - 1980



VG19
 EGR Valve Mounting
 Gasket

MD151886; 2562774010;
 2562774011; 94840211; 14091828

Contents: 10 Gaskets

Toyota 1986



VG44
 EGR Valve Mounting
 Gasket

VG44; 10191427

Contents: 10 Gaskets

Chevrolet 1999 - 1982
 GMC 1998 - 1982



VG88
 EGR Valve Mounting
 Gasket

14719W2511; 14719W2510

Contents: 1 Gasket

Nissan 1987 - 1981



VG113
 EGR Valve Spacer Plate

BC3Z9U433A; BC3Z9U433B;
 DC3Z9U433A

Contents: N/A
 Notes: N/A

Ford 2016 - 2011



VG120
 EGR Valve Mounting
 Gasket
 97288794

Contents: 1 Gasket

Chevrolet 2004 - 2002
 GMC 2004 - 2002



VG121
 EGR Valve Mounting
 Gasket
 97303656

Contents: 1 Gasket

Chevrolet 2005 - 2004
 GMC 2005 - 2004



VG122
 EGR Valve Mounting
 Gasket
 97288795

Chevrolet 2004 - 2002
 GMC 2004 - 2002



VG123
 EGR Valve Mounting
 Gasket
 97303655

Contents: 1 Gasket

Chevrolet 2008 - 2004
 GMC 2007 - 2004



VG124
EGR Valve Mounting Gasket
97318478

Contents: 1 Gasket
Notes: N/A

Chevrolet 2005 - 2004
GMC 2005 - 2004



VG125
EGR Valve Mounting Gasket
97367013

Contents: 1 Gasket

Chevrolet 2008 - 2006
GMC 2007 - 2006



VG126
EGR Valve Mounting Gasket
97367014

Contents: 1 Gasket

Chevrolet 2008 - 2006
GMC 2007 - 2006



VG127
EGR Valve Mounting Gasket
4882884; 4897172AA

Contents: 1 Gasket
Notes: N/A

Dodge 1998 - 1994



VG164
EGR Valve Mounting Gasket
8942410601; 8943343380

Contents: 1 Gasket
Notes: N/A

Isuzu 1987 - 1982



VG169
EGR Valve Mounting Gasket
3C3Z9P455AB

Contents: 1 Gasket

Ford 2010 - 2003



VG175
EGR Valve Mounting Gasket
6041420480; 6041420580

Contents: 1 Gasket

Mercedes-Benz 1997 - 1984



VG177
EGR Valve Mounting Gasket
6021420180

Contents: 10 Gaskets
Notes: N/A

Mercedes-Benz 1985



VG182
EGR Valve Mounting Gasket
90521601; N90521601; N90521604

Contents: 1 Gasket

Volkswagen 2006 - 1998



VG183
EGR Valve Mounting Gasket
069131547D

Contents: 1 Gasket

Volkswagen 2009 - 1993



VG184
EGR Valve Mounting Gasket
068131547B

Contents: 1 Gasket

Volkswagen 1997 - 1985



VG185
EGR Valve Mounting Gasket
90927301

Contents: 1 O-ring

Volkswagen 2006 - 2005



VG186
EGR Valve Mounting Gasket
90062702; N90062702; 90062701

Contents: 1 O-ring

Volkswagen 2006 - 2004



VG236
EGR Valve Mounting Gasket
2562754011; 2562754010

Contents: 1 Gasket

Toyota 1985



VG238
EGR Valve Mounting Gasket
0259973448

Contents: 1 O-ring
Notes: N/A

Jeep 2009 - 2007
Mercedes-Benz 2009 - 2007

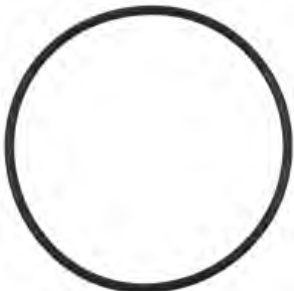

VG239
EGR Valve Mounting Gasket
07Z133557

Contents: 1 O-ring
Notes: N/A
Volkswagen 2008 - 2004



VG240
EGR Valve Mounting Gasket
07Z129646A

Contents: 1 O-ring
Notes: N/A
Volkswagen 2008 - 2004



VG241
EGR Valve Mounting Gasket
HC3Z9D476A; BC3Z9D476D

Contents: 1 Gasket
Notes: N/A
Ford 2017 - 2011



VG242
EGR Valve Mounting Gasket
BC3Z9D476B

Contents: 1 Gasket
Notes: N/A
Ford 2019 - 2011



VG246
EGR Valve Mounting Gasket
12635466

Contents: 1 Gasket
Notes: N/A
Chevrolet 2016 - 2011
GMC 2016 - 2011



VG247
EGR Valve Mounting Gasket
98062923

Contents: 1 Gasket
Notes: N/A
Chevrolet 2016 - 2011
GMC 2016 - 2011



VG248
EGR Valve Mounting Gasket
11612245439

Contents: N/A
Notes: N/A

BMW 2013 - 2009



VG249
EGR Valve Mounting Gasket
13547792098

Contents: N/A
Notes: N/A
BMW 2013 - 2009

BMW 2013 - 2009



VG251
EGR Valve Mounting Gasket
059131120A; 059131120B

Contents: 1 Gasket
Notes: N/A
Audi 2015 - 2014
Volkswagen 2014 - 2013



VG253
EGR Valve Mounting Gasket
03L131547B

Contents: 1 Gasket
Notes: N/A
Audi 2013 - 2010
Volkswagen 2014 - 2009



VG257
EGR Valve Mounting Gasket
98054443

Contents: 1 Gasket
Notes: N/A
Chevrolet 2010 - 2009
GMC 2010 - 2007



VG263
EGR Valve Mounting Gasket
14722EZ40A

Contents: 1 Gasket
Notes: N/A
Nissan 2019 - 2016



VG265
EGR Valve Mounting Gasket
14719EZ40A

Contents: 1 Gasket
Notes: N/A
Nissan 2019 - 2016



VG266
EGR Tube Gasket
14722EZ40B

Nissan 2019 - 2016



VG267
EGR Valve Mounting Gasket
8C3Z9D476A

Contents: 1 Gasket
Notes: Includes O-Ring
Ford 2010 - 2008



VG270
EGR Valve Mounting Gasket
68005465AA

Contents: 1 Gasket
Notes: N/A
Dodge 2010 - 2007
Ram 2018 - 2011



VG273
EGR Valve Mounting Gasket
68211320AA

Contents: 1 Gasket
Notes: N/A
Jeep 2019 - 2014
Ram 2018 - 2014



VG274
EGR Tube Gasket
4861785AB

Dodge 2009 - 2007
Freightliner 2009 - 2007
Jeep 2009 - 2007



VG275
EGR Valve Mounting Gasket
68340386AA; 68095489AA

Contents: 1 Gasket
Notes: N/A
Ram 2018 - 2014



VG279
EGR Tube Gasket
68211317AA

Jeep 2019 - 2014
Ram 2018 - 2014



VG281
EGR Valve Mounting Gasket
6C1Z9E464A

Contents: 1 Gasket
Notes: Includes Mounting Gasket
Ford 2019 - 2015



VG282
EGR Valve Mounting Gasket
BK2Z9E464A

Contents: 1 Gasket
Notes: Includes Mounting Gasket
Ford 2018 - 2015



VP1
EGR Valve Position Sensor
F2ZE9G428AA; F2ZZ9G428B;
F2ZZ9G428G; E7TZ9G428A;
F2AZ9F483A; F2SZ9F483A;
F2TZ9G428A; E5AF9G428AA;
E5AZ9G428A; E7TF9G428AA;
E2TZ9G428A; 12352212

Connector Gender: Female
Terminal Gender: Male
Terminal Quantity: 3
Ford 1987 - 1985



VP2
EGR Valve Position Sensor
E43F9G428A2A; E43F9G428AA;
E43Z9G428A; E43Z9G428B;
D9AE9G428A4A; D9AE9G428A5A;
D9AZ9G428A; E43F9G428A1A;
E43F9G428A1B; D9AE9G428A1A;
12352211

Connector Gender: Female
Terminal Gender: Male
Terminal Quantity: 3
Ford 1986 - 1985



VP16
Exhaust Back Pressure Sensor
1850353C2; 1850353C1;
F7TZ9J460AA; F7TZ9J460BA;
3C3Z9J460AA; 4C3Z9J460A;
F7TE9J460AA; 1807330C1

Connector Gender: Female
Connector Shape: Round
Mounting Hardware Included: No
Terminal Gender: Male
Terminal Quantity: 3
Terminal Type: Blade
Ford 2004 - 1994



VP18
Exhaust Back Pressure Sensor
1840078C1; F4TZ9J460A;
1C3Z9J460AA; 5C4Z12A697BA;
1813658C2

Connector Gender: Female

Connector Shape: Round
 Mounting Hardware Included: No
 Mounting Location: Engine Bay
 Notes: N/A
 O.E.M. Replacement: Yes
 Terminal Gender: Male
 Terminal Quantity: 3
 Terminal Type: Blade
 Ford 1996 - 1995
 International 2005 - 1994



VP22
 Exhaust Back Pressure Sensor
 1850352C2; 1850352C1;
 5C3Z9J460B; 5C3Z9J460A

Connector Gender: Female
 Connector Shape: Round
 Mounting Hardware Included: No
 O.E.M. Replacement: Yes
 Terminal Gender: Male
 Terminal Quantity: 3
 Terminal Type: Blade
 Ford 2010 - 1997



VP24
 Diesel Particulate Filter (DPF) Pressure Sensor
 8C3Z9J460B; 8C3Z9J460D

Ford 2010 - 2008



VP25
 Exhaust Back Pressure Sensor
 7E7Z9J460AA

Connector Gender: Female
 Connector Shape: Round
 Mounting Hardware Included: No
 Mounting Location: Engine Bay
 Notes: N/A
 O.E.M. Replacement: Yes
 Terminal Gender: Male
 Terminal Quantity: 3
 Terminal Type: Pin

Ford 2008



VP26
 Exhaust Back Pressure Sensor
 1846480C2; 1847913C91;
 8C3Z9J460A

Connector Gender: Female
 Connector Shape: Round
 Mounting Hardware Included: No
 Mounting Location: N/A
 Notes: N/A
 O.E.M. Replacement: Yes
 Terminal Gender: Male
 Terminal Quantity: 3
 Terminal Type: Pin

Ford 2010 - 2008



VP27
 Diesel Particulate Filter (DPF) Pressure Sensor
 12598445

Chevrolet 2010 - 2007
 GMC 2010 - 2007



VP29
 EGR Valve Pressure Feedback Sensor
 0071536128; 0061539528;
 68012053AA

Connector Gender: Female
 Terminal Gender: Male
 Terminal Quantity: 3
 Terminal Type: Blade

Dodge 2009 - 2007
 Mercedes-Benz 2009 - 2007



VP30
 Exhaust Back Pressure Sensor
 BC3Z9J460E; BC3Z9J460B

Connector Gender: Female
 Connector Shape: Oval
 Terminal Gender: Male
 Terminal Quantity: 3
 Terminal Type: Blade

Ford 2015 - 2011



VP31
 Diesel Particulate Filter (DPF) Pressure Sensor
 BC3Z9J460D; BC3Z9J460A

Ford 2015 - 2011



VP32
 EGR Valve Pressure Feedback Sensor
 BC3Z9J460C

Connector Gender: Female
 Terminal Gender: Male
 Terminal Quantity: 3
 Terminal Type: Blade

Ford 2018 - 2011



VP34
 EGR Valve Pressure Feedback Sensor
 4928594; 4921746; 68002442AA

Connector Gender: Female

Connector Shape: Rectangular
 Mounting Hardware Included: No
 Mounting Location: Engine Bay
 Notes: Sensor Only
 O.E.M. Replacement: Yes
 Terminal Gender: Male
 Terminal Quantity: 3
 Terminal Type: Blade

Blue Bird 2019 - 2008
 Dodge 2010 - 2007
 Freightliner 2019 - 2007
 International 2020 - 2014
 Ram 2020 - 2011
 Sterling Truck 2010 - 2008
 Thomas 2020 - 2019
 Workhorse 2009 - 2007



VP35
 Exhaust Back Pressure Sensor
 68089421AB; 0071534328;
 68089421AA; 5175812AA;
 68013186AB; 006153602828;
 5103558AA; 68013186AA

Connector Gender: Female
 Connector Shape: Rectangular
 Mounting Hardware Included: No
 Mounting Location: N/A
 Notes: Sensor Only
 O.E.M. Replacement: Yes
 Terminal Gender: Male
 Terminal Quantity: 3
 Terminal Type: Blade

Dodge 2004 - 2003
 Jeep 2009 - 2007



VP36
 Diesel Particulate Filter (DPF) Pressure Sensor
 DC3Z9J460D

Ford 2016 - 2013



VP37
 EGR Valve Pressure Feedback Sensor
 68211254AA

Connector Gender: Female
 Terminal Gender: Male
 Terminal Quantity: 3

Terminal Type: Blade
 Vacuum Port Quantity: N/A
 Vacuum Port Size: N/A
 Jeep..... 2019 - 2014
 Ram..... 2018 - 2014



VP38
Exhaust Back Pressure Sensor
 1850351C1

Connector Gender: Female
 Connector Shape: Round
 Mounting Hardware Included: No
 Mounting Location: N/A
 Notes: Sensor Only
 O.E.M. Replacement: Yes
 Terminal Gender: Male
 Terminal Quantity: 3
 Terminal Type: Blade
 International..... 2009 - 2006



VR842
Voltage Regulator
 0031543806; 0031540106

Connector Gender: No Connector
 Mounting Location: Alternator
 Terminal Gender: N/A
 Terminal Quantity: N/A
 Voltage: 12
 Mercedes-Benz 1997 - 1996



VR859
Voltage Regulator
 12317561939

Connector Gender: Female
 Connector Quantity: 1
 Connector Shape: Oval
 Mounting Location: External
 Terminal Gender: Male
 Terminal Quantity: 2
 Voltage: 14
 BMW..... 2009



VR-111
Voltage Regulator

J8125716; J8125716; J8125716;
 J8125716; J8125716; J8125716;
 J8125176; J8125176; 8125716;
 8125716; 8125716; 8125716;
 AR55827; D8HZ10316C;
 303301699; 1116439; 1116423;
 1116392; 1116387; 1116385;
 1116384; 1116380; 1116368;
 10470886; 358228; 3N3754;
 8983505214; 83300084; 9000595;
 83505214

****Additional OE Numbers Available Online****

Connector Gender: Female; Male
 Connector Quantity: 1
 Connector Shape: N/A
 Mounting Location: Alternator
 Terminal Gender: Male
 Terminal Quantity: 2
 Voltage: 12
 Chevrolet 1984 - 1980
 International..... 1986 - 1981



VR-125
Voltage Regulator

1119180; 1119165; 3438150;
 4379225; 4379100; 5234625;
 12338616; 4111990; 12336870;
 4091050; 3755850; 3755960
 Dodge..... 1992 - 1990



VR-134
Voltage Regulator

D5RY10316B; 8559577; AZ24490;
 82302913; 9927829; 35237106;
 068903803; 070903803;
 070903803A; 028903803A;
 052903803; 059903803B;
 063903803; 0192052019;
 0192052016; 0192052005;
 0192052012; 0192052008;
 0192052006; 0192052004;
 0192052001; 0190052016;
 46600188; 46602201; 8129785;
 2091722

Connector Gender: Female
 Mounting Location: Internal
 Terminal Gender: Male
 Terminal Quantity: 1
 Voltage: 12
 Mercedes-Benz 1983 - 1980
 Volkswagen 1981



VR-144
Voltage Regulator

D8HZ10316B; SFD221064; 1116389;
 1116383; B71699; 9L6774;
 19107023; 1876388
 Connector Gender: Female
 Mounting Location: Distributor
 Terminal Gender: Male
 Terminal Quantity: 2
 Voltage: N/A
 Ford 1992 - 1980
 Freightliner 1992 - 1991
 International..... 1986 - 1981
 Mack 1992 - 1980
 Peterbilt 1991 - 1980



VR-155
Voltage Regulator

2770035010; 2770013060;
 0260003851; 0260003940;
 12321672
 Connector Gender: Female
 Mounting Location: Universal
 Terminal Gender: Male
 Terminal Quantity: 6
 Voltage: 12
 Toyota..... 1986 - 1981



VR-160
Voltage Regulator

2770028030; 2770041050;
 2770026050; 2770038100;
 12322126
 Connector Gender: Male
 Connector Quantity: 1
 Connector Shape: Square
 Mounting Location: External
 Terminal Gender: Female
 Terminal Quantity: 3
 Voltage: N/A
 Toyota..... 1986 - 1981



VR-162
Voltage Regulator

23215Q4601; 23215Q4602;
 495757101; 495757301;
 23215B9800; 23215F2500;
 23215P2500; 2098379
 Connector Gender: Female
 Terminal Gender: Male
 Terminal Quantity: 5
 Voltage: 12
 Nissan 1986



VR-166

Voltage Regulator

J3229408; J3229408; J3229408;
 J3229408; F0PU10316AA;
 F0PZ10316A; E4TF10316AA;
 E6DF10316AA; F0AU10316AA;
 F0AZ10316A; E2TZ10316AA;
 E4AF10316AA; E4AF10316BA;
 E4AZ10316B; E2PF10316AA;
 E2PF10316BA; E2PZ10316A;
 E2TF10316AA; D9PZ10316A;
 D9VF10316AB; E1PF10316A;
 E2AF10316AA; D8VF10316A;
 D8VZ10316A; D9PF10316AA;
 D9PF10316AB; D4HZ10316A;
 D4TZ10316A; D8BF10316AA;
 D8BZ10316A

****Additional OE Numbers Available Online****

Connector Gender: N/A
 Terminal Gender: Male
 Terminal Quantity: 4
 Voltage: N/A

Ford 1992 - 1980
 Mercury 1985 - 1984



VR-169

Voltage Regulator

055903803; 171903803; 035903803;
 036903803; 036903803A;
 049903803H; 12327092

Connector Gender: Female
 Mounting Location: Alternator
 Terminal Gender: Female
 Terminal Quantity: 2
 Voltage: 12

Audi 1983 - 1982
 Volkswagen 1984 - 1981



VR-175

Voltage Regulator

8942509640; 5812700020;
 2321554A00; 23215W1701;
 19019006; 94250964

Connector Gender: Female
 Terminal Gender: Male
 Terminal Quantity: 6
 Voltage: N/A

Nissan 1985 - 1981



VR-179

Voltage Regulator

94460314101; 92860314201;
 E5RY10316A; E7RY10316A;
 E8RY10316A; 068903803A;
 068903803B; 034903803; 5226313;
 92860314200; 034903803;
 90009353; 96460314100

Connector Gender: Female
 Terminal Gender: Male
 Terminal Quantity: 2
 Voltage: N/A

Audi 1983 - 1982
 Volkswagen 1984 - 1982



VR-185

Voltage Regulator

MD607619

Connector Gender: Female
 Mounting Location: Alternator
 Terminal Gender: Male
 Terminal Quantity: 2
 Voltage: 12

Dodge 1985 - 1983
 Mitsubishi 1983

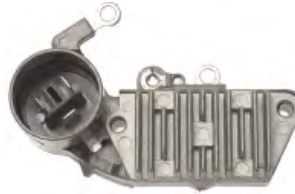

VR-405

Voltage Regulator

8971227960; 8941230530;
 2770072070; 31150PD1004;
 31150PD2004; 31150PDJ004;
 2770063020; 2770063021;
 2770070030; 2770070070;
 2770072040; 2770001010;
 2770002010; 2770016010;
 1260000510; 1260000340;
 1260000371; 1260000400;
 19019000; 94847133; 94849090;
 94840314

Connector Gender: Female
 Terminal Gender: Male
 Terminal Quantity: 5
 Voltage: 12

Toyota 1986 - 1984

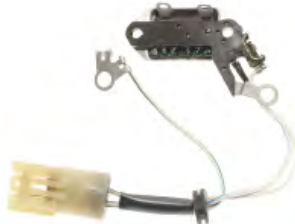

VR-424

Voltage Regulator

8942498600; 8942521850

Connector Gender: Female
 Terminal Gender: Male
 Terminal Quantity: 6
 Voltage: 12

Isuzu 1984



VR-432

Voltage Regulator

D8HZ10316D

Connector Gender: N/A
 Connector Quantity: N/A
 Connector Shape: N/A
 Mounting Location: Universal
 Terminal Gender: Male
 Terminal Quantity: 2
 Voltage: 12

Ford 2003 - 1994



VR-435

Voltage Regulator

2770057050

Connector Gender: Female
 Mounting Location: Alternator
 Terminal Gender: Male
 Terminal Quantity: 3
 Voltage: 24 v

Toyota 1985 - 1981



VR-439

Voltage Regulator

2770057060

Connector Gender: Female
 Terminal Gender: Male
 Terminal Quantity: 3

Toyota 1987 - 1981



VR-455

Voltage Regulator

ZZL139030; F1DU10316AA;
 F1DZ10C359A; F1DZ10C359AA;
 F5DU10316AA; F0DZ10316A;
 F0DU10316AA; F0DZ10316A;
 F0DZ10316AA; F0DZ10316AMR;
 19019009

Connector Gender: Female
 Mounting Location: Alternator
 Terminal Gender: Male
 Terminal Quantity: 3
 Voltage: 12

Ford 2003 - 1999



VR-471

Voltage Regulator

J8129785; J8129785; J8129785;
 J8129785; 059903803C;
 059903803C; 049903803F;
 049903803F; 049903803E;
 049903803E; 049903803A;
 049903803A; 94460314100;
 9933186; 9934791; 86GB10316AA;
 E5RD10316AA; 576155; 4475269;
 4731653; 74GB10316AA;
 12321271644; 12321279548;
 12321711399; 4474755;
 12311279548; 11610050600800;
 11610050601100; 0021541806;
 0021542506

****Additional OE Numbers Available Online****

Connector Gender: N/A
 Terminal Gender: N/A
 Terminal Quantity: 2
 Voltage: 14

BMW 1986 - 1985
 Mercedes-Benz 1992 - 1985
 Peugeot 1983



VR-472

Voltage Regulator

1116437; 1116429; 1116436;
 1116411; 1116419; 1116413

Connector Gender: Female
 Mounting Location: Alternator
 Terminal Gender: Male
 Terminal Quantity: 6
 Voltage: 12

Chevrolet 2000 - 1994



VR-485

Voltage Regulator

8571846; 1197311023

Connector Gender: No Connector
 Mounting Location: Alternator
 Terminal Gender: Male
 Terminal Quantity: 1
 Voltage: 12

Mercedes-Benz 1989 - 1985



VR-506

Voltage Regulator

028903803B; 028903803B;
 021903803B; 021903803B;
 4737151; 5246863; 078903803;
 028903803C; 90543230; 90541990;
 90486255; 93253788; 12311747920;
 12311730604

Connector Gender: No Connector
 Mounting Location: Alternator
 Terminal Gender: Male
 Terminal Quantity: 2
 Voltage: 12

Volkswagen 1998



VR-788

Voltage Regulator

048903803; 028903803L

Connector Gender: Female
 Mounting Location: Alternator
 Terminal Gender: Male
 Terminal Quantity: 2
 Voltage: 12

Volkswagen 2006 - 2004



VR-789

Voltage Regulator

028903803F; 028903803FX

Connector Gender: Male
 Mounting Location: Alternator
 Terminal Gender: Male
 Terminal Quantity: 1
 Voltage: 12

Volkswagen 2005 - 2000



VR-831

Voltage Regulator

078903803C; 038903803J;
 038903803K; 06B903803;
 06B903803A; 06B903803B

Connector Gender: Female
 Mounting Location: Alternator
 Terminal Gender: Male
 Terminal Quantity: 2
 Voltage: 12

Volkswagen 2009 - 2000



VR-850

Voltage Regulator

06F903803A; 06F903803AX;
 06F903803B

Connector Gender: Female
 Mounting Location: Alternator
 Terminal Gender: Male
 Terminal Quantity: 2
 Voltage: 12

Volkswagen 2009 - 2000



VRV109

Fuel Tank Vent Valve

4C2Z9B593AA; 4C2Z9B593AB

Functions: N/A
 Notes: Valve Stem Only
 Port Quantity: 1

Ford 2015 - 2011



VS36

EGR Control Solenoid

1997226

Contents: Sensor

Chevrolet 1997 - 1994
 GMC 1997 - 1994



VS37

EGR Control Solenoid

1997225

Contents: Valve

Chevrolet 1998 - 1994
 GMC 1997 - 1994



VS52

EGR Control Solenoid

ZZM22035A; F0TZ9J459A;
 F0TZ9J459A

Contents: Solenoid

Ford 1997 - 1994



VS62
Turbocharger Boost Solenoid
1997227

Chevrolet 1997 - 1994
GMC 1997 - 1994



VS76
EGR Control Solenoid
1997254

Contents: Solenoid

Chevrolet 2004 - 1997
GMC 2004 - 1997



VS146
Secondary Air Injection Solenoid
5099822AA; 68086987AA

Dodge 2009
Freightliner 2009



VS153
EGR Control Solenoid
1J0906283B; 1K0906283;
1K0906283C; 1K0906283A;
1J0906283C

Contents: Sensor

Audi 2016 - 2011

Volkswagen 2014 - 2007



VS154
EGR Control Solenoid
98063338; 98057041

Contents: Solenoid

Chevrolet 2010 - 2006
GMC 2010 - 2006



VS198
Secondary Air Injection Solenoid
1K0906627A; 1J0906627B

Connector Gender: Female
Terminal Gender: Male
Terminal Quantity: 2

Audi 2013 - 2010
Volkswagen 2014 - 2009



VS234
EGR Control Solenoid
68092518AA

Contents: Solenoid

Jeep 2020 - 2014
Ram 2018 - 2014



VS237
Vacuum Regulator Valve
11747810831; 11747537612

BMW 2016 - 2009



VS239
EGR Valve Vacuum Modulator
68282570AA; 68212653AA

Contents: Valve

Jeep 2019 - 2014
Ram 2018 - 2014



VS244
EGR Valve Vacuum Modulator
191906283A

Contents: Solenoid

Volkswagen 1997 - 1993



VS245
Vacuum Pump
68250450AA

Contents: Valve

Ram 2018 - 2014



VTS20
Engine Variable Valve Lift Eccentric Shaft Sensor
11377603979

BMW 2018 - 2014



VVT136
Variable Valve Timing Solenoid
06E115243G

Audi 2016



VVT137
Variable Valve Timing Solenoid
06H115243J; 06H115243F;
06H115243E

Audi 2011 - 2010



VVT138
Variable Valve Timing Solenoid
059115243B; 059115243A
Audi 2012 - 2009
Volkswagen 2010



VVT393
Variable Valve Timing Solenoid
T4N32636; AJ813329
Jaguar 2019 - 2017



VVT711
Engine Variable Valve Timing Sprocket
06F109088J; 06F109088G; 06F109088C
Volkswagen 2015 - 2010

Functions: Lateral Acceleration Detection
Terminal Quantity: 6
Chevrolet 2007



YA161
YAW Rate Sensor
0025426618; 5120342AB; 5120342AA



VVT214
Variable Valve Timing Solenoid
06E109257T; 06E109257M
Audi 2016



VVT405
Variable Valve Timing Solenoid
95810530403; 95810530401
Porsche 2018 - 2012



WGS1
Turbocharger Wastegate Solenoid
5140305AA; 4036054
Terminal Quantity: 2
Terminal Type: Blade
Dodge 2009 - 2004

Connector Gender: Female
Connector Quantity: 1
Connector Shape: Oval
Functions: Sensor
Terminal Quantity: 6
Dodge 2006 - 2004
Freightliner 2006 - 2004



VVT353
Variable Valve Timing Solenoid
11367593719
BMW 2016 - 2015



VVT408
Variable Valve Timing Solenoid
94610505379; 94610505376; 94610505375; 0PB109259A; 0PB109259
Porsche 2017 - 2016



WP-236
Windshield Wiper Switch
BA3066123; BA3066135
Connector Gender: Female
Terminal Quantity: 6
Terminal Type: Blade
Mazda 1984 - 1982



VVT369
Variable Valve Timing Solenoid
04L906423
Audi 2015
Volkswagen 2015



VVT666
Engine Variable Valve Timing Sprocket
11367583208; 11367522290
BMW 2018 - 2009



YA132
Yaw Rate Sensor
15161769; 15189628; 15951953; 15220053
Connector Gender: Female

BMW

3.0L

Diesel Emission Fluid Injection Nozzle

DF15

18307807206

BMW 335d 2011-2010

BMW X5 - X6 2013-2010



CUMMINS

5.9L

Air Intake Heater

DIH1

4746694, 4762012, 4882815, 4762012AB, 5086720AA,
5086720AB, 5086720AC

Dodge Ram 2500 - 3500 2005-1998, 1994



Air Intake Heater

DIH2

3913348, 4429348, 4856670, 4856670AB

Dodge D250 1993-1989

Dodge D350 1993-1988

Dodge W250 -W350 1993-1989



CUMMINS (Cont'd)

5.9L (Cont'd)

Air Intake Heater

DIH3

5175548AA

Dodge Ram 2500 - 3500 2008-2006



Diesel EGR Cooler Kit

ECK10

4089256NX, 4089256RX

Ford F650 - F750 2008-2003

Freightliner FC70 2004-2002

Freightliner FC80 2006-2003

Freightliner FL50 - FL80 2003-2002

Freightliner MT35 2006-2004

Freightliner MT45 - MT55 2006-2003

Freightliner XC 2005-2002

* Remanufactured



Diesel Oil Cooler Kit

OCK16

5114411AA, 5086837AA, 5104874AA

Dodge Ram 2500 - 3500 2008-2005



Engine Block Heater

L25001

5086737AA, 5086737AB

Dodge Ram 2500 - 3500 2007-2003



Fuel Injector

FJ252

4761596, R476 1596

Dodge Ram 2500 - 3500 1995-1994

* Remanufactured



CUMMINS (Cont'd)

5.9L (Cont'd)

Fuel Injector

FJ253

432133888, 4429238, 4720540, R4429238, R4720540

Dodge D250 - D350 1991-1989

Dodge W250 - W350 1991-1989

* New



Fuel Injector

FJ254

4864328

Dodge Ram 2500 - 3500 1998-1996

* Remanufactured



Fuel Injector

FJ255

4761595, R476 1595

Dodge Ram 2500 - 3500 1998-1994

* Remanufactured



Fuel Injector

FJ256

3918965, 3919093, 3802246RX

Dodge D250 - D350 1993-1991

Dodge W250 - W350 1993-1991

* New



Fuel Injector

FJ330

4882120

Dodge Ram 2500 - 3500 1998-1996

* New



Fuel Injector

FJ607

4856671

Dodge Ram 2500 -3500 1998-1994

* New



CUMMINS (Cont'd)

5.9L (Cont'd)

Fuel Injector

FJ642

5011038AA, 5013847AA

Dodge Ram 2500 - 3500 2002-1998

* New



Fuel Injector

FJ643

5013848AA

Dodge Ram 2500 - 3500 2003-1998

* New



Fuel Injector

FJ932

5086894AA, 68004082AA, R5086894AA, R8004082AA,
R8004082AB, R8004082AC

Dodge Ram 2500 - 3500 2004-2003

* Remanufactured



Fuel Injector

FJ933

5135790AA, 5135790AB, 5135790AC, 5135790AD, 5135790AE,
5135790AF, R5135790AC, R5135790AD, R5135790AE,
R5135790AF

Dodge Ram 2500 - 3500 2009-2004

* Remanufactured



Fuel Injector

FJ976

5018177AA

Dodge Ram 2500 - 3500 2002-2001

* New



Fuel Pressure Relief Valve

PRV2

5093113AA

Dodge Ram 2500 - 3500 2009-2003



CUMMINS (Cont'd)

5.9L (Cont'd)

Fuel Shut-Off Solenoid

FSS101

3903575, 4429575

Dodge D250 - D350 1993-1989

Dodge W250 - W350 1993-1989



Fuel Shut-Off Solenoid

FSS102

4761273, 4886531AA, 4897260AA, 5015364AA, 5016244AB

Dodge Ram 2500 - 3500 1998-1994



Fuel Transfer Pump

FTP1

4935730, 4932707, 3990105, 3990082

Dodge Ram 2500 - 3500 2002-1998



Fuel Transfer Pump

FTP2

3969705

Dodge Ram 2500 - 3500 2004-2003



CUMMINS (Cont'd)

5.9L (Cont'd)

Fuel Transfer Pump

FTP5

5015553AA, 5080885AA

Dodge Ram 250 - 3500 2002-1998



Fuel/Water Separator Sensor

FWSS106

5015582AA, 5015582AB

Dodge Ram 2500 - 3500 2002-2000



Fuel/Water Separator Sensor

FWSS107

5011620AA

Dodge Ram 2500 - 3500 1999-1998

Dodge Ram 3500 Van 1999



Fuel/Water Separator Sensor

FWSS112

5093128AA, 5093128AB

Dodge Ram 2500 - 3500 2009-2003



CUMMINS (Cont'd)

5.9L (Cont'd)

Injection Pump

IP17

R4761367

Dodge Ram 2500 - 3500 1998-1994

* Remanufactured



Injection Pump

IP18

R4798548

Dodge Ram 2500 - 3500 1998-1994

* Remanufactured



Injection Pump

IP19

R5013925AA, R5019658AD

Dodge Ram 2500 - 3500 2002-1998

* Remanufactured



Injection Pump

IP20

R5019657AD

Dodge Ram 2500 - 3500 2002-2000

* Remanufactured



CUMMINS (Cont'd)

5.9L (Cont'd)

Injection Pump

IP21

5086765AA, 5104877AA, 5143425AA, 5191780AA, 5191780AB,
5191780AC, 5191780AD, R5104877AA, R5143425AA,
R5191780AA, R5191780AB, R5191780AC, R5191780AD

Dodge Ram 2500 -3500 2007-2003

* Remanufactured



Injection Pump

IP26

R4429991

Dodge D250 - D350 1993-1989

Dodge W250 - W350 1993-1989

* Remanufactured



Injection Pump

IP27

3923346, 4429570, 4638723, 4728745, R4638723, R4728745

Dodge D250 - D350 1993-1990

Dodge W250 - W350 1993-1990

* Remanufactured



Injector Connector Tube

IFS3

2873295, 4929864, 4929865, 5175565AC, 68005335AA,
F00RJ01831

Dodge Ram 2500 - 3500 2010-2003

Dodge Ram 4000 2009-2005



CUMMINS (Cont'd)

5.9L (Cont'd)

Turbocharger

TBC541

5010 961AA, R5010961AA

Dodge Ram 2500 - 3500 1998

* Remanufactured



Turbocharger

TBC544

R4728036

Dodge D250 - D350 1991-1989

Dodge W250 - W350 1991-1989

* Remanufactured



Turbocharger

TBC545

4882121, 4864 283, R4864283, R4886031AA, R5010278AA

Dodge Ram 2500 - 3500 1998-1996

* Remanufactured



Turbocharger

TBC553

5017 787AA, 5017 787AC, 5017787AB, 5017787AD, 5017787AE,
R5017787AE

Dodge Ram 2500 - 3500 2002-2001

* Remanufactured



CUMMINS (Cont'd)

5.9L (Cont'd)

Turbocharger

TBC555

4883 755AA, 4886016AA, 5010 280AA, R4883755AA,
R4886016AA, R5010280AA

Dodge Ram 2500 - 3500 1998-1996

* Remanufactured



Turbocharger

TBC567

5135 784AB, 5135784AA, 5143 256AA, R5135784AB,
R5143256AA

Dodge Ram 2500 - 3500 2009-2004

* Remanufactured



Turbocharger

TBC568

5014 203AA, R5014203AA

Dodge Ram 2500 - 3500 2000-1999

* Remanufactured



Turbocharger

TBC569

5086 863AA, 5086 863AB, R5086863AA, R5086863AB

Dodge Ram 2500 - 3500 2004-2003

* Remanufactured



Turbocharger

TBC570

5017509AA, R5017509AA

Dodge Ram 2500 - 3500 2002-2000

* Remanufactured



CUMMINS (Cont'd)

5.9L (Cont'd)

Turbocharger

TBC575

R5010276AA

Dodge Ram 2500 - 3500 1998-1995

* Remanufactured



Turbocharger

TBC579

R4728700

Dodge D250 - D350 1993-1991

Dodge W250 - W350 1993-1991

* Remanufactured



Turbocharger

TBC584

R5010960AA

Dodge Ram 2500 - 3500 1995-1994

* Remanufactured



Turbocharger Speed Sensor

L86001

68039104AA

Dodge Ram 2500 - 3500 2010-2007



CUMMINS (Cont'd)

5.9L (Cont'd)

Vacuum Pump

VCP112

53032373AB, 53032373AC, 53032373AA

Dodge Ram 2500 - 3500 2004-2003



Valve Cover Gasket

VCG8

5086954AA

Dodge Ram 2500 - 3500 2005-2003

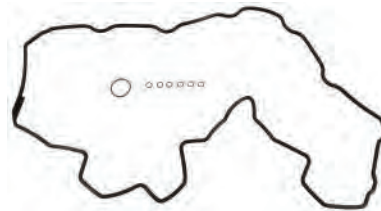

Valve Cover Gasket

VCG9

5016356AB

Dodge Ram 2500 2002-1998

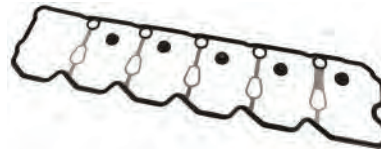

6.7L

Air Intake Heater

DIH9

68002431AA, 68002431AB

Dodge Ram 3500 2010-2007

Dodge Ram 4500 - 5500 2010-2008

Ram 3500 - 5500 2014-2011



Air Intake Heater

DIH11

68027046AA, 68069387AA

Dodge Ram 2500 - 3500 2010-2007

Ram 2500 - 3500 2012-2011



CUMMINS (Cont'd)

6.7L (Cont'd)

Diesel EGR Cooler Kit

ECK9

4946088NX, 4955518RX

Ford F650 -F750 2010-2008
 Freightliner M2 106 2010-2008

* Remanufactured



Diesel Oil Cooler Kit

OCK4

68015126AA, 3975818

Dodge Ram 2500 - 3500 2010-2007
 Ram 2500 - 5500 2018-2011



Diesel Particulate Filter (DPF) Pressure Sensor

DPS101

2871960

Blue Bird All American FE, RE 2018-2010
 Blue Bird SHL All American 2017
 Blue Bird Vision School Bus 2018-2017
 Freightliner 108SD 2017-2012
 Freightliner B2, M2 106 2018-2010
 Freightliner MB, MC Line 2017
 Freightliner MT45 2018-2010
 Freightliner MT55 2017-2010
 Freightliner S2C 2017
 Freightliner XB Line 2015-2012
 Freightliner XB Straight Rail 2018-2010
 Freightliner XC Lowered Rail 2017, 2015-2011
 Freightliner XC Modular, XC Straight Rail 2017-2010
 Freightliner XC Raised Rail 2018-2010
 International 4300 2018-2017
 International 4300LP, 7300 2018-2017
 Sterling Truck Acterra 2010



EGR Cooler Kit

ECK11

53041182AA, 68026996AA, 68048991AA

Dodge Ram 2500 - 3500 2010-2007
 Ram 2500 - 3500 2012-2011



CUMMINS (Cont'd)

6.7L (Cont'd)

EGR Valve

EGV1241

68002438AA, 68026995AA, 68026995AB, 68038088AA,
R8026995AA

Dodge Ram 2500 - 3500	2010-2007
Dodge Ram 4500 - 5500	2010-2008
Ram 2500 - 5500	2016-2011



Emission Fluid Injection Nozzle

DFI3

4627241AA, 4627241AB, 4627241AD, 4627241AE

Ram 2500 - 5500	2014-2013
-----------------------	-----------



Fuel Injector

FJ1009

68027067AA, 68027067AB, 68069384AA, R8027067AA

Dodge Ram 2500	2010-2008
Dodge Ram 3500	2010-2007
Ram 2500	2012-2011
Ram 3500	2012-2011

* Remanufactured



Fuel Injector

FJ1010

68002012AA, 68002012AB, 68002012AC, RL002012AB,
RL002012AC

Dodge Ram 2500	2007
Dodge Ram 3500	2010-2007
Dodge Ram 4500 - 5500	2010-2008

* Remanufactured



CUMMINS (Cont'd)

6.7L (Cont'd)

Fuel Injector

FJ1229

68086182AA
Ram 3500 - 5500 2012-2011
* Remanufactured



Fuel Injector

FJ1230

6821 0512AA
Ram 3500 - 5500 2015-2013
* Remanufactured



Fuel Injector

FJ1310

6821 0105AA
Ram 2500 - 3500 2015-2013
* Remanufactured



Fuel Injector

FJ1310NX

6821 0105AA
Ram 2500 - 3500 2015-2013
* New



Fuel Injector Seal Kit

SK146

68031602AA,
Dodge Ram 2500 - 3500 2010-2007
Ram 2500 - 5500 2015-2011



CUMMINS (Cont'd)

6.7L (Cont'd)

Injection Pump

IP33

68002013AA, 68002013AB, 68002013AC, 68027022AA,
68027022AB, 68027022AC, R8027022AA, R8027022AB,
R8027022AC

Dodge Ram 2500 - 3500 2010-2007
Dodge Ram 4500 - 5500 2010-2008
Ram 2500 - 5500 2015-2011

* New



Turbocharger

TBC-521

6804 8234AC, 6804 8234AD, 6804 8234AF, 68048234AA,
68048234AB, 68048234AE, 68048234AG, R8048234AE,
R8048234AF, R8048234AG

Dodge Ram 2500 - 3500 2010-2007
Dodge Ram 4500 - 5500 2010-2008
Ram 2500 - 5500 2012-2011

* Remanufactured



Turbocharger Speed Sensor

L86001

68039104AA

Dodge Ram 2500 - 3500 2010-2007



Valve Cover Gasket

VCG7

5179091AC

Dodge Ram 2500 - 3500 2010-2006
Ram 2500 - 3500 2013-2011
Ram 4500 - 5500 2013-2011



CUMMINS (Cont'd)

6.7L ISB

Diesel Particulate Filter (DPF) Pressure Sensor

DPS101

2871960

International 4300 2016-2014



8.9L

Diesel Particulate Filter (DPF) Pressure Sensor

DPS101

2871960

Blue Bird All American RE 2018-2014
Crane Carrier Low Entry 2017-2010
Freightliner 108SD 2018-2017, 2015-2014
Freightliner 114SD 2018-2012
Freightliner M2 106, M2 112 2018-2013
Freightliner XB Line 2014
Freightliner XC Lowered Rail 2017-2010
Freightliner XC Modular Rail 2017-2012
Freightliner XC Raised Rail 2018-2010
International 4400, 7400, 7500 2018-2017
Kenworth T400 2016-2010
Kenworth T460 2017
Kenworth T800 2014, 2012-2010
Kenworth W900 2013-2012, 2010
Mack GU4, GU5 2018-2012
Peterbilt 320, 365 2014-2010
Peterbilt 382 2014-2011
Peterbilt 384 2013-2011
Pierce Mfg. Inc. Arrow XT 2014-2013, 2011-2010
Pierce Mfg. Inc. Custom 2012-2010
Pierce Mfg. Inc. Dash CF 2014
Pierce Mfg. Inc. Enforcer 2011-2010
Pierce Mfg. Inc. Impel, Saber, Velocity ... 2014-2013, 2011-2010
Sterling Truck L8500 2010
Western Star 4700 2018-2012



CUMMINS (Cont'd)

8.9L ISL

Diesel Particulate Filter (DPF) Pressure Sensor

DPS101

2871960

International 5500i, 5600i 2011-2010



ISX 15.0

Diesel Particulate Filter (DPF) Pressure Sensor

DPS101

2871960

Freightliner Argosy 2012
Freightliner Cascadia 2017-2010
Freightliner Columbia 2014-2012
Freightliner Coronado 2017-2011
Freightliner FLD32 2011
Freightliner XC Modular Rail 2017-2013
Freightliner XC Raised Rail 2017-2015
International 5900i SBA 2012
International 9900i, HX620, LoneStar, LT625 2017
International ProStar 2017-2010
Kenworth C500 2015-2010
Kenworth T2000 2011-2010
Kenworth T660 2017-2010
Kenworth T680 2017-2013
Kenworth T700 2015-2011
Kenworth T800 2017-2010
Kenworth T880 2017, 2015
Kenworth W900 2017-2010
Oshkosh Motor Truck Co. H, S 2011
Peterbilt 320, 365 2011
Peterbilt 367, 386, 388 2015-2010
Peterbilt 384 2011-2015
Peterbilt 387 2011-2010
Peterbilt 389 2017, 2015-2010
Peterbilt 567 2017, 2015-2014
Peterbilt 579 2017, 2015-2013
Peterbilt 587 2017, 2015-2011
Volvo VNL 2017-2010
Volvo VT 2010
Western Star 4900SA 2014-2010
Western Star 6900XD 2013



CUMMINS (Cont'd)

11.9L

Diesel Particulate Filter (DPF) Pressure Sensor

DPS101

2871960

Freightliner Cascadia	2017-2012
Kenworth T660	2015-2011
Kenworth T680	2017-2014
Kenworth T800	2017, 2015-2011
Kenworth T880	2017, 2015
Kenworth W900	2017-2016, 2014-2012
Peterbilt 320, 365	2017, 2015-2011
Peterbilt 384, 388	2015-2011
Peterbilt 386	2014-2011
Peterbilt 389	2017, 2015
Peterbilt 520	2017
Peterbilt 567, 579	2017, 2015-2014
Pierce Mfg. Inc. Arrow XT	2014
Pierce Mfg. Inc. Custom	2012
Pierce Mfg. Inc. Velocity	2014-2013
Volvo VNL	2016-2013



5.0L

Diesel Particulate Filter (DPF) Pressure Sensor

DPS108

22771EZ40A

Nissan Titan XD	2018-2016
-----------------	-----------



Diesel Particulate Filter (DPF) Pressure Sensor

DPS109

22640-EZ41B

Nissan Titan XD	2018-2016
-----------------	-----------



FORD

6.9L IDI

Diesel Oil Cooler Kit

OCK18

E4TZ6A642A, F3TZ6A642C, XU2Z6A642AAPRM, XU2Z6VA642AARM

Ford E-250 - E-350 Econoline Club Wagon, E-350

Econoline 1987-1984

Ford F-250 - F-350 1987-1984



Fuel Injector

FJ258

2C3Z-9VE527-ERM, 2C3Z-9VE527-FRM, E8TZ-9E527A

Ford E-250 Econoline Club Wagon 1991-1983

Ford E-350 Econoline 1992-1983

Ford E-350 Econoline Club Wagon 1992-1983

Ford F Super Duty 1992-1988

Ford F-250 - F-350 1992-1983

Ford F59 1992-1990

* New



Glow Plug Relay

RY-175

E3TZ-12A343C

Ford E-250 Econoline Club Wagon 1987-1983

Ford E-350 Econoline 1987-1983

Ford E-350 Econoline Club Wagon 1987-1983

Ford F-250 - F-350 1987-1983



Injection Pump

IP38

E7TZ-9A543-B

Ford E-250 - E-350 Econoline Club Wagon 1987-1983

Ford E-350 Econoline 1987-1983

Ford F-250 - F-350 1987-1983

* Remanufactured



FORD (Cont'd)

6.9L IDI (Cont'd)

Injection Pump

IP38NX

E7TZ-9A543-A

Ford E-250 - E-350 Econoline Club Wagon	1987-1983
Ford E-350 Econoline	1987-1983
Ford F-250 - F-350	1987-1983

* New

* Reman numbers for reference only. No new OE part numbers available.



7.3L IDI

Diesel Injector Install Kit

SK38

E6TZ-9229A

Ford E-350 Econoline	1994-1988
Ford E-350 Econoline Club Wagon	1994-1988
Ford F Super Duty	1994-1988
Ford F-250 - F-350	1994-1988



Diesel Oil Cooler Kit

OCK18

E4TZ6A642A, F3TZ6A642C, XU2Z6A642AAPRM, XU2Z6VA642AARM

Ford E-250 - E-350 Econoline Club Wagon, E-350 Econoline	1989-1988
Ford F Super Duty	1994-1988
Ford F-250 - F-350	1993-1988



Fuel Injector

FJ258

2C3Z-9VE527-ERM, 2C3Z-9VE527-FRM, E8TZ-9E527A

Ford E-250 Econoline Club Wagon	1991-1988
Ford E-350 Econoline	1992-1988
Ford E-350 Econoline Club Wagon	1992-1988
Ford F Super Duty	1992-1988
Ford F-250 - F-350	1992-1988
Ford F59	1992-1990

* New



FORD (Cont'd)

7.3L IDI (Cont'd)

Fuel/Water Separator Sensor

FWSS110

E8TZ-9J308-A

Ford E-250 Econoline Club Wagon	1991-1988
Ford E-350 Econoline	1994-1988
Ford E-350 Econoline Club Wagon	1994-1988
Ford F Super Duty	1994-1990, 1988
Ford F-250 - F-350	1994-1988



Glow Plug

GP105

E7TZ-12A342A, F2TZ-12A342A

Ford E-250 Econoline Club Wagon	1991-1987
Ford E-350 Econoline	1994-1987
Ford E-350 Econoline Club Wagon	1994-1987
Ford F Super Duty	1994-1988
Ford F-250 - F350	1994-1987



Injection Control Pressure Sensor

ICP105

E8TZ-9F838-A

Ford E-250 - E-350 Econoline	1994-1988
Ford E-250 Econoline Club Wagon	1991-1988
Ford E-350 Econoline Club Wagon	1994-1988
Ford F Super Duty	1994-1988
Ford F-250 - F-350	1994-1988
Ford F59	1997-1994



Injection Pump

IP39

E9TZ-9A543-B, F0TZ-9A543-B, F0TZ-9A543-D, F0TZ-9A543-D

Ford E-350 Econoline	1992-1988
Ford E-350 Econoline Club Wagon	1992-1988
Ford F Super Duty	1992, 1989-1988
Ford F-250 - F-350	1992-1988
Ford F59	1992, 1989-1988

* Remanufactured



FORD (Cont'd)

7.3L IDI (Cont'd)

Injection Pump

IP39NX

E9TZ-9A543-C

Ford E-350 Econoline	1989-1988
Ford F Super Duty	1989-1988
Ford F-250 - F-350	1989-1988
Ford F59	1989-1988

✧ New

✧ Reman numbers for reference only. No new OE part numbers available.



Injection Pump

IP40NX

F0TZ-9A543-C

Ford E-250 Econoline Club Wagon	1991-1990
Ford E-350 Econoline	1992-1990
Ford E-350 Econoline Club Wagon	1992-1990
Ford F Super Duty	1992-1990
Ford F-250 - F-350	1992-1990
Ford F59	1992-1990

✧ New

✧ Reman numbers for reference only. No new OE part numbers available.



Injection Pump

IP41

F2TZ-9A543-D

Ford E-350 Econoline	1994-1992
Ford E-350 Econoline Club Wagon	1994-1992
Ford F Super Duty	1994-1992
Ford F-250 - F-350	1994-1992
Ford F59	1997-1992

✧ Remanufactured



FORD (Cont'd)

7.3L IDI (Cont'd)

Injection Pump

IP41NX

F2TZ9A543A

Ford E-350 Econoline	1993-1992
Ford E-350 Econoline Club Wagon	1994-1992
Ford F Super Duty	1994-1992
Ford F-250 - F-350	1994-1992
Ford F59	1994-1992

* New

* Reman numbers for reference only. No new OE part numbers available.



Injection Pump

IP42

F3TZ-9A543-B

Ford F Super Duty	1994-1993
Ford F-250 - F-350	1994-1993
Ford F59	1993

* Remanufactured



Injection Pump

IP42NX

F2TZ-9A543-C

Ford E-350 Econoline	1994
Ford F Super Duty	1994, 1992
Ford F-250 - F-350	1994-1992
Ford F59	1994-1992

* New

* Reman numbers for reference only. No new OE part numbers available.



Injection Pump

IP45NX

F3TZ-9A543-B

Ford F Super Duty	1994
Ford F-250 - F-350	1994-1993
Ford F59	1994-1993

* New

* Reman numbers for reference only. No new OE part numbers available.



FORD (Cont'd)

7.3L POWERSTROKE

Diesel Injector Sleeve

B42001

F4TZ-9F538-A

Ford E-350 Club Wagon	2003
Ford E-350 Econoline Club Wagon	2002-1995
Ford E-350 Econoline	1998-1995
Ford E-350 - E-550 Super Duty	2002-1999
Ford E-450 Econoline Super Duty	2002-2000
Ford E-550 Econoline Super Duty	2002
Ford E-550 Super Duty	2003
Ford Econoline Super Duty	1999-1996
Ford Excursion	2003-2000
Ford F Super Duty	1997-1995
Ford F-250 - F-350	1997-1994
Ford F-250 - F-550 Super Duty	2003-1999



Diesel Valve Cover Gasket

Z98001

F81Z-6584-AA

Ford E-350 Club Wagon	2003
Ford E-350 Econoline	1998
Ford E-350 Econoline Club Wagon	2002-1998
Ford E-350 Super Duty	2000-1999
Ford E-450 Econoline Super Duty	2002-2000
Ford E-450 - E550 Super Duty	2003
Ford E-550 Econoline Super Duty	2002
Ford Econoline Super Duty	1999-1998
Ford Excursion	2003-2000
Ford F-250 - F-550 Super Duty	2003-1999



Diesel Valve Cover Gasket

Z98002

F4TZ-9D930-K

Ford E-350 Econoline	1997-1995
Ford E-350 Econoline Club Wagon	1997-1994
Ford Econoline Super Duty	1997-1996
Ford F Super Duty	1997-1994
Ford F-250 - F-350	1997-1994
Ford F59	1997-1994



FORD (Cont'd)

7.3L POWERSTROKE (Cont'd)

Fuel Filter Housing

FFH1

F81Z-9155-AA, F81Z-9155-AC

Ford E-350 Econoline Club Wagon	2002-1999
Ford E-350 Super Duty	2000-1999
Ford E-450 Econoline Super Duty	2002-2000
Ford E-550 Econoline Super Duty	2002
Ford Econoline Super Duty	1999
Ford Excursion	2002-2000
Ford F-250 - F-350 Super Duty	2003-1999



Fuel Filter Housing

FFH2

F6TZ-9155-A, F6TZ-9155-AB

Ford E-350 Econoline	1996
Ford E-350 Econoline Club Wagon	1996
Ford Econoline Super Duty	1996
Ford F-250 - F-350	1997



Fuel Heater

DFH101

F81Z-9J294-AA

Ford E-350 Club Wagon	2003
Ford E-350 Econoline Club Wagon	2002-1998
Ford E-350 Econoline	1998
Ford E-350 Super Duty	2003, 2000-1999
Ford E-450 Econoline Super Duty	2002-1999
Ford E-550 Econoline Super Duty	2002
Ford E-550 Super Duty	2003
Ford Econoline Super Duty	1999-1998
Ford Excursion	2003-2000
Ford F-250 - F-550 Super Duty	2003-1999



FORD (Cont'd)

7.3L POWERSTROKE (Cont'd)

Fuel Heater

DFH103

F81Z-9J294-BA

Ford E-350 Club Wagon	2003
Ford E-350 Econoline Club Wagon	2002-1998
Ford E-350 Econoline	1998
Ford E-350 Super Duty	2003, 2000-1999
Ford E-450 Econoline Super Duty	2002-1999
Ford E-550 Econoline Super Duty	2002
Ford E-550 Super Duty	2003
Ford Econoline Super Duty	1999-1998
Ford Excursion	2003-2000
Ford F-250 - F-550 Super Duty	2003-1999



Fuel Heater

DFH104

F5TZ-9J294-A

Ford E-350 Econoline	1997-1994
Ford E-350 Econoline Club Wagon	1997-1994
Ford Econoline Super Duty	1997-1996
Ford F Super Duty	1997-1995
Ford F-250 - F-350	1997-1994
Ford F59	1997-1994
Ford E-550 Super Duty	2003



Fuel Heater

DFH105

F4TZ-9J294-A

Ford E-350 Econoline	1997-1994
Ford E-350 Econoline Club Wagon	1997-1994
Ford Econoline Super Duty	1997-1996
Ford F Super Duty	1997-1995
Ford F-250 -F-350	1997-1994
Ford F59	1997-1994



FORD (Cont'd)

7.3L POWERSTROKE (Cont'd)

Fuel Injection Harness

IFH5

F4TZ-9D930-K

Ford E-350 Econoline	1997-1995
Ford E-350 Econoline Club Wagon	1997-1995
Ford Econoline Super Duty	1997-1996
Ford F Super Duty	1997-1994
Ford F-250 -F-350	1997-1994
Ford F59	1997-1994
Ford E-550 Super Duty	2003



Fuel Injection Harness

IFH6

F81Z-9D930-AB

Ford E-350 Econoline	1998
Ford E-350 Econoline Club Wagon	2002-1998
Ford E-450 Econoline Super Duty	2002
Ford E-450 Super Duty	2003-2002
Ford Econoline Super Duty	1999-1998
Ford Excursion	2003-2000
Ford F-250 - F-450 Super Duty	2003-1999
Ford F-550 Super Duty	2003-2001, 1999



Fuel Injector

FJ593

2C3Z-9VE527-DRM, F2TZ-9E527A

Ford E-350 Econoline	1994-1992
Ford E-350 Econoline Club Wagon	1994-1992
Ford F Super Duty	1994-1992
Ford F-250 - F350	1994-1992
Ford F59	1997-1992

* New



Fuel Injector

FJ595

F4TZ-9VE527AARM, F7TZ-9E527ARM, F81Z-9E527-DRM

Ford E-250 - E-350 Econoline	1998-1995
Ford E-350 Econoline Club Wagon	1998-1995
Ford Econoline Super Duty	1998-1996
Ford F Super Duty	1997-1995
Ford F-250 - F-350	1997-1994
Ford F59	1997-1994

* Remanufactured



FORD (Cont'd)

7.3L POWERSTROKE (Cont'd)

Fuel Injector

FJ595NX

F4TZ-9VE527-AA

Ford E-250 - E-350 Econoline	1998-1995
Ford E-350 Econoline Club Wagon	1998-1995
Ford Econoline Super Duty	1998-1996
Ford F Super Duty	1997-1995
Ford F-250 - F-350	1997-1994
Ford F59	1997-1994
Ford F-250 - F-450 Super Duty	2003-1999

✱ New

✳ Reman numbers for reference only. No new OE part numbers available.



Fuel Injector

FJ596

F61Z-9VE527BRM, F7TZ-9E527BRM, F81Z9E527ARM,
F81Z-9E527BRM

Ford E-250 - E-350 Econoline	1998-1995
Ford E-350 Econoline Club Wagon	1999-1995
Ford E-350 Super Duty	1999
Ford Econoline Super Duty	1999-1996
Ford F Super Duty	1997-1995
Ford F-250 - F-350	1997-1995
Ford F-250 - F-550 Super Duty	1999
Ford F59	1997-1995

✳ Remanufactured



Fuel Injector

FJ596NX

F61Z-9VE527-B

Ford E-250 Econoline	1998-1995
Ford E-350 Econoline	1998-1995
Ford E-350 Econoline Club Wagon	1999-1995
Ford E-350 Super Duty	1999
Ford Econoline Super Duty	1999-1996
Ford F Super Duty	1997-1995
Ford F-250	1997-1995
Ford F-350	1997-1995
Ford F-250 - F-550 Super Duty	1999
Ford F59	1997-1995

✱ New

✳ Reman numbers for reference only. No new OE part numbers available.



FORD (Cont'd)

7.3L POWERSTROKE (Cont'd)

Fuel Injector

FJ738

5C3Z-9VE527-BRM, F81Z-9E527CRM

Ford E-350 Club Wagon	2003
Ford E-350 Econoline Club Wagon	2002-1999
Ford E-350 Super Duty	2003-1999
Ford E-450 Econoline Super Duty	2002-2000
Ford E-450 Super Duty	2003
Ford E-550 Econoline Super Duty	2002
Ford E-550 Super Duty	2003
Ford Econoline Super Duty	1999
Ford Excursion	2003-2000
Ford F-250 - F-550 Super Duty	2003-1999
Ford F650 - F750	2003-2000

* Remanufactured



Fuel Injector

FJ738NX

5C3Z-9VE527-B

Ford E-350 Club Wagon	2003
Ford E-350 Econoline Club Wagon	2002-1999
Ford E-350 Super Duty	2003-1999
Ford E-450 Econoline Super Duty	2002-2000
Ford E-450 Super Duty	2003
Ford E-550 Econoline Super Duty	2002
Ford E-550 Super Duty	2003
Ford Econoline Super Duty	1999
Ford Excursion	2003-2000
Ford F-250 - F-550 Super Duty	2003-1999
Ford F650 - F750	2003-2000

* New

* Reman numbers for reference only. No new OE part numbers available.



FORD (Cont'd)

7.3L POWERSTROKE (Cont'd)

Fuel Injector

FJ926

5C3Z-9VE527-ARM, F61Z-9VE527-ERM, F81Z-9E527-EARM,
XC3Z-9E527AARM

Ford E-350 Club Wagon	2003
Ford E-350 Econoline Club Wagon	2002-1999
Ford E-350 Super Duty	2003-1999
Ford E-450 Econoline Super Duty	2002-2000
Ford E-450 Super Duty	2003
Ford E-550 Econoline Super Duty	2002
Ford E-550 Super Duty	2003
Ford Econoline Super Duty	1999
Ford Excursion	2003-2000
Ford F-250 - F-550 Super Duty	2003-1999
Ford F650 - F750	2003-2000

* Remanufactured



Fuel Injector

FJ926NX

5C3Z-9VE527-A

Ford E-350 Club Wagon	2003
Ford E-350 Econoline Club Wagon	2002-1999
Ford E-350 Super Duty	2003-1999
Ford E-450 Econoline Super Duty	2002-2000
Ford E-450 Super Duty	2003
Ford E-550 Econoline Super Duty	2002
Ford E-550 Super Duty	2003
Ford Econoline Super Duty	1999
Ford Excursion	2003-2000
Ford F-250 - F-550 Super Duty	2003-1999
Ford F650 - F750	2003-2000

* New

* Reman numbers for reference only. No new OE part numbers available.



Fuel Injector

FJ1232

F3TZ-9E527A, F3TZ-9E527B

Ford F Super Duty	1994-1993
Ford F-250 - F-350	1994-1993
Ford F59	1997-1994

* New



FORD (Cont'd)

7.3L POWERSTROKE (Cont'd)

Fuel Injector Driver Module (IDM)

FIDM1

F7TZ-12B559-AC

Ford E-350 Econoline	1998-1995
Ford E-350 Econoline Club Wagon	1998-1995
Ford Econoline Super Duty	1998-1996
Ford F Super Duty	1997-1995
Ford F-250 - F-350	1997-1994
Ford F59	1997-1994



Fuel Injector Driver Module (IDM)

FIDM2

XC3Z-12B559-AA

Ford E-350 Club Wagon	2003
Ford E-350 Econoline Club Wagon	2002-1999
Ford E-350 Super Duty	2003-1999
Ford E-450 Econoline Super Duty	2002-2000
Ford E-450 -E-550 Super Duty	2003
Ford E-550 Econoline Super Duty	2002
Ford Econoline Super Duty	1999
Ford Excursion	2003-2000
Ford F-250 - F-550 Super Duty	2003-1999



Fuel Injector Seal Kit

SK55

F4TZ-9229A, XC3Z9229AA, XC3Z-9229AB

Ford E-350 Club Wagon	2003
Ford E-350 Econoline	1998-1995
Ford E-350 Econoline Club Wagon	2002-1995
Ford E-450 Econoline Super Duty	2002-2000
Ford E-450 - E-550 Super Duty	2003
Ford Econoline Super Duty	1999-1996
Ford Excursion	2003-2000
Ford F Super Duty	1997-1995
Ford F-250 - F-550 Super Duty	2003-1999
Ford F-250 - F-350	1997-1994
Ford F59	1994-1993



FORD (Cont'd)

7.3L POWERSTROKE (Cont'd)

Fuel Pressure Regulator

PR315

F5TZ-9C968A, F81Z-9C968AA, F81Z-9C968AB

Ford E-250 Econoline	1998-1995
Ford E-350 Club Wagon	2003
Ford E-350 Econoline	1998-1995
Ford E-350 Econoline Club Wagon	2002-1995
Ford E-450 Econoline Super Duty	2002-2000
Ford E-450 Super Duty	2003
Ford E-550 Econoline Super Duty	2002
Ford E-550 Super Duty	2003
Ford Econoline Super Duty	1999-1996
Ford Excursion	2003-2000
Ford F Super Duty	1997-1995
Ford F-250 - F-550	1997-1995
Ford F-250 - F-550 Super Duty	2003-1999
Ford F59	1997-1995
Ford F650 - F750	2003-2000



Fuel Pump Strainer

F08001

E5TZ9J306BA

Ford E-350 Econoline	1995-1990
Ford E-350 Super Duty	2008-2004
Ford E-450 - E-550 Econoline Super Duty	2002
Ford Excursion	2003-2000
Ford F-250	1994-1990
Ford F-250 - F-350 Super Duty	2007-1999
Ford F-350	1994-1990



Fuel Transfer Pump

FTP3

F6TZ-9350A, YC3Z-9350-AA, YC3Z-9350-CA

Ford E-150 - E-250 Econoline	1998-1997
Ford E-350 Econoline	1998-1995
Ford E-350 Econoline Club Wagon	1998-1995
Ford Econoline Super Duty	1998-1996
Ford F-250 - F-350	1997-1994



FORD (Cont'd)

7.3L POWERSTROKE (Cont'd)

Fuel Transfer Pump

FTP4

F81Z-9C407-AC

Ford E-150 Econoline	2002-1998
Ford E-150 Econoline Club Wagon	2002-1998
Ford E-250 Econoline	2002, 1999-1998
Ford E-350 Econoline	1998
Ford E-350 Econoline Club Wagon	2002-1998
Ford E-350 Super Duty	2000-1999
Ford E-450 - E-550 Econoline Super Duty	2002-2000
Ford Econoline Super Duty	1999-1998
Ford Excursion	2003-2000
Ford F-250 - F-350 Super Duty	2003-1999



Fuel/Water Separator Sensor

FWSS113

F4TZ-9S281-B

Ford E-350 Econoline	1998-1995
Ford E-350 Econoline Club Wagon	1998-1995
Ford F Super Duty	1997-1995
Ford F-250 - F-350	1997-1994



Fuel/Water Separator Sensor

FWSV102

F81Z-9A153-AA

Ford E-350 Club Wagon	2003
Ford E-350 Econoline	1998
Ford E-350 Econoline Club Wagon	2002-1998
Ford E-350 Super Duty	2003, 1999
Ford E-450 Econoline Super Duty	2002-1999
Ford E-450 Super Duty	2003-2001, 1999
Ford E-550 Econoline Super Duty	2002
Ford E-550 Super Duty	2003
Ford Excursion	2003-2000
Ford F-250 Super Duty, F-350 Super Duty, F-450 Super Duty, F-550 Super Duty	2003-1999



FORD (Cont'd)

7.3L POWERSTROKE (Cont'd)

Glow Plug

GP107

F4TZ-12A342-BA

Ford E-350 Club Wagon	2004-2003
Ford E-350 Econoline	1998-1995
Ford E-350 Econoline Club Wagon	2002-1995
Ford E-350 Super Duty	2003-1999
Ford E-450 Econoline Super Duty	2002-2000
Ford E-450 Super Duty	2003-2001
Ford Econoline Super Duty	1999-1996
Ford Excursion	2003-2000
Ford F Super Duty	1997-1995
Ford F-250 - F-550 Super Duty	2003-1999
Ford F-250 - F-350	1997-1995



Glow Plug

GP109

3C3Z-12A342-AA

Ford E-350 Club Wagon	2004
Ford E-350 - E-450 Super Duty	2004
Ford Excursion	2004-2003
Ford F-250 - F-550 Super Duty	2004-2003



Glow Plug Relay

RY-316

E7TZ-12B533A, E9TZ-12B533A, F0TZ-12B533A, F0TZ-12B533A

Ford E-250 - E-350 Econoline Club Wagon	1989-1987
Ford E-350 Econoline	1989-1987
Ford F Super Duty	1989-1988
Ford F-250 - F-350	1994-1987



Glow Plug Relay

RY-525

F4TZ-12B533A, F81Z-12B533AC

Ford E-350 Econoline	1998-1995
Ford E-350 Econoline Club Wagon	1999-1997
Ford E-450 -E-550 Super Duty	2003
Ford Econoline Super Duty	1999-1997
Ford F Super Duty	1997-1990
Ford F-250 - F-350	1997-1995
Ford F-250 HD	1997
Ford F-250 - F-550 Super Duty	2003-1999



FORD (Cont'd)

7.3L POWERSTROKE (Cont'd)

Glow Plug Relay

RY-553

F7TZ-12B533CA

Ford E-250 - E-350 Econoline Club Wagon	1991-1990
Ford E-350 Econoline	1996-1990
Ford Econoline Super Duty	1996
Ford F Super Duty	1996-1990
Ford F-250	1996-1995
Ford F-350	1996-1994



High Pressure Oil Pump Hose

OPH1

F81 Z-9J323-E

Ford E-350 Club Wagon	2003
Ford E-350 Econoline Club Wagon	2002-1999
Ford E-450 Econoline Super Duty	2002-2000
Ford E-550 Econoline Super Duty	2002
Ford Econoline Super Duty	1999
Ford Excursion	2003-2000
Ford F-250 - F-550 Super Duty	2003-1999



High Pressure Oil Pump Hose

OPH2

YC3Z-9J323-E

Ford E-350 Econoline Club Wagon	2002-1999
Ford E-450 Econoline Super Duty	2002-1999
Ford Econoline Super Duty	1999
Ford Excursion	2003-2000
Ford F-250 - Ford F-550 Super Duty	2003-1999



High Pressure Oil Pump Hose

OPH3

YC3Z-9J323-F

Ford E-350 Club Wagon	2003
Ford E-350 Econoline Club Wagon	2002-2000
Ford E-350 Super Duty	2003
Ford E-450 Econoline Super Duty	2002-2000
Ford E-450 Super Duty	2003-2001
Ford Excursion	2003-2000
Ford F-250 - F-550 Super Duty	2003-2000



FORD (Cont'd)

7.3L POWERSTROKE (Cont'd)

High Pressure Oil Pump Hose

OPH4

F6TZ-95317-A, F6TZ-9S317-A

Ford E-350 Econoline	1997-1995
Ford E-350 Econoline Club Wagon	1997-1995
Ford F Super Duty	1997-1995
Ford F-250 - F-350	1997-1994
Ford F59	1997-1995



High Pressure Oil Pump Seal Kit

SK108

2C3Z-9G804-AA, 2C3Z-9G804-AB

Ford E-350 Club Wagon	2003
Ford E-350 Econoline	1998-1994
Ford E-350 Econoline Club Wagon	2002-1994
Ford E-450 Econoline Super Duty	2002-2000
Ford E-450 - E-550 Super Duty	2003
Ford E-550 Econoline Super Duty	2002
Ford Econoline Super Duty	1999-1996
Ford Excursion	2003-2000
Ford F Super Duty	1997-1994
Ford F-250 - F-350	1997-1994
Ford F-250 - F-550 Super Duty	2003-1999



Injection High Pressure Oil Pump

HPI1

F6TZ-9A543-AA, F6TZ-9A543-ARM, F6TZ-9VA543-ARM

Ford E-350 Econoline	1997-1996
Ford E-350 Econoline Club Wagon	1997-1996
Ford Econoline Super Duty	1997-1996
Ford F Super Duty	1997-1996
Ford F-250 - F-350	1997-1996
Ford F59	1997-1996

* Remanufactured



FORD (Cont'd)

7.3L POWERSTROKE (Cont'd)

Injection High Pressure Oil Pump

HPI2

F81Z-9A543-CRM

Ford E-350 Club Wagon	2003
Ford E-350 Econoline Club Wagon	2002-1999
Ford E-350 Super Duty	2003-1999
Ford E-450 Econoline Super Duty	2002-2000
Ford E-450 - E-550 Super Duty	2003
Ford E-550 Econoline Super Duty	2002
Ford Econoline Super Duty	1999
Ford Excursion	2003-2000
Ford F-250 - F-550 Super Duty	2003-1999
Ford F650 - F750	2003-2000

* Remanufactured



Injection High Pressure Oil Pump

HPI3

5C3Z-9VA543-BRM, F81Z-9A543-AA, F81Z-9A543-BRM

Ford E-350 Econoline	1998
Ford E-350 Econoline Club Wagon	1998
Ford Econoline Super Duty	1998
Ford F-250 - Ford F-550 Super Duty	1999

* Remanufactured



Injection High Pressure Oil Pump

HPI4

F4TZ-9A543-B, F4TZ-9A543-BRM, F4TZ-9VA543-AARM

Ford E-350 Econoline	1995
Ford E-350 Econoline Club Wagon	1995
Ford F Super Duty	1995
Ford F-250 - F-350	1995-1994
Ford F59	1995-1994

* Remanufactured



Oil Cooler Gasket Kit

OCG2

1C3Z6C610BA, 1C3Z-6K649-BA, F4TZ-6A636-A, F7TZ-6A636-AAA

Ford Excursion	2003-2000
Ford F-250 - F-350	1997-1994
Ford F-250 - F-550 Super Duty	2003-1999



FORD (Cont'd)

7.3L POWERSTROKE (Cont'd)

Oil Cooler Kit

OCK2

1C3Z-6A642-AA

Ford E-350 Econoline	1998-1995
Ford E-350 Econoline Club Wagon	2002-1995
Ford E-450 Econoline Super Duty	2001-2000
Ford E-550 Econoline Super Duty	2002
Ford Econoline Super Duty	1999-1996
Ford Excursion	2003-2000
Ford F-250	1996-1994
Ford F-250 - F-550 Super Duty	2003-1999
Ford F-350	1997-1994

* New



Turbocharger

TBC535

F3TZ6K682A, F3TZ6K682AAAMR, F4TZ 6VK682-BARM,
F4TZ6VK682AARM

Ford F Super Duty	1994
Ford F-250 - F-350	1994-1993

* Remanufactured



Turbocharger

TBC548

5C3Z 6V682-BRM, F8UZ6K682AARM

Ford E-350 Econoline	1998
Ford E-350 Econoline Club Wagon	1999-1998
Ford Econoline Super Duty	1999-1998

* Remanufactured



FORD (Cont'd)

7.3L POWERSTROKE (Cont'd)

Turbocharger

TBC549

5C3Z 6V682-ARM, F81Z6K682AARM

Ford F-250 - F-550 Super Duty 1999

* Remanufactured



Turbocharger

TBC566

F4TZ 6VK682-CARM, F4TZ6K682BRM, F6TZ6K682ARM

Ford E-350 Econoline 1998-1995

Ford E-350 Econoline Club Wagon 1998-1995

Ford Econoline Super Duty 1998-1996

Ford F Super Duty 1997-1995

Ford F-250 - F-350 1997-1994

* Remanufactured



Turbocharger

TBC592

YC3Z-6K682-AARM

Ford F650 - F750 2003-2000

* Remanufactured



Turbocharger

TBC-513

F81Z-6K682-BARM

Ford Excursion 2003-2000

Ford F-250 - F-550 Super Duty 2003-1999

* Remanufactured



FORD (Cont'd)

7.3L POWERSTROKE (Cont'd)

Turbocharger

TBC-515

XC2Z-6K682-AARM

Ford E-350 Club Wagon	2003
Ford E-350 Econoline	2000
Ford E-350 Econoline Club Wagon	2002-1999
Ford E-350 Super Duty	2003-1999
Ford E-450 Econoline Super Duty	2002-2000
Ford E-450 Super Duty	2003
Ford E-550 Econoline Super Duty	2002
Ford E-550 Super Duty	2003

* Remanufactured



Vacuum Pump

VCP112

4C3Z 2A451 BA

Ford E-450 Econoline Super Duty	2002-2000
Ford E-550 Econoline Super Duty	2002
Ford E-550 Super Duty	2003
Ford Excursion	2003-2000
Ford F-250 - F-550 Super Duty	2003-1999



Valve Cover Gasket

VCG4

F81Z-6584-AA-G

Ford E-350 Econoline	1998
Ford E-350 Econoline Club Wagon	2002-1998
Ford E-450 Econoline Super Duty	2002
Ford E-450 Super Duty	2003-2002
Ford Econoline Super Duty	1999-1998
Ford Excursion	2003-2000
Ford F-250 - F-550 Super Duty	2003-1999



Valve Cover Gasket

VCG6

F4TZ-6584-A

Ford E-350 Econoline	1997-1995
Ford E-350 Econoline Club Wagon	1997-1995
Ford Econoline Super Duty	1997-1996
Ford F Super Duty	1997-1994
Ford F-250 - F-350	1997-1994
Ford F59	1997-1994

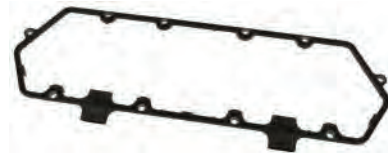

FORD (Cont'd)

6.0L POWERSTROKE

Diesel EGR Cooler Kit

ECK1

4C3Z-9P456-AC, 4C3Z-9P456-AF, 4C3Z-9P456-AH,
4C3Z-9P456-AJ

Ford E-350 Club Wagon	2005-2004
Ford E-350 - E-450 Super Duty	2010-2004
Ford Excursion	2005-2004
Ford F-250 - F-550 Super Duty	2007-2004
Ford F650 - F750	2007-2004



Diesel EGR Cooler Kit

ECK12

3C3Z9P456A, 3C3Z9P456AA, 3C3Z9P456AC, 3C3Z-9P456-AE,
3C3Z-9P456-B

Ford Excursion	2004-2003
Ford F-250 - F-550 Super Duty	2004-2003
Ford F650 - F750	2004



Diesel Rail Seal Kit

SK145

Ford F-250 Super Duty	2007-2003
Ford F-350 Super Duty	2007-2003
Ford F-450 Super Duty	2007-2003
Ford F-550 Super Duty	2007-2003
No OE Reference	



Drain Tube

L17001

6C3Z-9T515-A

Ford E-350 Club Wagon	2005-2004
Ford E-350 Super Duty	2010-2005
Ford E-450 Super Duty	2007-2004
Ford F-250 - F-550 Super Duty	2007-2003
Ford F650 - F750	2007-2005



FORD (Cont'd)

6.0L POWERSTROKE (Cont'd)

EGR Valve

EGV1031

5C3Z-9F452-AA, 5C3Z9F452ARM

Ford E-350 Club Wagon	2005
Ford E-350 - E-450 Super Duty	2010-2005
Ford Excursion	2005
Ford F-250 - F-550 Super Duty	2007-2005



EGR Valve

EGV1034

3C3Z9F452AB, 3C3Z9F452AC, 4C3Z-9F452-A, 4C3Z9F452ARM

Ford E-350 Club Wagon	2004
Ford E-350 - E-450 Super Duty	2004
Ford Excursion	2004-2003
Ford F-250 - F-550 Super Duty	2004-2003



EGR Valve

EGV1249

5C4Z-9F452-AA

Ford F650 - F750	2007-2004
------------------	-----------



FORD (Cont'd)

6.0L POWERSTROKE (Cont'd)

Fuel Injection Harness

IFH2

3C3Z-9D930-AA

Ford Excursion	2003
Ford F-250 - F-550 Super Duty	2003



Fuel Injection Harness

IFH3

4C3Z-9D930-AA

Ford Excursion	2004
Ford F-250 - F-550 Super Duty	2004
Ford F650 - F750	2004



Fuel Injection Harness

IFH4

5C3Z-9D930-A

Ford Excursion	2005
Ford F-250 - F-550 Super Duty	2007-2005
Ford F650 - F750	2008-2005



Fuel Injector

FJ927

3C3Z-9E527AE, 3C3Z-9E527-EBRM, 3C3Z-9E527-ECRM

Ford Excursion	2004-2003
Ford F-250 - F-550 Super Duty	2004-2003
Ford F650 - F750	2004

* Remanufactured



FORD (Cont'd)

6.0L POWERSTROKE (Cont'd)

Fuel Injector

FJ927NX

3C3Z-9E527AE, 3C3Z-9E527-EBRM, 3C3Z-9E527-ECRM

Ford Excursion 2004-2003
Ford F-250 - F-550 Super Duty 2004-2003
Ford F650 - F750 2004

* New

* Reman numbers for reference only. No new OE part numbers available.



Fuel Injector

FJ928

4C3Z-9E527AA, 4C3Z-9E527-BRM, 5C4Z-9E527-A, CN5019RM

Ford E-350 Club Wagon 2005-2004
Ford E-350 - E-450 Super Duty 2010-2004
Ford Excursion 2005-2004
Ford F-250 - F-550 Super Duty 2007-2004
Ford F650 - F750 2008-2004

* Remanufactured



Fuel Injector

FJ928NX

4C3Z-9E527AA, 4C3Z-9E527-BRM, 5C4Z-9E527-A, CN5019RM

Ford E-350 Club Wagon 2005-2004
Ford E-350 - E-450 Super Duty 2010-2004
Ford Excursion 2005-2004
Ford F-250 - F-550 Super Duty 2007-2004
Ford F650 - F750 2008-2004

* New

* Reman numbers for reference only. No new OE part numbers available.



Fuel Injector

FJ9288PCK

4C3Z9E527AA, 4C3Z9E527BRM, 5C4Z9E527A, CN5019RM,
5010120R92, 1844751C2, 1845150C92, 1846692C92,
1878285C91, 1879998C91, 1877748C1, 1878285C91

Ford E-350 - E-450 Super Duty 2010-2004
Ford E-350 Club Wagon, Excursion 2005-2004
Ford F-250 - F-550 Super Duty 2007-2004

* Remanufactured



FORD (Cont'd)

6.0L POWERSTROKE (Cont'd)

Fuel Injector Control Module (FICM)

FICM1

4C3Z-12B599-CRM

Ford Excursion 2004-2003

Ford F-250 - F-550 Super Duty 2004-2003



Fuel Injector Control Module (FICM)

FICM2

4C3Z-12B599-DRM

Ford Excursion 2005-2004

Ford F-250 - F-550 Super Duty 2004



Fuel Injector Control Module (FICM)

FICM3

4C3Z-12B599-ERM

Ford E-350 Club Wagon 2005-2004

Ford E-350 - E-450 Super Duty 2010-2004

Ford Excursion 2005

Ford F-250 - F-550 Super Duty 2007-2005



Fuel Injector Seal Kit

SK85

3C3Z-9229-AA

Ford E-350 Club Wagon 2005-2004

Ford E-350 Super Duty 2010-2004

Ford E-450 Super Duty 2010, 2007-2004

Ford Excursion 2005-2003

Ford F-250 - F-550 Super Duty 2007-2003

Ford F650 - F750 2007-2004



FORD (Cont'd)

6.0L POWERSTROKE (Cont'd)

Fuel Injector Sleeve

IFS1

3C3Z-9F538-AA

Ford E-350 - E-450 Super Duty	2004
Ford Excursion	2005-2003
Ford F-250 - F-550 Super Duty	2007-2003



Fuel/Water Separator Sensor

FWSS114

6C3Z-9C264-A

Ford E-350 Club Wagon	2005-2004
Ford E-350 Super Duty	2010-2004
Ford E-450 Super Duty	2010, 2008-2004
Ford Excursion	2005-2003
Ford F-250 - F-550 Super Duty	2007-2003



Glow Plug

GP113

4C3Z-12A342-AA

Ford E-350 Club Wagon	2005-2004
Ford E-350 - E-450 Super Duty	2010-2004
Ford Excursion	2005-2004
Ford F-250 - F-550 Super Duty	2007-2004



Glow Plug Wiring Harness

GPH101

4C3Z-12A690-AA

Ford Excursion	2004
Ford F-250 - F-550 Super Duty	2004



FORD (Cont'd)

6.0L POWERSTROKE (Cont'd)

Glow Plug Wiring Harness

GPH102

4C3Z-12A690-BA

Ford Excursion 2004

Ford F-250 - F-550 Super Duty 2004



Glow Plug Wiring Harness

GPH103

4C2Z-12A690-AB

Ford E-350 Club Wagon 2005-2004

Ford E-350 Super Duty 2010-2004

Ford E-450 Super Duty 2010, 2008-2004

Ford Excursion 2005-2004

Ford F-250 - F-550 Super Duty 2007-2004



Glow Plug Wiring Harness

GPH104

5C3Z-12A690-A

Ford Excursion 2005

Ford F-250 - F-550 Super Duty 2007-2005



Glow Plug Wiring Harness

GPH105

3C3Z-12A690-AA

Ford Excursion 2004-2003

Ford F-250 - F-550 Super Duty 2004-2003



Glow Plug Wiring Harness

GPH106

3C3Z-12A690-BA

Ford Excursion 2004-2003

Ford F-250 - F-550 Super Duty 2004-2003



FORD (Cont'd)

6.0L POWERSTROKE (Cont'd)

Glow Plug Wiring Harness

GPH107

4C2Z-12A690-BA

Ford E-350 Club Wagon	2005-2004
Ford E-350 Super Duty	2010-2004
Ford E-450 Super Duty	2010, 2008-2004
Ford Excursion	2004
Ford F-250 -F-550 Super Duty	2004



High Pressure Oil Pump Seal Kit

SK125

3C3Z-9G804-AA

Ford E-350 Club Wagon	2004
Ford E-350 Super Duty	2004
Ford Excursion	2004-2003
Ford F-250 F-550 Super Duty	2004-2003
Ford F650 - F-750	2004-2003



High Pressure Oil Pump Seal Kit

SK142

4C3Z-9B246-F

Ford E-350 Club Wagon	2005
Ford E-350 E-450 Super Duty	2010-2005
Ford Excursion	2005
Ford F-250 - F-550 Super Duty	2007-2005

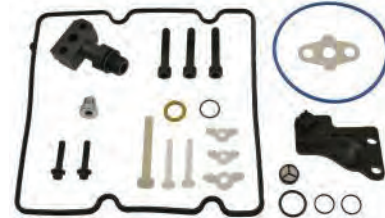

High Pressure Oil Rail Ball Installation Tool

DTL1

Ford E-350 Super Duty	2010-2004
Ford E-450 Super Duty	2010, 2008-2004
Ford Excursion	2005-2004
Ford F-250 Super Duty	2007-2004
Ford F-350 Super Duty	2007-2003
Ford F-450 Super Duty	2006-2004
Ford F-550 Super Duty	2007-2004
Ford F-650	2006-2004
Ford F-750	2006-2005

No OE Reference



FORD (Cont'd)

6.0L POWERSTROKE (Cont'd)

High Pressure Oil Rail Ball Tube

DBT1

Ford E-350 -E-450 Super Duty	2010-2004
Ford Excursion	2005-2004
Ford F-250 - F-550 Super Duty	2007-2004
No OE Reference	



Horizontal Fuel Conditioning Module

Z76002

6C3Z-9G282-C	
Ford Excursion	2005-2003
Ford F-250 - F-550 Super Duty	2007-2003



Injection Control Pressure Sensor

ICP101

4C3Z-9F838-A, 4C3Z-9F838-AA, 4C3Z-9F838-AB	
Ford E-250	2006-2005
Ford E-350 Club Wagon	2005-2004
Ford E-350 Super Duty	2010-2004
Ford E-450 Super Duty	2010-2004
Ford Excursion	2005-2004
Ford F-250 - F-550 Super Duty	2007-2004
Ford F650 - F750	2008-2004
Ford LCF	2010-2006



FORD (Cont'd)

6.0L POWERSTROKE (Cont'd)

Injection Control Pressure Sensor

ICP102

F6TZ-9F838-A

Ford E-250 - E-350 Econoline	1998-1997
Ford E-350 Club Wagon	2003
Ford E-350 Econoline Club Wagon	2002-1997
Ford E-450 Econoline Super Duty	2002-2000
Ford E-450 Super Duty	2003
Ford E-550 Econoline Super Duty	2002
Ford E-550 Super Duty	2003
Ford Econoline Super Duty	1999-1997
Ford Excursion	2003-2000
Ford F Super Duty	1997
Ford F-250 - F-550 Super Duty	2003-1999
Ford F-350	1997
Ford F650	2003-2000
Ford F750	2003-2000



Injection Control Pressure Sensor

ICP103

3C3Z-9F838-AA, 3C3Z-9F838-DA, 3C3Z-9F838-EA

Ford Excursion	2004-2003
Ford F-250 - F-550 Super Duty	2004-2003
Ford F650 - F750	2004
Ford E-450 Econoline Super Duty	2002-2000



Injection High Pressure Oil Pump

HPI6

3C3Z-9A543-AARM

Ford E-350 Club Wagon	2004
Ford Excursion	2004-2003
Ford F-250 - F-550 Super Duty	2004-2003
Ford F650 - F750	2004-2003

* Remanufactured



Injection High Pressure Oil Pump

HPI7

4C3Z-9H307-A, 5C4Z-9A543-A, 5C4Z-9A543-AA, 5C4Z-9A543-B, 5C4Z-9A543-C

Ford E-350 Club Wagon	2005
Ford E-350 Super Duty	2010-2005
Ford E-450 Super Duty	2010, 2008-2005
Ford Excursion	2005
Ford F-250 - F-550 Super Duty	2007-2005

* Remanufactured



FORD (Cont'd)

6.0L POWERSTROKE (Cont'd)

Oil Cooler Gasket Kit

OCG1

3C3Z-6A642-CAGK

Ford E-350 Club Wagon	2005-2004
Ford E-350 - E-450 Super Duty	2010-2004
Ford Excursion	2005-2003
Ford F-250 - F-550 Super Duty	2007-2003
Ford F650 - F750	2008-2004

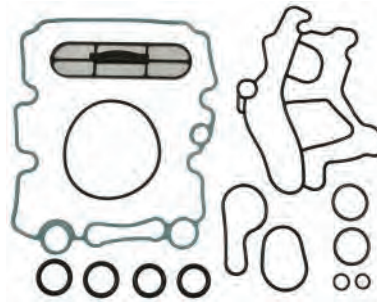

Oil Cooler Kit

OCK1

3C3Z-6A642-CA

Ford E-350 Club Wagon	2005-2004
Ford E-350 -E-450 Super Duty	2010-2004
Ford Excursion	2005-2003
Ford F-250 - F-550 Super Duty	2007-2003
Ford F650 - F750	2008-2004

* New

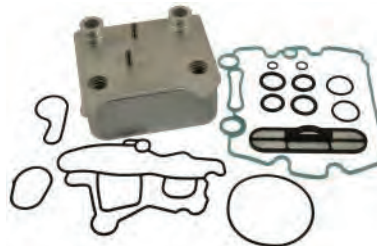

Turbo Boost Solenoid

R75002

3C3Z-6F089-AA, 5C3Z-6F089-A, 5C3Z-6F089-BA

Ford E-350 Super Duty	2010-2004
Ford F-250 - F-550 Super Duty	2007-2003



Turbocharger

TBC522

3C3Z-6K682-CBRM-N

Ford Excursion	2004-2003
Ford F-250 - F-550 Super Duty	2004-2003

* New

* Reman numbers for reference only. No new OE part numbers available.



FORD (Cont'd)

6.0L POWERSTROKE (Cont'd)

Turbocharger

TBC524

4C3Z-6K682-CCRM-N

Ford E-350 Club Wagon 2004

Ford E-350 - E-450 Super Duty 2004

Ford Excursion 2004

Ford F-250 - F-550 Super Duty 2005-2004

* New

* Reman numbers for reference only. No new OE part numbers available.



Turbocharger

TBC593

5C4Z-6K682-BRM

Ford F650 - F750 2007-2005

* New



Turbocharger

TBC594

4C4Z-6K682-ARM

Ford F650 - F750 2004-2003

* New



Turbocharger

TBC-511

3C3Z 6K682-CCRM, 3C3Z-6K682-AARM, 3C3Z-6K682-BARM,
3C3Z-6K682-CBRM, 3C3Z-9T428-AA

Ford Excursion 2004-2003

Ford F-250 - F-550 Super Duty 2004-2003

* Remanufactured



FORD (Cont'd)

6.0L POWERSTROKE (Cont'd)

Turbocharger

TBC-512

5C3Z 6K682-CCRM, 5C3Z-6K682-A, 5C3Z-6K682-AA,
5C3Z-6K682-BA, 5C3Z-6K682-BARM, 5C3Z-6K682-CA,
5C3Z-6K682-CARM, 5C3Z-6K682-DA, 5C3Z-9T428-AA,
5C3Z-9T428-CARM

Ford E-350 Club Wagon 2005
Ford E-350 - E-450 Super Duty 2010-2005
Ford Excursion 2005
Ford F-250 - F-550 Super Duty 2007-2005

* Remanufactured



Turbocharger

TBC-514

4C3Z 6K682-CDRM, 4C3Z-6K682-A, 4C3Z-6K682-AARM,
4C3Z-6K682-ARM, 4C3Z-6K682-BA, 4C3Z-6K682-CBRM,
4C3Z-6K682-CCRM, 4C3Z-9T428-CBRM

Ford E-350 Club Wagon 2004
Ford E-350 - E-450 Super Duty 2004
Ford Excursion 2004
Ford F-250 -F-550 Super Duty 2005-2004

* Remanufactured



Turbocharger

TBC-523

5C3Z-6K682-CARM-N

Ford E-350 Club Wagon 2005
Ford E-350 - E-450 Super Duty 2010-2005
Ford Excursion 2005
Ford F-250 - F-550 Super Duty 2007-2005

* New

* Reman numbers for reference only. No new OE part numbers available.



Turbocharger Hose

TIH1

6C3Z-6C640-C

Ford Excursion 2004-2003
Ford F-250 -F-550 Super Duty 2004-2003



FORD (Cont'd)

6.0L POWERSTROKE (Cont'd)

Turbocharger Hose

TIH2

6C3Z-6C640-A

Ford Excursion	2005-2004
Ford F-250 - F350 Super Duty	2007-2004
Ford F-450 - F-550 Super Duty	2005-2004



Vacuum Pump

VCP112

6C3Z2A451A

Ford E-350 Super Duty	2007-2004
Ford E-450 Super Duty	2007-2003
Ford Excursion	2005-2003
Ford F-250 - F-550 Super Duty	2007-2003



Vacuum Pump

VCP119

AC2Z2A451A

Ford E-350 Club Wagon	2005-2004
Ford E-350 - E-450 Super Duty	2010-2004



Vacuum Pump

VCP120

F6TZ-2A451-AA

Ford E-350 Club Wagon	2003
Ford E-350 Econoline	1998-1996
Ford E-350 Econoline Club Wagon	2002-1996
Ford E-450 Econoline Super Duty	2002-2000
Ford E-450 Super Duty	2003
Ford E-550 Econoline Super Duty	2002
Ford Econoline Super Duty	1999-1996



FORD (Cont'd)

6.0L POWERSTROKE (Cont'd)

Vertical Fuel Conditioning Module

Z76003

9C2Z-9G282-A

Ford E-350 Super Duty 2010-2004



4.5L POWERSTROKE

Fuel Injector

FJ928

4C3Z-9E527AA, 4C3Z-9E527-BRM, 5C4Z-9E527-A, CN5019RM

Ford LCF 2010-2006

* Remanufactured



Fuel Injector

FJ928NX

4C3Z-9E527AA, 4C3Z-9E527-BRM, 5C4Z-9E527-A, CN5019RM

Ford LCF 2010-2006

* New

* Reman numbers for reference only. No new OE part numbers available.



Fuel Injector Seal Kit

SK85

3C3Z-9229-AA

Ford LCF 2010-2006



High Pressure Oil Rail Ball Installation Tool

DTL1

Ford LCF 2010-2006

No OE Reference



FORD (Cont'd)

4.5L POWERSTROKE (Cont'd)

High Pressure Oil Rail Ball Tube

DBT1

Ford LCF 2010-2006
No OE Reference



Injection High Pressure Oil Pump

HPI11

8E7Z-9A543-AA, 8E7Z-9A543-B, 8E7Z-9A543-CRM
Ford LCF 2010-2008
* Remanufactured



Injection High Pressure Oil Pump

HPI16

6E7Z-9A543-A, 6E7Z-9A543-AA, 6E7Z-9A543-B,
6E7Z-9A543-BRM
Ford LCF 2007-2006
* Remanufactured



Oil Cooler Gasket Kit

OCG1

3C3Z-6A642-CAGK
Ford LCF 2010-2006

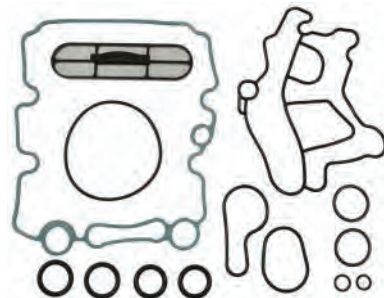

Oil Cooler Kit

OCK1

3C3Z-6A642-CA
Ford LCF 2010-2006
* New

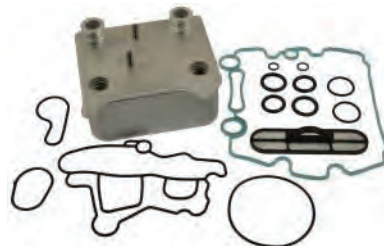

FORD (Cont'd)

6.4L POWERSTROKE

Diesel EGR Cooler Kit

ECK7

8C3Z9P456C, 8C3Z9P456A, 8C3Z9F464A, 8C3Z9P464E,
8C3Z9P45BA

Ford F-250 - F-550 Super Duty 2010-2008



Diesel EGR Cooler Kit

ECK8

8C3Z9F464B, 8C3Z9F464D, 8C3Z9F464F, 8C3Z9F464E,
1876888C91

Ford F-250 - F-550 Super Duty 2010-2008



Diesel Injection Pump Installation Kit

IPK1

Ford F-250 - F-550 Super Duty 2010-2008

No OE Reference



EGR Valve

EGV1151

8C3Z 9D475 B, 8C3Z 9D475-D, 8C3Z-9D475-C, 9C3Z 9D475-A

Ford F-250 - F-550 Super Duty 2010-2008



Fuel Injection Harness

IFH8

8C3Z-9D930-AA

Ford F-250 - F-550 Super Duty 2010-2008



FORD (Cont'd)

6.4L POWERSTROKE (Cont'd)

Fuel Injection Harness

IFH9

8C3Z-9D930-BA

Ford F-250 - F-550 Super Duty 2010-2008



Fuel Injector

FJ960

8C3Z-9E527-A, 8C3Z-9E527-DRM

Ford F-250 - F-550 Super Duty 2010-2008

* Remanufactured



Fuel Injector

FJ960NX

8C3Z-9E527-A, 8C3Z-9E527-DRM

Ford F-250 - F-550 Super Duty 2010-2008

* New

* Reman numbers for reference only. No new OE part numbers available.



Diesel Fuel Injector Installation Kit

SK64

8C3Z-9229-A

Ford F-250 - F-550 Super Duty 2010-2008



Fuel Transfer Pump

FTP6

8C3Z-9G282-A

Ford F-250 - F-550 Super Duty 2010-2008



FORD (Cont'd)

6.4L POWERSTROKE (Cont'd)

Injection Pump

IP30

8C3Z-9A543-B, 8C3Z9A543DRM

Ford F-250 - F-550 Super Duty 2010-2008

* Remanufactured



Turbocharger

TBC559

8C3Z 6K682-A, 8C3Z 6K682-AARM

Ford F-250 - F-550 Super Duty 2010-2008

* Remanufactured



Turbocharger

TBC576

8C3Z-6K682-CRM

Ford F-250 - F-550 Super Duty 2010-2008

* Remanufactured



6.7L POWERSTROKE

Charge Air Cooler

CAC1

BC3Z6K775B

Ford F-250 - F-550 Super Duty 2016-2011



Diesel EGR Cooler Kit

ECK13

BC3Z9V425A, HC3Z9V425A

Ford F-250 - F-550 Super Duty 2016-2011



FORD (Cont'd)

6.7L POWERSTROKE (Cont'd)

Diesel Emissions Fluid Pump

DFIP3

HC3Z5J229B

Ford F-250 - F-550 Super Duty 2019-2017



Diesel Oil Cooler Kit

OCK6

BC3Z6A642A, BC3Z6A642B, HC3Z6A642A

Ford F-250 - F-550 Super Duty 2019-2011

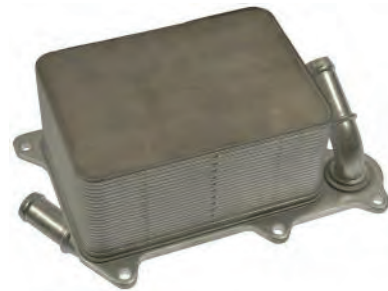

Diesel Pump Supply Line

IPL1

BC3Z-9J280-A, BC3Z-9J280-B, EC3Z-9J280-A

Ford F-250 -F550 Super Duty 2014-2011



EGR Valve

EGV1238

BC3Z9D475B, BC3Z-9D475D, BC3Z-9D475E

Ford F-250 - F-450 Super Duty 2016-2011



FORD (Cont'd)

6.7L POWERSTROKE (Cont'd)

EGR Valve

EGV1239

BC3Z9D475A, BC3Z-9D475C, BC3Z-9D475F, BC3Z9D475H

Ford F-350 - F-450 Super Duty 2015-2011

Ford F-550 Super Duty 2016, 2014-2011



Emission Fluid Injection Nozzle

DFI1

AL3Z-5J281-A

Ford F-250 - F-350 Super Duty 2015-2011

Ford F-450 Super Duty 2015-2013, 2011

Ford F-550 Super Duty 2015-2011



Emissions Fluid Pump

DFIP1

BC3Z-5J229-L

Ford F-250 -F550 Super Duty 2014-2011



Engine Oil Separator

EOS3

GC4Z6A785D

Ford F-250 - F-550 Super Duty 2019-2017



FORD (Cont'd)

6.7L POWERSTROKE (Cont'd)

Fuel Injector

FJ1221

BC3Z9H529B
Ford F-250 - F-550 Super Duty 2014-2011
* Remanufactured



Fuel Injector

FJ1222

BC3Z9H529A
Ford F-250 - F-550 Super Duty 2014-2011
* Remanufactured



Fuel Injector

FJ1223

FC3Z-9H529-B
Ford F-250 - F-550 Super Duty 2016-2015
* Remanufactured



Fuel Injector

FJ1224

FC3Z-9H529-A
Ford F-250 - F-550 Super Duty 2016-2015
* Remanufactured



Fuel Injector

FJ9288PCK

4C3Z9E527AA, 4C3Z9E527BRM, 5C4Z9E527A, CN5019RM,
5010120R92, 1844751C2, 1845150C92, 1846692C92,
1878285C91, 1879998C91, 1877748C1, 1878285C91
Ford F-650, F-750 2008-2004
* Remanufactured



Fuel Injector Rail

FIR1

BC3Z-9D280-A
Ford F-250 - F550 Super Duty 2016-2011



FORD (Cont'd)

6.7L POWERSTROKE (Cont'd)

Fuel Injector Rail

FIR2

BC3Z-9D280-B

Ford F-250 - F550 Super Duty 2016-2011



Fuel Injector Return Hose

RTL1

BC3Z-9A564-A, BC3Z-9A564-B

Ford F-250 - F550 Super Duty 2016-2011



Diesel Fuel Injector Installation Kit

SK138

BC3Z-9229-A

Ford F-250 - F-550 Super Duty 2015-2011



Diesel Fuel Injector Installation Kit

SK139

BC3Z-9229-B

Ford F-250 - F-550 Super Duty 2015-2011



Fuel Rail Supply Line

IRL1

BC3Z-9E964-A

Ford F-250 - F-550 Super Duty 2016-2011



FORD (Cont'd)

6.7L POWERSTROKE (Cont'd)

Fuel Transfer Pump

FTP7

BC3Z-9G282-A, BC3Z-9G282-B, BC3Z-9G282-C, BC3Z-9G282-E
Ford F-250 - F-550 Super Duty 2015-2011



Fuel Transfer Pump

FTP8

FC4Z-9G282-A
Ford F-250 - F-550 Super Duty 2016



Injection Pump

IP37

BC3Z-9A543-A
Ford F-250 - F-550 Super Duty 2014-2011
* Remanufactured



Injection Pump Supply Line

IPL2

FC3Z-9J280-A
Ford F-250 - F-550 Super Duty 2016-2015



FORD (Cont'd)

3.2L POWERSTROKE

Emission Fluid Injection Nozzle

DFI1

AL3Z-5J281-A

Ford Transit-150 - 350 2015

Ford Transit-350 HD 2015



Emissions Fluid Pump

DFIP1

BC3Z-5J229-L

Ford Transit-150 - 350 2016

Ford Transit-350 HD 2015



Fuel Injector

FJ1225NX

CK4Z-9E527-A

Ford Transit-150 - 350 2016-2015

Ford Transit-350 HD 2016-2015

* New



3.0L POWERSTROKE

Diesel Emissions Fluid Pump

DFIP3

HC3Z5J229B

Ford F-150 2019-2018



Diesel Injector Install Kit

SK54

Chevrolet Blazer 1991-1987
 Chevrolet C10 - C30, C10 - C20, K10 - K20 Suburban, K10 K30, K5
 Blazer 1986-1982
 No OE Reference

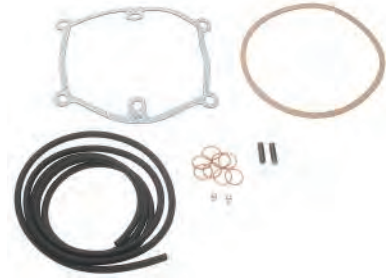

Fuel Injector

FJ171

14059057

Chevrolet Blazer, G20 - G30 1991-1987
 Chevrolet C10, C10 Suburban 1986-1983
 C20 - C30, C20 Suburban, K5 Blazer, K10 - K30, K10 - K20
 Suburban
 Chevrolet C1500 - C3500, K1500 - K3500 1991-1988
 Chevrolet P20 1989-1987
 Chevrolet P30 1990-1987
 Chevrolet R10, V10 - V30 1987
 Chevrolet R10 - R20 Suburban, R20 - R30, V10 - V20
 Suburban 1988-1987
 Chevrolet R1500 - R2500 Suburban, V1500 - V2500
 Suburban 1991-1989
 Chevrolet R2500 1989
 GMC C1500 - C3500 1991-1988, 1986-1983
 GMC C1500 - C2500 Suburban 1986-1983
 GMC G2500 - G3500, R1500 - R3500 Suburban, V1500 - V2500
 Suburban 1991-1987
 Jimmy 1991-1983
 GMC K1500 - K3500 1991-1988, 1986-1983
 GMC K1500 - K2500 Suburban 1986-1983
 GMC P2500 - P3500, R2500 1989-1987
 GMC R1500, V1500 - V3500 1987



* New

GM (Cont'd)

6.2L (Cont'd)

Fuel Injector

FJ172

14045021

Chevrolet C10 -C30	1982
Chevrolet C10 - C20 Suburban	1982
Chevrolet K10 - K30	1982
Chevrolet K10 - K20 Suburban	1982
Chevrolet K5 Blazer	1982
GMC C1500 - C3500	1982
GMC C1500 - C2500 Suburban	1982
GMC Jimmy	1982
GMC K1500 -K3500	1982
GMC K1500 - K2500 Suburban	1982

* New



Fuel Injector

FJ251

14063606

Chevrolet Blazer	1991-1987
Chevrolet C1500 β C3500, K1500 β K3500	1991-1988
Chevrolet G20 β G30	1991-1983
Chevrolet P20 β P30	1989-1982
Chevrolet R10, V10 β V20	1987
Chevrolet R10 β R20 Suburban, R20 β R30, V10 β V20 Suburban, V30	1988-1987
Chevrolet R1500 - 2500 Suburban, R3500, V1500 β V2500 Suburban, V3500	1991-1989
Chevrolet R2500	1989
GMC C1500, C2500, C3500, K1500, K2500, K3500 ...	1991-1988
GMC G2500, G3500	1991-1983
GMC Jimmy, R1500 Suburban, R2500, R2500 Suburban, R3500, V1500 Suburban, V2500 Suburban, V3500	1991-1987
GMC P2500 β P3500	1989-1982
GMC R1500, V1500 β V2500	1987
GMC R2500	1989-1987

* Remanufactured



GM (Cont'd)

6.2L (Cont'd)

Fuel/Water Separator Sensor

FWSS103

15546658

Chevrolet Blazer	1991-1987
Chevrolet C10 - C30, C10 - C20 Suburban, K10 - K30, K10 - K20 Suburban, K5 Blazer	1986-1985
Chevrolet C1500 - C3500, K1500 - K3500	1993-1988
Chevrolet G20 - G30, P30	1993-1985
Chevrolet P20	1989-1985
Chevrolet R10, V10 - V20, 1988 - 1987 Chevrolet R10, R20, V10, V20 Suburban, R20 - R30, V30	1987
Chevrolet R1500, R2500, 1500, V2500 Suburban, R3500, V3500	1991-1989
Chevrolet R2500	1989
GMC C1500 - C3500, K1500 - K3500	1993-1988, 1986-1985
GMC C1500 - C2500, K1500 - K2500 Suburban	1986-1985
GMC G2500 - G3500, P3500	1993-1985
GMC Jimmy	1991-1985
GMC P2500	1989-1985
GMC R1500, V1500 - V2500	1987
GMC R1500 - R2500, V1500 - V2500 Suburban	1991-1987
GMC R3500, V3500	1991-1987
GMC R2500	1989-1987



Injection Pump

IP10

23504000

Chevrolet C10	1985, 1982
Chevrolet C20 - C30, C20 Suburban, K20 - K30, K20 Suburban	1986-1982
Chevrolet C2500, K2500, R2500 - R3500, R2500, V2500 Suburban, V3500	1989
Chevrolet C3500, K3500	1989-1988
Chevrolet G20	1985-1984
Chevrolet G30	1990-1983
Chevrolet P20 - P30	1989-1982
Chevrolet R20 - R30, R20 Suburban, V20 Suburban, V30	1988-1987
Chevrolet V20	1987
GMC C1500	1986-1985, 1982
GMC C2500 - C3500, K2500 - C K3500	1989, 1986-1982
GMC C2500, 2500 Suburban	1986-1982
GMC G3500	1990-1983
GMC K1500	1986-1985
GMC P2500	1989-1982
GMC P3500	1990-1982
GMC R2500 - R3500, R2500, V2500 Suburban, V3500	1989-1987
GMC V2500	1987



* Remanufactured

GM (Cont'd)

6.2L (Cont'd)

Injection Pump

IP12

10183951

Chevrolet Blazer	1990
Chevrolet G20	1990
Chevrolet R1500 Suburban	1990
Chevrolet V1500 Suburban	1990
Chevrolet C2500 - C3500, G30, K2500 - K3500, P30, R2500, V2500 Suburban, R3500, V3500	1991-1990
GMC C2500 - C3500, G3500, K2500 - K3500, P3500, R2500, V2500 Suburban, R3500, V3500	1991-1990
GMC G2500, Jimmy, R1500, V1500 Suburban	1990

* Remanufactured



Injection Pump

IP48

23503123

Chevrolet Blazer	1989-1987
Chevrolet C10 - C20, C10, K10 Suburban, K10 - K20, K5 Blazer	1986-1982
Chevrolet C1500 - C2500, K1500 - K2500	1989-1988
Chevrolet G20	1987-1983
Chevrolet G30	1984
Chevrolet R10, R20, V10 - V20	1987
Chevrolet R10, V10 Suburban	1988-1987
Chevrolet R1500, V1500 Suburban	1989
GMC C1500 - C2500, K1500 - K2500	1989-1988, 1986-1982
GMC C1500, K1500 Suburban	1986-1982
GMC C3500, K3500	1983
GMC G2500	1987-1983
GMC Jimmy	1989-1982
GMC R1500 - R2500, V1500 - V2500	1987
GMC R1500, V1500 Suburban	1989-1987

* Remanufactured



GM (Cont'd)

6.2L (Cont'd)

Injection Pump

IP48NX

23500931

Chevrolet Blazer, C1500 - C3500, K1500 - K3500	1989-1988
Chevrolet R10 - R20, V-10 -V-20 Suburban, R20, R30, V30 . .	1988
Chevrolet R1500 - R2500, V1500 - V-2500 Suburban	1989
R2500 - R3500	
V3500	
GMC C1500 - C3500	1989-1988
Jimmy	
K1500 - K3500	
GMC R1500 - R2500, V1500 - V2500 Suburban	1989-1988
R2500 - R3500	
V3500	

* New

* Reman numbers for reference only. No new OE part numbers available.



Vacuum Pump

VCP114

7847031

Chevrolet Blazer, C2500, K2500 Suburban	1994
Chevrolet C1500 - C3500, K1500 - K3500	1994-1988
Chevrolet C3500HD	1994-1992
Chevrolet R20, R30, V30	1988
Chevrolet R2500	1989
Chevrolet R3500, V3500	1991-1989
GMC C1500 - C3500, K1500 - K3500	1995-1988
GMC C2500, K2500 Suburban	1994
GMC C3500HD	1995-1992
GMC Jimmy	1993-1992
GMC R2500	1989-1988
GMC R3500, V3500	1991-1988
GMC Yukon	1994-1992



6.5L

Diesel Injector Install Kit

SK54

Chevrolet C1500, K1500	1998-1988
Chevrolet C1500, K1500 Suburban, Tahoe	1999-1995
Chevrolet C2500 - C3500, K2500 - K3500	2000-1988
No OE Reference	

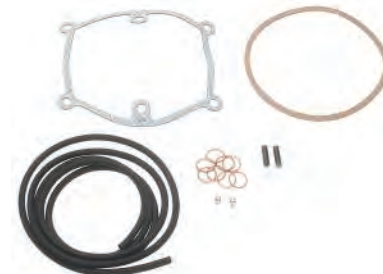

GM (Cont'd)

6.5L (Cont'd)

Diesel Oil Cooler Kit

OCK13

15557751

Chevrolet C2500 - C3500	1995-1994
GMC C2500 - C3500	1995-1994



Diesel Oil Cooler Kit

OCK14

15158525

Chevrolet C2500 - C3500	1998-1996
GMC C2500 - C3500	1998-1996



Fuel Heater

DFH102

12511964

Chevrolet Blazer	1994
Chevrolet C1500, K1500	1998-1994
Chevrolet C1500 Suburban	1999-1998
Chevrolet C2500 - C3500, K2500 - K3500	2000-1994
Chevrolet C3500HD	2002-1994
Chevrolet Express 2500 - 3500	1996
Chevrolet G20 - G30	1995-1994
Chevrolet G30	1996-1994
Chevrolet K1500 Suburban	1999-1995
Chevrolet P30	1999-1994
Chevrolet Tahoe	1997-1995
GMC C1500, Yukon	1997-1994
GMC C1500 Suburban	1999-1998
GMC C2500, K2500 - K3500	2000-1994
GMC C3500, C3500HD	2002-1994
GMC G2500	1995-1994
GMC G3500	1996-1994
GMC K1500	1998-1994
GMC P3500	1999-1994
GMC Savana 2500 - 3500	1996



GM (Cont'd)

6.5L (Cont'd)

Fuel Injector

FJ173

10183974, 10233973, 12458122

AM General Hummer	2001-1996
Chevrolet Blazer	1994
Chevrolet C1500, K1500	1998-1994
Chevrolet C1500, K1500 Suburban, Tahoe	1999-1995
Chevrolet C2500 - C3500, C3500HD, K2500 - K3500	2000-1992
Chevrolet C2500 Suburban	1999-1994
Chevrolet Express 2500 - 3500	2002-1996
Chevrolet G30	1996
Chevrolet K2500 Suburban, P30	1999-1994
GMC C1500, Yukon	1997-1994
GMC C1500, K1500 Suburban	1999-1995
GMC C2500, C3500, C3500HD, K2500 - K3500	2000-1992
GMC C2500, K2500 Suburban, K1500	1999-1994
GMC P3500	1999-1997
GMC Savana 2500 - 3500	2002-1996
Hummer H1	2004-2002

* New



Fuel Injector

FJ174

10233972, 12458121

AM General Hummer	1998-1992
Chevrolet C1500 - C2500	1995-1992
Chevrolet C3500, K3500	1993-1992
Chevrolet G20 - G30	1995-1992
Chevrolet K1500 - K2500	1995-1992
Chevrolet P30	1999-1991
GMC C1500 - C2500	1995-1992
GMC C3500	1993-1992
GMC G2500	1995-1992
GMC G3500, K3500	1996-1992
GMC K1500 - K2500	1995-1992
GMC P3500	1999-1994

* New



GM (Cont'd)

6.5L (Cont'd)

Fuel Shut-Off Solenoid

FSS103

33072

AM General Hummer	2001-1997
Chevrolet Blazer	1994
Chevrolet C1500, K1500, K2500 Suburban	1998-1994
Chevrolet C1500 Suburban	1999-1998
Chevrolet C2500 - C3500, K2500 - K3500	2000-1994
Chevrolet P30	1999-1991



Fuel/Water Separator Sensor

FWSS102

12375515, 12511965

Chevrolet C2500 Suburban, P30	1999-1994
Chevrolet C3500HD	2002-1994
Chevrolet Express 2500 - 3500	2002-1996
Chevrolet G20	1995-1994
Chevrolet K1500 Suburban, Tahoe	1999-1995
GMC C1500	1997-1994
GMC C1500 Suburban	1999-1995
GMC C2500, K2500 - K3500	2000-1994
GMC C2500, K2500 Suburban	1999-1994
GMC C3500, C3500HD	2002-1994
GMC G2500	1995-1994
GMC K1500	1998-1994
GMC P3500	1999-1997
GMC Savana 2500 - 3500	2002-1996
GMC Yukon	1997-1995
Hummer H1	2004-2002



Fuel/Water Separator Sensor

FWSV101

12532558

Chevrolet Express 2500 - 3500	2002-1996
Chevrolet G30	1996
GMC G3500	1996
GMC Savana 2500 - 3500	2002-1996



GM (Cont'd)

6.5L (Cont'd)

Glow Plug

GP104

5613738, 12563554, 25163212, 25168651

AM General Hummer	2001-1992
Chevrolet Blazer	1994, 1991-1987
Chevrolet C10 - C30, K10 - K30, K5 Blazer	1986-1982
Chevrolet C1500, K1500	1998-1988
Chevrolet C1500, K1500 Suburban, Tahoe	1999-1995
Chevrolet C2500 - C3500	2000-1988
Chevrolet C2500, K2500 Suburban	1999-1994
GMC C2500, K2500 - K3500	2000-1994



Injection Pump

IP1

12561307, 17800077, 19208315, 19209059

AM General Hummer	2001-1996
Chevrolet Blazer	1994
Chevrolet C1500, K1500	1998-1994
C1500, K1500 Suburban, Tahoe	
Chevrolet C2500 - C3500, K2500 - K3500	2000-1994
Chevrolet C2500, K2500 Suburban	1999-1994
Chevrolet P30	1999-1994
Chevrolet C3500HD	2002-1994
Chevrolet Express 2500 - 3500	2002-1996
Chevrolet G20	1995-1994
GMC K1500	1998-1994
GMC C1500, K1500 Suburban	1999-1995
GMC C2500, K2500 - K3500	2000-1994
GMC C2500, K2500 Suburban	1999-1994
GMC C1500, Yukon	1997-1994
GMC C3500, C3500HD	2002-1994
GMC G2500	1995-1994
GMC P3500	1999-1997
GMC Savana 2500 - 3500	2002-1996
Hummer H1	2004-2002

* Remanufactured



Injection Pump

IP25

12561307, 17800077, 19208315, 19209059

Chevrolet C3500HD	2002-1992
Chevrolet Express 2500 - 3500	2002-1996
Chevrolet G20	1995-1983
C1500, K1500 Suburban, Tahoe	

* Remanufactured

No OE cross reference for injection pump without driver module.

Part numbers for ref



GM (Cont'd)

6.5L (Cont'd)

Injection Pump

IP28

10225929

Chevrolet Blazer, C2500 - C3500, C3500HD, K3500, P30 1994

GMC C1500 - C3500, C3500HD, K1500 - K3500, Yukon 1994

* Remanufactured



Injection Pump

IP46NX

12561383

Chevrolet G20 - G30, P30 1994

GMC G2500 -3500, P3500 1994

* New

* Reman numbers for reference only. No new OE part numbers available.



Injection Pump

IP47

10183901

Chevrolet C2500 - C3500, C3500HD, K2500 - K3500 . . 1993-1992

GMC C2500 - C3500, C3500HD, K2500 - K3500 1993-1992

* Remanufactured



Injection Pump

IP47NX

10183901

Chevrolet C2500 - C3500, C3500HD 1993-1992

Chevrolet K2500 - K3500 1993-1992

GMC C2500 - C3500, C3500HD 1993-1992

GMC K2500 - K3500 1993-1992

* New

* Reman numbers for reference only. No new OE part numbers available.



GM (Cont'd)

6.5L (Cont'd)

Injector Pump Module

IPM1

12562836, 19209057

Chevrolet G30	1996-1983
Chevrolet K10 Suburban	1986-1985
Chevrolet K2500 - K3500	2000-1988
Chevrolet P20 - P30	1989-1982
Chevrolet R10, V10 - V20	1987
Chevrolet R20 - R30, V30	1988-1987
Chevrolet R2500	1989
Chevrolet R3500, V3500	1991-1989
GMC C1500	1997-1988, 1986-1982
GMC C1500, K2500 Suburban	1999-1995
GMC C2500, K2500 - K3500	2000-1988, 1986-1982
GMC C2500, K2500 Suburban	1999-1994
GMC C3500	2001-1988, 1986-1982
GMC C3500HD	2001-1994
GMC G2500	1995-1983
GMC G3500	1996-1983
GMC Jimmy	1991-1982
GMC K1500	1998-1988, 1986-1982
GMC P2500	1989-1982
GMC P3500	1999-1982
GMC R1500	1987
GMC R2500	1989-1987
GMC R1500 - R2500, V1500 - V2500 Suburban, R3500, V3500	1991-1987
GMC Savana 1500	2005-2003
GMC Savana 2500 - 3500	2005-1996
GMC V1500 - V2500	1987
GMC Yukon	1997-1994
Hummer H1	2006, 2004-2002



GM (Cont'd)

6.5L (Cont'd)

PMD Relocation Kit

S39001

AM General Hummer	2001-1996
Chevrolet Blazer	1994
Chevrolet C1500, K1500	1998-1994
C1500, K1500 Suburban, Tahoe	
Chevrolet C2500 - C3500, K2500 - K3500	2000-1994
Chevrolet C2500, K2500 Suburban	1999-1994
Chevrolet P30	1999-1994
Chevrolet C3500HD	2002-1994
Chevrolet Express 2500 - 3500	2002-1996
Chevrolet G20	1995-1994
GMC K1500	1998-1994
GMC C1500, K1500 Suburban	1999-1995
GMC C2500, K2500 - K3500	2000-1994
GMC C2500, K2500 Suburban	1999-1994
GMC C1500, Yukon	1997-1994
GMC C3500, C3500HD	2002-1994
GMC G2500	1995-1994
GMC P3500	1999-1997
GMC Savana 2500 - 3500	2002-1996
Hummer H1	2004-2002

No OE Reference



GM (Cont'd)

6.5L (Cont'd)

PMD Relocation Kit

S39002

AM General Hummer	2001-1996
Chevrolet Blazer	1994
Chevrolet C1500, K1500	1998-1994
C1500, K1500 Suburban, Tahoe	
Chevrolet C2500 - C3500, K2500 - K3500	2000-1994
Chevrolet C2500, K2500 Suburban	1999-1994
Chevrolet P30	1999-1994
Chevrolet C3500HD	2002-1994
Chevrolet Express 2500 - 3500	2002-1996
Chevrolet G20	1995-1994
GMC K1500	1998-1994
GMC C1500, K1500 Suburban	1999-1995
GMC C2500, K2500 - K3500	2000-1994
GMC C2500, K2500 Suburban	1999-1994
GMC C1500, Yukon	1997-1994
GMC C3500, C3500HD	2002-1994
GMC G2500	1995-1994
GMC P3500	1999-1997
GMC Savana 2500 - 3500	2002-1996
Hummer H1	2004-2002

No OE Reference



Turbo Boost Solenoid

U43001

1997255	
Chevrolet Blazer	1994
Chevrolet C1500 - C3500, C3500HD, K1500 - K3500, P30	1997-1994
Chevrolet Express 2500 - 3500	1997-1996
Chevrolet G30	1996
Chevrolet K1500 Suburban, Tahoe	1997-1995
GMC C1500 - C3500, C3500HD, 1997 - 1994 GMC K1500 - K3500, P3500	1997-1994
GMC G3500	1996
GMC Savana 2500 - 3500	1997-1996



GM (Cont'd)

6.5L (Cont'd)

Turbocharger

TBC-516

12530339

Chevrolet C3500HD	2002-1992
Chevrolet Express 2500 - 3500	2002-1996
Chevrolet G20	1995-1983
Chevrolet G30	1996-1983
Chevrolet K10 Suburban	1986-1985
Chevrolet K2500 - K3500	2000-1988
Chevrolet P20 - P30	1989-1982
Chevrolet R10, V10 - V20	1987
Chevrolet R20 - R30, V30	1988-1987
Chevrolet R2500	1989
Chevrolet R3500, V3500	1991-1989
GMC C1500	1997-1988, 1986-1982
GMC C1500, K2500 Suburban	1999-1995
GMC C2500, K2500 - K3500	2000-1988, 1986-1982
GMC C2500, K2500 Suburban	1999-1994
GMC C3500	2001-1988, 1986-1982
GMC C3500HD	2001-1994
GMC G2500	1995-1983
GMC G3500	1996-1983
GMC Jimmy	1991-1982
GMC K1500	1998-1988, 1986-1982
GMC P2500	1989-1982
GMC P3500	1999-1982
GMC R1500	1987
GMC R2500	1989-1987
GMC R1500 - R2500, V1500 - V2500 Suburban, R3500, V3500	1991-1987
GMC Savana 1500	2005-2003
GMC Savana 2500 - 3500	2005-1996
GMC V1500 - V2500	1987
GMC Yukon	1997-1994
Hummer H1	2006, 2004-2002

* Remanufactured



GM (Cont'd)

6.5L (Cont'd)

Turbocharger

TBC-517

12533738

Chevrolet C1500	1998-1995
Chevrolet C1500 - C2500, K-1500 - K2500 Suburban	1999-1997
Chevrolet K2500 - K3500, C2500 - C3500	2000-1995
Chevrolet C3500HD	2002-1995
Chevrolet K1500	1999-1995
GMC C1500	1997-1995
GMC C2500, K2500 - K3500	2000-1995
GMC C3500, C3500HD	2002-1995
GMC K1500	1998-1995

* Remanufactured



Vacuum Pump

VCP108

7849209

Chevrolet Blazer	1994, 1991-1987
Chevrolet C10	1986-1978
Chevrolet C10 Suburban	1986-1982, 1980-1978
Chevrolet C1500 - C3500, K1500 - K3500	1995-1988
Chevrolet C1500, K1500 Suburban, Tahoe	1995
Chevrolet C20, C20, K10, K20 Suburban, K10 - K30, K5 Blazer	1986-1982
Chevrolet C2500, K2500 Suburban	1995-1994
Chevrolet C30	1986-1982, 1978
Chevrolet C3500HD	1995-1992
Chevrolet R10, V10, V10 Suburban, V20	1987
Chevrolet R10 - R20, V20 Suburban, R20, R30, V30	1988-1987
Chevrolet R1500 - R3500, R2500, V1500 - V2500 Suburban, 1991 - 1989 Chevrolet V3500	1991-1989
Chevrolet R2500	1989
GMC C15, C15 Suburban	1978
GMC C1500	1995-1988, 1986-1979
GMC C1500 Suburban	1995, 1986-1979
GMC C2500 - C3500, K1500 - K3500	1995-1988, 1986-1982
GMC C2500 Suburban	1995-1994, 1986-1982, 1980
GMC C3500HD	1995-1992
GMC Jimmy	1993-1982
GMC K1500 Suburban	1995, 1986-1982
GMC K2500 Suburban	1995-1994, 1986-1982
GMC R1500, V1500	1987
GMC R1500 - R2500 Suburban, R3500, V1500 - V2500 Suburban, V3500	1991-1987
GMC R2500	1989-1987
GMC V2500	1987
GMC Yukon	1995-1992



GM (Cont'd)

6.6L DURAMAX

Air Intake Heater

DIH4

97251974

Chevrolet C4500 C-5500 Kodiak	2004-2003
Chevrolet Silverado 2500 HD	2004-2001
Chevrolet Silverado 3500	2004-2001
GMC C4500 - C5500 Topkick	2004-2003
GMC Sierra 2500 HD	2004-2001
GMC Sierra 3500	2004-2001



Air Intake Heater

DIH5

12601677

Chevrolet Silverado 2500 -3500 HD	2014-2011
GMC Sierra 2500 -3500 HD	2014-2011



Air Intake Heater

DIH6

12621907

Chevrolet Express 2500	2013-2010
Chevrolet Express 3500	2014-2010
GMC Savana 2500 - 3500	2013-2010



Air Intake Heater

DIH7

98050454

Chevrolet Silverado 2500 -3500 HD	2010-2007
GMC Sierra 2500 - 3500 HD	2010-2007



GM (Cont'd)

6.6L DURAMAX (Cont'd)

Air Intake Heater

DIH8

98028427

Chevrolet Silverado 2500 HD	2006
Chevrolet Silverado 2500 HD Classic	2007
Chevrolet Silverado 3500	2006
Chevrolet Silverado 3500 Classic	2007
GMC Sierra 2500 HD	2006
GMC Sierra 3500	2006
GMC Sierra 3500 Classic	2007



Air Intake Heater

DIH12

98050441

Chevrolet C4500 - C5500 Kodiak	2009-2006
Chevrolet Express 2500 - 3500	2010-2006
Chevrolet Express 4500	2009
GMC C4500 - C5500 Topkick	2009-2006
GMC Savana 2500 - 3500	2010-2006
GMC Savana 4500	2009



Diesel Fuel Injector Rail

FIR3

12620532

Chevrolet Express 2500 - 3500	2016-2010
Chevrolet Silverado 2500 - 3500 HD	2016-2011
GMC Savana 2500 - 3500	2016-2010
GMC Sierra 2500 - 3500 HD	2016-2011



Diesel Fuel Injector Rail

FIR4

12651989

Chevrolet Express 2500 - 3500	2016-2010
Chevrolet Silverado 2500 - 3500 HD	2016-2011
GMC Savana 2500 - 3500	2016-2010
GMC Sierra 2500 - 3500 HD	2016-2011



GM (Cont'd)

6.6L DURAMAX (Cont'd)

Diesel Injector Install Kit

SK115

Chevrolet C4500 - C5500 Kodiak	2009-2004
Chevrolet Express 2500 - 3500	2010-2006
Chevrolet Express 4500	2010-2009
Chevrolet Silverado 2500 HD	2010-2004
Chevrolet Silverado 3500	2006-2004
Chevrolet Silverado 3500 Classic	2007
Chevrolet Silverado 3500 HD	2010-2007
GMC C4500 - C5500 Topkick	2009-2004
GMC Savana 2500 - 3500	2010-2006
GMC Savana 4500	2010-2009
GMC Sierra 2500 HD	2010-2004
GMC Sierra 3500	2006-2004
GMC Sierra 3500 Classic	2007
GMC Sierra 3500 HD	2010-2007
Hummer H1	2006

No OE Reference

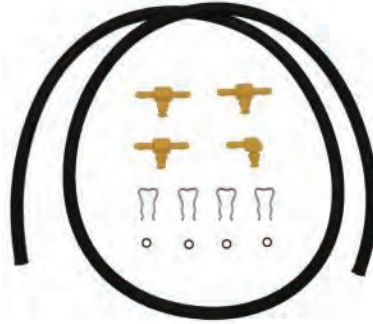

Diesel Oil Cooler Kit

OCK8

98062847, 12649227

Chevrolet Express 2500 - 4500	2016-2010
Chevrolet Silverado 2500 - 3500 HD	2016-2011
GMC Savana 2500 - 4500	2016-2010
GMC Sierra 2500 - 3500 HD	2016-2011



Diesel Oil Cooler Kit

OCK9

97213653, 97262115, 97329038, 97351829, 19210615

Chevrolet Express 3500	2009-2006
Chevrolet Silverado 2500 HD	2010-2004
Chevrolet Silverado 3500	2006-2004
Chevrolet Silverado 3500 HD	2010-2007
GMC Savana 3500	2009-2006
GMC Sierra 2500 HD	2010-2004
GMC Sierra 3500	2006-2004
GMC Sierra 3500 HD	2010-2007



GM (Cont'd)

6.6L DURAMAX (Cont'd)

Diesel Oil Cooler Kit

OCK10

12672505, 12678318

Chevrolet Silverado 2500 - 3500 HD 2019-2017

GMC Sierra 2500 - 3500 HD 2019-2017



Diesel Particulate Filter (DPF) Pressure Sensor

DPS105

12677718

Chevrolet Silverado 2500 - 3500HD 2019-2017

GMC Sierra 2500 - 3500 HD 2019-2017



Diesel Particulate Filter (DPF) Pressure Sensor

DPS107

12630257

Chevrolet Express 2500 - 3500 2016-2010

Chevrolet Express 4500 2012-2010

Chevrolet Silverado 2500 - 3500 HD 2016-2011

GMC Savana 4500 2012-2010

GMC Savana 2500 - 3500 2016-2010

GMC Sierra 2500 - 3500 HD 2016-2011



EGR Cooler Kit

ECK2

98034351

Chevrolet Silverado 2500 -3500 HD 2010-2007

GMC Sierra 2500 - 3500 HD 2010-2007



GM (Cont'd)

6.6L DURAMAX (Cont'd)

EGR Cooler Kit

ECK3

98034354

Chevrolet Express 2500 - 3500	2009-2006
GMC Savana 2500 - 3500	2009-2006



EGR Cooler Kit

ECK4

97358507, 8-97358-507-1

Chevrolet C4500 - C5500 Kodiak	2007-2006
Chevrolet Silverado 2500 HD	2006
Chevrolet Silverado 2500 HD Classic	2007
Chevrolet Silverado 3500	2006
Chevrolet Silverado 3500 Classic	2007
GMC C4500 - C5500 Topkick	2007-2006
GMC Sierra 2500 HD	2006
GMC Sierra 2500 HD Classic	2007
GMC Sierra 3500	2006
GMC Sierra 3500 Classic	2007



EGR Cooler Kit

ECK5

97303654

Chevrolet C4500 - C5500 Kodiak	2005-2004
Chevrolet Silverado 2500 HD	2005-2004
Chevrolet Silverado 3500	2005-2004
GMC C4500 - C5500 Topkick	2005-2004
GMC Sierra 2500 HD	2005-2004
GMC Sierra 3500	2005-2004



EGR Cooler Kit

ECK6

98042441

Chevrolet C4500 - C5500 Kodiak	2009-2007
GMC C4500 - C5500 Topkick	2009-2007



GM (Cont'd)

6.6L DURAMAX (Cont'd)

EGR Valve

EGV801

97303761

Chevrolet Silverado 2500 HD	2005-2004
Chevrolet Silverado 3500	2005
GMC Sierra 2500 HD	2005-2004
GMC Sierra 3500	2005-2004



EGR Valve

EGV802

97288827

Chevrolet Silverado 2500 HD	2004-2002
Chevrolet Silverado 3500	2004-2002
GMC Sierra 2500 HD	2004-2002
GMC Sierra 3500	2004-2002



EGR Valve

EGV803

97379347, 98025781

Chevrolet Express 2500 -3500	2010-2006
Chevrolet Express 4500	2010-2009
GMC Savana 2500 - 3500	2010-2006
GMC Savana 4500	2010-2009



EGR Valve

EGV1142

97365042, 98025695

Chevrolet Silverado 2500 HD	2010-2006
Chevrolet Silverado 3500	2006
Chevrolet Silverado 3500 Classic	2007
Chevrolet Silverado 3500 HD	2010-2007
GMC Sierra 2500 HD	2009-2006
GMC Sierra 3500	2006
GMC Sierra 3500 Classic	2007
GMC Sierra 3500 HD	2009-2007



GM (Cont'd)

6.6L DURAMAX (Cont'd)

EGR Valve

EGV1219

12636491, 12639422, 12660270

Chevrolet Express 2500	2013-2011
Chevrolet Express 3500 - 4500	2014-2010
GMC Savana 2500 - 3500	2015-2011
GMC Savana 4500	2015-2010



EGR Valve

EGV1240

12636492, 12639423, 12643238, XA12643238

Chevrolet Silverado 2500 - 3500 HD	2015-2011
GMC Sierra 2500 HD	2013-2011
GMC Sierra 3500 HD	2014-2011



Emission Fluid Injection Nozzle

DFI2

12635928, 12640359, 12647372

Chevrolet Express 2500, 4500	2013-2010
Chevrolet Express 3500	2014-2010
Chevrolet Silverado 2500 - 3500 HD	2014-2011
GMC Savana 2500 - 4500	2013-2010
GMC Sierra 2500 - 3500 HD	2014-2011



Emission Fluid Temperature Sensor

DFS1

20760381

Chevrolet Cruze	2015-2014
Chevrolet Express 2500 - 4500	2016-2010
Chevrolet Silverado 2500 - 3500 HD	2016-2011
GMC Savana 2500 - 4500	2016-2010
GMC Sierra 2500 - 3500 HD	2016-2011



GM (Cont'd)

6.6L DURAMAX (Cont'd)

Fuel Filter Housing Seal

F81003

12642623

Chevrolet Silverado 2500 HD	2010-2001
Chevrolet Silverado 3500	2006-2001
Chevrolet Silverado 3500 HD	2010-2007
GMC Sierra 2500 HD	2010-2001
GMC Sierra 3500	2006-2001
GMC Sierra 3500 Classic	2007
GMC Sierra 3500 HD	2010-2007



Fuel Injection Harness

IFH7

97207227

Chevrolet C4500 - C5500 Kodiak	2004-2003
Chevrolet Silverado 2500 HD	2004-2001
Chevrolet Silverado 3500	2004-2001
GMC C4500 - 5500 Topkick	2004-2003
GMC Sierra 2500 HD	2004-2001
GMC Sierra 3500	2004-2001



Fuel Injector

FJ489

97303657, 97780144

Chevrolet C4500 - C5500 Kodiak	2005-2004
Chevrolet Silverado 2500 HD	2005-2004
Chevrolet Silverado 3500	2005-2004
GMC C4500 - C5500 Topkick	2005-2004
GMC Sierra 2500 HD	2005-2004
GMC Sierra 3500	2005-2004

* Remanufactured



Fuel Injector

FJ495

97208074, 97720604, 97720661, 97729095

Chevrolet C4500 - C5500 Kodiak	2004-2003
Chevrolet Silverado 2500 HD	2004-2001
Chevrolet Silverado 3500	2004-2001
GMC C4500 -C5500 Topkick	2004-2003
GMC Sierra 2500 HD	2004-2001
GMC Sierra 3500	2004-2001

* Remanufactured



GM (Cont'd)

6.6L DURAMAX (Cont'd)

Fuel Injector

FJ961

97780360, 98002368

Chevrolet C4500 - C5500 Kodiak	2009-2008
Chevrolet Express 2500 - 3500	2010-2007
Chevrolet Express 4500	2010-2009
Chevrolet Silverado 2500 - 3500 HD	2010-2007
GMC C4500 Topkick	2009-2008
GMC C5500 Topkick	2008
GMC Savana 2500 - 3500	2010-2008
GMC Savana 4500	2010-2009
GMC Sierra 2500 -3500 HD	2010-2007
GMC Sierra 2500 HD Classic	2007

* Remanufactured



Fuel Injector

FJ962

97361355, 97780358

Chevrolet C4500 - C5500 Kodiak	2007-2006
Chevrolet Express 2500 - 3500	2006
Chevrolet Silverado 2500 HD	2006
Chevrolet Silverado 2500 HD Classic	2007
Chevrolet Silverado 3500	2006
Chevrolet Silverado 3500 Classic	2007
GMC C4500 Topkick	2007-2006
GMC C5500 Topkick	2009, 2007-2006
GMC Savana 2500 - 3500	2007-2006
GMC Sierra 2500 HD	2006
GMC Sierra 3500	2006
GMC Sierra 3500 Classic	2007
Hummer H1	2006

* Remanufactured



Fuel Injector

FJ1226

19256590

Chevrolet Silverado 2500 -3500 HD	2015-2011
GMC Sierra 2500 - 3500 HD	2015-2011

* Remanufactured



GM (Cont'd)

6.6L DURAMAX (Cont'd)

Fuel Injector

FJ1227

19210900

Chevrolet Express 2500 - 3500	2016-2011
Chevrolet Express 4500	2016-2010
Chevrolet Silverado 2500 - 3500 HD	2012-2011
GMC Savana 2500 - 3500	2016-2011
GMC Savana 4500	2016-2010
GMC Sierra 2500 - 3500HD	2012-2011

* Remanufactured



Fuel Injector Line

DIL1

97188720

Chevrolet C4500 - C5500 Kodiak	2004-2003
Chevrolet Silverado 2500 HD	2004-2001
Chevrolet Silverado 3500	2004-2001
GMC C4500 - C5500 Topkick	2004-2003
GMC Sierra 2500 HD	2004-2001
GMC Sierra 3500	2004-2001



Fuel Injector Line

DIL2

97188721

Chevrolet C4500 - C5500 Kodiak	2004-2003
Chevrolet Silverado 2500 HD	2004-2001
Chevrolet Silverado 3500	2004-2001
GMC C4500 - C5500 Topkick	2004-2003
GMC Sierra 2500 HD	2004-2001
GMC Sierra 3500	2004-2001



Fuel Injector Line

DIL3

97188722

Chevrolet C4500 - C5500 Kodiak	2004-2003
Chevrolet Silverado 2500 HD	2004-2001
Chevrolet Silverado 3500	2004-2001
GMC C4500 - C5500 Topkick	2004-2003
GMC Sierra 2500 HD	2004-2001
GMC Sierra 3500	2004-2001



GM (Cont'd)

6.6L DURAMAX (Cont'd)

Fuel Injector Line

DIL4

97188723

Chevrolet C4500 - C5500 Kodiak	2004-2003
Chevrolet Silverado 2500 HD	2004-2001
Chevrolet Silverado 3500	2004-2001
GMC C4500 - C5500 Topkick	2004-2003
GMC Sierra 2500 HD	2004-2001
GMC Sierra 3500	2004-2001



Fuel Injector Seal Kit

SK66

Chevrolet Silverado 2500 HD	2004-2001
Chevrolet Silverado 3500	2004-2001
GMC Sierra 2500 HD	2004-2001
GMC Sierra 3500	2004-2001

No OE Reference



Fuel Injector Seal Kit

SK67

94011699, 94011701, 97216082, 97239186,

Chevrolet Silverado 2500 HD	2004-2001
Chevrolet Silverado 3500	2004-2001
GMC Sierra 2500 HD	2004-2001
GMC Sierra 3500	2004-2001



Fuel Injector Seal Kit

SK68

Chevrolet Silverado 2500 HD	2004-2001
Chevrolet Silverado 3500	2004-2001
GMC Sierra 2500 HD	2004-2001
GMC Sierra 3500	2004-2001

No OE Reference

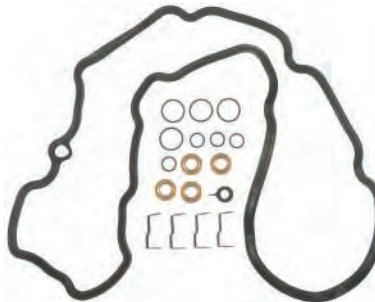

Fuel Level Sensor

K07020

13504926

Chevrolet Silverado 3500 HD	2015-2011
GMC Sierra 3500 HD	2015-2011



GM (Cont'd)

6.6L DURAMAX (Cont'd)

Fuel Level Sensor

K07025

19148811, 25350792

Chevrolet Silverado 2500 HD	2008-2004
Chevrolet Silverado 2500 HD Classic	2007
Chevrolet Silverado 3500	2006-2004
Chevrolet Silverado 3500 Classic	2007
GMC Sierra 2500 HD	2008-2004
GMC Sierra 3500	2006-2004
GMC Sierra 3500 Classic	2007



Fuel/Water Separator Sensor

FWSS101

12639277, 12639450, 97370565, 97384931

Chevrolet C4500 - C5500 Kodiak	2009-2003
Chevrolet Express 2500 - 3500	2006
Chevrolet Silverado 2500 HD	2011-2001
Chevrolet Silverado 3500	2006-2001
Chevrolet Silverado 3500 Classic	2007
Chevrolet Silverado 3500 HD	2011-2007
GMC Savana 2500 - 3500	2006
GMC Sierra 2500 HD	2011-2001
GMC Sierra 3500	2006-2001
GMC Sierra 3500 Classic	2007
GMC Sierra 3500 HD	2011-2007



Glow Plug

GP110

97226202

Chevrolet C4500 Kodiak - C5500	2004-2003
Chevrolet Silverado 2500 HD	2004-2001
Chevrolet Silverado 3500	2004-2001
GMC C4500 - C5500 Topkick	2004-2003
GMC Sierra 2500 HD	2004-2001
GMC Sierra 3500	2004-2001



GM (Cont'd)

6.6L DURAMAX (Cont'd)

Glow Plug

GP114

12639701, 97364968

Chevrolet C4500 - C5500 Kodiak	2009-2006
Chevrolet Express 2500 - 3500	2012-2006
Chevrolet Silverado 2500 HD	2012-2006
Chevrolet Silverado 3500	2006
Chevrolet Silverado 3500 Classic	2007
Chevrolet Silverado 3500 HD	2012-2007
GMC C4500 - C5500 Topkick	2009-2006
GMC Savana 2500 - 3500	2012-2006
GMC Sierra 2500 HD	2012-2006
GMC Sierra 3500	2006
GMC Sierra 3500 Classic	2007
GMC Sierra 3500 HD	2012-2007



Glow Plug

GP115

97326305

Chevrolet C4500 - C5500 Kodiak	2007, 2005-2004
Chevrolet Silverado 2500 HD	2005-2004
Chevrolet Silverado 3500	2005
GMC C4500 - C5500 Topkick	2006-2004
GMC Sierra 2500 HD	2005-2004
GMC Sierra 3500	2005-2004



Glow Plug Conductor

GPC101

97209343

Chevrolet C4500 - C5500 Kodiak	2004-2003
Chevrolet Silverado 2500 HD	2004-2001
Chevrolet Silverado 3500	2004-2001
GMC C4500 - C5500 Topkick	2004-2003
GMC Sierra 2500 HD	2004-2001
GMC Sierra 3500	2004-2001



GM (Cont'd)

6.6L DURAMAX (Cont'd)

Glow Plug Controller

RY1832

98041624

Chevrolet Silverado 2500 HD	2006
Chevrolet Silverado 2500 HD Classic	2007
Chevrolet Silverado 3500	2006
Chevrolet Silverado 3500 Classic	2007
GMC Sierra 2500 HD	2006
GMC Sierra 2500 HD Classic	2007
GMC Sierra 3500	2006
GMC Sierra 3500 Classic	2007



Glow Plug Controller

RY-1697

12604003, 97375411, 98022490, 98041625, 98089591

Chevrolet C4500 - C5500 Kodiak	2007-2006
Chevrolet Express 2500	2007-2006
GMC C4500 - C5500 Topkick	2007-2006
GMC Savana 2500 - 3500	2007-2006



Injection Pump

IP22

97720662

Chevrolet C4500 - C5500 Kodiak	2004-2003
Chevrolet Silverado 2500 HD	2004-2001
Chevrolet Silverado 3500	2004-2001
GMC C4500 - C5500 Topkick	2004-2003
GMC Sierra 2500 HD	2004-2001
GMC Sierra 3500	2004-2001

* Remanufactured



Injection Pump

IP23

97303762, 97780091

Chevrolet C4500 - C5500 Kodiak	2005-2004
Chevrolet Silverado 2500 HD	2005-2004
Chevrolet Silverado 3500	2005-2004
GMC C4500 - C5500 Topkick	2005-2004
GMC Sierra 2500 HD	2005-2004
GMC Sierra 3500	2005-2004

* Remanufactured



GM (Cont'd)

6.6L DURAMAX (Cont'd)

Injection Pump

IP24

97361351, 97780161

Chevrolet C4500 - C5500 Kodiak	2009-2006
Chevrolet Express 2500 - 3500	2010-2006
Chevrolet Express 4500	2010-2009
Chevrolet Silverado 2500 HD	2010-2006
Chevrolet Silverado 2500 HD Classic	2007
Chevrolet Silverado 3500	2006
Chevrolet Silverado 3500 Classic	2007
Chevrolet Silverado 3500 HD	2010-2007
GMC C4500 - C5500 Topkick	2009-2006
GMC Savana 2500 - 3500	2010-2006
GMC Savana 4500	2010-2009
GMC Sierra 2500 HD	2010-2006
GMC Sierra 2500 HD Classic	2007
GMC Sierra 3500	2006
GMC Sierra 3500 Classic	2007
GMC Sierra 3500 HD	2010-2007
Hummer H1	2006

* Remanufactured



Injection Pump

IP36

12638262, 12639150, 12645102, 12658095, 12661059, 98077841

Chevrolet Express 2500 - 3500	2016-2010
Chevrolet Express 4500	2015-2010
Chevrolet Silverado 2500 - 3500 HD	2016-2011
GMC Savana 2500	2016-2010
GMC Savana 3500 - 4500	2015-2010
GMC Sierra 2500 HD	2015-2011
GMC Sierra 3500 HD	2016-2011

* New



GM (Cont'd)

6.6L DURAMAX (Cont'd)

Turbocharger

TBC561

98011735

Chevrolet Express 2500 - 3500	2007-2006
Chevrolet Silverado 2500 HD	2006
Chevrolet Silverado 2500 HD Classic	2007
Chevrolet Silverado 3500	2006
Chevrolet Silverado 3500 Classic	2007
GMC Savana 2500 - 3500	2006
GMC Sierra 2500 HD	2006
GMC Sierra 3500	2006
GMC Sierra 3500 Classic	2007

* Remanufactured



Turbocharger

TBC562

97387896

Chevrolet Silverado 2500 HD	2005-2004
Chevrolet Silverado 3500	2005-2004
GMC Sierra 2500 HD	2005-2004
GMC Sierra 3500	2005-2004

* Remanufactured



Turbocharger

TBC563

12639460

Chevrolet Express 2500 - 3500	2010-2007
Chevrolet Express 4500	2010-2009
Chevrolet Silverado 2500 - 3500 HD	2010-2007
GMC Savana 2500 - 3500	2010-2007
GMC Savana 4500	2010-2009
GMC Sierra 2500 - 3500 HD	2010-2007

* Remanufactured



GM (Cont'd)

6.6L DURAMAX (Cont'd)

Turbocharger

TBC573

97720749

Chevrolet Silverado 2500 HD	2004-2002
Chevrolet Silverado 3500	2004-2002
GMC Sierra 2500 HD	2004-2002
GMC Sierra 3500	2004-2002

* Remanufactured



Turbocharger

TBC574

97720748

Chevrolet Silverado 2500 HD	2004-2002
Chevrolet Silverado 3500	2004-2002
GMC Sierra 2500 HD	2004-2002
GMC Sierra 3500	2004-2002

* Remanufactured



Turbocharger

TBC577

12640123

Chevrolet Express 2500 - 4500	2011-2010
GMC Savana 2500 - 4500	2011

* Remanufactured



GM (Cont'd)

6.6L DURAMAX (Cont'd)

Vacuum Pump

VCP113

94669091

Chevrolet C4500 - C5500 Kodiak	2009-2008
Chevrolet Express 2500 - 3500	2013-2006
GMC C4500 - C5500 Topkick	2009-2008
GMC Savana 2500 - 3500	2012-2006



Valve Cover Gasket

VCG3

97312341

Chevrolet C4500 - C5500 Kodiak	2009-2004
Chevrolet Express 2500 - 3500	2010-2006
Chevrolet Express 4500	2010-2009
Chevrolet Silverado 2500 HD	2010-2004
Chevrolet Silverado 2500 HD Classic	2007
Chevrolet Silverado 3500	2006-2004
Chevrolet Silverado 3500 Classic	2007
Chevrolet Silverado 3500 HD	2010-2007
GMC C4500 - C5500 Topkick	2009-2004
GMC Savana 2500 - 3500	2010-2006
GMC Savana 4500	2010-2009
GMC Sierra 2500 HD	2010-2004
GMC Sierra 2500 HD Classic	2007
GMC Sierra 3500	2006-2004
GMC Sierra 3500 Classic	2007
GMC Sierra 3500 HD	2010-2007
Hummer H1	2006



Valve Cover Gasket

VCG5

97188896

Chevrolet C4500 - C5500 Kodiak	2004-2003
Chevrolet Silverado 2500 HD	2004-2001
Chevrolet Silverado 3500	2004-2001
GMC C4500 - C5500 Topkick	2004-2003
GMC Sierra 2500 HD	2004-2001
GMC Sierra 3500	2004-2001

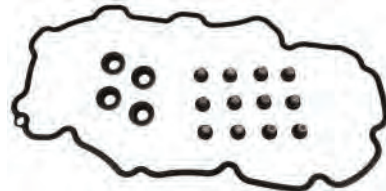

GM (Cont'd)

6.0L

Diesel Oil Cooler Kit

OCK15

52484139

Chevrolet Silverado 2500 HD, 3500 2003-2001

GMC Sierra 2500 HD, 3500 2003-2001



2.0L

Diesel Emission Fluid Injection Nozzle

DFI6

55573939, 12656061

Chevrolet Cruze 2015-2014



Diesel Particulate Filter (DPF) Pressure Sensor

DPS106

55599659

Chevrolet Cruze 2015-2014



Fuel Injector

FJ1216

55585712

Chevrolet Cruze 2015-2014

* New



Turbocharger

TBC543

55581063

Chevrolet Cruze 2015-2014

* New



GM (Cont'd)

1.6L

Diesel Particulate Filter (DPF) Pressure Sensor

DPS106

55599659

Chevrolet Equinox 2018

GMC Terrain 2018



2.8L

Diesel Oil Cooler Kit

OCK11

55484648

Chevrolet Express 2500 - 3500 2019-2017



Diesel Oil Cooler Kit

OCK12

55595793

Chevrolet Colorado 2019-2016

GMC Canyon 2019-2016



Diesel Particulate Filter (DPF) Pressure Sensor

DPS105

12677718

Chevrolet Express 2500 - 3500 2017

GMC Savana 2500 - 3500 2017



GM (Cont'd)

2.8L (Cont'd)

Diesel Particulate Filter (DPF) Pressure Sensor

DPS106

55599659

Chevrolet Colorado 2018-2016

GMC Canyon 2018-2016



Diesel Particulate Filter (DPF) Pressure Sensor

DPS114

55506443

Chevrolet Colorado 2019

Chevrolet Express 2500 - 3500 2019-2018

GMC Canyon 2019

GMC Savana 2500 - 3500 2019-2018



JEEP

2.8L

EGR Valve

EGV1218

5142807AA, 5159971AA, 5166555AB

Jeep Liberty 2006-2005



Fuel/Water Separator Sensor

FWSS109

5143002AA

Jeep Liberty 2006-2005



JEEP (Cont'd)

2.8L (Cont'd)

Turbocharger

TBC560

5142 797AB, 5142653AC, 5142797AC, RL142797AC

Jeep Liberty 2006-2005

* New



3.0L

EGR Valve

EGV1254

6821 1310AA

Jeep Grand Cherokee 2016-2015



Fuel Injector

FJ1268

6802 8405AA, RL028405AA

Jeep Grand Cherokee 2009-2007

* New



Fuel Injector

FJ1269

68211302AA

Jeep Grand Cherokee 2015-2014

* New



Fuel/Water Separator Sensor

FWSS104

5117 542AA

Jeep Grand Cherokee 2009-2007



JEEP (Cont'd)

3.0L (Cont'd)

Glow Plug

GP116

5175 756AA

Jeep Grand Cherokee 2009-2007



Turbocharger

TBC547

6800 4663AA, 6800 4666AA, 6801 9589AA, 6803 7206AA, 6804 3064AA

Jeep Grand Cherokee 2009-2007

* New



MERCEDES-BENZ

2.1L

Diesel Particulate Filter (DPF) Pressure Sensor

DPS112

6429050200

Mercedes-Benz ML250 2015

Mercedes-Benz Sprinter 2500 - 3500 2017-2014



3.0L

Diesel Particulate Filter (DPF) Pressure Sensor

DPS112

6429050200

Mercedes-Benz GL350 2016-2013

Mercedes-Benz ML350 2014-2012



MERCEDES-BENZ (Cont'd)

3.0L (Cont'd)

Fuel Injector

FJ1292NX

6420701187

Mercedes-Benz GL350 2016-2013

Mercedes-Benz ML350 2014-2012

Mercedes-Benz S350 2013-2012

* New

* Reman numbers for reference only. No new OE part numbers available.



NAVISTAR

6.9L IDI

Diesel Oil Cooler Kit

OCK18

E4TZ6A642A, F3TZ6A642C, XU2Z6A642AAPRM, XU2Z6VA642AARM

International 1452SC 1988-1987

International 1652SC 1988-1986



DT530, HT530

Fuel Injector

FJ1309

1830694C93

International 1552SC, 3400, Genesis RE 1996

International 1652SC, 3600, 3800, 4700, 4700LP 1996-1994

International 1652UPS, 4700LPX, 4800, 4900 1996-1995

International 4600, 7100 1995-1994

International 3700, 4600LP 1994

* Remanufactured



NAVISTAR (Cont'd)

DT530, HT530 (Cont'd)

Fuel Injector

FJ1309NX

1830694C93

International 1552SC, 3400, Genesis RE	1996
International 1652SC, 3600, 3800, 4700, 4700LP	1996-1994
International 1652UPS, 4700LPX, 4800, 4900	1996-1995
International 4600, 7100	1995-1994
International 3700, 4600LP	1994

* New

* Reman numbers for reference only. No new OE part numbers available.



DT530, HT530, I530E

Injection High Pressure Oil Pump

HPI20

1826458C92, 1842723C91

IC Corporation 3000 IC	2002
IC Corporation RE Commercial, RE School Bus	2004-2003
International 2554, 2654	2002-1995
International 2574, 2674, 4900	2003-1994
International 3000RE	2002
International 3200	2003
International 4400, 4400LP, 7400, 7500, 8500	2003-2002
International 4700, 4800	2003-1996
International 4700LP	2002-1997
International 5000	1999-1995
International 5500i, 5600i	2003-2000
International 7100	1995-1994
International 8100	2002-1994
International 8200	1997-1996
International Genesis RE	2002-2001, 1999-1997

* Remanufactured



DT570

Fuel Injector

FJ1241

1842225C91, 5010658R92

International 4400	2005-2004
International 4400LP, 7400	2005

* Remanufactured



NAVISTAR (Cont'd)

DT570 (Cont'd)

Fuel Injector

FJ1241NX

1842578C94

International 4400 2005-2004

International 4400LP, 7400 2005

✱ New

✱ Reman numbers for reference only. No new OE part numbers available.



Fuel Injector

FJ1258

1848492C91

International 4400, 4400LP, 7400, 8500, CXT 2006

International RXT 2007-2006

✱ Remanufactured



Fuel Injector

FJ1258NX

1848492C91

International 4400, 4400LP, 7400, 8500, CXT 2006

International RXT 2007-2006

✱ New

✱ Reman numbers for reference only. No new OE part numbers available.



DT570, HT570

Injection High Pressure Oil Pump

HPI17

1842425C96, 1842426C2, 1842617C91, 1885000C93

International 4400, 7500 - 8500, 8600 SBA 2006-2004

International 4400LP, 7400 2006-2005

International CXT, RXT 2006

✱ Remanufactured



HT570

Fuel Injector

FJ1239

1842226C91, 5010659R92

International 7500 - 8500, 8600 SBA 2005-2004

✱ Remanufactured



NAVISTAR (Cont'd)

HT570 (Cont'd)

Fuel Injector

FJ1239NX

1842579C94, 1842579C94

International 7500, 8500, 8600 SBA 2005-2004

* New

* Reman numbers for reference only. No new OE part numbers available.



Fuel Injector

FJ1256

1848495C91

International 7500, 8600 SBA 2006

* Remanufactured



Fuel Injector

FJ1256NX

1848495C91

International 7500, 8600 SBA 2006

* New

* Reman numbers for reference only. No new OE part numbers available.



I530E

Fuel Injector

FJ1304

1824931C94

International 2554, 2574, 2654, 2674, 4900, 5000, 8100 1997-1995

International 4700, 4800, 8200 1997-1996

International 4700LP, Genesis RE 1997

International 7100 1995

* Remanufactured



NAVISTAR (Cont'd)

I530E (Cont'd)

Fuel Injector

FJ1304NX

1824931C94

International 2554, 2574, 2654, 2674, 4900, 5000,
8100 1997-1995
International 4700, 4800, 8200 1997-1996
International 4700LP, Genesis RE 1997
International 7100 1995

* New

* Reman numbers for reference only. No new OE part numbers available.



Fuel Injector

FJ1306

1830148C2

International 2554, 2574, 2654, 2674, 4700, 4700LP, 4800, 4900,
5000, 8100, Genesis RE 1999-1998

* Remanufactured



Fuel Injector

FJ1306NX

1830148C2

International 2554, 2574, 2654, 2674, 4700, 4700LP, 4800, 4900,
5000, 8100, Genesis RE 1999-1998

* New

* Reman numbers for reference only. No new OE part numbers available.



Fuel Injector

FJ1308

1830573C2

International 2554, 2654, 3000, 3000FE, 3600, 3800, 4700,
4700LP, 4800, 4900, 8100 1999-1997
International 2574, 2674, 5000 1999
International 8200 1997
International Genesis RE 1999-1998

* Remanufactured



NAVISTAR (Cont'd)

I530E (Cont'd)

Fuel Injector

FJ1308NX

1830573C2

International 2554, 2654, 3000, 3000FE, 3600, 3800, 4700,
4700LP, 4800, 4900, 8100 1999-1997
International 2574, 2674, 5000 1999
International 8200 1997
International Genesis RE 1999-1998

* New

* Reman numbers for reference only. No new OE part numbers available.



I530E, DT466, DT530, HT530

Injection High Pressure Oil Pump

HPI8

1832092C92, 1832093C2, 1876105C95, 1879743C93, 1879744C2

IC Corporation 1300 FBC, CE Integrated, FE School Bus, RE
Commercial, RE School Bus 2010-2007
IC Corporation 3000 IC 2007
IC Corporation CE Commercial 2010, 2008
IC Corporation CE School Bus 2010
IC Corporation FE Commercial, HC Integrated
Commercial 2010-2008
IC Corporation FE Integrated 2008-2007
International 4300, 4300 LP, 4400, 4400 LP 2010-2007
International 7300 SBA, 7400 2007
International 4700LP 2002-1997

* Remanufactured



MAXXFORCE 5

Injection High Pressure Oil Pump

HPI11

4307327R91, 1880313C94

International CF500 - CF600 2009-2007

* Remanufactured



NAVISTAR (Cont'd)

MAXXFORCE 7

Diesel Injection Installation Kit

IPK2

IC Corporation BE School Bus	2010-2008
IC Corporation CE Commercial	2010, 2008
IC Corporation CE Integrated	2009-2008
IC Corporation CE School Bus	2010
IC Corporation HC Integrated Commercial	2010-2008
International 4100, 4300, 4300LP	2010-2008
International TerraStar	2010

No OE Reference



Diesel Injection Installation Kit

IPK3

IC Corporation AC Commercial Bus	2015-2012
IC Corporation AE School Bus	2015
IC Corporation AR School Bus	2015-2013
IC Corporation BE, CE School Bus	2015-2010
IC Corporation CE Commercial, HC Integrated Commercial	2015-2010
International 4100	2011-2010
International 4300, 4300LP	2015-2010
International TerraStar	2013-2010

No OE Reference



Fuel Injection Harness

IFH8

1856011C95	
International 4100, 4300, 4300LP	2010-2008
International TerraStar	2010



Fuel Injection Harness

IFH9

1856010C95	
International 4100, 4300, 4300LP	2010-2008
International TerraStar	2010



NAVISTAR (Cont'd)

MAXXFORCE 7 (Cont'd)

Fuel Injector

FJ960

1873422C93, 4307381R91, 4307369R91, 5010359R93

International 4100, 4300LP 2010-2008

International TerraStar 2010

* Remanufactured



Fuel Injector

FJ960NX

1873422C93, 4307381R91, 4307369R91, 5010359R93

International 4100, 4300LP 2010-2008

International TerraStar 2010

* New

* Reman numbers for reference only. No new OE part numbers available.



Fuel Injector

FJ1259

1883110C1, 1883111C92, 1899239C92

International 4100 2011-2010

International 4300, 4300LP 2015-2010

International TerraStar 2013-2010

* Remanufactured



Fuel Injector

FJ1259NX

1883110C1, 1883111C92, 1899239C92

International 4100 2011-2010

International 4300, 4300LP 2015-2010

International TerraStar 2013-2010

* New

* Reman numbers for reference only. No new OE part numbers available.



Injection Pump

IP34

1855860C94, 1876529C98, 4307291R91

IC Corporation BE School Bus, HC Integrated Commercial, 4100,
4300, 4300LP 2010-2008

IC Corporation CE Commercial 2010, 2008

IC Corporation CE Integrated 2009-2008

IC Corporation CE School Bus, TerraStar 2010

* Remanufactured



NAVISTAR (Cont'd)

MAXXFORCE 7 (Cont'd)

Injection Pump

IP35

7080839C92

IC Corporation AC Commercial Bus	2015-2012
IC Corporation AE School Bus	2015
IC Corporation AR School Bus	2015-2013
IC Corporation BE School Bus, CE Commercial, CE School Bus, HC Integrated Commercial	2015-2010
International 4100	2011-2010
International 4300, 4300LP	2015-2010
International TerraStar	2013-2010

* Remanufactured



MAXXFORCE 9, 10

Fuel Injector

FJ1244

4307212R91

International 4400, CXT	2008-2007
International 4400LP, 7400, 7500, 7600, 7700, 8500, 8600 SBA	2007
International 8500 TranStar	2009-2008

* Remanufactured



Fuel Injector

FJ1244NX

1848721C92, 4307212R91

International 4400, CXT	2008-2007
International 4400LP, 7400, 7500, 7600, 7700, 8500, 8600 SBA	2007
International 8500 TranStar	2009-2008

* New

* Reman numbers for reference only. No new OE part numbers available.



Injection High Pressure Oil Pump

HPI9

1832094C92, 1832095C2, 1876106C94, 1882259C93

International 4400, CXT	2008-2007
International 4400LP, 7400, 7500, 7600, 7700, 8500, 8600 SBA, RXT	2007
International 8500 TranStar	2009-2008

* Remanufactured



NAVISTAR (Cont'd)

MAXXFORCE 9, 10 (Cont'd)

Injection High Pressure Oil Pump

HPI14

1879745C93, 1879747C2

International 4400, CXT 2008-2007
 International 4400LP, 7400, 7500, 7600, 7700, 8500, 8600 SBA,
 RXT 2007
 International 8500 TranStar 2009-2008

* Remanufactured



7.3L IDI

Diesel Oil Cooler Kit

OCK18

E4TZ6A642A, F3TZ6A642C, XU2Z6A642AAPRM, XU2Z6VA642AARM

International 1452SC 1992-1988
 International 1652SC 1993-1988
 International 1652UPS 1993, 1991-1990
 International 3600 1993-1992
 International 3700 1993-1990
 International 3800 1990
 International 400 1991
 International 4600, 4600LP 1993-1990
 International 4600UH 1990
 International 4900, 500 1991
 International M1400, M1600 Metro II 1990-1988
 International 1654 1989-1984
 International S1654, S1654LP, S1753 1989-1988
 International S1754 1988



MAXXFORCE 9, 10, N9, N10

Fuel Injector

FJ1278

5010717R91

International Loadstar 2013

* Remanufactured



Fuel Injector

FJ1278NX

1890057C92, 1890058C2

International Loadstar 2013

* New

* Reman numbers for reference only. No new OE part numbers available.



NAVISTAR (Cont'd)

MAXXFORCE 9, 10, N9, N10 (Cont'd)

Injection High Pressure Oil Pump

HPI15

1885045C92, 1885046C2, 1889324C92

International Loadstar 2013

* Remanufactured



MAXXFORCE 10

Fuel Injector

FJ1291NX

1894556C93

International CXT 2008-2007

* New

* Reman numbers for reference only. No new OE part numbers available.



MAXXFORCE DT

Diesel Oil Cooler Kit

OCK3

1842417C94, 1842417C93, 1842417C92,
1842417C91, 396081600

International 4300, 4300LP, 4400, 4400LP 2009-2008



Diesel Particulate Filter (DPF) Pressure Sensor

DPS101

2871960

IC Corporation CE School Bus 2018-2017

IC Corporation HC Intergrated Commercial 2017



NAVISTAR (Cont'd)

MAXXFORCE DT (Cont'd)

Fuel Injector

FJ1243

5010561R91

IC Corporation 1300 FBC, CE Integrated, FE School Bus, RE Commercial, RE School Bus 2010-2007
IC Corporation CE Commercial 2010, 2008
IC Corporation FE Commercial, HC Integrated Commercial 2010-2008
IC Corporation CE School Bus 2010
IC Corporation FE Integrated 2008-2007
International 4300, 4300LP, 4400, 4400LP 2010-2007
International 7300 SBA, 7400 2007
International CXT 2008-2007
International Durastar 2013

* Remanufactured



Fuel Injector

FJ1243NX

1848718C92, 5010561R91

IC Corporation 1300 FBC, CE Integrated, FE School Bus, RE Commercial, RE School Bus 2010-2007
IC Corporation CE Commercial 2010, 2008
IC Corporation FE Commercial, HC Integrated Commercial 2010-2008
IC Corporation CE School Bus 2010
IC Corporation FE Integrated 2008-2007
International 4300, 4300LP, 4400, 4400LP 2010-2007
International 7300 SBA, 7400 2007
International CXT 2008-2007
International Durastar 2013

* New

* Reman numbers for reference only. No new OE part numbers available.



Fuel Injector

FJ1277

5010715R91

IC Corporation 1300 FBC, CE Commercial, CE Integrated, CE School Bus, HC Integrated Commercial, RE Commercial, RE School Bus 2014-2011
IC Corporation FE Commercial, FE School Bus 2011
International 4300, 4300LP, 4400, 4400LP 2012-2011

* Remanufactured



NAVISTAR (Cont'd)

MAXXFORCE DT (Cont'd)

Fuel Injector

FJ1277NX

1890055C92, 1890056C2

IC Corporation 1300 FBC, CE Commercial, CE Integrated, CE School Bus, HC Integrated Commercial, RE Commercial, RE School Bus

..... 2014-2011

IC Corporation FE Commercial, FE School Bus

..... 2011

International 4300, 4300LP, 4400, 4400LP

..... 2012-2011

* New

* Reman numbers for reference only. No new OE part numbers available.



Fuel Injector

FJ1279

1884057C92, 1884058C2

IC Corporation 1300 FBC, CE Commercial, CE Integrated, CE School Bus, HC Integrated Commercial, RE Commercial, RE School Bus

..... 2014-2011

IC Corporation FE Commercial, FE School Bus

..... 2011

International 4300, 4300LP, 4400, 4400LP

..... 2012-2011

* Remanufactured



Fuel Injector

FJ1279NX

1884057C92, 1884058C2

IC Corporation 1300 FBC, CE Commercial, CE Integrated, CE School Bus, HC Integrated Commercial, RE Commercial, RE School Bus

..... 2014-2011

IC Corporation FE Commercial, FE School Bus

..... 2011

International 4300, 4300LP, 4400, 4400LP

..... 2012-2011

* New

* Reman numbers for reference only. No new OE part numbers available.



Injection High Pressure Oil Pump

HPI10

1885043C92, 1885044C2, 1889323C93

IC Corporation 1300 FBC, CE Commercial, CE Integrated, CE School Bus, HC Integrated Commercial, RE Commercial, RE School Bus

..... 2014-2010

IC Corporation FE Commercial, FE School Bus

..... 2011-2010

International 4300, 4300LP, 4400, 4400LP

..... 2012-2010

International Durastar

..... 2013

* Remanufactured



NAVISTAR (Cont'd)

MAXXFORCE DT (Cont'd)

Injection High Pressure Oil Pump

HPI13

1882258C93

IC Corporation 1300 FBC, CE Integrated, FE School Bus, RE Commercial, RE School Bus	2010-2007
IC Corporation 3000 IC	2007
IC Corporation CE Commercial	2010, 2008
IC Corporation CE School Bus	2010
IC Corporation FE Commercial	2010-2008
HC Integrated Commercial	
IC Corporation FE Integrated	2008-2007
International 4300, 4300LP, 4400, 4400LP	2010-2007
International 7300 SBA, 7400	2007
International CXT	2008-2007

* Remanufactured



T444E

Fuel Heater

DFH101

1831196C92

IC Corporation 3000 IC	2007
IC Corporation CE Commercial	2010, 2008
IC Corporation CE School Bus	2010
IC Corporation FE Commercial, HC Integrated Commercial	2010-2008
IC Corporation FE Integrated	2008-2007
International 4300, 4300LP, 4400, 4400LP	2010-2007
International 7300 SBA, 7400	2007
International CXT	2008-2007



Fuel Heater

DFH104

1825186C91

International 1552SC, 3400, Genesis RE	1998-1996
International 3600, 1652SC, 4700, 4700LP, 3800	1998-1994
International 1652UPS, 4800, 4900	1997-1995
International 3000	1998-1997
International 3700, 4600LP	1994
International 4600, 7100	1995-1994
International 4700LPX	1998-1995



NAVISTAR (Cont'd)

T444E (Cont'd)

Fuel Injection Harness

IFH1

1824908C1, 1889905C91, 30360R1

International 2554, 2654, 4700LP, 8100	2002-1994
International 2574, 2674, 3800, 4700, 4800, 4900 . . .	2003-1994
International 3000, Genesis RE	2002-1996
International 3000FE	1999-1997
International 3000IC	2002-2000
International 3000RE	2002
International 3200, 4300, 4300LP, 4400, 4400LP, 7300 SBA, 7400, 7500, 8500	2003-2002
International 3600	1999-1995
International 3900FC	1996, 1994
International CXT	2008-2007



Fuel Injection Harness

IFH5

1815923C92

International 5000	1999-1996
International 5500i, 5600i	2003-2000
International 7100	1995-1994



Fuel Injection Harness

IFH7

97207227

International 1552SC	1998
International 1652SC	2005-1998
International 3000	2000-1998
International 3000IC	2002-2000
International 3400, 4700, 4700LP, 4700LPX, Genesis RE	2002-1998
International 3600	1999-1998
International 3800	2004-1998



NAVISTAR (Cont'd)

T444E (Cont'd)

Fuel Injector

FJ595

1816187C3, 1818259C2, 1821752C1, 1821836C3, 1822800C95,
1822801C91

International 1552SC, Genesis RE 1996
International 1652SC, 3600, 3800, 4700, 4700LP 1996-1994
International 1652UPS, 4700LPX, 4800, 4900 1996-1995
International 3400 1996
International 3700, 4600LP 1994
International 4600, 7100 1995-1994

* Remanufactured



Fuel Injector

FJ595NX

1816187C3, 1818259C2, 1821752C1, 1821836C3, 1822800C95,
1822801C91

International 1552SC, Genesis RE 1996
International 1652SC, 3600, 3800, 4700, 4700LP 1996-1994
International 1652UPS, 4700LPX, 4800, 4900 1996-1995
International 3400 1996
International 3700, 4600LP 1994
International 4600, 7100 1995-1994

* New

* Reman numbers for reference only. No new OE part numbers available.



Fuel Injector

FJ596

1822803C1, 1823561C1, 1824582C94, 1824583C97, 1825126C1

International 1552SC 1998-1997
International 1652SC, 3000, 3400, 3600, 3800, 4700, 4700LP,
4700LPX 1999-1997
International 1652UPS, 4800, 4900 1997
International Genesis RE 1999-1997

* Remanufactured



NAVISTAR (Cont'd)

T444E (Cont'd)

Fuel Injector

FJ596NX

1822803C1, 1823561C1, 1824582C94, 1824583C97, 1825126C1
International 1552SC 1998-1997
International 1652SC, 3000, 3400, 3600, 3800, 4700, 4700LP,
4700LPX 1999-1997
International 1652UPS, 4800, 4900 1997
International Genesis RE 1999-1997

* New

* Reman numbers for reference only. No new OE part numbers available.



Fuel Injector

FJ738

1823751C91, 1831487C92, 1831488C1, 1831489C12,
1831550C14, 1831551C13
IC Corporation 1000 SC, 1652 SC, CE Commercial, CE School Bus,
RE Commercial, RE School Bus 2004-2003
IC Corporation 3000 IC 2002
IC Corporation 3800 2003
International 1652SC 2005-1999
International 3000 2000-1999
International 3000IC 2002-2000
International 3400, 4700, 4700LP, 4700LPX, Genesis RE 2002-1999
International 3600 1999
International 3800 2004-1999
International CXT 2008-2007

* Remanufactured



Fuel Injector

FJ738NX

1823751C91, 1831487C92, 1831488C1, 1831489C12,
1831550C14, 1831551C13
IC Corporation 1000 SC, 1652 SC, CE Commercial, CE School Bus,
RE Commercial, RE School Bus 2004-2003
IC Corporation 3000 IC 2002
IC Corporation 3800 2003
International 1652SC 2005-1999
International 3000 2000-1999
International 3000IC 2002-2000
International 3400, 4700, 4700LP, 4700LPX, Genesis RE 2002-1999
International 3600 1999
International 3800 2004-1999
International CXT 2008-2007

* New

* Reman numbers for reference only. No new OE part numbers available.



NAVISTAR (Cont'd)

T444E (Cont'd)

Fuel Injector

FJ926

1833639C1, 1833640C1, 1833644C1, 1833645C1, 1833646C92,
1833647C91

IC Corporation 1000 SC, 1652 SC, CE Commercial, CE School Bus,
RE Commercial, RE School Bus 2004-2003
IC Corporation 3000 IC 2002
IC Corporation 3800 2003
International 1652SC 2005-1999
International 3000 2000-1999
International 3000IC 2002-2000
International 3400, 4700, 4700LP, 4700LPX, Genesis RE 2002-1999
International 3600 1999
International 3800 2004-1999
International CXT 2008-2007

* Remanufactured



Fuel Injector

FJ926NX

1833639C1, 1833640C1, 1833644C1, 1833645C1, 1833646C92,
1833647C91

IC Corporation 1000 SC, 1652 SC, CE Commercial, CE School Bus,
RE Commercial, RE School Bus 2004-2003
IC Corporation 3000 IC 2002
IC Corporation 3800 2003
International 1652SC 2005-1999
International 3000 2000-1999
International 3000IC 2002-2000
International 3400, 4700, 4700LP, 4700LPX, Genesis RE 2002-1999
International 3600 1999
International 3800 2004-1999
International CXT 2008-2007

* New

* Reman numbers for reference only. No new OE part numbers
available.



Fuel Injector

FJ1300

1824455C94

International 1552SC, 3400, Genesis RE 1996
International 1652SC, 3600, 3800, 4700, 4700LP 1996-1994
International 1652UPS, 4700LPX, 4800, 4900 1996-1995
International 4600, 7100 1995-1994
International 3700, 4600LP 1994

* Remanufactured



NAVISTAR (Cont'd)

T444E (Cont'd)

Fuel Injector

FJ1300NX

1824455C94

International 1552SC, 3400, Genesis RE 1996
International 1652SC, 3600, 3800, 4700, 4700LP 1996-1994
International 1652UPS, 4700LPX, 4800, 4900 1996-1995
International 4600, 7100 1995-1994
International 3700, 4600LP 1994

✱ New

✱ Reman numbers for reference only. No new OE part numbers available.



Fuel Injector Seal Kit

SK55

1833564C92

IC Corporation 1000 SC, 1652 SC, CE Commercial, CE School Bus,
RE Commercial, RE School Bus 2004-2003
IC Corporation 3000 IC 2002
IC Corporation 3800 2003
International 2554, 2654, 4700LP, 8100 2002-1995
International 2574, 2674, 4800, 4900 2003-1995
International 3000, Genesis RE 2002-1996
International 3000FE 1999-1997
International 3000IC 2002-2000
International 3000RE 2002, 2000, 1998-1996
International 3200, 7500 2004-2002
International 3400, 3900FC 1996
International 3600 2001, 1999-1994
International 3700 1994
International 3800, 4700 2003-1994
International 4300, 4300LP, 7300, 7300 SBA 2003-2002
International 4400, 4400LP, 7400, 8500 2005-2002
International 4600 1995-1994
International 5000 1999-1995
International 5500i, 5600i 2005-2000
International 7100 1995
International 8200 1997-1996



Fuel Pressure Regulator

PR315

1829856C91, 1836412C91, 1841086C91, 1841217C91

International 4700 2002-1995



NAVISTAR (Cont'd)

T444E (Cont'd)

Injection Control Pressure Sensor

ICP102

1825899C93, 1876735C91

International 1552SC	1998-1996
International 1652SC	2005-2004, 2002-1995
International 1652UPS, 4800, 4900	1997-1995
International 3000	2000-1997
International 3000IC	2002-2000
International 3400, Genesis RE	2002-1996
International 3600	1999-1994
International 3700, 4600LP	1994
International 3800	2004-1994
International 4600, 7100	1995-1994
International 4700, 4700LP	2002-1994
International 4700LPX	2002-1995



Injection High Pressure Oil Pump

HPI1

1825248C91, 1825259C91, 2503703C91

International 1552SC, 3400, Genesis RE	1997-1996
International 1652SC, 3600, 3800, 4700, 4700LP	1997-1994
International 1652UPS, 4700LPX, 4800, 4900	1997-1995
International 3000	1997
International 3700, 4600LP	1994
International 4600, 7100	1995-1994

* Remanufactured



Injection High Pressure Oil Pump

HPI2

1831449C91, 2589446C91

IC Corporation 1000 SC, 1652 SC, CE Commercial, CE School Bus, RE Commercial, RE School Bus	2004-2003
IC Corporation 3000 IC	2002
IC Corporation 3800	2003
International 1652SC	2005-1999
International 3000	2000-1999
International 3000IC, Genesis RE	2002-2000
International 3400, 4700, 4700LP, 4700LPX	2002-1999
International 3600	1999
International 3800	2004-1999

* Remanufactured



NAVISTAR (Cont'd)

T444E (Cont'd)

Injection High Pressure Oil Pump

HPI3

1830857C91, 2503704C91

International 1552SC 1998
International 1652SC, 3000, 3400, 3600, 3800, 4700, 4700LPX,
Genesis RE 1999-1998
International 4700LP 1999, 1997

* Remanufactured



Injection High Pressure Oil Pump

HPI4

1825247C91, 1825260C91, 1825271C93, 2503701C91

International 1552SC, 3400, Genesis RE 1997-1996
International 1652SC, 3600, 3800, 4700, 4700LP 1997-1994
International 1652UPS, 4700LPX, 4800, 4900 1997-1995
International 3000 1997
International 3700, 4600LP 1994
International 4600, 7100 1995-1994

* Remanufactured



Injection Pump

IP43NX

1813460C93

International 1452SC, 1652SC 1992

* New

* Reman numbers for reference only. No new OE part numbers available.



Injection Pump

IP44NX

1813465C93

International 1452SC, 1652SC 1992

* New

* Reman numbers for reference only. No new OE part numbers available.



NAVISTAR (Cont'd)

T444E (Cont'd)

Turbocharger

TBC591

1841839C91

International 2554, 2654, 3000, 4700, 4900, 8100 . . .	2002-1999
International 2574	2002-2001
International 3200, 4400, 7300, 3600	2003-2002
International 3800, 4800	2003-1999
International 4300	2008-2002
International 7500	2002

* New



Valve Cover Gasket

VCG4

1826703C1

International 1552SC	1998
International 1652SC	2005-1998
International 3000	2000-1998
International 3000IC	2002-2000
International 3400, 4700, 4700LP, 4700LPX, Genesis RE	2002-1998
International 3600	1999-1998
International 3800	2004-1998



Valve Cover Gasket

VCG6

1818350C2

International 1552SC, 3400, Genesis RE	1997-1996
International 1652SC, 3600, 3800, 4700, 4700LP	1997-1994
International 1652UPS, 4700LPX, 4800, 4900	1997-1995
International 3700, 4600LP	1994
International 4600, 7100	1995-1994



VT275

Fuel Injector

FJ9288PCK

4C3Z9E527AA, 4C3Z9E527BRM, 5C4Z9E527A, CN5019RM,
5010120R92, 1844751C2, 1845150C92, 1846692C92,
1878285C91, 1879998C91, 1877748C1, 1878285C91

Workhorse Custom Chassis W42	2009-2005
Workhorse W42	2009-2005

* Remanufactured



NAVISTAR (Cont'd)

VT275 (Cont'd)

Injection High Pressure Oil Pump

HPI16

4307325R91, 1884357C92

International CF500 - CF600 2006-2005

* Remanufactured



VT365

Diesel EGR Cooler Kit

ECK1

1845145C99

IC Corporation 1652 SC 2007-2006

IC Corporation 3000 Chassis 2007-2006

IC Corporation 3000 IC 2007-2006

IC Corporation 3200 2007

IC Corporation BE Commercial Bus 2008

IC Corporation BE School Bus 2008

IC Corporation CE Commercial 2008-2006

International 3600 1999

* New



Diesel EGR Cooler Kit

ECK12

1840700C99

International 1652SC 2004

International 3200, 4200 2004-2002

International 4200LP 2004-2003

International 4300, 4400 2003

* New

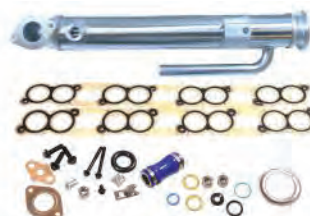

Diesel Rail Seal Kit

SK145

International 1652SC 2007-2004

International 3200, 4200, 4200LP 2007-2003

International 3300, CF500, RXT 2007-2005

International 4100, 4100 SBA, CXT 2007-2006

International 4300, 4400 2003

International MXT 2007

No OE Reference



NAVISTAR (Cont'd)

VT365 (Cont'd)

Fuel Injector

FJ927

184308C91, 1843481C95, 1845879C91, 1878281C92,
1878281C92

International 3200, 4200 2003-2002
International 4200LP, 4300, 4400 2003

* Remanufactured



Fuel Injector

FJ927NX

184308C91, 1843481C95, 1845879C91, 1878281C92,
1878281C92

International 3200, 4200 2003-2002
International 4200LP, 4300, 4400 2003

* New

* Reman numbers for reference only. No new OE part numbers available.



Fuel Injector

FJ9288PCK

4C3Z9E527AA, 4C3Z9E527BRM, 5C4Z9E527A, CN5019RM,
5010120R92, 1844751C2, 1845150C92, 1846692C92,
1878285C91, 1879998C91, 1877748C1, 1878285C91

IC Corporation 1652 SC, 3000 Chassis 2007-2005
IC Corporation 3000 IC 2007-2006
IC Corporation 3200 2007
IC Corporation 3300 Chassis 2005
IC Corporation BE Commercial Bus, BE School Bus 2008
IC Corporation CE Commercial, CE Integrated 2008-2005
IC Corporation HC Intergrated Commercial 2008-2007
IC Corporation RE Commercial 2007
IC Corporation RE Integrated 2005
IC Corporation RE School Bus 2008-2005
International 1652SC 2005-2004
International 3200 2007-2004
International 4100 2011-2008
International 4100 SBA 2008
International CXT, RXT 2008-2006

* Remanufactured



NAVISTAR (Cont'd)

VT365 (Cont'd)

High Pressure Oil Pump Seal Kit

SK142

International 1652SC, 3200, 3300, 4200, 4200LP, RXT 2007-2005
International 4100, 4100 SBA, CXT 2007-2006
International MXT 2007
No OE Reference



Injection Control Pressure Sensor

ICP101

1845428C92, 1845427C2

IC Corporation 1652 SC, 3000 Chassis 2007-2005
IC Corporation 3000 IC 2007-2006
IC Corporation 3200, RE Commercial 2007
IC Corporation 3300 Chassis, RE Integrated 2005
IC Corporation BE Commercial Bus, BE School Bus 2008
IC Corporation CE Commercial, CE Integrated, RE School
Bus 2008-2005
IC Corporation HC Integrated Commercial 2008-2007
International 1652SC 2012-2004
International 3200 2011-2004
International 3300 2011-2005
International 4100 2012-2006
International 4100 SBA, CXT 2008-2006
International 4200 2008-2002
International 4200LP 2007-2003
International CF500 - CF600 2009-2005
International CXT 2008-2006
International RXT 2008-2005



Injection Control Pressure Sensor

ICP103

1845274C92

International 1652SC, 4200, 4200LP 2004
International 3200 2004-2002
International 4300 - 4400 2003



NAVISTAR (Cont'd)

VT365 (Cont'd)

Injection High Pressure Oil Pump

HPI7

1882919C92, 1878865C91

IC Corporation 1652 SC, 3000 Chassis, RXT	2007-2005
IC Corporation 3000 IC	2007-2006
IC Corporation 3200, RE Commercial	2007
IC Corporation 3300 Chassis, RE Integrated	2005
IC Corporation BE Commercial Bus, BE School Bus	2008
IC Corporation CE Commercial, CE Integrated, RE School Bus	2008-2005
IC Corporation HC Integrated Commercial	2008-2007
International 1652SC, 3200, 4200, 4200LP	2007-2004
International 3300	2007-2005
International 4100, 4100 SBA, CXT	2007-2006
International MXT	2007

* Remanufactured



Turbocharger

TBC593

1856152C91

International 4100	2010-2006
International 4100 SBA, CXT	2008-2006
International 4200	2010-2004
International 4200LP	2008-2004
International MXT	2009-2007
International RXT	2008-2005

* New



Turbocharger

TBC594

1832161C91

IC Corporation 1652 SC, 3000 Chassis	2007-2005
IC Corporation 3000 IC	2007-2006
IC Corporation 3200, RE Commercial	2007
IC Corporation 3300 Chassis, RE Integrated	2005
IC Corporation BE Commercial Bus, BE School Bus	2008
IC Corporation CE Commercial, CE Integrated, RE School Bus	2008-2005
IC Corporation HC Integrated Commercial	2008-2007
International 1652SC, 3200	2010-2004
International 3300	2010-2005

* New



NAVISTAR (Cont'd)

VT365, VT275

Fuel Injector Seal Kit

SK85

1843682C91

IC Corporation 1652 SC, 3000 Chassis	2007-2005
IC Corporation 3000 IC	2007-2006
IC Corporation 3200, RE Commercial	2007
IC Corporation 3300 Chassis, RE Integrated	2005
IC Corporation BE Commercial Bus, BE School Bus	2008
IC Corporation CE Commercial, CE Integrated, RE School Bus, RXT	2008-2005
IC Corporation HC Integrated Commercial	2008-2007
International 1652SC	2012-2004
International 3200	2011-2002
International 3300	2011-2005
International 4100	2012-2006
International 4100 SBA	2008-2006
International 4200	2008-2002
International 4200LP	2007-2003
International 4300, 4400	2003
International CF500, CF600	2009-2005
International CXT	2008-2006
International MXT	2009-2007



Fuel Injector Sleeve

IFS1

IC Corporation 1652 SC, 3000 Chassis	2007-2005
IC Corporation 3000 IC	2007-2006
IC Corporation 3200, RE Commercial	2007
IC Corporation 3300 Chassis, RE Integrated	2005
IC Corporation BE Commercial Bus, BE School Bus, HC Integrated Commercial	2008
IC Corporation CE Commercial, CE Integrated, RE School Bus	2008-2005
International 1652SC	2010-2004
International 3200 - 4200	2010-2003
International 3300	2010-2005
International 4100	2010-2006
International 4100 SBA, CXT	2008-2006
International 4200LP	2008-2003
International 4300 - 4400	2003
International MXT	2009-2007
International RXT	2008-2005

No OE Reference



NAVISTAR (Cont'd)

VT365, VT275, MAXXFORCE 5

Fuel Injector

FJ928

1844751C2, 1845150C92, 1846692C92, 1877748C1,
1878284C91, 1878285C91, 1879998C91

IC Corporation 1652 SC, 3000 Chassis	2007-2005
IC Corporation 3000 IC	2007-2006
IC Corporation 3200, RE Commercial	2007
IC Corporation 3300 Chassis, RE Integrated	2005
IC Corporation BE Commercial Bus, BE School Bus	2008
IC Corporation CE Commercial, CE Integrated, RE School Bus	2008-2005
IC Corporation HC Integrated Commercial	2008-2007
International 1652SC	2012-2004
International 3200	2011-2004
International 3300	2011-2005
International 4100	2012-2006
International 4100 SBA, CXT	2008-2006
International 4200	2008-2004
International 4200LP	2007-2004
International CF500 - CF600	2009-2005
International MXT	2009-2007
International RXT	2008-2005

* Remanufactured



NAVISTAR (Cont'd)

VT365, VT275, MAXXFORCE 5 (Cont'd)

Fuel Injector

FJ928NX

1844751C2, 1845150C92, 1846692C92, 1877748C1,
1878284C91, 1878285C91, 1879998C91

IC Corporation 1652 SC, 3000 Chassis	2007-2005
IC Corporation 3000 IC	2007-2006
IC Corporation 3200, RE Commercial	2007
IC Corporation 3300 Chassis, RE Integrated	2005
IC Corporation BE Commercial Bus, BE School Bus	2008
IC Corporation CE Commercial, CE Integrated, RE School Bus	2008-2005
IC Corporation HC Integrated Commercial	2008-2007
International 1652SC	2012-2004
International 3200	2011-2004
International 3300	2011-2005
International 4100	2012-2006
International 4100 SBA, CXT	2008-2006
International 4200	2008-2004
International 4200LP	2007-2004
International CF500 - CF600	2009-2005
International MXT	2009-2007
International RXT	2008-2005

* New

* Reman numbers for reference only. No new OE part numbers available.



Oil Cooler Gasket Kit

OCG1

International 1652SC	2012-2004
International 3200	2011-2004
International 3300	2011-2005
International 4100	2012-2006
International 4100 SBA, CXT	2008-2006
International 4200	2008-2002
International 4200LP	2007-2003
International 4300 - 4400	2003
International CF500 - CF600	2009-2005
International MXT	2009-2007
International RXT	2008-2005

No OE Reference

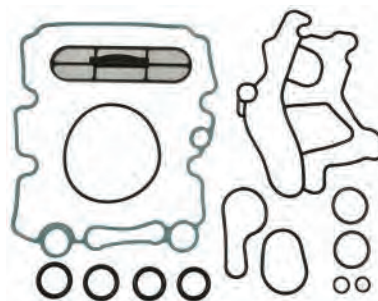

NAVISTAR (Cont'd)

VT365, VT275, MAXXFORCE 5 (Cont'd)

Oil Cooler Kit

OCK1

1886511C93

International 1652SC	2012-2004
International 3200	2011-2004
International 3300	2011-2005
International 4100	2012-2006
International 4100 SBA	2008-2006
International 4200	2008-2002
International 4200LP	2007-2003
International 4300	2003

* New

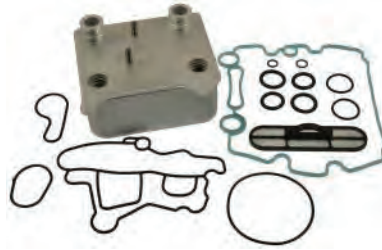

6 Cyl.

Diesel Particulate Filter (DPF) Pressure Sensor

DPS101

Freightliner Columbia	2017
No OE Reference	



DT466

Diesel Oil Cooler Kit

OCK3

1842417C94, 1842417C93, 1842417C92,
1842417C91, 396081600

IC Corporation 1300 FBC	2008-2006
IC Corporation 3000 Chassis	2006
IC Corporation 3000IC	2007-2006
IC Corporation CE Commercial	2008, 2006
IC Corporation CE Integrated, FE School Bus	2008-2006
IC Corporation FE Commercial	2008
IC Corporation FE Integrated	2008-2007
IC Corporation RE Commercial, RE School Bus	2009-2006
International 3200	2006
International 4300, 4300LP, 4400, 4400LP, 7300, 7400	2007-2006
International CXT	2008-2006



NAVISTAR (Cont'd)

DT466 (Cont'd)

Fuel Injector

FJ1240

1841491C91, 1842223C91, 5010656R91, 5010656R92

IC Corporation 3000 IC 2004

CE-FE-RE Commercial, CE-FE-RE School Bus

International 3200, 3800, 4300, 4300LP, 4400, 4400LP, 7300,
7300 SBA, 7400 2004

* Remanufactured



Fuel Injector

FJ1240NX

1842576C93

IC Corporation 3000 IC 2004

CE-FE-RE Commercial, CE-FE-RE School Bus

International 3200, 3800, 4300, 4300LP, 4400, 4400LP, 7300,
7300 SBA, 7400 2004

* New

* Reman numbers for reference only. No new OE part numbers
available.



Fuel Injector

FJ1242

1842224C91, 5010657R92

IC Corporation 3000, 3300 Chassis 2005

IC Corporation 3000 IC, CE-FE-RE School Bus, FE Commercial,
2005 - 2004 IC Corporation CE-RE Commercial

IC Corporation CE, FE, RE Integrated 2005

International 3000RE, CXT 2005

International 3200, 4300, 4300 LP, 4400, 4400 LP, 7300, 7300
SBA, 7400 2005-2004

International 3800 2004

* Remanufactured



NAVISTAR (Cont'd)

DT466 (Cont'd)

Fuel Injector

FJ1242NX

1842577C93

IC Corporation 3000, 3300 Chassis 2005
IC Corporation 3000 IC, CE-FE-RE School Bus, FE Commercial,
2005 - 2004 IC Corporation CE-RE Commercial 2004
IC Corporation CE, FE, RE Integrated 2005
International 3000RE, CXT 2005
International 3200, 4300, 4300 LP, 4400, 4400 LP, 7300, 7300
SBA, 7400 2005-2004
International 3800 2004

* New

* Reman numbers for reference only. No new OE part numbers available.



Fuel Injector

FJ1257

1848489C91

IC Corporation 1300 FBC, 3000 Chassis, CE-RE Commercial, CE
Integrated, FE-RE School Bus 2006
International 3200, 4300, 4300LP, 4400, 4400LP, 7300, 7300
SBA, 7400, CXT 2006

* Remanufactured



Fuel Injector

FJ1257NX

1848489C91

IC Corporation 1300 FBC, 3000 Chassis, CE-RE Commercial, CE
Integrated, FE-RE School Bus 2006
International 3200, 4300, 4300LP, 4400, 4400LP, 7300, 7300
SBA, 7400, CXT 2006

* New

* Reman numbers for reference only. No new OE part numbers available.



NAVISTAR (Cont'd)

DT466 (Cont'd)

Injection High Pressure Oil Pump

HPI12

1842423C97, 1842424C2, 1842614C91, 1871291C4,
1871292C96, 1883888C93

IC Corporation 1300 FBC 2006
IC Corporation 3000 Chassis, CE Integrated 2006-2005
IC Corporation 3000 IC, RE School Bus, FE School Bus 2006, 2004
IC Corporation 3300 Chassis, FE Integrated, RE Integrated 2005
IC Corporation CE Commercial, RE Commercial 2006-2004
IC Corporation CE School Bus, FE Commercial 2004
International 3200, 4300, 4300LP, 4400, 4400LP, 7300, 7300
SBA, 7400 2006-2004
International 3000RE 2005
International 3800 2004
International CXT 2006-2005

* Remanufactured



DT466 TRANSIT

Fuel Injector

FJ1262

1836253C1

International Genesis RE 2002-2000

* Remanufactured



Fuel Injector

FJ1262NX

1836252C91

International Genesis RE 2002-2000

* New

* Reman numbers for reference only. No new OE part numbers available.



NAVISTAR (Cont'd)

DT466, DT466E

Injection High Pressure Oil Pump

HPI19

1825681C95, 1842721C91

IC Corporation 3000 IC	2002
IC Corporation 3800, CE Commercial, CE School Bus, FE Commercial, FE School Bus, RE Commercial, RE School Bus	2003
International 2554, 2654, 4700LP, 8100	2002-1994
International 2574, 2674	2003-2001
International 3000	2002-1996
International 3000FE	1999-1997
International 3000IC	2002-2000
International 3200, 4300, 4300LP, 4400, 4400LP	2003-2002
International 3600	2001, 1999-1995
International 3800, 4700, 4800, 4900	2003-1994
International 3900FC	1996, 1994
International 5500i, 5600i	2002-2001
International 7100	1995-1994
International 7300, 7300 SBA, 7400	2003-2002
International 7500, 8500	2002
International 8200	1997-1996
International Genesis RE	2002-1998

* Remanufactured



DT466, DT530, HT530, I530E

Injection Control Pressure Sensor

ICP106

1830669C92

International 2554, 2654, 3000, 4700LP, 8100, Genesis RE	2002-1999
International 2574, 2674, 3800, 4700, 4800, 4900	2003-1999
International 3000FE, 5000	1999
International 3000IC	2002-2000
International 3000RE	2002
International 3200, 4300, 4300LP, 4400, 4400LP, 7300, 7300 SBA, 7400, 7500, 8500	2003-2002
International 3600	2001, 1999
International 5500i, 5600i	2003-2000



NAVISTAR (Cont'd)

DT466, DT530, HT530, I530E (Cont'd)

Injection High Pressure Oil Pump

HPI18

1830177C92, 1842722C91

IC Corporation 3000 IC, 3000RE	2002
IC Corporation 3800, CE Commercial, CE School Bus, FE Commercial, FE School Bus	2003
IC Corporation RE Commercial, RE School Bus	2004-2003
International 2554, 2564	2002-1995
International 2574, 2674	2003-1994
International 3000, 3000IC	2002-2000
International 3200, 4300, 4300LP, 4400, 4400LP, 7300, 7300 SBA, 7400, 7500, 8500	2003-2002
International 3800, 5500i, 5600i	2003-2000
International 3600	2001
International 4700, 4800	2003-1996
International 4700LP	2002-1997
International 4900	2003-1994
International 5000	1999-1995
International 7100	1995-1994
International 8100	2002-1994
International 8200	1997-1996
International Genesis RE	2002-1997

* Remanufactured



DT466, DT570, HT570, MAXXFORCE DT, MAXXFORCE 9, MAXXFORCE 10

Fuel Injector Seal Kit

SK140

1842624C92

International 3000RE	2005
International 3200, 7300	2006-2004
International 3800	2004
International 4300, 4300LP, 4400, 4400LP	2010-2004
International 7300 SBA, 7400, 7500, 8500, 8600 SBA ..	2007-2004
International 7600, 7700	2007
International 8500 TranStar	2009-2008
International CXT	2008-2005
International Durastar	2013
International RXT	2007-2006



NAVISTAR (Cont'd)

DT466, DT570, HT570, MAXXFORCE DT, MAXXFORCE 9, MAXXFORCE 10 (Cont'd)

Fuel Injector Seal Kit

SK141

1830317C1

International 2554, 2654, 4700LP, 8100	2002-1995
International 2574, 2674, 4700, 4800, 4900	2003-1995
International 3000	2002-1996
International 3000FE	1999-1997
International 3000IC	2002-2000
International 3000RE	2005, 2002
International 3200, 7300	2006-2002
International 3600	2001, 1999-1995
International 3800	2004-1995
International 3900FC	1996
International 4300, 4300LP, 4400, 4400LP	2010-2002
International 5000	1999-1995
International 5500i, 5600i	2005-2000
International 7100	1995
International 7300 SBA, 7400, 7500, 8500	2007-2002
International 7600, 7700	2007
International 8200	1997-1996
International 8500 TranStar	2009-2008
International 8600 SBA	2007-2004
International CXT	2008-2005
International Durastar	2013
International Genesis RE	2002-1997
International RXT	2007-2006



DT466E

Fuel Injector

FJ1301

1824928C94

International 2554, 2654, 3600, 3800, 4700, 4700 LP, 4800, 4900, 8100	1997-1995
International 3000, 8200	1997-1996
International 3000FE	1997
International 3900FC	1996
International 7100	1995

* Remanufactured



NAVISTAR (Cont'd)

DT466E (Cont'd)

Fuel Injector

FJ1301NX

1824928C94

International 2554, 2654, 3600, 3800, 4700, 4700 LP, 4800, 4900,
8100 1997-1995
International 3000, 8200 1997-1996
International 3000FE 1997
International 3900FC 1996
International 7100 1995

* New

* Reman numbers for reference only. No new OE part numbers available.



Fuel Injector

FJ1302

1824929C94

International 2554, 2654, 3600, 3800, 4700, 4700LP, 4800, 4900,
8100 1997-1995
International 3000, 8200 1997-1996
International 3000FE 1997
International 3900FC 1996
International 7100 1995

* Remanufactured



Fuel Injector

FJ1302NX

1824929C94

International 2554, 2654, 3600, 3800, 4700, 4700LP, 4800, 4900,
8100 1997-1995
International 3000, 8200 1997-1996
International 3000FE 1997
International 3900FC 1996
International 7100 1995

* New

* Reman numbers for reference only. No new OE part numbers available.



NAVISTAR (Cont'd)

DT466E (Cont'd)

Fuel Injector

FJ1303

1824930C94

International 2554, 2654, 3600, 3800, 4700, 4700LP, 4800, 4900,
8100 1997-1995
International 3000, 8200 1997-1996
International 3000FE 1997
International 3900FC 1996
International 7100 1995

* Remanufactured



Fuel Injector

FJ1303NX

1824930C94

International 2554, 2654, 3600, 3800, 4700, 4700LP, 4800, 4900,
8100 1997-1995
International 3000, 8200 1997-1996
International 3000FE 1997
International 3900FC 1996
International 7100 1995

* New

* Reman numbers for reference only. No new OE part numbers available.



Fuel Injector

FJ1305

1829926C2

International 2554, 2654, 3000, 3000FE, 3600, 3800, 4700,
4700LP, 4800, 4900, 8100 1999-1997
International 8200 1997
International Genesis RE 1999-1998

* Remanufactured



Fuel Injector

FJ1305NX

1829926C2

International 2554, 2654, 3000, 3000FE, 3600, 3800, 4700,
4700LP, 4800, 4900, 8100 1999-1997
International 8200 1997
International Genesis RE 1999-1998

* New

* Reman numbers for reference only. No new OE part numbers available.



NAVISTAR (Cont'd)

DT466E (Cont'd)

Fuel Injector

FJ1307

2593594C91

International 2554, 2654, 3000, 3000FE, 3600, 3800, 4700,
4700LP, 4800, 4900, 8100 1999-1997
International 2574, 2674, 5000 1999
International 8200 1997
International Genesis RE 1999-1998

* Remanufactured



Fuel Injector

FJ1307NX

2593594C91

International 2554, 2654, 3000, 3000FE, 3600, 3800, 4700,
4700LP, 4800, 4900, 8100 1999-1997
International 2574, 2674, 5000 1999
International 8200 1997
International Genesis RE 1999-1998

* New

* Reman numbers for reference only. No new OE part numbers available.



DT466E, I530E, DT466, DT530, HT530

Fuel Injector Sleeve

IFS2

1818778C3

International 3200, 4300, 4300LP, 4400, 4400LP, 7300, 7300
SBA, 7400 2003-2002
International 5500i, 5600i 2002-2001
International 7500, 8500 2002



NAVISTAR (Cont'd)

DT466E, I530E, DT466, DT530, HT530 (Cont'd)

Valve Cover Gasket

VCG1

1820909C91, 1825602C91

International 3000RE	2002
International 3200, 4300, 4300LP, 4400, 4400LP, 7300, 7300 SBA, 7400, 7500, 8500	2003-2002
International 3600	2001, 1999-1996
International 3900FC	1996
International 4800	2003-2002, 2000-1996
International 5000	1999-1996
International 5600i	2003-2000
International 8200	1997-1996

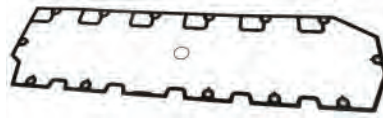

RAM

3.0L

EGR Valve

EGV1254

6821 1310AA

Ram 1500	2016-2014
----------------	-----------



SPRINTER

2.7L

Diesel Oil Cooler Kit

OCK7

5104010AA, 5080403AA, 5080402AA, 5183940AA

Dodge Sprinter 2500 - 3500	2006-2003
----------------------------------	-----------



SPRINTER (Cont'd)

2.7L (Cont'd)

Diesel Oil Cooler Kit

OCK17

5179360AA, 5179360AB

Dodge Sprinter 2500 - 3500 2009-2008



EGR Valve

EGV1139

5104008AA, 5127718AA

Dodge Sprinter 2500 - 3500 2003



Fuel Injector

FJ921

445110182, 5103575AA, 5135154AA, 5135154AB, 5140772AA,
68001712AA, R5135154AB

Dodge Sprinter 2500 - 3500 2003

Freightliner Sprinter 2500 - 3500 2003-2002

* Remanufactured



Fuel/Water Separator Sensor

FWSS104

5117 542AA

Dodge Sprinter 2500 - 3500 2009-2004



SPRINTER (Cont'd)

2.7L (Cont'd)

Fuel/Water Separator Sensor

FWSS108

5080457AA

Dodge Sprinter 2500 - 3500 2003

Freightliner Sprinter 2500 - 3500 2002



Glow Plug

GP111

5080 047AB, 5117592AA

Dodge Sprinter 2500 - 3500 2006-2003



Glow Plug Relay

RY-1528

5170859AA, 68079372AA

Dodge Sprinter 2500 - 3500 2006-2003



Injection Pump

IP31

5142257AA

Dodge Sprinter 2500 - 3500 2006-2004

* Remanufactured



SPRINTER (Cont'd)

2.7L (Cont'd)

Turbocharger

TBC546

5142 494AA, RL142494AA

Dodge Sprinter 2500 - 3500 2006-2004

Freightliner Sprinter 2500 - 3500 2006-2004

* New



Turbocharger

TBC554

5104 006AA, 5104006AB, R5104006AB

Dodge Sprinter 2500 - 3500 2003

Freightliner Sprinter 2500 - 3500 2003-2002

* New



3.0L

Fuel Injector

FJ922

5137297AA, 5137297AB, 68001837AA, R5137297AB

Dodge Sprinter 2500 - 3500 2006-2004

Freightliner Sprinter 2500 - 3500 2006-2004

* Remanufactured



Glow Plug

GP116

5175 756AA

Dodge Sprinter 2500 - 3500 2009-2007



SPRINTER (Cont'd)

3.0L (Cont'd)

Injection Pump

IP32

68014060AA

Dodge Sprinter 2500 - 3500 2009-2007

Freightliner Sprinter 2500 - 3500 2009-2007

* Remanufactured



VOLKSWAGEN

1.9L

Turbocharger

TBC542

028 145 701 QX

Volkswagen Jetta 1999-1997

Volkswagen Passat 1997-1996

* New



Turbocharger

TBC587

038 253 014 QX

Volkswagen Jetta 2006-2005

* New



VOLKSWAGEN (Cont'd)

1.9L (Cont'd)

Turbocharger

TBC-518

038 253 016P, 038 253 019S

Volkswagen Beetle	2006-2004
Volkswagen Golf	2006-2004
Volkswagen Jetta	2005-2004

* New



Turbocharger

TBC-519

038 253 019C, 03G 253 014R, 03G 253 016L

Volkswagen Beetle	2003-1999
Volkswagen Golf	2004-1999
Volkswagen Jetta	2004-2000

* New



2.0L

Diesel Glow Plug

GP119

03L905061D, 03L905061E, 03L905061F

Audi A3	2011-2010
Volkswagen Beetle	2014-2013
Volkswagen Golf	2014-2010
Volkswagen Jetta	2014-2009
Volkswagen Passat	2014-2012



Diesel Particulate Filter (DPF) Pressure Sensor

DPS104

076 906 051B

Volkswagen Beetle	2015-2013
Volkswagen Golf	2014-2010
Volkswagen Jetta	2015-2010
Volkswagen Passat	2015-2012



VOLKSWAGEN (Cont'd)

2.0L (Cont'd)

Turbocharger

TBC529

03L 253 010, 03L 253 056

Volkswagen Beetle 2014-2013

Volkswagen Golf 2014-2010

Volkswagen Jetta 2014-2009

* New



Turbocharger

TBC564

038 145 702 J, 038 145 702 NX, 038145702G, 038145702GX,
038145702JX, 038145702N

Volkswagen Passat 2005-2004

* New



Turbocharger

TBC580

03L 253 010 J

Volkswagen Passat 2014-2012

* New



VOLKSWAGEN (Cont'd)

3.0L

Diesel Emission Fluid Injection Nozzle

DF18

3C0131113B/C/D

Audi A7 Quattro	2015-2014
Audi Q7	2015-2010
Porsche Cayenne	2015-2013
Volkswagen Passat	2014-2012
Volkswagen Touareg	2015-2010



Diesel Glow Plug

GP119

03L905061D, 03L905061E, 03L905061F

Audi A6 Quattro	2015-2014
Audi A7 Quattro	2016-2014
Audi Q7	2015-2014
Volkswagen Taureg	2014-2009



Turbocharger

TBC585

059 145 873 F

Volkswagen Touareg	2012-2009
--------------------	-----------

* New



5.0L

Turbocharger

TBC586

07Z 145 873 J

Volkswagen Touareg	2008-2006
--------------------	-----------

* New

