

CATALOG NO.
STHPB-12

handypack®

STANDARD®

Wiring Center Accessories Guide

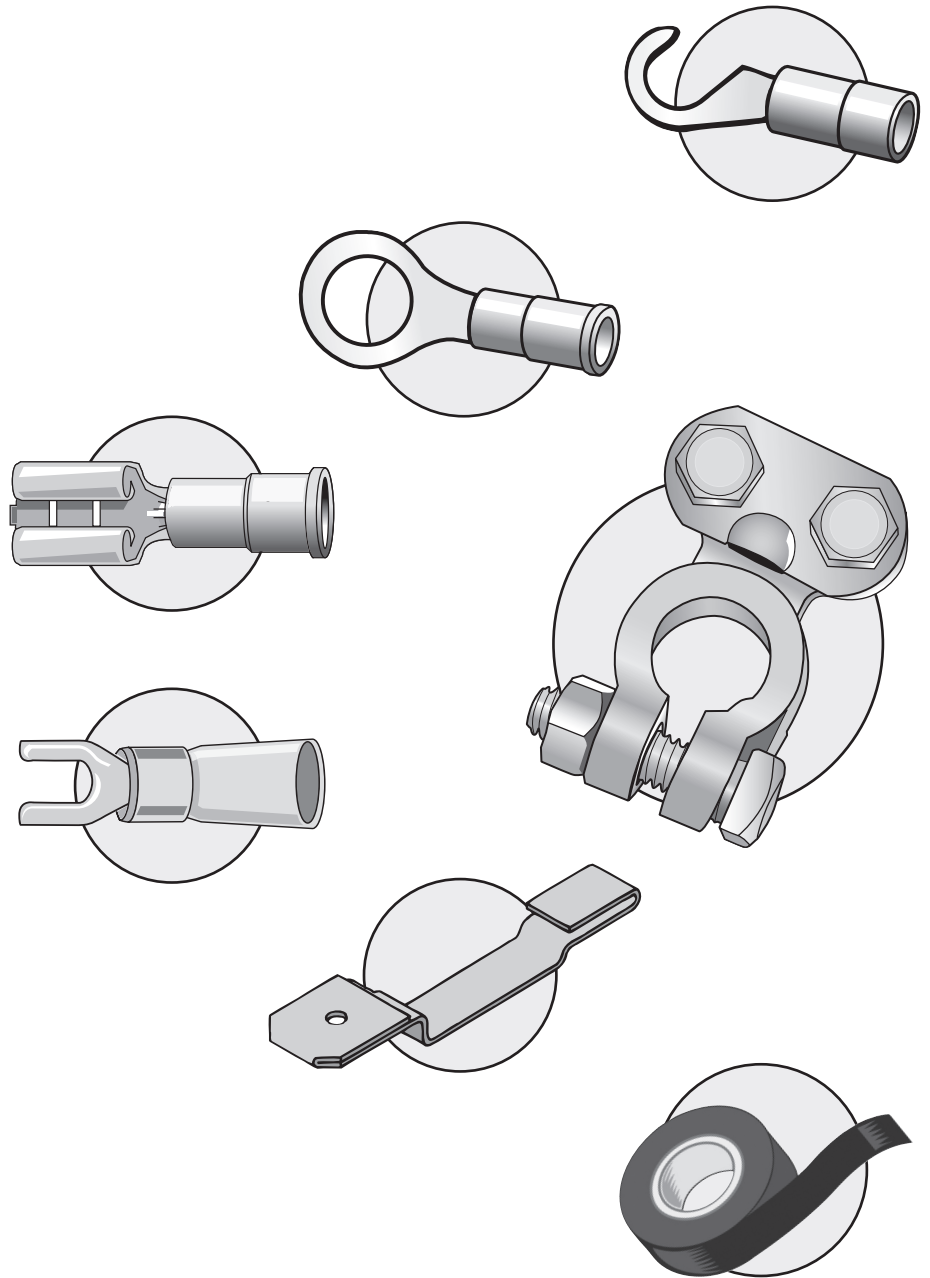

- **TERMINALS AND CONNECTORS**
- **PRIMARY WIRE**
- **FUSIBLE LINKS**
- **BATTERY PARTS**
- **TIE STRAPS AND LOOM**
- **SOCKETS, PIGTAILS AND SWITCHES**
- **AUDIO TERMINALS**
- **TOOLS**

Table of Contents

Description	Page
Terminals and Connectors	1–12
Fuse holders and taps	5
OEM terminals	9–12
Primary Wire	13–14
Battery Parts	14–15
Fusible Link	14
Bundling and Miscellaneous	16–18
Heat Shrink Tubing	16
Tie Straps	16–17
Loom	17
Pigtails & Sockets	19–29
Switches	30–33
Trailer Connectors	34–36
Tools	37–38
Safety Items	39
Wiring Center Contents	40–49
Index	52–54



- New rack design and small size packages for better use of space.
- Side channel graphics contain technical information and parts guides.
- Color coded packaging for ease of location and re-stocking.
- See page 40 for full details.



Terminals and Connectors

INSULATED RING TERMINALS



22–18 Gauge

Part No.	Stud Size	Qty. per Pkg.
HP1010	#6	17
HP1020	#8	17
HP1250	#10	70
HP1030	#10	17
HP1040	1/4"	17

16–14 Gauge

Part No.	Stud Size	Qty. per Pkg.
HP1500	#8	17
HP1750	#10	70
HP1510	#10	17
HP1520	1/4"	12
HP1530	5/16"	12
HP1540	3/8"	12

12–10 Gauge

Part No.	Stud Size	Qty. per Pkg.
HP2000	#8	12
HP2200	#10	60
HP2010	#10	12
HP2020	1/4"	12
HP2030	5/16"	9
HP2210	3/8"	60
HP2040	3/8"	9
HP2050	1/2"	9

INSULATED HOOK TERMINALS



Stud Size #10

Part No.	Gauge	Qty. per Pkg.
HP1170	22–18	17
HP1650	16–14	15
HP2110	12–10	14

INSULATED SPADE TERMINALS

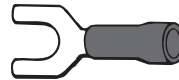

22–18 Gauge

Part No.	Stud Size	Qty. per Pkg.
HP1140	#8	17
HP1260	#10	70
HP1150	#10	17

16–14 Gauge

Part No.	Stud Size	Qty. per Pkg.
HP1740	#10	65
HP1640	#10	15

12–10 Gauge

Part No.	Stud Size	Qty. per Pkg.
HP2090	#8	14
HP2220	#10	60
HP2100	#10	14

INSULATED SLIDE-ON TERMINALS



22–18 Gauge

Part No.	Width	Male/Female	Qty. per Pkg.
HP1220	1/4"	M	70
HP1050	1/4"	M	17
HP1230	1/4"	F	70
HP1060	1/4"	F	17
HP1070	3/16"	M	12
HP1080	3/16"	F	12

16–14 Gauge

Part No.	Width	Male/Female	Qty. per Pkg.
HP1710	1/4"	M	70
HP1550	1/4"	M	17
HP1700	1/4"	F	70
HP1560	1/4"	F	17
HP1580	3/16"	M	12
HP1590	3/16"	F	12

Terminals and Connectors

INSULATED SLIDE-ON TERMINALS (CONT.)

12-10 Gauge

Part No.	Width	Male/Female	Qty. per Pkg.
HP2240	1/4"	M	60
HP2060	1/4"	M	12
HP2230	1/4"	F	60
HP2070	1/4"	F	12
HP2080	3/8"	F	6

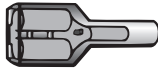
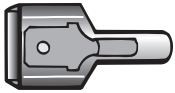

Nylon Fully Insulated 22-18 Gauge

Part No.	Width	Male/Female	Qty. per Pkg.
HP1280	1/4"	M	10
HP1270	1/4"	F	10
HP1310	3/16"	M	8
HP1320	3/16"	F	8

Nylon Fully Insulated 16-14 Gauge

Part No.	Width	Male/Female	Qty. per Pkg.
HP1770	1/4"	M	45
HP1820	1/4"	M	10
HP1780	1/4"	F	45
HP1810	1/4"	F	10

Nylon 12-10 Gauge

Part No.	Width	Male/Female	Qty. per Pkg.
HP2260	1/4"	M	8
HP2250	1/4"	F	8

FLAG TERMINALS

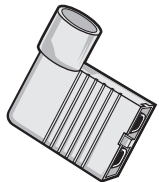

Fully Insulated Nylon

Part No.	Gauge	Male/Female	Qty. per Pkg.
HP1290	22-18	F	4
HP1800	16-14	F	4

DOUBLE MALE INSULATED—1/4" BLADE

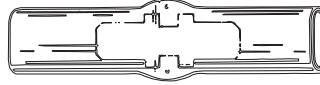

Part No. Qty. per Pkg.

HP2580

5

Mates with HP1060, HP1230, HP1560, HP1700, HP2070, HP2230

MALE & FEMALE DISCONNECTS

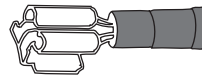

22-18 Gauge

Part No. Qty. per Pkg.

HP1090

12

BUTT SPLICE CONNECTORS



Insulated

Part No.	Gauge	Qty. per Pkg.
HP1210	22-18	70
HP1130	22-18	17
HP1730	16-14	70
HP1670	16-14	17
HP2190	12-10	60
HP2120	12-10	14

Nylon

Part No.	Gauge	Qty. per Pkg.
HP1300	22-18	10
HP1790	16-14	10
HP2270	12-10	6

Terminals and Connectors

PARALLEL SPLICE

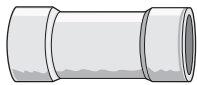

Part No.	Gauge	Qty. per Pkg.
HP1160	22-18	6
HP1690	16-14	5
HP2130	12-10	5

PARALLEL SPLICE

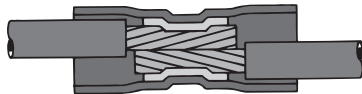

Stripped wires lie side by side in the splice and are secured by a single crimp in the middle.

BULLET CONNECTORS

- 176" Ford Applications
- 156" Universal



22-18 Gauge

Part No.	Size	Male/Female	Qty. per Pkg.
HP1100	.156"	F	12
HP1110	.156"	M	12

16-14 Gauge

Part No.	Size	Male/Female	Qty. per Pkg.
HP1610	.156"	M	12
HP1600	.156"	F	12
HP1630	.176"	M	10
HP1620	.176"	F	10



.156" Dual Female

Part No.	Qty. per Pkg.
HP2590	5

RING TERMINAL COMBO PACK



Part No.	Size	Gauge	Qty. per Pkg.
HP2645	#10	22-18	3 each
		16-14	4 each
		12-10	3 each

BUTT CONNECTOR COMBO PACK



Part No.	Gauge	Contains 14 Pieces:
HP2500	22-18	5 each
	16-14	5 each
	12-10	4 each

TERMINAL COMBO PACK

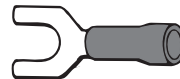
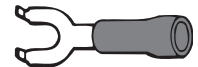

22-18 Gauge Terminals

Part No.	Item	Contains 14 Pieces:
HP1200	#10 ring	4 each
	splice	4 each
	#10 spade	3 each
	#10 hook	3 each

16-14 Gauge Terminals

Part No.	Item	Contains 14 Pieces:
HP1720	#10 ring	4 each
	splice	4 each
	#10 spade	3 each
	#10 hook	3 each

12-10 Gauge Terminals

Part No.	Item	Contains 12 Pieces:
HP2160	3/8" ring	3 each
	#10 spade	3 each
	splice	3 each
	#10 hook	3 each

PARALLEL SPLICE COMBO PACK



Part No.	Gauge	Contains 7 Pieces:
HP2620	20-18	2 each
	16-14	3 each
	12-10	2 each

Terminals and Connectors

SLIDE-ON TERMINAL COMBO PACK

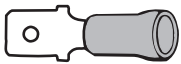

1/4" Male/Female Slides

Part No.	Gauge	Contains 10 Pieces:
HP2510	22-18 M	2 each
	22-18 F	2 each
	16-14 M	2 each
	16-14 F	2 each
	12-10 M	1 each
	12-10 F	1 each



1/4" Female Slides

Part No.	Gauge	Contains 10 Pieces:
HP2630	22-18 F	4 each
	16-14 F	3 each
	12-10 F	3 each

QUICK SPLICE CONNECTORS

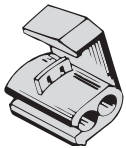

Parallel Quick Splice

Part No.	Gauge	Qty. per Pkg.
HP1240	22-18	25
HP1120	22-18	6
HP1760	18-14	25
HP1660	16-14	5
HP2170	12-10	12
HP2180	12-10	3

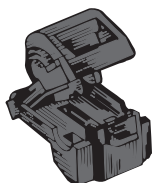

"T" Tap Female

Part No.	Gauge	Qty. per Pkg.
HP1190	22-18	6
HP1570	18-14	6
HP2150	12-10	6

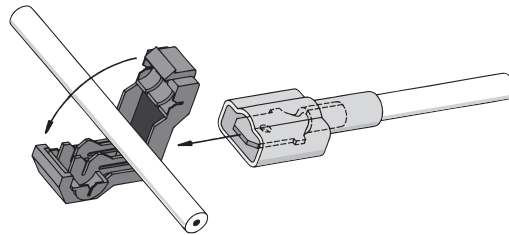

"T" Splice Quick Tap

Part No.	Gauge	Qty. per Pkg.
HP2640	18-14	3 sets

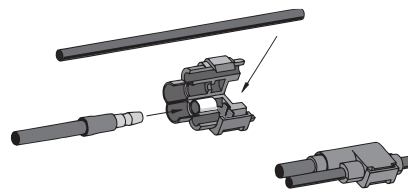

Bullet Quick Splice

Part No.	Gauge	Qty. per Pkg.
HP2610	18-14	2 pair

TWIST LOCK CONNECTORS

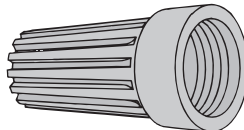

Part No.	Gauge	Wire Ranges		Qty. per Pkg.
		Min.	Max.	
HP2550	22-14	3 #22	3 #16	7
HP2560	22-14	3 #20	3 #16	6
HP2570	18-10	1 #18	4 #14	5
		w/1 #14		
HP2540	Various Sizes			10

CLOSED END SPLICE

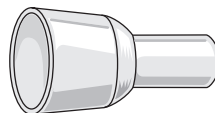

Part No.	Qty. per Pkg.
HP2600 assorted gauges and sizes	12

Gauge	Qty. per Pkg.
22-14	4 pcs.
16-10	4 pcs.
10-8	4 pcs.

Terminals and Connectors

FUSE TAPS

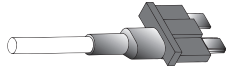
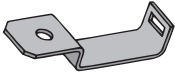
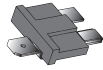
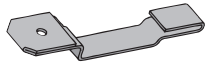

Typical Fuse Tap Assembly

Part No.	Description	Qty. per Pkg.
HP3000	GM Type Fuse Tap 1/4" Blade	17
HP3010	GM Type Mini Fuse Tap 3/16" Blade	17



Part No.	Description	Qty. per Pkg.
HP3020	Glass Type Fuse 1/4" Blade	7

IN-LINE FUSE HOLDERS



Glass Type

Part No.	Size	Gauge	Qty. per Pkg.
HP3110	20 amp.	14	1
HP3120	30 amp.	12	1
HP3070	Panel Mount Fuse Holder		1

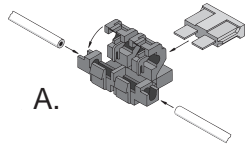

A.



C.



B.



D.

ATO/ATC Type

Part No.	Size	Gauge	Type	Qty. per Pkg.
HP3100	20 amp.	18-14	A	1
HP3030	10 amp.	14	B	1
HP3040	20 amp.	14	B	1
HP3050	30 amp.	12	B	1
HP3060	20 amp.	16	D	1
HP3090	30 amp.	12	D	1
HP3080	30 amp.	12	C	1



Maxi Fuse Holder with Cover

Part No.	Size	Gauge	Qty. per Pkg.
HP3190	40 amp	8	1

FUSE BOX

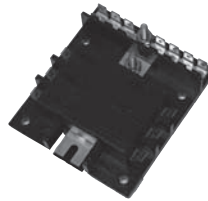

Part No.	Description	Qty. per Pkg.
HP3210	6 Gang, 1/4 Blade Terminals 25 Amp Per Circuit, wGround Buss Bar	1

1/4" SLIDE-ON CONNECTORS

20-14 Gauge

Part No.		Qty. per Pkg.
HP7150		5
HP7160		10
HP7170		5
HP7180		5
HP7210		7

Terminals and Connectors

STEP DOWN BUTT CONNECTORS



	Part No.	Gauge	Qty. per Pkg.
NEW	HP1181	16-14 to 22-18	3
NEW	HP1681	12-10 to 16-14	3
NEW	HP2141	8 to 12-10	3

HEAT SHRINK TERMINALS FOR ALL WEATHER PROTECTION...

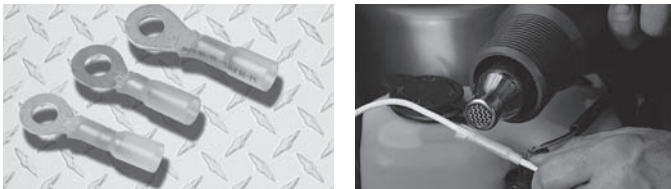

Ideal for marine, automotive, and industrial applications. Tough multiple wall tubing protects splice from moisture and corrosion. Adhesive tubing melts to form waterproof bond. Color-coded for easy identification. Temperature Rating -65° to 275°F.

1. Crimp type heat shrink terminal application is fast and foolproof.

Crimp type heat shrink terminals are ideal for applications where protection from moisture and corrosion is a must. Simply crimp connection as you would any regular terminal. Then heat tubing with a heat gun until shrink tube bonds to primary wire to form a waterproof bond.

2. Self solder heat shrink terminals solder and seal each connection in one step.

No crimping tools required which risk damage to wire insulation or provide unreliable connection. Solder ring melts when heated with a heat gun and provides superior current flow and tensile strength. Translucent tubing allows visual inspection of connection after termination.

3. Crimp, solder and heat shrink terminals offer the ultimate electrical connection.

Crimped for reliability, soldered for strength and conductivity, and sealed for moisture protection and durability. Crimp the connection as you would any regular terminal, heat solder ring until melted with a heat gun and then heat the shrink tube until bonded to primary wire.

FLAMELESS HEAT TORCH



Part No.
HP6370

Qty. per Pkg.
Std. Pkg. 1.

CAUTION: Read instructions before use. Refer to package for complete warnings and cautions. Do not ignite or operate near open flame, heater, furnace, near combustible materials or in engine compartment. Recommended for shop use in well ventilated areas.

Crimp Type with Heat Shrink

How to Use Crimp Type Heat Shrink Terminals...

1. Insert stripped wire.



Butt Splice Connector

2. Crimp connector



HP2680 Crimp Tool

3. Apply heat evenly across sleeve until shrinkage is complete.

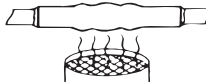

HP6370 Heat Torch

RING TERMINALS

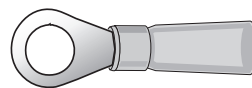

22-18 Gauge

Part No.	Stud Size	Qty. per Pkg.
HP1360	#6	3
HP1370	#8	3
HP1380	#10	3

16-14 Gauge

Part No.	Stud Size	Qty. per Pkg.
HP1860	#10	3

12-10 Gauge

Part No.	Stud Size	Qty. per Pkg.
HP2290	#10	3
HP2300	1/4"	3
HP2310	5/16"	3
HP2320	3/8"	3

Terminals and Connectors

SPADE TERMINALS

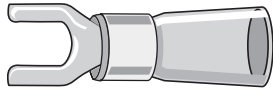

12-10 Gauge

Part No.	Stud Size	Qty. per Pkg.
HP2330	#10	3

BUTT SPLICE CONNECTORS



Part No.	Gauge	Qty. per Pkg.
HP1350	22-18	3
HP1850	16-14	3
HP2280	12-10	3

1/4" FULLY INSULATED NYLON COUPLERS



Part No.	Gauge	Male/Female	Qty. per Pkg.
HP1330	22-18	M	3
HP1340	22-18	F	3
HP1830	16-14	M	3
HP1840	16-14	F	3
HP2350	12-10	M	3
HP2340	12-10	F	3

Self Solder Heat Shrink Terminals

Instructions:

- Strip wires 3/8".
- Slide splice over one end of wire.
- Separate wire strands; push both ends together to mesh wire.
- Slide splice over joined wires; heat tubing from center out to terminal ends; then focus heat on solder until it flows.
- Remove from heat and let cool for a perfect connection.

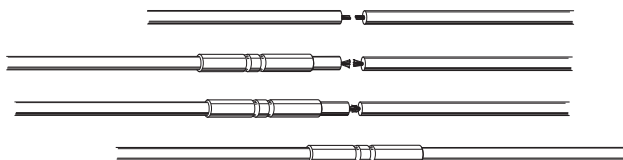

RING TERMINALS

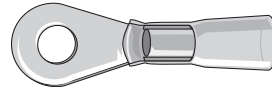

20-18 Gauge

Part No.	Stud Size	Qty. per Pkg.
HP1410	1/4"	3
HP1420	3/8"	3

16-14 Gauge

Part No.	Stud Size	Qty. per Pkg.
HP1880	1/4"	3
HP1890	3/8"	3

12-10 Gauge

Part No.	Stud Size	Qty. per Pkg.
HP2370	#10	3
HP2380	1/4"	3
HP2390	3/8"	3
HP2400	1/2"	3

BUTT CONNECTORS

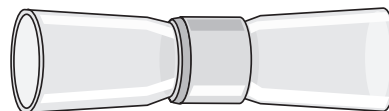

Part No.	Gauge	Qty. per Pkg.
HP1390	24-22	3
HP1400	20-18	3
HP1870	16-14	3
HP2360	12-10	3

1/4" SLIDE-ON TERMINALS

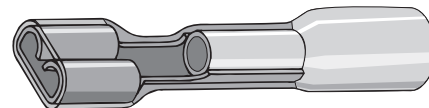

Part No.	Gauge	Qty. per Pkg.
HP1900	16-14	3

Terminals and Connectors

Crimp, Solder & Heat Shrink

Crimp, solder and heat shrink terminals offer the ultimate electrical connection. Crimped for reliability, soldered for strength and conductivity, and sealed for moisture protection and durability. Crimp the connection as you would any regular terminal, heat solder ring until melted with a heat gun and then heat the shrink tube until bonded to primary wire.

Crimp it



Solder it



Seal it

...Sealed for superior durability

BUTT CONNECTORS

Part No.	Gauge	Qty. per Pkg.
HP6620	24-22	3
HP6630	20-18	3
HP6640	16-14	3
HP6650	12-10	3

RING TERMINALS



Part No.	Stud Size	Gauge	Qty. per Pkg.
HP6660	#10	20-18	3
HP6670	#10	16-14	3
HP6680	1/4"	16-14	3
HP6690	3/8"	16-14	3
HP6700	#10	12-10	3
HP6710	3/8"	12-10	3

SLIDE ON TERMINAL

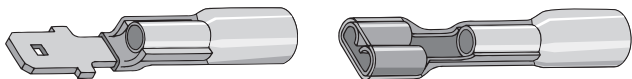

16-14 Gauge

Part No.	Width	Male/Female	Qty. per Pkg.
HP6720	1/4"	F	3
HP6730	1/4"	M	3

Why Use Heat Shrink Terminals?



CORROSION

When using a standard crimp terminal, the wire is exposed to moisture and other contaminants. Over time, the wire starts to corrode which reduces the current carrying capacity of the electrical system.



PULL-OUT

In most cases, electrical connectors must operate in adverse conditions: heat, cold, vibration, strain, etc. These conditions can cause the wire or wires to pull-out of the connector.



TECHNOLOGY

Advanced technology and computerization have resulted in OEMs designing sealed and molded components in all types of equipment. The integrity of the electrical system can be compromised when repairs are made with unsealed electrical connections.



DOWNTIME

Lighting and electrical problems are the most frequent causes of downtime when maintaining a fleet. Often these problems stem from faulty electrical connections. Equipment downtime can result in thousands of dollars in lost opportunities and repair costs.

SOLUTIONS

Adhesive-lined tubing prevents corrosion on wire.



Translucent tubing allows visual inspection of installation.



Adhesive-lined heat shrink tubing and solder combine to increase tensile strength.

Terminals and Connectors

TERMINAL STARTER KIT



HP2660 CONTENTS: 80 pcs.

Part No.	Qty. per Pkg.	Part No.	Qty. per Pkg.
HP1030	4	HP1560	5
HP1050	7	HP1600	4
HP1060	7	HP1610	4
HP1100	5	HP1650	5
HP1110	5	HP1670	6
HP1130	7	HP2020	2
HP1170	3	HP2110	1
HP1510	6	HP2120	4
HP1550	5		

TERMINAL STARTER KIT*



HP2700

Gauge	Stud Size	Description	Qty. per Pkg.
22-18	#10	Spade Terminal	3
22-18	#10	Ring Terminal	3
22-18	#8	Ring Terminal	7
22-18	#6	Ring Terminal	7
22-18	-	Butt Splice Connector	4
22-18	-	Male 1/4" Slide-on-Terminal	2
22-18	-	Female 1/4" Slide-on-Terminal	2
16-14	#10	Ring Terminal	7
16-14	#8	Spade Terminal	3
16-14	#6	Ring Terminal	7
16-14	#4	Ring Terminal	3
12-10	#10	Ring Terminal	1
12-10	#10	Spade Terminal	1
-	-	Economy Crimping Tool	1

*Contents may vary

O.E.M. COMPUTER TERMINAL MAKE UP TECHNIQUES

Terminal Extraction

1. **(A) Push-To-Seat Terminals**—Grasp the lead and **push** the terminal to the forward most position. Hold lead in this stop position.

(B) Pull-To-Seat Terminals—Grasp the lead and **pull** the terminal to the forward most position. Hold lead in this stop position.

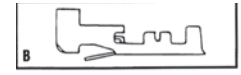

2. Locate terminal lock tang in connector canal.
3. Insert pick straight into the connector canal at the mating end of the connector.
4. Depress lock tang to unseat terminal. Never use force to remove terminal from connector.

5. **(A) Push-To-Seat Terminals**—Gently **Pull** the cable to remove the terminal through the back (wire end) of the connector.

(B) Pull-To-Seat Terminals—Gently **Push** the cable to remove the terminal through the front (mating end) of the connector.

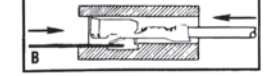
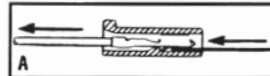

6. Look for terminal and connector damage. Replace if necessary. Note: When reseating existing terminal, assure lock tang(s) are to reseat properly.

Standard Replacement

1. Cut off damaged terminal end between core and insulation crimp.
2. Remove insulation. (Make sure you do not cut strands.)

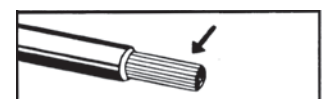

3. Position stripped wire in terminal.
4. Hand crimp core wings first, then insulation wings using crimping tool #HP7390.
5. Apply solder at all hand crimped locations.
6. Electrically check repaired terminal for continuity.

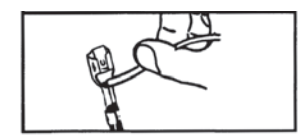
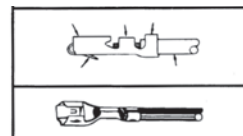

Insulation crimp — Strands visible in this area
Strands visible in this area — Crimp core

Terminals and Connectors

O.E.M. COMPUTER TERMINAL MAKE UP TECHNIQUES (CONT.)

Sealed Weather Pack and Metri-Pack Replacement

1. Cut off damaged terminal end between core and insulation crimp.
2. Apply correct seal per gauge size of wire and slide back along cable to enable insulation removal. (Make sure you do not cut strands.)



3. Align seal with cable insulation.
4. Position stripped wire and seal in terminal.

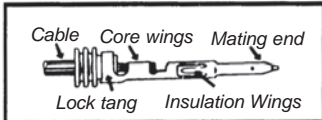

5. Hand crimp core wings first, then insulation wings using crimping tool #HP7390.
6. Solder all hand crimped terminals.



7. Electrically check repaired terminal for continuity.

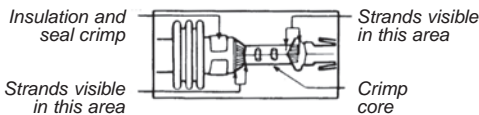

O.E.M. ELECTRONIC TERMINALS

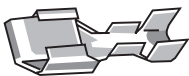

GM 56 Series, Female—Brass

Part No.	O.E. No.	Gauge	Qty. per Pkg.
HP7110	2962447	16-14	5

Mates with HP7120, Insulated with shell HP7130



GM 56 Series, Male—Brass

Part No.	O.E. No.	Gauge	Qty. per Pkg.
HP7120	2962987	16-14	5

Mates with HP7110

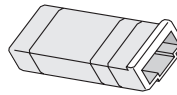

GM 56 Series, Terminal Insulator

Part No.	O.E. No.	Gauge	Qty. per Pkg.
HP7130	2962448	—	3

Insulates HP7110

GM 56 Series, Combo Pack

Part No.	O.E. No.	Gauge	Qty. per Pkg.
HP7140	—	—	2 each

Includes 2 HP7110 and 2 HP7130

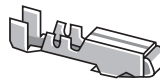

GM Metri-Pack 280 Series, Female

Part No.	O.E. No.	Gauge	Qty. per Pkg.
HP7030	12015857	18-14	5

Mates with HP7040

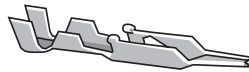

GM Metri-Pack 280 Series, Male, Tin-Plated

Part No.	O.E. No.	Gauge	Qty. per Pkg.
HP7040	12020116	18-14	5

Mates with HP7030

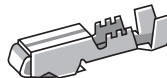

GM Metri-Pack 280 Series, Female, Tin-Plated

Part No.	O.E. No.	Gauge	Qty. per Pkg.
HP7050	12034046	20-18	5

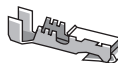

GM Metri-Pack 150 Series Female, Tin-Plated

Part No.	O.E. No.	Gauge	Qty. per Pkg.
HP7060	12047767	20-16	5

Terminals and Connectors

O.E.M. ELECTRONIC TERMINALS (CONT.)

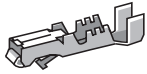

GM Metri-Pack 150 Series, Female, Tin-Plated

Part No.	O.E. No.	Gauge	Qty. per Pkg.
HP7070	12047680	20-18	5

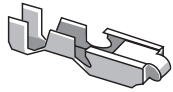

GM Metri-Pack 630 Series, Female, Tin-Plated

Part No.	O.E. No.	Gauge	Qty. per Pkg.
HP7080	12015870	16-14	5



GM Weather Pack Series Silicone Seal for Weather Pack Terminals

Part No.	O.E. No.	Gauge	Qty. per Pkg.
HP7200	12015323	—	5

Use with HP7230, HP7240, HP7250, and HP7260



GM Weather Pack Series Male, Tin Plated Brass

Part No.	O.E. No.	Gauge	Qty. per Pkg.
HP7240	12033674	20-18	5

Mates with HP7230



GM Weather Pack Series Female, Tin Plated Brass

Part No.	O.E. No.	Gauge	Qty. per Pkg.
HP7230	12034051	20-18	5

Mates with HP7240



GM Weather Pack Series Female, Tin Plated

Part No.	O.E. No.	Gauge	Qty. per Pkg.
HP7250	12010182	16-14	5

Mates with HP7260



GM Weather Pack Series Male, Tin Plated

Part No.	O.E. No.	Gauge	Qty. per Pkg.
HP7260	12089305	16-14	5

Mates with HP7250



Silicone Cavity Plug for GM. Weather Pack & Metri-Pack 280 Series

Part No.	O.E. No.	Gauge	Qty. per Pkg.
HP7190	12010300	—	5

Use with HP7040, HP7230, HP7250, HP7260



GM Power Window & Door Lock, Tin Plated

Part No.	O.E. No.	Gauge	Qty. per Pkg.
HP7090	2965880	16-14	3



Ford Wedglock Pin Type, Female

Part No.	O.E. No.	Gauge	Qty. per Pkg.
HP7270	D1AB-14488-CA	20-16	5



Ford Female Micro $\frac{1}{8}$ " Width

Part No.	O.E. No.	Gauge	Qty. per Pkg.
HP7280	E8EB-1114474-AMA	16-14	5

Terminals and Connectors

O.E.M. ELECTRONIC TERMINALS (CONT.)

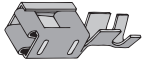

Ford, Female Standard Block $\frac{3}{16}$ " Blade

Part No.	O.E. No.	Gauge	Qty. per Pkg.
HP7290	E8EB-14474-VA	16-14	5



Ford, Female, Mini Block $\frac{1}{8}$ " Blade

Part No.	O.E. No.	Gauge	Qty. per Pkg.
HP7300	E8EB-14474-AJA	16-14	3

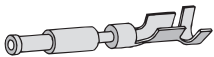

Chrysler, Female, $\frac{1}{16}$ " Diameter Pin

Part No.	O.E. No.	Gauge	Qty. per Pkg.
HP7100	4368960	20-18	5

Fits 60 Pin Connection Block on Engine Compartment Fire Wall



Universal $\frac{1}{4}$ " Female Slide

Part No.	O.E. No.	Gauge	Qty. per Pkg.
HP7220	GM: 2965580 Ford: C1SF-14474-A Chrys: 20964667	14-12	5

OEM Wiring Tools

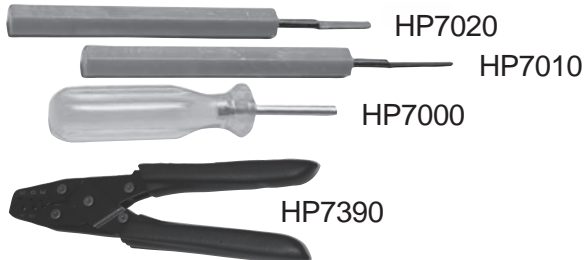

Part No.	Description
HP7000	Extractor tool for Weather-Pack Terminals.
HP7010	Terminal extractor pick. Narrow blade, .050"
HP7020	Terminal extractor pick. Wide blade, .090"
HP7390	OEM crimping tool

GOLD AUDIO TERMINALS

- Gold plated for maximum conductivity.
- Designed for modern hi-tech audio systems.



Butt Connectors

Part No.	Gauge	Qty. per Pkg.
HP6500	22-18	10
HP6530	16-14	10
HP6560	12-10	10



Female Slide Connectors

Part No.	Size	Gauge	Qty. per Pkg.
HP6510	.187"	22-18	8
HP6520	.110"	22-18	8
HP6540	.250"	16-14	8
HP6550	.110"	16-14	8
HP6570	.250"	12-10	8

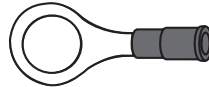

Ring Terminals

Part No.	Size	Gauge	Qty. per Pkg.
HP6580	$\frac{3}{8}$ "	12-10	8



Insulated Terminals

Part No.	Type	Gauge	Qty. per Pkg.
HP6590	round pin	16-12	2 red, 2 black
HP6600	flat pin	16-14	2 red, 2 black
HP6610	$\frac{3}{8}$ " ring	8	4 red, 4 black

Primary Wire

PRIMARY WIRE



Our wire is available in a broad range of sizes, types and colors for any electrical repair, replacement or customizing job.

20 Gauge

Part No.	Color	Ft.
HP5630	Black	40'
HP5610	Green	40'
HP5620	Red	40'

18 Gauge

Part No.	Color	Ft.
HP5690	Black	35'
HP5680	Blue	35'
HP5660	Green	35'
HP5650	Red	35'
HP5640	White	35'
HP5670	Yellow	35'

16 Gauge

Part No.	Color	Ft.
HP5790	Black	30'
HP5740	Blue	30'
HP5700	Brown	30'
HP5770	Green	30'
HP5730	Orange	30'
HP5720	Pink	30'
HP5710	Purple	30'
HP5780	Red	30'
HP5760	White	30'
HP5750	Yellow	30'

14 Gauge

Part No.	Color	Ft.
HP5900	Black	20'
HP5850	Blue	20'
HP5820	Brown	20'
HP5860	Black with Red Stripe	20'
HP5910	Green	20'

14 Gauge (CONT.)

Part No.	Color	Ft.
HP5840	Orange	20'
HP5920	Pink	20'
HP5830	Purple	20'
HP5880	Red	20'
HP5890	White	20'
HP5870	Yellow	20'

12 Gauge

Part No.	Color	Ft.
HP5970	Black	12'
HP5960	Blue	12'
HP5930	Green	12'
HP5980	Red	12'
HP5940	White	12'
HP5950	Yellow	12'

10 Gauge

Part No.	Color	Ft.
HP5810	Black	8'
HP6020	Blue	8'
HP5990	Green	8'
HP6030	Red	8'
HP6000	White	8'
HP6010	Yellow	8'

SPEAKER WIRE



Part No.	Wire Gauge	Color	Ft.
HP5600	20	Clear	25'
HP5800	16	Clear	15'

FLAT MULTI-CONDUCTOR AUTOMOTIVE CABLE

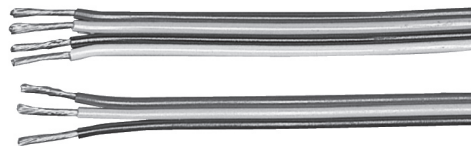

Parallel Bonded

Part No.	Gauge	Cond.	Color	Ft.
HP3730	16	4	Brown, Green Yellow, White	25'
HP3720	16	3	Brown, Green Yellow	25'

Fusible Links

FUSIBLE LINKS



HP3130



HP3140



HP3150



HP3160

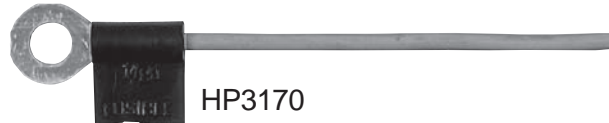

HP3170



HP3180

Part No.	Description	Gauge	Length
HP3130	Chrysler	16	8"
HP3140	Ford	16	9 ¹ / ₈ "
HP3150	Chrysler	14	8"
HP3160	GM	16	9 ¹ / ₄ "
HP3170	Ford	14	10 ¹ / ₈ "
HP3180	GM	14	9 ¹ / ₂ "

FUSIBLE LINK WIRE



Part No.	Gauge	Ft.
HP2710	18	10'
HP2720	16	10'
HP2730	14	10'
HP2740	12	10'

NOTE: Fusible link wire is made to replace the fusible links used by OE on battery cable and other circuits for protection from current overloads. Always replace fusible link with same size and gauge used on original circuit. In general, fusible link is four gauges smaller than the circuit wire.

(EXAMPLE: Circuit wire = 10 ga.; fusible link = 14 ga.)

Battery Parts

LEAD COUPLERS

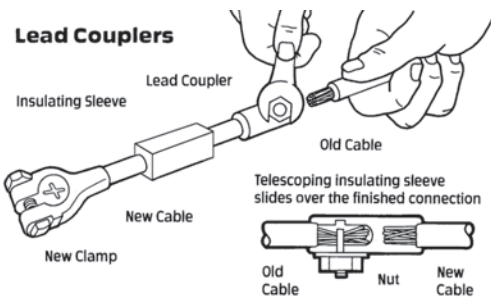

Top Mount

Part No.	Description	Qty. per Pkg.
HP6780	Single replacement end; top post battery terminal for 8, 6, and 4 ga. cable. Includes plastic insulator.	1



Side Mount

Part No.	Description	Qty. per Pkg.
HP6790	Side mount battery terminals; for 8, 6, and 4 ga. cable. Includes plastic insulator.	1

EMERGENCY SOLDERLESS TERMINALS



Part No.	Description	Gauge	Qty. per Pkg.
HP2890	Epoxy-coated lead terminals.	6-2/0	1 pair
HP2880	Universal side mount.	6-1/0	2

Battery Parts

TERMINAL ADAPTERS & BOLTS

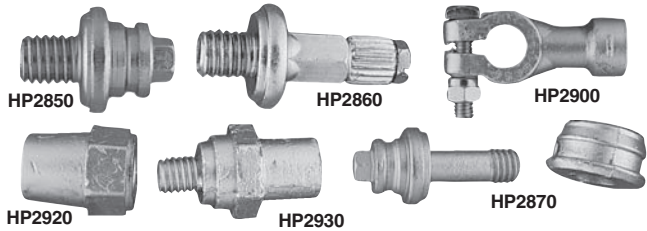

Part No.	Description	Qty. per Pkg.
HP2850	$\frac{3}{8}$ " x $\frac{1}{2}$ " side terminal bolt	2
HP2860	$\frac{3}{8}$ " x 1" extra long side terminal bolt.	2
HP2900	For adapting side terminal cable to top post batteries.	1 pair
HP2920	Stud-to-post conversion.	1 pair
HP2930	Charging post, side mount	1 pair
HP2870	Diesel side terminal bolt and spacer. For connecting 2 cables.	2 each

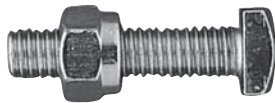

Bolts

Part No.	Description	Length	Qty. per Pkg.
HP2910	bolt and nut	$\frac{5}{16}$ " x $1\frac{1}{16}$ "	2 each

BATTERY CABLE LUGS

- Solid copper for maximum conductivity.
- One-piece seamless construction.



Part No.	Gauge	Stud Size	Qty. per Pkg.
HP2800	6	$\frac{3}{8}$ "	4
HP2810	4	$\frac{3}{8}$ "	2
HP2820	4	$\frac{5}{16}$ "	4
HP2830	2	$\frac{3}{8}$ "	4

BATTERY TERMINAL PROTECTORS



Prevents corrosion at battery posts.

Part No.	Description	Qty. per Pkg.
HP2840	Polyester pad protector post-type battery	1 pair

BATTERY TEST CLIPS

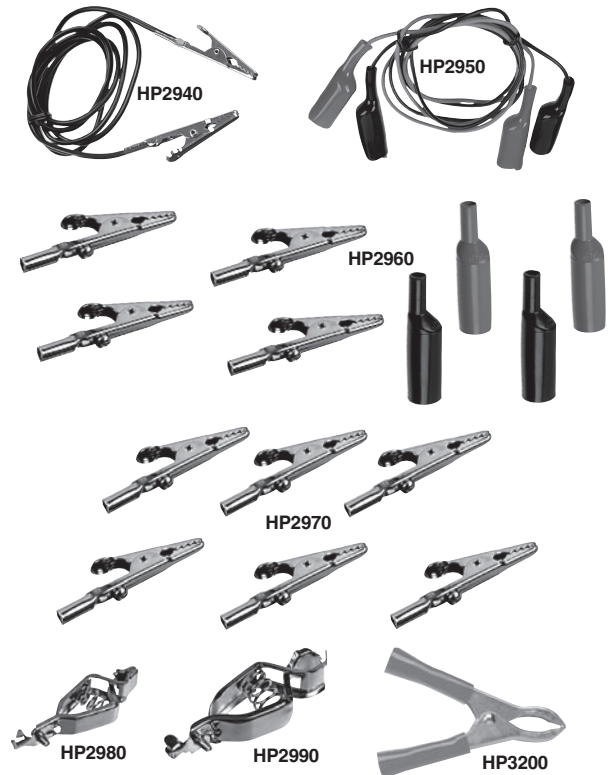

Part No.	Description	Qty. per Pkg.
HP2940	36" test lead. Un-insulated alligator clips. For test or emergency trouble lead.	1
HP2950	Pair of 30" insulated leads.	1 pair
HP2960	5 amp. Alligator clip— $1\frac{1}{2}$ ". Opens to $\frac{5}{16}$ " includes 2 black & 2 red vinyl boots	4
HP2970	5 amp alligator clips. $1\frac{1}{2}$ ", opens to $\frac{5}{16}$ ".	6
HP2980	10 amp. clip with serrated jaws—2". Opens to $\frac{7}{16}$ "	4
HP2990	25 amp. clip with serrated jaws—2". Opens to $\frac{3}{4}$ "	2
HP3200	75 amp. copper—3". Opens to $\frac{3}{4}$ "	1 red/1 blk

BATTERY CLEANERS



Part No.	Description	Qty. per Pkg.
HP6380	Battery post & terminal cleaning brush kit.	1

Bundling & Miscellaneous

How to Use Heat Shrink Tubing

CAUTION: Disconnect battery cables before applying heat shrink tubing!

1. Select tubing to assure a tight fit after shrinkage. Consider the outside dimension of the terminal when determining tubing diameter. Shrink ratios: 3:1 for double wall tubing; 2:1 for single wall.
2. Cover at least 1/2" of the terminal barrel and 1" of the cable.
3. Apply heat evenly to all areas of the tubing. When tubing starts to shrink, focus heat at center of tubing and move heat toward ends to eliminate any trapped air.

CLEAR DUAL WALL TUBING – 6" LONG

Dual Wall-Clear, 6" length with contamination proof, water-tight sealant. Provides strain relief and vibration resistance. 3 to 1 shrink ratio. Temperature range -55° C to 110° C / -67°F to 230°F.

Part No.	Color	I.D. Shrinks			Gauge	Qty. per Pkg.
		From	To			
HP3530	Clear	.187"	.060"	20-14	1	
asst.	Clear	.312"	.104"	14-08	1	
	Clear	.500"	.195"	8-1	1	
HP3540	Clear	.187"	.060"	20-14	3	

SINGLE WALL TUBING

Provides electrical insulation over splices and terminations. Excellent for bundling and cable identification. 2 to 1 shrink ratio. Temp. range -55°C to 135° C -67°F to 275°F. Color coded, no sealant.

Part No.	Color	I.D. Shrinks			Length	Qty. per Pkg.
		From	To	Gauge		
HP3550	Red	.187"	.093"	20-18	6"	3
HP3570	Blue	.250"	.125"	16-14	6"	3
HP3560	Yellow	.312"	.186"	12-10	6"	3
HP3520	Contains 1 each HP3570, HP3550, HP3560					

SINGLE WALL TUBING – 1 1/2" LONG

Part No.	Color	I.D. Shrinks		Gauge	Qty. per Pkg.
		From	To		
HP3500	Black	.187"	.093"	20-18	3
asst.	Black	.250"	.125"	16-14	3
	Black	.375"	.188"	12-10	3
HP3510	Black	.250"	.125"	16-14	9

NYLON WIRE TIE STRAPS



Part No.	Color	Length	Tensile		Bundle Dia.	Qty. per Pkg.
			Strength	Width		
HP3400	natural	4"	18 lbs.	.10"	.75"	14
HP3420	natural	8.5"	40 lbs.	.15"	2.00"	18
HP3440	natural	11.5"	40 lbs.	.15"	3.00"	12
HP3450	natural	14.5"	40 lbs.	.15"	4.00"	15
HP3410	black	8"	50 lbs.	.18"	1.75"	15
HP3430	black	11.75"	50 lbs.	.18"	3.00"	12
HP3460	natural	8.5"	50 lbs.	.18"	1.75"	15

MULTI-COLORED NYLON WIRE TIE STRAPS

Standard – Non Releasable



Part No.	Color	Length	Tensile		Bundle Dia.	Qty. per Pkg.
			Strength	Width		
HP6140	Blue	4"	18 lbs.	.10"	.75"	14
HP6150	Red	4"	18 lbs.	.10"	.75"	14
HP6160	Yellow	4"	18 lbs.	.10"	.75"	14
HP6170	White	4"	18 lbs.	.10"	.75"	14

Bundling & Miscellaneous

MULTI-COLORED NYLON WIRE TIE STRAPS (CONT.)

Part No.	Color	Length	Tensile Strength	Width	Bundle Dia.	Qty. per Pkg.
HP6180	Blue	8"	50 lbs.	.18"	1.75"	18
HP6190	Red	8"	50 lbs.	.18"	1.75"	18
HP6200	Yellow	8"	50 lbs.	.18"	1.75"	18
HP6210	White	8"	50 lbs.	.18"	1.75"	18



Adhesive-backed wiring clip

Part No.	Description	Qty. per Pkg.
HP3330	1.5" sq. nylon mount for tie straps	4

HOOK AND LOOP TIE STRAPS



Use these multi-colored, re-usable hook and loop tie straps for securing wiring harnesses together. Fits around irregular shapes. Easily removed and relocated. Hundreds of uses.

Part No.	Length	Color	Qty. per Pkg.
HP6100	8"	Blue	3
HP6110	8"	White	3
HP6120	8"	Red	3
HP6130	8"	Yellow	3

MULTI-COLORED SPIRAL WRAP



Protects cables while permitting wires to lead out from anywhere along the length.

Part No.	Color	O.D.	Qty. per Pkg.
HP3350	Natural	1/2"	5'
HP6220	Blue	1/2"	5'
HP6230	Red	1/2"	5'
HP6240	Yellow	1/2"	5'

MULTI-COLORED SPLIT LOOM

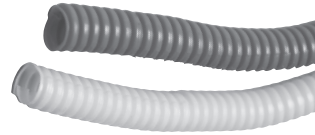

Part No.	Color	I.D.	Qty. per Pkg.
HP6250	Blue	3/8"	7'
HP6260	Red	3/8"	7'
HP6270	Yellow	3/8"	7'

PVC SPLIT LOOM



Protect your wiring. Split seam allows easy insertion and removal without disconnecting wire or cable. Temperature range: -15°F. to +195°F.

Part No.	Color	O.D.	Qty. per Pkg.
HP3360	Black	1/4"	7'
HP3370	Black	3/8"	7'
HP3380	Black	7/16"	7'
HP3390	Black	3/4"	4'

LOOM TEE



Connects branch runs to main loom wiring.

Part No.	Loom	Left I.D.	Center I.D.	Right I.D.	Qty. per Pkg.
HP3300	Use with HP3380	1/2"	1/2"	1/2"	1
HP3310	Use with HP3370, HP6250, HP6260, HP6270	3/8"	3/8"	3/8"	1
HP3320	Use with HP3390, HP3370	3/4"	3/8"	3/4"	1

LOOM INSTALLATION TOOL



Make installing wire loom quick and easy with this handy loom installation tool. Just slip over wire and start loom, tool spreads loom while it feeds over wire.

Part No.	Qty. per Pkg.
HP3340	1

Bundling & Miscellaneous

ELECTRICAL TAPE



Part No.	Description	Qty. per Pkg.
HP3740	Cold Seal Tape, 10' roll Cold shrink tape stretches over connection and seals it from environment. Good for large bulky connections.	1 roll
HP3750	$\frac{3}{4}$ " Wide Electrical Tape 30' roll	1 roll

WIRING CLIPS

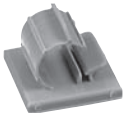

Adhesive-backed wiring clip

Part No.	Description	Qty. per Pkg.
HP3650	$\frac{1}{4}$ " I.D.	5
HP3660	$\frac{3}{8}$ " I.D.	4
HP3670	$\frac{1}{4}$ " I.D. 2 pcs. $\frac{3}{8}$ " I.D. 1 pc. $\frac{1}{2}$ " I.D. 1 pc.	4
HP3330	1.5" sq. nylon mount for tie straps	4



Molded nylon harness bracket

Part No.	Description	Qty. per Pkg.
HP3620	$\frac{1}{4}$ " I.D.	12
HP3630	$\frac{1}{2}$ " I.D.	10
HP3640	$\frac{1}{4}$ " I.D. 4 pcs. $\frac{1}{2}$ " I.D. 3 pcs. $\frac{3}{4}$ " I.D. 3 pcs.	10



Rubber cushioned steel clamp

Part No.	Description	Qty. per Pkg.
HP3580	$\frac{1}{4}$ " I.D.	6
HP3590	$\frac{1}{2}$ " I.D.	5
HP3600	$\frac{3}{4}$ " I.D.	4
HP3610	2 ea. HP3580, HP3590, HP3600 1 pc.	5

VACUUM CAPS

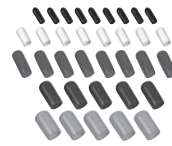

Part No.	Description	Qty. per Pkg.
HP2530	Rubber Vacuum Caps, with holder	8
HP2520	Vinyl Vacuum Caps,	35

VINYL WIRE GROMMETS

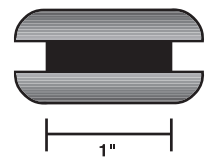
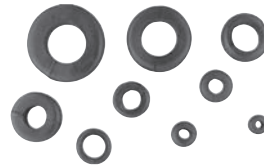

Flexible, oil resistant, high dielectric grommets resist harsh engine compartment conditions.

Part No.	Hole Dimension	Qty. per Pkg.
HP3680	$\frac{1}{4}$ "	33
HP3690	$\frac{3}{8}$ "	20
HP3700	$\frac{1}{2}$ "	26
HP3710	$\frac{1}{4}$ ", $\frac{5}{16}$ ", $\frac{3}{8}$ ", $\frac{7}{16}$ ", $\frac{1}{2}$ ", $\frac{5}{8}$ ", $\frac{21}{32}$ ", $\frac{7}{8}$ ", 1"	15

HEAT SHIELDS

- Universal size—fits most boots, even angle boots.
- Reflects and dissipates heat up to 1200°F.
- Protects plug wire from extremely hot exhaust.
- Excellent for race cars, motor home and RVs.



Part No.	Description	Qty. per Pkg.
HP2670	Spark plug boot insulating sleeve	2

WIRE SEPARATORS



Part No.	Description	Qty. per Pkg.
HP3760	Spark plug wire separator for 7mm	1 set
HP3770	Spark plug wire separator for 8mm	1 set

Pigtails & Sockets

SINGLE CONTACT LIGHT SOCKETS

HP4000



Pigtail assembly with terminal attached. Fits lamp No. 67, 89, 93, 97, 1003, 1073, 1141, 1156. Universal.

HP4010

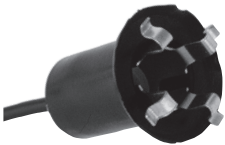

Snap-in-type for Instrument Panel. Miniature base ($\frac{5}{8}$ " dia.) for instrument panel lights. Fits lamp No. 53, 55, 57, 1985. Universal Applications.

HP4190



For shielded license plate and utility lights. Universal applications.

HP4600



For license plate and instrument light on most cars. Fits lamp No. 67, 89, 93, 97, 1003, 1073, 1141, 1156. Universal.

HP4620



AMC: 4486949, 4489412
Chry.: 3513162, 3780745
Ford: D00Z-15536A
GM: 2978302
Fits $1\frac{1}{8}$ " hole. Fits lamp No. 67, 89, 93, 97, 1003, 1073, 1141, 1156.
American Motors80-70
Chrysler Corp85-71
Dodge Trucks86-71
Ford, Mercury.....77-73

NEW HP4730



Acura, Nissan 1980-1995

NEW HP4745



Universal, use for backup, instrument, and turn lamps

NEW HP4780



Chrysler Products 1974-1995

DOUBLE CONTACT LIGHT SOCKETS

NEW HP3835



GM Cars & Trucks 1980-2005

HP3960



GM: 12101897 (Low Beam)
Socket for Halogen bulb headlamp with 2 prong and 9006 bulb.

Buick.....03-90
Cadillac03-90
Chevrolet.....03-90
GM Light Trucks.....03-92
Oldsmobile99-90
Pontiac03-88

HP3970



GM: 12101898 (High Beam)
Socket for Halogen bulb Headlamp with 2 prongs and a 9005 bulb.

Buick.....03-90
Cadillac04-90
Chevrolet.....03-90
GM Light Trucks.....03-92
Oldsmobile99-90
Pontiac03-88

HP3990



Pigtail assembly with terminals attached. Fits lamp No. 1034, 1154, 1157, 1158, 1176, 1178.

HP4020



AMC: 448869478
GM: 8912698.
For Park, Turn, Stop and Taillight applications.
Fits $1\frac{1}{8}$ " hole.

American Motors79-69
Cadillac73-70
Oldsmobile73-70

Pigtails & Sockets

DOUBLE CONTACT LIGHT SOCKETS (CONT.)

HP4040



For Parking and Taillight Assemblies. For most cars. Fits Lamp No. 1034, 1154, 1157.

HP4050

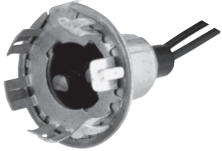

(D0AZ, D1AZ, D20Z-13410B) Park, Stop, Tail, Turn Signal. Fits Lamp No. 1034, 1154, 1157. Lincoln 80-70 Mercury 79-75

HP4060



AMC: 4489395
Ford: E1FZ-13410A; D5VY-15A442A.
GM: 6298892
IHC: 418977C91
License, Side Marker, Cornering. Fits Lamp No. 131, 168, 194, 194A.
AMC 88-70
Ford Cars 87-73
Ford Trucks 90-88
GM Cars 96-70
GM Light Trucks 92-82
IHC Trucks 80-57
Renault 87-72
Older Cars & Trucks

HP4070



Chry.: 3588314, 3588650.
Ford: E25Y-13410B.
Front and Rear Side Marker. Fits lamp No. 67, 158, 194, 194A.
Chrysler 98-79
Dodge, Plymouth 98-72
Dodge Trucks 98-86; 88-85
Ford, Mercury 98-83
Ford Trucks 98-92
Lincoln 98-82

HP4080



GM: 12037105, 12083460
Front, Side and Rear Marker. Cadillac 85 Chevrolet 01-87, 82 GM Light Trucks 03-82

HP4090

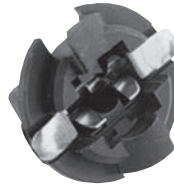

2 per package.

Fits instrument cluster with printed circuit board $\frac{5}{8}$ " mounting hole.

AMC: 8122474, 8126900
Chrysler: 2496279
Ford: E6FZ-13B764A
GM: 12004311, 2973932, 5655006

AMC 77-76
Buick 77-76
Cadillac 89-76
Chevrolet 84-70
GM Trucks 91-73
Oldsmobile 84-76
Pontiac 87-76

HP4100



2 per package.

Chry.: 3744750, 4124104
Ford: C80Z-13711A, B
Fits instrument cluster with printed circuit board. $\frac{1}{2}$ " mounting hole. Fits lamp No. 194.

Chrysler Corp. 90-74
Ford 96-80
Ford Trucks 92-80
Lincoln 89-73
Mercury 90-78

HP4310

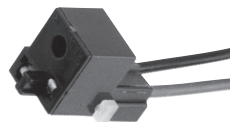

For 4701 Minisealed High Beam Headlamps. GM Vehicles 99-81

HP4320



For 4703 Minisealed Low Beam Headlamps. GM Vehicles 99-81

HP4410



Fog Lamp Socket. Fits bulb Nos. 880, 881, 884, 885, 886, 889, 890, 892, 893, 894, 896, 899.

Buick 97-89
Cadillac 91-90, 86
Eagle 94
Ford 97-90
Ford Light Trucks 97-93
Oldsmobile 97-92
Pontiac 97-92
Saturn 97-95

Pigtails & Sockets

DOUBLE CONTACT LIGHT SOCKETS (CONT.)

HP4450



Fits domestic and import vehicles with 2-prong headlights.

Acura	95-86
Audi	85-71
Austin	80-70
Chrysler Vehicles	91-65
De Lorean	82-81
Ford Vehicles.....	89-65
GM Vehicles	97-63
IHC Light Trucks.....	85-57

NEW HP4495



Universal, use for parking, stop, tail, and turn lamps.

NEW HP4515



Ford Cars & Trucks
1996-2003

NEW HP4555



GM Cars & Trucks
1992-2007

HP4560



For cornering and marker lamps. (12083007)

Chevrolet.....	03-84
Oldsmobile	98-88
Pontiac	96-87
Saturn.....	92-91

HP4570



AMC: 448649, 4488908
Chry: 3764747; GM: 8909910
Stop, Tail and Rear Signal
Lights. Fits 1 1/8" hole.
Fits lamp No. 1034, 1154, 1157.
American Motors

.....	80-72
Buick, Oldsmobile	81-64
Dodge.....	75

HP4580

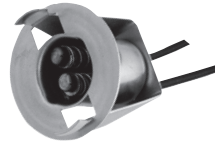

Socket clips for snap fit in 7/8" to 1 1/8" openings. Parking and Taillight Assemblies.
Fits Lamp No. 1034, 1154, 1157.

HP4590



Fits 1 1/8" hole. Parking, Directional, Taillight & Stoplights.
Fits Lamp No. 1034, 1154, 1157.

HP4610



Ford: E0SZ-15A442B
GM: 12001470.
Tail, Stop, Turn Signal.
Fits lamp No. 161, 168, 194, 194A. Cornering, License, Park, Side Marker.

Buick.....	99-76
Cadillac	97-76
Chevrolet.....	02-76
Ford	89-88
GM Light Trucks	99-78
Lincoln.....	89-81
Mercury	80
Oldsmobile	99-76
Pontiac	02-76

NEW HP4615



Universal, use for parking, stop, tail, and turn lamps.

HP4630



(3513686, 4055028) Front and Rear Side Marker. Fits lamp No. 67, 158, 194, 194A.
Chrysler Corp. Cars.....

.....	87-72
Dodge Trucks	91-72

HP4650



AMC: 3691072
Chrysler: 3764126, 159
Ford: D3AZ-13410A,
D80Z-15434A
Fits Lamp No. 1156.
American Motors

.....	77-76
Chrysler.....	78-74
Ford.....	80-73
Mercury	80-73
Plymouth	74

Pigtails & Sockets

DOUBLE CONTACT LIGHT SOCKETS (CONT.)

NEW HP4725



License Plate Light Socket
Chrysler Products
1989-1995

LIGHT SOCKET ASSEMBLIES WITH 3 WIRES

NEW HP3805



Ford Cars & Trucks
1996-2003

NEW HP3825



Dodge Truck 1996-2002

HP3940



For Halogen bulb head lamp
with 3 prongs and 9004/9007
bulb. Chry: 4400395; 4414332;
4430976; 4439076.

HP3950

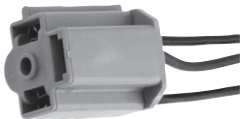

Fits domestic and import
vehicles with 3 prong
headlights.

NEW HP3955



Acura, Nissan,
Subaru, Toyota
1980-1994

HP4030



For stop, tail, or rear turn signal
lamps. (4399576)
Chrysler..... 89, 84-80
Dodge..... 89, 84-81
Dodge Truck.....90-86
Plymouth.....94-81

NEW HP4045



GM Cars & Trucks 1992-2002

HP4110



(8919916, 12013813)
Park & Turn Signal. Fits Lamp
No. 1034, 1154, 1157.
Buick.....96-79
Cadillac99-82
Chevrolet.....96-76
GM Light Trucks.....94-79
Oldsmobile99-79
Pontiac95-92

HP4120

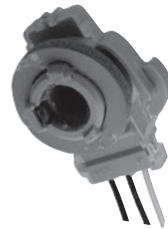

(12003757) Stop, Tail & Rear
Turn Signal lamps.
Buick.....96-81
Cadillac02-86
Chevrolet.....96-80
GM Light Trucks.....02-82
Oldsmobile96-82
Pontiac95-81

NEW HP4125



Ford Cars & Trucks 1990-2004

HP4130



For Park and Turn signal lamps.
Ford: D1FZ-13234A,
D7FZ-13234C.
Used with lamp No. 1157.
Ford.....78-73
Ford Trucks.....92-75
Mercury.....78-75

Pigtails & Sockets

LIGHT SOCKET ASSEMBLIES WITH 3 WIRES (CONT.)

HP4140

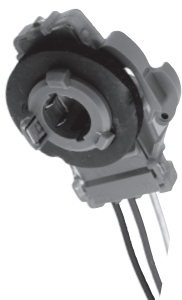

Chry.: 4331051, GM: 12003759.
Fits Back-up, Tail, Stop and
Turn Signal Lamps.

Buick.....96-77
Cadillac02-77
Chevrolet.....96-77
Chrysler, Dodge.....89-85
GM Light Trucks.....02-78
Oldsmobile.....96-77
Pontiac96-77

HP4150

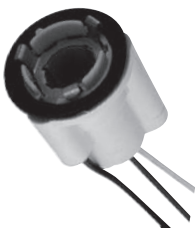

GM: 8903202, 8914822
IHC: 571722C91
Fits lamp No. 1034, 1154, 1157.
Park, Tail, Stop, Turn Signal.

Buick.....83-76
Cadillac86-76
Chevrolet.....86-69
GM Light Truck.....91-73
Oldsmobile.....89-76
Pontiac83-76

HP4160



(3843245, 3843432, 4163003)
Park & Front Turn Signal,
Side Marker, Tail, Stop or Rear
Turn Signal.

Chrysler Corp. Cars 92-75
Dodge Trucks 91-78

HP4170



Park & Turn Signal, Side
Marker, Stop & Turn Lamp.

Buick.....99-91
Cadillac 03-98, 92-90
Chevrolet..... 03-97, 94-90
GM Light Trucks.....03-94
Oldsmobile 03-93, 91-90
Pontiac03-90

HP4180

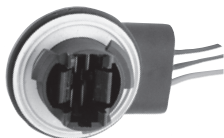

Park, Turn, and Taillight.
Chry: 4368264, 4400740
Chrysler Corp. Cars 89-86

NEW HP4200



Ford Cars & Trucks 1991-2006

HP4330

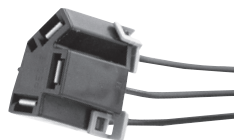

For #H4666 and H6545
Headlamps.
GM, Firebird, Blazer.....97-93
Ford Probe97-93
Chrysler, Daytona,
Lazer.....91-89

HP4640

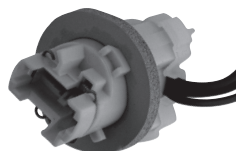

Park, Turn, and Taillight.
Ford: ESPZ-13411B
Ford95-83
Lincoln90-87
Mercury96-86

NEW HP4645



GM Cars 1988-1997

HP4660



(8093203, 9814823) Fits lamp
No. 1034, 1154, 1157. Park,
Tail, Stop, Turn Signal.
Buick.....90-77
Cadillac99-77
Chevrolet.....90-69
Oldsmobile90-76
Pontiac86-76

HP4670

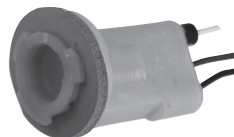

Park and Turn Lamp Socket.
Ford, Ford Trucks94-97
Mercury94-97

HP4680

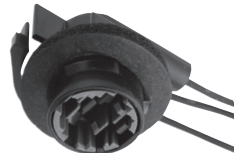

For Back-up, Stop, Tail and
Rear Turn Signal Lamps.
(12083680)
Buick.....96-91
Cadillac93-89
Oldsmobile94-90

HP4690



AMC: 3690736, 8124663
Chry.: 13588833, 3764123
Ford: D2FZ-13410A, D3AZ-
13410B; D5DZ, D5VY-13410A.
Park, Stop, Tail, Turn Signal.
Fits Lamp No. 1157.
American Motors80-77
Ford Motor Co. Cars..... 80-73
Plymouth-Barracuda 74-73

Pigtails & Sockets

LIGHT SOCKET ASSEMBLIES WITH 3 WIRES (CONT.)

NEW HP4700



Chrysler Products 1991-2000

NEW HP4740



Headlight Socket
Fits H13, HB13 or
9008 headlamp

1 WIRE PIGTAIL

HP3830



For Switch or Solenoid with
#8 and M4 Terminals.
Buick..... 93-92, 90
Chevrolet.....95-94
GM Light Trucks.....95-94
Oldsmobile, Pontiac.....94-82

HP3850



GM 12051234: 12102621
For GM Radiator Fan
Temperature Switch.
Buick..... 95-90, 88-82
Cadillac 95-93, 85-82
Chevrolet.....01-82
GM Light Trucks.....02-88
Oldsmobile92-82
Pontiac01-82

HP3890

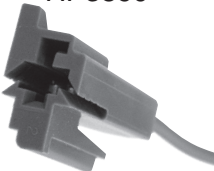

For carburetor choke heater.
Buick..... 96-93, 91-82
Cadillac88-84
Chevrolet.....96-82
Oldsmobile 95, 91-82
Pontiac90-82

2 WIRE PIGTAIL

HP3840



Multi-Purpose Pigtail.
AMC: 8983502327
GM: 12046623
Buick.....03-86
Cadillac02-92
Chevrolet.....03-87
GM Light Trucks.....03-96
Oldsmobile02-86
Pontiac03-86

HP3860



For Fuel Injector.
Lucas & Bosch Injectors
Domestic & Import Vehicles.

HP3870



Fits Delco Alternators with
Integral Regulator.
Buick.....88-70
Cadillac85-70
Chevrolet.....85-74
GM Trucks86-70
IHC Trucks.....82-70
Oldsmobile85-70
Pontiac88-70

HP3900



Injector-Fuel, Inline-To-Fuel
Injector Solenoid-Brake
Pressure Module Valve.
GM Vehicles99-86

NEW HP3945



Fuel Injector Connector
GM, Ford, Chrysler Products
1995-2003

HP3980

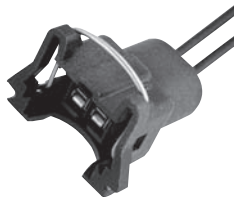

Multi-purpose. Replaces GM
P/N 12085491.
Buick.....03-86
Cadillac02-92
Chevrolet.....03-87
GM Light Trucks.....03-96
Oldsmobile02-86
Pontiac03-86

NEW HP4220



Alternator Connector
AMC, GM, IHC Cars & Trucks
1962-1988

HP4380

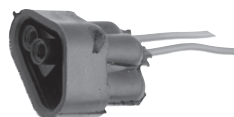

For Electronic Voltage
Regulator. (2983727).
Chrysler Corp.
Vehicles.....95-72

Pigtails & Sockets

2 WIRE PIGTAIL (CONT.)

HP4400



Temperature Sensor Pigtail.
 Ford 01-83, 81-80
 Ford Light Trucks 01-79
 Lincoln 01-98, 96-80
 Mazda 94-91
 Mercury 01-83, 81-80
 Nissan 99-96

HP4420

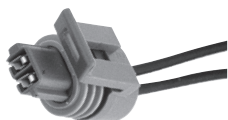

For manifold air temperature.
 (MAT) Fits GM Vehicles 1985
 and later.

HP4430



For GM cooling fan motors.
 GM: 22048271, 22074968,
 22074969 Replaces GM:
 12101906, 917.
 Buick.....03-90
 Cadillac02-89
 Chevrolet.....03-90
 GM Light Trucks00-92
 Medium Duty.... 02-00, 98-90
 Oldsmobile02-87
 Pontiac04-86

NEW HP4475



Speed Sensor Connector
 Ford Products 1993-1998

HP4490

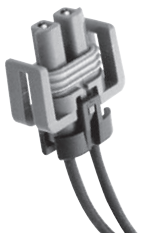

A/C Clutch GM: 12101937
 Buick.....03-89
 Cadillac04-89
 Chevrolet.....03-89
 GM Light Trucks03-87
 Medium Duty..... 03, 93-90
 Oldsmobile03-89
 Pontiac04-89

HP4550

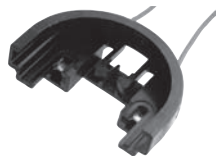

For Ford Ignition Coil.
 Ford, Mercury.....87-77
 Lincoln84-75

NEW HP4575



Alternator Connector
 Ford Cars & Trucks
 1974-1994

NEW HP4585



Fuel Injector Connector
 GM, Ford Cars & Trucks
 1981-2000

NEW HP4595



Ignition Coil Connector
 GM Cars & Trucks
 1985-1995

NEW HP4605



Ignition Coil Connector
 GM Cars & Trucks
 1985-1995

NEW HP4635



Ignition Coil Connector
 Ford Cars & Trucks
 1999-2004

NEW HP4710



Cam and Crank
 Sensor Connector
 Ford Cars & Trucks
 1980-2004

NEW HP4715



Stoplight Switch Connector
 Ford Cars & Trucks
 1969-2007

NEW HP4720



Sensor Connector
 GM Cars & Trucks
 1988-2004

Pigtails & Sockets

2 WIRE PIGTAIL (CONT.)

NEW HP4750



Switch and Sensor Connector
GM Cars & Trucks
1988-2005

HP7310

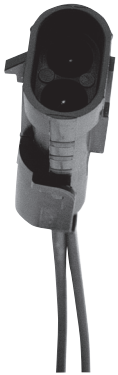

GM: 12085524
Multi-Purpose Connector.
In-line male 2-way connector
used on cars, trucks, stationary
engines, farm and industrial
equipment. Current capacity
of 20 amps, Silicone seals,
machine crimped terminals,
Fuel/Coolant/Brake fluid
resistant. Mates with HP7320.
Buick.....96-88
Cadillac 03, 01, 99-86
Chevrolet.....03-90
GM Light Trucks.....03-90
Medium Duty.....04-90
Oldsmobile 03-99, 96-87
Pontiac 03-99, 97-85

HP7320



Multi-Purpose Connector.
In-line female 2-way connector
used on cars, trucks, stationary
engines, farm and industrial
equipment. Current capacity
of 20 amps, Silicone seals,
machine crimped terminals,
Fuel/Coolant/Brake fluid
resistant. Mates with HP7310.

3 WIRE PIGTAIL

HP3800



Alternator Pigtail
Ford Vehicles.....89-81

HP3910



Voltage Regulator Pigtail
Ford Vehicles.....94-81

HP3920



For floor mounted dimmer
switches.
Buick.....83-63
Cadillac82-63
Chevrolet.....84-63
GM Trucks86-63
IHC Trucks.....80-57
Oldsmobile81-70
Pontiac84-65

NEW HP3925



Crankshaft Sensor Connector
Chrysler Products
1995-2005

NEW HP4210



Alternator Connector
Ford Cars & Trucks
1998-2005

NEW HP4240



Crankshaft Sensor Connector
GM Cars & Trucks
1988-2006

HP4300

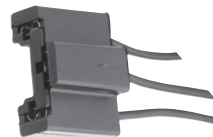

Fits dimmer switches.
American Motors81-67
Chrysler Vehicles80-65
Ford Vehicles.....81-65

HP4370

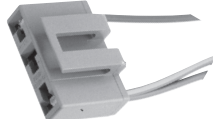

Ford Ignition Coil, EEC-IV
Ford Vehicles.....91-81

HP4440



Throttle Position Sensor Pigtail.
GM: 12102748
Also Various Sensors
and Switches
Buick.....03-90
Cadillac04-90
Chevrolet.....03-90
GM Light Trucks.....03-90
Medium Duty.....03-90
Oldsmobile03-90
Pontiac04-89

Pigtails & Sockets

3 WIRE PIGTAIL (CONT.)

HP4460

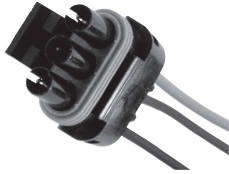

GM: 12116257 For GM throttle position sensors.
Chevrolet.....96-89
GM Light Trucks.....98-95
Medium Duty.....03, 96-90
Pontiac.....95-92

HP4470



MAP Sensor Pigtail.
GM: 12085502
Buick.....03-82
Chevrolet.....03-82
GM Light Trucks.....99-90
Medium Trucks.....98-90
Oldsmobile.....03-82
Pontiac.....03-82

HP4480



Oil Pressure Switch Pigtail.
GM Vehicles

HP4540



GM: 12126058
For Radiator Cooling Fan Motor.
#F4DZ-8C07B; F5CZ-8C607A
Ford Vehicles.....96-90

NEW HP4755



Neutral Safety Switch Connector
AMC & Chrysler Products
1969-1989

HP7330



Universal. In-line male 3-way connector used on cars, trucks, stationary engines, farm and industrial equipment. Current capacity of 20 amps, Silicone seals, machine crimped terminals, Fuel/Coolant/Brake fluid resistant. Mates with HP7340.

HP7340



In-line female 3-way connector used on cars, trucks, stationary engines, farm and industrial equipment. Current capacity of 20 amps, Silicone seals, machine crimped terminals, Fuel/Coolant/Brake fluid resistant. Mates with HP7330.

4 WIRE PIGTAIL

NEW HP3895



GM Cars & Trucks
1985-2005

HP3930



For Fuel Pump Relay.
Ford.....96-92
Ford Trucks.....96-92
Lincoln.....96-82
Mercury.....96-82

NEW HP3935



Ignition Control Module Connector
AMC 1977-1983,
Ford Products 1975-1997

HP4340



Fan Speed Switch Pigtail.
Ford.....93-86
Mercury.....93-86
Ford Trucks.....92

HP4350



Blower Motor Resistor Pigtail.
Ford Trucks.....94-86

HP4360



For Fan Speed Switch.
Buick, Chevrolet.....94-77
GM Trucks.....95-86
Oldsmobile, Pontiac.....94-77

HP4390

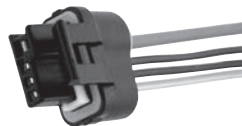

For Voltage Regulator
12004311, 12101895. Use to
Replace 3 or 4 Wire Pigtail.
GM Vehicles.....95-86

NEW HP4435



Voltage Regulator Connector
AMC, GM, IHC Cars & Trucks
1959-1988

Pigtails & Sockets

4 WIRE PIGTAIL (CONT.)

NEW HP4485



Ignition Coil Connector
GM Cars
1987-2005

HP4500

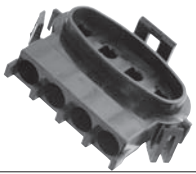

For fuel pump sending unit.
Ford.....90-85

NEW HP4695



Alternator Connector
GM Cars & Trucks
1990-2005

NEW HP4705



Taillamp Connector
GM Trucks
1988-1996

NEW HP4735



Ignition Control
Module Connector
AMC 1977-1983,
Ford Products 1975-1997

HP7350



Universal. In-line male 4-way
connector used on cars, trucks,
stationary engines, farm and
industrial equipment. Current
capacity of 20 amps, Silicone
seals, machine crimped termi-
nals, Fuel/Coolant/Brake fluid
resistant. Mates with HP7360.

HP7360



In-line female 4-way connector
used on cars, trucks, stationary
engines, farm and industrial
equipment. Current capacity
of 20 amps, Silicone seals,
machine crimped terminals,
Fuel/Coolant/Brake fluid
resistant. Mates with HP7350.

5 WIRE PIGTAIL

HP3810

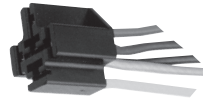

Fits 4 & 5 Terminal Relays.
Various Cars
& Trucks.....95-82

NEW HP3815



Relay Connector
4 or 5 Pin Relay
Buick 1985-1990

NEW HP4655



Relay Connector
GM Cars & Trucks
1991-2005

NEW HP4770



Blower Motor
Switch Connector
Ford Cars & Trucks
1973-1994

6 WIRE PIGTAIL

HP3880



Voltage Regulator Pigtail.
Ford Vehicles.....81-65

HP4520

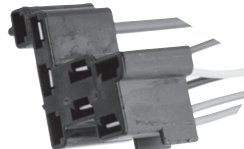

Headlamp Switch Pigtail.
GM Vehicles.....95-68

HP4530

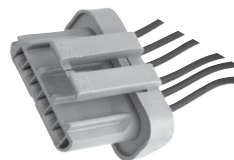

Ignition Module Pigtail.
Ford Vehicles.....91-81

Pigtails & Sockets

6 WIRE PIGTAIL (CONT.)

HP7370



Universal. In-line male 6-way connector used on cars, trucks, stationary engines, farm and industrial equipment. Current capacity of 20 amps, Silicone seals, machine crimped terminals, Fuel/Coolant/Brake fluid resistant. Mates with HP7380.

HP7380



Universal. In-line female 6-way connector used on cars, trucks, stationary engines, farm and industrial equipment. Current capacity of 20 amps, Silicone seals, machine crimped terminals, Fuel/Coolant/Brake fluid resistant. Mates with HP7370.

7 WIRE PIGTAIL

NEW HP4230

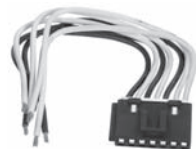

Blower Motor Resistor Connector
GM Cars & Trucks
1997-2006

8 WIRE PIGTAIL

HP4510

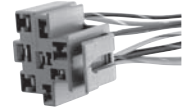

Headlamp Switch Harness.
Ford95-86
Mercury95-90

9 WIRE PIGTAIL

HP3820

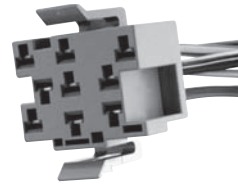

Headlamp Switch Pigtail.
Ford Trucks..... 99-73

NEW HP4195



Headlight Switch Connector
Dodge Truck
1973-2000

NEW HP4760



Ignition Switch Connector
GM Trucks
1967-1977

Switches

TOGGLE SWITCHES 2 POSITION

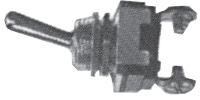

Part No.
HP4800

Description
On-Off, 10 Amp, single pole, single throw. 2 screw terminals. Mounting stem $\frac{15}{32}$ " diameter, $\frac{3}{8}$ " long.

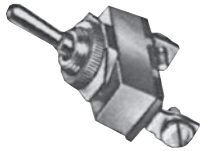

Part No.
HP4810

Description
On-Off, 20 Amp, Heavy duty, single pole, single throw, with face plate, 2 screw terminals. Mounting stem $\frac{15}{32}$ " diameter, $\frac{3}{8}$ " long.



Part No.
HP4830

Description
High performance style with safety cover, On-Off, 20 Amp, single pole, single throw. Mounting stem $\frac{15}{32}$ " diameter, $\frac{1}{4}$ " long.

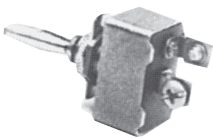

Part No.
HP4850

Description
On-Off, 50 Amp, Heavy duty, zinc diecast, single pole, single throw, with face plate, 2 screw terminals. Mounting stem $\frac{15}{32}$ " diameter, $\frac{3}{8}$ " long.

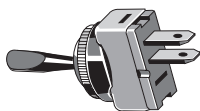

Part No.
HP4930

Description
Off-Momentary On, 10 Amp, single pole, single throw. Mounting stem $\frac{7}{16}$ " diameter, $\frac{3}{8}$ " long.

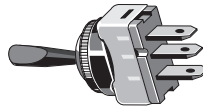

On-Off, 20 Amp, Illuminated, single pole, single throw. Mounting stem $\frac{7}{16}$ " diameter, $\frac{3}{8}$ " long.

Part No.	Color
HP5040	Green
HP5050	Red
HP5060	Amber
HP5070	Blue

TOGGLE SWITCHES 3 POSITION

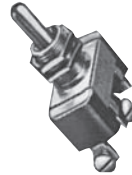

Part No.
HP4820

Description
On-Off-On, 15 Amp, single pole, double throw, 3 screw terminals. Mounting stem $\frac{15}{32}$ " diameter, $\frac{1}{2}$ " long.



Part No.
HP4860

Description
On-Off-On, 50 Amp, zinc diecast, single pole, double throw, 3 screw terminals, chrome plated handle. Mounting stem $\frac{15}{32}$ " diameter, $\frac{15}{32}$ " long.



Part No.
HP4870

Description
Momentary On-Off-Momentary On, 50 Amp, zinc diecast, single pole, double throw. 3 screw terminals, chrome plated handle. Mounting stem $\frac{15}{32}$ " diameter, $\frac{15}{32}$ " long.

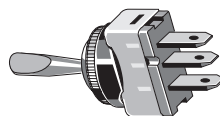

Part No.
HP4920

Description
On-Off-On, 10 Amp, single pole, double throw. Mounting stem $\frac{7}{16}$ " diameter, $\frac{3}{8}$ " long.

Switches

TOGGLE SWITCHES 3 POSITION (CONT.)

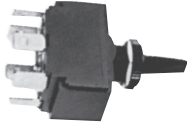

Part No.
HP4940

Description
Momentary On-Off-Momentary
On, 10 Amp, double pole,
double throw, 6 terminals.
Mounting stem $15/32$ " diameter, $3/8$ " long.



Part No.
HP4950

Description
On-Off-On, 10 Amp, double pole,
double throw, 6 terminals.
Mounting stem $15/32$ " diameter, $3/8$ " long.

DUCK BILL TOGGLE SWITCHES



Part No.
HP4960

Description
On-Off, 20 Amp. Black,
single pole, single throw.
Mounting stem $7/16$ " diameter, $3/8$ " long.



Part No.
HP4970

Description
On-Off, 20 Amp. Chrome,
single pole, single throw.
Mounting stem $7/16$ " diameter, $3/8$ " long.



Part No.
HP4980

Description
On-Off-On, 20 Amp. Black,
single pole, double throw.
Mounting stem $7/16$ " diameter, $3/8$ " long.



On-Off, 20 Amp. Illuminated, single pole, single throw.
Mounting stem $7/16$ " diameter, $3/8$ " long.

Part No.	Color
HP5000	Green
HP5010	Red
HP5020	Amber
HP5030	Blue

ROCKER SWITCHES



On-Off, 16 Amp. Illuminated, single pole, single throw,
blade terminals. $1\frac{1}{8}$ " x $7/16$ ". Fits panel HP5150.

Part No.	Color
HP5080	Green
HP5090	Red
HP5100	Amber
HP5110	Blue



Part No.
HP6760

Description
Rocker Switch Kit, 4 switches
and panel. Includes 1 each:
HP5080, HP5090, HP5100, HP5110.



On-Off, 16 Amp, Oval LED Illuminated, single pole,
single throw. Mounting stem $7/16$ " diameter, $1/4$ " long.

Part No.	Color
HP4880	Green
HP4890	Red
HP4900	Amber

Switches

PUSH PULL SWITCHES

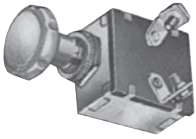

Push Pull Switch.

Part No.
HP5180

Description
On-Off, 10 Amp, Universal
2 position, single pole,
single throw. 2 screw terminals.
Mounting stem $1\frac{5}{32}$ " diameter, $\frac{1}{2}$ " long.



Push Pull Switch.

Part No.
HP4840

Description
On-Off, 75 Amp, Heavy duty
Push-Pull Switch, single pole,
single throw, chrome plated
knob, 2 screw terminals.
Mounting stem $1\frac{5}{32}$ " diameter, $\frac{5}{8}$ " long.

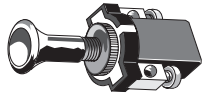

Push Pull Switch.

Part No.
HP4910

Description
On-Off, 16 Amp, Universal
Push-pull switch. European styling,
black, single pole, single throw.
Mounting stem $\frac{5}{16}$ " diameter, $\frac{1}{4}$ " long.

PUSH BUTTON SWITCHES



Push Button Switches.

Part No.
HP4990

Description
Off-Momentary On, 10 Amp.
Single pole, single throw,
2 screw terminals.
Mounting stem $1\frac{5}{32}$ " diameter, $\frac{7}{16}$ " long.

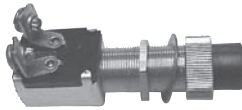

Part No.
HP5170

Description
Off-Momentary On, 15 Amp,
brass, moisture proof,
single pole, single throw.
Mounting stem $\frac{5}{8}$ " diameter, $1\frac{1}{16}$ " long.



Part No.
HP5190

Description
Off-Momentary On, 15 Amp,
single pole, single throw.
Mounting stem $\frac{5}{8}$ " diameter, $\frac{5}{8}$ " long.

MISCELLANEOUS SWITCHES



Horn Button.

Part No.
HP5160

Description
Off-Momentary On, 10 Amp,
with mounting bracket.
Single pole, single throw.



Horn Button.

Part No.
HP5200

Description
Off-Momentary On, 10 Amp,
with mounting bracket.
Single pole, single throw.

Switches

MISCELLANEOUS SWITCHES (CONT.)



Battery Disconnect Switch.

Part No.
HP5210

Description
On-Off, 100 Amp, continuous, with removable key, single pole, single throw, 2 terminals. Mounting holes $\frac{3}{16}$ ".

WARNING LIGHTS



Indicator Lamp.

Universal, warning indicator lamp with illuminated lens and long life non-replaceable bulb. Includes wire leads for easy installation. Mounting $\frac{1}{2}$ " round hole, 12 volt applications.

Part No.	Color
HP5120	Red
HP5130	Amber

SWITCH PANELS

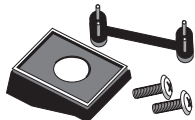

Part No.
HP5140

Description
Switch mounting panel. For $\frac{1}{2}$ " round hole mounting switches. Snap-in clips included for connecting multiple panels.



Part No.
HP5150

Description
Switch mounting panel. For $1\frac{1}{8}$ " x $\frac{7}{16}$ " rectangular switches. Snap-in clips included for connecting multiple panels. For HP5080, HP5090, HP5100, HP5110.

ACCESSORY RELAY KIT

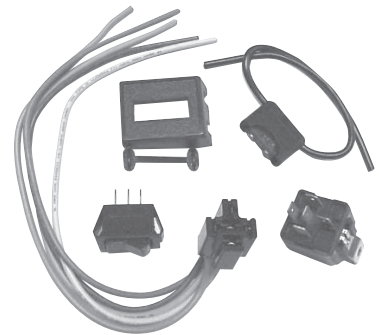

Part No.
HP6770

Universal 30 Amp Relay Kit

Use to add auxiliary electrical circuits such as lights, stereos, horns, radiator fans, etc.

Includes:

- 30 amp relay
- pigtail connector
- rocker switch
- switch panel
- fuseholder

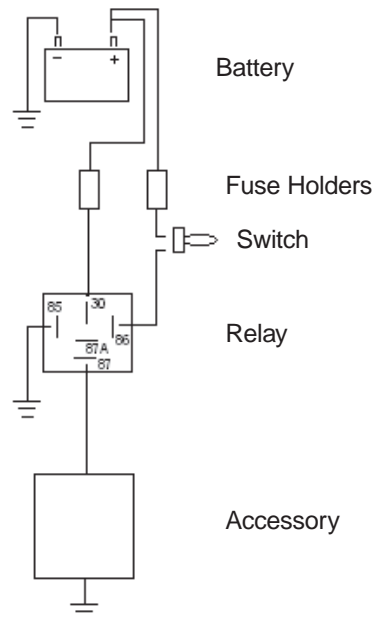

NOTE: NOT TO SCALE

Trailer Connectors

NOTE: Locate wires by function only. Color coding is not standard among all manufacturers.

2 POLE CONNECTORS

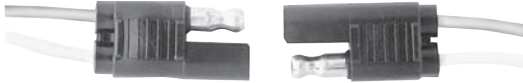

2-Pole Molded Trailer Connector

- 18 gauge pigtails for boats, trailers, etc.
- Plug and receptacle are not sold separately.

Part No.
HP5310

4 POLE CONNECTORS

- 18 gauge pigtails.
- Ideal for utility, boat, camper trailer.
- Will accommodate stop lights, directional lights, tail lights, and ground. Plug and receptacle not sold separately.



4-Pole Flat Molded Trailer Connector

- 12" Tow Vehicle End and 12" Trailer End Set.

Part No.
HP5300



4-Pole Flat Molded Trailer Connector

- 48" Long.
- Can use to extend existing connector.
- Can cut to desired lengths.

Part No.
HP5340

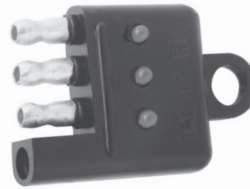

4-Pole Flat Trailer Connector Tester

- LED 4 pole trailer connector tester.
- Use with HP5300 and HP5340.

Part No.
HP5320



4-Pole Round Trailer Connector

- Polarized connector for marine and trailer use.
- Molded interiors.
- Spring loaded cover holds plug in position.
- Die-cast plug and socket casing.
- Heavy brass contacts.
- Accepts up to 12 ga. wire.

Part No.
HP5330
HP5350

Male/Female
Male
Female



4-Pole HD Trailer Connector

- Self-locking with coded sockets.
- Receptacle has concealed terminals.
- Plug has handle for ease of removing plug.
- Split clamp for securing cable.
- Accepts up to 12 ga. wire.
- Die-cast plug and socket casing.

Part No.
HP5420
HP5390

Male/Female
Female
Male

Trailer Connectors

NOTE: Locate wires by function only. Color coding is not standard among all manufacturers.

6 POLE CONNECTORS

Six pole round connectors are used on smaller campers, horse trailers, and car trailers. Added functions provided by a six pole round are electric brakes and an auxiliary power lead.



Universal 6-Pole Trailer Connector

Used for trailer requiring a six-circuit connection such as electric brakes.

- Plug and receptacle are not sold separately.

Part No.
HP5360

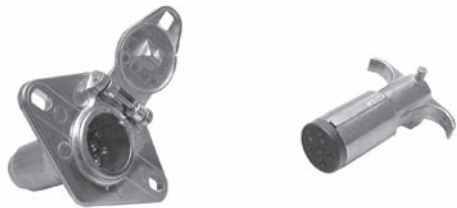

6-Pole Trailer Connector

- Self-locking with coded sockets.
- Receptacle has concealed terminals.
- Plug has handle for ease of removing plug.
- Split clamp for securing cable.
- Accepts five 12 ga. wires and one 10 ga. wire.

Part No.
HP5400
HP5430

Male/Female
Male
Female

7 POLE CONNECTORS

Seven pole connectors are found mostly on the largest trailers, RV campers and industrial. Seven pole connector function provides electric brakes, auxiliary power lead and backup lights.



Universal 7-Pole RV Trailer Connector

- Heavy duty weatherproof design eliminates corrosion, poor appearance, and difficulty of removal.
- Unique interior design incorporates vinyl inserts to seal out moisture and dirt.
- Safety latch prevents accidental pull-away.
- Detail instructions permit Used for both 6 and 7-way applications.
- Uses HP5370 boot.
- Used with HP5470 bracket.

Part No.
HP5490
HP5480

Male/Female
Female
Male



Universal 7-Pole RV Trailer Connector

- Corrosion resistant plated steel.
- Uses HP5370 boot.
- Used with HP5470 bracket.

Part No.
HP5450
HP5410

Male/Female
Female
Male

Trailer Connectors

NOTE: Locate wires by function only. Color coding is not standard among all manufacturers.

7 POLE CONNECTORS (CONT.)



Universal 7-Pole HD Trailer Connector

- Accepts six 12 ga. wires and one 10 ga. wire.
- Uses HP5370 boot.
- Used with HP5470 bracket.

Part No.	Male/Female
HP5510	Male
HP5500	Female

TRAILER CONNECTOR BRACKETS



Universal Trailer Connector Bracket

- Use with HP5450, HP5490, and HP5500.
- 7-Pole mounting bracket.
- Corrosion-resistant plated steel.

Part No.
HP5470



Boot

- Protects connector from moisture.
- Fits HP5450, HP5490, HP5500 Trailer Connector.

Part No.
HP5370

ADAPTERS

Adapters allow you to tow several other trailers without having to re-wire your tow vehicle.



Part No.	Description
HP5380	6-way round pin type to 4-way flat adapter.



Part No.	Description
HP5440	7-way RV blade type to 4-way flat adapter.



Part No.	Description
HP5460	7-way RV blade to 6-pin round adapter.

Typical Trailer Connector Color Codes	
Universal 4 Pole Flat Connector	
White	Ground Return
Green	Right Turn Signal and Brake Light
Yellow	Left Turn Signal and Brake Light
Brown	Tail Lights
Universal 6 Pole Round Connector	
White	Ground Return
Brown	Tail Lights
Yellow	Left Turn Signal
Red	Brake Lights
Green	Right Turn Signal
Blue	Auxiliary Circuit
Universal 7 Pole RV Connector (FLAT PINS)	
White	Ground Return
Blue	Electric Brakes
Green	Tail Lights, License Lights, Running Lights
Black	Battery Charge
Red	Left Turn Signal and Brake Light
Brown	Right Turn Signal and Brake Light
Yellow	Auxiliary Circuit
Universal 7 Pole Heavy Duty Connector	
White	Ground Return
Black	Clearance Lights and Side Marker Lights
Yellow	Left Turn Signal and Hazard Signal
Red	Brake Lights and Anti-Lock Devices
Green	Right Turn Signal and Hazard Signal
Brown	Tail Lights, License Lights, Running Lights
Blue	Auxiliary Circuit

CIRCUIT TESTERS

Economy tester finds open circuits, blown fuses, bad connections quickly and easily. Test lead with alligator clip included. Handle illuminates when circuit is working.



Part No.
HP2650

Economy Circuit Tester



Part No.
HP6330

Mid-grade Circuit Tester



Part No.
HP6350

Circuit Tester with Probe Hook

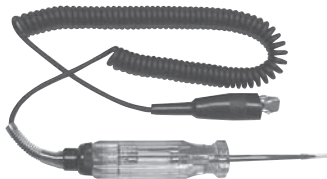

Part No.
HP6310

Professional Circuit Tester

CONTINUITY TESTER

Tests circuits with power off. Use to locate broken wires, bad connections, open circuits. Test lead with alligator clip included. Handle illuminates when continuity is present.



Part No.
HP6320

Economy Continuity Tester

Requires 2 AAA batteries (not included).



Part No.
HP6300

Professional Continuity Tester

Requires 1 AA battery (not included).

CRIMPING TOOLS

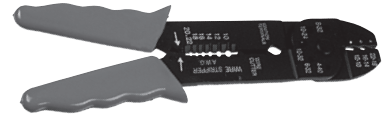

Part No.
HP2680

Economy Crimping Tool

- Cuts and strips primary wire 26 to 10 gauge.
- Crimps insulated and non-insulated terminals.



Part No.
HP6390

Premium Crimping Tool

- Cuts and strips primary wire 26 to 10 gauge.
- Crimps insulated and non-insulated terminals.
- Cushion grip handles.
- Precision ground.
- Cuts small screws and bolts.

ADDITIONAL TOOLS



Part No.
HP6340

LED Battery Voltage Tester

- LED indicators show normal, low, or flat charge level.
- Two leads, one with alligator clip, one with probe.
- Magnetic base for "hands-free" use.

Tools

ADDITIONAL TOOLS (CONT.)



Part No.
HP6360

Analog Multi Tester

- Pocket size.
- 9 functions/ranges.
- DC 150 mAmp current.
- DC Volts 0-15, 0-150, 0-500.
- AC Volts 0-15, 0-150, 0-500.
- Ohms x 1000.
- Battery test 1.5 volt.



Part No.
HP6370

Flameless Heat Torch.

CAUTION: Read instructions before use. Refer to package for complete warnings and cautions. Do not ignite or operate near open flame, heater, furnace, near combustible materials or in engine compartment. Recommended for shop use in well ventilated areas.

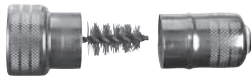

Part No.
HP6380

Battery Cleaners

Battery post & terminal cleaning brush kit.

OEM WIRING TOOLS

Part No.
HP7000



Extractor Tool.

Extractor tool for Weather-Pack Terminals.

Part No.
HP7010



Terminal Extractor Pick.

Narrow blade, .050"

Part No.
HP7020



Terminal Extractor Pick.

Wide blade, .090"

Part No.
HP7390



OEM Crimping Tool.

- Crimps 24-14 gauge wire.
- Hardened steel.

Safety Accessories

SAFETY ACCESSORIES



Back Up Alarm

Pulse alarm sounds when you shift into reverse. Alarm warns anyone behind your car, van or pickup. Simple two wire connection to back-up lights.

Part No.
HP6750



Cigarette Lighter Plug

Converts 12 volt accessories to plug-in operation.

Part No.
HP6740

ACCESSORY RELAY KIT

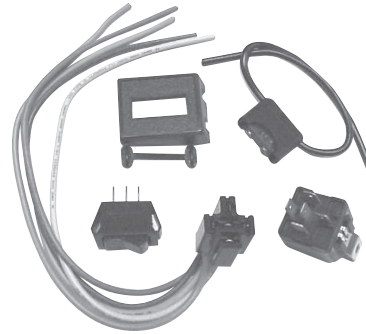

Universal 30 Amp Relay Kit

Use to add auxiliary electrical circuits such as lights, stereos, horns, radiator fans, etc.

Includes:

- 30 amp relay
- pigtail connector
- rocker switch
- switch panel
- fuseholder

Part No.
HP6770

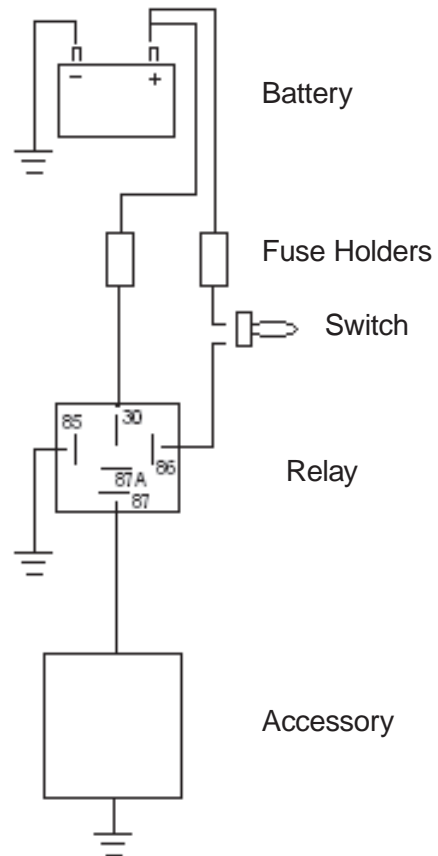

NOTE: NOT TO SCALE

Wiring Center Contents

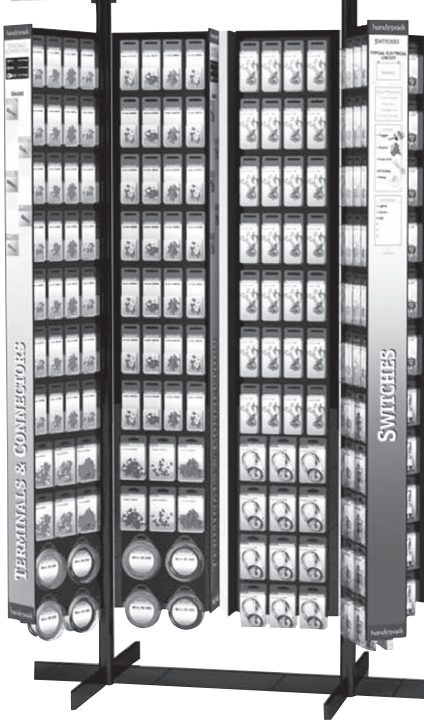

- Choose up to 16 of 22 available assortments.
- Order optional wheel kit for ease of movement and cleaning.
- Compact packaging for better use of space.
- Side channel graphics offer technical information and parts guides.
- Color coded packaging to aid in location and restocking.
- Overall dimensions: 54" wide x 26" deep x 78" tall.
- Individual panel dimensions: 56.5" tall x 10.125" wide.

DISPLAY HARDWARE AND ASSORTMENTS

Part No.	Description
HP1	Bases, Poles, Graphics Kit—will accommodate up to 8 framed pegboard panels/16 assortments
HP2	Framed Pegboard (2 per box) order 3 boxes to display 12 assortments
HP3	Wall mount kit. One kit will hold two framed pegboard panels/4 assortments.
HP4	Casters—8 total, 2 locking and 6 non-locking.
HP5*	Pigtail & Socket Assortment—40 pcs
HP6*	Pigtail & Socket Assortment—40 pcs
HP7	Switch Assortment—42 pcs
HP8	Primary Wire Assortment 16–20 GA.—22 pcs.
HP9	Primary Wire Assortment 10–14 GA.—22 pcs.
HP10	22–18 GA. Terminal & Connector Assortment—42 pcs.
HP11	16–14 GA. Terminal & Connector Assortment—41 pcs.
HP12	12–10 GA. Terminal & Connector Assortment—41 pcs.
HP13	Terminal & Connector Combo Packs, Fusible Link—25 pcs
HP14	Fuse Holders, Battery Accessories—42 pcs
HP15	Loom & Cable Ties—17 pcs.
HP16	Heat Shrink Tubing, Clamps—28 pcs.
HP17	Audio and Multilink Terminals—30 pcs
HP18	Tools—10 pcs.
HP19	Trailer Connectors—22 pcs
HP20	Multi-Colored Loom & Cable Ties—18 pcs.
HP21	OEM Weather Pack Terminals—40 pcs.
HP22 NEW	Pigtail & Socket Assortment—41 pcs.

HP23 NEW	Pigtail & Socket Assortment—39 pcs.
HP24 NEW	Pigtail & Socket Assortment—40 pcs.
HP25 NEW	Pigtail & Socket Assortment—80 pcs. - covers 2 panels, numbers run in consecutive order, comparable to 2 assortments
HP26 NEW	Pigtail & Socket Assortment—120 pcs. - covers 3 panels, numbers run in consecutive order, comparable to 3 assortments

HP5 Pigtails and Sockets 40 pieces

Part No.	Description
HP3800	alternator pigtail, Ford 1981–89
HP3810	relay pigtail, universal, 4 or 5 pin relays
HP3820	headlight switch pigtail, Ford 1987–94
HP3830	sensor pigtail, 1976–98 GM cars and trucks
HP3840	temp sender pigtail, GM, Chrysler, Jeep, 1980–2002
HP3850	radiator fan pigtail, GM cars and trucks, 1980–98
HP3860	fuel injector pigtail
HP3870	alternator pigtail, GM 1963–90
HP3880	voltage regulator pigtail, Ford products, 1959–94
HP3890	electric choke pigtail, GM 1982–89
HP3900	fuel injector pigtail, GM 1978–99
HP3910	voltage regulator pigtail, Ford products, 1981–94
HP3920	dimmer switch pigtail, GM vehicles, 1963–84
HP3930	fuel pump relay pigtail, Mazda, Ford, 1981–96
HP3940	headlight socket for halogen bulb #9004
HP3950	headlight socket for 3 terminal headlights
HP3960	headlight socket for halogen bulb #9006
HP3970	headlight socket for halogen bulb #9005
HP3980	GM fuel injector pigtail
HP3990	universal double contact pigtail

* replaced by HP22 and HP23

Wiring Center Contents

HP5

(CONT.)

Part No.	Description
HP4000	universal single contact pigtail
HP4010	single contact socket Instrument panel
HP4020	park, tail, stop, turn socket, GM vehicles, 1970-73
HP4030	stop, tail, turn socket, Chrysler products, 1980-94
HP4040	park, tail socket, universal
HP4050	stop, tail, turn socket, Chrysler products, 1970-91
HP4060	license, side marker socket, GM, Ford, 1970-96
HP4070	side marker socket, Ford, Chrysler, 1972-94
HP4080	side marker socket, GM products, 1982-01
HP4090	dash socket, GM products, 1970-91
HP4100	dash socket, Chrysler products, 1974-90
HP4110	park, turn socket, GM products, 1977-99
HP4120	stop, tail, turn socket, GM products, 1980-97
HP4130	park, turn socket, Ford products, 1975-92
HP4140	tail, stop, turn socket, GM, Chrysler, 1977-98
HP4150	park, tail, stop, turn socket, GM products, 1969-91
HP4160	turn, tail, stop, side marker socket, Chrysler, 1975-95
HP4170	park, turn, stop, tail socket, GM 1990-02
HP4180	stop, tail, turn socket, Chrysler 1986-93
HP4190	license light, universal

HP6

Pigtails and Sockets 40 pieces

Part No.	Description
HP4300	dimmer switch pigtail, Ford, Chrysler, AMC, 1965-81
HP4310	headlight socket for 4701 headlight
HP4320	headlight socket for 4703 headlight
HP4330	headlight socket for H4666 and H6545 headlights
HP4340	fan speed switch pigtail, Ford 1986-97
HP4350	blower motor resistor pigtail, Ford truck 1986-94
HP4360	fan speed switch pigtail, GM products, 1977-94
HP4370	ignition coil pigtail, Ford 1982-97
HP4380	voltage regulator pigtail, Chrysler, 1972-89
HP4390	voltage regulator pigtail, GM, 1986-94
HP4400	coolant temperature sensor pigtail, Ford, 1981-98
HP4410	foglamp pigtail, GM, Ford, 1989-01
HP4420	air temperature sensor pigtail, GM products, 1987-02
HP4430	cooling fan motor pigtail, GM, 1985-02
HP4440	various sensor and switch pigtail, GM, 1990-04
HP4450	headlight socket for 2 terminal sealed beams
HP4460	throttle position sensor pigtail, GM, 1980-2002
HP4470	MAP sensor pigtail, GM, 1982-2003
HP4480	oil pressure switch pigtail, GM, 1987-96
HP4490	A/C clutch pigtail, GM, 1989-04
HP4500	fuel pump pigtail, Ford, 1985-90
HP4510	headlight switch pigtail, Ford, 1986-94
HP4520	headlight switch pigtail, GM, 1965-90
HP4530	ignition module pigtail, 1981-89
HP4540	cooling fan motor pigtail, Ford, 1994-96
HP4550	ignition coil pigtail, Ford, 1975-87
HP4560	cornering, side marker socket, GM, 1988-01
HP4570	universal double contact socket
HP4580	universal double contact socket
HP4590	universal double contact socket
HP4600	universal single contact socket
HP4610	tail, stop, turn socket, GM, Ford, 1969-99
HP4620	universal single contact socket
HP4630	side marker socket, Chrysler, 1972-95
HP4640	stop, tail, turn, side marker socket, Ford, 1983-96
HP4650	backup light socket, Chrysler, Ford, AMC, 1973-93
HP4660	park, stop, turn, tail socket, GM, 1969-99
HP4670	park, turn socket, Ford, 1974-94
HP4680	stop, tail, turn, backup socket, GM, 1989-02
HP4690	park stop, tail, turn socket, Ford, 1973-80

HP7

Switches 42 pieces

Part No.	Description
HP4800	On-Off toggle switch
HP4810	On-Off toggle switch, 20 amp
HP4820	On-Off-On toggle switch, 15 amp
HP4830	On-Off toggle switch with safety cover
HP4840	push-pull switch, 75 amp
HP4850	On-Off toggle switch, 50 amp
HP4860	On-Off-On toggle switch, 50 amp
HP4870	On-Off-On toggle switch, 50 amp
HP4880	green dot oval rocker switch
HP4890	red dot oval rocker switch
HP4900	amber dot oval rocker switch
HP4910	On-Off black push pull switch
HP4920	On-Off-On black toggle switch
HP4930	Off-On black toggle switch
HP4940	On-Off-On toggle switch, 6 terminal
HP4950	On-Off-On toggle switch, 6 terminal
HP4960	On-Off black duckbill toggle switch
HP4970	On-Off chrome duckbill toggle switch
HP4980	On-Off-On black duckbill toggle switch
HP4990	Universal momentary pushbutton switch
HP5000	On-Off green glow duckbill toggle switch
HP5010	On-Off red glow duckbill toggle switch
HP5020	On-Off amber glow duckbill toggle switch
HP5030	On-Off blue glow duckbill toggle switch
HP5040	On-Off green glow toggle switch
HP5050	On-Off red glow toggle switch
HP5060	On-Off amber glow toggle switch
HP5070	On-Off blue glow toggle switch
HP5080	On-Off green glow rocker switch
HP5090	On-Off red glow rocker switch
HP5100	On-Off amber glow rocker switch
HP5110	On-Off blue glow rocker switch
HP5120	red indicator light
HP5130	amber indicator light
HP5140	one hole switch panel, 1/2" dia. hole
HP5150	one hole switch panel, rectangular hole
HP5160	universal horn button
HP5170	universal starter pushbutton switch
HP5180	On-Off push-pull switch
HP5190	universal pushbutton switch
HP5200	universal horn button
HP5210	On-Off battery disconnect switch

HP8

Primary Wire 22 pieces

Part No.	Description
HP5600	20 ga speaker wire clear
HP5610	20 ga primary wire green
HP5620	20 ga primary wire red
HP5630	20 ga primary wire black
HP5640	18 ga primary wire white
HP5650	18 ga primary wire red
HP5660	18 ga primary wire green
HP5670	18 ga primary wire yellow
HP5680	18 ga primary wire blue
HP5690	18 ga primary wire black
HP5700	16 ga primary wire brown
HP5710	16 ga primary wire purple
HP5720	16 ga primary wire pink
HP5730	16 ga primary wire orange

Wiring Center Contents

HP8 (CONT.)

Part No.	Description
HP5740	16 ga primary wire blue
HP5750	16 ga primary wire yellow
HP5760	16 ga primary wire white
HP5770	16 ga primary wire green
HP5780	16 ga primary wire red
HP5790	16 ga primary wire black
HP5800	16 ga speaker wire clear
HP5810	10 ga primary wire black

HP9 Primary Wire 22 pieces

Part No.	Description
HP5820	14 ga primary wire brown
HP5830	14 ga primary wire purple
HP5840	14 ga primary wire orange
HP5850	14 ga primary wire blue
HP5860	14 ga primary wire black/red stripe
HP5870	14 ga primary wire yellow
HP5880	14 ga primary wire red
HP5890	14 ga primary wire white
HP5900	14 ga primary wire black
HP5910	14 ga primary wire green
HP5920	14 ga primary wire pink
HP5930	12 ga primary wire green
HP5940	12 ga primary wire white
HP5950	12 ga primary wire yellow
HP5960	12 ga primary wire blue
HP5970	12 ga primary wire black
HP5980	12 ga primary wire red
HP5990	10 ga primary wire green
HP6000	10 ga primary wire white
HP6010	10 ga primary wire yellow
HP6020	10 ga primary wire blue
HP6030	10 ga primary wire red

HP10 22-18 ga. Terminals & Connectors 42 pieces

Part No.	Description
HP1010	ring terminal, #6 stud, 22-18 ga
HP1020	ring terminal, #8 stud, 22-18 ga
HP1030	ring terminal, #10 stud, 22-18 ga
HP1040	ring terminal, 1/4" stud, 22-18 ga
HP1050	male slide terminal, 1/4", 22-18 ga
HP1060	female slide terminal, 1/4", 22-18 ga
HP1070	male slide terminal, 3/16", 22-18 ga
HP1080	female slide terminal, 3/16", 22-18 ga
HP1090	female/male slide adapter terminal, 1/4", 22-18 ga
HP1100	female bullet terminal, .156", 22-18 ga
HP1110	male bullet terminal, .156", 22-18 ga
HP1120	quick splice connector, 22-18 ga
HP1130	butt connector, 22-18 ga
HP1140	spade terminal, #8 stud, 22-18 ga
HP1150	spade terminal, #10 stud, 22-18 ga
HP1160	parallel splice, 22-18 ga
HP1170	hook terminal, #10 stud, 22-18 ga
HP1181	step down butt connector, 16-14 ga to 22-18 ga
HP1190	"T" tap connector, 22-18 ga
HP1200	connector assortment, 22-18 ga
HP1210	butt connector, bulk pack, 22-18 ga
HP1220	male slide terminal, 1/4", bulk pack, 22-18 ga
HP1230	female slide terminal, 1/4", bulk pack, 22-18 ga

HP10 (CONT.)

Part No.	Description
HP1240	quick splice connector, bulk pack, 22-18 ga
HP1250	ring terminal, #10 stud, bulk pack, 22-18 ga
HP1260	spade terminal, #10 stud, bulk pack, 22-18 ga
HP1270	female slide terminal, 1/4", fully insulated, nylon, 22-18 ga
HP1280	male slide terminal, 1/4", fully insulated, nylon, 22-18 ga
HP1290	female flag terminal, 1/4", fully insulated, nylon, 22-18 ga
HP1300	butt connector, nylon, 22-18 ga
HP1310	male slide terminal, 3/16", fully insulated, nylon, 22-18 ga
HP1320	female slide terminal, 3/16", fully insulated, nylon, 22-18 ga
HP1330	male slide terminal, 1/4", fully insulated, nylon, heatshrink, 22-18 ga
HP1340	female slide terminal, 1/4", fully insulated, nylon, heatshrink, 22-18 ga
HP1350	butt connector, crimp with heat shrink, 22-18 ga
HP1360	ring terminal, #6 stud, crimp with heat shrink, 22-18 ga
HP1370	ring terminal, #8 stud, crimp with heat shrink, 22-18 ga
HP1380	ring terminal, #10 stud, crimp with heat shrink, 22-18 ga
HP1390	butt connector, self solder with heat shrink, 24-22 ga
HP1400	butt connector, self solder with heat shrink, 22-18 ga
HP1410	ring terminal, 1/4" stud, self solder with heat shrink, 22-18 ga
HP1420	ring terminal, 3/8" stud, self solder with heat shrink, 22-18 ga

HP11 16-14 ga. Terminals & Connectors 41 pieces

Part No.	Description
HP1500	ring terminal, #8 stud, 16-14 ga
HP1510	ring terminal, #10 stud, 16-14 ga
HP1520	ring terminal, 1/4" stud, 16-14 ga
HP1530	ring terminal, 5/16" stud, 16-14 ga
HP1540	ring terminal, 3/8" stud, 16-14 ga
HP1550	male slide terminal, 1/4", 16-14 ga
HP1560	female slide terminal, 1/4", 16-14 ga
HP1570	"T" tap connector, 16-14 ga
HP1580	male slide terminal, 3/16", 16-14 ga
HP1590	female slide terminal, 3/16", 16-14 ga
HP1600	female bullet terminal, .156", 16-14 ga
HP1610	male bullet terminal, .156", 16-14 ga
HP1620	female bullet terminal, .176", 16-14 ga
HP1630	male bullet terminal, .176", 16-14 ga
HP1640	spade terminal, #10 stud, 16-14 ga
HP1650	hook terminal, #10 stud, 16-14 ga
HP1660	quick splice connector, 18-14 ga
HP1670	butt connector, 16-14 ga
HP1681	step down butt connector, 12-10 ga to 16-14 ga
HP1690	parallel splice, 16-14 ga
HP1700	female slide terminal, 1/4", bulk pack, 16-14 ga
HP1710	male slide terminal, 1/4", bulk pack, 16-14 ga
HP1720	terminal assortment, 16-14 ga
HP1730	butt connector, bulk pack, 16-14 ga
HP1740	spade terminal, #10 stud, bulk pack, 16-14 ga
HP1750	ring terminal, #10 stud, bulk pack, 16-14 ga

Wiring Center Contents

HP11 (CONT.)

Part No. Description

HP1760	quick splice connector, bulk pack, 18–14 ga
HP1770	male slide terminal, 1/4", bulk pack, nylon, 16–14 ga
HP1780	female slide terminal, 1/4", bulk pack, nylon, 16–14 ga
HP1790	butt connector, nylon, 16–14 ga
HP1800	female flag terminal, 1/4", fully insulated, nylon, 16–14 ga
HP1810	female slide terminal, 1/4", fully insulated, nylon, 16–14 ga
HP1820	male slide terminal, 1/4", fully insulated, nylon, 16–14 ga
HP1830	male slide terminal, 1/4", fully insulated, nylon, heatshrink, 16–14 ga
HP1840	female slide terminal, 1/4", fully insulated, nylon, heatshrink, 16–14 ga
HP1850	butt connector, crimp with heat shrink, 16–14 ga
HP1860	ring terminal, #10 stud, crimp with heat shrink, 16–14 ga
HP1870	butt connector, self solder with heat shrink, 16–14 ga
HP1880	ring terminal, 1/4" stud, crimp, solder, with heat shrink, 16–14 ga
HP1890	ring terminal, 3/8" stud, crimp, solder, with heat shrink, 16–14 ga
HP1900	female slide terminal, 1/4", self solder, heat shrink, 16–14 ga

HP12 12–10 ga. Terminals & Connectors 41 pieces

Part No. Description

HP2000	ring terminal, #8 stud, 12–10 ga
HP2010	ring terminal, #10 stud, 12–10 ga
HP2020	ring terminal, 1/4" stud, 12–10 ga
HP2030	ring terminal, 5/16" stud, 12–10 ga
HP2040	ring terminal, 3/8" stud, 12–10 ga
HP2050	ring terminal, 1/2" stud, 12–10 ga
HP2060	male slide terminal, 1/4", 12–10 ga
HP2070	female slide terminal, 1/4", 12–10 ga
HP2080	female slide terminal, 3/8", 12–10 ga
HP2090	spade terminal, #8 stud, 12–10 ga
HP2100	spade terminal, #10 stud, 12–10 ga
HP2110	hook terminal, #10 stud, 12–10 ga
HP2120	butt connector, 12–10 ga
HP2130	parallel splice, 12–10 ga
HP2141	step down butt connector, 8 ga to 12–10 ga
HP2150	"T" tap connector, 12–10 ga
HP2160	terminal assortment, 12–10 ga
HP2170	quick splice connector, bulk pack, 12–10 ga
HP2180	quick splice connector, 12–10 ga
HP2190	butt connector, bulk pack, 12–10 ga
HP2200	ring terminal, #10 stud, bulk pack, 12–10 ga
HP2210	ring terminal, 3/8" stud, bulk pack, 12–10 ga
HP2220	spade terminal, #10 stud, bulk pack, 12–10 ga
HP2230	female slide terminal, 1/4", bulk pack, 12–10 ga
HP2240	male slide terminal, 1/4", bulk pack, 12–10 ga
HP2250	female slide terminal, 1/4", fully insulated, nylon, 12–10 ga
HP2260	female slide terminal, 1/4", fully insulated, nylon, 12–10 ga
HP2270	butt connector, nylon, 12–10 ga
HP2280	butt connector, crimp with heat shrink, 12–10 ga
HP2290	ring terminal, #10 stud, crimp with heat shrink, 12–10 ga
HP2300	ring terminal, 1/4" stud, crimp with heat shrink, 12–10 ga

HP12 (CONT.)

Part No. Description

HP2310	ring terminal, 5/16" stud, crimp with heat shrink, 12–10 ga
HP2320	ring terminal, 3/8" stud, crimp with heat shrink, 12–10 ga
HP2330	spade terminal, #10 stud, crimp with heat shrink, 12–10 ga
HP2340	female slide terminal, 1/4", fully insulated, nylon, heatshrink, 12–10 ga
HP2350	male slide terminal, 1/4", fully insulated, nylon, heatshrink, 12–10 ga
HP2360	butt connector, self solder with heat shrink, 12–10 ga
HP2370	ring terminal, #10 stud, self solder, with heat shrink, 12–10 ga
HP2380	ring terminal, 1/4" stud, self solder, with heat shrink, 12–10 ga
HP2390	ring terminal, 3/8" stud, self solder, with heat shrink, 12–10 ga
HP2400	ring terminal, 1/2" stud, self solder, with heat shrink, 12–10 ga

HP13 Terminal & Connector Combo Packs & fusible link - 25 pieces

Part No. Description

HP2500	butt connector combo pack, 3 sizes
HP2510	slide connector combo pack, male and female, 3 sizes
HP2520	vacuum caps, vinyl
HP2530	vacuum caps, EPDM
HP2540	twist lock wire nut assortment
HP2550	twist lock wire nut, blue, 22–14 ga
HP2560	twist lock wire nut, orange, 22–14 ga
HP2570	twist lock wire nut, yellow, 18–10 ga
HP2580	slide connector, dual male, 1/4"
HP2590	bullet connector, dual female, .156"
HP2600	closed end splice connector assortment
HP2610	bullet quick splice, 18–14 ga
HP2620	parallel splice combo pack
HP2630	slide connector combo pack, female, 3 sizes
HP2640	"T" tap quick splice kit
HP2645	ring terminal combo pack
HP2650	economy circuit tester
HP2660	terminal assortment
HP2670	spark plug boot protectors
HP2680	economy crimping tool
HP2700	terminal assortment
HP2710	fusible link wire, green, 18 ga
HP2720	fusible link wire, black, 16 ga
HP2730	fusible link wire, brown, 14 ga
HP2740	fusible link wire, blue, 12 ga

HP14 Fuse holders, Battery Accessories 42 pieces

Part No. Description

HP2800	copper battery cable lug, 3/8" hole, 6 ga
HP2810	copper battery cable lug, 3/8" hole, 4 ga
HP2820	copper battery cable lug, 5/16" hole, 4 ga
HP2830	copper battery cable lug, 3/8" hole, 2 ga
HP2840	battery terminal protectors
HP2850	side terminal battery bolt, 3/8" x 1/2"
HP2860	side terminal battery bolt, 3/8" x 1/2"
HP2870	side terminal battery bolt and spacer

Wiring Center Contents

HP14 (CONT.)

Part No.	Description
HP2880	side terminal battery cable emergency terminal
HP2890	top post battery cable emergency terminals, epoxy coated
HP2900	battery adapter, top post to side terminal
HP2910	battery cable bolts, top post, $\frac{5}{16}$ " x $\frac{17}{16}$ "
HP2920	battery adapter, stud to top post
HP2930	battery adapter, side terminal to top post
HP2940	test leads, 36" long, un-insulated alligator clips
HP2950	test leads, 30" long, insulated alligator clips
HP2960	4 alligator clips, 5 amp, 2 red boots, 2 black boots
HP2970	alligator clips, 5 amp
HP2980	alligator clips, 10 amp
HP2990	alligator clips, 25 amp
HP3000	fuse taps, spade type, $\frac{1}{4}$ "
HP3010	fuse taps, mini-spade type, $\frac{3}{16}$ "
HP3020	fuse taps, glass fuse type, $\frac{1}{4}$ " tab
HP3030	fuse holder, ATO or ATC type, 10 amp, 14 ga, w/fuse
HP3040	fuse holder, ATO or ATC type, 20 amp, 14 ga, w/fuse
HP3050	fuse holder, ATO or ATC type, 30 amp, 12 ga, w/fuse
HP3060	fuse holder, ATO or ATC type, 20 amp, 16 ga, w/cover, w/o fuse
HP3070	fuse holder, panel mount, glass fuse type, w/o fuse
HP3080	fuse holder, mini type, 30 amp, 12 ga, w/cover, w/o fuse
HP3090	fuse holder, ATO or ATC type, 30 amp, 12 ga, w/cover, w/o fuse
HP3100	fuse holder, ATO or ATC type, 20 amp, self stripping, 18–14 ga, w/o fuse
HP3110	fuse holder, glass fuse type, 20 amp, 14 ga, w/o fuse
HP3120	fuse holder, glass fuse type, 30 amp, 12 ga, w/o fuse
HP3130	fusible link, black, 16 ga
HP3140	fusible link, orange, 16 ga
HP3150	fusible link, brown, 14 ga
HP3160	fusible link, black, 16 ga
HP3170	fusible link, green, 14 ga
HP3180	fusible link, black, 14 ga
HP3190	Maxi™ fuse holder, w/cover, w/o fuse
HP3200	battery test clips, 75 amp, 1 red, 1 black
HP3210	fuse block, ATO or ATC type fuses, 6 gang, w/ground buss bar

HP15 Loom & Cable Ties 17 pieces

Part No.	Description
HP3300	loom tee, $\frac{1}{2}$ " x $\frac{1}{2}$ " x $\frac{1}{2}$ "
HP3310	loom tee, $\frac{3}{8}$ " x $\frac{3}{8}$ " x $\frac{3}{8}$ "
HP3320	loom tee, $\frac{3}{4}$ " x $\frac{3}{8}$ " x $\frac{3}{4}$ "
HP3330	tie strap mounting clip, self adhesive, 1.5" square
HP3340	loom installation tool
HP3350	spiral wrap, white, $\frac{1}{2}$ " diameter
HP3360	split loom, $\frac{1}{4}$ "
HP3370	split loom, $\frac{3}{8}$ "
HP3380	split loom, $\frac{7}{16}$ "
HP3390	split loom, $\frac{3}{4}$ "
HP3400	tie strap, 4", nylon, natural
HP3410	tie strap, 8", nylon, black
HP3420	tie strap, 8.5", nylon, natural
HP3430	tie strap, 11.75", nylon, black
HP3440	tie strap, 11.5", nylon, natural
HP3450	tie strap, 14.5", nylon, natural
HP3460	tie strap, 8.5", nylon, natural, w/mounting hole

HP16 Heat Shrink & Bundling 28 pieces

Part No.	Description
HP3500	heat shrink tubing assortment
HP3510	heat shrink tubing, black, 1.5" long, 16–14 ga
HP3520	heat shrink tubing assortment
HP3530	heat shrink tubing assortment
HP3540	heat shrink tubing, clear, 20–14 ga
HP3550	heat shrink tubing, red, 20–18 ga
HP3560	heat shrink tubing, yellow, 12–10 ga
HP3570	heat shrink tubing, blue, 16–14 ga
HP3580	rubber cushioned clamp, $\frac{1}{4}$ " I.D.
HP3590	rubber cushioned clamp, $\frac{1}{2}$ " I.D.
HP3600	rubber cushioned clamp, $\frac{3}{4}$ " I.D.
HP3610	rubber cushioned clamp, assortment
HP3620	nylon clamps, $\frac{1}{4}$ " I.D.
HP3630	nylon clamps, $\frac{1}{2}$ " I.D.
HP3640	nylon clamp assortment
HP3650	wiring clip, self adhesive, $\frac{1}{4}$ " I.D.
HP3660	wiring clip, self adhesive, $\frac{3}{8}$ " I.D.
HP3670	wiring clip, self adhesive, assortment
HP3680	vinyl grommets $\frac{1}{4}$ " I.D.
HP3690	vinyl grommets $\frac{3}{8}$ " I.D.
HP3700	vinyl grommets $\frac{1}{2}$ " I.D.
HP3710	vinyl grommet assortment
HP3720	multi-conductor wire, 3 colors, 16 ga
HP3730	multi-conductor wire, 4 colors, 16 ga
HP3740	cold seal tape - 1" x 10'
HP3750	electrical tape, black, $\frac{3}{4}$ " wide
HP3760	wire separators, 7mm wire
HP3770	wire separators, 8mm wire

HP17 Specialty Items 30 pieces

Part No.	Description
HP6500	gold butt connector, 22–18 ga
HP6510	gold female slide terminal, $\frac{1}{4}$ ", 22–18 ga
HP6520	gold female slide terminal, .110", 22–18 ga
HP6530	gold butt connector, 16–14 ga
HP6540	gold female slide terminal, $\frac{1}{4}$ ", 16–14 ga
HP6550	gold female slide terminal, .110", 16–14 ga
HP6560	gold butt connector, 12–10 ga
HP6570	gold female slide terminal, $\frac{1}{4}$ ", 12–10 ga
HP6580	gold ring terminal, $\frac{3}{8}$ " hole, 12–10 ga
HP6590	gold round pin set, 16–12 ga
HP6600	gold flat pin set, 16–14 ga
HP6610	gold ring terminal set, $\frac{3}{8}$ " hole, 8 ga
HP6620	butt connector, crimp, solder, heat shrink, 24–22 ga
HP6630	butt connector, crimp, solder, heat shrink, 22–18 ga
HP6640	butt connector, crimp, solder, heat shrink, 16–14 ga
HP6650	butt connector, crimp, solder, heat shrink, 12–10 ga
HP6660	ring terminal, crimp, solder, heat shrink, #10 stud, 22–18 ga
HP6670	ring terminal, crimp, solder, heat shrink, #10 stud, 16–14 ga
HP6680	ring terminal, crimp, solder, heat shrink, $\frac{1}{4}$ " stud, 16–14 ga
HP6690	ring terminal, crimp, solder, heat shrink, $\frac{3}{8}$ " stud, 16–14 ga
HP6700	ring terminal, crimp, solder, heat shrink, #10 stud, 12–10 ga
HP6710	ring terminal, crimp, solder, heat shrink, $\frac{3}{8}$ " stud, 12–10 ga

Wiring Center Contents

HP17 (CONT.)

Part No.	Description
HP6720	female slide terminal, crimp, solder, heat shrink, 1/4", 16-14 ga
HP6730	male slide terminal, crimp, solder, heat shrink, 1/4", 16-14 ga
HP6740	Cigarette Lighter Plug
HP6750	Back Up Alarm
HP6760	Illuminated Rocker Switch Kit
HP6770	Universal 30 amp relay kit
HP6780	Battery cable coupler
HP6790	Battery cable coupler

HP18 Tools 10 pieces

Part No.	Description
HP6300	continuity tester, professional grade
HP6310	circuit tester, professional grade
HP6320	continuity tester, economy grade
HP6330	circuit tester, mid level grade
HP6340	battery voltage analyzer
HP6350	circuit tester with probe hook
HP6360	multi-meter
HP6370	flameless heat torch
HP6380	battery post cleaner
HP6390	crimping tool, professional grade

HP19 Trailer Connectors 22 pieces

Part No.	Description
HP5300	4 pole flat trailer connector, male and female, 12"
HP5310	2 pole flat trailer connector, male and female
HP5320	4 pole flat tester LED
HP5330	4 pole round trailer connector, male half
HP5340	4 pole flat trailer connector extension, 48"
HP5350	4 pole round trailer connector female half
HP5360	6 pole trailer connector, male and female set
HP5370	Boot for 7 pole trailer connector HP5500
HP5380	trailer connector adapter from 6 pole round to 4 pole flat
HP5390	4 pole round HD trailer connector, male half
HP5400	6 pole round trailer connector, male half
HP5410	metal 7 pole RV trailer connector, male half
HP5420	4 pole round HD trailer connector, female half
HP5430	6 pole round trailer connector, female half
HP5440	trailer connector adapter from 7 pole RV to 4 pole flat
HP5450	metal 7 pole RV trailer connector, female half
HP5460	trailer connector adapter from 7 pole RV flat pin to 6 pole round
HP5470	mounting bracket for 7 pole trailer connectors
HP5480	plastic 7 pole RV trailer connector, male half
HP5490	plastic 7 pole RV trailer connector, female half
HP5500	metal 7 pole HD trailer connector, female half
HP5510	metal 7 pole HD trailer connector, male half

HP20 Multi-colored Loom & Cable Ties 18 pieces

Part No.	Description
HP6100	hook and loop tie strap, blue, 8"
HP6110	hook and loop tie strap, white, 8"
HP6120	hook and loop tie strap, red, 8"
HP6130	hook and loop tie strap, yellow, 8"
HP6140	tie strap, 4", blue
HP6150	tie strap, 4", red
HP6160	tie strap, 4", yellow
HP6170	tie strap, 4", white
HP6180	tie strap, 8", blue
HP6190	tie strap, 8", red
HP6200	tie strap, 8", yellow
HP6210	tie strap, 8", white
HP6220	spiral wrap, 1/2", blue
HP6230	spiral wrap, 1/2", red
HP6240	spiral wrap, 1/2", yellow
HP6250	split loom, 3/8", blue
HP6260	split loom, 3/8", red
HP6270	split loom, 3/8", yellow

HP21 OEM Items 40 pieces

Part No.	Description
HP7000	OEM terminal extractor tool
HP7010	OEM terminal extractor tool
HP7020	OEM terminal extractor tool
HP7030	OEM terminal, female, 18-14 ga
HP7040	OEM terminal, male, 18-14 ga
HP7050	OEM terminal, female slide, 20-18 ga
HP7060	OEM terminal, 150 Series female, 20-16 ga
HP7070	OEM terminal, 150 Series female, 20-18 ga
HP7080	OEM terminal, 630 series female, 16-14 ga
HP7090	OEM terminal, 16-14 ga
HP7100	OEM terminal, Chrysler, 20-18 ga
HP7110	OEM terminal, female slide, 16-14 ga
HP7120	OEM terminal, male, 16-14 ga
HP7130	OEM terminal insulator, used with HP7110
HP7140	OEM terminal and insulator, female
HP7150	Universal terminal, 1/4" male slide, 20-14 ga
HP7160	Universal terminal, 1/4" dual male slide
HP7170	Universal terminal, 1/4" male slide, #10 hole
HP7180	Universal terminal, 1/4" female slide, 20-14 ga
HP7190	OEM terminal, silicone seal
HP7200	OEM terminal, silicone seal
HP7210	Universal terminal, 1/4" dual male, single female slide
HP7220	Universal terminal, 1/4" female slide, 14-12 ga
HP7230	OEM terminal, female, 20-18 ga
HP7240	OEM terminal, male, 20-18 ga
HP7250	OEM terminal, female, tin plated, 16-14 ga
HP7260	OEM terminal, male, tin plated, 16-14 ga
HP7270	OEM terminal, female, pin type, 20-18 ga
HP7280	OEM terminal, female, micro, 1/8", 16-14 ga
HP7290	OEM terminal, female, 3/16", 16-14 ga
HP7300	OEM terminal, female, 1/8", 16-14 ga
HP7310	universal connector, 2 wire, male, 20 amp
HP7320	universal connector, 2 wire, female, 20 amp
HP7330	universal connector, 3 wire, male, 20 amp
HP7340	universal connector, 3 wire, female, 20 amp
HP7350	universal connector, 4 wire, male, 20 amp
HP7360	universal connector, 4 wire, female, 20 amp
HP7370	universal connector, 6 wire, male, 20 amp
HP7380	universal connector, 6 wire, female, 20 amp
HP7390	OEM terminal crimp tool

Wiring Center Contents

HP22 Pigtails and Sockets 41 pieces

Part No.	Description
HP3810	relay pigtail, universal, 4 or 5 pin relays
HP3820	headlight switch pigtail, Ford 1987-94
HP3825	Double Contact Socket, Dodge Truck 1996-2002
HP3835	Double Contact Socket, GM Cars & Trucks 1980-2005
HP3840	temp sender pigtail, GM, Chrysler, Jeep, 1980-2002
HP3850	radiator fan pigtail, GM cars and trucks, 1980-98
HP3860	fuel injector pigtail
HP3870	alternator pigtail, GM 1963-90
HP3880	voltage regulator pigtail, Ford products, 1959-94
HP3895	4 Wire Connector, GM Cars & Trucks 1985-2005
HP3900	fuel injector pigtail, GM 1978-99
HP3910	voltage regulator pigtail, Ford products, 1981-94
HP3920	dimmer switch pigtail, GM vehicles, 1963-84
HP3925	Crankshaft Sensor Connector, Chrysler Products 1995-2005
HP3940	headlight socket for halogen bulb # 9004
HP3950	headlight socket for 3 terminal headlights
HP3960	headlight socket for halogen bulb # 9006
HP3970	headlight socket for halogen bulb # 9005
HP3980	GM fuel injector pigtail
HP3990	universal double contact pigtail
HP4000	universal single contact pigtail
HP4010	park, tail, stop, turn socket, GM vehicles, 1969-92
HP4020	park, tail, stop, turn socket, GM vehicles, 1970-73
HP4030	stop, tail, turn socket, Chrysler products, 1980-94
HP4045	Double Contact Socket, GM Cars & Trucks 1992-2002
HP4050	stop, tail, turn socket, Chrysler products, 1970-91
HP4060	license, side marker socket, GM, Ford, 1970-96
HP4070	side marker socket, Ford, Chrysler, 1972-94
HP4080	side marker socket, GM products, 1982-01
HP4090	dash socket, GM products, 1970-91
HP4100	dash socket, Chrysler products, 1974-90
HP4110	park, turn socket, GM products, 1977-99
HP4120	stop, tail, turn socket, GM products, 1980-97
HP4125	Double Contact Socket, Ford Cars & Trucks 1990-2004
HP4140	tail, stop, turn socket, GM, Chrysler, 1977-98
HP4170	park, turn, stop, tail socket, GM 1990-02
HP4200	Double Contact Socket, Ford Cars & Trucks 1991-2006
HP4210	Alternator Connector, Ford Cars & Trucks 1998-2005
HP4220	Alternator Connector, AMC, GM, IHC Cars & Trucks 1962-1988
HP4230	Blower Motor Resistor Connector, GM Cars & Trucks 1997-2006
HP4240	Crankshaft Sensor Connector, GM Cars & Trucks 1988-2006

HP23 Pigtails and Sockets 39 pieces

Part No.	Description
HP3800	alternator pigtail, Ford 1981-89
HP3805	Double Contact Socket, Ford Cars & Trucks 1996-2003
HP3815	Relay Connector 4 or 5 Pin Relay, Buick 1985-1990
HP3930	fuel pump relay pigtail, Mazda, Ford, 1981-96
HP3935	Ignition Control Module Connector, AMC 1977-1983, Ford Products 1975-1997
HP3945	Fuel Injector Connector, GM, Ford, Chrysler Products 1995-2003
HP3955	Double Contact Socket, Acura, Nissan, Subaru, Toyota, 1980-1994
HP4130	park, turn socket, Ford products, 1975-92
HP4150	park, tail, stop, turn socket, GM products, 1969-91

HP23 (CONT.)

HP4160	turn, tail, stop, side marker socket, Chrysler, 1975-95
HP4180	stop, tail, turn socket, Chrysler 1986-93
HP4190	license light, universal
HP4195	Headlight Switch Connector, Dodge Truck 1973-2000
HP4300	dimmer switch pigtail, Ford, Chrysler, AMC, 1965-81
HP4350	blower motor resistor pigtail, Ford truck 1986-94
HP4370	ignition coil pigtail, Ford 1982-97
HP4400	coolant temperature sensor pigtail, Ford, 1981-98
HP4410	foglamp pigtail, GM, Ford, 1989-01
HP4420	air temperature sensor pigtail, GM products, 1987-02
HP4435	Voltage Regulator Connector, AMC, GM, IHC Cars & Trucks 1959-1988
HP4440	various sensor and switch pigtail, GM, 1990-04
HP4450	headlight socket for 2 terminal sealed beams
HP4460	throttle position sensor pigtail, GM, 0980-02
HP4470	MAP sensor pigtail, GM, 0982-03
HP4475	Speed Sensor Connector, Ford Products 1993-1998
HP4500	fuel pump pigtail, Ford, 1985-90
HP4520	headlight switch pigtail, GM, 1965-90
HP4550	ignition coil pigtail, Ford, 1975-87
HP4610	tail, stop, turn socket, GM, Ford, 1969-99
HP4620	universal single contact socket
HP4630	side marker socket, Chrysler, 1972-95
HP4635	Ignition Coil Connector, Ford Cars & Trucks 1999-2004
HP4640	stop, tail, turn, side marker socket, Ford, 1983-96
HP4680	stop, tail, turn, backup socket, GM, 1989-02
HP4700	Double Contact Socket, Chrysler Products 1991-2000
HP4710	Cam and Crank Sensor Connector, Ford Cars & Trucks 1980-2004
HP4720	Sensor Connector, GM Cars & Trucks 1988-2004
HP4730	Single Contact Socket, Acura, Nissan 1980-1995
HP4740	Headlight Socket, Fits H13, HB13 or 9008 headlamp

HP24 Pigtails and Sockets 40 pieces

Part No.	Description
HP3830	sensor pigtail, 1976-98 GM cars and trucks
HP4040	park, tail socket, universal
HP4320	headlight socket for 4703 headlight
HP4340	fan speed switch pigtail, Ford 1986-97
HP4360	fan speed switch pigtail, Gm products, 1977-94
HP4380	voltage regulator pigtail, Chrysler, 1972-89
HP4390	voltage regulator pigtail, GM, 1986-94
HP4430	cooling fan motor pigtail, GM, 1985-02
HP4480	oil pressure switch pigtail, GM, 1987-96
HP4485	Ignition Coil Connector, GM Cars 1987-2005
HP4490	A/C clutch pigtail, GM, 1989-04
HP4495	Double Contact Socket, Universal, use for parking, stop, tail, and turn lamps
HP4510	headlight switch pigtail, Ford, 1986-94
HP4515	Single Contact Socket, Ford Cars & Trucks 1996-2003
HP4530	ignition module pigtail, 1981-89
HP4555	Side Marker Socket, GM Cars & Trucks 1992-2007
HP4560	cornering, side marker socket, GM, 1988-01
HP4575	Alternator Connector, Ford Cars & Trucks 1974-1994
HP4580	universal double contact socket
HP4585	Fuel Injector Connector, GM, Ford Cars & Trucks 1981-2000
HP4595	Ignition Coil Connector, GM Cars & Trucks 1985-1995
HP4605	Ignition Coil Connector, GM Cars & Trucks 1985-1995

Wiring Center Contents

HP24

(CONT.)

Part No.	Description
HP4615	Double Contact Socket, Universal, use for parking, stop, tail, and turn lamps
HP4645	Double Contact Socket, GM Cars 1988-1997
HP4650	backup light socket, Chrysler, Ford, AMC, 1973-93
HP4655	Relay Connector, GM Cars & Trucks 1991-2005
HP4660	park, stop, turn, tail socket, GM, 1969-99
HP4670	park, turn socket, Ford, 1974-94
HP4690	park stop, tail, turn socket, Ford, 1973-80
HP4695	Alternator Connector, GM Cars & Trucks 1990-2005
HP4705	Taillamp Connector, GM Trucks 1988-1996
HP4715	Stoplight Switch Connector, Ford Cars & Trucks 1969-2007
HP4725	License Plate Light Socket, Chrysler Products 1989-1995
HP4735	Ignition Control Module Connector, AMC 1977-1983, Ford Products 1975-1997
HP4745	Single Contact Socket, Universal, use for backup, instrument, and turn lamps
HP4750	Switch and Sensor Connector, GM Cars & Trucks 1988-2005
HP4755	Neutral Safety Switch Connector, AMC & Chrysler Products 1969-1989
HP4760	Ignition Switch Connector, GM Trucks 1967-1977
HP4770	Blower Motor Switch Connector, Ford Cars & Trucks 1973-1994
HP4780	Single Contact Socket, Chrysler Products 1974-1995

HP25

Pigtails and Sockets 80 pieces

Part No.	Description
HP3800	alternator pigtail, Ford 1981-89
HP3805	Double Contact Socket, Ford Cars & Trucks 1996-2003
HP3810	relay pigtail, universal, 4 or 5 pin relays
HP3815	Relay Connector 4 or 5 Pin Relay, Buick 1985-1990
HP3820	headlight switch pigtail, Ford 1987-94
HP3825	Double Contact Socket, Dodge Truck 1996-2002
HP3835	Double Contact Socket, GM Cars & Trucks 1980-2005
HP3840	temp sender pigtail, GM, Chrysler, Jeep, 1980-2002
HP3850	radiator fan pigtail, GM cars and trucks, 1980-98
HP3860	fuel injector pigtail
HP3870	alternator pigtail, GM 1963-90
HP3880	voltage regulator pigtail, Ford products, 1959-94
HP3895	4 Wire Connector, GM Cars & Trucks 1985-2005
HP3900	fuel injector pigtail, GM 1978-99
HP3910	voltage regulator pigtail, Ford products, 1981-94
HP3920	dimmer switch pigtail, GM vehicles, 1963-84
HP3925	Crankshaft Sensor Connector, Chrysler Products 1995-2005
HP3930	fuel pump relay pigtail, Mazda, Ford, 1981-96
HP3935	Ignition Control Module Connector, AMC 1977-1983, Ford Products 1975-1997
HP3940	headlight socket for halogen bulb # 9004
HP3945	Fuel Injector Connector, GM, Ford, Chrysler Products 1995-2003
HP3950	headlight socket for 3 terminal headlights
HP3955	Double Contact Socket, Acura, Nissan, Subaru, Toyota, 1980-1994
HP3960	headlight socket for halogen bulb # 9006
HP3970	headlight socket for halogen bulb # 9005
HP3980	GM fuel injector pigtail
HP3990	universal double contact pigtail
HP4000	universal single contact pigtail

HP25

(CONT.)

Part No.	Description
HP4010	park, tail, stop, turn socket, GM vehicles, 1969-92
HP4020	park, tail, stop, turn socket, GM vehicles, 1970-73
HP4030	stop, tail, turn socket, Chrysler products, 1980-94
HP4045	Double Contact Socket, GM Cars & Trucks 1992-2002
HP4050	stop, tail, turn socket, Chrysler products, 1970-91
HP4060	license, side marker socket, GM, Ford, 1970-96
HP4070	side marker socket, Ford, Chrysler, 1972-94
HP4080	side marker socket, GM products, 1982-01
HP4090	dash socket, GM products, 1970-91
HP4100	dash socket, Chrysler products, 1974-90
HP4110	park, turn socket, GM products, 1977-99
HP4120	stop, tail, turn socket, GM products, 1980-97
HP4125	Double Contact Socket, Ford Cars & Trucks 1990-2004
HP4130	park, turn socket, Ford products, 1975-92
HP4140	tail, stop, turn socket, GM, Chrysler, 1977-98
HP4150	park, tail, stop, turn socket, GM products, 1969-91
HP4160	turn, tail, stop, side marker socket, Chrysler, 1975-95
HP4170	park, turn, stop, tail socket, GM 1990-02
HP4180	stop, tail, turn socket, Chrysler 1986-93
HP4190	license light, universal
HP4195	Headlight Switch Connector, Dodge Truck 1973-2000
HP4200	Double Contact Socket, Ford Cars & Trucks 1991-2006
HP4210	Alternator Connector, Ford Cars & Trucks 1998-2005
HP4220	Alternator Connector, AMC, GM, IHC Cars & Trucks 1962-1988
HP4230	Blower Motor Resistor Connector, GM Cars & Trucks 1997-2006
HP4240	Crankshaft Sensor Connector, GM Cars & Trucks 1988-2006
HP4300	dimmer switch pigtail, Ford, Chrysler, AMC, 1965-81
HP4350	blower motor resistor pigtail, Ford truck 1986-94
HP4370	ignition coil pigtail, Ford 1982-97
HP4400	coolant temperature sensor pigtail, Ford, 1981-98
HP4410	foglamp pigtail, GM, Ford, 1989-01
HP4420	air temperature sensor pigtail, GM products, 1987-02
HP4435	Voltage Regulator Connector, AMC, GM, IHC Cars & Trucks 1959-1988
HP4440	various sensor and switch pigtail, GM, 1990-04
HP4450	headlight socket for 2 terminal sealed beams
HP4460	throttle position sensor pigtail, GM, 0980-02
HP4470	MAP sensor pigtail, GM, 0982-03
HP4475	Speed Sensor Connector, Ford Products 1993-1998
HP4500	fuel pump pigtail, Ford, 1985-90
HP4520	headlight switch pigtail, GM, 1965-90
HP4550	ignition coil pigtail, Ford, 1975-87
HP4610	tail, stop, turn socket, GM, Ford, 1969-99
HP4620	universal single contact socket
HP4630	side marker socket, Chrysler, 1972-95
HP4635	Ignition Coil Connector, Ford Cars & Trucks 1999-2004
HP4640	stop, tail, turn, side marker socket, Ford, 1983-96
HP4680	stop, tail, turn, backup socket, GM, 1989-02
HP4700	Double Contact Socket, Chrysler Products 1991-2000
HP4710	Cam and Crank Sensor Connector, Ford Cars & Trucks 1980-2004
HP4720	Sensor Connector, GM Cars & Trucks 1988-2004
HP4730	Single Contact Socket Acura, Nissan 1980-1995
HP4740	Headlight Socket Fits H13, HB13 or 9008 headlamp

Wiring Center Contents

HP26 Pigtails and Sockets 120 pieces

Part No.	Description
HP3800	alternator pigtail, Ford 1981-89
HP3805	Double Contact Socket, Ford Cars & Trucks 1996-2003
HP3810	relay pigtail, universal, 4 or 5 pin relays
HP3815	Relay Connector 4 or 5 Pin Relay, Buick 1985-1990
HP3820	headlight switch pigtail, Ford 1987-94
HP3825	Double Contact Socket, Dodge Truck 1996-2002
HP3830	sensor pigtail, 1976-98 GM cars and trucks
HP3835	Double Contact Socket, GM Cars & Trucks 1980-2005
HP3840	temp sender pigtail, GM, Chrysler, Jeep, 1980-2002
HP3850	radiator fan pigtail, GM cars and trucks, 1980-98
HP3860	fuel injector pigtail
HP3870	alternator pigtail, GM 1963-90
HP3880	voltage regulator pigtail, Ford products, 1959-94
HP3895	4 Wire Connector, GM Cars & Trucks 1985-2005
HP3900	fuel injector pigtail, GM 1978-99
HP3910	voltage regulator pigtail, Ford products, 1981-94
HP3920	dimmer switch pigtail, GM vehicles, 1963-84
HP3925	Crankshaft Sensor Connector, Chrysler Products 1995-2005
HP3930	fuel pump relay pigtail, Mazda, Ford, 1981-96
HP3935	Ignition Control Module Connector, AMC 1977-1983, Ford Products 1975-1997
HP3940	headlight socket for halogen bulb # 9004
HP3945	Fuel Injector Connector, GM, Ford, Chrysler Products 1995-2003
HP3950	headlight socket for 3 terminal headlights
HP3955	Double Contact Socket, Acura, Nissan, Subaru, Toyota, 1980-1994
HP3960	headlight socket for halogen bulb # 9006
HP3970	headlight socket for halogen bulb # 9005
HP3980	GM fuel injector pigtail
HP3990	universal double contact pigtail
HP4000	universal single contact pigtail
HP4010	park, tail, stop, turn socket, GM vehicles, 1969-92
HP4020	park, tail, stop, turn socket, GM vehicles, 1970-73
HP4030	stop, tail, turn socket, Chrysler products, 1980-94
HP4040	park, tail socket, universal
HP4045	Double Contact Socket, GM Cars & Trucks 1992-2002
HP4050	stop, tail, turn socket, Chrysler products, 1970-91
HP4060	license, side marker socket, GM, Ford, 1970-96
HP4070	side marker socket, Ford, Chrysler, 1972-94
HP4080	side marker socket, GM products, 1982-01
HP4090	dash socket, GM products, 1970-91
HP4100	dash socket, Chrysler products, 1974-90
HP4110	park, turn socket, GM products, 1977-99
HP4120	stop, tail, turn socket, GM products, 1980-97
HP4125	Double Contact Socket, Ford Cars & Trucks 1990-2004
HP4130	park, turn socket, Ford products, 1975-92
HP4140	tail, stop, turn socket, GM, Chrysler, 1977-98
HP4150	park, tail, stop, turn socket, GM products, 1969-91
HP4160	turn, tail, stop, side marker socket, Chrysler, 1975-95
HP4170	park, turn, stop, tail socket, GM 1990-02
HP4180	stop, tail, turn socket, Chrysler 1986-93
HP4190	license light, universal
HP4195	Headlight Switch Connector, Dodge Truck 1973-2000
HP4200	Double Contact Socket, Ford Cars & Trucks 1991-2006
HP4210	Alternator Connector, Ford Cars & Trucks 1998-2005
HP4220	Alternator Connector, AMC, GM, IHC Cars & Trucks 1962-1988
HP4230	Blower Motor Resistor Connector, GM Cars & Trucks 1997-2006
HP4240	Crankshaft Sensor Connector, GM Cars & Trucks 1988-2006

HP26 (CONT.)

Part No.	Description
HP4300	dimmer switch pigtail, Ford, Chrysler, AMC, 1965-81
HP4320	headlight socket for 4703 headlight
HP4340	fan speed switch pigtail, Ford 1986-97
HP4350	blower motor resistor pigtail, Ford truck 1986-94
HP4360	fan speed switch pigtail, Gm products, 1977-94
HP4370	ignition coil pigtail, Ford 1982-97
HP4380	voltage regulator pigtail, Chrysler, 1972-89
HP4390	voltage regulator pigtail, GM, 1986-94
HP4400	coolant temperaure sensor pigtail, Ford, 1981-98
HP4410	foglamp pigtail, GM, Ford, 1989-01
HP4420	air temperature sensor pigtail, GM products, 1987-02
HP4430	cooling fan motor pigtail, GM, 1985-02
HP4435	Voltage Regulator Connector, AMC, GM, IHC Cars & Trucks 1959-1988
HP4440	various sensor and switch pigtail, GM, 1990-04
HP4450	headlight socket for 2 terminal sealed beams
HP4460	throttle position sensor pigtail, GM, 0980-02
HP4470	MAP sensor pigtail, GM, 0982-03
HP4475	Speed Sensor Connector, Ford Products 1993-1998
HP4480	oil pressure switch pigtail, GM, 1987-96
HP4485	Ignition Coil Connector, GM Cars 1987-2005
HP4490	A/C clutch pigtail, GM, 1989-04
HP4495	Double Contact Socket, Universal, use for parking, stop, tail, and turn lamps
HP4500	fuel pump pigtail, Ford, 1985-90
HP4510	headlight switch pigtail, Ford, 1986-94
HP4515	Single Contact Socket, Ford Cars & Trucks 1996-2003
HP4520	headlight switch pigtail, GM, 1965-90
HP4530	ignition module pigtail, 1981-89
HP4550	ignition coil pigtail, Ford, 1975-87
HP4555	Side Marker Socket, GM Cars & Trucks 1992-2007
HP4560	cornering, side marker socket, GM, 1988-01
HP4575	Alternator Connector, Ford Cars & Trucks 1974-1994
HP4580	universal double contact socket
HP4585	Fuel Injector Connector, GM, Ford Cars & Trucks 1981-2000
HP4595	Ignition Coil Connector, GM Cars & Trucks 1985-1995
HP4605	Ignition Coil Connector, GM Cars & Trucks 1985-1995
HP4610	tail, stop, turn socket, GM, Ford, 1969-99
HP4615	Double Contact Socket, Universal, use for parking, stop, tail, and turn lamps
HP4620	universal single contact socket
HP4630	side marker socket, Chrysler, 1972-95
HP4635	Ignition Coil Connector, Ford Cars & Trucks 1999-2004
HP4640	stop, tail, turn, side marker socket, Ford, 1983-96
HP4645	Double Contact Socket, GM Cars 1988-1997
HP4650	backup light socket, Chrysler, Ford, AMC, 1973-93
HP4655	Relay Connector, GM Cars & Trucks 1991-2005
HP4660	park, stop, turn, tail socket, GM, 1969-99
HP4670	park, turn socket, Ford, 1974-94
HP4680	stop, tail, turn, backup socket, GM, 1989-02
HP4690	park stop, tail, turn socket, Ford, 1973-80
HP4695	Alternator Connector, GM Cars & Trucks 1990-2005
HP4700	Double Contact Socket, Chrysler Products 1991-2000
HP4705	Taillamp Connector, GM Trucks 1988-1996
HP4710	Cam and Crank Sensor Connector, Ford Cars & Trucks 1980-2004
HP4715	Stoplight Switch Connector, Ford Cars & Trucks 1969-2007
HP4720	Sensor Connector, GM Cars & Trucks 1988-2004

Wiring Center Contents

HP26

(CONT.)

Part No.	Description
HP4725	License Plate Light Socket, Chrysler Products 1989-1995
HP4730	Single Contact Socket, Acura, Nissan 1980-1995
HP4735	Ignition Control Module Connector, AMC 1977-1983, Ford Products 1975-1997
HP4740	Headlight Socket, Fits H13, HB13 or 9008 headlamp
HP4745	Single Contact Socket, Universal, use for backup, instrument, and turn lamps
HP4750	Switch and Sensor Connector, GM Cars & Trucks 1988-2005
HP4755	Neutral Safety Switch Connector, AMC & Chrysler Products 1969-1989
HP4760	Ignition Switch Connector, GM Trucks 1967-1977
HP4770	Blower Motor Switch Connector, Ford Cars & Trucks 1973-1994
HP4780	Single Contact Socket, Chrysler Products 1974-1995

HP5



HP6



HP7



HP8



HP9



HP10



HP11



HP12



HP13



HP14



HP15



HP16



HP17



HP18



HP19



HP20



HP21



HP22



HP23



HP24



HP25



HP25, cont.



HP26



HP26, cont.



HP26, cont.



Index

PART NUMBER TO PAGE INDEX

Part No.	Page	Part No.	Page	Part No.	Page	Part No.	Page	Part No.	Page
HP1010	1	HP1610	3	HP2230	2	HP2900	15	HP3540	16
HP1020	1	HP1620	3	HP2240	2	HP2910	15	HP3550	16
HP1030	1	HP1630	3	HP2250	2	HP2920	15	HP3560	16
HP1040	1	HP1640	1	HP2260	2	HP2930	15	HP3570	16
HP1050	1	HP1650	1	HP2270	2	HP2940	15	HP3580	18
HP1060	1	HP1660	4	HP2280	7	HP2950	15	HP3590	18
HP1070	1	HP1670	2	HP2290	6	HP2960	15	HP3600	18
HP1080	1	HP1681	6	HP2300	6	HP2970	15	HP3610	18
HP1090	2	HP1690	3	HP2310	6	HP2980	15	HP3620	18
HP1100	3	HP1700	1	HP2320	6	HP2990	15	HP3630	18
HP1110	3	HP1710	1	HP2330	7	HP3000	5	HP3640	18
HP1120	4	HP1720	3	HP2340	7	HP3010	5	HP3650	18
HP1130	2	HP1730	2	HP2350	7	HP3020	5	HP3660	18
HP1140	1	HP1740	1	HP2360	7	HP3030	5	HP3670	18
HP1150	1	HP1750	1	HP2370	7	HP3040	5	HP3680	18
HP1160	3	HP1760	4	HP2380	7	HP3050	5	HP3690	18
HP1170	1	HP1770	2	HP2390	7	HP3060	5	HP3700	18
HP1181	6	HP1780	2	HP2400	7	HP3070	5	HP3710	18
HP1190	4	HP1790	2	HP2500	3	HP3080	5	HP3720	13
HP1200	3	HP1800	2	HP2510	4	HP3090	5	HP3730	13
HP1210	2	HP1810	2	HP2520	18	HP3100	5	HP3740	18
HP1220	1	HP1820	2	HP2530	18	HP3110	5	HP3750	18
HP1230	1	HP1830	7	HP2540	4	HP3120	5	HP3760	18
HP1240	4	HP1840	7	HP2550	4	HP3130	14	HP3770	18
HP1250	1	HP1850	7	HP2560	4	HP3140	14	HP3800	26
HP1260	1	HP1860	6	HP2570	4	HP3150	14	HP3805	22
HP1270	2	HP1870	7	HP2580	2	HP3160	14	HP3810	28
HP1280	2	HP1880	7	HP2590	3	HP3170	14	HP3815	28
HP1290	2	HP1890	7	HP2600	4	HP3180	14	HP3820	29
HP1300	2	HP1900	7	HP2610	4	HP3190	5	HP3825	22
HP1310	2	HP2000	1	HP2620	3	HP3200	15	HP3830	24
HP1320	2	HP2010	1	HP2630	4	HP3210	5	HP3835	19
HP1330	7	HP2020	1	HP2640	4	HP3300	17	HP3840	24
HP1340	7	HP2030	1	HP2645	3	HP3310	17	HP3850	24
HP1350	7	HP2040	1	HP2650	37	HP3320	17	HP3860	24
HP1360	6	HP2050	1	HP2660	9	HP3330	17, 18	HP3870	24
HP1370	6	HP2060	2	HP2670	18	HP3340	17	HP3880	28
HP1380	6	HP2070	2	HP2680	37	HP3350	17	HP3890	24
HP1390	7	HP2080	2	HP2700	9	HP3360	17	HP3895	27
HP1400	7	HP2090	1	HP2710	14	HP3370	17	HP3900	24
HP1410	7	HP2100	1	HP2720	14	HP3380	17	HP3910	26
HP1420	7	HP2110	1	HP2730	14	HP3390	17	HP3920	26
HP1500	1	HP2120	2	HP2740	14	HP3400	16	HP3925	26
HP1510	1	HP2130	3	HP2800	15	HP3410	16	HP3930	27
HP1520	1	HP2141	6	HP2810	15	HP3420	16	HP3935	27
HP1530	1	HP2150	4	HP2820	15	HP3430	16	HP3940	22
HP1540	1	HP2160	3	HP2830	15	HP3440	16	HP3945	24
HP1550	1	HP2170	4	HP2840	15	HP3450	16	HP3950	22
HP1560	1	HP2180	4	HP2850	15	HP3460	16	HP3955	22
HP1570	4	HP2190	2	HP2860	15	HP3500	16	HP3960	19
HP1580	1	HP2200	1	HP2870	15	HP3510	16	HP3970	19
HP1590	1	HP2210	1	HP2880	14	HP3520	16	HP3980	24
HP1600	3	HP2220	1	HP2890	14	HP3530	16	HP3990	19

Index

PART NUMBER TO PAGE INDEX (CONT.)

Part No.	Page	Part No.	Page	Part No.	Page	Part No.	Page	Part No.	Page
HP4000	19	HP4510	29	HP4880	31	HP5490	35	HP6160	16
HP4010	19	HP4515	21	HP4890	31	HP5500	36	HP6170	16
HP4020	19	HP4520	28	HP4900	31	HP5510	36	HP6180	17
HP4030	22	HP4530	28	HP4910	32	HP5600	13	HP6190	17
HP4040	20	HP4540	27	HP4920	30	HP5610	13	HP6200	17
HP4045	22	HP4550	25	HP4930	30	HP5620	13	HP6210	17
HP4050	20	HP4555	21	HP4940	31	HP5630	13	HP6220	17
HP4060	20	HP4560	21	HP4950	31	HP5640	13	HP6230	17
HP4070	20	HP4570	21	HP4960	31	HP5650	13	HP6240	17
HP4080	20	HP4575	25	HP4970	31	HP5660	13	HP6250	17
HP4090	20	HP4580	21	HP4980	31	HP5670	13	HP6260	17
HP4100	20	HP4585	25	HP4990	32	HP5680	13	HP6270	17
HP4110	22	HP4590	21	HP5000	31	HP5690	13	HP6300	37
HP4120	22	HP4595	25	HP5010	31	HP5700	13	HP6310	37
HP4125	22	HP4600	19	HP5020	31	HP5710	13	HP6320	37
HP4130	22	HP4605	25	HP5030	31	HP5720	13	HP6330	37
HP4140	23	HP4610	21	HP5040	30	HP5730	13	HP6340	37
HP4150	23	HP4615	21	HP5050	30	HP5740	13	HP6350	37
HP4160	23	HP4620	19	HP5060	30	HP5750	13	HP6360	38
HP4170	23	HP4630	21	HP5070	30	HP5760	13	HP6370	6, 38
HP4180	23	HP4635	25	HP5080	31	HP5770	13	HP6380	15, 38
HP4190	19	HP4640	23	HP5090	31	HP5780	13	HP6390	37
HP4195	29	HP4645	23	HP5100	31	HP5790	13	HP6500	12
HP4200	23	HP4650	21	HP5110	31	HP5800	13	HP6510	12
HP4210	26	HP4655	28	HP5120	33	HP5810	13	HP6520	12
HP4220	24	HP4660	23	HP5130	33	HP5820	13	HP6530	12
HP4230	29	HP4670	23	HP5140	33	HP5830	13	HP6540	12
HP4240	26	HP4680	23	HP5150	33	HP5840	13	HP6550	12
HP4300	26	HP4690	23	HP5160	32	HP5850	13	HP6560	12
HP4310	20	HP4695	28	HP5170	32	HP5860	13	HP6570	12
HP4320	20	HP4700	24	HP5180	32	HP5870	13	HP6580	12
HP4330	23	HP4705	28	HP5190	32	HP5880	13	HP6590	12
HP4340	27	HP4710	25	HP5200	32	HP5890	13	HP6600	12
HP4350	27	HP4715	25	HP5210	33	HP5900	13	HP6610	12
HP4360	27	HP4720	25	HP5300	34	HP5910	13	HP6620	8
HP4370	26	HP4725	22	HP5310	34	HP5920	13	HP6630	8
HP4380	24	HP4730	19	HP5320	34	HP5930	13	HP6640	8
HP4390	27	HP4735	28	HP5330	34	HP5940	13	HP6650	8
HP4400	25	HP4740	24	HP5340	34	HP5950	13	HP6660	8
HP4410	20	HP4745	19	HP5350	34	HP5960	13	HP6670	8
HP4420	25	HP4750	26	HP5360	35	HP5970	13	HP6680	8
HP4430	25	HP4755	27	HP5370	36	HP5980	13	HP6690	8
HP4435	27	HP4760	29	HP5380	36	HP5990	13	HP6700	8
HP4440	26	HP4770	28	HP5390	34	HP6000	13	HP6710	8
HP4450	21	HP4780	19	HP5400	35	HP6010	13	HP6720	8
HP4460	27	HP4800	30	HP5410	35	HP6020	13	HP6730	8
HP4470	27	HP4810	30	HP5420	34	HP6030	13	HP6740	39
HP4475	25	HP4820	30	HP5430	35	HP6100	17	HP6750	39
HP4480	27	HP4830	30	HP5440	36	HP6110	17	HP6760	31
HP4485	28	HP4840	32	HP5450	35	HP6120	17	HP6770	33, 39
HP4490	25	HP4850	30	HP5460	36	HP6130	17	HP6780	14
HP4495	21	HP4860	30	HP5470	36	HP6140	16	HP6790	14
HP4500	28	HP4870	30	HP5480	35	HP6150	16	HP7000	12, 38

Index

PART NUMBER TO PAGE INDEX (CONT.)

Part No.	Page			
HP7010	12, 38			
HP7020	12, 38			
HP7030	10			
HP7040	10			
HP7050	10			
HP7060	10			
HP7070	11			
HP7080	11			
HP7090	11			
HP7100	12			
HP7110	10			
HP7120	10			
HP7130	10			
HP7140	10			
HP7150	5			
HP7160	5			
HP7170	5			
HP7180	5			
HP7190	11			
HP7200	11			
HP7210	5			
HP7220	12			
HP7230	11			
HP7240	11			
HP7250	11			
HP7260	11			
HP7270	11			
HP7280	11			
HP7290	12			
HP7300	12			
HP7310	26			
HP7320	26			
HP7330	27			
HP7340	27			
HP7350	28			
HP7360	28			
HP7370	29			
HP7380	29			
HP7390	12, 38			

NEW ITEMS FROM handypack®

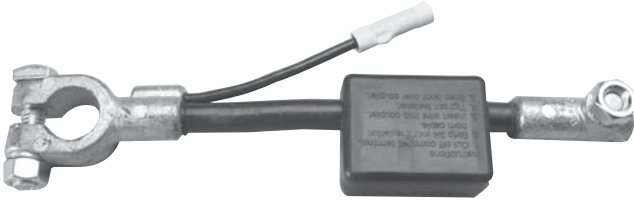

HP6780, Battery Cable Coupler, **See page 14.**



HP3340, Loom Installation Tool, **See page 17.**

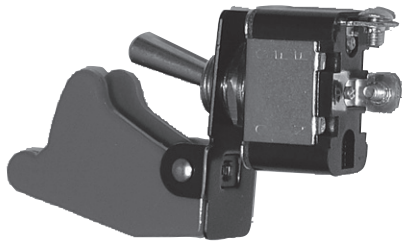

HP4830, High Performance Toggle Switch
w/Protective Cover, **See page 30.**



Step down butt connectors,
HP1181
HP1681
HP2141
See page 6.



HP6340, LED Battery Voltage Tester,
See page 37.



HP6350, Circuit Tester with Probe Hook,
See page 37.



HP6500 - HP6610, Gold Audio Terminals,
See page 12.