



SUNCOAST
PRODUCT CATALOG



WE CREATE AMERICAN PRODUCTS

Whether you're hauling ass across the race track or hauling asses in a trailer, we have you covered. All our products are made in America, by men and women who make a living by supporting every type of American in the diesel industry. Because we know you have places to be and records to beat.

AMERICAN PRODUCTS. AMERICAN WORKERS. AMERICAN CRAFTSMANSHIP.



FOR THE AMERICAN WORKING MAN.

SunCoast Converters, Inc., was established in 1989 as a two-man operation in the back of a transmission shop. Today, SunCoast has grown to more than 50 employees and 70,000 sq. ft. of room to conduct operations. SunCoast started with a quest to answer the demand for quality aftermarket torque converters, transmissions, and parts.

Since then, SunCoast has identified and corrected failure points within numerous OEM transmissions and torque converters. SunCoast formulates test data using real-world scenarios, along with the latest technology and design methods, to manufacture parts that correct the cause of these failures. This practice has helped SunCoast stay ahead of its competitors in not only quality, but also extending past that to the winners podium for its customers

and sponsored vehicles.

The company's research and development, combined with years of transmission and torque converter experience, is unparalleled. Pride in design, manufacturing, technical support, and customer satisfaction has been and always will be the primary goal of SunCoast. The company tries to educate the public on the differences in products from other manufacturers, mainly so its customers know when they are getting product of

substance versus a product that is simply relabeled. SunCoast will never sacrifice quality for price point. They have numerous CNC machines that run around the clock making parts for in-house use. They also have multiple CAD developers, as well as programmers on staff, making innovation in design second nature.

SunCoast is known throughout the transmission world for its top-of-the-line torque converters, because the company has taken the time to listen, learn, research, and respond to its customers' suggestions, with outstanding results. The company will continue to make its converters and transmissions the best in the business, while continuously researching new technologies that shine new light on the industry. Design copying is easy. Innovations however, are more difficult.



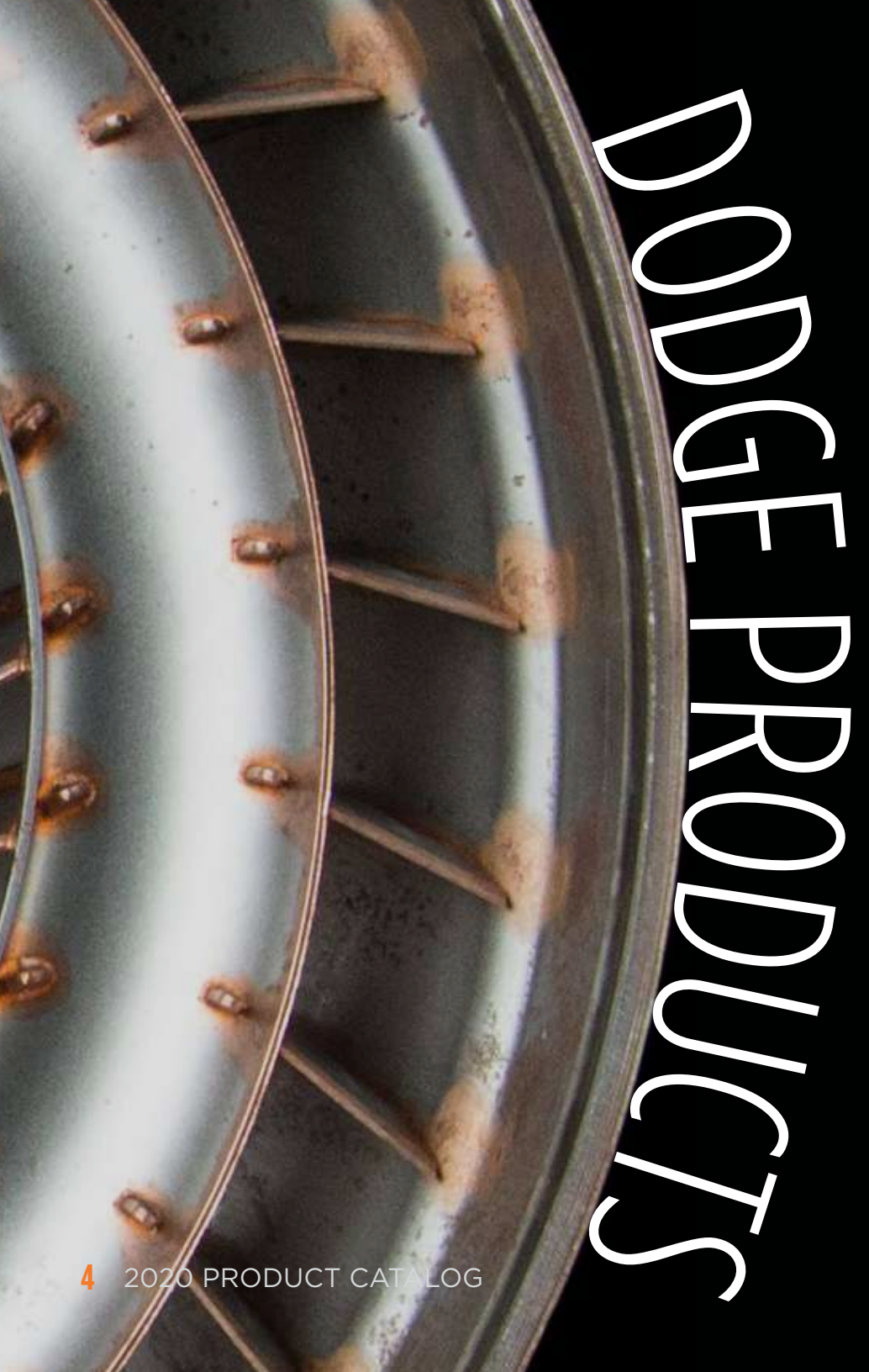

DODGE PRODUCTS

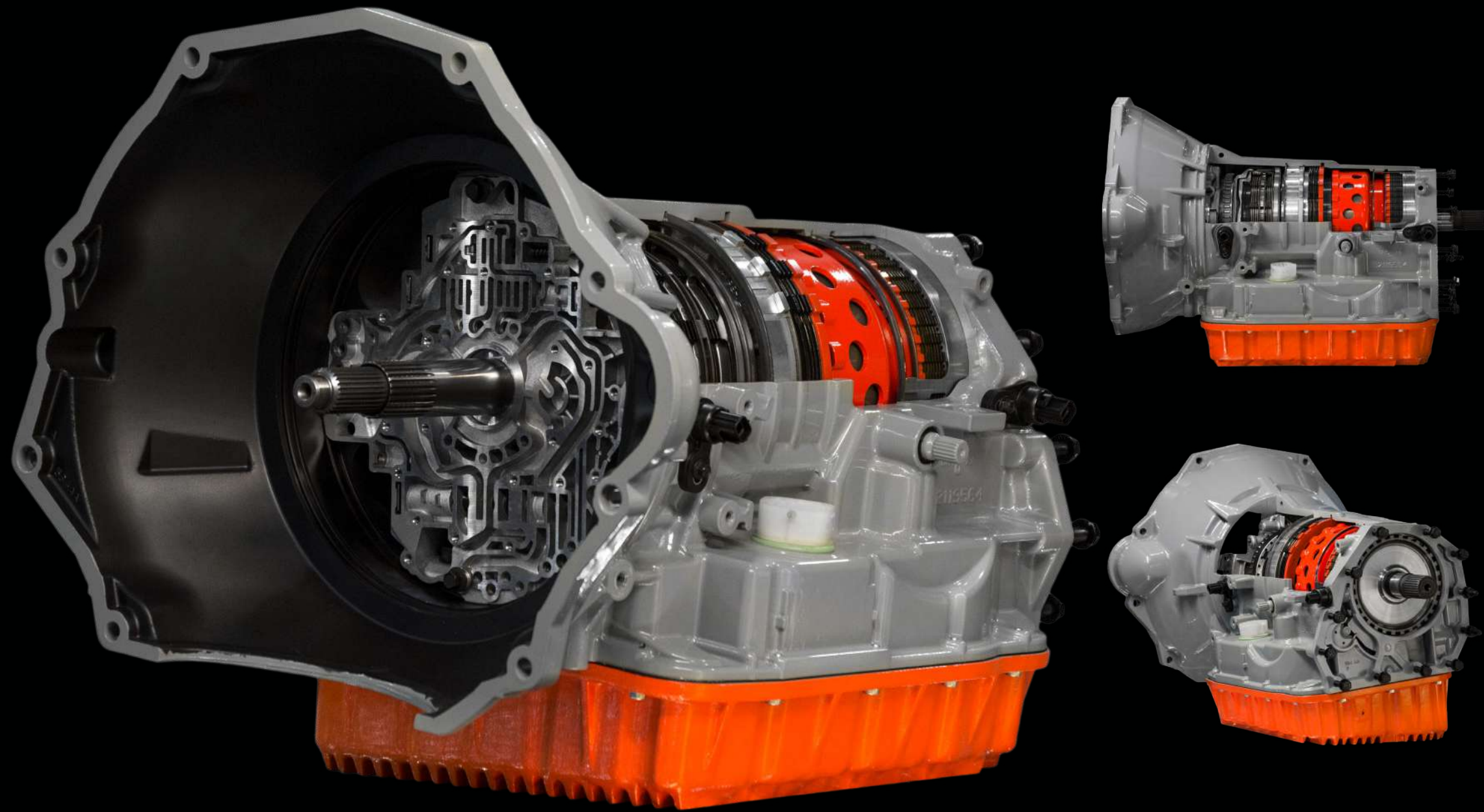

TABLE OF CONTENTS

- 6-11 DODGE TRANSMISSIONS
- 12-16 DODGE CONVERTERS
- 17-19 DODGE REBUILD KITS
- 20-39 DODGE ACCESSORIES

DODGE TRANSMISSIONS

46RH | 47RH | 47RE | 48RE | 68RFE

The SunCoast Dodge series transmission assemblies offer consumers the ultimate in performance and durability, which are needed to deliver Cummins power to the ground. All transmissions are rebuilt to exact specifications with new bushings, seals, rings, frictions, and steels. All hard parts are inspected, machined, and/or replaced to meet specifications. These blueprinted assemblies include the SunCoast valve body and are available with the Mag-Hytec double deep pan option. All transmissions are dyno-tested to ensure pressure and flow calibrations. Upgraded hard parts, such as billet input, intermediate, output shafts, and drums, vary depending on application (competition unit).

The SunCoast transmission includes increased clutch count with high-energy friction materials of choice (Alto® or Raybestos®), treated steels, and can also feature upgraded parts.

- Billet Band
- Billet Strut & Anchor
- Billet Forward & Direct Piston
- Billet 4-ring Accumulator Piston
- Billet Upgraded Governor Solenoid
- Billet 1-2 Servo
- Multiple Input Shaft Options (some require custom torque converter)

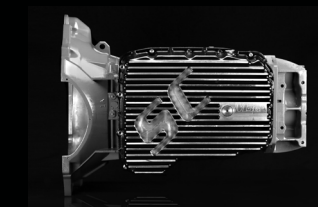
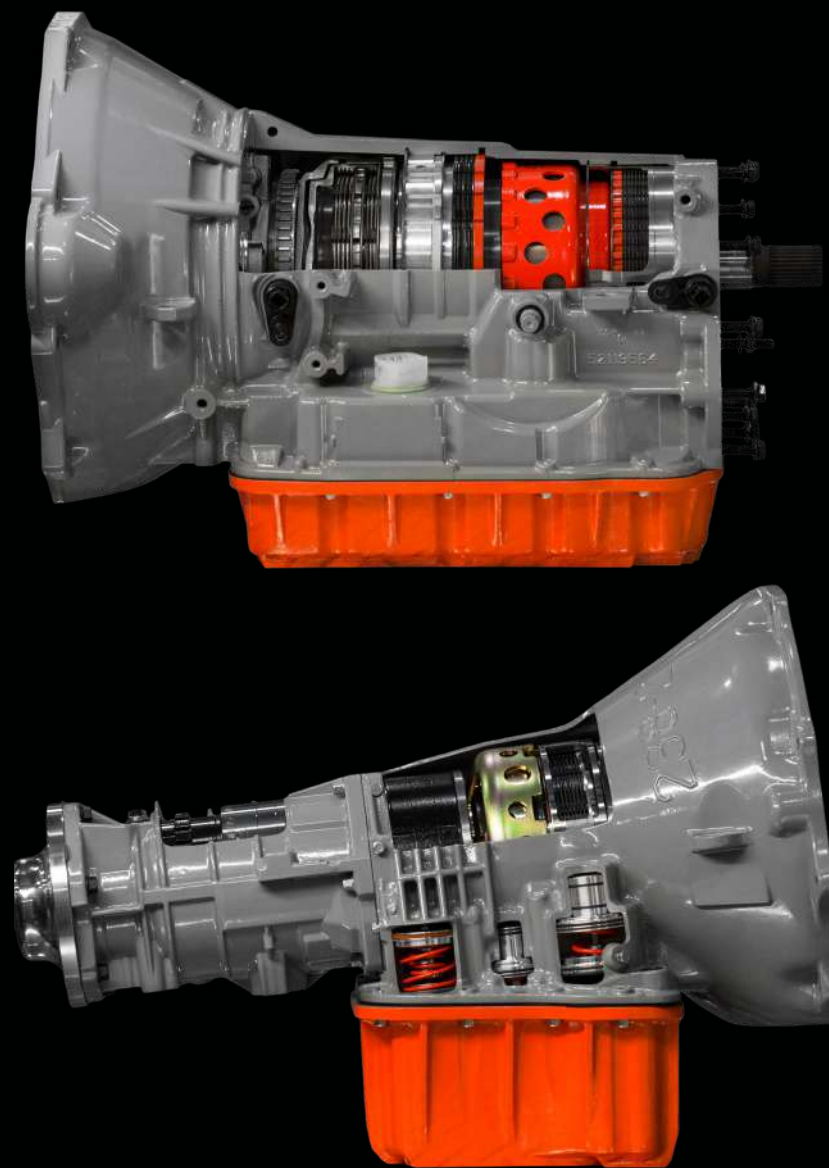

PART NUMBERS:

1989-1993

PLSD-46RH-2X	46RH 2WD TRANS ASSEMBLY
PLSD-46RH-4X	46RH 4WD TRANS ASSEMBLY

1994-1995

PLSD-47RH-2X	47RH 2WD TRANS ASSEMBLY
PLSD-47RH-4X	47RH 4WD TRANS ASSEMBLY
PLSD-47RH-COMP	47RH 4WD M3GA COMP TRANS ASSEMBLY

1996-2003

PLSD-47RE-M-COMP-2X	47RE 2WD M3GA COMP TRANS ASSEMBLY
PLSD-47RE-M-COMP-4X	47RE 4WD M3GA COMP TRANS ASSEMBLY
SC-47RECAT1-4WD	CATEGORY 1 450HP TRANSMISSION
SC-47RECAT2-4WD	CATEGORY 2 500HP TRANSMISSION
SC-47RECAT3-4WD	CATEGORY 3 550HP TRANSMISSION
SC-47RECAT4-4WD	CATEGORY 4 650HP TRANSMISSION
47RE-GUARDIAN-1	47RE GUARDIAN HD TOWING TRANS W/ CONVERTER

2003.5-2007

PLSD-48RE-27-COMP-2X	48RE 2WD M3GA COMP TRANS ASSEMBLY
PLSD-48RE-27-COMP-4X	48RE 4WD M3GA COMP TRANS ASSEMBLY
SC-48RECAT1-4WD	CATEGORY 1 450HP TRANSMISSION
SC-48RECAT2-4WD	CATEGORY 2 500HP TRANSMISSION
SC-48RECAT3-4WD	CATEGORY 3 550HP TRANSMISSION
SC-48RECAT4-4WD	CATEGORY 4 650HP TRANSMISSION
48RE-GUARDIAN-1	48RE GUARDIAN HD TOWING TRANS W/ CONVERTER

2007.5-2020

SC-68RFECAT1-4WD	CATEGORY 1 TRANSMISSION W/ CONVERTER
SC-68RFECAT2-4WD	CATEGORY 2 TRANSMISSION W/ CONVERTER
SC-68RFECAT3-4WD	CATEGORY 3 TRANSMISSION W/ CONVERTER
SC-68RFECAT4-4WD	CATEGORY 4 TRANSMISSION W/ CONVERTER
68RFE-GUARDIAN-1	68RFE GUARDIAN HD TOWING TRANS W/ CONVERTER

SUNCOAST 68RFE CATEGORY TRANSMISSIONS

SKU#: SC-68RFE-1 • SC-68RFE-2 • SC-68RFE-3

TRANSMISSIONS INCLUDE THE FOLLOWING:

- SunCoast Category 1 Billet Triple Disc Torque Converter
- New 68RFE Thrust Washer Kit
- New 68RFE Thrust Bearing Kit
- 68RFE Complete Gasket and Sealing Kit
- 68RFE Spin-on Filter
- 68RFE Pan Filter
- 68RFE Underdrive and Overdrive Piston Set
- Upgraded 2C Clutch Set
- 68RFE Billet 2C Piston
- SunCoast Pro-Loc Ducenti Valve Body
- SunCoast Upgraded Heavy Duty Sprag
- Deep Mag Hytec Pan
- SunCoast Zero Cavitation Filter Kit
- SunCoast OEM Solenoid Pack

CAT 1

- New Sonnax Smart Tech Overdrive Drum Assembly

CAT 2

- SunCoast Billet V2 Drum

CAT 3

- 68RFE Billet One-Piece Flexplate
- 68RFE Billet Input Shaft

THE 68RFE

The 68RFE transmission is the big brother to the 45/545RFE transmission. The RFE platform was originally designed by Chrysler and was introduced in 1999 with the debut of the new Jeep Grand

Cherokee. "RFE" stands for Rear-wheel drive Fully Electronic control. The RFE design was mostly noted in the new design to have 3 planetary sets for a 4-speed transmission in the 45RFE.

In 2007, Chrysler debuted the new 6.7 Powerplant in the all new Dodge Ram, and Dodge wanted a transmission that was specifically designed for function. The previous platform utilized the Torqueflite 48RE platform and had been around since the late 50's when they released the first 727 in 1956 after purchasing the license from Simpson on the gearset in 1955.

The 46/47/48 Chrysler platforms were 3 and 4-speed units that were mechanically and hydraulically controlled, with the most notable control system being governor pressure.

The first improvement Chrysler wanted to make over the Torqueflite platform was, obviously, the amount of forward gear. For the 68RFE transmission, Chrysler opted to change to a six-speed unit. The additional gears allowed Chrysler to add higher 1st-gear ratios and tighter shift recovery from one gear to the next. The tighter shift recovery essentially keeps the vehicle in higher averaged horsepower and torque numbers, while also adding torque multiplication.

The new 68RFE boasts a whopping 3.23:1 first gear, compared to the 2.45:1 first gear found in the previous 47/48RE platform. Chrysler also increased second gear to a 1.83:1 versus the 1.45:1 found previously. The 68RFE was also given two overdrive gears, with 5th being .81:1 and 6th with the very deep .62:1. The predecessor had a single overdrive that was a .69:1.

THE CATEGORY TRANSMISSIONS

The SunCoast Category 68RFE transmissions are designed and developed with intentions of taking a systematic approach to solving the issues with the 68RFE transmission. We approach each deficiency and need from a scientific approach.

We aim to offer you the most complete series of 68RFE transmissions available on the market today.

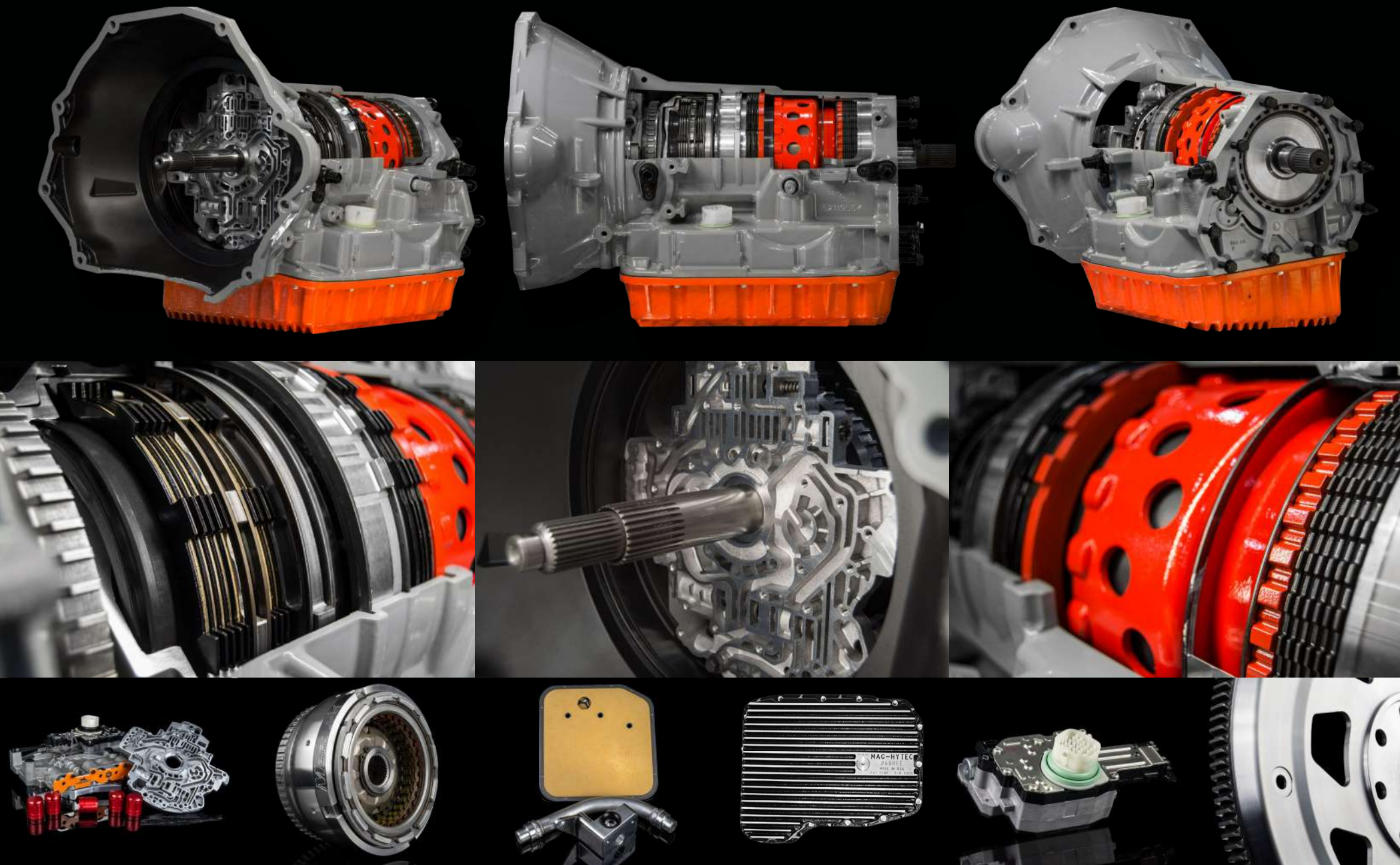

47/48RE GUARDIAN HD TOWING TRANSMISSION W/ CONVERTER

SKU#: 47RE-GUARDIAN-1 • 48RE-GUARDIAN-1

TRANSMISSION INCLUDES THE FOLLOWING:

- SunCoast Single-Disc Billet Torque Converter
- High Flow 48RE Transmission Filter
- 48RE Front Pump Bushing
- SunCoast High-Performance Carbon Fiber Band
- SunCoast 48RE Paper/Rubber/Gasket Kit
- 48RE Thrust Washer Kit
- SunCoast Billet Accumulator Piston
- 4.4 Billet Band Lever
- Billet Band Strut
- Billet Band Anchor
- Mag-Hytec Deep Pan

SunCoast's Guardian Heavy Duty (HD) line of 47/48RFE transmissions is a specialty line designed around the stress and rigors demanded with heavy duty towing, hauling and work applications. What you will find is a product that will function at the highest level but also offers the refinement that you demand.

Every aspect of the Guardian HD transmission line is strategically engineered and designed around functionality, reliability, and strength in the light, medium and heavy duty towing applications.



Some of the key features of this new 48RE Guardian line of heavy duty transmissions are our SunCoast Single-Disc Billet Torque Converter, billet accumulator piston, high flow transmission filter, gasket kit, thrust washer kit, front pump bushing, and high-performance carbon fiber band. Also included are a billet band lever, strut and anchor, and the addition of a Mag-Hytec deep pan.

When what you're carrying matters, you can trust the Guardian HD to be there every mile along the way.

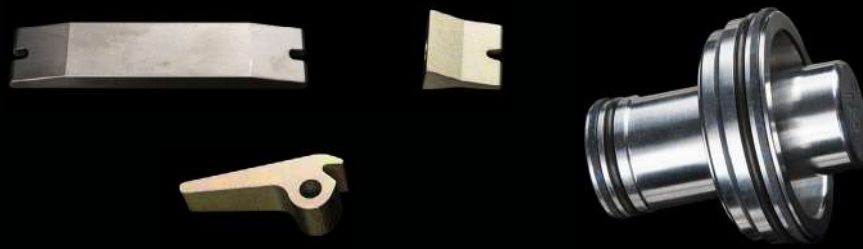

68RFE GUARDIAN HD TOWING TRANSMISSION W/ CONVERTER

SKU#: 68RFE-GUARDIAN-1

TRANSMISSION INCLUDES THE FOLLOWING:

- Billet Pro-Loc Ducenti Valve Body
- Upgraded Zero-Cavitation Filter Kit
- Mag-Hytec Deep Pan
- Upgraded Low/Reverse Sprag
- Increased Clutch Count in Overdrive
- New Solenoid Pack
- New Sensors
- Cat 1 Billet Triple-Disc Torque Converter

The SunCoast Guardian Heavy Duty (XD) line of transmissions is designed around the stress and rigors demanded with heavy duty towing, hauling and work applications. Every aspect of the Guardian HD transmission line is strategically engineered and designed around functionality, reliability, and strength in the light, medium and heavy duty towing applications. This Guardian HD series of transmissions is built to perform in tough conditions, day in and day out, and is designed for use in heavy duty industrial, or commercial operations.



Some of the key features of this new 68RFE Guardian line of heavy duty transmissions are our billet Pro-Loc Ducenti valve body, upgraded zero-cavitation filter kit with our new Mag-Hytec deep pan, upgraded low-reverse sprag, increased clutch count for overdrive, and upgraded billet triple-disc Category 1 torque converter.

When what you're carrying matters, you can trust the Guardian HD to be there every mile along the way.





DODGE TRIPLE-CLUTCH CONVERTERS

47RE | 48RE

SunCoast Dodge series torque converters are designed and manufactured in-house. Because of this, we're able to supply almost any request in regard to stall, torque multiplication, efficiency to custom applications.

Custom-designed billet stators provide better torque and efficiency prior to lockup. SunCoast's custom-designed CNC-machined billet piston houses its 3-disc converter lock up clutches and will not flex like other billet converters on the market. This clutch then applies to the custom CNC-machined forged billet cover.

*Core deposit required.

FEATURES

- Multiple Billet Stators for Various Stalls (1800-3000 Stocked)
- Custom Pump and Turbine Modifications (in-house)
- Tig Welding to Reinforce Furnace-brazed Fins
- Proprietary Converter Clutches with Trapezoid Clutch Teeth (No Round Tabs)
- CNC-Machined Billet Stators (1800-3000 RPM Stall)
- 4140 Turbine Splines (Heat-treated Depending on Application)
- Billet Steel and Aluminum Pistons
- Forged Billet Cover Strength (Proprietary Raybestos Converter Clutch Plates) Pressure-tested welds/spun-balanced to ensure highest quality

DODGE TRIPLE-CLUTCH CONVERTERS

68RFE

This triple-disc torque converter for the 2007-Current 68RFE-equipped 6.7L Cummins is manufactured and assembled at SunCoast. Boasting more than 3.4x the lockup clutch surface apply area over stock (8.7" vs. 29.7") and distributing the load over three separate surface apply areas, SunCoast's triple disc converters are sure to put all of the power to the ground. Starting with a solid chunk of steel, the cover is machined to exact specifications. Utilizing SunCoast's exclusive trapezoidal teeth design, the lockup portion of the converter is seamlessly integrated into the cover, eliminating a weak point and common source of chatter. An upgraded billet lockup apply piston is able to transfer a much higher pressure to the lockup clutch without sacrificing durability. Instead of the factory-style plastic stator cap/thrust spacer, SunCoast utilizes a metal Torrington roller style bearing, which is better suited to take the heat, as well as wear and tear. The turbine assembly is Tig-reinforced and heat-treated. This exponentially increases its lifespan under harsh conditions. Stall on this model is approximately 2000 RPM and much more efficient at energy transfer than the factory offering.

FEATURES

- Forged Billet Steel Covers
- Billet Aluminum Stators
- Pressure-tested Welds
- Spun-balanced on Stewart Warner Pro-balancer
- Furnace-brazed & Tig-Welded
- Signature Trapezoid Clutch Teeth (No Round Tabs)
- 3-year UNLIMITED MILEAGE Warranty



DODGE TRIPLE-CLUTCH CONVERTERS

PART NUMBER	DESCRIPTION	PART NUMBER	DESCRIPTION
2361819	2200 STALL 12V SINGLE-DISC CONVERTER	23618-SRT-24-3D	2400 STALL V-10 3D CONVERTER
2361819-3D	2200 STALL 12V 3D CONVERTER	23618-SRT-26-3D	2600 STALL V-10 3D CONVERTER
2361819-3D-PF	2200 STALL POWERFLITE REG. SHAFT CONVERTER	23618181-12-3D	RACE 12 3D CONVERTER
2361822-3D	2200 STOCK STALL 3D CONVERTER	2451816	518 NON LOCKUP CONVERTER
2361825-3D	2500 STALL 3D RACE CONVERTER	2451844	518 NON LOCKUP LOW STALL CONVERTER
2361825-3D-DF	DURAFLITE CONVERTER	2761819-3D	2200 STALL 27 SPLINE CONVERTER
2361825-PF-3D	2500 STALL POWERFLITE CONVERTER	2761825-3D	2500 STALL MEDIUM SHAFT 3D CONVERTER
2361826-3D	2600 STALL RACE/SLED CONVERTER	2761825-3D-DF	27 SPLINE DURAFLITE CONVERTER
2361826-1-3D	2600-2700 STALL RACE/SLED CONVERTER	2761827-3D	618 27 SPLINE 48RE CONVERTER
2361827-3D	2700-3000 STALL RACE/SLED CONVERTER	2761844-3D	618 27 SPLINE 48RE CONVERTER
2361827-3D-DF	DURAFLITE CONVERTER	2761848-3D	27 SPLINE 48RE CONVERTER
2361827-PF-3D	2700-3000 STALL POWERFLITE CONVERTER	BAC-2761819-3D	1900 STALL MEDIUM SHAFT 3D CONVERTER
2361838	1800 LOW STALL 24V SINGLE-DISC CONVERTER	BAC-2761822-3D	2200 STALL MEDIUM SHAFT 3D CONVERTER
2361838-3D	1800 LOW STALL 3D CONVERTER	BAC-2761827-3D	2700-3000 STALL MEDIUM SHAFT 3D CONVERTER
2361844	2000 STALL 24V SINGLE-DISC CONVERTER	BAC-2761848-3D	2000 STALL MEDIUM SHAFT 3D CONVERTER
2361844-3D	2000 STALL 24V 3D CONVERTER	68RFE-46-3D	1900-2000 STALL 3D CONVERTER
2361848	2000 STALL 24V SINGLE-DISC CONVERTER	68RFE-86-3D	68RFE 3D CONVERTER
2361848-3D	2000 STALL 24V 3D CONVERTER	SC-68RFE-20	68RFE CATEGORY 1 CONVERTER
2361848-3D-250	2000 STALL 48/68 3D CONVERTER	SC-23618C1-20	47/48RE CATEGORY 1 CONVERTER
2361848-9	2200 STALL SINGLE-DISC CONVERTER	AS68-3D	AS68RC CONVERTER
2361848-9-3D	2200 STALL 3D CONVERTER	AS69-4D	AS69RC CONVERTER
2361848-9-3D-DF	DURAFLITE CONVERTER		

47/48RE TRIPLE-DISC BILLET CATEGORY 1 TORQUE CONVERTER

SKU#: SC-23618C1-20

FEATURES AND BENEFITS:

- 3-YEAR, UNLIMITED-MILEAGE WARRANTY
- Billet Lockup Apply Piston
- CNC-Machined Billet Steel Cover
- Balloon Plate
- 4140 Turbine Splines
- 4140 Hardened Hub
- 3 Carbon-Graphitic Clutch Discs
- Furnaced-Brazed Fins
- Torrington Thrust Bearing Stator Design
- Pressurized "Hot Soak" Leak Testing
- Computer-Balanced to Within .01 Gram
- Precision-assembled by Caring American Workers

THE CATEGORY 1

This Category 1 SunCoast Torque Converter fits both 47 & 48RE transmissions and is engineered to handle all of your every-day duties. Whether you're towing a camper or hauling dirt to a job site, this torque converter is designed to improved vehicle response and give you years of solid, reliable performance.

It comes with furnace-brazed fins and hardened turbine splines. The clutches in this converter

are carbon-graphitic for precise and accurate lock-up.

If you're looking to increase the performance of the factory unit—and looking for a cost-effective solution—this is the converter for you. This converter, while great for heavy duty towing and hauling, is it not intended for racing.



68RFE TRIPLE-DISC BILLET CATEGORY 1 TORQUE CONVERTER

SKU#: SC-68RFEC1-20

FEATURES AND BENEFITS:

- 3-YEAR, UNLIMITED MILEAGE WARRANTY
- Billet Lockup Apply Piston
- CNC-Machined Billet Steel Cover
- Balloon Plate
- 4140 Turbine Splines
- 4140 Hardened Hub
- 3 Carbon-Graphitic Clutch Discs
- Furnaced-Brazed Fins
- Torrington Thrust Bearing Stator Design
- Pressurized "Hot Soak" Leak Testing
- Computer-Balanced to Within .01 Gram
- Precision-assembled by Caring American Workers

THE CATEGORY 1

This Category 1 SunCoast Torque Converter fits all 68RFE transmissions and is engineered to handle all of your everyday duties. Whether you're towing a camper or hauling dirt to a job site, this torque converter is designed to improved vehicle response and give you years of solid, reliable performance. It comes with furnace-brazed fins and hardened turbine splines. The clutches in this converter are carbon-graphitic for precise and accurate lock-up.

If you're looking to increase the performance of the factory unit—and looking for a cost-effective solution—this is the converter for you. This converter, while great for heavy duty towing and hauling, is it not intended for racing.



DODGE REBUILD KITS

47RE | 48RE | 68RFE

SunCoast's Dodge series rebuild kits cover all years from 1989-2017 (kit part number dependent upon year). These kits utilize the latest proven friction materials and steel technology from industry leading companies such as Alto® and Raybestos®. SunCoast works directly with these companies to design and manufacture proprietary exclusive SunCoast product lines, giving the end user uncompromised quality throughout the entire transmission. SunCoast has designed these kits in-house to exact specifications for many intents, including but not limited to towing, sled pulling, racing or having a vehicle to get from point A to point B. Along with these kits, SunCoast has a full line of billet single/triple disc torque converters ranging from 1800 stall to approximately 3000 RPM (manufactured in-house). In addition, the company has multiple input/output shaft options, multiple custom valve body options ranging from forward

manual, reverse manual, trans brake, electronic valve bodies, billet steel and aluminum drums (year dependent), SFI-approved flexplates, SFI-approved transmission jackets, and much more.

PRODUCT HIGHLIGHTS

- Billet 2nd gear band
- Billet strut anchor
- Billet accumulator (to replace the OEM plastic one).
- Governor pressure sensor – this is an upgrade that can be included in the kit or purchased separately. It has proven itself to be the most reliable governor pressure solenoid on the market. This part consists of a 4L60E EPC solenoid which is made from aircraft grade T-56 Billet Aluminum – this means no warping, leaking, sweating, or cracking and means it provides far more consistent pressures.
- SunCoast's billet 1-2 servo has 16% more apply area and provides more band holding power in second gear. Its easy-to-install part improves 1-2 and 2-3 shifts and features improved seal design which conserves pump volume.

SUNCOAST 48RE M3GA CATEGORY REBUILD KITS

KITS CONTAIN THE FOLLOWING:

- Complete Clutch and Steel Kit Using Raybestos Clutches and Steels
- 5 Alto Direct Clutches and 6 Raybestos Direct Clutch Steels
- 4 Alto Forward Frictions and 3 Kolene Steels
- 10 Overdrive Direct Frictions and 9 Kolene Steels
- 6 Overdrive Brake Frictions and 6 Kolene Steels
- SunCoast Custom Billet 2nd gear Band
- SunCoast Custom Billet Band Strut & Band Anchor
- SunCoast Custom Billet Accumulator Piston
- SunCoast Custom Billet Forward Clutch Piston
- SunCoast Custom Billet Direct Clutch Piston
- SunCoast Custom Billet 2nd Gear Servo
- SunCoast Custom Custom Direct Springs (10)
- SunCoast Gasket and Sealing Kit
- New Front Pump Bushing
- New Filter
- Upgraded Governor Pressure Solenoid
- TransGo Shift Calibration Kit
- Upgraded Valve Body Electronics
- Transmission Assembly Lube
- New Bushing Kit & Thrust Washers
- Billet Triple-disc Torque Converter



CATEGORY 0

SKU#: *M3GA-48-450HP*
BASE KIT. INCLUDES EVERYTHING LISTED ABOVE

CATEGORY 1

SKU#: *M3GA-48-550HP*
INCLUDES EVERYTHING FROM CATEGORY 0, IN ADDITION TO THE FOLLOWING:
- Billet Input Shaft
- Billet Flexplate

CATEGORY 2

SKU#: *M3GA-48-650HP*
INCLUDES EVERYTHING FROM CATEGORY 1, IN ADDITION TO THE FOLLOWING:
- Billet Output Shaft

CATEGORY 3

SKU#: *M3GA-48-750HP*
INCLUDES EVERYTHING FROM CATEGORY 2, IN ADDITION TO THE FOLLOWING:
- Billet Intermediate Shaft

CATEGORY 4

SKU#: *M3GA-48-450HP*
INCLUDES EVERYTHING FROM CATEGORY 3, IN ADDITION TO THE FOLLOWING:
- Billet 27 Spline M3GA Input Shaft
- 27-Spline Larger Stator Support
- Billet 29-Spline Larger Output Shaft
- Billet Flexplate
- Billet Direct Drum

SUNCOAST 68RFE M3GA CATEGORY REBUILD KITS

KITS CONTAIN THE FOLLOWING:

- New Sonnax Smart Tech Overdrive Drum Assembly
- New 68RFE Thrust Washer Kit
- New 68RFE Thrust Bearing Kit
- 68RFE Complete Gasket and Sealing Kit
- 68RFE Spin-on Filter
- 68RFE Pan Filter
- 68RFE Underdrive and Overdrive piston set
- Upgraded 2C Clutch Set
- 68RFE Billet 2C Piston



CATEGORY 0

SKU#: *SC-68-0*
BASE KIT. INCLUDES EVERYTHING LISTED ON PRECEEDING PAGE.

CATEGORY 1

SKU#: *SC-68-1*
INCLUDES EVERYTHING FROM CATEGORY 1, IN ADDITION TO THE FOLLOWING:
- 68RFE Billet Triple-Disc Converter
- Solenoid Repair & Spacer Kit

CATEGORY 2

SKU#: *SC-68-2*
INCLUDES EVERYTHING FROM CATEGORY 2, IN ADDITION TO THE FOLLOWING:
- 68RFE Billet Triple-Disc Converter w/ Billet Stator
- SunCoast V2 Drum

CATEGORY 3

SKU#: *SC-68-3*
INCLUDES EVERYTHING FROM CATEGORY 3, IN ADDITION TO THE FOLLOWING:
- 68RFE Billet Input Shaft
- 68RFE Billet One-Piece Flexplate

PRO-LOC DUCENTI 200PSI SHIFT CALIBRATION KIT

SKU#: 68RFE-VB-ZT

FEATURES INCLUDE:

- Tuneless 200psi
- Custom Billet Accumulator Pistons (5)
- Upgraded Heavy Duty Accumulator Plate
- New OE Solenoid Pack
- Rebuilt, Custom-recalibrated Pump Half w/ TCC Limit Valve Correction
- Upgraded Billet Valve Body Midplate
- New Front Pump Cover



SunCoast is proud to release its new Pro-Loc Ducenti 200psi Shift Calibration Kit for the 68RFE. What we present to you today is not just a haphazardly put together solution but the cumulation of many years of refinement.

In this kit, we address several key issues within this hydraulic circuit using a multi-faceted approach. This kit includes everything you will need to achieve 200psi without any additional tuning and is designed to be a complete drop-in.

Features and benefits of this shift calibration kit include a new pump half, TCC limit valve, TCC switch valve, five billet three-ring accumulator pistons, billet upgraded valve body plate, an upgraded heavy duty accumulator plate, and custom-calibrated spring rates for PR circuit.

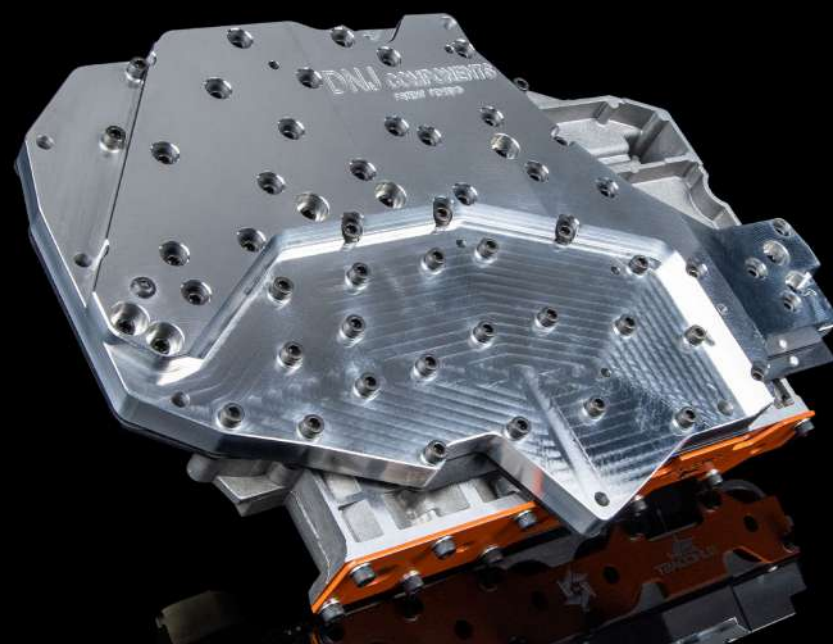

37 SPLINE SOLID BILLET INPUT SHAFT/TORQUE CONVERTER KIT

SKU#: 618-37-BIS-COMBO

FEATURES INCLUDE:

- SunCoast Triple-Disc Billet Torque Converter
- Your Choice of Stall Speed
- SunCoast Dampened Apply Piston
- SunCoast Billet Stator of Choice
- 4140 Impeller Hub
- Tig Welded Reinforced Furnace-brazed Fins
- SunCoast Proprietary Clutches with Trapezoid Teeth
- Billet 37 Spline Stator Support
- Billet 37 Spline Solid Input Shaft
- Increased Bearing Support Surface Area
- 1-3/16 diameter 37-tooth Involute Spline Geometry
- Eliminated High-stress Concentrations at Cross-drilled Fluid Ports and Sealing Ring Grooves
- Increased Shaft Length for Improved Torsional Dampening
- Proprietary Heat Treatment and Ultra High-strength VAR Alloy

For many years, we have seen the continued failure of this design of input shaft/stator/converter lockup circuit. This combination is the end-all-be-all and is sold as a complete kit with your choice of stall speeds.



E618 47/48RE TRANSMISSION CONTROLLER KIT

SKU#: E618-VB-TB

FEATURES INCLUDE:

- Custom Calibrated Billet Valve Body
- Custom Valve Body Electronics
- Custom Calibrated Transmission Control Module
- Custom Wiring Harness
- Custom Software Calibration
- Custom Transbrake
- Full Manual & Automatic Control

SunCoast has separated the 47/48RE electronic automatic transmission from yesterday's 47RH hydro-mechanical automatic transmission with some never-before-seen abilities. SunCoast, with its speed and simplicity in tuning, has done what may have seemed like a complex or impossible task in the past. The TCU can use these inputs as well as torque converter speed, engine speed, wheel speeds, traction control parameters, electronic throttle position, fluid temperature, engine temperature, brake pedal actuation, forward and lateral acceleration, in addition to several other parameters.

The E618 controller can be configured in many different ways. This controller offers 16 different digital inputs/outputs. With the can bus connection in the harness you are able to open up a whole new world in regards to additional accessories that are plug and play. These include optional push button shifters, paddle shifters, and many more.

Tuning is very straight forward for individuals who are familiar with HP Tuners / EFI live tuning software. Lockup can be applied by TPS vs. MPH or by boost reference, if you so choose.



This new E618 controller can be configured with dual map tuning for shift strategies & converter lockup. This allows you to have a normal street daily shifting pattern and a tow/haul mode if so desired. This unit also still allows full manual control of each gear.

**Tire size, gear ratio, wide open throttle shift RPM is required when ordering this controller.*

**This is a transbrake version of this valve body.*



68RFE UPGRADED L/R SPRAG

SKU#: 68-LRS

FLIPPIN' OUT OVER THE SPRAG

The factory low/reverse (L/R) sprag assembly has been a sore spot for many customers after a nasty boosted launch. It has left many of the 68RFEs stranded on the side of the road with a fat taste of disappointment in their mouth. The issue with this factory unit is inherent to the design. The factory unit utilizes a "dog bone" type sprag. The 68RFE L/R clutch is only on when the output shaft is turning below 150 RPM. These L/R clutches then release the load back onto the factory L/R sprag, which during heavy acceleration, boosted launches and burnouts will not stand up to such stress. The result will be the loss of first and second gear starts.

When SunCoast first saw this, we knew immediately this would not be acceptable for our torque-hungry clients, and so we went to work. SunCoast knew that the sprag had to be pre-loaded with tension, and the old "dog bone" style was not going to work. Hence, our very first design was to switch to an accordion style of spring. This

proved to not only provide a sufficient amount of tension to keep the sprag from flipping, but also held at the current power levels we were seeing at the time. However, we knew it was only a matter of time before we would see the limits being pushed with our new design. Fast forward to 8 years later, and now this design has been copied and almost every retailer



is selling their version of this design. The unfortunate aspect of this is the design has reached its capacity with the power levels being reached in the new 6.7 Cummins, and we are seeing even the new design achieve catastrophic failure. However, we already were aware of this potential failure and have been hard at work with the patent office yet again.

In all of our 68RFE units, we now include our new Patent-Pending Billet M3GA Sprag. This is an all-billet design, not the plastic stuff the competition wants to sell you. SunCoast's all-billet M3GA Sprag also includes a redesigned spring style to ensure the pre-load is sufficient to alleviate the problems. This new billet design is absolutely unbreakable and currently has a patent pending. Plastic or Billet? We will let you decide.

68RFE M3GA JR V2 DRUM

SKU#: T68REA01

FEATURES INCLUDE:

- 24% improvement in hydraulic clamping force over factory drum
- Increased friction elements in overdrive
- Quad-ring design of inner drum o'ring maintains compression during high rpm's
- Consistent factory like CVI's
- New lip seal style for outer sealing surface for outer seal with increased diameter
- Wall thickness increased to improved drum rigidity
- No Centrifugal apply springs
- Increased wall thickness to reduce lateral movement in overdrive apply plate
- Completely assembled drop in replacement

This is the V2 68RFE billet drum, the most revolutionary thing that has happened to the 68RFE. There has been no other project here that we have invested as much research and development in.

This new drum has many features that have been improved upon versus previous versions of this particular drum.



618 BILLET SFI-APPROVED FLEXPLATE

SKU#: 618-BFP

FEATURES AND BENEFITS:

- Billet Construction
- Replaces Factory Flexplate
- Exceeds 29.3 SFI Specifications

The SunCoast 618-BFP Billet Flexplate for your 1989-2007 Dodge 5.9L Cummins is a must have when it comes to putting power to the ground in your truck. The high torque of your Cummins in conjunction with a better designed torque converter can transfer the torque with no slip. The flexplate is bolted to the crank shaft, then the converter is bolted to flexplate. The torque from your Cummins is transferred to the flexplate, from the flexplate to the torque converter then to your input shaft in the trans. With increased torque from the engine and no slip out of the converter it can crack and/or rip the center out of a stock flexplate. *Twelve converter bolt holes now come standard.*



68RFE/AS69 BILLET SFI-APPROVED FLEXPLATE

SKU#: 68RFE-BFP

FEATURES AND BENEFITS:

- Billet Construction
- Replaces Factory Flexplate
- Exceeds 29.3 SFI Specifications

The SunCoast 68RFE Billet Flexplate for your 2007.5-2018 Dodge 6.7L Cummins is a must have when it comes to putting power to the ground in your truck. The high torque of your Cummins in conjunction with a better designed torque converter can transfer the torque with no slip. The flexplate is bolted to the crank shaft, then the converter is bolted to flexplate. The torque from your Cummins is transferred to the flexplate, from the flexplate to the torque converter then to your input shaft in the trans. With increased torque from the engine and no slip out of the converter it can crack and/or rip the center out of a stock flexplate. *Twelve converter bolt holes now come standard.*



2019-UP 68RFE/AS69 FLEXPLATE

SKU#: F6869R19

FEATURES AND BENEFITS:

- Billet Construction
- Replaces Factory Flexplate
- Exceeds 29.3 SFI Specifications

The SunCoast 68RFE/AS69 Billet Flexplate for your 2019-up Dodge 6.7L Cummins is a must have when it comes to putting power to the ground in your truck. The high torque of your Cummins in conjunction with a better designed torque converter can transfer the torque with no slip. The flexplate is bolted to the crank shaft, then the converter is bolted to flexplate. The torque from your Cummins is transferred to the flexplate, from the flexplate to the torque converter then to your input shaft in the trans. With increased torque from the engine and no slip out of the converter it can crack and/or rip the center out of a stock flexplate.



2019-UP 618 BILLET SFI-APPROVED FLEXPLATE

SKU#: FA618R19

FEATURES AND BENEFITS:

- Billet Construction
- Replaces Factory Flexplate
- Exceeds 29.3 SFI Specifications

The SunCoast 618 Billet Conversion Flexplate to adapt a 47/48 to your 2019-up Dodge 6.7L Cummins is a must have when it comes to putting power to the ground in your truck. The high torque of your Cummins in conjunction with a better designed torque converter can transfer the torque with no slip. The flexplate is bolted to the crank shaft, then the converter is bolted to flexplate. The torque from your Cummins is transferred to the flexplate, from the flexplate to the torque converter then to your input shaft in the trans. With increased torque from the engine and no slip out of the converter it can crack and/or rip the center out of a stock flexplate.

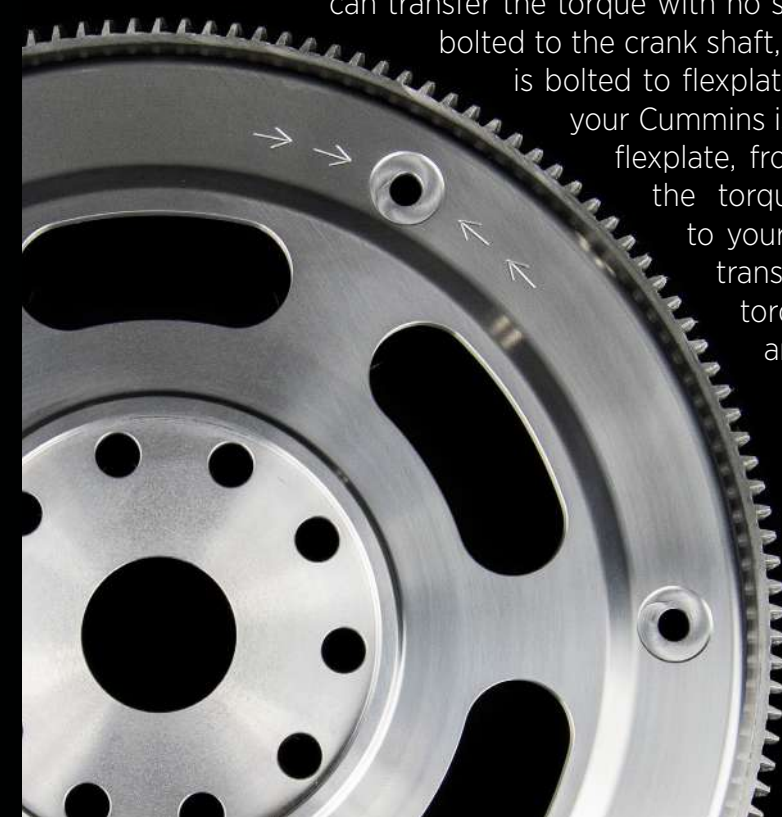

48RE TRANSFER CASE SUPPORT

SKU#: 48-TCS

FEATURES AND BENEFITS:

- Prevents cracking of the overdrive tail housing
- Quick installation—a few minutes and you're done
- Fits between transfer case and existing skid plate
- Uses a very popular universal GM RWD mount (included)
- All necessary hardware included

This can be installed, even if you do not have the factory skid plate, by using the following parts below available from Chrysler:

- SKID PLATE [52022048AH]
- CROSSMEMBER [52022046E]
- BOLTS (8 REQUIRED) [6507342AA]

CRACK KILLS

The 48RE Dodge Diesel 4WD transmissions are known for having repeated issues with cracking the overdrive housing. Their transfer cases, mated to the overdrive housing, weigh about 80lb but have absolutely nothing in place to support them. This new transfer case support solves this issue. If you have a cracked or damaged overdrive housing after replacing it, this is the solution to prevent this problem from rearing its ugly head in the future.



ULTRALIGHT BILLET REACTION SHELL

SKU#: 48-LRS

THE REASONING

Weight is always on the mind of any drag racer. Reciprocating mass is one of the most efficient ways to improve the performance of any vehicle. Lighter rotating mass improves an engine's response to throttle input, and it reduces parasitic loss, as well.

This new ultralight billet reaction shell weighs 30% less than the factory piece and yields itself much stronger. This piece fits both 727 TorqueFlites and 47/48 RH/RE transmissions. This piece is perfect for drag racers, sled pulls, and max effort street builds.

Whether you're looking to dominate on the street or at the track, this reaction shell has proven time and time again to be a must.



4-RING ACCUMULATOR PISTON

SKU#: 61822841HD

The SunCoast 4-Ring Billet Accumulator Piston is an upgrade for the plastic 2-ring piston found in the transmission of your 1994-2007 Dodge 5.9L Cummins. This 4-ring piston stops cross leaks and piston breakage commonly associated with the factory unit.



BILLET STRUT AND ANCHOR KIT

SKU#: 618-BSK

This replaces failure-prone factory struts that bend and break. The OEM band struts, manufactured from steel by stamping are notorious for bending, causing excessive band clearances that can potentially contribute to premature transmission failure.

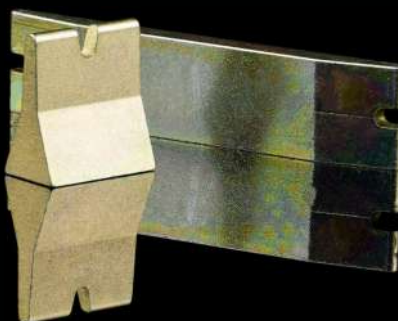

618 4.4 BILLET BAND LEVER

SKU#: 618-44

This SunCoast custom ratio 4.4 band lever is a product of our performance roots. This billet band lever is custom-machined from 4140 heat-treated, stress-relieved steel. When used with our billet band and billet intermediate servo, the SunCoast 618-44 lever provides shift timing that's unmatched by anything else within the industry.



BILLET BAND STRUT

SKU#: 618-BS

SunCoast's solution to OEM band strut failure. O.E.M. Band Struts are notorious for bending and causing excessive clearances that can result in premature transmission failure. SunCoast's billet band strut is made of heavier-duty material, preventing said damages.



GOVERNOR PRESSURE SOLENOID

SKU#: 618-GK

The governor pressure solenoid kit was specifically designed to improve the reliability of the governor solenoid in normal use and handle higher base pressure in high-performance applications. This unit will fit both early and late styles. We recommend you also install a new Governor Pressure Sensor/Transducer with this kit.



This kit in testing was found to be extremely reliable in every situation. Contamination metal, fiber, clutch materials do not phase the RE conversion kit.

CONTAINS THE FOLLOWING:

- Manifold is made of 6061T6 Billet Aluminum
- New Borg Warner Solenoid
- 1/4 20 Grade 5 bolts (4)
- Viton O-Rings (3)
- Gasket
- Cap screws (3)
- Set screw
- Delphi/Packard connectors
- Bracket for Solenoid and Governor sensor

618 BILLET BAND

SKU#: 618-BB

The SunCoast Billet Band for your 1989-2007 Dodge 5.9L Cummins replaces the OEM thin Flex Band with weak apply ends. It features a high-energy lining and is a must-have item when building your performance transmission.



BILLET BAND KIT, STRUT & ANCHOR

SKU#: 61822825HP

Our new billet band has reinforced apply ends, built end and hi-energy lining.

Billet apply strut and steel anchor replaces factory strut and anchor that bends and breaks.

Billet Intermediate band with Hi-Energy lining replaces OEM thin Flex Band with weak apply ends.



68RFE UPGRADED PUMP HALF



SKU#: 68-SCP

The 68RFE factory pump is replaced on every transmission that SunCoast builds.

From the factory, the 68RFE transmission pump is incapable of exceeding line pressures of 170 PSI. Many times, we see tuners request from the transmissions lines pressures in excess of 200psi, which the factory pump is unable to

achieve. In all forward gears, the factory pump bleeds off pressure at 165 PSI. This is done by design. When a vehicle is heavily modified (i.e. larger wheels and tires, aftermarket turbos, tuners) the line pressure becomes critical to keep the transmission alive.

The 68-SCP from SunCoast addresses this issue. When combined with our custom 68RFE separator plate, this pump half will allow you to achieve pressures in excess of 250 PSI.

Another issue plaguing the 68RFE is the torque converter circuit within the pump. This issue often leads to the ballooning of the torque converter. Here at SunCoast, we address this issue by modifying the release oil circuit within the pump.

Furthermore, each 68-SCP is vacuum-tested to ensure no cross leaks are present. This modified pump half fits all 68RFE transmissions.

TRANSGO 48RE SHIFT KIT



SKU#: SK-48RE

The TransGo SK-48RE Shift Kit for your 2003-2007 Dodge 5.9L Cummins 48RE improves your transmission's performance, as well as reducing converter slip. Great for heavy duty applications, towing, and high-performance use. Includes new stronger replacement separator plate.

45RFE/545RE/68RFE SHIFT KIT

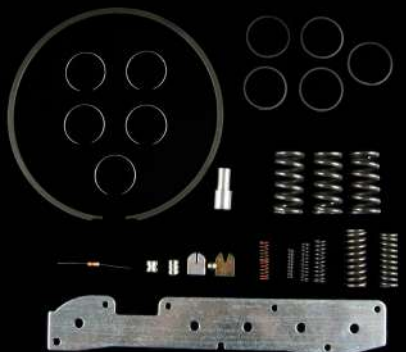

SKU#: 45RFE-HD2

TransGo's Performance shift kits give you the hard-launching, tire-blazing shifts you want after just a few hours' work with basic hand tools. TransGo even has kits for computer-controlled, 4-speed automatics. Their performance shift kits can be installed with the transmission in the vehicle, and they come with

complete instructions. Some kits even include a step-by-step video to walk you through the installation process.

68RFE INPUT CLUTCH HUB



SKU#: 618-ICH

Manufactured from 4140 heat-treated/stress-relieved billet steel vs. the OEM cast version.

- Provides greater strength at the input shaft spline area.
- 100% drop-in product.
- No modifications necessary.

BILLET INPUT SHAFT



SKU#: 618-HSX

The SunCoast 618-HSX Billet Input Shaft your 1994-2007 Dodge 5.9L Cummins has been designed for those higher horsepower engines. Machined from 300 Maraging AMS 6541 material, this shaft is designed to hold up under increased power levels and heavy loads that can exceed the OEM shaft and hub capacity.

FEATURES:

- Increased Strength
- Machined From 300 Maraging Steel
- Fits 47RH, 47RE, 48RE Automatic Transmissions

27 SPLINE STATOR SUPPORT



SKU#: 618-SS-27

This new stator support is designed to be used with the larger SunCoast 618-27 Input Shaft & Hub. This stator support is machined to exact tolerances to ensure true drop-in replacement.

68RFE M3GA BILLET INPUT SHAFT



SKU#: 618-BIS

This input shaft is a drop-in replacement part for high-power/torque applications.

Made from billet 300M steel alloy for high yield strength.

Heat-treated and precision-ground.

Gun-drilled through hole to eliminate stress risers often associated with conventional drilling procedures.

BILLET 300M INTERMEDIATE SHAFT

SKU#: 618-BIN

The Dodge Intermediate Shaft can be subjected to very high torsional stress with vehicles with larger wheels and tires, heavy towing, and aftermarket engine modifications. This Dodge Intermediate Shaft is precision-machined and ground from 300M billet steel. Furthermore, the shaft is heat-treated for increased durability.



VASCOMAX INTERMEDIATE SHAFT

SKU#: 618-BIN-M

The Dodge Intermediate Shaft can be subjected to very high torsional stress with vehicles with larger wheels and tires, heavy towing, and aftermarket engine modifications. Our Dodge Intermediate Shaft is precision-machined and ground from 300 Maraging steel (VASCOMAX). Furthermore, the shaft is heat-treated for increased durability.



618 27-SPLINE INPUT & HUB

SKU#: 618-27

The SunCoast 618-27 Proprietary 27-Spline Input Shaft, which requires custom torque converter has proven itself time and time again. This shaft takes an extreme amount of abuse where stock-sized billet input shafts simply can't stay in one piece.



618 BILLET DRUM

SKU#: 618-BDD

The SunCoast Billet Direct Drum for your 1994-2007 Dodge 5.9L Cummins Automatic Transmission is CNC machined from C1040 solid steel. This billet drum contains NO CAST IRON! It will hold 5 - 6 friction Plates. 55%, YES that's 55% MORE Piston Apply Area! This results in double the Clamping Force needed in Third Gear.



FEATURES:

- IC1040 Solid Steel Construction
- Holds 5-6 Friction Plates
- 5% More Piston Apply Area

29-SPLINE OUTPUT SHAFT

SKU#: 618-BOS-29

This kit allows your 2WD transmission to have a billet output shaft. SunCoast installs a specific bearing, which allows for a slip yoke (400-spline Mark Williams).



618 STUBBY KIT

SKU#: 618-SK

Will require drive-shaft modification.



68 2C BILLET PISTON

SKU#: 618-2CP

The SunCoast 68RFE Billet 2C Piston is designed to minimize coning and deflection that occurs with increased line pressure or additional clamping force.



BILLET FORWARD CLUTCH DRUM

SKU#: 48-FCB

This full billet rear clutch retaining hub is made from 4140 heat-treated, stress-relieved billet steel versus the OE cast piece. The factory cast retainer is known to fail in high torsional fatigue situations such as higher line pressure, commercial use and heavy duty towing and hauling. This new billet piece is the correction you've been looking for.



BILLET DIRECT PISTON

SKU#: 618-DBP

The new SunCoast Billet Direct Piston has a larger than factory apply area. This, along with the fact it is billet, allows us to achieve the greatest undeflected apply pressures in the industry. The SunCoast custom redesigned billet direct piston also comes with our own custom spring count with a set of custom return springs. This was an important issue we wanted to address in the direct clutch; after all, the release is just as valuable as the apply.



727/518/618 SUPER SERVO KIT

SKU#: *K080-MAG*

This Dodge 2nd gear Super Servo kit includes the New PowerStrut and PowerWedge components making this the strongest Servo Kit available, especially for use with hi-ratio levers (4.7 through 5.2) and is designed to handle 16% more holding power vs. a stock setup. It is considered a must-use in

any towing, hauling or performance diesel application. Fits all 1962-up 727/518/618/46-47RH-RE & 48RE units. The Dodge Intermediate Shaft can be subjected to very high torsional stress with vehicles with larger wheels and tires, heavy towing, and aftermarket engine modifications. This Dodge Intermediate Shaft is precision-machined and ground from 300M billet steel. Furthermore, the shaft is heat-treated for increased durability.



PRO-LOC BILLET ULTIMATE WEAPON

SKU#: *618-BDD-23-UW*

618/48RE LOW/REVERSE SUPER SERVO



SKU#: *K086*

This low/reverse super servo is constructed from 6061-T6 billet aluminum for strength and is available for 618 through 48RE. It stabilizes the piston so it will not flip or break in the bore. A steel servo pin is included.

727/518 LOW REVERSE SUPER SERVO



SKU#: *K029*

This newly designed piston is much wider and uses a teflon support ring along with lip seal to create a completely stable piston. This low/reverse super servo is constructed from steel for strength and is available for 727 thru A518.

This Problem Solver deals with these problems:

- Stabilized piston will not flip in the servo bore.
- Moves lip seal up and out of worn area in bore to enable it to work in a less worn portion of the bore.

518 STEEL GOVERNOR VALVE



SKU#: *K038*

This 518 no-stick steel series governor valve works on 727/904/A500-A518 1989-1995 RH units. It is designed to replace the commonly mushroomed-out aluminum OEM valve, which is the leading cause for a sticking governor problem.

A500/A618 END PLAY SHIM KIT

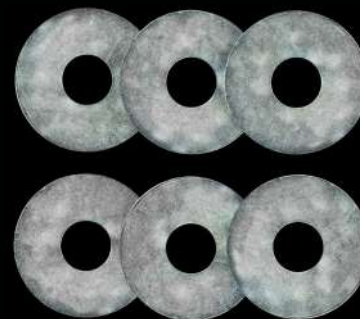

SKU#: *K055*

The A500/A618 End Play Shim Kit is designed to be placed under the 3-tang washer of the forward clutch drum. This allows the endplay to be tightened up without pulling the input shaft ring area outward from the stator support shaft. This kit includes three .025 shims and three .015 shims.

47RE CUSTOM TRANSBRAKE VALVE BODY



SKU#: *6188203-HD-TB*

The SunCoast valve bodies allow for crisper shifts, enhanced converter operation, cooler operating temperatures, and increased lube flow. All SunCoast Valve bodies are dyno tested for pinpoint accuracy before shipment.

AS69RC PML DEEP PAN



SKU#: *48-FCD*

FEATURES INCLUDE:

- Increased oil capacity for cooler temperatures
- Sand-cast aluminum with raised fins
- 3/16-inch thick wall construction to add strength to the transmission case
- 3/8-inch thick gasket flange will not bend when bolts are tightened
- Machined gasket surface for a secure seal
- Boss cast into pan can be machined for a temperature sensor
- Drain hole and magnetic drain plug for easier, less messy maintenance

The Aisin AS69RC transmission is found in 2013 and newer Ram 3500, 4500, 5500 trucks with the 6.7 Cummins Diesel. This PML pan features heavy duty construction, extra capacity, drain, and cooling fins. PML designed this pan to provide as much clearance as possible to the bolts at the rear of the pan. There is a cross member below these bolts and to access them on the stock pan or the PML pan, you will probably need to jack up the transfer case. This pan works with the stock gasket and filter. PML provides new mounting bolts and a magnetic drain plug with the pan.

FORD PRODUCTS

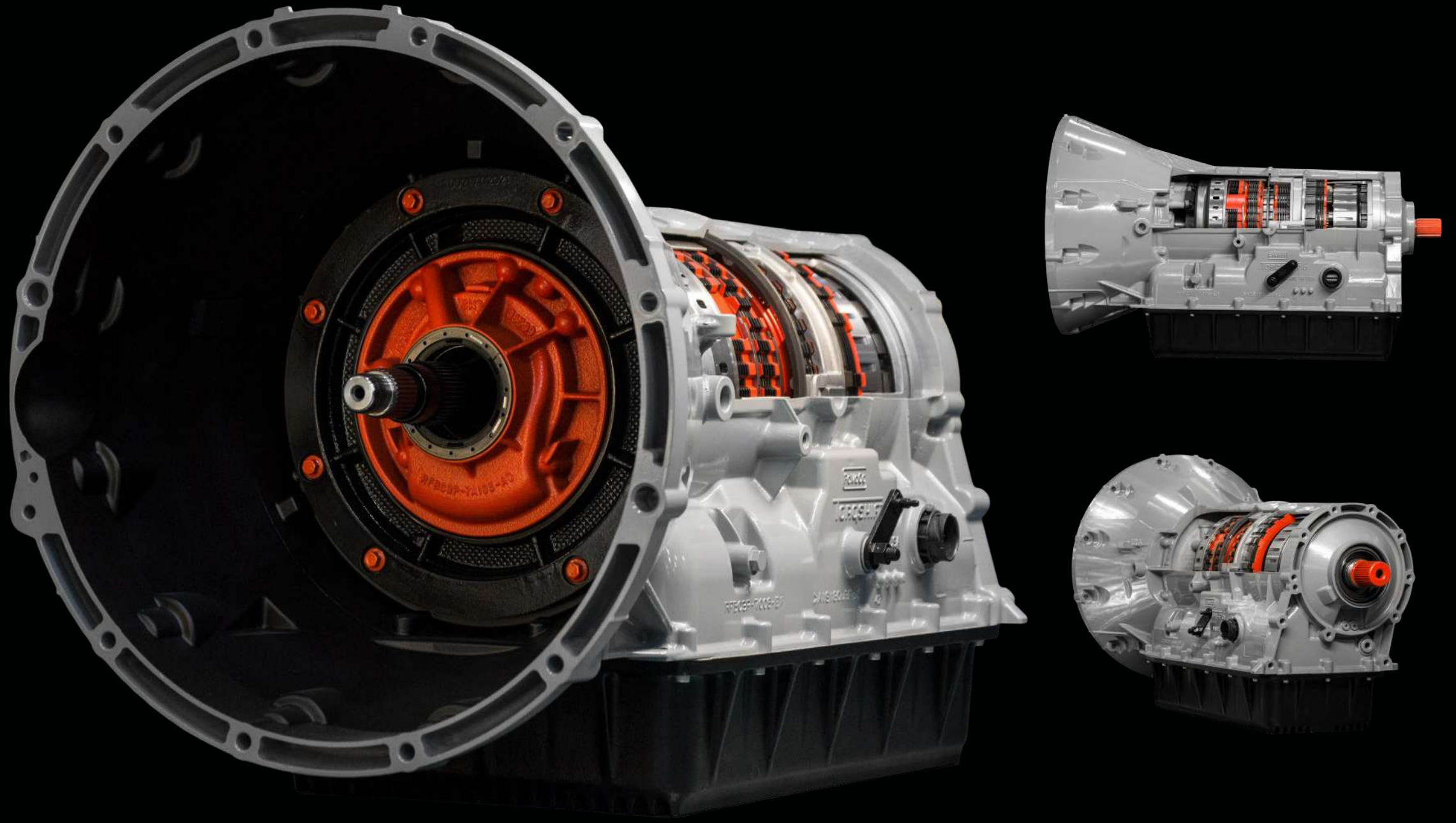

TABLE OF CONTENTS

42-45 FORD TRANSMISSIONS

46-47 FORD CONVERTERS

48-50 FORD REBUILD KITS

51-55 FORD ACCESSORIES

FORD TRANSMISSIONS

E40D | 4R100 | 5R110 | 6R140

OEM Transmission clutches fail in high stress applications due to excessive heat. This heat promotes and accelerates wear and tear that ultimately leads to premature catastrophic failure. SunCoast's Ford transmissions are engineered and built to the highest standards. These transmissions feature proven, better than OEM, aftermarket friction materials, and steel technologies that will hold up in almost any situation. SunCoast's increased clutch quantities are complimented with a TransGo® valve body re-calibration kit that gives the transmission superior shift quality and pressure. Mild to wild, SunCoast can suit any need.

The SunCoast transmission includes increased clutch count with high-energy friction materials of choice (Alto® or Raybestos®), treated steels, and can also feature upgraded parts.

- Standard built transmission: 3 year unlimited mile warranty
- Competition transmission: 1 year unlimited mile warranty

PART NUMBERS:

1989-1998

PLSD-E40D-2X.....	E40D 2WD TRANS ASSEMBLY
PLSD-E40D-4X.....	E40D 4WD TRANS ASSEMBLY
PLSD-E40D-COMP.....	E40D COMP TRANS ASSEMBLY

1999-2003

PLSD-4R100-2X.....	4R100 2WD TRANS ASSEMBLY
PLSD-4R100-4X.....	4R100 4WD TRANS ASSEMBLY
PLSD-4R100-2XPTO.....	4R100 2WD PTO TRANS ASSEMBLY
PLSD-4R100-4XPTO.....	4R100 4WD PTO TRANS ASSEMBLY
PLSD-4R100-COMP.....	4R100 4WD SUPER COMP TRANS ASSEMBLY

2003.5-2010

SC-5R110CAT0-2WD.....	5R110 CATEGORY 0 350HP 2WD TRANS ASSEMBLY
SC-5R110CAT0-4WD.....	5R110 CATEGORY 0 350HP 4WD TRANS ASSEMBLY
SC-5R110CAT1-4WD.....	5R110 CATEGORY 0 450HP 4WD TRANS ASSEMBLY
SC-5R110CAT2-4WD.....	5R110 CATEGORY 0 500HP 4WD TRANS ASSEMBLY
SC-5R110CAT3-4WD.....	5R110 CATEGORY 0 600HP 4WD TRANS ASSEMBLY
SC-5R110CAT4-4WD.....	5R110 CATEGORY 0 700+HP 4WD TRANS ASSEMBLY
PLSD-5R110-2X-COMP.....	5R110 4WD COMP TRANS ASSEMBLY
PLSD-5R110-4X-COMP.....	5R110 4WD COMP TRANS ASSEMBLY
PLSD-5R110-2X.....	5R110 2WD TRANS ASSEMBLY
PLSD-5R110-4X.....	5R110 4WD TRANS ASSEMBLY
PLSD-5R110-08-2X.....	5R110 '08 4WD TRANS ASSEMBLY
PLSD-5R110-08-4X.....	5R110 '08 4WD TRANS ASSEMBLY
PLSD-5R110-08-COMP2X.....	5R110 '08-UP 4WD COMP TRANS ASSEMBLY
PLSD-5R110-08-COMP4X.....	5R110 '08-UP 4WD COMP TRANS ASSEMBLY

2010-2016

PLSD-6R140-2X.....	6R140 2WD TRANS ASSEMBLY
PLSD-6R140-4X.....	6R140 4WD TRANS ASSEMBLY
SC-6R140CAT0-4WD.....	6R140 CATEGORY 0 350HP 4WD TRANS ASSEMBLY
SC-6R140CAT1-4WD.....	6R140 CATEGORY 1 400HP 4WD TRANS ASSEMBLY
SC-6R140CAT2-4WD.....	6R140 CATEGORY 2 550HP 4WD TRANS ASSEMBLY
SC-6R140CAT3-4WD.....	6R140 CATEGORY 3 650+HP 4WD TRANS ASSEMBLY

SUNCOAST 4WD 5R110 CATEGORY TRANSMISSIONS

TRANSMISSIONS INCLUDE THE FOLLOWING:

- SunCoast Low/Reverse Clutch Pack with 5 Clutches & 5 Kolene Steels
- SunCoast Overdrive Clutch Pack with 5 Clutches & 5 Kolene Steels
- SunCoast Overdrive Piston
- SunCoast Overdrive Pressure Plate
- SunCoast Intermediate Clutch Pack with 5 Clutches & 5 Kolene Steels
- SunCoast Intermediate Pressure Plate
- SunCoast Forward Clutch Pack with 5 Frictions & 5 Steels
- SunCoast Forward Pressure Plate
- SunCoast "Wide Load" Direct Clutch Pack with 5 Frictions & 5 Steels
- SunCoast Direct Pressure Plate
- SunCoast Direct Piston
- SunCoast Direct Snap Ring
- SunCoast "No Walk" Center Support
- SunCoast Overhaul Kit
- SunCoast Valve Body Calibration Kit

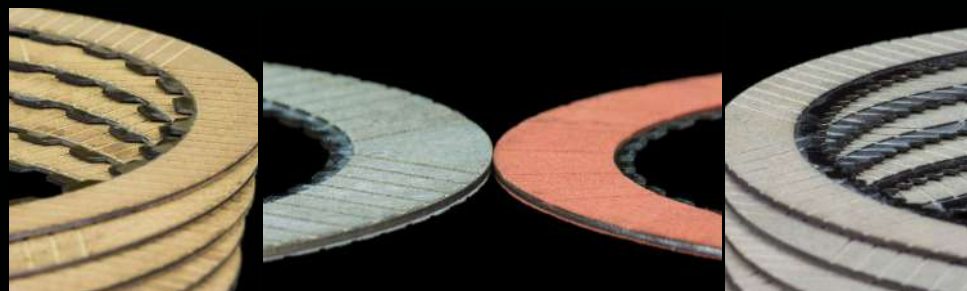

CATEGORY 0

SKU#: *SC-5R110CAT1-4WD*

BASE KIT.
INCLUDES EVERYTHING LISTED ABOVE.

CATEGORY 1

SKU#: *SC-5R110CAT1-4WD*

INCLUDES EVERYTHING FROM CATEGORY 0, IN ADDITION TO THE FOLLOWING:
- Billet Vascomax Input Shaft
- Mag-Hytec Deep Pan

CATEGORY 2

SKU#: *SC-5R110CAT2-4WD*

INCLUDES EVERYTHING FROM CATEGORY 1, IN ADDITION TO THE FOLLOWING:
- Billet Rear Ring Gear Hub

CATEGORY 3

SKU#: *SC-5R110CAT3-4WD*

INCLUDES EVERYTHING FROM CATEGORY 2, IN ADDITION TO THE FOLLOWING:
- Billet Overdrive Planet

CATEGORY 4

SKU#: *SC-5R110CAT4-4WD*

INCLUDES EVERYTHING FROM CATEGORY 3, IN ADDITION TO THE FOLLOWING:
- Billet Aeromet Input Shaft



FORD TRIPLE-CLUTCH CONVERTERS

E40D | 4R100 | 5R110 | 6R140

SunCoast's Ford series torque converters use a larger-than-stock, triple-clutch design for more holding power. Its forged billet steel covers provide added strength while also providing better heat distribution than stock type converters. Custom billet stators are available for increased torque multiplication and efficiency. These converters work for stock to high-power applications for higher torque multiplication and better drivability.

FEATURES

- Designed and manufactured in house
- Tig welding to reinforce furnace brazed fins
- Signature trapezoid clutch teeth (no round tabs)
- Forged billet cover
- Piston and stators machined in house
- Pressure tested welds/spun balanced

PART NUMBER.....	DESCRIPTION
4R100-SD265-3D	HIGH STALL GAS/DIESEL CONVERTER
4R100-SD36-3D	4R100 LOW STALL CONVERTER
4R100-SD44-3D	LOW STALL CUMMINS CONVERTER
5R110-64-3D	03-07 LOW STALL CONVERTER
5R110-64-3D-8	08-10 LOW STALL CONVERTER
5R110-65-3D	03-07 MEDIUM STALL CONVERTER
BAC-5R110-25-3D-8	08-10 HD 13" RACE/TOW CONVERTER
BAC-5R110-27-3D-6	03-07 HD 13" RACE/TOW CONVERTER
6R140-1	6R140 1700 RPM BILLET QUADRALOCK CONVERTER
6R140-2	6R140 1900 RPM BILLET QUADRALOCK CONVERTER
6R140-3	6R140 2300 RPM BILLET QUADRALOCK CONVERTER
SC-5RC1-6	5R110 CATEGORY 1 BILLET 6-BOLT CONVERTER
SC-5RC1-8	5R110 CATEGORY 1 BILLET 8-BOLT CONVERTER



FORD 5R110 TRIPLE DISC BILLET CATEGORY 1 TORQUE CONVERTER

AVAILABLE IN 6-BOLT OR 8-BOLT

SKU#: SC-5RC1-6 / SC-5RC1-8

FEATURES AND BENEFITS:

- 3-YEAR, UNLIMITED-MILEAGE WARRANTY
- Billet Lockup Apply Piston
- CNC-Machined Billet Steel Cover
- Balloon Plate
- 4140 Turbine Splines
- 4140 Hardened Hub
- 3 Carbon-Graphitic Clutch Discs
- Furnaced-Brazed Fins
- Torrington Thrust Bearing Stator Design
- Pressurized "Hot Soak" Leak Testing
- Computer-Balanced to Within .01 Gram
- Precisioned-Assembled by Caring American Workers

THE CATEGORY 1

This Category 1 SunCoast Torque Converter fits all 5R110 transmissions with 6-bolt or 8-bolt patterns and is engineered to handle all of your everyday duties. Whether you're towing a camper or hauling dirt to a job site, this torque converter is designed to

improved vehicle response and give you years of solid,

reliable performance. It comes with furnace-brazed fins and hardened turbine splines. The clutches in this converter are carbon-graphitic for precise and accurate lock-up.

If you're looking to increase the performance of the factory unit—and looking for a cost-effective solution—this is the converter for you. This converter, while great for heavy duty towing and hauling, is it not intended for racing.



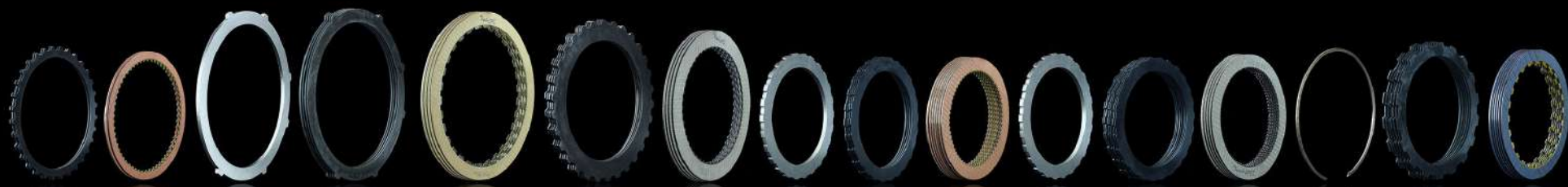

FORD REBUILD KITS

E40D | 4R100 | 5R110 | 6R140

SunCoast's Ford series rebuild kits cover all years from 1989-2017 (kit part number dependent upon year). These kits utilize the latest proven friction materials and steel technology from industry leading companies such as Alto®, Exedy®, and Raybestos®. SunCoast works directly with these companies to design and manufacture proprietary exclusive SunCoast product lines, giving the end user uncompromised quality throughout the entire transmission. SunCoast has designed these kits in-house to exact specifications for many intents, including but not limited to towing, sled pulling, racing or having a vehicle to get from point A to point B. Along with these kits, SunCoast has a full line of billet single and triple-disc torque converters ranging from 1800 stall to approximately 3000 RPM (manufactured in-house), billet input/output shaft options, SunCoast designed E-Clutch dampener, billet steel drums, low and reverse hubs (year-dependent), SunCoast 5R110 limit valve, SFI-approved flexplates, SFI-approved transmission jackets and much more.



SUNCOAST 5R110 CATEGORY REBUILD KITS

KITS CONTAIN THE FOLLOWING:

- SunCoast Low/Reverse Clutch Pack with 5 Clutches & 5 Kolene Steels
- SunCoast Overdrive clutch pack with 5 Clutches & 5 Kolene Steels
- SunCoast Overdrive Piston
- SunCoast Overdrive Pressure Plate
- SunCoast Intermediate Clutch Pack with 5 Clutches & 5 Kolene Steels
- SunCoast Intermediate Pressure Plate
- SunCoast Forward Clutch Pack with 5 Frictions & 5 Steels
- SunCoast Forward Pressure Plate
- SunCoast "Wide Load" Direct Clutch Pack with 5 Frictions & 5 Steels
- SunCoast Direct Pressure Plate
- SunCoast Direct Piston
- SunCoast Direct Snap Ring
- SunCoast "No Walk" Center Support
- SunCoast Overhaul Kit
- SunCoast Valve Body Calibration Kit

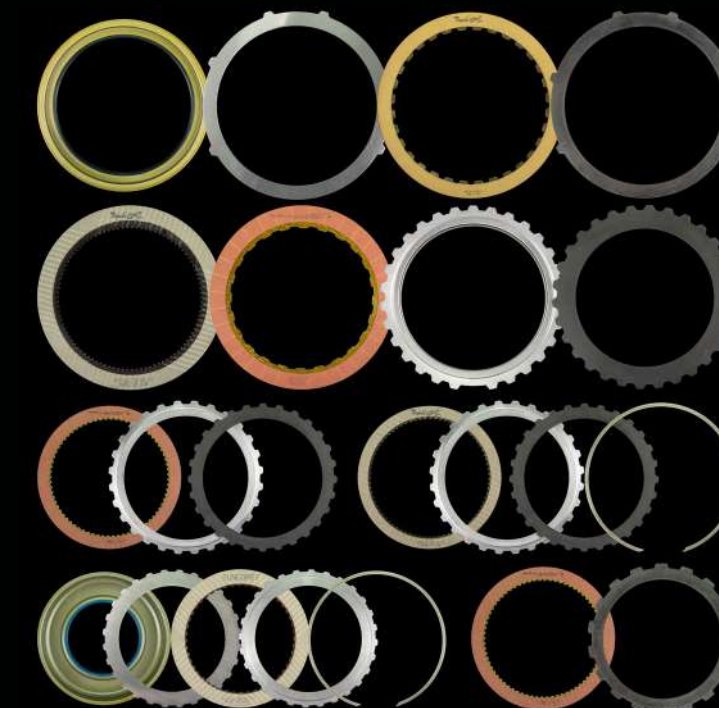

CATEGORY 0

SKU#: SC-5R110SC-0

BASE KIT.
INCLUDES EVERYTHING LISTED ABOVE.

CATEGORY 1

SKU#: SC-5R110SC-1

INCLUDES EVERYTHING FROM CATEGORY 0, IN ADDITION TO THE FOLLOWING:

- Billet Vascomax Input Shaft

CATEGORY 2

SKU#: SC-5R110SC-2

INCLUDES EVERYTHING FROM CATEGORY 1, IN ADDITION TO THE FOLLOWING:

- Billet Rear Ring Gear Hub

CATEGORY 3

SKU#: SC-5R110SC-3

INCLUDES EVERYTHING FROM CATEGORY 2, IN ADDITION TO THE FOLLOWING:

- Billet Overdrive Planet

CATEGORY 4

SKU#: SC-5R110SC-0

INCLUDES EVERYTHING FROM CATEGORY 3, IN ADDITION TO THE FOLLOWING:

- Billet Aeromet Input Shaft

SUNCOAST 6R140 CATEGORY REBUILD KITS

KITS CONTAIN THE FOLLOWING:

- All New Carbon Graphitic clutches
- All New Custom Machined Steels
- Improved Heavy Duty 4-5-6 Overdrive Clutch Pack
- Increased Overdrive Clutch Count
- Custom Machined Overdrive Apply Piston



CATEGORY 0

SKU#: SC-6R140SC-0

BASE KIT.
INCLUDES EVERYTHING LISTED ABOVE.

CATEGORY 1

SKU#: SC-6R140SC-1

INCLUDES EVERYTHING FROM CATEGORY 0, IN ADDITION TO THE FOLLOWING:

- New Transmission Filter Kit
- New Pump Bearing

CATEGORY 2

SKU#: SC-6R140SC-2

INCLUDES EVERYTHING FROM CATEGORY 1, IN ADDITION TO THE FOLLOWING:

- New SunCoast Patented Dampener

CATEGORY 3

SKU#: SC-6R140SC-3

INCLUDES EVERYTHING FROM CATEGORY 2, IN ADDITION TO THE FOLLOWING:

- Billet Flexplate
- Sure Cure Valve Body Calibration Kit

CATEGORY 4

SKU#: SC-6R140SC-4

INCLUDES EVERYTHING FROM CATEGORY 3, IN ADDITION TO THE FOLLOWING:

- Billet Intermediate Shaft
- Billet Clutch Hub

6R140 OVERDRIVE DAMPENER ASSEMBLY WITH BILLET INTERMEDIATE SHAFT AND HUB

SKU#: SC-6R140-ECD-BSH

6R140 OVERDRIVE DAMPENER ASSEMBLY

SKU#: SC-6R140-ECD

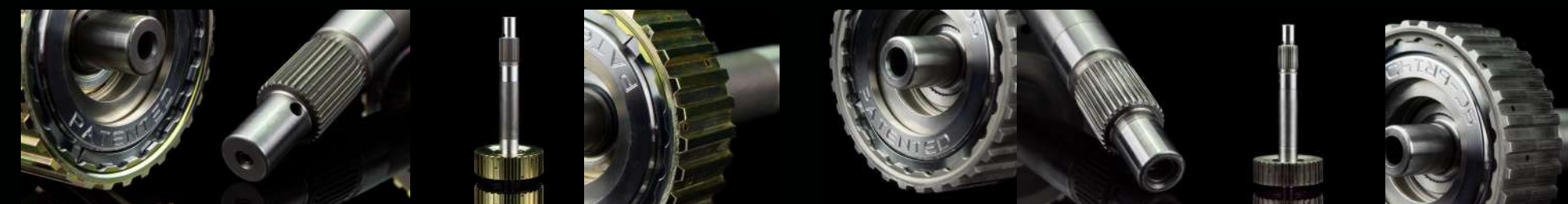

6R140 BILLET FLEXPLATE

SKU#: 6R140-BFP

FEATURES AND BENEFITS:

- SFI Certified 29.1
- Concentric Machined to less than .005
- Machined to exact tolerances from 4340 round bar
- One piece indestructible design
- Chamfered gear tooth providing exact engagement

SunCoast custom one-piece flexplate is not only stronger but more durable than any other flexplate out there today. SunCoast proprietary manufacturing process utilizing our state-of-the-art machining and hardening techniques, ensures unmatched strength and concentricity.



4R100 TRANSGO TUGGER KIT

SKU#: 4R100-HD2-TUGGER



The 4R100 TransGo Tugger Kit doubles low-clutch holding pressure in D1 for downhill use and high-speed pull into D1. Handles exhaust brake. Adjusts shift firmness, more cooling/lubrication, better converter feed & capacity.

NOTE: This kit requires removal of the transmission for installation of the internal parts.

E4/4R BILLET FORWARD DRUM

SKU#: E4100-BFWD



The SunCoast 4R100 Billet Forward Drum is machined from 4140 heat-treated, stress-relieved steel, which eliminates stripping of the input spline. It also increases the clutch frictions from 4-6.

E4OD/4R100 MAG-HYTEC PAN

SKU#: MAG-E4OD-4R100



The Mag-Hytec Ford E4OD/4R100 Transmission Pan for your 1990 & Up F-Series provides function and fashion all in one package. Cast from A356-T6 aluminum, this textured, powdercoated transmission pan provides increased fluid capacity for your hard-working truck. The

increased fluid capacity not only helps to cool your temperatures, but also the built-in cooling fins help remove heat. Each pan comes complete with hardware, magnetic drain plug assembly and an o-ring gasket for superior sealing.

Note: Due to the extended depth of the deep sump pan, this transmission pan requires the use of a 4WD filter (sold separately).

PRODUCT HIGHLIGHTS

- Magnetic Drain Plug
- Deep Sump For Increased Fluid
- Pre-Drilled & Tapped 1/8" NPT Sender Port
- O-Ring Seal Requires No Additional Gaskets Or Seals
- 7.6 Quarts Increased Capacity Over Stock

E4/4R 300M BILLET OUTPUT SHAFT

SKU#: *E4100-BOS*

The Ford E4/5R 300M Billet Output Shaft is manufactured from a select AeroSpace Alloy to meet the high torque demands of today's performance diesels.



DUAL-LOAD CENTER SUPPORT

SKU#: *4R36743*

With SunCoast's Dual-Load Center Support, the load is now shared with an added bronze bearing at the front of the hub. This stabilizes the load and stops point loading. It reduces bearing failure, while maintaining improved gear train alignment.



FORD 5R110 FLEXPLATE 6.0

SKU#: *60-BFP*

The Billet Steel Flexplate for the Ford 5R110 is a solid, one-piece flexplate design that can withstand the stress of your modified diesel engine. This flexplate will only fit the Ford 6.0 PowerStroke engine.



FORD 5R110 FLEXPLATE 6.4

SKU#: *64-BFP*

The Billet Steel Flexplate for the Ford 5R110 is a solid, one-piece flexplate design that can withstand the stress of your modified diesel engine. This flexplate will only fit the Ford 6.4 PowerStroke engine.



E40D/4R/5R BILLET 300M SHAFT

SKU#: *5R-BIS*

This 5r110W billet input shaft fits Ford Power Stroke E40D, 5R110, and 4R100 transmissions.

PRODUCT HIGHLIGHTS

- Made from 300M billet steel
- Heat treated and precision ground
- Comes with a 30/31 spline count
- Shaft is rated to 2000 ft of torque
- For high-torque diesel and off-road applications



5R BILLET LOW/REVERSE HUB

SKU#: *5R-LRH*

As you increase your horsepower and torque you quickly find out where your weakest links are. The factory rear ring gear is one of the weakest links and has addressed with this product. Designed out of 4140 HTSR steel for superior strength and longevity. If you are building a performance transmission this is a must buy.



03-07 & 08-UP 5R110 MAG-HYTEC PAN

SKU#: *MAG-5R110 / MAG-5R110W*

Deep sump, high capacity for maximum cooling. This pan increases fluid volume by (7) quarts. 1/8 NPT tap for temp. sender. Finned aircraft aluminum construction, drain plug with 303 stainless steel hardware. Increases case rigidity under hi-torque conditions.



PRODUCT HIGHLIGHTS

- 2003-2007 Ford PowerStroke 6.0L Diesel
- 5-speed Torque Shift
- Holds 8.3 quarts more fluid than stock pan
- Deep high-capacity sump for maximum cooling
- Magnetic drain plug
- 303 hardware except allen head cap screws are zinc plated
- 1/8 NPT temperature sender port
- Finned aircraft aluminum construction
- Requires only 3 allen key wrenches (included) for installation & service
- O-rings require no gaskets or sealants.

GM PRODUCTS

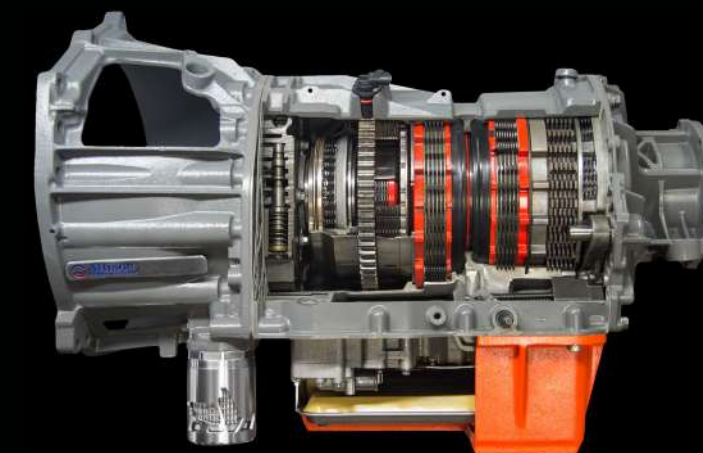

TABLE OF CONTENTS

58-63 GM TRANSMISSIONS

64-65 GM REBUILD KITS

66-68 GM CONVERTERS

69-73 GM ACCESSORIES

GM TRANSMISSIONS

ALLISON 1000: LB7 | LLY | LBZ | LMM | LML

The Allison 1000 transmission is more than suitable for stock applications, but it does have limitations. Once power exceeds 90-110 horsepower over stock, the OEM clutch packs begin to slip. Once slippage occurs, the transmission control module overrides the Allison and puts it into fail-safe mode, often referred to as "Limp Mode." Once the Allison reaches this state, it begins to limp easier and easier. Luckily, SunCoast has the solution. SunCoast's Allison 1000 series transmissions are designed and engineered to be the most dependable, heavy-duty transmission option on the market. SunCoast's Allison transmissions are proven to be more durable and dependable in any situation: street, sled pulling, towing or drag racing (transmission options may vary). Built with the best possible Allison parts on the market, these units can hold in excess of 1900 RWHP (with correct supporting hard parts).

STANDARD FEATURES:

- Upgraded BST Valve*
- Re-calibrated Valve Body*
- High-energy C1, C2, C3, and C4 Clutches and Steels**
- 3-year Unlimited Mileage Warranty (Non-competition Transmission)

*TransGo® Valve-body re-calibration kit, lock-up boost valve

**Multiple friction/steel options are available upon request such as Alto® & Raybestos®

OPTIONAL FEATURES:

- Billet Triple-disc Torque Converter (built in-house)
- Mag-Hytec Deep Transmission Pan
- Billet Input/Output/Intermediate Shafts

The SunCoast transmission includes increased clutch count with high-energy friction materials of choice (Alto® or Raybestos®), treated steels, and can also feature upgraded parts.



PART NUMBERS:

ALLISON 1000 5 SPEED: 2001-2005

GMAX-CAT1-LB7/LLY-4X.....	LB7/LLY CATEGORY 1 500HP TRANSMISSION W/ CONVERTER
GMAX-CAT2-LB7/LLY-4X.....	LB7/LLY CATEGORY 2 600HP TRANSMISSION W/ CONVERTER
GMAX-CAT3-LB7/LLY-4X.....	LB7/LLY CATEGORY 3 700HP TRANSMISSION W/ CONVERTER
GMAX-CAT4-LB7/LLY-4X.....	LB7/LLY CATEGORY 4 950+HP TRANSMISSION W/ CONVERTER
LB7LLY-GUARDIAN-1.....	LB7/LLY GUARDIAN HD TOWING TRANS W/ CONVERTER

ALLISON 1000 6-SPEED: 2006-2018

GMAX-CAT1-LBZ/LMM-4X.....	LBZ/LMM CATEGORY 1 500HP TRANSMISSION W/ CONVERTER
GMAX-CAT2-LBZ/LMM-4X.....	LBZ/LMM CATEGORY 2 600HP TRANSMISSION W/ CONVERTER
GMAX-CAT3-LBZ/LMM-4X.....	LBZ/LMM CATEGORY 3 700HP TRANSMISSION W/ CONVERTER
GMAX-CAT4-LBZ/LMM-4X.....	LBZ/LMM CATEGORY 4 950+HP TRANSMISSION W/ CONVERTER
GMAX-CAT1-LML-4X.....	LML CATEGORY 1 500HP TRANSMISSION W/ CONVERTER
GMAX-CAT2-LML-4X.....	LML CATEGORY 2 600HP TRANSMISSION W/ CONVERTER
GMAX-CAT3-LML-4X.....	LML CATEGORY 3 700HP TRANSMISSION W/ CONVERTER
GMAX-CAT4-LML-4X.....	LML CATEGORY 4 950+HP TRANSMISSION W/ CONVERTER
LBZLMM-GUARDIAN-1.....	LBZ/LMM GUARDIAN HD TOWING TRANS W/ CONVERTER
LML-GUARDIAN-1.....	LML GUARDIAN HD TOWING TRANS W/ CONVERTER



ALLISON GUARDIAN HD TOWING TRANSMISSION W/ CONVERTER

SKU#: LB7LLY-GUARDIAN-1 • LBZLMM-GUARDIAN-1 • LML-GUARDIAN-1

TRANSMISSIONS INCLUDE THE FOLLOWING:

- Billet Pro-Loc Ducenti Valve Body
- SunCoast Triple Disc Billet Category 1 Converter
- SunCoast Custom Clutch Packs
- SunCoast Custom Steels
- SunCoast Custom Billet Plates
- SunCoast Custom Overhaul Kit
- Valve Body Calibration Kit
- SunCoast Gasket Kit
- New Internal Wiring Harness
- Pan Filter
- Spin-on Filter
- Pan Gasket
- SunCoast Filter Loc
- Factory Deep Pan

When functionality is your primary concern, reliability matters. Our Guardian series of transmissions was specifically engineered to maintain OE standards in regards to NVH (noise vibration harmonics) factors. What you will find is a product that will function at the highest level but also offers the refinement that you demand.



The SunCoast Guardian Heavy Duty (HD) line of Allison transmissions is a specialty line designed around the stress and rigors demanded with heavy duty towing, hauling and work applications.

Every aspect of the Guardian HD transmission line is strategically engineered and designed around functionality, reliability, and strength in the light, medium and heavy duty towing applications. This Guardian HD series of transmissions is built to perform in tough conditions, day in and day out, and is designed for use in heavy duty industrial, or commercial operations.

Some of the key features of this new Allison Guardian line of heavy duty transmissions are our SunCoast Triple-Disc Billet Torque Converter, custom clutch packs, steels, and billet plates. They also include our SunCoast custom overhaul kit, valve body calibration kit, gasket kit, pan filter, spin-on filter, pan gasket, filter loc and a new internal wiring harness.

When what you're carrying matters, you can trust the Guardian HD to be there every mile along the way.

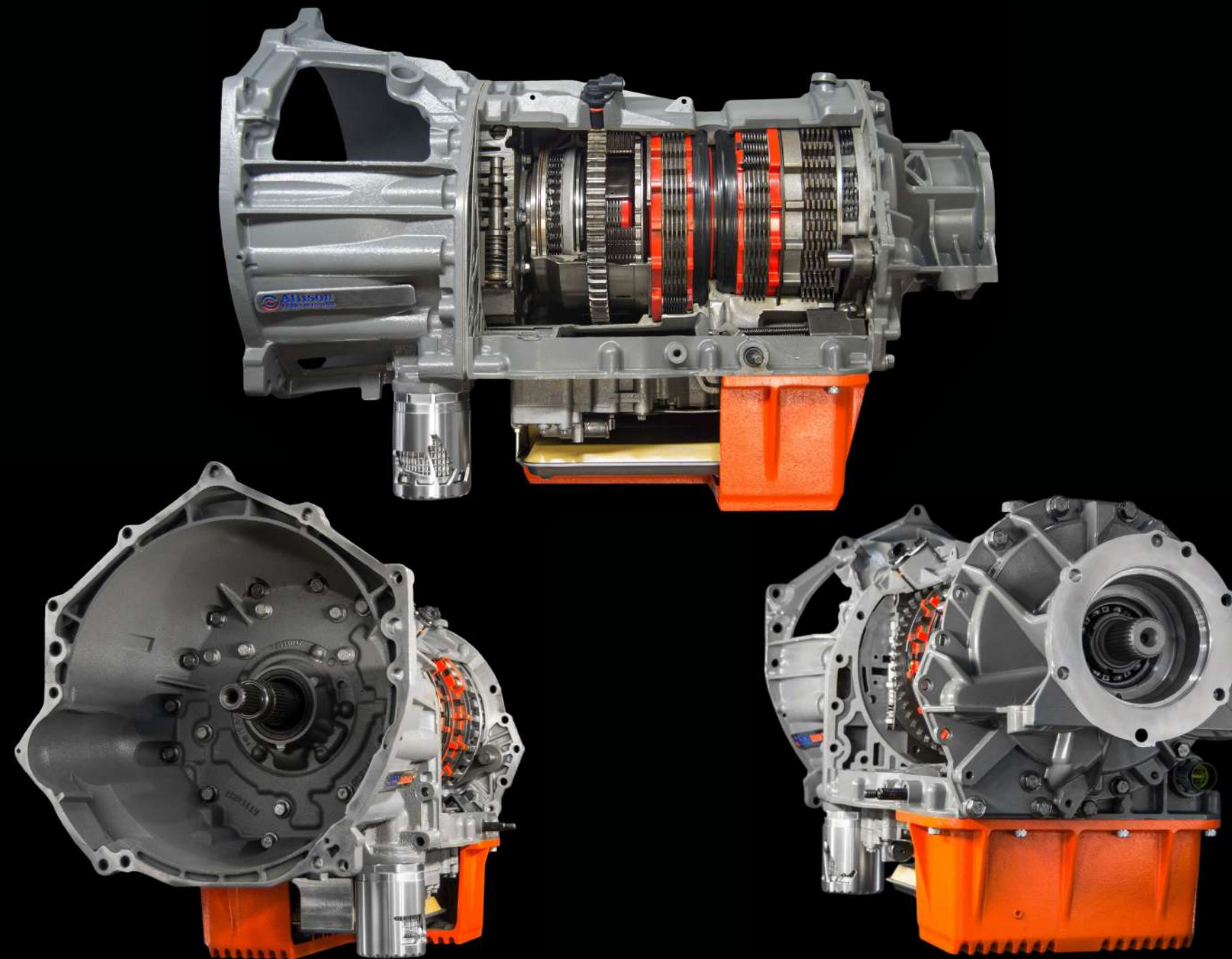

SUNCOAST ALLISON CATEGORY TRANSMISSIONS W/ CONVERTER

AVAILABLE FOR LB7/LLY, LBZ/LMM, AND LML.

TRANSMISSIONS INCLUDES THE FOLLOWING:

- SunCoast Custom Clutch Packs
- SunCoast Custom Steels
- SunCoast Custom Billet Plates
- SunCoast Custom Overhaul Kit
- SunCoast Custom Re-calibrated Valve Bodies
- SunCoast Gasket Kit
- Pan Filter
- Spin-on filter
- Pan Gasket
- SunCoast Filter Loc
- New Internal Wiring Harness
- All New OE Solenoids
- SunCoast Triple Disc Billet Category 1 Converter

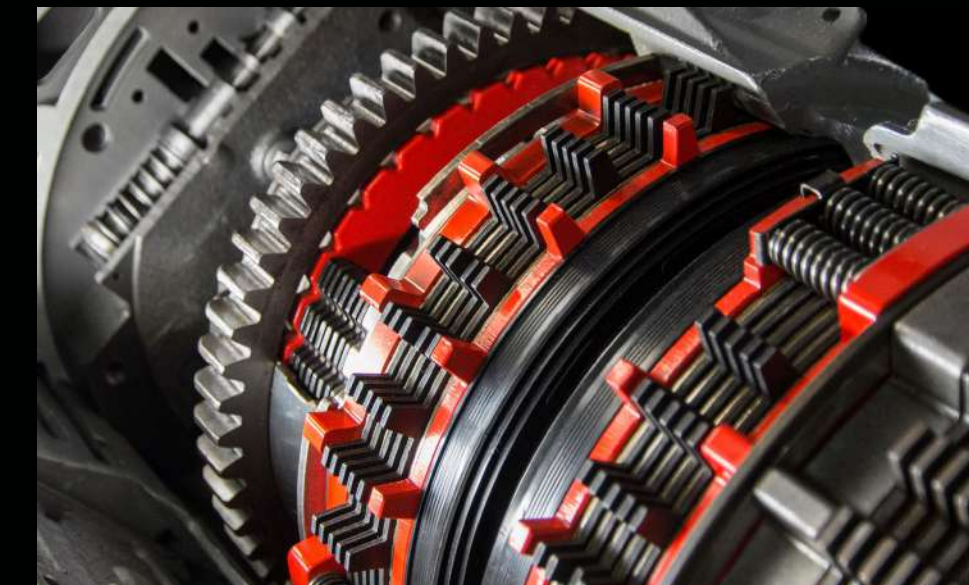

CATEGORY 1

SKU#: *GMAX-CAT1-LB7/LLY-4X*
GMAX-CAT1-LBZ/LMM-4X
GMAX-CAT1-LML-4X

BASE KIT.
INCLUDES EVERYTHING LISTED ABOVE.

CATEGORY 2

SKU#: *GMAX-CAT2-LB7/LLY-4X*
GMAX-CAT2-LBZ/LMM-4X
GMAX-CAT2-LML-4X

INCLUDES EVERYTHING FROM CATEGORY 1, IN ADDITION TO THE FOLLOWING:

- Billet SFI-Certified Flexplate
- Billet Input Shaft

CATEGORY 3

SKU#: *GMAX-CAT3-LB7/LLY-4X*
GMAX-CAT3-LBZ/LMM-4X
GMAX-CAT3-LML-4X

INCLUDES EVERYTHING FROM CATEGORY 2, IN ADDITION TO THE FOLLOWING:

- Billet P2 Planet
- Billet C2 Clutch Hub

CATEGORY 4

SKU#: *GMAX-CAT4-LB7/LLY-4X*
GMAX-CAT4-LBZ/LMM-4X
GMAX-CAT4-LML-4X

INCLUDES EVERYTHING FROM CATEGORY 3, IN ADDITION TO THE FOLLOWING:

- Billet Intermediate Shaft
- Billet Output Shaft



GM REBUILD KITS

ALLISON 1000: LB7 | LLY | LBZ | LMM | LML

SunCoast's Allison series rebuild kits cover all years from 2001-2017 (kit part number dependent upon year). These kits utilize the latest proven friction materials and steel technology from industry-leading companies such as Alto®, Exedy®, and Raybestos®. SunCoast works directly with these companies to design and manufacture proprietary exclusive SunCoast product lines, giving the end user uncompromised quality throughout the entire transmission. SunCoast has designed these kits in-house to exact specifications for many intents, including but not limited to, towing, sled pulling, racing or having a vehicle to get from point A to point B. Along with these kits, SunCoast has a full line of billet single and triple-disc torque converters ranging from 1800 stall to approximately 3000

RPM, 300M billet shaft options, custom valve body options ranging from 5-6 speed conversions and trans brake, SFI-approved billet steel, SFI-approved transmission jackets, & much more.

KIT EXCLUSIVES

- SunCoast-Proprietary C1, C2, C3, C4 ALTO® Carbonite Frictions & RAYBESTOS® GPZ Frictions, which contain no center slots. These frictions utilize a waffle pattern in the material to help retain oil, helping the clutch cool when not applied.
- Redesigned apply pistons with improved rubber compounds proven to hold more heat. This custom piston allows us to use a thicker spring apply plate, which replaces the thin OEM one and, in turn, causes an uneven apply surface.
- Custom apply plate that redirects fluid to better lubricate frictions from the inside out, which lubes the entire friction rather than the OEM style that lubricates from the center out, leaving the inner half of the clutch burnt.

*C5 clutches are not included but can be added to our kit upon request.



SUNCOAST ALLISON CATEGORY REBUILD KITS (5 OR 6-SPEED)

AVAILABLE FOR LB7/LLY, LBZ/LMM, AND LML.

KITS CONTAINS THE FOLLOWING:

- SunCoast Custom Clutch Packs
- SunCoast Custom Steels
- SunCoast Custom Billet Plates
- SunCoast Custom Overhaul Kit
- SunCoast Gasket Kit
- Pan Filter
- Spin-on filter
- Pan Gasket

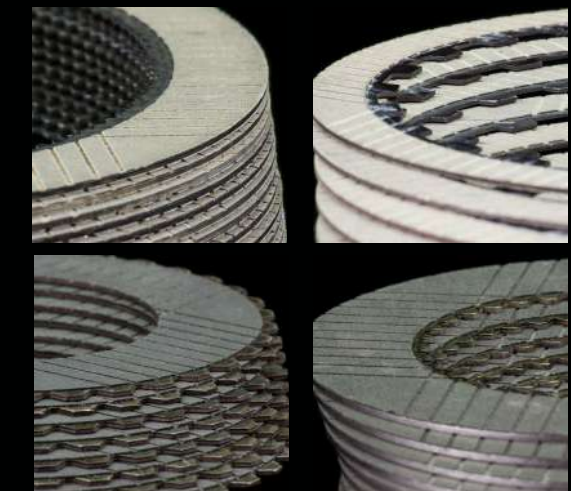

CATEGORY 0

SKU#: GMAX-CAT0-LB7/LLY-4X
GMAX-CAT0-LBZ/LMM-4X
GMAX-CAT0-LML-4X

BASE KIT.
INCLUDES EVERYTHING LISTED ABOVE.

CATEGORY 1

SKU#: GMAX-CAT1-LB7/LLY-4X
GMAX-CAT1-LBZ/LMM-4X
GMAX-CAT1-LML-4X

INCLUDES EVERYTHING FROM CATEGORY 0, IN ADDITION TO THE FOLLOWING:
- SunCoast Filter Loc
- New Internal Wiring Harness
- SunCoast Triple Disc Billet Cat 1 Converter

CATEGORY 2

SKU#: GMAX-CAT2-LB7/LLY-4X
GMAX-CAT2-LBZ/LMM-4X
GMAX-CAT2-LML-4X

INCLUDES EVERYTHING FROM CATEGORY 1, IN ADDITION TO THE FOLLOWING:
- Billet SFI-Certified Flexplate
- Billet Input Shaft

CATEGORY 3

SKU#: GMAX-CAT3-LB7/LLY-4X
GMAX-CAT3-LBZ/LMM-4X
GMAX-CAT3-LML-4X

INCLUDES EVERYTHING FROM CATEGORY 2, IN ADDITION TO THE FOLLOWING:
- Billet P2 Planet
- Billet C2 Clutch Hub

CATEGORY 4

SKU#: GMAX-CAT4-LB7/LLY-4X
GMAX-CAT4-LBZ/LMM-4X
GMAX-CAT4-LML-4X

INCLUDES EVERYTHING FROM CATEGORY 3, IN ADDITION TO THE FOLLOWING:
- Billet Intermediate Shaft
- Billet Output Shaft

GM TRIPLE-CLUTCH CONVERTERS

ALLISON 1000: LB7 | LLY | LBZ | LMM | LML

SunCoast Allison 1000 torque converters come in many varieties, from heavy hauling, sled pulling, drag racing, to daily driving. SunCoast designs and manufactures their torque converters in-house. Because of this, SunCoast can supply most any request in regards to stall or torque multiplication. All SunCoast triple disc converters are outfitted with a heavy-duty forged billet steel cover and give an unbeatable lock-up performance. The company's race series converter should be used in racing/pulling applications that require a higher "stall" RPM than a standard converter. Increased stall is usually needed in applications where a larger turbo or turbos have been installed and more RPM is required to get the turbo on boost while on the brakes (brake boosting). These HD converters feature a billet stator and will resist damage to the stator section from excessive brake stalling (over 5 seconds).

FEATURES:

- Custom pump and turbine modifications (in-house)
- Tig welding to reinforce furnace brazed fins
- Proprietary converter clutches with trapezoid clutch teeth (no round tabs)
- CNC-machined billet stators (1800-3000 RPM stall)
- 4140 turbine splines (heat treated depending on application)
- Billet steel and aluminum pistons
- Forged billet cover strength (proprietary Raybestos converter clutch plates)
- Pressure rested welds/spun balanced on Stewart Warner Pro-Bal to Ensure highest quality
- 3-year unlimited mileage warranty

PART NUMBER.....	DESCRIPTION
GM-10531-3D	TRIPLE DISC HIGH STALL
GM-1053-3D	ALLISON 3D 2600 STALL
GM-1054-3D	1900 STALL - VARIABLE- MEDIUM TURBO
GM-1055-3D	2500 STALL BIG TURBOS CONVERTER
GM-1056-3D	2000 STALL - TOW/DAILY DRIVER
GM-1057-3D	1800 LOW STALL VELOCITY CONVERTER
GM-1058-3D	2000-2300 STALL - DAILY DRIVER/RACE



ALLISON 70 SERIES TORQUE CONVERTERS

SKU#: GM-1071-3D / GM-1072-3D / GM-1073-3D / GM-1074-3D

FEATURES AND BENEFITS:

- 3-year, Unlimited Mileage Warranty
- Custom Pump and Turbine Modifications (in-house)
- Tig Welding to Reinforce Furnace-brazed Fins
- Proprietary Converter Clutches with Trapezoid Clutch Teeth (no round tabs)
- Forged Billet Cover Strength (Proprietary Raybestos Converter Clutch Plates)

THE 70 SERIES CONVERTERS

The 70 Series of torque converters are some of the most prolific converters ever manufactured under our roof for the Allison transmission. These converters drive a feel almost stock at part throttle, but once you start leaning on the throttle heavily, watch out! The 70 Series of converters is a dual-purpose converter that can be used for towing moderate loads and also works great with street/strip use. The perfect candidate for this torque converter would be a completely stock truck to a heavily modified one that is looking for that magical "best of both worlds."

GM-1071-3D	3,000 RPM STALL SPEED
GM-1072-3D	3,200 RPM STALL SPEED
GM-1073-3D	2,600 RPM STALL SPEED
GM-1074-3D	2,200/2,300 RPM STALL SPEED
GM-107X-3D	1,800 RPM STALL SPEED



ALLISON TRIPLE-DISC BILLET CATEGORY 1 TORQUE CONVERTER

SKU#: SC-23618C1-20

FEATURES AND BENEFITS:

- 3-YEAR, UNLIMITED-MILEAGE WARRANTY
- Billet Lockup Apply Piston
- CNC-Machined Billet Steel Cover
- Balloon Plate
- 4140 Turbine Splines
- 4140 Hardened Hub
- 3 Carbon-Graphitic Clutch Discs
- Furnaced-Brazed Fins
- Torrington Thrust Bearing Stator Design
- Pressurized "Hot Soak" Leak Testing
- Computer-Balanced to Within .01 Gram
- Precisioned-Assembled by Caring American Workers

THE CATEGORY 1

This Category 1 SunCoast Torque Converter fits all Allison transmissions and is engineered to handle all of your everyday duties. Whether you're towing a camper or hauling dirt to a job site, this torque converter is designed to improved vehicle response and give you years of solid, reliable performance. It comes with furnace-brazed fins and hardened turbine splines. The clutches in



this converter are carbon-graphitic for precise and accurate lock-up. If you're looking to increase the performance of the factory unit—and looking for a cost-effective solution—this is the converter for you. This converter, while great for heavy duty towing and hauling, is it not intended for racing.

GM ALLISON FLEXPLATES

SKU#: A1-BFP-ZB / A1-BFP-AZB / A1-BFP-1 / A1-BFP-2 / A1-BFP-3

This replaces the factory flywheel/flexplate with a improved billet steel one-piece design and eliminates the heavy cast iron and the weak stamped steel flexplate. This is a must with the high torque in conjunction with a better designed torque converter that can transfer the torque with no slip. The flexplate is bolted to the crankshaft and then the converter is bolted to flexplate. The torque from the motor is transferred to the flexplate, then goes from the flexplate to the torque converter and finally to the input shaft in the transmission. With increased torque from the engine, it can crack and/or rip the center out of a stock flexplate.

NOTE: An SFI-certified flywheel flexplate is required on drag racing vehicles running 11.99 and quicker in the 1/4 mile and 7.49 and quicker in the 1/8 mile, or any vehicle exceeding 135 mph. It was changed in 2008 from the 29.1 SFI specification to the SFI specification 29.3 for automatic transmission flexplates for diesel applications. The new rules for the flexplate requires that the material cannot be a stamped metal as are many OEM and after market flexplates. To maintain the SFI specification 29.3 requirements, the flexplate must be replaced every three years.

SUNCOAST OFFERS THE FOLLOWING FLEXPLATE OPTIONS:

ZERO-BALANCE FLEXPLATE	ALUM ZERO-BALANCE FLEXPLATE	LB7/LLY FLEXPLATE	LBZ/LMM FLEXPLATE	LML FLEXPLATE	L5P FLEXPLATE
SKU#: A1-BFP-ZB	SKU#: A1-BFP-AZB	SKU#: A1-BFP-1	SKU#: A1-BFP-2	SKU#: A1-BFP-3	SKU#: A1-BFP-4
					

PRESSURE REGULATOR SPRING



SKU#: *A01-PR*

Allison Pressure Regulator Spring Kit fits the 2001-2010 Allison 1000 series, Duramax Diesel Chevrolet, GMC Diesel/Gas Trucks Heavy Duty, Street, Show & Competition.

FEATURES:

Allison Transmission line pressure upgrade spring. This is a great upgrade when building your Allison transmission. Especially with over 800HP.

ALLISON LB7/LLY T-CASE BRACKET



SKU#: *A1-TCB*

Due to the cantilever effect of the rear trans mount, the transmission rear adapter housing is prone to cracking. The slightest amount of rear drive shaft vibration can result in a very expensive transmission repair. Help your transmission with this easily installed brace. Installs in less than 30 minutes with no special modifications or tools required.

ALLISON 1000 MAG-HYTEC PAN

SKU#: *68-SCP*



The Mag-Hytec pan is constructed of high-quality aircraft aluminum and has a powder-coated finish. The bolts are zinc-plated allen head screws, and the washers are stainless steel. These components require no maintenance.

ALLISON 01-04 L/U BOOST VALVE



SKU#: *68-SCP*

These TransGo automatic transmission fluid control valves are designed to reduce main line pressure to the torque converter clutch. The lower pressure will allow your transmission to operate more efficiently under no-load conditions.

ALLISON 01-04 L/U BOOST VALVE



SKU#: *618-ICH*

These TransGo automatic transmission fluid control valves are designed to reduce main line pressure to the torque converter clutch. The lower pressure will allow your transmission to operate more efficiently under no-load conditions.

ALLISON 01-05 SHIFT KIT



SKU#: *ALLISON-SK*

This Allison Valve Body kit is designed for 2001-2005 LB7 and LLY Chevrolet/GMC 1000, 2000, 2400 Heavy Duty, Work, Tow, or Race diesel trucks. This kit corrects, prevents and reduces the Allison transmission from going into neutral under a load, 3rd to 4th gear slips, C2 or C3 clutch burning, sticking in one gear, and so forth. This kit allows customers to experience short, crisp, and smooth up shifts and downshift. Kit includes all instructions for a trouble-free installation.



ALLISON 06-UP SHIFT KIT

SKU#: *SK-ALLISON-JR*

This Allison Valve Body kit is designed for Chevrolet/GMC 1000, 2000, 2400 Heavy Duty, Work, Tow, or Race diesel trucks. This kit corrects, prevents and reduces the Allison transmission from going into neutral under a load, 3rd to 4th gear slips, C2 or C3 clutch burning, sticking in one gear, and so forth. This kit allows customers to experience short, crisp, and smooth up shifts and downshift. Kit includes all instructions for a trouble-free installation.

ALLISON BILLET INPUT SHAFT

SKU#: A1-109600



Built to withstand everything thrown at it. Made from a select grade of super strength steel.

FEATURES:

- Shaft is 50% stronger than the O.E.M. shaft.
- Made from 9310 Vacumelt steel.
- Precision-ground for high dimensional accuracy.
- Ideal for heavy duty service applications. Input shaft is machined with larger than O.E.M. radius at turbine spline for added strength

ALLISON INTERMEDIATE SHAFT

SKU#: A1-109700

This Shaft is machined from 300M billet steel.

FEATURES:

- Stronger than the O.E.M. intermediate shaft
- Features an added lubrication hole for the P-3 sun gear and pilot
- CNC-machined and precision-ground
- Shaft is heat-treated for added strength and durability
- The shaft through-hole is gun-drilled to provide a polished interior finish, eliminating internal stress risers

ALLISON BILLET OUTPUT SHAFT

SKU#: A1-109100

FEATURES:

- Made from 300M Billet steel.
- Ideal for heavy duty service applications.
- Precision-ground for high dimensional accuracy.
- Ideal for those who challenge their vehicles at work or at play.

ALLISON 2011-UP BILLET OUTPUT SHAFT

SKU#: A1-109102



FEATURES:

- Made from 300M Billet steel.
- Ideal for heavy duty service applications.
- Precision-ground for high dimensional accuracy.
- Ideal for those who challenge their vehicles at work or at play.

BILLET P2 PLANET W/O SUNGEAR

SKU#: A1-P2K / A1-P2K-6



FEATURES:

- Available in 5-speed (A1-P2K) or 6-speed (A1-P2K-6)
- 4140 Billet Steel
- Induction Heat-treated
- This does not include a C2 clutch hub

P2 heat-treated Planetary fix kit contains (1) Machined P2 Planetary. The stock Allison 1000 P2 Planetary can strip or snap as a result of poor tuning, shock load, improperly built transmissions or higher horsepower applications and can cause catastrophic failure and/or immobility. The SunCoast P2 Planetary fix is the solution to this issue. This item is highly recommended for higher horsepower applications, including sled pulling, drag racing, as well as heavy duty towing (to accept billet P2 hub, machine work required on the P1 sun gear).

ALLISON BILLET C2 HUB

SKU#: A1-BC2



Made from 4140 HTSR material.

FEATURES:

- 18% increase of the spline contact area.
- 30% increase in wall thickness of the spline boss.
- No weight penalty for strength. The TCS hub is only 2.8oz heavier than stock.
- Comes with a modified thrust washer.

This billet C2 hub addresses the early failure of the C-2 clutch hub in high torque/horsepower applications. P1 sun gear requires machining in order to fit.

SUNCOAST FULL-SYNTHETIC TRANSMISSION FLUID

SKU#: *SC-TYPE-D-ATF*

FEATURES AND BENEFITS INCLUDE:

- Outstanding low temperature performance and sheer resistance
- Dramatic improvements in thermal stability during endurance environments
- Optimized frictional properties that can provide smoother shifting during low temperature operation, reducing shudder and vibration
- Outstanding resistance against sludge and deposit formation
- Improved anti-wear protection, which directly contributes to extended transmission life
- Unsurpassed low temperature stability
- Resists foaming and thereby promotes outstanding operability

Throughout the years, SunCoast has put enormous effort into the research and development of failure prevention in some of the most extreme environments that exist today. These environments are not limited to hot shot driving, sled pulling, drag racing, and the Texas Mile.

For our own success and growth, it has been imperative that oil analysis be our measuring stick for improvements. We can use this to determine the amount of degradation that transpires during a drive cycle. This is key when we are determining what friction coefficients work best in a particular application. This process has evolved with both the friction material and fluid types.

As technology has evolved, so has transmission fluid. Here at SunCoast, we have been on the leading edge of this development. We have seen the evolution from the original Dexron that was introduced back in



the late 60's, that utilized sperm whale oil as a friction modifier; to the early 70's when Jojoba oil was introduced, along with corrosion inhibitors, making it hygroscopic. Fast forward to today and the evolution continues.

SunCoast has known for quite some time that we have more success with certain fluids than others. There is a science to the madness, and we knew it was in our best interest to ensure we understood this. In 2006, when General Motors released Dexron VI it set a new standard within the industry. Through our independent testing, we were able

to verify that this was an improvement over anything we had seen to date. This is when SunCoast made the decision that this was an area we should definitely become more familiar with, knowing this is how we are protecting our units. Since 2006, SunCoast has spent countless hours reviewing data from oil samples that we have sent in for testing, in an attempt to figure out what works best for our environments.

Today, we are proud to present you with the fruits of our culmination of analysis and research, SunCoast Type-D Full Synthetic transmission fluid. This new full synthetic transmission fluid contains all of the prescribed combination additives that improve the lubricating qualities for your high stress transmission. The specialized additives include anti-wear, rust and corrosion inhibitors, detergents, dispersants, and

surfactants (which protect and clean metal surfaces). In addition, we have also added very specific viscosity modifiers, seal and swell additives, and anti-foam additives. This fluid has yielded us the best test results to date and offers uncompromised performance. We are also proud of the fact that this fluid is full synthetic, not a blended fluid as so many others have attempted to pass off. The SunCoast Type-D Full Synthetic transmission fluid also has a slightly lower viscosity at lower temperatures than the competitors' fluid, decreasing parasitic drag during normal driving conditions. This, of course, requires the use of higher-quality, more sheer stable base oil compounds when manufacturing. Rest assured, with this new full synthetic fluid you are getting the absolute best protection on the market today.



Check out the collection of performance transmission parts we offer.