

SEE & BE SEEN®

The logo features a red circle on the left side, partially overlapping the letter 'T'. The text 'Truck-Lite' is written in a bold, white, sans-serif font. A registered trademark symbol (®) is located at the top right of the word 'Lite'.

FULL-LINE  
2016  
CATALOG

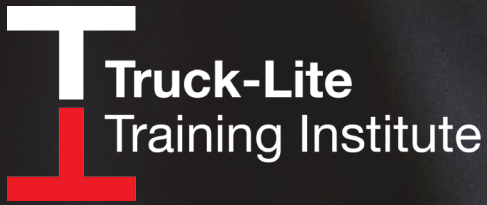

# GET WITH THE PROGRAM.

Become a Master Lighting  
& Harness Technician today.



# New Products



**LED 4"x6" Headlights 131**



**7" Heated LED Headlights 129**



**LED Snow Plow Lights, Heated 124**



**LED Economy Work Lights 117**



**LED Integral Flange S/T/T 9,16**



**LED 10 Diode S/T/T 10, 18**



**LED 10 Diode S/T/T Light 14**



**LED Integral Flange F/P/T 40, 41**



**LED 10 Diode F/P/T 40, 41**

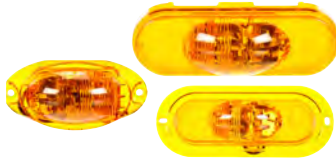

**LED 60° S/T, Signal & Marker 39**



**LED Super 44° Rear Turn 32**

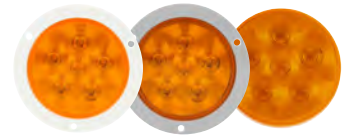

**LED Super 44° F/P/T 33**



**LED Int Flange 2"-2.5" M/C 60, 64**



**LED 1 Diode 2"-2.5" M/C 60, 64**



**LED 33° Dual Function Marker 87**



**LED 36° License Lamp 93**



**LED Int Flange Back-Up 97, 100**

## Symbols that appear in this catalog

We invite you to take a moment to read about the meaning of each symbol to help guide you in making the right purchase decision.

INT

### Product Sections

This catalog is divided into sections by product category as outlined in the table of contents found on the following two pages. Each section is easily identified by a colored bar on the top of each page.



### Upgrade to LED

Products with this symbol indicate it is an incandescent product that has a LED model available. The LED retrofit will be a quick and easy change.



### Limited Warranty

Truck-Lite extends a limited warranty on a variety of products throughout the catalog. Warranties are identified within the product element. Complete warranty information is explained in detail on pages 269-271.



### OmniVolt Products

Lighting products with this symbol will operate equally in electrical systems that range from 10 to 30 volts.

NEW!

### New Products

Truck-Lite adds new products and accessories continuously that are readily identified by the "NEW" product symbol either in the page heading, in the product group or by the part number. New part numbers are listed in blue.



### Rubbolite Products

Rubbolite products are identified throughout the catalog with the logo in the product group.



### Signal-Stat Products

Signal-Stat products are identified throughout the catalog with the logo in the product group.



### Diamond Shell® Products

Products marked with the Diamond Shell® logo are manufactured using a material that protects against damage from chemicals and solvents such as gasoline, motor oil, antifreeze, washer fluid, HD detergent and others. Diamond Shell products are identified in the part description.



**Universal Lighting 4-29**

Front & Rear Lighting	6-21
Box Lamps	22-24
Trailer Kits	24-25
Modules	26-29

**Signal Lighting 30-53**

Turn Signal Lamps	32-43
Pedestal Lamps	44-50
Long Life Vehicle Lamps (LLV)	51
High Mounted Stop Lamps (HMSL)	52-53

**Marker & Clearance Lighting 54-89**

Marker & Clearance Lamps	56-80
Cab Markers	81-85
Identification Bars	86-89

**License, Back-up & Interior Lighting 90-111**

License Lighting	92-95
Back-up Lighting	96-101
Dome & Utility Lighting	102-111

**Forward & Specialty Lighting 112-139**

Spot, Work & Flood Lamps	114-122
Auxiliary	123
Snow Plow Lamps	124-128
Headlamps, Fog & Driving Lamps	129-134
Bus lamps	135-139

**Warning & Emergency Lighting 140-163**

LED, Strobe & Beacons	142-147
Light Bars	148-150
LED Remote Strobe Systems	151-157
Traffic Control	158-161
Accessories	162-163

**Mirror & Reflector Systems 164-189**

Mirror Systems	166-182
Reflective Tape	183-185
Reflectors	186-188

**Electronics 190-205**

Flashers	192-198
Daytime Running Lamp Systems	199
Turn Signal Switches	200-202
Horns	203
Back-up Alarms	203-205

**Harness Systems & Accessories 206-239**

Sockets & Plugs	208-218
88 Series "Plug Together" Harnesses	219-228
50 Series "Super System" Harnesses	229-233
Junction Boxes, Receptacles & Accessories	234-239
Trailer Cords	239

**Accessories 240-273**

Accessories	242-246
Mounting Accessories	247-264
Lenses	265-272

**Merchandising & Traffic Builders 274-281**

Point of Purchase Displays	276-279
Showroom Displays	280-281

**Technical Information & Reference 282-344**

Federal Lighting Regulations	286-296
Tips & Technical Guides	297-299
Warranty & Procedures	299-302
LED Technology Education	304-307
Product Interchange	308-318
Numerical Index	320-341

# Universal Lighting



# Universal Lighting

**Front & Rear Lighting**

**6-21**



**Box Lamps**

**22-24**

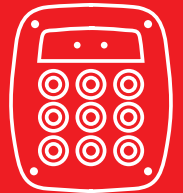

**Trailer Kits**

**24-25**

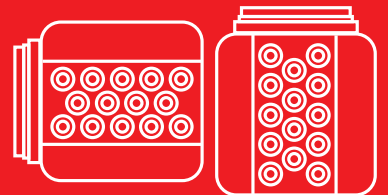

**Modules**

**26-29**

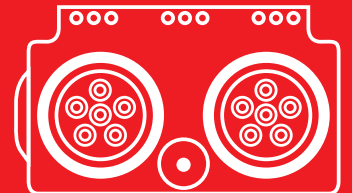



See Page 2



6 Diode Pattern

42 Diode Pattern

17 Diode Pattern

- U.S. Patent #6654172 & U.S. Registered TM #3483147
- Less current draw, resulting in increased battery & alternator life while allowing more power for other vehicle requirements
- Faster illumination offers significant safety benefit for following drivers to react quicker, resulting in an average distance of 3' for every 10 mph
- LEDs have no filament, therefore are extremely resistant to shock & vibration
- Flange mounts are permanently affixed to lamp

## LED Super 44® Stop/Turn/Tail 6, 17, & 42 Diode Pattern

### Material:

- Polycarbonate or acrylic lens (diamond shell), housing & flange
- PVC grommet
- 16 gauge wire

### Light Source:

- LED
- 6 diode designed at 14 V, .03/.3 A
- 42 diode designed at 14 V, .1/.5 A
- 17 diode designed at 28 V, .25/.5 A

### Recommended Accessories:

- Mounting: Pages 259-261
- Plugs: Pages 213-215

### FMVSS:

- I6, P2,S2, (3)T



### Grommet Kits

- 44030R Red, 6 diode
- 44092R Red, 6 diode, diamond shell
- 44002R Red, 42 diode

Kits include lamp, 40700 grommet & 94706 adapter



### LED Lamp Only

- 44302R Red, 6 diode
- 44982R Red, 6 diode, diamond shell
- 44202R Red, 42 diode
- 44882R Red, 42 diode, diamond shell
- 44253R Red, 17 diode, 24 volt



### Gray Flange Kits

- 44032R Red, 6 diode
- 44022R Red, 42 diode

Kits include lamp w/flange & 94706 adapter

### Black Flange Kits

- 44036R Red, 6 diode
- 44026R Red, 42 diode

Kits include lamp w/flange & 94706 adapter

### White Flange Kits

- 44038R Red, 6 diode

Kits include lamp w/flange & 94706 adapter

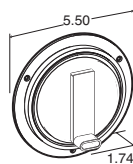

### Lamp & Gray Flange

- 44322R Red, 6 diode
- 44983R Red, 6 diode, diamond shell
- 44222R Red, 42 diode
- 44883R Red, 42 diode, diamond shell

### Lamp & Black Flange

- 44326R Red, 6 diode
- 44986R Red, 6 diode, diamond shell
- 44226R Red, 42 diode
- 44266R Red, 17 diode, 24 volt

### Lamp & White Flange

- 44328R Red, 6 diode
- 44988R Red, 6 diode, diamond shell



**LED Super 44®**  
**Stop, Turn & Tail**  
**6 Diode Pattern**  
**Hardwired**



**Material:**

- Polycarbonate lens, housing & flange
- 16 gauge wire

**Light Source:**

- LED
- Designed at 14 V, .03/.3 A

**Recommended Accessories:**

- Mounting: Pages 259-261

**FMVSS:**

- I6, P2,S2, (3)T

- U.S. Patent #6654172 & U.S. Registered TM #3483147
- Hardwired design results in decreased depth compared to integral plug versions, allowing for mounting in confined spaces
- LEDs have no filament, therefore are extremely resistant to shock & vibration, a major cause of failure for lamps with incandescent bulbs
- Less current draw, resulting in increased battery & alternator life while allowing more power for other vehicle requirements
- Faster illumination offers significant safety benefit for following drivers to react quicker, resulting in an average distance of 3' for every 10 m.p.h.

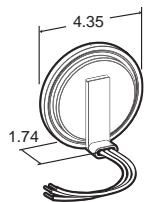

**Hardwired w/Blunt Cut, Lamp Only**  
**44350R Red**

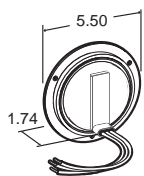

**Gray Flange Mount**  
**44362R Red**

**White Flange Mount**  
**44356R Red**

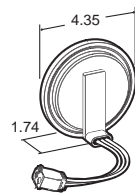

**Hardwired w/PL-3 Adapter, Lamp Only**  
**44351R Red**  
**44960R Red, diamond shell**



**Gray Flange Mount**  
**44363R Red**

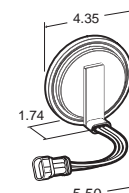

**Hardwired w/Mate for Fit 'N Forget®, Lamp Only**  
**44353R Red**  
**44972R Red, diamond shell**

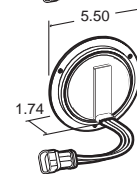

**Gray Flange Mount**  
**44365R Red**

**White Flange Mount**  
**44359R Red**

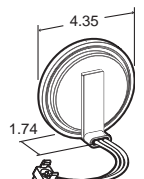

**Hardwired w/Male Pin Adapter Lamp Only**  
**44355R Red**

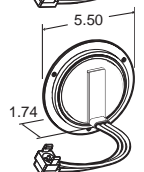

**Gray Flange Mount**  
**44367R Red**

**White Flange Mount**  
**44980R Red**

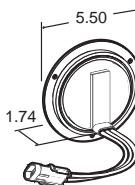

**Gray Flange Mount**  
**44957R Red, diamond shell**

**White Flange Mount**  
**44360R Red**



### 44® Series Security Grommet For Flanged Lamps

#### Material:

- PVC grommet

Recommended hole sizes for grommet installation:

Plate Thickness	Hole Size
1/16"	4.47"
1/8"	4.50"
3/16"	4.50"
1/4"	4.53"
3/8"	4.56"

- Eliminates ability to remove lamp from outside of vehicle
- Access to back of mounting application required to remove lamp
- With "Pull-Through" design, flanged lamp is partially installed from behind & mounting lip is pulled through on front of mounting application
- PVC construction allows lamp to fall back into mounting box upon great impact, reducing chance of damage
- Easily mounts over any Truck-Lite Super 44® series 4" flanged LED lamp

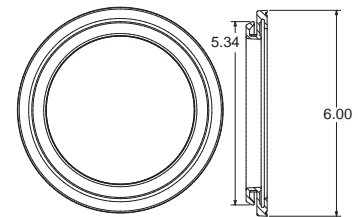

44710 Security grommet (lamp sold separately)



### 44® Series Security Flange For Non-Flanged Lamps

#### Material:

- Stainless steel ring
- EPDM mounting gasket

#### Kit Components:

##### 44034R kit:

1 - 44334R lamp & security flange

1 - 94706 adapter plug

#### Replacement Parts:

- 97334 - flange for 7 & 10 gauge applications
- 97337 - flange for 8 gauge applications

- Helps protect LED lamp from theft by locking them in place
- Snap-and-go installation greatly reduces mounting time & eliminates need for screw holes or mounting screws
- Stainless steel construction makes for a chrome-like, shiny appearance
- Fits Truck-Lite Super 44® 6 diode LED lamps

44334R Lamp & flange kit, 7, 8 & 10 gauge  
44034R Lamp, pigtail & flange kit, 7, 8 & 10 gauge

CUSTOMER PANEL THICKNESS  
7 GAUGE: .187 ± .015  
8 GAUGE: .160 ± .006  
10 GAUGE: .130 ± .006

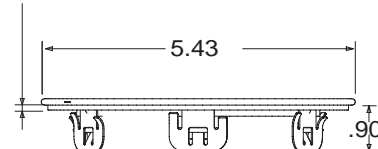

**LED Stop/Turn/Tail & Front/Park/Turn 24 Diode Pattern**



**Material:**

- Polycarbonate lens & housing

**Light Source:**

- LED
- 12 V lamp designed at 13.5 V, .030/.380 A

**Recommended Accessories:**

- Mounting: Pages 259-261
- Plugs: Pages 213-215

**FMVSS:**

- Red - I6,P2,S2, (3)T
- Yellow - I6,P2,P

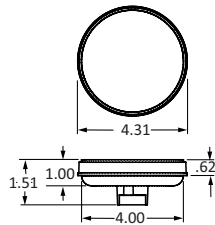

- Uses standard right Angle connection
- Unique LED array displays a full pattern light output design
- Epoxy encapsulated electronics prevents damage from moisture & corrosion

4050	Red lamp	4051	Red lamp w/clear lens
4050A	Yellow lamp	4051A	Yellow lamp w/clear lens

**LED Stop/Turn/Tail Integral Flange 24 Diode Pattern**



**Material:**

- Polycarbonate lens & housing

**Light Source:**

- LED
- 24 Diodes
- 12 V, 0.01/0.138 A

**FMVSS:**

- FMVSS P2; FMVSS S2; FMVSS I6; FMVSS T

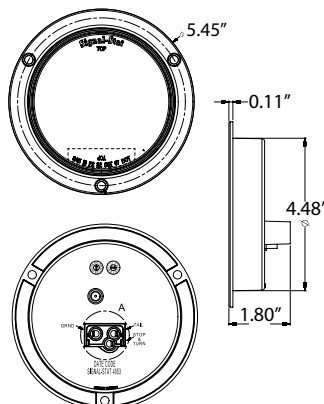

- Housing and flange are molded together to form one piece
- Uses standard right angle PL-3 connection
- Designed with impact-resistant polycarbonate material
- LEDs do not have a filament, therefore are not susceptible to shock and vibration damage major cause of failure for lamps with an incandescent bulb
- Epoxy encapsulated electronics prevents damage from moisture and corrosion
- When properly mounted, exceeds FMVSS DOT requirements for S/T/T and F/P/T
- Lamps come with Truck-Lite 2-Year Limited Warranty

4053	Integral flange, lamp, red
------	----------------------------

**NEW!**

Signal-Stat

2 YEAR WARRANTY

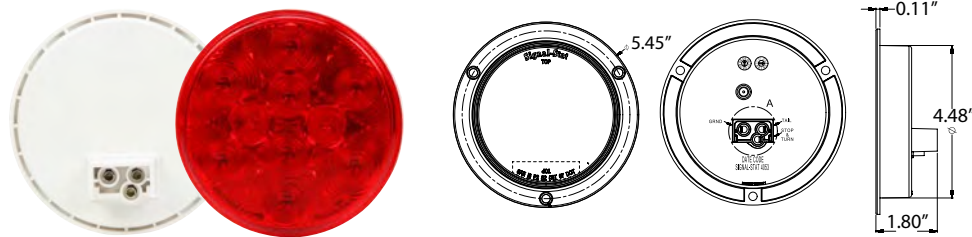
**LED Stop/Turn/Tail**  
10 Diode Pattern**Material:**

- Acrylic lens & housing

**Light Source:**

- LED
- 10 Diodes
- 12 V, 0.02/0.12 A

**FMVSS:**

- FMVSS P2; FMVSS I6;  
FMVSS S2 (3); FMVSS T

- Engineered to feature ten bright and economical light emitting diodes (LEDs)
- Uses standard PL-3 connector
- Designed with impact-resistant acrylic material
- Sealed lens and housing locks moisture out
- Epoxy encapsulated electronics prevents damage from moisture and corrosion
- Snap fit grommet requires no screws for installation

4058 Lamp, red

Super

LIFETIME WARRANTY

DiamondShell  
See Page 2

- LEDs have no filament, therefore are not susceptible to shock & vibration, a major cause of failure for incandescent bulb lamps
- Less current draw, resulting in increased battery & alternator life while allowing more power for other vehicle requirements
- Front, Park and Turn lamps meet stringent SAE and NHTSA requirements

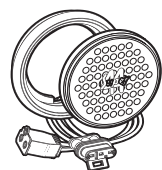

**LED Grommet Kits**  
44003Y Yellow  
44071Y Yellow, diamond shell

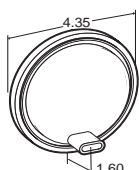

**LED Lamp**  
44203Y Yellow  
44871Y Yellow, diamond shell

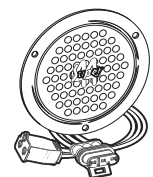

**LED Gray Flange Kits**  
44023Y Yellow  
**LED Black Flange Kits**  
44024Y Yellow

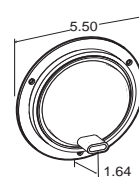

**LED Lamp & Gray Flange**  
44223Y Yellow  
44877Y Yellow, diamond shell  
**LED Lamp & Black Flange**  
44224Y Yellow  
44878Y Yellow, diamond shell  
**LED Lamp & White Flange**  
44233Y Yellow

**LED Super 44®**  
Front, Park & Turn  
60 Diode Pattern**Material:**

- Polycarbonate or acrylic lens, housing & flange
- PVC grommet
- 16 gauge wire

**Light Source:**

- LED
- Designed at 14 V, .1/.75 A

**Kit Components:****44024Y black flange:**

- 1 - 44224Y lamp & flange
- 1 - 94706 adapter plug

**44023Y gray flange:**

- 1 - 44223Y lamp & flange
- 1 - 94706 adapter plug

**44003Y & 44071Y grommet:**

- 1 - 44203Y or 44871Y lamp
- 1 - 40700 grommet
- 1 - 94706 adapter plug

**Recommended Accessories:**

- Mounting: Pages 253-255
- Plugs: Pages 207-209

**FMVSS:**

- I6,P



**Super 40®  
Stop/Turn/Tail &  
Front/Park/Turn  
4" Sealed**



**Material:**

- Polycarbonate or acrylic lens & housing
- ABS flange
- PVC grommet
- 16 gauge wire

**Light Source:**

- Heavy duty bulb
- Designed at 13.5 V, 2.16/.47 A, 32/2 cp

**Recommended Accessories:**

- Mounting: Pages 259-261
- Plugs: Pages 213-215

**FMVSS:**

- Non-reflectorized
- Red - I6P2,S2,T
- Yellow - I6,P2,P,O,T,C,W

- Uniquely designed shock-mount extends lamp life
- Diamond Shell versions available for additional protection
- Available with or without reflectorized lens

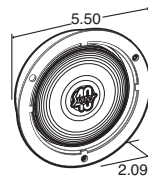

- Lamp & Gray Flange**  
40258R Red  
40258Y Yellow  
**Lamp & Black Flange**  
40259R Red

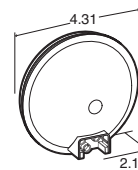

- Super 40 Lamps**  
40242R Red  
40248R Red reflectorized\*  
40242Y Yellow

\*8 Sq. in. (illuminating) stop/turn lens area for vehicles under 80 in. wide. Meets reflex, tail or clearance function for vehicles over 80 in. wide.

**40® Series Stop/Turn/Tail  
& Front/Park/Turn  
4" Sealed**



**Material:**

- Polycarbonate lens & housing
- ABS flange
- PVC grommet
- 16 gauge wire
- Light Source:
- Heavy duty dual filament bulb
- 12 V designed at 12.8 V, 2.1/.48 A, 32/2 cp,  
24 V designed at 28 V, .93/.34 A, 32/6 cp

**Kit Components:**

**40002R/Y grommet kits:**

- 1 - 40202R/Y 12v lamp
- 1 - 40700 grommet
- 1 - 94993 right angle PL3

**40009R/Y grommet kits:**

- 1 - 40209R/Y 24v lamp
- 1 - 40700 grommet
- 1 - 94993 right angle PL3

**40015R grommet kit:**

- 1 - 40215R lamp
- 1 - 40700 grommet
- 1 - 94993 right angle PL3

- Heavy duty bulb last longer
- Uniquely designed shock-mount extends lamp life
- Available with or without reflectorized lens
- Flush mount grommets are designed for mounting in a 4-1/2" hole



- Grommet Kits:**  
40002R Red  
40002Y Yellow  
40009R Red, 24v  
40009Y Yellow, 24v  
40015R Red, reflectorized\*

\*8 Sq. in. (illuminating) stop/turn lens area for vehicles under 80 in. wide. Meets reflex, tail or clearance function for vehicles over 80 in. wide.

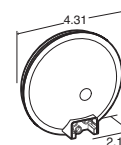

- Model 40 Lamps**  
40202R Red  
40202Y Yellow  
40209R Red, 24v  
40209Y Yellow, 24v  
40215R Red, reflectorized\*  
40232R Red, 24v, reflectorized\*

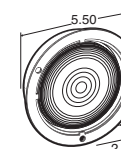

- Lamp & Black Flange**  
40233R Red  
40233Y Yellow



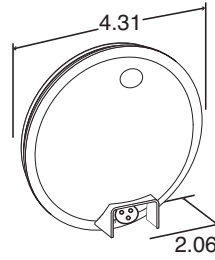

- Shock mount absorbs road shock & vibration
- Welded connections eliminate failures caused by arcing
- Replaces Grote® #53102

49002R Red, grommet kit  
49202R Red lamp

### Male Pin 40 Stop/Turn/Tail Sealed

#### Material:

- Polycarbonate lens & housing
- PVC grommet
- 16 gauge wire

#### Light Source:

- Heavy duty dual filament cartridge bulb
- Designed at 13.5 V, 2.16/.47 A, 32/2 cp

#### Kit Components:

- 49002R grommet kit:**
- 1 - 49202R lamp
  - 1 - 40700 grommet
  - 1 - 96107 plug

#### Recommended Accessories:

- Mounting: Pages 259-261

#### FMVSS:

- I6,P2,S2,T

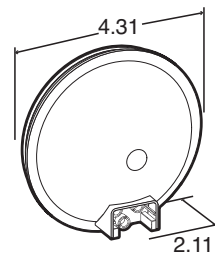

- Features clear back housing
- Not recommended for clearance marker applications
- Grommet kit features flush mounting in a 4 1/2" hole

40006R Red, grommet kit  
40206R Red lamp  
40206Y Yellow lamp

### 40® Series Stop/Turn/Tail & Front/Park/Turn Clear Back, Sealed

#### Material:

- Polycarbonate lens & housing
- PVC grommet
- 16 gauge wire

#### Light Source:

- Designed at 12.8 V, 2.1/.48 A
- Dual filament bulb rated at 32/2 cp

#### Kit Components:

- 40006R grommet kit:**
- 1 - 40206R lamp
  - 1 - 40700 grommet
  - 1 - 94993 plug

#### Recommended Accessories:

- Mounting: Pages 259-261
- Plugs: Pages 213-215

#### FMVSS:

- I6,P2,P

**40® Series**  
**Stop/Turn/Tail &**  
**Front/Park/Turn**  
**Bulb Replaceable**



**Material:**

- Polycarbonate or acrylic lens & housing
- Cam-in socket assembly
- PVC grommet

**Light Source:**

- Bulb: #1157 bulb

**Replacement Parts:**

- 99010R red lens & housing
- 99010Y yellow lens & housing
- 94938 socket assembly

**Recommended Accessories:**

- 99010B blue lens & housing
- 99010G green lens & housing

**FMVSS:**

- I6,P2,P

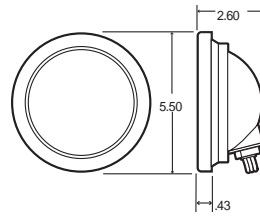

- Grommet kit includes lens, housing, socket assembly with bulb, grommet & ground screws
- Grommet features flush mounting in a 4 1/2" hole

- 40302R Red, grommet kit**
- 40302Y Yellow, grommet kit**

**40® Economy**  
**Stop/Turn/Tail & Front/**  
**Park/Turn**  
**Sealed**



**Material:**

- Polycarbonate lens & housing
- ABS flange
- PVC grommet
- 16 gauge wire

**Light Source:**

- Designed at 12.8 V, 2.1/48 A
- Dual filament bulb rated at 32/2 cp

**Kit Components:**

**40028R/40028Y grommet kit:**

- 1 - 40282R/Y lamp
- 1 - 40700 grommet
- 1 - 94993 plug

**Recommended Accessories:**

- Mounting: Pages 259-261
- Plugs: Pages 213-215

**FMVSS:**

- Non-reflectorized - I6,P2,P
- Reflectorized - I,S,T,A,P2

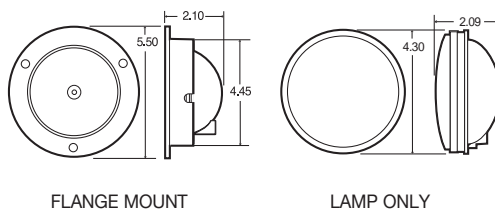

40282R

- Grommet kit features flush mounting in a 4 1/2" hole
- Flange kits feature a high impact plastic affixed to lamp

- 40028R Red, grommet kit**
- 40028Y Yellow, grommet kit**
- 40282R Red lamp**
- 40282Y Yellow lamp**
- 40285R Red lamp, reflectorized**
- 40029R Red, gray flange kit**
- 40229R Red lamp & gray flange**



- Specifically designed for use in trailer & body applications
- Mount horizontally or vertically

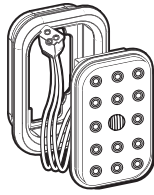

**LED Grommet Kits**  
45058R Red

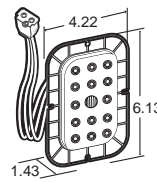

**LED Lamp & Flange**  
45259R Red

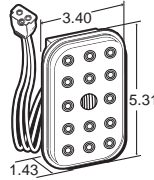

**LED Lamps**  
45258R Red

### LED 45® Series Stop/Turn/Tail 15 Diode Pattern

#### Material:

- Acrylic lens, housing & flange
- PVC grommet
- 18 gauge wire

#### Light Source:

- LED
- Lamp designed to operate from 10-30 V, 0.29 A (stop/turn), .03 A (tail)

#### Kit Components:

##### 45058R grommet kits:

- 1 – 45258R lamp
- 1 – 45700 grommet

#### Recommended Accessories:

- Mounting: Pages 259



- Uses standard right angle PL-3 connection
- 24 diode pattern
- Unique LED array displays full pattern light output

4550 Red lamp  
4550A Yellow lamp  
4560C Clear lamp, back-up

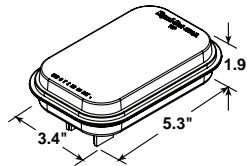

### LED Stop/Turn & Rear Turn 24 Diode Pattern

#### Material:

- Acrylic lens, housing & flange

#### Light Source:

- LED
- Designed at 13.5 V, .03/.38 A

#### Recommended Accessories:

- Mounting: Page 261
- Plugs: Pages 213-215

#### FMVSS:

- Red - I6,P2,S2,(3)T
- Yellow - I6,P2,P

### LED Stop/Turn/Tail 10 Diode Pattern

#### Material:

- Acrylic lens & Polycarbonate housing

#### Light Source:

- LED
- 10 Diodes
- 12 V, 0.03/0.28 A

#### FMVSS:

- FMVSS P2; FMVSS I6; FMVSS S2 (3); FMVSS T

NEW!



- Uses standard right angle PL-3 connection
- 10 diode pattern
- Unique LED array displays full pattern light output
- Epoxy encapsulated electronics

4558 Lamp, red

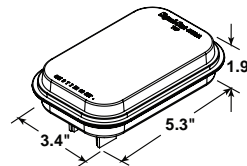

**Super 45®**  
**Stop/Turn/Tail &**  
**Front/Park/Turn**  
**Sealed**



**Material:**

- Polycarbonate lens & housing
- PVC grommet
- 16 gauge wire

**Light Source:**

- Dual filament bulb
- Designed at 13.5 V, 2.16/.47 A

**Kit Components:**

**45002R/Y grommet kits:**

- 1 - 45202R/Y lamp
- 1 - 45700 grommet;
- 94993 plug

**45004 grommet kit:**

- 1 each 45204 lamp; 45700 grommet; 94992 plug

- Mount horizontally or vertically
- Heavy duty dual filament cartridge bulb
- Unique shock mount absorbs shock & vibration

- 45004 Clear, kit
- 45002R Red, kit
- 45002Y Yellow, kit
- 45202R Red lamp
- 45202Y Yellow lamp
- 45204 Clear (Back-up)



**LED Super 66®**  
**Stop/Turn/Tail**  
**1 Diode Pattern**



**Material:**

- Polycarbonate lens, housing & flange
- PVC grommet
- 16 gauge wire

**Light Source:**

- LED
- Designed at 13.5 V, .40 A (stop/turn), .03 A (tail)

**Kit Components:**

**66050R & 66085R grommets:**

- 1 - 66250R or 66885R lamp,
- 1 - 60700 grommet
- 1 - 94706 adapter plug

**66056R black flange kits:**

- 1 - 66256R lamp & flange,
- 1 - 94706 adapter plug

**Recommended Accessories:**

- Mounting: Pages 262-263
- Plugs: Pages 213-215

**FMVSS:**

- I6,P2, S2,T



- World's first SingLEDiode® Stop, Turn & Tail lamp
- Designed to look more like a standard incandescent lamp but has more light output
- Less current draw, resulting in increased battery & alternator life while allowing more power for other vehicle requirements

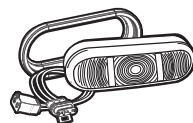

**LED Grommet Mount Kits**  
**66050R Red**

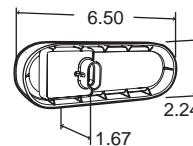

**LED Lamps**  
**66250R Red**  
**66885R Red, diamond shell**

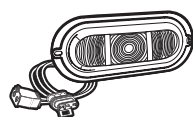

**LED Gray Flange Kits**  
**66052R Red**  
**66096Y Yellow**

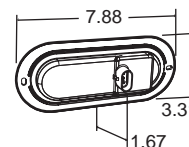

**LED Lamp & Gray Flange**  
**66252R Red**  
**66882R Red, diamond shell**  
**LED Lamp & Black Flange**  
**66256R Red**  
**66369R Red, hardwired**  
**LED Lamp & White Flange**  
**66254R Red**

**LED Black Flange Kits**  
**66056R Red**





- Uses standard right Angle plug
- Unique LED array displays full pattern light output design
- Epoxy encapsulated electronics prevents damage from moisture & corrosion

6050	Red lamp	6051	Red lamp w/clear lens
6050A	Yellow lamp	6051A	Yellow lamp w/clear lens

### LED Stop/Turn/Tail & Front/Park Turn 24 Diode Pattern

#### Material:

- Polycarbonate lens & housing

#### Light Source:

- LED
- Designed at 13.5 V, .030/.380 A

#### Recommended Accessories:

- Mounting: Pages 256-257
- Plugs: Pages 207-209

#### FMVSS:

- Red - I6,P2,S2,(3)T
- Yellow - I6,P2,P

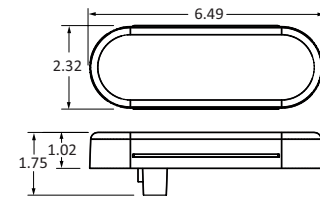

**NEW!**



- Housing and flange are molded together to form one piece
- Uses standard right angle PL-3 connection
- Designed with impact-resistant polycarbonate material
- LEDs do not have a filament, therefore are not susceptible to shock and vibration damage major cause of failure for lamps with an incandescent bulb
- Epoxy encapsulated electronics prevents damage from moisture and corrosion
- When properly mounted, exceeds FMVSS DOT requirements for S/T/T and F/P/T
- Lamps come with Truck-Lite 2-Year Limited Warranty

**6053 Integral flange, lamp, red**

### LED Stop/Turn/Tail Integral Flange 24 Diode Pattern

#### Material:

- Polycarbonate lens & housing

#### Light Source:

- LED
- 24 Diodes
- 12 V, 0.02/0.26 A

#### FMVSS:

- FMVSS P2; FMVSS I6; FMVSS S2 (3); FMVSS T

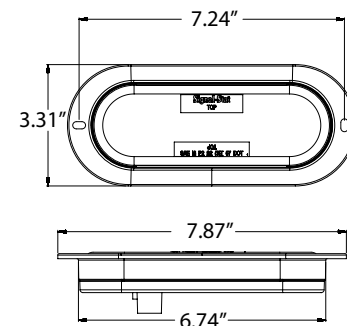



**LED 60® Series**  
**Stop/Turn/Tail**  
**Integral Flange**  
**18 Diode Pattern**

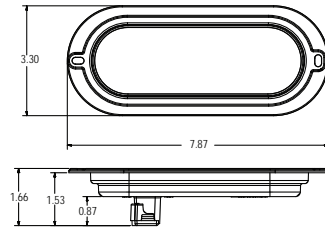

**Material:**

- Polycarbonate lens, housing and flange

**Light Source:**

- LED
- Designed at 14 V, .035 (stop/turn), 0.09 A (tail)

**FMVSS:**

- I6,P2,S2(3),T

- Features a PL-3 connector
- Shallow curved lens profile allows for flush mounting in applications where space is at a premium
- Ideal for vehicles featuring lift gates

**60356R Red, lamp & flange**

**LED Series 60® Stop/Turn/Tail**  
**& Front/Park/Turn**  
**26 (S/T/T) or**  
**44 (F/P/T) Diode Pattern**



See Page 2



**Material:**

- Polycarbonate lens & housing
- ABS flange
- PVC grommet
- 16 gauge wire

**Light Source:**

- LED
- Designed at 14v, .3 amp (stop), .1 amp (tail), .5 amp (turn)

**Kit Components:**

60050R/60094Y grommet kits:

- 1 - 60250R or 60290Y lamp
  - 1 - 60700 grommet
  - 1 - 94706 adapter plug
- 60085R grommet kit:
- 1 - 60885R lamp
  - 1 - 60700 grommet
  - 1 - 94706 adapter plug

60056R/60097Y black flange kits:

- 1 - 60256R or 60292Y lamp & flange
- 1 - 94706 adapter plug

60052R/60096Y gray flange kits:

- 1 - 60252R or 60291Y lamp & flange
- 1 - 94706 adapter plug

**Recommended Accessories:**

- Mounting: Pages 256-257
- Plugs: Pages 207-209

**FMVSS:**

- Red - I6,P2,S2(3),T
- Yellow - I6,P



- Faster illumination offers significant safety benefit for following drivers to react quicker, resulting in average 3' reaction time advantage for every 10 mph
- Meets stringent Front, Park and Turn requirements

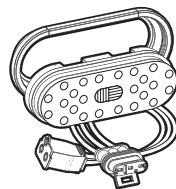

**Grommet Kits**

- 60050R Red**
- 60085R Red, diamond shell**
- 60094Y Yellow**

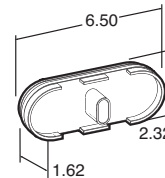

**LED Lamp**

- 60250R Red**
- 60885R Red, diamond shell**
- 60253R Red, 24v**
- 60264R Red, 24v, diamond shell**
- 60290Y Yellow**
- 60892Y Yellow, diamond shell**

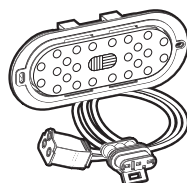

**Gray Flange Kits**

- 60052R Red**
- 60096Y Yellow**

**Black Flange Kits**

- 60056R Red**
- 60097Y Yellow**

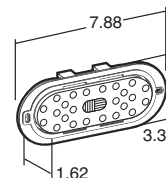

**LED Lamp & Gray Flange**

- 60252R Red**
- 60291Y Yellow**

**LED Lamp & Black Flange**

- 60256R Red**
- 60292Y Yellow**

**LED Lamp & Integral Flange**

- 60298Y Yellow, 24v, diamond shell**

NEW!

Signal-Stat

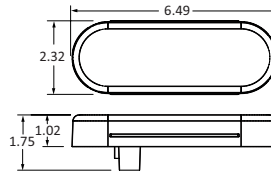

### LED Stop/Turn/Tail 10 Diode Pattern

#### Material:

- Acrylic lens & housing

#### Light Source:

- LED
- 10 Diodes
- 12 V, 0.02/0.172 A

#### FMVSS:

- FMVSS P2; FMVSS I6; FMVSS S2 (3); FMVSS T

- Engineered to feature ten bright and economical light emitting diodes (LEDs)
- When properly mounted, exceeds FMVSS-P2 DOT requirements for marker/clearance performance
- Designed with impact-resistant acrylic material
- Sealed lens and housing locks moisture out
- Snap fit grommet requires no screws for installation
- LEDs do not have a filament, therefore are not susceptible to shock and vibration damage major cause of failure for lamps with an incandescent bulb
- Epoxy encapsulated electronics prevents damage from moisture and corrosion
- Popular on owner/operator and show trucks
- Lamps come with Truck-Lite 2-Year Limited Warranty

6058 Lamp, red



**LED**  
UPGRADE  
See Page 16



60002R

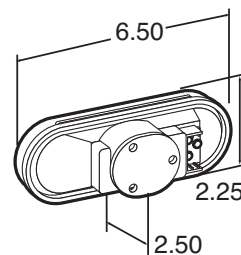

### Super 60® Stop/Turn/Tail & Front/Park/Turn Sealed

#### Material:

- Polycarbonate lens & housing
- PVC grommet
- 16 gauge wire

#### Light Source:

- 12v designed at 12.8 V, 2.1/.48 A, 32/2 cp
- 24 V designed at 28 V, .93/.34 A 32/6 cp

#### Kit Components:

##### 60002R/Y grommet kits:

- 1 - 60202R/Y 12v lamp
- 1 - 60700 grommet
- 1 - 94993 plug

##### 60007R/Y grommet kits:

- 1 - 60207R/Y 24v lamp
- 1 - 60700 grommet
- 1 - 94993 plug

#### FMVSS:

- Red - I6,P2,S2,T
- Yellow - I6,P2,P

- Mount horizontally or vertically
- Right angle plug assembly

60002R Red, grommet kit  
60002Y Yellow, grommet kit  
60007R Red, grommet kit, 24v  
60007Y Yellow, grommet kit, 24v

60202R Red lamp  
60202Y Yellow lamp  
60207R Red lamp, 24v  
60207Y Yellow lamp, 24v

**60® Economy  
Stop/Turn/Tail &  
Front/Park/Turn  
Sealed**



**Material:**

- Polycarbonate lens & housing
- PVC grommet
- 16 gauge wire

**Light Source:**

- 12v designed at 12.8 V, 2.1/.48 A, 32/2 cp

**Kit Components:**

**60083R/Y grommet kits:**

- 1 - 60283R/Y lamp
- 1 - 60700 grommet
- 1 - 94993 plug

**Recommended Accessories:**

- Mounting: Pages 262-263
- Plugs: Pages 213-215

**FMVSS:**

- Red - I6,P2,S2,T
- Yellow - I6,P2,P

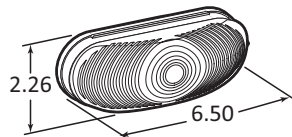

60283R

- Mount horizontally or vertically
- Contains a heavy-duty dual filament bulb

- 60083R Red, grommet kit**
- 60083Y Yellow, grommet kit**
- 60283R Red lamp**
- 60283Y Yellow lamp**

**60® Series  
Stop/Turn/Tail &  
Front/Park/Turn  
Bulb Replaceable**



**Material:**

- Polycarbonate lens & housing
- PVC grommet
- Socket assembly
- 16 gauge wire

**Light Source:**

- Bulb: #3157

**Replacement Parts:**

- 99184R red lens & housing
- 99184Y yellow lens & housing
- 95407 socket assembly

**Recommended Accessories:**

- Mounting: Pages 262-263

**FMVSS:**

- Red - I6,P2,S2,T
- Yellow - I6,P2,P

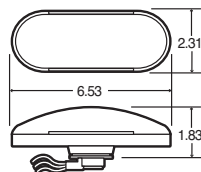

- Socket assembly cams-out for easy bulb replacement
- Mounts horizontally or vertically

- 60340R Red, kit**
- 60340Y Yellow, kit**

**60® Series  
Stop/Turn/Tail  
& Front/Park/Turn  
Bulb Replaceable**



**Material:**

- Polycarbonate lens & housing
- PVC grommet
- 16 gauge wire

**Light Source:**

- Bulb: #2057

**Replacement Parts:**

- 99011R/Y lens
- 60781 housing & socket

**Recommended Accessories:**

- Mounting: Pages 262-263

**FMVSS:**

- Red - I6,P2,S2,T
- Yellow - I6,P2,P

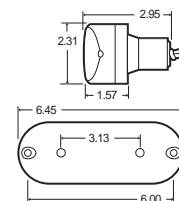

0.25 internal knockout holes  
1.62 clearance hole

- Lamp may be either grommet or screw mounted

- 60302R Red, kit**
- 60302Y Yellow, kit**

**LED**  
UPGRADE  
See Pages 6 - 10



80336R

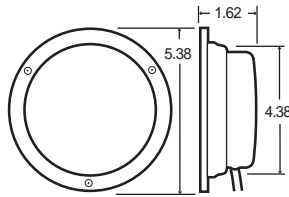

0.20 screw hole diameter  
5.00 bolt hole circle  
4.43 mounting hole

- Mounts flush to vehicle
- Retaining ring allows for easy bulb replacement

**80334R Red w/black housing**  
**80335R Red w/stainless steel housing**  
**80336R Red w/polished stainless steel housing**

### 80® Series Stop/Turn/Tail Bulb Replaceable

**Material:**

- Black painted steel or stainless steel housing
- Polycarbonate lens
- Steel retaining ring

**Light Source:**

- Bulb: #1157

**Replacement Parts:**

- 99008R red lens
- 97093 mounting gasket
- 97094 lens gasket
- 97945 steel retaining ring

**FMVSS:**

- I6,S2,P

**LED**  
UPGRADE  
See Pages 6 - 10



80302Y

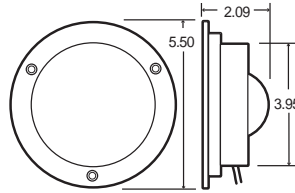

0.20 screw hole diameter  
4.94 bolt hole circle  
4.50 mounting hole

- Mounts flush to vehicle
- Allows for easy bulb replacement
- Not intended for P2 use

**80302R Red lamp**  
**80302Y Yellow lamp**  
**80304 Clear lamp, B/U**

### 80® Series Stop/Turn/Tail & Front/Park/Turn Bulb Replaceable

**Material:**

- Black plastic housing
- Acrylic lens
- Steel retaining ring

**Light Source:**

- Bulb: #1157

**Replacement Parts:**

- 99007R red lens
- 97945 retaining ring

**FMVSS:**

- Red - I6,S2,T
- Yellow - I6,P
- Clear - (2)R

**LED**  
UPGRADE  
See Pages 6 - 10

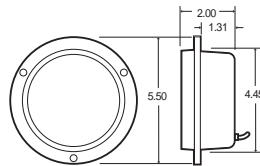

0.188 screw hole diameter  
5.000 bolt hole circle  
4.500 mounting hole

- Features rubber housing for shock absorbency
- Snap-in lens for quick bulb replacement
- Mounts flush to vehicle with recessed lens
- Not intended for use as (P2) clearance

**80339R Red**

### 80® Series Stop/Turn/Tail Bulb Replaceable

**Material:**

- Rubber housing
- Polycarbonate lens

**Light Source:**

- Bulb: #1157

**Replacement Parts:**

- 99008R red lens

**FMVSS:**

- I6,S2,T



**Die Cast  
Stop/Turn/Tail  
Bulb Replaceable**

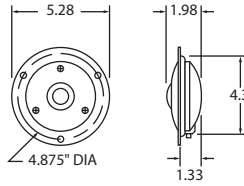

**Material:**

- Metal die cast housing
- Acrylic lens

**Light Source:**

- #1156 12 V bulb, one wire
- #1157 12 V bulb, two wire

**Replacement Parts:**

- 9016 red lens
- 9016W clear lens
- 9021 red lens kit
- 9021W clear lens kit
- 9102 plug, one wire
- 9101 plug, two wire

**FMVSS:**

- Red - I,P2,S,T

- Narrow depth behind flange allows lamp to fit where other lamps cannot
- Mounts through 4-1/2" diameter cut-out, 2" depth below flange

- 3612** Red, S/T/T, gray housing
- 3616** Red, S/T/T, chrome housing
- 3613W** Clear, B/U, chrome housing (utility or dome)



**41 Series Stop/Turn/Tail  
Sealed**

**Material:**

- Polycarbonate lens & housing
- 16 gauge wire

**Light Source:**

- Dual filament bulb
- Designed at 12.8 V, 2.1/.48 A, 32/2 cp

**Kit Components:**

**41005R LH kit:**

- 1 - 41202R & 41203R lamp
- 1 - 94948 LH plug

**41006R RH kit:**

- 1 - 41202R & 41203R lamp
- 1 - 94949 RH plug

**41007R universal kit:**

- 1 - 41202R & 41203R lamp
- 2 - 94926 universal plug

**41008R universal kit:**

- 1 - 41202R & 41203R lamp

**FMVSS:**

- I,S,T

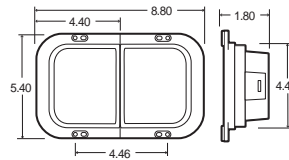

- Mounts in 7.83" x 4.43" hole
- Requires separate reflector to meet legal requirements

- 41005R** Red, LH kit
- 41006R** Red, RH kit
- 41007R** Red, universal kit
- 41008R** Red, universal kit w/o plugs
- 41202R** Red, LH
- 41203R** Red, RH



**Universal Mount  
Stop/Turn/Tail  
Bulb Replaceable**

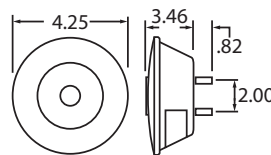

Two stud mount

**Material:**

- Polycarbonate lens & housing

**Light Source:**

- Bulb #1157

**Replacement Parts:**

- 9041 red lens
- 9041A yellow lens

**FMVSS:**

- Red - I,P,S,T
- License - L

- Two wire

- 540D** Red w/license, two stud, retail pack
- 541** Red w/o license, two stud







80324R

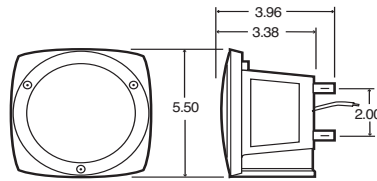

1/4 - 20 studs

- Features reflectorized lens

80322R Red, w/o license  
80324R Red, w/license

## 7-IN-1 Combination Products

### Bulb Replaceable

#### Material:

- Acrylic lens
- Polycarbonate housing

#### Light Source:

- Bulb: #1157 S/T/T, #1895 S/M

#### Replacement Parts:

- 99074R red lens

#### FMVSS:

- Side: A,P2
- Rear: A,I,ST,L



5070

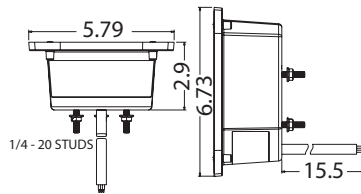

1/4 - 20 STUDS

- Upgrade to LED technology – provides significant ROI
- Unique LED array displays full pattern output
- 3 stud mounting design w/ground function

5070 Roadside w/license  
5071 Curbside  
5072 Roadside w/license & PE connector  
5073 Curbside w/PE connector

## LED Multi-Function

16 LED – S/T/T

5 LED – License

18 LED – B/U

#### Material:

- Polycarbonate lens & housing
- Acrylic S/T/T & B/U lens
- 18 gauge 3 wire

#### Light Source:

- Designed at 12 V, .731-.852 A major
- .308-.470 A minor

#### FMVSS:

- Roadside: A,I6,(2)R,S2,(3)T,L
- Curbside: A,I6,(2)R,S2,(3)T



4027

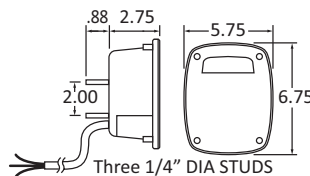

- Combination stop/turn/tail, back-up & reflex reflector
- Three bolt on 2" triangle

4027 Universal

## Multi-Function Three Stud Bulb Replaceable

#### Material:

- Acrylic lens
- Polycarbonate housing
- 18 gauge wire

#### Light Source:

- Bulb: #1157 S/T/T
- Bulb: #1156 B/U

#### Replacement Parts:

- 9049 lens kit
- 9288 license bracket
- 97706 lens gasket

#### FMVSS:

- A,I6,(2)R,S2,T,L

**Multi-Function  
Two Stud  
Bulb Replaceable**

**Material:**

- Polycarbonate lens & housing

**Light Source:**

- Bulb: #1157 S/T/T
- Bulb: #1165 B/U

**Replacement Parts:**

- 9049 lens kit
- 9288 license bracket
- 97706 lens gasket

**FMVSS:**

- A, I6, (2)R, S2, T, L

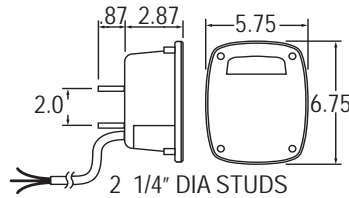

- Dodge Truck # 3895020 and 3895021
- Ford # D0TZ13404A, D3KZ13404A, D3TZ13403B, E2TB13404A & E2TB13405A

**4028 Universal w/license**

**Multi-Function  
Three Stud  
Bulb Replaceable**

**Material:**

- Polycarbonate lens & housing

**Light Source:**

- Bulb: #1157 S/T/T
- Bulb: #1156 B/U

**Replacement Parts:**

- 9071 lens & gasket
- 9288 license bracket
- 97706 lens gasket

**FMVSS:**

- Roadside: A, I6, (2)R, S2, T, L
- Curbside: A, I6, (2)R, S2, T

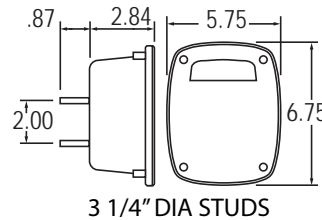

- Navistar #467707C91 & 424538C91 (LH)
- Navistar #467708C91 & 424539C91 (RH)

**4015 Roadside, w/license  
4016 Curbside**

**Multi-Function  
Three Stud  
Bulb Replaceable**

**Material:**

- Polycarbonate lens & housing

**Light Source:**

- Bulb: #1157 S/T/T
- Bulb: #1156 B/U

**Replacement Parts:**

- 9071 lens & gasket
- 9288 license bracket
- 97706 lens gasket

**FMVSS:**

- Roadside: A, I6, (2)R, S2, T, L
- Curbside: A, I6, (2)R, S2, T



- Replaces all GM medium & heavy duty 1972 to 1985

**4017 Roadside w/  
license  
4018 Curbside**

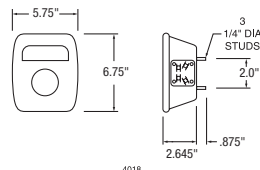

**Multi-Function  
Three Stud  
Bulb Replaceable**

**Material:**

- Polycarbonate lens & housing

**Light Source:**

- Bulb: #1157 S/T/T
- Bulb: #1156 B/U

**Replacement Parts:**

- 9071 lens & gasket
- 9288 license bracket
- 97706 lens gasket

**FMVSS:**

- Roadside: A, I6, (2)R, S2, T, L
- Curbside: A, I6, (2)R, S2, T



- Ford #D9HZ13405 A & B (curbside)
- Ford #D9HZ13404 A & B (roadside)
- Fits 1979 & up Ford models
- Freightliner #A06-13581-001 (curbside)
- Freightliner #A06-13581-000 (roadside)

**4023 Curbside w/license, Ford  
4024 Roadside w/license, Ford**

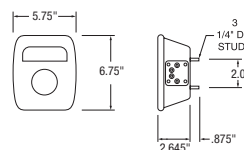

Signal-Stat

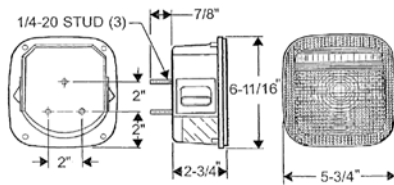

- Navistar #1661281C91 & Navistar #1661282C91
- RH lamp popular replacement for GM/IH OE #56139474, #15565732
- 5315Y101 has dual Metri-Pack connectors – one on either side of the lamp
- 5315Y101 uses #9470 main harness
- 5316Y101 uses #9469 jumper harness

5315Y101 Universal w/license  
5316Y101 Curbside w/license

### Multi-Function Three Stud Bulb Replaceable

#### Material:

- Polycarbonate lens & housing

#### Light Source:

- Bulb: #1157 S/T/T
- Bulb: #1156 B/U

#### Replacement Parts:

- 9049 lens kit
- 9470 5-wire harness
- 9469 4-wire jumper
- 97706 lens gasket

#### FMVSS:

- A,I,(2)R,S2,T,L

Signal-Stat

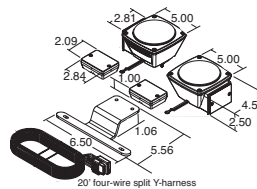

- Popular on camping, motorcycle, horse & utility trailers
- Kit provides all legal lamps & reflective products for trailers less than 80" wide

5050DK LED trailer kit, retail pack  
5051DK LED trailer kit, w/marker lights, retail pack  
5052AD LED marker lamp, retail pack  
5055D LED stop & tail, curbside, retail pack  
5056D LED stop & turn w/license, roadside, retail pack

### LED Universal Trailer Lighting Kit 12 Diode - S/T 1 Diode - Side Markers 1 Diode - M/C

#### Kit Components:

- 1 - 5055 curbside S/T
- 1 - 5056 roadside S/T
- 2 - 5052A M/C (optional)
- 1 - 25' trailer wire harness
- 1 - 4' truck connector
- 1 - license bracket
- 1 - mounting hardware

#### FMVSS:

- A,I,S,(3)T,L,P2

Signal-Stat

**LED**  
UPGRADE  
See Above

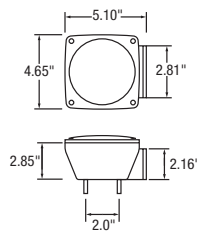
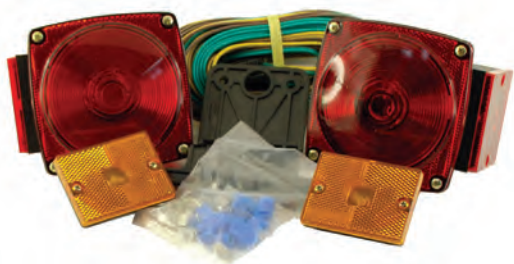

- For use on camping, motorcycle, horse & utility trailers
- Kit provides all legal lamps & reflective products for trailers LESS than 80" wide

533DK Trailer lamp kit, retail pack  
534D Left with license illuminator, retail pack  
535D Right without license illuminator, retail pack

### Trailer Lamp Kit

#### Light Source:

- Bulb: #1157 M/F
- Bulb: #194 marker

#### Kit Components:

- 1 - 534D LH lamp
- 1 - 535D RH lamp
- 1 - 1570 red marker lamp
- 1 - 1570A yellow marker lamp

#### Replacement Parts:

- 8948 M/F lens
- 8947 red marker lens
- 8947A yellow marker lens

#### FMVSS:

- A,I,S,T,L,P2



**Submersible Trailer Lighting Kits**

**Kit Components:**

**55554 kit:**

- 1 - 80317R M/F lamp
- 1 - 80318R M/F lamp w/license
- 1 - 80722 license bracket
- 1 - 93960 harness

**Replacement Parts:**

- 99126R lens w/license
- 99127R lens w/o license

**FMVSS:**

- Red: A,I,P2,S,T,L
- Yellow: A,P2

- Popular on boat trailers under 80" wide

**55554 Kit, w/o side markers**

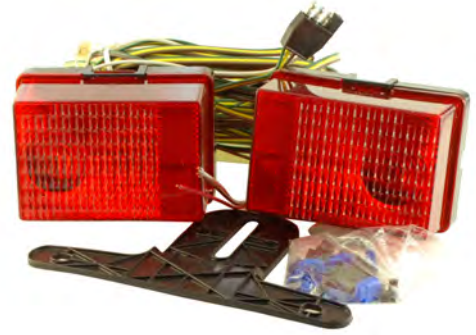

**Submersible Trailer Lighting Kit**

**Kit Components:**

- 1 - 528 LH lamp
- 1 - 529 RH lamp
- 1 - license bracket
- 1 - 25' wiring
- 1 - 4' trunk connector
- 1 - mounting accessories

**Replacement Parts:**

- 9676 red lens

**FMVSS:**

- Red: A,I,P2,S,T,L
- Yellow: A,P2

- Popular on boat trailers under 80" wide
- Deluxe kit features a Sealed lamp capsule that protects the bulb & electrical contacts from damage by water & corrosion
- Left hand lamp includes license plate illuminator
- S/T/T lamps 8L x 2-7/8H x 2-3/4D

**530DK Kit – slimline, retail pack**

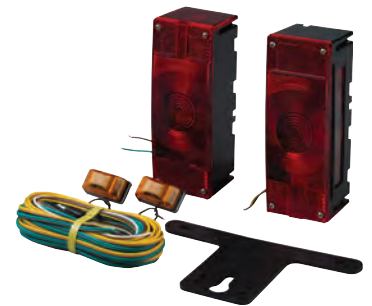

**Rubber Housed Module**

**Material:**

- Thermoplastic rubber housing
- Polypropylene cover

**Kit Components:**

**45740/45741 module kits:**

- 2 - 45202R Super 45 S/T/T
- 1 - 45204 Super 45 B/U
- 1 - 45323 module box
- 1 - 45333 latch cover

**45742/45743 module kits:**

- 1 - 45202R Super 45 S/T/T
- 1 - 45201Y Super 45 T/S
- 1 - 45204 Super 45 B/U
- 1 - 45323 module box
- 1 - 45333 latch cover

**45435/45436 module kits:**

- 1 - 4550 LED S/T/T
- 1 - 4550A LED F/P/T
- 1 - 4560C LED B/U
- 1 - 45323 module box
- 1 - 45333 latch cover

**FMVSS:**

- A,I6,P2,(2)R,S2,T
- Turn Signal: A,I6,(2)R,S2,T

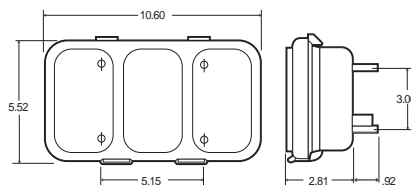

- Unique housing offers shock absorbency & allows lamp replacement without tools
- Features rugged thermoplastic rubber housing
- High impact polypropylene cover
- Pre-wired terminal contact strip included

- 45740 LH**
- 45741 RH**
- 45742 LH w/turn signal**
- 45743 RH w/turn signal**
- 45435 LH w/Signal-Stat LED's**
- 45436 RH w/Signal-Stat LED's**



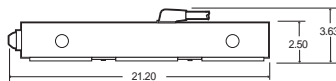
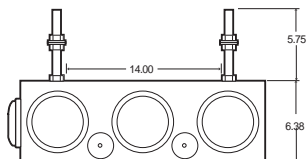

- Popular on straight truck applications
- Features metal module box with side marker & back-up lamps

**44808 RH, w/turn signal**

**44809 LH, w/turn signal**

### LED Metal Module Stop/Turn/Tail & Back/Up With Side Marker

#### Material:

- Metal module box
- PVC grommet
- 14 gauge wire

#### Light Source:

- Super 44 S/T/T lamps designed at 14v, .03/.3 amp
- Super 44 T/S lamps designed at 14v, .5 amp
- Model 44 B/U lamps designed at 13.5v, .25 amp
- Model 19 C/M lamps designed at 14v, .05 amp

#### Kit Components:

##### 44808/44809 module kits:

- 1 - 44302R Super 44 S/T/T
- 1 - 44201Y Super 44 T/S
- 1 - 19250R Model 19 C/M
- 1 - 44206C Model 44 B/U
- 3 - 40700 grommets
- 1 - 96502 RH harness
- 1 - 96503 LH harness

#### FMVSS:

- Side: P2
- Rear: A,(2)R,I6,S2,(3)T



40790

- Popular on straight truck applications
- Features metal module box with side marker & back-up lamp

**40758 LH, without turn signal**

**40759 RH, without turn signal**

**40790 RH, w/turn signal**

**40791 LH, w/turn signal**

**40808 LED RH, w/turn signal**

**40809 LED LH, w/turn signal**

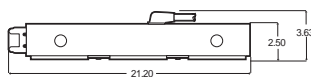
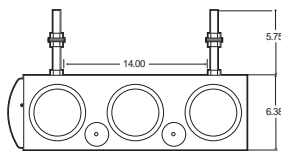

### LED Metal Module Stop/Turn/Tail & Back/Up With Side Marker

#### Material:

- Metal module box
- PVC grommet
- 14 gauge wire

#### Light Source:

- Super 40 lamps designed at 13.5 V, 2.1/.47 A, dual filament bulb
- Super 21 lamps designed at 14 V, .33 A

#### Kit Components:

##### 40758/40759 module kits:

- 2 - 40242R Super 40 S/T/T
- 1 - 40244 Super 40 B/U
- 1 - 21201R Super 21 S/M
- 3 - 40700 grommets
- 1 - 50526 RH harness
- 1 - 50525 LH harness

##### 40790/40791 module kits:

- 1 - 40242R Super 40 S/T/T
- 1 - 40241Y Super 40 T/S
- 1 - 40244 Super 40 B/U
- 1 - 21201R Super 21 S/M
- 3 - 40700 grommets
- 1 - 81" wire harness

##### 40808/40809 LED module kits:

- 1 - 44302R Super 44 S/T/T
- 1 - 44201Y Super 44 T/S
- 1 - 40244 Super 40 B/U
- 1 - 21201R Model 21 S/M
- 3 - 40700 grommets
- 1 - harness

#### FMVSS:

- Side: P2
- Rear: A,R,I6,S2,T



### Metal S/T/T Modules With Side Marker

**Material:**

- Metal module box
- PVC grommet
- 16 gauge wire

**Light Source:**

- Super 40 lamps designed at 13.5 V, 2.1/.47 A, dual filament bulb
- Model 19 lamps designed at 14v, .33 amp

**Kit Components:**

**40762/40763 module kits:**

- 2 - 40242R Super 40 S/T/T
- 1 - 40241Y Super 40 T/S
- 3 - 40700 grommets
- 1 - 19200R Model 19 S/M
- 1 - wire harness

**Recommended Accessories:**

- 50282 RH mating harness
- 50283 LH mating harness

**FMVSS:**

- Side: P2,P3,PC
- Rear: A,,6,P2,T



- Popular on straight truck applications
- Features metal module box with side marker & turn signal lamps

**40762 LH**  
**40763 RH**

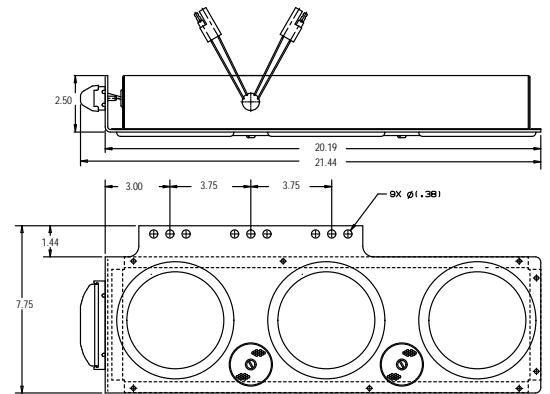

### Power Unit Module

**Material:**

- Metal module box
- PVC grommet
- Junction box
- 16 gauge wire

**Light Source:**

- Super 40 lamps designed at 13.5 V, 2.1/.47 A, dual filament bulb
- Model 40 lamp designed at 12.8v, 2.1/.48 amp

**Kit Components:**

**40850 module kit:**

- 2 - 40242R Super 40
- 1 - 40204 Model 40 B/U
- 3 - 40700 grommets
- 1 - 19206 Model 19 license
- 1 - Harness
- 1 - Junction box

**40894 module kit:**

- 2 - 44302R Super 44 S/T/T
- 1 - 40204 Model 40 B/U
- 3 - 40700 grommets
- 1 - 19206 Model 19 license
- 1 - 95723 harness

**FMVSS:**

- A,I6,R,S2,T



- Between frame rail mount
- Features heavy gauge metal module
- Comes with pre-assembled junction box with wiring harness
- 40894 features Peterbilt replacement with red LED lamps & excludes junction box

**40850 Module**  
**40894 Module, Peterbilt**

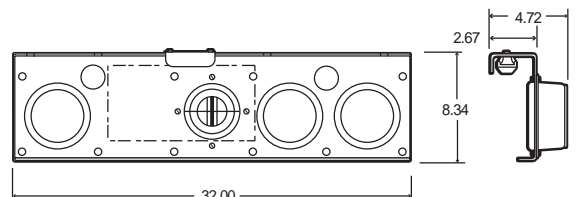

**LED KITS**  
AVAILABLE



40757



9536 &amp; 9537

### LED Metal S/T/T Module with Side Marker

#### Material:

- Polycarbonate lamps
- Metal module box
- PVC grommet
- 14 gauge wire

#### Kit Components:

##### 40756/40757 module kits:

- 2 - 40202R M40 S/T/T
- 1 - 19200R M19 C/M
- 2 - 40700 grommets
- 1 - module box
- 1 - 94942 LH/94943 RH wire harness
- 1 - 94933 wire harness

##### 40637/40638 module kits:

- 2 - 44326R LED S44 black flange
- 1 - 19250R LED M19 C/M
- 1 - module box

##### 40626/40627 module kit:

- 2 - 44222R Super 44 S/T/T
- 1 - 50200 or 50201 wire harness
- 1 - 94794 RH/94795 LH harness

##### 9536/9537 module kits:

- 2 - 4050 LED S/T/T
- 1 - 1960 LED C/M
- 2 - 40700 grommets
- 1 - module box
- 1 - 94942 LH/94943 RH wire harness
- 1 - 94933 wire harness

#### FMVSS:

- Side: P2,P3,PC
- Rear: A,I6,P2,S2,T

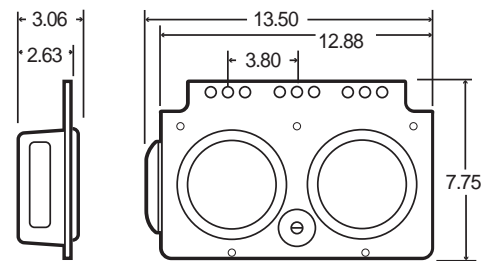

.380 bolt hole diameter

- Features universal mount designed to retrofit a wide variety of vehicles
- Optional mounting gasket available to provide extra seal between module & body

40757 RH Model 40 kit w/side marker

40756 LH Model 40 kit w/side marker

#### Truck-Lite LED kits:

40637 LED LH Super 44 flange kit

40638 LED RH Super 44 flange kit

40626 LED LH Super 44 kit w/o side marker

40627 LED RH Super 44 kit w/o side marker

#### Signal-Stat LED kits:

9536 LED LH kit w/side marker

9537 LED RH kit w/side marker

### Plastic S/T/T Module

**Material:**

- ABS module box
- PVC grommet
- 14 gauge wire

**Light Source:**

- Super 40 lamps designed at 13.5 V, 2.1/.47 A, dual filament bulb
- Model 40 lamps designed at 12.8 V, 2.1/.48 A, dual filament bulb

**Kit Components:**

**40742 or 40743 module kit:**

- 2 - 40202R Model 40 S/T/T
- 2 - 40700 grommets
- 1 - 40722 module box
- 1 - 50200 or 50201 wire harness

**40748 or 40749 module kit:**

- 1 - 40242R Super 40 S/T/T
- 1 - 40244 Super 40 B/U
- 2 - 40700 grommets
- 1 - 40722 module box
- 1 - 50200 or 50201 wire harness

**FMVSS:**

- I6,P2,S2,T



40742

- Mounts in 11" x 5.12" hole
- Optional mounting gasket #97938 available to provide extra seal between module & body

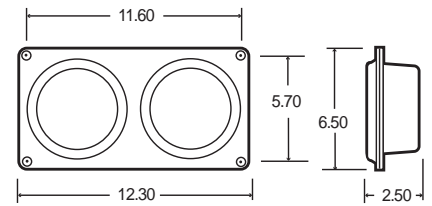

0.280 screw hole diameter

- 40742 LH Model 40 kit
- 40743 RH Model 40 kit
- 40748 LH Super 40 kit w/Back-Up
- 40749 RH Super 40 kit w/Back-Up

### Flanged Plastic S/T/T Module

**Material:**

- ABS module box
- Metal flange
- PVC grommet
- 14 gauge wire

**Kit Components:**

**40746 or 40747 module kit:**

- 2 - 40202R Model 40 S/T/T
- 2 - 40700 grommets
- 1 - 40721 mounting flange
- 1 - 40722 module box
- 1 - 50200 or 50201 wire harness

**40754 or 40755 module kit:**

- 1 - 40242R Super 40 S/T/T
- 1 - 40244 Super 40 B/U
- 2 - 40700 grommets
- 1 - 40721 mounting flange
- 1 - 40722 module box
- 1 - 50200 or 50201 wire harness

**FMVSS:**

- I6,R,S2,T



40755

- Features metal mounting flange with high impact plastic module box
- Optional mounting gasket #97938 available to provide extra seal between module & body

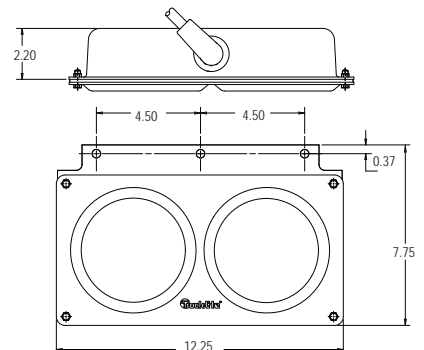

- 40746 LH Model 40 kit
- 40747 RH Model 40 kit
- 40754 LH Super 40 kit w/Back-Up
- 40755 RH Super 40 kit w/Back-Up

# Signal Lighting



# Signal Lighting

**Turn Signal Lamps**      **32-43**



**Pedestal Lamps**      **44-50**

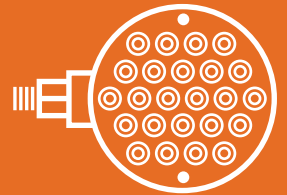

**Long Life Vehicle Lamps (LLV)**      **51**

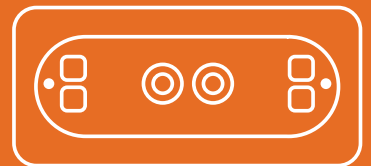

**High Mounted Stop Lamps (HMSL)**      **52-53**

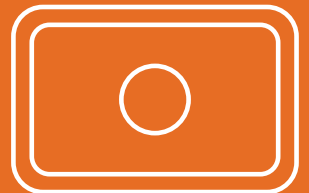

NEW!



## LED Super 44® Rear Turn

### Materials

- Polycarbonate or acrylic lens
- Polycarbonate or ABS housing
- PVC grommet
- 16 gauge wire

### Light Source

- 6 Light emitting diodes (LEDs)
- 12v designed at 0.249A - 0.31A
- 24v designed at 0.080A - 0.125A

### Kit Components:

#### 44107Y:

- 1 - 44285Y lamp and gray flange
- 1 - 94789 Fit N Forget stop/turn adapter

#### 44108Y:

- 1 - 44281Y lamp
- 1 - 40700 grommet
- 1 - 94789 fit forget stop/turn adapter

#### 44109Y:

- 1 - 44289Y lamp and black flange
- 1 - 94789 fit forget stop/turn adapter

#### 44113Y:

- 1 - 44283Y 24v lamp
- 1 - 94789 fit forget stop/turn adapter
- 1 - 40700 grommet

- Less current draw, resulting in increased battery & alternator life while allowing more power for other vehicle requirements
- Faster illumination offers significant safety benefit for following drivers to react quicker, resulting in an average distance of 3 for every 10 mph
- LEDs have no filament, therefore are impervious to shock and vibration
- Flange mounts are permanently affixed to lamp
- Mounts only to rear of vehicle
- Designed to comply with FMVSS 108
- Limited lifetime warranty

- 44280Y Diamond Shell, lamp, yellow
- 44281Y 12 V, lamp, yellow
- 44283Y 24 V, lamp, yellow
- 44285Y Gray flange, lamp, yellow
- 44286Y Black flange, 24 V, lamp, yellow
- 44287Y Diamond Shell, gray flange, lamp, yellow
- 44289Y Black flange, lamp, yellow

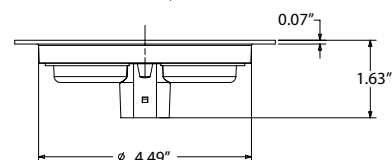
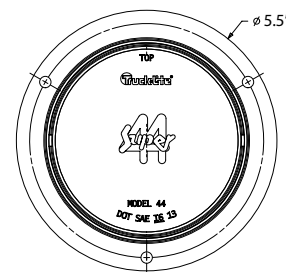
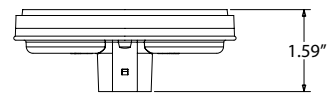
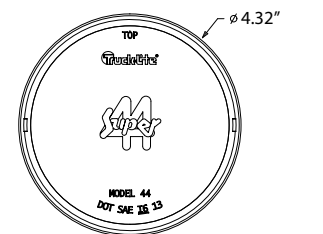

## LED Super 44® Front/Park Turn



NEW!

### Materials

- Polycarbonate or Diamond Shell lens
- Polycarbonate or ABS housing
- PVC grommet
- 16 gauge wire

### Light Source

- 6 light emitting diodes (LEDs)
- 12 V light designed at 14 V
- Major function draw: .513 A to .783 A
- Minor function draw: .023 A to .045 A

### Kit Components

#### 44091Y:

- 1 - 44291Y Diamond Shell light
- 1 - 94706 Fit N Forget stop/turn adapter

#### - 44092Y:

- 1 - 44292Y light and black flange
- 1 - 94706 Fit Forget stop/turn adapter

#### - 44093Y:

- 1 - 44293Y light and white flange
- 1 - 94706 Fit Forget stop/turn adapter

#### - 44094Y:

- 1 - 44294Y light
- 1 - 40700 grommet
- 1 - 94706 Fit Forget stop/turn adapter

#### - 44095Y:

- 1 - 44295Y light and gray flange
- 1 - 94706 Fit Forget stop/turn adapter

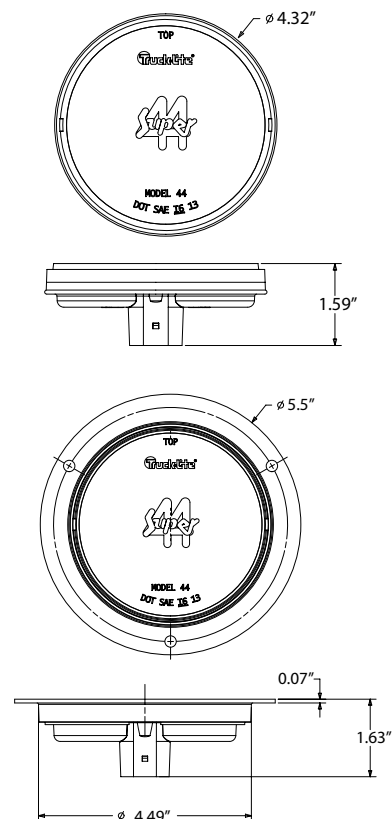

- Offers the same safety and low maintenance benefits of existing F/P/T lights, now with fewer diodes!
- Uses less current draw, resulting in increased battery & alternator life while allowing more power for other vehicle requirements
- LEDs have no filament, making them impervious to shock and vibration damage
- Flange mounts are permanently affixed to light
- Designed to comply with FMVSS 108
- Limited lifetime warranty

44291Y Diamond Shell, lamp, yellow

44292Y Diamond Shell, lamp, yellow, adapter kit

44293Y White flange, lamp, yellow

44294Y Lamp, yellow

44295Y Gray flange, lamp, yellow



See Page 2



- Less current draw, resulting in increased battery & alternator life while allowing more power for other vehicle requirements
- Faster illumination offers significant safety benefit for following drivers to react quicker, resulting in an average of 3' reaction time advantage for every 10 m.p.h.
- LEDs have no filament, therefore are not susceptible to shock & vibration, a major cause of failure for lamps with incandescent bulbs

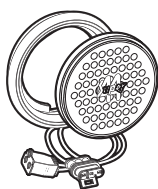

**LED Grommet Kits**  
 44001Y Yellow  
 44018Y Yellow, 24v



**LED Lamps**  
 44201Y Yellow  
 44881Y Yellow, diamond shell  
 44273Y Yellow, 24v

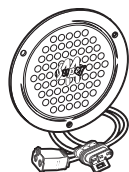

**LED Gray Flange Kits**  
 44021Y Yellow  
**LED Black Flange Kits**  
 44027Y Yellow

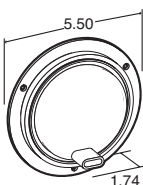

**LED Lamp & Gray Flange**  
 44221Y Yellow  
 44887Y Yellow, diamond shell  
**LED Lamp & Black Flange**  
 44227Y Yellow  
 44888Y Yellow, diamond shell  
 44276Y Yellow, 24v  
**LED Lamp & White Flange**  
 44231Y Yellow

**LED Super 44® Rear Turn 42 Diode Pattern**

**Material:**

- Polycarbonate or acrylic lens, housing & flange
- PVC grommet
- 16 gauge wire

**Light Source:**

- Light Emitting Diodes (LEDs)
- 12v designed at 14v, .5 amp
- 24v designed at 28v, .31 amp

**Kit Components:**

- 44001Y grommet kit  
 1 - 44201Y lamp  
 1 - 40700 grommet  
 1 - 94789 adapter plug
- 44021Y gray flange kit:  
 1 - 44221Y lamp & flange  
 1 - 94789 adapter plug
- 44027Y black flange kit:  
 1 - 44227Y lamp & flange  
 1 - 94789 adapter plug
- 44018Y grommet kit:  
 1 - 44273Y lamp  
 1 - 40700 grommet  
 1 - 94706 adapter plug

**Recommended Accessories:**

- Mounting: Pages 259-261
- Plugs: Pages 216-217

**FMVSS:**

- I6



See Above



40041Y

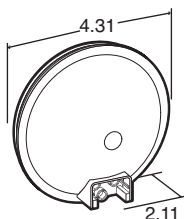

- Uniquely designed shock-mount extends lamp life
- Uses standard mounting holes & accessories

40041Y Yellow, grommet kit  
 40241R Red lamp  
 40241Y Yellow lamp

**Super 40® Turn Signal Sealed**

**Material:**

- Polycarbonate lens & housing
- PVC grommet
- 16 gauge wire

**Light Source:**

- Designed at 13.5v, 2.1 amps, 32cp

**Kit Components:**

- 40041Y grommet kit:  
 1 - 40241Y lamp  
 1 - 40700 grommet  
 1 - 94992 right angle plug

**Recommended Accessories:**

- Mounting: Pages 259-261
- Plugs: Pages 213-214

**FMVSS:**

- I6



**40® Series Turn & Tail  
4" Sealed**



**Material:**

- Polycarbonate lens & housing
- PVC grommet
- 16 gauge wire

**Light Source:**

- 12v bulb designed at 2.1 amps, 32 cp

**Recommended Accessories:**

- Mounting: Pages 259-261
- Plugs: Pages 216-217

**FMVSS:**

- I6

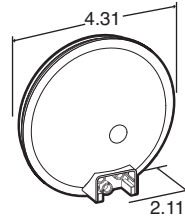

- Uses standard mounting holes and accessories
- Heavy duty shock-mounted bulb

**40201Y Yellow lamp**

**LED 45® Series Rear Turn  
70 Diode Pattern**



**Material:**

- Polycarbonate lens, housing & flange
- Black PVC grommet
- 18 gauge wire

**Light Source:**

- Light Emitting Diodes (LEDs)
- 12v designed at .75 amp
- 24v designed at 28v .7 amp

**Kit Components:**

45051Y 12v grommet kit:

- 1 - 45251Y lamp
- 1 - 45700 grommet

45063Y 24v grommet kit:

- 1 - 45263Y lamp
- 1 - 45700 grommet

**Recommended Accessories:**

- Mounting: Pages 259

**FMVSS:**

- I6

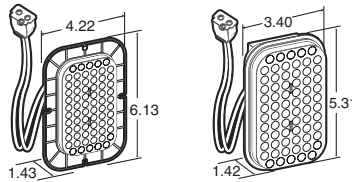

45251Y

- Hardwired design
- Mount horizontally or vertically
- Permanently affixed flange mount version
- Standard connector makes retrofitting a snap

**45051Y Yellow, grommet kit**  
**45063Y Yellow, grommet kit, diamond shell, 24v**  
**45251Y Yellow lamp**  
**45263Y Yellow lamp, diamond shell, 24v**

**Super 45®  
Turn Signal  
Sealed**



**Material:**

- Polycarbonate lens & housing
- PVC grommet
- 16 gauge wire

**Light Source:**

- Single filament baseless bulb
- Designed at 2.1, 32 cp

**Kit Components:**

45001 Y grommet kit:

- 1 - 45201R/Y lamp
- 1 - 45700 grommet
- 1 - 94992 plug

**Recommended Accessories:**

- Mounting: Pages 259
- Plugs: Pages 213-214

**FMVSS:**

- I6

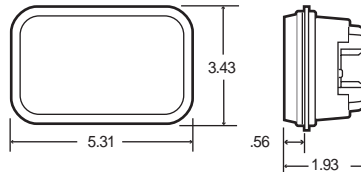

45001Y

- Heavy duty bulb for longer life
- Mount horizontally or vertically

**45001Y Yellow, grommet kit**  
**45201R Red lamp**  
**45201Y Yellow lamp**  
**45204 Clear back-up lamp w/reflector**

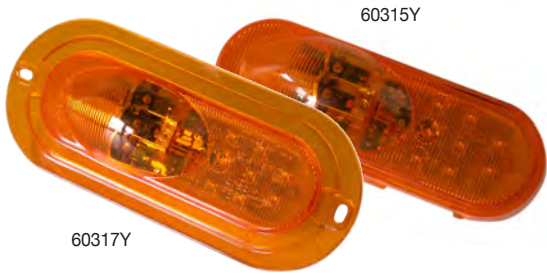

- U.S. Patent #7055996
- World's first LED side turn signal to surpass SAE J2039 standards in large vehicle applications
- Commonly mounted at "mid-point" on trailers or "no zone" areas on tractors
- Faster illumination offers significant safety benefit for following drivers to react quicker, resulting in an average of 3' reaction time advantage for every 10 m.p.h.

**LED Super 60® Side Turn Signal & Marker**  
11 Diode Pattern

**Material:**

- Polycarbonate lens, housing & flange
- ABS flange
- PVC grommet
- 16 gauge wire

**Light Source:**

- Light Emitting Diodes (LEDs)
- Designed at 13.5v, .5 amp (turn), .05 amp (marker)

**Kit Components:**

- 60115Y grommet kits:  
 1 - 60315Y lamp  
 1 - 60700 grommet  
 1 - 94706 adapter plug  
 60117Y flange kit:  
 1 - 60317Y lamp & flange  
 1 - 94706 adapter plug

**Recommended Accessories:**

- Mounting: Pages 262-263
- Plugs: Pages 213-215

**FMVSS:**

- E,P2

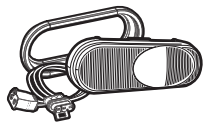

**LED Grommet Kits**  
60115Y Yellow

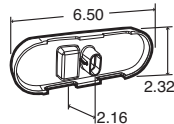

**LED Lamps**  
60315Y Yellow

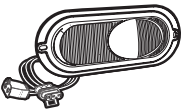

**LED Yellow Flange Kits**  
60117Y Yellow

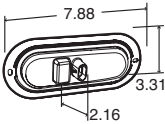

**LED Lamp & Yellow Flange**  
60317Y Yellow

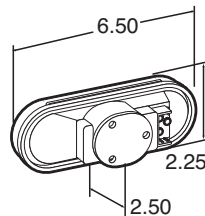

- Features side indicator, marker/clearance & reflector functions
- Narrow width facilitates horizontal mounting
- Red lamp should be used only for rear vehicle applications
- Meets SAE J2039 recommendation for side turn signal

**60® Series Side Turn & Marker**  
Sealed

**Material:**

- Polycarbonate lens & housing
- PVC grommet
- 16 gauge wire

**Light Source:**

- Dual filament baseless bulb
- 12v bulb designed at 2.1/.49 amp, 32/2 cp
- 24v designed at 28v, .93/.34 amp, 32.6 cp

**Kit Components:**

- 60015R/Y grommet kits:  
 1 - 60215R/Y lamp  
 1 - 60700 grommet  
 1 - 94993 right angle plug

**Recommended Accessories:**

- Mounting: Pages 262-263
- Plugs: Pages 213-215

**FMVSS:**

- Red: A,PS
- Yellow: A,E,P2

- 60015R Red, grommet kit
- 60015Y Yellow, grommet kit
- 60215R Red lamp

- 60215Y Yellow lamp
- 60216Y Yellow lamp & gray flange
- 60217Y Yellow lamp, 24v

**Male Pin Side Turn & Marker Sealed**

**Material:**

- Polycarbonate lens & housing
- PVC grommet
- 16 gauge wire

**Recommended Accessories:**

- Mounting: Pages 256-257

**FMVSS:**

- A,E,E2,P2

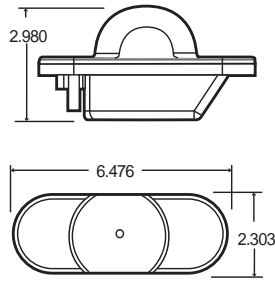

- Male pin connections
- Features side indicator, marker clearance & reflector functions
- Narrow width facilitates horizontal mounting
- Meets SAE J2039 recommendation for side turn signal
- Replaces Grote® #52533

**69202Y Yellow lamp**

**22® Series Side Turn Sealed**

**Material:**

- Polycarbonate lens & housing
- Foam gasket
- 16 gauge wire

**Light Source:**

- Dual filament baseless bulb
- 12v bulb designed at 2.1/.49 amps, 32/2 cp

**Kit Components:**

22002R/Y kits:

- 1 - 22202R/Y lamp
- 1 - 94993 right angle plug

22004R/Y kits:

- 1 - 22006R/Y lamp & gasket
- 1 - 94993 right angle plug

**Recommended Accessories:**

- 97987 lamp gasket

**FMVSS:**

- Red: P2
- Yellow: E,P2

- Features dual contact marker clearance and side turn or auxiliary turn functions
- Red lamp should be used for rear vehicle applications
- Yellow version exceeds SAE J2039 side turn & marker standards

- 22002R Red, kit**
- 22002Y Yellow, kit**
- 22004R Red, kit w/gasket**
- 22004Y Yellow, kit w/gasket**
- 22202R Red lamp**
- 22202Y Yellow lamp**
- 22006R Red lamp w/gasket**
- 22006Y Yellow lamp w/gasket**

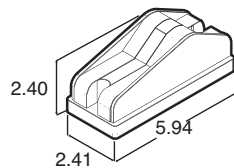
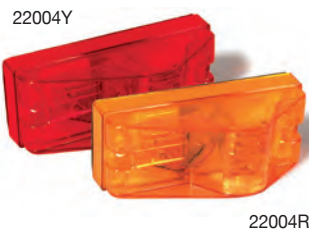

4.80 mounting holes

**40® Series Wide Turn Sealed**

**Material:**

- Polycarbonate lens
- Steel bracket
- Black PVC grommet
- 16 or 14 gauge wire

**Light Source:**

- Single filament baseless bulb
- 12v bulb designed at 2.1, 32 cp

**Kit Components:**

40802 & 40803 open kits:

- 2 - 40204 lamps
  - 2 - 40700 grommets
  - 1 - 40810 bracket
  - 1 - 99152 universal lens
  - 1 - 94932 PL3 "Y" adapter
- 40804 & 40805 enclosed kit:
- 2 - 40204 lamps
  - 2 - 40700 grommets
  - 1 - 40810 bracket
  - 1 - 99152 universal lens
  - 1 - 93843 or 93844 harness
- 40812 & 40830 enclosed kit:
- 2 - 44201Y lamps
  - 2 - 40700 grommets
  - 1 - 40810 bracket
  - 1 - 99152 universal lens
  - 1 - 93851 harness



40802

- Features large outer lens for greater visibility
- Includes slotted bracket for ease of installation & adjustment
- Available with enclosed housing for extra protection

- 40802 LH, kit w/open back**
- 40803 RH, kit w/open back**
- 40804 LH, kit w/enclosed back**
- 40805 RH, kit w/enclosed back**
- 40812 RH, LED kit w/enclosed back**
- 40830 LH, LED kit w/enclosed back**

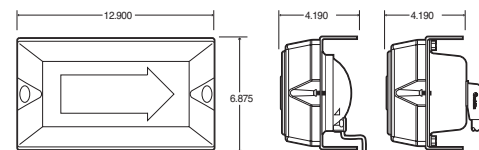

40802, 40803

40804, 40805,  
40812, 40830



See Page 2



60275Y



60272Y

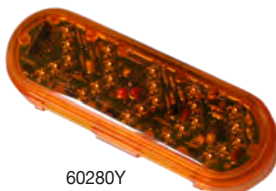

60280Y

- Auxiliary turn is a two function lamp & complies with SAE 592e & 2042 on both functions
- Sequential arrow is to be used as an auxiliary lamp only & requires a 50% on time flasher, #97231
- Not suitable for “stand alone” front or rear turn applications
- Use 60315Y for LED side turn applications SAE J2039



**LED Grommet Mount Kits**  
60075Y Yellow

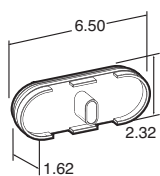

**LED Lamps**  
60275Y Yellow  
60891Y Yellow, diamond shell  
60255Y Yellow, 24v

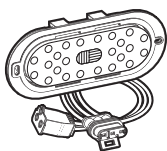

**LED Gray Flange Kits**  
60072Y Yellow

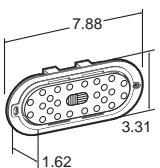

**LED Lamp & Gray Flange**  
60272Y Yellow  
60872Y Yellow, diamond shell



**LED Sequential Arrow**  
60080Y Yellow, grommet kit  
60280Y Yellow lamp

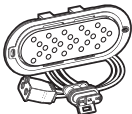

**LED Sequential Arrow**  
60082Y Yellow, flange kit  
60282Y Yellow, lamp & gray flange  
60286Y Yellow, lamp & black flange

**LED 60® Series**  
**Auxiliary Turn & Sequential Arrow**

**Material:**

- Polycarbonate or acrylic lens & housing
- ABS flange
- PVC grommet
- 16 gauge wire

**Light Source:**

- Light Emitting Diodes (LEDs)  
26 Diodes (Aux. Turn)  
25 Diodes (Seq. Arrow)
- 12v turn lamp designed at 14v, .42a (major), .10a (minor)
- 12v sequential arrow designed at 14v, .12a (major), .08a (minor)

**Kit Components:**

- 60075Y, 60036Y & 60080Y grommet kits:  
1 - 60275Y, 60255Y or 60280Y lamp  
1 - 60700 grommet  
1 - 94706 adapter plug  
60072Y & 60082Y gray flange kits:

- 1 - 60272Y or 60282Y lamp & flange  
1 - 94706 adapter plug

**Recommended Accessories:**

- Mounting: Pages 262-263
- Plugs: Pages 213-215
- 60750 gray flange
- 60725 black flange

**FMVSS:**

- Red: E2,P2,P3
- Sequential: P2



60201Y

60201R

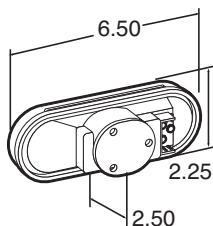

- Mount horizontally or vertically

60001R Red, grommet kit  
60001Y Yellow, grommet kit  
60201R Red lamp  
60201Y Yellow lamp

**Super 60® Turn Signal**  
**Sealed**

**Material:**

- Polycarbonate lens & housing
- PVC grommet
- 16 gauge wire

**Light Source:**

- Designed at 13.5v, 2.1 amps, 32 cp

**Kit Components:**

- 60001R/Y grommet kits:  
1 - 60201R/Y lamp  
1 - 60700 grommet  
1 - 94992 right angle plug

**Recommended Accessories:**

- Mounting: Pages 262-263
- Plugs: Pages 213-215

**FMVSS:**

- I6



**60® Series Turn Signal**  
Bulb Replaceable

**Material:**

- Polycarbonate lens & housing
- PVC grommet
- 16 gauge wire

**Light Source:**

- Bulb #3157 wedge
- Designed at 12v, 2.1 amps, 32 cp

**Kit Components:**

60344R/Y grommet kits:

- 1 - 99184R/Y lens & housing
- 1 - 60700 grommet
- 1 - 95415 socket assembly

**Replacement Parts:**

- 99184R red lens/housing
- 99184Y yellow lens/housing

**Recommended Accessories:**

- Mounting: Pages 262-263

**FMVSS:**

- I6

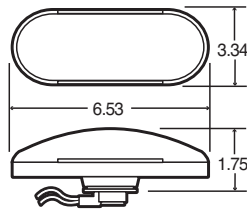

- Uses standard mounting holes & accessories

**60344R Red, kit**  
**60344Y Yellow, kit**



**LED 60 Series® Side Turn Signal & Marker Lamp**

**Materials**

- Polycarbonate Lens and Housing

**Light Source**

- 6 Diodes
- Signal Function: 0.6A @ 13.5V
- Marker Function: 0.035A @ 13.5V

**SAE Codes**

- P2 Rated
- E and E2 Rated

**Connectors**

- Hard-Wired .180 Bullet, Hard-Wired Blunt Cut, and Fit N Forget plugs, .180 terminals available

**Recommended Accessories**

- 60700: Grommet (Fits 60421Y & 60422Y)

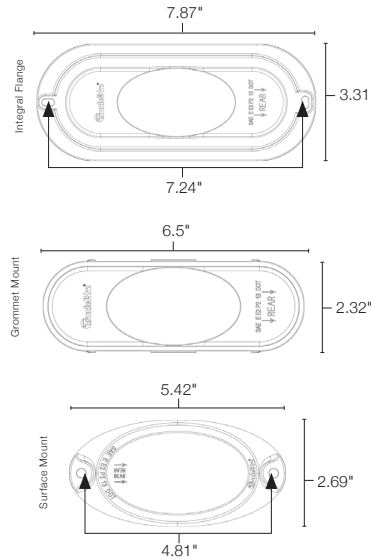

60420Y / 60423Y



60421Y / 60422Y



60424Y / 60425Y

- Complies with SAE J2039 standards; a requirement by California Title 13 law
- Available in integral flange, grommet, and surface mount
- Engineered to withstand the toughest working environments on earth
- Commonly mounted at “mid-point” on trailers or “no zone” areas on tractors
- Sealed design locks moisture out
- LEDs have no filament, therefore are not susceptible to shock & vibration, a major cause of failure for lamps with incandescent bulbs
- Less current draw, resulting in increased battery & alternator life while allowing more power for other vehicle requirements
- Backed by our industry-leading Lifetime Warranty

**60420Y Integral flange, Fit N Forget, lamp, yellow**  
**60421Y Grommet mount, Fit N Forget, lamp, yellow**  
**60422Y Grommet mount, hard-wired, blunt-cut**

**60423Y Integral flange, hard-wired, blunt-cut**  
**60424Y Surface mount, hard-wired, .180 bullet**  
**60425Y Surface mount, hard-wired, blunt-cut**

### LED Round Front/ Park/Turn w/Integral Flange

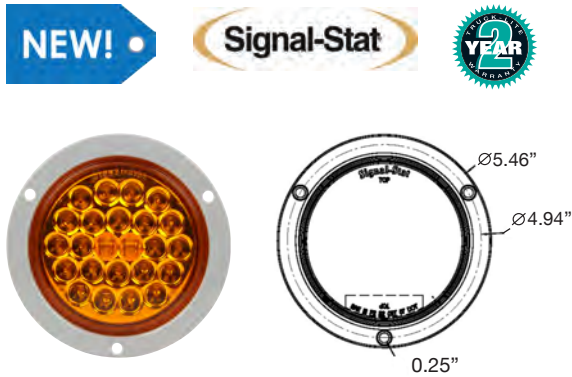

- Housing and flange are molded together to form one piece
- Uses standard right angle PL-3 connection
- Designed with impact-resistant polycarbonate material
- LEDs do not have a filament, therefore are not susceptible to shock and vibration damage major cause of failure for lamps with an incandescent bulb
- Epoxy encapsulated electronics prevents damage from moisture and corrosion
- When properly mounted, exceeds FMVSS DOT requirements for S/T/T and F/P/T
- Lamps come with Truck-Lite 2-Year Limited Warranty

4053A Integral flange, lamp, yellow

#### Material:

- Polycarbonate lens & housing

#### Light Source:

- LED, 24 diodes
- 12 V @ 0.01A - 0.138 A

#### FMVSS:

- FMVSS P2; FMVSS S2;  
FMVSS I6; FMVSS T



- Engineered to feature ten bright and economical light emitting diodes (LEDs)
- Uses standard PL-3 connector
- When properly mounted, exceeds FMVSS-P2 DOT requirements for marker/clearance performance
- Designed with impact-resistant acrylic material
- Sealed lens and housing locks moisture out
- Snap fit grommet requires no screws for installation
- LEDs do not have a filament, therefore are not susceptible to shock and vibration damage major cause of failure for lamps with an incandescent bulb
- Epoxy encapsulated electronics prevents damage from moisture and corrosion
- Popular on owner/operator and show trucks
- Lamps come with Truck-Lite 2-Year Limited Warranty

4058A Lamp, yellow

### LED Round, 10 Diode Front/Park/Turn

#### Material:

- Acrylic lens & housing

#### Light Source:

- LED, 10 diodes
- 12 V @ 0.02A - 0.12 A

#### FMVSS:

- FMVSS P2; FMVSS I6; FMVSS  
S2 (3); FMVSS T

### LED 10 Diode, Oval Front/Park/Turn Lights



NEW!

#### Material:

- Acrylic housing & lens

#### Light Source:

- LED, 10 diodes
- 12 V @ 0.02A - 0.172 A

#### FMVSS:

- FMVSS P2; FMVSS I6;  
FMVSS S2 (3); FMVSS T

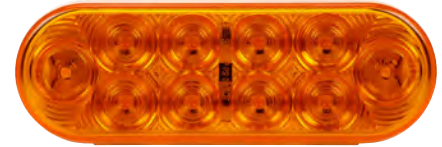
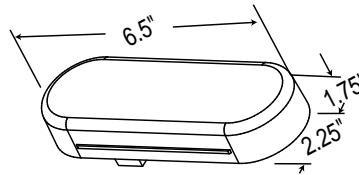

- Engineered to feature ten bright and economical light emitting diodes (LEDs)
- When properly mounted, exceeds FMVSS-P2 DOT requirements for marker/clearance performance
- Designed with impact-resistant acrylic material
- Sealed lens and housing locks moisture out
- Snap fit grommet requires no screws for installation
- LEDs do not have a filament, therefore are not susceptible to shock and vibration damage major cause of failure for lamps with an incandescent bulb
- Epoxy encapsulated electronics prevents damage from moisture and corrosion
- Popular on owner/operator and show trucks
- Lamps come with Truck-Lite 2-Year Limited Warranty

6058A Lamp, yellow

### LED Oval Front/Park/ Turn w/Integral Flange



NEW!

#### Material:

- Polycarbonate housing & acrylic lens

#### Light Source:

- LED, 24 diodes
- 12 V @ 0.02A - 0.26 A

#### FMVSS:

- FMVSS P2; FMVSS I6;  
FMVSS S2 (3); FMVSS T

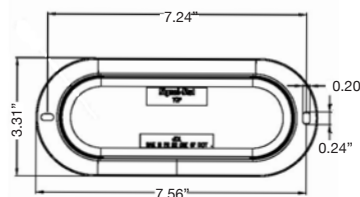

- Housing and flange are molded together to form one piece
- Uses standard right angle PL-3 connection
- Designed with impact-resistant polycarbonate material
- LEDs do not have a filament, therefore are not susceptible to shock and vibration damage major cause of failure for lamps with an incandescent bulb
- Epoxy encapsulated electronics prevents damage from moisture and corrosion
- When properly mounted, exceeds FMVSS DOT requirements for S/T/T and F/P/T
- Lamps come with Truck-Lite 2-Year Limited Warranty

6053A Integral flange, lamp, yellow



- Uses standard right angle PL-3 connection
- 10-24 diode pattern
- Unique LED array displays full pattern light output
- Epoxy encapsulated electronics

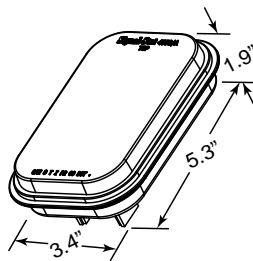

4558A Lamp, yellow

**LED 10 Diode Turn Signal Lights**

**Material:**

- Polycarbonate housing & acrylic lens

**Light Source:**

- LED, 10 diodes
- 12 V @ 0.03A - 0.28 A

**FMVSS:**

- FMVSS P2; FMVSS S2; FMVSS I6; FMVSS T

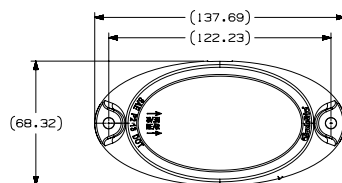

60424R Lamp, red

**LED Side Turn, .180 Bullet, Red**

**Material:**

- Polycarbonate lens & housing

**Light Source:**

- LED, 6 diodes
- 12 V @ 0.03A - 0.29 A

**SAE Codes**

- P2 Rated
- E and E2 Rated

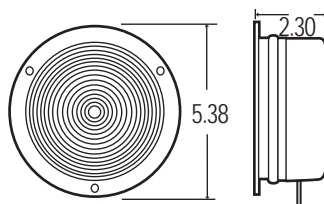

- Flush mount lamp with recessed lens

81300Y Yellow, black steel

**Turn Signal Bulb Replaceable**

**Material:**

- Polycarbonate lens
- Steel housing
- 18 gauge wire
- Stainless steel ring

**Light Source:**

- Bulb #1156, S-8 bayonet
- Designed at 12.8v, 2.1 amp, 32 cp

**Replacement Parts:**

- 99008R red lens
- 99008Y yellow lens
- 97945 retaining ring
- 97093 mounting gasket
- 97094 lens gasket

**FMVSS:**

- I6



4094A

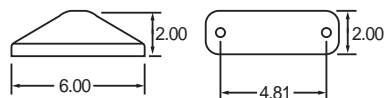

- Red for supplemental stop light or turn signal, yellow for side turn signal and marker lamp
- For Navistar #1677711C91 replacement use Signal Stat # 4091A w/9468

- 4091 Red lamp
- 4091A Yellow lamp
- 4094 Red lamp w/9463 harness
- 4094A Yellow lamp w/9463 harness

**Combination Side Marker & Side Turn Signal Bulb Replaceable**

**Material:**

- Polycarbonate lens & housing
- Rubber gasket
- 16 gauge wire

**Light Source:**

- Bulb: #3157

**Recommended Accessories:**

- 9289 mounting bracket

**FMVSS:**

- P2,PC



**Combination Side Marker & Side Turn Signal**  
Sealed

**Material:**

- Polycarbonate lens & housing
- Rubber gasket
- 16 gauge wire

**Light Source:**

- Bulb: #3157

**FMVSS:**

- P2,PC

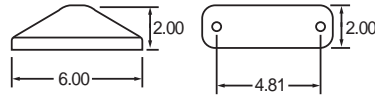

- Red for supplementary stop light or turn signal
- Yellow for side turn signal and marker lamp

- 4093 Red lamp**  
**4093A Yellow lamp**  
**4095 Red lamp w/9463 harness**  
**4095A Yellow lamp w/9463 harness**



4095A



9463 HARNESS

**Turn Signal**  
Bulb Replaceable

**Material:**

- Polycarbonate lens & housing
- 18 gauge wire

**Light Source:**

- Bulb: T-4 cartridge
- Designed at 13.5v, 1.55 amp, 20 cp

**Replacement Parts:**

- 80604 bulb

**FMVSS:**

- E
- Sequential: P2

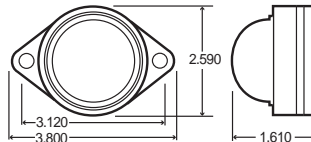

- Features snap-in lens with a 90° maximum edge visibility

- 20309Y Yellow lamp**  
**20310Y Yellow lamp w/ground wire**



20309Y

**Turn Signal**  
Bulb Replaceable

**Material:**

- Polycarbonate lens & housing
- 16 gauge wire

**Light Source:**

- 20301Y - Bulb #1156, S-8 bayonet 12v bulb designed at 2.1 amp, 32 cp
- 20304Y & 20316Y - Bulb #1157, S-8 DC 12v bulb designed at 2.1/.59 amp, 32/3 cp

**FMVSS:**

- E,I

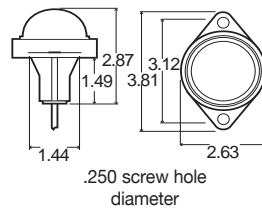

- Features side turn function, with two versions also meeting marker requirements

- 20301Y Yellow lamp**  
**20304Y Yellow lamp w/clear mkr.**  
**20316Y Yellow lamp w/clear mkr. & .180 molded bullet**



20301Y



- 24 diode pattern
- Chrome plated housing
- Ideal for show trucks, highway mowing, municipal & farm equipment

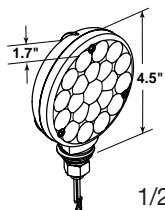

1/2 -  
20 stud

**Single Face LED Pedestal Lamps**  
 2751 Red lamp  
 2751A Yellow lamp

**LED Single & Double Face Pedestal Lamps**  
 24 Diode Pattern

**Material:**

- Polycarbonate lens
- Die cast housing

**Light Source:**

- Light Emitting Diodes (LEDs)
- Double face designed at 12.8v major 0.35 +/- 1.10 amp minor 0.025 +/- 0.075 amp
- Single face designed at 12.8v Red: major 0.13 +/- 0.34 amp Red: minor .005 +/- .023 amp Yellow: major 0.260 +/- 0.45 amp Yellow: minor .015 +/- .035 amp

**FMVSS:**

- Red: I6,S2,T
- Yellow: I6,P

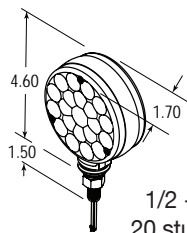

1/2 -  
20 stud

**Double Face LED Pedestal Lamps**  
 2750 Red/Yellow lamp



- 3805Y115 requires Phillips #28S 11/4SC or GE #13655 bulb
- For vehicle application with vehicle width under 80" wide
- Pigtail with spring and thermoplastic wire exits via hollow stud

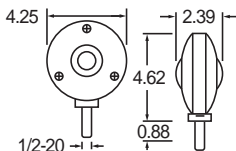

**Black Housing**

- Mack #47M0251P1
- 2801 Red/Yellow lamp, one wire
- 2803 Red/Yellow lamp, two wire

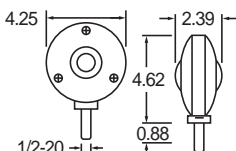

**Chrome Housing**

- 3802 Red/Yellow lamp, one wire
- 3812 Red/Yellow lamp, two wire

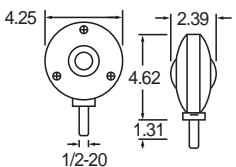

**Gray Housing**

- 3810 Red/Yellow lamp, three wire, shock/mount w/ 1-5/16" stud ground wire for fiberglass fenders
- 3805Y115 Red/Red lamp, railroad crossing lamp

**Double Face Pedestal Lamps**  
 Bulb Replaceable

**Material:**

- Acrylic lens
- Die cast housing
- 16 gauge wire

**Light Source:**

- Bulb: #1156 single contact
- Bulb: #1157 double contact

**Replacement Parts:**

- 9016 red lens
- 9021 red lens kit
- 9016A yellow lens
- 9021A yellow lens kit
- 9016W clear lens
- 9021W clear lens kit
- 9016B blue lens
- 9016G green lens
- 9102 single contact wire
- 9101 double contact wire

**FMVSS:**

- One wire: I
- Two wire: I,P,S,T

**Pedestal Style Lamps**  
**“Knock Down” Design**  
 Bulb Replaceable

**Material:**

- Polycarbonate lens & housing
- Permastat base
- 16 gauge wire

**Light Source:**

- Designed at 12v, 2.1 amp, 32 cp
- Bulb: #1076 T/S
- Bulb: #1157 S/T/T

**Replacement Parts:**

- 8936 red lens
- 8936A yellow lens

**FMVSS:**

- I6,P

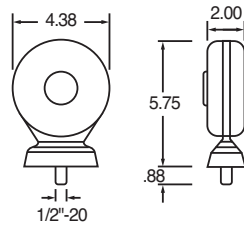

- Ideal for highway mowing, municipal lawn, and farm equipment
- Spring loaded “Knock-Down” feature allows lamp to flex under impact and return to original position

**3853AA Yellow/Yellow, two wire, w/ground**  
**3854 Red/Yellow, three wire, w/ground**



**Double Face Pedestal Lamp**  
**Chrome or Gray Housing**  
 Bulb Replaceable

**Material:**

- Acrylic lens
- Die cast housing
- 16 gauge wire

**Light Source:**

- Bulb: #1156 single contact
- Bulb: #1157 double contact
- Bulb: #1076 (3862) fiberglass fenders

**Replacement Parts:**

- 9341 red lens
- 9341A yellow lens
- 9160 one wire plug

**FMVSS:**

- I,P,S,T

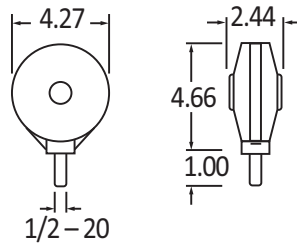

- Snap-Grip lens allows quick bulb & lens replacement
- “O-ring” lens gasket seals out dirt and moisture
- Mounting: Hollow stud, 1/2” diameter

**3861 Red/Yellow, T/S, chrome housing**  
**3860 Red/Yellow, T/S, gray housing**  
**3862 Red/Yellow, T/S, ground wire for fiberglass fenders, gray housing**  
**3863 Red/Yellow, S/T/T, gray housing**



**Double Face Pedestal Lamp**  
 Bulb Replaceable

**Material:**

- Acrylic lens & housing
- 16 gauge wire

**Light Source:**

- Bulb: #1156

**Replacement Parts:**

- 8936 red lens
- 8936A yellow lens

**FMVSS:**

- I6



- Lamp grounds through mounting stud

**3850 Red/Yellow**  
**3850AA Yellow/Yellow**

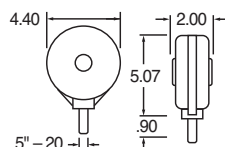

**Double Face Pedestal Lamp**  
 Bulb Replaceable

**Material:**

- Polycarbonate lens & housing
- 16 or 18 gauge wire

**Light Source:**

- Bulb: #1156, S-8 bayonet
- Designed at 12v, 2.1 amp, 32 cp

**Replacement Parts:**

- 99009Y yellow lens for 70300
- 99090R red lens for 70330R
- 99090Y yellow lens for 70330Y

**FMVSS:**

- I6

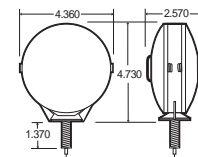

- Available as single or dual face lamp
- Dual face lamp mounts on a 3/8” - 24 stud, and single face lamp mounts on a 7/16” - 14 stud

**70300 Red/Yellow**  
**70330R Red**  
**70330Y Yellow**





**LED**  
UPGRADE  
See Page 44

**Single Face Pedestal Lamp**  
Bulb Replaceable



2702

- For vehicle application with vehicle width under 80" wide

2702 Red, black housing  
2702A Yellow, black housing

**Material:**

- Acrylic lens
- Zinc die cast housing
- 16 gauge wire

**Light Source:**

- Bulb: #1157 S/T/T

**Replacement Parts:**

- 9016 red lens
- 9016A yellow lens
- 9016W clear lens
- 9016B blue lens
- 9016G green lens

**FMVSS:**

- I,S,T

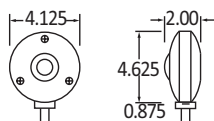

**LED**  
UPGRADE  
See Page 44

**Single Face Pedestal Lamp**  
Bulb Replaceable



- Rubber O-ring seals out dirt & moisture
- Snap-on lens for easy bulb replacement

3762 Red, gray housing

**Material:**

- Polycarbonate lens
- Zinc die cast housing
- 16 gauge wire

**Light Source:**

- Bulb: #1157 S/T/T

**Replacement Parts:**

- 9341 red lens
- 9341A yellow lens

**FMVSS:**

- I6,S2,T

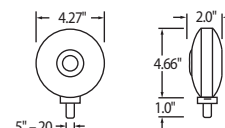

**Single Face Pedestal Lamp**  
Bulb Replaceable



3753A

3756

- Snap-on lens simplifies bulb and lens replacement

3753D Red, white housing, one wire, retail pack  
3754D Red, white housing, two wire, retail pack  
3755D Red, black housing, one wire, retail pack  
3756D Red, black housing, two wire, retail pack  
3753AD Yellow, white housing, one wire, retail pack  
3755A Yellow, black housing, one wire

**Material:**

- Acrylic lens
- Polycarbonate housing
- 16 gauge wire

**Light Source:**

- Designed at 12v, 2.1 amp, 32 cp
- Bulb: #1156 T/S
- Bulb: #1157 S/T/T

**Replacement Parts:**

- 8936 red lens
- 8936A yellow lens
- 9102 T/S plug

**FMVSS:**

- One wire: I6
- Two wire: S2,T

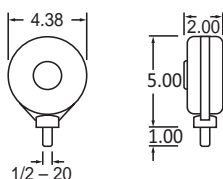

**LED**  
UPGRADE  
See Page 44

**Single Face Pedestal Lamp**  
Bulb Replaceable



- For vehicle application with vehicle width under 80" wide

2701 Red, black housing  
2701A Yellow, black housing  
3701 Red, gray housing

**Material:**

- Acrylic lens
- Zinc die cast housing
- 16 gauge wire

**Light Source:**

- Bulb: #1156

**Replacement Parts:**

- 9016 red lens
- 9021 red lens kit
- 9016A yellow lens
- 9021A yellow lens kit
- 9016W clear lens
- 9021W clear lens kits
- 9016B blue lens
- 9016G green lens
- 9102 pigtail

**FMVSS:**

- I

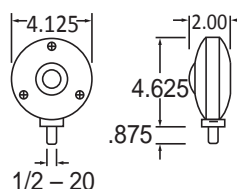



**Single & Double Face Pedestal Lamp**  
Bulb Replaceable

**Material:**

- Polycarbonate lens & housing
- 16 gauge wire

**Light Source:**

- Designed at 12v, 2.1 amp, 32 cp
- Bulb: #1157

**Replacement parts:**

- 99090R red lens
- 99090Y yellow lens
- 9102 pigtail

**FMVSS:**

- Red: I6,S2,T
- Yellow: I6,P

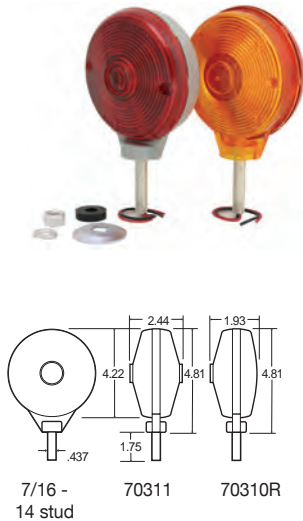

- Features high impact gray plastic housing

**70310R Red**  
**70311 Red/Yellow**

**Double Face Pedestal Lamp**  
Bulb Replaceable

**Material:**

- ABS housing
- Acrylic (red) or polycarbonate (yellow) lens
- 18 gauge wire

**Light Source:**

- Bulb: #1156, S-8 bayonet
- 12v bulb designed at 2.1 amp, 32 cp
- Bulb: #168, T-3-1/4 wedge
- 12v designed at .35 amp, 3 cp

**Replacement Parts:**

- 9102 pigtail

**FMVSS:**

- I6
- Side: A,P2

- Replaces Ford parts E5HT-13201-AA (LH) & E5HT-13200-AA (RH)
- Includes integral plug

**70352 Red/Yellow, LH chrome**  
**70353 Red/Yellow, RH chrome**  
**70356 Red/Yellow, LH black**  
**70357 Red/Yellow, RH black**

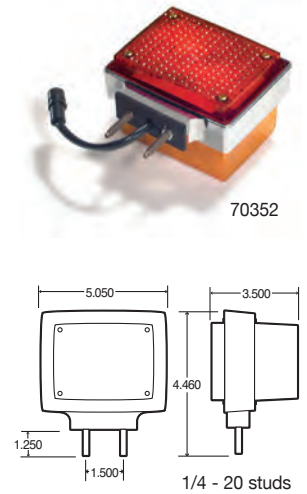

**Navistar Universal Front Signal Lamp**  
Bulb Replaceable

**Material:**

- Polycarbonate lens & housing
- 16 gauge wire

**Light Source:**

- 12v bulb designed at 2.1 amp, 32 cp
- Bulb: #3157

**Recommended Accessories:**

- 9467 harness

**FMVSS:**

- I6,P
- Side: A,P2

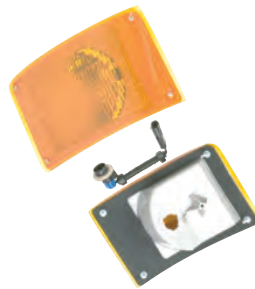

4097A with 9467 harness

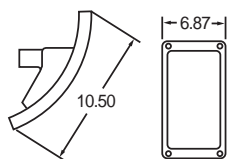

- Navistar #1677715C91
- Accepts rear entry bulb socket and harness assembly, not included

**4097A Yellow**

**5800 Series Universal Combination Double Face Front Turn Signal Lamp, Side Marker & Reflex Reflector**

**Material:**

- Polycarbonate lens & housing
- 16 gauge wire

**Light Source:**

- 12v bulb designed at 2.1 amp, 32 cp
- Bulb: #1157

**Replacement Parts:**

- 9084A yellow lens
- 9120 O-ring
- 9465 harness

**FMVSS:**

- I6,P

- Special Packard Metri-Pack connector
- GM #15565531

**5800AA Yellow/Yellow, vertical mount**  
**5800AAK Yellow/Yellow, vertical mount w/9465 harness**



5800AAK

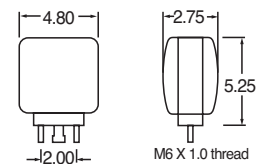

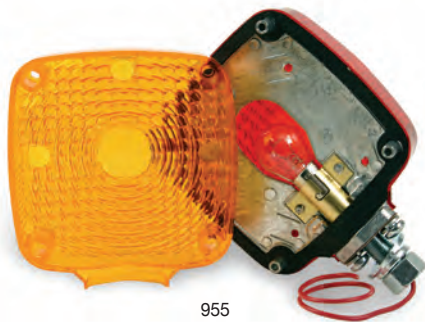

955

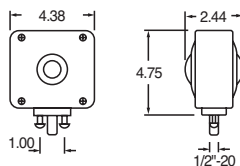

- Mounts left or right, horizontally or vertically
- Mounting hardware for stud or pedestal installation

**955 Red/Yellow w/side marker clearance lamp**

**Vertical/Horizontal Mount Turn Signal Bulb Replaceable**

**Material:**

- Acrylic lens
- Die cast housing
- 16 gauge wire

**Light Source:**

- Bulb: #1816 park, #1156 signal

**Replacement Parts:**

- 8960 red lens

**FMVSS:**

- I6,S2,T,P2



- Replaces GM #694627 (LH) & #694628 (RH)
- Mounts on 3.20" centers & connects with 2 spade terminals
- Unique GM harness connector (harness not available from Truck-Lite)

**4854 Red/Yellow, RH**  
**4855 Red/Yellow, LH**

**Dual Face GM Turn Signal Horizontal Mount Bulb Replaceable**

**Material:**

- Acrylic lens
- ABS housing

**Light Source:**

- Bulb: #1156 signal
- Bulb: #1895 marker
- Bulb: #1816 park

**Replacement Parts:**

- 9063 red lens
- 9080A yellow marker lens

**FMVSS:**

- I6,P2,P,A

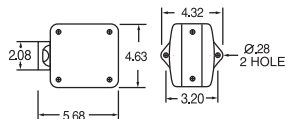

- GM #2029217
- Mounts on 3.20" centers & connects with 3 spade terminals
- Unique GM harness connector (harness not available from Truck-Lite)

**4872AA Yellow/Yellow**

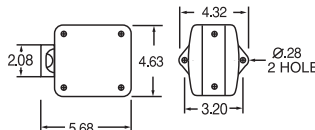

**Dual Face GM Turn Signal Horizontal Mount Bulb Replaceable**

**Material:**

- Polycarbonate lens & housing

**Light Source:**

- Bulb: #1157

**FMVSS:**

- I6,P



956AA

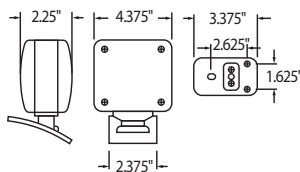

- Receptacle type connector
- Mounting bracket included

**956AA Yellow/Yellow w/o parking lamp, Navistar #582779C91**

**957AA Yellow/Yellow w/parking lamp, Navistar #582780C91**

**Navistar Turn Signal Horizontal Mount Bulb Replaceable**

**Material:**

- Acrylic lens
- Die cast housing
- 16 gauge wire

**Light Source:**

- Bulb: #1816 park
- Bulb: #1156 signal

**Replacement Parts:**

- 8960 red lens
- 96195 lens gasket

**LED Double Face Pedestal Lamp**  
2/24 Diode Pattern

**Material:**

- Polycarbonate lens
- Chrome plated housing

**Light Source:**

- Light Emitting Diodes (LEDs)
- Designed at 12.8v, Major 0.24 - 0.53 amp
- Minor 0.06 - 0.073 amp

**FMVSS:**

- I6

- 24 diode pattern (per side) with chrome plated housing
- Double-stud mount

2758 Red/Yellow, curbside  
2759 Red/Yellow, roadside

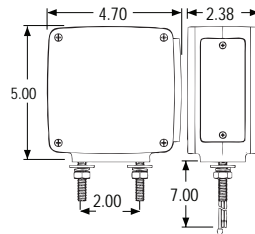

**Universal Dual Face Turn Signal**  
Bulb Replaceable

**Material:**

- Acrylic lens
- ABS housing
- 16 gauge wire

**Light Source:**

- Bulb: #1157

**Replacement Parts:**

- 8938 red signal lens
- 8938A yellow signal lens

**FMVSS:**

- I6,A,P2,S2,T

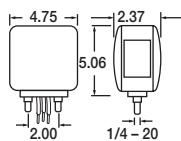

4742 4754



- Includes separate ground wire for installation

4742 Red/Yellow, flat surface mount,  
vertical mount  
4754 Red/Yellow, flat surface mount,  
horizontal mount

**Universal Dual Face Turn Signal**  
Vertical Mount  
Bulb Replaceable

**Material:**

- Acrylic lens
- Chrome plated polycarbonate housing
- 16 gauge wire

**Light Source:**

- Bulb: #1157

**Replacement Parts:**

- 9063A yellow lens
- 9080A S/M lens

**FMVSS:**

- I6,P,A,P2

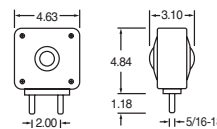

- Kenworth #K-256-D-324
- Plugs into Kenworth harness connector & includes terminated wire

4874AY101 Yellow/Yellow, chrome housing w/harness

**Dual Face Turn Signal**  
Vertical Mount  
Bulb Replaceable

**Material:**

- Polycarbonate lens & housing
- 16 gauge wire

**Light Source:**

- Bulb: #2356

**Replacement Parts:**

- 9079 red lens
- 9079A yellow lens
- 9080A yellow marker lens kit
- 9260 harness

**FMVSS:**

- I6

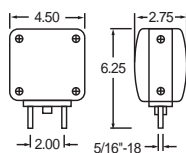

- Navistar #444660C91 (left), 659C91 (Right)
- Keyed plug-in receptacle accepts OEM harness

4842 Red/Yellow, black housing  
81331 Yellow/Yellow, black housing

**Dual Face Turn Signal**  
Horizontal Mount  
Bulb Replaceable

**Material:**

- Acrylic lens
- Polycarbonate housing
- 16 gauge wire

**Light Source:**

- Bulb: #1156 signal
- Bulb: #1895 marker

**Replacement Parts:**

- 9063 red lens
- 9063A yellow lens
- 9080A yellow marker lens

**FMVSS:**

- I6,P,P2,A



- GM #677914

4810 Red/Yellow, black housing

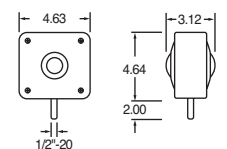



**LED Double Face Pedestal Lamp**  
Square Sealed  
24 Diode Pattern



- Material:**
- Polycarbonate lens
  - Chrome plated housing
- Light Source:**
- Light Emitting Diodes (LEDs)
  - Yellow/yellow designed at 12.8v; major 0.48 - 0.64 amp
  - Red/yellow designed at 12.8v; major 0.24 - 0.53 amp; minor 0.06 - 0.073

- FMVSS:**
- Red/Yellow: I6
  - Yellow/Yellow: I6,P2

- 24 diode pattern
- Chrome plated housing

- 2752 Yellow/Yellow w/side marker clearance lamp  
2753 Red/Yellow roadside  
2756 Red/Yellow curbside

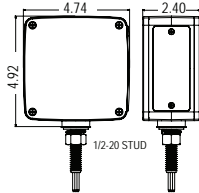

**Dual Face Turn Signal**  
Vertical Mount  
Bulb Replaceable

- Material:**
- Acrylic lens
  - Black or chrome plated polycarbonate housing
  - 16 gauge wire
- Light Source:**
- Bulb: #1156 turn signal
  - bulb: #1895 marker

- Replacement Parts:**
- 9063 red lens
  - 9063A yellow lens
  - 9080A yellow marker lens

- FMVSS:**
- I6,A,P2

- Black housed version is a popular Western Star replacement
- Chrome housed version is a popular replacement for Volvo & Peterbilt

- 4800 Red/Yellow, black housing  
4801 Red/Yellow, chrome housing

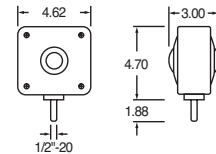

**Dual Face Turn Signal**  
Vertical Mount  
Bulb Replaceable



- Material:**
- Polycarbonate lens & housing
  - 16 gauge wire
- Light Source:**
- Bulb: #1156 signal
  - Bulb: #1895 marker
- Replacement Parts:**
- 9083 red lens kit
  - 9080A yellow marker lens kit
- FMVSS:**
- I6,A,P2

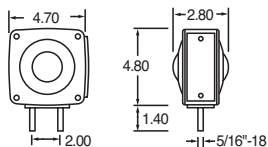

- Freightliner #A06-18900-000 (LH), #A06-18900-001 (RH)
- Includes OEM 49" harness that mates with truck harness – simplifying replacement
- Mounting pad included
- Two 5/16" studs on 2" centers

- 4805AY116 Red/Yellow, LH  
4805AY117 Red/Yellow, RH



**Dual Face Turn Signal**  
Vertical Mount  
Bulb Replaceable

- Material:**
- Polycarbonate lens & housing
  - 16 gauge wire
- Light Source:**
- Bulb: #1156 signal
  - Bulb: #1895 marker
- Replacement Parts:**
- 9079 red lens
  - 9079A yellow lens
  - 9080A yellow marker lens kit
- FMVSS:**
- I6,A,P2

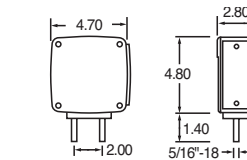

- 4805AAY115 includes OEM 7" harness that mates with truck harness – simplifying replacement
- 4805AAY118 included 75" OEM mating harness

- 4805AAY115 Yellow/Yellow, black housing, Freightliner #681-822-0020  
4805AAY118 Yellow/Yellow, black housing, Freightliner #681-822-0120



**LED Long Life Vehicle Retrofit**



**Material:**

- Polycarbonate lens & housing
- PVC grommet
- 18 gauge wire

**Replacement Parts:**

- 60701 LLV grommet
- 45701 LLV grommet



- Increases vehicle conspicuity with intense displays of light output
- Instantaneous response time, 200 milliseconds faster than that of incandescent lamps, creating 18 feet of additional stopping distance for trailing vehicles at highway speeds
- LED Versions rated at 100,000 hours of operation, covering 4 million miles
- Extended period of operation translates to less vehicle downtime and zero maintenance

FUNCTION	QTY REQUIRED	INCANDESCENT #	LED #
Stop & Tail Lamp	2	45022R	45032R
Turn & Hazard Lamp	4	45021Y	45073Y
Back-Up Lamp	2	45024	
Side Lamp, Rear	2	60023R	60180R
Side Lamp, Front	2	60024Y	60180Y
Front, Park & Turn Lamp	2	60022Y	60074Y
Center High Mount Stop Lamp	1	60021R	60060R

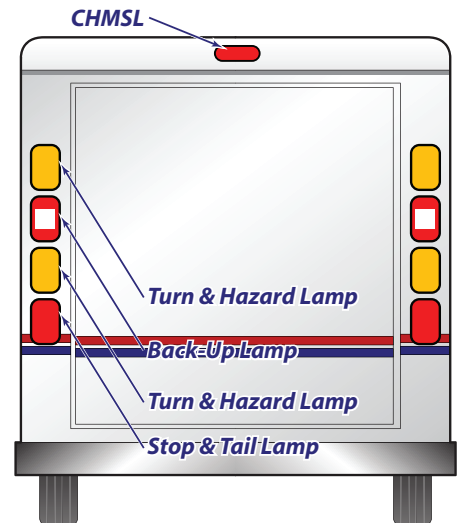
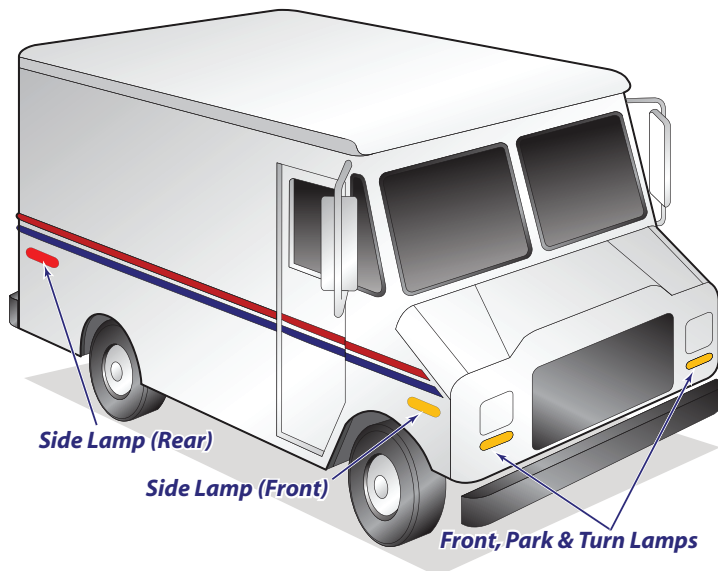

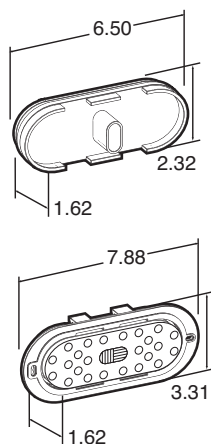

- Recommended for auxiliary brake light applications only
- Electronics completely sealed in epoxy to resist corrosion & moisture

60061R	Red, grommet kit	60262R	Red lamp & gray flange
60260R	Red lamp	60266R	Red lamp & black flange
60062R	Red, gray flange kit		

**LED 60® Series**  
**High Mounted**  
**Stop Lamp**  
26 Diode Pattern

**Material:**

- Polycarbonate lens, housing & flange
- PVC grommet
- 16 gauge wire

**Light Source:**

- Light Emitting Diodes (LEDs)
- Designed at 14v, .35 amp

**Kit Components:**

60061R grommet kit:

- 1 - 60260R lamp
- 1 - 60700 grommet
- 1 - 94789 adapter plug

60062R gray flange kits:

- 1 - 60262R lamp & flange
- 1 - 94789 adapter plug

**Recommended Accessories:**

- Mounting: Pages 262-263
- Plugs: Pages 213-215

**FMVSS:**

- U2,U3

**45® Series**  
**CHMSL Products**  
Sealed

**Material:**

- Polycarbonate lens & housing
- PVC grommet
- 16 gauge wire

**Light Source:**

- 12v bulb designed at 1.44 amp, 21 cp

**FMVSS:**

- U2,U3

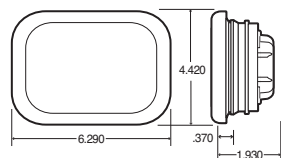

- Features high mount stop function when center mounted on the top rear of the vehicle

45207R Red lamp

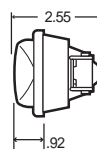
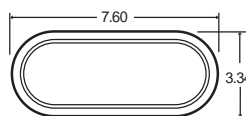
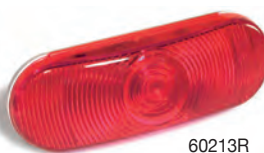

**Super 60® CHMSL**  
Sealed

**Material:**

- Polycarbonate lens & housing
- PVC grommet
- 16 gauge wire

**Light Source:**

- 12v bulb designed at 1.44 amp, 21 cp & rated for 500 hours

**Kit Components:**

60013R grommet kit:

- 1 - 60213R lamp
- 1 - 60700 grommet
- 1 - 94992 right angle plug

**Recommended Accessories:**

- Mounting: Pages 262-263
- Plugs: Pages 213-215

**FMVSS:**

- U2,U3

- Features high mount stop function when center mounted on the top rear of the vehicle
- Recommended for auxiliary brake light applications only

60013R	Red, grommet kit
60213R	Red lamp

**40® Series**  
**CHMSL Products**  
Sealed

**Material:**

- Polycarbonate lens & housing
- 16 gauge wire

**Light Source:**

- 12v bulb designed at 1.44 amps, 21 cp

**Recommended Accessories:**

- Mounting: Pages 262-263
- Plugs: Pages 213-215

**FMVSS:**

- U2,U3

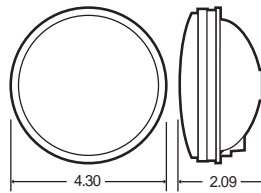

- Features high mount stop function when center mounted on the top rear of the vehicle
- Heavy duty shock-mounted bulb
- Recommended for use in center high mounted stop lamp applications only

**40247R Red lamp**

**LED 21® Series**  
**High Mount Stop & Marker Lamp**  
16 Diode Pattern

**Material:**

- Polycarbonate lens & housing
- 16 gauge wire

**Light Source:**

- Light Emitting Diodes (LEDs)
- 12v lamp designed at 14v, .18 amp (HMSL) and .03 amp (marker/clearance)

**Recommended Accessories:**

- 97034 mounting gasket
- 97036 sealing gasket

**FMVSS:**

- U2,U3,P2



- Optional gaskets available to improve seal between lamp & body
- Electronics completely sealed in epoxy to resist corrosion & moisture
- Hardwired design eliminates pin corrosion
- Recommended for use in center high mounted stop lamp applications only

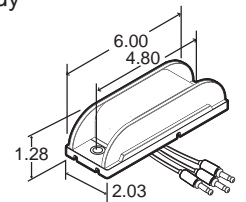

**21271R Red lamp**

**LED CHMSL Lamp**  
**Adhesive Mount**  
9 Diode Pattern

**Material:**

- Polycarbonate lens & housing

**Light Source:**

- Light Emitting Diodes (LEDs)
- Designed at 13.2v, .25 amp

**FMVSS:**

- U2,U3



- Slim lamp welcomes applications where space is at a premium
- Adhesive back adheres to mounting surface without the need for installation screws or brackets
- Peel & stick design makes for a tight, unbreakable seal
- DOT/SAE compliant
- 96" wire lead makes wiring easier
- Recommended for use in center high mounted stop lamp applications only

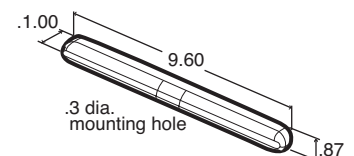

**92100 Red lamp**

**92101 Red lamp w/Packard connector**

# Marker & Clearance Lighting







- Provides solution that requires no mounting brackets or installation screws
- Lamps adhere directly to application surface through use of heavy-duty adhesive backing, with an easy-to-install peel-off liner
- Rear exit and side exit wires with 0.180 male bullets are available
- Side mount options can be mounted without any mounting holes
- LEDs draw much less current, allowing more power for other vehicle requirements
- Electronics are completely sealed in epoxy to resist damage caused by moisture & corrosion
- Reduces lighting costs caused by physical damage & heat entrapment

36105R Red lamp, side exit wires  
 36105Y Yellow lamp, side exit wires  
 36115R Red lamp, rear exit wires  
 36115Y Yellow lamp, rear exit wires

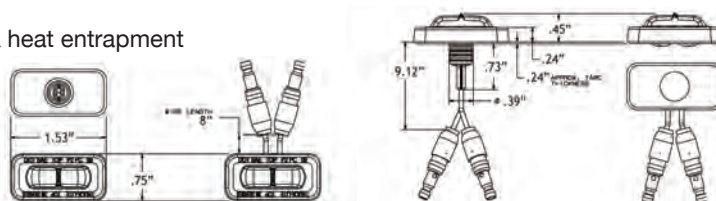

### LED 36 Series Flex-Lite With Non-Winged Housing 3 Diode Pattern

#### Material:

- Polycarbonate lens
- Over-molded hot-melt housing/substrate
- 20 gauge wire

#### Light Source:

- Light emitting diodes (LEDs)
- Designed at 12.8 A, 0.03 A (red), 0.05 A (yellow)

#### Recommended Accessories:

- Mounting: Page 247

#### FMVSS:

- P2,PC



- Winged housing provides option for mounting around radius corners
- Provides solution that requires no mounting brackets or installation screws
- Lamps adhere directly to application surface through use of heavy-duty adhesive backing, with an easy-to-install peel-off liner
- Rear exit and side exit wires with 0.180 male bullets are available
- Side mount options can be mounted without any mounting holes
- LEDs draw much less current, allowing more power for other vehicle requirements
- Electronics are completely sealed in epoxy to resist damage caused by moisture & corrosion
- Reduces lighting costs caused by physical damage & heat entrapment

36100R Red lamp, side exit wires  
 36100Y Yellow lamp, side exit wires  
 36110R Red lamp, rear exit wires  
 36110Y Yellow lamp, rear exit wires  
 36130R Red lamp, rear exit, 10-30 volt  
 36130Y Yellow lamp, rear exit, 10-30 volt

### LED 36 Series Flex-Lite With Winged Housing 3 Diode Pattern

#### Material:

- Polycarbonate lens
- Over-molded hot-melt housing/substrate
- 20 gauge wire

#### Light Source:

- Light emitting diodes (LEDs)
- Designed at 12.8v, 0.03 amp (red), 0.05 amp (yellow)

#### Recommended Accessories:

- Mounting: Page 248

#### FMVSS:

- P2,PC

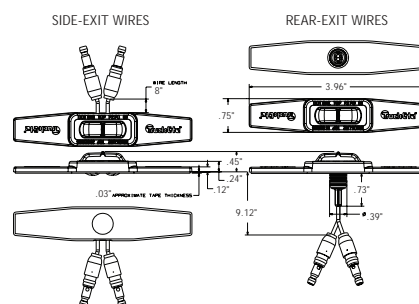

**LED 33® Series**

**3/4" Sealed**

**1 Diode Pattern**



**Material:**

- Polycarbonate lens & housing
- EPDM grommet
- Nylon flange
- 18 gauge wire

**Light Source:**

- Light Emitting Diodes (LEDs)
- P2 designed at 14 volts, 0.05 amp
- PC lamp designed at 13.5 volts, 0.14 amp

**Recommended Accessories:**

- Mounting: Page 248

**FMVSS:**

- P2 or P2,PC as noted below



- US patent #6612728
- World's smallest LED marker lamp for the transportation industry
- Standard lamp exceeds P2 legal requirements, while PC lamps are rated for combination clearance/ marker applications
- Hardwired lamp with .180 male bullet design is easily retrofitted
- LEDs draw less current, allowing more power for other vehicle requirements
- Electronics completely sealed in epoxy to resist corrosion & moisture
- Offers trailer new trailer & rear door structure design flexibility
- Reduces lighting costs due to physical damage & heat entrapment

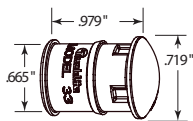

**PC Rated Lamps**

- 33275R Red
- 33275Y Yellow
- 33277Y Yellow, 20" plug
- 33285R Red w/clear lens
- 33285Y Yellow w/clear lens

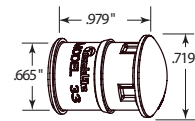

**P2 Rated Lamps**

- 33250R Red
- 33250Y Yellow

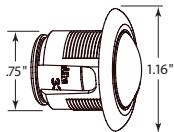

**PC Rated Black Flange Kits**

- 33080Y Yellow
- 33080R Red

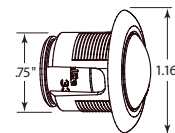

**P2 Rated Black Flange Kits**

- 33051R Red
- 33051Y Yellow

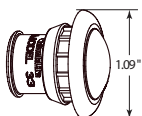

**PC Rated Grommet Kits**

- 33075R Red
- 33075Y Yellow

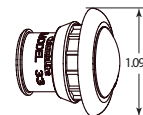

**P2 Rated Grommet Kits**

- 33050R Red
- 33050Y Yellow

**LED 10® Series**  
**PC Rated**  
**High Profile**  
 2-1/2" Sealed  
 8 Diode Pattern



- SAE PC rated for combination clearance/marker applications
- Available with Fit 'N Forget® or standard connections, with electronics completely sealed in epoxy to resist damage from corrosion & moisture

**Material:**

- Polycarbonate lens, housing & flange
- PVC grommet
- 16 gauge wire

**Light Source:**

- Light Emitting Diodes (LEDs)
- Designed at 14v, 0.1 amp

**Kit Components:**

10075R/Y grommet kits:

- 1 - 10275R/Y lamp
- 1 - 10700 grommet
- 1 - 94964 plug

10079R/Y gray flange kits:

- 1 - 10279R/Y lamp & flange
- 1 - 94964 plug

10085R/Y grommet kits:

- 1 - 10375R/Y lamp
- 1 - 10700 grommet
- 1 - 93745 plug

10090R/Y gray flange kits:

- 1 - 10379R/Y lamp & flange
- 1 - 93745 plug

**Recommended Accessories:**

- Mounting: Pages 249-252
- Plugs: Pages 225-228
- 97079 flange gasket

**FMVSS:**

- P2,PC,P3

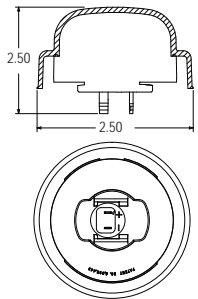

**LED Lamps**  
 10375R Red  
 10375Y Yellow

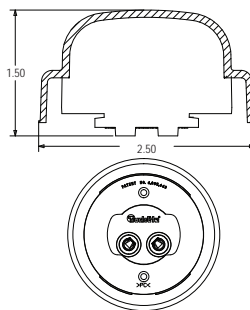

**LED Lamps**  
 10275R Red  
 10275Y Yellow

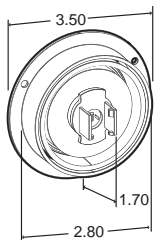

**LED Lamp & Gray Flange**  
 10379R Red  
 10379Y Yellow

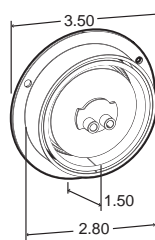

**LED Lamps & Gray Flange**  
 10279R Red  
 10279Y Yellow

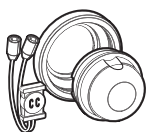

**LED Grommet Kits**  
 10085R Red  
 10085Y Yellow



**LED Grommet Kits**  
 10075R Red  
 10075Y Yellow

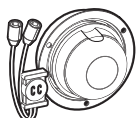

**LED Gray Flange Kits**  
 10090R Red  
 10090Y Yellow



**LED Gray Flange Kits**  
 10079R Red  
 10079Y Yellow



**LED 10® Series**

**PC Rated**

Low Profile

2-1/2" Sealed

8 Diode Pattern



**Material:**

- Polycarbonate lens, housing & flange
- PVC grommet
- 16 gauge wire

**Light Source:**

- Light Emitting Diodes (LEDs)
- Designed at 14v, 0.1 amp

**Kit Components:**

10076R/Y grommet kits:

- 1 - 10385R/Y lamp
- 1 - 10700 grommet
- 1 - 93745 plug

10091R/Y gray flange kits:

- 1 - 10389R/Y lamp & flange
- 1 - 93745 plug

10086R/Y grommet kits:

- 1 - 10286R/Y lamp
- 1 - 10700 grommet
- 1 - 94964 plug

10089R/Y gray flange kits:

- 1 - 10289R/Y lamp & flange
- 1 - 94964 plug

10088R/Y black flange kits:

- 1 - 10288R/Y lamp & flange
- 1 - 94964 plug

**Recommended Accessories:**

- Mounting: Pages 249-252
- Plugs: Pages 225-228
- 97079 flange gasket

**FMVSS:**

- P2,PC

- U.S. patent #6623150
- Less current draw, resulting in increased battery & alternator life
- Unique lens optics allows low profile lamp design
- SAE PC rated for combination marker clearance applications

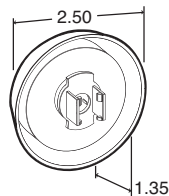

**LED Lamps**  
10385R Red  
10385Y Yellow

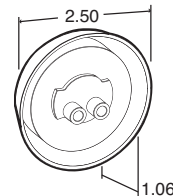

**LED Lamps**  
10286R Red  
10286Y Yellow

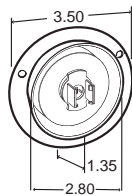

**LED Lamp & Gray Flange**  
10389R Red  
10389Y Yellow

**LED Lamp & Black Flange**  
10391R Red  
10391Y Yellow

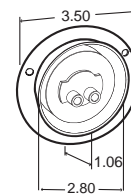

**LED Lamp & Black Flange**  
10288R Red  
10288Y Yellow

**LED Lamp & Gray Flange**  
10289R Red  
10289Y Yellow

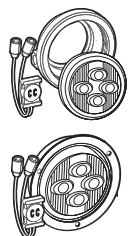

**LED Grommet Kits**  
10076R Red  
10076Y Yellow

**LED Flange Kits**  
10091R Red, Gray Flange  
10091Y Yellow, Gray Flange  
10092R Red, Black Flange  
10092Y Yellow, Black Flange

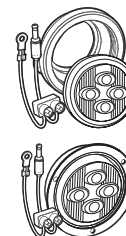

**LED Grommet Kits**  
10086R Red  
10086Y Yellow

**LED Gray Flange Kits**  
10089R Red  
10089Y Yellow



- Standard lamp has 2 diodes, Omni-Volt lamp has 3 diodes
- Less current draw, resulting in increased battery & alternator life
- Electronics completely sealed in epoxy to resist corrosion & moisture

**LED 10® Series**

2-1/2" Sealed  
2-3 Diode Pattern

**Material:**

- Polycarbonate lens, housing & flange
- PVC grommet
- 16 gauge wire

**Light Source:**

- Light Emitting Diodes (LEDs)
- Designed at 14v, 0.03 amp (red) and 0.08 amp (yellow)

**Kit Components:**

10050R/Y grommet Kits:

- 1 - 10250R/Y lamp
- 1 - 10700 grommet
- 1 - 93745 plug

10051R/Y gray flange kits:

- 1 - 10251R/Y lamp & flange
- 1 - 93745 plug

**Recommended Accessories:**

- Mounting: Pages 249-252
- Plugs: Pages 225-228
- 97079 flange gasket

**FMVSS:**

- P2

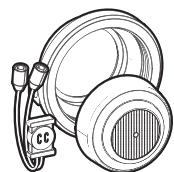

**LED Grommet Kits**

- 10050R Red
- 10050Y Yellow

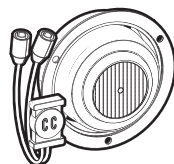

**LED Gray Flange Kits**

- 10051R Red
- 10051Y Yellow

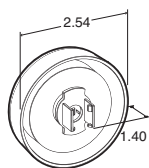

**LED Lamp**

- 10250R Red
- 10256R Red, 10-30v
- 10250Y Yellow
- 10256Y Yellow, 10-30v

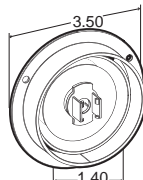

**LED Lamp & Gray Flange**

- 10251R Red
- 10251Y Yellow

**LED Lamp & Gray Flange (ABS system compatible)**

- 10271Y Yellow, w/ ABS logo

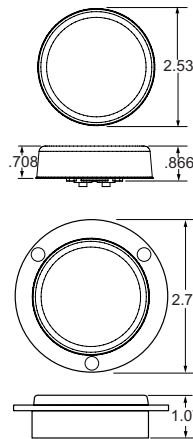
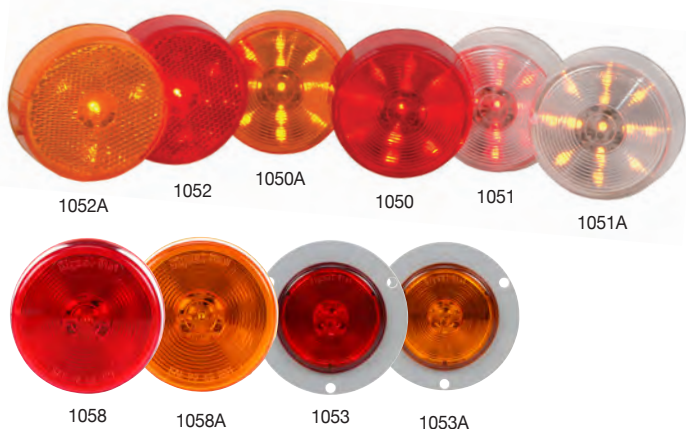

**LED 2-1/2" Sealed**

1-13 Diode Pattern

**Material:**

- Polycarbonate lens & housing

**Light Source:**

- Light Emitting Diodes (LED)
- Designed at 13.5v, .011 amp

**Recommended Accessories:**

- Mounting: Pages 249-252
- Plugs: Pages 225-228

**FMVSS:**

- P2
- Reflectorized - A,P2

- Popular on owner/operator & show trucks
- Standard PL-10 connection
- Reflectorized lamp has 4 diode pattern

- 1050 Red
- 1050A Yellow
- 1051 Red w/clear lens
- 1051A Yellow w/clear lens
- 1052 Red w/reflectorized lens
- 1052A Yellow w/reflectorized lens
- 1070 Red w/gray flange
- 1070A Yellow w/gray flange
- 1071 Red w/clear lens, gray flange
- 1071A Yellow w/clear lens, gray flange

- 1053 Integral flange, red
- 1053A Integral flange, yellow
- 1058 Single diode, lamp, red
- 1058A Single diode, lamp, yellow

**Super 10®**  
2-1/2" Sealed



**Material:**

- Polycarbonate lens & housing
- PVC grommet
- 16 gauge wire

**Light Source:**

- Designed at 14v, 0.33 amp, 2 cp

**Kit Components:**

- 10028R/Y grommet kits:  
1 - 10208R/Y lamp  
1 - 10700 grommet  
1 - 94902 plug

**Recommended Accessories:**

- Mounting: Pages 249-252
- Plugs: Pages 225-228

**FMVSS:**

- P2,PC
- Reflectorized - P2,PC,A

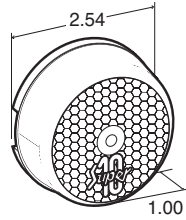

- Unique shock-mount extends bulb life
- Meets PC requirements on a 45° angle using all mounting devices
- Standard PL-10 connection

- 10028R Red, grommet kit  
10028Y Yellow, grommet kit  
10208R Red lamp  
10208Y Yellow lamp  
10212Y Yellow lamp, "ABS" horizontal logo  
10213Y Yellow lamp, "ABS" vertical logo

**10® Series**  
2-1/2" Sealed

**Material:**

- Polycarbonate lens & housing
- PVC grommet
- 16 gauge wire

**Light Source:**

- Designed at 14v, 0.33 amp, 2 cp

**Kit Components:**

- 10519R/Y grommet kits:  
1 - 10202R/Y lamp  
1 - 10700 grommet  
1 - 94902 plug  
10525R/Y reflector kits:  
1 - 10205R/Y lamp  
1 - 10700 grommet  
1 - 94902 plug

**Recommended Accessories:**

- Mounting: Pages 249-252
- Plugs: Pages 225-228

**FMVSS:**

- P2,PC
- Reflectorized - P2,PC,A

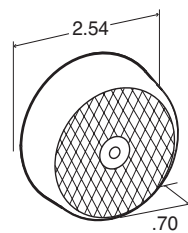

- High impact polycarbonate construction
- Replaces Signal-Stat 1010 & 1011 series
- Standard PL-10 connection
- Meets PC requirements on a 45° angle in mounting devices  
#10708, #10720, #00803 or #00804

- |                            |   |
|----------------------------|---|
| 10519R Red, grommet kit    | 10204R Red, 24v                           |
| 10519Y Yellow, grommet kit | 10204Y Yellow, 24v                        |
| 10202R Red, 12v            | 10525R Red, grommet kit, reflectorized    |
| 10202Y Yellow, 12v         | 10525Y Yellow, grommet kit, reflectorized |
| 10202B Blue, 12v           | 10205R Red reflectorized lamp             |
| 10202C Clear, 12v          | 10205Y Yellow reflectorized lamp          |
| 10202G Green, 12v          |   |





- U.S. patent #6623150
- LEDs have no filament, therefore are not susceptible to shock & vibration
- Less current draw, resulting in increased battery & alternator life while allowing more power for other vehicle requirements
- SAE PC rated for combination clearance/marker applications

**LED 30® Series**  
**Low Profile**  
**PC Rated**  
 2" Sealed  
 6 Diode Pattern

**Material:**

- Polycarbonate lens, housing & flange
- PVC grommet
- 16 gauge wire

**Light Source:**

- Light Emitting Diodes (LEDs)
- Designed at 14v, 0.12 amp

**Kit Components:**

30086R/Y grommet kits:

- 1 - 30385R/Y lamp
- 1 - 30700 grommet
- 1 - 93745 plug

30091R/Y gray flange kits:

- 1 - 30386R/Y lamp & flange
- 1 - 93745 plug

**Recommended Accessories:**

- Mounting: Pages 253-255
- Plugs: Pages 225-228
- FMVSS:
- P2,PC

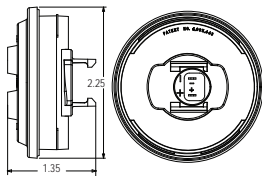

**LED Lamp**  
 30385R Red  
 30385Y Yellow

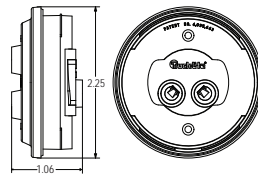

**LED Lamp**  
 30285R Red  
 30285Y Yellow

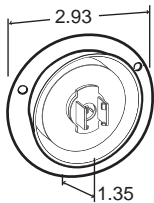

**LED Lamp & Gray Flange**  
 30386R Red  
 30386Y Yellow

**LED Lamp & Black Flange**  
 30391Y Yellow



**LED Lamp & Black Flange**  
 30288R Red  
 30288Y Yellow

**LED Lamp & Gray Flange**  
 30289R Red  
 30289Y Yellow

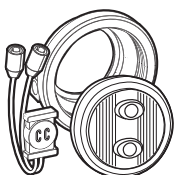

**LED Grommet Kits**  
 30086R Red  
 30086Y Yellow

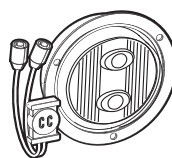

**LED Gray Flange Kits**  
 30091R Red  
 30091Y Yellow



**LED 30® Series**  
**High Profile**  
**PC Rated**  
 2" Sealed  
 8 Diode Pattern

**Material:**

- Polycarbonate lens, housing & flange
- PVC grommet
- 16 gauge wire

**Light Source:**

- Light Emitting Diodes (LEDs)
- Designed at 14v, 0.10 amp

**Kit Components:**

**30075R/Y grommet kits:**

- 1 - 30275R/Y lamp
- 1 - 30700 grommet
- 1 - 94964 plug
- 30080R/Y gray flange kits:
- 1 - 30279R/Y lamp & flange
- 1 - 94964 plug

**30085R/Y grommet kits:**

- 1 - 30375R/Y lamp
- 1 - 30700 grommet
- 1 - 93745 - plug
- 30090 Y gray flange kits:
- 1 - 30379R/Y lamp & flange
- 1 - 93745 plug

**Recommended Accessories:**

- Mounting: Pages 253-255
- Plugs: Pages 225-228

**FMVSS:**

- P2, P3, PC

- LEDs have no filament, therefore are not susceptible to shock & vibration
- Less current draw, resulting in increased battery & alternator life while allowing more power for other vehicle requirements
- SAE PC rated for combination clearance/ marker applications

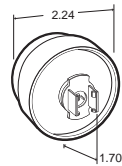

**LED Lamps**  
 30375R Red  
 30375Y Yellow

**LED Lamp w/ABS logo**  
 30282Y Yellow



**LED Lamp**  
 30275R Red  
 30275Y Yellow

**LED Lamp w/ABS logo**  
 30264Y Yellow

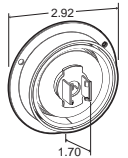

**LED Lamp & Gray Flange**  
 30379R Red  
 30379Y Yellow

**LED Lamp w/ABS logo**  
 30281Y Yellow

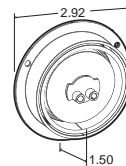

**LED Lamp & Gray Flange**  
 30279R Red  
 30279Y Yellow

**LED Lamp w/ABS logo**  
 30269Y Yellow



**LED Grommet Kits**  
 30075R Red  
 30075Y Yellow

**LED Gray Flange Kits**  
 30080R Red  
 30080Y Yellow

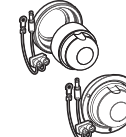

**LED Grommet Kits**  
 30085R Red  
 30085Y Yellow

**LED Gray Flange Kits**  
 30090Y Yellow

**LED 30® Series**  
**Low Profile**  
 2" Sealed  
 2 Diode Pattern

**Material:**

- Polycarbonate lens, housing & flange
- PVC grommet
- 16 gauge wire

**Light Source:**

- Light Emitting Diodes (LEDs)
- Designed at 0.05 amp

**Kit Components:**

- 30070R/Y grommet kits:
- 1 - 30270R/Y lamp
- 1 - 30700 grommet
- 1 - 93745 plug
- 30071R/Y gray flange kits:
- 1 - 30272R/Y lamp & flange
- 1 - 93745 plug

**Recommended Accessories:**

- Mounting: Pages 253-255
- Plugs: Pages 225-228

**FMVSS:**

- P2, P3

- Low profile design reduces damage from tree limbs & dock seals
- Epoxy encapsulated electronics prevent damage from moisture & corrosion
- Low current draw
- Resistant to shock & vibration
- Not recommended for PC applications

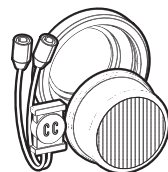

**LED Grommet Kits**  
 30070R Red  
 30070Y Yellow



**LED Lamp**  
 30270R Red  
 30270Y Yellow

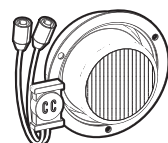

**LED Gray Flange Kits**  
 30071R Red  
 30071Y Yellow

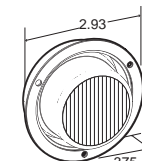

**LED Lamp & Gray Flange**  
 30272R Red  
 30272Y Yellow

**LED Lamp & Black Flange**  
 30277R Red  
 30277Y Yellow



- OmniVolt® universal lighting products address increasing vehicle power demands by operating equally in electrical systems that range from 10 to 30 volts

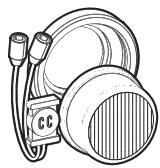

- LED Grommet Kits**
- 30050R Red, 12v
  - 30050Y Yellow, 12v
  - 30055R Red, 10-30v
  - 30055Y Yellow, 10-30v

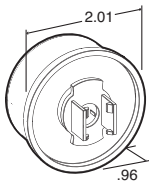

- LED Lamp**
- 30250R Red, 12v
  - 30250Y Yellow, 12v
  - 30255R Red, 10-30v
  - 30255Y Yellow, 10-30v

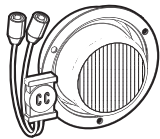

- LED Gray Flange Kits**
- 30051R Red, 12v
  - 30051Y Yellow, 12v



- LED Lamp & Gray Flange**
- 30251R Red, 12v
  - 30251Y Yellow, 12v
- LED Lamp & Flange w/ABS logo**
- 30271Y Yellow, 12v

**LED 30® Series**

2" Sealed  
2 or 3 Diode Pattern

**Material:**

- Polycarbonate lens, housing & flange
- PVC grommet
- 16 gauge wire

**Light Source:**

- Light Emitting Diodes (LEDs)
- Designed at .05 amp

**Kit Components:**

- 30050R/Y 12v grommet kits:
- 1 - 30250R/Y 12v amp
  - 1 - 30700 grommet
  - 1 - 93745 plug
- 30051R/Y gray flange kit:
- 1 - 30251R/Y lamp & flange
  - 1 - 93745 plug
- 30055R/Y 10-30 grommet kit:
- 1 - 30255R/Y 10-30v lamp
  - 1 - 30700 grommet
  - 1 - 93745 plug

**Recommended Accessories:**

- Mounting: Pages 253-255
- Plugs: Pages 225-228

**FMVSS:**

- P2,P3

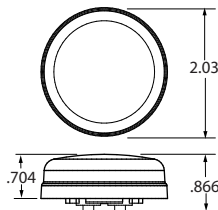
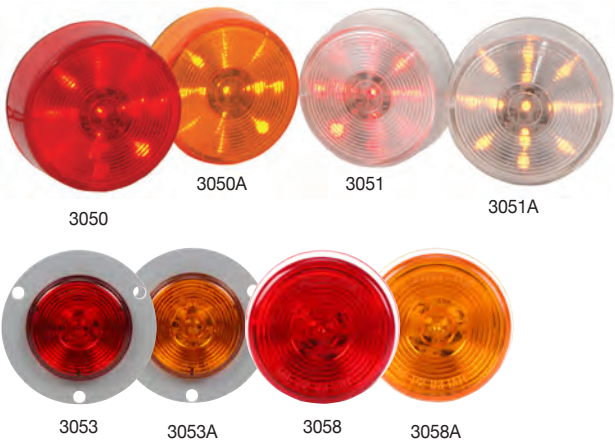

Flush Mount  
.195 screw hole diameter

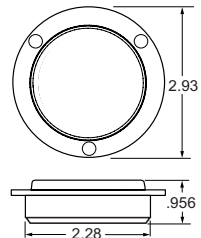

Surface Mount  
2.610 bolt hole diameter

**LED 2" Round**

1-10 Diode Pattern

**Material:**

- Polycarbonate lens & housing

**Light Source:**

- Light Emitting Diodes (LED)
- Designed at 13.5v, 0.05 amp

**Recommended Accessories:**

- Mounting: Pages 253-255
- Plugs: Pages 225-228

**FMVSS:**

- P2

- Unique combination of colored LEDs with clear lens draws attention to lamp only when lit
- Electronics completely sealed in epoxy to resist corrosion & moisture
- Standard PL-10 connection
- Lower power draw, allowing more power for other vehicle requirements
- Not suitable for PC requirements

3050	Red lamp	3053	Integral flange, lamp, red	3070A	Yellow lamp w/gray flange
3050A	Yellow lamp	3053A	Integral flange, lamp, yellow	3071	Red lamp w/clear lens & gray flange
3051	Red lamp w/clear lens	3058	Single diode, lamp, red	3071A	Yellow lamp w/clear lens & gray flange
3051A	Yellow lamp w/clear lens	3058A	Single diode, lamp, yellow		
3070	Red lamp w/gray flange				

**30® Series Products**

**2" Sealed**

**Material:**

- Polycarbonate lens & housing
- PVC grommet
- 16 gauge wire

**Light Source:**

- 15,000 hr rated 12v bulb life
- 12v designed at 14v, 0.33 amp, 2 cp
- 24v designed at 28v, 0.17 amp, 3 cp

**Kit Components:**

30503R/Y lamp kits:

- 1 - 30200R/Y lamp
- 1 - 30700 grommet
- 1 - 94902 plug

**Recommended Accessories:**

- Mounting: Pages 253-255
- Plugs: Pages 225-228

**FMVSS:**

- P2,P3,PC



- Wabash & Monon replacement
- "ABS" version complies with FMVSS 108 requirement for ABS malfunction indicator lamp on trailer & ABS braking systems
- Standard PL-10 connections
- Lamp designed for PC requirements on a 45° angle in mounting devices #30720, #00801, #00803, #00804 or surface mount flange
- Replaces Signal-Stat 1030 series

**Grommet Kits**

- 30503R Red, grommet kit
- 30503Y Yellow, grommet kit

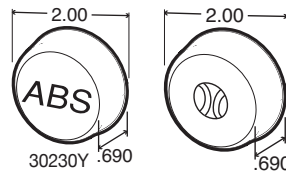

**12v Lamps**

- 30200R Red
- 30200Y Yellow
- 30200B Blue
- 30200G Green

**12v Lamp w/ABS logo**

- 30257Y Yellow, vertical
- 30230Y Yellow, horizontal

**24v Lamps**

- 30206R Red
- 30206Y Yellow
- 30206B Blue

**30® Series**

**PC Rated Products**

**2" Sealed**

**Material:**

- Polycarbonate lens & housing

**Light Source:**

- 15,000 hr rated 12v bulb life
- 12V designed at 14v, .33 amp, 2 cp

**Recommended Accessories:**

- Mounting: Pages 253-255
- Plugs: Pages 225-228

**FMVSS:**

- P2,PC2

30204R



- Innovative design allows one lamp ability to function as two
- Standard PL-10 connection
- Lamp designed for PC requirement on a 45° angle in grommet mounting devices #30700, #30702, #30704

- 30204R Red
- 30225R Red, lamp & flange
- 30204Y Yellow
- 30225Y Yellow, lamp & flange

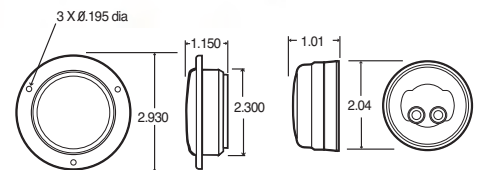

**30® Series**

**Flange Products**

**2" Sealed**

**Material:**

- Polycarbonate lens & flange
- 16 gauge wire

**Light Source:**

- 15,000 hr rated 12v bulb life
- Designed at 14v, 0.33 amp, 2 cp

**Recommended Accessories:**

- 97080 flange gasket
- Plugs: Pages 209-212

**FMVSS:**

- P2,PC2

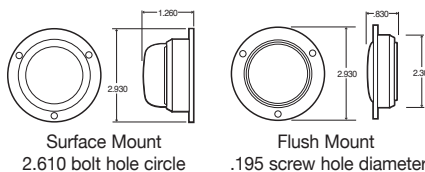

- Flanges are permanently affixed to lamp
- 12 volt 15,000 hr rated bulb
- Flush mount is not suitable for PC requirements

- 30221R Red, flush mount
- 30221Y Yellow, flush mount
- 30222R Red, surface mount
- 30222Y Yellow, surface mount





See Page 2



UNIVERSAL LIGHTING FROM TRUCK-LITE



- Uses standard mounting holes & accessories
- Draws less current, allowing more power for other vehicle requirements
- OmniVolt® versions also meet ECE standards
- Not suitable for PC requirements
- OmniVolt versions address increasing vehicle power demands by operating equally in electrical systems ranging from 10 to 30 volts
- Meets SAE J592e standards
- Meets SAE J594f when mounted with no rollout or rollback

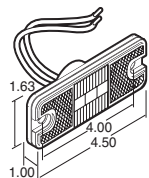

1.375 dia. mounting hole

**LED Lamp w/Blunt Cut**

- 18050R Red, diamond shell
- 18050Y Yellow, diamond shell
- 18011R Red, 10-30v
- 18011Y Yellow, 10-30v
- 18011C Clear, 12-30v

Note: Recommended for side marker & reflector use with no roll back mounted vertically or horizontally

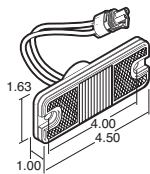

1.375 dia. mounting hole

**LED Lamp w/Packard**

- #12015792 (male)
- 18070R Red, diamond shell
- 18070Y Yellow, diamond shell

**LED Lamp w/Packard**

- #12010973 (female)
- 18060R Red, diamond shell
- 18060Y Yellow, diamond shell

Note: Recommended for horizontal applications requiring 0-20° roll back (yellow) or 0-35° roll back (red)

**LED 18® Series**

Sealed  
3 Diode Pattern

**Material:**

- Acrylic lens & housing
- 18 gauge wire

**Light Source:**

- Light Emitting Diodes (LEDs)
- 12v designed at 13.5v, 0.05 amp
- 10-30v designed at 13.5v & 28v, 0.05 amp

**FMVSS:**

- A,P2
- 18011R - ECE,R3,R7
- 18011Y - ECE,R3,R91

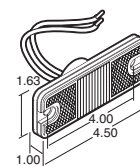

1.375 dia. mounting hole

**LED Lamp w/Blunt Cut**

- 18090R Red, diamond shell
- 18090Y Yellow, diamond shell

Note: Recommended for horizontal applications requiring 0-20° roll back (yellow) or 0-35° roll back (red)



See Above

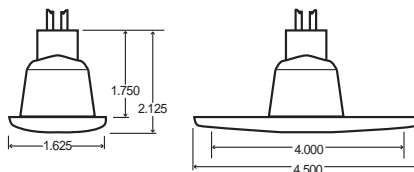

1.406 diameter hole for socket  
0.200 screw hole diameter

- Replaceable bulb
- Replaces Signal-Stat 1572/1572A

- 18300R Red, kit
- 18300Y Yellow, kit

**18® Series**

Bulb Replaceable

**Material:**

- Acrylic lens
- ABS housing
- Rubber mounting gasket
- 18 gauge wire

**Light Source:**

- Bulb: #194 wedge base

**Kit Components:**

- 18300R/Y kits:
- 1 - 99012R/Y lens/housing
- 1 - 94940 plug
- 1 - 97927 mounting gasket

**Replacement Parts:**

- 99012R red, lens/housing
- 99012Y yellow, lens/housing
- 97927 mounting gasket
- 94940 plug

**FMVSS:**

- A,P2





**LED 35® Series**

PC Rated  
Sealed  
5 Diode Pattern



**Material:**

- Polycarbonate lens & housing

**Light Source:**

- Light Emitting Diodes (LEDs)
- Designed at 13.5v, 0.12 amp

**Kit Components:**

- 35075R/Y kits:  
1 - 35375R/Y lamp  
1 - 94862 plug w/.180 molded bullet

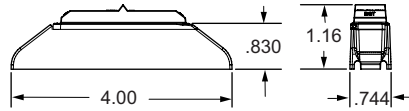

**Recommended Accessories:**

- 35720 armored mount
- 97035 sealing gasket
- Mounting: Page 259
- Plugs: Pages 225-228

- Slim 3/4" wide design makes lamp perfect solution for narrow rail designs
- SAE PC rated for combination clearance/marker applications
- Requires Fit 'N Forget connection
- Must be mounted horizontally

**FMVSS:**

- P2,PC

35075R Red, kit      35375R Red lamp  
35075Y Yellow, kit      35375Y Yellow lamp

**LED 35® Series**

Sealed  
1-2 Diode Pattern

**Material:**

- Polycarbonate or acrylic lens & housing
- 16 gauge wire

**Light Source:**

- Light Emitting Diodes (LEDs)
- Designed at .05 amp

**Recommended Accessories:**

- 35720 armored mount
- 97035 sealing gasket
- Mounting: Page 259
- Plugs: Pages 225-228

**FMVSS:**

- P2

- Unique combination of colored LEDs with clear lens draws attention to lamp only when lit
- Slim 3/4" wide design makes lamp perfect solution for narrow rail designs
- Must be mounted horizontally
- Optional gaskets to improve seal between lamp & body
- Requires Fit 'N Forget connection
- Not suitable for PC requirements



35201Y

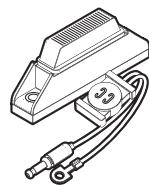

**LED Kits\***

- 35001R Red
  - 35001Y Yellow
  - 35080R Red, diamond shell
  - 35080Y Yellow, diamond shell
- \*Kits include lamp & 94862 plug

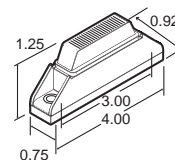

**LED Lamps**

- 35200R Red
- 35200Y Yellow
- 35201R Red w/clear lens
- 35201Y Yellow w/clear lens
- 35880R Red, diamond shell
- 35880Y Yellow, diamond shell
- 35890R Red, 10-30 volt
- 35890Y Yellow, 10-30 volt

**LED Side Marker**

Sealed  
6 Diode Pattern

**Material:**

- Polycarbonate lens & housing
- 18 gauge wire

**Light Source:**

- Light Emitting Diodes (LEDs)
- Designed at 12.8v, .05 amp

**FMVSS:**

- P2

- Full pattern light output
- Designed for areas with limited space
- Not suitable for PC requirements
- Hardwired design eliminates pin corrosion

3550 Red lamp  
3550A Yellow lamp

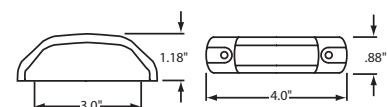

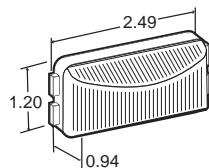

- Designed to fit applications requiring minimal space
- Less susceptible to shock & vibration
- Uses standard PL-10 connection
- Not suitable for PC applications
- 1 diode (red), 3 diode (yellow) LED pattern

15250R Red lamp  
15250Y Yellow lamp

**LED 15® Series**  
**Marker & Clearance**  
Sealed  
1-3 Diode Pattern

- Material:**
- Polycarbonate lens & housing
- Light Source:**
- Light Emitting Diodes (LEDs)
  - Designed at 14v, 0.05 amp
- Recommended Accessories:**
- Mounting: Pages 256-259
  - Plugs: Pages 225-228
- FMVSS:**
- P2,P3



- Standard PL-10 connection
- 2 diode (red), 3 diode (yellow) LED pattern
- Not suitable for PC requirements

1560 Red lamp  
1560A Yellow lamp  
1561 Red lamp w/clear lens  
1561A Yellow lamp w/clear lens

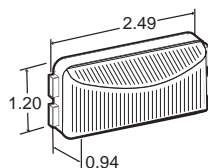

**LED Marker & Clearance**  
Sealed  
2-3 Diode Pattern

- Material:**
- Polycarbonate lens & housing
- Light Source:**
- Light Emitting Diodes (LEDs)
  - Designed at 13.5v, 0.05 amp
- Recommended Accessories:**
- Mounting: Pages 256-259
  - Plugs: Pages 225-228
- FMVSS:**
- P2

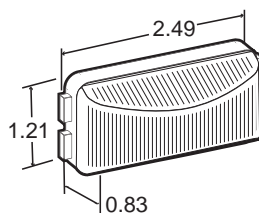

15203Y

- Fits in most narrow header rails
- Mount vertically or horizontally
- Uses standard PL-10 connection
- Snap-lock tabs allow quick & easy installation
- Blue, green & clear versions available upon request

15200R Red lamp  
15200Y Yellow lamp  
15203Y Yellow, w/"ABS" logo  
15201R Red, 24v  
15201Y Yellow, 24v

**15® Series Marker & Clearance**  
Rectangular Sealed

- Material:**
- Polycarbonate lens & housing
  - 16 gauge wire
- Light Source:**
- 15,000 hr. rated 12v bulb life
  - 12v designed at 14v, 0.33 amp, 2 cp
  - 24v designed at 28v, 0.17 amp, 3 cp
- Recommended Accessories:**
- Mounting: Pages 256-259
  - Plugs: Pages 225-228
- FMVSS:**
- P2,PC2

**Adapter Mounts**  
For 15<sup>®</sup> Series  
Products

**Material:**

- ABS mount
- 16 gauge wire

**Kit Components:**

- 15033R/Y kits:  
1 - 15250R/Y LED lamp  
1 - 00793 chrome mount  
1 - 96904 hot wire  
1 - 97705 grommet
- 15506R/Y kits:  
1 - 15200R/Y lamp  
1 - 00793 chrome mount  
1 - 96904 hot wire

**FMVSS:**

- P2,PC2

- Stylish design for contemporary look
- Sure contact, self-grounding feature
- Submersible for marine use
- Uses standard PL-10 connection
- 3 year lamp warranty on LED chrome mount kits

- 15033R Red, LED chrome mount kit**  
**15033Y Yellow, LED chrome mount kit**  
**15506R Red, chrome mount kit**  
**15506Y Yellow, chrome mount kit**



15033Y

**Dual Face Bracket**  
For 15<sup>®</sup> Series  
Products

**Material:**

- ABS mount
- 16 gauge wire

**Kit Components:**

- 15417 & 15418 kits:  
1 - 15250R/Y LED lamps  
1 - 15731 bracket  
1 - 94791 plug
- 15415 & 15416 kits:  
1 - 15200R/Y lamps  
1 - 15731 bracket  
1 - 94791 plug

**FMVSS:**

- P2,PC2

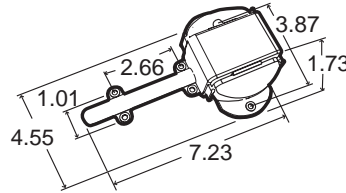

- Designed for use on most utility trailer fenders
- Wire cover is marked in 1/2" increments for easy length modifications
- Uses standard PL-10 connection

- 15417 LH kit w/LED lamps**  
**15418 RH kit w/LED lamps**  
**15415 LH kit**  
**15416 RH kit**



15418

**Rail Mounts**  
For 15<sup>®</sup> Series  
Products

**Material:**

- ABS mount
- 16 gauge wire

**Kit Components:**

- 15006 Y kits:  
1 - 15200R/Y lamp  
1 - 15727 mount  
1 - 94924 side entry plug
- 15008R/Y kits:  
1 - 15200R/Y lamp  
1 - 15728 mount  
1 - 94924 side entry plug

**FMVSS:**

- P2,PC2

- Features top cut-out area on mount
- #15727 for narrow rail design
- Easy snap-in lamp installation
- Replaces Signal-Stat 9387

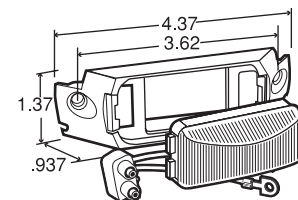

- 15006Y Yellow, kit w/cut mount**  
**15008R Red, kit**  
**15008Y Yellow, kit**



15006R/Y



- Innovative optic design allows combination lamps to function as two
- Draws less current, allowing more power for other vehicle requirements
- Designed to fit applications requiring minimal space
- Must be mounted horizontally
- PC rated lamps meet requirements when mounted on a 45° angle
- P2 red lamps have 2 diode pattern, PC rated red lamps & standard yellow lamps have 4 diode pattern, and P2 rated yellow lamps have 6 diode pattern

**LED 19® Series**  
**PC Rated**  
 Sealed  
 2-6 Diode Pattern

- Material:**
- Polycarbonate lens & housing
- Light Source:**
- Light Emitting Diodes (LEDs)
  - Designed at 14v, 0.05 amp
  - PC rated lamp designed at 14v, 0.05 amp (red), 0.12 amp (yellow)
- Recommended Accessories:**
- Mounting: Page 258
  - Plugs: Pages 226
- FMVSS:**
- P2,P3,PC2

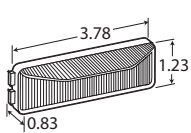

**LED P2 Lamp w/male pin connection**  
 19250R Red  
 19250Y Yellow  
 19251R Red w/clear lens  
 19251Y Yellow w/clear lens

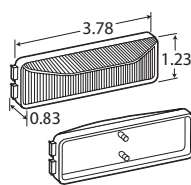

**LED PC Rated Lamp w/male pin connection**  
 19275R Red  
 19275Y Yellow

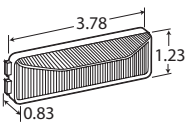

**LED P2 Lamp w/Fit 'N Forget connection**  
 19350R Red  
 19350Y Yellow

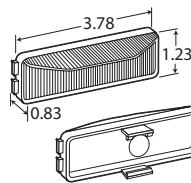

**LED PC Rated Lamp w/Fit 'N Forget connection**  
 19375R Red  
 19375Y Yellow

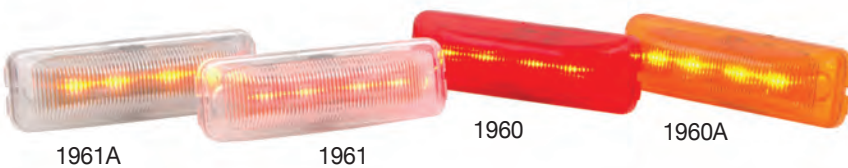

- Popular in owner/operator & show trucks
- Standard male pin connection
- 4 diode LED pattern
- Encapsulated electronics
- Not recommended for PC applications

1960 Red lamp  
 1960A Yellow lamp  
 1961 Red lamp w/clear lens  
 1961A Yellow lamp w/clear lens

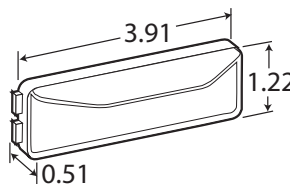

**LED Marker & Clearance**  
 Sealed  
 4 Diode Pattern

- Material:**
- Polycarbonate lens & housing
- Light Source:**
- Light Emitting diodes (LEDs)
  - Designed at 13.5v, 0.05 amp
- Recommended Accessories:**
- Mounting: Page 258
  - Plugs: Pages 226
- FMVSS:**
- P2



**19® Series Products**

**Rectangular Sealed**

**Material:**

- Polycarbonate lens & housing
- 16 gauge wire

**Light Source:**

- Two 12v bulbs designed at 14v, 0.33 amp, 2 cp

**Recommended Accessories:**

- Mounting: Page 258
- Plugs: Pages 226

**FMVSS:**

- P2,P3,PC

- Standard male pin connection
- Designed to fit in limited mounting areas
- Fits in most narrow header rails
- Can be mounted vertically or horizontally
- Snap-lock tabs allow quick & easy installation
- Suitable for PC requirements on 45° angle when using base mounts on page 234
- Replaces Signal-Stat 1900 series

- 19200R** Red lamp
- 19200Y** Yellow lamp
- 19205Y** Yellow lamp, w/"ABS" logo



19200R

19205Y

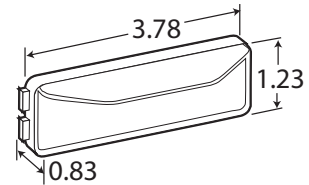

**Base Mount Kits**

**For LED 19® Series Products**

**Material:**

- Polycarbonate or chrome ABS mount

**Kit components:**

19006R/Y, 19020R/Y or 19002R/Y:

- 1 - 19250R/Y 19275R/Y or 19200R/Y lamp

- 1 - 19721 gray mount w/hot wire

19031R/Y or 19036R/Y kits:

- 1 - 19350R/Y or 19375R/Y LED lamp

- 1 - 19748 chrome mount

- 1 - 94718 plug

19032R/Y or 19037R/Y kits:

- 1 - 19350R/Y or 19375R/Y LED lamp

- 1 - 19728 black mount

- 1 - 94718 plug

19009R/Y kit:

- 1 - 19200R/Y lamp

- 1 - 19739 chrome mount & hot wire

- Popular in trailer & body applications
- Meets PC requirements on 45° angle
- Low profile lamp features unique plug-in design
- Must be mounted horizontally
- LED & incandescent kits available



19031Y

19002Y

**LED P2 Lamp & Gray Mount Kits**  
**19006R** Red  
**19006Y** Yellow

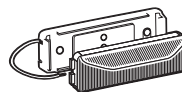

**LED P2 Lamp & Chrome Mount Kits**  
**19031R** Red  
**19031Y** Yellow

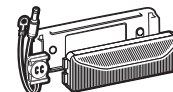

**LED P2 Lamp & Black Mount Kits**  
**19032R** Red  
**19032Y** Yellow

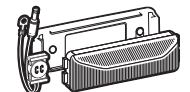

**LED PC Lamp & Gray Mount Kit**  
**19020R** Red  
**19020Y** Yellow

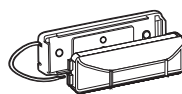

**LED PC Lamp & Chrome Mount Kit**  
**19036R** Red  
**19036Y** Yellow

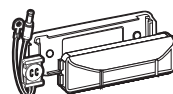

**LED PC Lamp & Black Mount Kit**  
**19037Y** Yellow

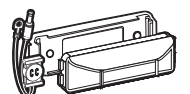

**Incandescent Lamp & Gray Mount Kit**  
**19002R** Red  
**19002Y** Yellow

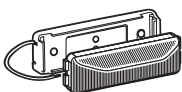

**Incandescent Lamp & Chrome Mount Kit**  
**19009R** Red  
**19009Y** Yellow

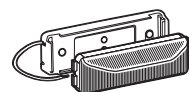



See Page 2

21275R



21251R

21251Y

- Available with standard or reflectorized lens
- PC rated lamps have 8 diode pattern
- Reflex lamps have 1 diode (red) & 2 diode (yellow) pattern

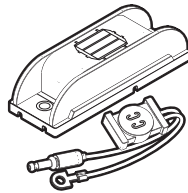

**LED PC Rated Kits**

- 21075R Red
- 21075Y Yellow

**LED 21® Series**

**PC Rated**

**Sealed**

**1-8 Diode Pattern**

**Material:**

- Polycarbonate or acrylic lens & housing

- 16 gauge wire

**Light Source:**

- Light Emitting Diodes (LEDs)
- 12v designed at 14v, 0.10 amp
- 24v designed at 28v, 0.05 amp

**Kit Components:**

- 21075R/Y kits:  
 1 - 21275R/Y lamp  
 1 - 94862 plug
- 21051R/Y & 21080R/Y kits:  
 1 - 21251R/Y or 21880R/Y lamp  
 1 - 94862 plug
- 21056R/Y kits:  
 1 - 21256R/Y lamp  
 1 - 94862 plug

**Recommended Accessories:**

- 97034 mounting gasket
- 97036 sealing gasket
- Plugs: Pages 225-228

**FMVSS:**

- P2,PC
- Reflectorized - A,P2

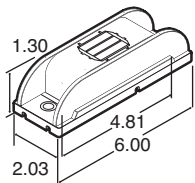

**LED PC Rated Lamps**

- 21275R Red
- 21275Y Yellow

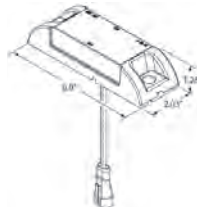

**LED P2 Hardwired Lamps w/Reflex**

- 21253Y Yellow

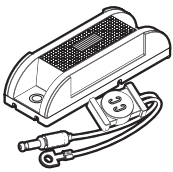

**LED P2 Kits w/Reflex**

- 21051R Red
- 21051Y Yellow
- 21080R Red, diamond shell
- 21080Y Yellow, diamond shell
- 21056R Red, 24v
- 21056Y Yellow, 24v

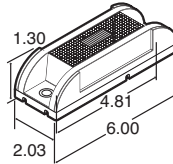

**LED P2 Lamps w/Reflex**

- 21251R Red
- 21251Y Yellow
- 21880R Red, diamond shell
- 21880Y Yellow, diamond shell
- 21256R Red, 24v
- 21256Y Yellow, 24v



2150

2152A

2152

2150A

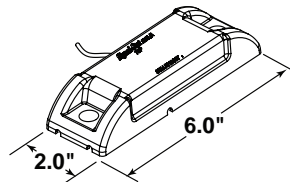

- Reflectorized lens on colored lens versions
- Optional mounting & sealing gaskets available to improve seal between lamps and body of vehicle
- Less susceptible to shock & vibration

**LED Marker &**

**Clearance**

**Sealed 8 Diode Pattern**

**Material:**

- Acrylic lens & housing
- 16 gauge wire

**Light Source:**

- Light Emitting Diodes (LEDs)
- Designed at 13.5v, 0.12 amp

**Recommended Accessories:**

- 97034 mounting gasket

**FMVSS:**

- Reflectorized - A,P2
- P2

- 2150 Red lamp
- 2150A Yellow lamp
- 2152 Red lamp w/clear non-reflectorized lens
- 2152A Yellow lamp w/clear non-reflectorized lens

**Super 21®**  
Rectangular Sealed



**Material:**

- Acrylic lens
- ABS housing
- 16 gauge wire

**Light Source:**

- 12v designed at 14v, 0.33 amp, 2 cp
- 24v designed at 28v, 0.17 amp, 3 cp

**Kit Components:**

21001R/Y kits:

- 1 – 21200R/Y or 21205R/Y 24v lamp
- 1 – 96930 hot wire

21002R/Y kits:

- 1 – 21201R/Y 12v lamp w/reflector
- 1 – 96930 hot wire

21506R kits:

- 1 – 21200R/Y 12v lamp
- 1 – self piercing plug

21501R/Y kits:

- 1 – 21203R/Y 12v lamp w/reflector
- 1 – 21720 extension bracket
- 1 – 96914 plug
- 1 – 96915 plug

**Recommended Accessories:**

- 97034 mounting gasket
- 97036 sealing gasket
- Plugs: Pages 226

**FMVSS:**

- Reflectorized - A,P2
- P2,PC



21201R

21210Y

- Available with standard or reflectorized lens
- Suitable for PC requirements on a 45° angle with additional reflectors
- Version available for ABS requirements
- Optional gaskets available to improve seal between lamp & body
- Kits with extension brackets are a direct replacement for Utility Trailer #03-5100-0-097/8

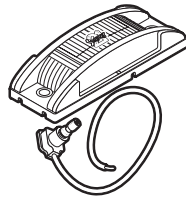

**Lamp Kits**

- 21001R Red
- 21001Y Yellow

**Reflectorized Kits**

- 21002R Red
- 21002Y Yellow

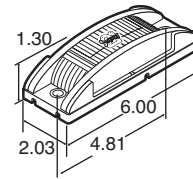

**Lamp**

- 21200R Red
- 21200Y Yellow
- 21205R Red, 24v
- 21205Y Yellow, 24v

**Reflectorized Lamp**

- 21201R Red
- 21201Y Yellow

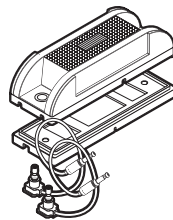

**Kits w/Extension Bracket**

- 21501R Red
- 21501Y Yellow

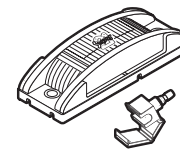

**12v Lamps w/Self Piercing Plug**

- 21506R Red

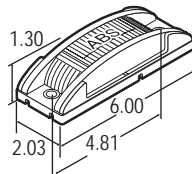

**"ABS" Logo Lamp**

- 21210Y Yellow

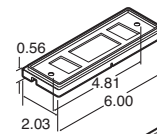

**Extension Bracket**

- 21720 White
- 21721 Black
- 21722 Black, angle

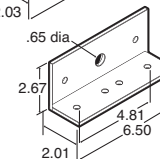

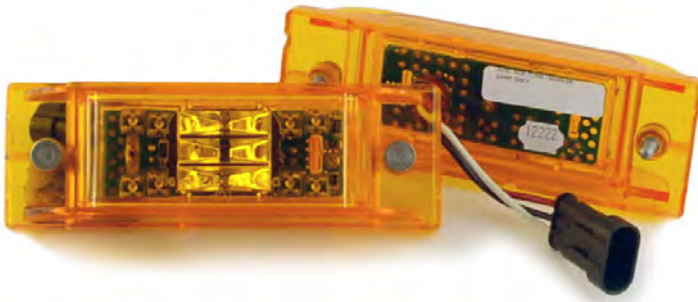

- Popular replacement on Freightliner vehicles where lamp is not mounted on a curved location
- LED lamps offer superior brightness & faster start-time than incandescent versions
- Recommend replacing the incandescent lamp & existing harness

21090Y Yellow w/59" harness, 3 wire, sealed connector, Freightliner #A06-27561-002  
 21094Y Yellow w/12" harness, 3 wire, non-sealed connector, Freightliner #A06-27561-000  
 21095Y Yellow w/12" harness, 3 wire, sealed connector, Freightliner #A06-27584-003 & A06-27584-001  
 21096Y Yellow, kit

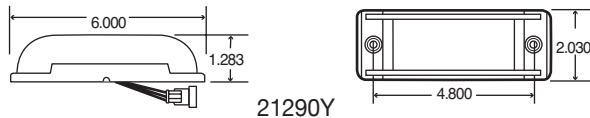

21290Y

## LED 21® Series Marker & Auxiliary Turn

Sealed  
 16 Diode Pattern

### Material:

- Polycarbonate lens & housing
- 16 gauge wire

### Light Source:

- Light Emitting diodes (LEDs)
- Designed at 14v, 0.15 amp (side turn), 0.02 amp (marker)

### Kit Components:

21096Y kit:

- 1 - 21290Y LED side turn/marker lamp
- 1 - 97047 mounting gasket
- 1 - 95918 hardware bag
- 1 - Replacement harness

### Recommended Accessories:

- 97034 mounting gasket
- 97036 sealing gasket

### FMVSS:

- P2



- Available with standard or reflectorized lens
- Features male pin connections
- Suitable for PC requirements on a 45° angle with additional reflectors

29002R Red kit, PC rated  
 29002Y Yellow kit, PC rated  
 29202R Red lamp, PC rated  
 29202Y Yellow lamp, PC rated  
 29003R Red kit w/reflex  
 29003Y Yellow kit w/reflex  
 29203R Red lamp w/reflex  
 29203Y Yellow lamp w/reflex

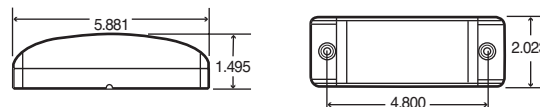

## Male Pin 21 Sealed

### Material:

- Polycarbonate lens & housing

### Light Source:

- Designed at 12v, 0.33 amp, 2pc

### Kit Components:

- 29002R/Y kit:  
 1 - 29202R/Y lamp  
 1 - 96106 plug
- 29003R/Y kit:  
 1 - 29203R/Y lamp  
 1 - 96106 plug

### Recommended Accessories:

- 96106 right angle plug

### FMVSS:

- P2,PC
- Reflectorized - A,P2



**LED 12® Series**  
PC Rated Sealed  
6 Diode Pattern

**Material:**

- Polycarbonate lens & housing
- Mounting bracket (ABS)

**Light Source:**

- Light Emitting Diodes (LEDs)
- Designed at 13.5v, 0.12 amp

**Recommended Accessories:**

- 12723 gray bracket
- 12724 brown bracket
- 12725 black bracket
- 97921 lamp gasket
- 97925 bracket gasket
- Plugs: Pages 225-228

**FMVSS:**

- P2,PC

- SAE PC rated for combination clearance/marker applications
- Snap-in lamp makes installation fast & easy
- Standard PL-10 connection
- Lamp gasket #97921 required for proper lamp & bracket fit

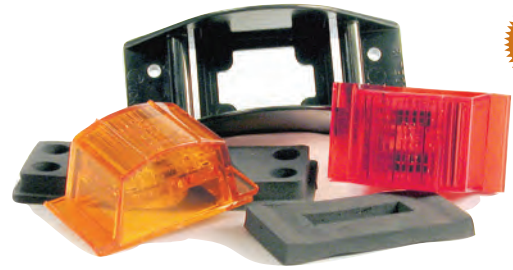

- 12275R Red lamp**
- 12275Y Yellow lamp**

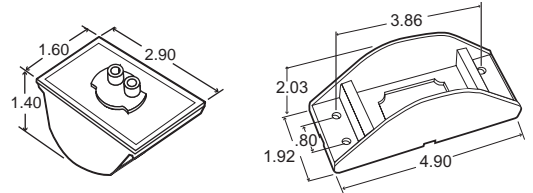

**12® Series**  
PC Rated Sealed

**Material:**

- Polycarbonate lens & housing
- Foam gaskets

**Light Source:**

- 12v designed at 14v, 0.33 amp, 2 cp
- 24v designed at 28v, 0.17 amp, 3 cp

**Recommended Accessories:**

- 12723 gray bracket
- 12724 brown bracket
- 12725 black bracket
- 97921 lamp gasket
- 97925 bracket gasket
- Plugs: Pages 225-228

**FMVSS:**

- P2,PC

- Standard replacement for UPS
- Sonically sealed lens & housing
- Standard PL-10 connection
- 12 & 24 volt models
- SAE PC rated for combination clearance/marker applications
- Optional mounting gasket to improve seal between lamp & body
- Replaces Signal-Stat 1111 series



12200R

- 12200R Red lamp**
- 12200Y Yellow lamp**
- 12200C Clear lamp**
- 12201Y Yellow lamp, 24v**

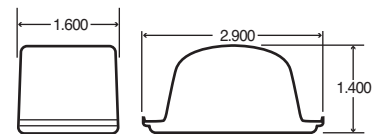

**Deflector Mounts**  
For 12® Series Lamps

**Material:**

- ABS plastic mounts
- Polycarbonate lens & housing
- Foam gaskets

**Kit Components:**

- 12001R/Y/C kits:  
1 - 12200R/Y/C lamp  
1 - 94850 plug
- 12003R/Y/C kits:  
1 - 12200R/Y/C lamp  
1 - 12723 gray mount  
1 - 94919 plug

**FMVSS:**

- P2,PC

- High impact plastic branch deflector mount
- Snap-in lamp design for easy replacement
- SAE PC rated for combination clearance/marker applications
- Standard PL-10 connection
- Standard replacement on UPS models



- 12001R Red kit w/brown mount & 94850 plug**
- 12001Y Yellow kit w/brown mount & 94850 plug**
- 12003R Red kit w/gray mount & 94919 plug**
- 12003Y Yellow kit w/gray mount & 94919 plug**

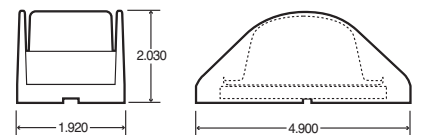

.210 screw hole diameter

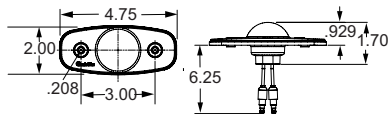

1.50 dia. mounting hole

- Unique dome lens design
- Popular in trailer & body applications
- Hardwired design with molded .180 bullet ends
- Innovative optics design allows for horizontal mounting
- LEDs have no filament, therefore are not susceptible to shock & vibration
- Not suitable for PC requirements

**26270R Red lamp**  
**26270Y Yellow lamp**

**LED 26 Series**  
**Dome Lens & Surface Mount**  
 3 Diode Pattern

**Material:**

- Polycarbonate lens & housing
- 16 gauge wire

**Light Source:**

- Light Emitting Diodes (LEDs)
- Designed at 14v, 0.05 amp

**Recommended Accessories:**

- Mounting: Page 259

**FMVSS:**

- P2

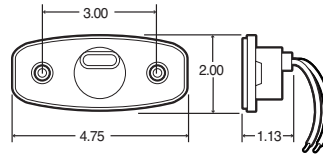

1.50 dia. mounting hole

**LED 26 Series**  
**Sealed**  
 3 Diode Pattern

**Material:**

- Polycarbonate lens & housing
- 16 gauge wire

**Light Source:**

- Light Emitting Diodes (LEDs)
- Designed at 14v, .05 amp

**Recommended Accessories:**

- Mounting: Page 259
- 97073 lamp gasket

**FMVSS:**

- P2

- Popular in trailer & body applications
- Hardwired design with blunt cut or molded bullet ends
- Innovative optics design allows for horizontal or vertical mounting
- Not suitable for PC requirements

**26250R Red lamp w/.180 molded bullet**  
**26250Y Yellow lamp w/.180 molded bullet**  
**26251R Red lamp, blunt cut**  
**26251Y Yellow lamp, blunt cut**



- Hardwired design eliminates pin corrosion
- Encapsulated electronics
- Hardwired design with blunt cut ends

**2660 Red lamp**  
**2660A Yellow lamp**  
**2661 Red lamp w/clear lens**  
**2661A Yellow lamp w/clear lens**

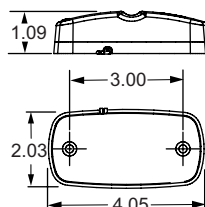

**LED Sealed**  
 16 Diode Pattern

**Material:**

- Polycarbonate lens & housing

**Light Source:**

- Light Emitting Diodes (LEDs)
- Designed at 13.5v, .080 amp

**Replacement Parts:**

- 99238R Red, lens
- 99238Y Yellow, lens
- 99238C clear lens

**Recommended Accessories:**

- Mounting: Page 259

**FMVSS:**

- P2

**LED PC Rated**  
Sealed  
8 Diode Pattern

**Material:**

- Polycarbonate lens & housing
- 16 gauge wire

**Light Source:**

- Light Emitting Diodes (LEDs)
- Designed at 12.8v, .12 amp

**FMVSS:**

- P2

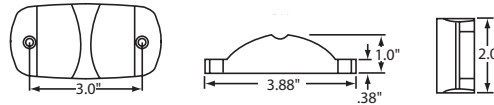

- Popular in owner-operator & show truck applications
- Hardwired design eliminates pin corrosion
- SAE PC rated for combination clearance/marker applications



- 2674** Red lamp
- 2674A** Yellow lamp

**Shock/Mount**  
**Two Bulb Die Cast**  
Bulb Replaceable

**Material:**

- Acrylic lens
- Die cast housing

**Light Source:**

- Bulbs: Two #193

**Replacement Parts:**

- 9006 red lens & O-ring
- 9006A yellow lens & O-ring
- 9180 O-ring
- 9523 mounting pad

**Recommended Accessories:**

- Mounting: Page 259

**FMVSS:**

- P2

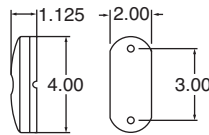

.218 screw hole diameter

- Die cast base with heavy mounting pad
- Shock/Mount for maximum bulb life
- Two bulb design – if one burns out, the other remains lit
- Lamp meets requirements with only one bulb
- Hardwired design with blunt cut ends
- Replaces Truck-Lite 26303 series

- 1203** Red lamp
- 1203A** Yellow lamp
- 1203G** Green lamp

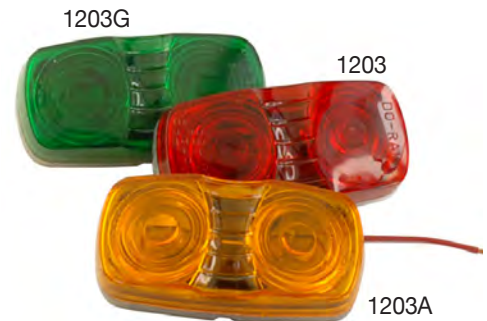

**Shock/Mount**  
**Two Bulb**  
Bulb Replaceable

**Material:**

- Acrylic lens
- Permastat housing

**Light Source:**

- Bulbs: Two #194

**Replacement Parts:**

- 9007 red lens
- 9007A yellow lens
- 9007G green lens
- 9007W clear lens
- 9523 mounting pad

**Recommended Accessories:**

- Mounting: Page 259

**FMVSS:**

- P2

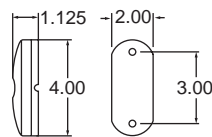

.218 screw hole diameter

- Shock/Mount (1213 model) for maximum bulb life
- Two bulb design – if one burns out, the other remains lit
- Hardwired design with blunt cut ends
- Snap-on lens makes bulb and lens replacement easy
- Lamp meets requirements with only one bulb
- Replaces Truck-Lite 26302 series

- 1211** Red lamp
- 1211A** Yellow lamp
- 1211W** Clear (Utility lamp)
- 1213** Red lamp, shock/mount
- 1213A** Yellow lamp, shock/mount



Signal-Stat

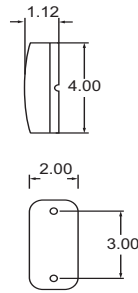

Reflex Two Bulb  
Bulb Replaceable

- Material:**
- Acrylic lens
  - ABS housing
- Light Source:**
- Bulbs: Two #193
- Replacement Parts:**
- 9057 red lens
  - 9057A yellow lens
- FMVSS:**
- A,P2

- SAE Class A reflex reflector snap-on lens
- Hardwired design eliminates pin corrosion
- Serves as a legal reflector when mounted between 15 & 60 inches from ground level on trailers less than 80" wide

1222 Red lamp      1222A Yellow lamp

Signal-Stat

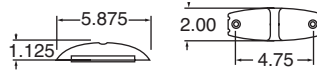

Shock/Mount  
Extended Lens  
Bulb Replaceable

- Material:**
- Polycarbonate lens & housing
- Light Source:**
- Bulbs: Two #193
- Replacement Parts:**
- 9077 red lens
  - 9077A yellow lens
  - 9180 O-ring
  - 9523 mounting pad
- FMVSS:**
- P2

- External mounting holes save installation time
- Hardwired design eliminates pin corrosion
- Two bulb design – if one burns out, the other remains lit

1233 Red lamp  
1233A Yellow lamp

Signal-Stat

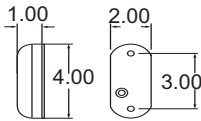

Shock/Mount  
Two Bulb  
Bulb Replaceable

- Material:**
- Acrylic lens
  - ABS housing
- Light Source:**
- Bulbs: Two #193
- Replacement Parts:**
- 9093 red lens
  - 9093A yellow lens
  - 9093B blue lens
  - 9093G green lens
  - 9522 mounting pad
  - 97937 gasket
- FMVSS:**
- P2

- Snap-on lens permits easy bulb & lens replacement
- Optional mounting gasket available to improve seal between lamp & body

1259 Red lamp  
1259A Yellow lamp

Signal-Stat



Reflex Two Bulb  
Bulb Replaceable

- Material:**
- Acrylic lens
  - ABS housing
- Light Source:**
- Bulbs: Two #193
- Replacement Parts:**
- 8933 red lens
  - 8933A yellow lens
  - 9522 mounting pad
- FMVSS:**
- A,P2

- Serves as a legal reflector when mounted between 15" & 60" from ground level on trailers less than 80" wide
- Hardwired design eliminates pin corrosion

1264 Red lamp  
1264A Yellow lamp

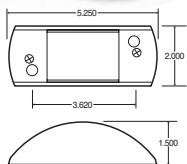
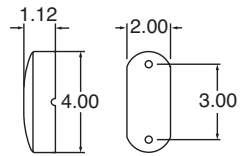

0.218 screw hole diameter

26 Series  
Armored  
Bulb Replaceable

- Material:**
- Acrylic lens
  - Zinc-plated steel housing
- Light Source:**
- Bulbs: #1895
- FMVSS:**
- P2

- Features zinc-plated steel housing
- Hardwired design eliminates pin corrosion

26315R Red lamp  
26315Y Yellow lamp

Signal-Stat

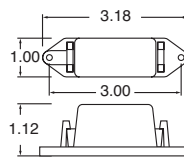

.188 screw hole diameter

Pee Wee  
Bulb Replaceable

- Material:**
- Polycarbonate lens
  - ABS housing
- Light Source:**
- Bulb: #1895
- Replacement Parts:**
- 9342 red lens
  - 9342A yellow lens
- FMVSS:**
- P2

- Mini lamp features external mounting holes
- Hardwired design eliminates pin corrosion

1507 Red lamp  
1507A Yellow lamp



**26 Series**  
Bulb Replaceable

**Material:**

- Acrylic lens
- Rubber housing

**Light Source:**

- Bulbs: Two #194 wedge base

**Replacement Parts:**

- 99051R red lens
- 99051Y yellow lens

**FMVSS:**

- P2

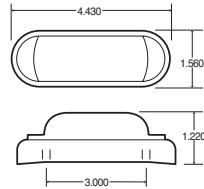

.215 screw hole diameter

- Features snap-in lens
- Rubber housing provides additional protection against shock & vibration
- Hardwired design eliminates pin corrosion

**26310R Red lamp      26310Y Yellow lamp**

**26 Series**  
Bulb Replaceable

**Material:**

- Polycarbonate lens
- ABS housing

**Light Source:**

- Bulbs: Two #194 wedge base

**Replacement Parts:**

- 99050R red lens
- 99050Y yellow lens

**FMVSS:**

- P2

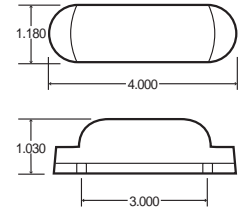

.218 screw hole diameter

- Features snap-on lens for quick and easy bulb replacement
- Hardwired design eliminates pin corrosion

**26312R Red lamp  
26312Y Yellow lamp**

**Rubber Body Mount**  
Bulb Replaceable

**Material:**

- Acrylic lens
- Rubber housing

**Light Source:**

- Bulb: two #1895

**FMVSS:**

- P2

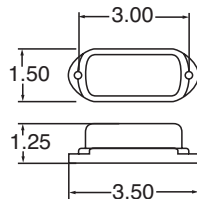

- Compact styling is ideal for narrow body channel mounting
- Hardwired design eliminates pin corrosion

**1506 Red lamp  
1506A Yellow lamp  
1506W Clear (utility lamp)**

**Model 14®**  
Rectangular Sealed

**Material:**

- Polycarbonate reflectorized lens & housing
- PVC grommet

**Light Source:**

- 12v designed at .33 amp, 2 cp

**Recommended Accessories**

- Plugs: Pages 209-212
- 14700 white grommet
- 14701 black grommet

**FMVSS:**

- A,P2

14700



14200Y

- Features snap-in lamp with reflector
- Grommets flush mount the lamp to vehicle
- Not suitable for PC requirements
- Uses standard PL-10 connection

**14200R Red lamp  
14200Y Yellow lamp**

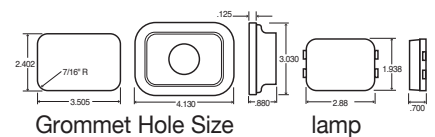

Grommet Hole Size

lamp

**Slimline**  
Bulb Replaceable

**Material:**

- Polycarbonate lens & housing
- 18 gauge wire

**Light Source:**

- Bulb: #193

**Replacement Parts:**

- 9082 red lens

**FMVSS:**

- P2,PC

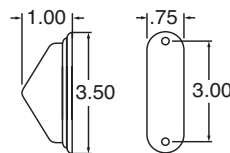

.220 screw hole diameter terminal size .180 diameter male bullet

- U-Haul and Stoughton Trailer replacement lamp
- "HT" suffix versions have .180" bullet terminal

**1520HT Red lamp w/harness terminated  
1520AHT Yellow lamp w/harness terminated**

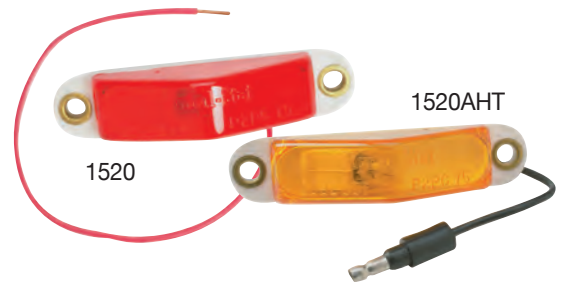

1520

1520AHT



**LED Narrow Rail Deflector Mount**  
PC Rated  
Lens Replaceable  
4 Diode Pattern

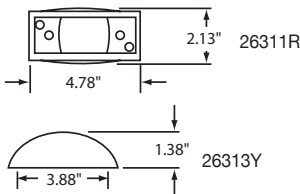

- Hardwired design eliminates pin corrosion
- Fully protected lens with high guard
- Snap-in lens for easy replacement

2671 Red lamp  
2671A Yellow lamp

- Material:**
- Acrylic lens
  - Chrome painted steel housing
  - Hardwired
- Light Source:**
- Light Emitting Diodes (LEDs)
  - Designed at 12.8v, 0.065 amp
- FMVSS:**
- P2



**26 Series Lamps**  
Bulb Replaceable

- Material:**
- Acrylic lens
  - Die cast or ABS housing
- Light Source:**
- Bulbs: #168 wedge base
- Replacement Parts:**
- 99160Y yellow lens
- FMVSS:**
- PC

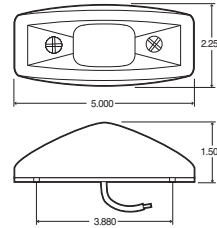

- SAE PC rated for combination clearance/marker application
- Hardwired design eliminates pin corrosion

26311R Red, one bulb & die cast  
26311Y Yellow, one bulb & die cast  
26313R Red, two bulbs & ABS  
26313Y Yellow, two bulbs & ABS



**LED Chrome Plated**  
2 Diode Pattern

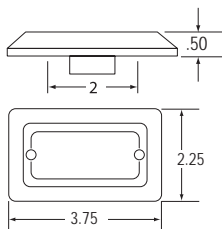

- Flush mount design
- Mounting gasket included
- Hardwired design eliminates pin corrosion

2675 Red lamp  
2675A Yellow lamp

- Material:**
- Acrylic lens
  - Chrome plated ABS housing
  - 16 gauge 2 wire
- Light Source:**
- Light Emitting Diodes (LEDs)
- FMVSS:**
- P2



**Reflectorized Lamp**  
Bulb Replaceable

- Material:**
- Acrylic lens & housing
- Light Source:**
- Bulb: #194
- Replacement Parts:**
- 8947 red lens
  - 8947A yellow lens
- FMVSS:**
- A,P2

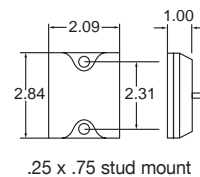

- Popular boat & utility trailer lamp
- Serves as legal reflector
- when mounted between 15 & 60 inches from ground level on trailers less than 80" wide
- Hardwired design eliminates pin corrosion

1570 Red lamp  
1570A Yellow lamp

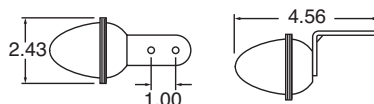

**Beehive Design**  
Bulb Replaceable

- Material:**
- Acrylic lens & ABS housing
  - Aluminum bracket
- Light Source:**
- Bulb: #67
- Replacement Parts:**
- 9004 red lens
  - 9004A yellow lens
- FMVSS:**
- P2



- High-impact acrylic housing protects against rust & corrosion
- Rigid right angle bracket
- Snap-on lens allows simple bulb replacement
- Hardwired design eliminates pin corrosion

1001D Red lamp, retail pack  
1001AD Yellow lamp, retail pack

**LED 25® Series**  
**Surface Mount**  
 Sealed  
 3 Diode Pattern



**Material:**

- Polycarbonate or acrylic lens & housing
- 18 gauge wire

**Light Source:**

- Light Emitting Diodes (LED)
- Designed at 13.5v, .1 amp

**Replacement Parts:**

- 97701 gasket

**FMVSS:**

- P2

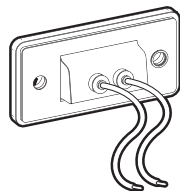

**Surface Mount**

- 25250R Red
- 25250Y Yellow

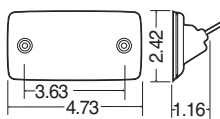

- Electronics completely sealed in epoxy to resist corrosion & moisture
- Draws less current
- Includes 97701 mounting gasket
- Hardwired design eliminates pin corrosion

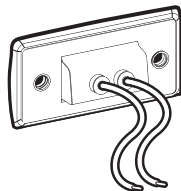

**Flush Mount**

- 25750Y Yellow

Legal when mounted from 0° to 40° rollback from vertical

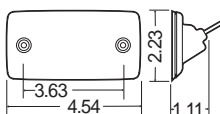

**25 Series**  
**Surface Mount**  
 Bulb Replaceable

**Material:**

- Polycarbonate lens & housing
- Rubber mounting gasket

**Light Source:**

- Bulb: #194 not included

**Recommended Accessories:**

- 94940 plug
- 97701 gasket

**FMVSS:**

- P2

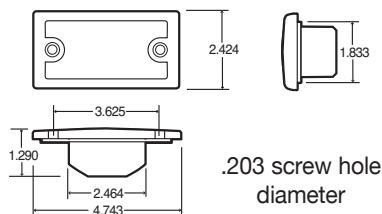

.203 screw hole diameter

- Replacement on Mack trucks
- Mounting gasket included to improve seal of lamp & body
- Recommend Truck-Lite's #94940 plug & #194 bulb
- Not suitable for PC requirements

25766Y Yellow lamp



**25 Series**  
**Flush Mount**  
 Bulb Replaceable

**Material:**

- Polycarbonate lens & housing

**Light Source:**

- Bulb: #194 not included

**Recommended Accessories:**

- 94940 plug
- 97701 gasket

**FMVSS:**

- P2

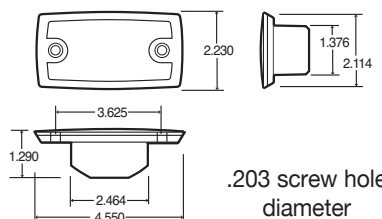

.203 screw hole diameter

- Features flush mount design for replacement on Mack trucks
- Recommend Truck-Lite's #94940 plug & #194 bulb
- Not suitable for PC requirements

25765Y Yellow lamp





- Popular replacement cab marker or corner trailer applications
- Meets SAE 592e standards
- Standard PL-10 connection

10276R Red lamp  
10276Y Yellow lamp

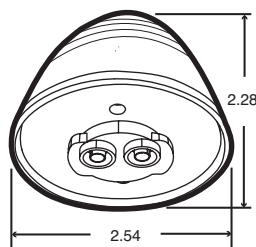

**LED 10 Series Beehive**  
2-1/2" Sealed  
8 Diode Pattern

- Material:**
- Polycarbonate lens & housing
- Light Source:**
- Light Emitting Diodes (LEDs)
  - Designed at 14v, 0.05 amp
- Recommended Accessories:**
- Mounting: Pages 249-252
  - Plugs: Pages 225-228
- FMVSS:**
- P2



- Meets SAE 592e standards
- Standard PL-10 connection
- Not recommended for use with cam-on mounts or PC applications

1075 Red lamp      1076 Red lamp w/clear lens  
1075A Yellow lamp      1076A Yellow lamp w/clear lens

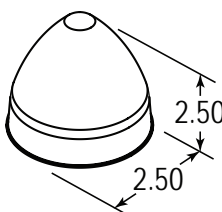

**LED Beehive**  
2-1/2" Sealed  
13 Diode Pattern

- Material:**
- Polycarbonate lens & housing
- Light Source:**
- Light Emitting Diodes (LEDs)
  - Designed at 14v, 0.1 amp
- Recommended Accessories:**
- Mounting: Pages 249-252
  - Plugs: Pages 225-228
- FMVSS:**
- P2



- Designed for cab marker use
- Standard PL-10 connection
- Suitable for PC requirements on a 45 degree angle in mounting devices #10708, 10720, 00801, 00803, or 00804

10203R Red lamp  
10203Y Yellow lamp

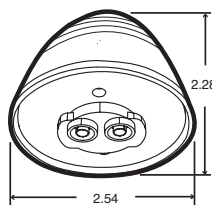

**10 Series Beehive**  
PC Rates  
2-1/2" Sealed

- Material:**
- Polycarbonate lens & housing
- Light Source:**
- Designed at 14v, 0.33 amp, 2cp
- Recommended Accessories:**
- Mounting: Pages 249-252
  - Plugs: Pages 225-228
- FMVSS:**
- P3, P2



- Features a beehive lens assembly designed for cab marker use
- Replaced KD#94175-0001
- Standard PL-10 connection

26762Y Yellow lens & housing

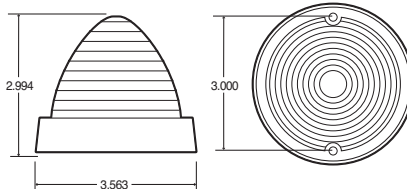

**26 Series Beehive**

- Material:**
- Polycarbonate lens & housing
- Light Source:**
- Designed at 14v, 0.33 amp, 2cp
- FMVSS:**
- P2



**LED 30 Series Beehive**

2" Sealed  
2-8 Diode Yellow

**Material:**

- Polycarbonate lens & housing

**Light Source:**

- Light Emitting Diodes (LEDs)
- Designed at 14v, 0.05 amp

**Recommended Accessories:**

- Mounting: Pages 249-252
- Plugs: Pages 225-228

**FMVSS:**

- P2

- Popular replacement cab marker or corner trailer applications
- Meets SAE 592e standards
- Fit 'N Forget connection
- Not recommended for use with cam-on mounts or PC applications
- Red lamp is 2 diode, yellow lamp is 8 diode



**30276R Red lamp**

**30276Y Yellow lamp**

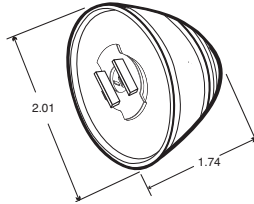

**LED Beehive**

2" Sealed  
10 Diode Pattern

**Material:**

- Polycarbonate lens & housing

**Light Source:**

- Light Emitting Diodes (LEDs)
- Designed at 14v, 0.1 amp

**Recommended Accessories:**

- Mounting: Pages 249-252
- Plugs: Pages 225-228

**FMVSS:**

- P2

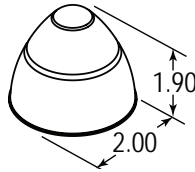

- Meets SAE 592e standards
- Standard PL-10 connection
- Not recommended for use with cam-on mounts or PC applications

**3075 Red lamp**

**3075A Yellow lamp**

**3076 Red lamp w/clear lens**

**3076A Yellow lamp w/clear lens**



**30 Series Beehive**

PC Rated  
2" Sealed

**Material:**

- Polycarbonate lens & housing

**Light Source:**

- Designed at 14v, 0.33 amp, 2cp

**Recommended Accessories:**

- Mounting: Pages 249-252
- Plugs: Pages 225-228

**FMVSS:**

- P2, PC

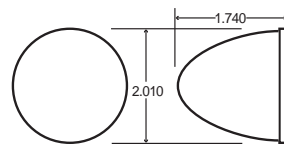

- Designed for cab marker use
- Suitable for PC requirements on a 45 degree angle
- Standard PL-10 connection

**30201R Red lamp**

**30201Y Yellow lamp**



**26 Series Chrome Mount**

**Material:**

- Plastic lens & housing

**Light Source:**

- Bulb #67

**Replacement Parts:**

- 99066Y yellow lens
- 97046 mounting pad

**FMVSS:**

- P2

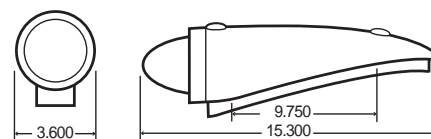

- Features chrome plated plastic housing with contour base & rubber mounting pad
- Includes one #67 bulb
- Hardwired design

**26760Y Yellow lamp**



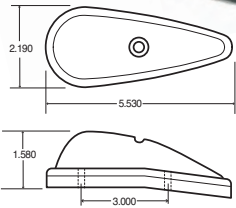

- Features single screw lens mounting for quick installation & bulb replacement
- Contoured rubber mount provides additional shock protection
- Suitable for PC requirements on a 45° angle
- Hardwired design

**26765R Red lamp**  
**26765Y Yellow lamp**

### Cab Marker Rubber Mount Bulb Replaceable

#### Material:

- Acrylic lens
- Rubber mount

#### Light Source:

- Bulb: #67, 12v

#### Replacement Parts:

- 99067Y yellow lens

#### FMVSS:

- PC

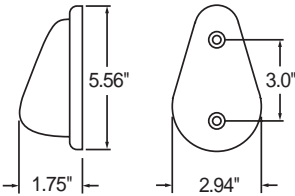

- High-impact polycarbonate, gray finish, protects against rust and corrosion
- Versatile installation – mounts on flat or slightly curved surface
- Thick neoprene pad seals out dirt & moisture
- Hardwired design

**1320AD Yellow, retail pack**

### Cab Marker Bulb Replaceable

#### Material:

- Polycarbonate lens & housing

#### Light Source:

- Bulb: #67, 12v

#### Replacement Parts:

- 99067Y yellow lens

#### FMVSS:

- PC

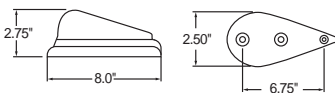

- One-piece chrome die cast housing
- Includes Neoprene mounting pad to cushion lamp for long bulb life
- Fits securely on all flat or slightly curved surfaces
- Hardwired design

**1312A Yellow lamp**

### Cab Marker Die Cast Chrome Bulb Replaceable

#### Material:

- Acrylic lens
- Die cast housing

#### Light Source:

- Bulb: #67, 12v

#### Replacement Parts:

- 9087A yellow lens

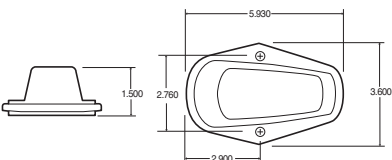

- Features surface mount design for replacement on many Ford trucks
- Contains #94940 plug assembly & one
- #194 wedge base bulb, 2 wire
- Suitable for PC requirements on a 45° angle
- Replaces Signal-Stat 1360A

**25760Y Yellow lamp w/gray mount**

### Cab Marker Surface Mount Bulb Replaceable

#### Material:

- Acrylic lens
- ABS housing

#### Light Source:

- Bulb: #194 wedge base

#### FMVSS:

- P2

**Cab Marker**  
**Plastic Mount**  
Bulb Replaceable

**Material:**

- Polycarbonate lens & housing
- 16 gauge wire

**Light Source:**

- Bulb: #194 wedge base

**Replacement Parts:**

- 07021 yellow lens
- 07022 gasket
- 94940 plug

**FMVSS:**

- P2,PC

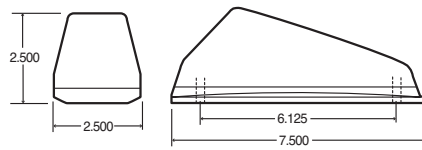

- Features snap-on lens & base mounting for quick bulb replacement
- Replace standard lamps used on many Mack trucks
- Mounting gasket #07022 included to improve seal between lamp & body
- Suitable for PC requirements on a 45° angle
- Hardwired design

**25761Y Yellow lamp**

**Chrome Cab Marker**  
Bulb Replaceable

**Material:**

- Polycarbonate lens & housing

**Light Source:**

- Bulb: #168

**Replacement Parts:**

- 8925A yellow lens

**FMVSS:**

- P2,PC

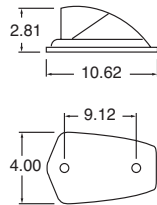

- Ford replacement lamp
- Mounts on flat or slightly curved surface without disassembly
- Hardwired design

**1350A Yellow lamp**

**Chrome Cab Marker**  
Bulb Replaceable

**Material:**

- Polycarbonate lens & housing

**Light Source:**

- Bulb: #168

**Replacement Parts:**

- 8943A yellow lens
- 8943 red lens

**FMVSS:**

- PC

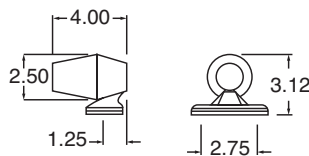

- Snap-on lens permits easy bulb & lens replacement
- Hardwired design

**1319 Red Lamp**  
**1319A Yellow Lamp**

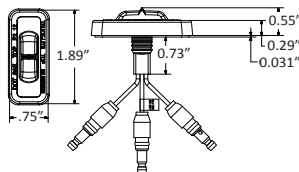

## LED 36® Series Flex-Lite Dual Function 3 Diode Pattern

### Materials:

- Polycarbonate Lens
- Over-Molded Housing
- Encapsulated Circuitry
- 20 Gauge Wire

### Light Source:

- 3 Light Emitting Diodes (LED)
- Designed at 13.5v
  - (Minor)0.004A - 0.015A
  - (Major)0.048A - 0.068A

### FMVSS:

- P2

- Lamps operate in minor and major output levels; major function activated by the brake function or turn signal
- Yellow Major function is 3 times brighter than minor function
- Red Major function is 7 times brighter than minor function
- Provides marker/clearance solution that requires no mounting brackets or installation screws
- Lamps adhere directly to application surface through use of heavy-duty adhesive backing
- Rear exit wire version requires a 3/8" mounting hole, and self-seals hole upon installation
- Care should be taken for proper installation

36203R Red Lamp

36203Y Yellow Lamp

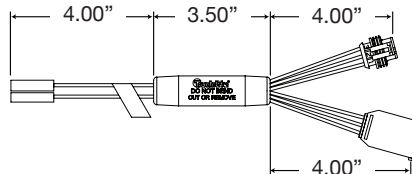

## Dual Function Pigtail Adapter

### Material:

- PVC Overmold
- 16 Gauge Wire

### Additional Specifications:

- Tested To Run From -40°C to 85°C
- Designed To Control a 3-lamp or 5-lamp 35 Series (35375R) installation
- Designed At 11.9v - 13.5

### Kit Components:

- 35033R kit includes 3x 35375R and 1x 97340 pigtail
- 35034R kit includes 5x 35375R and 1x 97340 pigtail
- 35035R kit includes 3x 35375R and 1x 97342 pigtail
- 35036R kit includes 5x 35375R and 1x 97342 pigtail

- Provides added safety benefit to trailing drivers, with additional braking awareness at a higher level on the vehicle, notifying drivers more quickly of vehicle stops
- Allows marker & clearance lamps to operate in two output levels; brighter lighting activated by the brake function
- Designed for use with Truck-Lite's Fit n' Forget Stop/Turn/Tail systems
- Great for retrofitting existing lighting systems
- Heavy-duty design allows for care-free maintenance
- Internal electronics protect vehicle from electrical feedback

35033R Red, kit w/three 35 Series LED lamps & 97340 pigtail

35034R Red, kit w/five 35 Series LED lamps & 97340 pigtail

35035R Red, kit w/three 35 Series LED lamps & 97342 pigtail

35036R Red, kit w/five 35 Series LED lamps & 97342 pigtail

97340 Plug w/ 2-position marker connector for 35 Series lamps

97342 Plug w/ 0.180 bullet connector for 35 Series lamps

97344 Plug w/ 0.180 bullet connector and PL3 connector for 35 Series lamps

97343 Plug w/ 2-position marker connection for 36 Series lamps

97345 Plug w/ 0.180 bullet connector for 33 Series lamps

97364 Plug w/ 2-position marker connection for 33 Series lamps

97365 Plug w/ 2-position marker connection for 33 Series lamps

97366 Plug w/ 0.180 bullet connector and PL3 connector for 33 Series lamps

97349 Plug w/ 2-position marker connection for 10 Series lamps

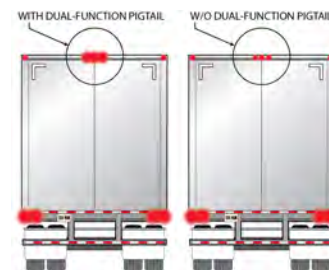

Note: Lamps must have between 11.9v and 13.5v in order to achieve maximum difference in light output.



**LED 33® Series Dual Function Marker Lamps**

**Material:**

- Polycarbonate lens & housing
- PVC grommet
- Nylon flange
- 16 gauge wire

**Light Source:**

- Light Emitting Diodes (LEDs)
- Designed at 14 volts, 0.05 amp

**FMVSS:**

- P2

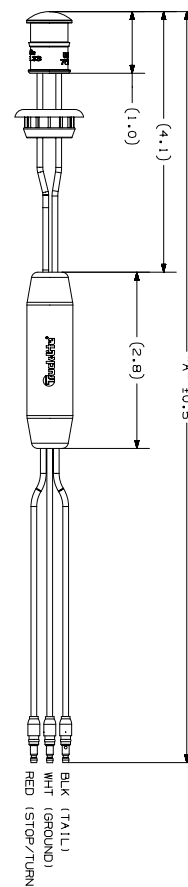

- World smallest LED marker lamp for the transportation industry
- Provides increased visibility when braking or turning
- Functions as a marker, auxiliary turn, and auxiliary stop when properly installed
- Best in class auxiliary brake function is seven times brighter than marker function
- Marker function exceeds P2 legal requirements
- Requires a 0.75 mounting hole
- Hard-wired lamp with .180 male bullet design can be easily retrofitted
- LEDs draw less current, allowing more power for other vehicle requirements
- LEDs have no filament, therefore are not susceptible to shock and vibration, a major cause of failure for lamps with incandescent bulbs
- Engineered to withstand the toughest working environments
- Electronics sealed in epoxy to resist corrosion and moisture
- Backed by our industry-leading limited Lifetime Warranty
- Complies with FMVSS-108 marker/clearance requirements

- |   |  |
|---|--|
| <b>33203R</b> Black grommet, 12 V               | <b>33206R</b> Black flange, 12 V             |
| <b>33204R</b> Black grommet (0.125-0.250), 12 V | <b>33207R</b> Red, 3 lamp grommet mount, 56" |
| <b>33205R</b> Black grommet (0.070-0.125), 12 V | <b>33208R</b> Chrome flange, 12 V            |

**LED 33® Series ID Assembly**

**Material:**

- Polycarbonate lens & housing
- PVC grommet
- Nylon flange
- 16 gauge wire

**Light Source:**

- Light Emitting Diodes (LEDs)
- Designed at 14 volts, 0.05 amp

**FMVSS:**

- P2



33741R

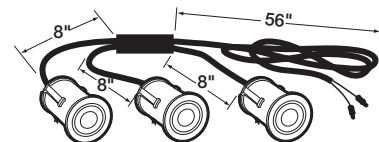

- US patent #6612728
- World's smallest LED marker lamp for the transportation industry
- Hardwired lamp design is easily retrofitted
- Requires 3/4" mounting hole

- |   |
|---|
| <b>33740R</b> Red, 3 lamp grommet mount w/ .180 bullets         |
| <b>33741R</b> Red, 3 lamp grommet mount, 56" w/ 2 position plug |
| <b>33751R</b> Red, 5 lamp grommet mount w/ 2 position plug      |



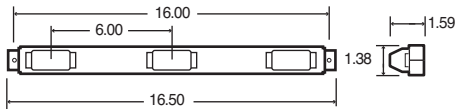

.218 screw hole diameter

- Designed to fit applications requiring minimal space
- Features stainless steel bar with three LED Model 15 lamps on 6" centers

**15050R Red kit**  
**15050Y Yellow kit**

## LED 15<sup>®</sup> Series Identification Bar

### Material:

- Polycarbonate lens & housing
- Stainless steel bar
- 14 gauge wire

### Light Source:

- Light Emitting Diodes (LED)
- Designed at 14v, 0.05 amps

### Kit Components:

#### 15050R/Y kit:

- 3 - 15250R or 15250Y LED lamps
- 1 - 00808 ID bar
- 1 - 93943 wiring harness

### FMVSS:

- P2

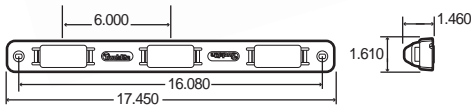

.310 screw hole diameter

- Direct replacement for Ford
- Fits in most narrow header rails
- Snap-lock tabs allow easy installation
- Replaces Signal-Stat 1515

**15745R Red kit**  
**15745Y Yellow kit**

## 15<sup>®</sup> Series Identification Bar

### Material:

- Polycarbonate lens, housing & ID bar
- 16 gauge wire

### Light Source:

- 12v bulb, .33 amp, 2 cp

### Kit Components:

#### 15745R/Y kits:

- 3 - 15200R 12v lamps
- 1 - 00817 ID bar
- 1 - 93945 wiring harness

### FMVSS:

- P2

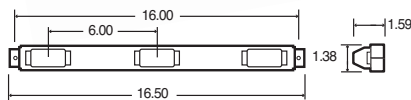

.218 screw hole diameter

- Direct replacement for Ford
- Fits in most narrow header rails
- Snap-lock tabs allow easy installation

**15741R Red kit**

## Model 15<sup>®</sup> Identification Bar

### Material:

- Polycarbonate lens & housing
- Stainless steel or metal bar
- 14 gauge wire

### Light Source:

- 12v bulb, .33 amp, 2 cp

### Kit Components:

#### 15741R kit:

- 3 - 15200R 12v lamps
- 1 - 00808 ID bar
- 1 - 93943 wiring harness

### FMVSS:

- P2

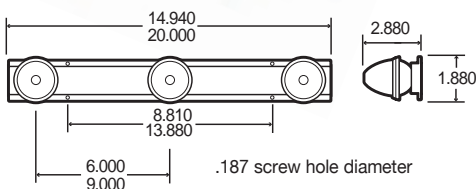

.187 screw hole diameter

- Features zinc-plated steel bar in either 15" or 20" lengths
- Bar contains three lamps with #67 bulb & lens retention snap rings
- Hardwired design eliminates pin corrosion

**26740R Red kit w/20" bar**  
**26741R Red kit w/15" bar**

## 26 Series Identification Bar

### Material:

- Acrylic lens
- Zinc-plated steel bar
- 18 gauge wire

### Light Source:

- Bulb: #67

### Replacement Parts:

- 9004 red lens
- 97947 snap ring

### FMVSS:

- P2



**LED 35® Series  
Aluminum ID Bar**

**Material:**

- Polycarbonate lens & housing
- Extruded aluminum bar
- 16 gauge wire

**Kit Components:**

- 35740R/Y kits:  
 3 - 35200R/Y LED lamps  
 1 - 00815 ID bar w/6" center  
 1 - 96989 wiring harness
- 35741R/Y kits:  
 3 - 35200R/Y LED lamps  
 1 - 00816 ID bar w/9" center  
 1 - 96996 wiring harness

**FMVSS:**

- P2,P3

- Designed to fit applications requiring minimal space
- Slim 1" width is perfect for upper rail mounting
- Draws less current, allowing more power for other vehicle requirements

**ID Bars - 9" centers/23" length**

- 35741R Red kit  
 35741Y Yellow kit

**ID Bars - 6" centers/17" length**

- 35740R Red kit  
 35740Y Yellow kit

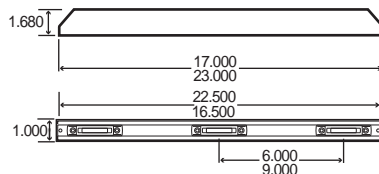

**10® & 30® Series  
Identification Bar**

**Material:**

- Polycarbonate lens & housing
- Steel bar
- 14 gauge wire

**Light Source:**

- 12v bulb, .33 amp, 2 cp

**Kit Components:**

- 10744R or 30740R kits:  
 3 - 10202R or 30200R lamps  
 1 - 00798 ID bar w/6" centers  
 1 - 93906 wiring harness
- 10745R or 30742R kits:  
 3 - 10202R or 30200R lamps  
 1 - 00799 ID bar w/9" centers  
 1 - 93908 wiring harness

**FMVSS:**

- P2

- Features rugged black enameled ID bar
- Lamps are mounted on 6" or 9" centers

- 10744R Red kit w/6" centers  
 10745R Red kit w/9" centers  
 30740R Red kit w/6" centers  
 30742R Red kit w/9" centers  
 00794 Stainless steel bar w/6" centers

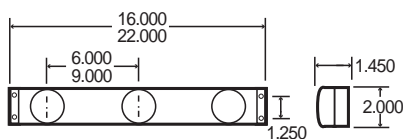

.140 screw hole diameter  
 30740R and 30742R

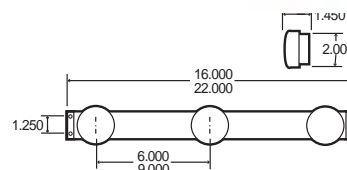

.140 screw hole diameter  
 10744R and 10745R

**26 Series  
Identification Bar**

**Material:**

- Acrylic lens
- ABS housing & bar
- 16 gauge wire

**Light Source:**

- Bulb: Two #193 wedge base

**Replacement Parts:**

- 9007 red lens
- 9007A yellow lens

**FMVSS:**

- P2,PC

- Uni-body housing simplifies installation & will never rust
- Low profile styling
- Each light features two bulbs for superior visibility & reliability
- Snap-on lens makes bulb & lens replacement easy
- Felt mounting pad is specially treated to protect against dirt & moisture
- Replaces Truck-Lite 26743 series
- Hardwired design eliminates pin corrosion

- 1215 Red kit w/black finish bar  
 1216 Red kit w/white finish bar  
 1216A Yellow kit w/white finish bar

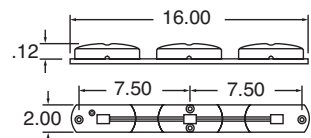
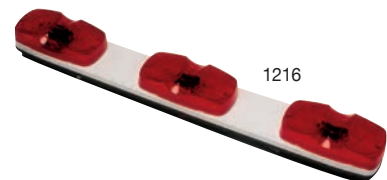

# License, Back-up & Interior Lighting



# License, Back-up & Interior Lighting

License Lighting

92-95

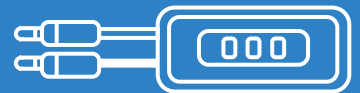

Back-up Lighting

96-101



Dome & Utility Lighting

102-111

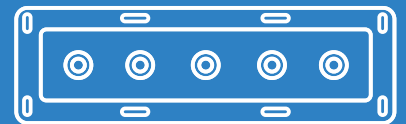

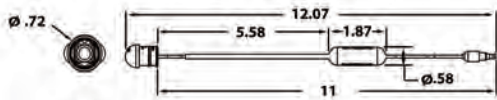

Lamp must be installed per instructions to comply with FMVSS-108

- Hardwired lamp design easily retrofitted, with only a 1-3/16 mounting hole required for grommet installation
- US Patent 5,943,798
- Product designed to fit in 33705 grommet
- Top & side plate mounting options
- When mounted into a module, all wires are hidden inside module, protecting against damage from corrosion
- Does not require a bracket, so it can be mounted directly into the vehicle
- Stealth, low profile design is resistant to damage, and hides lamp away from view to help prevent theft

- 33210C** Clear lamp
- 33010C** Clear, grommet kit

**LED 33 Series License**

**1 Diode**

**Material:**

- Polycarbonate lens, housing & flange
- EPDM grommet
- 18 gauge wire

**Light Source:**

- Light Emitting Diodes (LEDs)
- Designed at 12.8v, 0.15 amp

**Kit Components:**

- 33010C kit:**
- 1 - 33210C lamp
- 1 - 33705 grommet

**Recommended Accessories:**

- 33705 mounting grommet
- 33805 mounting flange

**FMVSS:**

- L



See Page 2

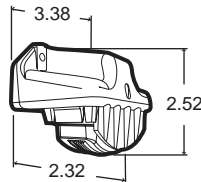

- Features snap-fit mount for quick installation & easy replacement
- Bracket may be surface mounted or used with bracket, #42722
- Recommended mounting locations available

**15® Series License Kits**

**Material:**

- Polycarbonate bracket

**Kit Components:**

- 15011/15040/15042 kits:**
- 1 - 15208, 15205 or 15905 lamp
- 1 - 15729 gray bracket
- 1 - 97032 mounting gasket
- 15012/15041/15043 kits:**
- 1 - 15208, 15205 or 15905 lamp
- 1 - 15730 black bracket
- 1 - 97032 mounting gasket

- 15013/15055 kits:**
- 1 - 15208, 15205 or 15905 lamp
- 1 - 15732 chrome bracket
- 1 - 97032 mounting gasket

- 15058/15060 kits:**
- 1 - 15227 lamp
- 1 - 15730 or 15732 bracket
- 1 - 97032 mounting gasket

- 15061/15059 kits:**
- 1 - 15226 lamp
- 1 - 15730 or 15732 bracket
- 1 - 97032 mounting gasket

**Recommended Accessories:**

- 97032 - mounting gasket

**LED Lamp & Black Bracket Kit**

- 15041 Kit
- 15043 Kit, 24v
- 15058 Kit
- 15061 Kit, diamond shell



**Incandescent Lamp & Black Bracket Kit**

- 15012 Kit

**Black Bracket**

- 15730 Black bracket

**LED Lamp & Gray Bracket Kit**

- 15040 Kit
- 15042 Kit, 24v
- 15053 Kit w/15226 lamp
- 15054 Kit w/15227 lamp



**Incandescent Lamp & Gray Bracket Kit**

- 15011 Kit

**Gray Bracket**

- 15729 Gray bracket

**LED Lamp & Chrome Bracket Kit**

- 15055 Kit
- 15059 Kit, diamond shell



**Incandescent Lamp & Chrome Bracket Kit**

- 15013 Kit

**Chrome Bracket**

- 15732 Chrome bracket



See Page 2



15205

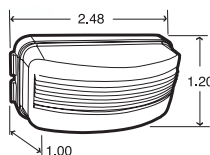

- US Patent #5934798
- Meets SAE J587 & European
- ECE Regulations 4
- License applications must use brackets shown on page 88 & 240
- Hardwired design w/adaptor plug for quick changeover without rewiring
- Product designed to fit in bracket #00820, #15729, #15730, #15732 or #15736

- 15205** Clear lamp
- 15226** Clear lamp, diamond shell
- 15227** Clear lamp w/.180 bullets
- 15905** Clear lamp w/blunt cut, 24v

**LED 15® Series License & Utility 3 Diode Pattern**

**Material:**

- Polycarbonate lens & housing

**Light Source:**

- Light Emitting Diodes (LEDs)
- 12v designed at 13.5v, 0.05 amp
- 24v designed at 28v, 0.03 amp

**Recommended Accessories:**

- Mounting: Page 258

**FMVSS:**

- L, ECE, R4

**LED 36® Series**  
License Lamp



Made in the U.S.A.



**Material:**

- Polycarbonate lens
- Over-molded thermoplastic resin housing/substrate
- 20 gauge wire measuring 9 1/4"

**Light Source:**

- Light Emitting Diodes (LEDs)•Designed from 13.5v to 28v
- Current draw ranges from 0.04a to 0.05a

**Recommended Accessories:**

- 36710 - Gray Mounting Bracket
- 36711 - Black Mounting Bracket

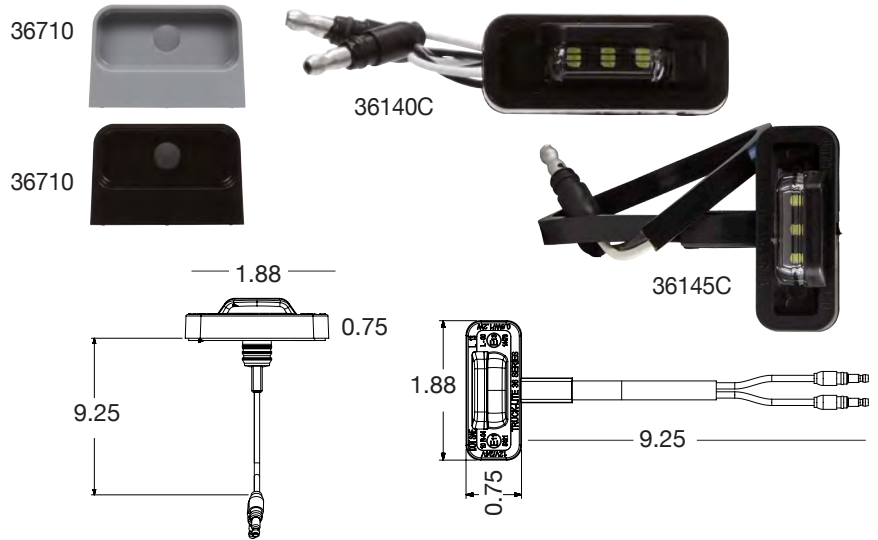

- Provides License Lamp solution that requires no mounting brackets or installation screws
- Lamp adheres directly to mounting surface through use of heavy-duty adhesive backing, with an easy-to-install, peel-off liner
- Gray and black brackets are only for rear exit wire lamp, (36140C), and are available if preferred over surface mounting
- Omni-Volt•Hard-wired with rear and side exit wires complete with .180 molded bullets
- Side mount options can be mounted without any mounting brackets or fasteners
- LEDs draw much less current and are rated at 100,000 hours
- Electronics are completely sealed in epoxy to resist damage caused by moisture, corrosion, shock, and vibration
- When properly mounted the lamps are designed to conform to the applicable requirements of FMVSS - 108

- 36140C** License, rear exit wires
- 36145C** License, side exit wires

- 36710** Mounting bracket, gray
- 36711** Mounting bracket, black

**15® Series License & Utility**  
Sealed

**Material:**

- Polycarbonate lens & housing

**Light Source:**

- 12v designed at 14v, 0.33 amp, 2 cp
- 24v designed at 24v, 0.17 amp, 2 cp

**Recommended Accessories:**

- Plugs: Pages 203-205
- Mounting: Page 258

**FMVSS:**

- L

- High impact polycarbonate sonically sealed lens & housing
- Available in 12 or 24 volt versions
- Features 15,000 hour long life 12v bulb
- Must be used with 15 Series mounting brackets shown on page 80 & 240
- Replaces Signal-Stat 1502W

- 15208** Clear lamp
- 15209** Clear lamp, 24v

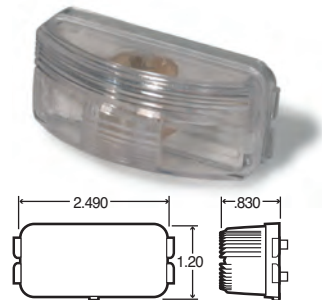

**19® Series License**  
Sealed

**Material:**

- Polycarbonate lens & housing

**Light Source:**

- Two bulbs designed at 14v, 0.33 amp, 2 cp each

**Recommended Accessories:**

- Plugs: Pages 204
- Mounting: Page 252

**FMVSS:**

- L

- Fruehauf replacement lamp
- High impact polycarbonate lens & housing are sonically sealed
- Long life 15,000 hour bulbs
- License or utility applications
- Replaces Signal-Stat 1901W

- 19206** Clear lamp

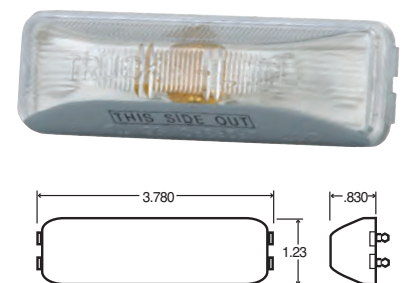

0.15 diameter male bullet



- Acrylic lens & ABS housing are sonically sealed
- Unique bulb cradle shock mount absorbs shock & vibration, prolonging bulb life
- Long life bulb is rated for 15,000 hours
- Lamp kit includes #96930 hot wire



21204C

**21004C** Clear kit  
**21204C** Clear lamp

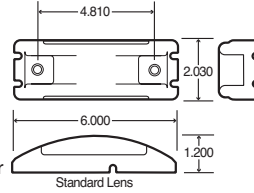

**Super 21® License Sealed**

**Material:**

- Acrylic lens
- ABS housing

**Light Source:**

- Designed at 14v, 0.33 amp, 2 cp

**Recommended Accessories:**

- Plugs: Pages 223

**FMVSS:**

- L

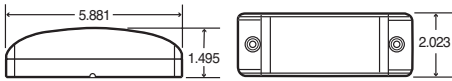

- Features male pin connections
- Polycarbonate lens & housing withstands impact & corrosion
- Shock mount absorbs road shock & vibration
- Replaces Grote® #60331

**29204C** Clear lamp

**Male Pin 21® License Sealed**

**Material:**

- Polycarbonate lens & housing

**Light Source:**

- Designed at 14v, 0.33 amp, 2 cp

**FMVSS:**

- L



17200

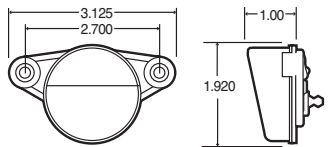

- High impact polycarbonate sonically sealed lens & housing
- Designed to mount with bracket, #17720
- Horizontal mount only

**17001** Clear kit w/90° angle hot wire (94922)  
**17002** Clear kit w/straight hot wire (94923)  
**17003** Clear kit w/bracket & hot wire (94922)  
**17200** Clear lamp

**17 Series License Sealed**

**Material:**

- Polycarbonate lens & housing

**Light Source:**

- Designed at 14v, .35 amp, 3 cp

**Recommended Accessories:**

- Plugs: Page 225

**FMVSS:**

- L



426W

- Snap-grip lens hood for easy bulb replacement
- Ideal for license, instrument, or step lighting
- Surface mount, grounds through screw

**425WD** Clear w/gray housing, retail pack  
**426W** Clear w/chrome housing

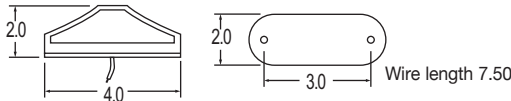

**License Illuminator Bulb Replaceable**

**Material:**

- Polycarbonate lens & housing

**Light Source:**

- Bulb: #67, 4 cp

**Replacement Parts:**

- 8951W gray hood

**FMVSS:**

- L



435W

- Original equipment on Airstream
- Lamp body chrome plated steel
- White painted steel license frame
- Rubber pad between lamp and frame

**435W** Clear lamp

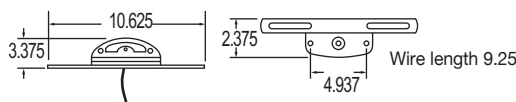

**License Kit Bulb Replaceable**

**Material:**

- Steel housing & bracket

**Light Source:**

- Bulb: #67, 4 cp

**Replacement Parts:**

- 97296 hood

**FMVSS:**

- L



**26 Series License**  
Bulb Replaceable

**Material:**

- Steel housing

**Light Source:**

- Bulb: #67 designed at 13.5v, 0.59 amp, 4 cp

**FMVSS:**

- L

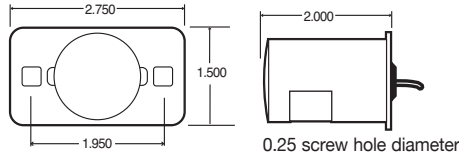

- Extra rugged cadmium-plated steel housing
- Screw lock cover cams on/off for easy bulb replacement
- Ideal for license, instrument or step lighting
- Surface mounts, grounds through screw
- Replaces Signal-Stat 431W



**26330 Clear lamp**

**26 Series License**  
Bulb Replaceable

**Material:**

- Steel housing
- Hardwired

**Light Source:**

- Bulb: #67 designed at 13.5v, 0.59 amp, 4 cp

**FMVSS:**

- L(2)

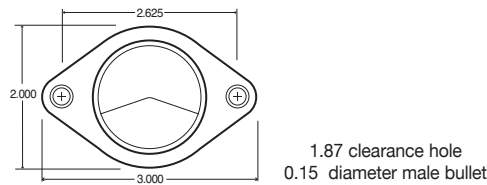

- Design is similar to lamps used on GM vehicles
- Two lamps required for license plate illumination
- Rubberized single contact electrical plug
- Replaces Signal-Stat 436W



**26336 Clear lamp**

**26 Series License**  
Bulb Replaceable

**Material:**

- Brass housing
- Hardwired

**Light Source:**

- Bulb: #67 designed at 13.5v, 0.59 amp, 4 cp

**FMVSS:**

- L(2)

- Features chrome-plated brass housing
- Snap-fit design uses standard 1-1/4" diameter hole
- Commonly used to illuminate a license plate on step bumpers
- Two units required for license illumination
- Ideal for courtesy, map, instrument, license or step lighting
- Snaps securely into any panel thickness up to .187"
- Replaces signal-Stat 430W

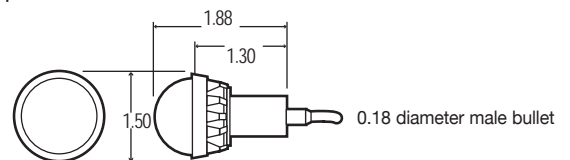

**26331 White lamp**

**26 Series License**  
Bulb Replaceable

**Material:**

- Polycarbonate lens
- ABS housing
- Hardwired

**Light Source:**

- Bulb: #67 designed at 13.5v, .59 amp, 4 cp

**Replacement Parts:**

- 26380 gray hood

**FMVSS:**

- L

- Features high impact housing with streamline design
- Mounts on 1-3/4" hole centers
- Replaces Signal-Stat 420W & 423W

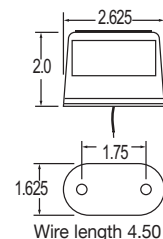

**26335 Clear lamp**



**LED**  
UPGRADE  
See page 97

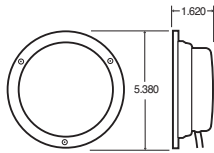

0.20 screw hole diameter  
5.00 bolt hole circle  
4.43 diameter mounting hole

- Features flush mount housing with recessed lens
- Snap-in retaining ring holds lens in place
- Requires two lamps to meet Federal Lighting Regulations
- Replaces Signal-Stat 4111W

**80342** Clear lamp w/black housing  
**80344** Clear lamp w/stainless steel housing  
**80345** Clear lamp w/polished stainless steel housing

**80® Series Back-Up**  
Bulb Replaceable

**Material:**

- Steel housing
- Polycarbonate lens
- Hardwired

**Light Source:**

- Bulb: #1156, 32 cp

**Replacement Parts:**

- 99008C lens
- 97945 retaining ring
- 97093 mounting gasket
- 97094 lens gasket

**FMVSS:**

- R(2)



**LED**  
UPGRADE  
See page 97



3693W

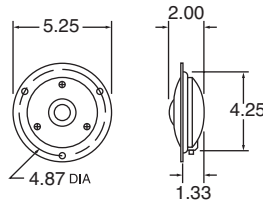

- Three screw polycarbonate lens security
- Narrow depth fits in trucks & vans with limited access
- Zinc die cast housing

**3693W** Clear lamp w/chrome housing

**Flush Back-Up**  
Bulb Replaceable

**Material:**

- Zinc die cast housing
- Polycarbonate lens
- Hardwired

**Light Source:**

- Bulb: #1156, 32 cp

**Replacement Parts:**

- 9016W lens
- 9021W lens kit
- 9102 plug

**FMVSS:**

- R(2)



**LED**  
UPGRADE  
See page 95



- Uniquely designed shock mount extends lamp life
- Sealed polycarbonate lens & housing resist heat & impact
- Flange & flush mount grommets designed for mounting in a 4-1/2" hole
- Not recommended for dome lamp use
- Two lamps required to meet Federal Lighting Regulations
- Uses standard PL-2 connection

**Super 40® Back-Up**  
Sealed

**Material:**

- Polycarbonate or acrylic lens & housing

**Light Source:**

- Designed at 13.5v, 2.1 A, 32 cp

**Kit Components:**

- 40044 grommet kit:
- 1 - 40244 lamp
- 1 - 40700 grommet
- 1 - 94992 plug

**Recommended Accessories:**

- Mounting: Pages 259-261
- Plugs: Pages 213-216

**FMVSS:**

- R(2)



**Super 40 Grommet Kit**  
**40044** Clear

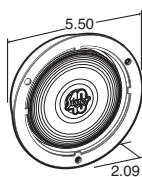

**Super 40 Lamp & Flange**  
**40260** Clear, black flange  
**40261** Clear, gray flange

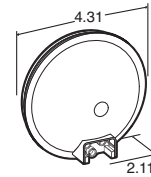

**Super 40 Lamp**  
**40244** Clear

**LED Super 44® Back-Up**

Sealed  
6 Diode Pattern



See Page 2



**Material:**

- Polycarbonate lens, housing & flange
- 16 gauge wire

**Light Source:**

- Light Emitting Diodes (LEDs)
- Designed at 12.5v, 0.53 amp

**Recommended Accessories:**

- Mounting: Pages 259-261
- Plugs: Pages 213-216

**FMVSS:**

- R

- Features robust, cost effective, efficient design
- Surpasses back-up specifications with 1 lamp, eliminating 2 lamp systems
- 6 diode pattern creates a uniform look when mounted with S44 products
- Epoxy encapsulated with exclusive Fit 'N Forget® plug assembly, keeps corrosives away from lamp
- Not recommended for dome lamp use
- U.S. Registered TM #3483147

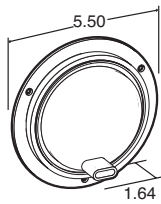

**Super 44 Lamp & Flange**

- 44344C Clear, gray flange
- 44991C Clear, gray flange, diamond shell
- 44346C Clear, black flange
- 44992C Clear, black flange, diamond shell
- 44348C Clear, black flange, hardwired blunt cut
- 44345C Clear, white flange
- 44349C Clear, white flange, hardwired blunt cut

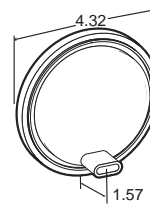

**Super 44 Lamp**

- 44350C Clear
- 44990C Clear, diamond shell
- 44347C Clear, Hardwired w/ PL3 connector



**Flange Kits**

- 44181C Kit, gray flange
- 44182C Kit, black flange, diamond shell

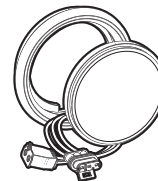

**Grommet Kits**

- 44180C Clear
- 44184C Clear, diamond shell

**LED Back-Up**

Sealed  
24 Diode Pattern



**Material:**

- Polycarbonate lens & housing

**Light Source:**

- Light Emitting Diodes (LEDs)
- Designed at 13.5v, 0.249 amp

**Recommended Accessories:**

- Mounting: Pages 259-261
- Plugs: Pages 213-216

**FMVSS:**

- R(2)

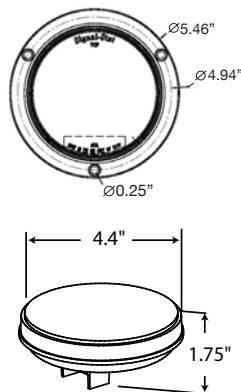

- Uses standard right angle PL-2 connection
- Unique LED array retains full pattern light output design
- Epoxy encapsulated electronics
- Two lamps required for back-up

- 4060C Clear lamp
- 4063C Clear lamp, integral flange





40204 or 40212



40224

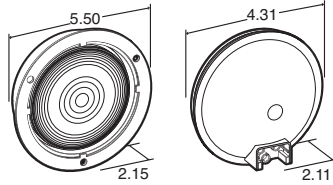

- Polycarbonate lens & housing are vibration sealed
- Bulb is shock mounted for extended life
- Legal only for back-up function for 1 or 2 lamp systems
- Not recommended for dome lamp use
- Replaces Signal-Stat 4041W & 4047W

40004	Clear grommet kit
40012	Clear grommet kit, 24v
40024	Clear gray flange kit
40071	Clear black flange kit
40204	Clear lamp
40212	Clear lamp, 24v
40206C	Clear lamp w/clear back
40224	Clear lamp & gray flange
40262	Clear lamp & black flange

## 40® Series Back-Up

### Sealed

#### Material:

- Polycarbonate lens & housing
- ABS flange

#### Light Source:

- Designed at 12.8v, 2.1 amp, 32 cp

#### Kit components:

- 40004 grommet kit:  
1 - 40204 12v lamp  
1 - 40700 grommet  
1 - 94992 plug
- 40012 grommet kit:  
1 - 40212 24v lamp  
1 - 40700 grommet  
1 - 94992 plug
- 40024 flange kit:  
1 - 40224 lamp & gray flange  
1 - 94992 plug

#### FMVSS:

- R

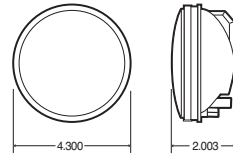

- Features male pin connections
- High impact polycarbonate lens & housing
- Shock mount resists road shock & vibration
- Two lamps required to meet federal lighting regulations
- Not recommended for dome lamp use
- Replaces Grote® #62211

49203C Clear lamp

## Male Pin Back-Up

### Sealed

#### Material:

- Polycarbonate lens & housing

#### Light Source:

- Designed at 12.8v, 2.1 amp, 32 cp

#### Recommended Accessories:

- Mounting: Pages 259-261

#### FMVSS:

- R(2)



See page 97

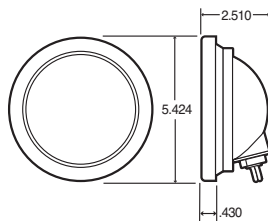

- Polycarbonate lens & housing are sonically welded
- Socket assembly cams-in for quick & easy bulb replacement
- Legal as back-up lamp only
- Not recommended for dome lamp use

40306 Clear grommet kit

## 40® Series Back-Up

### Bulb Replaceable

#### Material:

- Polycarbonate lens & housing

#### Light Source:

- Bulb: One #1156

#### Kit Components:

- 40306 kit:  
1 - 99010C lens/housing  
1 - 40700 grommet  
1 - 94937 socket assembly

#### Replacement Parts:

- 99010C clear lens/housing
- 40700 grommet
- 94937 socket assembly

#### Recommended Accessories:

- Mounting: Pages 259-261

#### FMVSS:

- R



**80® Series Back-Up**  
Bulb Replaceable

**Material:**

- Acrylic lens
- Rubber housing

**Light Source:**

- Bulb: #1156, 32 cp

**Replacement Parts:**

- 99095C clear lens

**FMVSS:**

- R(2)

- Features rubber body which helps absorb shock & vibration
- Can be used as back-up or utility lamp
- Requires two lamps to meet Federal Lighting Regulations as a back-up lamp
- Not recommended for dome lamp use

**80340 Clear lamp**

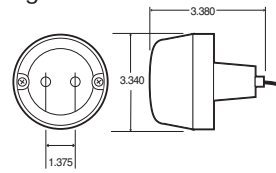

0.16 screw hole diameter  
1.12 mounting hole diameter



**Surface Mount Back-Up**  
Bulb Replaceable

**Material:**

- Aluminum housing
- Polycarbonate lens
- Rubber grommet
- 16 gauge wire

**Light Source:**

- Bulb: #1156, 32 cp

**Replacement Parts:**

- 9076W clear lens

**FMVSS:**

- R(2)

- Heavy duty, economical & efficient
- Allows one light instead of two to comply with back-up lamp regulations
- Polycarbonate twist-off lens & O-ring seal
- Black plate housing: heavy gauge anodized aluminum with staked tubular bulb socket & waterproof grommet on exit wire

**92WD Clear lamp, retail pack**

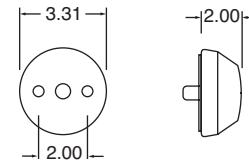

**LED 66® Series**  
Back-Up

Sealed  
1 Diode Pattern

**Material:**

- Polycarbonate lens, housing & flange

**Light Source:**

- Light Emitting diodes (LEDs)
- Designed at 13.5v, 0.5 amp

**Recommended Accessories:**

- Mounting: Pages 262-263
- Plugs: Pages 216-217

**FMVSS:**

- R(2)

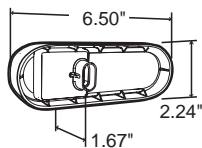
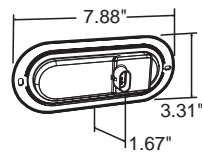

- Less current draw, resulting in increased battery & alternator life while allowing more power for other vehicle requirements
- Single Diode technology
- Uses Fit 'N Forget® connection for increased corrosion resistance
- Two lamps required for back-up
- Must be mounted vertically
- Meets specifications for dome lamp applications

**66205C Clear lamp**  
**66206C Clear lamp & black flange**  
**66404C Clear lamp & black flange, Hardwired**

NEW!

Signal-Stat



- Uses standard right angle PL-2 connection
- Epoxy encapsulated electronics
- Two lamps required for back-up
- Legal mounted horizontally or vertically

6060C Clear lamp

6063C Clear lamp, integral flange

**LED Back-Up**

Sealed

24 Diode Pattern

**Material:**

- Polycarbonate lens & housing

**Light Source:**

- Light Emitting Diodes (LEDs)
- Designed at 13.5v, 0.249 amp

**Recommended Accessories:**

- Mounting: Pages 262-263
- Plugs: Pages 216-217

**FMVSS:**

- R(2)

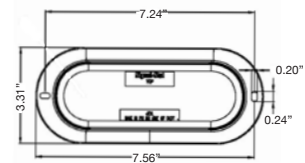
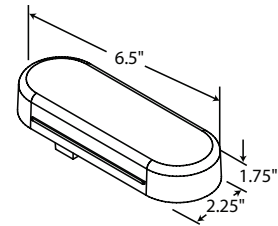
**Super 60® Back-Up**

Sealed

**Material:**

- Polycarbonate lens & housing

**Light Source:**

- Designed at 12.8v, 2.1 amps, 32 cp

**Kit Components:**

60004C grommet kits:

- 1 - 60204C lamp
- 1 - 60700 grommet
- 1 - 94992 plug

**Recommended Accessories:**

- Mounting: Pages 262-263
- Plugs: Pages 216-217

**FMVSS:**

- R



- High impact polycarbonate lens & housing are vibration welded
- Heavy duty shock mounted bulb
- Legal mounted vertically or horizontally
- Only one lamp required to meet Federal lighting regulations
- Not recommended for dome lamp use
- Replaces Signal-Stat 4071W

60004C Clear grommet kit

60204C Clear lamp

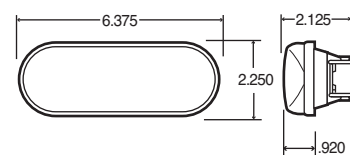

### Male Pin Back-Up

Sealed

**Material:**

- Polycarbonate lens & housing

**Light Source:**

- Designed at 12.8v, 2.1 amp, 32 cp

**Kit Components:**

69003C grommet kit:

- 1 - 69203C lamp
- 1 - 60700 grommet
- 1 - 96108 plug

**Recommended Accessories:**

- Mounting: Pages 247-248

**FMVSS:**

- R(2)

- Features male pin connections
- Two lamps required to meet federal lighting regulations
- Not recommended for dome lamp use
- Replaces Grote® #62241

**69003C Clear grommet kit**  
**69203C Clear lamp**

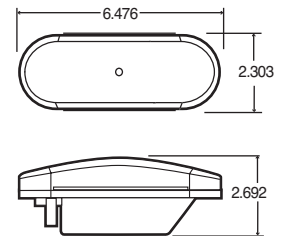

### 60® Series Back-Up Economy

Sealed

**Material:**

- Polycarbonate lens & housing

**Light Source:**

- Designed at 12.8v, 2.1 amp, 32 cp

**Kit Components:**

60092C grommet kit:

- 1 - 60284C lamp
- 1 - 60700 grommet
- 1 - 94992 plug

**Recommended Accessories:**

- Mounting: Pages 262-263

- Plugs: Pages 216-217

**FMVSS:**

- R

- Vibration welded lens & housing
- Shock-mounted bulb to extend life
- Legal mounted horizontally or vertically
- Only one lamp required to meet Federal lighting regulations
- Not recommended for dome lamp use

**60092C Clear grommet kit**  
**60284C Clear lamp**



60092C

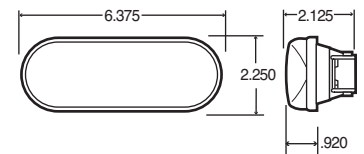

### 60® Series Back-Up Bulb Replaceable

**Material:**

- Polycarbonate lens & housing

**Light Source:**

- Bulb: One #3157

**Kit Components:**

60345C grommet kit:

- 1 - 99184C lens/housing
- 1 - 60700 grommet
- 1 - 95415 socket assembly

**Replacement Parts:**

- 99184C clear lens/housing

**Recommended Accessories:**

- Mounting: Pages 262-263

**FMVSS:**

- R(2)

- Vibration welded lens & housing
- Socket assembly cams out for ease of bulb installation
- Two lamps required to meet Federal lighting regulations
- Not recommended for dome lamp use

**60345C Clear grommet kit**

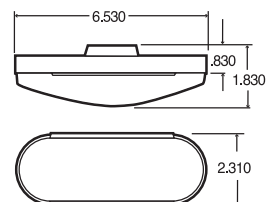

**84 SERIES**



**Super Strip Lite with lens**



**LED Super 84®**  
**Strip Lite**  
6-12 Diode Pattern

**Material:**

- Aluminum substrate
- Polycarbonate lens
- Hardwired 16 gauge wires & molded .180 bullets

**Light Source:**

- White Light Emitting Diodes (LEDs)
- Designed at 13.8V
- 4' lamps use 12 diodes at 1.4 amps, 540 lumens
- 2' lamps use 6 diodes at 0.7 amp, 270 lumens

**Replacement Parts:**

- 99233C lens for 84206C
- 99234C lens for 84216C
- 99235C lens for 84201C
- 99236C lens for 84211C

**Corner Mount**

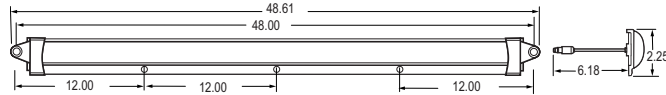
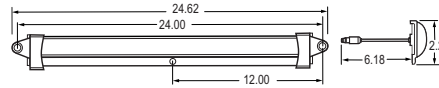
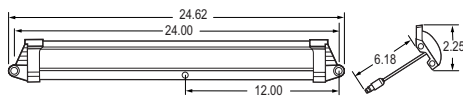
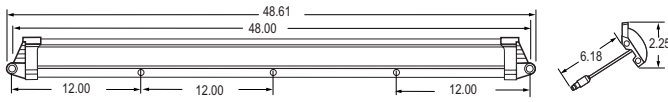

**Flat Mount**



**Super Strip Lite without lens**



- LED light source provides more even light for truck cargo
- Aluminum substrate won't rust
- Less susceptible to shock & vibration
- Reduces shadowed areas & increases visibility
- Can be mounted most anywhere
- LEDs draw less current, creating less heat

84200C	4' corner mount	84200C	4' corner mount
84210C	2' corner mount	84210C	2' corner mount
84205C	4' flat mount	84205C	4' flat mount
84215C	2' flat mount	84215C	2' flat mount
		84201C	4' corner mount w/lens

**Corner Mount**

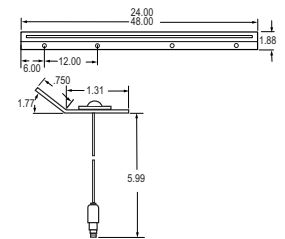

**Flat Mount**

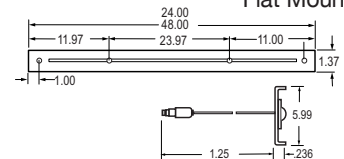



**LED Super 80® Dome**

10 Diode Pattern



**Material:**

- Polycarbonate lens
- Die cast aluminum housing
- White powder coat finish
- 6” harness, blunt cut 14 AWG SXL wire

**Light Source:**

- 10 white Light Emitting Diodes (LEDs)
- Designed at 7v-16v, 2 amp, 950 lumens

- U.S. Patent #7244058
- Lower profile than competitive lamps, mounts in 1” deep pocket
- Nearly flush mount, .1” protrusion
- Not affected by cold temperatures
- LEDs provide whiter, brighter light
- Retrofit or replacement quick & easy
- Flicker free lighting in all temperatures

**80251C Clear lamp**

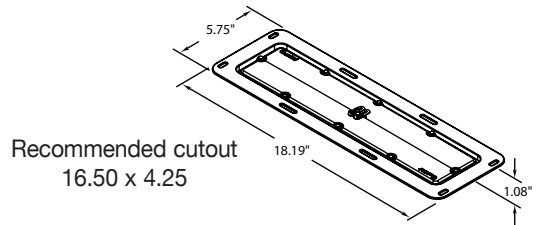

**LED Super 80® Dome**

10 Diode Pattern



**Material:**

- Die cast aluminum housing
- White powder coat finish
- Polycarbonate lens
- Weight : <2 pounds
- Harness length : 6”, .180 bullet terminals with 14 AWG SXL wire

**Light Source:**

- 10 Light Emitting Diodes (LED's)
- Operating voltage : 7V-16V
- Current draw : 2A
- Power consumption : 22Watt@11v

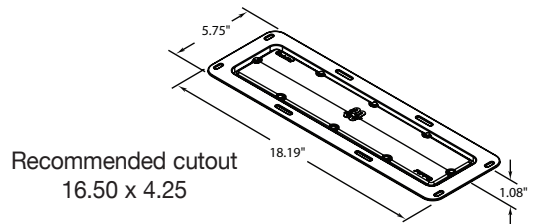

- Robust LED Dome Lamp w/Motion Sensor located in center of lamp to power lamp on
- Movement is determined by changes in heat, stays on through 5 minutes of inactivity
- Recognizes movement up to 10' away from lamp surface
- Nearly flush mount design, with only .1” protrusion to allow more room in vehicle body
- Not affected by cold temperatures, providing flicker-free lighting with a faster start-up time
- Ideal for refrigerated vehicles or those operating in cold weather
- LED's provide whiter, brighter light rated at 1,000 lumens, providing clearer, improved visibility
- Solid-state LED design is impervious to damage from shock and vibration
- Retrofit or replacement is quick and easy, with a standard 16” x 4” cut-out necessary for installation
- LED's are fully encapsulated in epoxy to prevent damage caused by moisture and corrosives

**80255C Clear lamp**

**Rubbolite®**

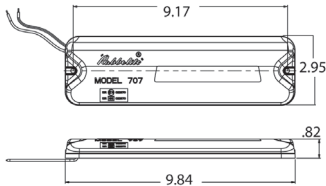

- Ideal for flood, cargo, step, locker & overhead lighting
- Can be fitted in semi-trailer, trailer, box van, mini-bus/coach, emergency services, utilities, recovery & load handling vehicles
- Utilize an extremely reliable slimline design & combines both dual voltage and dual polarity functions
- Instant switch on with easy surface mount & offset optical design making it easy to position in any orientation to direct light to the desired area
- Low profile, waterproof to IP67 & reliable to a temperature of minus 40 degrees C
- E approved LED interior lamp to EEC 95/54, EEC 2000/2, ECE Reg. 10

**8013 Clear lamp**

### LED Dome

Model 707  
4 Diode Pattern

#### Material:

- Polycarbonate lens

#### Light Source:

- Light Emitting Diodes
- Designed for 12 and 24 volt operation
- Current draw @ 12 volts: 1.25 amps
- Current draw @ 24 volts: 0.625 amps

**LED**  
UPGRADE  
See page 103

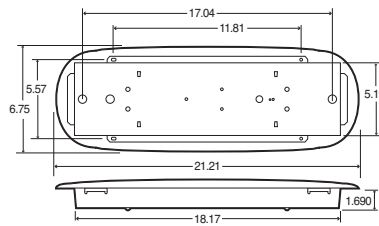

0.24 screw hole diameter

- High impact snap-on polycarbonate lens
- Metal housing is white epoxy powder coated
- Installation is easy with integrated 2 pin Packard connector
- Lamp plug connector mates with Packard connector #12129081

**80418 White lamp**

### Fluorescent Interior Flush Mount

#### Material:

- Steel housing
- Polycarbonate lens
- 1212915S Packard connection

#### Light Source:

- Two 15 watt F15T8 tubes designed at 12v, 2.2 amps

#### Replacement Parts:

- 80700 ballast assembly

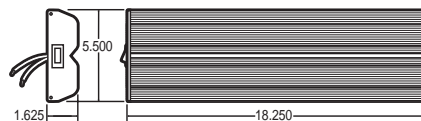

- Designed for heavy use service vehicles such as industrial supply trucks, emergency vehicles or mobile kitchens
- Clear acrylic snap-lock lens
- Anodized aluminum housing features black end caps
- Two 15 watt fluorescent tubes produce light output of 1650 design lumens
- Convenient on/off switch

**80444 White lamp**

### Fluorescent Interior Surface Mount

#### Material:

- Anodized aluminum housing
- Acrylic lens
- Hardwired connectors, 18 ga.

#### Light Source:

- Two 15 watt F15T8/CW tubes designed at 12v, 2.2 amp

**LED 33® Series Auxiliary**  
1 Diode Pattern



**Material:**

- Polycarbonate lens & housing
- EPDM grommet
- Nylon flange
- Chrome plated flange
- 18 gauge wire

**Light Source:**

- Light Emitting Diodes (LEDs)
- Model 33 standard intensity designed at 13.5v, 0.03 amp
- Super 33® high intensity designed at 13.5v, 0.12 amp

**Recommended Accessories:**

- Mounting: Page 248



- Excellent choice for interior applications such as truck cab, walkways, glove boxes, step lights, puddle lights & more
- Creates additional options for improving custom look & theme of vehicle exteriors, mounted on separate switch
- Hardwired lamp design easily retrofitted
- Low profile reduces damage from impact
- LEDs draw less current, allowing more power for other vehicle requirements
- Reduces lighting costs due to physical damage & heat entrapment
- Electronics completely sealed in epoxy to resist corrosion & moisture
- Designed for auxiliary lamp use only
- US Patent Pending
- Not recommended for marker clearance purposes

**Super 33® Lamp**

33260B	Blue
33260C	Clear
33260G	Green
33260R	Red
33260Y	Yellow

**Model 33® Lamp**

33265B	Blue
33265C	Clear
33265G	Green
33265R	Red
33265Y	Yellow

**Super 33® Lamp**

33260B	Blue
33260C	Clear
33260G	Green
33260R	Red
33260Y	Yellow

**Model 33® Grommet Kit**

33065B	Blue
33065C	Clear
33065G	Green
33065PR	Purple
33065R	Red
33065Y	Yellow

Kits include lamp & grommet

**Super 33® Flange Kits**

**Chrome Kits**

33062B	Blue
33062C	Clear
33062G	Green
33062PR	Purple
33062R	Red
33062Y	Yellow

**Black Kits**

33061G	Green
33061PR	Purple
33061R	Red

Kits include lamp & flange

**Model 33® Flange Kits**

**Chrome Kits**

33067C	Clear
33067G	Green
33067R	Red
33067Y	Yellow

**Black Kits**

33066C	Clear
33066G	Green
33066PR	Purple
33066R	Red
33066Y	Yellow

Kits include lamp & flange



Increase daytime interior lighting in your trailer without the addition of supplemental lighting products.

- Provides trailer access to external sunlight to assist in lighting up trailer interior, without the need for additional power or wiring
- Snap-in design and peel-and-stick adhesive gasket provide an easy to install lens that keeps water out
- Application surface that comes in contact with the gasket adhesive should be cleaned with a 50/50 isopropyl alcohol and water mixture before installation to remove any dirt or oils
- Gasket is to be pressed on around its entire perimeter to ensure complete adhesion and seal

40270C Sky-Lite for 0.05" Aluminum Sheets  
 40271C Sky-Lite for 0.31" Composite Panels  
 40275C Sky-Lite for 0.25" Composite Panels

## Sky-Lite

### Material:

- Polycarbonate lens
- Peel-and-stick adhesive gasket

### Additional Specifications:

- Fits a 4" (4.00" +/- 0.05") diameter hole
- Gaskets are designed at three separate thicknesses to accommodate:  
 0.05" Aluminum Sheeting  
 0.31" Composite Panels  
 0.25" Composite Panels

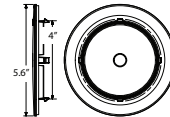

- Surface mount design eliminates the need for large hole cutouts in trailer ceiling
- Available with integrated on/off switch as well as externally controlled version
- Lens design recesses lens into housing, to prevent damage from impact
- Not affected by cold temperatures, providing flicker-free lighting with a faster start-up time
- Recommend 3 #10 machine screws for mounting, with torque of 15-18 in-lbs.

44438C Clear lamp w/switch  
 44439C Clear lamp

## LED Super 44® Surface Mount Dome

### Sealed

### 6 Diode Pattern

### Material:

- Polycarbonate lens & housing
- Hardwired, .180 bullet molded terminals
- 2 - 18 ga. blunt cut wire

### Light Source:

- 6 Light Emitting Diodes (LEDs)
- Designed at 13.5v, 0.5 amp, 380 lumens

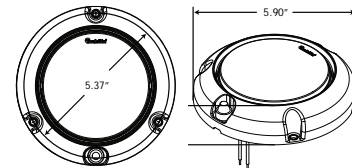

- Low profile lamp, approximately 1" deep for where space is at a premium
- Same 6 diode pattern used in Truck-Light Stop/Turn/Tail and Back-Up
- Designed to operate in extremely cold temperatures
- Broad light pattern with approximately 360 lumens of light output
- U.S. Registered TM #3483147

44308C Clear lamp  
 44339C Clear lamp & gray flange

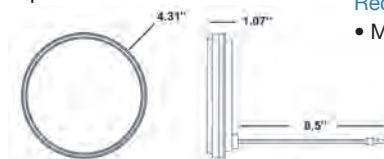

## LED Super 44® Dome

### Sealed

### 6 Diode Pattern

### Material:

- Polycarbonate lens, housing, flange or housing & flange
- Hardwired, .180 bullet molded terminals
- 2 - 6-1/2" 16 ga. wire

### Light Source:

- Light Emitting Diodes (LEDs)
- Designed at 13.5v, 0.500-0.575 amp, 360 lumens

### Recommended Accessories:

- Mounting: Pages 259-261



**LED 44® Series**  
**Dome**  
 Sealed  
 54 Diode Pattern



**Material:**

- Polycarbonate lens, housing & flange

- 16 gauge wire

**Light Source:**

- Light Emitting Diodes (LEDs)
- Designed at 13.5v, 0.5 amp, 100 lumens

**Kit components:**

44042C grommet kit:

- 1 - 44207C lamp
- 1 - 40700 grommet
- 1 - 94789 plug

44046C flange kit:

- 1 - 44237C lamp & flange
- 1 - 94789 plug

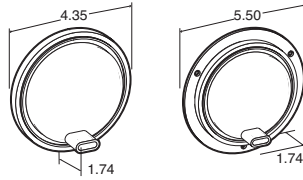

- Popular in trailer & body applications
- 85% reduction of load on electrical system allows more power for other vehicle requirements
- Virtually impervious to shock & vibration, a major cause of failure for lamps with incandescent bulbs



- 44042C** Clear grommet kit
- 44046C** Clear gray flange kit
- 44237C** Clear lamp & gray flange
- 44207C** Clear lamp

**40® Series Dome**  
**Sealed**

**Material:**

- Polycarbonate lens & housing
- ABS flange

**Light Source:**

- Designed at 12.8v, 1.44 amp, 21 cp

**Kit components:**

40003 grommet kit:

- 1 - 40203 lamp
- 1 - 40700 grommet
- 1 - 94992 plug

40023 gray flange kit:

- 1 - 40223 lamp & flange
- 1 - 94992 plug

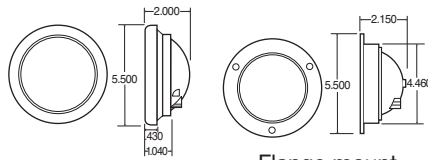

Grommet mount

Flange mount

- Shock mounted bulb to extend lamp life
- Uses standard PL-2 connection

- 40003** Clear grommet kit
- 40023** Clear flange kit
- 40203** Clear lamp
- 40223** Clear lamp & gray flange
- 40227** Clear lamp for exterior use



See above & page 106



40003



40023

**40® Series Dome**  
**Clear Back**  
 Sealed

**Material:**

- Polycarbonate lens & housing

**Light Source:**

- Designed at 12.8v, 1.44 amp, 21 cp

**Kit components:**

40011 grommet kit:

- 1 - 40211 lamp
- 1 - 40703 grommet
- 1 - 94961 plug

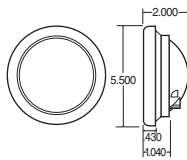

Grommet mount

- Features clear back housing
- Sealed polycarbonate lens & housing
- Grommet kit features flush mounting in a 4-1/2"

- 40011** Clear grommet kit
- 40211** Clear lamp



40011

# Rubbolite®



- Designed for 12 & 24 volt operation
- Lens & housing sealed to prevent moisture
- Meets Directive 95/54 & ECE regulation 10
- Fits many applications where space is limited
- Built for optimum durability in a variety of temperatures
- Rubbolite 708 series

**8010 LED interior Lamp, Rubbolite**

## Rubbolite® LED Round Interior 4" Sealed

### Material:

- Polycarbonate lens
- Aluminum base

### Light Source:

- Designed at 12v, .52 amp
- Designed at 24v, 26 amp
- 360 warm lumens

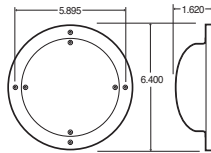

0.23 screw hole diameter  
5.89 bolt hole circle

- Available with push style on/off switch
- Choice of chrome plated or silver epoxy powder coated steel housing

**80350 Clear lamp w/chrome housing & switch**  
**80351 Clear lamp w/chrome housing**  
**80352 Clear lamp w/coated housing & switch**  
**80353 Clear lamp w/coated housing**

## 80® Series Dome Bulb Replaceable

### Material:

- Steel housing
- Polycarbonate lens
- Hardwired 18 gauge wire

### Light Source:

- Bulb: #1156, 32 cp
- Designed at 12.8v, 2.1 amp, 32 cp

### Replacement Parts:

- 99080C clear lens

# Signal-Stat

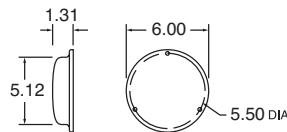

- Universal application – fits most vehicles
- Snap-on lens for easy bulb replacement
- Aluminum housing
- 5-1/8" polyethylene lens

**9380SW White lamp w/switch**  
**9380W White lamp w/o switch**

## Universal Dome Bulb Replaceable

### Material:

- Polyethylene lens
- Aluminum housing
- 16 gauge wire

### Light Source:

- Bulb: #1156, 32 cp

### Replacement Parts:

- 8935W lens
- 131 switch

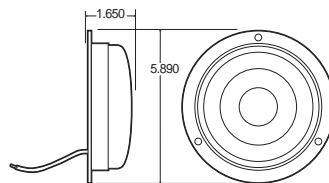

- Designed for interior use only
- Features snap-on lens for ease of installation
- Hardwired design for retrofitting ease

**80427 White lamp, 2 wire**

## 80® Series Dome Bulb Replaceable

### Material:

- Polycarbonate lens & housing
- 16 gauge wire

### Light Source:

- Bulb: #1141
- Designed at 12.8v, 1.44 amp, 21 cp

**LED 80® Series Dome**  
6 Diode Pattern



**Material:**

- Clear polycarbonate lens
- Steel housing

**Light Source:**

- 6 Light Emitting Diodes (LEDs)
- Designed at 13.5v, 0.40 amps, 100 lumens

**Recommended Accessories:**

- 973lens

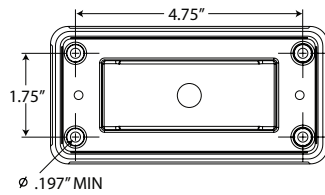

- Surpasses 2,000 hours of incandescent bulbs by nearly 50x
- As much as 60% lower power consumption than incandescent lamps, allowing additional power for other vehicle applications

- 80162C** Lamp w/blunt cut wire
- 80164C** Lamp w/.180 bullet connectors
- 80166C** Lamp w/blunt cut, 24v

**Super 10® Utility**  
Sealed



**Material:**

- Polycarbonate lens & housing

**Light Source:**

- 15,000 hr. rated bulb life
- Designed at 14v, 0.33 amp, 2cp

**Recommended Accessories:**

- Mounting: Pages 249-252
- Plugs: Page 225-228

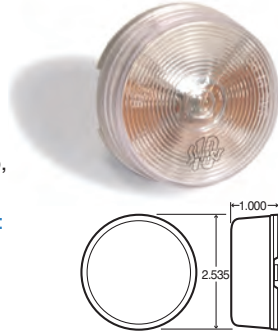

- Unique shock-mount extends bulb life
- 15,000 hour rated bulb life
- Standard PL-10 connection

**10209C** Clear lamp

**10® Series Utility**  
Sealed

**Material:**

- Polycarbonate lens & housing

**Light Source:**

- 15,000 hr. rated bulb life
- Designed at 14v, .33 amp, 2cp

**Recommended Accessories:**

- Mounting: Pages 249-252
- Plugs: Page 225-228

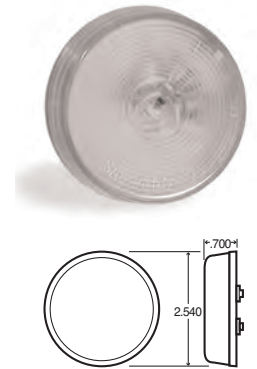

- Lens & housing are sonically sealed
- High impact polycarbonate construction
- 15,000 hour rated bulb life
- Replaces Signal-Stat 1010W

**10202C** Clear lamp

**10204C** Clear lamp, 24v

**30® Series Utility**  
Sealed

**Material:**

- Polycarbonate lens & housing

**Light Source:**

- 15,000 hr. rated 12v bulb life
- 12v designed at 14v, 0.33 amp, 2 cp.
- 24v designed at 28v., .17 amp, 3 cp

**Recommended Accessories:**

- Mounting: Pages 253-255
- Plugs: Page 225-228



- High impact polycarbonate construction
- Lens & housing are sonically sealed
- 15,000 hour rated bulb life
- Replaces Signal-Stat 1030W

**30200C** Clear lamp

**30206C** Clear lamp, 24v

**15® Series Utility**  
Sealed

**Material:**

- Polycarbonate lens & housing

**Light Source:**

- Designed at 14v, .33 amp, 2 cp

**Recommended Accessories:**

- Mounting: Pages 256-257
- Plugs: Page 225-228

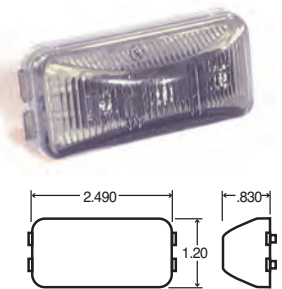

- High impact polycarbonate sonically sealed lens & housing
- Features 15,000 hour long life bulb
- Replaces Signal-Stat 1500W

**15200C** Clear lamp



### 19® Series Utility Sealed

#### Material:

- Polycarbonate lens & housing

#### Light Source:

- Two bulbs designed at 14v,  
0.33 amp, 2 cp each

#### Recommended Accessories:

- Mounting: Page 258
- Plugs: Page 226

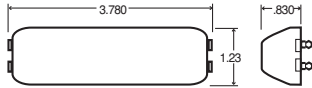

0.15 diameter male bullet

- High impact polycarbonate sonically sealed lens & housing
- Features 15,000 hour long life bulb

**19200C Clear lamp**



### Courtesy Lamp Sealed

#### Material:

- Polycarbonate lens & housing

#### Kit Components:

- 26001 lamp kit
- 1 - 04115 lamp w/gasket
- 1 - 94854 plug

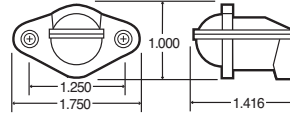

- Variety of interior & exterior applications
- Compact sealed polycarbonate construction

- 26001 Lamp kit**  
**04115 White lamp w/gasket**  
**04116 Black lamp w/o gasket**

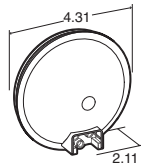

- Popular option on new Wabash trailers
- Uniquely designed shock mount extends lamp life
- For auxiliary use only
- Specially designed lens allows lamp to angle light away from trailer rather than straight back
- Output light up to 10' on sides at a 45° angle
- Illuminates area seen by driver through side

**40207 Clear lamp  
w/angled illumination**

### 40® Series Auxiliary Lamp w/Angled Illumination Sealed

#### Material:

- Polycarbonate lens & housing

#### Light Source:

- Designed at 12.8v, 2.1 amp,  
32 cp

#### Recommended Accessories:

- Mounting: Pages 259-261
- Plugs: Pages 216-217

### Model 80 Hook-Up Bulb Replaceable

#### Material:

- Chrome-plated die cast housing
- Acrylic lens
- 16 gauge wire
- Hardwired design

#### Light Source:

- Bulb: #1156
- Designed at 12.8v, 2.1 amp,  
32 cp

#### Replacement Parts:

- 99176C clear lens kit

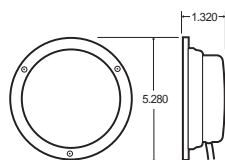

0.20 screw hole diameter  
 4.86 bolt hole circle  
 4.43 diameter mounting holes

- Designed to illuminate area between truck & trailer
- Mounts to flat body surface with three screws
- Not intended for use as a back-up lamp

**80423C Clear lamp**



**Stepwell Lamp**  
Bulb Replaceable

**Material:**

- Stainless steel housing
- Glass lens
- 16 gauge wire

**Light Source:**

- 26392C: 12v, 32 cp, #1076 bulb, 2 wire
- 26393C: 12v, 21 cp, #1141 bulb
- 26394C: 12v, 21 cp, #1142 bulb, 2 wire

- Glass lens holds up to extreme temperatures
- Mounts with two #10 screws on 1.625" centers
- Mounting hole requires 13/16" diameter cutout

- 26393C Clear lamp**
- 26394C Clear lamp w/ground wire**
- 26392C Clear lamp w/ground wire**

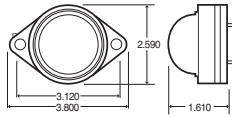

0.25 screw hole diameter

**Utility Lamp**  
Bulb Replaceable

**Material:**

- Polycarbonate housing
- Acrylic lens
- Hardwired design

**Light Source:**

- Bulb: #168, 3 cp

- Twist off lens hood for easy bulb replacement
- Lights up instrument panel & compartments
- Surface mounts on 2" centers
- Grounds through mounting screws

- 433WD Clear lamp, retail pack**

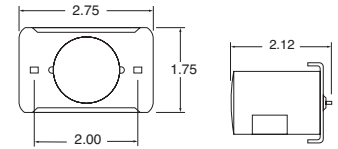

**Utility Lamp**  
Bulb Replaceable

**Material:**

- Rubber housing
- Aluminum base
- Acrylic lens
- Hardwired design

**Light Source:**

- Bulb: #1895, 2 cp

- Snap-in lens for easy bulb replacement
- Vulcanized rubber housing with aluminum base

- 1506W Clear lamp**

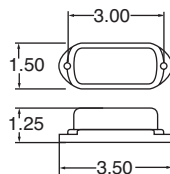
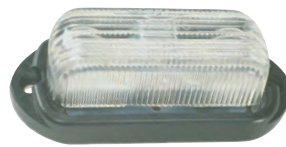

**Dome & Utility Lamp**  
Bulb Replaceable

**Material:**

- Polycarbonate lens & housing
- 16 gauge wire

**Light Source:**

- Bulb: #912, 12 cp

**Replacement Parts:**

- 131 switch

- Navistar replacement
- Use for dome or utility lamp
- Surface mount for easy installation
- Polycarbonate lens & housing provides durability

- 4094SW Clear lamp**

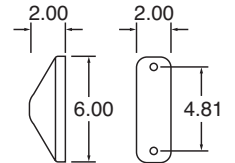

**Interior & Utility Lamp**  
Bulb Replaceable

**Material:**

- Polycarbonate lens & housing
- Hardwired design

**Light Source:**

- 20302 dome lamp bulb #211-2 designed at 12.8v, 0.97 amp, 12 cp
- 20308 utility lamp bulb #47278 designed at 13.5v, 2.10 amp, 32 cp

**Replacement Parts:**

- 99005C clear lens
- 80604 (#47278) bulb

- Beehive profile lens produces maximum 90° edge lighting
- Snap-in lens for quick and easy replacement

- 20302 Clear lamp dome w/#211-2 bulb**
- 20308 Clear lamp utility w/#47278**

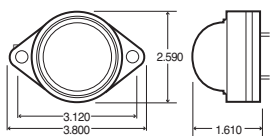

0.25 screw hole diameter

**Chrome Utility Lamp**  
Bulb Replaceable

**Material:**

- Chrome plated brass housing
- Acrylic lens
- 16 gauge wire

**Light Source:**

- Bulb: #193, 2 cp

- Focused light output
- Hooded guard to stop glare
- Separate ground wire

- 434WD Clear lamp, retail pack**

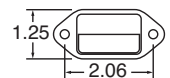

# Forward & Specialty Lighting

# Forward & Specialty Lighting

**Spot, Work, & Flood Lamps**

**114-122**

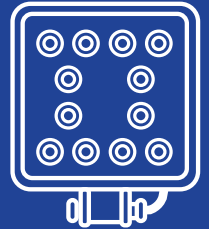

**Snow Plow Lamps**

**124-128**

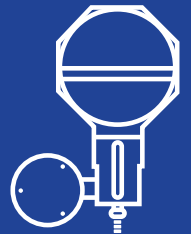

**Headlamps, Fog & Driving Lamps**

**129-134**

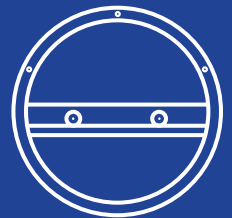

**Bus Lamps**

**135-139**

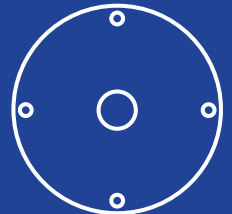

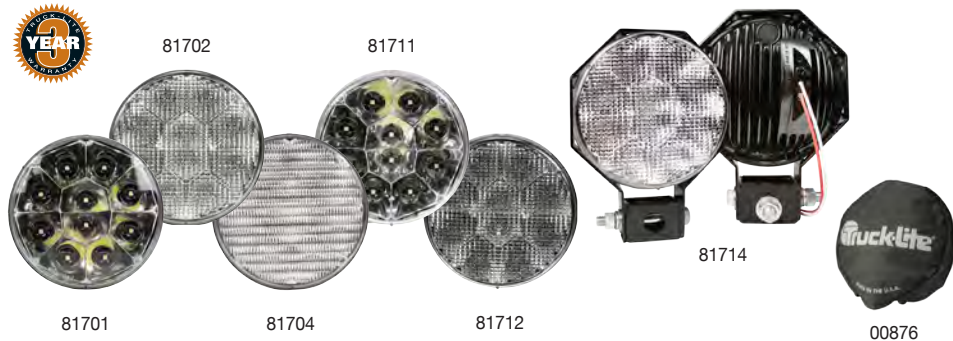

- Popular auxiliary lighting for off-road, utility, construction applications and more
- Provides LED, solid-state solution to applications in need for additional lighting, resistant to damage from shock and vibration
- Two mounting options: one with an integrated mount and one designed for use with a secondary mounting bracket (sold separately)
- Use of advanced white LED technology exceeds light output of HID lights, with no EMI and substantially longer life than comparable incandescent lamps, saving time and expense of replacing lamps multiple times
- Metalized reflector redirects light output effectively increasing visibility
- Hard-wired design and fully encapsulated electronics protect from damage caused by corrosive element
- Impact resistant, non-yellowing, headlamp-grade polycarbonate lens protects against damage caused by debris and other hazards

**Work Lamps**

- 81702 Lamp only, 12v
- 81712 Lamp & mount, 12v

**Spot Lamps**

- 81701 Lamp only, 12v
- 81711 Lamp & mount, 12v

**Flood Lamps**

- 81704 Lamp only, 12v
- 81714 Lamp & mount, 12v

**LED 81® Series**  
**7" Auxiliary Lamp**  
10 Diode Pattern

**Material:**

- Hard coated polycarbonate lens
- E-Coat aluminum housing
- Blunt cut 18 gage wire
- Encapsulated circuitry

**Light Source:**

- 10 LEDs
- 12V designed at 12.8V, 4.5A
- 24V designed at 28V, 1.5A
- 1300 lumens
- Overvoltage spike protection to 600v constant output
- Operating temperature range -50°C to 70°C

**Recommended Accessories:**

- 00872 short bracket
- 00874 long bracket
- 00876 denim cover

**Itar Regulations:**

These Items Are Subject To US Export Control Laws Export Of Such Items May Require Prior Authorization From The US Government, Including The US Commerce Department's Bureau Of Industry And Security Or The State Department's Directorate Of Defense Trade Controls Unauthorized Export, Re-Export, Or Diversion Contrary To US Law Is Prohibited



- US Patent #D572856, #000795034, #122406 and trademark #3483147
- Ideal for utility companies, construction, agricultural, airport and tow trucks and state and county highway departments
- 12 volt lamp operates at full brightness between 8.5v and 16v, over-voltage protection at 17v-18v
- 24 volt lamp operates at full brightness between 21v and 34v, over-voltage protection at 35v-36v
- Mounts on one 5/16" stud

**Flood Lamp w/Black Finish**

- 81380 Lamp, 12v
- 81250 Lamp, 24v

**Flood Lamp w/Chrome Finish**

- 81385 Lamp, 12v
- 81255 Lamp, 24v

**Spot Lamp w/Black Finish**

- 81390 Lamp, 12v
- 81290 Lamp, 24v

**Spot Lamp w/Chrome Finish**

- 81395 Lamp, 12v
- 81295 Lamp, 24v

**Spot Lamp w/White Finish**

- 81391 Lamp, 12v

**Work Lamp w/Black Finish**

- 81360 Lamp, 12v
- 81371 Lamp, 12v w/20' Lead
- 81240 Lamp, 24v

**Work Lamp w/Chrome Finish**

- 81365 Lamp, 12v
- 81245 Lamp, 24v

**Work Lamp w/White Finish**

- 81374 Lamp, 12v
- 81270 Lamp, 24v

**LED 81® Series**  
**4" Auxiliary Lamp**  
6 Diode Pattern

**Material:**

- Die cast aluminum housing
- Polycarbonate lens
- Stainless steel hardware
- 18 gauge wire
- Encapsulated circuitry

**Light Source:**

- 6 LEDs
- 12 V designed at 12.5 V, 1.2 A
- 24 V designed at 24 V, 0.5 A
- 500 lumens

**Replacement Parts:**

- 97432 hardware pack

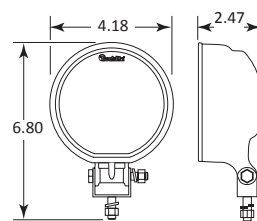



**LED Super 81®**

**Work Lamps**

4 - 12 Diode Pattern



Made in the U.S.A.

**Material:**

- Die cast aluminum housing
- Polycarbonate lens
- Black E-coat finish
- 18 gauge blunt cut wire

**Light Source:**

**81500 Lamp**

- 12 LEDs
- 2.61a-3.2a at 13.5V
- 1.15a-1.45a at 28v
- 2850 warm lumens
- 3050 cold lumens

**81510 Lamp**

- 8 LEDs
- 1.84a-2.25a at 13.5V
- 0.83a-1.03a at 28v
- 1800 warm lumens
- 2100 cold lumens

**81520 Lamp**

- 4 LEDs
- 0.77a-0.95a at 13.5V
- 0.38a-0.46a at 28v
- 850 warm lumens
- 950 cold lumens



81500



81510

81520

All LED lamps lose lumen power after being turned on and warming up. Cold Lumen power refers to the lumen power rating prior to the warm-up phase, and Warm Lumen power refers to the lumen power rating after the warm-up phase has occurred.

- Super bright output - up to 2850 warm lumens
- Circuitry protected by triple-pass conformal coating
- Rear fins keep heat away from LEDs and lamp circuitry, allowing for increased light output and lamp longevity
- White LEDs offer daylight-like visibility
- Current regulated switching circuit
- 18 gauge ADR compliant wires
- ECE reg 10-3 EMI compliant
- SAE voltage spike protected

- 81500** Lamp, 12 diode
- 81510** Lamp, 8 diode
- 81520** Lamp, 4 diode

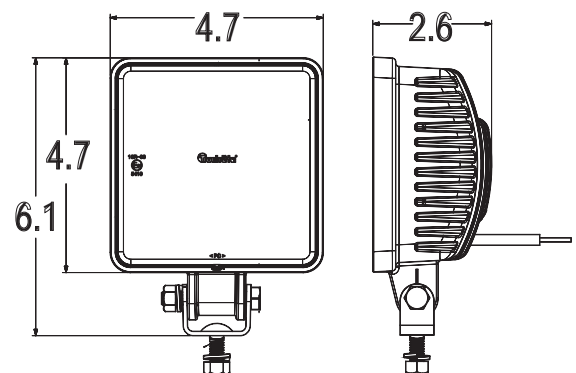



- Work pattern is ideal for light utility, construction, agricultural, airport and tow trucks, state and highway departments
- Operates at 9 to 36 volts without adjustment

8150	4" round lamp, 8 diode
8155	4" rectangular lamp, 8 diode
8160	4" rectangular lamp, 10 diode
8170	5" rectangular lamp, 9 diode

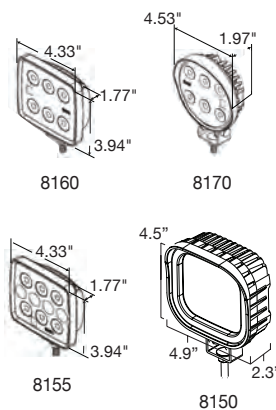

## LED Signal-Stat Series

### Auxiliary Lamps

#### 8 - 10 Diode Pattern

##### Material:

- Die cast aluminum housing
- Polycarbonate lens
- Stainless steel hardware
- 18 gauge wire
- Encapsulated circuitry

##### Light Source:

- Multi-Volt design

##### 8 Diode Pattern

- Designed at 9V-36V
- 1.02 @ 13.5V
- 0.5A @ 28V
- 8 watt, 540 lumens

##### 10 Diode Pattern

- Designed at 9V-36V
- 1.07A @ 13.5V
- 0.5A @ 28V
- 10 watt, 750 Lumens

##### 9 Diode pattern

- Designed at 12V-36V
- 1.5A @ 13.5V
- 1A @ 28V
- 1200 lumens

##### Replacement Parts:

- 97432 hardware pack

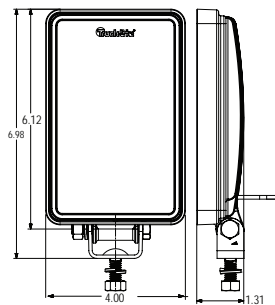

- UL recognized **cULus**
- 12v to 48v operation allows for use in 12v, 24v, 36v or 48v applications
- Vertical beam pattern is ideal for handling of large loads with obstructed views
- Elongated pattern lights up aisles and loading paths, while preventing glare caused by light reflecting off carried boxes
- Pattern lights up stocking racks from floor to ceiling
- Low profile design and impact-resistant aluminum housing and polycarbonate lens prevent from damage from collisions with racking systems
- One lamp for all applications, reducing inventory
- Significantly lower current draw than traditional material handling lighting systems

81560 Lamp

## LED Forklift Work

### Lamp

#### 12 Diode Pattern

##### Material:

- Polycarbonate lens
- Powder coat finish
- Hardwired 18 gauge wire

##### Light Source:

- 12 LEDs
- Designed at 12-48v
- Multi-Volt
- 750 Lumens

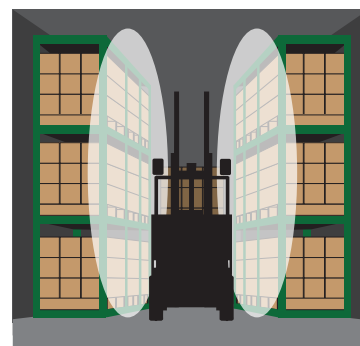

## LED Economy Work Lamps

### 4, 8 Diode Pattern

#### Material:

- Hard-coated polycarbonate heated lens
- eCoat aluminum housing and internal structures
- Metalized reflector
- Stainless steel bracket mount
- 20-inch, 18-gauge wire with blunt cut ends

#### Light Source:

- 8140  
4 LEDs  
700 lumens  
10-30v Multi-volt design: .64a at 12v, .33a at 24v
- 8180  
8 LEDs  
1400 lumens  
10-30v Multi-volt design: 1.3a at 12v, .7a at 24v

#### Additional Specifications:

- Operating temperature range: -40 to 65
- Flood pattern



NEW!



- Heavy-duty housing is constructed of die cast aluminum
- Lens manufactured with impact resistant polycarbonate material
- Rear fins keep heat away from LEDs and lamp circuitry, allowing for increased light output and light longevity
- White LEDs offer daylight-like visibility, cleaner and clearer than other light source options
- Current regulated switching circuit
- Overvoltage protection
- SAE voltage shock protection
- EMC protection and IP 67 certified

8140 3" round work lamp, 4 diode  
8180 5.5" oval work lamp, 8 diode

## LED Economy Pillow Optic Work Lamps

### 5, 8 Diode Pattern

#### Material

- Hard-coated acrylic lens
- eCoat aluminum housing
- Metalized reflector
- Stainless steel bracket mount
- 15-inch, 18-gauge wire with blunt cut ends

#### Light Source

- 8192:  
5 LEDs  
1200 lumens  
10-30 V Multi-volt design:  
12 V, 1.13 A  
24 V, 0.56 A
- 8193  
8 LEDs  
1900 lumens  
10-30 V Multi-volt design:  
12 V, 1.58 A  
24 V, 0.84 A

#### Additional Specifications:

- Operating temperature range: -30 to 50



NEW!



- Heavy-duty housing is constructed of die cast aluminum
- Lens manufactured with impact resistant acrylic material
- Rear fins keep heat away from LEDs and lamp circuitry, allowing for increased light output and light longevity
- White LEDs offer daylight-like visibility, cleaner and clearer than other light source options
- Current regulated switching circuit
- EMC protection

8192 3.5" square work lamp, 5 diodes  
8193 6" oval work lamp, 8 diode

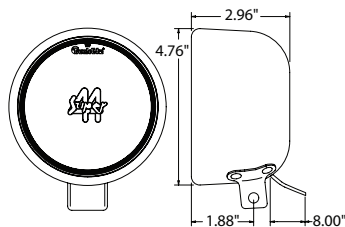

- U.S. Patent #D572856, #000795034, #122406, trademark #3483147
- Durable synthetic rubber housing resists corrosion
- Utilizes same 6 diode pattern as traditional Truck-Lite 4" round LED lamps
- Designed to operate in extremely cold temperatures
- Includes mounting hardware
- Mounts on one 5/16" -18 Stud

81260 Lamp

## LED Rubber Multi-purpose Flood Lamp 6 Diode Pattern

### Material:

- Polycarbonate lens
  - (2x) 8" 16 ga. wires w/blunt cut
  - Synthetic rubber housing
- Light Source:
- 6 LEDs
  - Designed at 13.5v, 0.53 amp, 16 watts, 250 lumens

### Replacement Parts:

- 97980 housing
- 95910 mounting hardware
- 44304C lamp



Pages 114-117

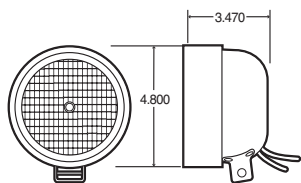

80438

- Durable synthetic rubber housing resists corrosion
- Includes mounting hardware
- Additional versions available with a lens shield, with switch or extended shroud
- Contains one Par 36 sealed trapezoid beam with multipurpose terminals
- Fluted lens disperses light evenly
- Mounts on one 5/16"-18 stud

- 80360 Lamp  
80361 Lamp w/lens shield  
80378 Lamp w/switch  
80438 Lamp w/extended shroud

## Par 36 Rubber Lamp

### Material:

- Synthetic rubber (TPE) housing
- Glass lens
- Polycarbonate lens shield
- 18 gauge wire

### Light Source:

- Bulb: Par 36 (4411-3)
- Designed at 12.8v, 2.9 amp, 35 watts, 2,500 cp

### Replacement Parts:

- 80200 clear beam
- 95910 mounting hardware
- 97980 housing



Pages 114-117

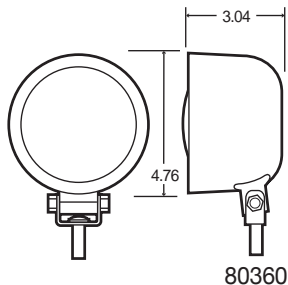

80360

- Durable synthetic rubber housing resists corrosion
- Includes mounting hardware
- Contains one Par 36 sealed spot beam with screw terminals
- Mounts on one 5/16"-18 stud

80374 Lamp

## Par 36 Rubber Spot Lamp

### Material:

- Synthetic rubber (TPE) housing
- Glass lens
- 18 gauge wire

### Light Source:

- Bulb: Par 36 (4509)
- Designed at 12v, 8.3 amp, 100 watts, 110,000 cp

### Replacement Parts:

- 95910 mounting hardware
- 97980 housing
- 80202 clear beam



### Par 36 Rubber Lamp

**Material:**

- Synthetic rubber (TPE) housing
- Glass lens
- 18 gauge wire

**Light Source:**

- Bulb: Par 36 (4589)
- Designed at 24v, 2.1 amp, 50 watts, 5000 cp

- Durable synthetic rubber housing resists corrosion
- Includes mounting hardware
- Contains one Par 36 sealed trapezoid beam with multipurpose terminals
- Fluted lens disperses light evenly
- Mounts on one 5/16"-18 stud

**80375 Clear, 24v**

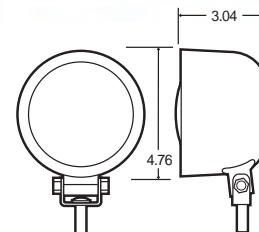

### Par 36 Rubber Lamp

**Material:**

- Rubber housing
- Glass lens
- 18 gauge wire

**Light Source:**

- Bulb: Par 36 (4411-3) 12v
- Bulb: Par 36 (4589) 24v
- Designed at 12.8v, 2.9 amp, 35 watts, 2500 cp
- Designed at 24v, 2.1 amp, 50 watts, 5000 cp

**Replacement Parts:**

- 620H housing assembly
- 95910 mounting hardware
- 80200 clear beam, 12v
- 80203 clear beam, 24v

- Ideal for agricultural applications
- Functions as tractor, utility, alley or hook-up lamp for fifth wheel
- Screw on bulb connections for positive contact & easy bulb replacement
- Single wire, stud ground
- Weather proof rubber shell protects sealed beam for longer life
- Shell remains flexible from -40° to +125°
- Adjustable bracket with 5/16" diameter stud

**620W Lamp**  
**620W4 Lamp, 24v**

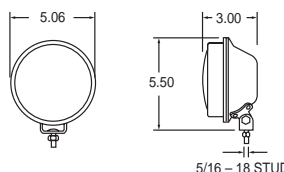

620W

### Bracket Accessories

- Two 1/2" mounting holes
- Size: 3-3/8" L x 1-3/16" H x 2-1/8" W

**9291 Universal adjustment bracket**



9291





Pages 114-117



- Heavy gauge steel housing is powder-coated in black epoxy
- Includes mounting hardware
- Contains one Par 36 clear trapezoid sealed beam or one yellow fog sealed beam
- Fluted lens disperses light evenly
- Mounts on one 5/16"-18 stud

**80364 Work lamp, clear**  
**80368 Fog lamp, yellow**

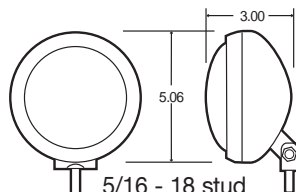

## Par 36 Metal Lamp

### Material:

- Steel bezel & housing
- Glass lens • 18 gauge wire

### Light Source:

- 80364 work lamp
- Bulb: Par 36 (4411-3)
- Designed at 12.8v, 2.9 amp, 35 watts, 2500 cp
- 80368 fog lamp
- Bulb: Par 36 (4415A)
- Designed at 12.8v, 2.7 amp, 35 watts, 7000 cp

### Replacement Parts:

- 80200 Clear beam
- 95910 mounting hardware
- 97982 housing



- Durable synthetic rubber housing resists corrosion
- Includes mounting hardware
- Rear mount lamp uses one 1/2"-13 stud
- Contains one Par 36 sealed trapezoid beam with multi-purpose terminals
- Fluted lens disperses light evenly

**80373 Lamp**

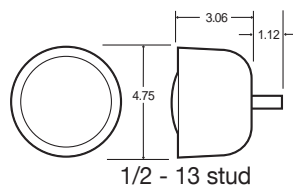

## Par 36 Rear Mount

### Material:

- Synthetic rubber (TPE) housing
- Glass lens • 18 gauge wire

### Light Source:

- Bulb: Par 36 (4411-3)
- Designed at 12.8v, 2.9 amp, 35 watts, 3000 cp

### Replacement Parts:

- 80200 Clear beam
- 95910 mounting hardware
- 97986 housing

### Recommended accessories:

- 99120B blue lens shield
- 99120R red lens shield



630W

- Rugged all-purpose lamp
- Screw-on bulb connections for positive contact & easy bulb replacement
- Single wire—stud ground
- Weatherproof rubber shell for extended bulb life
- Shell remains flexible from -40° to +125°F
- Housing available separately
- 1/2" dia. adjustable ball stud
- Replaces Truck-Lite 80384

**630W Work lamp**  
**630W4 Work lamp, 24v**  
**631W Fog lamp**  
**633W Halogen work lamp**  
**632W Halogen flood lamp**

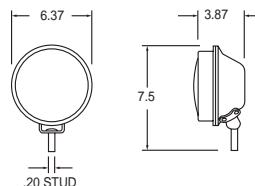

## Par 46 Lamps

### Material:

- Rubber housing
- Glass lens • 18 gauge wire

### Light Source:

- 630W (4419) 3.6 amp, 35 watts, 1,600 cp
- 631W (4412) 3.9 amp, 35 watts, 11,000 cp
- 632W (H7609) 3.9 amp, 50 watts, 2,200 cp
- 633W (H7619) 3.9 amp, 50 watts, 6,000 cp
- 630W4 (4578) 2.3 amp, 60 watts, 1,600 cp, 24v

### Replacement Parts:

- 630H housing
- 97111 hardware pack

### Single Beam Flood Lamp

**Material:**

- Polymer housing
- Glass lens
- Free form reflector
- 16 gauge hard-wired

**Light Source:**

- Bulb: one #H3, 12v, 55w, 4.5 amp, 1450 lumens

**Replacement Parts:**

- 80571 bulb
- 97433 mounting bracket

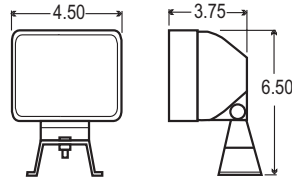

- Clear lens increases output 30-50%
- Compact 3" x 5" design
- Performs brighter & wider than larger lamps
- Bracket allows full tilt & 360° rotation adjustment
- Pre-wired with bulb



**80493 Lamp**

### Two Beam Work Lamp

**Material:**

- Polymer housing • Glass lens
- Free form reflector
- 16 gauge hard-wired

**Light Source:**

- Bulbs: two #H3, 12v, 55w, 4.5 amp ea., 1450 lumens ea.

**Replacement Parts:**

- 80571 bulb
- 97433 mounting bracket

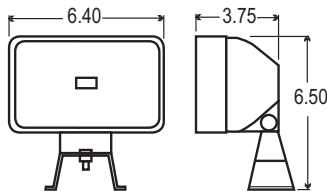

- Intelligent high performance solution for wide variety of work lamp applications
- Two beams mean twice the lighting output of a conventional single beam unit
- For single installations, this translates to significant cost savings while producing the same output as two traditional lamps
- For true high performance, installation of 2 two beam lamps results in phenomenal four lamp illumination
- Bracket allows full tilt & 360° rotation adjustment



<b>80498</b>	<b>Work lamp</b>	<b>80494</b>	<b>Flood lamp w/switch</b>
<b>80491</b>	<b>Flood lamp</b>	<b>80492</b>	<b>Spot lamp</b>

### Universal Mount

**Material:**

- Synthetic rubber (TPR) housing
- Glass lens
- 18 gauge wire

**Light Source:**

- 80388 auxiliary lamp
- Bulb: #H9420 4.2 amp, 50 watts, 47,000 cp
- 80389 fog lamp
- Bulb: #H9415 3.1 amp, 38 watts, 12,000 cp
- 80394 work lamp
- Bulb: #H9411/80206 4.2 amp, 50 watts, 5,400 cp
- 80395 medium flood lamp
- Bulb: #H9414 4.2 amp, 50 watts, 2,700 cp
- 80396 wide flood lamp
- Bulb: #H9406/80205 4.2 amp, 50 watts, 1,350 cp
- 80397 spot lamp
- Bulb: #H9405 4.2 amp, 50 watts, 100,000 cp

**Replacement Parts:**

- 80205 Wide flood beam
- 80206 Trapezoid beam
- 95910 Mounting hardware
- 97989 Housing

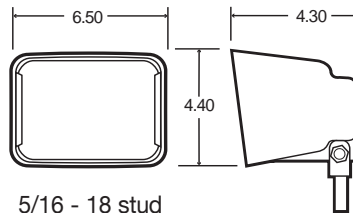

5/16 - 18 stud

- Durable synthetic rubber housing resists corrosion
- Includes mounting hardware
- Universal mount uses one 5/16"-18 stud
- Contains one glass rectangular sealed halogen beam with two right angle terminals
- Fluted lens disperses light evenly



<b>80388</b>	<b>Auxiliary lamp</b>	<b>80395</b>	<b>Medium flood lamp</b>
<b>80389</b>	<b>Fog lamp</b>	<b>80396</b>	<b>Wide flood lamp</b>
<b>80394</b>	<b>Work lamp</b>	<b>80397</b>	<b>Spot lamp</b>



610W

- Rugged molded PVC housing will not break or weather – remains flexible from -40° F to +120° F
- Advanced 55 Watt H3 bulb design eliminates the need for expensive sealed beam replacement
- Precision optics
- Adjustable bracket with 5/16"

**610W** Work lamp  
**612W** Fog lamp  
**613W** Driving lamp

## Halogen Auxiliary Lamps

### Material:

- PVC plastic housing
- Glass lens
- 18 gauge wire

### Replacement Parts:

- 80571 bulb, 4.5 amp, 55w, 1450 lumens
- 80560 bulb, 100w
- 80561 24v bulb, 3 amp, 70w, 1750 lumens



627WD

- Direct Hobbs replacement
- Durable hard plastic housing will not weather or rust
- Advanced 55 Watt H3 bulb technology means inexpensive bulb replacement instead of captive sealed beam replacement
- To convert these lamps to 24 volts – change bulb to #80561
- 1/2" adjustable hollow stud

**627WD** Work lamp, retail pack  
**628WD** Spot lamp, retail pack  
**629WD** Flood lamp, retail pack  
**637W** Work lamp, 24v

## Halogen Auxiliary Lamps

### Material:

- Plastic housing
- Glass lens
- 18 gauge wire

### Replacement Parts:

- 80571 12v bulb, 4.5 amp, 55 watts, 1450 lumens
- 80561 24v bulb, 3 amp, 70 watts, 1750 lumens

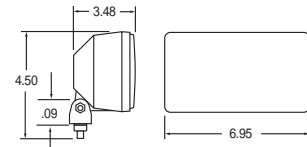

- Excellent replacement options for motorcycles using 4.5" auxiliary lamps
- Supplements headlamp with light that promotes safe driving
- Hardwired adapter connects to 2005 & newer Harley-Davidson models using 4.5 auxiliary lamps
- Classic, but modern look when installed with Truck-Lite's 27270C LED headlamp

**80275** LED auxiliary lamp

## LED Auxiliary Lamp

For Use in  
Supplementing  
Headlamps on  
Motorcycles

### Material:

- Hard coated polycarbonate lens
- Anodized aluminum housing
- 18 gauge wire

### Light Source:

- Designed at 12.8v, 0.7a, 3.100 max candela, 280 lumens
- Overvoltage protection to 600v, w/constant output between 9v & 15v, and automatic shutoff at 18-20v

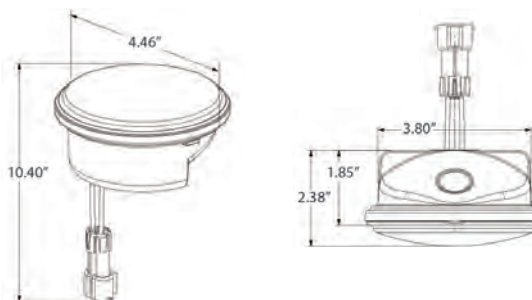



**LED Par 36**  
**Auxiliary Lamp**  
 8 Diode Pattern

**Material:**

- Polycarbonate lens
- Powder coated aluminum housing
- 18 gauge wire

**Light Source:**

- 8 Light Emitting Diodes
- 9V-36V Multi-volt operation
- Designed at 1.06 amp
- 500 lumens

- Fits into any standard Par 36 bulb application
- Perfect for retrofitting incandescent Par 36 lamps to high-efficiency LED lighting
- Heavy-duty powder coating provides excellent protection against the elements
- Die-cast aluminum housing with vertical heat sink pull heat from the housing



**80220 Lamp**  
**80240 Lamp w/Harley Davidson aux. passing lamp connector**

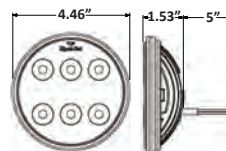

**LED Perimeter Lamp**  
 4 Diode Pattern

**Material:**

- Polycarbonate Lens
- Die-Cast Aluminum Housing
- Hard-Wired 18 Gauge Wire w/.180 Bullet Terminals
- Encapsulated Circuitry

**Light Source:**

- 4 Light Emitting Diodes
- Designed At 13.5V, 1.2A
- 365 Lumen Output

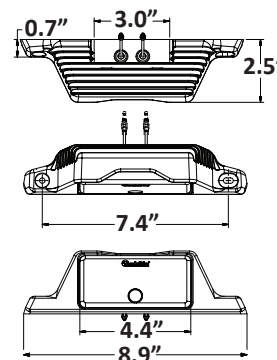
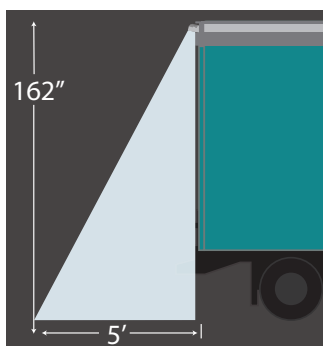

- Adds up to 5' of valuable lighting to perimeter of vehicle, increasing visibility in area dome or backup lighting won't reach
- Low profile lamp protrudes only 2.5" from vehicle surface, while projecting light far beyond lamp surface
- Rear fins keep heat away from LEDs and lamp circuitry, allowing for increased light output and lamp longevity
- Minimal electrical draw (1.2A) allows for the use of multiple lamps, without demanding significant power from vehicle
- Hard-wired .180 bullet terminals prevent concerns for pin corrosion at lamp, and install without the need for adapters or additional wiring connections
- Ideal for use with lift gate trailers and body vehicles
- Care should be taken to install this device so that it cannot operate while the trailer or vehicle is in motion. Contact the Trailer/Vehicle OEM or Truck-Lite Technical Service for assistance.

**81335C Lamp**

NEW!



- World's first heated lens LED headlight heats constantly under 10°C / 50°F
- Provides a robust, LED, solid-state solution to plowing applications in need of durable lighting that can withstand shock and vibration, replacing headlights and turn signal lights blocked by the plow assembly
- Utilizes Truck-Lite 27275C 7 inch round heated LED headlight
- Heated lens prevents snow, ice, and slush buildup
- Popular for utility/municipality use and more, as LED design draws less current, allowing more power for other vehicle requirements
- DOT compliant LED headlight provides a brighter, crisper and whiter light output, closer to the color temperature of daylight, dramatically improving light projection distance and increasing visibility
- Advanced white LED technology reduces concerns with EMI and offers substantially longer life than comparable incandescent lights
- Complex reflector design spreads light in a clean, more uniform pattern
- Pedestal light (front/park/turn) features a unique LED diode array with a full pattern appearance
- Lights are hard wired, with fully encapsulated electronics to protect from damage caused by corrosive elements and moisture
- Corrosion resistant, powder-coated aluminum housing dissipates heat efficiently
- Impact resistant polycarbonate lenses protects against damage caused by debris and other hazards
- Headlight component is backed with Truck-Lite 3-Year Limited Warranty, front/park/turn light component is covered by Truck-Lite 2-Year Limited Warranty, and bracket is covered by Truck-Lite standard 1-Year Limited Warranty

80988 RH, snowplow light, heated lens  
 80989 LH, snowplow light, heated lens  
 80990 Snowplow kit, heated lens

## LED Snowplow Light w/Heated Lens

### Material:

- Headlamp:
- Polycarbonate lens
- Die cast e-coat aluminum housing

- 1/2" bolt diameter

### Front/Park/Turn Lamp:

- Polycarbonate lens
- Die cast housing

### Light Source:

#### Headlamp:

- 2 LED Arrays
- Designed, with heater off, at:  
12.8v, 1.4a (low beam), 2.7a (high beam)  
25.6v, 0.7a (low beam), 2.5a (high beam)
- Designed, with heater on, at:  
12.8v, 3.1a (low beam), 4.5a (high beam)  
25.6v, 1.6a (low beam), 2.6a (high beam)

#### Front/Park/Turn Lamp:

- 21 Light Emitting Diodes
- Designed at 12.8v  
Major function: 0.625a,  
Minor function: 0.046a
- 432 Warm lumens

### Kit Components:

- 80990 kit:  
 1 - 80988 headlight  
 1 - 80989 headlight  
 1 - 80898 harness

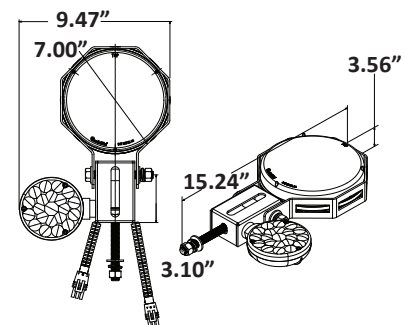

**LED Snow Plow & ATL Lamp Kit**

**Material:**

**Headlamp:**

- Polycarbonate lens
- Die cast e-coat aluminum housing

**Front/Park/Turn Lamp:**

- Polycarbonate lens
- Die cast housing

**Light Source:**

**Headlamp:**

- 2 LED Arrays
- Multi-volt design, operational from 9 to 33 volts at 12.8v operation, high beam function draws 3.60a, low beam function draws 1.80a

**Front/Park/Turn Lamp:**

- 21 Light Emitting Diodes
- Designed at 12.8v

Major function: 0.625a,  
Minor function: 0.046a

**Kit Components:**

80880 kit:

- 1 - 80878 RH assembly
- 1 - 80879 LH assembly
- 1 - 80898 harness

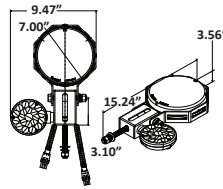

- DOT compliant LED Headlamp provides a brighter, crisper and whiter light output, closer to the color temperature of daylight, dramatically improving light projection distance and increasing visibility
- Advanced white LED technology reduces concerns with EMI and offers substantially longer life than comparable incandescent lamps
- Complex reflector design spreads light in a clean, more uniform pattern
- Pedestal lamp (Front/Park/Turn) features a unique LED diode array with a full pattern appearance
- Lamps are hard wired, with fully encapsulated electronics to protect from damage caused by corrosive elements and moisture
- Headlamp component is backed with Truck-Lite's 3-Year Limited Warranty, Front/ Park/Turn lamp component is covered by Truck-Lite's 2-Year Limited Warranty, and bracketry is covered by Truck-Lite's standard 1-Year Limited Warranty

**80880 Lighting kit**

**LED Snow Plow & ATL Lamp Kit**

**Material:**

**Headlamp**

- Polycarbonate lens
- E-Coat aluminum housing
- Metalized reflector

**Pedestal Lamp**

- Polycarbonate lens
- Zinc die cast housing
- Encapsulated circuitry

**Light Source:**

**Headlamp**

- 2 LED arrays
- 9V-33V multi-volt

**Designed At:**

- 12.8V, (LB)1.8A, (HB)3.6A
- 25.6V, (LB)1A, (HB)1.8A

**Pedestal Lamp**

- 21 Light Emitting Diodes
- Designed at 12.8V

Major funct: 0.62A,  
Minor funct: 0.46A

**Kit Components:**

80875 kit:

- 1 - 80874 RH assembly
- 1 - 80873 LH assembly
- 1 - 80898 harness

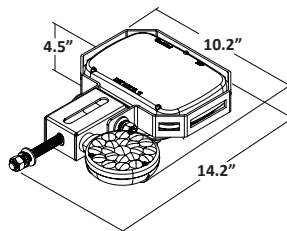

- Provides a robust, LED, solid-state solution to applications in need of durable lighting that can withstand shock and vibration, popular for utility/municipality use, as LED design draws less current and allows more power for other vehicle requirements
- Advanced white LED technology eliminates EMI and offers substantially longer life than comparable incandescent lamps
- Complex reflector design spreads light in a clean, more uniform pattern
- Pedestal lamp features a unique LED diode array with a full pattern
- Both lamps are hard wired, with fully encapsulated electronics to protect from damage caused by corrosive elements and moisture
- Brighter and crisper light output, improving light projection distance and increasing visibility
- DOT compliant, high beam and low beam performance

**80875 Lighting kit**

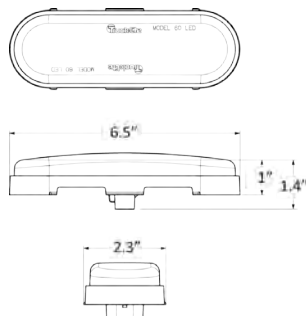

## LED 60® Series Auxiliary Lamp 6 Diode Pattern

### Material:

- Polycarbonate lens & housing
- Encapsulated Circuitry

### Light Source:

- 6 Light Emitting Diodes (LED)
- Designed at 13.5v, 0.78A
- 450 Cool lumens
- 432 Warm lumens

### Recommended Accessories:

- 60700 grommet
- 60703 grommet cover
- 94759 plug

- 180° coverage adds valuable lighting inside and outside of the vehicle, increasing visibility in areas dome/backup lighting won't reach
- Optic-free lens allows for smooth ambient distribution of light
- Lens/Housing constructed of high-grade, impact-resistant polycarbonate
- White LEDs offer daylight-bright visibility, cleaner and clearer than other light source options
- Minimal electrical draw (0.78A) allows for the use of multiple lamps, without demanding significant power from vehicle
- Fit into Truck-Lite 60 Series footprint, allowing for a simple retrofit of existing incandescent lamps as well as the use of existing 60 Series accessories
- Less current draw, resulting in increased battery and alternator life while allowing more power for other vehicle requirements
- Fit N' Forget® connection for increased corrosion resistance
- Perfect for lighting instruments beneath vehicle

### 60354C Lamp

Lamp is for auxiliary purposes only. 60 Series LED Auxiliary Lamp is not to be used as a back-up lamp. Care should be taken to install this device so that it cannot operate while the trailer or vehicle is in motion. Contact the Trailer/Vehicle OEM or Truck-Lite Technical Service for assistance.

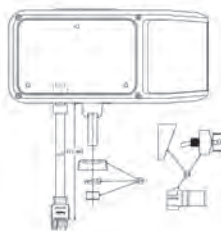

## Universal Snow Plow & ATL Kit

### Material:

- Glass headlamp lens
- Polycarbonate park/turn lens & housing
- Steel mounting bracket
- 16 gauge wire

### Light Source:

- Headlamp bulb #9007, HB5, 12v
- Park/turn bulb #1157a, 5-8 DC bayonet designed at 14v, 2.10/.59 amps

### Kit Components:

80893 kit:

- 1 - 80895 LH/driver side
- 1 - 80896 RH/driver side
- 1 - 80831 universal wire harness
- 1 - 80844 mounting hardware/switch components

### Replacement Parts:

- 27010 glass headlamp assembly
- 80895 LH/lamp assembly
- 80896 RH/lamp assembly
- 80831 universal wire harness
- 80844 hardware

- Incorporates complex reflector technology to help reduce driver fatigue
- Increased beam pattern output & improved beam pattern formation
- High impact polycarbonate & steel construction
- Features high beam/low beam halogen headlamps & integrated park/turn lamps
- Mounts on one 1/2" - 13 stud
- Lamp functions as a snow plow lights, all terrain light or off-road/auxiliary lights
- Kit also includes switch & wiring harness kit

### 80893 Lighting kit



## DRL Snow Plow & ATL Light Kits



**Material:**

- Polycarbonate park/turn lenses & housing
- Steel bracket
- 16 gauge wire

**Light Source:**

- Bulb: H6545, glass sealed beam
- Designed at 12.8v, 3.52 amp (low) and 5.08 amp (high)
- Bulb: #1157, S-8 DC bayonet
- Designed at 14v, 2.10/.59 amp

**Kit Components:**

80900 DRL kit:

1 - 80910 LH lamp

1 - 80920 RH lamp

80970 HB5 adapter kit:

1 - 80950 LH adapter

1 - 80951 RH adapter

80971 HB1 adapter kit:

1 - 80952 LH adapter

1 - 80953 RH adapter

80972 2E adapter kit:

1 - 80954 LH adapter

1 - 80955 RH adapter

80973 2D/2B adapter kit:

1 - 80956 LH adapter

1 - 80957 RH adapter

80974 1A/2A adapter kit:

1 - 80958 LH adapter

1 - 80959 RH adapter

80975 LF/UF adapter kit:

1 - 80960 LH adapter

1 - 80961 RH adapter

**Replacement Parts:**

- 80910 LH, lamp assembly
- 80920 RH, lamp assembly
- 08004 beam



- High impact polycarbonate & steel construction
- Features high/low beam halogen headlamps & integrated park/turn lamps
- Adapts easily to vehicle equipped with Daytime Running Light (DRL) systems
- Unique plug-in adapter design allows installation without cutting or splicing existing wiring
- Mounts on one 1/2"-13 stud
- Normal DRL function transferred to snow plow lights
- Use matrix to determine appropriate adapter plug kit, sold separately
- Wiring system features weatherproof Packard connectors to prevent corrosion problems
- DRL kit also includes a switch and a heavy-duty flasher
- Not compatible with vehicles using quad headlamps or separate DRL & headlamps

**80900 DRL kit**

### Kit Components

Kit Part #	Headlamp Type	Headlamp Bulb No.
80970	HB5	H9007
80971	HB1	H9004
80972	2E	HP6545/H6545/4166
80973	2D/2B	6014/H6024/H6014/6052/H6054/HP6054
80974	1A/2A	4651/4652/H4651/H4656/H4662
80975	LF/UF	H4701/H4703

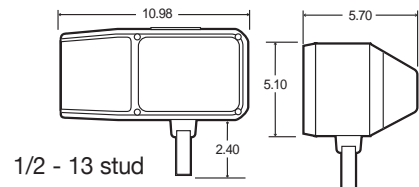

**Note:**

If your vehicle's lighting system is not listed above, you must use the 80800 Universal Snow Plow Light/ATL Kit.



80800

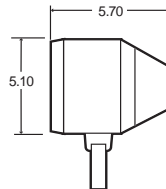
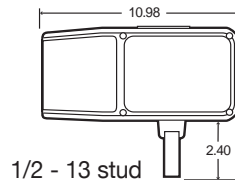

- Lamp functions as snow plow light, all terrain light, or off road/ auxiliary light
- Features high beam/low beam halogen headlamps & integrated park/turn lamps
- Kit also includes a switch, a grommet that protects wiring at the switch, and a heavy-duty flasher
- 80800 one-piece harness runs from switch to the front of the vehicle & attaches with Scotchlock™ connectors
- 80805 one-piece harness runs from switch to the front of the vehicle & attaches with Packard weather proof connectors

**80800** Lighting kit**80805** Lighting kit w/weatherproof connectors

## Universal Snow Plow & ATL Light Kits

### Material:

- Polycarbonate park/turn lenses & housing
- Steel bracket
- 16 gauge wire

### Light Source:

- Bulb: # H6545, glass sealed beam
- Designed at 12.8v, 3.52 amp (low) and 5.08 amp (high)
- Bulb: #1157, S-8 DC bayonet
- Designed at 14v, 2.10/.59 amp

### Kit Components:

- 80800 universal kit:
- 1 - 80810 LH lamp
  - 1 - 80820 RH lamp
  - 1 - 80830 main harness
  - 1 - 80840 hardware set
- 80805 universal kit:
- 1 - 80848 LH lamp
  - 1 - 80849 RH lamp
  - 1 - 80840 hardware set

### Replacement Parts:

- 08004 beam

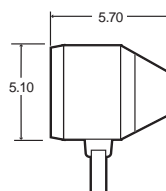
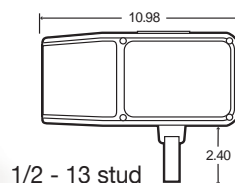

- High impact polycarbonate & steel construction
- Features high beam/low beam halogen headlamps and integrated park/turn lamps
- Mounts on one 1/2"-13 stud
- Lamp functions as a snow plow light, all terrain light, or an off road/auxiliary light
- Kit also includes a switch
- Two vehicle harnesses run from lamps & attach with twist-type connectors

**80888** Lighting kit

## Economy Snow Plow & ATL Light Kits

### Material:

- Polycarbonate park/turn lenses & housing
- Steel bracket
- 16 gauge wire

### Light Source:

- Bulb: # H6545, glass sealed beam
- Designed at 12.8v, 3.52 amp (low) and 5.08 amp (high)
- Bulb: #1157, S-8 DC bayonet
- Designed at 14v, 2.10/.59 amp

### Kit Components:

- 80888 economy kit:
- 1 - 80860 LH lamp
  - 1 - 80870 RH lamp
  - 1 - 80831 main harness
  - 1 - 80844 hardware set

### Replacement Parts:

- 80860 LH lamp
- 80870 RH lamp
- 80831 harness
- 80844 hardware
- 08004 beam

**LED Headlights**  
 Complex Reflector  
 Optics Design  
 2 LED Arrays



**Material:**

- Hard-coated polycarbonate lens
- E-coat aluminum housing
- Metalized reflector
- 16 gauge wire
- Encapsulated circuitry

**Light Source:**

- 2 LED arrays
- 9v-33v multi-volt design works with both 12v and 24v systems

**Designed at:**

12.8v, (lb)1.8a, (hb)3.60a  
 25.6v, (lb)1.0a, (hb)1.8a

**Heated 7" Round:**

- Designed, with heater off, at:  
 12.8v, 1.4a (low beam), 2.7a (high beam)  
 25.6v, 0.7a (low beam), 2.5a (high beam)
- Designed, with heater on, at:  
 12.8v, 3.1a (low beam), 4.5a (high beam)  
 25.6v, 1.6a (low beam), 2.6a (high beam)

**Additional Specifications:**

- Operating temperature range: -40°C to 50°C
- Over-voltage protection to 600v, w/constant output
- Mechanical aim - 27270C & 27450C
- Mechanical aim - 27275C
- Heated 7": Heater turns on at 10°C/50°F

**Recommended Accessories:**

- 96630 - H4 to H13 adapter
- 96830 - PWM pigtail with H4 to H13 adapter

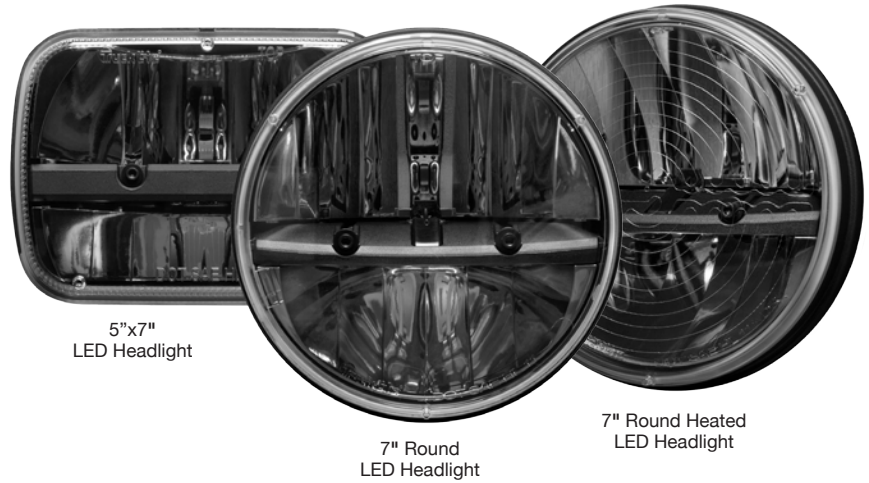

5"x7" LED Headlight

7" Round LED Headlight

7" Round Heated LED Headlight

- When properly mounted, the light is designed to conform to the requirements listed in the Department of Transportation (DOT), FMVSS-108 and Transport Canada (TC), CMVSS-108. Headlights marked with the DOT symbol signifies the lights are street legal.
- Metalized reflector optics provide a lighting experience that's smooth and clean across the driving surface
- Provides a brighter, crisper and whiter light output, closer to the color temperature of daylight, dramatically improving light projection distance and overall visibility
- Rugged design and cutting edge technology creates a light capable of lasting years longer than traditional bulb-operated lighting systems
- Durability and dependability of LED lighting provides a solid-state, bulb-free headlight design that's impervious to damage from shock and vibration
- Military grade, die-cast aluminum housing and non-yellowing, polycarbonate lens offer optimum protection against damage from impact, roadside debris and other hazards
- Electronics are sealed in epoxy to resist damage from shock and corrosion
- Proper aiming recommended after installation
- 7" Round plug and play replacement for #6014, 6015, 6016, H6024 and Par 56 headlight designs
- 5"x7" plug and play replacement for #6052, 6053, H6054, and HD6054 headlight designs
- Uses standard, H4, 3-blade wiring connector
- Heated lens LED headlight heats constantly under 10°C/50°F
- Heated lens LED headlight's unique heat pattern is designed to prevent ice and snow build-up on the lens
- Heated lens LED headlight is an excellent option for light, medium and heavy-duty trucks, and off-road vehicles that are frequently exposed to extreme weather conditions

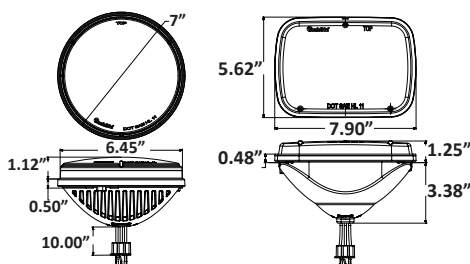

- 27270C 7" Round LED headlight, multi-volt
- 27450C 5" x 7" Rectangular LED headlight, multi-volt
- 27275C 7" Round LED headlight, heated, multi-volt

NEW!



7" Round ECE  
LED Headlight, LHT



5"x7" ECE  
LED Headlight, LHT

- ECE approved / ADR and ROHS compliant
- LED sealed beam technology with polycarbonate lens and sealed electronics
- Up to 50x longer life than halogen headlights
- Produces pure white light, nearly identical to daylight
- Includes built-in position light with optional wiring
- Offers great forward vision, improved roadside coverage and highly controlled beam patterns, offering glare protection to oncoming traffic
- Dipped/passing beam and main/driving beam functionality
- Ultra-bright output for maximum night visibility
- H4, 3-blade connector system
- Direct replacement for 1058 halogen light insert

27290C 7" Round LED Headlight, ECE, RHT  
 27291C 7" Round LED Headlight, ECE, LHT  
 27490C 5"x7" LED Headlight, ECE, RHT  
 27491C 5"x7" LED Headlight, ECE, LHT

## LED ECE Headlights

Complex Reflector

Optics Design

2 LED Arrays

### Material:

- Hard-coated polycarbonate lens
- eCoat aluminum housing and internal structures
- Metalized reflector
- 1.3mm CSA / 16 gauge wire

### Light Source:

- 2 LED arrays
- Multi-volt (9V-33V) design works with both 12V and 24V systems
- Headlight
  - 1.3A (dipped/passing) @ 13.2V
  - 2.3A (main/driving) @ 13.2V
  - 0.6A (dipped/passing) @ 26.4V
  - 1.1A (main/driving) @ 26.4V
- Position Light
  - 0.03A @ 13.2V, 0.03A @ 26.4V

### Additional Specifications:

- Overvoltage protection to 600V

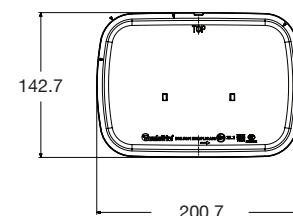
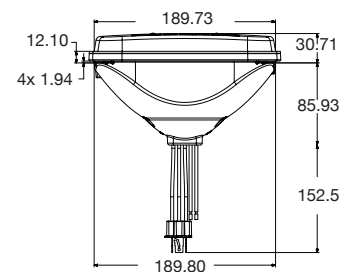
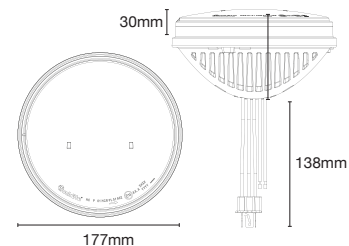



**LED 4"x6" LED  
Headlights (165mm)**



**Material:**

- Hard-coated polycarbonate lens
- eCoat aluminum housing and internal structures
- Metalized reflector
- 16 gauge wire

**Light Source:**

- 1 LED Array
- 9 V-33 V Multi-volt design works with both 12 V and 24 V systems
- Designed:
- 12.8 V, 1.5 A (low beam), 1.2 A (high beam)
- 28 V, 0.8 A (low beam), 0.7 A (high beam)

**Additional Specifications:**

- Overvoltage protection to 600V



- Best-in-class beam pattern
- Excellent option for light, medium and heavy-duty trucks, off-road and agricultural vehicles, classic cars, and more
- Metalized reflector optics provide a lighting experience that's smooth and clean across the driving surface
- When properly mounted, exceeds FMVSS-108 and CMVSS-108 DOT requirements for low beam and high beam performance
- Provides a brighter, crisper and whiter light output that is closer to the color temperature of daylight
- Dramatically improves light projection distance and overall visibility
- Durability of LEDs provide a solid-state, bulb-free headlight design that's impervious to damage from shock and vibration
- Durable housing and non-yellowing, hard-coated polycarbonate lens offer optimum protection against damage from impact, roadside debris and other hazards
- Advanced circuitry protects against voltage spikes
- Drop-in replacement for 1A1 and 2A1 headlight designs
- Uses standard, H4, 3-blade wiring connector
- Equipped with Truck-Lite's 3-Year Limited Warranty
- Up to 50x longer life than halogen technology

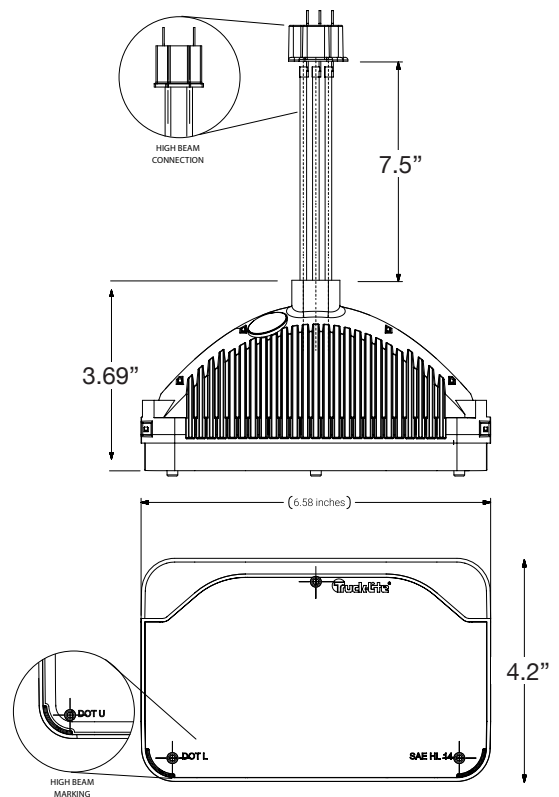

**27640C Headlight, 4"x6", low beam**  
**27645C Headlight, 4"x6", high beam**



- Mechanical aim
- Adapter plug easily converts 9007/9007LL connector
- Polycarbonate lens provides up to 30 times greater impact resistance than glass
- Easy-to-remove bulb changes out through the back of the lamp, allowing for replacement without re-aiming
- Bulb connector uses seal around bulb base to create weatherproof construction, preventing corrosion
- Review for appropriate bucket fit before installing

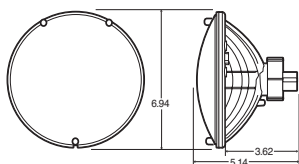

**27004** Lamp only  
**27003** Lamp kit  
**95400** Plug

## 7" Headlamp (PAR56)

Bulb Replaceable

### Material:

- Polycarbonate lens
- BMC housing
- 16 gauge wire

### Light Source:

- Bulb: #9007, HB5 headlight
- Designed at 12.8v, 4.3/5.1 amp, and 1100/1500 cp

### Kit Components:

27004 headlamp kit:  
 1 - 27003 headlamp  
 1 - 95400 adapter plug



- Exceeds DOT minimum requirements by an average of 300% low beam & 225% high beam
- Mechanical aim
- Review for appropriate bucket fit for installing
- Retrofits ANSI #6014, 6015, 6016 & H6024

**27012** Lamp only

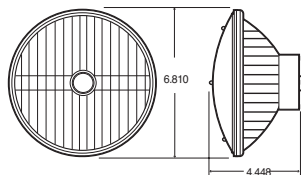

## 7" Headlamp (PAR56)

Bulb Replaceable

### Material:

- Glass lens
- Die cast aluminum reflector

### Light Source:

- Bulb: #9003, HB2, 12v

### Replacement Parts:

- 80596 bulb



- Exceeds DOT minimum requirements by an average of 300% low beam & 225% high beam
- Mechanical aim
- Review for appropriate bucket fit for installing
- Retrofits ANSI #6052, 6053, H6054 & HP6054

**27009** Lamp only

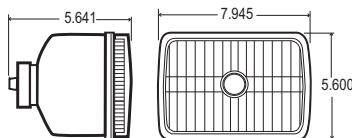

## 5" x 7" Headlamp

Bulb Replaceable

### Material:

- Glass lens
- Die cast aluminum reflector

### Light Source:

- Bulb: #9003, HB2, 12v

### Replacement Parts:

- 80596 bulb



- Exceeds DOT minimum requirements by an average of 300% low beam & 225% high beam
- Mechanical aim
- Review for appropriate bucket fit for installing
- Retrofits ANSI #H4656
- Adapter #95846 may be needed to retrofit
- Not recommended for certain Freightliner®, Kenworth® or Western Star® trucks

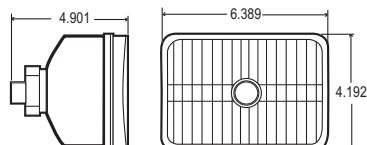

**27011** Lamp kit  
**27010** Lamp only  
**95846** Adapter

## 4" x 6" Headlamp (165mm)

Bulb Replaceable

### Material:

- Glass lens
- Die cast aluminum reflector

### Light Source:

- Bulb: #9007, HB5, 12v

### Kit Components:

27011 kit:  
 1 - 27010 lamp  
 1 - 95846 adapter

### Fog & Driving Kits

**Material:**

- Plastic housing & bezel
- Metalized steel reflector
- Lead crystal lens

**Light Source:**

- Bulb: #H3 55w, halogen
- Designed at 12.8v, 4.5 amp & 115 cp

**Recommended Accessories:**

- 80591 remote wiring kit

**Replacement Parts:**

- 80593 wiring kit
- 192, 40 amp relay
- 80594 rocker switch
- 80571 bulb

- Meets or exceeds DOT/SAE & ECE standards
- Mounts above or below bumper
- Ideal for many light & medium trucks/vans & original equipment applications
- Replaces Signal-Stat 880/881 series

- 80520 Clear, driving kit, retail pack**
- 80521 Clear, fog kit, retail pack**
- 80522 Yellow, fog kit, retail pack**

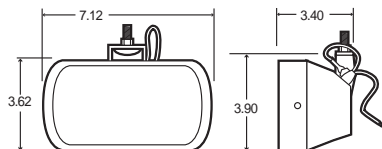

### Fog & Driving Kits

**Material:**

- Plastic housing & reflector
- Polycarbonate lens

**Light Source:**

- Bulb: #H3 55w, halogen
- Designed at 12.8v, 4.5 amp & 115 cp

**Recommended Accessories:**

- 80591 remote wiring kit

**Replacement Parts:**

- 80593 wiring kit
- 192, 40 amp relay
- 80594 rocker switch
- 80571 bulb

- Single-bolt, multi-position fastening system allows mounting from any angle & makes adjustments easier
- Simple replacement of bulb through front of lamp
- Meets or exceeds DOT/SAE & ECE standards
- Ideal for use on heavy or medium trucks & various off-highway vehicles
- Replaces Signal-Stat 872/873 series

- 80513 Clear, driving kit, retail pack**
- 80514 Clear, fog kit, retail pack**
- 80519 Yellow, fog kit, retail pack**

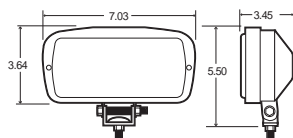

### Compact Fog & Driving Kits

**Material:**

- Plastic housing & bezel
- Metalized steel reflector
- Lead crystal lens

**Light Source:**

- Bulb: #H3 55w, halogen
- Designed at 12.8v, 4.5 amp, & 115 cp

**Recommended Accessories:**

- 80591 remote wiring kit

**Replacement Parts:**

- 80595 mounting bracket
- 192, 40 amp relay
- 80571 bulb

- Simple bulb replacement through front of lamp
- Kit contains two lamps, mounting hardware, wiring kit with switch, fuse & installation instructions
- Compact design fits bumpers & spoilers for a low profile look
- Flexible design allows mounting above or below bumper
- Ideal for many light & recreational vehicles
- Meets or exceeds DOT/SAE & ECE standards
- Replaces Signal-Stat 870/871 series

- 80525 Clear, driving kit, retail pack**
- 80526 Clear, fog kit, retail pack**
- 80527 Yellow, fog kit, retail pack**

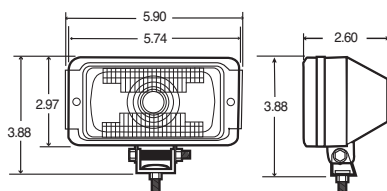



### Halogen Bulbs

- 12 volt, 55 Watt, H-3
- 115 candlepower, 4.5 amp
- For use on fog & driving lights

80571 [Halogen bulb, retail pack](#)

- 12 volt, 100 Watt, H-3
- 187 candlepower, 8.0 amp
- For use on off-road lights only

80560 [Halogen bulb, retail pack](#)

- 24 volt, 70 Watt, H-3, 3.0 amp
- For use in auxiliary & emergency lamps

80561 [Halogen bulb](#)

- 36 volt, 45 Watt, H-3, 1.2 amp
- For use in material handling industry



### Long Life Halogen Bulbs

- Ideal for everyday and heavy duty conditions
- For use in dual headlamp systems
- Emits white light
- DOT compliant
- 12 volt
- Lasts 6 times longer than standard halogen bulb



80596 **Halogen hi/low beam, HB2, 60/55 watts**

Note: It is recommended that replacement should be made in pairs for maximum halogen headlamp lighting benefits.

### Halogen Bulbs

- 12 volt, 55 Watt, H-1, 4.5 amp
- Popular beacon & lightbar replacement
- For use with units 331A, 332A, 334A, 360A, 360W, 365A



80563 **Halogen bulb, retail pack**

### Halogen Bulbs

- 12 volt, 50 Watt, 108 CP, 4.0 amp
- Bayonet style bulb replaces 1156 bulb for high powered off-road back-up lamps
- Can also be used in place of 1195 bulb to double the output of emergency warning lamps (i.e., 315, 335 series lamps)
- For use with 9682, 9683, 331A, 332A



80564 **Halogen bulb, retail pack**

### Heavy Duty Relays

- These relays replace both Hella and Bosch units.



- 190 **40 A, 12V, 5 terminal, (no tab), w/diode protection (switched outputs)**
- 191 **40 A, 12V, 5 terminal, (no tab)**
- 1924 **20 A, 24V, 5 terminal**
- 194 **40 A, 12V, 4 terminal**
- 195 **70 A, 12V, 4 terminal**
- 9185 **Relay connector w/12" length of 12 gauge wiring**

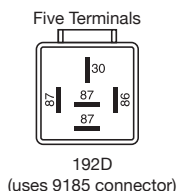
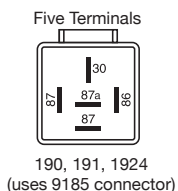
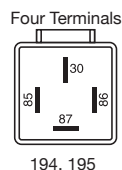

### Accessories

- Includes illuminated rocker switch, #192 40 amp relay, 15 amp fuse in-line, connectors, and 20 feet of 16 ga. wire



80593 [Wiring kit](#)

- On-off switch for use with auxiliary lights and heated mirrors



80594 [Illuminating rocker switch](#)

- Recommended for use where heavy amp draw is required
- Includes 20 ft. of 14 gauge wire, connectors, mounting hardware & wiring diagram



125 **70 amp heavy duty relay kit**



**LED 91® Series**  
**Stop, Turn & Tail & Rear Turn Lamps**  
 47 Diode  
 Hard Wired



**Material**

- Acrylic lens
- ABS housing
- 18 gauge wire

**Light Source:**

- Designed at 13.5v
- 0.55 - 0.07 amp stop/turn
- 0.03 - 0.04 amp tail
- 0.60 - 0.70 yellow

**Recommended Accessories:**

- 97039 gasket



91243Y

91244R

91242R

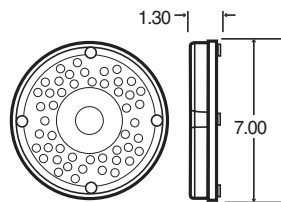

- Popular in bus applications
- Features over-voltage & spike protection circuitry
- Mounts in any 360° application

**91244R Stop, turn & tail lamp, red**

**91243Y Rear turn lamp, yellow**

**91242R Stop, turn & tail lamp w/reflex, red**

**91241Y Rear turn lamp w/reflex, yellow**

**91® Series**  
**Stop, Turn & Tail Front Park & Turn**  
 Sealed

**Material:**

- Polycarbonate lens & housing
- 16 gauge wire

**Light Source:**

- Heavy duty shock mount bulb
- 12v designed at 12.8v, 2.1/0.48 amp, 32/2 cp
- 24v designed at 24v, 0.93/0.34 amp, 32/6 cp

**Kit Components:**

- 91002R/Y lamp kits:
- 1 - 91202R/Y lamp
- 1 - 94993 plug

**Recommended Accessories:**

- 97031 mounting gasket

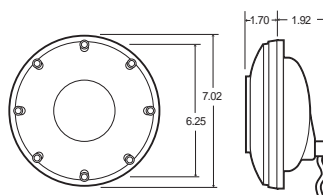

0.20 screw hole diameter  
 6.281 bolt hole circle

- Contains a heavy duty shock mount 12 volt dual filament bulb
- Mounting gasket provides additional protection between lamp & body
- Mounts in a 5.375" hole
- Replaces Signal-Stat 6510/A

**91002R Stop, turn & tail lamp kit, red**

**91002Y Front park & turn lamp kit, yellow**

**91202R Stop, turn & tail lamp, red**

**91202Y Front park & turn lamp, yellow**



- Socket assembly cams-out for ease in bulb replacement
- Mounts in a 3.84" hole
- Mounting gasket provides additional protection between lamp & body

**91315R Stop, turn & tail kit, red**

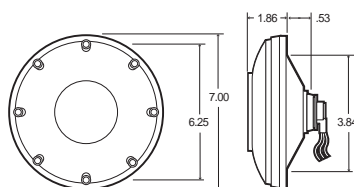

0.23 screw hole diameter  
6.244 bolt hole circle

**91® Series  
Stop, Turn & Tail  
Front Park & Turn  
Bulb Replaceable**

**Material:**

- Polycarbonate lens & housing
- 16 gauge wire

**Light Source:**

- Bulb: #3157

**Kit Components:**

- 91315R/Y lamp kits:
- 1 - 99021R/Y lens & housing
- 1 - 95407 socket assembly

**Recommended Accessories:**

- 97031 mounting gasket



- Surface mounts with four bolts on a 6.25" bolt circle
- Requires a 1" diameter hole, 1" deep
- Popular lamp on buses & emergency vehicles
- Replaces Signal-Stat 6504

**90327R Stop, turn & tail lamp, red  
90327Y Front park & turn lamp, yellow**

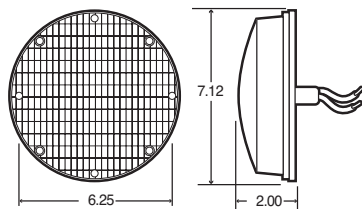

**Stop, Turn & Tail  
Front Park & Turn  
Bulb Replaceable**

**Material:**

- Acrylic lens
- Steel base w/black epoxy
- Black foam gasket
- 16 gauge wire

**Light Source:**

- Bulb: #1157, S-8 DC index
- Designed at 14.0v, 2.10/.59 amp & 32/3 cp

**Replacement Parts:**

- 99168R red lens
- 99168Y yellow lens
- 9520 lens gasket

- Recess mounts in a 5.25" diameter hole, 2.37" deep & uses four bolts on a 6.25" bolt circle
- Popular lamp on many school buses & emergency vehicles
- Replaces Signal-Stat 6507/A

**90326R Lamp, red  
90326Y Lamp, yellow**

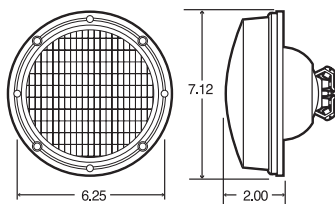

**Warning Lamps  
Bulb Replaceable**

**Material:**

- Acrylic lens
- Steel base w/black epoxy
- Black foam gasket
- 16 gauge wire

**Light Source:**

- Bulb: #4636, Par 46 sealed beam
- Designed at 14.0v, 5.75 amp & 90,000 cp

**Replacement Parts:**

- 99169R red lens
- 99169Y yellow lens
- 9520 lens gasket

**Arrow T/S Products**

**Bulb Replaceable**

**Material:**

- Acrylic lens
- Steel base w/black epoxy
- Black foam gasket
- 16 gauge wire

**Light Source:**

- Bulb: #1156
- Designed at 12.8v, 2.10 amp & 32 candlepower

**Replacement Parts:**

- 99167Y yellow lens w/arrow
- 9520 lens gasket
- 9521 mounting pad
- 99168R red lens for 6503
- 99168Y yellow lens 6503A

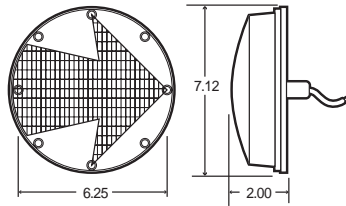

- 90325Y lamp functions as a turn signal & features a directional arrow
- Surface mounts with four #10 screws on a 6.25" bolt circle & 32 candlepower
- Requires a 1" diameter hole, 1" deep
- Popular lamp on buses & emergency vehicles
- Replaces Signal-Stat 6505/A

- 90325Y Turn signal lamp w/arrow, yellow**
- 6503 Turn signal lamp, red**
- 6503A Turn signal lamp, yellow**



**Combination**

**Bulb Replaceable**

**Material:**

- Acrylic lens
- Steel base
- 16 gauge wire

**Light Source:**

- Bulb: #1156, one wire
- Bulb: #1157, two wire

**Replacement Parts:**

- 9384A yellow lens for 6501A

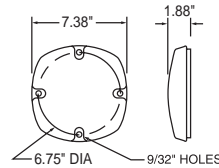

- Popular school bus signal lamps
- Rimless lens construction
- Positive seal prevents leaking and eliminates cracked lenses
- Double optic lens covers black enameled steel housing

- 6500 Red, one wire, turn signal**
- 6500A Amber, one wire turn signal**
- 6501 Red, one wire arrow lamp**
- 6501A Amber, one wire arrow lamp**
- 6502 Red, two wire S/T/T**



**Bus Products**

**Bulb Replaceable**

**Material:**

- Polycarbonate lens & housing
- Vinyl & rubber bulb socket
- 16 gauge wire

**Light Source:**

- 95415 S/T socket
- Bulb: #3157, wedge base
- Designed at 12.8v, 2.10 amp & 32 cp

95407 S/T/T socket

- Bulb: #3157, wedge base
- Designed at 12.8v/14.0v, 2.10/.48 amp & 32/2 cp
- Bulb socket cams-in for ease of repair/ replacement (sold separately)
- Recess mounts using two screws at 3.0" centers & two screws at 4.2" centers

- 07098 Lens/housing, red**
- 95415 S/T socket**
- 95407 S/T/T socket**

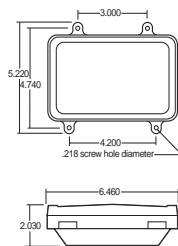

**Bus Products**

**Sealed**

**Material:**

- Polycarbonate lens & housing
- Nylon bulb mount
- 24 gauge bulb wire
- 18 gauge plug wire

**Light Source:**

- 12v dual filament baseless bulb
- 12v lamp designed at 12.8v/14.0v, 2.10/.48 amp & 32/2 cp

- Watertight lamp mates w/Packard connector
- Direct replacement for GMC buses
- Recess mounts using two screws at 3.0" centers & two screws at 4.2" centers
- 12v lamps mate with P.E. Connector 62884715

- 07080 Lamp, yellow**
- 07081 Lamp, red**
- 07082C Lamp, clear**

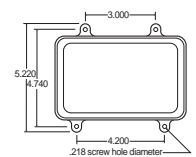





- 13 diode pattern
- Hard-wired design
- Suitable for PC requirements when mounted on a 45° angle

**1155** Lamp, red  
**1155A** Lamp, yellow

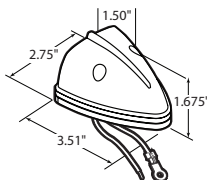

## LED Bus Lamps

### PC Rated

#### Material:

- Polycarbonate lens

#### Light Source:

- Light Emitting Diodes (LEDs)
- Designed at 12.8v, 0.18-0.23 amp



- Popular school bus lamp
- Galvanized steel housing
- Adaptable for front, side, and rear mounting
- Single lens screw for easy bulb replacement
- Includes cell sponge mounting pad for curved surfaces

**1150** Lamp, red  
**1150A** Lamp, yellow

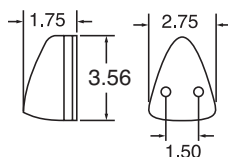

## Marker/ID Products

### Bulb Replaceable

#### Material:

- Galvanized steel housing

- Acrylic lens

- Rubber base

#### Light Source:

- Bulb: #193

#### Replacement Parts:

- 8861 red lens
- 8861A yellow lens



26354R

- Surface mounts on two pass-through lens screws at 1.5" centers
- Ground through base
- Popular for use on school buses & commercial vehicles
- Heavy duty steel & acrylic construction
- Lens attaches to base with one screw
- Optional zinc-plated steel guard provides additional protection

**26354R** Red  
**26354Y** Yellow

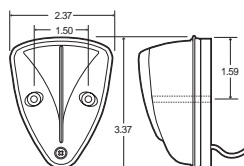

## Marker/ID Products

### Bulb Replaceable

#### Material:

- Acrylic lens

- Steel base

- Rubber gasket

#### Light Source:

- Bulb: #904

- Designed at 13.5v, 0.69 amp & 4 cp

#### Replacement Parts:

- 99171R red lens
- 99171Y yellow lens





**Marker Products**  
Bulb Replaceable

**Material:**

- Acrylic lens
- Steel base
- Rubber gasket

**Light Source:**

- Bulb: #168
- Designed at 14.0v, 0.35 amp & 3 cp

**Replacement Parts:**

- 99170R red lens
- 99170Y yellow lens

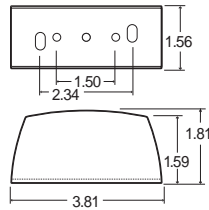

- Surface mounts on two screws at 1.5" centers
- Ground through base
- Popular for use on school & commercial buses
- Heavy duty steel & acrylic construction
- Lens attaches to base with one center screw
- Optional zinc-plated steel guard provides additional protection
- Replaces Signal-Stat 1151/1151A/9251



26353Y & 26723

- 26353R** Lamp only, red
- 26353Y** Lamp only, yellow
- 26723** Steel guard

**LED Dome Lamp**  
6 Diodes

**Material:**

- Clear Polycarbonate Lens
- Steel Housing

**Light Source:**

- 6 Light Emitting Diodes (LEDs)
- Designed at 13.5v, .40 amps

**Recommended Accessories:**

- 97301 clear lens

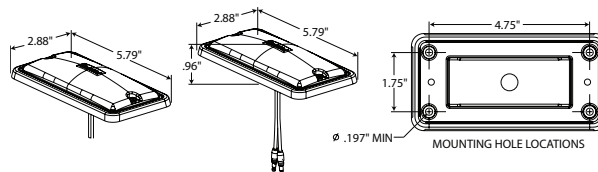

- Surpasses 2,000 hours of incandescent bulbs by nearly 50x
- 60% lower power consumption than "incandescent lamps, allowing more power for other vehicle requirements
- Electronics fully sealed in epoxy, to resist against corrosion & moisture



- 80162C** Lamp w/blunt cut wire
- 80164C** Lamp w/.180 bullet connectors

**Interior/Dome Products**  
Bulb Replaceable

**Material:**

- Acrylic lens
- Steel base

**Light Source:**

- Bulb: #93
- Designed at 12.8v, 1.04 amp & 15 cp

**Replacement Parts:**

- 99172 clear lens

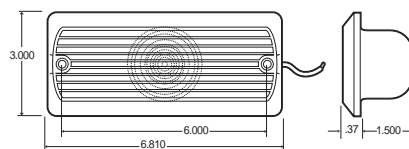

0.180 SCREW HOLE DIAMETER

- Flush mounts on two screws at 6.0" centers
- Requires a 2" x 5-1/4" hole
- Grounds through mounting screws
- Functions as an interior dome, a compartment, or a utility lamp
- Heavy-duty steel & acrylic construction



- 81350** Lamp only



# Warning & Emergency Lighting

# Warning & Emergency Lighting

**LED Strobes & Beacons**

**142-147**



**Light Bars**

**148-150**



**LED Remote Strobe Systems**

**151-157**



**Traffic Control**

**158-161**



**Accessories**

**162-163**

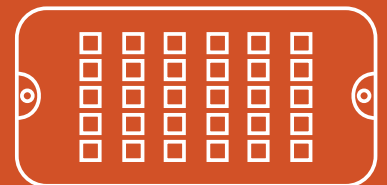

## CLASS I, II & III CLASSIFICATIONS

The classification of warning lamps is meant to aide in the differentiation of lamps and output based on application and need. Some applications require brighter light output, while others require light output of a different direction or visibility.

Class I - The Class I lighting classification differentiates warning lights with the sole purpose of being used in applications in motion at the speed of traffic.

Class II - Class II lighting products are designed for vehicles that are in motion, but not to the speed of traffic.

Class III - Class III products are designed for products that are not in motion at all.

## FLASHES PER MINUTE

Flashes per minute, also noted as flashes per sequence, depicts the number of pulses or spikes a lamp generates within one minute of activity. Flashes per second are usually depicted as single flash, dual flash or quad flash, with the pulses being grouped together in series of flashes. A great benefit that SWL lamps provide is in their qualification of the flash being 100% accurate. With the quad flash of an SWL lamp, four flashes of equally high intensity are recorded prior to a separation gap. When gas discharge lamps generate their quad flash pattern, the first flash peaks at a level greater than that of the three following spikes, as the lamp needs to recover from its use of power in order to create the next large flash. All four flashes are not equal, but all can be "counted" equally in determining flashes per second or flashes per minute.



- Additional color options excellent option for city/county municipal, cement mixer & other heavy-duty, construction or off-road applications
- Dual & quad class i flash patterns meet legal functions
- Designed for surface mount as well as pipe mount (1" NPT pipe thread)
- Electronics & light source fully encapsulated in epoxy to protect components from moisture damage & corrosives
- Protected against industry-standard electrical transient per SAE J1455
- Linear supply offers reduced EMI over that of gaseous discharge systems
- Threaded lens design does not require tool to replace lens
- Designed without external optics to reduce maintenance & cleaning
- Mounting gasket & #10 installation screws included
- Cigarette plug features on/off switch with LED indicator light

- 92569Y Magnetic mount lamp, yellow, 12v
- 92565Y Permanent mount lamp, yellow, 12v
- 92565R Permanent mount lamp, red, 12v
- 92565C Permanent mount lamp, clear, 12v
- 92565B Permanent mount lamp, blue, 12v
- 92566Y Permanent mount lamp, clear lens yellow LEDs
- 92568Y Permanent mount lamp, yellow, 24v
- 92568R Permanent mount lamp, red, 24v
- 92568B Permanent mount lamp, blue, 24v

### LED Warning Lamp Class 1 Medium Profile Dual & Quad Flash

#### Material:

- Polycarbonate lens
- Die cast aluminum housing
- Blunt cut 18 gauge wire

#### Light Source:

- 18 Light Emitting Diodes (LEDs)
- 12v designed at 13.5 volts w/ peak current at 3 amps
- 24v designed at 13.5 volts w/ peak current at 3 amps
- 12v meets SAE J845 Class 1 legal functions at 12v - 16v, operational at 8v - 16v
- 24v meets SAE J845 Class 1 legal functions at 12v - 16v, operational at 8v - 16v
- Operates from -40°F to 158°F (-40°C to 70°C)

#### Replacement Parts:

- 99250R clear lens
- 92545 guard

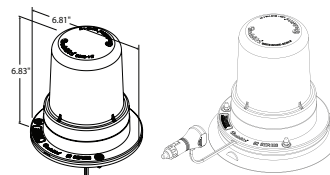

Mounts on 6.1 dia. 120° holes



## LED & Gas Discharge Strobes

Class 1 & 2, Medium Profile



### Material:

- Polycarbonate lens
- Die cast aluminum base
- 18 gauge wire

### Gas Discharge Light Source:

- Joules: 11 (single) 15.5 (double) 17.6 (quad)
- Amps: 2 at 12v
- Voltage: 12-24v
- Flash Rate: 80 SFPM, 65 DFPM, 65 QFPM
- Class: 1 quad & double flash, Class: 2 single flash

### LED Light Source:

- Amps: 0.6 at 12v, 0.3 at 24v
- Class: 1

### Replacement Parts:

- 99146C clear lens
- 92725 strobe tube
- 92713 power supply

92864Y

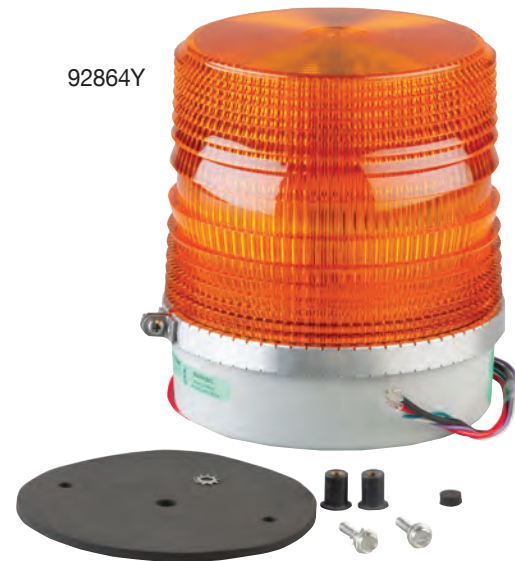

- LED version meets SAE Class 1 & California 13
- Field selectable flash patterns via internal jumper single, double, quad flash
- LED diagnostic indicator
- Modular circuit is completely encapsulated for increased shock & weather resistance
- 24 customer selectable flash patterns
- High/Low intensity feature (manual or automatic)
- LED version covered by 5-year limited warranty

**92864Y LED permanent mount lamp, yellow**

**92516Y Permanent mount lamp, yellow**

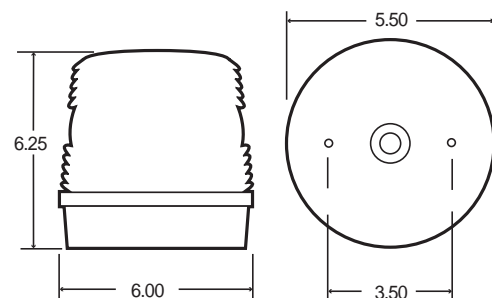

## Gas Discharge Strobe Class 1 Medium Profile

### Material:

- Polycarbonate lens
- Die cast aluminum housing
- Blunt cut 18 gauge wire

### Light Source:

- Operational at 10v - 30v
- 12v current draw - 2.0 amps
- 24v current draw - 1.0 amps
- Meets SAE J1318 Class 1 legal functions with dual & quad flash patterns
- Meets SAE J1318 Class II legal functions with single flash pattern
- Operates from -30°F to 135°F

### Replacement Parts:

- 92725 strobe tube

### Recommended Accessories:

- 92545 guard

- Excellent option for city/county municipal, cement mixer, heavy-duty construction or off-road applications
- Offers single, dual, quad flash patterns
- Innovative optic design keeps exterior lens free of optics, for ease of maintenance & cleaning
- Rugged black powder coated corrosion-resistant die-cast aluminum base
- Designed for surface mount as well as pipe mount (1" NPT pipe thread)
- Threaded lens design does not require tool to replace lens
- Built-in LED diagnostic indicator shows operational state of the lamp assembly
- Electronics are encapsulated in epoxy to protect against damage caused by moisture & corrosion
- Mounting gasket & #10 installation screws included

**92592Y Permanent mount lamp, yellow**

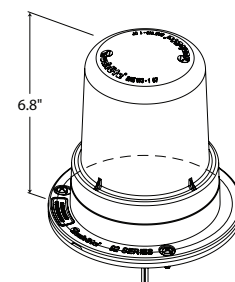

Mounts on 6.1" dia., 120° holes



6810A

- Field selectable flash patterns via internal jumper single, double, quad flash
- LED diagnostic indicator
- Twist on/off lens
- High/Low intensity feature (manual & automatic)
- Designed for surface & pipemount (1" NPT pipe thread)

**Low Profile Lamps**

- 6810B Permanent mount, blue
- 6810R Permanent mount, red
- 6810W Permanent mount, clear
- 6810A Permanent mount, yellow

**Medium Profile Lamps**

- 6811B Permanent mount lamp, blue
- 6811R Permanent mount lamp, red
- 6811A Permanent mount, yellow
- 6811MA Magnetic mount, yellow, 12 V

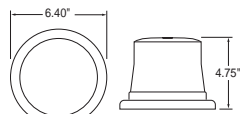

Low Profile

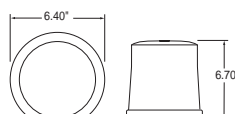

Medium Profile

**Gas Discharge Strobes**

Multi Flash  
Class 1 & 2  
Medium & Low Profile

**Material:**

- Polycarbonate lens
- Metal base

**Light Source:**

- Joules: 11 (single) 15.5 (double) 17.6 (quad)
- Amps: 2 @ 12v
- Voltage: 12 – 24v
- Flash Rate: 80 SFPM, 65 DFPM, 65 QFPM
- Class 1 quad & double flash
- Class 2 single flash

**Replacement Parts:**

- 99220Y/B/R/W medium profile lens
- 99221Y/B/R/W low profile lens
- 92725 strobe tube



- Field selectable flash patterns via internal jumper single, double, quad flash
- LED diagnostic indicator
- Modular circuit is completely encapsulated for increased shock & weather resistance
- Twist on/off lens
- High/Low intensity feature (manual & automatic)
- Designed for surface & pipemount (1" NPT pipe thread)
- LED version covered by 5-year limited warranty



92862Y



92863Y



92860Y

**Low Profile Lamps**

- 92862Y LED permanent mount, yellow
- 92863Y LED magnetic mount, yellow
- 6600R Permanent mount, red
- 6600W Permanent mount, clear
- 6600A Permanent mount, yellow
- 6600MA Magnetic mount, yellow, 12 V

**Medium Profile Lamps**

- 92860Y LED permanent mount, yellow
- 92861Y LED magnetic mount, yellow
- 6601B Permanent mount, blue
- 6601R Permanent mount, red
- 6601W Permanent mount, clear
- 6601A Permanent mount, yellow
- 6601MA Magnetic mount, yellow, 12 V

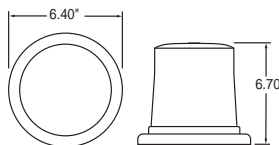

Medium Profile

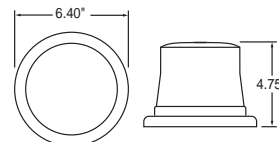

Low Profile

**LED & Gas Discharge Strobes**

Multi Flash Class 1 & 2  
Medium & Low Profile

**Material:**

- Polycarbonate lens & housing
- 18 gauge wire

**Gas Discharge Light Source:**

- Joules: 11 (single) 15.5 (double) 17.6 (quad)
- Amps: 2 at 12v
- Flash Rate: 80 SFPM, 65 DFPM, 65 QFPM
- Class: 1 quad & double flash, 2 single

**LED Light Source:**

- Amps: 0.6 at 12v, 0.3 at 24v
- Class: 1 medium profile, 2 low profile

**Replacement Parts:**

- 99220Y/B/R/W medium profile lens
- 99221Y/B/R/W low profile lens
- 92726 gas discharge strobe tube

## LED & Gas Discharge Strobes

Multi Flash  
Class 1 & 2

### Material:

- Acrylic cover
- Polycarbonate lens
- Aluminum base
- 18 gauge wire

### Gas Discharge Light Source:

- Joules: 11 (single) 15.5 (double) 17.6 (quad)
- Amps: 2 at 12v
- Voltage: 12-24v
- Flash Rate: 80 SFSPM, 65 DFSPM, 65 QFSPM
- Class: 1 quad & double flash
- Class: 2 single flash

### LED Light Source:

- Amps: 0.6 at 12v, 0.3 at 24v
- Voltage: 12-24v
- Class: 1

### Replacement Parts:

- 92725 strobe tube

- Field selectable flash patterns via internal jumper single, double, quad flash
- LED diagnostic indicator
- Clear dust cover seals out dirt & for easy cleaning
- Modular circuit is completely encapsulated for increased shock & weather resistance
- Mounts easily with two toggle bolts on 3-1/2" centers
- 24 customer selectable flash patterns
- High/Low intensity feature (manual & automatic)
- LED version covered by 5-year limited warranty

**92865Y** LED permanent mount lamp, yellow  
**92513Y** Permanent mount lamp, yellow  
**92513C** Permanent mount lamp, clear

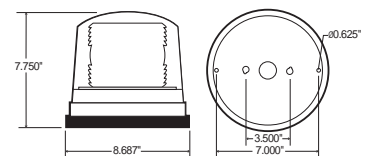

## LED & Gas Discharge Strobes

Multi Flash Class 3

### Material:

- Polycarbonate lens
- ABS base
- 18 gauge wire

### Light Source:

- Joules: 1.5 (strobe)
- Amps - .5 at 12v (strobe) .35 (LED)
- Voltage: 12-72v (strobe) 10-16v (LED)
- Class: 3 LED

### Replacement Parts:

- 92711 strobe tube

- Low profile strobe ideal for many applications
- Twist on/off lens
- LED version offers 29 selectable flash patterns
- Fully encapsulated LED circuitry ensures trouble free operation

**300A** LED permanent mount lamp, yellow  
**301A** LED magnetic mount lamp, yellow  
**307A** Permanent mount lamp, yellow  
**307B** Permanent mount lamp, blue  
**307R** Permanent mount lamp, red

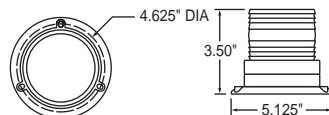

Signal-Stat

LED KITS AVAILABLE



## Gas Discharge Mini Strobes

Quad Flash Class 3

### Material:

- Polycarbonate lens
- ABS base
- 18 gauge wire

### Light Source:

- Joules: 3.75
- Amps - .5
- Voltage: 12v
- Flash rate 65 QFSPM
- Class: 3

### Replacement Parts:

- 92711 flash tube

- Modular components & encapsulated circuitry make for quick repairs & minimize downtime
- Quick snap on lens
- Mounts with 1/2" conduit pipe & includes knockouts for permanent surface mounting
- Review installation instructions & warning labels for proper use

**92534C** Permanent mount lamp, clear  
**92534Y** Permanent mount lamp, yellow  
**92539Y** Magnetic mount lamp, yellow

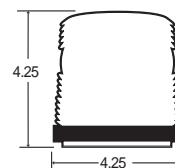

**Signal-Stat**



- Low profile strobe ideal for many applications including material handling market
- Twist on/off lens for field maintenance
- LED version offers 29 selectable flash patterns
- Fully encapsulated LED circuitry ensures trouble free operation

**92560 Permanent mount lamp, yellow**  
**92563 LED Permanent mount lamp, yellow**

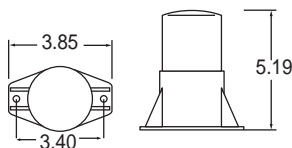

**LED & Gas Discharge Industrial Strobe Class 3**

**Material:**

- Polycarbonate lens
- ABS base
- 18 gauge wire

**Light Source:**

- Joules: 1.75 (strobe)
- Amps - .55 at 12v (strobe) .35v (LED)
- Voltage: 12-110v (strobe) 10-16v (LED)
- Class: 3 LED

**Replacement Parts:**

- 9719A lens
- 8812 strobe tube

**Low Profile Strobe**

**Material:**

- Polycarbonate lens
- Rubber base
- 18 gauge wire

**Replacement Parts:**

- 92713 quad flash power supply
- 92711 flash tube



92531Y

- Modular components & encapsulated circuitry for quick repairs
- Solid state electronics designed for long-term dependability
- Features reverse polarity protection
- Operates in temperatures ranging from -20° F to +135° F
- Operates at 12v, .5 amp & uses 3.0 joules per flash
- Mounts with two holes on 4.125" centers
- Available with magnetic mount & integral cigarette lighter adapter with 12' cord
- Magnet coated with protective rubber to prevent scratches
- Review installation instructions & warning labels for proper use

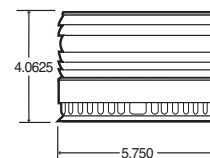

92531Y

**92530Y Permanent mount lamp, yellow**  
**92530C Permanent mount lamp, clear**  
**92531Y Magnetic mount lamp, yellow**

**Rubbolite®**



- Rubbolite M153 series
- "E" & "CE" approved rotating halogen beacons
- Magnetic mount with cigarette plug adapter
- Single bolt, 3 bolt fixings
- 11' cord

**6822A Permanent mount lamp, yellow**  
**6823A Magnetic mount lamp, yellow**

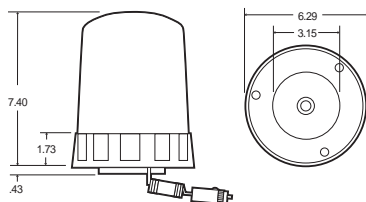

**Halogen Rotating Beacon Single Flash Class 3**

**Material:**

- Acrylic lens
- Rubber base

**Light Source:**

- Voltage: 12-24v
- Class: 3

**Replacement Parts:**

- 9723A lens
- 80563 bulb



## Halogen Rotating Beacon Class 2

### Material:

- Polycarbonate lens
- 18 gauge wire

### Light Source:

- Amps – 3.5
- Voltage: 12v
- Flashes: 120 rpm +/- 5 minute
- Class: 2

### Replacement Parts:

- 99148B/Y lens
- 80563 bulb

- Features magnetic base & 12v DC
- Cigarette plug, 8' max extended
- Improved rotating gear drive mechanism for quieter operation

**92602R** Magnetic mount lamp, red  
**92602Y** Magnetic mount lamp, yellow

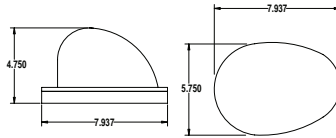

## Halogen Rotating Beacon Class 1

### Material:

- Polycarbonate lens
- Aluminum housing
- 18 gauge wire

### Light Source:

- Amps – 6.5 at 12v
- Voltage: 12v
- Class: 1

- Features heavy-duty motor & shaft assemblies
- Sealed gear assembly eliminates need for lubrication & reduces maintenance
- Review installation instructions & warning labels for proper use

**92600Y** Permanent mount lamp, yellow

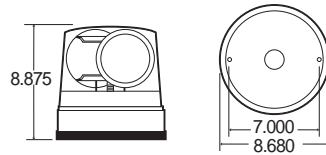



92644



92645



92648

- Sleek aerodynamic design
- Halogen minibar meets CA Title 13
- Halogen version includes two H-1 55W rotators
- Suction mag mount includes 12' straight cord & lighter plug with on/off switch

- 92642Y Yellow, halogen, permanent mount
- 92644Y Yellow, halogen, suction cup magnetic mount
- 92645Y Yellow, strobe, permanent mount
- 92646Y Yellow, strobe, suction cup magnetic mount

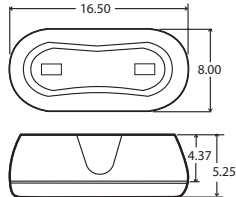

17" Minibars

Class 2

Material:

- Polycarbonate lens & housing
- 18 gauge wire

Light Source:

- Halogen 92642/92644
- Amp – 8
- Volts – 12V
- Class – 2
- Gas Discharge 92645/92646
- Joules – 10.5
- Amp – 9
- Volts – 12V
- Class – 2

Replacement Parts:

- Halogen 92642/92644
- 80563 bulb
- Gas Discharge 92645/92646
- 99200C clear lens
- 92649 flash tube



92522Y

92524Y

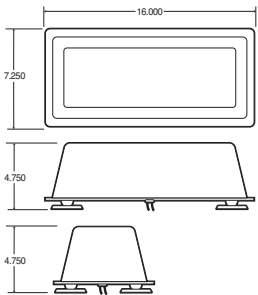

- Magnetic mount includes integral cigarette lighter adapter with 6' cord
- Durable polycarbonate dome resists UV deterioration & are fully gasketed to protect against elements
- Plastic base resists corrosion
- Compact unit operates quietly
- 92524/25 includes two halogen shock mounted, dual ball bearing rotators
- 92524/25 features wall mirror to enhance flashes
- 92522/23 includes user selectable flash pattern (double/quad) w/internal jumper
- 92522/23 features two 360° remote strobe heads, one double "V" mirror
- Review installation instructions & warning labels for proper use

- 92524Y Permanent mount halogen bar, yellow
- 92524B Permanent mount halogen bar, blue
- 92524R Permanent mount halogen bar, red
- 92525Y Magnetic mount halogen bar, yellow
- 92525B Magnetic mount halogen bar, blue
- 92525R Magnetic mount halogen bar, red
- 92522Y Permanent mount strobe bar, yellow
- 92523Y Magnetic mount strobe bar, yellow

16" Minibars

Class 1 & 2

Material:

- Polycarbonate lens & base
- 18 gauge wire

Light Source:

- 92524/92525
- 2-Bulb: #795, T-4 bayonets
- Amps – 8 at 12v
- Voltage: 12v
- Flashes: 80FPM (per rotator)
- Class: 1
- 92522/92523
- Joules: 11.25 (double)
- 17.5 (quad)
- Amps – 2 at 12v
- Voltage: 12-24v
- Class: 2 double quad flash

Replacement Parts:

- 92524/92525
- 92720 rotator assembly
- 92722 halogen bulb
- 92522/92523
- 92715 flash tube



- Compact and quiet operation
- LED version features 25 customer selectable flash patterns via external pattern select wire or internal jumper

- 92866Y Permanent mount lamp, yellow

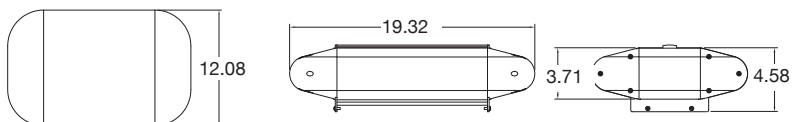

LED Mini-Bar

Material:

- Polycarbonate lens

Light Source:

- Amps: 2 at 12v
- Voltage: 10-30v

## 36" Light Bars

### Material:

- Polycarbonate lens & housing
- Extruded aluminum frame
- 18 gauge wire

### Light Source:

- Amps – 2 (strobe)
- 17.2 (linear strobe)
- 16 (halogen)
- Voltage: 12v
- Watts – 24 (strobe & halogen)
- 180 (linear strobe)

### Replacement Parts:

- 92715 strobe tube
- 92720 halogen rotor assembly
- 92722 halogen bulb

- Halogen version includes two halogen rotators, two fasthalogen rotators & two double V-mirrors
- Features two 360° strobe heads, one 2-head strobe pak, two double v-mirrors
- Compact unit operates quietly
- 110 FPM, 2 amp draw
- Review installation instructions & warning labels for proper use

**92669Y Strobe light bar, yellow**  
**92668Y Halogen light bar, yellow**

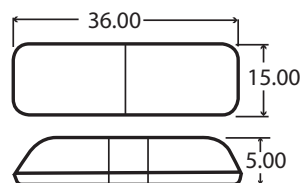
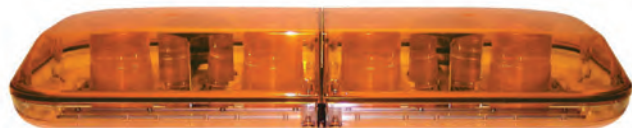

## 46" Light Bars

### Material:

- Polycarbonate lens & housing
- Extruded aluminum frame
- 18 gauge wire

### Light Source:

- Amps – 8.6 (strobe)
- 16 (halogen)
- Voltage: 12v
- Watts – 90 (strobe)
- 50 per halogen rotator

### Replacement Parts:

- 99193Y yellow center dome lens
- 92715 strobe tube
- 92722 halogen bulb
- 92720 rotator assembly

- Halogen version includes two halogen rotators, two fast halogen rotators, three double V-mirrors
- Strobe version features four 360° remote strobe heads, two double v-mirrors, two v-mirrors, one 4-head strobe pak
- Compact unit operates quietly
- Review installation instructions & warning labels for proper use

**92671Y Strobe light bar, yellow**  
**92670Y Halogen light bar, yellow**

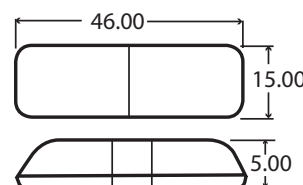
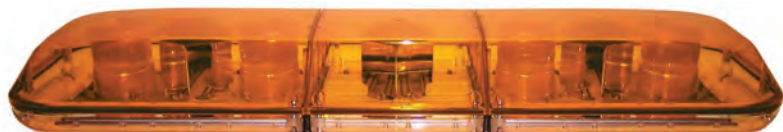

## 46" Light Bars With Directional Arrow

### Material:

- Polycarbonate lens & housing
- Extruded aluminum frame
- 18 gauge wire

### Light Source:

- Amps – 8.6 (strobe)
- 16 (halogen)
- Voltage: 12v
- Watts – 90 (strobe)
- 50 per halogen rotator

### Replacement Parts:

- 99193Y yellow center dome lens
- 92715 strobe tube
- 92720 halogen rotator assembly
- 92722 halogen bulb

- Strobe version includes four 360° remote strobe heads, two double v-mirrors, two v-mirrors, one 4-head strobe pak, rear lower directional arrow assembly with colored filters
- Halogen version includes two halogen rotators, two fast halogen rotators, three double v-mirrors, rear lower directional arrow assembly with colored filters
- Review installation instructions & warning labels for proper use

**92672Y Halogen light bar, yellow**  
**92673Y Strobe light bar, yellow**

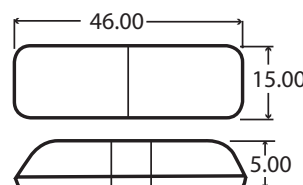



**LED 46" Light Bar**

**Material:**

- Polycarbonate lens & housing
- Extruded aluminum frame
- 18 gauge wire

**Light Source:**

- Amps: 4.6
- Voltage: 10-30v

- Dual level, full output, lightbar less than 4" tall, total height is 6" with mounting
- Adjustable lower level lights allow customizable positioning of light output
- Conformal coated circuitry protects against shock & vibration
- 35 customer selectable flash patterns via external wire
- High/low power select
- Low input voltage detection under 10v DC
- Independent enable of front and rear facing LEDs
- Provides 360 degrees of light

92867Y LED Light bar, yellow

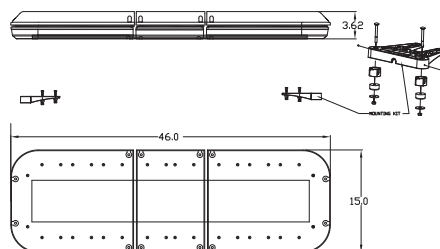

**47" Halogen Rotator Power Bar With Rear Traffic Director**

**Material:**

- Polycarbonate lens & housing
- Extruded aluminum frame
- 18 gauge wire

**Replacement Parts:**

- 99208C clear lower outboard lens
- 99209C clear lower center lens
- 92782 arrowstick light module
- 92761 traffic director control head

- Popular use for utility, construction, security & towing applications
- Features compact design with dual decks
- Extruded aluminum frame will not warp or bend
- Meets SAE J1318 Class I requirements
- Built-in rear traffic director with controller
- H1 55 watt halogen rotating assemblies
- Two diamond mirrors

92677Y Light bar, yellow, 4 rotators

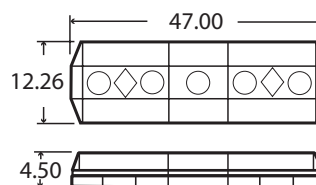



## Hide-A-Way System 2 Lamp Kit

### Light Source:

- Amps: 4.2
- Voltage: 12-24v
- Watts: 40

### Kit Components:

- 92844 kit:  
 2 - 92846 bulbs  
 1 - 6602PS power supply  
 2 - 9944 shielded cable  
 1 - Hi/low/off switch

- Hide-a-way system ideal for many types of vehicles found in fleets such as police, ambulance, fire, wrecker & municipal
- Emphasizes increased light visibility
- Increases vehicle conspicuity to reduce accidental rates (check local legal requirements & restrictions)
- Upgrades existing incandescent rear entry signal lamps
- Includes 2 hide-a-way light heads, 25w remote power supply & 15' shielded cables
- 10 selectable flash patterns
- Requires 1" diameter cut out in signal lamp



**92844 Two lamp system kit**

## Hide-A-Way System 4 Lamp Kit

### Kit Components:

- 92845 kit:  
 4 - 92846 bulbs  
 1 - 6660PS power supply  
 4 - 9944 shielded cable  
 1 - Hi/low/off switch

- Hide-a-way system ideal for many types of vehicles found in fleets such as police, fire, ambulance, wrecker & municipal
- Emphasizes increased light visibility
- Increases vehicle conspicuity to reduce accidental rates (check local legal requirements & restrictions)
- Upgrades existing incandescent rear entry signal lamps
- 10 selectable flash patterns
- Requires 1" diameter cut out in signal lamp
- Includes 4 hide-a-way lighthoods, 60w remote power supply & 15' shielded cables



**92845 Four lamp system kit**

## Cable With AMP Connectors

**9944** 15' shielded cable,  
AMP connectors



## "Hide-A-Way" Strobe Lighthouse

**8370A** Yellow  
**8370W** Clear



## "Hide-A-Way" LED Lighthouse



- Spherical LED heads are designed with diffusing optics for extremely wide angle light output
- LED heads easily replace standard hide-a-way remote strobe tubes (1" mounting hole)
- Changeable colored yellow, blue and red lenses
- 25 customer selectable flash patterns

**92855 LED head w/inline flasher**

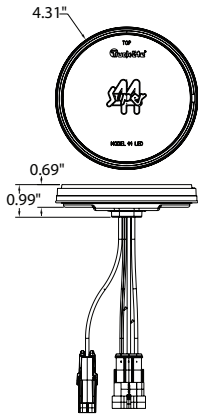

- Super 44® Series strobe lamp provides quad flash pattern with solid state LED technology
- Turn signal override feature momentarily overrides strobe function allowing lamps to signal for turn functions
- Lateral system allows alternating flash patterns without the need of a separate box, saving on cost & additional installation time
- Uses Truck-Lite's 6-Diode 4" round optics pattern to compliment S/T/T and B/U applications
- Fully encapsulated electronics & hard wired design protect lamp from corrosion & damage caused by chemicals & moisture
- New lamp design features slim profile for mounting in limited space areas
- Using 2 in-phase lamps or 2 out-phase lamps provides a synchronized flash, 1 in-phase lamp & 1 out-phase lamp provides alternating flash

- 44110Y Yellow, kit w/connectors
- 44217Y Yellow, in-phase lamp w/connectors
- 44218Y Yellow, out-phase lamp w/connectors
- 44114Y Yellow, kit, blunt cut
- 44248Y Yellow, in-phase blunt cut
- 44249Y Yellow, out-phase blunt cut

**LED Super 44® Strobe w/Turn Signal Override**

**Material:**

- Acrylic lens
- ABS housing
- Packard connection
- 16 gauge wire
- Hard-wired

**Light Source:**

- 6 Light Emitting Diodes (LEDs)
- Designed at 12v, .700 amps
- 9v minimum operating voltage
- Quad flashing pattern

**Kit Components:**

- 44110Y kit:
  - 2 - 44217Y in-phase lamps
  - 2 - 44218Y out-phase lamps
- 44144Y kit:
  - 2 - 44248Y in-phase lamps
  - 2 - 44249Y out-phase lamps

**Legal Specifications:**

- Strobe meets SAE J845 Class II selective coverage warning device
- Turn function meets SAE J1395 rear turn signal lamps
- Overvoltage protection to 600v meets SAE J1455



- External power pack not required
- Metalized reflector version offers more intense focused light
- Non-metalized version offers wider viewing angle
- Dual or quad flashing patterns
- Meets recommended SAE J1318 & J845 photometric specifications
- Synchronized alternating feature
- Lamp life rated at 100,000 hours
- Resistance to shock & vibration
- Fit 'N Forget® adapter plug provides corrosion & moisture resistance
- Integral flange option features

**LED Super 44® Strobe System 42 Diode Pattern**

**Material:**

- Polycarbonate lens, housing & flange
- PVC grommet
- 16 gauge wire

**Light Source:**

- Light Emitting Diodes (LEDs)
- Designed at .13.5v, .50 amp

**Kit Components:**

- 44102R/Y grommet kits:
  - 1 - 44212R/Y metalized reflector
  - 1 - 40700 grommet
  - 1 - 95220 connector
- 44101R/Y grommet kits:
  - 1 - 44211R/Y non-metalized reflector
  - 1 - 40700 grommet
  - 1 - 95220 connector
- 44104Y flange kits:
  - 1 - 44214R/Y metalized reflector
  - 1 - 95220 connector
- 44103Y flange kits:
  - 1 - 44213R/Y non-metalized reflector
  - 1 - 95220 connector

**Recommended Accessories:**

- Mounting: Pages 253-255



**Grommet Kits w/Metalized Reflector**

- 44102R Red
- 44102Y Yellow

**Grommet Kits w/Non-Metalized Reflector**

- 44101R Red
- 44101Y Yellow



**LED Lamp w/Metalized Reflector**

- 44212R Red
- 44212Y Yellow

**LED Lamp w/Non-Metalized Reflector**

- 44211R Red
- 44211Y Yellow

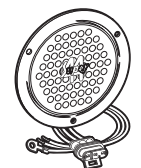

**Flange Kits w/Metalized Reflector**

- 44104Y Yellow

**Flange Kits w/Non-Metalized Reflector**

- 44103Y Yellow



**LED Lamp & Gray Flange w/Metalized Reflector**

- 44214R Red
- 44214Y Yellow

**LED Lamp & Gray Flange w/Non-Metalized Reflector**

- 44213R Red
- 44213Y Yellow

## LED Super 60® Strobe System 36 Diode Pattern



### Material:

- Polycarbonate lens, housing & flange
- PVC grommet
- 16 gauge wire

### Light Source:

- Light Emitting Diodes (LED)
- Designed at 13.5v, .50 amp

### Recommended Accessories:

- 60721 decorative grommet cover
- 60719 stainless steel flange cover
- 60734 assembly box

### Kit Components:

60120R/Y grommet kits:

- 1 - 60362R/Y metalized reflector
- 1 - 60700 grommet
- 1 - 95220 connector

60122R/Y grommet kits:

- 1 - 60360R/Y non-metalized reflector
- 1 - 60700 grommet
- 1 - 95220 connector

60124R/Y flange kits:

- 1 - 60364R/Y metalized reflector
- 1 - 95220 connector

60126R/Y flange kits:

- 1 - 60366R/Y non-metalized reflector
- 1 - 95220 connector

### Recommended Accessories:

- Mounting: Pages 256-257



- External power pack not required
- Metalized reflector version offers more intense focused light
- Non-metalized version offers wider viewing angle
- Dual or quad flashing patterns
- Meets recommended SAE J1318 & J845 photometric specifications
- Mounts horizontally or vertically
- Lamp life rated at 100,000 hours
- Resistance to shock & vibration
- Fit 'N Forget® adapter plug provides corrosion & moisture resistance
- Integral flange option features built-in lens

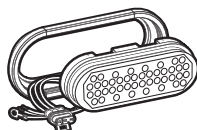

### LED Grommet Kits w/ Metalized Reflector

- 60120R Red
- 60120Y Yellow

### LED Grommet Kits w/ Non-Metalized Reflector

- 60122R Red
- 60122Y Yellow

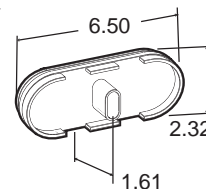

### LED Lamp w/ Metalized Reflector

- 60362R Red
- 60362Y Yellow

### LED Lamp w/Non- Metalized Reflector

- 60360R Red
- 60360Y Yellow

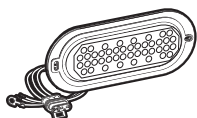

### LED Flange Kits w/ Metalized Reflector

- 60124R Red
- 60124Y Yellow

### LED flange Kits w/Non- Metalized Reflector

- 60126R Red
- 60126Y Yellow

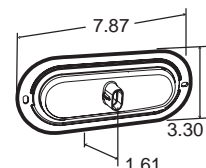

### LED Lamp & Flange w/Metalized Reflector

- 60364R Red
- 60364Y Yellow

### LED Lamp & Flange w/Non-Metalized Reflector

- 60366R Red
- 60366Y Yellow

## LED 30® Series Self-Flashing 3 Diode Pattern

### Material:

- Polycarbonate lens & housing

### Light Source:

- Light Emitting diodes (LEDs)
- Designed at 13.5v, .06 amp

### Recommended Accessories:

- Mounting: Pages 253-255
- Plugs: Pages 225-228

- Utilized to warn operator of fault conditions
- Features internal circuitry to create self-flashing lamp
- Flashes when power supplied (80 FPM)
- Uses Fit 'N Forget® connector for added corrosion & moisture resistance
- Not for standard marker applications, for auxiliary/strobe use only
- External power pack not required

- 30286R Lamp only, red
- 30286Y Lamp only, yellow

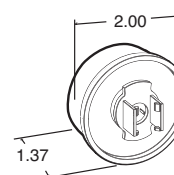





- LED retrofit kit for front loader waste haulers
- Features 2 LED Model 60 front, park & turn lamps & 4 LED Super 44 turn signal lamps

55597 Front loader retrofit kit

## LED Front Loader Retrofit

### Light Source:

- Light Emitting diodes (LEDs)
- 12 volt designed at 14v, .5 amp

### Kit Components:

- 1 - 97252 LED flasher
- 1 - 88824 chassis harness adapter
- 4 - 44201Y LED Super 44 T/S lamps
- 4 - 40700 4" grommets
- 6 - 94706 PL3 adapters
- 2 - 60290Y LED Model 60 F/P/T lamps
- 2 - 60700 oval grommets



- LED retrofit kit for rear loader waste haulers
- Features 4 LED Super 44 lamps with all components needed to upgrade your existing system

55598 Rear loader retrofit kit

## LED Rear Loader Retrofit

### Light Source:

- Light Emitting diodes (LEDs)
- 12 volt designed at 14v, .5 amp

### Kit Components:

- 1 - 97252 LED flasher
- 1 - 88824 chassis harness adapter
- 4 - 44201Y LED Super 44 T/S lamps
- 4 - 40700 4" grommets
- 4 - 94706 PL3 adapters



**Typical Two-Light Systems**

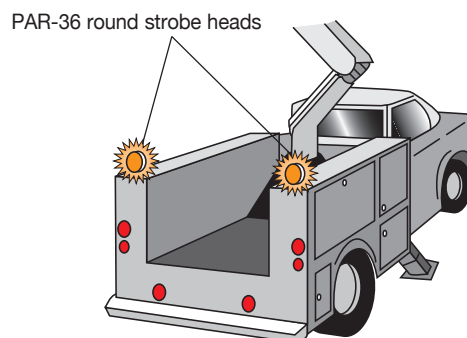
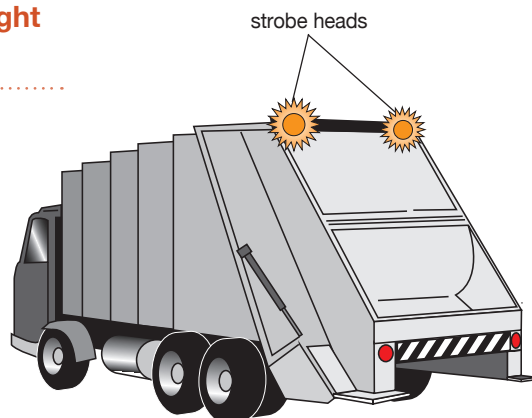

**Typical Four-Light Systems**

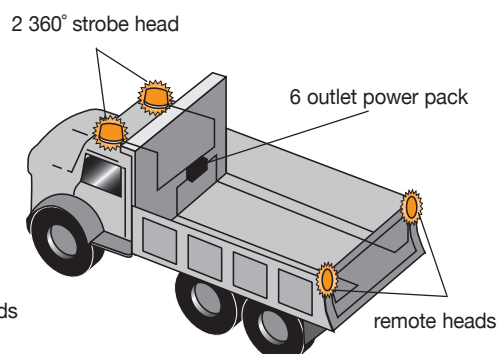
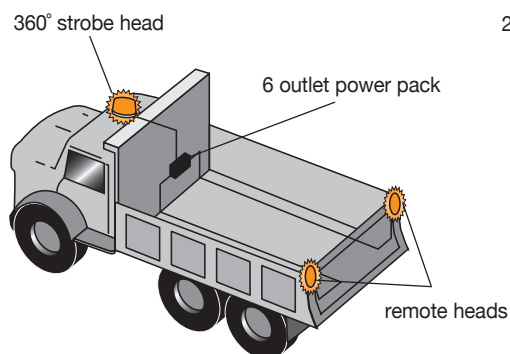

**Cable With Weatherproof Connector**

- Shielded cable reduces RFI (radio frequency interference)
- AMP connector at power supply end
- Deutsch weatherproof connector at remote strobe head end
- Detailed instructions included

- 9930 30' Shielded Cable, Weatherproof Connector
- 9940 40' Shielded Cable, Weatherproof Connector



**Remote Strobe Adapter**

- Used to convert a remote strobe systems with Packard connectors to Deutsch connectors

- 94236 Adapter, new harness to old strobe
- 94247 Adapter, new strobe to old harness



94236

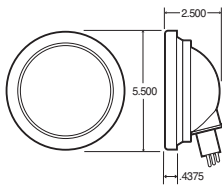

- Includes mounting grommet & weather-tight connectors
- Contains one flash tube rated for over five million flashes
- Lamp flush mounts

92550Y Yellow

**Remote Strobe Head**

**Material:**

- Polycarbonate lens & housing
- Black PVC grommet
- 18 gauge wire

**Recommended Accessories:**

- 92740 high/low switch

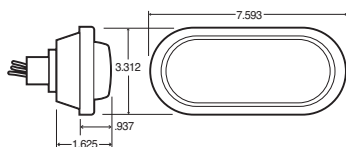

- Includes mounting grommet & weather-tight connectors
- Contains one flash tube rated for over five million flashes
- Lamp flush mounts

92551Y Yellow

**Remote Strobe Head**

**Material:**

- Polycarbonate lens & housing
- Black PVC grommet
- 18 gauge wire

**Recommended Accessories:**

- 92740 high/low switch

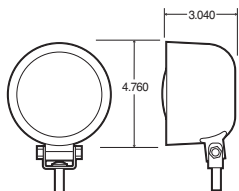

- Durable synthetic rubber housing resists corrosion
- Mounts to the grill or rear of the vehicle on one 5/16"-18 stud
- Features watertight connectors
- Contains one sealed beam flash tube rated for 5 million flashes
- Universal mounting bracket

92553Y Yellow

**Par 36 Remote Strobe Head**

**Material:**

- Synthetic rubber (TPE) housing
- Polycarbonate lens
- 18 gauge wire

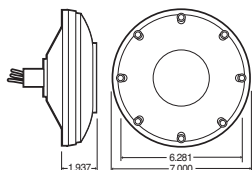

- Includes weather-tight connectors
- Contains one flash tube rated for over five million flashes
- Surface mounts to the rear of the vehicle by four holes on a 6.28" circle

92552Y Yellow

**Remote Strobe Head**

**Material:**

- Polycarbonate lens & housing
- 18 gauge wire

**Remote Strobe Head**

**Material:**

- Polycarbonate lenses
- Aluminum base
- 18 gauge wire

**Recommended**

**Accessories:**

- 92740 high/low switch

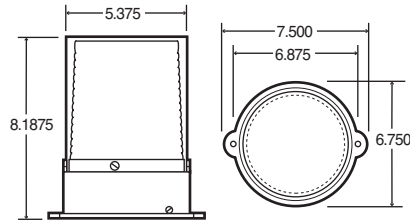

- Includes 180" cable
- Contains one flash tube rated for over five million flashes

**92554Y Yellow**

**Remote Strobe Head**

**Material:**

- Polycarbonate lens & housing
- Black foam gasket
- 18 gauge wire

**Recommended**

**Accessories:**

- 92740 high/low switch

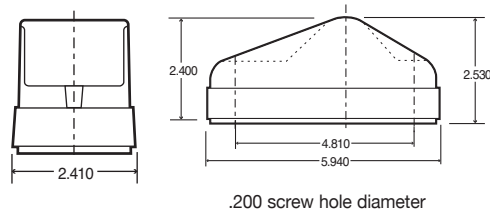

- Foam gasket provides additional seal between the vehicle body & the lamp
- Includes weather-tight connectors
- Contains one flash tube rated for over five million flashes
- Provides 270° of strobe warning light

**92556Y Yellow**

**Remote Strobe Head**

**Material:**

- Polycarbonate lens & housing
- Black PVC grommet
- 18 gauge wire

**Recommended**

**Accessories:**

- 92740 high/low switch

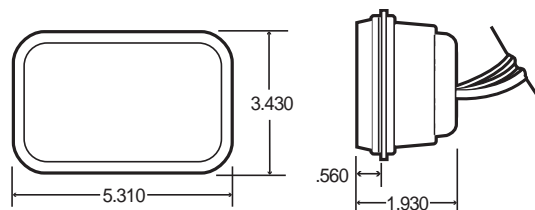

- Contains one flash tube rated for over five million flashes
- Ideal for use on LLV Postal vehicles
- Lamp flush mounts

**92557Y Yellow**



- Durable synthetic rubber housing resists corrosion
- Includes mounting hardware
- Mounts on 5/16" – 18 stud
- External power pack or control module not required
- Meets SAE J1318 & J845 photometric specifications
- Synchronized alternating feature

44216R Lamp, red  
44216Y Lamp, yellow

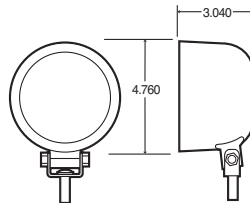

**LED Super 44®  
Strobe  
Rubber Housing**

**Material:**

- Polycarbonate lens
- Rubber housing
- 16 gauge wire

**Light Source:**

- Light Emitting diodes (LEDs)
- Designed at 13.5v

**Replacement Parts:**

- 44211R/Y lamp

**Total:**

- Input
- Output

**Per Lamp: Watts/Joules**

- 2 lamp only alternating
- 4 lamp only alternating
- 6 lamp only alternating

**Model  
6602PS**

**Watts/Joules**

35w  
25w/11.2 joules

**Model  
6660PS**

75w  
60w

12.5w/11.2 joules  
—  
—

15w  
15w  
10w

**Power Supply  
Information Chart**



6660PS



6602PS

- Flash patterns comply with SAE J1318 requirements for on-time/off time
- 6602PS/6606PS supply remote strobe heads with 80 quad flashes per minute
- 6660PS supply remote strobe heads with 70 quad or double flashes per minute
- High/low power control
- Input current regulation
- Input reverse polarity protection
- 6602PS draws 3 amp, 12 VDC - 1.5 amp, 24 VDC
- 6660PS draws 6 amp, 12 VDC - 3 amp, 24 VDC
- Recommend using only with shielded cable to avoid RFI problems

6602PS 12-24v – two outlets, 25 watt output  
6660PS 12-24v – six outlets, 60 watt output

**Power Supplies**

**Material:**

- Aluminum housing
- 18 gauge wire

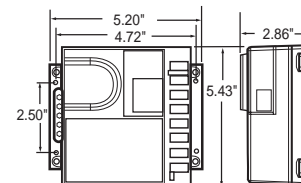
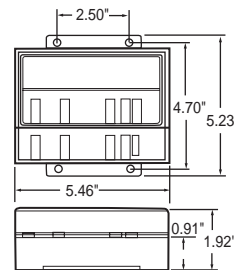



**LED Traffic Control**

**Material:**

- Polycarbonate lens
- Anodized aluminum housing

**Light Source:**

- Amps: 2.1
- Voltage: 10-16v

- Extremely weather resistant & high efficient LED optics
- Control unit is micro-processor controlled with tactile front
- Modules front load for easy replacement of individual lightheads
- Meets J595 Class 1 and J578 Color

**92868Y** LED module, 1-1/2"H x 47-1/2"W x 1-1/2"D  
**92869Y** LED module, 2-7/32"H x 47-1/2"W x 1-1/2"D

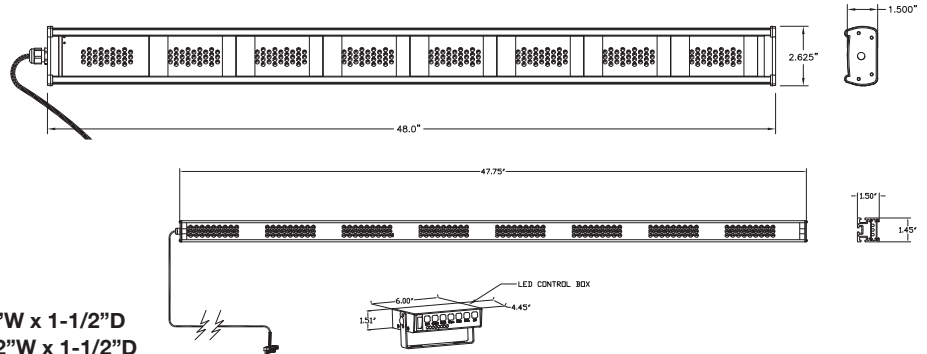

**Auxiliary Traffic Control Advisors**

**Material:**

- Polycarbonate lens
- Aluminum housing
- 18 gauge wire

**Replacement Parts:**

- 60-20123 bulb, 20w
- 92849 control head for 1968A



- Perfect for mounting to a utility body, the rear of a light bar, or as a stand alone rear deck unit
- Lightweight aluminum housing
- Halogen model includes tilt/pedestal mounting brackets that will accommodate vertical or horizontal mounting surfaces – no large body panel cutouts required for installation
- L.E.D. model features low profile surface mount which installs easily with just four screws Includes mounting hardware, control head, 15' cable & connectors
- L.E.D. model offers long life (L.E.D.s rated for 100,000 hours) and low current draw (.5 amp per lamp)
- Current draw on halogen model is 1.5 amps. per light head at 13.6 VDC
- Control head features four operating modes & eight programmable patterns with L.E.D. display of pattern in operation

**9680A** Eight lamp halogen traffic advisor with control head, black powder painted finish  
**19680A** Eight lamp L.E.D. traffic advisor with control head, black powder painted finish

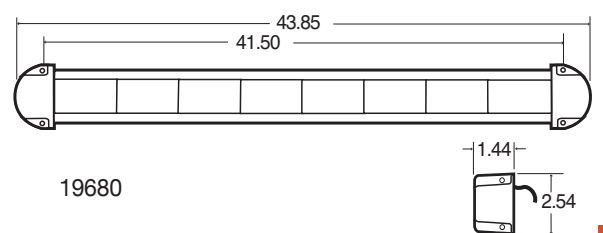
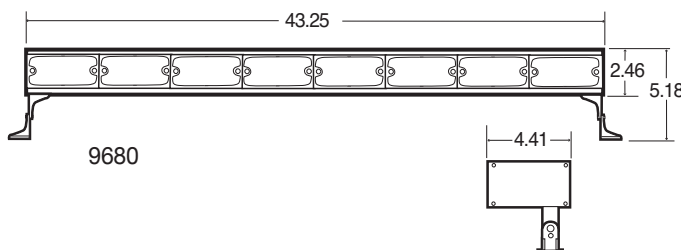



**LED Exterior Lighting**  
**Single Version**  
16 Diodes

**Material:**

- Black or silver aluminum housing

**Light Source:**

- Light Emitting Diodes (LEDs)
- 12-24v, 0.2 amp

- Designed for excellent versatile perimeter lighting
- Directional warning for any type of vehicle including trash, D.O.T., wreckers & utility vehicles
- Features five user-selectable flash pattern per light head
- Meets SAE J1318 Class II, J845, J595 when properly configured
- Potted circuitry & waterproof power supply
- Very bright signal in compact design
- Low amp draw
- Easy installation

92695R Red, aluminum housing  
92695Y Yellow, aluminum housing

92696R Red, black housing  
92696Y Yellow, black housing

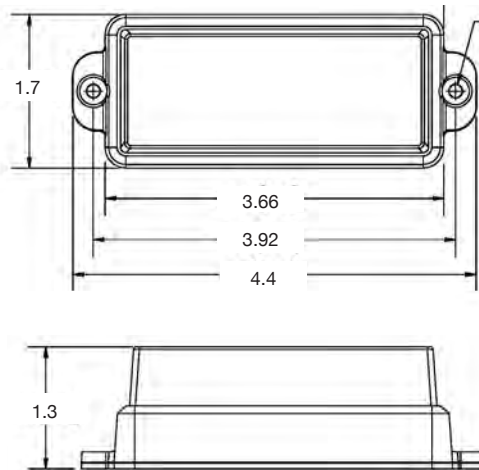
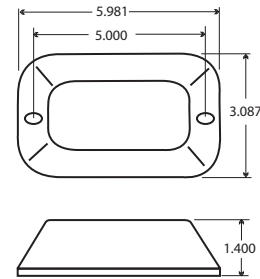

**LED Exterior Lighting**  
**Surface Mount**

**Dimension:**

- 4.4"W, 1.7"H, 1.3"D

**Recommended Accessories:**

- 92877 Black bracket
- 92878 Chrome bracket

- Versatile surface mount direction LED provides both flash pattern selection and synchronization capability via trigger wires
- Meets SAE J595 and J845, SAE Class 1, Cal. Title 13
- 16 flash patterns
- 3 High intensity LEDs
- Synchronization capable
- 12 V
- Encapsulated electronics extend product life
- 5-year manufacturers warranty

92870Y Yellow      92870C Clear  
92870B Blue      92870R Red

**LED Exterior Lighting Surface Mount**

**Dimension:**

- 3.8"W, 2"H, 0.3"D
- 5.1"W, 1.5"H, 0.3"D

**Recommended Accessories:**

92871 Series:

- 92880 Chrome bracket

92872 Series:

- 92882 Chrome bracket

- 18 High intensity LEDs
- 16 flash patterns including random
- Synchronization capable
- Encapsulated electronics extend product life
- 9-16 V
- 2-year manufacturers warranty

<b>92871Y</b>	<b>Yellow</b>	<b>92872Y</b>	<b>Yellow</b>
<b>92871B</b>	<b>Blue</b>	<b>92872B</b>	<b>Blue</b>
<b>92871C</b>	<b>Clear</b>	<b>92872C</b>	<b>Clear</b>
<b>92871R</b>	<b>Red</b>	<b>92872R</b>	<b>Red</b>

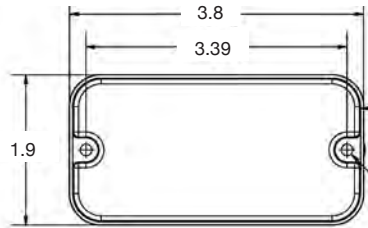
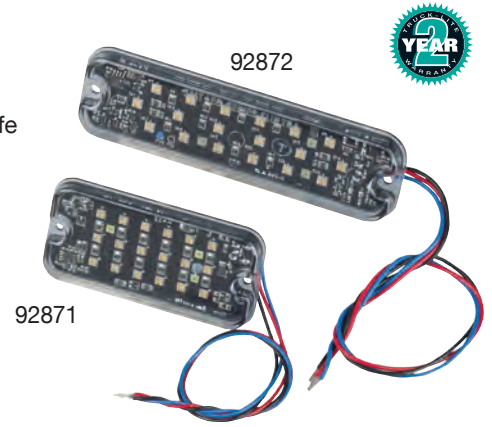

92871

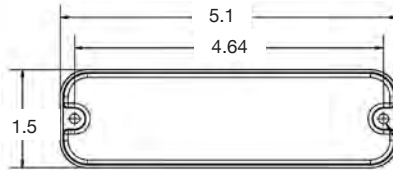

92872

**LED Exterior Lighting Surface or Grommet Mount**

- 56 High intensity LEDs
- 3 flash patterns including random
- Extremely thin design
- 12 V
- 2-year manufacturers warranty

<b>92873R</b>	<b>Red, oval grommet mount</b>
<b>92873Y</b>	<b>Yellow, oval grommet mount</b>
<b>92874R</b>	<b>Red, round grommet mount</b>
<b>92874Y</b>	<b>Yellow, round grommet mount</b>
<b>92875R</b>	<b>Red, oval surface mount</b>
<b>92875Y</b>	<b>Yellow, oval surface mount</b>
<b>92876R</b>	<b>Red, round surface mount</b>
<b>92876Y</b>	<b>Yellow, round surface mount</b>



92876R/Y



92874R/Y



92873R/Y

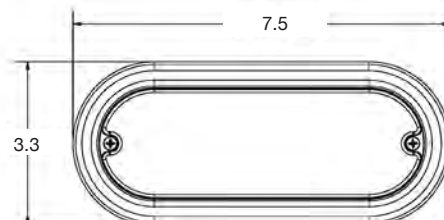
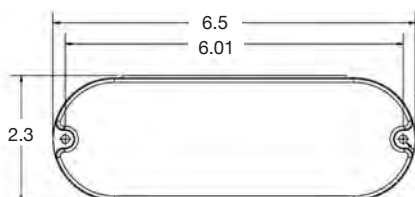
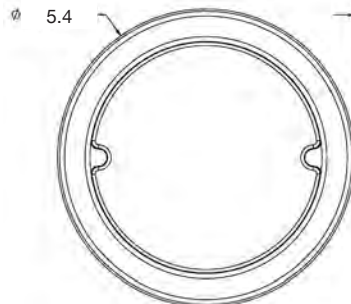
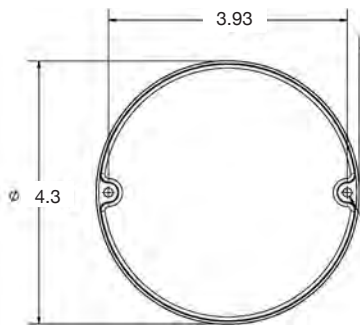



92546

- Fits medium profile SWL LED emergency lights
- Mounts on 5.93 diameter bolt hole

92545 Medium profile, 7.1" tall

**Branch Guards**

Material:

- Black painted steel

- Fits low profile SWL LED emergency lights

92546 Low profile, 5.3" tall



9702

- Four 3" diameter magnets with hardware
- 90# pull force
- For use with 6850A strobe bar

9674 Set of four magnets

**Magnet Kits**

- Kit contains: magnet, hardware, foam pad, 8' cigarette plug
- 90# pull force
- For use with 6600, 6601, 6610, 6810, and 6811 strobe beacons

9702 Magnet mount kit

**Accessories**

- Genuine Whelen replacement H27SN12
- Snap-in halogen bulb for Whelen 64, 508, 810 & 830 series scenelight lamps

60-27123



- Genuine Whelen replacement H35TL12
- Twist-lock 35 watt halogen bulb for Whelen 52, 64, 73 & 97 series lamps\*

60-35121



- Genuine Whelen replacement H50TL12
- Twist-lock 50 watt halogen bulb for Whelen 97 series lamps\*

60-50121



- Genuine Whelen replacement H50SN12
- Snap-in 50 watt halogen bulb for Whelen 64 & 73 series lamps & 4000 series light bar\*

60-50123



- Genuine Whelen replacement H50ASN12
- 50 Watt Snap-in
- Halogen

60-50124



- Strobe tube

92725



- Flash tube

92711



- Flash tube

8812



- Flash tube for 92560 strobes

92562



- Halogen bulb

92722





Accessories

- For 300, 301, 302, 309 & 337 series strobe lamps, 12v

88-43210



- For 6600, 6601, 6610 & 6611 strobe lamps, Whelen FT-10A

8810



- For 6800, 6801, 6810 & 6811 strobe lamps, Whelen FT-20A

8820



- Genuine Whelen replacement S30TL
- Twist-Lock flash tube for Whelen fire/ambulance strobe lamps

8830



- Genuine Whelen replacement TURBO64
- Linear flash tube for Whelen 64 series strobe lamps

8840



.240 x 6"

- Genuine Whelen replacement TURBOTUBE
- For Whelen 9000 series lightbars

8850



.240 x 6.75"

- Genuine Whelen replacement A20TLWD
- For 9770A

88-2101



- Genuine Whelen replacement ASTUBE
- For 6850A

88-2126



- Genuine Whelen replacement H20SN12
- 20 Watt Snap-in Halogen for 9680A

60-20123



- Genuine Whelen replacement STOPTL12
- Twist-lock dual filament bulb for Whelen 52, 64, 73 and 97 series S/T/T lamps\*

60-25121



- Genuine Whelen replacement STOPSN12
- Snap-in-dual filament bulb for Whelen 508, 810, 830 series S/T/T lamps

60-25123



- Genuine Whelen replacement H27TL12
- Twist-lock 27 watt halogen bulb for Whelen 52, 64, 73 & 97 series lamps\*

60-27121



# Mirror & Reflector Systems

# Mirror & Reflector Systems

**Mirror Systems**

**166-182**



**Reflective Tape**

**183-185**



**Reflectors**

**186-188**



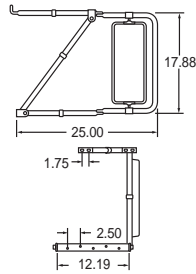
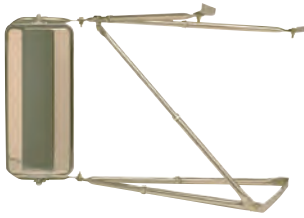

- Arms: 18" vertical span, 15" - 20" horizontal adjustment
- Swing away yoke
- Fits most conventional style trucks
- Replaces Signal-Stat 7515

**97693 Mirror kit**

## Universal West Coast Mirror Assembly Kits

### Material:

- Stainless steel housing and yoke
  - Silvered glass
- Replacement Parts:**
- 97822 mirror head
  - 97725 swing away yoke

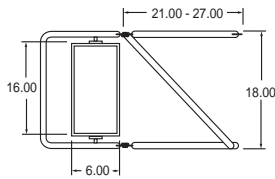

- Extends 18" - 23" as needed
- Swing away yoke helps prevent damage
- Fits all conventional style trucks
- Replaces Signal-Stat 7513

**97694 Mirror kit, black**

## Universal West Coast Mirror Assembly Kits

### Material:

- Black painted steel housing and yoke
  - Silvered glass
- Replacement Parts:**
- 97629 mirror head
  - 97726 swing away yoke

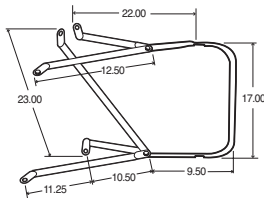

- Replacement for International Truck S-Series (4000-4700)
- Includes brackets, outer yoke and hardware
- Mirror not included

**97695 Mirror kit**

## West Coast Mirror Bracket Kit

### Material:

- Aluminum housing and yoke
- Recommended Accessories:**
- Mirror heads 97624 and 97625

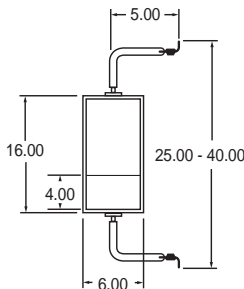

- Arms: 25" - 40" vertical, stainless steel finish 5" horizontal, stainless steel finish
- Fits any straight-sided vehicles and some tilt cabs
- Convex mirror on lower portion allows wide angle view without separate mirror
- 7/8" hex compression nut fits heavy duty 3/4" tubing
- Replaces Signal-Stat 7514

**97633 Mirror kit w/wide angle vision**

## Wide Angle West Coast Mirror Assembly Kit

### Material:

- Stainless steel
  - Silvered glass
- Replacement Parts:**
- 97634 mirror head



### Jr. West Coast Mirror Assembly Kit

#### Material:

- Stainless steel housing and yoke
- Silvered glass

#### Replacement Parts:

- 97643 mirror head

- Stainless steel mirror head
- Arms: 16-3/4" - 24" vertical, stainless steel finish, 13-3/4" - 15" horizontal, stainless steel finish
- Ideal for most pick-up trucks, small stake trucks and campers
- 7/8" hex compression nut fits heavy duty 3/4" tubing
- Replaces Signal-Stat 7547

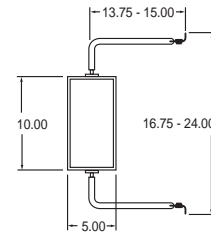

**97644 Jr. west coast**

### Step Van Mirror Assembly Kits

#### Material:

- Painted steel housing and yoke
- Silvered glass

#### Replacement Parts:

##### 97846 stainless steel

- 97847 6-1/2" x 10" flat
- 97674 6-1/2" x 6" flat
- 97848 6-1/2" x 6" convex

##### 97669 white steel

- 97673 6-1/2" x 10" flat
- 97676 6-1/2" x 6" flat
- 97671 6-1/2" x 6" convex

#### Universal clamps

- 97733 head clamp

- Replacement heads for Grumman Olson, Union City Body and Utilmaster vehicles
- Silvered mirror glass resists pitting, peeling and corrosion
- Glass is mounted in vinyl gasket
- Features a brushed stainless steel finish
- Flexible, adjustable bracket expands from 17" to 32" to fit most vehicles and offset mounting points
- Popular for use on step van and package delivery vans
- Assembly includes two mirrors – 6-1/2" x 10" flat glass head and 6-1/2" x 6" convex glass head
- Fits to either side of the vehicle
- Mounting hardware and bracketry also included
- Replaces Signal-Stat 7580/7581

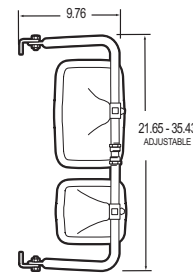

**97846 Stainless steel**  
**97669 White painted steel**

### Passenger and Cargo Van Mirror Assembly 8-1/2" Convex

#### Material:

- Stainless steel

#### Replacement Parts:

- 97803 mirror head

- Universal tripod bracket mounts easily to most Ford, Chevy and Dodge Vans
- Assembly includes 8" mirror head, tripod bracket, stainless steel hardware and fasteners
- Primarily used for rear vision when backing up vehicle
- 5/16" adjustable female ball stud and mount
- Replaces Signal-Stat 7770/7771

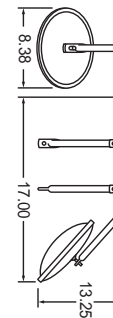

**97664 Stainless steel**  
**97665 White**

### Step and Commercial Van Assembly 10-1/2" Convex

#### Material:

- Stainless steel

#### Replacement Parts:

- 97863 mirror head

- Universal mounting bracket fits on step vans and other vehicles with flat mounting area
- Assembly includes 10-1/2" mirror head, reinforced 3/4" O.D. tubing arm, heavy duty mounting brackets and stainless steel hardware
- 5/16" adjustable female ball stud and mount
- Replaces Signal-Stat 771

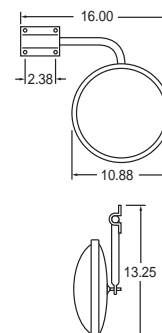

**97862 Stainless steel**

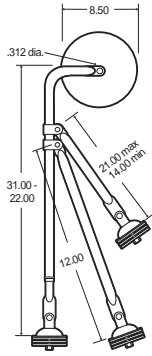

- Designed for conventional long nose trucks
- Bell mounts include 3" coated washers and 3" steel washers to prevent damage to fiberglass fenders
- Main arm expands from 22" to 31"; top support arm expands from 14" to 21"; bottom support arm is 12", non-adjustable

**97686 Tripod fender assembly**

## Tripod Fender Assembly Kit 8-1/2" Convex

**Material:**

- Stainless steel bracket
- Silvered glass

**Replacement Parts:**

- 97829 bracket
- 97803 convex mirror

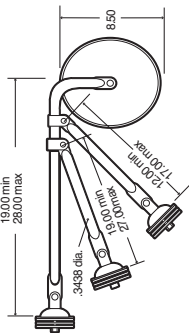

- Designed for newer aerodynamic styled heavy duty trucks, fitting most fiberglass, steel and aluminum fenders and hoods
- Stainless steel construction and fasteners

**97687 Fender mount assembly kit**

## Fender Mount Assembly Kit 8-1/2" Convex

**Material:**

- Stainless steel bracket

**Replacement Parts:**

- 97803 convex mirror

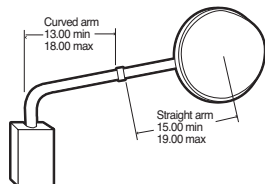

- Kit includes convex mirror head, nickel plated brass compression nuts, straight and curved arm bracket, installation instructions
- Meets NYS law 1446-2

**97688 Hood mounted assembly kit**

## Hood Mounted Assembly Kit 8-1/2" Convex

**Material:**

- Stainless steel bracket

**Replacement Parts:**

- 97803 convex mirror

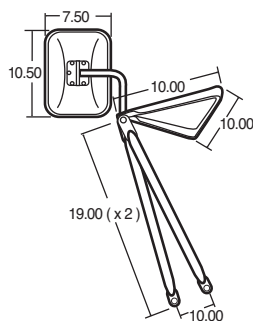

- Head can be positioned outside for wide vehicles or inside for narrow clearances
- Mounts below eye level to improve visibility to the front of vehicle
- Rugged stainless steel bracketry
- Kit includes mounting brackets and instructions
- Designed for full size pick-up trucks
- Size: 7-1/2" x 10-1/2" mirror head
- Replaces Signal-Stat 7559

**97681 Door/Fender assembly kit**

## Door/Fender Assembly Kit 7-1/2" x 10-1/2" Head

**Material:**

- Stainless steel housing and bracket
- Silvered glass

**Replacement Parts:**

- 97805 mirror head
- 97748 offset elbow

### Internal Elbow Tripod Assembly Kit 7-1/2" x 10-1/2" Head

#### Material:

- Stainless steel housing and bracket
- Silvered glass

#### Replacement Parts:

- 97662 mirror head

- Designed for full size pick-up trucks
- Extendable for trailer towing by swinging head out
- Glass mounted in ozone resistant vinyl gasket
- Kit includes mounting hardware and instructions

#### 97682 Internal elbow tripod assembly kit

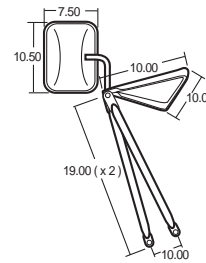

### OE Style Tripod Assembly Kits 7-1/2" x 10-1/2" Head

#### Material:

- Stainless steel housing and bracket
- Silvered glass

#### Replacement Parts:

- 97805 stainless steel mirror head
- 97660 white mirror head
- 97869 offset elbow

- Fits both right and left side of Chevy, Ford, GMC and other pick-ups and vans
- Features "second surface" silvered glass that resists pitting, peeling and corrosion
- Glass is mounted in vinyl gasket
- Slotted top bracket allows assembly to fit most light and medium duty vehicles
- Fits either the left or right side
- Assembly features bright stainless steel finish
- Includes 7-1/2" x 10-1/2" mirror, mounting hardware and instructions
- Replaces Signal-Stat 7546/7560

#### 97680 OE style tripod assembly kit, white 97852 OE style tripod assembly kit, stainless steel

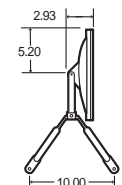
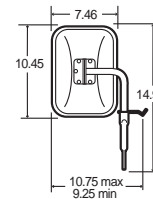

.28 dia.  
3 places



### Light Duty Tripod Assembly Kit 5-1/2" x 7-1/2" Head

#### Material:

- Stainless steel housing and bracket
- Silvered glass

#### Replacement Parts:

- 97655 mirror head
- 97869 offset elbow

- Below eye level tripod bracketry
- For smaller size vehicles
- Kit includes mounting hardware and installation instructions
- Simple, versatile, easy to mount
- Size: 5-1/2" x 7-1/2" mirror head
- Replaces Signal-Stat 7556

#### 97678 Light duty tripod assembly kit

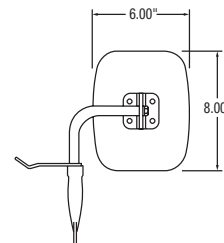

### Truck and Van Mirror Kits

#### Material:

- Stainless steel housing
- Aluminum bracket

#### Replacement Parts:

- 7224 mirror head, RH
- 7223 mirror head, LH

- Ford F0TZ-17696B and F0TZ-17696A
- Fits F-Series Pickups, Broncos 1987-1991; Vans 1975-1991
- Door mount with swing away feature
- Aerodynamic design
- Aluminum arm
- Stainless steel is corrosion free

#### 7218 Truck and van mirror kit, RH 7217 Truck and van mirror kit, LH

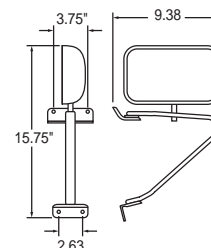

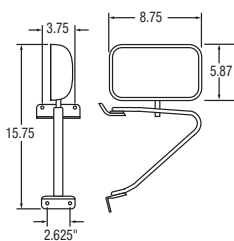

- Fits both left and right sides
- Door mount with swing away feature
- Aluminum arm
- ABS plastic is corrosion free

**7555 Universal truck and van mirror kit, chrome**  
**7557 Universal truck and van mirror kit, black**

## Universal Truck and Van Mirror Kits

**Material:**

- ABS plastic housing
- Aluminum bracket

**Replacement Parts:**

- 7269 chrome mirror head
- 7268 black mirror head

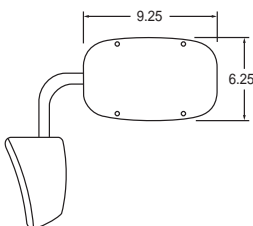

- Fits Chevy and GMC vans and pick-ups
- Extra wide field of vision
- Universal mounting bracket, fits right or left side
- Rust and corrosion resistant

**7575 Chevy / GMC truck and van mirror**

## Chevy/GMC Truck and Van Mirror

**Material:**

- Chrome plated steel housing

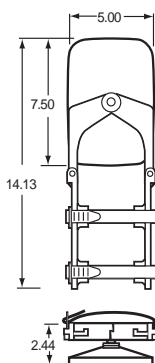

- Fits most pickups and vans
- Reduces accidents
- Installs with rubber strap to provide broad viewing area
- Black plastic housing with adjustable arm
- Flat lens with no distortion

**7973D Tow mirror extender, retail pack**

## Tow Mirror Extender

**Material:**

- Plastic housing
- Silvered glass





## Motorized Mirror Head

7" x 16"

### Material:

- Stainless steel housing
- Silvered glass
- Acrylic bezel
- 4 wires, 18 gauge, 53" long

### Recommended Accessories:

- 97843 rigid mount bracket
- Replacement Parts:
- 97845 heater element, 12v, 4 amp

- Light weight stainless steel housing weighs only 4 lbs.
- Features a sealed gearless motor that withstands manual adjustment without damage
- Turning mechanism designed to eliminate over rotation with built-in 60° adjustment limits
- Field replaceable PTC heating element that provides continuous heat even in sub-zero temperatures
- Fits most standard OEM brackets and mounts on two 5/16"-18 bolts
- 97840 replaces Moto Mirror R7-2410 and Velvac #2010
- Replaces Signal-Stat 7087/A

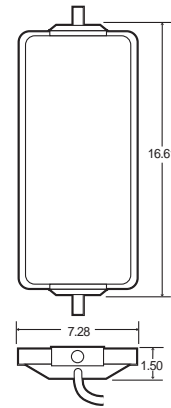

**97840 Motorized mirror head, heated**

## OEM Style Mirror Head

7" x 16"

### Material:

- Stainless steel housing
- Silvered glass
- Acrylic bezel
- 3 wires, 18 gauge, 60" long

### Light Source:

- 2 - Bulb: #67, G-6 bayonet
- Designed at 13.5v, .59 amp and 4 cp

### Recommended Accessories:

- 97843 rigid mount bracket
- Replacement Parts:
- 97845 heater element, 12v, 4 amp

- Standard OEM design
- 5/16"-18 mounting studs
- Heavy duty 2 channel constructions
- Wired for 12 volt systems with 60" leads
- Replaces Signal-Stat 7084/7085 series

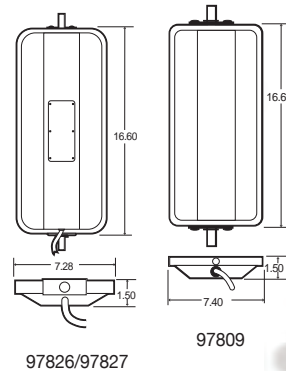

- 97822 OEM style mirror head**
- 97809 OEM style mirror head, heated**
- 97826 OEM style mirror head, lighted**
- 97827 OEM style mirror head, heated, lighted**

## Box Style Mirror Head

7" x 16"

### Material:

- Stainless steel or aluminum housing
- Silvered glass
- Acrylic bezel
- 2 Conductor cable, 18 gauge, 60" long

### Recommended Accessories:

- 97843 rigid mount bracket

### Replacement Parts:

- 97845 heater element, 12v, 4 amp

- Freightliner/Sterling style replacement
- Designed as a "rod-thru" style head with a 5/16"-18 threaded rod
- Field replaceable PTC heating element that provides continuous heat even in sub-zero temperatures
- Fits most standard OEM west coast brackets and mounts on two 5/16"-18 bolts
- Replaces Signal-Stat 7815-7819 series

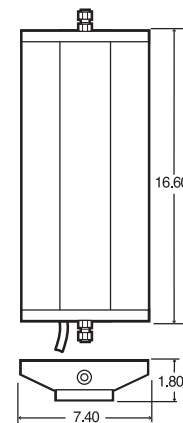

**97837 Box style mirror head, heated**

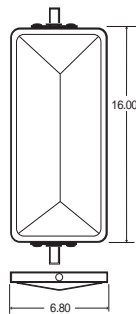

- Standard OE replacement for all pyramid back mirrors
- Mounts on two 5/16"-18 bolts
- Replaces Signal-Stat 7800/7801/7803/7804/7810/7814

- 97861** Pyramid style mirror head, stainless steel
- 97866** Pyramid style mirror head, stainless steel, heated
- 97636** Pyramid style mirror head, black
- 97637** Pyramid style mirror head, white

## Pyramid Style Mirror Head 7" x 16"

### Material:

- Stainless steel housing
- Silvered glass
- 18 gauge wire

### Recommended Accessories:

- 97843 rigid mount bracket

### Replacement Parts:

- 97845 heater element, 12v, 4 amp

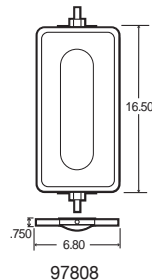

97808

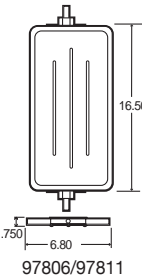

97806/97811

- Fits most standard OEM brackets with T-bolt mount
- Bubble back and rib back designs are popular for use on construction and delivery trucks
- Mounts on two 5/16"-18 bolts
- Replaces Signal-Stat 7081/7082/7083/7093

- 97806** Rib back mirror head, white
- 97811** Rib back mirror head, black
- 97650** Rib back mirror head, black, heated
- 97808** Bubble back mirror head, white

## One Piece Mirror Head 7" x 16" Ribbed and Bubble Back Styles

### Material:

- Painted steel housing
- Silvered glass
- 16 gauge wire

### Recommended Accessories:

- 97843 rigid mount bracket

### Replacement Parts:

- 97845 heater element, 12v, 4 amp

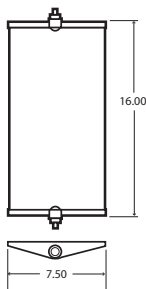

- OEM replacement for International S-series and other trucks
- Full vinyl gasket insulated glass
- Heated mirrors feature International "bullet style" door plug
- Mounts with two 5/16 x 1-1/2" stainless bolts

- 97624** Flange mount mirror head
- 97625** Flange mount mirror head, heated, LH

## Flange Mount Mirror Head 7" x 16"

### Material:

- Aluminum housing
- Silvered glass

### Recommended Accessories:

- 97695 bracket

### Replacement Parts:

- 97845 heater element, 12v, 4 amp

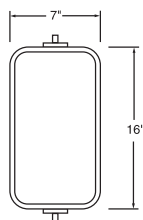

- Stainless steel west coast mirror head with 7" x 5" rectangular covex for wide angle view
- 5/16"- 18 stainless "T" bolts
- Replaces Signal-Stat 7086

- 97635** Wide angle mirror head

## Wide Angle Mirror Head 7" x 16"

### Material:

- Stainless steel housing
- Silvered glass

### Economy Mirror Head 6" x 16"

#### Material:

- Aluminum housing
- Silvered glass

#### Light Source:

- Bulb: #193

#### Replacement Parts:

- 97845 heater element, 12v, 4 amp
- 8933A lens

- Rod through construction
- 5/16" stud diameter with center rod
- Electrostatic applied paint provides additional corrosion protection
- Heater keeps glass free from icing and fogging
- Replaces Signal-Stat 7001/7005/7006/7010

- 97628 Economy mirror head, white**  
**97629 Economy mirror head, black**  
**97627 Economy mirror head, aluminum**  
**97630 Economy mirror head, aluminum, heated**  
**97631 Economy mirror head, aluminum, heated, lighted**

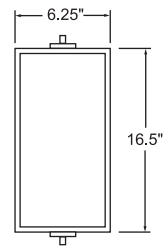

97631

### Box Style Mirror Head 6" x 16"

#### Material:

- Stainless steel or aluminum housing
- Silvered glass

#### Recommended Accessories:

- 97843 rigid mount bracket

- Designed as a "rod-thru" style head with a 5/16"-18 threaded rod
- Can be used as is or painted to match vehicle color

- 97812 Box style mirror head, stainless steel**  
**97860 Box style mirror head, aluminum**

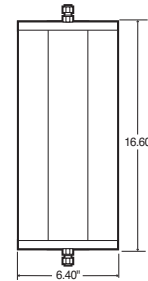

### Wide Angle Mirror Head 6" x 16" Economy

#### Material:

- Anodized aluminum housing
- Silvered glass
- Acrylic reflector

- 5/16" stud diameter, center rod
- Convex mirror on lower portion allows wide angle view without separate mirror
- Replaces Signal-Stat 7002

- 97632 Wide angle mirror head**

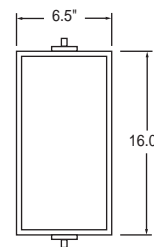

### Tube Mount Mirror Head

#### Material:

- Plastic housing
- Convex glass

- Convex glass with no distortion
- Does not meet FMVSS 111 requirements for West Coast Mirrors
- Use for added safety on off-highway equipment
- Fits 5/8 Ø O.D. mirror tubes
- Black ABS plastic housing
- Includes mounting clamp which tightens onto mirror tube with one screw

- 7460 Tube mount mirror head**

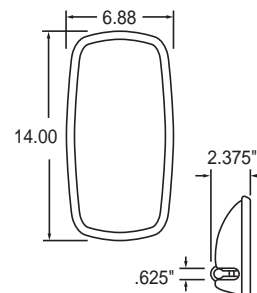

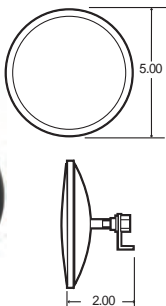

- Mounts with a 5/16" adjustable, female threaded ball stud to help prevent thread damage
- Replaces Signal-Stat 7061/7062

**97802 Convex mirror, black**  
**97872 Convex mirror, Stainless steel**

## Convex Mirror 5" Round

### Material:

- Steel housing
- Silvered glass

### Recommended Accessories:

- **97823 universal mounting kit**
- 97828 fender mount bracket
- 97829 tripod mound bracket

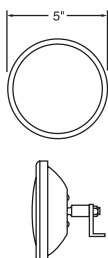

- Mounts with a 5/16" adjustable, female threaded ball stud to help prevent thread damage
- Replaces Signal-Stat 7313/7314/7315

**97618 Convex mirror, stainless steel**  
**97619 Convex mirror, black**

## Convex Mirror 5" Round

### Material:

- Zinc plated stainless steel housing
- Silvered glass

### Recommended Accessories:

- 97823 universal mounting kit
- 97828 fender mount bracket
- 97829 tripod mound bracket



- Mounts with a 5/16" adjustable, female threaded ball stud to help prevent thread damage
- Replaces Signal-Stat 7319/7328

**97612 Flat glass mirror, white**  
**97611 Flat glass mirror, black**

## Flat Glass Mirror 5" Round

### Material:

- Painted stainless steel housing

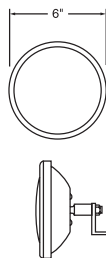

- Mounts with a 5/16" adjustable, female threaded ball stud to help prevent thread damage
- Replaces Signal-Stat 7316/7317/7318

**97621 Convex mirror, stainless steel**  
**97622 Convex mirror, black**  
**97623 Convex mirror, white**

## Convex Mirror 6" Round

### Material:

- Zinc plated stainless steel housing
- Silvered glass

### Recommended Accessories:

- 97823 universal mounting kit
- 97828 fender mount bracket
- 97829 tripod mound bracket



97819 SHOWN



97820 SHOWN

- Mounting: 5/16" - 24 female ball stud
- Replaces Signal-Stat 7070/7071/7072

**97819 Convex mirror, stainless steel**  
**97820 Convex mirror, black**

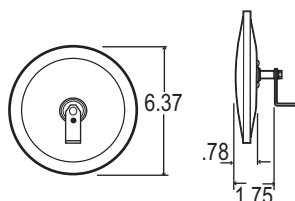

## Convex Mirror Head 6" Round

### Material:

- Steel housing
- Silvered glass

### Recommended Accessories:

- 97823 universal mounting kit
- 97828 fender mount bracket
- 97829 tripod mound bracket



### Convex Mirror Head 7-1/2" Round

**Material:**

- Stainless steel housing

- Mounting: 5/16" female adjustable ball stud and bolt
- Replaces Signal-Stat 7077

- 97815 Convex mirror, stainless steel, centered**  
**97816 Convex mirror, black, centered, ribbed**  
**97817 Convex mirror, stainless steel, w/offset mount**

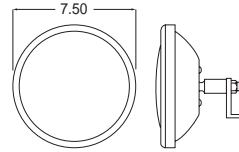

97817

### Convex Mirror Head 8-1/2" Round

**Material:**

- Steel housing
- Silvered glass

**Recommended Accessories:**

- 97823 universal mounting kit
- 97828 fender mount bracket
- 97829 tripod mound bracket

- Popular school bus convex head
- Mounting: 5/16" female adjustable ball stud and bolt
- Replaces Signal-Stat 7073/7074/7090

- 97803 Convex mirror, stainless steel**  
**97804 Convex mirror, black**  
**97814 Convex mirror, stainless steel, w/offset mount**

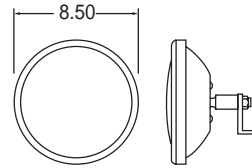

97814

### Convex Mirror Head Offset w/Heater 8-1/2" Round

**Material:**

- Steel housing
- Silvered glass

**Recommended Accessories:**

- 97823 universal mounting kit
- 97828 fender mount bracket
- 97829 tripod mound bracket

- 2.5 amps 12 VDC only
- 60" wire length (can use switch #102)
- Mounting: 5/16" female threaded adjustable ball stud with 1/2" bolt
- Replaces Signal-Stat 7078/7079/7091

- 97614 Convex mirror stainless steel, heated**  
**97615 Convex mirror, black, heated**

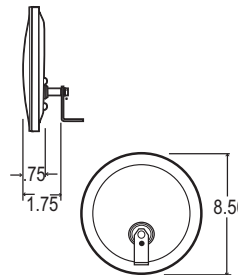

### Full-Bubble Wide Angle Convex Mirror Head 8-1/2" Round

**Material:**

- Painted steel housing
- Acrylic mirror

- Extra wide design helps eliminate blind spots for medium duty vehicles
- Mounts on a 5/16" adjustable, female threaded ball stud to prevent thread damage
- For use on many medium duty vehicles and buses
- Replaces Signal-Stat 7046

- 97831 Full bubble wide angle convex mirror, black**  
**97606 Full bubble wide angle convex mirror, stainless steel**

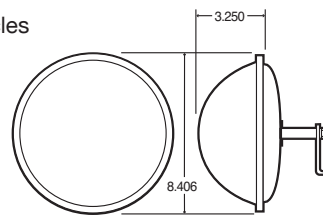

### Cross View Convex Mirror Head 10-1/2" Round

**Material:**

- Steel housing
- Acrylic lens

- Replacement mirror head for vans, straight trucks and panel trucks
- Directly replaces mirror head on 97862 assemblies
- 5/16" adjustable female ball stud and bolt included
- Increases visibility in blind spots
- Replaces Signal-Stat 7796/7797

- 97863 Cross view convex mirror, stainless steel**

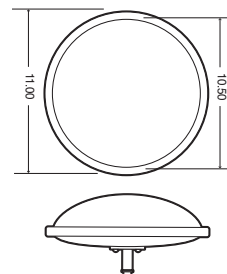

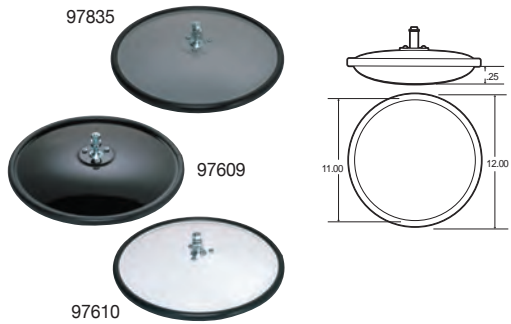

- Ideal spot mirror for large off-highway construction and earth moving equipment
- Popular as interior spot mirror on transit bus applications
- Corrosion resistant powder coated finish
- Large 1" steel ball stud with 3/8" - 24 threads for secure mounting and precise positioning
- Replaces Signal-Stat 7419/7420/7421

**97835 Convex mirror, gray**  
**97610 Convex mirror, white**  
**97609 Convex mirror, black**

## Convex Mirror Head 12" Round

### Material:

- Steel housing
- Silvered glass

### Recommended Accessories:

- 97823 universal mounting kit
- 97828 fender mount bracket
- 97829 tripod mound bracket

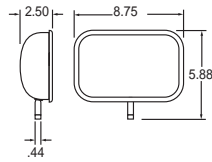

- Universal replacement head
- Replacement head for 7555 and 7557
- 1/4" female ball stud

**7268 Universal truck and van mirror head, black**  
**7269 Universal truck and van mirror head, chrome**

## Universal Truck and Van Mirror Head 5-1/2" x 8-1/2"

### Material:

- ABS plastic housing
- Silvered glass

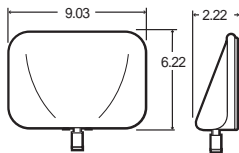

- 6" x 9" mirror head mounts with 5/16" - 18 female threaded ball stud
- Replaces Signal-Stat 7067/7068

**97659 Universal mirror head, black**

## Universal Mirror Head For Low Mount Assemblies

### Material:

- Stainless steel housing
- Silvered glass

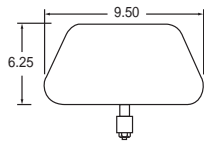

- Replacement head for part #97750
- Features chrome plated plastic corrosion free housing
- 5/16" - 18 female threaded ball stud
- Replaces Signal-Stat 7065

**97794 Mirror head, chrome**

## Mirror Head 6-1/4" x 9-1/2"

### Material:

- Chrome plated plastic
- Silvered glass

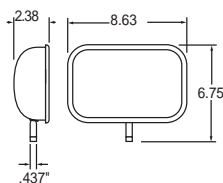

- OEM replacement for Ford F-Series
- Replacement for 7217 and 7218 assemblies
- 1/4" female ball stud

**7223 Truck and van mirror head, LH**  
**7224 Truck and van mirror head, RH**

## Ford Truck and Van Mirror Head 5-1/2" x 8-1/2"

### Material:

- Stainless steel housing
- Silvered glass



### Convex Mirror Head 6" x 8"

#### Material:

- Stainless steel housing
- Silvered glass

- 5/16" adjustable female ball stud and bolt
- Fits west coast tripod fender assemblies

**97602** Convex mirror, stainless steel  
**97603** Convex mirror, black

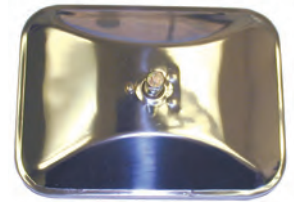
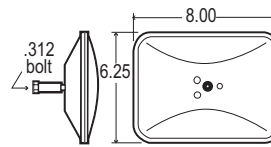

### Wide Angle Flat and Convex Mirror Head For Step Van Assemblies

#### Material:

- Stainless steel housing
- Silvered glass

- Brushed painted or stainless steel finish
- For use with 97846 and other assemblies
- Replaces Signal-Stat 7400-7405

**97674** Flat, stainless steel, 6-1/2"x6"  
**97676** Flat, white, 6-1/2"x6"  
**97848** Convex, stainless steel, 6-1/2"x6"  
**97671** Convex, white, 6-1/2"x6"  
**97847** Flat, stainless steel, 6-1/2"x10"  
**97673** Flat, white, 6-1/2"x10"

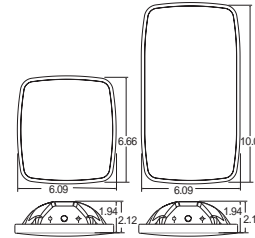

### Light Truck Mirror Head 5-1/2" x 7-1/2"

#### Material:

- Steel housing
- Silvered glass

- For use as a general purpose mirror
- Uses 5/16" - 16 adjustable, female threaded ball stud to prevent thread damage
- Replaces Signal-Stat 7041/7075/7076

**97807** Light truck mirror head, white  
**97654** Light truck mirror head, black  
**97653** Light truck mirror head, stainless steel

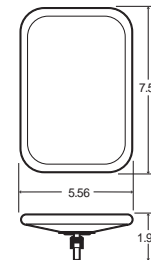

97807

### Light Truck Mirror Head 5-1/2" x 7-1/2"

#### Material:

- Stainless steel housing
- Silvered glass

- For small pick-ups
- Center bracket mount
- Replacement head for part #97678
- Replaces Signal-Stat 7052

**97655** Light truck mirror head

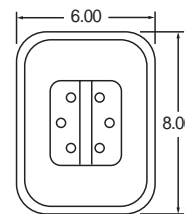

### Light and Medium Duty Truck Mirror Head 5-1/2" x 8-1/2"

#### Material:

- Stainless steel housing
- Vinyl gasket, black
- Silvered glass

- Popular size is ideal for use on moving and package delivery vehicles
- 5/16" adjustable ball stud mounting
- Replaces Signal-Stat 7059

**97656** Light and medium duty truck mirror head, stainless steel  
**97657** Light and medium duty truck mirror head, black

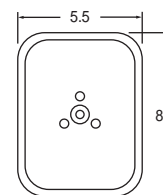

97656

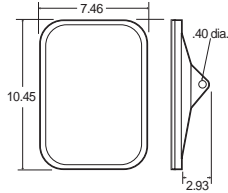

97805

- Features bright stainless steel finish
- For use as a replacement for 97852 and 97681
- Replaces Signal-Stat 7053/7054

- 97805 Medium duty truck mirror head, stainless steel**
- 97660 Medium duty truck mirror head, white**

## Medium Duty Truck Mirror Head 7-1/2" x 10-1/2"

### Material:

- Stainless steel housing
- Silvered glass

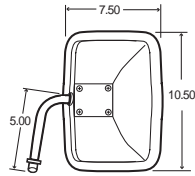

- Popular replacement for Ford, Chevy and Dodge trucks
- Features internal stainless steel elbow

- 97661 Medium duty truck mirror head, 4" elbow**
- 97662 Medium duty truck mirror head, 5" elbow**

## Medium Duty Truck Mirror Head 7-1/2" x 10-1/2" Rectangular

### Material:

- Stainless steel housing
- Silvered glass

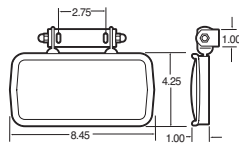

- Convex mirror adds vision to trucks, buses and other vehicles
- Fits either side of the vehicle
- Includes stainless steel mounting bracket
- Mounts above down window
- Replaces Signal-Stat 7057

- 97865 Over the door convex mirror**

## "Over the Door" Convex Mirror 4" x 8" Rectangular

### Material:

- Stainless steel housing
- Silvered glass



COUNTER DISPLAY

- Eliminates blind spots
- Adhesive back mirrors will mount on any clean flat surface
- Triples viewing area
- Black plastic housing
- Enhances viewing area for rectangular and square OEM side view mirrors

- 7038 2" round**
- 7039 3" round**
- 7044D 3-3/4" round, retail pack**
- 7044DB 3-3/4" round counter display box of 20**
- 7048D 4" x 5" rectangular**
- 7048DB 4" x 5" counter display box of 20**

## Stick-On Convex Mirrors

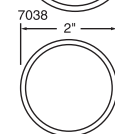
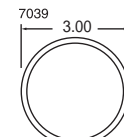
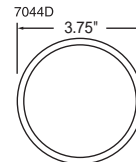
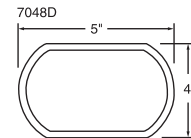

7038



7039



7044D



7048D



### Rigid Mount Bracket For West Coast Mirrors

**Material:**

- Steel housing

- Features Heavy Duty, stainless steel construction
- Includes steady brace, hardware and assembly instructions
- Adjusts to fit most medium and heavy duty trucks
- For use with 6" x 16" or 7" x 16" west coast mirror heads
- Replaces Signal-Stat 7113/7115/7117

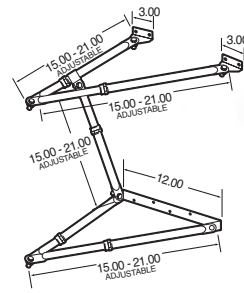

**97843 Rigid mount bracket**

### Tripod Bell Mount Fender Bracket For Convex Mirror Heads

**Material:**

- Stainless steel bracket

- Tripod extension-arms mount to most fiberglass, steel or aluminum fenders
- For use with convex mirror heads to increase wide angle vision and to minimize blind spots
- Bell mount design includes 3" coated washers to prevent damage to fiberglass fenders
- Designed for use on conventional long nose trucks
- Replaces Signal-Stat 7111/7112

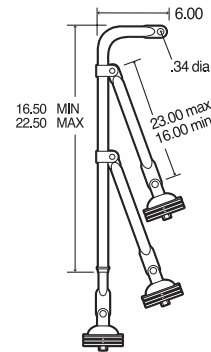

**97829 Tripod bell mount fender bracket, 22.5"**

### School Bus Fender Bracket

**Material:**

- Steel bracket

- Black painted steel
- Extends 13"-25" after mounting
- Can be used with any ball stud convex mirror
- Replaces Signal-Stat 7110

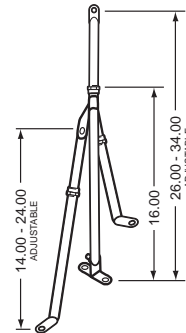

**97666 School bus fender bracket**

### Safety Yoke Bracket

**Material:**

- Steel bracket

- Adds swing away feature to any West Coast assembly
- Provides protection against damage in tight spots
- Comes complete with mounting clamps
- Size: 17-7/8" spread, 7-7/8" span
- Replaces Signal-Stat 7114/7118

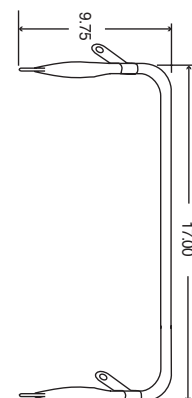

**97726 Safety yoke bracket, black**  
**97725 Safety yoke bracket, stainless steel**

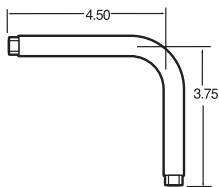

- Direct replacement for original elbows on medium duty mirrors
- Designed with 3/4" tubing, at 4-1/2" length
- For use with OE Style Tripod Assemblies (97852) and Large Rectangular Mirror Heads (97805)
- Replaces Signal-Stat 7933

**97869 Offset elbow extension**

## Offset Elbow Extension For Tripod Mirror Assemblies

**Material:**

- Stainless steel elbow

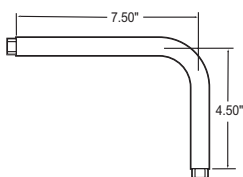

- Replacement elbow for 97681 mirror
- Provides vertical extension for tripod mounted mirrors
- Replaces Signal-Stat 7936
- Designed at 3/4" tubing at 7-1/2" length

**97748 Offset elbow extension**

## Offset Elbow Extension For Tripod Mirror Assemblies

**Material:**

- Stainless steel

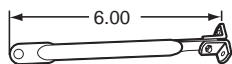

- 6" body mounting arm
- Black painted steel
- Replaces Signal-Stat 7202

**97720 Mounting arm**

## 6" Mounting Arm

**Material:**

- Black painted steel



97721

- Can be used as mirror bracket or brace with any convex or West Coast mirror assembly
- Clamps on 3/4" tubular arm
- Replaces Signal-Stat 7325/7326

**97721 Adjustable mirror brace, 15"-26"**  
**97722 Adjustable mirror brace, 10"-13"**

## Adjustable Mirror Brace

**Material:**

- Steel bracket



97722

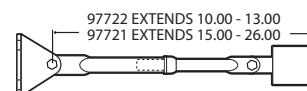

### Bell Mount Fender Bracket For Convex Mirror Heads

**Material:**

- Stainless steel bracket

- Features Heavy Duty stainless steel construction
- Single extension-arm mounts to most fiberglass, steel or aluminum fenders
- For use with 6" or smaller convex mirror heads or added support to other brackets
- Bell mount design includes 3" plastic washers to prevent damage to fiberglass fenders
- Replaces Signal-Stat 7331/7332



**97828 Bell mount fender bracket, 15"**

### 180° Extension Arm

**Material:**

- Stainless steel

- For use in mounting convex mirrors to "below eye level" mirror assemblies
- Mounting on 8-1/4" centers
- Replaces Signal-Stat 7922

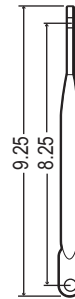

**97731 180° extension arm**

Mirror kit sold separately

### Universal Extender Bracket

**Material:**

- Black painted stainless steel

- Extends 10"-16"
- Black painted steel

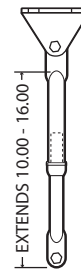

**97719 Universal extender bracket**

### Extension Bracket

**Material:**

- Chrome

- Extends mirror heads on low mount tripod
- 3/8"-16 thread (course)
- Replaces Signal-Stat 7924

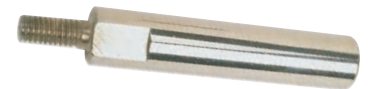

**97730 Extension bracket**

### 90° Mounting Bracket

**Material:**

- Stainless steel

- Door mount bracket for 97727 and 97843 mirror arm assemblies and 97633 and 97694 west coast mirror assemblies
- Mounting: 1-1/2" centers
- Replaces Signal-Stat 7926

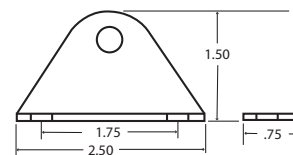

**97876 90° Mounting bracket**



- Fits either 3/4" or 5/8" diameter tubing
- Attaches convex mirrors to other bracketry with a two-part, clamshell style clamp
- Kit includes a 4-1/2" extension arm, and "L" bracket, clamshell clamp pieces and hardware
- Replaces Signal-Stat 7941

**97823 Universal mounting kit**

## Universal Mounting Kit For Convex Mirror Heads

**Material:**

- Stainless steel bracketry

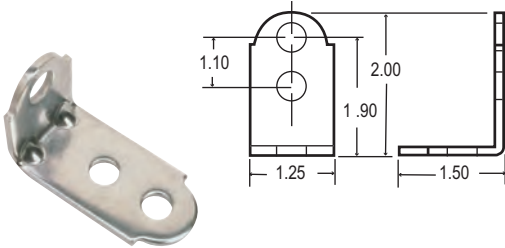

- For use with 5"-8-1/2" convex mirror heads
- Replaces Signal-Stat 7929

**97718 "L" bracket**

## "L" Bracket For Convex Mirror Heads

**Material:**

- Steel bracket

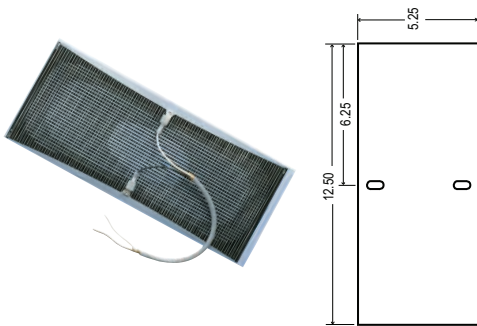

- Replacement heater element for West Coast mirrors
- Improved temperature control limits the temperature to 145°
- Draws 4.0 amp
- Replaces Signal-Stat 7930

**97845 Heater element, 12v**

## Heating Element

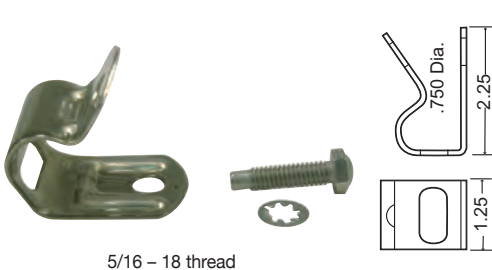

- Single piece stainless steel clamp and hardware
- Clamp has plastic coating to protect painted surfaces
- Replaces Signal-Stat 7932

**97733 Clamp for 3/4" O.D. tube**

## Clamp

**Material:**

- Stainless steel

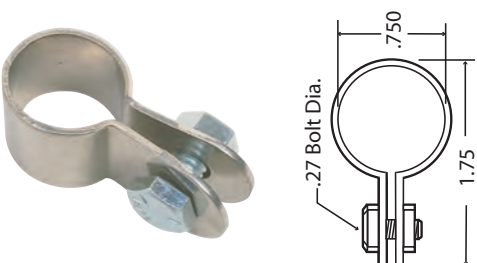

- Clamps onto 3/4" tubular arm
- Replacement for most west coast and tripod assemblies
- 1/4" holes
- Replaces Signal-Stat 7928

**97732 Universal clamp**

## Universal Clamp

**Material:**

- Stainless steel



## Reflective Tape

### Universal Features and Benefits

- Designed through use of multiple prismatic lenses formed in transparent, synthetic resin
- Tough, durable and rigid non-corroding conspicuity marking tape options are resistant to weather, dirt, aging and cracking
- Impact resistant, withstanding a blow from a forklift or loading dock while maintaining retro-reflective properties
- Strong tape construction and adhesive w/easily removable liner prevents lifting to look like new long after application
- Up to 1,000 candle power for maximum long side detection distance performance, exceeding legal requirements by up to 400%
- Vivid, bright color assures maximum reflectivity and superior daytime and color
- Reflects light at all application angles on the roadway
- Exceeds FHWA specifications
- All tape shown below has DOT-C2 markings

### Premium Reflective Marking Tape

- More rigid construction resists curling for easy application that goes on straight
- .014" to .018" thick Flexible Prismatic conspicuity tape

98100	White, 2" x 150' roll
98101	Red/White, 2" x 150' roll
98102	Red/white, 3" x 150' roll
98107	Red/white, 1 -1/2" x 150' roll
98104	Red/white, 2" x 18" strip
98113	Red/white, 2" x 24" strip
98105	White, 2" x 12" strip
98108	Red/white, 2" x 54" strip



### Standard Reflective Marking Tape

- More flexible construction conformable to vehicle rivets, adhering well to uneven surfaces and around corners
- .010" to .014" thick Flexible Prismatic conspicuity tape

98126	White, 2" x 150' roll
98127	Red/white, 2" x 150' roll
98146	Red/white, 2" x 150' roll, Kisscut (precut every 12" at color break)
98111	Red, 2" x 150' roll
98137	White, 2" x 12" strip
98136	Red/white, 2" x 18" strip
98138	Red/white, 2" x 54" strip
98144	Trailer kit w/o underride, 48' length



### Signal-Stat Line Economy Marking Tape

- More flexible construction conformable to vehicle rivets, adhering well to uneven surfaces and around corners
- .010" to .014" thick tape w/Signal-Stat logo printed in reflective material

37	Red/white, 2" x 150' roll
----	---------------------------

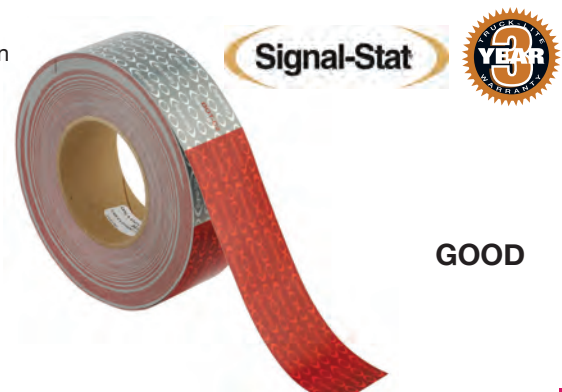

**Premium Series**

98165 2" x 150' roll, "School Bus Yellow"

98167 1" x 150' roll, "School Bus Yellow"

**Standard Series**

98168 2" x 150' roll, "School Bus Yellow"

98170 1" x 150' roll, "School Bus Yellow"

- FMVSS and CSA D520 compliant — bright and vivid yellow markings
- Makes school buses more visible, helping to improve safety for children and motorists
- Durable — resists weather, dirt and aging
- Strong adhesive adds to dependability of installation
- Non-metallic reflectors are non-corroding
- 98165 and 98167 options are constructed of stronger, durable material designed for smooth surface installation
- 98168 and 98170 options constructed of more flexible material, designed to be applied over and around rivets and corners
- Tough, durable films resist cracking and lifting to look line new, long after application
- Impact resistant, withstanding blow from forklift or loading dock and still retro-reflects

## School Bus Marking Tape

**Material:**

- Yellow school bus conspicuity tape
- 1" x 2" x 150' rolls



- Durable polycarbonate will not fade or rust
- Meets ANSI and ASAE standards S-276.5 for slow moving vehicles
- For agricultural vehicles, construction equipment and industrial vehicles

**797 Slow moving vehicle sign**

## Slow Moving Vehicle Sign

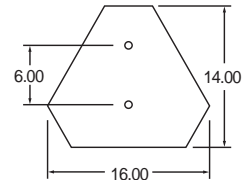

798

- Meets FMVSS 125 standards
- Triangle unfolds and locks together
- Non-skid heavy base withstands strong winds
- Reflex reflector strips form border for nighttime visibility – fluorescent orange inner triangle for daytime warning
- Housed in strong, heavy duty box – 18" x 4" x 4-1/2"
- Shipped in individual corrugated box for added measure of protection
- Replaces Truck-Lite 97974

**798 Triangle flare kit**  
**794 Replacement box**

## Triangle Flare Kit

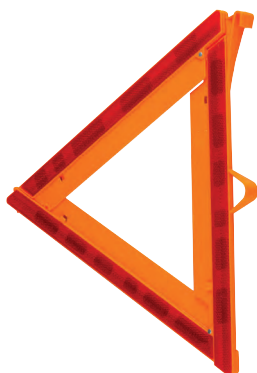
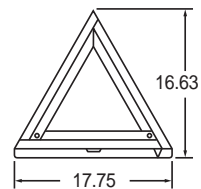

- Alerts motorists to roadside trouble whether it is day or night
- Window mount design installs from inside window
- Universally recognized shape, look and color
- Collapsible design for easy storage and quick set-up with no tools required

**800 Safety triangle kit**

## Emergency Triangle

### Narrow Rail Reflector Marking Systems

**Material:**

- Acrylic reflector
- Adhesive backing

- Meets requirements of final NHTSA ruling – see Federal Regulations Charts for details
- Ideal for use in areas where mounting clearance is limited
- Adhesive backing or screw on mounting
- Hermetically sealed construction
- 11" version has optics for vertical mounting

- 98153** 12" x 1" clear
- 98154R** 12" x 1" red
- 98155** 11" x 1" clear

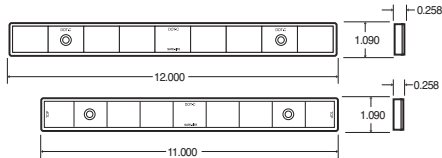

### Retro-Reflective Tape Reflectors 3" Round and 2" x 3-1/2" Rectangular

- Economical – reduced labor costs, no time installing screw-on reflectors
- Easy to apply, simply bend, peel and apply
- No drilling or mechanical fasteners needed
- Meets and exceeds DOT A and SAE J594f requirements
- Application temperature range 40° to 100°F

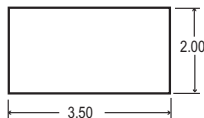
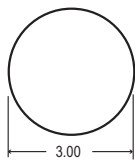

- ROUND:**
- 98175R** Retro-Reflective tape, red
  - 98175RB** Retro-Reflective tape, red, display box of 500
  - 98175Y** Retro-Reflective tape, yellow
  - 98175YB** Retro-Reflective tape, yellow, display box of 500

- RECTANGULAR:**
- 98176R** Retro-Reflective tape, red
  - 98176RB** Retro-Reflective tape, red, display box of 500
  - 98176Y** Retro-Reflective tape, yellow
  - 98176YB** Retro-Reflective tape, yellow, display box of 500



### Reflector

**Material:**

- Acrylic lens
- Adhesive backing

- Features acrylic lens
- Mounts with adhesive backing or #12 screws

- 98003R** Reflector, red
- 98003Y** Reflector, yellow

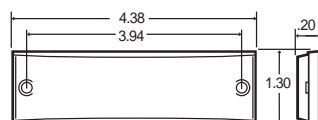

- Features chrome trimmed border
- Mounts with adhesive backing

**98034R Reflector, red**  
**98034Y Reflector, yellow**

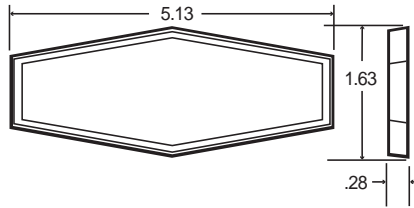

## Reflector w/ Chrome Housing

### Material:

- Adhesive backing
- Acrylic lens
- Chrome bezel



- Can be used as stick-on by peeling off back paper or can be mounted with two screws
- 98031R/Y version is mounted with 2 screws

**54 Reflector, red**  
**54A Reflector, yellow**  
**98031R Reflector, red, screw mount only**  
**98031Y Reflector, yellow, screw mount only**

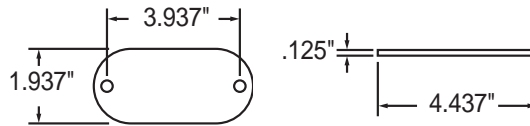

## Oval Two Hole Reflector

### Material:

- Acrylic lens and housing



31DB

- Perfect for marking darkened areas of garage entrances, mailbox posts, agricultural equipment, etc.
- Permanent adhesive backing
- Mounts on any clean flat surface
- For cars, marine and utility trailers

**31DB Reflector, red, counter display box of 150**  
**31ADB Reflector, yellow, counter display box of 150**

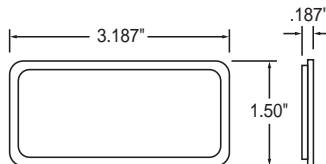

## Reflector

### Material

- Acrylic lens and housing

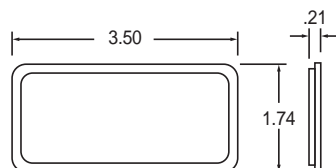
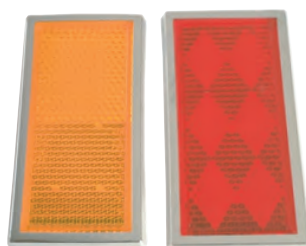

- Perfect for marking darkened areas of garage entrances, mailbox posts, agricultural equipment, etc.
- 32 family features chrome plated bezel
- Permanent adhesive backing
- Mounts on any clean flat surface
- For cars, marine and utility trailers

**32 Reflector, red**  
**32A Reflector, yellow**

## Reflector

### Material

- Acrylic lens
- Chrome bezel



## Reflector

**Material:**

- Acrylic lens and housing

- Mounts on any clean flat surface
- Mounts with 2 screws, not included
- Sealed acrylic lens and housing

**98035R Reflector, red**  
**98035Y Reflector, yellow**

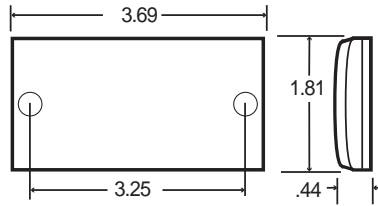

.250 SCREW HOLE DIAMETER

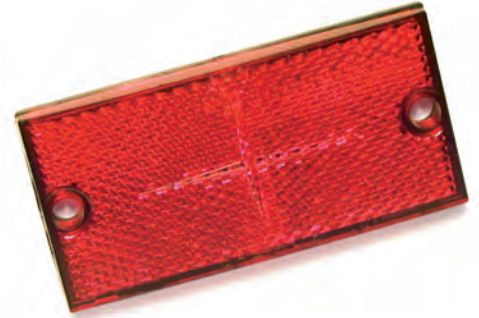

## ABS Housed Reflector

**Material:**

- Acrylic lens
- ABS housing

- Sonically welded sealed acrylic lens and ABS housing
- Replaces Signal-Stat 42A/42AD

**98004R Reflector, red**  
**98004Y Reflector, yellow**

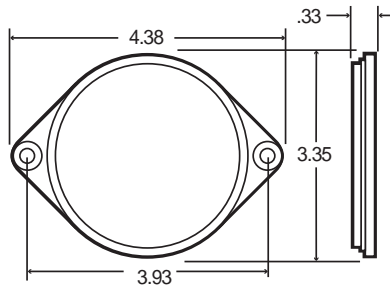

.200 SCREW HOLE DIAMETER



## Screw Mount Reflectors Flush Type

**Material:**

- Aluminum housing

- With 3" reflector and protective guard
- Replaces Truck-Lite 98030 series

**41 Screw mount reflector, red**  
**41A Screw mount reflector, yellow**

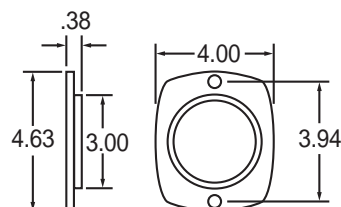

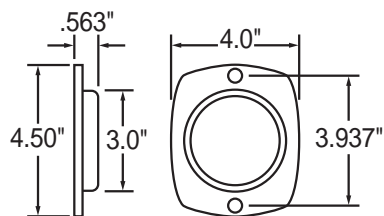

- Lens recessed for extra protection
- Armored aluminum guard protects reflector against impact
- Cuts down replacement due to lens breakage

**43** Screw mount reflector, red  
**43A** Screw mount reflector, yellow

### Screw Mount Reflectors Armored Type

**Material:**

- Aluminum housing

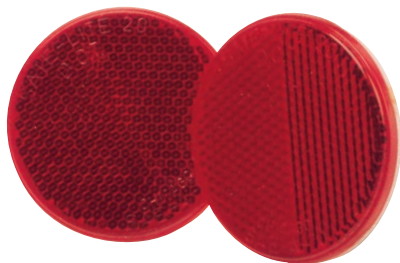

- Permanent adhesive backing
- Mounts on any clean flat surface

**45** Reflector, red  
**45A** Reflector, yellow

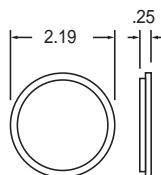

### 2-1/8" Round Stick-On Reflector

**Material:**

- Acrylic lens and housing



- Permanent adhesive backing
- Mounts on any clean flat surface

**47** Reflector, red  
**47DB** Reflector, red, counter display box of 50  
**47A** Reflector, yellow  
**47ADB** Reflector, yellow, counter display box of 50

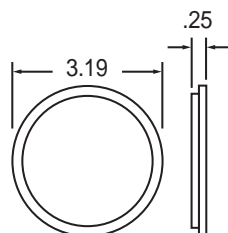

### 3-1/8" Round Stick-On Reflector

**Material:**

- Acrylic lens and housing

## 2" or 3" Center Mount Reflectors

### Material:

- Acrylic lens and housing
- Fast, permanent installation with nail, screw or rivet
- Use one #10 screw – 1/4" hole

52	Reflector, red, 2"
52A	Reflector, yellow, 2"
98006C	Reflector, clear, 3"
98006R	Reflector, red, 3"
98006Y	Reflector, yellow, 3"

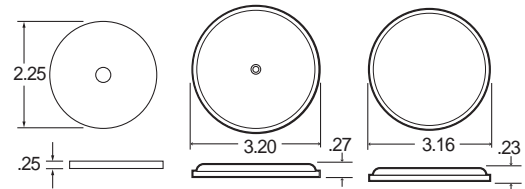

.20 SCREW HOLE DIAMETER

## 3.5" Center Mount Reflector

### Material:

- Acrylic lens and housing
- 3.5" SAE Class A reflector hermetically sealed
- Molded insert for center mount screw prevents cracking
- Use one #10 screw – 1/4" hole

57	Reflector, red
57A	Reflector, yellow

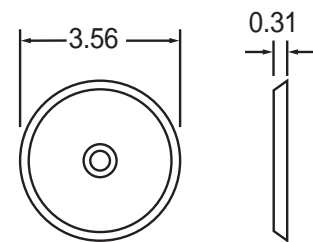

# 10 Screws

# Electronics



# Electronics

**Flashers**      **192-198**

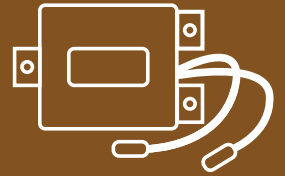

**Daytime Running Lamp Systems**      **199**

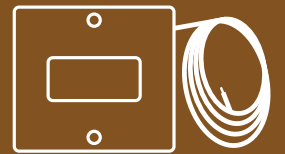

**Turn Signal Switches**      **200-202**



**Horns**      **203**

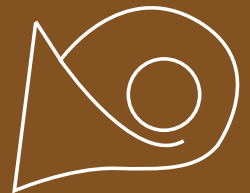

**Back-up Alarms**      **203-205**

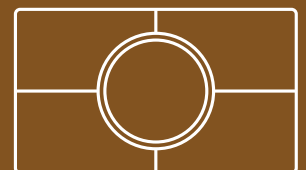

**Flasher devices provide four primary functions:**

Flashes the signal lamps on and off when the turn signal switch is activated. Provides outage indication (specific load flashers only) when a lamp is out of service. Causes the turn signal lamps to flash when the hazard warning switch is activated. Provides an audible sound indication when any signal device is activated. Alternating flashers provide the side to side flashing pattern required for emergency vehicles and school bus applications. "Fixed load" flashers are designed for a specific number of lamps and offer outage indication. "Variable load" flashers are designed for applications where the required load is not constant, such as when a tow vehicle is added or for vehicles pulling varying configurations of trailers. In order to determine your proper flasher requirements, engage the hazard warning switch and count the number of lamps that flash on both the primary power unit and trailer vehicle that unit may pull. The following chart will help you match your flasher load needs with your service requirements.

**Vehicle Flasher Application Guide**

VEHICLE CLASS	LIGHT SERVICE		MODERATE SERVICE		HEAVY SERVICE	
	WITHOUT PILOT	WITH PILOT	WITHOUT PILOT	WITH PILOT	WITHOUT PILOT	WITH PILOT
CARS, VANS, PICKUPS EQUIPPED FOR TOWING	2 LAMPS PER SIDE		3 LAMPS PER SIDE		3 OR MORE LAMPS PER SIDE	
	245 552	550	245 264*	552 550	245 264*	552 550
LIGHT AND MEDIUM TRUCK 2-3 LAMPS PER SIDE	2 LAMPS PER SIDE		2 LAMPS PER SIDE		3 LAMPS PER SIDE	
	245 264*	550 263	245 264*	550 263 263-4	250 262	258-4 266 252 263 263-4
HEAVY DUTY TRUCK AND ONE TRAILER 3-4 LAMPS PER SIDE	3 LAMPS PER SIDE		2 LAMPS PER SIDE		4 LAMPS PER SIDE	
	258-4 266*	252 263-4	258-4 266*	252 263-4	250 262	258-4 252 263 263-4
HEAVY DUTY TRUCK AND TWO TRAILERS 5-6 LAMPS PER SIDE	5 LAMPS PER SIDE		6 LAMPS PER SIDE		6 LAMPS PER SIDE	
	258-4 266*	252 263 173D	242 258-4 282	250 172 292	173 243 283	182 242 270 183 282 275 283
HEAVY DUTY TRUCK AND THREE TRAILERS 6-10 LAMPS PER SIDE	7 LAMPS PER SIDE		7-8 LAMPS PER SIDE		8-10 LAMPS PER SIDE	
	242 292	182 243 183D	182 270	242 282	183 275 283	270 282

VEHICLE CLASS	LIGHT SERVICE	MODERATE SERVICE	HEAVY SERVICE
CARS, VANS, PICKUPS EQUIPPED FOR TOWING	2 LAMPS PER SIDE		
	537A	256 286	286 97223 276 97272

**Alternating Flashers**

\*provides outage indication

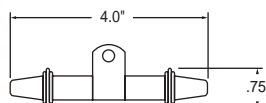

- 6 amp capacity @ 12 VDC
- Includes spade terminals for ease of installation
- Brass housing for corrosion resistance
- Mounts via single screw
- 4" lead wires

**Thermal Flashers**

**245 12v, 2-terminal**

### LED Electronic Flasher Module

**Material:**

- Molded glass filled housing
- 16 gauge wire

- Designed for use in automotive and heavy duty applications
- Creates a strobe flash on an LED lamp
- Hard-wired design eliminates pin corrosion
- Features coded wires and epoxy sealed circuitry for durability and long term use
- Designed to operate in temperature range -40° to +85° C
- Operates on 12v or 24v systems
- Maximum current-7 amps
- Flashes 3 times per 1/2 second

**97253 LED electronic flasher module**

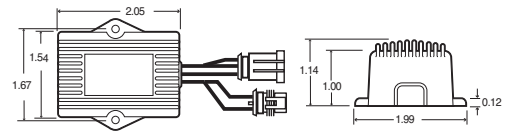

### LED Alternating Strobe Flash Modules

**Material:**

- Molded glass filled housing
- 16 gauge wire

- Hard-wired allowing alternating flashing of up to 20 LED lamps (10 lamps per side)
- Features color coded wires, epoxy sealed circuitry and installation instructions
- Operates on 12v or 24v systems
- Maximum 5-amp load
- Flashes 3 times per 1/2 second

**97235 LED alternating flasher**

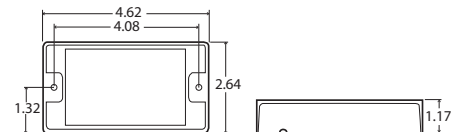

### LED Strobe Flash Modules For Super 44 & 60 Lamps

**Material:**

- Polypropylene housing
- 18 gauge wire

**Specifications:**

- Rated for loads below 3 amps
- One module required for each LED lamp

- Operates on 12v or 24v systems
- For use in a flashing circuit with the vehicle flasher controlling the rate of flashes per minute
- Creates a strobe flash on an LED lamp, with typical systems at a rate of 480 FPM
- For use with standard three-position male pin harness and Truck-Lite stop/turn LED lamps
- Features epoxy-sealed circuitry and a sealed polypropylene housing for durability and long-term use
- See the Stop, Turn and Tail Lighting section for the complete line of Super 44 and 60 LED lamps

**97251 LED flasher**

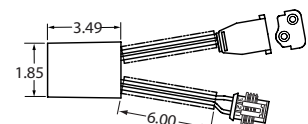



## ULTRAFASH II



97201



97231

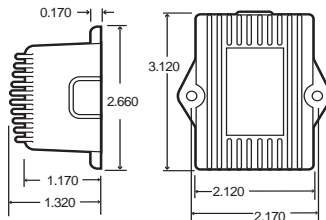

- For use with both LED and incandescent products
- Surface mounts with two 1/2" - 6 pan head screws at 2.12" centers or with two 4" cable ties (both included)
- Protects against short circuit overloads with a self-resetting feature
- 97231, 97232 and 97233 rated for loads below 25 amps or 12, 32 cp bulbs
- 97201 rated for loads below 17 amps per channel or 8-32/3 cp bulbs
- Optional remote wiring requires 12" jumper wire (94954)
- 97231, 97232 and 97233 feature folding bi-polar plug with 11" leads for reverse polarity operation
- 97201 features three 1/4" tabs and one 1/4" ring with heat-shrink tubing and 12" leads
- 97201 used for wig/wag system
- For interior/cab use only
- Do not expose to moisture or liquid

- 97201 Heavy-duty alternating non-audible flasher**  
**97231 Heavy-duty non-audible flasher**  
**97232 Heavy-duty audible flasher**  
**97233 Heavy-duty mechanical tone audible flasher**  
**94954 Remote wiring jumper**

### Heavy-Duty Solid State/ Alternating Flashers

2" x 3" Rectangular

#### Material:

- Die cast aluminum housing
- 14 gauge lead wire
- 18 gauge ground wire

#### Recommended Accessories:

- 94954 jumper wire
- 97250 adapter bracket

#### Specifications:

- Operates in temperatures -40°F to +145°F
- Available with or without audible signal
- Meets FMVSS 108 and SAE J590 and J1054 (alternating)
- Flashers rate 90 FPM
- 97232 = 85 db
- 97233 = 60 db



## ULTRAFASH II



97270

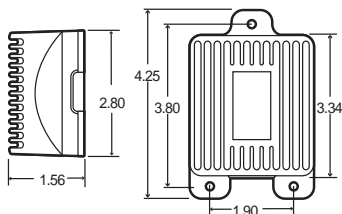

- For use with both LED and incandescent products
- Solid-state electronics are totally encapsulated in polyurethane for moisture and corrosion protection
- Designed to protect against short circuit overloads with a self-resetting feature
- 97270 and 97271 rated for loads below 40 amps at 12.8v (20, 32 cp) or below 20 amps at 25.6v
- 97272 rated for loads below 25 amps at 12.8v per channel or below 12.5 amps at 25.6v per channel
- 97270 and 97271 feature 12" leads with two 1/4" spade terminals and one 1/4" ring with heat-shrink tubing
- 97272 features 12" leads with three 1/4" spade terminals and one 1/4" ring with heat-shrink tubing
- Do not expose to moisture or liquid

- 97270 Heavy-duty non-audible flasher**  
**97271 Heavy-duty audible flasher**  
**97272 Heavy-duty non-audible alternating flasher**

### Heavy-Duty High Current Flashers

4-1/4" x 3" Rectangular

#### Material:

- Die cast aluminum housing
- 10 gauge lead wire
- 18 gauge ground wire

#### Specifications:

- Surface mounts with three pan head screws
- Operates in temperatures -40°F to +145°F
- Available with or without audible signal
- Flashes at a rate of 90 fpm
- Meets FMVSS 108 and SAE J590, J945 and J1054 (alternating)



### Solid State LED Heavy Duty Flashers

**Material:**

- Plastic housing
- 16 gauge wire

**Specifications:**

- 12v flasher operates at 11v to 15v
- 24v flasher operates at 22v to 30v
- Meets FMVSS 108 and SAE J590, J945 and J1054 (alternating)
- Non-audible

- For use with LED and incandescent products
- Rated for 42-amp load or twenty 32 cp bulbs
- For use on double and triple trailer combinations, sanitation vehicles, delivery and courier vehicles, heavy haulers and emergency vehicles
- Manufacturer's 5-year limited warranty
- Flasher unit includes 11" of wiring for remote mounting and includes simplified wiring instructions
- Maintains normal flash rate when used to flash LED lamps
- Compatible with trailer tow packages

- 270** 12v, 2-terminal
- 275** 12v, 3-terminal w/pilot
- 276** 12v, 3-terminal alternating



270

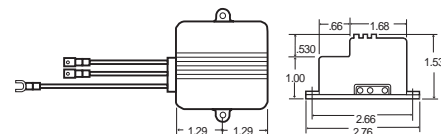

### LED Circuit Flasher

**Material:**

- Plastic housing

**Specifications:**

- 12v flasher operates at 11v to 15v
- Operates in a temperature range -25°F to +145°F
- Meets FMVSS 108 and SAE J590 and J945

- This solid state flasher operates from 1 milliamp up to 6 amps – allowing the use of two incandescent signal lamps with LED S/T/T lamps
- Solid state timing circuitry provides reliability
- Size: 1-1/8" W x 1-5/8" H
- Flashes at rate of 90 fpm

- 285** LED circuit flasher, 2-terminal

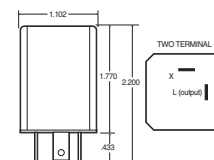
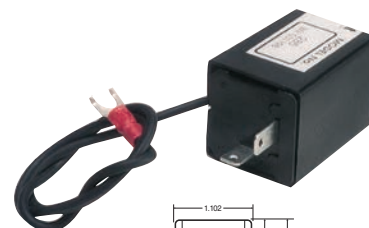

### Ever-Flash Flashers

**Material:**

- Plastic housing

**Specifications:**

- 12v flasher operates at 11v to 15v
- Operates in a temperature range -25°F to +145°F
- Meets FMVSS 108 and SAE J590 and J945t

- Certification for 16 bulb capacity for hazard warning
- Flashes up to eight 32 CP bulbs per side, plus pilot bulb
- 35-amp capacity @ 12 VDC
- Low profile, only 1-1/4" height above terminals

- 242** 12v, 2-terminal

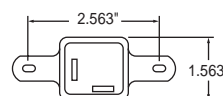
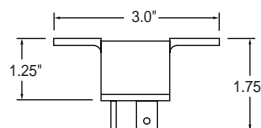

### Ever-Flash Flashers

**Material:**

- Plastic housing

**Specifications:**

- 12v flasher operates at 11v to 15v
- Operates in a temperature range -25°F to +145°F
- Meets FMVSS 108 and SAE J590 and J945

- Flashes up to five 32 CP bulbs per side, plus pilot bulb
- Flashes ten 32 CP bulbs for hazard warning
- 25-amp capacity @ 12 VDC
- Low profile, only 1-1/4" height above terminals

- 243** 12v, 3-terminal w/pilot

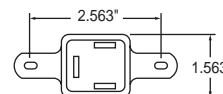
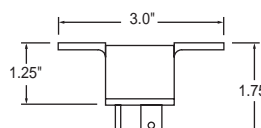

**Signal-Stat**



262

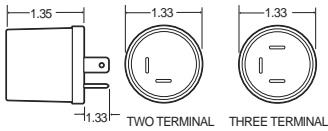

- Flashes at a rate of 60 to 120 fpm, with first flash less than 1.5 seconds after start-up
- Bi-polar flasher functions continuously at 13v for 36 hours with 10-32 cp lamps, 20-amp max
- Uses standard 1/4" male blade terminals
- Features double coil relay with electronic components

<b>262</b>	<b>12v, 2-terminal</b>
<b>263</b>	<b>12v, 3-terminal</b>
<b>263-4</b>	<b>24v, 3-terminal</b>

**10 Lamp Electro-Mechanical Flashers**

**Material:**

- Plastic housing

**Specifications:**

- 12v flasher operates at 11v to 15v
- 24v flasher operates at 22v to 30v
- Operates in a temperature range 0°F to +125°F
- Meets FMVSS 108 and SAE J590 and J945
- 42 db rating

**Signal-Stat**

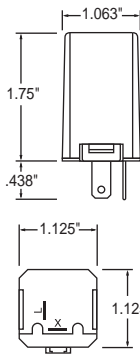

- Flashes at a rate of 70 to 120 fpm, with first flash less than 1.3 seconds after startup
- Functions at 13v for 36 continuous hours with 12-32 cp lamps, 25 amp
- 2-terminal and 3-terminal models available

<b>172</b>	<b>12v, 2-terminal</b>
<b>173</b>	<b>12v, 3-terminal</b>

**12 Lamp Electro-Mechanical Flashers**

**Material:**

- Plastic housing

**Specifications:**

- 12v flasher operates at 11v to 15v
- Operates in a temperature range -25°F to +145°F
- Meets FMVSS 108 and SAE J590 and J945

**Signal-Stat**



282

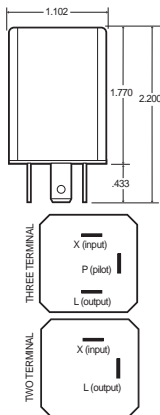

- Flashes at a rate of 70 to 120 fpm, with first flash less than 1.3 seconds after start-up
- Functions at 13v for 36 continuous hours with 16-32 cp lamps at 35 amp max (#182 and #183), 20-32 cp lamps at 45 amp max (#282 and #283) and 10-32 cp lamps alternating at 25 amp max per side (#286)
- Features ISO relay w/electronic control circuits

<b>182</b>	<b>16 lamp, 2-terminal</b>
<b>183</b>	<b>16 lamp, 3-terminal</b>
<b>282</b>	<b>20 lamp, 2-terminal</b>
<b>283</b>	<b>20 lamp, 3-terminal</b>
<b>286</b>	<b>Alternating 10 lamp, 3-terminal</b>

**20, 16 and Alternating 10 Lamp Flashers 1" x 1-3/4" Rectangular**

**Material:**

- Plastic housing

**Specifications:**

- 12v flasher operates at 11v to 15v
- Operates in a temperature range -25°F to +145°F
- Meets FMVSS 108 and SAE J590 and J945
- Alternating flasher meets FMVSS 108 and SAE J1054
- 50.9 db max rating

**Signal-Stat**



552

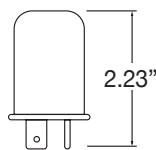

552

- Flashes up to three 32 CP bulbs per side, plus pilot bulb
- Flashes up to six 32 CP bulbs for hazard warning

<b>552</b>	<b>12v, 2-terminal</b>
------------	------------------------

- Heavy duty, longer life, variable load
- Flashes up to three 32 CP bulbs per side, plus pilot bulb (550 only)
- Flashes up to six 32 CP bulbs for hazard warning

<b>550</b>	<b>12v, 3-terminal w/pilot</b>
------------	--------------------------------

**Thermal Flashers**

**Material:**

- Aluminum housing

### 6 Lamp Electro-Mechanical Flasher

**Material:**

- Plastic housing

**Specifications:**

- 12v operates at 11v to 15v
- Meets FMVSS 108 and SAE J590 and J945

- GM #15607059
- 1988-1992 GM "CK" series truck replacement
- Replacement for Grumman postal vehicles, Chevrolet Sierra Crewcab and GMC Suburban and Yukon
- Third prong used for ground function
- 3-6 lamp load capability with outage indication, 12 lamps for hazard warning
- Replaces Tridon #10-424

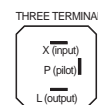
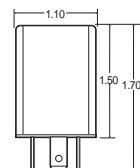

**266 12v, 3-terminal**

### 4 Lamp Electro-Mechanical Flasher

**Material:**

- Plastic housing

**Specifications:**

- 12v operates at 11v to 15v
- Meets FMVSS 108 and SAE J590 and J945

- GM #15607060
- 1988-1992 Chevrolet and GMC "S/T" series truck replacement
- Serves as replacement for GMC Jimmy, Chevrolet Blazer and S-10 pick-ups
- Third prong used for ground function
- 2-4 lamp load capability with outage indication, 8 for hazard warning
- Replaces Tridon #10-425

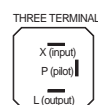
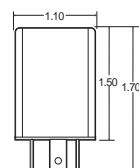

**264 12v, 3-terminal**

### Electro-Mechanical Flasher

**Material:**

- Plastic housing

**Specifications:**

- 12v operates at 9 to 15 VDC
- Operates in temperature range of 0° to +125°F
- Meets FMVSS 108 and SAE J590 and J945

- Features loud, pleasant audible sound
- Flash rate of 90 +/- 10 FMP with first flash less than 1.5 seconds after start-up
- Uses standard 1/4" male blade terminals
- Flashes up to three 32 cp bulbs per side
- Maximum load per side is 6.5 amps
- 71db max rating

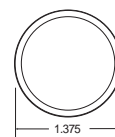
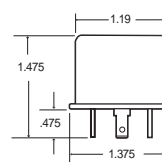

**537A 12v alternating, 3-terminal**

### Connectors

- For use with plug-in flashers or sealed beams
- Can be used with most Signal-Stat flashers
- Nylon housing provides greater durability
- 7" color coded wire leads
- Insulated 16-gauge wire
- For use with 12 or 24v applications

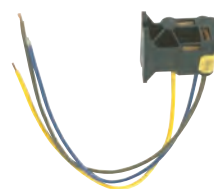

**9183 Flasher/bulb connector, universal**

### Connectors

- Includes 15 amp blade type fuse
- Ring terminal on lead wire
- 7" color coded wire leads
- Insulated 16 gauge wire leads
- For use with 12 or 24v applications

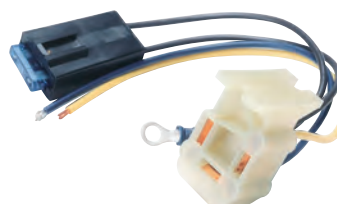

**9186 Flasher connector**

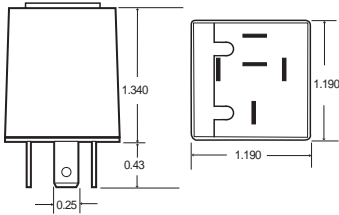

- Maintains normal flash rate when used to flash LED lamps
- Simple installation using existing plug footprint
- Heavy-duty solid state circuitry
- Long lasting service life means lower maintenance costs
- Designed for use with low current LED lamps
- Compatible with trailer tow packages
- 5 pin configuration for turn and hazard flashing
- 5-amp maximum per output
- Conforms to DOT FMVSS 108, SAE J590 and J945
- Non-audible

#### 97283 Flasher

### Flasher for Ford® F-Series Trucks F150, F250, F350 & Ford Ranger

#### Material:

- Plastic housing

#### Specifications:

- 12v/5 amp max. hazard, 2.5 amp max. turn signal
- LED and incandescent lighting systems

#### Replacement for:

- F150 (1999-2003)
- F250 (1999-2003)
- F250 SD (1999-2005)
- F350 (1999-2005)
- F450 (1999-2005)
- F550 (1999-2005)



250

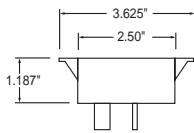

256

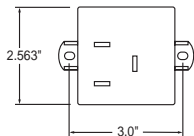

- Mack 47M019301P2 (SS# 250)
- Conforms to DOT and SAE specifications
- Proven to exceed 1.5 million cycles of continuous operation at max capacity without failure
- Certified for 10 bulb load hazard warning, 5 bulb load turn signal, plus pilot
- Polycarbonate housing and brass terminals for superior corrosion resistance and conductivity
- For school buses or emergency vehicles
- Flashes two 75 watt sealed beams per circuit

**250**    **12v electronic heavy duty, 2-terminal**  
**258-4**    **24v transistorized, 2-terminal**  
**256**    **12v alternating, 3-terminal**

### 10 Lamp Electronic Flashers

#### Material:

- Plastic housing
- 16 gauge wire

#### Specifications:

- 12v flasher operates at 11v to 15v
- 24v flasher operates at 22v to 30v
- Meets FMVSS 108 and SAE J590, J945 and J1054 (alternating)



### Daytime Running Lamp Systems

Daytime Running Lamp (DRL) systems have a proven safety record world wide. In fact, DRL's have reduced multiple vehicle accidents in Canada by 11%, Sweden by 23%, Finland by 37%, and Norway by 40%. As a result, DRLs are now being offered by many automobile and truck manufacturers as standard equipment. Now you can add the extra safety margin to your truck, bus, RV, or automobile with one of these easy-to-install electronic Daytime Running Lamp Control Module Kits.

#### DRL System

- Features state-of-the-art electronics sealed in epoxy
- Module installs easily using a three-wire design
- Relay controlled output activates low beam headlamps at full intensity whenever the ignition is turned on
- Meets or exceeds CSA guidelines
- Covered by manufacturer's lifetime warranty
- Do not expose to moisture, excessive engine compartment temperature or circuit overload
- Works with most Ford, GM and Dodge vehicles
- For use with positive switching headlamps only
- Not for use with positive ground vehicles

97300 DRL System, 12v

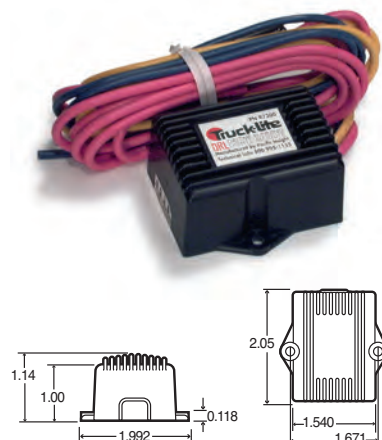

#### Heavy Duty DRL System

- Operates low beam headlamps at reduced intensity (75%) for prolonged lamp life
- Unit features 15-second "time-in" delay and tail/ marker lamp activation
- "Park brake disable" feature locks out system when parking brake is engaged
- Electronics are sealed in epoxy for protection and are short circuit protected
- Exceeds GM and Ford's electrical, environmental, RFI and EMI specifications, on most vehicles
- Meets or exceeds SAE, NHTSA and CSA guidelines
- For use with positive switching headlamps only
- Not for use with positive ground vehicles
- Covered by manufacturer's lifetime warranty

97302 Heavy Duty DRL System, 12v



#### Universal Switches and Accessories

- Mounts through 5/8" diameter hole in dashboard
- Single pole normally open circuit
- 20 amps @ 12 VDC
- Replacement red knob #07332, bulb #53

102 Heavy duty push pull switch



- 2 Position – Off-On
- Includes weather proof boot
- 10 amps @ 6 and 12 VDC application

131 Push button



- On-off switch for use with auxiliary lights and heated mirrors
- Operates 6 to 16 volts
- 15 amp max

80594 Illuminated rocker switch

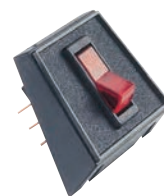



- Surpasses SAE J589 and J910 standards for turn and hazard functions
- Improved, light weight, nylon housing and handle
- Capable of flashing 16 lamps in hazard mode (8 lamps per side for turn signal flashing)
- 7 speed includes 5 speed intermittent, two speed (hi-low) or wash function
- Improved design eliminates premature breakage and component wear
- Feature Lift-to-Dim and Flash-to-Pass options
- Brake overrides hazard function lights when brake pedal is depressed

**91250 Self-cancel, 7 speed**

**91150 Self-cancel, 2 speed, hi-low**

### 960 Series Self-Canceling Turn Signal Switches

**Material:**

- Glass filled nylon housing

**Recommended Accessories:**

- Modules available for washer/wiper and headlamp functions – contact Technical Support for details

**Note:**

- 294Y200 for vehicles w/o DRL
- 294Y300 for vehicles w/DRL



- Surpasses SAE J589 and J910 standards for turn and hazard functions
- Improved lightweight, housing and handle
- Capable of flashing 18 lamps in hazard mode (9 lamps per side for turn signal flashing)
- Features a sealed boot to eliminate dust intrusion
- Includes self-canceling feature
- Features a lift-to-dim/flash-to-pass

**91002 Self-cancel**

### 960 Series Self-Canceling Turn Signal Switch

**Material:**

- Glass filled nylon housing



- 7 wire harness
- Pilot light for turn signal and hazard warning
- 16 bulb capacity for hazard warning, 8 bulbs per side for turn signal flashing
- Recommended flasher #275 when using LED lamps
- Recommended flasher for 12 to 16 lamps – #183 (not included)
- Recommended flasher for 16 to 20 lamps – #283 (not included)
- Recommended switch for trucks pulling double or triple trailers, and for vehicles that flash their hazard warning lamps regularly, or for prolonged periods of time

### Turn Signal Switches

**Material:**

- Die cast housing and handle

**Light Source:**

- Bulb: #53

**Replacement Parts:**

- 9190 mounting hardware

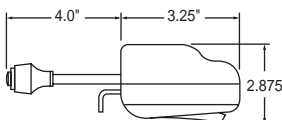
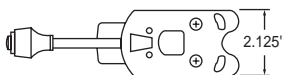

**910 Flat black, heavy load switch**

### Turn Signal Switches

**Material:**

- Die cast housing and handle

**Light Source:**

- Bulb: #53

**Replacement Parts:**

- 9190 mounting hardware

- 7 wire harness
- Pilot light for turn signal and hazard warning
- 10 bulb capacity for hazard warning, 5 bulbs per side for turn signal flashing
- Recommended flasher #275 when using LED lamps
- Recommended flasher #263 when using incandescent lamps
- Can be used for 24 volt applications by changing pilot bulb and flasher #2634
- Brake overrides hazard function when brakes are applied #920

**900** Flat black  
**901** Chrome



900

### Turn Signal Switches

**Material:**

- Die cast housing and handle

**Replacement Parts:**

- 9190 mounting hardware

- 10 wire harness with relay
- Signal arm features built-in push button high/low beam selector switch
- 10 bulb capacity for hazard warning, 5 bulbs per side for turn signal flashing
- Recommended flasher #275 when using LED lamps
- Recommended flasher #263 when using incandescent lamps

**905** Flat black



### Turn Signal Switches

**Material:**

- Die cast housing and handle

**Light Source:**

- Bulb: #53

**Replacement Parts:**

- 9196 handle
- 9190 mounting hardware

- 4 wire harness
- Only used in conjunction with single function turn signal lamps
- For automotive or agricultural applications
- Pilot light for turn signal and hazard warning
- Recommended flasher #275 when using LED lamps
- Recommended flasher #263 when using incandescent lamps
- Can be used for 24 volt applications by changing pilot bulb and flasher #2634

**902** Flat black

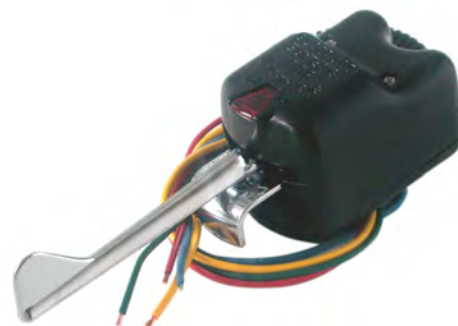

**Douglas Autotech**

OEM #	Truck-Lite #
49916	960Y101
49916A	960Y101

**Douglas Autotech**

OEM #	Truck-Lite #
50118	962Y102
50118A	962Y102

**Ford**

OEM #	Truck-Lite #
F0HT13B302AB	900Y179

**Ford**

OEM #	Truck-Lite #
E8HS13B02AA	915Y119

**Ford**

OEM #	Truck-Lite #
F0HS13B302BA	915Y128

**Ford**

OEM #	Truck-Lite #
F0HZ-13441-E	900Y180

**Ford/Sterling**

OEM #	Truck-Lite #
F6HT-13B302-AC	91250
F7HT-13B302-DA	91250
F8HT-13B302-BA	91250

**Freightliner**

OEM #	Truck-Lite #
A06-328389-000	90251Y103

**Freightliner**

OEM #	Truck-Lite #
E8HS13B302AA	915Y119

**Freightliner**

OEM #	Truck-Lite #
F0HT13B302AB	900Y179

**Freightliner**

OEM #	Truck-Lite #
F0HT13B302AB	900Y180

**Kenworth**

OEM #	Truck-Lite #
18500D044	915Y103
K301D230	

**Navistar**

OEM #	Truck-Lite #
1663595C91	900Y206

**Navistar**

OEM #	Truck-Lite #
2002874C91	962Y100
3566935C91	

**Navistar**

OEM #	Truck-Lite #
2002875C91	963Y100
3566936C91	

**Navistar**

OEM #	Truck-Lite #
2034257C91	962Y101
3566941C91	

**Navistar**

OEM #	Truck-Lite #
2042613C91	964Y100
3566942C91	

**Navistar**

OEM #	Truck-Lite #
2042615C91	961Y100
3566944C91	

**Navistar**

OEM #	Truck-Lite #
2042616C91	960Y100
3566945C91	

**Navistar**

OEM #	Truck-Lite #
775863C93	900Y114

**Peterbilt**

OEM #	Truck-Lite #
16-03827	915Y104

**Peterbilt**

OEM #	Truck-Lite #
16-4415	915Y114

**Peterbilt**

OEM #	Truck-Lite #
16-06432	915Y124

**Tennant**

OEM #	Truck-Lite #
60750	900Y205

**Volvo GMC**

OEM #	Truck-Lite #
3081534	915Y116

**Volvo GMC**

OEM #	Truck-Lite #
3081533	915Y117





**Trumpet Horns**

**Material:**

- Zinc galvanized steel

- Features trumpet horns (80 mm)
- Horns are interchangeable
- Can be mounted as horn or as theft warning device in commercial automotive applications
- Sound Pressure Level of 105 to 118 dB(A)
- 6A max for 12v
- Frequency: Low Tone, High Tone
- Horns can be used individually or as a pair

- 97360 Trumpet horn 12v, 420 Hz
- 97361 Trumpet horn 12v, 510 Hz



97360

**Single Sound Alarm**

**Material:**

- PVC plastic housing

- Single sound back-up alarm for light to medium duty use
- Features epoxy sealed solid state electronics and a rigid PVC plastic housing
- Connections are made with two #8-32 UNC terminal studs
- Meets OSHA, SAE J994, Bureau of Mines and all state regulations
- 2-year warranty

- 92909 97 db, 12 volt

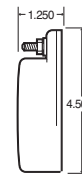
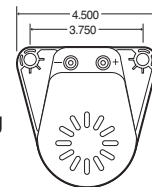

.343 screw hole diameter



**Self-Adjusting 4" Round Alarm**

**Material:**

- Urethane-filled housing
- Recommended Accessories:**
- 40700 grommet
- 94993 plug

- Features a urethane-filled housing to protect the alarm from moisture, dust and vibration
- Alarm is flush mounted to help protect against road debris, salt and mud
- No additional tools required for installation or replacement
- Uses industry standard grommets and pigtails
- Steam cleanable
- Voltage spike protected
- Meets OSHA, SAE J994, Bureau of Mines and all state regulations
- Operating temperatures range from -40°F to +170°F
- 2-year warranty

- 92914 "Self-Adjusting" 77-97 db, 12-48 volts
- 92916 Single sound 97 db, 12volts, type 'C'
- 92918 Single sound 102 db, 12-24 volts, type

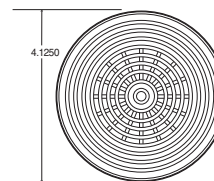
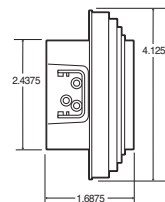

Requires 4.5 x 1.75 deep mounting hole



Note: Self-adjusting alarm must "hear" surrounding noise levels to properly adjust its sound output. Mount alarm at rear of vehicle facing the back without obstruction in the listening field.

**Single Sound Alarm**

- Material:**
- Rugged glass nylon housing

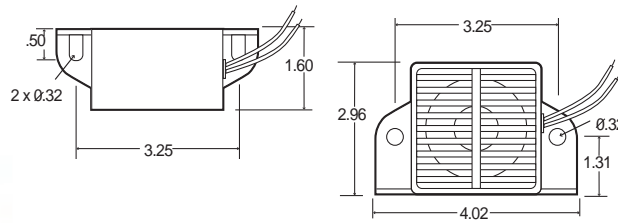

- Compact high sound level alarm
- Sealed solid state electronics with polarity protection
- Approximate .5 amp current draw
- Self-resonating circuit board automatically adjusts to environmental conditions to ensure a constant output
- Standard terminal studs are replaced by 12" length 18 gauge wire leads
- Meets J994 Type B requirements
- Manufacturer's 2-year warranty

**92924 Single sound 107 db, 12 volts**

**Self-Adjustable Single-Sound Alarm**

- Material:**
- Rugged glass nylon housing

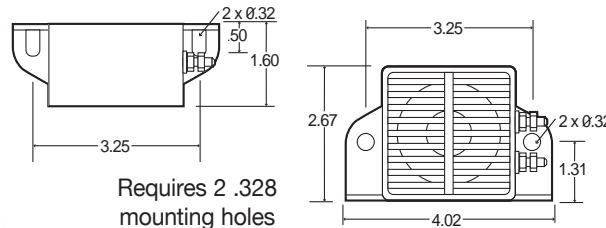

Note: Self-adjusting alarm must "hear" surrounding noise levels to properly adjust its sound output. Mount alarm at rear of vehicle facing the back without obstruction in the listening field.

- 92910 specifically designed low sound level alarm for electric powered vehicles
- Compact and extremely dependable back-up alarm
- Solid state electronics
- Steam cleanable
- Meets J994 Type C requirement
- U-L recognized for electric vehicle and forklifts
- Manufacturer's 2-year warranty

**92910 97 db, 12-48 volts**  
**92911 77 to 107 db, 12-24 volts, self adjusting**  
**92900 97 db, 12 volt**  
**92901 97 db, 12-24 volts**  
**92902 102 db, 12-24 volts**

**Single Sound Alarm**

- Material:**
- Rugged glass nylon housing

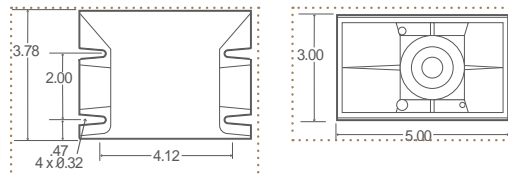

- Meets OSHA, SAE J994 Type B and C, Bureau of Mines and all state regulations
- Sealed solid state electronics
- Steam cleanable
- Operating temperatures range from -40°F to +170°F

**92923 97 to 107 db, 12-24 volts**

### Self-Adjusting and Single Sound Alarm

**Material:**

- Rugged glass nylon housing

**Specifications:**

- Draws .5 amp

CAUTION: Alarm must "hear" surrounding noise levels to properly adjust its sound output. Mount alarm at rear of vehicle facing the back without obstruction in the listening field.

- Adjusts automatically to environmental noise, reducing irritation for operators and workers
- Sealed solid state electronics
- Meets OSHA, SAE J994 Type A - D, Bureau of Mines and all state regulations
- Steam cleanable
- Operating temperatures range from
- -40°F to +170°F
- UNC terminal studs #8-32
- 2-year warranty

<b>92905</b>	<b>87 to 112 db, 6-36 volts, self adjusting</b>
<b>92903</b>	<b>107 db, 6-36 volts, single sound</b>
<b>92904</b>	<b>112 db, 6-36 volts, single sound</b>

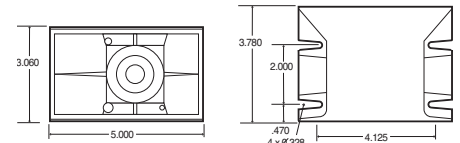

### Dual Tone Alarm

**Material:**

- Rugged glass nylon housing
- Draws 2 amps

- Self-adjusts automatically to produce 10 decibels (nominal) above surrounding noise
- Depending upon how power is applied, it can behave like a self-adjusting alarm or a pulsed warble sounding alarm
- Steam cleanable
- Operating temperatures range from
- -40°F to +170°F
- UNC terminal studs #8-32
- 2-year warranty

<b>92927</b>	<b>87 to 112 db, 12-48 volts</b>
--------------	----------------------------------

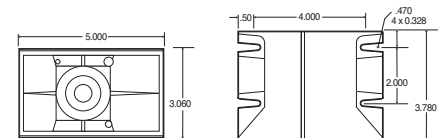

### Back-up Alarm Switch

**Material:**

- Plastic or die cast

- A water-resistant switch with a 5 amp rating
- Arm operates with a full 360° movement
- For use when a back-up light circuit is not available to activate the alarm
- For increased water resistance, an optional 3/8" ID water tight compression fitting is available and will accommodate a 2 conductor round cable
- UL and CSA approved
- Can be wired normally open or closed

<b>92925</b>	<b>Back-Up switch w/bracket, plastic</b>
<b>92907</b>	<b>Back-Up switch, die cast New</b>
<b>97003</b>	<b>3/8" ID water tight compression fitting</b>

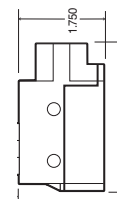
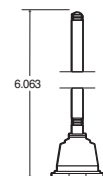

92925



92907

### Back-Up Safety Bulb and Alarm

**Material:**

- Metal housing

**Light Source:**

- 12v, 20W lamp

- Combination back-up safety device and lamp
- Provides clear 87dB "beep, beep" when vehicle is put into reverse gear
- Installs as easily as replacing the existing bulb!
- 20 watt halogen bulb provides greater light output when vehicle is in reverse
- Perfect for cars, school buses, vans, RVs and light trucks
- Additional safety devices safety bulbs do not meet OSHA or SAE J994 requirements for commercial back-up alarms

<b>328D</b>	<b>Beeping halogen bulb, bayonet base, 87dB (replaces 1156 bulb style), retail pack</b>
<b>329D</b>	<b>Beeping halogen bulb, wedge base, 87dB (replaces 3156 bulb style), retail pack</b>
<b>320</b>	<b>Beeping halogen bulb, 97dB</b>
<b>320-4</b>	<b>Beeping halogen bulb, 97cB, 24 volt</b>



328D



329D

# **Harness Systems & Accessories**



# Harness Systems & Accessories

Sockets & Plugs

208-218



88 Series "Plug Together"  
Harnesses

219-228



50 Series "Super System"  
Harnesses

229-233



Junction Boxes, Receptacle  
& Accessories

234-239

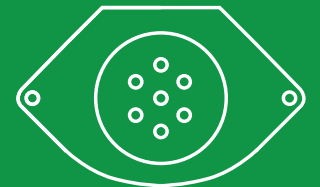

Trailer Cords

239



**HOW TO SELECT SIZE OF ELECTRIC CABLE**

Voltage drop is the primary consideration in selecting the proper electrical wire size. The length of wire in a circuit is the major contributing factor to voltage drop. The table below may be used in determining adequate wire gauge sizes for specific lengths of cable when the amperage requirements are known.

Example: A lamp is 38 ft. from the power source and requires 10 amperes. This figure, when rounded upwards to the nearest column heading given in the table, is 40 ft. The wire gauge in the "40-ft. Column" corresponding to 10 amperes is No. 12.

**Total length of cable in circuit from battery to most distant lamp**

12 Volt System							
Amperes (Approx.)	Up To 30 Feet	40 Feet	50 Feet	60 Feet	80 Feet	100 Feet	120 Feet
	Gauge	Gauge	Gauge	Gauge	Gauge	Gauge	Gauge
1.0	14	14	14	14	14	14	14
2	14	14	14	14	14	14	14
3	14	14	14	14	14	14	12
4	14	14	14	14	14	12	12
5	14	14	14	14	12	12	12
6	14	14	14	14	12	12	10
7	14	14	14	12	12	10	10
8	14	14	12	12	10	10	10
10	14	12	12	12	10	10	8
11	14	12	12	10	10	8	8
12	14	12	12	10	10	8	8
15	12	12	10	10	8	8	8
18	12	10	10	8	8	8	8
20	12	10	10	8	8	8	6
25	12	10	8	8	8	6	6
30	12	10	8	8	8	6	6
35	12	10	8	8	6	6	6

\*Recommended minimum wire gauge size for stop light and ground circuits.  
 Single trailer (up to 50' length)  
 Doubles trailer (2-28' lengths)  
 Doubles trailer (2-40' lengths)  
 Triples trailer (3-28' lengths)

Stop Light (Red)  
 12 Gauge  
 12 Gauge  
 10 Gauge  
 10 Gauge

Ground (White)  
 10 Gauge  
 10 Gauge  
 8 Gauge  
 8 Gauge

Cable size gauge no. (Copper)	length of wire in feet	Maximum current carrying capacity with 0.5 volt drop	wire resistance ohms (Ω) per foot
20 Ga.	10 Ft.	4.74 Amps	0.01054 Ω /ft.
18 Ga.	10 Ft.	7.53 Amps	0.00663 Ω /ft.
16 Ga.	10 Ft.	11.98 Amps	0.00417 Ω /ft.
14 Ga.	10 Ft.	19.05 Amps	0.00262 Ω /ft.
12 Ga.	10 Ft.	30.30 Amps	0.00165 Ω /ft.
10 Ga.	10 Ft.	48.16 Amps	0.00103 Ω /ft.
8 Ga.	10 Ft.	76.59 Amps	0.00065 Ω /ft.

Note: This table gives you the resistance of wire per foot so with ohms law V=I x R you can calculate voltage drops on any of the above wire gauges at any current level and length. For example, voltage drop in 50 ft. 10 AWG wire with 20 amp load is V=20 amp x (0.00103 Ω /ft.) x 50 ft. = 1.03 volts. Be sure to include both the positive and negative leads when calculating total wire length.

**SAE J560 Standards Conductor Identification**

Wire Color	Lamp and Signal Circuits	
Wht	White	Ground return to towing vehicle
Blk	*Black	Clearance, side marker & license plate lamps
Yel	Yellow	Left hand turn signal & hazard signal lamps
Red	Red	Stop lamps and antilock devices
Grn	Green	Right hand turn signal & hazard signal lamps
Brn	*Brown	Tail, clearance, side marker lamps & identification lamps
Blu	Blue	Auxiliary/ABS power

\*It is recommended to balance the circuits as practicable.

**Voltage Drop/Foot/Ampere**

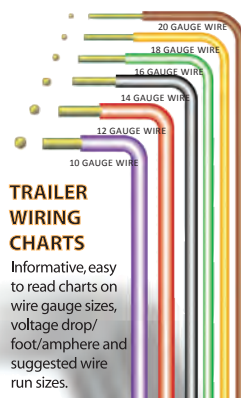
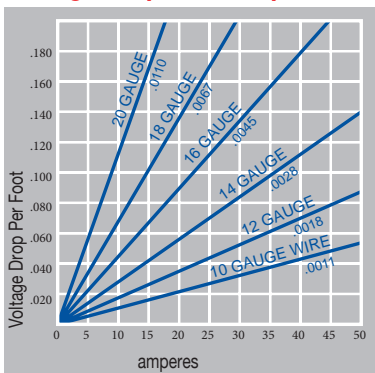

**TRAILER WIRING CHARTS**







Informative, easy to read charts on wire gauge sizes, voltage drop/foot/ampere and suggested wire run sizes.

**WIRE SIZE**

		TOTAL FOOTAGE OF WIRE FROM POWER SOURCE TO THE MOST DISTANT ELECTRIC LAMP									
24 VOLT SYSTEM (AMPERES)	12 VOLT SYSTEM (AMPERES)	10'	20'	30'	40'	50'	60'	70'	80'	90'	100'
		GAUGE	GAUGE	GAUGE	GAUGE	GAUGE	GAUGE	GAUGE	GAUGE	GAUGE	GAUGE
2.0	1.0	18	18	18	18	18	18	18	18	18	18
3.0	1.5	18	18	18	18	18	18	18	18	18	18
4.0	2.0	18	18	18	18	18	18	18	18	16	16
6.0	3.0	18	18	18	18	18	16	16	16	14	14
8.0	4.0	18	18	18	16	16	16	14	14	14	12
10.0	5.0	18	18	18	16	14	14	14	12	12	12
12.0	6.0	18	18	16	16	14	14	12	12	12	12
14.0	7.0	18	18	16	14	14	12	12	12	10	10
16.0	8.0	18	16	16	14	12	12	12	10	10	10
20.0	10.0	18	16	14	14	12	12	10	10	10	10
22.0	11.0	18	16	14	12	12	10	10	10	10	8
24.0	12.0	18	16	14	12	12	10	10	10	8	8
30.0	15.0	18	14	12	12	10	10	10	8	8	8
36.0	18.0	16	14	12	10	10	8	8	8	8	8
40.0	20.0	16	12	12	10	10	8	8	8	8	6

**LED Fit 'N Forget®  
Marker Clearance  
Plugs**

- Keeps water, salt & other corrosives from LED lamps
- Combine with LED lamps for Lifetime Lighting Warranty eligibility
- 16 gauge GPT wire
- Tin plated brass bullets/receptacles

94624	1 Ground 11.5" 2 M/C 11.5"	P/E connector #12010973 P/E connector #12010973	White Black	
94861	1 Ground 4.5" 2 M/C 5"	#6 ring terminal Heat shrink butt splice	White Black	
94862	1 Ground 4.5" 2 M/C 5"	#6 ring terminal .180 molded bullet	White Black	
94718	1 Ground 4.5" 2 M/C 5"	#10 ring terminal .180 molded bullet	White Black	
94888	1 Ground 4.5" 2 M/C 5"	#6 ring terminal .156 molded bullet	White Black	
94742	1 Ground 4.5" 2 M/C 5"	.156 shunt device .156 shunt device	White Black	
95410	1 Ground 5" 2 M/C 5"	.180 molded bullet .180 molded bullet	White Black	 9/16" hole
97005	1 Ground 5" 2 M/C 5"	.180 molded (slim) bullet .180 molded (slim) bullet	White Black	
94736	1 Ground 18" 2 M/C 18"	.180 molded (slim) bullet .180 molded (slim) bullet	White Brown	
95306	1 Ground 20" 2 M/C 20"	.180 molded (slim) bullet .180 molded (slim) bullet	White Brown	
97006	1 Ground 5" 2 M/C 5"	Heat shrink butt splice Heat shrink butt splice	White Black	





**LED Fit 'N Forget®  
Marker Clearance  
Adapter Plug**

- Keeps water, salt & other corrosives from LED lamps
- Combine with LED lamps for Lifetime Lighting Warranty eligibility
- Used to Adapt LED lamps to conventional plug harness systems
- 16 gauge GPT wire; tin plated brass terminals

93745	1 Ground 4" 2 M/C 4"	White Black	
-------	-------------------------	----------------	---

**Marker Clearance  
Plugs**

- For use in space limited areas
- 16 gauge GPT wire
- Tin plated brass terminals

94848	1 Ground 3.5" 2 M/C 3"	.156 molded receptacle .156 molded receptacle	White Black	
94850	1 Ground 6.5" 2 M/C 7"	.156 molded bullet .156 molded bullet	White Black	
94972	1 Ground 6.5" 2 M/C 6"	.180 molded bullet .180 molded bullet	White Black	
94902	1 Ground 7" 2 M/C 6.5"	#6 ground terminal 6/32" wire strip	White Black	
94909	1 Ground 12" 2 M/C 12"	#10 ring terminal 6/32" wire strip	White Black	
94916	1 Ground 18" 2 M/C 18"	#10 ring terminal 6/32" wire strip	White Black	
94919	1 Ground 6.5" 2 M/C 7"	#10 ring terminal 6/32" wire strip	White Black	
94920	1 Ground 6" 2 M/C 11"	#6 ground clip 6/32" wire strip	White Black	



94924 1 Ground 6.5" #10 ring terminal White  
2 M/C 6.5" 6/32" wire strip Black

**Right Angle Marker Clearance Plugs**

- Right angle design for use in space limited areas
- 16 gauge GPT wire
- Tin plated brass terminals



94964 1 Ground 6" #10 ring terminal White  
2 M/C 6" .180 molded bullet Black



94984 1 Ground 5.5" .156 shunt device White  
2 M/C 5.5" .156 shunt device Black



94940 1 Ground 12" #10 ring terminal White  
(Cream) 2 M/C 12" 12/32" wire strip Black

**Marker Clearance Socket Assembly**

- For use with 18300R/Y & 25760 bulb replaceable lamps
- Bulb not included
- 18 gauge wires



94727 1 Ground 7.5" blunt cut Black  
2 M/C 7.5" blunt cut Black

**Model 19® Plugs**

- For use with Model 19 incandescent lamps
- 16 gauge GPT wire



94729 1 Ground 7.5" #10 ring terminal White  
2 M/C 7.5" 6/32" wire strip Black



94821 1 Ground 7" .180 molded receptacle Black  
2 M/C 7" .180 molded bullet Black



95332 1 Ground 7.5" P/E Connector #12010973 White  
2 M/C 7.5" P/E Connector #12010973 Black



96904 Hot Wire 6" 6/32" wire strip Black



96919 Hot Wire 6" .180 molded bullet Black



96930 1 M/C 12" 6/32" wire strip Black

**Super 21® Plugs**

- For use with Super 21 incandescent lamps
- 16 gauge GPT wire, tin plated brass terminals

96936 1 M/C 48" 6/32" wire strip Black



96932 1 M/C 5" .180 molded bullet Black

96934 1 M/C 5" .156 molded bullet Black



96935 1 M/C 5" .156 shunt device Black



**LED Fit 'N Forget®  
Identification  
Harness**

- Keeps water, salt & other corrosives from LED lamps
- Combine with LED lamps for Lifetime Lighting Warranty eligibility
- 16 gauge GPT wire
- Tin plated brass bullets/receptacles

94892	1 Ground 22" (6" ctr) 2 M/C 22"	#6 ground terminal .156 molded bullet	White Black
96989	1 Ground 22" (6" ctr) 2 M/C 22"	#6 ground terminal .180 molded bullet	White Black
94898	1 Ground 27" (9" ctr) 2 M/C 27"	#6 ground terminal .156 molded bullet	White Black
96996	1 Ground 27" (9" ctr) 2 M/C 27"	#6 ground terminal .180 molded bullet	White Black



96990	1 Ground 22" (6" ctr) 2 M/C 22"	#6 ground terminal .180 molded receptacle	White Black
96995	1 Ground 27" (9" ctr) 2 M/C 27"	#6 ground terminal .156 molded receptacle	White Black



96992	1 Ground 22" (6" ctr) 2 M/C 22"	.180 molded bullet	White Black
96999	1 Ground 27" (9" ctr) 2 M/C 27"	.180 molded bullet	White Black



96993	1 Ground 23" (6" ctr) 2 M/C 23"	Heat shrink butt splice Heat shrink butt splice	White Black
-------	------------------------------------	--	----------------



**Identification  
Harness**

- For use with incandescent lamp identification bar
- 14 gauge GPT wire
- Tin plated brass terminals

93906	1 Ground 22.5" (8" ctr) 2 M/C 26"	#10 ring terminal 11/32" wire strip	White Black
93908	1 Ground 28" (11" ctr) 2 M/C 32"	#10 ring terminal 11/32" wire strip	White Black

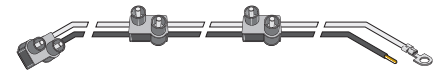

93943	1 Ground 22.5" (8" ctr) 2 M/C 26"	#10 ring terminal .180 molded bullet	White Black
-------	--------------------------------------	---	----------------

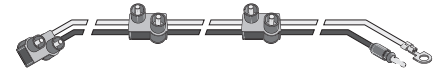

**LED Fit 'N Forget®  
Marker Clearance  
Multiple Plug  
Harness**

- Keeps water, salt & other corrosives from LED lamps
- Combine with LED lamps for Lifetime Lighting Warranty eligibility
- 16 gauge GPT wire
- Brass terminals
- For use with bumpers & skirts

95460	1 Ground 88" (10" ctr) 2 M/C 88"	Blunt cut Blunt cut	White Brown	(5 plugs w/10" ctr)
-------	-------------------------------------	------------------------	----------------	---------------------

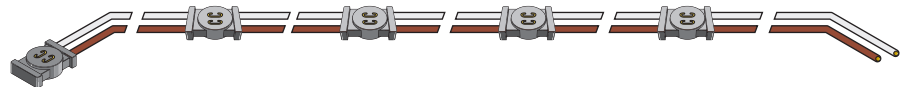

95461	1 Ground 108" (10" ctr) 2 M/C 108"	Blunt cut Blunt cut	White Brown	(7 plugs w/10" ctr)
-------	---------------------------------------	------------------------	----------------	---------------------

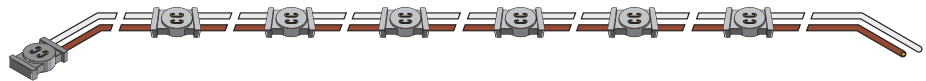

95462	1 Ground 128" (10" ctr) 2 M/C 128"	Blunt cut Blunt cut	White Brown	(9 plugs w/10" ctr)
-------	---------------------------------------	------------------------	----------------	---------------------



95463	1 Ground 148" (10" ctr) 2 M/C 148"	Blunt cut Blunt cut	White Brown	(11 plugs w/10" ctr)
-------	---------------------------------------	------------------------	----------------	----------------------



95464	1 Ground 61.5" (4" ctr) 2 M/C 61.5"	Blunt cut Blunt cut	White Brown	(4 plugs w/4" ctr)
-------	--	------------------------	----------------	--------------------

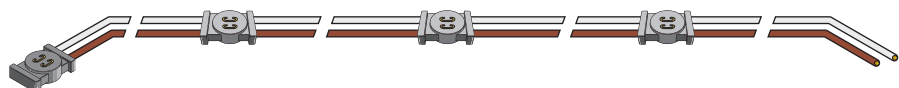

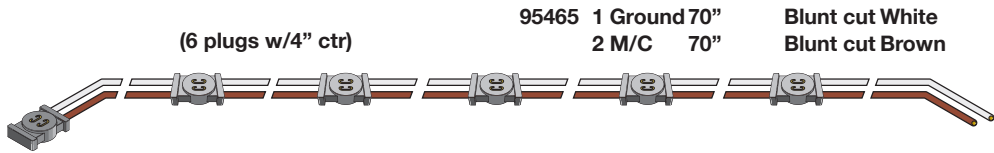

(6 plugs w/4" ctr)

95465 1 Ground 70"  
2 M/C 70"

Blunt cut White  
Blunt cut Brown

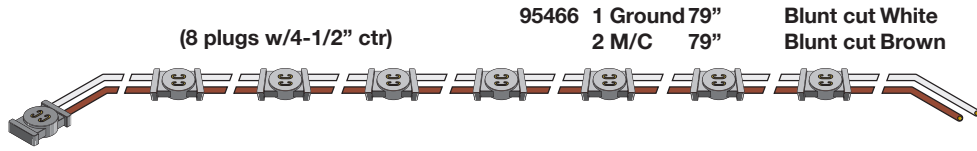

(8 plugs w/4-1/2" ctr)

95466 1 Ground 79"  
2 M/C 79"

Blunt cut White  
Blunt cut Brown

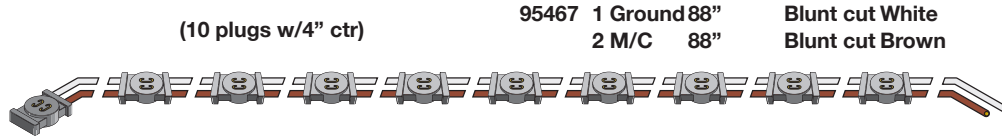

(10 plugs w/4" ctr)

95467 1 Ground 88"  
2 M/C 88"

Blunt cut White  
Blunt cut Brown

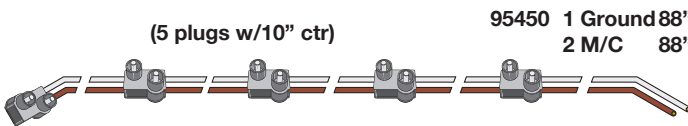

(5 plugs w/10" ctr)

95450 1 Ground 88"  
2 M/C 88"

Blunt cut White  
Blunt cut Brown

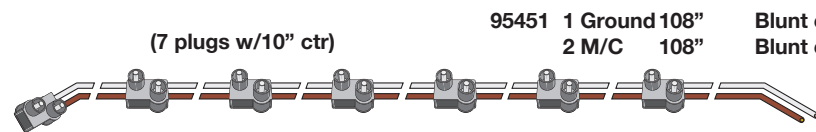

(7 plugs w/10" ctr)

95451 1 Ground 108"  
2 M/C 108"

Blunt cut White  
Blunt cut Brown

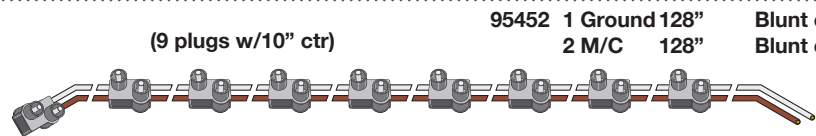

(9 plugs w/10" ctr)

95452 1 Ground 128"  
2 M/C 128"

Blunt cut White  
Blunt cut Brown

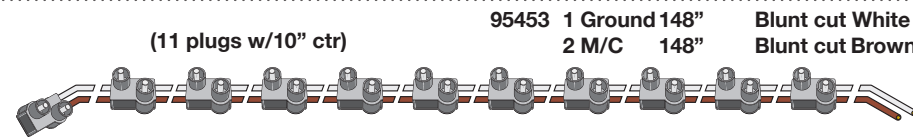

(11 plugs w/10" ctr)

95453 1 Ground 148"  
2 M/C 148"

Blunt cut White  
Blunt cut Brown

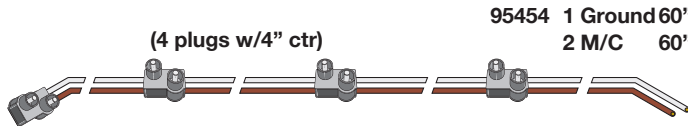

(4 plugs w/4" ctr)

95454 1 Ground 60"  
2 M/C 60"

Blunt cut White  
Blunt cut Brown

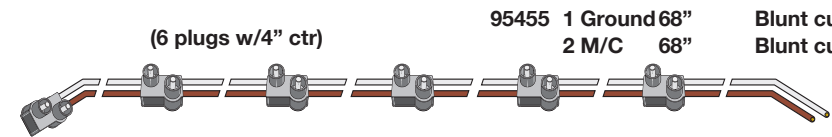

(6 plugs w/4" ctr)

95455 1 Ground 68"  
2 M/C 68"

Blunt cut White  
Blunt cut Brown

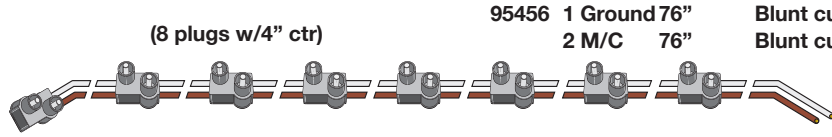

(8 plugs w/4" ctr)

95456 1 Ground 76"  
2 M/C 76"

Blunt cut White  
Blunt cut Brown

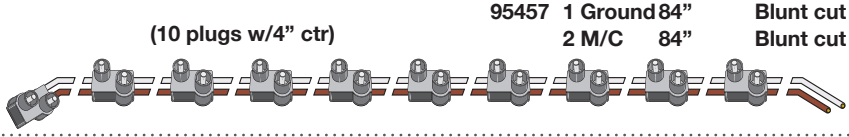

(10 plugs w/4" ctr)

95457 1 Ground 84"  
2 M/C 84"

Blunt cut White  
Blunt cut Brown

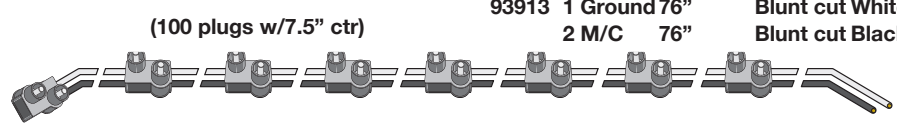

(100 plugs w/7.5" ctr)

93913 1 Ground 76"  
2 M/C 76"

Blunt cut White  
Blunt cut Black

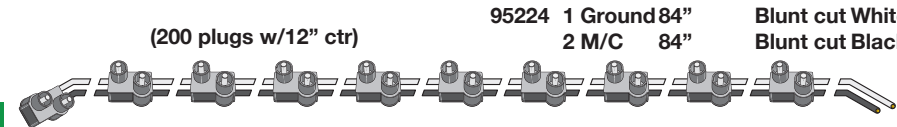

(200 plugs w/12" ctr)

95224 1 Ground 84"  
2 M/C 84"

Blunt cut White  
Blunt cut Black

### LED Fit 'N Forget® Marker Clearance Multiple Plug Harness

- Keeps water, salt & other corrosives from LED lamps
- Combine with LED lamps for Lifetime Lighting Warranty eligibility
- 16 gauge GPT wire
- Brass terminals
- For use with bumpers & skirts

### Marker Clearance Multiple Plug Harness

- For use with bumpers & skirts
- 16 gauge GPT wire
- Tin plated or brass terminals

**License Lamp Plugs**

- Use with Molded 17 incandescent license lamps
- 16 gauge GPT wire
- Tin plated brass terminals

94922	1 License (90 degree plug)	18"	Blunt cut	Black
95051	1 License (90 degree plug)	18"	.180 molded bullet	Black
94923	1 License (straight plug)	18"	6/32" wire strip	Black

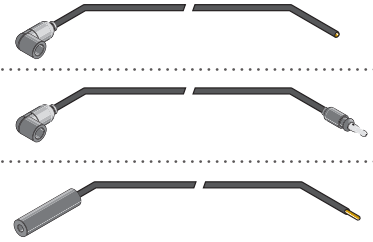

**LED Fit 'N Forget® Replacement Connector**

- Replaces damaged plugs or used for retrofitting
- 16 gauge GPT wire

**94766 Replacement connector**

Note: Recommend using 77825 crimping tool  
Includes 3 terminals, 3 seals and connector

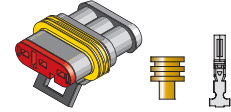

**LED Fit 'N Forget® Stop/Turn/Tail Plug**

- Keeps water, salt & other corrosives from LED lamps
- 16 gauge GPT wire; tin plated brass terminals
- Combine with LED lamps for Lifetime Lighting Warranty eligibility

94707	1 Ground	8"	#10 ring terminal	White
	2 Tail	8"	6/32" wire strip	Black
	3 Stop/Turn	8"	6/32" wire strip	Red



95424	1 Ground	6-1/2"	.180 molded bullet	White
	2 Tail	6-1/2"	.180 molded bullet	Black
	3 Stop/Turn	6-1/2"	.180 molded bullet	Red

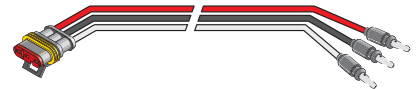

**LED Fit 'N Forget® Stop/Turn/Tail Adapter Plugs**

- Keeps water, salt & other corrosives from LED lamps
- 16 gauge GPT wire; tin plated brass terminals
- Combine with LED lamps for Lifetime Lighting Warranty eligibility

- Converts one stop/turn/tail plug into one LED Fit 'N Forget stop/turn/tail plug

94706	1 Ground	8"	White
	2 Tail	8"	Black
	3 Stop/Turn	8"	Red



- Converts one LED Fit 'N Forget stop/turn/tail plug into one incandescent
- 16 gauge GPT wire

94768	1 Ground	8-5/8"	White
	2 Tail	8-5/8"	Black
	3 Stop/Turn	8-5/8"	Red



- Converts one stop/turn/tail plug into two LED Fit 'N Forget stop/turn/tail plugs
- 16 gauge GPT wire

94769	1 Ground	8"	White
	2 Tail	8"	Black
	3 Stop/Turn	8"	Red



- Converts one LED Fit 'N Forget stop/turn/tail plug into two
- 16 gauge GPT wire

95399	1 Ground	12"	White
	2 Tail	12"	Brown
	3 Stop/Turn	12"	Red

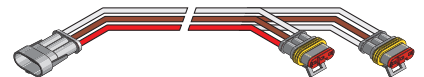

- Converts single male-pin style stop/turn/tail plug into two LED Fit 'N Forget plugs

95002	1 Ground	13"	White
	2 Tail	13"	Brown
	3 Stop/Turn	13"	Red

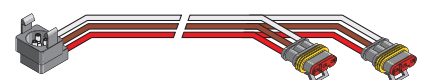

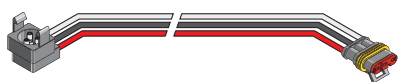

- Converts single male-pin style stop/turn/tail plug into a LED Fit 'N Forget® stop/turn/tail plug
- 16 gauge GPT wire

95001	1 Ground	8"	White
	2 Tail	8"	Black
	3 Stop/Turn	8"	Red



- Converts one stop/turn/tail plug into one LED Fit 'N Forget® stop/turn/tail & one LED Fit 'N Forget® M/C plug
- 16 gauge GPT wire

94770	1 Ground	19"	White
	2 Tail	19"	Brown
	3 Stop/Turn	19"	Red

### LED Fit 'N Forget® Stop/Turn/Tail Adapter Plugs

- Keeps water, salt & other corrosives from LED lamps
- 16 gauge GPT wire; tin plated brass terminals
- Combine with LED lamps for Lifetime Lighting Warranty eligibility

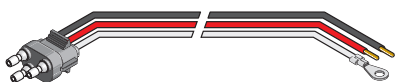

94926	1 Ground	11"	#10 ring terminal	White
	2 Tail	11"	6/32" wire strip	Black
	3 Stop/Turn	11"	6/32" wire strip	Red



94962	1 Ground	10"	#10 ring terminal	White
	2 Tail	10"	.156 molded bullet	Black
	3 Stop/Turn	10"	.156 molded bullet	Red

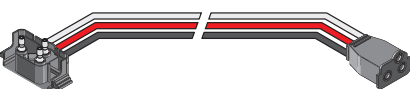

94743	1 Ground	10"	#10 ring terminal	White
	2 Tail	10"	.156 molded bullet	Black
	3 Stop/Turn	10"	.156 molded bullet	Red

### Stop/Turn/Tail Plugs

- For use with dual function sealed incandescent lamps
- 94962 is popular on UPS vehicles
- 16 gauge GPT wire
- Tin plated brass terminals

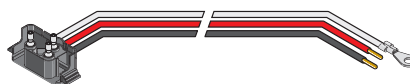

94931	1 Ground	49"	#10 ring terminal	White
	2 Tail	49"	6/32" wire strip	Black
	3 Stop/Turn	49"	6/32" wire strip	Red

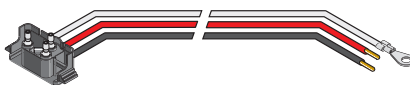

94993	1 Ground	11"	#10 ring terminal	White
	2 Tail	11"	6/32" wire strip	Black
	3 Stop/Turn	11"	6/32" wire strip	Red

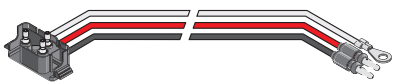

94802	1 Ground	14"	#10 ring terminal	White
	2 Tail	14"	.180 molded bullet	Black
	3 Stop/Turn	14"	.180 molded bullet	Red

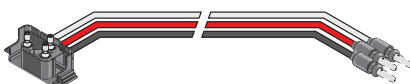

94882	1 Ground	14"	.180 molded bullet	White
	2 Tail	14"	.180 molded bullet	Black
	3 Stop/Turn	14"	.180 molded bullet	Red

### Right Angle Stop/Turn/Tail Plugs

- For use with dual function sealed incandescent lamps
- 16 gauge GPT wire
- Tin plated brass terminals



**LLV Right Angle Stop/Turn/Tail Plugs**

- For the U.S. Postal Service Long-Life Vehicle incandescent lamps
- 18 gauge SXL wires

94839 1 Park 19 3/4" Weather-Pack Connector White  
 2 Ground 19 3/4" P/E #12015793 Black  
 3 Turn 19 3/4" Red



94840 1 Park 4" Weather-Pack Connector White  
 2 Ground 4" P/E #12015793 Black  
 3 Turn 4" Red



94841 1 Park 4" Metri-Pack Connector White  
 2 Ground 4" P/E #12020398 Brown  
 3 Turn 4" Red

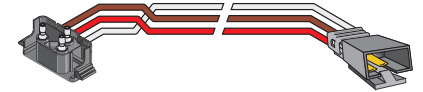

**Stop/Turn/Tail Socket Assemblies**

- 16 gauge GPT wire
- Tin plated brass terminals

- For use with Model 40 bulb replaceable lamps
- Bulb #1157 included

94938 1 Ground 7 1/2" #6 ring terminal White  
 2 Tail 8" 6/32" wire strip Black  
 3 Stop/Turn 8" 6/32" wire strip Red



- For use with Model 60 & Model 91 bulb replaceable lamps
- 16 gauge GPT wire
- Tin plated brass terminals
- Bulb #3157 included

95407 1 Ground 7 1/2" #10 ring terminal White  
 2 Tail 8" 6/32" wire strip Black  
 3 Stop/Turn 8" 6/32" wire strip Red



**Right Angle Stop/Turn/Tail Plugs with Adapter**

- 16 gauge GPT wire

- "Y" adapter plug used to accommodate additional side marker requirements
- Designed to adapt with Truck-Lite jumper harness part numbers 50321, 50322, 50331 & 50350

94853 1 Ground 6" White  
 2 Tail/Marker 6" Brown  
 3 Stop/Turn 6" Red

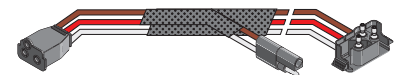

- "Y" adapter plug used to accommodate additional stop/turn/tail requirements
- Designed to adapt with 88 series harness

94760 1 Ground 6" White  
 2 Tail/Marker 6" Brown  
 3 Stop/Turn 6" Red

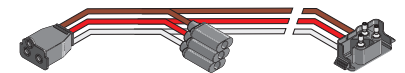

- Converts one incandescent stop/turn/tail plug into two

94932 1 Ground 10" White  
 2 Tail 10" Brown  
 3 Stop/Turn 10" Red  
 94750 1 Ground 18" White  
 2 Tail 18" Brown  
 3 Stop/Turn 18" Red

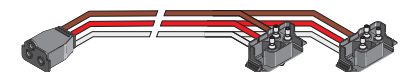

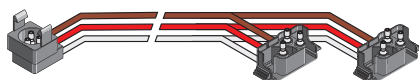

- Converts single male-pin style stop/turn/tail plug into a conventional two plug mail harness to mate with most incandescent stop/turn/tail lamps

**Right Angle Stop/Turn/Tail Plugs with Adapter**

- 16 gauge GPT wire

94865	1 Ground	10"	White
	2 Tail	10"	Brown
	3 Stop/Turn	0"	Red



94868	1 Ground	8"	Metri-Pack Connector	White
	2 Turn	8"	P/E #15300027	Red



- Converts single male-pin style stop/turn/tail plug into a conventional single plug male harness which mates with most incandescent stop/turn/tail lamps

94897	1 Ground	5"	White
	2 Tail	5"	Black
	3 Stop/Turn	5"	Red

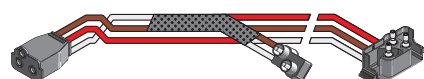

- Converts one stop/turn/tail plug into one stop/turn/tail plug & one 19" long marker clearance plug

94751	1 Ground	12"	White
	2 Tail	12"	Brown
	3 Stop/Turn	12"	Red



94948	1 Ground	12"	White
(L.H.)	2 Tail	6"	Brown/Black
	3 Turn	6"	Yellow
	4 Stop	6"	Red

**Stop/Turn/Tail Plugs with Adapter**

- For use with part numbers 41005R & 41006R
- 16 gauge GPT wire



94949	1 Ground	12"	White
(R.H.)	2 Tail	6"	Black
	3 Stop	6"	Red
	4 Turn	6"	Green

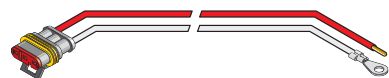

- Keeps water, salt & corrosives from LED lamps
- Combine with LED lamps for Lifetime Lighting Warranty eligibility

**LED Fit 'N Forget® Stop/Turn Plug**

- 16 gauge GPT wire
- Tin plated brass terminals

94759	1 Ground	8"	#6 ground terminal	White
	2 Stop/Turn	8"	6/32" wire strip	Red

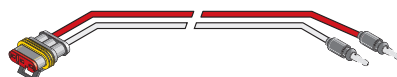

95500	1 Ground	8"	.180 molded bullet	White
	2 Stop/Turn	8"	.180 molded bullet	Red

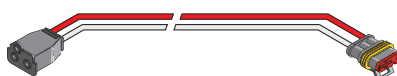

- Keeps water, salt & corrosives from LED lamps
- Combine with LED lamps for Lifetime Lighting Warranty eligibility
- Converts one incandescent stop/turn/tail plug into one LED stop/turn/tail plug

**LED Fit 'N Forget® Stop/Turn Adapter**

- 16 gauge GPT wire
- Tin plated brass terminals

94789	1 Ground	8"	White
	2 Stop/Turn	8"	Red

**Stop/Turn Plugs**

- 16 gauge GPT wire
- Tin plated brass terminals

- For use with single function sealed incandescent stop/turn lamps
- 94961 is popular on UPS vehicles

**94925** 1 Ground 11" #10 ring terminal White  
 2 Stop/Turn 11" 6/32" wire strip Red

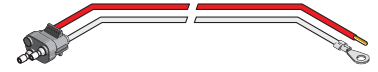

**94961** 1 Ground 10" #10 ring terminal White  
 2 Stop/Turn 10" .156 molded bullet Red



**Right Angle Stop/Turn Plugs**

- 16 gauge GPT wire
- Tin plated brass terminals

- For use with single function sealed incandescent stop/turn lamps

**94992** 1 Ground 10 1/2" #10 ring terminal White  
 2 Stop/Turn 10 1/4" 6/32" wire strip Red

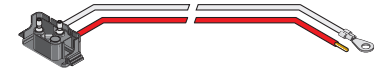

**LLV Right Angle Stop/Turn Plugs**

- 18 gauge SXL wire

- For the U.S. Postal Service Long-Life Vehicle incandescent lamps
- 18 gauge SXL wires

**94837** 1 Ground 4" Metri-Pack Connector Brown  
 2 Stop/Turn 4" P/E #12020398 Red



**94838** 1 Ground 4" Metri-Pack Connector Brown  
 2 Stop 4" P/E #12020398 Red



**Stop/Turn Socket Assemblies**

- 16 gauge GPT wire
- Tin plated brass terminals

- For use with Model 40 bulb replaceable lamps
- Bulb #1156 included

**94937** 1 Ground 7 1/2" #6 ring terminal White  
 2 Stop/Turn 7" 6/32" wire strip Red

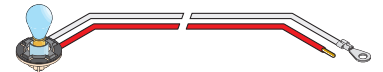

- For use with Model 60 & Model 91 bulb replaceable lamps
- Bulb #3157 included

**95415** 1 Ground 8" #10 ring terminal White  
 2 Stop/Turn 10" 6/32" wire strip Red

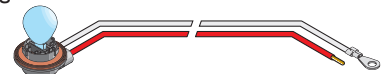

**Right Angle Tail Plug**

- 16 gauge GPT wire

- For using an incandescent stop/turn/tail lamp as marker only

**94991** 1 Ground 11" #10 ring terminal White  
 2 Tail 11" 6/32" wire strip Black



**LLV Right Angle Tail Plug**

- 18 gauge SXL wire

- For the U.S. Postal Service Long-Life Vehicle incandescent lamps

**94851** 1 Ground 6" Metri-Pack Connector Brown  
 2 Tail 6" P/E #12020398 Red

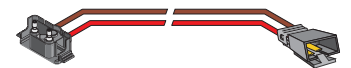

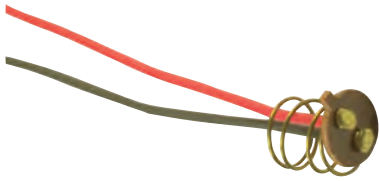

- With "in-line" guide pin for lamps with indexing, bayonet, candelabra type bases (e.g. nos. 1157, 1034 bulbs)

**9101 Double contact 8" wire**

### Pigtails



- For lamps with bayonet, candelabra type bases (e.g. nos. 67, 1073, 1156 bulbs)

**9102 Single contact 8" wire**

### Pigtails



- Packard Metri-Pack connector eliminates corrosion & salt creep easy hook-up
- 21" length, 18 gauge wire

**9465 5800 series connector**

### Signal Lamp Plugs



- Mates with new Male Pin series lamps

**96106 Plug for marker lamps, 2 pin right angle**  
**96108 Plug for stop/tail lamps, 2 pin straight**  
**96107 Plug for stop/turn/tail lamps, 3 pin straight**  
**96109 Plug for marker lamps, .180 bullets**

### Male Pin Plugs



- Five pin Packard® Metri-Pack #12084891 connection to lamps with two (Dual-Pack) connector sockets
- Used for installation of OEM rear signal lamps where harness is routed down one frame rail of vehicle

**9470 5020 Series dual-pack connector**

### Signal Lamp Plugs



- Replacement jumper harness for 'Daisy Chain' lamps supplied as original equipment on Navistar, Volvo & Freightliner vehicles
- P/E #12065862

**9469 5020 series 'Daisy Chain' jumper harness**

### Signal Lamp Plugs





## 6 Conductor Main Cable

88601 6 cond. main cable, 1-10, 5-12 gauge Dim "A"  
720"

Dimensions "A" indicate standard stocked length harness. Custom length available in 12" increments.

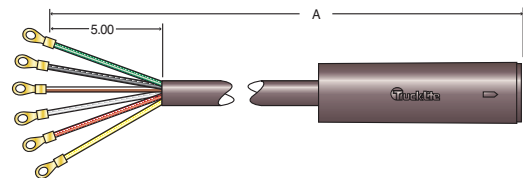

## 7 Conductor Main Cable

88701 7 cond. main cable, 1-10, 6-12 gauge Dim "A"  
720"  
88703 7 cond. ABS main cable, 1-8, 2-10, 4-12 gauge 720"

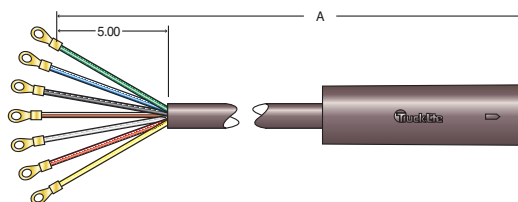

## 7 Conductor Main Cable

88750 7 cond. main cable, 1-10, 6-12 gauge Dim "A" 744" Dim "B" 384"  
88751 7 cond. main cable, 1-8, 2-10, 4-12 gauge 744" 384"

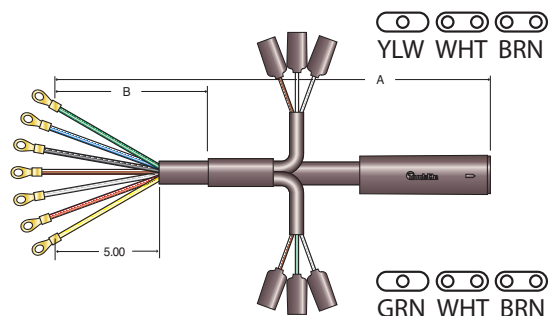

## Main Retro Fit/Repair Harness

88810 Main retro fit/repair harness Dim "A"  
24"  
97956 1" x 12" shrink tube, 1 piece

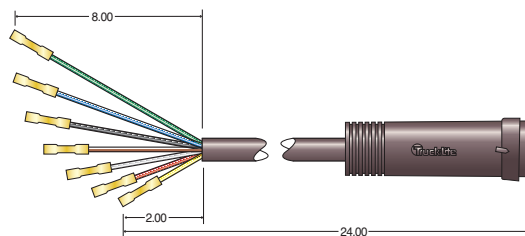

## Rear 7-Way Adapter Harness

88900 Rear 7-way adapter harness

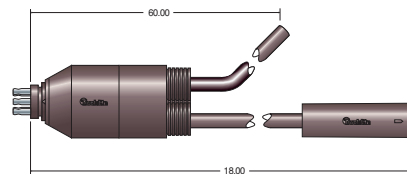

## Rear 7-Way Adapter ABS Power Harness

88902 Rear 7-way adapter ABS power harness

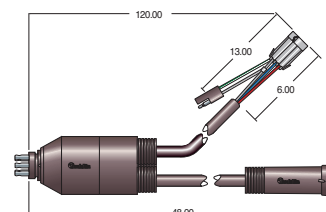



## 7 Conductor Main Cable w/Nose Box

88892 7 cond. main cable, 1-8, 2-10, 4-12 gauge Dim "A"  
14" 180"

Note: Uses 50897 nosebox

Dimensions "A" indicate standard stocked length harness. Custom length available in 12" increments.

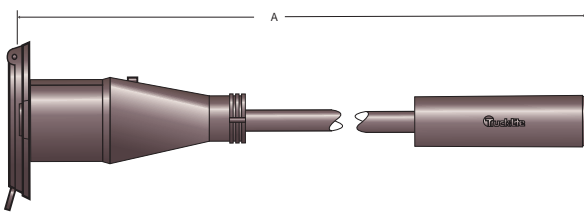

## 7 Conductor Main Cable w/Nose Box & Jumpers

88896 7 cond. main cable, 1-8, 2-10, 4-12 gauge Dim "A"  
27"

Note: Uses 50897 nosebox

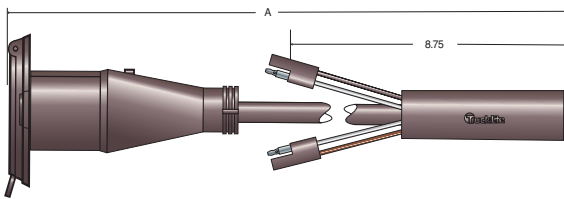

## 7 Conductor Main Cable

88820 7 cond. main cable, 1-8, 2-10, 4-12 gauge Dim "A"  
456"

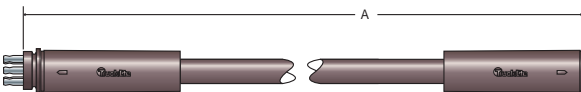

## 7 Conductor Main Cable w/Center Turn Breakouts

89751 7 cond. main cable, 1-8, 2-10, 4-12 gauge Dim "A" Dim "B"  
744" 372"

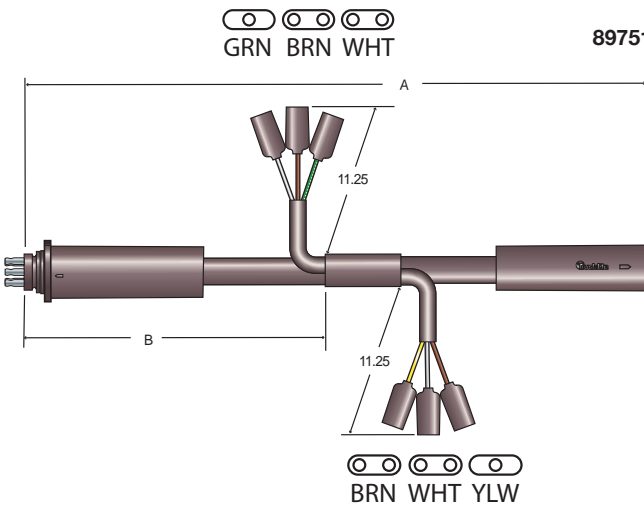



## 7 Conductor Nose Box Harness

50776 7 cond. main cable, 1-8, 2-10, 4-12 gauge

Dim "A"  
72"

Note: Uses 50897 nosebox

Dimensions "A" indicate standard stocked length harness. Custom length available in 12" increments.

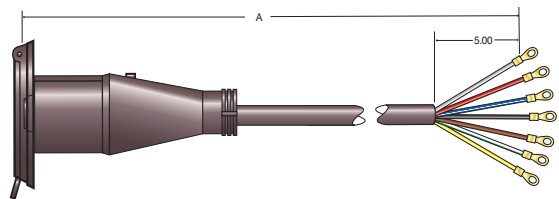

## 7 Conductor Nose Box Repair Harness

89810 7 cond. main cable, 1-8, 2-10, 4-12 gauge

Dim "A"  
24"

Note: Uses 50897 nosebox

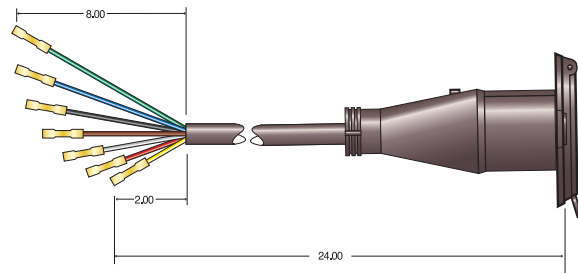

## Rear 7-Way Adapter Harness

88905 7-way adapter harness

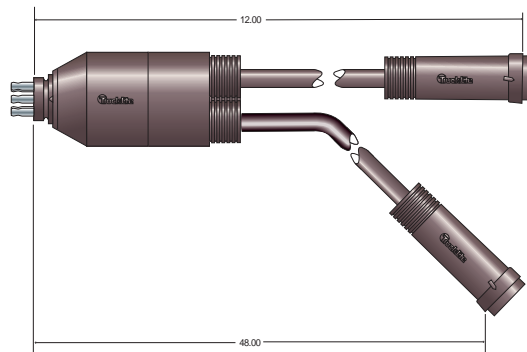

## Rear 7-Way Adapter Harness

88962 7-way adapter harness

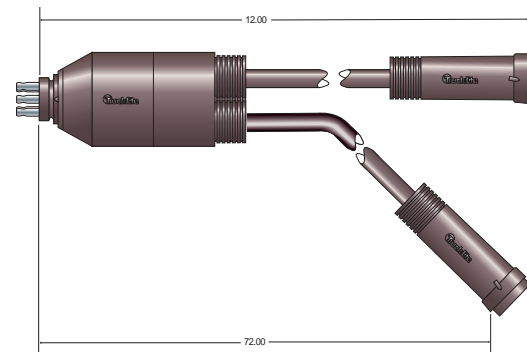

## Rear Nose Box Jumper

50969 7 cond. main cable, 1-8, 2-10, 4-12 gauge

Dim "A"  
14"

Note: Uses 50897 nosebox

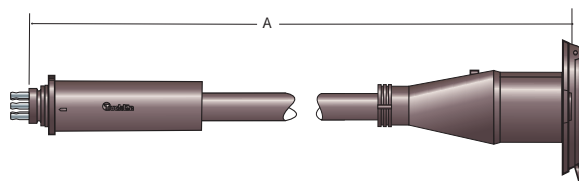

## Rear Sill Harness

- 88910 Rear sill harness
- 88915 Rear sill harness w/o mid-turn dropouts

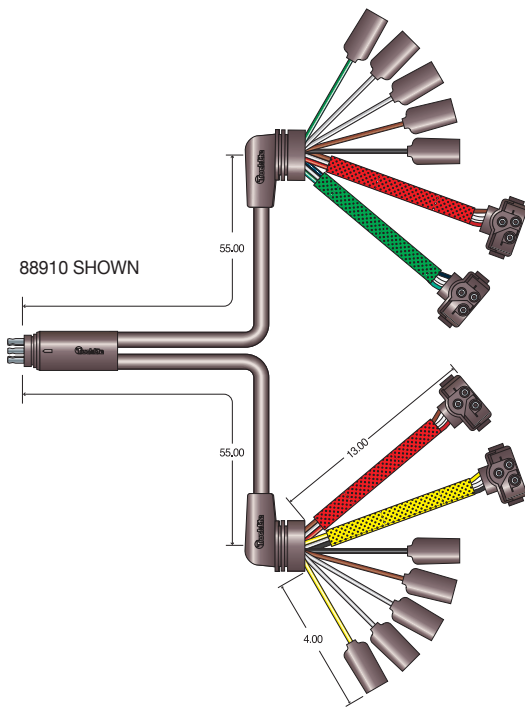

## LED Rear Sill Harness

- 88930 LED rear sill harness
- 88932 LED rear sill harness w/o mid-turn dropouts

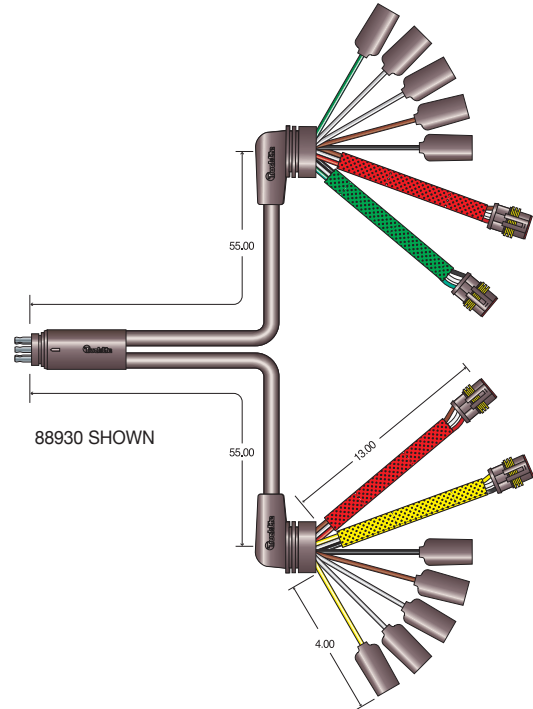

## Rear Sill Harness with Auxiliary Dropouts

- 88911 Rear sill harness w/auxiliary red/blue/white dropouts

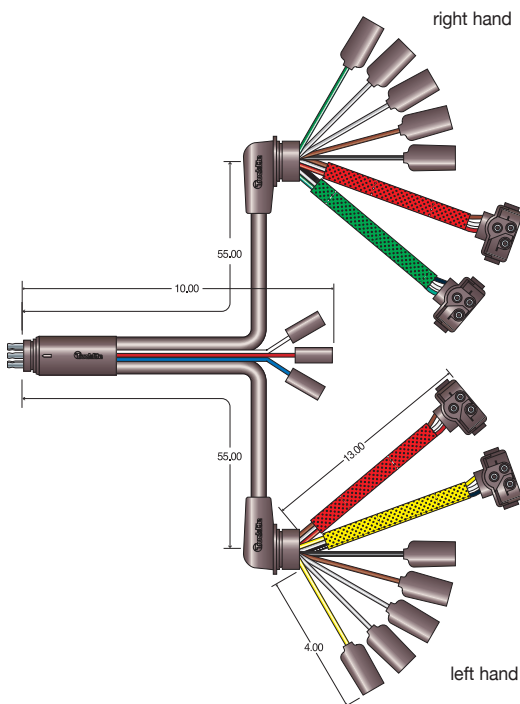

## LED Rear Sill Harness with Auxiliary Dropouts

- 88931 LED rear sill harness w/auxiliary red/blue/white dropouts

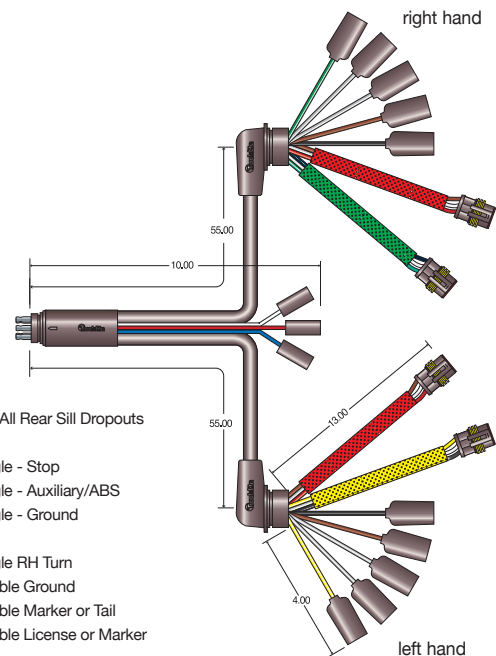

### Wire Color Coding For All Rear Sill Dropouts

- Center (ABS Power)
  - Red - (1) Single - Stop
  - Blue - (1) Single - Auxiliary/ABS
  - White - (1) Single - Ground
- Right Hand
  - Green - (1) Single RH Turn
  - White - (2) Double Ground
  - Brown - (1) Double Marker or Tail
  - Black - (1) Double License or Marker
- Left Hand
  - Yellow - (1) Single LH Turn
  - White - (2) Double Ground
  - Brown - (1) Double Marker or Tail
  - Black - (1) Double License or Marker



## ABS Power Harness



88100 3 cond. flat cable, 12 gauge Dim "A" 360"

Dimensions "A" indicate standard stocked length harness. Custom length available in 12" increments.

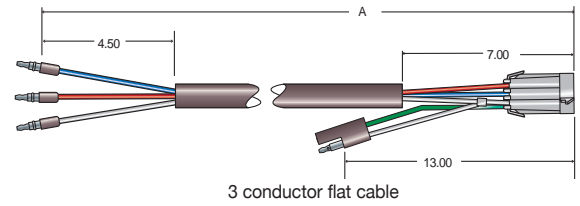

## ABS Fault Lamp Jumper Harness

52200 2 cond. flat cable, 14 gauge Dim "A" 120"

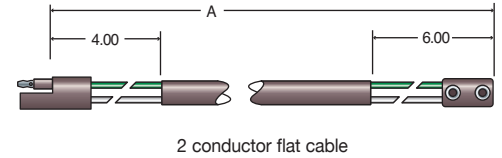

## ABS LED Fault Lamp Jumper Harness

52203 2 cond. flat cable, 14 gauge Dim "A" 96"

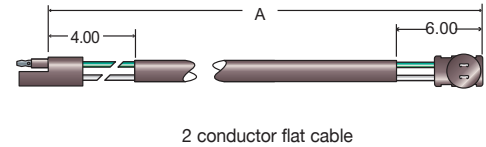

## Single Plug Marker/Clearance Harness

88303 2 cond. flat cable, 14 gauge brown/white Dim "A" 24"  
 88307 2 cond. flat cable, 14 gauge brown/white 36"  
 87357 Marker/clearance harness black/white 408"  
 87358 Marker/clearance harness brown/white 408"

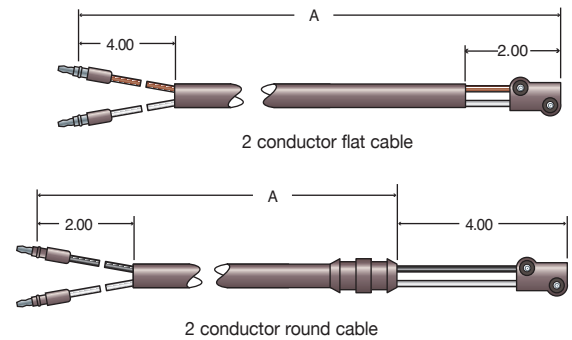

## Marker/Clearance Jumper Harness

50322 Marker/clearance jumper harness, brown/white Dim "A" 300"  
 50350 Marker/clearance jumper harness, brown/white 132"  
 50321 Marker/clearance jumper harness, brown/white 252"  
 50331 Marker/clearance jumper harness, brown/white 384"  
 51375 Marker/clearance harness w/jumper plug brown/white 120"

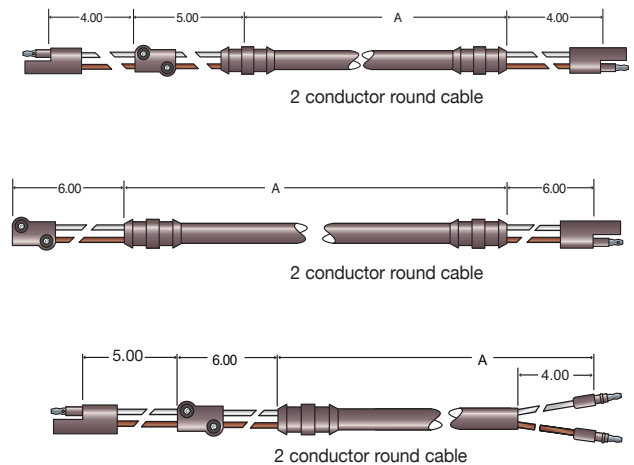



Dimensions "A" indicate standard stocked length harness. Custom length available in 12" increments.

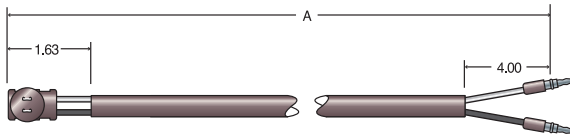

2 conductor flat cable

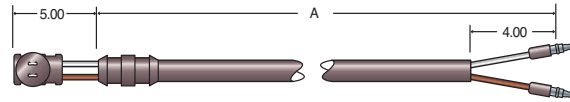

2 conductor round cable

## LED Single Plug Marker/Clearance Harness

88377	2 cond. flat cable, 16 gauge, black/white	Dim "A" 12"
88373	2 cond. flat cable, 14 gauge brown/white	24"

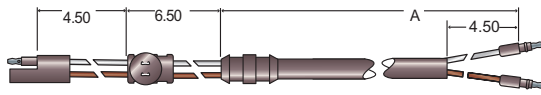

2 conductor round cable

## LED Marker/Clearance Jumper Harness

88385	LED marker/clearance harness w/jumper plug brown/white	Dim "A" 24"
-------	--	----------------

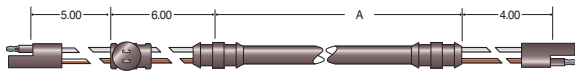

2 conductor round cable

50382	Marker/clearance jumper harness, brown/white	300"
-------	--	------

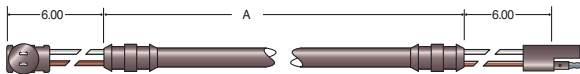

2 conductor round cable

50383	Marker/clearance jumper harness, brown/white	132"
50384	Marker/clearance jumper harness, brown/white	252"
50385	Marker/clearance jumper harness, brown/white	384"

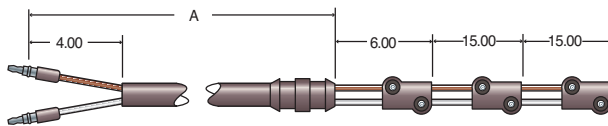

2 conductor round cable

## Three Plug Identification Harness

88300	Lower ID harness brown/white	Dim "A" 60"
88301	Upper ID harness brown/white	192"

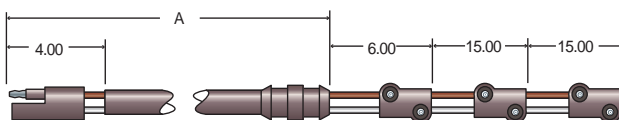

2 conductor round cable

## Three Plug Identification Harness

51305	Lower ID harness brown/white	Dim "A" 60"
-------	------------------------------	----------------

## LED Three Plug Identification Harness

		Dim "A"
88367	LED lower ID harness black/white	60"
88368	LED upper ID harness black/white	192"
88372	LED lower ID harness black/white with 14.25" centers	60"

Dimensions "A" indicate standard stocked length harness. Custom length available in 12" increments.

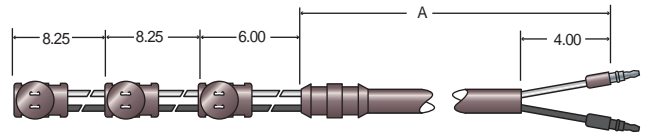

2 conductor round cable

## Four Plug Identification / License Harness

		Dim "A"
88308	Lower ID/license lamp harness brown/white	60"

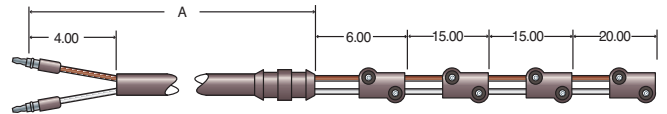

2 conductor round cable

## Seven Plug Identification / Marker Harness

		Dim "A"
89217	Lower ID/marker harness brown/white	60"

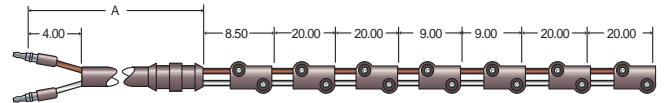

2 conductor round cable

## LED Four Plug Identification / License Harness

		Dim "A"
88338	LED lower ID/incandescent license harness black/white	60"

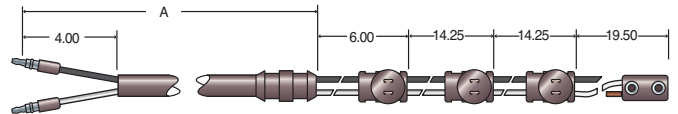

## 3 Plug Plug-In Identification Harness

95809	2 cond. flat cable, 14 gauge, black/white
-------	---

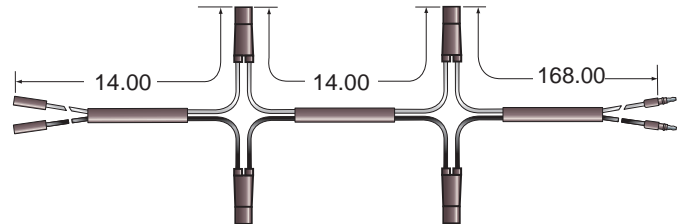

## 5 Plug Plug-In Identification Harness

95879	2 cond. flat cable, 14 gauge, black/white
-------	---

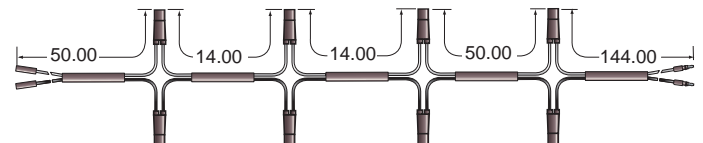



Dimensions "A" indicate standard stocked length harness. Custom length available in 12" increments.

## 6 Plug Plug-In Identification Harness

89274 2 cond. flat cable, 14 gauge, black/white

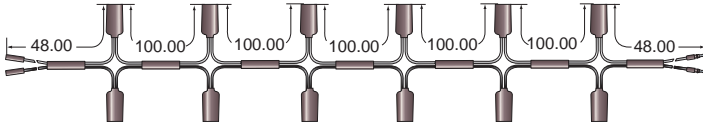

## 15 Plug Plug-In Identification Harness

96627 2 cond. flat cable, 14 gauge, black/white

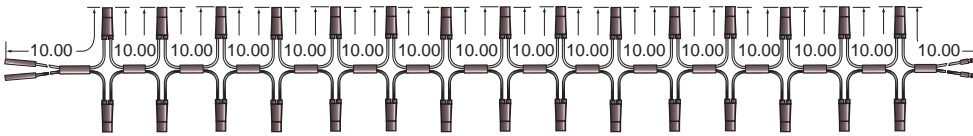

## 20 Plug Plug-In Identification Harness

89286 2 cond. flat cable, 14 gauge, black/white

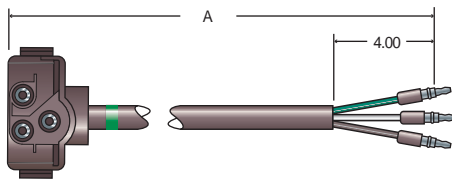
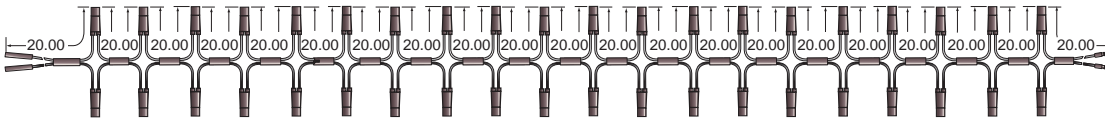

3 conductor flat cable

## From Rear Sill – Mid Turn Harness

- 51355 Mid turn/marker harness, L.H.
- 51356 Mid turn/marker harness, R.H.

Dim "A"	Custom Dim
420"	12" - 660"
420"	12" - 660"

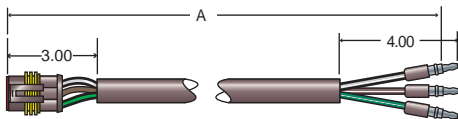

3 conductor flat cable

## From Rear Sill – LED Mid Turn Harness

- 51342 LED mid turn/marker harness, R.H.
- 51343 LED mid turn/marker harness, L.H.

Dim "A"	Custom Dim
420"	12" - 504"
420"	12" - 504"

## LED Marker/Clearance Jumper Feed Harness

	Dim "A"
51409 Marker/clearance jumper feed harness	192"

Dimensions "A" indicate standard stocked length harness. Custom length available in 12" increments.

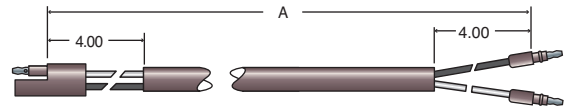

2 conductor round cable

## Marker/Clearance Jumper Feed Harness

	Dim "A"
88342 Marker/clearance jumper feed harness	12"

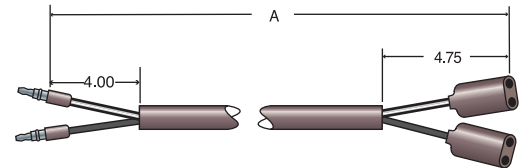

2 conductor flat cable

## Marker/Clearance Jumper Feed Harness

	Dim "A"
88401 Marker/clearance jumper feed harness	18" - 636"

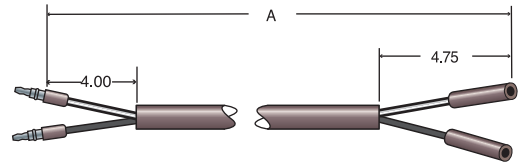

2 conductor flat cable

## Chassis Ground Components – Identification / License Harness

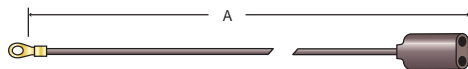

	Dim "A"
96928 Front marker/clearance harness	60"
96978 Front marker/clearance hot wire	168"

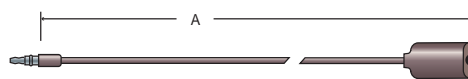

	Dim "A"
96959 License lamp jumper harness	48"
96966 Rear marker/clearance jumper harness	30"
96967 Lower ID/license jumper harness	72"
96970 Upper ID jumper harness	236"
96969 Marker/clearance jumper harness	168"
96979 Marker/clearance jumper harness	24"

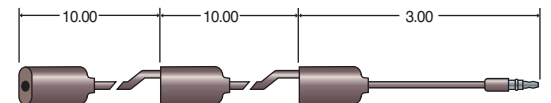

96968 Upper ID harness

	Dim "A"
96954 Double receptacle jumper harness	236"
96975 Double receptacle jumper harness	168"
96953 Double receptacle jumper harness	120"
96974 Double receptacle jumper harness	72"
96973 Double receptacle jumper harness	48"
96960 Double receptacle jumper harness	12"
96955 Double receptacle jumper harness	3"
97060 Double receptacle jumper harness	6"
97061 Double receptacle jumper harness	108"
97062 Double receptacle jumper harness	198"
97002 .180 filler plug	

Note: Harnesses in this section feature 14 gauge HDT black wire (.150" diameter).



## 28' Van Trailer Harness System

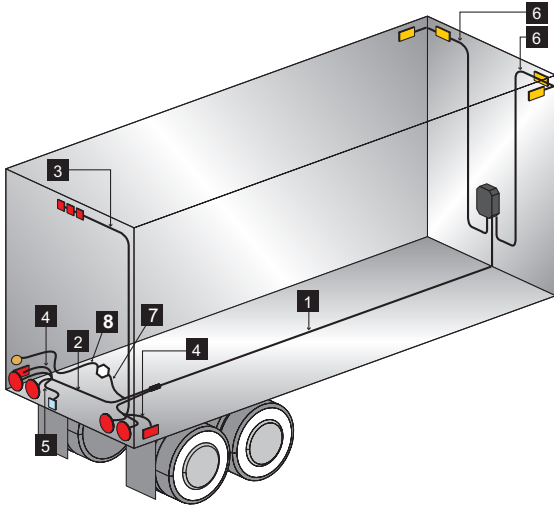

Internal Ground

Part No.	LED Part No.	Qty	Description
1	88703-0420	88703-0420	1 7 Conductor Main Cable, 35'
2	88911	88931	1 Rear Sill Harness
3	88301	88368	1 Upper ID Harness, 192"
4	88303	88373	2 Rear Marker Lamp Harness, 24"
5	88307	88307	1 License Lamp Harness, 36"
6	50309	50377	1 Front M/C, Harness, 168"
7	88100-0120	88100-0120	1 ABS Power Jumper Harness, 120"
8	52200	52203	1 ABS Fault Lamp Jumper Harness

## 48/53' Van Trailer Harness System

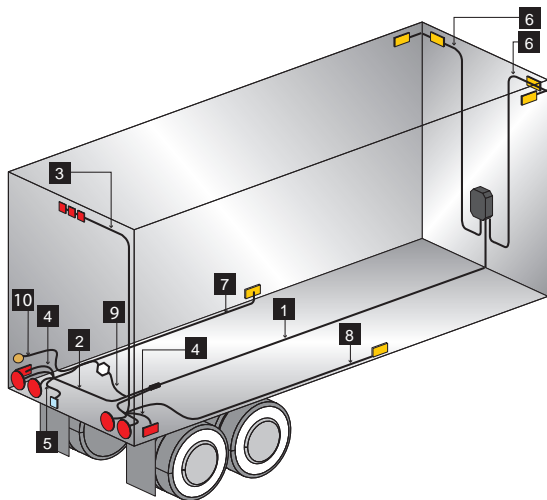

Internal Ground

Part No.	LED Part No.	Qty	Description
1	88703	88703	1 7 Conductor Main Cable, 60'
2	88911	88931	1 Rear Sill Harness
3	88301	88368	1 Upper ID Harness, 192"
4	88303	88373	2 Rear Marker Lamp Harness, 24"
5	88307	88307	1 License Lamp Harness, 36"
6	50309	50377	2 Front M/C, Harness, 168"
7	51355	51343	1 Mid Turn Harness, Left Side, 420"
8	51356	51342	1 Mid Turn Harness, Right Side, 420"
9	88100-0120	88100-0120	1 ABS Power Jumper Harness, 120"
10	52200	52203	1 ABS Fault Lamp Jumper Harness

## 48' Flatbed Trailer Harness System

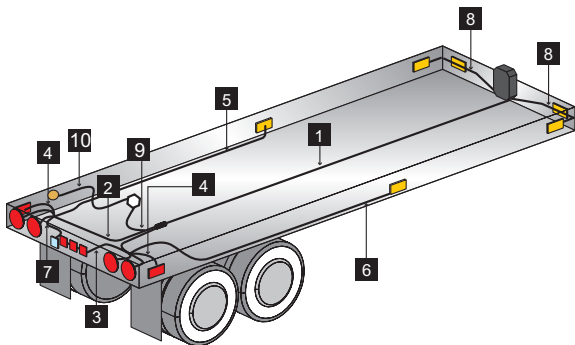

Internal Ground

Part No.	LED Part No.	Qty	Description
1	88703-0624	88703-0624	1 7 Conductor Main Cable, 52'
2	88911	88931	1 Rear Sill Harness
3	88300	88367	1 Lower ID Harness, 60"
4	88303	88373	2 Rear Marker Lamp Harness, 24"
5	51355	51343	1 Mid Turn Harness, Left Side, 420"
6	51356	51342	1 Mid Turn Harness, Right Side, 420"
7	88307	88307	1 License Lamp Harness
8	50309	50377	2 Front M/C, Harness
9	88100-0120	88100-0120	1 ABS Power Jumper Harness, 120"
10	52200	52203	1 ABS Fault Lamp Jumper Harness

## 6 Conductor Main Cable

Dimensions "A" indicate standard stocked length harness. A range of custom length harnesses are available in 12" increments.

Part No.	Dim. "A"	Part No.	Dim. "A"	Part No.	Dim. "A"
50103 0036	36"	50124 0288	288"	50145 0540	540"
50106 0072	72"	50127 0324	324"	50148 0576	576"
50109 0108	108"	50130 0360	360"	50151	612"
50112 0144	144"	50133	396"	50154 0648	648"
50115 0180	180"	50136 0432	432"	50157 0684	684"
50118 0216	216"	50139 0468	468"	50160 0720	720"
50121 0252	252"	50142 0504	504"	50163 0756	756"

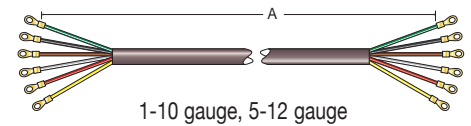

## 7 Conductor Main Cable

Part No.	Dim. "A"	Part No.	Dim. "A"	Part No.	Dim. "A"
52703 0036	36"	52724 0288	288"	52745 0540	540"
52706 0072	72"	52727 0324	324"	52748 0576	576"
52709 0108	108"	52730 0360	360"	52751	612"
52712 0144	144"	52733	396"	52754 0648	648"
52715 0180	180"	52736 0432	432"	52757 0684	684"
52718 0216	216"	52739 0468	468"	52760 0720	720"
52721 0252	252"	52742 0504	504"	52763 0756	756"

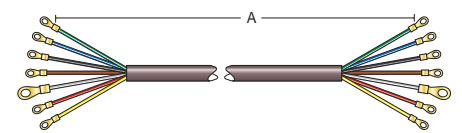

## Single Plug Turn/Tail Harness

Part No.	Description	Dim "A"	Custom Dim
50266	R.H. turn/tail harness, white/green/brown	456"	192" - 444"
50267	L.H. turn/tail harness, white/yellow/brown	456"	192" - 444"

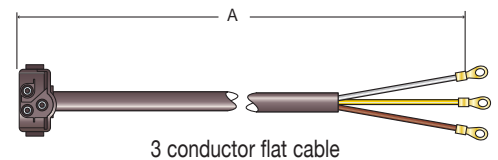

## LED Single Plug Stop/Turn/Tail Harness

Part No.	Description	Dim "A"	Custom Dim
51344	R.H. turn/tail harness, white/green/brown	420"	12" - 408"
51345	L.H. turn/tail harness, white/yellow/brown	420"	12" - 408"
51325	Stop/tail harness, white/red/black	180"	348"

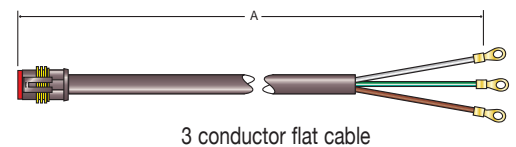

## Single Plug Stop/Turn/Tail Harness

Part No.	Description	Dim "A"	Custom Dim
50325	Stop/turn/tail harness, white/red/black	180"	12" - 168"
50338	Stop/turn/tail harness, white/red/black	456"	192" - 444"
50342	R.H. turn/marker harness, white/green/brown	180"	12" - 168"
50343	L.H. turn/marker harness, white/yellow/brown	180"	12" - 168"
50344	R.H. turn/marker harness, white/green/brown	456"	192" - 444"
50345	L.H. turn/marker harness, white/yellow/brown	456"	192" - 444"

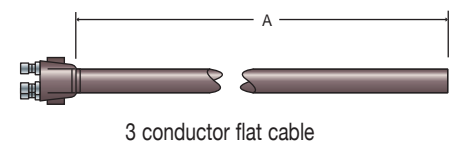

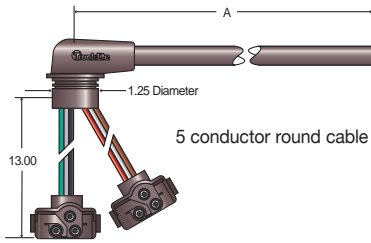

Dimensions "A" indicate standard stocked length harness. A range of custom length harnesses are available in 12" increments.

### Stop/Turn/Tail Harness

		Dim "A"	Custom Dim.
50200	R.H. stop/turn/tail harness	72"	12" - 60"
50201	L.H. stop/turn/tail harness	72"	12" - 60"
50202	R.H. stop/turn/tail harness	156"	84" - 144"
50203	L.H. stop/turn/tail harness	156"	84" - 144"

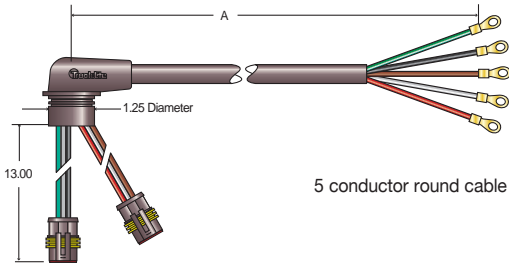

### LED Stop/Turn/Tail Harness

		Dim "A"	Custom Dim.
50240	R.H. stop/turn/tail harness	72"	12" - 96"
50241	L.H. stop/turn/tail harness	72"	12" - 96"

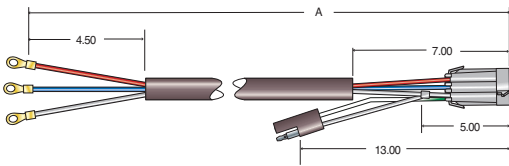

### ABS Power Jumper Harness

		Dim "A"	Custom Dim.
52100	ABS power harness	720"	120" - 600"

Connect from nosebox or 50-series junction box  
3 conductor 12 gauge flat cable for use with 50847  
compression fitting to connect with 50-series junction box

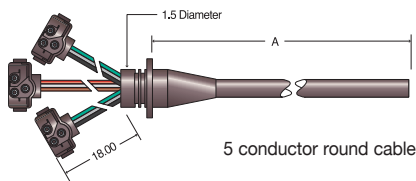

### 3 Plug Stop/Turn/Tail and Back-Up Harness

		Dim "A"	Custom Dim.
50204	R.H. 3 plug stop/turn/tail harness	72"	12" - 60"
50205	L.H. 3 plug stop/turn/tail harness	72"	12" - 60"
50250	L.H. 2 plug S/T/T & back-up harness	144"	84" - 132"
50251	R.H. 2 plug S/T/T & back-up harness	144"	84" - 132"

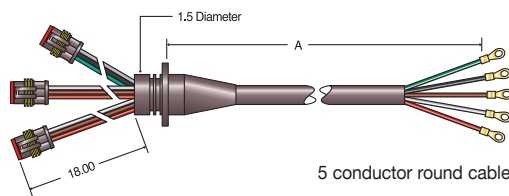

### LED 3 Plug Stop/Turn/Tail Harness

		Dim "A"	Custom Dim.
51270	R.H. 3 plug S/T/T harness	96"	12" - 192"
51271	L.H. 3 plug S/T/T harness	96"	12" - 192"

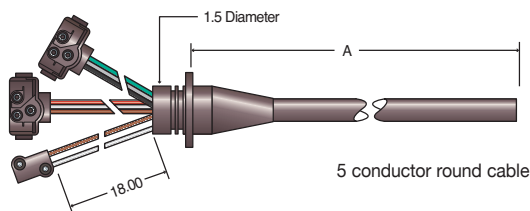

### Stop/Turn/Tail and Side Marker Harness

		Dim "A"	Custom Dim.
50208	R.H. S/T/T & side marker harness	96"	12" - 84"
50209	L.H. S/T/T & side marker harness	96"	12" - 84"
50210	R.H. S/T/T & side marker harness	192"	108" - 180"
50211	L.H. S/T/T & side marker harness	192"	108" - 180"

Dimensions "A" indicate standard stocked length harness.  
A range of custom length harnesses are available in 12" increments.



### LED Stop/Turn/Tail and Side Marker Harness

		Dim "A"	Custom Dim.
50242	R.H. S/T/T & rear marker harness	96"	12" - 240"
50243	L.H. S/T/T & rear marker harness	96"	12" - 240"

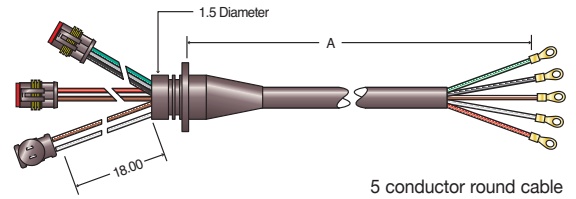

### Stop/Turn/Tail and Side Marker Harness

		Dim "A"	Custom Dim.
50230	R.H. S/T/T & side marker harness	180"	48" - 168"
50231	L.H. S/T/T & side marker harness	180"	48" - 168"

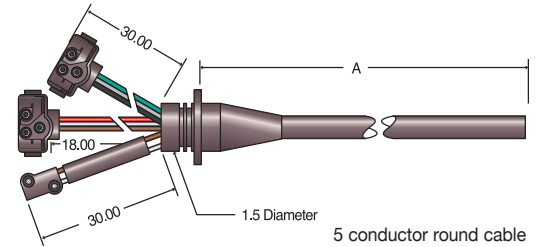

### Single Plug Marker/Clearance Harness

		Dim "A"	Custom Dim.
50307	Marker/clearance harness, black/white	36"	12" - 24"
50303	Marker/clearance harness, black/white	72"	36" - 60"
50310	Marker/clearance harness, black/white	336"	84" - 324"
50304	Marker/clearance harness, brown/white	168"	12" - 156"
50305	Marker/clearance harness, brown/white	456"	180" - 444"
50351	Marker/clearance harness, brown/white	720"	468" - 708"

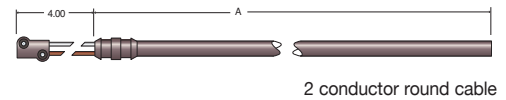

### LED Single Plug Marker/Clearance Harness

		Dim "A"	Custom Dim.
50373	Marker/clearance harness, black/white	72"	36" - 60"
50376	Marker/clearance harness, black/white	336"	84" - 324"
50374	Marker/clearance harness, brown/white	168"	12" - 156"
50375	Marker/clearance harness, brown/white	456"	180" - 444"

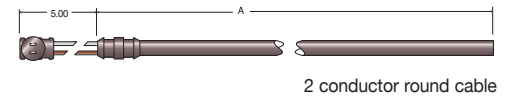

### LED Two Plug Marker/Clearance Harness

		Dim "A"	Custom Dim.
50309	2 plug, brown/white	168"	12" - 156"
50324	2 plug, brown/white	300"	180" - 288"

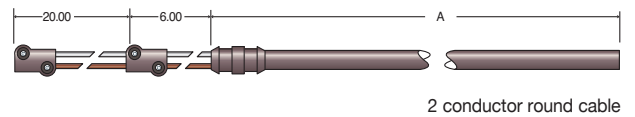

		Dim "A"	Custom Dim.
50377	2 plug, brown/white	168"	12" - 192"

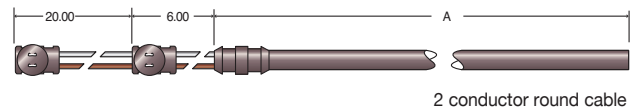

### Three Plug Identification Harness

		Dim "A"	Custom Dim.
50300	Lower, brown/white	36"	12" - 24"
50301	Upper, brown/white	288"	48" - 276"
50334	Upper, brown/white	324"	300" - 312"

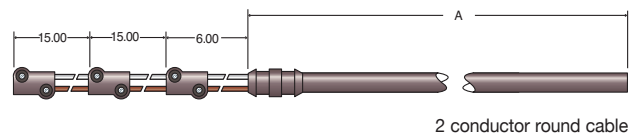

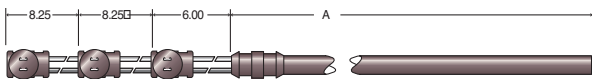

2 conductor round cable

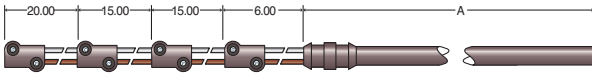

2 conductor round cable

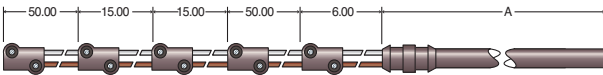

2 conductor round cable

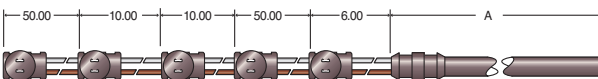

2 conductor round cable

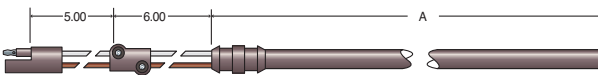

2 conductor round cable

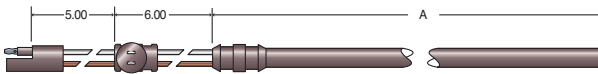

2 conductor round cable

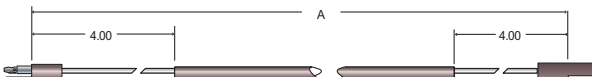

2 conductor round cable

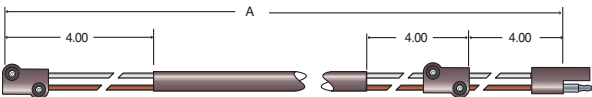

2 conductor round cable

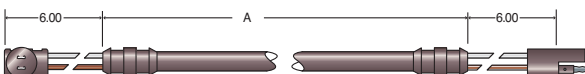

2 conductor round cable

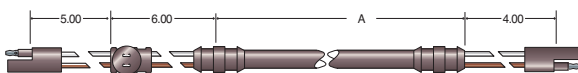

2 conductor round cable

Dimensions "A" indicate standard stocked length harness.  
A range of custom length harnesses are available in 12" increments.

### Marker/Clearance Jumper Harness

		Dim "A"	Custom Dim.
50367	Lower, black/white	36"	12" - 24"
50368	Upper, black/white	288"	48" - 276"

### Identification & License Lamp Harness

		Dim "A"	Custom Dim.
50308	Lower, brown/white	36"	12" - 24"
50335	Upper, brown/white	240"	48" - 228"
50341	Upper, brown/white	420"	252" - 408"

### Upper Marker and Identification Harness

		Dim "A"	Custom Dim.
50302	Upper, brown/white	240"	48" - 228"

### LED Upper Marker and Identification Harness

		Dim "A"	Custom Dim.
50388	Upper, brown/white	240"	48" - 228"

### Marker/Clearance Jumper Harness

		Dim "A"	Custom Dim.
50319	Marker/clearance harness, brown/white	336"	12" - 324"

### LED Marker/Clearance Jumper Harness

		Dim "A"	Custom Dim.
50381	Marker/clearance harness, brown/white	336"	12" - 324"

### Marker/Clearance Jumper Harness

		Dim "A"	Custom Dim.
50356	Marker/clearance jumper harness, brown/white	228"	12" - 276"

		Dim "A"
50357	Marker/clearance jumper harness, brown/white	112"

### LED Marker/Clearance Jumper Harness

		Dim "A"	Custom Dim.
50383	Marker/clearance jumper harness, brown/white	132"	12" - 120"
50384	Marker/clearance jumper harness, brown/white	252"	144" - 240"
50385	Marker/clearance jumper harness, brown/white	384"	264" - 372"

### LED Marker/Clearance Jumper Harness

		Dim "A"	Custom Dim.
50382	Marker/clearance jumper harness, brown/white	300"	12" - 288"



## 28 Foot 50 Series Super System Harness

Part Number	Qty	Description
1	1	7 Conductor Main Cable - 33'
2	1	R.H. Stop/Turn/Tail & Side Marker Harness - 60"
3	1	L.H. Stop/Turn/Tail & Side Marker Harness - 60"
4	1	Identification Lamp Harness - 216"
5	1	License Lamp Harness - 36"
6	2	Front Marker/Clearance Lamp Harness - 168"
7	1	Junction Box Kit
8	2	3/8" I.D. Compression Fitting
9	2	1/2" I.D. Compression Fitting
10	2	3/4" I.D. Compression Fitting
11	1	7 Conductor Main Cable - 6'
12	*	7 Way Receptacle - Front
13	*	7 Way Receptacle - Rear
14	1	ABS Power Jumper Harness
15	1	ABS Fault Lamp Jumper Harness

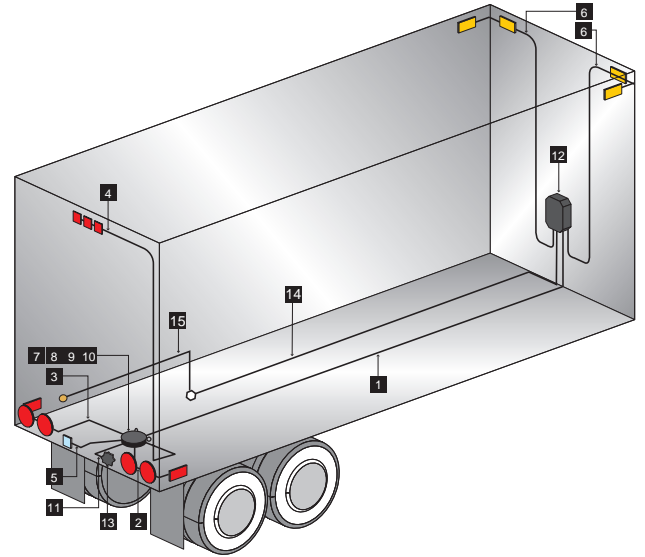

The sketch illustrates a typical 28' dry van using Truck-Lite's lighting and harness system. The list demonstrates how each harness system can be used to meet a 28' application. The part numbers listed are recommendations and substitutions may be made to customize each system to your exact needs.

## 48 Foot 50 Series Super System Harness

Part Number	Qty	Description
1	1	7 Conductor Main Cable - 51'
2	1	R.H. Stop/Turn/Tail & Side Marker Harness - 60"
3	1	L.H. Stop/Turn/Tail & Side Marker Harness - 60"
4	1	Identification Lamp Harness - 216"
5	1	License Lamp Harness - 36"
6	1	R.H. Center Turn & Marker/ Clearance Lamp Harness - 336"
7	1	L.H. Center Turn & Marker/ Clearance Lamp Harness - 336"
8	2	Front Marker/Clearance Lamp Harness - 168"
9	1	Junction Box Kit
10	2	3/8" Compression Fitting
11	2	1/2" Compression Fitting
12	1	3/4" Compression Fitting
13	2	Oval Hole Compression Fitting
14	*	7 Way Receptacle
15	1	ABS Power Jumper Harness
16	1	ABS Fault Lamp Jumper Harness

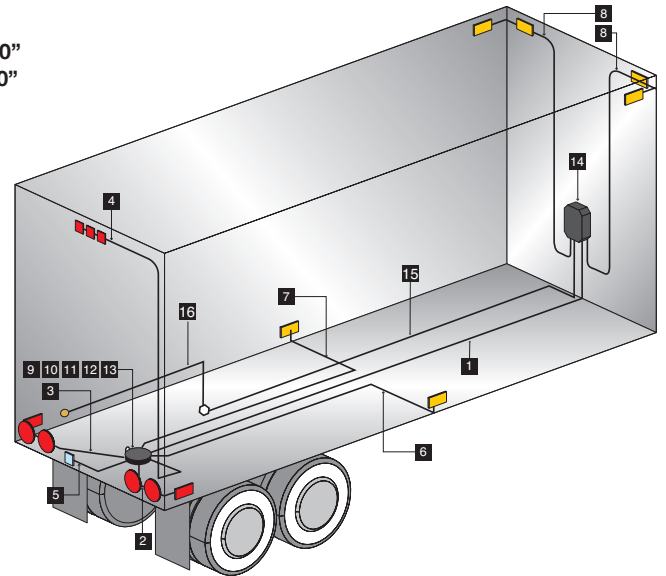

The sketch illustrates a typical 48' dry van using Truck-Lite's lighting and harness system. The list demonstrates how each harness system can be used to meet a 48' application. The part numbers listed are recommendations and substitutions may be made to customize each system to your exact needs.



- 50% more harness ports; alleviates need for multiple boxes while allowing additional harness systems and increased lighting
- Larger box makes it easier to work on internal connections
- Clear lid offers easy viewing of connections, saving time when identifying lighting system problems
- Dual “Dogbone” ground strap feature allows 4 terminals to be common, replacing need for multiple junction boxes and saving costs
- Silicone gasket on lid helps eliminate damage from moisture and corrosives
- High impact, chemical resistant, approved insulated plastic provides long life, eliminates time & money for repair & replacement
- Mounted by 4 eyelet reinforced holes in base of box for increased durability
- Contains 12 pre-tapped holes to accept compression fittings or filler plugs for greater configuration versatility
- Uses 50 Series compression fittings or 50830 filler plugs (6 included in kit)

## Super 50® Junction Box

### Material:

- Grey ABS plastic box
- Clear polycarbonate lid
- 12 ports
- 16 terminal studs with 4-common grounds

### 50600 Kit:

- 1 - Grey ABS junction box
- 1 - Clear polycarbonate lid w/ screws
- 1 - Terminal block w/hardware
- 1 - Ground strap
- 1 - Dual ground strap
- 6 - 50830 filler plugs

- 50600 Super 50® 12 port junction box kit
- 50601 Super 50® junction box
- 50606 Super 50® junction box cap w/screws
- 50607 Replacement lid & gasket
- 50608 Super 50® ground strap
- 50609 Super 50® dual ground strap
- 50830 Filler plug
- 50832 Replacement lid, gasket & 6 screws

- ### Compression Fittings
- 50840 2 conductors, 3/8” fitting
  - 50841 4 & 5 conductors, 1/2” fitting
  - 50842 6 & 7 conductors, 3/4” fitting
  - 50843 Single conductor wire, 5 hole fitting
  - 50846 3 conductor flat cable fitting
  - 50847 4 conductor flat cable fitting

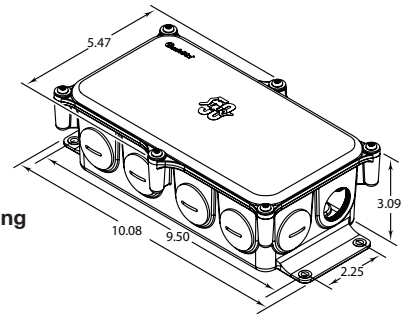

DOG BONE



CLEAR LID



GASKET



EYELETS



- A 3-part fitting consisting of a pre-tapped cap, a threaded base and a black PVC grommet that is available with 6 different hole sizes to accommodate various conductor cables.



- For 2 conductor cable.

50840 3/8” I.D. fitting

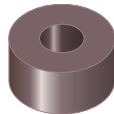

- For 6 & 7 conductor cable.

50842 3/4” I.D. fitting

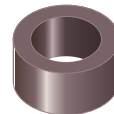

- For 3 conductor flat cable.

50846 Fitting

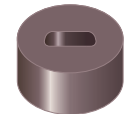

- For 4 & 5 conductor cable.

50841 -1/2” I.D. fitting

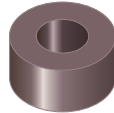

- For single conductor wire.

50843 5-hole fitting

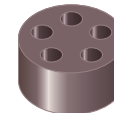

- For 4 cond

50847 Fitting

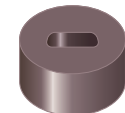

- Steel clips
- Supplied with all multi-plug S/T/T harness

- 97913 Straight mold, 1-1/2” steel
- 97011 Right angle, 1-1/4” steel



- Made of high impact, chemical resistant plastic
- Mounted by four holes on 5-1/2" diameter circle
- Contains 8 pre-tapped holes to accept compression fittings or filler plugs
- 50801 requires a 4-7/8" clearance hole.

**50800 Junction box**  
**50801 Junction box**

- Made of high impact, chemical resistant plastic
- Includes "O" ring for a weather proof seal

**50816 Junction box cap & "O" ring**  
**50812 Junction box cap, clear**  
**97933 "O" ring**

- Kit contains 50820 terminal block, four 50830 filler plugs, assembly and mounting screws

**50850 Hardware kit**

- Made of approved insulating plastic
- Contains 8 color coded terminals

**50820 Terminal block**

- Fill pre-tapped holes in junction box when compression fittings are not used

**50830 Filler plug**

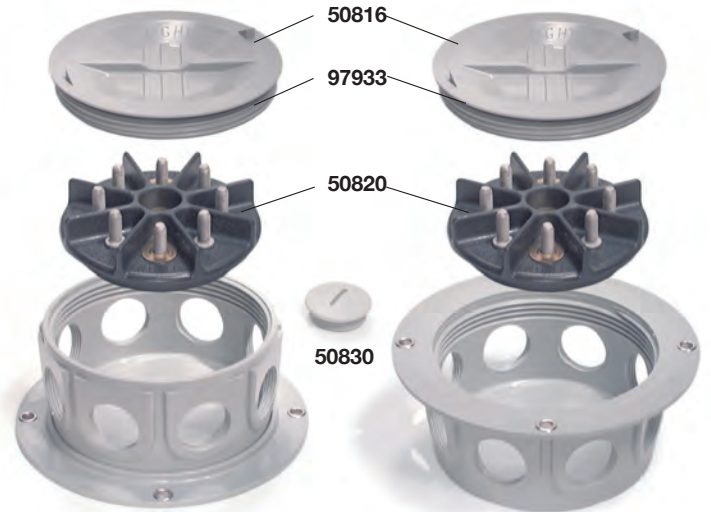

**50800 Surface Mount Box**      **50801 Buckplate Mount Box**

- Contains 50800 junction box, 50816 junction box cap, 50820 terminal block, four 50830 filler plugs and mounting & assembly screws.

**50400 Surface mount assembly**  
**50060 Surface mount assembly, clear cap**

- Contains 50801 junction box, 50816 junction box cap, 50820 terminal block, four 50830 filler plugs and mounting & assembly screws.

**50401 Buckplate mount assembly**  
**50061 Buckplate mount assembly, clear cap**

- Use for installation of 3-part compression fittings in areas other than in the junction boxes
- 1-1/8" clearance hole required

**50845 Jam nut**



- Uninsulated terminals for use with "50 series" harnesses & junction boxes
- 25 per bag
- For 14-16 gauge wire only

**97929 .156 diameter bullet terminal**  
**97912 #10 ring terminal**



- For external grounding of junction boxes or 7-way receptacles
- 26" long white wire

**96927 Ground wire, 8 gauge**



**77825 Crimp tool**  
**97388 Crimp tool**

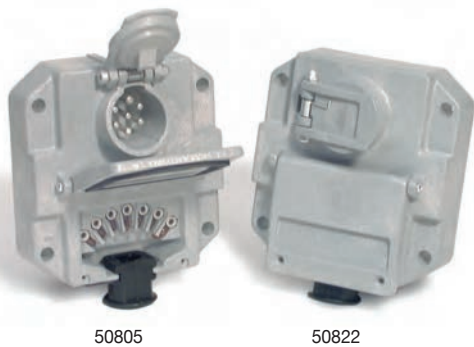

- Easily installed on new trailers or as a retrofit on existing equipment
- Chemical resistant and virtually indestructible box
- Internal electrical contacts sealed to eliminate corrosion
- 100% electrically pre-tested with a 40 amp capacity
- Available with or without circuit breakers
- Color-coded trailer main cable hook-up terminals for proper connections

## Nose Boxes

### Material:

- Foam polycarbonate box

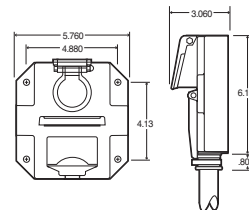

.410 screw hole diameter

- 50805** Nose box, without circuit breakers
- 50806** Nose box, with 15 amp circuit breakers
- 50822** Nose box, right angle
- 50807** Cable grommet
- 50808** Cap latch repair kit, round
- 50809** Cover, rectangular
- 87845** Cable clamp repair kit



- Tough GE Noryl, non-conductive, corrosion resistant body
- “Floating” type, cadmium plated brass pins allow best alignment and long-lasting contact with plug
- Internal connections feature a direct wired ground
- Ring terminals are used to connect wires
- Receptacle pins prevent increased resistance due to standard breakage caused by set screws
- Available in standard and circuit breaker version
- Meets SAE J560 standards
- Circuits are identified by color codes & embossed notations

## 7-Way Receptacles Surface Mount

### Material:

- GE Noryl body
- Cadmium plated brass pins

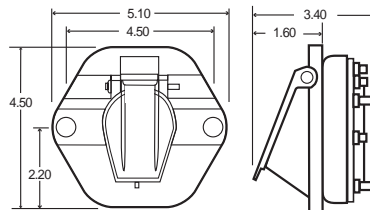

Note: We recommend use of rubber boots with flush mounting receptacles.

- 50860** Standard 7-way body, solid pins
- 50866** Receptacle w/threaded stacking studs, solid pins
- 50861** Standard 7-way body, split pins
- 50863** Receptacle w/15 amp circuit breakers, split pins
- 50865** Receptacle w/20 amp circuit breakers, split pins
- 50867** Receptacle w/threaded stacking studs, split pins

- Easy installation on all receptacles
- Includes Noryl cover, steel hinge pin, stainless steel spring, cotter pin & shaft retainer
- Not for use with #50805 style 7-ways

## 5-Piece Cover Service Kit



- 50875** Cover service kit



### 7-Way Receptacles Flush Mount

**Material:**

- GE Noryl® body
- Cadmium plated brass pins

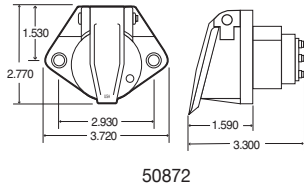

- Tough GE Noryl, non-conductive, corrosion resistant body with “floating” type, cadmium plated brass pins that allow best alignment & long-lasting contact with plug
- Internal connections feature a direct wired ground
- Circuits are identified by color codes and embossed notations
- Ring terminals are used to connect wires
- Receptacle pins prevent increased resistance due to strand breakage caused by set screws
- Meets SAE J560 standards
- Push-on-terminal design, #50872 & 50897 compatible as OEM replacement



50868

Note: We recommend use of rubber boots with flush mounting receptacles.

- 50868** 7-way body, 2 hole flange, solid pins
- 50869** 7-way body, 2 hole flange, split pins
- 50872** 7-way body, push-on, 2 hole flange, split pins
- 50875** Cover service kit (does not work with 50897)

### Adapter Boxes Surface Mount

**Material:**

- GE Noryl® box

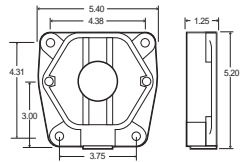

- Features molded threaded brass inserts for receptacle mounting
- Bottom entry for standard wiring with strain relief mechanism
- Available with back access hole to accommodate rear entry applications



50882

- 50882** 2" box, bottom access
- 50883** 2" box, rear access

### Receptacle Boots

**Material:**

- Natural rubber boots

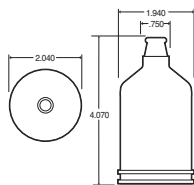

- Protects electrical connections from moisture in flush mount applications
- Large boot fits all full sized receptacles
- Small boots fit both 2 and 3 bolt flange receptacles with end or bottom access

- 50890** Small boot, rear access
- 50892** Large boot

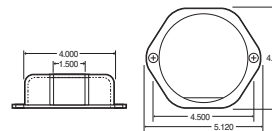

50892

50890



### Quick Connect Box

**Material:**

- Nylon lid & base w/UV stabilizers

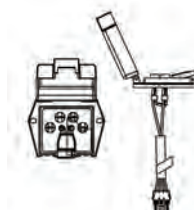

4-position Packard Electric connector #12015797 on main harness requires P/E connector #12010974 on the chassis.

- Provides secure connection to consumer trailers through stripped wire connection or stripped wire connection w/standard 4-pin flat molded connector
- Sealed connector to the main power harness in the truck
- Adhesive lined heat shrinks protect main harness connection to the box
- Easily replaced if necessary
- Black color blends into mounting location
- Hinge pin designed to fit tightly into hinge, keeps lid on and reduces chance for water to get into the connection terminals
- Easily adaptable for trailers, box trucks, retail vehicles, and box vans w/hitch set-up
- Mounting holes in same location as current Phillips boxes
- 1/4" bolt used to mount box



96511

96512

- 96512** Box w/ boat mold
- 96511** Box w/o boat mold



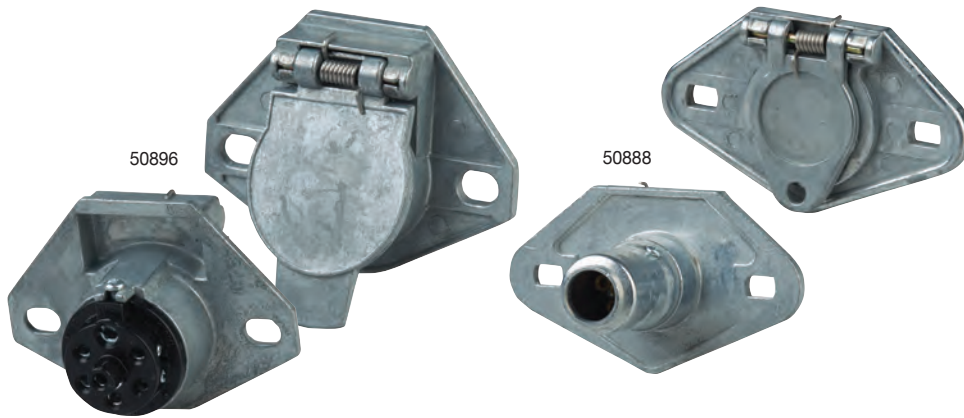

## Die Cast Receptacles

**Material:**

- Die cast housing

- Available in 7-way, 6-way and 4-way variations
- Compact socket design with exposed terminals for easy installation in modern trailers
- Extended interior plug prevents damage to shell
- Integral finger grips for positive pull

50886 4-way receptacle  
 50888 6-way receptacle  
 50896 7-way receptacle

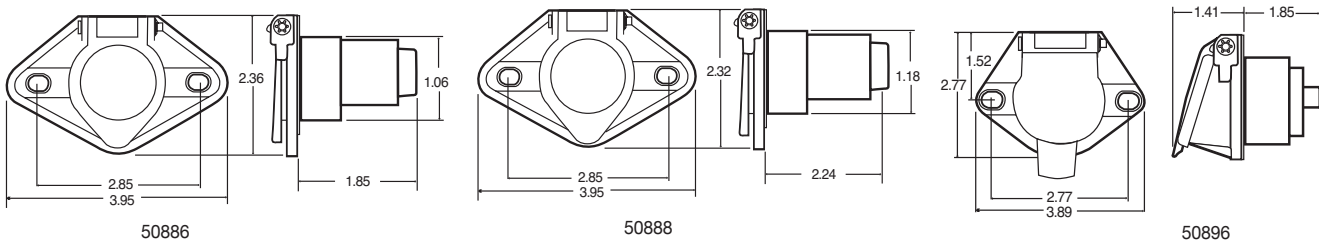

## Smart Box

**Material:**

- Plastic housing
- Replacement Parts:**
- 50813 solid pin
  - 50898 split pin

- Eliminates the need to rewire the nose box when replacing a damaged receptacle
- Fits standard mounting bolt pattern
- Includes 2 cable entry grommets
- Wiring remains stationary on studs inside the box
- No need to disturb wiring when replacing receptacle
- Receptacle simply plugs in and secures with 2 nuts
- Brass jumpers bridge from studs to receptacle pins

50878 Smart box w/solid pins  
 50879 Smart box w/split pins  
 50875 Cover service kit

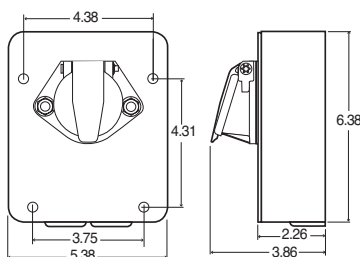

### Heavy Duty Anti-Lock Connector Cords

**Material:**

- 4-12, 2-10, 1-8 gauge

- Ideal for supplying power to trailer and dolly ABS systems
- Designed for use in wide temperature range (-87° to +195°F)
- Available in 12 and 15 foot lengths
- Meets TMC recommendations (RP137) and SAE J2222
- 100% pre-tested
- Covered by manufacturer's 3 year warranty

- 97160** 12', green jacket with nylon plugs
- 97161** 15', green jacket with nylon plugs



### Heavy Duty Connector Cords

**Material:**

- 6-12, 1-10 gauge

- Meets ATA, SAE and TMC requirements
- Designed for use in wide temperature range (-87° to +195°F)
- Available in 12 and 15 foot lengths
- Meets or exceeds SAE J559 or J1067 as applicable
- 100% pre-tested
- Covered by manufacturer's 3 year warranty

- 97151** 12', black jacket with metal plugs
- 97153** 15', black jacket with metal plugs



### Replacement Plug

**Material:**

- Rugged nylon housing or zinc die-cast housing
- Brass terminals

- Features brass terminals and rear moisture seal
- Unique 360° cable clamp that helps prevent the cable from being accidentally pulled out
- Resistant to degreasers, solvents and contact cleaners
- Features zinc die-cast housing and brass terminals
- Nylon insert is resistant to petro-chemicals

- 97158** Nylon plug, 7 way
- 97159** Metal plug, 7 way
- 50885** Metal plug, 4 way
- 50887** Metal plug, 6 way



97158 SHOWN



97159 SHOWN

# Accessories

# Accessories

**Accessories**      **242-246**



**Mounting Accessories**      **247-264**

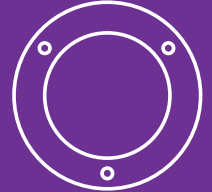

**Lenses**      **265-272**





- Features five wire brushes
- Designed for use with all Truck-Lite wiring accessories
- Small brushes have bronze wire bristles that will not harm tin-coated brass terminal material
- Large brush has stainless steel bristles for battery terminals & more heavily corroded areas

**97025 Brush kit**

## Electrical Connection Brush Kit

**Material:**

- Plastic, bronze & stainless steel



- Compliment to the lamp & circuit tester
- Uses high quality brass pins for reliable contact
- LEDs quickly identify faulty circuits in either of the connector cord assembly or the tractor
- Designed for use with 12 or 24 volt systems & negative or positive ground vehicles

**97101 Tester**

## Trailer Cable & Circuit Tester

**Material:**

- Glass filled polypropylene
- Polycarbonate case

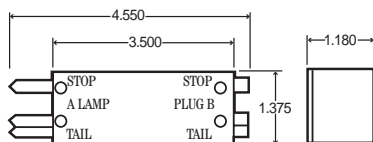

- Compact & rugged tester quickly checks function of lamps & wiring
- Can be used with all Truck-Lite sealed incandescent lamps & wiring systems
- Uses one standard 9-volt battery (included)
- Replaces Signal-Stat 9516/9517

**97100 Checker**

## Lamp & Circuit Checker

**Material:**

- Plastic case



97100



## Multi-Purpose Maintenance Spray

### Corrosion Control:

- Forms a protective “thin film” barrier to stop oxidation and prevent rust from spreading
- Dissolves corrosion oxide - stops rust on contact!

### Electronics:

- Prevents and removes corrosion build-up • High dielectric insulation against electrolysis
- For use on connectors including ABS, 4-13 way plugs & sockets, battery terminals and more

### Outperforms other penetrants:

- Quickly loosens frozen or seized parts • Invades hard to reach crevices and creeps through the tightest seams • Displaces moisture

### Extreme pressure lubricant:

- Maintains lubricity under high loads for superior reduction of friction, heat and noise
- Use on fifth wheel springs & rails, glad hands, control linkages, roll-up doors, hinges & latches, chains & pulleys and more

97946 Spray can, 14 oz.



## NYK-77 Compound

- Corrosion preventive compound for electrical contacts, switches & junction boxes
- For periodic use with all electrical contact not using Fit 'N Forget™ connectors
- Available in a variety of sizes

97940 Can, 8 oz.      97943 Can, 1 qt.  
 97944 Tube, 2 oz.    97948 Cartridge, 14 oz.  
 98013 Tube, 5 oz.



## Stoplight Switch

### Material:

- Silver cadmium contacts

- Designed specifically for heavy-duty truck air brake systems
- Excellent for use in anti-lock applications
- Sensitive & rugged internal “snap action” spring insures precise opening/closing at both low & high pressure

50899 Stoplight switch, 12v, 24 amps

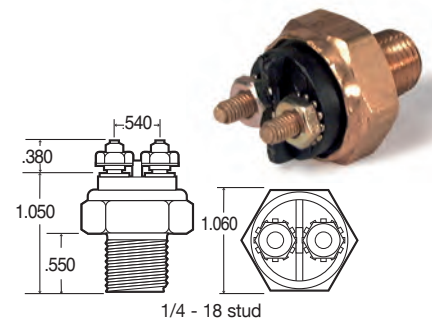

## ABS Accessory Switch

### Material:

- Silver cadmium

- Ensures that the full capacity of the shared ‘Blue’ circuit is available to the ABS when vehicle is moving
- Ensures that accessory leads are “turned off”
- Two 12 gauge 24” wires

50889 ABS switch  
 50894 Anchor tee for 1/2” tubing  
 50895 Anchor tee for 3/8” tubing

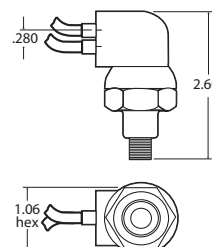



97960



97799

- Opaque gray cover protects document from deteriorating
- Designed for ease of installation
- Convenient insertion & removal of documents
- Retaining spring staked to base for strength & durability
- Rubber gasket ensures moisture resistance

**97799 Gray document holder, kit**  
**97960 Document holder kit**

## Document Holder

### Material:

- Polycarbonate base & cover
- Rubber gasket

### Replacement Parts:

- 97961 gray base w/retainer spring
- 97798 gray cover w/gasket
- 97962 clear cover w/gasket

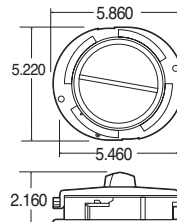

0.180 screw hole diameter



- All weather protection for permits, licenses, inspection stickers
- Self sealing zipper protects from moisture & dirt
- Mounting: Four brass eyelets
- Size: 5-3/4" W x 8-1/4" L

**50 Permit pouch**

## Permit Pouch



- Multi-purpose crimp tools

**77825 Crimp tool**  
**97388 Crimp tool**

## Crimp Tool



9415BL

- Ready to install, 6 or 12 volt
- Engineered for greater ease of use fuse snaps into place
- Circuit may be examined without removal of fuse
- 6" 16 gauge looped wire
- Nylon housing assures greater durability
- Use to protect tape decks, radios, C.B.s, fog lights, etc.

**9415BL 30 amp, counter display of 12**  
**9414BL 20 amp, counter display of 12**  
**9410BL Fuse not included, counter display of 12**

## Fuse-In-Lines Blade Type

## Test Kits

### Material:

- 12 volt power supply
- 9 pigtails to cover most LED & incandescent connections

### Kit Components:

- 96247 LED STT Fit 'n Forget plug
- 96248 Model 19 pigtail
- 96249 PL10 pigtail
- 96250 PL3 pigtail
- 96251 Male pin pigtail
- 96252 LED MC Fit 'n Forget plug
- 96253 .180 receptacle pigtail
- 96254 Packard metri-pak pigtail
- 96255 alligator clip pigtail
- 96257 12v power supply (included w/96259 kit)
- 96258 storage bag



- Quickly checks functions of Truck-Lite LED & incandescent lamps
- Includes durable zipper bag to conveniently store all included parts

### AVAILABLE SEPARATELY



**96256** Battery power supply pigtail

- 96259** Light test kit w/12v power supply
- 96260** Light test kit w/o power supply
- 96256** Battery power supply pigtail

## Lighting Test Kit – Instructions For Use

### For use with 12 V Power Supply

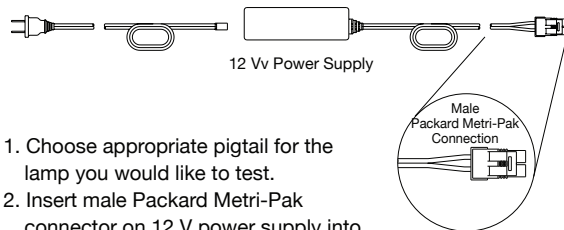

1. Choose appropriate pigtail for the lamp you would like to test.
2. Insert male Packard Metri-Pak connector on 12 V power supply into female Packard Metri-Pak connector on pigtail
3. Connect Lamp to be tested to pigtail
4. Plug in 12v power supply to test lamp

### For use with Battery Power Supply

(Sold Separately)

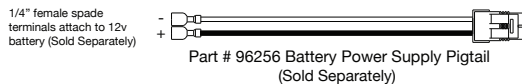

1. Choose appropriate pigtail for the lamp you would like to test.
2. Insert male Packard Metri-Pak connector on battery power supply into female Packard Metri-Pak connector on pigtail
3. Connect Lamp to be tested to pigtail
4. Connect terminal ends of battery power supply pigtail to battery power supply to test lamp

**WARNING :** DO NOT CONNECT MULTIPLE LAMPS  
**WARNING :** DO NOT LEAVE TESTER ON FOR EXTENDED PERIODS OF TIME

**NOTE :** To test lamps with major and minor functions use the red wire on pigtail for major functions and black wire on pigtail for minor functions

- Black Wire - Minor Function
- Red Wire - Major Function
- White Wire - Ground

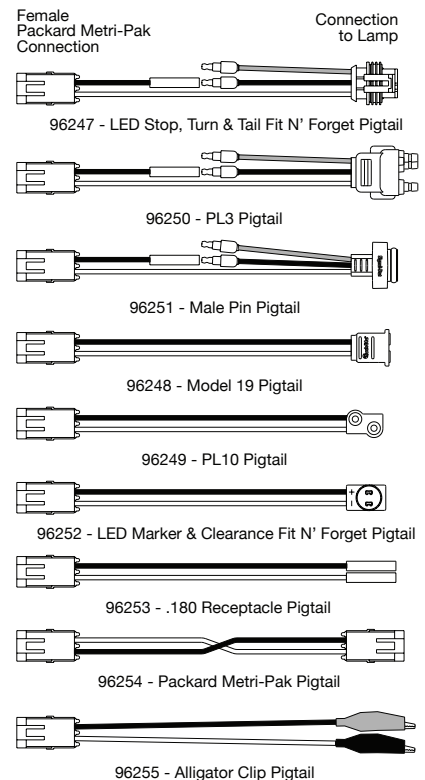



97321



97322

## Digital Clock & Temperature Gauge

- Universal clock & gauge
- Installation instructions included
- Covered by manufacturers 2-year limited warranty

- 97321** Multi-Function digital alarm clock  
**97322** Digital outside temperature gauge



### LED CSA Road-Side Repair Kit

- This LED kit includes only three LED lights and necessary tools to perform a quick road-side repair to get you back up and running without the cost of a ticket, minimizing downtime and saving the points on your CDL and driving record.

**97392** LED CSA road-side repair kit



### Incandescent CSA Road-Side Repair Kit

- A cost effective kit that includes the most popular incandescent lighting products and accessories in a convenient 12" X 8" storage bag that is small enough to fit in a glove box or under the seat for easy access.

**97382** Incandescent CSA road-side repair kit

## CSA Roadside Repair Kits

### Material:

- EPDM Grommet
- Nylon Flange
- Chrome Plated Flange

### 97392 Kit Contents:

- 1- 96258 Storage Bag
- 1- 97388 Crimper Tool
- 3- 97389 12/10 Ga. Butt Splice Connectors
- 3- 97390 16/14 Ga. Butt Splice Connectors
- 3- 97391 18/22 Ga. Butt Splice Connectors
- 1- 44302R LED Super 44 Series S/T/T Lamp
- 1- 40700 Grommet Mount
- 1- 94706 Fit Forget LED-to-PL3 Adapter
- 1- 36100R LED 36 Series Flex-Lite M/C Lamp, Red
- 1- 36100Y LED 36 Series Flex-Lite M/C Lamp, Yellow
- 1- 97944 NYK-77 Compound, 2 oz. tube

### 97382 Kit Contents:

- 1- 96258 Storage Bag
- 1- 97388 Crimper Tool
- 3- 97389 12/10 Ga. Butt Splice Connectors
- 3- 97390 16/14 Ga. Butt Splice Connectors
- 3- 97391 18/22 Ga. Butt Splice Connectors
- 1- 10201R 10 Series 2-1/2" M/C Lamp, Red
- 1- 10201Y 10 Series 2-1/2" M/C Lamp, Yellow
- 1- 30200R 30 Series M/C Lamp, Red
- 1- 30200Y 30 Series M/C Lamp, Yellow
- 1- 19200R 19 Series M/C Lamp, Red
- 1- 19200Y 19 Series M/C Lamp, Yellow
- 1- 19721 19 Series Gray Mount & Hot Wire
- 1- 10700 10 Series Grommet
- 1- 30700 30 Series Grommet
- 2- 94902 .5" M/C plug with No. 5 ground terminal
- 1- 40282R Economy 40 Series S/T/T Lamp
- 1- 40700 Grommet Mount
- 1- 97944 NYK-77 Compound, 2 oz. tube



**Light Kit Check**

**Material:**

**97330 System**

- Operates on a DC system, through the use of a vehicle battery or regulated 12v power system

**97331 System**

- Operates on a AC system, through direct connection to a 110v standard wall outlet

- Today, the process of pre-inspecting your vehicle before you head out on the road is more important than ever
- This system is designed to speed up your inspection times, and it virtually eliminates undetected electrical problems
- Features a remote-controlled active computer direct fault indication system, with 10 second automatic analysis of all electrical circuits
- The easy-to-read digital display provides a direct readout of electrical faults, including open circuits, open grounds, shorts and chassis ground faults
- Saves up to 25% of the time needed to troubleshoot and inspect trailer systems



97330 12v, DC powered system  
 97331 110v, AC powered system

**M/C Adapter Plates For 10 & 30 Series Flange Products**

**Material:**

- Polycarbonate construction

**Mounting Holes:**

- 10133 & 30133 use a 3/4" through hole for 33 Series Lamp use
- 10136 & 30136 use a 3/8" through hole for 36 Series Lamp use

- Provides an easy way to upgrade incandescent lamps to high quality Truck-Lite 33 Series & 36 Series M/C lamps, which offer Limited Lifetime warranties
- Mounting plates can be installed into every 2" round (30 series) or 2.5" round (10 series) mounting holes
- Adapterplates utilize the same mounting holes of standard 2" & 2.5" mounting flanges



10133 33 series adapter for 10 series installations  
 10136 36 series adapter for 10 series installations  
 30133 33 series adapter for 30 series installations  
 30136 36 series adapter for 30 series installations

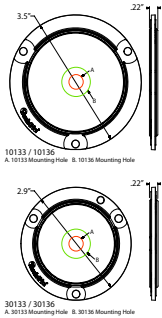

**Recommended Accessories:**

**33 Series M/C Lamps**

- 33250R - P2 lamp, Red
- 33250Y - P2 lamp, Yellow
- 33275R - PC lamp, Red
- 33275Y - PC lamp, Yellow
- 33285R - PC lamp, Red w/ Clear Lens
- 33285Y - PC lamp, Yellow w/ Clear Lens

**36 Series M/C Lamps**

- 36105R - P2 lamp, Red w/ Side Exit Wires
- 36105Y - P2 lamp, Yellow w/ Side Exit Wires
- 36115R - PC lamp, Red w/ Rear Exit Wires
- 36115Y - YPC lamp, Yellow w/ Rear Exit Wires

**Flex-Lite Mounting Bracket For 36® Series Flex-Lite**

**Material:**

- Gray ABS Plastic

**Additional specifications:**

- Recommended screw torque of 15-20 lbs.
- 0.08" wall thickness

- Design maintains PC rating and is specifically for 36 series Flex-Lite C/M lamps
- Inner wings assure placement every time
- Outer wings provide extra protection from branches and other objects brushing against the vehicle
- Plateable gray ABS allows for superior weatherability, leading to lower maintenance costs

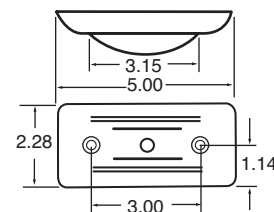

36705 Gray



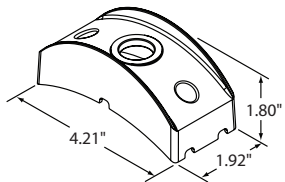

- Designed to mount on 4.6" radius corner
- Screws mount perpendicular to radius
- Allows lamp to be surface mounted using 33® series grommet or flange
- Suitable for PC requirements

**33715 Bracket**

Note: 33 series grommet or flange is required to install lamp in bracket

### Curved Deflector Mount For 33® Series Products

Material:

- Grey ABS plastic



33711

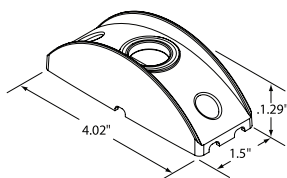

- High impact plastic deflector mount
- 33® series bracket mounting holes retrofit Model 19 bracket installations
- Suitable for PC requirements on 45° angle when using 33 series PC rated/ combination lamp
- 33711 allows lamp to be surface mounted & wiring routed outside vehicle

**33712 Branch deflector, gray**

**33711 Surface mounted deflector**

Note: 33 series grommet or flange is required to install lamp in bracket

### Deflector Mounts For 33® Series Products

Material:

- White polycarbonate plastic
- Grey ABS plastic

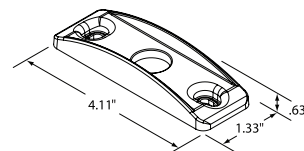

- Flush mounts 3/4" diameter lamps to vehicle
- Chrome plated flange improves the appearance on vehicle
- Snap fit grommet and flange, no screws required

**33700 Grommet, black**

**33702 Grommet, black, closed back**

**33800 Flange, black**

**33810 Flange, chrome**

**33705 License grommet, black**

**33720 Grommet, (0.070-0.125)**

**33725 Grommet, (0.125-0.250)**



33720



33725



33702

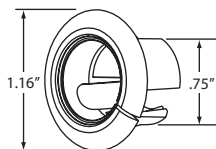

flange mount

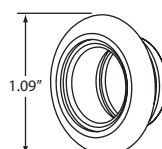

grommet mount

0.75 mounting hole

### Grommet & Flange Mounts For 33® Series Lamps

Material:

- EPDM Grommet
- Nylon Flange
- Chrome Plated Flange

### Grommet Mounts For 2-1/2" Lamps

**Material:**

- PVC grommet
- Thermal plastic rubber (TPR)
- 16 gauge wire

**Kit Components:**

**10401 open back kit:**

- 1 - 10700 grommet
- 1 - 94902 plug

**10402 closed back kit:**

- 1 - 10702 - grommet
- 1 - 94902 plug

- Flush mounts 2-1/2" diameter lamps
- Wide groove for panel thickness up to .250"
- Narrow groove for panel thickness up to .125"
- Suitable for PC requirements on a 45° angle when using LED or incandescent PC rated/combination lamps
- Closed back versions recommended for open installation where splash plate is not used
- Replaces Signal-Stat 9119 & 9156

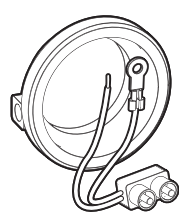

**Grommet Kits**  
**10401** Open back  
**10402** Closed back

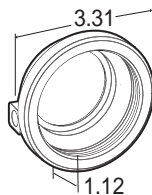

**Wide Groove**  
**Open Back Grommets**  
**10700** Black  
**Closed Back Grommets**  
**10702** Black  
**10718** Black TPR



**Narrow Groove Grommets**  
**10713** Black, open back  
**10714** Black, closed back

### Diaphragm Grommet For 2-1/2" Lamps

**Material:**

- Rubber grommet
- 16 gauge wire

**Kit Components:**

**10403 grommet kit:**

- 1 - 10708 grommet
- 1 - 94902

- Designed for edge lighting
- Suitable for PC requirements on a 45° angle using all 2-1/2" diameter lamps
- Adapts to surface thickness up to .25"

**10403** Grommet, kit  
**10708** Grommet

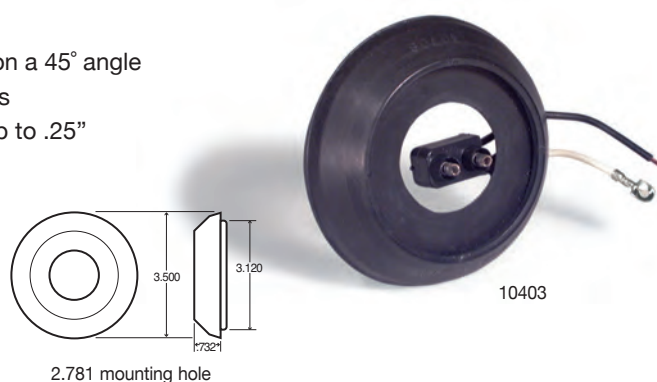

### Mounting Covers For 2-1/2" Mounts

**Material:**

- Polished stainless steel flange cover
- Chrome plated plastic grommet covers

- Designed to enhance appearance of lamps
- Flange cover offers improved theft resistance
- Screws required

**10740** Grommet cover  
**10719** Grommet cover w/visor  
**10715** Flange cover

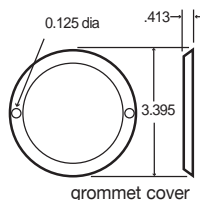
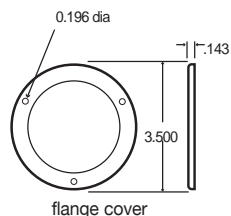

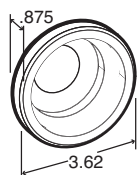

3.0 mounting hole

- Designed for recess mounting
- Suitable for PC requirements on a 45° angle when using LED or incandescent PC rated/combination lamps
- Adapts to surface thickness up to .125"
- Replaces Signal-Stat 9121

**10704** Black, grommet  
**10706** White, grommet  
**10404** Grommet kit

### 3" Grommet Mounts For 2-1/2" Lamps

#### Material:

- PVC grommet
- 16 gauge wire

#### Kit Components:

10404 grommet kit:  
 1 - 10704 grommet  
 1 - 94902 plug



10400

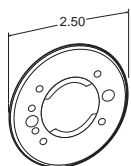

0.156 screw hole diameter  
 1.875 bolt hole clearance  
 1.25 clearance hole

- Rust resistant stainless steel mount
- Quick cam-on, cam-off lamp installation
- Suitable for PC requirements on a 45° angle using all 2-1/2" diameter lamps
- Mounts with screws to surface
- Not recommended for use with Signal-Stat LED products
- Replaces Signal-Stat 9394

**10004R** Red  
**10720** Mount  
**10400** Mount kit

### Surface Mounts For 2-1/2" Lamps

#### Material:

- Stainless steel mount
- 16 gauge wire

#### Kit Components:

**10400 mount kit:**  
 1 - 10720 mount  
 1 - 94902 plug  
**10004R/Y kits:**  
 1 - 10202R lamp  
 1 - 10720 mount  
 1 - 94902 plug



- Designed to mount on a 4.6" radius corner
- Screws mount perpendicular to radius
- Allows lamp to be surface mounted in a grommet
- Suitable for PC requirements on a 45° angle when using LED or incandescent PC rated/combination lamps

**10738** Mount

### Curved Bracket For 2-1/2" Lamps

#### Material:

- Polycarbonate bracket

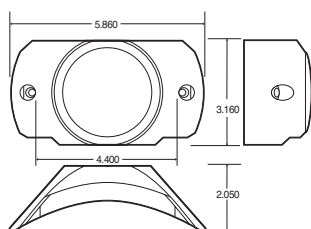

### Cam-On Mounts For 2 & 2-1/2" Lamps

**Material:**

- Polycarbonate mount
- 16 gauge wire

**Kit Components:**

**10410 mount kit:**

- 1 - 10728 gray mount
- 1 - 94924 side entry plug

- High impact plastic mount
- Branch deflector cams-on 2 & 2-1/2" lamps
- Requires 94924 side entry plug
- Suitable for PC requirements on a 45° angle when using LED or incandescent PC rated/combination lamps
- Not recommended for use with Signal-Stat LED products
- Replaces Signal-Stat 9390

- 10410** Gray mount, kit
- 10721** Clear mount w/o ribs
- 10724** Gray mount w/o ribs
- 10727** Clear mount 8-1/2" radius
- 10728** Gray mount



10410

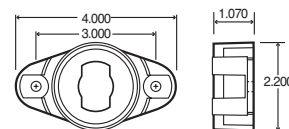

0.220 screw hole diameter

### Branch Deflector Mounts For 2-1/2" Lamps

**Material:**

- Polycarbonate mount
- PVC grommet
- 16 gauge wire

**Kit Components:**

**10414 mount kit:**

- 1 - 10725 mount
- 1 - 10700 grommet
- 1 - 94902 plug

- High impact plastic deflector mount
- Design allows surface mounting of 2-1/2" lamps
- Suitable for PC requirements on a 45° angle when using LED or incandescent PC rated/combination lamps

- 10520Y** Yellow lamp kit
- 10414** Gray mount kit
- 10725** Gray mount
- 10731** Black mount

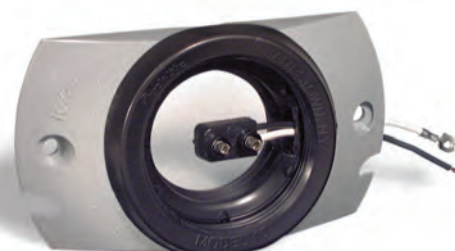

10414

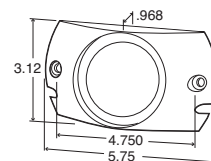

### Surface Mounts For 2-1/2" Lamps

**Material:**

- Aluminum mount
- PVC grommet
- 16 gauge wire

**Kit Components:**

**10412 mount kit:**

- 1 - 10722 mount
- 1 - 10700 open back grommet
- 1 - 94902 plug
- 1 - 97907 wire grommet

**10413 mount kit:**

- 1 - 10722 mount
- 1 - 10702 closed back grommet
- 1 - 94902 plug
- 1 - 97907 wire grommet

- Design allows surface mounting of 2-1/2" lamps in a grommet
- Suitable for PC requirements on a 45° angle when using LED or incandescent PC rated/combination lamps

- 10412** Open back mount, kit
- 10413** Closed back mount, kit
- 10722** Mount



10412

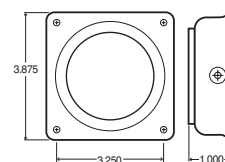

0.195 screw hole diameter



- Black epoxy painted heavy gauge steel
- 10729 is designed for mounting grommets: #10700, #10701, #10705, #10713, #10714 & #10708
- 10730 is designed for mounting grommets: #10704 & #10706

**10729** Bracket w/2.781 hole  
**10730** Bracket w/3" hole

### Mounting Bracket For 2-1/2" Lamps

Material:

- Steel bracket

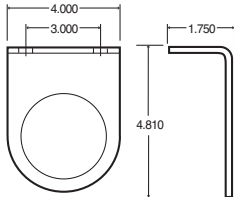

.375 bolt hole diameter



- Black epoxy painted heavy gauge steel
- Designed for mounting grommets: #10704 & #10706

**00814** Bracket

### Mounting Bracket For 2-1/2" Lamps

Material:

- Steel bracket

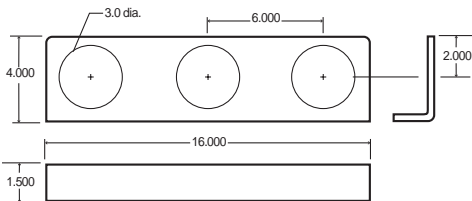

- Bracket is angle cut to fit most tanker applications
- Designed for mounting grommets requiring 2.871" hole, #10700, #10701, #10705, #10713, #10714 & #10708

**10732** Bracket

### Identification Bracket For 2-1/2" Lamps

Material:

- Stainless steel bracket

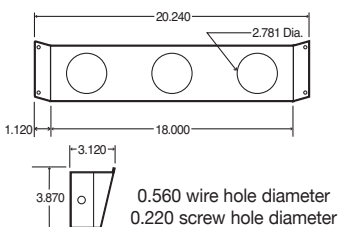

0.560 wire hole diameter  
0.220 screw hole diameter



### Grommet Mounts For 2" Lamps

**Material:**

- PVC grommet
- 16 gauge wire
- Thermal plastic rubber (TPR)

**Kit Components:**

30402 open back kits:

- 1 - 30700 grommet
- 1 - 94902 plug

30402 closed back kits:

- 1 - 30702 grommet
- 1 - 94902 plug

- Flush mounts 2" diameter lamps
- Wide groove for panel thickness up to .250"
- Suitable for PC requirements when using LED or incandescent PC rated/combination lamps
- Closed back versions recommended for open installation where splash plate is not used
- Replaces Signal-Stat 9139

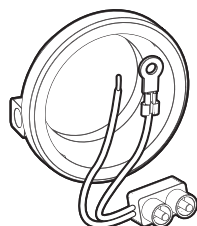

**Grommet Kits**  
30401 Open back  
30402 Closed back

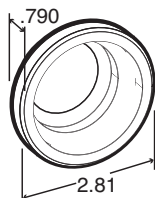

**Open Back Grommets**  
30700 Black

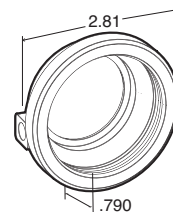

2.312 mounting hole

**Closed Back Grommets**  
30702 Black w/.75 dia. exit hole  
30704 Black w/.50 dia. exit hole

### Surface Mounts For 2" Lamps

**Material:**

- Polycarbonate lens & housing
- Stainless steel mount
- 16 gauge wire

**Kit Components:**

30400 kit:

- 1 - 30720 mount
- 1 - 94902 plug

- Rust resistant stainless steel mount
- Quick cam-on, cam-off lamp installation
- Meets PC requirements on a 45° angle
- Mounts with screws to surface, not included
- Not recommended for Signal-Stat LED lamps
- Replaces Signal-Stat 9396



- 30720 Mount
- 30400 Mount kit
- 30001R Red lamp kit
- 30001Y Yellow lamp kit

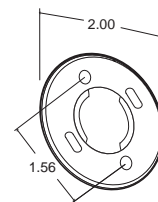

### Mounting Covers For 2" Mounts

**Material:**

- Polished stainless steel flange cover
- Chrome plated plastic grommet covers

- Grommet cover designed to enhance appearance of lamps
- Flange cover offers improved theft resistance of all incandescent flanged models & 30251R/Y or 30272R/Y LED model
- Screws required



- 30713 Grommet cover
- 30708 Flange cover
- 30712 Grommet cover w/visor
- 30715 Flange cover for PC rated lamps

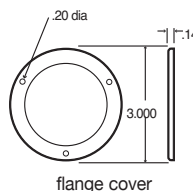

flange cover



visor

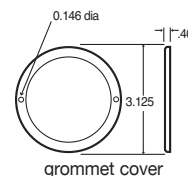

grommet cover



30403

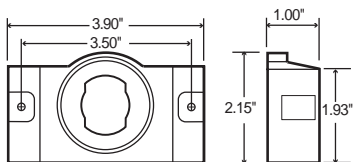

0.218 screw hole diameter

- High impact plastic mount
- Quick cam-on, cam-off lamp installation
- Suitable for PC requirements on a 45° angle using LED or incandescent PC rated/combination lamps
- Not recommended for use with Signal-Stat LED lamps

**30403** Mount, kit  
**00801** Mount

### Cam-On Mounts For 2" Lamps

#### Material:

- Polycarbonate mount
- 16 gauge wire

#### Kit Components:

#### **30403 mount kit:**

- 1 - 00801 mount
- 1 - 94902 plug



30727



30701

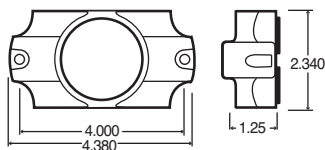

0.203 screw hole diameter

- High impact plastic mount
- Design allows surface mounting of 2" diameter lamps
- Not recommended for PC requirements or LED applications

**30727** Mount  
**30701** Grommet

### Adapter Mounts For 2" Lamps

#### Material:

- Polycarbonate mount
- PVC grommet



30404

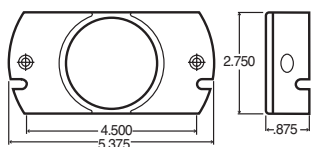

0.250 screw hole diameter

- High impact plastic mount
- Design allows surface mounting of 2" diameter lamps
- Meets PC requirements on a 45° angle using LED or incandescent PC rated/combination lamps
- Replaces Signal-Stat 9395

**30404** Mount, kit  
**30721** Gray mount  
**30729** Black mount

### Deflector Mounts For 2" Lamps

#### Material:

- Polycarbonate mount
- PVC grommet
- 16 gauge wire

#### Kit Components:

#### **30404 mount kit:**

- 1 - 30721 mount
- 1 - 30700 grommet
- 1 - 94902 plug

### Deflector Mount For 2" Lamps

**Material:**

- Polycarbonate mount
- PVC grommet
- 16 gauge wire

**Kit Components:**

30405 mount kit:

- 1 - 30722 mount
- 1 - 30701 grommet
- 1 - 94902 plug

- High impact plastic deflector mount
- Allows quick & easy surface mounting of 2" diameter lamps
- Meets PC requirements on a 45° angle using standard combination lamps
- Not recommended for LED applications
- Replaces Signal-Stat 9388

- 30504R** Red lamp kit
- 30504Y** Yellow lamp kit
- 30405** Gray mount kit
- 30722** Gray

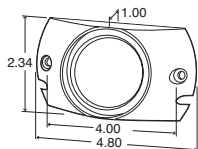

0.203 screw hole diameter



### Deflector Mount For 2" Lamps

**Material:**

- ABS mount

**Kit Components:**

**30410 mount kit:**

- 1 - 30730 inner mount
- 1 - 30731 outer mount

- High impact plastic deflector mount
- Inner bracket cams-on, cams-off lamp for quick installation
- Outer bracket provides additional protection
- Designed for use with lamp #30200R/Y or #30250R/Y
- Not recommended for PC requirements

- 30410** Mount, kit
- 30730** Inner mount
- 30731** Outer mount

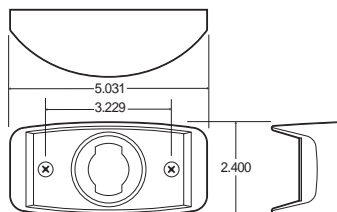

### Mounting Bracket For 2" Lamps

**Material:**

- Heavy gauge steel

- Black epoxy painted heavy steel
- Use for mounting Model 30 grommets
- Replaces Signal-Stat 9397

- 30728** Bracket

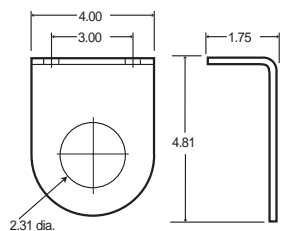

0.375 bolt hole diameter



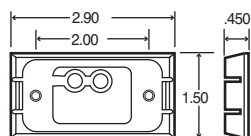
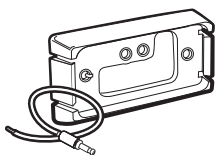

00793

0.197 screw hole diameter  
adapter mount

- Stylish design for contemporary look
- Sure contact, self-grounding feature
- Suitable for PC requirements on a 45° angle using incandescent lamps
- LED & incandescent lamp kits available

<b>15406</b>	<b>Gray, kit</b>
<b>15407</b>	<b>Chrome w/ground, kit</b>
<b>15408</b>	<b>Black, kit</b>
<b>15409</b>	<b>Chrome, kit</b>
<b>00792</b>	<b>Gray mount</b>
<b>00793</b>	<b>Chrome mount</b>
<b>00809</b>	<b>Black mount</b>

### Adapter Mounts For Model 15 Products

#### Material:

- ABS mount
- 16 gauge wire

#### Kit Components:

##### 15406/15408/15409 kits:

- 1 – appropriate mount
- 1 – 96913 hot wire

##### 15407 kit:

- 1 – 00793 chrome mount
- 1 – 97705 wire
- 1 – 96904 hot wire



15405

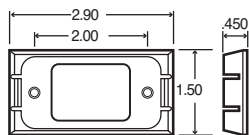

0.197 screw hole diameter

- Stylish design for contemporary look
- Sure contact, self-grounding feature
- Suitable for PC requirements on a 45° angle using incandescent lamps

<b>15404</b>	<b>Gray, kit</b>
<b>15405</b>	<b>Chrome, kit</b>
<b>00790</b>	<b>Gray mount</b>
<b>00791</b>	<b>Chrome mount</b>
<b>00802</b>	<b>Black mount</b>

### Adapter Mounts For Model 15 Products

#### Material:

- ABS mount
- 16 gauge wire

#### Kit Components:

##### 15404 kit:

- 1 – 00790 gray mount
- 1 – 94906 plug

##### 15405 kit:

- 1 – 00791 chrome mount
- 1 – 94906 plug

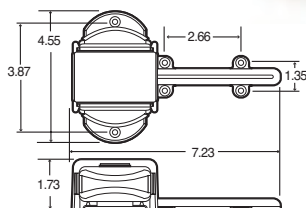

- Designed for use on most utility trailer fenders
- Wire cover is marked in 1/2" increments for easy modifications
- LED & incandescent lamp kits available

#### 15731 Bracket

### Dual Face Bracket For Model 15 Products

#### Material:

- ABS mount
- 16 gauge wire

### Deflector Mounts For Model 15 Products

**Material:**

- ABS mount
- 16 gauge wire

**Kit Components:**

- 15401 kit:  
 1 – 15720 mount  
 1 – 96904 hot wire

- High impact plastic construction
- Easy snap-on lamp installation
- Standard 1" mounting holes
- Permanently affixed hot & ground contacts
- Suitable for PC requirements on a 45° angle with incandescent lamps
- Not recommended for use with license or LED lamps

- 15720 Mount, gray**  
**15401 Mount kit**

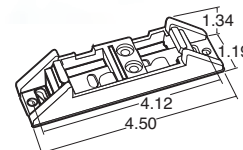
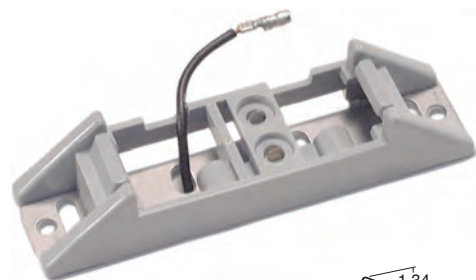

.203 screw hole dia.

### Rail Mounts For Model 15 Products

**Material:**

- ABS mount
- 16 gauge wire

**Kit Components:**

- 15412/15413 kits:**  
 1 – 15727 mount  
 1 – 94924 or 94927 plug  
**15414 kit:**  
 1 – 15728 mount  
 1 – 94924 plug

- Extra strength plastic construction
- Features top cut out area on mount #15727 for narrow rail design
- Easy snap-in lamp installation
- Suitable for PC requirements with incandescent lamps
- Incandescent lamp kits available

- 15728 Mount, white**  
**15727 Cut mount, white**  
**15733 Mount, gray**  
**15412 Cut mount**  
**15413 Cut mount**  
**15414 Mount**



15733



15727

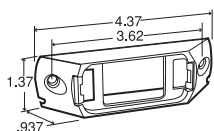

0.270 screw hole  
Standard Mount

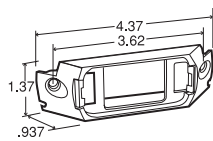

Cut Mount

### Grommet Mount For Model 15 Products

**Material:**

- PVC grommet

- Flush mount vinyl PVC grommet
- Mounts in panel thickness up to .250"
- Suitable for PC requirements on a 45° angle with incandescent lamps
- Replaces Signal-Stat 9362

- 15702 Grommet**

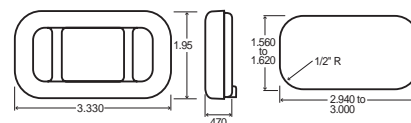





19721

- Features unique plug-in design for ease of installation
- Low profile extra strength base
- Suitable for PC requirements on a 45° angle
- LED & incandescent lamp kits available



19728

- 19720 Gray mount
- 19721 Gray mount & hot wire
- 19722 Gray mount w/9" radius
- 19729 Black mount
- 19726 Black mount & hot wire
- 19728 Black mount Chrysler #5600370415
- 19737 Gray mount Chrysler #5600370415
- 19738 Gray mount w/6.25" radius
- 19739 Chrome mount & hot wire
- 19740 Gray mount w/hot wire & .180 male terminal

## Base Mounts For Model 19 Products

### Material:

- Black or gray polycarbonate
- Chrome ABS mount

### Recommended Accessories:

- 96904 hot wire

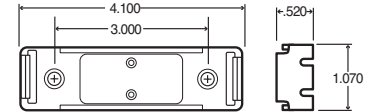

0.200 screw hole diameter  
Standard Mount



radius mount



19723

19724

- Designed for additional protection of Model 19 base mounts
- Aluminum mount designed with 3" center mounting holes
- Polycarbonate mount designed with 3" & 4.8" center mounting holes
- Not suitable for PC requirements
- Optional mounting gasket available to improve seal between lamp & body

- 19723 Gray guard
- 19724 Aluminum guard

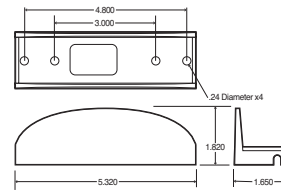

0.250 screw hole diameter  
Polycarbonate Mount

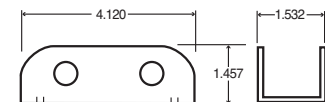

0.203 screw hole diameter  
Aluminum Mount

## Lamp Guards For Model 19 Products

### Material:

- Aluminum mount
- Polycarbonate mount

- Features unique plug-in design for ease of installation
- Low profile extra strength base
- Suitable for PC requirements on a 45° angle

- 19750 Bracket



## Curved Bracket 4.68" Radius For Model 19 Products

### Material:

- Gray polycarbonate base

### Recommended Accessories:

- 96904 hot wire

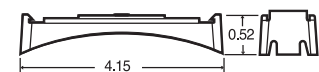
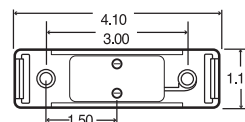

### Armored Mount For LED 35® Series Products

**Material:**

- Aluminum mount

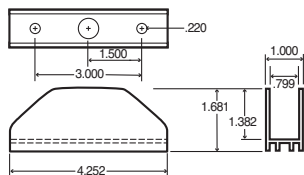

- Extruded aluminum armored mounting bracket protects individual lamps from physical damage
- Wiring routed through .65" access hole in base of mount

**35720 Mount**  
**35722 Mount, black**



35720

### Chrome Guard For Model 26 Lamps

**Material:**

- Chrome-plated steel guard

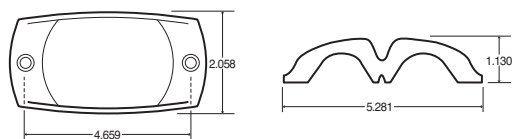

.230 screw hole diameter

- Features chrome-plated die cast with mounting holes
- Provides additional protection against the elements
- Replaces Truck-Lite 26720

**9179 Lamp guard**



### Chrome Bezel 26 Series

**Material:**

- Plateable grade ABS plastic
- Chrome plated

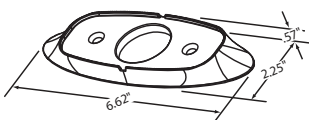

- Designed to enhance appearance of lamps
- Corrosion resistant chrome plating
- Sleek design
- Use with parts 26250R, 26251R, 26270R, 26250Y, 26251Y, 26270Y

**26002 Chrome bezel**



### Adapter Ring For 4" Lamps

**Material:**

- ABS ring

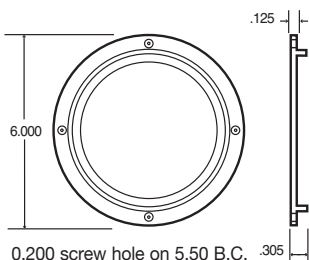

- Features high impact plastic construction
- Converts 4-3/4" hole to a 4-1/2" hole
- Replaces Signal-Stat 9117

**50831 Adapter**





- Flush mount 4" diameter lamps in a 4-1/2" hole
- Designed to provide additional shock absorbency to extend lamp life
- TPR grommet designed for extreme environmental applications & eliminates outgassing

**40403 Black, kit**  
**40700 Black**  
**40819 Black, TPR**  
**40701 Gray**  
**40702 White**  
**40703 Brown**  
**44710 Security grommet for flange mount lamps**

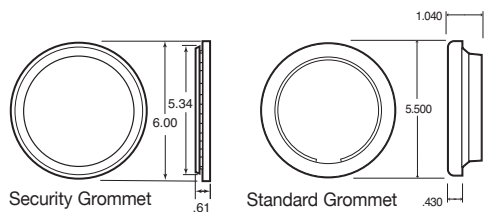

## Mounting Grommets For 4" Lamps

### Material:

- PVC grommet
- Thermal Plastic Rubber (TPR grommet)
- 16 gauge wire

### Kit Components:

40403 grommet kit:  
 1 - 40700 grommet  
 1 - 94993 plug

\*Recommended hole sizes for accepting the 40700 grommet:

Plate Thickness	Hole Size
1/16"	4.47"
1/8"	4.50"
3/16"	4.50"
1/4"	4.53"
3/8"	4.56"



- Designed to enhance appearance of lamps
- Flange cover offers improved theft resistance
- Two or three screws required

**44701 Grommet cover**  
**44700 Grommet cover w/visor**  
**44705 Flange cover, stainless steel**  
**44708 Flange cover, mirror finish**  
**44709 Flange cover, black stainless steel**

## Mounting Cover For 4" Mounts

### Material:

- Polished stainless steel
- Black powder coated stainless steel
- Chrome plated plastic

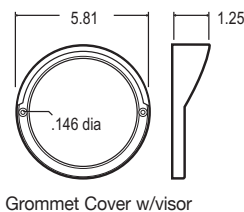
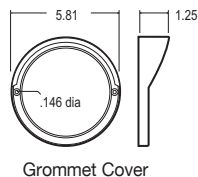
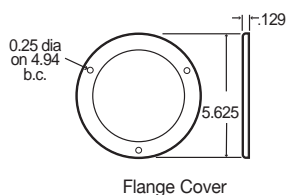

40720

- Features black painted reinforced steel
- Designed with 4-1/2" hole for mounting 4" lamps
- Available with or without flange

**40719 Without flange**  
**40720 With flange**  
**40726 With flange, slotted**

## Steel Mounting Brackets For 4" Lamps

### Material:

- Painted steel

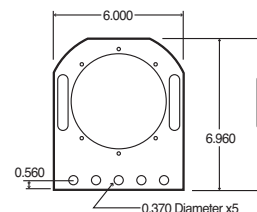
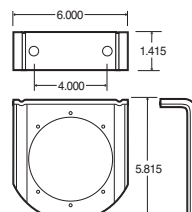

### Mounting Bracket For 4" Lamps

Material:  
• Steel bracket

- Features black epoxy painted steel
- Designed for two 4" lamps in 4-1/2" holes
- Replaces Signal-Stat 9239

**40715 Bracket**

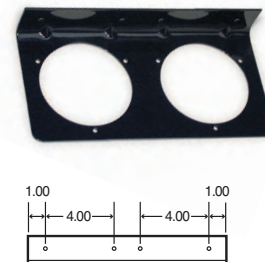
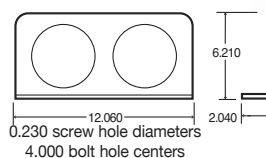

### Module Bracket For 4" Lamps

Material:  
• Metal Bracket

- Designed as replacement for many OEM trailer applications
- Includes red reflector
- Accepts all 4" grommet or flanged mount lamps
- Replaces Signal-Stat 9524

**40725 Bracket**

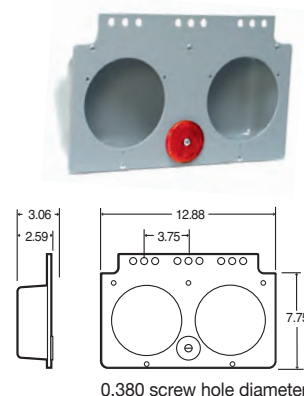

### Module Bracket For 4" Lamps

Material:  
• Stainless steel

- Popular on most tanker applications
- Designed for use with two 4" & one 2-1/2" grommet mounted lamps

**40680 LH bracket**  
**40681 RH bracket**

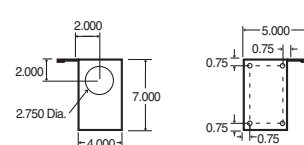
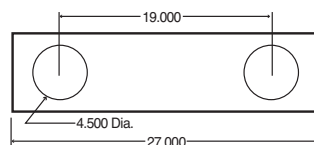

### Grommet Mounts For 45 Series Lamps

Material:  
• PVC grommet

- Designed for flush mounting 45 series lamps
- Standard grommet mounts in plate thickness of 1/8" to 3/8"
- LLV grommet designed specifically for Model 45 LLV lamps mounted in plate thickness of 1/16" to 3/32"
- Replaces Signal-Stat 9175 & 9329

**45700 Standard grommet**  
**45701 LLV grommet**

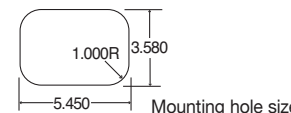
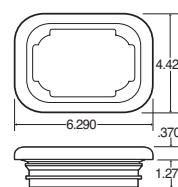

### Mounting Brackets For 45 Series Products

Material:  
• Painted reinforced steel

- Features rust resistant black epoxy painted reinforced steel
- Mount using the 45700 grommet
- Available with or without flange
- Replaces Signal-Stat 9287

**45720 Bracket with flange**  
**45721 Bracket without flange**

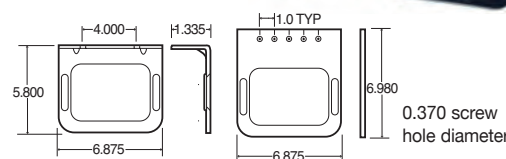



60403

- Flush mounts the 60 series lamps
- Provides lamps with additional shock absorbency to extend lamp life
- TPR grommet designed for extreme environmental applications & eliminates outgassing
- Semi-closed back recommended for incandescent lamps to protect lamp & wiring while allowing heat to escape
- Closed back recommended for Truck-Lite LED products only & protects against corrosion & stone damage
- Mounts in up to .25 maximum thick plate

**60403 Mount, kit**  
**60700 Grommet**  
**60708 Grommet, TPR**  
**60704 Closed back**



60700



60704

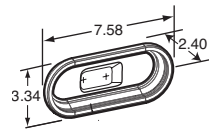

closed Back

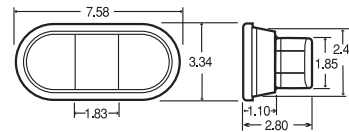

semi-closed Back

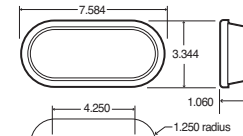

recommended hole size

## Grommet Mounts For 60 Series Products

### Material:

- PVC grommet
- Thermal Plastic Rubber (TPR) grommet
- 16 gauge wire

### Kit Components:

- 60403 grommet kit:**  
 1 - 60700 grommet  
 1 - 94993 plug

- Grommet cover features chrome plated plastics to enhance appearance of lamps
- Flange cover provides improved theft resistance of LED lamps
- Two screws required



**60718 Flange cover, unpolished stainless steel**  
**60719 Flange cover, stainless steel**  
**60703 Grommet cover**  
**60705 Grommet cover w/visor**

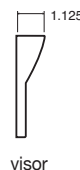

visor

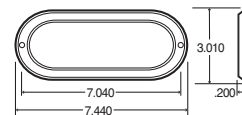
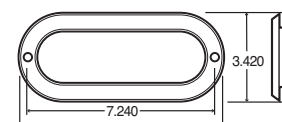
Grommet cover  
0.140 screw hole diameterFlange cover  
0.200 screw hole diameter

## Mounting Covers For 60 Series Products

### Material:

- Polished stainless steel
- Chrome plated plastic

- Popular for tanker requirements
- Features stainless steel constructions
- Available in flange or standoff versions
- Designed for 60 series products with grommet mount
- Replaces Signal-Stat 9292S

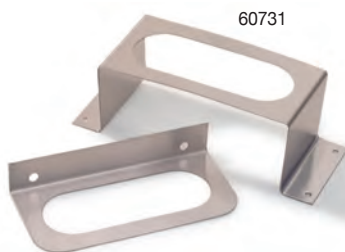

60731

60730

**60730 Flange mount**  
**60731 Standoff mount**

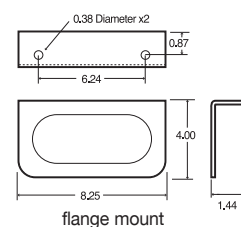

flange mount

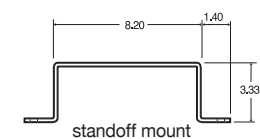
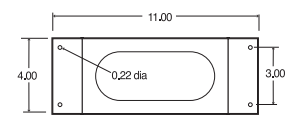

standoff mount

## Mounting Bracket For 60 Series Products

### Material:

- Stainless steel bracket



### Mounting Bracket For 60 Series Products

- Features epoxy black painted steel or aluminum construction
- Designed for 60 series products with grommet or flange mounts
- Available with or without flange
- Replaces Signal-Stat 9292

**Material:**

- Steel or aluminum

- 60720** Mount, steel w/flange
- 60722** Mount, steel w/o flange
- 60723** Mount, aluminum w/flange
- 60724** Mount, aluminum w/o flange

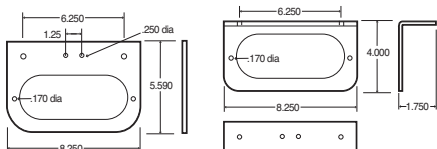

### Mounting Brackets For 60 Series Products

- “Z” configuration is designed for mounting side turn lamps on most trailers
- Notched flange version offers solution for trailer frame interference
- Features gray epoxy painted steel
- Designed for use with grommet or flange mounted 60 series products

**Material:**

- Steel bracket

- 60728** Bracket
- 60733** Bracket w/notch flange

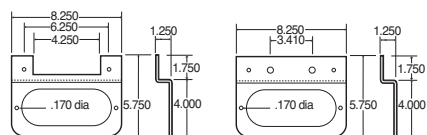

60733 0.200 screw hole diameter      60728 0.370 screw hole diameter



### Mounting Bracket For 60 Series Products

- Features gray epoxy painted steel
- Designed for use with grommet mounted Model 60 products
- Set of clamps included for side turn applications
- Most trailers do not require drilling or welding for installation

**Material:**

- Steel Bracket

- 60729** Bracket

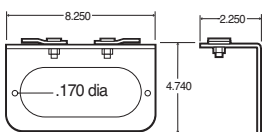

### Mounting Brackets For 60 Series Products

- Features bright finished stainless steel for corrosion resistance, added strength & durability
- Designs available for mounting two or three lamps systems
- Replaces Signal-Stat 9290S

**Material:**

- Stainless steel brackets

- 60737** Bracket, two lamp
- 60738** Bracket, three lamp

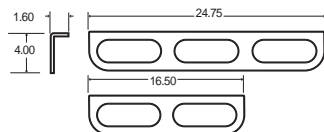

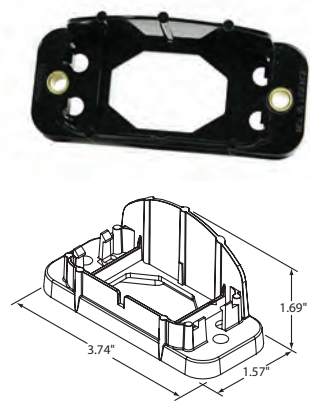

- Compatible with LED lamps 15205, 12v, & 15905, 24v
- Compatible with incandescent lamps 15208, 12v, & 15209, 24v
- Mounts at right angle to license plate
- Designed to prevent light from shining to rear, positioning light directly on license plate
- Snap-fit lamp mount for quick installation & easy replacement
- Addition to Model 15 license lamp brackets
- Only available in black
- Converts Model 19 incandescent configuration to Model 15 LED/ incandescent configuration

**15736 License lamp bracket**

### License Bracket For 15® Series Lamps

**Material:**

- Polycarbonate bracket

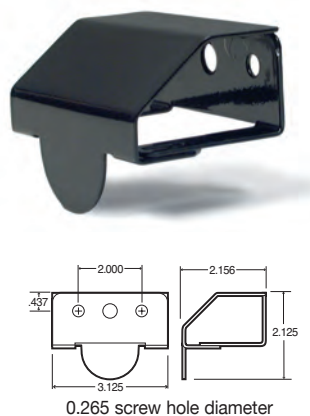

- Designed to adapt the Model 17 products to a vertical mounting surface
- Features black painted steel

**17720 Bracket**

### Mounting Bracket For Model 17 Products

**Material:**

- Steel bracket

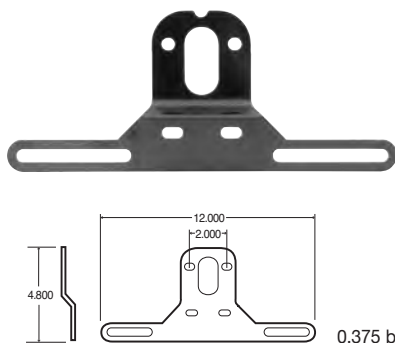

- Designed for universal mounting applications
- Features black painted extra strong steel construction
- Intended for use with Model 15 license lamps

**42722 Bracket**

### License Plate Bracket For 15® Series Products

**Material:**

- Steel bracket



- High impact plastic
- Universal mount
- Included in trailer lighting kit #55550

**80720 Bracket**  
**80722 Bracket w/slot**

### License Plate Bracket

**Material:**

- Plastic bracket

- Lens for 1150 & 1150A

8861 Red  
8861A Yellow



- Lens for 2110, 2112

8909 Red



- Lens & gasket for 1350A

8925A Yellow



- Lens for 1263, 1264
- Replaces 99045R/Y

8933 Red  
8933A Yellow  
9522 Mounting pad



- Lens for 9380

8935W White



- Lens for 677WK, 3753, 3754, 3755, 3756, 3850, 3853

8936 Red  
8936A Yellow



- Lens for 4742, 4754

8938 Red  
8938A Yellow

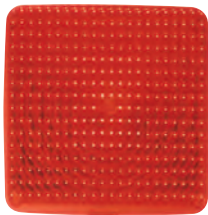

- Lens for 1319

8943 Red  
8943A Yellow



- Lens for 1115, 1116
- Replaces 99037R/Y

8945 Red  
8945A Yellow



- Lens hood for 425

8951W Clear  
8952W Gray

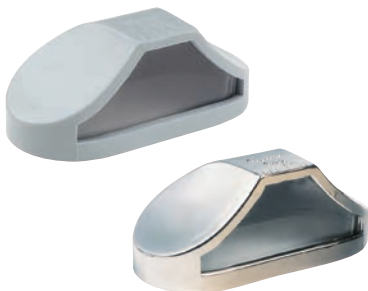

- Lens for 940, 941, 950, 955, 956, 957

8960 Red



- Lens for 2201, 2203, 2204

8974 Red



- Lens for beehive lamps
- Replaces 99039 series

9004 Red  
9004A Yellow



- Lens for 1101, 1102, 1105, 1108, 9365, 9366, 9369
- Replaces 99112 series

9005W Clear



- Lens & O-ring for 1201, 1203, 1204
- Replaces 99054R/Y

9006 Red  
9006A Yellow  
9180 O-ring  
9523 Mounting pad



- Lens for 1201, 1203, 1204, 1211, 1213, 1215, 1216, 1253
- Replaces 99053 series

9007 Red  
9007A Yellow  
9007G Green  
9007W Clear

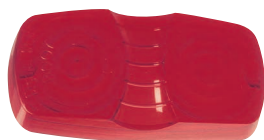

- Lens for 3600 series

9016 Red  
9016A Yellow  
9016B Blue  
9016G Green  
9016W Clear



- Polycarbonate lens, gasket, screws

9021 Red  
9021A Yellow  
9021W Clear



- Lens for snap ring lamps

9029 Red  
9029W Clear



- Lens for 1410

9040 Red  
9040A Yellow



- Lens for 540 series, 3751, 3752, 3851

9041 Red  
9041A Yellow



- Dual optic lens for 4027
- Fits all 4010 & 4020 series lamps
- Replaces 99164R

9049 Red  
97706 Lens gasket



- Lens for 1221, 1222
- Replaces 99048R/Y

9057 Red  
9057A Yellow



- Lens for 1550, 1551
- Replaces 99049R/Y

9059 Red  
9059A Yellow



- Lens & gasket for 4800 series
- Replaces 99128R/Y

9063 Red  
9063A Yellow



- Lens for 1313 GM #684662

9069A Yellow



- Spiral optic lens & gasket for 4010 & 4020 series lamps
- Replaces 99068R

9071 Red



- Lens for 5010 series lamps
- No screw holes

9072 Red



- Lens & gasket for 640W & 640WK

9073A Yellow



- Lens & O-ring for 92W

9076W Clear



- Lens for 1205, 1233, 1235

9077 Red  
9077A Yellow  
9180 O-ring  
9523 Mounting pad



- Lens & gasket for 4842
- Replaces 99128R/Y

9079 Red  
9079A Yellow

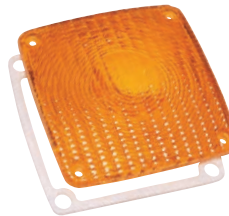

- Marker lens & gasket for 4800 series lamps

9080A Yellow

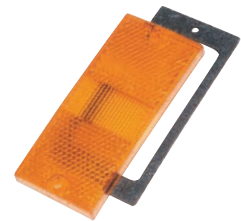

- GM #2004543 ( Red), #799386 (Yellow) cab marker lens & O-ring

9081A Yellow



- Lens for 1520, 1521, 1523
- Replaces 99166R/Y

9082 Red



- Lens for 4805AY116 & 4805AY117

9083 Red

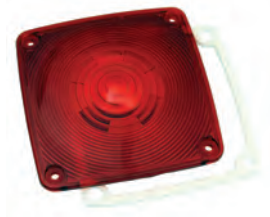



- Lens for 5800 series lamps

9084A Yellow



- Lens for 92560

92561 Yellow



- Lens for 549SWD

9373W Clear



- Lens for 92560 & 92563

9719A Yellow



- Lens, gasket & screw for 1312

9087A Yellow



- Lens for 3760, 3763, 3860, 3861, 3862, 3863

9341 Red  
9341A Yellow



- Lens for 6501

9384A Yellow

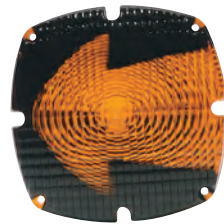

- Lens for 300, 301, 307 & 313 lamps

9720B Blue  
9720 Red  
9720W Clear



- Lens for 1258, 1259, 1262

- Replaces 99055 series

9093 Red  
9093A Yellow  
9093G Green



- Lens for 548 & 549

9372 Red  
9372A Yellow



- For 528, 529, 530

9676 Red



- Lens for Rubbolite 6822A & 6823A

9723A Yellow



- 2-1/2" diameter acrylic lens
- Replaces lenses for 10300R/Y & 10301R/Y
- Replacement lens for Do-Ray 8506R/Y-1

**99001R Red**



- Polycarbonate replacement lens for Model 20 lamps & Signal-Stat 9354 series

**99005R Red**  
**99005C Clear**



- Multi-purpose lens fits most 4" lamps
- Replaces 80302, 80334, 80335, 80339, 81300 & 81301

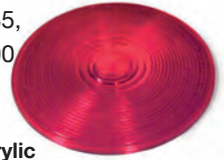

**99007R Red, acrylic**  
**99008C Clear, polycarbonate**  
**99008R Red, polycarbonate**  
**99008Y Yellow, polycarbonate**

- Polycarbonate lens for 70300 lamp

**99009Y Yellow**



- Polycarbonate lens & housing
- Replaces 40302R/Y & 40318R/Y

**99010R Red**  
**99010Y Yellow**  
**99010C Clear**  
**99010B Blue**



- Polycarbonate lens for 60 series lamps

**99011R Red**  
**99011Y Yellow**  
**99011B Blue**

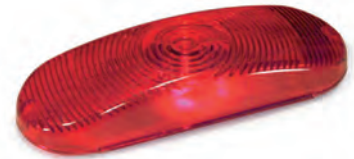

- Sealed reflector lens & housing
- Replaces 18300R/Y

**99012R Red**  
**99012Y Yellow**  
**97927 Gasket**



- 7" polycarbonate lens & housing
- Replacement for 91312R/Y & 91812R/Y

**99021R Red**  
**99021Y Yellow**



- 2-3/8" acrylic lens
- Replacement for Grote & Do-Ray lamps

**99034Y Yellow**



- 2-7/16" acrylic lens
- Replaces 26322, 26740, 26741 & Do-Ray lamps
- Replaces Signal-Stat 9004 series

**99039R Red**  
**99039Y Yellow**



- Acrylic lens
- Replaces Grote, Signal-Stat & Do-Ray lamps

**99041R Red**  
**99041Y Yellow**



- Acrylic lens
- Replaces Do-Ray & Betts lamps

**99043R Red**  
**99043Y Yellow**



- Polycarbonate lens
- Replaces 26312R/Y, 26317R/Y & Do-Ray 496 lamps

99050R Red  
99050Y Yellow



- Acrylic lens
- Replaces 26765Y, 1320, 1320A & Signal-Stat 9067/A

99067Y Yellow



- 7" diameter acrylic lens
- Replaces 80354, 80355, 90320R/Y & 90321R/Y lamps

99088C Clear



- Shatter resistant polycarbonate lens shield
- Protect Par 36 sealed beams

99120B Blue  
99120C Clear  
99120R Red



- Acrylic or polycarbonate lens
- Replaces 26310R/Y & Do-Ray 486

99051R Red  
99051Y Yellow



- 5" polycarbonate lens
- Replacement for 80350, 80351 & Do-Ray lamps

99082R Red w/switch hole



- 4-1/8" polycarbonate lens
- Replacement for 70310R, 70311, 70330R/Y, 80329R & Do-Ray lamps

99090R Red  
99090Y Yellow



- Acrylic lens
- Replacement for 80317R & 80318R lamps
- Available with & without license plate window

99126R Red, L.P.W.  
99127R Red

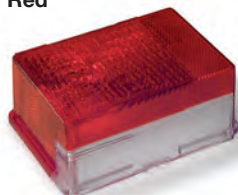

- 3-9/16" diameter acrylic lens
- Replacement for 26760Y lamp

99066Y Yellow



- Acrylic lens
- Replacement for 81304R/Y, 80308R & Do-Ray lamps

99087R Red  
99087Y Yellow



- 3-1/4" acrylic lens
- Replacement for 80340 & Signal-Stat 8927W

99095C Clear



- Lens for 92513 series

99145R Red  
99145B Blue  
99145Y Yellow





- Lens for 92534 & 92539 series

99147B Blue  
99147Y Yellow



- Lens for 92600 series

99148Y Yellow  
99148B Blue



- Lens for minibars

99151R Red  
99151B Blue



- Universal polycarbonate lens
- Replacement for 40802, 40803, 40804 and 40805

99152 Yellow, w/wide turn label



- Acrylic lens
- Replacement 26311, 26313 & Signal Stat 1113 & 1114 lamps or 8931 lens

99160Y Yellow



- Polycarbonate lens
- Replacement for 25762Y cab marker

99165Y Yellow  
99165C Clear



- Acrylic lens
- Replacement for 90325Y & Signal-Stat 6505 bus lamps or 9386A lens

99167Y Yellow



- Acrylic lens
- Replacement for 90327R/Y & Signal-Stat 6503, 6504 bus lamps & 9385 lenses

99168R Red  
99168Y Yellow  
99168C Clear



- Polycarbonate lens
- Replacement for 90326R/Y & 6507 bus lamps or 8865 lens

99169R Red  
99169Y Yellow



- Acrylic lens
- Replacement for 26353R/Y & 1151 bus lamps or 8862/A lens

99170R Red  
99170Y Yellow



- Acrylic lens
- Replacement for 26354R/Y bus lamps

99171R Red  
99171Y Yellow



- Acrylic lens
- Replacement for 81350 bus dome lamp or 8866W lens

99172 Clear



- Acrylic lens
- Replacement for 80423C hook-up lamp

99176C Clear



- Polycarbonate lens & housing are sealed
- Replaces 60340R/Y, 60345C & 60834C lamps

99184R Red  
99184Y Yellow  
99184C Clear



- Lens for center dome on light bars

99193Y Yellow



- Lens for 17" minibars

99200C Clear  
99200R Red  
99200Y Yellow



- Lens for upper outboard on light bars

99203Y Yellow



- Lens for lower outboard on light bars

99208C Clear

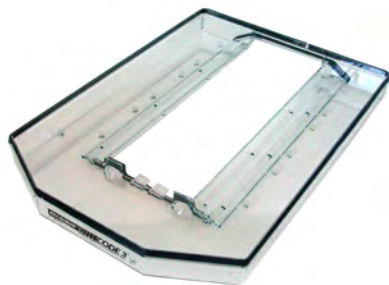

- Lens for lower outboard on light bars

99209C Clear

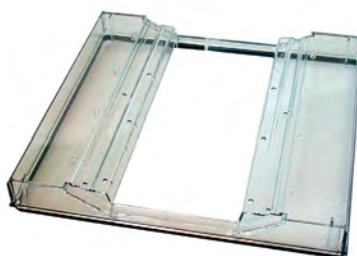

- Lens for 6600 & 6810 series, medium profile

99220B Blue  
99220R Red  
99220W Clear  
99220Y Yellow



- Lens for 6611 & 6601 series, low profile

99221B Blue  
99221R Red  
99221W Clear  
99221Y Yellow



- Lens for SWL medium profile lamps

99250B Blue  
99250C Clear  
99250B Yellow



- Lens for SWL low profile lamps

99252Y Yellow





# Merchandising

# Merchandising

**P.O.P. Displays 276-279**



**Lighted Displays 280-281**



## TRUCK-LITE MERCHANDISING

Truck-Lite's merchandising tools create a dynamic environment that, with one glance, encourages our customers to take a closer look. The environment must be engaging and well organized. Using displays and other marketing materials to showcase our products is a great form of branding - increase sales by using our solid reputation to offer the highest quality LED lighting products!



### Shop Floor Cabinet & Product Kit

Kit Components:

- 47 (10 ea)
- 10202R/Y (10 ea)
- 10700 (10 ea)
- 15200R/Y (10 ea)
- 15208 (10 ea)
- 19200R/Y (10 ea)
- 19206 (10 ea)
- 19721 (10 ea)
- 30200R/Y (10 ea)
- 30700 (10 ea)
- 40204 (5 ea)
- 40282R (10 ea)
- 40700 (10 ea)
- 60202R (10 ea)
- 60204C (5 ea)
- 60215Y (6 ea)
- 60700 (10 ea)
- 80360 (6 ea)
- 94902 (10 ea)
- 94993 (10 ea)

	19200R	19200Y	10202R	10202Y	15200R	15200Y	30200R	30200Y	
	19206	15208	19721	94902	94993	60204C	40204	47	
	60202R				40282R				42" H
	60215Y				80360				
11 7/8" L	30700	10700	40700	60700					
	33 7/8" W								

- 24 compartment cabinet
- Organizes cluttered shelf inventory
- Sampling of common replacement lamps
- Part selection covers 75% of common repair work
- Easy to manage and fulfill replacement orders
- Great assortment of lamps for standard repair and inspection stations

55653 Complete kit  
55650 Cabinet Only

## Gondola Baskets

Kit Components:

### 96199 basket kit

- 1 - basket
  - 3 - dividers (2 for outside / 1 for inside)
  - 2 - peg hooks
- Aesthetically pleasing quality baskets
  - Fits standard 4' gondola displays / pegboard
  - Allows for multiple products to be arranged in a variety of ways
  - 23.75" L x 8.875" W x 10.875" H



96199 Complete basket kit

Replacement Parts:

96197 Basket divider  
96198 Hook

Recommended Accessories:

97029 Plastic basket card clips  
P440 Basket card product tag bundles (2.13" x 5.0")

## 4' Gondolas

Recommended Accessories:

97882 Slat wall hook  
96189 Peg board hook

97020  
4' Gondola,  
white, peg board

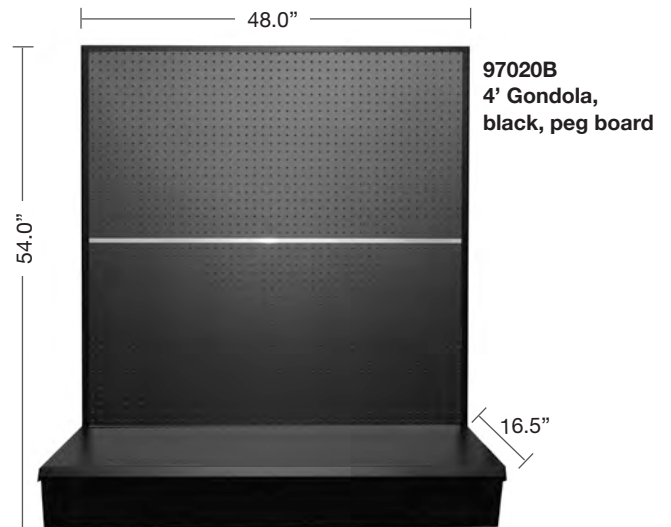
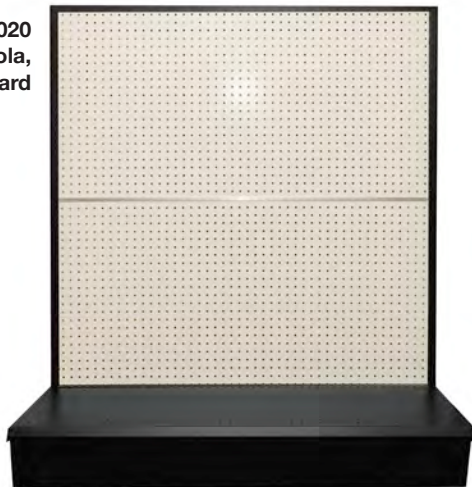

97020B  
4' Gondola,  
black, peg board

97920  
4' Gondola,  
white, slat wall



97920B  
4' Gondola,  
black, slat wall



- 97140 Small bin box (12"L x 4"W x 4.5" H)
- 97141 Medium bin box (12"L x 6"W x 4.5" H)
- 97142 Large bin box (12"L x 8"W x 4.5"H)



- P340 Basket card product tag bundles (1.75" x 3.6")



Examples of 4' Header (pg278) on all available 4' Gondolas (pg277)

4' Header on White Peg Board



4' Header on Black Peg Board



4' Header on White Slat Wall

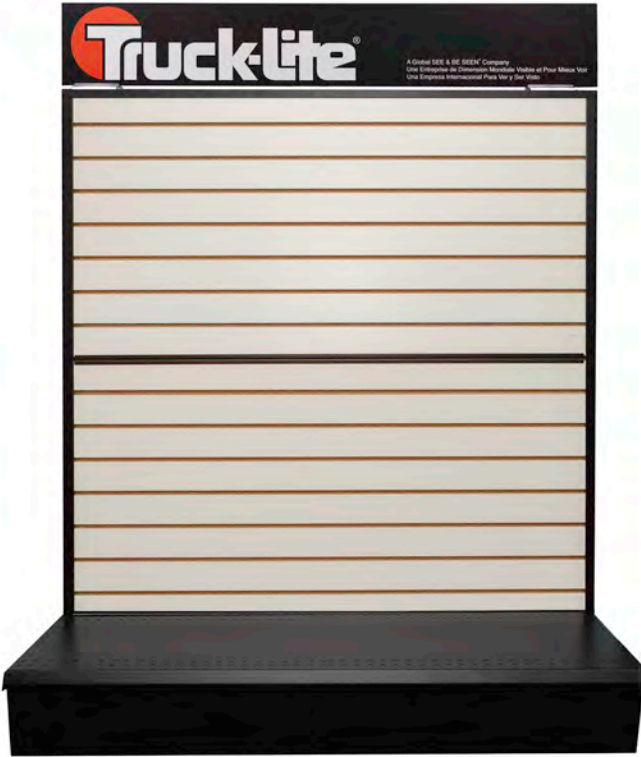

4' Header on Black Slat Wall



## LED Lighting Displays

- Lighted panels are interchangeable, offering flexibility in showcasing multiple product families or various product promotions
- Display bases hang on a wall or gondola and can stand on a counter, shelf or window exhibit
- Displays have finished backs for a clean look
- All units have individually contained power supplies
- Sleek, clean, professional look to assist in product sales
- Large display dimensions - 39.2"L x 5.75"W x 25.5"H



Truck-Lite LED Lighting Display

- 97377 Truck-Lite Lighting Display  
97483 Insert



Signal-Stat LED Lighting Display

- 97376 Signal-Stat Lighting Display  
97482 Insert

# LED Lighting Displays

- Lighted panels are interchangeable, offering flexibility in showcasing multiple product families or various product promotions
- Display bases hang on a wall or gondola and can stand on a counter, shelf or window exhibit
- Displays have finished backs for a clean look
- All units have individually contained power supplies
- Sleek, clean, professional look to assist in product sales
- Small display dimensions - 17"L x 5.75"W x 24.5"H

## Truck-Lite LED Lighting Display

97378 LED Auxiliary Display  
97484 Insert



## Truck-Lite LED Lighting Display

97380 Model 33 & 36 Series LED Lighting Display  
97486 Insert



## Truck-Lite LED Lighting Display

97379 4" LED Tail Lighting Display  
97485 Insert



## Truck-Lite LED Lighting Display

97405 5"x7" LED Headlight Display  
97489 Insert



## Truck-Lite LED Lighting Display

97383 4"x6" LED Headlight Display  
97488 Insert



## Truck-Lite LED Lighting Display

97381 7in Round LED Headlight Display  
97487 Insert



# Technical Information & Reference









**Truck-Lite<sup>®</sup> Sealed Systems**  
**- ARE -**

**CERTIFIED VAPOR-PROOF**

COMPLIANT



**Underwriters Laboratories | UL 1604**



**National Fire Protection Agency | NFPA 493**

## FEDERAL LIGHTING REGULATIONS

Full color illustrations show all basic equipment location requirements on trailers, trucks, buses, and many more.

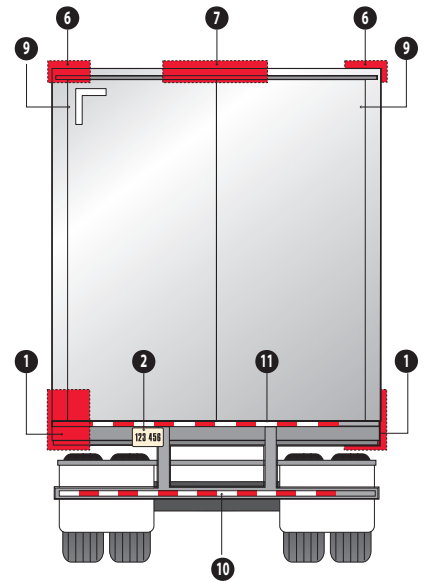
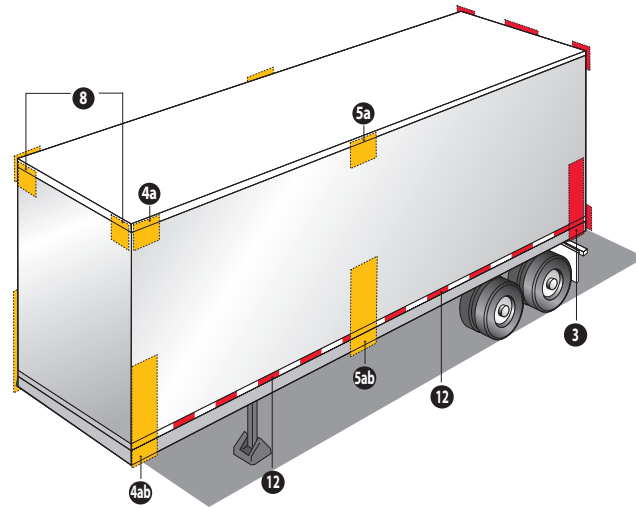

## USER GUIDES

Truck-Lite's series of User's Guides contains everything you wanted to know about lighting, harnessing and much more! These manuals are small enough to fit in the tool box and big enough to include expert electrical and lighting information. Manuals cover a variety of topics including: Basics of Electricity, Harness Fundamentals, Troubleshooting, Diagnosing Harness Failure, Harness Repair Methods, and a Glossary of Industry Terms. Ask a Truck-Lite Representative how to get training and copies of the User Guides today.



Part# L180



Part# L181

## MEASURING LED BRIGHTNESS

LED Technology is new but can be confusing. As lighting technology continues to improve, so does the importance of developing an understanding of technical terms and ideas related to LED lighting technology. Light pattern, lumen value, and candela value all play very important roles in LED lighting. Though it may be tempting to believe a single number on a package, you are now prepared to make a more informed decision when choosing your next lamp. Ask your Truck-Lite Representative for your copy.



## Frequently Asked Questions

### **"The vehicle has everything needed for 108, but the State Police gave me a ticket anyway."**

States can regulate anything not covered by "108." For example, any accessory lights or lights in addition to those in "108." Generally the problem is in these areas. Sometimes they make a mistake. In that case, Truck-Lite's lab can often write a letter to clarify the issue.

---

### **What are combination marker/clearance lamps, and how do I mount them?**

It is one light doing the work of two. It must be at a 45 degree angle (on corners) to be legal. It needs to be marked "PC" in the lens code. If there is a question, contact the Truck-Lite laboratory.

---

### **How hard should I tighten down (torque) plastic lights or devices?**

Overtorquing will generally cause cracking or distortion. Use the torque spec provided by the manufacturer. A marker lamp will generally be in the neighborhood of 8 to 20 inch lbs.. The "rule of thumb" is to use the minimum torque necessary to hold the device.

---

### **Are heavy-duty harnesses worth the extra cost?**

Heavy duty harnesses provide an independent (secure) ground, less voltage drop and are completely sealed to avoid corrosion.

---

### **What is the "12 Square Inch rule?"**

On December 1, 1991, the National Highway Traffic Safety Administration (NHTSA) made effective the final ruling regarding the "12 Square Inch Rule." This ruling requires that the total luminous lens area for a stop and turn lamp must not be less than 75 centimeters squared (11.625 square inches) when used on vehicles over 80" wide. It must be noted that the reflex reflector ring cannot be counted as square inch lens area. When the reflex ring is subtracted from the total 12 inch lens, it leaves less than the 12 square inches required.

---

### **Is it illegal or non-compliant to use red or yellow LED lamps that have clear lenses, but produce the same red or yellow light output?**

No. There is nothing illegal or non-compliant with having red or yellow LEDs behind clear lenses. The effective color of the light when illuminated is red or yellow, which are approved colors of SAE J578c requirements. Clear lenses are legally approved for SAE J578c regulations as well. For a specific statement of the requirements, please review the NHTSA regulations charts.

## Frequently Asked Questions

### Would it be alright to mount a light at an angle that isn't "square" on the vehicle?

"Maybe." You need to contact the Lab for a test in that position; otherwise, it can be questioned by NHTSA or enforcement officials.

### Can I ever use the Model 40 with Reflex reflector ring legally?

Yes, as follows: On any vehicle under 80" wide. As an "extra" light on over 80" (reflex is legal). On vehicles made in 1991 or earlier, when installed by the vehicles owner, although most states enforce the Federal requirement.

### Is "SAE" or "DOT" lettering required on lights?

No lettering is required by NHTSA (108) except for headlights and conspicuity tape. The Federal Motor Carrier Safety manual mentions that some lights should be marked "SAE" but this is not enforced. Truck-Lite marks all their lights with "SAE" and/or "DOT" markings.

### Are there any special lighting requirements for vehicles hauling flammable or explosive materials?

There are no "special" Federal requirements as "108" covers all over-the-road vehicles. Some states or municipalities have regulations, but these cannot "supersede" 108, they can only add to it. Truck-Lite's sealed lights and wiring systems have been tested to all known standards and certification. Reports are available from the Truck-Lite lab.

### "108" says that some lights must be mounted as high as "practical." What is "practical?"

NHTSA has stated that the vehicle manufacturer has the responsibility to choose the best mounting location "in light of the particular design/configuration of the vehicle involved" and they will not contest it unless it is "clearly erroneous." Recently, Canada has started to strictly enforce the word practical as meaning "capable of being done." In the case of sidemarkers, not more than six inches from the edge of the vehicle.

### My customer wants to use a light for a "side turn" that isn't listed for that function. Is this OK, seeing as how side turns aren't required anyway?

Be careful that it doesn't violate some state laws regarding color or location. If it is also used as a side marker, that function must be listed on the lens code.

### My customer wants to add some auxiliary lights (ie. illuminated signs, deceleration lights, decorative lamps). Are these legal?

Yes, provided they do not: Render inoperative any device in compliance with "108," negatively affect the performance of required equipment, create confusion or misunderstanding of lighting signals. Always contact the Truck-Lite Lab if you have any questions.

# Trailer Equipment Location Requirements

To read, please use the chart on the following pages.

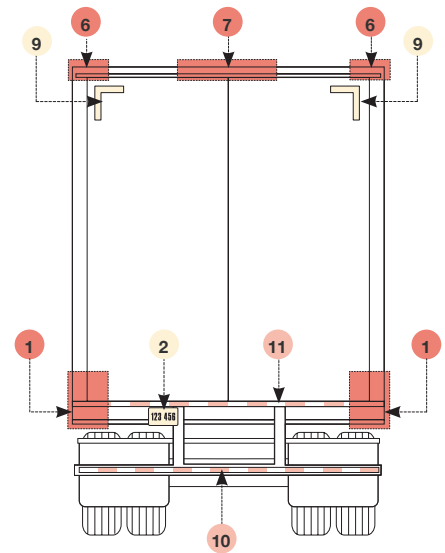
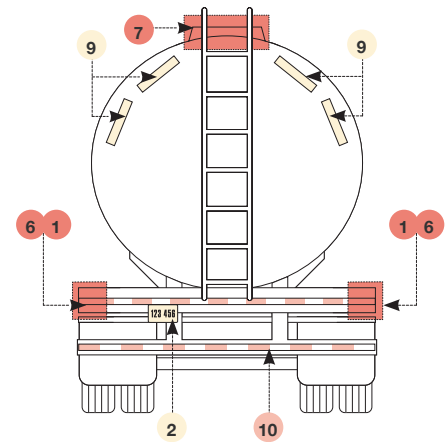
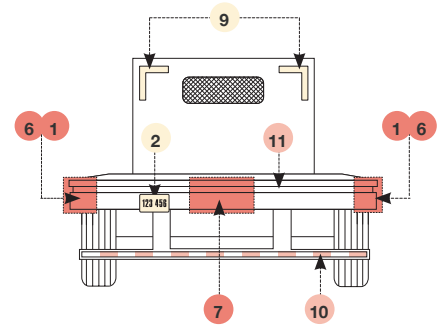
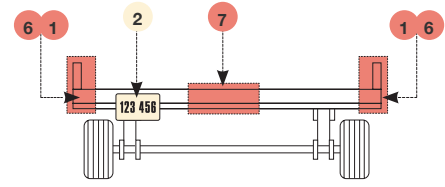
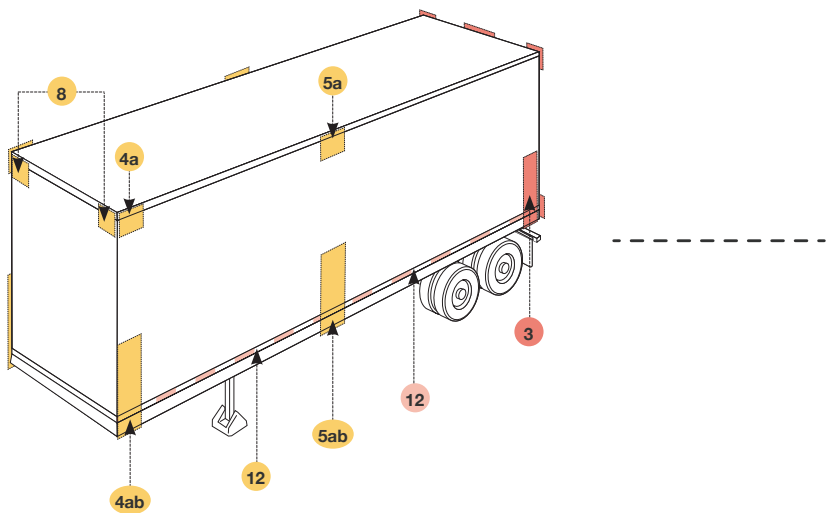
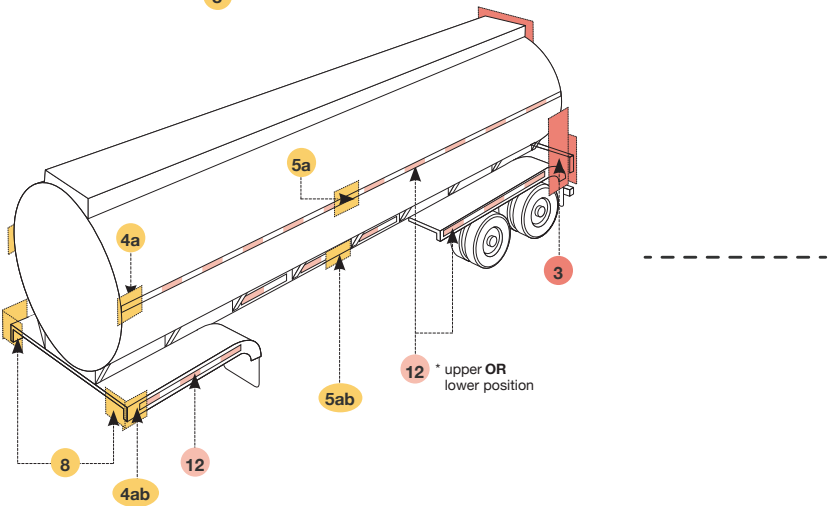
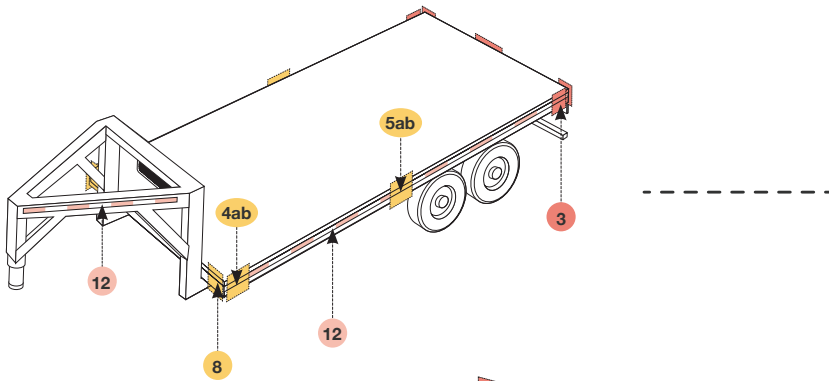
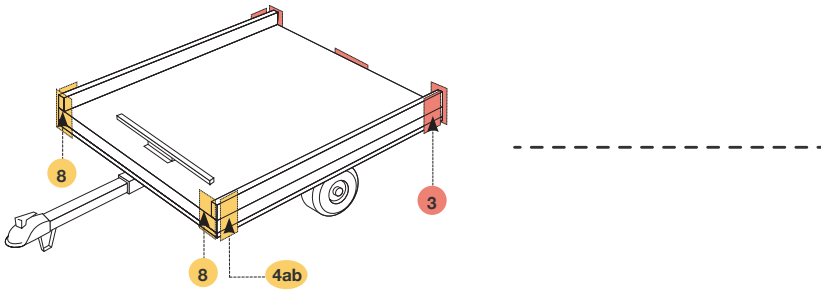



# Trailer Equipment Location Requirements

To read, please use the chart on the following pages.

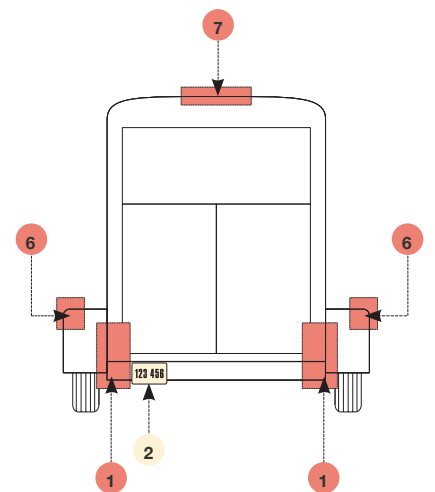
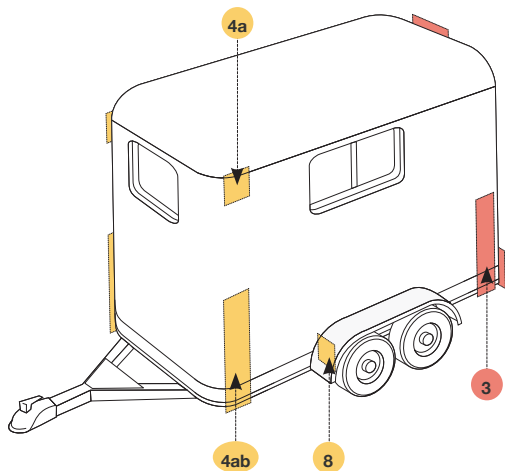
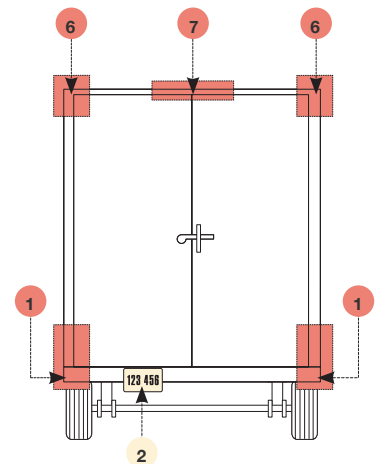
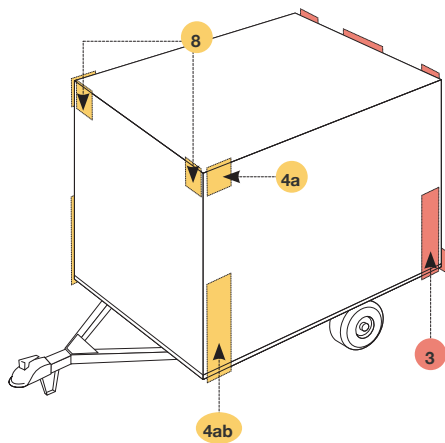
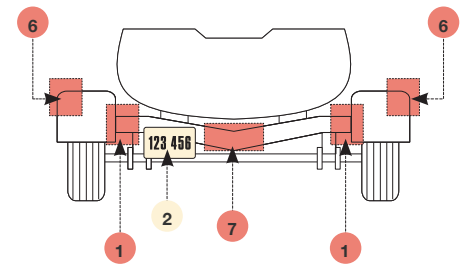
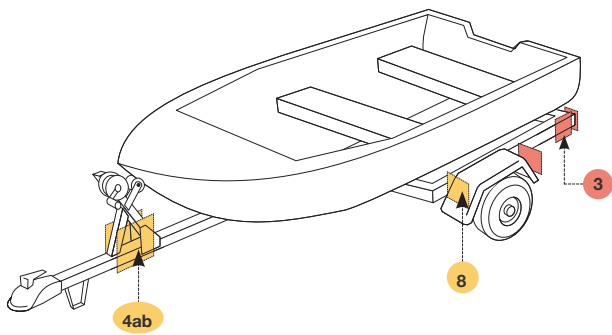
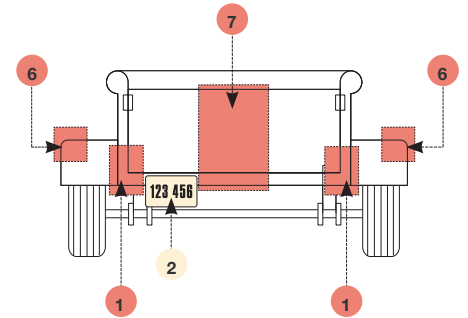
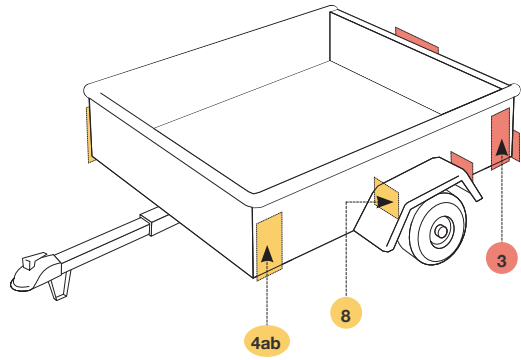

# BASIC EQUIPMENT REQUIRED ON ALL TRAILERS

Trailer Equipment Locations | All Trailers Over 80 Inches

Color of Lights :	Red	Red/Yellow	Yellow	White/Red	White
-------------------	-----	------------	--------	-----------	-------

\* Photometrically certified at installation angle

## Description & Mandatory Requirements

	Equipment	SAE Lens Coding	Function	Quantity	Location	Height & Height From Ground
<b>1</b>	Tail Lamps	(T)	Indicate vehicle's presence & width	Min. 2	On rear - symmetrical as far apart as practicable	380-1830mm (15-72 in.)
	Stop Lamps	(S)	Indicate breaking	Min. 2	On rear - symmetrical as far apart as practicable	380-1830mm (15-72 in.)
	Rear Turn Sig. Lamp	(I)	Indicate direction of turn	Min. 2	On rear - symmetrical as far apart as practicable	380-2110mm (15-83 in.)
	Rear Reflex Reflectors	(A)	Indicate vehicle's presence & width	Min. 2	On rear - symmetrical as far apart as practicable facing rearward	380-1530mm (15-60 in.)
<b>2</b>	License Plate Lamps	(L)	Illuminates license plate	Min. 1	On the rear - above or at the sides of license plate	No requirements
<b>3</b>	*Rear Side Marker Lamps	(P2, PC* or P3, PC2*)	Front & rear side marker lamps/side reflex reflectors indicate vehicle's presence & length	Min. 2	Each side at rear as far back as practicable	380-1530mm (15-60 in.) no max. for veh. under 2032 mm (80 in.) wide
	Rear Side Reflex Reflectors	(A)	Front & rear side marker lamps/side reflex reflectors indicate vehicle's presence & length	Min. 2	Each side at rear as far back as practicable facing sideways	380-1530mm (15-60 in.)
<b>4</b>	a *Front Side Marker Lamps	(P2, PC* or P3, PC2*)	Front & rear side marker lamps/side reflex reflectors indicate vehicle's presence & length	Min. 2	Each side at front as far forward as practicable	380 mm (15 in.) minimum
	b Front Side Reflex Reflectors	(A)	Front & rear side marker lamps/side reflex reflectors indicate vehicle's presence & length	Min. 2	Each side front as far forward as practicable facing sideways	380-1530mm (15-60 in.)

## Description & Mandatory Requirements

Length 9.1 m (30 ft.) or longer & Width 2032 mm (80 in.) or wider

	Equipment	SAE Lens Coding	Function	Quantity	Location	Height & Height From Ground
<b>5</b>	a Intermediate Side Marker Lamps	(P2 or P3)	Indicates presence of a long vehicle	Min. 2	Each side near center facing sideways	380mm (15 in.) minimum
	b Intermediate Side Reflex Reflectors	(A)		Min. 2	Each side near center facing sideways	380-1530mm (15-60 in.)
<b>6</b>	*Rear Clearance Lamps	(P2, PC* or P3, PC2*)	Show vehicle's width MAY NOT be combined with tail lamps	Min. 2	At widest point-symmetrical on the rear of near the rear facing rearward	As high as practicable may be lower only if ID lamps are at top
<b>7</b>	Rear Identification Lamps	(P2 or P3)	Indicates presence of a wide vehicle	Exactly 3	On the rear-center horizontally spaced-150 mm (6 in.) to 300 mm (12 in.) apart facing rearward	At the top-may be lower if door header narrower than 25 mm
<b>8</b>	*Front Clearance Lamps	(P2, PC* or P3, PC2*)	Show vehicle's width	Min. 2	At widest point-symmetrical on the front or near the front facing forward	As high as practicable

## Description & Mandatory Requirements

Width 2032 mm (80 in.) or wider & GVWR 4536 kg (10,001 lb.) or more

	Conspicuity Treatment	DOC Coding	Quantity	Location	Height	Options
<b>9</b>	Rear Upper Body Markings	DOT-C DOT-C2 DOT-C3 DOT-C4	Exactly 2 pairs of 300 mm long strips	On the rear upper corners facing rearward	At the top	Reflex reflectors (#3) may not be required if they are replaced in their required location with conspicuity treatment.  <b>Optional in Canada:</b>  Rear lower body and side conspicuity also be solid white, solid yellow, or white & yellow.
<b>10</b>	Bumper Bar Markings	DOT-C DOT-C2 DOT-C3 DOT-C4	Continuous	On the rear bumper bar's horizontal element full width of the vehicle facing rearward	No requirement	
<b>11</b>	Rear Lower Body Marking	DOT-C DOT-C2 DOT-C3 DOT-C4	Continuous	On the rear full width of the vehicle facing rearward	As horizontal & as close as practicable to the range of 375mm to 1525 mm from the ground	
<b>12</b>	Side Marking	DOT-C DOT-C2 DOT-C3 DOT-C4	(see location)	Each side-facing sideward continuous, or evenly spaced over minimum of 50% length starts & ends as close to the front & rear of the vehicle as practicable	As horizontal & as close as practicable to the range of 375 mm to 1525 mm from the ground	

# Truck, Bus, MPV Equipment Location Requirements

To read, please use the chart on the following pages.

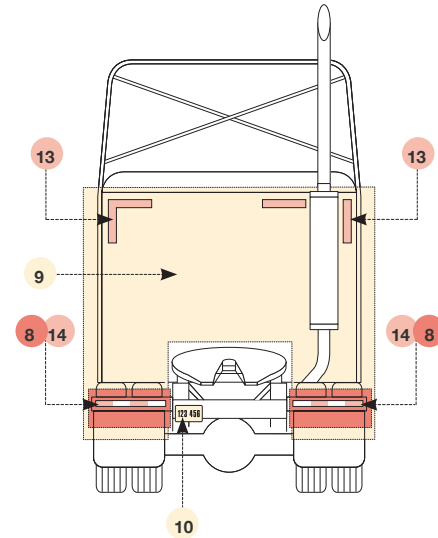
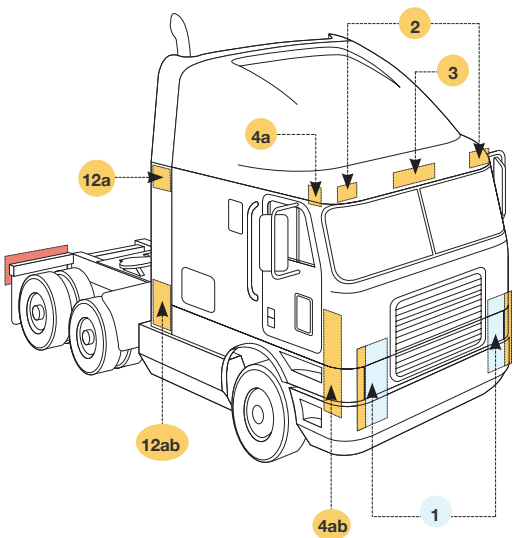
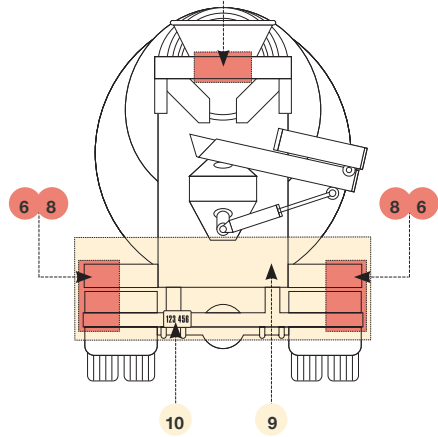
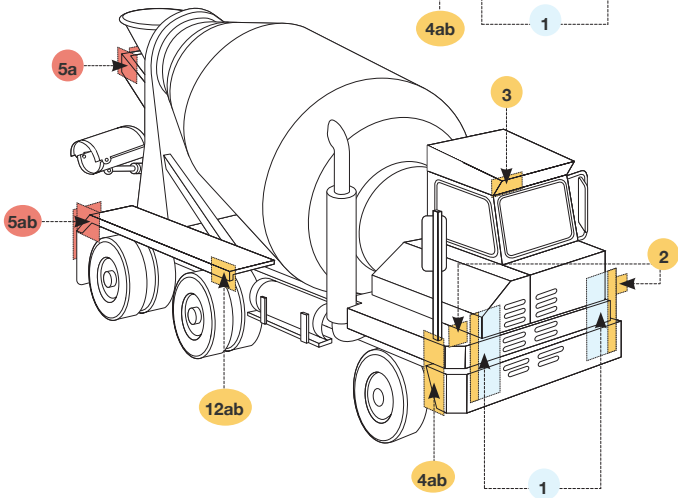
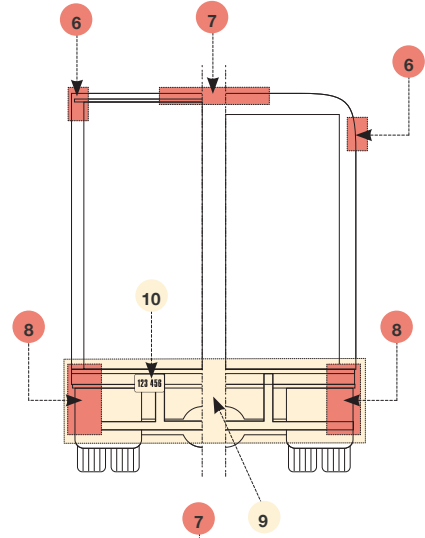
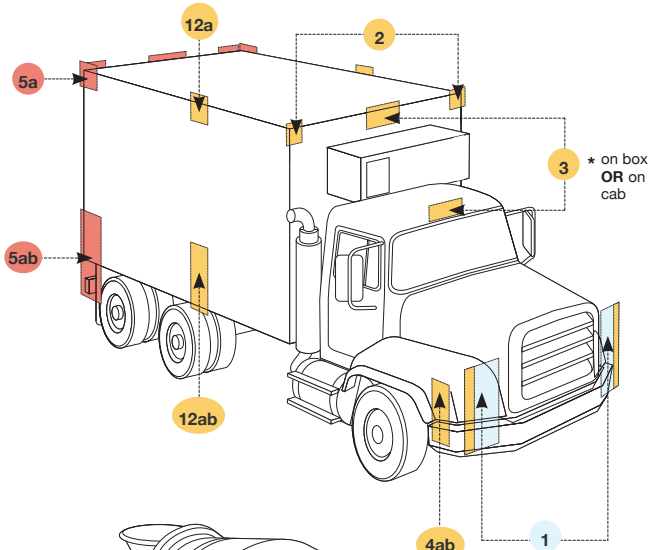

# Truck, Bus, MPV Equipment Location Requirements

To read, please use the chart on the following pages.

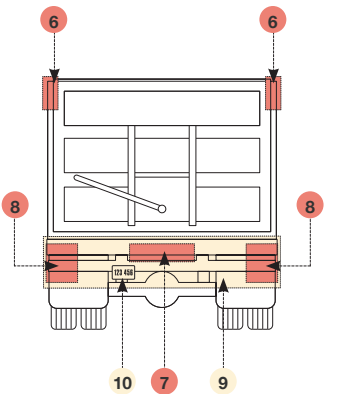
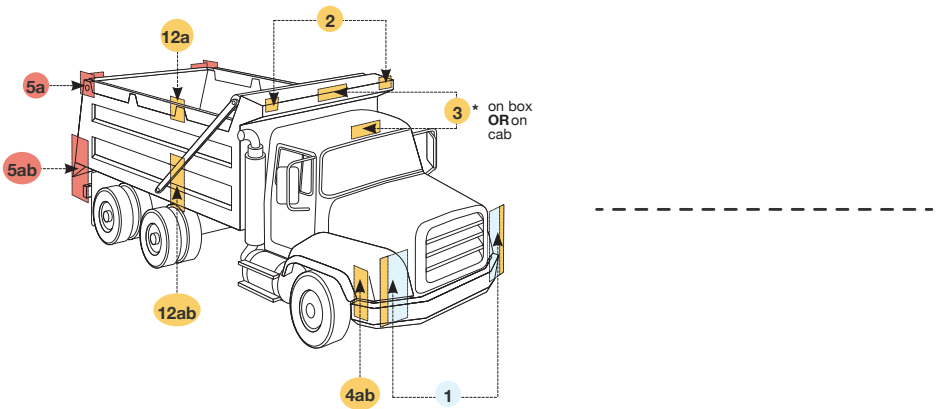
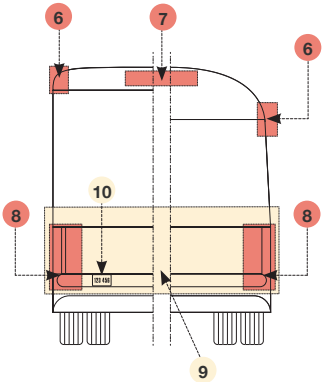
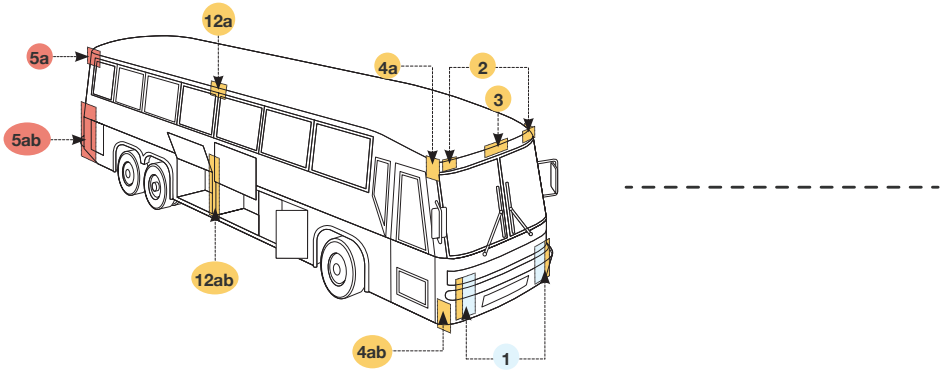
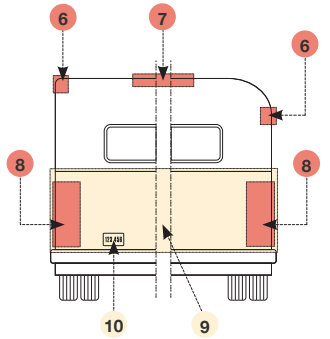
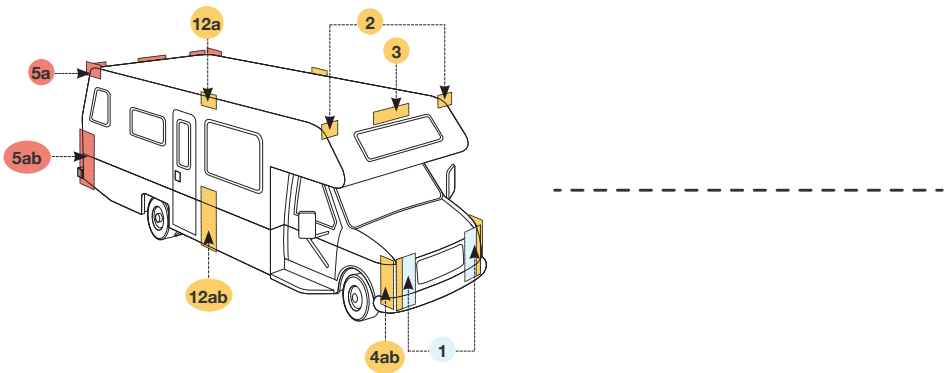
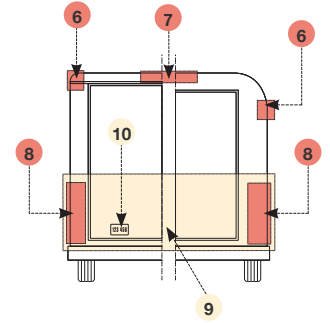
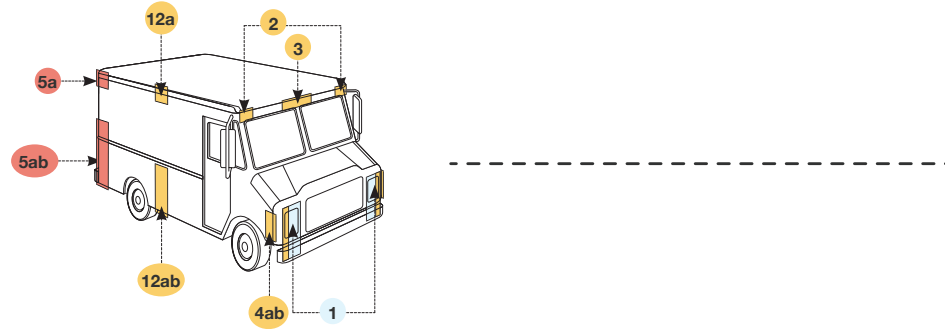



# TRUCK, BUS, MPV EQUIPMENT LOCATION REQUIREMENTS

Trailer Equipment Locations | All Trailers Over 80 Inches



\* Photometrically certified at installation angle

## Description & Mandatory Requirements

	Equipment	SAE Lens Coding	Function	Quantity	Location	Height From Ground
1	Headlamp-Lower Beam	(H, HR)	Forward road illumination, US requires 'DOT' lettering on lens US&Canada -light code required on lens	Min. 2	Front-symmetrical as far apart as practicable if 4 lamp system-outboard or above upper beams	560-1370mm (22-54 in.)
	Headlamps-Upper Beam	(H, HR)	Forward road illumination, US requires 'DOT' lettering on lens US&Canada -light code required on lens	Min. 2	Front-symmetrical if 4 system-inboard or below lower beams	560-1370mm (22-54 in.)
	Parking Lamps	(P)	Indicate parked vehicle vehicles less than 2032 mm wide	Min. 2	Front-symmetrical as far apart as practicable	380-1830mm (15-72 in.)
	Daytime Running Lamps	(Y2)	Indicate in use vehicle Canada- required/US option US requires lettering on lens if not headlamps	Min. 2	Front-symmetrical as far apart as practicable	380mm (15 in.) min. Max. depends on DRL type
	Front Turn Sig./Hazard Warning lamps	(I)	Indicate direction of turn/identify disabled vehicle	Min. 2	Front-symmetrical as far apart as practicable	380-2110mm (15-83 in.)
2	*Front Clearance Lamps	(P2, PC* or P3, PC2*)	Show vehicle's width Vehicles 2032mm wide or wider	Min. 2	At widest point-symmetrical on the front or near the front facing forward	As high as practicable
3	Front Identification Lamps	(P2, or P3)	Indicate presence of a wide vehicle Vehicles 2032mm wide or wider	Exactly 3	On the front-center horizontally space 150 mm (6 in.) to 300 mm (12 in.) apart	As high as practicable or the top of the cab
4	a *Front Side Marker Lamps	(P2, PC* or P3, PC2*)	Front & rear side marker lamps/side reflex reflectors indicate vehicle's presence & length	Min. 2	Each side at front as far forward as practicable	380mm (15 in.) minimum
	b Front Side Reflex Reflectors	(A)	Front & rear side marker lamps/side reflex reflectors indicate vehicle's presence & length	Min. 2	Each side front as far forward as practicable facing sideways	380-1530mm (15-60 in.)

## Description &amp; Mandatory Requirements

	Equipment	SAE Lens Coding	Function	Quantity	Location	Height From Ground
5	a *Rear Side Marker Lamps	(P2, PC* or P3, PC2*)	Front & rear side marker lamps/side reflex reflectors indicate vehicle's presence & length	Min. 2	Each side at rear as far back as practicable	380mm (15 in.) minimum
	b Rear Side Reflex Reflectors	(A)	Front & rear side marker lamps/side reflex reflectors indicate vehicle's presence & length Not required on Truck Tractors	Min. 2	Each side at rear as far back as practicable facing sideward	380-1530mm (15-60 in.)
6	*Rear Clearance Lamps	(P2, PC* or P3, PC2*)	Show vehicle's width MAY NOT be combined with tail lamps Vehicles 2032mm wide or wider Not required on Truck Tractors	Min. 2	At widest point-symmetrical on the rear of rear facing rearward	As high as practicable may be lower only if ID lamps are at top
7	Rear Identification Lamps	(P2 or P3)	Indicates presence of a wide vehicle Vehicles 2032mm wide or wider Not required on Truck Tractors	Exactly 3	On the rear-center horizontally spaced-150 mm (6 in.) to 300 mm (12 in.) apart facing rearward	At the top-may be lower if door header narrower than 25 mm
8	Trail Lamps	(T)	Indicates vehicle's presence and width	Min. 2	Rear-symmetrical as far as practicable	380-1830mm (15-72 in.)
	Stop Lamps	(S)	Indicate braking	Min. 2	Rear-symmetrical as far as practicable	380-1830mm (15-72 in.)
	Rear Turn Sig./Hazard Warning Lamps	(I)	Indicates direction of turn/identify disabled vehicle	Min. 2	Rear-symmetrical as far as practicable	380-1830mm (15-72 in.)
	Rear Reflex Reflectors	(A)	Show vehicle's presence & width	Min. 2	Rear-symmetrical as far as practicable	380-1830mm (15-72 in.)

CONTINUED ON NEXT PAGE

# TRUCK, BUS, MPV EQUIPMENT LOCATION REQUIREMENTS

Trailer Equipment Locations | All Trailers Over 80 Inches



\* Photometrically certified at installation angle

## Description & Mandatory Requirements Length 9.1 m (30 ft.) or longer & Truck Tractor

	Equipment	SAE Lens Coding	Function	Quantity	Location	Height From Ground
9	Backup Lamp	(R)	Illuminates ground behind the vehicle and alert road users	Min. 1	Rear	No requirement
	License Plate Lamp(s)	(L)	Illuminates license plate	Min. 1	Rear-above or at the sides of license plate	No requirement
12	a Intermediate Side Marker Lamps	(P2 or P3)	Indicate presence of a long vehicle	Min. 2	Each side near center	380mm (15 in.) minimum
	b Intermediate Side Reflex Reflectors	(A)	Indicate presence of a long vehicle	Min. 2	Each side near center facing sideward	380-1530mm (15-60 in.)
	Conspicuity Treatment	DOC Coding	Quantity	Location	Height	Options
13	Rear Upper Body Markings	DOT-C DOT-C2 DOT-C3 DOT-C4	Exactly 2 pairs of 300 mm long strips	Rear upper corners of cab facing rearward	As high as practicable excluding fairings	—
14	Rear Marking	DOT-C DOT-C2 DOT-C3 DOT-C4	Exactly 2 sections of min. 600 mm each	Rear-facing rearward-on fenders, on mud flap brackets, or within 300 mm below the top of mud flaps	As horizontal as practicable and higher than 1525 mm from the ground	If mud flaps not used- on the cab or frame mounted brackets

## SAE Device Codes • Letters Indicating Device Functions

A	Reflex reflector
A2	Reflex reflector for use on vehicles 2032mm or more in overall width
A3	Reflex reflector for conspicuity treatment (CT), for use on vehicles 2032mm or more in overall width
A4	Reflex reflector for CT (vehicles > 2032mm in width) - 50mm wide [truck/trailer]
A5	Reflex reflector for CT (vehicles > 2032mm in width) - 75mm wide [truck/trailer]
A6	Reflex reflector for CT (vehicles > 2032mm in width) - 100mm wide [truck/trailer]
A7	Reflex reflector for CT (vehicles > 2032mm in width) - 25mm wide [truck/trailer]
C	Motorcycle auxiliary front lamp
D	Motorcycle and motor-driven cycle turn signal lamp
DL	Distributed lighting system (headlamp)
E	Side turn signal lamp - vehicles 12m or more in length
E2	Side turn signal lamp - vehicles less than 12m in length
EVS1	Siren - interior location
EVS2	Siren - exterior location
EVS3	Siren - under hood location
F	Front fog lamp
F2	Fog tail lamps
G	Truck cargo lamp
H	Sealed beam headlamp
HC	Headlamp center
HG	Discharge forward lighting (headlamp)
HH	Sealed beam headlamp housing
HR	Replaceable bulb headlamp
I	Turn signal lamp spaced greater than 100mm from headlamp
I3	Turn signal lamp spaced from 75mm to less than 100mm from headlamp
I4	Turn signal lamp spaced from 60mm to less than 75mm from headlamp
I5	Turn signal lamp spaced less than 60mm from headlamp
I6	Rear mounted turn signal lamp and front mounted turn signal lamps mounted 100mm or more from the headlamp, for use on vehicles 2032mm or more in overall width
I7	Front mounted turn signal lamp mounted less than 100mm from the headlamp, for use on vehicles 2032mm or more in overall width
J1690	Flasher
K	Front cornering lamp
K2	Rear cornering lamp
L	License plate lamp
M	Motorcycle and motor-driven cycle headlamp - motorcycle type
N	Motorcycle and motor-driven cycle headlamp - moto driven cycle type
O	Spot lamp
P	Parking lamp
P2	Sidemarkers lamp for use on vehicles 2032mm or less in overall width
P3	Clearance, sidemarkers and identification lamp for use on vehicles 2032mm or more in overall width
PC2	Combination clearance and sidemarkers lamp for use on vehicles 2032mm in width or more in overall width
Q	Turn signal operating unit - Class A
QB	Turn Signal operating unit - Class B
QC	Vehicular hazard warning signal operating unit
QD1	Turn signal operating unit for use on vehicles 2032mm in width or more in overall width - Type 1
QD2	Turn signal operating unit for use on vehicles 2032mm in width or more in overall width - Type 2
QE1	Hazard warning operating unit for use on vehicles 2032mm in width or more in overall width - Type 1
QE2	Hazard warning operating unit for use on vehicles 2032mm in width or more in overall width - Type 2
R	Reversing (back-up) lamp
S	Stop lamp
S2	Stop lamp for use on vehicles 2032mm or more in overall width
T	Tail lamp (rear position lamp)
T2	Tail lamp (rear position lamp) for use on vehicles 2032mm or more in overall width
U	Supplemental high-mounted stop and turn signal lamp
U2	High-mounted stop lamp for use on vehicles 2032mm or more in overall width
U3	Center high-mounted stop lamp for passenger cars, light trucks and MPV's
W	Warning lamp for emergency, maintenance and service vehicles
W2	Warning lamp for school buses
W3-1	Optical warning device - Class 1
W3-2	Optical warning device - Class 2
W3-3	Optical warning device - Class 3
W4	Emergency warning device [triangular shape]
W5-1	360° gaseous discharge lamp - Class 1
W5-2	360° gaseous discharge lamp - Class 2
W5-3	360° gaseous discharge lamp - Class 3
X	Adaptive [forward] lighting system
Y	Auxiliary high beam lamp
Y2	Daytime running lamp
Z	Auxiliary low beam lamp

SOCIETY OF AUTOMOTIVE ENGINEERS

## Cleaning Materials

The use of solvents which are not compatible with polycarbonate will result in the softening, crazing, and/or cracking of the plastic part. This is especially true of polycarbonate lamps & mounting bases which may be under stress in their normal applications.

The following solvents/cleaners are compatible with polycarbonate:

Mild soap and water	Dirtex®
Mineral Spirits	2% Sol. Reg. Joy
Hexane	Heptane
VM & P Naphtha	White Kerosene
Varsol No. 2	Methyl, isopropyl & isobutyl
#1 & #3 denatured alcohol	alcohols
Freone TF & TE-35	Lacryl® PCL-2035
Ethanol	polycarbonate cleaner
10% Sol Bon Ami®	Petroleum Ether/65 degrees C boiling point

The following solvents/cleaners **MUST NOT** be used with polycarbonate:

Trichlor	Carbon Tetrachloride	Diversol®
Acetone	Chlorinated Hydrocarbons	Lemon Joy®
Triclene®	Texize-8006, 8129, 8758	(phosphate free)
Methyl Ethyl Keytone (MEK)	Liquid Cleaner - 8211	Kleenol Plastics
MIBK	Agitene®	Lestoil®
Toluol	Ajax®	Lysol®
Benzol	All Liquid Detergents	Stanisol Naphtha®
Gasoline	Pink Lux® (phosphate free)	Oils

Questions as to compatibility of other specific materials should be directed to the manufacturer and/or the Truck-Lite Corporate Laboratory.

## Tips To Prolong Equipment Lighting

- Never use a test probe to pierce wire insulation when troubleshooting lighting complaints. Wicking action takes place which causes moisture to travel along the wire strands and corrode critical connections. If probing a harness or wire is necessary, make sure the puncture is properly sealed.
- To correct voltage problems, discover the real cause. Under-voltage often is caused by poor electrical connections. To correct under-voltage, don't just turn up the voltage — find out what caused the under-voltage problem.
- Many discarded lamps are still in good condition. Play detective when solving lamp problems. First, test with either a meter, power supply, or battery. Our 97100 tester is an excellent tool for this. Then if you desire, open the lens on a discarded lamp and examine the bulb. It will tell you why it failed. For example:
  - A bulb with stretched or broken filaments was subjected to vibration.
  - A yellowish, whitish or bluish glaze on the bulb indicates a rupture in the bulb glass envelope.
  - A dark metallic finish indicates old age.
  - A black, sooty bulb indicates a poor seal in bulb.Test all lamps one more time before you discard them. Truck-Lite's warranty department reports that up to 20 percent of all lamps sent back are still in good operating condition. The ones that aren't working can be turned over to your lamp supplier.
- All lamps will live longer if they run cool. Dirt on the lens increases the heat, so keep them as clean as possible. Other people can see your rig, and that is one of the purposes of the lighting system – to be seen. **Certain lighting products generate heat. Care should be taken to avoid contact with flammable materials.**
- Treat the electrical system as you would the chassis. Lubricate sockets, pigtails, battery terminals and connections with NYK 77 "non-conductive" anti-corrosion compound. The purpose of the sealant is to totally encapsulate and protect against corrosion and water.
- Inspect for improper ground connections. This is a major cause of lamp failure, especially when the trailer is used for a ground. When lamps are grounded through the lamp housing, make sure there is a clean connection (i.e., metal-to-metal). Also, a fifth wheel ground strap may be used for added protection on the chassis ground system.
- Look for loose, bare or unsupported wire, and fixtures. Harnesses and wiring should be on the underside of top frame members rather than on the bottom where dirt and road splash collect.
- Always replace wiring, trailer light cables, and harnesses with an equal or heavier gauge of wire than was used in the original specifications. If you don't, you may cause unnecessary problems.
- On older trucks, you should never crank the truck when any lights or accessories are on. Also, never leave markers and hazard lights on when parked against a dock. Melted lenses are a sure sign that the vehicle has been parked against the dock while the lights were on.
- Inspect the grommets that house the lamps. As they age, they eventually will deteriorate from sunlight, ozone and harmful chemicals. New grommets restore shock protection, security and improves appearance.



## Warning Symbols



Lighting products generate heat! Care should be taken to avoid contact with flammable material.

Designed to conform to applicable Federal Safety Standards.  
Meets applicable SAE Standards and US DOT Requirements.



Any unauthorized substitution or modification to products or packaging manufactured or sold by Truck-Lite could cause bodily injury or affect the performance and safe operation of the product. Truck-Lite Co., Inc. shall not be liable for personal injury or property damages caused by unauthorized substitutions or modifications.



Truck-Lite products do not place a person at risk by exposure to chemicals and can be properly disposed of in an approved landfill.



LEDs (Light Emitting Diodes) use less current than incandescent products and may affect the proper operation of other electronic devices or systems on the vehicle. Always confirm proper operations and/or verify the LED Lighting products compatibility with the vehicle manufacturer.

## Limited Warranties & Procedures



Truck-Lite extends a Limited Warranty to the original purchaser that the warranted products defined below are free from defects in workmanship and/or materials only, whereby Truck-Lite will replace any warranted product to the original consumer/purchaser if the product fails because of defect due to workmanship and/or materials within the limited warranty period from the date imprinted on the product. Each Limited Warranty as applicable is not transferable and applies to the original installation of the Truck-Lite product. To be eligible for Limited Warranty protection the Truck-Lite products must remain intact, free from physical abuse, and not subject to improper installation. The Limited Warranty of the lamp products applies to 12-volt lamps only. This offer does not constitute in any way a product guarantee and Truck-Lite does not hereby assume any obligation of any kind whatsoever beyond sending a free replacement product. Unless expressly agreed to in writing by Truck-Lite, Truck-Lite does not warrant its products as to their fitness for any special use or function. Truck-Lite believes our products should provide good service under proper operating conditions. In view of this, many of our products have a Limited Warranty for special periods of time, based on product date. These Limited Warranties are as follows:

- Super 40 series, 4" round sealed lamps (12 volt only) have a thirty-six (36) month limited warranty.
- Model 40 series, 4" round sealed lamps (12 volt only) have a twenty-four (24) month limited warranty.
- Super 10 series, 2-1/2" round sealed lamps (12 volt only) have a twenty-four (24) month limited warranty.
- Super 21 series, rectangular sealed lamps (12 volt only) have a twenty-four (24) month limited warranty.
- Super 45 series, rectangular stop/turn/tail sealed lamps (12 volt only) have a twenty-four (24) month limited warranty.
- Super 60 series, oval stop/turn/tail sealed lamps (12 volt only) have a twenty-four (24) month limited warranty.
- Signal-Stat LED series, see Signal-Stat LED Series Lamp Warranty.
- LED series lamps, see LED Limited Lifetime Lamp Warranty.
- Harness limited warranty, see Harness Warranty.
- LED series lamps and 88 series harness, see LED Limited Lifetime Lamp and Harness System Warranty.

## Signal-Stat LED Series Lamp Warranty



Truck-Lite extends a Limited 2-Year Warranty to the original purchaser that the Signal-Stat Sealed LED lamp is free from defects in workmanship and/or materials only. Truck-Lite will replace any Sealed LED Lamp to the original consumer/purchaser, if the lamp fails due to defects in workmanship and/or materials only.

The LED Limited 2-Year Warranty does not apply to severe applications such as buses, construction equipment and off-road vehicles. These applications are example only and are not all inclusive of each excluded application. Many chemicals and/or cleaners are incompatible with Signal-Stat sealed LED products. The LED 2-Year Warranty does not apply to damage associated with incompatible chemicals or cleaners. Not subject to improper installation or modification and must be used only with Truck-Lite approved wiring accessories. Any violation of these conditions will void this LED 2-Year Lamp Warranty. This LED 2-Year Lamp Warranty is not transferable and applies to the original installation of the Signal-Stat Sealed LED lamp for as long as the original consumer/purchaser owns the vehicle.

## LED Limited Lifetime Lamp Warranty



Truck-Lite extends a Limited Lifetime Warranty to the original purchaser that the Truck-Lite Sealed LED lamp is free from defects in workmanship and/or materials only. Truck-Lite will replace any Sealed LED Lamp to the original consumer/purchaser, if the lamp fails due to defects in workmanship and/or materials only. The LED LIMITED LIFETIME LAMP WARRANTY DOES NOT APPLY TO SEVERE APPLICATIONS such as buses, construction equipment and off-road vehicles. These applications are examples only and are not all inclusive of each excluded applications. MANY CHEMICALS AND/OR CLEANERS ARE INCOMPATIBLE with Truck-Lite Sealed LED products. The LED Limited Lifetime Lamp Warranty does not apply to damage associated with incompatible chemicals or cleaners.

## LED Limited Lifetime Lamp Warranty



However, this LED Limited Lifetime Lamp Warranty will be extended to include exposure to chemicals and/or cleaners associated with use ONLY if Truck-Lite Sealed LED lamps are purchased with the optional "Diamond Shell™" hard coating. Truck-Lite Sealed LED lamps are to REMAIN INTACT, FREE FROM PHYSICAL ABUSE, NOT SUBJECT TO IMPROPER INSTALLATION OR MODIFICATION AND MUST BE USED ONLY WITH TRUCK-LITE APPROVED WIRING ACCESSORIES. ANY VIOLATION OF THESE CONDITIONS WILL VOID THIS LED LIMITED LIFETIME LAMP WARRANTY.

This LED Limited Lifetime Lamp Warranty is not transferable and applies to the ORIGINAL INSTALLATION of the Truck-Lite Sealed LED lamp for AS LONG AS THE ORIGINAL CONSUMER/ PURCHASER OWNS THE VEHICLE (LIFETIME).

Truck-Lite Sealed LED lamps are designed to give the purchaser a wide variety of plug/ connection options. Each plug/connection option offers different performance characteristics. Therefore, Sealed LED lamps have a Limited Lifetime Warranty with the following two exceptions:

- Sealed LED lamps using standard bullet terminal/receptacle type connections integral to the lamp housing will have a three (3) year Limited Warranty.
- Sealed LED lamps, which are hardwired and use standard bullet terminal/receptacle type connections have a limited lifetime warranty on the lamp. Connector failure, however, is covered by a three (3) year Limited Warranty.
- Sealed LED lamps noted with a specific year warranty.

## Limited Harness Warranty



Truck-Lite extends a Limited Harness Warranty to the original consumer/ purchaser that the Truck-Lite Series 50 and Series 88 harness systems are free from defects in workmanship and/or materials only. Truck-Lite will replace any Series 50 or Series 88 harness to the original consumer/ purchaser, if the product fails because of defects due to workmanship and/or materials only within five (5) years from the date of purchase of the product. This Limited Harness Warranty is not transferable and applies to the original installation of the product.

To be eligible for this Limited Harness Warranty protection the Series 50 or Series 88 harness system must have been PROPERLY INSTALLED, PROPERLY MAINTAINED, AND THE INTEGRITY OF THE SYSTEM MUST REMAIN INTACT. Series 50 or Series 88 harness systems MUST BE USED ONLY WITH TRUCK-LITE APPROVED LIGHTING PRODUCTS AND ACCESSORIES. USE OF UNAPPROVED LIGHTING PRODUCTS AND ACCESSORIES WILL VOID THIS LIMITED HARNESS WARRANTY.

## Limited Lifetime LED Lamp & Harness Systems Warranty



Truck-Lite extends a LIMITED LIFETIME LED LAMP AND HARNESS SYSTEMS WARRANTY that Lighting Systems featuring Truck-Lite Series 88 harness and Truck-Lite Sealed LED lamps equipped with Fit 'N Forget connections are free from defects in workmanship and/or materials only. Truck-Lite will replace defective Series 88 harness components and LED lamps with Fit 'N Forget connections to the original consumer/purchaser, if the product fails due to defects in workmanship or materials. This Limited Lifetime LED Lamp and Harness Systems Warranty applies to the original installation of the product only. This Limited Lifetime LED Lamp and Harness Systems Warranty extends for as long as the ORIGINAL CONSUMER/PURCHASER OWNS THE VEHICLE.

MANY CHEMICALS AND/OR CLEANERS ARE INCOMPATIBLE with Truck-Lite Sealed LED products. This Limited Lifetime LED Lamp and Harness Systems Warranty does not apply to damage associated with the use of incompatible chemicals or cleaners (Questions as to compatibility of specific materials should be directed to the manufacturer and/or the Truck-Lite Corporate Laboratory). However, this Limited Lifetime LED Lamp and Harness Systems Warranty will apply and include exposure to chemical/cleaners associated with use ONLY if Truck-Lite Sealed LED lamps are purchased with optional "Diamond Shell™" hard coating.

Truck-Lite Series 88 harness components and Truck-Lite Sealed LED lamps are to be PROPERLY INSTALLED, REMAIN INTACT, FREE FROM PHYSICAL ABUSE, AND NOT SUBJECT TO MODIFICATION. ANY VIOLATION OF THESE CONDITIONS WILL VOID THIS LIMITED LIFETIME LED LAMP AND HARNESS SYSTEMS WARRANTY.

The Truck-Lite Limited Lifetime LED Lamp and Harness Systems Warranty Program does not constitute, in any way, a product guarantee, and Truck-Lite does not assume any obligations of any kind whatsoever beyond sending a free replacement of the product covered by the Limited Lifetime LED Lamp and Harness Systems Warranty.

In no event shall Truck-Lite be liable for incidental or consequential damages, nor shall Truck-Lite's liability for any claims or damage arising out of or connected with this Limited Lifetime LED Lamp and Harness Systems Warranty or the manufacture, sales, delivery or use of the products with which this Limited Lifetime LED Lamp and Harness Systems Warranty is concerned exceed the purchase price of the products.

There are no warranties, expressed or implied (including any warranty of merchantability or fitness), which extend beyond this warranty. The loss of use of the product, loss of time, inconvenience, commercial loss, incidental or consequential damages are not covered. The manufacturer reserves the right to change the design of the product without assuming any obligation to modify any product previously manufactured or to replace warranted product other than with redesigned product.

## Product Warranty

All other products in our catalog may be eligible for a replacement if the failure is deemed to be due to a failure in either material or workmanship within one year of purchase. The replacement of defective products is made at the discretion of Truck-Lite Co., Inc. and is based on the results of an analysis of the returned products by our warranty administrator.

Products submitted for Limited Warranty consideration may be inspected by our laboratory. Replacement will be based upon Truck-Lite uniform limited warranty procedure and/or the result of the laboratory evaluation. Charges for damages and/or labor costs cannot be accepted by Truck-Lite Co., Inc. As stated earlier, we believe our products should provide good service under proper operating conditions, and this attitude will be reflected in our consideration of items returned for examination.

The Truck-Lite Limited Warranty Program does not constitute, in any way, a product guarantee, and Truck-Lite does not hereby assume any obligations of any kind whatsoever beyond sending a free replacement of the product when covered by a Limited Warranty.

There are no warranties, expressed or implied (including any warranty of merchantability or fitness), which extend beyond this Limited Warranty. The loss of use of the product, loss of time, inconvenience, commercial loss, incidental or consequential damages are not covered. The manufacturer reserves the right to change the design of the product without assuming any obligation to modify any product previously manufactured or to replace warranted product other than with redesigned product.

This Limited Warranty gives you special legal rights. You may also have other rights from state to state. Some states do not allow limitations on how long an implied warranty lasts. Some states do not allow the exclusion or limitation of incidental or consequential damages. Therefore, the above limitation(s) or exclusion(s) may not apply to you.

---

**LED Technology** is new and exciting. As lighting technology continues to improve, so does the importance of developing an understanding of technical terms and ideas related to LED lighting technology.

## Definitions

---

Watt: •noun• unit equivalent to Amps x Volts.

Ampere: •noun• unit of electric current, commonly shortened to “Amp”

Luminous Efficacy: •noun• measure of how efficiently a light source produces visible light

Volt: •noun• unit of electromotive force, difference of potential that would drive one ampere of current against one ohm of resistance

Candela: •noun• unit of measure equal to the intensity of light at a single point within a light pattern

Lumen: •noun• unit of measure equal to the total amount of light emitted

Iso-Candela Scan: •noun• method of measuring and quantifying total light output of a light source within a standard area

## The Problem With Watts: Why Watts Don't Mean What They Used To

---

Surprisingly, Watts are not a measure of light at all—they are a measure of energy consumed. Traditionally, with incandescent bulbs, the more power consumed the more light emitted, so light output was equated by power consumption. However, when dealing with LEDs, more power does not necessarily mean more light. LEDs consume *far* less power than incandescent bulbs. An incandescent bulb drawing 100W may light a single room, while an LED lamp drawing 100W could light up several large rooms.

Here's another way to understand this idea. Let's equate energy consumption of a lamp to gasoline consumption in a car. Let's assume Watts are the Gas, Light Output is the Distance Traveled, and the Lamp is the Car.

When asking how far away a destination may be, do we ask, “How many gallons away is that town?” No. Why not? Because, we know that different cars get different gas mileages. If all cars achieved the same gas mileage we could estimate distance by the amount of gallons of gas consumed. But with technology constantly making engines more fuel efficient, it would be inaccurate to measure distance by gallons of gasoline consumed.

**WATTS** = POWER CONSUMED **NOT** TOTAL LIGHT

Lights operate on this same principle. Before the advent of low current draw LED lighting, it was relatively accurate to measure light output by power consumed because most bulbs had identical light efficacy, or in terms of our cars, they traveled the same miles per gallon. Now, LED lighting has revolutionized the traditional power consumption to light ratios of incandescent lighting. LED lighting, when properly engineered, can produce far more light than an incandescent bulb drawing the same amount of power. In other words, LED lamps, are the hybrid car, getting 100 miles per gallon, and incandescent bulbs are the heavy 1963 Ford Galaxy, getting 8 miles per gallon.



## The Lumen: Not Just A Simple Number

“Lumen” is quickly becoming a buzz word among lighting industry marketing and sales teams. Companies are quick to throw out high numbers to dazzle their customers before the customers have a chance to understand what lumens really are and why they are important.

Remember, a lumen is a unit of measure equal to the total amount of light emitted in all directions.

When an LED lamp is engineered, the individual LEDs placed into the lamp have a maximum lumen capability rating. So, to go back to our car analogy, maximum lumen capability would be our car engine’s rated horse power. And just like a car’s engine that loses horsepower after being connected to other power-hungry objects (drive-train, A/C, etc.) so do the diodes lose Lumen power after being connected to a circuit board, being potted in epoxy, and placed behind a lens.

The total Lumen value of a lamp based solely on the LEDs maximum rated Lumen values is known as a lamp’s **Cold Lumen Value**. Conversely, the Lumen value that measures actual total light output through the use of a highly calibrated machine known as an integrating sphere, is known as a lamp’s **Warm Lumen Value**.

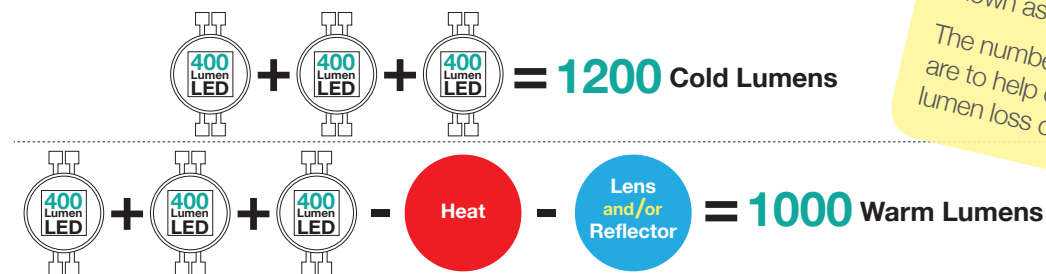

**Note:** Actual lumen loss varies with every lamp design. There is no way to calculate lumen loss exactly without the use of an advanced machine known as an integrating sphere. The numbers used in this example are to help convey the concept of lumen loss only.

**Although the diodes are rated at 400 lumens each, factors such as heat and lenses will affect the Cold Lumen Value resulting in a lower value known as Warm Lumens.**

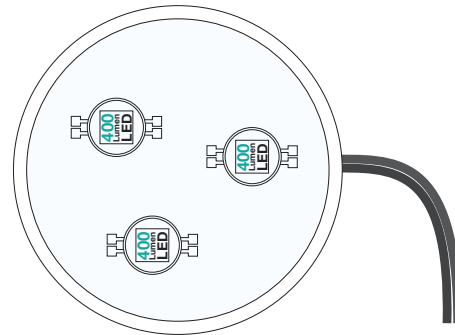

Also, when pushing performance to the limit, quality and longevity are often sacrificed. At **Truck-Lite®** we understand that people want lights that work—and keep on working—for years to come. Designing a lamp that over-exerts a diode’s lumen capability is a recipe for disaster. Much like we would never put our car in neutral and rev the engine for hours on end, we should not do the same for light emitting diodes by pushing them beyond their limits.

Remember, there is a difference between a lamp’s rateable lumen output (Cold Lumens) and actual lumen output (Warm Lumens).

Additionally, light emitting diodes have a tendency to become slightly dimmer after a warm-up phase. So, your 500 lumen lamp could be at 450 lumen or less after 30 minutes of continuous use. After the initial drop in lumen output during the warm-up phase, lumen output usually levels out for the remainder of the use, until the lamp is turned off.

It’s worth noting that **Truck-Lite®** lists actual (not theoretical) lumen output *after* a warm-up period—many of our competitors do not.

## The Candela: A Measurement In Flux

Candela is a term that refers to the amount of visible light at any one point, within a specific light pattern. Candela values measure intensity of light at a specific location, and this number, just as lumen values, can be used to mislead. For instance, you could have two different flashlights (Flashlights A and B) that both claim to be 18,000 candela. This gives us a general idea of the capabilities of the flashlight, but leaves much to be questioned about the performance.

Since candela is the measure of light intensity—*not* total light output. Remember, lumen equals total light. Both of these flashlights can claim that they output 18,000 candela even though they are clearly not performing at the same level. Flashlight A illuminates half of our subject, as does Flashlight B. However, Flashlight A is covering a much wider area of our subject at the same candela value as Flashlight B, which means we can assume that Flashlight A has a higher lumen value.

Lumen values cannot accurately be converted into candela values (and vice-versa), because they are measures of completely different elements.

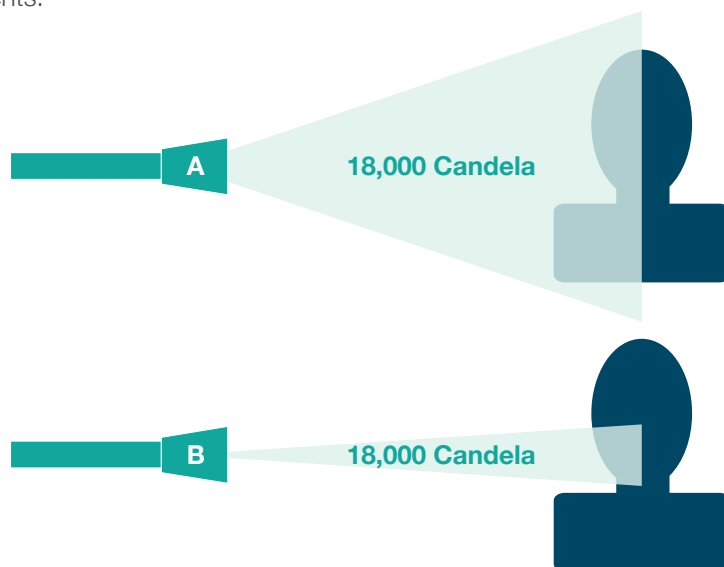

Another way to compare candela and lumen values, would be to think of a pressure-washer and a fire hose. Let's assume our fire hose has a 2-inch diameter barrel and our pressure-washer nozzle head is 1/16<sup>th</sup> inch. Now lets say that both our fire hose and pressure-washer are pressurized to 2700psi, or in other words the water will be flowing out of each hose at the same intensity. Both hoses are rated at 2700psi, yet, the fire hose displaces much more water overall.

Lumen would be the equivalent of the total amount of water coming out of the hoses and candela would be equivalent to the amount of pressure from where the water is flowing.

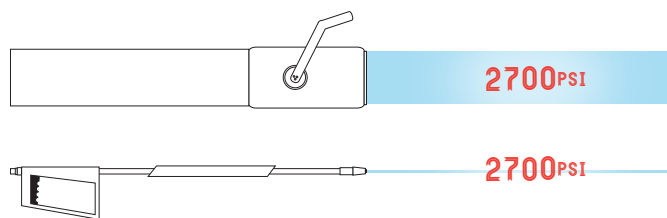

A lamp is successful only when it illuminates what it is supposed to be illuminating. A ball with ten, one-hundred lumen diodes placed all around its surface, would technically be rated at 1000 lumens, but it would make a very poor spot light.

Identical **INTENSITY**  
Different **OUTPUT**

## The Iso-Candela Scan: Putting It All Together

There are many different methods for measuring light. One of the most accurate tests for measuring the intensity of light within the pattern a lamp produces is known as an Iso-Candela Scan. The illustration below is an actual Iso-Candela scan from a lamp engineered by **Truck-Lite®**. There are points of intense light in red; these are often referred to as “hot spots.” We can also see areas of green which are areas of mid-range light which transitions out to areas of blue which are areas of very little light. These colors are simply representational of the light intensity in that area, they have nothing to do with the actual color of the lamp’s light.

Iso-Candela scans are rendered by placing a highly-calibrated tool, known as a Photo-Detector Cell, into a light tunnel along with a light source. The Photo Detector Cell acts as an eye looking at the light source, and is able to transpose the light beams it “sees” into the colorful chart you see below.

This specific scan shows a head-on angle of a lamp. We can look at the key at the bottom of the image to gauge the candela value for that specific area. Red being the hottest or area with the most intense light, reveals the area is around 16,000 candela; dark blue being the coolest or areas with the least amount of light, reveals areas around 25 candela.

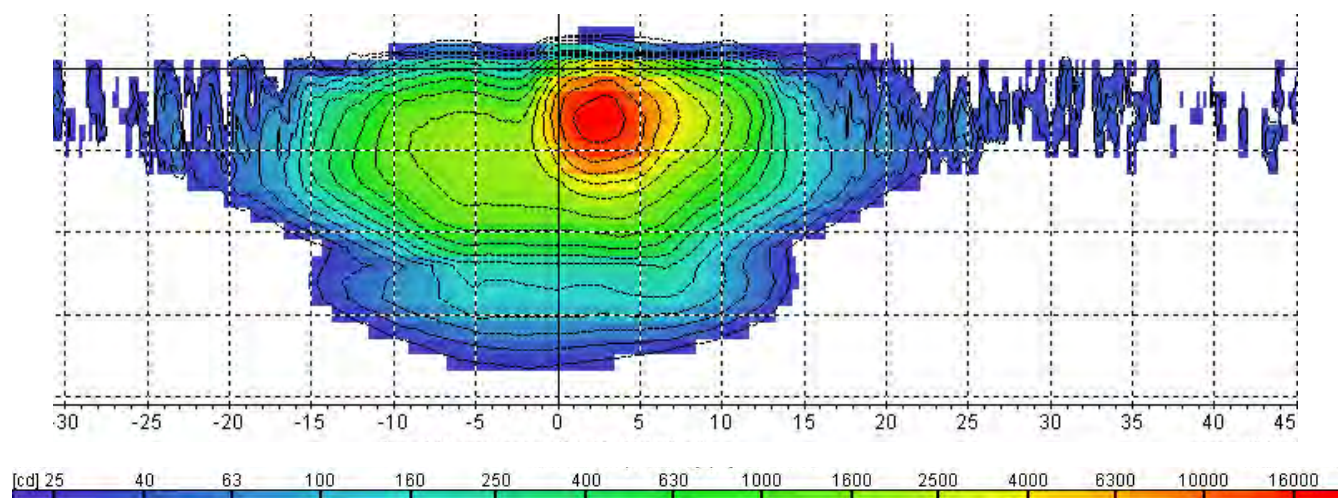

This scan shows the distribution of light as if you were looking directly at it. Some scans show a bird's eye view, which allow the viewer to see the width and length of light distribution, while others examine light distribution of a lamp from a different angle, i.e., 45°.

Notice the hot-spot on this scan. This lamp is designed for distance, so the hot-spot is very pronounced. To achieve distance from a lamp one must concentrate the light into a specific area, this concentration creates a hot-spot. This lamp measured all the way up to 20,000 candela!

In summary, let's review:

- Wattage is a measure of power consumed by a lamp, not the light emitted by it
- Lumen value can only be accurately calculated using an integrated sphere, and that there is a difference between **Cold Lumen Values** and **Warm Lumen Values**
- Candela is a measure of light intensity, not total light output
- Iso-Candela Scans measure light intensity and pattern

Light pattern, lumen value, and candela value all play very important roles in LED lighting. Though it may be tempting to trust a single number on a page, you are now prepared to make a more informed, rounded decision when choosing your next lamp.

Additional crosses are available online within the advanced catalog search section.

## AMERICAN SUPERLITE

AMERICAN SUPERLITE PART#	TRUCK-LITE PART #	MATCH LEVEL	AMERICAN SUPERLITE PART#	TRUCK-LITE PART #	MATCH LEVEL	AMERICAN SUPERLITE PART#	TRUCK-LITE PART #	MATCH LEVEL	AMERICAN SUPERLITE PART#	TRUCK-LITE PART #	MATCH LEVEL	AMERICAN SUPERLITE PART#	TRUCK-LITE PART #	MATCH LEVEL
20400	30700	M5	20200A	3050A	M5	40200RC	4051	M5	62100A	1050	M5	82200AC	6051A	M5
25400	10700	M5	20200AC	3051A	M5	40800W	4060C	M5	62100R	2150	M5	82200R	6050	M5
40400	40700	M5	20200RC	3051	M5	40800WU	44308C	M5	62100R	2660A	M5	82200RC	6051	M5
40500	40720	M5	40200A	4050A	M5	42100R	1050A	M5	62100R	3050	M5	82800W	6060C	M5
60400	60700	M5	40200AC	4051A	M5	42100R	2660	M5	80300G	60750	M5	82800WU	6060C	M5
60500	60720	M5	40200R	4050	M5	62100A	2150A	M5	82200A	6050A	M5			

## BETTS

BETTS PART#	TRUCK-LITE PART #	MATCH LEVEL	BETTS PART#	TRUCK-LITE PART #	MATCH LEVEL	BETTS PART#	TRUCK-LITE PART #	MATCH LEVEL	BETTS PART#	TRUCK-LITE PART #	MATCH LEVEL	BETTS PART#	TRUCK-LITE PART #	MATCH LEVEL
800514	81360	M4	805501	81360	M4	805505	81360	M4	805530	81360	M4			
800516	81360	M4	805503	81360	M4	805507	81360	M4	805531	81360	M4			
800518	81360	M4	805504	81360	M4	805509	81360	M4						

## BLAZER

BLAZER PART#	TRUCK-LITE PART #	MATCH LEVEL	BLAZER PART#	TRUCK-LITE PART #	MATCH LEVEL	BLAZER PART#	TRUCK-LITE PART #	MATCH LEVEL	BLAZER PART#	TRUCK-LITE PART #	MATCH LEVEL	BLAZER PART#	TRUCK-LITE PART #	MATCH LEVEL
BLAC6423	5050DK	M5	BLAC7421	5050DK	M5									

## CHAM-CAL

CHAM-CAL PART#	TRUCK-LITE PART #	MATCH LEVEL	CHAM-CAL PART#	TRUCK-LITE PART #	MATCH LEVEL	CHAM-CAL PART#	TRUCK-LITE PART #	MATCH LEVEL	CHAM-CAL PART#	TRUCK-LITE PART #	MATCH LEVEL	CHAM-CAL PART#	TRUCK-LITE PART #	MATCH LEVEL
7202	97720	M5	13501	97618	M5	20731	97837	M5	40305	97667	M5	70101	97869	M5
7325	97721	M5	13503	97619	M5	20851	97643	M5	40401	97846	M5	70111	97748	M5
7326	97722	M5	13504	97620	M5	20852	97644	M5	40403	97668	M5	70201	97823	M5
10300	97990	M5	13601	97621	M5	20901	97645	M5	40404	97669	M5	70203	97849	M5
10303	7044	M5	13603	97622	M5	20903	97646	M5	40601	97848	M5	70311	97876	M5
10400	7048	M5	13604	97623	M5	20904	97647	M5	40603	97670	M5	70401	97718	M5
10481	97865	M5	20000	97624	M5	21101	97840	M5	40604	97671	M5	70503	97719	M5
10501	97872	M5	20080	97625	M5	24403	97811	M5	41301	97847	M5	70601	97845	M5
10503	97802	M5	20090	97626	M5	24404	97806	M5	41303	97672	M5	70701	97725	M5
10601	97819	M5	20100	97860	M5	24413	97650	M5	41304	97673	M5	70703	97726	M5
10603	97820	M5	20101	97812	M5	25503	97818	M5	41601	97674	M5	70841	97730	M5
10681	97602	M5	20200	97627	M5	25504	97808	M5	41603	97675	M5	70851	97731	M5
10683	97603	M5	20203	97628	M5	26200	97652	M5	41604	97676	M5	70911	97868	M5
10701	97815	M5	20204	97629	M5	30101	97653	M5	50101	97678	M5	70931	97732	M5
10703	97816	M5	20210	97630	M5	30103	97654	M5	50201	97850	M5	70961	97733	M5
10801	97803	M5	20230	97631	M5	30104	97807	M5	50203	97679	M5	80501	97734	M5
10803	97804	M5	20250	97632	M5	30201	97655	M5	50301	97852	M5	82701	97740	M5
10891	97606	M5	20301	97822	M5	30301	97656	M5	50304	97680	M5	90012	60737	M5
10893	97831	M5	20311	97809	M5	30303	97657	M5	50401	97681	M5	90013	60738	M5
10901	97863	M5	20321	97826	M5	30401	97800	M5	50801	97682	M5			
11103	97609	M5	20331	97827	M5	30403	97659	M5	60101	97829	M5			
11104	97610	M5	20351	97635	M5	30501	97805	M5	60111	97686	M5			
11105	97835	M5	20601	97861	M5	30504	97660	M5	60151	97687	M5			
11503	97611	M5	20603	97636	M5	30701	97661	M5	60171	97688	M5			
11504	97612	M5	20604	97637	M5	31701	97662	M5	60201	97828	M5			
12701	97817	M5	20611	97866	M5	40101	97862	M5	60601	97843	M5			
12801	97814	M5	20700	97839	M5	40201	97664	M5	60611	97693	M5			
12811	97614	M5	20701	97836	M5	40204	97665	M5	60613	97694	M5			
12813	97615	M4	20711	97837	M5	40303	97666	M5	60699	97695	M5			

Additional crosses are available online within the advanced catalog search section.

DIALITE

DIALITE PART#	TRUCK-LITE PART #	MATCH LEVEL	DIALITE PART#	TRUCK-LITE PART #	MATCH LEVEL	DIALITE PART#	TRUCK-LITE PART #	MATCH LEVEL	DIALITE PART#	TRUCK-LITE PART #	MATCH LEVEL	DIALITE PART#	TRUCK-LITE PART #	MATCH LEVEL
13071A	15250Y	M4	17101A	10051Y	M4	41151R	44030R	M4	62091R	60062R	M4	70151R	91252R	M4
13071R	15250R	M4	17101R	10051R	M4	41161R	44036R	M4	65091R	60052R	M4	80001AB	45051Y	M4
15071A	35001Y	M4	18071A	21051Y	M4	41181A	44021Y	M4	65151R	60050R	M4	80131RB	45064R	M4
15071R	35001R	M4	18071R	21051R	M4	41191A	44001Y	M4	70071A	91251Y	M4	80133AB	45063Y	M4
16071A	30050Y	M4	18111A	21056Y	M4	41201A	44027Y	M4	70131AB	91256Y	M4	94007A	44705	M4
16071R	30050R	M4	18111R	21056R	M4	46051C	44350C	M5	70131RB	91255R	M4	95161R	60056R	M4
17071A	10050Y	M4	20071A	25250Y	M4	47051C	44350C	M5	70133AB	91257Y	M4	96007A	60719	M4
17071R	10050R	M4	41141R	44032R	M4	2071R	60061R	M4	70133RB	91257R	M4			

GROTE

GROTE PART#	TRUCK-LITE PART #	MATCH LEVEL	GROTE PART#	TRUCK-LITE PART #	MATCH LEVEL	GROTE PART#	TRUCK-LITE PART #	MATCH LEVEL	GROTE PART#	TRUCK-LITE PART #	MATCH LEVEL	GROTE PART#	TRUCK-LITE PART #	MATCH LEVEL
460	97017	M5	16092	97811	M5	28481	97665	M5	43120	19724	M5	43823	10715	M5
470	97018	M5	16101	97808	M5	28483	97664	M5	43202	9199	M4	43830	15729	M5
830	97127	M4	16102	97818	M5	28493	97862	M5	43212	45720	M5	43850	19721	M5
6197	44308C	M5	16123	97822	M5	28663	97621	M5	43220	60117Y1	M5	43901	97960	M5
10025	97721	M4	16123	97836	M5	28663	97623	M5	43220	60126R	M5	43952	60722	M4
10083	97730	M5	16141	97637	M5	28663	97819	M5	43220	60126Y	M5	43952	60728	M4
10113	97732	M5	16142	97636	M5	28763	97865	M5	43220	60126Y1	M5	43952	60733	M4
10173	97823	M4	16153	97866	M5	28912	7226	M5	43220	60366R	M5	43962	15730	M5
10173	97828	M4	16191	97631	M5	28913	7225	M5	43220	60366Y	M5	43970	790	M4
10173	97849	M4	16200	97630	M5	29060	97845	M5	43220	60038R	M5	43980	15405	M4
10623	97748	M4	16202	97629	M5	40192	43	M5	43220	60268R	M5	43990	19720	M5
10623	97869	M5	16223	97827	M5	40193	43A	M5	43230	30720	M5	43990	19740	M5
11133	97718	M5	16223	97837	M5	40232	41	M5	43240	92522Y	M4	44010	270	M4
11293	97733	M5	16244	97627	M5	40233	41A	M5	43240	92644Y	M5	44010	275	M4
12004	7039	M5	16244	97839	M5	40641	98100	M5	43240	92646Y	M5	44030	276	M4
12010	97863	M5	16273	97861	M5	40650	98101	M5	43272	42722	M5	44040	97300	M5
12014	7044	M5	16284	97624	M5	40970	98132	M5	43343	44705	M5	44060	97302	M5
12020	97609	M4	16294	97625	M5	40980	98131	M5	43343	44705-1	M5	44421	92925	M5
12020	97610	M4	16304	97626	M5	40980	98134	M5	43362	60720	M5	44460	192-4	M4
12020	97835	M4	22002	97666	M5	41080	98107	M5	43362	60720-1	M5	44530	172	M5
12071	97807	M5	22012	97694	M4	41093	98110	M5	43370	15006R	M5	44540	173	M5
12072	97654	M5	22013	97693	M5	41111	98155	M5	43370	15006Y	M5	44601	8820	M4
12073	97653	M5	22013	97695	M5	41121	98153	M5	43370	15412	M5	44690	182	M5
12153	97688	M5	22013	97843	M5	41122	98154R	M5	43370	15414	M5	44700	183	M5
12164	7048	M5	22193	97829	M5	41133	98165	M5	43380	15008R	M5	44710	282	M5
12173	97817	M5	22232	97726	M5	41133	98168	M5	43380	15008Y	M5	44720	283	M5
12182	97816	M5	22233	97725	M5	41142	98175R	M5	43380	15414	M5	44730	286	M4
12183	97815	M5	28031	97612	M5	41143	32A	M5	43411	50	M5	44750	264	M4
12301	97673	M5	28031	97620	M5	41143	98175Y	M5	43424	97960	M5	44760	266	M5
12303	97847	M5	28032	97802	M5	41152	98176R	M5	43430	10414	M4	44810	262	M5
12331	97676	M5	28033	97618	M5	41153	98176Y	M5	43463	30708	M5	44820	263	M5
12333	97674	M5	28033	97872	M5	41160	98127	M5	43512	10729	M5	44860	263-4	M5
12333	97848	M5	28041	97623	M5	41170	98146	M5	43522	10730	M5	44891	285	M4
12813	97614	M5	28042	97622	M5	41210	98126	M5	43532	30728	M5	44900	97223	M5
13303	97718	M5	28042	97820	M5	41223	98167	M5	43572	40720	M4	45042	10028R1	M5
16023	97812	M5	28043	97819	M4	41223	98170	M5	43642	40715	M5	45043	10028Y1	M5
16032	97804	M5	28162	97611	M5	42103	60719	M5	43655	40722	M5	45062	30503R	M5
16033	97803	M5	28162	97619	M5	42131	15727	M5	43655	40725	M5	45063	30503Y	M5
16043	97635	M5	28443	97686	M5	42160	15736	M5	43673	9179	M5	45072	10028R	M5
16053	97809	M5	28451	97669	M5	42162	15736	M5	43673	1204A	M5	45072	10525R	M5
16053	97837	M5	28453	97668	M4	43012	9925	M4	43690	30504R	M5	45073	10028Y	M5
16063	97826	M4	28453	97846	M5	43012	9928	M4	43723	60719	M4	45073	10525Y	M5
16091	97806	M5	28461	97840	M5	43022	9288	M5	43782	19729	M4	45082	15506R	M4



Additional crosses are available online within the advanced catalog search section.

## GROTE

GROTE PART#	TRUCK-LITE PART #	MATCH LEVEL	GROTE PART#	TRUCK-LITE PART #	MATCH LEVEL	GROTE PART#	TRUCK-LITE PART #	MATCH LEVEL	GROTE PART#	TRUCK-LITE PART #	MATCH LEVEL	GROTE PART#	TRUCK-LITE PART #	MATCH LEVEL
45083	15033Y	M4	46132	30285R	M5	47092	19006R	M5	50652	2751	M5	52691	40229R	M5
45092	19002R1	M5	46133	30285Y	M5	47092	19250R	M5	50652	3763	M5	52692	40029R	M5
45093	19002Y1	M5	46142	10288R	M5	47093	19006Y	M5	50662	2751	M5	52693	40058Y	M5
45152	21205R	M4	46143	10288Y	M5	47093	19250Y	M5	50662	3762	M5	52770	40206R	M5
45153	21205Y	M4	46282	26311R	M5	47102	3075	M5	50792	40757	M5	52772	4050	M4
45162	15201R	M5	46283	26311Y	M5	47102	30201R	M5	50802	40756	M5	52772	40202R	M5
45163	15201Y	M5	46302	1265	M5	47103	3075A	M5	50812	40742	M4	52773	40202Y	M5
45172	1101	M4	46303	1265A	M5	47103	30201Y	M5	50812	40743	M4	52783	4050A	M5
45172	1105	M4	46322	1155	M5	47112	30250R	M4	50812	40746	M4	52822	4026	M5
45172	26315R	M4	46322	1150	M5	47113	30250Y	M4	50812	40747	M4	52832	4025	M5
45172	1117	M4	46322	26354R	M5	47122	1050	M5	50820	40850	M4	52892	60202R	M5
45172	1117A	M4	46323	1155A	M5	47123	1050A	M5	50862	544	M4	52893	60202Y	M5
45173	1101A	M4	46323	1150A	M5	47162	21275R	M4	50862	541	M5	52902	4024Y106	M4
45173	1105A	M4	46323	26354Y	M5	47163	21275Y	M4	50872	80461R	M4	52912	4023Y106	M4
45173	26315Y	M4	46332	26353R	M5	47182	15050R	M4	50872	542	M5	52912	4023	M5
45182	10204R	M5	46333	26353Y	M5	47203	10051Y	M4	50882	80462R	M5	52912	4024	M5
45183	10204Y	M5	46333	26771Y	M5	47212	30276R	M4	50892	80463R	M5	52922	40282R	M5
45202	30206R	M5	46392	1570	M4	47222	10276R	M5	50902	4014	M5	52922	4050	M5
45203	30206Y	M5	46393	1570A	M4	47223	10276Y	M5	50902	4017	M5	52923	40282Y	M5
45232	14200R	M5	46412	15200R	M5	47232	10075R	M5	50912	4013	M5	52923	4050A	M5
45233	14200Y	M5	46412	1560	M5	47233	10075Y	M5	50912	4018	M5	52952	40242R	M5
45252	1555	M5	46413	15200Y	M5	47242	35200R	M5	50920	5061	M5	52952	4050	M5
45253	1555A	M5	46413	1560A	M5	47243	35200Y	M5	50927	5061	M5	52953	40242Y	M5
45262	1259	M5	46543	26765Y1	M5	47262	2673	M5	50942	4015	M5	52953	4050A	M5
45263	1259A	M5	46712	1264D	M5	47263	2673A	M5	50942	4018	M5	53000	2750	M5
45322	1075	M5	46742	19200R	M5	47352	21256R	M5	50952	4016	M5	53000	3812	M5
45323	1075A	M5	46742	1960	M5	47353	21256Y	M5	50952	4017	M5	53012	40028R	M5
45333	1312A	M5	46743	19200Y	M5	47372	10279R	M5	50972	4027	M5	53013	40028Y	M5
45412	1294	M5	46743	1960A	M5	47373	10279Y	M5	50992	5061	M5	53020	2750	M5
45413	1294A	M5	46772	1220	M5	47422	10288R	M4	52062	4091	M4	53020	2803	M5
45462	1233	M4	46773	1220A	M5	47423	10288Y	M4	52062	4094	M4	53032	2751	M4
45462	1205A	M4	46782	1203	M5	47462	35375R	M4	52063	4091A	M4	53032	3712	M4
45463	1233A	M4	46782	2660	M5	47463	35375Y	M4	52063	4094A	M4	53052	2751	M4
45463	1205	M4	46783	1203A	M5	47472	10050R	M4	52072	60253R	M5	53052	2702	M5
45503	25760Y	M5	46783	2660A	M5	47473	10050Y	M4	52072	60264R	M5	53053	2751A	M5
45512	1520	M5	46791	1211W	M5	47492	19275R	M5	52073	60255Y	M5	53053	2702A	M5
45513	1520A	M5	46792	1211	M5	47493	19275Y	M5	52152	40209R	M5	53062	22002R	M5
45522	1520HT	M5	46792	2660	M5	48072	902	M5	52153	4050A	M4	53063	2150A	M5
45523	1520AHT	M5	46793	1211A	M5	48072	910	M5	52153	40209Y	M5	53063	22002Y	M5
45562	30221R	M5	46793	1211AD	M5	48272	905	M5	52182	60283R	M5	53092	60083R	M5
45563	30221Y	M5	46793	2660A	M5	48282	905	M5	52182	6050	M5	53093	60083Y	M5
45811	10202C	M5	46813	1350A	M4	49002	26741R	M4	52183	60283Y	M5	53102	49202R	M5
45812	10202R	M4	46813	25761Y	M4	49062	1523	M4	52183	6050A	M5	53122	60050R	M5
45812	1050	M5	46832	21200R	M4	49082	1215	M4	52193	60215Y	M5	53123	60075Y	M5
45813	10202Y	M5	46833	21200Y	M4	49112	1508R	M5	52202	4550	M5	53132	548D	M5
45813	1050A	M5	46862	29203R	M4	49140	799	M4	52202	45202R	M5	53133	549AD	M5
45821	30200C	M5	46882	1507	M4	49142	10744R	M5	52203	4550A	M5	53163	2150A	M5
45822	3050	M4	46883	1507A	M4	49172	15745R	M5	52203	45202Y	M5	53182	44024Y	M5
45822	30200R	M5	46892	26313R	M4	49173	15745Y	M5	52233	45201Y	M5	53183	44877Y	M4
45822	30200R	M5	46893	26313Y	M4	49252	35200R	M4	52253	60015Y	M5	53212	44882R	M5
45823	3050A	M4	46913	25765Y	M5	49253	35200Y	M4	52323	60315Y	M4	53272	44322R	M5
45823	30200Y	M5	47032	21051R	M4	50132	90327R	M4	52383	60317Y	M4	53282	44038R	M5
45823	30200Y	M5	47033	21051Y	M4	50222	80302R	M5	52512	60215R	M5	53292	44036R	M4
45832	1052	M5	47051	1571W	M5	50222	80302Y	M5	52522	80335R	M5	53312	44202R	M4
45832	10205R	M5	47052	1571D	M5	50232	80334R	M5	52572	60002R	M5	53313	44203Y	M4
45833	1052A	M5	47053	1571AD	M5	50502	80339R	M5	52573	60002Y	M5	53313	44871Y	M4
45833	10205Y	M5	47063	25750Y	M5	50532	80324R	M5	52602	5060	M5	53323	44877Y	M4
45932	1264	M5	47072	21251R	M5	50542	80322R	M5	52602	4028	M5	53413	44201Y	M4
45933	1264A	M5	47072	21880R	M5	50630	2750	M4	52612	80336R	M5	53413	44881Y	M4
45993	26760Y	M4	47073	21251Y	M5	50630	70311	M4	52672	40215R	M5	53422	91244R	M5
46003	25062Y	M4	47073	21880Y	M5	50630	3863	M4	52672	40248R	M5	53422	91272R	M5
46072	21201R	M5	47082	15250R	M5	50642	2751	M5	52682	40048R	M5	53462	44030R	M4
46073	21201Y	M5	47083	15250Y	M5	50642	70310R	M5	52691	40222R	M5	53493	60315Y	M5

Additional crosses are available online within the advanced catalog search section.

GROTE

GROTE PART#	TRUCK-LITE PART #	MATCH LEVEL	GROTE PART#	TRUCK-LITE PART #	MATCH LEVEL	GROTE PART#	TRUCK-LITE PART #	MATCH LEVEL	GROTE PART#	TRUCK-LITE PART #	MATCH LEVEL	GROTE PART#	TRUCK-LITE PART #	MATCH LEVEL
53503	44887Y	M4	56000	3801	M4	62011	80340	M4	64440	97982	M4	67050	10403	M5
53513	44888Y	M4	56000	3802	M5	62021	92WD	M4	64441	650W	M4	67050	94902	M5
53592	66252R	M4	56000	3806	M5	62051	6060C	M4	64441	80364	M5	67050	94909	M5
53592	66882R	M4	56020	2801	M5	62061	6060C	M4	64461	650W-4	M5	67050	94916	M5
53593	60272Y	M4	56032	3711	M4	62091	4060C	M4	64491	630W4	M5	67050	94919	M5
53593	60872Y	M4	56052	2701	M5	62091	44350C	M4	64561	80438	M5	67050	94924	M5
53622	60256R	M4	56053	2701A	M5	62101	4060C	M4	64741	612W	M4	67090	94993	M5
53622	66256R	M4	56072	6503	M5	62111	60284C	M5	64801	613W	M4	68080	9104	M4
53623	60276Y	M5	56073	6503A	M5	62151	80344	M5	64890	97989	M4	68080	9160	M4
53702	5014K	M5	56083	6501A	M4	62171	40244	M5	64891	80395	M5	68080	9162	M4
53712	5013K	M5	60001	26335-1	M4	62171	40260	M5	64891	80392	M5	68100	9103	M5
53722	5016K	M4	60001	26335	M5	62171	40844	M5	64901	80498	M4	68110	9107	M4
53762	5315Y101	M5	60011	26371	M5	62181	40044	M5	64930	97980	M4	68130	9101	M5
53963	6050A	M4	60021	17001	M4	62181	40084	M5	64930	620H	M5	68170	9102	M5
53963	60891Y	M5	60021	17002	M4	62201	80345	M5	64931	80360-1	M5	68280	96904	M5
54012	2150	M5	60031	21004C	M4	62211	40204	M5	64931	80360	M5	68380	94940	M5
54043	10519Y1	M5	60081	9365W	M4	62231	60204C	M5	64931	80375	M5	68470	80974	M5
54132	6050	M4	60101	26331	M4	62231	60804C	M5	64940	630H	M5	68471	80970	M5
54133	6050A	M4	60151	26330	M5	62251	60004C	M5	64941	630W	M5	68472	80975	M5
54142	6050	M4	60191	17003	M4	62251	60084C	M5	64943	631W	M4	68473	80976	M5
54143	6050A	M4	60191	17200	M4	62321	40012	M5	65370	5050DK	M5	68474	80972	M5
54162	6050	M4	60251	26336	M5	62321	40212	M5	65530	5050DK	M5	68475	80971	M5
54163	6050A	M4	60261	15208	M5	62391	44206C	M4	65782	15041	M5	68680	95000	M5
54172	6050	M5	60271	15200C	M5	62391	44236C	M4	65790	15040	M5	69550	90073	M5
54173	6050A	M5	60280	15012	M4	62401	44350C	M4	66100	96959	M5	71152	797	M4
54332	4050	M4	60280	15013	M4	62421	40224	M4	66101	96970	M4	71422	798	M5
54333	4050A	M4	60280	15011	M5	62421	40004	M5	66110	96967	M4	71440	148-18500	M5
54342	4050	M5	60291	19206	M5	62421	40204	M5	66111	96968	M4	71450	148-28500	M5
54343	4050A	M5	60301	19200C	M5	62421	40262	M5	66122	97060	M4	73030	92904	M4
54362	4050	M4	60301	19206	M5	62441	40024	M5	66123	96953	M4	73040	92900	M5
54363	4050A	M4	60311	3613W	M5	62451	40004	M5	66123	97062	M4	73040	92901	M5
55092	81300R	M5	60311	80423C	M5	62561	6060C	M4	66125	96974	M4	73050	92903	M5
55220	70300	M4	60331	21204C	M4	62691	4060C	M5	66160	96960	M5	73080	92905	M5
55223	3850AA	M4	60341	15041	M4	62701	4060C	M4	66161	96973	M4	73090	92902	M4
55232	3711B	M4	60381	15040	M4	63381	80910	M4	66170	96979	M5	73090	92924	M4
55242	3753D	M5	60421	15205	M4	63391	80920	M4	66180	96975	M5	73100	92923	M4
55243	3753AD	M5	60581	84216C	M4	63491	884W	M4	66182	96954	M4	73110	92911	M4
55280	2750	M5	60601	15205	M5	63551	81380	M5	66201	96904	M5	73130	92916	M4
55280	3860	M5	60631	425WD	M5	63561	81360	M4	66202	96919	M5	73160	92918	M4
55290	2750	M5	61031	80490	M5	63571	81360	M4	66360	96930	M5	76121	387	M5
55290	3861	M5	61051	40206C	M5	63581	81360	M4	66800	94850	M5	76163	6822A	M5
55340	2753	M5	61141	44308C	M5	63591	81360	M4	66801	94964	M5	76223	92600Y	M5
55410	4742	M5	61161	80427	M5	63601	81360	M4	66801	94972	M5	76243	92601Y	M5
55420	4869	M4	61161	80482	M5	63611	81360	M4	66810	94932	M5	76451	92611C	M4
55450	4854	M4	61197	44308C	M5	63621	81360	M4	66811	94802	M5	76451	92612C	M4
55450	4754	M4	61261	80251C	M5	63641	81360	M4	66812	94962	M5	76452	92602R	M5
55450	81312Y	M5	61371	80418	M4	63651	81360	M4	66820	94853	M4	76453	92602Y	M5
55460	4855	M5	61371	80444	M4	63661	81360	M4	66830	94706	M4	76453	92602Y	M5
55470	4842	M5	61371	80442	M4	63751	81360	M4	66831	94897	M5	76455	92602B	M5
55572	40241R	M5	61431	40003	M4	63951	81374	M4	66840	94964	M5	76463	6822A	M5
55572	4050	M5	61451	44308C	M5	64021	653H	M5	66844	94882	M5	76483	6823A	M5
55573	40201Y	M5	61501	434WD	M5	64031	657W	M5	66851	94972	M5	76803	92524Y	M4
55573	40241Y	M5	61541	81350	M5	64071	675W	M5	66851	95477	M5	76803	92642Y	M4
55573	4050A	M5	61581	44207C	M4	64221	656W	M4	66930	94862	M5	76823	92685Y	M4
55612	81301R	M5	61611	80251C	M4	64231	652W	M5	66931	94736	M5	76933	92525Y	M4
55612	81301Y	M5	61861	80162C	M4	64231	653W	M5	66931	95410	M5	77013	92560	M5
55772	60201R	M5	61871	80162C	M4	64240	80860	M4	66931	97005	M5	77043	92513Y	M4
55772	6050	M5	61881	80251C	M5	64250	80870	M4	66950	94718	M5	77043	92513Y	M4
55773	60201Y	M5	61921	80162C	M4	64270	80810	M4	66981	94729	M5	77043	92513Y	M4
55773	6050A	M5	61931	80162C	M4	64271	80848	M4	67000	94926	M5	77053	92513Y	M4
55792	60001R	M5	61961	80162C	M5	64280	80820	M4	67002	94707	M4	77071	6611W	M4
55983	91271Y	M5	61971	44207C	M4	64281	80849	M4	67010	94925	M5	77072	6611R	M4
55993	91273Y	M5	61991	80162C	M5	64440	650H	M4	67011	94961	M5	77072	6801R	M4

Additional crosses are available online within the advanced catalog search section.

## GROTE

GROTE PART#	TRUCK-LITE PART #	MATCH LEVEL	GROTE PART#	TRUCK-LITE PART #	MATCH LEVEL	GROTE PART#	TRUCK-LITE PART #	MATCH LEVEL	GROTE PART#	TRUCK-LITE PART #	MATCH LEVEL	GROTE PART#	TRUCK-LITE PART #	MATCH LEVEL
77072	6801W	M4	87270	50872	M4	91513	8939A	M4	94100	30050R	M4	40132-3	98003RB	M5
77072	6811R	M4	87860	50860	M4	91513	9074A	M4	94100	30401	M5	40132-4	98003R	M5
77073	92516Y	M4	87890	97100	M5	91581	9016W	M4	94110	9180	M5	40132-5	98003R1	M5
77073	6601A	M4	87890	97100-1	M5	91581	99176C	M4	94180	45700	M5	40133-3	31ADB	M4
77073	6601A	M4	87891	97101	M5	91582	9016	M4	94233	791	M5	40152-4	98006R	M5
77082	6600R	M4	87891	97101-1	M5	91582	9021	M4	97750	318	M4	40153-4	98006Y	M5
77083	6600A	M4	90011	80342	M5	91583	9016A	M4	99140	97031	M5	40232-5	41D	M5
77091	6601W	M4	90012	9029	M4	91583	9021A	M4	99140	97039	M5	40232-5	43D	M5
77091	6610W	M4	90012	99008R	M4	91683	99067Y	M5	99170	97944	M5	40233-5	41AD	M5
77092	6601R	M4	90012	9030	M4	91740	40700	M5	99180	97943	M5	40233-5	43AD	M5
77092	6610R	M4	90013	81300Y	M5	91880	10700	M5	99192	9006	M4	40641-3	98137	M5
77093	6600A	M4	90013	99008Y	M5	91961	99053C	M5	99502	97002	M5	40641-5	98105	M4
77093	6810A	M4	90051	9005W	M4	91962	9007	M5	99593	97945	M5	40650-3	98136	M5
77093	6601A	M4	90052	9005	M4	91963	9006A	M4	99802	99170R	M5	40650-5	98104-1	M5
77095	6601B	M4	90052	99111R	M4	91963	9007A	M4	99832	99169R	M5	41012-4	52TD	M5
77095	6610B	M4	90053	9005A	M4	91964	9007G	M4	99833	99169Y	M5	41013-4	52ATD	M5
77101	307W	M4	90053	99111Y	M4	91965	9007B	M4	99842	99168R	M5	41022-4	42D	M5
77102	307	M4	90092	8904	M4	91992	9057	M4	99843	99168Y	M5	41023-4	42AD	M5
77103	307A	M4	90093	8904A	M4	91992	9075	M4	99850	6606PS	M4	41033-4	54ATD	M5
77105	307B	M4	90121	9093W	M4	91993	9057A	M4	99880	6602PS	M4	41042-4	54TD	M5
77123	92534Y	M4	90122	9093	M5	91993	9075A	M4	99912	8861	M5	41142-1	98175RB	M5
77123	92539Y	M4	90123	9093A	M4	92070	10402	M5	99912	99063R	M5	41143-1	98175YB	M5
77123	6610A	M4	90132	9087	M4	92070	10702	M5	99913	8861A	M5	41152-1	98176RB	M5
77123	6820A	M5	90133	8977A	M4	92070	10714	M5	99913	99063Y	M5	41153-1	98176YB	M5
77133	6601A	M4	90133	9087A	M4	92070	10718	M5	10706201	794	M5	42141-3	15412	M5
77153	92642Y	M4	90152	99041R	M5	92120	30711	M4	12004-5	7039D	M5	43262-5	80720	M5
77193	92553Y	M4	90153	99041Y	M5	92120	30700	M5	12014-5	7044D	M5	43673-5	9179D	M5
77193	92555Y	M4	90162	99034R	M5	92150	30702	M4	12111-5	97660	M5	44810-5	262D	M5
77203	313A	M5	90163	99034Y	M5	92150	30704	M4	12113-5	97805	M5	44840-5	192D	M4
77263	92551Y	M5	90202	8933	M5	92150	30402	M5	12164-5	7048D	M5	44870-5	80594	M5
77273	92554Y	M4	90203	8933A	M4	92420	60120R	M4	12193-5	97800	M5	45022-5	1001D	M5
77273	6859A	M4	90302	9004	M4	92420	60120Y	M4	12201-5	7038	M5	45023-5	1001AD	M5
77353	92550Y	M4	90302	9003	M4	92420	60120Y1	M4	12201-5	7038D	M5	45263-5	1259AD	M5
77362	60122R	M4	90302	99039R	M5	92420	60122Y1	M5	12243-5	97655	M5	45412-5	1294D	M4
77362	60362R	M4	90303	9003A	M4	92420	60403	M5	12263-5	97751	M5	45413-5	1294AD	M4
77362	92551R	M4	90303	99039Y	M5	92420	60700	M5	12272-5	97831	M5	45512-5	1520D	M5
77363	60122Y	M4	90305	99039B	M5	92432	9342	M5	18302-5	7618	M5	45513-5	1520AD	M5
77363	60362Y	M4	90342	99074R	M4	92433	9342A	M4	26012-5	97693	M4	45822-5	30200R1	M5
77365	92551B	M4	90482	9079	M4	92520	15702	M5	28083-5	97749	M5	45823-5	30200Y1	M5
77422	60360R	M4	90502	9063	M4	92581	9021W	M4	28091-5	97680	M5	46412-5	15200R1	M5
77423	60360Y	M4	90761	99007C	M5	92691	9371W	M4	28093-5	97852	M5	46413-5	15200Y1	M5
77583	6600A	M5	90762	99007R	M4	92692	9371	M4	28293-5	97850	M5	46543-5	1320AD	M5
77593	6810A	M5	90763	99007Y	M4	92693	9371A	M4	28313-5	97678	M5	46712-5	1264	M5
77703	92523Y	M4	90783	99128Y	M4	92762	9372	M4	28323-5	97681	M5	46742-5	19200R1	M5
77703	92645Y	M5	90900	80564	M5	92763	9372A	M4	28323-5	97682	M5	46743-5	19200Y1	M5
77703	92646Y	M5	91042	8900	M5	92773	26762Y	M4	28373-5	7575	M5	46792-5	1211D	M5
77723	92645Y	M5	91043	8900A	M5	92773	99066Y	M4	28393-5	7217	M4	46793-5	1211AD	M5
77853	92565Y	M5	91051	80561	M5	92792	8948	M4	28393-5	7218	M4	46882-5	1507D	M5
77863	92565Y	M5	91152	8947	M4	92802	8947	M4	28402-5	7576	M5	46883-5	1507AD	M5
77873	92565Y	M5	91302	9049	M4	92920	10708	M5	28412-5	7577	M5	46892-5	26313Y1	M5
78260	9680A	M4	91302	9071	M4	92951	99172	M5	28423-5	7518	M5	46893-5	26313R1	M5
78322	90326R	M5	91311	99008C	M5	93163	9020A	M5	28433-5	7519	M5	50642-5	3756D	M5
78323	90326Y	M5	91380	15702	M5	93190	50831	M5	28472-5	97679	M4	50852-5	540D	M5
78333	30257Y	M5	91400	10700	M5	93252	9082	M5	28473-5	7555	M5	50972-5	4027D	M5
78343	10212Y	M5	91400	10713	M5	93253	9082A	M4	28473-5	7557	M5	51-9115-01	97094	M5
78363	21210Y	M4	91410	10704	M5	93291	80572	M5	28473-5	97750	M5	52-1005	50868	M5
78393	19205Y	M5	91482	99083R	M5	93301	80573	M5	28790-5	7599	M5	52302-5	535D	M5
78423	30271Y	M4	91502	8938	M4	93311	80572	M5	28792-5	7597	M5	52312-5	534D	M5
87040	97151	M5	91502	9079	M4	93313	80574	M5	28793-5	7596	M5	52513-1	60215YB	M4
87041	97153	M5	91503	8938A	M4	93321	8965W	M5	40052-4	47TD	M5	52892-5	60202R1	M5
87100	97160	M5	91503	9063A	M4	93400	14700	M5	40053-5	47ATD	M5	52893-5	60202Y1	M5
87101	97161	M5	91503	9078A	M4	94000	10404	M5	40072-5	45TD	M5	55220-5	70300-1	M5
87250	50896	M5	91503	9079A	M4	94010	10401	M5	40073-5	45ATD	M5	60101-5	26331-1	M5

Additional crosses are available online within the advanced catalog search section.

**GROTE**

GROTE PART#	TRUCK-LITE PART #	MATCH LEVEL	GROTE PART#	TRUCK-LITE PART #	MATCH LEVEL	GROTE PART#	TRUCK-LITE PART #	MATCH LEVEL	GROTE PART#	TRUCK-LITE PART #	MATCH LEVEL	GROTE PART#	TRUCK-LITE PART #	MATCH LEVEL
60251-5	26336-1	M5	63503-5	80522	M5	73150-5	329D	M5	G1042	3051	M5	G4603	2660A	M5
60581-3	84216C	M4	63511-5	80513	M5	82-0550	550	M5	G1043	3051A	M5	G5082	5061	M5
60591-3	84216C	M4	63523-5	80519	M5	82-0552	536	M5	G1052	1051	M5	G5092	5060	M5
60601-3	15205	M5	64003-5	80527	M4	82-0552	552	M5	G1053	1051A	M5	G5202	5061	M5
61091-5	9380SWD	M5	64061-5	80525	M4	82-1000	3121	M4	G1082	1075	M5	G5212	5060	M5
61491-5	549SWD	M5	64161-5	80526	M4	82-1001	97159	M5	G1083	1075A	M5	G5300	2750	M5
61581-3	44046C3	M4	64161-5	80553	M4	82-1002	50869	M5	G1092	30275R	M4	G6012	6051	M5
63151-5	610WD	M4	64181-5	80551	M4	82-1016	50888	M5	G1093	30275Y	M4	G6013	6051A	M5
63181-5	629WD	M5	64260-4	80888	M4	82-1020	50886	M5	G1902	1960	M5			
63191-5	628WD	M5	64261-4	80893	M5	82-1021	50885	M5	G1903	1960A	M5			
63201-5	627WD	M5	64261-4	640WK	M5	82-2006	50887	M5	G2102	2150	M5			
63211-5	80396	M5	64290-4	80800	M5	82-2140	97158	M5	G2103	2150A	M5			
63221-5	80397	M5	64291-4	644WK	M5	82-2159	50899	M5	G3002	3050	M4			
63231-5	80394	M5	64931-1	80360-B	M5	82-2160	9414BL	M5	G3002	3051	M5			
63441-4	80893	M5	65340-5	55554-1	M4	82-2163	9415BL	M5	G3003	3050A	M4			
63441-4	645WK	M5	65370-5	533DK	M5	82-2311	3131	M4	G3003	3051A	M5			
63451-4	80893	M5	65402-4	580K	M5	82-5800	52700	M5	G3092	3075	M5			
63455-4	80893	M5	65432-4	44390R	M5	90325Y	90325Y	M5	G3093	3075A	M5			
63481-5	80513	M5	65720-5	44390R1	M5	90971-5	80571	M5	G4002	4050	M5			
63481-5	80520	M5	65730-5	580DK	M5	92701-5	80560	M5	G4003	4050A	M5			
63501-5	80514	M5	72100-5	97361	M4	99167Y	99167Y	M5	G4022	4051	M5			
63501-5	80521	M5	72110-5	97360	M4	G1032	1050	M5	G4023	4051A	M5			
63503-5	80519	M5	73140-5	328D	M5	G1033	1050A	M5	G4602	2660	M5			

**HELLA**

HELLA PART#	TRUCK-LITE PART #	MATCH LEVEL	HELLA PART#	TRUCK-LITE PART #	MATCH LEVEL	HELLA PART#	TRUCK-LITE PART #	MATCH LEVEL	HELLA PART#	TRUCK-LITE PART #	MATCH LEVEL	HELLA PART#	TRUCK-LITE PART #	MATCH LEVEL
1539	81380	M5												

**JETCO**

JETCO PART#	TRUCK-LITE PART #	MATCH LEVEL	JETCO PART#	TRUCK-LITE PART #	MATCH LEVEL	JETCO PART#	TRUCK-LITE PART #	MATCH LEVEL	JETCO PART#	TRUCK-LITE PART #	MATCH LEVEL	JETCO PART#	TRUCK-LITE PART #	MATCH LEVEL
126-1011	1050	M5	126-1500A	1560A	M5	127-10211	1960	M5	127-43002	4050	M5			
126-1011A	1050A	M5	126-1900	1960	M5	127-10211A	1960A	M5	127-44050R	4050	M5			
126-1018	3075	M5	126-1900A	1960	M5	127-15000	1560	M5	127-60010	6050	M5			
126-1018A	3075A	M5	126-4040	4050	M5	127-15000A	1560A	M5	127-63002	6050	M5			
126-1019	1075	M5	126-4040A	4050A	M5	127-16002	3050	M5	127-63002A	6050A	M5			
126-1019A	1075A	M5	126-4041W	4060C	M5	127-16002A	3050A	M5	127-66010A	6050A	M5			
126-1211	2660	M5	126-4070	6050	M5	127-17002	1050	M5	127-66050A	6050A	M5			
126-1211A	2660A	M5	126-4070A	6050A	M5	127-17002A	1050A	M5	127-66050R	6050	M5			
126-1500	1560	M5	126-4071W	6060C	M5	127-40010	4050	M5						

**MAXXIMA**

MAXXIMA PART#	TRUCK-LITE PART #	MATCH LEVEL	MAXXIMA PART#	TRUCK-LITE PART #	MATCH LEVEL	MAXXIMA PART#	TRUCK-LITE PART #	MATCH LEVEL	MAXXIMA PART#	TRUCK-LITE PART #	MATCH LEVEL	MAXXIMA PART#	TRUCK-LITE PART #	MATCH LEVEL
20321R	2675	M5	M11256Y	1052A	M5	M16800Y	1075A	M5	M20330Y	2670A	M5	M20395R	2150	M5
20321Y	2675A	M5	M11260R	10286R	M5	M20320R	1560	M5	M20330Y	2674A	M5	M20395Y	2150A	M5
40800WU	44308C	M5	M11260Y	10286Y	M5	M20320R-01	15507R	M5	M20343R	35740R	M5	M23012R	2660	M5
M09100R	3050	M5	M11300R	1050	M5	M20320Y	1560A	M5	M20350R	1960	M5	M23012Y	2660A	M5
M09100Y	3050A	M5	M11300Y	1050A	M5	M20320Y-01	15507Y	M5	M20350R-01	19032R	M5	M2328R	2751	M5
M09105R	3075	M5	M11325R	1050	M5	M20323R	15050R	M5	M20350Y	1960A	M5	M2328Y	2751A	M5
M09105Y	3075A	M5	M11325Y	1050A	M5	M20327	15408	M5	M20350Y-01	19032Y	M5	M27340R	26270R	M5
M09200R	3050	M5	M16100R	1050	M5	M20328	15409	M5	M20355	19748	M5	M27340Y	26270Y	M5
M09200Y	3050A	M5	M16100Y	1050A	M5	M20330R	2150	M5	M20356	19728	M5	M34100R	3050	M5
M11201R	1075	M5	M16280R	1050	M5	M20330R	2670	M5	M20360Y	18050Y	M5	M34100Y	3050A	M5
M11201Y	1075A	M5	M16280Y	1050A	M5	M20330R	2674	M5	M20390R	2150	M5	M34260R	3050	M5
M11256R	1052	M5	M16800R	1075	M5	M20330Y	2150A	M5	M20390Y	2150A	M5	M34260RCL	3051	M5

Additional crosses are available online within the advanced catalog search section.

## MAXXIMA

MAXXIMA PART#	TRUCK-LITE PART #	MATCH LEVEL	MAXXIMA PART#	TRUCK-LITE PART #	MATCH LEVEL	MAXXIMA PART#	TRUCK-LITE PART #	MATCH LEVEL	MAXXIMA PART#	TRUCK-LITE PART #	MATCH LEVEL	MAXXIMA PART#	TRUCK-LITE PART #	MATCH LEVEL
M34260Y	3050A	M5	M42322R	4050	M5	M43253CH	44708	M5	M50903	94840	M5	M63322RCL	6051	M5
M34260YCL	3051A	M5	M42322RCL	4051	M5	M43900	40403	M5	M50904	94897	M5	M63322Y	6050A	M5
M34600R	3075	M5	M42322Y	4050A	M5	M49700	45700	M5	M50950	94924	M5	M63322YCL	6051A	M5
M34600Y	3075A	M5	M42322YCL	4051A	M5	M50100-B	10700	M5	M50951	94964	M5	M63420R	6050	M5
M42100R	4050	M5	M42324	44350C	M5	M50102	10702	M5	M56100R	4050	M5	M63420Y	6050A	M5
M42100R-01	4050	M5	M42325	4060C	M5	M50105	10740	M5	M63100R	6050	M5	M63450R	6050	M5
M42100R-02	4050	M5	M42327	44236C	M5	M50300-B	30700	M5	M63100R-01	6050	M5	M63450Y	6050A	M5
M42100Y	4050A	M5	M42328R/Y	2750	M5	M50305	30713	M5	M63100Y	6050A	M5	M844820	84200C	M5
M42120R	44363R	M5	M42328RYCL	2750	M4	M50310	9179	M5	M63100Y-01	6050A	M5	M844821	84200C	M5
M42200R	4550	M5	M42400	44235C	M5	M50312	35720	M5	M63120Y	60315Y	M5	M90018Y	91271Y	M5
M42200Y	4550A	M5	M42450	4060C	M5	M50400-B	40700	M5	M63150	6060C	M5	M90061R	91272R	M5
M42201RCL	4551	M5	M42500R	4050	M5	M50405	44701	M5	M63200R	60360R	M5	M90081Y	91271Y	M5
M42205R	4550	M5	M42500Y	4050A	M5	M50410	44705	M5	M63200Y	60360Y	M5	MF-30A	97134-1	M5
M42205Y	4550A	M5	M42700R	44211R	M5	M50600-B	60700	M5	M63253	60750	M5	MWL-01	81360	M5
M42220	5060	M5	M42700Y	44211Y	M5	M50605	60703	M5	M63253CH	60750	M5			
M42320R	4050	M5	M43253	44705	M5	M50900	94993	M5	M63322R	6050	M5			

## OPTRONICS

OPTRONICS PART#	TRUCK-LITE PART #	MATCH LEVEL	OPTRONICS PART#	TRUCK-LITE PART #	MATCH LEVEL	OPTRONICS PART#	TRUCK-LITE PART #	MATCH LEVEL	OPTRONICS PART#	TRUCK-LITE PART #	MATCH LEVEL	OPTRONICS PART#	TRUCK-LITE PART #	MATCH LEVEL
53CB	44350C	M5	A-91LW	96913	M5	LP-41CB	26371	M4	MC-57RB	10205R	M5	MCL-46AB	2660A	M5
A-11AB	9342A	M5	A-91OB	791	M5	LP-42CB	26371	M4	MC-58AB	10202Y	M4	MCL-46RB	2660	M5
A-11RB	9342	M5	A-91RB	15200R	M5	LP-51CB	26371	M4	MC-58RB	10202R	M4	MCL-49AB	2674A	M5
A-13CB	60703	M5	A-91ZB	802	M5	LP-51CPG	26371	M4	MC-62AB	26312Y	M5	MCL-49AB	18050Y	M5
A13GB	60700	M5	AL-80AB	15033Y	M4	LP-52CB	26371	M4	MC-62RB	26312R	M5	MCL-49RB	2674	M5
A-19AB	194	M5	AL-80RB	15033R	M4	LP-54CB	26371	M4	MC-65AB	19200Y	M5	MCL-53AB	3050A	M5
A-21AB	9075A	M5	AL-91AB	1560A	M5	LP-55B	80720	M5	MC-65RB	19200R	M5	MCL-53RB	3050	M5
A-21B	9075	M5	AL-91RB	1560	M5	LP-71CB	26336	M5	MC-66AB	1259A	M5	MCL-55AB	3050A	M5
A-21CB	9075W	M5	BK-42CB	26001	M5	LP-81BB	26335	M5	MC-66HAB	1259A	M4	MCL-55RB	3050	M5
A-2RB	8948	M5	BK-45BB	40720	M5	LP-91CB	15208	M5	MC-66RB	1259	M5	MCL-57AB	1050A	M5
A-33GB	45700	M5	BK-57BB	10725	M5	LPL-31CB	434WD	M5	MC-67AB	19002Y	M5	MCL-57RB	1050	M5
A-45BB	44750	M5	BK-70BB	60720	M5	LPL-41CB	26371	M4	MC-67RB	19002R	M5	MCL-58AB	10286Y	M5
A-45CB	94924	M5	BU-40CB	80342	M5	MC-11AB	1507A	M5	MC-67RPG	19002R	M4	MCL-58RB	10286R	M5
A-45GB	40700	M5	BU-41CB	80342	M5	MC-11RB	1507	M5	MC-68AB	1555A	M5	MCL-59AB	1052A	M5
A-45PB	94926	M5	BU-44CB	40004	M5	MC-25AB	30201Y	M5	MC-68RB	1555	M5	MCL-59RB	1052	M5
A-46PB	94924	M5	BU-45CB	40204	M5	MC-25RB	30201R	M5	MC-69AB	1555A	M4	MCL-65AB	1960A	M5
A-46PPG	94924	M5	BU-65CB	60004C	M5	MC-27AB	10203Y	M5	MC-69RB	1555	M4	MCL-65RB	1960	M5
A-47PB	94993	M5	BU-70CB	60204C	M5	MC-27RB	10203R	M5	MC-76AB	1233A	M5	MCL-66AB	35200Y	M5
A-49PB	94992	M5	BU-74CB	60004C	M4	MC-31AB	1264A	M5	MC-76RB	1233	M5	MCL-66RB	35200R	M5
A-54GB	30700	M5	BU-74CBTK	60004C	M4	MC-31AB2	1264A	M5	MC-81AB	2671A	M4	MCL-67AB	1960A	M5
A-54GK	30401	M5	BUL-43CB	4060C	M5	MC-31RB	1264	M5	MC-81RB	2671	M4	MCL-67RB	1960	M5
A-55GB	10700	M5	BUL-52CB	6060C	M5	MC-32AB	1222A	M5	MC-82AB	1101A	M5	MCL-69AB	19275Y	M5
A-55GK	10401	M5	BUL-53CB	4060C	M5	MC-32RB	1222	M5	MC-82RB	1101	M5	MCL-69RB	19275R	M5
A-56GB	10702	M5	BUL-72CB	6060C	M5	MC-35AB	1525A	M4	MC-85AB	1507A	M5	MCL-71AB	2675A	M5
A-57GB	10700	M5	BUL-78CB	66205C	M5	MC-35RB	1525	M4	MC-85RB	1507	M5	MCL-71RB	2675	M5
A-57GK	10401	M5	CB-22AB	1150A	M5	MC-36AB	1570A	M5	MC-91AB	15506Y	M5	MCL-75AB	6050A	M5
A-65B	19728	M5	CB-22RB	1150	M5	MC-36RB	1570	M5	MC-91RB	15506R	M5	MCL-75RB	6050	M5
A-65BPPG	19721	M5	CBL-22AB	1155A	M5	MC-37AB	1570A	M5	MC-92AB	15507Y	M5	MCL-76AB	1233A	M4
A-67CB	19739	M5	IL-21CB	549SWD	M5	MC-38AB	1264A	M5	MC-92RB	15507R	M5	MCL-76RB	1233	M4
A-67CBPG	19739	M5	IL-22CB	549SWD	M5	MC-38RB	1264	M5	MC-95AB	15200Y	M4	MCL-77AB	1960A	M5
A-70GB	60700	M5	IL-61CB	80482	M5	MC-42AB	1211AD	M5	MC-95AB24	15200Y	M4	MCL-77RB	1960	M5
A-78CB	60719	M5	IL-91CB	80351	M5	MC-42RB	1211A	M5	MC-95APG	15200Y	M4	MCL-81AB	2671A	M5
A-80BB	809	M5	LP-10SB	42722	M5	MC-52AB	30221Y	M5	MC-95RB	15200R	M4	MCL-81RB	2671	M5
A-86PB	94902	M5	LP-11CB	26331	M5	MC-52RB	30221R	M5	MCL-21AB	3075A	M5	MCL-86AB	12275Y	M5
A-91AB	1560A	M5	LP-15SB	42722	M4	MC-53AB	4050A	M5	MCL-21RB	3075	M5	MCL-86RB	12275R	M5
A-91BB	802	M5	LP-21CB	26330	M5	MC-53RB	4050	M5	MCL-23AB	1075A	M5	MCL-91AB	1560A	M5
A-91BOB	802	M5	LP-25SB	15730	M5	MC-55AB	10202Y	M5	MCL-23RB	1075	M5	MCL-91RB	1560	M5
A-91CB	791	M5	LP-31CB	434WD	M5	MC-55RB	10202R	M5	MCL-45AB	2660A	M5	MCL-95AB	1560A	M5
A-91GB	15702	M5	LP-31CPG	434WD	M5	MC-57AB	10205Y	M5	MCL-45RB	2660	M5	MCL-95APG	1560A	M4



Additional crosses are available online within the advanced catalog search section.

**OPTRONICS**

OPTRONICS PART#	TRUCK-LITE PART #	MATCH LEVEL	OPTRONICS PART#	TRUCK-LITE PART #	MATCH LEVEL	OPTRONICS PART#	TRUCK-LITE PART #	MATCH LEVEL	OPTRONICS PART#	TRUCK-LITE PART #	MATCH LEVEL	OPTRONICS PART#	TRUCK-LITE PART #	MATCH LEVEL
MCL-95RB	1560	M4	ST-25RB	540D	M5	ST-5RB	535D	M5	ST-9RB	534D	M5	STL-78RPG	60056R	M5
MCL-95RPG	1560	M4	ST-2RB	535D	M5	ST-60RB	4027	M5	STL-34RB	45058R	M5	STL-82RCB	6051	M5
QH-16CTS	80520	M5	ST-33AB	45202Y	M5	ST-6RB	534D	M5	STL-42AB	4050A	M5	STL-90RB	91244R	M5
QH-36CTS	80525	M5	ST-33RB	45202R	M5	ST-6RPG	534D	M5	STL-42RB	4050	M5	STL-90RCB	91244R	M4
RE-10AB	98035Y	M5	ST-34RB	45002R	M5	ST-70AB	60202Y	M5	STL-43AB	4050A	M5	TL-10CB	80360	M5
RE-10RB	98035R	M5	ST-3RB	534D	M5	ST-70RB	60202R	M5	STL-43RB	4050	M5	TL-27BK	533DK	M5
RE-11AB	54A	M5	ST-40RB	80302R	M5	ST-74AB	60002Y	M5	STL-53RB	4050	M5	TL29BK	533DK	M4
RE-11RB	54	M5	ST-41RB	80302R	M4	ST-74RB	60002R	M5	STL-53RCB	4051	M5	TL-35TB	80394	M5
RE-15AB	98003Y	M5	ST-42RB	80302R	M4	ST-75AB	60215Y	M5	STL-70AB	6050A	M5	TL-5RK	5050DK	M5
RE-15RB	98003R	M5	ST-45AB	40282Y	M5	ST-77AB	60015Y	M5	STL-70RB	6050	M5	TLL-9RK	5050DK	M5
RE-21AB	47A	M5	ST-45RB	40282R	M5	ST-7RB	535D	M5	STL-71RB	60256R	M5	UL-94CB	15200C	M5
RE-21RB	47	M5	ST-47RB	80334R	M5	ST-7RPG	535D	M5	STL-72AB	6050A	M5			
RE-35AB	52ATD	M5	ST-4RB	534D	M5	ST-8RB	535D	M5	STL-72RB	6050	M5			
RE-9AB	98031Y	M5	ST-51RB	70310R	M5	ST-90AB	90327Y	M5	STL-78AB	60292Y	M5			
RE-9RB	98031R	M5	ST-52RB	70311	M5	ST-90RB	90327R	M5	STL-78RB	60256R	M5			

**PETERSON**

PETERSON PART#	TRUCK-LITE PART#	MATCH LEVEL	PETERSON PART#	TRUCK-LITE PART#	MATCH LEVEL	PETERSON PART#	TRUCK-LITE PART#	MATCH LEVEL	PETERSON PART#	TRUCK-LITE PART#	MATCH LEVEL	PETERSON PART#	TRUCK-LITE PART#	MATCH LEVEL
320	2753	M5	143R	1052	M5	717R	91244R	M5	M164R	3050	M5	M417TA-2	4050A	M5
321	2756	M5	313R	2751	M5	717R	91274R	M5	M165A	3050A	M5	M417W-2	81360	M5
324	2752	M5	334-2	2751	M4	850A	4550A	M5	M165R	3050	M5	M420R	4050	M5
325	2752	M5	337-2	2750	M5	M120A	1155A	M5	M166A	3075A	M5	M420R-2	4050	M5
335	2750	M5	417C	4060C	M5	M120R	1155	M5	M166R	3075	M5	M420R-3	4050	M5
337	2750	M5	417R-5	4050	M5	M122XR	2671	M5	M173A	1052A	M5	M420R-5	4050	M5
415	6060C	M5	417YA	4050A	M5	M139A	2660A	M5	M173R	1052	M5	M420SA-1AMP	60360R	M5
540	5050DK	M5	421R	6050	M5	M139R	2660	M5	M188A	2150A	M5	M421A	6050A	M5
907	81374	M4	4258A-1	44211R	M5	M153A	1560A	M5	M188R	2150	M5	M4260A	4050A	M5
1460	80360	M5	4258A-1	44212R	M5	M153C	15205	M5	M2875A-2	60275Y	M5	M4260R-3	4050	M5
4321	4050A	M5	4258A-2	44211Y	M5	M153R	1560	M5	M313-2R	2751	M4	M450A	4550A	M5
4409	80360	M5	4258A-2	44212Y	M5	M161A	1560A	M5	M350A	60315Y	M5	M509	80394	M5
4468	80394	M5	426A	4050A	M5	M161R	1560	M5	M416	6060C	M5	M907	81360	M5
4477	4060C	M5	426R	4050	M5	M162A	1050A	M5	M417C	4060C	M5	V339-2	2751	M4
4486	60275Y	M5	450R	4050	M5	M162R	1050	M5	M417R	4050	M5	V410-2	2751	M4
4487	6050A	M5	505K	80893	M5	M163A	10286Y	M5	M417R-2	4050	M5			
1217A-1	4050A	M5	717A	91243Y	M5	M163R	10286R	M5	M417R-3	4050	M5			
143A	1052A	M5	717A	91273Y	M5	M164A	3050A	M5	M417TA	4050A	M5			

**PHILLIPS**

PHILLIPS PART#	TRUCK-LITE PART#	MATCH LEVEL	PHILLIPS PART#	TRUCK-LITE PART#	MATCH LEVEL	PHILLIPS PART#	TRUCK-LITE PART#	MATCH LEVEL	PHILLIPS PART#	TRUCK-LITE PART#	MATCH LEVEL	PHILLIPS PART#	TRUCK-LITE PART#	MATCH LEVEL
60-2201	80251C	M5	60-2211	80251C	M5	60-2251	80251C	M5						

**PRECO**

PRECO PART#	TRUCK-LITE PART#	MATCH LEVEL	PRECO PART#	TRUCK-LITE PART#	MATCH LEVEL	PRECO PART#	TRUCK-LITE PART#	MATCH LEVEL	PRECO PART#	TRUCK-LITE PART#	MATCH LEVEL	PRECO PART#	TRUCK-LITE PART#	MATCH LEVEL
112	92903	M5	270	92924	M5	1020	92911	M5	4050	92918	M5			
230	92900	M5	360	92903	M5	1040	92905	M5	ELT 248	92910	M5			
240	92901	M5	370	92923	M5	4028	92914	M5	LDA 50	92909	M5			
250	92902	M5	380	92904	M5	4030	92916	M5	SWM 43C	92907	M5			

Additional crosses are available online within the advanced catalog search section.

## PRIMA TRONICS

PRIMA TRONICS PART#	TRUCK-LITE PART #	MATCH LEVEL	PRIMA TRONICS PART#	TRUCK-LITE PART #	MATCH LEVEL	PRIMA TRONICS PART#	TRUCK-LITE PART #	MATCH LEVEL	PRIMA TRONICS PART#	TRUCK-LITE PART #	MATCH LEVEL	PRIMA TRONICS PART#	TRUCK-LITE PART #	MATCH LEVEL
PT1000A	10202Y	M5	PT2101A	29203Y	M5	PT3000R-KIT	30503R	M5	PT5175	92902	M5	PTL1013R	1050	M5
PT1000A-KIT	10519Y	M5	PT2101R	29203R	M5	PT3000RS	30222R	M5	PT5412	262	M5	PTL1313A	10276Y	M5
PT1000BK	10729	M5	PT2102A	29202Y	M5	PT4000A	40282Y	M5	PT5413	263	M5	PTL1313R	10276R	M5
PT1000G	10700	M5	PT2102R	29202R	M5	PT4000BK	40720	M5	PT5453	172	M5	PTL1503A	15250Y	M5
PT1000GK	10401	M5	PT2200A	22202Y	M5	PT4000G	40700	M5	PT5454	173	M5	PTL1503A	1560A	M5
PT1000R	10202R	M5	PT2200R	22202R	M5	PT4000R	40282R	M5	PT5469	182	M5	PTL1503R	15250R	M5
PT1000R-KIT	10519R	M5	PT2601A	1259A	M5	PT4000RF	40229R	M5	PT5471	282	M5	PTL1503R	1560	M5
PT1001BK	10728	M5	PT2601A-LN	9093A	M5	PT4000RF	40233R	M5	PT5481	283	M5	PTL1508W	15205	M5
PT1002BK	10725	M5	PT2601R	1259	M5	PT4000R-KIT	40028R	M5	PT6000A	60202Y	M5	PTL1912A	1960A	M5
PT1002G	10702	M5	PT2601R-LN	9093	M5	PT4000W	40204	M5	PT6000BK	60720	M5	PTL1912R	1960	M5
PT1003BK	10410	M5	PT2602A	1211A	M5	PT4002BK	40715	M5	PT6000G	60700	M5	PTL3009A	30285Y	M5
PT1004G	10704	M5	PT2602A-LN	9007A	M5	PT4100R	40248R	M5	PT6000R	60202R	M5	PTL3009A	3050A	M5
PT1100A	10205Y	M5	PT2602R	1211	M5	PT4212RF	80334R	M5	PT6000R-KIT	60002R	M5	PTL3009R	30285R	M5
PT1100R	10205R	M5	PT2602R-LN	9007	M5	PT4212RF-LN	99008R	M5	PT6000W	60204C	M5	PTL3009R	3050	M5
PT1300A	10203Y	M5	PT2605A	1105A	M5	PT4902P	94902	M5	PT6500A	60215Y	M5	PTL3309A	30276Y	M5
PT1300R	10203R	M5	PT2700L	26330	M5	PT4924P	94924	M5	PT9805A	47A	M5	PTL3309R	30276R	M5
PT1500BK	15412	M5	PT2702L	26335	M5	PT4925P	94925	M5	PT9806A	98006Y	M5	PTL3606A	35200Y	M5
PT1500L	15208	M5	PT2703L	15011	M5	PT4926P	94926	M5	PT9806R	98006R	M5	PTL3606R	35200R	M5
PT1500R	15200R	M5	PT2704L	26331	M5	PT4992P	94992	M5	PT9807A	52A	M5	PTL4010R	44351R	M5
PT1500W	15200C	M5	PT3000A	30200Y	M5	PT4993P	94993	M5	PT9807R	52	M5	PTL4010RF	44363R	M5
PT1500Y	15200Y	M5	PT3000AF	30221Y	M5	PT4999P	94888	M5	PT9808A	45ATD	M5	PTL4018A	4050A	M5
PT1900A	19200Y	M5	PT3000AS	30222Y	M5	PT5000A	307A	M5	PT9808R	45TD	M5	PTL4018R	4050	M5
PT1900BK	19721	M5	PT3000BK	30728	M5	PT5000A-LN	9375A	M5	PT9810A	98175Y	M5	PTL5313A	2660A	M5
PT1900R	19200R	M5	PT3000G	30700	M5	PT5021	80360	M5	PT9810R	98175R	M5	PTL5313R	2660	M5
PT1900W	19200C	M5	PT3000GK	30401	M5	PT5023	629WD	M5	PT9832A	54A	M5	PTL6056A	6050A	M5
PT2100A	21201Y	M5	PT3000R	30200R	M5	PT5024	627WD	M5	PT9832R	54	M5	PTL6056R	6050	M5
PT2100R	21201R	M5	PT3000RF	30221R	M5	PT5110	92900	M5	PTL1013A	1050A	M5	PLT1508W	15205	M4

## PSE AMBER / CODE 3

PSE AMBER CODE 3 PART#	TRUCK-LITE PART #	MATCH LEVEL	PSE AMBER CODE 3 PART#	TRUCK-LITE PART #	MATCH LEVEL	PSE AMBER CODE 3 PART#	TRUCK-LITE PART #	MATCH LEVEL	PSE AMBER CODE 3 PART#	TRUCK-LITE PART #	MATCH LEVEL	PSE AMBER CODE 3 PART#	TRUCK-LITE PART #	MATCH LEVEL
2100	92678Y	M5	660CCH	92611C	M5	Beacon	92565Y	M5	S51176M	99211C	M5	T03281	99213C	M5
420AH	92642Y	M5	660CH	92612C	M5	LLPMK-1K	92565Y	M4	T01553	99201C	M5	T07891	99216R	M5
420AMH	92644Y	M5	660CRH	92602R	M5	LXEXBIF-AH	92575Y	M5	T01554	99201Y	M5	T07892	99216Y	M5
420ASH	92644Y	M5	7000H	92674Y	M5	LXEXBIF-RH	92575R	M5	T01555	99201R	M5	T07901	99215R	M5
45BZAH	92692Y	M5	8005H	92645Y	M5	LXEXIF-AH	92574Y	M5	T01556	99201B	M5	T07902	99215Y	M5
45BZRH	92692R	M5	8005MH	92646Y	M5	LXEXIF-RH	92574R	M5	T01691	99202R	M5	T07911	99214R	M5
65BZAH	92691Y	M5	85BZAH	92690Y	M5	S50204M	99210Y	M5	T01692	99202B	M5	T07912	99214Y	M5
65BZRH	92691R	M5	85BZRH	92690R	M5	S50260M	99205C	M5	T01693	99202Y	M5	T09352	99200R	M5
660AH	92602Y	M5	B20	6822A	M5	S50424M	99205Y	M5	T02104	99203Y	M5	T09354	99200Y	M5
660CAH	92602Y	M5	B20 MAG	6823A	M5	S50857M	99208C	M5	T02134	99204Y	M5	X391H	92676Y	M5
660CBH	92602B	M5	B20 SUCTION	6823A	M5	S50858M	99209C	M5	T03271	99212C	M5	X394H	92677Y	M5

## RE-TRAC

RE-TRAC CODE 3	TRUCK-LITE PART #	MATCH LEVEL	RE-TRAC CODE 3	TRUCK-LITE PART #	MATCH LEVEL	RE-TRAC CODE 3	TRUCK-LITE PART #	MATCH LEVEL	RE-TRAC CODE 3	TRUCK-LITE PART #	MATCH LEVEL	RE-TRAC CODE 3	TRUCK-LITE PART #	MATCH LEVEL
60	97848	M5	396	97865	M5	954	97820	M5	1151	97860	M5	2928	97661	M5
61	97671	M5	812	97800	M5	980	97814	M5	1152	97627	M5	3975	97665	M5
63	97673	M5	821	97659	M5	982	97814	M5	1152	97860	M5	3983	97828	M5
64	97847	M5	822	97800	M5	983	97803	M5	1156	97637	M5	3984	97829	M5
67	97671	M5	872	97817	M5	986	97804	M5	1159	97822	M5	21601	97644	M5
68	97673	M5	873	97815	M5	987	97831	M5	1160	97812	M5	273120	97681	M5
70	97990	M5	876	97816	M5	991	97606	M5	1731	97660	M5	608100	97862	M5
72	97670	M5	880	97803	M5	993	97609	M5	1732	97805	M5	1143H	97650	M5
73	97672	M5	880	97814	M5	1143	97811	M5	2640	97846	M5	1152-1	97860	M5
90	97872	M5	951	97820	M5	1145	97806	M5	2732	97678	M5	1156B	97636	M5
94	97802	M5	952	97819	M5	1146	97818	M5	2762	97852	M5	1157/1162	97861	M5
95	97872	M5	953	97819	M5	1148	97808	M5	2812	97850	M5	1157H	97866	M5

Additional crosses are available online within the advanced catalog search section.

RE-TRAC

RE-TRAC CODE 3	TRUCK-LITE PART #	MATCH LEVEL	RE-TRAC CODE 3	TRUCK-LITE PART #	MATCH LEVEL	RE-TRAC CODE 3	TRUCK-LITE PART #	MATCH LEVEL	RE-TRAC CODE 3	TRUCK-LITE PART #	MATCH LEVEL	RE-TRAC CODE 3	TRUCK-LITE PART #	MATCH LEVEL
1157H-IHN	97866	M5	872-4J5	97817	M5	880-4J5	97814	M5	980H	97614	M5	991J5	97606	M5
1159DV	97635	M5	872J5	97817	M5	880H	97614	M5	980J5	97814	M5	993-4	97609	M5
1159H	97809	M5	873-4	97815	M5	880J5	97803	M5	980SP	97814	M5	993J5	97609	M5
1159HL	97827	M5	873-4J5	97815	M5	880J5	97814	M5	980SPH	97614	M5	J502	97718	M5
1162H	97866	M5	873J5	97815	M5	881-4H	97615	M5	980SPHJ5	97614	M5	J510	97868	M5
1171H	97840	M5	876-4	97816	M5	881H	97615	M5	980SPJ5	97814	M5	J511	97868	M5
398B	97666	M5	876-4J5	97816	M5	96F	97653	M5	981-3H	97615	M5	J512	97718	M5
4MKSS	97823	M5	876J5	97816	M5	97F	97653	M5	981-3HJ5	97615	M5			
661-C	97732	M5	880-4	97803	M5	980-3	97814	M5	981H	97615	M5			
6MKSS	97823	M5	880-4	97814	M5	980-3H	97614	M5	983J5	97803	M5			
762V	97655	M5	880-4H	97614	M5	980-3HJ5	97614	M5	986J5	97804	M5			
872-4	97817	M5	880-4J5	97803	M5	980-3J5	97814	M5	987J5	97831	M5			

STAR HEADLAMP

STAR HEADLAMP PART#	TRUCK-LITE PART #	MATCH LEVEL	STAR HEADLAMP PART#	TRUCK-LITE PART #	MATCH LEVEL	STAR HEADLAMP PART#	TRUCK-LITE PART #	MATCH LEVEL	STAR HEADLAMP PART#	TRUCK-LITE PART #	MATCH LEVEL	STAR HEADLAMP PART#	TRUCK-LITE PART #	MATCH LEVEL
129	92710	M5	135L	99144Y	M5	20TD	92602Y	M5	6020S	92645Y	M5	920-3	99151Y	M5
295	99149Y	M5	181D	92713	M5	211R	6820A	M5	6020SM	92646Y	M5	920-5	92721	M5
297	99149Y	M5	181D4	92714	M5	211RM	6821A	M5	620-21	99191Y	M5	920-99	92720	M5
300	99145Y	M5	181-S	92701	M5	255TC	6601A	M5	820-21	99192Y	M5	ST3901-7	92715	M5
330	99147Y	M5	181Z	92702	M5	255TS	6610A	M5	820-21	99193Y	M5	VL22	92582	M5
333	99150C	M5	200A	92513Y	M5	300S	99146Y	M5	8300H	92668Y	M5	VL22	92583	M5
425	99148Y	M5	200AD	92513Y	M5	325L	99142Y	M5	8300S	92669Y	M5	VL22	92584	M5
3300	92730	M5	200AQ	92513Y	M5	3861-3	92731	M5	8400H	92670Y	M5			
3920	92551Y	M5	200B	92513Y	M5	3901-9	92715	M5	8400S	92671Y	M5			
3920	92551B	M5	200SQ	92516Y	M5	400A	92600Y	M5	8401H	92672Y	M5			
3930	92553Y	M5	201ZMQ	92539Y	M5	400A4	92601Y	M5	8401S	92673Y	M5			
3970	92552Y	M5	201ZQ	92534Y	M5	6020H	92642Y	M5	9200SMQ	92523Y	M5			
134L	99143Y	M5	20RI	6822A	M5	6020HM	92643Y	M5	9200SQ	92522Y	M5			

TECNIQ

TECNIQ PART#	TRUCK-LITE PART #	MATCH LEVEL	TECNIQ PART#	TRUCK-LITE PART #	MATCH LEVEL	TECNIQ PART#	TRUCK-LITE PART #	MATCH LEVEL	TECNIQ PART#	TRUCK-LITE PART #	MATCH LEVEL	TECNIQ PART#	TRUCK-LITE PART #	MATCH LEVEL
S10-0G00-1	10700	M5	S15-RR00-1	1560	M5	S30-AA00-1	3050A	M5	S90-0000-1	15417	M5	T40-RR00-1	4050	M5
S10-AA00-1	1052A	M5	S21-AA00-1	2660A	M4	S30-AC00-1	3051A	M5	S90-0B00-1	15731	M5	T60-0G00-1	60700	M5
S10-RR00-1	1052	M5	S21-AC00-1	2660A	M4	S30-RC00-1	3051	M5	S99-0010-1	94992	M5	T60-RR00-1	6050	M5
S15-0B00-1	802	M5	S21-RC00-1	2660	M4	S30-RR00-1	3050	M5	T40-0BT0-1	44701	M5			
S15-0C00-1	791	M5	S21-RR00-1	2660	M4	S35-AA00-1	3550A	M5	T40-0G00-1	40700	M5			
S15-AA00-1	1560A	M5	S30-0G00-1	30700	M5	S35-RR00-1	3550	M5	T40-RC00-1	4051	M5			

Additional crosses are available online within the advanced catalog search section.

## UNIBOND

UNIBOND PART#	TRUCK-LITE PART #	MATCH LEVEL	UNIBOND PART#	TRUCK-LITE PART #	MATCH LEVEL	UNIBOND PART#	TRUCK-LITE PART #	MATCH LEVEL	UNIBOND PART#	TRUCK-LITE PART #	MATCH LEVEL	UNIBOND PART#	TRUCK-LITE PART #	MATCH LEVEL
BD2000	30729	M5	KT3260R	60083R	M5	LED1225-3A	1560A	M5	LED7250A	10276Y	M5	SE1225A	1560A	M5
BD2500	10725	M5	KT3405A	40028Y	M5	LED1225-3R	1560	M5	LED7250R	10276R	M5	SE1225R	1560	M5
BM1020B	15720	M5	KT3405R	40028R	M5	LED1225-6A	1560A	M5	MB2000	30728	M5	SE2000R	3050	M5
BM1020C	791	M5	KT4060A	45002Y	M5	LED1225-6R	1560	M5	MB2238	60720	M5	SE2238A	6050A	M5
BM1020CB	802	M5	KT4060R	45002R	M5	LED2000-4A	3050A	M4	MB2500	10729	M5	SE2238R	60283R	M5
BM1020CG	790	M5	KTL1224A	15033Y	M5	LED2000-4R	3050	M4	MB4000	40720	M5	SE2238R	6050	M5
BM1020R	15728	M5	KTL1225R	15033R	M5	LED2000-9A	3050A	M4	MB4060	45720	M5	SE2238W	6060C	M5
BM1020RB	15733	M4	KTL4040R	44357R	M5	LED2000-9R	3050	M4	ML2030A-CB	2675A	M5	SE2238W	60284C	M5
BM1020RG	15733	M5	KTL4040RSS	44351R	M5	LED2040A	2660A	M5	ML2030R-CB	2675	M5	SE2500A	1050A	M5
BM1021CB	15408	M5	KTL4041A	44024Y	M5	LED2040R	2660	M5	ML2040A	2660A	M5	SE2500R	1050	M5
BM1021CG	15406	M5	KTL4041R	44363R	M4	LED2237A	6050A	M4	ML2040R	2660	M5	SE4000A	40282Y	M5
BM1040B	19721	M5	KTL4042A	44023Y	M5	LED2238-13R	6050	M4	ML7250A	1075A	M5	SE4000A	4050A	M5
BM1040BB	19726	M5	KTL4042R	44363R	M4	LED2238-27A	6050A	M4	ML7250R	1075	M5	SE4000C	40203	M5
BM1040BC	19739	M5	KTL4045A	44023Y	M4	LED2238-63A	6050A	M4	PT6020	94902	M5	SE4000R	40282R	M5
BM2238-1	60722	M5	KTL4045R	44357R	M4	LED2238-63R	6050	M4	PT6020-3	93943	M5	SE4000R	4050	M5
CL3500A	1155A	M5	KTL4050RSS	44357R	M4	LED2500-12A	1050A	M5	PT9180	94926	M5	SE4000W	4060C	M5
CL3500R	1155	M5	KTL4060ASS	44023Y	M4	LED2500-12R	1050	M5	PT9181	94840	M5	SE4000W	40204	M5
CL3501A	1155A	M5	KTR2238A	60015Y	M5	LED2500-4A	1050A	M5	PT9530	94993	M5	SE4060A	4550A	M5
CL3501R	1155	M5	LB1020R	1508R	M5	LED2500-4R	1050	M5	RF1421A	98003Y	M5	SE4060A	45202Y	M5
FM4202RA	2750	M5	LB1030A	35740Y	M4	LED4000-19C	4060C	M4	RF1421R	98003R	M5	SE4060R	4550	M5
FM5203RA	2753	M5	LB1030R	35740R	M4	LED4000-56A	4050A	M4	RF2001A	45A	M5	SE4060R	45202R	M5
FM5403RA	2753	M5	LB1225R	15741R	M5	LED4000-56R	4050	M5	RF2001R	45	M5	SR2238A	60215Y	M5
GR1225	15702	M5	LB2000R	30740R	M5	LED4000-56R	44351R	M5	RF2012A	45A	M5	SR2238R	60215R	M5
GR2000	30700	M5	LB2000RSS	30742R	M5	LED4000-61A	4050A	M4	RF2012R	45	M5	SR2500A	1052A	M5
GR2001	30702	M5	LB2040R	1215	M4	LED4000-61R	4050	M5	RF2421A	54A	M5	SR2500R	1052	M5
GR2238	60700	M5	LB2500R	10744R	M5	LED4000A	4050A	M5	RF2421R	54	M5	SR4000R	40285R	M5
GR2239	60704	M5	LB2500RSS	10745R	M5	LED4040-56R	44363R	M5	RF3001A	47A	M5	SW2238A	60283Y	M5
GR2500	10713	M5	LB7250R	26741R	M4	LED4040-61R	44363R	M5	RF3001R	47	M5	SW2238C	60284C	M5
GR2501	10714	M5	LBL1225R	1560	M5	LED4040A	44223Y	M4	RF3012A	98006Y	M5	TL6400	5060	M5
GR2502	10708	M5	LBL2000R	3050	M5	LED4060-60A	45251Y	M5	RF3012R	98006R	M5			
GR2504	10700	M5	LED0750A	35001Y	M5	LED4060-60R	45258R	M5	RF3022A	41A	M5			
GR4000	40700	M5	LED0750R	35001R	M5	LED4060A	45251Y	M5	RF3022R	41	M5			
GR4060	45700	M5	LED1040-12A	1960A	M5	LED7000A	91243Y	M5	RF3023A	41A	M5			
KT3207	30404	M5	LED1040-12R	1960	M5	LED7000R	91244R	M5	RF3023R	41	M5			
KT3257	10414	M5	LED1040-6A	1960A	M5	LED7007A	91241Y	M5	SE1040A	1960A	M5			
KT3260A	60083Y	M5	LED1040-6R	1960	M5	LED7007R	91244R	M5	SE1040R	1960	M5			

## VELVEC

VELVEC PART#	TRUCK-LITE PART #	MATCH LEVEL	VELVEC PART#	TRUCK-LITE PART #	MATCH LEVEL	VELVEC PART#	TRUCK-LITE PART #	MATCH LEVEL	VELVEC PART#	TRUCK-LITE PART #	MATCH LEVEL	VELVEC PART#	TRUCK-LITE PART #	MATCH LEVEL
700064	97843	M5	708005	97861	M5	708470	97872	M5	708521	97802	M5	723047	97828	M5
704068	97733	M5	708008	97866	M5	708471	97802	M5	708525	97837	M5	723065	97990	M5
704093	97674	M5	708020	97637	M5	708474	97611	M5	708526	97836	M5	723080	97718	M5
704095	97848	M5	708022	97861	M5	708476	97621	M5	709002	97805	M5	723083	97868	M5
704159	97675	M5	708046	97866	M5	708477	97622	M5	709004	97660	M5	748216	97869	M5
705038	97627	M5	708211	97840	M5	708478	97819	M5	709218	97863	M5	704040-5	97848	M5
705050	97860	M5	708212	97840	M5	708479	97820	M5	709276	97660	M5	704152-5	97672	M5
705102	97812	M5	708331	97827	M5	708501	97803	M5	712479	97681	M5	704153-5	97670	M5
705104	97811	M5	708441	97803	M5	708502	97814	M5	712643	97862	M5			
705105	97806	M5	708442	97804	M5	708503	97804	M5	713120	97665	M5			
705107	97632	M5	708444	97814	M5	708508	97815	M5	713121	97664	M5			
705332	97837	M5	708448	97606	M5	708509	97817	M5	713444	97686	M5			
705333	97822	M5	708449	97831	M5	708510	97816	M5	713445	97829	M5			
705334	97635	M5	708457	97614	M5	708515	97819	M5	714620	97688	M5			
708001	97636	M5	708467	97618	M5	708516	97820	M5	714721	97687	M5			
708003	97637	M5	708468	97619	M5	708520	97872	M5	721090	97846	M5			

Additional crosses are available online within the advanced catalog search section.

**VSM**

VSM PART#	TRUCK-LITE PART #	MATCH LEVEL	VSM PART#	TRUCK-LITE PART #	MATCH LEVEL	VSM PART#	TRUCK-LITE PART #	MATCH LEVEL	VSM PART#	TRUCK-LITE PART #	MATCH LEVEL	VSM PART#	TRUCK-LITE PART #	MATCH LEVEL
VSM1010	1050	M5	VSM1045A	3075A	M5	VSM1900	1960	M5	VSM2803	2750	M5	VSM4801	2753	M5
VSM1011	1051	M5	VSM1050	1075	M5	VSM1905AX	1960A	M5	VSM3074	2751	M5	VSM6064	6050	M5
VSM1015AX	1050A	M5	VSM1055	1075	M5	VSM1905X	1960	M5	VSM3704A	2751A	M5	VSM6464	6050	M5
VSM1015X	1050	M5	VSM1055A	1075A	M5	VSM2101	2150	M5	VSM3812	2750	M5	VSM64644	6050	M5
VSM1030	3050	M5	VSM1203	2660	M5	VSM2105	2150	M5	VSM4064	4050	M5	VSM6464rc	6051	M5
VSM1035AX	3050A	M5	VSM1255AX	2660A	M5	VSM2105A	2150A	M5	VSM4464	4050	M5			
VSM1035X	3050	M5	VSM1255X	2660	M5	VSM2311	2150	M5	VSM44644	4050	M5			
VSM1040	3075	M5	VSM1500	1560	M5	VSM2702	2751	M5	VSM4464rc	4051	M5			
VSM1045	3075	M5	VSM1505X	1560	M5	VSM2702A	2751A	M5	VSM4564	4550	M5			

**WAGNER**

WAGNER PART#	TRUCK-LITE PART #	MATCH LEVEL	WAGNER PART#	TRUCK-LITE PART #	MATCH LEVEL	WAGNER PART#	TRUCK-LITE PART #	MATCH LEVEL	WAGNER PART#	TRUCK-LITE PART #	MATCH LEVEL	WAGNER PART#	TRUCK-LITE PART #	MATCH LEVEL
795	80564	M5	7216	270	M5	7410	256	M5	1255/H1	80563	M5	852/5X	242	M5
7210	250	M5	7220	282	M5	7410	286	M5	1255/H3	80571	M5			
7210	262	M5	7310	263	M5	7410	97201	M5	2470/H2	80561	M5			
7210	97231	M5	7316	275	M5	7510	245	M5	795X	80564	M5			
7212	97210	M5	7320	283	M5	1210/H3	80560	M5	850/5X	243	M5			

**WHELEN**

WHELEN PART#	TRUCK-LITE PART #	MATCH LEVEL	WHELEN PART#	TRUCK-LITE PART #	MATCH LEVEL	WHELEN PART#	TRUCK-LITE PART #	MATCH LEVEL	WHELEN PART#	TRUCK-LITE PART #	MATCH LEVEL	WHELEN PART#	TRUCK-LITE PART #	MATCH LEVEL
21	92565Y	M5	2004BLAM	6600MA	M5	5020-0000-10	99171R	M5	68-3182182-20099227B		M5	EXT5	92847	M5
02-0363445-00	92833	M5	2012BHAM	6601MA	M5	5020-0000-20	99171Y	M5	68-3182182-30099227C		M5	H50ASN12	60-50124	M5
1000-1100-20	90325Y	M5	2012BLAM	6600MA	M5	5025-0000-00	26724	M5	68-3182182-50099227R		M5	MIRRORMT	92833	M5
1002-0000-20	99167Y	M5	2015BHAM	6601MA	M5	5050-1400-10	26354R	M5	68-3182183-10099226Y		M5	MKC29S	92687Y	M5
1003-0000-10	99168R	M5	2015BLAM	6810MA	M5	5050-1400-20	26354Y	M5	68-3182183-20099226R		M5	RB6PAM	6823A	M5
1003-0000-20	99168Y	M5	2022BHAM	6811MA	M5	68-1141474-10A99224Y		M5	68-3182183-30099226C		M5	S225CC	92844	M5
1004-0000-10	99169R	M5	2022BLAM	6810MA	M5	68-1983816-10	99228Y	M5	68-3182183-50099226B		M5	S30HACP	92846	M5
1004-0000-20	99169Y	M5	212650-02	92565Y	M4	68-1983817-10	99230Y	M5	7000-0000-01	97223	M5	S660CCCC	92845	M5
1010-1120-10	90327R	M5	212660-02	92565Y	M4	68-1983817-20	99230B	M5	8004-0000-30	99172	M5	SLPMAA	92585	M5
1010-1120-20	90327Y	M5	5000-1400-10	26353R	M5	68-1983817-30	99230C	M5	8005-1000-30	81350	M5	STPKT54S	92841	M5
1020-1100-10	90326R	M5	5000-1400-20	26353Y	M5	68-1983817-50	99230R	M5	9M148000	92687Y	M5	STPKT55S	92842	M5
1020-1100-20	90326Y	M5	5002-0000-10	99170R	M5	68-2141859-10E99218Y		M5	9M2LAA	92687Y	M5	VB247AAA	92685Y	M5
2004BHAM	6601MA	M5	5002-0000-20	99170Y	M5	68-3182182-10099227Y		M5	9MCPAA	99229Y	M5	VB447AAA	92684Y	M5



Truck-Lite Part No.	Page No.	Truck-Lite Part No.	Page No.	Truck-Lite Part No.	Page No.
L48SM	278	60-25121	163	285	195
L4HEADER	278	60-25123	163	286	196
P340	277	60-27121	163	300A	145
P440	277	60-27123	162	301A	145
00790	256	60-35121	162	307A	145
00791	256	60-50121	162	307B	145
00792	256	60-50123	162	307R	145
00793	256	60-50124	162	320	205
00794	89	88-2101	163	320-4	205
00801	254	88-2126	163	328D	205
00802	256	88-43210	163	329D	205
00809	256	92WD	99	425WD	94
00814	252	102	199	426W	94
04115	110	125	134	433WD	111
04116	110	131	199	434WD	111
07080	137	172	196	435W	94
07098	137	173	196	530DK	25
31DB	186	182	196	533DK	24
31ADB	186	183	196	534D	24
32	186	190	134	535D	24
32A	186	191	134	537A	197
37	183	192	134	540D	21
41	187	194	134	541	21
41A	187	195	134	550	196
43	188	242	195	610W	122
43A	188	243	195	612W	122
45	188	245	192	613W	122
45A	188	250	198	620W	119
47	188	256	198	627WD	122
47DB	188	258-4	198	628WD	122
47A	188	262	196	629WD	122
47ADB	188	263	196	630W	120
50	244	263-4	196	631W	120
52	189	264	197	632W	120
52A	189	266	197	633W	120
54	186	270	195	637W	122
54A	186	275	195	794	184
57	189	276	195	797	184
57A	189	282	196	798	184
60-20123	163	283	196	800	184

Truck-Lite Part No.	Page No.	Truck-Lite Part No.	Page No.	Truck-Lite Part No.	Page No.
900	201	1215	89	2660A	76
901	201	1216	89	2661	76
902	201	1216A	89	2661A	76
905	201	1222	78	2671	80
910	200	1222A	78	2671A	80
955	48	1233	78	2674	77
956AA	48	1233A	78	2674A	77
957AA	48	1259	78	2675	80
1001D	80	1259A	78	2675A	80
1001AD	80	1264	78	2701	46
1050	60	1264A	78	2701A	46
1050A	60	1312A	84	2702	46
1051	60	1319	85	2702A	46
1051A	60	1319A	85	2750	44
1052	60	1320AD	84	2751	44
1052A	60	1350A	85	2751A	44
1053	60	1506W	111	2752	50
1053A	60	1506	79	2753	50
1058	60	1506A	79	2756	50
1058A	60	1506W	79	2758	49
1070	60	1507	78	2759	49
1070A	60	1507A	78	2801	44
1071	60	1520HT	79	2803	44
1071A	60	1520AHT	79	3050	64
1075	82	1560	68	3050A	64
1075A	82	1560A	68	3051	64
1076	82	1561	68	3051A	64
1076A	82	1561A	68	3053	64
1150	138	1570	80	3053A	64
1150A	138	1570A	80	3058	64
1155	138	1924	134	3058A	64
1155A	138	1960	70	3070	64
1203	77	1960A	70	3070A	64
1203A	77	1961	70	3071	64
1203G	77	1961A	70	3071A	64
1211	77	2150	72	3075	83
1211A	77	2150A	72	3075A	83
1211W	77	2152	72	3076	83
1213	77	2152A	72	3076A	83
1213A	77	2660	76	3550	67

Truck-Lite Part No.	Page No.	Truck-Lite Part No.	Page No.	Truck-Lite Part No.	Page No.
3550A	67	4058	10	5073	22
3612	21	4060C	97	5220	233
3613W	21	4063C	97	5315Y101	24
3616	21	4091	42	5316Y101	24
3693W	96	4091A	42	5800AA	47
3701	46	4093	43	5800AAK	47
3753D	46	4093A	43	6050	16
3753AD	46	4094SW	111	6050A	16
3754D	46	4094	42	6051	16
3755D	46	4094A	42	6051A	16
3755A	46	4095	43	6053A	41
3756D	46	4095A	43	6053	16
3762	46	4097A	47	6058A	41
3802	44	4550	14	6058	18
3805Y115	44	4550A	14	6060C	100
3810	44	4558A	42	6063C	100
3812	44	4558	14	620W4	119
3850	45	4560C	14	630W4	120
3850AA	45	4742	49	6500	137
3853AA	45	4754	49	6500A	137
3854	45	4800	50	6501	137
3860	45	4801	50	6501A	137
3861	45	4805AAY115	50	6502	137
3862	45	4805AY116	50	6503	137
3863	45	4805AY117	50	6503A	137
4015	23	4805AAY118	50	6600R	144
4016	23	4810	49	6600W	144
4017	23	4842	49	6600A	144
4018	23	4854	48	6600MA	144
4023	23	4855	48	6601B	144
4024	23	4872AA	48	6601R	144
4027	22	4874AY101	49	6601W	144
4028	23	5050DK	24	6601A	144
4050	9	5051DK	24	6601MA	144
4050A	9	5052AD	24	6602PS	158
4051	9	5055D	24	6660PS	158
4051A	9	5056D	24	6810B	144
4053A	40	5070	22	6810R	144
4053	9	5071	22	6810W	144
4058A	40	5072	22	6810A	144

Truck-Lite Part No.	Page No.	Truck-Lite Part No.	Page No.	Truck-Lite Part No.	Page No.
6811B	144	8840	163	9040	266
6811R	144	8850	163	9040A	266
6811A	144	8861	265	9041	266
6811MA	144	8861A	265	9041A	266
6822A	146	8909	265	9049	266
6823A	146	8925A	265	9057	266
7038	178	8933	265	9057A	266
7039	178	8933A	265	9059	266
7044D	178	8935W	265	9059A	266
7044DB	178	8936	265	9063	267
7048D	178	8936A	265	9063A	267
7048DB	178	8938	265	9069A	267
07082C	137	8938A	265	9071	267
7217	169	8943	265	9072	267
7218	169	8943A	265	9073A	267
7223	176	8945	265	9076W	267
7224	176	8945A	265	9077	267
7268	176	8951W	265	9077A	267
7269	176	8952W	265	9079	267
7460	173	8960	265	9079A	267
7555	170	8974	265	9080A	267
7557	170	9004	266	9081A	267
7575	170	9004A	266	9082	267
7973D	170	9005W	266	9083	267
8010	108	9006	266	9084A	268
8013	104	9006A	266	9087A	268
8140	117	9007	266	9093	268
8150	116	9007A	266	9093A	268
8155	116	9007G	266	9093G	268
8160	116	9007W	266	9101	218
8170	116	9016	266	9102	218
8180	117	9016A	266	9179	259
8192	117	9016B	266	9180	266
8193	117	9016G	266	9180	267
8370A	151	9016W	266	9183	197
8370W	151	9021	266	9185	134
8810	163	9021A	266	9186	197
8812	162	9021W	266	9291	119
8820	163	9029	266	9341	268
8830	163	9029W	266	9341A	268

Truck-Lite Part No.	Page No.	Truck-Lite Part No.	Page No.	Truck-Lite Part No.	Page No.
9372	268	10079R	58	10271Y	60
9372A	268	10079Y	58	10275R	58
9373W	268	10085R	58	10275Y	58
9380SW	108	10085Y	58	10276R	82
9380W	108	10086R	59	10276Y	82
9384A	268	10086Y	59	10279R	58
9410BL	244	10089R	59	10279Y	58
9414BL	244	10089Y	59	10286R	59
9415BL	244	10090R	58	10286Y	59
9465	218	10090Y	58	10288R	59
9469	218	10091R	59	10288Y	59
9470	218	10091Y	59	10289R	59
9522	265	10092R	59	10289Y	59
9523	266	10092Y	59	10375R	58
9523	267	10133	247	10375Y	58
9536	28	10136	247	10379R	58
9537	28	10202C	109	10379Y	58
9674	162	10202R	61	10385R	59
9676	268	10202Y	61	10385Y	59
9680A	159	10202B	61	10389R	59
9702	162	10202C	61	10389Y	59
9719A	268	10202G	61	10391R	59
9720B	268	10203R	82	10391Y	59
9720	268	10203Y	82	10400	250
9720W	268	10204C	109	10401	249
9723A	268	10204R	61	10402	249
9930	155	10204Y	61	10403	249
9940	155	10205R	61	10404	250
9944	151	10205Y	61	10410	251
10004R	250	10208R	61	10412	251
10028R	61	10208Y	61	10413	251
10028Y	61	10209C	109	10414	251
10050R	60	10212Y	61	10519R	61
10050Y	60	10213Y	61	10519Y	61
10051R	60	10250R	60	10520Y	251
10051Y	60	10250Y	60	10525R	61
10075R	58	10251R	60	10525Y	61
10075Y	58	10251Y	60	10700	249
10076R	59	10256R	60	10702	249
10076Y	59	10256Y	60	10704	250



Truck-Lite Part No.	Page No.	Truck-Lite Part No.	Page No.	Truck-Lite Part No.	Page No.
10706	250	15033R	69	15418	69
10708	249	15033Y	69	15506R	69
10713	249	15040	92	15506Y	69
10714	249	15041	92	15702	257
10715	249	15042	92	15720	257
10718	249	15043	92	15727	257
10719	249	15050R	88	15728	257
10720	250	15050Y	88	15729	92
10721	251	15053	92	15730	92
10722	251	15054	92	15731	256
10724	251	15055	92	15732	92
10725	251	15058	92	15733	257
10727	251	15059	92	15736	264
10728	251	15061	92	15741R	88
10729	252	15200C	109	15745R	88
10730	252	15200R	68	15745Y	88
10731	251	15200Y	68	15905	92
10732	252	15201R	68	17001	94
10738	250	15201Y	68	17002	94
10740	249	15203Y	68	17003	94
10744R	89	15205	92	17200	94
10745R	89	15208	93	17720	264
12001R	75	15209	93	18011R	66
12001Y	75	15226	92	18011Y	66
12003R	75	15227	92	18011C	66
12003Y	75	15250R	68	18050R	66
12200R	75	15250Y	68	18050Y	66
12200Y	75	15401	257	18060R	66
12200C	75	15404	256	18060Y	66
12201Y	75	15405	256	18070R	66
12275R	75	15406	256	18070Y	66
12275Y	75	15407	256	18090R	66
14200R	79	15408	256	18090Y	66
14200Y	79	15409	256	18300R	66
15006Y	69	15412	257	18300Y	66
15008R	69	15413	257	19002R	71
15008Y	69	15414	257	19002Y	71
15011	92	15415	69	19006R	71
15012	92	15416	69	19006Y	71
15013	92	15417	69	19009R	71

Truck-Lite Part No.	Page No.	Truck-Lite Part No.	Page No.	Truck-Lite Part No.	Page No.
19009Y	71	20302	111	21501Y	73
19020R	71	20304Y	43	21506R	73
19020Y	71	20308	111	21720	73
19031R	71	20309Y	43	21721	73
19031Y	71	20310Y	43	21722	73
19032R	71	20316Y	43	21880R	72
19032Y	71	21001R	73	21880Y	72
19036R	71	21001Y	73	22002R	37
19036Y	71	21002R	73	22002Y	37
19037Y	71	21002Y	73	22004R	37
19200C	110	21004C	94	22004Y	37
19200R	71	21051R	72	22006R	37
19200Y	71	21051Y	72	22006Y	37
19205Y	71	21056R	72	22202R	37
19206	93	21056Y	72	22202Y	37
19250R	70	21075R	72	25250R	81
19250Y	70	21075Y	72	25250Y	81
19251R	70	21080R	72	25750Y	81
19251Y	70	21080Y	72	25760Y	84
19275R	70	21090Y	74	25761Y	85
19275Y	70	21094Y	74	25765Y	81
19350R	70	21095Y	74	25766Y	81
19350Y	70	21096Y	74	26001	110
19375R	70	21200R	73	26002	259
19375Y	70	21200Y	73	26250R	76
19680A	159	21201R	73	26250Y	76
19720	258	21201Y	73	26251R	76
19721	258	21204C	94	26251Y	76
19722	258	21205R	73	26270R	76
19723	258	21205Y	73	26270Y	76
19724	258	21210Y	73	26310R	79
19726	258	21251R	72	26310Y	79
19728	258	21251Y	72	26311R	80
19729	258	21253Y	72	26311Y	80
19737	258	21256R	72	26312R	79
19738	258	21256Y	72	26312Y	79
19739	258	21271R	53	26313R	80
19740	258	21275R	72	26313Y	80
19750	258	21275Y	72	26315R	78
20301Y	43	21501R	73	26315Y	78

Truck-Lite Part No.	Page No.	Truck-Lite Part No.	Page No.	Truck-Lite Part No.	Page No.
26330	95	29203Y	74	30221R	65
26331	95	29204C	94	30221Y	65
26335	95	30001R	253	30222R	65
26336	95	30001Y	253	30222Y	65
26353R	139	30050R	64	30225R	65
26353Y	139	30050Y	64	30225Y	65
26354R	138	30051R	64	30230Y	65
26354Y	138	30051Y	64	30250R	64
26392C	111	30055R	64	30250Y	64
26393C	111	30055Y	64	30251R	64
26394C	111	30070R	63	30251Y	64
26723	139	30070Y	63	30255R	64
26740R	88	30071R	63	30255Y	64
26741R	88	30071Y	63	30257Y	65
26760Y	83	30075R	63	30264Y	63
26762Y	82	30075Y	63	30269Y	63
26765R	84	30080R	63	30270R	63
26765Y	84	30080Y	63	30270Y	63
27003	132	30085R	63	30271Y	64
27004	132	30085Y	63	30272R	63
27009	132	30086R	62	30272Y	63
27010	132	30086Y	62	30275R	63
27011	132	30090Y	63	30275Y	63
27012	132	30091R	62	30276R	83
27270C	129	30091Y	62	30276Y	83
27275C	129	30133	247	30277R	63
27290C	130	30136	247	30277Y	63
27291C	130	30200C	109	30279R	63
27450C	129	30200R	65	30279Y	63
27490C	130	30200Y	65	30281Y	63
27491C	130	30200B	65	30282Y	63
27640C	131	30200G	65	30285R	62
27645C	131	30201R	83	30285Y	62
29002R	74	30201Y	83	30286R	153
29002Y	74	30204R	65	30286Y	153
29003R	74	30204Y	65	30288R	62
29003Y	74	30206C	109	30288Y	62
29202R	74	30206R	65	30289R	62
29202Y	74	30206Y	65	30289Y	62
29203R	74	30206B	65	30375R	63

Truck-Lite Part No.	Page No.	Truck-Lite Part No.	Page No.	Truck-Lite Part No.	Page No.
30375Y	63	33051R	57	33250Y	57
30379R	63	33051Y	57	33260B	105
30379Y	63	33061G	105	33260C	105
30385R	62	33061PR	105	33260G	105
30385Y	62	33061R	105	33260R	105
30386R	62	33062B	105	33260Y	105
30386Y	62	33062C	105	33260B	105
30391Y	62	33062G	105	33260C	105
30400	253	33062PR	105	33260G	105
30401	253	33062R	105	33260R	105
30402	253	33062Y	105	33260Y	105
30403	254	33065B	105	33265B	105
30404	254	33065C	105	33265C	105
30405	255	33065G	105	33265G	105
30410	255	33065PR	105	33265R	105
30503R	65	33065R	105	33265Y	105
30503Y	65	33065Y	105	33275R	247
30504R	255	33066C	105	33275Y	247
30504Y	255	33066G	105	33275R	57
30700	253	33066PR	105	33275Y	57
30701	254	33066R	105	33277Y	57
30702	253	33066Y	105	33285R	247
30704	253	33067C	105	33285Y	247
30708	253	33067G	105	33285R	57
30712	253	33067R	105	33285Y	57
30713	253	33067Y	105	33700	248
30715	253	33075R	57	33702	248
30720	253	33075Y	57	33705	248
30721	254	33080Y	57	33711	248
30722	255	33080R	57	33712	248
30727	254	33203R	87	33715	248
30728	255	33204R	87	33720	248
30729	254	33205R	87	33725	248
30730	255	33206R	87	33740R	87
30731	255	33207R	87	33741R	87
30740R	89	33208R	87	33751R	87
30742R	89	33210C	92	33800	248
33010C	92	33250R	247	33810	248
33050R	57	33250Y	247	35001R	67
33050Y	57	33250R	57	35001Y	67

Truck-Lite Part No.	Page No.	Truck-Lite Part No.	Page No.	Truck-Lite Part No.	Page No.
35033R	86	36203R	86	40229R	13
35034R	86	36203Y	86	40232R	11
35035R	86	36705	247	40233R	11
35036R	86	36710	93	40233Y	11
35075R	67	36711	93	40241R	34
35075Y	67	40002R	11	40241Y	34
35080R	67	40002Y	11	40242R	11
35080Y	67	40003	107	40242Y	11
35200R	67	40004	98	40244	96
35200Y	67	40006R	12	40247R	53
35201R	67	40009R	11	40248R	11
35201Y	67	40009Y	11	40258R	11
35375R	67	40011	107	40258Y	11
35375Y	67	40012	98	40259R	11
35720	259	40015R	11	40260	96
35722	259	40023	107	40261	96
35740R	89	40024	98	40262	98
35740Y	89	40028R	13	40270C	106
35741R	89	40028Y	13	40271C	106
35741Y	89	40029R	13	40275C	106
35880R	67	40041Y	34	40282R	13
35880Y	67	40044	96	40282Y	13
35890R	67	40071	98	40285R	13
35890Y	67	40201Y	35	40302R	13
36100R	56	40202R	11	40302Y	13
36100Y	56	40202Y	11	40306	98
36105R	247	40203	107	40403	260
36105Y	247	40204	98	40626	28
36105R	56	40206C	98	40627	28
36105Y	56	40206R	12	40637	28
36110R	56	40206Y	12	40638	28
36110Y	56	40207	110	40680	261
36115R	247	40209R	11	40681	261
36115Y	247	40209Y	11	40700	260
36115R	56	40211	107	40701	260
36115Y	56	40212	98	40702	260
36130R	56	40215R	11	40703	260
36130Y	56	40223	107	40715	261
36140C	93	40224	98	40719	260
36145C	93	40227	107	40720	260



Truck-Lite Part No.	Page No.	Truck-Lite Part No.	Page No.	Truck-Lite Part No.	Page No.
40725	261	44021Y	34	44216Y	158
40726	260	44022R	6	44217Y	152
40742	29	44023Y	10	44218Y	152
40743	29	44024Y	10	44221Y	34
40746	29	44026R	6	44222R	6
40747	29	44027Y	34	44223Y	10
40748	29	44030R	6	44224Y	10
40749	29	44032R	6	44226R	6
40754	29	44034R	8	44227Y	34
40755	29	44036R	6	44231Y	34
40756	28	44038R	6	44233Y	10
40757	28	44042C	107	44237C	107
40758	26	44046C	107	44248Y	152
40759	26	44071Y	10	44249Y	152
40762	27	44092R	6	44253R	6
40763	27	44101R	152	44266R	6
40790	26	44101Y	152	44273Y	34
40791	26	44102R	152	44276Y	34
40802	37	44102Y	152	44280Y	32
40803	37	44103Y	152	44281Y	32
40804	37	44104Y	152	44283Y	32
40805	37	44110Y	152	44285Y	32
40808	26	44114Y	152	44286Y	32
40809	26	44180C	97	44287Y	32
40812	37	44181C	97	44289Y	32
40819	260	44182C	97	44291Y	33
40830	37	44184C	97	44292Y	33
40850	27	44201Y	34	44293Y	33
40894	27	44202R	6	44294Y	33
41005R	21	44203Y	10	44295Y	33
41006R	21	44207C	107	44302R	6
41007R	21	44211R	152	44308C	106
41008R	21	44211Y	152	44322R	6
41202R	21	44212R	152	44326R	6
41203R	21	44212Y	152	44328R	6
42722	264	44213R	152	44334R	8
44001Y	34	44213Y	152	44339C	106
44002R	6	44214R	152	44344C	97
44003Y	10	44214Y	152	44345C	97
44018Y	34	44216R	158	44346C	97

Truck-Lite Part No.	Page No.	Truck-Lite Part No.	Page No.	Truck-Lite Part No.	Page No.
44347C	97	44986R	6	49203C	98
44348C	97	44988R	6	50060	235
44349C	97	44990C	97	50061	235
44350C	97	44991C	97	50103 0036	229
44350R	7	44992C	97	50106 0072	229
44351R	7	45001Y	35	50109 0108	229
44353R	7	45002R	15	50112 0144	229
44355R	7	45002Y	15	50115 0180	229
44356R	7	45004	15	50118 0216	229
44359R	7	45021Y	51	50121 0252	229
44360R	7	45022R	51	50124 0288	229
44362R	7	45024	51	50127 0324	229
44363R	7	45032R	51	50130 0360	229
44365R	7	45051Y	35	50133	229
44367R	7	45058R	14	50136 0432	229
44438C	106	45063Y	35	50139 0468	229
44439C	106	45073Y	51	50142 0504	229
44700	260	45201R	35	50145 0540	229
44701	260	45201Y	35	50148 0576	229
44705	260	45202R	15	50151	229
44708	260	45202Y	15	50154 0648	229
44709	260	45204	35	50157 0684	229
44710	260	45204	15	50160 0720	229
44710	8	45207R	52	50163 0756	229
44808	26	45251Y	35	50200	230
44809	26	45258R	14	50201	230
44871Y	10	45259R	14	50202	230
44877Y	10	45263Y	35	50203	230
44878Y	10	45435	25	50204	230
44881Y	34	45436	25	50205	230
44882R	6	45700	261	50208	230
44883R	6	45701	261	50208-0060	233
44887Y	34	45720	261	50209	230
44888Y	34	45721	261	50209-0060	233
44957R	7	45740	25	50210	230
44960R	7	45741	25	50211	230
44972R	7	45742	25	50230	231
44980R	7	45743	25	50231	231
44982R	6	49002R	12	50240	230
44983R	6	49202R	12	50241	230

Truck-Lite Part No.	Page No.	Truck-Lite Part No.	Page No.	Truck-Lite Part No.	Page No.
50242	231	50356	232	50807	236
50243	231	50357	232	50808	236
50250	230	50367	232	50809	236
50251	230	50368	232	50812	235
50266	229	50373	231	50816	235
50267	229	50374	231	50820	235
50300	231	50375	231	50822	236
50301	231	50376	231	50830	234
50301-0216	233	50377	228	50830	235
50302	232	50377	228	50831	259
50303	231	50377	228	50832	234
50304	231	50377	231	50840	233
50305	231	50381	232	50840	233
50307	231	50382	224	50840	234
50307	233	50382	232	50840	234
50308	232	50383	224	50841	233
50309	228	50383	232	50841	233
50309	228	50384	224	50841	234
50309	228	50384	232	50841	234
50309	231	50385	224	50842	233
50309	233	50385	232	50842	233
50309	233	50388	232	50842	234
50310	231	50400	233	50842	234
50319	232	50400	233	50843	234
50321	223	50400	235	50843	234
50322	223	50401	235	50845	235
50324	231	50600	234	50846	233
50331	223	50601	234	50846	234
50334	231	50606	234	50846	234
50335	232	50607	234	50847	234
50338	229	50608	234	50847	234
50341	232	50609	234	50850	235
50342	229	50706-0072	233	50860	236
50343	229	50733-0396	233	50861	236
50344	229	50751-0612	233	50863	236
50344-0336	233	50776	221	50865	236
50345	229	50800	235	50866	236
50345-0336	233	50801	235	50867	236
50350	223	50805	236	50868	237
50351	231	50806	236	50869	237

Truck-Lite Part No.	Page No.	Truck-Lite Part No.	Page No.	Truck-Lite Part No.	Page No.
50872	237	52100	230	60002R	18
50875	236	52100	233	60002Y	18
50875	237	52100-0396	233	60004C	100
50875	238	52200	223	60007R	18
50878	238	52200	228	60007Y	18
50879	238	52200	228	60013R	52
50882	237	52200	228	60015R	35
50883	237	52200	233	60015Y	35
50885	239	52203	223	60021R	51
50886	238	52203	228	60022Y	51
50887	239	52203	228	60023R	51
50888	238	52203	228	60024Y	51
50889	243	52703 0036	229	60050R	17
50890	237	52706 0072	229	60052R	17
50892	237	52709 0108	229	60056R	17
50894	243	52712 0144	229	60060R	51
50895	243	52715 0180	229	60061R	52
50896	238	52718 0216	229	60062R	52
50899	243	52721 0252	229	60072Y	38
50969	221	52724 0288	229	60074Y	51
51270	230	52727 0324	229	60075Y	38
51271	230	52730 0360	229	60080Y	38
51305	224	52733	229	60082Y	38
51325	229	52736 0432	229	60083R	19
51342	226	52739 0468	229	60083Y	19
51342	228	52742 0504	229	60085R	17
51342	228	52745 0540	229	60092C	101
51343	226	52748 0576	229	60094Y	17
51343	228	52751	229	60096Y	17
51343	228	52754 0648	229	60097Y	17
51344	229	52757 0684	229	60115Y	35
51345	229	52760 0720	229	60117Y	35
51355	226	52763 0756	229	60120R	153
51355	228	55554	25	60120Y	153
51355	228	55597	154	60122R	153
51356	226	55598	154	60122Y	153
51356	228	55650	276	60124R	153
51356	228	55653	276	60124Y	153
51375	223	60001R	38	60126R	153
51409	227	60001Y	38	60126Y	153

Truck-Lite Part No.	Page No.	Truck-Lite Part No.	Page No.	Truck-Lite Part No.	Page No.
60180R	51	60340R	19	60738	263
60180Y	51	60340Y	19	60872Y	38
60201R	38	60344R	39	60885R	17
60201Y	38	60344Y	39	60891Y	38
60202R	18	60345C	101	60892Y	17
60202Y	18	60354C	126	66050R	15
60204C	100	60356R	17	66052R	15
60207R	18	60360R	153	66056R	15
60207Y	18	60360Y	153	66096Y	15
60213R	52	60362R	153	66205C	99
60215R	35	60362Y	153	66206C	99
60215Y	35	60364R	153	66250R	15
60216Y	35	60364Y	153	66252R	15
60217Y	35	60366R	153	66254R	15
60250R	17	60366Y	153	66256R	15
60252R	17	60403	262	66369R	15
60253R	17	60420Y	39	66404C	99
60255Y	38	60421Y	39	66882R	15
60256R	17	60422Y	39	66885R	15
60260R	52	60423Y	39	69003C	101
60262R	52	60424Y	39	69202Y	37
60264R	17	60424R	42	69203C	101
60266R	52	60425Y	39	70300	45
60272Y	38	60700	262	70310R	47
60275Y	38	60703	262	70311	47
60276Y	38	60704	262	70330R	45
60280Y	38	60705	262	70330Y	45
60282Y	38	60708	262	70352	47
60283R	19	60718	262	70353	47
60283Y	19	60719	262	70356	47
60284C	101	60720	263	70357	47
60286Y	38	60722	263	77825	244
60290Y	17	60723	263	77825	235
60291Y	17	60724	263	80162C	139
60292Y	17	60728	263	80162C	109
60298Y	17	60729	263	80164C	139
60302R	19	60730	262	80164C	109
60302Y	19	60731	262	80166C	109
60315Y	35	60733	263	80220	123
60317Y	35	60737	263	80240	123



Truck-Lite Part No.	Page No.	Truck-Lite Part No.	Page No.	Truck-Lite Part No.	Page No.
80251C	103	80492	121	81290	114
80255C	103	80493	121	81295	114
80275	122	80494	121	81300Y	42
80302R	20	80498	121	81331	49
80302Y	20	80513	133	81335C	123
80304	20	80514	133	81350	139
80322R	22	80519	133	81360	114
80324R	22	80520	133	81365	114
80334R	20	80521	133	81371	114
80335R	20	80522	133	81374	114
80336R	20	80525	133	81380	114
80339R	20	80526	133	81385	114
80340	99	80527	133	81390	114
80342	96	80560	134	81391	114
80344	96	80561	134	81395	114
80345	96	80563	134	81500	115
80350	108	80564	134	81510	115
80351	108	80571	134	81520	115
80352	108	80593	134	81560	116
80353	108	80594	199	81701	114
80360	118	80594	134	81702	114
80361	118	80596	134	81704	114
80364	120	80720	264	81711	114
80368	120	80722	264	81712	114
80373	120	80800	128	81714	114
80374	118	80805	128	84200C	102
80375	119	80875	125	84200C	102
80378	118	80880	125	84201C	102
80388	121	80888	128	84205C	102
80389	121	80893	126	84205C	102
80394	121	80900	127	84210C	102
80395	121	80988	124	84210C	102
80396	121	80989	124	84215C	102
80397	121	80990	124	84215C	102
80418	104	81240	114	87357	223
80423C	110	81245	114	87358	223
80427	108	81250	114	87845	236
80438	118	81255	114	88100	223
80444	104	81260	118	88100-0120	228
80491	121	81270	114	88300	224

Truck-Lite Part No.	Page No.	Truck-Lite Part No.	Page No.	Truck-Lite Part No.	Page No.
88300	228	88820	220	91250	200
88301	224	88892	220	91250	202
88301	228	88896	220	91250	202
88301	228	88900	219	91250	202
88303	223	88902	219	91315R	136
88303	228	88905	221	92100	53
88303	228	88910	222	92101	53
88303	228	88911	222	92513Y	145
88307	223	88911	228	92513C	145
88307	228	88911	228	92516Y	143
88307	228	88911	228	92522Y	148
88307	228	88915	222	92523Y	148
88307	228	88930	222	92524Y	148
88307	228	88931	222	92524B	148
88307	228	88931	228	92524R	148
88308	225	88931	228	92525Y	148
88338	225	88931	228	92525B	148
88342	227	88932	222	92525R	148
88367	225	88962	221	92530Y	146
88367	228	89217	225	92530C	146
88368	225	89274	226	92531Y	146
88368	228	89286	226	92534C	145
88368	228	89751	220	92534Y	145
88372	225	89810	221	92539Y	145
88373	224	90251Y103	202	92545	162
88373	228	90325Y	137	92546	162
88373	228	90326R	136	92550Y	156
88373	228	90326Y	136	92551Y	156
88377	224	90327R	136	92552Y	156
88401	227	90327Y	136	92553Y	156
88601	219	91002	200	92554Y	157
88701	219	91002R	135	92556Y	157
88703	219	91002Y	135	92557Y	157
88703	228	91150	200	92560	146
88703	228	91202R	135	92561	268
88703-0420	228	91202Y	135	92562	162
88703-0624	228	91241Y	135	92563	146
88750	219	91242R	135	92565Y	142
88751	219	91243Y	135	92565R	142
88810	219	91244R	135	92565C	142

Truck-Lite Part No.	Page No.	Truck-Lite Part No.	Page No.	Truck-Lite Part No.	Page No.
92565B	142	92869Y	159	93908	211
92566Y	142	92870Y	160	93913	212
92568Y	142	92870B	160	93943	211
92568R	142	92870C	160	94236	155
92568B	142	92870R	160	94247	155
92569Y	142	92871Y	161	94624	209
92592Y	143	92871B	161	94706	213
92600Y	147	92871C	161	94707	213
92602R	147	92871R	161	94718	209
92602Y	147	92872Y	161	94727	210
92642Y	148	92872B	161	94729	210
92644Y	148	92872C	161	94736	209
92645Y	148	92872R	161	94742	209
92646Y	148	92873R	161	94743	214
92668Y	149	92873Y	161	94750	215
92669Y	149	92874R	161	94751	216
92670Y	149	92874Y	161	94759	216
92671Y	149	92875R	161	94760	215
92672Y	149	92875Y	161	94766	213
92673Y	149	92876R	161	94768	213
92677Y	150	92876Y	161	94769	213
92695R	160	92900	204	94770	214
92695Y	160	92901	204	94789	216
92696R	160	92902	204	94802	214
92696Y	160	92903	205	94821	210
92711	162	92904	205	94837	217
92722	162	92905	205	94838	217
92725	162	92907	205	94839	215
92844	151	92909	203	94840	215
92845	151	92910	204	94841	215
92855	151	92911	204	94848	209
92860Y	144	92914	203	94850	209
92861Y	144	92916	203	94851	217
92862Y	144	92918	203	94853	215
92863Y	144	92923	204	94861	209
92864Y	143	92924	204	94862	209
92865Y	145	92925	205	94865	216
92866Y	148	92927	205	94868	216
92867Y	150	93745	209	94882	214
92868Y	159	93906	211	94888	209

Truck-Lite Part No.	Page No.	Truck-Lite Part No.	Page No.	Truck-Lite Part No.	Page No.
94892	211	95415	137	96927	235
94897	216	95415	217	96928	227
94898	211	95424	213	96930	210
94902	209	95450	212	96932	210
94909	209	95451	212	96934	210
94916	209	95452	212	96935	210
94919	209	95453	212	96936	210
94920	209	95454	212	96953	227
94922	213	95455	212	96954	227
94923	213	95456	212	96955	227
94924	210	95457	212	96959	227
94925	217	95460	211	96960	227
94926	214	95461	211	96966	227
94931	214	95462	211	96967	227
94932	215	95463	211	96968	227
94937	217	95464	211	96969	227
94938	215	95465	212	96970	227
94940	210	95466	212	96973	227
94948	216	95467	212	96974	227
94949	216	95500	216	96975	227
94954	194	95809	225	96978	227
94961	217	95846	132	96979	227
94962	214	95879	225	96989	211
94964	210	96106	218	96990	211
94972	209	96107	218	96992	211
94984	210	96108	218	96993	211
94991	217	96109	218	96995	211
94992	217	96189	277	96996	211
94993	214	96197	277	96999	211
95001	214	96198	277	97002	227
95002	213	96199	277	97003	205
95051	213	96256	245	97005	209
95224	212	96256	245	97006	209
95306	209	96259	245	97011	234
95332	210	96260	245	97020	277
95399	213	96511	237	97020B	277
95400	132	96512	237	97025	242
95407	137	96627	226	97029	277
95407	215	96904	210	97060	227
95410	209	96919	210	97061	227

Truck-Lite Part No.	Page No.	Truck-Lite Part No.	Page No.	Truck-Lite Part No.	Page No.
97062	227	97376	280	97653	177
97100	242	97377	280	97654	177
97101	242	97378	281	97655	177
97140	278	97379	281	97656	177
97141	278	97380	281	97657	177
97142	278	97381	281	97659	176
97151	239	97382	246	97660	178
97153	239	97383	281	97661	178
97158	239	97388	244	97662	178
97159	239	97388	235	97664	167
97160	239	97392	246	97665	167
97161	239	97405	281	97666	179
97201	194	97602	177	97669	167
97231	194	97603	177	97671	177
97232	194	97606	175	97673	177
97233	194	97609	176	97674	177
97235	193	97610	176	97676	177
97251	193	97611	174	97678	169
97253	193	97612	174	97680	169
97270	194	97614	175	97681	168
97271	194	97615	175	97682	169
97272	194	97618	174	97686	168
97283	198	97619	174	97687	168
97300	199	97621	174	97688	168
97302	199	97622	174	97693	166
97321	246	97623	174	97694	166
97322	246	97624	172	97695	166
97330	247	97625	172	97706	266
97331	247	97627	173	97718	182
97340	86	97628	173	97719	181
97342	86	97629	173	97720	180
97343	86	97630	173	97721	180
97344	86	97631	173	97722	180
97345	86	97632	173	97725	179
97349	86	97633	166	97726	179
97360	203	97635	172	97730	181
97361	203	97636	172	97731	181
97364	86	97637	172	97732	182
97365	86	97644	167	97733	182
97366	86	97650	172	97748	180



Truck-Lite Part No.	Page No.	Truck-Lite Part No.	Page No.	Truck-Lite Part No.	Page No.
97794	176	97869	180	98126	183
97799	244	97872	174	98127	183
97802	174	97876	181	98136	183
97803	175	97882	277	98137	183
97804	175	97912	235	98138	183
97805	178	97913	234	98144	183
97806	172	97920	277	98146	183
97807	177	97920B	277	98153	185
97808	172	97927	269	98154R	185
97809	171	97929	235	98155	185
97811	172	97933	235	98165	184
97812	173	97940	243	98167	184
97814	175	97943	243	98168	184
97815	175	97944	243	98170	184
97816	175	97948	243	98175R	185
97817	175	97956	219	98175RB	185
97819	174	97960	244	98175Y	185
97820	174	98003R	185	98175YB	185
97822	171	98003Y	185	98176R	185
97823	182	98004R	187	98176RB	185
97826	171	98004Y	187	98176Y	185
97827	171	98006C	189	98176YB	185
97828	181	98006R	189	99001R	269
97829	179	98006Y	189	99005R	269
97831	175	98013	243	99005C	269
97835	176	98031R	186	99007R	269
97837	171	98031Y	186	99008C	269
97840	171	98034R	186	99008R	269
97843	179	98034Y	186	99008Y	269
97845	182	98035R	187	99009Y	269
97846	167	98035Y	187	99010R	269
97847	177	98100	183	99010Y	269
97848	177	98101	183	99010C	269
97852	169	98102	183	99010B	269
97860	173	98104	183	99011R	269
97861	172	98105	183	99011Y	269
97862	167	98107	183	99011B	269
97863	175	98108	183	99012R	269
97865	178	98111	183	99012Y	269
97866	172	98113	183	99021R	269

Truck-Lite Part No.	Page No.	Truck-Lite Part No.	Page No.	Truck-Lite Part No.	Page No.
99021Y	269	99168R	271	900Y206	202
99034Y	269	99168Y	271	915Y103	202
99039R	269	99168C	271	915Y104	202
99039Y	269	99169R	271	915Y114	202
99041R	269	99169Y	271	915Y116	202
99041Y	269	99170R	271	915Y117	202
99043R	269	99170Y	271	915Y119	202
99043Y	269	99171R	271	915Y119	202
99050R	270	99171Y	271	915Y124	202
99050Y	270	99172	272	915Y128	202
99051R	270	99176C	272	960Y100	202
99051Y	270	99184R	272	960Y101	202
99066Y	270	99184Y	272	960Y101	202
99067Y	270	99184C	272	961Y100	202
99082R	270	99193Y	272	962Y100	202
99087R	270	99200C	272	962Y101	202
99087Y	270	99200R	272	962Y102	202
99088C	270	99200Y	272	962Y102	202
99090R	270	99203Y	272	963Y100	202
99090Y	270	99208C	272	964Y100	202
99095C	270	99209C	272	97682	169
99120B	270	99220B	272	97686	168
99120C	270	99220R	272	97687	168
99120R	270	99220W	272	97688	168
99126R	270	99220Y	272	97693	166
99127R	270	99221B	272	97694	166
99145R	270	99221R	272	97695	166
99145B	270	99221W	272	97706	266
99145Y	270	99221Y	272	97718	182
99147B	271	99250B	272	97719	181
99147Y	271	99250C	272	97720	180
99148Y	271	99250B	272	97721	180
99148B	271	99252Y	272	97722	180
99151R	271	550307	233	97725	179
99151B	271	900Y114	202	97726	179
99152	271	900Y179	202	97730	181
99160Y	271	900Y179	202	97731	181
99165Y	271	900Y180	202	97732	182
99165C	271	900Y180	202	97733	182
99167Y	271	900Y205	202	97748	180

Learn more about emergency and warning lighting we have.