



CERTIFIED • OEM QUALITY • RELIABILITY

2019



WATER PUMPS



US Motor Works has combined the strength of a technologically orientated manufacturer, superior sales and service organization and a sophisticated global distribution network to keep the company on the forefront of the automotive marketplace.

With the focus of providing Automotive and Heavy-Duty engine parts and components, US Motor Works is constantly looking for ways to support its customers by increasing the availability of quality parts and components. Currently, US Motor Works manufactures a complete line of water pumps, fuel pumps and fan clutches. In addition to our traditional Automotive and Heavy-Duty market, US Motor Works has merged with Derale Performance and Pacer Performance to expand our manufacturing and quality assurance to the High Performance industry.

Precision Engineering and manufacturing are essential in creating products that you can depend on. At US Motor Works, quality begins with skilled technicians utilizing materials that meet or exceed OEM specifications to manufacture premium water pumps, fuel pumps and fan clutches. Our specially trained technicians apply stringent quality control standards utilizing sophisticated technology to make sure that all US Motor Works products meet the rigorous demands of our customers. When you buy US Motor Works manufactured items, you are investing in technology that has been meticulously engineered, manufactured from the highest quality materials and thoroughly tested to assure accuracy, reliability and workmanship.

With more than 50 years of combined experience, we are committed to providing an extensive line of high quality products, the finest customer service and the best support program available in the automotive, high performance and heavy-duty market. Our 99.05% fill rate is proof we're on the right track.



Fan Clutches
Water Pumps
Fuel Pumps
Max Cooling Kits
Timing Kit w/ Water
Pumps

Heavy-Duty
Water Pumps
Oil Pumps
Universal Fuel Pumps
Fuel Lift Pumps & Solenoids
Viscous Fan Clutches

H.O. Electric Fans
Belt Driven Fans
Fluid Coolers
Transmission Cooling Pans
Fluid Filtration
HP Fuel Pumps

Jeep Bumpers & Nerfbars
Hi-Five Cab Roof Lights
Flexy Flare®
Rubber Fender Extenders
Custom L.E.D. Lights



A Certified ISO 9001:2015 Company



US Motor works, LLC and its employees are committed to providing an extensive line of consistent High Quality Products, the finest Customer Service and Satisfaction, through our commitment to the continual improvement of our Quality Management System of ISO 9001:2015.

OPEX: Operational Excellence

US Motor Works adoption of OPEX is a business philosophy aimed to achieve a sustainable competitive advantage. Operational Excellence focuses on the customer's needs. By leadership, teamwork and problem solving principles, US Motor Works achieves continuous improvement, empowered employees, optimized activities and processes.

Implementation of this philosophy is built on 'Lean Manufacturing' principles designed to achieve:

- World-class quality
- Maximum productivity
- Reliable delivery to the customer
- Competitive pricing

Lean Manufacturing is the foundation of the Operational Excellence implementation program to create maximum value for your customers. It builds an integrated product delivery process to meet the changing needs of customers while creating a fundamental and sustainable change in organizational culture.

Lean Manufacturing has helped us achieve:

- Substantial response time and lead time reduction with best in class On Time Delivery rate
- Significant quality improvement, and overall cost reduction,
- Constant innovation embedded as part of the day to day work at all organizational levels
- A permanent, on-going cultural change that delivers Continuous Improvement on a daily basis, with collaboration, commitment and partnership among all of the organization's employees



TABLE OF CONTENTS



WATER PUMPS

Water Pumps 3 - 244

Application Guide..... 5

Buyers Guide 135 - 190

Cross Reference..... 191 - 200

Identification Guide..... 201 - 244

ISO 9001:2015 Certification 247

US Motor Works Timeline 248

All Manufacturers names, numbers, symbols and descriptions are used for reference purposes only, and in no way does it imply that any parts listed in this catalog are the products of these manufacturers.



WATER PUMPS

WATER PUMPS

Full line of Import and Domestic water pumps

- Case hardened bearings
- Precision CNC machined surfaces
- The leader in metal impeller integration
- All gaskets included

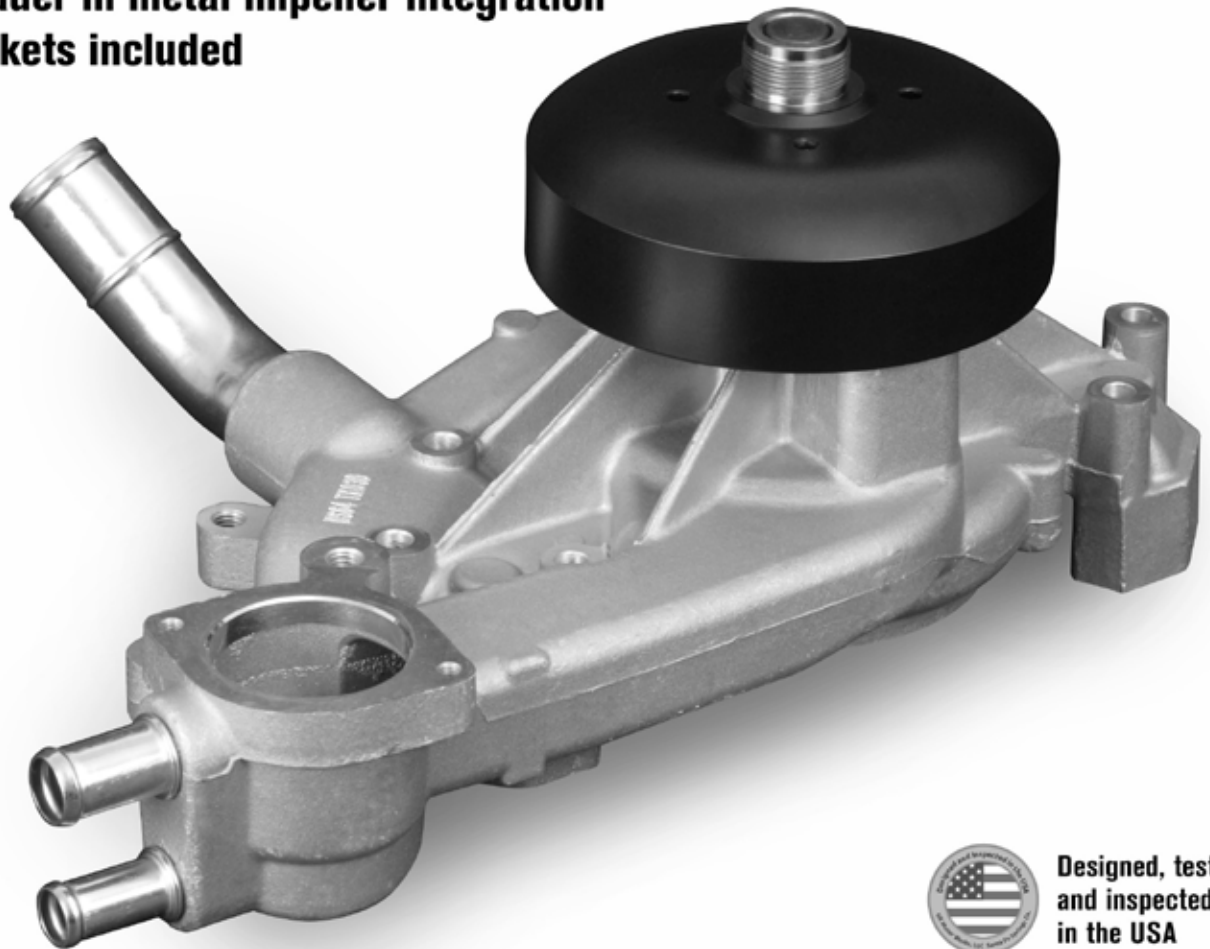

Designed, tested
and inspected
in the USA





WATER PUMPS

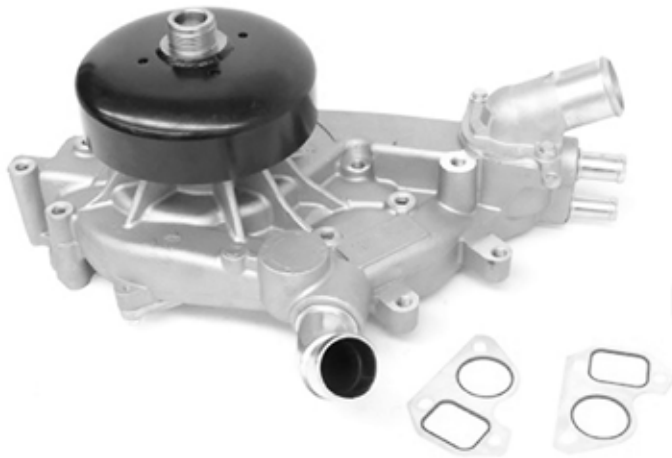

Benefits of case hardened bearings

- Long life
- High load capacity
- Tough on the outside and flexible on the inside
- Can better withstand an imbalance or vibration in the cooling system



Benefits of precision CNC machined surfaces

- Guaranteed fitment with mating components
- Inspected and tested to ISO9001:2015 standards
- Prevents leaks



Benefits of metal impellers

- Withstands high temperatures
- Withstands chemicals
- Performs at high RPMs
- Will not deform
- Withstands high torque forces
- Will not shatter
- Will not crack during press fit
- Highly durable
- Better for transits and storage
- Withstands variables in high mileage engines



Engine	Years	Application Description	USMW	Engine	Years	Application Description	USMW
ACURA				ACURA (cont'd.)			
CL				TL (cont'd.)			
2.2L L4 2156cc	1997	Base, Premium	US9209	3.2L V6 3210cc	2002-2003	Base, Type-S	US9383
2.3L L4 2254cc	1998	Base, Premium	US9209	3.2L V6 3210cc	2004-2008	Base	US9470
2.3L L4 2254cc	1999	Premium	US9209	3.5L V6 3471cc	2007-2008	Type-S	US9470
3.0L V6 2997cc	1997-1998	Base, Premium	US9383	3.5L V6 3471cc	2009-2014	Base	US9470
3.0L V6 2997cc	1999	Premium	US9383	3.7L V6 3664cc	2009-2014	SH-AWD	US9470
3.2L V6 3210cc	2001	Premium, Type-S	US9383	TLX			
3.2L V6 3210cc	2002-2003	Base, Type-S	US9383	2.4L L4 2354cc 144 CID	2015-2017	Base	US8103
ILX				3.5L V6 3471cc	2015-2017	Base, SH-AWD	US9470
1.5L L4 1497cc	2013-2014	Hybrid	US8144	TSX			
2.0L L4 1997cc 122 CID	2013-2015	Base	US8112	2.4L L4 2354cc 144 CID	2004	Base	US9461
2.4L L4 2354cc 144 CID	2013-2015	Base	US6213	2.4L L4 2354cc 144 CID	2005	Base; From Engine 2035526	US9461
2.4L L4 2354cc 144 CID	2016-2017	Base	US8103	2.4L L4 2354cc 144 CID	2005	Base; To Engine 2035525	US9461
INTEGRA				2.4L L4 2354cc 144 CID	2006-2008	Base	US9461
1.6L L4 1590cc	1986	LS, RS	US9115	2.4L L4 2354cc 144 CID	2009-2011	Base	US6233
1.6L L4 1590cc	1987-1988	LS, LS Special Edition, RS	US9115	2.4L L4 2354cc 144 CID	2012-2014	Base, Special Edition	US6233
1.6L L4 1590cc	1989	LS, RS	US9115	3.5L V6 3471cc	2010-2014	V6	US9470
1.7L L4 1678cc	1992-1993	GS-R	US9321	VIGOR			
1.8L L4 1797cc	1994-1995	GS-R	US9289	2.5L L5 2451cc	1992-1994	GS, LS	US9253
1.8L L4 1797cc	1996	GS-R	US9468	ZDX			
1.8L L4 1797cc	1997-1998	GS-R, Type R	US9468	3.7L V6 3664cc	2010-2013	Base	US9470
1.8L L4 1797cc	1999	GS-R	US9468	AMERICAN MOTORS			
1.8L L4 1797cc	2000-2001	GS-R, Type R	US9468	ALLIANCE			
1.8L L4 1834cc	1990-1993	GS, LS, RS	US9224	1.7L L4 1700cc 104 CID	1984-1986	Mexican Application	US8914
1.8L L4 1834cc	1994	LS, RS	US9224	AMERICAN			
1.8L L4 1834cc	1995	LS, RS, Special Edition	US9224	3.3L L6 3300cc 199 CID	1969-1970	Mexican Application	US843
1.8L L4 1834cc	1996	LS, RS, Special Edition	US9349	3.8L L6 3800cc 232 CID	1969-1973	Mexican Application	US843
1.8L L4 1834cc	1997-1998	GS, LS, RS	US9349	3.8L L6 3800cc 232 CID	1974	Mexican Application	US986
1.8L L4 1834cc	1999-2001	GS, LS	US9349	4.2L L6 4200cc 258 CID	1973-1974	Mexican Application	US986
LEGEND				4.2L L6 4200cc 258 CID	1978-1979	Mexican Application	US1077
2.5L V6 2494cc	1986	Base	US9097	4.2L L6 4200cc 258 CID	1980-1983	Mexican Application	US3403
2.5L V6 2494cc	1987	Base, L	US9097	4.6L L6 4600cc 282 CID	1975-1979	Mexican Application	US1077
2.7L V6 2675cc	1987-1990	Base, L, LS	US9097	4.6L L6 4600cc 282 CID	1980-1983	Mexican Application	US3403
3.2L V6 3206cc	1991-1992	Base, L, LS	US9218	AMX			
3.2L V6 3206cc	1993	L, LS	US9218	4.2L L6 258 CID	1978-1979		US1077
3.2L V6 3206cc	1993	Base, L, LS	US9288	4.2L L6 258 CID	1980	Base	US3403
3.2L V6 3206cc	1994	L, LS	US9288	4.2L L6 258 CID	1980	Base; Heater fitting required, V-Belt Drive	US3414
3.2L V6 3206cc	1994-1995	GS, L, LS	US9218	5.0L V8 304 CID	1978-1979		US3401
3.2L V6 3206cc	1995	L, LS, SE	US9288	5.0L V8 304 CID	1978-1979	High performance	US3401H
MDX				CLASSIC			
3.0L V6 2997cc	2017	Sport Hybrid	US9470	3.3L L6 3261cc 199 CID	1966		US843
3.5L V6 3471cc	2001-2002	Base, Touring	US9383	3.3L L6 3300cc 199 CID	1966-1970	Mexican Application	US843
3.5L V6 3471cc	2003-2006	Base, Touring	US9470	3.8L L6 3800cc 232 CID	1967-1973	Mexican Application	US843
3.5L V6 3471cc	2014-2017	Base, SH-AWD	US9470	3.8L L6 3800cc 232 CID	1974	Mexican Application	US986
3.7L V6 3664cc	2007-2013	Base	US9470	4.2L L6 4200cc 258 CID	1972	Mexican Application	US843
NSX				4.2L L6 4200cc 258 CID	1973-1974	Mexican Application	US986
3.0L V6 2977cc	1991-1994	Base	US9219	4.6L L6 4600cc 282 CID	1972	Mexican Application	US843
3.0L V6 2977cc	1995	Base, T; From Engine 5300249	US9219	4.6L L6 4600cc 282 CID	1973-1974	Mexican Application	US986
3.0L V6 2977cc	1995	Base, T; To Engine 5300248	US9219	4.6L L6 4600cc 282 CID	1975-1976	Mexican Application	US1077
3.0L V6 2977cc	1996-2001	Base, T	US9219	CONCORD			
3.0L V6 2977cc	2002-2003	T	US9219	2.0L L4 121 CID	1978-1979		US3400
3.0L V6 2977cc	2004-2005	Base	US9219	2.5L L4 151 CID	1980-1982	Base, DL, Limited	US1107
3.2L V6 3179cc	1997-1998	Base, T	US9219	3.8L L6 232 CID	1978-1979		US1077
3.2L V6 3179cc	1999	Alex Zanardi Edition, Base, T	US9219	4.2L L6 258 CID	1978-1979		US1077
3.2L V6 3179cc	2000-2001	Base, T	US9219	4.2L L6 258 CID	1980	Base, DL, Limited	US3403
3.2L V6 3179cc	2002-2003	T	US9219	4.2L L6 258 CID	1980-1983	Base, DL, Limited; Heater fitting required, V-Belt Drive	US3414
3.2L V6 3179cc	2004-2005	Base	US9219	4.2L L6 258 CID	1981-1983	Base, DL, Limited; V-Belt Drive	US3403
RDX				4.2L L6 258 CID	1981-1983	Base, DL, Limited; Serpentine Belt Drive	US3404
2.3L L4 2300cc	2007-2009	Base	US6223	5.0L V8 304 CID	1978-1979		US3401
2.3L L4 2300cc	2010-2012	Base, SH-AWD	US6223	5.0L V8 304 CID	1978-1979	High performance	US3401H
3.5L V6 3471cc	2013-2017	Base	US9470	EAGLE			
RL				2.5L L4 150 CID	1983	Base, DL SX4, Limited, SX4; V-Belt Drive	US3403
3.5L V6 3471cc	2005-2008	Base	US9470	2.5L L4 150 CID	1983	Base, DL SX4, Limited, SX4; Serpentine Belt Drive	US3404
3.5L V6 3475cc	1996-1997	Base, Premium	US9354	2.5L L4 150 CID	1983	Base, DL SX4, Limited, SX4; Heater fitting required, V-Belt Drive	US3414
3.5L V6 3475cc	1998	Base, Premium, SE	US9354	2.5L L4 150 CID	1984	Base, Limited; V-Belt Drive	US3403
3.5L V6 3475cc	1999-2004	Premium	US9354	2.5L L4 150 CID	1984	Base, Limited; Serpentine Belt Drive	US3413
3.7L V6 3664cc	2009-2012	Base	US9470	2.5L L4 150 CID	1984	Base, Limited; Heater fitting required, V-Belt Drive	US3414
RLX				2.5L L4 151 CID	1981-1982	Base, DL Kammback, DL SX4, Kammback, Limited, SX4	US1107
3.5L V6 3471cc	2014	Base, Sport Hybrid SH-AWD	US9470	2.5L L4 151 CID	1983	Base, DL SX4, Limited, SX4	US1107
3.5L V6 3471cc	2015	Base	US9470	4.2L L6 258 CID	1980	DL, Limited, Sport	US3403
3.5L V6 3471cc	2016-2017	Base, Sport Hybrid SH-AWD	US9470	4.2L L6 258 CID	1980	DL, Limited, Sport; Heater fitting required, V-Belt Drive	US3414
RSX				4.2L L6 258 CID	1981-1982	Base, DL Kammback, DL SX4, Kammback, Limited, SX4	US1107
2.0L L4 1998cc 122 CID	2002-2006	Type-S	US6703	2.5L L4 151 CID	1983	Base, DL SX4, Limited, SX4	US1107
2.0L L4 1998cc 122 CID	2002-2006	Base	US9434	4.2L L6 258 CID	1980	DL, Limited, Sport	US3403
SLX				4.2L L6 258 CID	1980	DL, Limited, Sport; Heater fitting required, V-Belt Drive	US3414
3.2L V6 3165cc	1996-1997	Base, Premium	US9278	4.2L L6 258 CID	1981-1982	Base, DL Kammback, DL SX4, Kammback, Limited, SX4; V-Belt Drive	US3403
3.5L V6 3494cc	1998-1999	Premium	US9365	WATER PUMPS			
TL							
2.5L L5 2451cc	1995-1998	Base, Premium	US9253				
3.2L V6 3206cc	1996-1998	Base, Premium	US9348				
3.2L V6 3210cc	1999-2001	Base	US9383				

Engine	Years	Application Description	USMW	Engine	Years	Application Description	USMW
AMERICAN MOTORS (cont'd.)				AM GENERAL			
EAGLE (cont'd.)				HUMMER			
4.2L L6 258 CID	1981-1982	Base, DL Kammback, DL SX4, Kammback, Limited, SX4; Serpentine Belt Drive	US3404	5.7L V8 350 CID	1995-1996	Base	US5049
4.2L L6 258 CID	1981-1982	Base, DL Kammback, DL SX4, Kammback, Limited, SX4; Heater fitting required, V-Belt Drive	US3414	5.7L V8 350 CID	1995-1996	Base; High performance	US5049H
4.2L L6 258 CID	1983	Base, DL SX4, Limited, SX4; V-Belt Drive	US3403	6.2L V8 379 CID	1992-1993	Base	US5008
4.2L L6 258 CID	1983	Base, DL SX4, Limited, SX4; Serpentine Belt Drive	US3404	6.5L V8 395 CID	1994-1995	Base	US5062
4.2L L6 258 CID	1983	Base, DL SX4, Limited, SX4; Heater fitting required, V-Belt Drive	US3414	6.5L V8 395 CID	1996	Base; (Y), Naturally Aspirated	US5062
4.2L L6 258 CID	1984-1987	Base, Limited; V-Belt Drive	US3403	6.5L V8 395 CID	1996	Base; (Z), Turbocharged	US5074
4.2L L6 258 CID	1984-1987	Base, Limited; Serpentine Belt Drive	US3413	6.5L V8 395 CID	1996-1998	Base; (Z), FI, Turbocharged	US5074
4.2L L6 258 CID	1984-1987	Base, Limited; Heater fitting required, V-Belt Drive	US3414	6.5L V8 395 CID	1997-1998	Base	US5074
4.2L L6 258 CID	1988	Base; V-Belt Drive	US3403	6.5L V8 395 CID	1997-1998	Base; (Y), FI, Naturally Aspirated	US5074
4.2L L6 258 CID	1988	Base; Serpentine Belt Drive	US3413	6.5L V8 395 CID	1999-2001	Base	US5086
4.2L L6 258 CID	1988	Base; Heater fitting required, V-Belt Drive	US3414	AUDI			
ENCORE				80			
1.7L L4 1700cc 104 CID	1985-1986	Mexican Application	US8914	2.0L L4 1983cc	1988-1990	Base	US9065
GREMLIN				2.0L L4 1983cc	1988-1990	Base; Includes back housing	US9065-2
2.0L L4 121 CID	1977-1978		US3400	2.3L L5 2309cc	1991-1992	Base	US9171
3.8L L6 232 CID	1975-1978		US1077	80 QUATTRO			
4.2L L6 258 CID	1975-1978		US1077	2.3L L5 2309cc	1988	Base; To Chassis/VIN 89-J-394 742	US9052
4.2L L6 4200cc 258 CID	1973-1974	Mexican Application	US986	2.3L L5 2309cc	1988	Base; From Chassis/VIN 89-J-394 743	US9171
4.2L L6 4200cc 258 CID	1975	Mexican Application	US1077	2.3L L5 2309cc	1989-1991	Base	US9171
4.2L L6 4200cc 258 CID	1979	Mexican Application	US1077	2.8L V6 2771cc	1993-1994	CS, S	US9263
4.2L L6 4200cc 258 CID	1980-1983	Mexican Application	US3403	2.8L V6 2771cc	1995	Base, Sport; To Chassis/VIN 8CS025820	US9263
4.2L L6 4228cc 258 CID	1974		US986	2.8L V6 2771cc	1995	Base, Sport; From Chassis/VIN 8CS025821	US9333
4.2L L6 4229cc 258 CID	1974		US986	90 QUATTRO			
4.6L L6 4600cc 282 CID	1979	Mexican Application	US1077	2.3L L5 2309cc	1988	Base; To Chassis/VIN 89-J-394 742	US9052
4.6L L6 4600cc 282 CID	1980-1983	Mexican Application	US3403	2.3L L5 2309cc	1988	Base; From Chassis/VIN 89-J-394 743	US9171
5.0L V8 304 CID	1975-1976		US3401	2.3L L5 2309cc	1989	Base	US9171
5.0L V8 304 CID	1975-1976	High performance	US3401H	2.3L L5 2309cc	1990-1991	20v	US9171
HORNET				2.8L V6 2771cc	1993-1994	CS	US9263
3.8L L6 232 CID	1975-1977		US1077	2.8L V6 2771cc	1995	Base, Sport	US9333
4.2L L6 258 CID	1975-1977		US1077	100			
5.0L V8 304 CID	1975-1977		US3401	2.3L L5 2309cc	1989	Base, E	US9171
5.0L V8 304 CID	1975-1977	High performance	US3401H	2.3L L5 2309cc	1990-1991	Base	US9171
JAVELIN				2.8L V6 2771cc	1992-1993	Base, CS, S	US9263
4.2L L6 4200cc 258 CID	1971-1973	Mexican Application	US986	2.8L V6 2771cc	1994	CS, S	US9263
4.6L L6 4600cc 282 CID	1968-1973	Mexican Application	US986	100 QUATTRO			
LERMA				2.3L L5 2309cc	1989-1991	Base	US9171
4.6L L6 4600cc 282 CID	1980-1983	Mexican Application	US3403	2.8L V6 2771cc	1992-1994	CS	US9263
MATADOR				200			
4.2L L6 258 CID	1975-1978		US1077	2.2L L5 2226cc	1989-1991	Base	US9171
5.0L V8 304 CID	1975-1977		US3401	200 QUATTRO			
5.0L V8 304 CID	1975-1977	High performance	US3401H	2.2L L5 2226cc	1989	Base; To Engine MC 039 950	US9052
5.9L V8 360 CID	1975-1978		US3401	2.2L L5 2226cc	1989	Base; From Engine MC 039 951	US9171
5.9L V8 360 CID	1975-1978	High performance	US3401H	2.2L L5 2226cc	1990	Base	US9171
6.6L V8 401 CID	1975-1976		US3401	2.2L L5 2226cc	1991	20v, 20v Avant, Avant, Base	US9171
6.6L V8 401 CID	1975-1976	High performance	US3401H	4000			
PACER				1.6L L4 1588cc 97 CID	1980	Base	US9066
3.8L L6 232 CID	1975-1978		US1077	1.6L L4 1588cc 97 CID	1982-1983	Base, S	US9065
4.2L L6 258 CID	1975-1979		US1077	1.6L L4 1588cc 97 CID	1982-1983	Base, S; Includes back housing	US9065-2
4.2L L6 258 CID	1980	DL, Limited	US3403	1.7L L4 1715cc	1981	Base; From Chassis/VIN 81-B-149 001	US9065
4.2L L6 258 CID	1980	DL, Limited; Heater fitting required, V-Belt Drive	US3414	1.7L L4 1715cc	1981	Base; From Chassis/VIN 81-B-149 001, Includes back housing	US9065-2
4.6L L6 4600cc 282 CID	1975-1979	Mexican Application	US1077	1.7L L4 1715cc	1981	Base; To Chassis/VIN 81-B-149 000	US9066
5.0L V8 304 CID	1978-1979		US3401	1.7L L4 1715cc	1982-1983	Base, GT, S	US9065
5.0L V8 304 CID	1978-1979	High performance	US3401H	1.7L L4 1715cc	1982-1983	Base, GT, S; Includes back housing	US9065-2
RALLY				1.8L L4 1780cc	1984-1987	S	US9065
4.2L L6 4200cc 258 CID	1981-1983	Mexican Application	US3403	1.8L L4 1780cc	1984-1987	S; Includes back housing	US9065-2
4.6L L6 4600cc 282 CID	1981-1983	Mexican Application	US3403	2.2L L5 2144cc	1980-1981	Base	US9052
SPIRIT				2.2L L5 2144cc	1982-1983	Base, GT, S	US9052
2.0L L4 121 CID	1979		US3400	4000 QUATTRO			
2.5L L4 151 CID	1980	Base, DL, Limited	US1107	2.2L L5 2226cc	1984-1985	S	US9052
2.5L L4 151 CID	1981-1982	Base, DL	US1107	2.2L L5 2226cc	1986-1987	CS	US9052
3.8L L6 232 CID	1979		US1077	5000			
4.2L L6 258 CID	1979		US1077	2.0L L5 1986cc	1979		US9071
4.2L L6 258 CID	1980	Base, DL, Limited	US3403	2.0L L5 1986cc	1980-1981	Base, S	US9071
4.2L L6 258 CID	1980	Base, DL, Limited; Heater fitting required, V-Belt Drive	US3414	2.0L L5 1986cc	1982-1983	Base	US9071
4.2L L6 258 CID	1981-1982	Base, DL; V-Belt Drive	US3403	2.2L L5 2144cc	1980	Base, S	US9052
4.2L L6 258 CID	1981-1982	Base, DL; Serpentine Belt Drive	US3404	2.2L L5 2144cc	1981-1983	Base, S, S Turbo	US9052
4.2L L6 258 CID	1981-1982	Base, DL; Heater fitting required, V-Belt Drive	US3414	2.2L L5 2144cc	1984	S, S Turbo	US9052
4.2L L6 258 CID	1983	DL, GT; V-Belt Drive	US3403	2.2L L5 2144cc	1985	CS Turbo, S Turbo	US9052
4.2L L6 258 CID	1983	DL, GT; Serpentine Belt Drive	US3404	2.2L L5 2226cc	1985	S	US9052
4.2L L6 258 CID	1983	DL, GT; Heater fitting required, V-Belt Drive	US3414	2.2L L5 2226cc	1986-1987	CS, S	US9052
				2.2L L5 2226cc	1988	CS	US9052

Engine	Years	Application Description	USMW	Engine	Years	Application Description	USMW
AUDI (cont'd.)				AUDI (cont'd.)			
5000 (cont'd.)				A4 (cont'd.)			
2.3L L5 2309cc	1987-1988	S	US9052	2.8L V6 2771cc	1998	Avant, Base	US9333
5000 QUATTRO				2.8L V6 2771cc	1999-2001	Base	US9333
2.2L L5 2226cc	1986-1988	CS	US9052	3.0L V6 2976cc	2002	Base	US9429
2.3L L5 2309cc	1987-1988	S	US9052	3.0L V6 2976cc	2003-2005	Base, Cabriolet	US9429
A1				3.2L V6 3123cc	2006-2008	Base	US6146
1.4L L4 1390cc 85 CID	2016	Mexican Application	US8952	3.2L V6 3200cc 195 CID	2010	Mexican Application	US6146
A3				A4 QUATTRO			
1.4L L4 1368cc 83 CID	2008-2009	Mexican Application	US8977	1.8L L4 1781cc	1997-1998	Base	US9401
1.4L L4 1390cc 85 CID	2013	Mexican Application	US8952	1.8L L4 1781cc	1999-2000	Avant, Base	US9401
1.4L L4 1395cc 85 CID	2016	Mexican Application	US8952	1.8L L4 1781cc	2001-2005	Avant, Base	US9377
1.8L L4 1754cc 107 CID	1999-2001	Mexican Application	US9377	2.0L L4 1984cc 121 CID	2005-2006	Avant, Base	US6022
1.8L L4 1781cc 108 CID	2002-2004	Mexican Application	US9377	2.0L L4 1984cc 121 CID	2007-2008	Avant, Base, Cabriolet	US6022
1.8L L4 1781cc 108 CID	2008-2010	Mexican Application	US9377	2.0L L4 1984cc 121 CID	2009	Cabriolet	US6022
2.0L H4 1984cc 121 CID	2006-2007	Mexican Application	US6022	2.0L L4 1984cc 121 CID	2009-2012	Avant, Base; Pump only	US9047
2.0L L4 1968cc 120 CID	2010-2013	TDI	US6034	2.0L L4 1984cc 121 CID	2009-2012	Avant, Base; With back plate housing	US9047-2
2.0L L4 1984cc 121 CID	2004-2005	Mexican Application	US9377	2.0L L4 1984cc 121 CID	2013	Base; From 05/15/2013, Pump only	US9047
2.0L L4 1984cc 121 CID	2006-2007	Base	US6022	2.0L L4 1984cc 121 CID	2013	Base; Pump only, To 05/15/2013	US9047
2.0L L4 1984cc 121 CID	2006-2008	Base	US11017	2.0L L4 1984cc 121 CID	2013	Base; From 05/15/2013, With back plate housing	US9047-2
2.0L L4 1984cc 121 CID	2008	Base; (BPY), (F)	US6022	2.0L L4 1984cc 121 CID	2013	Base; To 05/15/2013, With back plate housing	US9047-2
2.0L L4 1984cc 121 CID	2008-2009	Base; (CBFA); Pump only	US9047	2.0L L4 1984cc 121 CID	2013-2014	Base; Pump only	US9047
2.0L L4 1984cc 121 CID	2008-2009	Base; (CBFA); With back plate housing	US9047-2	2.0L L4 1984cc 121 CID	2013-2014	Base; With back plate housing	US9047-2
2.0L L4 1984cc 121 CID	2008-2011	Base; (CCTA); Pump only	US9047	2.0L L4 1984cc 121 CID	2014	Base; Includes back housing	US9047-2
2.0L L4 1984cc 121 CID	2008-2011	Base; (CCTA); With back plate housing	US9047-2	2.0L L4 1984cc 121 CID	2015	Premium, Premium Plus, Prestige; Pump only	US9047
2.0L L4 1984cc 121 CID	2008-2013	Base; Electric Water Pump	US11008	2.0L L4 1984cc 121 CID	2015	Premium, Premium Plus, Prestige; Includes back housing	US9047-2
2.0L L4 1984cc 121 CID	2010	Base; (CBFA); Pump only, To 05/17/2010	US9047	2.0L L4 1984cc 121 CID	2015	Premium, Premium Plus, Prestige; With back plate housing	US9047-2
2.0L L4 1984cc 121 CID	2010	Base; (CBFA); To 05/17/2010, With back plate housing	US9047-2	2.0L L4 1984cc 121 CID	2016	Premium, Premium Plus; Pump only	US9047
2.0L L4 1984cc 121 CID	2012	Base; (CCTA); From 06/01/2012, Pump only	US9047	2.0L L4 1984cc 121 CID	2016	Premium, Premium Plus; Includes back housing	US9047-2
2.0L L4 1984cc 121 CID	2012	Base; (CCTA); Pump only, To 06/01/2012	US9047	2.8L V6 2771cc	1996-1997	Base	US9333
2.0L L4 1984cc 121 CID	2012	Base; (CCTA); From 06/01/2012, With back plate housing	US9047-2	2.8L V6 2771cc	1998-2001	Avant, Base	US9333
2.0L L4 1984cc 121 CID	2012	Base; (CCTA); To 06/01/2012, With back plate housing	US9047-2	3.0L V6 2976cc	2002-2003	Avant, Base	US9429
2.0L L4 1984cc 121 CID	2012	Base; (CCTA); Pump only	US9047	3.0L V6 2976cc	2004-2005	Avant, Base, Cabriolet	US9429
2.0L L4 1984cc 121 CID	2013	Base; (CCTA); With back plate housing	US9047-2	3.0L V6 2976cc	2006	Cabriolet	US9429
2.0L L4 1984cc 122 CID	2005	Mexican Application	US9377	3.2L V6 3123cc	2005-2006	Avant, Base	US6146
3.2L V6 3189cc 195 CID	2004-2005	Mexican Application	US9471	3.2L V6 3123cc	2007-2008	Avant, Base, Cabriolet	US6146
A3 QUATTRO				3.2L V6 3123cc	2009	Cabriolet	US6146
2.0L L4 1984cc 121 CID	2009	Base; (CCTA); Pump only	US9047	3.2L V6 3123cc	2009	Base; From Chassis/VIN 8K-9-213 001	US6249
2.0L L4 1984cc 121 CID	2009	Base; (CCTA); With back plate housing	US9047-2	3.2L V6 3123cc	2009	Base; To Chassis/VIN 8K-9-213 000	US6249
2.0L L4 1984cc 121 CID	2009-2013	Electric Water Pump	US11008	A5			
2.0L L4 1984cc 121 CID	2010-2011	Base; Pump only	US9047	2.0L L4 1984cc 121 CID	2010-2014	Cabriolet; Pump only	US9047
2.0L L4 1984cc 121 CID	2010-2011	Base; With back plate housing	US9047-2	2.0L L4 1984cc 121 CID	2010-2014	Cabriolet; With back plate housing	US9047-2
2.0L L4 1984cc 121 CID	2012	Base; From 06/01/2012, Pump only	US9047	2.0L L4 1984cc 121 CID	2014	Cabriolet; Includes back housing	US9047-2
2.0L L4 1984cc 121 CID	2012	Base; Pump only, To 06/01/2012	US9047	3.2L V6 3200cc 195 CID	2008	Mexican Application	US9471
2.0L L4 1984cc 121 CID	2012	Base; From 06/01/2012, With back plate housing	US9047-2	A5 QUATTRO			
2.0L L4 1984cc 121 CID	2012	Base; To 06/01/2012, With back plate housing	US9047-2	2.0L L4 1984cc 121 CID	2010-2014	Base, Cabriolet; Pump only	US9047
2.0L L4 1984cc 121 CID	2013	Base; Pump only	US9047	2.0L L4 1984cc 121 CID	2010-2014	Base, Cabriolet; With back plate housing	US9047-2
2.0L L4 1984cc 121 CID	2013	Base; With back plate housing	US9047-2	2.0L L4 1984cc 121 CID	2014	Base, Cabriolet; Includes back housing	US9047-2
3.2L V6 3189cc 195 CID	2006-2009	Base	US9471	2.0L L4 1984cc 121 CID	2015	Premium, Premium Plus, Prestige; Pump only	US9047
3.2L V6 3189cc 195 CID	2006-2009	Base; Electric Water Pump	US11004	2.0L L4 1984cc 121 CID	2015	Premium, Premium Plus, Prestige; Includes back housing	US9047-2
A4				2.0L L4 1984cc 121 CID	2015	Premium, Premium Plus, Prestige; With back plate housing	US9047-2
1.8L L4 1781cc	1997-2000	Base	US9401	2.0L L4 1984cc 121 CID	2016	Premium, Premium Plus; Pump only	US9047
1.8L L4 1781cc	2001-2002	Base	US9377	2.0L L4 1984cc 121 CID	2016	Premium, Premium Plus; Includes back housing	US9047-2
1.8L L4 1781cc	2003-2005	Base, Cabriolet	US9377	2.0L L4 1984cc 121 CID	2017	Sport; Pump only	US9047
1.8L L4 1781cc	2006	Cabriolet	US9377	2.0L L4 1984cc 121 CID	2017	Sport; Includes back housing	US9047-2
1.8L L4 1781cc 108 CID	2007-2009	Mexican Application	US9377	3.2L V6 3123cc	2008	Base	US6249
2.0L L4 1984cc 121 CID	2005-2006	Base	US6022	3.2L V6 3123cc	2009	Base; From Chassis/VIN 8T-9-039 001	US6249
2.0L L4 1984cc 121 CID	2007-2008	Base, Cabriolet	US6022	3.2L V6 3123cc	2009	Base; To Chassis/VIN 8T-9-039 000	US6249
2.0L L4 1984cc 121 CID	2009	Cabriolet	US6022	3.2L V6 3123cc	2009-2010	Base; HVAC System	US11017
2.0L L4 1984cc 121 CID	2009-2012	Base; Pump only	US9047	3.2L V6 3123cc	2010	Base	US6249
2.0L L4 1984cc 121 CID	2009-2012	Base; With back plate housing	US9047-2	A6			
2.0L L4 1984cc 121 CID	2013	Base; From 05/15/2013, Pump only	US9047	2.0L L4 1984cc 121 CID	2012	Premium, Premium Plus; Pump only	US9047
2.0L L4 1984cc 121 CID	2013	Base; Pump only, To 05/15/2013	US9047	2.0L L4 1984cc 121 CID	2012	Premium, Premium Plus; With back plate housing	US9047-2
2.0L L4 1984cc 121 CID	2013	Base; From 05/15/2013, With back plate housing	US9047-2	2.0L L4 1984cc 121 CID	2013	Premium, Premium Plus; From 06/03/2012, Pump only	US9047
2.0L L4 1984cc 121 CID	2013	Base; To 05/15/2013, With back plate housing	US9047-2	2.0L L4 1984cc 121 CID	2013	Premium, Premium Plus; Pump only, To 06/03/2012	US9047
2.0L L4 1984cc 121 CID	2013	Base; Pump only	US9047	2.0L L4 1984cc 121 CID	2013	Premium, Premium Plus; From 06/03/2012, With back plate housing	US9047-2
2.0L L4 1984cc 121 CID	2014	Base; Includes back housing	US9047-2	2.0L L4 1984cc 121 CID	2013	Premium, Premium Plus; To 06/03/2012, With back plate housing	US9047-2
2.0L L4 1984cc 121 CID	2014	Base; With back plate housing	US9047-2	2.0L L4 1984cc 121 CID	2014-2015	Premium, Premium Plus; Pump only	US9047
2.0L L4 1984cc 121 CID	2015	Premium, Premium Plus, Prestige; Pump only	US9047	2.0L L4 1984cc 121 CID	2014-2015	Premium, Premium Plus; Includes back housing	US9047-2
2.0L L4 1984cc 121 CID	2015	Premium, Premium Plus, Prestige; Includes back housing	US9047-2	2.0L L4 1984cc 121 CID	2014-2015	Premium, Premium Plus; With back plate housing	US9047-2
2.0L L4 1984cc 121 CID	2015	Premium, Premium Plus, Prestige; With back plate housing	US9047-2	2.8L V6 2771cc	1995	Avant, Base; (A); To Chassis/VIN #4A-S-026 714	US9263
2.0L L4 1984cc 121 CID	2016	Premium, Premium Plus; Pump only	US9047				
2.0L L4 1984cc 121 CID	2016	Premium, Premium Plus; Includes back housing	US9047-2				
2.8L V6 2771cc	1996-1997	Base	US9333				

Engine	Years	Application Description	USMW	Engine	Years	Application Description	USMW
AUDI (cont'd.)				AUDI (cont'd.)			
A6 (cont'd.)				COUPE			
2.8L V6 2771cc	1995	Avant, Base; (C); To Chassis/VIN #4A-S-026 714	US9263	2.2L L5 2144cc	1981-1984	Base	US9052
2.8L V6 2771cc	1995	Avant, Base; To Chassis/VIN #4A-S-026 714	US9263	2.2L L5 2226cc	1984-1985	Base	US9052
2.8L V6 2771cc	1995	Avant, Base; (A); From Chassis/VIN #4A-S-026 715	US9333	2.2L L5 2226cc	1986-1987	GT	US9052
2.8L V6 2771cc	1995	Avant, Base; (C); From Chassis/VIN #4A-S-026 715	US9333	2.3L L5 2309cc	1987	GT	US9052
2.8L V6 2771cc	1995	Avant, Base; From Chassis/VIN #4A-S-026 715	US9333	COUPE QUATTRO			
2.8L V6 2771cc	1996-1997	Avant, Base	US9333	2.3L L5 2309cc	1990-1991	20v	US9171
2.8L V6 2771cc	1998-2001	Base	US9333	FOX			
2.8L V6 2773cc	2008-2009	Base	US9429	1.6L L4 1588cc 97 CID	1975-1979		US9066
3.0L V6 2976cc	2002-2004	Base	US9429	Q3			
3.0L V6 2976cc 182 CID	2005-2006	Mexican Application	US9429	2.0L L4 1984cc 121 CID	2015	Premium Plus, Prestige; With back plate housing	US9047-2
3.2L V6 3123cc	2006-2009	Base	US6146	2.0L L4 1984cc 121 CID	2015-2016	Premium Plus, Prestige; Pump only	US9047
3.2L V6 3123cc	2010	Base; From 06/10/2010	US6249	2.0L L4 1984cc 121 CID	2015-2016	Premium Plus, Prestige; Includes back housing	US9047-2
3.2L V6 3123cc	2010	Base; To 06/10/2010	US6249	2.0L L4 1984cc 121 CID	2017	Premium, Premium Plus, Prestige; Pump only	US9047
3.2L V6 3123cc	2011	Base	US6249	2.0L L4 1984cc 121 CID	2017	Premium, Premium Plus, Prestige; Includes back housing	US9047-2
A6 QUATTRO				Q3 QUATTRO			
2.0L L4 1984cc 121 CID	2013	Premium, Premium Plus; From 06/03/2012, Pump only	US9047	2.0L L4 1984cc 121 CID	2015	Premium Plus, Prestige; With back plate housing	US9047-2
2.0L L4 1984cc 121 CID	2013	Premium, Premium Plus; Pump only, To 06/03/2012	US9047	2.0L L4 1984cc 121 CID	2015-2016	Premium Plus, Prestige; Pump only	US9047
2.0L L4 1984cc 121 CID	2013	Premium, Premium Plus; From 06/03/2012, With back plate housing	US9047-2	2.0L L4 1984cc 121 CID	2015-2016	Premium Plus, Prestige; Includes back housing	US9047-2
2.0L L4 1984cc 121 CID	2013	Premium, Premium Plus; To 06/03/2012, With back plate housing	US9047-2	2.0L L4 1984cc 121 CID	2017	Premium, Premium Plus, Prestige; Pump only	US9047
2.0L L4 1984cc 121 CID	2014-2015	Premium, Premium Plus; Pump only	US9047	2.0L L4 1984cc 121 CID	2017	Premium, Premium Plus, Prestige; Includes back housing	US9047-2
2.0L L4 1984cc 121 CID	2014-2015	Premium, Premium Plus; Includes back housing	US9047-2	Q5			
2.0L L4 1984cc 121 CID	2014-2015	Premium, Premium Plus; With back plate housing	US9047-2	2.0L L4 1984cc 121 CID	2011-2012	Premium, Premium Plus; Pump only	US9047
2.7L V6 2671cc	2000-2002	Base; Electric Water Pump	US11003	2.0L L4 1984cc 121 CID	2011-2012	Premium, Premium Plus; With back plate housing	US9047-2
2.7L V6 2671cc	2000-2004	Base	US9446	2.0L L4 1984cc 121 CID	2013-2015	Hybrid Prestige, Premium, Premium Plus; With back plate housing	US9047-2
2.7L V6 2671cc	2003-2004	Base; Electric Water Pump	US11004	2.0L L4 1984cc 121 CID	2013-2016	Hybrid Prestige, Premium, Premium Plus; Pump only	US9047
2.8L V6 2771cc	1995	Avant, Base; To Chassis/VIN #4A-S-026 714	US9263	2.0L L4 1984cc 121 CID	2014-2016	Hybrid Prestige, Premium, Premium Plus; Includes back housing	US9047-2
2.8L V6 2771cc	1995	Avant, Base; From Chassis/VIN #4A-S-026 715	US9333	2.0L L4 1984cc 121 CID	2017	Premium, Premium Plus; Pump only	US9047
2.8L V6 2771cc	1996-2001	Avant, Base	US9333	2.0L L4 1984cc 121 CID	2017	Premium, Premium Plus; Includes back housing	US9047-2
3.0L V6 2976cc	2002-2004	Avant, Base	US9429	2.0L L4 1984cc 121 CID	2017	Premium, Premium Plus; Pump only	US9047
3.0L V6 2995cc	2009	Avant	US6146	2.0L L4 1984cc 121 CID	2017	Premium, Premium Plus; Includes back housing	US9047-2
3.0L V6 2995cc	2009	Base; From Chassis/VIN 4F-9-047 001	US6146	3.0L V6 2967cc 182 CID	2012	Mexican Application	US6146
3.0L V6 2995cc	2009	Base; To Chassis/VIN 4F-9-047 000	US6146	3.2L V6 3123cc	2009	Premium, Premium Plus, Prestige; From Chassis/VIN 8R-9-037 001	US6249
3.0L V6 2995cc	2010-2011	Avant, Base	US6146	3.2L V6 3123cc	2009	Premium, Premium Plus, Prestige; To Chassis/VIN 8R-9-037 000	US6249
3.2L V6 3123cc	2005	Base	US6146	3.2L V6 3123cc	2009-2010	Premium, Premium Plus, Prestige; HVAC System	US11017
3.2L V6 3123cc	2006-2008	Avant, Base	US6146	3.2L V6 3123cc	2010	Premium, Premium Plus, Prestige; From 06/10/2010	US6249
4.2L V8 4163cc	2005-2006	Base	US6000	3.2L V6 3123cc	2010	Premium, Premium Plus, Prestige; To 06/10/2010	US6249
4.2L V8 4163cc	2007-2011	Base	US6702	3.2L V6 3123cc	2011-2012	Premium Plus, Prestige	US6249
4.2L V8 4172cc	2000-2004	Base	US9410	3.2L V6 3123cc	2011-2012	Premium Plus, Prestige; HVAC System	US11017
A8				3.2L V6 3200cc 195 CID	2010-2012	Mexican Application	US6249
3.7L V8 3697cc	1997-1999	Base	US9362	Q7			
4.2L V8 4163cc 254 CID	2012	Mexican Application	US6702	3.0L V6 2967cc 181 CID	2009-2010	TDI	US6146
A8 QUATTRO				3.0L V6 2967cc 181 CID	2011-2012	TDI Premium, TDI Premium Plus, TDI Prestige	US6146
4.2L V8 4163cc	2007-2012	Base, L	US6702	3.0L V6 2967cc 182 CID	2008	Mexican Application	US9471
4.2L V8 4172cc	1997-1999	Base	US9362	3.0L V6 2967cc 182 CID	2011-2013	Mexican Application	US6146
4.2L V8 4172cc	2000-2003	Base, L	US9410	3.0L V6 2995cc	2011-2015	Premium, Premium Plus, Prestige	US6146
4.2L V8 4172cc	2004	L	US9410	3.6L V6 3597cc 219 CID	2007-2010	Base, Premium	US6221
4.2L V8 4172cc	2005-2006	Base, L	US9410	3.6L V6 3597cc 219 CID	2007-2010	Base, Premium; Electric Water Pump	US11004
6.0L W12 5998cc	2005-2009	L	US8111	4.2L V8 4163cc	2007	Base, Premium	US6702
ALLROAD				4.2L V8 4163cc	2008-2009	Premium	US6702
2.0L L4 1984cc 121 CID	2013-2015	Premium, Premium Plus, Prestige; Pump only	US9047	4.2L V8 4163cc	2010	Prestige	US6702
2.0L L4 1984cc 121 CID	2013-2015	Premium, Premium Plus, Prestige; With back plate housing	US9047-2	4.2L V8 4163cc 254 CID	2008-2009	Mexican Application	US9410
2.0L L4 1984cc 121 CID	2014-2015	Premium, Premium Plus, Prestige; Includes back housing	US9047-2	QUATTRO			
2.0L L4 1984cc 121 CID	2016	Premium, Premium Plus; Pump only	US9047	2.2L L5 2144cc	1983-1985	Base	US9052
2.0L L4 1984cc 121 CID	2016	Premium, Premium Plus; Includes back housing	US9047-2	R8			
ALLROAD QUATTRO				4.2L V8 4163cc	2008-2010	Base; Electric Water Pump	US11004
2.7L V6 2671cc	2001-2002	Base; Electric Water Pump	US11003	4.2L V8 4163cc	2011-2012	Base, Spyder; Electric Water Pump	US11004
2.7L V6 2671cc	2001-2005	Base	US9446	4.2L V8 4163cc	2014	Base, Spyder; Electric Water Pump	US11004
2.7L V6 2671cc	2003-2005	Base; Electric Water Pump	US11004	4.2L V8 4163cc	2014-2015	Base, Spyder	US6702
4.2L V8 4172cc	2004-2005	Base	US6000	4.2L V8 4163cc	2014-2015	Base	US6702
CABRIOLET				5.2L V10 5204cc	2010	Base; Electric Water Pump	US11004
2.8L V6 2771cc	1994	Base	US9263	5.2L V10 5204cc	2011	Base, Spyder; Electric Water Pump	US11004
2.8L V6 2771cc	1995	Base; (A); To Chassis/VIN 8G-S-001 302	US9263	5.2L V10 5204cc	2012	Base, GT, GT Spyder, Spyder; Electric Water Pump	US11004
2.8L V6 2771cc	1995	Base; (L); To Chassis/VIN 8G-S-001 302	US9263	5.2L V10 5204cc	2014	Base, Plus, Spyder; Electric Water Pump	US11004
2.8L V6 2771cc	1995	Base; (A); From Chassis/VIN 8G-S-001 303	US9333	RS4			
2.8L V6 2771cc	1995	Base; (L); From Chassis/VIN 8G-S-001 303	US9333	4.2L V8 4172cc	2007	Base	US6000
2.8L V6 2771cc	1996-1998	Base	US9333	4.2L V8 4172cc	2007	Base	US6702

Engine	Years	Application Description	USMW
AUDI (cont'd.)			
RS4 (cont'd.)			
4.2L V8 4172cc	2008	Base, Cabriolet	US6000
4.2L V8 4172cc	2008	Base, Cabriolet	US6702
RS5			
4.2L V8 4163cc 254 CID	2013	Base	US6702
4.2L V8 4163cc 254 CID	2014-2015	Base, Cabriolet	US6702
RS6			
4.2L V8 4172cc	2003	Base	US9410
RS6 QUATTRO			
4.2L V8 4179cc 255 CID	2004	Mexican Application	US9410
S3 QUATTRO			
1.8L L4 1754cc 107 CID	2000-2001	Mexican Application	US9377
1.8L L4 1781cc 108 CID	2002-2004	Mexican Application	US9377
2.0L L4 1998cc 122 CID	2008-2011	Mexican Application	US9377
S4			
2.2L L5 2226cc	1992-1994	Base	US9279
2.7L V6 2671cc	2000	Base	US9446
2.7L V6 2671cc	2000	Base; Electric Water Pump	US11003
2.7L V6 2671cc	2001-2002	Avant, Base	US9446
2.7L V6 2671cc	2001-2002	Avant, Base; Electric Water Pump	US11003
3.0L V6 2995cc	2010-2012	Base	US6146
4.2L V8 4163cc	2004-2008	Avant, Base, Cabriolet	US6000
4.2L V8 4163cc	2009	Cabriolet	US6000
S5			
3.0L V6 2995cc	2010-2012	Cabriolet	US6146
4.2L V8 4163cc	2008-2012	Base	US6702
S6			
2.2L L5 2226cc	1995	Avant, Base	US9279
4.2L V8 4172cc	2002-2003	Avant	US9410
5.2L V10 5204cc	2007-2011	Base	US6702
S6 QUATTRO			
4.2L V8 4172cc 255 CID	2001	Mexican Application	US9410
4.2L V8 4172cc 255 CID	2004	Mexican Application	US9410
S8			
4.2L V8 4172cc	2001-2003	Base	US9410
5.2L V10 5204cc	2007-2009	Base	US6702
TT			
1.8L L4 1781cc	2000-2006	Base	US9377
1.8L L4 1781cc	2002-2006	Base; Electric Water Pump	US11003
2.0L L4 1984cc 121 CID	2008-2009	Base; (BPY)	US6022
2.0L L4 1984cc 121 CID	2008-2009	Base	US11017
2.0L L4 1984cc 121 CID	2009	Base; (CCTA); Pump only	US9047
2.0L L4 1984cc 121 CID	2009	Base; (CCTA); With back plate housing	US9047-2
2.0L L4 1984cc 121 CID	2009	Base; Electric Water Pump	US11008
2.0L L4 1988cc 122 CID	2007	Mexican Application	US9377
2.0L L4 1988cc 122 CID	2010	Mexican Application	US9377
TT QUATTRO			
1.8L L4 1781cc	2000-2001	Base	US9377
1.8L L4 1781cc	2001	Base; Electric Water Pump	US11003
1.8L L4 1781cc	2002	ALMS Edition, Base	US9377
1.8L L4 1781cc	2002	ALMS Edition, Base; Electric Water Pump	US11003
1.8L L4 1781cc	2003-2006	Base	US9377
1.8L L4 1781cc	2003-2006	Base; Electric Water Pump	US11003
2.0L L4 1984cc 121 CID	2009-2010	Base, S; Electric Water Pump	US11008
2.0L L4 1984cc 121 CID	2009-2011	Base; Pump only	US9047
2.0L L4 1984cc 121 CID	2009-2011	Base; With back plate housing	US9047-2
2.0L L4 1984cc 121 CID	2009-2015	S	US6022
2.0L L4 1984cc 121 CID	2011	Base; Electric Water Pump	US11008
2.0L L4 1984cc 121 CID	2011-2015	S	US11017
2.0L L4 1984cc 121 CID	2012	Premium Plus, Prestige; From 06/03/2012, Pump only	US9047
2.0L L4 1984cc 121 CID	2012	Premium Plus, Prestige; Pump only, To 06/03/2012	US9047
2.0L L4 1984cc 121 CID	2012	Premium Plus, Prestige; From 06/03/2012, With back plate housing	US9047-2
2.0L L4 1984cc 121 CID	2012	Premium Plus, Prestige; To 06/03/2012, With back plate housing	US9047-2
2.0L L4 1984cc 121 CID	2012	Premium Plus, Prestige; Electric Water Pump	US11008
2.0L L4 1984cc 121 CID	2013	Premium Plus, Prestige; Pump only	US9047
2.0L L4 1984cc 121 CID	2013	Premium Plus, Prestige; With back plate housing	US9047-2
2.0L L4 1984cc 121 CID	2013	Base, Premium Plus, Prestige; Electric Water Pump	US11008
2.0L L4 1984cc 121 CID	2014	Base; Electric Water Pump	US11008
2.0L L4 1984cc 121 CID	2014-2015	Base	US9047
2.0L L4 1984cc 121 CID	2014-2015	Base; Pump only	US9047
2.0L L4 1984cc 121 CID	2014-2015	Base	US9047-2
2.0L L4 1984cc 121 CID	2014-2015	Base; With back plate housing	US9047-2
3.2L V6 3189cc 195 CID	2004-2005	Base	US9471
3.2L V6 3189cc 195 CID	2004-2005	Base; Electric Water Pump	US11004

Engine	Years	Application Description	USMW
AUDI (cont'd.)			
TT QUATTRO (cont'd.)			
3.2L V6 3189cc 195 CID	2006	Base, Special Edition	US9471
3.2L V6 3189cc 195 CID	2006	Base, Special Edition; Electric Water Pump	US11004
3.2L V6 3189cc 195 CID	2008-2009	Base	US9471
3.2L V6 3189cc 195 CID	2008-2009	Base; Electric Water Pump	US11004
V8 QUATTRO			
3.6L V8 3562cc	1990-1991	Base	US9226
4.2L V8 4172cc	1992-1994	Base	US9226
AVANTI			
II			
5.3L V8 5358cc 327 CID	1965-1969		US898
5.3L V8 5358cc 327 CID	1965-1969	High performance	US898H
5.4L V8 327 CID	1968-1969		US898
5.4L V8 327 CID	1968-1969	High performance	US898H
5.7L V8 350 CID	1969		US898
5.7L V8 350 CID	1969	High performance	US898H
5.7L V8 5736cc 350 CID	1969		US898
5.7L V8 5736cc 350 CID	1969	High performance	US898H
BMW			
1 SERIES M			
3.0L L6 2979cc	2011	Base	US6681
128i			
3.0L L6 2996cc	2008-2013	Base	US6680
130i			
3.0L L6 2996cc 183 CID	2006-2010	Mexican Application	US9261
135i			
3.0L L6 2979cc	2008-2013	Base	US6681
228i			
2.0L L4 1997cc 122 CID	2014-2016	Base	US8135
228i XDRIVE			
2.0L L4 1997cc 122 CID	2015-2016	Base	US8135
318			
1.8L L4 1800cc 110 CID	1986	Mexican Application	US9152
318i			
1.8L L4 1766cc 107 CID	1984-1985	Base	US9152
1.8L L4 1796cc	1991-1995	Base	US9275
1.8L L4 1800cc 110 CID	1997	Mexican Application	US9275
1.9L L4 1895cc	1996-1998	Base	US9275
318IS			
1.8L L4 1796cc	1991-1995	Base	US9275
1.9L L4 1895cc	1996-1997	Base	US9275
318Ti			
1.8L L4 1796cc	1995	Base	US9275
1.9L L4 1895cc	1996-1999	Base	US9275
320i			
1.8L L4 1766cc 107 CID	1980-1983	Base	US9149
2.0L L4 1990cc 121 CID	1977-1979		US9149
2.2L L6 2171cc 132 CID	2001-2005	Mexican Application	US9261
323Ci			
2.5L L6 2494cc 152 CID	2000	Base	US9261
323i			
2.5L L6 2494cc 152 CID	1997-1998	Mexican Application	US9261
2.5L L6 2494cc 152 CID	1998-2000	Base	US9261
323iS			
2.5L L6 2494cc 152 CID	1998-1999	Base	US9261
325			
2.7L L6 2693cc	1986-1987	Base	US9119
2.7L L6 2693cc	1988	Base	US9120
325Ci			
2.5L L6 2494cc 152 CID	2001-2006	Base	US9261
325E			
2.7L L6 2693cc	1984-1987	Base	US9119
325ES			
2.7L L6 2693cc	1986-1987	Base	US9119
325i			
2.5L L6 2494cc 152 CID	1987	Base	US9119
2.5L L6 2494cc 152 CID	1988-1991	Base	US9120
2.5L L6 2494cc 152 CID	1992	Base; (M50)	US9261
2.5L L6 2494cc 152 CID	1992-1993	Base; (M20)	US9120
2.5L L6 2494cc 152 CID	1993	Base; (M50TU)	US9261
2.5L L6 2494cc 152 CID	1994-1995	Base	US9261
2.5L L6 2494cc 152 CID	1996-1997	Mexican Application	US9261
2.5L L6 2494cc 152 CID	2001-2005	Base	US9261

WATER PUMPS

Engine	Years	Application Description	USMW	Engine	Years	Application Description	USMW
BMW (cont'd.)				BMW (cont'd.)			
325I (cont'd.)				528I XDRIVE (cont'd.)			
2.5L L6 2494cc 152 CID	2011-2013	Mexican Application	US9261	3.0L L6 2996cc	2009-2010	Base	US6680
2.5L L6 2497cc 152 CID	2006-2010	Mexican Application	US9261	528XI			
325IS				3.0L L6 2996cc	2008	Base	US6680
2.5L L6 2494cc 152 CID	1987	Base	US9119	530I			
2.5L L6 2494cc 152 CID	1988-1991	Base	US9120	3.0L L6 2979cc	2001-2005	Base	US9261
2.5L L6 2494cc 152 CID	1992-1995	Base	US9261	3.0L L6 2985cc	1975-1978		US9122
325IX				3.0L L6 2996cc 183 CID	2008-2010	Mexican Application	US9261
2.5L L6 2494cc 152 CID	1988-1991	Base	US9120	3.0L V8 2997cc	1994-1995	Base	US9276
325XI				533I			
2.5L L6 2494cc 152 CID	2001-2005	Base	US9261	3.2L L6 3210cc	1983-1984	Base	US9117
328CI				535I			
2.8L L6 2793cc	2000	Base	US9261	3.0L L6 2979cc	2008-2016	Base	US6681
328I				3.5L L6 3430cc	1985-1993	Base	US9117
2.0L L4 1997cc 122 CID	2012-2016	Base	US8135	535I GT			
2.8L L6 2793cc	1996-2000	Base	US9261	3.0L L6 2979cc	2010-2017	Base	US6681
3.0L L6 2996cc	2007-2013	Base	US6680	535I GT XDRIVE			
328I GT XDRIVE				3.0L L6 2979cc	2011-2017	Base	US6681
2.0L L4 1997cc 122 CID	2014-2016	Base	US8135	535IS			
328IS				3.5L L6 3430cc	1988	Base	US9117
2.8L L6 2793cc	1996-1999	Base	US9261	535I XDRIVE			
328I XDRIVE				3.0L L6 2979cc	2009-2016	Base	US6681
2.0L L4 1997cc 122 CID	2013-2016	Base	US8135	535XI			
3.0L L6 2996cc	2009-2013	Base	US6680	3.0L L6 2979cc	2008	Base	US6681
328XI				540I			
3.0L L6 2996cc	2007-2008	Base	US6680	4.0L V8 3982cc	1994-1995	Base	US9276
330CI				4.0L V8 3982cc 243 CID	1996	Mexican Application	US9332
3.0L L6 2979cc	2001-2006	Base	US9261	4.4L V8 4398cc	1997-1998	Base	US8926
330I				4.4L V8 4398cc	1999-2003	Base	US9465
3.0L L6 2979cc	2001-2005	Base	US9261	545I			
3.0L L6 2996cc 183 CID	2007	Mexican Application	US9261	4.4L V8 4398cc	2004-2005		US8990
330XI				550I			
3.0L L6 2979cc	2001-2005	Base	US9261	4.4L V8 4395cc	2011-2016	Base	US6708
335I				4.8L V8 4837cc	2006-2010	Base	US6238
3.0L L6 2979cc	2007-2012	Base	US6681	550I GT			
3.0L L6 2979cc	2013	Base; Exc.Sedan	US6681	4.4L V8 4395cc	2010-2015	Base	US6708
335IS				550I GT XDRIVE			
3.0L L6 2979cc	2011-2013	Base	US6681	4.4L V8 4395cc	2010-2017	Base	US6708
335I XDRIVE				550I XDRIVE			
3.0L L6 2979cc	2009-2012	Base	US6681	4.4L V8 4395cc	2011-2016	Base	US6708
3.0L L6 2979cc	2013	Base; Exc.Sedan	US6681	630CSI			
335XI				3.0L L6 2985cc	1977-1978		US9122
3.0L L6 2979cc	2007-2008	Base	US6681	633CSI			
428I				3.2L L6 3210cc	1978-1979		US9122
2.0L L4 1997cc 122 CID	2014-2016	Base	US8135	3.2L L6 3210cc	1980-1984	Base	US9117
428I GRAN COUPE				635CSI			
2.0L L4 1997cc 122 CID	2015-2016	Base	US8135	3.5L L6 3430cc	1985-1989	Base	US9117
428I XDRIVE				640I			
2.0L L4 1997cc 122 CID	2014-2016	Base	US8135	3.0L L6 2979cc	2012-2017	Base	US6681
428I XDRIVE GRAN COUPE				640I GRAN COUPE			
2.0L L4 1997cc 122 CID	2015-2016	Base	US8135	3.0L L6 2979cc	2013-2017	Base	US6681
524TD				3.0L L6 2979cc 182 CID	2016	Base	US6681
2.4L L6 2443cc	1985-1986	Base	US9154	640I XDRIVE			
525I				3.0L L6 2979cc	2014-2017	Base	US6681
2.5L L6 2494cc 152 CID	1986	Mexican Application	US9234	640I XDRIVE GRAN COUPE			
2.5L L6 2494cc 152 CID	1989-1990	Base	US9120	3.0L L6 2979cc	2014-2017	Base	US6681
2.5L L6 2494cc 152 CID	1991-1995	Base	US9261	645CI			
2.5L L6 2494cc 152 CID	2001-2005	Base	US9261	4.4L V8 4398cc	2004-2005		US8990
2.5L L6 2497cc 152 CID	2006-2010	Mexican Application	US9261	650I			
528				4.4L V8 4395cc	2012-2017	Base	US6708
2.8L L6 2800cc 173 CID	1996	Mexican Application	US9261	4.4L V8 4395cc 268 CID	2014-2015	Base	US6708
528E				4.8L V8 4837cc	2006-2010	Base	US6238
2.7L L6 2693cc	1982-1987	Base	US9119	650I GRAN COUPE			
2.7L L6 2693cc	1988	Base	US9120	4.4L V8 4395cc	2013-2017	Base	US6708
528I				4.4L V8 4395cc 268 CID	2015-2016	Base	US6708
2.0L L4 1997cc 122 CID	2012-2016	Base	US8135	650I XDRIVE			
2.8L L6 2788cc	1979		US9122	4.4L V8 4395cc	2012-2017	Base	US6708
2.8L L6 2788cc	1980-1981	Base	US9117	650I XDRIVE GRAN COUPE			
2.8L L6 2793cc	1997-2000	Base	US9261	4.4L V8 4395cc	2013-2017	Base	US6708
3.0L L6 2996cc	2008-2010	Base	US6680				
528I XDRIVE							
2.0L L4 1997cc 122 CID	2012-2016	Base	US8135				

Engine	Years	Application Description	USMW
BMW (cont'd.)			
728I			
2.8L L6 2788cc 170 CID	1997	Mexican Application	US9261
733I			
3.2L L6 3210cc	1978-1979		US9122
3.2L L6 3210cc	1980-1984	Base	US9117
735I			
3.5L L6 3430cc	1985-1987	Base	US9122
3.5L L6 3430cc	1988-1992	Base	US9117
735IL			
3.5L L6 3430cc	1988-1992	Base	US9117
740I			
3.0L L6 2979cc	2011-2015	Base	US6681
3.0L L6 2979cc 182 CID	2013-2015	Base	US6681
4.0L V8 3982cc	1993-1994	Base	US9276
4.0L V8 3982cc	1995	Base	US9332
4.4L V8 4398cc	1997-1998	Base	US8926
4.4L V8 4398cc	1999-2001	Base	US9465
740IL			
4.0L V8 3982cc	1993-1994	Base	US9276
4.0L V8 3982cc	1995	Base	US9332
4.4L V8 4398cc	1996-1998	Base	US8926
4.4L V8 4398cc	1999-2001	Base	US9465
740LI			
3.0L L6 2979cc	2011		US6681
3.0L L6 2979cc	2012-2015	Base	US6681
740LI XDRIVE			
3.0L L6 2979cc	2013-2015	Base	US6681
745I			
4.4L V8 4398cc	2002-2003	Base	US6003
4.4L V8 4398cc	2004	Base; To 10/03	US6003
4.4L V8 4398cc	2004-2005		US8990
745LI			
4.4L V8 4398cc	2002-2005		US8990
750I			
4.4L V8 4395cc	2009-2010	Base	US6708
4.4L V8 4395cc	2011-2012	ActiveHybrid, Base	US6708
4.4L V8 4395cc	2013-2016	Base	US6708
4.4L V8 4395cc 268 CID	2014-2015	Base	US6708
4.8L V8 4837cc	2006-2008	Base	US6238
750IL			
5.0L V12 4988cc	1988-1994	Base	US9128
5.4L V12 5379cc	1995-1998	Base	US9464
5.4L V12 5379cc	1998-2001	Base	US9467
750I XDRIVE			
4.4L V8 4395cc	2010-2016	Base	US6708
750LI			
4.4L V8 4395cc	2009-2010	Base	US6708
4.4L V8 4395cc	2011-2012	ActiveHybrid, Base	US6708
4.4L V8 4395cc	2013-2015	Base	US6708
4.4L V8 4395cc 268 CID	2014-2015	Base	US6708
4.8L V8 4837cc	2006-2008	Base	US6238
750LI XDRIVE			
4.4L V8 4395cc	2010-2015	Base	US6708
760I			
6.0L V12 5972cc	2004-2005	Base	US6003
760LI			
6.0L V12 5972cc	2003-2005	Base	US6003
840CI			
4.0L V8 3982cc	1994-1995	Base	US9332
4.4L V8 4398cc	1996-1997	Base	US8926
850			
5.0L V12 5000cc 305 CID	1995	Mexican Application	US9236
850CI			
5.0L V12 4988cc	1993-1994	Base	US9236
5.0L V12 5000cc 305 CID	1996-1997	Mexican Application	US9236
5.4L V12 5379cc	1995-1997	Base	US9464
5.4L V12 5379cc 328 CID	1998	Mexican Application	US9464
850CSI			
5.6L V12 5576cc	1994-1995	Base	US9236
850I			
5.0L V12 4988cc	1991-1992	Base	US9236

Engine	Years	Application Description	USMW
BMW (cont'd.)			
850I (cont'd.)			
5.0L V12 5000cc 305 CID	1990	Mexican Application	US9236
2002			
2.0L L4 1990cc 121 CID	1975-1976		US9153
ACTIVEHYBRID 5			
3.0L L6 2979cc	2012-2016	Base	US6681
ACTIVEHYBRID 7			
3.0L L6 2979cc	2013-2015	Base	US6681
ALPINA B6 XDRIVE GRAN COUPE			
4.4L V8 4395cc	2015-2017	Base	US6708
ALPINA B7			
4.4L V8 4395cc	2011-2015	Base	US6708
4.4L V8 4398cc	2007-2008		US8990
ALPINA B7L			
4.4L V8 4395cc	2011-2015	Base	US6708
ALPINA B7L XDRIVE			
4.4L V8 4395cc	2011-2015	Base	US6708
ALPINA B7 XDRIVE			
4.4L V8 4395cc	2011-2015	Base	US6708
L6			
3.5L L6 3430cc	1987	Base	US9117
L7			
3.5L L6 3430cc	1986-1987	Base	US9117
M3			
3.0L L6 2990cc	1995	Base, Lightweight	US9261
3.0L L6 2990cc 182 CID	1994	Mexican Application	US9261
3.0L L6 2990cc 182 CID	1996	Mexican Application	US9261
3.2L L6 3152cc	1996-1999	Base	US9261
M5			
3.4L L6 3430cc 209 CID	1993-1994	Mexican Application	US9275
3.5L L6 3453cc	1988	Base	US9117
3.6L L6 3553cc	1991-1993	Base	US9234
M6			
3.5L L6 3453cc	1987-1988	Base	US9117
X1			
2.0L L4 1997cc 122 CID	2013-2014	sDrive28i, xDrive28i	US8135
2.0L L4 1997cc 122 CID	2015	xDrive28i	US8135
3.0L L6 2979cc	2013-2015	xDrive35i	US6681
X3			
2.0L L4 1997cc 122 CID	2013-2014	xDrive28i	US8135
2.0L L4 1997cc 122 CID	2015-2017	sDrive28i, xDrive28i	US8135
2.5L L6 2494cc 152 CID	2004-2005	2.5i	US9261
2.5L L6 2494cc 152 CID	2006-2009	Mexican Application	US9261
2.5L L6 2497cc 152 CID	2010	Mexican Application	US9261
3.0L L6 2979cc	2004-2006	3.0i	US9261
3.0L L6 2979cc	2011-2017	xDrive35i	US6681
3.0L L6 2979cc 182 CID	2014	xDrive35i	US6681
3.0L L6 2996cc	2007-2008	3.0si	US6680
3.0L L6 2996cc	2009-2010	xDrive30i	US6680
3.0L L6 2996cc 183 CID	2010	Mexican Application	US6680
X4			
2.0L L4 1997cc 122 CID	2015-2017	xDrive28i	US8135
3.0L L6 2979cc	2015	xDrive35i	US6681
3.0L L6 2979cc	2016	M40i, xDrive35i	US6681
3.0L L6 2979cc	2017	M40i	US6681
X5			
2.0L L4 1997cc 122 CID	2016-2017	xDrive40e	US8135
3.0L L6 2979cc	2001-2006	3.0i	US9261
3.0L L6 2979cc	2011-2013	xDrive35i	US6681
3.0L L6 2979cc 182 CID	2013	xDrive35i	US6681
3.0L L6 2996cc	2007-2008	3.0si; (N52B30A); Exc. Auxiliary A/C	US6680
3.0L L6 2996cc	2009-2010	xDrive30i; Exc. Auxiliary A/C	US6680
4.4L V8 4395cc	2010	M	US6708
4.4L V8 4395cc	2011-2012	M, xDrive50i	US6708
4.4L V8 4395cc	2013	M	US6708
4.4L V8 4395cc	2013	xDrive50i; (N63B44A)	US6708
4.4L V8 4395cc	2014-2017	xDrive50i	US6708
4.4L V8 4395cc 268 CID	2014	xDrive50i	US6708
4.4L V8 4398cc	2000-2003	4.4i	US9465
4.4L V8 4398cc	2004-2006	4.4i	US8990
4.6L V8 4598cc	2002-2003	4.6is	US9465
4.8L V8 4837cc	2004-2006	4.8is	US8990
4.8L V8 4837cc	2007-2008	4.8i	US6238
4.8L V8 4837cc	2009-2010	xDrive48i	US6238
X6			
3.0L L6 2979cc	2008-2014	xDrive35i	US6681

WATER PUMPS



WATER PUMP APPLICATION GUIDE



Engine	Years	Application Description	USMW	Engine	Years	Application Description	USMW
BMW (cont'd.)				BUICK (cont'd.)			
X6 (cont'd.)				CENTURY (cont'd.)			
3.0L L6 2979cc 182 CID	2013-2014	xDrive35i	US6681	3.2L V6 196 CID	1978-1979		US1018
4.4L V8 4395cc	2008-2009	xDrive50i	US6708	3.2L V6 196 CID	1978-1979	High performance	US1018H
4.4L V8 4395cc	2010-2011	ActiveHybrid, M, xDrive50i	US6708	3.3L V6 204 CID	1989	Custom, Estate Wagon, Limited	US5050
4.4L V8 4395cc	2012	M, xDrive50i	US6708	3.3L V6 204 CID	1990	Custom, Limited	US5050
4.4L V8 4395cc	2013	M	US6708	3.3L V6 204 CID	1991-1993	Custom, Limited, Special	US5050
4.4L V8 4395cc	2013	xDrive50i; (N63B44A)	US6708	3.8L V6 231 CID	1975-1977		US1018
4.4L V8 4395cc	2014	M, xDrive50i	US6708	3.8L V6 231 CID	1975-1977	High performance	US1018H
4.4L V8 4395cc	2015-2017	xDrive50i	US6708	3.8L V6 231 CID	1979	High performance	US1018H
4.4L V8 4395cc 268 CID	2014	M, xDrive50i	US6708	3.8L V6 3800cc 231 CID	1978-1979		US1018
Z3				3.8L V6 3800cc 231 CID	1978-1979	High performance	US1018H
1.9L L4 1895cc	1996-1998	Roadster	US9275	3.8L V6 3800cc 231 CID	1980-1981	Base, Estate, Limited, Sport	US1018
1.9L L4 1895cc 116 CID	1999	Mexican Application	US9275	3.8L V6 3800cc 231 CID	1980-1981	Base, Estate, Limited, Sport; High performance	US1018H
2.0L L6 1991cc 121 CID	2000	Mexican Application	US9261	3.8L V6 3800cc 231 CID	1984	Custom, Estate, Limited, Olympia Limited, T-Type	US5028
2.2L L6 2171cc 132 CID	2001	Mexican Application	US9261	3.8L V6 3800cc 231 CID	1985	Custom, Estate Wagon, Limited, T-Type	US5028
2.5L L6 2494cc 152 CID	1999-2002	Roadster	US9261	3.8L V6 3800cc 231 CID	1986	Custom, Estate Wagon, Limited, T-Type	US5050
2.8L L6 2793cc	1997-1998	Roadster	US9261	3.8L V6 3800cc 231 CID	1987-1988	Custom, Estate Wagon, Limited	US5050
2.8L L6 2793cc	1999-2000	Coupe, Roadster	US9261	4.3L V6 260 CID	1982-1983	Custom, Limited; W/O Pulley	US5014
3.0L L6 2979cc	2001-2002	Coupe, Roadster	US9261	4.3L V6 260 CID	1982-1983	Custom, Limited; Includes pulley	US5014P
3.2L L6 3152cc	1998	M Roadster	US9261	4.3L V6 260 CID	1984	Custom, Estate, Limited, Olympia Limited; W/O Pulley	US5014
3.2L L6 3152cc	1999-2000	M Coupe, M Roadster	US9261	4.3L V6 260 CID	1984	Custom, Estate, Limited, Olympia Limited; Includes pulley	US5014P
Z4				4.3L V6 260 CID	1985	Custom, Estate Wagon, Limited; W/O Pulley	US5014P
2.0L L4 1997cc 122 CID	2012-2016	sDrive28i	US8135	4.3L V6 260 CID	1985	Custom, Estate Wagon, Limited; Includes pulley	US5014P
2.5L L6 2494cc 152 CID	2003-2005	2.5i	US9261	4.3L V8 265 CID	1980	Base, Estate, Limited	US975
2.5L L6 2494cc 152 CID	2007-2009	Mexican Application	US9261	4.3L V8 265 CID	1981	Base, Estate, Limited, Sport	US975
3.0L L6 2979cc	2003-2005	3.0i	US9261	4.9L V8 301 CID	1979		US975
3.0L L6 2979cc	2009-2010	sDrive35i	US6681	4.9L V8 301 CID	1980	Base, Estate, Limited, Sport	US975
3.0L L6 2979cc	2011-2016	sDrive35i, sDrive35is	US6681	5.0L V8 305 CID	1977-1979		US1121
3.0L L6 2979cc 182 CID	2011-2013	sDrive35i	US6681	5.0L V8 305 CID	1977-1979	High performance	US1121H
3.0L L6 2996cc	2008	Coupe 3.0si	US6680	5.0L V8 305 CID	1980	Base, Estate, Limited	US1121
3.0L L6 2996cc	2009-2011	sDrive30i	US6680	5.0L V8 305 CID	1980	Base, Estate, Limited; High performance	US1121H
Z8				5.0L V8 305 CID	1980	Base, Estate, Limited; High performance	US1121H
4.8L V8 4837cc	2003	Alpina	US9465	5.7L V8 350 CID	1975-1976		US1018
BUICK				5.7L V8 350 CID	1975-1978	High performance	US1018H
APOLLO				5.7L V8 350 CID	1975-1979	Exc.Air Cond	US1100
4.3L V8 260 CID	1975	Exc.Air Cond	US1100	5.7L V8 350 CID	1975-1979	Air Cond	US1120
4.3L V8 260 CID	1975	Air Cond	US1120	5.7L V8 350 CID	1975-1979	Air Cond, High performance	US1120H
4.3L V8 260 CID	1975	Air Cond, High performance	US1120H	5.7L V8 350 CID	1979	High performance	US1121H
5.7L V8 350 CID	1975		US1018	5.7L V8 350 CID	1981	Base, Estate, Limited; Exc.Air Cond	US1100
5.7L V8 350 CID	1975	High performance	US1018H	5.7L V8 350 CID	1981	Base, Estate, Limited; With air cond.	US1120
5.7L V8 350 CID	1975	Exc.Air Cond	US1100	5.7L V8 350 CID	1981	Base, Estate, Limited; High performance, With air cond.	US1120H
5.7L V8 350 CID	1975	Air Cond	US1120	6.6L V8 403 CID	1977	Exc.Air Cond	US1100
5.7L V8 350 CID	1975	Air Cond, High performance	US1120H	6.6L V8 403 CID	1977	Air Cond	US1120
CASCADA				6.6L V8 403 CID	1977	Air Cond, High performance	US1120H
1.6L L4 1598cc 98 CID	2016	Base, Premium	US8155	COMMERCIAL CHASSIS			
1.6L L4 1598cc 98 CID	2016	Base, Premium; Pump only	US8155	5.0L V8 305 CID	1991	Base	US5051
1.6L L4 1598cc 98 CID	2017	Base, Premium, Sport Touring	US8155	5.7L V8 350 CID	1992-1993	Base	US5051
1.6L L4 1598cc 98 CID	2017	Base, Premium, Sport Touring; Pump only	US8155	5.7L V8 350 CID	1994-1996	Base	US5069
CENTURION				ELECTRA			
7.5L V8 7456cc 455 CID	1971-1972		US821	3.0L V6 181 CID	1985	Limited	US5028
CENTURY				3.8L V6 3800cc 231 CID	1985	Limited, Park Avenue, T-Type	US5028
2.2L L4 2190cc 134 CID	1993	Custom, Limited, Special	US5032	3.8L V6 3800cc 231 CID	1986-1988	Limited, Park Avenue, T-Type	US5050
2.2L L4 2190cc 134 CID	1994	Custom, Special	US5032	3.8L V6 3800cc 231 CID	1989-1990	Limited, Park Avenue, Park Avenue Ultra, T-Type	US5050
2.2L L4 2190cc 134 CID	1995	Special	US5032	4.1L V6 252 CID	1980-1984	Limited, Park Avenue	US1018
2.2L L4 2190cc 134 CID	1996	Limited, Special	US5032	4.1L V6 252 CID	1980-1984	Limited, Park Avenue; High performance	US1018H
2.5L L4 2474cc 151 CID	1982-1983	Custom, Limited	US5000	4.3L V6 260 CID	1985	Limited, Park Avenue; W/O Pulley	US5014
2.5L L4 2474cc 151 CID	1982-1983	Custom, Limited; Includes pulley	US5000P	4.3L V6 260 CID	1985	Limited, Park Avenue; Includes pulley	US5014P
2.5L L4 2474cc 151 CID	1984	Custom, Estate, Limited, Olympia Limited	US5000	4.9L V8 301 CID	1980	Estate Wagon	US975
2.5L L4 2474cc 151 CID	1984	Custom, Estate, Limited, Olympia Limited; Includes pulley	US5000P	5.0L V8 307 CID	1981-1984	Estate Wagon, Limited, Park Avenue; Exc.Air Cond	US1100
2.5L L4 2474cc 151 CID	1985	Custom, Estate Wagon, Limited; Includes pulley	US5000P	5.0L V8 307 CID	1981-1984	Estate Wagon, Limited, Park Avenue; With air cond.	US1120
2.5L L4 2474cc 151 CID	1985-1986	Custom, Estate Wagon, Limited	US5000	5.0L V8 307 CID	1981-1984	Estate Wagon, Limited, Park Avenue; High performance, With air cond.	US1120H
2.5L L4 2474cc 151 CID	1986	Custom, Estate Wagon; Includes pulley	US5000P	5.0L V8 307 CID	1985	Estate Wagon; Exc.Air Cond	US1100
2.5L L4 2474cc 151 CID	1987-1989	Custom, Estate Wagon, Limited	US5041	5.0L V8 307 CID	1985	Estate Wagon; With air cond.	US1120
2.5L L4 2474cc 151 CID	1990	Custom, Limited	US5041	5.0L V8 307 CID	1985	Estate Wagon; High performance, With air cond.	US1120H
2.5L L4 2474cc 151 CID	1991-1992	Custom, Limited, Special	US5041	5.0L V8 307 CID	1986-1989	Estate Wagon	US1120
2.8L V6 173 CID	1986	Custom, Estate Wagon, Limited	US5001	5.0L V8 307 CID	1986-1989	Estate Wagon; High performance	US1120H
2.8L V6 173 CID	1987-1988	Custom, Estate Wagon, Limited	US5033	5.7L V8 350 CID	1976-1979	Exc.Air Cond	US1100
2.8L V6 173 CID	1989	Custom, Limited	US5033	5.7L V8 350 CID	1976-1979	Air Cond	US1120
3.0L V6 181 CID	1982	Custom, Limited	US5028	5.7L V8 350 CID	1976-1979	Air Cond, High performance	US1120H
3.0L V6 181 CID	1983	Custom, Limited, T-Type	US5028	5.7L V8 350 CID	1977-1979	High performance	US1018
3.0L V6 181 CID	1984	Custom, Estate, Limited, Olympia Limited, T-Type	US5028	5.7L V8 350 CID	1977-1979	High performance	US1018H
3.0L V6 181 CID	1985	Custom, Estate Wagon, Limited	US5028	5.7L V8 350 CID	1980	Estate Wagon, Limited, Park Avenue	US1018
3.1L V6 189 CID	1994-1995	Custom, Special	US5033	5.7L V8 350 CID	1980	Estate Wagon, Limited, Park Avenue; High performance	US1018H
3.1L V6 189 CID	1996	Custom, Limited, Special	US5033	5.7L V8 350 CID	1980	Estate Wagon, Limited, Park Avenue; High performance	US1018H
3.1L V6 189 CID	1997-2002	Custom, Limited	US5033				
3.1L V6 189 CID	2003	Custom	US5033				
3.1L V6 189 CID	2004	Custom, Limited	US5033				
3.1L V6 189 CID	2005	Custom, Limited, Special Edition	US5033				

Engine	Years	Application Description	USMW	Engine	Years	Application Description	USMW
BUICK (cont'd.)				BUICK (cont'd.)			
ELECTRA (cont'd.)				LESABRE			
5.7L V8 350 CID	1980-1983	Estate Wagon, Limited, Park Avenue; Exc.Air Cond	US1100	3.0L V6 181 CID	1986	Custom, Limited	US5050
5.7L V8 350 CID	1980-1983	Estate Wagon, Limited, Park Avenue; With air cond.	US1120	3.8L V6 231 CID	1976-1977		US1018
5.7L V8 350 CID	1980-1983	Estate Wagon, Limited, Park Avenue; High performance, With air cond.	US1120H	3.8L V6 231 CID	1976-1977	High performance	US1018H
5.7L V8 350 CID	1984-1985	Estate Wagon; Exc.Air Cond	US1100	3.8L V6 3800cc 231 CID	1977-1979		US1018
5.7L V8 350 CID	1984-1985	Estate Wagon; With air cond.	US1120	3.8L V6 3800cc 231 CID	1977-1979	High performance	US1018H
5.7L V8 350 CID	1984-1985	Estate Wagon; High performance, With air cond.	US1120H	3.8L V6 3800cc 231 CID	1980-1981	Base, Limited, Sport	US1018
6.6L V8 403 CID	1977-1979	Exc.Air Cond	US1100	3.8L V6 3800cc 231 CID	1980-1981	Base, Limited, Sport; High performance	US1018H
6.6L V8 403 CID	1977-1979	Air Cond	US1120	3.8L V6 3800cc 231 CID	1982	Custom, Limited, Limited Edition F/E	US1018
6.6L V8 403 CID	1977-1979	Air Cond, High performance	US1120H	3.8L V6 3800cc 231 CID	1982	Custom, Limited, Limited Edition F/E; High performance	US1018H
7.0L V8 7047cc 430 CID	1967-1969		US821	3.8L V6 3800cc 231 CID	1983-1984	Custom, Limited	US1018
7.5L V8 455 CID	1975		US1045	3.8L V6 3800cc 231 CID	1985	Collector's Edition, Custom, Limited	US1018
7.5L V8 7456cc 455 CID	1970-1972		US821	3.8L V6 3800cc 231 CID	1985	Collector's Edition, Custom, Limited; High performance	US1018H
ENCLAVE				3.8L V6 3800cc 231 CID	1986	Custom, Limited	US5050
3.6L V6 3564cc 217 CID	2008-2011	CX, CXL	US8932	3.8L V6 3800cc 231 CID	1987	Base, Custom, Limited, T-Type	US5050
3.6L V6 3564cc 217 CID	2012-2013	Base	US8932	3.8L V6 3800cc 231 CID	1988-1991	Base, Custom, Limited	US5050
3.6L V6 3564cc 217 CID	2015-2017	Convenience, Leather, Premium	US8932	3.8L V6 3800cc 231 CID	1992-1995	Custom, Limited	US5050
ENCORE				3.8L V6 3800cc 231 CID	1996-2005	Custom, Limited	US5075
1.4L L4 1364cc 83 CID	2013	Base	US6662	4.1L V6 252 CID	1980	Base, Limited	US1018
1.4L L4 1364cc 83 CID	2013	Base; (B), (LUV)	US6662	4.1L V6 252 CID	1980	Base, Limited; High performance	US1018H
1.4L L4 1364cc 83 CID	2014	Base, Convenience, Leather; (B), (LUV)	US6662	4.1L V6 252 CID	1981	Base, Limited, Sport	US1018
1.4L L4 1364cc 83 CID	2014	Premium; (B), (LUV), FI	US6662	4.1L V6 252 CID	1981	Base, Limited, Sport; High performance	US1018H
1.4L L4 1364cc 83 CID	2014-2016	Base, Convenience, Leather, Premium	US6662	4.1L V6 252 CID	1982	Custom, Limited, Limited Edition F/E	US1018
1.4L L4 1364cc 83 CID	2017	Base, Essence, Preferred, Preferred II, Premium, Sport Touring	US6662	4.1L V6 252 CID	1982	Custom, Limited, Limited Edition F/E; High performance	US1018H
1.4L L4 1399cc 85 CID	2016	Sport Touring	US8147	4.1L V6 252 CID	1983-1984	Custom, Limited	US1018
1.4L L4 1399cc 85 CID	2016	Sport Touring; Pump only	US8147	4.1L V6 252 CID	1983-1984	Custom, Limited; High performance	US1018H
1.4L L4 1399cc 85 CID	2017	Essence, Preferred II, Premium, Sport Touring	US8147	4.9L V8 300 CID	1965		US855
1.4L L4 1399cc 85 CID	2017	Essence, Preferred II, Premium, Sport Touring; Pump only	US8147	4.9L V8 301 CID	1977-1979		US975
ENVISION				4.9L V8 301 CID	1980	Base, Limited	US975
2.0L L4 1998cc 122 CID	2016-2017	Premium	US8102	4.9L V8 4917cc 300 CID	1964-1965		US855
2.5L L4 2457cc 153 CID	2017	Base, Essence, Preferred	US8102	5.0L V8 305 CID	1978		US1121
ESTATE WAGON				5.0L V8 305 CID	1978	High performance	US1121H
4.9L V8 301 CID	1980	Base	US975	5.0L V8 307 CID	1981	Base, Limited, Sport; Exc.Air Cond	US1100
4.9L V8 4917cc 300 CID	1964		US855	5.0L V8 307 CID	1981	Base, Limited, Sport; With air cond.	US1120
5.0L V8 307 CID	1981-1983	Base; Exc.Air Cond	US1100	5.0L V8 307 CID	1981	Base, Limited, Sport; High performance, With air cond.	US1120H
5.0L V8 307 CID	1981-1983	Base; With air cond.	US1120	5.0L V8 307 CID	1982	Custom, Limited, Limited Edition F/E; Exc.Air Cond	US1100
5.0L V8 307 CID	1981-1983	Base; High performance, With air cond.	US1120H	5.0L V8 307 CID	1982	Custom, Limited, Limited Edition F/E; With air cond.	US1120
5.7L V8 350 CID	1970		US855	5.0L V8 307 CID	1982	Custom, Limited, Limited Edition F/E; High performance, With air cond.	US1120H
5.7L V8 350 CID	1977-1979	Exc.Air Cond	US1100	5.0L V8 307 CID	1983-1984	Custom, Limited; Exc.Air Cond	US1100
5.7L V8 350 CID	1977-1979	Air Cond	US1120	5.0L V8 307 CID	1983-1984	Custom, Limited; With air cond.	US1120
5.7L V8 350 CID	1977-1979	Air Cond, High performance	US1120H	5.0L V8 307 CID	1983-1984	Custom, Limited; High performance, With air cond.	US1120H
5.7L V8 350 CID	1980	Base	US1018	5.0L V8 307 CID	1985	Collector's Edition, Custom, Estate Wagon, Limited; Exc.Air Cond	US1100
5.7L V8 350 CID	1980	Base; High performance	US1018H	5.0L V8 307 CID	1985	Collector's Edition, Custom, Estate Wagon, Limited; With air cond.	US1120
5.7L V8 350 CID	1980-1983	Base; Exc.Air Cond	US1100	5.0L V8 307 CID	1985	Collector's Edition, Custom, Estate Wagon, Limited; High performance, With air cond.	US1120H
5.7L V8 350 CID	1980-1983	Base; With air cond.	US1120	5.0L V8 307 CID	1986-1990	Estate Wagon	US1120
5.7L V8 350 CID	1980-1983	Base; High performance, With air cond.	US1120H	5.0L V8 307 CID	1986-1990	Estate Wagon; High performance	US1120H
5.7L V8 5736cc 350 CID	1970		US855	5.7L V8 350 CID	1968-1970		US855
6.6L V8 403 CID	1977-1979	Exc.Air Cond	US1100	5.7L V8 350 CID	1975	W/O AIR	US1018
6.6L V8 403 CID	1977-1979	Air Cond	US1120	5.7L V8 350 CID	1975-1979	High performance	US1018H
6.6L V8 403 CID	1977-1979	Air Cond, High performance	US1120H	5.7L V8 350 CID	1975-1979	Exc.Air Cond	US1100
7.5L V8 455 CID	1975		US1045	5.7L V8 350 CID	1975-1979	Air Cond	US1120
7.5L V8 7456cc 455 CID	1970-1972		US821	5.7L V8 350 CID	1975-1979	Air Cond, High performance	US1120H
GS				5.7L V8 350 CID	1976		US1018
5.7L V8 350 CID	1970		US855	5.7L V8 350 CID	1979		US1018
5.7L V8 5736cc 350 CID	1970		US855	5.7L V8 350 CID	1980	Base, Limited	US1018
GS 350				5.7L V8 350 CID	1980	Base, Limited; High performance	US1018H
5.7L V8 350 CID	1968-1969		US855	5.7L V8 350 CID	1980	Base, Limited; Exc.Air Cond	US1100
5.7L V8 5736cc 350 CID	1968-1969		US855	5.7L V8 350 CID	1980	Base, Limited; With air cond.	US1120
LACROSSE				5.7L V8 350 CID	1980	Base, Limited; High performance, With air cond.	US1120H
2.4L L4 2384cc 145 CID	2010	CX	US5092	5.7L V8 350 CID	1981	Base, Limited, Sport; Exc.Air Cond	US1100
2.4L L4 2384cc 145 CID	2011	CX, CXL	US5092	5.7L V8 350 CID	1981	Base, Limited, Sport; With air cond.	US1120
2.4L L4 2384cc 145 CID	2012	Base, Convenience, Leather	US5092	5.7L V8 350 CID	1981	Base, Limited, Sport; High performance, With air cond.	US1120H
2.4L L4 2384cc 145 CID	2013-2014	Base	US5092	5.7L V8 350 CID	1982	Custom, Limited, Limited Edition F/E; Exc.Air Cond	US1100
2.4L L4 2384cc 145 CID	2015-2016	Base, Leather	US5092	5.7L V8 350 CID	1982	Custom, Limited, Limited Edition F/E; With air cond.	US1120
3.0L V6 182 CID	2010	CX, CXL	US8932	5.7L V8 350 CID	1982	Custom, Limited, Limited Edition F/E; High performance, With air cond.	US1120H
3.6L V6 222 CID	2017	Base, Essence, Preferred, Premium	US8148	5.7L V8 350 CID	1982	Custom, Limited, Limited Edition F/E; With air cond.	US1120
3.6L V6 3564cc 217 CID	2005-2008	CXS	US8932	5.7L V8 350 CID	1982	Custom, Limited, Limited Edition F/E; High performance, With air cond.	US1120H
3.6L V6 3564cc 217 CID	2010	CXS	US8932	5.7L V8 350 CID	1983-1984	Custom, Limited; Exc.Air Cond	US1100
3.6L V6 3564cc 217 CID	2011	CX, CXL, CXS	US8932	5.7L V8 350 CID	1983-1984	Custom, Limited; With air cond.	US1120
3.6L V6 3564cc 217 CID	2012	Base, Convenience, Leather, Premium, Touring	US8932	5.7L V8 350 CID	1983-1984	Custom, Limited; High performance, With air cond.	US1120H
3.6L V6 3564cc 217 CID	2013	Base	US8932	5.7L V8 350 CID	1985	Collector's Edition, Custom, Estate Wagon, Limited; Exc.Air Cond	US1100
3.6L V6 3564cc 217 CID	2015	Base, Leather, Premium	US8932				
3.6L V6 3564cc 217 CID	2016	Base, Leather, Premium, Sport Touring	US8932				
3.8L V6 3800cc 231 CID	2005-2009	CX, CXL	US5075				
5.3L V8 5328cc 325 CID	2008-2009	Super	US6154				

WATER PUMPS

Engine	Years	Application Description	USMW	Engine	Years	Application Description	USMW
BUICK (cont'd.)				BUICK (cont'd.)			
LESABRE (cont'd.)				REGAL (cont'd.)			
5.7L V8 350 CID	1985	Collector's Edition, Custom, Estate Wagon, Limited; With air cond.	US1120	3.8L V6 3800cc 231 CID	1999	GS, LS	US5075
5.7L V8 350 CID	1985	Collector's Edition, Custom, Estate Wagon, Limited; High performance, With air cond.	US1120H	3.8L V6 3800cc 231 CID	2000	GS, GSE, LS, LSE	US5075
5.7L V8 5736cc 350 CID	1968-1970		US855	3.8L V6 3800cc 231 CID	2001-2004	GS, LS	US5075
6.6L V8 400 CID	1975	Exc.Air Cond	US1100	4.1L V6 252 CID	1982	Base, Estate Wagon, Limited, Limited Turbo	US1018
6.6L V8 400 CID	1975	Air Cond	US1120	4.1L V6 252 CID	1982	Base, Estate Wagon, Limited, Limited Turbo; High performance	US1018H
6.6L V8 400 CID	1975	Air Cond, High performance	US1120H	4.1L V6 252 CID	1983	Base, Estate Wagon, Limited	US1018
6.6L V8 403 CID	1977-1978	Exc.Air Cond	US1100	4.1L V6 252 CID	1983	Base, Estate Wagon, Limited; High performance	US1018H
6.6L V8 403 CID	1977-1978	Air Cond	US1120	4.1L V6 252 CID	1984	Base, Limited	US1018
6.6L V8 403 CID	1977-1978	Air Cond, High performance	US1120H	4.1L V6 252 CID	1984	Base, Limited; High performance	US1018H
7.5L V8 455 CID	1975		US1045	4.3L V6 260 CID	1982-1984	Base, Limited	US5012
7.5L V8 7456cc 455 CID	1970-1972		US821	4.3L V8 265 CID	1980-1981	Base, Limited	US975
LUCERNE				RENDEZVOUS			
3.8L V6 3800cc 231 CID	2006-2008	CX, CXL	US5075	3.4L V6 207 CID	2002-2003	CX, CXL, CXL Plus, CX Plus	US5033
3.9L V6 3880cc 237 CID	2009	CX, CXL	US6020	3.4L V6 207 CID	2004	CX, CXL	US5033
3.9L V6 3880cc 237 CID	2010	CX, CXL, CXL Special Edition	US6020	3.4L V6 207 CID	2005	CX, CXL, CX Plus	US5033
3.9L V6 3880cc 237 CID	2011	CX, CXL	US6020	3.5L V6 213 CID	2006-2007	CX, CXL	US5033
4.6L V8 281 CID	2006-2007	CXL, CXS	US8956	3.6L V6 3564cc 217 CID	2004	CXL, Ultra	US8932
4.6L V8 281 CID	2008	CXL, CXS, Super	US8956	3.6L V6 3564cc 217 CID	2005	CXL Plus, Ultra	US8932
4.6L V8 281 CID	2009-2011	Super	US8956	3.6L V6 3564cc 217 CID	2006	CX, CXL	US8932
OPEL				RIVIERA			
1.7L L4 1700cc 104 CID	1959-1964	Mexican Application	US1061	3.8L V6 3800cc 231 CID	1979		US1018
2.1L L4 2100cc 128 CID	1965-1972	Mexican Application	US1061	3.8L V6 3800cc 231 CID	1979	High performance	US1018H
PARK AVENUE				3.8L V6 3800cc 231 CID	1980	Base, S	US1018
3.8L V6 3800cc 231 CID	1991-1995	Base, Ultra	US5050	3.8L V6 3800cc 231 CID	1980	Base, S; High performance	US1018H
3.8L V6 3800cc 231 CID	1996-2005	Base, Ultra	US5075	3.8L V6 3800cc 231 CID	1981	Base, T-Type	US1018
RAINIER				3.8L V6 3800cc 231 CID	1981	Base, T-Type; High performance	US1018H
4.2L L6 256 CID	2004-2005	CXL, CXL Plus	US5097	3.8L V6 3800cc 231 CID	1982-1983	T-Type	US1018
4.2L L6 256 CID	2006-2007	CXL	US5097	3.8L V6 3800cc 231 CID	1982-1983	T-Type; High performance	US1018H
5.3L V8 5328cc 325 CID	2004-2005	CXL, CXL Plus	US64	3.8L V6 3800cc 231 CID	1984-1985	Base, Luxury, T-Type	US1018
5.3L V8 5328cc 325 CID	2004-2005	CXL, CXL Plus; Includes thermostat and thermostat housing	US64-T	3.8L V6 3800cc 231 CID	1984-1985	Base, Luxury, T-Type; High performance	US1018H
5.3L V8 5328cc 325 CID	2006	CXL	US64	3.8L V6 3800cc 231 CID	1986-1989	Luxury, T-Type	US5050
5.3L V8 5328cc 325 CID	2006	CXL; Includes thermostat and thermostat housing	US64-T	3.8L V6 3800cc 231 CID	1990-1993	Luxury	US5050
5.3L V8 5328cc 325 CID	2007	CXL	US6009	3.8L V6 3800cc 231 CID	1995	Base	US5050
5.3L V8 5328cc 325 CID	2007	CXL; Includes thermostat and thermostat housing	US6009-T	3.8L V6 3800cc 231 CID	1996-1999	Base	US5075
REATTA				4.1L V6 252 CID	1981	Base, T-Type	US1018
3.8L V6 3800cc 231 CID	1988-1991	Base	US5050	4.1L V6 252 CID	1981	Base, T-Type; High performance	US1018H
REGAL				4.1L V6 252 CID	1982	Base, Limited Edition	US1018
2.0L L4 1998cc 122 CID	2011	CXL	US5092	4.1L V6 252 CID	1982	Base, Limited Edition; High performance	US1018H
2.0L L4 1998cc 122 CID	2012-2013	GS, Turbo	US5092	4.1L V6 252 CID	1983	Base, Limited Edition; High performance	US1018H
2.0L L4 1998cc 122 CID	2014	GS, Turbo; Pump only	US8102	4.1L V6 252 CID	1983	Base, Limited Edition; High performance	US1018H
2.0L L4 1998cc 122 CID	2015	Base, GS, Premium	US8102	4.1L V6 252 CID	1983	Base, Limited Edition; High performance	US1018H
2.0L L4 1998cc 122 CID	2015	Base, GS, Premium; Pump only	US8102	4.1L V6 252 CID	1983	Base, Limited Edition; High performance	US1018H
2.0L L4 1998cc 122 CID	2016-2017	Base, GS, Premium, Sport Touring	US8102	4.1L V6 252 CID	1983	Base, Limited Edition; High performance	US1018H
2.4L L4 2384cc 145 CID	2011	CXL	US5092	4.1L V6 252 CID	1984	Base, Limited Edition; High performance	US1018H
2.4L L4 2384cc 145 CID	2012-2014	Base	US5092	4.1L V6 252 CID	1984	Base, Limited Edition; High performance	US1018H
2.4L L4 2384cc 145 CID	2015-2016	Base, Premium	US5092	4.1L V6 252 CID	1984	Base, Limited Edition; High performance	US1018H
2.4L L4 2384cc 145 CID	2017	Base	US5092	4.1L V6 252 CID	1984	Base, Limited Edition; High performance	US1018H
2.8L V6 173 CID	1988-1989	Custom, Limited	US5033	4.1L V6 252 CID	1984	Base, Limited Edition; High performance	US1018H
3.1L V6 189 CID	1989	Custom, Gran Sport, Limited	US5033	4.1L V6 252 CID	1984	Base, Limited Edition; High performance	US1018H
3.1L V6 189 CID	1990-1993	Custom, Limited	US5033	4.1L V6 252 CID	1984	Base, Limited Edition; High performance	US1018H
3.1L V6 189 CID	1994-1996	Custom	US5033	4.1L V6 252 CID	1984	Base, Limited Edition; High performance	US1018H
3.2L V6 196 CID	1978-1979		US1018	4.1L V6 252 CID	1984	Base, Limited Edition; High performance	US1018H
3.2L V6 196 CID	1978-1979	High performance	US1018H	4.1L V6 252 CID	1984	Base, Limited Edition; High performance	US1018H
3.8L V6 231 CID	1975-1977	High performance	US1018	4.1L V6 252 CID	1984	Base, Limited Edition; High performance	US1018H
3.8L V6 231 CID	1979		US1018	4.1L V6 252 CID	1984	Base, Limited Edition; High performance	US1018H
3.8L V6 231 CID	1979	High performance	US1018H	4.1L V6 252 CID	1984	Base, Limited Edition; High performance	US1018H
3.8L V6 3800cc 231 CID	1978-1979		US1018	4.1L V6 252 CID	1984	Base, Limited Edition; High performance	US1018H
3.8L V6 3800cc 231 CID	1978-1979	High performance	US1018H	4.1L V6 252 CID	1984	Base, Limited Edition; High performance	US1018H
3.8L V6 3800cc 231 CID	1980-1981	Base, Limited, Sport	US1018	4.1L V6 252 CID	1984	Base, Limited Edition; High performance	US1018H
3.8L V6 3800cc 231 CID	1980-1981	Base, Limited, Sport; High performance	US1018H	5.0L V8 307 CID	1980	Base, S; Exc.Air Cond	US1100
3.8L V6 3800cc 231 CID	1982	Base, Estate Wagon, Limited, Sport	US1018	5.0L V8 307 CID	1980	Base, S; With air cond.	US1120
3.8L V6 3800cc 231 CID	1982	Base, Estate Wagon, Limited, Sport; High performance	US1018H	5.0L V8 307 CID	1980	Base, S; High performance, With air cond.	US1120H
3.8L V6 3800cc 231 CID	1983	Base, Estate Wagon, Limited, T-Type	US1018	5.0L V8 307 CID	1981	Base, T-Type; Exc.Air Cond	US1100
3.8L V6 3800cc 231 CID	1983	Base, Estate Wagon, Limited, T-Type; High performance	US1018H	5.0L V8 307 CID	1981	Base, T-Type; With air cond.	US1120
3.8L V6 3800cc 231 CID	1984-1986	Base, Grand National, Limited, T-Type	US1018	5.0L V8 307 CID	1981	Base, T-Type; High performance, With air cond.	US1120H
3.8L V6 3800cc 231 CID	1984-1986	Base, Grand National, Limited, T-Type; High performance	US1018H	5.0L V8 307 CID	1982	Base, Limited Edition; Exc.Air Cond	US1100
3.8L V6 3800cc 231 CID	1987	Base, GNX, Grand National, Limited	US1018	5.0L V8 307 CID	1982	Base, Limited Edition; With air cond.	US1120
3.8L V6 3800cc 231 CID	1987	Base, GNX, Grand National, Limited; High performance	US1018H	5.0L V8 307 CID	1982	Base, Limited Edition; High performance, With air cond.	US1120H
3.8L V6 3800cc 231 CID	1990-1995	Custom, Gran Sport, Limited	US5050	5.0L V8 307 CID	1983	Base, Limited Edition; High performance, With air cond.	US1120H
3.8L V6 3800cc 231 CID	1996	Custom, Gran Sport, Limited, Olympic Gold Edition	US5075	5.0L V8 307 CID	1983	Base, Limited Edition; High performance, With air cond.	US1120H
3.8L V6 3800cc 231 CID	1997	GS, LS	US5075	5.0L V8 307 CID	1983	Base, Limited Edition; High performance, With air cond.	US1120H
3.8L V6 3800cc 231 CID	1998	25th Anniversary Edition, GS, LS	US5075	5.0L V8 307 CID	1984-1985	Base, Limited Edition; High performance, With air cond.	US1120H

Engine	Years	Application Description	USMW	Engine	Years	Application Description	USMW
BUICK (cont'd.)				BUICK (cont'd.)			
RIVIERA (cont'd.)				SKYLARK (cont'd.)			
5.0L V8 307 CID	1984-1985	Base, Luxury; With air cond.	US1120	3.1L V6 189 CID	1998	Custom	US5033
5.0L V8 307 CID	1984-1985	Base, Luxury; High performance, With air cond.	US1120H	3.3L V6 204 CID	1989	Custom, Limited	US5050
5.7L V8 350 CID	1977-1979		US1018	3.3L V6 204 CID	1990	Custom, Gran Sport, Luxury Edition	US5050
5.7L V8 350 CID	1977-1979	High performance	US1018H	3.3L V6 204 CID	1991	Base, Custom, Gran Sport, Luxury Edition	US5050
5.7L V8 350 CID	1977-1979	Exc.Air Cond	US1100	3.3L V6 204 CID	1992	Custom, Gran Sport	US5050
5.7L V8 350 CID	1977-1979	Air Cond	US1120	3.3L V6 204 CID	1993	Custom, Gran Sport, Limited	US5050
5.7L V8 350 CID	1977-1979	Air Cond, High performance	US1120H	3.7L V6 3687cc 225 CID	1964-1967		US855
5.7L V8 350 CID	1980	Base, S; Exc.Air Cond	US1100	3.8L V6 231 CID	1975-1977		US1018
5.7L V8 350 CID	1980	Base, S; With air cond.	US1120	3.8L V6 231 CID	1975-1977	High performance	US1018H
5.7L V8 350 CID	1980	Base, S; High performance, With air cond.	US1120H	3.8L V6 3800cc 231 CID	1978		US1018
5.7L V8 350 CID	1981	Base; Exc.Air Cond	US1100	3.8L V6 3800cc 231 CID	1978-1979	High performance	US1018H
5.7L V8 350 CID	1981	Base; With air cond.	US1120	4.3L V8 260 CID	1975-1976	Exc.Air Cond	US1100
5.7L V8 350 CID	1981	Base; High performance, With air cond.	US1120H	4.3L V8 260 CID	1975-1976	Air Cond	US1120
5.7L V8 350 CID	1982	Base, Limited Edition; Exc.Air Cond	US1100	4.3L V8 260 CID	1975-1976	Air Cond, High performance	US1120H
5.7L V8 350 CID	1982	Base, Limited Edition; With air cond.	US1120	4.9L V8 301 CID	1977		US975
5.7L V8 350 CID	1982	Base, Limited Edition; High performance, With air cond.	US1120H	4.9L V8 4917cc 300 CID	1964-1967		US855
5.7L V8 350 CID	1983	Base, Luxury, XX Anniversary Edition; Exc.Air Cond	US1100	5.0L V8 305 CID	1977-1979		US1121
5.7L V8 350 CID	1983	Base, Luxury, XX Anniversary Edition; With air cond.	US1120	5.0L V8 305 CID	1977-1979	High performance	US1121H
5.7L V8 350 CID	1983	Base, Luxury, XX Anniversary Edition; High performance, With air cond.	US1120H	5.7L V8 350 CID	1968-1970		US855
5.7L V8 350 CID	1984-1985	Base, Luxury; Exc.Air Cond	US1100	5.7L V8 350 CID	1975-1976	Exc.Air Cond	US1018
5.7L V8 350 CID	1984-1985	Base, Luxury; With air cond.	US1120	5.7L V8 350 CID	1975-1977	Air Cond	US1100
5.7L V8 350 CID	1984-1985	Base, Luxury; High performance, With air cond.	US1120H	5.7L V8 350 CID	1975-1977	Air Cond, High performance	US1120H
6.6L V8 403 CID	1977-1978	Exc.Air Cond	US1100	5.7L V8 350 CID	1975-1978	High performance	US1018H
6.6L V8 403 CID	1977-1978	Air Cond	US1120	5.7L V8 350 CID	1978-1979		US1121
6.6L V8 403 CID	1977-1978	Air Cond, High performance	US1120H	5.7L V8 350 CID	1979	High performance	US1121H
7.0L V8 7047cc 430 CID	1967-1969		US821	5.7L V8 5736cc 350 CID	1968-1970		US855
7.5L V8 455 CID	1975		US1045	SOMERSET			
7.5L V8 7456cc 455 CID	1970-1972		US821	2.5L L4 2474cc 151 CID	1986	Custom, Limited, T-Type	US5000
ROADMASTER				2.5L L4 2474cc 151 CID	1986-1987	With Multi-Groove pulley	US5067
5.0L V8 305 CID	1991	Estate Wagon	US5051	2.5L L4 2474cc 151 CID	1987	Custom, Limited	US5000
5.7L V8 350 CID	1992-1993	Base, Estate Wagon, Limited	US5051	2.5L L4 2474cc 151 CID	1987	Custom, Limited; Includes pulley	US5000P
5.7L V8 350 CID	1994-1995	Base, Estate Wagon, Limited	US5069	3.0L V6 181 CID	1986	Custom, Limited, T-Type	US5050
5.7L V8 350 CID	1996	Collector's Edition, Estate Wagon Collector's Edition, Limited Collector's Edition	US5069	3.0L V6 181 CID	1987	Custom, Limited	US5050
SKYHAWK				SOMERSET REGAL			
1.8L L4 112 CID	1982	Custom, Limited	US5007	2.5L L4 2474cc 151 CID	1985	Base, Limited	US5000
1.8L L4 112 CID	1982	Custom, Limited	US5017	2.5L L4 2474cc 151 CID	1985	With Multi-Groove pulley	US5067
1.8L L4 112 CID	1983-1985	Custom, Limited, T-Type	US5017	3.0L V6 181 CID	1985	Base, Limited	US5050
1.8L L4 112 CID	1986	Custom, Limited, Sport, T-Type	US5017	SPECIAL			
2.0L L4 122 CID	1983-1985	Custom, Limited	US5007	3.7L V6 3687cc 225 CID	1964-1967		US855
2.0L L4 122 CID	1986	Custom, Limited, Sport	US5007	4.9L V8 4917cc 300 CID	1964-1967		US855
2.0L L4 122 CID	1987	Custom, Limited, Sport, T-Type	US5032	5.7L V8 5736cc 350 CID	1968-1969		US855
2.0L L4 122 CID	1987	Custom, Limited, Sport, T-Type	US5036	SPORTWAGON			
2.0L L4 122 CID	1988	Custom, SE	US5036	3.7L V6 3687cc 225 CID	1964		US855
2.0L L4 122 CID	1988-1989	Custom, SE	US5032	4.9L V8 4917cc 300 CID	1964-1965		US855
3.8L V6 231 CID	1975-1977		US1018	5.7L V8 5736cc 350 CID	1968-1970		US855
3.8L V6 231 CID	1975-1977	High performance	US1018H	TERRAZA			
3.8L V6 3800cc 231 CID	1978-1979		US1018	3.5L V6 213 CID	2005-2006	CX, CXL	US5033
3.8L V6 3800cc 231 CID	1978-1979	High performance	US1018H	3.9L V6 3880cc 237 CID	2006-2007	CX, CXL	US6020
3.8L V6 3800cc 231 CID	1980	Base, Designers' Accent Edition, Road Hawk, S	US1018	VERANO			
3.8L V6 3800cc 231 CID	1980	Base, Designers' Accent Edition, Road Hawk, S; High performance	US1018H	2.0L L4 1998cc 122 CID	2013	Premium, Turbo	US5092
SKYLARK				2.0L L4 1998cc 122 CID	2014-2016	Premium	US5092
2.3L L4 138 CID	1988-1989	Custom, Limited	US5043	2.4L L4 2384cc 145 CID	2012	Base	US5092
2.3L L4 138 CID	1990	Custom, Gran Sport, Luxury Edition	US5043	2.4L L4 2384cc 145 CID	2013-2015	Base, Convenience, Leather	US5092
2.3L L4 138 CID	1991	Base, Custom, Gran Sport, Luxury Edition	US5043	2.4L L4 2384cc 145 CID	2016	Base, Convenience, Leather, Sport Touring	US5092
2.3L L4 138 CID	1992	Custom	US5043	2.4L L4 2384cc 145 CID	2017	Base, Leather, Sport Touring	US5092
2.3L L4 138 CID	1993-1995	Custom, Limited	US5043	WILDCAT			
2.4L L4 2392cc 146 CID	1996	Custom, Limited, Olympic Gold Edition	US5076	7.0L V8 7047cc 430 CID	1967-1969		US821
2.4L L4 2392cc 146 CID	1997	Custom, Limited	US5076	7.5L V8 7456cc 455 CID	1970		US821
2.4L L4 2392cc 146 CID	1998	Custom	US5076	CADILLAC			
2.5L L4 2474cc 151 CID	1980-1982	Base, Limited, Sport	US5000	60 SPECIAL			
2.5L L4 2474cc 151 CID	1980-1982	Base, Limited, Sport; Includes pulley	US5000P	4.9L V8 300 CID	1993	Base	US5023
2.5L L4 2474cc 151 CID	1983-1985	Custom, Limited; Includes pulley	US5000P	ALLANTE			
2.5L L4 2474cc 151 CID	1983-1989	Custom, Limited	US5000	4.1L V8 250 CID	1987-1988	Base	US5023
2.5L L4 2474cc 151 CID	1986-1991	With Multi-Groove pulley	US5067	4.5L V8 273 CID	1989	Base	US5023
2.5L L4 2474cc 151 CID	1990-1991	Base, Custom, Gran Sport, Luxury Edition	US5000	4.5L V8 273 CID	1990-1992	Base, Value Leader	US5023
2.8L V6 173 CID	1980-1982	Base, Limited, Sport	US5001	4.6L V8 281 CID	1993	Base, Indianapolis 500 Pace Car, Value Leader	US5064
2.8L V6 173 CID	1983	Custom, Limited, Sport, T-Type	US5001	ATS			
2.8L V6 173 CID	1984	Custom, Limited, T-Type	US5001	2.0L L4 1998cc 122 CID	2013-2015	Base, Luxury, Performance, Premium; Pump only	US8102
2.8L V6 173 CID	1985	Custom, Limited	US5001	2.0L L4 1998cc 122 CID	2015-2016	Base, Luxury, Performance, Premium	US8102
3.0L V6 181 CID	1986-1988	Custom, Limited	US5050	2.0L L4 1998cc 122 CID	2017	Base, Luxury	US8102
3.1L V6 189 CID	1994-1995	Custom, Gran Sport, Limited	US5033	2.5L L4 2457cc 150 CID	2013-2015	Base, Luxury; Pump only	US8102
3.1L V6 189 CID	1996	Custom, Gran Sport, Limited, Olympic Gold Edition	US5033	2.5L L4 2457cc 150 CID	2015-2016	Base, Luxury	US8102
3.1L V6 189 CID	1997	Custom, Gran Sport, Limited	US5033	3.6L V6 222 CID	2016	Luxury, Performance, Premium	US8148
				3.6L V6 222 CID	2017	Premium Luxury, Premium Performance	US8148
				3.6L V6 3564cc 217 CID	2013	Luxury, Performance, Premium	US8932

WATER PUMPS

Engine	Years	Application Description	USMW	Engine	Years	Application Description	USMW
CADILLAC (cont'd.)				CADILLAC (cont'd.)			
ATS (cont'd.)				DEVILLE (cont'd.)			
3.6L V6 3564cc 217 CID	2015	Luxury, Performance, Premium	US8932	4.5L V8 273 CID	1988-1990	Base	US5023
3.6L V6 3564cc 217 CID	2016-2017	V	US8932	4.6L V8 281 CID	1994	Concours	US5064
BROUGHAM				4.6L V8 281 CID	1995	Concours	US5072
5.0L V8 305 CID	1991-1992	Base, d'Elegance	US5049	4.6L V8 281 CID	1996-1999	Base, Concours, d'Elegance	US5072
5.0L V8 305 CID	1991-1992	Base, d'Elegance; High performance	US5049H	4.6L V8 281 CID	2000-2003	Base, DHS, DTS	US5072
5.0L V8 307 CID	1987-1990	Base, d'Elegance	US1120	4.6L V8 281 CID	2004-2005	Base, DHS, DTS, Protection Series	US5072
5.0L V8 307 CID	1987-1990	Base, d'Elegance; High performance	US1120H	4.6L V8 4573cc 279 CID	1993	Mexican Application	US5072
5.7L V8 350 CID	1990-1992	Base, d'Elegance	US5049	4.9L V8 300 CID	1991	Base, Spring Edition, Touring	US5023
5.7L V8 350 CID	1990-1992	Base, d'Elegance; High performance	US5049H	4.9L V8 300 CID	1992-1993	Base, Touring	US5023
CALAIS				4.9L V8 300 CID	1994-1995	Base	US5023
7.7L V8 472 CID	1968-1973		US5003	4.9L V8 4900cc 300 CID	1996-1997	Mexican Application	US5072
7.7L V8 7735cc 472 CID	1968-1973		US5003	5.7L V8 350 CID	1980-1984	Base, Cabriolet, d'Elegance	US1120
CATERA				5.7L V8 350 CID	1980-1984	Base, Cabriolet, d'Elegance; High performance	US1120H
3.0L V6 2962cc 181 CID	1997-1998	Base	US5079	6.0L V8 368 CID	1980-1981	Base, Cabriolet, d'Elegance	US5003
3.0L V6 2962cc 181 CID	1999-2001	Base, Sport	US5079	7.0L V8 425 CID	1977-1979		US5003
CIMARRON				7.7L V8 472 CID	1968-1973		US5003
1.8L L4 112 CID	1982	Base	US5007	7.7L V8 7735cc 472 CID	1968-1973		US5003
2.0L L4 122 CID	1983	Base	US5007	DTS			
2.0L L4 122 CID	1984-1986	Base, d'Oro	US5007	4.6L V8 281 CID	2006	Base	US8956
2.8L V6 173 CID	1985-1986	Base, d'Oro	US5020	4.6L V8 281 CID	2007	Base, L	US8956
2.8L V6 173 CID	1987-1988	Base	US5033	4.6L V8 281 CID	2008-2011	Base, L, Platinum	US8956
COMMERCIAL CHASSIS				ELDORADO			
4.1L V8 250 CID	1985-1987	Base	US5023	4.1L V6 252 CID	1981	Base, Biarritz, Brougham d'Elegance, Cabriolet	US1018
4.3L V6 260 CID	1985	Base; W/O Pulley	US5014	4.1L V6 252 CID	1981	Base, Biarritz, Brougham d'Elegance, Cabriolet; High performance	US1018H
4.3L V6 260 CID	1985	Base; Includes pulley	US5014P	4.1L V6 252 CID	1982	Base, Biarritz, Cabriolet, Touring	US1018
4.5L V8 273 CID	1988-1990	Base	US5023	4.1L V6 252 CID	1982	Base, Biarritz, Cabriolet, Touring; High performance	US1018H
4.9L V8 300 CID	1991-1993	Base	US5023	4.1L V8 250 CID	1982-1985	Base, Biarritz, Cabriolet, Touring	US5010
5.7L V8 350 CID	1992-1993	Brougham	US5049	4.1L V8 250 CID	1986-1987	Base, Biarritz	US5023
5.7L V8 350 CID	1992-1993	Brougham; High performance	US5049H	4.5L V8 273 CID	1988-1989	Base, Biarritz	US5023
5.7L V8 350 CID	1994-1996	Base, Brougham	US5069	4.5L V8 273 CID	1990	Base, Biarritz, Touring	US5023
6.0L V8 368 CID	1980-1984	Base	US5003	4.6L V8 281 CID	1993	Sport, Touring	US5064
6.4L V8 6392cc 390 CID	1963		US670	4.6L V8 281 CID	1994	Base, Touring	US5064
7.0L V8 7031cc 429 CID	1964-1965		US670	4.6L V8 281 CID	1995-1997	Base, ETC	US5072
7.7L V8 7735cc 472 CID	1968-1973		US5003	4.6L V8 281 CID	1998-2002	ESC, ETC	US5072
CT6				4.9L V8 300 CID	1991	Base, Biarritz, Spring Edition, Touring	US5023
2.0L L4 1998cc 122 CID	2016-2017	Base, Luxury	US8102	4.9L V8 300 CID	1992	Base, Touring	US5023
3.0L V6 182 CID	2016-2017	Luxury, Platinum, Premium Luxury	US8148	4.9L V8 300 CID	1993	Base	US5023
3.6L V6 222 CID	2016-2017	Base, Luxury, Platinum, Premium Luxury	US8148	5.7L V8 350 CID	1980	Base, Biarritz, Cabriolet	US1120
CTS				5.7L V8 350 CID	1980	Base, Biarritz, Cabriolet; High performance	US1120H
2.0L L4 1998cc 122 CID	2014-2015	Base, Luxury, Performance, Premium; Pump only	US8102	5.7L V8 350 CID	1981	Base, Biarritz, Brougham d'Elegance, Cabriolet	US1120
2.0L L4 1998cc 122 CID	2015-2016	Base, Luxury, Performance, Premium	US8102	5.7L V8 350 CID	1981	Base, Biarritz, Brougham d'Elegance, Cabriolet; High performance	US1120H
2.0L L4 1998cc 122 CID	2017	Base, Luxury	US8102	5.7L V8 350 CID	1982-1983	Base, Biarritz, Cabriolet, Touring	US1120
2.8L V6 2792cc 170 CID	2005-2007	Base	US8932	5.7L V8 350 CID	1982-1983	Base, Biarritz, Cabriolet, Touring; High performance	US1120H
3.0L V6 182 CID	2010-2011	Base, Luxury, Performance	US8932	5.7L V8 350 CID	1984-1985	Base, Cabriolet, Touring	US1120
3.0L V6 182 CID	2012-2013	Base, Luxury	US8932	5.7L V8 350 CID	1984-1985	Base, Cabriolet, Touring; High performance	US1120H
3.0L V6 2994cc 183 CID	2013	Mexican Application	US8932	6.0L V8 368 CID	1980	Base, Biarritz, Cabriolet	US5003
3.2L V6 197 CID	2003	Base, Luxury, Luxury Sport	US5079	6.0L V8 368 CID	1981	Base, Biarritz, Brougham d'Elegance, Cabriolet	US5003
3.2L V6 197 CID	2004	Base	US5079	7.0L V8 425 CID	1977-1978		US5003
3.6L V6 222 CID	2016	Luxury, Performance, Premium	US8148	7.7L V8 472 CID	1968-1969		US5003
3.6L V6 222 CID	2017	Luxury, Premium Luxury	US8148	7.7L V8 7735cc 472 CID	1968-1969		US5003
3.6L V6 3564cc 217 CID	2004-2009	Base	US8932	8.2L V8 500 CID	1970-1973		US5003
3.6L V6 3564cc 217 CID	2010	Luxury, Performance, Premium	US8932	8.2L V8 8193cc 500 CID	1970-1973		US5003
3.6L V6 3564cc 217 CID	2011-2013	Base, Performance, Premium	US8932	8.2L V8 8195cc 500 CID	1972-1973		US5003
3.6L V6 3564cc 217 CID	2015	Luxury, Performance, Premium, Vsport, Vsport Premium	US8932	ELR			
3.6L V6 3564cc 217 CID	2016	Vsport, Vsport Premium	US8932	1.4L L4 1398cc 85 CID	2014-2015	Base	US8152
3.6L V6 3564cc 217 CID	2017	Vsport, Vsport Premium Luxury	US8932	ESCALADE			
5.7L V8 346 CID	2004-2005	V	US65N	5.3L V8 5328cc 325 CID	2002-2005	Base	US64
5.7L V8 346 CID	2004-2005	V; Includes thermostat and thermostat housing	US65N-T	5.3L V8 5328cc 325 CID	2002-2005	Base; Includes thermostat and thermostat housing	US64-T
6.0L V8 5967cc 364 CID	2006-2007	V	US65N	5.7L V8 350 CID	1999-2000	Base	US5077
6.0L V8 5967cc 364 CID	2006-2007	V; Includes thermostat and thermostat housing	US65N-T	5.7L V8 350 CID	1999-2000	Base; High performance	US5077H
6.2L V8 6162cc 376 CID	2009-2015	V	US79	6.0L V8 5967cc 364 CID	2002-2006	Base	US64
6.2L V8 6162cc 376 CID	2016-2017	V	US8918	6.0L V8 5967cc 364 CID	2002-2006	Base; Includes thermostat and thermostat housing	US64-T
6.2L V8 6162cc 376 CID	2016-2017	V; Pump only	US8918	6.0L V8 5967cc 364 CID	2009	Hybrid	US6009
CTS-V				6.0L V8 5967cc 364 CID	2009	Hybrid; Includes thermostat and thermostat housing	US6009-T
6.2L V8 6200cc 378 CID	2013	Mexican Application	US8932	6.0L V8 5967cc 364 CID	2010-2013	Hybrid, Hybrid Platinum	US6009
DEVILLE				6.0L V8 5967cc 364 CID	2010-2013	Hybrid, Hybrid Platinum; Includes thermostat and thermostat housing	US6009-T
4.1L V6 252 CID	1980-1982	Base, Cabriolet, d'Elegance	US1018	6.2L V8 6162cc 376 CID	2007	Base	US6009
4.1L V6 252 CID	1980-1982	Base, Cabriolet, d'Elegance; High performance	US1018H	6.2L V8 6162cc 376 CID	2007	Base; Includes thermostat and thermostat housing	US6009-T
4.1L V8 250 CID	1982-1984	Base, Cabriolet, d'Elegance	US5010	6.2L V8 6162cc 376 CID	2008-2010	Base, Platinum	US6009
4.1L V8 250 CID	1985	Base, Cabriolet, d'Elegance	US5023	6.2L V8 6162cc 376 CID	2008-2010	Base, Platinum; Includes thermostat and thermostat housing	US6009-T
4.1L V8 250 CID	1986	d'Elegance, Touring	US5023	6.2L V8 6162cc 376 CID	2011-2014	Base, Luxury, Platinum, Premium	US6009
4.1L V8 250 CID	1987	Base, d'Elegance, Touring	US5023				
4.3L V6 260 CID	1985	Base, Cabriolet, d'Elegance; W/O Pulley	US5014				
4.3L V6 260 CID	1985	Base, Cabriolet, d'Elegance; Includes pulley	US5014P				

Engine	Years	Application Description	USMW	Engine	Years	Application Description	USMW
CADILLAC (cont'd.)				CADILLAC (cont'd.)			
ESCALADE (cont'd.)				STS			
6.2L V8 6162cc 376 CID	2011-2014	Base, Luxury, Platinum, Premium; Includes thermostat and thermostat housing	US6009-T	3.6L V6 3564cc 217 CID	2005-2007	Base	US8932
6.2L V8 6162cc 376 CID	2015-2016	Base, Luxury, Platinum, Premium	US8918	3.6L V6 3564cc 217 CID	2008-2009	Base, Platinum	US8932
6.2L V8 6162cc 376 CID	2017	Base, Luxury, Platinum, Premium	US8918	3.6L V6 3564cc 217 CID	2010-2011	Base	US8932
ESCALADE ESV				4.4L V8 4371cc 267 CID 2006-2009 V US8955			
6.0L V8 5967cc 364 CID	2003-2006	Base	US64	4.6L V8 281 CID	2005-2007	Base	US8955
6.0L V8 5967cc 364 CID	2003-2006	Base; Includes thermostat and thermostat housing	US64-T	4.6L V8 281 CID	2008-2009	Base, Platinum	US8955
6.2L V8 6162cc 376 CID	2007	Base	US6009	4.6L V8 281 CID	2010	Base	US8955
6.2L V8 6162cc 376 CID	2007	Base; Includes thermostat and thermostat housing	US6009-T	XLR			
6.2L V8 6162cc 376 CID	2008-2010	Base, Platinum	US6009	4.4L V8 4371cc 267 CID	2006-2009	V	US8955
6.2L V8 6162cc 376 CID	2008-2010	Base, Platinum; Includes thermostat and thermostat housing	US6009-T	4.6L V8 281 CID	2004-2007	Base	US8955
6.2L V8 6162cc 376 CID	2011-2014	Base, Luxury, Platinum, Premium	US6009	4.6L V8 281 CID	2008	Base, Platinum	US8955
6.2L V8 6162cc 376 CID	2011-2014	Base, Luxury, Platinum, Premium; Includes thermostat and thermostat housing	US6009-T	4.6L V8 281 CID	2009	Platinum	US8955
6.2L V8 6162cc 376 CID	2015-2016	Base, Luxury, Platinum, Premium	US8918	XT5			
6.2L V8 6162cc 376 CID	2017	Base, Luxury, Platinum, Premium	US8918	3.6L V6 222 CID	2017	Base, Luxury, Platinum, Premium	US8148
ESCALADE EXT				XTS			
6.0L V8 5967cc 364 CID	2002-2006	Base	US64	3.6L V6 3564cc 217 CID	2013	Base, Livery, Luxury, Platinum, Premium	US8932
6.0L V8 5967cc 364 CID	2002-2006	Base; Includes thermostat and thermostat housing	US64-T	3.6L V6 3564cc 217 CID	2015-2016	Base, Livery, Luxury, Platinum, Premium, Vsport Platinum, Vsport Premium	US8932
6.2L V8 6162cc 376 CID	2007-2010	Base	US6009	3.6L V6 3564cc 217 CID	2017	Base, Livery, Luxury, Platinum, Premium Luxury, Vsport Premium Luxury	US8932
6.2L V8 6162cc 376 CID	2007-2010	Base; Includes thermostat and thermostat housing	US6009-T	CHECKER			
6.2L V8 6162cc 376 CID	2011-2013	Base, Luxury, Premium	US6009	DELUXE			
6.2L V8 6162cc 376 CID	2011-2013	Base, Luxury, Premium; Includes thermostat and thermostat housing	US6009-T	5.3L V8 5358cc 327 CID	1969		US898
FLEETWOOD				5.3L V8 5358cc 327 CID 1969 High performance US898H			
4.1L V6 252 CID	1980-1982	Brougham, Brougham d'Elegance	US1018	MARATHON			
4.1L V6 252 CID	1980-1982	Brougham, Brougham d'Elegance; High performance	US1018H	4.6L V8 4638cc 283 CID	1965-1967		US898
4.1L V8 250 CID	1982-1985	Brougham, Brougham d'Elegance	US5010	4.6L V8 4638cc 283 CID	1965-1967	High performance	US898H
4.1L V8 250 CID	1985	75, 75 Formal, Base, d'Elegance	US5023	5.0L V8 307 CID	1968		US898
4.1L V8 250 CID	1986	75, 75 Formal, Base	US5023	5.0L V8 307 CID	1968	High performance	US898H
4.1L V8 250 CID	1987	60 Special, 75, 75 Formal, Base, d'Elegance	US5023	5.0L V8 5031cc 307 CID	1968		US898
4.3L V6 260 CID	1985	75, 75 Formal, Base, d'Elegance; W/O Pulley	US5014	5.0L V8 5031cc 307 CID	1968	High performance	US898H
4.3L V6 260 CID	1985	75, 75 Formal, Base, d'Elegance; Includes pulley	US5014P	5.3L V8 5358cc 327 CID	1965-1969		US898
4.5L V8 273 CID	1988-1990	60 Special, Base, d'Elegance	US5023	5.3L V8 5358cc 327 CID	1965-1969	High performance	US898H
4.9L V8 300 CID	1991-1992	60 Special, Base, d'Elegance	US5023	CHEVROLET			
5.0L V8 307 CID	1986	Brougham, Brougham d'Elegance	US1120	ASTRA			
5.0L V8 307 CID	1986	Brougham, Brougham d'Elegance; High performance	US1120H	1.8L L4 1796cc 110 CID	2000-2003		US8933
5.7L V8 350 CID	1980-1985	Brougham, Brougham d'Elegance	US1120	1.8L L4 1796cc 110 CID	2007-2008		US8933
5.7L V8 350 CID	1980-1985	Brougham, Brougham d'Elegance; High performance	US1120H	1.8L L4 1796cc 110 CID	2007-2008	Mexican Application	US8933
5.7L V8 350 CID	1993	Base, Brougham	US5049	ASTRO			
5.7L V8 350 CID	1993	Base, Brougham; High performance	US5049H	2.5L L4 2474cc 151 CID	1985	Base, CL, CS	US5022
5.7L V8 350 CID	1994-1996	Base, Brougham	US5069	2.5L L4 2474cc 151 CID	1986	Base	US5022
6.0L V8 368 CID	1980-1981	Base, Brougham, Brougham d'Elegance, Formal	US5003	2.5L L4 2474cc 151 CID	1987-1990	Base	US5040
6.0L V8 368 CID	1982-1984	Base, Formal	US5003	4.3L V6 262 CID	1985-1986	Base, CL, CS	US1121
7.0L V8 425 CID	1977-1979		US5003	4.3L V6 262 CID	1985-1986	Base, CL, CS; High performance	US1121H
7.7L V8 472 CID	1968-1973		US5003	4.3L V6 262 CID	1987-1995	Base, CL, CS, LT	US5049
7.7L V8 7735cc 472 CID	1968-1973		US5003	4.3L V6 262 CID	1987-1995	Base, CL, CS, LT; High performance	US5049H
SEVILLE				4.3L V6 262 CID 1996-2005 Base, LS, LT US5077			
4.1L V6 252 CID	1981-1982	Base, Elegante	US1018	AVALANCHE			
4.1L V6 252 CID	1981-1982	Base, Elegante; High performance	US1018H	5.3L V8 5328cc 325 CID	2007-2012	LS, LT, LTZ	US6009
4.1L V8 250 CID	1982-1985	Base, Elegante	US5010	5.3L V8 5328cc 325 CID	2007-2012	LS, LT, LTZ; Includes thermostat and thermostat housing	US6009-T
4.1L V8 250 CID	1986	Base, Elegante	US5023	5.3L V8 5328cc 325 CID	2010-2012	Mexican Application	US6009
4.1L V8 250 CID	1987	Base	US5023	5.3L V8 5328cc 325 CID	2013	Black Diamond LS, Black Diamond LT, Black Diamond LTZ	US6009
4.5L V8 273 CID	1988-1990	Base, STS	US5023	5.3L V8 5328cc 325 CID	2013	Black Diamond LS, Black Diamond LT, Black Diamond LTZ; Includes thermostat and thermostat housing	US6009-T
4.6L V8 281 CID	1993	STS	US5064	5.3L V8 5328cc 325 CID	2013	Black Diamond LTZ; (0), (LMG); Includes thermostat and thermostat housing	US6009-T
4.6L V8 281 CID	1994	SLS, STS	US5064	6.0L V8 5967cc 364 CID	2007-2009	LT, LTZ	US6009
4.6L V8 281 CID	1995-2003	SLS, STS	US5072	6.0L V8 5967cc 364 CID	2007-2009	LT, LTZ; Includes thermostat and thermostat housing	US6009-T
4.6L V8 281 CID	2004	SLS	US5072	AVALANCHE 1500			
4.9L V8 300 CID	1991-1992	Base, STS	US5023	5.3L V8 5328cc 325 CID	2002	Base, On Road Edition, Z71	US64
4.9L V8 300 CID	1993	Base	US5023	5.3L V8 5328cc 325 CID	2002	Base, On Road Edition, Z71; Includes thermostat and thermostat housing	US64-T
5.7L V8 350 CID	1980-1985	Base, Elegante	US1120	5.3L V8 5328cc 325 CID	2003	Base, North Face, On Road Edition, WBH, Z71	US64
5.7L V8 350 CID	1980-1985	Base, Elegante; High performance	US1120H	5.3L V8 5328cc 325 CID	2003	Base, North Face, On Road Edition, WBH, Z71; Includes thermostat and thermostat housing	US64-T
6.0L V8 368 CID	1980-1981	Base, Elegante	US5003	5.3L V8 5328cc 325 CID	2004	Base, Z66, Z71	US64
SRX				5.3L V8 5328cc 325 CID	2004	Base, Z66, Z71; Includes thermostat and thermostat housing	US64-T
2.8L V6 2792cc 170 CID	2010-2011	Performance, Premium	US8932	5.3L V8 5328cc 325 CID	2005	Base, LS, LT, Z66, Z71	US64
3.0L V6 182 CID	2010-2011	Base, Luxury, Performance, Premium	US8932	5.3L V8 5328cc 325 CID	2005	Base, LS, LT, Z66, Z71; Includes thermostat and thermostat housing	US64-T
3.6L V6 3564cc 217 CID	2004-2009	Base	US8932	5.3L V8 5328cc 325 CID	2005	Base, LS, LT, Z66, Z71	US64
3.6L V6 3564cc 217 CID	2012-2013	Base, Luxury, Performance, Premium	US8932	5.3L V8 5328cc 325 CID	2005	Base, LS, LT, Z66, Z71; Includes thermostat and thermostat housing	US64-T
3.6L V6 3564cc 217 CID	2015-2016	Base, Luxury, Performance, Premium	US8932	5.3L V8 5328cc 325 CID	2006	LS, LT, Z66, Z71	US64
4.6L V8 281 CID	2004-2009	Base	US8955				

WATER PUMPS

Engine	Years	Application Description	USMW	Engine	Years	Application Description	USMW
CHEVROLET (cont'd.)				CHEVROLET (cont'd.)			
AVALANCHE 1500 (cont'd.)				BISCAYNE			
5.3L V8 5328cc 325 CID	2006	LS, LT, Z66, Z71; Includes thermostat and thermostat housing	US64-T	4.6L V8 283 CID	1960		US898
AVALANCHE 2500				4.6L V8 283 CID	1960	High performance	US898H
8.1L V8 496 CID	2002-2004	Base	US5089	4.6L V8 4638cc 283 CID	1958-1967		US898
8.1L V8 496 CID	2002-2004	Base; High performance	US5089H	4.6L V8 4638cc 283 CID	1958-1967	High performance	US898H
8.1L V8 496 CID	2005-2006	LS, LT	US5089	5.0L V8 307 CID	1968		US898
8.1L V8 496 CID	2005-2006	LS, LT; High performance	US5089H	5.0L V8 307 CID	1968	High performance	US898H
AVEO				5.0L V8 5031cc 307 CID	1968		US898
1.6L L4 1598cc 97 CID	2010-2012	Mexican Application	US6184	5.0L V8 5031cc 307 CID	1968	High performance	US898H
1.6L L4 1598cc 97 CID	2010-2016	Mexican Application	US6046	5.3L V8 5358cc 327 CID	1962-1969		US898
1.6L L4 1598cc 98 CID	2004	Base, LS	US6046	5.3L V8 5358cc 327 CID	1962-1969	High performance	US898H
1.6L L4 1598cc 98 CID	2005-2006	LS, LT, Special Value	US6046	5.4L V8 327 CID	1968-1969		US898
1.6L L4 1598cc 98 CID	2007-2008	LS, LT	US6046	5.4L V8 327 CID	1968-1969	High performance	US898H
1.6L L4 1598cc 98 CID	2009-2011	LS, LT	US6184	5.7L V8 348 CID	1960		US898
AVEO5				5.7L V8 348 CID	1960	High performance	US898H
1.6L L4 1598cc 98 CID	2007-2008	LS, Special Value	US6046	5.7L V8 350 CID	1969-1972		US898
1.6L L4 1598cc 98 CID	2009-2011	LS, LT	US6184	5.7L V8 350 CID	1969-1972	High performance	US898H
B7				5.7L V8 5704cc 348 CID	1958-1961		US127
6.0L V8 366 CID	1993-1998	With threaded hub for fan clutch	US5078	5.7L V8 5704cc 348 CID	1958-1961		US898
7.0L V8 6998cc 427 CID	1994-1998	With threaded hub for fan clutch	US5078	5.7L V8 5704cc 348 CID	1958-1961	High performance	US898H
B60				5.7L V8 5736cc 350 CID	1969-1972		US898
6.0L V8 366 CID	1980-1990	Without threaded hub	US5084	5.7L V8 5736cc 350 CID	1969-1972	High performance	US898H
6.0L V8 366 CID	1990-1991	With threaded hub for fan clutch	US5078	6.5L V8 396 CID	1968-1969		US981
7.0L V8 427 CID	1980-1985	Without threaded hub	US5084	6.5L V8 396 CID	1968-1969		US981
BEL AIR				6.5L V8 6489cc 396 CID	1966-1969		US981
4.3L L6 4278cc 261 CID	1959-1960		US898	6.6L V8 400 CID	1970-1972		US981
4.3L L6 4278cc 261 CID	1959-1960	High performance	US898H	6.6L V8 402 CID	1971-1972		US981
4.3L V8 265 CID	1955-1957		US898	6.6L V8 6555cc 400 CID	1970-1972		US981
4.3L V8 265 CID	1955-1957	High performance	US898H	6.6L V8 6556cc 400 CID	1970-1972		US981
4.3L V8 4343cc 265 CID	1955-1957		US898	6.6L V8 6588cc 402 CID	1970-1972		US981
4.3L V8 4343cc 265 CID	1955-1957	High performance	US898H	6.7L V8 6704cc 409 CID	1961-1963		US127
4.6L V8 283 CID	1957		US898	6.7L V8 6704cc 409 CID	1964	1 3/4" mount holes 4 1/2" hub height	US127
4.6L V8 283 CID	1957	High performance	US898H	7.0L V8 427 CID	1968-1969		US981
4.6L V8 4638cc 283 CID	1957-1967		US898	7.0L V8 6998cc 427 CID	1966-1969		US981
4.6L V8 4638cc 283 CID	1957-1967	High performance	US898H	BLAZER			
5.0L V8 307 CID	1968		US898	4.3L V6 262 CID	1995	Base, LT	US5049
5.0L V8 307 CID	1968	High performance	US898H	4.3L V6 262 CID	1995	Base, LT; High performance	US5049H
5.0L V8 5031cc 307 CID	1968		US898	4.3L V6 262 CID	1996-1998	Base, LS, LT	US5077
5.0L V8 5031cc 307 CID	1968	High performance	US898H	4.3L V6 262 CID	1996-1998	Base, LS, LT; High performance	US5077H
5.3L V8 5272cc 322 CID	1959		US898	4.3L V6 262 CID	1999	Base, LS, LT, Trailblazer	US5077
5.3L V8 5272cc 322 CID	1959	High performance	US898H	4.3L V6 262 CID	1999	Base, LS, LT, Trailblazer; High performance	US5077H
5.3L V8 5358cc 327 CID	1962-1969		US898	4.3L V6 262 CID	2000	LS, LT, Trailblazer	US5077
5.3L V8 5358cc 327 CID	1962-1969	High performance	US898H	4.3L V6 262 CID	2000	LS, LT, Trailblazer; High performance	US5077H
5.4L V8 327 CID	1968-1969		US898	4.3L V6 262 CID	2001	LS, LT, Trailblazer, Xtreme	US5077
5.4L V8 327 CID	1968-1969	High performance	US898H	4.3L V6 262 CID	2001	LS, LT, Trailblazer, Xtreme; High performance	US5077H
5.7L V8 350 CID	1969-1972		US898	4.3L V6 262 CID	2002	LS, Xtreme	US5077
5.7L V8 350 CID	1969-1972	High performance	US898H	4.3L V6 262 CID	2002	LS, Xtreme; High performance	US5077H
5.7L V8 5704cc 348 CID	1958-1961		US127	4.3L V6 262 CID	2003-2004	LS, Xtreme, ZR2	US5077
5.7L V8 5704cc 348 CID	1958-1961	High performance	US898	4.3L V6 262 CID	2003-2004	LS, Xtreme, ZR2; High performance	US5077H
5.7L V8 5704cc 348 CID	1958-1961		US898H	4.3L V6 262 CID	2005	Base, Xtreme, ZR2	US5077
5.7L V8 5736cc 350 CID	1969-1972		US898	4.3L V6 262 CID	2005	Base, Xtreme, ZR2; High performance	US5077H
5.7L V8 5736cc 350 CID	1969-1972	High performance	US898H	4.8L L6 292 CID	1970		US896
6.5L V8 396 CID	1968-1969		US981	4.8L L6 292 CID	1973		US896
6.5L V8 396 CID	1968-1969		US981	4.8L L6 4786cc 292 CID	1973		US896
6.5L V8 6489cc 396 CID	1966-1969		US981	4.8L L6 4801cc 292 CID	1969-1974		US896
6.6L V8 400 CID	1970-1972		US981	5.0L V8 305 CID	1987	Custom Deluxe, Silverado	US1121
6.6L V8 400 CID	1975		US1109	5.0L V8 305 CID	1987	Custom Deluxe, Silverado; High performance	US1121H
6.6L V8 400 CID	1975	High performance	US1109H	5.0L V8 307 CID	1969-1972		US898
6.6L V8 402 CID	1971-1972		US981	5.0L V8 307 CID	1969-1972	High performance	US898H
6.6L V8 6555cc 400 CID	1970-1972		US981	5.0L V8 5031cc 307 CID	1969-1972		US898
6.6L V8 6556cc 400 CID	1970-1972		US981	5.0L V8 5031cc 307 CID	1969-1972	High performance	US898H
6.6L V8 6588cc 402 CID	1970-1972		US981	5.7L V8 350 CID	1969-1972		US898
6.7L V8 6704cc 409 CID	1961-1963		US127	5.7L V8 350 CID	1969-1972	High performance	US898H
6.7L V8 6704cc 409 CID	1964	1 3/4" mount holes 4 1/2" hub height	US127	5.7L V8 350 CID	1987	High performance	US898H
7.0L V8 427 CID	1968-1969		US981	5.7L V8 350 CID	1987	Custom Deluxe, Silverado	US1121
7.0L V8 6998cc 427 CID	1966-1969		US981	5.7L V8 350 CID	1987	Custom Deluxe, Silverado; High performance	US1121H
7.4L V8 454 CID	1975	Base	US1002	5.7L V8 350 CID	1988	Scottsdale, Silverado	US1121
7.4L V8 454 CID	1975	Base; High performance	US1002H	5.7L V8 350 CID	1988	Scottsdale, Silverado; High performance	US1121H
BERETTA				5.7L V8 350 CID	1989-1991	Scottsdale, Silverado	US5049
2.0L L4 122 CID	1987-1989	Base	US5032	5.7L V8 350 CID	1989-1991	Scottsdale, Silverado; High performance	US5049H
2.2L L4 134 CID	1990	Base, Indianapolis 500 Pace Car	US5032	5.7L V8 350 CID	1992-1993	Cheyenne, Silverado	US5049
2.2L L4 134 CID	1991	Base	US5032	5.7L V8 350 CID	1992-1993	Cheyenne, Silverado; High performance	US5049H
2.2L L4 2190cc 134 CID	1992-1993	Base, GT	US5032	5.7L V8 350 CID	1994	Base, Silverado, Silverado Sport	US5049
2.2L L4 2190cc 134 CID	1994-1996	Base	US5032	5.7L V8 350 CID	1994	Base, Silverado, Silverado Sport; High performance	US5049H
2.3L L4 140 CID	1990	GTZ, Indianapolis 500 Pace Car	US5043	5.7L V8 350 CID	1994	Base, Silverado, Silverado Sport; High performance	US5049H
2.3L L4 140 CID	1991-1993	GTZ	US5043	5.7L V8 5736cc 350 CID	1969-1972		US898
2.3L L4 140 CID	1994	Z26	US5043	5.7L V8 5736cc 350 CID	1969-1972	High performance	US898H
2.8L V6 173 CID	1987-1988	Base	US5033	6.2L V8 379 CID	1987	Custom Deluxe, Silverado	US5008
2.8L V6 173 CID	1989	Base, GT	US5033	6.2L V8 379 CID	1988-1991	Scottsdale, Silverado	US5008
3.1L V6 189 CID	1990	Base, GT, Indianapolis 500 Pace Car	US5033	6.5L V8 395 CID	1994	Base, Silverado, Silverado Sport	US5062
3.1L V6 189 CID	1991-1993	Base, GT, GTZ	US5033	BOSS TRUCK			
3.1L V6 189 CID	1994-1996	Base, Z26	US5033	5.7L V8 5700cc 350 CID	1996-1997	Mexican Application	US5077

Engine	Years	Application Description	USMW	Engine	Years	Application Description	USMW
CHEVROLET (cont'd.)				CHEVROLET (cont'd.)			
BROOKWOOD				C10 (cont'd.)			
4.6L V8 283 CID	1958		US898	7.4L V8 454 CID	1980	Big Ten, Cheyenne, Custom Deluxe, Scottsdale, Silverado	US1002
4.6L V8 283 CID	1958	High performance	US898H	7.4L V8 454 CID	1980	Big Ten, Cheyenne, Custom Deluxe, Scottsdale, Silverado; High performance	US1002H
4.6L V8 4638cc 283 CID	1959-1961		US898	C10 PICKUP			
4.6L V8 4638cc 283 CID	1959-1961	High performance	US898H	4.3L L6 4278cc 261 CID	1961-1962		US898
5.0L V8 5031cc 307 CID	1969		US898	4.3L L6 4278cc 261 CID	1961-1962	High performance	US898H
5.0L V8 5031cc 307 CID	1969	High performance	US898H	4.6L V8 4638cc 283 CID	1960-1967		US898
5.0L V8 5031cc 307 CID	1971-1972		US898	4.6L V8 4638cc 283 CID	1960-1967	High performance	US898H
5.0L V8 5031cc 307 CID	1971-1972	High performance	US898H	4.8L L6 292 CID	1968-1971		US896
5.3L V8 5358cc 327 CID	1969		US898	4.8L L6 292 CID	1973-1974		US896
5.3L V8 5358cc 327 CID	1969	High performance	US898H	4.8L L6 4786cc 292 CID	1973-1974		US896
5.7L V8 348 CID	1958		US898	4.8L L6 4801cc 292 CID	1965-1974		US896
5.7L V8 348 CID	1958	High performance	US898H	5.0L V8 307 CID	1968-1972		US898
5.7L V8 350 CID	1969-1972		US898	5.0L V8 307 CID	1968-1972	High performance	US898H
5.7L V8 350 CID	1969-1972	High performance	US898H	5.0L V8 5031cc 307 CID	1968-1972		US898
5.7L V8 5704cc 348 CID	1959-1961		US898	5.0L V8 5031cc 307 CID	1968-1972	High performance	US898H
5.7L V8 5704cc 348 CID	1959-1961	High performance	US898H	5.3L V8 5358cc 327 CID	1966-1969		US898
5.7L V8 5736cc 350 CID	1969-1972		US898	5.3L V8 5358cc 327 CID	1966-1969	High performance	US898H
5.7L V8 5736cc 350 CID	1969-1972	High performance	US898H	5.4L V8 327 CID	1968		US898
C10				5.4L V8 327 CID	1968	High performance	US898H
4.1L L6 250 CID	1975-1977		US1110	5.7L V8 350 CID	1969-1972		US898
4.1L L6 250 CID	1978-1979		US1107	5.7L V8 350 CID	1969-1972	High performance	US898H
4.1L L6 250 CID	1980	Big Ten, Cheyenne, Custom Deluxe, Scottsdale, Silverado	US1107	5.7L V8 5704cc 348 CID	1960-1961		US898
4.1L L6 250 CID	1981	Custom, Deluxe	US1107	5.7L V8 5704cc 348 CID	1960-1961	High performance	US898H
4.1L L6 250 CID	1982	Custom, Scottsdale, Silverado	US1107	5.7L V8 5736cc 350 CID	1969-1972		US898
4.1L L6 250 CID	1983	Custom, Silverado	US1107	5.7L V8 5736cc 350 CID	1969-1972	High performance	US898H
4.1L L6 250 CID	1984	Custom, Scottsdale, Silverado	US1107	6.5L V8 396 CID	1968-1969		US981
4.1L L6 4097cc 250 CID	1979		US1107	6.5L V8 6489cc 396 CID	1968-1969		US981
4.1L L6 4100cc 250 CID	1979-1984	Mexican Application	US1107	6.6L V8 402 CID	1970-1972		US981
4.3L V6 262 CID	1985-1986	Custom, Scottsdale, Silverado	US1121	6.6L V8 6588cc 402 CID	1970-1972		US981
4.3L V6 262 CID	1985-1986	Custom, Scottsdale, Silverado; High performance	US1121H	C10 SUBURBAN			
4.8L L6 292 CID	1980	Big Ten, Cheyenne, Custom Deluxe, Scottsdale, Silverado	US5030	4.1L L6 250 CID	1975-1977		US1110
4.8L L6 4800cc 292 CID	1981-1982	Mexican Application	US5030	4.1L L6 250 CID	1978-1979		US1107
4.8L L6 4800cc 292 CID	1982-1986	Mexican Application	US896	4.1L L6 250 CID	1980	Custom Deluxe, Scottsdale, Silverado	US1107
4.8L L6 4800cc 292 CID	1984-1986	Mexican Application	US5030	4.6L V8 4638cc 283 CID	1967		US898
5.0L V8 305 CID	1977-1979		US1121	4.6L V8 4638cc 283 CID	1967	High performance	US898H
5.0L V8 305 CID	1977-1979	High performance	US1121H	4.8L L6 292 CID	1968-1971		US896
5.0L V8 305 CID	1980	Big Ten, Cheyenne, Custom Deluxe, Scottsdale, Silverado	US1121	4.8L L6 292 CID	1973-1974		US896
5.0L V8 305 CID	1980	Big Ten, Cheyenne, Custom Deluxe, Scottsdale, Silverado; High performance	US1121H	4.8L L6 4786cc 292 CID	1973-1974		US896
5.0L V8 305 CID	1980	Big Ten, Cheyenne, Custom Deluxe, Scottsdale, Silverado; High performance	US1121H	4.8L L6 4801cc 292 CID	1967-1974		US896
5.0L V8 305 CID	1981	Custom, Deluxe	US1121	5.0L V8 305 CID	1977-1979		US1121
5.0L V8 305 CID	1981	Custom, Deluxe; High performance	US1121H	5.0L V8 305 CID	1977-1979	High performance	US1121H
5.0L V8 305 CID	1982	Custom, Scottsdale, Silverado	US1121	5.0L V8 305 CID	1980	Custom Deluxe, Scottsdale, Silverado	US1121
5.0L V8 305 CID	1982	Custom, Scottsdale, Silverado; High performance	US1121H	5.0L V8 305 CID	1980	Custom Deluxe, Scottsdale, Silverado; High performance	US1121H
5.0L V8 305 CID	1983	Custom, Silverado	US1121	5.0L V8 305 CID	1981	Custom, Deluxe	US1121
5.0L V8 305 CID	1983	Custom, Silverado; High performance	US1121H	5.0L V8 305 CID	1981	Custom, Deluxe; High performance	US1121H
5.0L V8 305 CID	1984-1986	Custom, Scottsdale, Silverado	US1121	5.0L V8 305 CID	1982	Custom, Scottsdale, Silverado	US1121
5.0L V8 305 CID	1984-1986	Custom, Scottsdale, Silverado; High performance	US1121H	5.0L V8 305 CID	1982	Custom, Scottsdale, Silverado; High performance	US1121H
5.0L V8 305 CID	1984-1986	Custom, Scottsdale, Silverado; High performance	US1121H	5.0L V8 305 CID	1983	Custom, Silverado	US1121
5.7L V8 350 CID	1975-1976		US1109	5.0L V8 305 CID	1983	Custom, Silverado; High performance	US1121H
5.7L V8 350 CID	1975-1976	High performance	US1109H	5.0L V8 305 CID	1984-1986	Custom, Scottsdale, Silverado	US1121
5.7L V8 350 CID	1977-1979		US1121	5.0L V8 305 CID	1984-1986	Custom, Scottsdale, Silverado; High performance	US1121H
5.7L V8 350 CID	1977-1979	High performance	US1121H	5.0L V8 307 CID	1968-1972		US898
5.7L V8 350 CID	1980	Big Ten, Cheyenne, Custom Deluxe, Scottsdale, Silverado	US1121	5.0L V8 307 CID	1968-1972	High performance	US898H
5.7L V8 350 CID	1980	Big Ten, Cheyenne, Custom Deluxe, Scottsdale, Silverado; High performance	US1121H	5.0L V8 5031cc 307 CID	1968-1972		US898
5.7L V8 350 CID	1981	Custom, Deluxe	US1121	5.0L V8 5031cc 307 CID	1968-1972	High performance	US898H
5.7L V8 350 CID	1981	Custom, Deluxe; High performance	US1121H	5.3L V8 5358cc 327 CID	1967-1969		US898
5.7L V8 350 CID	1982	Custom, Scottsdale, Silverado	US1121	5.3L V8 5358cc 327 CID	1967-1969	High performance	US898H
5.7L V8 350 CID	1982	Custom, Scottsdale, Silverado; High performance	US1121H	5.4L V8 327 CID	1968		US898
5.7L V8 350 CID	1983	Custom, Silverado	US1121	5.4L V8 327 CID	1968	High performance	US898H
5.7L V8 350 CID	1983	Custom, Silverado; High performance	US1121H	5.7L V8 350 CID	1969-1972		US898
5.7L V8 350 CID	1984-1986	Custom, Scottsdale, Silverado	US1121	5.7L V8 350 CID	1969-1972	High performance	US898H
5.7L V8 350 CID	1984-1986	Custom, Scottsdale, Silverado; High performance	US1121H	5.7L V8 350 CID	1975-1976		US1109
5.7L V8 350 CID	1984-1986	Custom, Scottsdale, Silverado; High performance	US1121H	5.7L V8 350 CID	1975-1976	High performance	US1109H
5.7L V8 5700cc 350 CID	1981-1985	Mexican Application	US1121	5.7L V8 350 CID	1977-1979		US1121
5.7L V8 5700cc 350 CID	1987	Mexican Application	US1121	5.7L V8 350 CID	1977-1979	High performance	US1121H
6.2L V8 379 CID	1982	Custom, Scottsdale, Silverado	US5008	5.7L V8 350 CID	1980	Custom Deluxe, Scottsdale, Silverado	US1121
6.2L V8 379 CID	1983	Custom, Silverado	US5008	5.7L V8 350 CID	1980	Custom Deluxe, Scottsdale, Silverado; High performance	US1121H
6.2L V8 379 CID	1984-1986	Custom, Scottsdale, Silverado	US5008	5.7L V8 350 CID	1981	Custom, Deluxe	US1121
6.6L V8 400 CID	1976		US1109	5.7L V8 350 CID	1981	Custom, Deluxe; High performance	US1121H
6.6L V8 400 CID	1976	High performance	US1109H	5.7L V8 350 CID	1982	Custom, Scottsdale, Silverado	US1121
6.6L V8 400 CID	1977-1979		US1121	5.7L V8 350 CID	1982	Custom, Scottsdale, Silverado; High performance	US1121H
6.6L V8 400 CID	1977-1979	High performance	US1121H	5.7L V8 350 CID	1983	Custom, Silverado	US1121
6.6L V8 400 CID	1980	Big Ten, Cheyenne, Custom Deluxe, Scottsdale, Silverado	US1121	5.7L V8 350 CID	1983	Custom, Silverado; High performance	US1121H
6.6L V8 400 CID	1980	Big Ten, Cheyenne, Custom Deluxe, Scottsdale, Silverado	US1121	5.7L V8 350 CID	1984-1986	Custom, Scottsdale, Silverado	US1121
6.6L V8 400 CID	1980	Big Ten, Cheyenne, Custom Deluxe, Scottsdale, Silverado; High performance	US1121H	5.7L V8 350 CID	1984-1986	Custom, Scottsdale, Silverado; High performance	US1121H
7.4L V8 454 CID	1975-1979		US1002	5.7L V8 5736cc 350 CID	1969-1972		US898
7.4L V8 454 CID	1975-1979	High performance	US1002H	5.7L V8 5736cc 350 CID	1969-1972	High performance	US898H
				6.2L V8 379 CID	1982	Custom, Scottsdale, Silverado	US5008

WATER PUMPS

Engine	Years	Application Description	USMW	Engine	Years	Application Description	USMW
CHEVROLET (cont'd.)				CHEVROLET (cont'd.)			
C10 SUBURBAN (cont'd.)				C20 (cont'd.)			
6.2L V8 379 CID	1983	Custom, Silverado	US5008	7.4L V8 454 CID	1983	Custom, Silverado	US1002
6.2L V8 379 CID	1984-1986	Custom, Scottsdale, Silverado	US5008	7.4L V8 454 CID	1983	Custom, Silverado; High performance	US1002H
6.5L V8 396 CID	1968-1969		US981	7.4L V8 454 CID	1984-1986	Custom, Scottsdale, Silverado	US1002
6.5L V8 6489cc 396 CID	1968-1969		US981	7.4L V8 454 CID	1984-1986	Custom, Scottsdale, Silverado; High performance	US1002H
6.6L V8 402 CID	1970-1972		US981	C20 PICKUP			
6.6L V8 6588cc 402 CID	1970-1972		US981	4.3L L6 4278cc 261 CID	1961-1962		US898
7.4L V8 454 CID	1975-1979		US1002	4.3L L6 4278cc 261 CID	1961-1962	High performance	US898H
7.4L V8 454 CID	1975-1979	High performance	US1002H	4.6L V8 4638cc 283 CID	1960-1967		US898
7.4L V8 454 CID	1980	Custom Deluxe, Scottsdale, Silverado	US1002	4.6L V8 4638cc 283 CID	1960-1967	High performance	US898H
7.4L V8 454 CID	1980	Custom Deluxe, Scottsdale, Silverado; High performance	US1002H	5.0L V8 307 CID	1968-1972		US898
C20				5.0L V8 307 CID	1968-1972	High performance	US898H
4.1L L6 250 CID	1975-1979		US1107	5.0L V8 5031cc 307 CID	1968-1972		US898
4.1L L6 250 CID	1980	Cheyenne, Custom Deluxe, Scottsdale, Silverado	US1107	5.0L V8 5031cc 307 CID	1968-1972	High performance	US898H
4.1L L6 250 CID	1981	Custom, Deluxe	US1107	5.3L V8 5358cc 327 CID	1966-1969		US898
4.1L L6 250 CID	1982	Custom, Scottsdale, Silverado	US1107	5.3L V8 5358cc 327 CID	1966-1969	High performance	US898H
4.1L L6 250 CID	1983	Custom, Silverado	US1107	5.4L V8 327 CID	1968		US898
4.1L L6 250 CID	1984	Custom, Scottsdale, Silverado	US1107	5.4L V8 327 CID	1968	High performance	US898H
4.3L V6 262 CID	1985-1986	Custom, Scottsdale, Silverado	US1121	5.7L V8 350 CID	1969-1972		US898
4.3L V6 262 CID	1985-1986	Custom, Scottsdale, Silverado; High performance	US1121H	5.7L V8 350 CID	1969-1972	High performance	US898H
4.8L L6 292 CID	1975-1977		US1137	5.7L V8 5704cc 348 CID	1960-1961		US898
4.8L L6 292 CID	1975-1977	High performance	US1137H	5.7L V8 5704cc 348 CID	1960-1961	High performance	US898H
4.8L L6 292 CID	1978-1979		US5030	5.7L V8 5736cc 350 CID	1969-1972		US898
4.8L L6 292 CID	1980	Cheyenne, Custom Deluxe, Scottsdale, Silverado	US5030	5.7L V8 5736cc 350 CID	1969-1972	High performance	US898H
4.8L L6 292 CID	1981	Custom, Deluxe	US5030	6.5L V8 396 CID	1968-1969		US981
4.8L L6 292 CID	1982	Custom, Scottsdale, Silverado	US5030	6.5L V8 6489cc 396 CID	1968-1969		US981
4.8L L6 292 CID	1983	Custom, Silverado	US5030	6.6L V8 402 CID	1970-1972		US981
4.8L L6 292 CID	1984-1986	Custom, Scottsdale, Silverado	US5030	6.6L V8 6588cc 402 CID	1970-1972		US981
5.0L V8 305 CID	1977-1979		US1121	C20 SUBURBAN			
5.0L V8 305 CID	1977-1979	High performance	US1121H	4.6L V8 4638cc 283 CID	1967		US898
5.0L V8 305 CID	1980	Cheyenne, Custom Deluxe, Scottsdale, Silverado	US1121	4.6L V8 4638cc 283 CID	1967	High performance	US898H
5.0L V8 305 CID	1980	Cheyenne, Custom Deluxe, Scottsdale, Silverado; High performance	US1121H	4.8L L6 292 CID	1968-1974		US896
5.0L V8 305 CID	1981	Custom, Deluxe	US1121	4.8L L6 292 CID	1975-1977		US1137
5.0L V8 305 CID	1981	Custom, Deluxe; High performance	US1121H	4.8L L6 292 CID	1975-1977	High performance	US1137H
5.0L V8 305 CID	1982	Custom, Scottsdale, Silverado	US1121	4.8L L6 292 CID	1978-1979		US5030
5.0L V8 305 CID	1982	Custom, Scottsdale, Silverado; High performance	US1121H	4.8L L6 292 CID	1980	Custom Deluxe, Scottsdale, Silverado	US5030
5.0L V8 305 CID	1983	Custom, Silverado	US1121	4.8L L6 292 CID	1981	Custom, Deluxe	US5030
5.0L V8 305 CID	1983	Custom, Silverado; High performance	US1121H	4.8L L6 292 CID	1982	Custom, Scottsdale, Silverado	US5030
5.0L V8 305 CID	1984-1986	Custom, Scottsdale, Silverado	US1121	4.8L L6 292 CID	1982	Custom, Scottsdale, Silverado	US896
5.0L V8 305 CID	1984-1986	Custom, Scottsdale, Silverado; High performance	US1121H	4.8L L6 4786cc 292 CID	1973-1974		US896
5.7L V8 350 CID	1975-1976		US1109	4.8L L6 4801cc 292 CID	1967-1974		US896
5.7L V8 350 CID	1975-1976	High performance	US1109H	5.0L V8 305 CID	1977-1979		US1121
5.7L V8 350 CID	1977-1979		US1121	5.0L V8 305 CID	1977-1979	High performance	US1121H
5.7L V8 350 CID	1977-1979	High performance	US1121H	5.0L V8 305 CID	1980	Custom Deluxe, Scottsdale, Silverado	US1121
5.7L V8 350 CID	1980	Cheyenne, Custom Deluxe, Scottsdale, Silverado	US1121	5.0L V8 305 CID	1980	Custom Deluxe, Scottsdale, Silverado; High performance	US1121H
5.7L V8 350 CID	1980	Cheyenne, Custom Deluxe, Scottsdale, Silverado; High performance	US1121H	5.0L V8 305 CID	1981	Custom, Deluxe	US1121
5.7L V8 350 CID	1981	Custom, Deluxe	US1121	5.0L V8 305 CID	1981	Custom, Deluxe; High performance	US1121H
5.7L V8 350 CID	1981	Custom, Deluxe; High performance	US1121H	5.0L V8 305 CID	1982	Custom, Scottsdale, Silverado	US1121
5.7L V8 350 CID	1982	Custom, Scottsdale, Silverado	US1121	5.0L V8 305 CID	1982	Custom, Scottsdale, Silverado; High performance	US1121H
5.7L V8 350 CID	1982	Custom, Scottsdale, Silverado; High performance	US1121H	5.0L V8 305 CID	1983	Custom, Silverado	US1121
5.7L V8 350 CID	1982	Custom, Scottsdale, Silverado; High performance	US1121H	5.0L V8 305 CID	1983	Custom, Silverado; High performance	US1121H
5.7L V8 350 CID	1983	Custom, Silverado	US1121	5.0L V8 305 CID	1984-1986	Custom, Scottsdale, Silverado	US1121
5.7L V8 350 CID	1983	Custom, Silverado; High performance	US1121H	5.0L V8 305 CID	1984-1986	Custom, Scottsdale, Silverado; High performance	US1121H
5.7L V8 350 CID	1984-1986	Custom, Scottsdale, Silverado	US1121	5.0L V8 307 CID	1968-1972		US898
5.7L V8 350 CID	1984-1986	Custom, Scottsdale, Silverado; High performance	US1121H	5.0L V8 307 CID	1968-1972	High performance	US898H
5.7L V8 350 CID	1984-1986	Custom, Scottsdale, Silverado; High performance	US1121H	5.0L V8 5031cc 307 CID	1968-1972		US898
5.7L V8 5700cc 350 CID	1985	Mexican Application	US1121	5.0L V8 5031cc 307 CID	1968-1972	High performance	US898H
5.7L V8 5700cc 350 CID	1987	Mexican Application	US1121	5.3L V8 5358cc 327 CID	1967-1969		US898
6.2L V8 379 CID	1982	Custom, Scottsdale, Silverado	US5008	5.3L V8 5358cc 327 CID	1967-1969	High performance	US898H
6.2L V8 379 CID	1983	Custom, Silverado	US5008	5.4L V8 327 CID	1968		US898
6.2L V8 379 CID	1984-1986	Custom, Scottsdale, Silverado	US5008	5.4L V8 327 CID	1968	High performance	US898H
6.6L V8 400 CID	1976		US1109	5.7L V8 350 CID	1969-1972		US898
6.6L V8 400 CID	1976	High performance	US1109H	5.7L V8 350 CID	1969-1972	High performance	US898H
6.6L V8 400 CID	1977-1979		US1121	5.7L V8 350 CID	1975-1976		US1109
6.6L V8 400 CID	1977-1979	High performance	US1121H	5.7L V8 350 CID	1975-1976	High performance	US1109H
6.6L V8 400 CID	1980	Cheyenne, Custom Deluxe, Scottsdale, Silverado	US1121	5.7L V8 350 CID	1977-1979		US1121
6.6L V8 400 CID	1980	Cheyenne, Custom Deluxe, Scottsdale, Silverado; High performance	US1121H	5.7L V8 350 CID	1977-1979	High performance	US1121H
6.6L V8 400 CID	1980	Cheyenne, Custom Deluxe, Scottsdale, Silverado; High performance	US1121H	5.7L V8 350 CID	1980	Custom Deluxe, Scottsdale, Silverado; High performance	US1121H
7.4L V8 454 CID	1975-1979		US1002	5.7L V8 350 CID	1981	Custom, Deluxe	US1121
7.4L V8 454 CID	1975-1979	High performance	US1002H	5.7L V8 350 CID	1981	Custom, Deluxe; High performance	US1121H
7.4L V8 454 CID	1980	Cheyenne, Custom Deluxe, Scottsdale, Silverado	US1002	5.7L V8 350 CID	1982	Custom, Scottsdale, Silverado	US1121
7.4L V8 454 CID	1980	Cheyenne, Custom Deluxe, Scottsdale, Silverado; High performance	US1002H	5.7L V8 350 CID	1982	Custom, Scottsdale, Silverado; High performance	US1121H
7.4L V8 454 CID	1981	Custom, Deluxe	US1002	5.7L V8 350 CID	1983	Custom, Silverado	US1121
7.4L V8 454 CID	1981	Custom, Deluxe; High performance	US1002H	5.7L V8 350 CID	1983	Custom, Silverado; High performance	US1121H
7.4L V8 454 CID	1982	Custom, Scottsdale, Silverado	US1002	5.7L V8 350 CID	1984-1986	Custom, Scottsdale, Silverado	US1121
7.4L V8 454 CID	1982	Custom, Scottsdale, Silverado; High performance	US1002H	5.7L V8 350 CID	1984-1986	Custom, Scottsdale, Silverado; High performance	US1121H
7.4L V8 454 CID	1982	Custom, Scottsdale, Silverado; High performance	US1002H	5.7L V8 5736cc 350 CID	1969-1972		US898
				5.7L V8 5736cc 350 CID	1969-1972	High performance	US898H
				6.2L V8 379 CID	1982	Custom, Scottsdale, Silverado	US5008
				6.2L V8 379 CID	1983	Custom, Silverado	US5008

Engine	Years	Application Description	USMW	Engine	Years	Application Description	USMW
CHEVROLET (cont'd.)				CHEVROLET (cont'd.)			
C20 SUBURBAN (cont'd.)				C30 PICKUP			
6.2L V8 379 CID	1984-1986	Custom, Scottsdale, Silverado	US5008	4.3L L6 4278cc 261 CID	1961-1962		US898
6.5L V8 396 CID	1968-1969		US981	4.3L L6 4278cc 261 CID	1961-1962	High performance	US898H
6.5L V8 6489cc 396 CID	1968-1969		US981	4.6L V8 4638cc 283 CID	1960-1967		US898
6.6L V8 400 CID	1976		US1109	4.6L V8 4638cc 283 CID	1960-1967	High performance	US898H
6.6L V8 400 CID	1976	High performance	US1109H	4.8L L6 292 CID	1968-1974		US896
6.6L V8 400 CID	1977-1979		US1121	4.8L L6 4786cc 292 CID	1973-1974		US896
6.6L V8 400 CID	1977-1979	High performance	US1121H	4.8L L6 4801cc 292 CID	1965-1974		US896
6.6L V8 400 CID	1980	Custom Deluxe, Scottsdale, Silverado	US1121	5.0L V8 307 CID	1968-1972		US898
6.6L V8 400 CID	1980	Custom Deluxe, Scottsdale, Silverado; High performance	US1121H	5.0L V8 307 CID	1968-1972	High performance	US898H
6.6L V8 402 CID	1970-1972		US981	5.0L V8 5031cc 307 CID	1968-1972		US898
6.6L V8 6588cc 402 CID	1970-1972		US981	5.0L V8 5031cc 307 CID	1968-1972	High performance	US898H
7.4L V8 454 CID	1975-1979		US1002	5.3L V8 5358cc 327 CID	1966-1969		US898
7.4L V8 454 CID	1975-1979	High performance	US1002H	5.3L V8 5358cc 327 CID	1966-1969	High performance	US898H
7.4L V8 454 CID	1980	Custom Deluxe, Scottsdale, Silverado	US1002	5.4L V8 327 CID	1968		US898
7.4L V8 454 CID	1980	Custom Deluxe, Scottsdale, Silverado; High performance	US1002H	5.4L V8 327 CID	1968	High performance	US898H
7.4L V8 454 CID	1981	Custom, Deluxe	US1002	5.7L V8 350 CID	1969-1972		US898
7.4L V8 454 CID	1981	Custom, Deluxe; High performance	US1002H	5.7L V8 350 CID	1969-1972	High performance	US898H
7.4L V8 454 CID	1982	Custom, Scottsdale, Silverado	US1002	5.7L V8 5704cc 348 CID	1960-1961		US898
7.4L V8 454 CID	1982	Custom, Scottsdale, Silverado; High performance	US1002H	5.7L V8 5704cc 348 CID	1960-1961	High performance	US898H
7.4L V8 454 CID	1982	Custom, Scottsdale, Silverado; High performance	US1002H	5.7L V8 5736cc 350 CID	1969-1972		US898
7.4L V8 454 CID	1983	Custom, Silverado	US1002	5.7L V8 5736cc 350 CID	1969-1972	High performance	US898H
7.4L V8 454 CID	1983	Custom, Silverado; High performance	US1002H	6.5L V8 396 CID	1968-1969		US981
7.4L V8 454 CID	1984-1986	Custom, Scottsdale, Silverado	US1002	6.5L V8 6489cc 396 CID	1968-1969		US981
7.4L V8 454 CID	1984-1986	Custom, Scottsdale, Silverado; High performance	US1002H	6.6L V8 402 CID	1970-1972		US981
7.4L V8 454 CID	1984-1986	Custom, Scottsdale, Silverado; High performance	US1002H	6.6L V8 6588cc 402 CID	1970-1972		US981
C25				C35			
5.7L V8 5700cc 350 CID	1992-1995	Mexican Application	US5049	4.8L L6 4800cc 292 CID	1987	Mexican Application	US5030
5.7L V8 5700cc 350 CID	1996-1997	Mexican Application	US5077	5.7L V8 5700cc 350 CID	1987	Mexican Application	US1121
C30				C50			
4.1L L6 250 CID	1980	Cheyenne, Custom Deluxe, Scottsdale, Silverado	US1107	6.0L V8 5999cc 366 CID	1966-1967	Without threaded hub	US5084
4.8L L6 292 CID	1975-1977		US1137	6.0L V8 5999cc 366 CID	1966-1978		US861
4.8L L6 292 CID	1975-1977	High performance	US1137H	7.0L V8 6998cc 427 CID	1969-1978		US861
4.8L L6 292 CID	1978-1979		US5030	C60			
4.8L L6 292 CID	1980	Cheyenne, Custom Deluxe, Scottsdale, Silverado	US5030	6.0L V8 366 CID	1980-1990	Without threaded hub	US5084
4.8L L6 292 CID	1981	Custom, Deluxe	US5030	6.0L V8 366 CID	1990	With threaded hub for fan clutch	US5078
4.8L L6 292 CID	1982	Custom, Scottsdale, Silverado	US5030	6.0L V8 5999cc 366 CID	1966-1967	Without threaded hub	US5084
4.8L L6 292 CID	1983	Custom, Silverado	US5030	6.0L V8 5999cc 366 CID	1966-1978		US861
4.8L L6 292 CID	1984-1986	Custom, Scottsdale, Silverado	US5030	7.0L V8 427 CID	1990	With threaded hub for fan clutch	US5078
5.0L V8 305 CID	1978-1979		US1121	7.0L V8 427 CID	1990	Without threaded hub	US5084
5.0L V8 305 CID	1978-1979	High performance	US1121H	7.0L V8 6998cc 427 CID	1969-1978		US861
5.7L V8 350 CID	1975-1976		US1109	7.8L V6 7828cc 478 CID	1967-1973		US835
5.7L V8 350 CID	1975-1976	High performance	US1109H	C60 KODIAK			
5.7L V8 350 CID	1977-1979		US1121	6.0L V8 366 CID	1990	Without threaded hub	US5084
5.7L V8 350 CID	1977-1979	High performance	US1121H	6.0L V8 366 CID	1990-1996	With threaded hub for fan clutch	US5078
5.7L V8 350 CID	1980	Cheyenne, Custom Deluxe, Scottsdale, Silverado	US1121	7.0L V8 6998cc 427 CID	1990	Without threaded hub	US5084
5.7L V8 350 CID	1980	Cheyenne, Custom Deluxe, Scottsdale, Silverado; High performance	US1121H	7.0L V8 6998cc 427 CID	1990-1996	With threaded hub for fan clutch	US5078
5.7L V8 350 CID	1981	Custom, Deluxe	US1121	C70			
5.7L V8 350 CID	1981	Custom, Deluxe; High performance	US1121H	6.0L V8 366 CID	1980-1990	Without threaded hub	US5084
5.7L V8 350 CID	1982	Custom, Scottsdale, Silverado	US1121	6.0L V8 366 CID	1990	With threaded hub for fan clutch	US5078
5.7L V8 350 CID	1982	Custom, Scottsdale, Silverado; High performance	US1121H	7.0L V8 427 CID	1980-1990	Without threaded hub	US5084
5.7L V8 350 CID	1983	Custom, Silverado	US1121	7.0L V8 427 CID	1990	With threaded hub for fan clutch	US5078
5.7L V8 350 CID	1983	Custom, Silverado; High performance	US1121H	7.4L V8 454 CID	1980	Without threaded hub	US5084
5.7L V8 350 CID	1984-1986	Custom, Scottsdale, Silverado	US1121	C70 KODIAK			
5.7L V8 350 CID	1984-1986	Custom, Scottsdale, Silverado; High performance	US1121H	6.0L V8 366 CID	1990	Without threaded hub	US5084
5.7L V8 5700cc 350 CID	1979-1985	Mexican Application	US1121	6.0L V8 366 CID	1990-1996	With threaded hub for fan clutch	US5078
6.2L V8 379 CID	1982	Custom, Scottsdale, Silverado	US5008	7.0L V8 6998cc 427 CID	1990	Without threaded hub	US5084
6.2L V8 379 CID	1983	Custom, Silverado	US5008	7.0L V8 6998cc 427 CID	1990-1996	With threaded hub for fan clutch	US5078
6.2L V8 379 CID	1984-1986	Custom, Scottsdale, Silverado	US5008	C1405			
6.6L V8 400 CID	1976		US1109	4.7L V8 4738cc 283 CID	1965-1966	Mexican Application	US898
6.6L V8 400 CID	1976	High performance	US1109H	4.8L L6 4800cc 292 CID	1965-1966	Mexican Application	US896
6.6L V8 400 CID	1977-1979		US1121	C1500			
6.6L V8 400 CID	1977-1979	High performance	US1121H	4.1L L6 4100cc 250 CID	1994-1997	Mexican Application	US895
7.4L V8 454 CID	1975-1979		US1002	4.1L L6 4100cc 250 CID	1998	Mexican Application	US5030
7.4L V8 454 CID	1975-1979	High performance	US1002H	4.3L V6 262 CID	1988-1989	Cheyenne, Scottsdale, Silverado	US5049
7.4L V8 454 CID	1980	Cheyenne, Custom Deluxe, Scottsdale, Silverado	US1002	4.3L V6 262 CID	1988-1989	Cheyenne, Scottsdale, Silverado; High performance	US5049H
7.4L V8 454 CID	1980	Cheyenne, Custom Deluxe, Scottsdale, Silverado	US1002	4.3L V6 262 CID	1990-1992	Cheyenne, Scottsdale, Silverado, WT	US5049
7.4L V8 454 CID	1980	Cheyenne, Custom Deluxe, Scottsdale, Silverado; High performance	US1002H	4.3L V6 262 CID	1990-1992	Cheyenne, Scottsdale, Silverado, WT; High performance	US5049H
7.4L V8 454 CID	1981	Custom, Deluxe	US1002	4.3L V6 262 CID	1993	Cheyenne, Silverado, WT	US5049
7.4L V8 454 CID	1981	Custom, Deluxe; High performance	US1002H	4.3L V6 262 CID	1993	Cheyenne, Silverado, WT; High performance	US5049H
7.4L V8 454 CID	1982	Custom, Scottsdale, Silverado	US1002	4.3L V6 262 CID	1994-1995	Base, Cheyenne, Silverado, WT	US5049
7.4L V8 454 CID	1982	Custom, Scottsdale, Silverado; High performance	US1002H	4.3L V6 262 CID	1994-1995	Base, Cheyenne, Silverado, WT; High performance	US5049H
7.4L V8 454 CID	1983	Custom, Silverado	US1002	4.3L V6 262 CID	1996-1997	Base, Cheyenne, Silverado, WT	US5077
7.4L V8 454 CID	1983	Custom, Silverado; High performance	US1002H	4.3L V6 262 CID	1996-1997	Base, Cheyenne, Silverado, WT; High performance	US5077H
7.4L V8 454 CID	1984-1986	Custom, Scottsdale, Silverado	US1002	4.3L V6 262 CID	1998	Cheyenne, Silverado, WT	US5077
7.4L V8 454 CID	1984-1986	Custom, Scottsdale, Silverado; High performance	US1002H	4.3L V6 262 CID	1998	Cheyenne, Silverado, WT; High performance	US5077H
				4.3L V6 4300cc 262 CID	1999	Mexican Application	US5077
				5.0L V8 305 CID	1988-1989	Cheyenne, Scottsdale, Silverado	US5049

WATER PUMPS



WATER PUMP APPLICATION GUIDE



Engine	Years	Application Description	USMWW	Engine	Years	Application Description	USMWW
CHEVROLET (cont'd.)				CHEVROLET (cont'd.)			
C1500 (cont'd.)				C2500 (cont'd.)			
5.0L V8 305 CID	1988-1989	Cheyenne, Scottsdale, Silverado; High performance	US5049H	4.3L V6 262 CID	1988-1992	Cheyenne, Scottsdale, Silverado; High performance	US5049H
5.0L V8 305 CID	1990-1991	Cheyenne, Scottsdale, Silverado, WT	US5049	4.3L V6 262 CID	1993	Cheyenne, Silverado	US5049
5.0L V8 305 CID	1990-1991	Cheyenne, Scottsdale, Silverado, WT; High performance	US5049H	4.3L V6 262 CID	1993	Cheyenne, Silverado; High performance	US5049H
5.0L V8 305 CID	1992	Cheyenne, Scottsdale, Silverado	US5049	4.3L V6 262 CID	1994-1995	Base, Cheyenne, Silverado, WT	US5049
5.0L V8 305 CID	1992	Cheyenne, Scottsdale, Silverado; High performance	US5049H	4.3L V6 262 CID	1994-1995	Base, Cheyenne, Silverado, WT; High performance	US5049H
5.0L V8 305 CID	1993	Cheyenne, Silverado, WT	US5049	5.0L V8 305 CID	1988-1992	Cheyenne, Scottsdale, Silverado	US5049
5.0L V8 305 CID	1993	Cheyenne, Silverado, WT; High performance	US5049H	5.0L V8 305 CID	1988-1992	Cheyenne, Scottsdale, Silverado; High performance	US5049H
5.0L V8 305 CID	1994-1995	Base, Cheyenne, Silverado, WT	US5049	5.0L V8 305 CID	1993	Cheyenne, Silverado	US5049
5.0L V8 305 CID	1994-1995	Base, Cheyenne, Silverado, WT; High performance	US5049H	5.0L V8 305 CID	1993	Cheyenne, Silverado; High performance	US5049H
5.0L V8 305 CID	1996-1997	Base, Cheyenne, Silverado, WT	US5077	5.0L V8 305 CID	1994-1995	Base, Cheyenne, Silverado, WT	US5049
5.0L V8 305 CID	1996-1997	Base, Cheyenne, Silverado, WT; High performance	US5077H	5.0L V8 305 CID	1994-1995	Base, Cheyenne, Silverado, WT; High performance	US5049H
5.0L V8 305 CID	1998	Cheyenne, Silverado, WT	US5077	5.0L V8 305 CID	1996-1997	Base, Cheyenne, Silverado	US5077
5.0L V8 305 CID	1998	Cheyenne, Silverado, WT; High performance	US5077H	5.0L V8 305 CID	1996-1997	Base, Cheyenne, Silverado; High performance	US5077H
5.0L V8 305 CID	1999	LS	US5077	5.0L V8 305 CID	1998	Cheyenne, Silverado, WT	US5077
5.0L V8 305 CID	1999	LS; High performance	US5077H	5.0L V8 305 CID	1998	Cheyenne, Silverado, WT; High performance	US5077H
5.7L V8 350 CID	1988-1989	Cheyenne, Scottsdale, Silverado	US5049	5.7L V8 350 CID	1988-1992	Cheyenne, Scottsdale, Silverado	US5049
5.7L V8 350 CID	1988-1989	Cheyenne, Scottsdale, Silverado; High performance	US5049H	5.7L V8 350 CID	1988-1992	Cheyenne, Scottsdale, Silverado; High performance	US5049H
5.7L V8 350 CID	1990-1991	Cheyenne, Scottsdale, Silverado, WT	US5049	5.7L V8 350 CID	1993	Cheyenne, Silverado	US5049
5.7L V8 350 CID	1990-1991	Cheyenne, Scottsdale, Silverado, WT; High performance	US5049H	5.7L V8 350 CID	1993	Cheyenne, Silverado; High performance	US5049H
5.7L V8 350 CID	1992	Cheyenne, Scottsdale, Silverado, WT; 6.9" HUB HEIGHT	US5049	5.7L V8 350 CID	1994-1995	Base, Cheyenne, Silverado, WT	US5049
5.7L V8 350 CID	1992	Cheyenne, Scottsdale, Silverado, WT; 6.9" HUB HEIGHT, High performance	US5049H	5.7L V8 350 CID	1994-1995	Base, Cheyenne, Silverado, WT; High performance	US5049H
5.7L V8 350 CID	1992	Cheyenne, Scottsdale, Silverado, WT; 5.8" HUB HEIGHT	US5073	5.7L V8 350 CID	1996-1997	Base, Cheyenne, Silverado	US5077
5.7L V8 350 CID	1993	Cheyenne, Silverado, WT	US5049	5.7L V8 350 CID	1996-1997	Base, Cheyenne, Silverado; High performance	US5077H
5.7L V8 350 CID	1993	Cheyenne, Silverado, WT; High performance	US5049H	5.7L V8 350 CID	1998	Cheyenne, Silverado, WT	US5077
5.7L V8 350 CID	1994-1995	Base, Cheyenne, Silverado, WT	US5049	5.7L V8 350 CID	1998	Cheyenne, Silverado, WT; High performance	US5077H
5.7L V8 350 CID	1994-1995	Base, Cheyenne, Silverado, WT; High performance	US5049H	5.7L V8 350 CID	1999-2000	Base, LS	US5077
5.7L V8 350 CID	1996-1997	Base, Cheyenne, Silverado, WT	US5077	5.7L V8 350 CID	1999-2000	Base, LS; High performance	US5077H
5.7L V8 350 CID	1996-1997	Base, Cheyenne, Silverado, WT; High performance	US5077H	5.7L V8 5700cc 350 CID	1988-1991	Mexican Application	US5049
5.7L V8 350 CID	1998	Cheyenne, Silverado, WT	US5077	5.7L V8 5700cc 350 CID	1998	Mexican Application	US5077
5.7L V8 350 CID	1998	Cheyenne, Silverado, WT; High performance	US5077H	5.7L V8 5737cc 350 CID	2000	Mexican Application	US5087
5.7L V8 350 CID	1999	LS	US5077	6.2L V8 379 CID	1988-1992	Cheyenne, Scottsdale, Silverado	US5062
5.7L V8 350 CID	1999	LS; High performance	US5077H	6.2L V8 379 CID	1993	Cheyenne, Silverado	US5062
5.7L V8 5700cc 350 CID	1988-1991	Mexican Application	US5049	6.5L V8 395 CID	1992-1993	Cheyenne, Silverado	US5062
5.7L V8 5737cc 350 CID	2000	Mexican Application	US5077	6.5L V8 395 CID	1994-1995	Base, Cheyenne, Silverado, WT	US5062
6.2L V8 379 CID	1988-1989	Cheyenne, Scottsdale, Silverado	US5062	6.5L V8 395 CID	1996	Base, Cheyenne, Silverado; Early	US5062
6.2L V8 379 CID	1990-1992	Cheyenne, Scottsdale, Silverado, WT	US5062	6.5L V8 395 CID	1996	Base, Cheyenne, Silverado; Late	US5074
6.2L V8 379 CID	1993	Cheyenne, Silverado, WT	US5062	6.5L V8 395 CID	1997	Base, Cheyenne, Silverado	US5074
6.5L V8 395 CID	1994-1995	Base, Cheyenne, Silverado, WT	US5062	6.5L V8 395 CID	1998	Cheyenne, Silverado, WT	US5074
6.5L V8 395 CID	1996	Base, Cheyenne, Silverado, WT; Early	US5062	6.5L V8 395 CID	1999	Base, LS; Bolt on pulley	US5074
6.5L V8 395 CID	1996	Base, Cheyenne, Silverado, WT; Late	US5074	6.5L V8 395 CID	1999-2000	Base, LS	US5086
6.5L V8 395 CID	1997	Base, Cheyenne, Silverado, WT	US5074	7.4L V8 454 CID	1991-1993	Cheyenne, Silverado	US5038
6.5L V8 395 CID	1998	Cheyenne, Silverado, WT	US5074	7.4L V8 454 CID	1991-1993	Cheyenne, Silverado; High performance	US5038H
7.4L V8 454 CID	1990	454 SS, Cheyenne, Scottsdale, Silverado, WT	US5038	7.4L V8 454 CID	1994-1995	Base, Cheyenne, Silverado, WT	US5038
7.4L V8 454 CID	1990	454 SS, Cheyenne, Scottsdale, Silverado, WT; High performance	US5038H	7.4L V8 454 CID	1994-1995	Base, Cheyenne, Silverado, WT; High performance	US5038H
7.4L V8 454 CID	1991-1992	454 SS, Cheyenne, Silverado, WT	US5038	7.4L V8 454 CID	1996-1997	Base, Cheyenne, Silverado	US5038
7.4L V8 454 CID	1991-1993	454 SS, Cheyenne, Silverado, WT; High performance	US5038H	7.4L V8 454 CID	1996-1997	Base, Cheyenne, Silverado; High performance	US5038H
7.4L V8 454 CID	1993	454 SS	US5038	7.4L V8 454 CID	1998	Cheyenne, Silverado, WT	US5038
C1500 SUBURBAN				C2500 SUBURBAN			
5.7L V8 350 CID	1992	Base, Silverado; 6.9" HUB HEIGHT	US5049	5.7L V8 350 CID	1992	Base, Silverado; 6.9" HUB HEIGHT	US5049
5.7L V8 350 CID	1992	Base, Silverado; 6.9" HUB HEIGHT, High performance	US5049H	5.7L V8 350 CID	1992	Base, Silverado; 6.9" HUB HEIGHT, High performance	US5049H
5.7L V8 350 CID	1992	Base, Silverado; 5.8" HUB HEIGHT	US5073	5.7L V8 350 CID	1992	Base, Silverado; 5.8" HUB HEIGHT	US5073
5.7L V8 350 CID	1993-1994	Base, Silverado	US5049	5.7L V8 350 CID	1993-1994	Base, Silverado	US5049
5.7L V8 350 CID	1993-1994	Base, Silverado; High performance	US5049H	5.7L V8 350 CID	1993-1994	Base, Silverado; High performance	US5049H
5.7L V8 350 CID	1995	Base, LS, LT	US5049	5.7L V8 350 CID	1995	Base, LS, LT	US5049
5.7L V8 350 CID	1995	Base, LS, LT; High performance	US5049H	5.7L V8 350 CID	1995	Base, LS, LT; High performance	US5049H
5.7L V8 350 CID	1996-1997	Base, LS, LT	US5077	5.7L V8 350 CID	1996-1997	Base, LS, LT	US5077
5.7L V8 350 CID	1996-1997	Base, LS, LT; High performance	US5077H	5.7L V8 350 CID	1996-1997	Base, LS, LT; High performance	US5077H
5.7L V8 350 CID	1998	Base, LS	US5077	5.7L V8 350 CID	1998-1999	Base, LS	US5077
5.7L V8 350 CID	1998-1999	Base, LS; High performance	US5077H	5.7L V8 350 CID	1998-1999	Base, LS; High performance	US5077H
5.7L V8 350 CID	1999	Base, LS, LT	US5077	6.5L V8 395 CID	1994	Base, Silverado	US5062
6.5L V8 395 CID	1995	Base, LS, LT	US5062	6.5L V8 395 CID	1995	Base, LS, LT	US5062
6.5L V8 395 CID	1996	Base, LS, LT; Early	US5062	6.5L V8 395 CID	1996	Base, LS, LT; Early	US5062
6.5L V8 395 CID	1996	Base, LS, LT; Late	US5074	6.5L V8 395 CID	1996	Base, LS, LT; Late	US5074
6.5L V8 395 CID	1997	Base, LS, LT	US5074	6.5L V8 395 CID	1997	Base, LS, LT	US5074
6.5L V8 395 CID	1998	Base, LS	US5074	6.5L V8 395 CID	1998	Base, LS	US5074
6.5L V8 395 CID	1999	Base, LS, LT; Bolt on pulley	US5074	6.5L V8 395 CID	1999	Base, LS; Bolt on pulley	US5074
6.5L V8 395 CID	1999	Base, LS, LT	US5086	6.5L V8 395 CID	1999	Base, LS	US5086
C2500				C2500			
4.3L V6 262 CID	1988-1992	Cheyenne, Scottsdale, Silverado	US5049	4.3L V6 262 CID	1988-1992	Cheyenne, Scottsdale, Silverado	US5049

Engine	Years	Application Description	USMW	Engine	Years	Application Description	USMW
CHEVROLET (cont'd.)				CHEVROLET (cont'd.)			
C2500 SUBURBAN (cont'd.)				CAMARO (cont'd.)			
7.4L V8 454 CID	1992-1994	Base, Silverado; High performance	US5038H	3.8L V6 229 CID	1981	Berlinetta, Sport	US1121
7.4L V8 454 CID	1995-1997	Base, LS, LT	US5038	3.8L V6 229 CID	1981	Berlinetta, Sport; High performance	US1121H
7.4L V8 454 CID	1995-1997	Base, LS, LT; High performance	US5038H	3.8L V6 3800cc 231 CID	1980	Base, Berlinetta, Rally Sport	US1018
7.4L V8 454 CID	1998-1999	Base, LS	US5038	3.8L V6 3800cc 231 CID	1980	Base, Berlinetta, Rally Sport; High performance	US1018H
7.4L V8 454 CID	1998-1999	Base, LS; High performance	US5038H	3.8L V6 3800cc 231 CID	1981	Berlinetta, Sport	US1018
C3500				3.8L V6 3800cc 231 CID	1981	Berlinetta, Sport; High performance	US1018H
5.7L V8 350 CID	1988-1992	Cheyenne, Scottsdale, Silverado	US5049	3.8L V6 3800cc 231 CID	1995	Base	US5050
5.7L V8 350 CID	1988-1992	Cheyenne, Scottsdale, Silverado; High performance	US5049H	3.8L V6 3800cc 231 CID	1996-1997	Base, RS	US5075
5.7L V8 350 CID	1993	Cheyenne, Silverado	US5049	3.8L V6 3800cc 231 CID	1998-2002	Base	US5075
5.7L V8 350 CID	1993	Cheyenne, Silverado; High performance	US5049H	4.1L L6 250 CID	1975-1979		US1107
5.7L V8 350 CID	1994-1995	Base, Cheyenne, Silverado	US5049	4.4L V8 267 CID	1980	Base, Berlinetta, Rally Sport	US1121
5.7L V8 350 CID	1994-1995	Base, Cheyenne, Silverado; High performance	US5049H	4.4L V8 267 CID	1980	Base, Berlinetta, Rally Sport; High performance	US1121H
5.7L V8 350 CID	1996-1997	Base, Cheyenne, Silverado	US5077	4.4L V8 267 CID	1981	Berlinetta, Sport	US1121
5.7L V8 350 CID	1996-1997	Base, Cheyenne, Silverado; High performance	US5077H	4.4L V8 267 CID	1981	Berlinetta, Sport; High performance	US1121H
5.7L V8 350 CID	1998	Cheyenne, Silverado	US5077	5.0L V8 305 CID	1976		US1109
5.7L V8 350 CID	1998	Cheyenne, Silverado; High performance	US5077H	5.0L V8 305 CID	1976	High performance	US1109H
5.7L V8 350 CID	1999-2000	Base, LS	US5077	5.0L V8 305 CID	1977-1979		US1121
5.7L V8 350 CID	1999-2000	Base, LS; High performance	US5077H	5.0L V8 305 CID	1977-1979	High performance	US1121H
5.7L V8 5700cc 350 CID	1988-1994	Mexican Application	US5049	5.0L V8 305 CID	1980	Base, Berlinetta, Rally Sport, Z28	US1121
6.2L V8 379 CID	1988-1992	Cheyenne, Scottsdale, Silverado	US5062	5.0L V8 305 CID	1980	Base, Berlinetta, Rally Sport, Z28; High performance	US1121H
6.2L V8 379 CID	1993	Cheyenne, Silverado	US5062	5.0L V8 305 CID	1981	Berlinetta, Sport, Z28	US1121
6.5L V8 395 CID	1992	Cheyenne, Scottsdale, Silverado	US5062	5.0L V8 305 CID	1981	Berlinetta, Sport, Z28; High performance	US1121H
6.5L V8 395 CID	1993	Cheyenne, Silverado	US5062	5.0L V8 305 CID	1982	Berlinetta, Sport, Z28, Z28 Indianapolis 500 Pace Car	US1121
6.5L V8 395 CID	1994-1995	Base, Cheyenne, Silverado	US5062	5.0L V8 305 CID	1982	Berlinetta, Sport, Z28, Z28 Indianapolis 500 Pace Car; High performance	US1121H
6.5L V8 395 CID	1996	Base, Cheyenne, Silverado; Early	US5062	5.0L V8 305 CID	1983-1984	Berlinetta, Sport, Z28	US1121
6.5L V8 395 CID	1996	Base, Cheyenne, Silverado; Late	US5074	5.0L V8 305 CID	1983-1985	Berlinetta, Sport, Z28; High performance	US1121H
6.5L V8 395 CID	1997	Base, Cheyenne, Silverado	US5074	5.0L V8 305 CID	1985-1986	Berlinetta, Iroc-Z, Sport, Z28	US1121
6.5L V8 395 CID	1998	Cheyenne, Silverado	US5074	5.0L V8 305 CID	1986	Berlinetta, Iroc-Z, Sport, Z28; High performance	US1121H
6.5L V8 395 CID	1999	Base, LS; Bolt on pulley	US5074	5.0L V8 305 CID	1987	Iroc-Z, LT, Sport, Z28	US1121
6.5L V8 395 CID	1999-2000	Base, LS	US5086	5.0L V8 305 CID	1987	Iroc-Z, LT, Sport, Z28; High performance	US1121H
7.4L V8 454 CID	1988-1990	Cheyenne, Scottsdale, Silverado; High performance	US5038H	5.0L V8 305 CID	1988	Base, Iroc-Z	US5049
7.4L V8 454 CID	1988-1992	Cheyenne, Scottsdale, Silverado	US5038	5.0L V8 305 CID	1988	Base, Iroc-Z; High performance	US5049H
7.4L V8 454 CID	1991-1993	Cheyenne, Silverado; High performance	US5038H	5.0L V8 305 CID	1989-1990	Iroc-Z, RS	US5049
7.4L V8 454 CID	1993	Cheyenne, Silverado	US5038	5.0L V8 305 CID	1989-1990	Iroc-Z, RS; High performance	US5049H
7.4L V8 454 CID	1994-1997	Base, Cheyenne, Silverado	US5038	5.0L V8 305 CID	1991	RS, Z28	US5049
7.4L V8 454 CID	1994-1997	Base, Cheyenne, Silverado; High performance	US5038H	5.0L V8 305 CID	1991	RS, Z28; High performance	US5049H
7.4L V8 454 CID	1998	Cheyenne, Silverado	US5038	5.0L V8 305 CID	1992	RS, RS Heritage Edition, Z28, Z28 Heritage Edition	US5049
7.4L V8 454 CID	1998	Cheyenne, Silverado; High performance	US5038H	5.0L V8 305 CID	1992	RS, RS Heritage Edition, Z28, Z28 Heritage Edition; High performance	US5049H
7.4L V8 454 CID	1999-2000	Base, LS	US5038	5.0L V8 307 CID	1969-1972		US898
7.4L V8 454 CID	1999-2000	Base, LS; High performance	US5038H	5.0L V8 307 CID	1969-1972	High performance	US898H
C3605				5.0L V8 5031cc 307 CID	1969-1972		US898
4.7L V8 4738cc 283 CID	1967	Mexican Application	US898	5.0L V8 5031cc 307 CID	1969-1972	High performance	US898H
4.8L L6 4800cc 292 CID	1967	Mexican Application	US896	5.3L V8 5358cc 327 CID	1967-1969		US898
C5500 KODIAK				5.3L V8 5358cc 327 CID	1967-1969	High performance	US898H
6.0L V8 366 CID	1990	Without threaded hub	US5084	5.4L V8 327 CID	1968-1969		US898
6.0L V8 366 CID	1990-1991	With threaded hub for fan clutch	US5078	5.4L V8 327 CID	1968-1969	High performance	US898H
C6500 KODIAK				5.7L V8 350 CID	1968-1972		US898
6.0L V8 366 CID	1997-1998	With threaded hub for fan clutch	US5078	5.7L V8 350 CID	1968-1972	High performance	US898H
7.0L V8 6998cc 427 CID	1997-1998	With threaded hub for fan clutch	US5078	5.7L V8 350 CID	1976		US1109
C7500 KODIAK				5.7L V8 350 CID	1976	High performance	US1109H
6.0L V8 366 CID	1997-1998	With threaded hub for fan clutch	US5078	5.7L V8 350 CID	1977-1979		US1121
7.0L V8 6998cc 427 CID	1997-1998	With threaded hub for fan clutch	US5078	5.7L V8 350 CID	1977-1979	High performance	US1121H
C20905				5.7L V8 350 CID	1980	Base, Berlinetta, Rally Sport, Z28	US1121
4.7L V8 4738cc 283 CID	1965-1967	Mexican Application	US898	5.7L V8 350 CID	1980	Base, Berlinetta, Rally Sport, Z28; High performance	US1121H
4.8L L6 4800cc 292 CID	1965-1967	Mexican Application	US896	5.7L V8 350 CID	1981	Berlinetta, Sport, Z28; High performance	US1121H
CAMARO				5.7L V8 350 CID	1981	Berlinetta, Sport, Z28	US1121
2.0L L4 1998cc 122 CID	2016	LT	US8102	5.7L V8 350 CID	1987	Iroc-Z	US1121
2.0L L4 1998cc 122 CID	2017	LS, LT	US8102	5.7L V8 350 CID	1987	Iroc-Z; High performance	US1121H
2.5L L4 2474cc 151 CID	1982-1984	Sport	US1107	5.7L V8 350 CID	1988-1990	Iroc-Z	US5049
2.5L L4 2474cc 151 CID	1985-1986	Sport	US5022	5.7L V8 350 CID	1988-1990	Iroc-Z; High performance	US5049H
2.8L V6 173 CID	1982-1984	Berlinetta, Sport	US5006	5.7L V8 350 CID	1991	Z28	US5049
2.8L V6 173 CID	1985-1986	Berlinetta, Sport	US5001	5.7L V8 350 CID	1991	Z28; High performance	US5049H
2.8L V6 173 CID	1987	LT, Sport	US5037	5.7L V8 350 CID	1992	Z28, Z28 Heritage Edition	US5049
2.8L V6 173 CID	1988	Base	US5037	5.7L V8 350 CID	1992	Z28, Z28 Heritage Edition; High performance	US5049H
2.8L V6 173 CID	1989	RS	US5037	5.7L V8 350 CID	1993	Indianapolis 500 Pace Car, Z28	US5068
3.1L V6 189 CID	1990-1991	RS	US5037	5.7L V8 350 CID	1994-1997	Z28	US5068
3.1L V6 189 CID	1992	RS, RS Heritage Edition	US5037	5.7L V8 350 CID	1998-2002	Z28, Z28 SS	US5081
3.4L V6 207 CID	1993-1995	Base	US5070	5.7L V8 5736cc 350 CID	1967-1972		US898
3.6L V6 222 CID	2016	LT	US8148	5.7L V8 5736cc 350 CID	1967-1972	High performance	US898H
3.6L V6 222 CID	2017	LS, LT	US8148	5.7L V8 5737cc 350 CID	1972		US898
3.6L V6 3564cc 217 CID	2010-2013	LS, LT	US8932	5.7L V8 5737cc 350 CID	1972	High performance	US898H
3.6L V6 3564cc 217 CID	2015	LS, LT	US8932	6.2L V8 6162cc 376 CID	2010-2015	SS	US6689
3.8L V6 229 CID	1980	Base, Berlinetta, Rally Sport	US1121	6.2L V8 6162cc 376 CID	2012-2015	ZL1	US79
3.8L V6 229 CID	1980	Base, Berlinetta, Rally Sport; High performance	US1121H	6.2L V8 6162cc 376 CID	2016	SS	US8918
				6.2L V8 6162cc 376 CID	2016	SS; Pump only	US8918

WATER PUMPS

Engine	Years	Application Description	USMW	Engine	Years	Application Description	USMW
CHEVROLET (cont'd.)				CHEVROLET (cont'd.)			
CAMARO (cont'd.)				CAPRICE (cont'd.)			
6.2L V8 6162cc 376 CID	2017	SS, ZL1	US8918	5.0L V8 305 CID	1989-1990	Base, Classic, Classic Brougham, Classic LS Brougham; High performance	US5049H
6.2L V8 6162cc 376 CID	2017	SS, ZL1; Pump only	US8918	5.0L V8 305 CID	1991-1992	Base, Classic, Classic LTZ	US5051
6.5L V8 396 CID	1968		US981	5.0L V8 305 CID	1993	Classic, Classic LS	US5051
6.5L V8 6489cc 396 CID	1967-1969		US981	5.0L V8 307 CID	1968		US898
6.6L V8 402 CID	1970-1972		US981	5.0L V8 307 CID	1968	High performance	US898H
6.6L V8 6588cc 402 CID	1970-1972		US981	5.0L V8 307 CID	1986	Classic, Classic Brougham	US1120
7.0L V8 427 CID	1969		US981	5.0L V8 307 CID	1986	Classic, Classic Brougham; High performance	US1120H
7.0L V8 6998cc 427 CID	1969		US981	5.0L V8 307 CID	1987	Base, Classic	US1120
CAPRICE				5.0L V8 307 CID	1987	Base, Classic; High performance	US1120H
3.6L V6 3564cc 217 CID	2012-2013	PPV	US8932	5.0L V8 307 CID	1988-1990	Classic	US1120
3.6L V6 3564cc 217 CID	2015-2017	PPV	US8932	5.0L V8 307 CID	1988-1990	Classic; High performance	US1120H
3.8L V6 229 CID	1980	Classic, Classic Landau, Classic Sport	US1121	5.0L V8 307 CID	1988-1990	Classic	US1120
3.8L V6 229 CID	1980	Classic, Classic Landau, Classic Sport; High performance	US1121H	5.0L V8 307 CID	1988-1990	Classic; High performance	US1120H
3.8L V6 229 CID	1981	Classic, Classic Estate, Classic Landau	US1121	5.0L V8 5031cc 307 CID	1968-1969	High performance	US898
3.8L V6 229 CID	1981	Classic, Classic Estate, Classic Landau; High performance	US1121H	5.0L V8 5031cc 307 CID	1968-1969	High performance	US898H
3.8L V6 229 CID	1982	Classic, Classic Estate	US1121	5.0L V8 5031cc 307 CID	1971-1972	High performance	US898
3.8L V6 229 CID	1982	Classic, Classic Estate; High performance	US1121H	5.0L V8 5031cc 307 CID	1971-1972	High performance	US898H
3.8L V6 229 CID	1982	Classic	US1121	5.3L V8 5358cc 327 CID	1966-1969		US898
3.8L V6 229 CID	1983-1984	Classic; High performance	US1121H	5.3L V8 5358cc 327 CID	1966-1969	High performance	US898H
3.8L V6 3800cc 231 CID	1980	Classic, Classic Landau, Classic Sport	US1018	5.4L V8 327 CID	1968-1969	High performance	US898
3.8L V6 3800cc 231 CID	1980	Classic, Classic Landau, Classic Sport; High performance	US1018H	5.4L V8 327 CID	1968-1969	High performance	US898H
3.8L V6 3800cc 231 CID	1981	Classic, Classic Estate, Classic Landau	US1018	5.7L V8 350 CID	1969-1972	High performance	US898
3.8L V6 3800cc 231 CID	1981	Classic, Classic Estate, Classic Landau; High performance	US1018H	5.7L V8 350 CID	1969-1972	High performance	US898H
3.8L V6 3800cc 231 CID	1982	Classic, Classic Estate	US1018	5.7L V8 350 CID	1976	High performance	US1109
3.8L V6 3800cc 231 CID	1982	Classic, Classic Estate; High performance	US1018H	5.7L V8 350 CID	1976	High performance	US1109H
3.8L V6 3800cc 231 CID	1983-1984	Classic	US1018	5.7L V8 350 CID	1977-1979	High performance	US1121
3.8L V6 3800cc 231 CID	1983-1984	Classic; High performance	US1018H	5.7L V8 350 CID	1977-1979	High performance	US1121H
4.3L V6 262 CID	1985	Classic	US1121	5.7L V8 350 CID	1980	Classic, Classic Landau, Classic Sport; Exc.Air Cond	US1100
4.3L V6 262 CID	1985	Classic; High performance	US1121H	5.7L V8 350 CID	1980	Classic, Classic Landau, Classic Sport; With air cond.	US1120
4.3L V6 262 CID	1986	Base, Classic, Classic Brougham	US1121	5.7L V8 350 CID	1980	Classic, Classic Landau, Classic Sport; High performance, With air cond.	US1120H
4.3L V6 262 CID	1986	Base, Classic, Classic Brougham; High performance	US1121H	5.7L V8 350 CID	1981	Classic, Classic Estate, Classic Landau; Exc.Air Cond	US1100
4.3L V6 262 CID	1987-1988	Base, Classic, Classic Brougham, Classic LS Brougham	US1121	5.7L V8 350 CID	1981	Classic, Classic Estate, Classic Landau; With air cond.	US1120
4.3L V6 262 CID	1987-1988	Base, Classic, Classic Brougham, Classic LS Brougham; High performance	US1121H	5.7L V8 350 CID	1981	Classic, Classic Estate, Classic Landau; High performance, With air cond.	US1120H
4.3L V6 262 CID	1989-1990	Base, Classic	US5049	5.7L V8 350 CID	1982	Classic, Classic Estate; 5" Cast, Exc.Air Cond	US1100
4.3L V6 262 CID	1989-1990	Base, Classic; High performance	US5049H	5.7L V8 350 CID	1982	Classic, Classic Estate; Exc.5" Cast, Exc.Air Cond	US1120
4.3L V6 262 CID	1992	Base	US5049	5.7L V8 350 CID	1982	Classic, Classic Estate; With air cond.	US1120
4.3L V6 262 CID	1992	Base; High performance	US5049H	5.7L V8 350 CID	1982	Classic, Classic Estate; Exc.5" Cast, Exc.Air Cond, High performance	US1120H
4.3L V6 262 CID	1993	Classic	US5049	5.7L V8 350 CID	1982	Classic, Classic Estate; High performance, With air cond.	US1120H
4.3L V6 262 CID	1993	Classic; High performance	US5049H	5.7L V8 350 CID	1983-1985	Classic; 5" Cast, Exc.Air Cond	US1100
4.3L V8 265 CID	1994	Classic, Classic LS	US5069	5.7L V8 350 CID	1983-1985	Classic; Exc.5" Cast, Exc.Air Cond	US1120
4.3L V8 265 CID	1995-1996	Classic	US5069	5.7L V8 350 CID	1983-1985	Classic; With air cond.	US1120
4.4L V8 267 CID	1980	Classic, Classic Landau, Classic Sport	US1121	5.7L V8 350 CID	1983-1985	Classic; Exc.5" Cast, Exc.Air Cond, High performance	US1120H
4.4L V8 267 CID	1980	Classic, Classic Landau, Classic Sport; High performance	US1121H	5.7L V8 350 CID	1983-1985	Classic; High performance, With air cond.	US1120H
4.4L V8 267 CID	1981	Classic, Classic Estate, Classic Landau	US1121	5.7L V8 350 CID	1989-1990	Base	US5049
4.4L V8 267 CID	1981	Classic, Classic Estate, Classic Landau; High performance	US1121H	5.7L V8 350 CID	1989-1990	Base; High performance	US5049H
4.4L V8 267 CID	1982	Classic, Classic Estate	US1121	5.7L V8 350 CID	1991-1992	Base, Classic, Classic LTZ	US5051
4.4L V8 267 CID	1982	Classic, Classic Estate; High performance	US1121H	5.7L V8 350 CID	1993	Classic LTZ	US5051
4.6L V8 4638cc 283 CID	1966-1967		US898	5.7L V8 350 CID	1994	Classic, Classic LS	US5069
4.6L V8 4638cc 283 CID	1966-1967	High performance	US898H	5.7L V8 350 CID	1995-1996	Classic	US5069
5.0L V8 305 CID	1977-1979		US1121	5.7L V8 5700cc 350 CID	1981	Mexican Application	US1121
5.0L V8 305 CID	1977-1979	High performance	US1121H	5.7L V8 5736cc 350 CID	1969-1972		US898
5.0L V8 305 CID	1980	Classic, Classic Landau, Classic Sport	US1121	5.7L V8 5736cc 350 CID	1969-1972	High performance	US898H
5.0L V8 305 CID	1980	Classic, Classic Landau, Classic Sport; High performance	US1121H	5.7L V8 5736cc 350 CID	1982	Mexican Application	US1121
5.0L V8 305 CID	1981	Classic, Classic Estate, Classic Landau	US1121	6.0L V8 5967cc 364 CID	2011-2017	PPV	US79
5.0L V8 305 CID	1981	Classic, Classic Estate, Classic Landau; High performance	US1121H	6.5L V8 396 CID	1968-1969		US981
5.0L V8 305 CID	1982	Classic, Classic Estate	US1121	6.5L V8 6489cc 396 CID	1966-1969		US981
5.0L V8 305 CID	1982	Classic, Classic Estate; High performance	US1121H	6.6L V8 400 CID	1970-1972		US981
5.0L V8 305 CID	1983-1985	Classic	US1121	6.6L V8 400 CID	1975-1976		US1109
5.0L V8 305 CID	1983-1985	Classic; High performance	US1121H	6.6L V8 400 CID	1975-1976	High performance	US1109H
5.0L V8 305 CID	1986	Base, Classic, Classic Brougham	US1121	6.6L V8 402 CID	1971-1972		US981
5.0L V8 305 CID	1986	Base, Classic, Classic Brougham; High performance	US1121H	6.6L V8 6555cc 400 CID	1970-1972		US981
5.0L V8 305 CID	1987-1988	Base, Classic, Classic Brougham, Classic LS Brougham	US1121	6.6L V8 6556cc 400 CID	1970-1972		US981
5.0L V8 305 CID	1987-1988	Base, Classic, Classic Brougham, Classic LS Brougham; High performance	US1121H	6.6L V8 6588cc 402 CID	1970-1972		US981
5.0L V8 305 CID	1989-1990	Base, Classic, Classic Brougham, Classic LS Brougham	US5049	7.0L V8 427 CID	1968-1969		US981
				CAPTIVA SPORT			
				2.4L L4 2384cc 145 CID	2012	LS	US5092
				2.4L L4 2384cc 145 CID	2013-2015	LS, LT, LTZ	US5092
				2.4L L4 2409cc 147 CID	2010-2015	Mexican Application	US5092
				3.0L V6 182 CID	2012	LT, LTZ	US8932

Engine	Years	Application Description	USMW	Engine	Years	Application Description	USMW
CHEVROLET (cont'd.)				CHEVROLET (cont'd.)			
CAPTIVA SPORT (cont'd.)				CHEVELLE (cont'd.)			
3.0L V6 3000cc 183 CID	2011-2012	Mexican Application	US8932	4.8L L6 4800cc 292 CID	1967-1970	Mexican Application	US896
3.6L V6 3564cc 217 CID	2008-2009	Mexican Application	US8932	4.8L L6 4800cc 292 CID	1973	Mexican Application	US896
CAVALIER				5.0L V8 307 CID	1968-1972		US898
1.8L L4 112 CID	1982	Base, Cadet, CL	US5007	5.0L V8 307 CID	1968-1972	High performance	US898H
2.0L L4 122 CID	1983	Base, CL, CS	US5007	5.0L V8 5031cc 307 CID	1968-1972		US898
2.0L L4 122 CID	1984	Base, CL, CS, Olympic, Type-10	US5007	5.0L V8 5031cc 307 CID	1968-1972	High performance	US898H
2.0L L4 122 CID	1985	Base, CL, CS, Type-10	US5007	5.3L V8 5358cc 327 CID	1964-1968		US898
2.0L L4 122 CID	1986	Base, CL, CS, RS	US5007	5.3L V8 5358cc 327 CID	1964-1968	High performance	US898H
2.0L L4 122 CID	1987	Base, CS, RS	US5032	5.4L V8 327 CID	1965		US898
2.0L L4 122 CID	1988-1989	Base, RS, VL	US5032	5.4L V8 327 CID	1965	High performance	US898H
2.2L L4 134 CID	1990	Base, RS, VL	US5032	5.4L V8 327 CID	1967-1968		US898
2.2L L4 134 CID	1991	RS, VL	US5032	5.4L V8 327 CID	1967-1968	High performance	US898H
2.2L L4 2190cc 134 CID	1992-1994	RS, VL	US5032	5.7L V8 350 CID	1969-1972		US898
2.2L L4 2190cc 134 CID	1995-1996	Base, LS	US5032	5.7L V8 350 CID	1969-1972	High performance	US898H
2.2L L4 2190cc 134 CID	1997	Base; (4)	US5032	5.7L V8 5736cc 350 CID	1968-1972		US898
2.2L L4 2190cc 134 CID	1997	LS, RS	US5032	5.7L V8 5736cc 350 CID	1968-1972	High performance	US898H
2.2L L4 2190cc 134 CID	1998-1999	Base, LS, RS	US5032	6.5L V8 396 CID	1966-1970		US981
2.2L L4 2190cc 134 CID	2000-2001	Base, LS	US5032	6.5L V8 6489cc 396 CID	1966-1969		US981
2.2L L4 2190cc 134 CID	2002	Base, LS, LS Sport; (4)	US5032	6.6L V8 400 CID	1970-1971		US981
2.2L L4 2198cc 134 CID	2002	Base, LS, LS Sport; (F)	US5092	6.6L V8 402 CID	1970		US981
2.2L L4 2198cc 134 CID	2003-2005	Base, LS, LS Sport	US5092	6.6L V8 402 CID	1972		US981
2.3L L4 138 CID	1995	LS, Z24	US5043	6.6L V8 6555cc 400 CID	1970-1972		US981
2.4L L4 2392cc 146 CID	1996-2001	LS, Z24	US5076	6.6L V8 6556cc 400 CID	1970-1971		US981
2.4L L4 2392cc 146 CID	2002	LS, LS Sport, Z24	US5076	6.6L V8 6588cc 402 CID	1970-1972		US981
2.8L V6 173 CID	1985	Base, CL, CS, Type-10	US5020	CHEVETTE			
2.8L V6 173 CID	1986	RS, Z24	US5020	1.6L L4 98 CID	1976-1979		US5004
2.8L V6 173 CID	1987	Base, CS, RS, Z24	US5033	1.6L L4 98 CID	1980-1982	Base, Scooter	US5004
2.8L V6 173 CID	1988	Base, Z24	US5033	1.6L L4 98 CID	1983	Base, S, Scooter	US5004
2.8L V6 173 CID	1989	Base, RS, Z24	US5033	1.6L L4 98 CID	1984-1985	Base, CS	US5004
2.8L V6 2800cc 173 CID	1990-1994	Mexican Application	US5033	1.6L L4 98 CID	1986-1987	CS	US5004
3.1L V6 189 CID	1990	Base, RS, Z24	US5033	1.8L L4 1819cc 110 CID	1985	Base, CS	US5027
3.1L V6 189 CID	1991-1994	RS, Z24	US5033	1.8L L4 1819cc 110 CID	1986	CS	US5027
CELEBRITY				CHEVY			
2.5L L4 2474cc 151 CID	1982	Base, CL, CS	US5000	1.6L L4 1598cc 98 CID	2010-2012	Mexican Application	US5057
2.5L L4 2474cc 151 CID	1982	Base, CL, CS; Includes pulley	US5000P	1.6L L4 1600cc 98 CID	1999-2003	Mexican Application	US5057
2.5L L4 2474cc 151 CID	1983	Base, CL	US5000	1.6L L4 1606cc 98 CID	2004-2009	Mexican Application	US5057
2.5L L4 2474cc 151 CID	1983	Base, CL; Includes pulley	US5000P	CHEVY II			
2.5L L4 2474cc 151 CID	1984	Base, Eurosport	US5000	4.6L V8 283 CID	1964-1966		US898
2.5L L4 2474cc 151 CID	1984	Base, Eurosport; Includes pulley	US5000P	4.6L V8 283 CID	1964-1966	High performance	US898H
2.5L L4 2474cc 151 CID	1985	Base, Classic, Estate, Eurosport	US5000	4.6L V8 4638cc 283 CID	1963-1967		US898
2.5L L4 2474cc 151 CID	1985	Base, Classic, Estate, Eurosport; Includes pulley	US5000P	4.6L V8 4638cc 283 CID	1963-1967	High performance	US898H
2.5L L4 2474cc 151 CID	1986	Base, Estate, Eurosport	US5000	5.0L V8 307 CID	1968		US898
2.5L L4 2474cc 151 CID	1986	Base, Estate, Eurosport; Includes pulley	US5000P	5.0L V8 307 CID	1968	High performance	US898H
2.5L L4 2474cc 151 CID	1987	Base, Estate, Eurosport	US5041	5.0L V8 5031cc 307 CID	1968		US898
2.5L L4 2474cc 151 CID	1988	Base, Eurosport	US5041	5.0L V8 5031cc 307 CID	1968	High performance	US898H
2.5L L4 2474cc 151 CID	1989	Base, CL, Eurosport	US5041	5.3L V8 5358cc 327 CID	1965-1968		US898
2.5L L4 2474cc 151 CID	1990	Base, Eurosport	US5041	5.3L V8 5358cc 327 CID	1965-1968	High performance	US898H
2.8L V6 173 CID	1982	Base, CL, CS	US5001	5.4L V8 327 CID	1965-1966		US898
2.8L V6 173 CID	1983	Base, CL	US5001	5.4L V8 327 CID	1965-1966	High performance	US898H
2.8L V6 173 CID	1984	Base, Eurosport	US5001	5.4L V8 327 CID	1968		US898
2.8L V6 173 CID	1985	Base, Classic, Estate, Eurosport	US5001	5.4L V8 327 CID	1968	High performance	US898H
2.8L V6 173 CID	1986	Base, Estate, Eurosport	US5001	5.7L V8 350 CID	1968		US898
2.8L V6 173 CID	1987	Base, Estate, Eurosport	US5033	5.7L V8 350 CID	1968	High performance	US898H
2.8L V6 173 CID	1988	Base, Eurosport	US5033	5.7L V8 5736cc 350 CID	1968		US898
2.8L V6 173 CID	1989	Base, CL, Eurosport	US5033	5.7L V8 5736cc 350 CID	1968	High performance	US898H
2.8L V6 2800cc 173 CID	1990	Mexican Application	US5033	6.5L V8 396 CID	1968		US981
2.8L V6 2835cc 173 CID	1982-1984	Mexican Application	US5033	6.5L V8 6489cc 396 CID	1968		US981
3.1L V6 189 CID	1990	Base, Eurosport	US5033	CHEYENNE			
4.3L V6 260 CID	1982	Base, CL, CS; W/O Pulley	US5014	5.3L V8 5300cc 323 CID	2007-2010	Mexican Application	US6009
4.3L V6 260 CID	1982	Base, CL, CS; Includes pulley	US5014P	CHEYENNE 2500			
4.3L V6 260 CID	1983	Base, CL; W/O Pulley	US5014	5.3L V8 5300cc 323 CID	2011	Mexican Application	US6009
4.3L V6 260 CID	1983	Base, CL; Includes pulley	US5014P	5.3L V8 5328cc 325 CID	2012-2015	Mexican Application	US6009
4.3L V6 260 CID	1984	Base, Eurosport; W/O Pulley	US5014	CITATION			
4.3L V6 260 CID	1984	Base, Eurosport; Includes pulley	US5014P	2.5L L4 2474cc 151 CID	1980	Base, Club, Custom, X-11	US5000
4.3L V6 260 CID	1985	Base, Classic, Estate, Eurosport; W/O Pulley	US5014	2.5L L4 2474cc 151 CID	1980	Base, Club, Custom, X-11; Includes pulley	US5000P
4.3L V6 260 CID	1985	Base, Classic, Estate, Eurosport; Includes pulley	US5014P	2.5L L4 2474cc 151 CID	1981-1983	Base, X-11	US5000
CENTURY				2.5L L4 2474cc 151 CID	1981-1983	Base, X-11; Includes pulley	US5000P
2.2L L4 2196cc 134 CID	1995	Mexican Application	US5033	2.8L V6 173 CID	1980	Base, Club, Custom, X-11	US5001
2.8L V6 2800cc 173 CID	1983-1986	Mexican Application	US5033	2.8L V6 173 CID	1981-1983	Base, X-11	US5001
2.8L V6 2800cc 173 CID	1990	Mexican Application	US5033	2.8L V6 2800cc 173 CID	1984-1988	Mexican Application	US5001
3.1L V6 3130cc 191 CID	1989-1997	Mexican Application	US5033	CITATION II			
CHEVELLE				2.5L L4 2474cc 151 CID	1984-1985	Base, X-11	US5000
3.2L L6 194 CID	1966	With A/C	US927	2.5L L4 2474cc 151 CID	1984-1985	Base, X-11; Includes pulley	US5000P
3.8L L6 230 CID	1967	With A/C	US927	2.8L V6 173 CID	1984-1985	Base, X-11	US5001
3.8L L6 3800cc 230 CID	1970	Mexican Application	US895	CITY EXPRESS			
4.1L L6 250 CID	1967	With A/C	US927	2.0L L4 1997cc	2015-2017	LS, LT	US6218
4.1L L6 4100cc 250 CID	1964-1966	Mexican Application	US895	CLASSIC			
4.6L V8 283 CID	1965-1967		US898	2.2L L4 2198cc 134 CID	2004	Base, LS	US5092
4.6L V8 283 CID	1965-1967	High performance	US898H	2.2L L4 2198cc 134 CID	2005	Base	US5092
4.6L V8 4638cc 283 CID	1964-1967		US898				
4.6L V8 4638cc 283 CID	1964-1967	High performance	US898H				

WATER PUMPS

Engine	Years	Application Description	USMW	Engine	Years	Application Description	USMW
CHEVROLET (cont'd.)				CHEVROLET (cont'd.)			
COBALT				CORVETTE (cont'd.)			
2.0L L4 122 CID	2005-2007	SS	US5092	5.7L V8 350 CID	1990-1995	ZR-1	US5056
2.0L L4 1998cc 122 CID	2008-2010	SS	US5092	5.7L V8 350 CID	1992	Base	US5063
2.2L L4 2198cc 134 CID	2005	Base, LS, LT	US5092	5.7L V8 350 CID	1993	40th Anniversary Edition, Base	US5066
2.2L L4 2198cc 134 CID	2006-2007	LS, LT, LTZ	US5092	5.7L V8 350 CID	1994	Base	US5066
2.2L L4 2198cc 134 CID	2008-2009	LS, LT	US5092	5.7L V8 350 CID	1995	Base, Indianapolis 500 Pace Car	US5066
2.2L L4 2198cc 134 CID	2010	Base, LS, LT	US5092	5.7L V8 350 CID	1996	Base, Collector's Edition, Grand Sport	US5066
2.4L L4 2384cc 145 CID	2006-2007	SS	US5092	5.7L V8 350 CID	1997	Base	US5081
2.4L L4 2384cc 145 CID	2008	Sport	US5092	5.7L V8 350 CID	1998	Base, Indianapolis 500 Pace Car	US5081
COLORADO				5.7L V8 350 CID	1999-2000	Base	US5081
2.5L L4 2457cc 153 CID	2015	Base, LT, WT, Z71; Pump only	US8102	5.7L V8 350 CID	2001-2002	Base, Z06	US5081
2.5L L4 2457cc 153 CID	2015-2017	Base, LT, WT, Z71	US8102	5.7L V8 350 CID	2003	50th Anniversary Edition, 50th Anniversary Edition Pace Car, Base, Z06	US5081
2.8L L4 171 CID	2016	LT, WT, Z71	US8154	5.7L V8 350 CID	2004	Base, Z06	US5081
2.8L L4 171 CID	2017	LT, WT, Z71, ZR2	US8154	5.7L V8 5736cc 350 CID	1969-1972	High performance	US898H
2.8L L4 2770cc 169 CID	2004	Base, LS, Sport, Sport LS, Z71, Z71 LS, Z85, Z85 LS	US5097	5.7L V8 5736cc 350 CID	1969-1972	High performance	US898H
2.8L L4 2770cc 169 CID	2005	Sport, Sport LS, Z71, Z71 LS, Z85, Z85 LS	US5097	5.7L V8 5737cc 350 CID	1972	High performance	US898H
2.8L L4 2770cc 169 CID	2006	LS, LT, WT	US5097	5.7L V8 5737cc 350 CID	1972	High performance	US898H
2.9L L4 2921cc 178 CID	2007	LS, LT	US5097	6.0L V8 364 CID	2005	Base	US65N
2.9L L4 2921cc 178 CID	2008	LS, LT, WT	US5097	6.0L V8 364 CID	2005	Base; Includes thermostat and thermostat housing	US65N-T
2.9L L4 2921cc 178 CID	2009-2012	LT, WT	US5097	6.0L V8 5967cc 364 CID	2006-2007	Base	US65N
3.5L L5 3460cc 211 CID	2004	Base, LS, Sport, Sport LS, Z71, Z71 LS, Z85, Z85 LS	US5097	6.0L V8 5967cc 364 CID	2006-2007	Base; Includes thermostat and thermostat housing	US65N-T
3.5L L5 3460cc 211 CID	2005	Sport, Sport LS, Z71, Z71 LS, Z85, Z85 LS	US5097	6.2L V8 6162cc 376 CID	2008	Base	US65N
3.5L L5 3460cc 211 CID	2006	LT, WT	US5097	6.2L V8 6162cc 376 CID	2008	Base; Includes thermostat and thermostat housing	US65N-T
3.6L V6 222 CID	2017	LT, WT, Z71, ZR2	US8153	6.2L V8 6162cc 376 CID	2009	Base	US79
3.6L V6 3564cc 217 CID	2014-2015	Mexican Application	US8932	6.2L V8 6162cc 376 CID	2009-2013	ZR1; Pump only	US8142
3.6L V6 3564cc 217 CID	2015-2016	LT, WT, Z71	US8932	6.2L V8 6162cc 376 CID	2009-2013	ZR1; Includes Thermostat and Thermostat Housing	US8142-T
3.6L V6 3600cc 217 CID	2013	Mexican Application	US8932	6.2L V8 6162cc 376 CID	2010-2013	Base, Grand Sport	US79
3.7L L5 3654cc 223 CID	2007-2008	LS, LT, WT	US5097	6.2L V8 6162cc 376 CID	2014	Stingray; Pump only	US8123
3.7L L5 3654cc 223 CID	2009-2012	LT, WT	US5097	6.2L V8 6162cc 376 CID	2015-2016	Stingray, Z06	US8123
5.3L V8 5328cc 325 CID	2009-2012	LT; Includes thermostat and thermostat housing	US6009	6.2L V8 6162cc 376 CID	2015-2016	Stingray, Z06; Pump only	US8123
5.3L V8 5328cc 325 CID	2009-2012		US6009-T	6.2L V8 6162cc 376 CID	2017	Grand Sport, Stingray, Z06	US8123
CORSA				6.2L V8 6162cc 376 CID	2017	Grand Sport, Stingray, Z06; Pump only	US8123
1.4L L4 1389cc 85 CID	2002	Mexican Application	US5057	7.0L V8 427 CID	1968-1969		US981
1.4L L4 1389cc 85 CID	2003	Mexican Application	US8933	7.0L V8 427 CID	1968-1969	Standard	US5019
1.8L L4 1796cc 110 CID	2003-2008		US8938	7.0L V8 427 CID	1968-1969	High performance	US5019H
CORSICA				7.0L V8 427 CID	1968-1969	High performance	US5019H
2.0L L4 122 CID	1987-1988	Base, LT	US5032	7.0L V8 6998cc 427 CID	1966-1969	Standard	US981
2.0L L4 122 CID	1989	Base	US5032	7.0L V8 6998cc 427 CID	1966-1969	Standard	US5019
2.2L L4 134 CID	1990-1991	LT	US5032	7.0L V8 6998cc 427 CID	1966-1969	High performance	US5019H
2.2L L4 2190cc 134 CID	1992	LT, LTZ	US5032	7.0L V8 7011cc 427 CID	2006-2007	Z06	US65N
2.2L L4 2190cc 134 CID	1993	LT	US5032	7.0L V8 7011cc 427 CID	2006-2007	Z06; Includes thermostat and thermostat housing	US65N-T
2.2L L4 2190cc 134 CID	1994-1996	Base	US5032	7.0L V8 7011cc 427 CID	2008	427 Limited Edition Z06, Z06	US65N
2.8L V6 173 CID	1987-1988	Base, LT	US5033	7.0L V8 7011cc 427 CID	2008	427 Limited Edition Z06, Z06; Includes thermostat and thermostat housing	US65N-T
2.8L V6 173 CID	1989	Base, LTZ	US5033	7.0L V8 7011cc 427 CID	2009-2010	Z06	US79
3.1L V6 189 CID	1990	LT, LTZ	US5033	7.0L V8 7011cc 427 CID	2011	Z06, Z06 Carbon	US79
3.1L V6 189 CID	1991	LT	US5033	7.0L V8 7011cc 427 CID	2012	Z06	US79
3.1L V6 189 CID	1992	LT, LTZ	US5033	7.0L V8 7011cc 427 CID	2013	427, Z06	US79
3.1L V6 189 CID	1993	LT	US5033	CRUZE			
3.1L V6 189 CID	1994-1996	Base	US5033	1.4L L4 1364cc 83 CID	2011-2015	Eco, LT, LTZ	US6662
CORVETTE				1.4L L4 1399cc 85 CID	2016-2017	L, LS, LT, Premier	US8147
4.3L V8 4343cc 265 CID	1955-1956		US898	1.4L L4 1399cc 85 CID	2016-2017	L, LS, LT, Premier; Pump only	US8147
4.3L V8 4343cc 265 CID	1955-1956	High performance	US898H	1.8L L4 1796cc 110 CID	2010-2016	Mexican Application	US6184
4.6L V8 4638cc 283 CID	1957-1961		US898	1.8L L4 1796cc 110 CID	2011-2014	LS	US6184
4.6L V8 4638cc 283 CID	1957-1961	High performance	US898H	1.8L L4 1796cc 110 CID	2012	Mexican Application	US6046
5.0L V8 305 CID	1980	Base	US984	1.8L L4 1796cc 110 CID	2015	L, LS	US6184
5.0L V8 305 CID	1980	Base; High performance	US984H	2.0L L4 1956cc 119 CID	2014-2015	Diesel	US8159
5.3L V8 5358cc 327 CID	1962-1968		US898	CRUZE LIMITED			
5.3L V8 5358cc 327 CID	1962-1968	High performance	US898H	1.4L L4 1364cc 83 CID	2016	Eco, LT, LTZ	US6662
5.4L V8 327 CID	1968		US898	1.8L L4 1796cc 110 CID	2016	L, LS	US6184
5.4L V8 327 CID	1968	High performance	US898H	CS1073			
5.7L V8 350 CID	1969-1972		US898	4.1L L6 4100cc 250 CID	1966-1974	Mexican Application	US895
5.7L V8 350 CID	1969-1972	High performance	US898H	4.1L L6 4100cc 250 CID	1975-1977	Mexican Application	US1110
5.7L V8 350 CID	1976-1979		US984	4.1L L6 4100cc 250 CID	1978	Mexican Application	US1107
5.7L V8 350 CID	1976-1979	High performance	US984H	4.7L V8 4738cc 283 CID	1964-1967	Mexican Application	US898
5.7L V8 350 CID	1980-1981	Base	US984	4.8L L6 4800cc 292 CID	1964-1974	Mexican Application	US896
5.7L V8 350 CID	1980-1981	Base; High performance	US984H	4.8L L6 4800cc 292 CID	1975-1977	Mexican Application	US1137
5.7L V8 350 CID	1982	Base, Collector's Edition	US984	4.8L L6 4800cc 292 CID	1978	Mexican Application	US5030
5.7L V8 350 CID	1982	Base, Collector's Edition; High performance	US984H	5.4L V8 5400cc 327 CID	1964-1969	Mexican Application	US898
5.7L V8 350 CID	1984-1985	Base	US5016	CS31003			
5.7L V8 350 CID	1984-1985	Base; High performance	US5016H	4.7L V8 4738cc 283 CID	1964-1967	Mexican Application	US898
5.7L V8 350 CID	1986	Base, Indianapolis 500 Pace Car	US5016	4.8L L6 4800cc 292 CID	1965-1974	Mexican Application	US896
5.7L V8 350 CID	1986	Base, Indianapolis 500 Pace Car; High performance	US5016H	4.8L L6 4800cc 292 CID	1975-1977	Mexican Application	US1137
5.7L V8 350 CID	1987	Base	US5016	4.8L L6 4800cc 292 CID	1978	Mexican Application	US5030
5.7L V8 350 CID	1987	Base; High performance	US5016H	5.4L V8 5400cc 327 CID	1964-1969	Mexican Application	US898
5.7L V8 350 CID	1988	35th Anniversary Edition, Base	US5016	5.7L V8 5700cc 350 CID	1968-1974	Mexican Application	US898
5.7L V8 350 CID	1988	35th Anniversary Edition, Base; High performance	US5016H	5.7L V8 5700cc 350 CID	1975-1976	Mexican Application	US1109
5.7L V8 350 CID	1989-1991	Base	US5016	5.7L V8 5700cc 350 CID	1977-1978	Mexican Application	US1121
5.7L V8 350 CID	1989-1991	Base; High performance	US5016H	CUTLASS			
				2.2L L4 2196cc 134 CID	1994-1996	Mexican Application	US5033

Engine	Years	Application Description	USMW	Engine	Years	Application Description	USMW
CHEVROLET (cont'd.)				CHEVROLET (cont'd.)			
CUTLASS (cont'd.)				EL CAMINO (cont'd.)			
2.8L V6 2835cc 173 CID	1986-1989	Mexican Application	US5033	5.7L V8 350 CID	1977-1979	High performance	US1121H
3.1L V6 3130cc 191 CID	1986-1997	Mexican Application	US5033	5.7L V8 350 CID	1983-1984	Base, Conquista, SS	US1120
DEL RAY				5.7L V8 350 CID	1983-1984	Base, Conquista, SS; High performance	US1120H
4.3L V8 4343cc 265 CID	1957		US898	5.7L V8 5704cc 348 CID	1959-1960		US898
4.3L V8 4343cc 265 CID	1957	High performance	US898H	5.7L V8 5704cc 348 CID	1959-1960	High performance	US898H
4.6L V8 4638cc 283 CID	1957-1958		US898	5.7L V8 5736cc 350 CID	1968-1972		US898
4.6L V8 4638cc 283 CID	1957-1958	High performance	US898H	5.7L V8 5736cc 350 CID	1968-1972	High performance	US898H
5.7L V8 5704cc 348 CID	1958		US127	6.5L V8 396 CID	1968-1970		US981
5.7L V8 5704cc 348 CID	1958		US898	6.5L V8 6489cc 396 CID	1966-1969		US981
5.7L V8 5704cc 348 CID	1958	High performance	US898H	6.6L V8 400 CID	1970		US981
EL CAMINO				6.6L V8 400 CID	1975-1976		US1109
3.2L L6 3180cc 194 CID	1966	With A/C	US927	6.6L V8 400 CID	1975-1976	High performance	US1109H
3.3L V6 200 CID	1978-1979		US1121	6.6L V8 402 CID	1971-1972		US981
3.3L V6 200 CID	1978-1979	High performance	US1121H	6.6L V8 6555cc 400 CID	1970-1972		US981
3.8L L6 3769cc 230 CID	1966-1967	With A/C	US927	6.6L V8 6588cc 402 CID	1970-1972		US981
3.8L V6 229 CID	1980	Base, Royal Knight	US1121	EQUINOX			
3.8L V6 229 CID	1980	Base, Royal Knight; High performance	US1121H	2.4L L4 2384cc 145 CID	2010-2014	LS, LT, LTZ	US5092
3.8L V6 229 CID	1981	Base, Conquista, Royal Knight	US1121	2.4L L4 2384cc 145 CID	2015-2016	L, LS, LT, LTZ	US5092
3.8L V6 229 CID	1981	Base, Conquista, Royal Knight; High performance	US1121H	2.4L L4 2384cc 145 CID	2017	L, LS, LT, Premier	US5092
3.8L V6 229 CID	1982	Base, Conquista	US1121	3.0L V6 182 CID	2010-2012	LT, LTZ	US8932
3.8L V6 229 CID	1982	Base, Conquista; High performance	US1121H	3.4L V6 207 CID	2005-2007	LS, LT	US6145
3.8L V6 229 CID	1983	Conquista, SS	US1121	3.4L V6 207 CID	2008-2009	LS, LT, LTZ	US6145
3.8L V6 229 CID	1983	Conquista, SS; High performance	US1121H	3.6L V6 3564cc 217 CID	2008-2009	Sport	US8932
3.8L V6 229 CID	1984	Base, Conquista, SS	US1121	3.6L V6 3564cc 217 CID	2013	LT, LTZ	US8932
3.8L V6 229 CID	1984	Base, Conquista, SS; High performance	US1121H	3.6L V6 3564cc 217 CID	2015-2016	LT, LTZ	US8932
3.8L V6 231 CID	1979		US1018	3.6L V6 3564cc 217 CID	2017	LT, Premier	US8932
3.8L V6 231 CID	1979	High performance	US1018H	EUROSPORT			
3.8L V6 3800cc 231 CID	1978-1979		US1018	3.1L V6 3135cc 191 CID	1991-1996	Mexican Application	US5033
3.8L V6 3800cc 231 CID	1978-1979	High performance	US1018H	EXPRESS			
3.8L V6 3800cc 231 CID	1980	Base, Royal Knight, SS	US1018	4.3L V6 4300cc 262 CID	2010-2013	Mexican Application	US5077
3.8L V6 3800cc 231 CID	1980	Base, Royal Knight, SS; High performance	US1018H	5.3L V8 5300cc 323 CID	2008	Mexican Application	US6009
3.8L V6 3800cc 231 CID	1981	Base, Conquista, Royal Knight, SS	US1018	5.3L V8 5300cc 323 CID	2010-2011	Mexican Application	US6009
3.8L V6 3800cc 231 CID	1981	Base, Conquista, Royal Knight, SS; High performance	US1018H	5.3L V8 5328cc 325 CID	2012-2013	Mexican Application	US6009
3.8L V6 3800cc 231 CID	1982-1984	Base, Conquista, SS	US1018	6.0L V8 5967cc 364 CID	2010-2013	Mexican Application	US6009
3.8L V6 3800cc 231 CID	1982-1984	Base, Conquista, SS; High performance	US1018H	EXPRESS 1500			
4.1L L6 250 CID	1975-1977		US1107	4.3L V6 262 CID	1996-2000	Base, LS	US5077
4.1L L6 4098cc 250 CID	1967	With A/C	US927	4.3L V6 262 CID	1996-2005	Base, LS; High performance	US5077H
4.3L V6 262 CID	1985-1986	Base, Conquista, SS	US1121	4.3L V6 262 CID	2001-2002	Base, LS, LT	US5077
4.3L V6 262 CID	1985-1986	Base, Conquista, SS; High performance	US1121H	4.3L V6 262 CID	2003-2005	Base, LS	US5077
4.3L V6 262 CID	1987	Base, SS	US1121	4.3L V6 262 CID	2006	Base, LS, LT	US5077
4.3L V6 262 CID	1987	Base, SS; High performance	US1121H	4.3L V6 262 CID	2006	Base, LS, LT; High performance	US5077H
4.4L V8 267 CID	1980	Base, Royal Knight, SS	US1121	4.3L V6 262 CID	2007-2011	Base; High performance	US5077H
4.4L V8 267 CID	1980	Base, Royal Knight, SS; High performance	US1121H	4.3L V6 262 CID	2007-2012	Base	US5077
4.4L V8 267 CID	1981	Base, Conquista, Royal Knight, SS	US1121	4.3L V6 4293cc 262 CID	2013-2014	Base	US5077
4.4L V8 267 CID	1981	Base, Conquista, Royal Knight, SS; High performance	US1121H	5.0L V8 305 CID	1996-2000	Base, LS	US5077
4.4L V8 267 CID	1982	Base, Conquista, SS	US1121	5.0L V8 305 CID	1996-2002	Base, LS; High performance	US5077H
4.4L V8 267 CID	1982	Base, Conquista, SS; High performance	US1121H	5.0L V8 305 CID	2001-2002	Base, LS, LT	US5077
4.6L V8 4638cc 283 CID	1959-1960		US898	5.3L V8 5328cc 325 CID	2003-2005	Base, LS	US64
4.6L V8 4638cc 283 CID	1959-1960	High performance	US898H	5.3L V8 5328cc 325 CID	2003-2005	Base, LS; Includes thermostat and thermostat housing	US64-T
4.6L V8 4638cc 283 CID	1964-1967		US898	5.3L V8 5328cc 325 CID	2006	Base, LS, LT	US64
4.6L V8 4638cc 283 CID	1964-1967	High performance	US898H	5.3L V8 5328cc 325 CID	2006	Base, LS, LT; Includes thermostat and thermostat housing	US64-T
5.0L V8 305 CID	1976		US1109	5.3L V8 5328cc 325 CID	2007	LS, LT	US6009
5.0L V8 305 CID	1976	High performance	US1109H	5.3L V8 5328cc 325 CID	2007	LS, LT; Includes thermostat and thermostat housing	US6009-T
5.0L V8 305 CID	1977-1979		US1121	5.3L V8 5328cc 325 CID	2008-2014	Base, LS, LT	US6009
5.0L V8 305 CID	1977-1979	High performance	US1121H	5.3L V8 5328cc 325 CID	2008-2014	Base, LS, LT; Includes thermostat and thermostat housing	US6009-T
5.0L V8 305 CID	1980	Base, Royal Knight, SS	US1121	5.7L V8 350 CID	1996-2000	Base, LS	US5077
5.0L V8 305 CID	1980	Base, Royal Knight, SS; High performance	US1121H	5.7L V8 350 CID	1996-2002	Base, LS; High performance	US5077H
5.0L V8 305 CID	1981	Base, Conquista, Royal Knight, SS	US1121	5.7L V8 350 CID	2001-2002	Base, LS, LT	US5077
5.0L V8 305 CID	1981	Base, Conquista, Royal Knight, SS; High performance	US1121H	EXPRESS 2500			
5.0L V8 305 CID	1982-1986	Base, Conquista, SS	US1121	2.8L L4 171 CID	2017	Base, LS, LT	US8154
5.0L V8 305 CID	1982-1986	Base, Conquista, SS; High performance	US1121H	4.3L V6 262 CID	1996-1997	Base, LS; High performance	US5077H
5.0L V8 305 CID	1987	Base, SS	US1121	4.3L V6 262 CID	1996-2001	Base	US5077
5.0L V8 305 CID	1987	Base, SS; High performance	US1121H	4.3L V6 262 CID	1998	Base; High performance	US5077H
5.0L V8 307 CID	1968-1972		US898	4.3L V6 262 CID	1999-2005	Base, LS; High performance	US5077H
5.0L V8 307 CID	1968-1972	High performance	US898H	4.3L V6 262 CID	2002-2005	Base, LS	US5077
5.0L V8 5031cc 307 CID	1968-1972		US898	4.8L V8 294 CID	2003-2005	Base, LS	US64
5.0L V8 5031cc 307 CID	1968-1972	High performance	US898H	4.8L V8 294 CID	2003-2005	Base, LS; Includes thermostat and thermostat housing	US64-T
5.3L V8 5358cc 327 CID	1966-1969		US898	4.8L V8 294 CID	2006	Base, LS, LT	US64
5.3L V8 5358cc 327 CID	1966-1969	High performance	US898H	4.8L V8 294 CID	2006	Base, LS, LT; Includes thermostat and thermostat housing	US64-T
5.4L V8 327 CID	1968		US898	4.8L V8 294 CID	2007-2011	Base	US6009
5.4L V8 327 CID	1968	High performance	US898H	4.8L V8 294 CID	2007-2011	Base; Includes thermostat and thermostat housing	US6009-T
5.7L V8 350 CID	1969-1972		US898	4.8L V8 294 CID	2012-2014	Base, LS, LT; Includes thermostat and thermostat housing	US6009-T
5.7L V8 350 CID	1969-1972	High performance	US898H	4.8L V8 294 CID	2012-2017	Base, LS, LT	US6009
5.7L V8 350 CID	1976		US1109	5.0L V8 305 CID	1996-2002	Base, LS	US5077
5.7L V8 350 CID	1976	High performance	US1109H	5.0L V8 305 CID	1996-2002	Base, LS; High performance	US5077H
5.7L V8 350 CID	1977-1979		US1121	5.3L V8 5328cc 325 CID	2003-2005	Base, LS	US64

Engine	Years	Application Description	USMW	Engine	Years	Application Description	USMW
CHEVROLET (cont'd.)				CHEVROLET (cont'd.)			
G20 (cont'd.)				G30 (cont'd.)			
6.2L V8 379 CID	1983-1984	Beauville, Bonaventure, Chevy Van, Sportvan	US5008	7.4L V8 454 CID	1988-1996	Beauville, Chevy Van, Hi-Cube, Sportvan	US5038
6.2L V8 379 CID	1985-1993	Beauville, Chevy Van, Sportvan	US5008	7.4L V8 454 CID	1988-1996	Beauville, Chevy Van, Hi-Cube, Sportvan; High performance	US5038H
6.5L V8 395 CID	1994-1995	Beauville, Chevy Van, Sportvan	US5062	G30 VAN			
6.6L V8 400 CID	1975-1976		US1109	4.8L L6 292 CID	1971-1972		US896
6.6L V8 400 CID	1975-1976	High performance	US1109H	4.8L L6 292 CID	1974		US896
6.6L V8 400 CID	1977-1979		US1121	4.8L L6 4786cc 292 CID	1974		US896
6.6L V8 400 CID	1977-1979	High performance	US1121H	5.7L V8 350 CID	1970-1972		US898
6.6L V8 400 CID	1980	Beauville, Chevy Van, Sportvan	US1121	5.7L V8 350 CID	1970-1972	High performance	US898H
6.6L V8 400 CID	1980	Beauville, Chevy Van, Sportvan; High performance	US1121H	HHR			
G20 VAN				IMPALA			
4.6L V8 4638cc 283 CID	1967		US898	2.0L L4 1998cc 122 CID	2008	SS	US5092
4.6L V8 4638cc 283 CID	1967	High performance	US898H	2.0L L4 1998cc 122 CID	2009	SS, SS Panel	US5092
4.8L L6 292 CID	1971		US896	2.0L L4 1998cc 122 CID	2010	SS	US5092
4.8L L6 292 CID	1973-1974		US896	2.2L L4 2198cc 134 CID	2006	LS, LT	US5092
4.8L L6 4786cc 292 CID	1973-1974		US896	2.2L L4 2198cc 134 CID	2007-2010	LS, LS Panel, LT, LT Panel	US5092
4.8L L6 4801cc 292 CID	1971-1974		US896	2.2L L4 2198cc 134 CID	2011	LS, LS Panel, LT	US5092
5.0L V8 307 CID	1968-1970		US898	2.4L L4 2384cc 145 CID	2006	LT	US5092
5.0L V8 307 CID	1968-1970	High performance	US898H	2.4L L4 2384cc 145 CID	2007-2010	LT, LT Panel	US5092
5.0L V8 5031cc 307 CID	1968-1972		US898	2.4L L4 2384cc 145 CID	2011	LT	US5092
5.0L V8 5031cc 307 CID	1968-1972	High performance	US898H	IMPALA			
5.7L V8 350 CID	1970-1972		US898	2.4L L4 2384cc 145 CID	2014	Eco	US5092
5.7L V8 350 CID	1970-1972	High performance	US898H	2.5L L4 2457cc 153 CID	2014-2015	LS, LT, LTZ; Pump only	US8102
5.7L V8 5736cc 350 CID	1970-1972		US898	2.5L L4 2457cc 153 CID	2015-2016	LS, LT, LTZ	US8102
5.7L V8 5736cc 350 CID	1970-1972	High performance	US898H	2.5L L4 2457cc 153 CID	2017	LS, LT	US8102
G30				3.4L V6 207 CID	2000-2005	Base	US5033
4.1L L6 250 CID	1981-1982	Beauville, Chevy Van, Hi-Cube	US1107	3.5L V6 3490cc 213 CID	2006-2007	LS, LT	US6020
4.1L L6 250 CID	1983-1984	Beauville, Bonaventure, Chevy Van, Hi-Cube	US1107	3.5L V6 3490cc 213 CID	2008	50th Anniversary Edition, LS, LT	US6020
4.3L V6 262 CID	1985-1986	Beauville, Chevy Van, Hi-Cube	US1121	3.5L V6 3490cc 213 CID	2009-2011	LS, LT	US6020
4.3L V6 262 CID	1985-1986	Beauville, Chevy Van, Hi-Cube; High performance	US1121H	3.6L V6 3564cc 217 CID	2012	LS, LT, LTZ	US8932
4.3L V6 262 CID	1987-1993	Beauville, Chevy Van, Hi-Cube	US5049	3.6L V6 3564cc 217 CID	2013	LS, LT, LTZ, Police	US8932
4.3L V6 262 CID	1987-1993	Beauville, Chevy Van, Hi-Cube; High performance	US5049H	3.6L V6 3564cc 217 CID	2015-2016	LS, LT, LTZ	US8932
4.3L V6 262 CID	1994-1995	Chevy Van, Hi-Cube	US5049	3.6L V6 3564cc 217 CID	2017	LS, LT, Premier	US8932
4.3L V6 262 CID	1994-1995	Chevy Van, Hi-Cube; High performance	US5049H	3.8L V6 229 CID	1980	Base, Sport	US1121
4.3L V6 262 CID	1996	Chevy Van	US5049	3.8L V6 229 CID	1980	Base, Sport; High performance	US1121H
4.3L V6 262 CID	1996	Chevy Van; High performance	US5049H	3.8L V6 229 CID	1981-1982	Base, Estate	US1121
4.8L L6 292 CID	1975-1977		US1137	3.8L V6 229 CID	1981-1982	Base, Estate; High performance	US1121H
4.8L L6 292 CID	1975-1977	High performance	US1137H	3.8L V6 229 CID	1983-1984	Base	US1121
4.8L L6 292 CID	1978		US5030	3.8L V6 229 CID	1983-1984	Base; High performance	US1121H
5.0L V8 305 CID	1978-1979		US1121	3.8L V6 229 CID	1983-1984	Base; High performance	US1121H
5.0L V8 305 CID	1978-1979	High performance	US1121H	3.8L V6 3800cc 231 CID	1980	Base, Sport	US1018
5.0L V8 305 CID	1982	Beauville, Chevy Van, Hi-Cube	US1121	3.8L V6 3800cc 231 CID	1980	Base, Sport; High performance	US1018H
5.0L V8 305 CID	1982	Beauville, Chevy Van, Hi-Cube; High performance	US1121H	3.8L V6 3800cc 231 CID	1981-1982	Base, Estate	US1018
5.0L V8 305 CID	1985	Beauville, Chevy Van, Hi-Cube	US1121	3.8L V6 3800cc 231 CID	1981-1982	Base, Estate; High performance	US1018H
5.0L V8 305 CID	1985	Beauville, Chevy Van, Hi-Cube; High performance	US1121H	3.8L V6 3800cc 231 CID	1983-1984	Base	US1018
5.7L V8 350 CID	1975-1976		US1109	3.8L V6 3800cc 231 CID	1983-1984	Base; High performance	US1018H
5.7L V8 350 CID	1975-1976	High performance	US1109H	3.8L V6 3800cc 231 CID	2000-2002	Base, LS	US5075
5.7L V8 350 CID	1977-1979		US1121	3.8L V6 3800cc 231 CID	2003	Base, LS, LS Sport	US5075
5.7L V8 350 CID	1977-1979	High performance	US1121H	3.8L V6 3800cc 231 CID	2004-2005	Base, LS, SS	US5075
5.7L V8 350 CID	1980-1982	Beauville, Chevy Van, Hi-Cube, Sportvan	US1121	3.9L V6 3880cc 237 CID	2006-2007	LT, LTZ	US6020
5.7L V8 350 CID	1980-1982	Beauville, Chevy Van, Hi-Cube, Sportvan; High performance	US1121H	3.9L V6 3880cc 237 CID	2008-2009	LT, LTZ, Police	US6020
5.7L V8 350 CID	1983-1984	Beauville, Bonaventure, Chevy Van, Hi-Cube, Sportvan	US1121	3.9L V6 3880cc 237 CID	2010-2011	LS, LTZ	US6020
5.7L V8 350 CID	1983-1984	Beauville, Bonaventure, Chevy Van, Hi-Cube, Sportvan; High performance	US1121H	4.1L L6 250 CID	1977-1979		US1107
5.7L V8 350 CID	1985-1986	Beauville, Chevy Van, Hi-Cube, Sportvan	US1121	4.1L L6 4100cc 250 CID	1965	Mexican Application	US895
5.7L V8 350 CID	1985-1986	Beauville, Chevy Van, Hi-Cube, Sportvan; High performance	US1121H	4.1L L6 4100cc 250 CID	1975-1976	Mexican Application	US1110
5.7L V8 350 CID	1987-1988	Beauville, Chevy Van, Hi-Cube	US1121	4.3L V6 262 CID	1985	Base	US1121
5.7L V8 350 CID	1987-1988	Beauville, Chevy Van, Hi-Cube; High performance	US1121H	4.3L V6 262 CID	1985	Base; High performance	US1121H
5.7L V8 350 CID	1987-1988	Beauville, Chevy Van, Hi-Cube; High performance	US1121H	4.4L V8 267 CID	1980	Base, Sport	US1121
5.7L V8 350 CID	1987-1996	Beauville, Chevy Van, Hi-Cube, Sportvan	US5049	4.4L V8 267 CID	1980	Base, Sport; High performance	US1121H
5.7L V8 350 CID	1987-1996	Beauville, Chevy Van, Hi-Cube, Sportvan; High performance	US5049H	4.4L V8 267 CID	1981-1982	Base, Estate	US1121
6.2L V8 379 CID	1983-1984	Beauville, Bonaventure, Chevy Van, Hi-Cube, Sportvan	US5008	4.4L V8 267 CID	1981-1982	Base, Estate; High performance	US1121H
6.2L V8 379 CID	1985-1993	Beauville, Chevy Van, Hi-Cube, Sportvan	US5008	4.6L V8 283 CID	1964		US898
6.5L V8 395 CID	1994-1996	Beauville, Chevy Van, Hi-Cube, Sportvan	US5062	4.6L V8 283 CID	1964	High performance	US898H
6.6L V8 400 CID	1975-1976		US1109	4.6L V8 283 CID	1966-1967		US898
6.6L V8 400 CID	1975-1976	High performance	US1109H	4.6L V8 283 CID	1966-1967	High performance	US898H
6.6L V8 400 CID	1977-1979		US1121	4.6L V8 4638cc 283 CID	1958-1967		US898
6.6L V8 400 CID	1977-1979	High performance	US1121H	4.6L V8 4638cc 283 CID	1958-1967	High performance	US898H
6.6L V8 400 CID	1980	Beauville, Chevy Van, Hi-Cube, Sportvan	US1121	4.8L L6 4800cc 292 CID	1965-1972	Mexican Application	US895
6.6L V8 400 CID	1980	Beauville, Chevy Van, Hi-Cube, Sportvan; High performance	US1121H	5.0L V8 305 CID	1977-1979		US1121
				5.0L V8 305 CID	1977-1979	High performance	US1121H
				5.0L V8 305 CID	1980	Base, Sport	US1121
				5.0L V8 305 CID	1980	Base, Sport; High performance	US1121H
				5.0L V8 305 CID	1981-1982	Base, Estate	US1121
				5.0L V8 305 CID	1981-1982	Base, Estate; High performance	US1121H
				5.0L V8 305 CID	1983-1985	Base	US1121
				5.0L V8 305 CID	1983-1985	Base; High performance	US1121H
				5.0L V8 307 CID	1968		US898
				5.0L V8 307 CID	1968	High performance	US898H
				5.0L V8 5031cc 307 CID	1968-1969		US898
				5.0L V8 5031cc 307 CID	1968-1969	High performance	US898H
				5.0L V8 5031cc 307 CID	1971-1972		US898
				5.0L V8 5031cc 307 CID	1971-1972	High performance	US898H
				5.3L V8 5328cc 325 CID	2006-2009	SS	US6154
				5.3L V8 5358cc 327 CID	1962-1969		US898
				5.3L V8 5358cc 327 CID	1962-1969	High performance	US898H
				5.4L V8 327 CID	1964-1969		US898

Engine	Years	Application Description	USMW	Engine	Years	Application Description	USMW
CHEVROLET (cont'd.)				CHEVROLET (cont'd.)			
IMPALA (cont'd.)				K5 BLAZER (cont'd.)			
5.4L V8 327 CID	1964-1969	High performance	US898H	5.7L V8 350 CID	1980	Cheyenne, Custom Deluxe, Silverado; High performance	US1121H
5.7L V8 350 CID	1969-1972		US898	5.7L V8 350 CID	1981	Custom, Deluxe, Silverado	US1121
5.7L V8 350 CID	1969-1972	High performance	US898H	5.7L V8 350 CID	1981	Custom, Deluxe, Silverado; High performance	US1121H
5.7L V8 350 CID	1976		US1109	5.7L V8 350 CID	1982-1983	Custom, Silverado	US1121
5.7L V8 350 CID	1976	High performance	US1109H	5.7L V8 350 CID	1982-1983	Custom, Silverado; High performance	US1121H
5.7L V8 350 CID	1977-1979		US1121	5.7L V8 350 CID	1984	Custom, Scottsdale, Silverado	US1121
5.7L V8 350 CID	1977-1979	High performance	US1121H	5.7L V8 350 CID	1984	Custom, Scottsdale, Silverado; High performance	US1121H
5.7L V8 350 CID	1980	Base, Sport; Exc.Air Cond	US1100	5.7L V8 350 CID	1985-1986	Custom, Silverado	US1121
5.7L V8 350 CID	1980	Base, Sport; With air cond.	US1120	5.7L V8 350 CID	1985-1986	Custom, Silverado; High performance	US1121H
5.7L V8 350 CID	1980	Base, Sport; High performance, With air cond.	US1120H	6.2L V8 379 CID	1982-1983	Custom, Silverado	US5008
5.7L V8 350 CID	1980	Base, Sport	US1121	6.2L V8 379 CID	1984	Custom, Scottsdale, Silverado	US5008
5.7L V8 350 CID	1980	Base, Sport; High performance	US1121H	6.2L V8 379 CID	1985-1986	Custom, Silverado	US5008
5.7L V8 350 CID	1981	Base, Estate; Exc.Air Cond	US1100	6.6L V8 400 CID	1975-1976		US1109
5.7L V8 350 CID	1981-1982	Base, Estate; With air cond.	US1120	6.6L V8 400 CID	1975-1976	High performance	US1109H
5.7L V8 350 CID	1981-1982	Base, Estate; High performance, With air cond.	US1120H	6.6L V8 400 CID	1977-1979		US1121
5.7L V8 350 CID	1981-1982	Base, Estate	US1121	6.6L V8 400 CID	1977-1979	High performance	US1121H
5.7L V8 350 CID	1981-1982	Base, Estate; High performance	US1121H	K10			
5.7L V8 350 CID	1982	Base, Estate; 5" Cast, Exc.Air Cond	US1100	4.1L L6 250 CID	1975-1977		US1110
5.7L V8 350 CID	1982	Base, Estate; Exc.5" Cast, Exc.Air Cond	US1120	4.1L L6 250 CID	1978-1979		US1107
5.7L V8 350 CID	1982	Base, Estate; Exc.5" Cast, Exc.Air Cond, High performance	US1120H	4.1L L6 250 CID	1980	Cheyenne, Custom Deluxe, Scottsdale, Silverado	US1107
5.7L V8 350 CID	1983-1985	Base; 5" Cast, Exc.Air Cond	US1100	4.1L L6 250 CID	1981	Custom, Deluxe	US1107
5.7L V8 350 CID	1983-1985	Base; Exc.5" Cast, Exc.Air Cond	US1120	4.1L L6 250 CID	1982	Custom, Scottsdale, Silverado	US1107
5.7L V8 350 CID	1983-1985	Base; With air cond.	US1120	4.1L L6 250 CID	1983	Custom, Silverado	US1107
5.7L V8 350 CID	1983-1985	Base; Exc.5" Cast, Exc.Air Cond, High performance	US1120H	4.1L L6 250 CID	1984	Custom, Scottsdale	US1107
5.7L V8 350 CID	1983-1985	Base; High performance, With air cond.	US1120H	4.3L V6 262 CID	1985-1986	Custom, Scottsdale, Silverado	US1121
5.7L V8 350 CID	1983-1985	Base	US1121	4.3L V6 262 CID	1985-1986	Custom, Scottsdale, Silverado; High performance	US1121H
5.7L V8 350 CID	1983-1985	Base; High performance	US1121H	4.8L L6 292 CID	1980	Cheyenne, Custom Deluxe, Scottsdale, Silverado	US5030
5.7L V8 350 CID	1994-1996	SS	US5069	5.0L V8 305 CID	1977-1979		US1121
5.7L V8 5704cc 348 CID	1958-1961		US898	5.0L V8 305 CID	1977-1979	High performance	US1121H
5.7L V8 5704cc 348 CID	1958-1961	High performance	US898H	5.0L V8 305 CID	1981	Custom, Deluxe	US1121
5.7L V8 5704cc 348 CID	1959-1961		US127	5.0L V8 305 CID	1981	Custom, Deluxe; High performance	US1121H
5.7L V8 5736cc 350 CID	1969-1972		US898	5.0L V8 305 CID	1982	Custom, Scottsdale, Silverado	US1121
5.7L V8 5736cc 350 CID	1969-1972	High performance	US898H	5.0L V8 305 CID	1982	Custom, Scottsdale, Silverado; High performance	US1121H
6.5L V8 396 CID	1966-1969		US981	5.0L V8 305 CID	1983	Custom, Silverado	US1121
6.5L V8 6489cc 396 CID	1966-1969		US981	5.0L V8 305 CID	1983	Custom, Silverado; High performance	US1121H
6.6L V8 400 CID	1970-1972		US981	5.0L V8 305 CID	1984	Custom, Scottsdale	US1121
6.6L V8 400 CID	1975-1976	High performance	US1109	5.0L V8 305 CID	1984	Custom, Scottsdale; High performance	US1121H
6.6L V8 400 CID	1975-1976	High performance	US1109H	5.0L V8 305 CID	1985-1986	Custom, Scottsdale, Silverado	US1121
6.6L V8 402 CID	1971-1972		US981	5.0L V8 305 CID	1985-1986	Custom, Scottsdale, Silverado; High performance	US1121H
6.6L V8 6555cc 400 CID	1970-1972		US981	5.7L V8 350 CID	1975-1976		US1109
6.6L V8 6556cc 400 CID	1970-1972		US981	5.7L V8 350 CID	1975-1976	High performance	US1109H
6.6L V8 6588cc 402 CID	1970-1972		US981	5.7L V8 350 CID	1977-1979		US1121
6.7L V8 6704cc 409 CID	1961-1963		US127	5.7L V8 350 CID	1977-1979	High performance	US1121H
6.7L V8 6704cc 409 CID	1964	1 3/4" mount holes 4 1/2" hub height	US127	5.7L V8 350 CID	1980	Cheyenne, Custom Deluxe, Scottsdale, Silverado	US1121
6.7L V8 6704cc 409 CID	1966-1969		US981	5.7L V8 350 CID	1980	Cheyenne, Custom Deluxe, Scottsdale, Silverado; High performance	US1121H
7.0L V8 427 CID	1966-1969		US981	5.7L V8 350 CID	1981	Custom, Deluxe	US1121
7.0L V8 6998cc 427 CID	1966-1969		US981	5.7L V8 350 CID	1981	Custom, Deluxe; High performance	US1121H
7.4L V8 454 CID	1975-1976		US1002	5.7L V8 350 CID	1982	Custom, Scottsdale, Silverado	US1121
7.4L V8 454 CID	1975-1976	High performance	US1002H	5.7L V8 350 CID	1982	Custom, Scottsdale, Silverado; High performance	US1121H
IMPALA LIMITED				5.7L V8 350 CID	1983	Custom, Silverado	US1121
3.6L V6 3564cc 217 CID	2014	Police	US8932	5.7L V8 350 CID	1983	Custom, Silverado; High performance	US1121H
3.6L V6 3564cc 217 CID	2015-2016	LS, LT, LTZ, Police	US8932	5.7L V8 350 CID	1984	Custom, Scottsdale	US1121
JOY				5.7L V8 350 CID	1984	Custom, Scottsdale; High performance	US1121H
1.4L L4 1400cc 85 CID	1994-1995	Mexican Application	US5057	5.7L V8 350 CID	1985-1986	Custom, Scottsdale, Silverado	US1121
1.6L L4 1600cc 98 CID	1996-2003	Mexican Application	US5057	5.7L V8 350 CID	1985-1986	Custom, Scottsdale, Silverado; High performance	US1121H
K5 BLAZER				6.2L V8 379 CID	1982	Custom, Scottsdale, Silverado	US5008
4.1L L6 250 CID	1975-1977		US1110	6.2L V8 379 CID	1983	Custom, Silverado	US5008
4.1L L6 250 CID	1978-1979		US1107	6.2L V8 379 CID	1984	Custom, Scottsdale	US5008
4.1L L6 250 CID	1980	Cheyenne, Custom Deluxe, Silverado	US1107	6.2L V8 379 CID	1985-1986	Custom, Scottsdale, Silverado	US5008
4.1L L6 250 CID	1981	Custom, Deluxe, Silverado	US1107	6.6L V8 400 CID	1975-1976		US1109
4.1L L6 250 CID	1982	Custom, Silverado	US1107	6.6L V8 400 CID	1975-1976	High performance	US1109H
5.0L V8 305 CID	1977-1979		US1121	6.6L V8 400 CID	1977-1979	High performance	US1121H
5.0L V8 305 CID	1977-1979	High performance	US1121H	6.6L V8 400 CID	1977-1979	Cheyenne, Custom Deluxe, Scottsdale, Silverado	US1121
5.0L V8 305 CID	1980	Cheyenne, Custom Deluxe, Silverado	US1121	6.6L V8 400 CID	1980	Cheyenne, Custom Deluxe, Scottsdale, Silverado	US1121
5.0L V8 305 CID	1980	Cheyenne, Custom Deluxe, Silverado; High performance	US1121H	6.6L V8 400 CID	1980	Cheyenne, Custom Deluxe, Scottsdale, Silverado; High performance	US1121H
5.0L V8 305 CID	1981	Custom, Deluxe, Silverado	US1121	7.4L V8 454 CID	1980	Cheyenne, Custom Deluxe, Scottsdale, Silverado	US1002
5.0L V8 305 CID	1981	Custom, Deluxe, Silverado; High performance	US1121H	7.4L V8 454 CID	1980	Cheyenne, Custom Deluxe, Scottsdale, Silverado; High performance	US1002H
5.0L V8 305 CID	1982-1983	Custom, Silverado	US1121	K10 PICKUP			
5.0L V8 305 CID	1982-1983	Custom, Silverado; High performance	US1121H	4.3L L6 4278cc 261 CID	1961-1962		US898
5.0L V8 305 CID	1984	Custom, Scottsdale, Silverado	US1121	4.3L L6 4278cc 261 CID	1961-1962	High performance	US898H
5.0L V8 305 CID	1984	Custom, Scottsdale, Silverado; High performance	US1121H	4.6L V8 4638cc 283 CID	1960-1967		US898
5.0L V8 305 CID	1985-1986	Custom, Silverado	US1121	4.6L V8 4638cc 283 CID	1960-1967	High performance	US898H
5.0L V8 305 CID	1985-1986	Custom, Silverado; High performance	US1121H				
5.7L V8 350 CID	1975-1976		US1109				
5.7L V8 350 CID	1975-1976	High performance	US1109H				
5.7L V8 350 CID	1977-1979		US1121				
5.7L V8 350 CID	1977-1979	High performance	US1121H				
5.7L V8 350 CID	1980	Cheyenne, Custom Deluxe, Silverado	US1121				

Engine	Years	Application Description	USMW	Engine	Years	Application Description	USMW
CHEVROLET (cont'd.)				CHEVROLET (cont'd.)			
K10 PICKUP (cont'd.)				K10 SUBURBAN (cont'd.)			
4.8L L6 292 CID	1969-1970		US896	6.6L V8 402 CID	1970-1972		US981
4.8L L6 292 CID	1972-1973		US896	6.6L V8 6588cc 402 CID	1970-1972		US981
4.8L L6 4786cc 292 CID	1972-1973		US896	K20			
4.8L L6 4801cc 292 CID	1965-1974		US896	4.1L L6 250 CID	1980	Cheyenne, Custom Deluxe, Scottsdale, Silverado	US1107
5.0L V8 307 CID	1968-1972		US898	4.3L V6 262 CID	1985	Custom, Scottsdale, Silverado	US1121
5.0L V8 307 CID	1968-1972	High performance	US898H	4.3L V6 262 CID	1985	Custom, Scottsdale, Silverado; High performance	US1121H
5.0L V8 5031cc 307 CID	1968-1972		US898	4.8L L6 292 CID	1975-1977		US1137
5.0L V8 5031cc 307 CID	1968-1972	High performance	US898H	4.8L L6 292 CID	1975-1977	High performance	US1137H
5.3L V8 5358cc 327 CID	1966-1969		US898	4.8L L6 292 CID	1978-1979		US5030
5.3L V8 5358cc 327 CID	1966-1969	High performance	US898H	4.8L L6 292 CID	1980	Cheyenne, Custom Deluxe, Scottsdale, Silverado	US5030
5.4L V8 327 CID	1968		US898	4.8L L6 292 CID	1981	Custom, Deluxe	US5030
5.4L V8 327 CID	1968	High performance	US898H	4.8L L6 292 CID	1982	Custom, Scottsdale, Silverado	US5030
5.7L V8 350 CID	1969-1972		US898	4.8L L6 292 CID	1983	Custom, Silverado	US5030
5.7L V8 350 CID	1969-1972	High performance	US898H	4.8L L6 292 CID	1984	Custom, Scottsdale	US5030
5.7L V8 5704cc 348 CID	1960-1961		US898	4.8L L6 292 CID	1985-1986	Custom, Scottsdale, Silverado	US5030
5.7L V8 5704cc 348 CID	1960-1961	High performance	US898H	5.0L V8 305 CID	1977-1978		US1121
5.7L V8 5736cc 350 CID	1969-1972		US898	5.0L V8 305 CID	1977-1978	High performance	US1121H
5.7L V8 5736cc 350 CID	1969-1972	High performance	US898H	5.0L V8 305 CID	1980	Cheyenne, Custom Deluxe, Scottsdale, Silverado	US1121
6.5L V8 396 CID	1968-1969		US981	5.0L V8 305 CID	1980	Cheyenne, Custom Deluxe, Scottsdale, Silverado; High performance	US1121H
6.5L V8 6489cc 396 CID	1968-1969		US981	5.0L V8 305 CID	1985	Custom, Scottsdale, Silverado	US1121
6.6L V8 6588cc 402 CID	1970-1972		US981	5.0L V8 305 CID	1985	Custom, Scottsdale, Silverado; High performance	US1121H
K10 SUBURBAN				5.0L V8 305 CID	1985	Custom, Scottsdale, Silverado; High performance	US1121H
4.1L L6 250 CID	1975-1977		US1110	5.7L V8 350 CID	1975-1976		US1109
4.1L L6 250 CID	1978-1979		US1107	5.7L V8 350 CID	1975-1976	High performance	US1109H
4.1L L6 250 CID	1980	Custom Deluxe, Scottsdale, Silverado	US1107	5.7L V8 350 CID	1977-1979		US1121
4.6L V8 4638cc 283 CID	1967		US898	5.7L V8 350 CID	1977-1979	High performance	US1121H
4.6L V8 4638cc 283 CID	1967	High performance	US898H	5.7L V8 350 CID	1980	Cheyenne, Custom Deluxe, Scottsdale, Silverado	US1121
4.8L L6 292 CID	1969-1970		US896	5.7L V8 350 CID	1980	Cheyenne, Custom Deluxe, Scottsdale, Silverado; High performance	US1121H
4.8L L6 4801cc 292 CID	1967		US896	5.7L V8 350 CID	1981	Custom, Deluxe	US1121
5.0L L6 305 CID	1977-1979		US1121	5.7L V8 350 CID	1981	Custom, Deluxe; High performance	US1121H
5.0L V8 305 CID	1977-1979	High performance	US1121H	5.7L V8 350 CID	1982	Custom, Scottsdale, Silverado	US1121
5.0L V8 305 CID	1980	Custom Deluxe, Scottsdale, Silverado	US1121	5.7L V8 350 CID	1982	Custom, Scottsdale, Silverado; High performance	US1121H
5.0L V8 305 CID	1980	Custom Deluxe, Scottsdale, Silverado; High performance	US1121H	5.7L V8 350 CID	1982	Custom, Silverado	US1121
5.0L V8 305 CID	1981	Custom, Deluxe	US1121	5.7L V8 350 CID	1983	Custom, Silverado; High performance	US1121H
5.0L V8 305 CID	1981	Custom, Deluxe; High performance	US1121H	5.7L V8 350 CID	1984	Custom, Scottsdale	US1121
5.0L V8 305 CID	1982	Custom, Scottsdale, Silverado	US1121	5.7L V8 350 CID	1984	Custom, Scottsdale; High performance	US1121H
5.0L V8 305 CID	1982	Custom, Scottsdale, Silverado; High performance	US1121H	5.7L V8 350 CID	1985-1986	Custom, Scottsdale, Silverado	US1121
5.0L V8 305 CID	1983	Custom, Silverado	US1121	5.7L V8 350 CID	1985-1986	Custom, Scottsdale, Silverado; High performance	US1121H
5.0L V8 305 CID	1983	Custom, Silverado; High performance	US1121H	6.2L V8 379 CID	1982	Custom, Scottsdale, Silverado	US5008
5.0L V8 305 CID	1984	Custom	US1121	6.2L V8 379 CID	1983	Custom, Silverado	US5008
5.0L V8 305 CID	1984	Custom; High performance	US1121H	6.2L V8 379 CID	1984	Custom, Scottsdale	US5008
5.0L V8 305 CID	1985-1986	Custom, Scottsdale, Silverado	US1121	6.2L V8 379 CID	1985-1986	Custom, Scottsdale, Silverado	US5008
5.0L V8 305 CID	1985-1986	Custom, Scottsdale, Silverado; High performance	US1121H	6.6L V8 400 CID	1975-1976		US1109
5.0L V8 307 CID	1968-1972		US898	6.6L V8 400 CID	1975-1976	High performance	US1109H
5.0L V8 307 CID	1968-1972	High performance	US898H	6.6L V8 400 CID	1977-1979		US1121
5.0L V8 5031cc 307 CID	1968-1972		US898	6.6L V8 400 CID	1977-1979	High performance	US1121H
5.0L V8 5031cc 307 CID	1968-1972	High performance	US898H	6.6L V8 400 CID	1980	Cheyenne, Custom Deluxe, Scottsdale, Silverado	US1121
5.3L V8 5358cc 327 CID	1967-1969		US898	6.6L V8 400 CID	1980	Cheyenne, Custom Deluxe, Scottsdale, Silverado; High performance	US1121H
5.3L V8 5358cc 327 CID	1967-1969	High performance	US898H	7.4L V8 454 CID	1980	Cheyenne, Custom Deluxe, Scottsdale, Silverado	US1002
5.4L V8 327 CID	1968		US898	7.4L V8 454 CID	1980	Cheyenne, Custom Deluxe, Scottsdale, Silverado; High performance	US1002H
5.4L V8 327 CID	1968	High performance	US898H	K20 PANEL			
5.7L V8 350 CID	1969-1972		US898	4.6L V8 283 CID	1967		US898
5.7L V8 350 CID	1969-1972	High performance	US898H	4.6L V8 283 CID	1967	High performance	US898H
5.7L V8 350 CID	1975-1976		US1109	5.4L V8 327 CID	1967		US898
5.7L V8 350 CID	1975-1976	High performance	US1109H	5.4L V8 327 CID	1967	High performance	US898H
5.7L V8 350 CID	1977-1979		US1121	K20 PICKUP			
5.7L V8 350 CID	1977-1979	High performance	US1121H	4.3L L6 4278cc 261 CID	1961-1962		US898
5.7L V8 350 CID	1980	Custom Deluxe, Scottsdale, Silverado	US1121	4.3L L6 4278cc 261 CID	1961-1962	High performance	US898H
5.7L V8 350 CID	1980	Custom Deluxe, Scottsdale, Silverado; High performance	US1121H	4.6L V8 4638cc 283 CID	1960-1967		US898
5.7L V8 350 CID	1981	Custom, Deluxe	US1121	4.6L V8 4638cc 283 CID	1960-1967	High performance	US898H
5.7L V8 350 CID	1981	Custom, Deluxe; High performance	US1121H	4.8L L6 292 CID	1969-1974		US896
5.7L V8 350 CID	1982	Custom, Scottsdale, Silverado	US1121	4.8L L6 4786cc 292 CID	1972-1974		US896
5.7L V8 350 CID	1982	Custom, Scottsdale, Silverado; High performance	US1121H	4.8L L6 4801cc 292 CID	1965-1974		US896
5.7L V8 350 CID	1983	Custom, Silverado	US1121	5.0L V8 307 CID	1968-1972		US898
5.7L V8 350 CID	1983	Custom, Silverado; High performance	US1121H	5.0L V8 307 CID	1968-1972	High performance	US898H
5.7L V8 350 CID	1984	Custom, Scottsdale	US1121	5.0L V8 5031cc 307 CID	1968-1972		US898
5.7L V8 350 CID	1984	Custom, Scottsdale; High performance	US1121H	5.0L V8 5031cc 307 CID	1968-1972	High performance	US898H
5.7L V8 350 CID	1985-1986	Custom, Scottsdale, Silverado	US1121	5.3L V8 5358cc 327 CID	1966-1969		US898
5.7L V8 350 CID	1985-1986	Custom, Scottsdale, Silverado; High performance	US1121H	5.3L V8 5358cc 327 CID	1966-1969	High performance	US898H
5.7L V8 5736cc 350 CID	1969-1972		US898	5.4L V8 327 CID	1968		US898
5.7L V8 5736cc 350 CID	1969-1972	High performance	US898H	5.4L V8 327 CID	1968	High performance	US898H
6.2L V8 379 CID	1982	Custom, Scottsdale, Silverado	US5008	5.7L V8 350 CID	1969-1972		US898
6.2L V8 379 CID	1983	Custom, Silverado	US5008	5.7L V8 350 CID	1969-1972	High performance	US898H
6.2L V8 379 CID	1984	Custom, Scottsdale	US5008	5.7L V8 5704cc 348 CID	1960-1961		US898
6.2L V8 379 CID	1985-1986	Custom, Scottsdale, Silverado	US5008				
6.5L V8 396 CID	1968-1969		US981				
6.5L V8 6489cc 396 CID	1968-1969		US981				
6.6L V8 400 CID	1975-1976		US1109				
6.6L V8 400 CID	1975-1976	High performance	US1109H				
6.6L V8 400 CID	1977-1979		US1121				
6.6L V8 400 CID	1977-1979	High performance	US1121H				

WATER PUMPS

Engine	Years	Application Description	USMW	Engine	Years	Application Description	USMW
CHEVROLET (cont'd.)				CHEVROLET (cont'd.)			
K20 PICKUP (cont'd.)				K30 (cont'd.)			
5.7L V8 5704cc 348 CID	1960-1961	High performance	US898H	5.7L V8 350 CID	1982	Custom, Scottsdale, Silverado	US1121
5.7L V8 5736cc 350 CID	1969-1972		US898	5.7L V8 350 CID	1982	Custom, Scottsdale, Silverado; High performance	US1121H
5.7L V8 5736cc 350 CID	1969-1972	High performance	US898H	5.7L V8 350 CID	1983	Custom, Silverado	US1121
6.5L V8 396 CID	1968-1969		US981	5.7L V8 350 CID	1983	Custom, Silverado; High performance	US1121H
6.5L V8 6489cc 396 CID	1968-1969		US981	5.7L V8 350 CID	1984	Custom, Scottsdale	US1121
6.6L V8 6588cc 402 CID	1970-1972		US981	5.7L V8 350 CID	1984	Custom, Scottsdale; High performance	US1121H
K20 SUBURBAN				5.7L V8 350 CID	1985-1986	Custom, Scottsdale, Silverado	US1121
4.6L V8 4638cc 283 CID	1967		US898	5.7L V8 350 CID	1985-1986	Custom, Scottsdale, Silverado; High performance	US1121H
4.6L V8 4638cc 283 CID	1967	High performance	US898H	6.2L V8 379 CID	1982	Custom, Scottsdale, Silverado	US5008
4.8L L6 292 CID	1968-1974		US896	6.2L V8 379 CID	1983	Custom, Silverado	US5008
4.8L L6 292 CID	1975-1977		US1137	6.2L V8 379 CID	1984	Custom, Scottsdale	US5008
4.8L L6 292 CID	1975-1977	High performance	US1137H	6.2L V8 379 CID	1984	Custom, Scottsdale	US5008
4.8L L6 292 CID	1978-1979		US5030	6.2L V8 379 CID	1985-1986	Custom, Scottsdale, Silverado	US5008
4.8L L6 292 CID	1980	Custom Deluxe, Scottsdale, Silverado	US5030	6.6L V8 400 CID	1977-1979	High performance	US1121H
4.8L L6 292 CID	1981	Custom, Deluxe	US5030	6.6L V8 400 CID	1980	Cheyenne, Custom Deluxe, Scottsdale, Silverado	US1121
4.8L L6 292 CID	1982	Custom, Scottsdale, Silverado	US5030	6.6L V8 400 CID	1980	Cheyenne, Custom Deluxe, Scottsdale, Silverado; High performance	US1121H
4.8L L6 4786cc 292 CID	1973-1974		US896	7.4L V8 454 CID	1980	Cheyenne, Custom Deluxe, Scottsdale, Silverado	US1002
4.8L L6 4801cc 292 CID	1967-1974		US896	7.4L V8 454 CID	1980	Cheyenne, Custom Deluxe, Scottsdale, Silverado; High performance	US1002H
5.0L V8 305 CID	1977-1978		US1121	7.4L V8 454 CID	1981	Custom, Deluxe	US1002
5.0L V8 305 CID	1977-1978	High performance	US1121H	7.4L V8 454 CID	1981	Custom, Deluxe; High performance	US1002H
5.0L V8 305 CID	1985-1986	Custom, Scottsdale, Silverado	US1121	7.4L V8 454 CID	1982	Custom, Scottsdale, Silverado	US1002
5.0L V8 305 CID	1985-1986	Custom, Scottsdale, Silverado; High performance	US1121H	7.4L V8 454 CID	1982	Custom, Scottsdale, Silverado; High performance	US1002H
5.0L V8 307 CID	1968-1972		US898	7.4L V8 454 CID	1983	Custom, Silverado	US1002
5.0L V8 307 CID	1968-1972	High performance	US898H	7.4L V8 454 CID	1983	Custom, Silverado; High performance	US1002H
5.0L V8 5031cc 307 CID	1968-1972		US898	7.4L V8 454 CID	1984	Custom, Scottsdale	US1002
5.0L V8 5031cc 307 CID	1968-1972	High performance	US898H	7.4L V8 454 CID	1984	Custom, Scottsdale; High performance	US1002H
5.3L V8 5358cc 327 CID	1967-1969		US898	7.4L V8 454 CID	1985-1986	Custom, Scottsdale, Silverado	US1002
5.3L V8 5358cc 327 CID	1967-1969	High performance	US898H	7.4L V8 454 CID	1985-1986	Custom, Scottsdale, Silverado; High performance	US1002H
5.4L V8 327 CID	1968		US898	K30 PICKUP			
5.4L V8 327 CID	1968	High performance	US898H	4.8L L6 292 CID	1968-1974		US896
5.7L V8 350 CID	1969-1972		US898	4.8L L6 4786cc 292 CID	1973-1974		US896
5.7L V8 350 CID	1969-1972	High performance	US898H	4.8L L6 4801cc 292 CID	1968-1974		US896
5.7L V8 350 CID	1975-1976		US1109	5.0L V8 307 CID	1968-1972		US898
5.7L V8 350 CID	1975-1976	High performance	US1109H	5.0L V8 307 CID	1968-1972	High performance	US898H
5.7L V8 350 CID	1977-1979		US1121	5.0L V8 5031cc 307 CID	1968-1972		US898
5.7L V8 350 CID	1977-1979	High performance	US1121H	5.0L V8 5031cc 307 CID	1968-1972	High performance	US898H
5.7L V8 350 CID	1980	Custom Deluxe, Scottsdale, Silverado	US1121	5.3L V8 5358cc 327 CID	1968-1969		US898
5.7L V8 350 CID	1980	Custom Deluxe, Scottsdale, Silverado; High performance	US1121H	5.3L V8 5358cc 327 CID	1968-1969	High performance	US898H
5.7L V8 350 CID	1981	Custom, Deluxe	US1121	5.4L V8 327 CID	1968		US898
5.7L V8 350 CID	1981	Custom, Deluxe; High performance	US1121H	5.4L V8 327 CID	1968	High performance	US898H
5.7L V8 350 CID	1982	Custom, Scottsdale, Silverado	US1121	5.7L V8 350 CID	1969-1972		US898
5.7L V8 350 CID	1982	Custom, Scottsdale, Silverado; High performance	US1121H	5.7L V8 350 CID	1969-1972	High performance	US898H
5.7L V8 350 CID	1983	Custom, Silverado	US1121	5.7L V8 5736cc 350 CID	1969-1972		US898
5.7L V8 350 CID	1983	Custom, Silverado; High performance	US1121H	5.7L V8 5736cc 350 CID	1969-1972	High performance	US898H
5.7L V8 350 CID	1984	Custom, Scottsdale	US1121	6.5L V8 396 CID	1968-1969		US981
5.7L V8 350 CID	1984	Custom, Scottsdale; High performance	US1121H	6.5L V8 6489cc 396 CID	1968-1969		US981
5.7L V8 350 CID	1985-1986	Custom, Scottsdale, Silverado	US1121	6.6L V8 402 CID	1970-1971		US981
5.7L V8 350 CID	1985-1986	Custom, Scottsdale, Silverado; High performance	US1121H	6.6L V8 6588cc 402 CID	1970-1972		US981
5.7L V8 5736cc 350 CID	1969-1972		US898	K1500			
5.7L V8 5736cc 350 CID	1969-1972	High performance	US898H	4.3L V6 262 CID	1988-1989	Cheyenne, Scottsdale, Silverado	US5049
6.2L V8 379 CID	1982	Custom, Scottsdale, Silverado	US5008	4.3L V6 262 CID	1988-1989	Cheyenne, Scottsdale, Silverado; High performance	US5049H
6.2L V8 379 CID	1983	Custom, Silverado	US5008	4.3L V6 262 CID	1990	Cheyenne, Scottsdale, Silverado, WT	US5049
6.2L V8 379 CID	1984	Custom, Scottsdale	US5008	4.3L V6 262 CID	1990	Cheyenne, Scottsdale, Silverado, WT; High performance	US5049H
6.2L V8 379 CID	1985-1986	Custom, Scottsdale, Silverado	US5008	4.3L V6 262 CID	1991	Cheyenne, Scottsdale, Silverado, Sport, WT	US5049
6.5L V8 6489cc 396 CID	1968-1969		US981	4.3L V6 262 CID	1991	Cheyenne, Scottsdale, Silverado, Sport, WT; High performance	US5049H
6.6L V8 400 CID	1975-1976		US1109	4.3L V6 262 CID	1992	Cheyenne, Scottsdale, Silverado, WT	US5049
6.6L V8 400 CID	1975-1976	High performance	US1109H	4.3L V6 262 CID	1992	Cheyenne, Scottsdale, Silverado, WT; High performance	US5049H
6.6L V8 400 CID	1977-1979		US1121	4.3L V6 262 CID	1993	Cheyenne, Silverado, WT	US5049
6.6L V8 400 CID	1977-1979	High performance	US1121H	4.3L V6 262 CID	1993	Cheyenne, Silverado, WT; High performance	US5049H
6.6L V8 400 CID	1980	Custom Deluxe, Scottsdale, Silverado	US1121	4.3L V6 262 CID	1994-1995	Base, Cheyenne, Silverado, WT	US5049
6.6L V8 400 CID	1980	Custom Deluxe, Scottsdale, Silverado; High performance	US1121H	4.3L V6 262 CID	1994-1995	Base, Cheyenne, Silverado, WT; High performance	US5049H
6.6L V8 6588cc 402 CID	1970-1972		US981	4.3L V6 262 CID	1996-1997	Base, Cheyenne, Silverado, WT	US5077
7.4L V8 454 CID	1985	Custom, Scottsdale, Silverado	US1002	4.3L V6 262 CID	1996-1997	Base, Cheyenne, Silverado, WT; High performance	US5077H
7.4L V8 454 CID	1985	Custom, Scottsdale, Silverado; High performance	US1002H	4.3L V6 262 CID	1998	Cheyenne, Silverado, WT	US5077
K30				4.3L V6 262 CID	1998	Cheyenne, Silverado, WT; High performance	US5077H
4.8L L6 292 CID	1977-1979		US5030	5.0L V8 305 CID	1988-1989	Cheyenne, Scottsdale, Silverado	US5049
4.8L L6 292 CID	1980	Cheyenne, Custom Deluxe, Scottsdale, Silverado	US5030	5.0L V8 305 CID	1988-1989	Cheyenne, Scottsdale, Silverado; High performance	US5049H
4.8L L6 292 CID	1981	Custom, Deluxe	US5030	5.0L V8 305 CID	1990	Cheyenne, Scottsdale, Silverado, WT	US5049
4.8L L6 292 CID	1982	Custom, Scottsdale, Silverado	US5030	5.0L V8 305 CID	1990	Cheyenne, Scottsdale, Silverado, WT; High performance	US5049H
4.8L L6 292 CID	1983	Custom, Silverado	US5030				
4.8L L6 292 CID	1984	Custom, Scottsdale	US5030				
4.8L L6 292 CID	1985-1986	Custom, Scottsdale, Silverado	US5030				
5.7L V8 350 CID	1977-1979		US1121				
5.7L V8 350 CID	1977-1979	High performance	US1121H				
5.7L V8 350 CID	1980	Cheyenne, Custom Deluxe, Scottsdale, Silverado	US1121				
5.7L V8 350 CID	1980	Cheyenne, Custom Deluxe, Scottsdale, Silverado; High performance	US1121H				
5.7L V8 350 CID	1981	Custom, Deluxe	US1121				
5.7L V8 350 CID	1981	Custom, Deluxe; High performance	US1121H				

Engine	Years	Application Description	USMW	Engine	Years	Application Description	USMW
CHEVROLET (cont'd.)				CHEVROLET (cont'd.)			
K1500 (cont'd.)				K2500 (cont'd.)			
5.0L V8 305 CID	1991	Cheyenne, Scottsdale, Silverado, Sport, WT	US5049	4.3L V6 262 CID	1994-1995	Base, Cheyenne, Silverado, WT; High performance	US5049H
5.0L V8 305 CID	1991	Cheyenne, Scottsdale, Silverado, Sport, WT; High performance	US5049H	5.0L V8 305 CID	1988-1992	Cheyenne, Scottsdale, Silverado	US5049
5.0L V8 305 CID	1992	Cheyenne, Scottsdale, Silverado, WT	US5049	5.0L V8 305 CID	1988-1992	Cheyenne, Scottsdale, Silverado; High performance	US5049H
5.0L V8 305 CID	1992	Cheyenne, Scottsdale, Silverado, WT; High performance	US5049H	5.0L V8 305 CID	1993	Cheyenne, Silverado	US5049
5.0L V8 305 CID	1993	Cheyenne, Silverado, WT	US5049	5.0L V8 305 CID	1993	Cheyenne, Silverado; High performance	US5049H
5.0L V8 305 CID	1993	Cheyenne, Silverado, WT; High performance	US5049H	5.0L V8 305 CID	1994-1995	Base, Cheyenne, Silverado, WT	US5049
5.0L V8 305 CID	1994-1995	Base, Cheyenne, Silverado, WT	US5049	5.0L V8 305 CID	1994-1995	Base, Cheyenne, Silverado, WT; High performance	US5049H
5.0L V8 305 CID	1994-1995	Base, Cheyenne, Silverado, WT; High performance	US5049H	5.0L V8 305 CID	1998	Cheyenne, Silverado, WT	US5077
5.0L V8 305 CID	1996-1997	Base, Cheyenne, Silverado, WT	US5077	5.0L V8 305 CID	1998	Cheyenne, Silverado, WT; High performance	US5077H
5.0L V8 305 CID	1996-1997	Base, Cheyenne, Silverado, WT; High performance	US5077H	5.7L V8 350 CID	1988-1992	Cheyenne, Scottsdale, Silverado	US5049
5.0L V8 305 CID	1998	Cheyenne, Silverado, WT	US5077	5.7L V8 350 CID	1988-1992	Cheyenne, Scottsdale, Silverado; High performance	US5049H
5.0L V8 305 CID	1998	Cheyenne, Silverado, WT; High performance	US5077H	5.7L V8 350 CID	1993	Cheyenne, Silverado	US5049
5.0L V8 305 CID	1999	LS	US5077	5.7L V8 350 CID	1993	Cheyenne, Silverado; High performance	US5049H
5.0L V8 305 CID	1999	LS; High performance	US5077H	5.7L V8 350 CID	1994-1995	Base, Cheyenne, Silverado, WT	US5049
5.7L V8 350 CID	1988-1989	Cheyenne, Scottsdale, Silverado	US5049	5.7L V8 350 CID	1994-1995	Base, Cheyenne, Silverado, WT; High performance	US5049H
5.7L V8 350 CID	1988-1989	Cheyenne, Scottsdale, Silverado; High performance	US5049H	5.7L V8 350 CID	1996-1997	Base, Cheyenne, Silverado	US5077
5.7L V8 350 CID	1990	Cheyenne, Scottsdale, Silverado, WT	US5049	5.7L V8 350 CID	1996-1997	Base, Cheyenne, Silverado; High performance	US5077H
5.7L V8 350 CID	1990	Cheyenne, Scottsdale, Silverado, WT; High performance	US5049H	5.7L V8 350 CID	1998	Cheyenne, Silverado, WT	US5077
5.7L V8 350 CID	1991	Cheyenne, Scottsdale, Silverado, Sport, WT	US5049	5.7L V8 350 CID	1998	Cheyenne, Silverado, WT; High performance	US5077H
5.7L V8 350 CID	1991	Cheyenne, Scottsdale, Silverado, Sport, WT; High performance	US5049H	5.7L V8 350 CID	1999-2000	Base, LS	US5077
5.7L V8 350 CID	1992	Cheyenne, Scottsdale, Silverado, WT	US5049	5.7L V8 350 CID	1999-2000	Base, LS; High performance	US5077H
5.7L V8 350 CID	1992	Cheyenne, Scottsdale, Silverado, WT; High performance	US5049H	5.7L V8 5737cc 350 CID	2000	Mexican Application	US5077
5.7L V8 350 CID	1993	Cheyenne, Silverado, WT	US5049	6.2L V8 379 CID	1988-1992	Cheyenne, Scottsdale, Silverado	US5062
5.7L V8 350 CID	1993	Cheyenne, Silverado, WT; High performance	US5049H	6.2L V8 379 CID	1993	Cheyenne, Silverado	US5062
5.7L V8 350 CID	1994-1995	Base, Cheyenne, Silverado, WT	US5049	6.5L V8 395 CID	1992-1993	Cheyenne, Silverado	US5062
5.7L V8 350 CID	1994-1995	Base, Cheyenne, Silverado, WT; High performance	US5049H	6.5L V8 395 CID	1994-1995	Base, Cheyenne, Silverado, WT	US5062
5.7L V8 350 CID	1996-1997	Base, Cheyenne, Silverado, WT	US5077	6.5L V8 395 CID	1996	Base, Cheyenne, Silverado; 1st Design, Single Thermostat	US5062
5.7L V8 350 CID	1996-1997	Base, Cheyenne, Silverado, WT; High performance	US5077H	6.5L V8 395 CID	1996	Base, Cheyenne, Silverado; 2nd Design, Dual Thermostat	US5074
5.7L V8 350 CID	1998	Cheyenne, Silverado, WT	US5077	6.5L V8 395 CID	1997	Base, Cheyenne, Silverado	US5074
5.7L V8 350 CID	1998	Cheyenne, Silverado, WT; High performance	US5077H	6.5L V8 395 CID	1998	Cheyenne, Silverado, WT	US5074
5.7L V8 350 CID	1999	LS	US5077	6.5L V8 395 CID	1999	Base, LS; Bolt on pulley	US5074
5.7L V8 350 CID	1999	LS; High performance	US5077H	6.5L V8 395 CID	1999-2000	Base, LS	US5086
5.7L V8 5737cc 350 CID	2000	Mexican Application	US5077	7.4L V8 454 CID	1991-1993	Cheyenne, Silverado	US5038
6.2L V8 379 CID	1988-1989	Cheyenne, Scottsdale, Silverado	US5062	7.4L V8 454 CID	1991-1993	Cheyenne, Silverado; High performance	US5038H
6.2L V8 379 CID	1990	Cheyenne, Scottsdale, Silverado, WT	US5062	7.4L V8 454 CID	1994-1995	Base, Cheyenne, Silverado, WT	US5038
6.2L V8 379 CID	1991	Cheyenne, Scottsdale, Silverado, Sport, WT	US5062	7.4L V8 454 CID	1994-1995	Base, Cheyenne, Silverado, WT; High performance	US5038H
6.2L V8 379 CID	1992	Cheyenne, Scottsdale, Silverado, WT	US5062	7.4L V8 454 CID	1996-1997	Base, Cheyenne, Silverado	US5038
6.2L V8 379 CID	1993	Cheyenne, Silverado, WT	US5062	7.4L V8 454 CID	1996-1997	Base, Cheyenne, Silverado; High performance	US5038H
6.5L V8 395 CID	1994-1995	Base, Cheyenne, Silverado, WT	US5062	7.4L V8 454 CID	1998	Cheyenne, Silverado, WT	US5038
6.5L V8 395 CID	1996	Base, Cheyenne, Silverado, WT; Early	US5062	7.4L V8 454 CID	1998	Cheyenne, Silverado, WT; High performance	US5038H
6.5L V8 395 CID	1996	Base, Cheyenne, Silverado, WT; Late	US5074	7.4L V8 454 CID	1999-2000	Base, LS	US5038
6.5L V8 395 CID	1997	Base, Cheyenne, Silverado, WT	US5074	7.4L V8 454 CID	1999-2000	Base, LS; High performance	US5038H
6.5L V8 395 CID	1998	Cheyenne, Silverado, WT	US5074	K2500 SUBURBAN			
K1500 SUBURBAN				5.7L V8 350 CID	1992	Base, Silverado; 6.9" HUB HEIGHT	US5049
5.7L V8 350 CID	1992	Base, Silverado; 6.9" HUB HEIGHT	US5049	5.7L V8 350 CID	1992	Base, Silverado; 6.9" HUB HEIGHT, High performance	US5049H
5.7L V8 350 CID	1992	Base, Silverado; 6.9" HUB HEIGHT, High performance	US5049H	5.7L V8 350 CID	1992	Base, Silverado; 5.8" HUB HEIGHT	US5073
5.7L V8 350 CID	1992	Base, Silverado; 5.8" HUB HEIGHT	US5073	5.7L V8 350 CID	1993-1994	Base, Silverado	US5049
5.7L V8 350 CID	1993-1994	Base, Silverado	US5049	5.7L V8 350 CID	1993-1994	Base, Silverado; High performance	US5049H
5.7L V8 350 CID	1993-1994	Base, Silverado; High performance	US5049H	5.7L V8 350 CID	1995	Base, LS, LT	US5049
5.7L V8 350 CID	1995	Base, LS, LT	US5049	5.7L V8 350 CID	1995	Base, LS, LT; High performance	US5049H
5.7L V8 350 CID	1995	Base, LS, LT; High performance	US5049H	5.7L V8 350 CID	1996-1997	Base, LS, LT	US5077
5.7L V8 350 CID	1996-1997	Base, LS, LT	US5077	5.7L V8 350 CID	1996-1997	Base, LS, LT; High performance	US5077H
5.7L V8 350 CID	1996-1997	Base, LS, LT; High performance	US5077H	5.7L V8 350 CID	1998-1999	Base, LS	US5077
5.7L V8 350 CID	1998	Base, LS	US5077	5.7L V8 350 CID	1998-1999	Base, LS; High performance	US5077H
5.7L V8 350 CID	1998-1999	Base, LS; High performance	US5077H	6.5L V8 395 CID	1994	Base, Silverado	US5062
5.7L V8 350 CID	1999	Base, LS, LT	US5077	6.5L V8 395 CID	1995	Base, LS, LT	US5062
6.5L V8 395 CID	1995	Base, LS, LT	US5062	6.5L V8 395 CID	1996	Base, LS, LT; Early	US5062
6.5L V8 395 CID	1996	Base, LS, LT; Early	US5062	6.5L V8 395 CID	1996	Base, LS, LT; Late	US5074
6.5L V8 395 CID	1996	Base, LS, LT; Late	US5074	6.5L V8 395 CID	1997	Base, LS, LT	US5074
6.5L V8 395 CID	1997	Base, LS, LT	US5074	6.5L V8 395 CID	1998	Base, LS	US5074
6.5L V8 395 CID	1998	Base, LS	US5074	6.5L V8 395 CID	1999	Base, LS; Bolt on pulley	US5074
6.5L V8 395 CID	1999	Base, LS, LT; Bolt on pulley	US5074	6.5L V8 395 CID	1999	Base, LS	US5086
6.5L V8 395 CID	1999	Base, LS, LT	US5086	7.4L V8 454 CID	1992-1994	Base, Silverado	US5038
K2500				7.4L V8 454 CID	1992-1994	Base, Silverado; High performance	US5038H
4.3L V6 262 CID	1988-1992	Cheyenne, Scottsdale, Silverado	US5049	7.4L V8 454 CID	1995-1997	Base, LS, LT	US5038
4.3L V6 262 CID	1988-1992	Cheyenne, Scottsdale, Silverado; High performance	US5049H	7.4L V8 454 CID	1995-1997	Base, LS, LT; High performance	US5038H
4.3L V6 262 CID	1993	Cheyenne, Silverado	US5049	7.4L V8 454 CID	1998-1999	Base, LS	US5038
4.3L V6 262 CID	1993	Cheyenne, Silverado; High performance	US5049H	7.4L V8 454 CID	1998-1999	Base, LS; High performance	US5038H
4.3L V6 262 CID	1994-1995	Base, Cheyenne, Silverado, WT	US5049	K3500			
				5.7L V8 350 CID	1988-1992	Cheyenne, Scottsdale, Silverado	US5049
				5.7L V8 350 CID	1988-1992	Cheyenne, Scottsdale, Silverado; High performance	US5049H

WATER PUMPS

Engine	Years	Application Description	USMW	Engine	Years	Application Description	USMW
CHEVROLET (cont'd.)				CHEVROLET (cont'd.)			
K3500 (cont'd.)				LUV PICKUP			
5.7L V8 350 CID	1993	Cheyenne, Silverado	US5049	1.8L L4 111 CID	1972-1974		US1046
5.7L V8 350 CID	1993	Cheyenne, Silverado; High performance	US5049H	MALIBU			
5.7L V8 350 CID	1994-1995	Base, Cheyenne, Silverado	US5049	1.5L L4 1490cc 91 CID	2016-2017	L, LS, LT; Pump only	US8147
5.7L V8 350 CID	1994-1995	Base, Cheyenne, Silverado; High performance	US5049H	1.5L L4 1490cc 91 CID	2017	L, LS, LT	US8147
5.7L V8 350 CID	1996-1997	Base, Cheyenne, Silverado	US5077	1.8L L4 1796cc 110 CID	2016-2017	Hybrid	US8155
5.7L V8 350 CID	1996-1997	Base, Cheyenne, Silverado; High performance	US5077H	1.8L L4 1796cc 110 CID	2016-2017	Hybrid; Pump only	US8155
5.7L V8 350 CID	1998	Cheyenne, Silverado	US5077	2.0L L4 1998cc 122 CID	2013-2015	LT, LTZ; Pump only	US8102
5.7L V8 350 CID	1998	Cheyenne, Silverado; High performance	US5077H	2.0L L4 1998cc 122 CID	2015	LT, LTZ	US8102
5.7L V8 350 CID	1999-2000	Base, LS	US5077	2.0L L4 1998cc 122 CID	2016	LT, Premier	US8102
5.7L V8 350 CID	1999-2000	Base, LS; High performance	US5077H	2.0L L4 1998cc 122 CID	2017	Premier	US8102
6.2L V8 379 CID	1988-1992	Cheyenne, Scottsdale, Silverado	US5062	2.2L L4 2198cc 134 CID	2004-2005	Base	US5092
6.2L V8 379 CID	1993	Cheyenne, Silverado	US5062	2.2L L4 2198cc 134 CID	2006-2007	LS, LT	US5092
6.5L V8 395 CID	1992	Cheyenne, Scottsdale, Silverado	US5062	2.2L L4 2198cc 134 CID	2008	Classic LS	US5092
6.5L V8 395 CID	1993	Cheyenne, Silverado	US5062	2.4L L4 2384cc 145 CID	2008-2010	Hybrid, LS, LT, LTZ	US5092
6.5L V8 395 CID	1994-1995	Base, Cheyenne, Silverado	US5062	2.4L L4 2384cc 145 CID	2011-2012	LS, LT, LTZ	US5092
6.5L V8 395 CID	1996	Base, Cheyenne, Silverado; 1st Design, Single Thermostat	US5062	2.4L L4 2384cc 145 CID	2013-2014	Eco	US5092
6.5L V8 395 CID	1996	Base, Cheyenne, Silverado; 2nd Design, Dual Thermostat	US5074	2.4L L4 2392cc 146 CID	1997-1999	Base	US5076
6.5L V8 395 CID	1997	Base, Cheyenne, Silverado	US5074	2.4L L4 2395cc 146 CID	2000-2001	Mexican Application	US5076
6.5L V8 395 CID	1998	Cheyenne, Silverado	US5074	2.5L L4 2457cc 153 CID	2013-2015	LS, LT, LTZ; Pump only	US8102
6.5L V8 395 CID	1999	Base, LS; Bolt on pulley	US5074	2.5L L4 2457cc 153 CID	2015	LS, LT, LTZ	US8102
6.5L V8 395 CID	1999-2000	Base, LS	US5086	3.1L V6 189 CID	1997-2003	Base, LS	US5033
7.4L V8 454 CID	1988-1990	Cheyenne, Scottsdale, Silverado; High performance	US5038H	3.2L L6 3180cc 194 CID	1966	With A/C	US927
7.4L V8 454 CID	1988-1992	Cheyenne, Scottsdale, Silverado	US5038	3.3L V6 200 CID	1978-1979		US1121
7.4L V8 454 CID	1991-1993	Cheyenne, Silverado; High performance	US5038H	3.3L V6 200 CID	1978-1979	High performance	US1121H
7.4L V8 454 CID	1993	Cheyenne, Silverado	US5038	3.5L V6 213 CID	2004	LS, LT, Maxx, Maxx LS, Maxx LT	US5033
7.4L V8 454 CID	1994-1997	Base, Cheyenne, Silverado	US5038	3.5L V6 213 CID	2005	LS, LT, Maxx LS, Maxx LT	US5033
7.4L V8 454 CID	1994-1997	Base, Cheyenne, Silverado; High performance	US5038H	3.5L V6 213 CID	2006	LS, LT, LTZ, Maxx LS, Maxx LT, Maxx LTZ	US5033
7.4L V8 454 CID	1998	Cheyenne, Silverado	US5038	3.5L V6 3490cc 213 CID	2007	LS, LT, LTZ, Maxx LS, Maxx LT, Maxx LTZ	US6020
7.4L V8 454 CID	1998	Cheyenne, Silverado; High performance	US5038H	3.5L V6 3490cc 213 CID	2008	Classic LS, Classic LT, LS	US6020
7.4L V8 454 CID	1999-2000	Base, LS	US5038	3.5L V6 3490cc 213 CID	2009	LS, LT	US6020
7.4L V8 454 CID	1999-2000	Base, LS; High performance	US5038H	3.5L V6 3490cc 213 CID	2010	LS	US6020
KINGSWOOD				3.6L V6 3564cc 217 CID	2008-2012	LT, LTZ	US8932
4.6L V8 4638cc 283 CID	1959-1961		US898	3.8L L6 3769cc 230 CID	1966-1967	With A/C	US927
4.6L V8 4638cc 283 CID	1959-1961	High performance	US898H	3.8L V6 229 CID	1980	Base, Classic, Classic Estate, Classic Landau, Classic Sport, Estate, Sport	US1121
5.0L V8 5031cc 307 CID	1969		US898	3.8L V6 229 CID	1981	Base, Classic, Classic Landau	US1121
5.0L V8 5031cc 307 CID	1969	High performance	US898H	3.8L V6 229 CID	1981	Base, Classic, Classic Landau; High performance	US1121H
5.0L V8 5031cc 307 CID	1971-1972		US898	3.8L V6 229 CID	1982-1983	Classic	US1121
5.0L V8 5031cc 307 CID	1971-1972	High performance	US898H	3.8L V6 229 CID	1982-1983	Classic; High performance	US1121H
5.3L V8 5358cc 327 CID	1969		US898	3.8L V6 231 CID	1979		US1018
5.3L V8 5358cc 327 CID	1969	High performance	US898H	3.8L V6 231 CID	1979	High performance	US1018H
5.7L V8 350 CID	1969-1972		US898	3.8L V6 231 CID	1979	High performance	US1018H
5.7L V8 350 CID	1969-1972	High performance	US898H	3.8L V6 3800cc 231 CID	1978-1979	High performance	US1018
5.7L V8 5704cc 348 CID	1959-1961		US898	3.8L V6 3800cc 231 CID	1978-1979	High performance	US1018H
5.7L V8 5704cc 348 CID	1959-1961	High performance	US898H	3.8L V6 3800cc 231 CID	1980	Base, Classic, Classic Estate, Classic Landau, Classic Sport, Estate, Sport; High performance	US1018H
5.7L V8 5736cc 350 CID	1969-1972		US898	3.8L V6 3800cc 231 CID	1981	Base, Classic, Classic Landau	US1018
5.7L V8 5736cc 350 CID	1969-1972	High performance	US898H	3.8L V6 3800cc 231 CID	1981	Base, Classic, Classic Landau; High performance	US1018H
LLV				3.8L V6 3800cc 231 CID	1981	Base, Classic, Classic Landau	US1018
2.2L L4 2190cc 134 CID	1994-1995	Base	US5032	3.8L V6 3800cc 231 CID	1982-1983	Classic	US1018
2.5L L4 2474cc 151 CID	1987-1993	Base	US5040	3.8L V6 3800cc 231 CID	1982-1983	Classic; High performance	US1018H
LUMINA				3.9L V6 3880cc 237 CID	2006-2007	Maxx SS, SS	US6020
2.5L L4 2474cc 151 CID	1990-1992	Base	US5041	4.1L L6 250 CID	1975-1977		US1107
3.1L V6 189 CID	1990-1994	Base, Euro	US5033	4.1L L6 4097cc 250 CID	1979		US1107
3.1L V6 189 CID	1995-1996	Base, LS	US5033	4.1L L6 4098cc 250 CID	1967	With A/C	US927
3.1L V6 189 CID	1997-1999	Base, LS, LTZ	US5033	4.1L L6 4100cc 250 CID	1965	Mexican Application	US895
3.1L V6 189 CID	2000-2001	Base	US5033	4.1L L6 4100cc 250 CID	1967	Mexican Application	US927
3.3L V6 3343cc 204 CID	1997	Mexican Application	US5033	4.1L L6 4100cc 250 CID	1978-1979	Mexican Application	US1107
3.4L V6 207 CID	1991	Z34	US5033	4.1L L6 4100cc 250 CID	1981	Mexican Application	US1107
3.4L V6 207 CID	1992-1994	Euro, Z34	US5033	4.3L V6 260 CID	1982-1983	Classic	US5012
3.4L V6 207 CID	1995-1996	LS	US5033	4.4L V8 267 CID	1980	Base, Classic, Classic Estate, Classic Landau, Classic Sport, Estate, Sport	US1121
3.4L V6 207 CID	1997	LTZ	US5033	4.4L V8 267 CID	1980	Base, Classic, Classic Estate, Classic Landau, Classic Sport, Estate, Sport; High performance	US1121H
3.8L V6 3800cc 231 CID	1998	LTZ	US5075	4.4L V8 267 CID	1981	Base, Classic, Classic Landau	US1121
3.8L V6 3800cc 231 CID	1999	Base, LS, LTZ	US5075	4.4L V8 267 CID	1981	Base, Classic, Classic Landau; High performance	US1121H
LUMINA APV				4.4L V8 267 CID	1982	Classic	US1121
3.1L V6 189 CID	1990-1992	Base, CL	US5033	4.4L V8 267 CID	1982	Classic; High performance	US1121H
3.1L V6 189 CID	1993-1995	Base, LS	US5033	4.6L V8 4638cc 283 CID	1964-1967		US898
3.4L V6 207 CID	1996	Base, LS	US5033	4.6L V8 4638cc 283 CID	1964-1967	High performance	US898H
3.8L V6 3800cc 231 CID	1992	Base, CL	US5050	5.0L V8 305 CID	1976		US1109
3.8L V6 3800cc 231 CID	1993-1995	Base, LS	US5050	5.0L V8 305 CID	1976	High performance	US1109H
LUV				5.0L V8 305 CID	1977-1979		US1121
1.8L L4 111 CID	1975		US1046	5.0L V8 305 CID	1977-1979	High performance	US1121H
1.8L L4 111 CID	1975-1979		US1127	5.0L V8 305 CID	1980	Base, Classic, Classic Estate, Classic Landau, Classic Sport, Estate, Sport	US1121
1.8L L4 111 CID	1980-1982	Base, Mikado, Sport	US1127	5.0L V8 305 CID	1980	Base, Classic, Classic Estate, Classic Landau, Classic Sport, Estate, Sport	US1121
2.2L L4 134 CID	1982	Base, Mikado, Sport	US9132	5.0L V8 305 CID	1980	Base, Classic, Classic Estate, Classic Landau, Classic Sport, Estate, Sport; High performance	US1121H
2.2L L4 2190cc 133 CID	1997-1999	Mexican Application	US5032				

Engine	Years	Application Description	USMW	Engine	Years	Application Description	USMW
CHEVROLET (cont'd.)				CHEVROLET (cont'd.)			
MALIBU (cont'd.)				MONTE CARLO (cont'd.)			
5.0L V8 305 CID	1981	Base, Classic, Classic Landau	US1121	4.3L V6 260 CID	1982	Base	US5012
5.0L V8 305 CID	1981	Base, Classic, Classic Landau; High performance	US1121H	4.3L V6 260 CID	1983	Base, CL	US5012
5.0L V8 305 CID	1982-1983	Classic	US1121	4.3L V6 262 CID	1985	Base	US1121
5.0L V8 305 CID	1982-1983	Classic; High performance	US1121H	4.3L V6 262 CID	1985	Base; High performance	US1121H
5.3L V8 5358cc 327 CID	1964-1967		US898	4.3L V6 262 CID	1986-1988	Base, LS	US1121
5.3L V8 5358cc 327 CID	1964-1967	High performance	US898H	4.3L V6 262 CID	1986-1988	Base, LS; High performance	US1121H
5.7L V8 350 CID	1976		US1109	4.4L V8 267 CID	1980	Landau, Sport	US1121
5.7L V8 350 CID	1976	High performance	US1109H	4.4L V8 267 CID	1980	Landau, Sport; High performance	US1121H
5.7L V8 350 CID	1977-1979		US1121	4.4L V8 267 CID	1981	Base, Landau	US1121
5.7L V8 350 CID	1977-1979	High performance	US1121H	4.4L V8 267 CID	1981	Base, Landau; High performance	US1121H
5.7L V8 350 CID	1980	Base, Estate, Sport	US1121	4.4L V8 267 CID	1982	Base	US1121
5.7L V8 350 CID	1980	Base, Estate, Sport; High performance	US1121H	4.4L V8 267 CID	1982	Base; High performance	US1121H
5.7L V8 350 CID	1981	Base	US1121	5.0L V8 305 CID	1976		US1109
5.7L V8 350 CID	1981	Base; High performance	US1121H	5.0L V8 305 CID	1976	High performance	US1109H
5.7L V8 350 CID	1982-1983	Classic; Exc.Air Cond	US1100	5.0L V8 305 CID	1977-1979		US1121
5.7L V8 350 CID	1982-1983	Classic; With air cond.	US1120	5.0L V8 305 CID	1977-1979	High performance	US1121H
5.7L V8 350 CID	1982-1983	Classic; High performance, With air cond.	US1120H	5.0L V8 305 CID	1980	Landau, Sport	US1121
5.7L V8 5700cc 350 CID	1979-1981	Mexican Application	US1121	5.0L V8 305 CID	1980	Landau, Sport; High performance	US1121H
6.5L V8 6489cc 396 CID	1966-1967		US981	5.0L V8 305 CID	1981	Base, Landau	US1121
6.6L V8 400 CID	1975-1976		US1109	5.0L V8 305 CID	1981	Base, Landau; High performance	US1121H
6.6L V8 400 CID	1975-1976	High performance	US1109H	5.0L V8 305 CID	1982	Base	US1121
7.4L V8 454 CID	1975		US1002	5.0L V8 305 CID	1982	Base; High performance	US1121H
7.4L V8 454 CID	1975	High performance	US1002H	5.0L V8 305 CID	1983	Base, CL, SS	US1121
MALIBU LIMITED				5.0L V8 305 CID	1983	Base, CL, SS; High performance	US1121H
2.5L L4 2457cc 153 CID	2016	LS, LT, LTZ	US8102	5.0L V8 305 CID	1984-1985	Base, SS	US1121
MATIZ				5.0L V8 305 CID	1984-1985	Base, SS; High performance	US1121H
1.0L L4 995cc 61 CID	2011-2015		US8928	5.0L V8 305 CID	1986-1988	Base, LS, SS	US1121
MERIVA				5.0L V8 305 CID	1986-1988	Base, LS, SS; High performance	US1121H
1.8L L4 1796cc 110 CID	2004-2008		US8938	5.3L V8 5328cc 325 CID	2006-2007	SS	US6154
METRO				5.7L V8 350 CID	1976		US1109
1.0L L3 993cc 61 CID	1998-2000	Base	US5058	5.7L V8 350 CID	1976	High performance	US1109H
1.3L L4 1295cc 79 CID	1998	LSi	US5058	5.7L V8 350 CID	1977	High performance	US1121H
1.3L L4 1295cc 79 CID	1999-2000	Base, LSi	US5058	5.7L V8 350 CID	1982	Base; Exc.Air Cond	US1100
1.3L L4 1295cc 79 CID	2001	LSi	US5058	5.7L V8 350 CID	1982	Base; With air cond.	US1120
MICROBUS				5.7L V8 350 CID	1982	Base; High performance, With air cond.	US1120H
5.7L V8 5700cc 350 CID	1986-1987	Mexican Application	US1121	5.7L V8 350 CID	1982	Base, CL, SS; Exc.Air Cond	US1100
5.7L V8 5700cc 350 CID	1990-1996	Mexican Application	US5049	5.7L V8 350 CID	1983	Base, CL, SS; With air cond.	US1120
MILENIO				5.7L V8 350 CID	1983	Base, CL, SS; High performance, With air cond.	US1120H
1.6L L4 1600cc 98 CID	2000	Mexican Application	US5057	5.7L V8 350 CID	1984	Base; Exc.Air Cond	US1100
MONTE CARLO				5.7L V8 350 CID	1984	Base; With air cond.	US1120
3.1L V6 189 CID	1995-1999	LS	US5033	5.7L V8 350 CID	1984	Base; High performance, With air cond.	US1120H
3.3L V6 200 CID	1978-1979		US1121	5.7L V8 350 CID	1984	Base; High performance, With air cond.	US1120H
3.3L V6 200 CID	1978-1979	High performance	US1121H	5.7L V8 350 CID	1984	Base; High performance, With air cond.	US1120H
3.4L V6 207 CID	1995-1997	Z34	US5033	5.7L V8 350 CID	1984	Base; High performance, With air cond.	US1120H
3.4L V6 207 CID	2000-2002	LS, LS	US5033	5.7L V8 350 CID	1984	Base; High performance, With air cond.	US1120H
3.4L V6 207 CID	2003	LS, LS Competition, LS Sport	US5033	6.6L V8 400 CID	1975-1976	Mexican Application	US1109
3.4L V6 207 CID	2004-2005	LS	US5033	6.6L V8 400 CID	1975-1976	High performance	US1109H
3.5L V6 3490cc 213 CID	2006-2007	LS, LT	US6020	7.4L V8 454 CID	1975		US1002
3.8L V6 229 CID	1980	Landau, Sport	US1121	7.4L V8 454 CID	1975	High performance	US1002H
3.8L V6 229 CID	1980	Landau, Sport; High performance	US1121H	MONZA			
3.8L V6 229 CID	1981	Base, Landau	US1121	1.6L L4 1600cc 98 CID	1997-2003	Mexican Application	US5057
3.8L V6 229 CID	1981	Base, Landau; High performance	US1121H	2.3L L4 2294cc 140 CID	1975		US1088
3.8L V6 229 CID	1982	Base	US1121	2.5L L4 2474cc 151 CID	1978-1979		US1107
3.8L V6 229 CID	1982	Base; High performance	US1121H	2.5L L4 2474cc 151 CID	1980	2+2, 2+2 Sport, 2+2 Spyder, Base, Spyder	US1107
3.8L V6 229 CID	1983	Base, CL	US1121	3.2L V6 196 CID	1978-1979		US1018
3.8L V6 229 CID	1983	Base, CL; High performance	US1121H	3.2L V6 196 CID	1978-1979	High performance	US1018H
3.8L V6 229 CID	1984	Base	US1121	3.8L V6 231 CID	1979		US1018
3.8L V6 229 CID	1984	Base; High performance	US1121H	3.8L V6 3800cc 231 CID	1978-1979		US1018
3.8L V6 231 CID	1979		US1018	3.8L V6 3800cc 231 CID	1978-1979	High performance	US1018H
3.8L V6 231 CID	1979	High performance	US1018H	3.8L V6 3800cc 231 CID	1980	2+2, 2+2 Sport, 2+2 Spyder, Base, Spyder	US1018
3.8L V6 3800cc 231 CID	1978-1979		US1018	3.8L V6 3800cc 231 CID	1980	2+2, 2+2 Sport, 2+2 Spyder, Base, Spyder; High performance	US1018H
3.8L V6 3800cc 231 CID	1978-1979	High performance	US1018H	4.3L V8 262 CID	1975-1976		US1069
3.8L V6 3800cc 231 CID	1980	Landau, Sport	US1018	5.0L V8 305 CID	1976-1979		US1069
3.8L V6 3800cc 231 CID	1980	Landau, Sport; High performance	US1018H	MONZA POP			
3.8L V6 3800cc 231 CID	1981	Base, Landau	US1018	1.4L L4 1400cc 85 CID	2002	Mexican Application	US5057
3.8L V6 3800cc 231 CID	1981	Base, Landau; High performance	US1018H	NOVA			
3.8L V6 3800cc 231 CID	1982	Base	US1018	1.6L L4 1588cc 98 CID	1985-1988	Base, CL	US9057
3.8L V6 3800cc 231 CID	1982	Base; High performance	US1018H	1.6L L4 1588cc 98 CID	1988	Twin Cam	US9076
3.8L V6 3800cc 231 CID	1983	Base, CL	US1018	3.8L L6 230 CID	1969	With A/C	US927
3.8L V6 3800cc 231 CID	1983	Base, CL; High performance	US1018H	4.1L L6 250 CID	1969	With A/C	US927
3.8L V6 3800cc 231 CID	1984	Base	US1018	4.1L L6 250 CID	1974	With A/C	US927
3.8L V6 3800cc 231 CID	1984	Base; High performance	US1018H	4.1L L6 250 CID	1975-1979		US1107
3.8L V6 3800cc 231 CID	1984	Base	US1018	5.0L V8 305 CID	1976		US1109
3.8L V6 3800cc 231 CID	1984	Base; High performance	US1018H	5.0L V8 305 CID	1976	High performance	US1109H
3.8L V6 3800cc 231 CID	1988	Z34	US5075	5.0L V8 305 CID	1977-1979		US1121
3.8L V6 3800cc 231 CID	1988	Indianapolis 500 Pace Car, LS, Z34	US5075	5.0L V8 305 CID	1977-1979	High performance	US1121H
3.8L V6 3800cc 231 CID	1989	SS	US5075	5.7L V8 350 CID	1976		US1109
3.8L V6 3800cc 231 CID	2000-2001	SS, SS 35th Anniversary Edition, SS Dale Earnhardt Signature Edition	US5075	5.7L V8 350 CID	1976	High performance	US1109H
3.8L V6 3800cc 231 CID	2002	SS, SS High Sport, SS Pace Car	US5075	5.7L V8 350 CID	1977-1979		US1121
3.8L V6 3800cc 231 CID	2003	SS	US5075	5.7L V8 350 CID	1977-1979	High performance	US1121H
3.8L V6 3800cc 231 CID	2004	LT, SS	US5075	ONE-FIFTY SERIES			
3.8L V6 3800cc 231 CID	2005	LT, SS	US5075	4.3L V8 4343cc 265 CID	1955-1957		US898
3.9L V6 3880cc 237 CID	2006	LT, LTZ	US6020	4.3L V8 4343cc 265 CID	1955-1957	High performance	US898H

WATER PUMPS

Engine	Years	Application Description	USMW
CHEVROLET (cont'd.)			
ONE-FIFTY SERIES (cont'd.)			
4.6L V8 4638cc 283 CID	1957		US898
4.6L V8 4638cc 283 CID	1957	High performance	US898H
OPTRA			
2.0L L4 1999cc 122 CID	2010	Mexican Application	US8925
2.0L L4 2000cc 122 CID	2006-2009	Mexican Application	US8925
P10			
4.8L L6 292 CID	1975-1979		US5030
4.8L L6 292 CID	1980	Base, Step-Van	US5030
P10 SERIES			
4.3L L6 4278cc 261 CID	1961-1962		US898
4.3L L6 4278cc 261 CID	1961-1962	High performance	US898H
4.6L V8 4638cc 283 CID	1961-1962		US898
4.6L V8 4638cc 283 CID	1961-1962	High performance	US898H
4.8L L6 4801cc 292 CID	1967		US896
P20			
4.8L L6 292 CID	1975-1977		US1137
4.8L L6 292 CID	1975-1977	High performance	US1137H
4.8L L6 292 CID	1978-1979		US5030
4.8L L6 292 CID	1980-1985	Base, Step-Van	US5030
4.8L L6 292 CID	1986	Base	US5030
4.8L L6 292 CID	1987-1989	Base, Step-Van	US5030
5.7L V8 350 CID	1975-1976		US1109
5.7L V8 350 CID	1975-1976	High performance	US1109H
5.7L V8 350 CID	1977-1979		US1121
5.7L V8 350 CID	1977-1979	High performance	US1121H
5.7L V8 350 CID	1980-1985	Base, Step-Van	US1121
5.7L V8 350 CID	1986	Base	US1121
5.7L V8 350 CID	1987-1989	Base, Step-Van	US1121
6.2L V8 379 CID	1982-1985	Base, Step-Van	US5008
6.2L V8 379 CID	1986	Base	US5008
6.2L V8 379 CID	1987-1989	Base, Step-Van	US5008
P20 SERIES			
4.8L L6 4801cc 292 CID	1965-1967		US896
P20 VAN			
4.8L L6 292 CID	1968-1974		US896
4.8L L6 4786cc 292 CID	1973-1974		US896
5.0L V8 307 CID	1968-1969		US898
5.0L V8 307 CID	1968-1969	High performance	US898H
5.7L V8 350 CID	1970-1972		US898
5.7L V8 350 CID	1970-1972	High performance	US898H
P30			
4.3L V6 262 CID	1990	Base, Step-Van	US1121
4.3L V6 262 CID	1990	Base, Step-Van; High performance	US1121H
4.3L V6 262 CID	1991-1995	Base	US1121
4.3L V6 262 CID	1991-1995	Base; High performance	US1121H
4.3L V6 262 CID	1996-1999	Base	US5077
4.3L V6 262 CID	1996-1999	Base; High performance	US5077H
4.3L V6 4300cc 262 CID	2001	High performance	US5077H
4.8L L6 292 CID	1975-1977		US1137
4.8L L6 292 CID	1975-1977	High performance	US1137H
4.8L L6 292 CID	1978-1979		US5030
4.8L L6 292 CID	1980-1985	Base, Step-Van	US5030
4.8L L6 292 CID	1986	Base	US5030
4.8L L6 292 CID	1987-1989	Base, Step-Van	US5030
5.7L V8 350 CID	1975-1976		US1109
5.7L V8 350 CID	1975-1976	High performance	US1109H
5.7L V8 350 CID	1977-1979		US1121
5.7L V8 350 CID	1977-1979	High performance	US1121H
5.7L V8 350 CID	1980-1985	Base, Step-Van	US1121
5.7L V8 350 CID	1985	Base, Step-Van; High performance	US1121H
5.7L V8 350 CID	1986	Base	US1121
5.7L V8 350 CID	1986	Base; High performance	US1121H
5.7L V8 350 CID	1987-1990	Base, Step-Van	US1121
5.7L V8 350 CID	1987-1990	Base, Step-Van; High performance	US1121H
5.7L V8 350 CID	1991-1996	Base	US1121
5.7L V8 350 CID	1991-1996	Base; High performance	US1121H
5.7L V8 350 CID	1997-1999	Base	US5077
5.7L V8 350 CID	1997-1999	Base; High performance	US5077H
6.2L V8 379 CID	1982-1985	Base, Step-Van	US5008
6.2L V8 379 CID	1986	Base	US5008
6.2L V8 379 CID	1987-1990	Base, Step-Van	US5008
6.2L V8 379 CID	1991-1993	Base	US5008
6.5L V8 395 CID	1994-1996	Base	US5062
6.5L V8 395 CID	1997-1998	Base	US5074
6.5L V8 395 CID	1999	Base	US5086
6.6L V8 400 CID	1976		US1109
6.6L V8 400 CID	1976	High performance	US1109H
7.4L V8 454 CID	1975-1979		US1002
7.4L V8 454 CID	1975-1979	High performance	US1002H
7.4L V8 454 CID	1980-1985	Base, Step-Van	US1002
7.4L V8 454 CID	1985	Base, Step-Van; High performance	US1002H
7.4L V8 454 CID	1986	Base	US1002

Engine	Years	Application Description	USMW
CHEVROLET (cont'd.)			
P30 (cont'd.)			
7.4L V8 454 CID	1986	Base; High performance	US1002H
7.4L V8 454 CID	1987-1990	Base, Step-Van	US1002
7.4L V8 454 CID	1987-1990	Base, Step-Van; High performance	US1002H
7.4L V8 454 CID	1991-1999	Base	US1002
7.4L V8 454 CID	1991-1999	Base; High performance	US1002H
P30 SERIES			
4.3L L6 4278cc 261 CID	1961-1962		US898
4.3L L6 4278cc 261 CID	1961-1962	High performance	US898H
4.6L V8 4638cc 283 CID	1961-1962		US898
4.6L V8 4638cc 283 CID	1961-1962	High performance	US898H
4.8L L6 4801cc 292 CID	1965-1967		US896
5.7L V8 5704cc 348 CID	1960-1965		US898
5.7L V8 5704cc 348 CID	1960-1965	High performance	US898H
P30 VAN			
4.1L L6 4100cc 250 CID	1998-2002	Mexican Application	US5030
4.3L V6 4300cc 262 CID	2001	Mexican Application	US5077
4.8L L6 292 CID	1968-1974		US896
4.8L L6 4786cc 292 CID	1973-1974		US896
5.0L V8 307 CID	1968-1969		US898
5.0L V8 307 CID	1968-1969	High performance	US898H
5.7L V8 350 CID	1970-1972		US898
5.7L V8 350 CID	1970-1972	High performance	US898H
5.7L V8 5700cc 350 CID	1989-1991	Mexican Application	US5049
6.6L V8 402 CID	1972		US981
P31 VAN			
4.8L L6 4800cc 292 CID	1991	Mexican Application	US1137
5.7L V8 5737cc 350 CID	1991-1995	Mexican Application	US1121
5.7L V8 5737cc 350 CID	1996	Mexican Application	US5049
5.7L V8 5737cc 350 CID	1998-1999	Mexican Application	US5077
P60			
7.0L V8 6998cc 427 CID	1990	With threaded hub for fan clutch	US5078
7.0L V8 6998cc 427 CID	1990	Without threaded hub	US5084
7.0L V8 6998cc 427 CID	1992-1996	With threaded hub for fan clutch	US5078
P6000			
6.0L V8 366 CID	1992-1996	With threaded hub for fan clutch	US5078
7.0L V8 6998cc 427 CID	1992-1996	With threaded hub for fan clutch	US5078
POP			
1.4L L4 1400cc 85 CID	1996-2001	Mexican Application	US5057
1.6L L4 1600cc 98 CID	2002-2003	Mexican Application	US5057
PRIZM			
1.8L L4 110 CID	1998-2002	Base, LSi	US9376
R10			
4.3L V6 262 CID	1987	Custom Deluxe, Scottsdale, Silverado	US1121
4.3L V6 262 CID	1987	Custom Deluxe, Scottsdale, Silverado; High performance	US1121H
5.0L V8 305 CID	1987	Custom Deluxe, Scottsdale, Silverado	US1121
5.0L V8 305 CID	1987	Custom Deluxe, Scottsdale, Silverado; High performance	US1121H
5.7L V8 350 CID	1987	Custom Deluxe, Scottsdale, Silverado	US1121
5.7L V8 350 CID	1987	Custom Deluxe, Scottsdale, Silverado; High performance	US1121H
6.2L V8 379 CID	1987	Custom Deluxe, Scottsdale, Silverado	US5008
R10 SUBURBAN			
5.0L V8 305 CID	1987	Custom Deluxe, Scottsdale, Silverado	US1121
5.0L V8 305 CID	1987	Custom Deluxe, Scottsdale, Silverado; High performance	US1121H
5.7L V8 350 CID	1987	Custom Deluxe, Scottsdale, Silverado	US5049
5.7L V8 350 CID	1987	Custom Deluxe, Scottsdale, Silverado; High performance	US5049H
5.7L V8 350 CID	1988	Scottsdale, Silverado	US5049
5.7L V8 350 CID	1988	Scottsdale, Silverado; High performance	US5049H
6.2L V8 379 CID	1987	Custom Deluxe, Scottsdale, Silverado	US5008
6.2L V8 379 CID	1988	Scottsdale, Silverado	US5008
R20			
4.3L V6 262 CID	1987	Custom Deluxe, Scottsdale, Silverado	US1121
4.3L V6 262 CID	1987	Custom Deluxe, Scottsdale, Silverado; High performance	US1121H
4.8L L6 292 CID	1987	Custom Deluxe, Scottsdale, Silverado	US5030
4.8L L6 292 CID	1988	Cheyenne, Custom Deluxe, Scottsdale, Silverado	US5030
5.0L V8 305 CID	1987	Custom Deluxe, Scottsdale, Silverado	US1121
5.0L V8 305 CID	1987	Custom Deluxe, Scottsdale, Silverado; High performance	US1121H
5.7L V8 350 CID	1987	Custom Deluxe, Scottsdale, Silverado	US1121
5.7L V8 350 CID	1987	Custom Deluxe, Scottsdale, Silverado; High performance	US1121H
5.7L V8 350 CID	1988	Cheyenne, Custom Deluxe, Scottsdale, Silverado	US1121
5.7L V8 350 CID	1988	Cheyenne, Scottsdale, Silverado; High performance	US1121H
6.2L V8 379 CID	1987	Custom Deluxe, Scottsdale, Silverado	US5008

Engine	Years	Application Description	USMW	Engine	Years	Application Description	USMW
CHEVROLET (cont'd.)				CHEVROLET (cont'd.)			
R20 (cont'd.)				S10 (cont'd.)			
6.2L V8 379 CID	1988	Cheyenne, Custom Deluxe, Scottsdale, Silverado	US5008	2.5L L4 2474cc 151 CID	1987-1989	Base, Durango, Sport, Tahoe	US5040
7.4L V8 454 CID	1987	Custom Deluxe, Scottsdale, Silverado	US1002	2.5L L4 2474cc 151 CID	1990	Base, Durango, Tahoe	US5040
7.4L V8 454 CID	1987	Custom Deluxe, Scottsdale, Silverado; High performance	US1002H	2.5L L4 2474cc 151 CID	1991	Base, Tahoe	US5040
7.4L V8 454 CID	1988	Cheyenne, Custom Deluxe, Scottsdale, Silverado	US1002	2.5L L4 2474cc 151 CID	1992	Base, EL, Tahoe	US5040
7.4L V8 454 CID	1988	Cheyenne, Custom Deluxe, Scottsdale, Silverado; High performance	US1002H	2.5L L4 2474cc 151 CID	1993	Base, EL	US5040
R20 SUBURBAN				S10 (cont'd.)			
5.7L V8 350 CID	1987	Custom Deluxe, Scottsdale, Silverado	US5049	2.8L V6 173 CID	1982	Base, Durango, Sport	US5006
5.7L V8 350 CID	1987	Custom Deluxe, Scottsdale, Silverado; High performance	US5049H	2.8L V6 173 CID	1983-1986	Base, Durango, Sport, Tahoe	US5006
5.7L V8 350 CID	1988	Scottsdale, Silverado	US5049	2.8L V6 173 CID	1987-1989	Base, Durango, Sport, Tahoe	US5035
5.7L V8 350 CID	1988	Scottsdale, Silverado; High performance	US5049H	2.8L V6 173 CID	1990	Base, Durango, Tahoe	US5035
6.2L V8 379 CID	1987	Custom Deluxe, Scottsdale, Silverado	US5008	2.8L V6 173 CID	1991	Baja, Base, Tahoe	US5035
6.2L V8 379 CID	1988	Scottsdale, Silverado	US5008	2.8L V6 173 CID	1992	Base, EL, Tahoe	US5035
7.4L V8 454 CID	1987	Custom Deluxe, Scottsdale, Silverado	US1002	2.8L V6 173 CID	1993	Base, EL	US5035
7.4L V8 454 CID	1987	Custom Deluxe, Scottsdale, Silverado; High performance	US1002H	4.3L V6 262 CID	1988-1989	Base, Durango, Sport, Tahoe	US5049
7.4L V8 454 CID	1988	Scottsdale, Silverado	US1002	4.3L V6 262 CID	1988-1989	Base, Durango, Sport, Tahoe; High performance	US5049H
7.4L V8 454 CID	1988	Scottsdale, Silverado; High performance	US1002H	4.3L V6 262 CID	1990	Base, Durango, Tahoe	US5049
R30				S10 (cont'd.)			
4.8L L6 292 CID	1987	Custom Deluxe, Scottsdale, Silverado	US5030	4.3L V6 262 CID	1990	Base, Durango, Tahoe; High performance	US5049H
4.8L L6 292 CID	1988	Cheyenne, Custom Deluxe, Scottsdale, Silverado	US5030	4.3L V6 262 CID	1991	Baja, Base, Tahoe	US5049
5.7L V8 350 CID	1987	Custom Deluxe, Scottsdale, Silverado	US1121	4.3L V6 262 CID	1991	Baja, Base, Tahoe; High performance	US5049H
5.7L V8 350 CID	1987	Custom Deluxe, Scottsdale, Silverado; High performance	US1121H	4.3L V6 262 CID	1992	Base, EL, Tahoe	US5049
5.7L V8 350 CID	1988	Cheyenne, Custom Deluxe, Scottsdale, Silverado	US1121	4.3L V6 262 CID	1992	Base, EL, Tahoe; High performance	US5049H
5.7L V8 350 CID	1988	Cheyenne, Scottsdale, Silverado; High performance	US1121H	4.3L V6 262 CID	1993	Base, EL	US5049
6.2L V8 379 CID	1987	Custom Deluxe, Scottsdale, Silverado	US5008	4.3L V6 262 CID	1993	Base, EL; High performance	US5049H
6.2L V8 379 CID	1988	Cheyenne, Custom Deluxe, Scottsdale, Silverado	US5008	4.3L V6 262 CID	1994-1995	Base, LS, SS, ZR2	US5049
7.4L V8 454 CID	1987	Custom Deluxe, Scottsdale, Silverado	US1002	4.3L V6 262 CID	1994-1995	Base, LS, SS, ZR2; High performance	US5049H
7.4L V8 454 CID	1987	Custom Deluxe, Scottsdale, Silverado; High performance	US1002H	4.3L V6 262 CID	1996-1998	Base, LS, SS, ZR2	US5077
7.4L V8 454 CID	1988	Cheyenne, Custom Deluxe, Scottsdale, Silverado	US1002	4.3L V6 262 CID	1996-1998	Base, LS, SS, ZR2; High performance	US5077H
7.4L V8 454 CID	1988	Cheyenne, Scottsdale, Silverado; High performance	US1002H	4.3L V6 262 CID	1999-2001	Base, LS, Xtreme, ZR2	US5077
R1500 SUBURBAN				S10 BLAZER			
5.7L V8 350 CID	1989-1991	Scottsdale, Silverado	US5049	1.9L L4 119 CID	1983-1984	Base, Sport, Tahoe	US5013
5.7L V8 350 CID	1989-1991	Scottsdale, Silverado; High performance	US5049H	2.0L L4 122 CID	1983-1984	Base, Sport, Tahoe	US5015
6.2L V8 379 CID	1989-1991	Scottsdale, Silverado	US5062	2.5L L4 2474cc 151 CID	1985-1986	Base, Sport, Tahoe	US5022
R2500				S10 BLAZER			
5.7L V8 350 CID	1989	Silverado	US1121	2.5L L4 2474cc 151 CID	1987-1988	Base, High Country, Sport, Tahoe	US5040
6.2L V8 379 CID	1989	Cheyenne, Scottsdale, Silverado	US5008	2.8L V6 173 CID	1983-1986	Base, Sport, Tahoe	US5006
7.4L V8 454 CID	1989	Cheyenne, Scottsdale, Silverado	US1002	2.8L V6 173 CID	1987-1988	Base, High Country, Sport, Tahoe	US5035
7.4L V8 454 CID	1989	Cheyenne, Scottsdale, Silverado; High performance	US1002H	2.8L V6 173 CID	1989	Base, High Country, Sport	US5035
R2500 SUBURBAN				S10 BLAZER			
5.7L V8 350 CID	1989-1991	Scottsdale, Silverado	US5049	3.1L V6 3100cc 191 CID	1990-1994	Mexican Application	US5033
5.7L V8 350 CID	1989-1991	Scottsdale, Silverado; High performance	US5049H	4.3L V6 262 CID	1988	Base, High Country, Sport, Tahoe	US5049
6.2L V8 379 CID	1989-1991	Scottsdale, Silverado	US5062	4.3L V6 262 CID	1988	Base, High Country, Sport, Tahoe; High performance	US5049H
7.4L V8 454 CID	1989-1991	Scottsdale, Silverado	US5038	4.3L V6 262 CID	1989	Base, High Country, Sport	US5049
7.4L V8 454 CID	1989-1991	Scottsdale, Silverado; High performance	US5038H	4.3L V6 262 CID	1989	Base, High Country, Sport; High performance	US5049H
R3500				S10 BLAZER			
5.7L V8 350 CID	1989-1990	Cheyenne, Scottsdale, Silverado	US1121	4.3L V6 262 CID	1990	Base, Sport, Tahoe	US5049
5.7L V8 350 CID	1989-1990	Cheyenne, Scottsdale, Silverado; High performance	US1121H	4.3L V6 262 CID	1990	Base, Sport, Tahoe; High performance	US5049H
5.7L V8 350 CID	1991	Cheyenne, Silverado	US1121	4.3L V6 262 CID	1991	Base, Tahoe, Tahoe LT	US5049
5.7L V8 350 CID	1991	Cheyenne, Silverado; High performance	US1121H	4.3L V6 262 CID	1991	Base, Tahoe, Tahoe LT; High performance	US5049H
6.2L V8 379 CID	1989-1990	Cheyenne, Scottsdale, Silverado	US5008	4.3L V6 262 CID	1992	Base, Sport, Tahoe, Tahoe LT	US5049
6.2L V8 379 CID	1991	Cheyenne, Silverado	US5008	4.3L V6 262 CID	1992	Base, Sport, Tahoe, Tahoe LT; High performance	US5049H
7.4L V8 454 CID	1989-1990	Cheyenne, Scottsdale, Silverado	US1002	4.3L V6 262 CID	1993	Base, Tahoe, Tahoe LT	US5049
7.4L V8 454 CID	1989-1990	Cheyenne, Scottsdale, Silverado; High performance	US1002H	4.3L V6 262 CID	1993	Base, Tahoe, Tahoe LT; High performance	US5049H
7.4L V8 454 CID	1991	Cheyenne, Silverado	US1002	4.3L V6 262 CID	1994	Base, LT, Tahoe, Tahoe LT	US5049
7.4L V8 454 CID	1991	Cheyenne, Silverado; High performance	US1002H	4.3L V6 262 CID	1994	Base, LT, Tahoe, Tahoe LT; High performance	US5049H
S10				SEDAN DELIVERY			
1.9L L4 119 CID	1982	Base, Durango, Sport	US5013	3.8L L6 3852cc 235 CID	1947-1951		US43N
1.9L L4 119 CID	1983-1985	Base, Durango, Sport, Tahoe	US5013	3.8L L6 3852cc 235 CID	1953-1954		US43N
2.0L L4 122 CID	1983-1984	Base, Durango, Sport, Tahoe	US5015	SILVERADO			
2.2L L4 2190cc 134 CID	1994-1998	Base, LS	US5032	5.7L V8 5700cc 350 CID	1995	Mexican Application	US5049
2.2L L4 2190cc 134 CID	1999-2003	Base, LS, Xtreme	US5032	5.7L V8 5700cc 350 CID	1996-1997	Mexican Application	US5077
2.2L L4 2200cc 134 CID	2001-2002	Mexican Application	US5032	SILVERADO 1500			
2.5L L4 2474cc 151 CID	1985-1986	Base, Durango, Sport, Tahoe	US5022	4.3L V6 262 CID	1999-2001	Base, LS, LT	US5077
				4.3L V6 262 CID	1999-2001	Base, LS, LT; High performance	US5077H
				4.3L V6 262 CID	2002-2003	Base, LS, LT, WT	US5077
				4.3L V6 262 CID	2002-2003	Base, LS, LT, WT; High performance	US5077H
				4.3L V6 262 CID	2004	Base, LS, LT, WT, Z71	US5077
				4.3L V6 262 CID	2004	Base, LS, LT, WT, Z71; High performance	US5077H
				4.3L V6 262 CID	2005	Base, LS, LT	US5077
				4.3L V6 262 CID	2005	Base, LS, LT; High performance	US5077H
				4.3L V6 262 CID	2006	LS, WT	US5077
				4.3L V6 262 CID	2006	LS, WT; High performance	US5077H
				4.3L V6 262 CID	2007-2011	WT; High performance	US5077H
				4.3L V6 262 CID	2007-2012	WT	US5077
				4.3L V6 262 CID	2014	LT, WT	US8918

WATER PUMPS

Engine	Years	Application Description	USMW	Engine	Years	Application Description	USMW
CHEVROLET (cont'd.)				CHEVROLET (cont'd.)			
SILVERADO 1500 (cont'd.)				SILVERADO 1500 HD (cont'd.)			
4.3L V6 262 CID	2015	LS, LT, WT	US8918	6.0L V8 5967cc 364 CID	2005	Base, LS, LT	US64
4.3L V6 262 CID	2016-2017	Custom, LS, LT, WT	US8918	6.0L V8 5967cc 364 CID	2005	Base, LS, LT; Includes thermostat and thermostat housing	US64-T
4.3L V6 4293cc 262 CID	2013	WT	US5077	6.0L V8 5967cc 364 CID	2006	LT	US64
4.3L V6 4300cc 262 CID	2013-2014	Mexican Application	US5077	6.0L V8 5967cc 364 CID	2006	LT; Includes thermostat and thermostat housing	US64-T
4.8L V8 294 CID	1999-2001	Base, LS, LT	US64	SILVERADO 1500 HD CLASSIC			
4.8L V8 294 CID	1999-2001	Base, LS, LT; Includes thermostat and thermostat housing	US64-T	6.0L V8 5967cc 364 CID	2007	LT	US6009
4.8L V8 294 CID	2002-2003	Base, LS, LT, WT	US64	6.0L V8 5967cc 364 CID	2007	LT; Includes thermostat and thermostat housing	US6009-T
4.8L V8 294 CID	2002-2003	Base, LS, LT, WT; Includes thermostat and thermostat housing	US64-T	SILVERADO 2500			
4.8L V8 294 CID	2004	Base, LS, LT, WT, Z71	US64	4.8L V8 4800cc 293 CID	2006-2009	Mexican Application	US64
4.8L V8 294 CID	2004	Base, LS, LT, WT, Z71; Includes thermostat and thermostat housing	US64-T	4.8L V8 4800cc 293 CID	2010-2011	Mexican Application	US6009
4.8L V8 294 CID	2005	Base, LS, LT	US64	4.8L V8 4800cc 293 CID	2013	Mexican Application	US6009
4.8L V8 294 CID	2005	Base, LS, LT; Includes thermostat and thermostat housing	US64-T	5.3L V8 5300cc 323 CID	2003	Mexican Application	US5087
4.8L V8 294 CID	2006	LS, LT, WT	US64	5.3L V8 5300cc 323 CID	2004-2009	Mexican Application	US64
4.8L V8 294 CID	2006	LS, LT, WT; Includes thermostat and thermostat housing	US64-T	5.3L V8 5300cc 323 CID	2010-2011	Mexican Application	US6009
4.8L V8 294 CID	2007	LT, WT	US6009	5.3L V8 5328cc 323 CID	2014	Mexican Application	US6009
4.8L V8 294 CID	2007	LT, WT; Includes thermostat and thermostat housing	US6009-T	5.3L V8 5328cc 325 CID	1999-2000	Base, LS, LT	US64
4.8L V8 294 CID	2008-2013	LS, LT, WT	US6009	5.3L V8 5328cc 325 CID	1999-2000	Base, LS, LT; Includes thermostat and thermostat housing	US64-T
4.8L V8 294 CID	2008-2013	LS, LT, WT; Includes thermostat and thermostat housing	US6009-T	5.3L V8 5328cc 325 CID	2013	Mexican Application	US6009
5.3L V8 5328cc 325 CID	1999-2001	Base, LS, LT	US64	5.3L V8 5328cc 325 CID	2015-2016	Mexican Application	US6009
5.3L V8 5328cc 325 CID	1999-2001	Base, LS, LT; Includes thermostat and thermostat housing	US64-T	5.7L V8 5737cc 350 CID	2001	Mexican Application	US5087
5.3L V8 5328cc 325 CID	2002-2003	Base, LS, LT, WT	US64	5.7L V8 5737cc 350 CID	2002	Mexican Application	US64
5.3L V8 5328cc 325 CID	2002-2003	Base, LS, LT, WT; Includes thermostat and thermostat housing	US64-T	6.0L V8 5967cc 364 CID	1999-2003	Base, LS, LT	US64
5.3L V8 5328cc 325 CID	2004	Base, Hybrid, LS, LT, WT, Z71	US64	6.0L V8 5967cc 364 CID	1999-2003	Base, LS, LT; Includes thermostat and thermostat housing	US64-T
5.3L V8 5328cc 325 CID	2004	Base, Hybrid, LS, LT, WT, Z71; Includes thermostat and thermostat housing	US64-T	6.0L V8 5967cc 364 CID	2004	Base, LS, LT, WT	US64
5.3L V8 5328cc 325 CID	2005	Base, Hybrid, LS, LT	US64	6.0L V8 5967cc 364 CID	2004	Base, LS, LT, WT; Includes thermostat and thermostat housing	US64-T
5.3L V8 5328cc 325 CID	2005	Base, Hybrid, LS, LT; Includes thermostat and thermostat housing	US64-T	SILVERADO 2500 HD			
5.3L V8 5328cc 325 CID	2006	Hybrid, LS, LT, WT	US64	6.0L V8 5967cc 364 CID	2001-2003	Base, LS, LT	US64
5.3L V8 5328cc 325 CID	2006	Hybrid, LS, LT, WT; Includes thermostat and thermostat housing	US64-T	6.0L V8 5967cc 364 CID	2001-2003	Base, LS, LT; Includes thermostat and thermostat housing	US64-T
5.3L V8 5328cc 325 CID	2007-2009	LT, LTZ, WT	US6009	6.0L V8 5967cc 364 CID	2004-2005	Base, LS, LT, WT	US64
5.3L V8 5328cc 325 CID	2007-2009	LT, LTZ, WT; Includes thermostat and thermostat housing	US6009-T	6.0L V8 5967cc 364 CID	2004-2005	Base, LS, LT, WT; Includes thermostat and thermostat housing	US64-T
5.3L V8 5328cc 325 CID	2010-2013	LS, LT, LTZ, WT, XFE	US6009	6.0L V8 5967cc 364 CID	2006	LS, LT, WT	US64
5.3L V8 5328cc 325 CID	2010-2013	LS, LT, LTZ, WT, XFE; Includes thermostat and thermostat housing	US6009-T	6.0L V8 5967cc 364 CID	2006	LS, LT, WT; Includes thermostat and thermostat housing	US64-T
5.3L V8 5328cc 325 CID	2014	High Country, LT, WT	US8918	6.0L V8 5967cc 364 CID	2007-2014	LT, LTZ, WT	US6009
5.3L V8 5328cc 325 CID	2015	High Country, LS, LT, LTZ, SSV, WT	US8918	6.0L V8 5967cc 364 CID	2007-2014	LT, LTZ, WT; Includes thermostat and thermostat housing	US6009-T
5.3L V8 5328cc 325 CID	2016-2017	Custom, High Country, LS, LT, LTZ, SSV, WT	US8918	6.0L V8 5967cc 364 CID	2015-2017	High Country, LT, LTZ, WT	US6009
6.0L V8 5967cc 364 CID	2003	SS	US64	6.6L V8 6599cc 403 CID	2001-2003	Base, LS, LT	US6009
6.0L V8 5967cc 364 CID	2003	SS; Includes thermostat and thermostat housing	US64-T	6.6L V8 6599cc 403 CID	2004	Base, LS, LT, WT	US63
6.0L V8 5967cc 364 CID	2004-2005	LS, LT, SS	US64	6.6L V8 6599cc 403 CID	2005	Base, LS, LT	US63
6.0L V8 5967cc 364 CID	2004-2005	LS, LT, SS; Includes thermostat and thermostat housing	US64-T	6.6L V8 6599cc 403 CID	2006	LS, LT, WT	US72
6.0L V8 5967cc 364 CID	2006	LT, SS	US64	6.6L V8 6599cc 403 CID	2007-2014	LT, LTZ, WT	US72
6.0L V8 5967cc 364 CID	2006	LT, SS; Includes thermostat and thermostat housing	US64-T	6.6L V8 6599cc 403 CID	2015-2016	High Country, LT, LTZ, WT	US72
6.0L V8 5967cc 364 CID	2007-2008	LT, LTZ	US6009	6.6L V8 6599cc 403 CID	2017	High Country, LT, LTZ, WT	US310
6.0L V8 5967cc 364 CID	2007-2008	LT, LTZ; Includes thermostat and thermostat housing	US6009-T	8.1L V8 496 CID	2001-2003	Base, LS, LT	US5089
6.0L V8 5967cc 364 CID	2009	Hybrid, LT, LTZ	US6009	8.1L V8 496 CID	2001-2003	Base, LS, LT; High performance	US5089H
6.0L V8 5967cc 364 CID	2009	Hybrid, LT, LTZ; Includes thermostat and thermostat housing	US6009-T	8.1L V8 496 CID	2004-2005	Base, LS, LT, WT	US5089
6.0L V8 5967cc 364 CID	2010-2013	Hybrid	US6009	8.1L V8 496 CID	2004-2005	Base, LS, LT, WT; High performance	US5089H
6.0L V8 5967cc 364 CID	2010-2013	Hybrid; Includes thermostat and thermostat housing	US6009-T	8.1L V8 496 CID	2006	LS, LT, WT	US5089
6.2L V8 6162cc 376 CID	2009	LTZ	US6009	8.1L V8 496 CID	2006	LS, LT, WT; High performance	US5089H
6.2L V8 6162cc 376 CID	2009	LTZ; Includes thermostat and thermostat housing	US6009-T	SILVERADO 2500 HD CLASSIC			
6.2L V8 6162cc 376 CID	2010-2013	LT, LTZ	US6009	6.0L V8 5967cc 364 CID	2007	LS, LT, WT	US6009
6.2L V8 6162cc 376 CID	2010-2013	LT, LTZ; Includes thermostat and thermostat housing	US6009-T	6.0L V8 5967cc 364 CID	2007	LS, LT, WT; Includes thermostat and thermostat housing	US6009-T
6.2L V8 6162cc 376 CID	2014-2017	High Country, LTZ	US8918	6.6L V8 6599cc 403 CID	2007	LS, LT, WT	US72
SILVERADO 1500 CLASSIC				8.1L V8 496 CID	2007	LS, LT, WT; High performance	US5089H
4.3L V6 262 CID	2007	LS, WT	US5077	SILVERADO 3500			
4.8L V8 294 CID	2007	LS, LT, WT	US6009	5.7L V8 5737cc 350 CID	2001-2003	Mexican Application	US5087
4.8L V8 294 CID	2007	LS, LT, WT; Includes thermostat and thermostat housing	US6009-T	5.7L V8 5737cc 350 CID	2007	Mexican Application	US64
5.3L V8 5328cc 325 CID	2007	Hybrid, LS, LT, WT	US6009	6.0L V8 5967cc 364 CID	2001-2003	Base, LS, LT	US64
5.3L V8 5328cc 325 CID	2007	Hybrid, LS, LT, WT; Includes thermostat and thermostat housing	US6009-T	6.0L V8 5967cc 364 CID	2001-2003	Base, LS, LT; Includes thermostat and thermostat housing	US64-T
6.0L V8 5967cc 364 CID	2007	LT, SS	US6009	6.0L V8 5967cc 364 CID	2004	Base, LS, LT, WT	US64
6.0L V8 5967cc 364 CID	2007	LT, SS; Includes thermostat and thermostat housing	US6009-T	6.0L V8 5967cc 364 CID	2004	Base, LS, LT, WT; Includes thermostat and thermostat housing	US64-T
SILVERADO 1500 HD				6.0L V8 5967cc 364 CID	2005	Base, LS, LT	US64
6.0L V8 5967cc 364 CID	2001-2003	LS, LT	US64	6.0L V8 5967cc 364 CID	2005	Base, LS, LT; Includes thermostat and thermostat housing	US64-T
6.0L V8 5967cc 364 CID	2001-2003	LS, LT; Includes thermostat and thermostat housing	US64-T	6.0L V8 5967cc 364 CID	2006	LS, LT, WT	US64

Engine	Years	Application Description	USMW	Engine	Years	Application Description	USMW
CHEVROLET (cont'd.)				CHEVROLET (cont'd.)			
SILVERADO 3500 (cont'd.)				SUBURBAN (cont'd.)			
8.1L V8 496 CID	2001-2003	Base, LS, LT	US5089	5.3L V8 5358cc 327 CID	1966		US898
8.1L V8 496 CID	2001-2003	Base, LS, LT; High performance	US5089H	5.3L V8 5358cc 327 CID	1966	High performance	US898H
8.1L V8 496 CID	2004	Base, LS, LT, WT	US5089	5.7L V8 5704cc 348 CID	1960-1961		US898
8.1L V8 496 CID	2004	Base, LS, LT, WT; High performance	US5089H	5.7L V8 5704cc 348 CID	1960-1961	High performance	US898H
8.1L V8 496 CID	2005	Base, LS, LT	US5089	SUBURBAN 1500			
8.1L V8 496 CID	2005	Base, LS, LT; High performance	US5089H	5.3L V8 5300cc 323 CID	2006	Mexican Application	US64
8.1L V8 496 CID	2006	LS, LT, WT	US5089	5.3L V8 5328cc 325 CID	2000-2001	Base, LS, LT	US64
8.1L V8 496 CID	2006	LS, LT, WT; High performance	US5089H	5.3L V8 5328cc 325 CID	2000-2001	Base, LS, LT; Includes thermostat and thermostat housing	US64-T
SILVERADO 3500 CLASSIC				5.3L V8 5328cc 325 CID	2002-2003	LS, LT	US64
6.0L V8 5967cc 364 CID	2007	LS, LT, WT	US6009	5.3L V8 5328cc 325 CID	2002-2003	LS, LT; Includes thermostat and thermostat housing	US64-T
6.0L V8 5967cc 364 CID	2007	LS, LT, WT; Includes thermostat and thermostat housing	US6009-T	5.3L V8 5328cc 325 CID	2004-2005	LS, LT, Z71	US64
6.6L V8 6599cc 403 CID	2007	LS, LT, WT	US72	5.3L V8 5328cc 325 CID	2004-2005	LS, LT, Z71; Includes thermostat and thermostat housing	US64-T
8.1L V8 496 CID	2007	LS, LT, WT	US5089	5.3L V8 5328cc 325 CID	2006	Base, LS, LT, Z71	US64
8.1L V8 496 CID	2007	LS, LT, WT; High performance	US5089H	5.3L V8 5328cc 325 CID	2006	Base, LS, LT, Z71; Includes thermostat and thermostat housing	US64-T
SILVERADO 3500 HD				5.3L V8 5328cc 325 CID	2007	LS, LT, LTZ, Z71	US6009
6.0L V8 5967cc 364 CID	2007-2014	LT, LTZ, WT	US6009	5.3L V8 5328cc 325 CID	2007	LS, LT, LTZ, Z71; Includes thermostat and thermostat housing	US6009-T
6.0L V8 5967cc 364 CID	2007-2014	LT, LTZ, WT; Includes thermostat and thermostat housing	US6009-T	5.3L V8 5328cc 325 CID	2008-2014	LS, LT, LTZ	US6009
6.0L V8 5967cc 364 CID	2015-2017	High Country, LT, LTZ, WT	US6009	5.3L V8 5328cc 325 CID	2008-2014	LS, LT, LTZ; Includes thermostat and thermostat housing	US6009-T
6.6L V8 6599cc 403 CID	2007-2014	LT, LTZ, WT	US72	5.7L V8 350 CID	2001-2002	High performance	US5077H
6.6L V8 6599cc 403 CID	2015-2016	High Country, LT, LTZ, WT	US72	5.7L V8 5733cc 350 CID	2002	Mexican Application	US5087
6.6L V8 6599cc 403 CID	2017	High Country, LT, LTZ, WT	US310	5.7L V8 5737cc 350 CID	2001	Mexican Application	US5087
SONIC				6.0L V8 5967cc 364 CID	2006	LTZ	US64
1.4L L4 1364cc 83 CID	2012	LT, LTZ	US6662	6.0L V8 5967cc 364 CID	2006	LTZ; Includes thermostat and thermostat housing	US64-T
1.4L L4 1364cc 83 CID	2013-2016	LT, LTZ, RS	US6662	6.0L V8 5967cc 364 CID	2007-2009	LT, LTZ	US6009
1.4L L4 1364cc 83 CID	2017	LT, Premier	US6662	6.0L V8 5967cc 364 CID	2007-2009	LT, LTZ; Includes thermostat and thermostat housing	US6009-T
1.6L L4 1598cc 97 CID	2012-2013	Mexican Application	US6184	SUBURBAN 2500			
1.6L L4 1600cc 98 CID	2014-2016	Mexican Application	US6184	6.0L V8 5967cc 364 CID	2000-2001	Base, LS, LT	US64
1.8L L4 1796cc 110 CID	2012-2014	LS, LT, LTZ	US6184	6.0L V8 5967cc 364 CID	2000-2001	Base, LS, LT; Includes thermostat and thermostat housing	US64-T
1.8L L4 1796cc 110 CID	2015-2017	LS, LT	US6184	6.0L V8 5967cc 364 CID	2002-2006	LS, LT	US64
SONORA				6.0L V8 5967cc 364 CID	2002-2006	LS, LT; Includes thermostat and thermostat housing	US64-T
4.3L V6 4300cc 262 CID	2003	Mexican Application	US5077	6.0L V8 5967cc 364 CID	2007	LS, LT, LTZ	US6009
5.3L V8 5300cc 323 CID	2003-2004	Mexican Application	US5087	6.0L V8 5967cc 364 CID	2007	LS, LT, LTZ; Includes thermostat and thermostat housing	US6009-T
5.3L V8 5300cc 323 CID	2005-2006	Mexican Application	US64	6.0L V8 5967cc 364 CID	2008-2013	LS, LT	US6009
5.7L V8 5737cc 350 CID	2000-2002	Mexican Application	US5049	6.0L V8 5967cc 364 CID	2008-2013	LS, LT; Includes thermostat and thermostat housing	US6009-T
6.0L V8 6000cc 364 CID	2003	Mexican Application	US5087	8.1L V8 496 CID	2001	Base, LS, LT	US5089
SPARK				8.1L V8 496 CID	2001	Base, LS, LT; High performance	US5089H
1.2L L4 1200cc 73 CID	2011-2015	Mexican Application	US8984	8.1L V8 496 CID	2002-2006	LS, LT	US5089
1.2L L4 1206cc 74 CID	2012	Base	US8984	8.1L V8 496 CID	2002-2006	LS, LT; High performance	US5089H
1.2L L4 1206cc 74 CID	2012	Base; Includes back housing	US8984-2	SUBURBAN 3500 HD			
1.2L L4 1206cc 74 CID	2013	LTZ	US8984	6.0L V8 5967cc 364 CID	2016-2017	LS, LT	US6009
1.2L L4 1206cc 74 CID	2013	LTZ	US8984	SWING			
1.2L L4 1206cc 74 CID	2013	LTZ	US8984	1.4L L4 1400cc 85 CID	1994-1995	Mexican Application	US5057
1.2L L4 1206cc 74 CID	2013	LTZ	US8984	1.6L L4 1600cc 98 CID	1996-2003	Mexican Application	US5057
1.2L L4 1206cc 74 CID	2013	LTZ; Includes back housing	US8984-2	T6500			
1.2L L4 1206cc 74 CID	2014	Byte, DOT, LTZ, ZMX	US8984	6.0L V8 366 CID	1997-1998	With threaded hub for fan clutch	US5078
1.2L L4 1206cc 74 CID	2014	Byte, DOT, LTZ, ZMX; Includes back housing	US8984-2	7.8L L6 475 CID	2000-2002	8 vane impeller, Medium/Heavy Duty	US73
1.2L L4 1206cc 74 CID	2014	Byte, DOT, LTZ, ZMX; Includes back housing	US8984-2	T7500			
1.2L L4 1249cc 76 CID	2013-2015	LS, LT	US8999	6.0L V8 366 CID	1997-1998	With threaded hub for fan clutch	US5078
1.4L L4 1399cc 85 CID	2016	LS, LT	US8147	7.8L L6 475 CID	2000-2002	8 vane impeller, Medium/Heavy Duty	US73
1.4L L4 1399cc 85 CID	2016	LS, LT; Pump only	US8147	TAHOE			
1.4L L4 1399cc 85 CID	2017	ACTIV, LS, LT	US8147	4.8L V8 294 CID	2000-2001	Base, LS, LT	US64
1.4L L4 1399cc 85 CID	2017	ACTIV, LS, LT; Pump only	US8147	4.8L V8 294 CID	2000-2001	Base, LS, LT; Includes thermostat and thermostat housing	US64-T
SPECTRUM				4.8L V8 294 CID	2002	LS, LT	US64
1.5L L4 1471cc 92 CID	1985-1986	Base	US5031	4.8L V8 294 CID	2002	LS, LT; Includes thermostat and thermostat housing	US64-T
1.5L L4 1471cc 92 CID	1987-1988	Base, CL, CL Plus, Express, Turbo	US5031	4.8L V8 294 CID	2003-2004	LS, LT, Z71	US64
SPRINT				4.8L V8 294 CID	2003-2004	LS, LT, Z71	US64
1.0L L3 993cc 61 CID	1985	Base	US5029	4.8L V8 294 CID	2003-2004	LS, LT, Z71; Includes thermostat and thermostat housing	US64-T
1.0L L3 993cc 61 CID	1986	Base, ER, Plus	US5029	4.8L V8 294 CID	2005	LS	US64
1.0L L3 993cc 61 CID	1987-1988	Base, ER, Metro, Turbo	US5029	4.8L V8 294 CID	2005	LS; Includes thermostat and thermostat housing	US64-T
SS				4.8L V8 294 CID	2006	Base, LS	US64
6.2L V8 6162cc 376 CID	2014-2017	Base	US79	4.8L V8 294 CID	2006	Base, LS; Includes thermostat and thermostat housing	US64-T
SSR				4.8L V8 294 CID	2007-2009	LS	US6009
5.3L V8 5328cc 325 CID	2003-2004	Base	US64	4.8L V8 294 CID	2007-2009	LS; Includes thermostat and thermostat housing	US6009-T
5.3L V8 5328cc 325 CID	2003-2004	Base; Includes thermostat and thermostat housing	US64-T	5.3L V8 5328cc 325 CID	2000-2001	Base, LS, LT	US64
6.0L V8 5967cc 364 CID	2005-2006	Base	US64	5.3L V8 5328cc 325 CID	2000-2001	Base, LS, LT; Includes thermostat and thermostat housing	US64-T
6.0L V8 5967cc 364 CID	2005-2006	Base; Includes thermostat and thermostat housing	US64-T	5.3L V8 5328cc 325 CID	2002	LS, LT	US64
STYLELINE DELUXE				5.3L V8 5328cc 325 CID	2002	LS, LT; Includes thermostat and thermostat housing	US64-T
3.8L L6 3852cc 235 CID	1950-1952		US43N	STYLINE SPECIAL			
STYLINE SPECIAL				3.8L L6 3852cc 235 CID	1950-1952		US43N
SUBURBAN				SUBURBAN			
4.3L L6 4278cc 261 CID	1961-1962		US898	4.3L L6 4278cc 261 CID	1961-1962	High performance	US898H
4.3L L6 4278cc 261 CID	1961-1962	High performance	US898H	4.6L V8 4638cc 283 CID	1960-1966		US898
4.6L V8 4638cc 283 CID	1960-1966		US898	4.6L V8 4638cc 283 CID	1960-1966	High performance	US898H
4.6L V8 4638cc 283 CID	1960-1966	High performance	US898H	4.8L L6 4801cc 292 CID	1965-1966		US896
4.8L L6 4801cc 292 CID	1965-1966		US896	5.3L V8 5328cc 325 CID	2010-2012	Mexican Application	US6009
5.3L V8 5328cc 325 CID	2010-2012	Mexican Application	US6009	5.3L V8 5328cc 325 CID	2015-2016	LS, LT, LTZ	US8918
5.3L V8 5328cc 325 CID	2015-2016	LS, LT, LTZ	US8918	5.3L V8 5328cc 325 CID	2017	LS, LT, Premier	US8918
5.3L V8 5328cc 325 CID	2017	LS, LT, Premier	US8918				

WATER PUMPS

Engine	Years	Application Description	USMW	Engine	Years	Application Description	USMW
CHEVROLET (cont'd.)				CHEVROLET (cont'd.)			
TAHOE (cont'd.)				TRAX (cont'd.)			
5.3L V8 5328cc 325 CID	2003-2005	LS, LT, Z71	US64	1.4L L4 1364cc 83 CID	2015-2016	LS, LT, LTZ	US6662
5.3L V8 5328cc 325 CID	2003-2005	LS, LT, Z71; Includes thermostat and thermostat housing	US64-T	1.4L L4 1364cc 83 CID	2017	LS, LT, Premier	US6662
5.3L V8 5328cc 325 CID	2006	Base, LS, LT, Z71	US64	1.8L L4 1796cc 110 CID	2013-2015	Mexican Application	US6184
5.3L V8 5328cc 325 CID	2006	Base, LS, LT, Z71; Includes thermostat and thermostat housing	US64-T	TRUCK			
5.3L V8 5328cc 325 CID	2007-2011	LS, LT, LTZ	US6009	4.3L L6 4278cc 261 CID	1955-1958		US898
5.3L V8 5328cc 325 CID	2007-2011	LS, LT, LTZ; Includes thermostat and thermostat housing	US6009-T	4.3L L6 4278cc 261 CID	1955-1958	High performance	US898H
5.3L V8 5328cc 325 CID	2011-2012	Mexican Application	US6009	4.3L L6 4278cc 261 CID	1960		US898
5.3L V8 5328cc 325 CID	2012-2014	LS, LT, LTZ, PPV, SSV	US6009	4.3L L6 4278cc 261 CID	1960	High performance	US898H
5.3L V8 5328cc 325 CID	2012-2014	LS, LT, LTZ, PPV, SSV; Includes thermostat and thermostat housing	US6009-T	4.3L V8 4343cc 265 CID	1955-1957		US898
5.3L V8 5328cc 325 CID	2015-2016	LS, LT, LTZ, PPV, SSV	US8918	4.3L V8 4343cc 265 CID	1955-1957	High performance	US898H
5.3L V8 5328cc 325 CID	2017	LS, LT, PPV, Premier, SSV	US8918	4.6L V8 4638cc 283 CID	1957-1958		US898
5.7L V8 350 CID	1995	Base, LS, LT	US5049	4.6L V8 4638cc 283 CID	1960	High performance	US898H
5.7L V8 350 CID	1995	Base, LS, LT; High performance	US5049H	5.3L V8 5272cc 322 CID	1956-1958		US898
5.7L V8 350 CID	1996-1999	Base, LS, LT	US5077	5.3L V8 5272cc 322 CID	1956-1958	High performance	US898H
5.7L V8 350 CID	1996-1999	Base, LS, LT; High performance	US5077H	5.3L V8 5310cc 324 CID	1955-1956		US898
5.7L V8 350 CID	2000	Limited, Z71	US5077	5.3L V8 5310cc 324 CID	1955-1956	High performance	US898H
5.7L V8 350 CID	2000	Limited, Z71; High performance	US5077H	5.7L V8 5704cc 348 CID	1958		US898
6.0L V8 5967cc 364 CID	2008-2013	Hybrid	US6009	5.7L V8 5704cc 348 CID	1958	High performance	US898H
6.0L V8 5967cc 364 CID	2008-2013	Hybrid; Includes thermostat and thermostat housing	US6009-T	5.7L V8 5704cc 348 CID	1960		US898
6.2L V8 6162cc 376 CID	2008-2009	LTZ	US6009	TWO-TEN SERIES			
6.2L V8 6162cc 376 CID	2008-2009	LTZ; Includes thermostat and thermostat housing	US6009-T	4.3L V8 4343cc 265 CID	1955-1957		US898
6.5L V8 395 CID	1995	Base, LS, LT	US5062	4.3L V8 4343cc 265 CID	1955-1957	High performance	US898H
6.5L V8 395 CID	1996	Base, LS, LT; Early	US5062	4.6L V8 4638cc 283 CID	1957		US898
6.5L V8 395 CID	1996	Base, LS, LT; Late	US5074	4.6L V8 4638cc 283 CID	1957	High performance	US898H
6.5L V8 395 CID	1997-1998	Base, LS, LT	US5074	UPLANDER			
6.5L V8 395 CID	1999	Base	US5074	3.5L V6 213 CID	2005-2006	Base, LS, LT	US5033
TIGRA				3.9L V6 3880cc 237 CID	2006	LT	US6020
1.6L L4 1600cc 98 CID	1999	Mexican Application	US5057	3.9L V6 3880cc 237 CID	2007-2008	Base, LS, LT	US6020
TORNADO				3.9L V6 3880cc 237 CID	2009	Mexican Application	US6020
1.8L L4 1796cc 110 CID	2006-2012		US8938	V10			
1.8L L4 1796cc 110 CID	2013-2015	Mexican Application	US8938	4.3L V6 262 CID	1987	Custom Deluxe, Scottsdale, Silverado	US1121
1.8L L4 1800cc 110 CID	2004-2005		US8938	4.3L V6 262 CID	1987	Custom Deluxe, Scottsdale, Silverado; High performance	US1121H
TRACKER				5.0L V8 305 CID	1987	Custom Deluxe, Scottsdale, Silverado	US1121
1.6L L4 1588cc 98 CID	1998	Base, LSi	US5048	5.0L V8 305 CID	1987	Custom Deluxe, Scottsdale, Silverado; High performance	US1121H
1.6L L4 1588cc 98 CID	1999-2000	Base, LSi	US9374	5.0L V8 305 CID	1987	Custom Deluxe, Scottsdale, Silverado	US1121
2.0L L4 122 CID	1999-2000	Base, LSi	US9342	5.7L V8 350 CID	1987	Custom Deluxe, Scottsdale, Silverado	US1121
2.0L L4 122 CID	2001-2003	Base, LT, ZR2	US9342	5.7L V8 350 CID	1987	Custom Deluxe, Scottsdale, Silverado; High performance	US1121H
2.0L L4 1983cc 121 CID	2005-2008	Mexican Application	US9342	6.2L V8 379 CID	1987	Custom Deluxe, Scottsdale, Silverado	US5008
2.2L L4 2190cc 134 CID	2005	Mexican Application	US5048	V10 SUBURBAN			
2.2L L4 2196cc 134 CID	1999-2001	Mexican Application	US5048	5.7L V8 350 CID	1987	Custom Deluxe, Scottsdale, Silverado	US5049
2.5L V6 2500cc	2001-2003	LT, ZR2	US9385	5.7L V8 350 CID	1987	Custom Deluxe, Scottsdale, Silverado; High performance	US5049H
2.5L V6 2500cc	2004	Base, LT, ZR2	US9385	5.7L V8 350 CID	1988	Scottsdale, Silverado	US5049
TRAILBLAZER				5.7L V8 350 CID	1988	Scottsdale, Silverado; High performance	US5049H
4.2L L6 256 CID	2002-2003	LS, LT, LTZ, North Face	US5097	6.2L V8 379 CID	1987	Custom Deluxe, Scottsdale, Silverado	US5008
4.2L L6 256 CID	2004	LS, LT, North Face	US5097	6.2L V8 379 CID	1988	Scottsdale, Silverado	US5008
4.2L L6 256 CID	2005-2007	LS, LT	US5097	V20			
4.2L L6 256 CID	2008	Base, LT	US5097	4.8L L6 292 CID	1987	Custom Deluxe, Scottsdale, Silverado	US5030
4.2L L6 256 CID	2009	LT	US5097	5.7L V8 350 CID	1987	Custom Deluxe, Scottsdale, Silverado	US1121
5.3L V8 5328cc 325 CID	2006	LS, LT	US64	5.7L V8 350 CID	1987	Custom Deluxe, Scottsdale, Silverado; High performance	US1121H
5.3L V8 5328cc 325 CID	2006	LS, LT; Includes thermostat and thermostat housing	US64-T	6.2L V8 379 CID	1987	Custom Deluxe, Scottsdale, Silverado	US5008
5.3L V8 5328cc 325 CID	2007	LS, LT	US6009	V20 SUBURBAN			
5.3L V8 5328cc 325 CID	2007	LS, LT; Includes thermostat and thermostat housing	US6009-T	5.7L V8 350 CID	1987	Custom Deluxe, Scottsdale, Silverado	US1121
5.3L V8 5328cc 325 CID	2008	Base, LT	US6009	5.7L V8 350 CID	1987	Custom Deluxe, Scottsdale, Silverado; High performance	US1121H
5.3L V8 5328cc 325 CID	2008	Base, LT; Includes thermostat and thermostat housing	US6009-T	5.7L V8 350 CID	1988	Scottsdale, Silverado	US5049
6.0L V8 5967cc 364 CID	2006	SS	US64	5.7L V8 350 CID	1988	Scottsdale, Silverado; High performance	US5049H
6.0L V8 5967cc 364 CID	2006	SS; Includes thermostat and thermostat housing	US64-T	6.2L V8 379 CID	1987	Custom Deluxe, Scottsdale, Silverado	US5008
6.0L V8 5967cc 364 CID	2007-2009	SS	US6009	6.2L V8 379 CID	1988	Scottsdale, Silverado	US5008
6.0L V8 5967cc 364 CID	2007-2009	SS; Includes thermostat and thermostat housing	US6009-T	7.4L V8 454 CID	1987	Custom Deluxe, Scottsdale, Silverado	US1002
TRAILBLAZER EXT				7.4L V8 454 CID	1987	Custom Deluxe, Scottsdale, Silverado; High performance	US1002H
4.2L L6 256 CID	2002	LT, North Face	US5097	7.4L V8 454 CID	1988	Scottsdale, Silverado	US1002
4.2L L6 256 CID	2003-2004	LS, LT, North Face	US5097	7.4L V8 454 CID	1988	Scottsdale, Silverado; High performance	US1002H
4.2L L6 256 CID	2005-2006	LS, LT	US5097	V30			
5.3L V8 5328cc 325 CID	2003-2004	LS, LT, North Face	US64	4.8L L6 292 CID	1987	Custom Deluxe, Scottsdale, Silverado	US5030
5.3L V8 5328cc 325 CID	2003-2004	LS, LT, North Face; Includes thermostat and thermostat housing	US64-T	4.8L L6 292 CID	1988	Cheyenne, Custom Deluxe, Scottsdale, Silverado	US5030
5.3L V8 5328cc 325 CID	2005-2006	LS, LT	US64	5.7L V8 350 CID	1987	Custom Deluxe, Scottsdale, Silverado	US1121
5.3L V8 5328cc 325 CID	2005-2006	LS, LT; Includes thermostat and thermostat housing	US64-T	5.7L V8 350 CID	1987	Custom Deluxe, Scottsdale, Silverado; High performance	US1121H
TRAVERSE				5.7L V8 350 CID	1988	Cheyenne, Custom Deluxe, Scottsdale, Silverado	US1121
3.6L V6 3564cc 217 CID	2009-2013	LS, LT, LTZ	US8932	5.7L V8 350 CID	1988	Cheyenne, Scottsdale, Silverado	US1121H
3.6L V6 3564cc 217 CID	2015-2016	LS, LT, LTZ	US8932	TRAX			
3.6L V6 3564cc 217 CID	2017	LS, LT, Premier	US8932	1.4L L4 1364cc 83 CID	2014	Mexican Application	US6662

Engine	Years	Application Description	USMW	Engine	Years	Application Description	USMW
CHEVROLET (cont'd.)				CHRYSLER (cont'd.)			
V30 (cont'd.)				300 (cont'd.)			
6.2L V8 379 CID	1987	Custom Deluxe, Scottsdale, Silverado	US5008	3.5L V6 3497cc 215 CID	2010	Limited, S, Touring	US8951
6.2L V8 379 CID	1988	Cheyenne, Custom Deluxe, Scottsdale, Silverado	US5008	3.6L V6 3604cc 220 CID	2011	Base, Limited, Touring	US8981
7.4L V8 454 CID	1987	Custom Deluxe, Scottsdale, Silverado	US1002	3.6L V6 3604cc 220 CID	2012	Base, Limited, S	US8981
7.4L V8 454 CID	1987	Custom Deluxe, Scottsdale, Silverado; High performance	US1002H	3.6L V6 3604cc 220 CID	2013-2014	Base, C, C Luxury, S	US8981
7.4L V8 454 CID	1988	Cheyenne, Custom Deluxe, Scottsdale, Silverado	US1002	3.6L V6 3604cc 220 CID	2015-2017	C, C Platinum, Limited, S	US8981
7.4L V8 454 CID	1988	Cheyenne, Custom Deluxe, Scottsdale, Silverado; High performance	US1002H	3.6L V6 3604cc 220 CID	2018	Limited, S, Touring	US8981
V1500 SUBURBAN				300M			
5.7L V8 350 CID	1989-1991	Scottsdale, Silverado	US5049	5.7L V8 345 CID	2005-2008	C	US8940
5.7L V8 350 CID	1989-1991	Scottsdale, Silverado; High performance	US5049H	5.7L V8 345 CID	2009	C	US8979
6.2L V8 379 CID	1989-1991	Scottsdale, Silverado	US5062	5.7L V8 345 CID	2010	C, S	US8979
V2500 SUBURBAN				300M			
5.7L V8 350 CID	1989-1991	Scottsdale, Silverado	US5049	5.7L V8 345 CID	2011	C	US8971
5.7L V8 350 CID	1989-1991	Scottsdale, Silverado; High performance	US5049H	5.7L V8 345 CID	2012	C, S	US8971
6.2L V8 379 CID	1989-1991	Scottsdale, Silverado	US5062	5.7L V8 345 CID	2014	C, C Luxury, S	US8115
7.4L V8 454 CID	1990	Scottsdale, Silverado; High performance	US1002H	5.7L V8 345 CID	2015-2017	C, C Platinum, S	US8115
7.4L V8 454 CID	1990	Scottsdale, Silverado; High performance	US1002H	5.7L V8 345 CID	2018	C, S	US8115
V3500				300M			
5.7L V8 350 CID	1989-1990	Cheyenne, Scottsdale, Silverado	US1121	5.7L V8 5654cc 345 CID	2013	C, C Luxury, S	US8115
5.7L V8 350 CID	1989-1990	Cheyenne, Scottsdale, Silverado; High performance	US1121H	6.1L V8 6059cc 370 CID	2005-2010	C SRT8	US8940
5.7L V8 350 CID	1991	Cheyenne, Silverado	US1121	6.4L V8 6424cc 392 CID	2012	SRT8	US8971
5.7L V8 350 CID	1991	Cheyenne, Silverado; High performance	US1121H	6.4L V8 6424cc 392 CID	2014	SRT8	US8115
6.2L V8 379 CID	1989-1990	Cheyenne, Scottsdale, Silverado	US5008	ASPEN			
6.2L V8 379 CID	1991	Cheyenne, Silverado	US5008	4.7L V8 287 CID	2007-2009	Limited	US7163
6.2L V8 379 CID	1989-1990	Cheyenne, Scottsdale, Silverado	US1002	5.7L V8 345 CID	2007-2008	Limited	US7168
7.4L V8 454 CID	1989-1990	Cheyenne, Scottsdale, Silverado; High performance	US1002H	5.7L V8 345 CID	2009	Limited	US6341
7.4L V8 454 CID	1991	Cheyenne, Silverado	US1002	CIRRUS			
7.4L V8 454 CID	1991	Cheyenne, Silverado; High performance	US1002H	2.0L L4 1996cc 122 CID	2000	LX	US7150
VAGONETA				2.0L L4 2001cc 122 CID	1995	Mexican Application	US7150
1.6L L4 1600cc 98 CID	2000-2002	Mexican Application	US5057	2.4L L4 2360cc 144 CID	2010	Mexican Application	US6038
VECTRA				2.4L L4 2426cc 148 CID	1998	Mexican Application	US7152
2.2L L4 2190cc 134 CID	2003-2005	Mexican Application	US5092	2.4L L4 2426cc 148 CID	1999-2000	Mexican Application	US7156
2.8L V6 2800cc 173 CID	2006-2008	Mexican Application	US8932	2.4L L4 2426cc 148 CID	2004	Mexican Application	US7156
3.2L V6 3171cc 193 CID	2004-2005	Mexican Application	US5079	2.4L L4 2429cc 148 CID	1995	LX	US7153
3.2L V6 3199cc 195 CID	2003	Mexican Application	US5079	2.4L L4 2429cc 148 CID	1996	LX; Hydraulic Tensioner	US7153
VEGA				2.4L L4 2429cc 148 CID	1996	LX; Mechanical Tensioner	US7156
2.3L L4 2294cc 140 CID	1975		US1088	2.4L L4 2429cc 148 CID	1997	LX, LXi	US7156
VENTURE				2.4L L4 2429cc 148 CID	1999-2000	LX	US7156
3.4L V6 207 CID	1997-1999	Base, LS	US5033	2.4L L4 2429cc 148 CID	2001-2003	Mexican Application	US7156
3.4L V6 207 CID	2000	Base, LS, LT, Plus, Value, Warner Bros.	US5033	2.4L L4 2429cc 148 CID	2005-2009	Mexican Application	US7156
3.4L V6 207 CID	2001	LS, LT, Plus, Value, Warner Bros.	US5033	2.5L V6 2497cc 152 CID	1995-1997	LX, LXi	US7152
3.4L V6 207 CID	2002	Base, LS, LT, Plus, Value, Warner Bros.	US5033	2.5L V6 2497cc 152 CID	1998-1999	LXi	US7152
3.4L V6 207 CID	2003	LS, LT, Plus, Value, Warner Bros.	US5033	2.5L V6 2497cc 152 CID	2000	LX, LXi	US7152
3.4L V6 207 CID	2004-2005	LS, LT, Plus	US5033	2.7L V6 2736cc 165 CID	2001-2003	Mexican Application	US7161
VOLT				2.7L V6 2737cc 167 CID	2004-2006	Mexican Application	US7161
1.4L L4 1398cc 85 CID	2011-2015	Base	US8152	3.5L V6 3500cc 213 CID	2007-2009	Mexican Application	US8951
1.5L L4 1490cc 91 CID	2016-2017	LT, Premier	US8158	3.5L V6 3518cc 215 CID	2010	Mexican Application	US8951
1.5L L4 1490cc 91 CID	2016-2017	LT, Premier; Pump only	US8158	CONCORDE			
YEOMAN				2.7L V6 2736cc 167 CID	1998-2004	LX	US7161
3.8L L6 3852cc 235 CID	1958		US43N	3.2L V6 3200cc 197 CID	1998-2001	LXi	US7162
ZAFIRA				3.3L V6 3294cc 201 CID	1992	Mexican Application	US7140
1.8L L4 1796cc 109 CID	2002-2005	Mexican Application	US8933	3.3L V6 3301cc 201 CID	1993-1995	Base	US7140
2.2L L4 2190cc 134 CID	2002-2006	Mexican Application	US5092	3.3L V6 3301cc 201 CID	1996	LX	US7140
CHRYSLER				3.5L V6 3497cc 215 CID	1993-1994	Base	US7141
200				3.5L V6 3497cc 215 CID	1995	Base	US7151
2.4L L4 2360cc 144 CID	2011-2014	Limited, LX, Touring	US6038	3.5L V6 3497cc 215 CID	1996	LX, LXi	US7151
2.4L L4 2360cc 144 CID	2015-2017	C, Limited, LX, S	US6038	3.5L V6 3497cc 215 CID	1997	LX, LXi; 3 Bolt Pattern	US7151
3.6L V6 3604cc 220 CID	2011-2014	Limited, LX, S, Touring	US8981	3.5L V6 3497cc 215 CID	1997	LX, LXi; 6 Bolt Pattern	US7158
3.6L V6 3604cc 220 CID	2013	Mexican Application	US8981	3.5L V6 3497cc 215 CID	2002-2004	Limited, LXi	US7162
3.6L V6 3604cc 220 CID	2015-2017	C, Limited, S	US8114	3.5L V6 3526cc 215 CID	1992	Mexican Application	US7141
200C				CONQUEST			
3.6L V6 3605cc 220 CID	2015-2016	Mexican Application	US8981	2.6L L4 2555cc 156 CID	1987	Base	US7120
300				2.6L L4 2555cc 156 CID	1987	Base; From 12/1986	US7124
2.7L V6 2736cc 167 CID	2005-2007	Base	US7161	2.6L L4 2555cc 156 CID	1988-1989	TSi	US7124
2.7L V6 2736cc 167 CID	2008-2009	LX	US6217	CORDOBA			
2.7L V6 2736cc 167 CID	2010	Touring	US6217	3.7L L6 3687cc 225 CID	1980	300, Base, Crown, LS	US7100
3.5L V6 3497cc 213 CID	2010	Mexican Application	US8951	3.7L L6 3687cc 225 CID	1981-1982	Base, LS	US7100
3.5L V6 3497cc 215 CID	2005-2008	Limited, Touring	US8951	3.7L L6 3687cc 225 CID	1983	Base	US7100
3.5L V6 3497cc 215 CID	2009	Limited, Signature Series, Touring	US8951	5.2L V8 318 CID	1975-1978	Exc.Air Pump	US1053
				5.2L V8 318 CID	1975-1978	Exc.Air Pump, High performance	US1053H
				5.2L V8 318 CID	1975-1979	Air Pump	US1053
				5.2L V8 318 CID	1975-1979	Air Pump, High performance	US1053H
				5.2L V8 318 CID	1980	300, Base, Crown	US1053
				5.2L V8 318 CID	1980	300, Base, Crown; High performance	US1053H
				5.2L V8 318 CID	1981-1982	Base, LS	US1053
				5.2L V8 318 CID	1981-1982	Base, LS; High performance	US1053H
				5.2L V8 318 CID	1983	Base	US1053
				5.2L V8 318 CID	1983	Base; High performance	US1053H
				5.9L V8 360 CID	1975-1979	Air Pump	US1053
				5.9L V8 360 CID	1975-1979	Air Pump, High performance	US1053H
				5.9L V8 360 CID	1980	300, Base, Crown, LS	US1053

WATER PUMPS

Engine	Years	Application Description	USMW	Engine	Years	Application Description	USMW
CHRYSLER (cont'd.)				CHRYSLER (cont'd.)			
CORDOBA (cont'd.)				LEBARON (cont'd.)			
5.9L V8 360 CID	1980	300, Base, Crown, LS; High performance	US1053H	3.0L V6 2972cc 181 CID	1992	Base, GTC, Landau, LX; With back plate housing	US7121-2
5.9L V8 360 CID	1981-1982		US1053	3.0L V6 2972cc 181 CID	1993	Base, GTC, Landau, LE, LX	US7121
5.9L V8 360 CID	1981-1982	High performance	US1053H	3.0L V6 2972cc 181 CID	1993	Base, GTC, Landau, LE, LX; With back plate housing	US7121-2
5.9L V8 5900cc 360 CID	1980-1982	Mexican Application	US1053	3.0L V6 2972cc 181 CID	1994	GTC, Landau, LE	US7121
6.6L V8 400 CID	1975-1978		US1040	3.0L V6 2972cc 181 CID	1994	GTC, Landau, LE; With back plate housing	US7121-2
CROSSFIRE				3.0L V6 2972cc 181 CID	1995	GTC	US7121
3.2L V6 3199cc	2005-2006	SRT-6	US9379	3.0L V6 2972cc 181 CID	1995	GTC; With back plate housing	US7121-2
3.2L V6 3200cc 195 CID	2004	Base	US9379	3.7L L6 3687cc 225 CID	1978-1979		US7100
3.2L V6 3200cc 195 CID	2005-2007	Base, Limited	US9379	3.7L L6 3687cc 225 CID	1980-1981	Base, Medallion, Salon, Special	US7100
3.2L V6 3200cc 195 CID	2008	Limited	US9379	5.2L V8 318 CID	1977-1978	Exc. Air Pump	US1053
DART				5.2L V8 318 CID	1977-1978	Exc. Air Pump, High performance	US1053H
2.2L L4 2200cc 135 CID	1986-1988	Mexican Application	US7110	5.2L V8 318 CID	1977-1979	Air Pump	US1053
2.2L L4 2200cc 135 CID	1989	Mexican Application	US7122	5.2L V8 318 CID	1977-1979	Air Pump, High performance	US1053H
E CLASS				5.2L V8 318 CID	1980-1981	Base, Medallion, Salon, Special	US1053
2.2L L4 135 CID	1983-1984	Base	US7110	5.2L V8 318 CID	1980-1981	Base, Medallion, Salon, Special; High performance	US1053H
2.2L L4 135 CID	1983-1984	Base; High performance	US7110H	5.9L V8 360 CID	1978-1979	Air Pump	US1053
2.6L L4 2555cc 156 CID	1983-1984	Base	US7111	5.9L V8 360 CID	1978-1979	Air Pump, High performance	US1053H
EXECUTIVE LIMOUSINE				5.9L V8 360 CID	1980-1982	High performance	US1053H
2.6L L4 2555cc 156 CID	1985	Base	US7111	5.9L V8 360 CID	1980-1982	High performance	US1053H
EXECUTIVE SEDAN				5.9L V8 5900cc 360 CID	1977	Mexican Application	US1053
2.6L L4 2555cc 156 CID	1983-1984	Base	US7111	5.9L V8 5900cc 360 CID	1980-1982	Mexican Application	US1053
FIFTH AVENUE				LHS			
3.7L L6 3687cc 225 CID	1983	Base	US7100	3.5L V6 3497cc 215 CID	1994	Base	US7141
5.2L V8 318 CID	1983-1989	Base	US1053	3.5L V6 3497cc 215 CID	1995-1996	Base	US7151
5.2L V8 318 CID	1983-1989	Base; High performance	US1053H	3.5L V6 3497cc 215 CID	1997	Base; 3 Bolt Pattern	US7151
GRAND VOYAGER				3.5L V6 3497cc 215 CID	1997	Base; 6 Bolt Pattern	US7158
3.0L V6 2972cc 181 CID	2000	Base, SE	US7121	3.5L V6 3497cc 215 CID	1999-2001	Base	US7162
3.0L V6 2972cc 181 CID	2000	Base, SE; With back plate housing	US7121-2	MAGNUM			
3.3L V6 3294cc 201 CID	2001	Mexican Application	US7165	2.5L L4 2507cc 153 CID	1987-1988	Mexican Application	US7110
3.3L V6 3301cc 201 CID	2000	Base, SE	US7126	NEWPORT			
3.8L V6 3800cc 231 CID	1991-1995	Mexican Application	US7126	3.7L L6 3687cc 225 CID	1980-1981	Base	US7100
3.8L V6 3800cc 232 CID	1998-2001	Mexican Application	US7126	5.2L V8 318 CID	1979	Air Pump	US1053
3.8L V6 3800cc 232 CID	2002	Mexican Application	US7165	5.2L V8 318 CID	1979	Air Pump, High performance	US1053H
IMPERIAL				5.2L V8 318 CID	1980-1981	Base	US1053
3.3L V6 3301cc 201 CID	1990-1991	Base	US7126	5.2L V8 318 CID	1980-1981	Base; High performance	US1053H
3.8L V6 230 CID	1991-1993	Base	US7126	5.9L V8 360 CID	1975-1979	Air Pump	US1053
5.2L V8 318 CID	1981-1983	Base	US1053	5.9L V8 360 CID	1975-1979	Air Pump, High performance	US1053H
5.2L V8 318 CID	1981-1983	Base; High performance	US1053H	5.9L V8 360 CID	1980	Base	US1053
7.2L V8 440 CID	1975		US1040	5.9L V8 360 CID	1980	Base; High performance	US1053H
LASER				6.6L V8 400 CID	1975-1978		US1040
2.2L L4 135 CID	1984-1986	Base, XE	US7110	7.2L V8 440 CID	1975-1978		US1040
2.2L L4 135 CID	1984-1986	Base, XE; High performance	US7110H	NEW YORKER			
2.5L L4 2507cc 153 CID	1986	Base, XE	US7110	2.2L L4 135 CID	1983-1987	Base	US7110
2.5L L4 2507cc 153 CID	1986	Base, XE; High performance	US7110H	2.2L L4 135 CID	1983-1987	Base; High performance	US7110H
LEBARON				2.2L L4 135 CID	1988		US7110
2.2L L4 135 CID	1982	Base, Medallion	US7110	2.2L L4 135 CID	1988	High performance	US7110H
2.2L L4 135 CID	1982	Base, Medallion; High performance	US7110H	2.2L L4 2200cc 135 CID	1985-1991	Mexican Application	US7110
2.2L L4 135 CID	1983-1984	Base, Mark Cross	US7110	2.5L L4 2507cc 153 CID	1986-1987	Base	US7110
2.2L L4 135 CID	1983-1984	Base, Mark Cross; High performance	US7110H	2.5L L4 2507cc 153 CID	1986-1987	Base; High performance	US7110H
2.2L L4 135 CID	1985-1986	Base, GTS, Mark Cross	US7110	2.6L L4 2555cc 156 CID	1983-1985	Base	US7111
2.2L L4 135 CID	1985-1986	Base, GTS, Mark Cross; High performance	US7110H	3.0L V6 2972cc 181 CID	1988-1989	Base, Landau	US7121
2.2L L4 135 CID	1987-1988	Base, GTS, Premium	US7110	3.0L V6 2972cc 181 CID	1988-1989	Base, Landau; With back plate housing	US7121-2
2.2L L4 135 CID	1987-1988	Base, GTS, Premium; High performance	US7110H	3.0L V6 3000cc 183 CID	1992-1994	Mexican Application	US7121
2.2L L4 135 CID	1989	Base, GTS, Premium	US7122	3.3L V6 3301cc 201 CID	1990	Fifth Avenue, Landau, Salon	US7126
2.2L L4 135 CID	1990	GTC	US7127	3.3L V6 3301cc 201 CID	1991-1993	Fifth Avenue, Salon	US7126
2.2L L4 2200cc 135 CID	1982-1987	Mexican Application	US7110	3.5L V6 3497cc 215 CID	1994	Base	US7141
2.5L L4 2500cc 153 CID	1993-1995	Mexican Application	US7127	3.5L V6 3497cc 215 CID	1995-1996	Base	US7151
2.5L L4 2507cc 153 CID	1986	Base, GTS, Mark Cross	US7110	3.7L L6 3687cc 225 CID	1982	Base	US7100
2.5L L4 2507cc 153 CID	1986	Base, GTS, Mark Cross; High performance	US7110H	3.8L V6 230 CID	1991-1993	Fifth Avenue	US7126
2.5L L4 2507cc 153 CID	1987-1988	Base, GTS, Premium	US7110	5.2L V8 318 CID	1979	Air Pump	US1053
2.5L L4 2507cc 153 CID	1987-1988	Base, GTS, Premium; High performance	US7110H	5.2L V8 318 CID	1979	Air Pump, High performance	US1053H
2.5L L4 2507cc 153 CID	1989	Base, GT, GTC, GTS, High Line, Premium	US7122	5.2L V8 318 CID	1980-1982	Base	US1053
2.5L L4 2507cc 153 CID	1990	Base, GT, GTC, High Line, Premium	US7127	5.2L V8 318 CID	1980-1982	Base; High performance	US1053H
2.5L L4 2507cc 153 CID	1991	Base, GTC	US7127	5.9L V8 360 CID	1977-1979	Air Pump	US1053
2.5L L4 2507cc 153 CID	1992	Base, GTC, Landau	US7127	5.9L V8 360 CID	1977-1979	Air Pump, High performance	US1053H
2.5L L4 2507cc 153 CID	1993	Base, LE	US7127	5.9L V8 360 CID	1980	Base	US1053
2.6L L4 2555cc 156 CID	1982	Base, Medallion	US7111	5.9L V8 360 CID	1980	Base; High performance	US1053H
2.6L L4 2555cc 156 CID	1983-1985	Base, Mark Cross	US7111	6.6L V8 400 CID	1975-1978		US1040
3.0L V6 2972cc 181 CID	1990	Base, GT, High Line, Premium	US7121	7.2L V8 440 CID	1975-1978		US1040
3.0L V6 2972cc 181 CID	1991	Base, GT, High Line, Premium; With back plate housing	US7121-2	PACIFICA			
3.0L V6 2972cc 181 CID	1991	Base, GTC, LX	US7121	3.5L V6 3497cc 215 CID	2004	Base	US7162
3.0L V6 2972cc 181 CID	1991	Base, GTC, LX; With back plate housing	US7121-2	3.5L V6 3497cc 215 CID	2005-2006	Base, Limited, Touring	US8951
3.0L V6 2972cc 181 CID	1992	Base, GTC, Landau, LX	US7121	3.6L V6 3604cc 220 CID	2017	Hybrid Platinum, Hybrid Premium, Limited, LX, Touring, Touring L, Touring L Plus	US8151
				3.6L V6 3604cc 220 CID	2018	Hybrid Limited, Hybrid Touring L, Hybrid Touring Plus, L, Limited, LX, Touring, Touring L, Touring L Plus	US8151
				3.8L V6 230 CID	2005	Base	US8968
				3.8L V6 230 CID	2007	Base	US8968
				3.8L V6 230 CID	2008	LX	US8968

Engine	Years	Application Description	USMW	Engine	Years	Application Description	USMW
CHRYSLER (cont'd.)				CHRYSLER (cont'd.)			
PACIFICA (cont'd.)				TOWN & COUNTRY (cont'd.)			
4.0L V6 3952cc 241 CID	2007	Base, Limited, Touring	US8951	2.5L L4 2507cc 153 CID	1987-1988	Base	US7110
4.0L V6 3952cc 241 CID	2008	Limited, LX, Touring	US8951	2.5L L4 2507cc 153 CID	1987-1988	Base; High performance	US7110H
PHANTOM				2.6L L4 2555cc 156 CID	1982	Base	US7111
2.2L L4 2200cc 135 CID	1987-1990	Mexican Application	US7110	2.6L L4 2555cc 156 CID	1984-1985	Base, Mark Cross	US7111
2.2L L4 2200cc 135 CID	1989	Mexican Application	US7122	3.3L V6 3301cc 201 CID	1990-1993	Base	US7126
2.2L L4 2200cc 135 CID	1990	Mexican Application	US7127	3.3L V6 3301cc 201 CID	1996	Base, LX	US7126
2.2L L4 2200cc 135 CID	1992-1994	Mexican Application	US7110	3.3L V6 3301cc 201 CID	1997-1998	LX, SX	US7126
2.5L L4 2500cc 153 CID	1990-1994	Mexican Application	US7127	3.3L V6 3301cc 201 CID	1999	LX, LXi, SX	US7126
PROWLER				3.3L V6 3301cc 201 CID	2000	LX, LXi	US7126
3.5L V6 3497cc 215 CID	2001-2002	Base	US7162	3.3L V6 3301cc 201 CID	2001	LX, LXi	US7165
PT CRUISER				3.3L V6 3301cc 201 CID	2002	EL, LX, LXi	US7165
2.4L L4 2429cc 148 CID	2001	Base, Limited, Touring	US7156	3.3L V6 3301cc 201 CID	2003	Base, EL, EX, Limited, LX, LXi	US7165
2.4L L4 2429cc 148 CID	2002	Base, Dream, Limited, Touring	US7156	3.3L V6 3301cc 201 CID	2004	Base, LX	US7165
2.4L L4 2429cc 148 CID	2003	Base, Limited, Touring	US7156	3.3L V6 3301cc 201 CID	2005	Base, Limited, LX, Touring	US7165
2.4L L4 2429cc 148 CID	2003-2004	GT	US7167	3.3L V6 3301cc 201 CID	2006-2007	Base, LX	US7165
2.4L L4 2429cc 148 CID	2004	Base	US7156	3.3L V6 3301cc 201 CID	2008-2010	LX	US6231
2.4L L4 2429cc 148 CID	2004-2007	Limited, Touring; Naturally Aspirated	US7156	3.6L V6 3604cc 220 CID	2011-2012	Limited, Touring, Touring L	US8981
2.4L L4 2429cc 148 CID	2004-2007	Limited, Touring; Turbocharged	US7167	3.6L V6 3604cc 220 CID	2011-2013	Mexican Application	US8981
2.4L L4 2429cc 148 CID	2005	Dream Cruiser, GT, Street Cruiser	US7167	3.6L V6 3604cc 220 CID	2013	Limited, S, Touring, Touring L	US8981
2.4L L4 2429cc 148 CID	2006	Base, Street Cruiser	US7156	3.6L V6 3604cc 220 CID	2014	30th Anniversary Edition, Limited, S, Touring, Touring L	US8981
2.4L L4 2429cc 148 CID	2006-2007	GT	US7167	3.6L V6 3604cc 220 CID	2015	Limited, LX, S, Touring, Touring L	US8981
2.4L L4 2429cc 148 CID	2007	Base	US7156	3.6L V6 3604cc 220 CID	2016	Limited, Limited Platinum, LX, S, Touring, Touring L	US8981
2.4L L4 2429cc 148 CID	2008	Base, LX	US7156	3.6L V6 3605cc 220 CID	2014-2015	Mexican Application	US8981
2.4L L4 2429cc 148 CID	2008	Base, Touring; Naturally Aspirated	US7156	3.7L L6 3687cc 225 CID	1978-1979		US7100
2.4L L4 2429cc 148 CID	2008	Base, Touring; Turbocharged	US7167	3.7L L6 3687cc 225 CID	1980-1981	Base	US7100
2.4L L4 2429cc 148 CID	2008-2009	Limited	US7167	3.8L V6 230 CID	1994-1995	Base	US7126
2.4L L4 2429cc 148 CID	2009	Base, LX, Touring	US7156	3.8L V6 230 CID	1996	Base, LX, LXi	US7126
2.4L L4 2429cc 148 CID	2010	Classic, Couture Edition	US7156	3.8L V6 230 CID	1997-1999	LX, LXi, SX	US7126
SEBRING				3.8L V6 230 CID	1999	Limited; (L)	US7126
2.0L L4 1996cc 122 CID	1995-1999	LX	US7150	3.8L V6 230 CID	2000	Limited, LX, LXi	US7126
2.4L L4 2351cc	2001-2003	LX	US9399	3.8L V6 230 CID	2001	EX, Limited	US7165
2.4L L4 2351cc	2004-2005	Base	US9399	3.8L V6 230 CID	2002-2003	EL, EX, Limited, LX, LXi	US7165
2.4L L4 2360cc 144 CID	2007	Base, Limited, Touring	US6038	3.8L V6 230 CID	2004	EX, Limited, Touring	US7165
2.4L L4 2360cc 144 CID	2008-2010	Limited, LX, Touring	US6038	3.8L V6 230 CID	2005	Limited, LX, Touring	US7165
2.4L L4 2429cc 148 CID	1996	JX; Hydraulic Tensioner	US7153	3.8L V6 230 CID	2006-2007	Limited, Touring	US7165
2.4L L4 2429cc 148 CID	1996	JX; Mechanical Tensioner	US7156	3.8L V6 230 CID	2008	Touring	US6231
2.4L L4 2429cc 148 CID	1997-1998	JX, JXi	US7156	3.8L V6 3778cc 231 CID	2009	Touring	US6231
2.4L L4 2429cc 148 CID	2001-2003	LX	US7156	3.8L V6 3778cc 231 CID	2010	Touring, Walter P. Chrysler Signature Series	US6231
2.4L L4 2429cc 148 CID	2004	Base, LX	US7156	3.8L V6 3800cc 231 CID	2010	LX	US6231
2.4L L4 2429cc 148 CID	2005-2006	Base	US7156	4.0L V6 3952cc 241 CID	2008-2009	Limited	US8951
2.5L V6 2497cc 152 CID	1995	LX, LXi	US7152	4.0L V6 3952cc 241 CID	2010	Limited, Touring	US8951
2.5L V6 2497cc 152 CID	1996-2000	JX, JXi, LX, LXi	US7152	5.2L V8 318 CID	1978-1979	Air Pump	US1053
2.7L V6 2736cc 167 CID	2001	LX, LXi, LXi Limited	US7161	5.2L V8 318 CID	1978-1979	Air Pump, High performance	US1053H
2.7L V6 2736cc 167 CID	2002-2003	GTC, Limited, LX, LXi	US7161	5.2L V8 318 CID	1980-1981	Base	US1053
2.7L V6 2736cc 167 CID	2004	Base, GTC, Limited, Touring	US7161	5.2L V8 318 CID	1980-1981	Base; High performance	US1053H
2.7L V6 2736cc 167 CID	2005-2006	GTC, Limited, Touring, TSi	US7161	5.9L V8 360 CID	1978-1979	Air Pump	US1053
2.7L V6 2736cc 167 CID	2007	Base, Touring	US7161	5.9L V8 360 CID	1978-1979	Air Pump, High performance	US1053H
2.7L V6 2736cc 167 CID	2008	Touring	US6217	VOLARE			
2.7L V6 2736cc 167 CID	2009-2010	LX, Touring	US6217	3.7L L6 3700cc 225 CID	1986-1989	Mexican Application	US7100
3.0L V6 2972cc 181 CID	2001-2002	LX, LXi	US7152	VOYAGER			
3.0L V6 2972cc 181 CID	2003	LX	US7152	2.4L L4 2426cc 148 CID	1996-1997	Mexican Application	US7156
3.0L V6 2972cc 181 CID	2004-2005	Limited	US7152	2.4L L4 2429cc 148 CID	2000-2001	Base	US7156
3.5L V6 3497cc 215 CID	2007-2010	Limited	US8951	2.4L L4 2429cc 148 CID	2002	Base, LX	US7156
SHADOW				2.4L L4 2429cc 148 CID	2003	LX	US7156
2.2L L4 2212cc 135 CID	1989	Mexican Application	US7122	2.5L L4 2507cc 153 CID	1990-1995	Mexican Application	US7127
2.2L L4 2212cc 135 CID	1990-1991	Mexican Application	US7127	3.0L V6 2966cc 181 CID	1992-1994	Mexican Application	US7121
2.5L L4 2507cc 153 CID	1988	Mexican Application	US7110	3.0L V6 2966cc 181 CID	1996-1997	Mexican Application	US7121
2.5L L4 2507cc 153 CID	1989	Mexican Application	US7122	3.0L V6 2972cc 181 CID	2000	Base	US7121
2.5L L4 2507cc 153 CID	1990-1994	Mexican Application	US7127	3.0L V6 2972cc 181 CID	2000	Base; With back plate housing	US7121-2
3.0L V6 2966cc 181 CID	1992	Mexican Application	US7121	3.3L V6 3294cc 201 CID	1993-1999	Mexican Application	US7126
SPIRIT				3.3L V6 3294cc 201 CID	2001-2002	Mexican Application	US7165
2.5L L4 2507cc 153 CID	1989	Mexican Application	US7122	3.3L V6 3294cc 201 CID	2004-2008	Mexican Application	US7165
2.5L L4 2507cc 153 CID	1990-1995	Mexican Application	US7127	3.3L V6 3301cc 201 CID	2000	Base, SE	US7126
3.0L V6 2966cc 181 CID	1989-1992	Mexican Application	US7121	3.3L V6 3301cc 201 CID	2001-2002	Base, LX	US7165
STRATUS				3.3L V6 3301cc 201 CID	2003	LX	US7165
2.4L L4 2429cc 148 CID	1996-1997	Mexican Application	US7156	DAEWOO			
TC MASERATI				LANOS			
2.2L L4 135 CID	1989	Base	US7122	1.6L L4 1588cc 98 CID	1999-2000	S, SE, SX	US8917
2.2L L4 135 CID	1990	Base	US7110	1.6L L4 1588cc 98 CID	2001-2002	S, Sport	US8917
2.2L L4 135 CID	1990	Base; High performance	US7110H	LEGANZA			
3.0L V6 2972cc 181 CID	1990-1991	Base	US7121	2.2L L4 2200cc	1999-2001	CDX, SE, SX	US9375
3.0L V6 2972cc 181 CID	1990-1991	Base; With back plate housing	US7121-2	2.2L L4 2200cc	2002	CDX, SE	US9375
TOWN & COUNTRY				NUBIRA			
2.2L L4 135 CID	1982	Base	US7110	2.0L L4 1998cc	1999	CDX, SX	US9375
2.2L L4 135 CID	1982	Base; High performance	US7110H	2.0L L4 1998cc	2000-2002	CDX, SE	US9375
2.2L L4 135 CID	1983-1986	Base, Mark Cross	US7110	DAIHATSU			
2.2L L4 135 CID	1983-1986	Base, Mark Cross; High performance	US7110H	CHARADE			
2.2L L4 135 CID	1987-1988	Base	US7110	1.0L L3 993cc 61 CID	1988	CLS, CLX, CSX	US9238
2.2L L4 135 CID	1987-1988	Base; High performance	US7110H	1.0L L3 993cc 61 CID	1989	CES, CLS, CLX	US9238
2.5L L4 2507cc 153 CID	1986	Base, Mark Cross	US7110				
2.5L L4 2507cc 153 CID	1986	Base, Mark Cross; High performance	US7110H				

WATER PUMPS

Engine	Years	Application Description	USMW
DAIHATSU (cont'd.)			
CHARADE (cont'd.)			
1.0L L3 993cc 61 CID	1990	SE, SX	US9238
1.0L L3 993cc 61 CID	1991-1992	SE	US9238
1.3L L4 1295cc	1989	CLS, CLX	US9237
1.3L L4 1295cc	1990-1992	SE, SX	US9237
ROCKY			
1.6L L4 1589cc	1990-1992	SE, SX	US8908
DODGE			
330			
4.5L V8 4473cc 273 CID	1964		US919
5.2L V8 5212cc 318 CID	1963-1964		US919
400			
2.2L L4 135 CID	1982	Base, LS	US7110
2.2L L4 135 CID	1982	Base, LS; High performance	US7110H
2.2L L4 135 CID	1983	Base	US7110
2.2L L4 135 CID	1983	Base; High performance	US7110H
2.6L L4 2555cc 156 CID	1982	Base, LS	US7111
2.6L L4 2555cc 156 CID	1983	Base	US7111
440			
5.2L V8 5212cc 318 CID	1963-1964		US919
600			
2.2L L4 135 CID	1983	Base, ES	US7110
2.2L L4 135 CID	1983	Base, ES; High performance	US7110H
2.2L L4 135 CID	1984	Base	US7110
2.2L L4 135 CID	1984	Base; High performance	US7110H
2.2L L4 135 CID	1985	Base, ES, SE	US7110
2.2L L4 135 CID	1985	Base, ES, SE; High performance	US7110H
2.2L L4 135 CID	1986-1988	Base, SE	US7110
2.2L L4 135 CID	1986-1988	Base, SE; High performance	US7110H
2.5L L4 2507cc 153 CID	1986-1988	Base, SE	US7110
2.5L L4 2507cc 153 CID	1986-1988	Base, SE; High performance	US7110H
2.6L L4 2555cc 156 CID	1983-1984	Base, ES	US7111
2.6L L4 2555cc 156 CID	1985	Base, SE	US7111
A100			
4.5L V8 4473cc 273 CID	1964-1966		US919
A100 TRUCK			
4.5L V8 273 CID	1964-1967		US919
5.2L V8 318 CID	1967-1969		US919
ARIES			
2.2L L4 135 CID	1981-1984	Base, Custom, SE	US7110
2.2L L4 135 CID	1981-1984	Base, Custom, SE; High performance	US7110H
2.2L L4 135 CID	1985-1986	Base, LE, SE	US7110
2.2L L4 135 CID	1985-1986	Base, LE, SE; High performance	US7110H
2.2L L4 135 CID	1987	Base, LE	US7110
2.2L L4 135 CID	1987	Base, LE; High performance	US7110H
2.2L L4 135 CID	1988	America	US7110
2.2L L4 135 CID	1988	America; High performance	US7110H
2.2L L4 135 CID	1989	America	US7122
2.5L L4 2507cc 153 CID	1986	LE, SE	US7110
2.5L L4 2507cc 153 CID	1986	LE, SE; High performance	US7110H
2.5L L4 2507cc 153 CID	1987	LE	US7110
2.5L L4 2507cc 153 CID	1987	LE; High performance	US7110H
2.5L L4 2507cc 153 CID	1988	America	US7110
2.5L L4 2507cc 153 CID	1988	America; High performance	US7110H
2.5L L4 2507cc 153 CID	1989	America	US7122
2.6L L4 2555cc 156 CID	1981-1984	Base, Custom, SE	US7111
2.6L L4 2555cc 156 CID	1985	LE, SE	US7111
ASPEN			
3.7L L6 3687cc 225 CID	1976-1979		US7100
3.7L L6 3687cc 225 CID	1980	Base	US7100
5.2L V8 318 CID	1976-1978	Exc.Air Pump	US1053
5.2L V8 318 CID	1976-1978	Exc.Air Pump, High performance	US1053H
5.2L V8 318 CID	1976-1979	Air Pump	US1053
5.2L V8 318 CID	1976-1979	Air Pump, High performance	US1053H
5.2L V8 318 CID	1980	Base	US1053
5.2L V8 318 CID	1980	Base; High performance	US1053H
5.9L V8 360 CID	1976-1978	Exc.Air Pump	US1053
5.9L V8 360 CID	1976-1978	Exc.Air Pump, High performance	US1053H
5.9L V8 360 CID	1976-1979	Air Pump	US1053
5.9L V8 360 CID	1976-1979	Air Pump, High performance	US1053H
5.9L V8 360 CID	1980	Base	US1053
5.9L V8 360 CID	1980	Base; High performance	US1053H
ATOS			
1.0L L4 1000cc 61 CID	2001-2004		US8935
1.1L L4 1086cc 66 CID	2005-2012		US8935
ATTITUDE			
1.2L L3 1193cc 73 CID	2015-2018	SE, SXT	US8143
1.4L L4 1388cc 85 CID	2006-2010	Mexican Application	US7115
1.4L L4 1399cc 85 CID	2011	Mexican Application	US7115
1.6L L4 1598cc 97 CID	2006-2010	Mexican Application	US9364

Engine	Years	Application Description	USMW
DODGE (cont'd.)			
ATTITUDE (cont'd.)			
1.6L L4 1599cc 98 CID	2011	Mexican Application	US9364
1.6L L4 1599cc 98 CID	2012	Mexican Application	US7115
AVENGER			
2.0L L4 1996cc 122 CID	1995	Base	US7150
2.0L L4 1996cc 122 CID	1996-1999	Base, ES	US7150
2.0L L4 2000cc 122 CID	2008-2010	Mexican Application	US6038
2.4L L4 2360cc 144 CID	2008-2009	SE, SXT	US6038
2.4L L4 2360cc 144 CID	2010	Express, R/T, SXT	US6038
2.4L L4 2360cc 144 CID	2010-2011	Mexican Application	US6038
2.4L L4 2360cc 144 CID	2011	Express, Lux, Mainstreet	US6038
2.4L L4 2360cc 144 CID	2012-2014	SE, SXT	US6038
2.4L L4 2360cc 144 CID	2013-2014	Mexican Application	US6038
2.5L V6 2497cc 152 CID	1995-1996	ES	US7152
2.5L V6 2497cc 152 CID	1997-2000	Base, ES	US7152
2.7L V6 2736cc 167 CID	2008-2009	SE, SXT	US6217
2.7L V6 2736cc 167 CID	2010	R/T, SXT	US6217
3.5L V6 3497cc 215 CID	2008-2010	R/T	US8951
3.6L V6 3604cc 220 CID	2011	Express, Heat, Lux, Mainstreet	US8981
3.6L V6 3604cc 220 CID	2012	R/T, SE, SXT Plus	US8981
3.6L V6 3604cc 220 CID	2013-2014	R/T, SE, SXT	US8981
B100			
3.7L L6 3687cc 225 CID	1975-1979		US7100
3.7L L6 3687cc 225 CID	1980	Base	US7100
5.2L V8 5211cc 318 CID	1975-1978	Exc.Air Pump	US1053
5.2L V8 5211cc 318 CID	1975-1978	Exc.Air Pump, High performance	US1053H
5.2L V8 5211cc 318 CID	1975-1979	Air Pump	US1053
5.2L V8 5211cc 318 CID	1975-1979	Air Pump, High performance	US1053H
5.2L V8 5211cc 318 CID	1980	Base	US1053
5.2L V8 5211cc 318 CID	1980	Base; High performance	US1053H
5.9L V8 360 CID	1976-1978	Air Pump	US1053
5.9L V8 360 CID	1976-1978	Exc.Air Pump	US1053
5.9L V8 360 CID	1976-1978	Air Pump, High performance	US1053H
5.9L V8 360 CID	1976-1978	Exc.Air Pump, High performance	US1053H
B150			
3.7L L6 3687cc 225 CID	1981-1987	Base	US7100
3.9L V6 3906cc 239 CID	1988-1991	Base	US1053
3.9L V6 3906cc 239 CID	1988-1991	Base; High performance	US1053H
3.9L V6 3906cc 239 CID	1992	Base	US7159
3.9L V6 3906cc 239 CID	1993-1994	Base	US7160
5.2L V8 5211cc 318 CID	1981-1991	Base	US1053
5.2L V8 5211cc 318 CID	1981-1991	Base; High performance	US1053H
5.2L V8 5211cc 318 CID	1992	Base	US7159
5.2L V8 5211cc 318 CID	1993-1994	Base	US7160
B200			
3.7L L6 225 CID	1979		US7100
3.7L L6 3687cc 225 CID	1975-1978		US7100
3.7L L6 3687cc 225 CID	1980	Base	US7100
5.2L V8 5211cc 318 CID	1975-1978	Exc.Air Pump	US1053
5.2L V8 5211cc 318 CID	1975-1978	Exc.Air Pump, High performance	US1053H
5.2L V8 5211cc 318 CID	1975-1979	Air Pump	US1053
5.2L V8 5211cc 318 CID	1975-1979	Air Pump, High performance	US1053H
5.2L V8 5211cc 318 CID	1980	Base	US1053
5.2L V8 5211cc 318 CID	1980	Base; High performance	US1053H
5.9L V8 360 CID	1975-1978	Exc.Air Pump	US1053
5.9L V8 360 CID	1975-1978	Exc.Air Pump, High performance	US1053H
5.9L V8 360 CID	1975-1979	Air Pump	US1053
5.9L V8 360 CID	1975-1979	Air Pump, High performance	US1053H
5.9L V8 360 CID	1980	Base	US1053
5.9L V8 360 CID	1980	Base; High performance	US1053H
6.6L V8 400 CID	1976-1978		US1040
7.2L V8 440 CID	1975-1978		US1040
B250			
3.7L L6 3687cc 225 CID	1981-1987	Base	US7100
3.9L V6 3906cc 239 CID	1988-1991	Base	US1053
3.9L V6 3906cc 239 CID	1988-1991	Base; High performance	US1053H
3.9L V6 3906cc 239 CID	1992	Base	US7159
3.9L V6 3906cc 239 CID	1993-1994	Base	US7160
5.2L V8 5211cc 318 CID	1981-1991	Base	US1053
5.2L V8 5211cc 318 CID	1981-1991	Base; High performance	US1053H
5.2L V8 5211cc 318 CID	1992	Base	US7159
5.2L V8 5211cc 318 CID	1993-1994	Base	US7160
5.9L V8 360 CID	1981	Base	US1053
5.9L V8 360 CID	1981	Base; High performance	US1053H
5.9L V8 360 CID	1984-1992	Base	US1053
5.9L V8 360 CID	1984-1992	Base; High performance	US1053H
5.9L V8 360 CID	1993-1994	Base	US7160
B300			
3.7L L6 225 CID	1980	Base	US7100
3.7L L6 3687cc 225 CID	1975-1979		US7100
5.2L V8 5211cc 318 CID	1975-1978	Exc.Air Pump	US1053
5.2L V8 5211cc 318 CID	1975-1978	Exc.Air Pump, High performance	US1053H
5.2L V8 5211cc 318 CID	1975-1979	Air Pump	US1053
5.2L V8 5211cc 318 CID	1975-1979	Air Pump, High performance	US1053H

Engine	Years	Application Description	USMW
DODGE (cont'd.)			
B300 (cont'd.)			
5.2L V8 5211cc 318 CID	1980	Base	US1053
5.2L V8 5211cc 318 CID	1980	Base; High performance	US1053H
5.9L V8 360 CID	1975-1978	Exc.Air Pump	US1053
5.9L V8 360 CID	1975-1978	Exc.Air Pump, High performance	US1053H
5.9L V8 360 CID	1975-1979	Air Pump	US1053
5.9L V8 360 CID	1975-1979	Air Pump, High performance	US1053H
5.9L V8 360 CID	1980	Base	US1053
5.9L V8 360 CID	1980	Base; High performance	US1053H
6.6L V8 400 CID	1976-1978		US1040
7.2L V8 440 CID	1975-1978		US1040
B350			
5.2L V8 5211cc 318 CID	1981-1991	Base	US1053
5.2L V8 5211cc 318 CID	1981-1991	Base; High performance	US1053H
5.2L V8 5211cc 318 CID	1992	Base	US7159
5.2L V8 5211cc 318 CID	1993-1994	Base	US7160
5.9L V8 360 CID	1981-1992	Base	US1053
5.9L V8 360 CID	1981-1992	Base; High performance	US1053H
5.9L V8 360 CID	1993-1994	Base	US7160
B1500			
3.9L V6 3906cc 239 CID	1995-1998	Base	US7160
5.2L V8 5211cc 318 CID	1995-1998	Base	US7160
5.9L V8 360 CID	1998	Base	US7160
B2500			
3.9L V6 3906cc 239 CID	1995-1997	Base	US7160
5.2L V8 5211cc 318 CID	1995-1998	Base	US7160
5.9L V8 360 CID	1995-1998	Base	US7160
B3500			
5.2L V8 5211cc 318 CID	1995-1998	Base	US7160
5.9L V8 360 CID	1995-1998	Base	US7160
CALIBER			
1.8L L4 1798cc 110 CID	2007-2009	SE, SXT	US6038
2.0L L4 1998cc 122 CID	2007-2009	SE, SXT	US6038
2.0L L4 1998cc 122 CID	2010	Express, Heat, Mainstreet, SE, SXT, Uptown	US6038
2.0L L4 1998cc 122 CID	2011	Express, Heat, Mainstreet, Uptown	US6038
2.0L L4 1998cc 122 CID	2012	SE, SXT, SXT Plus	US6038
2.4L L4 2360cc 144 CID	2007	R/T	US6038
2.4L L4 2360cc 144 CID	2008-2009	R/T, SRT-4	US6038
2.4L L4 2360cc 144 CID	2010	R/T, Rush	US6038
2.4L L4 2360cc 144 CID	2010-2011	Mexican Application	US6038
2.4L L4 2360cc 144 CID	2011	Rush, Uptown	US6038
CARAVAN			
2.2L L4 135 CID	1984-1987	Base, LE, SE	US7110
2.2L L4 135 CID	1984-1987	Base, LE, SE; High performance	US7110H
2.4L L4 2429cc 148 CID	1996	Base, SE; Hydraulic Tensioner	US7153
2.4L L4 2429cc 148 CID	1996	Base, SE; Mechanical Tensioner	US7156
2.4L L4 2429cc 148 CID	1997	Base, SE	US7156
2.4L L4 2429cc 148 CID	1998-1999	Base, ES	US7156
2.4L L4 2429cc 148 CID	2000	Base	US7156
2.4L L4 2429cc 148 CID	2001	SE	US7156
2.4L L4 2429cc 148 CID	2002	Ec, SE	US7156
2.4L L4 2429cc 148 CID	2003-2007	SE	US7156
2.5L L4 2507cc 153 CID	1988	Base, LE, SE	US7110
2.5L L4 2507cc 153 CID	1988	Base, LE, SE; High performance	US7110H
2.5L L4 2507cc 153 CID	1989	Base, C/V, LE, SE	US7122
2.5L L4 2507cc 153 CID	1990	Base, C/V, ES, LE, SE	US7127
2.5L L4 2507cc 153 CID	1991	Base, C/V, LE, SE	US7127
2.5L L4 2507cc 153 CID	1992	Base, C/V, ES, SE	US7127
2.5L L4 2507cc 153 CID	1993	Base, C/V, SE	US7127
2.5L L4 2507cc 153 CID	1994-1995	Base, C/V	US7127
2.6L L4 2555cc 156 CID	1984-1987	Base, LE, SE	US7111
3.0L V6 2972cc 181 CID	1987-1988	LE, SE	US7121
3.0L V6 2972cc 181 CID	1987-1988	LE, SE; With back plate housing	US7121-2
3.0L V6 2972cc 181 CID	1989	C/V, LE, SE	US7121
3.0L V6 2972cc 181 CID	1989	C/V, LE, SE; With back plate housing	US7121-2
3.0L V6 2972cc 181 CID	1990	Base, C/V, ES, LE, SE	US7121
3.0L V6 2972cc 181 CID	1990	Base, C/V, ES, LE, SE; With back plate housing	US7121-2
3.0L V6 2972cc 181 CID	1991	C/V, ES, LE, SE	US7121
3.0L V6 2972cc 181 CID	1991	C/V, ES, LE, SE; With back plate housing	US7121-2
3.0L V6 2972cc 181 CID	1992-1995	Base, C/V, ES, LE, SE	US7121
3.0L V6 2972cc 181 CID	1992-1995	Base, C/V, ES, LE, SE; With back plate housing	US7121-2
3.0L V6 2972cc 181 CID	1996-1997	Base, SE	US7121
3.0L V6 2972cc 181 CID	1996-1997	Base, SE; With back plate housing	US7121-2
3.0L V6 2972cc 181 CID	1998	Base, ES, LE, SE, Sport	US7121
3.0L V6 2972cc 181 CID	1998	Base, ES, LE, SE, Sport; With back plate housing	US7121-2
3.0L V6 2972cc 181 CID	1999	Base, ES, LE	US7121
3.0L V6 2972cc 181 CID	1999	Base, ES, LE; With back plate housing	US7121-2
3.0L V6 2972cc 181 CID	2000	Base, SE, Sport	US7121
3.0L V6 2972cc 181 CID	2000	Base, SE, Sport; With back plate housing	US7121-2

Engine	Years	Application Description	USMW
DODGE (cont'd.)			
CARAVAN (cont'd.)			
3.3L V6 3301cc 201 CID	1991-1993	C/V, ES, LE, SE	US7126
3.3L V6 3301cc 201 CID	1994-1995	Base, C/V, ES, LE, SE	US7126
3.3L V6 3301cc 201 CID	1996	ES, LE, SE	US7126
3.3L V6 3301cc 201 CID	1997	Base, ES, LE, SE	US7126
3.3L V6 3301cc 201 CID	1998-1999	Base, ES, LE, SE, Sport	US7126
3.3L V6 3301cc 201 CID	2000	Base, SE, Sport	US7126
3.3L V6 3301cc 201 CID	2001-2002	SE, Sport	US7165
3.3L V6 3301cc 201 CID	2003	C/V, SE, Sport	US7165
3.3L V6 3301cc 201 CID	2004	C/V, SXT	US7165
3.3L V6 3301cc 201 CID	2005	C/V, SE, SXT	US7165
3.3L V6 3301cc 201 CID	2006-2007	Base, SE, SXT	US7165
3.8L V6 230 CID	1996-1997	ES, LE	US7126
3.8L V6 230 CID	1998	Base, ES, LE, SE, Sport	US7126
3.8L V6 230 CID	1999	ES, LE, SE, Sport	US7126
CB300			
5.2L V8 5211cc 318 CID	1980	Base	US1053
5.2L V8 5211cc 318 CID	1980	Base; High performance	US1053H
5.9L V8 360 CID	1980	Base	US1053
5.9L V8 360 CID	1980	Base; High performance	US1053H
CHALLENGER			
1.6L L4 1597cc 98 CID	1978-1979		US7105
2.6L L4 2555cc 156 CID	1978-1979		US7120
2.6L L4 2555cc 156 CID	1980-1983	Base, Premium	US7120
3.5L V6 3497cc 215 CID	2009-2010	SE	US8951
3.6L V6 3604cc 220 CID	2011	SE	US8981
3.6L V6 3604cc 220 CID	2012	SXT, SXT Plus	US8981
3.6L V6 3604cc 220 CID	2013	SXT	US8981
3.6L V6 3604cc 220 CID	2013-2016	Mexican Application	US8981
3.6L V6 3604cc 220 CID	2014	Rallye Redline, SXT	US8981
3.6L V6 3604cc 220 CID	2015-2016	SXT, SXT Plus	US8981
3.6L V6 3604cc 220 CID	2017-2018	GT, SXT, SXT Plus	US8981
5.7L V8 345 CID	2009-2010	R/T	US8979
5.7L V8 345 CID	2011	R/T	US8971
5.7L V8 345 CID	2012	R/T, R/T Classic	US8971
5.7L V8 345 CID	2013	R/T; From 03/04/2013	US8115
5.7L V8 345 CID	2013	R/T; To 03/04/2013	US8971
5.7L V8 345 CID	2013-2014	R/T	US8115
5.7L V8 345 CID	2015	R/T, R/T Plus	US8115
5.7L V8 345 CID	2016	R/T, R/T Plus, R/T Plus Shaker, R/T Shaker	US8115
5.7L V8 345 CID	2017-2018	R/T, T/A	US8115
6.1L V8 6059cc 370 CID	2008-2010	SRT8	US8940
6.4L V8 6424cc 392 CID	2011-2013	SRT8	US8971
6.4L V8 6424cc 392 CID	2014	SRT8	US8115
6.4L V8 6424cc 392 CID	2015	Scat Pack, SRT 392	US8115
6.4L V8 6424cc 392 CID	2016	392 Hemi Scat Pack Shaker, R/T Scat Pack, SRT 392	US8115
6.4L V8 6424cc 392 CID	2017-2018	R/T 392, SRT 392, T/A 392	US8115
CHARGER			
1.6L L4 1595cc 97 CID	1984	Base	US7113
2.2L L4 135 CID	1984	Shelby	US7110
2.2L L4 135 CID	1984	Shelby; High performance	US7110H
2.2L L4 135 CID	1985-1986	2.2, Shelby	US7110
2.2L L4 135 CID	1985-1986	2.2, Shelby; High performance	US7110H
2.2L L4 135 CID	1987	Base, Shelby	US7110
2.2L L4 135 CID	1987	Base, Shelby; High performance	US7110H
2.7L V6 2736cc 167 CID	2006	Base	US7161
2.7L V6 2736cc 167 CID	2007	Base, SE	US7161
2.7L V6 2736cc 167 CID	2008-2010	SE	US6217
3.5L V6 3497cc 215 CID	2006-2010	SE, SXT	US8951
3.6L V6 3604cc 220 CID	2011	SE	US8981
3.6L V6 3604cc 220 CID	2012	SE, SXT, SXT Plus	US8981
3.6L V6 3604cc 220 CID	2013	SE, SXT	US8981
3.6L V6 3604cc 220 CID	2014-2017	Pursuit, SE, SXT	US8981
3.6L V6 3604cc 220 CID	2018	GT, GT Plus, Pursuit, SXT, SXT Plus, SXT Plus Leather	US8981
3.7L L6 3687cc 225 CID	1976		US7100
4.5L V8 4473cc 273 CID	1967		US919
5.2L V8 318 CID	1967-1969		US919
5.2L V8 318 CID	1975-1978	Air Pump	US1053
5.2L V8 318 CID	1975-1978	Exc.Air Pump	US1053
5.2L V8 318 CID	1975-1978	Air Pump, High performance	US1053H
5.2L V8 318 CID	1975-1978	Exc.Air Pump, High performance	US1053H
5.2L V8 5200cc 318 CID	1970-1971	Mexican Application	US1053
5.2L V8 5212cc 318 CID	1966-1969		US919
5.7L V8 345 CID	2006	Daytona R/T, R/T	US8940
5.7L V8 345 CID	2007	R/T	US8940
5.7L V8 345 CID	2008	R/T, SE	US8940
5.7L V8 345 CID	2009-2010	R/T, SE	US8979
5.7L V8 345 CID	2011-2012	R/T, SE	US8971
5.7L V8 345 CID	2013	Pursuit, R/T, SE	US8115
5.7L V8 345 CID	2014	Pursuit, R/T	US8115
5.7L V8 345 CID	2015-2016	Pursuit, R/T, R/T Road & Track	US8115
5.7L V8 345 CID	2017-2018	Daytona, Pursuit, R/T	US8115
5.9L V8 360 CID	1975-1978	Air Pump	US1053

WATER PUMPS

Engine	Years	Application Description	USMW
DODGE (cont'd.)			
CHARGER (cont'd.)			
5.9L V8 360 CID	1975-1978	Exc.Air Pump	US1053
5.9L V8 360 CID	1975-1978	Air Pump, High performance	US1053H
5.9L V8 360 CID	1975-1978	Exc.Air Pump, High performance	US1053H
5.9L V8 5900cc 360 CID	1972	Mexican Application	US1053
6.1L V8 6059cc 370 CID	2006-2010	SRT8	US8940
6.4L V8 6424cc 392 CID	2012	SRT8	US8971
6.4L V8 6424cc 392 CID	2014	SRT8	US8115
6.4L V8 6424cc 392 CID	2015-2016	R/T Scat Pack, SRT 392	US8115
6.4L V8 6424cc 392 CID	2017-2018	Daytona 392, R/T 392, SRT 392	US8115
6.6L V8 400 CID	1975-1978		US1040
CHARGER SXT			
3.6L V6 3604cc 220 CID	2011	Mexican Application	US8981
COLT			
1.4L L4 1410cc	1979		US7106
1.4L L4 1410cc	1980	Base	US7106
1.4L L4 1410cc	1981	Base	US7115
1.4L L4 1410cc	1982-1983	Base, Deluxe	US7115
1.4L L4 1410cc	1984	DL, E	US7115
1.5L L4 1468cc 90 CID	1985-1987	DL, E, Premier	US7115
1.5L L4 1468cc 90 CID	1988	Base, DL, E, Premier	US7115
1.5L L4 1468cc 90 CID	1989	Base, DL, E, GT	US7115
1.5L L4 1468cc 90 CID	1990	Base, DL, GL, GT	US7115
1.5L L4 1468cc 90 CID	1991-1993	Base, GL	US7115
1.5L L4 1468cc 90 CID	1994	Base, ES	US7115
1.6L L4 1597cc 98 CID	1975-1977		US1012
1.6L L4 1597cc 98 CID	1978		US7105
1.6L L4 1597cc 98 CID	1979		US7104
1.6L L4 1597cc 98 CID	1980	Base, Custom	US7104
1.6L L4 1597cc 98 CID	1981	Custom	US7108
1.6L L4 1597cc 98 CID	1982	Custom, Deluxe	US7108
1.6L L4 1597cc 98 CID	1983	Base, Custom, Deluxe	US7108
1.6L L4 1597cc 98 CID	1984	DL, E	US7108
1.6L L4 1597cc 98 CID	1985-1986	DL, Premier	US7108
1.6L L4 1597cc 98 CID	1987-1988	Premier	US7108
1.6L L4 1597cc 98 CID	1989-1990	GT	US7131
1.8L L4 1754cc 107 CID	1989-1990	DL	US7108
1.8L L4 1834cc 112 CID	1993	Base, GL	US7135
1.8L L4 1834cc 112 CID	1994	Base, ES	US7135
2.0L L4 1995cc 122 CID	1975		US1124
2.0L L4 1995cc 122 CID	1976-1977		US7120
2.0L L4 1995cc 122 CID	1984	Vista	US7118
2.0L L4 1997cc 122 CID	1985	Vista	US7118
2.0L L4 1997cc 122 CID	1986	Vista, Vista Custom	US7118
2.0L L4 1997cc 122 CID	1987-1991	Vista	US7118
2.6L L4 2555cc 156 CID	1978-1979		US7120
2.6L L4 2555cc 156 CID	1980	Base	US7120
CONQUEST			
2.6L L4 2555cc 156 CID	1984	Base	US7115
2.6L L4 2555cc 156 CID	1985-1986	Base	US7120
CORONET			
3.7L L6 3687cc 225 CID	1975-1976		US7100
3.7L L6 3700cc 225 CID	1965-1970	Mexican Application	US7100
4.5L V8 273 CID	1965-1968		US919
4.5L V8 4473cc 273 CID	1965-1968		US919
5.2L V8 318 CID	1965-1969		US919
5.2L V8 318 CID	1975-1976	Air Pump	US1053
5.2L V8 318 CID	1975-1976	Exc.Air Pump	US1053
5.2L V8 318 CID	1975-1976	Air Pump, High performance	US1053H
5.2L V8 318 CID	1975-1976	Exc.Air Pump, High performance	US1053H
5.2L V8 5200cc 318 CID	1970-1971	Mexican Application	US1053
5.2L V8 5212cc 318 CID	1965-1969		US919
5.9L V8 360 CID	1975-1976	Air Pump	US1053
5.9L V8 360 CID	1975-1976	Exc.Air Pump	US1053
5.9L V8 360 CID	1975-1976	Air Pump, High performance	US1053H
5.9L V8 360 CID	1975-1976	Exc.Air Pump, High performance	US1053H
6.6L V8 400 CID	1975-1976		US1040
7.2L V8 440 CID	1975-1976		US1040
D50			
2.0L L4 1995cc 122 CID	1979		US7120
2.0L L4 1995cc 122 CID	1980	Base	US7120
2.0L L4 1997cc 122 CID	1981-1982	Custom	US7120
2.6L L4 2555cc 156 CID	1979		US7120
2.6L L4 2555cc 156 CID	1980	Sport	US7120
2.6L L4 2555cc 156 CID	1981	Royal, Sport	US7120
2.6L L4 2555cc 156 CID	1982	Custom, Royal, Sport	US7120
D100			
3.7L L6 3687cc 225 CID	1975-1979		US7100
3.7L L6 3687cc 225 CID	1985-1987	Custom	US7100
3.7L L6 3700cc 225 CID	1970-1974	Mexican Application	US7100
3.9L V6 3906cc 239 CID	1988-1989	Custom	US1053
3.9L V6 3906cc 239 CID	1988-1989	Custom; High performance	US1053H
5.2L V8 5211cc 318 CID	1975-1978	Exc.Air Pump	US1053
5.2L V8 5211cc 318 CID	1975-1978	Exc.Air Pump, High performance	US1053H

Engine	Years	Application Description	USMW
DODGE (cont'd.)			
D100 (cont'd.)			
5.2L V8 5211cc 318 CID	1975-1979	Air Pump	US1053
5.2L V8 5211cc 318 CID	1975-1979	Air Pump, High performance	US1053H
5.2L V8 5211cc 318 CID	1985-1989	Custom	US1053
5.2L V8 5211cc 318 CID	1985-1989	Custom; High performance	US1053H
5.9L V8 360 CID	1975-1978	Exc.Air Pump	US1053
5.9L V8 360 CID	1975-1978	Exc.Air Pump, High performance	US1053H
5.9L V8 360 CID	1975-1979	Air Pump	US1053
5.9L V8 360 CID	1975-1979	Air Pump, High performance	US1053H
5.9L V8 360 CID	1985-1988	Custom	US1053
5.9L V8 360 CID	1985-1988	Custom; High performance	US1053H
6.6L V8 400 CID	1976-1978		US1040
7.2L V8 440 CID	1975-1978		US1040
D100 PICKUP			
3.8L L6 3770cc 230 CID	1958-1959		US713
5.2L V8 318 CID	1968-1969		US919
5.2L V8 5212cc 318 CID	1968-1969		US919
D100 SERIES			
5.2L V8 5212cc 318 CID	1960-1967		US919
D150			
3.7L L6 3687cc 225 CID	1977-1979		US7100
3.7L L6 3687cc 225 CID	1980-1981	Base	US7100
3.7L L6 3687cc 225 CID	1982-1983	Base, Miser	US7100
3.7L L6 3687cc 225 CID	1984-1987	Base	US7100
3.7L L6 3700cc 225 CID	1980	Mexican Application	US7100
3.7L L6 3700cc 225 CID	1988-1990	Mexican Application	US7100
3.9L V6 3906cc 239 CID	1988-1989	Base	US1053
3.9L V6 3906cc 239 CID	1988-1989	Base; High performance	US1053H
3.9L V6 3906cc 239 CID	1990-1991	Base, S	US1053
3.9L V6 3906cc 239 CID	1990-1991	Base, S; High performance	US1053H
3.9L V6 3906cc 239 CID	1992	Base	US7159
3.9L V6 3906cc 239 CID	1993	Base	US7160
5.2L V8 5211cc 318 CID	1977-1978	Exc.Air Pump	US1053
5.2L V8 5211cc 318 CID	1977-1978	Exc.Air Pump, High performance	US1053H
5.2L V8 5211cc 318 CID	1977-1979	Air Pump	US1053
5.2L V8 5211cc 318 CID	1977-1979	Air Pump, High performance	US1053H
5.2L V8 5211cc 318 CID	1980-1981	Base	US1053
5.2L V8 5211cc 318 CID	1980-1981	Base; High performance	US1053H
5.2L V8 5211cc 318 CID	1982-1983	Base, Miser	US1053
5.2L V8 5211cc 318 CID	1982-1983	Base, Miser; High performance	US1053H
5.2L V8 5211cc 318 CID	1984-1989	Base	US1053
5.2L V8 5211cc 318 CID	1984-1989	Base; High performance	US1053H
5.2L V8 5211cc 318 CID	1990-1991	Base, S	US1053
5.2L V8 5211cc 318 CID	1990-1991	Base, S; High performance	US1053H
5.2L V8 5211cc 318 CID	1992	Base	US7159
5.2L V8 5211cc 318 CID	1993	Base	US7160
5.9L V8 360 CID	1977-1978	Exc.Air Pump	US1053
5.9L V8 360 CID	1977-1978	Exc.Air Pump, High performance	US1053H
5.9L V8 360 CID	1977-1979	Air Pump	US1053
5.9L V8 360 CID	1977-1979	Air Pump, High performance	US1053H
5.9L V8 360 CID	1980-1981	Base	US1053
5.9L V8 360 CID	1980-1981	Base; High performance	US1053H
5.9L V8 360 CID	1982	Base, Miser	US1053
5.9L V8 360 CID	1982	Base, Miser; High performance	US1053H
5.9L V8 360 CID	1983		US1053
5.9L V8 360 CID	1983	High performance	US1053H
5.9L V8 360 CID	1984-1991	Base	US1053
5.9L V8 360 CID	1984-1991	Base; High performance	US1053H
5.9L V8 360 CID	1993	Base	US7160
5.9L V8 5900cc 360 CID	1980	Mexican Application	US1053
5.9L V8 5900cc 360 CID	1982-1983	Mexican Application	US1053
5.9L V8 5900cc 360 CID	1989-1990	Mexican Application	US1053
6.6L V8 400 CID	1977-1978		US1040
7.2L V8 440 CID	1978		US1040
D200			
3.7L L6 3687cc 225 CID	1975-1979		US7100
3.7L L6 3687cc 225 CID	1980	Base	US7100
5.2L V8 5211cc 318 CID	1975-1978	Exc.Air Pump	US1053
5.2L V8 5211cc 318 CID	1975-1978	Exc.Air Pump, High performance	US1053H
5.2L V8 5211cc 318 CID	1975-1979	Air Pump	US1053
5.2L V8 5211cc 318 CID	1975-1979	Air Pump, High performance	US1053H
5.2L V8 5211cc 318 CID	1980	Base	US1053
5.2L V8 5211cc 318 CID	1980	Base; High performance	US1053H
5.9L V8 360 CID	1975-1978	Exc.Air Pump	US1053
5.9L V8 360 CID	1975-1978	Exc.Air Pump, High performance	US1053H
5.9L V8 360 CID	1975-1979	Air Pump	US1053
5.9L V8 360 CID	1975-1979	Air Pump, High performance	US1053H
5.9L V8 360 CID	1980	Base	US1053
5.9L V8 360 CID	1980	Base; High performance	US1053H
6.6L V8 400 CID	1975-1978		US1040
7.2L V8 440 CID	1975-1978		US1040
D200 PICKUP			
3.8L L6 3770cc 230 CID	1958-1959		US713
5.2L V8 318 CID	1968-1969		US919

Engine	Years	Application Description	USMW	Engine	Years	Application Description	USMW
DODGE (cont'd.)				DODGE (cont'd.)			
D200 PICKUP (cont'd.)				DAKOTA (cont'd.)			
5.2L V8 5212cc 318 CID	1968-1969		US919	3.9L V6 3906cc 239 CID	1987	Base, LE, SE; High performance	US1053H
D200 SERIES				3.9L V6 3906cc 239 CID	1988-1989	Base, LE, SE, Sport	US1053
5.2L V8 5212cc 318 CID	1960-1967		US919	3.9L V6 3906cc 239 CID	1988-1989	Base, LE, SE, Sport; High performance	US1053H
D250				3.9L V6 3906cc 239 CID	1990-1991	Base, LE, S, SE, Sport	US1053
3.7L L6 3687cc 225 CID	1981-1987	Base	US7100	3.9L V6 3906cc 239 CID	1990-1991	Base, LE, S, SE, Sport; High performance	US1053H
3.9L V6 3906cc 239 CID	1988-1991	Base	US1053	3.9L V6 3906cc 239 CID	1992	Base, LE, S, Sport	US7159
3.9L V6 3906cc 239 CID	1988-1991	Base; High performance	US1053H	3.9L V6 3906cc 239 CID	1993	Base, LE, Sport	US7160
3.9L V6 3906cc 239 CID	1992	Base	US7159	3.9L V6 3906cc 239 CID	1994-1996	Base, SLT, Sport, WS	US7160
3.9L V6 3906cc 239 CID	1993	Base	US7160	3.9L V6 3906cc 239 CID	1997-2001	Base, SLT, Sport	US7160
5.2L V8 5211cc 318 CID	1981-1991	Base	US1053	3.9L V6 3906cc 239 CID	2002	Base, SLT, Sport, SXT	US7160
5.2L V8 5211cc 318 CID	1981-1991	Base; High performance	US1053H	3.9L V6 3906cc 239 CID	2003	Base, SLT, Sport	US7160
5.2L V8 5211cc 318 CID	1992	Base	US7159	4.7L V8 287 CID	2000-2001	Base, SLT, Sport	US7163
5.2L V8 5211cc 318 CID	1993	Base	US7160	4.7L V8 287 CID	2002	Base, SLT, Sport, SXT	US7163
5.9L L6 359 CID	1989-1993	Base	US7145	4.7L V8 287 CID	2003	Base, SLT, Sport	US7163
5.9L L6 359 CID	1989-1993	Base	US7145N	4.7L V8 287 CID	2004	SLT, SLT Plus, Sport, Sport Plus	US7163
5.9L V8 360 CID	1981-1982	Base	US1053	4.7L V8 287 CID	2005	Laramie, SLT, Sport, ST	US7163
5.9L V8 360 CID	1981-1982	Base; High performance	US1053H	4.7L V8 287 CID	2006-2007	Laramie, SLT, ST	US7163
5.9L V8 360 CID	1984-1992	Base	US1053	4.7L V8 287 CID	2008	Laramie, SLT, Sport, SXT, TRX, TRX4	US7163
5.9L V8 360 CID	1984-1992	Base; High performance	US1053H	4.7L V8 287 CID	2009-2010	Big Horn, Laramie, Lone Star, TRX4	US7163
5.9L V8 360 CID	1993	Base; (5)	US7160	5.2L V8 5211cc 318 CID	1989	Shelby	US1053
5.9L V8 360 CID	1993	Base; (Z)	US7160	5.2L V8 5211cc 318 CID	1989	Shelby; High performance	US1053H
5.9L V8 5900cc 360 CID	1989-1990	Mexican Application	US1053	5.2L V8 5211cc 318 CID	1990	Base, LE, SE	US7128
D300				5.2L V8 5211cc 318 CID	1991	Base, LE, S, SE, Sport	US7128
3.7L L6 3687cc 225 CID	1975-1978		US7100	5.2L V8 5211cc 318 CID	1992	Base, LE, S, Sport	US7159
3.7L L6 3700cc 225 CID	1967-1968	Mexican Application	US7100	5.2L V8 5211cc 318 CID	1993	Base, LE, Sport	US7160
3.7L L6 3700cc 225 CID	1978-1979	Mexican Application	US7100	5.2L V8 5211cc 318 CID	1994-1996	Base, SLT, Sport, WS	US7160
5.2L V8 5211cc 318 CID	1975-1978	Exc. Air Pump	US1053	5.2L V8 5211cc 318 CID	1997-1999	Base, SLT, Sport	US7160
5.2L V8 5211cc 318 CID	1975-1978	Exc. Air Pump, High performance	US1053H	5.9L V8 360 CID	1998-1999	R/T	US7160
5.2L V8 5211cc 318 CID	1975-1979	Air Pump	US1053	5.9L V8 360 CID	2000-2003	R/T, SLT, Sport	US7160
5.2L V8 5211cc 318 CID	1975-1979	Air Pump, High performance	US1053H	DART			
5.2L V8 5211cc 318 CID	1980	Base	US1053	1.4L L4 1368cc 83 CID	2013	Aero, Limited, Rallye, SXT	US8136
5.2L V8 5211cc 318 CID	1980	Base; High performance	US1053H	1.4L L4 1368cc 83 CID	2014-2016	Aero	US8136
5.9L V8 360 CID	1975-1978	Exc. Air Pump	US1053	2.0L L4 1995cc 122 CID	2013	Limited, Rallye, SE, SXT	US6038
5.9L V8 360 CID	1975-1978	Exc. Air Pump, High performance	US1053H	2.0L L4 1995cc 122 CID	2014-2016	SE, SXT	US6038
5.9L V8 360 CID	1975-1979	Air Pump	US1053	2.2L L4 2200cc 135 CID	1982-1988	Mexican Application	US7110
5.9L V8 360 CID	1975-1979	Air Pump, High performance	US1053H	2.2L L4 2200cc 135 CID	1989	Mexican Application	US7122
5.9L V8 360 CID	1980	Base	US1053	2.4L L4 2360cc 144 CID	2013	GT, R/T	US6038
5.9L V8 360 CID	1980	Base; High performance	US1053H	2.4L L4 2360cc 144 CID	2014-2016	GT, Limited, SXT	US6038
6.6L V8 400 CID	1976-1978		US1040	3.7L L6 3687cc 225 CID	1975-1976		US7100
7.2L V8 440 CID	1975-1978		US1040	3.7L L6 3687cc 225 CID	1977	Base	US7100
D300 PICKUP				3.7L L6 3700cc 225 CID	1965-1974	Mexican Application	US7100
3.8L L6 3770cc 230 CID	1958-1959		US713	3.7L L6 3700cc 225 CID	1977-1982	Mexican Application	US7100
5.2L V8 318 CID	1968-1969		US919	4.5L V8 273 CID	1964-1969		US919
5.2L V8 5212cc 318 CID	1968-1969		US919	4.5L V8 4473cc 273 CID	1964-1969		US919
D300 SERIES				5.2L V8 318 CID	1960-1962		US919
5.2L V8 5212cc 318 CID	1960-1967		US919	5.2L V8 318 CID	1968-1969		US919
D350				5.2L V8 318 CID	1975-1976	Air Pump	US1053
3.7L L6 3700cc 225 CID	1980-1987	Mexican Application	US7100	5.2L V8 318 CID	1975-1976	Exc. Air Pump	US1053
3.7L L6 3700cc 225 CID	1989-1990	Mexican Application	US7100	5.2L V8 318 CID	1975-1976	Air Pump, High performance	US1053H
5.2L V8 5200cc 318 CID	1980	Mexican Application	US1053	5.2L V8 318 CID	1975-1976	Exc. Air Pump, High performance	US1053H
5.2L V8 5200cc 318 CID	1982	Mexican Application	US1053	5.2L V8 318 CID	1975-1976		US919
5.2L V8 5211cc 318 CID	1981-1983	Base	US1053	5.2L V8 5212cc 318 CID	1960-1962		US919
5.2L V8 5211cc 318 CID	1981-1983	Base; High performance	US1053H	5.6L V8 340 CID	1968-1969		US919
5.9L L6 359 CID	1989-1993	Base	US7145	5.6L V8 340 CID	1968-1969		US919
5.9L L6 359 CID	1989-1993	Base	US7145N	5.6L V8 5572cc 340 CID	1968-1969		US919
5.9L V8 360 CID	1981-1992	Base	US1053	5.9L V8 360 CID	1975-1976	Air Pump	US1053
5.9L V8 360 CID	1981-1992	Base; High performance	US1053H	5.9L V8 360 CID	1975-1976	Exc. Air Pump	US1053
5.9L V8 360 CID	1993	Base	US7160	5.9L V8 360 CID	1975-1976	Air Pump, High performance	US1053H
5.9L V8 360 CID	1993	Base	US7160	5.9L V8 360 CID	1975-1976	Exc. Air Pump, High performance	US1053H
5.9L V8 5900cc 360 CID	1980-1983	Mexican Application	US1053	5.9L V8 360 CID	1982	High performance	US1053
5.9L V8 5900cc 360 CID	1989-1990	Mexican Application	US1053	5.9L V8 360 CID	1982	High performance	US1053H
DAKOTA				5.9L V8 5900cc 360 CID	1977-1978	Mexican Application	US1053
2.2L L4 135 CID	1987	Base, LE, SE	US7110	5.9L V8 5900cc 360 CID	1980-1982	Mexican Application	US1053
2.2L L4 135 CID	1987	Base, LE, SE; High performance	US7110H	DAYTONA			
2.2L L4 135 CID	1988	Base, LE, SE, Sport	US7110	2.2L L4 135 CID	1984-1986	Base	US7110
2.2L L4 135 CID	1988	Base, LE, SE, Sport; High performance	US7110H	2.2L L4 135 CID	1984-1986	Base; High performance	US7110H
2.5L L4 2507cc 153 CID	1989	Base, LE, SE, Sport	US7122	2.2L L4 135 CID	1987-1988	Base, Shelby Z	US7110
2.5L L4 2507cc 153 CID	1990-1991	Base, LE, S, SE	US7127	2.2L L4 135 CID	1987-1988	Base, Shelby Z; High performance	US7110H
2.5L L4 2507cc 153 CID	1992-1993	Base, LE, S, Sport	US7127	2.2L L4 135 CID	1989	Base, Shelby	US7122
2.5L L4 2507cc 153 CID	1994-1995	Base, SLT, Sport, WS	US7127	2.2L L4 135 CID	1990	Base, Shelby	US7127
2.5L L4 2507cc 153 CID	1996	Base, SLT, Sport, WS	US7136	2.2L L4 135 CID	1992-1993	Iroc R/T	US7139
2.5L L4 2507cc 153 CID	1997-2001	Base, SLT, Sport	US7136	2.5L L4 2507cc 153 CID	1986-1988	Base	US7110
2.5L L4 2507cc 153 CID	2002	Base, Sport	US7136	2.5L L4 2507cc 153 CID	1986-1988	Base; High performance	US7110H
3.7L V6 226 CID	2004	Base, SLT, SLT Plus, Sport, Sport Plus, SXT	US7163	2.5L L4 2507cc 153 CID	1989	Base, ES, ES Turbo, Shelby	US7122
3.7L V6 226 CID	2005	Laramie, SLT, Sport, ST	US7163	2.5L L4 2507cc 153 CID	1990	Base, ES, ES Turbo, Shelby	US7127
3.7L V6 226 CID	2006-2007	Laramie, SLT, ST	US7163	2.5L L4 2507cc 153 CID	1991	Base, ES, Iroc, Shelby	US7127
3.7L V6 226 CID	2008	SLT, Sport, ST, SXT, TRX, TRX4	US7163	2.5L L4 2507cc 153 CID	1992	Base, ES, Iroc	US7127
3.7L V6 226 CID	2009	Big Horn, Lone Star, ST, TRX4	US7163	2.5L L4 2507cc 153 CID	1993	Base, ES	US7127
3.7L V6 226 CID	2010	Big Horn, Laramie, Lone Star, ST	US7163	3.0L V6 2972cc 181 CID	1990	Base, ES	US7121
3.7L V6 3701cc 226 CID	2010	Mexican Application	US7163	3.0L V6 2972cc 181 CID	1990	Base, ES; With back plate housing	US7121-2
3.7L V6 3701cc 226 CID	2012	Mexican Application	US7163	3.0L V6 2972cc 181 CID	1991-1993	Base, ES, Iroc	US7121
3.9L V6 3906cc 239 CID	1987	Base, LE, SE	US1053	3.0L V6 2972cc 181 CID	1991-1993	Base, ES, Iroc; With back plate housing	US7121-2
DIPLOMAT				3.7L L6 3687cc 225 CID	1978-1979		US7100

WATER PUMPS

Engine	Years	Application Description	USMW
DODGE (cont'd.)			
DIPLOMAT (cont'd.)			
3.7L L6 3687cc 225 CID	1980	Base, Medallion, Salon	US7100
3.7L L6 3687cc 225 CID	1981	Base, Medallion, Salon, Sport	US7100
3.7L L6 3687cc 225 CID	1982-1983	Medallion, Salon	US7100
5.2L V8 318 CID	1977-1978	Exc.Air Pump	US1053
5.2L V8 318 CID	1977-1978	Exc.Air Pump, High performance	US1053H
5.2L V8 318 CID	1977-1979	Air Pump	US1053
5.2L V8 318 CID	1977-1979	Air Pump, High performance	US1053H
5.2L V8 318 CID	1980-1981	Base, Medallion, Salon	US1053
5.2L V8 318 CID	1980-1981	Base, Medallion, Salon; High performance	US1053H
5.2L V8 318 CID	1982-1983	Medallion, Salon	US1053
5.2L V8 318 CID	1982-1983	Medallion, Salon; High performance	US1053H
5.2L V8 318 CID	1984-1989	Salon, SE	US1053
5.2L V8 318 CID	1984-1989	Salon, SE; High performance	US1053H
5.2L V8 5211cc 318 CID	1983	Medallion	US1053
5.2L V8 5211cc 318 CID	1983	Medallion; High performance	US1053H
5.2L V8 5211cc 318 CID	1985	Salon, SE	US1053
5.2L V8 5211cc 318 CID	1985	Salon, SE; High performance	US1053H
5.9L V8 360 CID	1978	Exc.Air Pump	US1053
5.9L V8 360 CID	1978	Exc.Air Pump, High performance	US1053H
5.9L V8 360 CID	1978-1979	Air Pump	US1053
5.9L V8 360 CID	1978-1979	Air Pump, High performance	US1053H
DM350			
5.9L V8 5904cc 360 CID	1991	Mexican Application	US1053
DURANGO			
3.6L V6 3604cc 220 CID	2011	Citadel, Crew, Express, Heat	US8981
3.6L V6 3604cc 220 CID	2012-2013	Citadel, Crew, Special Service, SXT	US8981
3.6L V6 3604cc 220 CID	2012-2015	Mexican Application	US8981
3.6L V6 3604cc 220 CID	2014-2015	Citadel, Limited, Rallye, Special Service, SXT	US8981
3.6L V6 3604cc 220 CID	2016	Citadel, Limited, Special Service, SXT	US8160
3.6L V6 3604cc 220 CID	2017-2018	Citadel, GT, Special Service, SXT	US8160
3.7L V6 226 CID	2004-2005	SLT, ST	US7163
3.7L V6 226 CID	2006-2008	SLT, SXT	US7163
3.7L V6 226 CID	2009	SE, SLT	US7163
3.9L V6 3906cc 239 CID	1998	Base, SLT	US7160
3.9L V6 3906cc 239 CID	1999	Base, SLT, SLT Plus	US7160
4.7L V8 287 CID	2000	Base, SLT, SLT Plus, Sport	US7163
4.7L V8 287 CID	2001	Base, SLT	US7163
4.7L V8 287 CID	2002	SLT, SLT Plus, Sport	US7163
4.7L V8 287 CID	2003	SLT, SLT Plus, Sport, SXT	US7163
4.7L V8 287 CID	2004	Limited, SLT, ST	US7163
4.7L V8 287 CID	2005	Limited, SLT, ST, SXT	US7163
4.7L V8 287 CID	2006-2008	Adventurer, Limited, SLT, SXT	US7163
4.7L V8 287 CID	2009	Limited, SE, SLT	US7163
5.2L V8 5211cc 318 CID	1998	Base, SLT	US7160
5.2L V8 5211cc 318 CID	1999	Base, SLT, SLT Plus	US7160
5.2L V8 5211cc 318 CID	2000	Base, SLT, SLT Plus, Sport	US7160
5.2L V8 5211cc 318 CID	1998	Mexican Application	US7160
5.7L V8 345 CID	2004	Limited, SLT	US7168
5.7L V8 345 CID	2005	Limited, SLT, ST	US7168
5.7L V8 345 CID	2006	Adventurer, Limited, SLT	US7168
5.7L V8 345 CID	2007	Adventurer, Limited, SLT, SXT	US7168
5.7L V8 345 CID	2008	Adventurer, Limited, SLT	US7168
5.7L V8 345 CID	2009	Limited, SE, SLT	US6341
5.7L V8 345 CID	2011	Citadel, Crew, R/T	US8971
5.7L V8 345 CID	2012	Citadel, Crew, R/T, Special Service	US8971
5.7L V8 345 CID	2013	Citadel, Crew, R/T, Special Service; Exc.Oil Cooler	US8115
5.7L V8 345 CID	2013	Citadel, Crew, R/T, Special Service; Oil Cooler	US8115
5.7L V8 345 CID	2014-2016	Citadel, Limited, R/T, Special Service	US8115
5.7L V8 345 CID	2014-2016	Citadel, Limited, R/T, Special Service; Exc.Oil Cooler	US8115
5.7L V8 345 CID	2014-2016	Citadel, Limited, R/T, Special Service; Oil Cooler	US8115
5.7L V8 345 CID	2017	Citadel, R/T, Special Service	US8115
5.7L V8 345 CID	2018	Citadel, Pursuit, R/T, Special Service	US8115
5.7L V8 5654cc 345 CID	2012-2013	Mexican Application	US8971
5.9L V8 360 CID	1998	Base, SLT	US7160
5.9L V8 360 CID	1999	Base, SLT, SLT Plus	US7160
5.9L V8 360 CID	2000	Base, R/T, SLT, SLT Plus, Sport	US7160
5.9L V8 360 CID	2001	Base, R/T, SLT	US7160
5.9L V8 360 CID	2002	R/T, SLT, SLT Plus, Sport	US7160
5.9L V8 360 CID	2003	R/T, SLT, SLT Plus, Sport, SXT	US7160
6.4L V8 6424cc 392 CID	2018	SRT	US8115
DYNASTY			
2.5L L4 2507cc 153 CID	1988	Base, LE	US7110
2.5L L4 2507cc 153 CID	1988	Base, LE; High performance	US7110H
2.5L L4 2507cc 153 CID	1989	Base	US7122
2.5L L4 2507cc 153 CID	1990-1993	Base	US7127
3.0L V6 2972cc 181 CID	1988-1990	Base, LE	US7121
3.0L V6 2972cc 181 CID	1988-1990	Base, LE; With back plate housing	US7121-2
3.0L V6 2972cc 181 CID	1991-1993	Base, LS	US7121
3.0L V6 2972cc 181 CID	1991-1993	Base, LS; With back plate housing	US7121-2
3.3L V6 3301cc 201 CID	1990	LE	US7126

Engine	Years	Application Description	USMW
DODGE (cont'd.)			
DYNASTY (cont'd.)			
3.3L V6 3301cc 201 CID	1991-1993	Base, LS	US7126
GRAND CARAVAN			
2.4L L4 2429cc 148 CID	1996	Base, SE; Hydraulic Tensioner	US7153
2.4L L4 2429cc 148 CID	1996	Base, SE; Mechanical Tensioner	US7156
2.4L L4 2429cc 148 CID	1997	Base, SE	US7156
2.5L L4 2507cc 153 CID	1988	SE	US7110
2.5L L4 2507cc 153 CID	1988	SE; High performance	US7110H
3.0L V6 2972cc 181 CID	1988-1989	LE, SE	US7121
3.0L V6 2972cc 181 CID	1988-1989	LE, SE; With back plate housing	US7121-2
3.0L V6 2972cc 181 CID	1992	Base, ES, SE	US7121
3.0L V6 2972cc 181 CID	1992	Base, ES, SE; With back plate housing	US7121-2
3.0L V6 2972cc 181 CID	1993	Base	US7121
3.0L V6 2972cc 181 CID	1993	Base; With back plate housing	US7121-2
3.0L V6 2972cc 181 CID	1994-1997	Base, SE	US7121
3.0L V6 2972cc 181 CID	1994-1997	Base, SE; With back plate housing	US7121-2
3.0L V6 2972cc 181 CID	1998-1999	Base, ES, LE, SE	US7121
3.0L V6 2972cc 181 CID	1998-1999	Base, ES, LE, SE; With back plate housing	US7121-2
3.0L V6 2972cc 181 CID	2000	Base, SE, Sport	US7121
3.0L V6 2972cc 181 CID	2000	Base, SE, Sport; With back plate housing	US7121-2
3.3L V6 3301cc 201 CID	1990-1991	LE, SE	US7126
3.3L V6 3301cc 201 CID	1992	Base, ES, LE, SE	US7126
3.3L V6 3301cc 201 CID	1993-1996	ES, LE, SE	US7126
3.3L V6 3301cc 201 CID	1997-1999	Base, ES, LE, SE	US7126
3.3L V6 3301cc 201 CID	2000	Base, ES, LE, SE, Sport	US7126
3.3L V6 3301cc 201 CID	2001	ES, SE, Sport	US7165
3.3L V6 3301cc 201 CID	2002	EL, SE, Sport	US7165
3.3L V6 3301cc 201 CID	2003	Base, EL, SE, Sport	US7165
3.3L V6 3301cc 201 CID	2004	C/V, SE	US7165
3.3L V6 3301cc 201 CID	2005	C/V, SE, SE Plus	US7165
3.3L V6 3301cc 201 CID	2006-2007	Base, SE	US7165
3.3L V6 3301cc 201 CID	2008-2010	C/V, SE	US6231
3.6L V6 3604cc 220 CID	2011	C/V, Crew, Express, Mainstreet, R/T	US8981
3.6L V6 3604cc 220 CID	2012-2013	Crew, R/T, SE, SXT	US8981
3.6L V6 3604cc 220 CID	2014	American Value Package, R/T, SE, SE 30th Anniversary Edition, SXT, SXT 30th Anniversary Edition	US8981
3.6L V6 3604cc 220 CID	2015	American Value Package, R/T, SE, SXT	US8981
3.6L V6 3604cc 220 CID	2016	American Value Package, R/T, SE, SE Plus, SXT	US8981
3.6L V6 3604cc 220 CID	2017-2018	GT, SE, SXT	US8981
3.8L V6 230 CID	1994-1996	ES, LE	US7126
3.8L V6 230 CID	1997-1999	ES, LE, SE	US7126
3.8L V6 230 CID	2000	ES, LE, SE, Sport	US7126
3.8L V6 230 CID	2001-2003	ES, EX, Sport	US7165
3.8L V6 230 CID	2004	Anniversary Edition, EX, SXT	US7165
3.8L V6 230 CID	2005-2007	SXT	US7165
3.8L V6 230 CID	2008	SXT	US6231
3.8L V6 3778cc 231 CID	2009-2010	SXT	US6231
4.0L V6 3952cc 241 CID	2008-2010	SXT	US8951
H100			
2.5L L4 2476cc 151 CID	2006-2010		US8922
2.5L L4 2476cc 151 CID	2006-2014	Mexican Application	US8922
2.5L L4 2476cc 151 CID	2011-2013	Base; Standard Cargo Van	US8922
H-100			
2.4L L4 2351cc 144 CID	2003-2005	Mexican Application	US7114
I10			
1.1L L4 1100cc 67 CID	2012-2013	Mexican Application	US8939
INTREPID			
2.7L V6 2736cc 167 CID	1998	Base	US7161
2.7L V6 2736cc 167 CID	1999-2000	Base, ES	US7161
2.7L V6 2736cc 167 CID	2001	ES, SE	US7161
2.7L V6 2736cc 167 CID	2002-2004	SE	US7161
3.2L V6 3200cc 197 CID	1998-2000	ES	US7162
3.3L V6 3301cc 201 CID	1993-1995	Base, ES	US7140
3.3L V6 3301cc 201 CID	1996-1997	Base	US7140
3.5L V6 3497cc 215 CID	1993-1994	Base, ES	US7141
3.5L V6 3497cc 215 CID	1995	Base, ES	US7151
3.5L V6 3497cc 215 CID	1996	ES	US7151
3.5L V6 3497cc 215 CID	1997	Base, ES; 3 Bolt Pattern	US7151
3.5L V6 3497cc 215 CID	1997	Base, ES; 6 Bolt Pattern	US7158
3.5L V6 3497cc 215 CID	2000	R/T	US7162
3.5L V6 3497cc 215 CID	2001	R/T, SE	US7162
3.5L V6 3497cc 215 CID	2002	ES, R/T, SE	US7162
3.5L V6 3497cc 215 CID	2003	ES, SE, SXT	US7162
3.5L V6 3497cc 215 CID	2004	ES, Police, SXT	US7162
JOURNEY			
2.4L L4 2360cc 144 CID	2009	SE	US6038
2.4L L4 2360cc 144 CID	2010	Base, SE	US6038
2.4L L4 2360cc 144 CID	2011	Express	US6038
2.4L L4 2360cc 144 CID	2011	Mexican Application	US6038
2.4L L4 2360cc 144 CID	2012-2013	AVP, SE, SXT	US6038

Engine	Years	Application Description	USMW	Engine	Years	Application Description	USMW
DODGE (cont'd.)				DODGE (cont'd.)			
JOURNEY (cont'd.)				NEON			
2.4L L4 2360cc 144 CID	2014	Crossroad, SE, SXT	US6038	2.0L L4 1996cc 122 CID	1995-1997	Base, High Line, Sport	US7150
2.4L L4 2360cc 144 CID	2014	Mexican Application	US6038	2.0L L4 1996cc 122 CID	1998-1999	ACR, High Line, R/T, Sport	US7150
2.4L L4 2360cc 144 CID	2015	AVP, Crossroad, SE, SXT	US6038	2.0L L4 1996cc 122 CID	2000	ES, High Line	US7150
2.4L L4 2360cc 144 CID	2016-2018	Crossroad, SE, SXT	US6038	2.0L L4 1996cc 122 CID	2001-2002	ACR, Base, ES, R/T, SE	US7150
3.5L V6 3497cc 215 CID	2009	R/T, SXT	US8951	2.0L L4 1996cc 122 CID	2003-2004	R/T, SE, SXT	US7150
3.5L V6 3497cc 215 CID	2010	Crew, R/T, SXT	US8951	2.0L L4 1996cc 122 CID	2005	SE, SXT	US7150
3.6L V6 3604cc 220 CID	2011	Crew, Lux, Mainstreet, R/T	US8981	2.0L L4 1997cc 122 CID	1995	High Line	US7150
3.6L V6 3604cc 220 CID	2011-2013	Mexican Application	US8981	2.4L L4 2429cc 148 CID	2003-2005	SRT-4	US7167
3.6L V6 3604cc 220 CID	2012-2013	Crew, R/T, SXT	US8981	NITRO			
3.6L V6 3604cc 220 CID	2014-2015	Crossroad, Limited, R/T, SXT	US8981	3.7L V6 226 CID	2007-2008	SLT, SXT	US7163
3.6L V6 3604cc 220 CID	2016	Crossroad, R/T, SE, SXT	US8981	3.7L V6 226 CID	2009	SE, SLT	US7163
3.6L V6 3604cc 220 CID	2017-2018	Crossroad, GT, SE, SXT	US8981	3.7L V6 226 CID	2010	SE, SXT	US7163
3.6L V6 3605cc 220 CID	2014-2015	Mexican Application	US8981	3.7L V6 226 CID	2011	Heat, SE, SXT	US7163
LANCER				3.7L V6 3701cc 226 CID	2011-2012	Mexican Application	US7163
2.2L L4 135 CID	1985-1987	Base, ES	US7110	4.0L V6 3952cc 241 CID	2007-2009	R/T	US8951
2.2L L4 135 CID	1985-1987	Base, ES; High performance	US7110H	4.0L V6 3952cc 241 CID	2010-2011	Detonator, Heat, Shock, SXT	US8951
2.2L L4 135 CID	1988	Base, ES, Shelby	US7110	NITRO SE			
2.2L L4 135 CID	1988	Base, ES, Shelby; High performance	US7110H	3.7L V6 3701cc 226 CID	2011-2012	Mexican Application	US7163
2.2L L4 135 CID	1989	Base, Shelby	US7110	OMNI			
2.5L L4 2507cc 153 CID	1986-1988	Base, ES	US7110	1.6L L4 1595cc 97 CID	1983	Base, Custom	US7113
2.5L L4 2507cc 153 CID	1986-1988	Base, ES; High performance	US7110H	1.6L L4 1595cc 97 CID	1984	Base, GLH, SE	US7113
2.5L L4 2507cc 153 CID	1989	Base, ES, Shelby	US7122	1.6L L4 1595cc 97 CID	1985-1986	Base, SE	US7113
MAGNUM				1.7L L4 105 CID	1978-1979		US7101
2.2L L4 2200cc 135 CID	1983-1988	Mexican Application	US7110	1.7L L4 105 CID	1980	024, Base	US7101
2.7L V6 2736cc 167 CID	2005-2007	SE	US7161	1.7L L4 105 CID	1981	024, 024 Miser, Base, Miser	US7101
2.7L V6 2736cc 167 CID	2008	SE	US6217	1.7L L4 105 CID	1982	024, 024 Charger 2.2, 024 Miser, Custom, E-Type, Miser	US7101
3.5L V6 3497cc 215 CID	2005	SXT, SXT Special Edition	US8951	1.7L L4 105 CID	1983	Base, Custom	US7101
3.5L V6 3497cc 215 CID	2006	SXT	US8951	2.2L L4 135 CID	1981	024, 024 Miser, Base, Miser	US7110
3.5L V6 3497cc 215 CID	2007-2008	SE, SXT	US8951	2.2L L4 135 CID	1981	024, 024 Miser, Base, Miser; High performance	US7110H
5.2L V8 318 CID	1978	Exc.Air Pump	US1053	2.2L L4 135 CID	1982	024, 024 Charger 2.2, 024 Miser, Custom, E-Type, Miser	US7110
5.2L V8 318 CID	1978	Exc.Air Pump, High performance	US1053H	2.2L L4 135 CID	1982	024, 024 Charger 2.2, 024 Miser, Custom, E-Type, Miser; High performance	US7110H
5.2L V8 318 CID	1978-1979	Air Pump	US1053	2.2L L4 135 CID	1983	Base, Custom	US7110
5.2L V8 318 CID	1978-1979	Air Pump, High performance	US1053H	2.2L L4 135 CID	1983	Base, Custom; High performance	US7110H
5.7L V8 345 CID	2005-2008	R/T	US8940	2.2L L4 135 CID	1984-1986	Base, GLH, SE	US7110
5.9L V8 360 CID	1978	Exc.Air Pump	US1053	2.2L L4 135 CID	1984-1986	Base, GLH, SE; High performance	US7110H
5.9L V8 360 CID	1978	Exc.Air Pump, High performance	US1053H	2.2L L4 135 CID	1987-1988	America	US7110
5.9L V8 360 CID	1978-1979	Air Pump	US1053	2.2L L4 135 CID	1987-1988	America; High performance	US7110H
5.9L V8 360 CID	1978-1979	Air Pump, High performance	US1053H	2.2L L4 135 CID	1989	America	US7122
5.9L V8 360 CID	1982	High performance	US1053H	2.2L L4 135 CID	1990	Base	US7127
5.9L V8 5900cc 360 CID	1980-1982	Mexican Application	US1053	POLARA			
6.1L V8 6059cc 370 CID	2006-2008	SRT8	US8940	4.5L V8 4473cc 273 CID	1966		US919
6.6L V8 400 CID	1978		US1040	5.2L V8 318 CID	1968-1969		US919
MATADOR				5.2L V8 5212cc 318 CID	1960-1961		US919
5.2L V8 5212cc 318 CID	1960		US919	5.2L V8 5212cc 318 CID	1963-1969		US919
MICROBUS				POWER RAM 50			
5.9L V8 5900cc 360 CID	1988-1991	Mexican Application	US1053	2.0L L4 1995cc	1984	Custom	US7114
5.9L V8 5900cc 360 CID	1992	Mexican Application	US7159	2.0L L4 1997cc	1983	Custom	US7114
5.9L V8 5900cc 360 CID	1993-1997	Mexican Application	US7160	2.3L L4 2346cc	1983	Sport	US7117
MINI RAM				2.3L L4 2346cc	1984	Royal, Sport	US7117
2.2L L4 135 CID	1984-1987	Base, Royal	US7110	2.3L L4 2346cc	1985	Royal	US7117
2.2L L4 135 CID	1984-1987	Base, Royal; High performance	US7110H	2.6L L4 2555cc	1983	Sport	US7114
2.6L L4 2555cc 156 CID	1984-1987	Base, Royal	US7111	2.6L L4 2555cc	1984	Custom, Royal, Sport	US7120
3.0L V6 2972cc 181 CID	1987	Base, Royal	US7121	2.6L L4 2555cc 156 CID	1985	Custom, Royal, Sport	US7120
3.0L V6 2972cc 181 CID	1987	Base, Royal; With back plate housing	US7121-2	2.6L L4 2555cc 156 CID	1986	Custom, Sport	US7120
3.0L V6 2972cc 181 CID	1988	Base	US7121	PROMASTER 1500			
3.0L V6 2972cc 181 CID	1988	Base; With back plate housing	US7121-2	3.6L V6 3605cc 220 CID	2014	Mexican Application	US8981
MIRADA				PROMASTER 2500			
3.7L L6 3687cc 225 CID	1980-1983	Special Coupe	US7100	3.6L V6 3605cc 220 CID	2014	Mexican Application	US8981
5.2L V8 318 CID	1980-1983	Special Coupe	US1053	PROMASTER 3500			
5.2L V8 318 CID	1980-1983	Special Coupe; High performance	US1053H	3.6L V6 3605cc 220 CID	2014	Mexican Application	US8981
5.9L V8 360 CID	1980	Special Coupe	US1053	RAIDER			
5.9L V8 360 CID	1980	Special Coupe; High performance	US1053H	2.6L L4 2555cc 156 CID	1987-1989	Base	US7120
MONACO				3.0L V6 2972cc 181 CID	1989	Base	US7121
3.0L V6 2972cc 182 CID	1990	ES, LE	US3411	3.0L V6 2972cc 181 CID	1989	Base; With back plate housing	US7121-2
3.0L V6 2972cc 182 CID	1991	ES, LE; (Z7X-711)	US3411	RAM 50			
3.7L L6 3687cc 225 CID	1977-1978		US7100	2.0L L4 1995cc 122 CID	1984	Custom, Royal	US7114
5.2L V8 318 CID	1968-1969		US919	2.0L L4 1995cc 122 CID	1985-1986	Custom	US7114
5.2L V8 318 CID	1975-1978	Air Pump	US1053	2.0L L4 1995cc 122 CID	1987	Base, Custom	US7114
5.2L V8 318 CID	1975-1978	Exc.Air Pump	US1053	2.0L L4 1995cc 122 CID	1988-1989	Base	US7114
5.2L V8 318 CID	1975-1978	Air Pump, High performance	US1053H	2.0L L4 1997cc 122 CID	1983	Custom	US7114
5.2L V8 318 CID	1975-1978	Exc.Air Pump, High performance	US1053H	2.3L L4 2346cc 143 CID	1983-1984	Royal, Sport	US7117
5.2L V8 5200cc 318 CID	1970-1974	Mexican Application	US1053	2.3L L4 2346cc 143 CID	1985	Royal	US7117
5.2L V8 5212cc 318 CID	1968-1969		US919	2.4L L4 2351cc	1990-1991	Base, LE, SE	US7114
5.9L V8 360 CID	1975-1978	Air Pump	US1053	2.4L L4 2351cc	1992-1993	Base, SE	US7114
5.9L V8 360 CID	1975-1978	Exc.Air Pump	US1053	2.6L L4 2555cc 156 CID	1983	Royal, Sport	US7114
5.9L V8 360 CID	1975-1978	Air Pump, High performance	US1053H	2.6L L4 2555cc 156 CID	1984-1985	Custom, Royal, Sport	US7120
5.9L V8 360 CID	1975-1978	Exc.Air Pump, High performance	US1053H				
5.9L V8 5900cc 360 CID	1972-1973	Mexican Application	US1053				
6.6L V8 400 CID	1975-1978		US1040				
7.2L V8 440 CID	1975-1978		US1040				

WATER PUMPS



WATER PUMP APPLICATION GUIDE



Engine	Years	Application Description	USMW
DODGE (cont'd.)			
RAM 50 (cont'd.)			
2.6L L4 2555cc 156 CID	1985	Custom, Royal; To 01/1985	US7114
2.6L L4 2555cc 156 CID	1986	Sport	US7120
2.6L L4 2555cc 156 CID	1987-1989	Base, Custom, Sport	US7120
3.0L V6 2972cc 181 CID	1990-1991	Base, LE, SE	US7121
3.0L V6 2972cc 181 CID	1990-1991	Base, LE, SE; With back plate housing	US7121-2
RAM 1500			
3.6L V6 3600cc 220 CID	2014	Mexican Application	US8981
3.6L V6 3605cc 220 CID	2015	Mexican Application	US8981
3.7L V6 226 CID	2002	SLT, ST	US7163
3.7L V6 226 CID	2003	Laramie, SLT, ST	US7163
3.7L V6 226 CID	2004-2007	ST	US7163
3.7L V6 226 CID	2008	ST, SXT	US7163
3.7L V6 226 CID	2009-2010	ST	US7163
3.7L V6 3701cc 226 CID	2013	Mexican Application	US7163
3.9L V6 3906cc 239 CID	1994-1996	Base	US7160
3.9L V6 3906cc 239 CID	1997-2001	Laramie, Sport, ST, WS	US7160
4.7L V8 287 CID	2002	SLT, ST	US7163
4.7L V8 287 CID	2003-2004	Laramie, SLT, ST	US7163
4.7L V8 287 CID	2005	SLT, ST, SXT	US7163
4.7L V8 287 CID	2006	Laramie, SLT, ST, TRX4	US7163
4.7L V8 287 CID	2007	SLT, ST, TRX4	US7163
4.7L V8 287 CID	2008	SLT, ST, SXT	US7163
4.7L V8 287 CID	2009-2010	SLT, ST, TRX, TRX4	US7163
5.2L V8 5211cc 318 CID	1994-1996	Base	US7160
5.2L V8 5211cc 318 CID	1997-2001	Laramie, Sport, ST	US7160
5.7L V8 345 CID	2003-2005	Laramie, SLT, ST	US7168
5.7L V8 345 CID	2006-2007	Laramie, SLT, Sport, ST, TRX4	US7168
5.7L V8 345 CID	2008	Laramie, SLT, ST, SXT	US7168
5.7L V8 345 CID	2009-2010	Laramie, SLT, Sport, ST, TRX, TRX4	US6341
5.9L V8 360 CID	1994-1996	Base	US7160
5.9L V8 360 CID	1997-2001	Laramie, Sport, ST	US7160
5.9L V8 360 CID	2002	SLT, ST	US7160
5.9L V8 360 CID	2003	Laramie, SLT, ST	US7160
RAM 1500 VAN			
3.9L V6 3906cc 239 CID	1999-2003	Base	US7160
5.2L V8 5211cc 318 CID	1999-2003	Base	US7160
5.9L V8 360 CID	1999-2003	Base	US7160
RAM 2500			
4.7L V8 4700cc 287 CID	2002-2009	Mexican Application	US7163
4.7L V8 4700cc 287 CID	2011-2012	Mexican Application	US7163
4.7L V8 4701cc 287 CID	2010	Mexican Application	US7163
5.2L V8 5211cc 318 CID	1994-1996	Base	US7160
5.2L V8 5215cc 318 CID	1997-2001	Mexican Application	US7160
5.7L V8 345 CID	2003	Laramie, SLT	US7168
5.7L V8 345 CID	2004	SLT, ST	US7168
5.7L V8 345 CID	2005	Laramie, SLT, ST	US7168
5.7L V8 345 CID	2006-2007	Laramie, Power Wagon, SLT, Sport, ST, TRX4	US7168
5.7L V8 345 CID	2008	Laramie, Power Wagon, SLT, ST, SXT	US7168
5.7L V8 345 CID	2009-2010	Laramie, Power Wagon, SLT, ST, SXT	US6341
5.7L V8 5654cc 345 CID	2010-2014	Mexican Application	US8971
5.7L V8 5654cc 345 CID	2015-2016	Mexican Application	US6341
5.9L L6 359 CID	1994-1998	Base	US7145
5.9L L6 359 CID	1994-2001	Base	US7145N
5.9L L6 359 CID	1998-2002	Base	US7145HN
5.9L L6 359 CID	2003	Laramie, SLT, ST	US7145
5.9L L6 359 CID	2003-2009	Base	US7145HN
5.9L L6 359 CID	2004	SLT, ST	US7145
5.9L L6 359 CID	2005	Laramie	US7145
5.9L L6 359 CID	2006-2007	Laramie, SLT, Sport, ST, TRX4	US7145
5.9L V8 360 CID	1994-2002	Base	US7160
6.7L L6 408 CID	2007	Laramie, SLT, ST	US6222
6.7L L6 408 CID	2008-2010	Laramie, SLT, ST, SXT	US6222
8.0L V10 7990cc 488 CID	1994-2002	Base	US7169
8.0L V10 7990cc 488 CID	2003	Laramie, SLT	US7169
RAM 2500 VAN			
3.9L V6 3906cc 239 CID	2001	Base	US7160
5.2L V8 5211cc 318 CID	1999-2003	Base	US7160
5.9L V8 360 CID	1999-2003	Base	US7160
RAM 3500			
5.7L V8 345 CID	2003	SLT, ST	US7168
5.7L V8 345 CID	2004-2005	Laramie, SLT, ST	US7168
5.7L V8 345 CID	2006-2007	Laramie, SLT, Sport, ST	US7168
5.7L V8 345 CID	2008	Laramie, SLT, ST, SXT	US7168
5.7L V8 345 CID	2009	Laramie, SLT, ST, SXT	US6341
5.9L L6 359 CID	1994-1998	Base	US7145
5.9L L6 359 CID	1994-2001	Base	US7145N
5.9L L6 359 CID	1998-2002	Base	US7145HN
5.9L L6 359 CID	2003-2007	Base	US7145HN
5.9L L6 359 CID	2004-2005	Laramie, SLT, ST	US7145
5.9L L6 359 CID	2006	Laramie, SLT, Sport, ST	US7145
5.9L L6 359 CID	2007	Laramie, SLT, Sport, ST, TRX4	US7145

Engine	Years	Application Description	USMW
DODGE (cont'd.)			
RAM 3500 (cont'd.)			
5.9L V8 360 CID	1994-2002	Base	US7160
6.7L L6 408 CID	2007	Laramie, SLT, Sport, ST	US6222
6.7L L6 408 CID	2008-2010	Laramie, SLT, ST, SXT	US6222
8.0L V10 7990cc 488 CID	1994-2002	Base	US7169
8.0L V10 7990cc 488 CID	2003	SLT, ST	US7169
RAM 3500 VAN			
5.2L V8 5211cc 318 CID	1999-2003	Base	US7160
5.9L V8 360 CID	1999-2003	Base	US7160
RAM 4000			
5.7L V8 5654cc 345 CID	2012-2014	Mexican Application	US8971
5.7L V8 5654cc 345 CID	2015	Mexican Application	US7160
5.7L V8 5700cc 350 CID	2002	Mexican Application	US8971
5.7L V8 5700cc 350 CID	2005-2006	Mexican Application	US7168
5.7L V8 5700cc 350 CID	2008-2011	Mexican Application	US8971
5.7L V8 5700cc 350 CID	2010	Mexican Application	US6341
5.9L V8 5900cc 360 CID	1997-2001	Mexican Application	US7160
6.7L L6 6700cc 409 CID	2010-2013	Mexican Application	US6222
RAMCHARGER			
3.7L L6 3687cc 225 CID	1975-1979		US7100
3.7L L6 3687cc 225 CID	1980	Base, SE	US7100
5.2L V8 5211cc 318 CID	1975-1978	Exc.Air Pump	US1053
5.2L V8 5211cc 318 CID	1975-1978	Exc.Air Pump, High performance	US1053H
5.2L V8 5211cc 318 CID	1975-1979	Air Pump	US1053
5.2L V8 5211cc 318 CID	1975-1979	Air Pump, High performance	US1053H
5.2L V8 5211cc 318 CID	1980	Base, SE	US1053
5.2L V8 5211cc 318 CID	1980	Base, SE; High performance	US1053H
5.2L V8 5211cc 318 CID	1981-1990	Base, Royal SE	US1053
5.2L V8 5211cc 318 CID	1981-1990	Base, Royal SE; High performance	US1053H
5.2L V8 5211cc 318 CID	1991	Base, Canyon Sport, Royal SE	US1053
5.2L V8 5211cc 318 CID	1991	Base, Canyon Sport, Royal SE; High performance	US1053H
5.2L V8 5211cc 318 CID	1992	Base, Canyon Sport, Royal SE	US7159
5.2L V8 5211cc 318 CID	1993	Base, Canyon Sport, Royal SE	US7160
5.2L V8 5215cc 318 CID	1999-2001	Mexican Application	US7160
5.9L V8 360 CID	1975-1978	Exc.Air Pump	US1053
5.9L V8 360 CID	1975-1978	Exc.Air Pump, High performance	US1053H
5.9L V8 360 CID	1975-1979	Air Pump	US1053
5.9L V8 360 CID	1975-1979	Air Pump, High performance	US1053H
5.9L V8 360 CID	1980	Base, SE	US1053
5.9L V8 360 CID	1980	Base, SE; High performance	US1053H
5.9L V8 360 CID	1981	Base, Royal SE	US1053
5.9L V8 360 CID	1981	Base, Royal SE; High performance	US1053H
5.9L V8 360 CID	1984-1990	Base, Royal SE	US1053
5.9L V8 360 CID	1984-1990	Base, Royal SE; High performance	US1053H
5.9L V8 360 CID	1991-1992	Base, Canyon Sport, Royal SE	US1053
5.9L V8 360 CID	1991-1992	Base, Canyon Sport, Royal SE; High performance	US1053H
5.9L V8 360 CID	1993	Base, Canyon Sport, Royal SE	US7160
5.9L V8 5900cc 360 CID	1980-1990	Mexican Application	US1053
5.9L V8 5900cc 360 CID	1994-2000	Mexican Application	US7160
6.6L V8 400 CID	1977-1978		US1040
7.2L V8 440 CID	1975-1978		US1040
RAMPAGE			
2.2L L4 135 CID	1982	High Line, Sport	US7110
2.2L L4 135 CID	1982	High Line, Sport; High performance	US7110H
2.2L L4 135 CID	1983-1984	2.2, Base	US7110
2.2L L4 135 CID	1983-1984	2.2, Base; High performance	US7110H
RD200			
5.2L V8 5211cc 318 CID	1980	Base	US1053
5.2L V8 5211cc 318 CID	1980	Base; High performance	US1053H
5.9L V8 360 CID	1980	Base	US1053
5.9L V8 360 CID	1980	Base; High performance	US1053H
ROYAL MONACO			
5.2L V8 318 CID	1975	Air Pump	US1053
5.2L V8 318 CID	1975	Exc.Air Pump	US1053
5.2L V8 318 CID	1975	Air Pump, High performance	US1053H
5.2L V8 318 CID	1975	Exc.Air Pump, High performance	US1053H
5.2L V8 318 CID	1977	Air Pump	US1053
5.2L V8 318 CID	1977	Exc.Air Pump	US1053
5.2L V8 318 CID	1977	Air Pump, High performance	US1053H
5.2L V8 318 CID	1977	Exc.Air Pump, High performance	US1053H
5.9L V8 360 CID	1975-1977	Air Pump	US1053
5.9L V8 360 CID	1975-1977	Exc.Air Pump	US1053
5.9L V8 360 CID	1975-1977	Air Pump, High performance	US1053H
5.9L V8 360 CID	1975-1977	Exc.Air Pump, High performance	US1053H
6.6L V8 400 CID	1975-1977		US1040
7.2L V8 440 CID	1975-1977		US1040
SENECA			
5.2L V8 5212cc 318 CID	1960-1961		US919

Engine	Years	Application Description	USMW	Engine	Years	Application Description	USMW
DODGE (cont'd.)				DODGE (cont'd.)			
SHADOW				STRATUS (cont'd.)			
2.2L L4 135 CID	1987	Base, Shelby	US7110	2.4L L4 2429cc 148 CID	1996	Base, ES; Hydraulic Tensioner	US7153
2.2L L4 135 CID	1987	Base, Shelby; High performance	US7110H	2.4L L4 2429cc 148 CID	1996	Base, ES; Mechanical Tensioner	US7156
2.2L L4 135 CID	1988	Base, ES, Shelby	US7110	2.4L L4 2429cc 148 CID	1997-1998	Base, ES	US7156
2.2L L4 135 CID	1988	Base, ES, Shelby; High performance	US7110H	2.4L L4 2429cc 148 CID	1999	Base	US7156
2.2L L4 135 CID	1989	Base, Shelby	US7122	2.4L L4 2429cc 148 CID	2000-2001	SE	US7156
2.2L L4 135 CID	1990	Base	US7127	2.4L L4 2429cc 148 CID	2001-2006	Mexican Application	US7156
2.2L L4 135 CID	1991-1992	America, High Line	US7127	2.4L L4 2429cc 148 CID	2002	ES, SE, SE Plus	US7156
2.2L L4 135 CID	1993	Base, High Line	US7127	2.4L L4 2429cc 148 CID	2003	ES, SE, SXT	US7156
2.2L L4 135 CID	1994	Base	US7127	2.4L L4 2429cc 148 CID	2004	SE, SXT	US7156
2.2L L4 2200cc 135 CID	1988	Mexican Application	US7110	2.4L L4 2429cc 148 CID	2005-2006	SXT	US7156
2.2L L4 2200cc 135 CID	1989	Mexican Application	US7122	2.5L V6 2497cc 152 CID	1995-2000	ES	US7152
2.2L L4 2200cc 135 CID	1990	Mexican Application	US7127	2.7L V6 2736cc 167 CID	2001	ES, SE	US7161
2.5L L4 2500cc 153 CID	1990	Mexican Application	US7127	2.7L V6 2736cc 167 CID	2002	ES, R/T, SE, SE Plus	US7161
2.5L L4 2500cc 153 CID	1993-1994	Mexican Application	US7127	2.7L V6 2736cc 167 CID	2003	ES, R/T, SE, SXT	US7161
2.5L L4 2507cc 153 CID	1988	Base	US7110	2.7L V6 2736cc 167 CID	2004	ES, R/T, SE	US7161
2.5L L4 2507cc 153 CID	1988	Base; High performance	US7110H	2.7L V6 2736cc 167 CID	2005-2006	R/T, SXT	US7161
2.5L L4 2507cc 153 CID	1989	Base, ES	US7122	3.0L V6 2972cc 181 CID	2001-2002	R/T, SE	US7152
2.5L L4 2507cc 153 CID	1990	Base, ES	US7127	3.0L V6 2972cc 181 CID	2003-2005	R/T	US7152
2.5L L4 2507cc 153 CID	1991	ES, High Line	US7127	TRUCK			
2.5L L4 2507cc 153 CID	1992	America, ES, High Line	US7127	5.2L V8 5212cc 318 CID	1960		US919
2.5L L4 2507cc 153 CID	1993	Base, ES, High Line	US7127	VAN 1000			
2.5L L4 2507cc 153 CID	1994	Base, ES	US7127	2.4L L4 2429cc 148 CID	2008-2009	Mexican Application	US9389
3.0L V6 2972cc 181 CID	1992	ES	US7121	VERNA			
3.0L V6 2972cc 181 CID	1992	ES; With back plate housing	US7121-2	1.5L L4 1508cc 92 CID	2004-2006	Mexican Application	US7115
3.0L V6 2972cc 181 CID	1993	ES, High Line	US7121	1.6L L4 1598cc 97 CID	2004-2006	Mexican Application	US9364
3.0L V6 2972cc 181 CID	1993	ES, High Line; With back plate housing	US7121-2	VIPER			
3.0L V6 2972cc 181 CID	1994	ES	US7121	8.0L V10 7990cc 488 CID	1992-1993		US7137
3.0L V6 2972cc 181 CID	1994	ES; With back plate housing	US7121-2	8.0L V10 7990cc 488 CID	1994-1996	Base	US7146
SPIRIT				W100			
2.2L L4 135 CID	1991-1992	R/T	US7139	3.7L L6 3687cc 225 CID	1975-1977		US7100
2.2L L4 2200cc 135 CID	1993	Mexican Application	US7127	3.7L L6 3687cc 225 CID	1986-1987	Custom	US7100
2.5L L4 2500cc 153 CID	1989	Mexican Application	US7122	3.9L V6 3906cc 239 CID	1989	Custom	US1053
2.5L L4 2500cc 153 CID	1990	Mexican Application	US7127	3.9L V6 3906cc 239 CID	1989	Custom; High performance	US1053H
2.5L L4 2500cc 153 CID	1993-1995	Mexican Application	US7127	5.2L V8 5211cc 318 CID	1975-1977	Air Pump	US1053
2.5L L4 2507cc 153 CID	1989	Base, ES, LE	US7122	5.2L V8 5211cc 318 CID	1975-1977	Exc.Air Pump	US1053
2.5L L4 2507cc 153 CID	1990-1992	Base, ES, LE	US7127	5.2L V8 5211cc 318 CID	1975-1977	Air Pump, High performance	US1053H
2.5L L4 2507cc 153 CID	1993	ES, High Line	US7127	5.2L V8 5211cc 318 CID	1975-1977	Exc.Air Pump, High performance	US1053H
2.5L L4 2507cc 153 CID	1994-1995	Base	US7127	5.2L V8 5211cc 318 CID	1986-1989	Custom	US1053
3.0L V6 2972cc 181 CID	1989	ES	US7121	5.2L V8 5211cc 318 CID	1986-1989	Custom; High performance	US1053H
3.0L V6 2972cc 181 CID	1989	ES; With back plate housing	US7121-2	5.9L V8 360 CID	1975-1977	Air Pump	US1053
3.0L V6 2972cc 181 CID	1990-1992	Base, ES, LE	US7121	5.9L V8 360 CID	1975-1977	Exc.Air Pump	US1053
3.0L V6 2972cc 181 CID	1990-1992	Base, ES, LE; With back plate housing	US7121-2	5.9L V8 360 CID	1975-1977	Air Pump	US1053
3.0L V6 2972cc 181 CID	1993	ES, High Line	US7121	5.9L V8 360 CID	1975-1977	Exc.Air Pump, High performance	US1053H
3.0L V6 2972cc 181 CID	1993	ES, High Line; With back plate housing	US7121-2	5.9L V8 360 CID	1986-1988	Custom	US1053
3.0L V6 2972cc 181 CID	1994-1995	Base	US7121	6.6L V8 400 CID	1975-1977		US1040
3.0L V6 2972cc 181 CID	1994-1995	Base; With back plate housing	US7121-2	7.2L V8 440 CID	1975-1977		US1040
SPRINTER 2500				W100 PICKUP			
2.7L L5 2687cc 165 CID	2003	Base	US6008	3.8L L6 3770cc 230 CID	1958-1959		US713
2.7L L5 2687cc 165 CID	2004-2006	Base	US6007	5.2L V8 318 CID	1968-1969		US919
3.0L V6 2987cc	2007-2009	Base	US6155	5.2L V8 5212cc 318 CID	1968-1969		US919
SPRINTER 3500				W100 SERIES			
2.7L L5 2687cc 165 CID	2003	Base	US6008	5.2L V8 5212cc 318 CID	1960-1967		US919
2.7L L5 2687cc 165 CID	2004-2006	Base	US6007	W150			
3.0L V6 2987cc	2007-2009	Base	US6155	3.7L L6 3687cc 225 CID	1978-1979		US7100
ST. REGIS				3.7L L6 3687cc 225 CID	1980-1987	Base	US7100
3.7L L6 3687cc 225 CID	1979		US7100	3.9L V6 3906cc 239 CID	1989	Base	US1053
3.7L L6 3687cc 225 CID	1980-1981	Base	US7100	3.9L V6 3906cc 239 CID	1989	Base; High performance	US1053H
5.2L V8 318 CID	1979	Air Pump	US1053	3.9L V6 3906cc 239 CID	1990-1991	Base, S	US1053
5.2L V8 318 CID	1979	Air Pump, High performance	US1053H	3.9L V6 3906cc 239 CID	1990-1991	Base, S; High performance	US1053H
5.2L V8 318 CID	1980-1981	Base	US1053	3.9L V6 3906cc 239 CID	1992	Base	US7159
5.2L V8 318 CID	1980-1981	Base; High performance	US1053H	3.9L V6 3906cc 239 CID	1993	Base	US7160
5.9L V8 360 CID	1979	Air Pump	US1053	5.2L V8 5211cc 318 CID	1977-1978	Exc.Air Pump	US1053
5.9L V8 360 CID	1979	Air Pump, High performance	US1053H	5.2L V8 5211cc 318 CID	1977-1978	Exc.Air Pump, High performance	US1053H
5.9L V8 360 CID	1980	Base	US1053	5.2L V8 5211cc 318 CID	1977-1979	Air Pump	US1053
5.9L V8 360 CID	1980	Base; High performance	US1053H	5.2L V8 5211cc 318 CID	1977-1979	Air Pump, High performance	US1053H
STEALTH				5.2L V8 5211cc 318 CID	1980-1989	Base	US1053
3.0L V6 2972cc 181 CID	1991-1993	Base, ES, R/T, R/T Turbo	US7121	5.2L V8 5211cc 318 CID	1980-1989	Base; High performance	US1053H
3.0L V6 2972cc 181 CID	1991-1993	Base, ES, R/T, R/T Turbo; With back plate housing	US7121-2	5.2L V8 5211cc 318 CID	1990-1991	Base, S	US1053
3.0L V6 2972cc 181 CID	1994-1996	Base	US7121	5.2L V8 5211cc 318 CID	1990-1991	Base, S; High performance	US1053H
3.0L V6 2972cc 181 CID	1994-1996	Base; With back plate housing	US7121-2	5.2L V8 5211cc 318 CID	1992	Base	US7159
3.0L V6 2972cc 181 CID	1994-1996	R/T, R/T Turbo	US7129	5.2L V8 5211cc 318 CID	1993	Base	US7160
STRATUS				5.9L V8 360 CID	1977-1978	Exc.Air Pump	US1053
2.0L L4 1996cc 122 CID	1995-1997	Base, ES	US7150	5.9L V8 360 CID	1977-1978	Exc.Air Pump, High performance	US1053H
2.0L L4 1996cc 122 CID	1998-1999	Base	US7150	5.9L V8 360 CID	1977-1979	Air Pump	US1053
2.0L L4 1996cc 122 CID	2000	SE	US7150	5.9L V8 360 CID	1977-1979	Air Pump, High performance	US1053H
2.0L L4 1996cc 122 CID	2004-2006	Mexican Application	US7156	5.9L V8 360 CID	1980-1981	Base	US1053
2.0L L4 1998cc 122 CID	2001-2003	Mexican Application	US7156	5.9L V8 360 CID	1980-1981	Base; High performance	US1053H
2.4L L4 2351cc	2001-2002	SE	US9399	5.9L V8 360 CID	1984-1990	Base	US1053
2.4L L4 2351cc	2003	SE, SXT	US9399	5.9L V8 360 CID	1984-1990	Base; High performance	US1053H
2.4L L4 2351cc	2004-2005	SXT	US9399	WATER PUMPS			
2.4L L4 2426cc 148 CID	1998-2000	Mexican Application	US7156				
2.4L L4 2429cc 148 CID	1995	Base	US7153				



WATER PUMP APPLICATION GUIDE



Engine	Years	Application Description	USMW
DODGE (cont'd.)			
W150 (cont'd.)			
5.9L V8 360 CID	1991	Base, S	US1053
5.9L V8 360 CID	1991	Base, S; High performance	US1053H
5.9L V8 360 CID	1993	Base	US7160
W200			
3.7L L6 3687cc 225 CID	1975-1979		US7100
3.7L L6 3687cc 225 CID	1980	Base	US7100
5.2L V8 318 CID	1975	Air Pump	US1053
5.2L V8 318 CID	1975	Exc.Air Pump	US1053
5.2L V8 318 CID	1975	Air Pump, High performance	US1053H
5.2L V8 318 CID	1975	Exc.Air Pump, High performance	US1053H
5.2L V8 5211cc 318 CID	1975-1978	Air Pump	US1053
5.2L V8 5211cc 318 CID	1975-1978	Exc.Air Pump, High performance	US1053H
5.2L V8 5211cc 318 CID	1975-1979	Air Pump	US1053
5.2L V8 5211cc 318 CID	1975-1979	Exc.Air Pump, High performance	US1053H
5.2L V8 5211cc 318 CID	1980	Base	US1053
5.2L V8 5211cc 318 CID	1980	Base; High performance	US1053H
5.9L V8 360 CID	1975-1978	Exc.Air Pump	US1053
5.9L V8 360 CID	1975-1978	Exc.Air Pump, High performance	US1053H
5.9L V8 360 CID	1975-1979	Air Pump	US1053
5.9L V8 360 CID	1975-1979	Air Pump, High performance	US1053H
5.9L V8 360 CID	1980	Base	US1053
5.9L V8 360 CID	1980	Base; High performance	US1053H
6.6L V8 400 CID	1976-1978		US1040
7.2L V8 440 CID	1975-1978		US1040
W200 PICKUP			
3.8L L6 3770cc 230 CID	1958-1959		US713
5.2L V8 318 CID	1969		US919
5.2L V8 5212cc 318 CID	1968-1969		US919
W200 SERIES			
5.2L V8 5212cc 318 CID	1960-1967		US919
W250			
3.7L L6 3700cc 225 CID	1985-1987	Mexican Application	US7100
5.2L V8 5211cc 318 CID	1981-1991	Base	US1053
5.2L V8 5211cc 318 CID	1981-1991	Base; High performance	US1053H
5.2L V8 5211cc 318 CID	1992	Base	US7159
5.2L V8 5211cc 318 CID	1993	Base	US7160
5.9L L6 359 CID	1989-1993	Base	US7145
5.9L V8 360 CID	1981-1982	Base	US1053
5.9L V8 360 CID	1981-1982	Base; High performance	US1053H
5.9L V8 360 CID	1984-1992	Base	US1053
5.9L V8 360 CID	1984-1992	Base; High performance	US1053H
5.9L V8 360 CID	1993	Base	US7160
5.9L V8 5900cc 360 CID	1989-1990	Mexican Application	US1053
W300			
3.7L L6 3687cc 225 CID	1975-1978		US7100
5.2L V8 5211cc 318 CID	1975-1978	Air Pump	US1053
5.2L V8 5211cc 318 CID	1975-1978	Exc.Air Pump	US1053
5.2L V8 5211cc 318 CID	1975-1978	Air Pump, High performance	US1053H
5.2L V8 5211cc 318 CID	1975-1978	Exc.Air Pump, High performance	US1053H
5.2L V8 5211cc 318 CID	1980	Base	US1053
5.2L V8 5211cc 318 CID	1980	Base; High performance	US1053H
5.9L V8 360 CID	1975-1978	Exc.Air Pump	US1053
5.9L V8 360 CID	1975-1978	Exc.Air Pump, High performance	US1053H
5.9L V8 360 CID	1975-1979	Air Pump	US1053
5.9L V8 360 CID	1975-1979	Air Pump, High performance	US1053H
5.9L V8 360 CID	1980	Base	US1053
5.9L V8 360 CID	1980	Base; High performance	US1053H
6.6L V8 400 CID	1976-1978		US1040
7.2L V8 440 CID	1975-1978		US1040
W300 PICKUP			
3.8L L6 3770cc 230 CID	1958-1959		US713
5.2L V8 318 CID	1968-1969		US919
5.2L V8 5212cc 318 CID	1968-1969		US919
W300 SERIES			
5.2L V8 5212cc 318 CID	1960-1967		US919
W350			
5.2L V8 5211cc 318 CID	1982-1983	Base	US1053
5.2L V8 5211cc 318 CID	1982-1983	Base; High performance	US1053H
5.9L L6 359 CID	1989-1993	Base	US7145
5.9L V8 360 CID	1981-1992	Base	US1053
5.9L V8 360 CID	1981-1992	Base; High performance	US1053H
5.9L V8 360 CID	1993	Base	US7160
WM300 POWER WAGON			
3.8L L6 3770cc 230 CID	1958-1960		US713
5.2L V8 5212cc 318 CID	1960-1962		US919

Engine	Years	Application Description	USMW
EAGLE (cont'd.)			
PREMIER			
2.5L L4 150 CID	1988-1989	LX	US3412
3.0L V6 2972cc 182 CID	1988-1989	ES, LX	US3411
3.0L V6 2972cc 182 CID	1990	ES, ES Limited, LX	US3411
3.0L V6 2972cc 182 CID	1991	ES, ES Limited; (Z7X-711)	US3411
SUMMIT			
1.5L L4 1468cc 90 CID	1989	DL, LX	US7115
1.5L L4 1468cc 90 CID	1990	DL, ES, LX	US7115
1.5L L4 1468cc 90 CID	1991-1992	Base, ES	US7115
1.5L L4 1468cc 90 CID	1993-1994	DL, ES	US7115
1.5L L4 1468cc 90 CID	1995-1996	DL, ESi	US7115
1.6L L4 1597cc 98 CID	1989-1990	LX	US7131
1.8L L4 1834cc 112 CID	1992	Base, DL, LX	US7135
1.8L L4 1834cc 112 CID	1993	Base, DL, ES	US7135
1.8L L4 1834cc 112 CID	1994	DL, ES, ESi, LX	US7135
1.8L L4 1834cc 112 CID	1995	DL, ESi, LX	US7135
1.8L L4 1834cc 112 CID	1996	DL, LX	US7135
2.4L L4 2351cc	1992	Base, DL, LX	US9168
2.4L L4 2351cc	1993-1996	Base, DL, LX	US7148
TALON			
1.8L L4 1755cc 107 CID	1993-1994	DL	US7108
2.0L L4 1997cc 122 CID	1990-1992	Base, TSi	US9212
2.0L L4 1997cc 122 CID	1993-1994	ES, TSi	US9212
2.0L L4 1997cc 122 CID	1995	ESi	US7150
2.0L L4 1997cc 122 CID	1995-1998	TSi	US7148
2.0L L4 1997cc 122 CID	1996-1998	Base, ESi	US7150
VISION			
3.3L V6 3301cc 201 CID	1993-1997	ESi	US7140
3.5L V6 3497cc 215 CID	1993-1994	TSi	US7141
3.5L V6 3497cc 215 CID	1995-1996	TSi	US7151
3.5L V6 3497cc 215 CID	1997	ESi, TSi; 3 Bolt Pattern	US7151
3.5L V6 3497cc 215 CID	1997	ESi, TSi; 6 Bolt Pattern	US7158
EDSEL			
RANGER			
4.8L V8 4786cc 292 CID	1959-1960		US488
FIAT			
124			
1.2L L4 1197cc 73 CID	1966-1969		US9203
1.4L L4 1438cc 88 CID	1970-1973		US9203
1.6L L4 1593cc	1974		US9003
1.6L L4 1608cc	1971-1973	Spider	US9203
1.8L L4 1756cc	1974-1978		US9003
2.0L L4 1995cc	1979-1982		US9003
124 SPIDER			
1.4L L4 1368cc 83 CID	2017	Abarth, Classica, Lusso	US8136
128			
1.1L L4 1116cc	1971-1973		US9084
1.3L L4 1290cc	1973-1979		US9084
131			
1.8L L4 1756cc	1975-1978		US9003
500			
1.4L L4 1368cc 83 CID	2012	Abarth, c Gucci, c Lounge, c Pop, Gucci, Lounge, Pop, Sport	US8136
1.4L L4 1368cc 83 CID	2013-2015	Abarth, Abarth Cabrio, c Lounge, c Pop, Lounge, Pop, Sport, Turbo	US8136
1.4L L4 1368cc 83 CID	2016	Abarth, Abarth Cabrio, c Easy, c Lounge, c Pop, Easy, Lounge, Pop, Sport, Turbo	US8136
1.4L L4 1368cc 83 CID	2017	Abarth, Abarth Cabrio, c Lounge, c Pop, Lounge, Pop	US8136
500L			
1.4L L4 1368cc 83 CID	2014	Easy, Lounge, Pop, Trekking	US8136
1.4L L4 1368cc 83 CID	2016	Easy, Lounge, Pop, Trekking, Urbana	US8136
1.4L L4 1368cc 83 CID	2017	Lounge, Pop, Trekking, Urbana	US8136
500X			
1.4L L4 1368cc 83 CID	2016-2017	Pop	US8136
2.4L L4 2360cc 144 CID	2016	Easy, Lounge, Pop, Trekking, Trekking Plus	US6038
2.4L L4 2360cc 144 CID	2017-2018	Lounge, Pop, Trekking	US6038
BRAVA			
2.0L L4 1995cc	1978-1981		US9003
IDEA			
1.8L L4 1796cc 110 CID	2008	Adventure S	US8938
IDEA ADVENTURE			
1.8L L4 1796cc 110 CID	2008-2009	Mexican Application	US8938
PALIO			
1.6L L4 1596cc 97 CID	2004		US8948
1.8L L4 1796cc 110 CID	2005		US8938

Engine	Years	Application Description	USMW	Engine	Years	Application Description	USMW
FIAT (cont'd.)				FORD (cont'd.)			
PALIO (cont'd.)				BRONCO (cont'd.)			
1.8L L4 1796cc 110 CID	2005-2006		US8948	4.9L L6 4917cc 300 CID	1983	Custom, XLS, XLT Lariat	US4020
1.8L L4 1796cc 110 CID	2006-2008	SFI	US8938	4.9L L6 4917cc 300 CID	1984	Custom, XLT	US4020
1.8L L4 1796cc 110 CID	2007-2008		US8938	4.9L L6 4917cc 300 CID	1985-1986	Custom, Eddie Bauer, XLT	US4020
1.8L L4 1796cc 110 CID	2010	ST	US8938	4.9L L6 4917cc 300 CID	1987-1989	Custom, Eddie Bauer, XLT	US4048
PANDA				4.9L L6 4917cc 300 CID	1990-1991	Custom, Eddie Bauer, XL, XLT	US4048
1.2L L4 1242cc 76 CID	2007-2008		US8945	4.9L L6 4917cc 300 CID	1992	Eddie Bauer, XL, XLT, XLT Nite	US4048
1.2L L4 1242cc 76 CID	2011-2012		US8945	5.0L V8 302 CID	1975-1977		US1028
PUNTO				5.0L V8 302 CID	1975-1977	High performance	US1028H
1.4L L4 1368cc 83 CID	2007-2008	SFI	US8946	5.0L V8 302 CID	1980-1981	Custom, Ranger XLT; WINDSOR	US953
1.4L L4 1368cc 83 CID	2007-2009		US8946	5.0L V8 302 CID	1980-1981	Custom, Ranger XLT; High performance	US953H
1.4L L4 1368cc 83 CID	2008	FBF	US8946	5.0L V8 302 CID	1982-1983	Custom, XLS, XLT Lariat; WINDSOR	US953
STRADA				5.0L V8 302 CID	1982-1983	Custom, XLS, XLT Lariat; High performance	US953H
1.5L L4 1498cc	1979		US8944	5.0L V8 302 CID	1984	Custom, XLT; WINDSOR	US953
1.5L L4 1498cc	1979-1982	W/O AIR	US9084	5.0L V8 302 CID	1984	Custom, XLT; High performance	US953H
1.5L L4 1498cc	1979-1982	A/C	US9085	5.0L V8 302 CID	1985-1986	Custom, Eddie Bauer, XLT; WINDSOR	US953
1.8L L4 1796cc 110 CID	2007-2008	Adventure	US8938	5.0L V8 302 CID	1985-1986	Custom, Eddie Bauer, XLT; High performance	US953H
1.8L L4 1796cc 110 CID	2007-2008	Adventure; SFI	US8938	5.0L V8 302 CID	1987-1989	Custom, Eddie Bauer, XLT	US4044
1.8L L4 1796cc 110 CID	2010	Adventure, Trekking	US8938	5.0L V8 302 CID	1987-1989	Custom, Eddie Bauer, XLT; High performance	US4044H
X-1/9				5.0L V8 302 CID	1990-1991	Custom, Eddie Bauer, XL, XLT	US4044
1.3L L4 1290cc	1974-1978		US9084	5.0L V8 302 CID	1990-1991	Custom, Eddie Bauer, XL, XLT; High performance	US4044H
1.5L L4 1498cc	1979-1982	W/O AIR	US9084	5.0L V8 302 CID	1992	Custom, Eddie Bauer, XL, XLT, XLT Nite	US4044
1.5L L4 1498cc	1979-1982	A/C	US9085	5.0L V8 302 CID	1992	Custom, Eddie Bauer, XL, XLT, XLT Nite; High performance	US4044H
FORD				5.0L V8 302 CID	1993	Custom, Eddie Bauer, XL, XLT Lariat	US4044
AEROSTAR				5.0L V8 302 CID	1993	Custom, Eddie Bauer, XL, XLT Lariat; High performance	US4044H
2.3L L4 140 CID	1986-1987	Base, XL, XLT	US4054	5.0L V8 302 CID	1994	Eddie Bauer, XL, XLT	US4044
2.8L V6 171 CID	1986	Base, XL, XLT	US4023	5.0L V8 302 CID	1994	Eddie Bauer, XL, XLT; High performance	US4044H
3.0L V6 2986cc 182 CID	1986-1987	Base, XL, XLT	US4039	5.0L V8 302 CID	1995-1996	Eddie Bauer, XL, XLT, XLT Sport	US4044
3.0L V6 2986cc 182 CID	1988	Base, Eddie Bauer, XL, XLT	US4039	5.0L V8 302 CID	1995-1996	Eddie Bauer, XL, XLT, XLT Sport; High performance	US4044H
3.0L V6 2986cc 182 CID	1989-1990	Base, Eddie Bauer, XL, XL Plus, XLT, XLT Plus	US4039	5.8L V8 351 CID	1978-1979	MODIFIED	US932
3.0L V6 2986cc 182 CID	1991	Base, Eddie Bauer, XL, XL Plus, XL Sport, XLT, XLT Plus, XLT Sport	US4039	5.8L V8 351 CID	1978-1979	WINDSOR	US953
3.0L V6 2986cc 182 CID	1992-1994	Base, XL, XL Plus, XL Sport, XLT, XLT Plus, XLT Sport	US4039	5.8L V8 351 CID	1978-1979	High performance	US953H
3.0L V6 2986cc 182 CID	1995-1997	Base, XLT, XLT Plus, XLT Sport	US4095	5.8L V8 351 CID	1980-1981	Custom, Ranger XLT; MODIFIED	US932
4.0L V6 245 CID	1990	Base, Eddie Bauer, XL, XL Plus, XLT, XLT Plus	US4060	5.8L V8 351 CID	1980-1981	Custom, Ranger XLT; WINDSOR	US953
4.0L V6 245 CID	1991-1994	Base, Eddie Bauer, XL, XL Plus, XL Sport, XLT, XLT Plus, XLT Sport	US4060	5.8L V8 351 CID	1980-1981	Custom, Ranger XLT; High performance	US953H
4.0L V6 245 CID	1995-1997	Base, XLT, XLT Plus, XLT Sport	US4060	5.8L V8 351 CID	1982	Custom, XLS, XLT Lariat; MODIFIED	US932
ASPIRE				5.8L V8 351 CID	1982-1983	Custom, XLS, XLT Lariat; WINDSOR	US953
1.3L L4 1295cc	1994-1995	Base, SE	US4049	5.8L V8 351 CID	1982-1983	Custom, XLS, XLT Lariat; High performance	US953H
1.3L L4 1295cc	1996-1997	Base	US4049	5.8L V8 351 CID	1984	Custom, XLT; WINDSOR	US953
B100				5.8L V8 351 CID	1984	Custom, XLT; High performance	US953H
4.7L V8 4700cc 289 CID	1973-1974	Mexican Application	US953	5.8L V8 351 CID	1985-1987	Custom, Eddie Bauer, XLT; WINDSOR	US953
4.7L V8 4700cc 289 CID	1973-1974	Mexican Application	US1028	5.8L V8 351 CID	1985-1987	Custom, Eddie Bauer, XLT; High performance	US953H
4.7L V8 4700cc 289 CID	1979	Mexican Application	US953	5.8L V8 351 CID	1988-1989	Custom, Eddie Bauer, XLT	US4044
5.0L V8 5000cc 302 CID	1973-1974	Mexican Application	US953	5.8L V8 351 CID	1988-1989	Custom, Eddie Bauer, XLT; High performance	US4044H
5.0L V8 5000cc 302 CID	1973-1974	Mexican Application	US1028	5.8L V8 351 CID	1990-1991	Custom, Eddie Bauer, XL, XLT	US4044
5.0L V8 5000cc 302 CID	1979-1981	Mexican Application	US953	5.8L V8 351 CID	1990-1991	Custom, Eddie Bauer, XL, XLT; High performance	US4044H
B150				5.8L V8 351 CID	1992	Custom, Eddie Bauer, XL, XLT, XLT Nite	US4044
3.8L V6 3800cc 232 CID	1982-1985	Mexican Application	US953	5.8L V8 351 CID	1992	Custom, Eddie Bauer, XL, XLT, XLT Nite; High performance	US4044H
4.7L V8 4700cc 289 CID	1975-1978	Mexican Application	US953	5.8L V8 351 CID	1993	Custom, Eddie Bauer, XL, XLT Lariat	US4044
5.0L V8 5000cc 302 CID	1975-1978	Mexican Application	US953	5.8L V8 351 CID	1993	Custom, Eddie Bauer, XL, XLT Lariat; High performance	US4044H
5.0L V8 5000cc 302 CID	1982-1985	Mexican Application	US953	5.8L V8 351 CID	1994	Eddie Bauer, XL, XLT	US4044
B200				5.8L V8 351 CID	1994	Eddie Bauer, XL, XLT; High performance	US4044H
5.0L V8 5000cc 302 CID	1985-1986	Mexican Application	US953	5.8L V8 351 CID	1995-1996	Eddie Bauer, XL, XLT, XLT Sport	US4044
5.0L V8 5000cc 302 CID	1987-1992	Mexican Application	US4044	5.8L V8 351 CID	1995-1996	Eddie Bauer, XL, XLT, XLT Sport; High performance	US4044H
B600				6.6L V8 400 CID	1978-1979	MODIFIED	US932
6.1L V8 370 CID	1980-1989		US4037	BRONCO II			
6.6L L6 401 CID	1987-1990		US4062	2.8L V6 171 CID	1984-1985	Base, Eddie Bauer, XLS, XLT	US4023
7.0L V8 429 CID	1988-1989		US4037	2.9L V6 177 CID	1986	Base, Eddie Bauer, XLT	US4042
B700				2.9L V6 177 CID	1987	Eddie Bauer, XL, XLT	US4042
6.1L V8 370 CID	1980-1989		US4037	2.9L V6 177 CID	1988	Eddie Bauer, XL, XL Sport, XLT	US4042
6.6L L6 401 CID	1987-1990		US4062	2.9L V6 177 CID	1989-1990	Eddie Bauer, XL, XL Sport, XLT, XLT Plus	US4042
7.0L V8 429 CID	1980-1989		US4037	C600			
7.8L L6 473 CID	1987		US4062	6.1L V8 370 CID	1980-1986		US4037
7.8L L6 473 CID	1990		US4062	C700			
B-100				6.1L V8 370 CID	1980-1986		US4037
5.0L V8 302 CID	1979	WINDSOR	US953	7.0L V8 429 CID	1980-1986		US4037
BRONCO				C800			
2.8L L6 170 CID	1967-1972		US1044	6.1L V8 370 CID	1980-1986		US4037
2.8L L6 2786cc 170 CID	1966-1972		US1044	BRONCO I			
2.9L L6 2901cc 177 CID	1997	Mexican Application	US4042	2.8L V6 171 CID	1984-1985	Base, Eddie Bauer, XLS, XLT	US4023
3.3L L6 200 CID	1973-1974		US1044	2.9L V6 177 CID	1986	Base, Eddie Bauer, XLT	US4042
3.3L L6 3277cc 200 CID	1973-1974		US1044	2.9L V6 177 CID	1987	Eddie Bauer, XL, XLT	US4042
3.3L L6 3278cc 200 CID	1973-1974		US1044	2.9L V6 177 CID	1988	Eddie Bauer, XL, XL Sport, XLT	US4042
4.9L L6 4917cc 300 CID	1980-1981	Custom, Ranger XLT	US4030N	2.9L V6 177 CID	1989-1990	Eddie Bauer, XL, XL Sport, XLT, XLT Plus	US4042
4.9L L6 4917cc 300 CID	1982	Custom, XLS, XLT Lariat	US4030N	C600			
WATER PUMPS				6.1L V8 370 CID	1980-1986		US4037



WATER PUMP APPLICATION GUIDE



Engine	Years	Application Description	USMW	Engine	Years	Application Description	USMW
FORD (cont'd.)				FORD (cont'd.)			
C800 (cont'd.)				COURIER (cont'd.)			
7.0L V8 429 CID	1980-1986		US4037	1.6L L4 1598cc 98 CID	2010	L, XL	US8931
CF6000				1.6L L4 1600cc 98 CID	2003-2007		US8931
6.6L L6 401 CID	1986-1990		US4062	1.6L L4 1600cc 98 CID	2011	L	US8931
CF7000				1.6L L4 1600cc 98 CID	2012	XL	US8931
5.9L L6 359 CID	1993-1997		US7145N	1.8L L4 110 CID	1975-1979		US1042
6.6L L6 401 CID	1986-1990		US4062	2.0L L4 1989cc 122 CID	1979		US1042
CF8000				2.0L L4 1989cc 122 CID	1981-1982	Base, XLT	US1042
6.6L L6 401 CID	1987		US4062	2.3L L4 140 CID	1977-1979		US4005
7.8L L6 473 CID	1987-1990		US4062	2.3L L4 140 CID	1980-1982	Base, XLT	US4005
CLUB WAGON				COURIER SEDAN DELIVERY			
2.4L L6 2360cc 144 CID	1962-1964		US1044	3.9L V8 3917cc 239 CID	1954		US488
2.8L L6 170 CID	1962-1963		US1044	4.4L V8 4458cc 272 CID	1955-1957		US488
2.8L L6 170 CID	1966-1967		US1044	4.8L V8 4786cc 292 CID	1957-1958		US488
2.8L L6 2786cc 170 CID	1962-1967		US1044	CRESTLINE			
CONTOUR				CROWN VICTORIA			
2.0L L4 1989cc 121 CID	1995	GL, GL Sport, LX, LX Sport	US4088	4.6L V8 281 CID	1992	Base, LX, S, Touring Sedan	US4066
2.0L L4 1989cc 121 CID	1996	GL, LX, Sport	US4088	4.6L V8 281 CID	1993	Base, LX, Police Interceptor, S	US4066
2.0L L4 1989cc 121 CID	1997	Base, GL, LX	US4088	4.6L V8 281 CID	1994	Base, LX, Police Interceptor, S; From 04/94	US4066
2.0L L4 1989cc 121 CID	1998	Base, GL, LX; From 12/1997	US4115	4.6L V8 281 CID	1994	Base, LX, Police Interceptor, S; To 03/94	US4066
2.0L L4 1989cc 121 CID	1998	Base, GL, LX; To 12/1997	US4115	4.6L V8 281 CID	1995-1997	Base, LX, Police Interceptor, S	US4066
2.0L L4 1989cc 121 CID	1998	GL, LX, SE	US4115	4.6L V8 281 CID	1996	Base, LX, Police Interceptor, S; From 03/96	US4066
2.0L L4 1989cc 121 CID	1999-2000	LX, SE	US4115	4.6L V8 281 CID	1996	Base, LX, Police Interceptor, S; To 03/96	US4066
2.5L V6 2450cc 155 CID	1995	GL, GL Sport, LX, LX Sport, SE	US4091	4.6L V8 281 CID	1998	Base, LX, Police Interceptor, S; Pump Length: long	US4113
2.5L V6 2450cc 155 CID	1995	GL, GL Sport, LX, LX Sport, SE; Includes back housing	US4091-2	4.6L V8 281 CID	1999-2000	Base, LX, Police Interceptor, S; Exc.Police, Pump Length: long	US4113
2.5L V6 2450cc 155 CID	1996-1997	GL, LX, SE, Sport	US4091	4.6L V8 281 CID	1999-2001	Base, LX, Police Interceptor, S; Police, Pump Length: long	US4113
2.5L V6 2450cc 155 CID	1996-1997	GL, LX, SE, Sport; Includes back housing	US4091-2	4.6L V8 281 CID	2001	Base, LX, Police Interceptor, S; Exc.Police, Long Housing, Pump Length: long	US4113
2.5L V6 2450cc 155 CID	1998	GL, LX, SE, SVT	US4091	4.6L V8 281 CID	2001	Base, LX, Police Interceptor, S; Exc.Police, Short Housing	US4128
2.5L V6 2450cc 155 CID	1998	GL, LX, SE, SVT; Includes back housing	US4091-2	4.6L V8 281 CID	2002	Base, LX, Police Interceptor, S; Exc.Police, Long Housing, Pump Length: long	US4113
2.5L V6 2450cc 155 CID	1999	LX, SE	US4091	4.6L V8 281 CID	2002	Base, LX, Police Interceptor, S; Police, Pump Length: long	US4113
2.5L V6 2450cc 155 CID	1999	LX, SE; Includes back housing	US4091-2	4.6L V8 281 CID	2002	Base, LX, Police Interceptor, S; Police, Pump Length: long	US4113
2.5L V6 2450cc 155 CID	1999	SVT	US4115	4.6L V8 281 CID	2002	Base, LX, Police Interceptor, S; Exc.Police, Short Housing	US4128
2.5L V6 2450cc 155 CID	2000	LX, SE, SVT	US4091	4.6L V8 281 CID	2003	Base, LX, Police Interceptor, S	US4128
2.5L V6 2450cc 155 CID	2000	LX, SE, SVT; Includes back housing	US4091-2	4.6L V8 281 CID	2004	Base, LX, LX Sport, Police Interceptor	US4128
COUGAR				4.6L V8 281 CID	2005	Base, LX, LX Sport, Police Interceptor, S, Special Edition	US4128
3.8L L6 3802cc 232 CID	1996	Mexican Application	US4103	4.6L V8 281 CID	2006	Base, LX, LX Sport, Police Interceptor	US4128
3.8L V6 3797cc 232 CID	1990-1994	Mexican Application	US4050	4.6L V8 281 CID	2007-2008	Base, LX, Police Interceptor	US4128
3.8L V6 3800cc 232 CID	1985-1987	Mexican Application	US4016	4.6L V8 281 CID	2009	LX, Police Interceptor	US4128
3.8L V6 3800cc 232 CID	1988-1989	Mexican Application	US4050	4.6L V8 281 CID	2010-2011	Base, LX, Police Interceptor	US4128
3.8L V6 3802cc 232 CID	1987	Mexican Application	US4016	CUSTOM			
3.8L V6 3802cc 232 CID	1988-1993	Mexican Application	US4050	4.7L V8 4727cc 289 CID	1965		US819
3.8L V6 3802cc 232 CID	1994-1995	Mexican Application	US4090	4.8L V8 4786cc 292 CID	1957		US488
4.9L V8 4900cc 299 CID	1994	Mexican Application	US4057	CUSTOM 300			
5.0L V8 5000cc 302 CID	1991-1993	Mexican Application	US4057	4.8L V8 4786cc 292 CID	1958-1960		US488
COUNTRY SEDAN				CUSTOM 500			
2.4L L6 2360cc 144 CID	1960-1961		US1044	4.3L V8 260 CID	1964		US819
2.8L L6 2786cc 170 CID	1960-1961		US1044	4.7L V8 289 CID	1964-1967		US819
2.8L L6 2786cc 170 CID	1965-1969		US1044	5.8L V8 351 CID	1975-1977	MODIFIED	US932
3.3L L6 3277cc 200 CID	1965-1970		US1044	5.8L V8 351 CID	1975-1977	High performance	US953H
3.6L V8 3622cc 221 CID	1962-1963		US819	5.8L V8 351 CID	1976-1977	WINDSOR	US953
4.3L V8 4261cc 260 CID	1962-1965		US819	5.8L V8 352 CID	1964		US723
4.7L V8 4727cc 289 CID	1963-1967		US819	6.4L V8 390 CID	1964		US723
5.8L V8 5769cc 352 CID	1961-1964		US723	6.6L V8 400 CID	1975-1977	MODIFIED	US932
6.4L V8 6391cc 390 CID	1961-1964		US723	7.5L V8 460 CID	1975-1976		US1114
6.6L V8 6654cc 406 CID	1962-1963		US723	CUSTOMLINE			
7.0L V8 6997cc 427 CID	1963-1964		US723	3.9L V8 3917cc 239 CID	1954		US488
COUNTRY SQUIRE				4.4L V8 4458cc 272 CID	1955-1956		US488
2.4L L6 2360cc 144 CID	1960-1961		US1044	E-100 ECONOLINE			
2.8L L6 2786cc 170 CID	1960-1961		US1044	2.8L L6 170 CID	1969-1971		US1044
2.8L L6 2786cc 170 CID	1965-1969		US1044	2.8L L6 2786cc 170 CID	1969-1971		US1044
3.3L L6 3277cc 200 CID	1965-1970		US1044	4.9L L6 4917cc 300 CID	1975-1979		US4030N
3.6L V8 3622cc 221 CID	1962-1963		US819	4.9L L6 4917cc 300 CID	1980-1982	Base, Chateau, Custom	US4030N
4.3L V8 4261cc 260 CID	1962-1965		US819	4.9L L6 4917cc 300 CID	1983	Custom, XL	US4020
4.7L V8 4727cc 289 CID	1963-1965		US819	5.0L V8 302 CID	1974		US1052
5.0L V8 302 CID	1987	Base, LX	US4014	5.0L V8 302 CID	1975	WINDSOR	US953
5.0L V8 302 CID	1987	Base, LX; High performance	US4014H	5.0L V8 302 CID	1975	High performance	US953H
5.0L V8 302 CID	1988	Base, LX; To 06/1988	US4014	5.0L V8 302 CID	1979	WINDSOR	US953
5.0L V8 302 CID	1988	Base, LX; High performance, To 06/88	US4014H	5.0L V8 302 CID	1979	High performance	US953H
5.0L V8 302 CID	1988	Base, LX; From 06/1988	US4052	5.0L V8 302 CID	1980-1982	Base, Chateau, Custom; WINDSOR	US953
5.0L V8 302 CID	1988	Base, LX; From 06/88, High performance	US4052H	5.0L V8 302 CID	1980-1982	Base, Chateau, Custom; High performance	US953H
5.0L V8 302 CID	1989-1991	Base, LX	US4052	COURIER			
5.0L V8 302 CID	1989-1991	Base, LX; High performance	US4052H	1.6L L4 1598cc 98 CID	2001-2002		US8931
5.8L V8 5769cc 352 CID	1961-1964		US723	1.6L L4 1598cc 98 CID	2008-2009		US8931
6.4L V8 6391cc 390 CID	1961-1964		US723				
6.6L V8 6654cc 406 CID	1962-1963		US723				
7.0L V8 6997cc 427 CID	1963-1964		US723				

Engine	Years	Application Description	USMW	Engine	Years	Application Description	USMW
FORD (cont'd.)				FORD (cont'd.)			
E-100 ECONOLINE (cont'd.)				E-150 ECONOLINE (cont'd.)			
5.0L V8 302 CID	1983	Custom, XL; WINDSOR	US953	5.8L V8 351 CID	1988-1991	Custom, XL; High performance	US4044H
5.0L V8 302 CID	1983	Custom, XL; High performance	US953H	5.8L V8 351 CID	1992-1996	Base, XL	US4044
5.8L V8 351 CID	1975-1979	WINDSOR	US953	5.8L V8 351 CID	1992-1996	Base, XL; High performance	US4044H
5.8L V8 351 CID	1975-1979	High performance	US953H	E-150 ECONOLINE CLUB WAGON			
5.8L V8 351 CID	1980-1982	Base, Chateau, Custom; MODIFIED	US932	4.2L V6 256 CID	1997-2000	Chateau, Custom, XLT	US4105
5.8L V8 351 CID	1980-1982	Base, Chateau, Custom; WINDSOR	US953	4.2L V6 256 CID	2001-2002	Chateau, XL, XLT	US4105
5.8L V8 351 CID	1980-1982	Base, Chateau, Custom; High performance	US953H	4.6L V8 281 CID	1997-2000	Chateau, Custom, XLT	US8920
5.8L V8 351 CID	1983	Custom, XL; WINDSOR	US953	4.6L V8 281 CID	2001-2002	Chateau, XL, XLT	US8920
5.8L V8 351 CID	1983	Custom, XL; High performance	US953H	4.9L L6 4917cc 300 CID	1975-1977	From Engine #080001	US4030N
E-100 ECONOLINE CLUB WAGON				4.9L L6 4917cc 300 CID	1975-1977	Before S/N 080001	US4033
4.9L L6 4917cc 300 CID	1975-1979		US4030N	4.9L L6 4917cc 300 CID	1978-1979		US4030N
4.9L L6 4917cc 300 CID	1980-1982	Base, Chateau, Custom	US4030N	4.9L L6 4917cc 300 CID	1980-1982	Base, Chateau, Custom	US4030N
4.9L L6 4917cc 300 CID	1983	Custom, XL	US4020	4.9L L6 4917cc 300 CID	1983	Custom, XL	US4020
5.0L V8 302 CID	1979	WINDSOR	US953	4.9L L6 4917cc 300 CID	1984-1986	Base, XL, XLT	US4020
5.0L V8 302 CID	1979	High performance	US953H	4.9L L6 4917cc 300 CID	1987-1991	Custom, XL, XLT	US4048
5.0L V8 302 CID	1980-1982	Base, Chateau, Custom; WINDSOR	US953	4.9L L6 4917cc 300 CID	1992	Chateau, Custom, XLT	US4079
5.0L V8 302 CID	1980-1982	Base, Chateau, Custom; High performance	US953H	4.9L L6 4917cc 300 CID	1993-1996	Chateau, Custom, XLT	US4099
5.0L V8 302 CID	1983	Custom, XL; WINDSOR	US953	5.0L V8 302 CID	1979	WINDSOR	US953
5.0L V8 302 CID	1983	Custom, XL; High performance	US953H	5.0L V8 302 CID	1979	High performance	US953H
5.8L V8 351 CID	1975-1979	WINDSOR	US953	5.0L V8 302 CID	1980-1982	Base, Chateau, Custom; WINDSOR	US953
5.8L V8 351 CID	1975-1979	High performance	US953H	5.0L V8 302 CID	1980-1982	Base, Chateau, Custom; High performance	US953H
5.8L V8 351 CID	1980-1982	Base, Chateau, Custom; MODIFIED	US932	5.0L V8 302 CID	1983	Custom, XL; WINDSOR	US953
5.8L V8 351 CID	1980-1982	Base, Chateau, Custom; WINDSOR	US953	5.0L V8 302 CID	1983	Custom, XL; High performance	US953H
5.8L V8 351 CID	1980-1982	Base, Chateau, Custom; High performance	US953H	5.0L V8 302 CID	1984-1986	Base, XL, XLT; WINDSOR	US953
5.8L V8 351 CID	1983	Custom, XL; WINDSOR	US953	5.0L V8 302 CID	1984-1986	Base, XL, XLT; High performance	US953H
5.8L V8 351 CID	1983	Custom, XL; High performance	US953H	5.0L V8 302 CID	1987-1991	Custom, XL, XLT	US4044
E-150				5.0L V8 302 CID	1987-1991	Custom, XL, XLT; High performance	US4044H
4.2L V6 256 CID	2003	Base	US4105	5.0L V8 302 CID	1992-1996	Chateau, Custom, XLT	US4044
4.6L V8 281 CID	2003-2005	Base	US8920	5.0L V8 302 CID	1992-1996	Chateau, Custom, XLT; High performance	US4044H
4.6L V8 281 CID	2006-2007	Base, Chateau, XL, XLT	US8920	5.4L V8 330 CID	1997-2000	Chateau, Custom, XLT	US8920
4.6L V8 281 CID	2008-2014	Base, XL, XLT	US8920	5.4L V8 330 CID	2001-2002	Chateau, XL, XLT	US8920
5.4L V8 330 CID	2003-2005	Base	US8920	5.8L V8 351 CID	1975-1979	WINDSOR	US953
5.4L V8 330 CID	2006-2007	Base, Chateau, XL, XLT	US8920	5.8L V8 351 CID	1975-1979	High performance	US953H
5.4L V8 330 CID	2008-2014	Base, XL, XLT	US8920	5.8L V8 351 CID	1980-1982	Base, Chateau, Custom; MODIFIED	US932
E-150 CLUB WAGON				5.8L V8 351 CID	1980-1982	Base, Chateau, Custom; WINDSOR	US953
4.2L V6 256 CID	2003	Chateau, XL, XLT	US4105	5.8L V8 351 CID	1980-1982	Base, Chateau, Custom; High performance	US953H
4.6L V8 281 CID	2003-2005	Chateau, XL, XLT	US8920	5.8L V8 351 CID	1983	Custom, XL; WINDSOR	US953
5.4L V8 330 CID	2003-2005	Chateau, XL, XLT	US8920	5.8L V8 351 CID	1983	Custom, XL; High performance	US953H
E-150 ECONOLINE				5.8L V8 351 CID	1984-1986	Base, XL, XLT; WINDSOR	US953
4.2L V6 256 CID	1997-2000	Base, XL	US4105	5.8L V8 351 CID	1984-1986	Base, XL, XLT; High performance	US953H
4.2L V6 256 CID	2001-2002	Base	US4105	5.8L V8 351 CID	1987	Custom, XL, XLT; WINDSOR	US953
4.6L V8 281 CID	1997-2000	Base, XL	US8920	5.8L V8 351 CID	1987	Custom, XL, XLT; High performance	US953H
4.6L V8 281 CID	2001-2002	Base	US8920	5.8L V8 351 CID	1988-1991	Custom, XL, XLT	US4044
4.9L L6 4917cc 300 CID	1975-1977	From Engine #080001	US4030N	5.8L V8 351 CID	1988-1991	Custom, XL, XLT; High performance	US4044H
4.9L L6 4917cc 300 CID	1975-1977	Before S/N 080001	US4033	5.8L V8 351 CID	1992-1996	Chateau, Custom, XLT	US4044
4.9L L6 4917cc 300 CID	1978-1979		US4030N	5.8L V8 351 CID	1992-1996	Chateau, Custom, XLT; High performance	US4044H
4.9L L6 4917cc 300 CID	1980-1982	Base, Chateau, Custom	US4030N	E-200 ECONOLINE			
4.9L L6 4917cc 300 CID	1983	Custom, XL	US4020	2.8L L6 170 CID	1969-1971		US1044
4.9L L6 4917cc 300 CID	1984-1986	Base, XL	US4020	E-250			
4.9L L6 4917cc 300 CID	1987-1991	Custom, XL	US4048	4.2L V6 256 CID	2003	Base	US4105
4.9L L6 4917cc 300 CID	1992	Base, XL	US4079	4.6L V8 281 CID	2003-2014	Base	US8920
4.9L L6 4917cc 300 CID	1993-1996	Base, XL	US4099	5.4L V8 330 CID	2003-2014	Base	US8920
5.0L V8 302 CID	1975	WINDSOR	US953	E-250 ECONOLINE			
5.0L V8 302 CID	1975	High performance	US953H	4.2L V6 256 CID	1997-2000	Base, XL	US4105
5.0L V8 302 CID	1979	WINDSOR	US953	4.2L V6 256 CID	2001-2002	Base	US4105
5.0L V8 302 CID	1979	High performance	US953H	4.9L L6 4917cc 300 CID	1975-1977	From Engine #080001	US4030N
5.0L V8 302 CID	1980-1982	Base, Chateau, Custom; WINDSOR	US953	4.9L L6 4917cc 300 CID	1975-1977	Before S/N 080001	US4033
5.0L V8 302 CID	1980-1982	Base, Chateau, Custom; High performance	US953H	4.9L L6 4917cc 300 CID	1978-1979		US4030N
5.0L V8 302 CID	1983	Custom, XL; WINDSOR	US953	4.9L L6 4917cc 300 CID	1980-1982	Base, Chateau, Custom	US4030N
5.0L V8 302 CID	1983	Custom, XL; High performance	US953H	4.9L L6 4917cc 300 CID	1983	Custom, XL	US4020
5.0L V8 302 CID	1984-1986	Base, XL; WINDSOR	US953	4.9L L6 4917cc 300 CID	1984	Base, XL; Single rear wheels	US4020
5.0L V8 302 CID	1984-1986	Base, XL; High performance	US953H	4.9L L6 4917cc 300 CID	1984	Base, XL; Dual rear wheels	US4083
5.0L V8 302 CID	1987-1991	Custom, XL	US4044	4.9L L6 4917cc 300 CID	1985-1986	Base, XL	US4020
5.0L V8 302 CID	1987-1991	Custom, XL; High performance	US4044H	4.9L L6 4917cc 300 CID	1987-1991	Custom, XL	US4048
5.0L V8 302 CID	1992-1996	Base, XL	US4044	4.9L L6 4917cc 300 CID	1992	Base, XL	US4079
5.0L V8 302 CID	1992-1996	Base, XL; High performance	US4044H	4.9L L6 4917cc 300 CID	1993-1996	Base, XL	US4099
5.4L V8 330 CID	1997-2000	Base, XL	US8920	5.0L V8 302 CID	1975	WINDSOR	US953
5.4L V8 330 CID	2001-2002	Base	US8920	5.0L V8 302 CID	1975	High performance	US953H
5.8L V8 351 CID	1975-1979	WINDSOR	US953	5.0L V8 302 CID	1979	WINDSOR	US953
5.8L V8 351 CID	1975-1979	High performance	US953H	5.0L V8 302 CID	1979	High performance	US953H
5.8L V8 351 CID	1980-1982	Base, Chateau, Custom; MODIFIED	US932	5.0L V8 302 CID	1980-1982	Base, Chateau, Custom; WINDSOR	US953
5.8L V8 351 CID	1980-1982	Base, Chateau, Custom; WINDSOR	US953	5.0L V8 302 CID	1980-1982	Base, Chateau, Custom; High performance	US953H
5.8L V8 351 CID	1980-1982	Base, Chateau, Custom; High performance	US953H	5.0L V8 302 CID	1983	Custom, XL; WINDSOR	US953
5.8L V8 351 CID	1983	Custom, XL; WINDSOR	US953	5.0L V8 302 CID	1983	Custom, XL; High performance	US953H
5.8L V8 351 CID	1983	Custom, XL; High performance	US953H	5.0L V8 302 CID	1984-1986	Base, XL; WINDSOR	US953
5.8L V8 351 CID	1984-1986	Base, XL; WINDSOR	US953	5.0L V8 302 CID	1984-1986	Base, XL; High performance	US953H
5.8L V8 351 CID	1984-1986	Base, XL; High performance	US953H	5.0L V8 302 CID	1987-1991	Custom, XL	US4044
5.8L V8 351 CID	1987	Custom, XL; WINDSOR	US953	5.0L V8 302 CID	1987-1991	Custom, XL; High performance	US4044H
5.8L V8 351 CID	1987	Custom, XL; High performance	US953H	5.4L V8 330 CID	1997-2000	Base, XL	US8920
5.8L V8 351 CID	1988-1991	Custom, XL	US4044	5.4L V8 330 CID	2001-2002	Base	US8920

WATER PUMPS

Engine	Years	Application Description	USMW	Engine	Years	Application Description	USMW
FORD (cont'd.)				FORD (cont'd.)			
E-250 ECONOLINE (cont'd.)				E-350 ECONOLINE (cont'd.)			
5.8L V8 351 CID	1975-1979	WINDSOR	US953	5.0L V8 302 CID	1979	WINDSOR	US953
5.8L V8 351 CID	1975-1979	High performance	US953H	5.0L V8 302 CID	1979	High performance	US953H
5.8L V8 351 CID	1980-1982	Base, Chateau, Custom; MODIFIED	US932	5.4L V8 330 CID	1997-1998	Base, XL	US8920
5.8L V8 351 CID	1980-1982	Base, Chateau, Custom; WINDSOR	US953	5.8L V8 351 CID	1975-1979	WINDSOR	US953
5.8L V8 351 CID	1980-1982	Base, Chateau, Custom; High performance	US953H	5.8L V8 351 CID	1975-1979	High performance	US953H
5.8L V8 351 CID	1983	Custom, XL; WINDSOR	US953	5.8L V8 351 CID	1980-1982	Base, Chateau, Custom; MODIFIED	US932
5.8L V8 351 CID	1983	Custom, XL; High performance	US953H	5.8L V8 351 CID	1980-1982	Base, Chateau, Custom; WINDSOR	US953
5.8L V8 351 CID	1984-1986	Base, XL; WINDSOR	US953	5.8L V8 351 CID	1980-1982	Base, Chateau, Custom; High performance	US953H
5.8L V8 351 CID	1984-1986	Base, XL; High performance	US953H	5.8L V8 351 CID	1983	Custom, XL; WINDSOR	US953
5.8L V8 351 CID	1987	Custom, XL; WINDSOR	US953	5.8L V8 351 CID	1983	Custom, XL; High performance	US953H
5.8L V8 351 CID	1987	Custom, XL; High performance	US953H	5.8L V8 351 CID	1984-1986	Base, XL; WINDSOR	US953
5.8L V8 351 CID	1988-1991	Custom, XL	US4044	5.8L V8 351 CID	1984-1986	Base, XL; High performance	US953H
5.8L V8 351 CID	1988-1991	Custom, XL; High performance	US4044H	5.8L V8 351 CID	1987	Custom, XL; WINDSOR	US953
5.8L V8 351 CID	1992-1996	Base, XL	US4044	5.8L V8 351 CID	1987	Custom, XL; High performance	US953H
5.8L V8 351 CID	1992-1996	Base, XL; High performance	US4044H	5.8L V8 351 CID	1988-1991	Custom, XL	US4044
6.6L V8 400 CID	1980	Base, Chateau, Custom; MODIFIED	US932	5.8L V8 351 CID	1988-1991	Custom, XL; High performance	US4044H
7.5L V8 460 CID	1975-1979		US1114	5.8L V8 351 CID	1992-1996	Base, XL	US4044
7.5L V8 460 CID	1980	Base, Chateau, Custom	US1114	5.8L V8 351 CID	1992-1996	Base, XL; High performance	US4044H
E-250 ECONOLINE CLUB WAGON				E-350 ECONOLINE CLUB WAGON			
4.9L L6 4917cc 300 CID	1977	From Engine #080001	US4030N	4.9L L6 4917cc 300 CID	1977	From Engine #080001	US4030N
4.9L L6 4917cc 300 CID	1977	Before S/N 080001	US4033	4.9L L6 4917cc 300 CID	1977	Before S/N 080001	US4033
4.9L L6 4917cc 300 CID	1978-1979		US4030N	4.9L L6 4917cc 300 CID	1978-1979		US4030N
4.9L L6 4917cc 300 CID	1980	Base, Chateau, Custom	US4030N	4.9L L6 4917cc 300 CID	1980-1982	Base, Chateau, Custom	US4030N
4.9L L6 4917cc 300 CID	1983	Custom, XL	US4020	4.9L L6 4917cc 300 CID	1983	Custom, XL	US4020
4.9L L6 4917cc 300 CID	1984	Base, XL, XLT; Single rear wheels	US4020	4.9L L6 4917cc 300 CID	1984	Base, XL, XLT; Single rear wheels	US4020
4.9L L6 4917cc 300 CID	1984	Base, XL, XLT; Dual rear wheels	US4083	4.9L L6 4917cc 300 CID	1984	Base, XL, XLT; Dual rear wheels	US4083
4.9L L6 4917cc 300 CID	1985-1986	Base, XL, XLT	US4020	4.9L L6 4917cc 300 CID	1985-1986	Base, XL, XLT	US4020
4.9L L6 4917cc 300 CID	1987	XL, XLT	US4048	4.9L L6 4917cc 300 CID	1987-1989	Custom, XL, XLT	US4048
4.9L L6 4917cc 300 CID	1988-1991	Custom, XL, XLT	US4048	4.9L L6 4917cc 300 CID	1990	Custom, XL	US4048
5.0L V8 302 CID	1979	WINDSOR	US953	4.9L L6 4917cc 300 CID	1991	Custom, XL, XLT	US4048
5.0L V8 302 CID	1979	High performance	US953H	4.9L L6 4917cc 300 CID	1992	Chateau, Chateau HD, Custom, Custom HD, XLT, XLT HD	US4079
5.0L V8 302 CID	1980	Base, Chateau, Custom; WINDSOR	US953	4.9L L6 4917cc 300 CID	1993	Chateau, Chateau HD, Custom, Custom HD, XLT, XLT HD	US4099
5.0L V8 302 CID	1980	Base, Chateau, Custom; High performance	US953H	4.9L L6 4917cc 300 CID	1994-1996	Chateau, Chateau HD, Custom, XL HD, XLT, XLT HD	US4099
5.8L V8 351 CID	1975-1979	WINDSOR	US953	5.0L V8 302 CID	1979	WINDSOR	US953
5.8L V8 351 CID	1975-1979	High performance	US953H	5.0L V8 302 CID	1979	High performance	US953H
5.8L V8 351 CID	1980-1982	Base, Chateau, Custom; MODIFIED	US932	5.4L V8 330 CID	1997-1998	Chateau, Custom, XL HD, XLT, XLT HD	US8920
5.8L V8 351 CID	1980-1982	Base, Chateau, Custom; WINDSOR	US953	5.4L V8 330 CID	1999-2000	Chateau, Custom, XLT	US8920
5.8L V8 351 CID	1980-1982	Base, Chateau, Custom; High performance	US953H	5.4L V8 330 CID	2001-2002	Chateau, XL, XLT	US8920
5.8L V8 351 CID	1983	Custom, XL; WINDSOR	US953	5.8L V8 351 CID	1977-1979	WINDSOR	US953
5.8L V8 351 CID	1983	Custom, XL; High performance	US953H	5.8L V8 351 CID	1977-1979	High performance	US953H
5.8L V8 351 CID	1984-1986	Base, XL, XLT; WINDSOR	US953	5.8L V8 351 CID	1980-1982	Base, Chateau, Custom; MODIFIED	US932
5.8L V8 351 CID	1984-1986	Base, XL, XLT; High performance	US953H	5.8L V8 351 CID	1980-1982	Base, Chateau, Custom; WINDSOR	US953
5.8L V8 351 CID	1987	Custom, XL, XLT; WINDSOR	US953	5.8L V8 351 CID	1980-1982	Base, Chateau, Custom; High performance	US953H
5.8L V8 351 CID	1987	Custom, XL, XLT; High performance	US953H	5.8L V8 351 CID	1983	Custom, XL; WINDSOR	US953
5.8L V8 351 CID	1988-1991	Custom, XL, XLT	US4044	5.8L V8 351 CID	1984-1986	Base, XL, XLT; High performance	US953H
5.8L V8 351 CID	1988-1991	Custom, XL, XLT; High performance	US4044H	5.8L V8 351 CID	1987	Custom, XL, XLT; WINDSOR	US953
6.6L V8 400 CID	1980-1982	Base, Chateau, Custom; MODIFIED	US932	5.8L V8 351 CID	1987	Custom, XL, XLT; High performance	US953H
6.9L V8 420 CID	1983	Custom, XL	US4018	5.8L V8 351 CID	1988-1989	Custom, XL, XLT	US4044
6.9L V8 420 CID	1984-1986	Base, XL, XLT	US4018	5.8L V8 351 CID	1988-1989	Custom, XL, XLT; High performance	US4044H
6.9L V8 420 CID	1987	Custom, XL, XLT	US4018	5.8L V8 351 CID	1990	Custom, XL	US4044
7.3L V8 445 CID	1988-1991	Custom, XL, XLT	US4018	5.8L V8 351 CID	1990	Custom, XL; High performance	US4044H
7.5L V8 460 CID	1975-1979		US1114	5.8L V8 351 CID	1991	Custom, XL, XLT	US4044
7.5L V8 460 CID	1980-1982	Base, Chateau, Custom	US1114	5.8L V8 351 CID	1991	Custom, XL, XLT; High performance	US4044H
7.5L V8 460 CID	1983	Custom, XL	US1114	5.8L V8 351 CID	1992-1993	Chateau, Chateau HD, Custom, Custom HD, XLT, XLT HD	US4044
7.5L V8 460 CID	1984-1986	Base, XL, XLT	US1114				
7.5L V8 460 CID	1987	Custom, XL, XLT	US1114				
7.5L V8 460 CID	1988-1989	Custom, XL, XLT	US4081				
7.5L V8 460 CID	1990-1991	Custom, XL, XLT	US1114				
E-300 ECONOLINE				E-350 ECONOLINE			
2.8L L6 170 CID	1969-1970		US1044	4.9L L6 4917cc 300 CID	1975-1977	From Engine #080001	US4030N
5.0L V8 302 CID	1974		US1052	4.9L L6 4917cc 300 CID	1975-1977	Before S/N 080001	US4033
E-350 CLUB WAGON				E-350 ECONOLINE			
5.4L V8 330 CID	2003-2005	Chateau, XL, XLT	US8920	4.9L L6 4917cc 300 CID	1978-1979		US4030N
6.0L V8 363 CID	2004-2005	Chateau, XL, XLT	US67	4.9L L6 4917cc 300 CID	1980-1982	Base, Chateau, Custom	US4030N
6.8L V10 415 CID	2003	Chateau, XL, XLT	US4109	4.9L L6 4917cc 300 CID	1983	Custom, XL	US4020
6.8L V10 415 CID	2005	Chateau, XL, XLT	US4109	4.9L L6 4917cc 300 CID	1984	Base, XL, XLT; Single rear wheels	US4020
7.3L V8 445 CID	2003	Chateau, XL, XLT	US4114	4.9L L6 4917cc 300 CID	1984	Base, XL, XLT; Dual rear wheels	US4083
E-350 ECONOLINE				E-350 ECONOLINE			
4.9L L6 4917cc 300 CID	1975-1977	From Engine #080001	US4030N	4.9L L6 4917cc 300 CID	1985-1986	Base, XL, XLT	US4020
4.9L L6 4917cc 300 CID	1975-1977	Before S/N 080001	US4033	4.9L L6 4917cc 300 CID	1987-1989	Custom, XL, XLT	US4048
4.9L L6 4917cc 300 CID	1978-1979		US4030N	4.9L L6 4917cc 300 CID	1990	Custom, XL	US4048
4.9L L6 4917cc 300 CID	1980-1982	Base, Chateau, Custom	US4030N	4.9L L6 4917cc 300 CID	1991	Custom, XL, XLT	US4048
4.9L L6 4917cc 300 CID	1983	Custom, XL	US4020	4.9L L6 4917cc 300 CID	1992	Chateau, Chateau HD, Custom, Custom HD, XLT, XLT HD	US4079
4.9L L6 4917cc 300 CID	1984	Base, XL; Single rear wheels	US4020	4.9L L6 4917cc 300 CID	1993	Chateau, Chateau HD, Custom, Custom HD, XLT, XLT HD	US4099
4.9L L6 4917cc 300 CID	1984	Base, XL; Dual rear wheels	US4083	4.9L L6 4917cc 300 CID	1994-1996	Chateau, Chateau HD, Custom, XL HD, XLT, XLT HD	US4099
4.9L L6 4917cc 300 CID	1985-1986	Base, XL	US4020	5.0L V8 302 CID	1979	WINDSOR	US953
4.9L L6 4917cc 300 CID	1987-1991	Custom, XL	US4048	5.0L V8 302 CID	1979	High performance	US953H
4.9L L6 4917cc 300 CID	1992	Base, XL	US4079	5.4L V8 330 CID	1997-1998	Chateau, Custom, XL HD, XLT, XLT HD	US8920
4.9L L6 4917cc 300 CID	1993-1996	Base, XL	US4099	5.4L V8 330 CID	1999-2000	Chateau, Custom, XLT	US8920
5.0L V8 302 CID	1975	WINDSOR	US953	5.4L V8 330 CID	2001-2002	Chateau, XL, XLT	US8920
5.0L V8 302 CID	1975	High performance	US953H	5.8L V8 351 CID	1977-1979	WINDSOR	US953
				5.8L V8 351 CID	1977-1979	High performance	US953H
				5.8L V8 351 CID	1980-1982	Base, Chateau, Custom; MODIFIED	US932
				5.8L V8 351 CID	1980-1982	Base, Chateau, Custom; WINDSOR	US953
				5.8L V8 351 CID	1980-1982	Base, Chateau, Custom; High performance	US953H
				5.8L V8 351 CID	1983	Custom, XL; WINDSOR	US953
				5.8L V8 351 CID	1983	Custom, XL; High performance	US953H
				5.8L V8 351 CID	1984-1986	Base, XL, XLT; WINDSOR	US953
				5.8L V8 351 CID	1984-1986	Base, XL, XLT; High performance	US953H
				5.8L V8 351 CID	1987	Custom, XL, XLT; WINDSOR	US953
				5.8L V8 351 CID	1987	Custom, XL, XLT; High performance	US953H
				5.8L V8 351 CID	1988-1989	Custom, XL, XLT	US4044
				5.8L V8 351 CID	1988-1989	Custom, XL, XLT; High performance	US4044H
				5.8L V8 351 CID	1990	Custom, XL	US4044
				5.8L V8 351 CID	1990	Custom, XL; High performance	US4044H
				5.8L V8 351 CID	1991	Custom, XL, XLT	US4044
				5.8L V8 351 CID	1991	Custom, XL, XLT; High performance	US4044H
				5.8L V8 351 CID	1992-1993	Chateau, Chateau HD, Custom, Custom HD, XLT, XLT HD	US4044

Engine	Years	Application Description	USMW
FORD (cont'd.)			
ESCAPE (cont'd.)			
2.0L L4 1999cc 122 CID	2018	Titanium	US8975
2.3L L4 140 CID	2005	Hybrid, XLS, XLT, XLT No Boundaries	US4126
2.3L L4 140 CID	2005-2008	Hybrid; Electric Water Pump	US11002
2.3L L4 140 CID	2006-2008	Hybrid, XLS, XLT	US4126
2.5L L4 2488cc 152 CID	2009-2012	Hybrid, Limited, Limited Hybrid, XLS, XLT	US4126
2.5L L4 2488cc 152 CID	2009-2012	Hybrid, Limited Hybrid; Electric Water Pump, From Reservoir	US11001
2.5L L4 2488cc 152 CID	2009-2012	Hybrid, Limited Hybrid; Electric Water Pump, Heater	US11007
2.5L L4 2488cc 152 CID	2011	Hybrid, Limited Hybrid; Electric Water Pump	US11002
2.5L L4 2488cc 152 CID	2013-2014	S	US4126
2.5L L4 2488cc 152 CID	2015-2016	S, SE	US4126
2.5L L4 2488cc 152 CID	2017-2018	S	US4126
3.0L V6 2967cc 181 CID	2011-2012	Mexican Application	US6250
3.0L V6 2968cc 181 CID	2001-2002	XLS, XLT	US4091
3.0L V6 2968cc 181 CID	2001-2002	XLS, XLT; Includes back housing	US4091-2
3.0L V6 2968cc 181 CID	2003	Limited, XLS, XLT; To 04/01/2003	US4091
3.0L V6 2968cc 181 CID	2003	Limited, XLS, XLT; Includes back housing, To 04/01/2003	US4091-2
3.0L V6 2968cc 181 CID	2003	Limited, XLS, XLT; From 04/01/2003	US4132
3.0L V6 2968cc 181 CID	2003	Limited, XLS, XLT; From 04/01/2003, Includes back housing	US4132-2
3.0L V6 2968cc 181 CID	2004	Limited, XLS, XLT	US4132
3.0L V6 2968cc 181 CID	2004	Limited, XLS, XLT; Includes back housing	US4132-2
3.0L V6 2968cc 181 CID	2005	Limited, XLS, XLT, XLT No Boundaries, XLT Sport	US4132
3.0L V6 2968cc 181 CID	2005	Limited, XLS, XLT, XLT No Boundaries, XLT Sport; Includes back housing	US4132-2
3.0L V6 2968cc 181 CID	2006	Limited, XLT; To 01/30/2006	US4132
3.0L V6 2968cc 181 CID	2006	Limited, XLT; Includes back housing, To 01/30/2006	US4132-2
3.0L V6 2968cc 181 CID	2006	Limited, XLT; From 01/30/2006	US9489
3.0L V6 2968cc 181 CID	2006	Limited, XLT; From 01/30/2006, Includes back housing	US9489-2
3.0L V6 2968cc 181 CID	2007-2008	Limited, XLT	US9489
3.0L V6 2968cc 181 CID	2007-2008	Limited, XLT; Includes back housing	US9489-2
3.0L V6 2968cc 181 CID	2009-2012	Limited, XLT	US6250
ESORT			
1.6L L4 1598cc 98 CID	1981	Base, GL, GLX, L, SS	US4040
1.6L L4 1598cc 98 CID	1982	Base, GL, GLX, GT, L	US4040
1.6L L4 1598cc 98 CID	1983	Base, GL, GLX, GT, LX	US4040
1.6L L4 1598cc 98 CID	1984	Base, GL, GT, GT Turbo, LX	US4040
1.6L L4 1598cc 98 CID	1985	Base, GL, GT, GT Turbo, L, LX	US4040
1.8L L4 112 CID	1991	GT	US4068
1.8L L4 112 CID	1992-1993	GT, LX-E	US4068
1.8L L4 112 CID	1994-1996	GT	US4068
1.9L L4 116 CID	1985	Base, GL, L	US4040
1.9L L4 116 CID	1986	GL, GT, L, LX, Pony	US4040
1.9L L4 116 CID	1987	GL, GT, Pony	US4040
1.9L L4 116 CID	1988	GL, GT, LX, Pony	US4040
1.9L L4 116 CID	1989	GT, LX, Pony	US4040
1.9L L4 116 CID	1990	Base, GT, LX, LX Sport, Pony	US4040
1.9L L4 116 CID	1991	Base, LX, LX Sport; To 04/91	US4065
1.9L L4 116 CID	1991	Base, LX, LX Sport; From 04/91	US4069
1.9L L4 116 CID	1992-1993	Base, LX, LX Sport	US4069
1.9L L4 116 CID	1994	Base, LX, LX Sport; From 06/1994	US4069
1.9L L4 116 CID	1994	Base, LX, LX Sport; To 05/1994	US4069
1.9L L4 116 CID	1995	Base, LX, LX Sport	US4069
1.9L L4 116 CID	1996	Base, LX	US4069
2.0L L4 1989cc 121 CID	1997	Base, LX, Sport	US4107
2.0L L4 1989cc 121 CID	1998	ZX2 Cool Coupe, ZX2 Hot Coupe	US4115
2.0L L4 1989cc 121 CID	1998-1999	LX, SE	US4107
2.0L L4 1989cc 121 CID	1999	ZX2 Cool Coupe, ZX2 Hot Coupe, ZX2 S/R	US4115
2.0L L4 1989cc 121 CID	2000	LX	US4107
2.0L L4 1989cc 121 CID	2000	ZX2, ZX2 S/R	US4115
2.0L L4 1989cc 121 CID	2001-2002	SE	US4107
2.0L L4 1989cc 121 CID	2001-2003	ZX2	US4115
2.0L L4 1989cc 122 CID	1984	Base, GL, LX	US9067
2.0L L4 1989cc 122 CID	1985	Base, GL, L	US9067
2.0L L4 1989cc 122 CID	1986	GL, L	US9067
2.0L L4 1989cc 122 CID	1987	GL	US9067
EXCURSION			
5.4L V8 330 CID	2000-2002	Limited, XLT	US8920
5.4L V8 330 CID	2003	Eddie Bauer, Limited, XLT	US8920
5.4L V8 330 CID	2004-2005	Eddie Bauer, Limited, XLS, XLT	US8920
6.0L V8 363 CID	2003	Eddie Bauer, Limited, XLT	US61
6.0L V8 363 CID	2004-2005	Eddie Bauer, Limited, XLS, XLT	US61
6.8L V10 415 CID	2000-2002	Limited, XLT	US4109
6.8L V10 415 CID	2003	Eddie Bauer, Limited, XLT	US4109
6.8L V10 415 CID	2004-2005	Eddie Bauer, Limited, XLS, XLT	US4109
7.3L V8 445 CID	2000-2002	Limited, XLT	US4114
7.3L V8 445 CID	2003	Eddie Bauer, Limited, XLT	US4114

Engine	Years	Application Description	USMW
FORD (cont'd.)			
EXP			
1.6L L4 1598cc 98 CID	1982	Base	US4040
1.6L L4 1598cc 98 CID	1983	Base, GT, HO, Luxury	US4040
1.6L L4 1598cc 98 CID	1984-1985	Base, Luxury, Turbo	US4040
1.9L L4 116 CID	1986-1987	Luxury, Sport	US4040
1.9L L4 116 CID	1988	Base, Luxury, Sport	US4040
EXPEDITION			
3.5L V6 3496cc 213 CID	2015	EL King Ranch, EL Limited, EL Platinum, EL XL, EL XLT, King Ranch, Limited, Platinum, XL, XLT	US8916
3.5L V6 3496cc 213 CID	2015	EL King Ranch, EL Limited, EL Platinum, EL XL, EL XLT, King Ranch, Limited, Platinum, XL, XLT; Serpentine Belt Driven	US8916
3.5L V6 3496cc 213 CID	2016-2017	EL King Ranch, EL Limited, EL Platinum, EL SSV, EL XL, EL XLT, King Ranch, Limited, Platinum, SSV, XL, XLT	US8916
4.6L V8 281 CID	1997-2003	Eddie Bauer, XLT	US8920
4.6L V8 281 CID	2004	Eddie Bauer, NBX, XLS, XLT, XLT Sport	US8920
5.4L V8 330 CID	1997-2003	Eddie Bauer, XLT	US8920
5.4L V8 330 CID	2004	Eddie Bauer, NBX, XLS, XLT, XLT Sport	US8920
5.4L V8 330 CID	2005	Eddie Bauer, King Ranch, Limited, XLS, XLT	US8920
5.4L V8 330 CID	2006	Eddie Bauer, King Ranch, Limited, XLS, XLT, XLT Sport	US8920
5.4L V8 330 CID	2007	Eddie Bauer, EL Eddie Bauer, EL Limited, EL XLT, Limited, XLT	US6144
5.4L V8 330 CID	2008	Eddie Bauer, EL Eddie Bauer, EL King Ranch, EL Limited, EL XLT, Funkmaster Flex Edition, King Ranch, Limited, XLT	US6144
5.4L V8 330 CID	2009	Eddie Bauer, EL Eddie Bauer, EL King Ranch, Limited, Max Eddie Bauer, Max King Ranch, Max Limited, XLT	US8920
5.4L V8 330 CID	2010	Eddie Bauer, EL Eddie Bauer, EL King Ranch, EL Limited, EL XLT, King Ranch, Limited, XLT	US8920
5.4L V8 330 CID	2011-2014	EL King Ranch, EL Limited, EL XL, EL XLT, King Ranch, Limited, XL, XLT	US8920
5.4L V8 5408cc 330 CID	2014	King Ranch, Limited, XL	US8920
EXPLORER			
2.0L L4 1999cc 122 CID	2012-2015	Base, Limited, XLT	US4126
2.3L L4 2300cc 140 CID	2016-2018	Base, Limited, XLT	US8975
3.5L V6 3496cc 213 CID	2011	Base, Limited, XLT	US8980
3.5L V6 3496cc 213 CID	2012	Base, Limited, XLT; From 01/02/2012	US8910
3.5L V6 3496cc 213 CID	2012	Base, Limited, XLT; To 01/02/2012	US8980
3.5L V6 3496cc 213 CID	2013-2015	Base, Limited, Sport, XLT	US8910
3.5L V6 3496cc 213 CID	2016-2018	Base, Limited, Platinum, Sport, XLT	US8910
4.0L L6 4018cc 245 CID	1990	Mexican Application	US4060
4.0L V6 245 CID	1991-1992	Eddie Bauer, Sport, XL, XLT	US4060
4.0L V6 245 CID	1993-1994	Eddie Bauer, Limited, Sport, XL, XLT	US4060
4.0L V6 245 CID	1995	Eddie Bauer, Expedition, Limited, Sport, XL, XLT	US4060
4.0L V6 245 CID	1996	Eddie Bauer, Limited, Sport, XL, XLT	US4060
4.0L V6 245 CID	1997-1998	Sport, XL, XLT; (X)	US4060
4.0L V6 245 CID	1997-1998	Sport, XL, XLT; (E)	US4108
4.0L V6 245 CID	1997-2000	Eddie Bauer, Limited	US4108
4.0L V6 245 CID	1999	Sport, XL, XLS, XLT; (X)	US4060
4.0L V6 245 CID	1999	Sport, XL, XLS, XLT; (E)	US4108
4.0L V6 245 CID	2000	Postal, Sport, XL Fleet, XLS, XLT; (X)	US4060
4.0L V6 245 CID	2000	Postal, Sport, XL Fleet, XLS, XLT; (E)	US4108
4.0L V6 245 CID	2001	Eddie Bauer, Limited, Postal, XL Fleet, XLS, XLT	US4108
4.0L V6 245 CID	2002-2003	Eddie Bauer, Limited, Postal, XLS, XLT	US4108
4.0L V6 245 CID	2004	Eddie Bauer, Limited, NBX, XLS, XLS Sport, XLT, XLT Sport	US4108
4.0L V6 245 CID	2005	Eddie Bauer, Limited, XLS, XLS Sport, XLT, XLT Sport	US4108
4.0L V6 245 CID	2006	Eddie Bauer, Limited, XLS, XLT	US4108
4.0L V6 245 CID	2007-2010	Eddie Bauer, Limited, XLT	US4108
4.6L V8 281 CID	2002-2003	Eddie Bauer, Limited, XLT	US8920
4.6L V8 281 CID	2004	Eddie Bauer, Limited, NBX, XLT, XLT Sport	US8920
4.6L V8 281 CID	2005	Eddie Bauer, Limited, XLT, XLT Sport	US8920
4.6L V8 281 CID	2006-2009	Eddie Bauer, Limited, XLT	US8920
4.6L V8 281 CID	2010	Eddie Bauer, Limited	US8920
5.0L V8 302 CID	1996-1998	Eddie Bauer, Limited, XLT	US4101
5.0L V8 302 CID	1999	Eddie Bauer, Limited, XLS, XLT	US4101
5.0L V8 302 CID	2000-2001	Eddie Bauer, Limited, XLT	US4101
EXPLORER SPORT TRAC			
4.0L V6 245 CID	2001	Base	US4108
4.0L V6 245 CID	2002	XL	US4108
4.0L V6 245 CID	2003-2004	XLS, XLT	US4108
4.0L V6 245 CID	2005	Adrenalin, XLS, XLT	US4108
4.0L V6 245 CID	2007-2010	Limited, XLT	US4108
4.6L V8 281 CID	2007-2010	Limited, XLT	US8920

Engine	Years	Application Description	USMW	Engine	Years	Application Description	USMW
FORD (cont'd.)				FORD (cont'd.)			
F53				F800 LPO			
6.8L V10 415 CID	2011-2014	Base, Medium/Heavy Duty	US6144	5.9L L6 359 CID	1995-1998		US7145N
6.8L V10 415 CID	2014	Base	US6144	F-100			
6.8L V10 415 CID	2015	Base, Medium/Heavy Duty	US4109	3.8L V6 232 CID	1982	Custom, XL, XLS, XLT Lariat	US4016
6.8L V10 415 CID	2015-2018	Base	US4109	3.8L V6 232 CID	1983	Base, XL, XLS, XLT Lariat	US4016
F59				4.2L V8 255 CID	1981	Custom, Ranger, Ranger Lariat, Ranger XLT; WINDSOR	US953
6.8L V10 415 CID	2014	Base	US6144	4.2L V8 255 CID	1981	Custom, Ranger, Ranger Lariat, Ranger XLT; High performance	US953H
6.8L V10 415 CID	2015-2018	Base	US4109	4.2L V8 255 CID	1982	Custom, XL, XLS, XLT Lariat; WINDSOR	US953
7.3L V8 445 CID	1993-1994	Medium/Heavy Duty, Naturally Aspirated, XL	US4018	4.2L V8 255 CID	1982	Custom, XL, XLS, XLT Lariat; High performance	US953H
7.3L V8 445 CID	1993-1994	Medium/Heavy Duty, Turbocharged, XL	US4018	4.4L V8 4458cc 272 CID	1956-1958		US488
7.3L V8 445 CID	1994	Medium/Heavy Duty, Turbocharged, XL	US4096	4.8L V8 4786cc 292 CID	1958-1963		US488
7.3L V8 445 CID	1995-1997	Base, Medium/Heavy Duty, Naturally Aspirated	US4018	4.9L L6 4917cc 300 CID	1975-1979		US4030N
F100				4.9L L6 4917cc 300 CID	1980-1981	Custom, Ranger, Ranger Lariat, Ranger XLT	US4030N
4.7L V8 4700cc 289 CID	1965-1966	Mexican Application	US819	4.9L L6 4917cc 300 CID	1982	Custom, XL, XLS, XLT Lariat	US4030N
4.7L V8 4700cc 289 CID	1965-1978	Mexican Application	US1028	4.9L L6 4917cc 300 CID	1983	Base, XL, XLS, XLT Lariat	US4020
4.7L V8 4700cc 289 CID	1969-1978	Mexican Application	US953	5.0L V8 302 CID	1975-1979	WINDSOR	US953
F150				5.0L V8 302 CID	1975-1979	High performance	US953H
3.8L V6 3800cc 232 CID	1984-1990	Mexican Application	US4016	5.0L V8 302 CID	1980-1981	Custom, Ranger, Ranger Lariat, Ranger XLT; WINDSOR	US953
3.8L V6 3800cc 232 CID	1991-1993	Mexican Application	US4051	5.0L V8 302 CID	1980-1981	Custom, Ranger, Ranger Lariat, Ranger XLT; High performance	US953H
3.8L V6 3800cc 232 CID	1994-1995	Mexican Application	US4089	5.0L V8 302 CID	1982	Custom, XL, XLS, XLT Lariat; WINDSOR	US953
4.7L V8 4700cc 289 CID	1979	Mexican Application	US953	5.0L V8 302 CID	1982	Custom, XL, XLS, XLT Lariat; High performance	US953H
4.9L L6 4900cc 300 CID	1997	Mexican Application	US4099	5.0L V8 302 CID	1983	Base, XL, XLS, XLT Lariat; WINDSOR	US953
5.0L V8 5000cc 302 CID	1986	Mexican Application	US953	5.0L V8 302 CID	1983	Base, XL, XLS, XLT Lariat; High performance	US953H
5.0L V8 5000cc 302 CID	1986-1990	Mexican Application	US4044	5.8L V8 351 CID	1977-1979	MODIFIED	US932
F200				5.8L V8 351 CID	1977-1979	WINDSOR	US953
5.0L V8 5000cc 302 CID	1986-1990	Mexican Application	US4044	5.8L V8 351 CID	1977-1979	High performance	US953H
5.8L V8 5800cc 351 CID	1986-1987	Mexican Application	US953	5.9L V8 360 CID	1975-1976	High performance	US1075H
5.8L V8 5800cc 351 CID	1986-1990	Mexican Application	US4044	5.9L V8 360 CID	1975-1976	High performance	US1075
F250				6.4L V8 390 CID	1975-1976	High performance	US1075H
5.0L V8 5000cc 302 CID	1997	Mexican Application	US4044	6.4L V8 390 CID	1975-1976	High performance	US1075H
F350				6.6L V8 400 CID	1977-1979	MODIFIED	US932
4.7L V8 4700cc 289 CID	1965-1966	Mexican Application	US819	7.5L V8 460 CID	1979		US1114
4.7L V8 4700cc 289 CID	1965-1974	Mexican Application	US1028	F-150			
4.7L V8 4700cc 289 CID	1969-1977	Mexican Application	US953	2.7L V6 164 CID	2015-2016	Lariat, XL, XLT	US8141P
5.0L V8 5000cc 302 CID	1965-1966	Mexican Application	US819	2.7L V6 164 CID	2015-2016	Lariat, XL, XLT; Includes 3 hole pulley	US8141P
5.0L V8 5000cc 302 CID	1965-1967	Mexican Application	US1075	2.7L V6 164 CID	2015-2016	Lariat, XL, XLT; Includes 3 hole pulley and thermostat / housing	US8141P-T
5.0L V8 5000cc 302 CID	1967-1968	Mexican Application	US1028	2.7L V6 164 CID	2015-2017	Lariat, XL, XLT	US8141
5.0L V8 5000cc 302 CID	1968-1974	Mexican Application	US953	2.7L V6 164 CID	2015-2017	Lariat, XL, XLT; 3 Bolt Pulley	US8141
5.0L V8 5000cc 302 CID	1976	Mexican Application	US953	2.7L V6 164 CID	2015-2017	Lariat, XL, XLT; 3 Bolt hub Includes thermostat / housing	US8141-T
5.0L V8 5000cc 302 CID	1978-1980	Mexican Application	US953	3.5L V6 3496cc 213 CID	2011-2012	FX2, FX4, King Ranch, Lariat, Platinum, XL, XLT; Serpentine Belt Driven	US8916
5.0L V8 5000cc 302 CID	1983-1987	Mexican Application	US953	3.5L V6 3496cc 213 CID	2013-2014	FX2, FX4, King Ranch, Lariat, Limited, Platinum, XL, XLT; Serpentine Belt Driven	US8916
5.0L V8 5000cc 302 CID	1987-1992	Mexican Application	US4044	3.5L V6 3496cc 213 CID	2014	FX2, FX4, King Ranch, Lariat, Limited, Platinum, XL, XLT	US8916
5.0L V8 5000cc 302 CID	1994-1997	Mexican Application	US4044	3.5L V6 3496cc 213 CID	2015	XL, XLT	US6654
5.4L V8 5409cc 330 CID	2000	Mexican Application	US4121	3.5L V6 3496cc 213 CID	2015	XL, XLT; Naturally Aspirated; Serpentine Belt Driven	US6654
5.8L V8 5800cc 351 CID	1986-1987	Mexican Application	US953	3.5L V6 3496cc 213 CID	2015	King Ranch, Lariat, Platinum, XL, XLT	US8916
5.8L V8 5800cc 351 CID	1987-1990	Mexican Application	US4044	3.5L V6 3496cc 213 CID	2015	King Ranch, Lariat, Platinum, XL, XLT; Turbocharged; Serpentine Belt Driven	US8916
5.8L V8 5800cc 352 CID	1965-1967	Mexican Application	US1075	3.5L V6 3496cc 213 CID	2016	King Ranch, Lariat, Limited, Platinum, SSV, XL, XLT	US8916
F600				3.5L V6 3496cc 213 CID	2017	King Ranch, Lariat, Limited, Platinum, Raptor, SSV, XL, XLT	US8149
5.9L L6 359 CID	1974-1975	Before serial number V80,001	US1083	3.5L V6 3496cc 213 CID	2017	XL, XLT	US8916
5.9L L6 359 CID	1993-1994		US7145N	3.7L V6 3726cc 227 CID	2011-2013	STX, XL, XLT; Serpentine Belt Driven	US6654
6.1L V8 370 CID	1980-1991		US4037	3.7L V6 3726cc 227 CID	2014	STX, XL, XLT; Serpentine Belt Driven, To 11/15/2013	US6654
6.6L L6 401 CID	1986-1990		US4062	3.7L V6 3726cc 227 CID	2014	STX, XL, XLT; To 11/15/2013	US6654
7.0L V8 429 CID	1980-1994		US4037	3.7L V6 3726cc 227 CID	2014	STX, XL, XLT; From 11/15/2013	US8916
7.8L L6 473 CID	1987-1989		US4062	3.7L V6 3727cc 227 CID	2011-2014	Mexican Application	US6654
F600 LPO				4.2L V6 256 CID	1997-2000	Base, XL, XLT	US4105
5.9L L6 359 CID	1993-1994		US7145N	4.2L V6 256 CID	2001-2003	XL, XLT	US4105
6.6L L6 401 CID	1990		US4062	4.2L V6 256 CID	2005-2008	STX, XL, XLT	US4105
F650				4.6L V8 281 CID	1997-2000	Base, Lariat, XL, XLT	US8920
6L V8 365 CID	2004-2007	Medium/Heavy Duty	US85	4.6L V8 281 CID	2001-2003	King Ranch, Lariat, XL, XLT	US8920
7.3L V8 444 CID	2000-2003	Medium/Heavy Duty	US66	4.6L V8 281 CID	2004-2006	STX, XL, XLT	US8920
F700				4.6L V8 281 CID	2007	STX, XL, XLT	US6144
5.9L L6 359 CID	1993-1997		US7145N	4.6L V8 281 CID	2008	FX2, STX, THE 60TH ANNIVERSARY EDITION, XL, XLT	US6144
6.1L V8 370 CID	1980-1991		US4037	4.6L V8 281 CID	2009	STX, XL, XLT	US8920
6.6L L6 401 CID	1986-1990		US4062	4.6L V8 281 CID	2010	FX2, STX, XL, XLT	US8920
7.0L V8 429 CID	1980-1998		US4037	4.9L L6 4917cc 300 CID	1975-1977	From Engine #800001	US4030N
7.8L L6 473 CID	1987-1990		US4062	4.9L L6 4917cc 300 CID	1975-1977	Before S/N 080001	US4033
F750				4.9L L6 4917cc 300 CID	1978-1979		US4030N
6L V8 365 CID	2004-2007	Medium/Heavy Duty	US85				
7.3L V8 444 CID	2000-2003	Medium/Heavy Duty	US66				
F800							
5.9L L6 359 CID	1993-1999		US7145N				
6.1L V8 370 CID	1980-1991		US4037				
6.6L L6 401 CID	1987-1990		US4062				
7.0L V8 429 CID	1980-1990		US4037				
7.0L V8 429 CID	1997-1998		US4037				
7.8L L6 473 CID	1986-1990		US4062				

WATER PUMPS

Engine	Years	Application Description	USMW	Engine	Years	Application Description	USMW
FORD (cont'd.)				FORD (cont'd.)			
F-150 (cont'd.)				F-150 (cont'd.)			
4.9L L6 4917cc 300 CID	1980-1981	Custom, Ranger, Ranger Lariat, Ranger XLT	US4030N	5.8L V8 351 CID	1982	Custom, XL, XLS, XLT Lariat; WINDSOR	US953
4.9L L6 4917cc 300 CID	1982	Custom, XL, XLS, XLT Lariat	US4030N	5.8L V8 351 CID	1982	Custom, XL, XLS, XLT Lariat; High performance	US953H
4.9L L6 4917cc 300 CID	1983	Base, XL, XLS, XLT	US4020	5.8L V8 351 CID	1983	Base, XL, XLS, XLT; WINDSOR	US953
4.9L L6 4917cc 300 CID	1984	Base, XL, XLT	US4020	5.8L V8 351 CID	1983	Base, XL, XLS, XLT; High performance	US953H
4.9L L6 4917cc 300 CID	1985-1986	Base, XL, XLT Lariat	US4020	5.8L V8 351 CID	1984	Base, XL, XLT; WINDSOR	US953
4.9L L6 4917cc 300 CID	1987-1992	Custom, XL, XLT Lariat	US4048	5.8L V8 351 CID	1984	Base, XL, XLT; High performance	US953H
4.9L L6 4917cc 300 CID	1993-1994	XL, XLT	US4099	5.8L V8 351 CID	1984	Base, XL, XLT; High performance	US953H
4.9L L6 4917cc 300 CID	1995-1996	Eddie Bauer, Special, XL, XLT	US4099	5.8L V8 351 CID	1985-1986	Base, XL, XLT Lariat; WINDSOR	US953
5.0L V8 302 CID	1975-1979	WINDSOR	US953	5.8L V8 351 CID	1985-1986	Base, XL, XLT Lariat; High performance	US953H
5.0L V8 302 CID	1975-1979	High performance	US953H	5.8L V8 351 CID	1987	Custom, XL, XLT Lariat; WINDSOR	US953
5.0L V8 302 CID	1980-1981	Custom, Ranger, Ranger Lariat, Ranger XLT; WINDSOR	US953	5.8L V8 351 CID	1987	Custom, XL, XLT Lariat; High performance	US953H
5.0L V8 302 CID	1980-1981	Custom, Ranger, Ranger Lariat, Ranger XLT; High performance	US953H	5.8L V8 351 CID	1988-1992	Custom, XL, XLT Lariat	US4044
5.0L V8 302 CID	1982	Custom, XL, XLS, XLT Lariat; WINDSOR	US953	5.8L V8 351 CID	1988-1992	Custom, XL, XLT Lariat; High performance	US4044H
5.0L V8 302 CID	1982	Custom, XL, XLS, XLT Lariat; High performance	US953H	5.8L V8 351 CID	1993-1994	Lightning, XL, XLT	US4044
5.0L V8 302 CID	1983	Base, XL, XLS, XLT; WINDSOR	US953	5.8L V8 351 CID	1993-1994	Lightning, XL, XLT; High performance	US4044H
5.0L V8 302 CID	1983	Base, XL, XLS, XLT; High performance	US953H	5.8L V8 351 CID	1995	Eddie Bauer, Lightning, Special, XL, XLT	US4044
5.0L V8 302 CID	1984	Base, XL, XLT; WINDSOR	US953	5.8L V8 351 CID	1995	Eddie Bauer, Lightning, Special, XL, XLT; High performance	US4044H
5.0L V8 302 CID	1984	Base, XL, XLT; High performance	US953H	5.8L V8 351 CID	1996	Eddie Bauer, Special, XL, XLT	US4044
5.0L V8 302 CID	1985-1986	Base, XL, XLT Lariat; WINDSOR	US953	5.8L V8 351 CID	1996	Eddie Bauer, Special, XL, XLT; High performance	US4044H
5.0L V8 302 CID	1985-1986	Base, XL, XLT Lariat; High performance	US953H	5.9L V8 360 CID	1975-1976		US1075
5.0L V8 302 CID	1987-1992	Custom, XL, XLT Lariat	US4044	5.9L V8 360 CID	1975-1976	High performance	US1075H
5.0L V8 302 CID	1987-1992	Custom, XL, XLT Lariat; High performance	US4044H	6.2L V8 6210cc 379 CID	2010	SVT Raptor	US6006
5.0L V8 302 CID	1993-1994	XL, XLT	US4044	6.2L V8 6210cc 379 CID	2011	Harley-Davidson Edition, Lariat, Lariat Limited, Platinum, SVT Raptor	US6006
5.0L V8 302 CID	1993-1994	XL, XLT; High performance	US4044H	6.2L V8 6210cc 379 CID	2012	Harley-Davidson Edition, Lariat, Platinum, SVT Raptor	US6006
5.0L V8 302 CID	1995	Eddie Bauer, Special, XL, XLT	US4044	6.2L V8 6210cc 379 CID	2013	FX2, FX4, Lariat, Platinum, SVT Raptor	US6006
5.0L V8 302 CID	1995	Eddie Bauer, Special, XL, XLT; High performance	US4044H	6.2L V8 6210cc 379 CID	2014	FX2, FX4, Lariat, Platinum, SVT Raptor, XLT	US6006
5.0L V8 302 CID	1996	Eddie Bauer, Special, XL, XLT; Stamped #E9TE8505-A4A,A5A,F5TE8505-C4A	US4044	6.4L V8 390 CID	1975-1976		US1075
5.0L V8 302 CID	1996	Eddie Bauer, Special, XL, XLT; Stamped #F5TE8505-C5A	US4044	6.4L V8 390 CID	1975-1976	High performance	US1075H
5.0L V8 302 CID	1996	Eddie Bauer, Special, XL, XLT; High performance, Stamped #E9TE8505-A4A,A5A,F5TE8505-C4A	US4044H	6.6L V8 400 CID	1977-1979	MODIFIED	US932
5.0L V8 302 CID	1996	Eddie Bauer, Special, XL, XLT; High performance, Stamped #F5TE8505-C5A	US4044H	7.5L V8 460 CID	1975-1979		US1114
5.0L V8 302 CID	1996	Eddie Bauer, Special, XL, XLT; High performance, Stamped #F5TE8505-C5A	US4044H	F-150 HERITAGE			
5.0L V8 4951cc 302 CID	2011-2012	FX2, FX4, King Ranch, Lariat, Platinum, STX, XL, XLT	US8963	4.2L V6 256 CID	2004	XL, XLT	US4105
5.0L V8 4951cc 302 CID	2013	FX2, FX4, King Ranch, Lariat, Platinum, STX, XL, XLT; From 8-12-2013	US8116	4.6L V8 281 CID	2004	XL, XLT	US8920
5.0L V8 4951cc 302 CID	2013	FX2, FX4, King Ranch, Lariat, Platinum, STX, XL, XLT; To 8-11-2013	US8963	5.4L V8 330 CID	2004	SVT Lightning	US4125
5.0L V8 4951cc 302 CID	2014	FX2, FX4, King Ranch, Lariat, Platinum, STX, XL, XLT	US8116	5.4L V8 330 CID	2004	XL, XLT	US8920
5.0L V8 4951cc 302 CID	2015	King Ranch, Lariat, Platinum, XL, XLT	US8116	5.4L V8 330 CID	2004	SVT Lightning	US11014
5.0L V8 4951cc 302 CID	2016-2018	King Ranch, Lariat, Platinum, SSV, XL, XLT	US8116	F-250			
5.0L V8 5000cc 305 CID	2011-2014	Mexican Application	US8963	4.4L V8 4458cc 272 CID	1956-1958		US488
5.4L V8 330 CID	1997-1999	Base, Lariat, XL, XLT	US8920	4.6L V8 281 CID	1997-1999	Base, Lariat, XL, XLT	US8920
5.4L V8 330 CID	1999-2000	Lightning	US4121	4.8L V8 4786cc 292 CID	1958-1963		US488
5.4L V8 330 CID	1999-2001	Lightning	US11014	4.9L L6 4917cc 300 CID	1975-1977	From Engine #080001	US4030N
5.4L V8 330 CID	2000	Base, Harley-Davidson Edition, Lariat, XL, XLT	US8920	4.9L L6 4917cc 300 CID	1975-1977	Before S/N 080001	US4033
5.4L V8 330 CID	2001	Lightning; To 11/10/2000	US4121	4.9L L6 4917cc 300 CID	1978-1979		US4030N
5.4L V8 330 CID	2001	Lightning; From 11/10/2000	US4125	4.9L L6 4917cc 300 CID	1980-1981	Custom, Ranger, Ranger Lariat, Ranger XLT	US4030N
5.4L V8 330 CID	2001	Harley-Davidson Edition, King Ranch, Lariat, XL, XLT	US8920	4.9L L6 4917cc 300 CID	1982	Custom, XL, XLS, XLT Lariat	US4030N
5.4L V8 330 CID	2002-2003	Harley-Davidson Edition, Lightning	US4125	4.9L L6 4917cc 300 CID	1983	Base, XL, XLS, XLT	US4020
5.4L V8 330 CID	2002-2003	King Ranch, Lariat, XL, XLT	US8920	4.9L L6 4917cc 300 CID	1984	Base, XL, XLT	US4020
5.4L V8 330 CID	2002-2003	Harley-Davidson Edition, Lightning	US11014	4.9L L6 4917cc 300 CID	1985-1986	Base, XL, XLT Lariat	US4020
5.4L V8 330 CID	2004	FX4, Lariat, XL, XLT	US8920	4.9L L6 4917cc 300 CID	1987-1992	Custom, XL, XLT Lariat	US4048
5.4L V8 330 CID	2005	FX4, King Ranch, Lariat, XL, XLT	US8920	4.9L L6 4917cc 300 CID	1993-1994	XL, XLT	US4099
5.4L V8 330 CID	2006	FX4, Harley-Davidson Edition, King Ranch, Lariat, XL, XLT	US6144	4.9L L6 4917cc 300 CID	1995-1996	Eddie Bauer, Special, XL, XLT	US4099
5.4L V8 330 CID	2006	FX4, Harley-Davidson Edition, King Ranch, Lariat, XL, XLT	US8920	5.0L V8 302 CID	1977-1978	WINDSOR	US953
5.4L V8 330 CID	2007	FX2, FX4, Harley-Davidson Edition, King Ranch, Lariat, XL, XLT	US6144	5.0L V8 302 CID	1977-1978	High performance	US953H
5.4L V8 330 CID	2008	FX2, FX4, Harley-Davidson Edition, King Ranch, Lariat, Limited, THE 60TH ANNIVERSARY EDITION, XL, XLT	US6144	5.0L V8 302 CID	1980-1981	Custom, Ranger, Ranger Lariat, Ranger XLT; WINDSOR	US953
5.4L V8 330 CID	2009	FX4, King Ranch, Lariat, Platinum, XL, XLT	US6144	5.0L V8 302 CID	1980-1981	Custom, Ranger, Ranger Lariat, Ranger XLT; High performance	US953H
5.4L V8 330 CID	2010	FX2, FX4, Harley-Davidson Edition, King Ranch, Lariat, Platinum, SVT Raptor, XL, XLT	US8920	5.0L V8 302 CID	1982	Custom, XL, XLS, XLT Lariat; WINDSOR	US953
5.8L V8 351 CID	1977-1979	MODIFIED	US932	5.0L V8 302 CID	1982	Custom, XL, XLS, XLT Lariat; High performance	US953H
5.8L V8 351 CID	1977-1979	WINDSOR	US953	5.0L V8 302 CID	1983	Base, XL, XLS, XLT; WINDSOR	US953
5.8L V8 351 CID	1977-1979	High performance	US953H	5.0L V8 302 CID	1983	Base, XL, XLS, XLT; High performance	US953H
5.8L V8 351 CID	1980-1981	Custom, Ranger, Ranger Lariat, Ranger XLT; WINDSOR	US953	5.0L V8 302 CID	1984	Base, XL, XLT; WINDSOR	US953
5.8L V8 351 CID	1980-1981	Custom, Ranger, Ranger Lariat, Ranger XLT; High performance	US953H	5.0L V8 302 CID	1984	Base, XL, XLT; High performance	US953H
5.8L V8 351 CID	1980-1981	Custom, Ranger, Ranger Lariat, Ranger XLT; High performance	US953H	5.0L V8 302 CID	1985-1986	Base, XL, XLT Lariat; WINDSOR	US953
				5.0L V8 302 CID	1985-1986	Base, XL, XLT Lariat; High performance	US953H
				5.0L V8 302 CID	1987-1989	Custom, XL, XLT Lariat	US4044
				5.0L V8 302 CID	1987-1989	Custom, XL, XLT Lariat; High performance	US4044H
				5.0L V8 302 CID	1991-1992	Custom, XL, XLT Lariat	US4044
				5.0L V8 302 CID	1991-1992	Custom, XL, XLT Lariat; High performance	US4044H
				5.0L V8 302 CID	1993-1994	XL, XLT	US4044
				5.0L V8 302 CID	1993-1994	XL, XLT; High performance	US4044H
				5.0L V8 302 CID	1995-1996	Eddie Bauer, Special, XL, XLT	US4044

Engine	Years	Application Description	USMW	Engine	Years	Application Description	USMW
FORD (cont'd.)				FORD (cont'd.)			
F-250 (cont'd.)				F-250 SUPER DUTY (cont'd.)			
5.0L V8 302 CID	1995-1996	Eddie Bauer, Special, XL, XLT; High performance	US4044H	6.4L V8 391 CID	2009	Cabela's, FX4, Harley-Davidson Edition, King Ranch, Lariat, XL, XLT	US76
5.4L V8 330 CID	1997-1999	Base, Lariat, XL, XLT	US8920	6.4L V8 391 CID	2010	Cabela's, Harley-Davidson Edition, King Ranch, Lariat, XL, XLT	US76
5.8L V8 351 CID	1977-1979	MODIFIED	US932	6.4L V8 391 CID	2010	Harley-Davidson Edition, King Ranch, Lariat, XL, XLT; Electric Water Pump	US11006
5.8L V8 351 CID	1977-1979	WINDSOR	US953	6.7L V8 6651cc 406 CID	2011-2012	King Ranch, Lariat, XL, XLT	US77
5.8L V8 351 CID	1977-1979	High performance	US953H	6.7L V8 6651cc 406 CID	2011-2012	King Ranch, Lariat, XL, XLT; Pump only	US78
5.8L V8 351 CID	1980-1981	Custom, Ranger, Ranger Lariat, Ranger XLT; WINDSOR	US953	6.7L V8 6651cc 406 CID	2013-2016	King Ranch, Lariat, Platinum, XL, XLT	US77
5.8L V8 351 CID	1980-1981	Custom, Ranger, Ranger Lariat, Ranger XLT; High performance	US953H	6.7L V8 6651cc 406 CID	2013-2016	King Ranch, Lariat, Platinum, XL, XLT; Pump only	US78
5.8L V8 351 CID	1982	Custom, XL, XLS, XLT Lariat; WINDSOR	US953	6.7L V8 6651cc 406 CID	2017	King Ranch, Lariat, Platinum, XL, XLT	US8157
5.8L V8 351 CID	1982	Custom, XL, XLS, XLT Lariat; High performance	US953H	6.7L V8 6651cc 406 CID	2018	King Ranch, Lariat, Limited, Platinum, XL, XLT	US8157
5.8L V8 351 CID	1983	Base, XL, XLS, XLT; WINDSOR	US953	6.7L V8 6700cc 409 CID	2011-2016	Mexican Application	US77
5.8L V8 351 CID	1983	Base, XL, XLS, XLT; High performance	US953H	6.8L V10 415 CID	1999-2003	Lariat, XL, XLT	US4109
5.8L V8 351 CID	1984	Base, XL, XLT; WINDSOR	US953	6.8L V10 415 CID	2004-2005	Harley-Davidson Edition, King Ranch, Lariat, XL, XLT	US4109
5.8L V8 351 CID	1984	Base, XL, XLT; High performance	US953H	6.8L V10 415 CID	2006-2007	King Ranch, Lariat, XL, XLT	US4109
5.8L V8 351 CID	1985-1986	Base, XL, XLT Lariat; WINDSOR	US953	6.8L V10 415 CID	2008	FX4, Harley-Davidson Edition, King Ranch, Lariat, XL, XLT	US4109
5.8L V8 351 CID	1985-1986	Base, XL, XLT Lariat; High performance	US953H	6.8L V10 415 CID	2009	Cabela's, FX4, Harley-Davidson Edition, King Ranch, Lariat, XL, XLT	US4109
5.8L V8 351 CID	1987	Custom, XL, XLT Lariat; WINDSOR	US953	6.8L V10 415 CID	2010	Cabela's, King Ranch, Lariat, XL, XLT	US6144
5.8L V8 351 CID	1987	Custom, XL, XLT Lariat; High performance	US953H	7.3L V8 445 CID	1999-2003	Lariat, XL, XLT	US4114
5.8L V8 351 CID	1988-1992	Custom, XL, XLT Lariat	US4044	F-350			
5.8L V8 351 CID	1988-1992	Custom, XL, XLT Lariat; High performance	US4044H	4.4L V8 4458cc 272 CID	1956-1958		US488
5.8L V8 351 CID	1993-1994	XL, XLT	US4044	4.8L V8 4786cc 292 CID	1958-1963		US488
5.8L V8 351 CID	1993-1994	XL, XLT; High performance	US4044H	4.9L L6 4917cc 300 CID	1975-1977	From Engine #080001	US4030N
5.8L V8 351 CID	1995-1996	Eddie Bauer, Special, XL, XLT	US4044	4.9L L6 4917cc 300 CID	1975-1977	Before S/N 080001	US4033
5.8L V8 351 CID	1995-1996	Eddie Bauer, Special, XL, XLT; High performance	US4044H	4.9L L6 4917cc 300 CID	1978		US4030N
5.9L V8 360 CID	1975-1976	High performance	US1075	4.9L L6 4917cc 300 CID	1980-1981	Custom, Ranger, Ranger Lariat, Ranger XLT	US4030N
5.9L V8 360 CID	1975-1976	High performance	US1075H	4.9L L6 4917cc 300 CID	1982	Custom, XL, XLS, XLT Lariat	US4030N
6.4L V8 390 CID	1975-1976	High performance	US1075H	4.9L L6 4917cc 300 CID	1983	Base, XL, XLS, XLT	US4020
6.4L V8 390 CID	1977-1979	MODIFIED	US932	4.9L L6 4917cc 300 CID	1984	Base, XL, XLT	US4020
6.6L V8 400 CID	1980-1981	Custom, Ranger, Ranger Lariat, Ranger XLT; MODIFIED	US932	4.9L L6 4917cc 300 CID	1985-1986	Base, XL, XLT Lariat	US4020
6.6L V8 400 CID	1982	Custom, XL, XLS, XLT Lariat; MODIFIED	US932	4.9L L6 4917cc 300 CID	1987-1989	Custom, XL, XLT Lariat	US4048
6.9L V8 420 CID	1983	Base, XL, XLS, XLT	US4018	4.9L L6 4917cc 300 CID	1993-1994	XL, XLT	US4099
6.9L V8 420 CID	1984	Base, XL, XLT	US4018	5.0L V8 302 CID	1976	High performance	US953H
6.9L V8 420 CID	1985-1986	Base, XL, XLT Lariat	US4018	5.0L V8 302 CID	1980	Custom, Ranger, Ranger Lariat, Ranger XLT; WINDSOR	US953
6.9L V8 420 CID	1987	Custom, XL, XLT Lariat	US4018	5.0L V8 302 CID	1980	Custom, Ranger, Ranger Lariat, Ranger XLT; High performance	US953H
7.3L V8 445 CID	1988-1992	Custom, XL, XLT Lariat	US4018	5.8L V8 351 CID	1977-1979	MODIFIED	US932
7.3L V8 445 CID	1993	XL, XLT	US4018	5.8L V8 351 CID	1979		US4030N
7.3L V8 445 CID	1994	XL, XLT; (K), Turbocharged	US4018	5.8L V8 351 CID	1980-1981	Custom, Ranger, Ranger Lariat, Ranger XLT; WINDSOR	US953
7.3L V8 445 CID	1994	XL, XLT; (M), Naturally Aspirated	US4018	5.8L V8 351 CID	1980-1981	Custom, Ranger, Ranger Lariat, Ranger XLT; High performance	US953H
7.3L V8 445 CID	1994	XL, XLT; (F), Turbocharged	US4096	5.8L V8 351 CID	1982	Custom, XL, XLS, XLT Lariat; WINDSOR	US953
7.3L V8 445 CID	1995	Eddie Bauer, Special, XL, XLT	US4096	5.8L V8 351 CID	1982	Custom, XL, XLS, XLT Lariat; High performance	US953H
7.3L V8 445 CID	1996	Eddie Bauer, Special, XL, XLT; To Engine # 201680	US4096	5.8L V8 351 CID	1983	Base, XL, XLS, XLT; WINDSOR	US953
7.3L V8 445 CID	1996	Eddie Bauer, Special, XL, XLT; From Engine # 201681	US4114	5.8L V8 351 CID	1983	Base, XL, XLS, XLT; High performance	US953H
7.5L V8 460 CID	1975-1979		US1114	5.8L V8 351 CID	1984	Base, XL, XLT; WINDSOR	US953
7.5L V8 460 CID	1983	Base, XL, XLS, XLT	US1114	5.8L V8 351 CID	1984	Base, XL, XLT; High performance	US953H
7.5L V8 460 CID	1984	Base, XL, XLT	US1114	5.8L V8 351 CID	1985-1986	Base, XL, XLT Lariat; WINDSOR	US953
7.5L V8 460 CID	1985-1986	Base, XL, XLT Lariat	US1114	5.8L V8 351 CID	1985-1986	Base, XL, XLT Lariat; High performance	US953H
7.5L V8 460 CID	1987	Custom, XL, XLT Lariat	US1114	5.8L V8 351 CID	1987	Custom, XL, XLT Lariat; WINDSOR	US953
7.5L V8 460 CID	1988-1989	Custom, XL, XLT Lariat	US4081	5.8L V8 351 CID	1987	Custom, XL, XLT Lariat; High performance	US953H
7.5L V8 460 CID	1990-1991	Custom, XL, XLT Lariat	US1114	5.8L V8 351 CID	1988-1992	Custom, XL, XLT Lariat	US4044
7.5L V8 460 CID	1992	Custom, XL, XLT Lariat; To 02/03/1992	US1114	5.8L V8 351 CID	1988-1992	Custom, XL, XLT Lariat; High performance	US4044H
7.5L V8 460 CID	1992	Custom, XL, XLT Lariat; From 02/03/1992	US4077	5.8L V8 351 CID	1993-1994	XL, XLT	US4044
7.5L V8 460 CID	1993-1994	XL, XLT	US4077	5.8L V8 351 CID	1993-1994	XL, XLT; High performance	US4044H
7.5L V8 460 CID	1995-1996	Eddie Bauer, Special, XL, XLT	US4086	5.8L V8 351 CID	1995	Eddie Bauer, Special, XL, XLT	US4044
7.5L V8 460 CID	1997	Base, Lariat, XL, XLT	US4086	5.8L V8 351 CID	1995	Eddie Bauer, Special, XL, XLT; High performance	US4044H
F-250 SUPER DUTY				5.8L V8 351 CID	1996	Special, XL, XLT	US4044
5.4L V8 330 CID	1999-2003	Lariat, XL, XLT	US8920	5.8L V8 351 CID	1996	Special, XL, XLT; High performance	US4044H
5.4L V8 330 CID	2004-2007	King Ranch, Lariat, XL, XLT	US8920	5.8L V8 351 CID	1997	Base, XL, XLT	US4044
5.4L V8 330 CID	2008	FX4, King Ranch, Lariat, XL, XLT	US8920	5.8L V8 351 CID	1997	Base, XL, XLT; High performance	US4044H
5.4L V8 330 CID	2009	Cabela's, FX4, King Ranch, Lariat, XL, XLT	US8920	5.8L V8 351 CID	1997-1976		US1075
5.4L V8 330 CID	2010	Cabela's, King Ranch, Lariat, XL, XLT	US8920	5.9L V8 360 CID	1975-1976	High performance	US1075H
6.0L V8 363 CID	2003	Lariat, XL, XLT	US61	6.2L V8 6200cc 378 CID	2015	Mexican Application	US6006
6.0L V8 363 CID	2004	Harley-Davidson Edition, King Ranch, Lariat, XL, XLT; To 09/22/2003	US61	6.4L V8 390 CID	1975-1976		US1075
6.0L V8 363 CID	2004	Harley-Davidson Edition, King Ranch, Lariat, XL, XLT; From 09/22/03	US67	6.4L V8 390 CID	1975-1976	High performance	US1075H
6.0L V8 363 CID	2005-2007	Harley-Davidson Edition, King Ranch, Lariat, XL, XLT	US67	6.6L V8 400 CID	1977-1979	MODIFIED	US932
6.2L V8 6210cc 379 CID	2011-2012	King Ranch, Lariat, XL, XLT	US6006	6.6L V8 400 CID	1980-1981	Custom, Ranger, Ranger Lariat, Ranger XLT; MODIFIED	US932
6.2L V8 6210cc 379 CID	2013-2018	King Ranch, Lariat, Platinum, XL, XLT	US6006	6.6L V8 400 CID	1982	Custom, XL, XLS, XLT Lariat; MODIFIED	US932
6.4L V8 391 CID	2008	FX4, Harley-Davidson Edition, King Ranch, Lariat, XL, XLT	US76	6.9L V8 420 CID	1983	Base, XL, XLS, XLT	US4018
6.4L V8 391 CID	2008-2009	FX4, Harley-Davidson Edition, King Ranch, Lariat, XL, XLT; Electric Water Pump	US11006	6.9L V8 420 CID	1984	Base, XL, XLT	US4018
				6.9L V8 420 CID	1985-1986	Base, XL, XLT Lariat	US4018

WATER PUMPS

Engine	Years	Application Description	USMW	Engine	Years	Application Description	USMW
FORD (cont'd.)				FORD (cont'd.)			
F-550 SUPER DUTY (cont'd.)				FIESTA			
6L V8 363 CID	2004	Medium/Heavy Duty, To 09/22/2003, XL	US61	1.0L L3 999cc 61 CID	2014-2017	SE	US8146
6L V8 363 CID	2004	Medium/Heavy Duty, To 09/22/2003, XLT	US61	1.3L L4 1299cc 79 CID	1998-2000		US8934
6L V8 363 CID	2004	From 09/22/03, Lariat, Medium/Heavy Duty	US67	1.4L L4 1388cc 85 CID	1998-2000	Mexican Application	US4104
6L V8 363 CID	2004	From 09/22/03, Medium/Heavy Duty, XL	US67	1.6L L4 1596cc 97 CID	2001		US8931
6L V8 363 CID	2004	From 09/22/03, Medium/Heavy Duty, XLT	US67	1.6L L4 1596cc 97 CID	2003-2009		US8931
6L V8 363 CID	2005-2007	Lariat, Medium/Heavy Duty	US67	1.6L L4 1596cc 97 CID	2010	First, Trend Comfort	US8931
6L V8 363 CID	2005-2007	Medium/Heavy Duty, XL	US67	1.6L L4 1596cc 97 CID	2011-2012	S, SE, SEL, SES	US9449
6L V8 363 CID	2005-2007	Medium/Heavy Duty, XLT	US67	1.6L L4 1596cc 97 CID	2013	S, SE, Titanium	US9449
7.3L V8 445 CID	1999-2003	Lariat, Medium/Heavy Duty	US4114	1.6L L4 1596cc 97 CID	2014-2018	S, SE, ST, Titanium	US9449
7.3L V8 445 CID	1999-2003	Medium/Heavy Duty, XL	US4114	1.6L L4 1598cc 98 CID	1978-1979		US4003
7.3L V8 445 CID	1999-2003	Medium/Heavy Duty, XLT	US4114	1.6L L4 1598cc 98 CID	1980	Base	US4003
FAIRLANE				FIESTA IKON			
2.8L L6 2786cc 170 CID	1962-1966		US1044	1.6L L4 1596cc 97 CID	2002-2004		US8931
3.3L L6 200 CID	1965-1969		US1044	1.6L L4 1598cc 98 CID	2011		US8931
3.3L L6 3277cc 200 CID	1963-1969		US1044	1.6L L4 1598cc 98 CID	2012	First	US8931
3.3L L6 3278cc 200 CID	1968-1969		US1044	1.6L L4 1600cc 98 CID	2012-2015	Ambiente, Trend	US8931
3.6L L6 3655cc 223 CID	1962		US819	FIVE HUNDRED			
3.6L V8 221 CID	1962-1963		US819	3.0L V6 2968cc 181 CID	2005-2006	Limited, SE, SEL	US6186
3.6L V8 3622cc 221 CID	1962-1963		US819	3.0L V6 2968cc 181 CID	2007	Limited, SEL	US6186
4.3L V8 260 CID	1963-1964		US819	FLEX			
4.3L V8 4261cc 260 CID	1962-1964		US819	3.5L V6 3496cc 213 CID	2009-2010	Limited, SE, SEL	US6023
4.4L V8 4458cc 272 CID	1955-1957		US488	3.5L V6 3496cc 213 CID	2011	Limited, SEL, Titanium; Turbocharged	US8910
4.5L V8 272 CID	1957		US488	3.5L V6 3496cc 213 CID	2011	Limited, SEL, Titanium; Naturally Aspirated	US8980
4.7L V8 289 CID	1963-1967		US819	3.5L V6 3496cc 213 CID	2011	SE	US8980
4.7L V8 4727cc 289 CID	1963-1967		US819	3.5L V6 3496cc 213 CID	2012	Limited, SEL, Titanium; Naturally Aspirated; From 01/02/2012	US8910
4.8L V8 292 CID	1957-1961		US488	3.5L V6 3496cc 213 CID	2012	Limited, SEL, Titanium; Turbocharged; From 01/02/2012	US8910
5.8L V8 352 CID	1961-1964		US723	3.5L V6 3496cc 213 CID	2012	Limited, SEL, Titanium; Turbocharged; To 01/02/2012	US8910
5.8L V8 5769cc 352 CID	1961-1964		US723	3.5L V6 3496cc 213 CID	2012	SE; From 01/02/2012	US8910
6.4L V8 390 CID	1961-1964		US723	3.5L V6 3496cc 213 CID	2012	Limited, SEL, Titanium; Naturally Aspirated; To 01/02/2012	US8980
6.4L V8 6391cc 390 CID	1961-1964		US723	3.5L V6 3496cc 213 CID	2012	SE; To 01/02/2012	US8980
7.0L V8 6997cc 427 CID	1964		US723	3.5L V6 3496cc 213 CID	2013-2018	Limited, SE, SEL	US8910
FAIRMONT				FOCUS			
2.3L L4 140 CID	1978-1979		US4005	1.0L L3 999cc 61 CID	2015-2018	SE	US8146
2.3L L4 140 CID	1980	Base, Futura	US4005	2.0L L4 1989cc 121 CID	2000	Sony Limited Edition, ZTS, ZX3	US4115
2.3L L4 140 CID	1981	Base, Futura, S	US4005	2.0L L4 1989cc 121 CID	2000-2003	SE; (3)	US4115
2.3L L4 140 CID	1982	Base, Futura	US4005	2.0L L4 1989cc 121 CID	2000-2003	SE; (P)	US4123
2.3L L4 140 CID	1983	Futura, S	US4054	2.0L L4 1989cc 121 CID	2000-2004	LX	US4123
3.3L L6 200 CID	1978-1979		US4002	2.0L L4 1989cc 121 CID	2001	ZTS, ZX3	US4115
3.3L L6 200 CID	1980	Base, Futura	US4002	2.0L L4 1989cc 121 CID	2002-2003	SVT, ZTS, ZTW, ZX3, ZX5	US4115
3.3L L6 200 CID	1981	Base, Futura, S	US4002	2.0L L4 1989cc 121 CID	2004	SE, SVT, ZTS, ZX3, ZX5	US4115
3.3L L6 200 CID	1982	Base, Futura	US4002	2.0L L4 1989cc 121 CID	2007-2011		US4126
3.3L L6 200 CID	1983	Futura, S	US4002	2.0L L4 1999cc 122 CID	2005-2006	ZX3, ZX4, ZX5, ZXW	US4126
4.2L V8 255 CID	1980	Base, Futura; WINDSOR	US953	2.0L L4 1999cc 122 CID	2007-2008	S, SE, SES	US4126
4.2L V8 255 CID	1980	Base, Futura; High performance	US953H	2.0L L4 1999cc 122 CID	2009-2011	S, SE, SEL, SES	US4126
4.2L V8 255 CID	1981	Base, Futura, S; WINDSOR	US953	2.0L L4 1999cc 122 CID	2012	S, SE, SEL, Titanium	US4126
4.2L V8 255 CID	1981	Base, Futura, S; High performance	US953H	2.0L L4 1999cc 122 CID	2013-2016	S, SE, ST, Titanium	US4126
4.2L V8 255 CID	1982	Base, Futura; WINDSOR	US953	2.0L L4 1999cc 122 CID	2017-2018	S, SE, SEL, ST, Titanium	US4126
4.2L V8 255 CID	1982	Base, Futura; High performance	US953H	2.3L L4 140 CID	2003-2004	LX, SE, ZTS, ZTW, ZX3, ZX5	US4126
4.2L V8 4200cc 256 CID	1978-1979	Mexican Application	US953	2.3L L4 140 CID	2005-2006	ZX4 ST	US4126
5.0L V8 302 CID	1978-1979	WINDSOR	US953	2.3L L4 140 CID	2007	ST	US4126
5.0L V8 302 CID	1978-1979	High performance	US953H	2.3L L4 2300cc 140 CID	2016-2018	RS	US8117
5.0L V8 5000cc 302 CID	1981-1983	Mexican Application	US953	2.5L L5 2521cc 154 CID	2007-2011	Mexican Application	US9339
FALCON				FORD 300			
2.4L L6 144 CID	1962-1964		US1044	3.3L L6 3277cc 200 CID	1963		US1044
2.4L L6 2360cc 144 CID	1960-1964		US1044	4.3L V8 4261cc 260 CID	1963		US819
2.8L L6 170 CID	1962-1969		US1044	4.7L V8 4727cc 289 CID	1963		US819
2.8L L6 2786cc 170 CID	1960-1969		US1044	5.8L V8 5769cc 352 CID	1963		US723
3.3L L6 200 CID	1965-1970		US1044	6.4L V8 6391cc 390 CID	1963		US723
3.3L L6 3277cc 200 CID	1964-1970		US1044	6.6L V8 6654cc 406 CID	1963		US723
3.3L L6 3278cc 200 CID	1968-1970		US1044	7.0L V8 6997cc 427 CID	1963		US723
3.6L V8 3622cc 221 CID	1962-1963		US819	FREESTAR			
4.3L V8 260 CID	1963-1964		US819	3.9L V6 238 CID	2004	Base, S, SE, SES	US4102
4.3L V8 4261cc 260 CID	1962-1965		US819	3.9L V6 238 CID	2005	S, SE, SES	US4102
4.7L V8 289 CID	1964-1966		US819	3.9L V6 238 CID	2006-2007	Base, SE	US4102
4.7L V8 4727cc 289 CID	1964-1966		US819	4.2L V6 256 CID	2004-2007	Limited, SEL	US4102
5.0L V8 5000cc 302 CID	1969	Mexican Application	US1028	FREESTYLE			
FALCON SEDAN DELIVERY				F SUPER DUTY			
2.4L L6 2360cc 144 CID	1961-1964		US1044	7.3L V8 445 CID	1988-1989	Base, Medium/Heavy Duty	US4018
2.8L L6 2786cc 170 CID	1961-1965		US1044	7.3L V8 445 CID	1990-1992	Custom, Medium/Heavy Duty	US4018
3.3L L6 3277cc 200 CID	1964-1965		US1044	7.3L V8 445 CID	1993-1994	Medium/Heavy Duty, Naturally Aspirated, XL	US4018
4.3L V8 4261cc 260 CID	1962		US819	7.3L V8 445 CID	1994	Medium/Heavy Duty, Turbocharged, XL	US4018
4.7L V8 4727cc 289 CID	1965		US819	7.3L V8 445 CID	1995	Medium/Heavy Duty, XL	US4096
FESTIVA				7.3L V8 445 CID	1996	Medium/Heavy Duty, To Engine # 201680, XL	US4096
1.3L L4 1295cc	1988	L, LX; From 04/1987	US4049				
1.3L L4 1295cc	1988	L, LX; To 04/1987	US4049				
1.3L L4 1295cc	1989	L, LX	US4049				
1.3L L4 1295cc	1990	GL, L, L Plus, LX	US4049				
1.3L L4 1295cc	1991-1993	GL, L	US4049				

WATER PUMPS

Engine	Years	Application Description	USMW	Engine	Years	Application Description	USMW
FORD (cont'd.)				FORD (cont'd.)			
F SUPER DUTY (cont'd.)				GRAND MARQUIS (cont'd.)			
7.3L V8 445 CID	1996	From Engine # 201681, Medium/Heavy Duty, XL	US4114	4.6L V8 4608cc 281 CID	1998-2001	Mexican Application	US4113
7.3L V8 445 CID	1997	Base, Medium/Heavy Duty	US4114	4.6L V8 4608cc 281 CID	2002-2004	Mexican Application	US4128
7.3L V8 445 CID	1997	Medium/Heavy Duty, XL	US4114	5.0L V8 5000cc 302 CID	1991-1992	Mexican Application	US4052
7.5L V8 460 CID	1990-1991	Custom, Medium/Heavy Duty	US1114	GT			
7.5L V8 460 CID	1992	Custom, Medium/Heavy Duty, To 02/03/1992	US1114	5.4L V8 5409cc 330 CID	2005-2006	Base	US8125
7.5L V8 460 CID	1992	Custom, From 02/03/1992, Medium/Heavy Duty	US4077	GT40			
7.5L V8 460 CID	1993-1994	Medium/Heavy Duty, XL	US4077	4.7L V8 289 CID	1968		US819
7.5L V8 460 CID	1995-1997	Medium/Heavy Duty, XL	US4086	4.7L V8 4727cc 289 CID	1966-1968		US819
7.5L V8 460 CID	1997	Base, Medium/Heavy Duty	US4086	7.0L V8 6997cc 427 CID	1964		US723
FT800				KA			
6.1L V8 370 CID	1980-1986		US4037	1.6L L4 1596cc 97 CID	2001-2008		US8931
6.1L V8 370 CID	1988-1990		US4037	L800			
7.0L V8 429 CID	1980-1986		US4037	6.1L V8 370 CID	1980-1985		US4037
7.0L V8 429 CID	1988-1990		US4037	7.0L V8 429 CID	1980-1985		US4037
FUSION				LN600			
1.5L L4 1499cc 91 CID	2014-2018	SE	US8107	6.1L V8 370 CID	1980-1985		US4037
1.6L L4 1596cc 97 CID	2013-2014	SE	US9449	LN700			
2.0L L4 1999cc 122 CID	2013-2016	SE, Titanium	US4126	6.1L V8 370 CID	1980-1985		US4037
2.0L L4 1999cc 122 CID	2017-2018	Platinum, SE, Titanium	US8975	7.0L V8 429 CID	1980-1985		US4037
2.3L L4 140 CID	2006-2009	S, SE, SEL	US4126	LN800			
2.5L L4 2488cc 152 CID	2010-2012	Hybrid, S, SE, SEL	US4126	6.1L V8 370 CID	1980-1985		US4037
2.5L L4 2488cc 152 CID	2013-2018	S, SE	US4126	7.0L V8 429 CID	1980-1985		US4037
2.7L V6 164 CID	2017	Sport	US8141	LN7000			
2.7L V6 164 CID	2017	Sport; 3 Bolt Pulley	US8141P	5.9L L6 359 CID	1993-1997		US7145N
2.7L V6 164 CID	2017	Sport; Includes 3 hole pulley	US8141P-T	6.6L L6 401 CID	1987-1990		US4062
2.7L V6 164 CID	2017	Sport; Includes 3 hole pulley and thermostat / housing	US8141P-T	7.8L L6 473 CID	1987-1988		US4062
2.7L V6 164 CID	2017	Sport; 3 Bolt hub Includes thermostat / housing	US8141-T	LN8000			
2.7L V6 164 CID	2017-2018	Sport	US8141P	7.8L L6 473 CID	1987-1990		US4062
3.0L V6 2967cc 181 CID	2011-2012	Mexican Application	US6250	LOBO			
3.0L V6 2968cc 181 CID	2006-2009	SE, SEL	US9489	4.6L V8 4608cc 281 CID	2007	Mexican Application	US4125
3.0L V6 2968cc 181 CID	2006-2009	SE, SEL; Includes back housing	US9489-2	5.0L V8 5000cc 305 CID	2011-2014	Mexican Application	US8963
3.0L V6 2968cc 181 CID	2010-2012	SE, SEL	US6250	5.4L V8 5409cc 330 CID	1999-2010	Mexican Application	US4125
3.0L V6 3000cc 183 CID	2010	Mexican Application	US6250	6.2L V8 6200cc 378 CID	2011-2014	Mexican Application	US6006
3.5L V6 3496cc 213 CID	2010-2011	Sport	US6023	LTD			
3.5L V6 3496cc 213 CID	2012	Sport; From 01/02/2012	US8910	2.3L L4 140 CID	1983-1986	Base, Brougham	US4054
3.5L V6 3496cc 213 CID	2012	Sport; To 01/02/2012	US8980	3.3L L6 200 CID	1983	Base, Brougham	US4002
GALAXIE				3.8L V6 232 CID	1983-1986	Base, Brougham	US4016
3.3L L6 3277cc 200 CID	1963		US1044	4.2L V8 255 CID	1981-1982	Base, Crown Victoria, S	US4014
4.3L V8 4261cc 260 CID	1963-1964		US819	4.2L V8 255 CID	1981-1982	Base, Crown Victoria, S; High performance	US4014H
4.7L V8 4727cc 289 CID	1963-1965		US819	4.7L V8 4727cc 289 CID	1965-1967		US819
4.8L V8 4786cc 292 CID	1959-1962		US488	5.0L V8 302 CID	1977-1979	WINDSOR	US953
5.8L V8 5769cc 352 CID	1961-1964		US723	5.0L V8 302 CID	1977-1979	High performance	US953H
5.8L V8 5800cc 351 CID	1969	Mexican Application	US1028	5.0L V8 302 CID	1980-1982	Base, Country Squire, Crown Victoria, S	US4014
5.8L V8 5800cc 351 CID	1970-1976	Mexican Application	US953	5.0L V8 302 CID	1980-1982	Base, Country Squire, Crown Victoria, S; High performance	US4014H
6.4L V8 6391cc 390 CID	1961-1964		US723	5.0L V8 302 CID	1983	Country Squire, Crown Victoria	US4014
6.6L V8 6654cc 406 CID	1962-1963		US723	5.0L V8 302 CID	1983	Country Squire, Crown Victoria; High performance	US4014H
7.0L V8 6997cc 427 CID	1963-1964		US723	5.0L V8 302 CID	1984	Base, Brougham, Country Squire, Crown Victoria	US4014
GALAXIE 500				5.0L V8 302 CID	1984	Base, Brougham, Country Squire, Crown Victoria	US4014H
3.3L L6 200 CID	1963		US1044	5.0L V8 302 CID	1985	Country Squire, Crown Victoria	US4014
4.3L V8 260 CID	1963-1964		US819	5.0L V8 302 CID	1985	Country Squire, Crown Victoria; High performance	US4014H
4.7L V8 289 CID	1963-1967		US819	5.0L V8 302 CID	1985	Base, Brougham, LX Brougham	US4024
5.8L V8 352 CID	1962-1964		US723	5.0L V8 302 CID	1985	Base, Brougham, LX Brougham; High performance	US4024H
6.4L V8 390 CID	1962-1964		US723	5.0L V8 302 CID	1986	Country Squire, Country Squire LX, Crown Victoria, Crown Victoria LX	US4014
GHIA				5.0L V8 302 CID	1986	Country Squire, Country Squire LX, Crown Victoria, Crown Victoria LX; High performance	US4014H
2.3L L4 2300cc 140 CID	1990	Mexican Application	US4022	5.0L V8 5000cc 302 CID	1975-1976	Mexican Application	US953
2.3L L4 2300cc 140 CID	1991-1992	Mexican Application	US4041	5.8L V8 351 CID	1975-1979	MODIFIED	US932
3.0L V6 2985cc 182 CID	1992-1994	Mexican Application	US4070	5.8L V8 351 CID	1975-1979	WINDSOR	US953
GRANADA				5.8L V8 351 CID	1975-1979	High performance	US953H
2.3L L4 140 CID	1981-1982	GL, GLX, L	US4005	5.8L V8 351 CID	1980-1981	Base, Country Squire, Crown Victoria, S	US4014
3.3L L6 200 CID	1975	Air Cond	US1044	5.8L V8 351 CID	1980-1981	Base, Country Squire, Crown Victoria, S; High performance	US4014H
3.3L L6 200 CID	1975	W/O AIR	US4002	5.8L V8 351 CID	1982	Base, Crown Victoria, S	US4014
3.3L L6 200 CID	1976-1977		US4002	5.8L V8 351 CID	1982	Base, Crown Victoria, S; High performance	US4014H
3.3L L6 200 CID	1981-1982	GL, GLX, L	US4002	5.8L V8 351 CID	1983-1985	Country Squire, Crown Victoria	US4014
3.8L V6 232 CID	1982	GL, GLX, L	US4016	5.8L V8 351 CID	1983-1985	Country Squire, Crown Victoria; High performance	US4014H
4.1L L6 250 CID	1975-1979		US960	5.8L V8 351 CID	1986	Country Squire, Country Squire LX, Crown Victoria, Crown Victoria LX	US4014
4.1L L6 250 CID	1980	Base, ESS, Ghia	US960	GRAND MARQUIS			
4.2L V8 255 CID	1980	Base, ESS, Ghia; WINDSOR	US953	4.6L V8 4608cc 281 CID	1992-1997	Mexican Application	US4066
4.2L V8 255 CID	1980	Base, ESS, Ghia; High performance	US953H				
4.2L V8 255 CID	1981	GL, GLX, L; WINDSOR	US953				
4.2L V8 255 CID	1981	GL, GLX, L; High performance	US953H				
5.0L V8 302 CID	1975-1979	WINDSOR	US953				
5.0L V8 302 CID	1975-1979	High performance	US953H				
5.0L V8 302 CID	1980	Base, ESS, Ghia; WINDSOR	US953				
5.0L V8 302 CID	1980	Base, ESS, Ghia; High performance	US953H				
5.8L V8 351 CID	1975-1977	WINDSOR	US953				
5.8L V8 351 CID	1975-1977	High performance	US953H				

Engine	Years	Application Description	USMW	Engine	Years	Application Description	USMW
FORD (cont'd.)				FORD (cont'd.)			
LTD (cont'd.)				MUSTANG (cont'd.)			
5.8L V8 351 CID	1986	Country Squire, Country Squire LX, Crown Victoria, Crown Victoria LX; High performance	US4014H	3.7L V6 3726cc 227 CID	2015	V6; Serpentine Belt Driven	US6654
5.8L V8 5752cc 351 CID	1978	WINDSOR	US953	3.7L V6 3726cc 227 CID	2016-2017	V6	US8916
5.8L V8 5800cc 351 CID	1977-1978	Mexican Application	US953	3.8L V6 232 CID	1983	GL, GLX, L	US4016
5.8L V8 5800cc 351 CID	1979-1980	Mexican Application	US4052	3.8L V6 232 CID	1984	L, LX	US4016
6.6L V8 400 CID	1975-1978	MODIFIED	US932	3.8L V6 232 CID	1985-1986	LX	US4016
7.5L V8 460 CID	1975-1978		US1114	3.8L V6 232 CID	1994-1995	Base	US4090
LTD CROWN VICTORIA				3.8L V6 232 CID	1996-2004	Base	US4103
5.0L V8 302 CID	1987	Base, LX, S	US4014	3.9L V6 238 CID	2004	Base	US4103
5.0L V8 302 CID	1987	Base, LX, S; High performance	US4014H	4.0L V6 245 CID	2005-2010	Base	US4108
5.0L V8 302 CID	1988	Base, LX, S; To 06/1988	US4014	4.2L V8 255 CID	1980	Base, Ghia	US4024
5.0L V8 302 CID	1988	Base, LX, S; High performance, To 06/88	US4014H	4.2L V8 255 CID	1980	Base, Ghia; High performance	US4024H
5.0L V8 302 CID	1988	Base, LX, S; From 06/1988	US4052	4.2L V8 255 CID	1981	Base, Cobra, Ghia	US4024
5.0L V8 302 CID	1988	Base, LX, S; From 06/88, High performance	US4052H	4.2L V8 255 CID	1981	Base, Cobra, Ghia; High performance	US4024H
5.0L V8 302 CID	1989-1991	Base, LX, S	US4052	4.2L V8 255 CID	1982	GL, GLX, L	US4024
5.0L V8 302 CID	1989-1991	Base, LX, S; High performance	US4052H	4.2L V8 255 CID	1982	GL, GLX, L; High performance	US4024H
5.8L V8 351 CID	1987-1991	Base	US4014	4.3L V8 4261cc 260 CID	1964-1965		US819
5.8L V8 351 CID	1987-1991	Base; High performance	US4014H	4.6L V8 281 CID	1996-1998	GT, SVT Cobra; Pump Length: long	US4113
LTD II				4.6L V8 281 CID	1999	GT, SVT Cobra	US4119
5.0L V8 302 CID	1977-1979	WINDSOR	US953	4.6L V8 281 CID	2000	GT	US4119
5.0L V8 302 CID	1977-1979	High performance	US953H	4.6L V8 281 CID	2001	GT, GT Bullitt; 87mm From Pulley Surface To Mounting Surface	US4119
5.8L V8 351 CID	1977-1979	MODIFIED	US932	4.6L V8 281 CID	2001	SVT Cobra	US4119
5.8L V8 351 CID	1977-1979	WINDSOR	US953	4.6L V8 281 CID	2001	GT, GT Bullitt; 65mm From Pulley Surface To Mounting Surface	US4128
5.8L V8 351 CID	1977-1979	High performance	US953H	4.6L V8 281 CID	2002	GT; 65mm From Pulley Surface To Mounting Surface	US4128
6.6L V8 400 CID	1977-1978	MODIFIED	US932	4.6L V8 281 CID	2002-2004	GT; 87mm From Pulley Surface To Mounting Surface	US4119
MAINLINE				4.6L V8 281 CID	2003	GT, SVT Cobra 10th Anniversary; 65mm From Pulley Surface To Mounting Surface	US4128
3.9L V8 3917cc 239 CID	1954		US488	4.6L V8 281 CID	2003	SVT Cobra, SVT Cobra 10th Anniversary	US11014
4.4L V8 4458cc 272 CID	1955-1956		US488	4.6L V8 281 CID	2003-2004	Mach I	US4119
MAVERICK				4.6L V8 281 CID	2003-2004	SVT Cobra	US4128
2.8L L6 170 CID	1970-1972		US1044	4.6L V8 281 CID	2004	GT; 65mm From Pulley Surface To Mounting Surface	US4128
2.8L L6 2786cc 170 CID	1970-1972		US1044	4.6L V8 281 CID	2004	SVT Cobra	US11014
3.3L L6 200 CID	1970-1974		US1044	4.6L V8 281 CID	2005-2006	GT; Pump Length: long	US4113
3.3L L6 200 CID	1975	W/O AIR	US1044	4.6L V8 281 CID	2007	GT, Shelby GT	US4119
3.3L L6 200 CID	1975	Air Cond	US4002	4.6L V8 281 CID	2008	Bullitt, GT, Shelby GT	US4119
3.3L L6 200 CID	1976-1977		US4002	4.6L V8 281 CID	2009	Bullitt, GT	US4119
3.3L L6 3277cc 200 CID	1970-1974		US1044	4.6L V8 281 CID	2010		US4119
3.3L L6 3278cc 200 CID	1970-1974		US1044	4.7L V8 289 CID	1968		US819
4.1L L6 250 CID	1975-1977		US960	4.7L V8 4727cc 289 CID	1964-1968		US819
4.7L V8 4700cc 289 CID	1971-1977	Mexican Application	US953	5.0L V8 302 CID	1979		US4024
5.0L V8 302 CID	1975-1977	WINDSOR	US953	5.0L V8 302 CID	1979	High performance	US4024H
5.0L V8 302 CID	1975-1977	High performance	US953H	5.0L V8 302 CID	1982	GL, GLX, GT, L	US4024
5.0L V8 5000cc 302 CID	1970	Mexican Application	US953	5.0L V8 302 CID	1982	GL, GLX, GT, L; High performance	US4024H
MONDEO				5.0L V8 302 CID	1983	GT	US4024
2.0L L4 1999cc 122 CID	2001-2007		US4126	5.0L V8 302 CID	1983	GT; High performance	US4024H
2.5L V6 2544cc 155 CID	2001-2007	Mexican Application	US4091	5.0L V8 302 CID	1984	GT, GT-350 20th Anniversary, L, LX	US4024
3.0L V6 2966cc 181 CID	2005	Mexican Application	US4091	5.0L V8 302 CID	1984	GT, GT-350 20th Anniversary, L, LX; Exc.CFI, High performance	US4024H
MUSTANG				5.0L V8 302 CID	1984	GT, GT-350 20th Anniversary, L, LX	US4035
2.3L L4 140 CID	1979		US4005	5.0L V8 302 CID	1985	GT, LX	US4024
2.3L L4 140 CID	1980-1981	Base, Ghia	US4005	5.0L V8 302 CID	1985	GT, LX; High performance	US4024H
2.3L L4 140 CID	1982	GL, GLX, L	US4005	5.0L V8 302 CID	1985	GT	US4035
2.3L L4 140 CID	1983	GL, GLX, L, Turbo GT	US4054	5.0L V8 302 CID	1986-1992	GT, LX	US4038
2.3L L4 140 CID	1984	GT, GT-350 20th Anniversary, L, LX, SVO	US4054	5.0L V8 302 CID	1986-1992	GT, LX; High performance	US4038H
2.3L L4 140 CID	1985-1986	LX, SVO	US4054	5.0L V8 302 CID	1993	GT, LX, SVT Cobra	US4038
2.3L L4 140 CID	1987	LX	US4054	5.0L V8 302 CID	1993	GT, LX, SVT Cobra, SVT Cobra R; High performance	US4038H
2.3L L4 140 CID	1988	LX; From 12/1987	US4054	5.0L V8 302 CID	1994	GT, SVT Cobra	US4087
2.3L L4 140 CID	1988	LX; To 12/1987	US4054	5.0L V8 302 CID	1995	GT, GTS, SVT Cobra	US4087
2.3L L4 140 CID	1989-1993	LX	US4054	5.0L V8 4951cc 302 CID	2011	GT	US8963
2.3L L4 2300cc 140 CID	2015	EcoBoost, EcoBoost Premium	US8117	5.0L V8 4951cc 302 CID	2012-2013	Boss 302, GT	US8963
2.3L L4 2300cc 140 CID	2015-2016	EcoBoost, EcoBoost Premium; Engine # FX-195/6-AA (Engine # FV795/6-AA)	US8117	5.0L V8 4951cc 302 CID	2014	GT	US8963
2.3L L4 2300cc 140 CID	2015-2016	EcoBoost, EcoBoost Premium; Engine # FC-765-6-AA (Engine # FC-793/4-AA)	US8975	5.0L V8 4951cc 302 CID	2015	GT, GT 50 Years Limited Edition, GT Premium	US8116
2.3L L4 2300cc 140 CID	2016	EcoBoost, EcoBoost Premium; From 01/09/2016	US8975	5.0L V8 4951cc 302 CID	2016-2018	GT, GT Premium	US8116
2.3L L4 2300cc 140 CID	2016	EcoBoost, EcoBoost Premium; To 01/09/2016	US8975	5.0L V8 5000cc 302 CID	1969	Mexican Application	US1028
2.3L L4 2300cc 140 CID	2016-2018	EcoBoost, EcoBoost Premium	US8975	5.0L V8 5000cc 302 CID	1973-1974	Mexican Application	US953
2.8L L6 2786cc 170 CID	1964-1965		US1044	5.0L V8 5000cc 302 CID	1974	Mexican Application	US4024
2.8L V6 171 CID	1979		US1047	5.0L V8 5000cc 302 CID	1975	Mexican Application	US1070
3.3L L6 200 CID	1968-1970		US1044	5.0L V8 5000cc 302 CID	1976-1978	Mexican Application	US953
3.3L L6 200 CID	1979		US4002	5.0L V8 5000cc 302 CID	1979-1981	Mexican Application	US4024
3.3L L6 200 CID	1980-1981	Base, Ghia	US4002	5.0L V8 5000cc 302 CID	1983-1984	Mexican Application	US4024
3.3L L6 200 CID	1982	GL, GLX, L	US4002	5.2L V8 5163cc 315 CID	2015-2018	Shelby GT350, Shelby GT350R	US8116
3.3L L6 3277cc 200 CID	1964-1970		US1044	5.4L V8 5409cc 330 CID	2007	Shelby GT500	US8125
3.3L L6 3278cc 200 CID	1968-1970		US1044	5.4L V8 5409cc 330 CID	2008-2009	Shelby GT500, Shelby GT500KR	US8125
3.7L V6 3700cc 227 CID	2012	Mexican Application	US6654	5.4L V8 5409cc 330 CID	2010-2012	Shelby GT500	US8125
3.7L V6 3700cc 227 CID	2014	Mexican Application	US6654	5.8L V8 5800cc 351 CID	1974	Mexican Application	US953
3.7L V6 3726cc 227 CID	2011-2014	Base; Serpentine Belt Driven	US6654	5.8L V8 5812cc 355 CID	2013-2014	Shelby GT500	US8125
3.7L V6 3726cc 227 CID	2014	Base	US6654	MUSTANG II			
3.7L V6 3726cc 227 CID	2015	V6	US6654	2.3L L4 140 CID	1975-1978		US4005
				2.8L V6 171 CID	1975-1978		US1047
				5.0L V8 302 CID	1975		US1070

WATER PUMPS



WATER PUMP APPLICATION GUIDE



Engine	Years	Application Description	USMW	Engine	Years	Application Description	USMW
FORD (cont'd.)				FORD (cont'd.)			
MUSTANG II (cont'd.)				RANGER (cont'd.)			
5.0L V8 302 CID	1976	From 03/15/76, WINDSOR	US953	2.3L L4 140 CID	1991-1992	Custom, S, Sport, XLT	US4054
5.0L V8 302 CID	1976	From 03/15/76, High performance	US953H	2.3L L4 140 CID	1993	Splash, Sport, STX, XL, XLT	US4054
5.0L V8 302 CID	1976	To 03/15/76	US1070	2.3L L4 140 CID	1994	Splash, STX, XL, XLT	US4054
5.0L V8 302 CID	1976-1978	WINDSOR	US953	2.3L L4 140 CID	1995	Splash, STX, XL, XL Sport, XLT	US4093
5.0L V8 302 CID	1977-1978	High performance	US953H	2.3L L4 140 CID	1996	Splash, XL, XLT	US4093
MYSTIQUE				2.3L L4 140 CID	1997	Splash, Sport, XL, XLT	US4093
2.0L L4 1984cc 121 CID	1994-1995	Mexican Application	US4088	2.3L L4 140 CID	2001-2006	XL, XLT	US4126
2.5L V6 2544cc 155 CID	1995-2000	Mexican Application	US4091	2.3L L4 140 CID	2007	STX, XL, XLT	US4126
P350				2.3L L4 140 CID	2008	XL, XLT	US4126
5.0L V8 5000cc 302 CID	1975	Mexican Application	US953	2.3L L4 140 CID	2009	Sport, XL, XLT	US4126
5.0L V8 5000cc 302 CID	1989-1991	Mexican Application	US4044	2.3L L4 140 CID	2010-2011	XL, XLT	US4126
5.8L V8 5800cc 351 CID	1986-1987	Mexican Application	US953	2.5L L4 153 CID	1998	Splash, XL, XLT	US4093
5.8L V8 5800cc 351 CID	1988-1997	Mexican Application	US4044	2.5L L4 153 CID	1999-2001	XL, XLT	US4093
P400				2.8L V6 171 CID	1983	Base, XL, XLS, XLT	US4023
5.0L V8 5000cc 302 CID	1975	Mexican Application	US953	2.8L V6 171 CID	1984	S, XL, XLS, XLT	US4023
P-100				2.8L V6 171 CID	1985	Base, XL, XLS, XLT	US4023
2.4L L6 2360cc 144 CID	1960-1964		US1044	2.9L V6 177 CID	1986	Base, STX, XL, XLT	US4042
2.8L L6 2786cc 170 CID	1961-1970		US1044	2.9L V6 177 CID	1987-1988	Custom, STX, XLT	US4042
P-350				2.9L V6 177 CID	1989	Custom, GT, STX, XLT	US4042
2.8L L6 2786cc 170 CID	1961-1967		US1044	2.9L V6 177 CID	1990	Custom, STX, XLT	US4042
2.8L L6 2786cc 170 CID	1970		US1044	2.9L V6 177 CID	1991-1992	Custom, Sport, STX, XLT	US4042
PINTO				3.0L V6 2986cc 182 CID	1991-1992	Custom, S, Sport, STX, XLT	US4039
2.0L L4 1993cc 122 CID	1971-1974		US964	3.0L V6 2986cc 182 CID	1993	Splash, Sport, STX, XL, XLT	US4039
2.3L L4 140 CID	1975-1979		US4005	3.0L V6 2986cc 182 CID	1994	Splash, STX, XL, XLT	US4039
2.3L L4 140 CID	1980	Base, Pony, Squire	US4005	3.0L V6 2986cc 182 CID	1995	Splash, STX, XL, XL Sport, XLT	US4095
2.8L V6 171 CID	1975-1979		US1047	3.0L V6 2986cc 182 CID	1996	Splash, STX, XL, XLT; 28mm From Base To End Of Nipple	US4095
POLICE INTERCEPTOR SEDAN				3.0L V6 2986cc 182 CID	1996	Splash, STX, XL, XLT; 42.71mm From Base To End Of Nipple	US4095
3.5L V6 3496cc 213 CID	2013-2018	Base	US8910	3.0L V6 2986cc 182 CID	1997	Splash, Sport, STX, XL, XLT; 28mm From Base To End Of Nipple	US4095
3.7L V6 3726cc 227 CID	2013-2018	Base	US8910	3.0L V6 2986cc 182 CID	1997	Splash, Sport, STX, XL, XLT; 42.71mm From Base To End Of Nipple	US4095
POLICE INTERCEPTOR UTILITY				3.0L V6 2986cc 182 CID	1998	Splash, XL, XLT	US4095
3.5L V6 3496cc 213 CID	2014-2018	Base	US8910	3.0L V6 2986cc 182 CID	1999-2000	XL, XLT	US4095
3.7L V6 3726cc 227 CID	2013-2018	Base	US8910	3.0L V6 2986cc 182 CID	2001-2003	Edge, XL, XLT	US4095
PROBE				3.0L V6 2986cc 182 CID	2004	Edge, Tremor, XL, XLT	US4095
2.0L L4 1989cc 122 CID	1993-1996	Base, SE	US4078	3.0L V6 2986cc 182 CID	2005	Edge, STX, XL, XLT	US4095
2.0L L4 1989cc 122 CID	1997	Base, GTS	US4078	3.0L V6 2986cc 182 CID	2006	Sport, STX, XL, XLT; From 08/08/05	US4095
2.2L L4 133 CID	1989	GL, GT, LX	US4053	3.0L V6 2986cc 182 CID	2006	Sport, STX, XL, XLT; To 08/08/05	US4095
2.2L L4 133 CID	1990	GL, GT	US4053	3.0L V6 2986cc 182 CID	2007	Sport, STX, XL, XLT	US4095
2.2L L4 133 CID	1991-1992	Base, GL, GT	US4053	3.0L V6 2986cc 182 CID	2008	Sport, XL, XLT	US4095
2.5L V6 2497cc	1993-1994	GT	US9259	4.0L V6 245 CID	1990	Custom, S, S Plus, STX, XLT	US4060
2.5L V6 2497cc	1995-1997	GT	US9318	4.0L V6 245 CID	1991-1992	Custom, S, Sport, STX, XLT	US4060
3.0L V6 2986cc 182 CID	1990	LX	US4059	4.0L V6 245 CID	1993	Splash, Sport, STX, XL, XLT	US4060
3.0L V6 2986cc 182 CID	1991-1992	LX, SE	US4059	4.0L V6 245 CID	1994	Splash, STX, XL, XLT	US4060
RANCHERO				4.0L V6 245 CID	1995	Splash, STX, XL, XL Sport, XLT	US4060
2.4L L6 2360cc 144 CID	1960-1964		US1044	4.0L V6 245 CID	1996	Splash, STX, XL, XLT	US4060
2.8L L6 2786cc 170 CID	1961-1965		US1044	4.0L V6 245 CID	1997	Splash, Sport, STX, XLT	US4060
3.3L L6 200 CID	1966-1968		US1044	4.0L V6 245 CID	1998	Splash, XL, XLT	US4060
3.3L L6 3277cc 200 CID	1964-1968		US1044	4.0L V6 245 CID	1999-2000	XL, XLT	US4060
3.3L L6 3278cc 200 CID	1968		US1044	4.0L V6 245 CID	2001-2003	Edge, XL, XLT	US4108
4.4L V8 4458cc 272 CID	1957		US488	4.0L V6 245 CID	2004	Edge, Tremor, XLT	US4108
4.8L V8 4786cc 292 CID	1957-1959		US488	4.0L V6 245 CID	2005	Edge, FX4, XL, XLT	US4108
5.0L V8 302 CID	1977-1979	WINDSOR	US953	4.0L V6 245 CID	2006-2007	FX4, Sport, STX, XL, XLT	US4108
5.0L V8 302 CID	1977-1979	High performance	US953H	4.0L V6 245 CID	2008-2009	FX4, Sport, XL, XLT	US4108
5.8L V8 351 CID	1975	WINDSOR	US953	4.0L V6 245 CID	2010-2011	Sport, XL, XLT	US4108
5.8L V8 351 CID	1975-1979	MODIFIED	US932	SABLE			
5.8L V8 351 CID	1975-1979	High performance	US953H	3.0L V6 2966cc 181 CID	1998-2002	Mexican Application	US4094
5.8L V8 351 CID	1977-1978	WINDSOR	US953	3.0L V6 3000cc 183 CID	1996-1997	Mexican Application	US4094
6.6L V8 400 CID	1975-1978	MODIFIED	US932	3.8L V6 3800cc 232 CID	1994-1995	Mexican Application	US4089
7.5L V8 460 CID	1975-1977		US1114	SPECIAL SERVICE POLICE SEDAN			
RANCH WAGON				2.0L L4 1999cc 122 CID	2014-2018	Base	US4126
2.4L L6 2360cc 144 CID	1960-1961		US1044	SPRINT			
2.4L L6 2360cc 144 CID	1964		US1044	2.8L L6 2786cc 170 CID	1963-1964		US1044
2.8L L6 2786cc 170 CID	1960-1969		US1044	3.3L L6 3277cc 200 CID	1963-1964		US1044
3.3L L6 3277cc 200 CID	1963-1970		US1044	STATION BUS			
5.8L V8 5769cc 352 CID	1961-1964		US723	2.4L L6 144 CID	1962-1964		US1044
6.4L V8 6391cc 390 CID	1961-1964		US723	2.8L L6 170 CID	1965		US1044
6.6L V8 6654cc 406 CID	1962-1963		US723	TAURUS			
7.0L V8 6997cc 427 CID	1963-1964		US723	2.0L L4 1999cc 122 CID	2013-2017	Limited, SE, SEL	US4126
RANGER				2.5L L4 153 CID	1986-1988	GL, L, MT5	US4056
2.0L L4 1989cc 122 CID	1983	Base, XL, XLS, XLT	US4054	2.5L L4 153 CID	1989-1990	GL, L	US4056
2.0L L4 1989cc 122 CID	1984	S, XL, XLS, XLT	US4054	2.5L L4 153 CID	1991	GL	US4056
2.0L L4 1989cc 122 CID	1985	Base, XL, XLS, XLT	US4054	3.0L V6 2968cc 181 CID	1996-1997	LX	US4098
2.0L L4 1989cc 122 CID	1986-1988	S	US4054	3.0L V6 2968cc 181 CID	1998	LX, SE Comfort	US4098
2.3L L4 140 CID	1983	Base, XL, XLS, XLT	US4054	3.0L V6 2968cc 181 CID	1999	LX, SE	US4098
2.3L L4 140 CID	1984	S, XL, XLS, XLT	US4054	3.0L V6 2968cc 181 CID	2000	SE, SE Comfort, SEL, SVG	US4098
2.3L L4 140 CID	1985	Base, XL, XLS, XLT	US4054	3.0L V6 2968cc 181 CID	2001-2002	SE, SEL	US4091
2.3L L4 140 CID	1986	Base, S, STX, XL, XLT	US4054	3.0L V6 2968cc 181 CID	2001-2002	SE, SEL; Includes back housing	US4091-2
2.3L L4 140 CID	1987	Custom, STX, XLT	US4054	3.0L V6 2968cc 181 CID	2003	SE, SE Comfort, SEL, SES; To 04/01/2003	US4091
2.3L L4 140 CID	1988-1989	Custom, S, XL, XLT	US4054	3.0L V6 2968cc 181 CID	2003	SE, SE Comfort, SEL, SES; Includes back housing, To 04/01/2003	US4091-2
2.3L L4 140 CID	1990	Custom, S, S Plus, STX, XLT	US4054				

Engine	Years	Application Description	USMW	Engine	Years	Application Description	USMW
FORD (cont'd.)				FORD (cont'd.)			
TAURUS (cont'd.)				THUNDERBIRD (cont'd.)			
3.0L V6 2968cc 181 CID	2003	SE, SE Comfort, SEL, SES; From 04/01/2003	US4132	5.0L V8 302 CID	1981	Base, Heritage, Town Landau	US4014
3.0L V6 2968cc 181 CID	2003	SE, SE Comfort, SEL, SES; From 04/01/2003, Includes back housing	US4132-2	5.0L V8 302 CID	1981	Base, Heritage, Town Landau; High performance	US4014H
3.0L V6 2968cc 181 CID	2004	SE, SEL, SES	US4132	5.0L V8 302 CID	1983	Base, Heritage, LX, Sport	US4014
3.0L V6 2968cc 181 CID	2004	SE, SEL, SES; Includes back housing	US4132-2	5.0L V8 302 CID	1983	Base, Heritage, LX, Sport; High performance	US4014H
3.0L V6 2968cc 181 CID	2005	SE, SEL	US4132	5.0L V8 302 CID	1984-1985	Base, Elan, Fila, LX, Sport	US4014
3.0L V6 2968cc 181 CID	2005	SE, SEL; Includes back housing	US4132-2	5.0L V8 302 CID	1984-1985	Base, Elan, Fila, LX, Sport; High performance	US4014H
3.0L V6 2986cc 182 CID	1986-1992	GL, L, LX	US4034	5.0L V8 302 CID	1986	Base, Elan, LX, Sport	US4038
3.0L V6 2986cc 182 CID	1989-1995	SHO	US4061	5.0L V8 302 CID	1986	Base, Elan, LX, Sport; High performance	US4038H
3.0L V6 2986cc 182 CID	1993	GL, LX	US4034	5.0L V8 302 CID	1987-1988	Base, LX, Sport	US4038
3.0L V6 2986cc 182 CID	1994	GL, LX; From 02/1994	US4034	5.0L V8 302 CID	1987-1988	Base, LX, Sport; High performance	US4038H
3.0L V6 2986cc 182 CID	1994	GL, LX; To 01/1994	US4034	5.0L V8 302 CID	1991-1992	Base, LX	US4057
3.0L V6 2986cc 182 CID	1995	GL, LX, SE	US4094	5.0L V8 302 CID	1993	LX	US4057
3.0L V6 2986cc 182 CID	1996-1997	G, GL	US4094	5.1L V8 5114cc 312 CID	1956-1957		US488
3.0L V6 2986cc 182 CID	1998	SE, SE Comfort	US4094	5.8L V8 351 CID	1977-1979	MODIFIED	US932
3.0L V6 2986cc 182 CID	1999	LX, SE	US4094	5.8L V8 351 CID	1977-1979	WINDSOR	US953
3.0L V6 2986cc 182 CID	2000	LX, SE, SE Comfort, SES, SVG	US4094	5.8L V8 351 CID	1977-1979	High performance	US953H
3.0L V6 2986cc 182 CID	2001-2002	LX, SE, SES	US4094	6.4L V8 6391cc 390 CID	1961-1964		US723
3.0L V6 2986cc 182 CID	2003	LX, SE, SE Comfort, SEL, SES	US4094	6.6L V8 400 CID	1977-1978	MODIFIED	US932
3.0L V6 2986cc 182 CID	2004	LX, SE, SEL, SES	US4094	6.6L V8 6654cc 406 CID	1963		US723
3.0L V6 2986cc 182 CID	2005-2007	SE, SEL	US4094	7.0L V8 6997cc 427 CID	1963-1964		US723
3.2L V6 195 CID	1993-1995	SHO	US4082	7.5L V8 460 CID	1975-1976		US1114
3.4L V8 207 CID	1996-1999	SHO	US4106	TOPAZ			
3.5L V6 3496cc 213 CID	2008	Limited, SEL	US6023	2.3L L4 2294cc 140 CID	1986-1991	Mexican Application	US4022
3.5L V6 3496cc 213 CID	2009	Limited, SE, SEL	US6023	2.3L L4 2294cc 140 CID	1992-1994	Mexican Application	US4041
3.5L V6 3496cc 213 CID	2010	Limited, SE, SEL, SHO	US6023	2.3L L4 2300cc 140 CID	1984-1985	Mexican Application	US4022
3.5L V6 3496cc 213 CID	2011	SHO	US8910	3.0L V6 2985cc 182 CID	1992-1993	Mexican Application	US4070
3.5L V6 3496cc 213 CID	2011-2012	Limited, SE, SEL	US8980	TORINO			
3.5L V6 3496cc 213 CID	2012	SHO; From 01/02/2012	US8910	3.3L L6 200 CID	1968		US1044
3.5L V6 3496cc 213 CID	2012	SHO; To 01/02/2012	US8910	3.3L L6 3277cc 200 CID	1968		US1044
3.5L V6 3496cc 213 CID	2013-2018	Limited, SE, SEL, SHO	US8910	3.3L L6 3278cc 200 CID	1968		US1044
3.8L V6 232 CID	1988-1990	GL, LX	US4051	5.8L V8 351 CID	1975-1976	MODIFIED	US932
3.8L V6 232 CID	1991	GL, L, LX	US4051	5.8L V8 351 CID	1975-1976	High performance	US953H
3.8L V6 232 CID	1992-1993	GL, LX	US4051	5.8L V8 351 CID	1976	WINDSOR	US953
3.8L V6 232 CID	1994	GL, LX	US4089	6.6L V8 400 CID	1975-1976	MODIFIED	US932
3.8L V6 232 CID	1995	GL, LX, SE	US4089	7.5L V8 460 CID	1975-1976		US1114
TAURUS X				TRANSIT			
3.5L V6 3496cc 213 CID	2008-2009	Eddie Bauer, Limited, SEL	US6023	2.2L L4 2198cc 125 CID	2006-2014	Mexican Application	US8987
TEMPO				TRANSIT-150			
2.0L L4 1989cc 122 CID	1984-1986	Base, GL, GLX, LX	US9067	3.2L L5 195 CID	2016-2018	Base, XL, XLT	US8162
2.3L L4 140 CID	1984-1986	Base, GL, GLX, LX	US4022	3.5L V6 3496cc 213 CID	2015-2016	Base, XL, XLT; Serpentine Belt Driven	US8916
2.3L L4 140 CID	1987	AWD, GL, LX, Sport	US4022	3.5L V6 3496cc 213 CID	2015-2018	Base, XL, XLT	US8916
2.3L L4 140 CID	1988-1989	AWD, GL, GLS, LX, Sport	US4022	3.7L V6 3726cc 227 CID	2015	Base, XL, XLT	US6654
2.3L L4 140 CID	1990-1991	GL, GLS, L, L AWD, LX, LX AWD, Sport	US4022	3.7L V6 3726cc 227 CID	2015	Base, XL, XLT; Serpentine Belt Driven	US6654
2.3L L4 140 CID	1992	GL, LX	US4041	3.7L V6 3726cc 227 CID	2016-2018	Base, XL, XLT	US8916
2.3L L4 140 CID	1993	GL, LX; From 05/1993	US4041	TRANSIT-250			
2.3L L4 140 CID	1993	GL, LX; To 05/1993	US4041	3.2L L5 195 CID	2016-2018	Base, PTV	US8162
2.3L L4 140 CID	1994	GL, LX	US4041	3.5L V6 3496cc 213 CID	2015	Base	US8916
3.0L V6 2986cc 182 CID	1992	GL, GLS, LX, Sport	US4070	3.5L V6 3496cc 213 CID	2015-2016	Base; Serpentine Belt Driven	US8916
3.0L V6 2986cc 182 CID	1993-1994	GL, LX	US4070	3.5L V6 3496cc 213 CID	2016-2018	Base, PTV	US8916
THUNDERBIRD				TRANSIT-350			
2.3L L4 140 CID	1983-1988	Turbo	US4054	3.2L L5 195 CID	2016-2017	Base, XL, XLT	US8162
3.3L L6 200 CID	1980	Base, Silver Anniversary, Town Landau	US4002	3.2L L5 195 CID	2018	Base	US8162
3.3L L6 200 CID	1981-1982	Base, Heritage, Town Landau	US4002	3.5L V6 3496cc 213 CID	2015-2016	Base, XL, XLT; Serpentine Belt Driven	US8916
3.8L V6 232 CID	1982	Base, Heritage, Town Landau	US4016	3.5L V6 3496cc 213 CID	2015-2018	Base, XL, XLT	US8916
3.8L V6 232 CID	1983	Base, Heritage, LX, Sport	US4016	3.7L V6 3726cc 227 CID	2015	Base, XL, XLT	US6654
3.8L V6 232 CID	1984-1985	Base, Elan, Fila, LX, Sport	US4016	3.7L V6 3726cc 227 CID	2015	Base; Serpentine Belt Driven	US6654
3.8L V6 232 CID	1986	Base, Elan, LX, Sport	US4016	3.7L V6 3726cc 227 CID	2016-2018	Base, PTV	US8916
3.8L V6 232 CID	1987	Base, LX	US4016	TRANSIT-350 HD			
3.8L V6 232 CID	1988	Base, LX	US4050	3.2L L5 195 CID	2016-2017	Base, XL, XLT	US8162
3.8L V6 232 CID	1989	Base, LX, Super Coupe	US4050	3.2L L5 195 CID	2018	Base	US8162
3.8L V6 232 CID	1990-1992	Base, LX	US4050	3.5L V6 3496cc 213 CID	2015-2016	Base, XL, XLT; Serpentine Belt Driven	US8916
3.8L V6 232 CID	1990-1995	Super Coupe	US4055	3.5L V6 3496cc 213 CID	2015-2018	Base, XL, XLT	US8916
3.8L V6 232 CID	1993	LX	US4050	3.7L V6 3726cc 227 CID	2015	Base, XL, XLT	US6654
3.8L V6 232 CID	1994-1995	LX	US4090	3.7L V6 3726cc 227 CID	2015	Base, XL, XLT; Serpentine Belt Driven	US6654
3.8L V6 232 CID	1996-1997	LX	US4103	3.7L V6 3726cc 227 CID	2016-2018	Base, XL, XLT	US8916
3.8L V6 3800cc 232 CID	1984	Mexican Application	US4016	TRANSIT CONNECT			
3.9L V8 242 CID	2002-2003	Base	US4124	1.6L L4 1596cc 97 CID	2014-2016	Titanium, XL, XLT	US9449
3.9L V8 242 CID	2004	Base, Pacific Coast Roadster	US4124	1.6L L4 1596cc 97 CID	2016	Titanium, XL, XLT; From 06/29/2015	US9449
3.9L V8 242 CID	2005	50th Anniversary Edition, Base	US4124	2.0L L4 1999cc 122 CID	2010	XL, XLT	US4126
4.2L V8 255 CID	1980	Base, Town Landau	US4014	2.0L L4 1999cc 122 CID	2011-2013	XL, XLT, XLT Premium	US4126
4.2L V8 255 CID	1980	Base, Town Landau; High performance	US4014H	2.5L L4 2488cc 152 CID	2014-2018	Titanium, XL, XLT	US4126
4.2L V8 255 CID	1981-1982	Base, Heritage, Town Landau	US4014	VAGONETA			
4.2L V8 255 CID	1981-1982	Base, Heritage, Town Landau; High performance	US4014H	1.9L L4 1900cc 114 CID	1996-1997	Mexican Application	US4069
4.6L V8 281 CID	1994-1997	LX; Pump Length: long	US4113				
4.8L V8 4786cc 292 CID	1957		US488				
5.0L V8 302 CID	1977-1979	WINDSOR	US953				
5.0L V8 302 CID	1977-1979	High performance	US953H				
5.0L V8 302 CID	1980	Base, Silver Anniversary, Town Landau	US4014				
5.0L V8 302 CID	1980	Base, Silver Anniversary, Town Landau; High performance	US4014H				

WATER PUMPS

Engine	Years	Application Description	USMW	Engine	Years	Application Description	USMW
FORD (cont'd.)				GMC (cont'd.)			
WINDSTAR				C15/C1500 SUBURBAN (cont'd.)			
3.0L V6 2986cc 182 CID	1995-1997	Base, GL	US4094	6.5L V8 6489cc 396 CID	1968-1969		US981
3.0L V6 2986cc 182 CID	1998	3.0L, Base, GL	US4094	6.6L V8 402 CID	1970-1972		US981
3.0L V6 2986cc 182 CID	1999	3.0L, Base, SE, SEL	US4094	6.6L V8 6588cc 402 CID	1970-1972		US981
3.0L V6 2986cc 182 CID	2000	Base, SE, SEL	US4094	C15 SUBURBAN			
3.8L V6 232 CID	1995	Base, GL, LX	US4089	4.1L L6 250 CID	1975-1977		US1110
3.8L V6 232 CID	1996-1997	Base, GL, LX	US4102	4.1L L6 250 CID	1978		US1107
3.8L V6 232 CID	1998	Base, GL, Limited, LX	US4102	5.0L V8 305 CID	1977-1978		US1121
3.8L V6 232 CID	1999	Base, LX, SE, SEL	US4102	5.0L V8 305 CID	1977-1978	High performance	US1121H
3.8L V6 232 CID	2000	Base, Limited, LX, SE, SEL	US4102	5.7L V8 350 CID	1975-1976		US1109
3.8L V6 232 CID	2001-2003	Base, Limited, LX, SE, SEL, SE Sport	US4102	5.7L V8 350 CID	1975-1976	High performance	US1109H
3.8L V6 3800cc 232 CID	1994	Mexican Application	US4089	5.7L V8 350 CID	1977-1978		US1121
GEO				5.7L V8 350 CID	1977-1978	High performance	US1121H
METRO				C25			
1.0L L3 993cc 61 CID	1989-1994	Base, LSi, XFI	US5058	4.1L L6 250 CID	1977-1978		US1107
1.0L L3 993cc 61 CID	1995-1996	Base, LSi	US5058	4.8L L6 292 CID	1975-1977		US1137
1.0L L3 993cc 61 CID	1997	Base	US5058	4.8L L6 292 CID	1975-1977	High performance	US1137H
1.3L L4 1295cc 79 CID	1995	Base, LSi	US5058	4.8L L6 292 CID	1978		US5030
1.3L L4 1295cc 79 CID	1996-1997	LSi	US5058	5.0L V8 305 CID	1977-1978		US1121
PRIZM				5.0L V8 305 CID	1977-1978	High performance	US1121H
1.6L L4 1587cc	1990	Base	US9057	5.7L V8 350 CID	1975-1976		US1109
1.6L L4 1587cc	1990-1992	GSi	US9076	5.7L V8 350 CID	1975-1976	High performance	US1109H
1.6L L4 1587cc	1991-1992	Base, LSi	US9057	5.7L V8 350 CID	1977-1978		US1121
1.6L L4 1588cc 98 CID	1989	Base	US9057	5.7L V8 350 CID	1977-1978	High performance	US1121H
1.6L L4 1588cc 98 CID	1993-1997	Base, LSi	US9271	6.6L V8 400 CID	1976		US1109
1.8L L4 1788cc 110 CID	1993-1997	LSi	US9272	6.6L V8 400 CID	1976	High performance	US1109H
1.8L L4 1788cc 110 CID	1993-1997	LSi; Includes back housing	US9272-2	6.6L V8 400 CID	1977-1978		US1121
SPECTRUM				6.6L V8 400 CID	1977-1978	High performance	US1121H
1.5L L4 1471cc 92 CID	1989	Base	US5031	C25/C2500 PICKUP			
STORM				5.0L V6 5012cc 305 CID	1968-1969		US835
1.6L L4 1588cc 98 CID	1990-1991	2+2 GSi	US9220	6.5L V8 396 CID	1968-1969		US981
1.6L L4 1588cc 98 CID	1990-1993	2+2, Base	US9221	6.5L V8 6489cc 396 CID	1968-1969		US981
1.8L L4 1809cc 110 CID	1992-1993	2+2 GSi	US9221	6.6L V8 402 CID	1970-1972		US981
TRACKER				6.6L V8 6588cc 402 CID	1970-1972		US981
1.6L L4 1588cc 98 CID	1989	Base; 84.8mm	US5048	C25/C2500 SUBURBAN			
1.6L L4 1588cc 98 CID	1989	Base; 85.6mm	US5048	6.5L V8 396 CID	1968-1969		US981
1.6L L4 1588cc 98 CID	1989-1997	Base, LSi	US5048	6.5L V8 6489cc 396 CID	1968-1969		US981
1.6L L4 1588cc 98 CID	1995	Base, LSi; Early	US5048	6.6L V8 402 CID	1970-1972		US981
1.6L L4 1588cc 98 CID	1995	Base, LSi; Late	US5048	6.6L V8 6588cc 402 CID	1970-1972		US981
GMC				C25 SUBURBAN			
ACADIA				4.8L L6 292 CID	1975-1977		US1137
2.5L L4 2457cc 153 CID	2017	SL, SLE, SLT	US8102	4.8L L6 292 CID	1975-1977	High performance	US1137H
3.6L V6 222 CID	2017	Denali, SLE, SLT	US8148	4.8L L6 292 CID	1978		US5030
3.6L V6 3564cc 217 CID	2007-2009	SLE, SLT	US8932	5.0L V8 305 CID	1977-1978		US1121
3.6L V6 3564cc 217 CID	2010	SL, SLE, SLT	US8932	5.0L V8 305 CID	1977-1978	High performance	US1121H
3.6L V6 3564cc 217 CID	2010-2012	Mexican Application	US8932	5.7L V8 350 CID	1975-1976		US1109
3.6L V6 3564cc 217 CID	2011-2013	Denali, SL, SLE, SLT	US8932	5.7L V8 350 CID	1975-1976	High performance	US1109H
3.6L V6 3564cc 217 CID	2015	Denali, SLE, SLT	US8932	5.7L V8 350 CID	1977-1978		US1121
3.6L V6 3564cc 217 CID	2016	Denali, SL, SLE, SLT	US8932	5.7L V8 350 CID	1977-1978	High performance	US1121H
ACADIA LIMITED				6.6L V8 400 CID	1978		US1121
3.6L V6 3564cc 217 CID	2017	Base	US8932	6.6L V8 400 CID	1978	High performance	US1121H
B7				C35/C3500 PICKUP			
6.0L V8 366 CID	1993-1998	With threaded hub for fan clutch	US5078	5.0L V6 5012cc 305 CID	1968-1969		US835
7.0L V8 6998cc 427 CID	1994-1998	With threaded hub for fan clutch	US5078	6.5L V8 396 CID	1968-1969		US981
B6000				6.5L V8 6489cc 396 CID	1968-1969		US981
6.0L V8 366 CID	1980-1990	Without threaded hub	US5084	6.6L V8 402 CID	1970-1972		US981
6.0L V8 366 CID	1990-1991	With threaded hub for fan clutch	US5078	6.6L V8 6588cc 402 CID	1970-1972		US981
7.0L V8 427 CID	1980-1985	Without threaded hub	US5084	C1500			
C15				4.1L L6 250 CID	1979		US1107
4.1L L6 250 CID	1975-1977		US1110	4.1L L6 250 CID	1980	Base, Heavy Half, High Sierra, Sierra Classic, Sierra Grande, Street Coupe	US1107
4.1L L6 250 CID	1978		US1107	4.1L L6 250 CID	1981-1982	Base, High Sierra, Sierra Classic, Sierra Grande, Street Coupe	US1107
5.0L V8 305 CID	1977-1978		US1121	4.1L L6 250 CID	1983-1984	Base, High Sierra, Sierra Classic	US1107
5.0L V8 305 CID	1977-1978	High performance	US1121H	4.1L L6 4100cc 250 CID	1980-1984	Mexican Application	US1107
5.7L V8 350 CID	1975-1976		US1109	4.1L L6 4100cc 250 CID	1994-1997	Mexican Application	US895
5.7L V8 350 CID	1975-1976	High performance	US1109H	4.3L V6 262 CID	1985-1986	Base, High Sierra, Sierra Classic	US1121
5.7L V8 350 CID	1977-1978		US1121	4.3L V6 262 CID	1985-1986	Base, High Sierra, Sierra Classic; High performance	US1121H
5.7L V8 350 CID	1977-1978	High performance	US1121H	4.3L V6 262 CID	1988-1993	Sierra, Sierra SLE, Sierra SLX	US5049
6.6L V8 400 CID	1976		US1109	4.3L V6 262 CID	1988-1993	Sierra, Sierra SLE, Sierra SLX; High performance	US5049H
6.6L V8 400 CID	1976	High performance	US1109H	4.3L V6 262 CID	1994-1995	Sierra SL, Sierra SLE, Sierra SLT, Sierra Special	US5049
6.6L V8 400 CID	1978		US1121	4.3L V6 262 CID	1994-1995	Sierra SL, Sierra SLE, Sierra SLT, Sierra Special; High performance	US5049H
6.6L V8 400 CID	1978	High performance	US1121H	4.3L V6 262 CID	1996	Sierra SL, Sierra SLE, Sierra SLT, Sierra Special	US5077
C15/C1500 PICKUP				4.3L V6 262 CID	1996	Sierra SL, Sierra SLE, Sierra SLT, Sierra Special; High performance	US5077H
5.0L V6 5012cc 305 CID	1968-1969		US835	4.3L V6 262 CID	1997	Sierra GT, Sierra SL, Sierra SLE, Sierra SLT, Sierra Special	US5077
6.5L V8 396 CID	1968-1969		US981	4.3L V6 262 CID	1997	Sierra GT, Sierra SL, Sierra SLE, Sierra SLT, Sierra Special; High performance	US5077H
6.5L V8 6489cc 396 CID	1968-1969		US981	C15/C1500 SUBURBAN			
6.6L V8 402 CID	1970-1972		US981	6.5L V8 396 CID	1968-1969		US981
6.6L V8 6588cc 402 CID	1970-1972		US981				

Engine	Years	Application Description	USMW	Engine	Years	Application Description	USMW
GMC (cont'd.)				GMC (cont'd.)			
C1500 (cont'd.)				C1500 (cont'd.)			
4.3L V6 262 CID	1998	Sierra SL, Sierra SLE, Sierra SLT, Sierra Special	US5077	6.2L V8 379 CID	1982	Base, High Sierra, Sierra Classic, Sierra Grande, Street Coupe	US5008
4.3L V6 262 CID	1998	Sierra SL, Sierra SLE, Sierra SLT, Sierra Special; High performance	US5077H	6.2L V8 379 CID	1983-1986	Base, High Sierra, Sierra Classic	US5008
4.8L L6 292 CID	1980	Base, Heavy Half, High Sierra, Sierra Classic, Sierra Grande, Street Coupe	US5030	6.2L V8 379 CID	1988-1993	Sierra, Sierra SLE, Sierra SLX	US5062
4.8L L6 4800cc 292 CID	1981-1986	Mexican Application	US5030	6.5L V8 395 CID	1994-1995	Sierra SL, Sierra SLE, Sierra SLT, Sierra Special	US5062
5.0L V8 305 CID	1979		US1121	6.5L V8 395 CID	1996	Sierra SL, Sierra SLE, Sierra SLT, Sierra Special; Early	US5062
5.0L V8 305 CID	1979	High performance	US1121H	6.5L V8 395 CID	1996	Sierra SL, Sierra SLE, Sierra SLT, Sierra Special; Late	US5074
5.0L V8 305 CID	1980	Base, Heavy Half, High Sierra, Sierra Classic, Sierra Grande, Street Coupe	US1121	6.5L V8 395 CID	1997	Sierra GT, Sierra SL, Sierra SLE, Sierra SLT, Sierra Special	US5074
5.0L V8 305 CID	1980	Base, Heavy Half, High Sierra, Sierra Classic, Sierra Grande, Street Coupe; High performance	US1121H	6.6L V8 400 CID	1979		US1121
5.0L V8 305 CID	1981-1982	Base, High Sierra, Sierra Classic, Sierra Grande, Street Coupe	US1121	6.6L V8 400 CID	1979	High performance	US1121H
5.0L V8 305 CID	1981-1982	Base, High Sierra, Sierra Classic, Sierra Grande, Street Coupe; High performance	US1121H	6.6L V8 400 CID	1980	Base, Heavy Half, High Sierra, Sierra Classic, Sierra Grande, Street Coupe	US1121
5.0L V8 305 CID	1983-1986	Base, High Sierra, Sierra Classic	US1121	6.6L V8 400 CID	1980	Base, Heavy Half, High Sierra, Sierra Classic, Sierra Grande, Street Coupe; High performance	US1121H
5.0L V8 305 CID	1983-1986	Base, High Sierra, Sierra Classic; High performance	US1121H	7.4L V8 454 CID	1980	Base, Heavy Half, High Sierra, Sierra Classic, Sierra Grande, Street Coupe	US1002
5.0L V8 305 CID	1988-1993	Sierra, Sierra SLE, Sierra SLX	US5049	7.4L V8 454 CID	1980	Base, Heavy Half, High Sierra, Sierra Classic, Sierra Grande, Street Coupe; High performance	US1002H
5.0L V8 305 CID	1988-1993	Sierra, Sierra SLE, Sierra SLX; High performance	US5049H	C1500 SUBURBAN			
5.0L V8 305 CID	1994-1995	Sierra SL, Sierra SLE, Sierra SLT, Sierra Special	US5049	4.1L L6 250 CID	1979		US1107
5.0L V8 305 CID	1994-1995	Sierra SL, Sierra SLE, Sierra SLT, Sierra Special; High performance	US5049H	4.1L L6 250 CID	1980	Base, High Sierra, Sierra Classic, Sierra Grande	US1107
5.0L V8 305 CID	1996	Sierra SL, Sierra SLE, Sierra SLT, Sierra Special	US5077	5.0L V8 305 CID	1979		US1121
5.0L V8 305 CID	1996	Sierra SL, Sierra SLE, Sierra SLT, Sierra Special; High performance	US5077H	5.0L V8 305 CID	1979	High performance	US1121H
5.0L V8 305 CID	1997	Sierra GT, Sierra SL, Sierra SLE, Sierra SLT, Sierra Special	US5077	5.0L V8 305 CID	1980-1982	Base, High Sierra, Sierra Classic, Sierra Grande	US1121
5.0L V8 305 CID	1997	Sierra GT, Sierra SL, Sierra SLE, Sierra SLT, Sierra Special; High performance	US5077H	5.0L V8 305 CID	1980-1982	Base, High Sierra, Sierra Classic, Sierra Grande; High performance	US1121H
5.0L V8 305 CID	1998	Sierra SL, Sierra SLE, Sierra SLT, Sierra Special	US5077	5.0L V8 305 CID	1983-1986	Base, High Sierra, Sierra Classic	US1121
5.0L V8 305 CID	1998	Sierra SL, Sierra SLE, Sierra SLT, Sierra Special; High performance	US5077H	5.0L V8 305 CID	1983-1986	Base, High Sierra, Sierra Classic; High performance	US1121H
5.0L V8 305 CID	1999	Sierra SL, Sierra SLE, Sierra SLT	US5077	5.7L V8 350 CID	1979		US1121
5.0L V8 305 CID	1999	Sierra SL, Sierra SLE, Sierra SLT; High performance	US5077H	5.7L V8 350 CID	1979	High performance	US1121H
5.7L V8 350 CID	1979		US1121	5.7L V8 350 CID	1980-1982	Base, High Sierra, Sierra Classic, Sierra Grande	US1121
5.7L V8 350 CID	1979	High performance	US1121H	5.7L V8 350 CID	1980-1982	Base, High Sierra, Sierra Classic, Sierra Grande; High performance	US1121H
5.7L V8 350 CID	1980	Base, Heavy Half, High Sierra, Sierra Classic, Sierra Grande, Street Coupe	US1121	5.7L V8 350 CID	1983-1986	Base, High Sierra, Sierra Classic	US1121
5.7L V8 350 CID	1980	Base, Heavy Half, High Sierra, Sierra Classic, Sierra Grande, Street Coupe; High performance	US1121H	5.7L V8 350 CID	1983-1986	Base, High Sierra, Sierra Classic; High performance	US1121H
5.7L V8 350 CID	1981-1982	Base, High Sierra, Sierra Classic, Sierra Grande, Street Coupe	US1121	5.7L V8 350 CID	1992	Base, SLE; 6.9" HUB HEIGHT	US5049
5.7L V8 350 CID	1981-1982	Base, High Sierra, Sierra Classic, Sierra Grande, Street Coupe; High performance	US1121H	5.7L V8 350 CID	1992	Base, SLE; 6.9" HUB HEIGHT, High performance	US5049H
5.7L V8 350 CID	1983-1986	Base, High Sierra, Sierra Classic	US1121	5.7L V8 350 CID	1992	Base, SLE; 5.8" HUB HEIGHT	US5073
5.7L V8 350 CID	1983-1986	Base, High Sierra, Sierra Classic; High performance	US1121H	5.7L V8 350 CID	1993-1994	Base, SLE	US5049
5.7L V8 350 CID	1988-1991	Sierra, Sierra SLE, Sierra SLX	US5049	5.7L V8 350 CID	1993-1994	Base, SLE; High performance	US5049H
5.7L V8 350 CID	1988-1991	Sierra, Sierra SLE, Sierra SLX; High performance	US5049H	5.7L V8 350 CID	1995	Base, SLE, SLT	US5049
5.7L V8 350 CID	1992	Sierra, Sierra SLE, Sierra SLX; 6.9" HUB HEIGHT	US5049	5.7L V8 350 CID	1995	Base, SLE, SLT; High performance	US5049H
5.7L V8 350 CID	1992	Sierra, Sierra SLE, Sierra SLX; 6.9" HUB HEIGHT, High performance	US5049H	5.7L V8 350 CID	1996-1999	Base, SLE, SLT	US5077
5.7L V8 350 CID	1992	Sierra, Sierra SLE, Sierra SLX; 5.8" HUB HEIGHT	US5073	5.7L V8 350 CID	1996-1999	Base, SLE, SLT; High performance	US5077H
5.7L V8 350 CID	1993	Sierra, Sierra SLE, Sierra SLX	US5049	6.2L V8 379 CID	1982	Base, High Sierra, Sierra Classic, Sierra Grande	US5008
5.7L V8 350 CID	1993	Sierra, Sierra SLE, Sierra SLX; High performance	US5049H	6.2L V8 379 CID	1983-1986	Base, High Sierra, Sierra Classic	US5008
5.7L V8 350 CID	1994-1995	Sierra SL, Sierra SLE, Sierra SLT, Sierra Special	US5049	6.5L V8 395 CID	1995	Base, SLE, SLT	US5062
5.7L V8 350 CID	1994-1995	Sierra SL, Sierra SLE, Sierra SLT, Sierra Special; High performance	US5049H	6.5L V8 395 CID	1996	Base, SLE, SLT; Early	US5062
5.7L V8 350 CID	1996	Sierra SL, Sierra SLE, Sierra SLT, Sierra Special	US5077	6.5L V8 395 CID	1996	Base, SLE, SLT; Late	US5074
5.7L V8 350 CID	1996	Sierra SL, Sierra SLE, Sierra SLT, Sierra Special; High performance	US5077H	6.5L V8 395 CID	1997-1998	Base, SLE, SLT	US5074
5.7L V8 350 CID	1997	Sierra GT, Sierra SL, Sierra SLE, Sierra SLT, Sierra Special	US5077	6.5L V8 395 CID	1999	Base, SLE, SLT; Bolt on pulley	US5074
5.7L V8 350 CID	1997	Sierra GT, Sierra SL, Sierra SLE, Sierra SLT, Sierra Special; High performance	US5077H	6.5L V8 395 CID	1999	Base, SLE, SLT	US5086
5.7L V8 350 CID	1998	Sierra SL, Sierra SLE, Sierra SLT, Sierra Special	US5077	7.4L V8 454 CID	1980	Base, High Sierra, Sierra Classic, Sierra Grande	US1002
5.7L V8 350 CID	1998	Sierra SL, Sierra SLE, Sierra SLT, Sierra Special; High performance	US5077H	7.4L V8 454 CID	1980	Base, High Sierra, Sierra Classic, Sierra Grande; High performance	US1002H
5.7L V8 350 CID	1999	Sierra SL, Sierra SLE, Sierra SLT	US5077	C2500			
5.7L V8 350 CID	1999	Sierra SL, Sierra SLE, Sierra SLT; High performance	US5077H	4.1L L6 250 CID	1979		US1107
5.7L V8 5700cc 350 CID	1981-1985	Mexican Application	US1121	4.1L L6 250 CID	1980-1982	Base, High Sierra, Sierra Classic, Sierra Grande	US1107
5.7L V8 5700cc 350 CID	1987-1988	Mexican Application	US1121	4.1L L6 250 CID	1983-1984	Base, High Sierra, Sierra Classic	US1107
5.7L V8 5700cc 350 CID	1989-1990	Mexican Application	US5049	4.3L V6 262 CID	1985-1986	Base, High Sierra, Sierra Classic	US1121
				4.3L V6 262 CID	1985-1986	Base, High Sierra, Sierra Classic; High performance	US1121H
				4.3L V6 262 CID	1988-1993	Sierra, Sierra SLE, Sierra SLX	US5049
				4.3L V6 262 CID	1988-1993	Sierra, Sierra SLE, Sierra SLX; High performance	US5049H
				4.3L V6 262 CID	1994-1995	Sierra SL, Sierra SLE	US5049
				4.3L V6 262 CID	1994-1995	Sierra SL, Sierra SLE; High performance	US5049H
				4.8L L6 292 CID	1979		US5030
				4.8L L6 292 CID	1980-1982	Base, High Sierra, Sierra Classic, Sierra Grande	US5030
				4.8L L6 292 CID	1983-1986	Base, High Sierra, Sierra Classic	US5030
				5.0L V8 305 CID	1979		US1121
				5.0L V8 305 CID	1979	High performance	US1121H
				5.0L V8 305 CID	1980-1982	Base, High Sierra, Sierra Classic, Sierra Grande	US1121

Engine	Years	Application Description	USMW	Engine	Years	Application Description	USMW
GMC (cont'd.)				GMC (cont'd.)			
C2500 (cont'd.)				C2500 SUBURBAN (cont'd.)			
5.0L V8 305 CID	1980-1982	Base, High Sierra, Sierra Classic, Sierra Grande; High performance	US1121H	5.7L V8 350 CID	1995	Base, SLE, SLT; High performance	US5049H
5.0L V8 305 CID	1983-1986	Base, High Sierra, Sierra Classic	US1121	5.7L V8 350 CID	1996-1999	Base, SLE, SLT	US5077
5.0L V8 305 CID	1983-1986	Base, High Sierra, Sierra Classic; High performance	US1121H	5.7L V8 350 CID	1996-1999	Base, SLE, SLT; High performance	US5077H
5.0L V8 305 CID	1988-1993	Sierra, Sierra SLE, Sierra SLX	US5049	6.2L V8 379 CID	1982	Base, High Sierra, Sierra Classic, Sierra Grande	US5008
5.0L V8 305 CID	1988-1993	Sierra, Sierra SLE, Sierra SLX; High performance	US5049H	6.2L V8 379 CID	1983-1986	Base, High Sierra, Sierra Classic	US5008
5.0L V8 305 CID	1994-1995	Sierra SL, Sierra SLE, Sierra SLT	US5049	6.5L V8 395 CID	1994	Base, SLE	US5062
5.0L V8 305 CID	1994-1995	Sierra SL, Sierra SLE, Sierra SLT; High performance	US5049H	6.5L V8 395 CID	1995	Base, SLE, SLT	US5062
5.0L V8 305 CID	1996-1998	Sierra SL, Sierra SLE, Sierra SLT	US5077	6.5L V8 395 CID	1996	Base, SLE, SLT; Early	US5062
5.0L V8 305 CID	1996-1998	Sierra SL, Sierra SLE, Sierra SLT; High performance	US5077H	6.5L V8 395 CID	1996	Base, SLE, SLT; Late	US5074
5.7L V8 350 CID	1979		US1121	6.5L V8 395 CID	1997-1998	Base, SLE, SLT	US5074
5.7L V8 350 CID	1979	High performance	US1121H	6.5L V8 395 CID	1999	Base, SLE, SLT; Bolt on pulley	US5074
5.7L V8 350 CID	1980-1982	Base, High Sierra, Sierra Classic, Sierra Grande	US1121	6.5L V8 395 CID	1999	Base, SLE, SLT	US5086
5.7L V8 350 CID	1980-1982	Base, High Sierra, Sierra Classic, Sierra Grande; High performance	US1121H	6.6L V8 400 CID	1980	Base, High Sierra, Sierra Classic, Sierra Grande	US1121
5.7L V8 350 CID	1983-1986	Base, High Sierra, Sierra Classic	US1121	6.6L V8 400 CID	1980	Base, High Sierra, Sierra Classic, Sierra Grande; High performance	US1121H
5.7L V8 350 CID	1983-1986	Base, High Sierra, Sierra Classic; High performance	US1121H	7.4L V8 454 CID	1980-1982	Base, High Sierra, Sierra Classic, Sierra Grande	US1002
5.7L V8 350 CID	1988-1993	Sierra, Sierra SLE, Sierra SLX	US5049	7.4L V8 454 CID	1980-1982	Base, High Sierra, Sierra Classic, Sierra Grande; High performance	US1002H
5.7L V8 350 CID	1988-1993	Sierra, Sierra SLE, Sierra SLX; High performance	US5049H	7.4L V8 454 CID	1983-1986	Base, High Sierra, Sierra Classic	US1002
5.7L V8 350 CID	1994-1995	Sierra SL, Sierra SLE, Sierra SLT	US5049	7.4L V8 454 CID	1983-1986	Base, High Sierra, Sierra Classic; High performance	US1002H
5.7L V8 350 CID	1994-1995	Sierra SL, Sierra SLE, Sierra SLT; High performance	US5049H	7.4L V8 454 CID	1992-1994	Base, SLE	US5038
5.7L V8 350 CID	1996-2000	Sierra SL, Sierra SLE, Sierra SLT	US5077	7.4L V8 454 CID	1992-1994	Base, SLE; High performance	US5038H
5.7L V8 350 CID	1996-2000	Sierra SL, Sierra SLE, Sierra SLT; High performance	US5077H	7.4L V8 454 CID	1995-1999	Base, SLE, SLT	US5038
5.7L V8 5700cc 350 CID	1985	Mexican Application	US1121	7.4L V8 454 CID	1995-1999	Base, SLE, SLT; High performance	US5038H
5.7L V8 5700cc 350 CID	1987-1988	Mexican Application	US1121	C3500			
5.7L V8 5700cc 350 CID	1989-1991	Mexican Application	US5049	4.1L L6 250 CID	1980	Base, High Sierra, Sierra Classic, Sierra Grande	US1107
6.2L V8 379 CID	1982	Base, High Sierra, Sierra Classic, Sierra Grande	US5008	4.8L L6 292 CID	1980-1982	Base, High Sierra, Sierra Classic, Sierra Grande	US5030
6.2L V8 379 CID	1983-1986	Base, High Sierra, Sierra Classic	US5008	4.8L L6 292 CID	1983-1986	Base, High Sierra, Sierra Classic	US5030
6.2L V8 379 CID	1988-1993	Sierra, Sierra SLE, Sierra SLX	US5062	5.0L V8 305 CID	1986	Base, High Sierra, Sierra Classic	US1121
6.5L V8 395 CID	1992-1993	Sierra, Sierra SLE, Sierra SLX	US5062	5.0L V8 305 CID	1986	Base, High Sierra, Sierra Classic; High performance	US1121H
6.5L V8 395 CID	1994-1995	Sierra SL, Sierra SLE, Sierra SLT	US5062	5.7L V8 350 CID	1980-1982	Base, High Sierra, Sierra Classic, Sierra Grande	US1121
6.5L V8 395 CID	1996	Sierra SL, Sierra SLE, Sierra SLT; Early	US5062	5.7L V8 350 CID	1980-1982	Base, High Sierra, Sierra Classic, Sierra Grande; High performance	US1121H
6.5L V8 395 CID	1996	Sierra SL, Sierra SLE, Sierra SLT; Late	US5074	5.7L V8 350 CID	1983-1986	Base, High Sierra, Sierra Classic	US1121
6.5L V8 395 CID	1997-1998	Sierra SL, Sierra SLE, Sierra SLT	US5074	5.7L V8 350 CID	1983-1986	Base, High Sierra, Sierra Classic; High performance	US1121H
6.5L V8 395 CID	1999	Sierra SL, Sierra SLE, Sierra SLT; Bolt on pulley	US5074	5.7L V8 350 CID	1988-1993	Sierra, Sierra SLE, Sierra SLX	US5049
6.5L V8 395 CID	1999-2000	Sierra SL, Sierra SLE, Sierra SLT	US5086	5.7L V8 350 CID	1988-1993	Sierra, Sierra SLE, Sierra SLX; High performance	US5049H
6.6L V8 400 CID	1979		US1121	5.7L V8 350 CID	1994-1995	Sierra SL, Sierra SLE, Sierra SLT	US5049
6.6L V8 400 CID	1979	High performance	US1121H	5.7L V8 350 CID	1994-1995	Sierra SL, Sierra SLE, Sierra SLT; High performance	US5049H
7.4L V8 454 CID	1980-1982	Base, High Sierra, Sierra Classic, Sierra Grande	US1002	5.7L V8 350 CID	1996-2000	Sierra SL, Sierra SLE, Sierra SLT	US5077
7.4L V8 454 CID	1980-1982	Base, High Sierra, Sierra Classic, Sierra Grande; High performance	US1002H	5.7L V8 350 CID	1996-2000	Sierra SL, Sierra SLE, Sierra SLT; High performance	US5077H
7.4L V8 454 CID	1983-1986	Base, High Sierra, Sierra Classic	US1002	5.7L V8 5700cc 350 CID	1980-1985	Mexican Application	US1121
7.4L V8 454 CID	1983-1986	Base, High Sierra, Sierra Classic; High performance	US1002H	5.7L V8 5700cc 350 CID	1987-1988	Mexican Application	US1121
7.4L V8 454 CID	1991-1993	Sierra, Sierra SLE, Sierra SLX	US5038	5.7L V8 5700cc 350 CID	1989-1991	Mexican Application	US5049
7.4L V8 454 CID	1991-1993	Sierra, Sierra SLE, Sierra SLX; High performance	US5038H	6.2L V8 379 CID	1982	Base, High Sierra, Sierra Classic, Sierra Grande	US5008
7.4L V8 454 CID	1994-2000	Sierra SL, Sierra SLE, Sierra SLT	US5038	6.2L V8 379 CID	1983-1986	Base, High Sierra, Sierra Classic	US5008
7.4L V8 454 CID	1994-2000	Sierra SL, Sierra SLE, Sierra SLT; High performance	US5038H	6.2L V8 379 CID	1988-1993	Sierra, Sierra SLE, Sierra SLX	US5062
C2500 SUBURBAN				6.5L V8 395 CID	1992-1993	Sierra, Sierra SLE, Sierra SLX	US5062
4.8L L6 292 CID	1979		US5030	6.5L V8 395 CID	1994-1995	Sierra SL, Sierra SLE, Sierra SLT	US5062
4.8L L6 292 CID	1980-1982	Base, High Sierra, Sierra Classic, Sierra Grande	US5030	6.5L V8 395 CID	1996	Sierra SL, Sierra SLE, Sierra SLT; Early	US5062
4.8L L6 292 CID	1984	Base, High Sierra, Sierra Classic	US5030	6.5L V8 395 CID	1996	Sierra SL, Sierra SLE, Sierra SLT; Late	US5074
5.0L V8 305 CID	1982	Base, High Sierra, Sierra Classic, Sierra Grande	US1121	6.5L V8 395 CID	1997-1998	Sierra SL, Sierra SLE, Sierra SLT	US5074
5.0L V8 305 CID	1982	Base, High Sierra, Sierra Classic, Sierra Grande; High performance	US1121H	6.5L V8 395 CID	1999	Sierra SL, Sierra SLE, Sierra SLT; Bolt on pulley	US5074
5.0L V8 305 CID	1983-1986	Base, High Sierra, Sierra Classic	US1121	6.5L V8 395 CID	1999-2000	Sierra SL, Sierra SLE, Sierra SLT	US5086
5.0L V8 305 CID	1983-1986	Base, High Sierra, Sierra Classic; High performance	US1121H	7.4L V8 454 CID	1980-1982	Base, High Sierra, Sierra Classic, Sierra Grande	US1002
5.7L V8 350 CID	1979		US1121	7.4L V8 454 CID	1980-1982	Base, High Sierra, Sierra Classic, Sierra Grande; High performance	US1002H
5.7L V8 350 CID	1979	High performance	US1121H	7.4L V8 454 CID	1983-1986	Base, High Sierra, Sierra Classic	US1002
5.7L V8 350 CID	1980-1982	Base, High Sierra, Sierra Classic, Sierra Grande	US1121	7.4L V8 454 CID	1983-1986	Base, High Sierra, Sierra Classic; High performance	US1002H
5.7L V8 350 CID	1980-1982	Base, High Sierra, Sierra Classic, Sierra Grande; High performance	US1121H	7.4L V8 454 CID	1988-1993	Sierra, Sierra SLE, Sierra SLX	US5062
5.7L V8 350 CID	1983-1986	Base, High Sierra, Sierra Classic	US1121	7.4L V8 454 CID	1992-1993	Sierra, Sierra SLE, Sierra SLX	US5062
5.7L V8 350 CID	1983-1986	Base, High Sierra, Sierra Classic; High performance	US1121H	7.4L V8 454 CID	1994-1995	Sierra SL, Sierra SLE, Sierra SLT	US5062
5.7L V8 350 CID	1992	Base, SLE; 6.9" HUB HEIGHT	US5049	7.4L V8 454 CID	1996	Sierra SL, Sierra SLE, Sierra SLT; Early	US5062
5.7L V8 350 CID	1992	Base, SLE; 6.9" HUB HEIGHT, High performance	US5049H	7.4L V8 454 CID	1996	Sierra SL, Sierra SLE, Sierra SLT; Late	US5074
5.7L V8 350 CID	1992	Base, SLE; 5.8" HUB HEIGHT	US5073	7.4L V8 454 CID	1997-1998	Sierra SL, Sierra SLE, Sierra SLT	US5074
5.7L V8 350 CID	1993-1994	Base, SLE	US5049	7.4L V8 454 CID	1999	Sierra SL, Sierra SLE, Sierra SLT; Bolt on pulley	US5074
5.7L V8 350 CID	1993-1994	Base, SLE; High performance	US5049H	7.4L V8 454 CID	1999-2000	Sierra SL, Sierra SLE, Sierra SLT	US5086
5.7L V8 350 CID	1995	Base, SLE, SLT	US5049	7.4L V8 454 CID	1980-1982	Base, High Sierra, Sierra Classic, Sierra Grande	US1002
				C5000 TOPKICK			
				6.0L V8 366 CID	1990	Without threaded hub	US5084
				6.0L V8 366 CID	1990-1991	With threaded hub for fan clutch	US5078
				C6000			
				6.0L V8 366 CID	1980-1990	Without threaded hub	US5084
				6.0L V8 366 CID	1990	With threaded hub for fan clutch	US5078
				7.0L V8 427 CID	1990	With threaded hub for fan clutch	US5078

Engine	Years	Application Description	USMW	Engine	Years	Application Description	USMW
GMC (cont'd.)				GMC (cont'd.)			
C6000 (cont'd.)				CANYON (cont'd.)			
7.0L V8 427 CID	1990	Without threaded hub	US5084	2.8L L4 171 CID	2017	Denali, SLE, SLT	US8154
C6000 TOPKICK				2.8L L4 2770cc 169 CID	2004	SL, SLE, Z71 Fleet, Z71 SL, Z71 SLE, Z85 SL, Z85 SLE	US5097
6.0L V8 366 CID	1990	Without threaded hub	US5084	2.8L L4 2770cc 169 CID	2005	Z71 Fleet, Z71 SL, Z71 SLE, Z85 SL, Z85 SLE	US5097
6.0L V8 366 CID	1990-1996	With threaded hub for fan clutch	US5078	2.8L L4 2770cc 169 CID	2006	SL, SLE, WT	US5097
7.0L V8 6998cc 427 CID	1990	Without threaded hub	US5084	2.9L L4 2921cc 178 CID	2007	SL, SLE, WT	US5097
7.0L V8 6998cc 427 CID	1990-1996	With threaded hub for fan clutch	US5078	2.9L L4 2921cc 178 CID	2008	SL, SLE, SLT, WT	US5097
C6500 TOPKICK				2.9L L4 2921cc 178 CID	2009	SLE, SLT, WT	US5097
6.0L V8 366 CID	1997-1998	With threaded hub for fan clutch	US5078	2.9L L4 2921cc 178 CID	2010-2012	SLE, WT	US5097
7.0L V8 6998cc 427 CID	1997-1998	With threaded hub for fan clutch	US5078	3.5L L5 3460cc 211 CID	2004	SL, SLE, Z71 Fleet, Z71 SL, Z71 SLE, Z85 SL, Z85 SLE	US5097
C7000				3.5L L5 3460cc 211 CID	2005	Z71 Fleet, Z71 SL, Z71 SLE, Z85 SL, Z85 SLE	US5097
6.0L V8 366 CID	1980-1990	Without threaded hub	US5084	3.5L L5 3460cc 211 CID	2006	SLE, SLT, WT	US5097
6.0L V8 366 CID	1990	With threaded hub for fan clutch	US5078	3.6L V6 222 CID	2017	Base, Denali, SLE, SLT	US8153
7.0L V8 427 CID	1980-1990	Without threaded hub	US5084	3.6L V6 3564cc 217 CID	2015-2016	Base, SLE, SLT	US8932
7.0L V8 427 CID	1990	With threaded hub for fan clutch	US5078	3.7L L5 3654cc 223 CID	2007-2012	SLE, SLT, WT	US5097
7.4L V8 454 CID	1980	Without threaded hub	US5084	3.7L L5 3654cc 223 CID	2010-2012	Mexican Application	US5097
C7000 TOPKICK				5.3L V8 5328cc 325 CID	2009	SLT	US6009
6.0L V8 366 CID	1990	Without threaded hub	US5084	5.3L V8 5328cc 325 CID	2009	SLT; Includes thermostat and thermostat housing	US6009-T
6.0L V8 366 CID	1990-1996	With threaded hub for fan clutch	US5078	5.3L V8 5328cc 325 CID	2010-2012	SLE, SLT	US6009
7.0L V8 6998cc 427 CID	1990	Without threaded hub	US5084	5.3L V8 5328cc 325 CID	2010-2012	SLE, SLT; Includes thermostat and thermostat housing	US6009-T
7.0L V8 6998cc 427 CID	1990-1996	With threaded hub for fan clutch	US5078	ENVOY			
C7500 TOPKICK				4.2L L6 256 CID	2002-2009	SLE, SLT	US5097
6.0L V8 366 CID	1997-1998	With threaded hub for fan clutch	US5078	5.3L V8 5328cc 325 CID	2005-2006	Denali	US64
CABALLERO				5.3L V8 5328cc 325 CID	2005-2006	Denali; Includes thermostat and thermostat housing	US64-T
3.3L V6 200 CID	1978-1979		US1121	5.3L V8 5328cc 325 CID	2007-2009	Denali	US6009
3.3L V6 200 CID	1978-1979	High performance	US1121H	5.3L V8 5328cc 325 CID	2007-2009	Denali; Includes thermostat and thermostat housing	US6009-T
3.8L V6 229 CID	1980	Base, Diablo, Laredo	US1121	ENVOY XL			
3.8L V6 229 CID	1980	Base, Diablo, Laredo; High performance	US1121H	4.2L L6 256 CID	2002-2006	SLE, SLT	US5097
3.8L V6 229 CID	1981	Amarillo, Base, Conquista, Diablo, Royal Knight	US1121	5.3L V8 5328cc 325 CID	2003-2004	SLE, SLT	US64
3.8L V6 229 CID	1981	Amarillo, Base, Conquista, Diablo, Royal Knight; High performance	US1121H	5.3L V8 5328cc 325 CID	2003-2004	SLE, SLT; Includes thermostat and thermostat housing	US64-T
3.8L V6 229 CID	1982-1983	Amarillo, Base, Diablo	US1121	5.3L V8 5328cc 325 CID	2005	Denali, SLE, SLT	US64
3.8L V6 229 CID	1982-1983	Amarillo, Base, Diablo; High performance	US1121H	5.3L V8 5328cc 325 CID	2005	Denali, SLE, SLT; Includes thermostat and thermostat housing	US64-T
3.8L V6 229 CID	1984	Base, Diablo	US1121	5.3L V8 5328cc 325 CID	2006	Denali	US64
3.8L V6 229 CID	1984	Base, Diablo; High performance	US1121H	5.3L V8 5328cc 325 CID	2006	Denali; Includes thermostat and thermostat housing	US64-T
3.8L V6 3800cc 231 CID	1980	Base, Diablo, Laredo	US1018	ENVOY XUV			
3.8L V6 3800cc 231 CID	1980	Base, Diablo, Laredo; High performance	US1018H	4.2L L6 256 CID	2004-2005	SLE, SLT	US5097
3.8L V6 3800cc 231 CID	1981	Amarillo, Base, Conquista, Diablo, Royal Knight	US1018	5.3L V8 5328cc 325 CID	2004-2005	SLE, SLT	US64
3.8L V6 3800cc 231 CID	1981	Amarillo, Base, Conquista, Diablo, Royal Knight; High performance	US1018H	5.3L V8 5328cc 325 CID	2004-2005	SLE, SLT; Includes thermostat and thermostat housing	US64-T
3.8L V6 3800cc 231 CID	1982-1984	Amarillo, Base, Diablo	US1018	G15			
3.8L V6 3800cc 231 CID	1982-1984	Amarillo, Base, Diablo; High performance	US1018H	4.1L L6 250 CID	1975-1977		US1110
4.3L V6 262 CID	1985-1986	Amarillo, Base, Diablo	US1121	4.1L L6 250 CID	1978		US1107
4.3L V6 262 CID	1985-1986	Amarillo, Base, Diablo; High performance	US1121H	5.0L V8 305 CID	1977-1978		US1121
4.3L V6 262 CID	1987	Base, Diablo	US1121	5.0L V8 305 CID	1977-1978	High performance	US1121H
4.3L V6 262 CID	1987	Base, Diablo; High performance	US1121H	5.7L V8 350 CID	1975-1976		US1109
4.4L V8 267 CID	1980	Base, Diablo, Laredo	US1121	5.7L V8 350 CID	1975-1976	High performance	US1109H
4.4L V8 267 CID	1980	Base, Diablo, Laredo; High performance	US1121H	5.7L V8 350 CID	1977-1978		US1121
4.4L V8 267 CID	1981	Amarillo, Base, Conquista, Diablo, Royal Knight	US1121	5.7L V8 350 CID	1977-1978	High performance	US1121H
4.4L V8 267 CID	1981	Amarillo, Base, Conquista, Diablo, Royal Knight; High performance	US1121H	6.6L V8 400 CID	1976		US1109
4.4L V8 267 CID	1982	Amarillo, Base, Diablo	US1121	6.6L V8 400 CID	1976	High performance	US1109H
4.4L V8 267 CID	1982	Amarillo, Base, Diablo; High performance	US1121H	G25			
4.4L V8 267 CID	1982	Amarillo, Base, Diablo; High performance	US1121H	4.1L L6 250 CID	1978		US1107
5.0L V8 305 CID	1978-1979		US1121	4.8L L6 292 CID	1975-1977		US1137
5.0L V8 305 CID	1978-1979	High performance	US1121H	4.8L L6 292 CID	1975-1977	High performance	US1137H
5.0L V8 305 CID	1980	Base, Diablo, Laredo	US1121	4.8L L6 292 CID	1978		US5030
5.0L V8 305 CID	1980	Base, Diablo, Laredo; High performance	US1121H	5.0L V8 305 CID	1977-1978		US1121
5.0L V8 305 CID	1981	Amarillo, Base, Conquista, Diablo, Royal Knight	US1121	5.0L V8 305 CID	1977-1978	High performance	US1121H
5.0L V8 305 CID	1981	Amarillo, Base, Conquista, Diablo, Royal Knight	US1121	5.7L V8 350 CID	1975-1976		US1109
5.0L V8 305 CID	1981	Amarillo, Base, Conquista, Diablo, Royal Knight; High performance	US1121H	5.7L V8 350 CID	1975-1976	High performance	US1109H
5.0L V8 305 CID	1982-1986	Amarillo, Base, Diablo	US1121	5.7L V8 350 CID	1977-1978		US1121
5.0L V8 305 CID	1982-1986	Amarillo, Base, Diablo; High performance	US1121H	5.7L V8 350 CID	1977-1978	High performance	US1121H
5.0L V8 305 CID	1987	Base, Diablo	US1121	6.6L V8 400 CID	1975-1976		US1109
5.0L V8 305 CID	1987	Base, Diablo; High performance	US1121H	6.6L V8 400 CID	1975-1976	High performance	US1109H
5.7L V8 350 CID	1978-1979		US1121	6.6L V8 400 CID	1977-1978		US1121
5.7L V8 350 CID	1978-1979	High performance	US1121H	6.6L V8 400 CID	1977-1978	High performance	US1121H
5.7L V8 350 CID	1983-1984	Amarillo, Base, Diablo	US1120	G35			
5.7L V8 350 CID	1983-1984	Amarillo, Base, Diablo; High performance	US1120H	4.8L L6 292 CID	1975-1977		US1137
CANYON				4.8L L6 292 CID	1975-1977	High performance	US1137H
2.5L L4 2457cc 153 CID	2015	Base, SL, SLE, SLT	US8102	4.8L L6 292 CID	1978		US5030
2.5L L4 2457cc 153 CID	2015	Base, SL, SLE, SLT; Pump only	US8102	4.8L L6 292 CID	1978		US1109
2.5L L4 2457cc 153 CID	2016-2017	Base, SL, SLE	US8102	5.7L V8 350 CID	1975-1976		US1109H
2.8L L4 171 CID	2016	SLE, SLT	US8154	5.7L V8 350 CID	1975-1976	High performance	US1109H
				5.7L V8 350 CID	1977-1978		US1121
				5.7L V8 350 CID	1977-1978	High performance	US1121H
				6.6L V8 400 CID	1975-1976		US1109
				6.6L V8 400 CID	1975-1976	High performance	US1109H

WATER PUMPS

Engine	Years	Application Description	USMWW	Engine	Years	Application Description	USMWW
GMC (cont'd.)				GMC (cont'd.)			
G35 (cont'd.)				G2500 (cont'd.)			
6.6L V8 400 CID	1977-1978		US1121	5.7L V8 350 CID	1985-1986	Rally, Rally STX, Vandura	US1121
6.6L V8 400 CID	1977-1978	High performance	US1121H	5.7L V8 350 CID	1985-1986	Rally, Rally STX, Vandura; High performance	US1121H
G1500				5.7L V8 350 CID	1987-1995	Rally, Rally STX, Vandura	US5049
4.1L L6 250 CID	1979		US1107	5.7L V8 350 CID	1987-1995	Rally, Rally STX, Vandura; High performance	US5049H
4.1L L6 250 CID	1980-1982	Rally, Rally STX, Vandura	US1107	6.2L V8 379 CID	1983-1984	Rally, Rally Custom, Rally STX, Vandura	US5008
4.1L L6 250 CID	1983-1984	Rally, Rally Custom, Rally STX, Vandura	US1107	6.2L V8 379 CID	1985-1993	Rally, Rally STX, Vandura	US5008
4.3L V6 262 CID	1985-1986	Rally, Rally STX, Vandura	US1121	6.5L V8 395 CID	1994-1995	Rally, Rally STX, Vandura	US5062
4.3L V6 262 CID	1985-1986	Rally, Rally STX, Vandura; High performance	US1121H	6.6L V8 400 CID	1979		US1121
4.3L V6 262 CID	1987-1993	Rally, Rally STX, Vandura	US5049	6.6L V8 400 CID	1979	High performance	US1121H
4.3L V6 262 CID	1987-1993	Rally, Rally STX, Vandura; High performance	US5049H	6.6L V8 400 CID	1980	Rally, Rally STX, Vandura	US1121
4.3L V6 262 CID	1994-1995	Vandura	US5049	6.6L V8 400 CID	1980	Rally, Rally STX, Vandura; High performance	US1121H
4.3L V6 262 CID	1994-1995	Vandura; High performance	US5049H	G3500			
5.0L V8 305 CID	1979		US1121	4.1L L6 250 CID	1979		US1107
5.0L V8 305 CID	1979	High performance	US1121H	4.1L L6 250 CID	1982-1984	Vandura, Vandura Special	US1107
5.0L V8 305 CID	1980-1982	Rally, Rally STX, Vandura	US1121	4.3L V6 262 CID	1985-1986	Vandura, Vandura Special	US1121
5.0L V8 305 CID	1980-1982	Rally, Rally STX, Vandura; High performance	US1121H	4.3L V6 262 CID	1985-1986	Vandura, Vandura Special; High performance	US1121H
5.0L V8 305 CID	1983-1984	Rally, Rally Custom, Rally STX, Vandura	US1121	4.3L V6 262 CID	1987-1995	Vandura, Vandura Special	US5049
5.0L V8 305 CID	1983-1984	Rally, Rally Custom, Rally STX, Vandura; High performance	US1121H	4.3L V6 262 CID	1987-1995	Vandura, Vandura Special; High performance	US5049H
5.0L V8 305 CID	1985-1986	Rally, Rally STX, Vandura	US1121	5.0L V8 305 CID	1981	Vandura, Vandura Special	US1121
5.0L V8 305 CID	1985-1986	Rally, Rally STX, Vandura; High performance	US1121H	5.0L V8 305 CID	1981	Vandura, Vandura Special; High performance	US1121H
5.0L V8 305 CID	1987-1995	Rally, Rally STX, Vandura	US5049	5.7L V8 350 CID	1979		US1121
5.0L V8 305 CID	1987-1995	Rally, Rally STX, Vandura; High performance	US5049H	5.7L V8 350 CID	1979	High performance	US1121H
5.7L V8 350 CID	1979		US1121	5.7L V8 350 CID	1980-1982	Magnavan, Rally, Rally Camper Special, Rally STX, Vandura, Vandura Special	US1121
5.7L V8 350 CID	1979	High performance	US1121H	5.7L V8 350 CID	1980-1982	Magnavan, Rally, Rally Camper Special, Rally STX, Vandura, Vandura Special; High performance	US1121H
5.7L V8 350 CID	1980-1981	Rally, Rally STX, Vandura	US1121	5.7L V8 350 CID	1983-1984	Magnavan, Rally, Rally Camper Special, Rally Custom, Rally STX, Vandura, Vandura Special; High performance	US1121H
5.7L V8 350 CID	1980-1981	Rally, Rally STX, Vandura; High performance	US1121H	5.7L V8 350 CID	1983-1986	Magnavan, Rally, Rally Camper Special, Rally Custom, Rally STX, Vandura, Vandura Special	US1121
5.7L V8 350 CID	1982	Rally, Rally STX	US1121	5.7L V8 350 CID	1985-1986	Magnavan, Rally, Rally Camper Special, Rally STX, Vandura, Vandura Special; High performance	US1121H
5.7L V8 350 CID	1982	Rally, Rally STX; High performance	US1121H	5.7L V8 350 CID	1987-1988	Magnavan, Rally Custom	US1121
5.7L V8 350 CID	1983	Rally	US1121	5.7L V8 350 CID	1987-1988	Magnavan; High performance	US1121H
5.7L V8 350 CID	1983	Rally; High performance	US1121H	5.7L V8 350 CID	1987-1996	Magnavan, Rally, Rally Camper Special, Rally STX, Vandura, Vandura Special	US5049
5.7L V8 350 CID	1984	Rally, Rally Custom, Rally STX	US1121	5.7L V8 350 CID	1987-1996	Magnavan, Rally, Rally Camper Special, Rally STX, Vandura, Vandura Special; High performance	US5049H
5.7L V8 350 CID	1984	Rally, Rally Custom, Rally STX; High performance	US1121H	6.2L V8 379 CID	1983-1988	Magnavan, Rally, Rally Camper Special, Rally Custom, Rally STX, Vandura, Vandura Special	US5008
5.7L V8 350 CID	1985-1986	Rally, Rally STX	US1121	6.2L V8 379 CID	1989-1993	Magnavan, Rally, Rally Camper Special, Rally STX, Vandura, Vandura Special	US5008
5.7L V8 350 CID	1985-1986	Rally, Rally STX; High performance	US1121H	6.5L V8 395 CID	1994	Rally, Rally Camper Special, Rally STX, Vandura, Vandura Special	US5062
5.7L V8 350 CID	1987-1993	Rally, Rally STX	US5049	6.5L V8 395 CID	1995-1996	Magnavan, Rally, Rally Camper Special, Rally STX, Vandura, Vandura Special	US5062
5.7L V8 350 CID	1987-1993	Rally, Rally STX; High performance	US5049H	6.6L V8 400 CID	1979		US1121
6.6L V8 400 CID	1979		US1121	6.6L V8 400 CID	1979	High performance	US1121H
6.6L V8 400 CID	1979	High performance	US1121H	6.6L V8 400 CID	1980	Magnavan, Rally, Rally Camper Special, Rally STX, Vandura, Vandura Special	US1121
G2500				6.6L V8 400 CID	1980	Magnavan, Rally, Rally Camper Special, Rally STX, Vandura, Vandura Special; High performance	US1121H
4.1L L6 250 CID	1979		US1107	6.6L V8 400 CID	1980	Magnavan, Rally, Rally Camper Special, Rally STX, Vandura, Vandura Special	US1121
4.1L L6 250 CID	1980-1982	Rally, Rally STX, Vandura	US1107	6.6L V8 400 CID	1980	Magnavan, Rally, Rally Camper Special, Rally STX, Vandura, Vandura Special; High performance	US1121H
4.1L L6 250 CID	1983-1984	Rally, Rally Custom, Rally STX, Vandura	US1107	7.4L V8 454 CID	1988	Magnavan	US5038
4.3L V6 262 CID	1985-1986	Rally, Rally STX, Vandura	US1121	7.4L V8 454 CID	1988	Magnavan; High performance	US5038H
4.3L V6 262 CID	1985-1986	Rally, Rally STX, Vandura; High performance	US1121H	7.4L V8 454 CID	1989-1996	Magnavan, Rally, Rally Camper Special, Rally STX, Vandura, Vandura Special	US5038
4.3L V6 262 CID	1987-1995	Rally, Rally STX, Vandura	US5049	7.4L V8 454 CID	1989-1996	Magnavan, Rally, Rally Camper Special, Rally STX, Vandura, Vandura Special; High performance	US5038H
4.3L V6 262 CID	1987-1995	Rally, Rally STX, Vandura; High performance	US5049H	JIMMY			
5.0L V8 305 CID	1979		US1121	4.1L L6 250 CID	1975-1977		US1110
5.0L V8 305 CID	1979	High performance	US1121H	4.1L L6 250 CID	1978-1979		US1107
5.0L V8 305 CID	1980	Rally, Rally STX	US1121	4.1L L6 250 CID	1980-1982	Base, High Sierra, Sierra Classic, Sierra Grande, Street Coupe	US1107
5.0L V8 305 CID	1980	Rally, Rally STX; High performance	US1121H	4.3L V6 262 CID	1992	Base, SLE, SLT	US5049
5.0L V8 305 CID	1981-1982	Rally, Rally STX, Vandura	US1121	4.3L V6 262 CID	1992	Base, SLE, SLT; High performance	US5049H
5.0L V8 305 CID	1981-1982	Rally, Rally STX, Vandura; High performance	US1121H	4.3L V6 262 CID	1993-1994	Base, SLE, SLS, SLT	US5049
5.0L V8 305 CID	1983-1984	Rally, Rally Custom, Rally STX, Vandura	US1121	4.3L V6 262 CID	1993-1994	Base, SLE, SLS, SLT; High performance	US5049H
5.0L V8 305 CID	1983-1984	Rally, Rally Custom, Rally STX, Vandura; High performance	US1121H	4.3L V6 262 CID	1995	Base, SL, SLE, SLS, SLT	US5049
5.0L V8 305 CID	1985-1986	Rally, Rally STX, Vandura	US1121	4.3L V6 262 CID	1995	Base, SL, SLE, SLS, SLT; High performance	US5049H
5.0L V8 305 CID	1985-1986	Rally, Rally STX, Vandura; High performance	US1121H				
5.0L V8 305 CID	1987-1995	Rally, Rally STX, Vandura	US5049				
5.0L V8 305 CID	1987-1995	Rally, Rally STX, Vandura; High performance	US5049H				
5.7L V8 350 CID	1979		US1121				
5.7L V8 350 CID	1979	High performance	US1121H				
5.7L V8 350 CID	1980-1981	Rally, Rally STX, Vandura	US1121				
5.7L V8 350 CID	1980-1981	Rally, Rally STX, Vandura; High performance	US1121H				
5.7L V8 350 CID	1982	Rally, Rally STX	US1121				
5.7L V8 350 CID	1982	Rally, Rally STX; High performance	US1121H				
5.7L V8 350 CID	1983	Rally, Rally Custom, Rally STX, Vandura	US1121				
5.7L V8 350 CID	1983	Rally, Rally Custom, Rally STX, Vandura; High performance	US1121H				
5.7L V8 350 CID	1984	Rally, Rally Custom, Rally STX	US1121				
5.7L V8 350 CID	1984	Rally, Rally Custom, Rally STX; High performance	US1121H				

Engine	Years	Application Description	USMW	Engine	Years	Application Description	USMW
GMC (cont'd.)				GMC (cont'd.)			
JIMMY (cont'd.)				K15/K1500 SUBURBAN (cont'd.)			
4.3L V6 262 CID	1996	Base, SL, SLE, SLS, SLT	US5077	4.8L L6 4801cc 292 CID	1970-1971		US896
4.3L V6 262 CID	1996	Base, SL, SLE, SLS, SLT; High performance	US5077H	6.5L V8 396 CID	1968		US981
4.3L V6 262 CID	1997	SL, SLE, SLS, SLT	US5077	6.5L V8 6489cc 396 CID	1968-1969		US981
4.3L V6 262 CID	1997	SL, SLE, SLS, SLT; High performance	US5077H	6.6L V8 402 CID	1970-1972		US981
4.3L V6 262 CID	1998-1999	Envoy, SL, SLE, SLS, SLT	US5077	6.6L V8 6588cc 402 CID	1970-1972		US981
4.3L V6 262 CID	1998-1999	Envoy, SL, SLE, SLS, SLT; High performance	US5077H	K15 SUBURBAN			
4.3L V6 262 CID	2000	Diamond Edition, Envoy, SLE, SLS, SLT	US5077	4.1L L6 250 CID	1975-1977		US1110
4.3L V6 262 CID	2000	Diamond Edition, Envoy, SLE, SLS, SLT; High performance	US5077H	4.1L L6 250 CID	1978		US1107
4.3L V6 262 CID	2001	Diamond Edition, SLE, SLS, SLT	US5077	5.0L V8 305 CID	1977-1978	High performance	US1121
4.3L V6 262 CID	2001	Diamond Edition, SLE, SLS, SLT; High performance	US5077H	5.0L V8 305 CID	1977-1978	High performance	US1121H
4.8L L6 292 CID	1973		US896	5.7L V8 350 CID	1975-1976	High performance	US1109
4.8L L6 4786cc 292 CID	1973		US896	5.7L V8 350 CID	1975-1976	High performance	US1109H
4.8L L6 4801cc 292 CID	1970-1974		US896	5.7L V8 350 CID	1977-1978	High performance	US1121
5.0L V8 305 CID	1977-1979		US1121	5.7L V8 350 CID	1977-1978	High performance	US1121H
5.0L V8 305 CID	1977-1979	High performance	US1121H	6.6L V8 400 CID	1975-1976	High performance	US1109
5.0L V8 305 CID	1980-1982	Base, High Sierra, Sierra Classic, Sierra Grande, Street Coupe	US1121	6.6L V8 400 CID	1977-1978	High performance	US1121
5.0L V8 305 CID	1980-1982	Base, High Sierra, Sierra Classic, Sierra Grande, Street Coupe; High performance	US1121H	6.6L V8 400 CID	1977-1978	High performance	US1121H
5.0L V8 305 CID	1983-1985	Base, High Sierra, Sierra Classic	US1121	K25			
5.0L V8 305 CID	1983-1985	Base, High Sierra, Sierra Classic; High performance	US1121H	4.8L L6 292 CID	1975-1977		US1137
5.0L V8 305 CID	1986	Base, Silverado; High performance	US1121H	4.8L L6 292 CID	1975-1977	High performance	US1137H
5.0L V8 305 CID	1986-1987	Base, Sierra Classic	US1121	4.8L L6 292 CID	1978		US5030
5.0L V8 305 CID	1987	Base, Sierra Classic; High performance	US1121H	5.0L V8 305 CID	1977-1978	High performance	US1121
5.7L V8 350 CID	1975-1976		US1109	5.0L V8 305 CID	1977-1978	High performance	US1121H
5.7L V8 350 CID	1975-1976	High performance	US1109H	5.7L V8 350 CID	1975-1976	High performance	US1109
5.7L V8 350 CID	1977-1979		US1121	5.7L V8 350 CID	1977-1978	High performance	US1121
5.7L V8 350 CID	1977-1979	High performance	US1121H	5.7L V8 350 CID	1977-1978	High performance	US1121H
5.7L V8 350 CID	1980-1982	Base, High Sierra, Sierra Classic, Sierra Grande, Street Coupe	US1121	6.6L V8 400 CID	1975-1976	High performance	US1109
5.7L V8 350 CID	1980-1982	Base, High Sierra, Sierra Classic, Sierra Grande, Street Coupe; High performance	US1121H	6.6L V8 400 CID	1977-1978	High performance	US1121
5.7L V8 350 CID	1983-1985	Base, High Sierra, Sierra Classic	US1121	6.6L V8 400 CID	1977-1978	High performance	US1121H
5.7L V8 350 CID	1983-1985	Base, High Sierra, Sierra Classic; High performance	US1121H	K25/K2500 PICKUP			
5.7L V8 350 CID	1986	Base, Silverado; High performance	US1121H	4.8L L6 292 CID	1968		US896
5.7L V8 350 CID	1986-1988	Base, Sierra Classic	US1121	4.8L L6 292 CID	1970-1974		US896
5.7L V8 350 CID	1987-1988	Base, Sierra Classic; High performance	US1121H	4.8L L6 4786cc 292 CID	1973-1974		US896
5.7L V8 350 CID	1989-1990	Base, Sierra Classic	US5049	4.8L L6 4801cc 292 CID	1967-1974		US896
5.7L V8 350 CID	1989-1990	Base, Sierra Classic; High performance	US5049H	5.0L V6 5012cc 305 CID	1968-1969		US835
5.7L V8 350 CID	1991	Base	US5049	6.5L V8 396 CID	1968-1969		US981
5.7L V8 350 CID	1991	Base; High performance	US5049H	6.5L V8 6489cc 396 CID	1968-1969		US981
6.2L V8 379 CID	1982	Base, High Sierra, Sierra Classic, Sierra Grande, Street Coupe	US5008	6.6L V8 6588cc 402 CID	1970-1972		US981
6.2L V8 379 CID	1983-1985	Base, High Sierra, Sierra Classic	US5008	K25/K2500 SUBURBAN			
6.2L V8 379 CID	1986-1990	Base, Sierra Classic	US5008	4.8L L6 292 CID	1968-1974		US896
6.2L V8 379 CID	1991	Base	US5008	4.8L L6 4786cc 292 CID	1973-1974		US896
6.6L V8 400 CID	1975-1976		US1109	4.8L L6 4801cc 292 CID	1968-1974		US896
6.6L V8 400 CID	1975-1976	High performance	US1109H	6.5L V8 396 CID	1968		US981
6.6L V8 400 CID	1977-1979		US1121	6.5L V8 6489cc 396 CID	1968-1969		US981
6.6L V8 400 CID	1977-1979	High performance	US1121H	6.6L V8 6588cc 402 CID	1970-1972		US981
K15				K25 SUBURBAN			
4.1L L6 250 CID	1975-1977		US1110	4.8L L6 292 CID	1975-1977		US1137
4.1L L6 250 CID	1978		US1107	4.8L L6 292 CID	1975-1977	High performance	US1137H
5.0L V8 305 CID	1977-1978		US1121	4.8L L6 292 CID	1978		US5030
5.0L V8 305 CID	1977-1978	High performance	US1121H	5.0L V8 305 CID	1977-1978	High performance	US1121
5.7L V8 350 CID	1975-1976		US1109	5.0L V8 305 CID	1977-1978	High performance	US1121H
5.7L V8 350 CID	1975-1976	High performance	US1109H	5.7L V8 350 CID	1975-1976	High performance	US1109
5.7L V8 350 CID	1977-1978		US1121	5.7L V8 350 CID	1975-1976	High performance	US1121
5.7L V8 350 CID	1977-1978	High performance	US1121H	5.7L V8 350 CID	1977-1978	High performance	US1121H
6.6L V8 400 CID	1975-1976		US1109	6.6L V8 400 CID	1975-1976	High performance	US1109
6.6L V8 400 CID	1975-1976	High performance	US1109H	6.6L V8 400 CID	1975-1976	High performance	US1109H
6.6L V8 400 CID	1977-1978		US1121	6.6L V8 400 CID	1977-1978	High performance	US1121
6.6L V8 400 CID	1977-1978	High performance	US1121H	6.6L V8 400 CID	1977-1978	High performance	US1121H
K15/K1500 PICKUP				K35			
4.8L L6 292 CID	1968		US896	4.8L L6 292 CID	1977-1978		US5030
4.8L L6 292 CID	1970-1971		US896	5.7L V8 350 CID	1977-1978		US1121
4.8L L6 292 CID	1974		US896	5.7L V8 350 CID	1977-1978	High performance	US1121H
4.8L L6 4801cc 292 CID	1967-1974		US896	6.6L V8 400 CID	1977-1978		US1121
5.0L V6 5012cc 305 CID	1968-1969		US835	6.6L V8 400 CID	1977-1978	High performance	US1121
6.5L V8 396 CID	1968-1969		US981	6.6L V8 400 CID	1977-1978	High performance	US1121H
6.5L V8 6489cc 396 CID	1968-1969		US981	K35/K3500 PICKUP			
6.6L V8 6588cc 402 CID	1970-1972		US981	4.8L L6 292 CID	1968-1974		US896
K15/K1500 SUBURBAN				4.8L L6 4786cc 292 CID	1973-1974		US896
4.8L L6 292 CID	1968		US896	4.8L L6 4801cc 292 CID	1968-1974		US896
4.8L L6 292 CID	1970-1971		US896	6.5L V8 396 CID	1968-1969		US981
4.8L L6 292 CID	1974		US896	6.5L V8 6489cc 396 CID	1968-1969		US981
4.8L L6 4801cc 292 CID	1967-1974		US896	6.6L V8 402 CID	1970-1971		US981
5.0L V6 5012cc 305 CID	1968-1969		US835	6.6L V8 6588cc 402 CID	1970-1972		US981
6.5L V8 396 CID	1968-1969		US981	K1500			
6.5L V8 6489cc 396 CID	1968-1969		US981	4.1L L6 250 CID	1979		US1107
6.6L V8 6588cc 402 CID	1970-1972		US981	4.1L L6 250 CID	1980-1982	Base, High Sierra, Sierra Classic, Sierra Grande	US1107
K15/K1500 SUBURBAN				4.1L L6 250 CID	1983-1984	Base, High Sierra, Sierra Classic	US1107
4.8L L6 292 CID	1968		US896	4.3L V6 262 CID	1985-1986	Base, High Sierra, Sierra Classic	US1121
4.8L L6 292 CID	1970-1971		US896				
4.8L L6 4801cc 292 CID	1967-1968		US896				

WATER PUMPS

Engine	Years	Application Description	USMW	Engine	Years	Application Description	USMW
GMC (cont'd.)				GMC (cont'd.)			
K1500 (cont'd.)				K1500 (cont'd.)			
4.3L V6 262 CID	1985-1986	Base, High Sierra, Sierra Classic; High performance	US1121H	6.5L V8 395 CID	1994	Sierra SL, Sierra SLE, Sierra SLT, Sierra Special	US5062
4.3L V6 262 CID	1988-1992	Sierra, Sierra SLE, Sierra SLX	US5049	6.5L V8 395 CID	1995	Sierra SL, Sierra SLE, Sierra SLS, Sierra SLT, Sierra Special	US5062
4.3L V6 262 CID	1988-1992	Sierra, Sierra SLE, Sierra SLX; High performance	US5049H	6.5L V8 395 CID	1996	Sierra SL, Sierra SLE, Sierra SLT, Sierra Special; Early	US5062
4.3L V6 262 CID	1993	Sierra, Sierra SLE, Sierra SLX, Sierra Sport	US5049	6.5L V8 395 CID	1996	Sierra SL, Sierra SLE, Sierra SLT, Sierra Special; Late	US5074
4.3L V6 262 CID	1993	Sierra, Sierra SLE, Sierra SLX, Sierra Sport; High performance	US5049H	6.5L V8 395 CID	1997	Sierra SL, Sierra SLE, Sierra SLT	US5074
4.3L V6 262 CID	1994	Sierra SL, Sierra SLE, Sierra SLT, Sierra Special	US5049	6.5L V8 395 CID	1998	Sierra SL, Sierra SLE, Sierra SLT, Sierra Special	US5074
4.3L V6 262 CID	1994	Sierra SL, Sierra SLE, Sierra SLT, Sierra Special; High performance	US5049H	6.6L V8 400 CID	1979		US1121
4.3L V6 262 CID	1995	Sierra SL, Sierra SLE, Sierra SLS, Sierra SLT, Sierra Special	US5049	6.6L V8 400 CID	1979	High performance	US1121H
4.3L V6 262 CID	1995	Sierra SL, Sierra SLE, Sierra SLS, Sierra SLT, Sierra Special; High performance	US5049H	6.6L V8 400 CID	1980	Base, High Sierra, Sierra Classic, Sierra Grande	US1121
4.3L V6 262 CID	1995	Sierra SL, Sierra SLE, Sierra SLS, Sierra SLT, Sierra Special; High performance	US5049H	6.6L V8 400 CID	1980	Base, High Sierra, Sierra Classic, Sierra Grande; High performance	US1121H
4.3L V6 262 CID	1996-1998	Sierra SL, Sierra SLE, Sierra SLT, Sierra Special	US5077	7.4L V8 454 CID	1980	Base, High Sierra, Sierra Classic, Sierra Grande	US1002
4.3L V6 262 CID	1996-1998	Sierra SL, Sierra SLE, Sierra SLT, Sierra Special; High performance	US5077H	7.4L V8 454 CID	1980	Base, High Sierra, Sierra Classic, Sierra Grande; High performance	US1002H
4.8L L6 292 CID	1980	Base, High Sierra, Sierra Classic, Sierra Grande	US5030	K1500 SUBURBAN			
5.0L V8 305 CID	1979	High performance	US1121	4.1L L6 250 CID	1979		US1107
5.0L V8 305 CID	1979	High performance	US1121H	4.1L L6 250 CID	1980	Base, High Sierra, Sierra Classic, Sierra Grande	US1107
5.0L V8 305 CID	1981-1982	Base, High Sierra, Sierra Classic, Sierra Grande	US1121	5.0L V8 305 CID	1979		US1121
5.0L V8 305 CID	1981-1982	Base, High Sierra, Sierra Classic, Sierra Grande; High performance	US1121H	5.0L V8 305 CID	1979	High performance	US1121H
5.0L V8 305 CID	1983-1986	Base, High Sierra, Sierra Classic	US1121	5.0L V8 305 CID	1982	Base, High Sierra, Sierra Classic, Sierra Grande	US1121
5.0L V8 305 CID	1983-1986	Base, High Sierra, Sierra Classic; High performance	US1121H	5.0L V8 305 CID	1982	Base, High Sierra, Sierra Classic, Sierra Grande; High performance	US1121H
5.0L V8 305 CID	1988-1992	Sierra, Sierra SLE, Sierra SLX	US5049	5.0L V8 305 CID	1983-1985	Base, High Sierra, Sierra Classic	US1121
5.0L V8 305 CID	1988-1992	Sierra, Sierra SLE, Sierra SLX; High performance	US5049H	5.0L V8 305 CID	1983-1985	Base, High Sierra, Sierra Classic; High performance	US1121H
5.0L V8 305 CID	1993	Sierra, Sierra SLE, Sierra SLX, Sierra Sport	US5049	5.7L V8 350 CID	1979		US1121
5.0L V8 305 CID	1993	Sierra, Sierra SLE, Sierra SLX, Sierra Sport; High performance	US5049H	5.7L V8 350 CID	1979	High performance	US1121H
5.0L V8 305 CID	1994	Sierra SL, Sierra SLE, Sierra SLT, Sierra Special	US5049	5.7L V8 350 CID	1980-1982	Base, High Sierra, Sierra Classic, Sierra Grande	US1121
5.0L V8 305 CID	1994	Sierra SL, Sierra SLE, Sierra SLT, Sierra Special; High performance	US5049H	5.7L V8 350 CID	1980-1982	Base, High Sierra, Sierra Classic, Sierra Grande; High performance	US1121H
5.0L V8 305 CID	1995	Sierra SL, Sierra SLE, Sierra SLS, Sierra SLT, Sierra Special	US5049	5.7L V8 350 CID	1983-1986	Base, High Sierra, Sierra Classic	US1121
5.0L V8 305 CID	1995	Sierra SL, Sierra SLE, Sierra SLS, Sierra SLT, Sierra Special; High performance	US5049H	5.7L V8 350 CID	1983-1986	Base, High Sierra, Sierra Classic; High performance	US1121H
5.0L V8 305 CID	1996-1998	Sierra SL, Sierra SLE, Sierra SLT, Sierra Special	US5077	5.7L V8 350 CID	1992	Base, SLE; 6.9" HUB HEIGHT	US5049
5.0L V8 305 CID	1996-1998	Sierra SL, Sierra SLE, Sierra SLT, Sierra Special; High performance	US5077H	5.7L V8 350 CID	1992	Base, SLE; 6.9" HUB HEIGHT, High performance	US5049H
5.0L V8 305 CID	1999	Sierra SL, Sierra SLE, Sierra SLT	US5077	5.7L V8 350 CID	1992	Base, SLE; 5.8" HUB HEIGHT	US5073
5.0L V8 305 CID	1999	Sierra SL, Sierra SLE, Sierra SLT; High performance	US5077H	5.7L V8 350 CID	1993-1994	Base, SLE	US5049
5.7L V8 350 CID	1979	High performance	US1121	5.7L V8 350 CID	1993-1994	Base, SLE; High performance	US5049H
5.7L V8 350 CID	1979	High performance	US1121H	5.7L V8 350 CID	1995	Base, SLE, SLT	US5049
5.7L V8 350 CID	1980-1982	Base, High Sierra, Sierra Classic, Sierra Grande	US1121	5.7L V8 350 CID	1995	Base, SLE, SLT; High performance	US5049H
5.7L V8 350 CID	1980-1982	Base, High Sierra, Sierra Classic, Sierra Grande; High performance	US1121H	5.7L V8 350 CID	1996-1999	Base, SLE, SLT	US5077
5.7L V8 350 CID	1983-1986	Base, High Sierra, Sierra Classic	US1121	5.7L V8 350 CID	1996-1999	Base, SLE, SLT; High performance	US5077H
5.7L V8 350 CID	1983-1986	Base, High Sierra, Sierra Classic; High performance	US1121H	6.2L V8 379 CID	1982	Base, High Sierra, Sierra Classic, Sierra Grande	US5008
5.7L V8 350 CID	1988-1992	Sierra, Sierra SLE, Sierra SLX	US5049	6.2L V8 379 CID	1983-1986	Base, High Sierra, Sierra Classic	US5008
5.7L V8 350 CID	1988-1992	Sierra, Sierra SLE, Sierra SLX; High performance	US5049H	6.5L V8 395 CID	1995	Base, SLE, SLT	US5062
5.7L V8 350 CID	1993	Sierra, Sierra SLE, Sierra SLX, Sierra Sport	US5049	6.5L V8 395 CID	1996	Base, SLE, SLT; Early	US5062
5.7L V8 350 CID	1993	Sierra, Sierra SLE, Sierra SLX, Sierra Sport; High performance	US5049H	6.5L V8 395 CID	1996	Base, SLE, SLT; Late	US5074
5.7L V8 350 CID	1994	Sierra SL, Sierra SLE, Sierra SLT, Sierra Special	US5049	6.5L V8 395 CID	1997-1998	Base, SLE, SLT	US5074
5.7L V8 350 CID	1994	Sierra SL, Sierra SLE, Sierra SLT, Sierra Special; High performance	US5049H	6.5L V8 395 CID	1999	Base, SLE, SLT; Bolt on pulley	US5074
5.7L V8 350 CID	1995	Sierra SL, Sierra SLE, Sierra SLS, Sierra SLT, Sierra Special	US5049	6.5L V8 395 CID	1999	Base, SLE, SLT	US5086
5.7L V8 350 CID	1995	Sierra SL, Sierra SLE, Sierra SLS, Sierra SLT, Sierra Special; High performance	US5049H	6.6L V8 400 CID	1979		US1121
5.7L V8 350 CID	1996-1998	Sierra SL, Sierra SLE, Sierra SLT, Sierra Special	US5077	6.6L V8 400 CID	1979	High performance	US1121H
5.7L V8 350 CID	1996-1998	Sierra SL, Sierra SLE, Sierra SLT, Sierra Special; High performance	US5077H	K2500			
5.7L V8 350 CID	1999	Sierra SL, Sierra SLE, Sierra SLT	US5077	4.1L L6 250 CID	1980	Base, High Sierra, Sierra Classic, Sierra Grande	US1107
5.7L V8 350 CID	1999	Sierra SL, Sierra SLE, Sierra SLT; High performance	US5077H	4.3L V6 262 CID	1985	Base, High Sierra, Sierra Classic	US1121
6.2L V8 379 CID	1982	Base, High Sierra, Sierra Classic, Sierra Grande	US5008	4.3L V6 262 CID	1985	Base, High Sierra, Sierra Classic; High performance	US1121H
6.2L V8 379 CID	1983-1986	Base, High Sierra, Sierra Classic	US5008	4.3L V6 262 CID	1988-1993	Sierra, Sierra SLE, Sierra SLX	US5049
6.2L V8 379 CID	1988-1992	Sierra, Sierra SLE, Sierra SLX	US5062	4.3L V6 262 CID	1988-1993	Sierra, Sierra SLE, Sierra SLX; High performance	US5049H
6.2L V8 379 CID	1993	Sierra, Sierra SLE, Sierra SLX, Sierra Sport	US5062	4.3L V6 262 CID	1994-1995	Sierra SL, Sierra SLE	US5049
				4.3L V6 262 CID	1994-1995	Sierra SL, Sierra SLE; High performance	US5049H
				4.8L L6 292 CID	1979		US5030
				4.8L L6 292 CID	1980-1982	Base, High Sierra, Sierra Classic, Sierra Grande	US5030
				4.8L L6 292 CID	1983-1986	Base, High Sierra, Sierra Classic	US5030
				5.0L V8 305 CID	1988-1993	Sierra, Sierra SLE, Sierra SLX	US5049
				5.0L V8 305 CID	1988-1993	Sierra, Sierra SLE, Sierra SLX; High performance	US5049H
				5.0L V8 305 CID	1994-1995	Sierra SL, Sierra SLE, Sierra SLT	US5049
				5.0L V8 305 CID	1994-1995	Sierra SL, Sierra SLE, Sierra SLT; High performance	US5049H
				5.0L V8 305 CID	1998	Sierra SL, Sierra SLE, Sierra SLT	US5077
				5.0L V8 305 CID	1998	Sierra SL, Sierra SLE, Sierra SLT; High performance	US5077H
				5.7L V8 350 CID	1979		US1121

Engine	Years	Application Description	USMW	Engine	Years	Application Description	USMW
GMC (cont'd.)				GMC (cont'd.)			
K2500 (cont'd.)				K3500 (cont'd.)			
5.7L V8 350 CID	1979	High performance	US1121H	4.8L L6 292 CID	1980-1982	Base, High Sierra, Sierra Classic, Sierra Grande	US5030
5.7L V8 350 CID	1980-1982	Base, High Sierra, Sierra Classic, Sierra Grande	US1121	4.8L L6 292 CID	1983-1986	Base, High Sierra, Sierra Classic	US5030
5.7L V8 350 CID	1980-1982	Base, High Sierra, Sierra Classic, Sierra Grande; High performance	US1121H	5.7L V8 350 CID	1979	High performance	US1121H
5.7L V8 350 CID	1983-1986	Base, High Sierra, Sierra Classic	US1121	5.7L V8 350 CID	1979	High performance	US1121H
5.7L V8 350 CID	1983-1986	Base, High Sierra, Sierra Classic; High performance	US1121H	5.7L V8 350 CID	1980-1982	Base, High Sierra, Sierra Classic, Sierra Grande	US1121
5.7L V8 350 CID	1988-1993	Sierra, Sierra SLE, Sierra SLX	US5049	5.7L V8 350 CID	1980-1982	Base, High Sierra, Sierra Classic, Sierra Grande; High performance	US1121H
5.7L V8 350 CID	1988-1993	Sierra, Sierra SLE, Sierra SLX; High performance	US5049H	5.7L V8 350 CID	1983-1986	Base, High Sierra, Sierra Classic	US1121
5.7L V8 350 CID	1994-1995	Sierra SL, Sierra SLE, Sierra SLT	US5049	5.7L V8 350 CID	1983-1986	Base, High Sierra, Sierra Classic; High performance	US1121H
5.7L V8 350 CID	1994-1995	Sierra SL, Sierra SLE, Sierra SLT; High performance	US5049H	5.7L V8 350 CID	1988-1993	Sierra, Sierra SLE, Sierra SLX	US5049
5.7L V8 350 CID	1996-2000	Sierra SL, Sierra SLE, Sierra SLT	US5077	5.7L V8 350 CID	1988-1993	Sierra, Sierra SLE, Sierra SLX	US5049H
5.7L V8 350 CID	1996-2000	Sierra SL, Sierra SLE, Sierra SLT; High performance	US5077H	5.7L V8 350 CID	1994-1995	Sierra SL, Sierra SLE, Sierra SLT; High performance	US5049H
6.2L V8 379 CID	1982	Base, High Sierra, Sierra Classic, Sierra Grande	US5008	5.7L V8 350 CID	1994-1995	Sierra SL, Sierra SLE, Sierra SLT; High performance	US5049H
6.2L V8 379 CID	1983-1986	Base, High Sierra, Sierra Classic	US5008	5.7L V8 350 CID	1996-2000	Sierra SL, Sierra SLE, Sierra SLT	US5077
6.2L V8 379 CID	1988-1993	Sierra, Sierra SLE, Sierra SLX	US5062	5.7L V8 350 CID	1996-2000	Sierra SL, Sierra SLE, Sierra SLT; High performance	US5077H
6.5L V8 395 CID	1992-1993	Sierra, Sierra SLE, Sierra SLX	US5062	6.2L V8 379 CID	1982	Base, High Sierra, Sierra Classic, Sierra Grande	US5008
6.5L V8 395 CID	1994-1995	Sierra SL, Sierra SLE, Sierra SLT	US5062	6.2L V8 379 CID	1983-1986	Base, High Sierra, Sierra Classic	US5008
6.5L V8 395 CID	1996	Sierra SL, Sierra SLE, Sierra SLT; 1st Design, Single Thermostat	US5062	6.2L V8 379 CID	1988-1993	Sierra, Sierra SLE, Sierra SLX	US5062
6.5L V8 395 CID	1996	Sierra SL, Sierra SLE, Sierra SLT; 2nd Design, Dual Thermostat	US5074	6.5L V8 395 CID	1992-1993	Sierra, Sierra SLE, Sierra SLX	US5062
6.5L V8 395 CID	1997-1998	Sierra SL, Sierra SLE, Sierra SLT	US5074	6.5L V8 395 CID	1994-1995	Sierra SL, Sierra SLE, Sierra SLT	US5062
6.5L V8 395 CID	1999	Sierra SL, Sierra SLE, Sierra SLT; Bolt on pulley	US5074	6.5L V8 395 CID	1996	Sierra SL, Sierra SLE, Sierra SLT; 1st Design, Single Thermostat	US5062
6.5L V8 395 CID	1999-2000	Sierra SL, Sierra SLE, Sierra SLT	US5086	6.5L V8 395 CID	1996	Sierra SL, Sierra SLE, Sierra SLT; 2nd Design, Dual Thermostat	US5074
6.6L V8 400 CID	1979	High performance	US1121	6.5L V8 395 CID	1997-1998	Sierra SL, Sierra SLE, Sierra SLT	US5074
6.6L V8 400 CID	1979	High performance	US1121H	6.5L V8 395 CID	1999	Sierra SL, Sierra SLE, Sierra SLT; Bolt on pulley	US5074
6.6L V8 400 CID	1980	Base, High Sierra, Sierra Classic, Sierra Grande	US1121	6.5L V8 395 CID	1999-2000	Sierra SL, Sierra SLE, Sierra SLT	US5086
6.6L V8 400 CID	1980	Base, High Sierra, Sierra Classic, Sierra Grande; High performance	US1121H	6.6L V8 400 CID	1979	High performance	US1121
7.4L V8 454 CID	1991-1993	Sierra, Sierra SLE, Sierra SLX	US5038	6.6L V8 400 CID	1979	High performance	US1121H
7.4L V8 454 CID	1991-1993	Sierra, Sierra SLE, Sierra SLX; High performance	US5038H	6.6L V8 400 CID	1980	Base, High Sierra, Sierra Classic, Sierra Grande	US1121
7.4L V8 454 CID	1994-2000	Sierra SL, Sierra SLE, Sierra SLT	US5038	6.6L V8 400 CID	1980	Base, High Sierra, Sierra Classic, Sierra Grande; High performance	US1121H
7.4L V8 454 CID	1994-2000	Sierra SL, Sierra SLE, Sierra SLT; High performance	US5038H	7.4L V8 454 CID	1980-1982	Base, High Sierra, Sierra Classic, Sierra Grande	US1002
K2500 SUBURBAN				MICROBUS			
4.8L L6 292 CID	1979	High performance	US5030	5.7L V8 5700cc 350 CID	1990-1991	Mexican Application	US5049
4.8L L6 292 CID	1980-1982	Base, High Sierra, Sierra Classic, Sierra Grande	US5030	P15			
4.8L L6 292 CID	1984	Base, High Sierra, Sierra Classic	US5030	4.8L L6 292 CID	1975-1978		US5030
5.7L V8 350 CID	1979	High performance	US1121	P15/P1500 VAN			
5.7L V8 350 CID	1979	High performance	US1121H	4.8L L6 292 CID	1967		US896
5.7L V8 350 CID	1980-1982	Base, High Sierra, Sierra Classic, Sierra Grande	US1121	6.6L V8 400 CID	1971-1972		US981
5.7L V8 350 CID	1980-1982	Base, High Sierra, Sierra Classic, Sierra Grande; High performance	US1121H	P25			
5.7L V8 350 CID	1983-1986	Base, High Sierra, Sierra Classic	US1121	4.8L L6 292 CID	1975-1977		US1137
5.7L V8 350 CID	1983-1986	Base, High Sierra, Sierra Classic; High performance	US1121H	4.8L L6 292 CID	1975-1977	High performance	US1137H
5.7L V8 350 CID	1992	Base, SLE; 6.9" HUB HEIGHT	US5049	4.8L L6 292 CID	1978		US5030
5.7L V8 350 CID	1992	Base, SLE; 6.9" HUB HEIGHT, High performance	US5049H	5.7L V8 350 CID	1975-1976		US1109
5.7L V8 350 CID	1992	Base, SLE; 5.8" HUB HEIGHT	US5073	5.7L V8 350 CID	1975-1976	High performance	US1109H
5.7L V8 350 CID	1993-1994	Base, SLE	US5049	5.7L V8 350 CID	1977-1978		US1121
5.7L V8 350 CID	1993-1994	Base, SLE; High performance	US5049H	5.7L V8 350 CID	1977-1978	High performance	US1121H
5.7L V8 350 CID	1995	Base, SLE, SLT	US5049	P25/P2500 VAN			
5.7L V8 350 CID	1995	Base, SLE, SLT; High performance	US5049H	4.8L L6 292 CID	1967-1974		US896
5.7L V8 350 CID	1996-1999	Base, SLE, SLT	US5077	4.8L L6 4786cc 292 CID	1973-1974		US896
5.7L V8 350 CID	1996-1999	Base, SLE, SLT; High performance	US5077H	6.6L V8 400 CID	1971-1972		US981
6.2L V8 379 CID	1982	Base, High Sierra, Sierra Classic, Sierra Grande	US5008	P35			
6.2L V8 379 CID	1983-1986	Base, High Sierra, Sierra Classic	US5008	4.8L L6 292 CID	1975-1977		US1137
6.5L V8 395 CID	1994	Base, SLE	US5062	4.8L L6 292 CID	1975-1977	High performance	US1137H
6.5L V8 395 CID	1995	Base, SLE, SLT	US5062	4.8L L6 292 CID	1978		US5030
6.5L V8 395 CID	1996	Base, SLE, SLT; Early	US5062	5.7L V8 350 CID	1975-1976		US1109
6.5L V8 395 CID	1996	Base, SLE, SLT; Late	US5074	5.7L V8 350 CID	1975-1976	High performance	US1109H
6.5L V8 395 CID	1997-1998	Base, SLE, SLT	US5074	5.7L V8 350 CID	1977-1978		US1121
6.5L V8 395 CID	1999	Base, SLE, SLT; Bolt on pulley	US5074	5.7L V8 350 CID	1977-1978	High performance	US1121H
6.5L V8 395 CID	1999	Base, SLE, SLT	US5086	P35/P3500 VAN			
6.6L V8 400 CID	1979	High performance	US1121	4.8L L6 292 CID	1967-1974		US896
6.6L V8 400 CID	1979	High performance	US1121H	4.8L L6 4786cc 292 CID	1973-1974		US896
6.6L V8 400 CID	1980	Base, High Sierra, Sierra Classic, Sierra Grande	US1121	6.6L V8 400 CID	1971-1972		US981
6.6L V8 400 CID	1980	Base, High Sierra, Sierra Classic, Sierra Grande; High performance	US1121H	P35			
7.4L V8 454 CID	1992-1994	Base, SLE	US5038	4.8L L6 292 CID	1975-1977		US1137
7.4L V8 454 CID	1992-1994	Base, SLE; High performance	US5038H	4.8L L6 292 CID	1975-1977	High performance	US1137H
7.4L V8 454 CID	1995-1999	Base, SLE, SLT	US5038	4.8L L6 292 CID	1978		US5030
7.4L V8 454 CID	1995-1999	Base, SLE, SLT; High performance	US5038H	5.7L V8 350 CID	1975-1976		US1109
				5.7L V8 350 CID	1975-1976	High performance	US1109H
				5.7L V8 350 CID	1977-1978		US1121
				5.7L V8 350 CID	1977-1978	High performance	US1121H
K3500				P35/P3500 VAN			
4.8L L6 292 CID	1979	High performance	US5030	4.8L L6 292 CID	1967-1974		US896
				4.8L L6 4786cc 292 CID	1973-1974		US896
				6.6L V8 400 CID	1971-1972		US981

WATER PUMPS



WATER PUMP APPLICATION GUIDE



Engine	Years	Application Description	USMW
GMC (cont'd.)			
P1500			
4.8L L6 292 CID	1979		US5030
4.8L L6 292 CID	1980	Base, Value Van	US5030
P2500			
4.8L L6 292 CID	1979		US5030
4.8L L6 292 CID	1980-1987	Base, Value Van	US5030
4.8L L6 292 CID	1989	Base, Value Van	US5030
5.7L V8 350 CID	1979		US1121
5.7L V8 350 CID	1979	High performance	US1121H
5.7L V8 350 CID	1980-1989	Base, Value Van	US1121
6.2L V8 379 CID	1982-1989	Base, Value Van	US5008
P3500			
4.3L V6 262 CID	1990	Base, Value Van	US1121
4.3L V6 262 CID	1990	Base, Value Van; High performance	US1121H
4.3L V6 262 CID	1991-1995	Base	US1121
4.3L V6 262 CID	1991-1995	Base; High performance	US1121H
4.3L V6 262 CID	1996-1999	Base	US5077
4.3L V6 262 CID	1996-1999	Base; High performance	US5077H
4.8L L6 292 CID	1979		US5030
4.8L L6 292 CID	1980-1989	Base, Value Van	US5030
5.7L V8 350 CID	1979		US1121
5.7L V8 350 CID	1979	High performance	US1121H
5.7L V8 350 CID	1980-1990	Base, Value Van	US1121
5.7L V8 350 CID	1985-1990	Base, Value Van; High performance	US1121H
5.7L V8 350 CID	1991-1995	Base	US1121
5.7L V8 350 CID	1991-1995	Base; High performance	US1121H
5.7L V8 350 CID	1996-1999	Base	US5077
5.7L V8 350 CID	1996-1999	Base; High performance	US5077H
5.7L V8 5700cc 350 CID	1989-1991	Mexican Application	US5049
6.2L V8 379 CID	1982-1990	Base, Value Van	US5008
6.2L V8 379 CID	1991-1993	Base	US5008
6.5L V8 395 CID	1994-1996	Base	US5062
6.5L V8 395 CID	1997-1998	Base	US5074
6.5L V8 395 CID	1999	Base	US5086
7.4L V8 454 CID	1980-1990	Base, Value Van	US1002
7.4L V8 454 CID	1985-1990	Base, Value Van; High performance	US1002H
7.4L V8 454 CID	1991-1999	Base	US1002
7.4L V8 454 CID	1991-1999	Base; High performance	US1002H
P6000			
7.0L V8 6998cc 427 CID	1990	With threaded hub for fan clutch	US5078
7.0L V8 6998cc 427 CID	1990	Without threaded hub	US5084
P6500			
6.0L V8 366 CID	1992-1996	With threaded hub for fan clutch	US5078
7.0L V8 6998cc 427 CID	1992-1996	With threaded hub for fan clutch	US5078
PB15 SERIES			
4.8L L6 4801cc 292 CID	1966		US896
PB25 SERIES			
4.8L L6 4801cc 292 CID	1966		US896
PB1500 SERIES			
4.8L L6 4801cc 292 CID	1965		US896
PB2500 SERIES			
4.8L L6 4801cc 292 CID	1965		US896
R1500			
4.3L V6 262 CID	1987	Base, High Sierra, Sierra Classic	US1121
4.3L V6 262 CID	1987	Base, High Sierra, Sierra Classic; High performance	US1121H
5.0L V8 305 CID	1987	Base, High Sierra, Sierra Classic	US1121
5.0L V8 305 CID	1987	Base, High Sierra, Sierra Classic; High performance	US1121H
5.7L V8 350 CID	1987	Base, High Sierra, Sierra Classic	US1121
5.7L V8 350 CID	1987	Base, High Sierra, Sierra Classic; High performance	US1121H
6.2L V8 379 CID	1987	Base, High Sierra, Sierra Classic	US5008
R1500 SUBURBAN			
5.0L V8 305 CID	1987	Base, High Sierra, Sierra Classic	US1121
5.0L V8 305 CID	1987	Base, High Sierra, Sierra Classic; High performance	US1121H
5.7L V8 350 CID	1987	Base, High Sierra, Sierra Classic	US1121
5.7L V8 350 CID	1987	Base, High Sierra, Sierra Classic; High performance	US1121H
5.7L V8 350 CID	1988	Base, Sierra Classic	US1121
5.7L V8 350 CID	1988	Base, Sierra Classic; High performance	US1121H
5.7L V8 350 CID	1989	Base, Sierra Classic	US5049
5.7L V8 350 CID	1989	Base, Sierra Classic; High performance	US5049H
5.7L V8 350 CID	1990	Base, SLE	US5049
5.7L V8 350 CID	1990	Base, SLE; High performance	US5049H
5.7L V8 350 CID	1991	Base	US5049
5.7L V8 350 CID	1991	Base; High performance	US5049H
6.2L V8 379 CID	1987	Base, High Sierra, Sierra Classic	US5008
6.2L V8 379 CID	1988-1989	Base, Sierra Classic	US5062
6.2L V8 379 CID	1990	Base, SLE	US5062

Engine	Years	Application Description	USMW
GMC (cont'd.)			
R1500 SUBURBAN (cont'd.)			
6.2L V8 379 CID	1991	Base	US5062
R2500			
4.3L V6 262 CID	1987	Base, High Sierra, Sierra Classic	US1121
4.3L V6 262 CID	1987	Base, High Sierra, Sierra Classic; High performance	US1121H
4.8L L6 292 CID	1987-1988	Base, High Sierra, Sierra Classic	US5030
5.0L V8 305 CID	1987	Base, High Sierra, Sierra Classic	US1121
5.0L V8 305 CID	1987	Base, High Sierra, Sierra Classic; High performance	US1121H
5.7L V8 350 CID	1987-1989	Base, High Sierra, Sierra Classic	US1121
5.7L V8 350 CID	1987-1989	Base, High Sierra, Sierra Classic; High performance	US1121H
6.2L V8 379 CID	1987-1989	Base, High Sierra, Sierra Classic	US5008
7.4L V8 454 CID	1987-1989	Base, High Sierra, Sierra Classic	US1002
7.4L V8 454 CID	1987-1989	Base, High Sierra, Sierra Classic; High performance	US1002H
R2500 SUBURBAN			
5.7L V8 350 CID	1987	Base, High Sierra, Sierra Classic	US1121
5.7L V8 350 CID	1987	Base, High Sierra, Sierra Classic; High performance	US1121H
5.7L V8 350 CID	1988	Base, Sierra Classic	US1121
5.7L V8 350 CID	1988	Base, Sierra Classic; High performance	US1121H
5.7L V8 350 CID	1989	Base, Sierra Classic	US5049
5.7L V8 350 CID	1989	Base, Sierra Classic; High performance	US5049H
5.7L V8 350 CID	1990	Base, SLE	US5049
5.7L V8 350 CID	1990	Base, SLE; High performance	US5049H
5.7L V8 350 CID	1991	Base	US5049
5.7L V8 350 CID	1991	Base; High performance	US5049H
6.2L V8 379 CID	1987	Base, High Sierra, Sierra Classic	US5008
6.2L V8 379 CID	1988-1989	Base, Sierra Classic	US5062
6.2L V8 379 CID	1990	Base, SLE	US5062
6.2L V8 379 CID	1991	Base	US5062
7.4L V8 454 CID	1987	Base, High Sierra, Sierra Classic	US1002
7.4L V8 454 CID	1987	Base, High Sierra, Sierra Classic; High performance	US1002H
7.4L V8 454 CID	1988	Base, Sierra Classic	US1002
7.4L V8 454 CID	1988	Base, Sierra Classic; High performance	US1002H
7.4L V8 454 CID	1989	Base, Sierra Classic	US5038
7.4L V8 454 CID	1989	Base, Sierra Classic; High performance	US5038H
7.4L V8 454 CID	1990	Base, SLE	US5038
7.4L V8 454 CID	1990	Base, SLE; High performance	US5038H
7.4L V8 454 CID	1991	Base	US5038
7.4L V8 454 CID	1991	Base; High performance	US5038H
R3500			
4.8L L6 292 CID	1987-1988	Base, High Sierra, Sierra Classic	US5030
5.7L V8 350 CID	1987-1989	Base, High Sierra, Sierra Classic	US1121
5.7L V8 350 CID	1987-1989	Base, High Sierra, Sierra Classic; High performance	US1121H
5.7L V8 350 CID	1990-1991	Base, SLE	US1121
5.7L V8 350 CID	1990-1991	Base, SLE; High performance	US1121H
6.2L V8 379 CID	1987-1989	Base, High Sierra, Sierra Classic	US5008
6.2L V8 379 CID	1990-1991	Base, SLE	US5008
7.4L V8 454 CID	1987-1989	Base, High Sierra, Sierra Classic	US1002
7.4L V8 454 CID	1987-1989	Base, High Sierra, Sierra Classic; High performance	US1002H
7.4L V8 454 CID	1990-1991	Base, SLE	US1002
7.4L V8 454 CID	1990-1991	Base, SLE; High performance	US1002H
S15			
1.9L L4 119 CID	1982	Base, High Sierra, Sierra Classic, Sierra Grande	US5013
1.9L L4 119 CID	1983-1985	Base, High Sierra, Sierra Classic	US5013
2.0L L4 122 CID	1983-1984	Base, High Sierra, Sierra Classic	US5015
2.5L L4 2474cc 151 CID	1985	Base, High Sierra, Sierra Classic	US5022
2.5L L4 2474cc 151 CID	1986	Base, Gypsy, High Sierra, Sierra Classic	US5022
2.5L L4 2474cc 151 CID	1987	Base, EL, Gypsy, High Sierra, Sierra Classic	US5040
2.5L L4 2474cc 151 CID	1988	Base, Gypsy, High Sierra, Sierra Classic	US5040
2.5L L4 2474cc 151 CID	1989-1990	Base, High Sierra, Sierra Classic	US5040
2.8L V6 173 CID	1982	Base, High Sierra, Sierra Classic, Sierra Grande	US5006
2.8L V6 173 CID	1983-1985	Base, High Sierra, Sierra Classic	US5006
2.8L V6 173 CID	1986	Base, Gypsy, High Sierra, Sierra Classic	US5006
2.8L V6 173 CID	1987	Base, EL, Gypsy, High Sierra, Sierra Classic	US5035
2.8L V6 173 CID	1988	Base, Gypsy, High Sierra, Sierra Classic	US5035
2.8L V6 173 CID	1989-1990	Base, High Sierra, Sierra Classic	US5035
4.3L V6 262 CID	1988	Base, Gypsy, High Sierra, Sierra Classic	US5049
4.3L V6 262 CID	1988	Base, Gypsy, High Sierra, Sierra Classic; High performance	US5049H

Engine	Years	Application Description	USMW	Engine	Years	Application Description	USMW
GMC (cont'd.)				GMC (cont'd.)			
S15 (cont'd.)				SAVANA 1500 (cont'd.)			
4.3L V6 262 CID	1989-1990	Base, High Sierra, Sierra Classic	US5049	5.7L V8 350 CID	1996-2000	Base, SLE; High performance	US5077H
4.3L V6 262 CID	1989-1990	Base, High Sierra, Sierra Classic; High performance	US5049H	5.7L V8 350 CID	2001-2002	Base, SLT	US5077
S15 JIMMY				SAVANA 2500			
1.9L L4 119 CID	1983-1984	Base, Gypsy, Sierra Classic	US5013	2.8L L4 171 CID	2017	Base, LS, LT	US8154
2.0L L4 122 CID	1983-1984	Base, Gypsy, Sierra Classic	US5015	4.3L V6 262 CID	1996-1998	Base; High performance	US5077H
2.5L L4 2474cc 151 CID	1985	Base, Gypsy, High Sierra, Sierra Classic	US5022	4.3L V6 262 CID	1996-2001	Base	US5077
2.5L L4 2474cc 151 CID	1986	Base, Gypsy, Sierra Classic	US5022	4.3L V6 262 CID	1999-2000	Base, SLE; High performance	US5077H
2.5L L4 2474cc 151 CID	1987	Base, Gypsy, Sierra Classic	US5040	4.3L V6 262 CID	2001-2002	Base, SLT; High performance	US5077H
2.5L L4 2474cc 151 CID	1988	Base, Gypsy, Sierra Classic, Timberline	US5040	4.3L V6 262 CID	2002	Base, SLT	US5077
2.8L V6 173 CID	1983-1984	Base, Gypsy, Sierra Classic	US5006	4.3L V6 262 CID	2003	Base	US5077
2.8L V6 173 CID	1985	Base, Gypsy, High Sierra, Sierra Classic	US5006	4.3L V6 262 CID	2003-2005	Base, SLE; High performance	US5077H
2.8L V6 173 CID	1986	Base, Gypsy, Sierra Classic	US5006	4.3L V6 262 CID	2004-2005	Base, SLE	US5077
2.8L V6 173 CID	1987	Base, Gypsy, Sierra Classic	US5035	4.8L V8 294 CID	2003	Base	US64
2.8L V6 173 CID	1988-1989	Base, Gypsy, Sierra Classic, Timberline	US5035	4.8L V8 294 CID	2003	Base; Includes thermostat and thermostat housing	US64-T
4.3L V6 262 CID	1988-1989	Base, Gypsy, Sierra Classic, Timberline	US5049	4.8L V8 294 CID	2004-2005	Base, SLE	US64
4.3L V6 262 CID	1988-1989	Base, Gypsy, Sierra Classic, Timberline; High performance	US5049H	4.8L V8 294 CID	2004-2005	Base, SLE; Includes thermostat and thermostat housing	US64-T
4.3L V6 262 CID	1990	Base, Gypsy, Sierra Classic	US5049	4.8L V8 294 CID	2006	Base	US64
4.3L V6 262 CID	1990	Base, Gypsy, Sierra Classic; High performance	US5049H	4.8L V8 294 CID	2006	Base; Includes thermostat and thermostat housing	US64-T
4.3L V6 262 CID	1991	Base, SLE, SLS, SLT	US5049	4.8L V8 294 CID	2007-2011	Base	US6009
4.3L V6 262 CID	1991	Base, SLE, SLS, SLT; High performance	US5049H	4.8L V8 294 CID	2007-2011	Base; Includes thermostat and thermostat housing	US6009-T
SAFARI				SAVANA 3500			
2.5L L4 2474cc 151 CID	1985	Base, SL, SLE, SLX	US5022	2.8L L4 171 CID	2017	Base, LS, LT	US8154
2.5L L4 2474cc 151 CID	1986	Base	US5022	4.8L V8 294 CID	2004	Base	US64
2.5L L4 2474cc 151 CID	1987-1990	Base	US5040	4.8L V8 294 CID	2004	Base; Includes thermostat and thermostat housing	US64-T
4.3L V6 262 CID	1985-1986	Base, SL, SLE, SLX	US1121	4.8L V8 294 CID	2005	Base, SLE	US64
4.3L V6 262 CID	1985-1986	Base, SL, SLE, SLX; High performance	US1121H	4.8L V8 294 CID	2005	Base, SLE; Includes thermostat and thermostat housing	US64-T
4.3L V6 262 CID	1987	Base, SL, SLE, SLT, SLX	US5049	4.8L V8 294 CID	2006	Base	US64
4.3L V6 262 CID	1987	Base, SL, SLE, SLT, SLX; High performance	US5049H	4.8L V8 294 CID	2006	Base; Includes thermostat and thermostat housing	US64-T
4.3L V6 262 CID	1988-1990	Base, SLE, SLT, SLX	US5049	6.0L V8 5967cc 364 CID	2003-2005	Base, SLE	US64
4.3L V6 262 CID	1988-1990	Base, SLE, SLT, SLX; High performance	US5049H	6.0L V8 5967cc 364 CID	2003-2005	Base, SLE; Includes thermostat and thermostat housing	US64-T
4.3L V6 262 CID	1991-1992	Base, SLE, SLT	US5049	6.0L V8 5967cc 364 CID	2006	Base	US64
4.3L V6 262 CID	1991-1992	Base, SLE, SLT; High performance	US5049H	6.0L V8 5967cc 364 CID	2006	Base; Includes thermostat and thermostat housing	US64-T
4.3L V6 262 CID	1993	Base, GT, SLE, SLT	US5049	6.0L V8 5967cc 364 CID	2007-2014	Base, LS, LT; Includes thermostat and thermostat housing	US6009-T
4.3L V6 262 CID	1993	Base, GT, SLE, SLT; High performance	US5049H	6.0L V8 5967cc 364 CID	2007-2017	Base, LS, LT	US6009
4.3L V6 262 CID	1994	Base, SLE, SLT, SLX	US5049	6.5L V8 395 CID	1996-1998	Base, SLE	US5074
4.3L V6 262 CID	1994	Base, SLE, SLT, SLX; High performance	US5049H	6.5L V8 395 CID	1999-2000	Base, SLE	US5086
4.3L V6 262 CID	1995	Base, SL, SLE, SLT, SLX	US5049	6.5L V8 395 CID	2001	Base	US5086
4.3L V6 262 CID	1995	Base, SL, SLE, SLT, SLX; High performance	US5049H	6.5L V8 395 CID	2002	Base, SLT	US5086
4.3L V6 262 CID	1996-1997	Base, SL, SLE, SLT, SLX	US5077	6.6L V8 6599cc 403 CID	2006-2016	Base	US72
4.3L V6 262 CID	1996-1997	Base, SL, SLE, SLT, SLX; High performance	US5077H	SAVANA 3500			
4.3L V6 262 CID	1998	SL, SLE, SLT, SLX	US5077	2.8L L4 171 CID	2017	Base, LS, LT	US8154
4.3L V6 262 CID	1998	SL, SLE, SLT, SLX; High performance	US5077H	4.8L V8 294 CID	2004	Base	US64
4.3L V6 262 CID	1999-2002	SL, SLE, SLT	US5077	4.8L V8 294 CID	2004	Base; Includes thermostat and thermostat housing	US64-T
4.3L V6 262 CID	1999-2002	SL, SLE, SLT; High performance	US5077H	4.8L V8 294 CID	2005	Base, SLE	US64
4.3L V6 262 CID	2003-2005	Base, SLE, SLT	US5077	4.8L V8 294 CID	2005	Base, SLE; Includes thermostat and thermostat housing	US64-T
4.3L V6 262 CID	2003-2005	Base, SLE, SLT; High performance	US5077H	4.8L V8 294 CID	2006	Base	US64
SAVANA 1500				4.8L V8 294 CID	2006	Base; Includes thermostat and thermostat housing	US64-T
4.3L V6 262 CID	1996-2000	Base, SLE	US5077	4.8L V8 294 CID	2007-2011	Base	US6009
4.3L V6 262 CID	1996-2000	Base, SLE; High performance	US5077H	4.8L V8 294 CID	2007-2011	Base; Includes thermostat and thermostat housing	US6009-T
4.3L V6 262 CID	2001-2002	Base, SLT	US5077	4.8L V8 294 CID	2012-2014	Base, LS, LT; Includes thermostat and thermostat housing	US6009-T
4.3L V6 262 CID	2001-2002	Base, SLT; High performance	US5077H	4.8L V8 294 CID	2012-2017	Base, LS, LT	US6009
4.3L V6 262 CID	2003-2005	Base, SLE	US5077	5.7L V8 350 CID	1996-2000	Base, SLE	US5077
4.3L V6 262 CID	2003-2005	Base, SLE; High performance	US5077H	5.7L V8 350 CID	1996-2000	Base, SLE; High performance	US5077H
4.3L V6 262 CID	2006	Base, LS, LT	US5077	5.7L V8 350 CID	2001-2002	Base, SLT	US5077
4.3L V6 262 CID	2006	Base, LS, LT; High performance	US5077H	5.7L V8 350 CID	2001-2002	Base, SLT; High performance	US5077H
4.3L V6 262 CID	2007-2011	Base; High performance	US5077H	6.0L V8 5967cc 364 CID	2003-2005	Base, SLE	US64
4.3L V6 262 CID	2007-2012	Base	US5077	6.0L V8 5967cc 364 CID	2003-2005	Base, SLE; Includes thermostat and thermostat housing	US64-T
4.3L V6 262 CID	2014	Base	US5077	6.0L V8 5967cc 364 CID	2006	Base, LS, LT	US64
4.3L V6 4293cc 262 CID	2013	Base	US5077	6.0L V8 5967cc 364 CID	2006	Base, LS, LT; Includes thermostat and thermostat housing	US64-T
5.0L V8 305 CID	1996-2000	Base, SLE	US5077	6.0L V8 5967cc 364 CID	2007-2014	Base, LS, LT; Includes thermostat and thermostat housing	US6009-T
5.0L V8 305 CID	1996-2000	Base, SLE; High performance	US5077H	6.0L V8 5967cc 364 CID	2007-2017	Base, LS, LT	US6009
5.0L V8 305 CID	2001-2002	Base, SLT	US5077	6.5L V8 395 CID	1996-1998	Base, SLE	US5074
5.0L V8 305 CID	2001-2002	Base, SLT; High performance	US5077H	6.5L V8 395 CID	1999-2000	Base, SLE	US5086
5.3L V8 5328cc 325 CID	2003-2005	Base, SLE	US64	6.5L V8 395 CID	2001	Base	US5086
5.3L V8 5328cc 325 CID	2003-2005	Base, SLE; Includes thermostat and thermostat housing	US64-T	6.5L V8 395 CID	2002	Base, SLT	US5086
5.3L V8 5328cc 325 CID	2006	Base, LS, LT	US64	6.6L V8 6599cc 403 CID	2006-2016	Base	US72
5.3L V8 5328cc 325 CID	2006	Base, LS, LT; Includes thermostat and thermostat housing	US64-T	SAVANA 3500			
5.3L V8 5328cc 325 CID	2007-2014	Base, LS, LT	US6009	2.8L L4 171 CID	2017	Base, LS, LT	US8154
5.3L V8 5328cc 325 CID	2007-2014	Base, LS, LT; Includes thermostat and thermostat housing	US6009-T	4.8L V8 294 CID	2004	Base	US64
5.7L V8 350 CID	1996-2000	Base, SLE	US5077	4.8L V8 294 CID	2004	Base; Includes thermostat and thermostat housing	US64-T

WATER PUMPS

Engine	Years	Application Description	USMW	Engine	Years	Application Description	USMW
GMC (cont'd.)				GMC (cont'd.)			
SAVANA 3500 (cont'd.)				SIERRA 1500 (cont'd.)			
6.6L V8 6599cc 403 CID	2015-2016	Base, LS, LT	US72	6.0L V8 5967cc 364 CID	2007-2008	SLE, SLT	US6009
7.4L V8 454 CID	1996-2000	Base, SLE	US5038	6.0L V8 5967cc 364 CID	2007-2008	SLE, SLT; Includes thermostat and thermostat housing	US6009-T
7.4L V8 454 CID	1996-2000	Base, SLE; High performance	US5038H	6.0L V8 5967cc 364 CID	2009	Hybrid, SLE, SLT	US6009
8.1L V8 496 CID	2001-2002	Base, SLT	US5090	6.0L V8 5967cc 364 CID	2009	Hybrid, SLE, SLT; Includes thermostat and thermostat housing	US6009-T
SAVANA 4500				SIERRA 1500 CLASSIC			
6.0L V8 5967cc 364 CID	2015-2016	Base	US6009	4.3L V6 262 CID	2007	SL, WT	US5077
6.6L V8 6599cc 403 CID	2009-2014	Base, Medium/Heavy Duty	US72	4.8L V8 294 CID	2007	SL, SLE, WT	US6009
6.6L V8 6599cc 403 CID	2015-2016	Base	US72	4.8L V8 294 CID	2007	SL, SLE, WT; Includes thermostat and thermostat housing	US6009-T
6L V8 5967cc 364 CID	2009-2014	Base, Medium/Heavy Duty	US6009	5.3L V8 5328cc 325 CID	2007	Hybrid, SL, SLE, SLT, WT	US6009
SIERRA				SIERRA 1500 HD			
5.3L V8 5300cc 323 CID	2010-2012	Mexican Application	US6009	6.0L V8 5967cc 364 CID	2001-2003	SLE, SLT	US64
5.3L V8 5300cc 323 CID	2014	Mexican Application	US6009	6.0L V8 5967cc 364 CID	2001-2003	SLE, SLT; Includes thermostat and thermostat housing	US64-T
SIERRA 1500				SIERRA 1500 HD CLASSIC			
4.3L V6 262 CID	1999-2001	SL, SLE, SLT	US5077	6.0L V8 5967cc 364 CID	2007	SLE, SLT	US6009
4.3L V6 262 CID	1999-2001	SL, SLE, SLT; High performance	US5077H	6.0L V8 5967cc 364 CID	2007	SLE, SLT; Includes thermostat and thermostat housing	US6009-T
4.3L V6 262 CID	2002	Base, HT, SL, SLE, SLT, WT	US5077	SIERRA 2500			
4.3L V6 262 CID	2002	Base, HT, SL, SLE, SLT, WT; High performance	US5077H	5.3L V8 5328cc 325 CID	1999-2000	SL, SLE, SLT	US64
4.3L V6 262 CID	2003	Base, SL, SLE, SLT, WT	US5077	5.3L V8 5328cc 325 CID	1999-2000	SL, SLE, SLT; Includes thermostat and thermostat housing	US64-T
4.3L V6 262 CID	2003	Base, SL, SLE, SLT, WT; High performance	US5077H	6.0L V8 5967cc 364 CID	1999-2001	SL, SLE, SLT	US64
4.3L V6 262 CID	2004	Base, SLE, SLT, WT	US5077	6.0L V8 5967cc 364 CID	1999-2001	SL, SLE, SLT; Includes thermostat and thermostat housing	US64-T
4.3L V6 262 CID	2004	Base, SLE, SLT, WT; High performance	US5077H	6.0L V8 5967cc 364 CID	2002	Base, SL, SLE, SLT	US64
4.3L V6 262 CID	2005	Base, WT	US5077	6.0L V8 5967cc 364 CID	2002	Base, SL, SLE, SLT; Includes thermostat and thermostat housing	US64-T
4.3L V6 262 CID	2005	Base, WT; High performance	US5077H	6.0L V8 5967cc 364 CID	2002	Base, SLE, SLT, WT	US64
4.3L V6 262 CID	2006	SL, WT	US5077	6.0L V8 5967cc 364 CID	2003-2004	Base, SLE, SLT, WT	US64
4.3L V6 262 CID	2006	SL, WT; High performance	US5077H	6.0L V8 5967cc 364 CID	2003-2004	Base, SLE, SLT, WT; Includes thermostat and thermostat housing	US64-T
4.3L V6 262 CID	2007-2011	WT; High performance	US5077H	SIERRA 2500 HD			
4.3L V6 262 CID	2007-2013	WT	US5077	6.0L V8 5967cc 364 CID	2001	SL, SLE, SLT	US64
4.3L V6 262 CID	2014-2017	Base, SLE	US8918	6.0L V8 5967cc 364 CID	2001	SL, SLE, SLT; Includes thermostat and thermostat housing	US64-T
4.8L V8 294 CID	1999-2001	SL, SLE, SLT	US64	6.0L V8 5967cc 364 CID	2002	Base, SL, SLE, SLT	US64
4.8L V8 294 CID	1999-2001	SL, SLE, SLT; Includes thermostat and thermostat housing	US64-T	6.0L V8 5967cc 364 CID	2002	Base, SL, SLE, SLT; Includes thermostat and thermostat housing	US64-T
4.8L V8 294 CID	2002	Base, HT, SL, SLE, SLT, WT	US64	6.0L V8 5967cc 364 CID	2002	Base, SLE, SLT, WT	US64
4.8L V8 294 CID	2002	Base, HT, SL, SLE, SLT, WT; Includes thermostat and thermostat housing	US64-T	6.0L V8 5967cc 364 CID	2003-2004	Base, SLE, SLT, WT	US64
4.8L V8 294 CID	2003	Base, SL, SLE, SLT, WT	US64	6.0L V8 5967cc 364 CID	2003-2004	Base, SLE, SLT, WT; Includes thermostat and thermostat housing	US64-T
4.8L V8 294 CID	2003	Base, SL, SLE, SLT, WT; Includes thermostat and thermostat housing	US64-T	SIERRA 2500 HD			
4.8L V8 294 CID	2004	Base, SLE, SLT, WT	US64	6.0L V8 5967cc 364 CID	2001	SL, SLE, SLT	US64
4.8L V8 294 CID	2004	Base, SLE, SLT, WT; Includes thermostat and thermostat housing	US64-T	6.0L V8 5967cc 364 CID	2001	SL, SLE, SLT; Includes thermostat and thermostat housing	US64-T
4.8L V8 294 CID	2005	Base, SLE, WT	US64	6.0L V8 5967cc 364 CID	2002	Base, SL, SLE, SLT	US64
4.8L V8 294 CID	2005	Base, SLE, WT; Includes thermostat and thermostat housing	US64-T	6.0L V8 5967cc 364 CID	2002	Base, SL, SLE, SLT; Includes thermostat and thermostat housing	US64-T
4.8L V8 294 CID	2006	Base, SLE, WT	US64	6.0L V8 5967cc 364 CID	2002	Base, SLE, SLT, WT	US64
4.8L V8 294 CID	2006	SL, SLE, WT; Includes thermostat and thermostat housing	US64-T	6.0L V8 5967cc 364 CID	2003-2004	Base, SLE, SLT, WT	US64
4.8L V8 294 CID	2007	SLE, WT	US6009	6.0L V8 5967cc 364 CID	2003-2004	Base, SLE, SLT, WT; Includes thermostat and thermostat housing	US64-T
4.8L V8 294 CID	2007	SLE, WT; Includes thermostat and thermostat housing	US6009-T	SIERRA 2500 HD			
4.8L V8 294 CID	2008-2013	SL, SLE, WT	US6009	6.0L V8 5967cc 364 CID	2001	SL, SLE, SLT	US64
4.8L V8 294 CID	2008-2013	SL, SLE, WT; Includes thermostat and thermostat housing	US6009-T	6.0L V8 5967cc 364 CID	2001	SL, SLE, SLT; Includes thermostat and thermostat housing	US64-T
5.3L V8 5328cc 325 CID	1999-2001	SL, SLE, SLT	US64	6.0L V8 5967cc 364 CID	2002	Base, SL, SLE, SLT	US64
5.3L V8 5328cc 325 CID	1999-2001	SL, SLE, SLT; Includes thermostat and thermostat housing	US64-T	6.0L V8 5967cc 364 CID	2002	Base, SL, SLE, SLT; Includes thermostat and thermostat housing	US64-T
5.3L V8 5328cc 325 CID	2002	Base, HT, SL, SLE, SLT, WT	US64	6.0L V8 5967cc 364 CID	2002	Base, SLE, SLT, WT	US64
5.3L V8 5328cc 325 CID	2002	Base, HT, SL, SLE, SLT, WT; Includes thermostat and thermostat housing	US64-T	6.0L V8 5967cc 364 CID	2003-2005	Base, SLE, SLT, WT	US64
5.3L V8 5328cc 325 CID	2003	Base, SL, SLE, SLT, WT	US64	6.0L V8 5967cc 364 CID	2003-2005	Base, SLE, SLT, WT; Includes thermostat and thermostat housing	US64-T
5.3L V8 5328cc 325 CID	2003	Base, SL, SLE, SLT, WT; Includes thermostat and thermostat housing	US64-T	6.0L V8 5967cc 364 CID	2006	SL, SLE, SLT, WT	US64
5.3L V8 5328cc 325 CID	2004	Base, SLE, SLT, WT	US64	6.0L V8 5967cc 364 CID	2006	SL, SLE, SLT, WT; Includes thermostat and thermostat housing	US64-T
5.3L V8 5328cc 325 CID	2004	Base, SLE, SLT, WT; Includes thermostat and thermostat housing	US64-T	6.0L V8 5967cc 364 CID	2007-2010	SLE, SLT, WT	US6009
5.3L V8 5328cc 325 CID	2005	Base, Hybrid, SLE, SLT, WT	US64	6.0L V8 5967cc 364 CID	2007-2010	SLE, SLT, WT; Includes thermostat and thermostat housing	US6009-T
5.3L V8 5328cc 325 CID	2005	Base, Hybrid, SLE, SLT, WT; Includes thermostat and thermostat housing	US64-T	6.0L V8 5967cc 364 CID	2011-2014	Denali, SLE, SLT, WT	US6009
5.3L V8 5328cc 325 CID	2006	Hybrid, SL, SLE, SLT, WT	US64	6.0L V8 5967cc 364 CID	2011-2014	Denali, SLE, SLT, WT; Includes thermostat and thermostat housing	US6009-T
5.3L V8 5328cc 325 CID	2006	Hybrid, SL, SLE, SLT, WT; Includes thermostat and thermostat housing	US64-T	6.0L V8 5967cc 364 CID	2015-2017	Base, Denali, SLE, SLT	US6009
5.3L V8 5328cc 325 CID	2007-2009	SLE, SLT, WT	US6009	6.6L V8 6599cc 403 CID	2001	SL, SLE, SLT	US63
5.3L V8 5328cc 325 CID	2007-2009	SLE, SLT, WT; Includes thermostat and thermostat housing	US6009-T	6.6L V8 6599cc 403 CID	2002	Base, SL, SLE, SLT	US63
5.3L V8 5328cc 325 CID	2010-2013	SL, SLE, SLT, WT, XFE	US6009	6.6L V8 6599cc 403 CID	2003-2005	Base, SLE, SLT, WT	US63
5.3L V8 5328cc 325 CID	2010-2013	SL, SLE, SLT, WT, XFE; Includes thermostat and thermostat housing	US6009-T	6.6L V8 6599cc 403 CID	2006	SL, SLE, SLT, WT	US72
5.3L V8 5328cc 325 CID	2014-2017	Base, Denali, SLE, SLT	US8918	6.6L V8 6599cc 403 CID	2007-2010	SL, SLE, WT	US72
6.0L V8 5967cc 364 CID	2001	C3	US64	6.6L V8 6599cc 403 CID	2011-2014	Denali, SLE, SLT, WT	US72
6.0L V8 5967cc 364 CID	2001	C3; Includes thermostat and thermostat housing	US64-T	6.6L V8 6599cc 403 CID	2015-2016	Base, Denali, SLE, SLT	US72
6.0L V8 5967cc 364 CID	2002-2004	Denali	US64	6.6L V8 6599cc 403 CID	2017	Base, Denali, SLE, SLT	US310
6.0L V8 5967cc 364 CID	2002-2004	Denali; Includes thermostat and thermostat housing	US64-T	8.1L V8 496 CID	2001	SL, SLE, SLT	US5089
6.0L V8 5967cc 364 CID	2005-2006	Denali, SLE, SLT	US64	8.1L V8 496 CID	2001	SL, SLE, SLT; High performance	US5089H
6.0L V8 5967cc 364 CID	2005-2006	Denali, SLE, SLT; Includes thermostat and thermostat housing	US64-T	8.1L V8 496 CID	2002	Base, SL, SLE, SLT	US5089
				8.1L V8 496 CID	2002	Base, SL, SLE, SLT; High performance	US5089H
				8.1L V8 496 CID	2003-2005	Base, SLE, SLT, WT	US5089



WATER PUMP APPLICATION GUIDE



Engine	Years	Application Description	USMW	Engine	Years	Application Description	USMW			
GMC (cont'd.)				GMC (cont'd.)						
SIERRA 2500 HD (cont'd.)				SPRINT (cont'd.)						
8.1L V8 496 CID	2003-2005	Base, SLE, SLT, WT; High performance	US5089H	5.0L V8 305 CID	1977		US1121			
8.1L V8 496 CID	2006	SL, SLE, SLT, WT	US5089	5.0L V8 305 CID	1977	High performance	US1121H			
8.1L V8 496 CID	2006	SL, SLE, SLT, WT; High performance	US5089H	5.7L V8 350 CID	1977		US1121			
SIERRA 2500 HD CLASSIC				5.7L V8 350 CID				1977	High performance	US1121H
6.0L V8 5967cc 364 CID	2007	SL, SLE, SLT, WT	US6009	SUBURBAN						
6.0L V8 5967cc 364 CID	2007	SL, SLE, SLT, WT; Includes thermostat and thermostat housing	US6009-T	4.8L L6 4801cc 292 CID	1965-1966		US896			
6.6L V8 6599cc 403 CID	2007	SL, SLE, SLT, WT	US72	SYCLONE						
8.1L V8 496 CID	2007	SL, SLE, SLT, WT	US5089	4.3L V6 262 CID	1991	Base	US5049			
8.1L V8 496 CID	2007	SL, SLE, SLT, WT; High performance	US5089H	4.3L V6 262 CID	1991	Base; High performance	US5049H			
SIERRA 3500				T6500						
6.0L V8 5967cc 364 CID	2001	SL, SLE, SLT	US64	6.0L V8 366 CID	1997-1998	With threaded hub for fan clutch	US5078			
6.0L V8 5967cc 364 CID	2001	SL, SLE, SLT; Includes thermostat and thermostat housing	US64-T	7.8L L6 475 CID	2000-2002	8 vane impeller, Medium/Heavy Duty	US73			
6.0L V8 5967cc 364 CID	2002	Base, SL, SLE, SLT	US64	T7500						
6.0L V8 5967cc 364 CID	2002	Base, SL, SLE, SLT; Includes thermostat and thermostat housing	US64-T	6.0L V8 366 CID	1997-1998	With threaded hub for fan clutch	US5078			
6.0L V8 5967cc 364 CID	2003	Base, SLE, SLT	US64	7.8L L6 475 CID	2000-2002	8 vane impeller, Medium/Heavy Duty	US73			
6.0L V8 5967cc 364 CID	2003	Base, SLE, SLT; Includes thermostat and thermostat housing	US64-T	TERRAIN						
6.0L V8 5967cc 364 CID	2004-2005	Base, SLE, SLT, WT	US64	2.4L L4 2384cc 145 CID	2010-2012	SLE, SLT	US5092			
6.0L V8 5967cc 364 CID	2004-2005	Base, SLE, SLT, WT; Includes thermostat and thermostat housing	US64-T	2.4L L4 2384cc 145 CID	2013-2014	Denali, SLE, SLT	US5092			
6.0L V8 5967cc 364 CID	2006	SL, SLE, SLT, WT	US64	2.4L L4 2384cc 145 CID	2015-2017	Denali, SL, SLE, SLT	US5092			
6.0L V8 5967cc 364 CID	2006	SL, SLE, SLT, WT; Includes thermostat and thermostat housing	US64-T	3.0L V6 182 CID	2010-2012	SLE, SLT	US8932			
6.6L V8 6599cc 403 CID	2001	SL, SLE, SLT	US63	3.0L V6 2994cc 183 CID	2011-2012	Mexican Application	US8932			
6.6L V8 6599cc 403 CID	2002	Base, SL, SLE, SLT	US63	3.6L V6 3564cc 217 CID	2013	Denali, SLE, SLT	US8932			
6.6L V8 6599cc 403 CID	2003	Base, SLE, SLT	US63	3.6L V6 3564cc 217 CID	2013	Mexican Application	US8932			
6.6L V8 6599cc 403 CID	2004-2005	Base, SLE, SLT, WT	US63	3.6L V6 3564cc 217 CID	2015-2017	Denali, SLE, SLT	US8932			
6.6L V8 6599cc 403 CID	2006	SL, SLE, SLT, WT	US72	TYPHOON						
8.1L V8 496 CID	2001	SL, SLE, SLT	US5089	4.3L V6 262 CID	1992-1993	Base	US5049			
8.1L V8 496 CID	2001	SL, SLE, SLT; High performance	US5089H	4.3L V6 262 CID	1992-1993	Base; High performance	US5049H			
8.1L V8 496 CID	2002	Base, SL, SLE, SLT	US5089	V1500						
8.1L V8 496 CID	2002	Base, SL, SLE, SLT; High performance	US5089H	4.3L V6 262 CID	1987	Base, High Sierra, Sierra Classic	US1121			
8.1L V8 496 CID	2003	Base, SLE, SLT	US5089	4.3L V6 262 CID	1987	Base, High Sierra, Sierra Classic; High performance	US1121H			
8.1L V8 496 CID	2003	Base, SLE, SLT; High performance	US5089H	5.0L V8 305 CID	1987	Base, High Sierra, Sierra Classic	US1121			
8.1L V8 496 CID	2004-2005	Base, SLE, SLT, WT	US5089	5.0L V8 305 CID	1987	Base, High Sierra, Sierra Classic; High performance	US1121H			
8.1L V8 496 CID	2004-2005	Base, SLE, SLT, WT; High performance	US5089H	5.7L V8 350 CID	1987	Base, High Sierra, Sierra Classic	US1121			
8.1L V8 496 CID	2006	SL, SLE, SLT, WT	US5089	5.7L V8 350 CID	1987	Base, High Sierra, Sierra Classic; High performance	US1121H			
8.1L V8 496 CID	2006	SL, SLE, SLT, WT; High performance	US5089H	6.2L V8 379 CID	1987	Base, High Sierra, Sierra Classic	US5008			
SIERRA 3500 CLASSIC				V1500 SUBURBAN						
6.0L V8 5967cc 364 CID	2007	SL, SLE, SLT, WT	US6009	5.7L V8 350 CID	1987	Base, High Sierra, Sierra Classic	US1121			
6.0L V8 5967cc 364 CID	2007	SL, SLE, SLT, WT; Includes thermostat and thermostat housing	US6009-T	5.7L V8 350 CID	1987	Base, High Sierra, Sierra Classic; High performance	US1121H			
6.6L V8 6599cc 403 CID	2007	SL, SLE, SLT, WT	US72	5.7L V8 350 CID	1988	Base, Sierra Classic	US1121			
8.1L V8 496 CID	2007	SL, SLE, SLT, WT	US5089	5.7L V8 350 CID	1988	Base, Sierra Classic; High performance	US1121H			
8.1L V8 496 CID	2007	SL, SLE, SLT, WT; High performance	US5089H	5.7L V8 350 CID	1989	Base, Sierra Classic	US5049			
SIERRA 3500 HD				5.7L V8 350 CID	1989	Base, Sierra Classic; High performance	US5049H			
6.0L V8 5967cc 364 CID	2007-2010	SLE, SLT, WT	US6009	5.7L V8 350 CID	1990	Base, SLE	US5049			
6.0L V8 5967cc 364 CID	2007-2010	SLE, SLT, WT; Includes thermostat and thermostat housing	US6009-T	5.7L V8 350 CID	1990	Base, SLE; High performance	US5049H			
6.0L V8 5967cc 364 CID	2011-2014	Denali, SLE, SLT, WT	US6009	5.7L V8 350 CID	1991	Base	US5049			
6.0L V8 5967cc 364 CID	2011-2014	Denali, SLE, SLT, WT; Includes thermostat and thermostat housing	US6009-T	5.7L V8 350 CID	1991	Base; High performance	US5049H			
6.0L V8 5967cc 364 CID	2015-2017	Base, Denali, SLE, SLT	US6009	6.2L V8 379 CID	1987	Base, High Sierra, Sierra Classic	US5008			
6.6L V8 6599cc 403 CID	2007-2010	SLE, SLT, WT	US72	6.2L V8 379 CID	1988-1989	Base, Sierra Classic	US5062			
6.6L V8 6599cc 403 CID	2011-2014	Denali, SLE, SLT, WT	US72	6.2L V8 379 CID	1990	Base, SLE	US5062			
6.6L V8 6599cc 403 CID	2015-2016	Base, Denali, SLE, SLT	US72	6.2L V8 379 CID	1991	Base	US5062			
6.6L V8 6599cc 403 CID	2017	Base, Denali, SLE, SLT	US310	V2500						
SONOMA				4.8L L6 292 CID	1987	Base, High Sierra, Sierra Classic	US5030			
2.2L L4 2190cc 134 CID	1994-2001	SL, SLE, SLS	US5032	5.7L V8 350 CID	1987	Base, High Sierra, Sierra Classic	US1121			
2.2L L4 2190cc 134 CID	2002-2003	SL, SLS	US5032	5.7L V8 350 CID	1987	Base, High Sierra, Sierra Classic; High performance	US1121H			
2.5L L4 2474cc 151 CID	1991-1992	Base, SLE	US5040	6.2L V8 379 CID	1987	Base, High Sierra, Sierra Classic	US5008			
2.5L L4 2474cc 151 CID	1993	Base, SLE, SLS	US5040	V2500 SUBURBAN						
2.8L V6 173 CID	1991	Base, SLE	US5035	5.7L V8 350 CID	1987	Base, High Sierra, Sierra Classic	US1121			
2.8L V6 173 CID	1992	Base, GT, SLE	US5035	5.7L V8 350 CID	1987	Base, High Sierra, Sierra Classic; High performance	US1121H			
2.8L V6 173 CID	1993	Base, SLE, SLS	US5035	5.7L V8 350 CID	1988	Base, Sierra Classic	US1121			
4.3L V6 262 CID	1991	Base, SLE	US5049	5.7L V8 350 CID	1988	Base, Sierra Classic; High performance	US1121H			
4.3L V6 262 CID	1991	Base, SLE; High performance	US5049H	5.7L V8 350 CID	1989	Base, Sierra Classic	US5049			
4.3L V6 262 CID	1992	Base, GT, SLE	US5049	5.7L V8 350 CID	1989	Base, Sierra Classic; High performance	US5049H			
4.3L V6 262 CID	1992	Base, GT, SLE; High performance	US5049H	5.7L V8 350 CID	1990	Base, SLE	US5049			
4.3L V6 262 CID	1993	Base, SLE, SLS	US5049	5.7L V8 350 CID	1990	Base, SLE; High performance	US5049H			
4.3L V6 262 CID	1993	Base, SLE, SLS; High performance	US5049H	5.7L V8 350 CID	1991	Base	US5049			
4.3L V6 262 CID	1994-1995	SL, SLE, SLS	US5049	5.7L V8 350 CID	1991	Base; High performance	US5049H			
4.3L V6 262 CID	1994-1995	SL, SLE, SLS; High performance	US5049H	5.7L V8 350 CID	1991	Base; High performance	US5049H			
4.3L V6 262 CID	1996-2000	SL, SLE, SLS; High performance	US5077H	6.2L V8 379 CID	1987	Base, High Sierra, Sierra Classic	US5008			
4.3L V6 262 CID	1996-2001	SL, SLE, SLS	US5077	6.2L V8 379 CID	1988-1989	Base, Sierra Classic	US5062			
4.3L V6 262 CID	2001-2004	SL, SLS; High performance	US5077H	6.2L V8 379 CID	1990	Base, SLE	US5062			
4.3L V6 262 CID	2002-2004	SL, SLS	US5077	6.2L V8 379 CID	1991	Base	US5062			
SPRINT				V3500						
4.1L L6 250 CID	1975		US895	4.8L L6 292 CID	1987-1988	Base, High Sierra, Sierra Classic	US5030			
4.1L L6 250 CID	1977		US1107							

WATER PUMPS



WATER PUMP APPLICATION GUIDE



Engine	Years	Application Description	USMW	Engine	Years	Application Description	USMW
GMC (cont'd.)				GMC (cont'd.)			
V3500 (cont'd.)				YUKON XL 1500 (cont'd.)			
5.7L V8 350 CID	1987-1989	Base, High Sierra, Sierra Classic	US1121	6.0L V8 5967cc 364 CID	2001-2006	Denali; Includes thermostat and thermostat housing	US64-T
5.7L V8 350 CID	1987-1989	Base, High Sierra, Sierra Classic; High performance	US1121H	6.0L V8 5967cc 364 CID	2007-2009	SLE, SLT	US6009
5.7L V8 350 CID	1990-1991	Base, SLE	US1121	6.0L V8 5967cc 364 CID	2007-2009	SLE, SLT; Includes thermostat and thermostat housing	US6009-T
5.7L V8 350 CID	1990-1991	Base, SLE; High performance	US1121H	6.2L V8 6162cc 376 CID	2007-2009	Denali	US6009
6.2L V8 379 CID	1987-1989	Base, High Sierra, Sierra Classic	US5008	6.2L V8 6162cc 376 CID	2007-2009	Denali; Includes thermostat and thermostat housing	US6009-T
6.2L V8 379 CID	1990-1991	Base, SLE	US5008	6.2L V8 6162cc 376 CID	2010-2014	Denali, SLT	US6009
7.4L V8 454 CID	1987-1989	Base, High Sierra, Sierra Classic	US1002	6.2L V8 6162cc 376 CID	2010-2014	Denali, SLT; Includes thermostat and thermostat housing	US6009-T
7.4L V8 454 CID	1987-1989	Base, High Sierra, Sierra Classic; High performance	US1002H	YUKON XL 2500			
7.4L V8 454 CID	1990-1991	Base, SLE	US1002	6.0L V8 5967cc 364 CID	2000-2006	SLE, SLT	US64
7.4L V8 454 CID	1990-1991	Base, SLE; High performance	US1002H	6.0L V8 5967cc 364 CID	2000-2006	SLE, SLT; Includes thermostat and thermostat housing	US64-T
YUKON				6.0L V8 5967cc 364 CID	2007-2013	SLE, SLT	US6009
4.8L V8 294 CID	2000-2005	SLE, SLT	US64	6.0L V8 5967cc 364 CID	2007-2013	SLE, SLT; Includes thermostat and thermostat housing	US6009-T
4.8L V8 294 CID	2000-2005	SLE, SLT; Includes thermostat and thermostat housing	US64-T	8.1L V8 496 CID	2001-2006	SLE, SLT	US5089
4.8L V8 294 CID	2006	SL, SLE	US64	8.1L V8 496 CID	2001-2006	SLE, SLT; High performance	US5089H
4.8L V8 294 CID	2006	SL, SLE; Includes thermostat and thermostat housing	US64-T	HONDA			
4.8L V8 294 CID	2007-2009	SLE	US6009	ACCORD			
4.8L V8 294 CID	2007-2009	SLE; Includes thermostat and thermostat housing	US6009-T	1.6L L4 1599cc	1976-1978		US9034
5.3L V8 5328cc 325 CID	2000-2005	SLE, SLT	US64	1.8L L4 1751cc	1979		US9034
5.3L V8 5328cc 325 CID	2000-2005	SLE, SLT; Includes thermostat and thermostat housing	US64-T	1.8L L4 1751cc	1980	Base, LX	US9029
5.3L V8 5328cc 325 CID	2006	SL, SLE, SLT	US64	1.8L L4 1751cc	1981	Base, LX, SE	US9029
5.3L V8 5328cc 325 CID	2006	SL, SLE, SLT; Includes thermostat and thermostat housing	US64-T	1.8L L4 1751cc	1982	Base, LX	US9035
5.3L V8 5328cc 325 CID	2007-2009	SLE, SLT	US6009	1.8L L4 1751cc	1983	Base, LX, SE	US9035
5.3L V8 5328cc 325 CID	2007-2009	SLE, SLT; Includes thermostat and thermostat housing	US6009-T	1.8L L4 1829cc	1984	Base, LX; Early	US9056
5.3L V8 5328cc 325 CID	2010	Denali, SLE, SLT	US6009	1.8L L4 1829cc	1984	Base, LX; Late	US9056
5.3L V8 5328cc 325 CID	2010	Denali, SLE, SLT; Includes thermostat and thermostat housing	US6009-T	1.8L L4 1829cc	1985	Base, LX, S, SEi	US9056
5.3L V8 5328cc 325 CID	2011-2014	SLE, SLT	US6009	2.0L L4 1955cc	1986-1988	DX, LX, LXi	US9083
5.3L V8 5328cc 325 CID	2011-2014	SLE, SLT; Includes thermostat and thermostat housing	US6009-T	2.0L L4 1955cc	1989	DX, LX, LXi, SEi	US9083
5.3L V8 5328cc 325 CID	2015-2017	SLE, SLT	US8918	2.2L L4 2156cc	1990	DX, EX, LX	US9209
5.7L V8 350 CID	1992	Base, SLE, Sport	US5049	2.2L L4 2156cc	1991	DX, EX, LX, SE	US9209
5.7L V8 350 CID	1992	Base, SLE, Sport; High performance	US5049H	2.2L L4 2156cc	1992	DX, EX, LX	US9209
5.7L V8 350 CID	1993	Base, GT, SLE	US5049	2.2L L4 2156cc	1993	10th Anniversary, DX, EX, LX, SE	US9209
5.7L V8 350 CID	1993	Base, GT, SLE; High performance	US5049H	2.2L L4 2156cc	1994-1995	DX, EX, LX	US9209
5.7L V8 350 CID	1994	Base, SLE, Sport	US5049	2.2L L4 2156cc	1996	25th Anniversary Edition, DX, EX, LX, Value Package	US9209
5.7L V8 350 CID	1994	Base, SLE, Sport; High performance	US5049H	2.2L L4 2156cc	1997	DX, EX, LX, SE, Value Package	US9209
5.7L V8 350 CID	1995	Base, SLE, SLT	US5049	2.3L L4 2254cc	1998-1999	DX, EX, LX	US9209
5.7L V8 350 CID	1995	Base, SLE, SLT; High performance	US5049H	2.3L L4 2254cc	2000	DX, EX, LX, SE	US9209
5.7L V8 350 CID	1996-1997	SL, SLE, SLT	US5077	2.3L L4 2254cc	2001	DX, EX, LX, Value Package	US9209
5.7L V8 350 CID	1996-1997	SL, SLE, SLT; High performance	US5077H	2.3L L4 2254cc	2002	DX, EX, LX, SE, Value Package	US9209
5.7L V8 350 CID	1998	SLE, SLT	US5077	2.4L L4 2354cc 144 CID	2003-2004	DX, EX, LX; Exc. Japan Built	US9461
5.7L V8 350 CID	1998-1999	SLE, SLT; High performance	US5077H	2.4L L4 2354cc 144 CID	2003-2004	DX, EX, LX; Japan Built	US9461
5.7L V8 350 CID	1999	Denali, SLE, SLT	US5077	2.4L L4 2354cc 144 CID	2005	DX, EX, LX, SE; Exc. Japan Built	US9461
5.7L V8 350 CID	2000	Denali	US5077	2.4L L4 2354cc 144 CID	2005	DX, EX, LX, SE; Japan Built	US9461
6.0L V8 5967cc 364 CID	2001-2006	Denali	US64	2.4L L4 2354cc 144 CID	2006	EX, LX, Value Package; Exc. Japan Built	US9461
6.0L V8 5967cc 364 CID	2001-2006	Denali; Includes thermostat and thermostat housing	US64-T	2.4L L4 2354cc 144 CID	2006	EX, LX, Value Package; Japan Built	US9461
6.0L V8 5967cc 364 CID	2008-2009	Hybrid	US6009	2.4L L4 2354cc 144 CID	2007	LX Special Edition	US9461
6.0L V8 5967cc 364 CID	2008-2009	Hybrid; Includes thermostat and thermostat housing	US6009-T	2.4L L4 2354cc 144 CID	2007	EX, LX, Special Edition, Value Package; Exc. Japan Built	US9461
6.0L V8 5967cc 364 CID	2010-2013	Denali Hybrid, Hybrid	US6009	2.4L L4 2354cc 144 CID	2007	EX, LX, Special Edition, Value Package; Japan Built	US9461
6.0L V8 5967cc 364 CID	2010-2013	Denali Hybrid, Hybrid; Includes thermostat and thermostat housing	US6009-T	2.4L L4 2354cc 144 CID	2008-2010	EX, EX-L, LX, LX-P, LX-S	US6233
6.2L V8 6162cc 376 CID	2007-2009	Denali	US6009	2.4L L4 2354cc 144 CID	2011-2012	EX, EX-L, LX, LX-P, LX-S, SE	US6233
6.2L V8 6162cc 376 CID	2007-2009	Denali; Includes thermostat and thermostat housing	US6009-T	2.4L L4 2354cc 144 CID	2013-2016	EX, EX-L, LX, LX-S, Sport	US8103
6.2L V8 6162cc 376 CID	2011-2014	Denali	US6009	2.4L L4 2354cc 144 CID	2017	EX, EX-L, LX, LX-S, Sport, Special Edition	US8103
6.2L V8 6162cc 376 CID	2011-2014	Denali; Includes thermostat and thermostat housing	US6009-T	2.7L V6 2675cc	1995-1997	EX, LX	US9097
6.2L V8 6162cc 376 CID	2015-2017	Denali	US8918	3.0L V6 2997cc	1998-2002	EX, LX	US9383
6.2L V8 6162cc 378 CID	2009	Mexican Application	US6009	3.0L V6 2997cc	2003-2004	EX, LX	US9470
6.5L V8 395 CID	1994	Base, SLE, Sport	US5062	3.0L V6 2997cc	2005	EX, Hybrid, LX, SE	US9470
6.5L V8 395 CID	1995	Base, SLE, SLT	US5062	3.0L V6 2997cc	2006	EX, Hybrid, LX	US9470
6.5L V8 395 CID	1996	SL, SLE, SLT; Early	US5062	3.0L V6 2997cc	2007	EX, Hybrid, LX, Special Edition	US9470
6.5L V8 395 CID	1996	SL, SLE, SLT; Late	US5074	3.5L V6 3471cc	2008-2012	EX, EX-L	US9470
6.5L V8 395 CID	1997	SL, SLE, SLT	US5074	3.5L V6 3471cc	2013-2017	EX-L, Touring	US9470
YUKON XL				ACCORD CROSSTOUR			
5.3L V8 5328cc 325 CID	2015-2017	SLE, SLT	US8918	3.5L V6 3471cc	2010-2011	EX, EX-L	US9470
6.2L V8 6162cc 376 CID	2015-2017	Denali	US8918	CITY			
YUKON XL 1500				CIVIC			
5.3L V8 5328cc 325 CID	2000-2005	SLE, SLT	US64	1.2L L4 1237cc	1975-1977		US9033
5.3L V8 5328cc 325 CID	2000-2005	SLE, SLT; Includes thermostat and thermostat housing	US64-T	1.3L L4 1335cc	1980-1981	1300, 1300 DX	US9043N
5.3L V8 5328cc 325 CID	2006	SL, SLE, SLT	US64	1.3L L4 1335cc	1982-1983	1300, 1300 FE	US9043N
5.3L V8 5328cc 325 CID	2006	SL, SLE, SLT; Includes thermostat and thermostat housing	US64-T	1.3L L4 1339cc	2003-2008	Hybrid	US6216
5.3L V8 5328cc 325 CID	2007-2014	SLE, SLT	US6009	1.3L L4 1339cc	2009-2011	Hybrid, Hybrid-L	US6216
5.3L V8 5328cc 325 CID	2007-2014	SLE, SLT; Includes thermostat and thermostat housing	US6009-T	1.3L L4 1342cc 82 CID	1984	CRX	US9069
6.0L V8 5967cc 364 CID	2001-2006	Denali	US64	1.3L L4 1342cc 82 CID	1985-1987	Base	US9069
				1.5L L4 1487cc	1975-1979		US9034
				1.5L L4 1487cc	1980	1500, 1500 DX, 1500 GL	US9035
				1.5L L4 1487cc	1981	1500 DX, 1500 GL, Base	US9035

Engine	Years	Application Description	USMW	Engine	Years	Application Description	USMW
HONDA (cont'd.)				HONDA (cont'd.)			
CIVIC (cont'd.)				FIT			
1.5L L4 1487cc	1982	1500 DX, 1500 GL, Base, Wagovan	US9035	1.5L H4 1496cc 91 CID	2006	Mexican Application	US6018
1.5L L4 1487cc	1983	1500 DX, 1500 S, Base, Wagovan	US9035	1.5L H4 1496cc 91 CID	2011-2014	Mexican Application	US6350
1.5L L4 1487cc	1984	1500 S, Base, CRX 1.5, DX	US9069	1.5L L4 1496cc 91 CID	2010-2014	Mexican Application	US6350
1.5L L4 1487cc	1985	1500 S, Base, CRX Si, DX	US9069	1.5L L4 1497cc	2007-2008	Base, Sport	US6018
1.5L L4 1487cc	1986	CRX, CRX HF, CRX Si, DX, Si	US9069	1.5L L4 1497cc	2009-2013	Base, Sport	US6350
1.5L L4 1487cc	1987	Base, CRX, CRX HF, CRX Si, DX, Si	US9069	1.5L L4 1497cc	2015-2017	EX, EX-L, LX	US8119
1.5L L4 1493cc	1986	Base	US9069	INSIGHT			
1.5L L4 1493cc	1988-1989	Base, DX, LX, Wagovan	US9130	1.0L L3 995cc 61 CID	2000-2006	Base	US9494
1.5L L4 1493cc	1990-1991	Base, DX, LX	US9130	1.3L L4 1339cc	2010	EX, LX	US8983
1.5L L4 1493cc	1992-1995	CX, DX, LX	US9130	1.3L L4 1339cc	2011-2014	Base, EX, LX	US8983
1.5L L4 1493cc	1992-1995	VX	US9250	ODYSSEY			
1.5L L4 1497cc	2012-2015	Hybrid, Hybrid-L	US8144	2.2L L4 2156cc	1995-1997	EX, LX	US9209
1.5L L4 1497cc	2016	EX-L, EX-T, Touring	US8145	2.3L L4 2234cc	1998	EX, LX	US9209
1.5L L4 1497cc	2017	EX, EX-L, EX-T, LX, Si, Sport, Touring	US8145	3.5L V6 3471cc	2005-2010	EX, EX-L, LX, Touring	US9470
1.6L L4 1590cc	1996-2000	HX	US9352	3.5L V6 3471cc	2011-2015	EX, EX-L, LX, Touring, Touring Elite	US9470
1.6L L4 1590cc 97 CID	1988	RT 4WD	US9130	3.5L V6 3471cc	2016-2017	EX, EX-L, LX, SE, Touring, Touring Elite	US9470
1.6L L4 1590cc 97 CID	1989	RT 4WD, Si	US9130	3.5L V6 3474cc	1999-2001	Cargo, EX, LX	US9383
1.6L L4 1590cc 97 CID	1990-1991	EX, RT 4WD, Si	US9130	3.5L V6 3474cc	2002	Cargo, EX, EX-L, LX	US9383
1.6L L4 1590cc 97 CID	1992-1995	EX, Si	US9250	3.5L V6 3474cc	2003	EX, EX-L, LX	US9383
1.6L L4 1590cc 97 CID	1996-1997	CX, DX, EX, LX	US9352	3.5L V6 3474cc	2004	EX, LX	US9383
1.6L L4 1590cc 97 CID	1998	CX, DX, EX, GX, LX	US9352	PASSPORT			
1.6L L4 1590cc 97 CID	1999	CX, DX, EX, GX, LX, Value Package	US9352	2.6L L4 2559cc	1994-1996	DX	US9133
1.6L L4 1590cc 97 CID	1999-2000	Mexican Application	US9468	3.2L V6 3165cc	1994-1997	EX, LX	US9278
1.6L L4 1590cc 97 CID	2000	CX, DX, EX, GX, LX	US9352	3.2L V6 3165cc	1998-2002	EX, LX	US9365
1.6L L4 1595cc	1999-2000	Si	US9468	PILOT			
1.7L L4 1668cc	2001	DX, EX, GX, HX, LX	US9419	3.5L V6 3471cc	2005	EX, LX; Canada Built	US9470
1.7L L4 1668cc	2005	DX, EX, EX Special Edition, GX, HX, LX, LX Special Edition, Value Package	US9419	3.5L V6 3471cc	2005	EX, LX; USA Built	US9470
1.7L L4 1700cc	2002-2003	DX, EX, GX, HX, LX	US9419	3.5L V6 3471cc	2006-2007	EX, LX	US9470
1.7L L4 1700cc	2004	DX, EX, GX, HX, LX, Value Package	US9419	3.5L V6 3471cc	2008	EX, EX-L, Special Edition, Value Package	US9470
1.8L L4 1799cc	2006-2008	DX, EX, GX, LX	US6056	3.5L V6 3471cc	2009-2014	EX, EX-L, LX, Touring	US9470
1.8L L4 1799cc	2009-2011	DX, EX, EX-L, GX, LX, LX-S	US6056	3.5L V6 3471cc	2015	EX, EX-L, LX, SE, Touring	US9470
1.8L L4 1799cc	2012	DX, EX, EX-L, GX, HF, LX	US6693	3.5L V6 3471cc	2016-2017	Elite, EX, EX-L, LX, Touring	US9470
1.8L L4 1799cc	2013-2014	EX, EX-L, HF, LX, Natural Gas	US6693	3.5L V6 3475cc	2003-2004	EX, LX	US9383
1.8L L4 1799cc	2015	EX, EX-L, HF, LX, Natural Gas, SE	US6693	PRELUDE			
1.8L L4 1799cc 110 CID	2014-2015	EX, EX-L, LX	US6693	1.8L L4 1751cc	1979		US9034
2.0L L4 1996cc 122 CID	2016-2017	EX, LX, LX-P	US8103	1.8L L4 1751cc	1980-1981	Base	US9029
2.0L L4 1998cc 122 CID	2002-2005	Si	US9434	1.8L L4 1751cc	1982	Base	US9035
2.0L L4 1998cc 122 CID	2006-2007	Si	US9495	1.8L L4 1829cc	1983-1987	Base	US9056
2.0L L4 1998cc 122 CID	2008	MUGEN Si, Si	US9495	2.0L L4 1955cc	1985-1987	2.0 Si	US9083
2.0L L4 1998cc 122 CID	2009-2011	Si	US9495	2.0L L4 1958cc	1988-1989	2.0 Si, 2.0 Si 4WS	US9129
2.4L L4 2354cc 144 CID	2012-2015	Si	US6213	2.0L L4 1958cc	1988-1990	2.0 S	US9131
CIVIC DEL SOL				2.0L L4 1958cc	1990-1991	2.0 Si	US9129
1.5L L4 1493cc	1993-1995	S	US9130	2.1L L4 2056cc	1990-1991	Si, Si 4WS, Si ALB	US9129
1.6L L4 1590cc 97 CID	1993-1995	Si	US9130	2.2L L4 2156cc	1992-1996	S	US9209
1.6L L4 1590cc 97 CID	1994-1995	VTEC	US9321	2.2L L4 2156cc	1993-1996	VTEC	US9273
1.6L L4 1590cc 97 CID	1996-1997	S, Si	US9352	2.2L L4 2156cc	1997-2001	Base, Type SH	US9273
1.6L L4 1595cc	1996-1997	VTEC	US9468	2.3L L4 2259cc	1992-1994	Si, Si 4WS	US9251
CROSSTOUR				2.3L L4 2259cc	1995	SE, Si	US9251
2.4L L4 2354cc 144 CID	2015	EX, EX-L	US8138	2.3L L4 2259cc	1996	Si	US9251
3.5L V6 3471cc	2012-2015	EX, EX-L	US9470	RIDGELINE			
CR-V				3.5L V6 3471cc	2006	RT, RTL, RTS	US9470
1.5L L4 1497cc	2017	EX, EX-L, Touring	US8145	3.5L V6 3471cc	2007-2008	RT, RTL, RTS, RTX	US9470
2.0L L4 1972cc	1997	LX	US9349	3.5L V6 3471cc	2009-2011	RT, RTL, RTS	US9470
2.0L L4 1972cc	1998-1999	EX, LX	US9349	3.5L V6 3471cc	2012-2013	RT, RTL, RTS, Sport	US9470
2.0L L4 1972cc	2000-2001	EX, LX, SE	US9349	3.5L V6 3471cc	2014	RT, RTL, RTS, SE, Sport	US9470
2.4L L4 2354cc 144 CID	2002-2004	EX, LX; Exc.Japan Built	US9434	3.5L V6 3471cc	2017	Black Edition, RT, RTL, RTL-E, RTL-T, RTS, Sport	US9470
2.4L L4 2354cc 144 CID	2002-2004	EX, LX; Japan Built	US9434	S2000			
2.4L L4 2354cc 144 CID	2005-2006	EX, LX, SE; Exc.Japan Built	US9434	2.0L L4 1997cc	2000-2003	Base	US9403
2.4L L4 2354cc 144 CID	2005-2006	EX, LX, SE; Japan Built	US9434	2.2L L4 2157cc	2004-2007	Base	US9403
2.4L L4 2354cc 144 CID	2007-2009	EX, EX-L, LX; Exc.Japan Built	US9461	2.2L L4 2157cc	2008-2009	Base, CR	US9403
2.4L L4 2354cc 144 CID	2007-2009	EX, EX-L, LX; Japan Built	US9461	WAGOVAN			
2.4L L4 2354cc 144 CID	2010	EX, EX-L, LX	US6233	1.5L L4 1487cc	1984	DX	US9069
2.4L L4 2354cc 144 CID	2011	EX, EX-L, LX, SE	US6233	1.5L L4 1487cc	1986-1987	DX	US9069
2.4L L4 2354cc 144 CID	2012-2014	EX, EX-L, LX	US8137	HUMMER			
2.4L L4 2354cc 144 CID	2015	EX, EX-L, LX, Touring	US8118	H1			
2.4L L4 2354cc 144 CID	2016	EX, EX-L, LX, SE, Touring	US8118	6.5L V8 395 CID	2002-2004	Base	US5086
2.4L L4 2354cc 144 CID	2017	LX	US8118	H2			
CRX				6.0L V8 5967cc 364 CID	2003-2006	Base	US64
1.5L L4 1493cc	1988	DX, HF	US9130	6.0L V8 5967cc 364 CID	2003-2006	Base; Includes thermostat and thermostat housing	US64-T
1.5L L4 1493cc	1989-1991	Base, HF	US9130	6.0L V8 5967cc 364 CID	2007	Base	US6009
1.6L L4 1590cc 97 CID	1988-1991	Si	US9130	6.0L V8 5967cc 364 CID	2007	Base; Includes thermostat and thermostat housing	US6009-T
CR-Z				6.2L V8 6162cc 376 CID	2008-2009	Base	US6009
1.5L L4 1497cc 91 CID	2011-2015	Base, EX	US8983	6.2L V8 6162cc 376 CID	2008-2009	Base; Includes thermostat and thermostat housing	US6009-T
1.5L L4 1497cc 91 CID	2016	EX, EX-L, LX	US8983	ELEMENT			
ELEMENT				2.4L L4 2354cc 144 CID	2003	DX, EX	US9461
2.4L L4 2354cc 144 CID	2003	DX, EX	US9461	2.4L L4 2354cc 144 CID	2004	DX, EX, LX	US9461
2.4L L4 2354cc 144 CID	2004	DX, EX, LX	US9461	2.4L L4 2354cc 144 CID	2005-2006	EX, LX	US9461
2.4L L4 2354cc 144 CID	2005-2006	EX, LX	US9461	2.4L L4 2354cc 144 CID	2007-2010	EX, LX, SC	US9461
2.4L L4 2354cc 144 CID	2007-2010	EX, LX, SC	US9461	2.4L L4 2354cc 144 CID	2011	EX, LX	US9461
2.4L L4 2354cc 144 CID	2011	EX, LX	US9461				

WATER PUMPS

Engine	Years	Application Description	USMW
HUMMER (cont'd.)			
H3			
3.5L L4 3460cc 211 CID	2006	Base	US5097
3.7L L5 3654cc 223 CID	2007-2009	Base, X	US5097
3.7L L5 3654cc 223 CID	2010	Base	US5097
5.3L V8 5328cc 325 CID	2008	Alpha	US6009
5.3L V8 5328cc 325 CID	2008	Alpha; Includes thermostat and thermostat housing	US6009-T
5.3L V8 5328cc 325 CID	2009	Alpha, Championship Series	US6009
5.3L V8 5328cc 325 CID	2009	Alpha, Championship Series; Includes thermostat and thermostat housing	US6009-T
5.3L V8 5328cc 325 CID	2010	Alpha	US6009
5.3L V8 5328cc 325 CID	2010	Alpha; Includes thermostat and thermostat housing	US6009-T
H3T			
3.7L L5 3654cc 223 CID	2009-2010	Base	US5097
5.3L V8 5328cc 325 CID	2009-2010	Alpha	US6009
5.3L V8 5328cc 325 CID	2009-2010	Alpha; Includes thermostat and thermostat housing	US6009-T
HYUNDAI			
ACCENT			
1.5L L4 1495cc	1995-1996	Base, L	US7115
1.5L L4 1495cc	1996-1997	GT	US9364
1.5L L4 1495cc	1997	GL, GS, L	US7115
1.5L L4 1495cc	1998	GL, GS, GSi, L	US7115
1.5L L4 1495cc	1999-2000	GL, GS, L	US7115
1.5L L4 1495cc	2001	L; To 04/07/2001	US7115
1.5L L4 1495cc	2001	L; From 04/07/2001	US9364
1.5L L4 1495cc	2002	L	US9364
1.6L L4 1591cc 97 CID	2012-2014	GLS, GS, SE	US6247
1.6L L4 1591cc 97 CID	2015	GLS, GS, Sport	US6247
1.6L L4 1591cc 97 CID	2016	SE, Sport	US6247
1.6L L4 1591cc 97 CID	2017	SE, Sport, Value Edition	US6247
1.6L L4 1599cc	2006	GLS	US9364
1.6L L4 1599cc	2007-2009	GLS, GS, SE	US9364
1.6L L4 1599cc	2010	Blue, GLS, GS, SE	US9364
1.6L L4 1599cc	2011	GL, GLS, GS, SE	US9364
1.6L L4 1600cc	2001	GL, GS	US9364
1.6L L4 1600cc	2002	GL, GS; From 04/12/2002	US9364
1.6L L4 1600cc	2002	GL, GS; To 04/12/2002	US9364
1.6L L4 1600cc	2003	Base, GL	US9364
1.6L L4 1600cc	2004	Base, GL, GT	US9364
1.6L L4 1600cc	2005	GLS, GT	US9364
AZERA			
3.3L V6 3342cc	2007-2009	GLS	US6048
3.3L V6 3342cc	2010	GLS; From 11/03/2009	US6048
3.3L V6 3342cc	2010	GLS; To 11/03/2009	US6048
3.3L V6 3342cc	2011	GLS	US6048
3.3L V6 3342cc	2012	Base	US6048
3.3L V6 3342cc	2013-2014	Base; From 04/11/2013	US6048
3.3L V6 3342cc	2013-2014	Base; To 04/11/2013	US6048
3.3L V6 3342cc	2014-2017	Base, Limited	US6048
3.8L V6 3778cc	2006	Limited, SE; From 05/22/2006	US6048
3.8L V6 3778cc	2006	Limited, SE; To 05/22/2006	US6048
3.8L V6 3778cc	2007	Limited, SE	US6048
3.8L V6 3778cc	2008-2009	Limited	US6048
3.8L V6 3778cc	2010	Limited; From 11/03/2009	US6048
3.8L V6 3778cc	2010	Limited; To 11/03/2009	US6048
3.8L V6 3778cc	2011	Limited	US6048
ELANTRA			
1.6L L4 1591cc 97 CID	2017	Sport	US6247
1.6L L4 1596cc	1992	Base, GL, GLS	US7131
1.6L L4 1596cc	1993-1995	Base	US7131
1.8L L4 1795cc	1996-1997	Base, GL, GLS	US9353
1.8L L4 1796cc	1998	Base, GL, GLS	US9353
1.8L L4 1797cc	2011-2013	GLS, Limited	US8106
1.8L L4 1797cc	2014-2015	Limited, SE	US8106
1.8L L4 1797cc	2016	Limited, SE, Value Edition	US8106
1.8L L4 1797cc 110 CID	2015	Limited	US8106
1.8L L4 1836cc	1993-1995	Base, GLS	US9212
2.0L L4 1975cc	1999	GL, GLS; From 03/10/1999, To 06/03/1999	US9353
2.0L L4 1975cc	1999	GL, GLS; From 06/03/1999	US9353
2.0L L4 1975cc	1999	GL, GLS; To 03/10/1999	US9353
2.0L L4 1975cc	2000	GLS	US9353
2.0L L4 1975cc	2001-2005	GLS, GT	US8972
2.0L L4 1975cc	2006	GLS, GT, Limited	US8972
2.0L L4 1975cc	2007	GLS, Limited, SE	US8972
2.0L L4 1975cc	2008	GLS, SE	US8972
2.0L L4 1975cc	2009	GLS, SE, Touring	US8972
2.0L L4 1975cc	2010	Blue, GLS, SE, Touring GLS, Touring SE	US8972
2.0L L4 1975cc	2011-2012	Touring GLS, Touring SE	US8972
2.0L L4 1999cc	2014-2016	Sport	US8106
2.0L L4 1999cc	2017	Limited, SE, Value Edition	US8106

Engine	Years	Application Description	USMW
HYUNDAI (cont'd.)			
ELANTRA COUPE			
1.8L L4 1797cc	2013	GS, SE	US8106
2.0L L4 1999cc	2014	GS	US8106
ELANTRA GT			
1.8L L4 1797cc	2013	Base	US8106
2.0L L4 1999cc	2014-2017	Base	US8106
ENTOURAGE			
3.8L V6 3778cc	2007	GLS, Limited, SE; From 05/22/2006	US6048
3.8L V6 3778cc	2007	GLS, Limited, SE; To 05/22/2006	US6048
3.8L V6 3778cc	2008	GLS, Limited	US6048
EXCEL			
1.5L L4 1468cc	1986-1990	Base, GL, GLS	US7115
1.5L L4 1468cc	1991	Base, GL, GLS, GS	US7115
1.5L L4 1468cc	1992-1994	Base, GL, GS	US7115
GENESIS			
3.8L V6 3778cc	2009-2012	3.8	US6048
3.8L V6 3778cc	2013	3.8; From 04/11/2013	US6048
3.8L V6 3778cc	2013	3.8; To 04/11/2013	US6048
3.8L V6 3778cc	2014	3.8	US6048
GENESIS COUPE			
3.8L V6 3778cc	2010	3.8, 3.8 Grand Touring, 3.8 Track	US6048
3.8L V6 3778cc	2011	3.8, 3.8 Grand Touring, 3.8 R-Spec, 3.8 Track	US6048
3.8L V6 3778cc	2012	3.8 Grand Touring, 3.8 R-Spec, 3.8 Track	US6048
3.8L V6 3778cc	2013	3.8 Grand Touring, 3.8 R-Spec, 3.8 Track; From 04/13/2013	US6048
3.8L V6 3778cc	2013	3.8 Grand Touring, 3.8 R-Spec, 3.8 Track; To 04/13/2013	US6048
3.8L V6 3778cc	2014	3.8 Grand Touring, 3.8 R-Spec, 3.8 Ultimate	US6048
3.8L V6 3778cc	2015-2016	3.8, 3.8 R-Spec, 3.8 Ultimate	US6048
SANTA FE			
2.4L L4 2351cc	2001	GL	US9399
2.4L L4 2351cc	2002-2004	Base	US9399
2.4L L4 2359cc	2010-2012	GLS, Limited	US6220
2.7L V6 2656cc	2001	GL, GLS, LX	US9462
2.7L V6 2656cc	2002	GLS, LX	US9462
2.7L V6 2656cc	2003-2004	GLS	US9462
2.7L V6 2656cc	2005	Base, GLS	US9462
2.7L V6 2656cc	2006	GLS	US9462
2.7L V6 2656cc	2007-2009	GLS	US6215
3.3L V6 3342cc	2007	Limited, SE; From 01/29/2007	US6048
3.3L V6 3342cc	2007	Limited, SE; To 01/29/2007	US6048
3.3L V6 3342cc	2008-2009	Limited, SE	US6048
3.3L V6 3342cc	2013	GLS, Limited; From 04/11/2013	US6048
3.3L V6 3342cc	2013	GLS, Limited; To 04/11/2013	US6048
3.3L V6 3342cc	2014-2015	GLS, Limited	US6048
3.3L V6 3342cc	2016	Limited, SE	US6048
3.3L V6 3342cc	2017	Limited, Limited Ultimate, SE, SE Ultimate	US6048
3.5L V6 3467cc	2006	GLS, Limited	US9463
3.5L V6 3470cc	2010	Limited, SE	US6048
3.5L V6 3470cc	2011-2012	GLS, Limited, SE	US6048
3.5L V6 3500cc	2003-2005	GLS, LX	US9463
SANTA FE SPORT			
2.0L L4 1998cc 122 CID	2014-2016	2.0T	US6220
2.0L L4 1998cc 122 CID	2017	2.0T, 2.0T Ultimate	US8163
2.0L L4 1998cc 122 CID	2017	2.0T, 2.0T Ultimate; Pump only	US8163
2.4L L4 2359cc	2014-2016	Base	US8982
2.4L L4 2359cc	2017	Base	US8163
2.4L L4 2359cc	2017	Base; Pump only	US8163
SCOUBE			
1.5L L4 1468cc	1991-1992	Base, LS	US7115
1.5L L4 1495cc	1993-1995	Base, LS, Turbo	US7115
SONATA			
1.6L L4 1591cc 97 CID	2015-2017	Eco	US6247
2.0L L4 1997cc	1992-1993	Base, GLS	US9212
2.0L L4 1997cc	1994	Base, GL, GLS	US9212
2.0L L4 1997cc	1995-1998	Base, GL	US9212
2.0L L4 1998cc 122 CID	2011-2014	Limited, SE	US6220
2.0L L4 1998cc 122 CID	2015-2017	Limited 2.0T, Sport 2.0T	US8163
2.0L L4 1998cc 122 CID	2015-2017	Limited 2.0T, Sport 2.0T; Pump only	US8163
2.4L L4 2351cc	1989-1991	Base, GLS	US7118
2.4L L4 2351cc	1999-2004	Base	US9399
2.4L L4 2351cc	2005	GL	US9399
2.4L L4 2359cc	2006	GL, GLS	US6220
2.4L L4 2359cc	2007	GLS	US6220
2.4L L4 2359cc	2008-2010	GLS, Limited, SE	US6220
2.4L L4 2359cc	2011-2014	GLS, Limited, SE	US8982
2.4L L4 2359cc	2015-2017	Limited, SE, Sport	US8163
2.4L L4 2359cc	2015-2017	Limited, SE, Sport; Pump only	US8163
2.4L L4 2359cc 144 CID	2015-2016	Limited	US8163

Engine	Years	Application Description	USMW	Engine	Years	Application Description	USMW
HYUNDAI (cont'd.)				INFINITI (cont'd.)			
SONATA (cont'd.)				FX45			
2.5L V6 2493cc	1999-2001	GLS	US9462	4.5L V8 4494cc	2006-2008	Base	US6227
2.7L V6 2656cc	2002-2004	GLS, LX	US9462	4.5L V8 4500cc	2003-2005	Base	US6227
2.7L V6 2656cc	2005	GL, GLS, LX	US9462	FX50			
3.0L V6 2972cc	1990-1993	Base, GLS	US7121	5.0L V8 5026cc	2009-2013	Base	US9488
3.0L V6 2972cc	1990-1993	Base, GLS; With back plate housing	US7121-2	G20			
3.0L V6 2972cc	1994	Base, GL, GLS	US7121	2.0L L4 1998cc	1991-1993	Base	US9213
3.0L V6 2972cc	1994	Base, GL, GLS; With back plate housing	US7121-2	2.0L L4 1998cc	1994-1996	Base, T	US9213
3.0L V6 2972cc	1995-1998	GL, GLS	US7121	2.0L L4 2000cc	1999-2002	Base, T	US9213
3.0L V6 2972cc	1995-1998	GL, GLS; With back plate housing	US7121-2	G25			
3.3L V6 3342cc	2006	GLS, LX	US6048	2.5L V6 2496cc 152 CID	2011-2012	Base, Journey, X	US6198
3.3L V6 3342cc	2007	Limited, SE; From 05/22/2006	US6048	G35			
3.3L V6 3342cc	2007	Limited, SE; To 05/22/2006	US6048	3.5L V6 3498cc	2003	Base	US9426
3.3L V6 3342cc	2008-2009	GLS, Limited, SE	US6048	3.5L V6 3498cc	2004-2006	Base, X	US9426
3.3L V6 3342cc	2010	Limited, SE	US6048	3.5L V6 3498cc	2007	Base; (VQ35DE); From 03/07	US6198
TIBURON				3.5L V6 3498cc	2007	Base; (VQ35HR)	US8164
1.8L L4 1795cc	1997	Base	US9353	3.5L V6 3498cc	2007	Journey, Sport, X	US8164
2.0L L4 1975cc	1997	FX	US9353	3.5L V6 3498cc	2007	Base; (VQ35DE); To 03/2007	US9426
2.0L L4 1975cc	2003-2004	Base	US8972	3.5L V6 3498cc	2008	Base, Journey, Sport, X	US8164
2.0L L4 1975cc	2005-2008	GS	US8972	G37			
2.0L L4 1997cc	1998	Base, FX	US9353	3.7L V6 3696cc	2008	Base, Journey, Sport	US8164
2.0L L4 1997cc	1999	Base, FX; From 03/10/1999	US8972	3.7L V6 3696cc	2009-2010	Base, Journey, Sport, X	US8164
2.0L L4 1997cc	1999	Base, FX; To 03/10/1999	US9353	3.7L V6 3696cc	2011-2013	Base, IPL, Journey, Sport, X	US8164
2.0L L4 1997cc	2000-2001	Base	US8972	3.7L V6 3696cc 226 CID	2012	Base	US8164
2.7L V6 2656cc	2003-2004	GT	US9462	3.7L V6 3696cc 226 CID	2013	Base, Journey	US8164
2.7L V6 2656cc	2005-2006	GT, SE	US9462	I30			
2.7L V6 2656cc	2007-2008	GT, GT Limited, SE	US9462	3.0L V6 2988cc 182 CID	1996-2001	Base, T	US9309
TUCSON				I35			
1.6L L4 1591cc 97 CID	2016	Eco, Limited, Sport	US6247	3.5L V6 3498cc	2002-2004	Base	US9426
1.6L L4 1591cc 97 CID	2017	Eco, Limited, Sport, Value	US6247	J30			
2.0L L4 1975cc	2005-2006	GL	US8972	3.0L V6 2960cc 181 CID	1993-1997	Base, T	US9268
2.0L L4 1975cc	2007	GLS	US8972	JX35			
2.0L L4 1975cc	2008-2009	GLS, Limited	US8972	3.5L V6 3498cc	2013	Base	US6198
2.0L L4 1975cc	2011	GL	US6220	M30			
2.0L L4 1975cc	2012-2013	GL	US8982	3.0L V6 2960cc 181 CID	1990-1992	Base	US9058
2.0L L4 1999cc	2014-2015	GLS	US8106	M35			
2.0L L4 1999cc	2016	SE; From 08/28/2015	US8106	3.5L V6 3498cc	2006	Base, Sport, X	US9426
2.0L L4 1999cc	2016	SE; To 08/28/2015	US8106	3.5L V6 3498cc	2007	Base, Sport, X; From 03/07	US6198
2.0L L4 1999cc	2016-2017	SE	US8106	3.5L V6 3498cc	2007	Base, Sport, X; To 03/2007	US9426
2.4L L4 2359cc	2010-2011	GLS, Limited	US6220	3.5L V6 3498cc	2008	Base, X	US6198
2.4L L4 2359cc	2012-2013	GLS, Limited	US8982	3.5L V6 3498cc	2009-2010	Base, X	US8164
2.4L L4 2359cc	2014	Limited, SE; To 02/01/2014	US6220	M35H			
2.4L L4 2359cc	2014	Limited, SE; From 02/01/2014	US8982	3.5L V6 3498cc	2012-2013	Base	US8164
2.4L L4 2359cc	2014-2015	Limited, SE	US8982	M37			
2.7L V6 2656cc	2005	GLS, LX	US9462	3.7L V6 3696cc	2011-2013	Base, X	US8164
2.7L V6 2656cc	2006	GLS, Limited	US9462	3.7L V6 3696cc 226 CID	2012-2013	Base	US8164
2.7L V6 2656cc	2007-2009	Limited, SE	US9462	M45			
VELOSTER				4.5L V8 4494cc	2006-2007	Base, Sport	US6227
1.6L L4 1591cc 97 CID	2012	Base	US6247	4.5L V8 4494cc	2008-2010	Base, X	US6227
1.6L L4 1591cc 97 CID	2013	Base, Turbo	US6247	4.5L V8 4500cc	2003-2004		US6287
1.6L L4 1591cc 97 CID	2014-2015	Base, RE:FLEX, Turbo, Turbo R-Spec	US6247	M56			
1.6L L4 1591cc 97 CID	2016	Base, Rally Edition, Turbo, Turbo R-Spec	US6247	5.6L V8 5552cc	2011-2013	Base, X	US9488
1.6L L4 1591cc 97 CID	2017	Base, Turbo, Turbo R-Spec	US6247	Q40			
VERACRUZ				3.7L V6 3696cc	2015	Base	US8164
3.8L V6 3778cc	2007-2008	GLS, Limited, SE	US6048	Q45			
3.8L V6 3778cc	2009	GLS, Limited	US6048	4.1L V8 4130cc	1997-1999	Base, T	US9388
3.8L V6 3778cc	2010	GLS, Limited; From 11/03/2009	US6048	4.1L V8 4130cc	2000	Anniversary Edition, Base, T	US9388
3.8L V6 3778cc	2010	GLS, Limited; To 11/03/2009	US6048	4.1L V8 4130cc	2001	Base, T	US9388
3.8L V6 3778cc	2011-2012	GLS, Limited	US6048	4.5L V8 4494cc	1990	Base	US9239
XG300				4.5L V8 4494cc	1991-1992	A, Base	US9239
3.0L V6 2972cc	2001	Base, L	US9463	4.5L V8 4494cc	1993	A, Base; To 02/1993	US9239
XG350				4.5L V8 4494cc	1993	A, Base; From 02/1993	US9304
3.5L V6 3500cc	2002-2005	Base, L	US9463	4.5L V8 4494cc	1994-1996	A, Base, T	US9304
INFINITI				4.5L V8 4494cc	2002-2004		US6287
EX35				4.5L V8 4494cc	2005-2006	Base	US6227
3.5L V6 3498cc	2008-2012	Base, Journey	US8164	Q50			
EX37				3.5L V6 3498cc	2014-2015	Hybrid Premium, Hybrid Sport	US8164
3.7L V6 3696cc	2013	Base, Journey	US8164	3.5L V6 3498cc	2016-2017	Hybrid Premium	US8164
FX35				3.7L V6 3696cc	2014-2015	Base, Premium, Sport	US8164
3.5L V6 3498cc	2003-2006	Base	US9426	Q60			
3.5L V6 3498cc	2007	Base; From 03/07	US6198	3.7L V6 3696cc	2014	Base, IPL, Journey, S	US8164
3.5L V6 3498cc	2007	Base; To 03/2007	US9426	3.7L V6 3696cc	2015	Base, IPL, Journey, S, S Limited	US8164
3.5L V6 3498cc	2008	Base	US6198	Q70			
3.5L V6 3498cc	2009-2012	Base	US8164	3.5L V6 3498cc	2014-2017	Hybrid	US8164
FX37				3.7L V6 3696cc	2014-2017	3.7	US8164
3.7L V6 3696cc	2013	Base	US8164				
3.7L V6 3696cc 226 CID	2013	Base	US8164				

WATER PUMPS

Engine	Years	Application Description	USMW	Engine	Years	Application Description	USMW
INFINITI (cont'd.)				INTERNATIONAL (cont'd.)			
Q70 (cont'd.)				1000D (cont'd.)			
5.6L V8 5552cc	2014-2017	5.6	US9488	5.6L V8 5654cc 345 CID	1969-1970		US1099
Q70L				6.4L V8 6424cc 392 CID	1969-1970		US1099
3.7L V6 3696cc	2015-2017	3.7	US8164	1010			
5.6L V8 5552cc	2015-2017	5.6	US9488	5.0L V8 304 CID	1972-1973		US1099
QX4				5.0L V8 4982cc 304 CID	1971-1973		US1099
3.3L V6 3275cc	1997-2000	Base	US9338	5.0L V8 4983cc 304 CID	1972-1973		US1099
3.5L V6 3498cc	2001-2003	Base	US9309	5.6L V8 5654cc 345 CID	1971-1973		US1099
QX50				5.7L V8 345 CID	1971-1973		US1099
3.7L V6 3696cc	2014-2015	Base, Journey	US8164	6.4L V8 392 CID	1972-1973		US1099
3.7L V6 3696cc	2016-2017	Base	US8164	6.4L V8 6424cc 392 CID	1971-1973		US1099
QX56				6.4L V8 6425cc 392 CID	1972-1973		US1099
5.6L V8 5552cc	2004-2013	Base	US9488	1100A			
QX60				4.3L L6 4335cc 264 CID	1966		US1099
2.5L L4 2488cc 152 CID	2014-2017	Hybrid	US8105	4.3L V8 4360cc 266 CID	1966		US1099
3.5L V6 3498cc	2014-2016	Base	US6198	5.0L V8 304 CID	1966		US1099
QX70				5.0L V8 4982cc 304 CID	1966		US1099
3.7L V6 3696cc	2014-2017	Base	US8164	5.0L V8 4983cc 304 CID	1966		US1099
5.0L V8 5026cc	2014	Base	US9488	1100B			
QX80				4.3L L6 4335cc 264 CID	1967		US1099
5.6L V8 5552cc	2014-2015	Base	US9488	4.3L V8 4360cc 266 CID	1967		US1099
5.6L V8 5552cc	2016-2017	Base, Limited	US9488	5.0L V8 4982cc 304 CID	1967		US1099
5.6L V8 5552cc 339 CID	2014-2015	Base	US9488	5.6L V8 5654cc 345 CID	1967		US1099
INTERNATIONAL				1100C			
100				4.3L L6 4335cc 264 CID	1968		US1099
5.0L V8 304 CID	1974		US1099	4.3L V8 4360cc 266 CID	1968		US1099
5.0L V8 4982cc 304 CID	1974		US1099	5.0L V8 4982cc 304 CID	1968		US1099
5.0L V8 4983cc 304 CID	1974		US1099	5.0L V8 4983cc 304 CID	1968		US1099
5.6L V8 345 CID	1974		US1099	5.6L V8 5654cc 345 CID	1968		US1099
5.6L V8 5654cc 345 CID	1974		US1099	5.7L V8 345 CID	1971-1973		US1099
6.4L V8 392 CID	1974		US1099	6.4L V8 392 CID	1972-1973		US1099
6.4L V8 6424cc 392 CID	1974		US1099	6.4L V8 6424cc 392 CID	1971-1973		US1099
6.4L V8 6425cc 392 CID	1974		US1099	6.4L V8 6425cc 392 CID	1972-1973		US1099
150				1110			
5.0L V8 304 CID	1975		US1099	4.3L V8 4360cc 266 CID	1971		US1099
5.6L V8 345 CID	1975		US1099	5.0L V8 304 CID	1972-1973		US1099
6.4L V8 392 CID	1975		US1099	5.0L V8 4982cc 304 CID	1971-1973		US1099
200				5.0L V8 4983cc 304 CID	1972-1973		US1099
5.0L V8 304 CID	1974-1975		US1099	5.6L V8 5654cc 345 CID	1971-1973		US1099
5.0L V8 4982cc 304 CID	1974		US1099	5.7L V8 345 CID	1971-1973		US1099
5.0L V8 4983cc 304 CID	1974		US1099	6.4L V8 392 CID	1972-1973		US1099
5.6L V8 345 CID	1974-1975		US1099	6.4L V8 6424cc 392 CID	1971-1973		US1099
5.6L V8 5654cc 345 CID	1974		US1099	6.4L V8 6425cc 392 CID	1972-1973		US1099
6.4L V8 392 CID	1974-1975		US1099	1200A			
6.4L V8 6424cc 392 CID	1974		US1099	4.3L L6 4335cc 264 CID	1966		US1099
6.4L V8 6425cc 392 CID	1974		US1099	4.3L V8 4360cc 266 CID	1966		US1099
900A				5.0L V8 304 CID	1966		US1099
2.5L L4 2491cc 152 CID	1966-1967		US1099	5.0L V8 4982cc 304 CID	1966		US1099
908B				5.0L V8 4983cc 304 CID	1966		US1099
4.3L V8 4360cc 266 CID	1967		US1099	1200B			
5.0L V8 4982cc 304 CID	1967		US1099	4.3L L6 4335cc 264 CID	1967		US1099
908C				4.3L V8 4360cc 266 CID	1967		US1099
4.3L V8 4360cc 266 CID	1968-1969		US1099	4.3L V8 4360cc 266 CID	1967		US1099
5.0L V8 304 CID	1969		US1099	5.0L V8 4982cc 304 CID	1967		US1099
5.0L V8 4982cc 304 CID	1968-1969		US1099	5.6L V8 5654cc 345 CID	1967		US1099
5.0L V8 4983cc 304 CID	1969		US1099	1200C			
1000A				4.3L L6 4335cc 264 CID	1968		US1099
4.3L L6 4335cc 264 CID	1966		US1099	4.3L V8 4360cc 266 CID	1968		US1099
4.3L V8 4360cc 266 CID	1966		US1099	5.0L V8 4982cc 304 CID	1968		US1099
5.0L V8 4982cc 304 CID	1966		US1099	5.6L V8 5654cc 345 CID	1968		US1099
1000B				1200D			
4.3L L6 4335cc 264 CID	1967		US1099	4.3L L6 4335cc 264 CID	1969-1970		US1099
4.3L V8 4360cc 266 CID	1967		US1099	4.3L V8 4360cc 266 CID	1969-1970		US1099
5.0L V8 4982cc 304 CID	1967		US1099	5.0L V8 304 CID	1969-1970		US1099
5.6L V8 5654cc 345 CID	1967		US1099	5.0L V8 4982cc 304 CID	1969-1970		US1099
1000C				5.0L V8 4983cc 304 CID	1969-1970		US1099
4.3L L6 4335cc 264 CID	1968		US1099	5.6L V8 5654cc 345 CID	1969-1970		US1099
4.3L V8 4360cc 266 CID	1968		US1099	6.4L V8 6424cc 392 CID	1969-1970		US1099
5.0L V8 4982cc 304 CID	1968		US1099	1210			
5.6L V8 5654cc 345 CID	1968		US1099	5.0L V8 304 CID	1972-1973		US1099
1000D				5.0L V8 4982cc 304 CID	1971-1973		US1099
4.3L L6 4335cc 264 CID	1969-1970		US1099	5.0L V8 4983cc 304 CID	1972-1973		US1099
4.3L V8 4360cc 266 CID	1969-1970		US1099	5.6L V8 5654cc 345 CID	1971-1973		US1099
5.0L V8 304 CID	1969-1970		US1099	5.7L V8 345 CID	1971-1973		US1099
5.0L V8 4982cc 304 CID	1969-1970		US1099	6.4L V8 392 CID	1972-1973		US1099
5.0L V8 4983cc 304 CID	1969-1970		US1099	6.4L V8 6424cc 392 CID	1971-1973		US1099
5.0L V8 4983cc 304 CID	1969-1970		US1099	6.4L V8 6425cc 392 CID	1972-1973		US1099
1300A				1300A			
4.3L L6 4335cc 264 CID	1966		US1099	4.3L L6 4335cc 264 CID	1966		US1099

Engine	Years	Application Description	USMW	Engine	Years	Application Description	USMW
INTERNATIONAL (cont'd.)				INTERNATIONAL (cont'd.)			
1300A (cont'd.)				M800 (cont'd.)			
4.3L V8 4360cc 266 CID	1966		US1099	5.0L V8 4982cc 304 CID	1969-1971		US1099
5.0L V8 4982cc 304 CID	1966		US1099	5.0L V8 4983cc 304 CID	1969-1971		US1099
1300B				M1100			
4.3L L6 4335cc 264 CID	1967		US1099	2.5L L4 152 CID	1968		US1099
4.3L V8 4360cc 266 CID	1967		US1099	2.5L L4 152 CID	1971		US1099
5.0L V8 4982cc 304 CID	1967		US1099	2.5L L4 2491cc 152 CID	1966-1971		US1099
5.6L V8 5654cc 345 CID	1967		US1099	4.3L L6 4335cc 264 CID	1966-1970		US1099
1300C				M1200			
4.3L L6 4335cc 264 CID	1968		US1099	4.3L V8 4360cc 266 CID	1966-1970		US1099
4.3L V8 4360cc 266 CID	1968		US1099	5.0L V8 304 CID	1969-1972		US1099
5.0L V8 4982cc 304 CID	1968		US1099	5.0L V8 4982cc 304 CID	1966-1972		US1099
5.6L V8 5654cc 345 CID	1968		US1099	5.0L V8 4983cc 304 CID	1969-1972		US1099
1300D				M1400			
4.3L L6 4335cc 264 CID	1970		US1099	4.3L L6 4335cc 264 CID	1966-1967		US1099
4.3L V8 4360cc 266 CID	1970		US1099	4.3L V8 4360cc 266 CID	1966-1970		US1099
5.0L V8 304 CID	1969-1970		US1099	5.0L V8 304 CID	1969-1972		US1099
5.0L V8 4982cc 304 CID	1969-1970		US1099	5.0L V8 4982cc 304 CID	1969-1972		US1099
5.0L V8 4983cc 304 CID	1969-1970		US1099	5.0L V8 4983cc 304 CID	1969-1972		US1099
5.6L V8 5654cc 345 CID	1969-1970		US1099	M1400 METRO II			
6.4L V8 6424cc 392 CID	1969-1970		US1099	6.8L V8 420 CID	1987		US3705
1310				M1600 METRO II			
4.3L V8 4360cc 266 CID	1971		US1099	6.8L V8 420 CID	1987		US3705
5.0L V8 304 CID	1971-1973		US1099	7.3L V8 444 CID	1988-1990		US3705
5.0L V8 4982cc 304 CID	1971-1973		US1099	MA1200			
5.0L V8 4983cc 304 CID	1972-1973		US1099	4.3L V8 4360cc 266 CID	1967-1970		US1099
5.6L V8 5654cc 345 CID	1971-1973		US1099	5.0L V8 304 CID	1969-1971		US1099
5.7L V8 345 CID	1971-1973		US1099	5.0L V8 4982cc 304 CID	1967-1971		US1099
6.4L V8 392 CID	1972-1973		US1099	5.0L V8 4983cc 304 CID	1969-1971		US1099
6.4L V8 6424cc 392 CID	1971-1973		US1099	MHC1310			
6.4L V8 6425cc 392 CID	1972-1973		US1099	5.0L V8 304 CID	1974		US1099
1652SC				MS			
7.3L V8 444 CID	2004-2005	Medium/Heavy Duty	US66	5.6L V8 345 CID	1975		US1099
1652UPS				MS1210			
6.8L V8 420 CID	1990		US3705	6.4L V8 392 CID	1975		US1099
7.3L V8 444 CID	1990-1991		US3705	S1654			
3000				S1654LP			
7.3L V8 444 CID	1997-2000	Medium/Heavy Duty	US66	7.3L V8 444 CID	1988-1989		US3705
3000IC				S1723			
7.3L V8 444 CID	2000-2002	Medium/Heavy Duty	US66	6.6L V8 404 CID	1980		US3705
3400				S1724			
7.3L V8 444 CID	1996-2002	Medium/Heavy Duty	US66	6.6L V8 404 CID	1980		US3705
3600				S1753			
7.3L V8 444 CID	1992-1993		US3705	6.8L V8 420 CID	1984-1988		US3705
7.3L V8 444 CID	1994-1999	Medium/Heavy Duty	US66	7.3L V8 444 CID	1988-1989		US3705
3700				S1754			
6.8L V8 420 CID	1991		US3705	7.3L V8 444 CID	1988		US3705
7.3L V8 444 CID	1990-1993		US3705	S1823			
7.3L V8 444 CID	1994	Medium/Heavy Duty	US66	6.6L V8 404 CID	1980		US3705
3800				S1824			
6.8L V8 420 CID	1991		US3705	6.6L V8 404 CID	1980		US3705
7.3L V8 444 CID	1990		US3705	7.3L V8 446 CID	1980		US3705
7.3L V8 444 CID	1994-2004	Medium/Heavy Duty	US66	S1853			
4600LP				S1924			
7.3L V8 444 CID	1990-1993		US3705	7.3L V8 446 CID	1980		US3705
7.3L V8 444 CID	1994	Medium/Heavy Duty	US66	S1925			
4700LP				S1925			
7.3L V8 444 CID	1994-2002	Medium/Heavy Duty	US66	6.6L V8 404 CID	1980		US3705
4700LPX				S1925			
7.3L V8 444 CID	1995-2002	Medium/Heavy Duty	US66	S1925			
4900				S1925			
7.3L V8 444 CID	1991		US3705	S1925			
CARGOSTAR				S1925			
6.6L V8 404 CID	1980		US3705	S1925			
6.8L V8 420 CID	1984-1986		US3705	S1925			
7.3L V8 446 CID	1980		US3705	S1925			
F1954				S1925			
6.8L V8 420 CID	1986		US3705	S1925			
GENESIS RE				S1925			
7.3L V8 444 CID	1996-2002	Medium/Heavy Duty	US66	S1925			
M800				S1925			
2.5L L4 152 CID	1968		US1099	S1925			
2.5L L4 152 CID	1971		US1099	S1925			
2.5L L4 2491cc 152 CID	1966-1971		US1099	S1925			
5.0L V8 304 CID	1969-1971		US1099	S1925			

WATER PUMPS

Engine	Years	Application Description	USMW
INTERNATIONAL (cont'd.)			
S1925 (cont'd.)			
7.3L V8 446 CID	1980		US3705
SCOUT			
2.5L L4 152 CID	1968-1970		US1099
2.5L L4 2491cc 152 CID	1966-1971		US1099
4.3L L6 265 CID	1970		US1099
4.3L L6 4335cc 264 CID	1970		US1099
4.3L V8 4360cc 266 CID	1967-1968		US1099
5.0L V8 304 CID	1969-1970		US1099
5.0L V8 4982cc 304 CID	1969-1970		US1099
5.0L V8 4983cc 304 CID	1969-1970		US1099
SCOUT II			
5.0L V8 304 CID	1971-1975		US1099
5.0L V8 4982cc 304 CID	1971-1974		US1099
5.0L V8 4983cc 304 CID	1971-1974		US1099
5.6L V8 345 CID	1971		US1099
5.6L V8 345 CID	1975		US1099
5.6L V8 5654cc 345 CID	1971-1974		US1099
5.7L V8 345 CID	1972-1974		US1099
6.4L V8 392 CID	1975		US1099
TRAVELALL			
5.0L V8 304 CID	1975		US1099
5.6L V8 345 CID	1975		US1099
6.4L V8 392 CID	1975		US1099
ISUZU			
AMIGO			
2.2L L4 2180cc	1998-2000	S	US9375
2.3L L4 2254cc	1989	S, XS	US9105
2.3L L4 2254cc	1990	S, XS; From 12/1989	US9105
2.3L L4 2254cc	1990	S, XS; To 11/1989	US9105
2.3L L4 2254cc	1991	S, XS	US9105
2.3L L4 2254cc	1992	S	US9105
2.3L L4 2254cc	1993	S; From 07/1993	US9105
2.3L L4 2254cc	1993	S; To 06/1993	US9105
2.6L L4 2559cc	1989	S, XS	US9133
2.6L L4 2559cc	1990	S, XS; From 12/1989	US9133
2.6L L4 2559cc	1990	S, XS; To 11/1989	US9133
2.6L L4 2559cc	1991-1994	S, XS	US9133
3.2L V6 3165cc	1998-2000	S	US9365
ASCENDER			
4.2L L6 256 CID	2003	Base, Limited, LS	US5097
4.2L L6 256 CID	2004-2005	LS, S	US5097
4.2L L6 256 CID	2006	Base, LS	US5097
4.2L L6 256 CID	2007-2008	S	US5097
5.3L V8 5328cc 325 CID	2003	Base, Limited, LS	US64
5.3L V8 5328cc 325 CID	2003	Base, Limited, LS; Includes thermostat and thermostat housing	US64-T
5.3L V8 5328cc 325 CID	2004	Limited, LS	US64
5.3L V8 5328cc 325 CID	2004	Limited, LS; Includes thermostat and thermostat housing	US64-T
5.3L V8 5328cc 325 CID	2005	Limited, LS, S	US64
5.3L V8 5328cc 325 CID	2005	Limited, LS, S; Includes thermostat and thermostat housing	US64-T
5.3L V8 5328cc 325 CID	2006	LS	US64
5.3L V8 5328cc 325 CID	2006	LS; Includes thermostat and thermostat housing	US64-T
AXIOM			
3.5L V6 3475cc	2002	Base, XS	US9365
3.5L V6 3491cc	2003	Base, XS	US9365
3.5L V6 3494cc	2004	S, XS	US9365
FRR			
7.8L L6 475 CID	2000-2002	8 vane impeller, Medium/Heavy Duty	US73
HOMBRE			
2.2L L4 2190cc 134 CID	1996-2000	S, XS	US5032
4.3L V6 262 CID	2000	S, XS	US5077
4.3L V6 262 CID	2000	S, XS; High performance	US5077H
4.3L V6 4294cc	1997-1999	S, XS	US5077
4.3L V6 4294cc	1997-1999	S, XS; High performance	US5077H
I-280			
2.8L L4 2770cc 169 CID	2006	Base	US5097
I-290			
2.9L L4 2921cc 178 CID	2007	LS, S	US5097
2.9L L4 2921cc 178 CID	2008	S	US5097
I-350			
3.5L L5 3460cc 211 CID	2006	Base	US5097
I-370			
3.7L L5 3654cc 223 CID	2007-2008	LS	US5097
I-MARK			
1.5L L4 1471cc	1985	Base, DLX	US5031
1.5L L4 1471cc	1986	Base	US5031

Engine	Years	Application Description	USMW
ISUZU (cont'd.)			
I-MARK (cont'd.)			
1.5L L4 1471cc	1987	Base, S	US5031
1.5L L4 1471cc	1988	S, XS	US5031
1.5L L4 1471cc	1989	LS, S, XS	US5031
1.6L L4 1588cc	1989	RS	US9160
1.8L L4 1817cc	1981	Base, DLX	US1127
1.8L L4 1817cc	1982-1983	Base, DLX, LS	US1127
1.8L L4 1817cc	1983	Base, DLX, LS; DIESEL; From 02/1983	US5027
1.8L L4 1817cc	1984	Base, DLX	US1127
1.8L L4 1817cc	1984	Base, DLX; DIESEL	US5027
1.8L L4 1817cc	1985	Base	US1127
IMPULSE			
1.6L L4 1588cc	1990	XS	US9220
1.6L L4 1588cc	1991	RS, XS	US9220
1.6L L4 1588cc	1992	RS	US9220
1.8L L4 1809cc 110 CID	1992	XS	US9221
1.9L L4 1949cc	1983	Base	US1127
1.9L L4 1949cc	1984	Base, SE	US1127
1.9L L4 1949cc	1985-1987	Base	US1127
2.0L L4 1994cc	1985-1989	Base	US9106
2.0L L4 1994cc	1989		US9134
2.3L L4 2254cc	1988-1989	Base	US9105
OASIS			
2.2L L4 2156cc	1996-1997	LS, S	US9209
2.3L L4 2234cc	1999	LS, S	US9209
2.3L L4 2254cc	1998	LS, S	US9209
PICKUP			
1.8L L4 1817cc	1981-1982	Base, DLX	US1127
1.9L L4 1949cc	1983	Base, DLX, LS	US1127
1.9L L4 1949cc	1984-1985	Base, DLX, LX	US1127
1.9L L4 1949cc	1986-1987	Base, DLX, LS	US1127
2.2L L4 2238cc	1981-1982	Base, DLX	US9132
2.2L L4 2238cc	1983	Base, DLX, LS	US9132
2.2L L4 2238cc	1984-1985	Base, DLX, LX	US9132
2.2L L4 2238cc	1986-1987	Base, DLX, LS	US9132
2.3L L4 2254cc	1986-1987	Base, DLX, LS	US9105
2.3L L4 2254cc	1989	LS, S, XS	US9105
2.3L L4 2254cc	1990	LS, S; From 12/1989	US9105
2.3L L4 2254cc	1990	LS, S; To 11/1989	US9105
2.3L L4 2254cc	1991-1995	S	US9105
2.6L L4 2559cc	1988	1 Ton, LS, S	US9133
2.6L L4 2559cc	1989	1 Ton, LS, S, XS	US9133
2.6L L4 2559cc	1990	1 Ton, LS, S, XS; From 12/1989	US9133
2.6L L4 2559cc	1990	1 Ton, LS, S, XS; To 11/1989	US9133
2.6L L4 2559cc	1991-1992	1 Ton, LS, S	US9133
2.6L L4 2559cc	1993-1995	S	US9133
3.1L V6 3137cc	1991	LS, S	US5035
3.1L V6 3137cc	1992-1994	S	US5035
RODEO			
2.2L L4 2180cc	1998	S	US9375
2.2L L4 2180cc	1999-2000	LSE, S	US9375
2.2L L4 2180cc	2001-2002	S	US9375
2.2L L4 2180cc	2003	LS, LSE, S	US9375
2.6L L4 2559cc	1991	LS, S	US9133
2.6L L4 2559cc	1992	LS, S, XS	US9133
2.6L L4 2559cc	1993-1997	LS, S	US9133
3.1L V6 3137cc	1991-1992	LS, S, XS	US5035
3.2L V6 3165cc	1993-1994	LS, S	US9278
3.2L V6 3165cc	1995	LS, S; From 01/1995	US9278
3.2L V6 3165cc	1995	LS, S; To 12/1994	US9278
3.2L V6 3165cc	1996-1997	LS, S	US9278
3.2L V6 3165cc	1998	LS, S	US9365
3.2L V6 3165cc	1999-2000	LS, LSE, S	US9365
3.2L V6 3165cc	2001-2003	LS, LSE, S V6	US9365
3.2L V6 3165cc	2004	S	US9365
3.5L V6 3494cc	2004	S	US9365
RODEO SPORT			
2.2L L4 2180cc	2001	S	US9375
2.2L L4 2180cc	2002	S; From 08/01	US9375
2.2L L4 2180cc	2002	S; To 07/2001	US9375
2.2L L4 2180cc	2003	S	US9375
3.2L V6 3165cc	2001-2003	S V6	US9365
STYLUS			
1.6L L4 1588cc	1991	XS	US9220
1.6L L4 1588cc	1991-1993	S	US9221
1.8L L4 1809cc 110 CID	1992	RS	US9221
TROOPER			
1.9L L4 1949cc	1984-1985	Base	US1127
2.2L L4 2238cc	1984	Base	US1127
2.2L L4 2238cc	1986	DLX, LS, LX	US9132
2.2L L4 2238cc	1987	DLX, LS	US9132
2.3L L4 2254cc	1986	DLX, LS, LX	US9105
2.3L L4 2254cc	1987	DLX, LS	US9105

Engine	Years	Application Description	USMW	Engine	Years	Application Description	USMW
ISUZU (cont'd.)				JAGUAR (cont'd.)			
TROOPER (cont'd.)				XJRS			
2.6L L4 2559cc	1988	LS, S, XS; From 03/1988	US9133	6.0L V12 5994cc	1993	Base	US9165
2.6L L4 2559cc	1988	LS, S, XS; To 02/1988	US9133	XJS			
2.6L L4 2559cc	1989	LS, RS, S, XS	US9133	4.0L L6 3980cc	1993	Base; To Engine 163522	US9163
2.6L L4 2559cc	1990	RS, S	US9133	4.0L L6 3980cc	1993	Base; From Engine 163523, To Engine 196089	US9280
2.6L L4 2559cc	1991	S	US9133	4.0L L6 3980cc	1993	Base; From Engine B100136	US9356
2.8L V6 2827cc	1989	LS, S	US5035	4.0L L6 3980cc	1994	2+2, Base; To Engine 163522	US9163
2.8L V6 2827cc	1990	LS, S, XS	US5035	4.0L L6 3980cc	1994	2+2, Base; From Engine 163523, To Engine 196089	US9280
2.8L V6 2827cc	1991	LS, S, SE, XS	US5035	4.0L L6 3980cc	1994	2+2, Base; From Engine B100136	US9356
3.2L V6 3165cc	1992	LS, S	US9278	4.0L L6 3980cc	1995	2+2, Base	US9356
3.2L V6 3165cc	1993-1994	LS, RS, S	US9278	4.0L L6 3980cc	1996	2+2	US9356
3.2L V6 3165cc	1995	RS, S; From 01/1995	US9278	5.3L V12 5343cc	1976-1979		US9165
3.2L V6 3165cc	1995	RS, S; To 12/1994	US9278	5.3L V12 5343cc	1980	Base; From Engine 8S13094	US9165
3.2L V6 3165cc	1996	LS, S, SE	US9278	5.3L V12 5343cc	1980	Base; To Engine 8S13093	US9165
3.2L V6 3165cc	1997	LS, Ltd, S	US9278	5.3L V12 5343cc	1982-1986	Base	US9165
3.5L V6 3475cc	1998-1999	S	US9365	5.3L V12 5343cc	1987-1988	Base, C	US9165
3.5L V6 3475cc	2000-2002	Limited, LS, S	US9365	5.3L V12 5343cc	1989	Base, Collection Rouge	US9165
VEHICROSS				5.3L V12 5343cc	1990	Base, Classic Collection, Collection Rouge	US9165
3.5L V6 3475cc	1999-2001	Base	US9365	5.3L V12 5343cc	1991	Classic Collection	US9165
JAGUAR				5.3L V12 5343cc	1992	Base	US9165
S-TYPE				6.0L V12 5994cc	1994-1995	2+2, Base	US9165
3.0L V6 2968cc 181 CID	2000	Base; From Chassis/VIN L52823	US4118	XK			
3.0L V6 2968cc 181 CID	2000	Base; To Chassis/VIN L52822	US4118	4.2L V8 4196cc	2007-2009	Base	US4124
3.0L V6 2968cc 181 CID	2001-2002	Base	US4118	XK8			
3.0L V6 2968cc 181 CID	2003-2004	Base	US4129	4.0L V8 3996cc 244 CID	1997-2002	Base	US4124
3.0L V6 2968cc 181 CID	2005	Base, Sport	US4129	4.2L V8 4196cc	2003-2005	Base	US4124
3.0L V6 2968cc 181 CID	2006-2008	Base	US4129	4.2L V8 4196cc	2006	Base, Victory Edition	US4124
4.0L V8 3996cc 244 CID	2000-2002	Base	US4124	XKR			
4.2L V8 4196cc	2003-2004	Base, R	US4124	4.0L V8 3996cc 244 CID	2000	Base	US4124
4.2L V8 4196cc	2005	R, Sport	US4124	4.0L V8 3996cc 244 CID	2001	Base, Silverstone	US4124
4.2L V8 4196cc	2006	Base, R, VDP Edition	US4124	4.0L V8 3996cc 244 CID	2002	100, Base	US4124
4.2L V8 4196cc	2007-2008	Base, R	US4124	4.2L V8 4196cc	2003-2005	Base	US4124
SUPER V8				4.2L V8 4196cc	2006	Base, Victory Edition	US4124
4.2L V8 4196cc	2005	Base	US4124	4.2L V8 4196cc	2007	Base	US4124
4.2L V8 4196cc	2006	Base, Portfolio	US4124	4.2L V8 4196cc	2008-2009	Base, Portfolio	US4124
4.2L V8 4196cc	2007-2009	Base	US4124	X-TYPE			
VANDEN PLAS				2.5L V6 152 CID	2002-2005	Base	US6657
3.6L L6 3590cc	1988	Base; 80 Amp, Lucas Alternator	US9163	3.0L V6 2968cc 181 CID	2002-2004	Base	US6657
3.6L L6 3590cc	1988	Base; 90, 115 Amp, Bosch Alternator	US9163	3.0L V6 2968cc 181 CID	2005	Base, Premium, Vanden Plas	US6657
3.6L L6 3590cc	1989	Base, Majestic; 80 Amp, Lucas Alternator	US9163	3.0L V6 2968cc 181 CID	2006	Base, Sport, VDP Edition	US6657
3.6L L6 3590cc	1989	Base, Majestic; 90, 115 Amp, Bosch Alternator	US9163	3.0L V6 2968cc 181 CID	2007-2008	Base	US6657
4.0L L6 3980cc	1990	Base, Majestic	US9163	JEEP			
4.0L L6 3980cc	1991	Base	US9163	CHEROKEE			
4.0L L6 3980cc	1992	Base, Majestic	US9163	2.1L L4 126 CID	1985-1987	Base, Chief, Laredo, Pioneer	US3409
4.0L L6 3980cc	1993-1994	Base	US9280	2.4L L4 2360cc 144 CID	2014-2015	Latitude, Limited, Sport, Trailhawk	US6038
4.0L L6 3980cc	1995-1997	Base	US9356	2.4L L4 2360cc 144 CID	2016	75th Anniversary, Latitude, Limited, Overland, Sport, Trailhawk	US6038
4.0L V8 3996cc 244 CID	1998-1999	Base	US4124	2.4L L4 2360cc 144 CID	2017-2018	Latitude, Limited, Overland, Sport, Trailhawk	US6038
4.0L V8 3996cc 244 CID	2000-2003	Base, SC	US4124	2.5L L4 150 CID	1984	Base; V-Belt Drive	US3403
4.2L V8 4196cc	2004-2009	Base	US4124	2.5L L4 150 CID	1984	Base; Serpentine Belt Drive	US3413
XF				2.5L L4 150 CID	1984	Base; Heater fitting required, V-Belt Drive	US3414
4.2L V8 4196cc	2009	Luxury, Premium Luxury, Supercharged	US4124	2.5L L4 150 CID	1985-1988	Base, Chief, Laredo, Pioneer; V-Belt Drive	US3403
4.2L V8 4196cc	2010	Base	US4124	2.5L L4 150 CID	1985-1988	Base, Chief, Laredo, Pioneer; Serpentine Belt Drive	US3413
XJ6				2.5L L4 150 CID	1985-1988	Base, Chief, Laredo, Pioneer; Heater fitting required, V-Belt Drive	US3414
3.6L L6 3590cc	1988-1989	Base; 80 Amp, Lucas Alternator	US9163	2.5L L4 150 CID	1989	Base, Laredo, Pioneer, Sport; V-Belt Drive	US3403
3.6L L6 3590cc	1988-1989	Base; 90, 115 Amp, Bosch Alternator	US9163	2.5L L4 150 CID	1989	Base, Laredo, Pioneer, Sport; Serpentine Belt Drive	US3413
4.0L L6 3980cc	1990-1992	Base, Sovereign	US9163	2.5L L4 150 CID	1989	Base, Laredo, Pioneer, Sport; Heater fitting required, V-Belt Drive	US3414
4.0L L6 3980cc	1993	Base, Sovereign	US9280	2.5L L4 150 CID	1990	Base; V-Belt Drive	US3403
4.0L L6 3980cc	1994	Base	US9280	2.5L L4 150 CID	1990	Base; Serpentine Belt Drive	US3413
4.0L L6 3980cc	1995-1996	Base	US9356	2.5L L4 150 CID	1990	Base; Heater fitting required, V-Belt Drive	US3414
4.0L L6 3980cc	1997	Base, L	US9356	2.5L L4 150 CID	1991-1993	Base	US7136
4.2L L6 4235cc	1975-1979		US9211	2.5L L4 150 CID	1994-2000	SE	US7136
4.2L L6 4235cc	1980	L	US9211	2.8L V6 173 CID	1984	Base	US5006
4.2L L6 4235cc	1981	Base	US9211	2.8L V6 173 CID	1985-1986	Base, Chief, Laredo, Pioneer	US5006
4.2L L6 4235cc	1982	Base; To Chassis/VIN 330665	US9211	3.2L V6 3239cc 198 CID	2014-2015	Latitude, Limited, Trailhawk	US8114
XJ8				3.2L V6 3239cc 198 CID	2016	75th Anniversary, Latitude, Limited, Overland, Sport, Trailhawk	US8114
4.0L V8 3996cc 244 CID	1998-2001	Base, L	US4124	3.2L V6 3239cc 198 CID	2017-2018	Latitude, Limited, Overland, Sport, Trailhawk	US8114
4.0L V8 3996cc 244 CID	2002-2003	Base, Sport	US4124	4.0L L6 242 CID	1987-1988	Base, Chief, Laredo, Limited, Pioneer	US3412
4.2L V8 4196cc	2004	Base	US4124	4.0L L6 242 CID	1989-1990	Base, Laredo, Limited, Pioneer, Sport	US3412
4.2L V8 4196cc	2005-2009	Base, L	US4124	4.0L L6 242 CID	1991-1992	Base, Briarwood, Laredo, Limited, Sport	US3412
XJ12				4.0L L6 242 CID	1993	Base, Country, Sport	US3412
5.3L V12 5343cc	1975-1979		US9165				
6.0L V12 5994cc	1994-1996	Base	US9165				
XJR							
4.0L L6 3980cc	1995-1997	Base	US9356				
4.0L V8 3996cc 244 CID	1998-2001	Base	US4124				
4.0L V8 3996cc 244 CID	2002	100, Base	US4124				
4.0L V8 3996cc 244 CID	2003	Base	US4124				
4.2L V8 4196cc	2004-2009	Base	US4124				

WATER PUMPS

Engine	Years	Application Description	USMWW	Engine	Years	Application Description	USMWW
JEEP (cont'd.)				JEEP (cont'd.)			
CHEROKEE (cont'd.)				CJ6 (cont'd.)			
4.0L L6 242 CID	1994-1995	Country, SE, Sport	US3412	3.7L V6 225 CID	1968		US855
4.0L L6 242 CID	1996	Classic, Country, SE, Sport	US3412	3.7L V6 3687cc 225 CID	1966-1971		US855
4.0L L6 242 CID	1997	Country, SE, Sport	US3412	CJ6A			
4.0L L6 242 CID	1998-2001	Classic, Limited, SE, Sport	US3412	CJ7			
4.2L L6 258 CID	1975-1979		US1077	3.7L V6 3687cc 225 CID	1966-1968		US855
4.2L L6 258 CID	1980	Base, Wide Track	US3403	CJ7			
4.2L L6 258 CID	1980	Base, Wide Track; Heater fitting required, V-Belt Drive	US3414	2.5L L4 150 CID	1983	Base, Laredo, Limited, Renegade; V-Belt Drive	US3403
4.2L L6 258 CID	1981-1982	Base, Chief; V-Belt Drive	US3403	2.5L L4 150 CID	1983	Base, Laredo, Limited, Renegade; Serpentine Belt Drive	US3413
4.2L L6 258 CID	1981-1982	Base, Chief; Serpentine Belt Drive	US3413	2.5L L4 150 CID	1983	Base, Laredo, Limited, Renegade; Heater fitting required, V-Belt Drive	US3414
4.2L L6 258 CID	1981-1982	Base, Chief; Heater fitting required, V-Belt Drive	US3414	2.5L L4 150 CID	1984	Base, Renegade; V-Belt Drive	US3403
4.2L L6 258 CID	1983	Base, Chief, Pioneer; V-Belt Drive	US3403	2.5L L4 150 CID	1984	Base, Renegade; Serpentine Belt Drive	US3413
4.2L L6 258 CID	1983	Base, Chief, Pioneer; Serpentine Belt Drive	US3413	2.5L L4 150 CID	1984	Base, Renegade; Heater fitting required, V-Belt Drive	US3414
4.2L L6 258 CID	1983	Base, Chief, Pioneer; Heater fitting required, V-Belt Drive	US3414	2.5L L4 150 CID	1985-1986	Base, Laredo, Renegade; V-Belt Drive	US3403
5.9L V8 360 CID	1975-1979		US3401	2.5L L4 150 CID	1985-1986	Base, Laredo, Renegade; Serpentine Belt Drive	US3413
5.9L V8 360 CID	1975-1979	High performance	US3401H	2.5L L4 150 CID	1985-1986	Base, Laredo, Renegade; Heater fitting required, V-Belt Drive	US3414
5.9L V8 360 CID	1980	Base, Wide Track	US3401	2.5L L4 151 CID	1980	Base, Golden Hawk, Laredo, Renegade	US1107
5.9L V8 360 CID	1980	Base, Wide Track; High performance	US3401H	2.5L L4 151 CID	1981	Base, Laredo, Renegade	US1107
5.9L V8 360 CID	1981-1982	Base, Chief	US3401	2.5L L4 151 CID	1981	Base, Laredo, Renegade; V-Belt Drive	US3403
5.9L V8 360 CID	1981-1982	Base, Chief; High performance	US3401H	2.5L L4 151 CID	1981	Base, Laredo, Renegade; Serpentine Belt Drive	US3413
5.9L V8 360 CID	1983	Base, Chief, Pioneer	US3401	2.5L L4 151 CID	1981	Base, Laredo, Renegade; Heater fitting required, V-Belt Drive	US3414
5.9L V8 360 CID	1983	Base, Chief, Pioneer; High performance	US3401H	2.5L L4 151 CID	1982	Base, Laredo, Limited, Renegade; V-Belt Drive	US3403
6.6L V8 401 CID	1975-1978		US3401	2.5L L4 151 CID	1982	Base, Laredo, Limited, Renegade; Serpentine Belt Drive	US3413
6.6L V8 401 CID	1975-1978	High performance	US3401H	2.5L L4 151 CID	1982	Base, Laredo, Limited, Renegade; Heater fitting required, V-Belt Drive	US3414
CJ3				2.5L L4 151 CID	1982	Base, Laredo, Limited, Renegade; Heater fitting required, V-Belt Drive	US3413
3.7L V6 3687cc 225 CID	1966		US855	2.5L L4 151 CID	1982	Base, Laredo, Limited, Renegade; Serpentine Belt Drive	US3413
CJ5				2.5L L4 151 CID	1982	Base, Laredo, Limited, Renegade; Heater fitting required, V-Belt Drive	US3414
2.2L L4 2197cc 134 CID	1959-1971	Single groove pulley	US52	2.5L L4 151 CID	1982	Base, Laredo, Limited, Renegade; Heater fitting required, V-Belt Drive	US3414
2.5L L4 151 CID	1980	Base, Golden Eagle, Laredo, Renegade	US1107	2.5L L4 151 CID	1982-1983	Base, Laredo, Limited, Renegade	US1107
2.5L L4 151 CID	1981	Base, Laredo, Renegade; V-Belt Drive	US3403	3.8L L6 232 CID	1976-1978		US1077
2.5L L4 151 CID	1981	Base, Laredo, Renegade; Serpentine Belt Drive	US3413	3.8L L6 3800cc 232 CID	1965-1974	Mexican Application	US1021
2.5L L4 151 CID	1981	Base, Laredo, Renegade; Heater fitting required, V-Belt Drive	US3414	3.8L L6 3800cc 232 CID	1975	Mexican Application	US1077
2.5L L4 151 CID	1982-1983	Base, Laredo, Limited, Renegade; V-Belt Drive	US3403	4.2L L6 258 CID	1976-1979		US1077
2.5L L4 151 CID	1982-1983	Base, Laredo, Limited, Renegade; Serpentine Belt Drive	US3413	4.2L L6 258 CID	1980	Base, Golden Hawk, Laredo, Renegade	US3403
2.5L L4 151 CID	1982-1983	Base, Laredo, Limited, Renegade; Heater fitting required, V-Belt Drive	US3414	4.2L L6 258 CID	1980	Base, Golden Hawk, Laredo, Renegade; Heater fitting required, V-Belt Drive	US3414
3.7L V6 3687cc 225 CID	1966-1971		US855	4.2L L6 258 CID	1981	Base, Laredo, Renegade; V-Belt Drive	US3403
4.2L L6 258 CID	1980	Base, Golden Eagle, Laredo, Renegade; V-Belt Drive	US3403	4.2L L6 258 CID	1981	Base, Laredo, Renegade; Serpentine Belt Drive	US3413
4.2L L6 258 CID	1980	Base, Golden Eagle, Laredo, Renegade; Serpentine Belt Drive	US3413	4.2L L6 258 CID	1981	Base, Laredo, Renegade; Heater fitting required, V-Belt Drive	US3414
4.2L L6 258 CID	1980	Base, Golden Eagle, Laredo, Renegade; Heater fitting required, V-Belt Drive	US3414	4.2L L6 258 CID	1982-1983	Base, Laredo, Limited, Renegade; V-Belt Drive	US3403
4.2L L6 258 CID	1981	Base, Laredo, Renegade; V-Belt Drive	US3403	4.2L L6 258 CID	1982-1983	Base, Laredo, Limited, Renegade; Serpentine Belt Drive	US3413
4.2L L6 258 CID	1981	Base, Laredo, Renegade; Serpentine Belt Drive	US3413	4.2L L6 258 CID	1982-1983	Base, Laredo, Limited, Renegade; Heater fitting required, V-Belt Drive	US3414
4.2L L6 258 CID	1981	Base, Laredo, Renegade; Heater fitting required, V-Belt Drive	US3414	4.2L L6 258 CID	1984	Base, Renegade; V-Belt Drive	US3403
4.2L L6 258 CID	1982-1983	Base, Laredo, Limited, Renegade; V-Belt Drive	US3403	4.2L L6 258 CID	1984	Base, Renegade; Serpentine Belt Drive	US3413
4.2L L6 258 CID	1982-1983	Base, Laredo, Limited, Renegade; Serpentine Belt Drive	US3413	4.2L L6 258 CID	1984	Base, Renegade; Heater fitting required, V-Belt Drive	US3414
4.2L L6 258 CID	1982-1983	Base, Laredo, Limited, Renegade; Heater fitting required, V-Belt Drive	US3414	4.2L L6 258 CID	1985-1986	Base, Laredo, Renegade; V-Belt Drive	US3403
5.0L V8 304 CID	1980	Base, Golden Eagle, Laredo, Renegade	US3401	4.2L L6 258 CID	1985-1986	Base, Laredo, Renegade; Serpentine Belt Drive	US3413
5.0L V8 304 CID	1980	Base, Golden Eagle, Laredo, Renegade; High performance	US3401H	4.2L L6 258 CID	1985-1986	Base, Laredo, Renegade; Heater fitting required, V-Belt Drive	US3414
5.0L V8 304 CID	1981	Base, Laredo, Renegade	US3401	4.2L L6 4200cc 258 CID	1965-1974	Mexican Application	US1021
5.0L V8 304 CID	1981	Base, Laredo, Renegade; High performance	US3401H	4.2L L6 4200cc 258 CID	1975-1978	Mexican Application	US1077
5.0L V8 304 CID	1981	Base, Laredo, Renegade; High performance	US3401H	4.6L L6 4600cc 282 CID	1973	Mexican Application	US1021
CJ5A				4.6L L6 4600cc 282 CID	1974-1983	Mexican Application	US1077
3.7L V6 3687cc 225 CID	1966-1968		US855	4.6L L6 4600cc 282 CID	1980-1986	Mexican Application	US3403
CJ5D				5.0L V8 304 CID	1976-1979		US3401
3.8L L6 3800cc 232 CID	1965-1971	Mexican Application	US1021	5.0L V8 304 CID	1976-1979	High performance	US3401H
4.2L L6 4200cc 258 CID	1965-1971	Mexican Application	US1021	5.0L V8 304 CID	1980	Base, Golden Hawk, Laredo, Renegade	US3401
4.2L L6 4200cc 258 CID	1975-1978	Mexican Application	US3403	5.0L V8 304 CID	1980	Base, Golden Hawk, Laredo, Renegade; High performance	US3401H
4.2L L6 4200cc 258 CID	1984-1986	Mexican Application	US3403	5.0L V8 304 CID	1981	Base, Laredo, Renegade	US3401
4.6L L6 4600cc 282 CID	1973-1974	Mexican Application	US1077	5.0L V8 304 CID	1981	Base, Laredo, Renegade; High performance	US3401H
4.6L L6 4600cc 282 CID	1975-1986	Mexican Application	US3403	CJ10			
4.6L L6 4600cc 282 CID	1978-1983	Mexican Application	US1077	4.6L L6 4600cc 282 CID	1984-1985	Mexican Application	US3403
CJ5S				COMANCHE			
3.8L L6 3800cc 232 CID	1965-1971	Mexican Application	US1021	2.1L L4 126 CID	1986	Custom, X, XLS	US3409
4.2L L6 4200cc 258 CID	1965-1971	Mexican Application	US1021	2.1L L4 126 CID	1987	Base, Laredo, Pioneer	US3409
CJ6				2.5L L4 150 CID	1986	Custom, X, XLS; V-Belt Drive	US3403
2.2L L4 2197cc 134 CID	1959-1971	Single groove pulley	US52	2.5L L4 150 CID	1986	Custom, X, XLS; Serpentine Belt Drive	US3413
				2.5L L4 150 CID	1986	Custom, X, XLS; Heater fitting required, V-Belt Drive	US3414
				2.5L L4 150 CID	1987-1988	Base, Chief, Laredo, Pioneer; V-Belt Drive	US3403

Engine	Years	Application Description	USMW	Engine	Years	Application Description	USMW
JEEP (cont'd.)				JEEP (cont'd.)			
COMANCHE (cont'd.)				GRAND CHEROKEE (cont'd.)			
2.5L L4 150 CID	1987-1988	Base, Chief, Laredo, Pioneer; Serpentine Belt Drive	US3413	4.0L L6 242 CID	2004	Laredo, Limited, Special Edition	US7164
2.5L L4 150 CID	1987-1988	Base, Chief, Laredo, Pioneer; Heater fitting required, V-Belt Drive	US3414	4.7L V8 287 CID	1999-2001	Laredo, Limited	US7163
2.5L L4 150 CID	1989-1990	Base, Pioneer; V-Belt Drive	US3403	4.7L V8 287 CID	2002	Laredo, Limited, Overland, Sport	US7163
2.5L L4 150 CID	1989-1990	Base, Pioneer; Serpentine Belt Drive	US3413	4.7L V8 287 CID	2003	Laredo, Limited, Overland	US7163
2.5L L4 150 CID	1989-1990	Base, Pioneer; Heater fitting required, V-Belt Drive	US3414	4.7L V8 287 CID	2004	Laredo, Limited, Overland, Special Edition	US7163
2.5L L4 150 CID	1991	Base, Pioneer	US7136	4.7L V8 287 CID	2005	Laredo, Limited	US7163
2.5L L4 150 CID	1992	Base	US7136	4.7L V8 287 CID	2006	65th Anniversary Edition, Laredo, Limited	US7163
2.8L V6 173 CID	1986	Custom, X, XLS	US5006	4.7L V8 287 CID	2007-2009	Laredo, Limited	US7163
4.0L L6 242 CID	1987	Base, Chief, Laredo, Pioneer	US3412	4.7L V8 4700cc 287 CID	2008	Mexican Application	US7163
4.0L L6 242 CID	1988	Base, Chief, Eliminator, Laredo, Pioneer	US3412	5.2L V8 5211cc 318 CID	1993	Base, Laredo, Limited	US7160
4.0L L6 242 CID	1989-1992	Base, Eliminator, Pioneer	US3412	5.2L V8 5211cc 318 CID	1994	Laredo, Limited, SE	US7160
COMMANDER				GRAND CHEROKEE (cont'd.)			
3.7L V6 226 CID	2006	65th Anniversary Edition, Base	US7163	5.2L V8 5211cc 318 CID	1995	Laredo, Limited, Orvis, SE	US7160
3.7L V6 226 CID	2007	Base, Sport	US7163	5.2L V8 5211cc 318 CID	1996	Laredo, Limited	US7160
3.7L V6 226 CID	2008-2010	Sport	US7163	5.2L V8 5211cc 318 CID	1997	Laredo, Limited, Orvis, TSi	US7160
4.7L V8 287 CID	2006	65th Anniversary Edition, Base, Limited	US7163	5.2L V8 5211cc 318 CID	1998	Laredo, Limited, TSi	US7160
4.7L V8 287 CID	2007	Base, Limited, Sport	US7163	5.7L V8 345 CID	2005	Limited	US8940
4.7L V8 287 CID	2008-2009	Limited, Sport	US7163	5.7L V8 345 CID	2006-2008	Limited, Overland	US8940
5.7L V8 345 CID	2006	Limited	US8940	5.7L V8 345 CID	2009	Limited, Overland	US8979
5.7L V8 345 CID	2007-2008	Limited, Overland	US8940	5.7L V8 345 CID	2010	Laredo, Limited	US8979
5.7L V8 345 CID	2009	Limited, Overland	US8979	5.7L V8 345 CID	2011	Laredo, Limited, Overland	US8971
5.7L V8 345 CID	2010	Limited, Sport	US8979	5.7L V8 345 CID	2012	Laredo, Limited, Overland, Overland Summit	US8971
5.7L V8 5654cc 345 CID	2010	Mexican Application	US8971	5.7L V8 345 CID	2013	Laredo, Limited, Overland	US8115
COMMANDO				GRAND CHEROKEE (cont'd.)			
3.7L V6 3687cc 225 CID	1966-1971		US855	5.7L V8 345 CID	2014-2016	Limited, Overland, Summit	US8115
COMPASS				GRAND CHEROKEE (cont'd.)			
2.0L L4 1998cc 122 CID	2008-2010	Sport	US6038	5.7L V8 345 CID	2017	Limited, Overland, Summit, Trailhawk	US8115
2.0L L4 1998cc 122 CID	2011	Base, Latitude	US6038	5.7L V8 345 CID	2018	High Altitude, Limited, Overland, Summit, Trailhawk	US8115
2.0L L4 1998cc 122 CID	2012-2017	Latitude, Sport	US6038	5.7L V8 5654cc 345 CID	2011-2013	Mexican Application	US8971
2.4L L4 2360cc 144 CID	2007	Limited	US6038	5.9L V8 360 CID	1998	5.9 Limited	US7160
2.4L L4 2360cc 144 CID	2008-2010	Limited, Sport	US6038	6.1L V8 6059cc 370 CID	2006-2010	SRT8	US8940
2.4L L4 2360cc 144 CID	2011	Base, Latitude, Limited	US6038	6.4L V8 6424cc 392 CID	2012	SRT8	US8971
2.4L L4 2360cc 144 CID	2012-2014	Latitude, Limited, Sport	US6038	6.4L V8 6424cc 392 CID	2013	SRT8	US8115
2.4L L4 2360cc 144 CID	2015	Altitude, High Altitude, Latitude, Limited, Sport	US6038	6.4L V8 6424cc 392 CID	2014-2018	SRT	US8115
2.4L L4 2360cc 144 CID	2016	75th Anniversary, Latitude, Sport	US6038	GRAND WAGONEER			
2.4L L4 2360cc 144 CID	2017-2018	Latitude, Limited, Sport, Trailhawk	US6038	4.2L L6 258 CID	1984-1985	Base, Limited; V-Belt Drive	US3403
DISPATCHER				GRAND WAGONEER			
3.7L V6 3687cc 225 CID	1966-1969		US855	4.2L L6 258 CID	1984-1985	Base, Limited; Serpentine Belt Drive	US3413
DJ5				GRAND WAGONEER			
3.7L V6 3687cc 225 CID	1966-1971		US855	4.2L L6 258 CID	1984-1985	Base, Limited; Heater fitting required, V-Belt Drive	US3414
DJ6				GRAND WAGONEER			
3.7L V6 3687cc 225 CID	1966-1968		US855	4.2L L6 258 CID	1986	Base; V-Belt Drive	US3403
FC150				GRAND WAGONEER			
3.7L L6 3704cc 226 CID	1966		US855	4.2L L6 258 CID	1986	Base; Serpentine Belt Drive	US3413
3.7L V6 3687cc 225 CID	1966		US855	4.2L L6 258 CID	1986	Base; Heater fitting required, V-Belt Drive	US3414
FC170HD				GRAND WAGONEER			
3.7L L6 3687cc 225 CID	1966		US855	5.2L V8 5211cc 318 CID	1993	Base	US7160
GRAND CHEROKEE				GRAND WAGONEER			
3.0L V6 2985cc 182 CID	2007-2009	Laredo, Limited, Overland	US6155	5.9L V8 360 CID	1984-1985	Base, Limited	US3401
3.0L V6 2987cc 182 CID	2014-2016	Limited, Overland, Summit	US8161	5.9L V8 360 CID	1984-1985	Base, Limited; High performance	US3401H
3.0L V6 2987cc 182 CID	2017	Limited, Overland, Summit, Trailhawk	US8161	5.9L V8 360 CID	1986-1991	Base	US3401
3.0L V6 2987cc 182 CID	2018	High Altitude, Limited, Overland, Summit, Trailhawk	US8161	5.9L V8 360 CID	1986-1991	Base; High performance	US3401H
3.6L V6 3604cc 220 CID	2011	Laredo, Limited, Overland	US8981	6.6L V8 401 CID	1975-1978	High performance	US3401H
3.6L V6 3604cc 220 CID	2011-2014	Mexican Application	US8981	J20			
3.6L V6 3604cc 220 CID	2012	Laredo, Limited, Overland, Overland Summit	US8981	4.2L L6 258 CID	1976		US1077
3.6L V6 3604cc 220 CID	2013	Laredo, Limited, Overland	US8981	5.9L V8 360 CID	1975-1979		US3401
3.6L V6 3604cc 220 CID	2014-2015	Laredo, Limited, Overland, Summit	US8981	5.9L V8 360 CID	1975-1979	High performance	US3401H
3.6L V6 3604cc 220 CID	2016	75th Anniversary, Laredo, Limited, Overland, Summit	US8160	5.9L V8 360 CID	1980-1988	Base	US3401
3.6L V6 3604cc 220 CID	2017	Laredo, Limited, Overland, Summit, Trailhawk	US8160	5.9L V8 360 CID	1980-1988	Base; High performance	US3401H
3.6L V6 3604cc 220 CID	2018	Altitude, High Altitude, Laredo, Limited, Overland, Summit, Trailhawk	US8160	6.6L V8 401 CID	1975-1978	High performance	US3401H
3.7L V6 226 CID	2005	Laredo	US7163	6.6L V8 401 CID	1975-1978	High performance	US3401H
3.7L V6 226 CID	2006	65th Anniversary Edition, Laredo	US7163	J100			
3.7L V6 226 CID	2007-2009	Laredo	US7163	4.6L L6 4600cc 282 CID	1980-1983	Mexican Application	US1077
3.7L V6 226 CID	2010	Laredo, Limited	US7163	4.6L L6 4600cc 282 CID	1980-1986	Mexican Application	US3403
4.0L L6 242 CID	1993	Base, Laredo, Limited	US7136	J162			
4.0L L6 242 CID	1994	Laredo, Limited, SE	US7136	3.8L L6 3800cc 232 CID	1968-1969	Mexican Application	US1021
4.0L L6 242 CID	1995	Laredo, Limited, Orvis, SE	US7136	4.2L L6 4200cc 258 CID	1965	Mexican Application	US1021
4.0L L6 242 CID	1996	Laredo, Limited	US7136	4.2L L6 4200cc 258 CID	1968-1969	Mexican Application	US1021
4.0L L6 242 CID	1997	Laredo, Limited, Orvis, TSi	US7136	J164			
4.0L L6 242 CID	1998	Laredo, Limited, TSi	US7136	3.8L L6 3800cc 232 CID	1967-1972	Mexican Application	US1021
4.0L L6 242 CID	1999-2001	Laredo, Limited	US7164	4.2L L6 4200cc 258 CID	1965-1972	Mexican Application	US1021
4.0L L6 242 CID	2002	Laredo, Limited, Sport	US7164	4.6L L6 4600cc 282 CID	1973-1983	Mexican Application	US1077
4.0L L6 242 CID	2003	Laredo, Limited	US7164	4.6L L6 4600cc 282 CID	1980-1986	Mexican Application	US3403

WATER PUMPS



WATER PUMP APPLICATION GUIDE



Engine	Years	Application Description	USMW	Engine	Years	Application Description	USMW
JEEP (cont'd.)				JEEP (cont'd.)			
J164V				SCRAMBLER (cont'd.)			
3.8L L6 3800cc 232 CID	1967-1972	Mexican Application	US1021	2.5L L4 151 CID	1982	Base, SL, SR; Heater fitting required, V-Belt Drive	US3414
4.2L L6 4200cc 258 CID	1965-1972	Mexican Application	US1021	2.5L L4 151 CID	1982-1983	Base, SL, SR	US1107
4.6L L6 4600cc 282 CID	1973-1983	Mexican Application	US1077	4.2L L6 258 CID	1981	Base; V-Belt Drive	US3403
4.6L L6 4600cc 282 CID	1980-1986	Mexican Application	US3403	4.2L L6 258 CID	1981	Base; Serpentine Belt Drive	US3413
J262S				4.2L L6 258 CID	1981	Base; Heater fitting required, V-Belt Drive	US3414
3.8L L6 3800cc 232 CID	1968-1969	Mexican Application	US1021	4.2L L6 258 CID	1982-1983	Base, SL, SR; V-Belt Drive	US3403
3.8L L6 3800cc 232 CID	1971	Mexican Application	US1021	4.2L L6 258 CID	1982-1983	Base, SL, SR; Serpentine Belt Drive	US3413
4.2L L6 4200cc 258 CID	1968-1969	Mexican Application	US1021	4.2L L6 258 CID	1982-1983	Base, SL, SR; Heater fitting required, V-Belt Drive	US3414
4.2L L6 4200cc 258 CID	1971	Mexican Application	US1021	4.2L L6 258 CID	1984	Base, SR; V-Belt Drive	US3403
J264D				4.2L L6 258 CID	1984	Base, SR; Serpentine Belt Drive	US3413
3.8L L6 3800cc 232 CID	1967	Mexican Application	US1021	4.2L L6 258 CID	1984	Base, SR; Heater fitting required, V-Belt Drive	US3414
4.2L L6 4200cc 258 CID	1965	Mexican Application	US1021	4.2L L6 258 CID	1985	Base, Laredo, Renegade; V-Belt Drive	US3403
4.2L L6 4200cc 258 CID	1967	Mexican Application	US1021	4.2L L6 258 CID	1985	Base, Laredo, Renegade; Serpentine Belt Drive	US3413
J364R				4.2L L6 258 CID	1985	Base, Laredo, Renegade; Heater fitting required, V-Belt Drive	US3414
3.8L L6 3800cc 232 CID	1967-1972	Mexican Application	US1021	TRUCK			
4.2L L6 4200cc 258 CID	1965-1972	Mexican Application	US1021	2.2L L4 2197cc 134 CID	1958-1966	Single groove pulley	US52
4.6L L6 4600cc 282 CID	1973-1979	Mexican Application	US1077	3.7L L6 3704cc 226 CID	1958-1962	Single groove pulley	US52
4.6L L6 4600cc 282 CID	1980-1984	Mexican Application	US3403	UTILITY WAGON			
J-100				3.7L L6 3704cc 226 CID	1956-1962		US470
5.7L V8 350 CID	1969-1971		US855	WAGONEER			
5.7L V8 5736cc 350 CID	1968-1971		US855	2.1L L4 126 CID	1985	Base, Limited	US3409
J-2500				2.5L L4 150 CID	1984-1987	Base, Limited; V-Belt Drive	US3403
5.7L V8 350 CID	1969-1971		US855	2.5L L4 150 CID	1984-1987	Base, Limited; Serpentine Belt Drive	US3413
5.7L V8 5736cc 350 CID	1969-1971		US855	2.5L L4 150 CID	1984-1987	Base, Limited; Heater fitting required, V-Belt Drive	US3414
J-2600				2.8L V6 173 CID	1984-1986	Base, Limited	US5006
5.7L V8 350 CID	1969-1970		US855	4.0L L6 242 CID	1987	Base, Limited	US3412
5.7L V8 5736cc 350 CID	1969-1971		US855	4.0L L6 242 CID	1988-1990	Limited	US3412
J-2700				4.2L L6 258 CID	1980	Base, Limited	US3403
5.7L V8 350 CID	1969-1970		US855	4.2L L6 258 CID	1980-1981	Base, Limited; Heater fitting required, V-Belt Drive	US3414
5.7L V8 5736cc 350 CID	1969-1970		US855	4.2L L6 258 CID	1981	Base, Limited; V-Belt Drive	US3403
LIBERTY				4.2L L6 258 CID	1981	Base, Limited; Serpentine Belt Drive	US3413
2.4L L4 148 CID	2002	Renegade, Sport	US7156	4.2L L6 258 CID	1982	Base, Brougham, Limited; V-Belt Drive	US3403
2.4L L4 148 CID	2003-2005	Sport	US7156	4.2L L6 258 CID	1982	Base, Brougham, Limited; Serpentine Belt Drive	US3413
3.7L V6 226 CID	2002	Limited, Sport	US7163	4.2L L6 258 CID	1982	Base, Brougham, Limited; Serpentine Belt Drive	US3413
3.7L V6 226 CID	2003-2004	Limited, Renegade, Sport	US7163	4.2L L6 258 CID	1982	Base, Brougham, Limited; Serpentine Belt Drive	US3413
3.7L V6 226 CID	2005	Limited, Renegade, Rocky Mountain Edition, Sport	US7163	4.2L L6 258 CID	1982	Base, Brougham, Limited; Heater fitting required, V-Belt Drive	US3414
3.7L V6 226 CID	2006	65th Anniversary Edition, Limited, Renegade, Sport	US7163	4.2L L6 258 CID	1982	Brougham, Limited; V-Belt Drive	US3403
3.7L V6 226 CID	2007-2009	Limited, Sport	US7163	4.2L L6 258 CID	1983	Brougham, Limited; Serpentine Belt Drive	US3413
3.7L V6 226 CID	2010-2011	Limited, Renegade, Sport	US7163	4.2L L6 258 CID	1983	Brougham, Limited; Heater fitting required, V-Belt Drive	US3414
3.7L V6 226 CID	2012	Jet, Limited, Sport	US7163	4.6L L6 4600cc 282 CID	1976-1979	Mexican Application	US1077
3.7L V6 3701cc 226 CID	2011-2013	Mexican Application	US7163	4.6L L6 4600cc 282 CID	1980-1986	Mexican Application	US3403
PATRIOT				5.9L V8 360 CID	1975-1979		US3401
2.0L L4 1998cc 122 CID	2007-2010	Sport	US6038	5.9L V8 360 CID	1975-1979	High performance	US3401H
2.0L L4 1998cc 122 CID	2011-2017	Latitude, Sport	US6038	5.9L V8 360 CID	1980-1981	Base, Limited	US3401
2.4L L4 2360cc 144 CID	2007-2010	Limited, Sport	US6038	5.9L V8 360 CID	1980-1981	Base, Limited; High performance	US3401H
2.4L L4 2360cc 144 CID	2010-2013	Mexican Application	US6038	5.9L V8 360 CID	1982	Base, Brougham, Limited	US3401
2.4L L4 2360cc 144 CID	2011	Latitude, Latitude X, Sport	US6038	5.9L V8 360 CID	1982	Base, Brougham, Limited; High performance	US3401H
2.4L L4 2360cc 144 CID	2012-2015	Latitude, Limited, Sport	US6038	5.9L V8 360 CID	1983	Brougham, Limited	US3401
2.4L L4 2360cc 144 CID	2016	75th Anniversary, Latitude, Sport	US6038	5.9L V8 360 CID	1983	Brougham, Limited; High performance	US3401H
2.4L L4 2360cc 144 CID	2017	Latitude, Sport	US6038	6.6L V8 401 CID	1975-1978		US3401
RENEGADE				6.6L V8 401 CID	1975-1978	High performance	US3401H
1.4L L4 1368cc 83 CID	2015	Latitude, Sport	US8136	WRANGLER			
1.4L L4 1368cc 83 CID	2016	75th Anniversary, Latitude, Sport	US8136	2.4L L4 148 CID	2003-2006	SE	US7156
1.4L L4 1368cc 83 CID	2017	Latitude, Sport	US8136	2.5L L4 150 CID	1987	Base, Laredo, Sport; V-Belt Drive	US3403
2.4L L4 2360cc 144 CID	2015	Latitude, Limited, Sport, Trailhawk	US6038	2.5L L4 150 CID	1987	Base, Laredo, Sport; Serpentine Belt Drive	US3413
2.4L L4 2360cc 144 CID	2016	75th Anniversary, Dawn Of Justice, Latitude, Limited, Sport, Trailhawk	US6038	2.5L L4 150 CID	1987	Base, Laredo, Sport; Heater fitting required, V-Belt Drive	US3414
2.4L L4 2360cc 144 CID	2017-2018	Latitude, Limited, Sport, Trailhawk	US6038	2.5L L4 150 CID	1988	Base, Laredo, S, Sahara, Sport; V-Belt Drive	US3403
SCRAMBLER				2.5L L4 150 CID	1988	Base, Laredo, S, Sahara, Sport; Serpentine Belt Drive	US3413
2.5L L4 150 CID	1983	Base, SL, SR; V-Belt Drive	US3403	2.5L L4 150 CID	1988	Base, Laredo, S, Sahara, Sport; Heater fitting required, V-Belt Drive	US3414
2.5L L4 150 CID	1983	Base, SL, SR; Serpentine Belt Drive	US3413	2.5L L4 150 CID	1989-1990	Base, Islander, Sahara; V-Belt Drive	US3403
2.5L L4 150 CID	1983	Base, SL, SR; Heater fitting required, V-Belt Drive	US3414	2.5L L4 150 CID	1989-1990	Base, Islander, Sahara; Serpentine Belt Drive	US3413
2.5L L4 150 CID	1984	Base, SR; V-Belt Drive	US3403	2.5L L4 150 CID	1989-1990	Base, Islander, Sahara; Heater fitting required, V-Belt Drive	US3414
2.5L L4 150 CID	1984	Base, SR; Serpentine Belt Drive	US3413	2.5L L4 150 CID	1991	Base, Islander, S, Sahara	US7136
2.5L L4 150 CID	1984	Base, SR; Heater fitting required, V-Belt Drive	US3414	2.5L L4 150 CID	1992-1993	Base, S	US7136
2.5L L4 150 CID	1985	Base, Laredo, Renegade; V-Belt Drive	US3403	2.5L L4 150 CID	1994	S	US7136
2.5L L4 150 CID	1985	Base, Laredo, Renegade; Serpentine Belt Drive	US3413	2.5L L4 150 CID	1995	Rio Grande	US7136
2.5L L4 150 CID	1985	Base, Laredo, Renegade; Heater fitting required, V-Belt Drive	US3414	2.5L L4 150 CID	1997-2002	SE	US7136
2.5L L4 151 CID	1981	Base	US1107	3.6L L6 3604cc 220 CID	2012	Mexican Application	US6699
2.5L L4 151 CID	1981	Base; V-Belt Drive	US3403				
2.5L L4 151 CID	1981	Base; Serpentine Belt Drive	US3413				
2.5L L4 151 CID	1981	Base; Heater fitting required, V-Belt Drive	US3414				
2.5L L4 151 CID	1982	Base, SL, SR; V-Belt Drive	US3403				
2.5L L4 151 CID	1982	Base, SL, SR; Serpentine Belt Drive	US3413				

Engine	Years	Application Description	USMW	Engine	Years	Application Description	USMW
JEEP (cont'd.)				KIA (cont'd.)			
WRANGLER (cont'd.)				FORTE KOUP (cont'd.)			
3.6L V6 3604cc 220 CID	2012-2015	Rubicon, Sahara, Sport, Unlimited Rubicon, Unlimited Sahara, Unlimited Sport	US6699	2.4L L4 2359cc	2010	SX; To 12/28/2009	US6220
3.6L V6 3604cc 220 CID	2016	75th Anniversary, Rubicon, Sahara, Sport, Sport S, Unlimited 75th Anniversary, Unlimited Rubicon, Unlimited Sahara, Unlimited Sport, Unlimited Sport S	US6699	2.4L L4 2359cc	2011-2013	SX	US6220
3.6L V6 3604cc 220 CID	2017	Rubicon, Sahara, Sport, Unlimited Rubicon, Unlimited Sahara, Unlimited Sport	US6699	K900			
3.8L V6 3778cc 231 CID	2007-2009	Rubicon, Sahara, Unlimited Rubicon, Unlimited Sahara, Unlimited X, X	US8960	3.8L V6 3778cc	2016-2017	V6 Luxury, V6 Premium	US6048
3.8L V6 3778cc 231 CID	2010	Mexican Application	US8960	OPTIMA			
3.8L V6 3778cc 231 CID	2010	Rubicon, Sahara, Sport, Unlimited Rubicon, Unlimited Sahara, Unlimited Sport, Unlimited X, X	US8960	1.6L L4 1591cc 97 CID	2016-2017	LX 1.6T	US6247
3.8L V6 3778cc 231 CID	2011	70th Anniversary, Rubicon, Sahara, Sport, Unlimited 70th Anniversary, Unlimited Rubicon, Unlimited Sahara, Unlimited Sport	US8960	2.0L L4 1998cc 122 CID	2011-2012	EX, SX	US6220
4.0L L6 242 CID	1991-1992	Base, Islander, Renegade, Sahara	US7136	2.0L L4 1998cc 122 CID	2013	EX, SX, SXL	US6220
4.0L L6 242 CID	1993	Base, Renegade, Sahara	US7136	2.0L L4 1998cc 122 CID	2014-2015	Limited, SXL Turbo, SX Turbo	US6220
4.0L L6 242 CID	1994	Renegade, Sahara, SE	US7136	2.0L L4 1998cc 122 CID	2016-2017	SX, SX Limited	US8163
4.0L L6 242 CID	1995	Sahara, SE	US7136	2.0L L4 1998cc 122 CID	2016-2017	SX, SX Limited; Pump only	US8163
4.0L L6 242 CID	1997-1999	Sahara, Sport	US7136	2.4L L4 2351cc	2001-2003	LX, SE	US9399
4.0L L6 242 CID	2000-2001	Sahara, Sport	US7164	2.4L L4 2351cc	2004-2006	EX, LX	US9399
4.0L L6 242 CID	2002	Sahara, Sport, X	US7164	2.4L L4 2359cc	2006-2008	EX, LX	US6220
4.0L L6 242 CID	2003	Rubicon, Sahara, Sport, X	US7164	2.4L L4 2359cc	2009-2010	EX, LX, SX	US6220
4.0L L6 242 CID	2004	Rubicon, Sahara, Sport, Unlimited, X	US7164	2.4L L4 2359cc	2011-2013	EX, LX	US8982
4.0L L6 242 CID	2005	Rubicon, Sport, Unlimited, Unlimited Rubicon, X	US7164	2.4L L4 2359cc	2014-2015	EX, LX, SX; Korea Built Vehicle	US6220
4.0L L6 242 CID	2006	65th Anniversary Edition, Rubicon, SE, Sport, Unlimited, Unlimited Rubicon, X	US7164	2.4L L4 2359cc	2014-2015	EX, LX, SX	US8982
4.2L L6 258 CID	1987	Base, Laredo, Sport; V-Belt Drive	US3403	2.4L L4 2359cc	2014-2015	EX, LX, SX; USA Built Vehicle	US8982
4.2L L6 258 CID	1987	Base, Laredo, Sport; Serpentine Belt Drive	US3413	2.4L L4 2359cc	2016-2017	EX, LX	US8163
4.2L L6 258 CID	1987	Base, Laredo, Sport; Heater fitting required, V-Belt Drive	US3414	2.4L L4 2359cc	2016-2017	EX, LX; Pump only	US8163
4.2L L6 258 CID	1988	Base, Islander, Laredo, S, Sahara, Sport; V-Belt Drive	US3403	2.5L V6 2500cc	2001	LX, SE	US9462
4.2L L6 258 CID	1988	Base, Islander, Laredo, S, Sahara, Sport; Serpentine Belt Drive	US3413	2.7L V6 2656cc	2002-2003	LX, SE	US9462
4.2L L6 258 CID	1988	Base, Islander, Laredo, S, Sahara, Sport; Heater fitting required, V-Belt Drive	US3414	2.7L V6 2656cc	2004-2006	EX, LX	US9462
4.2L L6 258 CID	1989-1990	Base, Islander, Laredo, Sahara; V-Belt Drive	US3403	2.7L V6 2656cc	2006-2008	EX, LX	US6215
4.2L L6 258 CID	1989-1990	Base, Islander, Laredo, Sahara; Serpentine Belt Drive	US3413	2.7L V6 2656cc	2009-2010	EX, LX, SX	US6215
4.2L L6 258 CID	1989-1990	Base, Islander, Laredo, Sahara; Heater fitting required, V-Belt Drive	US3414	RIO			
KIA				1.5L L4 1493cc	2001	Base	US9473
AMANTI				1.5L L4 1493cc	2002	Base, Cinco	US9473
3.5L V6 3497cc	2004-2006	Base	US9463	1.6L L4 1591cc 97 CID	2012-2017	EX, LX, SX	US6247
3.8L V6 3778cc	2007-2009	Base	US6048	1.6L L4 1594cc	2003-2005	Base, Cinco	US9473
BORREGO				1.6L L4 1599cc	2006	Base, LX	US9364
3.8L V6 3778cc	2009	EX, LX	US6048	1.6L L4 1599cc	2007-2011	Base, LX, SX	US9364
CADENZA				RIO5			
3.3L V6 3342cc	2014	Limited, Premium; From 04/11/2013	US6048	1.6L L4 1599cc	2006-2007	SX	US9364
3.3L V6 3342cc	2014	Limited, Premium; To 04/11/2013	US6048	1.6L L4 1599cc	2008-2011	LX, SX	US9364
3.3L V6 3342cc	2014-2015	Limited, Premium	US6048	RONDO			
3.3L V6 3342cc	2016	Base, Limited, Premium	US6048	2.4L L4 2359cc	2007-2008	EX, LX	US6220
FORTE				2.4L L4 2359cc	2009	EX, LX; From 10/14/2008	US6220
1.8L L4 1797cc	2014-2016	LX	US8106	2.4L L4 2359cc	2009	EX, LX; To 10/14/2008	US6220
2.0L L4 1998cc 122 CID	2010	EX, LX; From 12/28/2009	US6220	2.4L L4 2359cc	2010	EX, LX	US6220
2.0L L4 1998cc 122 CID	2010	EX, LX; To 12/28/2009	US6220	2.7L V6 2656cc	2007-2010	EX, LX	US6215
2.0L L4 1998cc 122 CID	2011-2012	EX, LX	US6220	SEDONA			
2.0L L4 1998cc 122 CID	2013	EX	US6220	3.3L V6 3342cc	2015	EX, L, Limited, LX, SX, SXL	US6048
2.0L L4 1999cc 122 CID	2014-2016	EX	US8106	3.3L V6 3342cc	2016-2017	EX, L, LX, SX, SXL	US6048
2.0L L4 1999cc 122 CID	2017	EX; Exc.Mexico Built Vehicle	US8106	3.5L V6 3470cc	2011-2012	EX, LX	US6048
2.4L L4 2359cc	2010	SX; From 12/28/2009	US6220	3.5L V6 3470cc	2014	EX, LX	US6048
2.4L L4 2359cc	2010	SX; To 12/28/2009	US6220	3.5L V6 3497cc	2002-2005	EX, LX	US9463
2.4L L4 2359cc	2011-2013	SX	US6220	3.8L V6 3778cc	2006	EX, LX	US6048
FORTE5				3.8L V6 3778cc	2007-2009	Base, EX, LX	US6048
1.6L L4 1591cc 97 CID	2014-2016	SX	US6247	3.8L V6 3778cc	2010	Base, EX, LX; From 11/03/2009	US6048
1.6L L4 1591cc 97 CID	2017	SX; Exc.Mexico Built Vehicle	US6247	3.8L V6 3778cc	2010	Base, EX, LX; To 11/03/2009	US6048
2.0L L4 1999cc 122 CID	2014-2015	EX	US8106	SEPHIA			
2.0L L4 1999cc 122 CID	2016	EX, LX	US8106	1.6L L4 1597cc	1994	GS, LS, RS	US4049
2.0L L4 1999cc 122 CID	2017	EX, LX; Exc.Mexico Built Vehicle	US8106	1.6L L4 1597cc	1995	GS, LS, RS; (1)	US4049
FORTE KOUP				1.6L L4 1597cc	1995	GS, LS, RS; (3)	US9305
1.6L L4 1591cc 97 CID	2014-2016	SX	US6247	1.6L L4 1597cc	1996	GS, LS, RS	US9305
2.0L L4 1998cc 122 CID	2010	EX; From 12/28/2009	US6220	1.6L L4 1597cc	1997	LS, RS	US9305
2.0L L4 1998cc 122 CID	2010	EX; To 12/28/2009	US6220	1.8L L4 1793cc	1998-2001	Base, LS	US9393
2.0L L4 1998cc 122 CID	2011-2013	EX	US6220	1.8L L4 1839cc	1995	GS, LS	US9305
2.0L L4 1999cc 122 CID	2014-2016	EX	US8106	1.8L L4 1839cc	1996-1997	GS, LS, RS	US9305
2.0L L4 2359cc	2010	SX; From 12/28/2009	US6220	SORENTO			
2.0L L4 2359cc	2010	SX; To 12/28/2009	US6220	2.0L L4 1998cc 122 CID	2016	EX, Limited	US8163
2.0L L4 2359cc	2011-2013	SX	US6220	2.0L L4 1998cc 122 CID	2016	EX, Limited; Pump only	US8163
FORTE5				2.0L L4 1998cc 122 CID	2017	EX	US8163
1.6L L4 1591cc 97 CID	2014-2016	SX	US6247	2.0L L4 1998cc 122 CID	2017	EX; Pump only	US8163
1.6L L4 1591cc 97 CID	2017	SX; Exc.Mexico Built Vehicle	US6247	2.4L L4 2359cc	2011	Base, EX, LX	US6220
2.0L L4 1999cc 122 CID	2014-2015	EX	US8106	2.4L L4 2359cc	2012	Base	US6220
2.0L L4 1999cc 122 CID	2016	EX, LX	US8106	2.4L L4 2359cc	2012-2013	LX; (1)	US6220
2.0L L4 1999cc 122 CID	2017	EX, LX; Exc.Mexico Built Vehicle	US8106	2.4L L4 2359cc	2012-2013	EX	US8982
FORTE KOUP				2.4L L4 2359cc	2012-2013	LX; (6)	US8982
1.6L L4 1591cc 97 CID	2014-2016	SX	US6247	2.4L L4 2359cc	2014-2015	LX	US8982
2.0L L4 1998cc 122 CID	2010	EX; From 12/28/2009	US6220	2.4L L4 2359cc	2016-2017	L, LX	US8163
2.0L L4 1998cc 122 CID	2010	EX; To 12/28/2009	US6220	2.4L L4 2359cc	2016-2017	L, LX; Pump only	US8163
2.0L L4 1998cc 122 CID	2011-2013	EX	US6220	3.3L V6 3342cc	2008-2009	Base, LX	US6048
2.0L L4 1999cc 122 CID	2014-2016	EX	US8106	3.3L V6 3342cc	2014	EX, Limited, LX, SX; From 04/11/2013	US6048
2.4L L4 2359cc	2010	SX; From 12/28/2009	US6220	3.3L V6 3342cc	2014	EX, Limited, LX, SX; To 04/11/2013	US6048
FORTE5				3.3L V6 3342cc	2014-2016	EX, Limited, LX, SX	US6048
1.6L L4 1591cc 97 CID	2014-2016	SX	US6247	3.3L V6 3342cc	2017	EX, LX, SX	US6048
2.0L L4 1998cc 122 CID	2010	EX; From 12/28/2009	US6220	3.5L V6 3470cc	2011-2013	EX, LX, SX	US6048
2.0L L4 1998cc 122 CID	2010	EX; To 12/28/2009	US6220	3.5L V6 3497cc	2003-2006	EX, LX	US9448
2.0L L4 1998cc 122 CID	2011-2013	EX	US6220	WATER PUMPS			
2.0L L4 1999cc 122 CID	2014-2016	EX	US8106				
2.4L L4 2359cc	2010	SX; From 12/28/2009	US6220				

Engine	Years	Application Description	USMW	Engine	Years	Application Description	USMW
KIA (cont'd.)				LAND ROVER (cont'd.)			
SORENTO (cont'd.)				RANGE ROVER (cont'd.)			
3.8L V6 3778cc	2007	Base, EX, LX	US6048	3.9L V8 3950cc	1993	County, Sport; From Engine 36D25155B	US9369
3.8L V6 3778cc	2008-2009	EX	US6048	3.9L V8 3950cc	1994	County; To Engine 36D25155B	US9368
SOUL				3.9L V8 3950cc	1994	County; From Engine 36D25155B	US9369
1.6L L4 1591cc	2010	Base; From 12/21/2009	US6247	3.9L V8 3950cc	1995	County Classic; To Engine 36D25155B	US9368
1.6L L4 1591cc	2010	Base; To 12/21/2009	US6247	3.9L V8 3950cc	1995	County Classic; From Engine 36D25155B	US9369
1.6L L4 1591cc	2011-2016	Base	US6247	4.0L V8 3950cc	1995-1997	SE	US9369
1.6L L4 1591cc	2017	I, Base	US6247	4.0L V8 3950cc	1998	50th Anniversary Edition, SE	US9369
2.0L L4 1975cc	2010-2011	I, +, Sport	US8972	4.0L V8 3950cc	1999	Base, S, SE	US9369
2.0L L4 1999cc 122 CID	2012	I, +	US8106	4.0L V8 3950cc	2000	Base, County, SE	US9369
2.0L L4 1999cc 122 CID	2013	I, +, 4u Luxury	US8106	4.2L V8 4196cc	2006-2009	Supercharged	US4124
2.0L L4 1999cc 122 CID	2014-2016	I, +	US8106	4.2L V8 4200cc	1993-1994	County LWB; To Engine 40D09582B	US9368
2.0L L4 1999cc 122 CID	2017	+	US8106	4.2L V8 4200cc	1993-1994	County LWB; From Engine 40D09582B	US9369
SPECTRA				4.2L V8 4200cc	1995	25th Anniversary Edition, County LWB; To Engine 40D09582B	US9368
1.8L L4 1793cc	2000-2001	GS, GSX	US9393	4.2L V8 4200cc	1995	25th Anniversary Edition, County LWB; From Engine 40D09582B	US9369
1.8L L4 1793cc	2002	Base, GS, GSX, LS; From 12/13/2001	US9393	4.4L V8 4394cc	2006-2009	HSE	US4124
1.8L L4 1793cc	2002	Base, GS, GSX, LS; To 12/13/2001	US9393	4.6L V8 4554cc 278 CID	1996	HSE	US9369
1.8L L4 1793cc	2003-2004	Base, GS, GSX, LS	US9393	4.6L V8 4554cc 278 CID	1997	HSE, Kensington, Vitesse	US9369
2.0L L4 1975cc	2004	EX, LX	US8972	4.6L V8 4554cc 278 CID	1998	HSE	US9369
2.0L L4 1975cc	2005	EX, LX, SX	US8972	4.6L V8 4554cc 278 CID	1999	Callaway, HSE	US9369
2.0L L4 1975cc	2006	EX, SX	US8972	4.6L V8 4554cc 278 CID	2000	HSE, HSK, Vitesse	US9369
2.0L L4 1975cc	2007-2009	EX, LX, SX	US8972	4.6L V8 4554cc 278 CID	2001	HSE, SE	US9369
SPECTRA5				4.6L V8 4554cc 278 CID	2002	HSE	US9369
2.0L L4 1975cc	2005-2006	Base	US8972	5.0L V8 5000cc	2010-2011	HSE, Supercharged	US8120
2.0L L4 1975cc	2007-2009	SX	US8972	5.0L V8 5000cc	2012	Autobiography, HSE, HSE Lux, Supercharged	US8120
SPORTAGE				5.0L V8 5000cc	2013	Autobiography, Base, HSE, Supercharged	US8120
2.0L L4 1975cc	2005-2010	LX	US8972	5.0L V8 5000cc 305 CID	2014	Autobiography, Autobiography Black, Supercharged	US8120
2.0L L4 1998cc 122 CID	1995	Base, EX	US4053	5.0L V8 5000cc 305 CID	2015	Autobiography, Supercharged	US8120
2.0L L4 1998cc 122 CID	1995-2000	Base, EX	US9450	5.0L V8 5000cc 305 CID	2016-2017	Autobiography, Supercharged, SV Autobiography	US8120
2.0L L4 1998cc 122 CID	2001	Base, EX, Limited	US9450	RANGE ROVER EVOQUE			
2.0L L4 1998cc 122 CID	2002	Base	US9450	2.0L L4 1999cc 122 CID	2012	Dynamic, Prestige, Pure	US8120
2.0L L4 1998cc 122 CID	2011-2016	SX	US6220	RANGE ROVER SPORT			
2.0L L4 1998cc 122 CID	2017	SX Turbo	US8163	3.0L V6 2995cc 183 CID	2014-2016	HSE, SE	US8120
2.4L L4 2359cc	2011-2013	Base, EX, LX	US8982	3.0L V6 2995cc 183 CID	2017	HSE, HSE Dynamic, SE	US8120
2.4L L4 2359cc	2014-2016	EX, LX	US6220	4.2L V8 4196cc	2006-2007	Supercharged	US4124
2.4L L4 2359cc	2014-2016	EX, LX	US8982	4.2L V8 4196cc	2008	LE, Supercharged	US4124
2.4L L4 2359cc	2017	EX, LX	US8163	4.2L V8 4196cc	2009	Supercharged	US4124
2.7L V6 2656cc	2005-2010	EX, LX	US9462	4.4L V8 4394cc	2006-2009	HSE	US4124
LAND ROVER				5.0L V8 5000cc	2010	HSE, Supercharged	US8120
DEFENDER 90				5.0L V8 5000cc	2011	Autobiography, GT Limited Edition, HSE, Supercharged	US8120
3.9L V8 3950cc	1994-1995	Base	US9368	5.0L V8 5000cc	2012	Autobiography, GT Limited Edition 3, HSE, HSE Lux, Supercharged	US8120
4.0L V8 3950cc	1997	Base, LE	US9369	5.0L V8 5000cc	2013	Autobiography, GT Limited Edition, HSE, HSE Lux, Supercharged	US8120
DEFENDER 110				5.0L V8 5000cc 305 CID	2014	Autobiography, Supercharged	US8120
3.9L V8 3950cc	1993	Base	US9368	5.0L V8 5000cc 305 CID	2015	Autobiography, Supercharged, SVR	US8120
DISCOVERY				5.0L V8 5000cc 305 CID	2016	Autobiography, Supercharged, Supercharged Dynamic, SVR	US8120
3.0L V6 2995cc 183 CID	2017	First Edition, HSE, HSE Luxury, SE	US8120	5.0L V8 5000cc 305 CID	2017	Autobiography, Supercharged, SVR	US8120
3.9L V8 3950cc	1994-1995	Base	US9369	LEXUS			
4.0L V8 3950cc	1996	SD, SE, SE7	US9369	CT200H			
4.0L V8 3950cc	1997	LSE, SD, SE, SE7, XD	US9369	1.8L L4 1798cc 110 CID	2011-2012		US6682
4.0L V8 3950cc	1998	50th Anniversary Edition, LE, LSE	US9369	1.8L L4 1798cc 110 CID	2013	Base	US6682
4.0L V8 3950cc	1999	SD, Series II	US9369	1.8L L4 1798cc 110 CID	2014-2017	Base, F Sport	US6682
4.0L V8 3950cc	2000	Series II	US9369	ES250			
4.0L V8 3950cc	2001	Series II LE, Series II SD, Series II SE	US9369	2.5L V6 2508cc	1990-1991	Base	US9258
4.0L V8 3950cc	2002	Series II SD, Series II SE	US9369	ES300			
4.6L V8 4554cc 278 CID	2003-2004	HSE, S, SE	US9369	3.0L V6 2959cc	1992-1993	Base	US9258
FREELANDER				3.0L V6 2959cc	1996-1998	Base	US9306
2.5L V6 2500cc 153 CID	2002	HSE, S, SE	US9496	3.0L V6 2995cc	1994-1995	Base	US9306
2.5L V6 2500cc 153 CID	2003	HSE, S, SE, SE3	US9496	3.0L V6 2995cc	1999-2003	Base	US9306
2.5L V6 2500cc 153 CID	2004	HSE, SE, SE3	US9496	ES300H			
2.5L V6 2500cc 153 CID	2005	SE, SE3	US9496	2.5L L4 2494cc 152 CID	2014-2017	Base	US6211
LR3				ES330			
4.0L V6 4009cc 245 CID	2005	SE	US6251	3.3L V6 3300cc 202 CID	2004-2006	Base	US9306
4.0L V6 4009cc 245 CID	2006	Base, SE	US6251	ES350			
4.0L V6 4009cc 245 CID	2007	SE	US6251	3.5L V6 3456cc	2007-2017	Base	US6047
4.4L V8 4394cc	2005-2008	HSE, SE	US4124	GS300			
4.4L V8 4394cc	2009	HSE, HSE Lux	US4124	3.0L L6 2997cc	1993-1997	Base	US9256
LR4				3.0L L6 2997cc	1998-2004	Base	US9395
3.0L V6 2995cc 183 CID	2014-2016	Base, HSE, HSE Lux	US8120	3.0L V6 2994cc	2006	Base	US6143
5.0L V8 5000cc	2010	HSE, V8	US8120	GS350			
5.0L V8 5000cc	2011	Base, HSE	US8120	3.5L V6 3456cc	2007-2011	Base	US6143
5.0L V8 5000cc	2012-2013	Base, HSE, HSE Lux	US8120	3.5L V6 3456cc	2013-2015	Base, F Sport	US6143
RANGE ROVER							
3.0L V6 2995cc 183 CID	2014-2017	Base, HSE	US8120				
3.5L V8 3532cc 216 CID	1987	Base	US9368				
3.5L V8 3532cc 216 CID	1988	40th Anniversary Edition, Base	US9368				
3.9L V8 3947cc	1989	Base, County, Hunter	US9368				
3.9L V8 3947cc	1990	Base, County	US9368				
3.9L V8 3947cc	1991	Base, County SE, Great Divide, Hunter	US9368				
3.9L V8 3947cc	1992	Base, County, LSE	US9368				
3.9L V8 3950cc	1993	County, Sport; To Engine 36D25155B	US9368				

Engine	Years	Application Description	USMW
LEXUS (cont'd.)			
GS350 (cont'd.)			
3.5L V6 3456cc	2016-2017	Base, F Sport	US8150
GS400			
4.0L V8 3969cc	1998-2000	Base	US9257
GS430			
4.3L V8 4293cc	2001-2007	Base	US9257
GS450H			
3.5L V6 3456cc	2007-2011	Base	US6143
3.5L V6 3456cc	2013-2014	Base	US6143
3.5L V6 3456cc	2015-2017	Base, F Sport	US6143
GS460			
4.6L V8 4608cc	2008-2011	Base	US6338
GS F			
5.0L V8 4969cc 303 CID	2016-2017	Base	US6338
GX460			
4.6L V8 4608cc	2010-2013	Base, Premium	US6336
4.6L V8 4608cc	2014-2017	Base, Luxury, Premium	US6336
GX470			
4.7L V8 4663cc 285 CID	2003-2009	Base	US9257
HS250H			
2.4L L4 2362cc	2010-2012	Base, Premium	US9414
IS250			
2.5L V6 2499cc	2006-2008	Base	US6143
2.5L V6 2499cc	2009	Base; From 03/2009	US6143
2.5L V6 2499cc	2009	Base; To 03/2009	US6143
2.5L V6 2499cc	2010-2013	Base, C	US6143
2.5L V6 2499cc	2014-2015	Base, C, C F Sport, F Sport	US6143
IS300			
3.0L L6 2997cc	2001	Base	US9395
3.0L L6 2997cc	2002-2005	Base, Sportcross	US9395
3.5L V6 3456cc	2016-2017	Base, F Sport	US6143
IS350			
3.5L V6 3456cc	2006-2008	Base	US6143
3.5L V6 3456cc	2009	Base; From 03/2009	US6143
3.5L V6 3456cc	2009	Base; To 03/2009	US6143
3.5L V6 3456cc	2010-2013	Base, C	US6143
3.5L V6 3456cc	2014-2015	Base, C, C F Sport, F Sport	US6143
3.5L V6 3456cc	2016-2017	Base, F Sport	US6143
IS F			
5.0L V8 4969cc 303 CID	2008-2014	Base	US6338
LS400			
4.0L V8 3969cc	1990-1996	Base	US9257
4.0L V8 3969cc	1997	Base; From 07/97	US9257
4.0L V8 3969cc	1997	Base; To 07/97	US9257
4.0L V8 3969cc	1998-2000	Base	US9257
LS430			
4.3L V8 4293cc	2001-2006	Base	US9257
LS460			
4.6L V8 4608cc	2007-2012	Base, L	US6338
4.6L V8 4608cc	2013-2017	Base, F Sport, L	US6338
LS600H			
5.0L V8 4968cc	2008-2016	L	US6338
LX450			
4.5L L6 4477cc	1996-1997	Base	US9269
LX470			
4.7L V8 4663cc 285 CID	1998-2007	Base	US9257
LX570			
5.7L V8 5663cc 345 CID	2008-2011	Base	US6197
5.7L V8 5663cc 345 CID	2013-2017	Base	US6197
RC300			
3.5L V6 3456cc	2016-2017	Base, F Sport	US6143
RC350			
3.5L V6 3456cc	2015-2017	Base, F Sport	US6143
RC F			
5.0L V8 4969cc 303 CID	2015-2017	Base	US6338
RX300			
3.0L V6 2995cc	1999-2003	Base	US9306
RX330			
3.3L V6 3300cc 202 CID	2004-2006	Base	US9306
RX350			
3.5L V6 3456cc	2007-2009	Base	US6047
3.5L V6 3456cc	2010	Base; Exc. Japan Built	US6047

Engine	Years	Application Description	USMW
LEXUS (cont'd.)			
RX350 (cont'd.)			
3.5L V6 3456cc	2010	Base; Japan Built	US6047
3.5L V6 3456cc	2011-2012	Base	US6047
3.5L V6 3456cc	2013-2015	Base, F Sport	US6047
3.5L V6 3456cc	2016-2017	Base, F Sport	US8150
RX400H			
3.3L V6 3300cc 202 CID	2006-2008	Base	US9306
RX450H			
3.5L V6 3456cc	2010-2015	Base	US6047
3.5L V6 3456cc	2016-2017	Base, F Sport	US8150
SC300			
3.0L L6 2997cc	1992-1999	Base	US9256
3.0L L6 2997cc	1992-1999	With Toyota Supra twin-turbo engine	US9292
3.0L L6 2997cc	2000	Base	US9292
SC400			
4.0L V8 3969cc	1992-2000	Base	US9257
SC430			
4.3L V8 4293cc	2002-2008	Base	US9257
4.3L V8 4293cc	2009	Base; From 11/2008	US9257
4.3L V8 4293cc	2009	Base; To 11/2008	US9257
4.3L V8 4293cc	2010	Base	US9257
LINCOLN			
AVIATOR			
4.6L V8 281 CID	2003-2005	Base	US8920
BLACKWOOD			
5.4L V8 330 CID	2002	Base	US8920
5.4L V8 5409cc 330 CID	2003	Mexican Application	US4128
CONTINENTAL			
2.4L L6 146 CID	1984-1985	Base, Givenchy, Valentino	US9154
2.7L V6 164 CID	2017	Black Label, Reserve, Select; 3 Bolt Pulley	US8141
2.7L V6 164 CID	2017	Black Label, Reserve, Select; 3 Bolt hub Includes thermostat / housing	US8141-T
2.7L V6 164 CID	2017-2018	Black Label, Reserve, Select	US8141
3.0L V6 2956cc 181 CID	2017	Black Label, Reserve; 3 Bolt Pulley	US8141
3.0L V6 2956cc 181 CID	2017	Black Label, Reserve; 3 Bolt hub Includes thermostat / housing	US8141-T
3.0L V6 2956cc 181 CID	2017-2018	Black Label, Reserve	US8141
3.7L V6 3726cc 227 CID	2017-2018	Premiere, Select	US8910
3.8L V6 232 CID	1982	Base, Givenchy, Signature	US4016
3.8L V6 232 CID	1988-1990	Base, Signature	US4051
3.8L V6 232 CID	1991-1993	Base, Executive, Signature	US4051
3.8L V6 232 CID	1994	Base, Executive, Signature	US4089
4.6L V8 281 CID	1995	Diamond Anniversary, Signature, Spinnaker Edition	US4097
4.6L V8 281 CID	1996	Anniversary, Spinnaker Edition	US4097
4.6L V8 281 CID	1997	Spinnaker Edition	US4097
4.6L V8 281 CID	1998-2002	Base	US4097
5.0L V8 302 CID	1983-1984	Base, Givenchy, Valentino	US4014
5.0L V8 302 CID	1983-1984	Base, Givenchy, Valentino; High performance	US4014H
5.0L V8 302 CID	1985	Base, Givenchy, Valentino	US4024
5.0L V8 302 CID	1985	Base, Givenchy, Valentino; High performance	US4024H
5.0L V8 302 CID	1986-1987	Base, Givenchy	US4038
5.0L V8 302 CID	1986-1987	Base, Givenchy; High performance	US4038H
5.8L V8 351 CID	1980	Base	US4014
5.8L V8 351 CID	1980	Base; High performance	US4014H
6.6L V8 400 CID	1977-1979	MODIFIED	US932
7.5L V8 460 CID	1975-1978		US1114
LS			
3.0L V6 2968cc 181 CID	2000	Base	US4118
3.0L V6 2968cc 181 CID	2001-2002	Base, LSE	US4118
3.0L V6 2968cc 181 CID	2003	Base, LSE	US4129
3.0L V6 2968cc 181 CID	2004	Base	US4129
3.0L V6 2968cc 181 CID	2005	Appearance, Luxury, Premium	US4129
3.9L V8 242 CID	2000	Base	US4124
3.9L V8 242 CID	2001-2003	Base, LSE	US4124
3.9L V8 242 CID	2004	Base	US4124
3.9L V8 242 CID	2005	Sport, Ultimate	US4124
3.9L V8 242 CID	2006	Sport	US4124
MARK IV			
7.5L V8 460 CID	1975-1976		US1114
MARK LT			
5.4L V8 330 CID	2006	Base	US8920
5.4L V8 330 CID	2007-2008	Base	US6144
MARK V			
6.6L V8 400 CID	1977-1979	MODIFIED	US932
MARK VI			
5.0L V8 302 CID	1980-1981	Base	US4014

WATER PUMPS

Engine	Years	Application Description	USMW	Engine	Years	Application Description	USMW
LINCOLN (cont'd.)				LINCOLN (cont'd.)			
MARK VI (cont'd.)				MKZ			
5.0L V8 302 CID	1980-1981	Base; High performance	US4014H	2.0L L4 1999cc 122 CID	2013-2014	Base	US4126
5.0L V8 302 CID	1982	Base, Bill Blass, Givenchy, Pucci, Signature	US4014	2.0L L4 1999cc 122 CID	2015-2016	Base, Black Label	US4126
5.0L V8 302 CID	1982	Base, Bill Blass, Givenchy, Pucci, Signature; High performance	US4014H	2.0L L4 1999cc 122 CID	2017-2018	Black Label, Premiere, Reserve, Select	US8975
5.0L V8 302 CID	1983	Base, Bill Blass, Pucci, Signature	US4014	2.5L L4 2488cc 152 CID	2011-2012	Hybrid	US4126
5.0L V8 302 CID	1983	Base, Bill Blass, Pucci, Signature; High performance	US4014H	3.0L V6 2956cc 181 CID	2017	Black Label, Reserve, Select; 3 Bolt Pulley	US8141
5.8L V8 351 CID	1980	Base	US4014	3.0L V6 2956cc 181 CID	2017	Black Label, Reserve, Select; 3 Bolt hub Includes thermostat / housing	US8141-T
5.8L V8 351 CID	1980	Base; High performance	US4014H	3.0L V6 2956cc 181 CID	2017-2018	Black Label, Reserve, Select	US8141
MARK VII				3.5L V6 3496cc 213 CID	2007-2011	Base	US6023
2.4L L6 146 CID	1984-1985	Base, Bill Blass, LSC, Versace	US9154	3.5L V6 3496cc 213 CID	2012	Base; From 01/02/2012	US8910
5.0L V8 302 CID	1984	Base, Bill Blass, LSC, Versace	US4014	3.5L V6 3496cc 213 CID	2012	Base; To 01/02/2012	US8980
5.0L V8 302 CID	1984	Base, Bill Blass, LSC, Versace; High performance	US4014H	3.7L V6 3726cc 227 CID	2013-2014	Base	US8910
5.0L V8 302 CID	1985	Base, Bill Blass, Versace	US4024	3.7L V6 3726cc 227 CID	2015-2016	Base, Black Label	US8910
5.0L V8 302 CID	1985	Base, Bill Blass, Versace; High performance	US4024H	NAVIGATOR			
5.0L V8 302 CID	1985	LSC	US4038	3.5L V6 3496cc 213 CID	2015	Base, L	US8916
5.0L V8 302 CID	1985	LSC; High performance	US4038H	3.5L V6 3496cc 213 CID	2015	Base, L; Serpentine Belt Driven	US8916
5.0L V8 302 CID	1986-1987	Base, Bill Blass, LSC	US4038	3.5L V6 3496cc 213 CID	2016-2017	L Reserve, L Select, Reserve, Select	US8916
5.0L V8 302 CID	1986-1987	Base, Bill Blass, LSC; High performance	US4038H	5.4L V8 330 CID	1998-2005	Base	US8920
5.0L V8 302 CID	1988-1992	Bill Blass, LSC	US4038	5.4L V8 330 CID	2006	Luxury, Ultimate	US8920
5.0L V8 302 CID	1988-1992	Bill Blass, LSC; High performance	US4038H	5.4L V8 330 CID	2007	L Luxury, L Ultimate, Luxury, Ultimate	US6144
MARK VIII				5.4L V8 330 CID	2008	Base, L	US6144
4.6L V8 281 CID	1993-1994	Base; Pump Length: long	US4113	5.4L V8 330 CID	2009-2014	Base, L	US8920
4.6L V8 281 CID	1995	Base, LSC; Pump Length: long	US4113	TOWN CAR			
4.6L V8 281 CID	1996	Anniversary, LSC; Pump Length: long	US4113	4.6L V8 281 CID	1991-1992	Base, Cartier, Cypress, Executive, Signature, Touring Edition	US4066
4.6L V8 281 CID	1997-1998	Base, LSC; Pump Length: long	US4113	4.6L V8 281 CID	1993	Base, Cartier, Cypress, Executive, Jack Nicklaus, Signature, Touring Edition	US4066
MKC				4.6L V8 281 CID	1994	Base, Cartier, Cypress, Executive, Signature, Touring Edition, Tournament Edition; From 04/94	US4066
2.0L L4 1999cc 122 CID	2015	Base, Black Label	US4126	4.6L V8 281 CID	1994	Base, Cartier, Cypress, Executive, Signature, Touring Edition, Tournament Edition; To 03/94	US4066
2.0L L4 1999cc 122 CID	2016	Black Label, Premiere, Reserve, Select; To 09/24/2015	US4126	4.6L V8 281 CID	1995	Base, Cartier, Cypress, Executive, Signature, Touring Edition	US4066
2.0L L4 1999cc 122 CID	2016	Black Label, Premiere, Reserve, Select; From 09/24/215	US8117	4.6L V8 281 CID	1996	Anniversary, Base, Cartier, Executive, Signature; From 03/96	US4066
2.0L L4 1999cc 122 CID	2017-2018	Black Label, Premiere, Reserve, Select	US8975	4.6L V8 281 CID	1996	Anniversary, Base, Cartier, Executive, Signature; To 03/96	US4066
2.3L L4 2300cc 140 CID	2015	Base, Black Label	US8117	4.6L V8 281 CID	1997	Base, Cartier, Executive, Signature, Touring Edition	US4066
2.3L L4 2300cc 140 CID	2016-2018	Black Label, Reserve, Select	US8117	4.6L V8 281 CID	1998-2000	Base, Cartier, Executive, Signature; Pump Length: long	US4113
MKS				4.6L V8 281 CID	2001-2002	Base, Cartier, Cartier L, Executive, Executive L, Signature; Long Housing, Pump Length: long	US4113
3.5L V6 3496cc 213 CID	2010	EcoBoost	US6023	4.6L V8 281 CID	2001-2002	Base, Cartier, Cartier L, Executive, Executive L, Signature; Short Housing	US4128
3.5L V6 3496cc 213 CID	2011	EcoBoost	US8910	4.6L V8 281 CID	2003	Base, Executive, Executive L, Executive Protection Series, Signature; Short Housing	US4128
3.5L V6 3496cc 213 CID	2012	EcoBoost; From 01/02/2012	US8910	4.6L V8 281 CID	2003	Cartier, Cartier L	US4128
3.5L V6 3496cc 213 CID	2012	EcoBoost; To 01/02/2012	US8910	4.6L V8 281 CID	2004	Executive, Executive L, Signature, Ultimate, Ultimate L	US4128
3.5L V6 3496cc 213 CID	2013-2016	EcoBoost	US8910	4.6L V8 281 CID	2005	Executive, Executive L, Signature, Signature L, Signature Limited	US4128
3.7L V6 3726cc 227 CID	2009-2010	Base	US6023	4.6L V8 281 CID	2006-2007	Designer Series, Executive, Executive L, Signature, Signature L, Signature Limited	US4128
3.7L V6 3726cc 227 CID	2011	Base	US8980	4.6L V8 281 CID	2008-2010	Executive, Executive L, Signature L, Signature Limited	US4128
3.7L V6 3726cc 227 CID	2012	Base; From 01/02/2012	US8910	4.6L V8 281 CID	2011	Executive L, Signature L, Signature Limited	US4128
3.7L V6 3726cc 227 CID	2012	Base; To 01/02/2012	US8980	5.0L V8 302 CID	1982-1987	Base, Cartier, Signature	US4014
3.7L V6 3726cc 227 CID	2013-2016	Base	US8910	5.0L V8 302 CID	1982-1987	Base, Cartier, Signature; High performance	US4014H
MKT				5.0L V8 302 CID	1988	Base, Cartier, Signature; To 06/1988	US4014
2.0L L4 1999cc 122 CID	2013-2016	Base	US4126	5.0L V8 302 CID	1988	Base, Cartier, Signature; High performance, To 06/88	US4014H
3.5L V6 3496cc 213 CID	2010	EcoBoost	US6023	5.0L V8 302 CID	1988	Base, Cartier, Signature; From 06/1988	US4052
3.5L V6 3496cc 213 CID	2011	EcoBoost	US8910	5.0L V8 302 CID	1988	Base, Cartier, Signature; From 06/88, High performance	US4052H
3.5L V6 3496cc 213 CID	2012	EcoBoost; From 01/02/2012	US8910	5.0L V8 302 CID	1989	Base, Cartier, Signature, Signature SE	US4052
3.5L V6 3496cc 213 CID	2012	EcoBoost; To 01/02/2012	US8910	5.0L V8 302 CID	1989	Base, Cartier, Signature, Signature SE; High performance	US4052H
3.5L V6 3496cc 213 CID	2013-2016	EcoBoost	US8910	5.0L V8 302 CID	1990	Base, Cartier, Cypress, Executive, Signature, Touring Edition	US4052
3.5L V6 3496cc 213 CID	2017	Base	US8910	5.0L V8 302 CID	1990	Base, Cartier, Cypress, Executive, Signature, Touring Edition; High performance	US4052H
3.5L V6 3496cc 213 CID	2018	Reserve	US8910	VERSAILLES			
3.7L V6 3726cc 227 CID	2010	Base	US6023	5.0L V8 302 CID	1977-1979	WINDSOR	US953
3.7L V6 3726cc 227 CID	2011	Base	US8980	5.0L V8 302 CID	1977-1979	High performance	US953H
3.7L V6 3726cc 227 CID	2012	Base; From 01/02/2012	US8910	5.0L V8 302 CID	1980	Base; WINDSOR	US953
3.7L V6 3726cc 227 CID	2012	Base; To 01/02/2012	US8980	5.0L V8 302 CID	1980	Base; High performance	US953H
3.7L V6 3726cc 227 CID	2013-2015	Base	US8910	5.8L V8 351 CID	1977	WINDSOR	US953
3.7L V6 3726cc 227 CID	2016-2018	Premiere	US8910	5.8L V8 351 CID	1977	High performance	US953H
2.7L V6 164 CID	2016	Black Label, Premiere, Reserve, Select	US8141P				
2.7L V6 164 CID	2016	Black Label, Premiere, Reserve, Select; Includes 3 hole pulley	US8141P				
2.7L V6 164 CID	2016	Black Label, Premiere, Reserve, Select; Includes 3 hole pulley and thermostat / housing	US8141P-T				
2.7L V6 164 CID	2016-2017	Black Label, Premiere, Reserve, Select; 3 Bolt Pulley	US8141				
2.7L V6 164 CID	2016-2017	Black Label, Premiere, Reserve, Select; 3 Bolt hub Includes thermostat / housing	US8141-T				
2.7L V6 164 CID	2016-2018	Black Label, Premiere, Reserve, Select	US8141				
3.5L V6 3496cc 213 CID	2007-2010	Base	US6023				
3.7L V6 3726cc 227 CID	2011	Base	US8980				
3.7L V6 3726cc 227 CID	2012	Base; From 01/02/2012	US8910				
3.7L V6 3726cc 227 CID	2012	Base; To 01/02/2012	US8980				
3.7L V6 3726cc 227 CID	2013-2015	Base	US8910				
3.7L V6 3726cc 227 CID	2016-2018	Black Label, Premiere, Reserve, Select	US8910				

Engine	Years	Application Description	USMW	Engine	Years	Application Description	USMW
LINCOLN (cont'd.)				MAZDA (cont'd.)			
ZEPHYR				B2000			
3.0L V6 2968cc 181 CID	2006	Base	US9489	2.0L L4 1970cc	1979		US1042
3.0L V6 2968cc 181 CID	2006	Base; Includes back housing	US9489-2	2.0L L4 1970cc	1980-1981	Base, Sundowner, Sundowner Sport	US1042
MAZDA				2.0L L4 1970cc	1982-1983	Sundowner Base, Sundowner DLX, Sundowner Sport	US1042
2				2.0L L4 1970cc	1984	Sundowner Base, Sundowner SE-5, Sundowner Sport	US1042
1.5L L4 1498cc 91 CID	2011-2014	Sport, Touring	US6295	2.0L L4 1998cc 122 CID	1986-1987	Base, LX, SE-5	US9111
3				B2200			
2.0L L4 1998cc 122 CID	2012-2013	i	US6700	2.2L L4 2184cc	1987-1989	Base, LX, SE-5	US4053
2.0L L4 1998cc 122 CID	2013	i	US6219	2.2L L4 2184cc	1990-1993	Base, LE-5, SE-5	US4053
2.0L L4 1998cc 122 CID	2014	i, i Grand Touring, I Sport, i SV, I Touring	US6700	B2300			
2.0L L4 1998cc 122 CID	2015	i Grand Touring, I Sport, i SV, I Touring	US6700	2.3L L4 140 CID	1994	Base, SE	US4054
2.0L L4 1998cc 122 CID	2016	i Grand Touring, I Sport, I Touring	US6700	2.3L L4 140 CID	1995-1997	Base, SE	US4093
2.0L L4 1998cc 122 CID	2017	Sport, Touring	US6700	2.3L L4 140 CID	2001	SE, SX	US4126
2.0L L4 2000cc 122 CID	2004-2005	i	US4126	2.3L L4 140 CID	2002	Base	US4126
2.0L L4 2000cc 122 CID	2006-2013	i	US6219	2.3L L4 140 CID	2003-2004	Base, SE	US4126
2.3L L4 2260cc	2004	S	US4126	2.3L L4 140 CID	2005-2009	Base	US4126
2.3L L4 2260cc	2005	S, SP23	US4126	B2500			
2.3L L4 2260cc	2006-2009	S	US6219	2.5L L4 2492cc	1998	SE, SX	US4093
2.3L L4 2260cc	2007-2013	Mazdaspeed	US4126	2.5L L4 2492cc	1999	SE, SX, Troy Lee	US4093
2.5L L4 2488cc 152 CID	2010-2013	S	US6219	2.5L L4 2492cc	2000-2001	SE, SX	US4093
2.5L L4 2488cc 152 CID	2014-2016	s Grand Touring, s Touring	US6700	B2600			
2.5L L4 2488cc 152 CID	2017	Grand Touring, Touring	US6700	2.6L L4 2555cc	1987-1988	Base, LX, SE-5	US7120
5				2.6L L4 2606cc	1989	Base, LX, SE-5	US9167
2.3L L4 2260cc	2006	Sport, Touring	US4126	2.6L L4 2606cc	1990-1993	Base, LE-5, SE-5	US9167
2.3L L4 2260cc	2007	Grand Touring, Sport, Touring	US4126	B3000			
2.3L L4 2260cc	2008-2010	Grand Touring, Sport, Touring	US6219	3.0L V6 2986cc 182 CID	1994	Base, SE	US4039
2.5L L4 2488cc 152 CID	2012-2015	Grand Touring, Sport, Touring	US6219	3.0L V6 2986cc 182 CID	1995-1996	Base, SE	US4095
6				3.0L V6 2986cc 182 CID	1998	SE, SX	US4095
2.3L L4 2260cc	2003-2006	i	US4126	3.0L V6 2986cc 182 CID	1999	SE, Troy Lee	US4095
2.3L L4 2260cc	2006	Mazdaspeed; From 02/01/2006	US4126	3.0L V6 2986cc 182 CID	2000	SE, SX, Troy Lee	US4095
2.3L L4 2260cc	2006	Mazdaspeed; To 02/01/2006	US4126	3.0L V6 2986cc 182 CID	2001	DS, SE	US4095
2.3L L4 2260cc	2007	i, Mazdaspeed	US4126	3.0L V6 2986cc 182 CID	2002	Base, DS	US4095
2.3L L4 2260cc	2008	i	US4126	3.0L V6 2986cc 182 CID	2003-2004	DS, SE	US4095
2.5L L4 2488cc 152 CID	2009-2010	i	US4126	3.0L V6 2986cc 182 CID	2005-2007	Base, DS	US4095
2.5L L4 2488cc 152 CID	2011-2013	i	US6219	B4000			
2.5L L4 2488cc 152 CID	2014-2017	Grand Touring, Sport, Touring	US6700	4.0L V6 4016cc	1994-1996	LE, SE	US4060
3.0L V6 2968cc 181 CID	2003	S	US9489	4.0L V6 4016cc	1997	Base, SE	US4060
3.0L V6 2968cc 181 CID	2004	S; From 08/06/03	US9489	4.0L V6 4016cc	1998-1999	SE	US4060
3.0L V6 2968cc 181 CID	2004	S; To 08/06/2003	US9489	4.0L V6 4016cc	2000	SE, Troy Lee	US4060
3.0L V6 2968cc 181 CID	2005	S; From 07/05/2004	US9489	4.0L V6 4016cc	2001	DS, SE	US4108
3.0L V6 2968cc 181 CID	2005	S; To 07/05/2004	US9489	4.0L V6 4016cc	2002	Base, DS	US4108
3.0L V6 2968cc 181 CID	2006-2008	S	US9489	4.0L V6 4016cc	2003-2004	Base, DS, SE	US4108
3.7L V6 3726cc 227 CID	2009	S	US6023	4.0L V6 4016cc	2005-2008	Base, SE	US4108
3.7L V6 3726cc 227 CID	2010	S; To 12/14/2010	US6023	4.0L V6 4016cc	2009	Base	US4108
323				COSMO			
1.6L L4 1597cc	1986-1987	Base, DX, LX	US4049	1.3L R2 1308cc	1976-1978		US9053
1.6L L4 1597cc	1988	Base, DX, LX, SE	US4049	CX-3			
1.6L L4 1597cc	1988	GT, GTX	US4068	2.0L L4 1998cc 122 CID	2016-2017	Grand Touring, Sport, Touring	US6700
1.6L L4 1597cc	1989	Base, LX, SE	US4049	CX-5			
1.6L L4 1597cc	1989	GTX; From 10/01/1988	US4068	2.0L L4 1998cc 122 CID	2013	Grand Touring, Sport, Touring	US6700
1.6L L4 1597cc	1989	GTX; To 10/01/1988	US4068	2.0L L4 1998cc 122 CID	2014-2016	Sport	US6700
1.6L L4 1597cc	1990-1993	Base, SE	US4049	2.5L L4 2488cc 152 CID	2014	Grand Touring, Touring	US6700
1.6L L4 1597cc	1994	Base	US4049	2.5L L4 2488cc 152 CID	2015-2016	Grand Touring, Sport, Touring	US6700
626				2.5L L4 2488cc 152 CID	2017	Grand Select, Grand Touring, Sport, Touring	US6700
2.0L L4 1970cc	1979		US1042	CX-7			
2.0L L4 1970cc	1980	Base	US1042	2.3L L4 2260cc	2007-2009	Grand Touring, Sport, Touring	US4126
2.0L L4 1970cc	1981-1982	Base, LX	US1042	2.3L L4 2260cc	2010-2012	Grand Touring, Touring	US4126
2.0L L4 1970cc	1983	Base, LX	US9060	2.5L L4 2488cc 152 CID	2010	Sport, SV	US6219
2.0L L4 1991cc	1993-1998	DX, LX	US4078	2.5L L4 2488cc 152 CID	2011-2012	Sport, SV, Touring	US6219
2.0L L4 1991cc	1999-2001	ES, LX	US4078	CX-9			
2.0L L4 1991cc	2002	LX	US4078	3.5L V6 3496cc 213 CID	2007	Grand Touring, Sport, Touring	US6023
2.0L L4 1998cc 122 CID	1984-1985	DX, LX	US9060	3.7L V6 3726cc 227 CID	2008-2009	Grand Touring, Sport, Touring	US6023
2.0L L4 1998cc 122 CID	1984-1985	LX	US9067	3.7L V6 3726cc 227 CID	2010	Grand Touring, Sport, Touring; To 12/15/2010	US6023
2.0L L4 1998cc 122 CID	1986-1987	DX, GT, LX	US9111	FAMILIA			
2.2L L4 2184cc	1988	DX, LX, Turbo, Turbo 4WS	US4053	1.5L L4 1490cc 91 CID	1986	Mexican Application	US4049
2.2L L4 2184cc	1989	DX, LX, Turbo	US4053	1.6L L4 1597cc 97 CID	1986	Mexican Application	US4049
2.2L L4 2184cc	1990	DX, GT, LX	US4053	GLC			
2.2L L4 2184cc	1991	DX, GT, LE, LX	US4053	1.3L L4 1272cc	1977-1978		US9020
2.2L L4 2184cc	1992	DX, LX	US4053	1.4L L4 1415cc	1979		US9020
2.5L V6 2497cc	1993	ES	US9318	1.4L L4 1415cc	1980	Base, Custom, Sport	US9020
2.5L V6 2497cc	1994-2002	ES, LX	US9318	1.5L L4 1490cc	1981	Base, Sport; Early	US9050
808				1.5L L4 1490cc	1981	Base, Sport; Late	US9050
1.6L L4 1587cc	1977		US9300	1.5L L4 1490cc	1981	Custom, Custom L; Hatchback; Early	US9050
929				1.5L L4 1490cc	1981	Custom, Custom L; Hatchback; Late	US9050
3.0L V6 2954cc 180 CID	1988-1989	Base	US9166	1.5L L4 1490cc	1981-1982	Custom, Custom L; Sedan	US9050
3.0L V6 2954cc 180 CID	1990-1991	Base, S	US9166	1.5L L4 1490cc	1981-1983	Custom; Wagon	US9020
3.0L V6 2954cc 180 CID	1990-1991		US9225	WATER PUMPS			
3.0L V6 2954cc 180 CID	1992-1995	Base	US9260	B1800			
B1800				1.8L L4 1796cc	1977-1978		US1042

Engine	Years	Application Description	USMW
MAZDA (cont'd.)			
GLC (cont'd.)			
1.5L L4 1490cc	1982	Base, Sport	US9050
1.5L L4 1490cc	1982	Custom, Custom L; Hatchback	US9050
1.5L L4 1490cc	1983	Base	US9050
1.5L L4 1490cc	1983	Custom, Custom L, Sport; Hatchback	US9050
1.5L L4 1490cc	1983	Custom, Custom L, Sport; Sedan	US9050
1.5L L4 1490cc	1984-1985	Base, DX, LX	US9050
MIATA			
1.6L L4 1597cc	1990	Base	US4068
1.6L L4 1597cc	1991	Base, SE	US4068
1.6L L4 1597cc	1992	Base	US4068
1.6L L4 1597cc	1993	Base, LE	US4068
1.8L L4 1839cc	1994-1996	Base, M Edition	US9305
1.8L L4 1839cc	1997	Base, M Edition, STO	US9305
1.8L L4 1839cc	1999	10th Anniversary, Base	US9305
1.8L L4 1839cc	2000-2002	Base, LS, SE	US9305
1.8L L4 1839cc	2003	Base, LS, SE, Shinsen	US9305
1.8L L4 1839cc	2004-2005	Base, LS, Mazdaspeed	US9305
MILLENNIA			
2.3L V6 2254cc	1995-1999	S	US9328
2.3L V6 2254cc	2000	Millennium Edition, S	US9328
2.3L V6 2254cc	2001	Base	US9328
2.3L V6 2254cc	2002	S	US9328
2.5L V6 2450cc 155 CID	2002	Base	US9318
2.5L V6 2497cc	1995-1998	Base, L	US9318
2.5L V6 2497cc	1999-2001	Base	US9318
MPV			
2.5L V6 2450cc 155 CID	2000-2001	DX, ES, LX	US4091
2.6L L4 2606cc	1989-1992	Cargo, Passenger	US9167
2.6L L4 2606cc	1993-1994	Passenger	US9167
3.0L V6 2954cc 180 CID	1989-1990	Passenger	US9166
3.0L V6 2954cc 180 CID	1991	Cargo, Passenger	US9166
3.0L V6 2954cc 180 CID	1992-1994	Passenger	US9166
3.0L V6 2954cc 180 CID	1995	L, LX, LXE	US9166
3.0L V6 2954cc 180 CID	1996	DX, ES, LX	US9394
3.0L V6 2954cc 180 CID	1997-1998	ES, LX	US9394
3.0L V6 2968cc 181 CID	2002	ES, LX	US4091
3.0L V6 2968cc 181 CID	2003	ES, LX; To 07/01/03	US4091
3.0L V6 2968cc 181 CID	2003	ES, LX; From 07/01/03, To 08/01/2003	US4132
3.0L V6 2968cc 181 CID	2003	ES, LX; From 08/01/2003	US4132
3.0L V6 2968cc 181 CID	2004-2005	ES, LX	US4132
3.0L V6 2968cc 181 CID	2006	ES, LX, LX-SV	US4132
MX-3			
1.6L L4 1597cc	1992-1993	Base	US4049
1.6L L4 1597cc	1994-1995	Base	US9305
1.8L V6 1845cc	1992	GS	US9318
1.8L V6 1845cc	1993	GS, SE	US9318
1.8L V6 1845cc	1994	GS	US9318
MX-5			
2.0L L4 1999cc 122 CID	2006-2008	Mexican Application	US6219
2.0L L4 1999cc 122 CID	2010-2011	Mexican Application	US6219
2.0L L4 1999cc 122 CID	2013-2014	Mexican Application	US6219
MX-5 GRAND TOURING			
2.0L L4 1999cc 122 CID	2010	Mexican Application	US6219
2.0L L4 1999cc 122 CID	2012	Mexican Application	US6219
MX-5 MIATA			
2.0L L4 2000cc 122 CID	2006	Base, Club Spec, Grand Touring, Sport, Touring	US6219
2.0L L4 2000cc 122 CID	2007-2009	Grand Touring, Sport, SV, Touring	US6219
2.0L L4 2000cc 122 CID	2010	Grand Touring, Sport, Touring	US6219
2.0L L4 2000cc 122 CID	2011-2012	Grand Touring, Special Edition, Sport, Touring	US6219
2.0L L4 2000cc 122 CID	2013-2014	Club, Grand Touring, Sport	US6219
2.0L L4 2000cc 122 CID	2015	25th Anniversary Edition, Club, Grand Touring, Sport	US6219
MX-6			
2.0L L4 1991cc	1993-1997	Base	US4078
2.2L L4 2184cc	1988	DX, GT, LX	US4053
2.2L L4 2184cc	1989-1990	DX, GT, GT 4WS, LX	US4053
2.2L L4 2184cc	1991	DX, GT, LE, LX	US4053
2.2L L4 2184cc	1992	DX, GT, LX	US4053
2.5L V6 2497cc	1993-1995	LS	US9318
2.5L V6 2497cc	1996	LS, M Edition	US9318
2.5L V6 2497cc	1997	LS	US9318
NAVAJO			
4.0L V6 4016cc	1991	LX	US4060
4.0L V6 4016cc	1992-1994	DX, LX	US4060
PROTEGE			
1.5L L4 1489cc	1995	DX, LX	US9305
1.5L L4 1489cc	1996-1998	DX, LX	US9371
1.6L L4 1589cc	1999-2001	DX, LX	US9305
1.8L L4 1839cc	1990	4WD, SE	US4049

Engine	Years	Application Description	USMW
MAZDA (cont'd.)			
PROTEGE (cont'd.)			
1.8L L4 1839cc	1990-1992	LX	US4068
1.8L L4 1839cc	1991	4WD, DX	US4049
1.8L L4 1839cc	1992	DX	US4049
1.8L L4 1839cc	1993	DX, LX	US4049
1.8L L4 1839cc	1994	Base, DX, LX	US4049
1.8L L4 1839cc	1995-1998	ES	US9305
1.8L L4 1839cc	1999-2000	ES	US4078
2.0L L4 2000cc	2001	ES, LX, MP3	US4078
2.0L L4 2000cc	2002	DX, ES, LX	US4078
2.0L L4 2000cc	2003	DX, ES, LX, Mazdaspeed	US4078
PROTEGE5			
2.0L L4 2000cc	2002-2003	Base	US4078
ROTARY PICKUP			
1.3L R2 1308cc	1975-1977		US9053
RX-3			
1.1L R2 1146cc	1975-1978		US9053
RX-4			
1.3L R2 1308cc	1975-1978		US9053
RX-7			
1.1L R2 1146cc	1979		US9053
1.1L R2 1146cc	1985	GS, GSL, S	US9053
1.3L R2 1308cc	1985	GSL-SE	US9053
1.3L R2 1308cc	1986	Base, GXL, Turbo	US9102
1.3L R2 1308cc	1987	Base, Base 2+2, GXL, GXL 2+2, LX, LX 2+2, Sport; From 12/16/1986	US9102
1.3L R2 1308cc	1987	Turbo	US9102
1.3L R2 1308cc	1988	10th Anniversary, Convertible, GTU, GXL, GXL 2+2, SE, SE 2+2, Turbo	US9102
1.3L R2 1308cc	1989-1990	Convertible, GTU, GTUs, GXL, GXL 2+2, Turbo	US9208
1.3L R2 1308cc	1991	Base, Convertible, Turbo	US9208
RX-8			
1.3L R2 1308cc	2004	Base	US6156
1.3L R2 1308cc	2005	Base, Shinka	US6156
1.3L R2 1308cc	2006-2007	Base	US6156
1.3L R2 1308cc	2008	40th Anniversary Edition, Grand Touring, Sport, Touring	US6156
TRIBUTE			
2.0L L4 1989cc 121 CID	2001-2004	DX	US4115
2.3L L4 140 CID	2005-2006	i	US4126
2.3L L4 140 CID	2008	Hybrid, i	US4126
2.5L L4 2488cc 152 CID	2009-2010	Hybrid, i	US4126
2.5L L4 2488cc 152 CID	2011	i	US4126
3.0L V6 2968cc 181 CID	2001-2002	DX, ES, LX	US4091
3.0L V6 2968cc 181 CID	2003-2004	ES, LX	US4091
3.0L V6 2968cc 181 CID	2005-2006	S	US4132
3.0L V6 2968cc 181 CID	2008	S	US4132
3.0L V6 2968cc 181 CID	2009-2011	S	US6250
MERCEDES-BENZ			
190D			
2.5L L5 2497cc	1986	2.5	US9228
2.5L L5 2497cc	1987	2.5, 2.5 Turbo	US9228
2.5L L5 2497cc	1988-1989	2.5	US9228
190DT			
2.5L L5 2497cc 152 CID	1990	Mexican Application	US9228
190E			
2.3L L4 2299cc	1984	2.3	US9173
2.3L L4 2299cc	1985	2.3	US9175
2.3L L4 2299cc	1986-1987	2.3, 2.3-16	US9175
2.3L L4 2299cc	1988	2.3	US9175
2.3L L4 2299cc	1991-1993	2.3	US9175
2.6L L6 2599cc	1987-1993	2.6	US9202
220E			
2.2L L4 2199cc 134 CID	1994	Mexican Application	US9314
230			
2.3L L4 2307cc	1975-1978		US9172
2.3L L6 2306cc 141 CID	1966-1969		US9299
230E			
2.3L L4 2300cc 140 CID	1986-1989	Mexican Application	US9175
2.3L L4 2300cc 140 CID	1991	Mexican Application	US9175
240D			
2.4L L4 2404cc	1975-1979		US9172
2.4L L4 2404cc	1980-1983	Base	US9172
250			
2.5L L6 2496cc 152 CID	1968-1972		US9299

Engine	Years	Application Description	USMW	Engine	Years	Application Description	USMW
MERCEDES-BENZ (cont'd.)				MERCEDES-BENZ (cont'd.)			
250C				300TD (cont'd.)			
2.8L L6 2778cc	1970-1972		US9299	3.0L L5 3005cc	1981-1982	Base	US9172
250D				3.0L L6 2998cc	1987	Base	US9228
2.5L L5 2497cc 152 CID	1986	Mexican Application	US9228	300TE			
260E				3.0L L6 2962cc	1988-1989	Base	US9202
2.6L L6 2599cc	1987-1989	Base	US9202	3.0L L6 2962cc	1990-1992	4Matic, Base	US9202
2.6L L6 2599cc 158 CID	1992	Mexican Application	US9202	3.0L L6 2962cc	1993	4Matic	US9202
260SE				3.0L L6 2962cc 180 CID	1986-1987	Mexican Application	US9202
2.6L L6 2599cc 158 CID	1987	Mexican Application	US9202	3.2L L6 3199cc	1993	Base; To Engine 072236	US9313
2.6L L6 2599cc 158 CID	1989	Mexican Application	US9202	3.2L L6 3199cc	1993	Base; From Engine 072237	US9345
280				350SD			
2.8L L6 2746cc	1973-1976		US9299	3.4L L6 3449cc	1991	Base	US9228
280C				350SDL			
2.8L L6 2746cc	1973-1976		US9299	3.4L L6 3449cc	1990-1991	Base	US9228
280CE				380SE			
2.8L L6 2746cc	1978-1980		US9299	3.8L V8 3839cc	1984-1985	Base	US9230
280E				380SEC			
2.8L L6 2746cc	1978-1980		US9299	3.8L V8 3839cc	1982-1983	Base	US9230
2.8L L6 2799cc 171 CID	1993	Mexican Application	US9345	380SEL			
280S				3.8L V8 3839cc	1981-1983	Base	US9230
2.8L L6 2746cc	1975-1976		US9299	380SL			
2.8L L6 2778cc	1969-1971		US9299	3.8L V8 3839cc	1981-1985	Base	US9230
280SE				380SLC			
2.8L L6 2746cc	1977-1980		US9299	3.8L V8 3839cc	1981	Base	US9230
2.8L L6 2778cc	1969-1972		US9299	400E			
280SEL				4.2L V8 4196cc	1992-1993	Base; To Engine 020771	US9315
2.8L L6 2778cc	1969-1971		US9299	4.2L V8 4196cc	1992-1993	Base; From Engine 020772	US9346
280SL				4.2L V8 4196cc 256 CID	1994	Mexican Application	US9346
2.8L L6 2778cc	1969-1971		US9299	400SE			
300CD				4.2L V8 4196cc	1992	Base; To Engine 026750	US9315
3.0L L5 2998cc	1983-1985	Base	US9172	4.2L V8 4196cc	1992	Base; From Engine 026751	US9346
3.0L L5 3005cc	1978-1979		US9172	4.2L V8 4196cc 256 CID	1996-1997	Mexican Application	US9346
3.0L L5 3005cc	1980-1981	Base; Early	US9172	400SEL			
3.0L L5 3005cc	1980-1981	Base; Late	US9172	4.2L V8 4196cc	1993	Base; To Engine 026750	US9315
3.0L L5 3005cc	1982	Base	US9172	4.2L V8 4196cc	1993	Base; From Engine 026751	US9346
300CE				4.2L V8 4196cc 256 CID	1995	Mexican Application	US9346
3.0L L6 2962cc	1988-1989	Base	US9202	4.2L V8 4196cc 256 CID	1997	Mexican Application	US9346
3.0L L6 2962cc	1990-1992	Base	US9222	420SE			
3.0L L6 2962cc 180 CID	1993	Mexican Application	US9202	4.2L V8 4196cc 256 CID	1986	Mexican Application	US9231
3.2L L6 3199cc	1993	Base; To Engine 072236	US9313	420SEL			
3.2L L6 3199cc	1993	Base; From Engine 072237	US9345	4.2L V8 4196cc	1986-1991	Base	US9231
300D				420SL			
2.5L L5 2497cc	1990-1993	2.5	US9228	4.2L V8 4196cc 256 CID	1986	Mexican Application	US9231
3.0L L5 2998cc	1983-1985	Base	US9172	4.2L V8 4196cc 256 CID	1996-1997	Mexican Application	US9346
3.0L L5 2998cc 182 CID	1986	Mexican Application	US9228	450SE			
3.0L L5 3005cc	1975-1979		US9172	4.5L V8 4520cc	1975-1976		US9176
3.0L L5 3005cc	1980-1982	Base	US9172	450SEL			
3.0L L6 2985cc 182 CID	1989	Mexican Application	US9172	4.5L V8 4520cc	1975-1979		US9176
3.0L L6 2998cc	1987	Base	US9228	4.5L V8 4520cc	1980	Base	US9176
300E				450SL			
2.6L L6 2599cc	1990-1992	2.6	US9202	4.5L V8 4520cc	1975-1979		US9176
2.8L L6 2799cc	1993	2.8	US9313	4.5L V8 4520cc	1980	Base	US9176
3.0L L6 2962cc	1986-1989	Base	US9202	450SLC			
3.0L L6 2962cc	1990-1992	4Matic, Base	US9202	4.5L V8 4520cc	1975-1979		US9176
3.0L L6 2962cc	1993	4Matic	US9202	4.5L V8 4520cc	1980	Base	US9176
3.2L L6 3199cc	1993	Base; To Engine 072236	US9313	500CL			
3.2L L6 3199cc	1993	Base; From Engine 072237	US9345	5.0L V8 4973cc 303 CID	1996-1997	Mexican Application	US9346
300SD				500E			
3.0L L5 2998cc	1983-1985	Base	US9172	5.0L V8 4973cc	1992-1993	Base; To Engine 010204	US9315
3.0L L5 3005cc	1978-1979		US9172	5.0L V8 4973cc	1992-1993	Base; From Engine 010205	US9346
3.0L L5 3005cc	1980-1982	Base	US9172	5.0L V8 4973cc 303 CID	1991	Mexican Application	US9315
3.4L L6 3449cc	1992-1993	Base	US9228	500SE			
300SDL				5.0L V8 4973cc 303 CID	1986	Mexican Application	US9230
3.0L L6 2998cc	1986-1987	Base	US9228	500SEC			
300SE				5.0L V8 4973cc	1984-1985	Base	US9230
3.0L L6 2962cc	1988-1991	Base	US9202	5.0L V8 4973cc	1993	Base; To Engine 056885	US9315
3.2L L6 3199cc	1992-1993	Base	US9343	5.0L V8 4973cc	1993	Base; From Engine 056886	US9346
300SEL				5.0L V8 4973cc 303 CID	1987	Mexican Application	US9230
2.8L L6 2778cc	1968-1969		US9299	5.0L V8 4973cc 303 CID	1996-1997	Mexican Application	US9346
3.0L L6 2962cc	1988-1991	Base	US9202	500SEL			
300SL				5.0L V8 4973cc	1984-1985	Base	US9230
3.0L L6 2962cc	1990-1993	Base	US9222	5.0L V8 4973cc	1992-1993	Base; To Engine 056885	US9315
3.0L L6 2962cc 180 CID	1986	Mexican Application	US9202	5.0L V8 4973cc	1992-1993	Base; From Engine 056886	US9346
300TD				300TD			
3.0L L5 2998cc	1983-1985	Base	US9172	3.0L L5 2998cc	1983-1985	Base	US9172

WATER PUMPS

Engine	Years	Application Description	USMW
MERCEDES-BENZ (cont'd.)			
500SEL (cont'd.)			
5.0L V8 4973cc 303 CID	1991	Mexican Application	US9315
5.0L V8 4973cc 303 CID	1994	Mexican Application	US9315
5.0L V8 4973cc 303 CID	1995-1997	Mexican Application	US9346
500SL			
5.0L V8 4973cc	1990-1992	Base	US9315
5.0L V8 4973cc	1993	Base; To Engine 013777	US9315
5.0L V8 4973cc	1993	Base; From Engine 013778	US9346
5.0L V8 4973cc 303 CID	1986	Mexican Application	US9230
5.0L V8 4973cc 303 CID	1989	Mexican Application	US9315
560SE			
5.6L V8 5547cc 338 CID	1986	Mexican Application	US9231
560SEC			
5.6L V8 5547cc	1986-1991	Base	US9231
560SEL			
5.6L V8 5547cc	1986-1991	Base	US9231
5.6L V8 5547cc 338 CID	1994	Mexican Application	US9231
5.6L V8 5547cc 338 CID	1996	Mexican Application	US9231
560SL			
5.6L V8 5547cc	1986-1989	Base	US9231
600CL			
6.0L V12 5987cc 365 CID	1996-1997	Mexican Application	US9277
600SEC			
6.0L V12 5987cc	1993	Base	US9277
6.0L V12 5987cc 365 CID	1994-1997	Mexican Application	US9277
600SEL			
6.0L V12 5987cc	1992-1993	Base	US9277
6.0L V12 5987cc 365 CID	1991	Mexican Application	US9277
6.0L V12 5987cc 365 CID	1994-1997	Mexican Application	US9277
600SL			
6.0L V12 5987cc	1993	Base	US9277
A160			
1.6L L4 1587cc 97 CID	2000-2001	Mexican Application	US8985
1.6L L4 1598cc 98 CID	2002-2005	Mexican Application	US8985
C32 AMG			
3.2L V6 3199cc	2002-2004	Supercharged; Engine Cooling	US11015
C36 AMG			
3.6L L6 3606cc	1995	Base	US9345
3.6L L6 3606cc	1996-1997	Base	US9311
C43 AMG			
4.3L V8 4266cc	1998-2000	Base	US9379
C55 AMG			
5.5L V8 5439cc 332 CID	2007	Mexican Application	US9380
5.5L V8 5439cc 335 CID	2005-2006	Base	US9380
C220			
2.2L L4 2199cc	1994-1996	Base	US9314
C230			
1.8L L4 1796cc	2003-2005	Kompressor	US6030
2.3L L4 2295cc	1997-1998	Base	US9314
2.3L L4 2295cc	1999-2000	Kompressor	US9440
2.3L L4 2295cc	2002	Kompressor	US6229
2.5L V6 2496cc	2006	Sport; To 03/02/2005	US6075
2.5L V6 2496cc	2006	Sport; From 03/02/2005	US6142
2.5L V6 2496cc	2007	Sport	US6142
C240			
2.6L V6 2597cc	2001-2002	Base	US9379
2.6L V6 2597cc	2003-2005	4Matic, Base	US9379
C280			
2.8L L6 2799cc	1994	Base	US9313
2.8L L6 2799cc	1995	Base; To Engine 034966	US9313
2.8L L6 2799cc	1995	Base; From Engine 034967	US9345
2.8L L6 2799cc	1996-1997	Base	US9344
2.8L V6 2799cc	1998-2000	Base	US9379
3.0L V6 2996cc	2006	4Matic, Luxury; To 03/02/2005	US6075
3.0L V6 2996cc	2006	4Matic, Luxury; From 03/02/2005	US6142
3.0L V6 2996cc	2006-2007	4Matic, Luxury; Engine Cooling	US11015
3.0L V6 2996cc	2007	4Matic, Luxury	US6142
C300			
3.0L V6 2996cc	2008-2011	4Matic Luxury, 4Matic Sport, Luxury, Sport	US6142
3.0L V6 2996cc	2012	4Matic Luxury, 4Matic Sport	US6142

Engine	Years	Application Description	USMW
MERCEDES-BENZ (cont'd.)			
C320			
3.2L V6 3199cc	2001-2002	Base	US9379
3.2L V6 3199cc	2003-2005	4Matic, Base	US9379
C350			
3.5L V6 3498cc	2006	4Matic, Luxury, Sport; To 03/02/2005	US6075
3.5L V6 3498cc	2006	4Matic, Luxury, Sport; From 03/02/2005	US6142
3.5L V6 3498cc	2006-2007	4Matic, Luxury, Sport; Engine Cooling	US11015
3.5L V6 3498cc	2007	4Matic, Luxury, Sport	US6142
3.5L V6 3498cc	2008-2011	Sport	US6142
CL55 AMG			
5.5L V8 5439cc 335 CID	2001-2002	Base	US9380
CL63 AMG			
6.3L V8 6208cc	2008-2010	Engine Cooling	US11015
CL65 AMG			
6.0L V12 5980cc 365 CID	2005-2006		US6273
6.0L V12 5980cc 365 CID	2005-2006	Turbocharged; Engine Cooling	US11015
6.0L V12 5980cc 365 CID	2008-2013		US6273
6.0L V12 5980cc 365 CID	2008-2014	Turbocharged; Engine Cooling	US11015
6.0L V12 5980cc 365 CID	2014	Base	US6273
CL500			
5.0L V8 4966cc	2006	Base	US9379
5.0L V8 4973cc	1998-1999	Base	US9346
5.0L V8 4973cc	2000-2005	Base	US9379
5.5L V8 5461cc 333 CID	2008-2010	Mexican Application	US9380
CL550			
4.6L V8 4663cc	2011-2014	4Matic; Turbocharged; Engine Cooling	US11015
5.5L V8 5461cc	2007-2008	Base	US6235
5.5L V8 5461cc	2009-2010	4Matic	US6235
CL600			
5.5L V12 5513cc 336 CID	2003-2014	Base	US6273
5.5L V12 5513cc 336 CID	2003-2014	Turbocharged; Engine Cooling	US11015
5.8L V12 5786cc	2001-2002		US6273
5.8L V12 5786cc 353 CID	2003	Mexican Application	US9277
6.0L V12 5987cc	1998-1999	Base	US9277
CLK55 AMG			
5.5L V8 5439cc 335 CID	2001-2006	Base	US9380
CLK320			
3.2L V6 3199cc	1998-2002	Base; From Engine 30 033141	US9379
3.2L V6 3199cc	1998-2002	Base; To Engine 30 033140	US9380
3.2L V6 3199cc	2003-2005	Base	US9379
CLK350			
3.5L V6 3498cc	2006	Base; To 03/02/2005	US6075
3.5L V6 3498cc	2006	Base; From 03/02/2005	US6142
3.5L V6 3498cc	2007-2009	Base	US6142
CLK430			
4.3L V8 4266cc	1999-2003	Base	US9379
CLK500			
5.0L V8 4966cc	2006	Base	US9379
5.0L V8 4966cc 303 CID	2007-2009	Mexican Application	US9379
5.0L V8 4973cc	2003-2005	Base	US9379
CLK550			
5.5L V8 5461cc	2007-2009	Base	US6235
CLS55 AMG			
5.5L V8 5439cc 335 CID	2006	Electric Water Pump, HVAC System	US11009
5.5L V8 5439cc 335 CID	2006	Supercharged; Engine Cooling	US11015
CLS63 AMG			
5.5L V8 5461cc	2012-2013	Base; Turbocharged; Engine Cooling	US11015
5.5L V8 5461cc	2014	4Matic; Turbocharged; Engine Cooling	US11015
6.3L V8 6208cc	2007-2011	Electric Water Pump	US11009
CLS500			
5.0L V8 4966cc	2006	Base	US9379
5.0L V8 4966cc	2006	Electric Water Pump	US11009
5.0L V8 4966cc 303 CID	2007	Mexican Application	US9379
5.5L V8 5461cc 333 CID	2008-2011	Mexican Application	US9380
CLS550			
4.6L V8 4663cc	2012-2014	4Matic, Base; Turbocharged; Engine Cooling	US11015
5.5L V8 5461cc	2007-2011	Base	US6235
5.5L V8 5461cc	2007-2011	Electric Water Pump	US11009

Engine	Years	Application Description	USMW	Engine	Years	Application Description	USMW
MERCEDES-BENZ (cont'd.)				MERCEDES-BENZ (cont'd.)			
E55 AMG				G500L			
5.5L V8 5439cc 335 CID	1999-2002	Base	US9380	5.0L V8 4973cc 303 CID	2000	Mexican Application	US9379
5.5L V8 5439cc 335 CID	2003-2006	Electric Water Pump, HVAC System	US11009	5.0L V8 4973cc 303 CID	2001	Mexican Application	US9380
5.5L V8 5439cc 335 CID	2003-2006	Supercharged; Engine Cooling	US11015	G550			
E63 AMG				5.5L V8 5461cc 2009-2015 Base US6235			
5.5L V8 5461cc	2012-2013	Base; Turbocharged; Engine Cooling	US11015	5.5L V8 5461cc	2009-2015	Base; Electric Water Pump, Optional	US11024
5.5L V8 5461cc	2014	4Matic; Turbocharged; Engine Cooling	US11015	GL63 AMG			
6.3L V8 6208cc	2007-2009	Electric Water Pump	US11009	5.5L V8 5461cc 333 CID	2013-2014	Base; Turbocharged	US11015
E63 AMG S				GL320			
5.5L V8 5461cc	2014	4Matic; Turbocharged; Engine Cooling	US11015	3.0L V6 2987cc	2007-2008	CDI	US6155
E280				3.0L V6 2987cc 2007-2008 CDI; Electric Water Pump US11009			
2.8L L6 2800cc 171 CID	1999	Mexican Application	US9344	3.0L V6 2987cc	2009	Bluetec 4Matic	US6155
3.0L V6 2996cc 183 CID	2007	Mexican Application	US6142	3.0L V6 2987cc	2009	Bluetec 4Matic; Electric Water Pump	US11009
E300				GL350			
3.0L L6 2996cc	1995-1999	Base	US9228	2010-2012 Bluetec 4Matic; Electric Water Pump US11009			
E320				2010-2013 Bluetec 4Matic US6155			
3.0L V6 2987cc	2007-2009	Bluetec	US6155	GL450			
3.0L V6 2987cc	2007-2009	Bluetec; Electric Water Pump	US11009	4.6L V8 4663cc 2007-2012 Base US6235			
3.2L L6 3199cc	1994-1995	Base; To Engine 072236	US9313	4.6L V8 4663cc	2007-2012		US11009
3.2L L6 3199cc	1994-1995	Base; From Engine 072237	US9345	4.6L V8 4663cc	2013-2014	Base; Turbocharged	US11015
3.2L L6 3199cc	1996-1997	Base	US9344	GL500			
3.2L L6 3222cc	2005-2006	CDI	US6152	5.5L V8 5461cc 333 CID 2008-2011 Mexican Application US9380			
3.2L L6 3222cc	2005-2006	CDI; Electric Water Pump	US11009	GL550			
3.2L V6 3199cc	1998-2003	4Matic, Base; Exc.Oil Cooler Fitting	US9379	4.6L V8 4663cc 2013-2014 4Matic; Turbocharged US11015			
3.2L V6 3199cc	1998-2003	4Matic, Base; Oil Cooler Fitting	US9380	5.5L V8 5461cc 2008-2012 Base US6235			
3.2L V6 3199cc	2003	Base; Electric Water Pump	US11009	5.5L V8 5461cc 2008-2012 Base US11009			
3.2L V6 3199cc	2004-2005	4Matic	US9379	GLK350			
3.2L V6 3199cc	2004-2005	Base; Exc.Oil Cooler Fitting	US9379	3.5L V6 3498cc 2010-2012 4Matic, Base US6142			
3.2L V6 3199cc	2004-2005	Base; Oil Cooler Fitting	US9380	MAYBACH S600			
3.2L V6 3199cc	2004-2005	4Matic, Base; Electric Water Pump	US11009	6.0L V12 5980cc 365 CID 2016-2017 Base US6273			
E350				ML55 AMG			
3.0L V6 2987cc	2011-2013	Bluetec	US6155	5.5L V8 5439cc 335 CID 2000-2003 Base US9380			
3.5L V6 3498cc	2006	4Matic, Base; To 03/02/2005	US6075	ML63 AMG			
3.5L V6 3498cc	2006	4Matic, Base; From 03/02/2005	US6142	5.5L V8 5461cc 2012 Charge Air Cooling, Electric Water Pump, To 12/02/2011 US11009			
3.5L V6 3498cc	2006-2009	4Matic, Base; Electric Water Pump	US11009	5.5L V8 5461cc 2012-2014 Base; Turbocharged US11015			
3.5L V6 3498cc	2007-2011	4Matic, Base	US6142	6.3L V8 6208cc 2007-2011 Electric Water Pump, HVAC System US11009			
E420				6.3L V8 6208cc 2007-2011 Base; Naturally Aspirated US11015			
4.2L V8 4196cc	1994-1995	Base; To Engine 020771	US9315	ML320			
4.2L V8 4196cc	1994-1995	Base; From Engine 020772	US9346	3.0L V6 2987cc 2007-2008 CDI US6155			
4.2L V8 4196cc	1997	Base	US9346	3.0L V6 2987cc 2007-2008 CDI; Electric Water Pump US11009			
E430				3.0L V6 2987cc 2009 Bluetec 4Matic US6155			
4.3L V8 4266cc	1998-1999	Base	US9379	3.0L V6 2987cc 2009 Bluetec 4Matic; Electric Water Pump US11009			
4.3L V8 4266cc	2000-2002	4Matic, Base	US9379	3.2L V6 3199cc 1998-2003 Base US9379			
E500				ML350			
5.0L V8 4966cc	2004-2005	4Matic	US9379	3.0L V6 2987cc 2010-2011 Bluetec 4Matic; Electric Water Pump US11009			
5.0L V8 4966cc	2004-2005	4Matic; Electric Water Pump	US11009	3.0L V6 2987cc 2010-2013 Bluetec 4Matic US6155			
5.0L V8 4966cc	2006	4Matic, Base	US9379	3.5L V6 3498cc 2006 4Matic; To 03/02/2005 US6075			
5.0L V8 4966cc	2006	4Matic, Base; Electric Water Pump	US11009	3.5L V6 3498cc 2006 4Matic; From 03/02/2005 US6142			
5.0L V8 4973cc	1994	Base; To Engine 010204	US9315	3.5L V6 3498cc 2006-2008 4Matic; Electric Water Pump US11009			
5.0L V8 4973cc	1994	Base; From Engine 010205	US9346	3.5L V6 3498cc 2007-2008 4Matic US6142			
5.0L V8 4973cc	2003-2005	Base	US9379	3.5L V6 3498cc 2009-2011 4Matic, Base US6142			
5.0L V8 4973cc	2003-2005	Base; Electric Water Pump	US11009	3.5L V6 3498cc 2009-2011 4Matic, Base; Electric Water Pump US11009			
5.5L V8 5461cc 333 CID	2008-2011	Mexican Application	US9380	3.7L V6 3699cc 2003-2005 Base US9379			
E550				ML430			
4.6L V8 4663cc	2012-2014	4Matic, Base; Turbocharged; Engine Cooling	US11015	4.3L V8 4266cc 1999-2001 Base US9380			
5.5L V8 5461cc	2007-2009	4Matic, Base; Electric Water Pump	US11009	ML450			
5.5L V8 5461cc	2007-2011	4Matic, Base	US6235	3.5L V6 3498cc 2010-2011 Hybrid 4Matic; Electric Water Pump, Engine Cooling US11009			
G55 AMG				3.5L V6 3498cc 2010-2011 Hybrid 4Matic; ELECTRIC/GAS; Inverter Cooling US11015			
5.5L V8 5439cc 335 CID	2003-2004	Base	US9380	ML500			
5.5L V8 5439cc 335 CID	2003-2004	Base; Electric Water Pump, Optional	US11024	5.0L V8 4966cc 2002 Base US9380			
5.5L V8 5439cc 335 CID	2005-2011	Supercharged; Charge Air Cooling	US11015	5.0L V8 4966cc 2006 Base US9380			
5.5L V8 5439cc 335 CID	2005-2011	Base; Electric Water Pump, Engine Cooling(Optional)	US11024	5.0L V8 4966cc 2006 Base; Electric Water Pump US11009			
G63 AMG				5.0L V8 4966cc 303 CID 2003-2005 Base US9380			
5.5L V8 5461cc	2013-2014	Electric Water Pump, HVAC System	US11009	5.0L V8 4966cc 303 CID 2007 Base US9380			
G65 AMG				5.0L V8 4973cc 2007 Base; Electric Water Pump US11009			
6.0L V12 5980cc 365 CID	2016-2017	Base	US6273	ML550			
G500				4.6L V8 4663cc 2014 Base; Turbocharged US11015			
5.0L V8 4966cc	2002-2004	Base; Exc.Oil Cooler Fitting	US9379	5.5L V8 5461cc 2008-2011 Base US6235			
5.0L V8 4966cc	2002-2004	Base; Oil Cooler Fitting	US9380	5.5L V8 5461cc 2008-2011 Base; Electric Water Pump US11009			
5.0L V8 4966cc	2002-2004	Base; Electric Water Pump, Optional	US11024	R63 AMG			
5.0L V8 4966cc	2006-2008	Base; Exc.Oil Cooler Fitting	US9379	6.3L V8 6208cc 2007 Base; Electric Water Pump, HVAC System (Auxiliary Heater) US11009			
5.0L V8 4966cc	2006-2008	Base; Oil Cooler Fitting	US9380	6.3L V8 6208cc 2007 Naturally Aspirated US11015			
5.0L V8 4966cc	2006-2008	Base; Electric Water Pump, Optional	US11024				
5.0L V8 4973cc	2005	Base; Exc.Oil Cooler Fitting	US9379				
5.0L V8 4973cc	2005	Base; Oil Cooler Fitting	US9380				
5.0L V8 4973cc	2005	Base; Electric Water Pump, Optional	US11024				

Engine	Years	Application Description	USMW	Engine	Years	Application Description	USMW
MERCURY (cont'd.)				MERCURY (cont'd.)			
CALIENTE				COUGAR (cont'd.)			
3.3L L6 3277cc 200 CID	1964-1967		US1044	3.8L V6 232 CID	1982	Base, GS, LS, XR-7	US4016
CAPRI				3.8L V6 232 CID	1983-1986	Base, LS	US4016
1.6L L4 1598cc 98 CID	1991-1994	Base, XR2	US4068	3.8L V6 232 CID	1987	LS	US4016
2.0L L4 1993cc 122 CID	1971-1974		US964	3.8L V6 232 CID	1988	LS	US4050
2.3L L4 140 CID	1975-1977		US4005	3.8L V6 232 CID	1989	LS, XR-7	US4050
2.3L L4 140 CID	1979		US4005	3.8L V6 232 CID	1990	XR-7	US4055
2.3L L4 140 CID	1980	Base, Ghia	US4005	3.8L V6 232 CID	1990-1992	LS	US4050
2.3L L4 140 CID	1981	Base, GS	US4005	3.8L V6 232 CID	1993	XR-7	US4050
2.3L L4 140 CID	1982	Base, Black Magic, GS, L	US4005	3.8L V6 232 CID	1994-1995	XR-7	US4090
2.3L L4 140 CID	1983	Base, Black Magic, Crimson Cat, GS, L	US4054	3.8L V6 232 CID	1996-1997	XR-7	US4103
2.3L L4 140 CID	1984	GS, RS Turbo	US4054	4.2L V8 255 CID	1980	XR-7	US4014
2.3L L4 140 CID	1985-1986	GS	US4054	4.2L V8 255 CID	1980	XR-7; High performance	US4014H
2.8L V6 171 CID	1979		US1047	4.2L V8 255 CID	1981	Base, XR-7	US4014
3.3L L6 200 CID	1979		US4002	4.2L V8 255 CID	1981	Base, XR-7; High performance	US4014H
3.3L L6 200 CID	1980	Base, Ghia	US4002	4.2L V8 255 CID	1982	XR-7	US4014
3.3L L6 200 CID	1981	Base, GS	US4002	4.2L V8 255 CID	1982	XR-7; High performance	US4014H
3.3L L6 200 CID	1982	Base, Black Magic, GS, L	US4002	4.6L V8 281 CID	1994-1997	XR-7; Pump Length: long	US4113
3.8L V6 232 CID	1983	Base, Black Magic, Crimson Cat, GS, L	US4016	5.0L V8 302 CID	1977-1979	WINDSOR	US953
3.8L V6 232 CID	1984-1986	GS	US4016	5.0L V8 302 CID	1977-1979	High performance	US953H
4.2L V8 255 CID	1980	Base, Ghia	US4024	5.0L V8 302 CID	1980-1981	XR-7	US4014
4.2L V8 255 CID	1980	Base, Ghia; High performance	US4024H	5.0L V8 302 CID	1980-1981	XR-7; High performance	US4014H
4.2L V8 255 CID	1981	Base, GS	US4024	5.0L V8 302 CID	1983-1985	Base, LS	US4014
4.2L V8 255 CID	1981	Base, GS; High performance	US4024H	5.0L V8 302 CID	1983-1985	Base, LS; High performance	US4014H
4.2L V8 255 CID	1982	Base, Black Magic, GS, L, RS	US4024	5.0L V8 302 CID	1986	Base, LS	US4038
4.2L V8 255 CID	1982	Base, Black Magic, GS, L, RS; High performance	US4024H	5.0L V8 302 CID	1986	Base, LS; High performance	US4038H
5.0L V8 302 CID	1979		US4024	5.0L V8 302 CID	1987-1988	LS, XR-7	US4038
5.0L V8 302 CID	1979	High performance	US4024H	5.0L V8 302 CID	1987-1988	LS, XR-7; High performance	US4038H
5.0L V8 302 CID	1982-1983	RS; High performance	US4024H	5.0L V8 302 CID	1991-1992	LS, XR-7	US4057
5.0L V8 302 CID	1982-1985	RS	US4024	5.0L V8 302 CID	1993	XR-7	US4057
5.0L V8 302 CID	1984	RS; Exc.CFI, High performance	US4024H	5.8L V8 351 CID	1975-1979	MODIFIED	US932
5.0L V8 302 CID	1985	RS; High performance	US4024H	5.8L V8 351 CID	1975-1979	WINDSOR	US953
5.0L V8 302 CID	1985	RS	US4035	5.8L V8 351 CID	1975-1979	High performance	US953H
5.0L V8 302 CID	1986	5.0	US4038	6.6L V8 400 CID	1975-1978	MODIFIED	US932
5.0L V8 302 CID	1986	5.0; High performance	US4038H	7.5L V8 460 CID	1975-1976		US1114
COLONY PARK				COUNTRY CRUISER			
5.0L V8 302 CID	1987	GS, LS	US4014	3.3L L6 3277cc 200 CID	1963		US1044
5.0L V8 302 CID	1987	GS, LS; High performance	US4014H	6.4L V8 6391cc 390 CID	1963		US723
5.0L V8 302 CID	1988	GS, LS; To 06/1988	US4014	CUSTOM			
5.0L V8 302 CID	1988	GS, LS; High performance, To 06/88	US4014H	4.2L V8 4196cc 256 CID	1954		US488
5.0L V8 302 CID	1988	GS, LS; From 06/1988	US4052	5.1L V8 5114cc 312 CID	1956		US488
5.0L V8 302 CID	1988	GS, LS; From 06/88, High performance	US4052H	CYCLONE			
5.0L V8 302 CID	1989-1991	GS, LS	US4052	3.3L L6 3277cc 200 CID	1964		US1044
5.0L V8 302 CID	1989-1991	GS, LS; High performance	US4052H	GRAND MARQUIS			
5.8L V8 5769cc 352 CID	1961-1962		US723	4.2L V8 255 CID	1981-1982	Base	US4014
6.4L V8 6391cc 390 CID	1961-1964		US723	4.2L V8 255 CID	1981-1982	Base; High performance	US4014H
6.6L V8 6654cc 406 CID	1962-1963		US723	4.6L V8 281 CID	1992-1993	GS, LS	US4066
7.0L V8 6997cc 427 CID	1963-1964		US723	4.6L V8 281 CID	1994	GS, LS; From 04/94	US4066
COMET				4.6L V8 281 CID	1994	GS, LS; To 03/94	US4066
2.4L L6 144 CID	1961-1963		US1044	4.6L V8 281 CID	1995-1997	GS, LS	US4066
2.4L L6 2360cc 144 CID	1960-1963		US1044	4.6L V8 281 CID	1996	GS, LS; From 03/96	US4066
2.8L L6 170 CID	1964		US1044	4.6L V8 281 CID	1996	GS, LS; To 03/96	US4066
2.8L L6 170 CID	1971-1972		US1044	4.6L V8 281 CID	1998-2000	GS, LS; Pump Length: long	US4113
2.8L L6 2786cc 170 CID	1961-1972		US1044	4.6L V8 281 CID	2001-2002	GS, LS; Long Housing, Pump Length: long	US4113
3.3L L6 200 CID	1965		US1044	4.6L V8 281 CID	2001-2002	GS, LS; Short Housing	US4128
3.3L L6 200 CID	1968		US1044	4.6L V8 281 CID	2003	GS, LS, LSE	US4128
3.3L L6 200 CID	1971-1974		US1044	4.6L V8 281 CID	2004	GS, LS	US4128
3.3L L6 200 CID	1975	W/O AIR	US1044	4.6L V8 281 CID	2005	GS, GSL, Limited Edition, LS, Ultimate Edition	US4128
3.3L L6 200 CID	1975	Air Cond	US4002	4.6L V8 281 CID	2006-2008	GS, LS	US4128
3.3L L6 200 CID	1976-1977		US4002	4.6L V8 281 CID	2009-2011	LS	US4128
3.3L L6 3277cc 200 CID	1963-1974		US1044	5.0L V8 302 CID	1979		US4014
3.3L L6 3278cc 200 CID	1968		US1044	5.0L V8 302 CID	1979	High performance	US4014H
3.3L L6 3278cc 200 CID	1971-1974		US1044	5.0L V8 302 CID	1980-1982	Base, Colony Park	US4014
4.1L L6 250 CID	1975-1977		US960	5.0L V8 302 CID	1980-1982	Base, Colony Park; High performance	US4014H
5.0L V8 302 CID	1975-1977	WINDSOR	US953	5.0L V8 302 CID	1983	Base, LS	US4014
5.0L V8 302 CID	1975-1977	High performance	US953H	5.0L V8 302 CID	1983-1986	Base, Colony Park, LS; High performance	US4014H
COMMUTER				5.0L V8 302 CID	1984-1986	Base, Colony Park, LS	US4014
5.8L V8 5769cc 352 CID	1961-1962		US723	5.0L V8 302 CID	1987	GS, LS	US4014
6.4L V8 6391cc 390 CID	1961-1964		US723	5.0L V8 302 CID	1987	GS, LS; High performance	US4014H
6.6L V8 6654cc 406 CID	1962-1963		US723	5.0L V8 302 CID	1988	GS, LS; To 06/1988	US4014
7.0L V8 6997cc 427 CID	1963-1964		US723	5.0L V8 302 CID	1988	GS, LS; High performance, To 06/88	US4014H
COUGAR				5.0L V8 302 CID	1988	GS, LS; From 06/1988	US4052
2.0L L4 1989cc 121 CID	1999-2002	Base	US4115	5.0L V8 302 CID	1988	GS, LS; From 06/88, High performance	US4052H
2.3L L4 140 CID	1984-1986	XR-7	US4054	5.0L V8 302 CID	1988	GS, LS	US4052
2.5L V6 2450cc 155 CID	1999-2000	V6	US4091	5.0L V8 302 CID	1989-1991	GS, LS	US4052H
2.5L V6 2450cc 155 CID	1999-2000	V6; Includes back housing	US4091-2	5.0L V8 302 CID	1989-1991	GS, LS; High performance	US4052H
2.5L V6 2450cc 155 CID	2001	Base, S, V6	US4091	5.8L V8 351 CID	1979		US4014
2.5L V6 2450cc 155 CID	2001	Base, S, V6; Includes back housing	US4091-2	5.8L V8 351 CID	1979	High performance	US4014H
2.5L V6 2450cc 155 CID	2002	Base, V6	US4091	5.8L V8 351 CID	1980-1981	Base, Colony Park	US4014
2.5L V6 2450cc 155 CID	2002	Base, V6; Includes back housing	US4091-2	5.8L V8 351 CID	1980-1981	Base, Colony Park; High performance	US4014H
3.3L L6 200 CID	1980	XR-7	US4002	5.8L V8 351 CID	1986	Base, LS	US4014
3.3L L6 200 CID	1981	Base, XR-7	US4002	5.8L V8 351 CID	1986	Base, LS; High performance	US4014H
3.3L L6 200 CID	1982	Base, GS, LS, XR-7	US4002	5.8L V8 5800cc 351 CID	1977-1978	Mexican Application	US932

Engine	Years	Application Description	USMW
MERCURY (cont'd.)			
GRAND MARQUIS (cont'd.)			
5.8L V8 5800cc 351 CID	1979-1981	Mexican Application	US4052
LN7			
1.6L L4 1598cc 98 CID	1982	Base	US4040
1.6L L4 1598cc 98 CID	1983	Base, Grand Sport, RS, Sport	US4040
LYNX			
1.6L L4 1598cc 98 CID	1981	Base, GL, GS, LS, RS	US4040
1.6L L4 1598cc 98 CID	1982	Base, GL, GS, L, LS, RS	US4040
1.6L L4 1598cc 98 CID	1983-1984	Base, GL, GS, LS, LTS, RS	US4040
1.6L L4 1598cc 98 CID	1985	Base, GL, GS, L, XR3	US4040
1.9L L4 116 CID	1985	Base, GL, GS, L, XR3	US4040
1.9L L4 116 CID	1986	Base, GS, L, XR3	US4040
1.9L L4 116 CID	1987	GS, L, XR3	US4040
2.0L L4 1989cc 122 CID	1984	Base, GL, GS, RS	US9067
2.0L L4 1989cc 122 CID	1985	Base, GL, GS, L, XR3	US9067
2.0L L4 1989cc 122 CID	1986-1987	GS, L	US9067
MARAUDER			
4.6L V8 281 CID	2003-2004	Base	US4128
6.4L V8 6391cc 390 CID	1963-1964		US723
6.6L V8 6654cc 406 CID	1963		US723
7.0L V8 6997cc 427 CID	1963-1964		US723
MARINER			
2.3L L4 140 CID	2005	Base	US4126
2.3L L4 140 CID	2006-2007	Convenience, Hybrid	US4126
2.3L L4 140 CID	2006-2008	Hybrid; Electric Water Pump	US11002
2.3L L4 140 CID	2008	Base, Hybrid	US4126
2.5L L4 2488cc 152 CID	2009-2010	Base, Hybrid, Premier	US4126
2.5L L4 2488cc 152 CID	2009-2011	Hybrid; Electric Water Pump, From Reservoir	US11001
2.5L L4 2488cc 152 CID	2009-2011	Hybrid; Electric Water Pump, Heater	US11007
2.5L L4 2488cc 152 CID	2011	Base, Hybrid	US4126
3.0L V6 2968cc 181 CID	2005	Premier	US4132
3.0L V6 2968cc 181 CID	2005	Premier; Includes back housing	US4132-2
3.0L V6 2968cc 181 CID	2006	Luxury, Premier; To 01/30/2006	US4132
3.0L V6 2968cc 181 CID	2006	Luxury, Premier; Includes back housing, To 01/30/2006	US4132-2
3.0L V6 2968cc 181 CID	2006	Luxury, Premier; From 01/30/2006	US9489
3.0L V6 2968cc 181 CID	2006	Luxury, Premier; From 01/30/2006, Includes back housing	US9489-2
3.0L V6 2968cc 181 CID	2007	Luxury, Premier	US9489
3.0L V6 2968cc 181 CID	2007	Luxury, Premier; Includes back housing	US9489-2
3.0L V6 2968cc 181 CID	2008	Base, Premier	US9489
3.0L V6 2968cc 181 CID	2008	Base, Premier; Includes back housing	US9489-2
3.0L V6 2968cc 181 CID	2009-2011	Base, Premier	US6250
MARQUIS			
2.3L L4 140 CID	1983-1986	Base, Brougham	US4054
3.3L L6 200 CID	1983	Base, Brougham	US4002
3.8L V6 232 CID	1983-1986	Base, Brougham	US4016
4.2L V8 255 CID	1981-1982	Base, Brougham	US4014
4.2L V8 255 CID	1981-1982	Base, Brougham; High performance	US4014H
5.0L V8 302 CID	1979	WINDSOR	US953
5.0L V8 302 CID	1979	High performance	US953H
5.0L V8 302 CID	1980-1982	Base, Brougham	US4014
5.0L V8 302 CID	1980-1982	Base, Brougham; High performance	US4014H
5.8L V8 351 CID	1978-1979	MODIFIED	US932
5.8L V8 351 CID	1978-1979	WINDSOR	US953
5.8L V8 351 CID	1978-1979	High performance	US953H
5.8L V8 351 CID	1980-1981	Base, Brougham	US4014
5.8L V8 351 CID	1980-1981	Base, Brougham; High performance	US4014H
6.6L V8 400 CID	1975-1978	MODIFIED	US932
7.5L V8 460 CID	1975-1978		US1114
MEDALIST			
5.1L V8 5114cc 312 CID	1956		US488
5.1L V8 5114cc 312 CID	1958		US488
METEOR			
2.8L L6 170 CID	1962-1963		US1044
2.8L L6 2786cc 170 CID	1961-1963		US1044
3.3L L6 3277cc 200 CID	1963		US1044
4.8L V8 4786cc 292 CID	1961		US488
5.8L V8 5769cc 352 CID	1961-1962		US723
6.4L V8 6391cc 390 CID	1961-1963		US723
MILAN			
2.3L L4 140 CID	2006-2009	Base, Premier	US4126
2.5L L4 2488cc 152 CID	2010-2011	Base, Hybrid, Premier	US4126
3.0L V6 2968cc 181 CID	2006-2009	Base, Premier	US9489
3.0L V6 2968cc 181 CID	2006-2009	Base, Premier; Includes back housing	US9489-2
3.0L V6 2968cc 181 CID	2010-2011	Premier	US6250
MONARCH			
3.3L L6 200 CID	1975	W/O AIR	US1044
3.3L L6 200 CID	1975	Air Cond	US4002
3.3L L6 200 CID	1976-1977		US4002
4.1L L6 250 CID	1975-1979		US960

Engine	Years	Application Description	USMW
MERCURY (cont'd.)			
MONARCH (cont'd.)			
4.1L L6 250 CID	1980	Base	US960
4.2L V8 255 CID	1980	Base; WINDSOR	US953
4.2L V8 255 CID	1980	Base; High performance	US953H
5.0L V8 302 CID	1975-1979	WINDSOR	US953
5.0L V8 302 CID	1975-1979	High performance	US953H
5.0L V8 302 CID	1980	Base; WINDSOR	US953
5.0L V8 302 CID	1980	Base; High performance	US953H
5.8L V8 351 CID	1975-1977	WINDSOR	US953
5.8L V8 351 CID	1975-1977	High performance	US953H
MONTECLAIR			
5.1L V8 5114cc 312 CID	1956-1957		US488
5.1L V8 5114cc 312 CID	1960		US488
6.4L V8 6391cc 390 CID	1964		US723
7.0L V8 6997cc 427 CID	1964		US723
MONTEGO			
3.0L V6 2968cc 181 CID	2005	Base, Premier	US6186
3.0L V6 2968cc 181 CID	2006-2007	Luxury, Premier	US6186
3.3L L6 200 CID	1968		US1044
3.3L L6 3277cc 200 CID	1968		US1044
3.3L L6 3278cc 200 CID	1968		US1044
5.8L V8 351 CID	1975-1976	MODIFIED	US932
5.8L V8 351 CID	1975-1976	WINDSOR	US953
5.8L V8 351 CID	1975-1976	High performance	US953H
6.6L V8 400 CID	1975-1976	MODIFIED	US932
7.5L V8 460 CID	1975-1976		US1114
MONTEREY			
4.2L V6 256 CID	2004-2005	Base, Premier	US4102
4.2L V6 256 CID	2006-2007	Luxury	US4102
4.2L V8 4196cc 256 CID	1954		US488
4.8L V8 4786cc 292 CID	1961-1962		US488
5.1L V8 5114cc 312 CID	1956-1957		US488
5.1L V8 5114cc 312 CID	1959-1960		US488
5.8L V8 5769cc 352 CID	1961-1962		US723
6.4L V8 390 CID	1962-1963		US723
6.4L V8 6391cc 390 CID	1961-1964		US723
6.6L V8 6654cc 406 CID	1962-1963		US723
7.0L V8 6997cc 427 CID	1963-1964		US723
MOUNTAINEER			
4.0L V6 245 CID	1998-2003	Base	US4108
4.0L V6 245 CID	2004-2005	Base, Premier	US4108
4.0L V6 245 CID	2006	Convenience, Luxury	US4108
4.0L V6 245 CID	2007-2010	Base, Premier	US4108
4.6L V8 281 CID	2002-2003	Base	US8920
4.6L V8 281 CID	2004-2005	Base, Premier	US8920
4.6L V8 281 CID	2006	Luxury, Premier	US8920
4.6L V8 281 CID	2007-2010	Premier	US8920
5.0L V8 302 CID	1997-2001	Base	US4101
MYSTIQUE			
2.0L L4 1989cc 121 CID	1995	Base, GS, GS Spree, LS	US4088
2.0L L4 1989cc 121 CID	1996-1997	GS, LS	US4088
2.0L L4 1989cc 121 CID	1998	GS; From 12/1997	US4115
2.0L L4 1989cc 121 CID	1998	GS; To 12/1997	US4115
2.0L L4 1989cc 121 CID	1999-2000	GS	US4115
2.5L V6 2450cc 155 CID	1995	Base, GS, GS Spree, LS Young America	US4091
2.5L V6 2450cc 155 CID	1995	Base, GS, GS Spree, LS Young America; Includes back housing	US4091-2
2.5L V6 2450cc 155 CID	1996-1997	GS, LS	US4091
2.5L V6 2450cc 155 CID	1996-1997	GS, LS; Includes back housing	US4091-2
2.5L V6 2450cc 155 CID	1998-2000	LS	US4091
2.5L V6 2450cc 155 CID	1998-2000	LS; Includes back housing	US4091-2
PARK LANE			
6.4L V8 6391cc 390 CID	1964		US723
7.0L V8 6997cc 427 CID	1964		US723
SABLE			
2.5L L4 153 CID	1986	GS	US4056
3.0L V6 2968cc 181 CID	1996	LS	US4098
3.0L V6 2968cc 181 CID	1997	GS, LS	US4098
3.0L V6 2968cc 181 CID	1998	GS, LS, LS Premium	US4098
3.0L V6 2968cc 181 CID	1999	GS, LS	US4098
3.0L V6 2968cc 181 CID	2000	LS, LS Premium	US4098
3.0L V6 2968cc 181 CID	2001	LS, LS Premium	US4091
3.0L V6 2968cc 181 CID	2001	LS, LS Premium; Includes back housing	US4091-2
3.0L V6 2968cc 181 CID	2002	LS Premium	US4091
3.0L V6 2968cc 181 CID	2002	LS Premium; Includes back housing	US4091-2
3.0L V6 2968cc 181 CID	2003	LS Premium; To 04/01/2003	US4091
3.0L V6 2968cc 181 CID	2003	LS Premium; Includes back housing, To 04/01/2003	US4091-2
3.0L V6 2968cc 181 CID	2003	LS	US4094
3.0L V6 2968cc 181 CID	2003	LS Premium; From 04/01/2003	US4132
3.0L V6 2968cc 181 CID	2003	LS Premium; From 04/01/2003, Includes back housing	US4132-2

Engine	Years	Application Description	USMW	Engine	Years	Application Description	USMW
MERCURY (cont'd.)				MINI (cont'd.)			
SABLE (cont'd.)				COOPER (cont'd.)			
3.0L V6 2968cc 181 CID	2004	LS Premium	US4132	1.6L L4 1598cc	2008	Base, Clubman, S, S Clubman	US6244
3.0L V6 2968cc 181 CID	2004	LS Premium; Includes back housing	US4132-2	1.6L L4 1598cc	2009-2011	Base, Clubman, John Cooper Works, John Cooper Works Clubman, S, S Clubman	US6244
3.0L V6 2968cc 181 CID	2005	LS, Platinum Edition	US4132	1.6L L4 1598cc	2012	Base, Clubman, Coupe, Coupe John Cooper Works, John Cooper Works Clubman, Roadster, Roadster John Cooper Works, Roadster S, S Clubman	US6244
3.0L V6 2968cc 181 CID	2005	LS, Platinum Edition; Includes back housing	US4132-2	1.6L L4 1598cc	2013	Base, Clubman, Coupe, Coupe John Cooper Works, John Cooper Works Clubman, John Cooper Works GP, Roadster, Roadster John Cooper Works, Roadster S, S Clubman	US6244
3.0L V6 2986cc 182 CID	1986-1993	GS, LS	US4034	1.6L L4 1598cc	2014	Base, Clubman, Coupe, Coupe John Cooper Works, John Cooper Works Clubman, Roadster, Roadster John Cooper Works, Roadster S, S Clubman	US6244
3.0L V6 2986cc 182 CID	1994	GS, LS; From 02/1994	US4034	1.6L L4 1598cc	2015	Base, Clubman, Coupe, Coupe John Cooper Works, John Cooper Works Clubman, Roadster, Roadster John Cooper Works, Roadster S, S Clubman	US6244
3.0L V6 2986cc 182 CID	1994	GS, LS; To 01/1994	US4034	1.6L L4 1598cc 98 CID	2011-2013	Mexican Application	US6244
3.0L V6 2986cc 182 CID	1995	GS, LS, LTS	US4094	1.6L L4 1598cc 98 CID	2014	John Cooper Works, S Clubman	US6244
3.0L V6 2986cc 182 CID	1996	G, GS	US4094	1.6L L4 1598cc 98 CID	2015	John Cooper Works	US6244
3.0L V6 2986cc 182 CID	1997	GS	US4094	1.6L L4 1600cc	2002-2008	S	US6001
3.0L V6 2986cc 182 CID	1998	GS, LS, LS Premium	US4094	1.6L L4 1600cc	2002-2008	Base	US9474
3.0L V6 2986cc 182 CID	1999-2002	GS, LS	US4094	COOPER COUNTRYMAN			
3.0L V6 2986cc 182 CID	2003-2005	GS	US4094	1.6L L4 1598cc	2011-2012	Base, S, S ALL4	US6244
3.5L V6 3496cc 213 CID	2008-2009	Base, Premier	US6023	1.6L L4 1598cc	2013-2016	Base, John Cooper Works ALL4, S, S ALL4	US6244
3.8L V6 232 CID	1988-1993	GS, LS	US4051	1.6L L4 1598cc 98 CID	2014-2016	John Cooper Works ALL4	US6244
3.8L V6 232 CID	1994-1995	GS, LS	US4089	COOPER PACEMAN			
TOPAZ				1.6L L4 1598cc	2013-2016	Base, John Cooper Works ALL4, S, S ALL4	US6244
2.0L L4 1989cc 122 CID	1984-1986	Base, GS, LS	US9067	MITSUBISHI			
2.3L L4 140 CID	1984-1986	Base, GS, LS	US4022	3000GT			
2.3L L4 140 CID	1987	GS, GS AWD, LS, LS AWD, Sport, Sport AWD, XR5	US4022	3.0L V6 2972cc 181 CID	1991-1994	Base, SL, VR-4	US7129
2.3L L4 140 CID	1988-1989	GS, GS AWD, LS, LS AWD, LTS, Sport, Sport AWD, XR5	US4022	3.0L V6 2972cc 181 CID	1995-1996	Base, SL, Spyder SL, Spyder VR-4, VR-4	US7129
2.3L L4 140 CID	1990-1991	GS, GS AWD, LS, LS AWD, LTS, LTS AWD, Sport, Sport AWD, XR5, XR5 AWD	US4022	3.0L V6 2972cc 181 CID	1997-1999	Base	US7121
2.3L L4 140 CID	1992	GS, LS, LTS, Sport	US4041	3.0L V6 2972cc 181 CID	1997-1999	Base; With back plate housing	US7121-2
2.3L L4 140 CID	1993	GS; From 05/1993	US4041	3.0L V6 2972cc 181 CID	1997-1999	SL, VR-4	US7129
2.3L L4 140 CID	1993	GS; To 05/1993	US4041	CORDIA			
2.3L L4 140 CID	1994	GS	US4041	1.8L L4 1795cc	1983	Base, L, LS	US7118
2.3L L4 2300cc 140 CID	1984-1989	Mexican Application	US4022	1.8L L4 1795cc	1984-1988	Turbo	US7118
3.0L V6 2986cc 182 CID	1992	GS, LS, LTS, Sport, XR5	US4070	2.0L L4 1997cc 122 CID	1984	Base, L, LS	US7118
3.0L V6 2986cc 182 CID	1993-1994	GS	US4070	2.0L L4 1997cc 122 CID	1985-1988	L	US7118
TRACER				DIAMANTE			
1.6L L4 1598cc 98 CID	1988-1989	Base	US4049	3.0L V6 2972cc 181 CID	1992-1994	ES	US7121
1.8L L4 112 CID	1991-1996	LTS	US4068	3.0L V6 2972cc 181 CID	1992-1994	ES; With back plate housing	US7121-2
1.9L L4 116 CID	1991	Base, Trio; To 04/91	US4065	3.0L V6 2972cc 181 CID	1992-1994	LS	US7129
1.9L L4 116 CID	1991	Base, Trio; From 04/91	US4069	3.0L V6 2972cc 181 CID	1995	ES, LS	US7121
1.9L L4 116 CID	1992-1993	Base, Trio	US4069	3.0L V6 2972cc 181 CID	1995	ES, LS; With back plate housing	US7121-2
1.9L L4 116 CID	1994	Base, Trio; From 06/1994	US4069	3.0L V6 2972cc 181 CID	1996	ES	US7121
1.9L L4 116 CID	1994	Base, Trio; To 05/1994	US4069	3.0L V6 2972cc 181 CID	1996	ES; With back plate housing	US7121-2
1.9L L4 116 CID	1995-1996	Base, Trio	US4069	3.5L V6 3497cc 215 CID	1997-1998	ES, LS	US7152
2.0L L4 1989cc 121 CID	1997-1999	GS, LS, Trio	US4107	3.5L V6 3497cc 215 CID	1999	Base	US7152
VILLAGER				3.5L V6 3497cc 215 CID	2000-2001	ES, LS	US7152
2.4L L6 2360cc 144 CID	1962-1963		US1044	3.5L V6 3497cc 215 CID	2002-2004	ES, LS, VR-X	US7152
2.8L L6 2786cc 170 CID	1962-1967		US1044	ECLIPSE			
3.0L V6 182 CID	1993	GS, LS	US9074	1.8L L4 1755cc 107 CID	1990-1994	Base, GS	US7108
3.0L V6 182 CID	1994-1998	GS, LS, Nautica	US9074	2.0L L4 1997cc 122 CID	1990-1994	GS, GST, GSX	US9212
3.3L L6 3277cc 200 CID	1963-1967		US1044	2.0L L4 1997cc 122 CID	1995	GST, GSX	US7148
3.3L V6 3275cc	1999-2002	Base, Estate, Sport	US9402	2.0L L4 1997cc 122 CID	1995	GS, RS	US7150
VOYAGER				2.0L L4 1997cc 122 CID	1996-1997	Base, GS, RS	US7150
2.8L L6 2786cc 170 CID	1966-1967		US1044	2.0L L4 1997cc 122 CID	1996-1999	GST, GSX, Spyder GST	US7148
3.3L L6 3277cc 200 CID	1966-1967		US1044	2.0L L4 1997cc 122 CID	1998-1999	GS, RS	US7150
ZEPHYR				2.4L L4 2351cc	1996-1999	Spyder GS	US7148
2.3L L4 140 CID	1978-1979		US4005	2.4L L4 2351cc	2000	GS, RS	US9399
2.3L L4 140 CID	1980-1981	Base, Z7	US4005	2.4L L4 2351cc	2001-2004	GS, RS, Spyder GS	US9399
2.3L L4 140 CID	1982	Base, GS, Z7	US4005	2.4L L4 2351cc	2005	GS, Spyder GS	US9399
2.3L L4 140 CID	1983	Base, GS, Z7, Z7 GS	US4054	2.4L L4 2378cc	2006	GS	US6149
3.3L L6 200 CID	1978-1979		US4002	2.4L L4 2378cc	2007	GS, Spyder GS	US6149
3.3L L6 200 CID	1980-1981	Base, Z7	US4002	2.4L L4 2378cc	2008	GS, SE, Spyder GS	US6149
3.3L L6 200 CID	1982	Base, GS, Z7	US4002	2.4L L4 2378cc	2009	GS, Spyder GS	US6149
3.3L L6 200 CID	1983	Base, GS, Z7, Z7 GS	US4002	2.4L L4 2378cc	2010-2011	GS, GS Sport, Spyder GS	US6149
4.2L V8 255 CID	1980-1981	Base, Z7; WINDSOR	US953	3.0L V6 2972cc 181 CID	2000	GT	US7152
4.2L V8 255 CID	1980-1981	Base, Z7; High performance	US953H	3.0L V6 2972cc 181 CID	2001-2002	GT, Spyder GT	US7152
4.2L V8 255 CID	1982	Base, GS; WINDSOR	US953	3.0L V6 2972cc 181 CID	2003	GT, GTS, Spyder GT, Spyder GTS	US7152
4.2L V8 255 CID	1982	Base, GS; High performance	US953H	3.0L V6 2972cc 181 CID	2004	GT, GTS, Spyder GT, Spyder GTS; From 10/2003	US7152
5.0L V8 302 CID	1978-1979	WINDSOR	US953	3.0L V6 2972cc 181 CID	2004	GT, GTS, Spyder GT, Spyder GTS; To 09/03	US7152
5.0L V8 302 CID	1978-1979	High performance	US953H	3.0L V6 2972cc 181 CID	2005	GT, GTS, Spyder GT, Spyder GTS	US7152
MERKUR				SCORPIO			
XR4TI				XR4TI			
2.3L L4 140 CID	1985-1989	Base	US4054	2.9L V6 177 CID	1988-1989	Base	US4042
MG				MGB			
MGB				MGB			
1.8L L4 1798cc	1972-1980		US9082	MINI			
MINI				COOPER			
1.6L L4 1598cc	2007	Base, S	US6244				

WATER PUMPS

Engine	Years	Application Description	USMW
MITSUBISHI (cont'd.)			
ECLIPSE (cont'd.)			
3.8L V6 3828cc 230 CID	2006	GT	US7152
3.8L V6 3828cc 230 CID	2007	GT, Spyder GT	US7152
3.8L V6 3828cc 230 CID	2008	GT, SE, Spyder GT	US7152
3.8L V6 3828cc 230 CID	2009-2011	GT, Spyder GT	US7152
ENDEAVOR			
3.8L V6 3797cc 230 CID	2004	Limited, LS, XLS; From 10/2003	US7152
3.8L V6 3797cc 230 CID	2004	Limited, LS, XLS; To 09/03	US7152
3.8L V6 3828cc 230 CID	2005	Limited, LS, XLS	US7152
3.8L V6 3828cc 230 CID	2006	Limited, LS	US7152
3.8L V6 3828cc 230 CID	2007-2008	LS, SE	US7152
3.8L V6 3828cc 230 CID	2010-2011	LS, SE	US7152
3.8L V6 3828cc 234 CID	2010-2011	Mexican Application	US7152
EXPO			
2.4L L4 2351cc	1992	Base, SP	US9168
2.4L L4 2351cc	1993	Base, SP	US7148
2.4L L4 2351cc	1994-1995	Base	US7148
EXPO LRV			
1.8L L4 1834cc 112 CID	1992	Base, Sport	US7135
1.8L L4 1834cc 112 CID	1993	Base; From 04/1993	US7135
1.8L L4 1834cc 112 CID	1993	Base; To 03/1993	US7135
1.8L L4 1834cc 112 CID	1994	Base	US7135
2.4L L4 2351cc	1993-1994	Base, Sport	US7148
GALANT			
2.0L L4 1997cc 122 CID	1989	GS	US9212
2.0L L4 1997cc 122 CID	1989-1992	Base, LS	US9168
2.0L L4 1997cc 122 CID	1990	GS, GSX	US9212
2.0L L4 1997cc 122 CID	1991-1992	GS, GSR, GSX, VR-4	US9212
2.0L L4 1997cc 122 CID	1993	ES, LS, S	US7148
2.4L L4 2351cc	1985-1987	Base	US7118
2.4L L4 2351cc	1994	ES, GS, LS, S	US7148
2.4L L4 2351cc	1995-1996	ES, LS, S	US7148
2.4L L4 2351cc	1997-1998	DE, ES, LS	US7148
2.4L L4 2351cc	1999-2001	DE, ES	US9399
2.4L L4 2351cc	2002-2003	DE, ES, LS	US9399
2.4L L4 2351cc	2004	DE, ES	US6149
2.4L L4 2378cc	2005-2007	DE, ES, SE	US6149
2.4L L4 2378cc	2008	DE, ES	US6149
2.4L L4 2378cc	2009	ES, Sport Edition	US6149
2.4L L4 2378cc	2010-2011	ES, SE	US6149
3.0L V6 2972cc 181 CID	1988	Sigma	US7121
3.0L V6 2972cc 181 CID	1988	Sigma; With back plate housing	US7121-2
3.0L V6 2972cc 181 CID	1999-2003	ES, GTZ, LS	US7152
3.8L V6 3828cc 230 CID	2004	GTS, LS; From 10/2003	US7152
3.8L V6 3828cc 230 CID	2004	GTS, LS; TO 10/03	US7152
3.8L V6 3828cc 230 CID	2005-2006	GTS, LS	US7152
3.8L V6 3828cc 230 CID	2007	GTS, Ralliart	US7152
3.8L V6 3828cc 230 CID	2008	Ralliart	US7152
3.8L V6 3828cc 230 CID	2009	Ralliart, Sport V6	US7152
GRANDIS			
2.4L L4 2378cc 145 CID	2007-2009	Mexican Application	US9399
L200			
2.4L L4 2378cc 145 CID	2008-2012	Mexican Application	US9399
LANCER			
2.0L L4 1997cc 122 CID	2005	Evolution, Evolution MR, Evolution RS; To 07/05	US6159
2.0L L4 1998cc 122 CID	2008	DE, ES, Evolution GSR, Evolution MR, GTS	US6038
2.0L L4 1998cc 122 CID	2009	DE, ES, Ralliart	US6038
2.0L L4 1998cc 122 CID	2010	DE, ES, Evolution GSR, Evolution MR, Evolution MR Touring, Ralliart, Ralliart Sportback	US6038
2.0L L4 1998cc 122 CID	2011	DE, ES, ES Sportback, Evolution GSR, Evolution MR, Evolution MR Touring, Ralliart, Ralliart Sportback	US6038
2.0L L4 1999cc 122 CID	2005	ES, OZ Rally	US9360
2.0L L4 1999cc 122 CID	2006	ES, OZ Rally, SE	US9360
2.0L L4 1999cc 122 CID	2007	ES	US9360
2.0L L4 2000cc	2002-2004	ES, LS, OZ Rally	US9360
2.0L L4 2000cc	2003-2004	Evolution	US6159
2.4L L4 2360cc 144 CID	2009	GTS	US6038
2.4L L4 2360cc 144 CID	2010-2011	GTS, GTS Sportback	US6038
2.4L L4 2378cc	2005-2006	Ralliart	US6149
2.4L L4 2400cc	2004	Ralliart, Sportback, Sportback Ralliart	US6149
MIGHTY MAX			
2.0L L4 1997cc 122 CID	1983-1984	Base, S	US7114
2.0L L4 1997cc 122 CID	1985-1989	Base	US7114
2.3L L4 2346cc 143 CID	1983	SP	US7117
2.3L L4 2346cc 143 CID	1984	SP, SPX	US7117
2.3L L4 2346cc 143 CID	1985	SP, SPX; From 10/1984	US7117
2.3L L4 2346cc 143 CID	1985	SP, SPX; To 09/1984	US7117
2.4L L4 2351cc	1990-1992	1 Ton, Base	US7114
2.4L L4 2351cc	1993-1996	Base	US7114
2.6L L4 2555cc 156 CID	1983-1985	SP, SPX	US7120

Engine	Years	Application Description	USMW
MITSUBISHI (cont'd.)			
MIGHTY MAX (cont'd.)			
2.6L L4 2555cc 156 CID	1986	Base, Sport, SPX	US7120
2.6L L4 2555cc 156 CID	1987	1 Ton, Base, Sport, SPX	US7120
2.6L L4 2555cc 156 CID	1988	1 Ton, Sport, SPX	US7120
2.6L L4 2555cc 156 CID	1989	1 Ton, Base, Sport, SPX	US7120
3.0L V6 2972cc 181 CID	1990-1994	Base	US7121
3.0L V6 2972cc 181 CID	1990-1994	Base; With back plate housing	US7121-2
MIRAGE			
1.2L L3 1193cc 73 CID	2015-2016	GLS, GLX	US8143
1.2L L3 1193cc 73 CID	2017-2018	ES, GLS, GLX, GT, SE	US8143
1.5L L4 1468cc 90 CID	1985	Base, L, LS	US7115
1.5L L4 1468cc 90 CID	1986-1987	Base, L	US7115
1.5L L4 1468cc 90 CID	1988	L	US7115
1.5L L4 1468cc 90 CID	1989	Base, LS	US7115
1.5L L4 1468cc 90 CID	1990	Base, RS, VL	US7115
1.5L L4 1468cc 90 CID	1991-1992	Base, LS, SE, VL	US7115
1.5L L4 1468cc 90 CID	1993	ES, LS, S	US7115
1.5L L4 1468cc 90 CID	1994-1995	ES, S	US7115
1.5L L4 1468cc 90 CID	1996	S	US7115
1.5L L4 1468cc 90 CID	1997-2002	DE	US9359
1.6L L4 1597cc 98 CID	1985-1988	Turbo	US7108
1.6L L4 1597cc 98 CID	1989	Turbo	US7131
1.6L L4 1597cc 98 CID	1991-1992	GS	US7131
1.8L L4 1834cc 112 CID	1993	ES, LS; From 04/1993	US7135
1.8L L4 1834cc 112 CID	1993	ES, LS; To 03/1993	US7135
1.8L L4 1834cc 112 CID	1994-1995	ES, LS	US7135
1.8L L4 1834cc 112 CID	1996	LS	US7135
1.8L L4 1834cc 112 CID	1997-1999	LS	US9360
1.8L L4 1834cc 112 CID	2000	DE, LS	US9360
1.8L L4 1834cc 112 CID	2001	ES, LS	US9360
1.8L L4 1834cc 112 CID	2002	LS	US9360
MIRAGE G4			
1.2L L3 1193cc 73 CID	2017-2018	ES	US8143
MONTERO			
2.6L L4 2555cc 156 CID	1983	Base	US7120
2.6L L4 2555cc 156 CID	1984	Base, Sport	US7120
2.6L L4 2555cc 156 CID	1985-1986	Base	US7120
2.6L L4 2555cc 156 CID	1987-1988	Base, Sport	US7120
2.6L L4 2555cc 156 CID	1989	Base, SP	US7120
3.0L V6 2972cc 181 CID	1989	Base, LS, SP, Sport	US7121
3.0L V6 2972cc 181 CID	1989	Base, LS, SP, Sport; With back plate housing	US7121-2
3.0L V6 2972cc 181 CID	1990	Base, LS, RS, SP, Sport	US7121
3.0L V6 2972cc 181 CID	1990	Base, LS, RS, SP, Sport; With back plate housing	US7121-2
3.0L V6 2972cc 181 CID	1991	Base, LS, RS	US7121
3.0L V6 2972cc 181 CID	1991	Base, LS, RS; With back plate housing	US7121-2
3.0L V6 2972cc 181 CID	1992-1993	Base, LS, RS, SR	US7121
3.0L V6 2972cc 181 CID	1992-1993	Base, LS, RS, SR; With back plate housing	US7121-2
3.0L V6 2972cc 181 CID	1994	LS	US7121
3.0L V6 2972cc 181 CID	1994	LS; With back plate housing	US7121-2
3.0L V6 2972cc 181 CID	1995-1996	LS	US9460
3.5L V6 3497cc 215 CID	1994-1995	SR	US9310
3.5L V6 3497cc 215 CID	1996	SR; To 04/1996	US9310
3.5L V6 3497cc 215 CID	1996	SR; From 05/1996	US9460
3.5L V6 3497cc 215 CID	1997	LS, SR	US9460
3.5L V6 3497cc 215 CID	1998-2000	Base	US9460
3.5L V6 3497cc 215 CID	2001-2002	Limited, XLS	US9415
3.8L V6 3797cc 230 CID	2003-2004	Limited, XLS	US9415
3.8L V6 3797cc 230 CID	2005	Limited	US9415
3.8L V6 3800cc 232 CID	2008-2009	Mexican Application	US7152
3.8L V6 3828cc 230 CID	2006	Limited	US9415
3.8L V6 3828cc 234 CID	2010	Mexican Application	US7152
MONTERO LIMITED			
3.8L V6 3828cc 234 CID	2011	Mexican Application	US7152
MONTERO SPORT			
2.4L L4 2351cc	1997-1999	ES	US9389
3.0L V6 2972cc 181 CID	1997-1999	LS, XLS	US9460
3.0L V6 2972cc 181 CID	2000-2001	ES, LS, XLS	US9460
3.0L V6 2972cc 181 CID	2002-2003	ES, LS	US9460
3.5L V6 3497cc 213 CID	2005-2008	Mexican Application	US7152
3.5L V6 3497cc 215 CID	1999-2000	Limited	US9460
3.5L V6 3497cc 215 CID	2001	Limited, XS	US9460
3.5L V6 3497cc 215 CID	2002-2003	Limited, XLS	US9460
3.5L V6 3497cc 215 CID	2004	LS, XLS	US9460
OUTLANDER			
2.4L L4 2351cc	2003	LS, XLS	US6228
2.4L L4 2351cc	2004	LS, XLS	US6149
2.4L L4 2360cc 144 CID	2008-2011	ES, SE	US6038
2.4L L4 2378cc	2005	Limited, LS, XLS	US6149
2.4L L4 2378cc	2006	Limited, LS, SE	US6149
3.0L V6 2998cc 182 CID	2007	ES, LS, XLS	US6240
3.0L V6 2998cc 182 CID	2008	LS, XLS	US6240

Engine	Years	Application Description	USMW	Engine	Years	Application Description	USMW
MITSUBISHI (cont'd.)				NISSAN (cont'd.)			
OUTLANDER (cont'd.)				300ZX			
3.0L V6 2998cc 182 CID	2009	XLS	US6240	3.0L V6 2960cc	1984-1986	2+2, Base, Turbo	US9058
3.0L V6 2998cc 182 CID	2010-2011	GT, XLS	US6240	3.0L V6 2960cc	1987	2+2, Base, Turbo; From 05/87	US9058
OUTLANDER SPORT				3.0L V6 2960cc	1987	2+2, Base, Turbo; To 05/87	US9058
2.0L L4 1998cc 122 CID	2011	ES, SE	US6038	3.0L V6 2960cc	1988-1989	2+2, Base, Turbo	US9058
PRECIS				3.0L V6 2960cc	1990-1996	2+2, Base, Turbo	US9201
1.5L L4 1468cc	1987	Base, LS	US7115	310			
1.5L L4 1468cc	1988-1989	Base, LS, RS	US7115	1.4L L4 1393cc 85 CID	1980	Deluxe, GX	US9010
1.5L L4 1468cc	1990-1991	Base, RS	US7115	1.5L L4 1488cc	1981	Deluxe, GX	US9010
1.5L L4 1468cc	1992-1994	Base	US7115	1.5L L4 1488cc	1982	Deluxe, GX	US9041
RAIDER				350Z			
3.7L V6 226 CID	2006-2007	DuroCross, LS	US7163	3.5L V6 3498cc	2003-2004	Base, Enthusiast, Performance, Touring, Track	US9426
3.7L V6 226 CID	2008-2009	LS	US7163	3.5L V6 3498cc	2005	35th Anniversary Edition, Base, Enthusiast, Grand Touring, Performance, Touring, Track	US9426
4.7L V8 287 CID	2006	DuroCross, XLS	US7163	3.5L V6 3498cc	2006	Base, Enthusiast, Grand Touring, Touring, Track	US9426
4.7L V8 287 CID	2007	LS, SE	US7163	3.5L V6 3498cc	2007-2008	Base, Enthusiast, Grand Touring, Nismo, Touring	US8164
SIGMA				3.5L V6 3498cc	2009	Enthusiast, Grand Touring, Touring	US8164
3.0L V6 2972cc 181 CID	1989-1990	Base	US7121	3.5L V6 3498cc 213 CID	2003	Touring	US9426
3.0L V6 2972cc 181 CID	1989-1990	Base; With back plate housing	US7121-2	370Z			
SPACE STAR				3.7L V6 3696cc	2009	Base, Nismo, Touring	US8164
1.8L L4 1755cc 107 CID	2003-2004	Mexican Application	US9360	3.7L V6 3696cc	2010	40th Anniversary Edition, Base, Nismo, Touring	US8164
STARION				3.7L V6 3696cc	2011-2014	Base, Nismo, Touring	US8164
2.6L L4 2555cc 156 CID	1983	Base, LS	US7120	3.7L V6 3696cc	2015-2017	Base, Nismo, Nismo Tech, Sport, Sport Tech, Touring, Touring Sport	US8164
2.6L L4 2555cc 156 CID	1984	ES, LE, LS	US7120	3.7L V6 3696cc 226 CID	2010-2016	Touring	US8164
2.6L L4 2555cc 156 CID	1985	ES, ESi, LE	US7120	411			
2.6L L4 2555cc 156 CID	1986	ESi-R, LE	US7120	1.3L L4 1299cc 79 CID	1965-1967		US9179
2.6L L4 2555cc 156 CID	1987	ESi-R	US7120	510			
2.6L L4 2555cc 156 CID	1987	ESi-R, LE; From 12/1986	US7124	2.0L L4 1952cc	1978		US9031
2.6L L4 2555cc 156 CID	1988	ESi, ESi-R	US7124	2.0L L4 1952cc	1978-1979	Exc.Air Cond	US9008
2.6L L4 2555cc 156 CID	1989	ESi-R	US7124	2.0L L4 1952cc	1979	To 01/79	US9031
TREDIA				2.0L L4 1952cc	1980-1981	Base; Exc.Air Cond	US9008
1.8L L4 1795cc	1983	Base, L, LS	US7118	2.0L L4 1952cc	1980-1981	Base; With air cond.	US9031
1.8L L4 1795cc	1984-1988	Turbo	US7118	520 PICKUP			
2.0L L4 1997cc 122 CID	1984	Base, L, LS	US7118	1.3L L4 1299cc 79 CID	1965-1968		US9179
2.0L L4 1997cc 122 CID	1985	Base, L	US7118	521 PICKUP			
2.0L L4 1997cc 122 CID	1986	Base, L, LS	US7118	1.3L L4 1299cc 79 CID	1968-1969		US9179
2.0L L4 1997cc 122 CID	1987-1988	L, LS	US7118	610			
VAN				2.0L L4 1952cc	1975-1976	Exc.Air Cond	US9008
2.4L L4 2351cc	1987-1990	Base, LS	US7114	2.0L L4 1952cc	1975-1976	Air Cond	US9031
NISSAN				2.0L L4 1952cc	1976	Exc. air cond. (From 04/76)	US9031
200SX				2.0L L4 1952cc 119 CID	1974	Includes fan clutch	US9031
1.6L L4 1597cc 97 CID	1995	Base, SE	US9214	620			
1.6L L4 1597cc 97 CID	1996	Base, SE; From 11/1995	US9214	2.0L L4 1952cc	1975-1979	Exc.Air Cond	US9008
1.6L L4 1597cc 97 CID	1996	Base, SE; To 11/1995	US9214	2.0L L4 1952cc	1975-1979	Air Cond	US9031
1.6L L4 1597cc 97 CID	1997-1998	Base, SE	US9214	710			
1.8L L4 1809cc	1984-1986	Turbo	US9063	2.0L L4 1952cc	1975-1977	Exc.Air Cond	US9008
2.0L L4 1952cc	1977-1978		US9031	2.0L L4 1952cc	1975-1977	Air Cond	US9031
2.0L L4 1952cc	1979	From 02/79	US9031	2.0L L4 1952cc	1976	Air Cond (To 03/76)	US9031
2.0L L4 1952cc	1979	To 01/79	US9031	2.0L L4 1952cc	1976	From 04/76	US9031
2.0L L4 1952cc	1980-1981	Base	US9031	2.0L L4 1952cc	1977		US9031
2.0L L4 1974cc	1984-1986	Base, XE	US9063	720			
2.0L L4 1974cc	1984-1988	Includes fan clutch	US9031	2.0L L4 1952cc	1980	Deluxe; Automatic Trans; Exc.Air Cond	US9008
2.0L L4 1974cc	1987-1988	XE	US9063	2.0L L4 1952cc	1980	Base; Exc.Air Cond	US9009
2.0L L4 1998cc	1995-1998	SE-R	US9213	2.0L L4 1952cc	1980	Deluxe; Standard Trans; Exc.Air Cond	US9009
2.2L L4 2187cc	1982-1983	Base	US9031	2.0L L4 1952cc	1983-1984	Base, Deluxe; With air cond.	US9031
3.0L V6 2960cc 181 CID	1987	SE; From 04/1987	US9058	2.0L L4 1952cc	1985-1986	Base; Includes fan clutch	US9031
3.0L V6 2960cc 181 CID	1987	SE; To 04/1987	US9058	2.2L L4 2164cc	1981-1983	Deluxe	US9198
3.0L V6 2960cc 181 CID	1988	SE	US9058	2.2L L4 2187cc	1981-1983	Base, Deluxe; wo/Fan Clutch	US9009
210				2.2L L4 2187cc	1981-1983	Base, Deluxe; w/Fan Clutch	US9031
1.2L L4 1237cc	1980-1982	Base	US9026	2.4L L4 2389cc	1983-1984	Base, Deluxe	US9031
1.4L L4 1393cc 85 CID	1979	Air Cond	US9026	2.4L L4 2389cc	1985-1986	Base, Deluxe, Sport Truck; Includes fan clutch	US9031
1.4L L4 1393cc 85 CID	1980	Deluxe	US9026	2.5L L4 2488cc 152 CID	1983-1986	Deluxe	US9198
1.4L L4 1393cc 85 CID	1981	Base	US9026	810			
1.4L L4 1393cc 85 CID	1982	Base, MPG	US9026	2.4L L6 2393cc	1977-1979		US9011
1.5L L4 1488cc	1980-1982	Deluxe	US9026	2.4L L6 2393cc	1980	Base	US9011
240SX				2.4L L6 2393cc	1981	DX	US9011
2.4L L4 2389cc	1989-1990	SE, XE	US9206	2.8L L6 2793cc	1981	DX	US9011
2.4L L4 2389cc	1991-1992	Base, LE, SE	US9206	ALMERA			
2.4L L4 2389cc	1993	Base, SE	US9206	1.8L L4 1769cc 107 CID	2001	Mexican Application	US9416
2.4L L4 2389cc	1994	SE	US9206	1.8L L4 1769cc 107 CID	2005	Mexican Application	US9416
2.4L L4 2389cc	1995-1996	Base, SE	US9206	1.8L L4 1781cc 108 CID	2002-2004	Mexican Application	US9416
2.4L L4 2389cc	1997-1998	Base, LE, SE	US9206				
280Z							
2.8L L6 2753cc	1975-1978		US9011				
280ZX							
2.8L L6 2753cc	1979		US9011				
2.8L L6 2753cc	1980	2+2 GL, Base, GL	US9011				
2.8L L6 2753cc	1981	2+2 GL, Base, GL, GL Turbo	US9011				
2.8L L6 2753cc	1982-1983	2+2, 2+2 Turbo, Base, Turbo	US9011				

WATER PUMPS

Engine	Years	Application Description	USMW
NISSAN (cont'd.)			
ALTIMA			
2.4L L4 2389cc	1993-2001	GLE, GXE, SE, XE	US9270
2.5L L4 2488cc 152 CID	2002-2004	Base, S, SL	US9427
2.5L L4 2488cc 152 CID	2002-2004	Base, S, SL; Includes back housing	US9427-2
2.5L L4 2488cc 152 CID	2005	S, SL; From 04/05	US9427
2.5L L4 2488cc 152 CID	2005	S, SL; To 04/05	US9427
2.5L L4 2488cc 152 CID	2005	S, SL; From 04/05, Includes back housing	US9427-2
2.5L L4 2488cc 152 CID	2005	S, SL; Includes back housing, To 04/05	US9427-2
2.5L L4 2488cc 152 CID	2006	Base, S, SL	US9427
2.5L L4 2488cc 152 CID	2006	Base, S, SL; Includes back housing	US9427-2
2.5L L4 2488cc 152 CID	2007-2009	Base, Hybrid, S	US9427
2.5L L4 2488cc 152 CID	2007-2009	Base, Hybrid, S; Includes back housing	US9427-2
2.5L L4 2488cc 152 CID	2010-2011	Base, Hybrid, S, SL	US9427
2.5L L4 2488cc 152 CID	2010-2011	Base, Hybrid, S, SL; Includes back housing	US9427-2
2.5L L4 2488cc 152 CID	2012	Base, S, SL	US9427
2.5L L4 2488cc 152 CID	2012	Base, S, SL; Includes back housing	US9427-2
2.5L L4 2488cc 152 CID	2013	S	US9427
2.5L L4 2488cc 152 CID	2013	S; Includes back housing	US9427-2
2.5L L4 2488cc 152 CID	2013-2015	Base, S, SL, SV	US8105
2.5L L4 2488cc 152 CID	2016-2017	Base, S, SL, SR, SV	US8105
3.5L V6 3498cc	2002	SE; From 12/2001	US9426
3.5L V6 3498cc	2002	SE; To 12/2001	US9426
3.5L V6 3498cc	2003	SE; From 12/2002	US9426
3.5L V6 3498cc	2003	SE; To 12/2002	US9426
3.5L V6 3498cc	2004	SE	US9426
3.5L V6 3498cc	2005	SE, SE-R, SL; From 10/2004	US9426
3.5L V6 3498cc	2005	SE, SE-R, SL; To 10/2004	US9426
3.5L V6 3498cc	2006	SE, SE-R, SL	US9426
3.5L V6 3498cc	2007-2009	SE, SL	US6198
3.5L V6 3498cc	2010-2012	SR	US6198
3.5L V6 3498cc	2013-2015	S, SL, SV	US6198
3.5L V6 3498cc	2016-2017	SL, SR	US6198
APRIO			
1.6L L4 1597cc 97 CID	2008-2009	Mexican Application	US8927
1.6L L4 1598cc 97 CID	2010	Mexican Application	US8927
1.6L L4 1598cc 98 CID	2008		US8927
1.6L L4 1598cc 98 CID	2010	Convenience	US8927
ARMADA			
5.6L V8 5552cc	2005-2006	LE, SE, SE Off-Road	US9488
5.6L V8 5552cc	2007-2009	LE, SE	US9488
5.6L V8 5552cc	2010	Platinum, SE, Titanium	US9488
5.6L V8 5552cc	2011-2015	Platinum, SL, SV	US9488
5.6L V8 5552cc	2017	Platinum, SL, SV	US9488
AXXESS			
2.4L L4 2389cc	1990	SE, XE	US9162
B210			
1.4L L4 1393cc 85 CID	1975-1978	Exc.Air Cond	US9010
1.4L L4 1393cc 85 CID	1975-1978	Air Cond	US9026
CABSTAR			
2.5L L4 2488cc 151 CID	2008-2011	Mexican Application	US8998
CUBE			
1.8L L4 1798cc	2009-2011	Base, Krom, S, SL	US6218
1.8L L4 1798cc	2012	Base, S, SL	US6218
1.8L L4 1798cc	2013-2014	S, SL	US6218
D21			
2.4L L4 2389cc	1986-1987	Base, E, XE; Includes fan clutch	US9031
2.4L L4 2389cc	1988	Base, E, XE; From 04/1988, Incl.Fan Clutch,Gasket and Pulley	US9031
2.4L L4 2389cc	1988	Base, E, XE; To 04/1988	US9031
2.4L L4 2389cc	1989	Base, E, XE; Includes fan clutch	US9031
2.4L L4 2389cc	1990-1993	Base	US9206
2.4L L4 2389cc	1994	Base, XE	US9206
3.0L V6 2960cc	1986-1989	E, SE; RWD	US9058
3.0L V6 2960cc	1986-1989	E, SE; 4WD	US9104
3.0L V6 2960cc 181 CID	1990-1993	Base, SE; RWD	US9058
3.0L V6 2960cc 181 CID	1990-1993	Base, SE; 4WD	US9104
3.0L V6 2960cc 181 CID	1994	Base	US9058
3.0L V6 2960cc 181 CID	1994	SE, XE; RWD	US9058
3.0L V6 2960cc 181 CID	1994	SE, XE; 4WD	US9104
FRONTIER			
2.4L L4 2389cc	1998	Base, SE, XE	US9206
2.4L L4 2389cc	1999	SE, XE	US9206
2.4L L4 2389cc	2000-2001	XE	US9206
2.4L L4 2389cc	2002-2003	Base, XE	US9206
2.4L L4 2389cc	2004	XE	US9206
2.4L L4 2389cc 146 CID	2006	Mexican Application	US6242
2.4L L4 2389cc 146 CID	2008	Mexican Application	US9206
2.5L L4 2488cc 152 CID	2005-2007	XE	US6242
2.5L L4 2488cc 152 CID	2008-2010	SE, XE	US6242
2.5L L4 2488cc 152 CID	2011-2017	S, SV	US6242
3.3L V6 3275cc	1999	SE, XE	US9338

Engine	Years	Application Description	USMW
NISSAN (cont'd.)			
FRONTIER (cont'd.)			
3.3L V6 3275cc	2000	SE, XE; From 12/1999	US9338
3.3L V6 3275cc	2000	SE, XE; To 12/1999	US9338
3.3L V6 3275cc	2001	SC, SE, XE	US9338
3.3L V6 3275cc	2002-2003	SC, SE, SVE, XE	US9338
3.3L V6 3275cc	2004	SC, SVE, XE	US9338
4.0L V6 3954cc	2005	LE, Nismo Off-Road, SE	US9426
4.0L V6 3954cc	2006	LE, Nismo Off-Road, SE; From 09/2005	US9426
4.0L V6 3954cc	2006	LE, Nismo Off-Road, SE; To 09/2005	US9426
4.0L V6 3954cc	2007	LE, Nismo Off-Road, SE; From 09/2006	US9426
4.0L V6 3954cc	2007	LE, Nismo Off-Road, SE; To 09/2006	US9426
4.0L V6 3954cc	2008	LE, Nismo Off-Road, SE	US9426
4.0L V6 3954cc	2009-2010	LE, PRO-4X, SE	US9426
4.0L V6 3954cc	2011-2012	PRO-4X, S, SL, SV	US9426
4.0L V6 3954cc	2013-2017	Desert Runner, PRO-4X, S, SL, SV	US9426
4.0L V6 3954cc 241 CID	2008	SE	US9426
4.0L V6 3954cc 241 CID	2010	SE	US9426
4.0L V6 3954cc 241 CID	2011	PRO-4X, SV	US9426
4.0L V6 3954cc 241 CID	2012	PRO-4X	US9426
4.0L V6 3954cc 241 CID	2014	PRO-4X, S	US9426
4.0L V6 3954cc 241 CID	2015	PRO-4X	US9426
GT-R			
3.8L V6 3799cc	2009-2010	Base, Premium	US8164
3.8L V6 3799cc	2011	Premium	US8164
3.8L V6 3799cc	2012-2013	Black Edition, Premium	US8164
3.8L V6 3799cc	2014	Black Edition, Premium, Track Edition	US8164
3.8L V6 3799cc	2015	Black Edition, Nismo, Premium, Track Edition	US8164
3.8L V6 3799cc	2016	Black Edition, Nismo, Premium	US8164
3.8L V6 3799cc	2017	Nismo, Premium	US8164
HIKARI			
1.6L L4 1597cc 97 CID	1988-1990	Base, Turbo	US9284
1.6L L4 1597cc 97 CID	1991-1992	Turbo	US9284
ICHI VAN			
1.8L L4 1800cc 110 CID	1987-1989	Mexican Application	US9116
1.8L L4 1800cc 110 CID	1990-1992	Mexican Application	US9179
2.4L L4 2389cc 146 CID	1991-1994	Mexican Application	US9206
JUKE			
1.6L L4 1618cc	2011-2016	Mexican Application	US8104
1.6L L4 1618cc	2014-2017	Nismo, Nismo RS, S, SL, SV	US8104
LUCINO			
1.6L L4 1597cc 97 CID	1996-2000	Mexican Application	US9214
2.0L L4 1998cc 122 CID	1996-2000	Mexican Application	US9213
MARCH			
1.6L L4 1598cc 98 CID	2014-2016	Mexican Application	US6687
MAXIMA			
2.4L L6 2393cc	1982-1984	GL	US9011
2.8L L6 2793cc	1982-1983	GL	US9011
3.0L V6 2960cc 181 CID	1985-1986	GL, SE	US9074
3.0L V6 2960cc 181 CID	1987-1991	GXE, SE	US9074
3.0L V6 2960cc 181 CID	1992-1994	GXE	US9074
3.0L V6 2960cc 181 CID	1992-1994	SE	US9252
3.0L V6 2988cc 182 CID	1995-2000	GLE, GXE, SE	US9309
3.0L V6 2988cc 182 CID	2001	GLE, GXE, SE, SE 20th Anniversary Edition	US9309
3.5L H6 3500cc 214 CID	2010	Mexican Application	US9426
3.5L V6 3498cc	2002-2003	GLE, GXE, SE	US9426
3.5L V6 3498cc	2004-2008	SE, SL	US9426
3.5L V6 3498cc	2009-2014	S, SV	US6198
3.5L V6 3498cc	2016-2017	Platinum, S, SL, SR, SV	US6198
MICRA			
1.4L L4 1386cc 85 CID	2006-2007		US8967
MURANO			
2.5L L4 2488cc 152 CID	2016	Platinum Hybrid, SL Hybrid	US8105
3.5L H6 3500cc 213 CID	2008	Mexican Application	US9426
3.5L V6 3498cc	2003	SE, SL; From 10/2002	US9426
3.5L V6 3498cc	2003	SE, SL; To 10/2002	US9426
3.5L V6 3498cc	2004	SE, SL	US9426
3.5L V6 3498cc	2005-2006	S, SE, SL	US9426
3.5L V6 3498cc	2007	S, SE, SL; (VQ35DE); From 03/07	US6198
3.5L V6 3498cc	2007	S, SE, SL; To 03/2007	US9426
3.5L V6 3498cc	2009	LE, S, SL; (VQ35DE)	US6198
3.5L V6 3498cc	2010	LE, S, SL	US6198
3.5L V6 3498cc	2011-2014	CrossCabriolet, LE, S, SL, SV	US6198
3.5L V6 3498cc	2015-2017	Platinum, S, SL, SV	US6198
NP300			
2.4L L4 2389cc 146 CID	2009-2012	Mexican Application	US9206
2.5L L4 2488cc 151 CID	2008-2011	Mexican Application	US8998
2.5L L4 2488cc 151 CID	2012	Mexican Application	US9206

Engine	Years	Application Description	USMW	Engine	Years	Application Description	USMW
NISSAN (cont'd.)				NISSAN (cont'd.)			
NV200				QUEST (cont'd.)			
2.0L L4 1997cc	2013	SV; From 07/2013	US6218	3.5L V6 3498cc	2004	S, SE, SL	US9426
2.0L L4 1997cc	2014-2017	S, SV, Taxi	US6218	3.5L V6 3498cc	2005	Base, S, SE, SL; From 07/2005	US9426
NV1500				3.5L V6 3498cc	2005	Base, S, SE, SL; To 07/2005	US9426
4.0L V6 3954cc	2012-2017	S, SV	US9426	3.5L V6 3498cc	2006	Base, S, SE, SL; From 05/2006	US9426
NV2500				3.5L V6 3498cc	2006	Base, S, SE, SL; To 05/2006	US9426
4.0L V6 3954cc	2012-2014	S, SV	US9426	3.5L V6 3498cc	2007-2009	Base, S, SE, SL	US9426
4.0L V6 3954cc	2015-2016	S, SL, SV	US9426	3.5L V6 3498cc	2011-2014	LE, S, SL, SV	US6198
4.0L V6 3954cc	2017	S, SV	US9426	3.5L V6 3498cc	2015-2017	Platinum, S, SL, SV	US6198
5.6L V8 5552cc	2012-2014	S, SV	US9488	ROGUE			
5.6L V8 5552cc	2015-2017	S, SL, SV	US9488	2.5L L4 2488cc 152 CID	2008-2009	S, SL	US9427
NV3500				2.5L L4 2488cc 152 CID	2008-2009	S, SL; Includes back housing	US9427-2
4.0L V6 3954cc	2012-2017	S, SV	US9426	2.5L L4 2488cc 152 CID	2010	Krom, S, SL	US9427
5.6L V8 5552cc	2012-2017	S, SL, SV	US9488	2.5L L4 2488cc 152 CID	2010	Krom, S, SL; Includes back housing	US9427-2
NX				2.5L L4 2488cc 152 CID	2011	S, S Krom, SV	US9427-2
1.6L L4 1597cc 97 CID	1991-1993	SE, XE	US9214	2.5L L4 2488cc 152 CID	2011	S, S Krom, SV; Includes back housing	US9427-2
2.0L L4 1998cc	1991-1993	SE, XE	US9213	2.5L L4 2488cc 152 CID	2012-2013	S, SV	US9427
PATHFINDER				2.5L L4 2488cc 152 CID	2012-2013	S, SV; Includes back housing	US9427-2
2.4L L4 2389cc	1987	E; Includes fan clutch	US9031	2.5L L4 2488cc 152 CID	2014-2017	S, SL, SV	US8105
2.5L L4 2488cc 152 CID	2014	Platinum Hybrid, SL Hybrid, SV Hybrid	US8105	2.5L L4 2488cc 152 CID	2015-2016	S, SL, SV; USA Built	US8105
3.0L V6 2960cc 181 CID	1987-1993	SE, XE	US9104	2.5L L4 2488cc 152 CID	2016	S, SL, SV; Korea Built Vehicle (From 10/2015)	US8105
3.0L V6 2960cc 181 CID	1994-1995	LE, SE, XE	US9104	2.5L L4 2488cc 152 CID	2017	S, SL, SV; Korea Built Vehicle	US8105
3.3L V6 3275cc	1996	LE, SE, XE	US9338	ROGUE SELECT			
3.3L V6 3275cc	1997-1998	LE, SE, XE; (A)	US9338	2.5L L4 2488cc 152 CID	2014-2015	S	US9427
3.3L V6 3275cc	1999	LE, SE, XE; From 12/1998	US9338	2.5L L4 2488cc 152 CID	2014-2015	S; Includes back housing	US9427-2
3.3L V6 3275cc	1999	LE, SE, XE; To 12/1998	US9338	ROGUE SPORT			
3.3L V6 3275cc	2000	LE, SE, XE	US9338	2.0L L4 1997cc	2017	S, SL, SV	US8104
3.5L V6 3498cc	2001	LE, SE, XE	US9309	SAKURA			
3.5L V6 3498cc	2002-2004	LE, SE	US9309	1.8L L4 1750cc 107 CID	1982-1986	Mexican Application	US9063
3.5L V6 3498cc	2013-2016	Platinum, S, SL, SV	US6198	SEDAN			
4.0L V6 3954cc	2005	LE, SE, SE Off-Road, XE	US9426	1.6L L4 1597cc 97 CID	1973-1984	Mexican Application	US9009
4.0L V6 3954cc	2005	LE, SE, SE Off-Road, XE; Electric Water Pump	US11005	1.8L L4 1750cc 107 CID	1982-1984	Mexican Application	US9063
4.0L V6 3954cc	2006	LE, S, SE, SE Off-Road; From 09/2005	US9426	SENTRA			
4.0L V6 3954cc	2006	LE, S, SE, SE Off-Road; To 09/2005	US9426	1.5L L4 1488cc	1982-1983	Base, DX	US9041
4.0L V6 3954cc	2006-2009	LE, S, SE, SE Off-Road; Electric Water Pump	US11005	1.6L L4 1597cc	1983	Base, DX, XE	US9041
4.0L V6 3954cc	2007-2009	LE, S, SE, SE Off-Road	US9426	1.6L L4 1597cc	1984-1985	Base, DX, SE, XE	US9041
4.0L V6 3954cc	2010	LE, S, SE	US9426	1.6L L4 1597cc	1987-1988	Base, E, GXE, SE, XE	US9041
4.0L V6 3954cc	2010	LE, S, SE; Electric Water Pump	US11005	1.6L L4 1597cc 97 CID	1986	Base, DX, SE, XE	US9041
4.0L V6 3954cc	2011	LE, S, Silver Edition, SV; Electric Water Pump	US11005	1.6L L4 1597cc 97 CID	1987	Base, E, GXE, SE, XE	US9041
4.0L V6 3954cc	2011-2012	LE, S, Silver Edition, SV	US9426	1.6L L4 1597cc 97 CID	1989	Base, E, SE, XE	US9207
4.0L V6 3954cc	2012	LE, S, SV; Electric Water Pump	US11005	1.6L L4 1597cc 97 CID	1990	Base, SE, XE	US9207
4.0L V6 3954cc 241 CID	2010	LE, SE	US9426	1.6L L4 1597cc 97 CID	1991-1993	E, GXE, SE, XE	US9214
4.0L V6 3954cc 241 CID	2011	LE, SV	US9426	1.6L L4 1597cc 97 CID	1994	E, GXE, Limited Edition, SE, XE	US9214
5.6L V8 5552cc	2008	LE, SE	US9488	1.6L L4 1597cc 97 CID	1995	Base, GLE, GXE, XE; USA Built	US9214
5.6L V8 5552cc	2009-2012	LE	US9488	1.6L L4 1597cc 97 CID	1995-1997	Base, GLE, GXE, XE; Mexico Built Vehicle	US9214
PATHFINDER ARMADA				1.6L L4 1597cc 97 CID	1996	Base, GLE, GXE, XE; From 11/1995, USA Built	US9214
5.6L V8 5552cc	2004	LE, SE	US9488	1.6L L4 1597cc 97 CID	1996	Base, GLE, GXE, XE; To 11/1995, USA Built	US9214
PICKUP				1.6L L4 1597cc 97 CID	1997	Base, GLE, GXE, XE; USA Built	US9214
1.3L L4 1300cc 79 CID	1965-1969	Mexican Application	US9179	1.6L L4 1597cc 97 CID	1998	Base, GLE, GXE, XE	US9214
1.6L L4 1600cc 98 CID	1970-1983	Mexican Application	US9009	1.6L L4 1597cc 97 CID	1999	GXE, XE	US9214
1.8L L4 1800cc 110 CID	1981-1984	Mexican Application	US9063	1.6L L4 1597cc 97 CID	2000	Mexican Application	US9213
1.8L L4 1800cc 110 CID	1985-1990	Mexican Application	US9116	1.6L L4 1618cc	2017	Nismo, SR Turbo	US8104
1.8L L4 1800cc 110 CID	1991-1994	Mexican Application	US9179	1.7L L4 1688cc	1983	Base, DX	US9044
2.4L L4 2389cc	1995	Base, XE	US9206	1.7L L4 1688cc	1984	Base, DX, SE, XE	US9044
2.4L L4 2389cc	1996	Base, SE, XE; From 01/1996	US9206	1.7L L4 1688cc	1985-1986	Base	US9044
2.4L L4 2389cc	1996	Base, SE, XE; To 01/1996	US9206	1.8L L4 1798cc 110 CID	2013-2014	FE+S, FE+SV, S, SL, SR, SV	US8104
2.4L L4 2389cc	1997	Base, SE, XE	US9206	1.8L L4 1798cc 110 CID	2015-2016	FE+S, S, SL, SR, SV	US8104
2.4L L4 2389cc 146 CID	1991-1993	Mexican Application	US9206	1.8L L4 1798cc 110 CID	2017	S, SL, SR, SV	US8104
2.4L L4 2389cc 146 CID	1998-2008	Mexican Application	US9206	1.8L L4 1809cc	2000	GXE, XE	US9416
3.0L V6 2960cc 181 CID	1995	XE; RWD	US9058	1.8L L4 1809cc	2001-2002	CA, GXE, XE	US9416
3.0L V6 2960cc 181 CID	1995	SE, XE; 4WD	US9104	1.8L L4 1809cc	2003	GXE, XE	US9416
PLATINA				1.8L L4 1809cc	2004-2006	Base, S	US9416
1.6L L4 1597cc 97 CID	2010	Mexican Application	US8927	2.0L L4 1997cc 122 CID	2007-2008	Base, S, SL	US6218
1.6L L4 1598cc 97 CID	2002-2010	Mexican Application	US8927	2.0L L4 1997cc 122 CID	2009-2012	Base, S, SL, SR	US6218
1.6L L4 1598cc 98 CID	2002-2010		US8927	2.0L L4 1997cc 122 CID	2010-2012	Mexican Application	US6218
PULSAR				2.0L L4 1998cc	1991-1994	SE-R	US9213
1.6L L4 1597cc	1983	Base	US9041	2.0L L4 1998cc	1998-2001	SE	US9213
PULSAR NX				2.0L L4 1998cc 122 CID	1996-1997	Mexican Application	US9213
1.5L L4 1488cc	1983-1984	Turbo	US9041	2.5L L4 2488cc 152 CID	2002	SE-R, SE-R Spec V	US9427
1.6L L4 1597cc	1983-1986	Base	US9041	2.5L L4 2488cc 152 CID	2002	SE-R, SE-R Spec V; Includes back housing	US9427-2
1.6L L4 1597cc	1987	SE; To 10/1986	US9063	2.5L L4 2488cc 152 CID	2003	Limited Edition, SE-R, SE-R Spec V	US9427
1.6L L4 1597cc	1987	SE; From 10/1986	US9116	2.5L L4 2488cc 152 CID	2003	Limited Edition, SE-R, SE-R Spec V; Includes back housing	US9427-2
1.6L L4 1597cc	1987-1988	XE	US9041	2.5L L4 2488cc 152 CID	2004	S, SE-R, SE-R Spec V	US9427
1.6L L4 1597cc 97 CID	1989-1990	XE	US9207	2.5L L4 2488cc 152 CID	2004	S, SE-R, SE-R Spec V; Includes back housing	US9427-2
1.8L L4 1809cc	1988-1989	SE	US9116	2.5L L4 2488cc 152 CID	2005-2012	SE-R, SE-R Spec V	US9427
QUEST				2.5L L4 2488cc 152 CID	2005-2012	SE-R, SE-R Spec V; Includes back housing	US9427-2
3.0L V6 2960cc 181 CID	1993-1998	GXE, XE	US9074				
3.3L V6 3275cc	1999-2002	GLE, GXE, SE	US9402				



WATER PUMP APPLICATION GUIDE



Engine	Years	Application Description	USMW	Engine	Years	Application Description	USMW
NISSAN (cont'd.)				OLDSMOBILE (cont'd.)			
STANZA				98 (cont'd.)			
2.0L L4 1974cc	1982	Base	US9114	3.8L V6 3800cc 231 CID	1996	Regency Elite	US5075
2.0L L4 1974cc	1983	Base, GL	US9114	4.1L V6 252 CID	1981	Luxury, Regency	US1018
2.0L L4 1974cc	1984-1986	GL, XE	US9114	4.1L V6 252 CID	1981	Luxury, Regency; High performance	US1018H
2.0L L4 1974cc	1987-1989	E, GXE, XE	US9116	4.1L V6 252 CID	1982-1983	Regency, Regency Brougham	US1018
2.4L L4 2389cc	1990-1991	GXE, XE	US9162	4.1L V6 252 CID	1982-1983	Regency, Regency Brougham; High performance	US1018H
2.4L L4 2389cc	1992	GXE, SE, XE	US9162	4.3L V6 260 CID	1985	Regency, Regency Brougham; W/O Pulley	US5014
STATION WAGON				4.3L V6 260 CID	1985	Regency, Regency Brougham; Includes pulley	US5014P
1.6L L4 1597cc 97 CID	1973-1984	Mexican Application	US9009	5.0L V8 307 CID	1980-1981	Luxury, Regency; Exc.Air Cond	US1100
1.8L L4 1750cc 107 CID	1982-1984	Mexican Application	US9063	5.0L V8 307 CID	1980-1981	Luxury, Regency; With air cond.	US1120
TIIDA				5.0L V8 307 CID	1980-1981	Luxury, Regency; High performance, With air cond.	US1120H
1.8L L4 1798cc 110 CID	2010-2012	Mexican Application	US6218	5.0L V8 307 CID	1982-1984	Regency, Regency Brougham	US1120
TITAN				5.0L V8 307 CID	1982-1984	Regency, Regency Brougham; High performance	US1120H
5.6L V8 5552cc	2004-2007	LE, SE, XE	US9488	5.7L V8 350 CID	1977-1979	Exc.Air Cond	US1100
5.6L V8 5552cc	2008-2010	LE, PRO-4X, SE, XE	US9488	5.7L V8 350 CID	1977-1979	Air Cond	US1120
5.6L V8 5552cc	2011-2015	PRO-4X, S, SL, SV	US9488	5.7L V8 350 CID	1977-1979	Air Cond, High performance	US1120H
5.6L V8 5552cc	2017	Platinum Reserve, PRO-4X, S, SL, SV	US9488	5.7L V8 350 CID	1980-1981	Luxury, Regency; Exc.Air Cond	US1100
TITAN XD				5.7L V8 350 CID	1980-1981	Luxury, Regency; With air cond.	US1120
5.6L V8 5552cc	2016-2017	Platinum Reserve, PRO-4X, S, SL, SV	US9488	5.7L V8 350 CID	1980-1981	Luxury, Regency; High performance, With air cond.	US1120H
TSUBAME				5.7L V8 350 CID	1982-1984	Regency, Regency Brougham	US1120
1.6L L4 1597cc 97 CID	1993-2004	Mexican Application	US9214	5.7L V8 350 CID	1982-1984	Regency, Regency Brougham; High performance	US1120H
TSURU				6.6L V8 400 CID	1975	Exc.Air Cond	US1100
1.5L L4 1487cc 91 CID	1984-1985	Mexican Application	US9041	6.6L V8 400 CID	1975	Air Cond	US1120
1.5L L4 1488cc	1985		US9284	6.6L V8 400 CID	1975	Air Cond, High performance	US1120H
1.6L L4 1597cc 97 CID	1986-1987		US9284	6.6L V8 403 CID	1977-1979	Exc.Air Cond	US1100
1.6L L4 1597cc 97 CID	1988-2013	Mexican Application	US9214	6.6L V8 403 CID	1977-1979	Air Cond	US1120
1.6L L4 1598cc 97 CID	1995-1997	Mexican Application	US9214	6.6L V8 403 CID	1977-1979	Air Cond, High performance	US1120H
2.0L L4 1998cc 122 CID	1993-1996	Mexican Application	US9213	7.0L V8 6966cc 425 CID	1965-1967	Without A/C	US773
URVAN				7.5L V8 455 CID	1968-1970	With A/C	US926
2.4L L4 2389cc 146 CID	2000-2005	Mexican Application	US9206	7.5L V8 455 CID	1975-1976	Exc.Air Cond	US1100
2.4L L4 2392cc 146 CID	2006-2007	Mexican Application	US9206	7.5L V8 455 CID	1975-1976	Air Cond	US1120
2.5L L4 2488cc 152 CID	2008-2013	Base	US6242	7.5L V8 455 CID	1975-1976	Air Cond, High performance	US1120H
2.5L L4 2500cc 153 CID	2008	Mexican Application	US6242	7.5L V8 7456cc 455 CID	1968-1970		US773
2.5L L4 2500cc 153 CID	2011-2013	Mexican Application	US6242	442			
3.0L L4 2999cc 182 CID	2008-2010	Mexican Application	US8978	6.6L V8 6555cc 400 CID	1968-1969	With A/C	US926
3.0L L4 3000cc 183 CID	2011	Mexican Application	US8978	7.5L V8 7456cc 455 CID	1968-1970	With A/C	US926
VAN				ACHIEVA			
2.4L L4 2389cc	1987-1988	E, GXE, XE	US9110	2.3L L4 138 CID	1992	S, SC, SL	US5043
VERSA				2.3L L4 138 CID	1993	S, SL	US5043
1.6L L4 1598cc	2009-2011	1.6, 1.6 Base	US6687	2.3L L4 138 CID	1994	S, SC, SL	US5043
1.6L L4 1598cc	2014-2017	1.6 S, 1.6 SL, 1.6 S Plus, 1.6 SV	US6687	2.3L L4 138 CID	1995	S, SL	US5043
1.8L L4 1798cc	2007-2011	S, SL	US6218	2.3L L4 140 CID	1992	S, SC, SCX	US5043
1.8L L4 1798cc	2012	1.8 S, 1.8 SL	US6218	2.3L L4 140 CID	1993	S, SCX	US5043
VERSA NOTE				2.3L L4 140 CID	1994	SC, SL	US5043
1.6L L4 1598cc	2014	S, S Plus, SV	US6687	2.4L L4 2392cc 146 CID	1996	S, SC, SL	US5076
1.6L L4 1598cc	2015-2016	S, SL, S Plus, SR, SV	US6687	2.4L L4 2392cc 146 CID	1997	SC, SL	US5076
1.6L L4 1598cc	2017	SL, S Plus, SR, SV	US6687	2.4L L4 2392cc 146 CID	1998	S	US5076
XTERRA				3.1L V6 189 CID	1994	S, SC, SL	US5033
2.4L L4 2389cc	2000-2004	XE	US9206	3.1L V6 189 CID	1995	S, SL	US5033
3.3L V6 3275cc	2000	SE, XE; From 12/1999	US9338	3.1L V6 189 CID	1996	S, SC, SL	US5033
3.3L V6 3275cc	2000	SE, XE; To 12/1999	US9338	3.1L V6 189 CID	1997	SC, SL	US5033
3.3L V6 3275cc	2001-2004	SE, XE	US9338	3.1L V6 189 CID	1998	S	US5033
4.0L V6 3954cc	2005	Off-Road, S, SE	US9426	3.3L V6 204 CID	1992	S, SC, SL	US5050
4.0L V6 3954cc	2006	Off-Road, S, SE, X; From 09/2005	US9426	3.3L V6 204 CID	1993	S, SL	US5050
4.0L V6 3954cc	2006	Off-Road, S, SE, X; To 09/2005	US9426	ALERO			
4.0L V6 3954cc	2007-2010	Off-Road, S, SE, X	US9426	2.2L L4 2198cc 134 CID	2002-2003	GL, GLS, GX	US5092
4.0L V6 3954cc	2011-2015	PRO-4X, S, X	US9426	2.2L L4 2198cc 134 CID	2004	GL, GX	US5092
X-TRAIL				2.4L L4 2392cc 146 CID	1999-2001	GL, GLS, GX	US5076
2.5L L4 2488cc 152 CID	2002-2010		US9427	3.4L V6 207 CID	1999	GL, GLS	US5033
2.5L L4 2488cc 152 CID	2002-2010	Includes back housing	US9427-2	3.4L V6 207 CID	2000-2002	GL, GLS, GX	US5033
OLDSMOBILE				3.4L V6 207 CID	2003-2004	GL, GLS	US5033
88				AURORA			
3.8L V6 3800cc 231 CID	1992-1994	Royale, Royale LS	US5050	3.5L V6 214 CID	2001-2002	Base	US5085
3.8L V6 3800cc 231 CID	1995	Royale, Royale LS, Royale LSS	US5050	4.0L V8 244 CID	1995-1999	Base	US5072
3.8L V6 3800cc 231 CID	1996-1998	Royale, Royale LS	US5075	4.0L V8 244 CID	2001-2003	Base	US5072
3.8L V6 3800cc 231 CID	1999	50th Anniversary Edition, Royale, Royale LS	US5075	BRAVADA			
98				4.2L L6 256 CID	2002-2004	Base	US5097
3.0L V6 181 CID	1985	Regency	US5028	4.3L V6 262 CID	1991-1994	Base	US5049
3.8L V6 3800cc 231 CID	1985	Regency, Regency Brougham	US5028	4.3L V6 262 CID	1991-1994	Base; High performance	US5049H
3.8L V6 3800cc 231 CID	1986	Regency, Regency Brougham	US5050	4.3L V6 262 CID	1996-2001	Base	US5077
3.8L V6 3800cc 231 CID	1987	Regency, Regency Brougham, Regency Grande, Regency Touring	US5050	4.3L V6 262 CID	1996-2001	Base; High performance	US5077H
3.8L V6 3800cc 231 CID	1988-1990	Regency, Regency Brougham, Regency Touring	US5050	CALAIS			
3.8L V6 3800cc 231 CID	1991	Regency Elite, Touring	US5050	2.3L L4 138 CID	1987	Base, GT	US5043
3.8L V6 3800cc 231 CID	1992-1993	Regency, Regency Elite, Touring	US5050	2.5L L4 2474cc 151 CID	1985	500, Base, Supreme	US5000
3.8L V6 3800cc 231 CID	1994	Regency, Regency Elite	US5050	2.5L L4 2474cc 151 CID	1985-1987	With Multi-Groove pulley	US5067
3.8L V6 3800cc 231 CID	1995	Regency Elite	US5050	2.5L L4 2474cc 151 CID	1986	Base, ES, GT, Supreme	US5000
				2.5L L4 2474cc 151 CID	1987	Base, GT, Supreme	US5000
				3.0L V6 181 CID	1985	500, Base, Supreme	US5050

Engine	Years	Application Description	USMW	Engine	Years	Application Description	USMW
OLDSMOBILE (cont'd.)				OLDSMOBILE (cont'd.)			
CALAIS (cont'd.)				CUTLASS CALAIS (cont'd.)			
3.0L V6 181 CID	1986	Base, ES, GT, Supreme	US5050	3.8L V6 3800cc 231 CID	1980-1982	Base	US1018
3.0L V6 181 CID	1987	Base, GT, Supreme	US5050	3.8L V6 3800cc 231 CID	1980-1982	Base; High performance	US1018H
CUSTOM CRUISER				3.8L V6 3800cc 231 CID	1983	Base, Hurst	US1018
5.0L V8 305 CID	1991-1992	Base	US5051	3.8L V6 3800cc 231 CID	1983	Base, Hurst; High performance	US1018H
5.0L V8 307 CID	1980-1985	Base; Exc.Air Cond	US1100	3.8L V6 3800cc 231 CID	1984	Base	US1018
5.0L V8 307 CID	1980-1985	Base; With air cond.	US1120	3.8L V6 3800cc 231 CID	1984	Base; High performance	US1018H
5.0L V8 307 CID	1980-1985	Base; High performance, With air cond.	US1120H	4.3L V6 260 CID	1982	Base	US5012
5.0L V8 307 CID	1986-1990	Base	US1120	4.3L V6 260 CID	1983	Base, Hurst	US5012
5.0L V8 307 CID	1986-1990	Base; High performance	US1120H	4.3L V6 260 CID	1984	Base	US5012
5.7L V8 350 CID	1977-1979	Exc.Air Cond	US1100	4.3L V8 260 CID	1978-1979	Exc.Air Cond	US1100
5.7L V8 350 CID	1977-1979	Air Cond	US1120	4.3L V8 260 CID	1978-1979	Air Cond	US1120
5.7L V8 350 CID	1977-1979	Air Cond, High performance	US1120H	4.3L V8 260 CID	1978-1979	Air Cond, High performance	US1120H
5.7L V8 350 CID	1980-1985	Base; Exc.Air Cond	US1100	4.3L V8 260 CID	1980	Base; With air cond.	US1120
5.7L V8 350 CID	1980-1985	Base; With air cond.	US1120	4.3L V8 260 CID	1980	Base; High performance, With air cond.	US1120H
5.7L V8 350 CID	1980-1985	Base; High performance, With air cond.	US1120H	4.3L V8 260 CID	1980-1982	Base; Exc.Air Cond	US1100
5.7L V8 350 CID	1992	Base	US5051	4.3L V8 260 CID	1982	Base; With air cond.	US1120
6.6L V8 400 CID	1975		US975	4.3L V8 260 CID	1982	Base; High performance, With air cond.	US1120H
6.6L V8 400 CID	1975	Exc.Air Cond	US1100	5.0L V8 305 CID	1980	Base	US1121
6.6L V8 400 CID	1975	Air Cond	US1120	5.0L V8 305 CID	1980	Base; High performance	US1121H
6.6L V8 400 CID	1975	Air Cond, High performance	US1120H	5.0L V8 307 CID	1982	Base; Exc.Air Cond	US1100
6.6L V8 403 CID	1977-1979	Exc.Air Cond	US1100	5.0L V8 307 CID	1982	Base; With air cond.	US1120
6.6L V8 403 CID	1977-1979	Air Cond	US1120	5.0L V8 307 CID	1982	Base; High performance, With air cond.	US1120H
6.6L V8 403 CID	1977-1979	Air Cond, High performance	US1120H	5.0L V8 307 CID	1983-1984	Base, Hurst; Exc.Air Cond	US1100
6.6L V8 403 CID	1977-1979	Air Cond, High performance	US1120H	5.0L V8 307 CID	1983-1984	Base, Hurst; With air cond.	US1120
7.5L V8 455 CID	1975-1976	Exc.Air Cond	US1100	5.0L V8 307 CID	1983-1984	Base, Hurst; High performance, With air cond.	US1120H
7.5L V8 455 CID	1975-1976	Air Cond	US1120	5.7L V8 350 CID	1979	Exc.Air Cond	US1100
7.5L V8 455 CID	1975-1976	Air Cond, High performance	US1120H	5.7L V8 350 CID	1979	Air Cond	US1120
CUTLASS				5.7L V8 350 CID	1979	Air Cond, High performance	US1120H
3.1L V6 189 CID	1997-1998	Base, GLS	US5033	5.7L V8 350 CID	1980-1981	Base; Exc.Air Cond	US1100
3.1L V6 189 CID	1999	GL, GLS	US5033	5.7L V8 350 CID	1980-1982	Base; With air cond.	US1120
3.8L V6 231 CID	1977		US1018	5.7L V8 350 CID	1980-1982	Base; High performance, With air cond.	US1120H
3.8L V6 231 CID	1977	High performance	US1018H	5.7L V8 350 CID	1982	Base; 5" Cast, Exc.Air Cond	US1100
3.8L V6 3800cc 231 CID	1980	Base, Brougham, LS	US1018	5.7L V8 350 CID	1982	Base; Exc.5" Cast, Exc.Air Cond	US1120
3.8L V6 3800cc 231 CID	1980	Base, Brougham, LS; High performance	US1018H	5.7L V8 350 CID	1982	Base; Exc.5" Cast, Exc.Air Cond, High performance	US1120H
3.8L V6 3800cc 231 CID	1981	Brougham, LS	US1018	5.7L V8 350 CID	1983	Base, Hurst	US1120
3.8L V6 3800cc 231 CID	1981	Brougham, LS; High performance	US1018H	5.7L V8 350 CID	1983	Base, Hurst; High performance	US1120H
4.1L L6 250 CID	1975-1976		US1107	5.7L V8 350 CID	1984	Base	US1120
4.3L V8 260 CID	1975-1979	Exc.Air Cond	US1100	5.7L V8 350 CID	1984	Base; High performance	US1120H
4.3L V8 260 CID	1975-1979	Air Cond	US1120	CUTLASS CIERA			
4.3L V8 260 CID	1975-1979	Air Cond, High performance	US1120H	2.2L L4 2190cc 134 CID	1993	Base, S	US5032
4.3L V8 260 CID	1980	Base, Brougham, LS; Exc.Air Cond	US1100	2.2L L4 2190cc 134 CID	1994	S	US5032
4.3L V8 260 CID	1980	Base, Brougham, LS; With air cond.	US1120	2.2L L4 2190cc 134 CID	1995-1996	Base	US5032
4.3L V8 260 CID	1980	Base, Brougham, LS; High performance, With air cond.	US1120H	2.5L L4 2474cc 151 CID	1982	Base, Brougham, LS	US5000
4.3L V8 260 CID	1981	Brougham, LS; Exc.Air Cond	US1100	2.5L L4 2474cc 151 CID	1982	Base, Brougham, LS; Includes pulley	US5000P
4.3L V8 260 CID	1981	Brougham, LS; With air cond.	US1120	2.5L L4 2474cc 151 CID	1983	Base, Brougham, ES, LS	US5000
4.3L V8 260 CID	1981	Brougham, LS; High performance, With air cond.	US1120H	2.5L L4 2474cc 151 CID	1983	Base, Brougham, ES, LS; Includes pulley	US5000P
5.0L V8 305 CID	1980	Base, Brougham, LS	US1121	2.5L L4 2474cc 151 CID	1984	Brougham, Cruiser LS, LS	US5000
5.0L V8 305 CID	1980	Base, Brougham, LS; High performance	US1121H	2.5L L4 2474cc 151 CID	1984	Brougham, Cruiser LS, LS; Includes pulley	US5000P
5.7L V8 350 CID	1968-1970	With A/C	US926	2.5L L4 2474cc 151 CID	1985	Brougham, Cruiser LS, ES, Holiday, LS	US5000
5.7L V8 350 CID	1975-1979	Exc.Air Cond	US1100	2.5L L4 2474cc 151 CID	1985	Brougham, Cruiser LS, ES, Holiday, LS; Includes pulley	US5000P
5.7L V8 350 CID	1975-1979	Air Cond	US1120	2.5L L4 2474cc 151 CID	1985-1987	With Multi-Groove pulley	US5067
5.7L V8 350 CID	1975-1979	Air Cond, High performance	US1120H	2.5L L4 2474cc 151 CID	1986	Brougham, ES, GT, Holiday, LS, S, SL	US5000
5.7L V8 350 CID	1980	Base, Brougham, LS; Exc.Air Cond	US1100	2.5L L4 2474cc 151 CID	1986	Brougham, ES, GT, Holiday, LS, S, SL; Includes pulley	US5000P
5.7L V8 350 CID	1980	Base, Brougham, LS; With air cond.	US1120	2.5L L4 2474cc 151 CID	1987	Brougham, GT, LS, S, SL	US5041
5.7L V8 350 CID	1980	Base, Brougham, LS; High performance, With air cond.	US1120H	2.5L L4 2474cc 151 CID	1987	Base, Brougham, LS, S, SL	US5041
5.7L V8 350 CID	1981	Brougham, LS; Exc.Air Cond	US1100	2.5L L4 2474cc 151 CID	1988	Base, SL	US5041
5.7L V8 350 CID	1981	Brougham, LS; With air cond.	US1120	2.5L L4 2474cc 151 CID	1989	Base, S, SL	US5041
5.7L V8 350 CID	1981	Brougham, LS; High performance, With air cond.	US1120H	2.5L L4 2474cc 151 CID	1991	Base, S	US5041
6.6L V8 403 CID	1977	Exc.Air Cond	US1100	2.5L L4 2474cc 151 CID	1992	Base	US5041
6.6L V8 403 CID	1977	Air Cond	US1120	2.8L V6 173 CID	1986	Brougham, ES, GT, Holiday, LS, S, SL	US5001
6.6L V8 403 CID	1977	Air Cond, High performance	US1120H	2.8L V6 173 CID	1987	Brougham, GT, LS, S, SL	US5033
7.5L V8 455 CID	1970	With A/C	US926	2.8L V6 173 CID	1988	Base, Brougham, LS, S, SL	US5033
7.5L V8 455 CID	1975-1976	Exc.Air Cond	US1100	2.8L V6 173 CID	1989	Base, SL	US5033
7.5L V8 455 CID	1975-1976	Air Cond	US1120	3.0L V6 181 CID	1982	Base, Brougham, LS	US5028
7.5L V8 455 CID	1975-1976	Air Cond, High performance	US1120H	3.0L V6 181 CID	1983	Base, Brougham, ES, LS	US5028
CUTLASS CALAIS				3.0L V6 181 CID	1984	Brougham, Cruiser LS, LS	US5028
2.3L L4 138 CID	1988	Base, GT, International, SL	US5043	3.0L V6 181 CID	1985	Brougham, Cruiser LS, ES, Holiday, LS	US5028
2.3L L4 138 CID	1989-1990	International, S, SL	US5043	3.1L V6 189 CID	1994	S, SL	US5033
2.3L L4 138 CID	1991	Base, GT, International, S, SL	US5043	3.1L V6 189 CID	1995-1996	Base	US5033
2.3L L4 140 CID	1989	International	US5043	3.3L V6 204 CID	1989	Base, GT, SL	US5050
2.3L L4 140 CID	1990-1991	International, S	US5043	3.3L V6 204 CID	1990	Base, GT, S, SL	US5050
2.5L L4 2474cc 151 CID	1988	Base, GT, SL	US5000	3.3L V6 204 CID	1991-1993	Base, S, SL	US5050
2.5L L4 2474cc 151 CID	1989	Base, GT, S, SL	US5000	3.8L V6 3800cc 231 CID	1984	Brougham, LS	US5028
2.5L L4 2474cc 151 CID	1990-1991	Base, GT, S	US5000	3.8L V6 3800cc 231 CID	1985	Brougham, Cruiser LS, ES, GT, Holiday, LS	US5028
3.0L V6 181 CID	1988	Base, GT, SL	US5050	3.8L V6 3800cc 231 CID	1986	ES, GT, Holiday, LS, S, SL	US5050
3.3L V6 204 CID	1989	S, SL	US5050	3.8L V6 3800cc 231 CID	1987	Brougham, GT, LS, S, SL	US5050
3.3L V6 204 CID	1990-1991	SL	US5050	3.8L V6 3800cc 231 CID	1988	Base, Brougham, International, LS, S, SL	US5050
3.8L V6 231 CID	1979		US1018	4.3L V6 260 CID	1982	Base, Brougham, LS; W/O Pulley	US5014
3.8L V6 231 CID	1979	High performance	US1018H	4.3L V6 260 CID	1982	Base, Brougham, LS; Includes pulley	US5014P
3.8L V6 3800cc 231 CID	1978-1979		US1018				
3.8L V6 3800cc 231 CID	1978-1979	High performance	US1018H				

WATER PUMPS



WATER PUMP APPLICATION GUIDE



Engine	Years	Application Description	USMW
OLDSMOBILE (cont'd.)			
CUTLASS CIERA (cont'd.)			
4.3L V6 260 CID	1983	Brougham, LS; W/O Pulley	US5014
4.3L V6 260 CID	1983	Brougham, LS; Includes pulley	US5014P
4.3L V6 260 CID	1984-1985	Brougham, Cruiser LS, LS; W/O Pulley	US5014
4.3L V6 260 CID	1984-1985	Brougham, Cruiser LS, LS; Includes pulley	US5014P
CUTLASS CRUISER			
2.5L L4 2474cc 151 CID	1987	Brougham, LS	US5041
2.5L L4 2474cc 151 CID	1987	With Multi-Groove pulley	US5067
2.5L L4 2474cc 151 CID	1988	Brougham LS, LS, SL	US5041
2.5L L4 2474cc 151 CID	1989	Base, SL	US5041
2.5L L4 2474cc 151 CID	1990	Base	US5041
2.8L V6 173 CID	1987	Brougham, LS	US5033
2.8L V6 173 CID	1988	Brougham LS, LS, SL	US5033
2.8L V6 173 CID	1989	Base, SL	US5033
3.1L V6 189 CID	1994	Base, S, Special Edition	US5033
3.3L V6 204 CID	1989-1990	Base, SL	US5050
3.3L V6 204 CID	1991-1992	S, SL	US5050
3.3L V6 204 CID	1993	Base, S	US5050
3.8L V6 3800cc 231 CID	1980-1981	Base, Brougham	US1018
3.8L V6 3800cc 231 CID	1980-1981	Base, Brougham; High performance	US1018H
3.8L V6 3800cc 231 CID	1982	Base	US1018
3.8L V6 3800cc 231 CID	1982	Base; High performance	US1018H
3.8L V6 3800cc 231 CID	1987	Brougham, LS	US5050
3.8L V6 3800cc 231 CID	1988	Brougham LS, LS, SL	US5050
4.3L V8 260 CID	1980-1981	Base, Brougham; Exc.Air Cond	US1100
4.3L V8 260 CID	1982	Base	US1100
5.0L V8 305 CID	1980	Base, Brougham	US1121
5.0L V8 305 CID	1980	Base, Brougham; High performance	US1121H
5.0L V8 305 CID	1982	Base; For A/C Belt	US1121
5.0L V8 305 CID	1982	Base; For A/C Belt, High performance	US1121H
5.0L V8 307 CID	1981	Base, Brougham; Exc.Air Cond	US1100
5.0L V8 307 CID	1982-1983	Base; Exc.Air Cond	US1100
5.0L V8 307 CID	1982-1983	Base; With air cond.	US1120
5.0L V8 307 CID	1982-1983	Base; High performance, With air cond.	US1120H
5.7L V8 350 CID	1980	Base, Brougham; With air cond.	US1120
5.7L V8 350 CID	1980	Base, Brougham; High performance, With air cond.	US1120H
5.7L V8 350 CID	1980-1981	Base, Brougham; 5" Cast, Exc.Air Cond	US1100
5.7L V8 350 CID	1981	Brougham; With air cond.	US1120
5.7L V8 350 CID	1981	Brougham; High performance, With air cond.	US1120H
5.7L V8 350 CID	1982	Base; Exc. air cond.	US1120
5.7L V8 350 CID	1982	Base; Exc. air cond., High performance	US1120H
5.7L V8 350 CID	1982-1983	Base; With air cond.	US1120
5.7L V8 350 CID	1982-1983	Base; High performance, With air cond.	US1120H
5.7L V8 350 CID	1983	Base; Exc.Air Cond	US1100
CUTLASS SALON			
3.8L V6 231 CID	1979		US1018
3.8L V6 231 CID	1979	High performance	US1018H
3.8L V6 3800cc 231 CID	1978-1979		US1018
3.8L V6 3800cc 231 CID	1978-1979	High performance	US1018H
3.8L V6 3800cc 231 CID	1980	Base, Brougham	US1018
3.8L V6 3800cc 231 CID	1980	Base, Brougham; High performance	US1018H
3.8L V6 3800cc 231 CID	1985-1987	Base	US1018
3.8L V6 3800cc 231 CID	1985-1987	Base; High performance	US1018H
4.3L V8 260 CID	1975-1979	Exc.Air Cond	US1100
4.3L V8 260 CID	1975-1979	Air Cond	US1120
4.3L V8 260 CID	1975-1979	Air Cond, High performance	US1120H
4.3L V8 260 CID	1980	Base, Brougham; Exc.Air Cond	US1100
4.3L V8 260 CID	1980	Base, Brougham; With air cond.	US1120
4.3L V8 260 CID	1980	Base, Brougham; High performance, With air cond.	US1120H
4.3L V8 260 CID	1980	Base, Brougham	US1121
5.0L V8 305 CID	1980	Base, Brougham; High performance	US1121H
5.0L V8 307 CID	1985-1986	442, Base; Exc.Air Cond	US1100
5.0L V8 307 CID	1985-1986	442, Base; With air cond.	US1120
5.0L V8 307 CID	1985-1986	442, Base; High performance, With air cond.	US1120H
5.0L V8 307 CID	1987	Base	US1120
5.0L V8 307 CID	1987	Base; High performance	US1120H
5.7L V8 350 CID	1975-1977	Exc.Air Cond	US1100
5.7L V8 350 CID	1975-1977	Air Cond	US1120
5.7L V8 350 CID	1975-1977	Air Cond, High performance	US1120H
5.7L V8 350 CID	1979	Exc.Air Cond	US1100
5.7L V8 350 CID	1979	Air Cond	US1120
5.7L V8 350 CID	1979	Air Cond, High performance	US1120H
5.7L V8 350 CID	1980	Base, Brougham; Exc.Air Cond	US1100
5.7L V8 350 CID	1980	Base, Brougham; With air cond.	US1120
5.7L V8 350 CID	1980	Base, Brougham; High performance, With air cond.	US1120H
5.7L V8 350 CID	1985	Base	US1120
5.7L V8 350 CID	1985	Base; High performance	US1120H
6.6L V8 403 CID	1977	Exc.Air Cond	US1100
6.6L V8 403 CID	1977	Air Cond	US1120
6.6L V8 403 CID	1977	Air Cond, High performance	US1120H

Engine	Years	Application Description	USMW
OLDSMOBILE (cont'd.)			
CUTLASS SALON (cont'd.)			
7.5L V8 455 CID	1975-1976	Exc.Air Cond	US1100
7.5L V8 455 CID	1975-1976	Air Cond	US1120
7.5L V8 455 CID	1975-1976	Air Cond, High performance	US1120H
CUTLASS SUPREME			
2.3L L4 138 CID	1990-1991	Base	US5043
2.3L L4 140 CID	1990	Base, International	US5043
2.8L V6 173 CID	1988	Base, Indy 500 Pace Car, International, SL	US5033
2.8L V6 173 CID	1989	Base, International, SL	US5033
3.1L V6 189 CID	1989-1991	Base, International, SL	US5033
3.1L V6 189 CID	1992-1993	Base, International, S	US5033
3.1L V6 189 CID	1994	Base, S	US5033
3.1L V6 189 CID	1995-1997	Base, SL	US5033
3.4L V6 207 CID	1991	Base, International, SL	US5033
3.4L V6 207 CID	1992	International, S	US5033
3.4L V6 207 CID	1993	Base, International, S	US5033
3.4L V6 207 CID	1994	Base, S	US5033
3.4L V6 207 CID	1995-1996	Base, SL	US5033
3.8L V6 3800cc 231 CID	1980	Base, Brougham	US1018
3.8L V6 3800cc 231 CID	1980	Base, Brougham; High performance	US1018H
3.8L V6 3800cc 231 CID	1981	Base, Brougham, LS	US1018
3.8L V6 3800cc 231 CID	1981	Base, Brougham, LS; High performance	US1018H
3.8L V6 3800cc 231 CID	1982	Base, Brougham	US1018
3.8L V6 3800cc 231 CID	1982	Base, Brougham; High performance	US1018H
3.8L V6 3800cc 231 CID	1982	Base, Brougham	US1018
3.8L V6 3800cc 231 CID	1983	Brougham; High performance	US1018H
3.8L V6 3800cc 231 CID	1984	Base, Brougham	US1018
3.8L V6 3800cc 231 CID	1984	Base, Brougham; High performance	US1018H
3.8L V6 3800cc 231 CID	1985	Base, Brougham, LS	US1018
3.8L V6 3800cc 231 CID	1985	Base, Brougham, LS; High performance	US1018H
3.8L V6 3800cc 231 CID	1986	Base, Brougham	US1018
3.8L V6 3800cc 231 CID	1986	Base, Brougham; High performance	US1018H
3.8L V6 3800cc 231 CID	1987	442, Base, Brougham	US1018
3.8L V6 3800cc 231 CID	1987	442, Base, Brougham; High performance	US1018H
4.3L V6 260 CID	1982-1983	Base, Brougham	US1120
4.3L V6 260 CID	1982-1983	Base, Brougham; High performance	US1120H
4.3L V6 260 CID	1984	Base, Brougham	US5012
4.3L V8 260 CID	1980	Base, Brougham; Exc.Air Cond	US1100
4.3L V8 260 CID	1981	Base, Brougham, LS; Exc.Air Cond	US1100
4.3L V8 260 CID	1982	Base, Brougham	US1100
5.0L V8 305 CID	1980	Base, Brougham	US1121
5.0L V8 305 CID	1980	Base, Brougham; High performance	US1121H
5.0L V8 307 CID	1982-1984	Base, Brougham; Exc.Air Cond	US1100
5.0L V8 307 CID	1982-1984	Base, Brougham; With air cond.	US1120
5.0L V8 307 CID	1982-1984	Base, Brougham; High performance, With air cond.	US1120H
5.0L V8 307 CID	1985	Base, Brougham, LS; Exc. air cond.	US1120
5.0L V8 307 CID	1985	Base, Brougham, LS; With air cond.	US1120
5.0L V8 307 CID	1985	Base, Brougham, LS; Exc. air cond., High performance	US1120H
5.0L V8 307 CID	1985	Base, Brougham, LS; High performance, With air cond.	US1120H
5.0L V8 307 CID	1986	Base, Brougham	US1120
5.0L V8 307 CID	1986	Base, Brougham; High performance	US1120H
5.0L V8 307 CID	1987	442, Base, Brougham	US1120
5.0L V8 307 CID	1987	442, Base, Brougham; High performance	US1120H
5.0L V8 307 CID	1988	Classic, Classic Brougham	US1120
5.0L V8 307 CID	1988	Classic, Classic Brougham; High performance	US1120H
5.7L V8 350 CID	1980	Base, Brougham; Exc.Air Cond	US1100
5.7L V8 350 CID	1980	Base, Brougham; With air cond.	US1120
5.7L V8 350 CID	1980	Base, Brougham; High performance, With air cond.	US1120H
5.7L V8 350 CID	1981	Base, Brougham, LS; Exc.Air Cond	US1100
5.7L V8 350 CID	1981	Base, Brougham, LS; With air cond.	US1120
5.7L V8 350 CID	1981	Base, Brougham, LS; High performance, With air cond.	US1120H
5.7L V8 350 CID	1982	Base, Brougham; Exc. air cond.	US1120
5.7L V8 350 CID	1982	Base, Brougham; Exc. air cond., High performance	US1120H
5.7L V8 350 CID	1982-1984	Base, Brougham; With air cond.	US1120
5.7L V8 350 CID	1982-1984	Base, Brougham; High performance, With air cond.	US1120H
5.7L V8 350 CID	1983-1984	Base, Brougham; Exc.Air Cond	US1100
5.7L V8 350 CID	1985	Base, Brougham, LS	US1120
5.7L V8 350 CID	1985	Base, Brougham, LS; High performance	US1120H
CUTLASS TIARA			
4.3L V8 260 CID	1976	Exc.Air Cond	US1100
4.3L V8 260 CID	1976	Air Cond	US1120
4.3L V8 260 CID	1976	Air Cond, High performance	US1120H
5.7L V8 350 CID	1976	Exc.Air Cond	US1100
5.7L V8 350 CID	1976	Air Cond	US1120
5.7L V8 350 CID	1976	Air Cond, High performance	US1120H

Engine	Years	Application Description	USMW
OLDSMOBILE (cont'd.)			
CUTLASS TIARA (cont'd.)			
7.5L V8 455 CID	1976	Exc.Air Cond	US1100
7.5L V8 455 CID	1976	Air Cond	US1120
7.5L V8 455 CID	1976	Air Cond, High performance	US1120H
DELMONT 88			
5.7L V8 350 CID	1968	With A/C	US926
7.5L V8 455 CID	1968	With A/C	US926
DELTA 88			
3.0L V6 181 CID	1986	Royale, Royale Brougham	US5050
3.8L V6 231 CID	1977		US1018
3.8L V6 231 CID	1977	High performance	US1018H
3.8L V6 3800cc 231 CID	1977-1979		US1018
3.8L V6 3800cc 231 CID	1977-1979	High performance	US1018H
3.8L V6 3800cc 231 CID	1980-1981	Base, Holiday, Royale, Royale Brougham	US1018
3.8L V6 3800cc 231 CID	1980-1981	Base, Holiday, Royale, Royale Brougham; High performance	US1018H
3.8L V6 3800cc 231 CID	1982-1983	Base, Royale, Royale Brougham	US1018
3.8L V6 3800cc 231 CID	1982-1983	Base, Royale, Royale Brougham; High performance	US1018H
3.8L V6 3800cc 231 CID	1984	Royale, Royale Brougham, Royale Brougham LS	US1018
3.8L V6 3800cc 231 CID	1984	Royale, Royale Brougham, Royale Brougham LS; High performance	US1018H
3.8L V6 3800cc 231 CID	1985	Royale, Royale Brougham	US1018
3.8L V6 3800cc 231 CID	1985	Royale, Royale Brougham; High performance	US1018H
3.8L V6 3800cc 231 CID	1986-1991	Royale, Royale Brougham	US5050
4.3L V8 260 CID	1977-1979	Exc.Air Cond	US1100
4.3L V8 260 CID	1977-1979	Air Cond	US1120
4.3L V8 260 CID	1977-1979	Air Cond, High performance	US1120H
4.3L V8 260 CID	1980-1981	Base, Holiday, Royale, Royale Brougham; Exc.Air Cond	US1100
4.3L V8 260 CID	1980-1981	Base, Holiday, Royale, Royale Brougham; With air cond.	US1120
4.3L V8 260 CID	1980-1981	Base, Holiday, Royale, Royale Brougham; High performance, With air cond.	US1120H
4.3L V8 260 CID	1982	Base, Royale, Royale Brougham; Exc.Air Cond	US1100
4.3L V8 260 CID	1982	Base, Royale, Royale Brougham; With air cond.	US1120
4.3L V8 260 CID	1982	Base, Royale, Royale Brougham; High performance, With air cond.	US1120H
4.9L V8 301 CID	1979		US975
5.0L V8 307 CID	1980-1981	Base, Holiday, Royale, Royale Brougham; Exc.Air Cond	US1100
5.0L V8 307 CID	1980-1981	Base, Holiday, Royale, Royale Brougham; With air cond.	US1120
5.0L V8 307 CID	1980-1981	Base, Holiday, Royale, Royale Brougham; High performance, With air cond.	US1120H
5.0L V8 307 CID	1982-1983	Base, Royale, Royale Brougham; Exc.Air Cond	US1100
5.0L V8 307 CID	1982-1983	Base, Royale, Royale Brougham; With air cond.	US1120
5.0L V8 307 CID	1982-1983	Base, Royale, Royale Brougham; High performance, With air cond.	US1120H
5.0L V8 307 CID	1984-1985	Royale, Royale Brougham, Royale Brougham LS; Exc.Air Cond	US1100
5.0L V8 307 CID	1984-1985	Royale, Royale Brougham, Royale Brougham LS; With air cond.	US1120
5.0L V8 307 CID	1984-1985	Royale, Royale Brougham, Royale Brougham LS; High performance, With air cond.	US1120H
5.7L V8 350 CID	1968-1970	With A/C	US926
5.7L V8 350 CID	1975-1979	Exc.Air Cond	US1100
5.7L V8 350 CID	1975-1979	Air Cond	US1120
5.7L V8 350 CID	1975-1979	Air Cond, High performance	US1120H
5.7L V8 350 CID	1980-1981	Base, Holiday, Royale, Royale Brougham; Exc.Air Cond	US1100
5.7L V8 350 CID	1980-1981	Base, Holiday, Royale, Royale Brougham; With air cond.	US1120
5.7L V8 350 CID	1980-1981	Base, Holiday, Royale, Royale Brougham; High performance, With air cond.	US1120H
5.7L V8 350 CID	1982-1983	Base, Royale, Royale Brougham; Exc.Air Cond	US1100
5.7L V8 350 CID	1982-1983	Base, Royale, Royale Brougham; With air cond.	US1120
5.7L V8 350 CID	1982-1983	Base, Royale, Royale Brougham; High performance, With air cond.	US1120H
5.7L V8 350 CID	1984-1985	Royale, Royale Brougham, Royale Brougham LS; Exc.Air Cond	US1100
5.7L V8 350 CID	1984-1985	Royale, Royale Brougham, Royale Brougham LS; With air cond.	US1120
5.7L V8 350 CID	1984-1985	Royale, Royale Brougham, Royale Brougham LS; High performance, With air cond.	US1120H
6.6L V8 400 CID	1975	Exc.Air Cond	US1100
6.6L V8 400 CID	1975	Air Cond	US1120
6.6L V8 400 CID	1975	Air Cond, High performance	US1120H
6.6L V8 403 CID	1977-1979	Exc.Air Cond	US1100

Engine	Years	Application Description	USMW
OLDSMOBILE (cont'd.)			
DELTA 88 (cont'd.)			
6.6L V8 403 CID	1977-1979	Air Cond	US1120
6.6L V8 403 CID	1977-1979	Air Cond, High performance	US1120H
7.0L V8 6966cc 425 CID	1965-1967	Without A/C	US773
7.5L V8 455 CID	1968-1970	With A/C	US926
7.5L V8 455 CID	1975-1976	Exc.Air Cond	US1100
7.5L V8 455 CID	1975-1976	Air Cond	US1120
7.5L V8 455 CID	1975-1976	Air Cond, High performance	US1120H
7.5L V8 7456cc 455 CID	1968-1970	Without A/C	US773
F85			
5.7L V8 350 CID	1968-1970	With A/C	US926
7.5L V8 455 CID	1970	With A/C	US926
FIRENZA			
1.8L L4 112 CID	1982	LX, S, SX	US5007
1.8L L4 112 CID	1982	LX, SX	US5017
1.8L L4 112 CID	1983	Cruiser LX, Cruiser S, Cruiser SX, LX, S, SX	US5017
1.8L L4 112 CID	1984	Base, Brougham LX, Brougham SX, Cruiser, Cruiser LX, Cruiser SX, ES, GT, S	US5017
1.8L L4 112 CID	1985	Base, Brougham LX, Brougham SX, Cruiser LX, Cruiser SX, ES, GT	US5017
1.8L L4 112 CID	1986	Base, Cruiser, Cruiser LX, LC, LX, S	US5017
2.0L L4 122 CID	1983	Cruiser LX, Cruiser S, Cruiser SX, LX, S, SX	US5007
2.0L L4 122 CID	1984	Base, Brougham LX, Brougham SX, Cruiser, Cruiser LX, Cruiser SX, ES, GT, S	US5007
2.0L L4 122 CID	1985	Base, Brougham LX, Brougham SX, Cruiser LX, Cruiser SX, ES, GT	US5007
2.0L L4 122 CID	1986	Base, Cruiser, Cruiser LX, LC, LX, S	US5007
2.0L L4 122 CID	1987	Base, Cruiser, LC, LX, S	US5032
2.0L L4 122 CID	1987	Base, Cruiser, LC, LX, S	US5036
2.0L L4 122 CID	1988	Base, Cruiser	US5032
2.0L L4 122 CID	1988	Base, Cruiser	US5036
2.8L V6 173 CID	1985	Base, Brougham LX, Brougham SX, Cruiser LX, Cruiser SX, ES, GT	US5020
2.8L V6 173 CID	1986	GT	US5020
2.8L V6 173 CID	1987	GT	US5033
INTRIGUE			
3.5L V6 214 CID	1999-2002	GL, GLS, GX	US5085
3.8L V6 3800cc 231 CID	1998	Base, GL, GLS	US5075
3.8L V6 3800cc 231 CID	1999	GL, GX	US5075
LSS			
3.8L V6 3800cc 231 CID	1996-1999	Base	US5075
OMEGA			
2.5L L4 2474cc 151 CID	1980	Base, Brougham, SX	US5000
2.5L L4 2474cc 151 CID	1980	Base, Brougham, SX; Includes pulley	US5000P
2.5L L4 2474cc 151 CID	1981	Base, Brougham, ES, Sport, SX	US5000
2.5L L4 2474cc 151 CID	1981	Base, Brougham, ES, Sport, SX; Includes pulley	US5000P
2.5L L4 2474cc 151 CID	1982	Base, Brougham, ES	US5000
2.5L L4 2474cc 151 CID	1982	Base, Brougham, ES; Includes pulley	US5000P
2.5L L4 2474cc 151 CID	1983	Base, Brougham, ES, ESC	US5000
2.5L L4 2474cc 151 CID	1983	Base, Brougham, ES, ESC; Includes pulley	US5000P
2.5L L4 2474cc 151 CID	1984	Base, Brougham, ES	US5000
2.5L L4 2474cc 151 CID	1984	Base, Brougham, ES; Includes pulley	US5000P
2.8L V6 173 CID	1980	Base, Brougham, SX	US5001
2.8L V6 173 CID	1981	Base, Brougham, ES, Sport, SX	US5001
2.8L V6 173 CID	1982	Base, Brougham, ES	US5001
2.8L V6 173 CID	1983	Base, Brougham, ES, ESC	US5001
2.8L V6 173 CID	1984	Base, Brougham, ES	US5001
2.8L V6 173 CID	1984	Brougham; (Z)	US5001
3.8L V6 231 CID	1977		US1018
3.8L V6 231 CID	1977	High performance	US1018H
3.8L V6 3800cc 231 CID	1978-1979		US1018
3.8L V6 3800cc 231 CID	1978-1979	High performance	US1018H
4.1L L6 250 CID	1974	With A/C	US927
4.1L L6 250 CID	1975-1976		US1107
4.3L V8 260 CID	1975-1977	Exc.Air Cond	US1100
4.3L V8 260 CID	1975-1977	Air Cond	US1120
4.3L V8 260 CID	1975-1977	Air Cond, High performance	US1120H
5.7L V8 350 CID	1975-1979	Exc.Air Cond	US1100
5.7L V8 350 CID	1975-1979	Air Cond	US1120
5.7L V8 350 CID	1975-1979	Air Cond, High performance	US1120H
REGENCY			
3.8L V6 3800cc 231 CID	1997-1998	Base	US5075
SILHOUETTE			
3.1L V6 189 CID	1990-1994	Base	US5033
3.4L V6 207 CID	1996	Base	US5033
3.4L V6 207 CID	1997	Base, GL, GLS	US5033
3.4L V6 207 CID	1998-1999	GL, GLS, GS, Premiere	US5033
3.4L V6 207 CID	2000-2004	GL, GLS, Premiere	US5033
3.8L V6 3800cc 231 CID	1992-1995	Base	US5050

WATER PUMPS



WATER PUMP APPLICATION GUIDE



Engine	Years	Application Description	USMW	Engine	Years	Application Description	USMW
OLDSMOBILE (cont'd.)				PLYMOUTH (cont'd.)			
STARFIRE				ACCLAIM (cont'd.)			
2.5L L4 2474cc 151 CID	1978-1979		US1107	3.0L V6 2972cc 181 CID	1992-1995	Base	US7121
2.5L L4 2474cc 151 CID	1980	Base, Firenza, GT, SX	US1107	3.0L V6 2972cc 181 CID	1992-1995	Base; With back plate housing	US7121-2
3.8L V6 231 CID	1975-1976		US1018	ARROW			
3.8L V6 231 CID	1975-1976	High performance	US1018H	1.6L L4 1597cc 98 CID	1976-1977		US1012
3.8L V6 3800cc 231 CID	1977-1979		US1018	1.6L L4 1597cc 98 CID	1978-1979		US7105
3.8L V6 3800cc 231 CID	1977-1979	High performance	US1018H	1.6L L4 1597cc 98 CID	1980	Base, GS, GT	US7105
3.8L V6 3800cc 231 CID	1980	Base, Firenza, GT, SX	US1018	2.0L L4 1997cc 122 CID	1976-1978		US7120
3.8L V6 3800cc 231 CID	1980	Base, Firenza, GT, SX; High performance	US1018H	2.6L L4 2555cc 156 CID	1979		US7120
5.0L V8 305 CID	1977-1979		US1069	2.6L L4 2555cc 156 CID	1980	Base, GS, GT	US7120
TORONADO				ARROW PICKUP			
3.8L V6 3800cc 231 CID	1986	Brougham	US5050	2.0L L4 1997cc 122 CID	1979		US7120
3.8L V6 3800cc 231 CID	1987	Brougham, Trofeo	US5050	2.0L L4 1997cc 122 CID	1980-1982	Base, Sport	US7120
3.8L V6 3800cc 231 CID	1988-1992	Base, Trofeo	US5050	2.6L L4 2555cc 156 CID	1979		US7120
4.1L V6 252 CID	1981-1984	Brougham	US1018	2.6L L4 2555cc 156 CID	1980-1982	Base, Sport	US7120
4.1L V6 252 CID	1981-1984	Brougham; High performance	US1018H	BARRACUDA			
5.0L V8 307 CID	1980-1981	Brougham, XSC; Exc.Air Cond	US1100	4.5L V8 4473cc 273 CID	1964-1968		US919
5.0L V8 307 CID	1980-1981	Brougham, XSC; With air cond.	US1120	5.2L V8 318 CID	1968-1969		US919
5.0L V8 307 CID	1980-1981	Brougham, XSC; High performance, With air cond.	US1120H	5.2L V8 5200cc 318 CID	1967-1969	Mexican Application	US907
5.0L V8 307 CID	1982-1984	Brougham	US1120	5.2L V8 5212cc 318 CID	1966-1969		US919
5.0L V8 307 CID	1982-1984	Brougham; High performance	US1120H	5.6L V8 340 CID	1968-1969		US919
5.0L V8 307 CID	1985	Brougham, Caliente	US1120	5.6L V8 5572cc 340 CID	1968-1969		US919
5.0L V8 307 CID	1985	Brougham, Caliente; High performance	US1120H	BELVEDERE			
5.7L V8 350 CID	1979	Exc.Air Cond	US1100	3.8L L6 3770cc 230 CID	1955-1956		US713
5.7L V8 350 CID	1979	Air Cond	US1120	4.5L V8 273 CID	1968		US919
5.7L V8 350 CID	1979	Air Cond, High performance	US1120H	4.5L V8 4473cc 273 CID	1964-1968		US919
5.7L V8 350 CID	1980-1981	Brougham, XSC; Exc.Air Cond	US1100	5.2L V8 317 CID	1958-1959		US919
5.7L V8 350 CID	1980-1981	Brougham, XSC; With air cond.	US1120	5.2L V8 318 CID	1968-1969		US919
5.7L V8 350 CID	1980-1981	Brougham, XSC; High performance, With air cond.	US1120H	5.2L V8 5212cc 318 CID	1958-1969		US919
5.7L V8 350 CID	1982-1984	Brougham	US1120	BELVEDERE II			
5.7L V8 350 CID	1982-1984	Brougham; High performance	US1120H	4.5L V8 273 CID	1965-1967		US919
5.7L V8 350 CID	1985	Brougham, Caliente	US1120	5.2L V8 318 CID	1965-1967		US919
5.7L V8 350 CID	1985	Brougham, Caliente; High performance	US1120H	BREEZE			
6.6L V8 403 CID	1977-1978	Exc.Air Cond	US1100	2.0L L4 1996cc 122 CID	1996-1997	Base	US7150
6.6L V8 403 CID	1977-1978	Air Cond	US1120	2.0L L4 1996cc 122 CID	1998-1999	Base, Espresso	US7150
6.6L V8 403 CID	1977-1978	Air Cond, High performance	US1120H	2.0L L4 1996cc 122 CID	2000	Base	US7150
7.5L V8 455 CID	1975-1976	Exc.Air Cond	US1100	2.4L L4 2429cc 148 CID	1997	Base	US7156
7.5L V8 455 CID	1975-1976	Air Cond	US1120	2.4L L4 2429cc 148 CID	1998-1999	Base, Espresso	US7156
7.5L V8 455 CID	1975-1976	Air Cond, High performance	US1120H	2.4L L4 2429cc 148 CID	2000	Base	US7156
VISTA CRUISER				CARAVELLE			
5.7L V8 350 CID	1968-1970	With A/C	US926	2.2L L4 135 CID	1985	SE	US7110
7.5L V8 455 CID	1970	With A/C	US926	2.2L L4 135 CID	1985	SE; High performance	US7110H
PEUGEOT				2.2L L4 135 CID	1986-1988	Base, SE	US7110
206				2.2L L4 135 CID	1986-1988	Base, SE; High performance	US7110H
1.4L L4 1360cc 83 CID	2000-2004		US8936	2.5L L4 2507cc 153 CID	1986-1988	Base, SE	US7110
1.4L L4 1360cc 83 CID	2006-2008		US8936	2.5L L4 2507cc 153 CID	1986-1988	Base, SE; High performance	US7110H
1.6L L4 1587cc 97 CID	2001-2009		US8937	2.6L L4 2555cc 156 CID	1985	SE	US7111
207				CHAMP			
1.6L L4 1598cc 98 CID	2008-2009		US8937	1.4L L4 1410cc	1979		US7106
1.6L L4 1598cc 98 CID	2010	CC	US8937	1.4L L4 1410cc	1980	Base	US7106
306				1.4L L4 1410cc	1981	Base	US7115
1.8L L4 1766cc 107 CID	2001-2002	Mexican Application	US8974	1.4L L4 1410cc	1982	Base, Custom, Deluxe	US7115
307				1.6L L4 1597cc 98 CID	1979		US7104
2.0L L4 1998cc 122 CID	2003-2010	Mexican Application	US8954	1.6L L4 1597cc 98 CID	1980	Base, Custom	US7104
406				1.6L L4 1597cc 98 CID	1981	Base, Custom	US7108
2.0L L4 1998cc 122 CID	2000-2005	Mexican Application	US8954	1.6L L4 1597cc 98 CID	1982	Custom	US7108
505				COLT			
2.0L L4 1971cc	1980-1982	Base	US9193	1.4L L4 1410cc	1979		US7106
2.0L L4 1971cc	1980-1987	With fixed fan	US9480	1.4L L4 1410cc	1983	Base, Deluxe	US7115
2.0L L4 1971cc	1983	Base, STI	US9193	1.4L L4 1410cc	1984	DL, E	US7115
2.0L L4 1971cc	1984-1986	GL, S, STI	US9193	1.5L L4 1468cc 90 CID	1985-1987	DL, E, Premier	US7115
2.0L L4 1971cc	1987	Liberte	US9193	1.5L L4 1468cc 90 CID	1988	Base, DL, E, Premier	US7115
2.2L L4 2155cc	1985-1991	With fixed fan	US9480	1.5L L4 1468cc 90 CID	1989	Base, DL, E, GT	US7115
2.3L L4 2304cc	1980-1985	With fixed fan	US9480	1.5L L4 1468cc 90 CID	1990	Base, DL, GL, GT	US7115
GRAND RAID				1.5L L4 1468cc 90 CID	1991-1994	Base, GL	US7115
1.6L L4 1587cc 97 CID	2007-2009		US8937	1.6L L4 1597cc 98 CID	1976-1977		US1012
PARTNER				1.6L L4 1597cc 98 CID	1978		US7105
1.6L L4 1587cc 97 CID	2004-2009		US8937	1.6L L4 1597cc 98 CID	1979		US7104
PLYMOUTH				1.6L L4 1597cc 98 CID	1983	Base, Custom, Deluxe	US7108
ACCLAIM				1.6L L4 1597cc 98 CID	1984	DL, E	US7108
2.5L L4 2507cc 153 CID	1989	Base, LE	US7122	1.6L L4 1597cc 98 CID	1985-1986	DL, Premier	US7108
2.5L L4 2507cc 153 CID	1990-1991	Base, LE	US7127	1.6L L4 1597cc 98 CID	1987	Premier	US7108
2.5L L4 2507cc 153 CID	1992-1995	Base	US7127	1.6L L4 1597cc 98 CID	1988	DL, Premier	US7108
3.0L V6 2972cc 181 CID	1989	LX	US7121	1.6L L4 1597cc 98 CID	1989-1990	GT	US7131
3.0L V6 2972cc 181 CID	1989	LX; With back plate housing	US7121-2	1.8L L4 1754cc 107 CID	1989-1990	DL	US7108
3.0L V6 2972cc 181 CID	1990-1991	Base, LE, LX	US7121	1.8L L4 1834cc 112 CID	1992	Vista, Vista SE	US7135
3.0L V6 2972cc 181 CID	1990-1991	Base, LE, LX; With back plate housing	US7121-2	1.8L L4 1834cc 112 CID	1993	Base, GL, Vista	US7135
				1.8L L4 1834cc 112 CID	1994	Base, GL, Vista, Vista SE	US7135
				2.0L L4 1995cc 122 CID	1976-1978		US7120
				2.0L L4 1997cc 122 CID	1984-1991	Vista	US7118
				2.4L L4 2351cc	1992	Vista, Vista SE	US9168
				2.4L L4 2351cc	1993	Vista, Vista SE; From 11/03/1992	US7148

Engine	Years	Application Description	USMW	Engine	Years	Application Description	USMW
PLYMOUTH (cont'd.)				PLYMOUTH (cont'd.)			
COLT (cont'd.)				GRAND VOYAGER (cont'd.)			
2.4L L4 2351cc	1993	Vista, Vista SE; To 11/03/1992	US7148	3.8L V6 230 CID	1999	Expresso, SE	US7126
2.4L L4 2351cc	1994	Vista, Vista SE	US7148	3.8L V6 3800cc 232 CID	1997	Mexican Application	US7126
2.6L L4 2555cc 156 CID	1978-1979		US7120	GRAN FURY			
CONQUEST				3.7L L6 3687cc 225 CID	1980	Base, Salon	US7100
2.6L L4 2555cc 156 CID	1984	Base; Exc.Intercooler	US7115	3.7L L6 3687cc 225 CID	1981-1983	Base	US7100
2.6L L4 2555cc 156 CID	1985-1986	Base	US7120	5.2L V8 318 CID	1975-1977	Air Pump	US1053
CRICKET				5.2L V8 318 CID	1975-1977	Exc.Air Pump	US1053
1.5L L4 1498cc	1971-1973		US1010	5.2L V8 318 CID	1975-1977	Air Pump, High performance	US1053H
CUSTOM				5.2L V8 318 CID	1975-1977	Exc.Air Pump, High performance	US1053H
5.2L V8 5212cc 318 CID	1958-1961		US919	5.2L V8 318 CID	1980	Base, Salon	US1053
DUSTER				5.2L V8 318 CID	1980	Base, Salon; High performance	US1053H
3.7L L6 3687cc 225 CID	1975-1976		US7100	5.2L V8 318 CID	1981-1983	Base	US1053
5.2L V8 318 CID	1975-1976	Air Pump	US1053	5.2L V8 318 CID	1981-1983	Base; High performance	US1053H
5.2L V8 318 CID	1975-1976	Exc.Air Pump	US1053	5.2L V8 318 CID	1984-1987	Salon; High performance	US1053H
5.2L V8 318 CID	1975-1976	Air Pump, High performance	US1053H	5.2L V8 318 CID	1988	Base, Salon	US1053
5.2L V8 318 CID	1975-1976	Exc.Air Pump, High performance	US1053H	5.2L V8 318 CID	1988	Base, Salon; High performance	US1053H
5.9L V8 360 CID	1975-1976	Air Pump	US1053	5.2L V8 318 CID	1989	Salon	US1053
5.9L V8 360 CID	1975-1976	Exc.Air Pump	US1053	5.2L V8 318 CID	1989	Salon; High performance	US1053H
5.9L V8 360 CID	1975-1976	Air Pump, High performance	US1053H	5.2L V8 5211cc 318 CID	1985	Salon	US1053
5.9L V8 360 CID	1975-1976	Exc.Air Pump, High performance	US1053H	5.2L V8 5211cc 318 CID	1985	Salon; High performance	US1053H
FLEET SPECIAL				5.9L V8 360 CID	1975-1977	Air Pump	US1053
5.2L V8 5212cc 318 CID	1960-1963		US919	5.9L V8 360 CID	1975-1977	Exc.Air Pump	US1053
FURY				5.9L V8 360 CID	1975-1977	Air Pump, High performance	US1053H
3.7L L6 3687cc 225 CID	1975-1978		US7100	5.9L V8 360 CID	1975-1977	Exc.Air Pump, High performance	US1053H
4.5L V8 273 CID	1965		US919	5.9L V8 360 CID	1980	Base, Salon	US1053
4.5L V8 4473cc 273 CID	1964-1965		US919	5.9L V8 360 CID	1980	Base, Salon; High performance	US1053H
5.2L V8 317 CID	1958-1959		US919	6.6L V8 400 CID	1975-1977		US1040
5.2L V8 318 CID	1959		US919	7.2L V8 440 CID	1975-1977		US1040
5.2L V8 318 CID	1965-1969		US919	GTX			
5.2L V8 318 CID	1975-1978	Air Pump	US1053	5.2L V8 318 CID	1968		US919
5.2L V8 318 CID	1975-1978	Exc.Air Pump	US1053	5.2L V8 5212cc 318 CID	1968		US919
5.2L V8 318 CID	1975-1978	Air Pump, High performance	US1053H	HORIZON			
5.2L V8 318 CID	1975-1978	Exc.Air Pump, High performance	US1053H	1.6L L4 1595cc 97 CID	1983	Base, Custom	US7113
5.2L V8 5212cc 318 CID	1958-1969		US919	1.6L L4 1595cc 97 CID	1984-1986	Base, SE	US7113
5.9L V8 360 CID	1975-1978	Air Pump	US1053	1.7L L4 105 CID	1978-1979		US7101
5.9L V8 360 CID	1975-1978	Exc.Air Pump	US1053	1.7L L4 105 CID	1980	Base	US7101
5.9L V8 360 CID	1975-1978	Air Pump, High performance	US1053H	1.7L L4 105 CID	1981	Base, Miser	US7101
5.9L V8 360 CID	1975-1978	Exc.Air Pump, High performance	US1053H	1.7L L4 105 CID	1982	Base, E-Type, Miser	US7101
6.6L V8 400 CID	1975-1978		US1040	1.7L L4 105 CID	1983	Base, Custom	US7101
7.2L V8 440 CID	1975		US1040	2.2L L4 135 CID	1981	Base, Miser	US7110
7.2L V8 440 CID	1977-1978		US1040	2.2L L4 135 CID	1981	Base, Miser; High performance	US7110H
FURY I				2.2L L4 135 CID	1982	Base, E-Type, Miser	US7110
5.2L V8 318 CID	1968-1969		US919	2.2L L4 135 CID	1982	Base, E-Type, Miser; High performance	US7110H
5.2L V8 5212cc 318 CID	1968-1969		US919	2.2L L4 135 CID	1983	Base, Custom	US7110
FURY II				2.2L L4 135 CID	1983	Base, Custom; High performance	US7110H
4.5L V8 273 CID	1965		US919	2.2L L4 135 CID	1984-1986	Base, SE	US7110
5.2L V8 318 CID	1965-1969		US919	2.2L L4 135 CID	1984-1986	Base, SE; High performance	US7110H
5.2L V8 5212cc 318 CID	1968-1969		US919	2.2L L4 135 CID	1987-1988	America	US7110
FURY III				2.2L L4 135 CID	1987-1988	America; High performance	US7110H
4.5L V8 273 CID	1965		US919	2.2L L4 135 CID	1989	America	US7122
5.2L V8 318 CID	1965-1969		US919	2.2L L4 135 CID	1990	Base	US7127
5.2L V8 5212cc 318 CID	1968-1969		US919	LASER			
GRAND VOYAGER				1.8L L4 1755cc 107 CID	1990	Base, RS	US7108
2.4L L4 2429cc 148 CID	1996	Base, SE; Hydraulic Tensioner	US7153	1.8L L4 1755cc 107 CID	1991-1994	Base	US7108
2.4L L4 2429cc 148 CID	1996	Base, SE; Mechanical Tensioner	US7156	2.0L L4 1997cc 122 CID	1990-1994	RS	US9212
2.4L L4 2429cc 148 CID	1997	Base, SE	US7156	NEON			
2.5L L4 2507cc 153 CID	1988	SE	US7110	2.0L L4 1996cc 122 CID	1995-1996	Base, High Line, Sport	US7150
2.5L L4 2507cc 153 CID	1988	SE; High performance	US7110H	2.0L L4 1996cc 122 CID	1997	Base, High Line	US7150
3.0L V6 2972cc 181 CID	1988	LE	US7121	2.0L L4 1996cc 122 CID	1998-1999	ACR, Expresso, High Line, Style	US7150
3.0L V6 2972cc 181 CID	1988	LE; With back plate housing	US7121-2	2.0L L4 1996cc 122 CID	2000-2001	High Line, LX	US7150
3.0L V6 2972cc 181 CID	1989	LE, SE	US7121	PB100			
3.0L V6 2972cc 181 CID	1989	LE, SE; With back plate housing	US7121-2	3.7L L6 3687cc 225 CID	1975-1979		US7100
3.0L V6 2972cc 181 CID	1992-1993	Base, LE, SE	US7121	3.7L L6 3687cc 225 CID	1980	Voyager	US7100
3.0L V6 2972cc 181 CID	1992-1993	Base, LE, SE; With back plate housing	US7121-2	5.2L V8 5211cc 318 CID	1975-1978	Exc.Air Pump	US1053
3.0L V6 2972cc 181 CID	1994	Base	US7121	5.2L V8 5211cc 318 CID	1975-1978	Exc.Air Pump, High performance	US1053H
3.0L V6 2972cc 181 CID	1994	Base; With back plate housing	US7121-2	5.2L V8 5211cc 318 CID	1975-1979	Air Pump	US1053
3.0L V6 2972cc 181 CID	1995-1997	Base, SE	US7121	5.2L V8 5211cc 318 CID	1975-1979	Air Pump, High performance	US1053H
3.0L V6 2972cc 181 CID	1995-1997	Base, SE; With back plate housing	US7121-2	5.2L V8 5211cc 318 CID	1980	Voyager	US1053
3.0L V6 2972cc 181 CID	1998-1999	Base, Expresso, SE	US7121	5.2L V8 5211cc 318 CID	1980	Voyager; High performance	US1053H
3.0L V6 2972cc 181 CID	1998-1999	Base, Expresso, SE; With back plate housing	US7121-2	5.9L V8 360 CID	1976-1978	Air Pump	US1053
3.0L V6 2972cc 181 CID	2000	Base, SE	US7121	5.9L V8 360 CID	1976-1978	Exc.Air Pump	US1053
3.0L V6 2972cc 181 CID	2000	Base, SE; With back plate housing	US7121-2	5.9L V8 360 CID	1976-1978	Air Pump, High performance	US1053H
3.3L V6 3301cc 201 CID	1990-1994	LE, SE	US7126	5.9L V8 360 CID	1976-1978	Exc.Air Pump, High performance	US1053H
3.3L V6 3301cc 201 CID	1995	LE	US7126	PB150			
3.3L V6 3301cc 201 CID	1996	SE	US7126	3.7L L6 3687cc 225 CID	1981-1983	Voyager	US7100
3.3L V6 3301cc 201 CID	1997	Base, SE	US7126	5.2L V8 5211cc 318 CID	1981	Voyager	US1053
3.3L V6 3301cc 201 CID	1998-1999	Base, Expresso, SE	US7126	5.2L V8 5211cc 318 CID	1981	Voyager; High performance	US1053H
3.3L V6 3301cc 201 CID	2000	Base, SE	US7126	5.2L V8 5211cc 318 CID	1983	Voyager	US1053
3.8L V6 230 CID	1994-1995	LE	US7126	5.2L V8 5211cc 318 CID	1983	Voyager; High performance	US1053H

WATER PUMPS

Engine	Years	Application Description	USMW
PLYMOUTH (cont'd.)			
PB200			
3.7L L6 3687cc 225 CID	1975-1978		US7100
3.7L L6 3687cc 225 CID	1980	Voyager	US7100
5.2L V8 5211cc 318 CID	1975-1978	Exc.Air Pump	US1053
5.2L V8 5211cc 318 CID	1975-1978	Exc.Air Pump, High performance	US1053H
5.2L V8 5211cc 318 CID	1975-1979	Air Pump	US1053
5.2L V8 5211cc 318 CID	1975-1979	Air Pump, High performance	US1053H
5.2L V8 5211cc 318 CID	1980	Voyager	US1053
5.2L V8 5211cc 318 CID	1980	Voyager; High performance	US1053H
5.9L V8 360 CID	1975-1978	Exc.Air Pump	US1053
5.9L V8 360 CID	1975-1978	Exc.Air Pump, High performance	US1053H
5.9L V8 360 CID	1975-1979	Air Pump	US1053
5.9L V8 360 CID	1975-1979	Air Pump, High performance	US1053H
5.9L V8 360 CID	1980	Voyager	US1053
5.9L V8 360 CID	1980	Voyager; High performance	US1053H
6.6L V8 400 CID	1976-1978		US1040
7.2L V8 440 CID	1976-1978		US1040
PB250			
3.7L L6 3687cc 225 CID	1981-1983	Voyager	US7100
5.2L V8 5211cc 318 CID	1981-1983	Voyager	US1053
5.2L V8 5211cc 318 CID	1981-1983	Voyager; High performance	US1053H
5.9L V8 360 CID	1981	Voyager	US1053
5.9L V8 360 CID	1981	Voyager; High performance	US1053H
PB300			
5.2L V8 5211cc 318 CID	1975-1978	Exc.Air Pump	US1053
5.2L V8 5211cc 318 CID	1975-1978	Exc.Air Pump, High performance	US1053H
5.2L V8 5211cc 318 CID	1975-1979	Air Pump	US1053
5.2L V8 5211cc 318 CID	1975-1979	Air Pump, High performance	US1053H
5.2L V8 5211cc 318 CID	1980	Voyager	US1053
5.2L V8 5211cc 318 CID	1980	Voyager; High performance	US1053H
5.9L V8 360 CID	1975-1978	Exc.Air Pump	US1053
5.9L V8 360 CID	1975-1978	Exc.Air Pump, High performance	US1053H
5.9L V8 360 CID	1975-1979	Air Pump	US1053
5.9L V8 360 CID	1975-1979	Air Pump, High performance	US1053H
5.9L V8 360 CID	1980	Voyager	US1053
5.9L V8 360 CID	1980	Voyager; High performance	US1053H
6.6L V8 400 CID	1976-1978		US1040
7.2L V8 440 CID	1976-1978		US1040
PB350			
5.2L V8 5211cc 318 CID	1981-1983	Voyager	US1053
5.2L V8 5211cc 318 CID	1981-1983	Voyager; High performance	US1053H
5.9L V8 360 CID	1981-1983	Voyager	US1053
5.9L V8 360 CID	1981-1983	Voyager; High performance	US1053H
PLAZA			
3.8L L6 3770cc 230 CID	1955-1956		US713
5.2L V8 317 CID	1958		US919
5.2L V8 5212cc 318 CID	1958		US919
PROWLER			
3.5L V6 3497cc 215 CID	1997	Base; 3 Bolt Pattern	US7151
3.5L V6 3497cc 215 CID	1997	Base; 6 Bolt Pattern	US7158
3.5L V6 3497cc 215 CID	1999-2001	Base	US7162
RELIANT			
2.2L L4 135 CID	1981-1984	Base, Custom, SE	US7110
2.2L L4 135 CID	1981-1984	Base, Custom, SE; High performance	US7110H
2.2L L4 135 CID	1985-1986	Base, LE, SE	US7110
2.2L L4 135 CID	1985-1986	Base, LE, SE; High performance	US7110H
2.2L L4 135 CID	1987	Base, LE	US7110
2.2L L4 135 CID	1987	Base, LE; High performance	US7110H
2.2L L4 135 CID	1988	America	US7110
2.2L L4 135 CID	1988	America; High performance	US7110H
2.2L L4 135 CID	1989	America	US7122
2.5L L4 2507cc 153 CID	1986	LE, SE	US7110
2.5L L4 2507cc 153 CID	1986	LE, SE; High performance	US7110H
2.5L L4 2507cc 153 CID	1987	LE	US7110
2.5L L4 2507cc 153 CID	1987	LE; High performance	US7110H
2.5L L4 2507cc 153 CID	1988	America	US7110
2.5L L4 2507cc 153 CID	1988	America; High performance	US7110H
2.5L L4 2507cc 153 CID	1989	America	US7122
2.6L L4 2555cc 156 CID	1981-1984	Base, Custom, SE	US7111
2.6L L4 2555cc 156 CID	1985	LE, SE	US7111
ROAD RUNNER			
4.5L V8 273 CID	1968		US919
4.5L V8 4473cc 273 CID	1968		US919
5.2L V8 318 CID	1968		US919
5.2L V8 5212cc 318 CID	1968		US919
5.6L V8 5572cc 340 CID	1968		US919
SAPPORO			
1.6L L4 1597cc 98 CID	1978-1979		US7105
2.6L L4 2555cc 156 CID	1978-1979		US7120
2.6L L4 2555cc 156 CID	1980-1981	Base	US7120
SATELLITE			
4.5L V8 273 CID	1968		US919

Engine	Years	Application Description	USMW
PLYMOUTH (cont'd.)			
SATELLITE (cont'd.)			
4.5L V8 4473cc 273 CID	1965-1968		US919
5.2L V8 318 CID	1968-1969		US919
5.2L V8 5212cc 318 CID	1965-1969		US919
5.6L V8 5572cc 340 CID	1968-1969		US919
SAVOY			
3.8L L6 3770cc 230 CID	1955-1956		US713
4.5L V8 4473cc 273 CID	1964		US919
5.2L V8 317 CID	1958-1959		US919
5.2L V8 318 CID	1960-1961		US919
5.2L V8 5212cc 318 CID	1958-1964		US919
SCAMP			
2.2L L4 135 CID	1983	Base	US7110
2.2L L4 135 CID	1983	Base; High performance	US7110H
3.7L L6 3687cc 225 CID	1975-1976		US7100
5.2L V8 318 CID	1975-1976	Air Pump	US1053
5.2L V8 318 CID	1975-1976	Exc.Air Pump	US1053
5.2L V8 318 CID	1975-1976	Air Pump, High performance	US1053H
5.2L V8 318 CID	1975-1976	Exc.Air Pump, High performance	US1053H
SPORT WAGON			
5.2L V8 5212cc 318 CID	1960-1961		US919
SUBURBAN			
5.2L V8 317 CID	1958-1959		US919
5.2L V8 318 CID	1958-1961		US919
5.2L V8 5212cc 318 CID	1958-1961		US919
SUNDANCE			
2.2L L4 135 CID	1987	Base	US7110
2.2L L4 135 CID	1987	Base; High performance	US7110H
2.2L L4 135 CID	1988	Base, RS	US7110
2.2L L4 135 CID	1988	Base, RS; High performance	US7110H
2.2L L4 135 CID	1989	Base	US7122
2.2L L4 135 CID	1990	Base	US7127
2.2L L4 135 CID	1991-1992	America, High Line	US7127
2.2L L4 135 CID	1993-1994	Base	US7127
2.5L L4 2507cc 153 CID	1988	Base	US7110
2.5L L4 2507cc 153 CID	1988	Base; High performance	US7110H
2.5L L4 2507cc 153 CID	1989	Base, RS	US7122
2.5L L4 2507cc 153 CID	1990	Base, RS	US7127
2.5L L4 2507cc 153 CID	1991	High Line, RS	US7127
2.5L L4 2507cc 153 CID	1992	Duster, High Line	US7127
2.5L L4 2507cc 153 CID	1993-1994	Base, Duster	US7127
3.0L V6 2972cc 181 CID	1992-1994	Duster	US7121
3.0L V6 2972cc 181 CID	1992-1994	Duster; With back plate housing	US7121-2
TC3			
1.7L L4 105 CID	1980	Base	US7101
1.7L L4 105 CID	1981	Base, Miser	US7101
1.7L L4 105 CID	1982	Custom, Miser	US7101
2.2L L4 135 CID	1981	Base, Miser	US7110
2.2L L4 135 CID	1981	Base, Miser; High performance	US7110H
2.2L L4 135 CID	1982	Custom, Miser, Turismo	US7110
2.2L L4 135 CID	1982	Custom, Miser, Turismo; High performance	US7110H
TRAILDUSTER			
3.7L L6 3687cc 225 CID	1975-1979		US7100
3.7L L6 3687cc 225 CID	1980	Base	US7100
5.2L V8 5211cc 318 CID	1975-1978	Exc.Air Pump	US1053
5.2L V8 5211cc 318 CID	1975-1978	Exc.Air Pump, High performance	US1053H
5.2L V8 5211cc 318 CID	1975-1979	Air Pump	US1053
5.2L V8 5211cc 318 CID	1975-1979	Air Pump, High performance	US1053H
5.2L V8 5211cc 318 CID	1980-1981	Base	US1053
5.2L V8 5211cc 318 CID	1980-1981	Base; High performance	US1053H
5.9L V8 360 CID	1975-1978	Exc.Air Pump	US1053
5.9L V8 360 CID	1975-1978	Exc.Air Pump, High performance	US1053H
5.9L V8 360 CID	1975-1979	Air Pump	US1053
5.9L V8 360 CID	1975-1979	Air Pump, High performance	US1053H
5.9L V8 360 CID	1980-1981	Base	US1053
5.9L V8 360 CID	1980-1981	Base; High performance	US1053H
6.6L V8 400 CID	1977-1978		US1040
7.2L V8 440 CID	1975-1978		US1040
TURISMO			
1.6L L4 1595cc 97 CID	1983-1984	Base	US7113
1.6L L4 1595cc 97 CID	1986	Base	US7113
1.7L L4 105 CID	1983	Base	US7101
2.2L L4 135 CID	1983-1984	Base	US7110
2.2L L4 135 CID	1983-1984	Base; High performance	US7110H
2.2L L4 135 CID	1986-1987	Base	US7110
2.2L L4 135 CID	1986-1987	Base; High performance	US7110H
TURISMO 2.2			
2.2L L4 135 CID	1983-1986	Base	US7110
2.2L L4 135 CID	1983-1986	Base; High performance	US7110H

Engine	Years	Application Description	USMW	Engine	Years	Application Description	USMW
PLYMOUTH (cont'd.)				PONTIAC (cont'd.)			
VALIANT				6000 (cont'd.)			
3.7L L6 3687cc 225 CID	1975-1976		US7100	2.8L V6 173 CID	1987-1988	Base, LE, SE, STE	US5033
3.7L L6 3700cc 225 CID	1974-1976	Mexican Application	US7100	2.8L V6 173 CID	1989	LE, Special Edition	US5033
3.7L L6 3700cc 225 CID	1981	Mexican Application	US7100	3.1L V6 189 CID	1988-1989	STE	US5033
4.5L V8 273 CID	1964-1969		US919	3.1L V6 189 CID	1990-1991	LE, Special Edition	US5033
4.5L V8 4473cc 273 CID	1964-1969		US919	4.3L V6 260 CID	1982-1985	Base, LE; W/O Pulley	US5014
5.2L V8 318 CID	1968-1969		US919	4.3L V6 260 CID	1982-1985	Base, LE; Includes pulley	US5014P
5.2L V8 318 CID	1975-1976	Air Pump	US1053	ACADIAN			
5.2L V8 318 CID	1975-1976	Exc.Air Pump	US1053	5.7L V8 5736cc 350 CID	1968		US850
5.2L V8 318 CID	1975-1976	Air Pump, High performance	US1053H	ASTRE			
5.2L V8 318 CID	1975-1976	Exc.Air Pump, High performance	US1053H	2.3L L4 2294cc 140 CID	1975		US1088
5.2L V8 5212cc 318 CID	1968-1969		US919	2.5L L4 2474cc 151 CID	1977		US1107
5.2L V8 5212cc 318 CID	1970-1974		US1053	AZTEK			
5.2L V8 5212cc 318 CID	1970-1974	High performance	US1053H	3.4L V6 207 CID	2001	Base, GT	US5033
5.6L V8 5572cc 340 CID	1968-1969		US919	3.4L V6 207 CID	2002-2003	Base	US5033
5.9L V8 360 CID	1976	Air Pump	US1053	3.4L V6 207 CID	2004-2005	Base, Rally	US5033
5.9L V8 360 CID	1976	Exc.Air Pump	US1053	BONNEVILLE			
5.9L V8 360 CID	1976	Air Pump, High performance	US1053H	3.8L V6 3800cc 231 CID	1980	Base	US1018
5.9L V8 360 CID	1976	Exc.Air Pump, High performance	US1053H	3.8L V6 3800cc 231 CID	1980	Base; High performance	US1018H
VIP				3.8L V6 3800cc 231 CID	1981-1983	Base, Brougham	US1018
5.2L V8 5212cc 318 CID	1967		US919	3.8L V6 3800cc 231 CID	1981-1983	Base, Brougham; High performance	US1018H
VOLARE				3.8L V6 3800cc 231 CID	1984-1986	Base, Brougham, LE	US1018
2.2L L4 2200cc 135 CID	1982-1988	Mexican Application	US7110	3.8L V6 3800cc 231 CID	1984-1986	Base, Brougham, LE; High performance	US1018H
3.7L L6 3687cc 225 CID	1976-1979		US7100	3.8L V6 3800cc 231 CID	1987	Base, LE	US5050
3.7L L6 3687cc 225 CID	1980	Base	US7100	3.8L V6 3800cc 231 CID	1988-1991	LE, SE, SSE	US5050
3.7L L6 3700cc 225 CID	1982	Mexican Application	US7100	3.8L V6 3800cc 231 CID	1992-1995	SE, SSE, SSEi	US5050
5.2L V8 318 CID	1976-1978	Exc.Air Pump	US1053	3.8L V6 3800cc 231 CID	1996-1999	SE, SSE, SSEi	US5075
5.2L V8 318 CID	1976-1978	Exc.Air Pump, High performance	US1053H	3.8L V6 3800cc 231 CID	2000-2003	SE, SLE, SSEi	US5075
5.2L V8 318 CID	1976-1979	Air Pump	US1053	3.8L V6 3800cc 231 CID	2004-2005	SE, SLE	US5075
5.2L V8 318 CID	1976-1979	Air Pump, High performance	US1053H	4.1L V6 252 CID	1982	Base, Brougham	US1018
5.2L V8 318 CID	1980	Base	US1053	4.1L V6 252 CID	1982	Base, Brougham; High performance	US1018H
5.2L V8 318 CID	1980	Base; High performance	US1053H	4.3L V6 262 CID	1986	Base, Brougham, LE	US1121
5.9L V8 360 CID	1976-1978	Exc.Air Pump	US1053	4.3L V6 262 CID	1986	Base, Brougham, LE; High performance	US1121H
5.9L V8 360 CID	1976-1978	Exc.Air Pump, High performance	US1053H	4.3L V6 262 CID	1986	Base, Brougham, LE; High performance	US1121H
5.9L V8 360 CID	1976-1979	Air Pump	US1053	4.3L V8 265 CID	1980-1981	Base, Brougham	US975
5.9L V8 360 CID	1976-1979	Air Pump, High performance	US1053H	4.6L V8 281 CID	2004-2005	GXP	US5072
5.9L V8 360 CID	1980	Base	US1053	4.9L V8 301 CID	1977-1979		US975
5.9L V8 360 CID	1980	Base; High performance	US1053H	4.9L V8 301 CID	1980	Base, Brougham, Safari	US975
VOYAGER				4.9L V8 301 CID	1983	Base, Brougham	US1121
2.2L L4 135 CID	1984-1987	Base, LE, SE	US7110	5.0L V8 305 CID	1983	Base, Brougham; High performance	US1121H
2.2L L4 135 CID	1984-1987	Base, LE, SE; High performance	US7110H	5.0L V8 305 CID	1984-1986	Base, Brougham, LE	US1121
2.4L L4 2429cc 148 CID	1996	Base, SE; Hydraulic Tensioner	US7153	5.0L V8 305 CID	1984-1986	Base, Brougham, LE; High performance	US1121H
2.4L L4 2429cc 148 CID	1996	Base, SE; Mechanical Tensioner	US7156	5.0L V8 305 CID	1984-1986	Base, Brougham, LE; High performance	US1121H
2.4L L4 2429cc 148 CID	1997	Base, SE	US7156	5.0L V8 307 CID	1981	Base, Brougham, Safari; Exc.Air Cond	US1100
2.4L L4 2429cc 148 CID	1998-2000	Base	US7156	5.0L V8 307 CID	1981	Base, Brougham, Safari; With air cond.	US1120
2.5L L4 2507cc 153 CID	1987	SE	US7110	5.0L V8 307 CID	1981	Base, Brougham, Safari; High performance, With air cond.	US1120H
2.5L L4 2507cc 153 CID	1987	SE; High performance	US7110H	5.7L V8 350 CID	1977-1978		US975
2.5L L4 2507cc 153 CID	1988	Base, LE, SE	US7110	5.7L V8 350 CID	1977-1979	Exc.Air Cond	US1100
2.5L L4 2507cc 153 CID	1988	Base, LE, SE; High performance	US7110H	5.7L V8 350 CID	1977-1979	Air Cond	US1120
2.5L L4 2507cc 153 CID	1989	Base, LE, SE	US7122	5.7L V8 350 CID	1977-1979	Air Cond, High performance	US1120H
2.5L L4 2507cc 153 CID	1990-1991	Base, LE, LX, SE	US7127	5.7L V8 350 CID	1979		US1018
2.5L L4 2507cc 153 CID	1992-1993	Base, SE	US7127	5.7L V8 350 CID	1979	High performance	US1018H
2.5L L4 2507cc 153 CID	1994-1995	Base	US7127	5.7L V8 350 CID	1980	Brougham, Safari	US1018
2.6L L4 2555cc 156 CID	1984-1987	Base, LE, SE	US7111	5.7L V8 350 CID	1980	Brougham, Safari; High performance	US1018H
3.0L V6 2972cc 181 CID	1987-1989	LE, SE	US7121	5.7L V8 350 CID	1980-1981	Base, Brougham, Safari; Exc.Air Cond	US1100
3.0L V6 2972cc 181 CID	1987-1989	LE, SE; With back plate housing	US7121-2	5.7L V8 350 CID	1980-1981	Base, Brougham, Safari; With air cond.	US1120
3.0L V6 2972cc 181 CID	1990	LE, LX, SE	US7121	5.7L V8 350 CID	1980-1981	Base, Brougham, Safari; High performance, With air cond.	US1120H
3.0L V6 2972cc 181 CID	1990	LE, LX, SE; With back plate housing	US7121-2	5.7L V8 350 CID	1980-1981	Base, Brougham, Safari; With air cond.	US1120
3.0L V6 2972cc 181 CID	1991-1994	Base, LE, LX, SE	US7121	5.7L V8 350 CID	1982-1983	Base, Brougham; 5" Cast, Exc.Air Cond	US1100
3.0L V6 2972cc 181 CID	1991-1994	Base, LE, LX, SE; With back plate housing	US7121-2	5.7L V8 350 CID	1982-1983	Base, Brougham; Exc.5" Cast, Exc.Air Cond	US1120
3.0L V6 2972cc 181 CID	1995	Base, LE, SE	US7121	5.7L V8 350 CID	1982-1983	Base, Brougham; With air cond.	US1120
3.0L V6 2972cc 181 CID	1995	Base, LE, SE; With back plate housing	US7121-2	5.7L V8 350 CID	1982-1983	Base, Brougham; Exc.5" Cast, Exc.Air Cond, High performance	US1120H
3.0L V6 2972cc 181 CID	1996-1998	Base, SE	US7121	5.7L V8 350 CID	1982-1983	Base, Brougham; High performance, With air cond.	US1120H
3.0L V6 2972cc 181 CID	1996-1998	Base, SE; With back plate housing	US7121-2	5.7L V8 350 CID	1982-1983	Base, Brougham, LE; 5" Cast, Exc.Air Cond	US1100
3.0L V6 2972cc 181 CID	1999-2000	Base	US7121	5.7L V8 350 CID	1984	Base, Brougham, LE; Exc.5" Cast, Exc.Air Cond	US1120
3.0L V6 2972cc 181 CID	1999-2000	Base; With back plate housing	US7121-2	5.7L V8 350 CID	1984	Base, Brougham, LE; With air cond.	US1120
3.3L V6 3301cc 201 CID	1991-1993	LE, SE	US7126	5.7L V8 350 CID	1984	Base, Brougham, LE; With air cond.	US1120
3.3L V6 3301cc 201 CID	1994	Base, LE, LX, SE	US7126	5.7L V8 350 CID	1984	Base, Brougham, LE; Exc.5" Cast, Exc.Air Cond, High performance	US1120H
3.3L V6 3301cc 201 CID	1995	Base, LE, SE	US7126	5.7L V8 350 CID	1984	Base, Brougham, LE; Exc.5" Cast, Exc.Air Cond	US1120
3.3L V6 3301cc 201 CID	1996	SE	US7126	5.7L V8 350 CID	1984	Base, Brougham, LE; With air cond.	US1120
3.3L V6 3301cc 201 CID	1997	Base, SE	US7126	5.7L V8 350 CID	1984	Base, Brougham, LE; Exc.5" Cast, Exc.Air Cond, High performance	US1120H
3.3L V6 3301cc 201 CID	1998-1999	Base, Espresso, SE	US7126	5.7L V8 350 CID	1984	Base, Brougham, LE; High performance, With air cond.	US1120H
3.3L V6 3301cc 201 CID	2000	Base, SE	US7126	6.4L V8 389 CID	1959-1962		US850
3.8L V6 230 CID	1999	Espresso, SE	US7126	6.4L V8 6376cc 389 CID	1959-1966		US850
PONTIAC				6.6L V8 400 CID	1968		US850
6000				6.6L V8 400 CID	1975-1978		US975
2.5L L4 2474cc 151 CID	1982-1986	Base, LE	US5000	6.6L V8 400 CID	1975-1978	Exc.Air Cond	US1100
2.5L L4 2474cc 151 CID	1982-1986	Base, LE; Includes pulley	US5000P	6.6L V8 400 CID	1975-1978	Air Cond	US1120
2.5L L4 2474cc 151 CID	1987-1989	Base, LE	US5041	6.6L V8 400 CID	1975-1978	Air Cond, High performance	US1120H
2.5L L4 2474cc 151 CID	1990-1991	LE	US5041	6.6L V8 403 CID	1977-1979		US975
2.8L V6 173 CID	1982	Base, LE	US5001	6.6L V8 403 CID	1977-1979	Exc.Air Cond	US1100
2.8L V6 173 CID	1983-1985	Base, LE, STE	US5001	6.6L V8 403 CID	1977-1979	Air Cond	US1120
2.8L V6 173 CID	1986	Base, LE, SE, STE	US5001				

WATER PUMPS

Engine	Years	Application Description	USMW	Engine	Years	Application Description	USMW
PONTIAC (cont'd.)				PONTIAC (cont'd.)			
BONNEVILLE (cont'd.)				FIREBIRD (cont'd.)			
6.6L V8 403 CID	1977-1979	Air Cond, High performance	US1120H	5.0L V8 305 CID	1977-1979	High performance	US1121H
6.6L V8 6555cc 400 CID	1967-1968		US850	5.0L V8 305 CID	1980	Base, Esprit, Formula, Trans Am	US1121
6.9L V8 6900cc 421 CID	1963-1966		US850	5.0L V8 305 CID	1980	Base, Esprit, Formula, Trans Am; High performance	US1121H
7.0L V8 428 CID	1968		US850	5.0L V8 305 CID	1981	Formula, Trans Am	US1121
7.0L V8 7014cc 428 CID	1967-1968		US850	5.0L V8 305 CID	1981	Formula, Trans Am; High performance	US1121H
7.5L V8 455 CID	1975-1976		US975	5.0L V8 305 CID	1982-1986	Base, S/E, Trans Am	US1121
CATALINA				5.0L V8 305 CID	1982-1986	Base, S/E, Trans Am; High performance	US1121H
3.8L V6 3800cc 231 CID	1978-1979		US1018	5.0L V8 305 CID	1987	Base, Trans Am	US1121
3.8L V6 3800cc 231 CID	1978-1979	High performance	US1018H	5.0L V8 305 CID	1987	Base, Trans Am; High performance	US1121H
3.8L V6 3800cc 231 CID	1980-1981	Base	US1018	5.0L V8 305 CID	1988	Base, Trans Am	US5049
3.8L V6 3800cc 231 CID	1980-1981	Base; High performance	US1018H	5.0L V8 305 CID	1988	Base, Trans Am; High performance	US5049H
4.1L L6 250 CID	1977-1979		US975	5.0L V8 305 CID	1989-1992	Base, Formula, Trans Am, Trans Am GTA	US5049
4.3L V8 265 CID	1980-1981	Base	US975	5.0L V8 305 CID	1989-1992	Base, Formula, Trans Am, Trans Am GTA; High performance	US5049H
4.9L V8 301 CID	1977-1979		US975	5.7L V8 350 CID	1968		US850
4.9L V8 301 CID	1980	Base, Safari	US975	5.7L V8 350 CID	1975-1976		US975
5.0L V8 307 CID	1981	Base, Safari; Exc.Air Cond	US1100	5.7L V8 350 CID	1975-1978	Exc.Air Cond	US1100
5.0L V8 307 CID	1981	Base, Safari; With air cond.	US1120	5.7L V8 350 CID	1975-1978	Air Cond	US1120
5.0L V8 307 CID	1981	Base, Safari; High performance, With air cond.	US1120H	5.7L V8 350 CID	1975-1978	Air Cond, High performance	US1120H
5.7L V8 350 CID	1976-1977		US975	5.7L V8 350 CID	1977-1979	High performance	US1121H
5.7L V8 350 CID	1976-1979	Exc.Air Cond	US1100	5.7L V8 350 CID	1979		US1121
5.7L V8 350 CID	1976-1979	Air Cond	US1120	5.7L V8 350 CID	1987	Base, Trans Am	US1121
5.7L V8 350 CID	1976-1979	Air Cond, High performance	US1120H	5.7L V8 350 CID	1987	Base, Trans Am; High performance	US1121H
5.7L V8 350 CID	1978-1979		US1018	5.7L V8 350 CID	1988	Trans Am	US5049
5.7L V8 350 CID	1978-1979	High performance	US1018H	5.7L V8 350 CID	1988	Trans Am; High performance	US5049H
5.7L V8 350 CID	1980	Safari	US1018	5.7L V8 350 CID	1989-1992	Formula, Trans Am, Trans Am GTA	US5049
5.7L V8 350 CID	1980	Safari; High performance	US1018H	5.7L V8 350 CID	1989-1992	Formula, Trans Am, Trans Am GTA; High performance	US5049H
5.7L V8 350 CID	1980-1981	Base, Safari; Exc.Air Cond	US1100	5.7L V8 350 CID	1993	Formula, Trans Am	US5068
5.7L V8 350 CID	1980-1981	Base, Safari; With air cond.	US1120	5.7L V8 350 CID	1994	Formula, Trans Am, Trans Am GT	US5068
5.7L V8 350 CID	1980-1981	Base, Safari; High performance, With air cond.	US1120H	5.7L V8 350 CID	1995-1997	Formula, Trans Am	US5068
6.4L V8 6376cc 389 CID	1959-1966		US850	5.7L V8 350 CID	1998-2002	Formula, Trans Am	US5081
6.6L V8 400 CID	1967-1968		US850	5.7L V8 5733cc 350 CID	1968		US850
6.6L V8 400 CID	1975-1978		US975	6.6L V8 400 CID	1967-1968		US850
6.6L V8 400 CID	1975-1978	Exc.Air Cond	US1100	6.6L V8 400 CID	1975-1979		US975
6.6L V8 400 CID	1975-1978	Air Cond	US1120	6.6L V8 400 CID	1975-1979	Exc.Air Cond	US1100
6.6L V8 400 CID	1975-1978	Air Cond, High performance	US1120H	6.6L V8 400 CID	1975-1979	Air Cond	US1120
6.6L V8 403 CID	1977-1979		US975	6.6L V8 400 CID	1975-1979	Air Cond, High performance	US1120H
6.6L V8 403 CID	1977-1979	Exc.Air Cond	US1100	6.6L V8 403 CID	1977-1979		US975
6.6L V8 403 CID	1977-1979	Air Cond	US1120	6.6L V8 403 CID	1977-1979	Exc.Air Cond	US1100
6.6L V8 403 CID	1977-1979	Air Cond, High performance	US1120H	6.6L V8 403 CID	1977-1979	Air Cond	US1120
6.6L V8 6555cc 400 CID	1967-1968		US850	6.6L V8 403 CID	1977-1979	Air Cond, High performance	US1120H
6.9L V8 6900cc 421 CID	1961-1966		US850	6.6L V8 6555cc 400 CID	1967-1968		US850
7.0L V8 428 CID	1968		US850	7.5L V8 455 CID	1975-1976		US975
7.0L V8 7014cc 428 CID	1967-1968		US850	G3			
7.5L V8 455 CID	1975-1976		US975	1.6L L4 1598cc 98 CID	2009-2010	Base	US6184
EXECUTIVE				1.6L L4 1606cc 98 CID	2006-2008	Mexican Application	US6046
6.6L V8 6555cc 400 CID	1967-1968		US850	G4			
7.0L V8 7014cc 428 CID	1967-1968		US850	2.2L L4 2190cc 134 CID	2005-2006	Mexican Application	US5092
FIERO				2.4L L4 2395cc 146 CID	2006	Mexican Application	US5092
2.5L L4 2474cc 151 CID	1984-1985	Base, SE, Sport	US5000	G5			
2.5L L4 2474cc 151 CID	1986-1987	SE, Sport, Value Leader	US5000	2.2L L4 2198cc 134 CID	2007-2008	Base	US5092
2.5L L4 2474cc 151 CID	1988	Sport, Value Leader	US5000	2.2L L4 2198cc 134 CID	2009	Base, GT	US5092
2.8L V6 173 CID	1985	GT, SE, Sport	US5001	2.4L L4 2384cc 145 CID	2007-2008	GT	US5092
2.8L V6 173 CID	1986-1987	GT, SE	US5001	G6			
2.8L V6 173 CID	1988	GT, Sport, Value Leader	US5001	2.4L L4 2384cc 145 CID	2006-2010	Base	US5092
FIREBIRD				3.5L V6 211 CID	2005	Base, GT	US5033
2.5L L4 2474cc 151 CID	1982-1984	Base, S/E	US1107	3.5L V6 214 CID	2006	Base, GT	US5033
2.5L L4 2474cc 151 CID	1985-1986	Base	US5022	3.5L V6 3490cc 213 CID	2007-2010	Base, GT	US6020
2.8L V6 173 CID	1982-1984	Base, S/E	US5006	3.6L V6 3564cc 217 CID	2007	GTP	US8932
2.8L V6 173 CID	1985-1986	Base, S/E	US5001	3.6L V6 3564cc 217 CID	2008-2009	GXP	US8932
2.8L V6 173 CID	1987-1989	Base	US5037	3.9L V6 3880cc 237 CID	2006	GTP	US6020
3.1L V6 189 CID	1990-1992	Base	US5037	3.9L V6 3880cc 237 CID	2007-2009	GT	US6020
3.4L V6 207 CID	1993-1995	Base	US5070	G8			
3.8L V6 231 CID	1977		US1018	3.6L V6 3564cc 217 CID	2008-2009	Base	US8932
3.8L V6 231 CID	1977	High performance	US1018H	6.0L V8 5967cc 364 CID	2008-2009	GT	US65N
3.8L V6 3800cc 231 CID	1978-1979		US1018	6.0L V8 5967cc 364 CID	2008-2009	GT; Includes thermostat and thermostat housing	US65N-T
3.8L V6 3800cc 231 CID	1978-1979	High performance	US1018H	6.2L V8 6162cc 376 CID	2009	GXP	US79
3.8L V6 3800cc 231 CID	1980	Base, Esprit	US1018	GRAND AM			
3.8L V6 3800cc 231 CID	1980	Base, Esprit; High performance	US1018H	2.0L L4 122 CID	1987-1988	LE, SE	US5036
3.8L V6 3800cc 231 CID	1981	Base, Esprit, Formula	US1018	2.0L L4 122 CID	1989	SE	US5036
3.8L V6 3800cc 231 CID	1981	Base, Esprit, Formula; High performance	US1018H	2.2L L4 2198cc 134 CID	2002-2003	SE, SE1	US5092
3.8L V6 3800cc 231 CID	1981	Base, Esprit, Formula; High performance	US1018H	2.2L L4 2198cc 134 CID	2004-2005	SE	US5092
3.8L V6 3800cc 231 CID	1989	Trans Am, Trans Am GTA SE	US1018	2.3L L4 138 CID	1988	Base, LE, SE	US5043
3.8L V6 3800cc 231 CID	1989	Trans Am, Trans Am GTA SE; High performance	US1018H	2.3L L4 138 CID	1989-1991	LE, SE	US5043
3.8L V6 3800cc 231 CID	1995	Base	US5050	2.3L L4 138 CID	1992-1995	GT, SE	US5043
3.8L V6 3800cc 231 CID	1996-2002	Base	US5075	2.3L L4 140 CID	1989-1990	SE	US5043
4.1L L6 250 CID	1974	With A/C	US927	2.3L L4 140 CID	1991	LE, SE	US5043
4.1L L6 250 CID	1975-1976		US1107	2.3L L4 140 CID	1992-1994	GT	US5043
4.3L V8 265 CID	1981	Base, Esprit, Formula	US975	2.4L L4 2392cc 146 CID	1996-1999	GT, SE	US5076
4.9L V8 301 CID	1977		US975				
4.9L V8 301 CID	1979		US975				
4.9L V8 301 CID	1980-1981	Base, Esprit, Formula, Trans Am	US975				
5.0L V8 305 CID	1977-1979		US1121				

Engine	Years	Application Description	USMW	Engine	Years	Application Description	USMW
PONTIAC (cont'd.)				PONTIAC (cont'd.)			
GRAND AM (cont'd.)				GRAND PRIX (cont'd.)			
2.4L L4 2392cc 146 CID	2000	SE, SE1, SE2	US5076	5.0L V8 305 CID	1983	Base, Brougham, LJ; High performance	US1121H
2.4L L4 2392cc 146 CID	2001	SE, SE1	US5076	5.0L V8 305 CID	1984-1987	Base, Brougham, LE	US1121
2.5L L4 2474cc 151 CID	1985-1986	Base, LE	US5000	5.0L V8 305 CID	1984-1987	Base, Brougham, LE; High performance	US1121H
2.5L L4 2474cc 151 CID	1985-1991	With Multi-Groove pulley	US5067	5.3L V8 5328cc 325 CID	2005-2008	GXP	US6154 US975
2.5L L4 2474cc 151 CID	1987	Base, LE, SE	US5000	5.7L V8 350 CID	1976		US1100 US1120
2.5L L4 2474cc 151 CID	1988	Base, LE	US5000	5.7L V8 350 CID	1976-1977	Exc.Air Cond	US1120H
2.5L L4 2474cc 151 CID	1989-1990	LE	US5000	5.7L V8 350 CID	1976-1977	Air Cond	US1121H
2.5L L4 2474cc 151 CID	1991	LE, Value Leader	US5000	5.7L V8 350 CID	1976-1977	Air Cond, High performance	US1121H
3.0L V6 181 CID	1985	Base, LE	US5050	5.7L V8 350 CID	1977	High performance	US1121H
3.0L V6 181 CID	1986-1987	Base, LE, SE	US5050	5.7L V8 350 CID	1981	Base, Brougham, LJ; Exc.Air Cond	US1100
3.1L V6 189 CID	1994-1998	GT, SE	US5033	5.7L V8 350 CID	1981-1983	Base, Brougham, LJ; With air cond.	US1120
3.3L V6 204 CID	1992-1993	GT, SE	US5050	5.7L V8 350 CID	1981-1983	Base, Brougham, LJ; High performance, With air cond.	US1120H
3.4L V6 207 CID	1999	GT, SE	US5033	5.7L V8 350 CID	1982-1983	Base, Brougham, LJ; 5" Cast, Exc.Air Cond	US1100
3.4L V6 207 CID	2000	GT, GT1, SE1, SE2	US5033	5.7L V8 350 CID	1982-1983	Base, Brougham, LJ; Exc.5" Cast, Exc.Air Cond	US1120H
3.4L V6 207 CID	2001-2002	GT, GT1, SE1	US5033	5.7L V8 350 CID	1984	Base, Brougham, LE; 5" Cast, Exc.Air Cond	US1100
3.4L V6 207 CID	2003-2004	GT, GT1, SE1, SE2	US5033	5.7L V8 350 CID	1984	Base, Brougham, LE; Exc.5" Cast, Exc.Air Cond	US1120
3.4L V6 207 CID	2005	GT, GT1, SE	US5033	5.7L V8 350 CID	1984	Base, Brougham, LE; With air cond.	US1120
3.8L V6 3800cc 231 CID	1979		US1018	5.7L V8 350 CID	1984	Base, Brougham, LE; Exc.5" Cast, Exc.Air Cond	US1120H
3.8L V6 3800cc 231 CID	1979	High performance	US1018H	5.7L V8 350 CID	1984	Base, Brougham, LE; Exc.5" Cast, Exc.Air Cond	US1120H
4.9L V8 301 CID	1978-1979		US975	5.7L V8 350 CID	1984	Base, Brougham, LE; Exc.5" Cast, Exc.Air Cond	US1120H
4.9L V8 301 CID	1980	Base	US975	5.7L V8 350 CID	1984	Base, Brougham, LE; With air cond.	US1120H
5.0L V8 305 CID	1978-1979	High performance	US1121	5.7L V8 350 CID	1984	Base, Brougham, LE; Exc.5" Cast, Exc.Air Cond, High performance	US1120H
5.0L V8 305 CID	1980	Base	US1121H	5.7L V8 350 CID	1984	Base, Brougham, LE; High performance, With air cond.	US850 US850 US975
5.0L V8 305 CID	1980	Base; High performance	US1121	6.4L V8 6376cc 389 CID	1962-1966		US850 US850 US975
5.0L V8 305 CID	1980	Base; High performance	US1121H	6.6L V8 400 CID	1968		US1100 US1120 US1120H
5.7L V8 350 CID	1975		US975	6.6L V8 400 CID	1975-1977	Exc.Air Cond	US975
6.6L V8 400 CID	1975		US975	6.6L V8 400 CID	1975-1977	Air Cond	US1100
7.5L V8 455 CID	1975		US975	6.6L V8 400 CID	1975-1977	Air Cond, High performance	US1120H
GRAND LEMANS				GRAND SAFARI			
3.8L V6 229 CID	1980	Base, Safari	US1121	4.9L V8 301 CID	1977		US975
3.8L V6 229 CID	1980	Base, Safari; High performance	US1121H	5.7L V8 350 CID	1977		US975
3.8L V6 3800cc 231 CID	1980-1981	Base, Safari	US1018	5.7L V8 350 CID	1977	Exc.Air Cond	US1100
3.8L V6 3800cc 231 CID	1980-1981	Base, Safari; High performance	US1018H	5.7L V8 350 CID	1977	Air Cond	US1120
4.3L V8 265 CID	1980-1981	Base, Safari	US975	5.7L V8 350 CID	1977	Air Cond, High performance	US1120H
4.9L V8 301 CID	1980	Base, Safari	US975	5.7L V8 350 CID	1977	Air Cond, High performance	US975
4.9L V8 301 CID	1981	Safari	US975	6.6L V8 400 CID	1975-1978		US1100
5.0L V8 305 CID	1980	Base, Safari	US1121	6.6L V8 400 CID	1975-1978	Exc.Air Cond	US1100
5.0L V8 305 CID	1980	Base, Safari; High performance	US1121H	6.6L V8 400 CID	1975-1978	Air Cond	US1120
GRAND PRIX				GTO			
2.3L L4 138 CID	1990	LE	US5043	5.7L V8 350 CID	2004	Base	US5081
2.3L L4 138 CID	1991	LE, SE	US5043	6.0L V8 5967cc 364 CID	2005-2006	Base	US65
2.8L V6 173 CID	1988-1989	Base, LE, SE	US5033	6.0L V8 5967cc 364 CID	2005-2006	Base; Includes thermostat and thermostat housing	US65-T
3.1L V6 189 CID	1989	Base, LE, SE	US5033	6.4L V8 6376cc 389 CID	1964-1966		US850
3.1L V6 189 CID	1990	LE, McLaren, SE, STE	US5033	6.6L V8 400 CID	1967-1968		US850
3.1L V6 189 CID	1991-1993	GT, LE, SE, STE	US5033	6.6L V8 400 CID	1967-1968		US850
3.1L V6 189 CID	1994-1995	SE	US5033	6.6L V8 6555cc 400 CID	1967-1968		US850
3.1L V6 189 CID	1996	Base, SE	US5033	J2000			
3.1L V6 189 CID	1997-2003	SE	US5033	1.8L L4 112 CID	1982	Base, LE, SE	US5007
3.4L V6 207 CID	1991	GT, SE, STE	US5033	1.8L L4 112 CID	1982-1983	Base, LE, SE	US5036
3.4L V6 207 CID	1992-1993	GT, GTP, LE, SE, STE	US5033	J2000 SUNBIRD			
3.4L V6 207 CID	1994	SE	US5033	1.8L L4 112 CID	1984	Base, LE, SE	US5036
3.4L V6 207 CID	1995-1996	GT, GTP	US5033	1.8L L4 112 CID	1985	Base, LE, SE	US5017
3.8L V6 231 CID	1979		US1018	2.0L L4 122 CID	1984-1985	Base, LE	US5007
3.8L V6 231 CID	1979	High performance	US1018H	LEMANS			
3.8L V6 3800cc 231 CID	1978-1979		US1018	1.6L L4 1588cc 98 CID	1988	Aerocoupe, Aerocoupe YL, Base, SE, Value Leader	US5045
3.8L V6 3800cc 231 CID	1978-1979	High performance	US1018H	1.6L L4 1588cc 98 CID	1989-1990	LE, Value Leader	US5045
3.8L V6 3800cc 231 CID	1980	Base, LJ	US1018	1.6L L4 1588cc 98 CID	1991	LE, Value Leader	US5057
3.8L V6 3800cc 231 CID	1980	Base, LJ; High performance	US1018H	1.6L L4 1588cc 98 CID	1992	LE, SE, Value Leader	US5057
3.8L V6 3800cc 231 CID	1981-1983	Base, Brougham, LJ	US1018	1.6L L4 1588cc 98 CID	1993	SE, Value Leader	US5057
3.8L V6 3800cc 231 CID	1981-1983	Base, Brougham, LJ; High performance	US1018H	2.0L L4 122 CID	1989	GSE, LE, SE	US5036
3.8L V6 3800cc 231 CID	1984-1987	Base, Brougham, LE	US1018	2.0L L4 122 CID	1990	GSE	US5036
3.8L V6 3800cc 231 CID	1984-1987	Base, Brougham, LE; High performance	US1018H	3.8L V6 229 CID	1980	Base, Safari	US1121
3.8L V6 3800cc 231 CID	1997-2002	GT, GTP, SE	US5075	3.8L V6 229 CID	1980	Base, Safari; High performance	US1121H
3.8L V6 3800cc 231 CID	2003	GT, GTP	US5075	WATER PUMPS			
3.8L V6 3800cc 231 CID	2004	GT1, GT2, GTP	US5075				
3.8L V6 3800cc 231 CID	2005	Base, GT, GTP	US5075				
3.8L V6 3800cc 231 CID	2006-2007	Base, GT	US5075				
3.8L V6 3800cc 231 CID	2008	Base	US5075				
4.1L V6 252 CID	1982	Base, Brougham, LJ	US1018				
4.1L V6 252 CID	1982	Base, Brougham, LJ; High performance	US1018H				
4.3L V6 262 CID	1986-1987	Base, Brougham, LE	US1121				
4.3L V6 262 CID	1986-1987	Base, Brougham, LE; High performance	US1121H				
4.3L V8 265 CID	1980	Base, LJ	US975				
4.3L V8 265 CID	1981	Base, Brougham, LJ	US975				
4.9L V8 301 CID	1977-1979		US975				
4.9L V8 301 CID	1980	Base, LJ, SJ	US975				
5.0L V8 305 CID	1978-1979		US1121				
5.0L V8 305 CID	1978-1979	High performance	US1121H				
5.0L V8 305 CID	1980	Base, LJ, SJ	US1121				
5.0L V8 305 CID	1980	Base, LJ, SJ; High performance	US1121H				
5.0L V8 305 CID	1983	Base, Brougham, LJ	US1121				

Engine	Years	Application Description	USMW	Engine	Years	Application Description	USMW
PONTIAC (cont'd.)				PONTIAC (cont'd.)			
LEMANS (cont'd.)				SAFARI (cont'd.)			
3.8L V6 231 CID	1977		US1018	5.0L V8 307 CID	1987-1989	Base; High performance	US1120H
3.8L V6 231 CID	1977	High performance	US1018H	SOLSTICE			
3.8L V6 231 CID	1979		US1018	2.0L L4 1998cc 122 CID	2007-2009	GXP	US5092
3.8L V6 231 CID	1979	High performance	US1018H	2.4L L4 2384cc 145 CID	2006-2009	Base	US5092
3.8L V6 3800cc 231 CID	1978-1979		US1018	STAR CHIEF			
3.8L V6 3800cc 231 CID	1978-1979	High performance	US1018H	6.4L V8 6376cc 389 CID	1959-1966		US850
3.8L V6 3800cc 231 CID	1980	Base, Safari; High performance	US1018H	6.9L V8 6900cc 421 CID	1963-1966		US850
3.8L V6 3800cc 231 CID	1980-1981	Base, Safari	US1018	SUNBIRD			
3.8L V6 3800cc 231 CID	1981	High performance	US1018H	1.8L L4 112 CID	1986	Base, GT, SE	US5017
4.1L L6 250 CID	1974	With A/C	US927	2.0L L4 122 CID	1986	SE	US5007
4.1L L6 250 CID	1975-1977		US1107	2.0L L4 122 CID	1987-1988	Base, GT, SE	US5036
4.3L V8 260 CID	1976	Exc.Air Cond	US1100	2.0L L4 122 CID	1989-1990	GT, LE, SE	US5036
4.3L V8 260 CID	1976	Air Cond	US1120	2.0L L4 122 CID	1991	LE, SE, Value Leader	US5036
4.3L V8 260 CID	1976	Air Cond, High performance	US1120H	2.0L L4 122 CID	1992-1993	LE Value Leader, SE	US5036
4.3L V8 265 CID	1980-1981	Base, Safari	US975	2.0L L4 122 CID	1994	LE	US5036
4.9L V8 301 CID	1977		US975	2.5L L4 2474cc 151 CID	1977-1979		US1107
4.9L V8 301 CID	1979		US975	2.5L L4 2474cc 151 CID	1980	Base	US1107
4.9L V8 301 CID	1980	Base, Safari	US975	3.1L V6 189 CID	1991	GT, LE, SE	US5033
4.9L V8 301 CID	1981	Safari	US975	3.1L V6 189 CID	1992	GT, SE	US5033
5.0L V8 305 CID	1977-1979		US1121	3.1L V6 189 CID	1993	GT, LE Value Leader, SE	US5033
5.0L V8 305 CID	1977-1979	High performance	US1121H	3.1L V6 189 CID	1994	GT, LE, SE	US5033
5.0L V8 305 CID	1980	Base, Safari	US1121	3.8L V6 231 CID	1976	High performance	US1018
5.0L V8 305 CID	1980	Base, Safari; High performance	US1121H	3.8L V6 231 CID	1976		US1018H
5.7L V8 350 CID	1968		US850	3.8L V6 3800cc 231 CID	1977-1979	High performance	US1018
5.7L V8 350 CID	1975-1976		US975	3.8L V6 3800cc 231 CID	1980	Base	US1018
5.7L V8 350 CID	1975-1979	Exc.Air Cond	US1100	3.8L V6 3800cc 231 CID	1980	Base; High performance	US1018H
5.7L V8 350 CID	1975-1979	Air Cond	US1120	5.0L V8 305 CID	1978		US1121
5.7L V8 350 CID	1975-1979	Air Cond, High performance	US1120H	5.0L V8 305 CID	1978-1979	High performance	US1121H
5.7L V8 350 CID	1977-1979	High performance	US1121H	5.0L V8 305 CID	1979		US1069
5.7L V8 5733cc 350 CID	1968		US850	SUNFIRE			
6.6L V8 400 CID	1968		US850	2.2L L4 2190cc 134 CID	1995-2001	SE	US5032
6.6L V8 400 CID	1975-1977		US975	2.2L L4 2190cc 134 CID	2002	GT, SE	US5032
6.6L V8 400 CID	1975-1977	Exc.Air Cond	US1100	2.2L L4 2198cc 134 CID	2002-2003	GT, SE	US5092
6.6L V8 400 CID	1975-1977	Air Cond	US1120	2.2L L4 2198cc 134 CID	2004	SE	US5092
6.6L V8 400 CID	1975-1977	Air Cond, High performance	US1120H	2.2L L4 2198cc 134 CID	2005	Base	US5092
6.6L V8 403 CID	1977		US975	2.3L L4 138 CID	1995	GT, SE	US5043
6.6L V8 403 CID	1977	Exc.Air Cond	US1100	2.4L L4 2392cc 146 CID	1996-2002	GT, SE	US5076
6.6L V8 403 CID	1977	Air Cond	US1120	T1000			
6.6L V8 403 CID	1977	Air Cond, High performance	US1120H	1.6L L4 98 CID	1981-1987	Base	US5004
6.6L V8 403 CID	1977		US1100	TEMPEST			
6.6L V8 403 CID	1977	Air Cond	US1120	5.7L V8 5733cc 350 CID	1968		US850
6.6L V8 403 CID	1977	Air Cond, High performance	US1120H	6.4L V8 6376cc 389 CID	1961		US850
6.6L V8 6555cc 400 CID	1968		US850	6.6L V8 6555cc 400 CID	1968		US850
7.5L V8 455 CID	1976		US975	TORRENT			
MATIZ				3.4L V6 207 CID	2006-2009	Base	US6145
1.0L L4 995cc 61 CID	2004-2010		US8928	3.6L V6 3564cc 217 CID	2008-2009	GXP	US8932
MONTANA				TRANS SPORT			
3.4L V6 207 CID	1999-2005	Base	US5033	3.1L V6 189 CID	1990-1995	Base	US5033
3.5L V6 213 CID	2005-2006	SV6	US5033	3.4L V6 207 CID	1996-1997	Base	US5033
3.9L V6 3880cc 237 CID	2006	SV6	US6020	3.4L V6 207 CID	1998	Base, Montana	US5033
3.9L V6 3880cc 237 CID	2007-2009	Mexican Application	US6020	3.8L V6 3800cc 231 CID	1992-1995	Base	US5050
3.9L V6 3880cc 237 CID	2007-2009		US8928	VENTURA			
PARISIENNE				2.5L L4 2474cc 151 CID	1977		US1107
3.8L V6 3800cc 231 CID	1984	Base, Brougham	US1018	3.8L V6 231 CID	1977		US1018
3.8L V6 3800cc 231 CID	1984	Base, Brougham; High performance	US1018H	3.8L V6 231 CID	1977	High performance	US1018H
4.3L V6 262 CID	1985-1986	Base, Brougham	US1121	4.1L L6 250 CID	1974	With A/C	US927
4.3L V6 262 CID	1985-1986	Base, Brougham; High performance	US1121H	4.1L L6 250 CID	1975-1976		US1107
5.0L V8 305 CID	1983-1986	Base, Brougham	US1121	4.3L V8 260 CID	1975-1976	Exc.Air Cond	US1100
5.0L V8 305 CID	1983-1986	Base, Brougham; High performance	US1121H	4.3L V8 260 CID	1975-1976	Air Cond	US1120
5.0L V8 307 CID	1986	Base, Brougham	US1120	4.3L V8 260 CID	1975-1976	Air Cond, High performance	US1120H
5.0L V8 307 CID	1986	Base, Brougham; High performance	US1120H	4.9L V8 301 CID	1977		US975
5.7L V8 350 CID	1983-1985	Base, Brougham	US1120	5.0L V8 305 CID	1977		US1121
5.7L V8 350 CID	1983-1985	Base, Brougham; High performance	US1120H	5.0L V8 305 CID	1977	High performance	US1121H
PHOENIX				5.7L V8 350 CID	1975-1976	High performance	US1018
2.5L L4 2474cc 151 CID	1977-1978		US1107	5.7L V8 350 CID	1977	Exc.Air Cond	US1100
2.5L L4 2474cc 151 CID	1980-1983	Base, LJ	US5000	5.7L V8 350 CID	1977	Air Cond	US1120
2.5L L4 2474cc 151 CID	1980-1983	Base, LJ; Includes pulley	US5000P	5.7L V8 350 CID	1977	Air Cond, High performance	US1120H
2.5L L4 2474cc 151 CID	1984	Base, LE	US5000	5.7L V8 350 CID	1977	High performance	US1121H
2.5L L4 2474cc 151 CID	1984	Base, LE; Includes pulley	US5000P	6.4L V8 6376cc 389 CID	1960-1961		US850
2.8L V6 173 CID	1980-1981	Base, LJ	US5001	6.9L V8 6900cc 421 CID	1961		US850
2.8L V6 173 CID	1982-1983	Base, LJ, SJ	US5001	VIBE			
2.8L V6 173 CID	1984	Base, LE, SE	US5001	1.8L L4 1794cc	2003-2008	Base	US5099
3.8L V6 231 CID	1977		US1018	1.8L L4 1795cc	2003-2006	GT	US9405
3.8L V6 231 CID	1977	High performance	US1018H	1.8L L4 1798cc	2009	Base	US6232
3.8L V6 3800cc 231 CID	1978-1979		US1018	1.8L L4 1798cc	2010	Base; From 06/01/2009	US6232
3.8L V6 3800cc 231 CID	1978-1979	High performance	US1018H	1.8L L4 1798cc	2010	Base; To 05/31/2009	US6232
5.0L V8 305 CID	1977-1978		US1121	2.4L L4 2362cc	2009-2010	AWD, Base, GT	US9414
5.0L V8 305 CID	1977-1979	High performance	US1121H				
5.0L V8 305 CID	1979		US1069				
5.7L V8 350 CID	1977-1978		US1121				
5.7L V8 350 CID	1977-1979	Exc.Air Cond	US1100				
5.7L V8 350 CID	1977-1979	Air Cond	US1120				
5.7L V8 350 CID	1977-1979	Air Cond, High performance	US1120H				
5.7L V8 350 CID	1977-1979	High performance	US1121H				
SAFARI							
5.0L V8 307 CID	1987-1989	Base	US1120				

Engine	Years	Application Description	USMW	Engine	Years	Application Description	USMW
PONTIAC (cont'd.)				RAM (cont'd.)			
WAVE				1500 (cont'd.)			
1.6L L4 1598cc 98 CID	2005-2007		US6046	4.7L V8 287 CID	2011	Big Horn, Outdoorsman, SLT, ST	US7163
PORSCHE				4.7L V8 287 CID	2012	Outdoorsman, SLT, ST, Tradesman	US7163
911				4.7L V8 287 CID	2013	SLT, Tradesman	US7163
3.4L H6 3400cc	1999-2001	Carrera, Carrera 4	US9475	5.7L V8 345 CID	2011	Big Horn, Laramie, Laramie Longhorn, Outdoorsman, SLT, Sport, ST, Tradesman	US6341
3.6L H6 3596cc	2002-2003	Carrera, Carrera 4, Carrera 4S	US9475	5.7L V8 345 CID	2012	Big Horn, Express, Laramie, Laramie Longhorn, Outdoorsman, SLT, Sport, ST, Tradesman, Tradesman HD	US6341
3.6L H6 3596cc	2004	40th Anniversary Edition, Carrera, Carrera 4, Carrera 4S	US9475	5.7L V8 345 CID	2013	Big Horn, Express, Laramie, Laramie Longhorn, Outdoorsman, R/T, SLT, Sport, Tradesman	US6341
3.6L H6 3596cc	2005	Carrera, Carrera 4S	US9475	5.7L V8 345 CID	2014	Big Horn, Express, Laramie, Laramie Limited, Laramie Longhorn, Lone Star, Outdoorsman, SLT, Special Service, Sport, Tradesman	US6341
3.6L H6 3596cc	2006	Carrera, Carrera 4	US9475	5.7L V8 345 CID	2015	Big Horn, Express, Laramie, Laramie Limited, Laramie Longhorn, Limited, Lone Star, Outdoorsman, Rebel, SLT, Special Service, Sport, Tradesman	US6341
3.6L H6 3596cc	2007	Carrera, Carrera 4, Targa 4, Turbo	US9475	5.7L V8 345 CID	2016	Big Horn, Express, Laramie, Laramie Longhorn, Limited, Lone Star, Outdoorsman, Rebel, SLT, Special Service, Sport, Tradesman	US6341
3.6L H6 3596cc	2008	Carrera, Carrera 4, GT2, Targa 4, Turbo	US9475	5.7L V8 345 CID	2017	Big Horn, Express, Laramie, Laramie Longhorn, Limited, Lone Star, Rebel, SLT, Special Service, Sport, Tradesman	US6341
3.6L H6 3596cc	2009	GT2, Turbo	US9475	5.7L V8 345 CID	2018	Big Horn, Express, Laramie, Laramie Longhorn, Limited, Lone Star, Rebel, SLT, Special Service, Sport, ST, Tradesman	US6341
3.6L H6 3598cc	2007-2008	GT3, GT3 RS	US9475	2500			
3.6L H6 3600cc 220 CID	2011	GT2 RS	US9475	5.7L V8 345 CID	2011	Laramie, Laramie Longhorn, Power Wagon, SLT, ST	US6341
3.8L H6 3800cc	2010	GT3	US9475	5.7L V8 345 CID	2012	Laramie, Laramie Longhorn, Outdoorsman, Power Wagon, SLT, ST	US6341
3.8L H6 3800cc	2011	GT3, GT3 RS	US9475	5.7L V8 345 CID	2013	Big Horn, Laramie, Laramie Longhorn, Lone Star, Outdoorsman, Power Wagon, SLT, ST, Tradesman	US6341
3.8L H6 3824cc	2005	Carrera S	US9475	5.7L V8 345 CID	2014-2015	Big Horn, Laramie, Laramie Limited, Laramie Longhorn, Lone Star, Outdoorsman, SLT, Tradesman	US6341
3.8L H6 3824cc	2006	Carrera 4S, Carrera S	US9475	5.7L V8 345 CID	2016	Big Horn, Laramie, Laramie Longhorn, Limited, Outdoorsman, SLT, Tradesman	US6341
3.8L H6 3824cc	2007-2008	Carrera 4S, Carrera S, Targa 4S	US9475	5.7L V8 345 CID	2017	Big Horn, Laramie, Laramie Longhorn, Limited, SLT, Tradesman	US6341
4.0L H6 3996cc	2011	GT3 RS 4.0	US9475	5.7L V8 345 CID	2018	Big Horn, Limited, SLT, Tradesman	US6341
924				6.4L V8 6424cc 392 CID	2014-2015	Big Horn, Laramie, Laramie Limited, Laramie Longhorn, Lone Star, Outdoorsman, Power Wagon, SLT, Tradesman	US8140
2.0L L4 1983cc	1977-1979		US9177	6.4L V8 6424cc 392 CID	2016	Big Horn, Laramie, Laramie Longhorn, Limited, Power Wagon, SLT, Tradesman	US8140
2.0L L4 1983cc	1980	Base, Turbo	US9177	6.7L L6 408 CID	2011	Laramie, Laramie Longhorn, SLT, ST	US6222
2.0L L4 1983cc	1981-1982	Base	US9177	6.7L L6 408 CID	2012	Laramie, Laramie Longhorn, Outdoorsman, SLT, ST	US6222
2.5L L4 2475cc	1987-1988	S	US9245	6.7L L6 408 CID	2013	Big Horn, Laramie, Laramie Longhorn, Lone Star, Outdoorsman, SLT, ST, Tradesman	US99
928				6.7L L6 408 CID	2014-2015	Big Horn, Laramie, Laramie Limited, Laramie Longhorn, Lone Star, Outdoorsman, SLT, Tradesman	US99
4.5L V8 4474cc	1978-1979		US9242	6.7L L6 408 CID	2016	Big Horn, Laramie, Laramie Longhorn, Limited, Outdoorsman, SLT, Tradesman	US99
4.5L V8 4474cc	1980-1982	Base	US9242	6.7L L6 408 CID	2017-2018	Big Horn, Laramie, Laramie Longhorn, Limited, Power Wagon, SLT, Tradesman	US8140
4.7L V8 4671cc	1983-1984	S	US9242	6.7L L6 408 CID	2011	Laramie, Laramie Longhorn, SLT, ST	US6222
5.0L V8 4950cc	1985-1986	S	US9242	6.7L L6 408 CID	2012	Laramie, Laramie Longhorn, Outdoorsman, SLT, ST	US6222
5.0L V8 4950cc	1987-1989	S4	US9241	6.7L L6 408 CID	2013	Big Horn, Laramie, Laramie Longhorn, Lone Star, Outdoorsman, SLT, ST, Tradesman	US99
5.0L V8 4950cc	1990-1991	Base, GT	US9241	6.7L L6 408 CID	2014-2015	Big Horn, Laramie, Laramie Limited, Laramie Longhorn, Lone Star, Outdoorsman, SLT, Tradesman	US99
5.4L V8 5392cc	1993-1995	GTS	US9241	6.7L L6 408 CID	2016	Big Horn, Laramie, Laramie Longhorn, Limited, Outdoorsman, SLT, Tradesman	US99
944				6.7L L6 408 CID	2017-2018	Big Horn, Laramie, Laramie Longhorn, Limited, SLT, Tradesman	US99
2.5L L4 2475cc	1983-1985	Base	US9245	6.7L L6 408 CID	2011-2012	Laramie, SLT, ST	US6341
2.5L L4 2475cc	1986	Base, Turbo	US9245	5.7L V8 345 CID	2013	Big Horn, Laramie, Laramie Longhorn, Lone Star, SLT, Tradesman	US6341
2.5L L4 2475cc	1987-1988	Base, S, Turbo	US9245	5.7L V8 345 CID	2014-2015	Big Horn, Laramie, Laramie Limited, Laramie Longhorn, Lone Star, SLT, Tradesman	US6341
2.5L L4 2475cc	1989	Turbo	US9245	5.7L V8 345 CID	2016	Big Horn, Laramie, Laramie Longhorn, Limited, SLT, Tradesman	US6341
BOXSTER				5.7L V8 345 CID	2017	Big Horn, Laramie, Laramie Longhorn, Limited, Lone Star, SLT, Tradesman	US6341
2.5L H6 2480cc	1997-1999	Base	US9475	5.7L V8 345 CID	2018	Big Horn, Laramie, Laramie Longhorn, Limited, SLT, Tradesman	US6341
2.5L H6 2480cc 151 CID	2000	Mexican Application	US9475	6.4L V8 6424cc 392 CID	2014-2015	Big Horn, Laramie, Laramie Limited, Laramie Longhorn, Lone Star, Outdoorsman, Power Wagon, SLT, Tradesman	US8140
2.7L H6 2687cc	2000-2003	Roadster	US9475	6.4L V8 6424cc 392 CID	2016	Big Horn, Laramie, Laramie Longhorn, Limited, Outdoorsman, Power Wagon, SLT, Tradesman	US8140
2.7L H6 2687cc	2004-2007	Base	US9475	6.4L V8 6424cc 392 CID	2017-2018	Big Horn, Laramie, Laramie Longhorn, Limited, Power Wagon, SLT, Tradesman	US8140
2.7L H6 2687cc	2008	Base, Limited Edition	US9475	6.7L L6 408 CID	2011	Laramie, Laramie Longhorn, SLT, ST	US6222
2.7L H6 2687cc	2000-2003	Roadster S	US9475	6.7L L6 408 CID	2012	Laramie, Laramie Longhorn, Outdoorsman, SLT, ST	US6222
3.2L H6 3179cc	2004	S, S Special Edition	US9475	6.7L L6 408 CID	2013	Big Horn, Laramie, Laramie Longhorn, Lone Star, Outdoorsman, SLT, ST, Tradesman	US99
3.2L H6 3179cc	2005-2006	S	US9475	6.7L L6 408 CID	2014-2015	Big Horn, Laramie, Laramie Limited, Laramie Longhorn, Lone Star, Outdoorsman, SLT, Tradesman	US99
3.4L H6 3387cc	2007	S	US9475	6.7L L6 408 CID	2016	Big Horn, Laramie, Laramie Longhorn, Limited, Outdoorsman, SLT, Tradesman	US99
3.4L H6 3387cc	2008	RS 60 Spyder, S, S Limited Edition	US9475	6.7L L6 408 CID	2017-2018	Big Horn, Laramie, Laramie Longhorn, Limited, SLT, Tradesman	US99
CAYENNE				3500			
3.2L V6 3189cc 195 CID	2004-2006	Base	US9471	5.7L V8 345 CID	2011-2012	Laramie, SLT, ST	US6341
CAYMAN				5.7L V8 345 CID	2013	Big Horn, Laramie, Laramie Longhorn, Lone Star, SLT, ST, Tradesman	US6341
2.7L H6 2687cc	2007-2008	Base	US9475	5.7L V8 345 CID	2014-2015	Big Horn, Laramie, Laramie Limited, Laramie Longhorn, Lone Star, SLT, Tradesman	US6341
3.4L H6 3387cc	2006-2008	S	US9475	5.7L V8 345 CID	2016	Big Horn, Laramie, Laramie Longhorn, Limited, SLT, Tradesman	US6341
RAM				5.7L V8 345 CID	2017	Big Horn, Laramie, Laramie Longhorn, Limited, Lone Star, SLT, Tradesman	US6341
1500				5.7L V8 345 CID	2018	Big Horn, Laramie, Laramie Longhorn, Limited, SLT, Tradesman	US6341
3.0L V6 2987cc 182 CID	2014	Big Horn, Laramie, Laramie Limited, Laramie Longhorn, Lone Star, Outdoorsman, SLT, Tradesman	US8161	6.4L V8 6424cc 392 CID	2014-2015	Big Horn, Laramie, Laramie Longhorn, Lone Star, SLT, Tradesman	US8140
3.0L V6 2987cc 182 CID	2015	Big Horn, Laramie, Laramie Limited, Laramie Longhorn, Limited, Lone Star, Outdoorsman, SLT, Tradesman	US8161	6.4L V8 6424cc 392 CID	2016	Big Horn, Laramie, Laramie Longhorn, Limited, SLT, Tradesman	US8140
3.0L V6 2987cc 182 CID	2016	Big Horn, HFE, Laramie, Laramie Longhorn, Limited, Lone Star, Outdoorsman, SLT, Tradesman	US8161	6.4L V8 6424cc 392 CID	2017	Big Horn, Laramie, Laramie Longhorn, Limited, Lone Star, SLT, Tradesman	US8140
3.0L V6 2987cc 182 CID	2017	Big Horn, HFE, Laramie, Laramie Longhorn, Limited, Lone Star, SLT, Tradesman	US8161	6.4L V8 6424cc 392 CID	2018	Big Horn, Laramie, Laramie Longhorn, Limited, SLT, Tradesman	US8140
3.0L V6 2987cc 182 CID	2018	Big Horn, Laramie, Laramie Longhorn, Limited, Lone Star, SLT, ST, Tradesman	US8161	6.7L L6 408 CID	2011-2012	Laramie, Laramie Longhorn, SLT, ST	US6222
3.6L V6 3604cc 220 CID	2013	HFE, Outdoorsman, SLT, Tradesman	US8981	6.7L L6 408 CID	2013	Big Horn, Laramie, Laramie Longhorn, Lone Star, SLT, ST, Tradesman	US99
3.6L V6 3604cc 220 CID	2014	Big Horn, Express, HFE, Laramie, Lone Star, Outdoorsman, SLT, Tradesman	US8981	WATER PUMPS			
3.6L V6 3604cc 220 CID	2015-2016	Big Horn, Express, HFE, Laramie, Lone Star, Outdoorsman, Rebel, SLT, Tradesman	US8981				
3.6L V6 3604cc 220 CID	2017	Big Horn, Express, Laramie, Lone Star, Rebel, SLT, Sport, Tradesman	US8981				
3.6L V6 3604cc 220 CID	2018	Big Horn, Express, Laramie, Lone Star, Rebel, SLT, Sport, ST, Tradesman	US8981				
3.7L V6 226 CID	2011-2012	ST	US7163				

Engine	Years	Application Description	USMW	Engine	Years	Application Description	USMW
RAM (cont'd.)				RENAULT (cont'd.)			
3500 (cont'd.)				R5 (cont'd.)			
6.7L L6 408 CID	2014-2015	Big Horn, Laramie, Laramie Limited, Laramie Longhorn, Lone Star, SLT, Tradesman	US99	1.3L L4 1289cc 79 CID	1981	Base, Mirage L, Mirage S	US9301
6.7L L6 408 CID	2016	Big Horn, Laramie, Laramie Longhorn, Limited, SLT, Tradesman	US99	1.3L L4 1289cc 79 CID	1982-1983	Mirage	US9282
6.7L L6 408 CID	2017	Big Horn, Laramie, Laramie Longhorn, Limited, Lone Star, SLT, Tradesman	US99	1.3L L4 1289cc 79 CID	1982-1983	Base, Mirage	US9301
6.7L L6 408 CID	2018	Big Horn, Laramie, Laramie Longhorn, Limited, SLT, Tradesman	US99	1.3L L4 1300cc 79 CID	1977-1984	Mexican Application	US9282
4500				R8S			
6.4L V8 6424cc 392 CID	2014-2016	Laramie, SLT, Tradesman	US8140	1.3L L4 1300cc 79 CID	1968-1975	Mexican Application	US9282
6.4L V8 6424cc 392 CID	2017	Base	US8140	R10			
6.7L L6 408 CID	2011-2012	Laramie, SLT, ST	US6222	1.3L L4 1300cc 79 CID	1967-1972	Mexican Application	US9282
6.7L L6 408 CID	2013	Laramie, SLT, ST, Tradesman	US99	R12			
6.7L L6 408 CID	2014-2016	Laramie, SLT, Tradesman	US99	1.3L L4 1289cc 79 CID	1980-1982		US9282
6.7L L6 408 CID	2017-2018	Base	US99	1.3L L4 1300cc 79 CID	1971-1983	Mexican Application	US9282
5500				1.6L L4 1600cc 98 CID	1975-1980	Mexican Application	US3406
6.4L V8 6424cc 392 CID	2014-2016	Laramie, SLT, Tradesman	US8140	1.6L L4 1647cc 100 CID	1975-1979	TS	US3406
6.4L V8 6424cc 392 CID	2017	Base	US8140	R18			
6.7L L6 408 CID	2011-2012	Laramie, SLT, ST	US6222	1.6L L4 1600cc 98 CID	1980	Mexican Application	US3406
6.7L L6 408 CID	2013	Laramie, SLT, ST, Tradesman	US99	1.6L L4 1600cc 98 CID	1984	Mexican Application	US3406
6.7L L6 408 CID	2014-2016	Laramie, SLT, Tradesman	US99	2.0L L4 1995cc 122 CID	1984-1986	Mexican Application	US8914
6.7L L6 408 CID	2017-2018	Base	US99	R18I			
CV				1.6L L4 1647cc 100 CID	1981-1982	Base, Deluxe	US3406
3.6L V6 3604cc 220 CID	2012-2014	Base	US8981	1.6L L4 1647cc 100 CID	1983	Deluxe	US3406
3.6L V6 3604cc 220 CID	2015	Base, Tradesman	US8981	2.2L L4 2152cc 131 CID	1984-1986	Sportwagon	US3410
DAKOTA				SANDERO			
3.7L V6 226 CID	2011	Big Horn, Laramie, SLT, ST	US7163	1.6L L4 1598cc 97 CID	2010-2011	Mexican Application	US8927
4.7L V8 287 CID	2011	Big Horn, Laramie, SLT, TRX4	US7163	1.6L L4 1598cc 98 CID	2010-2011	Authentique	US8927
PROMASTER 1500				SCENIC			
3.6L V6 3604cc 220 CID	2014-2018	Base	US8981	2.0L L4 1998cc 122 CID	2003-2004	Mexican Application	US8914
PROMASTER 2500				2.0L L4 2000cc 122 CID	2002	Mexican Application	US8914
3.6L V6 3604cc 220 CID	2014-2018	Base	US8981	SCENIC II			
PROMASTER 3500				2.0L L4 1998cc 122 CID	2005-2008	Mexican Application	US8914
3.6L V6 3604cc 220 CID	2014-2018	Base	US8981	TRAFIC			
PROMASTER CITY				1.9L L4 1870cc 114 CID	2008-2012		US8921
2.4L L4 2360cc 144 CID	2015-2018	Base, SLT, Tradesman, Tradesman SLT	US6038	1.9L L4 1900cc 114 CID	2007-2012	Mexican Application	US8921
RENAULT				ROVER			
ALLIANCE				75			
1.7L L4 105 CID	1985	DL, L, Limited	US3408	2.5L V6 2497cc 152 CID	2000		US9496
1.7L L4 105 CID	1986	Base, DL, L	US3408	2.5L V6 2497cc 152 CID	2003-2005		US9496
1.7L L4 105 CID	1987	Base, DL, GS, L	US3408	SAAB			
CLIO				9-2X			
1.6L L4 1598cc 97 CID	2003-2010	Mexican Application	US8927	2.0L H4 1994cc	2005	Aero	US9215
1.6L L4 1598cc 98 CID	2002-2010		US8927	2.5L H4 2458cc	2005	Linear	US9223
1.6L L4 1600cc 98 CID	2002	Mexican Application	US8927	2.5L H4 2458cc	2006	Aero	US9215
2.0L L4 1998cc 122 CID	2003-2006	Mexican Application	US8914	2.5L H4 2458cc	2006	2.5i	US9223
2.0L L4 2000cc 122 CID	2002	Mexican Application	US8914	9-3			
ENCORE				2.0L L4 1985cc	1999-2001	Base, SE	US9307
1.7L L4 105 CID	1985	GS, LS, S	US3408	2.0L L4 1985cc	2002-2003	SE	US9307
1.7L L4 105 CID	1986	Electronic, GS, LS, S	US3408	2.0L L4 1985cc	2003	Arc, Linear, Vector	US5092
FUEGO				2.0L L4 1985cc	2004-2005	Aero, Arc, Linear	US5092
1.6L L4 1565cc	1982-1984	Turbo	US3406	2.0L L4 1985cc	2006-2009	2.0T	US5092
1.6L L4 1647cc 100 CID	1982-1983	Base	US3410	2.0L L4 1985cc	2010	2.0T, Aero	US5092
2.2L L4 2152cc 131 CID	1984-1985	Base	US3410	2.0L L4 1985cc	2011	Aero, Turbo4	US5092
KANGOO				2.3L L4 2290cc 140 CID	1999-2002	Viggen	US9307
1.6L L4 1598cc 97 CID	2004-2010	Mexican Application	US8927	2.8L V6 2792cc 170 CID	2006	Aero; From Chassis/VIN 61112756	US8932
1.6L L4 1598cc 98 CID	2007-2009		US8927	2.8L V6 2792cc 170 CID	2006	Aero; To Chassis/VIN 61112755	US8932
KANGOO EXPRESS				2.8L V6 2792cc 170 CID	2007	Aero	US8932
1.6L L4 1598cc 98 CID	2004-2008		US8927	2.8L V6 2792cc 170 CID	2008	Aero, Aero XWD, Turbo X	US8932
1.6L L4 1598cc 98 CID	2010		US8927	2.8L V6 2792cc 170 CID	2009	Aero, Aero XWD	US8932
LAGUNA				9-3X			
3.0L V6 2950cc 180 CID	2003-2005	Mexican Application	US8973	2.0L L4 1985cc	2010-2011	Base	US5092
MEGANE				9-5			
2.0L L4 1998cc 122 CID	2003-2004	Mexican Application	US8914	2.3L L4 2290cc 140 CID	1999	Base, SE	US9307
2.0L L4 2000cc 122 CID	2001-2002	Mexican Application	US8914	2.3L L4 2290cc 140 CID	2000	2.3t, Aero, Gary Fisher	US9307
MEGANE II				2.3L L4 2290cc 140 CID	2001	2.3t, Aero	US9307
1.6L L4 1598cc 97 CID	2008-2010	Mexican Application	US8927	2.3L L4 2290cc 140 CID	2002-2003	Aero, Linear	US9307
2.0L L4 1998cc 122 CID	2004-2010	Mexican Application	US8914	2.3L L4 2290cc 140 CID	2004-2005	Aero, Arc, Linear	US9307
R5				2.3L L4 2290cc 140 CID	2006-2007	2.3t	US9307
1.3L L4 1289cc 79 CID	1979		US9282	2.3L L4 2290cc 140 CID	2008-2009	2.3t, Aero	US9307
1.3L L4 1289cc 79 CID	1979		US9301	2.8L V6 2792cc 170 CID	2010	Aero	US8932
1.3L L4 1289cc 79 CID	1980		US9282	2.8L V6 2792cc 170 CID	2011	Aero, Turbo6	US8932
1.3L L4 1289cc 79 CID	1980	Mirage	US9301	3.0L V6 2961cc 181 CID	1999-2001	SE	US5079
1.3L L4 1289cc 79 CID	1981	Base, Mirage	US9282	3.0L V6 2961cc 181 CID	2002-2003	Arc	US5079
				9-7X			
				4.2L L6 256 CID	2005	Linear	US5097
				4.2L L6 256 CID	2006-2009	4.2i	US5097
				5.3L V8 5328cc 325 CID	2005	Arc	US64
				5.3L V8 5328cc 325 CID	2005	Arc; Includes thermostat and thermostat housing	US64-T

Engine	Years	Application Description	USMW	Engine	Years	Application Description	USMW
SAAB (cont'd.)				SATURN (cont'd.)			
9-7X (cont'd.)				LW300			
5.3L V8 5328cc 325 CID	2006	5.3i	US64	3.0L V6 3000cc 181 CID	2001-2003	Base	US5079
5.3L V8 5328cc 325 CID	2006	5.3i; Includes thermostat and thermostat housing	US64-T	OUTLOOK			
5.3L V8 5328cc 325 CID	2007-2009	5.3i	US6009	3.6L V6 3564cc 217 CID	2007-2010	XE, XR	US8932
5.3L V8 5328cc 325 CID	2007-2009	5.3i; Includes thermostat and thermostat housing	US6009-T	RELAY			
6.0L V8 5967cc 364 CID	2008-2009	Aero	US6009	3.5L V6 213 CID	2005-2006	2, 3	US5033
6.0L V8 5967cc 364 CID	2008-2009	Aero; Includes thermostat and thermostat housing	US6009-T	3.9L V6 3880cc 237 CID	2006	3	US6020
900				3.9L V6 3880cc 237 CID	2007	1, 2, 3	US6020
2.0L L4 1985cc	1981-1985	Base, S, Turbo	US9108	SC			
2.0L L4 1985cc	1986-1990	Base, S, SPG, Turbo	US9108	1.9L L4 116 CID	1991-1992	Base	US5054
2.0L L4 1985cc	1991	SE Turbo, SPG, S Turbo	US9108	SC1			
2.0L L4 1985cc	1992	Turbo	US9108	1.9L L4 116 CID	1993-2002	Base	US5054
2.0L L4 1985cc	1993	Turbo, Turbo Commemorative Edition	US9108	SC2			
2.0L L4 1985cc	1994	SE Turbo, Turbo, Turbo Commemorative Edition	US9307	1.9L L4 116 CID	1993-2002	Base	US5054
2.0L L4 1985cc	1995-1997	SE Turbo	US9307	SKY			
2.0L L4 1985cc	1998	SE Turbo, S Turbo	US9307	2.0L L4 1998cc 122 CID	2007-2010	Red Line	US5092
2.1L L4 2119cc	1991-1992	Base, S	US9108	2.4L L4 2384cc 145 CID	2007-2010	Base	US5092
2.1L L4 2119cc	1993-1994	S	US9108	SL			
2.3L L4 2290cc 140 CID	1994-1998	S	US9307	1.9L L4 116 CID	1991-2002	Base	US5054
2.5L V6 2498cc	1994-1997	SE	US5079	SL1			
9000				1.9L L4 116 CID	1991-2002	Base	US5054
2.0L L4 1985cc	1986	Turbo	US9107	SL2			
2.0L L4 1985cc	1987-1988	S, Turbo	US9107	1.9L L4 116 CID	1991-2002	Base	US5054
2.0L L4 1985cc	1989	Base, CD, S	US9107	SW1			
2.0L L4 1985cc	1990	CD, S, Turbo	US9107	1.9L L4 116 CID	1993-1999	Base	US5054
2.3L L4 2290cc	1991	CD Turbo, Turbo	US9264	SW2			
2.3L L4 2290cc	1992	CD Griffin Edition, CD Turbo, Turbo	US9264	1.9L L4 116 CID	1993-2001	Base	US5054
2.3L L4 2290cc	1993	Aero, CDE Turbo, CD Turbo, CSE Turbo, CS Turbo	US9264	VUE			
2.3L L4 2290cc	1994	Aero, CDE Turbo, CSE Turbo, CS Turbo	US9264	2.2L L4 2198cc 134 CID	2002-2007	Base	US5092
2.3L L4 2290cc	1995-1997	Aero, CS, CSE Turbo	US9264	2.4L L4 2384cc 145 CID	2007	Green Line	US5092
2.3L L4 2290cc	1998	CSE Turbo	US9264	2.4L L4 2384cc 145 CID	2008	Green Line, XE	US5092
2.3L L4 2290cc 140 CID	1990	S	US9264	2.4L L4 2384cc 145 CID	2009	Hybrid, XE, XR	US5092
2.3L L4 2290cc 140 CID	1991-1992	Base, CD, S	US9264	2.4L L4 2384cc 145 CID	2010	XE	US5092
2.3L L4 2290cc 140 CID	1993	CD, CDE, CS, CSE	US9264	3.0L V6 3000cc 181 CID	2002-2003	Base	US5079
2.3L L4 2290cc 140 CID	1994	CDE, CS, CSE	US9264	3.5L V6 3471cc	2006-2007	Base, Red Line	US9470
3.0L V6 2961cc 181 CID	1995	CDE, CSE	US5079	3.5L V6 3474cc	2004	Red Line	US9470
3.0L V6 2961cc 181 CID	1996-1997	CSE	US5079	3.5L V6 3474cc	2005	Base, Red Line	US9470
SATURN				3.5L V6 3475cc	2004	Base	US9470
ASTRA				3.5L V6 3490cc 213 CID	2008-2009	XE	US6020
1.8L L4 1796cc 110 CID	2008	XE, XR	US6184	3.6L V6 3564cc 217 CID	2008-2009	Red Line, XR	US8932
AURA				3.6L V6 3564cc 217 CID	2010	XR	US8932
2.4L L4 2384cc 145 CID	2007	Green Line	US5092	SCION			
2.4L L4 2384cc 145 CID	2008	Green Line, XE	US5092	FR-S			
2.4L L4 2384cc 145 CID	2009	Hybrid, XE, XR	US5092	2.0L H4 1998cc 122 CID	2013-2016	Base	US9384
3.5L V6 3490cc 213 CID	2007-2008	XE	US6020	IA			
3.6L V6 3564cc 217 CID	2007-2009	XR	US8932	1.5L L4 1496cc 91 CID	2016	Base	US6700
ION				TC			
2.0L L4 122 CID	2004-2007	Red Line	US5092	2.4L L4 2362cc	2010	Base	US9414
2.2L L4 2198cc 134 CID	2003-2005	1, 2, 3	US5092	2.4L L4 2398cc	2005-2006	Base	US9414
2.2L L4 2198cc 134 CID	2006-2007	2, 3	US5092	2.4L L4 2398cc	2007-2008	Base, Spec	US9414
2.4L L4 2384cc 145 CID	2006-2007	3	US5092	2.4L L4 2398cc	2009	Base	US9414
L100				2.5L L4 2494cc 152 CID	2011-2016	Base	US6252
2.2L L4 2198cc 134 CID	2001-2002	Base	US5092	XA			
L200				1.5L L4 1497cc	2004-2006	Base	US9406
2.2L L4 2198cc 134 CID	2001-2003	Base	US5092	XB			
L300				1.5L L4 1497cc	2004-2006	Base	US9406
2.2L L4 2198cc 134 CID	2004	1	US5092	2.4L L4 2362cc	2008-2010	Base	US8970
3.0L V6 3000cc 181 CID	2001-2003	Base	US5079	2.4L L4 2362cc	2011	Base; To 11/2010	US8970
3.0L V6 3000cc 181 CID	2004	2, 3	US5079	2.4L L4 2362cc	2011	Base; Engine # 0XXXXXX-6XXXXXX, Engine # BXXXXXX, Engine # HXXXXXX-KXXXXXX, From 11/2010	US9414
3.0L V6 3000cc 181 CID	2005	Base	US5079	2.4L L4 2362cc	2011-2014	Base; Engine # CXXXXXX-GXXXXXX, From 11/2010	US8970
LS				2.4L L4 2362cc	2012-2015	Base; Engine # 0XXXXXX-6XXXXXX, Engine # BXXXXXX, Engine # HXXXXXX-KXXXXXX	US9414
2.2L L4 2198cc 134 CID	2000	Base	US5092	2.4L L4 2362cc	2014	Base; From 11/2010 (Engine # CXXXXXX-GXXXXXX)	US8970
LS1				2.4L L4 2362cc	2014-2015	Base; Engine # 0XXXXXX-6XXXXXX (Engine # BXXXXXX) (Engine # HXXXXXX-KXXXXXX)	US9414
2.2L L4 2198cc 134 CID	2000	Base	US5092	2.4L L4 2362cc	2015	Base; Engine # CXXXXXX-GXXXXXX	US8970
LS2				XD			
3.0L V6 3000cc 181 CID	2000	Base	US5079	1.8L L4 1798cc	2008-2014	Base	US6232
LW1				WATER PUMPS			
2.2L L4 2198cc 134 CID	2000	Base	US5092				
LW2							
3.0L V6 3000cc 181 CID	2000	Base	US5079				
LW200							
2.2L L4 2198cc 134 CID	2001-2003	Base	US5092				

Engine	Years	Application Description	USMW	Engine	Years	Application Description	USMW
SEAT				SUBARU (cont'd.)			
ALHAMBRA				FORESTER			
1.8L L4 1781cc 108 CID	2002-2003	Mexican Application	US9377	2.5L H4 2458cc	1998-2001	Base, L, S	US9223
1.8L L4 1781cc 109 CID	2004-2007	Mexican Application	US9377	2.5L H4 2458cc	2002	Base, L, S; Standard Trans	US9223
1.8L L4 1798cc 110 CID	2003	Mexican Application	US9377	2.5L H4 2458cc	2002	Base, L, S; Automatic Trans	US9472
2.8L V6 2792cc 170 CID	2002-2005	Mexican Application	US9262	2.5L H4 2458cc	2003-2005	X, XS; Standard Trans	US9223
2.8L V6 2792cc 170 CID	2007-2008	Mexican Application	US9262	2.5L H4 2458cc	2003-2005	X, XS; Automatic Trans	US9472
ALTEA				2.5L H4 2458cc	2004	XT	US9215
2.0L L4 1984cc 121 CID	2005-2006	Mexican Application	US9377	2.5L H4 2458cc	2005	XT, XT Premium	US9215
2.0L L4 1984cc 121 CID	2008-2009	Mexican Application	US9377	2.5L H4 2458cc	2005	XS L.L. Bean Edition	US9472
CORDOBA				2.5L H4 2458cc	2006	X; Standard Trans	US6049
1.6L L4 1600cc 98 CID	2001-2002	Mexican Application	US8959	2.5L H4 2458cc	2006	X; Automatic Trans	US6160
1.6L L4 1600cc 98 CID	2004-2006	Mexican Application	US8949	2.5L H4 2458cc	2006	X L.L. Bean Edition	US6160
1.6L L4 1600cc 98 CID	2007	Mexican Application	US9378	2.5L H4 2458cc	2006-2007	XT Limited	US9215
1.6L L4 1600cc 98 CID	2008-2009	Mexican Application	US8949	2.5L H4 2458cc	2007	X, X L.L. Bean Edition	US6049
2.0L L4 1984cc 121 CID	2003-2009	Mexican Application	US9377	2.5L H4 2458cc	2008	Sports 2.5 X, X, X L.L. Bean Edition	US6049
FREETRACK				2.5L H4 2458cc	2008	Sports 2.5 XT, XT Limited	US9255
2.0L L4 1998cc 122 CID	2009	Mexican Application	US9377	2.5L H4 2458cc	2009	XT, XT Limited	US9255
IBIZA				2.5L H4 2458cc	2009-2010	X, X Limited, X Premium	US6049
1.4L L4 1390cc 85 CID	2012-2013	Mexican Application	US8952	2.5L H4 2458cc	2010	XT Limited, XT Premium	US9255
1.4L L4 1390cc 85 CID	2015	Mexican Application	US8952	2.5L H4 2458cc	2011-2013	XT Premium, XT Touring	US9255
1.6L L4 1600cc 98 CID	2001	Mexican Application	US9378	2.5L H4 2498cc 152 CID	2011-2013	X, X Limited, X Premium, X Touring; (FB25BA)	US9384
1.6L L4 1600cc 98 CID	2002	Mexican Application	US8959	2.5L H4 2498cc 152 CID	2011-2013	X, X Limited, X Premium, X Touring; (FB25BC)	US9384
1.6L L4 1600cc 98 CID	2004	Mexican Application	US9378	2.5L H4 2498cc 152 CID	2014-2015	2.5i, 2.5i Limited, 2.5i Premium, 2.5i Touring; (FB25BA)	US9384
1.6L L4 1600cc 98 CID	2005-2009	Mexican Application	US8949	2.5L H4 2498cc 152 CID	2014-2015	2.5i, 2.5i Limited, 2.5i Premium, 2.5i Touring; (FB25BC)	US9384
1.6L L4 1600cc 98 CID	2010	Mexican Application	US8996	2.5L L4 2457cc 150 CID	2010	Mexican Application	US9215
1.8L L4 1781cc 108 CID	2006-2008	Mexican Application	US9377	2.5L L4 2498cc 152 CID	2014	Mexican Application	US9384
1.8L L4 1798cc 110 CID	2005	Mexican Application	US9377	GL			
2.0L L4 1984cc 121 CID	2003-2012	Mexican Application	US9377	1.6L H4 1595cc	1980	Base	US9025
LEON				1.6L H4 1595cc	1986-1987	Base	US9025
1.4L L4 1368cc 83 CID	2008-2009	Mexican Application	US8949	1.8L H4 1781cc	1980-1983	Base	US9025
1.4L L4 1390cc 85 CID	2008		US8949	1.8L H4 1781cc	1984	Base, Turbo	US9025
1.4L L4 1390cc 85 CID	2010	Mexican Application	US8976	1.8L H4 1781cc	1985-1986	Base, Turbo; With air cond.	US9080
1.4L L4 1390cc 85 CID	2010-2014	Mexican Application	US8952	1.8L H4 1781cc	1985-1986	Base, Turbo; Exc. air cond.	US9161
1.8L L4 1781cc 108 CID	2001-2003	Mexican Application	US9377	1.8L H4 1781cc	1987	Base; With air cond.	US9080
1.8L L4 1781cc 109 CID	2004-2006	Mexican Application	US9377	1.8L H4 1781cc	1987	Base; Exc. air cond.	US9161
1.8L L4 1798cc 110 CID	2009-2010	Mexican Application	US9377	1.8L H4 1781cc	1988-1989	Base, Turbo; With air cond.	US9080
2.0L L4 1984cc 121 CID	2007	Mexican Application	US9377	1.8L H4 1781cc	1988-1989	Base, Turbo; Exc. air cond.	US9161
2.0L L4 1984cc 121 CID	2010	Mexican Application	US9377	GL-10			
2.0L L4 1998cc 122 CID	2008-2009	Mexican Application	US9377	1.8L H4 1781cc	1985	Base; With air cond.	US9080
2.0L L4 2000cc 122 CID	2006-2007	Mexican Application	US9377	1.8L H4 1781cc	1985	Base; Exc. air cond.	US9161
TOLEDO				1.8L H4 1781cc	1986-1989	Base, Turbo; With air cond.	US9080
1.4L L4 1390cc 85 CID	2013	Mexican Application	US8952	1.8L H4 1781cc	1986-1989	Base, Turbo; Exc. air cond.	US9161
1.4L L4 1390cc 85 CID	2015-2016	Mexican Application	US8952	GLF			
1.8L L4 1781cc 108 CID	2001-2003	Mexican Application	US9377	1.6L H4 1595cc	1980	Base	US9025
1.8L L4 1781cc 109 CID	2003-2005	Mexican Application	US9377	1.8L H4 1781cc	1980-1982	Base	US9025
1.8L L4 1798cc 110 CID	2004	Mexican Application	US9377	IMPREZA			
2.0L L4 1984cc 121 CID	2006	Mexican Application	US9377	1.8L H4 1781cc	1993-1994	Base, L, LS	US9223
SMART				1.8L H4 1781cc	1995	Base, L, Outback	US9223
FORTWO				1.8L H4 1781cc	1996	Brighton, L	US9223
1.0L L3 1000cc 61 CID	2008	Passion, Passion Cabrio, Pure	US8121	1.8L H4 1781cc	1997	Brighton	US9223
1.0L L3 1000cc 61 CID	2009-2010	Brabus, Passion, Passion Cabrio, Pure	US8121	2.0L H4 1994cc	2002-2005	WRX	US9215
1.0L L3 1000cc 61 CID	2011-2015	Passion, Passion Cabrio, Pure	US8121	2.0L H4 1995cc	2012-2015	Base, Limited, Premium, Sport Limited, Sport Premium	US9384
STERLING				2.0L L4 1983cc 121 CID	2008-2009	Mexican Application	US9223
825				2.2L H4 2212cc	1995	L, LX, Outback	US9223
2.5L V6 2494cc	1987-1988	S, SL	US9097	2.2L H4 2212cc	1996	L, Outback	US9223
827				2.2L H4 2212cc	1997	Brighton, L, Outback	US9223
2.7L V6 2675cc	1989-1990	S, SL, SLi	US9097	2.2L H4 2212cc	1998-2001	L, Outback	US9223
SUBARU				2.5L H4 2458cc	1998-2001	RS	US9223
B9 TRIBECA				2.5L H4 2458cc	2002-2004	Outback, RS, TS	US9223
3.0L H6 3000cc	2006-2007	Base, Limited	US9421	2.5L H4 2458cc	2004-2005	WRX STI	US9215
BAJA				2.5L H4 2458cc	2005	Outback Sport, RS	US9223
2.5L H4 2458cc	2003	Base, Sport	US9223	2.5L H4 2458cc	2006	WRX, WRX Limited, WRX STI, WRX TR	US9215
2.5L H4 2458cc	2004-2006	Turbo	US9215	2.5L H4 2458cc	2006-2009	2.5i, Outback Sport	US6049
2.5L H4 2458cc	2004-2006	Sport	US9223	2.5L H4 2458cc	2007	WRX, WRX Limited, WRX STI, WRX STI Limited, WRX TR	US9215
BRAT				2.5L H4 2458cc	2008	WRX	US9255
1.6L H4 1595cc	1980	DL, GL	US9025	2.5L H4 2458cc	2008-2009	WRX STI	US9215
1.8L H4 1781cc	1980-1983	DL, GL	US9025	2.5L H4 2458cc	2009	2.5 GT, WRX, WRX Premium	US9255
1.8L H4 1781cc	1984	GL Turbo	US9093	2.5L H4 2458cc	2010	WRX STI, WRX STI Special Edition	US9215
1.8L H4 1781cc	1984-1987	GL	US9025	2.5L H4 2458cc	2010	2.5 GT, WRX, WRX Limited, WRX Premium	US9255
BRZ				2.5L H4 2458cc	2010-2011	2.5i, 2.5i Premium, Outback Sport	US6049
2.0L H4 1998cc 122 CID	2013-2014	Limited, Premium	US9384	2.5L H4 2458cc	2011-2014	WRX STI, WRX STI Limited	US9215
2.0L H4 1998cc 122 CID	2015	Limited, Premium, Series.Blue	US9384	2.5L H4 2458cc	2011-2014	WRX, WRX Limited, WRX Premium	US9255
DL				2.5L L4 2457cc 150 CID	2010	Mexican Application	US9215
1.6L H4 1595cc	1980-1984	Base	US9025	2.5L L4 2457cc 150 CID	2010-2011	Mexican Application	US6049
1.8L H4 1781cc	1980-1984	Base	US9025	JUSTY			
1.8L H4 1781cc	1985-1989	Base; With air cond.	US9080	1.2L L3 1189cc	1987-1988	DL, GL; Cover	US9486
1.8L H4 1781cc	1985-1989	Base; Exc. air cond.	US9161	1.2L L3 1189cc	1987-1988	DL, GL; Impeller Set	US9486
				1.2L L3 1189cc	1989	DL, GL, RS; Cover	US9486

Engine	Years	Application Description	USMW	Engine	Years	Application Description	USMW
SUBARU (cont'd.)				SUBARU (cont'd.)			
JUSTY (cont'd.)				RX			
1.2L L3 1189cc	1989	DL, GL, RS; Impeller Set	US9486	1.8L H4 1781cc	1986-1989	Turbo; With air cond.	US9080
1.2L L3 1189cc	1990	DL, GL; Cover	US9486	1.8L H4 1781cc	1986-1989	Turbo; Exc. air cond.	US9161
1.2L L3 1189cc	1990	DL, GL; Impeller Set	US9486	STANDARD			
1.2L L3 1189cc	1991-1993	GL; Cover	US9486	1.6L H4 1595cc	1980-1987	Base	US9025
1.2L L3 1189cc	1991-1993	GL; Impeller Set	US9486	1.8L H4 1781cc	1981-1982	Base	US9025
1.2L L3 1189cc	1994	DL, GL; Cover	US9486	SVX			
1.2L L3 1189cc	1994	DL, GL; Impeller Set	US9486	3.3L H6 3318cc	1992	LS, LSL	US9254
LEGACY				3.3L H6 3318cc	1993	LSL	US9254
2.0L L4 1987cc 122 CID	2008	Mexican Application	US9223	3.3L H6 3318cc	1994-1995	L, LS, LSi	US9254
2.2L H4 2212cc	1990	Base, L, LS	US9223	3.3L H6 3318cc	1996-1997	L, LSi	US9254
2.2L H4 2212cc	1991-1993	L, LS, LSi	US9223	TRIBECA			
2.2L H4 2212cc	1991-1994	Sport	US9255	3.6L H6 3630cc	2008-2009	Base, Limited	US6692
2.2L H4 2212cc	1994	Alpine Sport, GT, L, LS, LSi, Outdoor, Sun Sport, Touring	US9223	3.6L H6 3630cc	2010-2012	Limited, Premium, Touring	US6692
2.2L H4 2212cc	1995	Base, Brighton, L, LS, LSi, Outback, Postal	US9223	3.6L H6 3630cc	2013-2014	Limited	US6692
2.2L H4 2212cc	1996	Brighton, L, LS, Outback, Postal	US9223	WRX			
2.2L H4 2212cc	1997	Brighton, L, Postal; From 03/1997	US9223	2.5L L4 2457cc 150 CID	2012-2014	Mexican Application	US9215
2.2L H4 2212cc	1997	Brighton, L, Postal; To 02/1997	US9223	WRX STI			
2.2L H4 2212cc	1998	Brighton, L, Postal	US9223	2.5L H4 2458cc	2015	Base, Launch Edition, Limited	US9215
2.2L H4 2212cc	1999	Brighton, L, L 30th Anniversary, Limited 30th Anniversary	US9223	XT			
2.5L H4 2458cc	1996	GT, LSi, Outback	US9223	1.8L H4 1781cc	1985-1986	DL, GL, GL-10 Turbo	US9080
2.5L H4 2458cc	1997	GT, LSi, Outback, Outback Limited; From 03/1997	US9223	1.8L H4 1781cc	1987	DL, GL, GL-10, GL-10 Turbo	US9080
2.5L H4 2458cc	1997	GT, LSi, Outback, Outback Limited; To 02/1997	US9223	1.8L H4 1781cc	1988	DL, GL	US9080
2.5L H4 2458cc	1998	GT, GT Limited, Outback	US9223	1.8L H4 1781cc	1989-1991	GL	US9080
2.5L H4 2458cc	1999	GT, Limited 30th Anniversary, Outback, Outback Limited, SUS 30th Anniversary	US9223	2.7L H6 2672cc	1988-1991	XT6	US9109
2.5L H4 2458cc	2000	Brighton, GT, GT Limited, L	US9223	XV CROSSTREK			
2.5L H4 2458cc	2001-2002	GT, GT Limited, L	US9223	2.0L H4 1995cc	2013-2014	Limited, Premium	US9384
2.5L H4 2458cc	2003	GT, L, L SE	US9223	2.0L H4 1995cc	2015	Base, Limited, Premium	US9384
2.5L H4 2458cc	2004	GT, L, L 35th Anniversary	US9223	SUZUKI			
2.5L H4 2458cc	2005	GT, GT Limited	US9215	AERIO			
2.5L H4 2458cc	2005	i, Limited	US9223	2.0L L4 2000cc	2002-2003	GS, S, SX	US9342
2.5L H4 2458cc	2006	2.5i	US6049	2.3L L4 2290cc 140 CID	2004-2005	LX, S, SX	US9342
2.5L H4 2458cc	2006	GT, GT spec.B	US9215	2.3L L4 2290cc 140 CID	2006	Base, Premium, SX, SX Premium	US9342
2.5L H4 2458cc	2007-2009	2.5i, 2.5i Limited, 2.5i Special Edition	US6049	2.3L L4 2290cc 140 CID	2007	Base, Premium	US9342
2.5L H4 2458cc	2007-2009	GT Limited, GT spec.B	US9215	EQUATOR			
2.5L H4 2458cc	2010-2012	2.5i, 2.5i Limited, 2.5i Premium	US6049	4.0L V6 3954cc	2009	Base, RMZ-4, Sport	US9426
2.5L H4 2458cc	2010-2012	2.5GT	US8139	4.0L V6 3954cc	2010-2012	RMZ-4, Sport	US9426
2.5L H4 2498cc 152 CID	2013	2.5i, 2.5i Limited, 2.5i Premium	US9384	ESTEEM			
2.5L H4 2498cc 152 CID	2014	2.5i, 2.5i Limited, 2.5i Premium, 2.5i Sport	US9384	1.6L L4 1590cc 97 CID	1995-1996	GL, GLX, GLX Plus	US5048
2.5L H4 2498cc 152 CID	2015	2.5i, 2.5i Limited, 2.5i Premium	US9384	1.6L L4 1590cc 97 CID	1997-2000	GL, GLX, GLX Plus	US9374
2.5L L4 2457cc 150 CID	2011-2013	Mexican Application	US6049	1.8L L4 1790cc	1999-2002	GL, GLX, GLX Plus	US9342
2.5L L4 2457cc 150 CID	2013	Mexican Application	US9215	FORENZA			
3.0L H6 3000cc	2008	3.0 R Limited	US9421	2.0L L4 2000cc	2004-2005	EX, LX, S	US8925
3.0L H6 3000cc	2009	3.0 R, 3.0 R Limited	US9421	2.0L L4 2000cc	2006	Base, Premium	US8925
3.6L H6 3630cc	2010-2012	3.6R, 3.6R Limited, 3.6R Premium	US6692	2.0L L4 2000cc	2007-2008	Base	US8925
3.6L H6 3630cc	2013	3.6R, 3.6R Limited	US6692	GRAND VITARA			
3.6L H6 3630cc	2014-2015	3.6R Limited	US6692	2.4L L4 2393cc	2009	Base, Luxury, Premium, XSport	US6292
3.6L H6 3630cc 222 CID	2014	Mexican Application	US9421	2.4L L4 2393cc	2010	Base, Limited, Premium, XSport	US6292
LOYALE				2.4L L4 2393cc	2011	Base, Limited, Premium	US6292
1.8L H4 1781cc	1990	Base, RS, RS Turbo, Turbo	US9161	2.4L L4 2393cc	2012	Base, Limited, Premium, Ultimate Adventure Edition	US6292
1.8L H4 1781cc	1991-1994	Base	US9161	2.4L L4 2393cc	2013	Base, Limited, Premium	US6292
OUTBACK				2.4L L4 2393cc 146 CID	2010-2015	Mexican Application	US6292
2.5L H4 2458cc	2000-2004	Base, Limited	US9223	2.5L V6 2500cc	1999	JLX, JLX Plus, JS, JS Plus	US9385
2.5L H4 2458cc	2005	XT, XT Limited	US9215	2.5L V6 2500cc	2000	JLS, JLS Plus, JLX, JLX Plus, Limited	US9385
2.5L H4 2458cc	2005	i, Limited	US9223	2.5L V6 2500cc	2001	JLS, JLS Plus, JLS Plus SE, JLX, JLX Plus, JLX Plus SE, Limited	US9385
2.5L H4 2458cc	2006	2.5i, 2.5i Limited	US6049	2.5L V6 2500cc	2002	JLS, JLX, Limited	US9385
2.5L H4 2458cc	2006	XT	US9215	2.5L V6 2500cc	2003	Base	US9385
2.5L H4 2458cc	2007	2.5i, 2.5i Basic, 2.5i Limited	US6049	2.5L V6 2500cc	2004-2005	EX, LX	US9385
2.5L H4 2458cc	2007-2009	XT Limited	US9215	2.7L V6 2737cc	2001	XL-7, XL-7 Limited, XL-7 Plus, XL-7 Touring	US9385
2.5L H4 2458cc	2008	2.5i, 2.5i L.L. Bean Edition, 2.5i Limited, 2.5i Limited L.L. Bean Edition, Base	US6049	2.7L V6 2737cc	2006	Base, Luxury, Premium, XSport	US9385
2.5L H4 2458cc	2009	2.5i, 2.5i Limited	US6049	2.7L V6 2737cc	2007-2008	Base, Luxury, XSport	US9385
2.5L H4 2458cc	2010-2012	2.5i, 2.5i Limited, 2.5i Premium	US6049	3.2L V6 3195cc	2009	Luxury, XSport	US8932
2.5L H4 2498cc 152 CID	2013-2015	2.5i, 2.5i Limited, 2.5i Premium	US9384	3.2L V6 3195cc	2010	Limited, XSport	US8932
2.5L L4 2457cc 150 CID	2013	Mexican Application	US6049	KIZASHI			
3.0L H6 3000cc	2001	L.L. Bean, VDC	US9421	2.4L L4 2388cc 146 CID	2010	GTS, S, SE, SLS	US6292
3.0L H6 3000cc	2002-2003	H6, L.L. Bean, VDC	US9421	2.4L L4 2388cc 146 CID	2011-2012	S, SE, Sport GTS, Sport SLS	US6292
3.0L H6 3000cc	2004	H6, H6 35th Anniversary Edition, H6 VDC, L.L. Bean	US9421	2.4L L4 2388cc 146 CID	2013	Base, GTS, SE, SLS	US6292
3.0L H6 3000cc	2005	R, R L.L. Bean Edition, VDC Limited	US9421	RENO			
3.0L H6 3000cc	2006	R, R L.L. Bean Edition, R VDC Limited	US9421	2.0L L4 1998cc	2005	EX, LX, S	US8925
3.0L H6 3000cc	2007-2008	R L.L. Bean Edition	US9421	2.0L L4 1998cc	2006	Base, Convenience, Premium	US8925
3.0L H6 3000cc	2009	3.0 R Limited	US9421	2.0L L4 1998cc	2007	Base	US8925
3.6L H6 3630cc	2010-2012	3.6R, 3.6R Limited, 3.6R Premium	US6692	2.0L L4 1998cc 122 CID	2008	Base	US8925
3.6L H6 3630cc	2013	3.6R, 3.6R Limited	US6692	SAMURAI			
3.6L H6 3630cc	2014-2015	3.6R Limited	US6692	1.3L L4 1298cc 79 CID	1990	JL	US5029
3.6L H6 3630cc 222 CID	2014	Mexican Application	US9421	1.3L L4 1298cc 79 CID	1991	JA, JL, JS	US5029

WATER PUMPS



WATER PUMP APPLICATION GUIDE



Engine	Years	Application Description	USMWW	Engine	Years	Application Description	USMWW
SUZUKI (cont'd.)				TOYOTA (cont'd.)			
SAMURAI (cont'd.)				86			
1.3L L4 1298cc 79 CID	1992-1993	JA, JL	US5029	2.0L H4 1998cc 122 CID	2017	Base, Special Edition	US9384
1.3L L4 1298cc 79 CID	1994-1995	JL	US5029	AVALON			
1.3L L4 1325cc 81 CID	1986-1987	JA, JX, JX SE	US5029	2.5L L4 2494cc 152 CID	2014	Hybrid Limited, Hybrid XLE	US6211
1.3L L4 1325cc 81 CID	1988	JA, JX	US5029	2.5L L4 2494cc 152 CID	2015	Hybrid Limited, Hybrid XLE Premium, Hybrid XLE Touring	US6211
1.3L L4 1325cc 81 CID	1989	Base	US5029	2.5L L4 2494cc 152 CID	2016-2017	Hybrid Limited, Hybrid XLE Plus, Hybrid XLE Premium	US6211
SIDEKICK				3.0L V6 2995cc	1995	XL, XLS	US9306
1.3L L4 1325cc 81 CID	1989	JA	US5029	3.0L V6 2995cc	1996	XL	US9306
1.6L L4 1590cc 97 CID	1989	JLX, JX	US5048	3.0L V6 2995cc	1997-2004	XL, XLS	US9306
1.6L L4 1590cc 97 CID	1990	JLX, JS, JX	US5048	3.5L V6 3456cc	2005-2008	Limited, Touring, XL, XLS	US6047
1.6L L4 1590cc 97 CID	1991	JL, JLX, JS, JX	US5048	3.5L V6 3456cc	2009-2010	Limited, XL, XLS	US6047
1.6L L4 1590cc 97 CID	1992	JLX, JS, JX	US5048	3.5L V6 3456cc	2011	Base, Limited, XLS	US6047
1.6L L4 1590cc 97 CID	1993	Base, JLX, JS, JX	US5048	3.5L V6 3456cc	2012	Base, Limited	US6047
1.6L L4 1590cc 97 CID	1994-1995	JLX, JS, JX	US5048	3.5L V6 3456cc	2013-2014	Limited, XLE	US6047
1.6L L4 1590cc 97 CID	1996-1998	JS, JX	US5048	3.5L V6 3456cc	2015	Limited, XLE, XLE Premium, XLE Touring, XLE Touring SE	US6047
1.8L L4 1840cc	1996	JLX Sport, JX Sport	US9342	3.5L V6 3456cc	2016-2017	Limited, Touring, XLE, XLE Plus, XLE Premium	US6047
1.8L L4 1840cc	1997-1998	JLX Sport, JS Sport, JX Sport	US9342	AVANZA			
SJ410				CAMRY			
1.0L L3 993cc 61 CID	1982	To Vin# F10A548473	US9227	1.8L L4 1839cc	1984-1986	DLX	US9059
1.0L L3 993cc 61 CID	1982	From Vin# F10A548474	US9232	2.0L L4 1974cc	1986	DLX	US9059
1.0L L4 970cc 59 CID	1983-1984	To Vin# F10A548473	US9227	2.0L L4 1995cc	1983-1986	DLX, LE	US9048
1.0L L4 970cc 59 CID	1983-1984	From Vin# F10A548474	US9232	2.0L L4 1998cc 122 CID	1987	DLX, LE; Pump only	US9099
SWIFT				2.0L L4 1998cc 122 CID	1987	DLX, LE; Includes back housing	US9099-2
1.3L L4 1298cc 79 CID	1989	GLX, GTI	US5058	2.0L L4 1998cc 122 CID	1988-1991	Base, DLX, DLX All Trac, LE, LE All Trac; Pump only	US9099
1.3L L4 1298cc 79 CID	1990	GA, GL, GLX, GS, GT, S	US5058	2.0L L4 1998cc 122 CID	1988-1991	Base, DLX, DLX All Trac, LE, LE All Trac; Includes back housing	US9099-2
1.3L L4 1298cc 79 CID	1991-1994	GA, GS, GT	US5058	2.2L L4 2164cc	1992	DLX, LE, XLE; Pump only	US9099
1.3L L4 1298cc 79 CID	1995-1999	Base	US5058	2.2L L4 2164cc	1992	DLX, LE, XLE; Includes back housing	US9099-2
1.3L L4 1298cc 79 CID	2000-2001	GA, GL	US5058	2.2L L4 2164cc	1993-1996	DX, LE, XLE; Pump only	US9099
1.5L L4 1500cc 92 CID	2007-2009	Mexican Application	US9374	2.2L L4 2164cc	1993-1996	DX, LE, XLE; Includes back housing	US9099-2
SX4				2.2L L4 2164cc	1997-2001	CE, LE, XLE; Pump only	US9099
2.0L L4 1995cc	2007-2009	Base, Sport	US9342	2.2L L4 2164cc	1997-2001	CE, LE, XLE; Includes back housing	US9099-2
2.0L L4 1995cc	2010	Base, Crossover, LE, Sportback, Sport GTS, Sport S, Sport SE	US6292	2.4L L4 2362cc	2002-2004	LE, SE, XLE; Exc.Japan Built Part	US9414
2.0L L4 1995cc	2011	Crossover, LE, LE Anniversary Edition, Sportback, Sport GTS, Sport S, Sport SE	US6292	2.4L L4 2362cc	2002-2004	LE, SE, XLE; Japan Built Part	US9414
2.0L L4 1995cc	2012-2013	Crossover, LE, Sportback, Sport SE	US6292	2.4L L4 2362cc	2005-2006	Base, LE, SE, XLE; Exc.Japan Built Part	US9414
VERONA				2.4L L4 2362cc	2005-2006	Base, LE, SE, XLE; Japan Built Part	US9414
2.5L L6 2492cc	2004-2005	EX, LX, S	US6241	2.4L L4 2362cc	2007-2008	CE, LE, SE, XLE; Exc.Japan Built Part	US9414
2.5L L6 2492cc	2006	Base, Luxury	US6241	2.4L L4 2362cc	2007-2008	CE, LE, SE, XLE; Japan Built Part	US9414
VITARA				2.4L L4 2362cc	2007-2008	Hybrid; Exc.Japan Built, Exc.Japan Built Part	US9414
1.6L L4 1590cc 97 CID	1999	JS, JS Plus, JX, JX Plus	US9374	2.4L L4 2362cc	2007-2008	Hybrid; Exc.Japan Built, Japan Built Part	US9414
1.6L L4 1590cc 97 CID	2000-2001	JLS, JLX, JS, JX	US9374	2.4L L4 2362cc	2007-2008	Hybrid; Exc.Japan Built, Japan Built Part	US9414
2.0L L4 2000cc	1999	JS, JS Plus, JX, JX Plus	US9342	2.4L L4 2362cc	2007-2008	Hybrid; Exc.Japan Built, Japan Built Part	US9414
2.0L L4 2000cc	2000-2001	JLS, JLX, JS, JX	US9342	2.4L L4 2362cc	2007-2011	Hybrid; ELECTRIC/GAS; HVAC System	US11012
2.0L L4 2000cc	2002	JLS, JLX	US9342	2.4L L4 2362cc	2009	Base, LE, SE, XLE; Exc.Japan Built Part	US9414
2.0L L4 2000cc	2003	Base	US9342	2.4L L4 2362cc	2009	Base, LE, SE, XLE; Japan Built Part	US9414
2.5L V6 2500cc	2004	LX	US9385	2.4L L4 2362cc	2009	Hybrid; Exc.Japan Built, Exc.Japan Built Part, To 03/2009	US9414
X-90				2.4L L4 2362cc	2009	Hybrid; Exc.Japan Built, Japan Built Part, To 03/2009	US9414
1.6L L4 1590cc 97 CID	1996-1997	Base	US5048	2.4L L4 2362cc	2010-2011	LE, SE, XLE; Engine Serial # Starts With 0 or 6, Exc.Japan Built	US6252
1.6L L4 1590cc 97 CID	1998	Base, SE	US5048	2.5L L4 2494cc 152 CID	2010-2011	LE, SE, XLE; Engine Serial # Starts With A or D, Exc.Japan Built	US6252
XL-7				2.5L L4 2494cc 152 CID	2010-2011	LE, SE, XLE; Japan Built	US6252
2.7L V6 2737cc	2002	Base, Limited, Plus, Touring	US9385	2.5L L4 2494cc 152 CID	2012-2013	L, LE, SE, XLE	US6252
2.7L V6 2737cc	2003	Limited, Touring	US9385	2.5L L4 2494cc 152 CID	2014	L, LE, SE, SE Sport, XLE	US6252
2.7L V6 2737cc	2004-2005	EX, LX	US9385	2.5L L4 2494cc 152 CID	2014-2017	Hybrid LE, Hybrid SE, Hybrid XLE	US6211
2.7L V6 2737cc	2006	Base, Premium	US9385	2.5L L4 2494cc 152 CID	2015	LE, SE, XLE, XSE	US6252
3.6L V6 3564cc	2007	Base, Limited, Luxury	US8932	2.5L L4 2494cc 152 CID	2016	LE, SE, Special Edition, XLE, XSE	US6252
3.6L V6 3564cc	2008	Base, Limited, Luxury, Premium	US8932	2.5L L4 2494cc 152 CID	2017	LE, SE, XLE, XSE	US6252
3.6L V6 3564cc	2009	Limited, Luxury, Premium	US8932	2.5L V6 2508cc	1988-1991	DLX, LE	US9258
TOYOTA				3.0L V6 2959cc	1992	DLX, LE, SE, XLE	US9258
4RUNNER				3.0L V6 2959cc	1993	DX, LE, SE, XLE	US9258
2.4L L4 2366cc	1984	DLX, SR5	US9017	3.0L V6 2995cc	1994-1996	LE, SE, XLE	US9306
2.4L L4 2366cc	1985-1989	DLX, SR5	US9141	3.0L V6 2995cc	1997-1998	CE, LE, XLE	US9306
2.4L L4 2366cc	1990-1995	SR5	US9141	3.0L V6 2995cc	1999-2001	LE, XLE	US9306
2.7L L4 2694cc	1996-2000	Base	US9293	3.0L V6 2995cc	2002-2003	LE, SE, XLE	US9306
2.7L L4 2694cc	2010	SR5	US9293	3.0L V6 2995cc	2004-2006	LE, XLE	US9306
3.0L V6 2959cc	1988	SR5	US9142	3.0L V6 2995cc	2004	SE	US9306
3.0L V6 2959cc	1989	DLX, SR5; Standard Trans	US9142	3.0L V6 2995cc	2005-2006	SE	US9306
3.0L V6 2959cc	1989	DLX, SR5; Automatic Trans	US9145	3.5L V6 3456cc	2007-2011	LE, SE, XLE	US6047
3.0L V6 2959cc	1990	SR5; Standard Trans	US9142	3.5L V6 3456cc	2012-2014	SE, XLE	US6047
3.0L V6 2959cc	1990	SR5; Automatic Trans	US9145	3.5L V6 3456cc	2015-2017	XLE, XSE	US6047
3.0L V6 2959cc	1991-1992	SR5	US9145	CELICA			
3.0L V6 2959cc	1993-1995	SR5	US9291	1.6L L4 1587cc	1990-1993	ST	US9057
3.0L V6 2959cc	1993-1995	W/O BYPASS TUBE	US9320	1.8L L4 1762cc 107 CID	1994-1997	ST	US9272
3.4L V6 3378cc	1996-2000	Limited, SR5	US9324				
3.4L V6 3378cc	2001	Base, Limited, SR5	US9324				
3.4L V6 3378cc	2002	Limited, SR5	US9324				
4.0L V6 3956cc 241 CID	2003-2009	Limited, Sport, SR5	US6037				
4.0L V6 3956cc 241 CID	2010-2014	Limited, SR5, Trail	US6599				
4.0L V6 3956cc 241 CID	2015-2016	Limited, SR5, Trail, TRD Pro	US6599				
4.0L V6 3956cc 241 CID	2017	Limited, SR5, TRD Off-Road, TRD Pro	US6599				
4.7L V8 4663cc 285 CID	2003-2009	Limited, Sport, SR5	US9257				

Engine	Years	Application Description	USMW	Engine	Years	Application Description	USMW
TOYOTA (cont'd.)				TOYOTA (cont'd.)			
CELICA (cont'd.)				CORONA (cont'd.)			
1.8L L4 1762cc 107 CID	1994-1997	ST; Includes back housing	US9272-2	2.4L L4 2366cc	1981-1982	DLX, LE	US9017
1.8L L4 1794cc	2000-2005	GT	US9376	CRESSIDA			
1.8L L4 1795cc	2000-2005	GTS	US9405	2.6L L6 2563cc	1978-1979		US9170
2.0L L4 1995cc	1986	ST	US9048	2.6L L6 2563cc	1978-1979		US9180
2.0L L4 1998cc	1986	GT	US9048	2.8L L6 2754cc	1983-1988	Luxury	US9040N
2.0L L4 1998cc	1986-1989	GTS	US9140	3.0L L6 2954cc	1989-1992	Luxury	US9100
2.0L L4 1998cc 122 CID	1987-1989	GT, ST; Pump only	US9099	CROWN			
2.0L L4 1998cc 122 CID	1987-1989	GT, ST; Includes back housing	US9099-2	2.3L L6 2253cc 138 CID	1967-1971		US9180
2.0L L4 1998cc 122 CID	1988-1992	All Trac	US9140	ECHO			
2.0L L4 1998cc 122 CID	1993	GTS All Trac	US9140	1.5L L4 1497cc	2000-2005	Base	US9406
2.2L L4 2164cc	1990-1993	GT, GTS; Pump only	US9099	FJ CRUISER			
2.2L L4 2164cc	1990-1993	GT, GTS; Includes back housing	US9099-2	4.0L V6 3956cc 241 CID	2007	Base, TRD Special Edition	US6037
2.2L L4 2164cc	1994-1999	GT; Pump only	US9099	4.0L V6 3956cc 241 CID	2008	Base, Trail Teams Special Edition	US6037
2.2L L4 2164cc	1994-1999	GT; Includes back housing	US9099-2	4.0L V6 3956cc 241 CID	2009	Base	US6037
2.2L L4 2189cc	1975-1977		US9027	4.0L V6 3956cc 241 CID	2010-2014	Base	US6599
2.2L L4 2189cc	1978-1979		US9017	4.0L V6 3956cc 241 CID	2013-2014	Mexican Application	US6599
2.2L L4 2189cc	1980	GT, ST	US9017	HIACE			
2.4L L4 2366cc	1981-1982	GT, ST	US9017	2.7L L4 2694cc 164 CID	2006-2009	Mexican Application	US9293
2.4L L4 2366cc	1983-1984	GT, GTS, ST	US9017	2.7L L4 2694cc 164 CID	2011-2012	Mexican Application	US9293
2.4L L4 2366cc	1985	GT, GTS, ST	US9141	HIGHLANDER			
2.6L L6 2563cc	1979	Supra	US9170	2.4L L4 2362cc	2001-2007	Base	US9414
2.6L L6 2563cc	1979	Supra	US9180	2.7L L4 2672cc 163 CID	2009-2011	Base	US6252
2.8L L6 2754cc	1982-1986	Supra	US9040N	2.7L L4 2672cc 163 CID	2012	Base, SE	US6252
COROLLA				2.7L L4 2672cc 163 CID	2013	Base, Plus	US6252
1.2L L4 1166cc	1977		US9021	2.7L L4 2672cc 163 CID	2014-2017	LE	US6252
1.2L L4 1166cc	1978-1979		US9015	3.0L V6 2995cc	2001-2003	Base, Limited	US9306
1.2L L4 1166cc 71 CID	1971-1974		US1006	3.3L V6 3300cc	2004	Base, Limited	US9306
1.6L L4 1587cc	1983	Base, DLX, SR5	US9057	3.3L V6 3300cc 202 CID	2005	Base, Limited	US9306
1.6L L4 1587cc	1984	Base, DLX, LE	US9057	3.3L V6 3300cc 202 CID	2006-2007	Base, Hybrid, Hybrid Limited, Limited, Sport	US9306
1.6L L4 1587cc	1984-1987	Sport DLX, Sport SR5	US9046	3.3L V6 3300cc 202 CID	2008-2010	Hybrid, Hybrid Limited	US9306
1.6L L4 1587cc	1985-1986	DLX, LE, LE Limited	US9057	3.5L V6 3456cc	2008-2009	Base, Limited, Sport	US6047
1.6L L4 1587cc	1985-1987	Sport GTS	US9075	3.5L V6 3456cc	2010	Base, Limited, SE, Sport	US6047
1.6L L4 1587cc	1987	DLX, FX, LE	US9057	3.5L V6 3456cc	2011	Base, Hybrid, Hybrid Limited, Limited	US6047
1.6L L4 1587cc	1987	FX16, FX16 GTS	US9076	3.5L V6 3456cc	2012	Base, Hybrid, Hybrid Limited, Limited, SE	US6047
1.6L L4 1587cc	1988	DLX, DLX All Trac, FX, LE, SR5, SR5 All Trac	US9057	3.5L V6 3456cc	2013	Base, Hybrid, Hybrid Limited, Limited, Plus, SE	US6047
1.6L L4 1587cc	1988	FX16, FX16 GTS, GTS	US9076	3.5L V6 3456cc	2014-2016	Hybrid Limited, LE, LE Plus, Limited, XLE	US6047
1.6L L4 1587cc	1989	DLX, DLX All Trac, LE, SR5, SR5 All Trac	US9057	3.5L V6 3456cc	2017	Hybrid LE, Hybrid Limited, Hybrid XLE, LE, LE Plus, Limited, SE, XLE	US8150
1.6L L4 1587cc	1989-1991	GTS	US9076	HILUX			
1.6L L4 1587cc	1990	Base, DLX, DLX All Trac, LE, SR5, SR5 All Trac	US9057	2.7L L4 2694cc 164 CID	2004-2010	Mexican Application	US9293
1.6L L4 1587cc	1991	Base, DLX, DLX All Trac, LE, SR5	US9057	LAND CRUISER			
1.6L L4 1587cc	1992	Base, DLX, DLX All Trac, LE	US9057	3.9L L6 3878cc	1969-1974		US9078
1.6L L4 1587cc	1993-1996	Base	US9271	4.0L L6 3956cc	1988-1989	Base	US9155
1.6L L4 1587cc	1997	Base, CE	US9271	4.0L L6 3956cc	1990	Base; From 01/1990	US9155
1.6L L4 1588cc	1975		US9012	4.0L L6 3956cc	1990	Base; To 01/1990	US9155
1.6L L4 1588cc	1976	To 12/75	US9012	4.0L L6 3956cc	1991-1992	Base	US9155
1.6L L4 1588cc	1976	From 12/75	US9012	4.2L L6 4227cc	1977-1979	(Exc.Oil Cooler)	US9327
1.6L L4 1588cc	1977-1979		US9018	4.2L L6 4227cc	1977-1979	(Exc.Oil Cooler) (To 01/79)	US9493
1.8L L4 1762cc 107 CID	1993-1995	DX, LE	US9272	4.2L L6 4227cc	1979	(From 01/79)	US9189
1.8L L4 1762cc 107 CID	1993-1995	DX, LE; Includes back housing	US9272-2	4.2L L6 4227cc	1980	Base	US9189
1.8L L4 1762cc 107 CID	1996	DX	US9272	4.2L L6 4227cc	1981-1987	Base	US9337
1.8L L4 1762cc 107 CID	1996	DX; Includes back housing	US9272-2	4.5L L6 4477cc	1993-1997	Base	US9269
1.8L L4 1762cc 107 CID	1997	CE, DX, LE	US9272	4.7L V8 4663cc 285 CID	1998-2007	Base	US9257
1.8L L4 1762cc 107 CID	1997	CE, DX, LE; Includes back housing	US9272-2	5.7L V8 5663cc 345 CID	2008-2011	Base	US6197
1.8L L4 1770cc	1980-1982	Base, DLX, SR5	US9018	5.7L V8 5663cc 345 CID	2013-2017	Base	US6197
1.8L L4 1794cc	1998	CE, LE, VE; Exc.Japan Built Part	US9376	MARK II			
1.8L L4 1794cc	1998	CE, LE, VE; Japan Built Part	US9376	2.6L L6 2563cc	1974-1976		US9180
1.8L L4 1794cc	1999-2000	CE, LE, VE	US9376	MATRIX			
1.8L L4 1794cc	2001-2002	CE, LE, S	US9376	1.8L L4 1794cc	2003-2008	Base, XR	US9376
1.8L L4 1794cc	2003-2008	CE, LE, S; Exc.Japan Built	US9376	1.8L L4 1795cc	2003	XRS	US9405
1.8L L4 1794cc	2003-2008	CE, LE, S; Japan Built	US9376	1.8L L4 1795cc	2004	XRS; From 05/04	US9405
1.8L L4 1795cc	2005-2006	XRS	US9405	1.8L L4 1795cc	2004	XRS; To 05/04	US9405
1.8L L4 1798cc	2009-2010	Base, LE, S, XLE	US6232	1.8L L4 1795cc	2005-2006	XRS	US9405
1.8L L4 1798cc	2011	Base, LE, S; Exc.Japan Built Part	US6232	1.8L L4 1798cc	2009-2010	Base	US6232
1.8L L4 1798cc	2011	Base, LE, S; Japan Built Part	US6232	1.8L L4 1798cc	2011-2013	Base; Exc.Japan Built Part	US6232
1.8L L4 1798cc	2012-2015	L, LE, S; Exc.Japan Built Part	US6232	1.8L L4 1798cc	2011-2013	Base; Japan Built Part	US6232
1.8L L4 1798cc	2012-2015	L, LE, S; Japan Built Part	US6232	2.4L L4 2362cc	2009-2010	S, XRS; Exc.Japan Built Part	US9414
1.8L L4 1798cc	2014-2015	L, LE, S	US6232	2.4L L4 2362cc	2009-2010	S, XRS; Japan Built Part	US9414
1.8L L4 1798cc	2016	L, LE, S, Special Edition	US6232	2.4L L4 2362cc	2011	S	US9414
1.8L L4 1798cc	2017	50th Anniversary Special Edition, L, LE, SE, XLE, XSE	US6232	2.4L L4 2362cc	2012	S; From 04/2012	US9414
1.8L L4 1839cc	1984-1985	DLX	US9059	2.4L L4 2362cc	2012	S; To 04/2012	US9414
2.4L L4 2362cc	2009-2010	XRS; Engine # 0XXXXXX-6XXXXXX, Engine # 0XXXXXX-BXXXXXX, Engine # 0XXXXXX-HXXXXXX	US9414	2.4L L4 2362cc	2013	S	US9414
2.4L L4 2362cc	2009-2010	XRS; Engine # 7XXXXXX-9XXXXXX, Engine # 7XXXXXX-A9XXXXXX, Engine # 7XXXXXX-AXXXXXX	US9414	MR2			
CORONA				1.6L L4 1587cc	1985-1987	GT	US9076
1.9L L4 1897cc 116 CID	1968-1970		US9181	1.6L L4 1587cc	1988-1989	GT, Super Charged	US9076
2.2L L4 2189cc	1975		US9005	2.0L L4 1998cc 122 CID	1991-1995	Turbo	US9140
2.2L L4 2189cc	1976	From 09/75	US9027	2.2L L4 2164cc	1991-1995	Base; Pump only	US9099
2.2L L4 2189cc	1977		US9027				
2.2L L4 2189cc	1978-1979		US9017				
2.2L L4 2189cc	1980	DLX, LE	US9017				

WATER PUMPS

Engine	Years	Application Description	USMW
TOYOTA (cont'd.)			
MR2 (cont'd.)			
2.2L L4 2164cc	1991-1995	Base; Includes back housing	US9099-2
MR2 SPYDER			
1.8L L4 1794cc	2000-2005	Base	US9376
1.8L L4 1794cc	2006		US9376
PASEO			
1.5L L4 1497cc	1992-1994	Base	US9098
1.5L L4 1497cc	1995-1996	Base	US9334
1.5L L4 1497cc	1997	Base, Convertible; From 11/1996	US9334
1.5L L4 1497cc	1997	Base, Convertible; To 11/1996	US9334
1.5L L4 1497cc	1998	Base, Convertible	US9334
PICKUP			
2.2L L4 2188cc	1981-1982	DLX	US9094
2.2L L4 2188cc	1983	DLX, SR5	US9094
2.2L L4 2189cc	1975		US9005
2.2L L4 2189cc	1976-1977		US9027
2.2L L4 2189cc	1978-1979		US9017
2.2L L4 2189cc	1980	Base, DLX, SR5	US9017
2.4L L4 2366cc	1981-1984	Base, DLX, SR5	US9017
2.4L L4 2366cc	1985	Base, DLX, SR5, SR5 Turbo	US9141
2.4L L4 2366cc	1986-1987	Base, Base Turbo, DLX, SR5, SR5 Turbo	US9141
2.4L L4 2366cc	1988	Base, DLX, SR5, SR5 Turbo	US9141
2.4L L4 2366cc	1989-1990	Base, DLX, SR5	US9141
2.4L L4 2366cc	1991-1995	Base, DLX	US9141
2.4L L4 2446cc	1984	DLX	US9200
2.4L L4 2446cc	1985	DLX, DLX Turbo	US9200
3.0L V6 2959cc	1988	Base, DLX, SR5	US9142
3.0L V6 2959cc	1989	DLX, SR5; 4WD, Standard Trans	US9142
3.0L V6 2959cc	1989	DLX, SR5; RWD, Standard Trans; 1/2 Ton Chassis	US9142
3.0L V6 2959cc	1989	DLX, SR5; 4WD, Automatic Trans	US9145
3.0L V6 2959cc	1989	DLX, SR5; Automatic Trans, RWD; 1/2 Ton Chassis	US9145
3.0L V6 2959cc	1989	DLX, SR5; RWD; 1 Ton Chassis	US9145
3.0L V6 2959cc	1990	DLX, SR5; 4WD, Standard Trans; To 02/1990	US9142
3.0L V6 2959cc	1990	DLX, SR5; RWD, Standard Trans; 1/2 Ton Chassis, To 02/1990	US9142
3.0L V6 2959cc	1990	DLX, SR5; 4WD, Automatic Trans; To 02/1990	US9145
3.0L V6 2959cc	1990	DLX, SR5; 4WD; From 02/1990	US9145
3.0L V6 2959cc	1990	DLX, SR5; Automatic Trans, RWD; 1/2 Ton Chassis, To 02/1990	US9145
3.0L V6 2959cc	1990	DLX, SR5; RWD; 1 Ton Chassis, To 02/1990	US9145
3.0L V6 2959cc	1990	DLX, SR5; RWD; From 02/1990	US9145
3.0L V6 2959cc	1991-1992	DLX, SR5	US9145
3.0L V6 2959cc	1993-1995	DLX, SR5	US9291
3.0L V6 2959cc	1993-1995	W/O BYPASS TUBE	US9320
PREVIA			
2.4L L4 2438cc	1991-1997	DX, LE	US9216
PRIUS			
1.5L L4 1497cc	2001-2006	Base	US9406
1.5L L4 1497cc	2004-2006	Base; ELECTRIC/GAS; HVAC System	US11011
1.5L L4 1497cc	2004-2006	Base; ELECTRIC/GAS; Heat Storage Tank Assy.	US11013
1.5L L4 1497cc	2007-2009	Base, Touring	US9406
1.5L L4 1497cc	2007-2009	Base, Touring; ELECTRIC/GAS; HVAC System	US11011
1.5L L4 1497cc	2007-2009	Base, Touring; ELECTRIC/GAS; Heat Storage Tank Assy.	US11013
1.8L L4 1798cc 110 CID	2010-2011	Base	US6682
1.8L L4 1798cc 110 CID	2012-2014	Five, Four, Three, Two	US6682
1.8L L4 1798cc 110 CID	2013-2014	Mexican Application	US6682
1.8L L4 1798cc 110 CID	2015	Five, Four, One, Persona Series, Three, Two	US6682
PRIUS C			
1.5L L4 1497cc 91 CID	2012-2015	Four, One, Three, Two	US6682
1.5L L4 1497cc 91 CID	2016	Four, One, Persona Series, Three, Two	US6682
1.5L L4 1497cc 91 CID	2017	Four, One, Three, Two	US6682
PRIUS PLUG-IN			
1.8L L4 1798cc 110 CID	2012	Base	US6682
1.8L L4 1798cc 110 CID	2013		US6682
1.8L L4 1798cc 110 CID	2014-2015	Base	US6682
PRIUS V			
1.8L L4 1798cc 110 CID	2012-2014	Five, Three, Two	US6682
1.8L L4 1798cc 110 CID	2015-2017	Five, Four, Three, Two	US6682
RAV4			
2.0L L4 1998cc 122 CID	1996-2000	Base; Pump only	US9099
2.0L L4 1998cc 122 CID	1996-2000	Base; Includes back housing	US9099-2
2.0L L4 1998cc 122 CID	2001-2003	Base	US9414
2.4L L4 2362cc	2004	Base	US9414
2.4L L4 2362cc	2005	Base, L, Sport	US9414

Engine	Years	Application Description	USMW
TOYOTA (cont'd.)			
RAV4 (cont'd.)			
2.4L L4 2362cc	2006-2008	Base, Limited, Sport	US9414
2.5L L4 2494cc 152 CID	2009-2012	Base, Limited, Sport	US6252
2.5L L4 2494cc 152 CID	2013-2015	LE, Limited, XLE	US6252
2.5L L4 2494cc 152 CID	2016	LE, Limited, SE, XLE	US6252
2.5L L4 2494cc 152 CID	2017	LE, Limited, Platinum, SE, XLE	US6252
3.5L V6 3456cc	2006-2012	Base, Limited, Sport	US6047
SEQUOIA			
4.6L V8 4608cc	2010-2011	Limited, SR5; Exc.Japan Built Part	US6336
4.6L V8 4608cc	2010-2011	Limited, SR5; Japan Built Part	US6336
4.6L V8 4608cc	2012	SR5; Exc.Japan Built Part	US6336
4.6L V8 4608cc	2012	SR5; Japan Built Part	US6336
4.7L V8 4663cc 285 CID	2001-2008	Limited, SR5	US9257
4.7L V8 4663cc 285 CID	2009	Limited, SR5; From 11/2008	US9257
4.7L V8 4663cc 285 CID	2009	Limited, SR5; To 11/2008	US9257
5.7L V8 5663cc 345 CID	2008-2009	Limited, Platinum, SR5	US6197
5.7L V8 5663cc 345 CID	2010	Limited, Platinum, SR5; Exc.Japan Built Part	US6197
5.7L V8 5663cc 345 CID	2010	Limited, Platinum, SR5; Japan Built Part	US6197
5.7L V8 5663cc 345 CID	2011-2017	Limited, Platinum, SR5	US6197
SIENNA			
2.7L L4 2672cc 163 CID	2011-2012	Base, LE	US6252
3.0L V6 2995cc	1998	CE, LE	US9306
3.0L V6 2995cc	1999	CE, LE, XLE	US9306
3.0L V6 2995cc	2000	CE, LE	US9306
3.0L V6 2995cc	2001-2003	CE, LE, XLE	US9306
3.3L V6 3300cc 202 CID	2004-2005	CE, LE, XLE, XLE Limited	US9306
3.3L V6 3300cc 202 CID	2006	CE, LE, Limited, XLE	US9306
3.5L V6 3456cc	2007-2008	CE, LE, Limited, XLE	US6047
3.5L V6 3456cc	2009	CE, LE, XLE; From 01/2009	US6047
3.5L V6 3456cc	2009	CE, LE, XLE; To 01/2009	US6047
3.5L V6 3456cc	2010	CE, LE, XLE	US6047
3.5L V6 3456cc	2011-2012	Base, LE, Limited, SE, XLE	US6047
3.5L V6 3456cc	2013	Base, L, LE, Limited, SE, XLE	US6047
3.5L V6 3456cc	2014-2016	L, LE, Limited, SE, XLE	US6047
3.5L V6 3456cc	2017	L, LE, Limited, SE, XLE	US8150
SOLARA			
2.2L L4 2164cc	1999-2001	SE; Pump only	US9099
2.2L L4 2164cc	1999-2001	SE; Includes back housing	US9099-2
2.4L L4 2362cc	2002-2003	SE; Exc.Japan Built Part	US9414
2.4L L4 2362cc	2002-2003	SE; Japan Built Part	US9414
2.4L L4 2362cc	2004-2005	SE, SLE; Exc.Japan Built Part	US9414
2.4L L4 2362cc	2004-2005	SE, SLE; Japan Built Part	US9414
2.4L L4 2362cc	2006	SE, SE Sport, SLE; Exc.Japan Built Part	US9414
2.4L L4 2362cc	2006	SE, SE Sport, SLE; Japan Built Part	US9414
2.4L L4 2362cc	2007-2008	SE, SLE, Sport; Exc.Japan Built Part	US9414
2.4L L4 2362cc	2007-2008	SE, SLE, Sport; Japan Built Part	US9414
3.0L V6 2995cc	1999-2003	SE, SLE	US9306
3.0L V6 3300cc	2004	SE, SLE	US9306
3.0L V6 3300cc 202 CID	2005	SE, SLE	US9306
3.0L V6 3300cc 202 CID	2006	SE, SE Sport, SLE	US9306
3.0L V6 3300cc 202 CID	2007-2008	SE, SLE, Sport	US9306
STARLET			
1.3L L4 1290cc	1981-1982	Base	US9015
1.3L L4 1290cc	1983-1984	Base	US9064
SUPRA			
3.0L L6 2954cc	1986	Base	US9100
3.0L L6 2954cc	1987-1990	Base, Turbo	US9100
3.0L L6 2954cc	1991	Base; Naturally Aspirated	US9100
3.0L L6 2954cc	1991	Turbo	US9100
3.0L L6 2954cc	1992	Base, Turbo	US9100
3.0L L6 2997cc	1993-1998	Base	US9256
3.0L L6 2997cc	1993-1998	Twin Turbo	US9292
T100			
2.7L L4 2694cc	1994-1998	Base	US9293
3.0L V6 2959cc	1993	Base, One-Ton, SR5	US9291
3.0L V6 2959cc	1993-1994	W/O BYPASS TUBE	US9320
3.0L V6 2959cc	1994	DX, SR5	US9291
3.4L V6 3378cc	1995	Base, One-Ton DLX; Standard Trans	US9324
3.4L V6 3378cc	1995	DX, SR5; 4WD	US9324
3.4L V6 3378cc	1995	DX, SR5; RWD, Standard Trans	US9324
3.4L V6 3378cc	1995	Base, One-Ton DLX; Automatic Trans	US9325
3.4L V6 3378cc	1995	DX, SR5; Automatic Trans, RWD	US9325
3.4L V6 3378cc	1996-1997	DLX, SR5; 4WD	US9324
3.4L V6 3378cc	1996-1997	DLX, SR5; RWD, Standard Trans	US9324
3.4L V6 3378cc	1996-1997	DLX, SR5; Automatic Trans, RWD	US9325
3.4L V6 3378cc	1998	Base, SR5; 4WD	US9324
3.4L V6 3378cc	1998	Base, SR5; RWD, Standard Trans	US9324
3.4L V6 3378cc	1998	Base, SR5; Automatic Trans, RWD	US9325
TACOMA			
2.4L L4 2438cc	1995-1997	Base	US9293
2.4L L4 2438cc	1998-2000	Base, SR5	US9293

Engine	Years	Application Description	USMW	Engine	Years	Application Description	USMW
TOYOTA (cont'd.)				TOYOTA (cont'd.)			
TACOMA (cont'd.)				YARIS (cont'd.)			
2.4L L4 2438cc	2001-2004	Base	US9293	1.5L L4 1497cc	2012	L, LE, SE; To 11/2011	US9406
2.7L L4 2694cc	1995-1997	Base	US9293	1.5L L4 1497cc	2013-2017	L, LE, SE	US9406
2.7L L4 2694cc	1998-2000	Base, Pre Runner, SR5	US9293	1.5L L4 1497cc 91 CID	2006	Mexican Application	US9406
2.7L L4 2694cc	2001-2015	Base, Pre Runner	US9293	1.5L L4 1497cc 91 CID	2011	Mexican Application	US9406
2.7L L4 2694cc	2016-2017	SR, SR5	US9293	1.5L L4 1497cc 91 CID	2015-2016	SE	US9406
3.4L V6 3378cc	1995-1997	Base; 4WD	US9324	YARIS IA			
3.4L V6 3378cc	1995-1997	Base; Automatic Trans, RWD; Floor Shift	US9324	1.5L L4 1496cc 91 CID	2017	Base	US6700
3.4L V6 3378cc	1995-1997	Base; RWD, Standard Trans	US9324	VOLKSWAGEN			
3.4L V6 3378cc	1995-1997	SR5	US9324	ATLANTIC			
3.4L V6 3378cc	1995-1997	Base; Automatic Trans, RWD; Column Shift	US9325	1.7L L4 1700cc 104 CID	1981	Mexican Application	US9066
3.4L V6 3378cc	1998-2000	Base, SR5; 4WD	US9324	1.7L L4 1700cc 104 CID	1982-1986	Mexican Application	US9065
3.4L V6 3378cc	1998-2000	Base, SR5; Automatic Trans, RWD; Floor Shift	US9324	1.8L L4 1800cc 110 CID	1984-1987	Mexican Application	US9065
3.4L V6 3378cc	1998-2000	Base, SR5; RWD, Standard Trans	US9324	BETLE			
3.4L V6 3378cc	1998-2000	Limited	US9324	1.8L L4 1781cc	1999-2000	GL, GLS, GLX	US9377
3.4L V6 3378cc	1998-2000	Pre Runner; Floor Shift	US9324	1.8L L4 1781cc	1999-2000	GL, GLS, GLX; Electric Water Pump	US11034
3.4L V6 3378cc	1998-2000	Base, SR5; Automatic Trans, RWD; Column Shift	US9325	1.8L L4 1781cc	2001	GL, GLS, GLX, Sport	US9377
3.4L V6 3378cc	1998-2000	Pre Runner; Column Shift	US9325	1.8L L4 1781cc	2001	GL, GLS, GLX, Sport; Electric Water Pump	US11034
3.4L V6 3378cc	2001-2004	Base, Pre Runner, S-Runner	US9324	1.8L L4 1781cc	2002	GL, GLS, GLX, Sport, Turbo S	US9377
4.0L V6 3956cc 241 CID	2005-2013	Base, Pre Runner, X-Runner	US6037	1.8L L4 1781cc	2002	GL, GLS, GLX, Sport, Turbo S; Electric Water Pump	US11034
4.0L V6 3956cc 241 CID	2014	Base, Pre Runner	US6037	1.8L L4 1781cc	2003	GL, GLS, GLX, Turbo S	US9377
4.0L V6 3956cc 241 CID	2015	Base, Pre Runner, TRD Pro	US6037	1.8L L4 1781cc	2003	GL, GLS, GLX, Turbo S; Electric Water Pump	US11034
TERCEL				1.8L L4 1781cc	2004	GLS, GLX, Turbo S	US9377
1.5L L4 1452cc	1980	DLX, SR5, STD	US9028	1.8L L4 1781cc	2004	GLS, GLX, Turbo S; Electric Water Pump	US11034
1.5L L4 1452cc	1981-1982	DLX, SR5, STD; Exc.Calif	US9045	1.8L L4 1781cc	2005	GLS	US9377
1.5L L4 1452cc	1981-1982	DLX, SR5, STD; Calif	US9086	1.8L L4 1781cc	2005	GLS; Electric Water Pump	US11034
1.5L L4 1452cc	1983-1986	DLX, SR5, STD	US9045	1.8L L4 1798cc 110 CID	2015	Base, Classic, Fleet Edition; From 07/01/2014	US8124
1.5L L4 1452cc	1987-1988	DLX, DX, SR5	US9045	1.8L L4 1798cc 110 CID	2016	Denim, Dune, Fleet Edition, S, SE, SEL, Wolfsburg Edition	US8124
1.5L L4 1456cc	1987	DLX, STD	US9098	1.8L L4 1798cc 110 CID	2017	#PinkBeetle, Classic, Dune, S, SE, SEL	US8124
1.5L L4 1456cc	1988	DLX, EZ, STD	US9098	1.9L L4 1896cc 116 CID	1998	TDI	US9378
1.5L L4 1456cc	1989-1990	Base, DX, EZ, STD	US9098	1.9L L4 1896cc 116 CID	1999-2000	GL, GLS	US9378
1.5L L4 1456cc	1991-1993	DLX, LE, STD	US9098	1.9L L4 1896cc 116 CID	2001-2002	GL, GLS, Sport	US9378
1.5L L4 1456cc	1994	DLX, LE, STD; To 08/1994	US9098	1.9L L4 1896cc 116 CID	2003	GL, GLS	US9378
1.5L L4 1456cc	1994	DLX, LE, STD; From 08/1994	US9334	1.9L L4 1896cc 116 CID	2004	GL, GLS; (BEW)	US6034
1.5L L4 1497cc	1995-1996	DX, STD	US9334	1.9L L4 1896cc 116 CID	2005	GLS TDI	US6034
1.5L L4 1497cc	1997	CE; From 11/1996	US9334	1.9L L4 1896cc 116 CID	2006	TDI	US6034
1.5L L4 1497cc	1997	CE; To 11/1996	US9334	2.0L L4 1968cc 120 CID	2013	TDI; From 04/28/2012	US6034
1.5L L4 1497cc	1998	CE	US9334	2.0L L4 1968cc 120 CID	2013	TDI; To 04/28/2012	US6034
TUNDRA				2.0L L4 1968cc 120 CID	2014	TDI	US6034
3.4L V6 3378cc	2000-2004	Base, SR5; Floor Shift	US9324	2.0L L4 1984cc 121 CID	1998	Base	US9377
3.4L V6 3378cc	2000-2004	SR5	US9324	2.0L L4 1984cc 121 CID	1999-2000	GL, GLS	US9377
3.4L V6 3378cc	2000-2004	Base, SR5; Column Shift	US9325	2.0L L4 1984cc 121 CID	2001-2002	GL, GLS, Sport	US9377
4.0L V6 3956cc 241 CID	2005-2010	Base, SR5	US6037	2.0L L4 1984cc 121 CID	2003	GL, GLS	US9377
4.0L V6 3956cc 241 CID	2011	Base, SR5; To 10/2010	US6037	2.0L L4 1984cc 121 CID	2004	GL, GLS; (BGD)	US9377
4.0L V6 3956cc 241 CID	2011	Base, SR5; From 10/2010	US6599	2.0L L4 1984cc 121 CID	2004-2005	GL, GLS; (BEV)	US9377
4.0L V6 3956cc 241 CID	2012-2013	Base	US6599	2.0L L4 1984cc 121 CID	2006-2011	Mexican Application	US9377
4.0L V6 3956cc 241 CID	2014	SR	US6599	2.0L L4 1984cc 121 CID	2012	Turbo; (CCTA); From 05/31/2012, Pump only	US9047
4.6L V8 4608cc	2010	Base, Limited, SR5; Exc.Japan Built Part	US6336	2.0L L4 1984cc 121 CID	2012	Turbo; (CCTA); Pump only, To 05/31/2012	US9047
4.6L V8 4608cc	2010	Base, Limited, SR5; Japan Built Part	US6336	2.0L L4 1984cc 121 CID	2012	Turbo; (CCTA); From 05/31/2012, With back plate housing	US9047-2
4.6L V8 4608cc	2011	Base, SR5; Exc.Japan Built Part	US6336	2.0L L4 1984cc 121 CID	2012	Turbo; (CCTA); To 05/31/2012, With back plate housing	US9047-2
4.6L V8 4608cc	2011	Base, SR5; Japan Built Part	US6336	2.0L L4 1984cc 121 CID	2012-2013	Turbo; Electric Water Pump	US11008
4.6L V8 4608cc	2012-2013	Base; Exc.Japan Built Part	US6336	2.0L L4 1984cc 121 CID	2013	Turbo; (CCTA); Pump only	US9047
4.6L V8 4608cc	2012-2013	Base; Japan Built Part	US6336	2.0L L4 1984cc 121 CID	2013	Turbo; (CCTA); With back plate housing	US9047-2
4.6L V8 4608cc	2014-2017	SR, SR5	US6336	2.0L L4 1984cc 121 CID	2015	R-Line	US8124
4.7L V8 4663cc 285 CID	2000-2002	Limited, SR5	US9257	2.0L L4 1984cc 121 CID	2016	R-Line S, R-Line SE, R-Line SEL	US8124
4.7L V8 4663cc 285 CID	2003-2004	Limited, SR5; Exc.Japan Built Part	US9257	2.0L L4 1984cc 121 CID	2017	R-Line SEL	US8124
4.7L V8 4663cc 285 CID	2005-2008	Base, Limited, SR5	US9257	2.5L L5 2480cc 151 CID	2006-2007	2.5; (BPR)	US6050
4.7L V8 4663cc 285 CID	2009	Base, Limited, SR5; From 11/2008	US9257	2.5L L5 2480cc 151 CID	2006-2007	2.5; (BPS)	US6050
4.7L V8 4663cc 285 CID	2009	Base, Limited, SR5; To 11/2008	US9257	2.5L L5 2480cc 151 CID	2008	S, SE; (BPR)	US6050
4.7L V8 4663cc 285 CID	2009	Base, Limited, SR5	US9257	2.5L L5 2480cc 151 CID	2008	S, SE; (BPS)	US6050
5.7L V8 5663cc 345 CID	2007-2011	Base, Limited, SR5	US6197	2.5L L5 2480cc 151 CID	2009-2010	Base; (BPR)	US6050
5.7L V8 5663cc 345 CID	2012	Base, Limited	US6197	2.5L L5 2480cc 151 CID	2009-2010	Base; (BPS)	US6050
5.7L V8 5663cc 345 CID	2013	Base, Limited, Platinum	US6197	2.5L L5 2480cc 151 CID	2010	Mexican Application	US6050
5.7L V8 5663cc 345 CID	2014	1794 Edition, Limited, Platinum, SR, SR5	US6197	2.5L L5 2480cc 151 CID	2012-2014	Base; (CBTA)	US6050
5.7L V8 5663cc 345 CID	2015-2017	1794 Edition, Limited, Platinum, SR, SR5, TRD Pro	US6197	2.5L L5 2480cc 151 CID	2012-2014	Base; (CBUA)	US6050
VAN				2.5L L5 2480cc 151 CID	2014	Mexican Application	US6050
2.0L L4 1998cc 122 CID	1984-1985	Wagon Crg, Wagon DX, Wagon LE	US9092	BORA			
2.2L L4 2237cc	1986-1989	Wagon Crg, Wagon DX, Wagon LE	US9092	1.9L L4 1896cc 116 CID	2007-2010	Mexican Application	US6212
VENZA				2.0L H4 1984cc 121 CID	2007-2010	Mexican Application	US6022
2.7L L4 2672cc 163 CID	2009-2011	Base	US6252	2.0L L4 1984cc 121 CID	2006	Mexican Application	US9377
2.7L L4 2672cc 163 CID	2012-2015	LE, XLE	US6252	2.5L L5 2480cc 151 CID	2005-2009	Mexican Application	US6050
3.5L V6 3456cc	2009-2011	Base	US6047	2.5L L5 2480cc 151 CID	2010	Mexican Application	US9262
3.5L V6 3456cc	2012-2014	LE, Limited, XLE	US6047				
3.5L V6 3456cc	2015	Limited, XLE	US6047				
YARIS							
1.3L L4 1295cc 79 CID	2004-2005	Mexican Application	US9406				
1.5L L4 1497cc	2007-2009	Base, S	US9406				
1.5L L4 1497cc	2010-2011	Base	US9406				
1.5L L4 1497cc	2012	L, LE, SE; From 11/2011	US9406				

WATER PUMPS

Engine	Years	Application Description	USMW	Engine	Years	Application Description	USMW
VOLKSWAGEN (cont'd.)				VOLKSWAGEN (cont'd.)			
CABRIO				COMBI			
2.0L L4 1984cc 121 CID	1995-1996	Base	US9065	1.8L L4 1780cc 108 CID	1998-2001	Mexican Application	US9065
2.0L L4 1984cc 121 CID	1995-1996	Base; Includes back housing	US9065-2	1.8L L4 1800cc 110 CID	1989-1997	Mexican Application	US9065
2.0L L4 1984cc 121 CID	1997	Base, High Line	US9065	CORRADO			
2.0L L4 1984cc 121 CID	1997	Base, High Line; Includes back housing	US9065-2	1.8L L4 1780cc	1990-1992	G60	US9065
2.0L L4 1984cc 121 CID	1998	Base, GL, GLS	US9065	1.8L L4 1780cc	1990-1992	G60; Includes back housing	US9065-2
2.0L L4 1984cc 121 CID	1998	Base, GL, GLS; Includes back housing	US9065-2	2.8L V6 2792cc	1992-1994	SLC	US9262
2.0L L4 1984cc 121 CID	1999	Base, GLS	US9065	2.8L V6 2792cc	1992-1994	SLC; Electric Water Pump	US11034
2.0L L4 1984cc 121 CID	1999	Base, GLS; Includes back housing	US9065-2	CRAFTER			
2.0L L4 1984cc 121 CID	2000	GL, GLS	US9065	2.5L L5 2459cc 150 CID	2008-2011		US9274-20
2.0L L4 1984cc 121 CID	2000	GL, GLS; Includes back housing	US9065-2	2.5L L5 2459cc 151 CID	2008-2011	Mexican Application	US6050
2.0L L4 1984cc 121 CID	2001-2002	GL, GLS, GLX	US9065	CROSSFOX			
2.0L L4 1984cc 121 CID	2001-2002	GL, GLS, GLX; Includes back housing	US9065-2	1.6L L4 1599cc 98 CID	2007-2009		US8949
CABRIOLET				1.6L L4 1600cc 98 CID	2007-2009	Mexican Application	US8949
1.8L L4 1780cc	1985-1986	Base	US9065	DASHER			
1.8L L4 1780cc	1985-1986	Base; Includes back housing	US9065-2	1.5L L4 1471cc	1975		US9066
1.8L L4 1780cc	1987	Base, Wolfsburg Edition	US9065	1.5L L4 1471cc	1979		US9066
1.8L L4 1780cc	1987	Base, Wolfsburg Edition; Includes back housing	US9065-2	1.5L L4 1471cc	1980	Base	US9066
1.8L L4 1780cc	1988	Base, Bestseller, Boutique	US9065	1.6L L4 1588cc 97 CID	1976-1979		US9066
1.8L L4 1780cc	1988	Base, Bestseller, Boutique; Includes back housing	US9065-2	1.6L L4 1588cc 97 CID	1980-1981	Base	US9066
1.8L L4 1780cc	1989	Base, Bestseller, Boutique, Wolfsburg Edition	US9065	DERBY			
1.8L L4 1780cc	1989	Base, Bestseller, Boutique, Wolfsburg Edition; Includes back housing	US9065-2	1.8L L4 1780cc 108 CID	1998-2001	Mexican Application	US9065
1.8L L4 1780cc	1990	Base, Bestseller, Boutique	US9065	1.8L L4 1781cc 109 CID	2002-2009	Mexican Application	US9065
1.8L L4 1780cc	1990	Base, Bestseller, Boutique; Includes back housing	US9065-2	1.8L L4 1800cc 110 CID	1995-1997	Mexican Application	US9065
1.8L L4 1780cc	1991	Base, Carat, Etienne Aigner	US9065	2.0L L4 1984cc 121 CID	2002-2003	Mexican Application	US9377
1.8L L4 1780cc	1991	Base, Carat, Etienne Aigner; Includes back housing	US9065-2	EOS			
1.8L L4 1780cc	1992	Base, Carat, Classic, Wolfsburg Edition	US9065	2.0L L4 1984cc 121 CID	2007	2.0T, Base	US6022
1.8L L4 1780cc	1992	Base, Carat, Classic, Wolfsburg Edition; Includes back housing	US9065-2	2.0L L4 1984cc 121 CID	2007	2.0T, Base	US11017
1.8L L4 1780cc	1993	Base, Classic	US9065	2.0L L4 1984cc 121 CID	2008	Komfort, Lux, Turbo	US6022
1.8L L4 1780cc	1993	Base, Classic; Includes back housing	US9065-2	2.0L L4 1984cc 121 CID	2008	Komfort, Lux, Turbo	US11017
CARIBE				2.0L L4 1984cc 121 CID	2009	Komfort, Lux; (BPY)	US6022
1.6L L4 1588cc 97 CID	1977-1978		US9066	2.0L L4 1984cc 121 CID	2009	Komfort, Lux; (CBFA); Pump only	US9047
1.6L L4 1588cc 97 CID	1979	Diesel	US9066	2.0L L4 1984cc 121 CID	2009	Komfort, Lux; (CCTA); Pump only	US9047
1.6L L4 1600cc 98 CID	1977-1980	Mexican Application	US9066	2.0L L4 1984cc 121 CID	2009	Komfort, Lux; (CBFA); With back plate housing	US9047-2
1.7L L4 1700cc 104 CID	1981-1986	Mexican Application	US9065	2.0L L4 1984cc 121 CID	2009	Komfort, Lux; (CCTA); With back plate housing	US9047-2
1.8L L4 1800cc 110 CID	1984	Mexican Application	US9066	2.0L L4 1984cc 121 CID	2009-2011	Komfort, Lux; Electric Water Pump	US11008
1.8L L4 1800cc 110 CID	1985-1987	Mexican Application	US9065	2.0L L4 1984cc 121 CID	2010-2011	Komfort, Lux; Pump only	US9047
CC				2.0L L4 1984cc 121 CID	2010-2011	Komfort, Lux; With back plate housing	US9047-2
2.0L L4 1984cc 121 CID	2009-2010	Luxury, Sport; Pump only	US9047	2.0L L4 1984cc 121 CID	2012	Executive, Komfort, Lux; Pump only	US9047
2.0L L4 1984cc 121 CID	2009-2010	Luxury, Sport; With back plate housing	US9047-2	2.0L L4 1984cc 121 CID	2012	Executive, Komfort, Lux; With back plate housing	US9047-2
2.0L L4 1984cc 121 CID	2009-2010	Luxury, Sport; Electric Water Pump	US11008	2.0L L4 1984cc 121 CID	2012	Executive, Komfort, Lux; Electric Water Pump	US11008
2.0L L4 1984cc 121 CID	2011	Luxury, R-Line, Sport; Pump only	US9047	2.0L L4 1984cc 121 CID	2012	Executive, Komfort, Lux; Sport; Pump only	US9047
2.0L L4 1984cc 121 CID	2011	Luxury, R-Line, Sport; With back plate housing	US9047-2	2.0L L4 1984cc 121 CID	2013	Executive, Komfort, Lux, Sport; With back plate housing	US9047-2
2.0L L4 1984cc 121 CID	2011	Luxury, R-Line, Sport; Electric Water Pump	US11008	2.0L L4 1984cc 121 CID	2013	Executive, Komfort, Lux, Sport; Electric Water Pump	US11008
2.0L L4 1984cc 121 CID	2012	Lux, Lux Limited, Lux Plus, R-Line, Sport; Pump only	US9047	2.0L L4 1984cc 121 CID	2013	Executive, Komfort, Sport; Pump only	US9047
2.0L L4 1984cc 121 CID	2012	Lux, Lux Limited, Lux Plus, R-Line, Sport; With back plate housing	US9047-2	2.0L L4 1984cc 121 CID	2014	Executive, Komfort, Sport; Includes back housing	US9047-2
2.0L L4 1984cc 121 CID	2012	Lux, Lux Limited, Lux Plus, R-Line, Sport; Electric Water Pump	US11008	2.0L L4 1984cc 121 CID	2014	Executive, Komfort, Sport; With back plate housing	US9047-2
2.0L L4 1984cc 121 CID	2013	Lux, R-Line, Sport, Sport Plus; Pump only	US9047	2.0L L4 1984cc 121 CID	2014	Executive, Komfort, Sport; Electric Water Pump	US11008
2.0L L4 1984cc 121 CID	2013	Lux, R-Line, Sport, Sport Plus; With back plate housing	US9047-2	2.0L L4 1984cc 121 CID	2014	Executive, Final Edition, Komfort; Pump only	US9047
2.0L L4 1984cc 121 CID	2013	Lux, Sport, Sport Plus; Electric Water Pump	US11008	2.0L L4 1984cc 121 CID	2015	Executive, Final Edition, Komfort; Includes back housing	US9047-2
2.0L L4 1984cc 121 CID	2014	Executive, R-Line, Sport; Electric Water Pump	US11008	2.0L L4 1984cc 121 CID	2015	Executive, Final Edition, Komfort; With back plate housing	US9047-2
2.0L L4 1984cc 121 CID	2014-2015	Executive, R-Line, Sport; Pump only	US9047	2.0L L4 1984cc 121 CID	2016	Komfort; Pump only	US9047
2.0L L4 1984cc 121 CID	2014-2015	Executive, R-Line, Sport; Includes back housing	US9047-2	2.0L L4 1984cc 121 CID	2016	Komfort; Includes back housing	US9047-2
2.0L L4 1984cc 121 CID	2014-2015	Executive, R-Line, Sport; With back plate housing	US9047-2	3.2L V6 3189cc 195 CID	2007	3.2	US9471
2.0L L4 1984cc 121 CID	2016	R-Line, R-Line Executive, Sport, Trend; Pump only	US9047	3.2L V6 3189cc 195 CID	2007	3.2; Electric Water Pump	US11004
2.0L L4 1984cc 121 CID	2016	R-Line, R-Line Executive, Sport, Trend; Includes back housing	US9047-2	3.2L V6 3189cc 195 CID	2008	VR6	US9471
2.0L L4 1984cc 121 CID	2017	R-Line Executive, Sport; Pump only	US9047	3.2L V6 3189cc 195 CID	2008	VR6; Electric Water Pump	US11004
2.0L L4 1984cc 121 CID	2017	R-Line Executive, Sport; Includes back housing	US9047-2	3.2L V6 3197cc 195 CID	2008	VR6	US9471
3.6L V6 3597cc 219 CID	2009-2010	VR6, VR6 4Motion, VR6 Sport	US6221	3.2L V6 3197cc 195 CID	2008	VR6; Electric Water Pump	US11004
3.6L V6 3597cc 219 CID	2011	VR6 4Motion	US6221	EUROVAN			
3.6L V6 3597cc 219 CID	2012	Executive	US6221	1.9L L4 1896cc 116 CID	2006-2008	Mexican Application	US6212
3.6L V6 3597cc 219 CID	2013	Lux, VR6 4Motion Executive	US6221	1.9L L4 1896cc 116 CID	2009	Mexican Application	US9378
3.6L V6 3597cc 219 CID	2014	4 Motion	US6221	2.4L L5 2370cc 144 CID	1993-1996		US9274
3.6L V6 3597cc 219 CID	2015	Executive 4 Motion	US6221	2.4L L5 2390cc 146 CID	1997		US9274
3.6L V6 3597cc 219 CID	2016	V6 Executive 4Motion	US6221	2.5L L5 2459cc 150 CID	1992-1996		US9274
CLASICO				2.5L L5 2459cc 150 CID	1995	Camper; Electric Water Pump	US11034
2.0L H4 1984cc 121 CID	2012	Mexican Application	US6022	2.5L L5 2461cc 150 CID	2001-2003	Mexican Application	US9262
				2.5L L5 2461cc 150 CID	2001-2004		US9274-20
				2.5L L5 2461cc 150 CID	2004	Mexican Application	US9274
				2.8L V6 2792cc	1997	Camper	US9262
				2.8L V6 2792cc	1997	Camper; Electric Water Pump	US11034
				2.8L V6 2792cc	1999	GLS, MV; Electric Water Pump	US11034

Engine	Years	Application Description	USMW	Engine	Years	Application Description	USMW
VOLKSWAGEN (cont'd.)				VOLKSWAGEN (cont'd.)			
EUROVAN (cont'd.)				GOLF (cont'd.)			
2.8L V6 2792cc	1999-2001	GLS, MV	US9262	2.0L L4 1984cc 121 CID	1998	GL, GTI, K2; Includes back housing	US9065-2
2.8L V6 2792cc	2000	GLS, MV, VR6; Electric Water Pump	US11004	2.0L L4 1984cc 121 CID	1999	GL; (ABA)	US9065
2.8L V6 2792cc	2000	GLS, MV; Electric Water Pump, To Chassis/VIN 70-Y-000 001	US11034	2.0L L4 1984cc 121 CID	1999	Wolfsburg Edition	US9065
2.8L V6 2792cc	2001-2003	GLS, MV; Electric Water Pump	US11004	2.0L L4 1984cc 121 CID	1999	GL; (ABA); Includes back housing	US9065-2
2.8L V6 2792cc	2002	GLS, MV; To Chassis/VIN 70-2-097 000	US9262	2.0L L4 1984cc 121 CID	1999	Wolfsburg Edition; Includes back housing	US9065-2
2.8L V6 2792cc	2002	GLS, MV; From Chassis/VIN 70-2-097 001	US9471	2.0L L4 1984cc 121 CID	1999	GL, GTI; (AEG)	US9377
2.8L V6 2792cc	2003	GLS, MV	US9471	2.0L L4 1984cc 121 CID	1999	GLS	US9377
FOX				2.0L L4 1984cc 121 CID	2000	GL, GLS, GTI GLS	US9377
1.8L L4 1780cc	1987-1988	Base, GL	US9065	2.0L L4 1984cc 121 CID	2001-2003	Mexican Application	US9377
1.8L L4 1780cc	1987-1988	Base, GL; Includes back housing	US9065-2	2.0L L4 1984cc 121 CID	2001-2006	GL, GLS	US9377
1.8L L4 1780cc	1989-1990	Base, GL, GL Sport	US9065	2.0L L4 1984cc 121 CID	2007	Mexican Application	US9377
1.8L L4 1780cc	1989-1990	Base, GL, GL Sport; Includes back housing	US9065-2	2.0L L4 1984cc 121 CID	2012-2013	R	US11017
1.8L L4 1780cc	1991-1993	Base, GL	US9065	2.5L L5 2480cc 151 CID	2010-2014	Base	US6050
1.8L L4 1780cc	1991-1993	Base, GL; Includes back housing	US9065-2	2.8L V6 2792cc	1995-1998	GTI VR6	US9262
GLI				2.8L V6 2792cc	1996-1998	GTI VR6; Electric Water Pump	US11034
2.0L L4 1984cc 121 CID	2007	Mexican Application	US9377	2.8L V6 2792cc	1999	GTI	US9262
GOL				2.8L V6 2792cc	1999	GTI; Electric Water Pump	US11034
1.6L L4 1598cc 98 CID	2009-2011		US8949	2.8L V6 2792cc	2000-2001	GTI GLX	US9262
1.6L L4 1598cc 98 CID	2012	GT	US8949	2.8L V6 2792cc	2000-2001	GTI GLX; Electric Water Pump	US11004
1.6L L4 1598cc 98 CID	2013	Comfortline	US8949	2.8L V6 2792cc	2000-2001	GTI GLX; Brazil Built Vehicle, Electric Water Pump	US11034
1.6L L4 1599cc 98 CID	2011-2013	Mexican Application	US8949	2.8L V6 2792cc	2002	GTI VR6; (AFP)	US9262
1.6L L4 1600cc 98 CID	2009-2010	Mexican Application	US8949	2.8L V6 2792cc	2002	GTI VR6; (BDF)	US9471
GOLF				2.8L V6 2792cc	2002	GTI VR6; Electric Water Pump	US11034
1.4L L4 1390cc 85 CID	2013	Mexican Application	US8952	2.8L V6 2792cc	2002-2005	GTI VR6; Electric Water Pump	US11004
1.4L L4 1390cc 85 CID	2015-2016	Mexican Application	US8952	2.8L V6 2792cc	2003-2005	GTI VR6	US9471
1.6L L4 1588cc 97 CID	1985-1986	Base	US9065	3.2L V6 3189cc	2004	R32	US9471
1.6L L4 1588cc 97 CID	1985-1986	Base; Includes back housing	US9065-2	3.2L V6 3189cc	2004	R32; Electric Water Pump	US11004
1.6L L4 1588cc 97 CID	1987-1988	GL	US9065	GOLF ALLTRACK			
1.6L L4 1588cc 97 CID	1987-1988	GL; Includes back housing	US9065-2	1.8L L4 1798cc 110 CID	2017	S, SE, SEL	US8124
1.8L L4 1780cc	1985-1986	Base, GTI	US9065	GOLF SPORTWAGEN			
1.8L L4 1780cc	1985-1986	Base, GTI; Includes back housing	US9065-2	1.8L L4 1798cc 110 CID	2015-2017	S, SE, SEL	US8124
1.8L L4 1780cc	1987	GL, GT, GTI, GTI 16-Valve	US9065	GOL SEDAN			
1.8L L4 1780cc	1987	GL, GT, GTI, GTI 16-Valve; Includes back housing	US9065-2	1.6L L4 1598cc 98 CID	2011	Comfortline, Sport, Trendline	US8949
1.8L L4 1780cc	1988	Base, GL, GT, GTI 16-Valve	US9065	GTI			
1.8L L4 1780cc	1988	Base, GL, GT, GTI 16-Valve; Includes back housing	US9065-2	2.0L L4 1984cc 121 CID	2006	Base	US6022
1.8L L4 1780cc	1989	Base, GL, GTI 16-Valve	US9065	2.0L L4 1984cc 121 CID	2006	Base	US11017
1.8L L4 1780cc	1989	Base, GL, GTI 16-Valve; Includes back housing	US9065-2	2.0L L4 1984cc 121 CID	2007	Base, Fahrenheit	US6022
1.8L L4 1780cc	1990-1992	GL, GTI 8-Valve	US9065	2.0L L4 1984cc 121 CID	2007	Base, Fahrenheit	US11017
1.8L L4 1780cc	1990-1992	GL, GTI 8-Valve; Includes back housing	US9065-2	2.0L L4 1984cc 121 CID	2008	Base; (BPY)	US6022
1.8L L4 1781cc	2000-2001	GLS, GTI GLS	US9377	2.0L L4 1984cc 121 CID	2008	Base; (CBFA); Pump only	US9047
1.8L L4 1781cc	2002	GTI 1.8T, GTI 337	US9377	2.0L L4 1984cc 121 CID	2008	Base; (CCTA); Pump only	US9047
1.8L L4 1781cc	2002	GTI 1.8T, GTI 337; Electric Water Pump	US11003	2.0L L4 1984cc 121 CID	2008	Base; (CBFA); With back plate housing	US9047-2
1.8L L4 1781cc	2003	GTI 1.8T, GTI 20th Anniversary	US9377	2.0L L4 1984cc 121 CID	2008	Base; (CCTA); With back plate housing	US11017
1.8L L4 1781cc	2003	GTI 1.8T, GTI 20th Anniversary; Electric Water Pump	US11003	2.0L L4 1984cc 121 CID	2008-2013	Base; Electric Water Pump	US11008
1.8L L4 1781cc	2004-2006	GTI 1.8T	US9377	2.0L L4 1984cc 121 CID	2009-2010	Base; Pump only	US9047
1.8L L4 1781cc	2004-2006	GTI 1.8T; Electric Water Pump	US11003	2.0L L4 1984cc 121 CID	2009-2010	Base; With back plate housing	US9047-2
1.8L L4 1781cc 109 CID	1998-1999	Mexican Application	US9065	2.0L L4 1984cc 121 CID	2011	Base; Pump only, To 10/31/2010	US9047
1.8L L4 1798cc 110 CID	2015	Launch Edition, S, SE, SEL	US8124	2.0L L4 1984cc 121 CID	2011	Base; To 10/31/2010, With back plate housing	US9047-2
1.8L L4 1798cc 110 CID	2016	Base, S, SE, SEL	US8124	2.0L L4 1984cc 121 CID	2013	Base; Pump only	US9047
1.8L L4 1798cc 110 CID	2017	S, Wolfsburg Edition	US8124	2.0L L4 1984cc 121 CID	2013	Base; With back plate housing	US9047-2
1.8L L4 1800cc 110 CID	1987-1997	Mexican Application	US9065	2.0L L4 1984cc 121 CID	2014	Driver's Edition, Wolfsburg Edition; Pump only	US9047
1.9L L4 1896cc 116 CID	1999	GL, TDI	US9378	2.0L L4 1984cc 121 CID	2014	Driver's Edition, Wolfsburg Edition; Includes back housing	US9047-2
1.9L L4 1896cc 116 CID	2000-2003	GL, GLS	US9378	2.0L L4 1984cc 121 CID	2014	Driver's Edition, Wolfsburg Edition; With back plate housing	US9047-2
1.9L L4 1896cc 116 CID	2004	GLS TDI, GL TDI; (BEW)	US6034	2.0L L4 1984cc 121 CID	2014	Wolfsburg Edition; Electric Water Pump	US11008
1.9L L4 1896cc 116 CID	2004	GLS TDI, GL TDI; (ALH)	US9378	2.0L L4 1984cc 121 CID	2015-2016	Autobahn, S, SE	US8124
1.9L L4 1896cc 116 CID	2005	TDI	US6034	2.0L L4 1984cc 121 CID	2017	Autobahn, S, SE, Sport	US8124
1.9L L4 1896cc 116 CID	2006	GLS TDI	US6034	JETTA			
2.0L L4 1968cc 120 CID	2010-2011	TDI	US6034	1.4L L4 1395cc 85 CID	2013-2016	Mexican Application	US8952
2.0L L4 1968cc 120 CID	2012	TDI; From 04/28/2012	US6034	1.6L L4 1588cc 97 CID	1980	Base	US9066
2.0L L4 1968cc 120 CID	2012	TDI; To 04/28/2012	US6034	1.6L L4 1588cc 97 CID	1981	Base, Special Edition	US9066
2.0L L4 1984cc 121 CID	1990-1992	GTI 16-Valve	US9065	1.6L L4 1588cc 97 CID	1982	Base; From Chassis/VIN 630001	US9065
2.0L L4 1984cc 121 CID	1990-1992	GTI 16-Valve; Includes back housing	US9065-2	1.6L L4 1588cc 97 CID	1982	Base; From Chassis/VIN 630001, Includes back housing	US9065-2
2.0L L4 1984cc 121 CID	1993	GL	US9065	1.6L L4 1588cc 97 CID	1982	Base; To Chassis/VIN 630000	US9066
2.0L L4 1984cc 121 CID	1993	GL; Includes back housing	US9065-2	1.6L L4 1588cc 97 CID	1983	Base	US9065
2.0L L4 1984cc 121 CID	1994	GL, GTI, Limited Edition	US9065	1.6L L4 1588cc 97 CID	1983	Base; Includes back housing	US9065-2
2.0L L4 1984cc 121 CID	1994	GL, GTI, Limited Edition; Includes back housing	US9065-2	1.6L L4 1588cc 97 CID	1984-1986	Base, GL	US9065
2.0L L4 1984cc 121 CID	1995	Celebration Edition, City, GL, Sport	US9065	1.6L L4 1588cc 97 CID	1984-1986	Base, GL; Includes back housing	US9065-2
2.0L L4 1984cc 121 CID	1995	Celebration Edition, City, GL, Sport; Includes back housing	US9065-2	1.6L L4 1588cc 97 CID	1987	Base, GL, Wolfsburg Edition	US9065
2.0L L4 1984cc 121 CID	1996	GL, GTI	US9065	1.6L L4 1588cc 97 CID	1987	Base, GL, Wolfsburg Edition; Includes back housing	US9065-2
2.0L L4 1984cc 121 CID	1996	GL, GTI; Includes back housing	US9065-2	1.6L L4 1588cc 97 CID	1989	Base	US9065
2.0L L4 1984cc 121 CID	1997	GL, GTI, Jazz, K2, Trek	US9065	1.6L L4 1588cc 97 CID	1989	Base; Includes back housing	US9065-2
2.0L L4 1984cc 121 CID	1997	GL, GTI, Jazz, K2, Trek; Includes back housing	US9065-2	1.6L L4 1588cc 97 CID	1990-1992	GL	US9065
2.0L L4 1984cc 121 CID	1998	GL, GTI, K2	US9065	1.6L L4 1588cc 97 CID	1990-1992	GL; Includes back housing	US9065-2
				1.7L L4 1715cc	1981	Base, Special Edition	US9065

WATER PUMPS

Engine	Years	Application Description	USMW	Engine	Years	Application Description	USMW
VOLKSWAGEN (cont'd.)				VOLKSWAGEN (cont'd.)			
PASSAT (cont'd.)				QUANTUM (cont'd.)			
1.8L L4 1781cc	2000	GLS; (AUG)	US9377	1.6L L4 1588cc 97 CID	1984	GL; Includes back housing	US9065-2
1.8L L4 1781cc	2000	GLS; (ATW)	US9401	1.6L L4 1588cc 97 CID	1985	Base, GL	US9065
1.8L L4 1781cc	2001-2002	GLS	US9377	1.6L L4 1588cc 97 CID	1985	Base, GL; Includes back housing	US9065-2
1.8L L4 1781cc	2003	GL, GLS	US9377	1.7L L4 1715cc	1982-1983	Base, GL	US9065
1.8L L4 1781cc	2004-2005	GL, GLS, GLS 4 Motion	US9377	1.7L L4 1715cc	1982-1983	Base, GL; Includes back housing	US9065-2
1.8L L4 1798cc 110 CID	2014	S, SE, SEL Premium, Wolfsburg Edition	US8124	1.8L L4 1780cc	1984	GL	US9065
1.8L L4 1798cc 110 CID	2015	Limited Edition, S, SE, SEL Premium, Sport, Wolfsburg Edition	US8124	1.8L L4 1780cc	1984	GL; Includes back housing	US9065-2
1.8L L4 1798cc 110 CID	2016	R-Line, S, SE, SEL, SEL Premium	US8124	1.8L L4 1780cc	1985	Base, GL	US9065
1.8L L4 1798cc 110 CID	2017	R-Line, S, SE, SEL Premium	US8124	1.8L L4 1780cc	1985	Base, GL; Includes back housing	US9065-2
1.9L L4 1896cc 116 CID	1996-1997	TDI	US9065	2.2L L5 2144cc	1983	Base, GL	US9052
1.9L L4 1896cc 116 CID	1996-1997	TDI; Includes back housing	US9065-2	2.2L L5 2144cc	1984	GL	US9052
2.0L H4 1985cc 121 CID	2010	Mexican Application	US6022	2.2L L5 2226cc	1985	Base, GL	US9052
2.0L L4 1967cc 120 CID	2004-2005	GLS TDI, GL TDI	US6034	2.2L L5 2226cc	1986-1987	Base, GL, Syncro	US9052
2.0L L4 1968cc 120 CID	2014	TDI SE, TDI SEL Premium	US8108	2.2L L5 2226cc	1988	GL, Syncro	US9052
2.0L L4 1984cc 121 CID	1990-1991	GL	US9065	R32			
2.0L L4 1984cc 121 CID	1990-1991	GL; Includes back housing	US9065-2	3.2L V6 3189cc 195 CID	2008	Base	US9471
2.0L L4 1984cc 121 CID	1992	CL, GL	US9065	3.2L V6 3189cc 195 CID	2008	Base; Electric Water Pump	US11004
2.0L L4 1984cc 121 CID	1992	CL, GL; Includes back housing	US9065-2	RABBIT			
2.0L L4 1984cc 121 CID	1993	GL	US9065	1.5L L4 1457cc	1978-1979		US9066
2.0L L4 1984cc 121 CID	1993	GL; Includes back housing	US9065-2	1.5L L4 1457cc	1980	Base, Custom, Deluxe	US9066
2.0L L4 1984cc 121 CID	1995-1996	GLS	US9065	1.5L L4 1471cc	1975		US9066
2.0L L4 1984cc 121 CID	1995-1996	GLS; Includes back housing	US9065-2	1.5L L4 1471cc	1977-1979		US9066
2.0L L4 1984cc 121 CID	2006	2.0T, Value Edition	US6022	1.5L L4 1471cc	1980	Base, Custom, Deluxe	US9066
2.0L L4 1984cc 121 CID	2006	2.0T, Value Edition	US11017	1.6L L4 1588cc 97 CID	1976-1977		US9066
2.0L L4 1984cc 121 CID	2007	2.0T, Value Edition, Wolfsburg Edition	US6022	1.6L L4 1588cc 97 CID	1980	Base, Custom, Deluxe	US9066
2.0L L4 1984cc 121 CID	2007	2.0T, Value Edition, Wolfsburg Edition	US11017	1.6L L4 1588cc 97 CID	1981	L Custom, Ls Deluxe	US9066
2.0L L4 1984cc 121 CID	2008	Komfort, Lux, Turbo; (BPY)	US6022	1.6L L4 1588cc 97 CID	1982	L, LS	US9066
2.0L L4 1984cc 121 CID	2008	Komfort, Lux, Turbo; (CCTA); Pump only	US9047	1.6L L4 1588cc 97 CID	1983	L, LS, Wolfsburg Edition; 30mm Hub	US9065
2.0L L4 1984cc 121 CID	2008	Komfort, Lux, Turbo; (CCTA); With back plate housing	US9047-2	1.6L L4 1588cc 97 CID	1983	L, LS, Wolfsburg Edition; 30mm Hub, Includes back housing	US9065-2
2.0L L4 1984cc 121 CID	2008	Komfort, Lux, Turbo; Electric Water Pump	US11008	1.6L L4 1588cc 97 CID	1984	L, LS, Wolfsburg Edition; 40mm Hub	US9066
2.0L L4 1984cc 121 CID	2008	Komfort, Lux, Turbo	US11017	1.6L L4 1588cc 97 CID	1984	L; Includes back housing	US9065-2
2.0L L4 1984cc 121 CID	2009-2010	Komfort; Pump only	US9047	1.7L L4 1715cc	1981	Base, L, LS, S; 30mm Hub, With air cond.	US9065
2.0L L4 1984cc 121 CID	2009-2010	Komfort; With back plate housing	US9047-2	1.7L L4 1715cc	1981	Base, L, LS, S; 30mm Hub, Includes back housing, With air cond.	US9065-2
2.0L L4 1984cc 121 CID	2009-2010	Komfort; Electric Water Pump	US11008	1.7L L4 1715cc	1981	Base, L, LS, S; 40mm Hub, Exc.Air Cond	US9066
2.5L L5 2480cc 151 CID	2012	S, SE, SEL, SEL Premium	US6050	1.7L L4 1715cc	1982	Base, L, Limited Edition, LS, S; 30mm Hub	US9065
2.5L L5 2480cc 151 CID	2013	S, SE, SEL, SEL Premium, Wolfsburg Edition	US6050	1.7L L4 1715cc	1982	Base, L, Limited Edition, LS, S; 30mm Hub, With air cond.	US9065
2.5L L5 2480cc 151 CID	2014	S, SE, Wolfsburg Edition	US6050	1.7L L4 1715cc	1982	Base, L, Limited Edition, LS, S; 30mm Hub, Includes back housing	US9065-2
2.8L V6 2771cc	1998-1999	GLS, GLX	US9333	1.7L L4 1715cc	1982	Base, L, Limited Edition, LS, S; 30mm Hub, Includes back housing, With air cond.	US9065-2
2.8L V6 2771cc	2000	4 Motion, GLS, GLX	US9333	1.7L L4 1715cc	1982	Base, L, Limited Edition, LS, S; 40mm Hub	US9066
2.8L V6 2771cc	2001-2002	GLS, GLS 4 Motion, GLX, GLX 4 Motion	US9333	1.7L L4 1715cc	1982	Base, L, Limited Edition, LS, S; 40mm Hub, Includes back housing, With air cond.	US9065-2
2.8L V6 2771cc	2003-2004	GL, GLS, GLX, GLX 4 Motion	US9333	1.7L L4 1715cc	1982	Base, L, Limited Edition, LS, S; 40mm Hub	US9066
2.8L V6 2771cc	2005	GLS, GLS 4 Motion, GLX, GLX 4 Motion	US9333	1.7L L4 1715cc	1982	Base, L, Limited Edition, LS, S; 40mm Hub, Exc.Air Cond	US9066
2.8L V6 2771cc 170 CID	2000	GLX	US9333	1.7L L4 1715cc	1983	GL, L, LS, Wolfsburg Edition; 30mm Hub	US9065
2.8L V6 2788cc 170 CID	1997	Mexican Application	US9262	1.7L L4 1715cc	1983	GL, L, LS, Wolfsburg Edition; 30mm Hub, Includes back housing	US9065-2
2.8L V6 2792cc	1993-1994	GLX; Electric Water Pump	US11034	1.7L L4 1715cc	1983	GL, L, LS, Wolfsburg Edition; 30mm Hub, Includes back housing, With air cond.	US9065-2
2.8L V6 2792cc	1993-1997	GLX	US9262	1.7L L4 1715cc	1983	GL, L, LS, Wolfsburg Edition; 40mm Hub	US9066
3.6L V6 3597cc 219 CID	2006-2007	3.6	US6221	1.7L L4 1715cc	1983	GL, L, LS, Wolfsburg Edition; 30mm Hub, With air cond.	US9065
3.6L V6 3597cc 219 CID	2008	VR6	US6221	1.7L L4 1715cc	1983	GL, L, LS, Wolfsburg Edition; 30mm Hub, Includes back housing	US9065-2
3.6L V6 3597cc 219 CID	2009	Mexican Application	US6221	1.7L L4 1715cc	1983	GL, L, LS, Wolfsburg Edition; 30mm Hub, Includes back housing, With air cond.	US9065-2
3.6L V6 3597cc 219 CID	2012-2015	SE, SEL Premium	US6221	1.7L L4 1715cc	1983	GL, L, LS, Wolfsburg Edition; 30mm Hub	US9066
3.6L V6 3597cc 219 CID	2016	SEL Premium	US6221	1.7L L4 1715cc	1983	GL, L, LS, Wolfsburg Edition; 40mm Hub	US9066
3.6L V6 3597cc 219 CID	2017	SE, SEL Premium	US6221	1.7L L4 1715cc	1983	GL, L, LS, Wolfsburg Edition; 40mm Hub, Exc.Air Cond	US9065
4.0L W8 3998cc 244 CID	2002-2004	W8	US8111	1.7L L4 1715cc	1984	L; 30mm Hub, With air cond.	US9065
4.0L W8 3998cc 244 CID	2002-2004		US11004	1.7L L4 1715cc	1984	L; 30mm Hub, Includes back housing	US9065-2
PHAETON				RABBIT CONVERTIBLE			
4.2L V8 4172cc	2004-2006	V8	US9410	1.6L L4 1588cc 97 CID	1980	Base	US9066
6.0L W12 5998cc	2005	W12	US8111	1.7L L4 1715cc	1981	Base; With air cond.	US9065
6.0L W12 5998cc 366 CID	2006	W12	US8111	1.7L L4 1715cc	1981	Base; Includes back housing, With air cond.	US9065-2
6.0L W12 5998cc 366 CID	2006	W12; Electric Water Pump	US11004	1.7L L4 1715cc	1981	Base; Exc.Air Cond	US9066
6.0L W12 6000cc	2004	W12	US8111	1.7L L4 1715cc	1982	Base	US9065
6.0L W12 6000cc	2004	W12; Electric Water Pump	US11004	1.7L L4 1715cc	1982	Base; Includes back housing	US9065-2
POINTER				RABBIT CONVERTIBLE			
1.8L L4 1780cc 108 CID	1998-2002	Mexican Application	US9065	1.6L L4 1588cc 97 CID	1980	Base	US9066
1.8L L4 1780cc 108 CID	1999-2002	Mexican Application	US9066	1.7L L4 1715cc	1981	Base; With air cond.	US9065
1.8L L4 1781cc 109 CID	2003-2009	Mexican Application	US9377	1.7L L4 1715cc	1981	Base; Includes back housing, With air cond.	US9065-2
1.8L L4 1781cc 109 CID	2003-2010	Mexican Application	US9065	1.7L L4 1715cc	1981	Base; Exc.Air Cond	US9066
2.0L L4 1984cc 121 CID	2000-2003	Mexican Application	US9377	1.7L L4 1715cc	1982	Base	US9065
POLO				RABBIT CONVERTIBLE			
1.4L L4 1390cc 85 CID	2013-2014	Mexican Application	US8952	1.6L L4 1588cc 97 CID	1980	Base	US9066
1.6L L4 1596cc 97 CID	2003-2007		US8949	1.7L L4 1715cc	1981	Base; With air cond.	US9065
1.6L L4 1596cc 97 CID	2003-2007	Mexican Application	US8949	1.7L L4 1715cc	1981	Base; Includes back housing, With air cond.	US9065-2
2.0L L4 1984cc 121 CID	2003-2007	Mexican Application	US9377	1.7L L4 1715cc	1981	Base; Exc.Air Cond	US9066
QUANTUM				RABBIT CONVERTIBLE			
1.6L L4 1588cc 97 CID	1982-1983	Base, GL	US9065	1.7L L4 1715cc	1982	Base	US9065
1.6L L4 1588cc 97 CID	1982-1983	Base, GL; Includes back housing	US9065-2	1.7L L4 1715cc	1982	Base; Includes back housing	US9065-2
1.6L L4 1588cc 97 CID	1984	GL	US9065	1.7L L4 1715cc	1983	Base, Wolfsburg Edition	US9065

WATER PUMPS

Engine	Years	Application Description	USMW
VOLKSWAGEN (cont'd.)			
RABBIT CONVERTIBLE (cont'd.)			
1.7L L4 1715cc	1983	Base, Wolfsburg Edition; Includes back housing	US9065-2
RABBIT PICKUP			
1.5L L4 1457cc	1980	Base, LX, Sport	US9066
1.6L L4 1588cc 97 CID	1980	Base, LX, Sport	US9066
1.6L L4 1588cc 97 CID	1981-1982	Base, LX, Sport; 40mm Hub	US9066
1.6L L4 1588cc 97 CID	1981-1983	Base, LX, Sport; 30mm Hub	US9065
1.6L L4 1588cc 97 CID	1981-1983	Base, LX, Sport; 30mm Hub, Includes back housing	US9065-2
1.7L L4 1715cc	1981-1982	Base, LX, Sport; 30mm Hub	US9065
1.7L L4 1715cc	1981-1982	Base, LX, Sport; 30mm Hub, Includes back housing	US9065-2
1.7L L4 1715cc	1981-1983	Base, LX, Sport; 40mm Hub	US9066
ROUTAN			
3.6L V6 3604cc 220 CID	2011-2012	S, SE, SEL, SEL Premium	US8981
3.6L V6 3604cc 220 CID	2013-2014	S, SE, SEL Premium	US8981
3.8L V6 3778cc 230 CID	2010	Mexican Application	US6231
3.8L V6 3778cc 231 CID	2009-2010	S, SE	US6231
4.0L V6 3952cc 241 CID	2009	SEL	US8951
4.0L V6 3952cc 241 CID	2010	SEL, SEL Premium	US8951
SCIROCCO			
1.5L L4 1457cc	1978		US9066
1.5L L4 1471cc	1975		US9066
1.6L L4 1588cc 97 CID	1976-1977		US9066
1.6L L4 1588cc 97 CID	1979		US9066
1.6L L4 1588cc 97 CID	1980	Base, S	US9066
1.7L L4 1715cc	1981	Base, S; With air cond.	US9065
1.7L L4 1715cc	1981	Base, S; Includes back housing, With air cond.	US9065-2
1.7L L4 1715cc	1981	Base, S; Exc. Air Cond	US9066
1.7L L4 1715cc	1982-1983	Base, GL	US9065
1.7L L4 1715cc	1982-1983	Base, GL; Includes back housing	US9065-2
1.8L L4 1780cc	1984-1986	Base	US9065
1.8L L4 1780cc	1984-1986	Base; Includes back housing	US9065-2
1.8L L4 1780cc	1987	16-Valve, Base	US9065
1.8L L4 1780cc	1987	16-Valve, Base; Includes back housing	US9065-2
1.8L L4 1780cc	1988	16-Valve	US9065
1.8L L4 1780cc	1988	16-Valve; Includes back housing	US9065-2
SHARAN			
1.8L L4 1781cc 109 CID	2002-2008	Mexican Application	US9377
SPORTVAN			
1.6L L4 1599cc 98 CID	2007-2009		US8949
1.6L L4 1599cc 98 CID	2010	Comfortline	US8949
1.6L L4 1599cc 98 CID	2010	Mexican Application	US8949
1.6L L4 1600cc 98 CID	2007-2009	Mexican Application	US8949
TIGUAN			
2.0L L4 1984cc 121 CID	2009	S, SE, SEL; Pump only	US9047
2.0L L4 1984cc 121 CID	2009	S, SE, SEL; With back plate housing	US9047-2
2.0L L4 1984cc 121 CID	2009	S, SE, SEL; Electric Water Pump	US11008
2.0L L4 1984cc 121 CID	2010	S, SE, SEL, Wolfsburg Edition; Pump only	US9047
2.0L L4 1984cc 121 CID	2010	S, SE, SEL, Wolfsburg Edition; With back plate housing	US9047-2
2.0L L4 1984cc 121 CID	2010	S, SE, SEL, Wolfsburg Edition; Electric Water Pump	US11008
2.0L L4 1984cc 121 CID	2011-2013	S, SE, SEL; Pump only	US9047
2.0L L4 1984cc 121 CID	2011-2013	S, SE, SEL; With back plate housing	US9047-2
2.0L L4 1984cc 121 CID	2011-2013	S, SE, SEL; Electric Water Pump	US11008
2.0L L4 1984cc 121 CID	2014	R-Line, S, SE, SEL; Electric Water Pump	US11008
2.0L L4 1984cc 121 CID	2014-2015	R-Line, S, SE, SEL; With back plate housing	US9047-2
2.0L L4 1984cc 121 CID	2014-2016	R-Line, S, SE, SEL; Pump only	US9047
2.0L L4 1984cc 121 CID	2014-2016	R-Line, S, SE, SEL; Includes back housing	US9047-2
2.0L L4 1984cc 121 CID	2017	S, SEL, Sport, Wolfsburg Edition; Pump only	US9047
2.0L L4 1984cc 121 CID	2017	S, SEL, Sport, Wolfsburg Edition; Includes back housing	US9047-2
TOUAREG			
3.0L V6 2967cc 181 CID	2009-2011	TDI	US6146
3.0L V6 2967cc 181 CID	2012	TDI Executive, TDI Lux, TDI Sport	US6146
3.0L V6 2967cc 182 CID	2012	Mexican Application	US6146
3.2L V6 3189cc 195 CID	2004	V6; Electric Water Pump	US11004
3.2L V6 3189cc 195 CID	2005-2006	Base	US9471
3.2L V6 3189cc 195 CID	2005-2006	Base; Electric Water Pump	US11004
3.2L V6 3189cc 195 CID	2007	Mexican Application	US9471
3.2L V6 3200cc 195 CID	2004	V6	US9471
3.2L V6 3200cc 195 CID	2004	V6; Electric Water Pump	US11004
3.2L V6 3200cc 195 CID	2005	Base; Electric Water Pump	US11004
3.6L V6 3597cc 219 CID	2007-2009	Base	US6221
3.6L V6 3597cc 219 CID	2007-2009	Base; Electric Water Pump	US11004
3.6L V6 3597cc 219 CID	2010	VR6	US6221
3.6L V6 3597cc 219 CID	2010	VR6; Electric Water Pump	US11004
4.2L V8 4163cc	2007-2009	Base	US6702

Engine	Years	Application Description	USMW
VOLKSWAGEN (cont'd.)			
TOUAREG (cont'd.)			
4.2L V8 4163cc	2007-2009	Base; Electric Water Pump	US11004
4.2L V8 4172cc	2004	V8	US9410
4.2L V8 4172cc	2005-2007	Base	US9410
TRANSPORTER			
2.4L L5 2370cc 144 CID	1993-1994		US9274
2.5L L5 2459cc 150 CID	1992-1993		US9274
VAN			
1.8L L4 1781cc 109 CID	2003	Mexican Application	US9065
VANAGON			
1.9L H4 1915cc	1983-1985	Campmobile, GL, L	US9061
2.1L H4 2109cc	1986	Campmobile, GL, L, Syncro	US9150
2.1L H4 2109cc	1987-1988	Campmobile, GL, Syncro	US9150
2.1L H4 2109cc	1989	Campmobile, Carat, GL, Syncro	US9150
2.1L H4 2109cc	1990-1991	Base, Campmobile, Carat, GL, Syncro	US9150
VENTO			
1.6L L4 1598cc 98 CID	2014-2015	Mexican Application	US8109
1.6L L4 1598cc 98 CID	2014-2016	Mexican Application	US8108
VOLKSWAGEN TRUCK			
TIGUAN			
1.4L L4 1390cc 85 CID	2013-2016	Mexican Application	US8952
VOLVO			
164			
3.0L L6 2980cc	1975		US9077
240			
2.3L L4 2316cc	1990	Base, DL	US9068
2.3L L4 2316cc	1991	Base, SE	US9068
2.3L L4 2316cc	1992	Base, GL	US9068
2.3L L4 2316cc	1993	Base	US9068
242			
2.1L L4 2127cc	1976-1979		US9049
2.1L L4 2127cc	1980	DL	US9049
2.1L L4 2127cc	1981	DL, GL, GLT, Turbo	US9049
2.1L L4 2127cc	1982	DL, GLT	US9049
2.1L L4 2127cc	1983-1984	GLT	US9049
2.3L L4 2316cc	1983-1984	DL	US9049
244			
2.1L L4 2127cc	1976-1979		US9049
2.1L L4 2127cc	1980-1981	DL	US9049
2.1L L4 2127cc	1982	DL, GL, GLT	US9049
2.1L L4 2127cc	1983	GLT	US9049
2.1L L4 2127cc	1984	Base	US9049
2.1L L4 2127cc	1985	Turbo	US9049
2.3L L4 2316cc	1983	DL	US9049
2.3L L4 2316cc	1984	DL, GL	US9049
2.3L L4 2316cc	1985-1989	DL, GL	US9068
2.4L L6 2383cc	1982	DL, GL	US9071
2.4L L6 2383cc	1983	GL	US9071
2.4L L6 2383cc	1984	DL, GL	US9071
245			
2.1L L4 2127cc	1976-1979		US9049
2.1L L4 2127cc	1980	DL	US9049
2.1L L4 2127cc	1981	DL, GLT	US9049
2.1L L4 2127cc	1982	DL, GL, GLT	US9049
2.1L L4 2127cc	1983	GLT	US9049
2.1L L4 2127cc	1984-1985	Base	US9049
2.3L L4 2316cc	1983	DL, GL	US9049
2.3L L4 2316cc	1984	Base	US9049
2.3L L4 2316cc	1985	Base	US9068
2.3L L4 2316cc	1986-1989	DL, GL	US9068
2.4L L6 2383cc	1982	DL	US9071
2.4L L6 2383cc	1983	GL	US9071
2.4L L6 2383cc	1984	Base	US9071
262			
2.7L V6 2673cc	1976		US9147
2.7L V6 2673cc	1978		US9147
2.7L V6 2673cc	1979		US9146
2.8L V6 2849cc	1980	Base	US9146
2.8L V6 2849cc	1981	GL	US9146
264			
2.4L L6 2383cc	1980	GL, GLE	US9071
2.4L L6 2383cc	1981	GL	US9071
2.7L V6 2673cc	1976-1978		US9147
2.7L V6 2673cc	1979		US9146
2.8L V6 2849cc	1980	GL, GLE	US9146
2.8L V6 2849cc	1981-1982	GLE	US9146
265			
2.4L L6 2383cc	1980	GLE	US9071

Engine	Years	Application Description	USMW	Engine	Years	Application Description	USMW
VOLVO (cont'd.)				VOLVO (cont'd.)			
265 (cont'd.)				S70			
2.7L V6 2673cc	1976-1978		US9147	2.3L L5 2319cc	1998-2000	T5	US9339
2.7L V6 2673cc	1979		US9146	2.4L L5 2435cc	1998	Base, GLT	US9339
2.8L V6 2849cc	1980-1981	GLE	US9146	2.4L L5 2435cc	1999	AWD, Base, GLT	US9339
740				2.4L L5 2435cc	2000	AWD, Base, GLT, GLT SE	US9339
2.3L L4 2316cc	1985-1988	GLE	US9068	S80			
2.3L L4 2316cc	1989-1990	Base, GL, GLE	US9068	2.5L L5 2521cc	2004-2006	2.5T, 2.5T AWD	US9339
2.3L L4 2316cc	1991-1992	Base, T	US9068	2.8L L6 2783cc 170 CID	2004-2006	Mexican Application	US9339
2.4L L6 2377cc	1986	GLE	US9071	2.8L L6 2798cc	1999-2001	T6	US9382
745				2.9L L6 2917cc	1999-2001	2.9	US9382
2.3L L4 2316cc	1985	GLE	US9068	2.9L L6 2917cc	2002	2.9, T6	US9382
2.4L L6 2383cc	1985	GLE	US9071	2.9L L6 2917cc	2003-2004	2.9, T6	US9456
760				2.9L L6 2917cc	2005	T6, T6 Premier	US9456
2.3L L4 2316cc	1984	GLE	US9049	3.0L L6 2953cc	2011-2015	T6	US8134
2.3L L4 2316cc	1985	Base, GLE	US9068	3.2L L6 3192cc	2011-2014	3.2	US8134
2.3L L4 2316cc	1986-1988	GLE	US9068	4.4L V8 4414cc 269 CID	2007-2010	V8	US6276
2.3L L4 2316cc	1989-1990	Base	US9068	S90			
2.4L L6 2377cc	1985	GLE	US9071	2.9L L6 2917cc	1997-1998	Base	US9340
2.4L L6 2383cc	1983-1984	GLE	US9071	V40			
780				1.9L L4 1948cc	2000-2003	Base	US9339
2.3L L4 2316cc	1989-1991	Base	US9068	1.9L L4 1948cc	2003	Base; (B4204T4)	US9339
850				1.9L L4 1948cc	2004	Base, LSE	US9339
2.3L L5 2319cc	1994	Turbo; From Engine 131035	US9339	1.9L L4 1948cc 119 CID	1999	Mexican Application	US9339
2.3L L5 2319cc	1994	Turbo; To Engine 131034	US9339	V50			
2.3L L5 2319cc	1995	T-5R, Turbo; From Engine 131035	US9339	2.4L L5 2435cc	2005	i	US9339
2.3L L5 2319cc	1995	T-5R, Turbo; To Engine 131034	US9339	2.4L L5 2435cc	2006-2010	2.4i	US9339
2.3L L5 2319cc	1996	R, Turbo; From Engine 131035	US9339	2.5L L5 2521cc	2005-2009	T5	US9339
2.3L L5 2319cc	1996	R, Turbo; To Engine 131034	US9339	2.5L L5 2521cc	2010	T5 R-Design	US9339
2.3L L5 2319cc	1997	R, T-5; From Engine 131035	US9339	2.5L L5 2521cc	2011	T5, T5 R-Design	US9339
2.3L L5 2319cc	1997	R, T-5; To Engine 131034	US9339	V60			
2.4L L5 2435cc	1993	GLT; From Engine 131035	US9339	2.5L L5 2521cc	2015	T5, T5 Platinum, T5 Premier, T5 Premier Plus	US9339
2.4L L5 2435cc	1993	GLT; To Engine 131034	US9339	2.5L L5 2521cc	2016	T5 Platinum, T5 Premier	US9339
2.4L L5 2435cc	1994-1997	Base, GLT; From Engine 131035	US9339	3.0L L6 2953cc	2015-2016	T6 Polestar, T6 R-Design, T6 R-Design Platinum	US8134
2.4L L5 2435cc	1994-1997	Base, GLT; To Engine 131034	US9339	V60 CROSS COUNTRY			
940				2.5L L5 2521cc	2015	T5	US9339
2.3L L4 2316cc	1991	GLE, SE, T	US9068	2.5L L5 2521cc	2016	T5, T5 Platinum	US9339
2.3L L4 2316cc	1992	GL, T	US9068	V70			
2.3L L4 2316cc	1993-1995	Base, T	US9068	2.3L L5 2319cc	1998	R, T5	US9339
960				2.3L L5 2319cc	1999-2000	R AWD, T5	US9339
2.9L L6 2922cc	1992-1994	Base	US9339	2.3L L5 2319cc	2001-2004	T5	US9339
2.9L L6 2922cc	1995-1997	Base	US9340	2.4L L5 2435cc	1998-1999	AWD, Base, GLT, X/C AWD	US9339
C30				2.4L L5 2435cc	2000	Base, GLT, GLT SE, X/C AWD, X/C AWD SE	US9339
2.4L L5 2400cc 146 CID	2008-2009	Mexican Application	US9339	2.4L L5 2435cc	2001	2.4T, Base, X/C	US9339
2.5L L5 2521cc	2008-2013	T5, T5 R-Design	US9339	2.4L L5 2435cc	2002	2.4T, AWD, Base, X/C	US9339
C70				2.4L L5 2435cc	2003	2.4T, Base	US9339
2.3L L5 2319cc	1998-2004	Base	US9339	2.4L L5 2435cc	2004	2.4	US9339
2.4L L5 2435cc	1998-2004	Base	US9339	2.4L L5 2435cc	2005	2.4, T5	US9339
2.5L L5 2521cc	2006-2013	T5	US9339	2.4L L5 2435cc	2006-2007	2.4	US9339
S40				2.5L L5 2521cc	2003	AWD	US9339
1.9L L4 1948cc	2000-2003	Base	US9339	2.5L L5 2521cc	2004	R	US9339
1.9L L4 1948cc	2004	Base, LSE	US9339	2.5L L5 2521cc	2005-2007	2.5T, R	US9339
1.9L L4 1948cc 119 CID	1999	Mexican Application	US9339	V90			
2.4L L5 2435cc	2004-2005	i	US9339	2.9L L6 2917cc	1997-1998	Base	US9340
2.4L L5 2435cc	2006-2010	2.4i	US9339	XC60			
2.5L L5 2521cc	2004-2009	T5	US9339	2.5L L5 2521cc	2015	T5	US9339
2.5L L5 2521cc	2010	T5 R-Design	US9339	2.5L L5 2521cc	2016	T5, T5 Platinum, T5 Premier	US9339
2.5L L5 2521cc	2011	T5, T5 R-Design	US9339	3.0L L6 2953cc	2011-2014	T6, T6 R-Design	US8134
S60				3.0L L6 2953cc	2015	T6, T6 Ocean Race, T6 R-Design	US8134
2.3L L5 2319cc	2001-2004	T5	US9339	3.0L L6 2953cc	2016	T6, T6 Platinum, T6 Premier, T6 R-Design, T6 R-Design Platinum	US8134
2.4L L5 2435cc	2001	2.4T, Base	US9339	3.0L L6 2953cc 180 CID	2013	T6 R-Design	US8134
2.4L L5 2435cc	2002	2.4T, AWD, Base	US9339	3.2L L6 3192cc	2011	3.2, 3.2 R-Design	US8134
2.4L L5 2435cc	2003	2.4T, Base	US9339	3.2L L6 3192cc	2012-2015	3.2	US8134
2.4L L5 2435cc	2004	2.4	US9339	XC70			
2.4L L5 2435cc	2005	2.4, T5	US9339	2.5L L5 2521cc	2003	X/C	US9339
2.4L L5 2435cc	2006-2009	T5	US9339	2.5L L5 2521cc	2004-2005	Base	US9339
2.5L L5 2521cc	2003	AWD	US9339	2.5L L5 2521cc	2006	Base, Ocean Race	US9339
2.5L L5 2521cc	2004-2005	2.5T, 2.5T AWD, R	US9339	2.5L L5 2521cc	2007	Base	US9339
2.5L L5 2521cc	2006-2007	2.5T, R	US9339	2.5L L5 2521cc	2016	T5, T5 Platinum, T5 Premier	US9339
2.5L L5 2521cc	2008-2009	2.5T	US9339	3.0L L6 2953cc	2011-2015	T6	US8134
2.5L L5 2521cc	2012-2014	T5	US9339	3.2L L6 3192cc	2011-2015	3.2	US8134
2.5L L5 2521cc	2015	T5, T5 Platinum, T5 Premier, T5 Premier Plus	US9339	XC90			
2.5L L5 2521cc	2016	T5, T5 Inscription Platinum, T5 Inscription Premier, T5 Premier	US9339	2.5L L5 2521cc	2003	Base	US9339
3.0L L6 2953cc	2011-2012	T6	US8134	2.5L L5 2521cc	2004-2006	2.5T	US9339
3.0L L6 2953cc	2013-2014	T6, T6 R-Design	US8134	2.5L L5 2521cc 154 CID	2007	Mexican Application	US9339
3.0L L6 2953cc	2015-2016	T6 Polestar, T6 R-Design, T6 R-Design Platinum	US8134	2.8L L6 2783cc 170 CID	2003-2006	Mexican Application	US9339
3.0L L6 2953cc 180 CID	2013	T6 R-Design	US8134	2.9L L6 2917cc	2003-2005	T6	US9456
S60 CROSS COUNTRY				4.4L V8 4414cc 269 CID	2005	V8	US6276
2.5L L5 2521cc	2016	T5 Platinum	US9339				

WATER PUMPS



WATER PUMP APPLICATION GUIDE



Engine	Years	Application Description	USMW	Engine	Years	Application Description	USMW
VOLVO (cont'd.)							
XC90 (cont'd.)							
4.4L V8 4414cc 269 CID	2006	V8, V8 Ocean Race	US6276				
4.4L V8 4414cc 269 CID	2007-2008	V8, V8 Sport	US6276				
4.4L V8 4414cc 269 CID	2009-2011	V8	US6276				

USMW	Years	Application	Engine	USMW	Years	Application	Engine
US43N	1947-1951	CHEVROLET SEDAN DELIVERY	3.8L L6 3852cc 235 CID	US64-T	1999-2006	GMC SIERRA 1500	5.3L V8 5328cc 325 CID
	1950-1952	CHEVROLET STYLELINE DELUXE	3.8L L6 3852cc 235 CID		2000-2006	CHEVROLET SUBURBAN 1500	5.3L V8 5328cc 325 CID
	1950-1952	CHEVROLET STYLELINE SPECIAL	3.8L L6 3852cc 235 CID		2000-2006	CHEVROLET SUBURBAN 2500	6.0L V8 5967cc 364 CID
	1953-1954	CHEVROLET SEDAN DELIVERY	3.8L L6 3852cc 235 CID		2000-2006	CHEVROLET TAHOE	4.8L V8 294 CID
1958	CHEVROLET YEOMAN	3.8L L6 3852cc 235 CID	2000-2006		CHEVROLET TAHOE	5.3L V8 5328cc 325 CID	
US52	1958-1962	JEEP TRUCK	3.7L L6 3704cc 226 CID		2000-2006	GMC YUKON	4.8L V8 294 CID
	1958-1966	JEEP TRUCK	2.2L L4 2197cc 134 CID		2000-2006	GMC YUKON	5.3L V8 5328cc 325 CID
	1959-1971	JEEP CJ5	2.2L L4 2197cc 134 CID		2000-2006	GMC YUKON XL 1500	5.3L V8 5328cc 325 CID
	1959-1971	JEEP CJ6	2.2L L4 2197cc 134 CID		2000-2006	GMC YUKON XL 2500	6.0L V8 5967cc 364 CID
US61	2003-2004	FORD F-250 SUPER DUTY	6.0L V8 363 CID		2001-2003	CHEVROLET SILVERADO 1500 HD	6.0L V8 5967cc 364 CID
	2003-2004	FORD F-350 SUPER DUTY	6.0L V8 363 CID		2001-2003	GMC SIERRA 1500 HD	6.0L V8 5967cc 364 CID
	2003-2004	FORD F-450 SUPER DUTY	6L V8 363 CID		2001-2006	CHEVROLET SILVERADO 2500 HD	6.0L V8 5967cc 364 CID
	2003-2004	FORD F-550 SUPER DUTY	6L V8 363 CID		2001-2006	CHEVROLET SILVERADO 3500	6.0L V8 5967cc 364 CID
2003-2005	FORD EXCURSION	6.0L V8 363 CID	2001-2006		GMC SIERRA 1500	6.0L V8 5967cc 364 CID	
US63	2001-2005	CHEVROLET SILVERADO 2500 HD	6.6L V8 6599cc 403 CID		2001-2006	GMC SIERRA 2500 HD	6.0L V8 5967cc 364 CID
	2001-2005	CHEVROLET SILVERADO 3500	6.6L V8 6599cc 403 CID		2001-2006	GMC SIERRA 3500	6.0L V8 5967cc 364 CID
	2001-2005	GMC SIERRA 2500 HD	6.6L V8 6599cc 403 CID		2001-2006	GMC YUKON	6.0L V8 5967cc 364 CID
	2001-2005	GMC SIERRA 3500	6.6L V8 6599cc 403 CID		2001-2006	GMC YUKON XL 1500	6.0L V8 5967cc 364 CID
US64	1999-2000	CHEVROLET SILVERADO 2500	5.3L V8 5328cc 325 CID		2002-2005	CADILLAC ESCALADE	5.3L V8 5328cc 325 CID
	1999-2000	GMC SIERRA 2500	5.3L V8 5328cc 325 CID		2002-2006	CADILLAC ESCALADE	6.0L V8 5967cc 364 CID
	1999-2004	CHEVROLET SILVERADO 2500	6.0L V8 5967cc 364 CID		2002-2006	CADILLAC ESCALADE EXT	6.0L V8 5967cc 364 CID
	1999-2004	GMC SIERRA 2500	6.0L V8 5967cc 364 CID		2002-2006	CHEVROLET AVALANCHE 1500	5.3L V8 5328cc 325 CID
	1999-2006	CHEVROLET SILVERADO 1500	4.8L V8 294 CID		2003-2004	CHEVROLET SSR	5.3L V8 5328cc 325 CID
	1999-2006	CHEVROLET SILVERADO 1500	5.3L V8 5328cc 325 CID		2003-2005	CHEVROLET EXPRESS 2500	5.3L V8 5328cc 325 CID
	1999-2006	GMC SIERRA 1500	4.8L V8 294 CID	2003-2005	GMC SAVANA 2500	5.3L V8 5328cc 325 CID	
	1999-2006	GMC SIERRA 1500	5.3L V8 5328cc 325 CID	2003-2006	CADILLAC ESCALADE ESV	6.0L V8 5967cc 364 CID	
	2000-2006	CHEVROLET SUBURBAN 1500	5.3L V8 5328cc 325 CID	2003-2006	CHEVROLET EXPRESS 1500	5.3L V8 5328cc 325 CID	
	2000-2006	CHEVROLET SUBURBAN 2500	6.0L V8 5967cc 364 CID	2003-2006	CHEVROLET EXPRESS 2500	4.8L V8 294 CID	
	2000-2006	CHEVROLET TAHOE	4.8L V8 294 CID	2003-2006	CHEVROLET EXPRESS 2500	6.0L V8 5967cc 364 CID	
	2000-2006	CHEVROLET TAHOE	5.3L V8 5328cc 325 CID	2003-2006	CHEVROLET EXPRESS 3500	6.0L V8 5967cc 364 CID	
	2000-2006	GMC YUKON	4.8L V8 294 CID	2003-2006	CHEVROLET SILVERADO 1500	6.0L V8 5967cc 364 CID	
	2000-2006	GMC YUKON	5.3L V8 5328cc 325 CID	2003-2006	CHEVROLET TRAILBLAZER EXT	5.3L V8 5328cc 325 CID	
	2000-2006	GMC YUKON XL 1500	5.3L V8 5328cc 325 CID	2003-2006	GMC ENVOY XL	5.3L V8 5328cc 325 CID	
	2000-2006	GMC YUKON XL 2500	6.0L V8 5967cc 364 CID	2003-2006	GMC SAVANA 1500	5.3L V8 5328cc 325 CID	
	2001-2003	CHEVROLET SILVERADO 1500 HD	6.0L V8 5967cc 364 CID	2003-2006	GMC SAVANA 2500	4.8L V8 294 CID	
	2001-2003	GMC SIERRA 1500 HD	6.0L V8 5967cc 364 CID	2003-2006	GMC SAVANA 2500	6.0L V8 5967cc 364 CID	
	2001-2006	CHEVROLET SILVERADO 2500 HD	6.0L V8 5967cc 364 CID	2003-2006	GMC SAVANA 3500	6.0L V8 5967cc 364 CID	
	2001-2006	CHEVROLET SILVERADO 3500	6.0L V8 5967cc 364 CID	2003-2006	HUMMER H2	6.0L V8 5967cc 364 CID	
	2001-2006	GMC SIERRA 1500	6.0L V8 5967cc 364 CID	2003-2006	ISUZU ASCENDER	5.3L V8 5328cc 325 CID	
	2001-2006	GMC SIERRA 2500 HD	6.0L V8 5967cc 364 CID	2004-2005	GMC ENVOY XUV	5.3L V8 5328cc 325 CID	
	2001-2006	GMC SIERRA 3500	6.0L V8 5967cc 364 CID	2004-2006	BUICK RAINIER	5.3L V8 5328cc 325 CID	
	2001-2006	GMC YUKON	6.0L V8 5967cc 364 CID	2004-2006	GMC SAVANA 3500	4.8L V8 294 CID	
	2001-2006	GMC YUKON XL 1500	6.0L V8 5967cc 364 CID	2005-2006	CHEVROLET EXPRESS 3500	4.8L V8 294 CID	
	2002	CHEVROLET SILVERADO 2500	5.7L V8 5737cc 350 CID	2005-2006	CHEVROLET SILVERADO 1500 HD	6.0L V8 5967cc 364 CID	
	2002-2005	CADILLAC ESCALADE	5.3L V8 5328cc 325 CID	2005-2006	CHEVROLET SSR	6.0L V8 5967cc 364 CID	
	2002-2006	CADILLAC ESCALADE	6.0L V8 5967cc 364 CID	2005-2006	GMC ENVOY	5.3L V8 5328cc 325 CID	
	2002-2006	CADILLAC ESCALADE EXT	6.0L V8 5967cc 364 CID	2005-2006	GMC SIERRA 1500 HD	6.0L V8 5967cc 364 CID	
	2002-2006	CHEVROLET AVALANCHE 1500	5.3L V8 5328cc 325 CID	2005-2006	SAAB 9-7X	5.3L V8 5328cc 325 CID	
	2003-2004	CHEVROLET SSR	5.3L V8 5328cc 325 CID	2006	CHEVROLET SUBURBAN 1500	6.0L V8 5967cc 364 CID	
	2003-2005	CHEVROLET EXPRESS 2500	5.3L V8 5328cc 325 CID	2006	CHEVROLET TRAILBLAZER	5.3L V8 5328cc 325 CID	
	2003-2005	GMC SAVANA 2500	5.3L V8 5328cc 325 CID	2006	CHEVROLET TRAILBLAZER	6.0L V8 5967cc 364 CID	
	2003-2006	CADILLAC ESCALADE ESV	6.0L V8 5967cc 364 CID	US65	2005-2006	PONTIAC GTO	6.0L V8 5967cc 364 CID
	2003-2006	CHEVROLET EXPRESS 1500	5.3L V8 5328cc 325 CID	US65N	2004-2005	CADILLAC CTS	5.7L V8 346 CID
	2003-2006	CHEVROLET EXPRESS 2500	4.8L V8 294 CID	2005	CHEVROLET CORVETTE	6.0L V8 364 CID	
	2003-2006	CHEVROLET EXPRESS 2500	6.0L V8 5967cc 364 CID	2006-2007	CADILLAC CTS	6.0L V8 5967cc 364 CID	
	2003-2006	CHEVROLET EXPRESS 3500	6.0L V8 5967cc 364 CID	2006-2007	CHEVROLET CORVETTE	6.0L V8 5967cc 364 CID	
	2003-2006	CHEVROLET SILVERADO 1500	6.0L V8 5967cc 364 CID	2006-2008	CHEVROLET CORVETTE	7.0L V8 7011cc 427 CID	
	2003-2006	CHEVROLET TRAILBLAZER EXT	5.3L V8 5328cc 325 CID	2008	CHEVROLET CORVETTE	6.2L V8 6162cc 376 CID	
	2003-2006	GMC ENVOY XL	5.3L V8 5328cc 325 CID	2008-2009	PONTIAC G8	6.0L V8 5967cc 364 CID	
	2003-2006	GMC SAVANA 1500	5.3L V8 5328cc 325 CID	US65N-T	2004-2005	CADILLAC CTS	5.7L V8 346 CID
	2003-2006	GMC SAVANA 2500	4.8L V8 294 CID	2005	CHEVROLET CORVETTE	6.0L V8 364 CID	
	2003-2006	GMC SAVANA 2500	6.0L V8 5967cc 364 CID	2006-2007	CADILLAC CTS	6.0L V8 5967cc 364 CID	
	2003-2006	GMC SAVANA 3500	6.0L V8 5967cc 364 CID	2006-2007	CHEVROLET CORVETTE	6.0L V8 5967cc 364 CID	
	2003-2006	HUMMER H2	6.0L V8 5967cc 364 CID	2006-2008	CHEVROLET CORVETTE	7.0L V8 7011cc 427 CID	
	2003-2006	ISUZU ASCENDER	5.3L V8 5328cc 325 CID	2008	CHEVROLET CORVETTE	6.2L V8 6162cc 376 CID	
	2004-2005	GMC ENVOY XUV	5.3L V8 5328cc 325 CID	2008-2009	PONTIAC G8	6.0L V8 5967cc 364 CID	
2004-2006	BUICK RAINIER	5.3L V8 5328cc 325 CID	US65-T	2005-2006	PONTIAC GTO	6.0L V8 5967cc 364 CID	
2004-2006	GMC SAVANA 3500	4.8L V8 294 CID	US66	1994	INTERNATIONAL 3700	7.3L V8 444 CID	
2004-2009	CHEVROLET SILVERADO 2500	5.3L V8 5300cc 323 CID	1994	INTERNATIONAL 4600LP	7.3L V8 444 CID		
2005-2006	CHEVROLET EXPRESS 3500	4.8L V8 294 CID	1994-1999	INTERNATIONAL 3600	7.3L V8 444 CID		
2005-2006	CHEVROLET SILVERADO 1500 HD	6.0L V8 5967cc 364 CID	1994-2002	INTERNATIONAL 4700LP	7.3L V8 444 CID		
2005-2006	CHEVROLET SONORA	5.3L V8 5300cc 323 CID	1994-2004	INTERNATIONAL 3800	7.3L V8 444 CID		
2005-2006	CHEVROLET SSR	6.0L V8 5967cc 364 CID	1995-2002	INTERNATIONAL 4700LPX	7.3L V8 444 CID		
2005-2006	GMC ENVOY	5.3L V8 5328cc 325 CID	1996-2002	INTERNATIONAL 3400	7.3L V8 444 CID		
2005-2006	GMC SIERRA 1500 HD	6.0L V8 5967cc 364 CID	1996-2002	INTERNATIONAL GENESIS RE	7.3L V8 444 CID		
2005-2006	SAAB 9-7X	5.3L V8 5328cc 325 CID	1997-2000	INTERNATIONAL 3000	7.3L V8 444 CID		
2006	CHEVROLET SUBURBAN 1500	5.3L V8 5300cc 323 CID	2000-2002	INTERNATIONAL 3000IC	7.3L V8 444 CID		
2006	CHEVROLET SUBURBAN 1500	6.0L V8 5967cc 364 CID	2000-2003	FORD F650	7.3L V8 444 CID		
2006	CHEVROLET TRAILBLAZER	5.3L V8 5328cc 325 CID	2000-2003	FORD F750	7.3L V8 444 CID		
2006	CHEVROLET TRAILBLAZER	6.0L V8 5967cc 364 CID	2004-2005	INTERNATIONAL 1652SC	7.3L V8 444 CID		
2006-2009	CHEVROLET SILVERADO 2500	4.8L V8 4800cc 293 CID	US67	2004-2005	FORD E-350 CLUB WAGON	6.0L V8 363 CID	
2007	CHEVROLET SILVERADO 3500	5.7L V8 5737cc 350 CID	2004-2007	FORD F-250 SUPER DUTY	6.0L V8 363 CID		
US64-T	1999-2000	CHEVROLET SILVERADO 2500	5.3L V8 5328cc 325 CID	2004-2007	FORD F-350 SUPER DUTY	6.0L V8 363 CID	
	1999-2000	GMC SIERRA 2500	5.3L V8 5328cc 325 CID	2004-2007	FORD F-450 SUPER DUTY	6L V8 363 CID	
	1999-2004	CHEVROLET SILVERADO 2500	6.0L V8 5967cc 364 CID	2004-2007	FORD F-550 SUPER DUTY	6L V8 363 CID	
	1999-2004	GMC SIERRA 2500	6.0L V8 5967cc 364 CID	2004-2010	FORD E-350 SUPER DUTY	6.0L V8 363 CID	
	1999-2006	CHEVROLET SILVERADO 1500	4.8L V8 294 CID	2004-2010	FORD E-450 SUPER DUTY	6L V8 363 CID	
	1999-2006	CHEVROLET SILVERADO 1500	5.3L V8 5328cc 325 CID	US72	2006	CHEVROLET SILVERADO 3500	6.6L V8 6599cc 403 CID
	1999-2006	CHEVROLET SILVERADO 1500	5.3L V8 5328cc 325 CID	2006	GMC SIERRA 3500	6.6L V8 6599cc 403 CID	



WATER PUMP BUYERS GUIDE



USMW	Years	Application	Engine	USMW	Years	Application	Engine
US72	2006-2016	CHEVROLET EXPRESS 2500	6.6L V8 6599cc 403 CID	US488	1959-1960	MERCURY MONTEREY	5.1L V8 5114cc 312 CID
	2006-2016	CHEVROLET EXPRESS 3500	6.6L V8 6599cc 403 CID		1959-1962	FORD GALAXIE	4.8L V8 4786cc 292 CID
	2006-2016	CHEVROLET SILVERADO 2500 HD	6.6L V8 6599cc 403 CID	1960	MERCURY MONTCLAIR	5.1L V8 5114cc 312 CID	
	2006-2016	GMC SAVANA 2500	6.6L V8 6599cc 403 CID	1961	MERCURY METEOR	4.8L V8 4786cc 292 CID	
	2006-2016	GMC SAVANA 3500	6.6L V8 6599cc 403 CID	1961-1962	MERCURY MONTEREY	4.8L V8 4786cc 292 CID	
	2006-2016	GMC SIERRA 2500 HD	6.6L V8 6599cc 403 CID	US670	1963	CADILLAC COMMERCIAL CHASSIS	6.4L V8 6392cc 390 CID
	2007	CHEVROLET SILVERADO 2500 HD CLASSIC	6.6L V8 6599cc 403 CID		1964-1965	CADILLAC COMMERCIAL CHASSIS	7.0L V8 7031cc 429 CID
	2007	CHEVROLET SILVERADO 3500 CLASSIC	6.6L V8 6599cc 403 CID		1955-1956	PLYMOUTH BELVEDERE	3.8L L6 3770cc 230 CID
	2007	GMC SIERRA 2500 HD CLASSIC	6.6L V8 6599cc 403 CID		1955-1956	PLYMOUTH PLAZA	3.8L L6 3770cc 230 CID
	2007	GMC SIERRA 3500 CLASSIC	6.6L V8 6599cc 403 CID		1958-1959	PLYMOUTH SAVOY	3.8L L6 3770cc 230 CID
	2007-2016	CHEVROLET SILVERADO 3500 HD	6.6L V8 6599cc 403 CID		1958-1959	DODGE D100 PICKUP	3.8L L6 3770cc 230 CID
	2007-2016	GMC SIERRA 3500 HD	6.6L V8 6599cc 403 CID		1958-1959	DODGE D200 PICKUP	3.8L L6 3770cc 230 CID
	2009-2016	CHEVROLET EXPRESS 4500	6.6L V8 6599cc 403 CID		1958-1959	DODGE D300 PICKUP	3.8L L6 3770cc 230 CID
	2009-2016	GMC SAVANA 4500	6.6L V8 6599cc 403 CID		1958-1959	DODGE W100 PICKUP	3.8L L6 3770cc 230 CID
	US73	2000-2002	CHEVROLET T6500		7.8L L6 475 CID	1958-1959	DODGE W200 PICKUP
		2000-2002	CHEVROLET T7500	7.8L L6 475 CID	1958-1959	DODGE W300 PICKUP	3.8L L6 3770cc 230 CID
		2000-2002	GMC T6500	7.8L L6 475 CID	1958-1960	DODGE WM300 POWER WAGON	3.8L L6 3770cc 230 CID
2000-2002		GMC T7500	7.8L L6 475 CID	1961-1962	MERCURY COLONY PARK	5.8L V8 5769cc 352 CID	
2000-2002		ISUZU FRR	7.8L L6 475 CID	1961-1962	MERCURY COMMUTER	5.8L V8 5769cc 352 CID	
US76		2008-2010	FORD F-250 SUPER DUTY	6.4L V8 391 CID	1961-1962	MERCURY METEOR	5.8L V8 5769cc 352 CID
		2008-2010	FORD F-350 SUPER DUTY	6.4L V8 391 CID	1961-1963	MERCURY MONTEREY	6.4L V8 6391cc 390 CID
	2008-2010	FORD F-450 SUPER DUTY	6.4L V8 391 CID	1961-1964	MERCURY METEOR	5.8L V8 5769cc 352 CID	
	2008-2010	FORD F-550 SUPER DUTY	6.4L V8 391 CID	1961-1964	FORD COUNTRY SEDAN	6.4L V8 6391cc 390 CID	
	2008-2010	FORD F-550 SUPER DUTY	6.4L V8 391 CID	1961-1964	FORD COUNTRY SEDAN	6.4L V8 6391cc 390 CID	
US77	2011-2016	FORD F-250 SUPER DUTY	6.7L V8 6651cc 406 CID	1961-1964	FORD COUNTRY SQUIRE	5.8L V8 5769cc 352 CID	
	2011-2016	FORD F-250 SUPER DUTY	6.7L V8 6700cc 409 CID	1961-1964	FORD COUNTRY SQUIRE	6.4L V8 6391cc 390 CID	
	2011-2016	FORD F-350 SUPER DUTY	6.7L V8 6651cc 406 CID	1961-1964	FORD FAIRLANE	5.8L V8 352 CID	
	2011-2016	FORD F-450 SUPER DUTY	6.7L V8 6651cc 406 CID	1961-1964	FORD FAIRLANE	5.8L V8 5769cc 352 CID	
	2011-2016	FORD F-550 SUPER DUTY	6.7L V8 6651cc 406 CID	1961-1964	FORD FAIRLANE	6.4L V8 390 CID	
	2013-2014	FORD F-450	6.7L V8 6700cc 409 CID	1961-1964	FORD FAIRLANE	6.4L V8 6391cc 390 CID	
	2013-2014	FORD F-550	6.7L V8 6700cc 409 CID	1961-1964	FORD GALAXIE	5.8L V8 5769cc 352 CID	
	US78	2011-2016	FORD F-250 SUPER DUTY	6.7L V8 6651cc 406 CID	1961-1964	FORD GALAXIE	6.4L V8 6391cc 390 CID
		2011-2016	FORD F-350 SUPER DUTY	6.7L V8 6651cc 406 CID	1961-1964	FORD RANCH WAGON	5.8L V8 5769cc 352 CID
	US79	2009	PONTIAC G8	6.2L V8 6162cc 376 CID	1961-1964	FORD RANCH WAGON	6.4L V8 6391cc 390 CID
2009-2013		CHEVROLET CORVETTE	6.2L V8 6162cc 376 CID	1961-1964	FORD THUNDERBIRD	6.4L V8 6391cc 390 CID	
US85	2009-2013	CHEVROLET CORVETTE	7.0L V8 7011cc 427 CID	1961-1964	MERCURY COLONY PARK	6.4L V8 6391cc 390 CID	
	2009-2015	CADILLAC CTS	6.2L V8 6162cc 376 CID	1961-1964	MERCURY COMMUTER	6.4L V8 6391cc 390 CID	
	2011-2017	CHEVROLET CAMARO	6.0L V8 5967cc 364 CID	1961-1964	MERCURY MONTEREY	6.4L V8 6391cc 390 CID	
	2012-2015	CHEVROLET CAPRICE	6.2L V8 6162cc 376 CID	1962-1963	FORD COUNTRY SEDAN	6.6L V8 6654cc 406 CID	
	2014-2017	CHEVROLET SS	6.2L V8 6162cc 376 CID	1962-1963	FORD COUNTRY SQUIRE	6.6L V8 6654cc 406 CID	
	2004-2007	FORD F650	6L V8 365 CID	1962-1963	FORD GALAXIE	6.6L V8 6654cc 406 CID	
	2004-2007	FORD F750	6L V8 365 CID	1962-1963	FORD RANCH WAGON	6.6L V8 6654cc 406 CID	
	US99	2013-2018	RAM 2500	6.7L L6 408 CID	1962-1963	MERCURY COLONY PARK	6.6L V8 6654cc 406 CID
		2013-2018	RAM 3500	6.7L L6 408 CID	1962-1963	MERCURY COMMUTER	6.6L V8 6654cc 406 CID
		2013-2018	RAM 4500	6.7L L6 408 CID	1962-1963	MERCURY MONTEREY	6.4L V8 390 CID
2013-2018		RAM 5500	6.7L L6 408 CID	1962-1963	MERCURY MONTEREY	6.6L V8 6654cc 406 CID	
2013-2018		RAM 5500	6.7L L6 408 CID	1962-1964	FORD GALAXIE 500	5.8L V8 352 CID	
US127	1958	CHEVROLET DEL RAY	5.7L V8 5704cc 348 CID	1962-1964	FORD GALAXIE 500	6.4L V8 390 CID	
	1958-1961	CHEVROLET BEL AIR	5.7L V8 5704cc 348 CID	1963	FORD FORD 300	5.8L V8 5769cc 352 CID	
	1958-1961	CHEVROLET BISCAVNE	5.7L V8 5704cc 348 CID	1963	FORD FORD 300	6.4L V8 6391cc 390 CID	
	1959-1961	CHEVROLET IMPALA	5.7L V8 5704cc 348 CID	1963	FORD FORD 300	6.6L V8 6654cc 406 CID	
	1961-1964	CHEVROLET BEL AIR	6.7L V8 6704cc 409 CID	1963	FORD FORD 300	7.0L V8 6997cc 427 CID	
	1961-1964	CHEVROLET BISCAVNE	6.7L V8 6704cc 409 CID	1963	FORD THUNDERBIRD	6.6L V8 6654cc 406 CID	
	1961-1964	CHEVROLET IMPALA	6.7L V8 6704cc 409 CID	1963	MERCURY COUNTRY CRUISER	6.4L V8 6391cc 390 CID	
	US310	2017	CHEVROLET SILVERADO 2500 HD	6.6L V8 6599cc 403 CID	1963	MERCURY MARAUDER	6.6L V8 6654cc 406 CID
		2017	CHEVROLET SILVERADO 3500 HD	6.6L V8 6599cc 403 CID	1963-1964	FORD COUNTRY SEDAN	7.0L V8 6997cc 427 CID
		2017	GMC SIERRA 2500 HD	6.6L V8 6599cc 403 CID	1963-1964	FORD COUNTRY SQUIRE	7.0L V8 6997cc 427 CID
2017		GMC SIERRA 3500 HD	6.6L V8 6599cc 403 CID	1963-1964	FORD GALAXIE	7.0L V8 6997cc 427 CID	
2017		GMC SIERRA 3500 HD	6.6L V8 6599cc 403 CID	1963-1964	FORD RANCH WAGON	7.0L V8 6997cc 427 CID	
US470	1956-1962	JEEP UTILITY WAGON	3.7L L6 3704cc 226 CID	1963-1964	FORD THUNDERBIRD	7.0L V8 6997cc 427 CID	
	1954	FORD COURIER SEDAN DELIVERY	3.9L V8 3917cc 239 CID	1963-1964	MERCURY COLONY PARK	7.0L V8 6997cc 427 CID	
US488	1954	FORD CRESTLINE	3.9L V8 3917cc 239 CID	1963-1964	MERCURY COMMUTER	7.0L V8 6997cc 427 CID	
	1954	FORD CUSTOMLINE	3.9L V8 3917cc 239 CID	1963-1964	MERCURY MARAUDER	6.4L V8 6391cc 390 CID	
	1954	FORD MAINLINE	3.9L V8 3917cc 239 CID	1963-1964	MERCURY MARAUDER	7.0L V8 6997cc 427 CID	
	1954	MERCURY CUSTOM	4.2L V8 4196cc 256 CID	1963-1964	MERCURY MONTEREY	7.0L V8 6997cc 427 CID	
	1954	MERCURY MONTEREY	4.2L V8 4196cc 256 CID	1964	FORD CUSTOM 500	5.8L V8 352 CID	
	1955-1956	FORD CUSTOMLINE	4.4L V8 4458cc 272 CID	1964	FORD CUSTOM 500	6.4L V8 390 CID	
	1955-1956	FORD MAINLINE	4.4L V8 4458cc 272 CID	1964	FORD FAIRLANE	7.0L V8 6997cc 427 CID	
	1955-1957	FORD COURIER SEDAN DELIVERY	4.4L V8 4458cc 272 CID	1964	FORD GT40	7.0L V8 6997cc 427 CID	
	1955-1957	FORD FAIRLANE	4.4L V8 4458cc 272 CID	1964	MERCURY MONTCLAIR	6.4L V8 6391cc 390 CID	
	1956	MERCURY CUSTOM	5.1L V8 5114cc 312 CID	1964	MERCURY MONTCLAIR	7.0L V8 6997cc 427 CID	
	1956	MERCURY MEDALIST	5.1L V8 5114cc 312 CID	1964	MERCURY PARK LANE	6.4L V8 6391cc 390 CID	
	1956-1957	FORD THUNDERBIRD	5.1L V8 5114cc 312 CID	1964	MERCURY PARK LANE	7.0L V8 6997cc 427 CID	
	1956-1957	MERCURY MONTCLAIR	5.1L V8 5114cc 312 CID	1965-1967	OLDSMOBILE 98	7.0L V8 6966cc 425 CID	
	1956-1957	MERCURY MONTEREY	5.1L V8 5114cc 312 CID	1965-1967	OLDSMOBILE DELTA 88	7.0L V8 6966cc 425 CID	
	1956-1958	FORD F-100	4.4L V8 4458cc 272 CID	1968-1970	OLDSMOBILE 98	7.5L V8 7456cc 455 CID	
	1956-1958	FORD F-250	4.4L V8 4458cc 272 CID	1968-1970	OLDSMOBILE DELTA 88	7.5L V8 7456cc 455 CID	
	1956-1958	FORD F-350	4.4L V8 4458cc 272 CID	US819	1962	FORD FAIRLANE	3.6L L6 3655cc 223 CID
	1957	FORD CUSTOM	4.5L V8 272 CID		1962	FORD FALCON SEDAN DELIVERY	4.3L V8 4261cc 260 CID
	1957	FORD FAIRLANE	4.4L V8 4458cc 272 CID		1962-1963	FORD COUNTRY SEDAN	3.6L V8 3622cc 221 CID
	1957	FORD RANCHERO	4.4L V8 4458cc 272 CID		1962-1963	FORD COUNTRY SQUIRE	3.6L V8 3622cc 221 CID
	1957	FORD THUNDERBIRD	4.8L V8 4786cc 292 CID		1962-1963	FORD FAIRLANE	3.6L V8 221 CID
	1957-1958	FORD COURIER SEDAN DELIVERY	4.8L V8 4786cc 292 CID		1962-1963	FORD FAIRLANE	3.6L V8 3622cc 221 CID
	1957-1959	FORD RANCHERO	4.8L V8 4786cc 292 CID		1962-1963	FORD FALCON	3.6L V8 3622cc 221 CID
	1957-1961	FORD FAIRLANE	4.8L V8 292 CID		1962-1964	FORD FAIRLANE	4.3L V8 4261cc 260 CID
	1958	MERCURY MEDALIST	5.1L V8 5114cc 312 CID		1962-1965	FORD COUNTRY SEDAN	4.3L V8 4261cc 260 CID
	1958-1960	FORD CUSTOM 300	4.8L V8 4786cc 292 CID		1962-1965	FORD COUNTRY SQUIRE	4.3L V8 4261cc 260 CID
	1958-1963	FORD F-100	4.8L V8 4786cc 292 CID	1962-1965	FORD FALCON	4.3L V8 4261cc 260 CID	
	1958-1963	FORD F-250	4.8L V8 4786cc 292 CID	1963	FORD FORD 300	4.3L V8 4261cc 260 CID	
	1958-1963	FORD F-350	4.8L V8 4786cc 292 CID				
	1959-1960	EDSEL RANGER	4.8L V8 4786cc 292 CID				

USMW	Years	Application	Engine	USMW	Years	Application	Engine	
US819	1963	FORD FORD 300	4.7L V8 4727cc 289 CID	US855	1964	BUICK SPORTWAGON	3.7L V6 3687cc 225 CID	
	1963-1964	FORD FAIRLANE	4.3L V8 260 CID		1964-1965	BUICK LESABRE	4.9L V8 4917cc 300 CID	
	1963-1964	FORD FALCON	4.3L V8 260 CID		1964-1965	BUICK SPORTWAGON	4.9L V8 4917cc 300 CID	
	1963-1964	FORD GALAXIE	4.3L V8 4261cc 260 CID		1964-1967	BUICK SKYLARK	3.7L V6 3687cc 225 CID	
	1963-1964	FORD GALAXIE 500	4.3L V8 260 CID		1964-1967	BUICK SKYLARK	4.9L V8 4917cc 300 CID	
	1963-1965	FORD COUNTRY SQUIRE	4.7L V8 4727cc 289 CID		1964-1967	BUICK SPECIAL	3.7L V6 3687cc 225 CID	
	1963-1965	FORD GALAXIE	4.7L V8 4727cc 289 CID		1964-1967	BUICK SPECIAL	4.9L V8 4917cc 300 CID	
	1963-1967	FORD COUNTRY SEDAN	4.7L V8 4727cc 289 CID		1965	BUICK LESABRE	4.9L V8 300 CID	
	1963-1967	FORD FAIRLANE	4.7L V8 289 CID		1966	JEEP CJ3	3.7L V6 3687cc 225 CID	
	1963-1967	FORD FAIRLANE	4.7L V8 4727cc 289 CID		1966	JEEP FC150	3.7L L6 3704cc 226 CID	
	1963-1967	FORD GALAXIE 500	4.7L V8 289 CID		1966	JEEP FC150	3.7L V6 3687cc 225 CID	
	1964	FORD CUSTOM 500	4.3L V8 260 CID		1966	JEEP FC170HD	3.7L L6 3687cc 225 CID	
	1964-1965	FORD MUSTANG	4.3L V8 4261cc 260 CID		1966-1968	JEEP CJ5A	3.7L V6 3687cc 225 CID	
	1964-1966	FORD FALCON	4.7L V8 289 CID		1966-1968	JEEP CJ6A	3.7L V6 3687cc 225 CID	
	1964-1966	FORD FALCON	4.7L V8 4727cc 289 CID		1966-1968	JEEP DJ6	3.7L V6 3687cc 225 CID	
	1964-1967	FORD CUSTOM 500	4.7L V8 289 CID		1966-1969	JEEP DISPATCHER	3.7L V6 3687cc 225 CID	
	1964-1968	FORD MUSTANG	4.7L V8 4727cc 289 CID		1966-1971	JEEP CJ5	3.7L V6 3687cc 225 CID	
	1965	FORD CUSTOM	4.7L V8 4727cc 289 CID		1966-1971	JEEP CJ6	3.7L V6 3687cc 225 CID	
	1965	FORD FALCON SEDAN DELIVERY	4.7L V8 4727cc 289 CID		1966-1971	JEEP COMMANDO	3.7L V6 3687cc 225 CID	
	1965-1966	FORD F100	4.7L V8 4700cc 289 CID		1966-1971	JEEP DJ5	3.7L V6 3687cc 225 CID	
	1965-1966	FORD F350	4.7L V8 4700cc 289 CID		1968	JEEP CJ6	3.7L V6 225 CID	
	1965-1966	FORD F350	5.0L V8 5000cc 302 CID		1968-1969	BUICK GS 350	5.7L V8 350 CID	
	1965-1967	FORD LTD	4.7L V8 4727cc 289 CID		1968-1969	BUICK GS 350	5.7L V8 5736cc 350 CID	
	1966-1968	FORD GT40	4.7L V8 4727cc 289 CID		1968-1969	BUICK SPECIAL	5.7L V8 5736cc 350 CID	
	1968	FORD GT40	4.7L V8 289 CID		1968-1970	BUICK LESABRE	5.7L V8 350 CID	
	1968	FORD MUSTANG	4.7L V8 289 CID		1968-1970	BUICK LESABRE	5.7L V8 5736cc 350 CID	
	US821	1967-1969	BUICK ELECTRA		7.0L V8 7047cc 430 CID	1968-1970	BUICK SKYLARK	5.7L V8 350 CID
		1967-1969	BUICK RIVIERA		7.0L V8 7047cc 430 CID	1968-1970	BUICK SKYLARK	5.7L V8 5736cc 350 CID
		1967-1969	BUICK WILDCAT		7.0L V8 7047cc 430 CID	1968-1970	BUICK SPORTWAGON	5.7L V8 5736cc 350 CID
		1970	BUICK WILDCAT		7.5L V8 7456cc 455 CID	1968-1971	JEEP J-100	5.7L V8 5736cc 350 CID
		1970-1972	BUICK ELECTRA		7.5L V8 7456cc 455 CID	1969-1970	JEEP J-2600	5.7L V8 350 CID
		1970-1972	BUICK ESTATE WAGON		7.5L V8 7456cc 455 CID	1969-1970	JEEP J-2700	5.7L V8 350 CID
		1970-1972	BUICK LESABRE		7.5L V8 7456cc 455 CID	1969-1970	JEEP J-2700	5.7L V8 5736cc 350 CID
1970-1972		BUICK RIVIERA	7.5L V8 7456cc 455 CID	1969-1971	JEEP J-100	5.7L V8 350 CID		
1971-1972		BUICK CENTURION	7.5L V8 7456cc 455 CID	1969-1971	JEEP J-2500	5.7L V8 350 CID		
US835		1967-1973	CHEVROLET C60	7.8L V6 7828cc 478 CID	1969-1971	JEEP J-2500	5.7L V8 5736cc 350 CID	
		1968-1969	GMC C15/C1500 PICKUP	5.0L V6 5012cc 305 CID	1969-1971	JEEP J-2600	5.7L V8 5736cc 350 CID	
	1968-1969	GMC C25/C2500 PICKUP	5.0L V6 5012cc 305 CID	1970	BUICK ESTATE WAGON	5.7L V8 350 CID		
	1968-1969	GMC C35/C3500 PICKUP	5.0L V6 5012cc 305 CID	1970	BUICK ESTATE WAGON	5.7L V8 5736cc 350 CID		
	1968-1969	GMC K15/K1500 PICKUP	5.0L V6 5012cc 305 CID	1970	BUICK GS	5.7L V8 350 CID		
	1968-1969	GMC K25/K2500 PICKUP	5.0L V6 5012cc 305 CID	1970	BUICK GS	5.7L V8 5736cc 350 CID		
	US843	1966	AMERICAN MOTORS CLASSIC	3.3L L6 3261cc 199 CID	US861	1966-1978	CHEVROLET C50	6.0L V8 5999cc 366 CID
1966-1970		AMERICAN MOTORS CLASSIC	3.3L L6 3300cc 199 CID	1966-1978		CHEVROLET C60	6.0L V8 5999cc 366 CID	
1967-1973		AMERICAN MOTORS CLASSIC	3.8L L6 3800cc 232 CID	1969-1978		CHEVROLET C50	7.0L V8 6998cc 427 CID	
1969-1970		AMERICAN MOTORS AMERICAN	3.3L L6 3300cc 199 CID	1969-1978		CHEVROLET C60	7.0L V8 6998cc 427 CID	
1969-1973		AMERICAN MOTORS AMERICAN	3.8L L6 3800cc 232 CID	US895		1964-1966	CHEVROLET CHEVELLE	4.1L L6 4100cc 250 CID
1972		AMERICAN MOTORS CLASSIC	4.2L L6 4200cc 258 CID			1965	CHEVROLET IMPALA	4.1L L6 4100cc 250 CID
1972	AMERICAN MOTORS CLASSIC	4.6L L6 4600cc 282 CID	1965		CHEVROLET MALIBU	4.1L L6 4100cc 250 CID		
US850	1959-1962	PONTIAC BONNEVILLE	6.4L V8 389 CID		1965-1972	CHEVROLET IMPALA	4.8L L6 4800cc 292 CID	
	1959-1966	PONTIAC BONNEVILLE	6.4L V8 6376cc 389 CID		1966-1974	CHEVROLET CS1073	4.1L L6 4100cc 250 CID	
	1959-1966	PONTIAC CATALINA	6.4L V8 6376cc 389 CID		1970	CHEVROLET CHEVELLE	3.8L L6 3800cc 230 CID	
	1959-1966	PONTIAC STAR CHIEF	6.4L V8 6376cc 389 CID	1975	GMC SPRINT	4.1L L6 250 CID		
	1960-1961	PONTIAC VENTURA	6.4L V8 6376cc 389 CID	1994-1997	CHEVROLET C1500	4.1L L6 4100cc 250 CID		
	1961	PONTIAC TEMPEST	6.4L V8 6376cc 389 CID	1994-1997	GMC C1500	4.1L L6 4100cc 250 CID		
	1961	PONTIAC VENTURA	6.9L V8 6900cc 421 CID	US896	1964-1974	CHEVROLET CS1073	4.8L L6 4800cc 292 CID	
	1961-1966	PONTIAC CATALINA	6.9L V8 6900cc 421 CID		1965	GMC PB1500 SERIES	4.8L L6 4801cc 292 CID	
	1962-1966	PONTIAC GRAND PRIX	6.4L V8 6376cc 389 CID		1965	GMC PB2500 SERIES	4.8L L6 4801cc 292 CID	
	1963-1966	PONTIAC BONNEVILLE	6.9L V8 6900cc 421 CID		1965-1966	CHEVROLET C1405	4.8L L6 4800cc 292 CID	
	1963-1966	PONTIAC GRAND PRIX	6.9L V8 6900cc 421 CID		1965-1966	CHEVROLET SUBURBAN	4.8L L6 4801cc 292 CID	
	1963-1966	PONTIAC STAR CHIEF	6.9L V8 6900cc 421 CID		1965-1966	GMC SUBURBAN	4.8L L6 4801cc 292 CID	
	1964-1966	PONTIAC GTO	6.4L V8 6376cc 389 CID		1965-1967	CHEVROLET C20905	4.8L L6 4800cc 292 CID	
	1967-1968	PONTIAC BONNEVILLE	6.6L V8 6555cc 400 CID		1965-1967	CHEVROLET P20 SERIES	4.8L L6 4801cc 292 CID	
	1967-1968	PONTIAC BONNEVILLE	7.0L V8 7014cc 428 CID		1965-1967	CHEVROLET P30 SERIES	4.8L L6 4801cc 292 CID	
	1967-1968	PONTIAC CATALINA	6.6L V8 400 CID		1965-1974	CHEVROLET C10 PICKUP	4.8L L6 4801cc 292 CID	
	1967-1968	PONTIAC CATALINA	6.6L V8 6555cc 400 CID		1965-1974	CHEVROLET C30 PICKUP	4.8L L6 4801cc 292 CID	
	1967-1968	PONTIAC CATALINA	7.0L V8 7014cc 428 CID	1965-1974	CHEVROLET CS31003	4.8L L6 4800cc 292 CID		
	1967-1968	PONTIAC EXECUTIVE	6.6L V8 6555cc 400 CID	1965-1974	CHEVROLET K10 PICKUP	4.8L L6 4801cc 292 CID		
	1967-1968	PONTIAC EXECUTIVE	7.0L V8 7014cc 428 CID	1965-1974	CHEVROLET K20 PICKUP	4.8L L6 4801cc 292 CID		
	1967-1968	PONTIAC FIREBIRD	6.6L V8 400 CID	1966	GMC PB15 SERIES	4.8L L6 4801cc 292 CID		
	1967-1968	PONTIAC FIREBIRD	6.6L V8 6555cc 400 CID	1966	GMC PB25 SERIES	4.8L L6 4801cc 292 CID		
	1967-1968	PONTIAC GRAND PRIX	6.6L V8 6555cc 400 CID	1967	CHEVROLET C3605	4.8L L6 4800cc 292 CID		
	1967-1968	PONTIAC GRAND PRIX	7.0L V8 7014cc 428 CID	1967	CHEVROLET K10 SUBURBAN	4.8L L6 4801cc 292 CID		
	1967-1968	PONTIAC GTO	6.6L V8 400 CID	1967	CHEVROLET P10 SERIES	4.8L L6 4801cc 292 CID		
	1967-1968	PONTIAC GTO	6.6L V8 6555cc 400 CID	1967	GMC P15/P1500 VAN	4.8L L6 292 CID		
	1968	PONTIAC ACADIAN	5.7L V8 5736cc 350 CID	1967-1968	GMC K15/K1500 SUBURBAN	4.8L L6 4801cc 292 CID		
	1968	PONTIAC BONNEVILLE	6.6L V8 400 CID	1967-1970	CHEVROLET CHEVELLE	4.8L L6 4800cc 292 CID		
	1968	PONTIAC BONNEVILLE	7.0L V8 428 CID	1967-1974	CHEVROLET C10 SUBURBAN	4.8L L6 4801cc 292 CID		
	1968	PONTIAC CATALINA	7.0L V8 428 CID	1967-1974	CHEVROLET C20 SUBURBAN	4.8L L6 4801cc 292 CID		
	1968	PONTIAC FIREBIRD	5.7L V8 350 CID	1967-1974	CHEVROLET K20 SUBURBAN	4.8L L6 4801cc 292 CID		
	1968	PONTIAC FIREBIRD	5.7L V8 5733cc 350 CID	1967-1974	GMC K15/K1500 PICKUP	4.8L L6 4801cc 292 CID		
	1968	PONTIAC GRAND PRIX	6.6L V8 400 CID	1967-1974	GMC K25/K2500 PICKUP	4.8L L6 4801cc 292 CID		
1968	PONTIAC GRAND PRIX	7.0L V8 428 CID	1967-1974	GMC P25/P2500 VAN	4.8L L6 292 CID			
1968	PONTIAC LEMANS	5.7L V8 350 CID	1967-1974	GMC P35/P3500 VAN	4.8L L6 292 CID			
1968	PONTIAC LEMANS	5.7L V8 5733cc 350 CID	1968	GMC K15/K1500 PICKUP	4.8L L6 292 CID			
1968	PONTIAC LEMANS	6.6L V8 400 CID	1968	GMC K15/K1500 SUBURBAN	4.8L L6 292 CID			
1968	PONTIAC LEMANS	6.6L V8 6555cc 400 CID	1968	GMC K25/K2500 PICKUP	4.8L L6 292 CID			
1968	PONTIAC TEMPEST	5.7L V8 5733cc 350 CID	1968-1971	CHEVROLET C10 PICKUP	4.8L L6 292 CID			
1968	PONTIAC TEMPEST	6.6L V8 6555cc 400 CID	1968-1971	CHEVROLET C10 SUBURBAN	4.8L L6 292 CID			
US855	1964	BUICK ESTATE WAGON	4.9L V8 4917cc 300 CID	1968-1974	CHEVROLET C20 SUBURBAN	4.8L L6 292 CID		

USMW	Years	Application	Engine	USMW	Years	Application	Engine	
US896	1968-1974	CHEVROLET C30 PICKUP	4.8L L6 292 CID	US898	1960	CHEVROLET TRUCK	4.6L V8 4638cc 283 CID	
	1968-1974	CHEVROLET K20 SUBURBAN	4.8L L6 292 CID		1960	CHEVROLET TRUCK	5.7L V8 5704cc 348 CID	
	1968-1974	CHEVROLET K30 PICKUP	4.8L L6 292 CID		1960-1961	CHEVROLET C10 PICKUP	5.7L V8 5704cc 348 CID	
	1968-1974	CHEVROLET K30 PICKUP	4.8L L6 4801cc 292 CID		1960-1961	CHEVROLET C20 PICKUP	5.7L V8 5704cc 348 CID	
	1968-1974	CHEVROLET P20 VAN	4.8L L6 292 CID		1960-1961	CHEVROLET C30 PICKUP	5.7L V8 5704cc 348 CID	
	1968-1974	CHEVROLET P30 VAN	4.8L L6 292 CID		1960-1961	CHEVROLET K10 PICKUP	5.7L V8 5704cc 348 CID	
	1968-1974	GMC K25/K2500 SUBURBAN	4.8L L6 292 CID		1960-1961	CHEVROLET K20 PICKUP	5.7L V8 5704cc 348 CID	
	1968-1974	GMC K25/K2500 SUBURBAN	4.8L L6 4801cc 292 CID		1960-1961	CHEVROLET SUBURBAN	5.7L V8 5704cc 348 CID	
	1968-1974	GMC K35/K3500 PICKUP	4.8L L6 292 CID		1960-1965	CHEVROLET P30 SERIES	5.7L V8 5704cc 348 CID	
	1968-1974	GMC K35/K3500 PICKUP	4.8L L6 4801cc 292 CID		1960-1966	CHEVROLET SUBURBAN	4.6L V8 4638cc 283 CID	
	1969-1970	CHEVROLET K10 PICKUP	4.8L L6 292 CID		1960-1967	CHEVROLET C10 PICKUP	4.6L V8 4638cc 283 CID	
	1969-1970	CHEVROLET K10 SUBURBAN	4.8L L6 292 CID		1960-1967	CHEVROLET C20 PICKUP	4.6L V8 4638cc 283 CID	
	1969-1974	CHEVROLET BLAZER	4.8L L6 4801cc 292 CID		1960-1967	CHEVROLET C30 PICKUP	4.6L V8 4638cc 283 CID	
	1969-1974	CHEVROLET K20 PICKUP	4.8L L6 292 CID		1960-1967	CHEVROLET K10 PICKUP	4.6L V8 4638cc 283 CID	
	1970	CHEVROLET BLAZER	4.8L L6 292 CID		1960-1967	CHEVROLET K20 PICKUP	4.6L V8 4638cc 283 CID	
	1970-1971	GMC K15/K1500 PICKUP	4.8L L6 292 CID		1961-1962	CHEVROLET C10 PICKUP	4.3L L6 4278cc 261 CID	
	1970-1971	GMC K15/K1500 SUBURBAN	4.8L L6 292 CID		1961-1962	CHEVROLET C20 PICKUP	4.3L L6 4278cc 261 CID	
	1970-1971	GMC K15/K1500 SUBURBAN	4.8L L6 4801cc 292 CID		1961-1962	CHEVROLET C30 PICKUP	4.3L L6 4278cc 261 CID	
	1970-1974	GMC JIMMY	4.8L L6 4801cc 292 CID		1961-1962	CHEVROLET K10 PICKUP	4.3L L6 4278cc 261 CID	
	1970-1974	GMC K25/K2500 PICKUP	4.8L L6 292 CID		1961-1962	CHEVROLET K20 PICKUP	4.3L L6 4278cc 261 CID	
	1971	CHEVROLET G20 VAN	4.8L L6 292 CID		1961-1962	CHEVROLET P10 SERIES	4.3L L6 4278cc 261 CID	
	1971-1972	CHEVROLET G30 VAN	4.8L L6 292 CID		1961-1962	CHEVROLET P10 SERIES	4.6L V8 4638cc 283 CID	
	1971-1974	CHEVROLET G20 VAN	4.8L L6 4801cc 292 CID		1961-1962	CHEVROLET P30 SERIES	4.3L L6 4278cc 261 CID	
	1972-1973	CHEVROLET K10 PICKUP	4.8L L6 292 CID		1961-1962	CHEVROLET P30 SERIES	4.6L V8 4638cc 283 CID	
	1972-1973	CHEVROLET K10 PICKUP	4.8L L6 4786cc 292 CID		1961-1962	CHEVROLET SUBURBAN	4.3L L6 4278cc 261 CID	
	1972-1974	CHEVROLET K20 PICKUP	4.8L L6 4786cc 292 CID		1962-1968	CHEVROLET CORVETTE	5.3L V8 5358cc 327 CID	
	1973	CHEVROLET BLAZER	4.8L L6 292 CID		1962-1969	CHEVROLET BEL AIR	5.3L V8 5358cc 327 CID	
	1973	CHEVROLET BLAZER	4.8L L6 4786cc 292 CID		1962-1969	CHEVROLET BISCAYNE	5.3L V8 5358cc 327 CID	
	1973	CHEVROLET CHEVELLE	4.8L L6 4800cc 292 CID		1962-1969	CHEVROLET IMPALA	5.3L V8 5358cc 327 CID	
	1973	GMC JIMMY	4.8L L6 292 CID		1963-1967	CHEVROLET CHEVY II	4.6L V8 4638cc 283 CID	
	1973	GMC JIMMY	4.8L L6 4786cc 292 CID		1964	CHEVROLET IMPALA	4.6L V8 283 CID	
	1973-1974	CHEVROLET C10 PICKUP	4.8L L6 292 CID		1964-1966	CHEVROLET CHEVY II	4.6L V8 283 CID	
	1973-1974	CHEVROLET C10 PICKUP	4.8L L6 4786cc 292 CID		1964-1967	CHEVROLET CHEVELLE	4.6L V8 4638cc 283 CID	
	1973-1974	CHEVROLET C10 SUBURBAN	4.8L L6 292 CID		1964-1967	CHEVROLET CS1073	4.7L V8 4738cc 283 CID	
	1973-1974	CHEVROLET C10 SUBURBAN	4.8L L6 4786cc 292 CID		1964-1967	CHEVROLET CS31003	4.7L V8 4738cc 283 CID	
	1973-1974	CHEVROLET C20 SUBURBAN	4.8L L6 4786cc 292 CID		1964-1967	CHEVROLET EL CAMINO	4.6L V8 4638cc 283 CID	
	1973-1974	CHEVROLET C30 PICKUP	4.8L L6 4786cc 292 CID		1964-1967	CHEVROLET MALIBU	4.6L V8 4638cc 283 CID	
	1973-1974	CHEVROLET G20 VAN	4.8L L6 292 CID		1964-1967	CHEVROLET MALIBU	5.3L V8 5358cc 327 CID	
	1973-1974	CHEVROLET G20 VAN	4.8L L6 4786cc 292 CID		1964-1968	CHEVROLET CHEVELLE	5.3L V8 5358cc 327 CID	
	1973-1974	CHEVROLET K20 SUBURBAN	4.8L L6 4786cc 292 CID		1964-1969	CHEVROLET CS1073	5.4L V8 5400cc 327 CID	
	1973-1974	CHEVROLET K30 PICKUP	4.8L L6 4786cc 292 CID		1964-1969	CHEVROLET CS31003	5.4L V8 5400cc 327 CID	
	1973-1974	CHEVROLET P20 VAN	4.8L L6 4786cc 292 CID		1964-1969	CHEVROLET IMPALA	5.4L V8 327 CID	
	1973-1974	CHEVROLET P30 VAN	4.8L L6 4786cc 292 CID		1965	CHEVROLET CHEVELLE	5.4L V8 327 CID	
	1973-1974	GMC K25/K2500 PICKUP	4.8L L6 4786cc 292 CID		1965-1966	CHEVROLET C1405	4.7L V8 4738cc 283 CID	
	1973-1974	GMC K25/K2500 SUBURBAN	4.8L L6 4786cc 292 CID		1965-1966	CHEVROLET CHEVY II	5.4L V8 327 CID	
	1973-1974	GMC K35/K3500 PICKUP	4.8L L6 4786cc 292 CID		1965-1967	CHECKER MARATHON	4.6L V8 4638cc 283 CID	
	1973-1974	GMC P25/P2500 VAN	4.8L L6 4786cc 292 CID		1965-1967	CHEVROLET C20905	4.7L V8 4738cc 283 CID	
	1973-1974	GMC P35/P3500 VAN	4.8L L6 4786cc 292 CID		1965-1967	CHEVROLET CHEVELLE	4.6L V8 283 CID	
	1974	CHEVROLET G30 VAN	4.8L L6 292 CID		1965-1968	CHEVROLET CHEVY II	5.3L V8 5358cc 327 CID	
	1974	CHEVROLET G30 VAN	4.8L L6 4786cc 292 CID		1965-1969	AVANTI II	5.3L V8 5358cc 327 CID	
	1974	GMC K15/K1500 PICKUP	4.8L L6 292 CID		1965-1969	CHECKER MARATHON	5.3L V8 5358cc 327 CID	
	1982-1986	CHEVROLET C10	4.8L L6 4800cc 292 CID		1966	CHEVROLET SUBURBAN	5.3L V8 5358cc 327 CID	
	US898	1955-1956	CHEVROLET CORVETTE		4.3L V8 4343cc 265 CID	1966-1967	CHEVROLET CAPRICE	4.6L V8 4638cc 283 CID
		1955-1956	CHEVROLET TRUCK		5.3L V8 5310cc 324 CID	1966-1967	CHEVROLET IMPALA	4.6L V8 283 CID
		1955-1957	CHEVROLET BEL AIR		4.3L V8 265 CID	1966-1969	CHEVROLET C10 PICKUP	5.3L V8 5358cc 327 CID
		1955-1957	CHEVROLET BEL AIR		4.3L V8 4343cc 265 CID	1966-1969	CHEVROLET C20 PICKUP	5.3L V8 5358cc 327 CID
		1955-1957	CHEVROLET ONE-FIFTY SERIES		4.3L V8 4343cc 265 CID	1966-1969	CHEVROLET C30 PICKUP	5.3L V8 5358cc 327 CID
1955-1957		CHEVROLET TRUCK	4.3L V8 4343cc 265 CID	1966-1969	CHEVROLET CAPRICE	5.3L V8 5358cc 327 CID		
1955-1957		CHEVROLET TWO-TEN SERIES	4.3L V8 4343cc 265 CID	1966-1969	CHEVROLET EL CAMINO	5.3L V8 5358cc 327 CID		
1955-1958		CHEVROLET TRUCK	4.3L L6 4278cc 261 CID	1966-1969	CHEVROLET K10 PICKUP	5.3L V8 5358cc 327 CID		
1956-1958		CHEVROLET TRUCK	5.3L V8 5272cc 322 CID	1966-1969	CHEVROLET K20 PICKUP	5.3L V8 5358cc 327 CID		
1957		CHEVROLET BEL AIR	4.6L V8 283 CID	1967	CHEVROLET C10 SUBURBAN	4.6L V8 4638cc 283 CID		
1957		CHEVROLET DEL RAY	4.3L V8 4343cc 265 CID	1967	CHEVROLET C20 SUBURBAN	4.6L V8 4638cc 283 CID		
1957		CHEVROLET ONE-FIFTY SERIES	4.6L V8 4638cc 283 CID	1967	CHEVROLET C3605	4.7L V8 4738cc 283 CID		
1957		CHEVROLET TWO-TEN SERIES	4.6L V8 4638cc 283 CID	1967	CHEVROLET G20 VAN	4.6L V8 4638cc 283 CID		
1957-1958		CHEVROLET DEL RAY	4.6L V8 4638cc 283 CID	1967	CHEVROLET K10 SUBURBAN	4.6L V8 4638cc 283 CID		
1957-1958		CHEVROLET TRUCK	4.6L V8 4638cc 283 CID	1967	CHEVROLET K20 PANEL	4.6L V8 283 CID		
1957-1961		CHEVROLET CORVETTE	4.6L V8 4638cc 283 CID	1967	CHEVROLET K20 PANEL	5.4L V8 327 CID		
1957-1967		CHEVROLET BEL AIR	4.6L V8 4638cc 283 CID	1967	CHEVROLET K20 SUBURBAN	4.6L V8 4638cc 283 CID		
1958		CHEVROLET BROOKWOOD	4.6L V8 283 CID	1967-1968	CHEVROLET CHEVELLE	5.4L V8 327 CID		
1958		CHEVROLET BROOKWOOD	5.7L V8 348 CID	1967-1969	CHEVROLET C10 SUBURBAN	5.3L V8 5358cc 327 CID		
1958		CHEVROLET DEL RAY	5.7L V8 5704cc 348 CID	1967-1969	CHEVROLET C20 SUBURBAN	5.3L V8 5358cc 327 CID		
1958		CHEVROLET TRUCK	5.7L V8 5704cc 348 CID	1967-1969	CHEVROLET CAMARO	5.3L V8 5358cc 327 CID		
1958-1961		CHEVROLET BEL AIR	5.7L V8 5704cc 348 CID	1967-1969	CHEVROLET K10 SUBURBAN	5.3L V8 5358cc 327 CID		
1958-1961		CHEVROLET BISCAYNE	5.7L V8 5704cc 348 CID	1967-1969	CHEVROLET K20 SUBURBAN	5.3L V8 5358cc 327 CID		
1958-1961		CHEVROLET IMPALA	5.7L V8 5704cc 348 CID	1967-1972	CHEVROLET CAMARO	5.7L V8 5736cc 350 CID		
1958-1967		CHEVROLET BISCAYNE	4.6L V8 4638cc 283 CID	1968	CHECKER MARATHON	5.0L V8 307 CID		
1958-1967		CHEVROLET IMPALA	4.6L V8 4638cc 283 CID	1968	CHECKER MARATHON	5.0L V8 5031cc 307 CID		
1959		CHEVROLET BEL AIR	5.3L V8 5272cc 322 CID	1968	CHEVROLET BEL AIR	5.0L V8 307 CID		
1959-1960		CHEVROLET BEL AIR	4.3L L6 4278cc 261 CID	1968	CHEVROLET BEL AIR	5.0L V8 5031cc 307 CID		
1959-1960		CHEVROLET EL CAMINO	4.6L V8 4638cc 283 CID	1968	CHEVROLET BISCAYNE	5.0L V8 307 CID		
1959-1960		CHEVROLET EL CAMINO	5.7L V8 5704cc 348 CID	1968	CHEVROLET BISCAYNE	5.0L V8 5031cc 307 CID		
1959-1961		CHEVROLET BROOKWOOD	4.6L V8 4638cc 283 CID	1968	CHEVROLET C10 PICKUP	5.4L V8 327 CID		
1959-1961		CHEVROLET BROOKWOOD	5.7L V8 5704cc 348 CID	1968	CHEVROLET C10 SUBURBAN	5.4L V8 327 CID		
1959-1961		CHEVROLET KINGSWOOD	4.6L V8 4638cc 283 CID	1968	CHEVROLET C20 PICKUP	5.4L V8 327 CID		
1959-1961		CHEVROLET KINGSWOOD	5.7L V8 5704cc 348 CID	1968	CHEVROLET C20 SUBURBAN	5.4L V8 327 CID		
1960		CHEVROLET BISCAYNE	4.6L V8 283 CID	1968	CHEVROLET C30 PICKUP	5.4L V8 327 CID		
1960		CHEVROLET BISCAYNE	5.7L V8 348 CID	1968	CHEVROLET CAPRICE	5.0L V8 307 CID		
1960		CHEVROLET TRUCK	4.3L L6 4278cc 261 CID	1968	CHEVROLET CHEVY II	5.0L V8 307 CID		

USMW	Years	Application	Engine	USMW	Years	Application	Engine	
US898	1968	CHEVROLET CHEVY II	5.0L V8 5031cc 307 CID	US898	1969-1972	CHEVROLET IMPALA	5.7L V8 5736cc 350 CID	
	1968	CHEVROLET CHEVY II	5.4L V8 327 CID		1969-1972	CHEVROLET K10 PICKUP	5.7L V8 350 CID	
	1968	CHEVROLET CHEVY II	5.7L V8 350 CID		1969-1972	CHEVROLET K10 PICKUP	5.7L V8 5736cc 350 CID	
	1968	CHEVROLET CHEVY II	5.7L V8 5736cc 350 CID		1969-1972	CHEVROLET K10 SUBURBAN	5.7L V8 350 CID	
	1968	CHEVROLET CORVETTE	5.4L V8 327 CID		1969-1972	CHEVROLET K10 SUBURBAN	5.7L V8 5736cc 350 CID	
	1968	CHEVROLET EL CAMINO	5.4L V8 327 CID		1969-1972	CHEVROLET K20 PICKUP	5.7L V8 350 CID	
	1968	CHEVROLET IMPALA	5.0L V8 307 CID		1969-1972	CHEVROLET K20 PICKUP	5.7L V8 5736cc 350 CID	
	1968	CHEVROLET K10 PICKUP	5.4L V8 327 CID		1969-1972	CHEVROLET K20 SUBURBAN	5.7L V8 350 CID	
	1968	CHEVROLET K10 SUBURBAN	5.4L V8 327 CID		1969-1972	CHEVROLET K20 SUBURBAN	5.7L V8 5736cc 350 CID	
	1968	CHEVROLET K20 PICKUP	5.4L V8 327 CID		1969-1972	CHEVROLET K30 PICKUP	5.7L V8 350 CID	
	1968	CHEVROLET K20 SUBURBAN	5.4L V8 327 CID		1969-1972	CHEVROLET K30 PICKUP	5.7L V8 5736cc 350 CID	
	1968	CHEVROLET K30 PICKUP	5.4L V8 327 CID		1969-1972	CHEVROLET KINGSWOOD	5.7L V8 350 CID	
	1968-1969	AVANTI II	5.4L V8 327 CID		1969-1972	CHEVROLET KINGSWOOD	5.7L V8 5736cc 350 CID	
	1968-1969	CHEVROLET BEL AIR	5.4L V8 327 CID		1970-1972	CHEVROLET G10 VAN	5.7L V8 350 CID	
	1968-1969	CHEVROLET BISCAYNE	5.4L V8 327 CID		1970-1972	CHEVROLET G20 VAN	5.7L V8 350 CID	
	1968-1969	CHEVROLET CAMARO	5.4L V8 327 CID		1970-1972	CHEVROLET G20 VAN	5.7L V8 5736cc 350 CID	
	1968-1969	CHEVROLET CAPRICE	5.0L V8 5031cc 307 CID		1970-1972	CHEVROLET G30 VAN	5.7L V8 350 CID	
	1968-1969	CHEVROLET CAPRICE	5.4L V8 327 CID		1970-1972	CHEVROLET G20 VAN	5.7L V8 350 CID	
	1968-1969	CHEVROLET IMPALA	5.0L V8 5031cc 307 CID		1970-1972	CHEVROLET P30 VAN	5.7L V8 350 CID	
	1968-1969	CHEVROLET K30 PICKUP	5.3L V8 5358cc 327 CID		1971-1972	CHEVROLET BROOKWOOD	5.0L V8 5031cc 307 CID	
	1968-1969	CHEVROLET P20 VAN	5.0L V8 307 CID		1971-1972	CHEVROLET CAPRICE	5.0L V8 5031cc 307 CID	
	1968-1969	CHEVROLET P30 VAN	5.0L V8 307 CID		1971-1972	CHEVROLET IMPALA	5.0L V8 5031cc 307 CID	
	1968-1970	CHEVROLET G20 VAN	5.0L V8 307 CID		1971-1972	CHEVROLET KINGSWOOD	5.0L V8 5031cc 307 CID	
	1968-1972	CHEVROLET C10 PICKUP	5.0L V8 307 CID		1972	CHEVROLET CAMARO	5.7L V8 5737cc 350 CID	
	1968-1972	CHEVROLET C10 PICKUP	5.0L V8 5031cc 307 CID		1972	CHEVROLET CORVETTE	5.7L V8 5737cc 350 CID	
	1968-1972	CHEVROLET C10 SUBURBAN	5.0L V8 307 CID		US898H	1955-1956	CHEVROLET CORVETTE	4.3L V8 4343cc 265 CID
	1968-1972	CHEVROLET C10 SUBURBAN	5.0L V8 5031cc 307 CID			1955-1956	CHEVROLET TRUCK	5.3L V8 5310cc 324 CID
	1968-1972	CHEVROLET C20 PICKUP	5.0L V8 307 CID			1955-1957	CHEVROLET BEL AIR	4.3L V8 265 CID
	1968-1972	CHEVROLET C20 PICKUP	5.0L V8 5031cc 307 CID			1955-1957	CHEVROLET BEL AIR	4.3L V8 4343cc 265 CID
	1968-1972	CHEVROLET C20 SUBURBAN	5.0L V8 307 CID			1955-1957	CHEVROLET ONE-FIFTY SERIES	4.3L V8 4343cc 265 CID
	1968-1972	CHEVROLET C20 SUBURBAN	5.0L V8 5031cc 307 CID			1955-1957	CHEVROLET TRUCK	4.3L V8 4343cc 265 CID
	1968-1972	CHEVROLET C30 PICKUP	5.0L V8 307 CID			1955-1957	CHEVROLET TWO-TEN SERIES	4.3L V8 4343cc 265 CID
	1968-1972	CHEVROLET C30 PICKUP	5.0L V8 5031cc 307 CID			1955-1958	CHEVROLET TRUCK	4.3L L6 4278cc 261 CID
	1968-1972	CHEVROLET CAMARO	5.7L V8 350 CID			1956-1958	CHEVROLET TRUCK	5.3L V8 5272cc 322 CID
	1968-1972	CHEVROLET CHEVELLE	5.0L V8 307 CID			1957	CHEVROLET BEL AIR	4.6L V8 283 CID
	1968-1972	CHEVROLET CHEVELLE	5.0L V8 5031cc 307 CID			1957	CHEVROLET DEL RAY	4.3L V8 4343cc 265 CID
	1968-1972	CHEVROLET CHEVELLE	5.7L V8 5736cc 350 CID			1957	CHEVROLET ONE-FIFTY SERIES	4.6L V8 4638cc 283 CID
	1968-1972	CHEVROLET EL CAMINO	5.0L V8 307 CID			1957	CHEVROLET TWO-TEN SERIES	4.6L V8 4638cc 283 CID
	1968-1972	CHEVROLET EL CAMINO	5.0L V8 5031cc 307 CID			1957-1958	CHEVROLET DEL RAY	4.6L V8 4638cc 283 CID
	1968-1972	CHEVROLET EL CAMINO	5.7L V8 5736cc 350 CID			1957-1958	CHEVROLET TRUCK	4.6L V8 4638cc 283 CID
	1968-1972	CHEVROLET G10 VAN	5.0L V8 307 CID			1957-1961	CHEVROLET CORVETTE	4.6L V8 4638cc 283 CID
	1968-1972	CHEVROLET G20 VAN	5.0L V8 5031cc 307 CID			1957-1967	CHEVROLET BEL AIR	4.6L V8 4638cc 283 CID
	1968-1972	CHEVROLET K10 PICKUP	5.0L V8 307 CID			1958	CHEVROLET BROOKWOOD	4.6L V8 283 CID
	1968-1972	CHEVROLET K10 PICKUP	5.0L V8 5031cc 307 CID			1958	CHEVROLET BROOKWOOD	5.7L V8 5704cc 348 CID
	1968-1972	CHEVROLET K10 SUBURBAN	5.0L V8 307 CID			1958	CHEVROLET DEL RAY	5.7L V8 5704cc 348 CID
	1968-1972	CHEVROLET K10 SUBURBAN	5.0L V8 5031cc 307 CID			1958	CHEVROLET TRUCK	5.7L V8 5704cc 348 CID
	1968-1972	CHEVROLET K20 PICKUP	5.0L V8 307 CID			1958-1961	CHEVROLET BEL AIR	5.7L V8 5704cc 348 CID
	1968-1972	CHEVROLET K20 PICKUP	5.0L V8 5031cc 307 CID			1958-1961	CHEVROLET BISCAYNE	5.7L V8 5704cc 348 CID
	1968-1972	CHEVROLET K20 SUBURBAN	5.0L V8 5031cc 307 CID			1958-1961	CHEVROLET IMPALA	5.7L V8 5704cc 348 CID
	1968-1972	CHEVROLET K20 SUBURBAN	5.0L V8 307 CID			1958-1967	CHEVROLET BISCAYNE	4.6L V8 4638cc 283 CID
	1968-1972	CHEVROLET K30 PICKUP	5.0L V8 307 CID			1958-1967	CHEVROLET IMPALA	4.6L V8 4638cc 283 CID
	1968-1972	CHEVROLET K30 PICKUP	5.0L V8 5031cc 307 CID			1959	CHEVROLET BEL AIR	5.3L V8 5272cc 282 CID
	1968-1974	CHEVROLET CS31003	5.7L V8 5700cc 350 CID			1959-1960	CHEVROLET BEL AIR	4.3L L6 4278cc 261 CID
	1969	AVANTI II	5.7L V8 350 CID			1959-1960	CHEVROLET EL CAMINO	4.6L V8 4638cc 283 CID
	1969	AVANTI II	5.7L V8 5736cc 350 CID			1959-1960	CHEVROLET EL CAMINO	5.7L V8 5704cc 348 CID
	1969	CHECKER DELUXE	5.3L V8 5358cc 327 CID			1959-1961	CHEVROLET BROOKWOOD	4.6L V8 4638cc 283 CID
	1969	CHEVROLET BROOKWOOD	5.0L V8 5031cc 307 CID			1959-1961	CHEVROLET BROOKWOOD	5.7L V8 5704cc 348 CID
	1969	CHEVROLET BROOKWOOD	5.3L V8 5358cc 327 CID			1959-1961	CHEVROLET KINGSWOOD	4.6L V8 4638cc 283 CID
	1969	CHEVROLET KINGSWOOD	5.0L V8 5031cc 307 CID			1959-1961	CHEVROLET KINGSWOOD	5.7L V8 5704cc 348 CID
	1969	CHEVROLET KINGSWOOD	5.3L V8 5358cc 327 CID			1960	CHEVROLET BISCAYNE	4.6L V8 283 CID
	1969-1972	CHEVROLET BEL AIR	5.7L V8 350 CID			1960	CHEVROLET BISCAYNE	5.7L V8 348 CID
	1969-1972	CHEVROLET BEL AIR	5.7L V8 5736cc 350 CID			1960	CHEVROLET TRUCK	4.3L L6 4278cc 261 CID
	1969-1972	CHEVROLET BISCAYNE	5.7L V8 350 CID			1960	CHEVROLET TRUCK	4.6L V8 4638cc 283 CID
	1969-1972	CHEVROLET BISCAYNE	5.7L V8 5736cc 350 CID			1960	CHEVROLET TRUCK	5.7L V8 5704cc 348 CID
	1969-1972	CHEVROLET BLAZER	5.0L V8 307 CID			1960-1961	CHEVROLET C10 PICKUP	5.7L V8 5704cc 348 CID
	1969-1972	CHEVROLET BLAZER	5.0L V8 5031cc 307 CID			1960-1961	CHEVROLET C20 PICKUP	5.7L V8 5704cc 348 CID
	1969-1972	CHEVROLET BLAZER	5.7L V8 350 CID			1960-1961	CHEVROLET C30 PICKUP	5.7L V8 5704cc 348 CID
	1969-1972	CHEVROLET BLAZER	5.7L V8 5736cc 350 CID			1960-1961	CHEVROLET K10 PICKUP	5.7L V8 5704cc 348 CID
	1969-1972	CHEVROLET BROOKWOOD	5.7L V8 350 CID			1960-1961	CHEVROLET K20 PICKUP	5.7L V8 5704cc 348 CID
	1969-1972	CHEVROLET BROOKWOOD	5.7L V8 5736cc 350 CID			1960-1961	CHEVROLET SUBURBAN	5.7L V8 5704cc 348 CID
	1969-1972	CHEVROLET C10 PICKUP	5.7L V8 350 CID			1960-1965	CHEVROLET P30 SERIES	5.7L V8 5704cc 348 CID
	1969-1972	CHEVROLET C10 PICKUP	5.7L V8 5736cc 350 CID			1960-1966	CHEVROLET SUBURBAN	4.6L V8 4638cc 283 CID
	1969-1972	CHEVROLET C10 SUBURBAN	5.7L V8 350 CID			1960-1967	CHEVROLET C10 PICKUP	4.6L V8 4638cc 283 CID
	1969-1972	CHEVROLET C10 SUBURBAN	5.7L V8 5736cc 350 CID			1960-1967	CHEVROLET C20 PICKUP	4.6L V8 4638cc 283 CID
	1969-1972	CHEVROLET C20 PICKUP	5.7L V8 350 CID			1960-1967	CHEVROLET C30 PICKUP	4.6L V8 4638cc 283 CID
	1969-1972	CHEVROLET C20 PICKUP	5.7L V8 5736cc 350 CID			1960-1967	CHEVROLET K10 PICKUP	4.6L V8 4638cc 283 CID
	1969-1972	CHEVROLET C20 SUBURBAN	5.7L V8 350 CID			1960-1967	CHEVROLET K20 PICKUP	4.6L V8 4638cc 283 CID
	1969-1972	CHEVROLET C20 SUBURBAN	5.7L V8 5736cc 350 CID			1961-1962	CHEVROLET C10 PICKUP	4.3L L6 4278cc 261 CID
	1969-1972	CHEVROLET C30 PICKUP	5.7L V8 350 CID			1961-1962	CHEVROLET C20 PICKUP	4.3L L6 4278cc 261 CID
	1969-1972	CHEVROLET C30 PICKUP	5.7L V8 5736cc 350 CID			1961-1962	CHEVROLET C30 PICKUP	4.3L L6 4278cc 261 CID
	1969-1972	CHEVROLET CAMARO	5.0L V8 307 CID			1961-1962	CHEVROLET K10 PICKUP	4.3L L6 4278cc 261 CID
	1969-1972	CHEVROLET CAMARO	5.0L V8 5031cc 307 CID			1961-1962	CHEVROLET K20 PICKUP	4.3L L6 4278cc 261 CID
	1969-1972	CHEVROLET CAPRICE	5.7L V8 350 CID			1961-1962	CHEVROLET P10 SERIES	4.3L L6 4278cc 261 CID
	1969-1972	CHEVROLET CAPRICE	5.7L V8 5736cc 350 CID			1961-1962	CHEVROLET P10 SERIES	4.6L V8 4638cc 283 CID
	1969-1972	CHEVROLET CHEVELLE	5.7L V8 350 CID			1961-1962	CHEVROLET P30 SERIES	4.3L L6 4278cc 261 CID
	1969-1972	CHEVROLET CORVETTE	5.7L V8 350 CID			1961-1962	CHEVROLET P30 SERIES	4.6L V8 4638cc 283 CID
	1969-1972	CHEVROLET CORVETTE	5.7L V8 5736cc 350 CID			1961-1962	CHEVROLET SUBURBAN	4.3L L6 4278cc 261 CID
	1969-1972	CHEVROLET EL CAMINO	5.7L V8 350 CID			1962-1968	CHEVROLET CORVETTE	5.3L V8 5358cc 327 CID
	1969-1972	CHEVROLET IMPALA	5.7L V8 350 CID			1962-1969	CHEVROLET BEL AIR	5.3L V8 5358cc 327 CID

WATER PUMPS

USMW	Years	Application	Engine	USMW	Years	Application	Engine	
US898H	1962-1969	CHEVROLET BISCAYNE	5.3L V8 5358cc 327 CID	US898H	1968-1972	CHEVROLET CHEVELLE	5.0L V8 307 CID	
	1962-1969	CHEVROLET IMPALA	5.3L V8 5358cc 327 CID		1968-1972	CHEVROLET CHEVELLE	5.0L V8 5031cc 307 CID	
	1963-1967	CHEVROLET CHEVY II	4.6L V8 4638cc 283 CID		1968-1972	CHEVROLET CHEVELLE	5.7L V8 5736cc 350 CID	
	1964	CHEVROLET IMPALA	4.6L V8 283 CID		1968-1972	CHEVROLET EL CAMINO	5.0L V8 307 CID	
	1964-1966	CHEVROLET CHEVY II	4.6L V8 283 CID		1968-1972	CHEVROLET EL CAMINO	5.0L V8 5031cc 307 CID	
	1964-1967	CHEVROLET CHEVELLE	4.6L V8 4638cc 283 CID		1968-1972	CHEVROLET EL CAMINO	5.7L V8 5736cc 350 CID	
	1964-1967	CHEVROLET EL CAMINO	4.6L V8 4638cc 283 CID		1968-1972	CHEVROLET G10 VAN	5.0L V8 307 CID	
	1964-1967	CHEVROLET MALIBU	4.6L V8 4638cc 283 CID		1968-1972	CHEVROLET G20 VAN	5.0L V8 5031cc 307 CID	
	1964-1967	CHEVROLET MALIBU	5.3L V8 5358cc 327 CID		1968-1972	CHEVROLET K10 PICKUP	5.0L V8 307 CID	
	1964-1968	CHEVROLET CHEVELLE	5.3L V8 5358cc 327 CID		1968-1972	CHEVROLET K10 PICKUP	5.0L V8 5031cc 307 CID	
	1964-1969	CHEVROLET IMPALA	5.4L V8 327 CID		1968-1972	CHEVROLET K10 SUBURBAN	5.0L V8 307 CID	
	1965	CHEVROLET CHEVELLE	5.4L V8 327 CID		1968-1972	CHEVROLET K10 SUBURBAN	5.0L V8 5031cc 307 CID	
	1965-1966	CHEVROLET CHEVY II	5.4L V8 327 CID		1968-1972	CHEVROLET K20 PICKUP	5.0L V8 307 CID	
	1965-1967	CHECKER MARATHON	4.6L V8 4638cc 283 CID		1968-1972	CHEVROLET K20 PICKUP	5.0L V8 5031cc 307 CID	
	1965-1967	CHEVROLET CHEVELLE	4.6L V8 283 CID		1968-1972	CHEVROLET K20 SUBURBAN	5.0L V8 307 CID	
	1965-1968	CHEVROLET CHEVY II	5.3L V8 5358cc 327 CID		1968-1972	CHEVROLET K20 SUBURBAN	5.0L V8 5031cc 307 CID	
	1965-1969	AVANTI II	5.3L V8 5358cc 327 CID		1968-1972	CHEVROLET K30 PICKUP	5.0L V8 307 CID	
	1965-1969	CHECKER MARATHON	5.3L V8 5358cc 327 CID		1968-1972	CHEVROLET K30 PICKUP	5.0L V8 5031cc 307 CID	
	1966	CHEVROLET SUBURBAN	5.3L V8 5358cc 327 CID		1969	AVANTI II	5.7L V8 350 CID	
	1966-1967	CHEVROLET CAPRICE	4.6L V8 4638cc 283 CID		1969	AVANTI II	5.7L V8 5736cc 350 CID	
	1966-1967	CHEVROLET IMPALA	4.6L V8 283 CID		1969	CHECKER DELUXE	5.3L V8 5358cc 327 CID	
	1966-1969	CHEVROLET C10 PICKUP	5.3L V8 5358cc 327 CID		1969	CHEVROLET BROOKWOOD	5.0L V8 5031cc 307 CID	
	1966-1969	CHEVROLET C20 PICKUP	5.3L V8 5358cc 327 CID		1969	CHEVROLET BROOKWOOD	5.3L V8 5358cc 327 CID	
	1966-1969	CHEVROLET C30 PICKUP	5.3L V8 5358cc 327 CID		1969	CHEVROLET KINGSWOOD	5.0L V8 5031cc 307 CID	
	1966-1969	CHEVROLET CAPRICE	5.3L V8 5358cc 327 CID		1969	CHEVROLET KINGSWOOD	5.3L V8 5358cc 327 CID	
	1966-1969	CHEVROLET EL CAMINO	5.3L V8 5358cc 327 CID		1969-1972	CHEVROLET BEL AIR	5.7L V8 350 CID	
	1966-1969	CHEVROLET K10 PICKUP	5.3L V8 5358cc 327 CID		1969-1972	CHEVROLET BEL AIR	5.7L V8 5736cc 350 CID	
	1966-1969	CHEVROLET K20 PICKUP	5.3L V8 5358cc 327 CID		1969-1972	CHEVROLET BISCAYNE	5.7L V8 350 CID	
	1967	CHEVROLET C10 SUBURBAN	4.6L V8 4638cc 283 CID		1969-1972	CHEVROLET BISCAYNE	5.7L V8 5736cc 350 CID	
	1967	CHEVROLET C20 SUBURBAN	4.6L V8 4638cc 283 CID		1969-1972	CHEVROLET BLAZER	5.0L V8 307 CID	
	1967	CHEVROLET G20 VAN	4.6L V8 4638cc 283 CID		1969-1972	CHEVROLET BLAZER	5.0L V8 5031cc 307 CID	
	1967	CHEVROLET K10 SUBURBAN	4.6L V8 4638cc 283 CID		1969-1972	CHEVROLET BLAZER	5.7L V8 350 CID	
	1967	CHEVROLET K20 PANEL	4.6L V8 283 CID		1969-1972	CHEVROLET BLAZER	5.7L V8 5736cc 350 CID	
	1967	CHEVROLET K20 PANEL	5.4L V8 327 CID		1969-1972	CHEVROLET BROOKWOOD	5.7L V8 350 CID	
	1967	CHEVROLET K20 SUBURBAN	4.6L V8 4638cc 283 CID		1969-1972	CHEVROLET BROOKWOOD	5.7L V8 5736cc 350 CID	
	1967-1968	CHEVROLET CHEVELLE	5.4L V8 327 CID		1969-1972	CHEVROLET C10 PICKUP	5.7L V8 350 CID	
	1967-1969	CHEVROLET C10 SUBURBAN	5.3L V8 5358cc 327 CID		1969-1972	CHEVROLET C10 PICKUP	5.7L V8 5736cc 350 CID	
	1967-1969	CHEVROLET C20 SUBURBAN	5.3L V8 5358cc 327 CID		1969-1972	CHEVROLET C10 SUBURBAN	5.7L V8 350 CID	
	1967-1969	CHEVROLET CAMARO	5.3L V8 5358cc 327 CID		1969-1972	CHEVROLET C10 SUBURBAN	5.7L V8 5736cc 350 CID	
	1967-1969	CHEVROLET K10 SUBURBAN	5.3L V8 5358cc 327 CID		1969-1972	CHEVROLET C20 PICKUP	5.7L V8 350 CID	
	1967-1969	CHEVROLET K20 SUBURBAN	5.3L V8 5358cc 327 CID		1969-1972	CHEVROLET C20 PICKUP	5.7L V8 5736cc 350 CID	
	1967-1972	CHEVROLET CAMARO	5.7L V8 5736cc 350 CID		1969-1972	CHEVROLET C20 SUBURBAN	5.7L V8 350 CID	
	1968	CHECKER MARATHON	5.0L V8 307 CID		1969-1972	CHEVROLET C20 SUBURBAN	5.7L V8 5736cc 350 CID	
	1968	CHECKER MARATHON	5.0L V8 5031cc 307 CID		1969-1972	CHEVROLET C30 PICKUP	5.7L V8 350 CID	
	1968	CHEVROLET BEL AIR	5.0L V8 307 CID		1969-1972	CHEVROLET C30 PICKUP	5.7L V8 5736cc 350 CID	
	1968	CHEVROLET BEL AIR	5.0L V8 5031cc 307 CID		1969-1972	CHEVROLET CAMARO	5.0L V8 307 CID	
	1968	CHEVROLET BISCAYNE	5.0L V8 307 CID		1969-1972	CHEVROLET CAMARO	5.0L V8 5031cc 307 CID	
	1968	CHEVROLET BISCAYNE	5.0L V8 5031cc 307 CID		1969-1972	CHEVROLET CAPRICE	5.7L V8 350 CID	
	1968	CHEVROLET C10 PICKUP	5.4L V8 327 CID		1969-1972	CHEVROLET CAPRICE	5.7L V8 5736cc 350 CID	
	1968	CHEVROLET C10 SUBURBAN	5.4L V8 327 CID		1969-1972	CHEVROLET CHEVELLE	5.7L V8 350 CID	
	1968	CHEVROLET C20 PICKUP	5.4L V8 327 CID		1969-1972	CHEVROLET CORVETTE	5.7L V8 350 CID	
	1968	CHEVROLET C20 SUBURBAN	5.4L V8 327 CID		1969-1972	CHEVROLET CORVETTE	5.7L V8 5736cc 350 CID	
	1968	CHEVROLET C30 PICKUP	5.4L V8 327 CID		1969-1972	CHEVROLET EL CAMINO	5.7L V8 350 CID	
	1968	CHEVROLET CAPRICE	5.0L V8 307 CID		1969-1972	CHEVROLET IMPALA	5.7L V8 350 CID	
	1968	CHEVROLET CHEVY II	5.0L V8 307 CID		1969-1972	CHEVROLET IMPALA	5.7L V8 5736cc 350 CID	
	1968	CHEVROLET CHEVY II	5.0L V8 5031cc 307 CID		1969-1972	CHEVROLET K10 PICKUP	5.7L V8 350 CID	
	1968	CHEVROLET CHEVY II	5.4L V8 327 CID		1969-1972	CHEVROLET K10 PICKUP	5.7L V8 5736cc 350 CID	
	1968	CHEVROLET CHEVY II	5.7L V8 350 CID		1969-1972	CHEVROLET K10 SUBURBAN	5.7L V8 350 CID	
	1968	CHEVROLET CHEVY II	5.7L V8 5736cc 350 CID		1969-1972	CHEVROLET K10 SUBURBAN	5.7L V8 5736cc 350 CID	
	1968	CHEVROLET CORVETTE	5.4L V8 327 CID		1969-1972	CHEVROLET K20 PICKUP	5.7L V8 350 CID	
	1968	CHEVROLET EL CAMINO	5.4L V8 327 CID		1969-1972	CHEVROLET K20 PICKUP	5.7L V8 5736cc 350 CID	
	1968	CHEVROLET IMPALA	5.0L V8 307 CID		1969-1972	CHEVROLET K20 SUBURBAN	5.7L V8 350 CID	
	1968	CHEVROLET K10 PICKUP	5.4L V8 327 CID		1969-1972	CHEVROLET K20 SUBURBAN	5.7L V8 5736cc 350 CID	
	1968	CHEVROLET K10 SUBURBAN	5.4L V8 327 CID		1969-1972	CHEVROLET K30 PICKUP	5.7L V8 350 CID	
	1968	CHEVROLET K20 PICKUP	5.4L V8 327 CID		1969-1972	CHEVROLET K30 PICKUP	5.7L V8 5736cc 350 CID	
	1968	CHEVROLET K20 SUBURBAN	5.4L V8 327 CID		1969-1972	CHEVROLET KINGSWOOD	5.7L V8 350 CID	
	1968	CHEVROLET K30 PICKUP	5.4L V8 327 CID		1969-1972	CHEVROLET KINGSWOOD	5.7L V8 5736cc 350 CID	
	1968-1969	AVANTI II	5.4L V8 327 CID		1970-1972	CHEVROLET G10 VAN	5.7L V8 350 CID	
	1968-1969	CHEVROLET BEL AIR	5.4L V8 327 CID		1970-1972	CHEVROLET G20 VAN	5.7L V8 350 CID	
	1968-1969	CHEVROLET BISCAYNE	5.4L V8 327 CID		1970-1972	CHEVROLET G20 VAN	5.7L V8 5736cc 350 CID	
	1968-1969	CHEVROLET CAMARO	5.4L V8 327 CID		1970-1972	CHEVROLET G30 VAN	5.7L V8 350 CID	
	1968-1969	CHEVROLET CAPRICE	5.0L V8 5031cc 307 CID		1970-1972	CHEVROLET P20 VAN	5.7L V8 350 CID	
	1968-1969	CHEVROLET CAPRICE	5.4L V8 327 CID		1970-1972	CHEVROLET P30 VAN	5.7L V8 350 CID	
	1968-1969	CHEVROLET IMPALA	5.0L V8 5031cc 307 CID		1971-1972	CHEVROLET BROOKWOOD	5.0L V8 5031cc 307 CID	
	1968-1969	CHEVROLET K30 PICKUP	5.3L V8 5358cc 327 CID		1971-1972	CHEVROLET CAPRICE	5.0L V8 5031cc 307 CID	
	1968-1969	CHEVROLET P20 VAN	5.0L V8 307 CID		1971-1972	CHEVROLET IMPALA	5.0L V8 5031cc 307 CID	
	1968-1969	CHEVROLET P30 VAN	5.0L V8 307 CID		1971-1972	CHEVROLET KINGSWOOD	5.0L V8 5031cc 307 CID	
	1968-1970	CHEVROLET G20 VAN	5.0L V8 307 CID		1972	CHEVROLET CAMARO	5.7L V8 5737cc 350 CID	
	1968-1972	CHEVROLET C10 PICKUP	5.0L V8 307 CID		1972	CHEVROLET CORVETTE	5.7L V8 5737cc 350 CID	
	1968-1972	CHEVROLET C10 PICKUP	5.0L V8 5031cc 307 CID		US907	1967-1969	PLYMOUTH BARRACUDA	5.2L V8 5200cc 318 CID
	1968-1972	CHEVROLET C10 SUBURBAN	5.0L V8 307 CID		US919	1958	PLYMOUTH PLAZA	5.2L V8 317 CID
	1968-1972	CHEVROLET C10 SUBURBAN	5.0L V8 5031cc 307 CID		1958	PLYMOUTH PLAZA	5.2L V8 5212cc 318 CID	
	1968-1972	CHEVROLET C20 PICKUP	5.0L V8 307 CID		1958-1959	PLYMOUTH BELVEDERE	5.2L V8 317 CID	
	1968-1972	CHEVROLET C20 PICKUP	5.0L V8 5031cc 307 CID		1958-1959	PLYMOUTH FURY	5.2L V8 317 CID	
	1968-1972	CHEVROLET C20 SUBURBAN	5.0L V8 307 CID		1958-1959	PLYMOUTH SAVOY	5.2L V8 317 CID	
	1968-1972	CHEVROLET C20 SUBURBAN	5.0L V8 5031cc 307 CID		1958-1959	PLYMOUTH SUBURBAN	5.2L V8 317 CID	
	1968-1972	CHEVROLET C30 PICKUP	5.0L V8 307 CID		1958-1961	PLYMOUTH CUSTOM	5.2L V8 5212cc 318 CID	
	1968-1972	CHEVROLET C30 PICKUP	5.0L V8 5031cc 307 CID		1958-1961	PLYMOUTH SUBURBAN	5.2L V8 318 CID	
	1968-1972	CHEVROLET CAMARO	5.7L V8 350 CID		1958-1961	PLYMOUTH SUBURBAN	5.2L V8 5212cc 318 CID	

USMW	Years	Application	Engine	USMW	Years	Application	Engine		
US919	1958-1964	PLYMOUTH SAVOY	5.2L V8 5212cc 318 CID	US919	1968-1969	PLYMOUTH FURY III	5.2L V8 5212cc 318 CID		
	1958-1969	PLYMOUTH BELVEDERE	5.2L V8 5212cc 318 CID		1968-1969	PLYMOUTH SATELLITE	5.2L V8 318 CID		
	1958-1969	PLYMOUTH FURY	5.2L V8 5212cc 318 CID		1968-1969	PLYMOUTH SATELLITE	5.6L V8 5572cc 340 CID		
	1959	PLYMOUTH FURY	5.2L V8 318 CID		1968-1969	PLYMOUTH VALIANT	5.2L V8 318 CID		
	1960	DODGE MATADOR	5.2L V8 5212cc 318 CID		1968-1969	PLYMOUTH VALIANT	5.2L V8 5212cc 318 CID		
	1960	DODGE TRUCK	5.2L V8 5212cc 318 CID		1968-1969	PLYMOUTH VALIANT	5.6L V8 5572cc 340 CID		
	1960-1961	DODGE POLARA	5.2L V8 5212cc 318 CID		1969	DODGE W200 PICKUP	5.2L V8 318 CID		
	1960-1961	DODGE SENECA	5.2L V8 5212cc 318 CID		US926	1968	OLDSMOBILE DELMONT 88	5.7L V8 350 CID	
	1960-1961	PLYMOUTH SAVOY	5.2L V8 318 CID			1968	OLDSMOBILE DELMONT 88	7.5L V8 455 CID	
	1960-1961	PLYMOUTH SPORT WAGON	5.2L V8 5212cc 318 CID		1968-1969	OLDSMOBILE 442	6.6L V8 6555cc 400 CID		
	1960-1962	DODGE DART	5.2L V8 318 CID		1968-1970	OLDSMOBILE 98	7.5L V8 455 CID		
	1960-1962	DODGE DART	5.2L V8 5212cc 318 CID		1968-1970	OLDSMOBILE 442	7.5L V8 7456cc 455 CID		
	1960-1962	DODGE WM300 POWER WAGON	5.2L V8 5212cc 318 CID		1968-1970	OLDSMOBILE CUTLASS	5.7L V8 350 CID		
	1960-1963	PLYMOUTH FLEET SPECIAL	5.2L V8 5212cc 318 CID		1968-1970	OLDSMOBILE DELTA 88	5.7L V8 350 CID		
	1960-1967	DODGE D100 SERIES	5.2L V8 5212cc 318 CID		1968-1970	OLDSMOBILE DELTA 88	7.5L V8 455 CID		
	1960-1967	DODGE D200 SERIES	5.2L V8 5212cc 318 CID		1968-1970	OLDSMOBILE F85	5.7L V8 350 CID		
	1960-1967	DODGE D300 SERIES	5.2L V8 5212cc 318 CID		1968-1970	OLDSMOBILE VISTA CRUISER	5.7L V8 350 CID		
	1960-1967	DODGE W100 SERIES	5.2L V8 5212cc 318 CID		1970	OLDSMOBILE CUTLASS	7.5L V8 455 CID		
	1960-1967	DODGE W200 SERIES	5.2L V8 5212cc 318 CID		1970	OLDSMOBILE F85	7.5L V8 455 CID		
	1960-1967	DODGE W300 SERIES	5.2L V8 5212cc 318 CID		1970	OLDSMOBILE VISTA CRUISER	7.5L V8 455 CID		
	1963-1964	DODGE 330	5.2L V8 5212cc 318 CID		US927	1966	CHEVROLET CHEVELLE	3.2L L6 194 CID	
	1963-1964	DODGE 440	5.2L V8 5212cc 318 CID			1966	CHEVROLET EL CAMINO	3.2L L6 3180cc 194 CID	
	1963-1969	DODGE POLARA	5.2L V8 5212cc 318 CID		1966	CHEVROLET MALIBU	3.2L L6 3180cc 194 CID		
	1964	DODGE 330	4.5L V8 4473cc 273 CID		1966-1967	CHEVROLET EL CAMINO	3.8L L6 3769cc 230 CID		
	1964	PLYMOUTH SAVOY	4.5L V8 4473cc 273 CID		1966-1967	CHEVROLET MALIBU	3.8L L6 3769cc 230 CID		
	1964-1965	PLYMOUTH FURY	4.5L V8 4473cc 273 CID		1967	CHEVROLET CHEVELLE	3.8L L6 230 CID		
	1964-1966	DODGE A100	4.5L V8 4473cc 273 CID		1967	CHEVROLET CHEVELLE	4.1L L6 250 CID		
	1964-1967	DODGE A100 TRUCK	4.5L V8 273 CID		1967	CHEVROLET EL CAMINO	4.1L L6 4098cc 250 CID		
	1964-1968	PLYMOUTH BARRACUDA	4.5L V8 4473cc 273 CID		1967	CHEVROLET MALIBU	4.1L L6 4098cc 250 CID		
	1964-1968	PLYMOUTH BELVEDERE	4.5L V8 4473cc 273 CID		1967	CHEVROLET MALIBU	4.1L L6 4100cc 250 CID		
	1964-1969	DODGE DART	4.5L V8 273 CID		1969	CHEVROLET NOVA	3.8L L6 230 CID		
	1964-1969	DODGE DART	4.5L V8 4473cc 273 CID		1969	CHEVROLET NOVA	4.1L L6 250 CID		
	1964-1969	PLYMOUTH VALIANT	4.5L V8 273 CID		1974	CHEVROLET NOVA	4.1L L6 250 CID		
	1964-1969	PLYMOUTH VALIANT	4.5L V8 4473cc 273 CID		1974	OLDSMOBILE OMEGA	4.1L L6 250 CID		
	1965	PLYMOUTH FURY	4.5L V8 273 CID		1974	PONTIAC FIREBIRD	4.1L L6 250 CID		
	1965	PLYMOUTH FURY II	4.5L V8 273 CID		1974	PONTIAC LEMANS	4.1L L6 250 CID		
	1965	PLYMOUTH FURY III	4.5L V8 273 CID		1974	PONTIAC VENTURA	4.1L L6 250 CID		
	1965-1967	PLYMOUTH BELVEDERE II	4.5L V8 273 CID		US932	1975-1976	FORD ELITE	5.8L V8 351 CID	
	1965-1967	PLYMOUTH BELVEDERE II	5.2L V8 318 CID			1975-1976	FORD ELITE	6.6L V8 400 CID	
	1965-1968	DODGE CORONET	4.5L V8 273 CID			1975-1976	FORD TORINO	5.8L V8 351 CID	
	1965-1968	DODGE CORONET	4.5L V8 4473cc 273 CID			1975-1976	FORD TORINO	6.6L V8 400 CID	
	1965-1968	PLYMOUTH SATELLITE	4.5L V8 4473cc 273 CID			1975-1976	MERCURY MONTEGO	5.8L V8 351 CID	
	1965-1969	DODGE CORONET	5.2L V8 318 CID			1975-1976	MERCURY MONTEGO	6.6L V8 400 CID	
	1965-1969	DODGE CORONET	5.2L V8 5212cc 318 CID			1975-1977	FORD CUSTOM 500	5.8L V8 351 CID	
	1965-1969	PLYMOUTH FURY	5.2L V8 318 CID			1975-1977	FORD CUSTOM 500	6.6L V8 400 CID	
	1965-1969	PLYMOUTH FURY II	5.2L V8 318 CID			1975-1978	FORD LTD	6.6L V8 400 CID	
	1965-1969	PLYMOUTH FURY III	5.2L V8 318 CID			1975-1978	FORD RANCHERO	6.6L V8 400 CID	
	1965-1969	PLYMOUTH SATELLITE	5.2L V8 5212cc 318 CID			1975-1978	MERCURY COUGAR	6.6L V8 400 CID	
	1966	DODGE POLARA	4.5L V8 4473cc 273 CID			1975-1978	MERCURY MARQUIS	6.6L V8 400 CID	
	1966-1969	DODGE CHARGER	5.2L V8 5212cc 318 CID			1975-1979	FORD LTD	5.8L V8 351 CID	
	1966-1969	PLYMOUTH BARRACUDA	5.2L V8 5212cc 318 CID			1975-1979	FORD RANCHERO	5.8L V8 351 CID	
	1967	DODGE CHARGER	4.5L V8 4473cc 273 CID			1975-1979	MERCURY COUGAR	5.8L V8 351 CID	
	1967	PLYMOUTH VIP	5.2L V8 5212cc 318 CID			1977-1978	FORD LTD II	6.6L V8 400 CID	
	1967-1969	DODGE A100 TRUCK	5.2L V8 318 CID			1977-1978	FORD THUNDERBIRD	6.6L V8 400 CID	
	1967-1969	DODGE CHARGER	5.2L V8 318 CID			1977-1978	MERCURY GRAND MARQUIS	5.8L V8 5800cc 351 CID	
	1968	PLYMOUTH BELVEDERE	4.5L V8 273 CID			1977-1979	FORD F-100	5.8L V8 351 CID	
	1968	PLYMOUTH GTX	5.2L V8 318 CID			1977-1979	FORD F-100	6.6L V8 400 CID	
	1968	PLYMOUTH GTX	5.2L V8 5212cc 318 CID			1977-1979	FORD F-150	5.8L V8 351 CID	
	1968	PLYMOUTH ROAD RUNNER	4.5L V8 273 CID			1977-1979	FORD F-150	6.6L V8 400 CID	
	1968	PLYMOUTH ROAD RUNNER	4.5L V8 4473cc 273 CID			1977-1979	FORD F-250	5.8L V8 351 CID	
	1968	PLYMOUTH ROAD RUNNER	5.2L V8 318 CID			1977-1979	FORD F-350	5.8L V8 351 CID	
	1968	PLYMOUTH ROAD RUNNER	5.2L V8 5212cc 318 CID			1977-1979	FORD LTD II	5.8L V8 351 CID	
	1968	PLYMOUTH ROAD RUNNER	5.6L V8 5572cc 340 CID			1977-1979	FORD THUNDERBIRD	5.8L V8 351 CID	
	1968	PLYMOUTH SATELLITE	4.5L V8 273 CID			1977-1979	LINCOLN CONTINENTAL	6.6L V8 400 CID	
	1968-1969	DODGE D100 PICKUP	5.2L V8 318 CID			1977-1979	LINCOLN MARK V	6.6L V8 400 CID	
	1968-1969	DODGE D100 PICKUP	5.2L V8 5212cc 318 CID			1977-1982	FORD F-250	6.6L V8 400 CID	
	1968-1969	DODGE D200 PICKUP	5.2L V8 318 CID			1977-1982	FORD F-350	6.6L V8 400 CID	
	1968-1969	DODGE D200 PICKUP	5.2L V8 5212cc 318 CID			1978-1979	FORD BRONCO	6.6L V8 400 CID	
	1968-1969	DODGE D300 PICKUP	5.2L V8 318 CID			1978-1979	MERCURY MARQUIS	5.8L V8 351 CID	
	1968-1969	DODGE D300 PICKUP	5.2L V8 5212cc 318 CID			1978-1982	FORD BRONCO	5.8L V8 351 CID	
	1968-1969	DODGE DART	5.2L V8 318 CID			1980	FORD E-250 ECONOLINE	6.6L V8 400 CID	
	1968-1969	DODGE DART	5.2L V8 5212cc 318 CID			1980-1982	FORD E-100 ECONOLINE	5.8L V8 351 CID	
	1968-1969	DODGE DART	5.6L V8 340 CID			1980-1982	FORD E-100 ECONOLINE CLUB WAGON	5.8L V8 351 CID	
	1968-1969	DODGE MONACO	5.2L V8 318 CID			1980-1982	FORD E-150 ECONOLINE	5.8L V8 351 CID	
	1968-1969	DODGE MONACO	5.2L V8 5212cc 318 CID			1980-1982	FORD E-150 ECONOLINE CLUB WAGON	5.8L V8 351 CID	
	1968-1969	DODGE POLARA	5.2L V8 318 CID			1980-1982	FORD E-250 ECONOLINE	5.8L V8 351 CID	
	1968-1969	DODGE W100 PICKUP	5.2L V8 318 CID			1980-1982	FORD E-250 ECONOLINE CLUB WAGON	5.8L V8 351 CID	
	1968-1969	DODGE W100 PICKUP	5.2L V8 5212cc 318 CID			1980-1982	FORD E-250 ECONOLINE CLUB WAGON	5.8L V8 351 CID	
	1968-1969	DODGE W200 PICKUP	5.2L V8 5212cc 318 CID			1980-1982	FORD E-250 ECONOLINE CLUB WAGON	6.6L V8 400 CID	
	1968-1969	DODGE W300 PICKUP	5.2L V8 318 CID			1980-1982	FORD E-350 ECONOLINE	5.8L V8 351 CID	
	1968-1969	DODGE W300 PICKUP	5.2L V8 5212cc 318 CID			1980-1982	FORD E-350 ECONOLINE	6.6L V8 400 CID	
	1968-1969	PLYMOUTH BARRACUDA	5.2L V8 318 CID			1980-1982	FORD E-350 ECONOLINE CLUB WAGON	5.8L V8 351 CID	
	1968-1969	PLYMOUTH BARRACUDA	5.6L V8 340 CID			1980-1982	FORD E-350 ECONOLINE CLUB WAGON	5.8L V8 351 CID	
	1968-1969	PLYMOUTH BARRACUDA	5.6L V8 5572cc 340 CID			1980-1982	FORD E-350 ECONOLINE CLUB WAGON	6.6L V8 400 CID	
	1968-1969	PLYMOUTH BELVEDERE	5.2L V8 318 CID			US953	1968-1974	FORD F350	5.0L V8 5000cc 302 CID
	1968-1969	PLYMOUTH FURY I	5.2L V8 318 CID				1969-1977	FORD F350	4.7L V8 4700cc 289 CID
	1968-1969	PLYMOUTH FURY I	5.2L V8 5212cc 318 CID				1969-1978	FORD F100	4.7L V8 4700cc 289 CID
	1968-1969	PLYMOUTH FURY II	5.2L V8 5212cc 318 CID						

USMW	Years	Application	Engine	USMW	Years	Application	Engine	
US953	1970	FORD MAVERICK	5.0L V8 5000cc 302 CID	US953	1980-1986	FORD F-250	5.0L V8 302 CID	
	1970-1976	FORD GALAXIE	5.8L V8 5800cc 351 CID		1980-1987	FORD F-350	5.8L V8 351 CID	
	1971-1977	FORD MAVERICK	4.7L V8 4700cc 289 CID		1981-1982	FORD F-100	4.2L V8 255 CID	
	1973-1974	FORD B100	4.7L V8 4700cc 289 CID		1981-1983	FORD FAIRMONT	5.0L V8 5000cc 302 CID	
	1973-1974	FORD B100	5.0L V8 5000cc 302 CID		1982-1985	FORD B150	3.8L V6 3800cc 232 CID	
	1973-1974	FORD MUSTANG	5.0L V8 5000cc 302 CID		1982-1985	FORD B150	5.0L V8 5000cc 302 CID	
	1974	FORD MUSTANG	5.8L V8 5800cc 351 CID		1983-1987	FORD F350	5.0L V8 5000cc 302 CID	
	1975	FORD E-100 ECONOLINE	5.0L V8 302 CID		1985-1986	FORD B200	5.0L V8 5000cc 302 CID	
	1975	FORD E-150 ECONOLINE	5.0L V8 302 CID		1986	FORD F150	5.0L V8 5000cc 302 CID	
	1975	FORD E-250 ECONOLINE	5.0L V8 302 CID		1986-1987	FORD F200	5.8L V8 5800cc 351 CID	
	1975	FORD E-350 ECONOLINE	5.0L V8 302 CID		1986-1987	FORD F350	5.8L V8 5800cc 351 CID	
	1975	FORD ELITE	5.8L V8 351 CID		1986-1987	FORD P350	5.8L V8 5800cc 351 CID	
	1975	FORD P350	5.0L V8 5000cc 302 CID		US953H	1975	FORD E-100 ECONOLINE	5.0L V8 302 CID
	1975	FORD P400	5.0L V8 5000cc 302 CID			1975	FORD E-150 ECONOLINE	5.0L V8 302 CID
	1975	FORD RANCHERO	5.8L V8 351 CID			1975	FORD E-250 ECONOLINE	5.0L V8 302 CID
	1975-1976	FORD LTD	5.0L V8 5000cc 302 CID			1975	FORD E-350 ECONOLINE	5.0L V8 302 CID
	1975-1976	MERCURY MONTEGO	5.8L V8 351 CID			1975-1976	FORD ELITE	5.8L V8 351 CID
	1975-1977	FORD GRANADA	5.8L V8 351 CID			1975-1976	FORD TORINO	5.8L V8 351 CID
	1975-1977	FORD MAVERICK	5.0L V8 302 CID			1975-1976	MERCURY MONTEGO	5.8L V8 351 CID
	1975-1977	MERCURY COMET	5.0L V8 302 CID	1975-1977		FORD CUSTOM 500	5.8L V8 351 CID	
	1975-1977	MERCURY MONARCH	5.8L V8 351 CID	1975-1977		FORD GRANADA	5.8L V8 351 CID	
	1975-1978	FORD B150	4.7L V8 4700cc 289 CID	1975-1977		FORD MAVERICK	5.0L V8 302 CID	
	1975-1978	FORD B150	5.0L V8 5000cc 302 CID	1975-1977		MERCURY COMET	5.0L V8 302 CID	
	1975-1979	FORD LTD	5.8L V8 351 CID	1975-1977		MERCURY MONARCH	5.8L V8 351 CID	
	1975-1979	MERCURY COUGAR	5.8L V8 351 CID	1975-1979		FORD LTD	5.8L V8 351 CID	
	1975-1980	FORD GRANADA	5.0L V8 302 CID	1975-1979		FORD RANCHERO	5.8L V8 351 CID	
	1975-1980	MERCURY MONARCH	5.0L V8 302 CID	1975-1979		MERCURY COUGAR	5.8L V8 351 CID	
	1975-1983	FORD E-100 ECONOLINE	5.8L V8 351 CID	1975-1980		FORD GRANADA	5.0L V8 302 CID	
	1975-1983	FORD E-100 ECONOLINE CLUB WAGON	5.8L V8 351 CID	1975-1980		MERCURY MONARCH	5.0L V8 302 CID	
	1975-1983	FORD F-100	5.0L V8 302 CID	1975-1983		FORD E-100 ECONOLINE	5.8L V8 351 CID	
	1975-1986	FORD F-150	5.0L V8 302 CID	1975-1983		FORD E-100 ECONOLINE CLUB WAGON	5.8L V8 351 CID	
	1975-1987	FORD E-150 ECONOLINE	5.8L V8 351 CID	1975-1983		FORD F-100	5.0L V8 302 CID	
	1975-1987	FORD E-150 ECONOLINE CLUB WAGON	5.8L V8 351 CID	1975-1986		FORD F-150	5.0L V8 302 CID	
	1975-1987	FORD E-250 ECONOLINE	5.8L V8 351 CID	1975-1987		FORD E-150 ECONOLINE	5.8L V8 351 CID	
	1975-1987	FORD E-250 ECONOLINE CLUB WAGON	5.8L V8 351 CID	1975-1987		FORD E-150 ECONOLINE CLUB WAGON	5.8L V8 351 CID	
	1975-1987	FORD E-350 ECONOLINE	5.8L V8 351 CID	1975-1987		FORD E-250 ECONOLINE	5.8L V8 351 CID	
	1976	FORD F350	5.0L V8 5000cc 302 CID	1975-1987		FORD E-250 ECONOLINE CLUB WAGON	5.8L V8 351 CID	
	1976	FORD TORINO	5.8L V8 351 CID	1975-1987		FORD E-350 ECONOLINE	5.8L V8 351 CID	
	1976-1977	FORD CUSTOM 500	5.8L V8 351 CID	1976		FORD F-350	5.0L V8 302 CID	
	1976-1978	FORD MUSTANG	5.0L V8 5000cc 302 CID	1976-1978		FORD MUSTANG II	5.0L V8 302 CID	
	1976-1978	FORD MUSTANG II	5.0L V8 302 CID	1977		LINCOLN VERSAILLES	5.8L V8 351 CID	
	1977	LINCOLN VERSAILLES	5.8L V8 351 CID	1977-1978		FORD F-250	5.0L V8 302 CID	
	1977-1978	FORD F-250	5.0L V8 302 CID	1977-1979		FORD F-100	5.8L V8 351 CID	
	1977-1978	FORD LTD	5.8L V8 5800cc 351 CID	1977-1979		FORD LTD	5.0L V8 302 CID	
	1977-1978	FORD RANCHERO	5.8L V8 351 CID	1977-1979		FORD LTD II	5.0L V8 302 CID	
	1977-1979	FORD F-100	5.8L V8 351 CID	1977-1979		FORD LTD II	5.8L V8 351 CID	
	1977-1979	FORD LTD	5.0L V8 302 CID	1977-1979		FORD RANCHERO	5.0L V8 302 CID	
	1977-1979	FORD LTD II	5.0L V8 302 CID	1977-1979		FORD THUNDERBIRD	5.0L V8 302 CID	
	1977-1979	FORD LTD II	5.8L V8 351 CID	1977-1979		FORD THUNDERBIRD	5.8L V8 351 CID	
	1977-1979	FORD RANCHERO	5.0L V8 302 CID	1977-1979		MERCURY COUGAR	5.0L V8 302 CID	
	1977-1979	FORD THUNDERBIRD	5.0L V8 302 CID	1977-1980		LINCOLN VERSAILLES	5.0L V8 302 CID	
	1977-1979	FORD THUNDERBIRD	5.8L V8 351 CID	1977-1987		FORD E-350 ECONOLINE CLUB WAGON	5.8L V8 351 CID	
	1977-1979	MERCURY COUGAR	5.0L V8 302 CID	1977-1987		FORD F-150	5.8L V8 351 CID	
	1977-1980	LINCOLN VERSAILLES	5.0L V8 302 CID	1977-1987		FORD F-250	5.8L V8 351 CID	
	1977-1987	FORD E-350 ECONOLINE CLUB WAGON	5.8L V8 351 CID	1978-1979	FORD FAIRMONT	5.0L V8 302 CID		
	1977-1987	FORD F-150	5.8L V8 351 CID	1978-1979	MERCURY MARQUIS	5.8L V8 351 CID		
	1977-1987	FORD F-250	5.8L V8 351 CID	1978-1979	MERCURY ZEPHYR	5.0L V8 302 CID		
	1978	FORD LTD	5.8L V8 5752cc 351 CID	1978-1987	FORD BRONCO	5.8L V8 351 CID		
	1978-1979	FORD FAIRMONT	4.2L V8 4200cc 256 CID	1979	FORD E-350 ECONOLINE	5.0L V8 302 CID		
	1978-1979	FORD FAIRMONT	5.0L V8 302 CID	1979	FORD E-350 ECONOLINE CLUB WAGON	5.0L V8 302 CID		
	1978-1979	MERCURY MARQUIS	5.8L V8 351 CID	1979	MERCURY MARQUIS	5.0L V8 302 CID		
	1978-1979	MERCURY ZEPHYR	5.0L V8 302 CID	1979-1980	FORD E-250 ECONOLINE CLUB WAGON	5.0L V8 302 CID		
	1978-1980	FORD F350	5.0L V8 5000cc 302 CID	1979-1983	FORD E-100 ECONOLINE	5.0L V8 302 CID		
	1978-1987	FORD BRONCO	5.8L V8 351 CID	1979-1983	FORD E-100 ECONOLINE CLUB WAGON	5.0L V8 302 CID		
	1979	FORD B100	4.7L V8 4700cc 289 CID	1979-1986	FORD E-150 ECONOLINE	5.0L V8 302 CID		
	1979	FORD B-100	5.0L V8 302 CID	1979-1986	FORD E-150 ECONOLINE CLUB WAGON	5.0L V8 302 CID		
	1979	FORD E-350 ECONOLINE	5.0L V8 302 CID	1979-1986	FORD E-250 ECONOLINE	5.0L V8 302 CID		
	1979	FORD E-350 ECONOLINE CLUB WAGON	5.0L V8 302 CID	1980	FORD F-350	5.0L V8 302 CID		
	1979	FORD F150	4.7L V8 4700cc 289 CID	1980	MERCURY MONARCH	4.2L V8 255 CID		
	1979	MERCURY MARQUIS	5.0L V8 302 CID	1980-1981	FORD GRANADA	4.2L V8 255 CID		
	1979-1980	FORD E-250 ECONOLINE CLUB WAGON	5.0L V8 302 CID	1980-1982	FORD FAIRMONT	4.2L V8 255 CID		
	1979-1981	FORD B100	5.0L V8 5000cc 302 CID	1980-1982	MERCURY ZEPHYR	4.2L V8 255 CID		
	1979-1983	FORD E-100 ECONOLINE	5.0L V8 302 CID	1980-1986	FORD BRONCO	5.0L V8 302 CID		
	1979-1983	FORD E-100 ECONOLINE CLUB WAGON	5.0L V8 302 CID	1980-1986	FORD F-250	5.0L V8 302 CID		
	1979-1986	FORD E-150 ECONOLINE	5.0L V8 302 CID	1980-1987	FORD F-350	5.8L V8 351 CID		
	1979-1986	FORD E-150 ECONOLINE CLUB WAGON	5.0L V8 302 CID	1981-1982	FORD F-100	4.2L V8 255 CID		
	1979-1986	FORD E-250 ECONOLINE	5.0L V8 302 CID	US960	1975-1977	FORD MAVERICK	4.1L L6 250 CID	
	1979-1986	FORD E-250 ECONOLINE CLUB WAGON	5.0L V8 302 CID		1975-1977	MERCURY COMET	4.1L L6 250 CID	
	1980	FORD F-350	5.0L V8 302 CID		1975-1980	FORD GRANADA	4.1L L6 250 CID	
	1980	MERCURY MONARCH	4.2L V8 255 CID		1975-1980	MERCURY MONARCH	4.1L L6 250 CID	
	1980-1981	FORD GRANADA	4.2L V8 255 CID	US964	1971-1974	FORD PINTO	2.0L L4 1993cc 122 CID	
	1980-1982	FORD FAIRMONT	4.2L V8 255 CID		1971-1974	MERCURY CAPRI	2.0L L4 1993cc 122 CID	
	1980-1982	MERCURY ZEPHYR	4.2L V8 255 CID	US975	1975	OLDSMOBILE CUSTOM CRUISER	6.6L V8 400 CID	
	1980-1986	FORD BRONCO	5.0L V8 302 CID					

USMW	Years	Application	Engine	USMW	Years	Application	Engine
US975	1975	PONTIAC GRAND AM	5.7L V8 350 CID	US981	1968-1969	CHEVROLET CAPRICE	6.5L V8 396 CID
	1975	PONTIAC GRAND AM	6.6L V8 400 CID		1968-1969	CHEVROLET CAPRICE	7.0L V8 427 CID
	1975	PONTIAC GRAND AM	7.5L V8 455 CID		1968-1969	CHEVROLET CORVETTE	7.0L V8 427 CID
	1975-1976	PONTIAC BONNEVILLE	7.5L V8 455 CID		1968-1969	CHEVROLET K10 PICKUP	6.5L V8 396 CID
	1975-1976	PONTIAC CATALINA	7.5L V8 455 CID		1968-1969	CHEVROLET K10 PICKUP	6.5L V8 6489cc 396 CID
	1975-1976	PONTIAC FIREBIRD	5.7L V8 350 CID		1968-1969	CHEVROLET K10 SUBURBAN	6.5L V8 396 CID
	1975-1976	PONTIAC FIREBIRD	7.5L V8 455 CID		1968-1969	CHEVROLET K10 SUBURBAN	6.5L V8 6489cc 396 CID
	1975-1976	PONTIAC GRAND PRIX	7.5L V8 455 CID		1968-1969	CHEVROLET K20 PICKUP	6.5L V8 396 CID
	1975-1976	PONTIAC GRAND SAFARI	7.5L V8 455 CID		1968-1969	CHEVROLET K20 PICKUP	6.5L V8 6489cc 396 CID
	1975-1976	PONTIAC LEMANS	5.7L V8 350 CID		1968-1969	CHEVROLET K20 SUBURBAN	6.5L V8 6489cc 396 CID
	1975-1977	PONTIAC GRAND PRIX	6.6L V8 400 CID		1968-1969	CHEVROLET K30 PICKUP	6.5L V8 396 CID
	1975-1977	PONTIAC LEMANS	6.6L V8 400 CID		1968-1969	CHEVROLET K30 PICKUP	6.5L V8 6489cc 396 CID
	1975-1978	PONTIAC BONNEVILLE	6.6L V8 400 CID		1968-1969	GMC C15/C1500 PICKUP	6.5L V8 396 CID
	1975-1978	PONTIAC CATALINA	6.6L V8 400 CID		1968-1969	GMC C15/C1500 PICKUP	6.5L V8 6489cc 396 CID
	1975-1978	PONTIAC GRAND SAFARI	6.6L V8 400 CID		1968-1969	GMC C15/C1500 SUBURBAN	6.5L V8 396 CID
	1975-1979	PONTIAC FIREBIRD	6.6L V8 400 CID		1968-1969	GMC C15/C1500 SUBURBAN	6.5L V8 6489cc 396 CID
	1976	PONTIAC GRAND PRIX	5.7L V8 350 CID		1968-1969	GMC C25/C2500 PICKUP	6.5L V8 396 CID
	1976	PONTIAC LEMANS	7.5L V8 455 CID		1968-1969	GMC C25/C2500 PICKUP	6.5L V8 6489cc 396 CID
	1976-1977	PONTIAC CATALINA	5.7L V8 350 CID		1968-1969	GMC C25/C2500 SUBURBAN	6.5L V8 396 CID
	1977	BUICK SKYLARK	4.9L V8 301 CID		1968-1969	GMC C25/C2500 SUBURBAN	6.5L V8 6489cc 396 CID
	1977	PONTIAC FIREBIRD	4.9L V8 301 CID		1968-1969	GMC C35/C3500 PICKUP	6.5L V8 396 CID
	1977	PONTIAC GRAND PRIX	6.6L V8 403 CID		1968-1969	GMC C35/C3500 PICKUP	6.5L V8 6489cc 396 CID
	1977	PONTIAC GRAND SAFARI	4.9L V8 301 CID		1968-1969	GMC K15/K1500 PICKUP	6.5L V8 396 CID
	1977	PONTIAC GRAND SAFARI	5.7L V8 350 CID		1968-1969	GMC K15/K1500 PICKUP	6.5L V8 6489cc 396 CID
	1977	PONTIAC LEMANS	4.9L V8 301 CID		1968-1969	GMC K15/K1500 SUBURBAN	6.5L V8 6489cc 396 CID
	1977	PONTIAC LEMANS	6.6L V8 403 CID		1968-1969	GMC K25/K2500 PICKUP	6.5L V8 396 CID
	1977	PONTIAC VENTURA	4.9L V8 301 CID		1968-1969	GMC K25/K2500 PICKUP	6.5L V8 6489cc 396 CID
	1977-1978	PONTIAC BONNEVILLE	5.7L V8 350 CID		1968-1969	GMC K25/K2500 SUBURBAN	6.5L V8 6489cc 396 CID
	1977-1978	PONTIAC GRAND SAFARI	6.6L V8 403 CID		1968-1969	GMC K35/K3500 PICKUP	6.5L V8 396 CID
	1977-1979	PONTIAC BONNEVILLE	6.6L V8 403 CID		1968-1969	GMC K35/K3500 PICKUP	6.5L V8 6489cc 396 CID
	1977-1979	PONTIAC CATALINA	4.1L L6 250 CID		1968-1970	CHEVROLET EL CAMINO	6.5L V8 396 CID
	1977-1979	PONTIAC CATALINA	6.6L V8 403 CID		1969	CHEVROLET CAMARO	7.0L V8 427 CID
	1977-1979	PONTIAC FIREBIRD	6.6L V8 403 CID		1969	CHEVROLET CAMARO	7.0L V8 6998cc 427 CID
	1977-1980	BUICK LESABRE	4.9L V8 301 CID		1970	CHEVROLET CHEVELLE	6.6L V8 402 CID
	1977-1980	PONTIAC BONNEVILLE	4.9L V8 301 CID		1970	CHEVROLET EL CAMINO	6.6L V8 400 CID
	1977-1980	PONTIAC CATALINA	4.9L V8 301 CID		1970-1971	CHEVROLET CHEVELLE	6.6L V8 400 CID
	1977-1980	PONTIAC GRAND PRIX	4.9L V8 301 CID		1970-1971	CHEVROLET CHEVELLE	6.6L V8 6556cc 400 CID
	1978-1980	PONTIAC GRAND AM	4.9L V8 301 CID		1970-1971	CHEVROLET K30 PICKUP	6.6L V8 402 CID
	1979	OLDSMOBILE DELTA 88	4.9L V8 301 CID		1970-1971	GMC K35/K3500 PICKUP	6.6L V8 402 CID
	1979-1980	BUICK CENTURY	4.9L V8 301 CID		1970-1972	CHEVROLET BEL AIR	6.6L V8 400 CID
	1979-1980	BUICK REGAL	4.9L V8 301 CID		1970-1972	CHEVROLET BEL AIR	6.6L V8 6555cc 400 CID
	1979-1981	PONTIAC FIREBIRD	4.9L V8 301 CID		1970-1972	CHEVROLET BEL AIR	6.6L V8 6556cc 400 CID
	1979-1981	PONTIAC LEMANS	4.9L V8 301 CID		1970-1972	CHEVROLET BEL AIR	6.6L V8 6588cc 402 CID
	1980	BUICK ELECTRA	4.9L V8 301 CID		1970-1972	CHEVROLET BISCAYNE	6.6L V8 400 CID
	1980	BUICK ESTATE WAGON	4.9L V8 301 CID		1970-1972	CHEVROLET BISCAYNE	6.6L V8 6555cc 400 CID
	1980-1981	BUICK CENTURY	4.3L V8 265 CID		1970-1972	CHEVROLET BISCAYNE	6.6L V8 6556cc 400 CID
	1980-1981	BUICK REGAL	4.3L V8 265 CID		1970-1972	CHEVROLET BISCAYNE	6.6L V8 6588cc 402 CID
	1980-1981	PONTIAC BONNEVILLE	4.3L V8 265 CID		1970-1972	CHEVROLET C10 PICKUP	6.6L V8 402 CID
	1980-1981	PONTIAC CATALINA	4.3L V8 265 CID		1970-1972	CHEVROLET C10 PICKUP	6.6L V8 6588cc 402 CID
	1980-1981	PONTIAC GRAND LEMANS	4.3L V8 265 CID		1970-1972	CHEVROLET C10 SUBURBAN	6.6L V8 402 CID
1980-1981	PONTIAC GRAND LEMANS	4.9L V8 301 CID	1970-1972	CHEVROLET C10 SUBURBAN	6.6L V8 6588cc 402 CID		
1980-1981	PONTIAC GRAND PRIX	4.3L V8 265 CID	1970-1972	CHEVROLET C20 PICKUP	6.6L V8 402 CID		
1980-1981	PONTIAC LEMANS	4.3L V8 265 CID	1970-1972	CHEVROLET C20 PICKUP	6.6L V8 6588cc 402 CID		
1981	PONTIAC FIREBIRD	4.3L V8 265 CID	1970-1972	CHEVROLET C20 SUBURBAN	6.6L V8 402 CID		
US981	1966-1967	CHEVROLET MALIBU	6.5L V8 6489cc 396 CID	1970-1972	CHEVROLET C20 SUBURBAN	6.6L V8 6588cc 402 CID	
	1966-1969	CHEVROLET BEL AIR	6.5L V8 6489cc 396 CID	1970-1972	CHEVROLET C30 PICKUP	6.6L V8 402 CID	
	1966-1969	CHEVROLET BEL AIR	7.0L V8 6998cc 427 CID	1970-1972	CHEVROLET C30 PICKUP	6.6L V8 6588cc 402 CID	
	1966-1969	CHEVROLET BISCAYNE	6.5L V8 6489cc 396 CID	1970-1972	CHEVROLET CAMARO	6.6L V8 402 CID	
	1966-1969	CHEVROLET BISCAYNE	7.0L V8 6998cc 427 CID	1970-1972	CHEVROLET CAMARO	6.6L V8 6588cc 402 CID	
	1966-1969	CHEVROLET CAPRICE	6.5L V8 6489cc 396 CID	1970-1972	CHEVROLET CAPRICE	6.6L V8 400 CID	
	1966-1969	CHEVROLET CAPRICE	7.0L V8 6998cc 427 CID	1970-1972	CHEVROLET CAPRICE	6.6L V8 6555cc 400 CID	
	1966-1969	CHEVROLET CHEVELLE	6.5L V8 6489cc 396 CID	1970-1972	CHEVROLET CAPRICE	6.6L V8 6556cc 400 CID	
	1966-1969	CHEVROLET CORVETTE	7.0L V8 6998cc 427 CID	1970-1972	CHEVROLET CAPRICE	6.6L V8 6588cc 402 CID	
	1966-1969	CHEVROLET EL CAMINO	6.5L V8 6489cc 396 CID	1970-1972	CHEVROLET CHEVELLE	6.6L V8 6555cc 400 CID	
	1966-1969	CHEVROLET IMPALA	6.5L V8 396 CID	1970-1972	CHEVROLET CHEVELLE	6.6L V8 6588cc 402 CID	
	1966-1969	CHEVROLET IMPALA	6.5L V8 6489cc 396 CID	1970-1972	CHEVROLET EL CAMINO	6.6L V8 6555cc 400 CID	
	1966-1969	CHEVROLET IMPALA	7.0L V8 427 CID	1970-1972	CHEVROLET EL CAMINO	6.6L V8 6588cc 402 CID	
	1966-1969	CHEVROLET IMPALA	7.0L V8 6998cc 427 CID	1970-1972	CHEVROLET IMPALA	6.6L V8 400 CID	
	1966-1970	CHEVROLET CHEVELLE	6.5L V8 396 CID	1970-1972	CHEVROLET IMPALA	6.6L V8 6555cc 400 CID	
	1967-1969	CHEVROLET CAMARO	6.5L V8 6489cc 396 CID	1970-1972	CHEVROLET IMPALA	6.6L V8 6556cc 400 CID	
	1968	CHEVROLET CAMARO	6.5L V8 396 CID	1970-1972	CHEVROLET IMPALA	6.6L V8 6588cc 402 CID	
	1968	CHEVROLET CHEVY II	6.5L V8 396 CID	1970-1972	CHEVROLET K10 PICKUP	6.6L V8 6588cc 402 CID	
	1968	CHEVROLET CHEVY II	6.5L V8 6489cc 396 CID	1970-1972	CHEVROLET K10 SUBURBAN	6.6L V8 402 CID	
	1968	GMC K15/K1500 SUBURBAN	6.5L V8 396 CID	1970-1972	CHEVROLET K10 SUBURBAN	6.6L V8 6588cc 402 CID	
	1968	GMC K25/K2500 SUBURBAN	6.5L V8 396 CID	1970-1972	CHEVROLET K20 PICKUP	6.6L V8 6588cc 402 CID	
	1968-1969	CHEVROLET BEL AIR	6.5L V8 396 CID	1970-1972	CHEVROLET K20 SUBURBAN	6.6L V8 6588cc 402 CID	
	1968-1969	CHEVROLET BEL AIR	7.0L V8 427 CID	1970-1972	CHEVROLET K30 PICKUP	6.6L V8 6588cc 402 CID	
	1968-1969	CHEVROLET BISCAYNE	6.5L V8 396 CID	1970-1972	GMC C15/C1500 PICKUP	6.6L V8 402 CID	
	1968-1969	CHEVROLET BISCAYNE	7.0L V8 427 CID	1970-1972	GMC C15/C1500 PICKUP	6.6L V8 6588cc 402 CID	
	1968-1969	CHEVROLET C10 PICKUP	6.5L V8 396 CID	1970-1972	GMC C15/C1500 SUBURBAN	6.6L V8 402 CID	
	1968-1969	CHEVROLET C10 PICKUP	6.5L V8 6489cc 396 CID	1970-1972	GMC C15/C1500 SUBURBAN	6.6L V8 6588cc 402 CID	
	1968-1969	CHEVROLET C10 SUBURBAN	6.5L V8 396 CID	1970-1972	GMC C25/C2500 PICKUP	6.6L V8 402 CID	
	1968-1969	CHEVROLET C10 SUBURBAN	6.5L V8 6489cc 396 CID	1970-1972	GMC C25/C2500 PICKUP	6.6L V8 6588cc 402 CID	
	1968-1969	CHEVROLET C20 PICKUP	6.5L V8 396 CID	1970-1972	GMC C25/C2500 SUBURBAN	6.6L V8 402 CID	
	1968-1969	CHEVROLET C20 PICKUP	6.5L V8 6489cc 396 CID	1970-1972	GMC C25/C2500 SUBURBAN	6.6L V8 6588cc 402 CID	
	1968-1969	CHEVROLET C20 SUBURBAN	6.5L V8 396 CID	1970-1972	GMC C35/C3500 PICKUP	6.6L V8 402 CID	
	1968-1969	CHEVROLET C20 SUBURBAN	6.5L V8 6489cc 396 CID	1970-1972	GMC C35/C3500 PICKUP	6.6L V8 6588cc 402 CID	
	1968-1969	CHEVROLET C30 PICKUP	6.5L V8 396 CID	1970-1972	GMC K15/K1500 PICKUP	6.6L V8 6588cc 402 CID	
	1968-1969	CHEVROLET C30 PICKUP	6.5L V8 6489cc 396 CID	1970-1972	GMC K15/K1500 SUBURBAN	6.6L V8 402 CID	

WATER PUMPS

USMW	Years	Application	Engine	USMW	Years	Application	Engine		
US981	1970-1972	GMC K15/K1500 SUBURBAN	6.6L V8 6588cc 402 CID	US1002H	1987-1988	CHEVROLET R20 SUBURBAN	7.4L V8 454 CID		
	1970-1972	GMC K25/K2500 PICKUP	6.6L V8 6588cc 402 CID		1987-1988	CHEVROLET R30	7.4L V8 454 CID		
	1970-1972	GMC K25/K2500 SUBURBAN	6.6L V8 6588cc 402 CID		1987-1988	CHEVROLET V20 SUBURBAN	7.4L V8 454 CID		
	1970-1972	GMC K35/K3500 PICKUP	6.6L V8 6588cc 402 CID		1987-1988	CHEVROLET V30	7.4L V8 454 CID		
	1971-1972	CHEVROLET BEL AIR	6.6L V8 402 CID		1987-1988	GMC R2500 SUBURBAN	7.4L V8 454 CID		
	1971-1972	CHEVROLET BISCAYNE	6.6L V8 402 CID		1987-1989	GMC R2500	7.4L V8 454 CID		
	1971-1972	CHEVROLET CAPRICE	6.6L V8 402 CID		1987-1991	GMC R3500	7.4L V8 454 CID		
	1971-1972	CHEVROLET EL CAMINO	6.6L V8 402 CID		1987-1991	GMC V3500	7.4L V8 454 CID		
	1971-1972	CHEVROLET IMPALA	6.6L V8 402 CID		1989	CHEVROLET R2500	7.4L V8 454 CID		
	1971-1972	GMC P15/P1500 VAN	6.6L V8 400 CID		1989-1991	CHEVROLET R3500	7.4L V8 454 CID		
	1971-1972	GMC P25/P2500 VAN	6.6L V8 400 CID		1989-1991	CHEVROLET V3500	7.4L V8 454 CID		
	1971-1972	GMC P35/P3500 VAN	6.6L V8 400 CID		1990	CHEVROLET V2500 SUBURBAN	7.4L V8 454 CID		
	1972	CHEVROLET CHEVELLE	6.6L V8 402 CID		US1006	1971-1974	TOYOTA COROLLA	1.2L L4 1166cc 71 CID	
	1972	CHEVROLET P30 VAN	6.6L V8 402 CID		US1010	1971-1973	PLYMOUTH CRICKET	1.5L L4 1498cc	
	US984	1976-1982	CHEVROLET CORVETTE		5.7L V8 350 CID	US1012	1975-1977	DODGE COLT	1.6L L4 1597cc 98 CID
	1980	CHEVROLET CORVETTE	5.0L V8 305 CID		US984H	1976-1977	PLYMOUTH ARROW	1.6L L4 1597cc 98 CID	
	1976-1982	CHEVROLET CORVETTE	5.7L V8 350 CID		1980	1976-1977	PLYMOUTH COLT	1.6L L4 1597cc 98 CID	
	1980	CHEVROLET CORVETTE	5.0L V8 305 CID		US1018	1975	BUICK APOLLO	5.7L V8 350 CID	
	US986	1968-1973	AMERICAN MOTORS JAVELIN		4.6L L6 4600cc 282 CID	1975-1976	BUICK CENTURY	5.7L V8 350 CID	
1971-1973		AMERICAN MOTORS JAVELIN	4.2L L6 4200cc 258 CID	1975-1976	BUICK LESABRE	5.7L V8 350 CID			
1973-1974		AMERICAN MOTORS AMERICAN	4.2L L6 4200cc 258 CID	1975-1976	BUICK REGAL	5.7L V8 350 CID			
1973-1974		AMERICAN MOTORS CLASSIC	4.2L L6 4200cc 258 CID	1975-1976	BUICK SKYLARK	5.7L V8 350 CID			
1973-1974		AMERICAN MOTORS CLASSIC	4.6L L6 4600cc 282 CID	1975-1976	OLDSMOBILE STARFIRE	3.8L V6 231 CID			
1973-1974		AMERICAN MOTORS GREMLIN	4.2L L6 4200cc 258 CID	1975-1976	PONTIAC VENTURA	5.7L V8 350 CID			
1974		AMERICAN MOTORS AMERICAN	3.8L L6 3800cc 232 CID	1975-1977	BUICK CENTURY	3.8L V6 231 CID			
1974		AMERICAN MOTORS CLASSIC	3.8L L6 3800cc 232 CID	1975-1977	BUICK REGAL	3.8L V6 231 CID			
1974		AMERICAN MOTORS GREMLIN	4.2L L6 4228cc 258 CID	1975-1977	BUICK SKYHAWK	3.8L V6 231 CID			
1974		AMERICAN MOTORS GREMLIN	4.2L L6 4229cc 258 CID	1975-1977	BUICK SKYLARK	3.8L V6 231 CID			
US1002		1975	CHEVROLET BEL AIR	7.4L V8 454 CID	1976	PONTIAC SUNBIRD	3.8L V6 231 CID		
1975		CHEVROLET MALIBU	7.4L V8 454 CID	1976-1977	BUICK LESABRE	3.8L V6 231 CID			
1975		CHEVROLET MONTE CARLO	7.4L V8 454 CID	1977	OLDSMOBILE CUTLASS	3.8L V6 231 CID			
1975-1976	CHEVROLET CAPRICE	7.4L V8 454 CID	1977	OLDSMOBILE DELTA 88	3.8L V6 231 CID				
1975-1976	CHEVROLET IMPALA	7.4L V8 454 CID	1977	OLDSMOBILE OMEGA	3.8L V6 231 CID				
1975-1980	CHEVROLET C10	7.4L V8 454 CID	1977	PONTIAC FIREBIRD	3.8L V6 231 CID				
1975-1980	CHEVROLET C10 SUBURBAN	7.4L V8 454 CID	1977	PONTIAC LEMANS	3.8L V6 231 CID				
1975-1986	CHEVROLET C20	7.4L V8 454 CID	1977	PONTIAC PHOENIX	3.8L V6 231 CID				
1975-1986	CHEVROLET C20 SUBURBAN	7.4L V8 454 CID	1977	PONTIAC VENTURA	3.8L V6 231 CID				
1975-1986	CHEVROLET C30	7.4L V8 454 CID	1977-1979	BUICK RIVIERA	5.7L V8 350 CID				
1975-1999	CHEVROLET P30	7.4L V8 454 CID	1977-1980	BUICK ELECTRA	5.7L V8 350 CID				
1980	CHEVROLET K10	7.4L V8 454 CID	1977-1980	OLDSMOBILE STARFIRE	3.8L V6 3800cc 231 CID				
1980	CHEVROLET K20	7.4L V8 454 CID	1977-1980	PONTIAC SUNBIRD	3.8L V6 3800cc 231 CID				
1980	GMC C1500	7.4L V8 454 CID	1977-1985	BUICK LESABRE	3.8L V6 3800cc 231 CID				
1980	GMC C1500 SUBURBAN	7.4L V8 454 CID	1977-1985	OLDSMOBILE DELTA 88	3.8L V6 3800cc 231 CID				
1980	GMC K1500	7.4L V8 454 CID	1978	BUICK SKYLARK	3.8L V6 3800cc 231 CID				
1980-1986	CHEVROLET K30	7.4L V8 454 CID	1978-1979	BUICK CENTURY	3.2L V6 196 CID				
1980-1986	GMC C2500	7.4L V8 454 CID	1978-1979	BUICK REGAL	3.2L V6 196 CID				
1980-1986	GMC C2500 SUBURBAN	7.4L V8 454 CID	1978-1979	CHEVROLET MONZA	3.2L V6 196 CID				
1980-1986	GMC C3500	7.4L V8 454 CID	1978-1979	OLDSMOBILE OMEGA	3.8L V6 3800cc 231 CID				
1980-1986	GMC K3500	7.4L V8 454 CID	1978-1979	PONTIAC PHOENIX	3.8L V6 3800cc 231 CID				
1980-1999	GMC P3500	7.4L V8 454 CID	1978-1980	BUICK SKYHAWK	3.8L V6 3800cc 231 CID				
1985	CHEVROLET K20 SUBURBAN	7.4L V8 454 CID	1978-1980	CHEVROLET MONZA	3.8L V6 3800cc 231 CID				
1987-1988	CHEVROLET R20 SUBURBAN	7.4L V8 454 CID	1978-1980	OLDSMOBILE CUTLASS SALON	3.8L V6 3800cc 231 CID				
1987-1988	CHEVROLET R20 SUBURBAN	7.4L V8 454 CID	1978-1980	PONTIAC CATALINA	5.7L V8 350 CID				
1987-1988	CHEVROLET R30	7.4L V8 454 CID	1978-1981	BUICK CENTURY	3.8L V6 3800cc 231 CID				
1987-1988	CHEVROLET V20 SUBURBAN	7.4L V8 454 CID	1978-1981	PONTIAC CATALINA	3.8L V6 3800cc 231 CID				
1987-1988	CHEVROLET V30	7.4L V8 454 CID	1978-1981	PONTIAC FIREBIRD	3.8L V6 3800cc 231 CID				
1987-1988	GMC R2500 SUBURBAN	7.4L V8 454 CID	1978-1981	PONTIAC LEMANS	3.8L V6 3800cc 231 CID				
1987-1989	GMC R2500	7.4L V8 454 CID	1978-1983	CHEVROLET MALIBU	3.8L V6 3800cc 231 CID				
1987-1991	GMC R3500	7.4L V8 454 CID	1978-1984	CHEVROLET EL CAMINO	3.8L V6 3800cc 231 CID				
1987-1991	GMC V3500	7.4L V8 454 CID	1978-1984	CHEVROLET MONTE CARLO	3.8L V6 3800cc 231 CID				
1989	CHEVROLET R2500	7.4L V8 454 CID	1978-1984	OLDSMOBILE CUTLASS CALAIS	3.8L V6 3800cc 231 CID				
1989-1991	CHEVROLET R3500	7.4L V8 454 CID	1978-1987	BUICK REGAL	3.8L V6 3800cc 231 CID				
1989-1991	CHEVROLET V3500	7.4L V8 454 CID	1978-1987	PONTIAC GRAND PRIX	3.8L V6 3800cc 231 CID				
1990	CHEVROLET V2500 SUBURBAN	7.4L V8 454 CID	1979	BUICK REGAL	3.8L V6 231 CID				
US1002H	1975	CHEVROLET BEL AIR	7.4L V8 454 CID	1979	CHEVROLET EL CAMINO	3.8L V6 231 CID			
1975	CHEVROLET MALIBU	7.4L V8 454 CID	1979	CHEVROLET MALIBU	3.8L V6 231 CID				
1975	CHEVROLET MONTE CARLO	7.4L V8 454 CID	1979	CHEVROLET MONTE CARLO	3.8L V6 231 CID				
1975-1976	CHEVROLET CAPRICE	7.4L V8 454 CID	1979	CHEVROLET MONZA	3.8L V6 231 CID				
1975-1976	CHEVROLET IMPALA	7.4L V8 454 CID	1979	OLDSMOBILE CUTLASS CALAIS	3.8L V6 231 CID				
1975-1979	CHEVROLET P30	7.4L V8 454 CID	1979	OLDSMOBILE CUTLASS SALON	3.8L V6 231 CID				
1975-1980	CHEVROLET C10	7.4L V8 454 CID	1979	PONTIAC GRAND AM	3.8L V6 3800cc 231 CID				
1975-1980	CHEVROLET C10 SUBURBAN	7.4L V8 454 CID	1979	PONTIAC GRAND PRIX	3.8L V6 231 CID				
1975-1986	CHEVROLET C20	7.4L V8 454 CID	1979	PONTIAC LEMANS	3.8L V6 231 CID				
1975-1986	CHEVROLET C20 SUBURBAN	7.4L V8 454 CID	1979-1980	BUICK LESABRE	5.7L V8 350 CID				
1975-1986	CHEVROLET C30	7.4L V8 454 CID	1979-1980	PONTIAC BONNEVILLE	5.7L V8 350 CID				
1980	CHEVROLET K10	7.4L V8 454 CID	1979-1985	BUICK RIVIERA	3.8L V6 3800cc 231 CID				
1980	CHEVROLET K20	7.4L V8 454 CID	1980	BUICK ESTATE WAGON	5.7L V8 350 CID				
1980	GMC C1500	7.4L V8 454 CID	1980-1981	CHEVROLET CAMARO	3.8L V6 3800cc 231 CID				
1980	GMC C1500 SUBURBAN	7.4L V8 454 CID	1980-1981	OLDSMOBILE CUTLASS	3.8L V6 3800cc 231 CID				
1980	GMC K1500	7.4L V8 454 CID	1980-1981	PONTIAC GRAND LEMANS	3.8L V6 3800cc 231 CID				
1980-1986	CHEVROLET K30	7.4L V8 454 CID	1980-1982	CADILLAC DEVILLE	4.1L V6 252 CID				
1980-1986	GMC C2500	7.4L V8 454 CID	1980-1982	CADILLAC FLEETWOOD	4.1L V6 252 CID				
1980-1986	GMC C2500 SUBURBAN	7.4L V8 454 CID	1980-1982	OLDSMOBILE CUTLASS CRUISER	3.8L V6 3800cc 231 CID				
1980-1986	GMC C3500	7.4L V8 454 CID	1980-1984	BUICK ELECTRA	4.1L V6 252 CID				
1980-1986	GMC K3500	7.4L V8 454 CID	1980-1984	BUICK LESABRE	4.1L V6 252 CID				
1985	CHEVROLET K20 SUBURBAN	7.4L V8 454 CID	1980-1984	CHEVROLET CAPRICE	3.8L V6 3800cc 231 CID				
1985-1999	CHEVROLET P30	7.4L V8 454 CID	1980-1984	CHEVROLET IMPALA	3.8L V6 3800cc 231 CID				
1985-1999	GMC P3500	7.4L V8 454 CID	1980-1984	GMC CABALLERO	3.8L V6 3800cc 231 CID				
1987-1988	CHEVROLET R20	7.4L V8 454 CID	1980-1986	PONTIAC BONNEVILLE	3.8L V6 3800cc 231 CID				

USMW	Years	Application	Engine	USMW	Years	Application	Engine		
US1018	1980-1987	OLDSMOBILE CUTLASS SUPREME	3.8L V6 3800cc 231 CID	US1018H	1982	PONTIAC BONNEVILLE	4.1L V6 252 CID		
	1981-1982	CADILLAC ELDORADO	4.1L V6 252 CID		1982	PONTIAC GRAND PRIX	4.1L V6 252 CID		
	1981-1982	CADILLAC SEVILLE	4.1L V6 252 CID		1982-1984	BUICK REGAL	4.1L V6 252 CID		
	1981-1983	OLDSMOBILE 98	4.1L V6 252 CID		1984	PONTIAC PARISIENNE	3.8L V6 3800cc 231 CID		
	1981-1984	BUICK RIVIERA	4.1L V6 252 CID		1985-1987	OLDSMOBILE CUTLASS SALON	3.8L V6 3800cc 231 CID		
	1981-1984	OLDSMOBILE TORONADO	4.1L V6 252 CID		1989	PONTIAC FIREBIRD	3.8L V6 3800cc 231 CID		
	1982	PONTIAC BONNEVILLE	4.1L V6 252 CID		US1021	1965	JEEP J162	4.2L L6 4200cc 258 CID	
	1982	PONTIAC GRAND PRIX	4.1L V6 252 CID			1965	JEEP J264D	4.2L L6 4200cc 258 CID	
	1982-1984	BUICK REGAL	4.1L V6 252 CID			1965-1971	JEEP CJ5D	3.8L L6 3800cc 232 CID	
	1984	PONTIAC PARISIENNE	3.8L V6 3800cc 231 CID			1965-1971	JEEP CJ5D	4.2L L6 4200cc 258 CID	
	1985-1987	OLDSMOBILE CUTLASS SALON	3.8L V6 3800cc 231 CID			1965-1971	JEEP CJ5S	3.8L L6 3800cc 232 CID	
	1989	PONTIAC FIREBIRD	3.8L V6 3800cc 231 CID			1965-1971	JEEP CJ5S	4.2L L6 4200cc 258 CID	
	US1018H	1975	BUICK APOLLO			5.7L V8 350 CID	1965-1972	JEEP J164	4.2L L6 4200cc 258 CID
		1975-1976	OLDSMOBILE STARFIRE			3.8L V6 231 CID	1965-1972	JEEP J164V	4.2L L6 4200cc 258 CID
1975-1976		PONTIAC VENTURA	5.7L V8 350 CID	1965-1972		JEEP J364R	4.2L L6 4200cc 258 CID		
1975-1977		BUICK CENTURY	3.8L V6 231 CID	1965-1974		JEEP CJ7	3.8L L6 3800cc 232 CID		
1975-1977		BUICK REGAL	3.8L V6 231 CID	1965-1974		JEEP CJ7	4.2L L6 4200cc 258 CID		
1975-1977		BUICK REGAL	5.7L V8 350 CID	1967		JEEP J264D	3.8L L6 3800cc 232 CID		
1975-1977		BUICK SKYHAWK	3.8L V6 231 CID	1967		JEEP J264D	4.2L L6 4200cc 258 CID		
1975-1977		BUICK SKYLARK	3.8L V6 231 CID	1967-1972		JEEP J164	3.8L L6 3800cc 232 CID		
1975-1978		BUICK CENTURY	5.7L V8 350 CID	1967-1972	JEEP J164V	3.8L L6 3800cc 232 CID			
1975-1978		BUICK SKYLARK	5.7L V8 350 CID	1967-1972	JEEP J364R	3.8L L6 3800cc 232 CID			
1975-1980		BUICK LESABRE	5.7L V8 350 CID	1968-1969	JEEP J162	3.8L L6 3800cc 232 CID			
1976		PONTIAC SUNBIRD	3.8L V6 231 CID	1968-1969	JEEP J162	4.2L L6 4200cc 258 CID			
1976-1977		BUICK LESABRE	3.8L V6 231 CID	1968-1969	JEEP J262S	3.8L L6 3800cc 232 CID			
1977		OLDSMOBILE CUTLASS	3.8L V6 231 CID	1968-1969	JEEP J262S	4.2L L6 4200cc 258 CID			
1977	OLDSMOBILE DELTA 88	3.8L V6 231 CID	1971	JEEP J262S	3.8L L6 3800cc 232 CID				
1977	OLDSMOBILE OMEGA	3.8L V6 231 CID	1971	JEEP J262S	4.2L L6 4200cc 258 CID				
1977	PONTIAC FIREBIRD	3.8L V6 231 CID	1973	JEEP CJ7	4.6L L6 4600cc 282 CID				
1977	PONTIAC LEMANS	3.8L V6 231 CID	US1028	1965-1974	FORD F350	4.7L V8 4700cc 289 CID			
1977	PONTIAC PHOENIX	3.8L V6 231 CID		1965-1978	FORD F100	4.7L V8 4700cc 289 CID			
1977	PONTIAC VENTURA	3.8L V6 231 CID		1967-1968	FORD F350	5.0L V8 5000cc 302 CID			
1977-1979	BUICK RIVIERA	5.7L V8 350 CID		1969	FORD FALCON	5.0L V8 5000cc 302 CID			
1977-1980	BUICK ELECTRA	5.7L V8 350 CID		1969	FORD GALAXIE	5.8L V8 5800cc 351 CID			
1977-1980	OLDSMOBILE STARFIRE	3.8L V6 3800cc 231 CID		1969	FORD MUSTANG	5.0L V8 5000cc 302 CID			
1977-1980	PONTIAC SUNBIRD	3.8L V6 3800cc 231 CID		1973-1974	FORD B100	4.7L V8 4700cc 289 CID			
1977-1985	BUICK LESABRE	3.8L V6 3800cc 231 CID		1973-1974	FORD B100	5.0L V8 5000cc 302 CID			
1977-1985	OLDSMOBILE DELTA 88	3.8L V6 3800cc 231 CID		1975-1977	FORD BRONCO	5.0L V8 302 CID			
1978-1979	BUICK CENTURY	3.2L V6 196 CID		US1028H	1975-1977	FORD BRONCO	5.0L V8 302 CID		
1978-1979	BUICK REGAL	3.2L V6 196 CID			US1040	1975	CHRYSLER IMPERIAL	7.2L V8 440 CID	
1978-1979	BUICK SKYLARK	3.8L V6 3800cc 231 CID				1975	PLYMOUTH FURY	7.2L V8 440 CID	
1978-1979	CHEVROLET MONZA	3.2L V6 196 CID				1975-1976	DODGE CORONET	6.6L V8 400 CID	
1978-1979	OLDSMOBILE OMEGA	3.8L V6 3800cc 231 CID				1975-1976	DODGE CORONET	7.2L V8 440 CID	
1978-1979	PONTIAC PHOENIX	3.8L V6 3800cc 231 CID	1975-1977			DODGE ROYAL MONACO	6.6L V8 400 CID		
1978-1980	BUICK SKYHAWK	3.8L V6 3800cc 231 CID	1975-1977			DODGE ROYAL MONACO	7.2L V8 440 CID		
1978-1980	CHEVROLET MONZA	3.8L V6 3800cc 231 CID	1975-1977			DODGE W100	6.6L V8 400 CID		
1978-1980	OLDSMOBILE CUTLASS SALON	3.8L V6 3800cc 231 CID	1975-1977			DODGE W100	7.2L V8 440 CID		
1978-1980	PONTIAC CATALINA	5.7L V8 350 CID	1975-1977			PLYMOUTH GRAN FURY	6.6L V8 400 CID		
1978-1981	BUICK CENTURY	3.8L V6 3800cc 231 CID	1975-1977			PLYMOUTH GRAN FURY	7.2L V8 440 CID		
1978-1981	PONTIAC CATALINA	3.8L V6 3800cc 231 CID	1975-1978			CHRYSLER CORDOBA	6.6L V8 400 CID		
1978-1981	PONTIAC FIREBIRD	3.8L V6 3800cc 231 CID	1975-1978			CHRYSLER NEWPORT	6.6L V8 400 CID		
1978-1981	PONTIAC LEMANS	3.8L V6 3800cc 231 CID	1975-1978			CHRYSLER NEWPORT	7.2L V8 440 CID		
1978-1983	CHEVROLET MALIBU	3.8L V6 3800cc 231 CID	1975-1978	CHRYSLER NEW YORKER		6.6L V8 400 CID			
1978-1984	CHEVROLET EL CAMINO	3.8L V6 3800cc 231 CID	1975-1978	CHRYSLER NEW YORKER	7.2L V8 440 CID				
1978-1984	CHEVROLET MONTE CARLO	3.8L V6 3800cc 231 CID	1975-1978	DODGE B200	7.2L V8 440 CID				
1978-1984	OLDSMOBILE CUTLASS CALAIS	3.8L V6 3800cc 231 CID	1975-1978	DODGE B300	7.2L V8 440 CID				
1978-1987	BUICK REGAL	3.8L V6 3800cc 231 CID	1975-1978	DODGE CHARGER	6.6L V8 400 CID				
1978-1987	PONTIAC GRAND PRIX	3.8L V6 3800cc 231 CID	1975-1978	DODGE D100	7.2L V8 440 CID				
1979	BUICK CENTURY	3.8L V6 231 CID	1975-1978	DODGE D200	6.6L V8 400 CID				
1979	BUICK REGAL	3.8L V6 231 CID	1975-1978	DODGE D200	7.2L V8 440 CID				
1979	CHEVROLET EL CAMINO	3.8L V6 231 CID	1975-1978	DODGE D300	7.2L V8 440 CID				
1979	CHEVROLET MALIBU	3.8L V6 231 CID	1975-1978	DODGE MONACO	6.6L V8 400 CID				
1979	CHEVROLET MONTE CARLO	3.8L V6 231 CID	1975-1978	DODGE MONACO	7.2L V8 440 CID				
1979	OLDSMOBILE CUTLASS CALAIS	3.8L V6 231 CID	1975-1978	DODGE RAMCHARGER	7.2L V8 440 CID				
1979	OLDSMOBILE CUTLASS SALON	3.8L V6 231 CID	1975-1978	DODGE W200	7.2L V8 440 CID				
1979	PONTIAC GRAND AM	3.8L V6 3800cc 231 CID	1975-1978	DODGE W300	7.2L V8 440 CID				
1979	PONTIAC GRAND PRIX	3.8L V6 231 CID	1975-1978	PLYMOUTH FURY	6.6L V8 400 CID				
1979	PONTIAC LEMANS	3.8L V6 231 CID	1975-1978	PLYMOUTH TRAILDUSTER	7.2L V8 440 CID				
1979-1980	PONTIAC BONNEVILLE	5.7L V8 350 CID	1976-1978	DODGE B200	6.6L V8 400 CID				
1979-1985	BUICK RIVIERA	3.8L V6 3800cc 231 CID	1976-1978	DODGE B300	6.6L V8 400 CID				
1980	BUICK ESTATE WAGON	5.7L V8 350 CID	1976-1978	DODGE D100	6.6L V8 400 CID				
1980-1981	CHEVROLET CAMARO	3.8L V6 3800cc 231 CID	1976-1978	DODGE D300	6.6L V8 400 CID				
1980-1981	OLDSMOBILE CUTLASS	3.8L V6 3800cc 231 CID	1976-1978	DODGE W200	6.6L V8 400 CID				
1980-1981	PONTIAC GRAND LEMANS	3.8L V6 3800cc 231 CID	1976-1978	DODGE W300	6.6L V8 400 CID				
1980-1982	CADILLAC DEVILLE	4.1L V6 252 CID	1976-1978	PLYMOUTH PB200	6.6L V8 400 CID				
1980-1982	CADILLAC FLEETWOOD	4.1L V6 252 CID	1976-1978	PLYMOUTH PB200	7.2L V8 440 CID				
1980-1982	OLDSMOBILE CUTLASS CRUISER	3.8L V6 3800cc 231 CID	1976-1978	PLYMOUTH PB300	6.6L V8 400 CID				
1980-1984	BUICK ELECTRA	4.1L V6 252 CID	1976-1978	PLYMOUTH PB300	7.2L V8 440 CID				
1980-1984	BUICK LESABRE	4.1L V6 252 CID	1977-1978	DODGE D150	6.6L V8 400 CID				
1980-1984	CHEVROLET CAPRICE	3.8L V6 3800cc 231 CID	1977-1978	DODGE RAMCHARGER	6.6L V8 400 CID				
1980-1984	CHEVROLET IMPALA	3.8L V6 3800cc 231 CID	1977-1978	PLYMOUTH FURY	7.2L V8 440 CID				
1980-1984	GMC CABALLERO	3.8L V6 3800cc 231 CID	1977-1978	PLYMOUTH TRAILDUSTER	6.6L V8 400 CID				
1980-1986	PONTIAC BONNEVILLE	3.8L V6 3800cc 231 CID	1978	DODGE D150	7.2L V8 440 CID				
1980-1987	OLDSMOBILE CUTLASS SUPREME	3.8L V6 3800cc 231 CID	1978	DODGE MAGNUM	6.6L V8 400 CID				
1981-1982	CADILLAC ELDORADO	4.1L V6 252 CID	US1042	1975-1979	FORD COURIER	1.8L L4 110 CID			
1981-1982	CADILLAC SEVILLE	4.1L V6 252 CID		1977-1978	MAZDA B1800	1.8L L4 1796cc			
1981-1983	OLDSMOBILE 98	4.1L V6 252 CID		1979	FORD COURIER	2.0L L4 1989cc 122 CID			
1981-1984	BUICK RIVIERA	4.1L V6 252 CID		1979-1982	MAZDA 626	2.0L L4 1970cc			
1981-1984	OLDSMOBILE TORONADO	4.1L V6 252 CID		1979-1984	MAZDA B2000	2.0L L4 1970cc			

WATER PUMPS



WATER PUMP BUYERS GUIDE



USMWW	Years	Application	Engine	USMWW	Years	Application	Engine
US1042	1981-1982	FORD COURIER	2.0L L4 1989cc 122 CID	US1044	1971-1972	MERCURY COMET	2.8L L6 170 CID
US1044	1960-1961	FORD COUNTRY SEDAN	2.4L L6 2360cc 144 CID	1971-1974	MERCURY COMET	3.3L L6 3278cc 200 CID	
	1960-1961	FORD COUNTRY SEDAN	2.8L L6 2786cc 170 CID	1971-1975	MERCURY COMET	3.3L L6 200 CID	
	1960-1961	FORD COUNTRY SQUIRE	2.4L L6 2360cc 144 CID	1973-1974	FORD BRONCO	3.3L L6 200 CID	
	1960-1961	FORD COUNTRY SQUIRE	2.8L L6 2786cc 170 CID	1973-1974	FORD BRONCO	3.3L L6 3277cc 200 CID	
	1960-1961	FORD RANCH WAGON	2.4L L6 2360cc 144 CID	1973-1974	FORD BRONCO	3.3L L6 3278cc 200 CID	
	1960-1963	MERCURY COMET	2.4L L6 2360cc 144 CID	1975	FORD GRANADA	3.3L L6 200 CID	
	1960-1964	FORD FALCON	2.4L L6 2360cc 144 CID	1975	MERCURY MONARCH	3.3L L6 200 CID	
	1960-1964	FORD P-100	2.4L L6 2360cc 144 CID	US1045	1975	BUICK ELECTRA	7.5L V8 455 CID
	1960-1964	FORD RANCHERO	2.4L L6 2360cc 144 CID	1975	BUICK ESTATE WAGON	7.5L V8 455 CID	
	1960-1969	FORD FALCON	2.8L L6 2786cc 170 CID	1975	BUICK LESABRE	7.5L V8 455 CID	
	1960-1969	FORD RANCH WAGON	2.8L L6 2786cc 170 CID	1975	BUICK RIVIERA	7.5L V8 455 CID	
	1961-1963	MERCURY COMET	2.4L L6 144 CID	US1046	1972-1974	CHEVROLET LUV PICKUP	1.8L L4 111 CID
	1961-1963	MERCURY METEOR	2.8L L6 2786cc 170 CID	1975	CHEVROLET LUV	1.8L L4 111 CID	
	1961-1964	FORD FALCON SEDAN DELIVERY	2.4L L6 2360cc 144 CID	US1047	1975-1978	FORD MUSTANG II	2.8L V6 171 CID
	1961-1965	FORD ECONOLINE	2.4L L6 144 CID	1975-1979	FORD PINTO	2.8L V6 171 CID	
	1961-1965	FORD FALCON SEDAN DELIVERY	2.8L L6 2786cc 170 CID	1975-1979	MERCURY BOBCAT	2.8L V6 171 CID	
	1961-1965	FORD RANCHERO	2.8L L6 2786cc 170 CID	1979	FORD MUSTANG	2.8L V6 171 CID	
	1961-1967	FORD P-350	2.8L L6 2786cc 170 CID	1979	MERCURY CAPRI	2.8L V6 171 CID	
	1961-1970	FORD P-100	2.8L L6 2786cc 170 CID	US1052	1974	FORD E-100 ECONOLINE	5.0L V8 302 CID
	1961-1972	MERCURY COMET	2.8L L6 2786cc 170 CID	1974	FORD E-300 ECONOLINE	5.0L V8 302 CID	
	1962-1963	FORD CLUB WAGON	2.8L L6 170 CID	US1053	1970-1971	DODGE CHARGER	5.2L V8 5200cc 318 CID
	1962-1963	MERCURY METEOR	2.8L L6 170 CID	1970-1971	DODGE CORONET	5.2L V8 5200cc 318 CID	
	1962-1963	MERCURY VILLAGER	2.4L L6 2360cc 144 CID	1970-1974	DODGE MONACO	5.2L V8 5200cc 318 CID	
	1962-1964	FORD CLUB WAGON	2.4L L6 2360cc 144 CID	1970-1974	PLYMOUTH VALIANT	5.2L V8 5212cc 318 CID	
	1962-1964	FORD FALCON	2.4L L6 144 CID	1972	DODGE CHARGER	5.9L V8 5900cc 360 CID	
	1962-1964	FORD STATION BUS	2.4L L6 144 CID	1972-1973	DODGE MONACO	5.9L V8 5900cc 360 CID	
	1962-1966	FORD ECONOLINE	2.8L L6 170 CID	1975	DODGE ROYAL MONACO	5.2L V8 318 CID	
	1962-1966	FORD FAIRLANE	2.8L L6 2786cc 170 CID	1975	DODGE W200	5.2L V8 318 CID	
	1962-1967	FORD CLUB WAGON	2.8L L6 2786cc 170 CID	1975-1976	DODGE CORONET	5.2L V8 318 CID	
	1962-1967	MERCURY VILLAGER	2.8L L6 2786cc 170 CID	1975-1976	DODGE CORONET	5.9L V8 360 CID	
	1962-1969	FORD FALCON	2.8L L6 170 CID	1975-1976	DODGE DART	5.2L V8 318 CID	
	1963	FORD FORD 300	3.3L L6 3277cc 200 CID	1975-1976	DODGE DART	5.9L V8 360 CID	
	1963	FORD GALAXIE	3.3L L6 3277cc 200 CID	1975-1976	PLYMOUTH DUSTER	5.2L V8 318 CID	
	1963	FORD GALAXIE 500	3.3L L6 200 CID	1975-1976	PLYMOUTH DUSTER	5.9L V8 360 CID	
	1963	MERCURY COUNTRY CRUISER	3.3L L6 3277cc 200 CID	1975-1976	PLYMOUTH SCAMP	5.2L V8 318 CID	
	1963	MERCURY METEOR	3.3L L6 3277cc 200 CID	1975-1976	PLYMOUTH VALIANT	5.2L V8 318 CID	
	1963-1964	FORD SPRINT	2.8L L6 2786cc 170 CID	1975-1977	DODGE ROYAL MONACO	5.9L V8 360 CID	
	1963-1964	FORD SPRINT	3.3L L6 3277cc 200 CID	1975-1977	DODGE W100	5.2L V8 5211cc 318 CID	
	1963-1967	MERCURY VILLAGER	3.3L L6 3277cc 200 CID	1975-1977	DODGE W100	5.9L V8 360 CID	
	1963-1969	FORD FAIRLANE	3.3L L6 3277cc 200 CID	1975-1977	PLYMOUTH GRAN FURY	5.2L V8 318 CID	
	1963-1970	FORD RANCH WAGON	3.3L L6 3277cc 200 CID	1975-1977	PLYMOUTH GRAN FURY	5.9L V8 360 CID	
	1963-1974	MERCURY COMET	3.3L L6 3277cc 200 CID	1975-1978	DODGE CHARGER	5.2L V8 318 CID	
	1964	FORD RANCH WAGON	2.4L L6 2360cc 144 CID	1975-1978	DODGE CHARGER	5.9L V8 360 CID	
	1964	MERCURY COMET	2.8L L6 170 CID	1975-1978	DODGE MONACO	5.2L V8 318 CID	
	1964	MERCURY CYCLONE	3.3L L6 3277cc 200 CID	1975-1978	DODGE MONACO	5.9L V8 360 CID	
	1964-1965	FORD FALCON SEDAN DELIVERY	3.3L L6 3277cc 200 CID	1975-1978	DODGE W300	5.2L V8 5211cc 318 CID	
	1964-1965	FORD MUSTANG	2.8L L6 2786cc 170 CID	1975-1978	PLYMOUTH FURY	5.2L V8 318 CID	
	1964-1967	MERCURY CALIENTE	3.3L L6 3277cc 200 CID	1975-1978	PLYMOUTH FURY	5.9L V8 360 CID	
	1964-1968	FORD RANCHERO	3.3L L6 3277cc 200 CID	1975-1979	DODGE D100	5.2L V8 5211cc 318 CID	
	1964-1970	FORD FALCON	3.3L L6 3277cc 200 CID	1975-1979	DODGE D100	5.9L V8 360 CID	
	1964-1970	FORD MUSTANG	3.3L L6 3277cc 200 CID	1975-1980	CHRYSLER NEWPORT	5.9L V8 360 CID	
	1965	FORD STATION BUS	2.8L L6 170 CID	1975-1980	DODGE B100	5.2L V8 5211cc 318 CID	
	1965	MERCURY COMET	3.3L L6 200 CID	1975-1980	DODGE B200	5.2L V8 5211cc 318 CID	
	1965-1969	FORD COUNTRY SEDAN	2.8L L6 2786cc 170 CID	1975-1980	DODGE B200	5.9L V8 360 CID	
	1965-1969	FORD COUNTRY SQUIRE	2.8L L6 2786cc 170 CID	1975-1980	DODGE B300	5.2L V8 5211cc 318 CID	
	1965-1969	FORD FAIRLANE	3.3L L6 200 CID	1975-1980	DODGE B300	5.9L V8 360 CID	
	1965-1970	FORD COUNTRY SEDAN	3.3L L6 3277cc 200 CID	1975-1980	DODGE D200	5.2L V8 5211cc 318 CID	
	1965-1970	FORD COUNTRY SQUIRE	3.3L L6 3277cc 200 CID	1975-1980	DODGE D200	5.9L V8 360 CID	
	1965-1970	FORD FALCON	3.3L L6 200 CID	1975-1980	DODGE D300	5.2L V8 5211cc 318 CID	
	1966-1967	FORD CLUB WAGON	2.8L L6 170 CID	1975-1980	DODGE D300	5.9L V8 360 CID	
	1966-1967	MERCURY VOYAGER	2.8L L6 2786cc 170 CID	1975-1980	DODGE W200	5.2L V8 5211cc 318 CID	
	1966-1967	MERCURY VOYAGER	3.3L L6 3277cc 200 CID	1975-1980	DODGE W200	5.9L V8 360 CID	
	1966-1968	FORD RANCHERO	3.3L L6 200 CID	1975-1980	DODGE W300	5.9L V8 360 CID	
	1966-1972	FORD BRONCO	2.8L L6 2786cc 170 CID	1975-1980	PLYMOUTH PB100	5.2L V8 5211cc 318 CID	
	1967-1972	FORD BRONCO	2.8L L6 170 CID	1975-1980	PLYMOUTH PB200	5.2L V8 5211cc 318 CID	
	1968	FORD RANCHERO	3.3L L6 3278cc 200 CID	1975-1980	PLYMOUTH PB200	5.9L V8 360 CID	
	1968	FORD TORINO	3.3L L6 200 CID	1975-1980	PLYMOUTH PB300	5.2L V8 5211cc 318 CID	
	1968	FORD TORINO	3.3L L6 3277cc 200 CID	1975-1980	PLYMOUTH PB300	5.9L V8 360 CID	
	1968	FORD TORINO	3.3L L6 3278cc 200 CID	1975-1981	DODGE RAMCHARGER	5.9L V8 360 CID	
	1968	MERCURY COMET	3.3L L6 200 CID	1975-1981	PLYMOUTH TRAILDUSTER	5.2L V8 5211cc 318 CID	
	1968	MERCURY COMET	3.3L L6 3278cc 200 CID	1975-1981	PLYMOUTH TRAILDUSTER	5.9L V8 360 CID	
	1968	MERCURY MONTEGO	3.3L L6 200 CID	1975-1982	CHRYSLER CORDOBA	5.9L V8 360 CID	
	1968	MERCURY MONTEGO	3.3L L6 3277cc 200 CID	1975-1983	CHRYSLER CORDOBA	5.2L V8 318 CID	
	1968	MERCURY MONTEGO	3.3L L6 3278cc 200 CID	1975-1991	DODGE RAMCHARGER	5.2L V8 5211cc 318 CID	
	1968-1969	FORD FAIRLANE	3.3L L6 3278cc 200 CID	1976	PLYMOUTH VALIANT	5.9L V8 360 CID	
	1968-1970	FORD FALCON	3.3L L6 3278cc 200 CID	1976-1978	DODGE B100	5.9L V8 360 CID	
	1968-1970	FORD MUSTANG	3.3L L6 200 CID	1976-1978	PLYMOUTH PB100	5.9L V8 360 CID	
	1968-1970	FORD MUSTANG	3.3L L6 3278cc 200 CID	1976-1980	DODGE ASPEN	5.2L V8 318 CID	
	1969-1970	FORD E-300 ECONOLINE	2.8L L6 170 CID	1976-1980	DODGE ASPEN	5.9L V8 360 CID	
	1969-1971	FORD E-100 ECONOLINE	2.8L L6 170 CID	1976-1980	PLYMOUTH VOLARE	5.2L V8 318 CID	
	1969-1971	FORD E-100 ECONOLINE	2.8L L6 2786cc 170 CID	1976-1980	PLYMOUTH VOLARE	5.9L V8 360 CID	
	1969-1971	FORD E-200 ECONOLINE	2.8L L6 170 CID	1977	CHRYSLER LEBARON	5.9L V8 5900cc 360 CID	
	1970	FORD P-350	2.8L L6 2786cc 170 CID	1977	DODGE ROYAL MONACO	5.2L V8 318 CID	
	1970-1972	FORD MAVERICK	2.8L L6 170 CID	1977-1978	DODGE DART	5.9L V8 5900cc 360 CID	
	1970-1972	FORD MAVERICK	2.8L L6 2786cc 170 CID	1977-1980	CHRYSLER NEW YORKER	5.9L V8 360 CID	
	1970-1974	FORD MAVERICK	3.3L L6 3277cc 200 CID	1977-1981	CHRYSLER LEBARON	5.2L V8 318 CID	
	1970-1974	FORD MAVERICK	3.3L L6 3278cc 200 CID	1977-1981	DODGE W150	5.9L V8 360 CID	
	1970-1975	FORD MAVERICK	3.3L L6 200 CID	1977-1989	DODGE DIPLOMAT	5.2L V8 318 CID	

USMW	Years	Application	Engine	USMW	Years	Application	Engine	
US1053	1977-1991	DODGE D150	5.2L V8 5211cc 318 CID	US1053H	1975-1976	PLYMOUTH DUSTER	5.2L V8 318 CID	
	1977-1991	DODGE D150	5.9L V8 360 CID		1975-1976	PLYMOUTH DUSTER	5.9L V8 360 CID	
	1977-1991	DODGE W150	5.2L V8 5211cc 318 CID		1975-1976	PLYMOUTH SCAMP	5.2L V8 318 CID	
	1978-1979	CHRYSLER TOWN & COUNTRY	5.9L V8 360 CID		1975-1976	PLYMOUTH VALIANT	5.2L V8 318 CID	
	1978-1979	DODGE DIPLOMAT	5.9L V8 360 CID		1975-1977	DODGE ROYAL MONACO	5.9L V8 360 CID	
	1978-1979	DODGE MAGNUM	5.2L V8 318 CID		1975-1977	DODGE W100	5.2L V8 5211cc 318 CID	
	1978-1979	DODGE MAGNUM	5.9L V8 360 CID		1975-1977	DODGE W100	5.9L V8 360 CID	
	1978-1981	CHRYSLER TOWN & COUNTRY	5.2L V8 318 CID		1975-1977	PLYMOUTH GRAN FURY	5.2L V8 318 CID	
	1978-1982	CHRYSLER LEBARON	5.9L V8 360 CID		1975-1977	PLYMOUTH GRAN FURY	5.9L V8 360 CID	
	1979-1980	DODGE ST. REGIS	5.9L V8 360 CID		1975-1978	DODGE CHARGER	5.2L V8 318 CID	
	1979-1981	CHRYSLER NEWPORT	5.2L V8 318 CID		1975-1978	DODGE CHARGER	5.9L V8 360 CID	
	1979-1981	DODGE ST. REGIS	5.2L V8 318 CID		1975-1978	DODGE MONACO	5.2L V8 318 CID	
	1979-1982	CHRYSLER NEW YORKER	5.2L V8 318 CID		1975-1978	DODGE MONACO	5.9L V8 360 CID	
	1980	DODGE CB300	5.2L V8 5211cc 318 CID		1975-1978	DODGE W300	5.2L V8 5211cc 318 CID	
	1980	DODGE CB300	5.9L V8 360 CID		1975-1978	PLYMOUTH FURY	5.2L V8 318 CID	
	1980	DODGE D150	5.9L V8 5900cc 360 CID		1975-1978	PLYMOUTH FURY	5.9L V8 360 CID	
	1980	DODGE D350	5.2L V8 5200cc 318 CID		1975-1979	DODGE D100	5.2L V8 5211cc 318 CID	
	1980	DODGE MIRADA	5.9L V8 360 CID		1975-1979	DODGE D100	5.9L V8 360 CID	
	1980	DODGE RD200	5.2L V8 5211cc 318 CID		1975-1980	CHRYSLER NEWPORT	5.9L V8 360 CID	
	1980	DODGE RD200	5.9L V8 360 CID		1975-1980	DODGE B100	5.2L V8 5211cc 318 CID	
	1980	DODGE W300	5.2L V8 5211cc 318 CID		1975-1980	DODGE B200	5.2L V8 5211cc 318 CID	
	1980	PLYMOUTH GRAN FURY	5.9L V8 360 CID		1975-1980	DODGE B200	5.9L V8 360 CID	
	1980-1982	CHRYSLER CORDOBA	5.9L V8 5900cc 360 CID		1975-1980	DODGE B300	5.2L V8 5211cc 318 CID	
	1980-1982	CHRYSLER LEBARON	5.9L V8 5900cc 360 CID		1975-1980	DODGE B300	5.9L V8 360 CID	
	1980-1982	DODGE DART	5.9L V8 5900cc 360 CID		1975-1980	DODGE D200	5.2L V8 5211cc 318 CID	
	1980-1982	DODGE MAGNUM	5.9L V8 5900cc 360 CID		1975-1980	DODGE D200	5.9L V8 360 CID	
	1980-1983	DODGE D350	5.9L V8 5900cc 360 CID		1975-1980	DODGE D300	5.2L V8 5211cc 318 CID	
	1980-1983	DODGE MIRADA	5.2L V8 318 CID		1975-1980	DODGE D300	5.9L V8 360 CID	
	1980-1989	PLYMOUTH GRAN FURY	5.2L V8 318 CID		1975-1980	DODGE W200	5.2L V8 5211cc 318 CID	
	1980-1990	DODGE RAMCHARGER	5.9L V8 5900cc 360 CID		1975-1980	DODGE W200	5.9L V8 360 CID	
	1981	DODGE B250	5.9L V8 360 CID		1975-1980	DODGE W300	5.9L V8 360 CID	
	1981	PLYMOUTH PB150	5.2L V8 5211cc 318 CID		1975-1980	PLYMOUTH PB100	5.2L V8 5211cc 318 CID	
	1981	PLYMOUTH PB250	5.9L V8 360 CID		1975-1980	PLYMOUTH PB200	5.2L V8 5211cc 318 CID	
	1981-1982	DODGE D250	5.9L V8 360 CID		1975-1980	PLYMOUTH PB200	5.9L V8 360 CID	
	1981-1982	DODGE W250	5.9L V8 360 CID		1975-1980	PLYMOUTH PB300	5.2L V8 5211cc 318 CID	
	1981-1983	CHRYSLER IMPERIAL	5.2L V8 318 CID		1975-1980	PLYMOUTH PB300	5.9L V8 360 CID	
	1981-1983	DODGE D350	5.2L V8 5211cc 318 CID		1975-1981	DODGE RAMCHARGER	5.9L V8 360 CID	
	1981-1983	PLYMOUTH PB250	5.2L V8 5211cc 318 CID		1975-1981	PLYMOUTH TRAILDUSTER	5.2L V8 5211cc 318 CID	
	1981-1983	PLYMOUTH PB350	5.2L V8 5211cc 318 CID		1975-1981	PLYMOUTH TRAILDUSTER	5.9L V8 360 CID	
	1981-1983	PLYMOUTH PB350	5.9L V8 360 CID		1975-1982	CHRYSLER CORDOBA	5.9L V8 360 CID	
	1981-1991	DODGE B150	5.2L V8 5211cc 318 CID		1975-1983	CHRYSLER CORDOBA	5.2L V8 318 CID	
	1981-1991	DODGE B250	5.2L V8 5211cc 318 CID		1975-1991	DODGE RAMCHARGER	5.2L V8 5211cc 318 CID	
	1981-1991	DODGE B350	5.2L V8 5211cc 318 CID		1976	PLYMOUTH VALIANT	5.9L V8 360 CID	
	1981-1991	DODGE D250	5.2L V8 5211cc 318 CID		1976-1978	DODGE B100	5.9L V8 360 CID	
	1981-1991	DODGE W250	5.2L V8 5211cc 318 CID		1976-1978	PLYMOUTH PB100	5.9L V8 360 CID	
	1981-1992	DODGE B350	5.9L V8 360 CID		1976-1980	DODGE ASPEN	5.2L V8 318 CID	
	1981-1992	DODGE D350	5.9L V8 360 CID		1976-1980	DODGE ASPEN	5.9L V8 360 CID	
	1981-1992	DODGE W350	5.9L V8 360 CID		1976-1980	PLYMOUTH VOLARE	5.2L V8 318 CID	
	1982	DODGE D350	5.2L V8 5200cc 318 CID		1976-1980	PLYMOUTH VOLARE	5.9L V8 360 CID	
	1982	DODGE DART	5.9L V8 360 CID		1977	DODGE ROYAL MONACO	5.2L V8 318 CID	
	1982	DODGE MAGNUM	5.9L V8 360 CID		1977-1980	CHRYSLER NEW YORKER	5.9L V8 360 CID	
	1982-1983	DODGE D150	5.9L V8 5900cc 360 CID		1977-1981	CHRYSLER LEBARON	5.2L V8 318 CID	
	1982-1983	DODGE W350	5.2L V8 5211cc 318 CID		1977-1981	DODGE W150	5.9L V8 360 CID	
	1983	DODGE DIPLOMAT	5.2L V8 5211cc 318 CID		1977-1989	DODGE DIPLOMAT	5.2L V8 318 CID	
	1983	PLYMOUTH PB150	5.2L V8 5211cc 318 CID		1977-1991	DODGE D150	5.2L V8 5211cc 318 CID	
	1983-1989	CHRYSLER FIFTH AVENUE	5.2L V8 318 CID		1977-1991	DODGE W150	5.2L V8 5211cc 318 CID	
	1984-1991	DODGE W150	5.9L V8 360 CID		1978-1979	CHRYSLER TOWN & COUNTRY	5.9L V8 360 CID	
	1984-1992	DODGE B250	5.9L V8 360 CID		1978-1979	DODGE DIPLOMAT	5.9L V8 360 CID	
	1984-1992	DODGE D250	5.9L V8 360 CID		1978-1979	DODGE MAGNUM	5.2L V8 318 CID	
	1984-1992	DODGE RAMCHARGER	5.9L V8 360 CID		1978-1979	DODGE MAGNUM	5.9L V8 360 CID	
	1984-1992	DODGE W250	5.9L V8 360 CID		1978-1981	CHRYSLER TOWN & COUNTRY	5.2L V8 318 CID	
	1985	DODGE DIPLOMAT	5.2L V8 5211cc 318 CID		1978-1982	CHRYSLER LEBARON	5.9L V8 360 CID	
	1985	PLYMOUTH GRAN FURY	5.2L V8 5211cc 318 CID		1979-1980	DODGE ST. REGIS	5.9L V8 360 CID	
	1985-1988	DODGE D100	5.9L V8 360 CID		1979-1981	CHRYSLER NEWPORT	5.2L V8 318 CID	
	1985-1989	DODGE D100	5.2L V8 5211cc 318 CID		1979-1981	DODGE ST. REGIS	5.2L V8 318 CID	
	1986-1988	DODGE W100	5.9L V8 360 CID		1979-1982	CHRYSLER NEW YORKER	5.2L V8 318 CID	
	1986-1989	DODGE W100	5.2L V8 5211cc 318 CID		1980	DODGE CB300	5.2L V8 5211cc 318 CID	
	1987-1991	DODGE DAKOTA	3.9L V6 3906cc 239 CID		1980	DODGE CB300	5.9L V8 360 CID	
	1988-1989	DODGE D100	3.9L V6 3906cc 239 CID		1980	DODGE MIRADA	5.9L V8 360 CID	
	1988-1991	DODGE B150	3.9L V6 3906cc 239 CID		1980	DODGE RD200	5.2L V8 5211cc 318 CID	
	1988-1991	DODGE B250	3.9L V6 3906cc 239 CID		1980	DODGE RD200	5.9L V8 360 CID	
	1988-1991	DODGE D150	3.9L V6 3906cc 239 CID		1980	DODGE W300	5.2L V8 5211cc 318 CID	
	1988-1991	DODGE D250	3.9L V6 3906cc 239 CID		1980	PLYMOUTH GRAN FURY	5.9L V8 360 CID	
	1988-1991	DODGE MICROBUS	5.9L V8 5900cc 360 CID		1980-1983	DODGE MIRADA	5.2L V8 318 CID	
	1989	DODGE DAKOTA	5.2L V8 5211cc 318 CID		1980-1989	PLYMOUTH GRAN FURY	5.2L V8 318 CID	
	1989	DODGE W100	3.9L V6 3906cc 239 CID		1981	DODGE B250	5.9L V8 360 CID	
	1989-1990	DODGE D150	5.9L V8 5900cc 360 CID		1981	PLYMOUTH PB150	5.2L V8 5211cc 318 CID	
	1989-1990	DODGE D250	5.9L V8 5900cc 360 CID		1981	PLYMOUTH PB250	5.9L V8 360 CID	
	1989-1990	DODGE D350	5.9L V8 5900cc 360 CID		1981-1982	DODGE D250	5.9L V8 360 CID	
	1989-1990	DODGE W250	5.9L V8 5900cc 360 CID		1981-1982	DODGE W250	5.9L V8 360 CID	
	1989-1991	DODGE W150	3.9L V6 3906cc 239 CID		1981-1983	CHRYSLER IMPERIAL	5.2L V8 318 CID	
	1991	DODGE DM350	5.9L V8 5904cc 360 CID		1981-1983	DODGE D350	5.2L V8 5211cc 318 CID	
	US1053H	1970-1974	PLYMOUTH VALIANT		5.2L V8 5212cc 318 CID	1981-1983	PLYMOUTH PB250	5.2L V8 5211cc 318 CID
		1975	DODGE ROYAL MONACO		5.2L V8 318 CID	1981-1983	PLYMOUTH PB350	5.2L V8 5211cc 318 CID
		1975	DODGE W200		5.2L V8 318 CID	1981-1983	PLYMOUTH PB350	5.9L V8 360 CID
		1975-1976	DODGE CORONET		5.2L V8 318 CID	1981-1991	DODGE B150	5.2L V8 5211cc 318 CID
		1975-1976	DODGE CORONET		5.9L V8 360 CID	1981-1991	DODGE B250	5.2L V8 5211cc 318 CID
		1975-1976	DODGE DART		5.2L V8 318 CID	1981-1991	DODGE B350	5.2L V8 5211cc 318 CID
		1975-1976	DODGE DART		5.9L V8 360 CID			



WATER PUMP BUYERS GUIDE



USMWW	Years	Application	Engine	USMWW	Years	Application	Engine
US1053H	1981-1991	DODGE D250	5.2L V8 5211cc 318 CID	US1077	1979	AMERICAN MOTORS SPIRIT	3.8L L6 232 CID
	1981-1991	DODGE W250	5.2L V8 5211cc 318 CID		1979	AMERICAN MOTORS SPIRIT	4.2L L6 258 CID
	1981-1992	DODGE B350	5.9L V8 360 CID	1980-1983	JEEP J100	4.6L L6 4600cc 282 CID	
	1981-1992	DODGE D350	5.9L V8 360 CID	US1082	1975	FORD F-500	5.4L L6 330 CID
	1981-1992	DODGE W350	5.9L V8 360 CID	US1083	1974-1975	FORD F600	
	1982	DODGE DART	5.9L V8 360 CID	US1088	1975	CHEVROLET MONZA	2.3L L4 2294cc 140 CID
	1982	DODGE MAGNUM	5.9L V8 360 CID		1975	CHEVROLET VEGA	2.3L L4 2294cc 140 CID
	1982-1983	DODGE W350	5.2L V8 5211cc 318 CID		1975	PONTIAC ASTRE	2.3L L4 2294cc 140 CID
	1983	DODGE DIPLOMAT	5.2L V8 5211cc 318 CID	US1096	1975-1977	FORD F-500	5.4L V8 330 CID
	1983	PLYMOUTH PB150	5.2L V8 5211cc 318 CID	US1099	1966	INTERNATIONAL 1000A	4.3L L6 4335cc 264 CID
	1983-1989	CHRYSLER FIFTH AVENUE	5.2L V8 318 CID		1966	INTERNATIONAL 1000A	4.3L V8 4360cc 266 CID
	1984-1991	DODGE W150	5.9L V8 360 CID	1966	INTERNATIONAL 1000A	5.0L V8 4982cc 304 CID	
	1984-1992	DODGE B250	5.9L V8 360 CID	1966	INTERNATIONAL 1100A	4.3L L6 4335cc 264 CID	
	1984-1992	DODGE D250	5.9L V8 360 CID	1966	INTERNATIONAL 1100A	4.3L V8 4360cc 266 CID	
	1984-1992	DODGE RAMCHARGER	5.9L V8 360 CID	1966	INTERNATIONAL 1100A	5.0L V8 304 CID	
	1984-1992	DODGE W250	5.9L V8 360 CID	1966	INTERNATIONAL 1100A	5.0L V8 4982cc 304 CID	
	1985	DODGE DIPLOMAT	5.2L V8 5211cc 318 CID	1966	INTERNATIONAL 1100A	5.0L V8 4983cc 304 CID	
	1985	PLYMOUTH GRAN FURY	5.2L V8 5211cc 318 CID	1966	INTERNATIONAL 1200A	4.3L L6 4335cc 264 CID	
	1985-1988	DODGE D100	5.9L V8 360 CID	1966	INTERNATIONAL 1200A	4.3L V8 4360cc 266 CID	
	1985-1989	DODGE D100	5.2L V8 5211cc 318 CID	1966	INTERNATIONAL 1200A	5.0L V8 304 CID	
	1986-1988	DODGE W100	5.9L V8 360 CID	1966	INTERNATIONAL 1200A	5.0L V8 4982cc 304 CID	
	1986-1989	DODGE W100	5.2L V8 5211cc 318 CID	1966	INTERNATIONAL 1200A	5.0L V8 4983cc 304 CID	
	1987-1991	DODGE DAKOTA	3.9L V6 3906cc 239 CID	1966	INTERNATIONAL 1200A	4.3L L6 4335cc 264 CID	
	1988-1989	DODGE D100	3.9L V6 3906cc 239 CID	1966	INTERNATIONAL 1300A	4.3L V8 4360cc 266 CID	
	1988-1991	DODGE B150	3.9L V6 3906cc 239 CID	1966	INTERNATIONAL 1300A	5.0L V8 4982cc 304 CID	
	1988-1991	DODGE B250	3.9L V6 3906cc 239 CID	1966-1967	INTERNATIONAL 900A	2.5L L4 2491cc 152 CID	
	1988-1991	DODGE D150	3.9L V6 3906cc 239 CID	1966-1967	INTERNATIONAL M1400	4.3L L6 4335cc 264 CID	
	1988-1991	DODGE D250	3.9L V6 3906cc 239 CID	1966-1967	INTERNATIONAL M1400	4.3L V8 4360cc 266 CID	
	1989	DODGE DAKOTA	5.2L V8 5211cc 318 CID	1966-1967	INTERNATIONAL M1400	5.0L V8 4982cc 304 CID	
	1989	DODGE W100	3.9L V6 3906cc 239 CID	1966-1970	INTERNATIONAL M1100	4.3L L6 4335cc 264 CID	
	1989-1991	DODGE W150	3.9L V6 3906cc 239 CID	1966-1970	INTERNATIONAL M1100	4.3L V8 4360cc 266 CID	
	US1061	1959-1964	BUICK OPEL	1.7L L4 1700cc 104 CID	1966-1970	INTERNATIONAL M1200	4.3L L6 4335cc 264 CID
		1965-1972	BUICK OPEL	2.1L L4 2100cc 128 CID	1966-1970	INTERNATIONAL M1200	4.3L V8 4360cc 266 CID
	US1069	1975-1976	CHEVROLET MONZA	4.3L V8 262 CID	1966-1971	INTERNATIONAL M800	2.5L L4 2491cc 152 CID
		1976-1979	CHEVROLET MONZA	5.0L V8 305 CID	1966-1971	INTERNATIONAL M1100	2.5L L4 2491cc 152 CID
		1977-1979	OLDSMOBILE STARFIRE	5.0L V8 305 CID	1966-1971	INTERNATIONAL M1200	2.5L L4 2491cc 152 CID
		1979	PONTIAC PHOENIX	5.0L V8 305 CID	1966-1971	INTERNATIONAL SCOUT	2.5L L4 2491cc 152 CID
		1979	PONTIAC SUNBIRD	5.0L V8 305 CID	1966-1972	INTERNATIONAL M1100	5.0L V8 4982cc 304 CID
US1070	1975	FORD MUSTANG	5.0L V8 5000cc 302 CID	1967	INTERNATIONAL 908B	4.3L V8 4360cc 266 CID	
	1975-1976	FORD MUSTANG II	5.0L V8 302 CID	1967	INTERNATIONAL 908B	5.0L V8 4982cc 304 CID	
US1075	1965-1967	FORD F350	5.0L V8 5000cc 302 CID	1967	INTERNATIONAL 1000B	4.3L L6 4335cc 264 CID	
	1965-1967	FORD F350	5.8L V8 5800cc 352 CID	1967	INTERNATIONAL 1000B	4.3L V8 4360cc 266 CID	
	1975-1976	FORD F-100	5.9L V8 360 CID	1967	INTERNATIONAL 1000B	5.0L V8 4982cc 304 CID	
	1975-1976	FORD F-100	6.4L V8 390 CID	1967	INTERNATIONAL 1000B	5.6L V8 5654cc 345 CID	
	1975-1976	FORD F-150	5.9L V8 360 CID	1967	INTERNATIONAL 1100B	4.3L L6 4335cc 264 CID	
	1975-1976	FORD F-150	6.4L V8 390 CID	1967	INTERNATIONAL 1100B	4.3L V8 4360cc 266 CID	
	1975-1976	FORD F-250	5.9L V8 360 CID	1967	INTERNATIONAL 1100B	5.0L V8 4982cc 304 CID	
	1975-1976	FORD F-250	6.4L V8 390 CID	1967	INTERNATIONAL 1100B	5.6L V8 5654cc 345 CID	
	1975-1976	FORD F-350	5.9L V8 360 CID	1967	INTERNATIONAL 1200B	4.3L L6 4335cc 264 CID	
	1975-1976	FORD F-350	6.4L V8 390 CID	1967	INTERNATIONAL 1200B	4.3L V8 4360cc 266 CID	
	1975-1976	FORD F-100	5.9L V8 360 CID	1967	INTERNATIONAL 1200B	5.0L V8 4982cc 304 CID	
	1975-1976	FORD F-100	6.4L V8 390 CID	1967	INTERNATIONAL 1200B	5.6L V8 5654cc 345 CID	
	1975-1976	FORD F-150	5.9L V8 360 CID	1967	INTERNATIONAL 1300B	4.3L L6 4335cc 264 CID	
	1975-1976	FORD F-150	6.4L V8 390 CID	1967	INTERNATIONAL 1300B	4.3L V8 4360cc 266 CID	
	1975-1976	FORD F-250	5.9L V8 360 CID	1967	INTERNATIONAL 1300B	5.0L V8 4982cc 304 CID	
1975-1976	FORD F-250	6.4L V8 390 CID	1967	INTERNATIONAL 1300B	5.6L V8 5654cc 345 CID		
1975-1976	FORD F-350	5.9L V8 360 CID	1967-1968	INTERNATIONAL SCOUT	4.3L V8 4360cc 266 CID		
1975-1976	FORD F-350	6.4L V8 390 CID	1967-1970	INTERNATIONAL MA1200	4.3L V8 4360cc 266 CID		
US1077	1973-1974	JEEP CJ5D	4.6L L6 4600cc 282 CID	1967-1971	INTERNATIONAL MA1200	5.0L V8 4982cc 304 CID	
	1973-1979	JEEP J364R	4.6L L6 4600cc 282 CID	1968	INTERNATIONAL 1000C	4.3L L6 4335cc 264 CID	
	1973-1983	JEEP J164	4.6L L6 4600cc 282 CID	1968	INTERNATIONAL 1000C	4.3L V8 4360cc 266 CID	
	1973-1983	JEEP J164V	4.6L L6 4600cc 282 CID	1968	INTERNATIONAL 1000C	5.0L V8 4982cc 304 CID	
	1974-1983	JEEP CJ7	4.6L L6 4600cc 282 CID	1968	INTERNATIONAL 1000C	5.6L V8 5654cc 345 CID	
	1975	AMERICAN MOTORS GREMLIN	4.2L L6 4200cc 258 CID	1968	INTERNATIONAL 1100C	4.3L L6 4335cc 264 CID	
	1975	JEEP CJ7	3.8L L6 3800cc 232 CID	1968	INTERNATIONAL 1100C	4.3L V8 4360cc 266 CID	
	1975-1976	AMERICAN MOTORS CLASSIC	4.6L L6 4600cc 282 CID	1968	INTERNATIONAL 1100C	5.0L V8 4982cc 304 CID	
	1975-1977	AMERICAN MOTORS HORNET	3.8L L6 232 CID	1968	INTERNATIONAL 1100C	5.6L V8 5654cc 345 CID	
	1975-1977	AMERICAN MOTORS HORNET	4.2L L6 258 CID	1968	INTERNATIONAL 1200C	4.3L L6 4335cc 264 CID	
	1975-1978	AMERICAN MOTORS GREMLIN	3.8L L6 232 CID	1968	INTERNATIONAL 1200C	4.3L V8 4360cc 266 CID	
	1975-1978	AMERICAN MOTORS GREMLIN	4.2L L6 258 CID	1968	INTERNATIONAL 1200C	5.0L V8 4982cc 304 CID	
	1975-1978	AMERICAN MOTORS MATADOR	4.2L L6 258 CID	1968	INTERNATIONAL 1200C	5.6L V8 5654cc 345 CID	
	1975-1978	AMERICAN MOTORS PACER	3.8L L6 232 CID	1968	INTERNATIONAL 1300C	4.3L L6 4335cc 264 CID	
	1975-1978	JEEP CJ7	4.2L L6 4200cc 258 CID	1968	INTERNATIONAL 1300C	4.3L V8 4360cc 266 CID	
	1975-1979	AMERICAN MOTORS AMERICAN	4.6L L6 4600cc 282 CID	1968	INTERNATIONAL 1300C	5.0L V8 4982cc 304 CID	
	1975-1979	AMERICAN MOTORS PACER	4.2L L6 258 CID	1968	INTERNATIONAL 1300C	5.6L V8 5654cc 345 CID	
	1975-1979	AMERICAN MOTORS PACER	4.6L L6 4600cc 282 CID	1968	INTERNATIONAL M800	2.5L L4 152 CID	
	1975-1979	JEEP CHEROKEE	4.2L L6 258 CID	1968	INTERNATIONAL M1100	2.5L L4 152 CID	
	1975-1979	JEEP J10	4.2L L6 258 CID	1968-1969	INTERNATIONAL 908C	4.3L V8 4360cc 266 CID	
	1976	JEEP J20	4.2L L6 258 CID	1968-1969	INTERNATIONAL 908C	5.0L V8 4982cc 304 CID	
	1976-1978	JEEP CJ7	3.8L L6 232 CID	1968-1970	INTERNATIONAL SCOUT	2.5L L4 152 CID	
	1976-1979	JEEP CJ7	4.2L L6 258 CID	1969	INTERNATIONAL 908C	5.0L V8 304 CID	
	1976-1979	JEEP WAGONEER	4.6L L6 4600cc 282 CID	1969	INTERNATIONAL 908C	5.0L V8 4983cc 304 CID	
	1978-1979	AMERICAN MOTORS AMERICAN	4.2L L6 4200cc 258 CID	1969	INTERNATIONAL M1400	5.0L V8 304 CID	
	1978-1979	AMERICAN MOTORS AMX	4.2L L6 258 CID	1969	INTERNATIONAL M1400	5.0L V8 4983cc 304 CID	
	1978-1979	AMERICAN MOTORS CONCORD	3.8L L6 232 CID	1969-1970	INTERNATIONAL 1000D	4.3L L6 4335cc 264 CID	
	1978-1979	AMERICAN MOTORS CONCORD	4.2L L6 258 CID	1969-1970	INTERNATIONAL 1000D	4.3L V8 4360cc 266 CID	
	1978-1983	JEEP CJ5D	4.6L L6 4600cc 282 CID	1969-1970	INTERNATIONAL 1000D	5.0L V8 304 CID	
	1979	AMERICAN MOTORS GREMLIN	4.2L L6 4200cc 258 CID	1969-1970	INTERNATIONAL 1000D	5.0L V8 4982cc 304 CID	
	1979	AMERICAN MOTORS GREMLIN	4.6L L6 4600cc 282 CID	1969-1970	INTERNATIONAL 1000D	5.0L V8 4983cc 304 CID	

USMW	Years	Application	Engine	USMW	Years	Application	Engine	
US1099	1969-1970	INTERNATIONAL 1000D	5.6L V8 5654cc 345 CID	US1099	1974	INTERNATIONAL 100	6.4L V8 392 CID	
	1969-1970	INTERNATIONAL 1000D	6.4L V8 6424cc 392 CID		1974	INTERNATIONAL 100	INTERNATIONAL 100	6.4L V8 6424cc 392 CID
	1969-1970	INTERNATIONAL 1100D	4.3L L6 4335cc 264 CID		1974	INTERNATIONAL 100	INTERNATIONAL 100	6.4L V8 6425cc 392 CID
	1969-1970	INTERNATIONAL 1100D	4.3L V8 4360cc 266 CID		1974	INTERNATIONAL 200	INTERNATIONAL 200	5.0L V8 4982cc 304 CID
	1969-1970	INTERNATIONAL 1100D	5.0L V8 304 CID		1974	INTERNATIONAL 200	INTERNATIONAL 200	5.0L V8 4983cc 304 CID
	1969-1970	INTERNATIONAL 1100D	5.0L V8 4982cc 304 CID		1974	INTERNATIONAL 200	INTERNATIONAL 200	5.6L V8 5654cc 345 CID
	1969-1970	INTERNATIONAL 1100D	5.6L V8 5654cc 345 CID		1974	INTERNATIONAL 200	INTERNATIONAL 200	6.4L V8 6424cc 392 CID
	1969-1970	INTERNATIONAL 1100D	6.4L V8 6424cc 392 CID		1974	INTERNATIONAL 200	INTERNATIONAL 200	6.4L V8 6425cc 392 CID
	1969-1970	INTERNATIONAL 1200D	4.3L L6 4335cc 264 CID		1974	INTERNATIONAL 200	INTERNATIONAL MHC1310	5.0L V8 304 CID
	1969-1970	INTERNATIONAL 1200D	4.3L V8 4360cc 266 CID		1974	INTERNATIONAL 200	INTERNATIONAL MHC1310	5.0L V8 4982cc 304 CID
	1969-1970	INTERNATIONAL 1200D	5.0L V8 304 CID		1974	INTERNATIONAL 200	INTERNATIONAL MHC1310	5.0L V8 4983cc 304 CID
	1969-1970	INTERNATIONAL 1200D	5.0L V8 4982cc 304 CID		1974-1975	INTERNATIONAL 200	INTERNATIONAL 200	5.0L V8 304 CID
	1969-1970	INTERNATIONAL 1200D	5.0L V8 4983cc 304 CID		1974-1975	INTERNATIONAL 200	INTERNATIONAL 200	5.6L V8 345 CID
	1969-1970	INTERNATIONAL 1200D	5.6L V8 5654cc 345 CID		1974-1975	INTERNATIONAL 200	INTERNATIONAL 200	6.4L V8 392 CID
	1969-1970	INTERNATIONAL 1200D	6.4L V8 6424cc 392 CID		1975	INTERNATIONAL 150	INTERNATIONAL 150	5.0L V8 304 CID
	1969-1970	INTERNATIONAL 1300D	5.0L V8 304 CID		1975	INTERNATIONAL 150	INTERNATIONAL 150	5.6L V8 345 CID
	1969-1970	INTERNATIONAL 1300D	5.0L V8 4982cc 304 CID		1975	INTERNATIONAL 150	INTERNATIONAL 150	6.4L V8 392 CID
	1969-1970	INTERNATIONAL 1300D	5.0L V8 4983cc 304 CID		1975	INTERNATIONAL MS	INTERNATIONAL MS	5.6L V8 345 CID
	1969-1970	INTERNATIONAL 1300D	5.6L V8 5654cc 345 CID		1975	INTERNATIONAL MS	INTERNATIONAL MS	6.4L V8 392 CID
	1969-1970	INTERNATIONAL 1300D	6.4L V8 6424cc 392 CID		1975	INTERNATIONAL SCOUT II	INTERNATIONAL SCOUT II	5.6L V8 345 CID
	1969-1970	INTERNATIONAL SCOUT	5.0L V8 304 CID		1975	INTERNATIONAL SCOUT II	INTERNATIONAL SCOUT II	6.4L V8 392 CID
	1969-1970	INTERNATIONAL SCOUT	5.0L V8 4982cc 304 CID		1975	INTERNATIONAL SCOUT II	INTERNATIONAL SCOUT II	6.4L V8 392 CID
	1969-1970	INTERNATIONAL SCOUT	5.0L V8 4983cc 304 CID		1975	INTERNATIONAL TRAVELALL	INTERNATIONAL TRAVELALL	5.0L V8 304 CID
	1969-1970	INTERNATIONAL SCOUT	5.0L V8 4983cc 304 CID		1975	INTERNATIONAL TRAVELALL	INTERNATIONAL TRAVELALL	5.6L V8 345 CID
	1969-1971	INTERNATIONAL M800	5.0L V8 304 CID		1975	INTERNATIONAL TRAVELALL	INTERNATIONAL TRAVELALL	6.4L V8 392 CID
	1969-1971	INTERNATIONAL M800	5.0L V8 4982cc 304 CID		US1100	1975	BUICK APOLLO	4.3L V8 260 CID
	1969-1971	INTERNATIONAL M800	5.0L V8 4983cc 304 CID		1975	BUICK APOLLO	BUICK APOLLO	5.7L V8 350 CID
	1969-1971	INTERNATIONAL MA1200	5.0L V8 304 CID		1975	BUICK APOLLO	BUICK LESABRE	6.6L V8 400 CID
	1969-1971	INTERNATIONAL MA1200	5.0L V8 4983cc 304 CID		1975	BUICK APOLLO	OLDSMOBILE 98	6.6L V8 400 CID
	1969-1972	INTERNATIONAL M1100	5.0L V8 304 CID		1975	BUICK APOLLO	OLDSMOBILE CUSTOM CRUISER	6.6L V8 400 CID
	1969-1972	INTERNATIONAL M1100	5.0L V8 4983cc 304 CID		1975	BUICK APOLLO	OLDSMOBILE DELTA 88	6.6L V8 400 CID
	1969-1972	INTERNATIONAL M1200	5.0L V8 304 CID		1975-1976	BUICK APOLLO	BUICK SKYLARK	4.3L V8 260 CID
	1969-1972	INTERNATIONAL M1200	5.0L V8 4982cc 304 CID		1975-1976	BUICK APOLLO	OLDSMOBILE 98	7.5L V8 455 CID
	1969-1972	INTERNATIONAL M1200	5.0L V8 4983cc 304 CID		1975-1976	BUICK APOLLO	OLDSMOBILE CUSTOM CRUISER	7.5L V8 455 CID
	1970	INTERNATIONAL 1300D	4.3L L6 4335cc 264 CID		1975-1976	BUICK APOLLO	OLDSMOBILE CUTLASS	7.5L V8 455 CID
	1970	INTERNATIONAL 1300D	4.3L V8 4360cc 266 CID		1975-1976	BUICK APOLLO	OLDSMOBILE CUTLASS SALON	7.5L V8 455 CID
	1970	INTERNATIONAL SCOUT	4.3L L6 265 CID		1975-1976	BUICK APOLLO	OLDSMOBILE DELTA 88	7.5L V8 455 CID
	1970	INTERNATIONAL SCOUT	4.3L L6 4335cc 264 CID		1975-1976	BUICK APOLLO	OLDSMOBILE TORONADO	7.5L V8 455 CID
	1971	INTERNATIONAL 1110	4.3L V8 4360cc 266 CID		1975-1976	BUICK APOLLO	PONTIAC VENTURA	4.3L V8 260 CID
	1971	INTERNATIONAL 1310	4.3L V8 4360cc 266 CID		1975-1977	BUICK APOLLO	BUICK REGAL	5.7L V8 350 CID
	1971	INTERNATIONAL M800	2.5L L4 152 CID		1975-1977	BUICK APOLLO	BUICK SKYLARK	5.7L V8 350 CID
	1971	INTERNATIONAL M1100	2.5L L4 152 CID		1975-1977	BUICK APOLLO	OLDSMOBILE CUTLASS SALON	5.7L V8 350 CID
	1971	INTERNATIONAL SCOUT II	5.6L V8 345 CID		1975-1977	BUICK APOLLO	OLDSMOBILE OMEGA	4.3L V8 260 CID
	1971-1973	INTERNATIONAL 1010	5.0L V8 4982cc 304 CID		1975-1977	BUICK APOLLO	PONTIAC GRAND PRIX	6.6L V8 400 CID
	1971-1973	INTERNATIONAL 1010	5.6L V8 5654cc 345 CID		1975-1977	BUICK APOLLO	PONTIAC LEMANS	6.6L V8 400 CID
	1971-1973	INTERNATIONAL 1010	5.7L V8 345 CID		1975-1978	BUICK APOLLO	PONTIAC BONNEVILLE	6.6L V8 400 CID
	1971-1973	INTERNATIONAL 1010	6.4L V8 6424cc 392 CID		1975-1978	BUICK APOLLO	PONTIAC CATALINA	6.6L V8 400 CID
	1971-1973	INTERNATIONAL 1110	5.0L V8 4982cc 304 CID		1975-1978	BUICK APOLLO	PONTIAC FIREBIRD	5.7L V8 350 CID
	1971-1973	INTERNATIONAL 1110	5.6L V8 5654cc 345 CID		1975-1978	BUICK APOLLO	PONTIAC GRAND SAFARI	6.6L V8 400 CID
	1971-1973	INTERNATIONAL 1110	5.7L V8 345 CID		1975-1979	BUICK APOLLO	BUICK CENTURY	5.7L V8 350 CID
	1971-1973	INTERNATIONAL 1110	6.4L V8 6424cc 392 CID		1975-1979	BUICK APOLLO	OLDSMOBILE OMEGA	5.7L V8 350 CID
	1971-1973	INTERNATIONAL 1210	5.0L V8 4982cc 304 CID		1975-1979	BUICK APOLLO	PONTIAC FIREBIRD	6.6L V8 400 CID
	1971-1973	INTERNATIONAL 1210	5.6L V8 5654cc 345 CID		1975-1979	BUICK APOLLO	PONTIAC LEMANS	5.7L V8 350 CID
	1971-1973	INTERNATIONAL 1210	5.7L V8 345 CID		1975-1980	BUICK APOLLO	OLDSMOBILE CUTLASS SALON	4.3L V8 260 CID
	1971-1973	INTERNATIONAL 1210	6.4L V8 6424cc 392 CID		1975-1981	BUICK APOLLO	OLDSMOBILE CUTLASS	4.3L V8 260 CID
	1971-1973	INTERNATIONAL 1310	5.0L V8 304 CID		1975-1981	BUICK APOLLO	OLDSMOBILE CUTLASS	5.7L V8 350 CID
	1971-1973	INTERNATIONAL 1310	5.0L V8 4982cc 304 CID		1975-1985	BUICK APOLLO	BUICK LESABRE	5.7L V8 350 CID
	1971-1973	INTERNATIONAL 1310	5.6L V8 5654cc 345 CID		1976	BUICK APOLLO	OLDSMOBILE DELTA 88	5.7L V8 350 CID
	1971-1973	INTERNATIONAL 1310	5.7L V8 345 CID		1976	BUICK APOLLO	OLDSMOBILE CUTLASS TIARA	4.3L V8 260 CID
	1971-1973	INTERNATIONAL 1310	6.4L V8 6424cc 392 CID		1976	BUICK APOLLO	OLDSMOBILE CUTLASS TIARA	5.7L V8 350 CID
	1971-1974	INTERNATIONAL SCOUT II	5.0L V8 4982cc 304 CID		1976	BUICK APOLLO	OLDSMOBILE CUTLASS TIARA	7.5L V8 455 CID
	1971-1974	INTERNATIONAL SCOUT II	5.0L V8 4983cc 304 CID		1976	BUICK APOLLO	PONTIAC LEMANS	4.3L V8 260 CID
	1971-1974	INTERNATIONAL SCOUT II	5.6L V8 5654cc 345 CID		1976-1977	BUICK APOLLO	PONTIAC GRAND PRIX	5.7L V8 350 CID
	1971-1975	INTERNATIONAL SCOUT II	5.0L V8 304 CID		1976-1981	BUICK APOLLO	PONTIAC CATALINA	5.7L V8 350 CID
	1972-1973	INTERNATIONAL 1010	5.0L V8 304 CID		1976-1985	BUICK APOLLO	BUICK ELECTRA	5.7L V8 350 CID
	1972-1973	INTERNATIONAL 1010	5.0L V8 4983cc 304 CID		1977	BUICK APOLLO	BUICK CENTURY	6.6L V8 403 CID
	1972-1973	INTERNATIONAL 1010	6.4L V8 392 CID		1977	BUICK APOLLO	OLDSMOBILE CUTLASS	6.6L V8 403 CID
	1972-1973	INTERNATIONAL 1010	6.4L V8 6425cc 392 CID		1977	BUICK APOLLO	OLDSMOBILE CUTLASS SALON	6.6L V8 403 CID
	1972-1973	INTERNATIONAL 1110	5.0L V8 304 CID		1977	BUICK APOLLO	PONTIAC GRAND PRIX	6.6L V8 403 CID
	1972-1973	INTERNATIONAL 1110	5.0L V8 4983cc 304 CID		1977	BUICK APOLLO	PONTIAC GRAND SAFARI	5.7L V8 350 CID
	1972-1973	INTERNATIONAL 1110	6.4L V8 392 CID		1977	BUICK APOLLO	PONTIAC LEMANS	6.6L V8 403 CID
	1972-1973	INTERNATIONAL 1110	6.4L V8 6425cc 392 CID		1977	BUICK APOLLO	PONTIAC VENTURA	5.7L V8 350 CID
	1972-1973	INTERNATIONAL 1210	5.0L V8 304 CID		1977-1978	BUICK APOLLO	BUICK LESABRE	6.6L V8 403 CID
	1972-1973	INTERNATIONAL 1210	5.0L V8 4983cc 304 CID		1977-1978	BUICK APOLLO	BUICK RIVIERA	6.6L V8 403 CID
	1972-1973	INTERNATIONAL 1210	6.4L V8 392 CID		1977-1978	BUICK APOLLO	OLDSMOBILE TORONADO	6.6L V8 403 CID
	1972-1973	INTERNATIONAL 1210	6.4L V8 6425cc 392 CID		1977-1978	BUICK APOLLO	PONTIAC GRAND SAFARI	6.6L V8 403 CID
	1972-1973	INTERNATIONAL 1310	5.0L V8 4983cc 304 CID		1977-1979	BUICK APOLLO	BUICK ELECTRA	6.6L V8 403 CID
	1972-1973	INTERNATIONAL 1310	6.4L V8 392 CID		1977-1979	BUICK APOLLO	BUICK ESTATE WAGON	6.6L V8 403 CID
	1972-1973	INTERNATIONAL 1310	6.4L V8 6425cc 392 CID		1977-1979	BUICK APOLLO	OLDSMOBILE 98	6.6L V8 403 CID
	1972-1974	INTERNATIONAL MS1210	5.0L V8 304 CID		1977-1979	BUICK APOLLO	OLDSMOBILE CUSTOM CRUISER	6.6L V8 403 CID
	1972-1974	INTERNATIONAL MS1210	5.0L V8 4982cc 304 CID		1977-1979	BUICK APOLLO	OLDSMOBILE DELTA 88	6.6L V8 403 CID
	1972-1974	INTERNATIONAL MS1210	5.0L V8 4983cc 304 CID		1977-1979	BUICK APOLLO	PONTIAC BONNEVILLE	6.6L V8 403 CID
	1972-1974	INTERNATIONAL MS1210	5.6L V8 5654cc 345 CID		1977-1979	BUICK APOLLO	PONTIAC CATALINA	6.6L V8 403 CID
	1972-1974	INTERNATIONAL MS1210	6.4L V8 6424cc 392 CID		1977-1979	BUICK APOLLO	PONTIAC FIREBIRD	6.6L V8 403 CID
	1972-1974	INTERNATIONAL SCOUT II	5.7L V8 345 CID		1977-1979	BUICK APOLLO	PONTIAC PHOENIX	5.7L V8 350 CID
	1974	INTERNATIONAL 100	5.0L V8 304 CID		1977-1981	BUICK APOLLO	OLDSMOBILE 98	5.7L V8 350 CID
	1974	INTERNATIONAL 100	5.0L V8 4982cc 304 CID		1977-1982	BUICK APOLLO	OLDSMOBILE DELTA 88	4.3L V8 260 CID
	1974	INTERNATIONAL 100	5.0L V8 4983cc 304 CID		1977-1983	BUICK APOLLO	BUICK ESTATE WAGON	5.7L V8 350 CID
	1974	INTERNATIONAL 100	5.6L V8 345 CID		1977-1984	BUICK APOLLO	PONTIAC BONNEVILLE	5.7L V8 350 CID
	1974	INTERNATIONAL 100	5.6L V8 5654cc 345 CID		1977-1985	BUICK APOLLO	BUICK RIVIERA	5.7L V8 350 CID

USMW	Years	Application	Engine	USMW	Years	Application	Engine	
US1100	1977-1985	OLDSMOBILE CUSTOM CRUISER	5.7L V8 350 CID	US1107	1981-1983	JEEP SCRAMBLER	2.5L L4 151 CID	
	1978-1982	OLDSMOBILE CUTLASS CALAIS	4.3L V8 260 CID		1981-1984	CHEVROLET G30	4.1L L6 250 CID	
	1979-1980	OLDSMOBILE CUTLASS SALON	5.7L V8 350 CID		1982-1984	CHEVROLET CAMARO	2.5L L4 2474cc 151 CID	
	1979-1981	OLDSMOBILE TORONADO	5.7L V8 350 CID	1982-1984	GMC G3500	4.1L L6 250 CID		
	1979-1982	OLDSMOBILE CUTLASS CALAIS	5.7L V8 350 CID	1982-1984	PONTIAC FIREBIRD	2.5L L4 2474cc 151 CID		
	1980-1981	OLDSMOBILE 98	5.0L V8 307 CID	US1109	1975	CHEVROLET BEL AIR	6.6L V8 400 CID	
	1980-1981	OLDSMOBILE CUTLASS CRUISER	5.7L V8 350 CID		1975-1976	CHEVROLET C10	5.7L V8 350 CID	
	1980-1981	OLDSMOBILE CUTLASS SUPREME	5.7L V8 350 CID		1975-1976	CHEVROLET C10 SUBURBAN	5.7L V8 350 CID	
	1980-1981	OLDSMOBILE TORONADO	5.0L V8 307 CID		1975-1976	CHEVROLET C20	5.7L V8 350 CID	
	1980-1982	OLDSMOBILE CUTLASS CRUISER	4.3L V8 260 CID		1975-1976	CHEVROLET C20 SUBURBAN	5.7L V8 350 CID	
	1980-1982	OLDSMOBILE CUTLASS SUPREME	4.3L V8 260 CID		1975-1976	CHEVROLET C30	5.7L V8 350 CID	
	1980-1985	BUICK RIVIERA	5.0L V8 307 CID		1975-1976	CHEVROLET CAPRICE	6.6L V8 400 CID	
	1980-1985	CHEVROLET CAPRICE	5.7L V8 350 CID		1975-1976	CHEVROLET CS31003	5.7L V8 5700cc 350 CID	
	1980-1985	CHEVROLET IMPALA	5.7L V8 350 CID		1975-1976	CHEVROLET EL CAMINO	6.6L V8 400 CID	
	1980-1985	OLDSMOBILE CUSTOM CRUISER	5.0L V8 307 CID		1975-1976	CHEVROLET G10	5.7L V8 350 CID	
	1980-1985	OLDSMOBILE DELTA 88	5.0L V8 307 CID		1975-1976	CHEVROLET G20	5.7L V8 350 CID	
	1981	BUICK CENTURY	5.7L V8 350 CID		1975-1976	CHEVROLET G20	6.6L V8 400 CID	
	1981	PONTIAC BONNEVILLE	5.0L V8 307 CID		1975-1976	CHEVROLET G20	5.7L V8 350 CID	
	1981	PONTIAC CATALINA	5.0L V8 307 CID		1975-1976	CHEVROLET G30	6.6L V8 400 CID	
	1981-1983	BUICK ESTATE WAGON	5.0L V8 307 CID		1975-1976	CHEVROLET G30	6.6L V8 400 CID	
	1981-1983	OLDSMOBILE CUTLASS CRUISER	5.0L V8 307 CID		1975-1976	CHEVROLET IMPALA	6.6L V8 400 CID	
	1981-1984	PONTIAC GRAND PRIX	5.7L V8 350 CID		1975-1976	CHEVROLET K5 BLAZER	5.7L V8 350 CID	
	1981-1985	BUICK ELECTRA	5.0L V8 307 CID		1975-1976	CHEVROLET K5 BLAZER	6.6L V8 400 CID	
	1981-1985	BUICK LESABRE	5.0L V8 307 CID		1975-1976	CHEVROLET K10	5.7L V8 350 CID	
	1982-1983	BUICK REGAL	5.7L V8 350 CID		1975-1976	CHEVROLET K10	6.6L V8 400 CID	
	1982-1983	CHEVROLET MALIBU	5.7L V8 350 CID		1975-1976	CHEVROLET K10 SUBURBAN	5.7L V8 350 CID	
	1982-1984	CHEVROLET MONTE CARLO	5.7L V8 350 CID		1975-1976	CHEVROLET K10 SUBURBAN	6.6L V8 400 CID	
	1982-1984	OLDSMOBILE CUTLASS CALAIS	5.0L V8 307 CID		1975-1976	CHEVROLET K20	5.7L V8 350 CID	
	1982-1984	OLDSMOBILE CUTLASS SUPREME	5.0L V8 307 CID		1975-1976	CHEVROLET K20	6.6L V8 400 CID	
	1983	OLDSMOBILE CUTLASS CRUISER	5.7L V8 350 CID		1975-1976	CHEVROLET K20 SUBURBAN	5.7L V8 350 CID	
	1983-1984	OLDSMOBILE CUTLASS SUPREME	5.7L V8 350 CID		1975-1976	CHEVROLET K20 SUBURBAN	6.6L V8 400 CID	
	1985-1986	OLDSMOBILE CUTLASS SALON	5.0L V8 307 CID		1975-1976	CHEVROLET MALIBU	6.6L V8 400 CID	
	US1107	1975-1976	OLDSMOBILE CUTLASS		4.1L L6 250 CID	1975-1976	CHEVROLET MONTE CARLO	6.6L V8 400 CID
		1975-1976	OLDSMOBILE OMEGA		4.1L L6 250 CID	1975-1976	CHEVROLET P20	5.7L V8 350 CID
		1975-1976	PONTIAC FIREBIRD		4.1L L6 250 CID	1975-1976	CHEVROLET P30	5.7L V8 350 CID
		1975-1976	PONTIAC VENTURA		4.1L L6 250 CID	1975-1976	GMC C15	5.7L V8 350 CID
		1975-1977	CHEVROLET EL CAMINO		4.1L L6 250 CID	1975-1976	GMC C15 SUBURBAN	5.7L V8 350 CID
		1975-1977	CHEVROLET MALIBU		4.1L L6 250 CID	1975-1976	GMC C25	5.7L V8 350 CID
		1975-1977	PONTIAC LEMANS		4.1L L6 250 CID	1975-1976	GMC C25 SUBURBAN	5.7L V8 350 CID
1975-1979		CHEVROLET CAMARO	4.1L L6 250 CID		1975-1976	GMC G15	5.7L V8 350 CID	
1975-1979		CHEVROLET NOVA	4.1L L6 250 CID		1975-1976	GMC G25	5.7L V8 350 CID	
1975-1984		CHEVROLET C20	4.1L L6 250 CID	1975-1976	GMC G25	6.6L V8 400 CID		
1975-1984		CHEVROLET G20	4.1L L6 250 CID	1975-1976	GMC G35	5.7L V8 350 CID		
1977		GMC SPRINT	4.1L L6 250 CID	1975-1976	GMC G35	6.6L V8 400 CID		
1977		PONTIAC ASTRE	2.5L L4 2474cc 151 CID	1975-1976	GMC G35	5.7L V8 350 CID		
1977		PONTIAC VENTURA	2.5L L4 2474cc 151 CID	1975-1976	GMC JIMMY	6.6L V8 400 CID		
1977-1978		GMC C25	4.1L L6 250 CID	1975-1976	GMC JIMMY	6.6L V8 400 CID		
1977-1978		PONTIAC PHOENIX	2.5L L4 2474cc 151 CID	1975-1976	GMC K15	5.7L V8 350 CID		
1977-1979		CHEVROLET IMPALA	4.1L L6 250 CID	1975-1976	GMC K15	6.6L V8 400 CID		
1977-1980		PONTIAC SUNBIRD	2.5L L4 2474cc 151 CID	1975-1976	GMC K15 SUBURBAN	5.7L V8 350 CID		
1977-1984		CHEVROLET G10	4.1L L6 250 CID	1975-1976	GMC K15 SUBURBAN	6.6L V8 400 CID		
1978		CHEVROLET CS1073	4.1L L6 4100cc 250 CID	1975-1976	GMC K25	5.7L V8 350 CID		
1978		GMC C15	4.1L L6 250 CID	1975-1976	GMC K25	6.6L V8 400 CID		
1978		GMC C15 SUBURBAN	4.1L L6 250 CID	1975-1976	GMC K25 SUBURBAN	5.7L V8 350 CID		
1978		GMC G15	4.1L L6 250 CID	1975-1976	GMC K25 SUBURBAN	6.6L V8 400 CID		
1978		GMC G25	4.1L L6 250 CID	1975-1976	GMC P25	5.7L V8 350 CID		
1978		GMC K15	4.1L L6 250 CID	1975-1976	GMC P35	5.7L V8 350 CID		
1978		GMC K15 SUBURBAN	4.1L L6 250 CID	1976	CHEVROLET C10	6.6L V8 400 CID		
1978-1979		CHEVROLET MALIBU	4.1L L6 4100cc 250 CID	1976	CHEVROLET C20	6.6L V8 400 CID		
1978-1980		CHEVROLET C10 SUBURBAN	4.1L L6 250 CID	1976	CHEVROLET C20 SUBURBAN	6.6L V8 400 CID		
1978-1980		CHEVROLET K10 SUBURBAN	4.1L L6 250 CID	1976	CHEVROLET C30	6.6L V8 400 CID		
1978-1980		CHEVROLET MONZA	2.5L L4 2474cc 151 CID	1976	CHEVROLET CAMARO	5.0L V8 305 CID		
1978-1980		OLDSMOBILE STARFIRE	2.5L L4 2474cc 151 CID	1976	CHEVROLET CAMARO	5.7L V8 350 CID		
1978-1982		CHEVROLET K5 BLAZER	4.1L L6 250 CID	1976	CHEVROLET CAMARO	5.7L V8 350 CID		
1978-1982		GMC JIMMY	4.1L L6 250 CID	1976	CHEVROLET CAPRICE	5.7L V8 350 CID		
1978-1984		CHEVROLET C10	4.1L L6 250 CID	1976	CHEVROLET EL CAMINO	5.0L V8 305 CID		
1978-1984		CHEVROLET K10	4.1L L6 250 CID	1976	CHEVROLET EL CAMINO	5.7L V8 350 CID		
1979		CHEVROLET C10	4.1L L6 4097cc 250 CID	1976	CHEVROLET G10	6.6L V8 400 CID		
1979		CHEVROLET MALIBU	4.1L L6 4097cc 250 CID	1976	CHEVROLET G10	6.6L V8 400 CID		
1979		GMC G3500	4.1L L6 250 CID	1976	CHEVROLET IMPALA	5.7L V8 350 CID		
1979-1980		GMC C1500 SUBURBAN	4.1L L6 250 CID	1976	CHEVROLET IMPALA	5.0L V8 305 CID		
1979-1980		GMC K1500 SUBURBAN	4.1L L6 250 CID	1976	CHEVROLET MALIBU	5.7L V8 350 CID		
1979-1984		CHEVROLET C10	4.1L L6 4100cc 250 CID	1976	CHEVROLET MALIBU	5.7L V8 350 CID		
1979-1984		GMC C1500	4.1L L6 250 CID	1976	CHEVROLET MONTE CARLO	5.0L V8 305 CID		
1979-1984		GMC C2500	4.1L L6 250 CID	1976	CHEVROLET MONTE CARLO	5.7L V8 350 CID		
1979-1984		GMC G1500	4.1L L6 250 CID	1976	CHEVROLET NOVA	5.0L V8 305 CID		
1979-1984		GMC G2500	4.1L L6 250 CID	1976	CHEVROLET NOVA	5.7L V8 350 CID		
1979-1984		GMC K1500	4.1L L6 250 CID	1976	CHEVROLET P30	6.6L V8 400 CID		
1980		CHEVROLET C30	4.1L L6 250 CID	1976	GMC C15	6.6L V8 400 CID		
1980		CHEVROLET K20	4.1L L6 250 CID	1976	GMC C25	6.6L V8 400 CID		
1980		GMC C3500	4.1L L6 250 CID	1976	GMC G15	6.6L V8 400 CID		
1980		GMC K2500	4.1L L6 250 CID	US1109H	1975	CHEVROLET BEL AIR	6.6L V8 400 CID	
1980		JEEP C.J5	2.5L L4 151 CID		1975-1976	CHEVROLET BEL AIR	5.7L V8 350 CID	
1980-1982		AMERICAN MOTORS CONCORD	2.5L L4 151 CID		1975-1976	CHEVROLET C10	5.7L V8 350 CID	
1980-1982		AMERICAN MOTORS SPIRIT	2.5L L4 151 CID		1975-1976	CHEVROLET C10 SUBURBAN	5.7L V8 350 CID	
1980-1983		JEEP C.J7	2.5L L4 151 CID		1975-1976	CHEVROLET C20	5.7L V8 350 CID	
1980-1984		GMC C1500	4.1L L6 4100cc 250 CID		1975-1976	CHEVROLET C20	5.7L V8 350 CID	
1981		CHEVROLET MALIBU	4.1L L6 4100cc 250 CID		1975-1976	CHEVROLET C20 SUBURBAN	5.7L V8 350 CID	
1981-1983		AMERICAN MOTORS EAGLE	2.5L L4 151 CID		1975-1976	CHEVROLET C30	5.7L V8 350 CID	
					1975-1976	CHEVROLET CAPRICE	6.6L V8 400 CID	
			1975-1976		CHEVROLET EL CAMINO	6.6L V8 400 CID		
			1975-1976		CHEVROLET EL CAMINO	5.7L V8 350 CID		
			1975-1976		CHEVROLET G10	5.7L V8 350 CID		
			1975-1976		CHEVROLET G20	5.7L V8 350 CID		
			1975-1976		CHEVROLET G20	6.6L V8 400 CID		
			1975-1976		CHEVROLET G30	5.7L V8 350 CID		
			1975-1976	CHEVROLET G30	6.6L V8 400 CID			

USMW	Years	Application	Engine	USMW	Years	Application	Engine
US1109H	1975-1976	CHEVROLET IMPALA	6.6L V8 400 CID	US1114	1977-1987	FORD E-350 ECONOLINE CLUB WAGON	7.5L V8 460 CID
	1975-1976	CHEVROLET K5 BLAZER	5.7L V8 350 CID		1979	FORD F-100	7.5L V8 460 CID
	1975-1976	CHEVROLET K5 BLAZER	6.6L V8 400 CID		1983-1987	FORD F-250	7.5L V8 460 CID
	1975-1976	CHEVROLET K10	5.7L V8 350 CID		1983-1987	FORD F-350	7.5L V8 460 CID
	1975-1976	CHEVROLET K10	6.6L V8 400 CID		1990-1991	FORD E-250 ECONOLINE CLUB WAGON	7.5L V8 460 CID
	1975-1976	CHEVROLET K10 SUBURBAN	5.7L V8 350 CID		1990-1992	FORD E-350 ECONOLINE	7.5L V8 460 CID
	1975-1976	CHEVROLET K10 SUBURBAN	6.6L V8 400 CID		1990-1992	FORD E-350 ECONOLINE CLUB WAGON	7.5L V8 460 CID
	1975-1976	CHEVROLET K20	5.7L V8 350 CID		1990-1992	FORD F-250	7.5L V8 460 CID
	1975-1976	CHEVROLET K20	6.6L V8 400 CID		1990-1992	FORD F-350	7.5L V8 460 CID
	1975-1976	CHEVROLET K20 SUBURBAN	5.7L V8 350 CID		1990-1992	FORD F SUPER DUTY	7.5L V8 460 CID
	1975-1976	CHEVROLET K20 SUBURBAN	6.6L V8 400 CID	US1120	1975	BUICK APOLLO	4.3L V8 260 CID
	1975-1976	CHEVROLET MALIBU	6.6L V8 400 CID		1975	BUICK APOLLO	5.7L V8 350 CID
	1975-1976	CHEVROLET MONTE CARLO	6.6L V8 400 CID		1975	BUICK LESABRE	6.6L V8 400 CID
	1975-1976	CHEVROLET P20	5.7L V8 350 CID		1975	OLDSMOBILE 98	6.6L V8 400 CID
	1975-1976	CHEVROLET P30	5.7L V8 350 CID		1975	OLDSMOBILE CUSTOM CRUISER	6.6L V8 400 CID
	1975-1976	GMC C15	5.7L V8 350 CID		1975	OLDSMOBILE DELTA 88	6.6L V8 400 CID
	1975-1976	GMC C15 SUBURBAN	5.7L V8 350 CID		1975-1976	BUICK SKYLARK	4.3L V8 260 CID
	1975-1976	GMC C25	5.7L V8 350 CID		1975-1976	OLDSMOBILE 98	7.5L V8 455 CID
	1975-1976	GMC C25 SUBURBAN	5.7L V8 350 CID		1975-1976	OLDSMOBILE CUSTOM CRUISER	7.5L V8 455 CID
	1975-1976	GMC G15	5.7L V8 350 CID		1975-1976	OLDSMOBILE CUTLASS	7.5L V8 455 CID
	1975-1976	GMC G25	5.7L V8 350 CID	1975-1976	OLDSMOBILE CUTLASS SALON	7.5L V8 455 CID	
	1975-1976	GMC G25	6.6L V8 400 CID	1975-1976	OLDSMOBILE DELTA 88	7.5L V8 455 CID	
	1975-1976	GMC G35	5.7L V8 350 CID	1975-1976	OLDSMOBILE TORONADO	7.5L V8 455 CID	
	1975-1976	GMC G35	6.6L V8 400 CID	1975-1976	PONTIAC VENTURA	4.3L V8 260 CID	
	1975-1976	GMC JIMMY	5.7L V8 350 CID	1975-1977	BUICK REGAL	5.7L V8 350 CID	
	1975-1976	GMC JIMMY	6.6L V8 400 CID	1975-1977	BUICK SKYLARK	5.7L V8 350 CID	
	1975-1976	GMC K15	5.7L V8 350 CID	1975-1977	OLDSMOBILE CUTLASS SALON	5.7L V8 350 CID	
	1975-1976	GMC K15 SUBURBAN	6.6L V8 400 CID	1975-1977	OLDSMOBILE OMEGA	4.3L V8 260 CID	
	1975-1976	GMC K15 SUBURBAN	5.7L V8 350 CID	1975-1977	PONTIAC GRAND PRIX	6.6L V8 400 CID	
	1975-1976	GMC K25	6.6L V8 400 CID	1975-1977	PONTIAC LEMANS	6.6L V8 400 CID	
	1975-1976	GMC K25	5.7L V8 350 CID	1975-1978	PONTIAC BONNEVILLE	6.6L V8 400 CID	
	1975-1976	GMC K25 SUBURBAN	5.7L V8 350 CID	1975-1978	PONTIAC CATALINA	6.6L V8 400 CID	
	1975-1976	GMC K25 SUBURBAN	6.6L V8 400 CID	1975-1978	PONTIAC FIREBIRD	5.7L V8 350 CID	
	1975-1976	GMC P25	5.7L V8 350 CID	1975-1978	PONTIAC GRAND SAFARI	6.6L V8 400 CID	
	1975-1976	GMC P35	5.7L V8 350 CID	1975-1979	BUICK CENTURY	5.7L V8 350 CID	
	1976	CHEVROLET C10	6.6L V8 400 CID	1975-1979	OLDSMOBILE OMEGA	5.7L V8 350 CID	
	1976	CHEVROLET C20	6.6L V8 400 CID	1975-1979	PONTIAC FIREBIRD	6.6L V8 400 CID	
	1976	CHEVROLET C20 SUBURBAN	6.6L V8 400 CID	1975-1979	PONTIAC LEMANS	5.7L V8 350 CID	
	1976	CHEVROLET C30	6.6L V8 400 CID	1975-1980	OLDSMOBILE CUTLASS SALON	4.3L V8 260 CID	
	1976	CHEVROLET CAMARO	5.0L V8 305 CID	1975-1981	OLDSMOBILE CUTLASS	4.3L V8 260 CID	
	1976	CHEVROLET CAMARO	5.7L V8 350 CID	1975-1981	OLDSMOBILE CUTLASS	5.7L V8 350 CID	
	1976	CHEVROLET CAPRICE	5.7L V8 350 CID	1975-1985	BUICK LESABRE	5.7L V8 350 CID	
	1976	CHEVROLET EL CAMINO	5.0L V8 305 CID	1975-1985	OLDSMOBILE DELTA 88	5.7L V8 350 CID	
	1976	CHEVROLET EL CAMINO	5.7L V8 350 CID	1976	OLDSMOBILE CUTLASS TIARA	4.3L V8 260 CID	
	1976	CHEVROLET G10	6.6L V8 400 CID	1976	OLDSMOBILE CUTLASS TIARA	5.7L V8 350 CID	
	1976	CHEVROLET IMPALA	5.7L V8 350 CID	1976	OLDSMOBILE CUTLASS TIARA	5.7L V8 455 CID	
	1976	CHEVROLET MALIBU	5.0L V8 305 CID	1976	PONTIAC LEMANS	4.3L V8 260 CID	
	1976	CHEVROLET MALIBU	5.7L V8 350 CID	1976	PONTIAC GRAND PRIX	5.7L V8 350 CID	
	1976	CHEVROLET MONTE CARLO	5.0L V8 305 CID	1976-1981	PONTIAC CATALINA	5.7L V8 350 CID	
	1976	CHEVROLET MONTE CARLO	5.7L V8 350 CID	1976-1985	BUICK ELECTRA	5.7L V8 350 CID	
1976	CHEVROLET NOVA	5.0L V8 305 CID	1977	BUICK CENTURY	6.6L V8 403 CID		
1976	CHEVROLET NOVA	5.7L V8 350 CID	1977	OLDSMOBILE CUTLASS	6.6L V8 403 CID		
1976	CHEVROLET P30	6.6L V8 400 CID	1977	OLDSMOBILE CUTLASS SALON	6.6L V8 403 CID		
1976	GMC C15	6.6L V8 400 CID	1977	PONTIAC GRAND PRIX	6.6L V8 403 CID		
1976	GMC C25	6.6L V8 400 CID	1977	PONTIAC GRAND SAFARI	5.7L V8 350 CID		
1976	GMC G15	6.6L V8 400 CID	1977	PONTIAC LEMANS	6.6L V8 403 CID		
US1110	1975-1976	CHEVROLET G10	4.1L L6 250 CID	1977	PONTIAC VENTURA	5.7L V8 350 CID	
	1975-1976	CHEVROLET IMPALA	4.1L L6 4100cc 250 CID	1977-1978	BUICK LESABRE	6.6L V8 403 CID	
	1975-1977	CHEVROLET C10	4.1L L6 250 CID	1977-1978	BUICK RIVIERA	6.6L V8 403 CID	
	1975-1977	CHEVROLET C10 SUBURBAN	4.1L L6 250 CID	1977-1978	OLDSMOBILE TORONADO	6.6L V8 403 CID	
	1975-1977	CHEVROLET CS1073	4.1L L6 4100cc 250 CID	1977-1978	PONTIAC GRAND SAFARI	6.6L V8 403 CID	
	1975-1977	CHEVROLET K5 BLAZER	4.1L L6 250 CID	1977-1979	BUICK ELECTRA	6.6L V8 403 CID	
	1975-1977	CHEVROLET K10	4.1L L6 250 CID	1977-1979	BUICK ESTATE WAGON	6.6L V8 403 CID	
	1975-1977	CHEVROLET K10 SUBURBAN	4.1L L6 250 CID	1977-1979	OLDSMOBILE 98	6.6L V8 403 CID	
	1975-1977	GMC C15	4.1L L6 250 CID	1977-1979	OLDSMOBILE CUSTOM CRUISER	6.6L V8 403 CID	
	1975-1977	GMC C15 SUBURBAN	4.1L L6 250 CID	1977-1979	OLDSMOBILE DELTA 88	6.6L V8 403 CID	
	1975-1977	GMC G15	4.1L L6 250 CID	1977-1979	PONTIAC BONNEVILLE	6.6L V8 403 CID	
	1975-1977	GMC JIMMY	4.1L L6 250 CID	1977-1979	PONTIAC CATALINA	6.6L V8 403 CID	
	1975-1977	GMC K15	4.1L L6 250 CID	1977-1979	PONTIAC FIREBIRD	6.6L V8 403 CID	
	1975-1977	GMC K15 SUBURBAN	4.1L L6 250 CID	1977-1979	PONTIAC PHOENIX	5.7L V8 350 CID	
	US1114	1975-1976	FORD CUSTOM 500	7.5L V8 460 CID	1977-1982	OLDSMOBILE DELTA 88	4.3L V8 260 CID
		1975-1976	FORD ELITE	7.5L V8 460 CID	1977-1983	BUICK ESTATE WAGON	5.7L V8 350 CID
		1975-1976	FORD THUNDERBIRD	7.5L V8 460 CID	1977-1984	OLDSMOBILE 98	5.7L V8 350 CID
		1975-1976	FORD TORINO	7.5L V8 460 CID	1977-1984	PONTIAC BONNEVILLE	5.7L V8 350 CID
		1975-1976	LINCOLN MARK IV	7.5L V8 460 CID	1977-1985	BUICK RIVIERA	5.7L V8 350 CID
		1975-1976	MERCURY COUGAR	7.5L V8 460 CID	1977-1985	OLDSMOBILE CUSTOM CRUISER	5.7L V8 350 CID
1975-1976		MERCURY MONTEGO	7.5L V8 460 CID	1978-1980	OLDSMOBILE CUTLASS CALAIS	4.3L V8 260 CID	
1975-1977		FORD RANCHERO	7.5L V8 460 CID	1979-1980	OLDSMOBILE CUTLASS SALON	5.7L V8 350 CID	
1975-1978		FORD LTD	7.5L V8 460 CID	1979-1984	OLDSMOBILE CUTLASS CALAIS	5.7L V8 350 CID	
1975-1978		LINCOLN CONTINENTAL	7.5L V8 460 CID	1979-1985	OLDSMOBILE TORONADO	5.7L V8 350 CID	
1975-1978		MERCURY MARQUIS	7.5L V8 460 CID	1980-1983	OLDSMOBILE CUTLASS CRUISER	5.7L V8 350 CID	
1975-1979		FORD F-150	7.5L V8 460 CID	1980-1984	CADILLAC DEVILLE	5.7L V8 350 CID	
1975-1979		FORD F-250	7.5L V8 460 CID	1980-1984	OLDSMOBILE 98	5.0L V8 307 CID	
1975-1979		FORD F-350	7.5L V8 460 CID	1980-1985	BUICK RIVIERA	5.0L V8 307 CID	
1975-1980		FORD E-250 ECONOLINE	7.5L V8 460 CID	1980-1985	CADILLAC ELDORADO	5.7L V8 350 CID	
1975-1987		FORD E-250 ECONOLINE CLUB WAGON	7.5L V8 460 CID	1980-1985	CADILLAC FLEETWOOD	5.7L V8 350 CID	
1975-1987		FORD E-350 ECONOLINE	7.5L V8 460 CID	1980-1985	CADILLAC SEVILLE	5.7L V8 350 CID	

USMWW	Years	Application	Engine	USMWW	Years	Application	Engine	
US1120	1980-1985	CHEVROLET CAPRICE	5.7L V8 350 CID	US1120H	1977-1979	PONTIAC BONNEVILLE	6.6L V8 403 CID	
	1980-1985	CHEVROLET IMPALA	5.7L V8 350 CID		1977-1979	PONTIAC CATALINA	6.6L V8 403 CID	
	1980-1985	OLDSMOBILE CUTLASS SUPREME	5.7L V8 350 CID		1977-1979	PONTIAC FIREBIRD	6.6L V8 403 CID	
	1980-1985	OLDSMOBILE DELTA 88	5.0L V8 307 CID		1977-1979	PONTIAC PHOENIX	5.7L V8 350 CID	
	1980-1985	OLDSMOBILE TORONADO	5.0L V8 307 CID		1977-1982	OLDSMOBILE DELTA 88	4.3L V8 260 CID	
	1980-1990	OLDSMOBILE CUSTOM CRUISER	5.0L V8 307 CID		1977-1983	BUICK ESTATE WAGON	5.7L V8 350 CID	
	1981	BUICK CENTURY	5.7L V8 350 CID		1977-1984	OLDSMOBILE 98	5.7L V8 350 CID	
	1981	PONTIAC BONNEVILLE	5.0L V8 307 CID		1977-1984	PONTIAC BONNEVILLE	5.7L V8 350 CID	
	1981	PONTIAC CATALINA	5.0L V8 307 CID		1977-1985	BUICK RIVIERA	5.7L V8 350 CID	
	1981-1983	BUICK ESTATE WAGON	5.0L V8 307 CID		1977-1985	OLDSMOBILE CUSTOM CRUISER	5.7L V8 350 CID	
	1981-1984	PONTIAC GRAND PRIX	5.7L V8 350 CID		1978-1980	OLDSMOBILE CUTLASS CALAIS	4.3L V8 260 CID	
	1981-1989	BUICK ELECTRA	5.0L V8 307 CID		1979-1980	OLDSMOBILE CUTLASS SALON	5.7L V8 350 CID	
	1981-1990	BUICK LESABRE	5.0L V8 307 CID		1979-1984	OLDSMOBILE CUTLASS CALAIS	5.7L V8 350 CID	
	1982	OLDSMOBILE CUTLASS CALAIS	4.3L V8 260 CID		1979-1985	OLDSMOBILE TORONADO	5.7L V8 350 CID	
	1982-1983	BUICK REGAL	5.7L V8 350 CID		1980-1983	OLDSMOBILE CUTLASS CRUISER	5.7L V8 350 CID	
	1982-1983	CHEVROLET MALIBU	5.7L V8 350 CID		1980-1984	CADILLAC DEVILLE	5.7L V8 350 CID	
	1982-1983	OLDSMOBILE CUTLASS CRUISER	5.0L V8 307 CID		1980-1984	OLDSMOBILE 98	5.0L V8 307 CID	
	1982-1983	OLDSMOBILE CUTLASS SUPREME	4.3L V6 260 CID		1980-1985	BUICK RIVIERA	5.0L V8 307 CID	
	1982-1984	CHEVROLET MONTE CARLO	5.7L V8 350 CID		1980-1985	CADILLAC ELDORADO	5.7L V8 350 CID	
	1982-1984	OLDSMOBILE CUTLASS CALAIS	5.0L V8 307 CID		1980-1985	CADILLAC FLEETWOOD	5.7L V8 350 CID	
	1982-1988	OLDSMOBILE CUTLASS SUPREME	5.0L V8 307 CID		1980-1985	CADILLAC SEVILLE	5.7L V8 350 CID	
	1983-1984	CHEVROLET EL CAMINO	5.7L V8 350 CID		1980-1985	CHEVROLET CAPRICE	5.7L V8 350 CID	
	1983-1984	GMC CABALLERO	5.7L V8 350 CID		1980-1985	CHEVROLET IMPALA	5.7L V8 350 CID	
	1983-1985	PONTIAC PARISIENNE	5.7L V8 350 CID		1980-1985	OLDSMOBILE CUTLASS SUPREME	5.7L V8 350 CID	
	1985	BUICK REGAL	5.7L V8 350 CID		1980-1985	OLDSMOBILE DELTA 88	5.0L V8 307 CID	
	1985	OLDSMOBILE CUTLASS SALON	5.7L V8 350 CID		1980-1985	OLDSMOBILE TORONADO	5.0L V8 307 CID	
	1985-1987	OLDSMOBILE CUTLASS SALON	5.0L V8 307 CID		1980-1990	OLDSMOBILE CUSTOM CRUISER	5.0L V8 307 CID	
	1986	CADILLAC FLEETWOOD	5.0L V8 307 CID		1981	BUICK CENTURY	5.7L V8 350 CID	
	1986	PONTIAC PARISIENNE	5.0L V8 307 CID		1981	PONTIAC BONNEVILLE	5.0L V8 307 CID	
	1986-1987	BUICK REGAL	5.0L V8 307 CID		1981	PONTIAC CATALINA	5.0L V8 307 CID	
	1986-1990	CHEVROLET CAPRICE	5.0L V8 307 CID		1981-1983	BUICK ESTATE WAGON	5.0L V8 307 CID	
	1987-1989	PONTIAC SAFARI	5.0L V8 307 CID		1981-1984	PONTIAC GRAND PRIX	5.7L V8 350 CID	
	1987-1990	CADILLAC BROUGHAM	5.0L V8 307 CID		1981-1989	BUICK ELECTRA	5.0L V8 307 CID	
	US1120H	1975	BUICK APOLLO		4.3L V8 260 CID	1981-1990	BUICK LESABRE	5.0L V8 307 CID
		1975	BUICK APOLLO		5.7L V8 350 CID	1982	OLDSMOBILE CUTLASS CALAIS	4.3L V8 260 CID
		1975	BUICK LESABRE		6.6L V8 400 CID	1982-1983	BUICK REGAL	5.7L V8 350 CID
		1975	OLDSMOBILE 98		6.6L V8 400 CID	1982-1983	CHEVROLET MALIBU	5.7L V8 350 CID
		1975	OLDSMOBILE CUSTOM CRUISER		6.6L V8 400 CID	1982-1983	OLDSMOBILE CUTLASS CRUISER	5.0L V8 307 CID
		1975	OLDSMOBILE DELTA 88		6.6L V8 400 CID	1982-1983	OLDSMOBILE CUTLASS SUPREME	4.3L V6 260 CID
		1975-1976	BUICK SKYLARK		4.3L V8 260 CID	1982-1984	CHEVROLET MONTE CARLO	5.7L V8 350 CID
1975-1976		OLDSMOBILE 98	7.5L V8 455 CID	1982-1984	OLDSMOBILE CUTLASS CALAIS	5.0L V8 307 CID		
1975-1976		OLDSMOBILE CUSTOM CRUISER	7.5L V8 455 CID	1982-1988	OLDSMOBILE CUTLASS SUPREME	5.0L V8 307 CID		
1975-1976		OLDSMOBILE CUTLASS	7.5L V8 455 CID	1983-1984	CHEVROLET EL CAMINO	5.7L V8 350 CID		
1975-1976		OLDSMOBILE CUTLASS SALON	7.5L V8 455 CID	1983-1984	GMC CABALLERO	5.7L V8 350 CID		
1975-1976		OLDSMOBILE DELTA 88	7.5L V8 455 CID	1983-1985	PONTIAC PARISIENNE	5.7L V8 350 CID		
1975-1976		OLDSMOBILE TORONADO	7.5L V8 455 CID	1985	BUICK REGAL	5.7L V8 350 CID		
1975-1976		PONTIAC VENTURA	4.3L V8 260 CID	1985	OLDSMOBILE CUTLASS SALON	5.7L V8 350 CID		
1975-1977		BUICK REGAL	5.7L V8 350 CID	1985-1987	OLDSMOBILE CUTLASS SALON	5.0L V8 307 CID		
1975-1977		BUICK SKYLARK	5.7L V8 350 CID	1986	CADILLAC FLEETWOOD	5.0L V8 307 CID		
1975-1977		OLDSMOBILE CUTLASS SALON	5.7L V8 350 CID	1986	PONTIAC PARISIENNE	5.0L V8 307 CID		
1975-1977		OLDSMOBILE OMEGA	4.3L V8 260 CID	1986-1987	BUICK REGAL	5.0L V8 307 CID		
1975-1977		PONTIAC GRAND PRIX	6.6L V8 400 CID	1986-1990	CHEVROLET CAPRICE	5.0L V8 307 CID		
1975-1977		PONTIAC LEMANS	6.6L V8 400 CID	1987-1989	PONTIAC SAFARI	5.0L V8 307 CID		
1975-1978		PONTIAC BONNEVILLE	6.6L V8 400 CID	1987-1990	CADILLAC BROUGHAM	5.0L V8 307 CID		
1975-1978		PONTIAC CATALINA	6.6L V8 400 CID	US1121	1977	CHEVROLET MONTE CARLO	5.7L V8 350 CID	
1975-1978		PONTIAC FIREBIRD	5.7L V8 350 CID		1977	GMC SPRINT	5.0L V8 305 CID	
1975-1978		PONTIAC GRAND SAFARI	6.6L V8 400 CID		1977	GMC SPRINT	5.7L V8 350 CID	
1975-1979		BUICK CENTURY	5.7L V8 350 CID		1977	PONTIAC VENTURA	5.0L V8 305 CID	
1975-1979		OLDSMOBILE OMEGA	5.7L V8 350 CID		1977-1978	CHEVROLET CS31003	5.7L V8 5700cc 350 CID	
1975-1979		PONTIAC FIREBIRD	6.6L V8 400 CID		1977-1978	CHEVROLET K20	5.0L V8 305 CID	
1975-1979		PONTIAC LEMANS	5.7L V8 350 CID		1977-1978	CHEVROLET K20 SUBURBAN	5.0L V8 305 CID	
1975-1980		OLDSMOBILE CUTLASS SALON	4.3L V8 260 CID		1977-1978	GMC C15	5.0L V8 305 CID	
1975-1981		OLDSMOBILE CUTLASS	4.3L V8 260 CID		1977-1978	GMC C15	5.7L V8 350 CID	
1975-1981		OLDSMOBILE CUTLASS	5.7L V8 350 CID		1977-1978	GMC C15 SUBURBAN	5.0L V8 305 CID	
1975-1985		BUICK LESABRE	5.7L V8 350 CID		1977-1978	GMC C15 SUBURBAN	5.7L V8 350 CID	
1975-1985		OLDSMOBILE DELTA 88	5.7L V8 350 CID		1977-1978	GMC C25	5.0L V8 305 CID	
1976		OLDSMOBILE CUTLASS TIARA	4.3L V8 260 CID		1977-1978	GMC C25	5.7L V8 350 CID	
1976		OLDSMOBILE CUTLASS TIARA	5.7L V8 350 CID		1977-1978	GMC C25	6.6L V8 400 CID	
1976		OLDSMOBILE CUTLASS TIARA	7.5L V8 455 CID		1977-1978	GMC C25 SUBURBAN	5.0L V8 305 CID	
1976		PONTIAC LEMANS	4.3L V8 260 CID		1977-1978	GMC C25 SUBURBAN	5.7L V8 350 CID	
1976-1977		PONTIAC GRAND PRIX	5.7L V8 350 CID		1977-1978	GMC G15	5.0L V8 305 CID	
1976-1981		PONTIAC CATALINA	5.7L V8 350 CID		1977-1978	GMC G15	5.7L V8 350 CID	
1976-1985		BUICK ELECTRA	5.7L V8 350 CID		1977-1978	GMC G25	5.0L V8 305 CID	
1977	BUICK CENTURY	6.6L V8 403 CID	1977-1978		GMC G25	5.7L V8 350 CID		
1977	OLDSMOBILE CUTLASS	6.6L V8 403 CID	1977-1978		GMC G25	6.6L V8 400 CID		
1977	OLDSMOBILE CUTLASS SALON	6.6L V8 403 CID	1977-1978		GMC G35	5.7L V8 350 CID		
1977	PONTIAC GRAND PRIX	6.6L V8 403 CID	1977-1978		GMC G35	6.6L V8 400 CID		
1977	PONTIAC GRAND SAFARI	5.7L V8 350 CID	1977-1978		GMC K15	5.0L V8 305 CID		
1977	PONTIAC LEMANS	6.6L V8 403 CID	1977-1978		GMC K15	5.7L V8 350 CID		
1977	PONTIAC VENTURA	5.7L V8 350 CID	1977-1978		GMC K15	6.6L V8 400 CID		
1977-1978	BUICK LESABRE	6.6L V8 403 CID	1977-1978		GMC K15 SUBURBAN	5.0L V8 305 CID		
1977-1978	BUICK RIVIERA	6.6L V8 403 CID	1977-1978		GMC K15 SUBURBAN	5.7L V8 350 CID		
1977-1978	OLDSMOBILE TORONADO	6.6L V8 403 CID	1977-1978		GMC K15 SUBURBAN	6.6L V8 400 CID		
1977-1978	PONTIAC GRAND SAFARI	6.6L V8 403 CID	1977-1978		GMC K25	5.0L V8 305 CID		
1977-1979	BUICK ELECTRA	6.6L V8 403 CID	1977-1978		GMC K25	5.7L V8 350 CID		
1977-1979	BUICK ESTATE WAGON	6.6L V8 403 CID	1977-1978		GMC K25	6.6L V8 400 CID		
1977-1979	OLDSMOBILE 98	6.6L V8 403 CID	1977-1978		GMC K25 SUBURBAN	5.0L V8 305 CID		
1977-1979	OLDSMOBILE CUSTOM CRUISER	6.6L V8 403 CID	1977-1978		GMC K25 SUBURBAN	5.7L V8 350 CID		
1977-1979	OLDSMOBILE DELTA 88	6.6L V8 403 CID	1977-1978		GMC K25 SUBURBAN	6.6L V8 400 CID		

USMW	Years	Application	Engine	USMW	Years	Application	Engine
US1121	1977-1978	GMC K35	5.7L V8 350 CID	US1121	1979-1980	GMC K2500	6.6L V8 400 CID
	1977-1978	GMC K35	6.6L V8 400 CID		1979-1980	GMC K2500 SUBURBAN	6.6L V8 400 CID
	1977-1978	GMC P25	5.7L V8 350 CID		1979-1980	GMC K3500	6.6L V8 400 CID
	1977-1978	GMC P35	5.7L V8 350 CID		1979-1981	CHEVROLET MALIBU	5.7L V8 350cc 350 CID
	1977-1978	PONTIAC PHOENIX	5.0L V8 305 CID		1979-1985	CHEVROLET C30	5.7L V8 5700cc 350 CID
	1977-1978	PONTIAC PHOENIX	5.7L V8 350 CID		1979-1986	GMC C1500	5.0L V8 305 CID
	1977-1979	BUICK SKYLARK	5.0L V8 305 CID		1979-1986	GMC C1500	5.7L V8 350 CID
	1977-1979	CHEVROLET C30	6.6L V8 400 CID		1979-1986	GMC C1500 SUBURBAN	5.0L V8 305 CID
	1977-1979	CHEVROLET EL CAMINO	5.7L V8 350 CID		1979-1986	GMC C1500 SUBURBAN	5.7L V8 350 CID
	1977-1979	CHEVROLET K5 BLAZER	6.6L V8 400 CID		1979-1986	GMC C2500	5.0L V8 305 CID
	1977-1979	CHEVROLET K10	5.0L V8 305 CID		1979-1986	GMC C2500	5.7L V8 350 CID
	1977-1979	CHEVROLET K10 SUBURBAN	6.6L V8 400 CID		1979-1986	GMC C2500 SUBURBAN	5.7L V8 350 CID
	1977-1979	CHEVROLET NOVA	5.0L V8 305 CID		1979-1986	GMC G1500	5.0L V8 305 CID
	1977-1979	CHEVROLET NOVA	5.7L V8 350 CID		1979-1986	GMC G1500	5.7L V8 350 CID
	1977-1979	GMC JIMMY	6.6L V8 400 CID		1979-1986	GMC G2500	5.0L V8 305 CID
	1977-1980	BUICK CENTURY	5.0L V8 305 CID		1979-1986	GMC G2500	5.7L V8 350 CID
	1977-1980	BUICK REGAL	5.0L V8 305 CID		1979-1986	GMC K1500	5.7L V8 350 CID
	1977-1980	CHEVROLET C10	6.6L V8 400 CID		1979-1986	GMC K1500 SUBURBAN	5.7L V8 350 CID
	1977-1980	CHEVROLET C20	6.6L V8 400 CID		1979-1986	GMC K2500	5.7L V8 350 CID
	1977-1980	CHEVROLET C20 SUBURBAN	6.6L V8 400 CID		1979-1986	GMC K2500 SUBURBAN	5.7L V8 350 CID
	1977-1980	CHEVROLET CAPRICE	5.7L V8 350 CID		1979-1986	GMC K3500	5.7L V8 350 CID
	1977-1980	CHEVROLET G20	6.6L V8 400 CID		1979-1988	GMC G3500	5.7L V8 350 CID
	1977-1980	CHEVROLET G30	6.6L V8 400 CID		1979-1989	GMC P2500	5.7L V8 350 CID
	1977-1980	CHEVROLET K10	6.6L V8 400 CID		1979-1995	GMC P3500	5.7L V8 350 CID
	1977-1980	CHEVROLET K20	6.6L V8 400 CID		1980	CHEVROLET K20	5.0L V8 305 CID
	1977-1980	CHEVROLET K20 SUBURBAN	6.6L V8 400 CID		1980	GMC C2500 SUBURBAN	6.6L V8 400 CID
	1977-1980	CHEVROLET K30	6.6L V8 400 CID		1980	OLDSMOBILE CUTLASS	5.0L V8 305 CID
	1977-1980	PONTIAC LEMANS	5.0L V8 305 CID		1980	OLDSMOBILE CUTLASS CALAIS	5.0L V8 305 CID
	1977-1981	CHEVROLET CAMARO	5.7L V8 350 CID		1980	OLDSMOBILE CUTLASS CRUISER	5.0L V8 305 CID
	1977-1981	CHEVROLET MALIBU	5.7L V8 350 CID		1980	OLDSMOBILE CUTLASS SALON	5.0L V8 305 CID
	1977-1983	CHEVROLET MALIBU	5.0L V8 305 CID		1980	OLDSMOBILE CUTLASS SUPREME	5.0L V8 305 CID
	1977-1985	CHEVROLET IMPALA	5.0L V8 305 CID		1980	PONTIAC GRAND LEMANS	3.8L V6 229 CID
	1977-1985	CHEVROLET IMPALA	5.7L V8 350 CID		1980	PONTIAC GRAND LEMANS	5.0L V8 305 CID
	1977-1986	CHEVROLET C10	5.0L V8 305 CID		1980	PONTIAC LEMANS	3.8L V6 229 CID
	1977-1986	CHEVROLET C10	5.7L V8 350 CID		1980-1981	CHEVROLET CAMARO	3.8L V6 229 CID
	1977-1986	CHEVROLET C10 SUBURBAN	5.0L V8 305 CID		1980-1981	CHEVROLET CAMARO	4.4L V8 267 CID
	1977-1986	CHEVROLET C10 SUBURBAN	5.7L V8 350 CID		1980-1982	CHEVROLET CAPRICE	4.4L V8 267 CID
	1977-1986	CHEVROLET C20	5.0L V8 305 CID		1980-1982	CHEVROLET EL CAMINO	4.4L V8 267 CID
	1977-1986	CHEVROLET C20	5.7L V8 350 CID		1980-1982	CHEVROLET IMPALA	4.4L V8 267 CID
	1977-1986	CHEVROLET C20 SUBURBAN	5.0L V8 305 CID		1980-1982	CHEVROLET MALIBU	4.4L V8 267 CID
	1977-1986	CHEVROLET C20 SUBURBAN	5.7L V8 350 CID		1980-1982	CHEVROLET MONTE CARLO	4.4L V8 267 CID
	1977-1986	CHEVROLET C30	5.7L V8 350 CID		1980-1982	GMC CABALLERO	4.4L V8 267 CID
	1977-1986	CHEVROLET G10	5.0L V8 305 CID		1980-1983	CHEVROLET MALIBU	3.8L V6 229 CID
	1977-1986	CHEVROLET G10	5.7L V8 350 CID		1980-1984	CHEVROLET CAPRICE	3.8L V6 229 CID
	1977-1986	CHEVROLET G20	5.0L V8 305 CID		1980-1984	CHEVROLET EL CAMINO	3.8L V6 229 CID
	1977-1986	CHEVROLET G20	5.7L V8 350 CID		1980-1984	CHEVROLET IMPALA	3.8L V6 229 CID
	1977-1986	CHEVROLET K5 BLAZER	5.0L V8 305 CID		1980-1984	CHEVROLET MONTE CARLO	3.8L V6 229 CID
	1977-1986	CHEVROLET K5 BLAZER	5.7L V8 350 CID		1980-1984	GMC CABALLERO	3.8L V6 229 CID
	1977-1986	CHEVROLET K10	5.7L V8 350 CID		1980-1985	GMC C3500	5.7L V8 5700cc 350 CID
	1977-1986	CHEVROLET K10 SUBURBAN	5.0L V8 305 CID		1980-1986	GMC C3500	5.7L V8 350 CID
	1977-1986	CHEVROLET K10 SUBURBAN	5.7L V8 350 CID		1981	CHEVROLET CAPRICE	5.7L V8 5700cc 350 CID
	1977-1986	CHEVROLET K20	5.7L V8 350 CID		1981	GMC G3500	5.0L V8 305 CID
	1977-1986	CHEVROLET K20 SUBURBAN	5.7L V8 350 CID		1981-1985	CHEVROLET C10	5.7L V8 5700cc 350 CID
	1977-1986	CHEVROLET K30	5.7L V8 350 CID		1981-1985	GMC C1500	5.7L V8 5700cc 350 CID
	1977-1987	CHEVROLET CAMARO	5.0L V8 305 CID		1981-1986	CHEVROLET K10	5.0L V8 305 CID
	1977-1987	CHEVROLET EL CAMINO	5.0L V8 305 CID		1981-1986	GMC K1500	5.0L V8 305 CID
	1977-1987	GMC JIMMY	5.0L V8 305 CID		1982	CHEVROLET CAPRICE	5.7L V8 5736cc 350 CID
1977-1987	PONTIAC FIREBIRD	5.0L V8 305 CID	1982	CHEVROLET G30	5.0L V8 305 CID		
1977-1988	CHEVROLET CAPRICE	5.0L V8 305 CID	1982	OLDSMOBILE CUTLASS CRUISER	5.0L V8 305 CID		
1977-1988	CHEVROLET G30	5.7L V8 350 CID	1982-1983	CHEVROLET MONTE CARLO	5.7L V8 5700cc 350 CID		
1977-1988	CHEVROLET MONTE CARLO	5.0L V8 305 CID	1982-1985	GMC K1500 SUBURBAN	5.0L V8 305 CID		
1977-1988	GMC JIMMY	5.7L V8 350 CID	1982-1986	GMC C2500 SUBURBAN	5.0L V8 305 CID		
1977-1989	CHEVROLET P20	5.7L V8 350 CID	1983-1986	PONTIAC BONNEVILLE	5.0L V8 305 CID		
1977-1996	CHEVROLET P30	5.7L V8 350 CID	1983-1986	PONTIAC PARISIENNE	5.0L V8 305 CID		
1978	BUICK LESABRE	5.0L V8 305 CID	1983-1987	PONTIAC GRAND PRIX	5.0L V8 305 CID		
1978	GMC C15	6.6L V8 400 CID	1985	CHEVROLET C20	5.7L V8 5700cc 350 CID		
1978	GMC C25 SUBURBAN	6.6L V8 400 CID	1985	CHEVROLET G30	5.0L V8 305 CID		
1978	PONTIAC SUNBIRD	5.0L V8 305 CID	1985	CHEVROLET IMPALA	4.3L V6 262 CID		
1978-1979	BUICK SKYLARK	5.7L V8 350 CID	1985	CHEVROLET K20	4.3L V6 262 CID		
1978-1979	CHEVROLET C30	5.0L V8 305 CID	1985	CHEVROLET K20	5.0L V8 305 CID		
1978-1979	CHEVROLET EL CAMINO	3.3L V6 200 CID	1985	GMC C2500	5.7L V8 5700cc 350 CID		
1978-1979	CHEVROLET G30	5.0L V8 305 CID	1985	GMC K2500	4.3L V6 262 CID		
1978-1979	CHEVROLET MALIBU	3.3L V6 200 CID	1985-1986	CHEVROLET ASTRO	4.3L V6 262 CID		
1978-1979	CHEVROLET MONTE CARLO	3.3L V6 200 CID	1985-1986	CHEVROLET C10	4.3L V6 262 CID		
1978-1979	GMC CABALLERO	3.3L V6 200 CID	1985-1986	CHEVROLET C20	4.3L V6 262 CID		
1978-1979	GMC CABALLERO	5.7L V8 350 CID	1985-1986	CHEVROLET G10	4.3L V6 262 CID		
1978-1980	PONTIAC GRAND AM	5.0L V8 305 CID	1985-1986	CHEVROLET G20	4.3L V6 262 CID		
1978-1980	PONTIAC GRAND PRIX	5.0L V8 305 CID	1985-1986	CHEVROLET G30	4.3L V6 262 CID		
1978-1987	GMC CABALLERO	5.0L V8 305 CID	1985-1986	CHEVROLET K10	4.3L V6 262 CID		
1979	GMC C2500	6.6L V8 400 CID	1985-1986	CHEVROLET K20 SUBURBAN	5.0L V8 305 CID		
1979	GMC G1500	6.6L V8 400 CID	1985-1986	GMC C1500	4.3L V6 262 CID		
1979	GMC K1500	5.0L V8 305 CID	1985-1986	GMC C2500	4.3L V6 262 CID		
1979	GMC K1500 SUBURBAN	5.0L V8 305 CID	1985-1986	GMC G1500	4.3L V6 262 CID		
1979	GMC K1500 SUBURBAN	6.6L V8 400 CID	1985-1986	GMC G2500	4.3L V6 262 CID		
1979	PONTIAC FIREBIRD	5.7L V8 350 CID	1985-1986	GMC G3500	4.3L V6 262 CID		
1979-1980	GMC C1500	6.6L V8 400 CID	1985-1986	GMC K1500	4.3L V6 262 CID		
1979-1980	GMC G2500	6.6L V8 400 CID	1985-1986	GMC SAFARI	4.3L V6 262 CID		
1979-1980	GMC G3500	6.6L V8 400 CID	1985-1986	PONTIAC PARISIENNE	4.3L V6 262 CID		
1979-1980	GMC K1500	6.6L V8 400 CID	1985-1987	CHEVROLET EL CAMINO	4.3L V6 262 CID		

WATER PUMPS

USMW	Years	Application	Engine	USMW	Years	Application	Engine
US1121	1985-1987	GMC CABALLERO	4.3L V6 262 CID	US1121H	1977-1978	GMC K25 SUBURBAN	6.6L V8 400 CID
	1985-1988	CHEVROLET CAPRICE	4.3L V6 262 CID		1977-1978	GMC K35	5.7L V8 350 CID
	1985-1988	CHEVROLET MONTE CARLO	4.3L V6 262 CID		1977-1978	GMC K35	6.6L V8 400 CID
	1986	GMC C3500	5.0L V8 305 CID		1977-1978	GMC P25	5.7L V8 350 CID
	1986	PONTIAC BONNEVILLE	4.3L V6 262 CID		1977-1978	GMC P35	5.7L V8 350 CID
	1986-1987	CHEVROLET MICROBUS	5.7L V8 5700cc 350 CID		1977-1979	BUICK SKYLARK	5.0L V8 305 CID
	1986-1987	PONTIAC GRAND PRIX	4.3L V6 262 CID		1977-1979	CHEVROLET C30	6.6L V8 400 CID
	1987	CHEVROLET BLAZER	5.0L V8 305 CID		1977-1979	CHEVROLET EL CAMINO	5.7L V8 350 CID
	1987	CHEVROLET C10	5.7L V8 5700cc 350 CID		1977-1979	CHEVROLET K5 BLAZER	6.6L V8 400 CID
	1987	CHEVROLET C20	5.7L V8 5700cc 350 CID		1977-1979	CHEVROLET K10	5.0L V8 305 CID
	1987	CHEVROLET C35	5.7L V8 5700cc 350 CID		1977-1979	CHEVROLET K10 SUBURBAN	6.6L V8 400 CID
	1987	CHEVROLET CAMARO	5.7L V8 350 CID		1977-1979	CHEVROLET NOVA	5.0L V8 305 CID
	1987	CHEVROLET R10	4.3L V6 262 CID		1977-1979	CHEVROLET NOVA	5.7L V8 350 CID
	1987	CHEVROLET R10	5.0L V8 305 CID		1977-1979	CHEVROLET P20	5.7L V8 350 CID
	1987	CHEVROLET R10	5.7L V8 350 CID		1977-1979	CHEVROLET P30	5.7L V8 350 CID
	1987	CHEVROLET R10 SUBURBAN	5.0L V8 305 CID		1977-1979	GMC JIMMY	6.6L V8 400 CID
	1987	CHEVROLET R20	4.3L V6 262 CID		1977-1979	PONTIAC FIREBIRD	5.7L V8 350 CID
	1987	CHEVROLET R20	5.0L V8 305 CID		1977-1979	PONTIAC LEMANS	5.7L V8 350 CID
	1987	CHEVROLET V10	4.3L V6 262 CID		1977-1979	PONTIAC PHOENIX	5.0L V8 305 CID
	1987	CHEVROLET V10	5.0L V8 305 CID		1977-1979	PONTIAC PHOENIX	5.7L V8 350 CID
	1987	CHEVROLET V10	5.7L V8 350 CID		1977-1980	BUICK CENTURY	5.0L V8 305 CID
	1987	CHEVROLET V20	5.7L V8 350 CID		1977-1980	BUICK REGAL	5.0L V8 305 CID
	1987	CHEVROLET V20 SUBURBAN	5.7L V8 350 CID		1977-1980	CHEVROLET C10	6.6L V8 400 CID
	1987	GMC R1500	4.3L V6 262 CID		1977-1980	CHEVROLET C20	6.6L V8 400 CID
	1987	GMC R1500	5.0L V8 305 CID		1977-1980	CHEVROLET C20 SUBURBAN	6.6L V8 400 CID
	1987	GMC R1500	5.7L V8 350 CID		1977-1980	CHEVROLET CAPRICE	5.7L V8 350 CID
	1987	GMC R1500 SUBURBAN	5.0L V8 305 CID		1977-1980	CHEVROLET G20	6.6L V8 400 CID
	1987	GMC R2500	4.3L V6 262 CID		1977-1980	CHEVROLET G30	6.6L V8 400 CID
	1987	GMC R2500	5.0L V8 305 CID		1977-1980	CHEVROLET K10	6.6L V8 400 CID
	1987	GMC V1500	4.3L V6 262 CID		1977-1980	CHEVROLET K20	6.6L V8 400 CID
	1987	GMC V1500	5.0L V8 305 CID		1977-1980	CHEVROLET K20 SUBURBAN	6.6L V8 400 CID
	1987	GMC V1500	5.7L V8 350 CID		1977-1980	CHEVROLET K30	6.6L V8 400 CID
	1987	GMC V2500	5.7L V8 350 CID		1977-1980	PONTIAC LEMANS	5.0L V8 305 CID
	1987	PONTIAC FIREBIRD	5.7L V8 350 CID		1977-1981	CHEVROLET CAMARO	5.7L V8 350 CID
	1987-1988	CHEVROLET BLAZER	5.7L V8 350 CID		1977-1981	CHEVROLET MALIBU	5.7L V8 350 CID
	1987-1988	CHEVROLET R20	5.7L V8 350 CID		1977-1983	CHEVROLET MALIBU	5.0L V8 305 CID
	1987-1988	CHEVROLET R30	5.7L V8 350 CID		1977-1985	CHEVROLET IMPALA	5.0L V8 305 CID
	1987-1988	CHEVROLET V30	5.7L V8 350 CID		1977-1985	CHEVROLET IMPALA	5.7L V8 350 CID
	1987-1988	GMC C1500	5.7L V8 5700cc 350 CID		1977-1986	CHEVROLET C10	5.0L V8 305 CID
	1987-1988	GMC C2500	5.7L V8 5700cc 350 CID		1977-1986	CHEVROLET C10	5.7L V8 350 CID
	1987-1988	GMC C3500	5.7L V8 5700cc 350 CID		1977-1986	CHEVROLET C10 SUBURBAN	5.0L V8 305 CID
	1987-1988	GMC R1500 SUBURBAN	5.7L V8 350 CID		1977-1986	CHEVROLET C10 SUBURBAN	5.7L V8 350 CID
	1987-1988	GMC R2500 SUBURBAN	5.7L V8 350 CID		1977-1986	CHEVROLET C20	5.0L V8 305 CID
	1987-1988	GMC V1500 SUBURBAN	5.7L V8 350 CID		1977-1986	CHEVROLET C20	5.7L V8 350 CID
	1987-1988	GMC V2500 SUBURBAN	5.7L V8 350 CID		1977-1986	CHEVROLET C20 SUBURBAN	5.0L V8 305 CID
	1987-1989	GMC R2500	5.7L V8 350 CID		1977-1986	CHEVROLET C20 SUBURBAN	5.7L V8 350 CID
	1987-1991	GMC R3500	5.7L V8 350 CID		1977-1986	CHEVROLET C30	5.7L V8 350 CID
	1987-1991	GMC V3500	5.7L V8 350 CID		1977-1986	CHEVROLET G10	5.0L V8 305 CID
	1989	CHEVROLET R2500	5.7L V8 350 CID		1977-1986	CHEVROLET G10	5.7L V8 350 CID
	1989-1991	CHEVROLET R3500	5.7L V8 350 CID		1977-1986	CHEVROLET G20	5.0L V8 305 CID
1989-1991	CHEVROLET V3500	5.7L V8 350 CID	1977-1986	CHEVROLET G20	5.7L V8 350 CID		
1990-1995	CHEVROLET P30	4.3L V6 262 CID	1977-1986	CHEVROLET K5 BLAZER	5.0L V8 305 CID		
1990-1995	GMC P3500	4.3L V6 262 CID	1977-1986	CHEVROLET K5 BLAZER	5.7L V8 350 CID		
1991-1995	CHEVROLET P31 VAN	5.7L V8 5737cc 350 CID	1977-1986	CHEVROLET K10	5.7L V8 350 CID		
US1121H	1977	CHEVROLET MONTE CARLO	5.7L V8 350 CID	1977-1986	CHEVROLET K10 SUBURBAN	5.0L V8 305 CID	
	1977	GMC SPRINT	5.0L V8 305 CID	1977-1986	CHEVROLET K10 SUBURBAN	5.7L V8 350 CID	
	1977	GMC SPRINT	5.7L V8 350 CID	1977-1986	CHEVROLET K20	5.7L V8 350 CID	
	1977	PONTIAC GRAND PRIX	5.7L V8 350 CID	1977-1986	CHEVROLET K20 SUBURBAN	5.7L V8 350 CID	
	1977	PONTIAC VENTURA	5.0L V8 305 CID	1977-1986	CHEVROLET K30	5.7L V8 350 CID	
	1977	PONTIAC VENTURA	5.7L V8 350 CID	1977-1987	CHEVROLET CAMARO	5.0L V8 305 CID	
	1977-1978	CHEVROLET K20	5.0L V8 305 CID	1977-1987	CHEVROLET EL CAMINO	5.0L V8 305 CID	
	1977-1978	CHEVROLET K20 SUBURBAN	5.0L V8 305 CID	1977-1987	GMC JIMMY	5.0L V8 305 CID	
	1977-1978	GMC C15	5.0L V8 305 CID	1977-1987	PONTIAC FIREBIRD	5.0L V8 305 CID	
	1977-1978	GMC C15	5.7L V8 350 CID	1977-1988	CHEVROLET CAPRICE	5.0L V8 305 CID	
	1977-1978	GMC C15 SUBURBAN	5.0L V8 305 CID	1977-1988	CHEVROLET G30	5.7L V8 350 CID	
	1977-1978	GMC C15 SUBURBAN	5.7L V8 350 CID	1977-1988	CHEVROLET MONTE CARLO	5.0L V8 305 CID	
	1977-1978	GMC C25	5.0L V8 305 CID	1977-1988	GMC JIMMY	5.7L V8 350 CID	
	1977-1978	GMC C25	5.7L V8 350 CID	1978	BUICK LESABRE	5.0L V8 305 CID	
	1977-1978	GMC C25	6.6L V8 400 CID	1978	GMC C15	6.6L V8 400 CID	
	1977-1978	GMC C25 SUBURBAN	5.0L V8 305 CID	1978	GMC C25 SUBURBAN	6.6L V8 400 CID	
	1977-1978	GMC C25 SUBURBAN	5.7L V8 350 CID	1978-1979	CHEVROLET C30	5.0L V8 305 CID	
	1977-1978	GMC G15	5.0L V8 305 CID	1978-1979	CHEVROLET EL CAMINO	3.3L V6 200 CID	
	1977-1978	GMC G15	5.7L V8 350 CID	1978-1979	CHEVROLET G30	5.0L V8 305 CID	
	1977-1978	GMC G25	5.0L V8 305 CID	1978-1979	CHEVROLET MALIBU	3.3L V6 200 CID	
	1977-1978	GMC G25	5.7L V8 350 CID	1978-1979	CHEVROLET MONTE CARLO	3.3L V6 200 CID	
	1977-1978	GMC G25	6.6L V8 400 CID	1978-1979	GMC CABALLERO	3.3L V6 200 CID	
	1977-1978	GMC G35	5.7L V8 350 CID	1978-1979	GMC CABALLERO	5.7L V8 350 CID	
	1977-1978	GMC G35	6.6L V8 400 CID	1978-1979	PONTIAC SUNBIRD	5.0L V8 305 CID	
	1977-1978	GMC K15	5.0L V8 305 CID	1978-1980	PONTIAC GRAND AM	5.0L V8 305 CID	
	1977-1978	GMC K15	5.7L V8 350 CID	1978-1980	PONTIAC GRAND PRIX	5.0L V8 305 CID	
	1977-1978	GMC K15	6.6L V8 400 CID	1978-1987	GMC CABALLERO	5.0L V8 305 CID	
	1977-1978	GMC K15 SUBURBAN	5.0L V8 305 CID	1979	BUICK CENTURY	5.7L V8 350 CID	
	1977-1978	GMC K15 SUBURBAN	5.7L V8 350 CID	1979	BUICK SKYLARK	5.7L V8 350 CID	
	1977-1978	GMC K15 SUBURBAN	6.6L V8 400 CID	1979	GMC C2500	6.6L V8 400 CID	
	1977-1978	GMC K25	5.0L V8 305 CID	1979	GMC G1500	6.6L V8 400 CID	
	1977-1978	GMC K25	5.7L V8 350 CID	1979	GMC K1500	5.0L V8 305 CID	
	1977-1978	GMC K25	6.6L V8 400 CID	1979	GMC K1500 SUBURBAN	5.0L V8 305 CID	
	1977-1978	GMC K25 SUBURBAN	5.0L V8 305 CID	1979	GMC K1500 SUBURBAN	6.6L V8 400 CID	
	1977-1978	GMC K25 SUBURBAN	5.7L V8 350 CID	1979	GMC P2500	5.7L V8 350 CID	

USMW	Years	Application	Engine	USMW	Years	Application	Engine	
US1121H	1979	GMC P3500	5.7L V8 350 CID	US1121H	1986-1987	PONTIAC GRAND PRIX	4.3L V6 262 CID	
	1979-1980	GMC C1500	6.6L V8 400 CID		1987	CHEVROLET BLAZER	5.0L V8 305 CID	
	1979-1980	GMC G2500	6.6L V8 400 CID		1987	CHEVROLET CAMARO	5.7L V8 350 CID	
	1979-1980	GMC G3500	6.6L V8 400 CID		1987	CHEVROLET R10	4.3L V6 262 CID	
	1979-1980	GMC K1500	6.6L V8 400 CID		1987	CHEVROLET R10	5.0L V8 305 CID	
	1979-1980	GMC K2500	6.6L V8 400 CID		1987	CHEVROLET R10	5.7L V8 350 CID	
	1979-1980	GMC K2500 SUBURBAN	6.6L V8 400 CID		1987	CHEVROLET R10 SUBURBAN	5.0L V8 305 CID	
	1979-1980	GMC K3500	6.6L V8 400 CID		1987	CHEVROLET R20	4.3L V6 262 CID	
	1979-1986	GMC C1500	5.0L V8 305 CID		1987	CHEVROLET R20	5.0L V8 305 CID	
	1979-1986	GMC C1500	5.7L V8 350 CID		1987	CHEVROLET V10	4.3L V6 262 CID	
	1979-1986	GMC C1500 SUBURBAN	5.0L V8 305 CID		1987	CHEVROLET V10	5.0L V8 305 CID	
	1979-1986	GMC C1500 SUBURBAN	5.7L V8 350 CID		1987	CHEVROLET V10	5.7L V8 350 CID	
	1979-1986	GMC C2500	5.0L V8 305 CID		1987	CHEVROLET V20	5.7L V8 350 CID	
	1979-1986	GMC C2500	5.7L V8 350 CID		1987	CHEVROLET V20 SUBURBAN	5.7L V8 350 CID	
	1979-1986	GMC C2500 SUBURBAN	5.7L V8 350 CID		1987	GMC R1500	4.3L V6 262 CID	
	1979-1986	GMC G1500	5.0L V8 305 CID		1987	GMC R1500	5.0L V8 305 CID	
	1979-1986	GMC G1500	5.7L V8 350 CID		1987	GMC R1500	5.7L V8 350 CID	
	1979-1986	GMC G2500	5.0L V8 305 CID		1987	GMC R1500 SUBURBAN	5.0L V8 305 CID	
	1979-1986	GMC G2500	5.7L V8 350 CID		1987	GMC R2500	4.3L V6 262 CID	
	1979-1986	GMC K1500	5.7L V8 350 CID		1987	GMC R2500	5.0L V8 305 CID	
	1979-1986	GMC K1500 SUBURBAN	5.7L V8 350 CID		1987	GMC V1500	4.3L V6 262 CID	
	1979-1986	GMC K2500	5.7L V8 350 CID		1987	GMC V1500	5.0L V8 305 CID	
	1979-1986	GMC K2500 SUBURBAN	5.7L V8 350 CID		1987	GMC V1500	5.7L V8 350 CID	
	1979-1986	GMC K3500	5.7L V8 350 CID		1987	GMC V2500	5.7L V8 350 CID	
	1979-1988	GMC G3500	5.7L V8 350 CID		1987	PONTIAC FIREBIRD	5.7L V8 350 CID	
	1980	CHEVROLET K20	5.0L V8 305 CID		1987-1988	CHEVROLET BLAZER	5.7L V8 350 CID	
	1980	GMC C2500 SUBURBAN	6.6L V8 400 CID		1987-1988	CHEVROLET R20	5.7L V8 350 CID	
	1980	OLDSMOBILE CUTLASS	5.0L V8 305 CID		1987-1988	CHEVROLET R30	5.7L V8 350 CID	
	1980	OLDSMOBILE CUTLASS CALAIS	5.0L V8 305 CID		1987-1988	CHEVROLET V30	5.7L V8 350 CID	
	1980	OLDSMOBILE CUTLASS CRUISER	5.0L V8 305 CID		1987-1988	GMC R1500 SUBURBAN	5.7L V8 350 CID	
	1980	OLDSMOBILE CUTLASS SALON	5.0L V8 305 CID		1987-1988	GMC R2500 SUBURBAN	5.7L V8 350 CID	
	1980	OLDSMOBILE CUTLASS SUPREME	5.0L V8 305 CID		1987-1988	GMC V1500 SUBURBAN	5.7L V8 350 CID	
	1980	PONTIAC GRAND LEMANS	3.8L V6 229 CID		1987-1988	GMC V2500 SUBURBAN	5.7L V8 350 CID	
	1980	PONTIAC GRAND LEMANS	5.0L V8 305 CID		1987-1989	GMC R2500	5.7L V8 350 CID	
	1980	PONTIAC LEMANS	3.8L V6 229 CID		1987-1991	GMC R3500	5.7L V8 350 CID	
	1980-1981	CHEVROLET CAMARO	3.8L V6 229 CID		1987-1991	GMC V3500	5.7L V8 350 CID	
	1980-1981	CHEVROLET CAMARO	4.4L V8 267 CID		1989-1991	CHEVROLET R3500	5.7L V8 350 CID	
	1980-1982	CHEVROLET CAPRICE	4.4L V8 267 CID		1989-1991	CHEVROLET V3500	5.7L V8 350 CID	
	1980-1982	CHEVROLET EL CAMINO	4.4L V8 267 CID		1990-1995	CHEVROLET P30	4.3L V6 262 CID	
	1980-1982	CHEVROLET IMPALA	4.4L V8 267 CID		1990-1995	GMC P3500	4.3L V6 262 CID	
	1980-1982	CHEVROLET MALIBU	4.4L V8 267 CID		US1124	1975	DODGE COLT	2.0L L4 1995cc 122 CID
	1980-1982	CHEVROLET MONTE CARLO	4.4L V8 267 CID		US1127	1975-1982	CHEVROLET LUV	1.8L L4 111 CID
	1980-1982	GMC CABALLERO	4.4L V8 267 CID		1981-1982	ISUZU PICKUP	1.8L L4 1817cc	
	1980-1983	CHEVROLET MALIBU	3.8L V6 229 CID		1981-1985	ISUZU I-MARK	1.8L L4 1817cc	
	1980-1984	CHEVROLET CAPRICE	3.8L V6 229 CID		1983-1987	ISUZU IMPULSE	1.9L L4 1949cc	
	1980-1984	CHEVROLET EL CAMINO	3.8L V6 229 CID		1983-1987	ISUZU PICKUP	1.9L L4 1949cc	
	1980-1984	CHEVROLET IMPALA	3.8L V6 229 CID		1984	ISUZU TROOPER	2.2L L4 2238cc	
	1980-1984	CHEVROLET MONTE CARLO	3.8L V6 229 CID		1984-1985	ISUZU TROOPER	1.9L L4 1949cc	
	1980-1984	GMC CABALLERO	3.8L V6 229 CID		US1137	1975-1977	CHEVROLET C20	4.8L L6 292 CID
	1980-1986	GMC C3500	5.7L V8 350 CID		1975-1977	CHEVROLET C20 SUBURBAN	4.8L L6 292 CID	
	1981	GMC G3500	5.0L V8 305 CID		1975-1977	CHEVROLET C30	4.8L L6 292 CID	
	1981-1986	CHEVROLET K10	5.0L V8 305 CID		1975-1977	CHEVROLET CS1073	4.8L L6 4800cc 292 CID	
	1981-1986	GMC K1500	5.0L V8 305 CID		1975-1977	CHEVROLET CS31003	4.8L L6 4800cc 292 CID	
	1982	CHEVROLET G30	5.0L V8 305 CID		1975-1977	CHEVROLET G20	4.8L L6 292 CID	
	1982	OLDSMOBILE CUTLASS CRUISER	5.0L V8 305 CID		1975-1977	CHEVROLET G30	4.8L L6 292 CID	
	1982-1985	GMC K1500 SUBURBAN	5.0L V8 305 CID		1975-1977	CHEVROLET K20	4.8L L6 292 CID	
	1982-1986	GMC C2500 SUBURBAN	5.0L V8 305 CID		1975-1977	CHEVROLET K20 SUBURBAN	4.8L L6 292 CID	
	1983-1986	PONTIAC BONNEVILLE	5.0L V8 305 CID		1975-1977	CHEVROLET P20	4.8L L6 292 CID	
	1983-1986	PONTIAC PARISIENNE	5.0L V8 305 CID		1975-1977	CHEVROLET P30	4.8L L6 292 CID	
	1983-1987	PONTIAC GRAND PRIX	5.0L V8 305 CID		1975-1977	GMC C25	4.8L L6 292 CID	
	1985	CHEVROLET G30	5.0L V8 305 CID		1975-1977	GMC C25 SUBURBAN	4.8L L6 292 CID	
	1985	CHEVROLET IMPALA	4.3L V6 262 CID		1975-1977	GMC G25	4.8L L6 292 CID	
	1985	CHEVROLET K20	4.3L V6 262 CID		1975-1977	GMC G35	4.8L L6 292 CID	
	1985	CHEVROLET K20	5.0L V8 305 CID		1975-1977	GMC K25	4.8L L6 292 CID	
	1985	GMC K2500	4.3L V6 262 CID		1975-1977	GMC K25 SUBURBAN	4.8L L6 292 CID	
	1985-1986	CHEVROLET ASTRO	4.3L V6 262 CID		1975-1977	GMC P25	4.8L L6 292 CID	
	1985-1986	CHEVROLET C10	4.3L V6 262 CID		1975-1977	GMC P35	4.8L L6 292 CID	
	1985-1986	CHEVROLET C20	4.3L V6 262 CID		1991	CHEVROLET P31 VAN	4.8L L6 4800cc 292 CID	
	1985-1986	CHEVROLET G10	4.3L V6 262 CID		US1137H	1975-1977	CHEVROLET C20	4.8L L6 292 CID
	1985-1986	CHEVROLET G20	4.3L V6 262 CID		1975-1977	CHEVROLET C20 SUBURBAN	4.8L L6 292 CID	
	1985-1986	CHEVROLET G30	4.3L V6 262 CID		1975-1977	CHEVROLET C30	4.8L L6 292 CID	
	1985-1986	CHEVROLET K10	4.3L V6 262 CID		1975-1977	CHEVROLET G20	4.8L L6 292 CID	
	1985-1986	CHEVROLET K20 SUBURBAN	5.0L V8 305 CID		1975-1977	CHEVROLET G30	4.8L L6 292 CID	
	1985-1986	GMC C1500	4.3L V6 262 CID		1975-1977	CHEVROLET K20	4.8L L6 292 CID	
	1985-1986	GMC C2500	4.3L V6 262 CID		1975-1977	CHEVROLET K20 SUBURBAN	4.8L L6 292 CID	
	1985-1986	GMC G1500	4.3L V6 262 CID		1975-1977	CHEVROLET P20	4.8L L6 292 CID	
	1985-1986	GMC G2500	4.3L V6 262 CID		1975-1977	CHEVROLET P30	4.8L L6 292 CID	
	1985-1986	GMC G3500	4.3L V6 262 CID		1975-1977	GMC C25	4.8L L6 292 CID	
	1985-1986	GMC K1500	4.3L V6 262 CID		1975-1977	GMC C25 SUBURBAN	4.8L L6 292 CID	
	1985-1986	GMC SAFARI	4.3L V6 262 CID		1975-1977	GMC G25	4.8L L6 292 CID	
	1985-1986	PONTIAC PARISIENNE	4.3L V6 262 CID		1975-1977	GMC G35	4.8L L6 292 CID	
	1985-1987	CHEVROLET EL CAMINO	4.3L V6 262 CID		1975-1977	GMC K25	4.8L L6 292 CID	
	1985-1987	GMC CABALLERO	4.3L V6 262 CID		1975-1977	GMC K25 SUBURBAN	4.8L L6 292 CID	
	1985-1988	CHEVROLET CAPRICE	4.3L V6 262 CID		1975-1977	GMC P25	4.8L L6 292 CID	
	1985-1988	CHEVROLET MONTE CARLO	4.3L V6 262 CID		1975-1977	GMC P35	4.8L L6 292 CID	
	1985-1995	GMC P3500	5.7L V8 350 CID		US3400	1977-1978	AMERICAN MOTORS GREMLIN	2.0L L4 121 CID
	1985-1996	CHEVROLET P30	5.7L V8 350 CID		1978-1979	AMERICAN MOTORS CONCORD	2.0L L4 121 CID	
	1986	GMC C3500	5.0L V8 305 CID		1979	AMERICAN MOTORS SPIRIT	2.0L L4 121 CID	
	1986	PONTIAC BONNEVILLE	4.3L V6 262 CID		US3401	1975-1976	AMERICAN MOTORS GREMLIN	5.0L V8 304 CID

USMWW	Years	Application	Engine	USMWW	Years	Application	Engine	
US3401	1975-1976	AMERICAN MOTORS MATADOR	6.6L V8 401 CID	US3409	1985	JEEP WAGONEER	2.1L L4 126 CID	
	1975-1977	AMERICAN MOTORS HORNET	5.0L V8 304 CID		1985-1987	JEEP CHEROKEE	2.1L L4 126 CID	
	1975-1977	AMERICAN MOTORS MATADOR	5.0L V8 304 CID		1986-1987	JEEP COMANCHE	2.1L L4 126 CID	
	1975-1978	AMERICAN MOTORS MATADOR	5.9L V8 360 CID	US3410	1982-1983	RENAULT FUEGO	1.6L L4 1647cc 100 CID	
	1975-1978	JEEP CHEROKEE	6.6L V8 401 CID		1984-1985	RENAULT FUEGO	2.2L L4 2152cc 131 CID	
	1975-1978	JEEP J10	6.6L V8 401 CID		1984-1986	RENAULT R18I	2.2L L4 2152cc 131 CID	
	1975-1978	JEEP J20	6.6L V8 401 CID	1988-1989	EAGLE MEDALLION	2.2L L4 2163cc 132 CID		
	1975-1978	JEEP WAGONEER	6.6L V8 401 CID	US3411	1988-1991	EAGLE PREMIER	3.0L V6 2972cc 182 CID	
	1975-1983	JEEP CHEROKEE	5.9L V8 360 CID		1990-1991	DODGE MONACO	3.0L V6 2972cc 182 CID	
	1975-1983	JEEP WAGONEER	5.9L V8 360 CID	US3412	1987-1990	JEEP WAGONEER	4.0L L6 242 CID	
	1975-1988	JEEP J10	5.9L V8 360 CID		1987-1992	JEEP COMANCHE	4.0L L6 242 CID	
	1975-1988	JEEP J20	5.9L V8 360 CID		1987-2001	JEEP CHEROKEE	4.0L L6 242 CID	
	1976-1981	JEEP CJ7	5.0L V8 304 CID		1988-1989	EAGLE PREMIER	2.5L L4 150 CID	
	1978-1979	AMERICAN MOTORS AMX	5.0L V8 304 CID	US3413	1980-1983	JEEP CJ5	4.2L L6 258 CID	
	1978-1979	AMERICAN MOTORS CONCORD	5.0L V8 304 CID		1981-1982	JEEP CJ7	2.5L L4 151 CID	
	1978-1979	AMERICAN MOTORS PACER	5.0L V8 304 CID		1981-1982	JEEP SCRAMBLER	2.5L L4 151 CID	
	1980-1981	JEEP CJ5	5.0L V8 304 CID		1981-1983	JEEP CHEROKEE	4.2L L6 258 CID	
	1984-1991	JEEP GRAND WAGONEER	5.9L V8 360 CID		1981-1983	JEEP CJ5	2.5L L4 151 CID	
	US3401H	1975-1976	AMERICAN MOTORS GREMLIN		5.0L V8 304 CID	1981-1983	JEEP WAGONEER	4.2L L6 258 CID
		1975-1976	AMERICAN MOTORS MATADOR		6.6L V8 401 CID	1981-1985	JEEP SCRAMBLER	4.2L L6 258 CID
1975-1977		AMERICAN MOTORS HORNET	5.0L V8 304 CID		1981-1986	JEEP CJ7	4.2L L6 258 CID	
1975-1977		AMERICAN MOTORS MATADOR	5.0L V8 304 CID		1981-1987	JEEP J10	4.2L L6 258 CID	
1975-1978		AMERICAN MOTORS MATADOR	5.9L V8 360 CID		1983-1985	JEEP SCRAMBLER	2.5L L4 150 CID	
1975-1978		JEEP CHEROKEE	6.6L V8 401 CID	1983-1986	JEEP CJ7	2.5L L4 150 CID		
1975-1978		JEEP J10	6.6L V8 401 CID	1984	AMERICAN MOTORS EAGLE	2.5L L4 150 CID		
1975-1978		JEEP J20	6.6L V8 401 CID	1984-1986	JEEP GRAND WAGONEER	4.2L L6 258 CID		
1975-1978		JEEP WAGONEER	6.6L V8 401 CID	1984-1987	JEEP WAGONEER	2.5L L4 150 CID		
1975-1983		JEEP CHEROKEE	5.9L V8 360 CID	1984-1988	AMERICAN MOTORS EAGLE	4.2L L6 258 CID		
1975-1983		JEEP WAGONEER	5.9L V8 360 CID	1984-1990	JEEP CHEROKEE	2.5L L4 150 CID		
1975-1988		JEEP J10	5.9L V8 360 CID	1986-1990	JEEP COMANCHE	2.5L L4 150 CID		
1975-1988		JEEP J20	5.9L V8 360 CID	1987-1990	JEEP WRANGLER	2.5L L4 150 CID		
1976-1981		JEEP CJ7	5.0L V8 304 CID	1987-1990	JEEP WRANGLER	4.2L L6 258 CID		
1978-1979		AMERICAN MOTORS AMX	5.0L V8 304 CID	US3414	1980	AMERICAN MOTORS AMX	4.2L L6 258 CID	
1978-1979		AMERICAN MOTORS CONCORD	5.0L V8 304 CID		1980	AMERICAN MOTORS PACER	4.2L L6 258 CID	
1978-1979		AMERICAN MOTORS PACER	5.0L V8 304 CID		1980-1983	AMERICAN MOTORS CONCORD	4.2L L6 258 CID	
1980-1981		JEEP CJ5	5.0L V8 304 CID		1980-1983	AMERICAN MOTORS SPIRIT	4.2L L6 258 CID	
1984-1991		JEEP GRAND WAGONEER	5.9L V8 360 CID		1980-1983	JEEP CHEROKEE	4.2L L6 258 CID	
1975-1978		JEEP CJ5D	4.2L L6 4200cc 258 CID		1980-1983	JEEP CJ5	4.2L L6 258 CID	
1975-1986	JEEP CJ5D	4.6L L6 4600cc 282 CID	1980-1983		JEEP WAGONEER	4.2L L6 258 CID		
1980	AMERICAN MOTORS AMX	4.2L L6 258 CID	1980-1986		JEEP CJ7	4.2L L6 258 CID		
1980	AMERICAN MOTORS PACER	4.2L L6 258 CID	1980-1987		JEEP J10	4.2L L6 258 CID		
1980-1983	AMERICAN MOTORS AMERICAN	4.2L L6 4200cc 258 CID	1980-1988		AMERICAN MOTORS EAGLE	4.2L L6 258 CID		
1980-1983	AMERICAN MOTORS AMERICAN	4.6L L6 4600cc 282 CID	1981-1982	JEEP CJ7	2.5L L4 151 CID			
1980-1983	AMERICAN MOTORS CONCORD	4.2L L6 258 CID	1981-1982	JEEP SCRAMBLER	2.5L L4 151 CID			
1980-1983	AMERICAN MOTORS GREMLIN	4.2L L6 4200cc 258 CID	1981-1983	JEEP CJ5	2.5L L4 151 CID			
1980-1983	AMERICAN MOTORS GREMLIN	4.6L L6 4600cc 282 CID	1981-1985	JEEP SCRAMBLER	4.2L L6 258 CID			
1980-1983	AMERICAN MOTORS LERMA	4.6L L6 4600cc 282 CID	1983-1984	AMERICAN MOTORS EAGLE	2.5L L4 150 CID			
1980-1983	AMERICAN MOTORS SPIRIT	4.2L L6 258 CID	1983-1985	JEEP SCRAMBLER	2.5L L4 150 CID			
1980-1983	JEEP CHEROKEE	4.2L L6 258 CID	1983-1986	JEEP CJ7	2.5L L4 150 CID			
1980-1983	JEEP CJ5	4.2L L6 258 CID	1984-1986	JEEP GRAND WAGONEER	4.2L L6 258 CID			
1980-1983	JEEP WAGONEER	4.2L L6 258 CID	1984-1987	JEEP WAGONEER	2.5L L4 150 CID			
1980-1984	JEEP J364R	4.6L L6 4600cc 282 CID	1984-1990	JEEP CHEROKEE	2.5L L4 150 CID			
1980-1986	JEEP CJ7	4.2L L6 258 CID	1986-1990	JEEP COMANCHE	2.5L L4 150 CID			
1980-1986	JEEP CJ7	4.6L L6 4600cc 282 CID	1987-1990	JEEP WRANGLER	2.5L L4 150 CID			
1980-1986	JEEP J100	4.6L L6 4600cc 282 CID	1987-1990	JEEP WRANGLER	4.2L L6 258 CID			
1980-1986	JEEP J164	4.6L L6 4600cc 282 CID	US3705	1980	INTERNATIONAL CARGOSTAR	6.6L V8 404 CID		
1980-1986	JEEP J164V	4.6L L6 4600cc 282 CID		1980	INTERNATIONAL CARGOSTAR	7.3L V8 446 CID		
1980-1986	JEEP WAGONEER	4.6L L6 4600cc 282 CID		1980	INTERNATIONAL S1723	6.6L V8 404 CID		
1980-1987	JEEP J10	4.2L L6 258 CID		1980	INTERNATIONAL S1724	6.6L V8 404 CID		
1980-1988	AMERICAN MOTORS EAGLE	4.2L L6 258 CID		1980	INTERNATIONAL S1823	6.6L V8 404 CID		
1981-1982	JEEP CJ7	2.5L L4 151 CID		1980	INTERNATIONAL S1823	7.3L V8 446 CID		
1981-1982	JEEP SCRAMBLER	2.5L L4 151 CID		1980	INTERNATIONAL S1824	6.6L V8 404 CID		
1981-1983	AMERICAN MOTORS RALLY	4.2L L6 4200cc 258 CID		1980	INTERNATIONAL S1824	7.3L V8 446 CID		
1981-1983	AMERICAN MOTORS RALLY	4.6L L6 4600cc 282 CID		1980	INTERNATIONAL S1824	7.3L V8 446 CID		
1981-1983	JEEP CJ5	2.5L L4 151 CID		1980	INTERNATIONAL S1924	7.3L V8 446 CID		
1981-1985	JEEP SCRAMBLER	4.2L L6 258 CID		1980	INTERNATIONAL S1925	6.6L V8 404 CID		
1983-1984	AMERICAN MOTORS EAGLE	2.5L L4 150 CID		1980	INTERNATIONAL S1925	7.3L V8 446 CID		
1983-1985	JEEP SCRAMBLER	2.5L L4 150 CID		1984-1986	INTERNATIONAL CARGOSTAR	6.8L V8 420 CID		
1983-1986	JEEP CJ7	2.5L L4 150 CID		1984-1988	INTERNATIONAL S1654	6.8L V8 420 CID		
1984-1985	JEEP CJ10	4.6L L6 4600cc 282 CID		1984-1988	INTERNATIONAL S1753	6.8L V8 420 CID		
1984-1986	JEEP CJ5D	4.2L L6 4200cc 258 CID		1986	INTERNATIONAL F1954	6.8L V8 420 CID		
1984-1986	JEEP GRAND WAGONEER	4.2L L6 258 CID		1987	INTERNATIONAL M1400 METRO II	6.8L V8 420 CID		
1984-1987	JEEP WAGONEER	2.5L L4 150 CID		1987	INTERNATIONAL M1600 METRO II	6.8L V8 420 CID		
1984-1990	JEEP CHEROKEE	2.5L L4 150 CID		1988	INTERNATIONAL S1754	7.3L V8 444 CID		
1986-1990	JEEP COMANCHE	2.5L L4 150 CID		1988	INTERNATIONAL S1853	6.8L V8 420 CID		
1987-1990	JEEP WRANGLER	2.5L L4 150 CID	1988-1989	INTERNATIONAL S1654	7.3L V8 444 CID			
1987-1990	JEEP WRANGLER	4.2L L6 258 CID	1988-1989	INTERNATIONAL S1654LP	7.3L V8 444 CID			
US3404	1981-1983	AMERICAN MOTORS CONCORD	4.2L L6 258 CID	1988-1989	INTERNATIONAL S1753	7.3L V8 444 CID		
	1981-1983	AMERICAN MOTORS EAGLE	4.2L L6 258 CID	1988-1989	INTERNATIONAL M1400 METRO II	7.3L V8 444 CID		
	1981-1983	AMERICAN MOTORS SPIRIT	4.2L L6 258 CID	1988-1990	INTERNATIONAL M1600 METRO II	7.3L V8 444 CID		
	1983	AMERICAN MOTORS EAGLE	2.5L L4 150 CID	1990	INTERNATIONAL 1652UPS	6.8L V8 420 CID		
US3406	1975-1979	RENAULT R12	1.6L L4 1647cc 100 CID	1990	INTERNATIONAL 3800	7.3L V8 444 CID		
	1975-1980	RENAULT R12	1.6L L4 1600cc 98 CID	1990-1991	INTERNATIONAL 1652UPS	7.3L V8 444 CID		
	1980	RENAULT R18	1.6L L4 1600cc 98 CID	1990-1993	INTERNATIONAL 3700	7.3L V8 444 CID		
	1981-1983	RENAULT R18I	1.6L L4 1647cc 100 CID	1990-1993	INTERNATIONAL 4600LP	7.3L V8 444 CID		
	1982-1984	RENAULT FUEGO	1.6L L4 1565cc	1991	INTERNATIONAL 3700	6.8L V8 420 CID		
	1984	RENAULT R18	1.6L L4 1600cc 98 CID	1991	INTERNATIONAL 3800	6.8L V8 420 CID		
	US3408	1985-1986	RENAULT ENCORE	1.7L L4 105 CID	1991	INTERNATIONAL 4900	7.3L V8 444 CID	
		1985-1987	RENAULT ALLIANCE	1.7L L4 105 CID	1992-1993	INTERNATIONAL 3600	7.3L V8 444 CID	
US4002	1975-1977	FORD GRANADA	3.3L L6 200 CID					

USMW	Years	Application	Engine	USMW	Years	Application	Engine	
US4002	1975-1977	FORD MAVERICK	3.3L L6 200 CID	US4018	1983-1987	FORD E-350 ECONOLINE	6.9L V8 420 CID	
	1975-1977	MERCURY COMET	3.3L L6 200 CID		1983-1987	FORD E-350 ECONOLINE CLUB WAGON	6.9L V8 420 CID	
	1975-1977	MERCURY MONARCH	3.3L L6 200 CID		1983-1987	FORD F-250	6.9L V8 420 CID	
	1978-1983	FORD FAIRMONT	3.3L L6 200 CID		1983-1987	FORD F-350	6.9L V8 420 CID	
	1978-1983	MERCURY ZEPHYR	3.3L L6 200 CID		1988-1991	FORD E-250 ECONOLINE CLUB WAGON	7.3L V8 445 CID	
	1979-1982	FORD MUSTANG	3.3L L6 200 CID		1988-1994	FORD E-350 ECONOLINE	7.3L V8 445 CID	
	1979-1982	MERCURY CAPRI	3.3L L6 200 CID		1988-1994	FORD E-350 ECONOLINE CLUB WAGON	7.3L V8 445 CID	
	1980-1982	FORD THUNDERBIRD	3.3L L6 200 CID		1988-1994	FORD F-250	7.3L V8 445 CID	
	1980-1982	MERCURY COUGAR	3.3L L6 200 CID		1988-1994	FORD F-350	7.3L V8 445 CID	
	1981-1982	FORD GRANADA	3.3L L6 200 CID		1988-1994	FORD F SUPER DUTY	7.3L V8 445 CID	
	1983	FORD LTD	3.3L L6 200 CID		1993-1997	FORD F59	7.3L V8 445 CID	
	1983	MERCURY MARQUIS	3.3L L6 200 CID					
	US4003	1978-1980	FORD FIESTA		1.6L L4 1598cc 98 CID	US4020	1983	FORD E-100 ECONOLINE
US4005	1975-1977	MERCURY CAPRI	2.3L L4 140 CID	1983	FORD E-100 ECONOLINE CLUB WAGON		4.9L L6 4917cc 300 CID	
	1975-1978	FORD MUSTANG II	2.3L L4 140 CID	1983	FORD F-100		4.9L L6 4917cc 300 CID	
	1975-1980	FORD PINTO	2.3L L4 140 CID	1983-1986	FORD BRONCO		4.9L L6 4917cc 300 CID	
	1975-1980	MERCURY BOBCAT	2.3L L4 140 CID	1983-1986	FORD E-150 ECONOLINE		4.9L L6 4917cc 300 CID	
	1977-1982	FORD COURIER	2.3L L4 140 CID	1983-1986	FORD E-150 ECONOLINE CLUB WAGON		4.9L L6 4917cc 300 CID	
	1978-1982	FORD FAIRMONT	2.3L L4 140 CID	1983-1986	FORD E-250 ECONOLINE		4.9L L6 4917cc 300 CID	
	1978-1982	MERCURY ZEPHYR	2.3L L4 140 CID	1983-1986	FORD E-250 ECONOLINE CLUB WAGON		4.9L L6 4917cc 300 CID	
	1979-1982	FORD MUSTANG	2.3L L4 140 CID	1983-1986	FORD E-350 ECONOLINE		4.9L L6 4917cc 300 CID	
	1979-1982	MERCURY CAPRI	2.3L L4 140 CID	1983-1986	FORD E-350 ECONOLINE CLUB WAGON		4.9L L6 4917cc 300 CID	
	1981-1982	FORD GRANADA	2.3L L4 140 CID	1983-1986	FORD F-150		4.9L L6 4917cc 300 CID	
	1979-1981	MERCURY GRAND MARQUIS	5.8L V8 351 CID	1983-1986	FORD F-250		4.9L L6 4917cc 300 CID	
	1979-1988	MERCURY GRAND MARQUIS	5.0L V8 302 CID	1983-1986	FORD F-350		4.9L L6 4917cc 300 CID	
1980	LINCOLN CONTINENTAL	5.8L V8 351 CID	US4022	1984-1985	FORD TOPAZ	2.3L L4 2300cc 140 CID		
1980	LINCOLN MARK VI	5.8L V8 351 CID		1984-1989	MERCURY TOPAZ	2.3L L4 2300cc 140 CID		
1980-1981	FORD THUNDERBIRD	5.0L V8 302 CID		1984-1991	FORD TEMPO	2.3L L4 140 CID		
1980-1981	MERCURY COUGAR	5.0L V8 302 CID		1984-1991	MERCURY TOPAZ	2.3L L4 140 CID		
1980-1981	MERCURY MARQUIS	5.8L V8 351 CID		1986-1991	FORD TOPAZ	2.3L L4 2294cc 140 CID		
1980-1982	FORD THUNDERBIRD	4.2L V8 255 CID		1990	FORD GHIA	2.3L L4 2300cc 140 CID		
1980-1982	MERCURY COUGAR	4.2L V8 255 CID		US4023	1983-1985	FORD RANGER	2.8L V6 171 CID	
1980-1982	MERCURY MARQUIS	5.0L V8 302 CID			1984-1985	FORD BRONCO II	2.8L V6 171 CID	
1980-1983	LINCOLN MARK VI	5.0L V8 302 CID		1986	FORD AEROSTAR	2.8L V6 171 CID		
1980-1986	FORD LTD	5.0L V8 302 CID		US4024	1974	FORD MUSTANG	5.0L V8 5000cc 302 CID	
1980-1986	FORD LTD	5.8L V8 351 CID			1979	FORD MUSTANG	5.0L V8 302 CID	
1981-1982	FORD LTD	4.2L V8 255 CID			1979	MERCURY CAPRI	5.0L V8 302 CID	
1981-1982	MERCURY GRAND MARQUIS	4.2L V8 255 CID	1979-1981		FORD MUSTANG	5.0L V8 5000cc 302 CID		
1981-1982	MERCURY MARQUIS	4.2L V8 255 CID	1980-1982		FORD MUSTANG	4.2L V8 255 CID		
1982-1988	LINCOLN TOWN CAR	5.0L V8 302 CID	1980-1982		MERCURY CAPRI	4.2L V8 255 CID		
1983-1984	LINCOLN CONTINENTAL	5.0L V8 302 CID	1982-1985		FORD MUSTANG	5.0L V8 302 CID		
1983-1985	FORD THUNDERBIRD	5.0L V8 302 CID	1982-1985		MERCURY CAPRI	5.0L V8 302 CID		
1983-1985	MERCURY COUGAR	5.0L V8 302 CID	1983-1984		FORD MUSTANG	5.0L V8 5000cc 302 CID		
1984	LINCOLN MARK VII	5.0L V8 302 CID	1985		FORD LTD	5.0L V8 302 CID		
1986	MERCURY GRAND MARQUIS	5.8L V8 351 CID	1985		LINCOLN CONTINENTAL	5.0L V8 302 CID		
1987-1988	FORD COUNTRY SQUIRE	5.0L V8 302 CID	1985		LINCOLN MARK VII	5.0L V8 302 CID		
1987-1988	FORD LTD CROWN VICTORIA	5.0L V8 302 CID	US4024H	1979	FORD MUSTANG	5.0L V8 302 CID		
1987-1988	MERCURY COLONY PARK	5.0L V8 302 CID		1979	MERCURY CAPRI	5.0L V8 302 CID		
1987-1991	FORD LTD CROWN VICTORIA	5.8L V8 351 CID		1980-1982	FORD MUSTANG	4.2L V8 255 CID		
US4014H	1979-1981	MERCURY GRAND MARQUIS		5.8L V8 351 CID	1980-1982	MERCURY CAPRI	4.2L V8 255 CID	
	1979-1988	MERCURY GRAND MARQUIS		5.0L V8 302 CID	1982-1985	FORD MUSTANG	5.0L V8 302 CID	
	1980	LINCOLN CONTINENTAL		5.8L V8 351 CID	1982-1985	MERCURY CAPRI	5.0L V8 302 CID	
	1980	LINCOLN MARK VI		5.8L V8 351 CID	1985	FORD LTD	5.0L V8 302 CID	
	1980-1981	FORD THUNDERBIRD		5.0L V8 302 CID	1985	LINCOLN CONTINENTAL	5.0L V8 302 CID	
	1980-1981	MERCURY COUGAR		5.0L V8 302 CID	1985	LINCOLN MARK VII	5.0L V8 302 CID	
	1980-1981	MERCURY MARQUIS		5.8L V8 351 CID	US4030N	1975-1978	FORD F-350	4.9L L6 4917cc 300 CID
	1980-1982	FORD THUNDERBIRD		4.2L V8 255 CID		1975-1982	FORD E-100 ECONOLINE	4.9L L6 4917cc 300 CID
	1980-1982	MERCURY COUGAR		4.2L V8 255 CID		1975-1982	FORD E-100 ECONOLINE CLUB WAGON	4.9L L6 4917cc 300 CID
	1980-1982	MERCURY MARQUIS	5.0L V8 302 CID	1975-1982		FORD E-150 ECONOLINE	4.9L L6 4917cc 300 CID	
	1980-1983	LINCOLN MARK VI	5.0L V8 302 CID	1975-1982		FORD E-150 ECONOLINE CLUB WAGON	4.9L L6 4917cc 300 CID	
	1980-1986	FORD LTD	5.0L V8 302 CID	1975-1982		FORD E-250 ECONOLINE	4.9L L6 4917cc 300 CID	
1980-1986	FORD LTD	5.8L V8 351 CID	1975-1982	FORD E-350 ECONOLINE		4.9L L6 4917cc 300 CID		
1981-1982	FORD LTD	4.2L V8 255 CID	1975-1982	FORD F-100		4.9L L6 4917cc 300 CID		
1981-1982	MERCURY GRAND MARQUIS	4.2L V8 255 CID	1975-1982	FORD F-150		4.9L L6 4917cc 300 CID		
1981-1982	MERCURY MARQUIS	4.2L V8 255 CID	1975-1982	FORD F-250		4.9L L6 4917cc 300 CID		
1982-1988	LINCOLN TOWN CAR	5.0L V8 302 CID	1977-1980	FORD E-250 ECONOLINE CLUB WAGON		4.9L L6 4917cc 300 CID		
1983-1984	LINCOLN CONTINENTAL	5.0L V8 302 CID	1977-1982	FORD E-350 ECONOLINE CLUB WAGON		4.9L L6 4917cc 300 CID		
1983-1985	FORD THUNDERBIRD	5.0L V8 302 CID	1979	FORD F-350	5.8L V8 351 CID			
1983-1985	MERCURY COUGAR	5.0L V8 302 CID	1980-1982	FORD BRONCO	4.9L L6 4917cc 300 CID			
1984	LINCOLN MARK VII	5.0L V8 302 CID	1980-1982	FORD F-350	4.9L L6 4917cc 300 CID			
1986	MERCURY GRAND MARQUIS	5.8L V8 351 CID	US4033	1975-1977	FORD E-150 ECONOLINE	4.9L L6 4917cc 300 CID		
1987-1988	FORD COUNTRY SQUIRE	5.0L V8 302 CID		1975-1977	FORD E-150 ECONOLINE CLUB WAGON	4.9L L6 4917cc 300 CID		
1987-1988	FORD LTD CROWN VICTORIA	5.0L V8 302 CID		1975-1977	FORD E-250 ECONOLINE	4.9L L6 4917cc 300 CID		
1987-1988	MERCURY COLONY PARK	5.0L V8 302 CID		1975-1977	FORD E-350 ECONOLINE	4.9L L6 4917cc 300 CID		
1987-1991	FORD LTD CROWN VICTORIA	5.8L V8 351 CID		1975-1977	FORD F-150	4.9L L6 4917cc 300 CID		
US4016	1982	FORD GRANADA		3.8L V6 232 CID	1975-1977	FORD F-250	4.9L L6 4917cc 300 CID	
	1982	LINCOLN CONTINENTAL		3.8L V6 232 CID	1975-1977	FORD F-350	4.9L L6 4917cc 300 CID	
	1982-1983	FORD F-100		3.8L V6 232 CID	1977	FORD E-250 ECONOLINE CLUB WAGON	4.9L L6 4917cc 300 CID	
	1982-1987	FORD THUNDERBIRD		3.8L V6 232 CID	1977	FORD E-350 ECONOLINE CLUB WAGON	4.9L L6 4917cc 300 CID	
	1982-1987	MERCURY COUGAR		3.8L V6 232 CID				
	1983-1986	FORD LTD		3.8L V6 232 CID				
	1983-1986	FORD MUSTANG		3.8L V6 232 CID				
	1983-1986	MERCURY CAPRI	3.8L V6 232 CID					
	1983-1986	MERCURY MARQUIS	3.8L V6 232 CID					
	1984	FORD THUNDERBIRD	3.8L V6 3800cc 232 CID					
	1984-1990	FORD F150	3.8L V6 3800cc 232 CID					
	1985-1987	FORD COUGAR	3.8L V6 3800cc 232 CID					
1987	FORD COUGAR	3.8L V6 3802cc 232 CID						
US4018	1983-1987	FORD E-250 ECONOLINE CLUB WAGON	6.9L V8 420 CID					

WATER PUMPS

USMWW	Years	Application	Engine	USMWW	Years	Application	Engine		
US4034	1986-1994	FORD TAURUS	3.0L V6 2986cc 182 CID	US4044	1994-1997	FORD F350	5.0L V8 5000cc 302 CID		
	1986-1994	MERCURY SABLE	3.0L V6 2986cc 182 CID		1996	FORD ECONOLINE SUPER DUTY	5.8L V8 351 CID		
US4035	1984-1985	FORD MUSTANG	5.0L V8 302 CID	1997	FORD F250	5.0L V8 5000cc 302 CID			
	1985	MERCURY CAPRI	5.0L V8 302 CID	1999-2002	FORD ECONOLINE WAGON	5.0L V8 5000cc 305 CID			
US4037	1980-1985	FORD L800	6.1L V8 370 CID	US4044H	1987-1989	FORD F-250	5.0L V8 302 CID		
	1980-1985	FORD L800	7.0L V8 429 CID		1987-1991	FORD E-250 ECONOLINE	5.0L V8 302 CID		
	1980-1985	FORD LN600	6.1L V8 370 CID		1987-1996	FORD BRONCO	5.0L V8 302 CID		
	1980-1985	FORD LN700	6.1L V8 370 CID		1987-1996	FORD E-150 ECONOLINE	5.0L V8 302 CID		
	1980-1985	FORD LN700	7.0L V8 429 CID		1987-1996	FORD E-150 ECONOLINE CLUB WAGON	5.0L V8 302 CID		
	1980-1985	FORD LN800	6.1L V8 370 CID		1987-1996	FORD F-150	5.0L V8 302 CID		
	1980-1985	FORD LN800	7.0L V8 429 CID		1988-1991	FORD E-250 ECONOLINE CLUB WAGON	5.8L V8 351 CID		
	1980-1986	FORD C600	6.1L V8 370 CID		1988-1996	FORD BRONCO	5.8L V8 351 CID		
	1980-1986	FORD C700	6.1L V8 370 CID		1988-1996	FORD E-150 ECONOLINE	5.8L V8 351 CID		
	1980-1986	FORD C700	7.0L V8 429 CID		1988-1996	FORD E-150 ECONOLINE CLUB WAGON	5.8L V8 351 CID		
	1980-1986	FORD C800	6.1L V8 370 CID		1988-1996	FORD E-250 ECONOLINE	5.8L V8 351 CID		
	1980-1986	FORD C800	7.0L V8 429 CID		1988-1996	FORD E-350 ECONOLINE	5.8L V8 351 CID		
	1980-1986	FORD FT800	6.1L V8 370 CID		1988-1996	FORD E-350 ECONOLINE CLUB WAGON	5.8L V8 351 CID		
	1980-1986	FORD FT800	7.0L V8 429 CID		1988-1996	FORD F-150	5.8L V8 351 CID		
	1980-1989	FORD B600	6.1L V8 370 CID		1988-1996	FORD F-250	5.8L V8 351 CID		
	1980-1989	FORD B700	6.1L V8 370 CID		1988-1997	FORD F-350	5.8L V8 351 CID		
	1980-1989	FORD B700	7.0L V8 429 CID		1991-1996	FORD F-250	5.0L V8 302 CID		
	1980-1990	FORD F800	7.0L V8 429 CID		1996	FORD ECONOLINE SUPER DUTY	5.8L V8 351 CID		
	1980-1991	FORD F600	6.1L V8 370 CID		US4048	1987-1989	FORD F-350	4.9L L6 4917cc 300 CID	
	1980-1991	FORD F700	6.1L V8 370 CID			1987-1991	FORD E-150 ECONOLINE	4.9L L6 4917cc 300 CID	
	1980-1991	FORD F800	6.1L V8 370 CID			1987-1991	FORD E-150 ECONOLINE CLUB WAGON	4.9L L6 4917cc 300 CID	
	1980-1994	FORD F600	7.0L V8 429 CID			1987-1991	FORD E-250 ECONOLINE	4.9L L6 4917cc 300 CID	
	1980-1998	FORD F700	7.0L V8 429 CID			1987-1991	FORD E-250 ECONOLINE CLUB WAGON	4.9L L6 4917cc 300 CID	
	1988-1989	FORD B600	7.0L V8 429 CID			1987-1991	FORD E-350 ECONOLINE	4.9L L6 4917cc 300 CID	
	1988-1990	FORD FT800	6.1L V8 370 CID			1987-1991	FORD E-350 ECONOLINE CLUB WAGON	4.9L L6 4917cc 300 CID	
	1988-1990	FORD FT800	7.0L V8 429 CID			1987-1992	FORD BRONCO	4.9L L6 4917cc 300 CID	
	1997-1998	FORD F800	7.0L V8 429 CID			1987-1992	FORD F-150	4.9L L6 4917cc 300 CID	
	US4038	1985-1992	LINCOLN MARK VII			5.0L V8 302 CID	1987-1992	FORD F-250	4.9L L6 4917cc 300 CID
		1986	MERCURY CAPRI		5.0L V8 302 CID	US4049	1986	MAZDA FAMILIA	1.5L L4 1490cc 91 CID
		1986-1987	LINCOLN CONTINENTAL		5.0L V8 302 CID		1986	MAZDA FAMILIA	1.6L L4 1597cc 97 CID
		1986-1988	FORD THUNDERBIRD		5.0L V8 302 CID		1986-1994	MAZDA 323	1.6L L4 1597cc
		1986-1988	MERCURY COUGAR		5.0L V8 302 CID		1988-1989	MERCURY TRACER	1.6L L4 1598cc 98 CID
	1986-1993	FORD MUSTANG	5.0L V8 302 CID		1988-1993		FORD FESTIVA	1.3L L4 1295cc	
US4038H	1985-1992	LINCOLN MARK VII	5.0L V8 302 CID	1990-1994	MAZDA PROTEGE		1.8L L4 1839cc		
	1986	MERCURY CAPRI	5.0L V8 302 CID	1992-1993	MAZDA MX-3		1.6L L4 1597cc		
	1986-1987	LINCOLN CONTINENTAL	5.0L V8 302 CID	1994-1995	KIA SEPHIA		1.6L L4 1597cc		
	1986-1988	FORD THUNDERBIRD	5.0L V8 302 CID	1994-1997	FORD ASPIRE		1.3L L4 1295cc		
	1986-1988	MERCURY COUGAR	5.0L V8 302 CID	US4050	1988-1989		FORD COUGAR	3.8L V6 3800cc 232 CID	
1986-1993	FORD MUSTANG	5.0L V8 302 CID	1988-1993		FORD COUGAR	3.8L V6 3802cc 232 CID			
US4039	1986-1994	FORD AEROSTAR	3.0L V6 2986cc 182 CID		1988-1993	FORD THUNDERBIRD	3.8L V6 232 CID		
	1991-1994	FORD RANGER	3.0L V6 2986cc 182 CID		1988-1993	MERCURY COUGAR	3.8L V6 232 CID		
	1994	MAZDA B3000	3.0L V6 2986cc 182 CID		1990-1994	FORD COUGAR	3.8L V6 3797cc 232 CID		
	US4040	1981-1985	FORD ESCORT		1.6L L4 1598cc 98 CID	US4051	1988-1993	FORD TAURUS	3.8L V6 232 CID
		1981-1985	MERCURY LYNX		1.6L L4 1598cc 98 CID		1988-1993	LINCOLN CONTINENTAL	3.8L V6 232 CID
1982-1983		MERCURY LN7	1.6L L4 1598cc 98 CID		1988-1993		MERCURY SABLE	3.8L V6 232 CID	
1982-1985		FORD EXP	1.6L L4 1598cc 98 CID		1991-1993		FORD F150	3.8L V6 3800cc 232 CID	
1985-1987		MERCURY LYNX	1.9L L4 116 CID		US4052		1979-1980	FORD LTD	5.8L V8 5800cc 351 CID
1985-1990	FORD ESCORT	1.9L L4 116 CID	1979-1981	MERCURY GRAND MARQUIS		5.8L V8 5800cc 351 CID			
1986-1988	FORD EXP	1.9L L4 116 CID	1988-1990	LINCOLN TOWN CAR		5.0L V8 302 CID			
US4041	1991-1992	FORD GHIA	2.3L L4 2300cc 140 CID	1988-1991		FORD COUNTRY SQUIRE	5.0L V8 302 CID		
	1992-1994	FORD TEMPO	2.3L L4 140 CID	1988-1991		FORD LTD CROWN VICTORIA	5.0L V8 302 CID		
	1992-1994	FORD TOPAZ	2.3L L4 2294cc 140 CID	1988-1991	MERCURY COLONY PARK	5.0L V8 302 CID			
	1992-1994	MERCURY TOPAZ	2.3L L4 140 CID	1988-1991	MERCURY GRAND MARQUIS	5.0L V8 302 CID			
	US4042	1986-1990	FORD BRONCO II	2.9L V6 177 CID	1991-1992	FORD GRAND MARQUIS	5.0L V8 5000cc 302 CID		
1986-1992		FORD RANGER	2.9L V6 177 CID	US4052H	1988-1990	LINCOLN TOWN CAR	5.0L V8 302 CID		
1988-1989		MERKUR SCORPIO	2.9L V6 177 CID		1988-1991	FORD COUNTRY SQUIRE	5.0L V8 302 CID		
1997		FORD BRONCO	2.9L L6 2901cc 177 CID		1988-1991	FORD LTD CROWN VICTORIA	5.0L V8 302 CID		
US4044		1986-1990	FORD F150		5.0L V8 5000cc 302 CID	1988-1991	MERCURY COLONY PARK	5.0L V8 302 CID	
	1986-1990	FORD F200	5.0L V8 5000cc 302 CID		1988-1991	MERCURY GRAND MARQUIS	5.0L V8 302 CID		
	1986-1990	FORD F200	5.8L V8 5800cc 351 CID		US4053	1987-1993	MAZDA B2200	2.2L L4 2184cc	
	1987-1989	FORD F-250	5.0L V8 302 CID			1988-1992	MAZDA 626	2.2L L4 2184cc	
	1987-1990	FORD F350	5.8L V8 5800cc 351 CID			1988-1992	MAZDA MX-6	2.2L L4 2184cc	
	1987-1991	FORD E-250 ECONOLINE	5.0L V8 302 CID			1989-1992	FORD PROBE	2.2L L4 133 CID	
	1987-1992	FORD B200	5.0L V8 5000cc 302 CID			1995	KIA SPORTAGE	2.0L L4 1998cc 122 CID	
	1987-1992	FORD F350	5.0L V8 5000cc 302 CID	US4054		1983	FORD FAIRMONT	2.3L L4 140 CID	
	1987-1996	FORD BRONCO	5.0L V8 302 CID			1983	MERCURY ZEPHYR	2.3L L4 140 CID	
	1987-1996	FORD E-150 ECONOLINE	5.0L V8 302 CID			1983-1986	FORD LTD	2.3L L4 140 CID	
	1987-1996	FORD E-150 ECONOLINE CLUB WAGON	5.0L V8 302 CID			1983-1986	MERCURY CAPRI	2.3L L4 140 CID	
	1987-1996	FORD F-150	5.0L V8 302 CID			1983-1986	MERCURY MARQUIS	2.3L L4 140 CID	
	1988-1991	FORD E-250 ECONOLINE CLUB WAGON	5.8L V8 351 CID		1983-1988	FORD RANGER	2.0L L4 1989cc 122 CID		
	1988-1996	FORD BRONCO	5.8L V8 351 CID		1983-1988	FORD THUNDERBIRD	2.3L L4 140 CID		
	1988-1996	FORD E-150 ECONOLINE	5.8L V8 351 CID		1983-1993	FORD MUSTANG	2.3L L4 140 CID		
1988-1996	FORD E-150 ECONOLINE CLUB WAGON	5.8L V8 351 CID	1983-1994		FORD RANGER	2.3L L4 140 CID			
1988-1996	FORD E-250 ECONOLINE	5.8L V8 351 CID	1984-1986		MERCURY COUGAR	2.3L L4 140 CID			
1988-1996	FORD E-350 ECONOLINE	5.8L V8 351 CID	1985-1989	MERKUR XR4TI	2.3L L4 140 CID				
1988-1996	FORD E-350 ECONOLINE CLUB WAGON	5.8L V8 351 CID	1986-1987	FORD AEROSTAR	2.3L L4 140 CID				
1988-1996	FORD F-150	5.8L V8 351 CID	1994	MAZDA B2300	2.3L L4 140 CID				
1988-1996	FORD F-250	5.8L V8 351 CID	US4055	1990	MERCURY COUGAR	3.8L V6 232 CID			
1988-1997	FORD F-350	5.8L V8 351 CID		1990-1995	FORD THUNDERBIRD	3.8L V6 232 CID			
1988-1997	FORD P350	5.8L V8 351 CID		US4056	1986	MERCURY SABLE	2.5L L4 153 CID		
1988-1997	FORD P350	5.8L V8 5800cc 351 CID							
1989-1991	FORD P350	5.0L V8 5000cc 302 CID							
1991-1996	FORD F-250	5.0L V8 302 CID							

USMW	Years	Application	Engine	USMW	Years	Application	Engine
US4056	1986-1991	FORD TAURUS	2.5L L4 153 CID	US4088	1994-1995	FORD MYSTIQUE	2.0L L4 1984cc 121 CID
US4057	1991-1993	FORD COUGAR	5.0L V8 5000cc 302 CID	1995-1997	FORD CONTOUR	2.0L L4 1989cc 121 CID	
	1991-1993	FORD THUNDERBIRD	5.0L V8 302 CID	1995-1997	MERCURY MYSTIQUE	2.0L L4 1989cc 121 CID	
	1991-1993	MERCURY COUGAR	5.0L V8 302 CID	US4089	1994	FORD WINDSTAR	3.8L V6 3800cc 232 CID
	1994	FORD COUGAR	4.9L V8 4900cc 299 CID	1994	LINCOLN CONTINENTAL	3.8L V6 232 CID	
US4059	1990-1992	FORD PROBE	3.0L V6 2986cc 182 CID	1994-1995	FORD F150	3.8L V6 3800cc 232 CID	
US4060	1990	FORD EXPLORER	4.0L L6 4018cc 245 CID	1994-1995	FORD SABLE	3.8L V6 3800cc 232 CID	
	1990-1997	FORD AEROSTAR	4.0L V6 245 CID	1994-1995	FORD TAURUS	3.8L V6 232 CID	
	1990-2000	FORD RANGER	4.0L V6 245 CID	1994-1995	MERCURY SABLE	3.8L V6 232 CID	
	1991-1994	MAZDA NAVAJO	4.0L V6 4016cc	1995	FORD WINDSTAR	3.8L V6 232 CID	
	1991-2000	FORD EXPLORER	4.0L V6 245 CID	US4090	1994-1995	FORD COUGAR	3.8L V6 3802cc 232 CID
	1994-2000	MAZDA B4000	4.0L V6 4016cc	1994-1995	FORD MUSTANG	3.8L V6 232 CID	
US4061	1989-1995	FORD TAURUS	3.0L V6 2986cc 182 CID	1994-1995	FORD THUNDERBIRD	3.8L V6 232 CID	
US4062	1986-1990	FORD CF6000	6.6L L6 401 CID	1994-1995	MERCURY COUGAR	3.8L V6 232 CID	
	1986-1990	FORD CF7000	6.6L L6 401 CID	US4091	1995-2000	FORD CONTOUR	2.5L V6 2450cc 155 CID
	1986-1990	FORD F600	6.6L L6 401 CID	1995-2000	FORD MYSTIQUE	2.5L V6 2544cc 155 CID	
	1986-1990	FORD F700	6.6L L6 401 CID	1995-2000	MERCURY MYSTIQUE	2.5L V6 2450cc 155 CID	
	1986-1990	FORD F800	7.8L L6 473 CID	1999-2002	MERCURY COUGAR	2.5L V6 2450cc 155 CID	
	1987	FORD B700	7.8L L6 473 CID	2000-2001	MAZDA MPV	2.5L V6 2450cc 155 CID	
	1987	FORD CF8000	6.6L L6 401 CID	2001-2003	FORD ESCAPE	3.0L V6 2968cc 181 CID	
	1987-1988	FORD LN7000	7.8L L6 473 CID	2001-2003	FORD TAURUS	3.0L V6 2968cc 181 CID	
	1987-1989	FORD F600	7.8L L6 473 CID	2001-2003	MERCURY SABLE	3.0L V6 2968cc 181 CID	
	1987-1990	FORD B600	6.6L L6 401 CID	2001-2004	MAZDA TRIBUTE	3.0L V6 2968cc 181 CID	
	1987-1990	FORD B700	6.6L L6 401 CID	2001-2007	FORD MONDEO	2.5L V6 2544cc 155 CID	
	1987-1990	FORD CF8000	7.8L L6 473 CID	2002-2003	MAZDA MPV	3.0L V6 2968cc 181 CID	
	1987-1990	FORD F700	7.8L L6 473 CID	2005	FORD MONDEO	3.0L V6 2966cc 181 CID	
	1987-1990	FORD F800	6.6L L6 401 CID	US4091-2	1995-2000	FORD CONTOUR	2.5L V6 2450cc 155 CID
	1987-1990	FORD LN7000	6.6L L6 401 CID	1995-2000	MERCURY MYSTIQUE	2.5L V6 2450cc 155 CID	
	1987-1990	FORD LN8000	7.8L L6 473 CID	1999-2002	MERCURY COUGAR	2.5L V6 2450cc 155 CID	
	1990	FORD B700	7.8L L6 473 CID	2001-2003	FORD ESCAPE	3.0L V6 2968cc 181 CID	
	1990	FORD F600 LPO	6.6L L6 401 CID	2001-2003	FORD TAURUS	3.0L V6 2968cc 181 CID	
US4065	1991	FORD ESCORT	1.9L L4 116 CID	2001-2003	MERCURY SABLE	3.0L V6 2968cc 181 CID	
	1991	MERCURY TRACER	1.9L L4 116 CID	US4093	1995-1997	FORD RANGER	2.3L L4 140 CID
US4066	1991-1997	LINCOLN TOWN CAR	4.6L V8 281 CID	1995-1997	MAZDA B2300	2.3L L4 140 CID	
	1992-1997	FORD CROWN VICTORIA	4.6L V8 281 CID	1998-2001	FORD RANGER	2.5L L4 153 CID	
	1992-1997	FORD GRAND MARQUIS	4.6L V8 4608cc 281 CID	1998-2001	MAZDA B2500	2.5L L4 2492cc	
	1992-1997	MERCURY GRAND MARQUIS	4.6L V8 281 CID	US4094	1995-2000	FORD WINDSTAR	3.0L V6 2986cc 182 CID
US4068	1988-1989	MAZDA 323	1.6L L4 1597cc	1995-2005	MERCURY SABLE	3.0L V6 2986cc 182 CID	
	1990-1992	MAZDA PROTEGE	1.8L L4 1839cc	1995-2007	FORD TAURUS	3.0L V6 2986cc 182 CID	
	1990-1993	MAZDA MIATA	1.6L L4 1597cc	1996-1997	FORD SABLE	3.0L V6 3000cc 183 CID	
	1991-1994	MERCURY CAPRI	1.6L L4 1598cc 98 CID	1998-2002	FORD SABLE	3.0L V6 2966cc 181 CID	
	1991-1996	FORD ESCORT	1.8L L4 112 CID	2003	MERCURY SABLE	3.0L V6 2968cc 181 CID	
	1991-1996	MERCURY TRACER	1.8L L4 112 CID	US4095	1995-1996	MAZDA B3000	3.0L V6 2986cc 182 CID
US4069	1991-1996	FORD ESCORT	1.9L L4 116 CID	1995-1997	FORD AEROSTAR	3.0L V6 2986cc 182 CID	
	1991-1996	MERCURY TRACER	1.9L L4 116 CID	1995-2008	FORD RANGER	3.0L V6 2986cc 182 CID	
	1996-1997	FORD VAGONETA	1.9L L4 1900cc 114 CID	1998-2007	MAZDA B3000	3.0L V6 2986cc 182 CID	
US4070	1992-1993	FORD TOPAZ	3.0L V6 2985cc 182 CID	US4096	1994	FORD F59	7.3L V8 445 CID
	1992-1994	FORD GHIA	3.0L V6 2985cc 182 CID	1994-1996	FORD F-250	7.3L V8 445 CID	
	1992-1994	FORD TEMPO	3.0L V6 2986cc 182 CID	1994-1996	FORD F-350	7.3L V8 445 CID	
	1992-1994	MERCURY TOPAZ	3.0L V6 2986cc 182 CID	1995-1996	FORD E-350 ECONOLINE	7.3L V8 445 CID	
US4077	1992-1994	FORD E-350 ECONOLINE	7.5L V8 460 CID	1995-1996	FORD E-350 ECONOLINE CLUB WAGON	7.3L V8 445 CID	
	1992-1994	FORD E-350 ECONOLINE CLUB WAGON	7.5L V8 460 CID	1995-1996	FORD F SUPER DUTY	7.3L V8 445 CID	
	1992-1994	FORD F-250	7.5L V8 460 CID	1996	FORD ECONOLINE SUPER DUTY	7.3L V8 445 CID	
	1992-1994	FORD F-350	7.5L V8 460 CID	US4097	1995-2002	LINCOLN CONTINENTAL	4.6L V8 281 CID
	1992-1994	FORD F SUPER DUTY	7.5L V8 460 CID	US4098	1996-2000	FORD TAURUS	3.0L V6 2968cc 181 CID
US4078	1993-1997	FORD PROBE	2.0L L4 1989cc 122 CID	1996-2000	MERCURY SABLE	3.0L V6 2968cc 181 CID	
	1993-1997	MAZDA MX-6	2.0L L4 1991cc	US4099	1993-1994	FORD F-350	4.9L L6 4917cc 300 CID
	1993-2002	MAZDA 626	2.0L L4 1991cc	1993-1996	FORD E-150 ECONOLINE	4.9L L6 4917cc 300 CID	
	1999-2000	MAZDA PROTEGE	1.8L L4 1839cc	1993-1996	FORD E-150 ECONOLINE CLUB WAGON	4.9L L6 4917cc 300 CID	
	2001-2003	MAZDA PROTEGE	2.0L L4 2000cc	1993-1996	FORD E-250 ECONOLINE	4.9L L6 4917cc 300 CID	
	2002-2003	MAZDA PROTEGE5	2.0L L4 2000cc	1993-1996	FORD E-350 ECONOLINE	4.9L L6 4917cc 300 CID	
US4079	1992	FORD E-150 ECONOLINE	4.9L L6 4917cc 300 CID	1993-1996	FORD E-350 ECONOLINE CLUB WAGON	4.9L L6 4917cc 300 CID	
	1992	FORD E-150 ECONOLINE CLUB WAGON	4.9L L6 4917cc 300 CID	1993-1996	FORD F-150	4.9L L6 4917cc 300 CID	
	1992	FORD E-250 ECONOLINE	4.9L L6 4917cc 300 CID	1993-1996	FORD F-250	4.9L L6 4917cc 300 CID	
	1992	FORD E-350 ECONOLINE	4.9L L6 4917cc 300 CID	1997	FORD F150	4.9L L6 4900cc 300 CID	
	1992	FORD E-350 ECONOLINE CLUB WAGON	4.9L L6 4917cc 300 CID	US4101	1996-2001	FORD EXPLORER	5.0L V8 302 CID
US4081	1987-1989	FORD E-350 ECONOLINE	7.5L V8 460 CID	1997-2001	MERCURY MOUNTAINEER	5.0L V8 302 CID	
	1988-1989	FORD E-250 ECONOLINE CLUB WAGON	7.5L V8 460 CID	US4102	1996-2003	FORD WINDSTAR	3.8L V6 232 CID
	1988-1989	FORD E-350 ECONOLINE CLUB WAGON	7.5L V8 460 CID	2004-2007	FORD FREESTAR	3.9L V6 238 CID	
	1988-1989	FORD F-250	7.5L V8 460 CID	2004-2007	FORD FREESTAR	4.2L V6 256 CID	
	1988-1989	FORD F-350	7.5L V8 460 CID	2004-2007	MERCURY MONTEREY	4.2L V6 256 CID	
US4082	1993-1995	FORD TAURUS	3.2L V6 195 CID	US4103	1996	FORD COUGAR	3.8L L6 3802cc 232 CID
US4083	1984	FORD E-250 ECONOLINE	4.9L L6 4917cc 300 CID	1996-1997	FORD THUNDERBIRD	3.8L V6 232 CID	
	1984	FORD E-250 ECONOLINE CLUB WAGON	4.9L L6 4917cc 300 CID	1996-1997	MERCURY COUGAR	3.8L V6 232 CID	
	1984	FORD E-350 ECONOLINE	4.9L L6 4917cc 300 CID	1996-2004	FORD MUSTANG	3.8L V6 232 CID	
	1984	FORD E-350 ECONOLINE CLUB WAGON	4.9L L6 4917cc 300 CID	2004	FORD MUSTANG	3.9L V6 238 CID	
US4086	1995-1996	FORD E-350 ECONOLINE	7.5L V8 460 CID	US4104	1998-2000	FORD FIESTA	1.4L L4 1388cc 85 CID
	1995-1996	FORD E-350 ECONOLINE CLUB WAGON	7.5L V8 460 CID	US4105	1997-2002	FORD E-150 ECONOLINE	4.2L V6 256 CID
	1995-1997	FORD F-250	7.5L V8 460 CID	1997-2002	FORD E-150 ECONOLINE CLUB WAGON	4.2L V6 256 CID	
	1995-1997	FORD F-350	7.5L V8 460 CID	1997-2002	FORD E-250 ECONOLINE	4.2L V6 256 CID	
	1995-1997	FORD F SUPER DUTY	7.5L V8 460 CID	1997-2003	FORD F-150	4.2L V6 256 CID	
	1996	FORD ECONOLINE SUPER DUTY	7.5L V8 460 CID	1999-2002	FORD ECONOLINE WAGON	4.2L V6 4195cc 256 CID	
US4087	1994-1995	FORD MUSTANG	5.0L V8 302 CID	2003	FORD E-150	4.2L V6 256 CID	
				2003	FORD E-150 CLUB WAGON	4.2L V6 256 CID	
				2003	FORD E-250	4.2L V6 256 CID	
				2004	FORD F-150 HERITAGE	4.2L V6 256 CID	

USMW	Years	Application	Engine	USMW	Years	Application	Engine
US4105	2005-2008	FORD F-150	4.2L V6 256 CID	US4124	2002-2005	FORD THUNDERBIRD	3.9L V8 242 CID
US4106	1996-1999	FORD TAURUS	3.4L V8 207 CID	2003-2006	JAGUAR XK8	4.2L V8 4196cc	
US4107	1997-1999	MERCURY TRACER	2.0L L4 1989cc 121 CID	2003-2008	JAGUAR S-TYPE	4.2L V8 4196cc	
	1997-2002	FORD ESCORT	2.0L L4 1989cc 121 CID	2003-2009	JAGUAR XKR	4.2L V8 4196cc	
US4108	1997-2010	FORD EXPLORER	4.0L V6 245 CID	2004-2009	JAGUAR VANDEN PLAS	4.2L V8 4196cc	
	1998-2010	MERCURY MOUNTAINEER	4.0L V6 245 CID	2004-2009	JAGUAR XJ8	4.2L V8 4196cc	
	2001-2005	FORD EXPLORER SPORT TRAC	4.0L V6 245 CID	2004-2009	JAGUAR XJR	4.2L V8 4196cc	
	2001-2009	MAZDA B4000	4.0L V6 4016cc	2005-2009	JAGUAR SUPER V8	4.2L V8 4196cc	
	2001-2011	FORD RANGER	4.0L V6 245 CID	2005-2009	LAND ROVER LR3	4.4L V8 4394cc	
	2005-2010	FORD MUSTANG	4.0L V6 245 CID	2006-2009	LAND ROVER RANGE ROVER	4.2L V8 4196cc	
	2007-2010	FORD EXPLORER SPORT TRAC	4.0L V6 245 CID	2006-2009	LAND ROVER RANGE ROVER	4.4L V8 4394cc	
US4109	1997-1998	FORD E-350 ECONOLINE	6.8L V10 415 CID	2006-2009	LAND ROVER RANGE ROVER SPORT	4.2L V8 4196cc	
	1997-1999	FORD ECONOLINE SUPER DUTY	6.8L V10 415 CID	2006-2009	LAND ROVER RANGE ROVER SPORT	4.4L V8 4394cc	
	1997-2002	FORD E-350 ECONOLINE CLUB WAGON	6.8L V10 415 CID	2007-2009	JAGUAR XK	4.2L V8 4196cc	
	1999-2008	FORD F-450 SUPER DUTY	6.8L V10 415 CID	2009-2010	JAGUAR XF	4.2L V8 4196cc	
	1999-2008	FORD F-550 SUPER DUTY	6.8L V10 415 CID	US4125	1999-2010	FORD LOBO	5.4L V8 5409cc 330 CID
	1999-2009	FORD E-350 SUPER DUTY	6.8L V10 415 CID	2001-2003	FORD F-150	5.4L V8 330 CID	
	1999-2009	FORD F-250 SUPER DUTY	6.8L V10 415 CID	2004	FORD F-150 HERITAGE	5.4L V8 330 CID	
	1999-2009	FORD F-350 SUPER DUTY	6.8L V10 415 CID	2007	FORD LOBO	4.6L V8 4608cc 281 CID	
	2000-2002	FORD E-450 ECONOLINE SUPER DUTY	6.8L V10 415 CID	US4126	2001-2007	FORD MONDEO	2.0L L4 1999cc 122 CID
	2000-2005	FORD EXCURSION	6.8L V10 415 CID	2001-2009	MAZDA B2300	2.3L L4 140 CID	
	2002	FORD E-550 ECONOLINE SUPER DUTY	6.8L V10 415 CID	2001-2011	FORD RANGER	2.3L L4 140 CID	
	2003	FORD E-350 CLUB WAGON	6.8L V10 415 CID	2003-2007	FORD FOCUS	2.3L L4 140 CID	
	2003	FORD E-550 SUPER DUTY	6.8L V10 415 CID	2003-2008	MAZDA 6	2.3L L4 2260cc	
	2003-2009	FORD E-450 SUPER DUTY	6.8L V10 415 CID	2004-2005	MAZDA 3	2.0L L4 2000cc 122 CID	
	2005	FORD E-350 CLUB WAGON	6.8L V10 415 CID	2004-2005	MAZDA 3	2.3L L4 2260cc	
	2014	FORD F-450	6.8L V10 6751cc 412 CID	2005-2006	MAZDA TRIBUTE	2.3L L4 140 CID	
	2014	FORD F-550	6.8L V10 6751cc 412 CID	2005-2008	FORD ESCAPE	2.3L L4 140 CID	
	2015-2018	FORD F53	6.8L V10 415 CID	2005-2008	MERCURY MARINER	2.3L L4 140 CID	
	2015-2018	FORD F59	6.8L V10 415 CID	2005-2011	FORD ECOSPORT	2.0L L4 1999cc 122 CID	
	2016-2017	FORD E-450 SUPER DUTY	6.8L V10 415 CID	2005-2018	FORD FOCUS	2.0L L4 1999cc 122 CID	
	2016-2018	FORD E-350 SUPER DUTY	6.8L V10 415 CID	2006-2007	MAZDA 5	2.3L L4 2260cc	
	2016-2018	FORD F-450 SUPER DUTY	6.8L V10 415 CID	2006-2009	FORD FUSION	2.3L L4 140 CID	
	2016-2018	FORD F-550 SUPER DUTY	6.8L V10 415 CID	2006-2009	MERCURY MILAN	2.3L L4 140 CID	
US4113	1993-1998	LINCOLN MARK VIII	4.6L V8 281 CID	2007-2011	FORD FOCUS	2.0L L4 1989cc 121 CID	
	1994-1997	FORD THUNDERBIRD	4.6L V8 281 CID	2007-2012	MAZDA CX-7	2.3L L4 2260cc	
	1994-1997	MERCURY COUGAR	4.6L V8 281 CID	2007-2013	MAZDA 3	2.3L L4 2260cc	
	1996-1998	FORD MUSTANG	4.6L V8 281 CID	2008	MAZDA TRIBUTE	2.3L L4 140 CID	
	1998-2001	FORD GRAND MARQUIS	4.6L V8 4608cc 281 CID	2009-2010	MAZDA 6	2.5L L4 2488cc 152 CID	
	1998-2002	FORD CROWN VICTORIA	4.6L V8 281 CID	2009-2011	MAZDA TRIBUTE	2.5L L4 2488cc 152 CID	
	1998-2002	LINCOLN TOWN CAR	4.6L V8 281 CID	2009-2011	MERCURY MARINER	2.5L L4 2488cc 152 CID	
	1998-2002	MERCURY GRAND MARQUIS	4.6L V8 281 CID	2009-2018	FORD ESCAPE	2.5L L4 2488cc 152 CID	
	2005-2006	FORD MUSTANG	4.6L V8 281 CID	2010-2011	MERCURY MILAN	2.5L L4 2488cc 152 CID	
US4114	1996	FORD F-250	7.3L V8 445 CID	2010-2013	FORD TRANSIT CONNECT	2.0L L4 1999cc 122 CID	
	1996-1997	FORD F-350	7.3L V8 445 CID	2010-2018	FORD FUSION	2.5L L4 2488cc 152 CID	
	1996-1997	FORD F SUPER DUTY	7.3L V8 445 CID	2011-2012	LINCOLN MKZ	2.5L L4 2488cc 152 CID	
	1996-1998	FORD E-350 ECONOLINE	7.3L V8 445 CID	2012-2015	FORD EDGE	2.0L L4 1999cc 122 CID	
	1996-1999	FORD ECONOLINE SUPER DUTY	7.3L V8 445 CID	2012-2015	FORD EXPLORER	2.0L L4 1999cc 122 CID	
	1996-2002	FORD E-350 ECONOLINE CLUB WAGON	7.3L V8 445 CID	2013-2016	FORD ESCAPE	2.0L L4 1999cc 122 CID	
	1999-2003	FORD E-350 SUPER DUTY	7.3L V8 445 CID	2013-2016	FORD FUSION	2.0L L4 1999cc 122 CID	
	1999-2003	FORD F-250 SUPER DUTY	7.3L V8 445 CID	2013-2016	LINCOLN MKT	2.0L L4 1999cc 122 CID	
	1999-2003	FORD F-350 SUPER DUTY	7.3L V8 445 CID	2013-2016	LINCOLN MKZ	2.0L L4 1999cc 122 CID	
	1999-2003	FORD F-450 SUPER DUTY	7.3L V8 445 CID	2013-2017	FORD TAURUS	2.0L L4 1999cc 122 CID	
	1999-2003	FORD F-550 SUPER DUTY	7.3L V8 445 CID	2014-2018	FORD SPECIAL SERVICE POLICE SEDAN	2.0L L4 1999cc 122 CID	
	2000-2002	FORD E-450 ECONOLINE SUPER DUTY	7.3L V8 445 CID	2014-2018	FORD TRANSIT CONNECT	2.5L L4 2488cc 152 CID	
	2000-2003	FORD EXCURSION	7.3L V8 445 CID	2015-2016	LINCOLN MKC	2.0L L4 1999cc 122 CID	
	2002	FORD E-550 ECONOLINE SUPER DUTY	7.3L V8 445 CID	2018	FORD ECOSPORT	2.0L L4 1999cc 122 CID	
	2003	FORD E-350 CLUB WAGON	7.3L V8 445 CID	US4128	2001-2004	FORD MUSTANG	4.6L V8 281 CID
	2003	FORD E-450 SUPER DUTY	7.3L V8 445 CID	2001-2011	FORD CROWN VICTORIA	4.6L V8 281 CID	
	2003	FORD E-550 SUPER DUTY	7.3L V8 445 CID	2001-2011	LINCOLN TOWN CAR	4.6L V8 281 CID	
US4115	1998-2000	FORD CONTOUR	2.0L L4 1989cc 121 CID	2001-2011	MERCURY GRAND MARQUIS	4.6L V8 281 CID	
	1998-2000	MERCURY MYSTIQUE	2.0L L4 1989cc 121 CID	2002-2004	FORD GRAND MARQUIS	4.6L V8 4608cc 281 CID	
	1998-2003	FORD ESCORT	2.0L L4 1989cc 121 CID	2003	LINCOLN BLACKWOOD	5.4L V8 5409cc 330 CID	
	1999	FORD CONTOUR	2.5L V6 2450cc 155 CID	2003-2004	MERCURY MARAUDER	4.6L V8 281 CID	
	1999-2002	MERCURY COUGAR	2.0L L4 1989cc 121 CID	US4129	2003-2005	LINCOLN LS	3.0L V6 2968cc 181 CID
	2000-2004	FORD FOCUS	2.0L L4 1989cc 121 CID	2003-2008	JAGUAR S-TYPE	3.0L V6 2968cc 181 CID	
	2001-2004	FORD ESCAPE	2.0L L4 1989cc 121 CID	US4132	2003-2005	FORD TAURUS	3.0L V6 2968cc 181 CID
	2001-2004	MAZDA TRIBUTE	2.0L L4 1989cc 121 CID	2003-2005	MERCURY SABLE	3.0L V6 2968cc 181 CID	
	2004	FORD ECOSPORT	2.0L L4 1984cc 121 CID	2003-2006	FORD ESCAPE	3.0L V6 2968cc 181 CID	
US4118	2000-2002	JAGUAR S-TYPE	3.0L V6 2968cc 181 CID	2003-2006	MAZDA MPV	3.0L V6 2968cc 181 CID	
	2000-2002	LINCOLN LS	3.0L V6 2968cc 181 CID	2005-2006	MAZDA TRIBUTE	3.0L V6 2968cc 181 CID	
US4119	1999-2004	FORD MUSTANG	4.6L V8 281 CID	2005-2006	MERCURY MARINER	3.0L V6 2968cc 181 CID	
	2007-2010	FORD MUSTANG	4.6L V8 281 CID	2008	MAZDA TRIBUTE	3.0L V6 2968cc 181 CID	
US4121	1999-2001	FORD F-150	5.4L V8 330 CID	US4132-2	2003-2005	FORD TAURUS	3.0L V6 2968cc 181 CID
	2000	FORD F350	5.4L V8 5409cc 330 CID	2003-2005	MERCURY SABLE	3.0L V6 2968cc 181 CID	
US4123	2000-2004	FORD FOCUS	2.0L L4 1989cc 121 CID	2003-2006	FORD ESCAPE	3.0L V6 2968cc 181 CID	
US4124	1997-2002	JAGUAR XK8	4.0L V8 3996cc 244 CID	2005-2006	MERCURY MARINER	3.0L V6 2968cc 181 CID	
	1998-2003	JAGUAR VANDEN PLAS	4.0L V8 3996cc 244 CID	US5000	1980-1983	CHEVROLET CITATION	2.5L L4 2474cc 151 CID
	1998-2003	JAGUAR XJ8	4.0L V8 3996cc 244 CID	1980-1984	OLDSMOBILE OMEGA	2.5L L4 2474cc 151 CID	
	1998-2003	JAGUAR XJR	4.0L V8 3996cc 244 CID	1980-1984	PONTIAC PHOENIX	2.5L L4 2474cc 151 CID	
	2000-2002	JAGUAR S-TYPE	4.0L V8 3996cc 244 CID	1980-1991	BUICK SKYLARK	2.5L L4 2474cc 151 CID	
	2000-2002	JAGUAR XKR	4.0L V8 3996cc 244 CID	1982-1986	BUICK CENTURY	2.5L L4 2474cc 151 CID	
	2000-2006	LINCOLN LS	3.9L V8 242 CID	1982-1986	CHEVROLET CELEBRITY	2.5L L4 2474cc 151 CID	
				1982-1986	OLDSMOBILE CUTLASS CIERA	2.5L L4 2474cc 151 CID	
				1982-1986	PONTIAC 6000	2.5L L4 2474cc 151 CID	
				1984-1985	CHEVROLET CITATION II	2.5L L4 2474cc 151 CID	
				1984-1988	PONTIAC FIERO	2.5L L4 2474cc 151 CID	

USMW	Years	Application	Engine	USMW	Years	Application	Engine	
US5000	1985	BUICK SOMERSET REGAL	2.5L L4 2474cc 151 CID	US5008	1982-1986	GMC K2500 SUBURBAN	6.2L V8 379 CID	
	1985-1987	OLDSMOBILE CALAIS	2.5L L4 2474cc 151 CID		1982-1986	GMC K3500	6.2L V8 379 CID	
	1985-1991	PONTIAC GRAND AM	2.5L L4 2474cc 151 CID		1982-1989	CHEVROLET P20	6.2L V8 379 CID	
	1986-1987	BUICK SOMERSET	2.5L L4 2474cc 151 CID		1982-1989	GMC P2500	6.2L V8 379 CID	
	1988-1991	OLDSMOBILE CUTLASS CALAIS	2.5L L4 2474cc 151 CID		1982-1991	GMC JIMMY	6.2L V8 379 CID	
US5000P	1980-1983	CHEVROLET CITATION	2.5L L4 2474cc 151 CID	1982-1993	CHEVROLET P30	6.2L V8 379 CID		
	1980-1984	OLDSMOBILE OMEGA	2.5L L4 2474cc 151 CID	1982-1993	GMC P3500	6.2L V8 379 CID		
	1980-1984	PONTIAC PHOENIX	2.5L L4 2474cc 151 CID	1983-1993	CHEVROLET G20	6.2L V8 379 CID		
	1980-1985	BUICK SKYLARK	2.5L L4 2474cc 151 CID	1983-1993	CHEVROLET G30	6.2L V8 379 CID		
	1982-1986	BUICK CENTURY	2.5L L4 2474cc 151 CID	1983-1993	GMC G2500	6.2L V8 379 CID		
	1982-1986	CHEVROLET CELEBRITY	2.5L L4 2474cc 151 CID	1983-1993	GMC G3500	6.2L V8 379 CID		
	1982-1986	OLDSMOBILE CUTLASS CIERA	2.5L L4 2474cc 151 CID	1987	CHEVROLET R10	6.2L V8 379 CID		
	1982-1986	PONTIAC 6000	2.5L L4 2474cc 151 CID	1987	CHEVROLET V10	6.2L V8 379 CID		
	1984-1985	CHEVROLET CITATION II	2.5L L4 2474cc 151 CID	1987	CHEVROLET V20	6.2L V8 379 CID		
	1987	BUICK SOMERSET	2.5L L4 2474cc 151 CID	1987	GMC R1500	6.2L V8 379 CID		
US5001	1980-1983	CHEVROLET CITATION	2.8L V6 173 CID	1987	GMC R1500 SUBURBAN	6.2L V8 379 CID		
	1980-1984	OLDSMOBILE OMEGA	2.8L V6 173 CID	1987	GMC R2500 SUBURBAN	6.2L V8 379 CID		
	1980-1984	PONTIAC PHOENIX	2.8L V6 173 CID	1987	GMC V1500	6.2L V8 379 CID		
	1980-1985	BUICK SKYLARK	2.8L V6 173 CID	1987	GMC V1500 SUBURBAN	6.2L V8 379 CID		
	1982-1986	CHEVROLET CELEBRITY	2.8L V6 173 CID	1987	GMC V2500	6.2L V8 379 CID		
	1982-1986	PONTIAC 6000	2.8L V6 173 CID	1987	GMC V2500 SUBURBAN	6.2L V8 379 CID		
	1984-1985	CHEVROLET CITATION II	2.8L V6 173 CID	1987-1988	CHEVROLET R10 SUBURBAN	6.2L V8 379 CID		
	1984-1988	CHEVROLET CITATION	2.8L V6 2800cc 173 CID	1987-1988	CHEVROLET R20	6.2L V8 379 CID		
	1985-1986	CHEVROLET CAMARO	2.8L V6 173 CID	1987-1988	CHEVROLET R20 SUBURBAN	6.2L V8 379 CID		
	1985-1986	PONTIAC FIREBIRD	2.8L V6 173 CID	1987-1988	CHEVROLET R30	6.2L V8 379 CID		
	1985-1988	PONTIAC FIERO	2.8L V6 173 CID	1987-1988	CHEVROLET V10 SUBURBAN	6.2L V8 379 CID		
	1986	BUICK CENTURY	2.8L V6 173 CID	1987-1988	CHEVROLET V20 SUBURBAN	6.2L V8 379 CID		
	1986	OLDSMOBILE CUTLASS CIERA	2.8L V6 173 CID	1987-1988	CHEVROLET V30	6.2L V8 379 CID		
	US5003	1968-1969	CADILLAC ELDORADO	7.7L V8 472 CID	1987-1989	GMC R2500	6.2L V8 379 CID	
		1968-1969	CADILLAC ELDORADO	7.7L V8 7735cc 472 CID	1987-1991	CHEVROLET BLAZER	6.2L V8 379 CID	
1968-1973		CADILLAC CALAIS	7.7L V8 472 CID	1987-1991	GMC R3500	6.2L V8 379 CID		
1968-1973		CADILLAC CALAIS	7.7L V8 7735cc 472 CID	1987-1991	GMC V3500	6.2L V8 379 CID		
1968-1973		CADILLAC COMMERCIAL CHASSIS	7.7L V8 7735cc 472 CID	1989	CHEVROLET R2500	6.2L V8 379 CID		
1968-1973		CADILLAC DEVILLE	7.7L V8 472 CID	1989-1991	CHEVROLET R3500	6.2L V8 379 CID		
1968-1973		CADILLAC DEVILLE	7.7L V8 7735cc 472 CID	1989-1991	CHEVROLET V3500	6.2L V8 379 CID		
1968-1973		CADILLAC FLEETWOOD	7.7L V8 472 CID	1992-1993	AM GENERAL HUMMER	6.2L V8 379 CID		
1968-1973		CADILLAC FLEETWOOD	7.7L V8 7735cc 472 CID	US5010	1982-1984	CADILLAC DEVILLE	4.1L V8 250 CID	
1970-1973		CADILLAC ELDORADO	8.2L V8 500 CID		1982-1985	CADILLAC ELDORADO	4.1L V8 250 CID	
1970-1973		CADILLAC ELDORADO	8.2L V8 8193cc 500 CID		1982-1985	CADILLAC FLEETWOOD	4.1L V8 250 CID	
1972-1973		CADILLAC ELDORADO	8.2L V8 8195cc 500 CID		1982-1985	CADILLAC SEVILLE	4.1L V8 250 CID	
1977-1978		CADILLAC ELDORADO	7.0L V8 425 CID		1982-1983	CHEVROLET MALIBU	4.3L V6 260 CID	
1977-1979		CADILLAC DEVILLE	7.0L V8 425 CID	1982-1983	CHEVROLET MONTE CARLO	4.3L V6 260 CID		
1977-1979		CADILLAC FLEETWOOD	7.0L V8 425 CID	1982-1984	BUICK REGAL	4.3L V6 260 CID		
1980-1981		CADILLAC DEVILLE	6.0L V8 368 CID	1982-1984	OLDSMOBILE CUTLASS CALAIS	4.3L V6 260 CID		
1980-1981		CADILLAC ELDORADO	6.0L V8 368 CID	1984	OLDSMOBILE CUTLASS SUPREME	4.3L V6 260 CID		
1980-1981		CADILLAC SEVILLE	6.0L V8 368 CID	US5013	1982-1985	CHEVROLET S10	1.9L L4 119 CID	
1980-1984		CADILLAC COMMERCIAL CHASSIS	6.0L V8 368 CID		1982-1985	GMC S15	1.9L L4 119 CID	
1980-1984		CADILLAC FLEETWOOD	6.0L V8 368 CID		1983-1984	CHEVROLET S10 BLAZER	1.9L L4 119 CID	
1980-1984	CADILLAC FLEETWOOD	6.0L V8 368 CID	1983-1984		GMC S15 JIMMY	1.9L L4 119 CID		
1981-1987	CHEVROLET CHEVETTE	1.6L L4 98 CID	US5014		1982-1985	BUICK CENTURY	4.3L V6 260 CID	
1981-1987	PONTIAC T1000	1.6L L4 98 CID		1982-1985	CHEVROLET CELEBRITY	4.3L V6 260 CID		
US5006	1982-1984	CHEVROLET CAMARO		2.8L V6 173 CID	1982-1985	OLDSMOBILE CUTLASS CIERA	4.3L V6 260 CID	
	1982-1984	PONTIAC FIREBIRD		2.8L V6 173 CID	1982-1985	PONTIAC 6000	4.3L V6 260 CID	
	1982-1986	CHEVROLET S10		2.8L V6 173 CID	1985	BUICK ELECTRA	4.3L V6 260 CID	
	1982-1986	GMC S15	2.8L V6 173 CID	1985	CADILLAC COMMERCIAL CHASSIS	4.3L V6 260 CID		
	1983-1986	CHEVROLET S10 BLAZER	2.8L V6 173 CID	1985	CADILLAC DEVILLE	4.3L V6 260 CID		
	1983-1986	GMC S15 JIMMY	2.8L V6 173 CID	1985	CADILLAC FLEETWOOD	4.3L V6 260 CID		
	1984-1986	JEEP CHEROKEE	2.8L V6 173 CID	1985	OLDSMOBILE 98	4.3L V6 260 CID		
	1984-1986	JEEP WAGONEER	2.8L V6 173 CID	US5014P	1982-1985	BUICK CENTURY	4.3L V6 260 CID	
	1986	JEEP COMANCHE	2.8L V6 173 CID		1982-1985	CHEVROLET CELEBRITY	4.3L V6 260 CID	
	US5007	1982	BUICK SKYHAWK		1.8L L4 112 CID	1982-1985	OLDSMOBILE CUTLASS CIERA	4.3L V6 260 CID
1982		CADILLAC CIMARRON	1.8L L4 112 CID		1982-1985	PONTIAC 6000	4.3L V6 260 CID	
1982		CHEVROLET CAVALIER	1.8L L4 112 CID		1985	BUICK ELECTRA	4.3L V6 260 CID	
1982		OLDSMOBILE FIRENZA	1.8L L4 112 CID	1985	CADILLAC COMMERCIAL CHASSIS	4.3L V6 260 CID		
1982		PONTIAC J2000	1.8L L4 112 CID	1985	CADILLAC DEVILLE	4.3L V6 260 CID		
1983-1986		BUICK SKYHAWK	2.0L L4 122 CID	1985	CADILLAC FLEETWOOD	4.3L V6 260 CID		
1983-1986		CADILLAC CIMARRON	2.0L L4 122 CID	1985	OLDSMOBILE 98	4.3L V6 260 CID		
1983-1986		CHEVROLET CAVALIER	2.0L L4 122 CID	US5015	1983-1984	CHEVROLET S10	2.0L L4 122 CID	
1983-1986		OLDSMOBILE FIRENZA	2.0L L4 122 CID		1983-1984	CHEVROLET S10 BLAZER	2.0L L4 122 CID	
1984-1985		PONTIAC J2000 SUNBIRD	2.0L L4 122 CID		1983-1984	GMC S15	2.0L L4 122 CID	
1986	PONTIAC SUNBIRD	2.0L L4 122 CID	1983-1984		GMC S15 JIMMY	2.0L L4 122 CID		
US5008	1982-1986	CHEVROLET C10	6.2L V8 379 CID		US5016	1984-1991	CHEVROLET CORVETTE	5.7L V8 350 CID
	1982-1986	CHEVROLET C10 SUBURBAN	6.2L V8 379 CID	US5016H		1984-1991	CHEVROLET CORVETTE	5.7L V8 350 CID
	1982-1986	CHEVROLET C20	6.2L V8 379 CID		US5017	1982-1986	BUICK SKYHAWK	1.8L L4 112 CID
	1982-1986	CHEVROLET C20 SUBURBAN	6.2L V8 379 CID	1982-1986		OLDSMOBILE FIRENZA	1.8L L4 112 CID	
	1982-1986	CHEVROLET C30	6.2L V8 379 CID	1985	PONTIAC J2000 SUNBIRD	1.8L L4 112 CID		
	1982-1986	CHEVROLET K5 BLAZER	6.2L V8 379 CID	1986	PONTIAC SUNBIRD	1.8L L4 112 CID		
	1982-1986	CHEVROLET K10	6.2L V8 379 CID	US5019	1966-1969	CHEVROLET CORVETTE	7.0L V8 6998cc 427 CID	
	1982-1986	CHEVROLET K10 SUBURBAN	6.2L V8 379 CID		1968-1969	CHEVROLET CORVETTE	7.0L V8 427 CID	
	1982-1986	CHEVROLET K20	6.2L V8 379 CID		US5019H	1966-1969	CHEVROLET CORVETTE	7.0L V8 6998cc 427 CID
	1982-1986	CHEVROLET K20 SUBURBAN	6.2L V8 379 CID	1968-1969		CHEVROLET CORVETTE	7.0L V8 427 CID	
	1982-1986	CHEVROLET K30	6.2L V8 379 CID	US5020		1985-1986	CADILLAC CIMARRON	2.8L V6 173 CID
	1982-1986	GMC C1500	6.2L V8 379 CID		1985-1986	CHEVROLET CAVALIER	2.8L V6 173 CID	
	1982-1986	GMC C1500 SUBURBAN	6.2L V8 379 CID		1985-1986	OLDSMOBILE FIRENZA	2.8L V6 173 CID	
	1982-1986	GMC C2500 SUBURBAN	6.2L V8 379 CID		US5022	1985-1986	CHEVROLET ASTRO	2.5L L4 2474cc 151 CID
	1982-1986	GMC C3500	6.2L V8 379 CID			1985-1986	CHEVROLET CAMARO	2.5L L4 2474cc 151 CID
1982-1986	GMC K1500 SUBURBAN	6.2L V8 379 CID	1985-1986	CHEVROLET S10		2.5L L4 2474cc 151 CID		
1982-1986	GMC K2500	6.2L V8 379 CID	1985-1986	CHEVROLET S10 BLAZER	2.5L L4 2474cc 151 CID			
				1985-1986	GMC S15	2.5L L4 2474cc 151 CID		

WATER PUMPS

USMWW	Years	Application	Engine	USMWW	Years	Application	Engine
US5022	1985-1986	GMC S15 JIMMY	2.5L L4 2474cc 151 CID	US5031	1985-1988	CHEVROLET SPECTRUM	1.5L L4 1471cc 92 CID
	1985-1986	GMC SAFARI	2.5L L4 2474cc 151 CID		1985-1989	ISUZU I-MARK	1.5L L4 1471cc
	1985-1986	PONTIAC FIREBIRD	2.5L L4 2474cc 151 CID		1989	GEO SPECTRUM	1.5L L4 1471cc 92 CID
US5023	1985-1987	CADILLAC COMMERCIAL CHASSIS	4.1L V8 250 CID	US5032	1987-1988	OLDSMOBILE FIRENZA	2.0L L4 122 CID
	1985-1987	CADILLAC DEVILLE	4.1L V8 250 CID		1987-1989	BUICK SKYHAWK	2.0L L4 122 CID
	1985-1987	CADILLAC FLEETWOOD	4.1L V8 250 CID		1987-1989	CHEVROLET BERETTA	2.0L L4 122 CID
	1986-1987	CADILLAC ELDORADO	4.1L V8 250 CID		1987-1989	CHEVROLET CAVALIER	2.0L L4 122 CID
	1986-1987	CADILLAC SEVILLE	4.1L V8 250 CID		1987-1989	CHEVROLET CORSICA	2.0L L4 122 CID
	1987-1988	CADILLAC ALLANTE	4.1L V8 250 CID		1990-1991	CHEVROLET BERETTA	2.2L L4 134 CID
	1988-1990	CADILLAC COMMERCIAL CHASSIS	4.5L V8 273 CID		1990-1991	CHEVROLET CAVALIER	2.2L L4 134 CID
	1988-1990	CADILLAC DEVILLE	4.5L V8 273 CID		1990-1991	CHEVROLET CORSICA	2.2L L4 134 CID
	1988-1990	CADILLAC ELDORADO	4.5L V8 273 CID		1992-1996	CHEVROLET BERETTA	2.2L L4 2190cc 134 CID
	1988-1990	CADILLAC FLEETWOOD	4.5L V8 273 CID		1992-1996	CHEVROLET CORSICA	2.2L L4 2190cc 134 CID
	1988-1990	CADILLAC SEVILLE	4.5L V8 273 CID		1992-2002	CHEVROLET CAVALIER	2.2L L4 2190cc 134 CID
	1989-1992	CADILLAC ALLANTE	4.5L V8 273 CID		1993-1996	BUICK CENTURY	2.2L L4 2190cc 134 CID
	1991-1992	CADILLAC FLEETWOOD	4.9L V8 300 CID		1993-1996	OLDSMOBILE CUTLASS CIERA	2.2L L4 2190cc 134 CID
	1991-1993	CADILLAC COMMERCIAL CHASSIS	4.9L V8 300 CID		1994-1995	CHEVROLET LLV	2.2L L4 2190cc 134 CID
	1991-1993	CADILLAC ELDORADO	4.9L V8 300 CID		1994-2003	CHEVROLET S10	2.2L L4 2190cc 134 CID
	1991-1993	CADILLAC SEVILLE	4.9L V8 300 CID		1994-2003	GMC SONOMA	2.2L L4 2190cc 134 CID
	1991-1995	CADILLAC DEVILLE	4.9L V8 300 CID		1995-2002	PONTIAC SUNFIRE	2.2L L4 2190cc 134 CID
1993	CADILLAC 60 SPECIAL	4.9L V8 300 CID	1996-2000	ISUZU HOMBRE	2.2L L4 2190cc 134 CID		
US5027	1983-1984	ISUZU I-MARK	1.8L L4 1817cc	1997-1999	CHEVROLET LUV	2.2L L4 2190cc 133 CID	
	1985-1986	CHEVROLET CHEVETTE	1.8L L4 1819cc 110 CID	2001-2002	CHEVROLET S10	2.2L L4 2200cc 134 CID	
US5028	1982-1985	BUICK CENTURY	3.0L V6 181 CID	US5033	1982-1984	CHEVROLET CELEBRITY	2.8L V6 2835cc 173 CID
	1982-1985	OLDSMOBILE CUTLASS CIERA	3.0L V6 181 CID		1983-1986	CHEVROLET CENTURY	2.8L V6 2800cc 173 CID
	1984-1985	BUICK CENTURY	3.8L V6 3800cc 231 CID		1986-1989	CHEVROLET CUTLASS	2.8L V6 2835cc 173 CID
	1984-1985	OLDSMOBILE CUTLASS CIERA	3.8L V6 3800cc 231 CID		1986-1997	CHEVROLET CUTLASS	3.1L V6 3130cc 191 CID
	1985	BUICK ELECTRA	3.0L V6 181 CID		1987	OLDSMOBILE FIRENZA	2.8L V6 173 CID
	1985	BUICK ELECTRA	3.8L V6 3800cc 231 CID		1987-1988	CADILLAC CIMARRON	2.8L V6 173 CID
	1985	OLDSMOBILE 98	3.0L V6 181 CID		1987-1989	BUICK CENTURY	2.8L V6 173 CID
US5029	1985-1988	CHEVROLET SPRINT	1.0L L3 993cc 61 CID	1987-1989	CHEVROLET BERETTA	2.8L V6 173 CID	
	1986-1989	SUZUKI SAMURAI	1.3L L4 1325cc 81 CID	1987-1989	CHEVROLET CAVALIER	2.8L V6 173 CID	
	1989	SUZUKI SIDEKICK	1.3L L4 1325cc 81 CID	1987-1989	CHEVROLET CELEBRITY	2.8L V6 173 CID	
US5030	1990-1995	SUZUKI SAMURAI	1.3L L4 1298cc 79 CID	1987-1989	CHEVROLET CORSICA	2.8L V6 173 CID	
	1975-1978	GMC P15	4.8L L6 292 CID	1987-1989	OLDSMOBILE CUTLASS CIERA	2.8L V6 173 CID	
	1975-1980	CHEVROLET P10	4.8L L6 292 CID	1987-1989	OLDSMOBILE CUTLASS CRUISER	2.8L V6 173 CID	
1977-1978	GMC K35	4.8L L6 292 CID	1987-1989	PONTIAC 6000	2.8L V6 173 CID		
1977-1986	CHEVROLET K30	4.8L L6 292 CID	1988-1989	BUICK REGAL	2.8L V6 173 CID		
1978	CHEVROLET CS1073	4.8L L6 4800cc 292 CID	1988-1989	OLDSMOBILE CUTLASS SUPREME	2.8L V6 173 CID		
1978	CHEVROLET CS31003	4.8L L6 4800cc 292 CID	1988-1989	PONTIAC GRAND PRIX	2.8L V6 173 CID		
1978	CHEVROLET G20	4.8L L6 292 CID	1988-1991	PONTIAC 6000	3.1L V6 189 CID		
1978	CHEVROLET G30	4.8L L6 292 CID	1989-1996	BUICK REGAL	3.1L V6 189 CID		
1978	GMC C25	4.8L L6 292 CID	1989-1997	CHEVROLET CENTURY	3.1L V6 3130cc 191 CID		
1978	GMC C25 SUBURBAN	4.8L L6 292 CID	1989-1997	OLDSMOBILE CUTLASS SUPREME	3.1L V6 189 CID		
1978	GMC G25	4.8L L6 292 CID	1989-2003	PONTIAC GRAND PRIX	3.1L V6 189 CID		
1978	GMC G35	4.8L L6 292 CID	1990	CHEVROLET CELEBRITY	2.8L V6 2800cc 173 CID		
1978	GMC K25	4.8L L6 292 CID	1990	CHEVROLET CELEBRITY	3.1L V6 189 CID		
1978	GMC K25 SUBURBAN	4.8L L6 292 CID	1990	CHEVROLET CENTURY	2.8L V6 2800cc 173 CID		
1978	GMC P25	4.8L L6 292 CID	1990-1994	CHEVROLET CAVALIER	2.8L V6 2800cc 173 CID		
1978	GMC P35	4.8L L6 292 CID	1990-1994	CHEVROLET CAVALIER	3.1L V6 189 CID		
1978-1982	CHEVROLET C20 SUBURBAN	4.8L L6 292 CID	1990-1994	CHEVROLET S10 BLAZER	3.1L V6 3100cc 191 CID		
1978-1982	CHEVROLET K20 SUBURBAN	4.8L L6 292 CID	1990-1994	OLDSMOBILE SILHOUETTE	3.1L V6 189 CID		
1978-1986	CHEVROLET C20	4.8L L6 292 CID	1990-1995	CHEVROLET LUMINA APV	3.1L V6 189 CID		
1978-1986	CHEVROLET C30	4.8L L6 292 CID	1990-1995	PONTIAC TRANS SPORT	3.1L V6 189 CID		
1978-1986	CHEVROLET K20	4.8L L6 292 CID	1990-1996	CHEVROLET BERETTA	3.1L V6 189 CID		
1978-1989	CHEVROLET P20	4.8L L6 292 CID	1990-1996	CHEVROLET CORSICA	3.1L V6 189 CID		
1978-1989	CHEVROLET P30	4.8L L6 292 CID	1990-2001	CHEVROLET LUMINA	3.1L V6 189 CID		
1979-1980	GMC P1500	4.8L L6 292 CID	1991-1994	PONTIAC SUNBIRD	3.1L V6 189 CID		
1979-1982	GMC C2500 SUBURBAN	4.8L L6 292 CID	1991-1996	CHEVROLET EUROSPOUR	3.1L V6 3135cc 191 CID		
1979-1982	GMC K2500 SUBURBAN	4.8L L6 292 CID	1991-1996	OLDSMOBILE CUTLASS SUPREME	3.4L V6 207 CID		
1979-1986	GMC C2500	4.8L L6 292 CID	1991-1996	PONTIAC GRAND PRIX	3.4L V6 207 CID		
1979-1986	GMC K2500	4.8L L6 292 CID	1991-1997	CHEVROLET LUMINA	3.4L V6 207 CID		
1979-1986	GMC K3500	4.8L L6 292 CID	1994	OLDSMOBILE CUTLASS CRUISER	3.1L V6 189 CID		
1979-1987	GMC P2500	4.8L L6 292 CID	1994-1996	CHEVROLET CUTLASS	2.2L L4 2196cc 134 CID		
1979-1989	GMC P3500	4.8L L6 292 CID	1994-1996	OLDSMOBILE CUTLASS CIERA	3.1L V6 189 CID		
1980	CHEVROLET C10	4.8L L6 292 CID	1994-1998	BUICK SKYLARK	3.1L V6 189 CID		
1980	CHEVROLET G20	4.8L L6 292 CID	1994-1998	OLDSMOBILE ACHIEVA	3.1L V6 189 CID		
1980	CHEVROLET K10	4.8L L6 292 CID	1994-1998	PONTIAC GRAND AM	3.1L V6 189 CID		
1980	GMC C1500	4.8L L6 292 CID	1994-2005	BUICK CENTURY	3.1L V6 189 CID		
1980	GMC K1500	4.8L L6 292 CID	1995	CHEVROLET CENTURY	2.2L L4 2196cc 134 CID		
1980-1986	GMC C3500	4.8L L6 292 CID	1995-1997	CHEVROLET MONTE CARLO	3.4L V6 207 CID		
1981-1982	CHEVROLET C10	4.8L L6 4800cc 292 CID	1995-1999	CHEVROLET MONTE CARLO	3.1L V6 189 CID		
1981-1986	GMC C1500	4.8L L6 4800cc 292 CID	1996	CHEVROLET LUMINA APV	3.4L V6 207 CID		
1984	GMC C2500 SUBURBAN	4.8L L6 292 CID	1996-1998	PONTIAC TRANS SPORT	3.4L V6 207 CID		
1984	GMC K2500 SUBURBAN	4.8L L6 292 CID	1996-2004	OLDSMOBILE SILHOUETTE	3.4L V6 207 CID		
1984-1986	CHEVROLET C10	4.8L L6 4800cc 292 CID	1997	CHEVROLET LUMINA	3.3L V6 3343cc 204 CID		
1987	CHEVROLET C35	4.8L L6 4800cc 292 CID	1997-1999	OLDSMOBILE CUTLASS	3.1L V6 189 CID		
1987	CHEVROLET V20	4.8L L6 292 CID	1997-2003	CHEVROLET MALIBU	3.1L V6 189 CID		
1987	GMC V2500	4.8L L6 292 CID	1997-2005	CHEVROLET VENTURE	3.4L V6 207 CID		
1987-1988	CHEVROLET R20	4.8L L6 292 CID	1999-2004	OLDSMOBILE ALERO	3.4L V6 207 CID		
1987-1988	CHEVROLET R30	4.8L L6 292 CID	1999-2005	PONTIAC GRAND AM	3.4L V6 207 CID		
1987-1988	CHEVROLET V30	4.8L L6 292 CID	1999-2005	PONTIAC MONTANA	3.4L V6 207 CID		
1987-1988	GMC R2500	4.8L L6 292 CID	2000-2005	CHEVROLET IMPALA	3.4L V6 207 CID		
1987-1988	GMC R3500	4.8L L6 292 CID	2000-2005	CHEVROLET MONTE CARLO	3.4L V6 207 CID		
1987-1988	GMC V3500	4.8L L6 292 CID	2001-2005	PONTIAC AZTEK	3.4L V6 207 CID		
1989	GMC P2500	4.8L L6 292 CID	2002-2005	BUICK RENDEZVOUS	3.4L V6 207 CID		
1998	CHEVROLET C1500	4.1L L6 4100cc 250 CID	2004-2006	CHEVROLET MALIBU	3.5L V6 213 CID		
1998-2002	CHEVROLET P30 VAN	4.1L L6 4100cc 250 CID	2005	PONTIAC G6	3.5L V6 211 CID		
				2005-2006	BUICK TERRAZA	3.5L V6 213 CID	

USMW	Years	Application	Engine	USMW	Years	Application	Engine
US5033	2005-2006	CHEVROLET UPLANDER	3.5L V6 213 CID	US5043	1995	PONTIAC SUNFIRE	2.3L L4 138 CID
	2005-2006	PONTIAC MONTANA	3.5L V6 213 CID	US5045	1988-1990	PONTIAC LEMANS	1.6L L4 1588cc 98 CID
	2005-2006	SATURN RELAY	3.5L V6 213 CID	US5048	1989-1997	GEO TRACKER	1.6L L4 1588cc 98 CID
	2006	PONTIAC G6	3.5L V6 214 CID		1989-1998	SUZUKI SIDEKICK	1.6L L4 1590cc 97 CID
	2006-2007	BUICK RENDEZVOUS	3.5L V6 213 CID		1995-1996	SUZUKI ESTEEM	1.6L L4 1590cc 97 CID
US5035	1987-1989	CHEVROLET S10 BLAZER	2.8L V6 173 CID		1996-1998	SUZUKI X-90	1.6L L4 1590cc 97 CID
	1987-1989	GMC S15 JIMMY	2.8L V6 173 CID		1998	CHEVROLET TRACKER	1.6L L4 1588cc 98 CID
	1987-1990	GMC S15	2.8L V6 173 CID	1999-2001	CHEVROLET TRACKER	2.2L L4 2196cc 134 CID	
	1987-1993	CHEVROLET S10	2.8L V6 173 CID	2005	CHEVROLET TRACKER	2.2L L4 2190cc 134 CID	
	1989-1991	ISUZU TROOPER	2.8L V6 2827cc	US5049	1987-1988	CHEVROLET R10 SUBURBAN	5.7L V8 350 CID
	1991-1992	ISUZU RODEO	3.1L V6 3137cc		1987-1988	CHEVROLET R20 SUBURBAN	5.7L V8 350 CID
	1991-1993	GMC SONOMA	2.8L V6 173 CID		1987-1988	CHEVROLET V10 SUBURBAN	5.7L V8 350 CID
	1991-1994	ISUZU PICKUP	3.1L V6 3137cc		1987-1993	CHEVROLET G10	5.7L V8 350 CID
US5036	1982-1983	PONTIAC J2000	1.8L L4 112 CID		1987-1993	GMC G1500	5.7L V8 350 CID
	1984	PONTIAC J2000 SUNBIRD	1.8L L4 112 CID		1987-1995	CHEVROLET ASTRO	4.3L V6 262 CID
	1987-1988	BUICK SKYHAWK	2.0L L4 122 CID		1987-1995	CHEVROLET G10	4.3L V6 262 CID
	1987-1988	OLDSMOBILE FIRENZA	2.0L L4 122 CID		1987-1995	CHEVROLET G10	5.0L V8 305 CID
	1987-1989	PONTIAC GRAND AM	2.0L L4 122 CID		1987-1995	CHEVROLET G20	4.3L V6 262 CID
	1987-1994	PONTIAC SUNBIRD	2.0L L4 122 CID		1987-1995	CHEVROLET G20	5.0L V8 305 CID
	1989-1990	PONTIAC LEMANS	2.0L L4 122 CID		1987-1995	CHEVROLET G20	5.7L V8 350 CID
	1987-1989	CHEVROLET CAMARO	2.8L V6 173 CID		1987-1995	GMC G1500	4.3L V6 262 CID
	1987-1989	PONTIAC FIREBIRD	2.8L V6 173 CID		1987-1995	GMC G1500	5.0L V8 305 CID
	1990-1992	CHEVROLET CAMARO	3.1L V6 189 CID		1987-1995	GMC G2500	4.3L V6 262 CID
US5037	1990-1992	PONTIAC FIREBIRD	3.1L V6 189 CID		1987-1995	GMC G2500	5.0L V8 305 CID
	1988-1996	CHEVROLET G30	7.4L V8 454 CID	1987-1995	GMC G2500	5.7L V8 350 CID	
US5038	1988-1996	GMC G3500	7.4L V8 454 CID	1987-1995	GMC G3500	4.3L V6 262 CID	
	1988-2000	CHEVROLET C3500	7.4L V8 454 CID	1987-1995	GMC SAFARI	4.3L V6 262 CID	
US5038H	1988-2000	CHEVROLET K3500	7.4L V8 454 CID	1987-1996	CHEVROLET G30	4.3L V6 262 CID	
	1988-2000	GMC C3500	7.4L V8 454 CID	1987-1996	CHEVROLET G30	5.7L V8 350 CID	
	1988-2000	GMC K3500	7.4L V8 454 CID	1987-1996	GMC G3500	5.7L V8 350 CID	
	1989-1991	CHEVROLET R2500 SUBURBAN	7.4L V8 454 CID	1988	CHEVROLET V20 SUBURBAN	5.7L V8 350 CID	
	1989-1991	GMC R2500 SUBURBAN	7.4L V8 454 CID	1988-1990	GMC S15	4.3L V6 262 CID	
	1990-1993	CHEVROLET C1500	7.4L V8 454 CID	1988-1991	CHEVROLET C1500	5.7L V8 5700cc 350 CID	
	1991-2000	CHEVROLET C2500	7.4L V8 454 CID	1988-1991	CHEVROLET C2500	5.7L V8 5700cc 350 CID	
	1991-2000	CHEVROLET K2500	7.4L V8 454 CID	1988-1991	GMC S15 JIMMY	4.3L V6 262 CID	
	1991-2000	GMC C2500	7.4L V8 454 CID	1988-1992	CHEVROLET CAMARO	5.0L V8 305 CID	
	1991-2000	GMC K2500	7.4L V8 454 CID	1988-1992	CHEVROLET CAMARO	5.7L V8 305 CID	
	1992-1999	CHEVROLET C2500 SUBURBAN	7.4L V8 454 CID	1988-1992	PONTIAC FIREBIRD	5.0L V8 305 CID	
	1992-1999	CHEVROLET K2500 SUBURBAN	7.4L V8 454 CID	1988-1992	PONTIAC FIREBIRD	5.7L V8 350 CID	
	1992-1999	GMC C2500 SUBURBAN	7.4L V8 454 CID	1988-1992	CHEVROLET FIREBIRD	5.7L V8 5700cc 350 CID	
	1992-1999	GMC K2500 SUBURBAN	7.4L V8 454 CID	1988-1994	CHEVROLET C3500	4.3L V6 262 CID	
	1996-2000	CHEVROLET EXPRESS 3500	7.4L V8 454 CID	1988-1994	CHEVROLET S10 BLAZER	4.3L V6 262 CID	
	1996-2000	GMC SAVANA 3500	7.4L V8 454 CID	1988-1995	CHEVROLET C1500	4.3L V6 262 CID	
	1988-1996	CHEVROLET G30	7.4L V8 454 CID	1988-1995	CHEVROLET C1500	5.0L V8 305 CID	
	1988-1996	GMC G3500	7.4L V8 454 CID	1988-1995	CHEVROLET C1500	5.7L V8 350 CID	
	1988-2000	CHEVROLET C3500	7.4L V8 454 CID	1988-1995	CHEVROLET C2500	4.3L V6 262 CID	
	1988-2000	CHEVROLET K3500	7.4L V8 454 CID	1988-1995	CHEVROLET C2500	5.0L V8 305 CID	
1988-2000	GMC C3500	7.4L V8 454 CID	1988-1995	CHEVROLET C2500	5.7L V8 350 CID		
1988-2000	GMC K3500	7.4L V8 454 CID	1988-1995	CHEVROLET C3500	5.7L V8 350 CID		
1989-1991	CHEVROLET R2500 SUBURBAN	7.4L V8 454 CID	1988-1995	CHEVROLET K1500	4.3L V6 262 CID		
1989-1991	GMC R2500 SUBURBAN	7.4L V8 454 CID	1988-1995	CHEVROLET K1500	5.0L V8 305 CID		
1990-1993	CHEVROLET C1500	7.4L V8 454 CID	1988-1995	CHEVROLET K1500	5.7L V8 350 CID		
1991-2000	CHEVROLET C2500	7.4L V8 454 CID	1988-1995	CHEVROLET K2500	4.3L V6 262 CID		
1991-2000	CHEVROLET K2500	7.4L V8 454 CID	1988-1995	CHEVROLET K2500	5.0L V8 305 CID		
1991-2000	GMC C2500	7.4L V8 454 CID	1988-1995	CHEVROLET K2500	5.7L V8 350 CID		
1991-2000	GMC K2500	7.4L V8 454 CID	1988-1995	CHEVROLET K3500	5.7L V8 350 CID		
1992-1999	CHEVROLET C2500 SUBURBAN	7.4L V8 454 CID	1988-1995	CHEVROLET S10	4.3L V6 262 CID		
1992-1999	CHEVROLET K2500 SUBURBAN	7.4L V8 454 CID	1988-1995	GMC C1500	4.3L V6 262 CID		
1992-1999	GMC C2500 SUBURBAN	7.4L V8 454 CID	1988-1995	GMC C1500	5.0L V8 305 CID		
1992-1999	GMC K2500 SUBURBAN	7.4L V8 454 CID	1988-1995	GMC C1500	5.7L V8 350 CID		
1996-2000	CHEVROLET EXPRESS 3500	7.4L V8 454 CID	1988-1995	GMC C2500	4.3L V6 262 CID		
1996-2000	GMC SAVANA 3500	7.4L V8 454 CID	1988-1995	GMC C2500	5.0L V8 305 CID		
1987-1988	CHEVROLET S10 BLAZER	2.5L L4 2474cc 151 CID	1988-1995	GMC C2500	5.7L V8 350 CID		
1987-1988	GMC S15 JIMMY	2.5L L4 2474cc 151 CID	1988-1995	GMC C3500	5.7L V8 350 CID		
1987-1990	CHEVROLET ASTRO	2.5L L4 2474cc 151 CID	1988-1995	GMC K1500	4.3L V6 262 CID		
1987-1990	GMC S15	2.5L L4 2474cc 151 CID	1988-1995	GMC K1500	5.0L V8 305 CID		
1987-1990	GMC SAFARI	2.5L L4 2474cc 151 CID	1988-1995	GMC K1500	5.7L V8 350 CID		
1987-1993	CHEVROLET LLV	2.5L L4 2474cc 151 CID	1988-1995	GMC K2500	4.3L V6 262 CID		
1987-1993	CHEVROLET S10	2.5L L4 2474cc 151 CID	1988-1995	GMC K2500	5.0L V8 305 CID		
1991-1993	GMC SONOMA	2.5L L4 2474cc 151 CID	1988-1995	GMC K2500	5.7L V8 350 CID		
US5041	1987-1990	CHEVROLET CELEBRITY	2.5L L4 2474cc 151 CID	1988-1995	GMC K3500	5.7L V8 350 CID	
	1987-1990	OLDSMOBILE CUTLASS CRUISER	2.5L L4 2474cc 151 CID	1989-1990	CHEVROLET CAPRICE	4.3L V6 262 CID	
	1987-1991	PONTIAC 6000	2.5L L4 2474cc 151 CID	1989-1990	CHEVROLET CAPRICE	5.0L V8 305 CID	
	1987-1992	BUICK CENTURY	2.5L L4 2474cc 151 CID	1989-1990	CHEVROLET CAPRICE	5.7L V8 350 CID	
	1987-1992	OLDSMOBILE CUTLASS CIERA	2.5L L4 2474cc 151 CID	1989-1990	GMC C1500	5.7L V8 5700cc 350 CID	
1990-1992	CHEVROLET LUMINA	2.5L L4 2474cc 151 CID	1989-1991	CHEVROLET P30 VAN	5.7L V8 5700cc 350 CID		
US5043	1987	OLDSMOBILE CALAIS	2.3L L4 138 CID	1989-1991	CHEVROLET R1500 SUBURBAN	5.7L V8 350 CID	
	1988-1991	OLDSMOBILE CUTLASS CALAIS	2.3L L4 138 CID	1989-1991	CHEVROLET R2500 SUBURBAN	5.7L V8 350 CID	
	1988-1995	BUICK SKYLARK	2.3L L4 138 CID	1989-1991	CHEVROLET V1500 SUBURBAN	5.7L V8 350 CID	
	1988-1995	PONTIAC GRAND AM	2.3L L4 138 CID	1989-1991	CHEVROLET V2500 SUBURBAN	5.7L V8 350 CID	
	1989-1991	OLDSMOBILE CUTLASS CALAIS	2.3L L4 140 CID	1989-1991	GMC C2500	5.7L V8 5700cc 350 CID	
	1989-1994	PONTIAC GRAND AM	2.3L L4 140 CID	1989-1991	GMC C3500	5.7L V8 5700cc 350 CID	
	1990	OLDSMOBILE CUTLASS SUPREME	2.3L L4 140 CID	1989-1991	GMC JIMMY	5.7L V8 350 CID	
	1990-1991	OLDSMOBILE CUTLASS SUPREME	2.3L L4 138 CID	1989-1991	GMC P3500	5.7L V8 5700cc 350 CID	
	1990-1991	PONTIAC GRAND PRIX	2.3L L4 138 CID	1989-1991	GMC R1500 SUBURBAN	5.7L V8 350 CID	
	1990-1994	CHEVROLET BERETTA	2.3L L4 140 CID	1989-1991	GMC R2500 SUBURBAN	5.7L V8 350 CID	
	1992-1994	OLDSMOBILE ACHIEVA	2.3L L4 140 CID	1989-1991	GMC V1500 SUBURBAN	5.7L V8 350 CID	
	1992-1995	OLDSMOBILE ACHIEVA	2.3L L4 138 CID	1989-1991	GMC V2500 SUBURBAN	5.7L V8 350 CID	
	1995	CHEVROLET CAVALIER	2.3L L4 138 CID	1989-1994	CHEVROLET BLAZER	5.7L V8 350 CID	
				1990-1991	GMC MICROBUS	5.7L V8 5700cc 350 CID	

WATER PUMPS

USMW	Years	Application	Engine	USMW	Years	Application	Engine		
US5049	1990-1992	CADILLAC BROUGHAM	5.7L V8 350 CID	US5049H	1989-1991	CHEVROLET R2500 SUBURBAN	5.7L V8 350 CID		
	1990-1996	CHEVROLET MICROBUS	5.7L V8 5700cc 350 CID		1989-1991	CHEVROLET V1500 SUBURBAN	5.7L V8 350 CID		
	1991	GMC SYCLONE	4.3L V6 262 CID		1989-1991	CHEVROLET V2500 SUBURBAN	5.7L V8 350 CID		
	1991-1992	CADILLAC BROUGHAM	5.0L V8 305 CID		1989-1991	GMC JIMMY	5.7L V8 350 CID		
	1991-1994	OLDSMOBILE BRAVADA	4.3L V6 262 CID		1989-1991	GMC R1500 SUBURBAN	5.7L V8 350 CID		
	1991-1995	GMC SONOMA	4.3L V6 262 CID		1989-1991	GMC R2500 SUBURBAN	5.7L V8 350 CID		
	1992-1993	CADILLAC COMMERCIAL CHASSIS	5.7L V8 350 CID		1989-1991	GMC V1500 SUBURBAN	5.7L V8 350 CID		
	1992-1993	CHEVROLET CAPRICE	4.3L V6 262 CID		1989-1991	GMC V2500 SUBURBAN	5.7L V8 350 CID		
	1992-1993	GMC TYPHOON	4.3L V6 262 CID		1989-1994	CHEVROLET BLAZER	5.7L V8 350 CID		
	1992-1995	CHEVROLET C25	5.7L V8 5700cc 350 CID		1990-1992	CADILLAC BROUGHAM	5.7L V8 350 CID		
	1992-1995	CHEVROLET C1500 SUBURBAN	5.7L V8 350 CID		1991	GMC SYCLONE	4.3L V6 262 CID		
	1992-1995	CHEVROLET C2500 SUBURBAN	5.7L V8 350 CID		1991-1992	CADILLAC BROUGHAM	5.0L V8 305 CID		
	1992-1995	CHEVROLET K1500 SUBURBAN	5.7L V8 350 CID		1991-1994	OLDSMOBILE BRAVADA	4.3L V6 262 CID		
	1992-1995	CHEVROLET K2500 SUBURBAN	5.7L V8 350 CID		1991-1995	GMC SONOMA	4.3L V6 262 CID		
	1992-1995	GMC C1500 SUBURBAN	5.7L V8 350 CID		1992-1993	CADILLAC COMMERCIAL CHASSIS	5.7L V8 350 CID		
	1992-1995	GMC C2500 SUBURBAN	5.7L V8 350 CID		1992-1993	CHEVROLET CAPRICE	4.3L V6 262 CID		
	1992-1995	GMC JIMMY	4.3L V6 262 CID		1992-1993	GMC TYPHOON	4.3L V6 262 CID		
	1992-1995	GMC K1500 SUBURBAN	5.7L V8 350 CID		1992-1995	CHEVROLET C1500 SUBURBAN	5.7L V8 350 CID		
	1992-1995	GMC K2500 SUBURBAN	5.7L V8 350 CID		1992-1995	CHEVROLET C2500 SUBURBAN	5.7L V8 350 CID		
	1992-1995	GMC YUKON	5.7L V8 350 CID		1992-1995	CHEVROLET K1500 SUBURBAN	5.7L V8 350 CID		
	1993	CADILLAC FLEETWOOD	5.7L V8 350 CID		1992-1995	CHEVROLET K2500 SUBURBAN	5.7L V8 350 CID		
	1995	CHEVROLET BLAZER	4.3L V6 262 CID		1992-1995	GMC C1500 SUBURBAN	5.7L V8 350 CID		
	1995	CHEVROLET SILVERADO	5.7L V8 5700cc 350 CID		1992-1995	GMC C2500 SUBURBAN	5.7L V8 350 CID		
	1995	CHEVROLET TAHOE	5.7L V8 350 CID		1992-1995	GMC JIMMY	4.3L V6 262 CID		
	1995-1996	AM GENERAL HUMMER	5.7L V8 350 CID		1992-1995	GMC K1500 SUBURBAN	5.7L V8 350 CID		
	1996	CHEVROLET P31 VAN	5.7L V8 5737cc 350 CID		1992-1995	GMC K2500 SUBURBAN	5.7L V8 350 CID		
	2000-2002	CHEVROLET SONORA	5.7L V8 5737cc 350 CID		1992-1995	GMC YUKON	5.7L V8 350 CID		
	US5049H	1987-1988	CHEVROLET R10 SUBURBAN		5.7L V8 350 CID	1993	CADILLAC FLEETWOOD	5.7L V8 350 CID	
		1987-1988	CHEVROLET R20 SUBURBAN		5.7L V8 350 CID	1995	CHEVROLET BLAZER	4.3L V6 262 CID	
		1987-1988	CHEVROLET V10 SUBURBAN		5.7L V8 350 CID	1995	CHEVROLET TAHOE	5.7L V8 350 CID	
		1987-1993	CHEVROLET G10		5.7L V8 350 CID	1995-1996	AM GENERAL HUMMER	5.7L V8 350 CID	
		1987-1993	GMC G1500		5.7L V8 350 CID	US5050	1985	BUICK SOMERSET REGAL	3.0L V6 181 CID
		1987-1995	CHEVROLET ASTRO		4.3L V6 262 CID		1985-1987	OLDSMOBILE CALAIS	3.0L V6 181 CID
		1987-1995	CHEVROLET G10		4.3L V6 262 CID		1985-1987	PONTIAC GRAND AM	3.0L V6 181 CID
		1987-1995	CHEVROLET G10		5.0L V8 305 CID		1986	BUICK LESABRE	3.0L V6 181 CID
		1987-1995	CHEVROLET G20		4.3L V6 262 CID		1986	OLDSMOBILE DELTA 88	3.0L V6 181 CID
		1987-1995	CHEVROLET G20		5.0L V8 305 CID		1986-1987	BUICK SOMERSET	3.0L V6 181 CID
		1987-1995	CHEVROLET G20		5.7L V8 350 CID		1986-1988	BUICK CENTURY	3.8L V6 3800cc 231 CID
		1987-1995	GMC G1500		4.3L V6 262 CID		1986-1988	BUICK SKYLARK	3.0L V6 181 CID
		1987-1995	GMC G1500		5.0L V8 305 CID		1986-1988	OLDSMOBILE CUTLASS CIERA	3.8L V6 3800cc 231 CID
1987-1995		GMC G2500	4.3L V6 262 CID	1986-1990	BUICK ELECTRA		3.8L V6 3800cc 231 CID		
1987-1995		GMC G2500	5.0L V8 305 CID	1986-1991	OLDSMOBILE DELTA 88		3.8L V6 3800cc 231 CID		
1987-1995		GMC G2500	5.7L V8 350 CID	1986-1992	OLDSMOBILE TORONADO		3.8L V6 3800cc 231 CID		
1987-1995		GMC G3500	4.3L V6 262 CID	1986-1993	BUICK RIVIERA		3.8L V6 3800cc 231 CID		
1987-1995		GMC SAFARI	4.3L V6 262 CID	1986-1995	BUICK LESABRE		3.8L V6 3800cc 231 CID		
1987-1996		CHEVROLET G30	4.3L V6 262 CID	1986-1995	OLDSMOBILE 98		3.8L V6 3800cc 231 CID		
1987-1996		CHEVROLET G30	5.7L V8 350 CID	1987-1988	OLDSMOBILE CUTLASS CRUISER		3.8L V6 3800cc 231 CID		
1987-1996		GMC G3500	5.7L V8 350 CID	1987-1995	PONTIAC BONNEVILLE		3.8L V6 3800cc 231 CID		
1988		CHEVROLET V20 SUBURBAN	5.7L V8 350 CID	1988	OLDSMOBILE CUTLASS CALAIS		3.0L V6 181 CID		
1988-1990		GMC S15	4.3L V6 262 CID	1988-1991	BUICK REATTA		3.8L V6 3800cc 231 CID		
1988-1991		GMC S15 JIMMY	4.3L V6 262 CID	1989-1991	OLDSMOBILE CUTLASS CALAIS		3.3L V6 204 CID		
1988-1992		CHEVROLET CAMARO	5.0L V8 305 CID	1989-1993	BUICK CENTURY		3.3L V6 204 CID		
1988-1992		CHEVROLET CAMARO	5.7L V8 350 CID	1989-1993	BUICK SKYLARK		3.3L V6 204 CID		
1988-1992		PONTIAC FIREBIRD	5.0L V8 305 CID	1989-1993	OLDSMOBILE CUTLASS CIERA		3.3L V6 204 CID		
1988-1992		PONTIAC FIREBIRD	5.7L V8 350 CID	1989-1993	OLDSMOBILE CUTLASS CRUISER		3.3L V6 204 CID		
1988-1994		CHEVROLET S10 BLAZER	4.3L V6 262 CID	1990-1995	BUICK REGAL		3.8L V6 3800cc 231 CID		
1988-1995		CHEVROLET C1500	4.3L V6 262 CID	1991-1995	BUICK PARK AVENUE		3.8L V6 3800cc 231 CID		
1988-1995		CHEVROLET C1500	5.0L V8 305 CID	1992-1993	OLDSMOBILE ACHIEVA		3.3L V6 204 CID		
1988-1995		CHEVROLET C1500	5.7L V8 350 CID	1992-1993	PONTIAC GRAND AM		3.3L V6 204 CID		
1988-1995		CHEVROLET C2500	4.3L V6 262 CID	1992-1995	CHEVROLET LUMINA APV		3.8L V6 3800cc 231 CID		
1988-1995		CHEVROLET C2500	5.0L V8 305 CID	1992-1995	OLDSMOBILE 88		3.8L V6 3800cc 231 CID		
1988-1995		CHEVROLET C2500	5.7L V8 350 CID	1992-1995	OLDSMOBILE SILHOUETTE		3.8L V6 3800cc 231 CID		
1988-1995		CHEVROLET C3500	5.7L V8 350 CID	1992-1995	PONTIAC TRANS SPORT		3.8L V6 3800cc 231 CID		
1988-1995		CHEVROLET K1500	4.3L V6 262 CID	1995	BUICK RIVIERA		3.8L V6 3800cc 231 CID		
1988-1995		CHEVROLET K1500	5.0L V8 305 CID	1995	CHEVROLET CAMARO		3.8L V6 3800cc 231 CID		
1988-1995		CHEVROLET K1500	5.7L V8 350 CID	1995	PONTIAC FIREBIRD		3.8L V6 3800cc 231 CID		
1988-1995		CHEVROLET K2500	4.3L V6 262 CID	US5051	1991		BUICK COMMERCIAL CHASSIS	5.0L V8 305 CID	
1988-1995	CHEVROLET K2500	5.0L V8 305 CID	1991		BUICK ROADMASTER		5.0L V8 305 CID		
1988-1995	CHEVROLET K2500	5.7L V8 350 CID	1991-1992		OLDSMOBILE CUSTOM CRUISER		5.0L V8 305 CID		
1988-1995	CHEVROLET K3500	5.7L V8 350 CID	1991-1993		CHEVROLET CAPRICE		5.0L V8 305 CID		
1988-1995	CHEVROLET S10	4.3L V6 262 CID	1991-1993		CHEVROLET CAPRICE		5.7L V8 350 CID		
1988-1995	GMC C1500	4.3L V6 262 CID	1992		OLDSMOBILE CUSTOM CRUISER	5.7L V8 350 CID			
1988-1995	GMC C1500	5.0L V8 305 CID	1992-1993		BUICK COMMERCIAL CHASSIS	5.7L V8 350 CID			
1988-1995	GMC C1500	5.7L V8 350 CID	1992-1993		BUICK ROADMASTER	5.7L V8 350 CID			
1988-1995	GMC C2500	4.3L V6 262 CID	US5054		1991-1992	SATURN SC	1.9L L4 116 CID		
1988-1995	GMC C2500	5.0L V8 305 CID			1991-2002	SATURN SL	1.9L L4 116 CID		
1988-1995	GMC C2500	5.7L V8 350 CID			1991-2002	SATURN SL1	1.9L L4 116 CID		
1988-1995	GMC C3500	5.7L V8 350 CID			1991-2002	SATURN SL2	1.9L L4 116 CID		
1988-1995	GMC K1500	4.3L V6 262 CID			1993-1999	SATURN SW1	1.9L L4 116 CID		
1988-1995	GMC K1500	5.0L V8 305 CID			1993-2001	SATURN SW2	1.9L L4 116 CID		
1988-1995	GMC K1500	5.7L V8 350 CID			1993-2002	SATURN SC1	1.9L L4 116 CID		
1988-1995	GMC K2500	4.3L V6 262 CID			1993-2002	SATURN SC2	1.9L L4 116 CID		
1988-1995	GMC K2500	5.0L V8 305 CID			US5056	1990-1995	CHEVROLET CORVETTE	5.7L V8 350 CID	
1988-1995	GMC K2500	5.7L V8 350 CID				US5057	1991-1993	PONTIAC LEMANS	1.6L L4 1588cc 98 CID
1988-1995	GMC K3500	5.7L V8 350 CID	1994-1995				CHEVROLET JOY	1.4L L4 1400cc 85 CID	
1989-1990	CHEVROLET CAPRICE	4.3L V6 262 CID	1994-1995				CHEVROLET SWING	1.4L L4 1400cc 85 CID	
1989-1990	CHEVROLET CAPRICE	5.0L V8 305 CID	1996-2001				CHEVROLET POP	1.4L L4 1400cc 85 CID	
1989-1990	CHEVROLET CAPRICE	5.7L V8 350 CID	1996-2003				CHEVROLET JOY	1.6L L4 1600cc 98 CID	
1989-1991	CHEVROLET R1500 SUBURBAN	5.7L V8 350 CID	1996-2003		CHEVROLET SWING		1.6L L4 1600cc 98 CID		

USMW	Years	Application	Engine	USMW	Years	Application	Engine		
US5057	1997-2003	CHEVROLET MONZA	1.6L L4 1600cc 98 CID	US5072	1993	CADILLAC DEVILLE	4.6L V8 4573cc 279 CID		
	1999	CHEVROLET TIGRA	1.6L L4 1600cc 98 CID		1995-1999	OLDSMOBILE AURORA	4.0L V8 244 CID		
	1999-2003	CHEVROLET CHEVY	1.6L L4 1600cc 98 CID		1995-2002	CADILLAC ELDRADO	4.6L V8 281 CID		
	2000	CHEVROLET MILENIO	1.6L L4 1600cc 98 CID		1995-2004	CADILLAC SEVILLE	4.6L V8 281 CID		
	2000-2002	CHEVROLET VAGONETA	1.6L L4 1600cc 98 CID		1995-2005	CADILLAC DEVILLE	4.6L V8 281 CID		
	2002	CHEVROLET CORSA	1.4L L4 1389cc 85 CID		1996-1997	CADILLAC DEVILLE	4.9L V8 4900cc 300 CID		
	2002	CHEVROLET MONZA POP	1.4L L4 1400cc 85 CID		2001-2003	OLDSMOBILE AURORA	4.0L V8 244 CID		
	2002-2003	CHEVROLET POP	1.6L L4 1600cc 98 CID		2004-2005	PONTIAC BONNEVILLE	4.6L V8 281 CID		
	2004-2009	CHEVROLET CHEVY	1.6L L4 1606cc 98 CID		US5073	1992	CHEVROLET C1500	5.7L V8 350 CID	
	2010-2012	CHEVROLET CHEVY	1.6L L4 1598cc 98 CID			1992	CHEVROLET C1500 SUBURBAN	5.7L V8 350 CID	
	US5058	1989-1997	GEO METRO			1.0L L3 993cc 61 CID	1992	CHEVROLET C2500 SUBURBAN	5.7L V8 350 CID
		1989-2001	SUZUKI SWIFT			1.3L L4 1298cc 79 CID	1992	CHEVROLET K1500 SUBURBAN	5.7L V8 350 CID
1995-1997		GEO METRO	1.3L L4 1295cc 79 CID	1992		CHEVROLET K2500 SUBURBAN	5.7L V8 350 CID		
1998-2000		CHEVROLET METRO	1.0L L3 993cc 61 CID	1992		GMC C1500	5.7L V8 350 CID		
1998-2001		CHEVROLET METRO	1.3L L4 1295cc 79 CID	1992		GMC C1500 SUBURBAN	5.7L V8 350 CID		
US5062		1988-1991	GMC R1500 SUBURBAN	6.2L V8 379 CID		1992	GMC C2500 SUBURBAN	5.7L V8 350 CID	
		1988-1991	GMC R2500 SUBURBAN	6.2L V8 379 CID		1992	GMC K1500 SUBURBAN	5.7L V8 350 CID	
		1988-1991	GMC V1500 SUBURBAN	6.2L V8 379 CID		1992	GMC K2500 SUBURBAN	5.7L V8 350 CID	
		1988-1991	GMC V2500 SUBURBAN	6.2L V8 379 CID	US5074	1996-1997	GMC C1500	6.5L V8 395 CID	
		1988-1993	CHEVROLET C1500	6.2L V8 379 CID		1996-1997	GMC YUKON	6.5L V8 395 CID	
		1988-1993	CHEVROLET C2500	6.2L V8 379 CID		1996-1998	AM GENERAL HUMMER	6.5L V8 395 CID	
		1988-1993	CHEVROLET C3500	6.2L V8 379 CID		1996-1998	CHEVROLET C1500	6.5L V8 395 CID	
	1988-1993	CHEVROLET K1500	6.2L V8 379 CID	1996-1998		CHEVROLET EXPRESS 2500	6.5L V8 395 CID		
	1988-1993	CHEVROLET K2500	6.2L V8 379 CID	1996-1998		CHEVROLET EXPRESS 3500	6.5L V8 395 CID		
	1988-1993	CHEVROLET K3500	6.2L V8 379 CID	1996-1998		CHEVROLET K1500	6.5L V8 395 CID		
	1988-1993	GMC C1500	6.2L V8 379 CID	1996-1998		GMC K1500	6.5L V8 395 CID		
	1988-1993	GMC C2500	6.2L V8 379 CID	1996-1998		GMC SAVANA 2500	6.5L V8 395 CID		
1988-1993	GMC C3500	6.2L V8 379 CID	1996-1998	GMC SAVANA 3500		6.5L V8 395 CID			
1988-1993	GMC K1500	6.2L V8 379 CID	1996-1999	CHEVROLET C1500 SUBURBAN		6.5L V8 395 CID			
1988-1993	GMC K2500	6.2L V8 379 CID	1996-1999	CHEVROLET C2500		6.5L V8 395 CID			
1988-1993	GMC K3500	6.2L V8 379 CID	1996-1999	CHEVROLET C2500 SUBURBAN	6.5L V8 395 CID				
1989-1991	CHEVROLET R1500 SUBURBAN	6.2L V8 379 CID	1996-1999	CHEVROLET C3500	6.5L V8 395 CID				
1989-1991	CHEVROLET R2500 SUBURBAN	6.2L V8 379 CID	1996-1999	CHEVROLET K1500 SUBURBAN	6.5L V8 395 CID				
1989-1991	CHEVROLET V1500 SUBURBAN	6.2L V8 379 CID	1996-1999	CHEVROLET K2500	6.5L V8 395 CID				
1989-1991	CHEVROLET V2500 SUBURBAN	6.2L V8 379 CID	1996-1999	CHEVROLET K2500 SUBURBAN	6.5L V8 395 CID				
1992-1996	CHEVROLET C2500	6.5L V8 395 CID	1996-1999	CHEVROLET K3500	6.5L V8 395 CID				
1992-1996	CHEVROLET C3500	6.5L V8 395 CID	1996-1999	CHEVROLET TAHOE	6.5L V8 395 CID				
1992-1996	CHEVROLET K2500	6.5L V8 395 CID	1996-1999	GMC C1500 SUBURBAN	6.5L V8 395 CID				
1992-1996	CHEVROLET K3500	6.5L V8 395 CID	1996-1999	GMC C2500	6.5L V8 395 CID				
1992-1996	GMC C2500	6.5L V8 395 CID	1996-1999	GMC C2500 SUBURBAN	6.5L V8 395 CID				
1992-1996	GMC C3500	6.5L V8 395 CID	1996-1999	GMC C3500	6.5L V8 395 CID				
1992-1996	GMC K2500	6.5L V8 395 CID	1996-1999	GMC K1500 SUBURBAN	6.5L V8 395 CID				
1992-1996	GMC K3500	6.5L V8 395 CID	1996-1999	GMC K2500	6.5L V8 395 CID				
1994	CHEVROLET BLAZER	6.5L V8 395 CID	1996-1999	GMC K2500 SUBURBAN	6.5L V8 395 CID				
1994-1995	CHEVROLET G20	6.5L V8 395 CID	1996-1999	GMC K3500	6.5L V8 395 CID				
1994-1995	GMC G2500	6.5L V8 395 CID	1997-1998	CHEVROLET P30	6.5L V8 395 CID				
1994-1996	AM GENERAL HUMMER	6.5L V8 395 CID	1997-1998	GMC P3500	6.5L V8 395 CID				
1994-1996	CHEVROLET C1500	6.5L V8 395 CID	US5075	1996	OLDSMOBILE 98	3.8L V6 3800cc 231 CID			
1994-1996	CHEVROLET C2500 SUBURBAN	6.5L V8 395 CID		1996-1999	BUICK RIVIERA	3.8L V6 3800cc 231 CID			
1994-1996	CHEVROLET G30	6.5L V8 395 CID		1996-1999	OLDSMOBILE 88	3.8L V6 3800cc 231 CID			
1994-1996	CHEVROLET K1500	6.5L V8 395 CID		1996-1999	OLDSMOBILE LSS	3.8L V6 3800cc 231 CID			
1994-1996	CHEVROLET K2500 SUBURBAN	6.5L V8 395 CID		1996-2002	CHEVROLET CAMARO	3.8L V6 3800cc 231 CID			
1994-1996	CHEVROLET P30	6.5L V8 395 CID		1996-2002	PONTIAC FIREBIRD	3.8L V6 3800cc 231 CID			
1994-1996	GMC C1500	6.5L V8 395 CID		1996-2004	BUICK REGAL	3.8L V6 3800cc 231 CID			
1994-1996	GMC C2500 SUBURBAN	6.5L V8 395 CID		1996-2005	BUICK LESABRE	3.8L V6 3800cc 231 CID			
1994-1996	GMC G3500	6.5L V8 395 CID		1996-2005	BUICK PARK AVENUE	3.8L V6 3800cc 231 CID			
1994-1996	GMC K1500	6.5L V8 395 CID		1996-2005	PONTIAC BONNEVILLE	3.8L V6 3800cc 231 CID			
1994-1996	GMC K2500 SUBURBAN	6.5L V8 395 CID		1997-1998	OLDSMOBILE REGENCY	3.8L V6 3800cc 231 CID			
1994-1996	GMC P3500	6.5L V8 395 CID		1997-2008	PONTIAC GRAND PRIX	3.8L V6 3800cc 231 CID			
1994-1996	GMC YUKON	6.5L V8 395 CID	1998-1999	CHEVROLET LUMINA	3.8L V6 3800cc 231 CID				
1995-1996	CHEVROLET C1500 SUBURBAN	6.5L V8 395 CID	1998-1999	OLDSMOBILE INTRIGUE	3.8L V6 3800cc 231 CID				
1995-1996	CHEVROLET K1500 SUBURBAN	6.5L V8 395 CID	1998-2005	CHEVROLET MONTE CARLO	3.8L V6 3800cc 231 CID				
1995-1996	CHEVROLET TAHOE	6.5L V8 395 CID	2000-2005	CHEVROLET IMPALA	3.8L V6 3800cc 231 CID				
1995-1996	GMC C1500 SUBURBAN	6.5L V8 395 CID	2005-2009	BUICK LACROSSE	3.8L V6 3800cc 231 CID				
1995-1996	GMC K1500 SUBURBAN	6.5L V8 395 CID	2006-2008	BUICK LUCERNE	3.8L V6 3800cc 231 CID				
US5063	1992	CHEVROLET CORVETTE	5.7L V8 350 CID	US5076	1996-1998	BUICK SKYLARK	2.4L L4 2392cc 146 CID		
	1993	CADILLAC ALLANTE	4.6L V8 281 CID		1996-1998	OLDSMOBILE ACHIEVA	2.4L L4 2392cc 146 CID		
US5064	1993-1994	CADILLAC ELDRADO	4.6L V8 281 CID		1996-2001	PONTIAC GRAND AM	2.4L L4 2392cc 146 CID		
	1993-1994	CADILLAC SEVILLE	4.6L V8 281 CID		1996-2002	CHEVROLET CAVALIER	2.4L L4 2392cc 146 CID		
	1994	CADILLAC DEVILLE	4.6L V8 281 CID		1996-2002	PONTIAC SUNFIRE	2.4L L4 2392cc 146 CID		
	1994	CADILLAC DEVILLE	4.6L V8 281 CID		1997-1999	CHEVROLET MALIBU	2.4L L4 2392cc 146 CID		
US5066	1993-1996	CHEVROLET CORVETTE	5.7L V8 350 CID		1999-2001	OLDSMOBILE ALERO	2.4L L4 2392cc 146 CID		
US5067	1985	BUICK SOMERSET REGAL	2.5L L4 2474cc 151 CID		2000-2001	CHEVROLET MALIBU	2.4L L4 2395cc 146 CID		
	1985-1987	OLDSMOBILE CALAIS	2.5L L4 2474cc 151 CID		1996-1997	CHEVROLET BOSS TRUCK	5.7L V8 5700cc 350 CID		
	1985-1987	OLDSMOBILE CUTLASS CIERA	2.5L L4 2474cc 151 CID		1996-1997	CHEVROLET C25	5.7L V8 5700cc 350 CID		
	1985-1991	PONTIAC GRAND AM	2.5L L4 2474cc 151 CID		1996-1997	CHEVROLET SILVERADO	5.7L V8 5700cc 350 CID		
	1986-1987	BUICK SOMERSET	2.5L L4 2474cc 151 CID		1996-1998	CHEVROLET C1500	4.3L V6 262 CID		
	1986-1991	BUICK SKYLARK	2.5L L4 2474cc 151 CID	1996-1998	CHEVROLET C2500	5.0L V8 305 CID			
	1987	OLDSMOBILE CUTLASS CRUISER	2.5L L4 2474cc 151 CID	1996-1998	CHEVROLET K1500	4.3L V6 262 CID			
	US5068	1993-1997	CHEVROLET CAMARO	5.7L V8 350 CID	1996-1998	GMC C1500	4.3L V6 262 CID		
		1993-1997	PONTIAC FIREBIRD	5.7L V8 350 CID	1996-1998	GMC C2500	5.0L V8 305 CID		
	US5069	1994-1996	BUICK COMMERCIAL CHASSIS	5.7L V8 350 CID	1996-1998	GMC K1500	4.3L V6 262 CID		
1994-1996		BUICK ROADMASTER	5.7L V8 350 CID	1996-1999	CHEVROLET C1500	5.0L V8 305 CID			
1994-1996		CADILLAC COMMERCIAL CHASSIS	5.7L V8 350 CID	1996-1999	CHEVROLET C1500	5.7L V8 350 CID			
1994-1996		CADILLAC FLEETWOOD	5.7L V8 350 CID	1996-1999	CHEVROLET C1500 SUBURBAN	5.7L V8 350 CID			
1994-1996		CHEVROLET CAPRICE	4.3L V8 265 CID	1996-1999	CHEVROLET C2500 SUBURBAN	5.7L V8 350 CID			
1994-1996		CHEVROLET CAPRICE	5.7L V8 350 CID	1996-1999	CHEVROLET K1500	5.0L V8 305 CID			
US5070	1993-1995	CHEVROLET CAMARO	3.4L V6 207 CID	1996-1999	CHEVROLET K1500	5.7L V8 350 CID			
	1993-1995	PONTIAC FIREBIRD	3.4L V6 207 CID	1996-1999	CHEVROLET K1500 SUBURBAN	5.7L V8 350 CID			

USMW	Years	Application	Engine	USMW	Years	Application	Engine	
US5077	1996-1999	CHEVROLET K2500 SUBURBAN	5.7L V8 350 CID	US5077H	1996-1999	GMC K2500 SUBURBAN	5.7L V8 350 CID	
	1996-1999	CHEVROLET P30	4.3L V6 262 CID		1996-1999	GMC P3500	4.3L V6 262 CID	
	1996-1999	GMC C1500	5.0L V8 305 CID		1996-1999	GMC P3500	5.7L V8 350 CID	
	1996-1999	GMC C1500	5.7L V8 350 CID		1996-1999	GMC YUKON	5.7L V8 350 CID	
	1996-1999	GMC C1500 SUBURBAN	5.7L V8 350 CID		1996-2000	CHEVROLET C2500	5.7L V8 350 CID	
	1996-1999	GMC C2500 SUBURBAN	5.7L V8 350 CID		1996-2000	CHEVROLET C3500	5.7L V8 350 CID	
	1996-1999	GMC K1500	5.0L V8 305 CID		1996-2000	CHEVROLET K2500	5.7L V8 350 CID	
	1996-1999	GMC K1500	5.7L V8 350 CID		1996-2000	CHEVROLET K3500	5.7L V8 350 CID	
	1996-1999	GMC K1500 SUBURBAN	5.7L V8 350 CID		1996-2000	CHEVROLET TAHOE	5.7L V8 350 CID	
	1996-1999	GMC K2500 SUBURBAN	5.7L V8 350 CID		1996-2000	GMC C2500	5.7L V8 350 CID	
	1996-1999	GMC P3500	4.3L V6 262 CID		1996-2000	GMC C3500	5.7L V8 350 CID	
	1996-1999	GMC P3500	5.7L V8 350 CID		1996-2000	GMC K2500	5.7L V8 350 CID	
	1996-2000	CHEVROLET C2500	5.7L V8 350 CID		1996-2000	GMC K3500	5.7L V8 350 CID	
	1996-2000	CHEVROLET C3500	5.7L V8 350 CID		1996-2001	GMC JIMMY	4.3L V6 262 CID	
	1996-2000	CHEVROLET K2500	5.7L V8 350 CID		1996-2001	OLDSMOBILE BRAVADA	4.3L V6 262 CID	
	1996-2000	CHEVROLET K3500	5.7L V8 350 CID		1996-2002	CHEVROLET EXPRESS 1500	5.0L V8 305 CID	
	1996-2000	CHEVROLET TAHOE	5.7L V8 350 CID		1996-2002	CHEVROLET EXPRESS 1500	5.7L V8 350 CID	
	1996-2000	GMC C2500	5.7L V8 350 CID		1996-2002	CHEVROLET EXPRESS 2500	5.0L V8 305 CID	
	1996-2000	GMC C3500	5.7L V8 350 CID		1996-2002	CHEVROLET EXPRESS 2500	5.7L V8 350 CID	
	1996-2000	GMC K2500	5.7L V8 350 CID		1996-2002	CHEVROLET EXPRESS 3500	5.7L V8 350 CID	
	1996-2000	GMC K3500	5.7L V8 350 CID		1996-2002	GMC SAVANA 1500	5.0L V8 305 CID	
	1996-2000	GMC YUKON	5.7L V8 350 CID		1996-2002	GMC SAVANA 1500	5.7L V8 350 CID	
	1996-2001	GMC JIMMY	4.3L V6 262 CID		1996-2002	GMC SAVANA 2500	5.0L V8 305 CID	
	1996-2001	OLDSMOBILE BRAVADA	4.3L V6 262 CID		1996-2002	GMC SAVANA 2500	5.7L V8 350 CID	
	1996-2002	CHEVROLET EXPRESS 1500	5.0L V8 305 CID		1996-2002	GMC SAVANA 3500	5.7L V8 350 CID	
	1996-2002	CHEVROLET EXPRESS 1500	5.7L V8 350 CID		1996-2004	CHEVROLET S10	4.3L V6 262 CID	
	1996-2002	CHEVROLET EXPRESS 2500	5.0L V8 305 CID		1996-2004	GMC SONOMA	4.3L V6 262 CID	
	1996-2002	CHEVROLET EXPRESS 2500	5.7L V8 350 CID		1996-2005	CHEVROLET ASTRO	4.3L V6 262 CID	
	1996-2002	CHEVROLET EXPRESS 3500	5.7L V8 350 CID		1996-2005	CHEVROLET BLAZER	4.3L V6 262 CID	
	1996-2002	GMC SAVANA 1500	5.0L V8 305 CID		1996-2005	CHEVROLET EXPRESS 2500	4.3L V6 262 CID	
	1996-2002	GMC SAVANA 1500	5.7L V8 350 CID		1996-2005	GMC SAFARI	4.3L V6 262 CID	
	1996-2002	GMC SAVANA 2500	5.0L V8 305 CID		1996-2005	GMC SAVANA 2500	4.3L V6 262 CID	
	1996-2002	GMC SAVANA 2500	5.7L V8 350 CID		1996-2011	CHEVROLET EXPRESS 1500	4.3L V6 262 CID	
	1996-2002	GMC SAVANA 3500	5.7L V8 350 CID		1996-2011	GMC SAVANA 1500	4.3L V6 262 CID	
	1996-2004	CHEVROLET S10	4.3L V6 262 CID		1997-1999	CHEVROLET P30	5.7L V8 350 CID	
	1996-2004	GMC SONOMA	4.3L V6 262 CID		1997-1999	ISUZU HOMBRE	4.3L V6 4294cc	
	1996-2005	CHEVROLET ASTRO	4.3L V6 262 CID		1998	CHEVROLET K2500	5.0L V8 305 CID	
	1996-2005	CHEVROLET BLAZER	4.3L V6 262 CID		1998	GMC K2500	5.0L V8 305 CID	
	1996-2005	CHEVROLET EXPRESS 2500	4.3L V6 262 CID		1999-2000	CADILLAC ESCALADE	5.7L V8 350 CID	
	1996-2005	GMC SAFARI	4.3L V6 262 CID		1999-2011	CHEVROLET SILVERADO 1500	4.3L V6 262 CID	
	1996-2005	GMC SAVANA 2500	4.3L V6 262 CID		1999-2011	GMC SIERRA 1500	4.3L V6 262 CID	
	1996-2012	CHEVROLET EXPRESS 1500	4.3L V6 262 CID		2000	ISUZU HOMBRE	4.3L V6 262 CID	
	1996-2012	GMC SAVANA 1500	4.3L V6 262 CID		2001	CHEVROLET P30	4.3L V6 4300cc 262 CID	
	1997-1999	CHEVROLET P30	5.7L V8 350 CID		2001-2002	CHEVROLET SUBURBAN 1500	5.7L V8 350 CID	
	1997-1999	ISUZU HOMBRE	4.3L V6 4294cc		US5078	1990	CHEVROLET C60	6.0L V8 366 CID
	1998	CHEVROLET C2500	5.7L V8 5700cc 350 CID			1990	CHEVROLET C60	7.0L V8 427 CID
	1998	CHEVROLET K2500	5.0L V8 305 CID			1990	CHEVROLET C70	6.0L V8 366 CID
	1998	GMC K2500	5.0L V8 305 CID			1990	CHEVROLET C70	7.0L V8 427 CID
	1998-1999	CHEVROLET P31 VAN	5.7L V8 5737cc 350 CID			1990	CHEVROLET P60	7.0L V8 6998cc 427 CID
	1999	CHEVROLET C1500	4.3L V6 4300cc 262 CID			1990	GMC C6000	6.0L V8 366 CID
	1999-2000	CADILLAC ESCALADE	5.7L V8 350 CID			1990	GMC C6000	7.0L V8 427 CID
	1999-2012	CHEVROLET SILVERADO 1500	4.3L V6 262 CID			1990	GMC C7000	6.0L V8 366 CID
	1999-2013	GMC SIERRA 1500	4.3L V6 262 CID			1990	GMC C7000	7.0L V8 427 CID
	2000	CHEVROLET C1500	5.7L V8 5737cc 350 CID			1990	GMC P6000	7.0L V8 6998cc 427 CID
	2000	CHEVROLET K1500	5.7L V8 5737cc 350 CID			1990-1991	CHEVROLET B60	6.0L V8 366 CID
	2000	CHEVROLET K2500	5.7L V8 5737cc 350 CID			1990-1991	CHEVROLET C5500 KODIAK	6.0L V8 366 CID
	2000	ISUZU HOMBRE	4.3L V6 262 CID			1990-1991	GMC B6000	6.0L V8 366 CID
2001	CHEVROLET P30 VAN	4.3L V6 4300cc 262 CID	1990-1991	GMC C5000 TOPKICK		6.0L V8 366 CID		
2003	CHEVROLET SONORA	4.3L V6 4300cc 262 CID	1990-1996	CHEVROLET C60 KODIAK		6.0L V8 366 CID		
2007	CHEVROLET SILVERADO 1500 CLASSIC	4.3L V6 262 CID	1990-1996	CHEVROLET C60 KODIAK		7.0L V8 6998cc 427 CID		
2007	GMC SIERRA 1500 CLASSIC	4.3L V6 262 CID	1990-1996	CHEVROLET C70 KODIAK		6.0L V8 366 CID		
2010-2013	CHEVROLET EXPRESS	4.3L V6 4300cc 262 CID	1990-1996	CHEVROLET C70 KODIAK		7.0L V8 6998cc 427 CID		
2013	CHEVROLET SILVERADO 1500	4.3L V6 4293cc 262 CID	1990-1996	GMC C6000 TOPKICK		6.0L V8 366 CID		
2013	GMC SAVANA 1500	4.3L V6 4293cc 262 CID	1990-1996	GMC C6000 TOPKICK		7.0L V8 6998cc 427 CID		
2013-2014	CHEVROLET EXPRESS 1500	4.3L V6 4293cc 262 CID	1990-1996	GMC C7000 TOPKICK		6.0L V8 366 CID		
2013-2014	CHEVROLET SILVERADO 1500	4.3L V6 4300cc 262 CID	1990-1996	GMC C7000 TOPKICK		7.0L V8 6998cc 427 CID		
2014	GMC SAVANA 1500	4.3L V6 262 CID	1992-1996	CHEVROLET P60		7.0L V8 6998cc 427 CID		
US5077H	1996-1998	CHEVROLET C1500	4.3L V6 262 CID	1992-1996		CHEVROLET P6000	6.0L V8 366 CID	
	1996-1998	CHEVROLET C2500	5.0L V8 305 CID	1992-1996		CHEVROLET P6000	7.0L V8 6998cc 427 CID	
	1996-1998	CHEVROLET K1500	4.3L V6 262 CID	1992-1996		GMC P6500	6.0L V8 366 CID	
	1996-1998	GMC C1500	4.3L V6 262 CID	1992-1996		GMC P6500	7.0L V8 6998cc 427 CID	
	1996-1998	GMC C2500	5.0L V8 305 CID	1993-1998		CHEVROLET B7	6.0L V8 366 CID	
	1996-1998	GMC K1500	4.3L V6 262 CID	1993-1998		GMC B7	6.0L V8 366 CID	
	1996-1999	CHEVROLET C1500	5.0L V8 305 CID	1994-1998		CHEVROLET B7	7.0L V8 6998cc 427 CID	
	1996-1999	CHEVROLET C1500	5.0L V8 305 CID	1994-1998		GMC B7	7.0L V8 6998cc 427 CID	
	1996-1999	CHEVROLET C1500 SUBURBAN	5.7L V8 350 CID	1997-1998		CHEVROLET C6500 KODIAK	6.0L V8 366 CID	
	1996-1999	CHEVROLET C2500 SUBURBAN	5.7L V8 350 CID	1997-1998		CHEVROLET C6500 KODIAK	7.0L V8 6998cc 427 CID	
	1996-1999	CHEVROLET K1500	5.0L V8 305 CID	1997-1998		CHEVROLET C7500 KODIAK	6.0L V8 366 CID	
	1996-1999	CHEVROLET K1500	5.7L V8 350 CID	1997-1998		CHEVROLET C7500 KODIAK	7.0L V8 6998cc 427 CID	
	1996-1999	CHEVROLET K1500 SUBURBAN	5.7L V8 350 CID	1997-1998		CHEVROLET T6500	6.0L V8 366 CID	
	1996-1999	CHEVROLET K2500 SUBURBAN	5.7L V8 350 CID	1997-1998		CHEVROLET T7500	6.0L V8 366 CID	
	1996-1999	CHEVROLET P30	4.3L V6 262 CID	1997-1998		GMC C6500 TOPKICK	6.0L V8 366 CID	
	1996-1999	GMC C1500	5.0L V8 305 CID	1997-1998		GMC C6500 TOPKICK	7.0L V8 6998cc 427 CID	
	1996-1999	GMC C1500	5.7L V8 350 CID	1997-1998		GMC C7500 TOPKICK	6.0L V8 366 CID	
	1996-1999	GMC C1500 SUBURBAN	5.7L V8 350 CID	1997-1998		GMC T6500	6.0L V8 366 CID	
	1996-1999	GMC C2500 SUBURBAN	5.7L V8 350 CID	1997-1998		GMC T7500	6.0L V8 366 CID	
	1996-1999	GMC K1500	5.0L V8 305 CID	US5079		1994-1997	SAAB 900	2.5L V6 2498cc
	1996-1999	GMC K1500	5.7L V8 350 CID			1995-1997	SAAB 9000	3.0L V6 2961cc 181 CID
	1996-1999	GMC K1500 SUBURBAN	5.7L V8 350 CID			1997-2001	CADILLAC CATERA	3.0L V6 2962cc 181 CID

USMW	Years	Application	Engine	USMW	Years	Application	Engine
US5079	1999-2003	SAAB 9-5	3.0L V6 2961cc 181 CID	US5089H	2001-2006	CHEVROLET SUBURBAN 2500	8.1L V8 496 CID
	2000	SATURN LS2	3.0L V6 3000cc 181 CID		2001-2006	GMC SIERRA 2500 HD	8.1L V8 496 CID
	2000	SATURN LW2	3.0L V6 3000cc 181 CID		2001-2006	GMC SIERRA 3500	8.1L V8 496 CID
	2001-2003	SATURN LW300	3.0L V6 3000cc 181 CID		2001-2006	GMC YUKON XL 2500	8.1L V8 496 CID
	2001-2005	SATURN L300	3.0L V6 3000cc 181 CID		2002-2006	CHEVROLET AVALANCHE 2500	8.1L V8 496 CID
	2002-2003	SATURN VUE	3.0L V6 3000cc 181 CID		2007	CHEVROLET SILVERADO 2500 HD CLASSIC	8.1L V8 496 CID
	2003	CHEVROLET VECTRA	3.2L V6 3199cc 195 CID		2007	CHEVROLET SILVERADO 3500 CLASSIC	8.1L V8 496 CID
	2003-2004	CADILLAC CTS	3.2L V6 197 CID		2007	GMC SIERRA 2500 HD CLASSIC	8.1L V8 496 CID
	2004-2005	CHEVROLET VECTRA	3.2L V6 3171cc 193 CID		2007	GMC SIERRA 3500 CLASSIC	8.1L V8 496 CID
	US5081	1997-2004	CHEVROLET CORVETTE		5.7L V8 350 CID	US5090	2001-2002
1998-2002		CHEVROLET CAMARO	5.7L V8 350 CID	2001-2002	GMC SAVANA 3500		8.1L V8 496 CID
1998-2002		PONTIAC FIREBIRD	5.7L V8 350 CID	US5092	2000	SATURN LS	2.2L L4 2198cc 134 CID
2004		PONTIAC GTO	5.7L V8 350 CID		2000	SATURN LS1	2.2L L4 2198cc 134 CID
US5084	1966-1967	CHEVROLET C50	6.0L V8 5999cc 366 CID		2000	SATURN LW1	2.2L L4 2198cc 134 CID
	1966-1967	CHEVROLET C60	6.0L V8 5999cc 366 CID		2001-2002	SATURN L100	2.2L L4 2198cc 134 CID
	1980	CHEVROLET C70	7.4L V8 454 CID		2001-2003	SATURN L200	2.2L L4 2198cc 134 CID
	1980	GMC C7000	7.4L V8 454 CID		2001-2003	SATURN LW200	2.2L L4 2198cc 134 CID
	1980-1985	CHEVROLET B60	7.0L V8 427 CID		2002-2004	OLDSMOBILE ALERO	2.2L L4 2198cc 134 CID
	1980-1985	GMC B6000	7.0L V8 427 CID		2002-2005	CHEVROLET CAVALIER	2.2L L4 2198cc 134 CID
	1980-1990	CHEVROLET B60	6.0L V8 366 CID		2002-2005	PONTIAC GRAND AM	2.2L L4 2198cc 134 CID
	1980-1990	CHEVROLET C60	6.0L V8 366 CID		2002-2005	PONTIAC SUNFIRE	2.2L L4 2198cc 134 CID
	1980-1990	CHEVROLET C70	6.0L V8 366 CID	2002-2006	CHEVROLET ZAFIRA	2.2L L4 2190cc 134 CID	
	1980-1990	CHEVROLET C70	7.0L V8 427 CID	2002-2007	SATURN VUE	2.2L L4 2198cc 134 CID	
1980-1990	GMC B6000	6.0L V8 366 CID	2003-2005	CHEVROLET VECTRA	2.2L L4 2190cc 134 CID		
1980-1990	GMC C6000	6.0L V8 366 CID	2003-2007	SATURN ION	2.2L L4 2198cc 134 CID		
1980-1990	GMC C7000	6.0L V8 366 CID	2003-2011	SAAB 9-3	2.0L L4 1985cc		
1980-1990	GMC C7000	7.0L V8 427 CID	2004	SATURN L300	2.2L L4 2198cc 134 CID		
1990	CHEVROLET C60	7.0L V8 427 CID	2004-2005	CHEVROLET CLASSIC	2.2L L4 2198cc 134 CID		
1990	CHEVROLET C60 KODIAK	6.0L V8 366 CID	2004-2007	SATURN ION	2.0L L4 122 CID		
1990	CHEVROLET C60 KODIAK	7.0L V8 6998cc 427 CID	2004-2008	CHEVROLET MALIBU	2.2L L4 2198cc 134 CID		
1990	CHEVROLET C70 KODIAK	6.0L V8 366 CID	2005-2006	PONTIAC G4	2.2L L4 2190cc 134 CID		
1990	CHEVROLET C70 KODIAK	7.0L V8 6998cc 427 CID	2005-2007	CHEVROLET COBALT	2.0L L4 122 CID		
1990	CHEVROLET C5500 KODIAK	6.0L V8 366 CID	2005-2010	CHEVROLET COBALT	2.2L L4 2198cc 134 CID		
1990	CHEVROLET P60	7.0L V8 6998cc 427 CID	2006	PONTIAC G4	2.4L L4 2395cc 146 CID		
1990	GMC C5000 TOPKICK	6.0L V8 366 CID	2006-2007	SATURN ION	2.4L L4 2384cc 145 CID		
1990	GMC C6000	7.0L V8 427 CID	2006-2008	CHEVROLET COBALT	2.4L L4 2384cc 145 CID		
1990	GMC C6000 TOPKICK	6.0L V8 366 CID	2006-2009	PONTIAC SOLSTICE	2.4L L4 2384cc 145 CID		
1990	GMC C6000 TOPKICK	7.0L V8 6998cc 427 CID	2006-2010	PONTIAC G6	2.4L L4 2384cc 145 CID		
1990	GMC C7000 TOPKICK	6.0L V8 366 CID	2006-2011	CHEVROLET HHR	2.2L L4 2198cc 134 CID		
1990	GMC C7000 TOPKICK	7.0L V8 6998cc 427 CID	2006-2011	CHEVROLET HHR	2.4L L4 2384cc 145 CID		
1990	GMC P6000	7.0L V8 6998cc 427 CID	2007-2008	PONTIAC G5	2.4L L4 2384cc 145 CID		
US5085	1999-2002	OLDSMOBILE INTRIGUE	3.5L V6 214 CID	2007-2009	PONTIAC G5	2.2L L4 2198cc 134 CID	
	2001-2002	OLDSMOBILE AURORA	3.5L V6 214 CID	2007-2009	PONTIAC SOLSTICE	2.0L L4 1998cc 122 CID	
US5086	1999	CHEVROLET C1500 SUBURBAN	6.5L V8 395 CID	2007-2009	SATURN AURA	2.4L L4 2384cc 145 CID	
	1999	CHEVROLET C2500 SUBURBAN	6.5L V8 395 CID	2007-2010	SATURN SKY	2.0L L4 1998cc 122 CID	
	1999	CHEVROLET K1500 SUBURBAN	6.5L V8 395 CID	2007-2010	SATURN SKY	2.4L L4 2384cc 145 CID	
	1999	CHEVROLET K2500 SUBURBAN	6.5L V8 395 CID	2007-2010	SATURN VUE	2.4L L4 2384cc 145 CID	
	1999	CHEVROLET P30	6.5L V8 395 CID	2008-2010	CHEVROLET COBALT	2.0L L4 1998cc 122 CID	
	1999	GMC C1500 SUBURBAN	6.5L V8 395 CID	2008-2010	CHEVROLET HHR	2.0L L4 1998cc 122 CID	
	1999	GMC C2500 SUBURBAN	6.5L V8 395 CID	2008-2014	CHEVROLET MALIBU	2.4L L4 2384cc 145 CID	
	1999	GMC K1500 SUBURBAN	6.5L V8 395 CID	2010-2011	SAAB 9-3X	2.0L L4 1985cc	
	1999	GMC K2500 SUBURBAN	6.5L V8 395 CID	2010-2015	CHEVROLET CAPTIVA SPORT	2.4L L4 2409cc 147 CID	
	1999	GMC P3500	6.5L V8 395 CID	2010-2016	BUICK LACROSSE	2.4L L4 2384cc 145 CID	
	1999-2000	CHEVROLET C2500	6.5L V8 395 CID	2010-2017	CHEVROLET EQUINOX	2.4L L4 2384cc 145 CID	
	1999-2000	CHEVROLET C3500	6.5L V8 395 CID	2010-2017	GMC TERRAIN	2.4L L4 2384cc 145 CID	
	1999-2000	CHEVROLET K2500	6.5L V8 395 CID	2011-2013	BUICK REGAL	2.0L L4 1998cc 122 CID	
	1999-2000	CHEVROLET K3500	6.5L V8 395 CID	2011-2017	BUICK REGAL	2.4L L4 2384cc 145 CID	
	1999-2000	GMC C2500	6.5L V8 395 CID	2012-2015	CHEVROLET CAPTIVA SPORT	2.4L L4 2384cc 145 CID	
	1999-2000	GMC C3500	6.5L V8 395 CID	2012-2017	BUICK VERANO	2.4L L4 2384cc 145 CID	
	1999-2000	GMC K2500	6.5L V8 395 CID	2013-2016	BUICK VERANO	2.0L L4 1998cc 122 CID	
	1999-2000	GMC K3500	6.5L V8 395 CID	2014	CHEVROLET IMPALA	2.4L L4 2384cc 145 CID	
	1999-2001	AM GENERAL HUMMER	6.5L V8 395 CID	US5097	2002-2004	OLDSMOBILE BRAVADA	4.2L L6 256 CID
	1999-2002	CHEVROLET EXPRESS 2500	6.5L V8 395 CID		2002-2006	CHEVROLET TRAILBLAZER EXT	4.2L L6 256 CID
1999-2002	CHEVROLET EXPRESS 3500	6.5L V8 395 CID	2002-2006		GMC ENVOY XL	4.2L L6 256 CID	
1999-2002	GMC SAVANA 2500	6.5L V8 395 CID	2002-2009		CHEVROLET TRAILBLAZER	4.2L L6 256 CID	
1999-2002	GMC SAVANA 3500	6.5L V8 395 CID	2002-2009		GMC ENVOY	4.2L L6 256 CID	
2002-2004	HUMMER H1	6.5L V8 395 CID	2003-2008		ISUZU ASCENDER	4.2L L6 256 CID	
US5087	2000	CHEVROLET C2500	5.7L V8 5737cc 350 CID		2004-2005	GMC ENVOY XUV	4.2L L6 256 CID
	2001	CHEVROLET SILVERADO 2500	5.7L V8 5737cc 350 CID		2004-2006	CHEVROLET COLORADO	2.8L L4 2770cc 169 CID
	2001	CHEVROLET SUBURBAN 1500	5.7L V8 5737cc 350 CID		2004-2006	CHEVROLET COLORADO	3.5L L5 3460cc 211 CID
	2001-2003	CHEVROLET SILVERADO 3500	5.7L V8 5737cc 350 CID		2004-2006	GMC CANYON	2.8L L4 2770cc 169 CID
	2002	CHEVROLET SUBURBAN 1500	5.7L V8 5733cc 350 CID	2004-2006	GMC CANYON	3.5L L5 3460cc 211 CID	
	2002	CHEVROLET SILVERADO 2500	5.3L V8 5300cc 323 CID	2004-2007	BUICK RAINIER	4.2L L6 256 CID	
	2003	CHEVROLET SONORA	6.0L V8 6000cc 364 CID	2005-2009	SAAB 9-7X	4.2L L6 256 CID	
	2003-2004	CHEVROLET SONORA	5.3L V8 5300cc 323 CID	2006	HUMMER H3	3.5L L5 3460cc 211 CID	
	US5089	2001-2006	CHEVROLET SILVERADO 2500 HD	8.1L V8 496 CID	2006	ISUZU I-280	2.8L L4 2770cc 169 CID
		2001-2006	CHEVROLET SILVERADO 3500	8.1L V8 496 CID	2006	ISUZU I-350	3.5L L5 3460cc 211 CID
2001-2006		CHEVROLET SUBURBAN 2500	8.1L V8 496 CID	2007-2008	ISUZU I-290	2.9L L4 2921cc 178 CID	
2001-2006		GMC SIERRA 2500 HD	8.1L V8 496 CID	2007-2008	ISUZU I-370	3.7L L5 3654cc 223 CID	
2001-2006		GMC SIERRA 3500	8.1L V8 496 CID	2007-2010	HUMMER H3	3.7L L5 3654cc 223 CID	
2001-2006		GMC YUKON XL 2500	8.1L V8 496 CID	2007-2012	CHEVROLET COLORADO	2.9L L4 2921cc 178 CID	
2002-2006		CHEVROLET AVALANCHE 2500	8.1L V8 496 CID	2007-2012	CHEVROLET COLORADO	3.7L L5 3654cc 223 CID	
2007		CHEVROLET SILVERADO 2500 HD CLASSIC	8.1L V8 496 CID	2007-2012	GMC CANYON	2.9L L4 2921cc 178 CID	
2007		CHEVROLET SILVERADO 3500 CLASSIC	8.1L V8 496 CID	2007-2012	GMC CANYON	3.7L L5 3654cc 223 CID	
2007		GMC SIERRA 2500 HD CLASSIC	8.1L V8 496 CID	2009-2010	HUMMER H3T	3.7L L5 3654cc 223 CID	
2007	GMC SIERRA 3500 CLASSIC	8.1L V8 496 CID	US5099	2003-2008	PONTIAC VIBE	1.8L L4 1794cc	
US5089H	2001-2006	CHEVROLET SILVERADO 2500 HD		8.1L V8 496 CID	2004-2005	AUDI ALLROAD QUATTRO	4.2L V8 4172cc
	2001-2006	CHEVROLET SILVERADO 3500		8.1L V8 496 CID	2004-2009	AUDI S4	4.2L V8 4163cc

WATER PUMPS

USMWW	Years	Application	Engine	USMWW	Years	Application	Engine
US6000	2005-2006	AUDI A6 QUATTRO	4.2L V8 4163cc	US6009	2009-2010	HUMMER H3T	5.3L V8 5328cc 325 CID
	2007-2008	AUDI RS4	4.2L V8 4172cc		2009-2012	CHEVROLET COLORADO	5.3L V8 5328cc 325 CID
US6001	2002-2008	MINI COOPER	1.6L L4 1600cc	2009-2012	GMC CANYON	5.3L V8 5328cc 325 CID	
US6003	2002-2004	BMW 745I	4.4L V8 4398cc	2009-2013	CADILLAC ESCALADE	6.0L V8 5967cc 364 CID	
	2003-2005	BMW 760LI	6.0L V12 5972cc	2009-2013	CHEVROLET SILVERADO 1500	6.2L V8 6162cc 376 CID	
US6006	2004-2005	BMW 760I	6.0L V12 5972cc	2009-2014	CHEVROLET EXPRESS 4500	6L V8 5967cc 364 CID	
	2010-2014	FORD F-150	6.2L V8 6210cc 379 CID	2009-2014	GMC SAVANA 4500	6L V8 5967cc 364 CID	
	2011-2014	FORD F-350 XL	6.2L V8 6200cc 378 CID	2010-2011	CHEVROLET EXPRESS	5.3L V8 5300cc 323 CID	
	2011-2014	FORD F-350 XLT	6.2L V8 6200cc 378 CID	2010-2011	CHEVROLET SILVERADO 2500	4.8L V8 4800cc 293 CID	
	2011-2014	FORD LOBO	6.2L V8 6200cc 378 CID	2010-2011	CHEVROLET SILVERADO 2500	5.3L V8 5300cc 323 CID	
	2011-2018	FORD F-250 SUPER DUTY	6.2L V8 6210cc 379 CID	2010-2012	CHEVROLET SUBURBAN	5.3L V8 5328cc 325 CID	
	2011-2018	FORD F-350 SUPER DUTY	6.2L V8 6210cc 379 CID	2010-2012	GMC SIERRA	5.3L V8 5300cc 323 CID	
	2015	FORD F-350	6.2L V8 6200cc 378 CID	2010-2013	CHEVROLET EXPRESS	6.0L V8 5967cc 364 CID	
	2017-2018	FORD E-350 SUPER DUTY	6.2L V8 6210cc 379 CID	2011	CHEVROLET CHEYENNE 2500	5.3L V8 5300cc 323 CID	
	US6007	2004-2006	DODGE SPRINTER 2500	2.7L L5 2687cc 165 CID	2011-2014	GMC YUKON	6.2L V8 6162cc 376 CID
		2004-2006	DODGE SPRINTER 3500	2.7L L5 2687cc 165 CID	2012-2013	CHEVROLET EXPRESS	5.3L V8 5328cc 325 CID
	US6008	2004-2006	MERCEDES-BENZ SPRINTER	2.7L L5 2685cc 165 CID	2012-2015	CHEVROLET CHEYENNE 2500	5.3L V8 5328cc 325 CID
2003		DODGE SPRINTER 2500	2.7L L5 2687cc 165 CID	2013	CHEVROLET SILVERADO 2500	4.8L V8 4800cc 293 CID	
US6009	2003	DODGE SPRINTER 3500	2.7L L5 2687cc 165 CID	2013	CHEVROLET SILVERADO 2500	5.3L V8 5328cc 325 CID	
	2007	BUICK RAINIER	5.3L V8 5328cc 325 CID	2014	CHEVROLET SILVERADO 2500	5.3L V8 5328cc 323 CID	
	2007	CHEVROLET SILVERADO 1500 CLASSIC	4.8L V8 294 CID	2014	GMC SIERRA	5.3L V8 5300cc 323 CID	
	2007	CHEVROLET SILVERADO 1500 CLASSIC	5.3L V8 5328cc 325 CID	2015-2016	CHEVROLET EXPRESS 4500	6.0L V8 5967cc 364 CID	
	2007	CHEVROLET SILVERADO 1500 CLASSIC	6.0L V8 5967cc 364 CID	2015-2016	CHEVROLET SILVERADO 2500	5.3L V8 5328cc 325 CID	
	2007	CHEVROLET SILVERADO 1500 HD CLASSIC	6.0L V8 5967cc 364 CID	2015-2016	CHEVROLET SILVERADO 3500	6.0L V8 5967cc 364 CID	
	2007	CHEVROLET SILVERADO 2500 HD CLASSIC	6.0L V8 5967cc 364 CID	2015-2016	GMC SAVANA 4500	6.0L V8 5967cc 364 CID	
	2007	CHEVROLET SILVERADO 3500 CLASSIC	6.0L V8 5967cc 364 CID	2016-2017	CHEVROLET SUBURBAN 3500 HD	6.0L V8 5967cc 364 CID	
	2007	GMC SIERRA 1500 CLASSIC	4.8L V8 294 CID	US6009-T	2007	BUICK RAINIER	5.3L V8 5328cc 325 CID
	2007	GMC SIERRA 1500 CLASSIC	5.3L V8 5328cc 325 CID	2007	CHEVROLET SILVERADO 1500 CLASSIC	4.8L V8 294 CID	
	2007	GMC SIERRA 1500 CLASSIC	6.0L V8 5967cc 364 CID	2007	CHEVROLET SILVERADO 1500 CLASSIC	5.3L V8 5328cc 325 CID	
	2007	GMC SIERRA 1500 HD CLASSIC	6.0L V8 5967cc 364 CID	2007	CHEVROLET SILVERADO 1500 CLASSIC	6.0L V8 5967cc 364 CID	
	2007	GMC SIERRA 2500 HD CLASSIC	6.0L V8 5967cc 364 CID	2007	CHEVROLET SILVERADO 1500 HD CLASSIC	6.0L V8 5967cc 364 CID	
	2007	GMC SIERRA 3500 CLASSIC	6.0L V8 5967cc 364 CID	2007	CHEVROLET SILVERADO 2500 HD CLASSIC	6.0L V8 5967cc 364 CID	
	2007	HUMMER H2	6.0L V8 5967cc 364 CID	2007	CHEVROLET SILVERADO 3500 CLASSIC	6.0L V8 5967cc 364 CID	
	2007-2008	CHEVROLET TRAILBLAZER	5.3L V8 5328cc 325 CID	2007	GMC SIERRA 1500 CLASSIC	4.8L V8 294 CID	
	2007-2009	CHEVROLET AVALANCHE	6.0L V8 5967cc 364 CID	2007	GMC SIERRA 1500 CLASSIC	5.3L V8 5328cc 325 CID	
	2007-2009	CHEVROLET SUBURBAN 1500	6.0L V8 5967cc 364 CID	2007	GMC SIERRA 1500 CLASSIC	6.0L V8 5967cc 364 CID	
	2007-2009	CHEVROLET TAHOE	4.8L V8 294 CID	2007	GMC SIERRA 1500 HD CLASSIC	6.0L V8 5967cc 364 CID	
	2007-2009	CHEVROLET TRAILBLAZER	6.0L V8 5967cc 364 CID	2007	GMC SIERRA 2500 HD CLASSIC	6.0L V8 5967cc 364 CID	
	2007-2009	GMC ENVOY	5.3L V8 5328cc 325 CID	2007	GMC SIERRA 3500 CLASSIC	6.0L V8 5967cc 364 CID	
	2007-2009	GMC YUKON	4.8L V8 294 CID	2007	HUMMER H2	6.0L V8 5967cc 364 CID	
	2007-2009	GMC YUKON	6.2L V8 6162cc 376 CID	2007-2008	CHEVROLET TRAILBLAZER	5.3L V8 5328cc 325 CID	
	2007-2009	GMC YUKON XL 1500	6.0L V8 5967cc 364 CID	2007-2009	CHEVROLET AVALANCHE	6.0L V8 5967cc 364 CID	
	2007-2009	SAAB 9-7X	5.3L V8 5328cc 325 CID	2007-2009	CHEVROLET SUBURBAN 1500	6.0L V8 5967cc 364 CID	
	2007-2010	CHEVROLET CHEYENNE	5.3L V8 5300cc 323 CID	2007-2009	CHEVROLET TAHOE	4.8L V8 294 CID	
	2007-2013	CADILLAC ESCALADE EXT	6.2L V8 6162cc 376 CID	2007-2009	CHEVROLET TRAILBLAZER	6.0L V8 5967cc 364 CID	
	2007-2013	CHEVROLET AVALANCHE	5.3L V8 5328cc 325 CID	2007-2009	GMC ENVOY	5.3L V8 5328cc 325 CID	
	2007-2013	CHEVROLET SILVERADO 1500	4.8L V8 294 CID	2007-2009	GMC YUKON	4.8L V8 294 CID	
	2007-2013	CHEVROLET SILVERADO 1500	5.3L V8 5328cc 325 CID	2007-2009	GMC YUKON	6.2L V8 6162cc 376 CID	
	2007-2013	CHEVROLET SILVERADO 1500	6.0L V8 5967cc 364 CID	2007-2009	GMC YUKON XL 1500	6.0L V8 5967cc 364 CID	
	2007-2013	CHEVROLET SUBURBAN 2500	6.0L V8 5967cc 364 CID	2007-2009	SAAB 9-7X	5.3L V8 5328cc 325 CID	
	2007-2013	GMC SIERRA 1500	4.8L V8 294 CID	2007-2013	CADILLAC ESCALADE EXT	6.2L V8 6162cc 376 CID	
	2007-2013	GMC SIERRA 1500	5.3L V8 5328cc 325 CID	2007-2013	CHEVROLET AVALANCHE	5.3L V8 5328cc 325 CID	
	2007-2013	GMC SIERRA 1500	6.0L V8 5967cc 364 CID	2007-2013	CHEVROLET SILVERADO 1500	4.8L V8 294 CID	
	2007-2013	GMC SIERRA 1500	6.2L V8 6162cc 376 CID	2007-2013	CHEVROLET SILVERADO 1500	5.3L V8 5328cc 325 CID	
	2007-2014	GMC YUKON XL 2500	6.0L V8 5967cc 364 CID	2007-2013	CHEVROLET SILVERADO 1500	6.0L V8 5967cc 364 CID	
	2007-2014	CADILLAC ESCALADE	6.2L V8 6162cc 376 CID	2007-2013	CHEVROLET SUBURBAN 2500	6.0L V8 5967cc 364 CID	
	2007-2014	CADILLAC ESCALADE ESV	6.2L V8 6162cc 376 CID	2007-2013	GMC SIERRA 1500	4.8L V8 294 CID	
	2007-2014	CHEVROLET EXPRESS 1500	5.3L V8 5328cc 325 CID	2007-2013	GMC SIERRA 1500	5.3L V8 5328cc 325 CID	
	2007-2014	CHEVROLET SUBURBAN 1500	5.3L V8 5328cc 325 CID	2007-2013	GMC SIERRA 1500	6.0L V8 5967cc 364 CID	
	2007-2014	CHEVROLET TAHOE	5.3L V8 5328cc 325 CID	2007-2013	GMC SIERRA 1500	6.2L V8 6162cc 376 CID	
	2007-2014	GMC SAVANA 1500	5.3L V8 5328cc 325 CID	2007-2013	GMC SIERRA 1500	6.2L V8 6162cc 376 CID	
	2007-2014	GMC YUKON	5.3L V8 5328cc 325 CID	2007-2013	GMC SIERRA 1500	6.0L V8 5967cc 364 CID	
	2007-2014	GMC YUKON XL 1500	5.3L V8 5328cc 325 CID	2007-2013	GMC SIERRA 1500	6.2L V8 6162cc 376 CID	
	2007-2014	GMC YUKON XL 1500	6.2L V8 6162cc 376 CID	2007-2014	CADILLAC ESCALADE ESV	6.2L V8 6162cc 376 CID	
	2007-2017	CHEVROLET EXPRESS 2500	4.8L V8 294 CID	2007-2014	CHEVROLET EXPRESS 1500	5.3L V8 5328cc 325 CID	
	2007-2017	CHEVROLET EXPRESS 2500	6.0L V8 5967cc 364 CID	2007-2014	CHEVROLET EXPRESS 2500	4.8L V8 294 CID	
2007-2017	CHEVROLET EXPRESS 3500	4.8L V8 294 CID	2007-2014	CHEVROLET EXPRESS 2500	6.0L V8 5967cc 364 CID		
2007-2017	CHEVROLET EXPRESS 3500	6.0L V8 5967cc 364 CID	2007-2014	CHEVROLET EXPRESS 3500	4.8L V8 294 CID		
2007-2017	CHEVROLET SILVERADO 2500 HD	6.0L V8 5967cc 364 CID	2007-2014	CHEVROLET EXPRESS 3500	6.0L V8 5967cc 364 CID		
2007-2017	CHEVROLET SILVERADO 3500 HD	6.0L V8 5967cc 364 CID	2007-2014	CHEVROLET SILVERADO 2500 HD	6.0L V8 5967cc 364 CID		
2007-2017	GMC SAVANA 2500	4.8L V8 294 CID	2007-2014	CHEVROLET SILVERADO 3500 HD	6.0L V8 5967cc 364 CID		
2007-2017	GMC SAVANA 2500	6.0L V8 5967cc 364 CID	2007-2014	CHEVROLET SUBURBAN 1500	5.3L V8 5328cc 325 CID		
2007-2017	GMC SAVANA 3500	4.8L V8 294 CID	2007-2014	CHEVROLET TAHOE	5.3L V8 5328cc 325 CID		
2007-2017	GMC SAVANA 3500	6.0L V8 5967cc 364 CID	2007-2014	GMC SAVANA 1500	5.3L V8 5328cc 325 CID		
2007-2017	GMC SIERRA 2500 HD	6.0L V8 5967cc 364 CID	2007-2014	GMC SAVANA 2500	4.8L V8 294 CID		
2007-2017	GMC SIERRA 3500 HD	6.0L V8 5967cc 364 CID	2007-2014	GMC SAVANA 2500	6.0L V8 5967cc 364 CID		
2008	CHEVROLET EXPRESS	5.3L V8 5300cc 323 CID	2007-2014	GMC SAVANA 3500	4.8L V8 294 CID		
2008-2009	CHEVROLET TAHOE	6.2L V8 6162cc 376 CID	2007-2014	GMC SAVANA 3500	6.0L V8 5967cc 364 CID		
2008-2009	HUMMER H2	6.2L V8 6162cc 376 CID	2007-2014	GMC SIERRA 2500 HD	6.0L V8 5967cc 364 CID		
2008-2009	SAAB 9-7X	6.0L V8 5967cc 364 CID	2007-2014	GMC SIERRA 3500 HD	6.0L V8 5967cc 364 CID		
2008-2010	HUMMER H3	5.3L V8 5328cc 325 CID	2007-2014	GMC YUKON	5.3L V8 5328cc 325 CID		
2008-2013	CHEVROLET SILVERADO 3500	6.0L V8 5967cc 364 CID	2007-2014	GMC YUKON XL 1500	5.3L V8 5328cc 325 CID		
2008-2013	CHEVROLET TAHOE	6.0L V8 5967cc 364 CID	2007-2014	GMC YUKON XL 1500	6.2L V8 6162cc 376 CID		
2008-2013	GMC YUKON	6.0L V8 5967cc 364 CID	2008-2009	CHEVROLET TAHOE	6.2L V8 6162cc 376 CID		
2008-2013	GMC YUKON	6.0L V8 5967cc 364 CID	2008-2009	HUMMER H2	6.2L V8 6162cc 376 CID		
2009	GMC YUKON	6.2L V8 6162cc 378 CID	2008-2009	SAAB 9-7X	6.0L V8 5967cc 364 CID		

USMW	Years	Application	Engine	USMW	Years	Application	Engine		
US6009-T	2008-2010	HUMMER H3	5.3L V8 5328cc 325 CID	US6038	2014-2018	JEEP CHEROKEE	2.4L L4 2360cc 144 CID		
	2008-2013	CHEVROLET TAHOE	6.0L V8 5967cc 364 CID		2015-2018	JEEP RENEGADE	2.4L L4 2360cc 144 CID		
	2008-2013	GMC YUKON	6.0L V8 5967cc 364 CID		2015-2018	RAM PROMASTER CITY	2.4L L4 2360cc 144 CID		
	2009-2010	HUMMER H3T	5.3L V8 5328cc 325 CID		2016-2018	FIAT 500X	2.4L L4 2360cc 144 CID		
	2009-2012	CHEVROLET COLORADO	5.3L V8 5328cc 325 CID		US6046	2004-2008	CHEVROLET AVEO	1.6L L4 1598cc 98 CID	
	2009-2012	GMC CANYON	5.3L V8 5328cc 325 CID			2005-2007	PONTIAC WAVE	1.6L L4 1598cc 98 CID	
	2009-2013	CADILLAC ESCALADE	6.0L V8 5967cc 364 CID			2006-2008	PONTIAC G3	1.6L L4 1606cc 98 CID	
	2009-2013	CHEVROLET SILVERADO 1500	6.2L V8 6162cc 376 CID			2007-2008	CHEVROLET AVEO5	1.6L L4 1598cc 98 CID	
	2009-2014	CHEVROLET EXPRESS 4500	6L V8 5967cc 364 CID			2010-2016	CHEVROLET AVEO	1.6L L4 1598cc 97 CID	
	2011-2014	GMC YUKON	6.2L V8 6162cc 376 CID		2012	CHEVROLET CRUZE	1.8L L4 1796cc 110 CID		
	US6018	2006	HONDA FIT		1.5L H4 1496cc 91 CID	US6047	2005-2017	TOYOTA AVALON	3.5L V6 3456cc
2007-2008		HONDA FIT	1.5L L4 1497cc	2006-2012	TOYOTA RAV4		3.5L V6 3456cc		
US6020	2006	CHEVROLET MONTE CARLO	3.9L V6 3880cc 237 CID	2007-2015	LEXUS RX350		3.5L V6 3456cc		
	2006-2007	BUICK TERRAZA	3.9L V6 3880cc 237 CID	2007-2016	TOYOTA SIENNA		3.5L V6 3456cc		
	2006-2007	CHEVROLET MALIBU	3.9L V6 3880cc 237 CID	2007-2017	LEXUS ES350		3.5L V6 3456cc		
	2006-2007	CHEVROLET MONTE CARLO	3.5L V6 3490cc 213 CID	2007-2017	TOYOTA CAMRY		3.5L V6 3456cc		
	2006-2007	SATURN RELAY	3.9L V6 3880cc 237 CID	2008-2016	TOYOTA HIGHLANDER		3.5L V6 3456cc		
	2006-2009	CHEVROLET UPLANDER	3.9L V6 3880cc 237 CID	2009-2015	TOYOTA VENZA		3.5L V6 3456cc		
	2006-2009	PONTIAC G6	3.9L V6 3880cc 237 CID	2010-2015	LEXUS RX450H		3.5L V6 3456cc		
	2006-2009	PONTIAC MONTANA	3.9L V6 3880cc 237 CID	US6048	2006-2010		HYUNDAI SONATA	3.3L V6 3342cc	
	2006-2011	CHEVROLET IMPALA	3.5L V6 3490cc 213 CID		2006-2010		KIA SEDONA	3.8L V6 3778cc	
	2006-2011	CHEVROLET IMPALA	3.9L V6 3880cc 237 CID		2006-2011	HYUNDAI AZERA	3.8L V6 3778cc		
	2007-2008	SATURN AURA	3.5L V6 3490cc 213 CID		2007-2008	HYUNDAI ENTOURAGE	3.8L V6 3778cc		
	2007-2010	CHEVROLET MALIBU	3.5L V6 3490cc 213 CID		2007-2009	HYUNDAI SANTA FE	3.3L V6 3342cc		
	2007-2010	PONTIAC G6	3.5L V6 3490cc 213 CID		2007-2009	KIA AMANTI	3.8L V6 3778cc		
	2008-2009	SATURN VUE	3.5L V6 3490cc 213 CID		2007-2009	KIA SORENTO	3.8L V6 3778cc		
	2009-2011	BUICK LUCERNE	3.9L V6 3880cc 237 CID		2007-2012	HYUNDAI VERACRUZ	3.8L V6 3778cc		
	US6022	2005-2009	AUDI A4		2.0L L4 1984cc 121 CID	2007-2017	HYUNDAI AZERA	3.3L V6 3342cc	
		2005-2009	AUDI A4 QUATTRO		2.0L L4 1984cc 121 CID	2008-2009	KIA SORENTO	3.3L V6 3342cc	
2006-2007		AUDI A3	2.0L H4 1984cc 121 CID		2009	KIA BORREGO	3.8L V6 3778cc		
2006-2008		AUDI A3	2.0L L4 1984cc 121 CID	2009-2014	HYUNDAI GENESIS	3.8L V6 3778cc			
2006-2008		VOLKSWAGEN GTI	2.0L L4 1984cc 121 CID	2010-2012	HYUNDAI SANTA FE	3.5L V6 3470cc			
2006-2008		VOLKSWAGEN JETTA	2.0L L4 1984cc 121 CID	2010-2016	HYUNDAI GENESIS COUPE	3.8L V6 3778cc			
2006-2008		VOLKSWAGEN PASSAT	2.0L L4 1984cc 121 CID	2011-2012	KIA SEDONA	3.5L V6 3470cc			
2007-2009		VOLKSWAGEN EOS	2.0L L4 1984cc 121 CID	2011-2013	KIA SORENTO	3.5L V6 3470cc			
2007-2010		VOLKSWAGEN BORA	2.0L H4 1984cc 121 CID	2013-2017	HYUNDAI SANTA FE	3.3L V6 3342cc			
2008-2009		AUDI TT	2.0L L4 1984cc 121 CID	2014	KIA SEDONA	3.5L V6 3470cc			
2009-2015		AUDI TT QUATTRO	2.0L L4 1984cc 121 CID	2014-2016	KIA CADENZA	3.3L V6 3342cc			
2010		VOLKSWAGEN JETTA	2.0L H4 1984cc 121 CID	2014-2017	KIA SORENTO	3.3L V6 3342cc			
2010		VOLKSWAGEN PASSAT	2.0L H4 1985cc 121 CID	2015-2017	KIA SEDONA	3.3L V6 3342cc			
2012		VOLKSWAGEN CLASICO	2.0L H4 1984cc 121 CID	2016-2017	KIA K900	3.8L V6 3778cc			
US6023		2007	MAZDA CX-9	3.5L V6 3496cc 213 CID	US6049	2006-2010	SUBARU FORESTER	2.5L H4 2458cc	
		2007-2010	FORD EDGE	3.5L V6 3496cc 213 CID		2006-2011	SUBARU IMPREZA	2.5L H4 2458cc	
		2007-2010	LINCOLN MKX	3.5L V6 3496cc 213 CID		2006-2012	SUBARU LEGACY	2.5L H4 2458cc	
	2007-2011	LINCOLN MKZ	3.5L V6 3496cc 213 CID	2006-2012		SUBARU OUTBACK	2.5L H4 2458cc		
	2008-2009	FORD TAURUS X	3.5L V6 3496cc 213 CID	2010-2011		SUBARU IMPREZA	2.5L L4 2457cc 150 CID		
	2008-2009	MERCURY SABLE	3.5L V6 3496cc 213 CID	2011-2013		SUBARU LEGACY	2.5L L4 2457cc 150 CID		
	2008-2010	FORD TAURUS	3.5L V6 3496cc 213 CID	2013		SUBARU OUTBACK	2.5L L4 2457cc 150 CID		
	2008-2010	MAZDA CX-9	3.7L V6 3726cc 227 CID	US6050		2005-2009	VOLKSWAGEN BORA	2.5L L5 2480cc 151 CID	
	2009-2010	FORD FLEX	3.5L V6 3496cc 213 CID			2005-2014	VOLKSWAGEN JETTA	2.5L L5 2480cc 151 CID	
	2009-2010	LINCOLN MKS	3.7L V6 3726cc 227 CID			2006-2009	VOLKSWAGEN RABBIT	2.5L L5 2480cc 151 CID	
	2009-2010	MAZDA 6	3.7L V6 3726cc 227 CID			2006-2010	VOLKSWAGEN BEETLE	2.5L L5 2480cc 151 CID	
	2010	LINCOLN MKS	3.5L V6 3496cc 213 CID		2008-2011	VOLKSWAGEN CRAWFTER	2.5L L5 2459cc 151 CID		
	2010	LINCOLN MKT	3.5L V6 3496cc 213 CID	2010-2014	VOLKSWAGEN GOLF	2.5L L5 2480cc 151 CID			
	2010	LINCOLN MKT	3.7L V6 3726cc 227 CID	2012-2014	VOLKSWAGEN BEETLE	2.5L L5 2480cc 151 CID			
	2010-2011	FORD FUSION	3.5L V6 3496cc 213 CID	2012-2014	VOLKSWAGEN PASSAT	2.5L L5 2480cc 151 CID			
	US6030	2003-2005	MERCEDES-BENZ C230	1.8L L4 1796cc	US6056	2006-2011	HONDA CIVIC	1.8L L4 1799cc	
		2004-2005	VOLKSWAGEN JETTA	1.9L L4 1896cc 116 CID		US6075	2005-2006	MERCEDES-BENZ SLK350	3.5L V6 3498cc
US6034	2004-2005	VOLKSWAGEN PASSAT	2.0L L4 1967cc 120 CID	2006	MERCEDES-BENZ C230		2.5L V6 2496cc		
	2004-2006	VOLKSWAGEN BEETLE	1.9L L4 1896cc 116 CID	2006	MERCEDES-BENZ C280		3.0L V6 2996cc		
	2004-2006	VOLKSWAGEN GOLF	1.9L L4 1896cc 116 CID	2006	MERCEDES-BENZ C350		3.5L V6 3498cc		
	2009	VOLKSWAGEN JETTA	1.9L L4 1896cc 116 CID	2006	MERCEDES-BENZ CLK350		3.5L V6 3498cc		
	2009-2014	VOLKSWAGEN JETTA	2.0L L4 1968cc 120 CID	2006	MERCEDES-BENZ E350		3.5L V6 3498cc		
	2010-2013	AUDI A3	2.0L L4 1968cc 120 CID	2006	MERCEDES-BENZ ML350		3.5L V6 3498cc		
	2010-2014	VOLKSWAGEN GOLF	2.0L L4 1968cc 120 CID	2006	MERCEDES-BENZ R350		3.5L V6 3498cc		
	2013-2014	VOLKSWAGEN BEETLE	2.0L L4 1968cc 120 CID	2006	MERCEDES-BENZ SLK280		3.0L V6 2996cc		
	US6037	2003-2009	TOYOTA 4RUNNER	4.0L V6 3956cc 241 CID	US6142		2005-2011	MERCEDES-BENZ SLK350	3.5L V6 3498cc
		2005-2011	TOYOTA TUNDRA	4.0L V6 3956cc 241 CID			2006-2007	MERCEDES-BENZ C230	2.5L V6 2496cc
		2005-2015	TOYOTA TACOMA	4.0L V6 3956cc 241 CID		2006-2007	MERCEDES-BENZ C280	3.0L V6 2996cc	
2007-2009		TOYOTA FJ CRUISER	4.0L V6 3956cc 241 CID	2006-2008		MERCEDES-BENZ SLK280	3.0L V6 2996cc		
US6038	2007-2009	DODGE CALIBER	1.8L L4 1798cc 110 CID	2006-2009		MERCEDES-BENZ CLK350	3.5L V6 3498cc		
	2007-2010	CHRYSLER SEBRING	2.4L L4 2360cc 144 CID	2006-2011		MERCEDES-BENZ C350	3.5L V6 3498cc		
	2007-2011	DODGE CALIBER	2.4L L4 2360cc 144 CID	2006-2011		MERCEDES-BENZ E350	3.5L V6 3498cc		
	2007-2012	DODGE CALIBER	2.0L L4 1998cc 122 CID	2006-2011		MERCEDES-BENZ ML350	3.5L V6 3498cc		
	2007-2017	JEEP PATRIOT	2.0L L4 1998cc 122 CID	2006-2011		MERCEDES-BENZ R350	3.5L V6 3498cc		
	2007-2017	JEEP PATRIOT	2.4L L4 2360cc 144 CID	2007		MERCEDES-BENZ E280	3.0L V6 2996cc 183 CID		
	2007-2018	JEEP COMPASS	2.4L L4 2360cc 144 CID	2008-2012		MERCEDES-BENZ C300	3.0L V6 2996cc		
	2008-2010	DODGE AVENGER	2.0L L4 2000cc 122 CID	2009-2011	MERCEDES-BENZ SLK300	3.0L V6 2996cc			
	2008-2011	MITSUBISHI LANCER	2.0L L4 1998cc 122 CID	2010-2012	MERCEDES-BENZ GLK350	3.5L V6 3498cc			
	2008-2011	MITSUBISHI OUTLANDER	2.4L L4 2360cc 144 CID	US6143	2006	LEXUS GS300	3.0L V6 2994cc		
	2008-2014	DODGE AVENGER	2.4L L4 2360cc 144 CID		2006-2015	LEXUS IS250	2.5L V6 2499cc		
	2008-2017	JEEP COMPASS	2.0L L4 1998cc 122 CID		2006-2017	LEXUS IS350	3.5L V6 3456cc		
	2009-2011	MITSUBISHI LANCER	2.4L L4 2360cc 144 CID		2007-2011	LEXUS GS350	3.5L V6 3456cc		
	2009-2018	DODGE JOURNEY	2.4L L4 2360cc 144 CID		2007-2011	LEXUS GS450H	3.5L V6 3456cc		
	2010	CHRYSLER CIRRUS	2.4L L4 2360cc 144 CID		2013-2015	LEXUS GS350	3.5L V6 3456cc		
	2011	MITSUBISHI OUTLANDER SPORT	2.0L L4 1998cc 122 CID		2013-2017	LEXUS GS450H	3.5L V6 3456cc		
	2011-2017	CHRYSLER 200	2.4L L4 2360cc 144 CID		2015-2017	LEXUS RC350	3.5L V6 3456cc		
2013-2016	DODGE DART	2.0L L4 1995cc 122 CID	2016-2017		LEXUS IS300	3.5L V6 3456cc			
2013-2016	DODGE DART	2.4L L4 2360cc 144 CID	2016-2017		LEXUS RC300	3.5L V6 3456cc			

USMW	Years	Application	Engine	USMW	Years	Application	Engine	
US6144	2006-2009	FORD F-150	5.4L V8 330 CID	US6198	2013-2016	NISSAN PATHFINDER	3.5L V6 3498cc	
	2007-2008	FORD EXPEDITION	5.4L V8 330 CID		2014-2016	INFINITI QX60	3.5L V6 3498cc	
	2007-2008	FORD F-150	4.6L V8 281 CID	2016-2017	NISSAN MAXIMA	3.5L V6 3498cc		
	2007-2008	LINCOLN MARK LT	5.4L V8 330 CID	US6211	2014-2017	LEXUS ES300H	2.5L L4 2494cc 152 CID	
	2007-2008	LINCOLN NAVIGATOR	5.4L V8 330 CID		2014-2017	TOYOTA AVALON	2.5L L4 2494cc 152 CID	
	2009-2015	FORD F-550 SUPER DUTY	6.8L V10 415 CID	2014-2017	TOYOTA CAMRY	2.5L L4 2494cc 152 CID		
	2010	FORD F-250 SUPER DUTY	6.8L V10 415 CID	US6212	2005-2007	VOLKSWAGEN JETTA	1.9L L4 1896cc 116 CID	
	2010	FORD F-350 SUPER DUTY	6.8L V10 415 CID		2006-2008	VOLKSWAGEN EUROVAN	1.9L L4 1896cc 116 CID	
	2010-2015	FORD E-350 SUPER DUTY	6.8L V10 415 CID		2007-2010	VOLKSWAGEN BORA	1.9L L4 1896cc 116 CID	
	2010-2015	FORD E-450 SUPER DUTY	6.8L V10 415 CID		2010	VOLKSWAGEN JETTA	1.9L L4 1896cc 116 CID	
	2010-2015	FORD F-450 SUPER DUTY	6.8L V10 415 CID	US6213	2012-2015	HONDA CIVIC	2.4L L4 2354cc 144 CID	
	2011-2014	FORD F53	6.8L V10 415 CID		2013-2015	ACURA ILX	2.4L L4 2354cc 144 CID	
	2014	FORD F59	6.8L V10 415 CID	US6215	2006-2010	KIA OPTIMA	2.7L V6 2656cc	
	US6145	2005-2009	CHEVROLET EQUINOX		3.4L V6 207 CID	2007-2009	HYUNDAI SANTA FE	2.7L V6 2656cc
2006-2009		PONTIAC TORRENT	3.4L V6 207 CID		2007-2010	KIA RONDO	2.7L V6 2656cc	
US6146	2005-2008	AUDI A6 QUATTRO	3.2L V6 3123cc	US6216	2003-2011	HONDA CIVIC	1.3L L4 1339cc	
	2005-2009	AUDI A4 QUATTRO	3.2L V6 3123cc		2008	DODGE MAGNUM	2.7L V6 2736cc 167 CID	
	2006-2008	AUDI A4	3.2L V6 3123cc	2008-2010	CHRYSLER 300	2.7L V6 2736cc 167 CID		
	2006-2009	AUDI A6	3.2L V6 3123cc	2008-2010	CHRYSLER SEBRING	2.7L V6 2736cc 167 CID		
	2009-2011	AUDI A6 QUATTRO	3.0L V6 2995cc	2008-2010	DODGE AVENGER	2.7L V6 2736cc 167 CID		
	2009-2012	AUDI Q7	3.0L V6 2967cc 181 CID	2008-2010	DODGE CHARGER	2.7L V6 2736cc 167 CID		
	2009-2012	VOLKSWAGEN TOUAREG	3.0L V6 2967cc 181 CID	US6218	2007-2012	NISSAN SENTRA	2.0L L4 1997cc 122 CID	
	2010	AUDI A4	3.2L V6 3200cc 195 CID		2007-2012	NISSAN VERSA	1.8L L4 1798cc	
	2010-2012	AUDI S4	3.0L V6 2995cc	2009-2014	NISSAN CUBE	1.8L L4 1798cc		
	2010-2012	AUDI S5	3.0L V6 2995cc	2010-2012	NISSAN TIIDA	1.8L L4 1798cc 110 CID		
	2011-2013	AUDI Q7	3.0L V6 2967cc 182 CID	2013-2017	NISSAN NV200	2.0L L4 1997cc		
	2011-2015	AUDI Q7	3.0L V6 2995cc	2015-2017	CHEVROLET CITY EXPRESS	2.0L L4 1997cc		
	2012	AUDI Q5	3.0L V6 2967cc 182 CID	US6219	2006-2008	MAZDA MX-5	2.0L L4 1999cc 122 CID	
	2012	VOLKSWAGEN TOUAREG	3.0L V6 2967cc 182 CID		2006-2009	MAZDA 3	2.3L L4 2260cc	
US6149	2004	MITSUBISHI GALANT	2.4L L4 2351cc		2006-2013	MAZDA 3	2.0L L4 2000cc 122 CID	
	2004	MITSUBISHI LANCER	2.4L L4 2400cc		2006-2015	MAZDA MX-5 MIATA	2.0L L4 2000cc 122 CID	
2004	MITSUBISHI OUTLANDER	2.4L L4 2351cc	2008-2010		MAZDA 5	2.3L L4 2260cc		
2005-2006	MITSUBISHI LANCER	2.4L L4 2378cc	2010		MAZDA MX-5 GRAND TOURING	2.0L L4 1999cc 122 CID		
2005-2006	MITSUBISHI OUTLANDER	2.4L L4 2378cc	2010-2011		MAZDA MX-5	2.0L L4 1999cc 122 CID		
2005-2011	MITSUBISHI GALANT	2.4L L4 2378cc	2010-2012		MAZDA CX-7	2.5L L4 2488cc 152 CID		
2006-2011	MITSUBISHI ECLIPSE	2.4L L4 2378cc	2010-2013		MAZDA 3	2.5L L4 2488cc 152 CID		
US6152	2005-2006	MERCEDES-BENZ E320	3.2L L6 3222cc		2011-2013	MAZDA 6	2.5L L4 2488cc 152 CID	
	2005-2008	PONTIAC GRAND PRIX	5.3L V8 5328cc 325 CID	2012	MAZDA MX-5 GRAND TOURING	2.0L L4 1999cc 122 CID		
US6154	2006-2007	CHEVROLET MONTE CARLO	5.3L V8 5328cc 325 CID	2012-2015	MAZDA 5	2.5L L4 2488cc 152 CID		
	2006-2009	CHEVROLET IMPALA	5.3L V8 5328cc 325 CID	2013	MAZDA 3	2.0L L4 1998cc 122 CID		
2008-2009	BUICK LACROSSE	5.3L V8 5328cc 325 CID	2013-2014	MAZDA MX-5	2.0L L4 1999cc 122 CID			
US6155	2007-2008	MERCEDES-BENZ R320	3.0L V6 2987cc	US6220	2006-2010	HYUNDAI SONATA	2.4L L4 2359cc	
	2007-2009	DODGE SPRINTER 2500	3.0L V6 2987cc		2006-2010	KIA OPTIMA	2.4L L4 2359cc	
	2007-2009	DODGE SPRINTER 3500	3.0L V6 2987cc	2007-2010	KIA RONDO	2.4L L4 2359cc		
	2007-2009	JEEP GRAND CHEROKEE	3.0L V6 2985cc 182 CID	2010-2011	HYUNDAI TUCSON	2.4L L4 2359cc		
	2007-2009	MERCEDES-BENZ E320	3.0L V6 2987cc	2010-2012	HYUNDAI SANTA FE	2.4L L4 2359cc		
	2007-2009	MERCEDES-BENZ GL320	3.0L V6 2987cc	2010-2013	KIA FORTE	2.0L L4 1998cc 122 CID		
	2007-2009	MERCEDES-BENZ ML320	3.0L V6 2987cc	2010-2013	KIA FORTE	2.4L L4 2359cc		
	2010-2012	MERCEDES-BENZ R350	3.0L V6 2987cc	2010-2013	KIA FORTE KOUP	2.0L L4 1998cc 122 CID		
	2010-2012	MERCEDES-BENZ SPRINTER 2500	3.0L V6 2987cc	2010-2013	KIA FORTE KOUP	2.4L L4 2359cc		
	2010-2012	MERCEDES-BENZ SPRINTER 3500	3.0L V6 2987cc	2011	HYUNDAI TUCSON	2.0L L4 1975cc		
	2010-2013	MERCEDES-BENZ GL350	3.0L V6 2987cc	2011-2013	KIA SORENTO	2.4L L4 2359cc		
	2010-2013	MERCEDES-BENZ ML350	3.0L V6 2987cc	2011-2014	HYUNDAI SONATA	2.0L L4 1998cc 122 CID		
	2011-2013	MERCEDES-BENZ E350	3.0L V6 2987cc	2011-2015	KIA OPTIMA	2.0L L4 1998cc 122 CID		
	2012-2013	MERCEDES-BENZ S350	3.0L V6 2987cc	2011-2016	KIA SPORTAGE	2.0L L4 1998cc 122 CID		
US6156	2004-2008	MAZDA RX-8	1.3L R2 1308cc	2014	HYUNDAI TUCSON	2.4L L4 2359cc		
	US6159	2003-2004	MITSUBISHI LANCER	2.0L L4 2000cc	2014-2015	KIA OPTIMA	2.4L L4 2359cc	
2005		MITSUBISHI LANCER	2.0L L4 1997cc 122 CID	2014-2016	HYUNDAI SANTA FE SPORT	2.0L L4 1998cc 122 CID		
US6160	2006	SUBARU FORESTER	2.5L H4 2458cc	2014-2016	KIA SPORTAGE	2.4L L4 2359cc		
	US6184	2008	SATURN ASTRA	1.8L L4 1796cc 110 CID	US6221	2006-2009	VOLKSWAGEN PASSAT	3.6L V6 3597cc 219 CID
2009-2010		PONTIAC G3	1.6L L4 1598cc 98 CID	2007-2010		AUDI Q7	3.6L V6 3597cc 219 CID	
2009-2011		CHEVROLET AVEO	1.6L L4 1598cc 98 CID	2007-2010	VOLKSWAGEN TOUAREG	3.6L V6 3597cc 219 CID		
2009-2011		CHEVROLET AVEO5	1.6L L4 1598cc 98 CID	2009-2016	VOLKSWAGEN CC	3.6L V6 3597cc 219 CID		
2010-2012		CHEVROLET AVEO	1.6L L4 1598cc 97 CID	2012-2017	VOLKSWAGEN PASSAT	3.6L V6 3597cc 219 CID		
2010-2016		CHEVROLET CRUZE	1.8L L4 1796cc 110 CID	US6222	2007-2010	DODGE RAM 2500	6.7L L6 408 CID	
2012-2013		CHEVROLET SONIC	1.6L L4 1598cc 97 CID		2007-2010	DODGE RAM 3500	6.7L L6 408 CID	
2012-2017		CHEVROLET SONIC	1.8L L4 1796cc 110 CID		2010-2013	DODGE RAM 4000	6.7L L6 6700cc 409 CID	
2013-2015		CHEVROLET TRAX	1.8L L4 1796cc 110 CID		2011-2012	RAM 2500	6.7L L6 408 CID	
2014-2016		CHEVROLET SONIC	1.6L L4 1600cc 98 CID		2011-2012	RAM 3500	6.7L L6 408 CID	
2016		CHEVROLET CRUZE LIMITED	1.8L L4 1796cc 110 CID		2011-2012	RAM 4500	6.7L L6 408 CID	
2016		CHEVROLET SONIC	1.6L L4 1600cc 98 CID		2011-2012	RAM 5500	6.7L L6 408 CID	
US6186		2005-2007	FORD FIVE HUNDRED	3.0L V6 2968cc 181 CID	US6223	2007-2012	ACURA RDX	2.3L L4 2300cc
		2005-2007	FORD FREESTYLE	3.0L V6 2968cc 181 CID		2003-2005	INFINITI FX45	4.5L V8 4500cc
2005-2007	MERCURY MONTEGO	3.0L V6 2968cc 181 CID	2005-2006	INFINITI Q45	4.5L V8 4494cc			
US6197	2007-2017	TOYOTA TUNDRA	5.7L V8 5663cc 345 CID	2006-2008	INFINITI FX45	4.5L V8 4494cc		
	2008-2011	LEXUS LX570	5.7L V8 5663cc 345 CID	2006-2010	INFINITI M45	4.5L V8 4494cc		
	2008-2011	TOYOTA LAND CRUISER	5.7L V8 5663cc 345 CID	US6228	2003	MITSUBISHI OUTLANDER	2.4L L4 2351cc	
	2008-2017	TOYOTA SEQUOIA	5.7L V8 5663cc 345 CID		US6229	1998-2004	MERCEDES-BENZ SLK230	2.3L L4 2295cc
	2013-2017	LEXUS LX570	5.7L V8 5663cc 345 CID	2002		MERCEDES-BENZ C230	2.3L L4 2295cc	
	2013-2017	TOYOTA LAND CRUISER	5.7L V8 5663cc 345 CID	US6231	2008	CHRYSLER TOWN & COUNTRY	3.8L V6 230 CID	
US6198	2007	INFINITI G35	3.5L V6 3498cc		2008	DODGE GRAND CARAVAN	3.8L V6 230 CID	
	2007	NISSAN MURANO	3.5L V6 3498cc		2008-2010	CHRYSLER TOWN & COUNTRY	3.3L V6 3301cc 201 CID	
2007-2008	INFINITI FX35	3.5L V6 3498cc	2008-2010		DODGE GRAND CARAVAN	3.3L V6 3301cc 201 CID		
2007-2008	INFINITI M35	3.5L V6 3498cc	2009-2010		CHRYSLER TOWN & COUNTRY	3.8L V6 3778cc 231 CID		
2007-2017	NISSAN ALTIMA	3.5L V6 3498cc	2009-2010		DODGE GRAND CARAVAN	3.8L V6 3778cc 231 CID		
2009-2014	NISSAN MAXIMA	3.5L V6 3498cc	2009-2010		VOLKSWAGEN ROUTAN	3.8L V6 3778cc 231 CID		
2009-2017	NISSAN MURANO	3.5L V6 3498cc	2010-2010		CHRYSLER TOWN & COUNTRY	3.8L V6 3800cc 231 CID		
2011-2012	INFINITI G25	2.5L V6 2496cc 152 CID	2010		VOLKSWAGEN ROUTAN	3.8L V6 3778cc 230 CID		
2011-2017	NISSAN QUEST	3.5L V6 3498cc	US6232		2008-2014	SCION XD	1.8L L4 1798cc	
2013	INFINITI JX35	3.5L V6 3498cc						

USMW	Years	Application	Engine	USMW	Years	Application	Engine	
US6232	2009-2010	PONTIAC VIBE	1.8L L4 1798cc	US6287	2002-2004	INFINITI Q45	4.5L V8 4494cc	
	2009-2013	TOYOTA MATRIX	1.8L L4 1798cc		2003-2004	INFINITI M45	4.5L V8 4500cc	
	2009-2017	TOYOTA COROLLA	1.8L L4 1798cc	US6292	2009-2013	SUZUKI GRAND VITARA	2.4L L4 2393cc	
US6233	2008-2012	HONDA ACCORD	2.4L L4 2354cc 144 CID		2010-2013	SUZUKI KIZASHI	2.4L L4 2388cc 146 CID	
	2009-2014	ACURA TSX	2.4L L4 2354cc 144 CID		2010-2013	SUZUKI SX4	2.0L L4 1995cc	
2010-2011	HONDA CR-V	2.4L L4 2354cc 144 CID	US6295		2010-2015	SUZUKI GRAND VITARA	2.4L L4 2393cc 146 CID	
US6235	2007-2009	MERCEDES-BENZ CLK550		5.5L V8 5461cc	2011-2014	MAZDA 2	1.5L L4 1498cc 91 CID	
	2007-2009	MERCEDES-BENZ SL550	5.5L V8 5461cc	US6336	2010-2012	TOYOTA SEQUOIA	4.6L V8 4608cc	
	2007-2010	MERCEDES-BENZ CL550	5.5L V8 5461cc		2010-2017	LEXUS GX460	4.6L V8 4608cc	
	2007-2011	MERCEDES-BENZ CLS550	5.5L V8 5461cc	2010-2017	TOYOTA TUNDRA	4.6L V8 4608cc		
	2007-2011	MERCEDES-BENZ E550	5.5L V8 5461cc	US6338	2007-2017	LEXUS LS460	4.6L V8 4608cc	
	2007-2011	MERCEDES-BENZ S550	5.5L V8 5461cc		2008-2011	LEXUS GS460	4.6L V8 4608cc	
	2007-2012	MERCEDES-BENZ GL450	4.6L V8 4663cc		2008-2014	LEXUS IS F	5.0L V8 4969cc 303 CID	
	2008-2011	MERCEDES-BENZ ML550	5.5L V8 5461cc		2008-2016	LEXUS LS600H	5.0L V8 4968cc	
	2008-2012	MERCEDES-BENZ GL550	5.5L V8 5461cc		2015-2017	LEXUS RC F	5.0L V8 4969cc 303 CID	
	2009-2015	MERCEDES-BENZ G550	5.5L V8 5461cc	2016-2017	LEXUS GS F	5.0L V8 4969cc 303 CID		
	2011-2012	MERCEDES-BENZ SL550	5.5L V8 5461cc	US6341	2009	CHRYSLER ASPEN	5.7L V8 345 CID	
	US6238	2006-2008	BMW 750I		4.8L V8 4837cc	2009	DODGE DURANGO	5.7L V8 345 CID
2006-2008		BMW 750LI	4.8L V8 4837cc		2009	DODGE RAM 3500	5.7L V8 345 CID	
2006-2010		BMW 550I	4.8L V8 4837cc		2009-2010	DODGE RAM 1500	5.7L V8 345 CID	
2006-2010		BMW 650I	4.8L V8 4837cc		2009-2010	DODGE RAM 2500	5.7L V8 345 CID	
2007-2010		BMW X5	4.8L V8 4837cc		2010	DODGE RAM 4000	5.7L V8 5700cc 350 CID	
US6240	2007-2011	MINI COOPER	1.6L L4 1598cc		2011-2018	RAM 1500	5.7L V8 345 CID	
US6241	2004-2006	SUZUKI VERONA	2.5L L4 2488cc 152 CID	2011-2018	RAM 2500	5.7L V8 345 CID		
US6242	2005-2017	NISSAN FRONTIER	2.5L L4 2488cc 152 CID	2011-2018	RAM 3500	5.7L V8 345 CID		
	2006	NISSAN FRONTIER	2.4L L4 2389cc 146 CID	2015-2016	DODGE RAM 2500	5.7L V8 5654cc 345 CID		
	2008	NISSAN URVAN	2.5L L4 2500cc 153 CID	US6349	2009	MERCEDES-BENZ R320	3.0L V6 2987cc	
	2008-2013	NISSAN URVAN	2.5L L4 2488cc 152 CID		US6350	2009-2013	HONDA FIT	1.5L L4 1497cc
2011-2013	NISSAN URVAN	2.5L L4 2500cc 153 CID	2010-2014	HONDA CITY		1.5L L4 1496cc 91 CID		
US6244	2007-2015	MINI COOPER	1.6L L4 1598cc	2010-2014		HONDA FIT	1.5L L4 1496cc 91 CID	
	2011-2015	MINI COOPER	1.6L L4 1598cc 98 CID	2011-2014	HONDA FIT	1.5L H4 1496cc 91 CID		
	2011-2016	MINI COOPER COUNTRYMAN	1.6L L4 1598cc	US6599	2010-2014	TOYOTA FJ CRUISER	4.0L V6 3956cc 241 CID	
	2013-2016	MINI COOPER PACEMAN	1.6L L4 1598cc		2010-2017	TOYOTA 4RUNNER	4.0L V6 3956cc 241 CID	
	2014-2016	MINI COOPER COUNTRYMAN	1.6L L4 1598cc 98 CID	2011-2014	TOYOTA TUNDRA	4.0L V6 3956cc 241 CID		
US6247	2010-2017	KIA SOUL	1.6L L4 1591cc	US6654	2011-2014	FORD F-150	3.7L V6 3726cc 227 CID	
	2012-2017	HYUNDAI ACCENT	1.6L L4 1591cc 97 CID		2011-2014	FORD F-150	3.7L V6 3727cc 227 CID	
	2012-2017	HYUNDAI VELOSTER	1.6L L4 1591cc 97 CID	2011-2015	FORD MUSTANG	3.7L V6 3726cc 227 CID		
	2012-2017	KIA RIO	1.6L L4 1591cc 97 CID	2012	FORD MUSTANG	3.7L V6 3700cc 227 CID		
	2014-2016	KIA FORTE KOUP	1.6L L4 1591cc 97 CID	2014	FORD MUSTANG	3.7L V6 3700cc 227 CID		
	2014-2017	KIA FORTE5	1.6L L4 1591cc 97 CID	2015	FORD F-150	3.5L V6 3496cc 213 CID		
	2015-2017	HYUNDAI SONATA	1.6L L4 1591cc 97 CID	2015	FORD TRANSIT-150	3.7L V6 3726cc 227 CID		
	2016-2017	HYUNDAI TUCSON	1.6L L4 1591cc 97 CID	2015	FORD TRANSIT-250	3.7L V6 3726cc 227 CID		
	2016-2017	KIA OPTIMA	1.6L L4 1591cc 97 CID	2015	FORD TRANSIT-350	3.7L V6 3726cc 227 CID		
	2017	HYUNDAI ELANTRA	1.6L L4 1591cc 97 CID	2015	FORD TRANSIT-350 HD	3.7L V6 3726cc 227 CID		
	US6249	2008-2010	AUDI A5 QUATTRO	3.2L V6 3123cc	US6657	2002-2005	JAGUAR X-TYPE	2.5L V6 152 CID
		2009	AUDI A4 QUATTRO	3.2L V6 3123cc		2002-2008	JAGUAR X-TYPE	3.0L V6 2968cc 181 CID
2009-2012		AUDI Q5	3.2L V6 3123cc	US6662	2011-2015	CHEVROLET CRUZE	1.4L L4 1364cc 83 CID	
2010-2011		AUDI A6	3.2L V6 3123cc		2012-2017	CHEVROLET SONIC	1.4L L4 1364cc 83 CID	
2010-2012		AUDI Q5	3.2L V6 3200cc 195 CID		2013-2017	BUICK ENCORE	1.4L L4 1364cc 83 CID	
2014-2017	HYUNDAI ELANTRA	1.6L L4 1591cc 97 CID	2014-2017		CHEVROLET TRAX	1.4L L4 1364cc 83 CID		
US6250	2009-2011	MAZDA TRIBUTE	3.0L V6 2968cc 181 CID	2016	CHEVROLET CRUZE LIMITED	1.4L L4 1364cc 83 CID		
	2009-2011	MERCURY MARINER	3.0L V6 2968cc 181 CID	US6680	2007-2008	BMW 328XI	3.0L L6 2996cc	
	2009-2012	FORD ESCAPE	3.0L V6 2968cc 181 CID		2007-2010	BMW X3	3.0L L6 2996cc	
	2010-2011	MERCURY MILAN	3.0L V6 2968cc 181 CID		2007-2010	BMW X5	3.0L L6 2996cc	
	2010-2012	FORD FUSION	3.0L V6 2968cc 181 CID		2007-2013	BMW 328I	3.0L L6 2996cc	
	2011-2012	FORD ESCAPE	3.0L V6 2967cc 181 CID		2008	BMW 528XI	3.0L L6 2996cc	
	2011-2012	FORD FUSION	3.0L V6 2967cc 181 CID		2008-2010	BMW 528I	3.0L L6 2996cc	
	US6251	2005-2007	LAND ROVER LR3		4.0L V6 4009cc 245 CID	2008-2011	BMW Z4	3.0L L6 2996cc
US6252		2009-2015	TOYOTA VENZA		2.7L L4 2672cc 163 CID	2008-2013	BMW 128I	3.0L L6 2996cc
	2009-2017	TOYOTA HIGHLANDER	2.7L L4 2672cc 163 CID	2009-2010	BMW 528I XDRIVE	3.0L L6 2996cc		
	2009-2017	TOYOTA RAV4	2.5L L4 2494cc 152 CID	2009-2013	BMW 328I XDRIVE	3.0L L6 2996cc		
	2010-2017	TOYOTA CAMRY	2.5L L4 2494cc 152 CID	2010	BMW X3	3.0L L6 2996cc 183 CID		
	2011-2012	TOYOTA SIENNA	2.7L L4 2672cc 163 CID	US6681	2007-2008	BMW 335XI	3.0L L6 2979cc	
	2011-2016	SCION TC	2.5L L4 2494cc 152 CID		2007-2013	BMW 335I	3.0L L6 2979cc	
	US6273	2001-2002	MERCEDES-BENZ CL600		5.8L V12 5786cc	2008	BMW 535XI	3.0L L6 2979cc
2001-2002		MERCEDES-BENZ S600	5.8L V12 5786cc		2008-2013	BMW 135I	3.0L L6 2979cc	
2003-2013		MERCEDES-BENZ S600	5.5L V12 5513cc 336 CID		2008-2014	BMW X6	3.0L L6 2979cc	
2003-2014		MERCEDES-BENZ CL600	5.5L V12 5513cc 336 CID		2008-2016	BMW 535I	3.0L L6 2979cc	
2004-2009		MERCEDES-BENZ SL600	5.5L V12 5513cc 336 CID		2009-2013	BMW 335I XDRIVE	3.0L L6 2979cc	
2005-2006		MERCEDES-BENZ CL65 AMG	6.0L V12 5980cc 365 CID		2009-2016	BMW 535I XDRIVE	3.0L L6 2979cc	
2005-2011		MERCEDES-BENZ SL65 AMG	6.0L V12 5980cc 365 CID		2009-2016	BMW Z4	3.0L L6 2979cc	
2006-2013		MERCEDES-BENZ S65 AMG	6.0L V12 5980cc 365 CID		2010-2017	BMW 535I GT	3.0L L6 2979cc	
2008-2014		MERCEDES-BENZ CL65 AMG	6.0L V12 5980cc 365 CID		2011	BMW 1 SERIES M	3.0L L6 2979cc	
2013-2017		MERCEDES-BENZ SL65 AMG	6.0L V12 5980cc 365 CID		2011-2013	BMW 335IS	3.0L L6 2979cc	
2015-2017		MERCEDES-BENZ S65 AMG	6.0L V12 5980cc 365 CID	2011-2013	BMW X5	3.0L L6 2979cc		
2015-2017		MERCEDES-BENZ S600	6.0L V12 5980cc 365 CID	2011-2013	BMW Z4	3.0L L6 2979cc 182 CID		
US6276	2005-2011	VOLVO XC90	4.4L V8 4414cc 269 CID	2011-2015	BMW 740I	3.0L L6 2979cc		
	2007-2010	VOLVO S80	4.4L V8 4414cc 269 CID	2011-2015	BMW 740LI	3.0L L6 2979cc		
	2007-2010	VOLVO S80	4.4L V8 4414cc 269 CID	2011-2017	BMW 535I GT XDRIVE	3.0L L6 2979cc		
	2007-2010	VOLVO S80	4.4L V8 4414cc 269 CID	2011-2017	BMW X3	3.0L L6 2979cc		
	2007-2010	VOLVO S80	4.4L V8 4414cc 269 CID	2012-2016	BMW ACTIVEHYBRID 5	3.0L L6 2979cc		
	2007-2010	VOLVO S80	4.4L V8 4414cc 269 CID	2012-2017	BMW 640I	3.0L L6 2979cc		
	2007-2010	VOLVO S80	4.4L V8 4414cc 269 CID	2013	BMW X5	3.0L L6 2979cc 182 CID		
	2007-2010	VOLVO S80	4.4L V8 4414cc 269 CID	2013-2014	BMW X6	3.0L L6 2979cc 182 CID		
	2007-2010	VOLVO S80	4.4L V8 4414cc 269 CID	2013-2015	BMW 740I	3.0L L6 2979cc 182 CID		
	2007-2010	VOLVO S80	4.4L V8 4414cc 269 CID	2013-2015	BMW 740LI XDRIVE	3.0L L6 2979cc		
	2007-2010	VOLVO S80	4.4L V8 4414cc 269 CID	2013-2015	BMW ACTIVEHYBRID 7	3.0L L6 2979cc		
	2007-2010	VOLVO S80	4.4L V8 4414cc 269 CID	2013-2015	BMW X1	3.0L L6 2979cc		
2007-2010	VOLVO S80	4.4L V8 4414cc 269 CID	2013-2017	BMW 640I GRAN COUPE	3.0L L6 2979cc			

USMW	Years	Application	Engine	USMW	Years	Application	Engine	
US6681	2014	BMW X3	3.0L L6 2979cc 182 CID	US7100	1975-1980	DODGE W200	3.7L L6 3687cc 225 CID	
	2014-2017	BMW 640I XDRIVE	3.0L L6 2979cc		1975-1980	PLYMOUTH PB100	3.7L L6 3687cc 225 CID	
	2014-2017	BMW 640I XDRIVE GRAN COUPE	3.0L L6 2979cc		1975-1980	PLYMOUTH TRAILDUSTER	3.7L L6 3687cc 225 CID	
	2015-2017	BMW X4	3.0L L6 2979cc		1976	DODGE CHARGER	3.7L L6 3687cc 225 CID	
US6682	2016	BMW 640I GRAN COUPE	3.0L L6 2979cc 182 CID	1976-1980	DODGE ASPEN	3.7L L6 3687cc 225 CID		
	2010-2015	TOYOTA PRIUS	1.8L L4 1798cc 110 CID	1976-1980	PLYMOUTH VOLARE	3.7L L6 3687cc 225 CID		
	2011-2017	LEXUS CT200H	1.8L L4 1798cc 110 CID	1977-1978	DODGE MONACO	3.7L L6 3687cc 225 CID		
	2012-2015	TOYOTA PRIUS PLUG-IN	1.8L L4 1798cc 110 CID	1977-1982	DODGE DART	3.7L L6 3700cc 225 CID		
	2012-2017	TOYOTA PRIUS C	1.5L L4 1497cc 91 CID	1977-1987	DODGE D150	3.7L L6 3687cc 225 CID		
US6687	2012-2017	TOYOTA PRIUS V	1.8L L4 1798cc 110 CID	1978-1979	DODGE D300	3.7L L6 3700cc 225 CID		
	2009-2011	NISSAN VERSA	1.6L L4 1598cc	1978-1981	CHRYSLER LEBARON	3.7L L6 3687cc 225 CID		
	2014-2016	NISSAN MARCH	1.6L L4 1598cc 98 CID	1978-1981	CHRYSLER TOWN & COUNTRY	3.7L L6 3687cc 225 CID		
	2014-2017	NISSAN VERSA	1.6L L4 1598cc	1978-1983	DODGE DIPLOMAT	3.7L L6 3687cc 225 CID		
US6689	2014-2017	NISSAN VERSA NOTE	1.6L L4 1598cc	1978-1987	DODGE W150	3.7L L6 3687cc 225 CID		
	2010-2015	CHEVROLET CAMARO	6.2L V8 6162cc 376 CID	1979	DODGE B200	3.7L L6 225 CID		
US6692	2008-2014	SUBARU TRIBECA	3.6L H6 3630cc	1979-1981	DODGE ST. REGIS	3.7L L6 3687cc 225 CID		
	2010-2015	SUBARU LEGACY	3.6L H6 3630cc	1980	DODGE B200	3.7L L6 3687cc 225 CID		
	2010-2015	SUBARU OUTBACK	3.6L H6 3630cc	1980	DODGE B300	3.7L L6 225 CID		
US6693	2012-2015	HONDA CIVIC	1.8L L4 1799cc	1980	DODGE D150	3.7L L6 3700cc 225 CID		
	2014-2015	HONDA CIVIC	1.8L L4 1799cc 110 CID	1980	PLYMOUTH PB200	3.7L L6 3687cc 225 CID		
US6699	2012	JEEP WRANGLER	3.6L L6 3604cc 220 CID	1980-1981	CHRYSLER NEWPORT	3.7L L6 3687cc 225 CID		
	2012-2017	JEEP WRANGLER	3.6L V6 3604cc 220 CID	1980-1983	CHRYSLER CORDOBA	3.7L L6 3687cc 225 CID		
US6700	2012-2017	MAZDA 3	2.0L L4 1998cc 122 CID	1980-1983	DODGE MIRADA	3.7L L6 3687cc 225 CID		
	2013-2016	MAZDA CX-5	2.0L L4 1998cc 122 CID	1980-1983	PLYMOUTH GRAN FURY	3.7L L6 3687cc 225 CID		
	2014-2017	MAZDA 3	2.5L L4 2488cc 152 CID	1980-1987	DODGE D350	3.7L L6 3700cc 225 CID		
	2014-2017	MAZDA 6	2.5L L4 2488cc 152 CID	1981	PLYMOUTH VALIANT	3.7L L6 3700cc 225 CID		
	2014-2017	MAZDA CX-5	2.5L L4 2488cc 152 CID	1981-1983	PLYMOUTH PB150	3.7L L6 3687cc 225 CID		
	2016	SCION IA	1.5L L4 1496cc 91 CID	1981-1983	PLYMOUTH PB250	3.7L L6 3687cc 225 CID		
	2016-2017	MAZDA CX-3	2.0L L4 1998cc 122 CID	1981-1987	DODGE B150	3.7L L6 3687cc 225 CID		
	2017	TOYOTA YARIS IA	1.5L L4 1496cc 91 CID	1981-1987	DODGE B250	3.7L L6 3687cc 225 CID		
	US6702	2007-2008	AUDI RS4	4.2L V8 4172cc	1981-1987	DODGE D250	3.7L L6 3687cc 225 CID	
2007-2009		AUDI S8	5.2L V10 5204cc	1982	CHRYSLER NEW YORKER	3.7L L6 3687cc 225 CID		
2007-2009		VOLKSWAGEN TOUAREG	4.2L V8 4163cc	1982	PLYMOUTH VOLARE	3.7L L6 3700cc 225 CID		
2007-2010		AUDI Q7	4.2L V8 4163cc	1983	CHRYSLER FIFTH AVENUE	3.7L L6 3687cc 225 CID		
2007-2011		AUDI A6 QUATTRO	4.2L V8 4163cc	1985-1987	DODGE D100	3.7L L6 3687cc 225 CID		
2007-2011		AUDI S6	5.2L V10 5204cc	1985-1987	DODGE W250	3.7L L6 3700cc 225 CID		
2007-2012		AUDI A8 QUATTRO	4.2L V8 4163cc	1986-1987	DODGE W100	3.7L L6 3687cc 225 CID		
2008-2012		AUDI S5	4.2L V8 4163cc	1986-1989	CHRYSLER VOLARE	3.7L L6 3700cc 225 CID		
2012		AUDI A8	4.2L V8 4163cc 254 CID	1988-1990	DODGE D150	3.7L L6 3700cc 225 CID		
2013-2015		AUDI RS5	4.2L V8 4163cc 254 CID	1989-1990	DODGE D350	3.7L L6 3700cc 225 CID		
2014-2015		AUDI R8	4.2L V8 4163cc	1978-1983	DODGE OMNI	1.7L L4 105 CID		
2014-2015		AUDI R8	4.2L V8 4163cc 254 CID	1978-1983	PLYMOUTH HORIZON	1.7L L4 105 CID		
2002-2006		ACURA RSX	2.0L L4 1998cc 122 CID	1980-1982	PLYMOUTH TC3	1.7L L4 105 CID		
US6703		2008-2017	BMW X6	4.4L V8 4395cc	1983	PLYMOUTH TURISMO	1.7L L4 105 CID	
		2009-2015	BMW 750LI	4.4L V8 4395cc	US7104	1979	PLYMOUTH COLT	1.6L L4 1597cc 98 CID
	2009-2016	BMW 750I	4.4L V8 4395cc	1979-1980		DODGE COLT	1.6L L4 1597cc 98 CID	
	2010-2015	BMW 550I GT	4.4L V8 4395cc	1979-1980	PLYMOUTH CHAMP	1.6L L4 1597cc 98 CID		
	2010-2015	BMW 750LI XDRIVE	4.4L V8 4395cc	US7105	1978	DODGE COLT	1.6L L4 1597cc 98 CID	
	2010-2016	BMW 750I XDRIVE	4.4L V8 4395cc		1978	PLYMOUTH COLT	1.6L L4 1597cc 98 CID	
	2010-2017	BMW 550I GT XDRIVE	4.4L V8 4395cc	1978-1979	DODGE CHALLENGER	1.6L L4 1597cc 98 CID		
	2010-2017	BMW X5	4.4L V8 4395cc	1978-1979	PLYMOUTH SAPPORO	1.6L L4 1597cc 98 CID		
	2011-2015	BMW ALPINA B7	4.4L V8 4395cc	1978-1980	PLYMOUTH ARROW	1.6L L4 1597cc 98 CID		
	2011-2015	BMW ALPINA B7L	4.4L V8 4395cc	US7106	1979	PLYMOUTH COLT	1.4L L4 1410cc	
	2011-2015	BMW ALPINA B7L XDRIVE	4.4L V8 4395cc		1979-1980	DODGE COLT	1.4L L4 1410cc	
	2011-2015	BMW ALPINA B7 XDRIVE	4.4L V8 4395cc		1979-1980	PLYMOUTH CHAMP	1.4L L4 1410cc	
	2011-2016	BMW 550I	4.4L V8 4395cc		US7108	1981-1982	PLYMOUTH CHAMP	1.6L L4 1597cc 98 CID
	2011-2016	BMW 550I XDRIVE	4.4L V8 4395cc	1981-1988		DODGE COLT	1.6L L4 1597cc 98 CID	
	2012-2017	BMW 650I	4.4L V8 4395cc	1983-1988		PLYMOUTH COLT	1.6L L4 1597cc 98 CID	
	2012-2017	BMW 650I XDRIVE	4.4L V8 4395cc	1985-1988		MITSUBISHI MIRAGE	1.6L L4 1597cc 98 CID	
	2013-2017	BMW 650I GRAN COUPE	4.4L V8 4395cc	1989-1990		DODGE COLT	1.8L L4 1754cc 107 CID	
	2013-2017	BMW 650I XDRIVE GRAN COUPE	4.4L V8 4395cc	1989-1990		PLYMOUTH COLT	1.8L L4 1754cc 107 CID	
	2014	BMW X5	4.4L V8 4395cc 268 CID	1990-1994		MITSUBISHI ECLIPSE	1.8L L4 1755cc 107 CID	
	2014	BMW X6	4.4L V8 4395cc 268 CID	1990-1994		PLYMOUTH LASER	1.8L L4 1755cc 107 CID	
	2014-2015	BMW 650I	4.4L V8 4395cc 268 CID	1993-1994		EAGLE TALON	1.8L L4 1755cc 107 CID	
	2014-2015	BMW 750I	4.4L V8 4395cc 268 CID	US7110		1981-1982	PLYMOUTH TC3	2.2L L4 135 CID
	2014-2015	BMW 750LI	4.4L V8 4395cc 268 CID		1981-1988	DODGE ARIES	2.2L L4 135 CID	
	2015-2016	BMW 650I GRAN COUPE	4.4L V8 4395cc 268 CID		1981-1988	DODGE OMNI	2.2L L4 135 CID	
	2015-2017	BMW ALPINA B6 XDRIVE GRAN COUPE	4.4L V8 4395cc		1981-1988	PLYMOUTH HORIZON	2.2L L4 135 CID	
	US7100	1965-1970	DODGE CORONET		3.7L L6 3700cc 225 CID	1981-1988	PLYMOUTH RELIANT	2.2L L4 135 CID
		1965-1974	DODGE DART		3.7L L6 3700cc 225 CID	1982-1983	DODGE 400	2.2L L4 135 CID
1967-1968		DODGE D300	3.7L L6 3700cc 225 CID		1982-1984	DODGE RAMPAGE	2.2L L4 135 CID	
1970-1974		DODGE D100	3.7L L6 3700cc 225 CID		1982-1987	CHRYSLER LEBARON	2.2L L4 2200cc 135 CID	
1974-1976		PLYMOUTH VALIANT	3.7L L6 3700cc 225 CID		1982-1988	CHRYSLER LEBARON	2.2L L4 135 CID	
1975-1976		DODGE CORONET	3.7L L6 3687cc 225 CID		1982-1988	CHRYSLER TOWN & COUNTRY	2.2L L4 135 CID	
1975-1976		PLYMOUTH DUSTER	3.7L L6 3687cc 225 CID		1982-1988	DODGE DART	2.2L L4 2200cc 135 CID	
1975-1976		PLYMOUTH SCAMP	3.7L L6 3687cc 225 CID		1982-1988	PLYMOUTH VOLARE	2.2L L4 2200cc 135 CID	
1975-1976		PLYMOUTH VALIANT	3.7L L6 3687cc 225 CID		1983	PLYMOUTH SCAMP	2.2L L4 135 CID	
1975-1977		DODGE DART	3.7L L6 3687cc 225 CID		1983-1984	CHRYSLER E CLASS	2.2L L4 135 CID	
1975-1977		DODGE W100	3.7L L6 3687cc 225 CID		1983-1984	PLYMOUTH TURISMO	2.2L L4 135 CID	
1975-1978		DODGE B200	3.7L L6 3687cc 225 CID	1983-1986	PLYMOUTH TURISMO 2.2	2.2L L4 135 CID		
1975-1978		DODGE D300	3.7L L6 3687cc 225 CID	1983-1988	CHRYSLER NEW YORKER	2.2L L4 135 CID		
1975-1978		DODGE W300	3.7L L6 3687cc 225 CID	1983-1988	DODGE 600	2.2L L4 135 CID		
1975-1978		PLYMOUTH FURY	3.7L L6 3687cc 225 CID	1983-1988	DODGE MAGNUM	2.2L L4 2200cc 135 CID		
1975-1978		PLYMOUTH PB200	3.7L L6 3687cc 225 CID	1984-1986	CHRYSLER LASER	2.2L L4 135 CID		
1975-1979		DODGE B300	3.7L L6 3687cc 225 CID	1984-1987	DODGE CARAVAN	2.2L L4 135 CID		
1975-1979		DODGE D100	3.7L L6 3687cc 225 CID	1984-1987	DODGE CHARGER	2.2L L4 135 CID		
1975-1980		DODGE B100	3.7L L6 3687cc 225 CID	1984-1987	DODGE MINI RAM	2.2L L4 135 CID		
1975-1980		DODGE D200	3.7L L6 3687cc 225 CID	1984-1987	PLYMOUTH VOYAGER	2.2L L4 135 CID		
1975-1980		DODGE RAMCHARGER	3.7L L6 3687cc 225 CID	1984-1988	DODGE DAYTONA	2.2L L4 135 CID		

USMW	Years	Application	Engine	USMW	Years	Application	Engine
US7110	1985-1988	DODGE LANCER	2.2L L4 135 CID	US7111	1985	CHRYSLER EXECUTIVE LIMOUSINE	2.6L L4 2555cc 156 CID
	1985-1988	PLYMOUTH CARAVELLE	2.2L L4 135 CID		1985	PLYMOUTH CARAVELLE	2.6L L4 2555cc 156 CID
	1985-1991	CHRYSLER NEW YORKER	2.2L L4 2200cc 135 CID	US7113	1983-1984	PLYMOUTH TURISMO	1.6L L4 1595cc 97 CID
	1986	CHRYSLER LASER	2.5L L4 2507cc 153 CID		1983-1986	DODGE OMNI	1.6L L4 1595cc 97 CID
	1986-1987	CHRYSLER NEW YORKER	2.5L L4 2507cc 153 CID		1983-1986	PLYMOUTH HORIZON	1.6L L4 1595cc 97 CID
	1986-1987	PLYMOUTH TURISMO	2.2L L4 135 CID		1984	DODGE CHARGER	1.6L L4 1595cc 97 CID
	1986-1988	CHRYSLER DART	2.2L L4 2200cc 135 CID	US7114	1986	PLYMOUTH TURISMO	1.6L L4 1595cc 97 CID
	1986-1988	CHRYSLER LEBARON	2.5L L4 2507cc 153 CID		1983	DODGE POWER RAM 50	2.0L L4 1997cc
	1986-1988	CHRYSLER TOWN & COUNTRY	2.5L L4 2507cc 153 CID		1983	DODGE POWER RAM 50	2.6L L4 2555cc
	1986-1988	DODGE 600	2.5L L4 2507cc 153 CID		1983	DODGE RAM 50	2.0L L4 1997cc 122 CID
	1986-1988	DODGE ARIES	2.5L L4 2507cc 153 CID		1983	DODGE RAM 50	2.6L L4 2555cc 156 CID
	1986-1988	DODGE DAYTONA	2.5L L4 2507cc 153 CID		1983-1989	MITSUBISHI MIGHTY MAX	2.0L L4 1997cc 122 CID
	1986-1988	DODGE LANCER	2.5L L4 2507cc 153 CID		1984	DODGE POWER RAM 50	2.0L L4 1995cc
	1986-1988	PLYMOUTH CARAVELLE	2.5L L4 2507cc 153 CID		1984-1989	DODGE RAM 50	2.0L L4 1995cc 122 CID
	1986-1988	PLYMOUTH RELIANT	2.5L L4 2507cc 153 CID		1985	DODGE RAM 50	2.6L L4 2555cc 156 CID
	1987-1988	CHRYSLER MAGNUM	2.5L L4 2507cc 153 CID		1987-1990	MITSUBISHI VAN	2.4L L4 2351cc
	1987-1988	DODGE DAKOTA	2.2L L4 135 CID		1990-1993	DODGE RAM 50	2.4L L4 2351cc
	1987-1988	DODGE SHADOW	2.2L L4 135 CID		1990-1996	MITSUBISHI MIGHTY MAX	2.4L L4 2351cc
	1987-1988	PLYMOUTH SUNDANCE	2.2L L4 135 CID		2003-2005	DODGE H-100	2.4L L4 2351cc 144 CID
	1987-1988	PLYMOUTH VOYAGER	2.5L L4 2507cc 153 CID		US7115	1981-1982	PLYMOUTH CHAMP
	1987-1990	CHRYSLER PHANTOM	2.2L L4 2200cc 135 CID	1981-1984		DODGE COLT	1.4L L4 1410cc
	1988	CHRYSLER SHADOW	2.5L L4 2507cc 153 CID	1983-1984		PLYMOUTH COLT	1.4L L4 1410cc
	1988	DODGE CARAVAN	2.5L L4 2507cc 153 CID	1984		DODGE CONQUEST	2.6L L4 2555cc 156 CID
	1988	DODGE DYNASTY	2.5L L4 2507cc 153 CID	1984		PLYMOUTH CONQUEST	2.6L L4 2555cc 156 CID
	1988	DODGE GRAND CARAVAN	2.5L L4 2507cc 153 CID	1985-1994		DODGE COLT	1.5L L4 1468cc 90 CID
	1988	DODGE SHADOW	2.2L L4 2200cc 135 CID	1985-1994		PLYMOUTH COLT	1.5L L4 1468cc 90 CID
	1988	DODGE SHADOW	2.5L L4 2507cc 153 CID	1985-1996		MITSUBISHI MIRAGE	1.5L L4 1468cc 90 CID
	1988	PLYMOUTH GRAND VOYAGER	2.5L L4 2507cc 153 CID	1986-1994		HYUNDAI EXCEL	1.5L L4 1468cc
	1988	PLYMOUTH SUNDANCE	2.5L L4 2507cc 153 CID	1987-1994		MITSUBISHI PRECIS	1.5L L4 1468cc
	1990	CHRYSLER TC MASERATI	2.2L L4 135 CID	1989-1996	EAGLE SUMMIT	1.5L L4 1468cc 90 CID	
	1992-1994	CHRYSLER PHANTOM	2.2L L4 2200cc 135 CID	1991-1992	HYUNDAI SCOUPE	1.5L L4 1468cc	
	US7110H	1981-1982	PLYMOUTH TC3	2.2L L4 135 CID	1993-1995	HYUNDAI SCOUPE	1.5L L4 1495cc
		1981-1988	DODGE ARIES	2.2L L4 135 CID	1995-2001	HYUNDAI ACCENT	1.5L L4 1495cc
		1981-1988	DODGE OMNI	2.2L L4 135 CID	2004-2006	DODGE VERNA	1.5L L4 1508cc 92 CID
1981-1988		PLYMOUTH HORIZON	2.2L L4 135 CID	2006-2010	DODGE ATTITUDE	1.4L L4 1388cc 85 CID	
1981-1988		PLYMOUTH RELIANT	2.2L L4 135 CID	2011	DODGE ATTITUDE	1.4L L4 1399cc 85 CID	
1982-1983		DODGE 400	2.2L L4 135 CID	2012	DODGE ATTITUDE	1.6L L4 1599cc 98 CID	
1982-1984		DODGE RAMPAGE	2.2L L4 135 CID	US7117	1983-1985	DODGE POWER RAM 50	2.3L L4 2346cc
1982-1988		CHRYSLER LEBARON	2.2L L4 135 CID		1983-1985	DODGE RAM 50	2.3L L4 2346cc 143 CID
1982-1988		CHRYSLER TOWN & COUNTRY	2.2L L4 135 CID		1983-1985	MITSUBISHI MIGHTY MAX	2.3L L4 2346cc 143 CID
1983		PLYMOUTH SCAMP	2.2L L4 135 CID	US7118	1983-1988	MITSUBISHI CORDIA	1.8L L4 1795cc
1983-1984		CHRYSLER E CLASS	2.2L L4 135 CID		1983-1988	MITSUBISHI TREDIA	1.8L L4 1795cc
1983-1984		PLYMOUTH TURISMO	2.2L L4 135 CID		1984	DODGE COLT	2.0L L4 1995cc 122 CID
1983-1986		PLYMOUTH TURISMO 2.2	2.2L L4 135 CID		1984-1988	MITSUBISHI CORDIA	2.0L L4 1997cc 122 CID
1983-1988		CHRYSLER NEW YORKER	2.2L L4 135 CID		1984-1988	MITSUBISHI TREDIA	2.0L L4 1997cc 122 CID
1983-1988		DODGE 600	2.2L L4 135 CID		1984-1991	PLYMOUTH COLT	2.0L L4 1997cc 122 CID
1984-1986		CHRYSLER LASER	2.2L L4 135 CID		1985-1987	MITSUBISHI GALANT	2.4L L4 2351cc
1984-1987		DODGE CARAVAN	2.2L L4 135 CID		1985-1991	DODGE COLT	2.0L L4 1997cc 122 CID
1984-1987		DODGE CHARGER	2.2L L4 135 CID		1989-1991	HYUNDAI SONATA	2.4L L4 2351cc
1984-1987		DODGE MINI RAM	2.2L L4 135 CID		US7120	1976-1977	DODGE COLT
1984-1987		PLYMOUTH VOYAGER	2.2L L4 135 CID	1976-1978		PLYMOUTH ARROW	2.0L L4 1997cc 122 CID
1984-1988		DODGE DAYTONA	2.2L L4 135 CID	1976-1978		PLYMOUTH COLT	2.0L L4 1995cc 122 CID
1985-1988		DODGE LANCER	2.2L L4 135 CID	1978-1979		PLYMOUTH COLT	2.6L L4 2555cc 156 CID
1985-1988		PLYMOUTH CARAVELLE	2.2L L4 135 CID	1978-1980		DODGE COLT	2.6L L4 2555cc 156 CID
1986		CHRYSLER LASER	2.5L L4 2507cc 153 CID	1978-1981		PLYMOUTH SAPPORO	2.6L L4 2555cc 156 CID
1986-1987		CHRYSLER NEW YORKER	2.5L L4 2507cc 153 CID	1978-1983		DODGE CHALLENGER	2.6L L4 2555cc 156 CID
1986-1987		PLYMOUTH TURISMO	2.2L L4 135 CID	1979-1980		DODGE D50	2.0L L4 1995cc 122 CID
1986-1988		CHRYSLER LEBARON	2.5L L4 2507cc 153 CID	1979-1980		PLYMOUTH ARROW	2.6L L4 2555cc 156 CID
1986-1988		CHRYSLER TOWN & COUNTRY	2.5L L4 2507cc 153 CID	1979-1982		DODGE D50	2.6L L4 2555cc 156 CID
1986-1988		DODGE 600	2.5L L4 2507cc 153 CID	1979-1982		PLYMOUTH ARROW PICKUP	2.0L L4 1997cc 122 CID
1986-1988		DODGE ARIES	2.5L L4 2507cc 153 CID	1979-1982		PLYMOUTH ARROW PICKUP	2.6L L4 2555cc 156 CID
1986-1988		DODGE DAYTONA	2.5L L4 2507cc 153 CID	1981-1982		DODGE D50	2.0L L4 1997cc 122 CID
1986-1988		DODGE LANCER	2.5L L4 2507cc 153 CID	1983-1987		MITSUBISHI STARION	2.6L L4 2555cc 156 CID
1986-1988		PLYMOUTH CARAVELLE	2.5L L4 2507cc 153 CID	1983-1989	MITSUBISHI MIGHTY MAX	2.6L L4 2555cc 156 CID	
1986-1988		PLYMOUTH RELIANT	2.5L L4 2507cc 153 CID	1983-1989	MITSUBISHI MONTERO	2.6L L4 2555cc 156 CID	
1987-1988	DODGE DAKOTA	2.2L L4 135 CID	1984	DODGE POWER RAM 50	2.6L L4 2555cc		
1987-1988	DODGE SHADOW	2.2L L4 135 CID	1984-1989	DODGE RAM 50	2.6L L4 2555cc 156 CID		
1987-1988	PLYMOUTH SUNDANCE	2.2L L4 135 CID	1985-1986	DODGE CONQUEST	2.6L L4 2555cc 156 CID		
1987-1988	PLYMOUTH VOYAGER	2.5L L4 2507cc 153 CID	1985-1986	DODGE POWER RAM 50	2.6L L4 2555cc 156 CID		
1988	DODGE CARAVAN	2.5L L4 2507cc 153 CID	1985-1986	PLYMOUTH CONQUEST	2.6L L4 2555cc 156 CID		
1988	DODGE DYNASTY	2.5L L4 2507cc 153 CID	1987	CHRYSLER CONQUEST	2.6L L4 2555cc 156 CID		
1988	DODGE GRAND CARAVAN	2.5L L4 2507cc 153 CID	1987-1988	MAZDA B2600	2.6L L4 2555cc		
1988	DODGE SHADOW	2.5L L4 2507cc 153 CID	1987-1989	DODGE RAIDER	2.6L L4 2555cc 156 CID		
1988	PLYMOUTH GRAND VOYAGER	2.5L L4 2507cc 153 CID	1987-1988	DODGE MINI RAM	3.0L V6 2972cc 181 CID		
1988	PLYMOUTH SUNDANCE	2.5L L4 2507cc 153 CID	1987-2000	DODGE CARAVAN	3.0L V6 2972cc 181 CID		
1990	CHRYSLER TC MASERATI	2.2L L4 135 CID	1987-2000	PLYMOUTH VOYAGER	3.0L V6 2972cc 181 CID		
US7111	1981-1985	DODGE ARIES	2.6L L4 2555cc 156 CID	1988	MITSUBISHI GALANT	3.0L V6 2972cc 181 CID	
	1981-1985	PLYMOUTH RELIANT	2.6L L4 2555cc 156 CID	1988-1989	CHRYSLER NEW YORKER	3.0L V6 2972cc 181 CID	
	1982	CHRYSLER TOWN & COUNTRY	2.6L L4 2555cc 156 CID	1988-1989	DODGE GRAND CARAVAN	3.0L V6 2972cc 181 CID	
	1982-1983	DODGE 400	2.6L L4 2555cc 156 CID	1988-1989	PLYMOUTH GRAND VOYAGER	3.0L V6 2972cc 181 CID	
	1982-1985	CHRYSLER LEBARON	2.6L L4 2555cc 156 CID	1988-1993	DODGE DYNASTY	3.0L V6 2972cc 181 CID	
	1983-1984	CHRYSLER E CLASS	2.6L L4 2555cc 156 CID	1989	DODGE RAIDER	3.0L V6 2972cc 181 CID	
	1983-1984	CHRYSLER EXECUTIVE SEDAN	2.6L L4 2555cc 156 CID	1989-1990	MITSUBISHI SIGMA	3.0L V6 2972cc 181 CID	
	1983-1985	CHRYSLER NEW YORKER	2.6L L4 2555cc 156 CID	1989-1992	CHRYSLER SPIRIT	3.0L V6 2966cc 181 CID	
	1983-1985	DODGE 600	2.6L L4 2555cc 156 CID	1989-1994	MITSUBISHI MONTERO	3.0L V6 2972cc 181 CID	
	1984-1985	CHRYSLER TOWN & COUNTRY	2.6L L4 2555cc 156 CID	1989-1995	DODGE SPIRIT	3.0L V6 2972cc 181 CID	
	1984-1987	DODGE CARAVAN	2.6L L4 2555cc 156 CID	1989-1995	PLYMOUTH ACCLAIM	3.0L V6 2972cc 181 CID	
	1984-1987	DODGE MINI RAM	2.6L L4 2555cc 156 CID	1990-1991	CHRYSLER TC MASERATI	3.0L V6 2972cc 181 CID	
	1984-1987	PLYMOUTH VOYAGER	2.6L L4 2555cc 156 CID	1990-1991	DODGE RAM 50	3.0L V6 2972cc 181 CID	

WATER PUMPS

USMW	Years	Application	Engine	USMW	Years	Application	Engine		
US7121	1990-1993	DODGE DAYTONA	3.0L V6 2972cc 181 CID	US7126	1993-1999	CHRYSLER VOYAGER	3.3L V6 3294cc 201 CID		
	1990-1994	MITSUBISHI MIGHTY MAX	3.0L V6 2972cc 181 CID		1994-1995	PLYMOUTH GRAND VOYAGER	3.8L V6 230 CID		
	1990-1995	CHRYSLER LEBARON	3.0L V6 2972cc 181 CID		1994-2000	CHRYSLER TOWN & COUNTRY	3.8L V6 230 CID		
	1990-1998	HYUNDAI SONATA	3.0L V6 2972cc		1994-2000	DODGE GRAND CARAVAN	3.8L V6 230 CID		
	1991-1996	DODGE STEALTH	3.0L V6 2972cc 181 CID		1996-1999	DODGE CARAVAN	3.8L V6 230 CID		
	1992	CHRYSLER SHADOW	3.0L V6 2966cc 181 CID		1996-2000	CHRYSLER TOWN & COUNTRY	3.3L V6 3301cc 201 CID		
	1992-1994	CHRYSLER NEW YORKER	3.0L V6 3000cc 183 CID		1997	PLYMOUTH GRAND VOYAGER	3.8L V6 3800cc 232 CID		
	1992-1994	CHRYSLER VOYAGER	3.0L V6 2966cc 181 CID		1998-2001	CHRYSLER GRAND VOYAGER	3.8L V6 3800cc 232 CID		
	1992-1994	DODGE SHADOW	3.0L V6 2972cc 181 CID		1999	PLYMOUTH GRAND VOYAGER	3.8L V6 230 CID		
	1992-1994	PLYMOUTH SUNDANCE	3.0L V6 2972cc 181 CID		1999	PLYMOUTH VOYAGER	3.8L V6 230 CID		
	1992-1996	MITSUBISHI DIAMANTE	3.0L V6 2972cc 181 CID		2000	CHRYSLER GRAND VOYAGER	3.3L V6 3301cc 201 CID		
	1992-2000	DODGE GRAND CARAVAN	3.0L V6 2972cc 181 CID		2000	CHRYSLER VOYAGER	3.3L V6 3301cc 201 CID		
	1992-2000	PLYMOUTH GRAND VOYAGER	3.0L V6 2972cc 181 CID		US7127	1990	CHRYSLER LEBARON	2.2L L4 135 CID	
	1996-1997	CHRYSLER VOYAGER	3.0L V6 2966cc 181 CID			1990	CHRYSLER PHANTOM	2.2L L4 2200cc 135 CID	
	1997-1999	MITSUBISHI 3000GT	3.0L V6 2972cc 181 CID			1990	DODGE DAYTONA	2.2L L4 135 CID	
	2000	CHRYSLER GRAND VOYAGER	3.0L V6 2972cc 181 CID			1990	DODGE OMNI	2.2L L4 135 CID	
	2000	CHRYSLER VOYAGER	3.0L V6 2972cc 181 CID			1990	DODGE SHADOW	2.2L L4 2200cc 135 CID	
	US7121-2	1987-1988	DODGE MINI RAM			3.0L V6 2972cc 181 CID	1990	DODGE SHADOW	2.5L L4 2500cc 153 CID
		1987-2000	DODGE CARAVAN			3.0L V6 2972cc 181 CID	1990	DODGE SPIRIT	2.5L L4 2500cc 153 CID
		1987-2000	PLYMOUTH VOYAGER			3.0L V6 2972cc 181 CID	1990	PLYMOUTH HORIZON	2.2L L4 135 CID
1988		MITSUBISHI GALANT	3.0L V6 2972cc 181 CID	1990-1991		CHRYSLER SHADOW	2.2L L4 2212cc 135 CID		
1988-1989		CHRYSLER NEW YORKER	3.0L V6 2972cc 181 CID	1990-1993		CHRYSLER LEBARON	2.5L L4 2507cc 153 CID		
1988-1989		DODGE GRAND CARAVAN	3.0L V6 2972cc 181 CID	1990-1993		DODGE DAYTONA	2.5L L4 2507cc 153 CID		
1988-1989		PLYMOUTH GRAND VOYAGER	3.0L V6 2972cc 181 CID	1990-1995		DODGE DYNASTY	2.5L L4 2507cc 153 CID		
1988-1993		DODGE DYNASTY	3.0L V6 2972cc 181 CID	1990-1994		CHRYSLER PHANTOM	2.5L L4 2500cc 153 CID		
1989		DODGE RAIDER	3.0L V6 2972cc 181 CID	1990-1994		CHRYSLER SHADOW	2.5L L4 2507cc 153 CID		
1989-1990		MITSUBISHI SIGMA	3.0L V6 2972cc 181 CID	1990-1994		DODGE SHADOW	2.2L L4 135 CID		
1989-1994		MITSUBISHI MONTERO	3.0L V6 2972cc 181 CID	1990-1994		DODGE SHADOW	2.5L L4 2507cc 153 CID		
1989-1995		DODGE SPIRIT	3.0L V6 2972cc 181 CID	1990-1994		PLYMOUTH SUNDANCE	2.2L L4 135 CID		
1989-1995		PLYMOUTH ACCLAIM	3.0L V6 2972cc 181 CID	1990-1994		PLYMOUTH SUNDANCE	2.5L L4 2507cc 153 CID		
1990-1991		CHRYSLER TC MASERATI	3.0L V6 2972cc 181 CID	1990-1995		CHRYSLER SPIRIT	2.5L L4 2507cc 153 CID		
1990-1991		DODGE RAM 50	3.0L V6 2972cc 181 CID	1990-1995		CHRYSLER VOYAGER	2.5L L4 2507cc 153 CID		
1990-1993		DODGE DAYTONA	3.0L V6 2972cc 181 CID	1990-1995	DODGE CARAVAN	2.5L L4 2507cc 153 CID			
1990-1994		MITSUBISHI MIGHTY MAX	3.0L V6 2972cc 181 CID	1990-1995	DODGE DAKOTA	2.5L L4 2507cc 153 CID			
1990-1995		CHRYSLER LEBARON	3.0L V6 2972cc 181 CID	1990-1995	DODGE SPIRIT	2.5L L4 2507cc 153 CID			
1990-1998		HYUNDAI SONATA	3.0L V6 2972cc	1990-1995	PLYMOUTH ACCLAIM	2.5L L4 2507cc 153 CID			
1991-1996		DODGE STEALTH	3.0L V6 2972cc 181 CID	1990-1995	PLYMOUTH VOYAGER	2.5L L4 2507cc 153 CID			
1992-1994	DODGE SHADOW	3.0L V6 2972cc 181 CID	1993	DODGE SPIRIT	2.2L L4 2200cc 135 CID				
1992-1994	PLYMOUTH SUNDANCE	3.0L V6 2972cc 181 CID	1993-1994	DODGE SHADOW	2.5L L4 2500cc 153 CID				
1992-1996	MITSUBISHI DIAMANTE	3.0L V6 2972cc 181 CID	1993-1995	CHRYSLER LEBARON	2.5L L4 2500cc 153 CID				
1992-2000	DODGE GRAND CARAVAN	3.0L V6 2972cc 181 CID	1993-1995	DODGE SPIRIT	2.5L L4 2500cc 153 CID				
1992-2000	PLYMOUTH GRAND VOYAGER	3.0L V6 2972cc 181 CID	US7128	1990-1991	DODGE DAKOTA	5.2L V8 5211cc 318 CID			
1997-1999	MITSUBISHI 3000GT	3.0L V6 2972cc 181 CID		US7129	1991-1999	MITSUBISHI 3000GT	3.0L V6 2972cc 181 CID		
2000	CHRYSLER GRAND VOYAGER	3.0L V6 2972cc 181 CID			1992-1994	MITSUBISHI DIAMANTE	3.0L V6 2972cc 181 CID		
2000	CHRYSLER VOYAGER	3.0L V6 2972cc 181 CID	1994-1996		DODGE STEALTH	3.0L V6 2972cc 181 CID			
US7122	1989	CHRYSLER DART	2.2L L4 2200cc 135 CID	US7131	1989	MITSUBISHI MIRAGE	1.6L L4 1597cc 98 CID		
	1989	CHRYSLER LEBARON	2.2L L4 135 CID		1989-1990	DODGE COLT	1.6L L4 1597cc 98 CID		
	1989	CHRYSLER LEBARON	2.5L L4 2507cc 153 CID		1989-1990	EAGLE SUMMIT	1.6L L4 1597cc 98 CID		
	1989	CHRYSLER PHANTOM	2.2L L4 2200cc 135 CID		1989-1990	PLYMOUTH COLT	1.6L L4 1597cc 98 CID		
	1989	CHRYSLER SHADOW	2.2L L4 2212cc 135 CID		1991-1992	MITSUBISHI MIRAGE	1.6L L4 1597cc 98 CID		
	1989	CHRYSLER SHADOW	2.5L L4 2507cc 153 CID		1992-1995	HYUNDAI ELANTRA	1.6L L4 1596cc		
	1989	CHRYSLER SPIRIT	2.5L L4 2507cc 153 CID		US7135	1992-1994	MITSUBISHI EXPO LRV	1.8L L4 1834cc 112 CID	
	1989	CHRYSLER TC MASERATI	2.2L L4 135 CID			1992-1994	PLYMOUTH COLT	1.8L L4 1834cc 112 CID	
	1989	DODGE ARIES	2.2L L4 135 CID			1992-1996	EAGLE SUMMIT	1.8L L4 1834cc 112 CID	
	1989	DODGE ARIES	2.5L L4 2507cc 153 CID		1993-1994	DODGE COLT	1.8L L4 1834cc 112 CID		
	1989	DODGE CARAVAN	2.5L L4 2507cc 153 CID		1993-1996	MITSUBISHI MIRAGE	1.8L L4 1834cc 112 CID		
	1989	DODGE DAKOTA	2.5L L4 2507cc 153 CID		US7136	1991-1992	JEEP COMANCHE	2.5L L4 150 CID	
	1989	DODGE DART	2.2L L4 2200cc 135 CID			1991-1995	JEEP WRANGLER	2.5L L4 150 CID	
	1989	DODGE DAYTONA	2.2L L4 135 CID			1991-1995	JEEP WRANGLER	4.0L L6 242 CID	
	1989	DODGE DAYTONA	2.5L L4 2507cc 153 CID			1991-2000	JEEP CHEROKEE	2.5L L4 150 CID	
	1989	DODGE DYNASTY	2.5L L4 2507cc 153 CID			1993-1998	JEEP GRAND CHEROKEE	4.0L L6 242 CID	
	1989	DODGE LANCER	2.2L L4 135 CID			1996-2002	DODGE DAKOTA	2.5L L4 2507cc 153 CID	
	1989	DODGE LANCER	2.5L L4 2507cc 153 CID			1997-1999	JEEP WRANGLER	4.0L L6 242 CID	
	1989	DODGE OMNI	2.2L L4 135 CID			1997-2002	JEEP WRANGLER	2.5L L4 150 CID	
	1989	DODGE SHADOW	2.2L L4 135 CID			US7137	1992-1993	DODGE VIPER	8.0L V10 7990cc 488 CID
1989	DODGE SHADOW	2.2L L4 2200cc 135 CID	US7139	1991-1992			DODGE SPIRIT	2.2L L4 135 CID	
1989	DODGE SHADOW	2.5L L4 2507cc 153 CID		1992-1993	DODGE DAYTONA		2.2L L4 135 CID		
1989	DODGE SPIRIT	2.5L L4 2500cc 153 CID		US7140	1992	CHRYSLER CONCORDE	3.3L V6 3294cc 201 CID		
1989	DODGE SPIRIT	2.5L L4 2507cc 153 CID	1993-1996		CHRYSLER CONCORDE	3.3L V6 3301cc 201 CID			
1989	PLYMOUTH ACCLAIM	2.5L L4 2507cc 153 CID	1993-1997		DODGE INTREPID	3.3L V6 3301cc 201 CID			
1989	PLYMOUTH HORIZON	2.2L L4 135 CID	1993-1997	EAGLE VISION	3.3L V6 3301cc 201 CID				
1989	PLYMOUTH RELIANT	2.2L L4 135 CID	US7141	1992	CHRYSLER CONCORDE	3.5L V6 3526cc 215 CID			
1989	PLYMOUTH RELIANT	2.5L L4 2507cc 153 CID		1993-1994	CHRYSLER CONCORDE	3.5L V6 3497cc 215 CID			
1989	PLYMOUTH SUNDANCE	2.2L L4 135 CID		1993-1994	DODGE INTREPID	3.5L V6 3497cc 215 CID			
1989	PLYMOUTH SUNDANCE	2.5L L4 2507cc 153 CID		1993-1994	EAGLE VISION	3.5L V6 3497cc 215 CID			
1989	PLYMOUTH VOYAGER	2.5L L4 2507cc 153 CID		1994	CHRYSLER LHS	3.5L V6 3497cc 215 CID			
1989	CHRYSLER CONQUEST	2.6L L4 2555cc 156 CID		1994	CHRYSLER NEW YORKER	3.5L V6 3497cc 215 CID			
US7124	1987-1989	MITSUBISHI STARION	2.6L L4 2555cc 156 CID	US7145	1989-1993	DODGE D250	5.9L L6 359 CID		
	1987-1989	MITSUBISHI STARION	2.6L L4 2555cc 156 CID		1989-1993	DODGE D350	5.9L L6 359 CID		
US7126	1990-1991	CHRYSLER IMPERIAL	3.3L V6 3301cc 201 CID		1989-1993	DODGE W250	5.9L L6 359 CID		
	1990-1993	CHRYSLER NEW YORKER	3.3L V6 3301cc 201 CID		1989-1993	DODGE W350	5.9L L6 359 CID		
	1990-1993	CHRYSLER TOWN & COUNTRY	3.3L V6 3301cc 201 CID		1994-1998	DODGE RAM 2500	5.9L L6 359 CID		
	1990-1993	DODGE DYNASTY	3.3L V6 3301cc 201 CID		1994-1998	DODGE RAM 3500	5.9L L6 359 CID		
	1990-2000	DODGE GRAND CARAVAN	3.3L V6 3301cc 201 CID		2003-2007	DODGE RAM 2500	5.9L L6 359 CID		
	1990-2000	PLYMOUTH GRAND VOYAGER	3.3L V6 3301cc 201 CID		2004-2007	DODGE RAM 3500	5.9L L6 359 CID		
	1991-1993	CHRYSLER IMPERIAL	3.8L V6 230 CID		US7145HN	1998-2007	DODGE RAM 3500	5.9L L6 359 CID	
	1991-1993	CHRYSLER NEW YORKER	3.8L V6 230 CID			1998-2009	DODGE RAM 2500	5.9L L6 359 CID	
	1991-1995	CHRYSLER GRAND VOYAGER	3.8L V6 3800cc 231 CID	US7145N		1989-1993	DODGE D250	5.9L L6 359 CID	
	1991-2000	DODGE CARAVAN	3.3L V6 3301cc 201 CID		1989-1993	DODGE D350	5.9L L6 359 CID		
	1991-2000	PLYMOUTH VOYAGER	3.3L V6 3301cc 201 CID						

USMW	Years	Application	Engine	USMW	Years	Application	Engine	
US7145N	1993-1994	FORD F600	5.9L L6 359 CID	US7158	1997	PLYMOUTH PROWLER	3.5L V6 3497cc 215 CID	
	1993-1994	FORD F600 LPO	5.9L L6 359 CID	US7159	1992	DODGE B150	3.9L V6 3906cc 239 CID	
	1993-1997	FORD CF7000	5.9L L6 359 CID		1992	DODGE B150	5.2L V8 5211cc 318 CID	
	1993-1997	FORD F700	5.9L L6 359 CID		1992	DODGE B250	3.9L V6 3906cc 239 CID	
	1993-1997	FORD LN7000	5.9L L6 359 CID		1992	DODGE B250	5.2L V8 5211cc 318 CID	
	1993-1999	FORD F800	5.9L L6 359 CID		1992	DODGE B350	5.2L V8 5211cc 318 CID	
	1994-2001	DODGE RAM 2500	5.9L L6 359 CID		1992	DODGE D150	3.9L V6 3906cc 239 CID	
	1994-2001	DODGE RAM 3500	5.9L L6 359 CID		1992	DODGE D150	5.2L V8 5211cc 318 CID	
	1995-1998	FORD F800 LPO	5.9L L6 359 CID		1992	DODGE D250	3.9L V6 3906cc 239 CID	
			1992		DODGE D250	5.2L V8 5211cc 318 CID		
US7146	1994-1996	DODGE VIPER	8.0L V10 7990cc 488 CID		1992	DODGE DAKOTA	3.9L V6 3906cc 239 CID	
US7148	1993	MINISUBISHI GALANT	2.0L L4 1997cc 122 CID	1992	DODGE DAKOTA	5.2L V8 5211cc 318 CID		
	1993-1994	MINISUBISHI EXPO LRV	2.4L L4 2351cc	1992	DODGE MICROBUS	5.9L V8 5900cc 360 CID		
	1993-1994	PLYMOUTH COLT	2.4L L4 2351cc	1992	DODGE RAMCHARGER	5.2L V8 5211cc 318 CID		
	1993-1995	MINISUBISHI EXPO	2.4L L4 2351cc	1992	DODGE W150	3.9L V6 3906cc 239 CID		
	1993-1996	EAGLE SUMMIT	2.4L L4 2351cc	1992	DODGE W150	5.2L V8 5211cc 318 CID		
	1994-1998	MINISUBISHI GALANT	2.4L L4 2351cc	1992	DODGE W250	5.2L V8 5211cc 318 CID		
	1995-1998	EAGLE TALON	2.0L L4 1997cc 122 CID	1993	DODGE D150	3.9L V6 3906cc 239 CID		
	1995-1999	MINISUBISHI ECLIPSE	2.0L L4 1997cc 122 CID	1993	DODGE D150	5.2L V8 5211cc 318 CID		
	1996-1999	MINISUBISHI ECLIPSE	2.4L L4 2351cc	1993	DODGE D150	5.9L V8 360 CID		
				1993	DODGE D250	3.9L V6 3906cc 239 CID		
US7150	1995	CHRYSLER CIRRUS	2.0L L4 2001cc 122 CID	1993	DODGE D250	5.2L V8 5211cc 318 CID		
	1995	DODGE NEON	2.0L L4 1997cc 122 CID	1993	DODGE D250	5.9L V8 360 CID		
	1995-1998	EAGLE TALON	2.0L L4 1997cc 122 CID	1993	DODGE D250	5.9L V8 360 CID		
	1995-1999	CHRYSLER SEBRING	2.0L L4 1996cc 122 CID	1993	DODGE D350	5.2L V8 5211cc 318 CID		
	1995-1999	DODGE AVENGER	2.0L L4 1996cc 122 CID	1993	DODGE RAMCHARGER	5.9L V8 360 CID		
	1995-1999	MINISUBISHI ECLIPSE	2.0L L4 1997cc 122 CID	1993	DODGE RAMCHARGER	3.9L V6 3906cc 239 CID		
	1995-2000	DODGE STRATUS	2.0L L4 1996cc 122 CID	1993	DODGE W150	5.2L V8 5211cc 318 CID		
	1995-2001	PLYMOUTH NEON	2.0L L4 1996cc 122 CID	1993	DODGE W150	5.9L V8 360 CID		
	1995-2005	DODGE NEON	2.0L L4 1996cc 122 CID	1993	DODGE W250	5.2L V8 5211cc 318 CID		
	1996-2000	PLYMOUTH BREEZE	2.0L L4 1996cc 122 CID	1993	DODGE W250	5.9L V8 360 CID		
	2000	CHRYSLER CIRRUS	2.0L L4 1996cc 122 CID	1993	DODGE W350	5.2L V8 5211cc 318 CID		
	1995-1996	CHRYSLER NEW YORKER	3.5L V6 3497cc 215 CID	1993	JEEP GRAND WAGONEER	3.9L V6 3906cc 239 CID		
	1995-1997	CHRYSLER CONCORDE	3.5L V6 3497cc 215 CID	1993	JEEP GRAND WAGONEER	5.2L V8 5211cc 318 CID		
	1995-1997	CHRYSLER LHS	3.5L V6 3497cc 215 CID	1993-1994	DODGE B150	3.9L V6 3906cc 239 CID		
	1995-1997	DODGE INTREPID	3.5L V6 3497cc 215 CID	1993-1994	DODGE B150	5.2L V8 5211cc 318 CID		
	1995-1997	EAGLE VISION	3.5L V6 3497cc 215 CID	1993-1994	DODGE B250	3.9L V6 3906cc 239 CID		
	1997	PLYMOUTH PROWLER	3.5L V6 3497cc 215 CID	1993-1994	DODGE B250	5.2L V8 5211cc 318 CID		
	US7152	1995-2000	CHRYSLER CIRRUS	2.5L V6 2497cc 152 CID	1993-1994	DODGE B250	5.9L V8 360 CID	
		1995-2000	CHRYSLER SEBRING	2.5L V6 2497cc 152 CID	1993-1994	DODGE B350	5.2L V8 5211cc 318 CID	
1995-2000		DODGE AVENGER	2.5L V6 2497cc 152 CID	1993-1994	DODGE B350	5.9L V8 360 CID		
1995-2000		DODGE STRATUS	2.5L V6 2497cc 152 CID	1993-1997	DODGE MICROBUS	5.9L V8 5900cc 360 CID		
1997-2004		MINISUBISHI DIAMANTE	3.5L V6 3497cc 215 CID	1993-1998	JEEP GRAND CHEROKEE	5.2L V8 5211cc 318 CID		
1998		CHRYSLER CIRRUS	2.4L L4 2426cc 148 CID	1993-1999	DODGE DAKOTA	5.2L V8 5211cc 318 CID		
1999-2003		MINISUBISHI GALANT	3.0L V6 2972cc 181 CID	1993-2003	DODGE DAKOTA	3.9L V6 3906cc 239 CID		
2000-2005		MINISUBISHI ECLIPSE	3.0L V6 2972cc 181 CID	1994-1996	DODGE RAM 2500	5.2L V8 5211cc 318 CID		
2001-2005		CHRYSLER SEBRING	3.0L V6 2972cc 181 CID	1994-2000	DODGE RAMCHARGER	5.9L V8 5900cc 360 CID		
2001-2005		DODGE STRATUS	3.0L V6 2972cc 181 CID	1994-2001	DODGE RAM 1500	3.9L V6 3906cc 239 CID		
2004		MINISUBISHI ENDEAVOR	3.8L V6 3797cc 230 CID	1994-2001	DODGE RAM 1500	5.2L V8 5211cc 318 CID		
2004-2009		MINISUBISHI GALANT	3.8L V6 3828cc 230 CID	1994-2002	DODGE RAM 2500	5.9L V8 360 CID		
2005-2008		MINISUBISHI ENDEAVOR	3.8L V6 3828cc 230 CID	1994-2002	DODGE RAM 3500	5.9L V8 360 CID		
2005-2008		MINISUBISHI MONTERO SPORT	3.5L V6 3497cc 213 CID	1994-2003	DODGE RAM 1500	5.9L V8 360 CID		
2006-2011		MINISUBISHI ECLIPSE	3.8L V6 3828cc 230 CID	1995-1997	DODGE B2500	3.9L V6 3906cc 239 CID		
2008-2009		MINISUBISHI MONTERO	3.8L V6 3800cc 232 CID	1995-1998	DODGE B1500	3.9L V6 3906cc 239 CID		
2010		MINISUBISHI MONTERO	3.8L V6 3828cc 234 CID	1995-1998	DODGE B1500	5.2L V8 5211cc 318 CID		
2010-2011		MINISUBISHI ENDEAVOR	3.8L V6 3828cc 230 CID	1995-1998	DODGE B2500	5.2L V8 5211cc 318 CID		
2010-2011		MINISUBISHI ENDEAVOR	3.8L V6 3828cc 234 CID	1995-1998	DODGE B2500	5.9L V8 360 CID		
2011		MINISUBISHI MONTERO LIMITED	3.8L V6 3828cc 234 CID	1995-1998	DODGE B3500	5.2L V8 5211cc 318 CID		
US7153		1995-1996	CHRYSLER CIRRUS	2.4L L4 2429cc 148 CID	1995-1998	DODGE B3500	5.9L V8 360 CID	
		1995-1996	DODGE STRATUS	2.4L L4 2429cc 148 CID	1997-2001	DODGE RAM 2500	5.2L V8 5215cc 318 CID	
		1996	CHRYSLER SEBRING	2.4L L4 2429cc 148 CID	1997-2001	DODGE RAM 4000	5.9L V8 5900cc 360 CID	
		1996	DODGE CARAVAN	2.4L L4 2429cc 148 CID	1998	DODGE B1500	5.9L V8 360 CID	
		1996	DODGE GRAND CARAVAN	2.4L L4 2429cc 148 CID	1998	DODGE DURANGO	5.2L V8 5215cc 318 CID	
		1996	PLYMOUTH GRAND VOYAGER	2.4L L4 2429cc 148 CID	1998	JEEP GRAND CHEROKEE	5.9L V8 360 CID	
		1996	PLYMOUTH VOYAGER	2.4L L4 2429cc 148 CID	1998-1999	DODGE DURANGO	3.9L V6 3906cc 239 CID	
					1998-2000	DODGE DURANGO	5.2L V8 5211cc 318 CID	
US7156		1996-1997	CHRYSLER CIRRUS	2.4L L4 2429cc 148 CID	1998-2003	DODGE DAKOTA	5.9L V8 360 CID	
		1996-1997	CHRYSLER SEBRING	2.4L L4 2429cc 148 CID	1998-2003	DODGE DURANGO	5.9L V8 360 CID	
		1996-1997	CHRYSLER VOYAGER	2.4L L4 2426cc 148 CID	1999-2001	DODGE RAMCHARGER	5.2L V8 5215cc 318 CID	
		1996-1997	DODGE GRAND CARAVAN	2.4L L4 2429cc 148 CID	1999-2003	DODGE RAM 1500 VAN	3.9L V6 3906cc 239 CID	
		1996-1997	PLYMOUTH GRAND VOYAGER	2.4L L4 2429cc 148 CID	1999-2003	DODGE RAM 1500 VAN	5.2L V8 5211cc 318 CID	
	1996-1998	CHRYSLER SEBRING	2.4L L4 2429cc 148 CID	1999-2003	DODGE RAM 1500 VAN	5.9L V8 360 CID		
	1996-2000	PLYMOUTH VOYAGER	2.4L L4 2429cc 148 CID	1999-2003	DODGE RAM 2500 VAN	5.2L V8 5211cc 318 CID		
	1996-2006	DODGE STRATUS	2.4L L4 2429cc 148 CID	1999-2003	DODGE RAM 2500 VAN	5.9L V8 360 CID		
	1996-2007	DODGE CARAVAN	2.4L L4 2429cc 148 CID	1999-2003	DODGE RAM 3500 VAN	5.2L V8 5211cc 318 CID		
	1997-2000	PLYMOUTH BREEZE	2.4L L4 2429cc 148 CID	1999-2003	DODGE RAM 3500 VAN	5.9L V8 360 CID		
	1998-2000	DODGE STRATUS	2.4L L4 2426cc 148 CID	2001	DODGE RAM 2500 VAN	3.9L V6 3906cc 239 CID		
	1999-2000	CHRYSLER CIRRUS	2.4L L4 2426cc 148 CID	2015	DODGE RAM 4000	5.7L V8 5654cc 345 CID		
	1999-2003	CHRYSLER CIRRUS	2.4L L4 2429cc 148 CID					
	2000-2003	CHRYSLER VOYAGER	2.4L L4 2429cc 148 CID	US7161	1998-2004	CHRYSLER CONCORDE	2.7L V6 2736cc 167 CID	
	2001-2003	DODGE STRATUS	2.0L L4 1998cc 122 CID	1998-2004	DODGE INTREPID	2.7L V6 2736cc 167 CID		
	2001-2006	CHRYSLER SEBRING	2.4L L4 2429cc 148 CID	2001-2003	CHRYSLER CIRRUS	2.7L V6 2736cc 165 CID		
	2001-2010	CHRYSLER PT CRUISER	2.4L L4 2429cc 148 CID	2001-2006	DODGE STRATUS	2.7L V6 2736cc 167 CID		
	2002-2005	JEEP LIBERTY	2.4L L4 148 CID	2001-2007	CHRYSLER SEBRING	2.7L V6 2736cc 167 CID		
	2003-2006	JEEP WRANGLER	2.4L L4 148 CID	2004-2006	CHRYSLER CIRRUS	2.7L V6 2737cc 167 CID		
	2004	CHRYSLER CIRRUS	2.4L L4 2426cc 148 CID	2005-2007	CHRYSLER 300	2.7L V6 2736cc 167 CID		
	2004-2006	DODGE STRATUS	2.0L L4 1996cc 122 CID	2005-2007	DODGE MAGNUM	2.7L V6 2736cc 167 CID		
	2005-2009	CHRYSLER CIRRUS	2.4L L4 2429cc 148 CID	2006-2007	DODGE CHARGER	2.7L V6 2736cc 167 CID		
	US7158	1997	CHRYSLER CONCORDE	3.5L V6 3497cc 215 CID	US7162	1998-2000	DODGE INTREPID	3.2L V6 3200cc 197 CID
		1997	CHRYSLER LHS	3.5L V6 3497cc 215 CID	1998-2001	CHRYSLER CONCORDE	3.2L V6 3200cc 197 CID	
1997		DODGE INTREPID	3.5L V6 3497cc 215 CID	1999-2001	CHRYSLER LHS	3.5L V6 3497cc 215 CID		
1997		EAGLE VISION	3.5L V6 3497cc 215 CID					

USMW	Years	Application	Engine	USMW	Years	Application	Engine
US7162	1999-2001	PLYMOUTH PROWLER	3.5L V6 3497cc 215 CID	US8106	2013	HYUNDAI ELANTRA GT	1.8L L4 1797cc
	1999-2004	CHRYSLER 300M	3.5L V6 3497cc 215 CID		2014	HYUNDAI ELANTRA COUPE	2.0L L4 1999cc
	2000-2004	DODGE INTREPID	3.5L V6 3497cc 215 CID		2014-2016	KIA FORTE	1.8L L4 1797cc
	2001-2002	CHRYSLER PROWLER	3.5L V6 3497cc 215 CID		2014-2016	KIA FORTE KOUP	2.0L L4 1999cc 122 CID
	2002-2004	CHRYSLER CONCORDE	3.5L V6 3497cc 215 CID		2014-2017	HYUNDAI ELANTRA	2.0L L4 1999cc
2004	CHRYSLER PACIFICA	3.5L V6 3497cc 215 CID	2014-2017	HYUNDAI ELANTRA GT	2.0L L4 1999cc		
US7163	1999-2009	JEEP GRAND CHEROKEE	4.7L V8 287 CID	2014-2017	HYUNDAI TUCSON	2.0L L4 1999cc	
	2000-2009	DODGE DURANGO	4.7L V8 287 CID	2014-2017	KIA FORTE	2.0L L4 1999cc 122 CID	
	2000-2010	DODGE DAKOTA	4.7L V8 287 CID	2014-2017	KIA FORTE5	2.0L L4 1999cc 122 CID	
	2002-2009	DODGE RAM 2500	4.7L V8 4700cc 287 CID	2015	HYUNDAI ELANTRA	1.8L L4 1797cc 110 CID	
	2002-2010	DODGE RAM 1500	3.7L V6 226 CID	US8107	2014-2018	FORD FUSION	1.5L L4 1499cc 91 CID
	2002-2010	DODGE RAM 1500	4.7L V8 287 CID		2017-2018	FORD ESCAPE	1.5L L4 1499cc 91 CID
	2002-2012	JEEP LIBERTY	3.7L V6 226 CID	US8108	2014	VOLKSWAGEN PASSAT	2.0L L4 1968cc 120 CID
	2004-2009	DODGE DURANGO	3.7L V6 226 CID		2014-2016	VOLKSWAGEN VENTO	1.6L L4 1598cc 98 CID
	2004-2010	DODGE DAKOTA	3.7L V6 226 CID	US8109	2014-2015	VOLKSWAGEN VENTO	1.6L L4 1598cc 98 CID
	2005-2010	JEEP GRAND CHEROKEE	3.7L V6 226 CID		US8111	2002-2004	VOLKSWAGEN PASSAT
	2006-2007	MITSUBISHI RAIDER	4.7L V8 287 CID	2004		VOLKSWAGEN PHAETON	6.0L W12 6000cc
	2006-2009	JEEP COMMANDER	4.7L V8 287 CID	2005	VOLKSWAGEN PHAETON	6.0L W12 5998cc	
	2006-2009	MITSUBISHI RAIDER	3.7L V6 226 CID	2005-2009	AUDI A8 QUATTRO	6.0L W12 5998cc	
	2006-2010	JEEP COMMANDER	3.7L V6 226 CID	2006	VOLKSWAGEN PHAETON	6.0L W12 5998cc 366 CID	
	2007-2009	CHRYSLER ASPEN	4.7L V8 287 CID		US8112	2013-2015	ACURA ILX
	2007-2011	DODGE NITRO	3.7L V6 226 CID	2014-2018		JEEP CHEROKEE	3.2L V6 3239cc 198 CID
	2008	JEEP GRAND CHEROKEE	4.7L V8 4700cc 287 CID	US8114	2015-2017	CHRYSLER 200	3.6L V6 3604cc 220 CID
	2010	DODGE DAKOTA	3.7L V6 3701cc 226 CID		US8115	2013	CHRYSLER 300
	2010	DODGE RAM 2500	4.7L V8 4701cc 287 CID	2013-2018		DODGE CHALLENGER	5.7L V8 345 CID
	2011	RAM DAKOTA	3.7L V6 226 CID	2013-2018	DODGE CHARGER	5.7L V8 345 CID	
	2011	RAM DAKOTA	4.7L V8 287 CID	2013-2018	DODGE DURANGO	5.7L V8 345 CID	
	2011-2012	DODGE NITRO	3.7L V6 3701cc 226 CID	2013-2018	JEEP GRAND CHEROKEE	5.7L V8 345 CID	
	2011-2012	DODGE NITRO SE	3.7L V6 3701cc 226 CID	2013-2018	JEEP GRAND CHEROKEE	6.4L V8 6424cc 392 CID	
	2011-2012	DODGE RAM 2500	4.7L V8 4700cc 287 CID	2014	CHRYSLER 300	6.4L V8 6424cc 392 CID	
	2011-2012	RAM 1500	3.7L V6 226 CID	2014-2018	CHRYSLER 300	5.7L V8 345 CID	
2011-2013	JEEP LIBERTY	3.7L V6 3701cc 226 CID	2014-2018	DODGE CHALLENGER	6.4L V8 6424cc 392 CID		
2011-2013	RAM 1500	4.7L V8 287 CID	2014-2018	DODGE CHARGER	6.4L V8 6424cc 392 CID		
2012	DODGE DAKOTA	3.7L V6 3701cc 226 CID	2018	DODGE DURANGO	6.4L V8 6424cc 392 CID		
2013	DODGE RAM 1500	3.7L V6 3701cc 226 CID	US8116	2013-2018	FORD F-150	5.0L V8 4951cc 302 CID	
US7164	1999-2004	JEEP GRAND CHEROKEE		4.0L L6 242 CID	2015-2018	FORD MUSTANG	5.0L V8 4951cc 302 CID
	2000-2006	JEEP WRANGLER	4.0L L6 242 CID	2015-2018	FORD MUSTANG	5.2L V8 5163cc 315 CID	
US7165	2001	CHRYSLER GRAND VOYAGER	3.3L V6 3294cc 201 CID	US8117	2015	FORD EDGE	2.0L L4 1999cc 122 CID
	2001-2002	CHRYSLER VOYAGER	3.3L V6 3294cc 201 CID		2015-2016	FORD MUSTANG	2.3L L4 2300cc 140 CID
	2001-2003	CHRYSLER VOYAGER	3.3L V6 3301cc 201 CID	2015-2018	LINCOLN MKC	2.3L L4 2300cc 140 CID	
	2001-2007	CHRYSLER TOWN & COUNTRY	3.3L V6 3301cc 201 CID	2016	FORD ESCAPE	2.0L L4 1999cc 122 CID	
	2001-2007	CHRYSLER TOWN & COUNTRY	3.8L V6 230 CID	2016	LINCOLN MKC	2.0L L4 1999cc 122 CID	
	2001-2007	DODGE CARAVAN	3.3L V6 3301cc 201 CID	2016-2018	FORD FOCUS	2.3L L4 2300cc 140 CID	
	2001-2007	DODGE GRAND CARAVAN	3.3L V6 3301cc 201 CID	US8118	2015-2017	HONDA CR-V	2.4L L4 2354cc 144 CID
	2001-2007	DODGE GRAND CARAVAN	3.8L V6 230 CID		US8119	2015-2017	HONDA FIT
	2002	CHRYSLER GRAND VOYAGER	3.8L V6 3800cc 232 CID	US8120		2010-2013	LAND ROVER LR4
	2004-2008	CHRYSLER VOYAGER	3.3L V6 3294cc 201 CID		2010-2013	LAND ROVER RANGE ROVER	5.0L V8 5000cc
	US7167	2003-2005	DODGE NEON	2.4L L4 2429cc 148 CID	2010-2013	LAND ROVER RANGE ROVER SPORT	5.0L V8 5000cc
		2003-2009	CHRYSLER PT CRUISER	2.4L L4 2429cc 148 CID	2012	LAND ROVER RANGE ROVER EVOQUE	2.0L L4 1999cc 122 CID
US7168		2003-2008	DODGE RAM 1500	5.7L V8 345 CID		2014-2016	LAND ROVER LR4
		2003-2008	DODGE RAM 2500	5.7L V8 345 CID	2014-2017	LAND ROVER RANGE ROVER	3.0L V6 2995cc 183 CID
2003-2008		DODGE RAM 3500	5.7L V8 345 CID	2014-2017	LAND ROVER RANGE ROVER	5.0L V8 5000cc 305 CID	
2004-2008		DODGE DURANGO	5.7L V8 345 CID	2014-2017	LAND ROVER RANGE ROVER SPORT	3.0L V6 2995cc 183 CID	
2005-2006		DODGE RAM 4000	5.7L V8 5700cc 350 CID	2014-2017	LAND ROVER RANGE ROVER SPORT	5.0L V8 5000cc 305 CID	
2007-2008		CHRYSLER ASPEN	5.7L V8 345 CID	2017	LAND ROVER DISCOVERY	3.0L V6 2995cc 183 CID	
US7169	1994-2003	DODGE RAM 2500	8.0L V10 7990cc 488 CID		US8121	2008-2015	SMART FORTWO
	1994-2003	DODGE RAM 3500	8.0L V10 7990cc 488 CID	US8123		2014-2017	CHEVROLET CORVETTE
US8102	2013-2015	CHEVROLET MALIBU	2.5L L4 2457cc 153 CID		US8124	2014-2017	VOLKSWAGEN PASSAT
	2013-2016	CADILLAC ATS	2.5L L4 2457cc 150 CID	2015-2017		VOLKSWAGEN BEETLE	1.8L L4 1798cc 110 CID
	2013-2017	CADILLAC ATS	2.0L L4 1998cc 122 CID	2015-2017	VOLKSWAGEN BEETLE	2.0L L4 1984cc 121 CID	
	2013-2017	CHEVROLET MALIBU	2.0L L4 1998cc 122 CID	2015-2017	VOLKSWAGEN GOLF	1.8L L4 1798cc 110 CID	
	2014-2017	BUICK REGAL	2.0L L4 1998cc 122 CID	2015-2017	VOLKSWAGEN GOLF SPORTWAGEN	1.8L L4 1798cc 110 CID	
	2014-2017	CADILLAC CTS	2.0L L4 1998cc 122 CID	2015-2017	VOLKSWAGEN GTI	2.0L L4 1984cc 121 CID	
	2014-2017	CHEVROLET IMPALA	2.5L L4 2457cc 153 CID	2015-2017	VOLKSWAGEN JETTA	1.8L L4 1798cc 110 CID	
	2015-2017	CHEVROLET COLORADO	2.5L L4 2457cc 153 CID	2015-2017	VOLKSWAGEN JETTA	2.0L L4 1984cc 121 CID	
	2015-2017	GMC CANYON	2.5L L4 2457cc 153 CID	2017	VOLKSWAGEN GOLF ALLTRACK	1.8L L4 1798cc 110 CID	
	2016	CHEVROLET MALIBU LIMITED	2.5L L4 2457cc 153 CID	US8125	2005-2006	FORD GT	5.4L V8 5409cc 330 CID
	2016-2017	BUICK ENVISION	2.0L L4 1998cc 122 CID		2007-2012	FORD MUSTANG	5.4L V8 5409cc 330 CID
	2016-2017	CADILLAC CT6	2.0L L4 1998cc 122 CID	2013-2014	FORD MUSTANG	5.8L V8 5812cc 355 CID	
	2016-2017	CHEVROLET CAMARO	2.0L L4 1998cc 122 CID	US8134	2011-2014	VOLVO S80	3.2L L6 3192cc
	2017	BUICK ENVISION	2.5L L4 2457cc 153 CID		2011-2015	VOLVO S80	3.0L L6 2953cc
	2017	GMC ACADIA	2.5L L4 2457cc 153 CID	2011-2015	VOLVO XC60	3.2L L6 3192cc	
	US8103	2013-2017	HONDA ACCORD	2.4L L4 2354cc 144 CID	2011-2015	VOLVO XC70	3.0L L6 2953cc
		2015-2017	ACURA TLX	2.4L L4 2354cc 144 CID	2011-2015	VOLVO XC70	3.2L L6 3192cc
2016-2017		ACURA ILX	2.4L L4 2354cc 144 CID	2011-2016	VOLVO S60	3.0L L6 2953cc	
2016-2017		HONDA CIVIC	2.0L L4 1996cc 122 CID	2011-2016	VOLVO XC60	3.0L L6 2953cc	
US8104		2011-2017	NISSAN JUKE	1.6L L4 1618cc	2013	VOLVO S60	3.0L L6 2953cc 180 CID
	2013-2017	NISSAN SENTRA	1.8L L4 1798cc 110 CID	2015-2016	VOLVO V60	3.0L L6 2953cc	
	2017	NISSAN ROGUE SPORT	2.0L L4 1997cc	US8135	2012-2016	BMW 328i	2.0L L4 1997cc 122 CID
2017	NISSAN SENTRA	1.6L L4 1618cc	2012-2016		BMW 528i	2.0L L4 1997cc 122 CID	
US8105	2013-2017	NISSAN ALTIMA	2.5L L4 2488cc 152 CID	2012-2016	BMW 528i XDRIVE	2.0L L4 1997cc 122 CID	
	2014	NISSAN PATHFINDER	2.5L L4 2488cc 152 CID	2012-2016	BMW Z4	2.0L L4 1997cc 122 CID	
	2014-2017	INFINITI QX60	2.5L L4 2488cc 152 CID	2013-2015	BMW X1	2.0L L4 1997cc 122 CID	
	2014-2017	NISSAN ROGUE	2.5L L4 2488cc 152 CID	2013-2016	BMW 328i XDRIVE	2.0L L4 1997cc 122 CID	
	2016	NISSAN MURANO	2.5L L4 2488cc 152 CID				
US8106	2011-2016	HYUNDAI ELANTRA	1.8L L4 1797cc				
	2012-2017	KIA SOUL	2.0L L4 1999cc 122 CID				
	2013	HYUNDAI ELANTRA COUPE	1.8L L4 1797cc				

USMW	Years	Application	Engine	USMW	Years	Application	Engine	
US8135	2013-2017	BMW X3	2.0L L4 1997cc 122 CID	US8157	2017-2018	FORD F-250 SUPER DUTY	6.7L V8 6651cc 406 CID	
	2014-2016	BMW 228i	2.0L L4 1997cc 122 CID		2017-2018	FORD F-350 SUPER DUTY	6.7L V8 6651cc 406 CID	
	2014-2016	BMW 328i GT XDRIVE	2.0L L4 1997cc 122 CID		2017-2018	FORD F-450 SUPER DUTY	6.7L V8 6651cc 406 CID	
	2014-2016	BMW 428i	2.0L L4 1997cc 122 CID		2017-2018	FORD F-550 SUPER DUTY	6.7L V8 6651cc 406 CID	
	2014-2016	BMW 428i XDRIVE	2.0L L4 1997cc 122 CID		US8158	2016-2017	CHEVROLET VOLT	1.5L L4 1490cc 91 CID
	2015-2016	BMW 228i XDRIVE	2.0L L4 1997cc 122 CID		US8159	2014-2015	CHEVROLET CRUZE	2.0L L4 1956cc 119 CID
	2015-2016	BMW 428i GRAN COUPE	2.0L L4 1997cc 122 CID		US8160	2016-2018	DODGE DURANGO	3.6L V6 3604cc 220 CID
	2015-2016	BMW 428i XDRIVE GRAN COUPE	2.0L L4 1997cc 122 CID		2016-2018	JEEP GRAND CHEROKEE	3.6L V6 3604cc 220 CID	
	2015-2017	BMW X4	2.0L L4 1997cc 122 CID		US8161	2014-2018	JEEP GRAND CHEROKEE	3.0L V6 2987cc 182 CID
	2016-2017	BMW X5	2.0L L4 1997cc 122 CID		2014-2018	RAM 1500	3.0L V6 2987cc 182 CID	
US8136	2012-2017	FIAT 500	1.4L L4 1368cc 83 CID	US8162	2016-2018	FORD TRANSIT-150	3.2L L5 195 CID	
	2013-2016	DODGE DART	1.4L L4 1368cc 83 CID	2016-2018	FORD TRANSIT-250	3.2L L5 195 CID		
	2014	FIAT 500L	1.4L L4 1368cc 83 CID	2016-2018	FORD TRANSIT-350	3.2L L5 195 CID		
	2015-2017	JEEP RENEGADE	1.4L L4 1368cc 83 CID	2016-2018	FORD TRANSIT-350 HD	3.2L L5 195 CID		
	2016-2017	FIAT 500L	1.4L L4 1368cc 83 CID	US8163	2015-2016	HYUNDAI SONATA	2.4L L4 2359cc 144 CID	
	2016-2017	FIAT 500X	1.4L L4 1368cc 83 CID	2015-2017	HYUNDAI SONATA	2.0L L4 1998cc 122 CID		
2017	FIAT 124 SPIDER	1.4L L4 1368cc 83 CID	2015-2017	HYUNDAI SONATA	2.4L L4 2359cc			
US8137	2012-2014	HONDA CR-V	2.0L L4 2354cc 144 CID	2016-2017	KIA OPTIMA	2.0L L4 1998cc 122 CID		
US8138	2015	HONDA CROSSTOUR	2.4L L4 2354cc 144 CID	2016-2017	KIA OPTIMA	2.4L L4 2359cc		
US8139	2010-2012	SUBARU LEGACY	2.5L H4 2458cc	2016-2017	KIA SORENTO	2.0L L4 1998cc 122 CID		
US8140	2014-2017	RAM 4500	6.4L V8 6424cc 392 CID	2016-2017	KIA SORENTO	2.4L L4 2359cc		
	2014-2017	RAM 5500	6.4L V8 6424cc 392 CID	2017	HYUNDAI SANTA FE SPORT	2.0L L4 1998cc 122 CID		
	2014-2018	RAM 2500	6.4L V8 6424cc 392 CID	2017	HYUNDAI SANTA FE SPORT	2.4L L4 2359cc		
	2014-2018	RAM 3500	6.4L V8 6424cc 392 CID	2017	KIA SPORTAGE	2.0L L4 1998cc 122 CID		
	2017	KIA SPORTAGE	2.4L L4 2359cc	2017	KIA SPORTAGE	2.4L L4 2359cc		
US8141	2015-2017	FORD F-150	2.7L V6 164 CID	US8164	2007-2008	INFINITI G35	3.5L V6 3498cc	
	2016-2018	FORD EDGE	2.7L V6 164 CID	2007-2009	NISSAN 350Z	3.5L V6 3498cc		
	2016-2018	LINCOLN MKX	2.7L V6 164 CID	2008-2012	INFINITI EX35	3.5L V6 3498cc		
	2017	FORD FUSION	2.7L V6 164 CID	2008-2013	INFINITI G37	3.7L V6 3696cc		
	2017-2018	LINCOLN CONTINENTAL	3.0L V6 2956cc 181 CID	2009-2010	INFINITI M35	3.5L V6 3498cc		
	2017-2018	LINCOLN CONTINENTAL	3.0L V6 2956cc 181 CID	2009-2012	INFINITI FX35	3.5L V6 3498cc		
	2017-2018	LINCOLN MKZ	3.0L V6 2956cc 181 CID	2009-2017	NISSAN 370Z	3.7L V6 3696cc		
	2015-2016	FORD F-150	2.7L V6 164 CID	2009-2017	NISSAN GT-R	3.8L V6 3799cc		
	2016	FORD EDGE	2.7L V6 164 CID	2010-2016	NISSAN 370Z	3.7L V6 3696cc 226 CID		
	2016	LINCOLN MKX	2.7L V6 164 CID	2011-2013	INFINITI M37	3.7L V6 3696cc		
US8141P	2015-2016	FORD F-150	2.7L V6 164 CID	2012-2013	INFINITI G37	3.7L V6 3696cc 226 CID		
	2016	FORD EDGE	2.7L V6 164 CID	2012-2013	INFINITI M35H	3.5L V6 3498cc		
	2016	LINCOLN MKX	2.7L V6 164 CID	2012-2013	INFINITI M37	3.7L V6 3696cc 226 CID		
	2017-2018	FORD FUSION	2.7L V6 164 CID	2013	INFINITI EX37	3.7L V6 3696cc		
	US8141P-T	2015-2016	FORD F-150	2.7L V6 164 CID	2013	INFINITI FX37	3.7L V6 3696cc	
		2016	FORD EDGE	2.7L V6 164 CID	2013	INFINITI FX37	3.7L V6 3696cc 226 CID	
		2016	LINCOLN MKX	2.7L V6 164 CID	2014-2015	INFINITI Q50	3.7L V6 3696cc	
		2017	FORD FUSION	2.7L V6 164 CID	2014-2015	INFINITI Q60	3.7L V6 3696cc	
		US8141-T	2015-2017	FORD F-150	2.7L V6 164 CID	2014-2017	INFINITI Q50	3.5L V6 3498cc
			2016-2017	FORD EDGE	2.7L V6 164 CID	2014-2017	INFINITI Q70	3.5L V6 3498cc
2016-2017			LINCOLN MKX	2.7L V6 164 CID	2014-2017	INFINITI Q70	3.7L V6 3696cc	
2017			FORD FUSION	2.7L V6 164 CID	2014-2017	INFINITI QX50	3.7L V6 3696cc	
2017			LINCOLN CONTINENTAL	2.7L V6 164 CID	2014-2017	INFINITI QX70	3.7L V6 3696cc	
2017			LINCOLN CONTINENTAL	3.0L V6 2956cc 181 CID	2015	INFINITI Q40	3.7L V6 3696cc	
2017	LINCOLN CONTINENTAL		3.0L V6 2956cc 181 CID	2015-2017	INFINITI Q70L	3.7L V6 3696cc		
2017	LINCOLN MKZ		3.0L V6 2956cc 181 CID	US8908	1990-1992	DAIHATSU ROCKY	1.6L L4 1589cc	
US8142	2009-2013		CHEVROLET CORVETTE	6.2L V8 6162cc 376 CID	US8910	2011-2016	LINCOLN MKS	3.5L V6 3496cc 213 CID
US8142-T	2009-2013		CHEVROLET CORVETTE	6.2L V8 6162cc 376 CID	2011-2018	FORD FLEX	3.5L V6 3496cc 213 CID	
US8143	2015-2018	DODGE ATTITUDE	1.2L L3 1193cc 73 CID	2011-2018	FORD TAURUS	3.5L V6 3496cc 213 CID		
	2015-2018	MINI COOPER	1.2L L3 1193cc 73 CID	2011-2018	LINCOLN MKT	3.5L V6 3496cc 213 CID		
	2017-2018	MINI COOPER S	1.2L L3 1193cc 73 CID	2012	FORD FUSION	3.5L V6 3496cc 213 CID		
US8144	2012-2015	HONDA CIVIC	1.5L L4 1497cc	2012	LINCOLN MKZ	3.5L V6 3496cc 213 CID		
	2013-2014	ACURA ILX	1.5L L4 1497cc	2012-2014	FORD EDGE	3.7L V6 3726cc 227 CID		
	2016-2017	HONDA CIVIC	1.5L L4 1497cc	2012-2016	LINCOLN MKS	3.7L V6 3726cc 227 CID		
US8145	2016-2017	HONDA CIVIC	1.5L L4 1497cc	2012-2018	FORD EDGE	3.5L V6 3496cc 213 CID		
	2017	HONDA CR-V	1.5L L4 1497cc	2012-2018	FORD EXPLORER	3.5L V6 3496cc 213 CID		
US8146	2014-2017	FORD FIESTA	1.0L L3 999cc 61 CID	2012-2018	LINCOLN MKT	3.7L V6 3726cc 227 CID		
	2015-2018	FORD FOCUS	1.0L L3 999cc 61 CID	2012-2018	LINCOLN MKX	3.7L V6 3726cc 227 CID		
	2018	FORD ECOSPORT	1.0L L3 999cc 61 CID	2013-2016	LINCOLN MKZ	3.7L V6 3726cc 227 CID		
US8147	2016-2017	BUICK ENCORE	1.4L L4 1399cc 85 CID	2013-2018	FORD POLICE INTERCEPTOR SEDAN	3.5L V6 3496cc 213 CID		
	2016-2017	CHEVROLET CRUZE	1.4L L4 1399cc 85 CID	2013-2018	FORD POLICE INTERCEPTOR SEDAN	3.7L V6 3726cc 227 CID		
	2016-2017	CHEVROLET MALIBU	1.5L L4 1490cc 91 CID	2013-2018	FORD POLICE INTERCEPTOR UTILITY	3.7L V6 3726cc 227 CID		
	2016-2017	CHEVROLET SPARK	1.4L L4 1399cc 85 CID	2014-2018	FORD POLICE INTERCEPTOR UTILITY	3.5L V6 3496cc 213 CID		
	2017	CHEVROLET SPARK	1.4L L4 1399cc 85 CID	2017-2018	LINCOLN CONTINENTAL	3.7L V6 3726cc 227 CID		
US8148	2016-2017	CADILLAC ATS	3.6L V6 222 CID	1984-1986	AMERICAN MOTORS ALLIANCE	1.7L L4 1700cc 104 CID		
	2016-2017	CADILLAC CT6	3.0L V6 182 CID	1984-1986	RENAULT R18	2.0L L4 1995cc 122 CID		
	2016-2017	CADILLAC CT6	3.6L V6 222 CID	1985-1986	AMERICAN MOTORS ENCORE	1.7L L4 1700cc 104 CID		
	2016-2017	CADILLAC CTS	3.6L V6 222 CID	2001-2002	RENAULT MEGANE	2.0L L4 2000cc 122 CID		
	2016-2017	CHEVROLET CAMARO	3.6L V6 222 CID	2002	RENAULT CLIO	2.0L L4 2000cc 122 CID		
	2017	BUICK LACROSSE	3.6L V6 222 CID	2002	RENAULT SCENIC	2.0L L4 2000cc 122 CID		
	2017	CADILLAC XT5	3.6L V6 222 CID	2003-2004	RENAULT MEGANE	2.0L L4 1998cc 122 CID		
	2017	GMC ACADIA	3.6L V6 222 CID	2003-2004	RENAULT SCENIC	2.0L L4 1998cc 122 CID		
US8149	2017	FORD F-150	3.5L V6 3496cc 213 CID	2003-2006	RENAULT CLIO	2.0L L4 1998cc 122 CID		
	2017	FORD F-150	3.5L V6 3496cc 213 CID	2004-2010	RENAULT MEGANE II	2.0L L4 1998cc 122 CID		
US8150	2016-2017	LEXUS GS350	3.5L V6 3456cc	2005-2008	RENAULT SCENIC II	2.0L L4 1998cc 122 CID		
	2016-2017	LEXUS RX350	3.5L V6 3456cc	2011-2017	FORD F-150	3.5L V6 3496cc 213 CID		
	2016-2017	LEXUS RX450H	3.5L V6 3456cc	2014	FORD F-150	3.7L V6 3726cc 227 CID		
	2017	TOYOTA HIGHLANDER	3.5L V6 3456cc	2015-2017	FORD EXPEDITION	3.5L V6 3496cc 213 CID		
	2017	TOYOTA SIENNA	3.5L V6 3456cc	2015-2017	LINCOLN NAVIGATOR	3.5L V6 3496cc 213 CID		
US8151	2017-2018	CHRYSLER PACIFICA	3.6L V6 3604cc 220 CID	2015-2018	FORD TRANSIT-150	3.5L V6 3496cc 213 CID		
	2011-2015	CHEVROLET VOLT	1.4L L4 1398cc 85 CID	2015-2018	FORD TRANSIT-250	3.5L V6 3496cc 213 CID		
US8152	2014-2015	CADILLAC ELR	1.4L L4 1398cc 85 CID					
	2017	CHEVROLET COLORADO	3.6L V6 222 CID					
US8153	2017	GMC CANYON	3.6L V6 222 CID					
	2017	GMC CANYON	3.6L V6 222 CID					
US8154	2016-2017	CHEVROLET COLORADO	2.8L L4 171 CID					
	2016-2017	GMC CANYON	2.8L L4 171 CID					
	2017	CHEVROLET EXPRESS 2500	2.8L L4 171 CID					
	2017	CHEVROLET EXPRESS 3500	2.8L L4 171 CID					
	2017	GMC SAVANA 2500	2.8L L4 171 CID					
US8155	2016-2017	BUICK CASCADA	1.6L L4 1598cc 98 CID					
	2016-2017	CHEVROLET MALIBU	1.8L L4 1796cc 110 CID					

WATER PUMPS

USMW	Years	Application	Engine	USMW	Years	Application	Engine	
US8916	2015-2018	FORD TRANSIT-350	3.5L V6 3496cc 213 CID	US8927	2010	NISSAN APRIO	1.6L L4 1598cc 98 CID	
	2015-2018	FORD TRANSIT-350 HD	3.5L V6 3496cc 213 CID		2010	NISSAN PLATINA	1.6L L4 1597cc 97 CID	
	2016-2017	FORD MUSTANG	3.7L V6 3726cc 227 CID		2010	RENAULT KANGOO EXPRESS	1.6L L4 1598cc 98 CID	
	2016-2018	FORD TRANSIT-150	3.7L V6 3726cc 227 CID	2010-2011	RENAULT SANDERO	1.6L L4 1598cc 97 CID		
	2016-2018	FORD TRANSIT-250	3.7L V6 3726cc 227 CID	2010-2011	RENAULT SANDERO	1.6L L4 1598cc 98 CID		
	2016-2018	FORD TRANSIT-350	3.7L V6 3726cc 227 CID	US8928	2004-2010	PONTIAC MATIZ	1.0L L4 995cc 61 CID	
2016-2018	FORD TRANSIT-350 HD	3.7L V6 3726cc 227 CID	2007-2009		PONTIAC MONTANA	3.9L V6 3880cc 237 CID		
2016-2018	FORD TRANSIT-350 HD	3.7L V6 3726cc 227 CID	2011-2015		CHEVROLET MATIZ	1.0L L4 995cc 61 CID		
US8917	1999-2002	DAEWOO LANOS	1.6L L4 1588cc 98 CID	US8931	2001	FORD FIESTA	1.6L L4 1596cc 97 CID	
US8918	2014-2017	CHEVROLET SILVERADO 1500	4.3L V6 262 CID		2001-2002	FORD COURIER	1.6L L4 1598cc 98 CID	
	2014-2017	CHEVROLET SILVERADO 1500	5.3L V8 5328cc 325 CID		2001-2008	FORD KA	1.6L L4 1596cc 97 CID	
	2014-2017	CHEVROLET SILVERADO 1500	6.2L V8 6162cc 376 CID		2002-2004	FORD FIESTA IKON	1.6L L4 1596cc 97 CID	
	2014-2017	GMC SIERRA 1500	4.3L V6 262 CID		2003-2007	FORD COURIER	1.6L L4 1600cc 98 CID	
	2014-2017	GMC SIERRA 1500	5.3L V8 5328cc 325 CID		2003-2010	FORD FIESTA	1.6L L4 1596cc 97 CID	
	2014-2017	GMC SIERRA 1500	6.2L V8 6162cc 376 CID		2008-2010	FORD COURIER	1.6L L4 1598cc 98 CID	
	2015-2017	CADILLAC ESCALADE	6.2L V8 6162cc 376 CID		2011-2012	FORD COURIER	1.6L L4 1600cc 98 CID	
	2015-2017	CADILLAC ESCALADE ESV	6.2L V8 6162cc 376 CID		2011-2012	FORD FIESTA IKON	1.6L L4 1598cc 98 CID	
	2015-2017	CHEVROLET SUBURBAN	5.3L V8 5328cc 325 CID		2012-2015	FORD FIESTA IKON	1.6L L4 1600cc 98 CID	
	2015-2017	CHEVROLET TAHOE	5.3L V8 5328cc 325 CID		US8932	2004-2006	BUICK RENDEZVOUS	3.6L V6 3564cc 217 CID
	2015-2017	GMC YUKON	5.3L V8 5328cc 325 CID			2004-2009	CADILLAC SRX	3.6L V6 3564cc 217 CID
	2015-2017	GMC YUKON XL	5.3L V8 5328cc 325 CID	2004-2013		CADILLAC CTS	3.6L V6 3564cc 217 CID	
	2015-2017	GMC YUKON XL	6.2L V8 6162cc 376 CID	2005-2007		CADILLAC CTS	2.8L V6 2792cc 170 CID	
	2016-2017	CADILLAC CTS	6.2L V8 6162cc 376 CID	2005-2008		BUICK LACROSSE	3.6L V6 3564cc 217 CID	
	2016-2017	CHEVROLET CAMARO	6.2L V8 6162cc 376 CID	2005-2011		CADILLAC STS	3.6L V6 3564cc 217 CID	
	US8920	1997-1998	FORD E-350 ECONOLINE	5.4L V8 330 CID		2006-2008	CHEVROLET VECTRA	2.8L V6 2800cc 173 CID
		1997-1999	FORD F-250	4.6L V8 281 CID		2006-2009	SAAB 9-3	2.8L V6 2792cc 170 CID
1997-1999		FORD F-250	5.4L V8 330 CID	2007-2009		PONTIAC G6	3.6L V6 3564cc 217 CID	
1997-2002		FORD E-150 ECONOLINE	4.6L V8 281 CID	2007-2009		SATURN AURA	3.6L V6 3564cc 217 CID	
1997-2002		FORD E-150 ECONOLINE	5.4L V8 330 CID	2007-2009		SUZUKI XL-7	3.6L V6 3564cc	
1997-2002		FORD E-150 ECONOLINE CLUB WAGON	4.6L V8 281 CID	2007-2010		SATURN OUTLOOK	3.6L V6 3564cc 217 CID	
1997-2002		FORD E-150 ECONOLINE CLUB WAGON	5.4L V8 330 CID	2007-2013	GMC ACADIA	3.6L V6 3564cc 217 CID		
1997-2002		FORD E-250 ECONOLINE	5.4L V8 330 CID	2008-2009	CHEVROLET CAPTIVA SPORT	3.6L V6 3564cc 217 CID		
1997-2002		FORD E-350 ECONOLINE CLUB WAGON	5.4L V8 330 CID	2008-2009	CHEVROLET EQUINOX	3.6L V6 3564cc 217 CID		
1997-2002		FORD E-350 ECONOLINE CLUB WAGON	5.4L V8 330 CID	2008-2009	PONTIAC G8	3.6L V6 3564cc 217 CID		
1997-2004		FORD EXPEDITION	4.6L V8 281 CID	2008-2009	PONTIAC TORRENT	3.6L V6 3564cc 217 CID		
1997-2006		FORD EXPEDITION	5.4L V8 330 CID	2008-2010	SATURN VUE	3.6L V6 3564cc 217 CID		
1997-2006	FORD F-150	4.6L V8 281 CID	2008-2012	CHEVROLET MALIBU	3.6L V6 3564cc 217 CID			
1997-2006	FORD F-150	5.4L V8 330 CID	2008-2013	BUICK ENCLAVE	3.6L V6 3564cc 217 CID			
1998-2006	LINCOLN NAVIGATOR	5.4L V8 330 CID	2009-2010	SUZUKI GRAND VITARA	3.2L V6 3195cc			
1999-2010	FORD F-250 SUPER DUTY	5.4L V8 330 CID	2009-2013	CHEVROLET TRAVERSE	3.6L V6 3564cc 217 CID			
1999-2010	FORD F-350 SUPER DUTY	5.4L V8 330 CID	2010	BUICK LACROSSE	3.0L V6 182 CID			
1999-2016	FORD E-350 SUPER DUTY	5.4L V8 330 CID	2010-2011	CADILLAC SRX	2.8L V6 2792cc 170 CID			
2000-2005	FORD EXCURSION	5.4L V8 330 CID	2010-2011	CADILLAC SRX	3.0L V6 182 CID			
2002	LINCOLN BLACKWOOD	5.4L V8 330 CID	2010-2011	SAAB 9-5	2.8L V6 2792cc 170 CID			
2002-2010	FORD EXPLORER	4.6L V8 281 CID	2010-2012	CHEVROLET EQUINOX	3.0L V6 182 CID			
2002-2010	MERCURY MOUNTAINEER	4.6L V8 281 CID	2010-2012	GMC TERRAIN	3.0L V6 182 CID			
2003-2005	FORD E-150 CLUB WAGON	4.6L V8 281 CID	2010-2013	BUICK LACROSSE	3.6L V6 3564cc 217 CID			
2003-2005	FORD E-150 CLUB WAGON	5.4L V8 330 CID	2010-2013	CADILLAC CTS	3.0L V6 182 CID			
2003-2005	FORD E-350 CLUB WAGON	5.4L V8 330 CID	2010-2013	CHEVROLET CAMARO	3.6L V6 3564cc 217 CID			
2003-2005	LINCOLN AVIATOR	4.6L V8 281 CID	2011-2012	CHEVROLET CAPTIVA SPORT	3.0L V6 3000cc 183 CID			
2003-2014	FORD E-150	4.6L V8 281 CID	2011-2012	GMC TERRAIN	3.0L V6 2994cc 183 CID			
2003-2014	FORD E-150	5.4L V8 330 CID	2012	CHEVROLET CAPTIVA SPORT	3.0L V6 182 CID			
2003-2014	FORD E-250	4.6L V8 281 CID	2012-2013	CADILLAC SRX	3.6L V6 3564cc 217 CID			
2003-2014	FORD E-250	5.4L V8 330 CID	2012-2013	CHEVROLET CAPRICE	3.6L V6 3564cc 217 CID			
2004	FORD F-150 HERITAGE	4.6L V8 281 CID	2012-2013	CHEVROLET IMPALA	3.6L V6 3564cc 217 CID			
2004	FORD F-150 HERITAGE	5.4L V8 330 CID	2013	CADILLAC ATS	3.6L V6 3564cc 217 CID			
2006	LINCOLN MARK LT	5.4L V8 330 CID	2013	CADILLAC CTS	3.0L V6 2994cc 183 CID			
2007-2010	FORD EXPLORER SPORT TRAC	4.6L V8 281 CID	2013	CADILLAC CTS-V	6.2L V8 6200cc 378 CID			
2009-2010	FORD F-150	4.6L V8 281 CID	2013	CADILLAC XTS	3.6L V6 3564cc 217 CID			
2009-2014	FORD EXPEDITION	5.4L V8 330 CID	2013	CHEVROLET COLORADO	3.6L V6 3600cc 217 CID			
2009-2014	LINCOLN NAVIGATOR	5.4L V8 330 CID	2013	CHEVROLET EQUINOX	3.6L V6 3564cc 217 CID			
2010	FORD F-150	5.4L V8 330 CID	2013	GMC TERRAIN	3.6L V6 3564cc 217 CID			
2014	FORD EXPEDITION	5.4L V8 5408cc 330 CID	2014-2016	CHEVROLET COLORADO	3.6L V6 3564cc 217 CID			
2014-2016	FORD E-450 SUPER DUTY	5.4L V8 330 CID	2014-2016	CHEVROLET IMPALA LIMITED	3.6L V6 3564cc 217 CID			
US8921	2007-2012	RENAULT TRAFIC	1.9L L4 1900cc 114 CID	2015	CHEVROLET CAMARO	3.6L V6 3564cc 217 CID		
	2008-2012	RENAULT TRAFIC	1.9L L4 1870cc 114 CID	2015-2016	BUICK LACROSSE	3.6L V6 3564cc 217 CID		
US8922	2006-2014	DODGE H100	2.5L L4 2476cc 151 CID	2015-2016	CADILLAC SRX	3.6L V6 3564cc 217 CID		
US8925	2004-2008	SUZUKI FORENZA	2.0L L4 2000cc	2015-2016	GMC ACADIA	3.6L V6 3564cc 217 CID		
	2005-2007	SUZUKI RENO	2.0L L4 1998cc	2015-2017	GMC CANYON	3.6L V6 3564cc 217 CID		
	2006-2009	CHEVROLET OPTRA	2.0L L4 2000cc 122 CID	2015-2017	BUICK ENCLAVE	3.6L V6 3564cc 217 CID		
	2008	SUZUKI RENO	2.0L L4 1998cc 122 CID	2015-2017	CADILLAC ATS	3.6L V6 3564cc 217 CID		
	2010	CHEVROLET OPTRA	2.0L L4 1999cc 122 CID	2015-2017	CADILLAC CTS	3.6L V6 3564cc 217 CID		
US8926	1996-1997	BMW 840CI	4.4L V8 4398cc	2015-2017	CADILLAC XTS	3.6L V6 3564cc 217 CID		
	1996-1998	BMW 740IL	4.4L V8 4398cc	2015-2017	CHEVROLET CAPRICE	3.6L V6 3564cc 217 CID		
	1997-1998	BMW 540I	4.4L V8 4398cc	2015-2017	CHEVROLET EQUINOX	3.6L V6 3564cc 217 CID		
	1997-1998	BMW 740I	4.4L V8 4398cc	2015-2017	CHEVROLET IMPALA	3.6L V6 3564cc 217 CID		
	1997-1998	BMW 740I	4.4L V8 4398cc	2015-2017	CHEVROLET TRAVERSE	3.6L V6 3564cc 217 CID		
US8927	2002	RENAULT CLIO	1.6L L4 1600cc 98 CID	2015-2017	CHEVROLET TRAVERSE	3.6L V6 3564cc 217 CID		
	2002-2010	NISSAN PLATINA	1.6L L4 1598cc 97 CID	2015-2017	GMC TERRAIN	3.6L V6 3564cc 217 CID		
	2002-2010	NISSAN PLATINA	1.6L L4 1598cc 98 CID	2017	GMC ACADIA LIMITED	3.6L V6 3564cc 217 CID		
	2002-2010	RENAULT CLIO	1.6L L4 1598cc 98 CID	US8933	2000-2003	CHEVROLET ASTRA	1.8L L4 1796cc 110 CID	
	2003-2010	RENAULT CLIO	1.6L L4 1598cc 97 CID		2002-2005	CHEVROLET ZAFIRA	1.8L L4 1796cc 109 CID	
	2003-2010	RENAULT CLIO	1.6L L4 1598cc 97 CID		2003	CHEVROLET CORSA	1.4L L4 1389cc 85 CID	
	2004-2008	RENAULT KANGOO EXPRESS	1.6L L4 1598cc 98 CID	2007-2008	CHEVROLET ASTRA	1.8L L4 1796cc 110 CID		
	2004-2010	RENAULT KANGOO	1.6L L4 1598cc 97 CID	US8934	1998-2000	FORD FIESTA	1.3L L4 1299cc 79 CID	
	2007-2009	RENAULT KANGOO	1.6L L4 1598cc 98 CID		US8935	2001-2004	DODGE ATOS	1.0L L4 1000cc 61 CID
	2008	NISSAN APRIO	1.6L L4 1598cc 98 CID	2005-2012		DODGE ATOS	1.1L L4 1086cc 66 CID	
	2008-2009	NISSAN APRIO	1.6L L4 1597cc 97 CID	US8936	2000-2004	PEUGEOT 206	1.4L L4 1360cc 83 CID	
	2008-2010	RENAULT MEGANE II	1.6L L4 1598cc 97 CID		2006-2008	PEUGEOT 206	1.4L L4 1360cc 83 CID	
	2010	NISSAN APRIO	1.6L L4 1598cc 97 CID	US8937	2001-2009	PEUGEOT 206	1.6L L4 1587cc 97 CID	

USMW	Years	Application	Engine	USMW	Years	Application	Engine
US8937	2004-2009	PEUGEOT PARTNER	1.6L L4 1587cc 97 CID	US8963	2011-2014	FORD LOBO	5.0L V8 5000cc 305 CID
	2007-2009	PEUGEOT GRAND RAID	1.6L L4 1587cc 97 CID		2011-2014	FORD MUSTANG	5.0L V8 4951cc 302 CID
	2008-2010	PEUGEOT 207	1.6L L4 1598cc 98 CID	US8967	2006-2007	NISSAN MICRA	1.4L L4 1386cc 85 CID
US8938	2003-2008	CHEVROLET CORSA	1.8L L4 1796cc 110 CID	US8968	2005	CHRYSLER PACIFICA	3.8L V6 230 CID
	2004-2005	CHEVROLET TORNADO	1.8L L4 1800cc 110 CID	2007-2008	CHRYSLER PACIFICA	3.8L V6 230 CID	
	2004-2008	CHEVROLET MERIVA	1.8L L4 1796cc 110 CID	US8970	2008-2015	SCION XB	2.4L L4 2362cc
	2005-2008	FIAT PALIO	1.8L L4 1796cc 110 CID	US8971	2002	DODGE RAM 4000	5.7L V8 5700cc 350 CID
	2006-2015	CHEVROLET TORNADO	1.8L L4 1796cc 110 CID	2008-2011	DODGE RAM 4000	5.7L V8 5700cc 350 CID	
	2007-2008	FIAT STRADA	1.8L L4 1796cc 110 CID	2010	JEEP COMMANDER	5.7L V8 5654cc 345 CID	
	2008	FIAT IDEA	1.8L L4 1796cc 110 CID	2010-2014	DODGE RAM 2500	5.7L V8 5654cc 345 CID	
	2008-2009	FIAT IDEA ADVENTURE	1.8L L4 1796cc 110 CID	2011-2012	CHRYSLER 300	5.7L V8 345 CID	
	2010	FIAT PALIO	1.8L L4 1796cc 110 CID	2011-2012	DODGE CHARGER	5.7L V8 345 CID	
	2010	FIAT STRADA	1.8L L4 1796cc 110 CID	2011-2012	DODGE DURANGO	5.7L V8 345 CID	
	US8939	2012-2013	DODGE H10	1.1L L4 1100cc 67 CID	2011-2012	JEEP GRAND CHEROKEE	5.7L V8 345 CID
US8940	2005-2008	CHRYSLER 300	5.7L V8 345 CID	2011-2013	DODGE CHALLENGER	5.7L V8 345 CID	
	2005-2008	DODGE MAGNUM	5.7L V8 345 CID	2011-2013	DODGE CHALLENGER	6.4L V8 6424cc 392 CID	
	2005-2008	JEEP GRAND CHEROKEE	5.7L V8 345 CID	2011-2013	JEEP GRAND CHEROKEE	5.7L V8 5654cc 345 CID	
	2005-2010	CHRYSLER 300	6.1L V8 6059cc 370 CID	2012	CHRYSLER 300	6.4L V8 6424cc 392 CID	
	2006-2008	DODGE CHARGER	5.7L V8 345 CID	2012	DODGE CHARGER	6.4L V8 6424cc 392 CID	
	2006-2008	DODGE MAGNUM	6.1L V8 6059cc 370 CID	2012	JEEP GRAND CHEROKEE	6.4L V8 6424cc 392 CID	
	2006-2008	JEEP COMMANDER	5.7L V8 345 CID	2012-2013	DODGE DURANGO	5.7L V8 5654cc 345 CID	
	2006-2010	DODGE CHARGER	6.1L V8 6059cc 370 CID	2012-2014	DODGE RAM 4000	5.7L V8 5654cc 345 CID	
	2006-2010	JEEP GRAND CHEROKEE	6.1L V8 6059cc 370 CID	US8972	1999-2001	HYUNDAI TIBURON	2.0L L4 1997cc
	2008-2010	DODGE CHALLENGER	6.1L V8 6059cc 370 CID	2001-2012	HYUNDAI ELANTRA	2.0L L4 1975cc	
	US8944	1979	FIAT STRADA	1.5L L4 1498cc	2003-2008	HYUNDAI TIBURON	2.0L L4 1975cc
US8945	2007-2008	FIAT PANDA	1.2L L4 1242cc 76 CID	2004-2009	KIA SPECTRA	2.0L L4 1975cc	
	2011-2012	FIAT PANDA	1.2L L4 1242cc 76 CID	2005-2009	HYUNDAI TUCSON	2.0L L4 1975cc	
US8946	2007-2009	FIAT PUNTO	1.4L L4 1368cc 83 CID	2005-2009	KIA SPECTRA5	2.0L L4 1975cc	
US8948	2004	FIAT PALIO	1.6L L4 1596cc 97 CID	2005-2010	KIA SPORTAGE	2.0L L4 1975cc	
	2005-2006	FIAT PALIO	1.8L L4 1796cc 110 CID	2010-2011	KIA SOUL	2.0L L4 1975cc	
US8949	2003-2007	VOLKSWAGEN POLO	1.6L L4 1596cc 97 CID	US8973	2003-2005	RENAULT LAGUNA	3.0L V6 2950cc 180 CID
	2004-2006	SEAT CORDOBA	1.6L L4 1600cc 98 CID	US8974	2001-2002	PEUGEOT 306	1.8L L4 1766cc 107 CID
	2005-2009	SEAT IBIZA	1.6L L4 1600cc 98 CID	US8975	2015-2018	FORD EDGE	2.0L L4 1999cc 122 CID
	2005-2009	VOLKSWAGEN LUPO	1.6L L4 1599cc 98 CID	2015-2018	FORD MUSTANG	2.3L L4 2300cc 140 CID	
	2005-2009	VOLKSWAGEN LUPO	1.6L L4 1600cc 98 CID	2016-2018	FORD EXPLORER	2.3L L4 2300cc 140 CID	
	2007-2009	VOLKSWAGEN CROSSFOX	1.6L L4 1599cc 98 CID	2017-2018	FORD ESCAPE	2.0L L4 1999cc 122 CID	
	2007-2009	VOLKSWAGEN CROSSFOX	1.6L L4 1600cc 98 CID	2017-2018	FORD FUSION	2.0L L4 1999cc 122 CID	
	2007-2009	VOLKSWAGEN SPORTVAN	1.6L L4 1600cc 98 CID	2017-2018	LINCOLN MKC	2.0L L4 1999cc 122 CID	
	2007-2010	VOLKSWAGEN SPORTVAN	1.6L L4 1599cc 98 CID	2017-2018	LINCOLN MKZ	2.0L L4 1999cc 122 CID	
	2008	SEAT LEON	1.4L L4 1390cc 85 CID	US8976	2010	SEAT LEON	1.4L L4 1390cc 85 CID
	2008-2009	SEAT CORDOBA	1.6L L4 1600cc 98 CID	US8977	2008-2009	AUDI A3	1.4L L4 1368cc 83 CID
	2008-2009	SEAT LEON	1.4L L4 1368cc 83 CID	US8978	2008-2010	NISSAN URVAN	3.0L L4 2999cc 182 CID
	2009-2010	VOLKSWAGEN GOL	1.6L L4 1600cc 98 CID	2011	NISSAN URVAN	3.0L L4 3000cc 183 CID	
	2009-2013	VOLKSWAGEN GOL	1.6L L4 1598cc 98 CID	US8979	2009-2010	CHRYSLER 300	5.7L V8 345 CID
	2011	VOLKSWAGEN GOL SEDAN	1.6L L4 1598cc 98 CID	2009-2010	DODGE CHALLENGER	5.7L V8 345 CID	
	2011-2013	VOLKSWAGEN GOL	1.6L L4 1599cc 98 CID	2009-2010	DODGE CHARGER	5.7L V8 345 CID	
	US8951	2005-2006	CHRYSLER PACIFICA	3.5L V6 3497cc 215 CID	2009-2010	JEEP COMMANDER	5.7L V8 345 CID
2005-2008		DODGE MAGNUM	3.5L V6 3497cc 215 CID	2009-2010	JEEP GRAND CHEROKEE	5.7L V8 345 CID	
2005-2010		CHRYSLER 300	3.5L V6 3497cc 215 CID	US8980	2011-2012	FORD EDGE	3.5L V6 3496cc 213 CID
2006-2010		DODGE CHARGER	3.5L V6 3497cc 215 CID	2011-2012	FORD EDGE	3.7L V6 3726cc 227 CID	
2007-2008		CHRYSLER PACIFICA	4.0L V6 3952cc 241 CID	2011-2012	FORD EXPLORER	3.5L V6 3496cc 213 CID	
2007-2009		CHRYSLER CIRRUS	3.5L V6 3500cc 213 CID	2011-2012	FORD FLEX	3.5L V6 3496cc 213 CID	
2007-2010		CHRYSLER CIRBRING	3.5L V6 3497cc 215 CID	2011-2012	FORD TAURUS	3.5L V6 3496cc 213 CID	
2007-2011		DODGE NITRO	4.0L V6 3952cc 241 CID	2011-2012	LINCOLN MKS	3.7L V6 3726cc 227 CID	
2008-2010		CHRYSLER TOWN & COUNTRY	4.0L V6 3952cc 241 CID	2011-2012	LINCOLN MKT	3.7L V6 3726cc 227 CID	
2008-2010		DODGE AVENGER	3.5L V6 3497cc 215 CID	2011-2012	LINCOLN MKX	3.7L V6 3726cc 227 CID	
2008-2010		DODGE GRAND CARAVAN	4.0L V6 3952cc 241 CID	2012	FORD FUSION	3.5L V6 3496cc 213 CID	
2009-2010		DODGE CHALLENGER	3.5L V6 3497cc 215 CID	2012	LINCOLN MKZ	3.5L V6 3496cc 213 CID	
2009-2010		DODGE JOURNEY	3.5L V6 3497cc 215 CID	US8981	2011	DODGE CHARGER SXT	3.6L V6 3604cc 220 CID
2009-2010		VOLKSWAGEN ROUTAN	4.0L V6 3952cc 241 CID	2011-2014	CHRYSLER 200	3.6L V6 3604cc 220 CID	
2010		CHRYSLER 300	3.5L V6 3497cc 213 CID	2011-2014	DODGE AVENGER	3.6L V6 3604cc 220 CID	
2010		CHRYSLER CIRRUS	3.5L V6 3518cc 215 CID	2011-2014	VOLKSWAGEN ROUTAN	3.6L V6 3604cc 220 CID	
US8952		2010-2014	SEAT LEON	1.4L L4 1390cc 85 CID	2011-2015	DODGE DURANGO	3.6L V6 3604cc 220 CID
	2012-2013	SEAT IBIZA	1.4L L4 1390cc 85 CID	2011-2015	JEEP GRAND CHEROKEE	3.6L V6 3604cc 220 CID	
	2013	AUDI A3	1.4L L4 1390cc 85 CID	2011-2016	CHRYSLER TOWN & COUNTRY	3.6L V6 3604cc 220 CID	
	2013	SEAT TOLEDO	1.4L L4 1390cc 85 CID	2011-2018	CHRYSLER 300	3.6L V6 3604cc 220 CID	
	2013	VOLKSWAGEN GOLF	1.4L L4 1390cc 85 CID	2011-2018	DODGE CHALLENGER	3.6L V6 3604cc 220 CID	
	2013-2014	VOLKSWAGEN POLO	1.4L L4 1390cc 85 CID	2011-2018	DODGE CHARGER	3.6L V6 3604cc 220 CID	
	2013-2016	VOLKSWAGEN JETTA	1.4L L4 1395cc 85 CID	2011-2018	DODGE GRAND CARAVAN	3.6L V6 3604cc 220 CID	
	2013-2016	VOLKSWAGEN TRUCK TIGUAN	1.4L L4 1390cc 85 CID	2011-2018	DODGE JOURNEY	3.6L V6 3604cc 220 CID	
	2015	SEAT IBIZA	1.4L L4 1390cc 85 CID	2012-2015	RAM C/V	3.6L V6 3604cc 220 CID	
	2015-2016	SEAT TOLEDO	1.4L L4 1390cc 85 CID	2013-2018	RAM 1500	3.6L V6 3604cc 220 CID	
	2015-2016	VOLKSWAGEN GOLF	1.4L L4 1390cc 85 CID	2014	DODGE PROMASTER 1500	3.6L V6 3605cc 220 CID	
	2016	AUDI A1	1.4L L4 1390cc 85 CID	2014	DODGE PROMASTER 2500	3.6L V6 3605cc 220 CID	
	2016	AUDI A3	1.4L L4 1395cc 85 CID	2014	DODGE PROMASTER 3500	3.6L V6 3605cc 220 CID	
	US8954	2000-2005	PEUGEOT 406	2.0L L4 1998cc 122 CID	2014	DODGE RAM 1500	3.6L V6 3600cc 220 CID
2003-2010		PEUGEOT 307	2.0L L4 1998cc 122 CID	2014-2015	CHRYSLER TOWN & COUNTRY	3.6L V6 3605cc 220 CID	
2004-2009		CADILLAC SRX	4.6L V8 281 CID	2014-2015	DODGE JOURNEY	3.6L V6 3605cc 220 CID	
US8955	2004-2009	CADILLAC XLR	4.6L V8 281 CID	2014-2018	RAM PROMASTER 1500	3.6L V6 3604cc 220 CID	
	2005-2010	CADILLAC STS	4.6L V8 281 CID	2014-2018	RAM PROMASTER 2500	3.6L V6 3604cc 220 CID	
	2006-2009	CADILLAC STS	4.4L V8 4371cc 267 CID	2014-2018	RAM PROMASTER 3500	3.6L V6 3604cc 220 CID	
	2006-2009	CADILLAC XLR	4.4L V8 4371cc 267 CID	2015	DODGE RAM 1500	3.6L V6 3605cc 220 CID	
	2006-2011	BUICK LUCERNE	4.6L V8 281 CID	2015-2016	CHRYSLER 200C	3.6L V6 3605cc 220 CID	
US8956	2006-2011	CADILLAC DTS	4.6L V8 281 CID	US8982	2011-2014	HYUNDAI SONATA	2.4L L4 2359cc
US8959	2001-2002	SEAT CORDOBA	1.6L L4 1600cc 98 CID	2011-2015	KIA OPTIMA	2.4L L4 2359cc	
	2002	SEAT IBIZA	1.6L L4 1600cc 98 CID	2011-2016	KIA SPORTAGE	2.4L L4 2359cc	
US8960	2007-2011	JEEP WRANGLER	3.8L V6 3778cc 231 CID	2012-2013	HYUNDAI TUCSON	2.0L L4 1975cc	
US8963	2011-2013	FORD F-150	5.0L V8 4951cc 302 CID	2012-2015	HYUNDAI TUCSON	2.4L L4 2359cc	
	2011-2014	FORD F-150	5.0L V8 5000cc 305 CID	2012-2015	KIA SORENTO	2.4L L4 2359cc	

WATER PUMPS



WATER PUMP BUYERS GUIDE



USMWW	Years	Application	Engine	USMWW	Years	Application	Engine
US8982	2014-2016	HYUNDAI SANTA FE SPORT	2.4L L4 2359cc	US9031	1978-1981	NISSAN 510	2.0L L4 1952cc
US8983	2010-2014	HONDA INSIGHT	1.3L L4 1339cc	1980	NISSAN 720	2.0L L4 1952cc	
	2011-2016	HONDA CR-Z	1.5L L4 1497cc 91 CID	1981-1983	NISSAN 720	2.2L L4 2187cc	
US8984	2011-2015	CHEVROLET SPARK	1.2L L4 1200cc 73 CID	1982-1983	NISSAN 200SX	2.2L L4 2187cc	
	2012-2014	CHEVROLET SPARK	1.2L L4 1206cc 74 CID	1983-1986	NISSAN 720	2.0L L4 1952cc	
US8984-2	2012-2014	CHEVROLET SPARK	1.2L L4 1206cc 74 CID	1983-1986	NISSAN 720	2.4L L4 2389cc	
US8985	2000-2001	MERCEDES-BENZ A160	1.6L L4 1587cc 97 CID	1984-1988	NISSAN 200SX	2.0L L4 1974cc	
	2002-2005	MERCEDES-BENZ A160	1.6L L4 1598cc 98 CID	1986-1989	NISSAN D21	2.4L L4 2389cc	
US8987	2006-2014	FORD TRANSIT	2.2L L4 2198cc 125 CID	1987	NISSAN PATHFINDER	2.4L L4 2389cc	
US8990	2002-2005	BMW 745LI	4.4L V8 4398cc	US9033	1975-1977	HONDA CIVIC	1.2L L4 1237cc
	2004-2005	BMW 545I	4.4L V8 4398cc	US9034	1975-1979	HONDA CIVIC	1.5L L4 1487cc
	2004-2005	BMW 645CI	4.4L V8 4398cc	1976-1978	HONDA ACCORD	1.6L L4 1599cc	
	2004-2005	BMW 745I	4.4L V8 4398cc	1979	HONDA ACCORD	1.8L L4 1751cc	
	2004-2006	BMW X5	4.4L V8 4398cc	1979	HONDA PRELUDE	1.8L L4 1751cc	
	2004-2006	BMW X5	4.8L V8 4837cc	US9035	1980-1983	HONDA CIVIC	1.5L L4 1487cc
	2007-2008	BMW ALPINA B7	4.4L V8 4398cc	1982	HONDA PRELUDE	1.8L L4 1751cc	
US8996	2010	SEAT IBIZA	1.6L L4 1600cc 98 CID	1982-1983	HONDA ACCORD	1.8L L4 1751cc	
US8998	2008-2011	NISSAN CABSTAR	2.5L L4 2488cc 151 CID	1982-1986	TOYOTA CELICA	2.8L L6 2754cc	
	2008-2011	NISSAN NP300	2.5L L4 2488cc 151 CID	1983-1988	TOYOTA CRESSIDA	2.8L L6 2754cc	
US8999	2013-2015	CHEVROLET SPARK	1.2L L4 1249cc 76 CID	US9041	1982	NISSAN 310	1.5L L4 1488cc
US9003	1974	FIAT 124	1.6L L4 1593cc	1982-1983	NISSAN SENTRA	1.5L L4 1488cc	
	1974-1978	FIAT 124	1.8L L4 1756cc	1983	NISSAN PULSAR	1.6L L4 1597cc	
	1975-1978	FIAT 131	1.8L L4 1756cc	1983-1984	NISSAN PULSAR NX	1.5L L4 1488cc	
	1978-1981	FIAT BRAVA	2.0L L4 1995cc	1983-1985	NISSAN SENTRA	1.6L L4 1597cc	
	1979-1982	FIAT 124	2.0L L4 1995cc	1983-1988	NISSAN PULSAR NX	1.6L L4 1597cc	
US9005	1975	TOYOTA CORONA	2.2L L4 2189cc	1984-1985	NISSAN TSURU	1.5L L4 1487cc 91 CID	
	1975	TOYOTA PICKUP	2.2L L4 2189cc	1986-1987	NISSAN SENTRA	1.6L L4 1597cc 97 CID	
US9008	1975-1976	NISSAN 610	2.0L L4 1952cc	1987-1988	NISSAN SENTRA	1.6L L4 1597cc	
	1975-1977	NISSAN 710	2.0L L4 1952cc	US9043N	1980-1983	HONDA CIVIC	1.3L L4 1335cc
	1975-1979	NISSAN 620	2.0L L4 1952cc	US9044	1983-1986	NISSAN SENTRA	1.7L L4 1688cc
	1978-1981	NISSAN 510	2.0L L4 1952cc	US9045	1981-1988	TOYOTA TERCEL	1.5L L4 1452cc
	1980	NISSAN 720	2.0L L4 1952cc	US9046	1984-1987	TOYOTA COROLLA	1.6L L4 1587cc
US9009	1970-1983	NISSAN PICKUP	1.6L L4 1600cc 98 CID	US9047	2008-2010	VOLKSWAGEN JETTA	2.0L L4 1984cc 121 CID
	1973-1984	NISSAN SEDAN	1.6L L4 1597cc 97 CID	2008-2010	VOLKSWAGEN PASSAT	2.0L L4 1984cc 121 CID	
	1973-1984	NISSAN STATION WAGON	1.6L L4 1597cc 97 CID	2008-2011	VOLKSWAGEN GTI	2.0L L4 1984cc 121 CID	
	1980	NISSAN 720	2.0L L4 1952cc	2008-2013	AUDI A3	2.0L L4 1984cc 121 CID	
	1981-1983	NISSAN 720	2.2L L4 2187cc	2009	AUDI TT	2.0L L4 1984cc 121 CID	
US9010	1975-1978	NISSAN B210	1.4L L4 1393cc 85 CID	2009-2013	AUDI A3 QUATTRO	2.0L L4 1984cc 121 CID	
	1980	NISSAN 310	1.4L L4 1393cc 85 CID	2009-2015	AUDI TT QUATTRO	2.0L L4 1984cc 121 CID	
	1981	NISSAN 310	1.5L L4 1488cc	2009-2016	AUDI A4	2.0L L4 1984cc 121 CID	
US9011	1975-1978	NISSAN 280Z	2.8L L6 2753cc	2009-2016	AUDI A4 QUATTRO	2.0L L4 1984cc 121 CID	
	1977-1981	NISSAN 810	2.4L L6 2393cc	2009-2016	VOLKSWAGEN EOS	2.0L L4 1984cc 121 CID	
	1979-1983	NISSAN 280ZX	2.8L L6 2753cc	2009-2017	VOLKSWAGEN CC	2.0L L4 1984cc 121 CID	
	1981	NISSAN 810	2.8L L6 2793cc	2009-2017	VOLKSWAGEN TIGUAN	2.0L L4 1984cc 121 CID	
	1982-1983	NISSAN MAXIMA	2.8L L6 2793cc	2010-2014	AUDI A5	2.0L L4 1984cc 121 CID	
	1982-1984	NISSAN MAXIMA	2.4L L6 2393cc	2010-2017	AUDI A5 QUATTRO	2.0L L4 1984cc 121 CID	
US9012	1975-1976	TOYOTA COROLLA	1.6L L4 1588cc	2011-2017	AUDI Q5	2.0L L4 1984cc 121 CID	
US9015	1978-1979	TOYOTA COROLLA	1.2L L4 1166cc	2012-2013	VOLKSWAGEN BEETLE	2.0L L4 1984cc 121 CID	
	1981-1982	TOYOTA STARLET	1.3L L4 1290cc	2012-2013	VOLKSWAGEN JETTA	2.0L L4 1984cc 121 CID	
US9016	1976	TOYOTA COROLLA	1.6L L4 1588cc	2012-2015	AUDI A6	2.0L L4 1984cc 121 CID	
US9017	1978-1980	TOYOTA CELICA	2.2L L4 2189cc	2013-2014	VOLKSWAGEN GTI	2.0L L4 1984cc 121 CID	
	1978-1980	TOYOTA CORONA	2.2L L4 2189cc	2013-2015	AUDI A6 QUATTRO	2.0L L4 1984cc 121 CID	
	1978-1980	TOYOTA PICKUP	2.2L L4 2189cc	2013-2016	AUDI ALLROAD	2.0L L4 1984cc 121 CID	
	1981-1982	TOYOTA CORONA	2.4L L4 2366cc	2015-2017	AUDI Q3	2.0L L4 1984cc 121 CID	
	1981-1984	TOYOTA CELICA	2.4L L4 2366cc	2015-2017	AUDI Q3 QUATTRO	2.0L L4 1984cc 121 CID	
	1981-1984	TOYOTA PICKUP	2.4L L4 2366cc	US9047-2	2008-2010	VOLKSWAGEN JETTA	2.0L L4 1984cc 121 CID
	1984	TOYOTA 4RUNNER	2.4L L4 2366cc	2008-2010	VOLKSWAGEN PASSAT	2.0L L4 1984cc 121 CID	
US9018	1977-1979	TOYOTA COROLLA	1.6L L4 1588cc	2008-2011	VOLKSWAGEN GTI	2.0L L4 1984cc 121 CID	
	1980-1982	TOYOTA COROLLA	1.8L L4 1770cc	2008-2013	AUDI A3	2.0L L4 1984cc 121 CID	
US9020	1977-1978	MAZDA GLC	1.3L L4 1272cc	2009	AUDI TT	2.0L L4 1984cc 121 CID	
	1979-1980	MAZDA GLC	1.4L L4 1415cc	2009-2013	AUDI A3 QUATTRO	2.0L L4 1984cc 121 CID	
	1981-1983	MAZDA GLC	1.5L L4 1490cc	2009-2015	AUDI TT QUATTRO	2.0L L4 1984cc 121 CID	
US9021	1977	TOYOTA COROLLA	1.2L L4 1166cc	2009-2016	AUDI A4	2.0L L4 1984cc 121 CID	
US9025	1980	SUBARU BRAT	1.6L H4 1595cc	2009-2016	AUDI A4 QUATTRO	2.0L L4 1984cc 121 CID	
	1980	SUBARU GL	1.6L H4 1595cc	2009-2016	VOLKSWAGEN EOS	2.0L L4 1984cc 121 CID	
	1980	SUBARU GLF	1.6L H4 1595cc	2009-2017	VOLKSWAGEN CC	2.0L L4 1984cc 121 CID	
	1980-1982	SUBARU GLF	1.8L H4 1781cc	2009-2017	VOLKSWAGEN TIGUAN	2.0L L4 1984cc 121 CID	
	1980-1984	SUBARU DL	1.6L H4 1595cc	2010-2014	AUDI A5	2.0L L4 1984cc 121 CID	
	1980-1984	SUBARU DL	1.8L H4 1781cc	2010-2017	AUDI A5 QUATTRO	2.0L L4 1984cc 121 CID	
	1980-1984	SUBARU GL	1.8L H4 1781cc	2011-2017	AUDI Q5	2.0L L4 1984cc 121 CID	
	1980-1987	SUBARU BRAT	1.8L H4 1781cc	2012-2013	VOLKSWAGEN BEETLE	2.0L L4 1984cc 121 CID	
	1980-1987	SUBARU STANDARD	1.6L H4 1595cc	2012-2013	VOLKSWAGEN JETTA	2.0L L4 1984cc 121 CID	
	1981-1982	SUBARU STANDARD	1.8L H4 1781cc	2012-2015	AUDI A6	2.0L L4 1984cc 121 CID	
	1986-1987	SUBARU GL	1.6L H4 1595cc	2013-2014	VOLKSWAGEN GTI	2.0L L4 1984cc 121 CID	
US9026	1975-1978	NISSAN B210	1.4L L4 1393cc 85 CID	2013-2015	AUDI A6 QUATTRO	2.0L L4 1984cc 121 CID	
	1979-1982	NISSAN 210	1.4L L4 1393cc 85 CID	2013-2016	AUDI ALLROAD	2.0L L4 1984cc 121 CID	
	1980-1982	NISSAN 210	1.2L L4 1237cc	2015-2017	AUDI Q3	2.0L L4 1984cc 121 CID	
	1980-1982	NISSAN 210	1.5L L4 1488cc	2015-2017	AUDI Q3 QUATTRO	2.0L L4 1984cc 121 CID	
US9027	1975-1977	TOYOTA CELICA	2.2L L4 2189cc	US9048	1983-1986	TOYOTA CAMRY	2.0L L4 1995cc
	1976-1977	TOYOTA CORONA	2.2L L4 2189cc	1986	TOYOTA CELICA	2.0L L4 1995cc	
	1976-1977	TOYOTA PICKUP	2.2L L4 2189cc	1986	TOYOTA CELICA	2.0L L4 1998cc	
US9028	1980	TOYOTA TERCEL	1.5L L4 1452cc	US9049	1976-1984	VOLVO 242	2.1L L4 2127cc
US9029	1980-1981	HONDA ACCORD	1.8L L4 1751cc	1976-1985	VOLVO 244	2.1L L4 2127cc	
	1980-1981	HONDA PRELUDE	1.8L L4 1751cc	1976-1985	VOLVO 245	2.1L L4 2127cc	
US9031	1974	NISSAN 610	2.0L L4 1952cc 119 CID	1983-1984	VOLVO 242	2.3L L4 2316cc	
	1975-1976	NISSAN 610	2.0L L4 1952cc	1983-1984	VOLVO 244	2.3L L4 2316cc	
	1975-1977	NISSAN 710	2.0L L4 1952cc	1983-1984	VOLVO 245	2.3L L4 2316cc	
	1975-1979	NISSAN 620	2.0L L4 1952cc	1984	VOLVO 760	2.3L L4 2316cc	
	1977-1981	NISSAN 200SX	2.0L L4 1952cc	US9050	1981-1985	MAZDA GLC	1.5L L4 1490cc

USMW	Years	Application	Engine	USMW	Years	Application	Engine	
US9052	1980-1983	AUDI 4000	2.2L L5 2144cc	US9065	1995-2002	VOLKSWAGEN CABRIO	2.0L L4 1984cc 121 CID	
	1980-1985	AUDI 5000	2.2L L5 2144cc		1996-1997	VOLKSWAGEN PASSAT	1.9L L4 1896cc 116 CID	
	1981-1984	AUDI COUPE	2.2L L5 2144cc		1997-1999	VOLKSWAGEN JETTA	1.9L L4 1896cc 116 CID	
	1983-1984	VOLKSWAGEN QUANTUM	2.2L L5 2144cc		1998-1999	VOLKSWAGEN GOLF	1.8L L4 1781cc 109 CID	
	1983-1985	AUDI QUATTRO	2.2L L5 2144cc		1998-2001	VOLKSWAGEN COMBI	1.8L L4 1780cc 108 CID	
	1984-1987	AUDI 4000 QUATTRO	2.2L L5 2226cc		1998-2001	VOLKSWAGEN DERBY	1.8L L4 1780cc 108 CID	
	1984-1987	AUDI COUPE	2.2L L5 2226cc		1998-2001	VOLKSWAGEN PANEL	1.8L L4 1780cc 108 CID	
	1985-1988	AUDI 5000	2.2L L5 2226cc		1998-2002	VOLKSWAGEN POINTER	1.8L L4 1780cc 108 CID	
	1985-1988	VOLKSWAGEN QUANTUM	2.2L L5 2226cc		2002-2009	VOLKSWAGEN DERBY	1.8L L4 1781cc 109 CID	
	1986-1988	AUDI 5000 QUATTRO	2.2L L5 2226cc		2003	VOLKSWAGEN VAN	1.8L L4 1781cc 109 CID	
	1987	AUDI COUPE	2.3L L5 2309cc		2003-2010	VOLKSWAGEN POINTER	1.8L L4 1781cc 109 CID	
	1987-1988	AUDI 5000	2.3L L5 2309cc		US9065-2	1981-1982	VOLKSWAGEN RABBIT PICKUP	1.7L L4 1715cc
	1987-1988	AUDI 5000 QUATTRO	2.3L L5 2309cc			1981-1983	AUDI 4000	1.7L L4 1715cc
	1988	AUDI 80 QUATTRO	2.3L L5 2309cc		1981-1983	VOLKSWAGEN RABBIT CONVERTIBLE	1.7L L4 1715cc	
	1988	AUDI 90	2.3L L5 2309cc			1981-1983	VOLKSWAGEN RABBIT PICKUP	1.6L L4 1588cc 97 CID
	1988	AUDI 90 QUATTRO	2.3L L5 2309cc		1981-1983	VOLKSWAGEN SCIROCCO	1.7L L4 1715cc	
	1989	AUDI 200 QUATTRO	2.2L L5 2226cc		1981-1984	VOLKSWAGEN JETTA	1.7L L4 1715cc	
	US9053	1975-1977	MAZDA ROTARY PICKUP		1.3L R2 1308cc	1981-1984	VOLKSWAGEN RABBIT	1.7L L4 1715cc
		1975-1978	MAZDA RX-3		1.1L R2 1146cc	1982-1983	AUDI 4000	1.6L L4 1588cc 97 CID
		1975-1978	MAZDA RX-4		1.3L R2 1308cc	1982-1983	VOLKSWAGEN QUANTUM	1.7L L4 1715cc
1976-1978		MAZDA COSMO	1.3L R2 1308cc	1982-1985	VOLKSWAGEN QUANTUM	1.6L L4 1588cc 97 CID		
1979		MAZDA RX-7	1.1L R2 1146cc	1982-1987	VOLKSWAGEN JETTA	1.6L L4 1588cc 97 CID		
1985		MAZDA RX-7	1.1L R2 1146cc	1983-1984	VOLKSWAGEN RABBIT	1.6L L4 1588cc 97 CID		
1985		MAZDA RX-7	1.3L R2 1308cc	1983-1984	VOLKSWAGEN RABBIT	1.8L L4 1780cc		
US9056	1983-1987	HONDA PRELUDE	1.8L L4 1829cc	1984-1985	VOLKSWAGEN QUANTUM	1.8L L4 1780cc		
	1984-1985	HONDA ACCORD	1.8L L4 1829cc	1984-1987	AUDI 4000	1.8L L4 1780cc		
US9057	1983-1992	TOYOTA COROLLA	1.6L L4 1587cc	1984-1988	VOLKSWAGEN SCIROCCO	1.8L L4 1780cc		
	1985-1988	CHEVROLET NOVA	1.6L L4 1588cc 98 CID	1984-1992	VOLKSWAGEN JETTA	1.8L L4 1780cc		
	1989	GEO PRIZM	1.6L L4 1588cc 98 CID	1985-1988	VOLKSWAGEN GOLF	1.6L L4 1588cc 97 CID		
	1990-1992	GEO PRIZM	1.6L L4 1587cc	1985-1992	VOLKSWAGEN GOLF	1.8L L4 1780cc		
	1990-1993	TOYOTA CELICA	1.6L L4 1587cc	1985-1993	VOLKSWAGEN CABRIOLET	1.8L L4 1780cc		
US9058	1984-1989	NISSAN 300ZX	3.0L V6 2960cc	1987-1993	VOLKSWAGEN FOX	1.8L L4 1780cc		
	1986-1989	NISSAN D21	3.0L V6 2960cc	1988	AUDI 90	2.0L L4 1983cc		
	1987-1988	NISSAN 200SX	3.0L V6 2960cc 181 CID	1988-1990	AUDI 80	2.0L L4 1983cc		
	1990-1992	INFINITI M30	3.0L V6 2960cc 181 CID	1989-1992	VOLKSWAGEN JETTA	1.6L L4 1588cc 97 CID		
	1990-1994	NISSAN D21	3.0L V6 2960cc 181 CID	1990-1992	VOLKSWAGEN CORRADO	1.8L L4 1780cc		
US9059	1984-1985	TOYOTA COROLLA	1.8L L4 1839cc	1990-1993	VOLKSWAGEN PASSAT	2.0L L4 1984cc 121 CID		
	1984-1986	TOYOTA CAMRY	1.8L L4 1839cc	1990-1999	VOLKSWAGEN GOLF	2.0L L4 1984cc 121 CID		
	1986	TOYOTA CAMRY	2.0L L4 1974cc	1990-1999	VOLKSWAGEN JETTA	2.0L L4 1984cc 121 CID		
	1983	MAZDA 626	2.0L L4 1970cc	1995-1996	VOLKSWAGEN PASSAT	2.0L L4 1984cc 121 CID		
US9060	1984-1985	MAZDA 626	2.0L L4 1998cc 122 CID	1995-2002	VOLKSWAGEN CABRIO	2.0L L4 1984cc 121 CID		
	1983-1985	VOLKSWAGEN VANAGON	1.9L H4 1915cc	1996-1997	VOLKSWAGEN PASSAT	1.9L L4 1896cc 116 CID		
US9061	1981-1984	NISSAN PICKUP	1.8L L4 1800cc 110 CID	1997-1999	VOLKSWAGEN JETTA	1.9L L4 1896cc 116 CID		
	1982-1984	NISSAN SEDAN	1.8L L4 1750cc 107 CID	US9066	1975	VOLKSWAGEN DASHER	1.5L L4 1471cc	
1982-1984	NISSAN STATION WAGON	1.8L L4 1750cc 107 CID	1975		VOLKSWAGEN RABBIT	1.5L L4 1471cc		
1982-1986	NISSAN SAKURA	1.8L L4 1750cc 107 CID	1975		VOLKSWAGEN SCIROCCO	1.5L L4 1471cc		
1984-1986	NISSAN 200SX	1.8L L4 1809cc	1975-1979		AUDI FOX	1.6L L4 1588cc 97 CID		
1984-1988	NISSAN 200SX	2.0L L4 1974cc	1976-1977		VOLKSWAGEN RABBIT	1.6L L4 1588cc 97 CID		
1987	NISSAN PULSAR NX	1.6L L4 1597cc	1976-1977		VOLKSWAGEN SCIROCCO	1.6L L4 1588cc 97 CID		
US9064	1983-1984	TOYOTA STARLET	1.3L L4 1290cc		1976-1981	VOLKSWAGEN DASHER	1.6L L4 1588cc 97 CID	
	1981-1982	VOLKSWAGEN RABBIT PICKUP	1.7L L4 1715cc		1977-1979	VOLKSWAGEN CARIBE	1.6L L4 1588cc 97 CID	
US9065	1981-1983	AUDI 4000	1.7L L4 1715cc		1977-1980	VOLKSWAGEN CARIBE	1.6L L4 1600cc 98 CID	
	1981-1983	VOLKSWAGEN RABBIT CONVERTIBLE	1.7L L4 1715cc		1977-1980	VOLKSWAGEN RABBIT	1.5L L4 1471cc	
1981-1983	VOLKSWAGEN RABBIT PICKUP	1.6L L4 1588cc 97 CID	1978		VOLKSWAGEN SCIROCCO	1.5L L4 1457cc		
1981-1983	VOLKSWAGEN SCIROCCO	1.7L L4 1715cc	1978-1980		VOLKSWAGEN RABBIT	1.5L L4 1457cc		
1981-1984	VOLKSWAGEN JETTA	1.7L L4 1715cc	1979-1980		VOLKSWAGEN DASHER	1.5L L4 1471cc		
1981-1984	VOLKSWAGEN RABBIT	1.7L L4 1715cc	1979-1980		VOLKSWAGEN SCIROCCO	1.6L L4 1588cc 97 CID		
1981-1986	VOLKSWAGEN CARIBE	1.7L L4 1700cc 104 CID	1980		AUDI 4000	1.6L L4 1588cc 97 CID		
1982-1983	AUDI 4000	1.6L L4 1588cc 97 CID	1980		VOLKSWAGEN RABBIT CONVERTIBLE	1.6L L4 1588cc 97 CID		
1982-1983	VOLKSWAGEN QUANTUM	1.7L L4 1715cc	1980		VOLKSWAGEN RABBIT PICKUP	1.5L L4 1457cc		
1982-1985	VOLKSWAGEN QUANTUM	1.6L L4 1588cc 97 CID	1980-1982		VOLKSWAGEN JETTA	1.6L L4 1588cc 97 CID		
1982-1986	VOLKSWAGEN ATLANTIC	1.7L L4 1700cc 104 CID	1980-1982		VOLKSWAGEN RABBIT PICKUP	1.6L L4 1588cc 97 CID		
1982-1987	VOLKSWAGEN JETTA	1.6L L4 1588cc 97 CID	1980-1983		VOLKSWAGEN RABBIT	1.6L L4 1588cc 97 CID		
1983-1984	VOLKSWAGEN RABBIT	1.6L L4 1588cc 97 CID	1981	AUDI 4000	1.7L L4 1715cc			
1983-1984	VOLKSWAGEN RABBIT	1.8L L4 1780cc	1981	VOLKSWAGEN ATLANTIC	1.7L L4 1700cc 104 CID			
1984-1985	VOLKSWAGEN QUANTUM	1.8L L4 1780cc	1981	VOLKSWAGEN RABBIT CONVERTIBLE	1.7L L4 1715cc			
1984-1987	AUDI 4000	1.8L L4 1780cc	1981	VOLKSWAGEN SCIROCCO	1.7L L4 1715cc			
1984-1987	VOLKSWAGEN ATLANTIC	1.8L L4 1800cc 110 CID	1981-1983	VOLKSWAGEN RABBIT PICKUP	1.7L L4 1715cc			
1984-1988	VOLKSWAGEN SCIROCCO	1.8L L4 1780cc	1981-1984	VOLKSWAGEN RABBIT	1.7L L4 1715cc			
1984-1992	VOLKSWAGEN JETTA	1.8L L4 1780cc	1984	VOLKSWAGEN CARIBE	1.8L L4 1800cc 110 CID			
1985-1987	VOLKSWAGEN CARIBE	1.8L L4 1800cc 110 CID	1988-1999	VOLKSWAGEN JETTA	1.8L L4 1780cc 108 CID			
1985-1988	VOLKSWAGEN GOLF	1.6L L4 1588cc 97 CID	1999-2002	VOLKSWAGEN POINTER	1.8L L4 1780cc 108 CID			
1985-1992	VOLKSWAGEN GOLF	1.8L L4 1780cc	US9067	1984-1985	MAZDA 626	2.0L L4 1998cc 122 CID		
1985-1993	VOLKSWAGEN CABRIOLET	1.8L L4 1780cc		1984-1986	FORD TEMPO	2.0L L4 1989cc 122 CID		
1987-1993	VOLKSWAGEN FOX	1.8L L4 1780cc		1984-1986	MERCURY TOPAZ	2.0L L4 1989cc 122 CID		
1987-1997	VOLKSWAGEN GOLF	1.8L L4 1800cc 110 CID		1984-1987	FORD ESCORT	2.0L L4 1989cc 122 CID		
1987-1997	VOLKSWAGEN JETTA	1.8L L4 1800cc 110 CID		1984-1987	MERCURY LYNX	2.0L L4 1989cc 122 CID		
1988	AUDI 90	2.0L L4 1983cc	US9068	1985	VOLVO 745	2.3L L4 2316cc		
1988-1990	AUDI 80	2.0L L4 1983cc		1985-1989	VOLVO 244	2.3L L4 2316cc		
1988-1997	VOLKSWAGEN PANEL	1.8L L4 1800cc 110 CID		1985-1989	VOLVO 245	2.3L L4 2316cc		
1989-1992	VOLKSWAGEN JETTA	1.6L L4 1588cc 97 CID		1985-1990	VOLVO 760	2.3L L4 2316cc		
1989-1997	VOLKSWAGEN COMBI	1.8L L4 1800cc 110 CID		1985-1992	VOLVO 740	2.3L L4 2316cc		
1990-1992	VOLKSWAGEN CORRADO	1.8L L4 1780cc		1989-1991	VOLVO 780	2.3L L4 2316cc		
1990-1993	VOLKSWAGEN PASSAT	2.0L L4 1984cc 121 CID		1990-1993	VOLVO 240	2.3L L4 2316cc		
1990-1999	VOLKSWAGEN GOLF	2.0L L4 1984cc 121 CID		1991-1995	VOLVO 940	2.3L L4 2316cc		
1990-1999	VOLKSWAGEN JETTA	2.0L L4 1984cc 121 CID		US9069	1984	HONDA WAGOVAN	1.5L L4 1487cc	
1995-1996	VOLKSWAGEN PASSAT	2.0L L4 1984cc 121 CID			1984-1987	HONDA CIVIC	1.3L L4 1342cc 82 CID	
1995-1997	VOLKSWAGEN DERBY	1.8L L4 1800cc 110 CID						

USMWW	Years	Application	Engine	USMWW	Years	Application	Engine	
US9069	1984-1987	HONDA CIVIC	1.5L L4 1487cc	US9116	1988-1989	NISSAN PULSAR NX	1.8L L4 1809cc	
	1986	HONDA CIVIC	1.5L L4 1493cc		US9117	1980-1981	BMW 528I	2.8L L6 2788cc
	1986-1987	HONDA WAGOVAN	1.5L L4 1487cc	1980-1984		BMW 633CSI	3.2L L6 3210cc	
US9071	1979-1983	AUDI 5000	2.0L L5 1986cc	1980-1984		BMW 733I	3.2L L6 3210cc	
	1980	VOLVO 265	2.4L L6 2383cc	1983-1984		BMW 533I	3.2L L6 3210cc	
	1980-1981	VOLVO 264	2.4L L6 2383cc	1985-1989		BMW 635CSI	3.5L L6 3430cc	
	1982-1984	VOLVO 244	2.4L L6 2383cc	1985-1993		BMW 535I	3.5L L6 3430cc	
	1982-1984	VOLVO 245	2.4L L6 2383cc	1986-1987		BMW L7	3.5L L6 3430cc	
	1983-1984	VOLVO 760	2.4L L6 2383cc	1987		BMW L6	3.5L L6 3430cc	
	1985	VOLVO 745	2.4L L6 2383cc	1987-1988		BMW M6	3.5L L6 3453cc	
	1985	VOLVO 760	2.4L L6 2377cc	1988		BMW 535IS	3.5L L6 3430cc	
	1986	VOLVO 740	2.4L L6 2377cc	1988		BMW M5	3.5L L6 3453cc	
US9074	1985-1994	NISSAN MAXIMA	3.0L V6 2960cc 181 CID	1988-1992		BMW 735I	3.5L L6 3430cc	
	1993-1998	MERCURY VILLAGER	3.0L V6 182 CID	1988-1992	BMW 735IL	3.5L L6 3430cc		
	1993-1998	NISSAN QUEST	3.0L V6 2960cc 181 CID	US9119	1982-1987	BMW 528E	2.7L L6 2693cc	
US9075	1985-1987	TOYOTA COROLLA	1.6L L4 1587cc		1984-1987	BMW 325E	2.7L L6 2693cc	
	US9076	1985-1989	TOYOTA MR2		1.6L L4 1587cc	1986-1987	BMW 325	2.7L L6 2693cc
1987-1991		TOYOTA COROLLA	1.6L L4 1587cc		1986-1987	BMW 325ES	2.7L L6 2693cc	
US9077	1988	CHEVROLET NOVA	1.6L L4 1588cc 98 CID		1987	BMW 325I	2.5L L6 2494cc 152 CID	
	1990-1992	GEO PRIZM	1.6L L4 1587cc		1987	BMW 325IS	2.5L L6 2494cc 152 CID	
US9078	1975	VOLVO 164	3.0L L6 2980cc	US9120	1988	BMW 325	2.7L L6 2693cc	
US9078	1969-1974	TOYOTA LAND CRUISER	3.9L L6 3878cc		1988	BMW 528E	2.7L L6 2693cc	
	US9080	1985-1989	SUBARU DL	1.8L H4 1781cc	1988-1991	BMW 325IS	2.5L L6 2494cc 152 CID	
1985-1989		SUBARU GL	1.8L H4 1781cc	1988-1991	BMW 325IX	2.5L L6 2494cc 152 CID		
US9082	1985-1989	SUBARU GL-10	1.8L H4 1781cc	1988-1993	BMW 325I	2.5L L6 2494cc 152 CID		
	1985-1991	SUBARU XT	1.8L H4 1781cc	1989-1990	BMW 525I	2.5L L6 2494cc 152 CID		
US9082	1986-1989	SUBARU RX	1.8L H4 1781cc	US9122	1975-1978	BMW 530I	3.0L L6 2985cc	
	1972-1980	MG MGB	1.8L L4 1798cc		1977-1978	BMW 630CSI	3.0L L6 2985cc	
US9083	1985-1987	HONDA PRELUDE	2.0L L4 1955cc		1978-1979	BMW 633CSI	3.2L L6 3210cc	
	1986-1989	HONDA ACCORD	2.0L L4 1955cc		1978-1979	BMW 733I	3.2L L6 3210cc	
US9084	1971-1973	FIAT 128	1.1L L4 1116cc		1979	BMW 528I	2.8L L6 2788cc	
	1973-1979	FIAT 128	1.3L L4 1290cc		1985-1987	BMW 735I	3.5L L6 3430cc	
	1974-1978	FIAT X-1/9	1.3L L4 1290cc	US9128	1988-1994	BMW 750IL	5.0L V12 4988cc	
	1979-1982	FIAT STRADA	1.5L L4 1498cc		US9129	1988-1991	HONDA PRELUDE	2.0L L4 1958cc
	1979-1982	FIAT X-1/9	1.5L L4 1498cc	1990-1991		HONDA PRELUDE	2.1L L4 2056cc	
US9085	1979-1982	FIAT STRADA	1.5L L4 1498cc	US9130	1988-1991	HONDA CIVIC	1.6L L4 1590cc 97 CID	
	1979-1982	FIAT X-1/9	1.5L L4 1498cc		1988-1991	HONDA CRX	1.5L L4 1493cc	
US9086	1981-1982	TOYOTA TERCEL	1.5L L4 1452cc	1988-1991	HONDA CRX	1.6L L4 1590cc 97 CID		
US9092	1984-1985	TOYOTA VAN	2.0L L4 1998cc 122 CID	1988-1995	HONDA CIVIC	1.5L L4 1493cc		
	1986-1989	TOYOTA VAN	2.2L L4 2237cc	1993-1995	HONDA CIVIC DEL SOL	1.5L L4 1493cc		
US9093	1984	SUBARU BRAT	1.8L H4 1781cc	1993-1995	HONDA CIVIC DEL SOL	1.6L L4 1590cc 97 CID		
	US9094	1981-1983	TOYOTA PICKUP	2.2L L4 2188cc	US9131	1988-1990	HONDA PRELUDE	2.0L L4 1958cc
US9097		1986-1987	ACURA LEGEND	2.5L V6 2494cc		US9132	1981-1987	ISUZU PICKUP
	1987-1988	STERLING 825	2.5L V6 2494cc	1982	CHEVROLET LUV		2.2L L4 134 CID	
	1987-1990	ACURA LEGEND	2.7L V6 2675cc	1986-1987	ISUZU TROOPER	2.2L L4 2238cc		
	1989-1990	STERLING 827	2.7L V6 2675cc	US9133	1988-1991	ISUZU TROOPER	2.6L L4 2559cc	
	1995-1997	HONDA ACCORD	2.7L V6 2675cc		1988-1995	ISUZU PICKUP	2.6L L4 2559cc	
	US9098	1987-1994	TOYOTA TERCEL		1.5L L4 1456cc	1989-1994	ISUZU AMIGO	2.6L L4 2559cc
		1992-1994	TOYOTA PASEO		1.5L L4 1497cc	1991-1997	ISUZU RODEO	2.6L L4 2559cc
	US9099	1987-1989	TOYOTA CELICA		2.0L L4 1998cc 122 CID	1994-1996	HONDA PASSPORT	2.6L L4 2559cc
		1987-1991	TOYOTA CAMRY	2.0L L4 1998cc 122 CID	US9134	1989	ISUZU IMPULSE	2.0L L4 1994cc
		1990-1999	TOYOTA CELICA	2.2L L4 2164cc		US9140	1986-1989	TOYOTA CELICA
1991-1995		TOYOTA MR2	2.2L L4 2164cc	1988-1993	TOYOTA CELICA		2.0L L4 1998cc 122 CID	
1992-2001		TOYOTA CAMRY	2.2L L4 2164cc	1991-1995	TOYOTA MR2	2.0L L4 1998cc 122 CID		
1996-2000		TOYOTA RAV4	2.0L L4 1998cc 122 CID	US9141	1985	TOYOTA CELICA	2.4L L4 2366cc	
1999-2001		TOYOTA SOLARA	2.2L L4 2164cc		1985-1995	TOYOTA 4RUNNER	2.4L L4 2366cc	
US9099-2		1987-1989	TOYOTA CELICA	2.0L L4 1998cc 122 CID	US9142	1985-1995	TOYOTA PICKUP	2.4L L4 2366cc
		1987-1991	TOYOTA CAMRY	2.0L L4 1998cc 122 CID		1988-1990	TOYOTA 4RUNNER	3.0L V6 2959cc
		1990-1999	TOYOTA CELICA	2.2L L4 2164cc	US9145	1988-1990	TOYOTA PICKUP	3.0L V6 2959cc
	1991-1995	TOYOTA MR2	2.2L L4 2164cc	1989-1992		TOYOTA 4RUNNER	3.0L V6 2959cc	
	1992-2001	TOYOTA CAMRY	2.2L L4 2164cc	US9146	1989-1992	TOYOTA PICKUP	3.0L V6 2959cc	
	1996-2000	TOYOTA RAV4	2.0L L4 1998cc 122 CID		1979	VOLVO 262	2.7L V6 2673cc	
	1999-2001	TOYOTA SOLARA	2.2L L4 2164cc	1979	VOLVO 264	2.7L V6 2673cc		
	US9100	1986-1992	TOYOTA SUPRA	3.0L L6 2954cc	1979	VOLVO 265	2.7L V6 2673cc	
		US9102	1989-1992	TOYOTA CRESSIDA	3.0L L6 2954cc	1980-1981	VOLVO 262	2.8L V6 2849cc
			1986-1988	MAZDA RX-7	1.3L R2 1308cc	1980-1981	VOLVO 265	2.8L V6 2849cc
US9104	1986-1989	NISSAN D21	3.0L V6 2960cc	1980-1982	VOLVO 264	2.8L V6 2849cc		
	1987-1995	NISSAN PATHFINDER	3.0L V6 2960cc 181 CID	US9147	1976	VOLVO 262	2.7L V6 2673cc	
	1990-1994	NISSAN D21	3.0L V6 2960cc 181 CID		1976-1978	VOLVO 264	2.7L V6 2673cc	
	1995	NISSAN PICKUP	3.0L V6 2960cc 181 CID		1976-1978	VOLVO 265	2.7L V6 2673cc	
US9105	1986-1987	ISUZU PICKUP	2.3L L4 2254cc		1978	VOLVO 262	2.7L V6 2673cc	
	1986-1987	ISUZU TROOPER	2.3L L4 2254cc		US9149	1977-1979	BMW 320I	2.0L L4 1990cc 121 CID
	1988-1989	ISUZU IMPULSE	2.3L L4 2254cc	1980-1983		BMW 320I	1.8L L4 1766cc 107 CID	
	1989-1993	ISUZU AMIGO	2.3L L4 2254cc	US9150	1986-1991	VOLKSWAGEN VANAGON	2.1L H4 2109cc	
	1989-1995	ISUZU PICKUP	2.3L L4 2254cc		US9152	1984-1985	BMW 318I	1.8L L4 1766cc 107 CID
US9106	1985-1989	ISUZU IMPULSE	2.0L L4 1994cc	1986		BMW 318	1.8L L4 1800cc 110 CID	
	US9107	1986-1990	SAAB 9000	2.0L L4 1985cc	US9153	1975-1976	BMW 2002	2.0L L4 1990cc 121 CID
US9108	1981-1993	SAAB 900	2.0L L4 1985cc	US9154		1984-1985	LINCOLN CONTINENTAL	2.4L L6 146 CID
	1991-1994	SAAB 900	2.1L L4 2119cc		1984-1985	LINCOLN MARK VII	2.4L L6 146 CID	
US9109	1988-1991	SUBARU XT	2.7L H6 2672cc		1985-1986	BMW 524TD	2.4L L6 2443cc	
US9110	1987-1988	NISSAN VAN	2.4L L4 2389cc		US9155	1988-1992	TOYOTA LAND CRUISER	4.0L L6 3956cc
US9111	1986-1987	MAZDA 626	2.0L L4 1998cc 122 CID	US9160		1989	ISUZU I-MARK	1.6L L4 1588cc
	1986-1987	MAZDA B2000	2.0L L4 1998cc 122 CID		US9161	1985-1989	SUBARU DL	1.8L H4 1781cc
US9114	1982-1986	NISSAN STANZA	2.0L L4 1974cc	1985-1989		SUBARU GL	1.8L H4 1781cc	
US9115	1986-1989	ACURA INTEGRA	1.6L L4 1590cc	1985-1989	SUBARU GL-10	1.8L H4 1781cc		
US9116	1985-1990	NISSAN PICKUP	1.8L L4 1800cc 110 CID	1986-1989	SUBARU RX	1.8L H4 1781cc		
	1987	NISSAN PULSAR NX	1.6L L4 1597cc	1990-1994	SUBARU LOYALE	1.8L H4 1781cc		
	1987-1989	NISSAN ICHI VAN	1.8L L4 1800cc 110 CID	US9162	1990	NISSAN AXCESS	2.4L L4 2389cc	
	1987-1989	NISSAN STANZA	2.0L L4 1974cc		1990-1992	NISSAN STANZA	2.4L L4 2389cc	

USMW	Years	Application	Engine	USMW	Years	Application	Engine	
US9163	1988-1989	JAGUAR VANDEN PLAS	3.6L L6 3590cc	US9206	1995-1997	NISSAN PICKUP	2.4L L4 2389cc	
	1988-1989	JAGUAR XJ6	3.6L L6 3590cc		1998-2004	NISSAN FRONTIER	2.4L L4 2389cc	
	1990-1992	JAGUAR VANDEN PLAS	4.0L L6 3980cc		1998-2008	NISSAN PICKUP	2.4L L4 2389cc 146 CID	
	1990-1992	JAGUAR XJ6	4.0L L6 3980cc		2000-2004	NISSAN XTERRA	2.4L L4 2389cc	
	1993-1994	JAGUAR XJS	4.0L L6 3980cc		2000-2005	NISSAN URVAN	2.4L L4 2389cc 146 CID	
US9165	1975-1979	JAGUAR XJ12	5.3L V12 5343cc		2006-2007	NISSAN URVAN	2.4L L4 2392cc 146 CID	
	1976-1980	JAGUAR XJS	5.3L V12 5343cc		2008	NISSAN FRONTIER	2.4L L4 2389cc 146 CID	
	1982-1992	JAGUAR XJS	5.3L V12 5343cc		2009-2012	NISSAN NP300	2.4L L4 2389cc 146 CID	
	1993	JAGUAR XJRS	6.0L V12 5994cc		2012	NISSAN NP300	2.5L L4 2488cc 151 CID	
	1994-1995	JAGUAR XJS	6.0L V12 5994cc		US9207	1989-1990	NISSAN PULSAR NX	1.6L L4 1597cc 97 CID
	1994-1996	JAGUAR XJ12	6.0L V12 5994cc			1989-1990	NISSAN SENTRA	1.6L L4 1597cc 97 CID
US9166	1988-1991	MAZDA 929	3.0L V6 2954cc 180 CID		US9208	1989-1991	MAZDA RX-7	1.3L R2 1308cc
	1989-1995	MAZDA MPV	3.0L V6 2954cc 180 CID		US9209	1990-1997	HONDA ACCORD	2.2L L4 2156cc
US9167	1989-1993	MAZDA B2600	2.6L L4 2606cc			1992-1996	HONDA PRELUDE	2.2L L4 2156cc
	1989-1994	MAZDA MPV	2.6L L4 2606cc		1995-1997	HONDA ODYSSEY	2.2L L4 2156cc	
US9168	1989-1992	MITSUBISHI GALANT	2.0L L4 1997cc 122 CID		1996-1997	ISUZU OASIS	2.2L L4 2156cc	
	1992	EAGLE SUMMIT	2.4L L4 2351cc		1997	ACURA CL	2.2L L4 2156cc	
	1992	MITSUBISHI EXPO	2.4L L4 2351cc		1998	HONDA ODYSSEY	2.3L L4 2234cc	
	1992	PLYMOUTH COLT	2.4L L4 2351cc		1998	ISUZU OASIS	2.3L L4 2254cc	
US9170	1978-1979	TOYOTA CRESSIDA	2.6L L6 2563cc		1998-1999	ACURA CL	2.3L L4 2254cc	
	1979	TOYOTA CELICA	2.6L L6 2563cc		1998-2002	HONDA ACCORD	2.3L L4 2254cc	
US9171	1988-1991	AUDI 90	2.3L L5 2309cc		1999	ISUZU OASIS	2.3L L4 2234cc	
	1988-1991	AUDI 90 QUATTRO	2.3L L5 2309cc		US9211	1975-1982	JAGUAR XJ6	4.2L L6 4235cc
	1988-1992	AUDI 80 QUATTRO	2.3L L5 2309cc	US9212		1989-1992	MITSUBISHI GALANT	2.0L L4 1997cc 122 CID
	1989-1991	AUDI 100	2.3L L5 2309cc	1990-1994	EAGLE TALON	2.0L L4 1997cc 122 CID		
	1989-1991	AUDI 100 QUATTRO	2.3L L5 2309cc	1990-1994	MITSUBISHI ECLIPSE	2.0L L4 1997cc 122 CID		
	1989-1991	AUDI 200	2.2L L5 2226cc	1990-1994	PLYMOUTH LASER	2.0L L4 1997cc 122 CID		
	1989-1991	AUDI 200 QUATTRO	2.2L L5 2226cc	1992-1998	HYUNDAI SONATA	2.0L L4 1997cc		
	1990-1991	AUDI COUPE QUATTRO	2.3L L5 2309cc	1993-1995	HYUNDAI ELANTRA	1.8L L4 1836cc		
	1991-1992	AUDI 80	2.3L L5 2309cc	US9213	1991-1993	NISSAN NX	2.0L L4 1998cc	
	US9172	1975-1978	MERCEDES-BENZ 230		2.3L L4 2307cc	1991-1994	NISSAN SENTRA	2.0L L4 1998cc
1975-1982		MERCEDES-BENZ 300D	3.0L L5 3005cc		1991-1996	INFINITI G20	2.0L L4 1998cc	
1975-1983		MERCEDES-BENZ 240D	2.4L L4 2404cc		1993-1996	NISSAN TSURU	2.0L L4 1998cc 122 CID	
1978-1982		MERCEDES-BENZ 300CD	3.0L L5 3005cc		1995-1998	NISSAN 200SX	2.0L L4 1998cc	
1978-1982		MERCEDES-BENZ 300SD	3.0L L5 3005cc		1996-1997	NISSAN SENTRA	2.0L L4 1998cc 122 CID	
1981-1982		MERCEDES-BENZ 300TD	3.0L L5 3005cc		1996-2000	NISSAN LUCINO	2.0L L4 1998cc 122 CID	
1983-1985		MERCEDES-BENZ 300CD	3.0L L5 2998cc	1998-2001	NISSAN SENTRA	2.0L L4 1998cc		
1983-1985		MERCEDES-BENZ 300D	3.0L L5 2998cc	1999-2002	INFINITI G20	2.0L L4 2000cc		
1983-1985		MERCEDES-BENZ 300SD	3.0L L5 2998cc	2000	NISSAN SENTRA	1.6L L4 1597cc 97 CID		
1983-1985		MERCEDES-BENZ 300TD	3.0L L5 2998cc	US9214	1988-2013	NISSAN TSURU	1.6L L4 1597cc 97 CID	
1989		MERCEDES-BENZ 300D	3.0L L6 2985cc 182 CID		1991-1993	NISSAN NX	1.6L L4 1597cc 97 CID	
US9173		1984	MERCEDES-BENZ 190E		2.3L L4 2299cc	1991-1999	NISSAN SENTRA	1.6L L4 1597cc 97 CID
	US9175	1985-1988	MERCEDES-BENZ 190E		2.3L L4 2299cc	1993-2004	NISSAN TSBAME	1.6L L4 1597cc 97 CID
1986-1989		MERCEDES-BENZ 230E	2.3L L4 2300cc 140 CID	1995-1997	NISSAN TSURU	1.6L L4 1598cc 97 CID		
1991		MERCEDES-BENZ 230E	2.3L L4 2300cc 140 CID	1995-1998	NISSAN 200SX	1.6L L4 1597cc 97 CID		
US9176	1991-1993	MERCEDES-BENZ 190E	2.3L L4 2299cc	1996-2000	NISSAN LUCINO	1.6L L4 1597cc 97 CID		
	1975-1976	MERCEDES-BENZ 450SE	4.5L V8 4520cc	US9215	2002-2005	SUBARU IMPREZA	2.0L H4 1994cc	
	1975-1980	MERCEDES-BENZ 450SEL	4.5L V8 4520cc		2004-2006	SUBARU BAJA	2.5L H4 2458cc	
	1975-1980	MERCEDES-BENZ 450SL	4.5L V8 4520cc	2004-2007	SUBARU FORESTER	2.5L H4 2458cc		
	1975-1980	MERCEDES-BENZ 450SLC	4.5L V8 4520cc	2004-2014	SUBARU IMPREZA	2.5L H4 2458cc		
US9177	1977-1982	PORSCHE 924	2.0L L4 1983cc	2005	SAAB 9-2X	2.0L H4 1994cc		
	US9179	1965-1967	NISSAN 411	1.3L L4 1299cc 79 CID	2005-2009	SUBARU LEGACY	2.5L H4 2458cc	
1965-1968		NISSAN 520 PICKUP	1.3L L4 1299cc 79 CID	2005-2009	SUBARU OUTBACK	2.5L H4 2458cc		
1965-1969		NISSAN PICKUP	1.3L L4 1300cc 79 CID	2006	SAAB 9-2X	2.5L H4 2458cc		
1968-1969		NISSAN 521 PICKUP	1.3L L4 1299cc 79 CID	2010	SUBARU FORESTER	2.5L L4 2457cc 150 CID		
1990-1992		NISSAN ICHI VAN	1.8L L4 1800cc 110 CID	2010	SUBARU IMPREZA	2.5L L4 2457cc 150 CID		
1991-1994		NISSAN PICKUP	1.8L L4 1800cc 110 CID	2012-2014	SUBARU WRX	2.5L L4 2457cc 150 CID		
US9180		1967-1971	TOYOTA CROWN	2.3L L6 2253cc 138 CID	2013	SUBARU LEGACY	2.5L L4 2457cc 150 CID	
		1974-1976	TOYOTA MARK II	2.6L L6 2563cc	2015	SUBARU WRX STI	2.5L H4 2458cc	
		1978-1979	TOYOTA CRESSIDA	2.6L L6 2563cc	US9216	1991-1997	TOYOTA PREVIA	2.4L L4 2438cc
		1979	TOYOTA CELICA	2.6L L6 2563cc		US9218	1991-1995	ACURA LEGEND
	US9181	1968-1970	TOYOTA CORONA	1.9L L4 1897cc 116 CID	US9219	1991-2005	ACURA NSX	3.0L V6 2977cc
1979-1980		TOYOTA LAND CRUISER	4.2L L6 4227cc	1997-2005		ACURA NSX	3.2L V6 3179cc	
US9189	1980-1987	PEUGEOT 505	2.0L L4 1971cc	US9220	1990-1991	GEO STORM	1.6L L4 1588cc 98 CID	
US9198	1981-1983	NISSAN 720	2.2L L4 2164cc		1990-1992	ISUZU IMPULSE	1.6L L4 1588cc	
	1983-1986	NISSAN 720	2.5L L4 2488cc 152 CID	1991	ISUZU STYLUS	1.6L L4 1588cc		
US9200	1984-1985	TOYOTA PICKUP	2.4L L4 2446cc	US9221	1990-1993	GEO STORM	1.6L L4 1588cc 98 CID	
US9201	1990-1996	NISSAN 300ZX	3.0L V6 2960cc		1991-1993	ISUZU STYLUS	1.6L L4 1588cc	
	US9202	1986	MERCEDES-BENZ 300SL		3.0L L6 2962cc 180 CID	1992	ISUZU IMPULSE	1.8L L4 1809cc 110 CID
1986-1987		MERCEDES-BENZ 300TE	3.0L L6 2962cc 180 CID		1992	ISUZU STYLUS	1.8L L4 1809cc 110 CID	
1986-1993		MERCEDES-BENZ 300E	3.0L L6 2962cc	1992-1993	GEO STORM	1.8L L4 1809cc 110 CID		
1987		MERCEDES-BENZ 260SE	2.6L L6 2599cc 158 CID	US9222	1990-1992	MERCEDES-BENZ 300CE	3.0L L6 2962cc	
1987-1989		MERCEDES-BENZ 260E	2.6L L6 2599cc		1990-1993	MERCEDES-BENZ 300SL	3.0L L6 2962cc	
1987-1993		MERCEDES-BENZ 190E	2.6L L6 2599cc	US9223	1990-1999	SUBARU LEGACY	2.2L H4 2212cc	
1988-1989		MERCEDES-BENZ 300CE	3.0L L6 2962cc		1993-1997	SUBARU IMPREZA	1.8L H4 1781cc	
1988-1991		MERCEDES-BENZ 300SE	3.0L L6 2962cc		1995-2001	SUBARU IMPREZA	2.2L H4 2212cc	
1988-1991		MERCEDES-BENZ 300SEL	3.0L L6 2962cc		1996-2005	SUBARU LEGACY	2.5L H4 2458cc	
1988-1993		MERCEDES-BENZ 300TE	3.0L L6 2962cc		1998-2005	SUBARU FORESTER	2.5L H4 2458cc	
1989		MERCEDES-BENZ 260SE	2.6L L6 2599cc 158 CID		1998-2005	SUBARU IMPREZA	2.5L H4 2458cc	
1990-1992		MERCEDES-BENZ 300E	2.6L L6 2599cc		2000-2005	SUBARU OUTBACK	2.5L H4 2458cc	
1992		MERCEDES-BENZ 260E	2.6L L6 2599cc 158 CID		2003-2006	SUBARU BAJA	2.5L H4 2458cc	
1993		MERCEDES-BENZ 300CE	3.0L L6 2962cc 180 CID		2005-2006	SAAB 9-2X	2.5L H4 2458cc	
US9203		1966-1969	FIAT 124		1.2L L4 1197cc 73 CID	2008	SUBARU LEGACY	2.0L L4 1987cc 122 CID
		1970-1973	FIAT 124		1.4L L4 1438cc 88 CID	2008-2009	SUBARU IMPREZA	2.0L L4 1983cc 121 CID
		1971-1973	FIAT 124		1.6L L4 1608cc	US9224	1990-1995	ACURA INTEGRA
US9206		1989-1998	NISSAN 240SX	2.4L L4 2389cc	US9225		1990-1991	MAZDA 929
	1990-1994	NISSAN D21	2.4L L4 2389cc	US9226	1990-1991	AUDI V8 QUATTRO	3.6L V8 3562cc	
	1991-1993	NISSAN PICKUP	2.4L L4 2389cc 146 CID	1992-1994	AUDI V8 QUATTRO	4.2L V8 4172cc		
	1991-1994	NISSAN ICHI VAN	2.4L L4 2389cc 146 CID	US9227	1982	SUZUKI SJ410	1.0L L3 993cc 61 CID	

USMWW	Years	Application	Engine	USMWW	Years	Application	Engine
US9227	1983-1984	SUZUKI SJ410	1.0L L4 970cc 59 CID	US9261	1994	BMW M3	3.0L L6 2990cc 182 CID
US9228	1986	MERCEDES-BENZ 250D	2.5L L5 2497cc 152 CID	1995	BMW M3	3.0L L6 2990cc	
	1986	MERCEDES-BENZ 300D	3.0L L5 2998cc 182 CID	1996	BMW 528	2.8L L6 2800cc 173 CID	
	1986-1987	MERCEDES-BENZ 300SDL	3.0L L6 2998cc	1996	BMW M3	3.0L L6 2990cc 182 CID	
	1986-1989	MERCEDES-BENZ 190D	2.5L L5 2497cc	1996-1999	BMW 328IS	2.8L L6 2793cc	
	1987	MERCEDES-BENZ 300D	3.0L L6 2998cc	1996-1999	BMW M3	3.2L L6 3152cc	
	1987	MERCEDES-BENZ 300TD	3.0L L6 2998cc	1996-2000	BMW 328I	2.8L L6 2793cc	
	1990	MERCEDES-BENZ 190DT	2.5L L5 2497cc 152 CID	1997	BMW 728I	2.8L L6 2788cc 170 CID	
	1990-1991	MERCEDES-BENZ 350SDL	3.4L L6 3449cc	1997-2000	BMW 323i	2.5L L6 2494cc 152 CID	
	1990-1993	MERCEDES-BENZ 300D	2.5L L5 2497cc	1997-2000	BMW 528I	2.8L L6 2793cc	
	1991	MERCEDES-BENZ 350SD	3.4L L6 3449cc	1997-2000	BMW Z3	2.8L L6 2793cc	
	1992-1993	MERCEDES-BENZ 300SD	3.4L L6 3449cc	1998-1999	BMW 323iS	2.5L L6 2494cc 152 CID	
	1994-1995	MERCEDES-BENZ S350	3.4L L6 3449cc	1998-2000	BMW Z3	3.2L L6 3152cc	
	1995-1999	MERCEDES-BENZ E300	3.0L L6 2996cc	1999-2002	BMW Z3	2.5L L6 2494cc 152 CID	
US9230	1981	MERCEDES-BENZ 380SLC	3.8L V8 3839cc	2000	BMW 323CI	2.5L L6 2494cc 152 CID	
	1981-1983	MERCEDES-BENZ 380SEL	3.8L V8 3839cc	2000	BMW 328CI	2.8L L6 2793cc	
	1981-1985	MERCEDES-BENZ 380SL	3.8L V8 3839cc	2000	BMW Z3	2.0L L6 1991cc 121 CID	
	1982-1983	MERCEDES-BENZ 380SEC	3.8L V8 3839cc	2001	BMW Z3	2.2L L6 2171cc 132 CID	
	1984-1985	MERCEDES-BENZ 380SE	3.8L V8 3839cc	2001-2002	BMW Z3	3.0L L6 2979cc	
	1984-1985	MERCEDES-BENZ 500SEC	5.0L V8 4973cc	2001-2005	BMW 320I	2.2L L6 2171cc 132 CID	
	1984-1985	MERCEDES-BENZ 500SEL	5.0L V8 4973cc	2001-2005	BMW 325I	2.5L L6 2494cc 152 CID	
	1986	MERCEDES-BENZ 500SE	5.0L V8 4973cc 303 CID	2001-2005	BMW 325XI	2.5L L6 2494cc 152 CID	
	1986	MERCEDES-BENZ 500SL	5.0L V8 4973cc 303 CID	2001-2005	BMW 330I	3.0L L6 2979cc	
	1987	MERCEDES-BENZ 500SEC	5.0L V8 4973cc 303 CID	2001-2005	BMW 330XI	3.0L L6 2979cc	
US9231	1986	MERCEDES-BENZ 420SE	4.2L V8 4196cc 256 CID	2001-2005	BMW 525I	2.5L L6 2494cc 152 CID	
	1986	MERCEDES-BENZ 420SL	4.2L V8 4196cc 256 CID	2001-2005	BMW 530I	3.0L L6 2979cc	
	1986	MERCEDES-BENZ 560SE	5.6L V8 5547cc 338 CID	2001-2006	BMW 325CI	2.5L L6 2494cc 152 CID	
	1986-1989	MERCEDES-BENZ 560SL	5.6L V8 5547cc	2001-2006	BMW 330CI	3.0L L6 2979cc	
	1986-1991	MERCEDES-BENZ 420SEL	4.2L V8 4196cc	2001-2006	BMW X5	3.0L L6 2979cc	
	1986-1991	MERCEDES-BENZ 560SEC	5.6L V8 5547cc	2003-2005	BMW Z4	2.5L L6 2494cc 152 CID	
	1986-1991	MERCEDES-BENZ 560SEL	5.6L V8 5547cc	2003-2005	BMW Z4	3.0L L6 2979cc	
	1994	MERCEDES-BENZ 560SEL	5.6L V8 5547cc 338 CID	2004-2006	BMW X3	3.0L L6 2979cc	
	1996	MERCEDES-BENZ 560SEL	5.6L V8 5547cc 338 CID	2004-2009	BMW X3	2.5L L6 2494cc 152 CID	
US9232	1982	SUZUKI SJ410	1.0L L3 993cc 61 CID	2006-2010	BMW 130I	3.0L L6 2996cc 183 CID	
	1983-1984	SUZUKI SJ410	1.0L L4 970cc 59 CID	2006-2010	BMW 325I	2.5L L6 2497cc 152 CID	
US9234	1986	BMW 525i	2.5L L6 2494cc 152 CID	2006-2010	BMW 525i	2.5L L6 2497cc 152 CID	
	1991-1993	BMW M5	3.6L L6 3553cc	2007	BMW 330I	3.0L L6 2996cc 183 CID	
US9236	1990	BMW 850i	5.0L V12 5000cc 305 CID	2007-2009	BMW Z4	2.5L L6 2494cc 152 CID	
	1991-1992	BMW 850i	5.0L V12 4988cc	2008-2010	BMW 530I	3.0L L6 2996cc 183 CID	
	1993-1994	BMW 850CI	5.0L V12 4988cc	2010	BMW X3	2.5L L6 2497cc 152 CID	
	1994-1995	BMW 850CSI	5.6L V12 5576cc	2011-2013	BMW 325I	2.5L L6 2494cc 152 CID	
	1995	BMW 850	5.0L V12 5000cc 305 CID	US9262	1992-1994	VOLKSWAGEN CORRADO	2.8L V6 2792cc
	1996-1997	BMW 850CI	5.0L V12 5000cc 305 CID	1993-1997	VOLKSWAGEN PASSAT	2.8L V6 2792cc	
US9237	1989-1992	DAIHATSU CHARADE	1.3L L4 1295cc	1994-2002	VOLKSWAGEN JETTA	2.8L V6 2792cc	
US9238	1988-1992	DAIHATSU CHARADE	1.0L L3 993cc 61 CID	1995-2002	VOLKSWAGEN GOLF	2.8L V6 2792cc	
US9239	1990-1993	INFINITI Q45	4.5L V8 4494cc	1997	VOLKSWAGEN EUROVAN	2.8L V6 2792cc	
US9241	1987-1991	PORSCHE 928	5.0L V8 4950cc	1997	VOLKSWAGEN PASSAT	2.8L V6 2788cc 170 CID	
	1993-1995	PORSCHE 928	5.4L V8 5392cc	1999-2002	VOLKSWAGEN EUROVAN	2.8L V6 2792cc	
US9242	1978-1982	PORSCHE 928	4.5L V8 4474cc	2001-2003	VOLKSWAGEN EUROVAN	2.5L L5 2461cc 150 CID	
	1983-1984	PORSCHE 928	4.7L V8 4671cc	2002-2005	SEAT ALHAMBRA	2.8L V6 2792cc 170 CID	
	1985-1986	PORSCHE 928	5.0L V8 4950cc	2007-2008	SEAT ALHAMBRA	2.8L V6 2792cc 170 CID	
US9245	1983-1989	PORSCHE 944	2.5L L4 2475cc	2010	VOLKSWAGEN BORA	2.5L L5 2480cc 151 CID	
	1987-1988	PORSCHE 924	2.5L L4 2475cc	US9263	1992-1994	AUDI 100	2.8L V6 2771cc
US9250	1992-1995	HONDA CIVIC	1.5L L4 1493cc	1992-1994	AUDI 100 QUATTRO	2.8L V6 2771cc	
	1992-1995	HONDA CIVIC	1.6L L4 1590cc 97 CID	1993-1994	AUDI 90 QUATTRO	2.8L V6 2771cc	
US9251	1992-1996	HONDA PRELUDE	2.3L L4 2259cc	1993-1995	AUDI 90	2.8L V6 2771cc	
US9252	1992-1994	NISSAN MAXIMA	3.0L V6 2960cc 181 CID	1994-1995	AUDI CABRIOLET	2.8L V6 2771cc	
US9253	1992-1994	ACURA VIGOR	2.5L L5 2451cc	1995	AUDI A6	2.8L V6 2771cc	
	1995-1998	ACURA TL	2.5L L5 2451cc	1995	AUDI A6 QUATTRO	2.8L V6 2771cc	
US9254	1992-1997	SUBARU SVX	3.3L H6 3318cc	US9264	1990-1994	SAAB 9000	2.3L L4 2290cc 140 CID
US9255	1991-1994	SUBARU LEGACY	2.2L H4 2212cc	1991-1998	SAAB 9000	2.3L L4 2290cc	
	2008-2013	SUBARU FORESTER	2.5L H4 2458cc	US9268	1993-1997	INFINITI J30	3.0L V6 2960cc 181 CID
	2008-2014	SUBARU IMPREZA	2.5L H4 2458cc	US9269	1993-1997	TOYOTA LAND CRUISER	4.5L L6 4477cc
US9256	1992-1999	LEXUS SC300	3.0L L6 2997cc	1996-1997	LEXUS LX450	4.5L L6 4477cc	
	1993-1997	LEXUS GS300	3.0L L6 2997cc	US9270	1993-2001	NISSAN ALTIMA	2.4L L4 2389cc
	1993-1998	TOYOTA SUPRA	3.0L L6 2997cc	US9271	1993-1997	GEO PRIZM	1.6L L4 1588cc 98 CID
US9257	1990-2000	LEXUS LS400	4.0L V8 3969cc	1993-1997	TOYOTA COROLLA	1.6L L4 1587cc	
	1992-2000	LEXUS SC400	4.0L V8 3969cc	US9272	1993-1997	GEO PRIZM	1.8L L4 1788cc 110 CID
	1998-2000	LEXUS GS400	4.0L V8 3969cc	1993-1997	TOYOTA COROLLA	1.8L L4 1762cc 107 CID	
	1998-2007	LEXUS LX470	4.7L V8 4663cc 285 CID	1994-1997	TOYOTA CELICA	1.8L L4 1762cc 107 CID	
	1998-2007	TOYOTA LAND CRUISER	4.7L V8 4663cc 285 CID	US9272-2	1993-1997	GEO PRIZM	1.8L L4 1788cc 110 CID
	2000-2009	TOYOTA TUNDRA	4.7L V8 4663cc 285 CID	1993-1997	TOYOTA COROLLA	1.8L L4 1762cc 107 CID	
	2001-2006	LEXUS LS430	4.3L V8 4293cc	1994-1997	TOYOTA CELICA	1.8L L4 1762cc 107 CID	
	2001-2007	LEXUS GS430	4.3L V8 4293cc	US9273	1993-2001	HONDA PRELUDE	2.2L L4 2156cc
	2001-2009	TOYOTA SEQUOIA	4.7L V8 4663cc 285 CID	US9274	1992-1993	VOLKSWAGEN TRANSPORTER	2.5L L5 2459cc 150 CID
	2002-2010	LEXUS SC430	4.3L V8 4293cc	1992-1996	VOLKSWAGEN EUROVAN	2.5L L5 2459cc 150 CID	
	2003-2009	LEXUS GX470	4.7L V8 4663cc 285 CID	1993-1994	VOLKSWAGEN TRANSPORTER	2.4L L5 2370cc 144 CID	
	2003-2009	TOYOTA 4RUNNER	4.7L V8 4663cc 285 CID	1993-1996	VOLKSWAGEN EUROVAN	2.4L L5 2370cc 144 CID	
US9258	1988-1991	TOYOTA CAMRY	2.5L V6 2508cc	1997	VOLKSWAGEN EUROVAN	2.4L L5 2390cc 146 CID	
	1990-1991	LEXUS ES250	2.5L V6 2508cc	2004	VOLKSWAGEN EUROVAN	2.5L L5 2461cc 150 CID	
	1992-1993	LEXUS ES300	3.0L V6 2959cc	US9274-20	2001-2004	VOLKSWAGEN EUROVAN	2.5L L5 2461cc 150 CID
	1992-1993	TOYOTA CAMRY	3.0L V6 2959cc	2008-2011	VOLKSWAGEN CRAFTER	2.5L L5 2459cc 150 CID	
US9259	1993-1994	FORD PROBE	2.5L V6 2497cc	US9275	1991-1995	BMW 318I	1.8L L4 1796cc
US9260	1992-1995	MAZDA 929	3.0L V6 2954cc 180 CID	1991-1995	BMW 318iS	1.8L L4 1796cc	
US9261	1991-1995	BMW 525i	2.5L L6 2494cc 152 CID	1993-1994	BMW M5	3.4L L6 3430cc 209 CID	
	1992-1995	BMW 325iS	2.5L L6 2494cc 152 CID	1995	BMW 318TI	1.8L L4 1796cc	
	1992-1997	BMW 325i	2.5L L6 2494cc 152 CID	1996-1997	BMW 318iS	1.9L L4 1895cc	
				1996-1998	BMW 318I	1.9L L4 1895cc	
				1996-1998	BMW Z3	1.9L L4 1895cc	

USMW	Years	Application	Engine	USMW	Years	Application	Engine		
US9275	1996-1999	BMW 318TI	1.9L L4 1895cc	US9306	2004	TOYOTA CAMRY	3.3L V6 3300cc		
	1997	BMW 318I	1.8L L4 1800cc 110 CID		2004	TOYOTA HIGHLANDER	3.3L V6 3300cc		
	1999	BMW Z3	1.9L L4 1895cc 116 CID		2004	TOYOTA SOLARA	3.3L V6 3300cc		
US9276	1993-1994	BMW 740I	4.0L V8 3982cc	2004-2006	LEXUS ES330	3.3L V6 3300cc 202 CID			
	1993-1994	BMW 740IL	4.0L V8 3982cc	2004-2006	LEXUS RX330	3.3L V6 3300cc 202 CID			
	1994-1995	BMW 530I	3.0L V8 2997cc	2004-2006	TOYOTA SIENNA	3.3L V6 3300cc 202 CID			
	1994-1995	BMW 540I	4.0L V8 3982cc	2005-2006	TOYOTA CAMRY	3.3L V6 3300cc 202 CID			
				2005-2008	TOYOTA SOLARA	3.3L V6 3300cc 202 CID			
US9277	1991	MERCEDES-BENZ 600SEL	6.0L V12 5987cc 365 CID	2005-2010	TOYOTA HIGHLANDER	3.3L V6 3300cc 202 CID			
	1992-1993	MERCEDES-BENZ 600SEL	6.0L V12 5987cc	2006-2008	LEXUS RX400H	3.3L V6 3300cc 202 CID			
	1993	MERCEDES-BENZ 600SEC	6.0L V12 5987cc	US9307	1994-1998	SAAB 900	2.0L L4 1985cc		
	1993	MERCEDES-BENZ 600SL	6.0L V12 5987cc		1994-1998	SAAB 900	2.3L L4 2290cc 140 CID		
	1994-1997	MERCEDES-BENZ 600SEC	6.0L V12 5987cc 365 CID		1999-2002	SAAB 9-3	2.3L L4 2290cc 140 CID		
					1999-2003	SAAB 9-3	2.0L L4 1985cc		
					1999-2009	SAAB 9-5	2.3L L4 2290cc 140 CID		
	1994-1997	MERCEDES-BENZ 600SEL	6.0L V12 5987cc 365 CID	US9309	1995-2001	NISSAN MAXIMA	3.0L V6 2988cc 182 CID		
	1994-1999	MERCEDES-BENZ S600	6.0L V12 5987cc		1996-2001	INFINITI I30	3.0L V6 2988cc 182 CID		
	1994-2002	MERCEDES-BENZ SL600	6.0L V12 5987cc		2001-2003	INFINITI QX4	3.5L V6 3498cc		
1996-1997	MERCEDES-BENZ 600CL	6.0L V12 5987cc 365 CID	2001-2004		NISSAN PATHFINDER	3.5L V6 3498cc			
1998-1999	MERCEDES-BENZ CL600	6.0L V12 5987cc	US9310	1994-1996	MINI COOPER	3.5L V6 3497cc 215 CID			
2003	MERCEDES-BENZ CL600	5.8L V12 5786cc 353 CID		US9311	1996-1997	MERCEDES-BENZ C36 AMG	3.6L L6 3606cc		
US9278	1992-1997	ISUZU TROOPER	3.2L V6 3165cc		US9313	1993	MERCEDES-BENZ 300CE	3.2L L6 3199cc	
	1993-1997	ISUZU RODEO	3.2L V6 3165cc	1993		MERCEDES-BENZ 300E	2.8L L6 2799cc		
	1994-1997	HONDA PASSPORT	3.2L V6 3165cc	1993		MERCEDES-BENZ 300E	3.2L L6 3199cc		
	1996-1997	ACURA SLX	3.2L V6 3165cc	1993		MERCEDES-BENZ 300TE	3.2L L6 3199cc		
US9279	1992-1994	AUDI S4	2.2L L5 2226cc	1994-1995	MERCEDES-BENZ C280	2.8L L6 2799cc			
	1995	AUDI S6	2.2L L5 2226cc	1994-1995	MERCEDES-BENZ E320	3.2L L6 3199cc			
				1994-1996	MERCEDES-BENZ SL320	3.2L L6 3199cc			
US9280	1993-1994	JAGUAR VANDEN PLAS	4.0L L6 3980cc	US9314	1994	MERCEDES-BENZ 220E	2.2L L4 2199cc 134 CID		
	1993-1994	JAGUAR XJ6	4.0L L6 3980cc		1994-1996	MERCEDES-BENZ C220	2.2L L4 2199cc		
	1993-1994	JAGUAR XJS	4.0L L6 3980cc		1997	MERCEDES-BENZ SLK230	2.3L L4 2295cc 140 CID		
US9282	1967-1972	RENAULT R10	1.3L L4 1300cc 79 CID	1997-1998	MERCEDES-BENZ C230	2.3L L4 2295cc			
	1968-1975	RENAULT R8S	1.3L L4 1300cc 79 CID	US9315	1989	MERCEDES-BENZ 500SL	5.0L V8 4973cc 303 CID		
	1971-1983	RENAULT R12	1.3L L4 1300cc 79 CID		1990-1993	MERCEDES-BENZ 500SL	5.0L V8 4973cc		
	1977-1984	RENAULT R5	1.3L L4 1300cc 79 CID		1991	MERCEDES-BENZ 500E	5.0L V8 4973cc 303 CID		
	1979-1983	RENAULT R5	1.3L L4 1289cc 79 CID		1991	MERCEDES-BENZ 500SEL	5.0L V8 4973cc 303 CID		
	1980-1982	RENAULT R12	1.3L L4 1289cc 79 CID		1992	MERCEDES-BENZ 400SE	4.2L V8 4196cc		
	1985	NISSAN TSURU	1.5L L4 1488cc		1992-1993	MERCEDES-BENZ 400E	4.2L V8 4196cc		
1986-1987	NISSAN TSURU	1.6L L4 1597cc 97 CID	1992-1993		MERCEDES-BENZ 500E	5.0L V8 4973cc			
1988-1992	NISSAN HIKARI	1.6L L4 1597cc 97 CID	1992-1993	MERCEDES-BENZ 500SEL	5.0L V8 4973cc				
US9288	1993-1995	ACURA LEGEND	3.2L V6 3206cc	1993	MERCEDES-BENZ 400SEL	4.2L V8 4196cc			
US9289	1994-1995	ACURA INTEGRA	1.8L L4 1797cc	1993	MERCEDES-BENZ 500SEC	5.0L V8 4973cc			
US9291	1993-1994	TOYOTA T100	3.0L V6 2959cc	1994	MERCEDES-BENZ 500SEL	5.0L V8 4973cc 303 CID			
	1993-1995	TOYOTA 4RUNNER	3.0L V6 2959cc	1994	MERCEDES-BENZ E500	5.0L V8 4973cc			
	1993-1995	TOYOTA PICKUP	3.0L V6 2959cc	1994-1995	MERCEDES-BENZ E420	4.2L V8 4196cc			
US9292	1992-2000	LEXUS SC300	3.0L L6 2997cc	1994-1995	MERCEDES-BENZ S420	4.2L V8 4196cc			
	1993-1998	TOYOTA SUPRA	3.0L L6 2997cc	1994-1995	MERCEDES-BENZ S500	5.0L V8 4973cc			
US9293	1994-1998	TOYOTA T100	2.7L L4 2694cc	1994-1996	MERCEDES-BENZ SL500	5.0L V8 4973cc			
	1995-2004	TOYOTA TACOMA	2.4L L4 2438cc	US9318	1992-1994	MAZDA MX-3	1.8L V6 1845cc		
	1995-2017	TOYOTA TACOMA	2.7L L4 2694cc		1993-1997	MAZDA MX-6	2.5L V6 2497cc		
	1996-2000	TOYOTA 4RUNNER	2.7L L4 2694cc		1993-2002	MAZDA 626	2.5L V6 2497cc		
	2004-2010	TOYOTA HILUX	2.7L L4 2694cc 164 CID		1995-1997	FORD PROBE	2.5L V6 2497cc		
	2006-2009	TOYOTA HIACE	2.7L L4 2694cc 164 CID		1995-2001	MAZDA MILLENIA	2.5L V6 2497cc		
	2010	TOYOTA 4RUNNER	2.7L L4 2694cc		2002	MAZDA MILLENIA	2.5L V6 2450cc 155 CID		
	2011-2012	TOYOTA HIACE	2.7L L4 2694cc 164 CID		US9320	1993-1994	TOYOTA T100	3.0L V6 2959cc	
	US9299	1966-1969	MERCEDES-BENZ 230			2.3L L6 2306cc 141 CID	1993-1995	TOYOTA 4RUNNER	3.0L V6 2959cc
		1968-1969	MERCEDES-BENZ 300SEL			2.8L L6 2778cc	1993-1995	TOYOTA PICKUP	3.0L V6 2959cc
1968-1972		MERCEDES-BENZ 250	2.5L L6 2496cc 152 CID		US9321	1992-1993	ACURA INTEGRA	1.7L L4 1678cc	
1969-1971		MERCEDES-BENZ 280S	2.8L L6 2778cc	1994-1995		HONDA CIVIC DEL SOL	1.6L L4 1590cc 97 CID		
1969-1971		MERCEDES-BENZ 280SEL	2.8L L6 2778cc	US9324	1995-1998	TOYOTA T100	3.4L V6 3378cc		
1969-1971		MERCEDES-BENZ 280SL	2.8L L6 2778cc		1995-2004	TOYOTA TACOMA	3.4L V6 3378cc		
1969-1972		MERCEDES-BENZ 280SE	2.8L L6 2778cc		1996-2002	TOYOTA 4RUNNER	3.4L V6 3378cc		
1970-1972		MERCEDES-BENZ 250C	2.8L L6 2778cc	2000-2004	TOYOTA TUNDRA	3.4L V6 3378cc			
1973-1976		MERCEDES-BENZ 280	2.8L L6 2746cc	US9325	1995-1998	TOYOTA T100	3.4L V6 3378cc		
1973-1976		MERCEDES-BENZ 280C	2.8L L6 2746cc		1995-2000	TOYOTA TACOMA	3.4L V6 3378cc		
1975-1976		MERCEDES-BENZ 280S	2.8L L6 2746cc	2000-2004	TOYOTA TUNDRA	3.4L V6 3378cc			
1977-1980		MERCEDES-BENZ 280SE	2.8L L6 2746cc	US9327	1977-1979	TOYOTA LAND CRUISER	4.2L L6 4227cc		
1978-1980		MERCEDES-BENZ 280CE	2.8L L6 2746cc		US9328	1995-2002	MAZDA MILLENIA	2.3L V6 2254cc	
1978-1980		MERCEDES-BENZ 280E	2.8L L6 2746cc	US9332		1994-1995	BMW 840CI	4.0L V8 3982cc	
US9300		1977	MAZDA 808		1.6L L4 1587cc	1995	BMW 740I	4.0L V8 3982cc	
		US9301	1979-1983		RENAULT R5	1.3L L4 1289cc 79 CID	1995	BMW 740IL	4.0L V8 3982cc
			1993-1996	INFINITI Q45	4.5L V8 4494cc	1996	BMW 540I	4.0L V8 3982cc 243 CID	
US9304		1994-1995	MAZDA MX-3	1.6L L4 1597cc	US9333	1995	AUDI 90	2.8L V6 2771cc	
	1994-1997	MAZDA MIATA	1.8L L4 1839cc	1995		AUDI 90 QUATTRO	2.8L V6 2771cc		
	1995	MAZDA PROTEGE	1.5L L4 1489cc	1995-1998		AUDI CABRIOLET	2.8L V6 2771cc		
	1995-1997	KIA SEPHIA	1.6L L4 1597cc	1995-2001		AUDI A6	2.8L V6 2771cc		
	1995-1997	KIA SEPHIA	1.8L L4 1839cc	1995-2001		AUDI A6 QUATTRO	2.8L V6 2771cc		
	1995-1998	MAZDA PROTEGE	1.8L L4 1839cc	1996-2001		AUDI A4	2.8L V6 2771cc		
	1999-2001	MAZDA PROTEGE	1.6L L4 1589cc	1996-2001		AUDI A4 QUATTRO	2.8L V6 2771cc		
	1999-2005	MAZDA MIATA	1.8L L4 1839cc	1998-2005		VOLKSWAGEN PASSAT	2.8L V6 2771cc		
	US9306	1994-1995	LEXUS ES300	3.0L V6 2995cc		2000	VOLKSWAGEN PASSAT	2.8L V6 2771cc 170 CID	
		1994-2006	TOYOTA CAMRY	3.0L V6 2995cc		US9334	1994	TOYOTA TERCEL	1.5L L4 1456cc
		1995-2004	TOYOTA AVALON	3.0L V6 2995cc			1995-1998	TOYOTA PASEO	1.5L L4 1497cc
		1996-1998	LEXUS ES300	3.0L V6 2995cc			1995-1998	TOYOTA TERCEL	1.5L L4 1497cc
1998-2003		TOYOTA SIENNA	3.0L V6 2995cc	US9337	1981-1987		TOYOTA LAND CRUISER	4.2L L6 4227cc	
1999-2003		LEXUS ES300	3.0L V6 2995cc		US9338		1996-2000	NISSAN PATHFINDER	3.3L V6 3275cc
1999-2003		LEXUS RX300	3.0L V6 2995cc	1997-2000			INFINITI QX4	3.3L V6 3275cc	
1999-2003		TOYOTA SOLARA	3.0L V6 2995cc	1999-2004			NISSAN FRONTIER	3.3L V6 3275cc	
2001-2003		TOYOTA HIGHLANDER	3.0L V6 2995cc	2000-2004			NISSAN XTERRA	3.3L V6 3275cc	

USMW	Years	Application	Engine	USMW	Years	Application	Engine
US9339	1992-1994	VOLVO 960	2.9L L6 2922cc	US9352	1996-2000	HONDA CIVIC	1.6L L4 1590cc
	1993-1997	VOLVO 850	2.4L L5 2435cc		1996-2000	HONDA CIVIC	1.6L L4 1590cc 97 CID
	1994-1997	VOLVO 850	2.3L L5 2319cc	US9353	1996-1997	HYUNDAI ELANTRA	1.8L L4 1795cc
	1998-2000	VOLVO S70	2.3L L5 2319cc		1997	HYUNDAI TIBURON	1.8L L4 1795cc
	1998-2000	VOLVO S70	2.4L L5 2435cc		1997	HYUNDAI TIBURON	2.0L L4 1975cc
	1998-2004	VOLVO C70	2.3L L5 2319cc		1998	HYUNDAI ELANTRA	1.8L L4 1796cc
	1998-2004	VOLVO C70	2.4L L5 2435cc		1998-1999	HYUNDAI TIBURON	2.0L L4 1997cc
	1998-2004	VOLVO V70	2.3L L5 2319cc		1999-2000	HYUNDAI ELANTRA	2.0L L4 1975cc
	1998-2007	VOLVO V70	2.4L L5 2435cc	US9354	1996-2004	ACURA RL	3.5L V6 3475cc
	1999	VOLVO S40	1.9L L4 1948cc 119 CID	US9356	1993-1996	JAGUAR XJS	4.0L L6 3980cc
	1999	VOLVO V40	1.9L L4 1948cc 119 CID	1995-1997	JAGUAR VANDEN PLAS	4.0L L6 3980cc	
	2000-2004	VOLVO S40	1.9L L4 1948cc	1995-1997	JAGUAR XJ6	4.0L L6 3980cc	
	2000-2004	VOLVO V40	1.9L L4 1948cc	1995-1997	JAGUAR XJR	4.0L L6 3980cc	
	2001-2004	VOLVO S60	2.3L L5 2319cc	US9359	1997-2002	MITSUBISHI MIRAGE	1.5L L4 1468cc 90 CID
	2001-2009	VOLVO S60	2.4L L5 2435cc	US9360	1997-2002	MITSUBISHI MIRAGE	1.8L L4 1834cc 112 CID
	2003-2006	VOLVO XC90	2.5L L5 2521cc	2002-2004	MITSUBISHI LANCER	2.0L L4 2000cc	
	2003-2006	VOLVO XC90	2.8L L6 2783cc 170 CID	2003-2004	MITSUBISHI SPACE STAR	1.8L L4 1755cc 107 CID	
	2003-2007	VOLVO V70	2.5L L5 2521cc	2005-2007	MITSUBISHI LANCER	2.0L L4 1995cc 122 CID	
	2003-2007	VOLVO XC70	2.5L L5 2521cc	US9362	1997-1999	AUDI A8	3.7L V8 3697cc
	2003-2009	VOLVO S60	2.5L L5 2521cc	1997-1999	AUDI A8 QUATTRO	4.2L V8 4172cc	
	2004-2006	VOLVO S80	2.5L L5 2521cc	US9364	1996-1997	HYUNDAI ACCENT	1.5L L4 1495cc
	2004-2006	VOLVO S80	2.8L L6 2783cc 170 CID	2001-2002	HYUNDAI ACCENT	1.5L L4 1495cc	
	2004-2010	VOLVO S40	2.4L L5 2435cc	2001-2005	HYUNDAI ACCENT	1.6L L4 1600cc	
	2004-2011	VOLVO S40	2.5L L5 2521cc	2004-2006	DODGE VERNA	1.6L L4 1598cc 97 CID	
	2005-2010	VOLVO V50	2.4L L5 2435cc	2006-2010	DODGE ATTITUDE	1.6L L4 1598cc 97 CID	
	2005-2011	VOLVO V50	2.5L L5 2521cc	2006-2011	HYUNDAI ACCENT	1.6L L4 1599cc	
	2006-2013	VOLVO C70	2.5L L5 2521cc	2006-2011	KIA RIO	1.6L L4 1599cc	
	2007	VOLVO XC90	2.5L L5 2521cc 154 CID	2006-2011	KIA RIO5	1.6L L4 1599cc	
	2007-2011	FORD FOCUS	2.5L L5 2521cc 154 CID	2011	DODGE ATTITUDE	1.6L L4 1599cc 98 CID	
	2008-2009	VOLVO C30	2.4L L5 2400cc 146 CID	US9365	1998-1999	ACURA SLX	3.5L V6 3494cc
	2008-2013	VOLVO C30	2.5L L5 2521cc	1998-2000	ISUZU AMIGO	3.2L V6 3165cc	
	2012-2016	VOLVO S60	2.5L L5 2521cc	1998-2002	HONDA PASSPORT	3.2L V6 3165cc	
	2015-2016	VOLVO V60	2.5L L5 2521cc	1998-2002	ISUZU TROOPER	3.5L V6 3475cc	
	2015-2016	VOLVO V60 CROSS COUNTRY	2.5L L5 2521cc	1998-2004	ISUZU RODEO	3.2L V6 3165cc	
	2015-2016	VOLVO XC60	2.5L L5 2521cc	1999-2001	ISUZU VEHICROSS	3.5L V6 3475cc	
	2016	VOLVO S60 CROSS COUNTRY	2.5L L5 2521cc	2001-2003	ISUZU RODEO SPORT	3.2L V6 3165cc	
	2016	VOLVO XC70	2.5L L5 2521cc	2002	ISUZU AXIOM	3.5L V6 3475cc	
	US9340	1995-1997	VOLVO 960	2.9L L6 2922cc	2003	ISUZU AXIOM	3.5L V6 3491cc
		1997-1998	VOLVO S90	2.9L L6 2917cc	2004	ISUZU AXIOM	3.5L V6 3494cc
		1997-1998	VOLVO V90	2.9L L6 2917cc	2004	ISUZU RODEO	3.5L V6 3494cc
	US9342	1996-1998	SUZUKI SIDEKICK	1.8L L4 1840cc	US9368	1987-1988	LAND ROVER RANGE ROVER
	1999-2002	SUZUKI ESTEEM	1.8L L4 1790cc	1989-1992	LAND ROVER RANGE ROVER	3.9L V8 3947cc	
	1999-2003	CHEVROLET TRACKER	2.0L L4 122 CID	1993	LAND ROVER DEFENDER 110	3.9L V8 3950cc	
	1999-2003	SUZUKI VITARA	2.0L L4 2000cc	1993-1995	LAND ROVER RANGE ROVER	3.9L V8 3950cc	
	2002-2003	SUZUKI AERIO	2.0L L4 2000cc	1993-1995	LAND ROVER RANGE ROVER	4.2L V8 4200cc	
	2004-2007	SUZUKI AERIO	2.3L L4 2290cc 140 CID	1994-1995	LAND ROVER DEFENDER 90	3.9L V8 3950cc	
	2005-2008	CHEVROLET TRACKER	2.0L L4 1983cc 121 CID	US9369	1993-1995	LAND ROVER RANGE ROVER	3.9L V8 3950cc
	2007-2009	SUZUKI SX4	2.0L L4 1995cc	1993-1995	LAND ROVER RANGE ROVER	4.2L V8 4200cc	
US9343	1992-1993	MERCEDES-BENZ 300SE	3.2L L6 3199cc	1994-1995	LAND ROVER DISCOVERY	3.9L V8 3950cc	
	1994-1996	MERCEDES-BENZ S320	3.2L L6 3199cc	1995-2000	LAND ROVER RANGE ROVER	4.0L V8 3950cc	
US9344	1996-1997	MERCEDES-BENZ C280	2.8L L6 2799cc	1996-2002	LAND ROVER DISCOVERY	4.0L V8 3950cc	
	1996-1997	MERCEDES-BENZ E320	3.2L L6 3199cc	1996-2002	LAND ROVER RANGE ROVER	4.6L V8 4554cc 278 CID	
	1997	MERCEDES-BENZ SL320	3.2L L6 3199cc	1997	LAND ROVER DEFENDER 90	4.0L V8 3950cc	
	1999	MERCEDES-BENZ E280	2.8L L6 2800cc 171 CID	2003-2004	LAND ROVER DISCOVERY	4.6L V8 4554cc 278 CID	
US9345	1993	MERCEDES-BENZ 280E	2.8L L6 2799cc 171 CID	US9371	1996-1998	MAZDA PROTEGE	1.5L L4 1489cc
	1993	MERCEDES-BENZ 300CE	3.2L L6 3199cc	US9374	1997-2000	SUZUKI ESTEEM	1.6L L4 1590cc 97 CID
	1993	MERCEDES-BENZ 300E	3.2L L6 3199cc	1999-2000	CHEVROLET TRACKER	1.6L L4 1588cc 98 CID	
	1993	MERCEDES-BENZ 300TE	3.2L L6 3199cc	1999-2001	SUZUKI VITARA	1.6L L4 1590cc 97 CID	
	1994-1995	MERCEDES-BENZ E320	3.2L L6 3199cc	2007-2009	SUZUKI SWIFT	1.5L L4 1500cc 92 CID	
	1994-1996	MERCEDES-BENZ SL320	3.2L L6 3199cc	US9375	1998-2000	ISUZU AMIGO	2.2L L4 2180cc
	1995	MERCEDES-BENZ C36 AMG	3.6L L6 3606cc	1998-2003	ISUZU RODEO	2.2L L4 2180cc	
	1995	MERCEDES-BENZ C280	2.8L L6 2799cc	1999-2002	DAEWOO LEGANZA	2.2L L4 2200cc	
US9346	1992	MERCEDES-BENZ 400SE	4.2L V8 4196cc	1999-2002	DAEWOO NUBIRA	2.0L L4 1998cc	
	1992-1993	MERCEDES-BENZ 400E	4.2L V8 4196cc	2001-2003	ISUZU RODEO SPORT	2.2L L4 2180cc	
	1992-1993	MERCEDES-BENZ 500E	5.0L V8 4973cc	US9376	1998-2002	CHEVROLET PRIZM	1.8L L4 110 CID
	1992-1993	MERCEDES-BENZ 500SEL	5.0L V8 4973cc	1998-2008	TOYOTA COROLLA	1.8L L4 1794cc	
	1993	MERCEDES-BENZ 400SEL	4.2L V8 4196cc	2000-2005	TOYOTA CELICA	1.8L L4 1794cc	
	1993	MERCEDES-BENZ 500SEC	5.0L V8 4973cc	2000-2006	TOYOTA MR2 SPYDER	1.8L L4 1794cc	
	1993	MERCEDES-BENZ 500SL	5.0L V8 4973cc	2003-2008	TOYOTA MATRIX	1.8L L4 1794cc	
	1994	MERCEDES-BENZ 400E	4.2L V8 4196cc 256 CID	US9377	1998-2011	VOLKSWAGEN BEETLE	2.0L L4 1984cc 121 CID
	1994	MERCEDES-BENZ E500	5.0L V8 4973cc	1999-2001	AUDI A3	1.8L L4 1754cc 107 CID	
	1994-1995	MERCEDES-BENZ E420	4.2L V8 4196cc	1999-2005	VOLKSWAGEN BEETLE	1.8L L4 1781cc	
	1994-1999	MERCEDES-BENZ S420	4.2L V8 4196cc	1999-2007	VOLKSWAGEN GOLF	2.0L L4 1984cc 121 CID	
	1994-1999	MERCEDES-BENZ S500	5.0L V8 4973cc	1999-2015	VOLKSWAGEN JETTA	2.0L L4 1984cc 121 CID	
	1994-1999	MERCEDES-BENZ SL500	5.0L V8 4973cc	2000-2001	AUDI S3 QUATTRO	1.8L L4 1754cc 107 CID	
	1995	MERCEDES-BENZ 400SEL	4.2L V8 4196cc 256 CID	2000-2003	VOLKSWAGEN POINTER	2.0L L4 1984cc 121 CID	
	1995-1997	MERCEDES-BENZ 500SEL	5.0L V8 4973cc 303 CID	2000-2005	VOLKSWAGEN JETTA	1.8L L4 1781cc	
	1996-1997	MERCEDES-BENZ 400SE	4.2L V8 4196cc 256 CID	2000-2005	VOLKSWAGEN PASSAT	1.8L L4 1781cc	
	1996-1997	MERCEDES-BENZ 420SL	4.2L V8 4196cc 256 CID	2000-2006	AUDI TT	1.8L L4 1781cc	
	1996-1997	MERCEDES-BENZ 500CL	5.0L V8 4973cc 303 CID	2000-2006	AUDI TT QUATTRO	1.8L L4 1781cc	
	1996-1997	MERCEDES-BENZ 500SEC	5.0L V8 4973cc 303 CID	2000-2006	VOLKSWAGEN GOLF	1.8L L4 1781cc	
	1997	MERCEDES-BENZ 400SEL	4.2L V8 4196cc 256 CID	2001-2003	SEAT LEON	1.8L L4 1781cc 108 CID	
	1997	MERCEDES-BENZ E420	4.2L V8 4196cc	2001-2003	SEAT TOLEDO	1.8L L4 1781cc 108 CID	
	1998-1999	MERCEDES-BENZ CL500	5.0L V8 4973cc	2001-2005	AUDI A4 QUATTRO	1.8L L4 1781cc	
US9348	1996-1998	ACURA TL	3.2L V6 3206cc	2001-2006	AUDI A4	1.8L L4 1781cc	
US9349	1996-2001	ACURA INTEGRA	1.8L L4 1834cc	2002-2003	SEAT ALHAMBRA	1.8L L4 1781cc 108 CID	
	1997-2001	HONDA CR-V	2.0L L4 1972cc	2002-2003	VOLKSWAGEN DERBY	2.0L L4 1984cc 121 CID	
US9351	1997-1999	MERCEDES-BENZ S320	3.2L L6 3199cc	2002-2004	AUDI A3	1.8L L4 1781cc 108 CID	
US9352	1996-1997	HONDA CIVIC DEL SOL	1.6L L4 1590cc 97 CID	2002-2004	AUDI S3 QUATTRO	1.8L L4 1781cc 108 CID	

USMW	Years	Application	Engine	USMW	Years	Application	Engine											
US9377	2002-2008	VOLKSWAGEN SHARAN	1.8L L4 1781cc 109 CID	US9380	2006	MERCEDES-BENZ ML500	5.0L V8 4966cc											
	2003	SEAT ALHAMBRA	1.8L L4 1798cc 110 CID		2006-2008	MERCEDES-BENZ G500	5.0L V8 4966cc											
	2003-2005	SEAT TOLEDO	1.8L L4 1781cc 109 CID		2007	MERCEDES-BENZ C55 AMG	5.5L V8 5439cc 332 CID											
	2003-2007	VOLKSWAGEN POLO	2.0L L4 1984cc 121 CID		2007	MERCEDES-BENZ ML500	5.0L V8 4966cc 303 CID											
	2003-2009	SEAT CORDOBA	2.0L L4 1984cc 121 CID		2007-2011	MERCEDES-BENZ S500L	5.5L V8 5461cc 333 CID											
	2003-2009	VOLKSWAGEN POINTER	1.8L L4 1781cc 109 CID		2008-2009	MERCEDES-BENZ S600L	5.5L V12 5513cc 336 CID											
	2003-2012	SEAT IBIZA	2.0L L4 1984cc 121 CID		2008-2010	MERCEDES-BENZ CL500	5.5L V8 5461cc 333 CID											
	2004	SEAT TOLEDO	1.8L L4 1798cc 110 CID		2008-2011	MERCEDES-BENZ CLS500	5.5L V8 5461cc 333 CID											
	2004-2005	AUDI A3	2.0L L4 1984cc 121 CID		2008-2011	MERCEDES-BENZ E500	5.5L V8 5461cc 333 CID											
	2004-2006	SEAT LEON	1.8L L4 1781cc 109 CID		2008-2011	MERCEDES-BENZ GL500	5.5L V8 5461cc 333 CID											
	2004-2007	SEAT ALHAMBRA	1.8L L4 1781cc 109 CID		2008-2011	MERCEDES-BENZ SL500	5.5L V8 5461cc 333 CID											
	2005	AUDI A3	2.0L L4 1998cc 122 CID		US9382	1999-2001	VOLVO S80	2.8L L6 2798cc										
	2005	SEAT IBIZA	1.8L L4 1798cc 110 CID			1999-2002	VOLVO S80	2.9L L6 2917cc										
	2005-2006	SEAT ALTEA	2.0L L4 1984cc 121 CID			1997-1999	ACURA CL	3.0L V6 2997cc										
	2006	SEAT TOLEDO	2.0L L4 1984cc 121 CID			1998-2002	HONDA ACCORD	3.0L V6 2997cc										
	2006	VOLKSWAGEN BORA	2.0L L4 1984cc 121 CID			1999-2003	ACURA TL	3.2L V6 3210cc										
	2006-2007	SEAT LEON	2.0L L4 2000cc 122 CID			1999-2004	HONDA ODYSSEY	3.5L V6 3474cc										
	2006-2008	SEAT IBIZA	1.8L L4 1781cc 108 CID			2001-2002	ACURA MDX	3.5L V6 3471cc										
	2007	AUDI TT	2.0L L4 1998cc 122 CID			2001-2003	ACURA CL	3.2L V6 3210cc										
	2007	SEAT LEON	2.0L L4 1984cc 121 CID			2003-2004	HONDA PILOT	3.5L V6 3475cc										
	2007	VOLKSWAGEN GLI	2.0L L4 1984cc 121 CID			US9384	2011-2015	SUBARU FORESTER	2.5L H4 2498cc 152 CID									
	2007-2009	AUDI A4	1.8L L4 1781cc 108 CID				2012-2015	SUBARU IMPREZA	2.0L H4 1995cc									
	2008-2009	SEAT ALTEA	2.0L L4 1984cc 121 CID				2013-2015	SUBARU BRZ	2.0L H4 1998cc 122 CID									
	2008-2009	SEAT LEON	2.0L L4 1998cc 122 CID				2013-2015	SUBARU LEGACY	2.5L H4 2498cc 152 CID									
	2008-2010	AUDI A3	1.8L L4 1781cc 108 CID				2013-2015	SUBARU OUTBACK	2.5L H4 2498cc 152 CID									
	2008-2011	AUDI S3 QUATTRO	2.0L L4 1998cc 122 CID				2013-2015	SUBARU XV CROSSTREK	2.0L H4 1995cc									
	2009	SEAT FREETRACK	2.0L L4 1998cc 122 CID				2013-2016	SCION FR-S	2.0L H4 1998cc 122 CID									
	2009	VOLKSWAGEN JETTA	1.8L L4 1781cc 109 CID				2014	SUBARU FORESTER	2.5L L4 2498cc 152 CID									
	2009-2010	SEAT LEON	1.8L L4 1798cc 110 CID				2017	TOYOTA 86	2.0L H4 1998cc 122 CID									
	2010	AUDI TT	2.0L L4 1998cc 122 CID				US9385	1999-2005	SUZUKI GRAND VITARA	2.5L V6 2500cc								
	2010	SEAT LEON	2.0L L4 1984cc 121 CID					2001	SUZUKI GRAND VITARA	2.7L V6 2737cc								
	US9378	1998-2003	VOLKSWAGEN BEETLE					1.9L L4 1896cc 116 CID	2001-2004	CHEVROLET TRACKER	2.5L V6 2500cc							
		1999-2004	VOLKSWAGEN GOLF					1.9L L4 1896cc 116 CID	2002-2006	SUZUKI XL-7	2.7L V6 2737cc							
1999-2004		VOLKSWAGEN JETTA	1.9L L4 1896cc 116 CID	2004				SUZUKI VITARA	2.5L V6 2500cc									
2001		SEAT IBIZA	1.6L L4 1600cc 98 CID	2006-2008				SUZUKI GRAND VITARA	2.7L V6 2737cc									
2004		SEAT IBIZA	1.6L L4 1600cc 98 CID	US9388				1997-2001	INFINITI Q45	4.1L V8 4130cc								
2007		SEAT CORDOBA	1.6L L4 1600cc 98 CID					US9389	1997-1999	MINI MONTERO SPORT	2.4L L4 2351cc							
2008		VOLKSWAGEN JETTA	1.9L L4 1896cc 116 CID						2008-2009	DODGE VAN 1000	2.4L L4 2429cc 148 CID							
2009		VOLKSWAGEN EUROVAN	1.9L L4 1896cc 116 CID						US9393	1998-2001	KIA SEPIA	1.8L L4 1793cc						
US9379		1998-1999	MERCEDES-BENZ S430							4.3L V8 4266cc 260 CID	2000-2004	KIA SPECTRA	1.8L L4 1793cc					
		1998-2000	MERCEDES-BENZ C43 AMG							4.3L V8 4266cc	US9394	1996-1998	MAZDA MPV	3.0L V6 2954cc 180 CID				
		1998-2000	MERCEDES-BENZ C280							2.8L V6 2799cc		US9395	1998-2004	LEXUS GS300	3.0L L6 2997cc			
		1998-2002	MERCEDES-BENZ E430							4.3L V8 4266cc			2001-2005	LEXUS IS300	3.0L L6 2997cc			
		1998-2003	MERCEDES-BENZ ML320							3.2L V6 3199cc			US9399	1999-2003	MINI GALANT	2.4L L4 2351cc		
		1998-2005	MERCEDES-BENZ CLK320		3.2L V6 3199cc					1999-2005				HYUNDAI SONATA	2.4L L4 2351cc			
		1998-2005	MERCEDES-BENZ E320		3.2L V6 3199cc					2000-2005				MINI ECLIPSE	2.4L L4 2351cc			
		1999-2003	MERCEDES-BENZ CLK430		4.3L V8 4266cc					2001-2004				HYUNDAI SANTA FE	2.4L L4 2351cc			
		2000	MERCEDES-BENZ G500L		5.0L V8 4973cc 303 CID					2001-2005				CHRYSLER SEBRING	2.4L L4 2351cc			
		2000-2005	MERCEDES-BENZ CL500		5.0L V8 4973cc					2001-2005				DODGE STRATUS	2.4L L4 2351cc			
		2000-2005	MERCEDES-BENZ SL500		5.0L V8 4973cc					2001-2006				KIA OPTIMA	2.4L L4 2351cc			
		2000-2006	MERCEDES-BENZ S430		4.3L V8 4266cc					2007-2009				MINI GRANDIS	2.4L L4 2378cc 145 CID			
		2000-2006	MERCEDES-BENZ S500		5.0L V8 4966cc					2008-2012				MINI L200	2.4L L4 2378cc 145 CID			
		2001-2004	MERCEDES-BENZ SLK320		3.2L V6 3199cc					US9401				1997-2000	AUDI A4	1.8L L4 1781cc		
		2001-2005	MERCEDES-BENZ C240		2.6L V6 2597cc	1997-2000								AUDI A4 QUATTRO	1.8L L4 1781cc			
		2001-2005	MERCEDES-BENZ C320		3.2L V6 3199cc	1998-2000								VOLKSWAGEN PASSAT	1.8L L4 1781cc			
		2002-2004	MERCEDES-BENZ G500		5.0L V8 4966cc	US9402								1999-2002	MERCURY VILLAGER	3.3L V6 3275cc		
		2003-2005	MERCEDES-BENZ CLK500		5.0L V8 4973cc									1999-2002	NISSAN QUEST	3.3L V6 3275cc		
		2003-2005	MERCEDES-BENZ E500		5.0L V8 4973cc									US9403	2000-2003	HONDA S2000	2.0L L4 1997cc	
		2003-2005	MERCEDES-BENZ ML350		3.7L V6 3699cc										2004-2009	HONDA S2000	2.2L L4 2157cc	
		2004-2006	MERCEDES-BENZ E500		5.0L V8 4966cc										US9405	2000-2005	TOYOTA CELICA	1.8L L4 1795cc
		2004-2008	CHRYSLER CROSSFIRE		3.2L V6 3200cc 195 CID											2003-2006	PONTIAC VIBE	1.8L L4 1795cc
		2005	MERCEDES-BENZ G500		5.0L V8 4973cc											2003-2006	TOYOTA MATRIX	1.8L L4 1795cc
		2005-2006	CHRYSLER CROSSFIRE		3.2L V6 3199cc		2005-2006									TOYOTA COROLLA	1.8L L4 1795cc	
		2006	MERCEDES-BENZ CL500		5.0L V8 4966cc		US9406									2000-2005	TOYOTA ECHO	1.5L L4 1497cc
	2006	MERCEDES-BENZ CLK500	5.0L V8 4966cc		2001-2009											TOYOTA PRIUS	1.5L L4 1497cc	
	2006	MERCEDES-BENZ CLS500	5.0L V8 4966cc		2004-2005											TOYOTA YARIS	1.3L L4 1295cc 79 CID	
	2006	MERCEDES-BENZ R500	5.0L V8 4966cc		2004-2006											SCION XA	1.5L L4 1497cc	
	2006	MERCEDES-BENZ S350	3.7L V6 3724cc		2004-2006											SCION XB	1.5L L4 1497cc	
	2006	MERCEDES-BENZ SL500	5.0L V8 4966cc	2006	TOYOTA YARIS											1.5L L4 1497cc 91 CID		
	2006-2008	MERCEDES-BENZ G500	5.0L V8 4966cc	2007-2011	TOYOTA AVANZA			1.5L L4 1497cc 91 CID										
	2007	MERCEDES-BENZ CLS500	5.0L V8 4966cc 303 CID	2007-2017	TOYOTA YARIS			1.5L L4 1497cc										
	2007	MERCEDES-BENZ R500	5.0L V8 4973cc	2011	TOYOTA YARIS			1.5L L4 1497cc 91 CID										
2007-2009	MERCEDES-BENZ CLK500	5.0L V8 4966cc 303 CID	2015-2016	TOYOTA YARIS	1.5L L4 1497cc 91 CID													
US9380	1998-2002	MERCEDES-BENZ CLK320	3.2L V6 3199cc	US9410	2000-2004			AUDI A6 QUATTRO	4.2L V8 4172cc									
	1998-2005	MERCEDES-BENZ E320	3.2L V6 3199cc		2000-2006			AUDI A8 QUATTRO	4.2L V8 4172cc									
	1999-2001	MERCEDES-BENZ ML430	4.3L V8 4266cc		2001			AUDI S6 QUATTRO	4.2L V8 4172cc 255 CID									
	1999-2002	MERCEDES-BENZ E55 AMG	5.5L V8 5439cc 335 CID		2001-2003			AUDI S8	4.2L V8 4172cc									
	2000-2003	MERCEDES-BENZ ML55 AMG	5.5L V8 5439cc 335 CID		2002-2003			AUDI S6	4.2L V8 4172cc									
	2001	MERCEDES-BENZ G500L	5.0L V8 4973cc 303 CID		2003			AUDI RS6	4.2L V8 4172cc									
	2001-2002	MERCEDES-BENZ CL55 AMG	5.5L V8 5439cc 335 CID		2004			AUDI RS6 QUATTRO	4.2L V8 4179cc 255 CID									
	2001-2002	MERCEDES-BENZ S55 AMG	5.5L V8 5439cc 335 CID		2004			AUDI S6 QUATTRO	4.2L V8 4172cc 255 CID									
	2001-2003	MERCEDES-BENZ SLK320	3.2L V6 3199cc		2004-2006			VOLKSWAGEN PHAETON	4.2L V8 4172cc									
	2001-2006	MERCEDES-BENZ CLK55 AMG	5.5L V8 5439cc 335 CID		2004-2007			VOLKSWAGEN TOUAREG	4.2L V8 4172cc									
	2002	MERCEDES-BENZ ML500	5.0L V8 4966cc		2008-2009			AUDI Q7	4.2L V8 4163cc 254 CID									
	2002-2004	MERCEDES-BENZ G500	5.0L V8 4966cc		US9414			2001-2003	TOYOTA RAV4		2.0L L4 1998cc 122 CID							
	2003-2004	MERCEDES-BENZ G55 AMG	5.5L V8 5439cc 335 CID					2001-2007	TOYOTA HIGHLANDER	2.4L L4 2362cc								
	2003-2005	MERCEDES-BENZ ML500	5.0L V8 4966cc 303 CID					2002-2008	TOYOTA SOLARA	2.4L L4 2362cc								
	2005	MERCEDES-BENZ G500	5.0L V8 4973cc					2002-2011	TOYOTA CAMRY	2.4L L4 2362cc								
	2005-2006	MERCEDES-BENZ C55 AMG	5.5L V8 5439cc 335 CID			2004-2008		TOYOTA RAV4	2.4L L4 2362cc									

USMW	Years	Application	Engine	USMW	Years	Application	Engine
US9414	2005-2009	SCION TC	2.4L L4 2398cc	US9462	2003-2008	HYUNDAI TIBURON	2.7L V6 2656cc
	2009-2010	PONTIAC VIBE	2.4L L4 2362cc		2005-2009	HYUNDAI TUCSON	2.7L V6 2656cc
	2009-2010	TOYOTA COROLLA	2.4L L4 2362cc	2005-2010	KIA SPORTAGE	2.7L V6 2656cc	
	2009-2013	TOYOTA MATRIX	2.4L L4 2362cc	US9463	2001	HYUNDAI XG300	3.0L V6 2972cc
	2010	SCION TC	2.4L L4 2362cc		2002-2005	HYUNDAI XG350	3.5L V6 3500cc
2010-2012	LEXUS HS250H	2.4L L4 2362cc	2002-2005		KIA SEDONA	3.5L V6 3497cc	
2011-2015	SCION XB	2.4L L4 2362cc	2003-2005		HYUNDAI SANTA FE	3.5L V6 3500cc	
US9415	2001-2002	MINI COOPER	1.8L L4 1809cc		2004-2006	KIA AMANTI	3.5L V6 3497cc
	2003-2005	MINI COOPER	1.8L L4 1809cc	2006	HYUNDAI SANTA FE	3.5L V6 3467cc	
	2006	MINI COOPER	1.8L L4 1809cc	US9464	1995-1997	BMW 850CI	5.4L V12 5379cc
US9416	2000-2006	NISSAN SENTRA	1.8L L4 1769cc 107 CID		1995-1998	BMW 750IL	5.4L V12 5379cc
	2001	NISSAN ALMERA	1.8L L4 1781cc 108 CID		1998	BMW 850CI	5.4L V12 5379cc 328 CID
	2002-2004	NISSAN ALMERA	1.8L L4 1781cc 108 CID	US9465	1999-2001	BMW 740I	4.4L V8 4398cc
2005	NISSAN ALMERA	1.8L L4 1769cc 107 CID	1999-2001		BMW 740IL	4.4L V8 4398cc	
US9419	2001	HONDA CIVIC	1.7L L4 1668cc		1999-2003	BMW 540I	4.4L V8 4398cc
	2002-2004	HONDA CIVIC	1.7L L4 1700cc		2000-2003	BMW X5	4.4L V8 4398cc
	2005	HONDA CIVIC	1.7L L4 1668cc		2002-2003	BMW X5	4.6L V8 4598cc
US9421	2001-2009	SUBARU OUTBACK	3.0L H6 3000cc	2003	BMW Z8	4.8L V8 4837cc	
	2006-2007	SUBARU B9 TRIBECA	3.0L H6 3000cc	US9467	1998-2001	BMW 750IL	5.4L V12 5379cc
	2008-2009	SUBARU LEGACY	3.0L H6 3000cc		US9468	1996-1997	HONDA CIVIC DEL SOL
	2014	SUBARU LEGACY	3.6L H6 3630cc 222 CID	1996-2001		ACURA INTEGRA	1.8L L4 1797cc
	2014	SUBARU OUTBACK	3.6L H6 3630cc 222 CID	1999-2000	HONDA CIVIC	1.6L L4 1590cc 97 CID	
US9426	2002-2004	INFINITI I35	3.5L V6 3498cc	1999-2000	HONDA CIVIC	1.6L L4 1595cc	
	2002-2006	NISSAN ALTIMA	3.5L V6 3498cc	US9470	2003-2006	ACURA MDX	3.5L V6 3471cc
	2002-2008	NISSAN MAXIMA	3.5L V6 3498cc		2003-2007	HONDA ACCORD	3.0L V6 2997cc
	2003	NISSAN 350Z	3.5L V6 3498cc 213 CID		2004	SATURN VUE	3.5L V6 3475cc
	2003-2006	NISSAN 350Z	3.5L V6 3498cc		2004-2005	SATURN VUE	3.5L V6 3474cc
	2003-2007	INFINITI FX35	3.5L V6 3498cc		2004-2008	ACURA TL	3.2L V6 3210cc
	2003-2007	INFINITI G35	3.5L V6 3498cc	2005-2008	ACURA RL	3.5L V6 3471cc	
	2003-2007	NISSAN MURANO	3.5L V6 3498cc	2005-2017	HONDA ODYSSEY	3.5L V6 3471cc	
	2004-2009	NISSAN QUEST	3.5L V6 3498cc	2005-2017	HONDA PILOT	3.5L V6 3471cc	
	2005-2012	NISSAN PATHFINDER	4.0L V6 3954cc	2006-2007	SATURN VUE	3.5L V6 3471cc	
	2005-2015	NISSAN XTERRA	4.0L V6 3954cc	2006-2014	HONDA RIDGELINE	3.5L V6 3471cc	
	2005-2017	NISSAN FRONTIER	4.0L V6 3954cc	2007-2013	ACURA MDX	3.7L V6 3664cc	
	2006-2007	INFINITI M35	3.5L V6 3498cc	2007-2014	ACURA TL	3.5L V6 3471cc	
	2008	NISSAN FRONTIER	4.0L V6 3954cc 241 CID	2008-2017	HONDA ACCORD	3.5L V6 3471cc	
	2008	NISSAN MURANO	3.5L H6 3500cc 213 CID	2009-2012	ACURA RL	3.7L V6 3664cc	
	2009-2012	SUZUKI EQUATOR	4.0L V6 3954cc	2009-2014	ACURA TL	3.7L V6 3664cc	
	2010	NISSAN MAXIMA	3.5L H6 3500cc 214 CID	2010-2011	HONDA ACCORD CROSSTOUR	3.5L V6 3471cc	
	2010-2011	NISSAN PATHFINDER	4.0L V6 3954cc 241 CID	2010-2013	ACURA ZDX	3.7L V6 3664cc	
	2010-2012	NISSAN FRONTIER	4.0L V6 3954cc 241 CID	2010-2014	ACURA TSX	3.5L V6 3471cc	
	2012-2017	NISSAN NV1500	4.0L V6 3954cc	2012-2015	HONDA CROSSTOUR	3.5L V6 3471cc	
	2012-2017	NISSAN NV2500	4.0L V6 3954cc	2013-2017	ACURA RDX	3.5L V6 3471cc	
	2012-2017	NISSAN NV3500	4.0L V6 3954cc	2014-2017	ACURA MDX	3.5L V6 3471cc	
	2014-2015	NISSAN FRONTIER	4.0L V6 3954cc 241 CID	2014-2017	ACURA RLX	3.5L V6 3471cc	
	US9427	2002-2010	NISSAN X-TRAIL	2.5L L4 2488cc 152 CID	2015-2017	ACURA TLX	3.5L V6 3471cc
		2002-2012	NISSAN SENTRA	2.5L L4 2488cc 152 CID	2017	ACURA MDX	3.0L V6 2997cc
2002-2013		NISSAN ALTIMA	2.5L L4 2488cc 152 CID	2017	HONDA RIDGELINE	3.5L V6 3471cc	
2008-2013		NISSAN ROGUE	2.5L L4 2488cc 152 CID	US9471	2002-2003	VOLKSWAGEN EUROVAN	2.8L V6 2792cc
2014-2015		NISSAN ROGUE SELECT	2.5L L4 2488cc 152 CID		2002-2004	VOLKSWAGEN JETTA	2.8L V6 2792cc
US9427-2	2002-2010	NISSAN X-TRAIL	2.5L L4 2488cc 152 CID	2002-2005	VOLKSWAGEN GOLF	2.8L V6 2792cc	
	2002-2012	NISSAN SENTRA	2.5L L4 2488cc 152 CID	2004	VOLKSWAGEN GOLF	3.2L V6 3189cc	
	2002-2013	NISSAN ALTIMA	2.5L L4 2488cc 152 CID	2004	VOLKSWAGEN TOUAREG	3.2L V6 3200cc 195 CID	
	2008-2013	NISSAN ROGUE	2.5L L4 2488cc 152 CID	2004-2005	AUDI A3	3.2L V6 3189cc 195 CID	
	2014-2015	NISSAN ROGUE SELECT	2.5L L4 2488cc 152 CID	2004-2006	AUDI TT QUATTRO	3.2L V6 3189cc 195 CID	
US9429	2002-2004	AUDI A6	3.0L V6 2976cc	2004-2006	PORSCHE CAYENNE	3.2L V6 3189cc 195 CID	
	2002-2004	AUDI A6 QUATTRO	3.0L V6 2976cc	2005-2007	VOLKSWAGEN TOUAREG	3.2L V6 3189cc 195 CID	
	2002-2005	AUDI A4	3.0L V6 2976cc	2006-2009	AUDI A3 QUATTRO	3.2L V6 3189cc 195 CID	
	2002-2006	AUDI A4 QUATTRO	3.0L V6 2976cc	2007-2008	VOLKSWAGEN EOS	3.2L V6 3189cc 195 CID	
	2005-2006	AUDI A6	3.0L V6 2976cc 182 CID	2008	AUDI A5	3.2L V6 3200cc 195 CID	
	2008-2009	AUDI A6	2.8L V6 2773cc	2008	AUDI Q7	3.0L V6 2967cc 182 CID	
	2008	AUDI A6	2.8L V6 2773cc	2008	VOLKSWAGEN EOS	3.2L V6 3197cc 195 CID	
US9434	2002-2005	HONDA CIVIC	2.0L L4 1998cc 122 CID	2008	VOLKSWAGEN R32	3.2L V6 3189cc 195 CID	
	2002-2006	ACURA RSX	2.0L L4 1998cc 122 CID	2008-2009	AUDI TT QUATTRO	3.2L V6 3189cc 195 CID	
	2002-2006	HONDA CR-V	2.4L L4 2354cc 144 CID	US9472	2002-2005	SUBARU FORESTER	2.5L H4 2458cc
US9440	1999-2000	MERCEDES-BENZ C230	2.3L L4 2295cc		US9473	2001-2002	KIA RIO
	2000-2002	AUDI S4	2.7L V6 2671cc	2003-2005		KIA RIO	1.6L L4 1594cc
	2000-2004	AUDI A6 QUATTRO	2.7L V6 2671cc	US9474	2002-2008	MINI COOPER	1.6L L4 1600cc
2001-2005	AUDI ALLROAD QUATTRO	2.7L V6 2671cc	US9475		1997-1999	PORSCHE BOXSTER	2.5L H6 2480cc
2003-2006	KIA SORENTO	3.5L V6 3497cc		1999-2001	PORSCHE 911	3.4L H6 3400cc	
US9449	2011-2018	FORD FIESTA	1.6L L4 1596cc 97 CID	2000	PORSCHE BOXSTER	2.5L H6 2480cc 151 CID	
	2013-2014	FORD FUSION	1.6L L4 1596cc 97 CID	2000-2006	PORSCHE BOXSTER	3.2L H6 3179cc	
	2013-2016	FORD ESCAPE	1.6L L4 1601cc 98 CID	2000-2008	PORSCHE BOXSTER	2.7L H6 2687cc	
	2014-2016	FORD TRANSIT CONNECT	1.6L L4 1596cc 97 CID	2002-2009	PORSCHE 911	3.6L H6 3596cc	
US9450	1995-2002	KIA SPORTAGE	2.0L L4 1998cc 122 CID	2005-2008	PORSCHE 911	3.8L H6 3824cc	
US9456	2003-2005	VOLVO S80	2.9L L6 2917cc	2006-2008	PORSCHE CAYMAN	3.4L H6 3387cc	
	2003-2005	VOLVO XC90	2.9L L6 2917cc	2007-2008	PORSCHE 911	3.6L H6 3598cc	
US9460	1995-1996	MINI COOPER	1.8L L4 1809cc	2007-2008	PORSCHE BOXSTER	3.4L H6 3387cc	
	1996-2000	MINI COOPER	1.8L L4 1809cc	2007-2008	PORSCHE CAYMAN	2.7L H6 2687cc	
	1997-2003	MINI COOPER	1.8L L4 1809cc	2010-2011	PORSCHE 911	3.8L H6 3800cc	
	1999-2004	MINI COOPER	1.8L L4 1809cc	2011	PORSCHE 911	3.6L H6 3600cc 220 CID	
	2003-2007	HONDA ACCORD	2.4L L4 2354cc 144 CID	2011	PORSCHE 911	4.0L H6 3996cc	
US9461	2003-2011	HONDA ELEMENT	2.4L L4 2354cc 144 CID	US9480	1980-1985	PEUGEOT 505	2.3L L4 2304cc
	2004-2008	ACURA TSX	2.4L L4 2354cc 144 CID		1980-1987	PEUGEOT 505	2.0L L4 1971cc
	2007-2009	HONDA CR-V	2.4L L4 2354cc 144 CID	1985-1991	PEUGEOT 505	2.2L L4 2155cc	
	US9462	1999-2001	HYUNDAI SONATA	2.5L V6 2493cc	US9486	1987-1994	SUBARU JUSTY
2001		KIA OPTIMA	2.5L V6 2500cc	US9488		2004	NISSAN PATHFINDER ARMADA
2001-2006		HYUNDAI SANTA FE	2.7L V6 2656cc		2004-2013	INFINITI QX56	5.6L V8 5552cc
2002-2005		HYUNDAI SONATA	2.7L V6 2656cc		2004-2015	NISSAN TITAN	5.6L V8 5552cc
2002-2006		KIA OPTIMA	2.7L V6 2656cc				

USMW	Years	Application	Engine	USMW	Years	Application	Engine	
US9488	2005-2015	NISSAN ARMADA	5.6L V8 5552cc	US11009	2003-2006	MERCEDES-BENZ E55 AMG	5.5L V8 5439cc 335 CID	
	2008-2012	NISSAN PATHFINDER	5.6L V8 5552cc		2004-2006	MERCEDES-BENZ E500	5.0L V8 4966cc	
	2009-2013	INFINITI FX50	5.0L V8 5026cc		2005-2006	MERCEDES-BENZ E320	3.2L L6 3222cc	
	2011-2013	INFINITI M56	5.6L V8 5552cc		2006	MERCEDES-BENZ CLS55 AMG	5.5L V8 5439cc 335 CID	
	2012-2017	NISSAN NV2500	5.6L V8 5552cc		2006	MERCEDES-BENZ CLS500	5.0L V8 4966cc	
	2012-2017	NISSAN NV3500	5.6L V8 5552cc		2006	MERCEDES-BENZ ML500	5.0L V8 4966cc	
	2014	INFINITI QX70	5.0L V8 5026cc		2006	MERCEDES-BENZ R500	5.0L V8 4966cc	
	2014-2015	INFINITI QX80	5.6L V8 5552cc 339 CID		2006-2009	MERCEDES-BENZ E350	3.5L V6 3498cc	
	2014-2017	INFINITI Q70	5.6L V8 5552cc		2006-2011	MERCEDES-BENZ ML350	3.5L V6 3498cc	
	2014-2017	INFINITI QX80	5.6L V8 5552cc		2006-2012	MERCEDES-BENZ R350	3.5L V6 3498cc	
	2015-2017	INFINITI Q70L	5.6L V8 5552cc		2007	MERCEDES-BENZ ML500	5.0L V8 4973cc	
	2016-2017	NISSAN TITAN XD	5.6L V8 5552cc		2007	MERCEDES-BENZ R63 AMG	6.3L V8 6208cc	
	2017	NISSAN ARMADA	5.6L V8 5552cc		2007	MERCEDES-BENZ R500	5.0L V8 4973cc	
	2017	NISSAN TITAN	5.6L V8 5552cc		2007-2009	MERCEDES-BENZ E63 AMG	6.3L V8 6208cc	
	US9489	2003-2008	MAZDA 6		3.0L V6 2968cc 181 CID	2007-2009	MERCEDES-BENZ E320	3.0L V6 2987cc
		2006	LINCOLN ZEPHYR		3.0L V6 2968cc 181 CID	2007-2009	MERCEDES-BENZ E550	5.5L V8 5461cc
		2006-2008	FORD ESCAPE		3.0L V6 2968cc 181 CID	2007-2009	MERCEDES-BENZ GL320	3.0L V6 2987cc
2006-2008		MERCURY MARINER	3.0L V6 2968cc 181 CID	2007-2009	MERCEDES-BENZ ML320	3.0L V6 2987cc		
2006-2009		FORD FUSION	3.0L V6 2968cc 181 CID	2007-2009	MERCEDES-BENZ R320	3.0L V6 2987cc		
2006-2009		MERCURY MILAN	3.0L V6 2968cc 181 CID	2007-2011	MERCEDES-BENZ CLS63 AMG	6.3L V8 6208cc		
US9489-2		2006	LINCOLN ZEPHYR	3.0L V6 2968cc 181 CID	2007-2011	MERCEDES-BENZ CLS550	5.5L V8 5461cc	
		2006-2008	FORD ESCAPE	3.0L V6 2968cc 181 CID	2007-2011	MERCEDES-BENZ ML63 AMG	6.3L V8 6208cc	
		2006-2008	MERCURY MARINER	3.0L V6 2968cc 181 CID	2007-2012	MERCEDES-BENZ GL450	4.6L V8 4663cc	
		2006-2009	FORD FUSION	3.0L V6 2968cc 181 CID	2008-2011	MERCEDES-BENZ ML550	5.5L V8 5461cc	
	2006-2009	MERCURY MILAN	3.0L V6 2968cc 181 CID	2008-2012	MERCEDES-BENZ GL550	5.5L V8 5461cc		
US9493	1977-1979	TOYOTA LAND CRUISER	4.2L L6 4227cc	2010-2011	MERCEDES-BENZ ML350	3.0L V6 2987cc		
US9494	2000-2006	HONDA INSIGHT	1.0L L3 995cc 61 CID	2010-2011	MERCEDES-BENZ ML450	3.5L V6 3498cc		
US9495	2006-2011	HONDA CIVIC	2.0L L4 1998cc 122 CID	2010-2012	MERCEDES-BENZ GL350			
US9496	2000	ROVER 75	2.5L V6 2497cc 152 CID	2010-2012	MERCEDES-BENZ R350	3.0L V6 2987cc		
	2002-2005	LAND ROVER FREELANDER	2.5L V6 2500cc 153 CID	2012	MERCEDES-BENZ ML63 AMG	5.5L V8 5461cc		
	2003-2005	ROVER 75	2.5L V6 2497cc 152 CID	2013-2014	MERCEDES-BENZ G63 AMG	5.5L V8 5461cc		
US11001	2009-2011	MERCURY MARINER	2.5L L4 2488cc 152 CID	2014	MERCEDES-BENZ SPRINTER 2500	2.1L L4 2143cc 131 CID		
	2009-2012	FORD ESCAPE	2.5L L4 2488cc 152 CID	2014	MERCEDES-BENZ SPRINTER 3500	2.1L L4 2143cc 131 CID		
US11002	2005-2008	FORD ESCAPE	2.3L L4 140 CID	US11011	2004-2009	TOYOTA PRIUS	1.5L L4 1497cc	
	2006-2008	MERCURY MARINER	2.3L L4 140 CID	US11012	2007-2011	TOYOTA CAMRY	2.4L L4 2362cc	
	2011	FORD ESCAPE	2.5L L4 2488cc 152 CID	US11013	2004-2009	TOYOTA PRIUS	1.5L L4 1497cc	
US11003	2000-2002	AUDI A6 QUATTRO	2.7L V6 2671cc	US11014	1999-2003	FORD F-150	5.4L V8 330 CID	
	2000-2002	AUDI S4	2.7L V6 2671cc	2003-2004	FORD MUSTANG	4.6L V8 281 CID		
	2001-2002	AUDI ALLROAD QUATTRO	2.7L V6 2671cc	2004	FORD F-150 HERITAGE	5.4L V8 330 CID		
	2001-2006	AUDI TT QUATTRO	1.8L L4 1781cc	US11015	2002-2004	MERCEDES-BENZ C32 AMG	3.2L V6 3199cc	
	2002-2005	VOLKSWAGEN JETTA	1.8L L4 1781cc		2002-2004	MERCEDES-BENZ SLK32 AMG	3.2L V6 3199cc	
	2002-2006	AUDI TT	1.8L L4 1781cc		2003-2006	MERCEDES-BENZ E55 AMG	5.5L V8 5439cc 335 CID	
	2002-2006	VOLKSWAGEN GOLF	1.8L L4 1781cc		2003-2013	MERCEDES-BENZ S600	5.5L V12 5513cc 336 CID	
	2000-2003	VOLKSWAGEN EUROVAN	2.8L V6 2792cc		2003-2014	MERCEDES-BENZ CL600	5.5L V12 5513cc 336 CID	
	2000-2004	VOLKSWAGEN JETTA	2.8L V6 2792cc		2004-2009	MERCEDES-BENZ SL600	5.5L V12 5513cc 336 CID	
	2000-2005	VOLKSWAGEN GOLF	2.8L V6 2792cc		2005-2006	MERCEDES-BENZ CL65 AMG	6.0L V12 5980cc 365 CID	
	2002-2004	VOLKSWAGEN PASSAT	4.0L V8 3998cc 244 CID		2005-2009	MERCEDES-BENZ SLR MCLAREN	5.5L V8 5439cc 335 CID	
	2003-2004	AUDI A6 QUATTRO	2.7L V6 2671cc		2005-2011	MERCEDES-BENZ G55 AMG	5.5L V8 5439cc 335 CID	
	2003-2005	AUDI ALLROAD QUATTRO	2.7L V6 2671cc		2005-2011	MERCEDES-BENZ SL65 AMG	6.0L V12 5980cc 365 CID	
	2004	VOLKSWAGEN GOLF	3.2L V6 3189cc	2006	MERCEDES-BENZ CLS55 AMG	5.5L V8 5439cc 335 CID		
2004	VOLKSWAGEN PHAETON	6.0L W12 6000cc	2006	MERCEDES-BENZ S65 AMG	6.0L V12 5980cc 365 CID			
2004-2005	VOLKSWAGEN TOUAREG	3.2L V6 3200cc 195 CID	2006-2007	MERCEDES-BENZ C280	3.0L V6 2996cc			
2004-2006	AUDI TT QUATTRO	3.2L V6 3189cc 195 CID	2006-2007	MERCEDES-BENZ C350	3.5L V6 3498cc			
2004-2006	VOLKSWAGEN TOUAREG	3.2L V6 3189cc 195 CID	2007	MERCEDES-BENZ R63 AMG	6.3L V8 6208cc			
US11004	2006	VOLKSWAGEN PHAETON	6.0L W12 5998cc 366 CID	2007-2011	MERCEDES-BENZ ML63 AMG	6.3L V8 6208cc		
	2006-2009	AUDI A3 QUATTRO	3.2L V6 3189cc 195 CID	2008-2010	MERCEDES-BENZ CL63 AMG	6.3L V8 6208cc		
	2007-2008	VOLKSWAGEN EOS	3.2L V6 3189cc 195 CID	2008-2014	MERCEDES-BENZ CL65 AMG	6.0L V12 5980cc 365 CID		
	2007-2009	VOLKSWAGEN TOUAREG	4.2L V8 4163cc	2010-2011	MERCEDES-BENZ ML450	3.5L V6 3498cc		
	2007-2010	AUDI Q7	3.6L V6 3597cc 219 CID	2011-2013	MERCEDES-BENZ S63 AMG	5.5L V8 5461cc		
	2007-2010	VOLKSWAGEN TOUAREG	3.6L V6 3597cc 219 CID	2011-2014	MERCEDES-BENZ CL550	4.6L V8 4663cc		
	2008	VOLKSWAGEN EOS	3.2L V6 3197cc 195 CID	2012-2013	MERCEDES-BENZ S550	4.6L V8 4663cc		
	2008	VOLKSWAGEN R32	3.2L V6 3189cc 195 CID	2012-2014	MERCEDES-BENZ CLS63 AMG	5.5L V8 5461cc		
	2008-2009	AUDI TT QUATTRO	3.2L V6 3189cc 195 CID	2012-2014	MERCEDES-BENZ CLS550	4.6L V8 4663cc		
	2008-2012	AUDI R8	4.2L V8 4163cc	2012-2014	MERCEDES-BENZ E63 AMG	5.5L V8 5461cc		
	2010-2012	AUDI R8	5.2L V10 5204cc	2012-2014	MERCEDES-BENZ E550	4.6L V8 4663cc		
	2014	AUDI R8	4.2L V8 4163cc	2012-2014	MERCEDES-BENZ ML63 AMG	5.5L V8 5461cc		
	2014	AUDI R8	5.2L V10 5204cc	2013-2014	MERCEDES-BENZ GL63 AMG	5.5L V8 5461cc 333 CID		
	US11005	2005-2012	NISSAN PATHFINDER	4.0L V6 3954cc	2013-2014	MERCEDES-BENZ GL450	4.6L V8 4663cc	
	US11006	2008-2010	FORD F-250 SUPER DUTY	6.4L V8 391 CID	2013-2014	MERCEDES-BENZ GL550	4.6L V8 4663cc	
		2008-2010	FORD F-350 SUPER DUTY	6.4L V8 391 CID	2013-2014	MERCEDES-BENZ SL550	4.6L V8 4663cc	
		2008-2010	FORD F-450 SUPER DUTY	6.4L V8 391 CID	2014	MERCEDES-BENZ E63 AMG S	5.5L V8 5461cc	
2008-2010		FORD F-550 SUPER DUTY	6.4L V8 391 CID	2014	MERCEDES-BENZ ML550	4.6L V8 4663cc		
2010		FORD F-550 SUPER DUTY	6.4L V8 6400cc 391 CID	US11017	2006-2008	AUDI A3	2.0L L4 1984cc 121 CID	
US11007	2009-2011	MERCURY MARINER	2.5L L4 2488cc 152 CID		2006-2008	VOLKSWAGEN GTI	2.0L L4 1984cc 121 CID	
	2009-2012	FORD ESCAPE	2.5L L4 2488cc 152 CID		2006-2008	VOLKSWAGEN JETTA	2.0L L4 1984cc 121 CID	
US11008	2008-2010	VOLKSWAGEN JETTA	2.0L L4 1984cc 121 CID		2006-2008	VOLKSWAGEN PASSAT	2.0L L4 1984cc 121 CID	
	2008-2010	VOLKSWAGEN PASSAT	2.0L L4 1984cc 121 CID		2007-2009	VOLKSWAGEN EOS	2.0L L4 1984cc 121 CID	
	2008-2013	AUDI A3	2.0L L4 1984cc 121 CID		2008-2009	AUDI TT	2.0L L4 1984cc 121 CID	
	2008-2014	VOLKSWAGEN GTI	2.0L L4 1984cc 121 CID		2009-2010	AUDI A5 QUATTRO	3.2L V6 3123cc	
	2009	AUDI TT	2.0L L4 1984cc 121 CID		2009-2012	AUDI Q5	3.2L V6 3123cc	
	2009-2013	AUDI A3 QUATTRO	2.0L L4 1984cc 121 CID		2011-2015	AUDI TT QUATTRO	2.0L L4 1984cc 121 CID	
	2009-2014	AUDI TT QUATTRO	2.0L L4 1984cc 121 CID		2012-2013	VOLKSWAGEN GOLF	2.0L L4 1984cc 121 CID	
	2009-2014	VOLKSWAGEN CC	2.0L L4 1984cc 121 CID	US11024	2000-2004	MERCEDES-BENZ SLK230	2.3L L4 2295cc	
	2009-2014	VOLKSWAGEN EOS	2.0L L4 1984cc 121 CID		2001-2004	MERCEDES-BENZ SLK320	3.2L V6 3199cc	
	2009-2014	VOLKSWAGEN TIGUAN	2.0L L4 1984cc 121 CID					
	2012-2013	VOLKSWAGEN BEETLE	2.0L L4 1984cc 121 CID					
	2012-2013	VOLKSWAGEN JETTA	2.0L L4 1984cc 121 CID					
	US11009	2003-2005	MERCEDES-BENZ E320	3.2L V6 3199cc				
		2003-2005	MERCEDES-BENZ E500	5.0L V8 4973cc				

WATER PUMPS



WATER PUMP BUYERS GUIDE



USMW	Years	Application	Engine	USMW	Years	Application	Engine
US11024	2002-2004	MERCEDES-BENZ G500	5.0L V8 4966cc				
	2002-2004	MERCEDES-BENZ SLK32 AMG	3.2L V6 3199cc				
	2003-2011	MERCEDES-BENZ G55 AMG	5.5L V8 5439cc 335 CID				
	2005	MERCEDES-BENZ G500	5.0L V8 4973cc				
	2006-2008	MERCEDES-BENZ G500	5.0L V8 4966cc				
	2009-2015	MERCEDES-BENZ G550	5.5L V8 5461cc				
US11034	1992-1994	VOLKSWAGEN CORRADO	2.8L V6 2792cc				
	1993-1994	VOLKSWAGEN PASSAT	2.8L V6 2792cc				
	1994	VOLKSWAGEN JETTA	2.8L V6 2792cc				
	1995	VOLKSWAGEN EUROVAN	2.5L L5 2459cc 150 CID				
	1996-1999	VOLKSWAGEN JETTA	2.8L V6 2792cc				
	1996-2002	VOLKSWAGEN GOLF	2.8L V6 2792cc				
	1997	VOLKSWAGEN EUROVAN	2.8L V6 2792cc				
	1999-2000	VOLKSWAGEN EUROVAN	2.8L V6 2792cc				
	1999-2005	VOLKSWAGEN BEETLE	1.8L L4 1781cc				



WATER PUMP CROSS REFERENCE



Chrysler (cont'd.)		Chrysler (cont'd.)		Chrysler (cont'd.)	
5302 1018AD	US7160	J813 4321	US3404	MD997623	US7124
5302 1074AB	US7169	JR77 5045	US1107	MD997634	US7121
5302 1074AC	US7169	JR77 5046	US3403	MD997643	US7129
5302 1074AE	US7169	JR77 5047	US3413	MD997686	US8922
5302 1074AF	US7169	JR77 5049	US5006	MN187244	US7156
5302 1187AA	US7163	JR77 5050	US3401	R429 3898	US7110
5302 1380AG	US7168	JR77 5053	US3410	R462 1172	US7127
5302 1380AK	US7168	JR77 5056	US3409	R462 6215	US3412
5302 1380AL	US7168	JR77 5122	US3412	R462 6682	US7139
5302 1380AM	US7168	M04667660	US7150	R479 8497	US7122
5302 1844AA	US7169	MD001300	US1012	R500 3665AA	US7145
5302 2058AA	US7163	MD008431	US7104	RL02 2340AC	US8971
5302 2095AD	US8979	MD009000	US7105	RL18 4498AI	US8981
5302 2095AE	US8979	MD021450	US1124	RL184498AI	US8981
5302 2095AF	US8979	MD025190	US7111	T1464552	US3411
5302 2189AA	US7163	MD030751	US7106		
5302 2189AB	US7163	MD030863	US7115	Cummins	
5302 2189AC	US7163	MD034152	US7108	6821 0961AA	US99
5302 2189AD	US7163	MD179030	US7135	2881804	US6222
5302 2189AG	US7163	MD300799	US7135	3003749	US7145HN
5302 2189AH	US7163	MD306414	US7135	3286275	US7145HN
5302 2192AE	US6341	MD309756	US7135	3286277	US7145HN
5302 2192AF	US6341	MD365087	US9360	3800984	US6222
5302 2192AI	US6341	MD971538	US9359	3802004	US7145HN
5302 2192AJ	US6341	MD971582	US7148	3802358	US7145HN
5302 2192AK	US6341	MD972001	US7114	3802970	US7145HN
5302 2340AC	US8971	MD972002	US7117	3913432	US7145HN
5302 2340AF	US8115	MD972003	US8922	4309429	US99
6800 3402AA	US6222	MD972004	US7121	4891252	US6222
6800 3402AB	US6222	MD972005	US7121		
6804 5797AA	US7163	MD972050	US7129	Daihatsu	
6804 6026AA	US6038	MD972051	US7148	16100-87182-000	US9237
6805 8321AA	US9379	MD972052	US7114	16100-87183-000	US8908
6807 9412AB	US6699	MD972053	US9212	16100-87790-000	US9238
6807 9412AC	US6699	MD972440	US9168		
6807 9412AD	US6699	MD972897	US9310	Fiat	
6808 7367AA	US6155	MD972934	US7114	4892 713AB	US8136
6808 7367AB	US6155	MD973025	US9389	4892 713AC	US8136
6811 1624AB	US8114	MD973940	US7152	4893 386AA	US8136
6811 1624AD	US8114	MD974649	US7121	6829 1913AA	US8136
6811 1624AE	US8114	MD974719	US7115	4129810	US9203
6821 1202AB	US8161	MD976464	US7108	4129812	US9203
6829 1856AA	US8136	MD976943	US9399	4331825	US9003
6831 1108AA	US8160	MD977705	US9399	4336009	US8944
6831 1109AB	US8151	MD978552	US9399	4429226	US9085
6831 3815AA	US8136	MD978743	US7152	5882684	US9203
6834 6915AA	US8115	MD978764	US6228	5882689	US9003
6834 6916AA	US8115	MD979171	US7152	5882691	US8944
6838 2489AA	US7136	MD979395	US7152	5890406	US8944
6838 2490AA	US7150	MD980000	US9415	5936404	US9084
6838 2491AA	US7165	MD997076	US6149	5936406	US9084
6838 2492AA	US7164	MD997077	US7121	5960469	US9084
6838 2493AA	US7160	MD997078	US7115	5980756	US9084
6838 2494AA	US7168	MD997079	US7105	5983960	US9084
6841 4058AB	US99	MD997081	US7108	7671808	US9085
7124 4450	US1010	MD997084	US7114	7671810	US9085
7522 1515	US1010	MD997150	US7118	7784974	US9084
8120 131	US1021	MD997158	US7117	46400058	US8948
8125 131	US3401	MD997178	US7117	46444355	US8948
8125 501	US1077	MD997244	US7120	46526243	US8945
8127 974	US3400	MD997403	US7120	46805736	US8945
8129 459	US1077	MD997404	US7121	55184080	US8945
8130 749	US3403	MD997417	US7124	71716878	US8948
8132 274	US1107	MD997418	US7124		
8133 033	US3403	MD997421	US9212	Ford	
8277 5049	US5006	MD997464	US7131	1E04-15-010	US8934
8350 2957	US3414	MD997485	US7108	1F1Z 8501-AA	US4094
1752422	US919	MD997515	US7108	1L2Z 8501-BA	US8920
2421375	US919	MD997609	US7106	1L2Z 8501-BB	US8920
2448315	US919	MD997614	US7108	1L3Z 8501-AB	US4125
2485385	US919	MD997615	US7121	1L3Z 8501-BA	US4121
3004762	US919	MD997616	US7115	1S7Z 8501-A	US4126
3004991	US919	MD997619	US7118	1S7Z 8501-AK	US4126
J323 4427	US3401	MD997620	US7114	1S7Z 8501-D	US4126
J813 4320	US3403	MD997622	US7120	1S7Z 8501-K	US4126
			US7108	1U2Z 8V501-CA	US4096
			US7131	2C3Z 8V501-BA	US4114
			US9168	2R8Z 8501-AE	US4129



WATER PUMP CROSS REFERENCE



WATER PUMPS

Ford (cont'd.)		Ford (cont'd.)		Ford (cont'd.)	
2S7Z 8501-BG	US4094	BE8Z 8501-B	US9449	E9TZ 8501-B	US4018
2W9Z 8501-BB	US4124	BK3Z 8501-B	US8162	E43Z 8501-B	US9067
3C3Z 8501	US61	BL3Z 8501-A	US8916	E45Y 8501-A	US9154
3C3Z 8501-A	US61	BL3Z 8501-C	US8916	E69Z 8501-A	US4039
3F2Z 8501-BB	US4102	BR3Z 8501-C	US8963	E92Z 8501-A	US4053
3L3Z 8501-CA	US8920	BR3Z 8501-G	US6654	E93Z 8501-A	US4022
3L3Z 8501-DB	US4105	BR3Z 8501-H	US8963	EJ7Z 8501-A	US8117
3R3Z 8501-A	US4103	BR3Z 8501-J	US8116	EJ7Z 8501-C	US8117
3R3Z 8501-BB	US4103	BR3Z 8501-K	US8916	EJ7Z 8501-D	US8975
4C3Z 8501-ABRM	US67	BR3Z 8501-N	US8916	EJ7Z 8501-F	US8117
4C3Z 8501-AC	US67	BR3Z 8501-P	US8116	EJ7Z 8501-G	US8975
4C3Z 8501-B	US4109	C2AZ 8501-A	US723	ER3Z 8501-C	US8916
4G7Z 8501-AA	US8125	C2AZ 8501-B	US723	EU2Z 8501-B	US4091
4S4Z 8501-AA	US4126	C4AZ 8501-A	US723	EU2Z 8501-B	US4091-2
4S4Z 8501-D	US4126	C4AZ 8501-B	US723	EU2Z 8501-D	US9489
5F1Z 8501-A	US4094	C5AZ 8501-B	US819	EU2Z 8501-D	US9489-2
5F2Z 8501-A	US4102	C5AZ 8501-K	US819	F0TZ 8501-E	US4044
5F9Z 8501-A	US6186	C5OZ 8501-A	US819	F0TZ 8501-G	US4060
5F9Z 8501-BB	US6186	CM5Z 8501-A	US8146	F0ZZ 8501-A	US4038
5L2Z 8501-A	US8920	D00Z 8501-C	US953	F1CZ 8501-A	US4069
5L3Z 8501-A	US4105	D1FZ 8501-A	US964	F1SZ 8501-A	US4057
5L8Z 8501-A	US4132	D3RY 8501-A	US964	F1SZ 8501-B	US4050
5L8Z 8501-AA	US4132	D3UZ 8501-A	US1028	F1TZ 8501-A	US1114
5M6Z 8C419-A	US11002	D4DZ 8501-A	US1044	F1VY 8501-A	US4066
5M8Z 8501-A	US9489	D4TZ 8501-H	US1075	F2TZ 8501-A	US4077
5M8Z 8501-B	US9489	D4TZ 8501-K	US1083	F2UZ 8501-A	US4079
5R3Z 8501-A	US4119	D4UZ 8501-A	US1052	F2UZ 8501-C	US4081
5R8Z 8501-A	US4129	D5DZ 8501-A	US960	F0ZZ 8501-B	US4059
5R8Z 8501-B	US4129	D5ZZ 8501-A	US1070	F3DZ 8501-A	US4082
5W7Z 8501-AA	US4128	D6AZ 8501-A	US932	F3LY 8501-A	US4113
6L2Z 8501-A	US4108	D6ZZ 8501-B	US953	F3TZ 8501-C	US4044
6M6Z 8C419-A	US11002	D8BZ 8501-A	US4002	F3TZ 8501-E	US4079
6U7Z 8501-A	US4102	D8FZ 8501-A	US4005	F3XZ 8501-BA	US9074
6U7Z 8501-B	US4102	D8RZ 8501-A	US4003	F3ZZ 8501-B	US4038
7C3Z 8B552-A	US11006	D8TZ 8501-B	US1114	F4AZ 8501-A	US4066
7L3Z 8501-A	US6144	D8ZZ 8501-A	US1047	F4BZ 8501-B	US4049
7R3Z 8501-A	US8125	D9HZ 8501-A	US4037	F4CZ 8501-A	US4069
7R3Z 8501-BB	US8125	D9HZ 8501-B	US4037	F4DZ 8501-A	US4089
7S7Z 8501-A	US9449	D7TZ 8501-A	US1042	F4DZ 8501-B	US4034
7S7Z 8501-C	US9449	DG1Z 8501-A	US8910	F4SZ 8501-A	US4090
7S7Z 8501-G	US9449	DG1Z 8501-C	US8910	F4TZ 8501-ARM	US4096
7S7Z 8501-L	US9449	DS7Z 8501-E	US8107	F4TZ 8501-B	US4086
7T4Z 8501-B	US6023	E0ZZ 8501-A	US4024	F4ZZ 8501-B	US4087
7T4Z 8501-C	US6023	E1AZ 8501-A	US4014	F5DZ 8501-A	US4094
7T4Z 8501-D	US6023	E1AZ 8501-A	US4014H	F5DZ 8501-CL	US4098
8C3Z 8501-B	US76	E2DZ 8501-A	US4016	F5OY 8501-A	US4097
8M6Z 18D473-A	US11007	E2HZ 8501-B	US4037	F5RZ 8501-B	US4088
9L8Z 8501-A	US6250	E2TZ 8501-A	US4030N	F5TZ 8501-A	US4099
9L8Z 8501-C	US6250	E3TZ 8501-F	US4023	F5TZ 8501-BRM	US4096
9M6Z 8C419-A	US11001	E3TZ 8501-G	US4033	F5TZ 8501-C	US4060
96BX 8591-A2B	US8934	E4BZ 8501-A	US4054	F5TZ 8501H2-A	US4044
96BX 8591-AA	US8934	E4ZZ 8501-A	US4024	F6DZ 8501-A	US4098
1000398	US8934	E5HZ 8501-B	US4037	F6DZ 8501-B	US4106
1020567	US8934	E5TZ 8501-C	US1114	F6DZ 8501-FA	US4094
1089795	US8931	E5ZZ 8501-A	US4035	F6LZ 8501-AA	US4113
1109341	US8934	E6AZ 8501-B	US4014	F6PZ 8501-AA	US4069
1229571	US8931	E6AZ 8501-B	US4014H	F6TZ 8501-AA	US4114
1429037	US8934	E6DZ 8501-A	US4034	F6TZ 8501-KA	US4099
1518911	US8934	E6TZ 8501-A	US4042	F6TZ 8501-KB	US4079
AA5Z 8501-A	US6023	E6ZZ 8501-A	US4054	F6ZZ 8501-A	US4103
AA5Z 8501-C	US8910	E7FZ 8501-B	US9067	F7BZ 8501-A	US4049
AA5Z 8501-D	US6023	E7TZ 8501-A	US4044	F7CZ 8501-AB	US4107
AC3Z 8501-A	US6006	E7TZ 8501-B	US4048	F7DZ 8501-A	US4098
AL3Z 8501-A	US6006	E8AZ 8501-A	US4052	F7TZ 8501-AB	US4060
AL3Z 8501-B	US8920	E8BZ 8501-A	US4049	F7TZ 8501-AC	US4060
AR3Z 8501-A	US4119	E8DZ 8501-A	US4051	F7TZ 8501-CRM	US4114
AT4Z 8501-A	US8980	E8DZ 8501-B	US4051	F7UZ 8501-CA	US8920
AT4Z 8501-B	US8910	E8FZ 8501-A	US4040	F7ZZ 8501-AA	US4103
AT4Z 8501-CA	US8910	E9BZ 8501-A	US4049	F8AZ 8501-AA	US4066
B5A-8501-C	US488	E9DZ 8501-B	US4056	F8DZ 8501-AA	US4094
B6A-8501-B	US488	E9JY 8501-B	US4068	F8OZ 8501-AA	US4097
B6A-8501-C	US488	E9PZ 8501-A	US4020	F8RZ 8501-EN	US4115
BC3Z 8501-A	US77	E9PZ 8501-C	US4083	F8RZ 8501-NE	US4115
BC3Z 8501-B	US78	E9PZ 8501-D	US4030N	F8YZ 8501-AA	US11014
BC3Z 8501-C	US78	E9SZ 8501-B	US4055	F8ZZ 8501-AA	US4103



WATER PUMP CROSS REFERENCE



Ford (cont'd.)		Ford / International (cont'd.)		General Motors (cont'd.)	
F23Z 8501-A	US4070	8C3Z 8501-B	US76	3957982	US981
F23Z 8501-B	US4041	1812313C93	US4096	3960122	US927
F32Z 8501-A	US9259	1823669C92	US66	3986364	US898
F32Z 8501-B	US4078	1831005C92	US4114	4409162	US8914
F33Z 8501-A	US4041	1831676C91	US66	4640058	US8946
F42Z 8501-A	US9318	1831676C92	US66	5740079	US5008
F57Z 8501-A	US4093	1845002C91	US85	05740079	US5008
F59Z 8501-A	US4095	BC3Z 8501-A	US77	05743241	US5062
F59Z 8501-B	US4039	D9HZ 8501-A	US4037	05743939	US5049
F63Z 8501-AA	US4091	D9HZ 8501-B	US4037	05744474	US5074
F65Z 8501-BA	US8920	E2HZ 8501-B	US4037	5744662	US5074
F68Z 8501-A	US4102	E4TZ 8501-C	US4018	05744662	US5074
F77Z 8501-AD	US4108	E5HZ 8501-B	US4037	05744938	US5074
F81Z 8501-ARM	US4114	E7HN 8A513 AB	US4062	6258119	US896
F81Z 8501-CRM	US4114	E8HZ 8501-B	US4062	6258551	US984
F81Z 8501-DA	US4109	E9TZ 8501-B	US4018	7490004	US5064
F81Z 8501-FA	US4114	F5TZ 8501-B	US4096	7490007	US5072
F85Z 8501-AA	US4105	F5TZ 8501-C	US4096	9772372	US850
F87Z 8501-BA	US4093	F6TZ 8501-AA	US4114	9784281	US850
F87Z 8501-BB	US4093	F7TZ 8501-BRM	US4114	9788606	US850
F87Z 8501-CA	US4101	F7TZ 8501-C	US4114	9793130	US850
F87Z 8501-DA	US4095	F81Z 8501-A	US4114	10013800	US5000
FOAZ 8501-A	US4052	F81Z 8501-ABRM	US67	10032022	US5022
FOCZ 8501-A	US4065	F81Z 8501-ARM	US4114	10046305	US5030
FODZ 8501-A	US4061	F81Z 8501-B	US4114	10048917	US1121
FOPZ 8501-A	US4020	F81Z 8501-CRM	US4114	10048919	US5016
FOTZ 8501-D	US4060	F81Z 8501F-A	US4114	10048949	US5033
FOTZ 8501-F	US4048	YC3Z 8501-AARM	US66	10048950	US5035
FT4Z 8501-C	US8141P	YC3Z 8501-CA	US66	10065240	US5007
FT4Z 8501-C	US8141P-T	General Motors		10074182	US5084
FT4Z 8501-D	US8141	2402 903	US1053	10077051	US5004
FT4Z 8501-D	US8141-T	230337	US926	10077059	US5049
HC3Z 8501-A	US8157	230609	US926	10089654	US5032
HL3Z 8501-A	US8149	230900	US926	10089659	US5006
XC2Z 8501-BA	US8920	231462	US1120	10120938	US1107
XF1Z 8501-AA	US4094	231886	US1100	10120943	US5035
XF2Z 8501-AA	US4102	231933	US926	10120944	US5037
XF5Z 8501-AA	US9402	357261	US895	10120945	US5001
XF5Z 8501-BA	US9402	358937	US927	10140667	US5078
XL3Z 8501-AA	US8920	359913	US1069	10159526	US5000
XL3Z 8501-BA	US4121	361053	US1088	10159599	US5056
XL5Z 8501-AA	US4095	361054	US1107	10174846	US5051
XL5Z 8501-AC	US4095	361055	US1110	10174979	US5020
XL5Z 8501-AD	US4095	400269	US926	10181235	US5040
XL5Z 8501-CA	US4093	404847	US926	10181327	US5040
XR3Z 8501-AA	US4119	458486	US981	12300305	US975
XS2Z 8501-BC	US4091	474028	US1109	12307798	US896
XS2Z 8501-CC	US4091	474029	US1121	12307815	US898
XS2Z 8501-CD	US4091	474055	US5030	12309445	US975
XS2Z 8501-CF	US4091	474056	US1137	12309978	US5003
XS2Z 8501-EA	US4091	488377	US975	12334884	US5028
XS2Z 8501-EA	US4091-2	556283	US1120	12336298	US5050
XS6E 6659	US8931	1241680	US1061	12337519	US1120
XS6E 8501AD	US8931	1247080	US1045	12337663	US5012
XU2Z 8501-EA	US4018	1260709	US1018	12337664	US5014
XW4Z 8501-BA	US4118	1334037	US1061	12363169	US5032
XW4Z 8501-CD	US4118	1334135	US8933	12369484	US5023
YC2Z 8501-BA	US8920	1334139	US8925	12369487	US5049
YC3Z 8501-AA	US4109	1363989	US855	12369537	US5081
YC3Z 8501-AB	US4109	1396317	US855	12455105	US5085
YF3Z 8501-A	US4097	1396346	US855	12456112	US5081
YF3Z 8501-AB	US4097	1396715	US855	12456113	US64
YR3Z 8501-AB	US4119	1396876	US855	12456113	US64-T
YS4Z 8501-AA	US4123	3634580	US5010	12456231	US5086
YSG6 8501-A2C	US4104	3634838	US5010	12456326	US5038
YW7Z 8501-AA	US4113	3856284	US981	12458115	US5085
YW7Z 8501-BB	US4128	3861920	US896	12458326	US5038
Ford / International		3876172	US896	12458920	US5040
3C3Z 8501-A	US61	3876173	US981	12458922	US5051
3C3Z 8501-ABRM	US61	3877021	US927	12458934	US5081
3C3Z 8501-BA	US61	3929218	US896	12458935	US64
4C3Z 8501-AB	US67	3929233	US898	12458935	US64-T
4C3Z 8501-ABRM	US67	3932422	US896	12462265	US5032
4C4Z 8501-AARM	US85	3937996	US898	12481997	US5000
5C4Z 8501-AA	US85	3957981	US898	12482000	US5041



WATER PUMP CROSS REFERENCE



General Motors (cont'd.)		General Motors (cont'd.)		General Motors (cont'd.)	
12482690	US5035	12671394	US8918	24571389	US5043
12482694	US5037	12671752	US8123	24576952	US5097
12482696	US5001	12672035	US8148	24577255	US5076
12482903	US5075	12673412	US8147	25186130	US8999
12482919	US5050	12674640	US8918	25188341	US8984
12484890	US1002	12676472	US8123	25189098	US8999
12487361	US5072	12678128	US8123	25191164	US8999
12491038	US5040	12679360	US8153	25191167	US8984
12507232	US5067	12680257	US310	25192709	US6662
12508606	US5017	12681171	US8147	25195119	US6184
12509653	US5063	12681174	US8147	25527536	US1018
12512740	US5078	12681259	US8123	52273124	US5017
12514269	US5008	12681417	US6009	55352002	US5079
12514574	US5062	12681417	US6009-T	55352570	US5092
12517379	US5017	12683010	US8918	55486342	US6662
12518277	US5068	12683012	US8918	55486344	US6662
12518443	US5032	12683013	US8123	55488983	US8159
12520263	US5078	12685257	US8918	55492937	US8155
12520914	US5070	12685731	US8123	55561623	US6662
12521037	US5038	12685733	US8918	55570270	US8152
12522031	US5049	12687615	US8918	55579016	US6662
12522033	US1121	12687616	US8123	55580028	US8152
12522034	US5051	12688645	US8123	55582273	US8155
12522036	US5073	12692045	US8918	88893906	US5089
12523499	US5066	14002440	US5084	88893907	US5090
12523502	US5069	14058915	US5019	88894005	US5049
12523505	US5030	14058915	US5019H	88894035	US5086
12524131	US1121	14063641	US5015	88894036	US5074
12525123	US5038	14071866	US5004	88894044	US5062
12527740	US5069	14079351	US5004	88894290	US64
12527741	US5068	14085847	US1121	88894290	US64-T
12527759	US5038	14085852	US1002	88894341	US1121
12529192	US5078	14089011	US5020	88894344	US5072
12529305	US1121	14101304	US5001	88972167	US5099
12529993	US5072	15633465	US5008	88972167	US9376
12530176	US5074	15633466	US5062	88972819	US9405
12532528	US5077	16444355	US8946	88973887	US9376
12532529	US5049	19168601	US5038	88974712	US9405
12532531	US5049	19168601	US5038H	89017269	US5033
12534417	US5062	19168602	US5019	89017311	US5033
12534418	US5008	19168602	US5019H	89017439	US64
12534772	US5074	19168606	US1002	89017439	US64-T
12537495	US5050	19168609	US5086	89017456	US5081
12551474	US5078	19168610	US5074	89017457	US65N
12581517	US9470	19168611	US5062	89017457	US65N-T
12583033	US8956	19168612	US5054	89017467	US5072
12585226	US5092	19168613	US5085	89017583	US6145
12591894	US5092	19168888	US63	89017592	US65
12595614	US8955	19179031	US6145	89017592	US65-T
12600767	US6009	19180610	US79	89017593	US65
12600767	US6009-T	19185381	US9414	89017593	US65-T
12618472	US8932	19185491	US6232	89017693	US5089
12620226	US5097	19201601	US5049	89017748	US5077
12622036	US8142	19205246	US6232	89017757	US6020
12622036	US8142-T	19207665	US6689	89017771	US5089
12624936	US5092	19208815	US6009	89017773	US5090
12630084	US5092	19208815	US6009-T	89017900	US5072
12635743	US9470	19209288	US5075	89018052	US65N
12637105	US72	19210509	US5072	89018052	US65N-T
12637479	US8932	19317040	US6218	89018053	US65
12638455	US8158	21006933	US5054	89018053	US65-T
12645126	US8154	21007155	US5054	89018165	US6154
12645159	US8158	21007225	US5054	89018166	US64
12645176	US8932	21007288	US5054	89018166	US64-T
12653661	US8102	21007655	US5054	89018214	US5075
12656810	US8918	21015340	US5054	89060462	US5075
12656811	US8123	22514839	US5012	89060479	US6020
12657499	US8932	22519584	US5014	89060527	US5077
12663909	US8102	23500133	US5008	90220568	US5036
12663910	US8102	23500138	US5062	90325660	US8917
12667383	US8147	24405895	US6184	90392900	US5045
12667384	US8147	24409355	US8925	90392901	US5057
12667385	US8147	24439798	US5092	90392902	US5036
12667387	US8147	24467301	US5092	90392908	US5017
12670051	US8918	24570464	US5043	90543277	US5079

WATER PUMPS



WATER PUMP CROSS REFERENCE



General Motors (cont'd.)		Honda (cont'd.)		Hyundai	
90543935	US8933	19200-P1R-003	US9253	25100-2B000	US6247
91160212	US8914	19200-P2A-A01	US9352	25100-2B700	US6247
91172178	US5048	19200-P5A-004	US9354	25100-2E000	US8106
91173189	US5058	19200-P5G-004	US9348	25100-2E005	US8106
91173496	US5048	19200-P08-004	US9250	25100-2E020	US8106
91174230	US9374	19200-P8A-A01	US9383	25100-2G000	US6220
91174494	US9342	19200-P8A-A02	US9383	25100-2G100	US6220
91175666	US5058	19200-P8A-A03	US9383	25100-2G200	US6220
91176170	US9385	19200-P10-A02	US9130	25100-2G400	US6220
91176915	US5058	19200-P13-003	US9273	25100-2G500	US8982
91177756	US9342	19200-P14-A01	US9251	25100-2G510	US8982
91177757	US9385	19200-P30-003	US9321	25100-2G600	US6220
92064250	US8925	19200-P72-003	US9289	25100-2G650	US6220
92149009	US8932	19200-P72-013	US9468	25100-2GTA0	US8163
93170697	US5079	19200-P75-003	US9349	25100-2GTC0	US8163
93231147	US5017	19200-PA6-030	US9035	25100-3C100	US6048
93385844	US8938	19200-PB2-010	US9029	25100-3C120	US6048
94013802	US8917	19200-PB2-405	US9029	25100-3C130	US6048
94022627	US1046	19200-PC1-000	US9035	25100-3C131	US6048
94109591	US5031	19200-PD2-660	US9056	25100-3E001	US6215
94118501	US5027	19200-PD6-000	US9056	25100-02500	US8935
94202477	US1127	19200-PE0-010	US9069	25100-02501	US8935
94239153	US5013	19200-PE0-415	US9069	25100-02502	US8935
94239649	US9132	19200-PE0-515	US9069	25100-02555	US8935
94360200	US9220	19200-PE8-405	US9043N	25100-02577	US8939
94391670	US73	19200-PE8-600	US9043N	25100-02588	US8939
94840612	US9057	19200-PH1-000	US9083	25100-12500	US8935
94844775	US9076	19200-PH7-003	US9097	25100-12501	US8935
94847609	US9057	19200-PLM-A01	US9419	25100-21000	US7115
94854103	US9272	19200-PNA-003	US9434	25100-22650	US7115
94856254	US9271	19200-PNL-E01	US9434	25100-22900	US9364
94858649	US9376	19200-PR4-013	US9224	25100-23001	US9353
95711070	US8932	19200-PR7-305	US9219	25100-23002	US9353
96054298	US5029	19200-PR7-A01	US9219	25100-23003	US9353
96059659	US5048	19200-PR7-A02	US9219	25100-23010	US9353
96062832	US5048	19200-PR7-A03	US9219	25100-23021	US8972
96182871	US8917	19200-PRB-A01	US6703	25100-23022	US8972
96351971	US8917	19200-PV1-A01	US9253	25100-23513	US9353
96352649	US8917	19200-PV3-003	US9253	25100-23522	US8972
96352650	US6046	19200-PY3-010	US9218	25100-23530	US8972
96352652	US8917	19200-PY3-A00	US9288	25100-24030	US7115
96416294	US8984	19200-PZA-013	US6216	25100-25002	US6220
96518977	US8928	19200-R1A-A01	US6693	25100-26900	US9364
96872700	US8917	19200-R5A-A01	US8137	25100-26902	US9364
96872702	US6046	19200-R40-A01	US6233	25100-32515	US7118
96930074	US6046	19200-R70-A11	US9470	25100-33012	US7131
96990997	US8917	19200-RAA-A01	US9461	25100-33132	US9212
97031472	US9221	19200-RAD-003	US9461	25100-35050	US7121
97216136	US63	19200-RB0-003	US6350	25100-37202	US9462
97372515	US72	19200-RBB-013	US9461	25100-38200	US9399
98031233	US72	19200-RBC-013	US9495	25100-39010	US9463
98098889	US72	19200-RBJ-003	US8983	25100-39012	US9463
Honda		19200-RCA-A01	US9470	25100-42540	US8922
8-97081-623-0	US9133	19200-RDF-A01	US8103	25110-2G000	US6220
8-97125-975-0	US9278	19200-RDM-A01	US9470	25110-2G400	US6220
8-97167-554-0	US9365	19200-RDM-A02	US9470	25110-2G500	US8982
06192-R1A-305	US6056	19200-RDV-J01	US9470	25110-2G510	US6220
06194-RNA-305	US6056	19200-RFE-003	US9461	25110-25002	US6220
19110-634-375	US9033	19200-RME-A01	US6018	International / Navistar	
19110-634-405	US9033	19200-RMX-003	US6216	4C4Z-8501-AARM	US85
19110-657-335	US9034	19200-RNA-A01	US6056	5C4Z-8501-AA	US85
19110-657-405	US9034	19200-RNA-A02	US6056	270918C93	US1099
19110-671-335	US9034	19200-RW0-003	US8144	463365C91	US1099
19110-673-335	US9034	19200-RWC-A01	US6223	861236R92	US1099
19110-689-335	US9034	19200-RX0-A01	US6213	1803276C95	US3705
19110-689-405	US9034	19210-PC1-515	US9035	1805952C91	US3705
19200-5A2-A01	US8103	19210-PCX-003	US9403	1809374	US3705
19200-5J0-A01	US8138	19210-PD2-515	US9056	1809374C91	US3705
19200-5LA-A01	US8118	19210-PD6-505	US9056	1812313C93	US4096
19200-5R0-003	US8119	19210-PD6-515	US9056	1845002C91	US85
19200-59B-003	US8145	19210-PG6-305	US9115	F5TZ 8501-B	US4096
19200-657-010	US9034	19210-PH1-515	US9083	Isuzu	
19200-P0A-003	US9209	19210-PH3-305	US9131	5-86202-375-0	US9209
19200-P0G-A01	US9097	19210-PHM-010	US9494	8-10120-943-0	US5035
19200-P01-004	US9130	19210-PK2-305	US9129	8-12462-265-0	US5032

Isuzu (cont'd.)		Jaguar (cont'd.)		Mazda (cont'd.)	
8-12482-690-0	US5035	NBB2200DA	US9280	8AF3-15-010B	US9102
8-12532-528-0	US5077	XR813290	US4118	8AF4-15-010B	US9102
8-12620-226-0	US5097	Kia		8AFB-15-010A	US9208
8-24576-952-0	US5097	0FE1H-15-010H	US4053	8AFC-15-010A	US9208
8-88894-290-0	US64	0K24A-15-010	US9305	8AFC-15-010B	US9208
8-88894-290-0	US64-T	0K30E-15-010	US9473	8AFD-15-010	US9208
8-89017-439-0	US64	0K247-15-010A	US9393	8AG6-15-010	US9067
8-89017-439-0	US64-T	0K247-15-010B	US9393	8AG6-15-010A	US9067
8-89018-166-0	US64	0K930-15-010A	US4049	8AG7-15-010	US9060
8-89018-166-0	US64-T	21355-3C510	US6048	8AG7-15-010A	US9060
8-89060-527-0	US5077	25100-2B000	US6247	8AG9-15-010	US4078
8-90466-343-0	US9375	25100-2B700	US6247	8AH3-15-010A	US9166
8-92064-250-0	US9375	25100-2X401	US9473	8AH3-15-010B	US9166
8-92065-969-0	US9375	25100-2Y000	US9393	8AH6-15-010	US9225
8-93284-724-0	US9375	25100-2Y010	US9393	8AH6-15-010B	US9225
8-94109-591-1	US5031	25100-2Y011	US9393	8AH7-15-010A	US9260
8-94118-501-0	US5027	25100-3C100	US6048	8AL1-15-010A	US9167
8-94120-768-1	US9132	25100-3C120	US6048	8AL1-15-010C	US9167
8-94131-330-1	US9106	25100-3C121	US6048	8AL4-15-010	US9394
8-94146-326-0	US9105	25100-3C130	US6048	8AL4-15-010A	US9394
8-94146-326-1	US9105	25100-3C131	US6048	8AS4-15-010A	US9020
8-94174-226-2	US9133	25100-3C160	US6048	8BU1-15-010	US7120
8-94202-477-1	US1127	25100-3C170	US6048	8BU1-15-010RMO	US7120
8-94224-894-0	US1127	25100-3E000	US9462	0305-15-010D	US9300
8-94239-649-0	US9132	25100-3E001	US6215	0305-15-010E	US9300
8-94332-636-0	US9134	25100-3X000	US9450	0305-99-151	US9300
8-94332-637-1	US9105	25100-23021	US8972	0324-15-010D	US9020
8-94332-638-2	US9133	25100-23022	US8972	0324-15-010E	US9020
8-94376-837-0	US9132	25100-25002	US6220	0381-15-010A	US1042
8-94376-845-0	US9106	25100-26902	US9364	0381-15-010B	US1042
8-94376-846-0	US9105	25100-37102	US9462	0381-99-151	US1042
8-94376-847-0	US9133	25100-37201	US9462	0381-99-151A	US1042
8-94376-859-1	US9132	25100-37202	US9462	1757-23-925B	US9053
8-94376-866-0	US5031	25100-38002	US9399	1757-99-151	US9053
8-94376-868-0	US9160	25100-38200	US9399	3648-15-130B	US9053
8-94391-670-5	US73	25100-39010	US9463	8872-15-010B	US9053
8-94437-048-1	US9160	25100-39012	US9463	8872-15-010D	US9053
8-97010-201-0	US5027	25100-39800	US9448	8872-15-0101	US9053
8-97012-298-0	US1127	25100-39802	US9448	AJ03-15-010B	US4091
8-97021-773-0	US9105	Land Rover		AJ03-15-010F	US4132
8-97021-774-0	US9133	138 6525	US6251	AJ03-15-010G	US4132
8-97031-472-0	US9221	457 5902	US4124	AJ57-15-010	US9489
8-97031-473-0	US9220	LR0 10801	US8120	AJ57-15-010A	US9489
8-97061-280-0	US9278	LR0 33993	US8120	AJ57-15-010B	US9489
8-97081-623-0	US9133	LR0 55239	US8120	AJTM-15-010	US9489
8-97081-623-1	US9133	LR0 73711	US8120	AJY1-15-010	US4091
8-97081-624-0	US9105	LR0 97165	US8120	B6BF-15-010F	US9305
8-97081-624-1	US9105	PEB 102240L	US9496	B6BF-15-010RMF	US9305
8-97125-975-0	US9278	RTC 6339	US9368	B630-15-010RMD	US4049
8-97167-554-0	US9365	ST 1693	US9369	B660-15-010RME	US4068
8-97602-776-0	US73	ST 4378	US9369	CY02-15-010	US6023
Jaguar		STC 483	US9368	CY02-15-010A	US6023
AJ84817	US4129	STC 1693	US9369	CY02-15-010C	US6023
AJ88417	US4124	STC 4378	US9369	CY02-15-010D	US6023
AJ88912	US4124	Mazda		E301-15-010	US9050
AJ811935	US4118	1F00-15-010	US4093	E301-15-010A	US9050
AJ813157	US4118	1F20-15-010	US4126	E301-15-010B	US9050
C2C32677	US4129	1F22-15-010	US4108	E301-15-010C	US9050
C2C38862	US4129	1F70-15-010	US4126	F801-15-010C	US9060
C2S26232	US4118	1F70-15-010	US4126	F801-15-010D	US9060
C2S43292	US6657	1F70-15-100	US4126	FE79-15-010B	US9060
C38405	US9165	1F82-15-010	US4108	FE79-15-010C	US9060
EAC3033	US9165	8A81-15-010	US9050	FE79-15-010E	US9111
EAC7242	US9163	8AB4-15-010A	US4049	FE79-15-010RMJ	US9060
EAC9213	US9163	8AB5-15-010A	US4068	FEMJ-15-100RMO	US4053
EBC4437	US9163	8AB7-15-010	US4049	FP01-15-010F	US4078
EBC8550	US9163	8AB8-15-010	US4068	FP01-15-010G	US4078
EBC10566	US9356	8ABB-15-010A	US9305	FS01-15-010F	US4078
EBC10967	US9356	8ABC-15-010	US9371	FS01-15-010RMF	US4078
JLM361	US9165	8ABE-15-010	US9371	GY01-15-010B	US4091
JLM398	US9211	8ABT-15-010A	US9050	JE96-15-010B	US9394
JLM9696	US9211	8AD2-15-010A	US4049	JE96-15-010RM	US9394
JLM9697	US9165	8AF2-15-010B	US9102	JE96-15-010RMB	US9166
JLM10648	US9165	8AF2-15-010C	US9102	JF03-15-010RME	US9166
JLM10819	US9165	8AF3-15-010A	US9102	KJ01-15-010H	US9328

Mazda (cont'd.)	Mercedes-Benz (cont'd.)	Nissan (cont'd.)			
KL01-15-010RMB	US9328	602 200 04 20	US9228	21010-31U25	US9309
KL47-15-010C	US9318	605 200 08 20	US9228	21010-31U26	US9309
KL47-15-010RMC	US9318	611 200 05 01	US6008	21010-31U27	US9309
L3G2-15-100	US4126	611 200 11 01	US6008	21010-31U28	US9309
L3G2-15-100A	US4126	611 220 01 10	US6008	21010-31U29	US9309
L327-15-100	US4126	613 200 09 01	US6152	21010-31U85	US9309
L327-15-100A	US4126	642 200 07 01	US6155	21010-31W26	US9198
LF01-15-100	US4126	642 200 10 01	US6349	21010-40F25	US9206
LF52-15-100	US4126	642 200 13 01	US6155	21010-50A25	US9041
LF52-15-100A	US4126	642 200 17 01	US6155	21010-50A27	US9041
LF94-15-100	US6219	647 200 01 01	US6007	21010-50A89	US9284
LF94-15-100A	US6219	5103 576AA	US6008	21010-50A94	US9041
N3H1-15-100B	US6156	5103 576AB	US6008	21010-50AY8	US9041
N3H81-15-100A	US6156	5138 057AA	US6007	21010-53J05	US9213
N232-99-153A	US9053	A211 835 02 64	US11009	21010-53Y01	US9214
N232-99-153B	US9053	A611 200 11 01	US6008	21010-60U26	US9239
N304-15-010C	US9053	A642 200 13 01	US6007	21010-60UY6	US9041
PE01-15-010B	US6700	MG		21010-77A00	US9207
PEDD-15-010	US6700	GWP130	US9082	21010-77AY0	US9207
RF01-99-154	US9067	Mitsubishi		21010-80W26	US9031
RF01-99-154A	US9067	1300A011	US7152	21010-80W89	US9031
YF09-15-100	US4115	1300A012	US9460	21010-82W25	US9031
ZJ01-15-010B	US6295	1300A055	US6240	21010-86G00	US9206
ZJ01-15-010C	US6295	1300A065	US6159	21010-86G25	US9206
ZL01-15-010	US9305	1300A066	US6149	21010-88R00	US9214
ZL01-15-010A	US9305	1300A067	US6159	21010-88R10	US9214
ZZC4-15-010	US6250	1300A069	US6228	21010-97E00	US9252
ZZJ1-15-010	US6023	1300A082	US6038	21010-13200	US9179
ZZL0-15-010A	US4060	1300A083	US6038	21010-13201	US9179
ZZM0-15-010	US4054	1300A107	US8143	21010-13202	US9179
ZZM3-15-010	US4093	M245611	US8914	21010-13205	US9179
ZZM5-15-010	US4060	M855991	US8914	21010-13206	US9179
ZZM5-15-010A	US4060	Nissan		21010-13225	US9179
ZZM7-15-010	US4095	21010-0M302	US9214	21010-13226	US9179
ZZMA-15-010	US4039	21010-00Q0K	US8921	21010-21028	US9009
ZZR1-15-010	US4095	21010-00QAA	US8927	21010-21089	US9009
ZZR1-15-010A	US4095	21010-0W002	US9338	21010-23028	US9008
ZZR1-15-010B	US4095	21010-0W003	US9338	21010-AL525	US9426
Mercedes-Benz		21010-0W025	US9338	21010-AL526	US9426
000 500 03 86	US11015	21010-0W027	US9338	21010-AL527	US9426
001 835 13 64	US11024	21010-1E4Y0	US9270	21010-AL528	US9426
102 200 42 01	US9173	21010-1E400	US9270	21010-AR025	US6287
102 200 62 01	US9175	21010-1E401	US9270	21010-AR725	US6227
103 200 37 01	US9202	21010-1E403	US9270	21010-B17G2	US9284
104 200 31 01	US9222	21010-01M25	US9041	21010-BX000	US8967
104 200 33 01	US9313	21010-02P26	US9058	21010-D0126	US9114
104 200 44 01	US9311	21010-02P27	US9058	21010-EA010	US6242
104 200 47 01	US9345	21010-02P85	US9058	21010-EB30A	US8998
104 200 48 01	US9343	21010-3RC1A	US8104	21010-EB300	US8998
104 200 49 01	US9344	21010-3TA0B	US8105	21010-ET025	US6218
104 200 54 01	US9344	21010-3TA1B	US8105	21010-F460A	US9416
104 200 57 01	US9344	21010-3TS0A	US8105	21010-F461A	US9427
104 200 58 01	US9351	21010-4S10A	US9338	21010-F461B	US9427
110 200 02 20	US9299	21010-4S125	US9338	21010-F462A	US9427
110 200 17 20	US9172	21010-4S126	US9338	21010-F4300	US9214
110 200 20 20	US9299	21010-06EY6	US9116	21010-F4400	US9270
111 200 04 01	US9314	21010-6N226	US9427	21010-F4600	US9416
111 200 23 01	US9440	21010-7B000	US9402	21010-G3925	US9031
111 200 40 01	US9314	21010-7S000	US9488	21010-G3926	US9031
111 200 42 01	US6229	21010-7Y00A	US9426	21010-G3928	US9031
112 200 14 01	US9380	21010-7Y025	US9426	21010-H7227	US9026
112 200 15 01	US9379	21010-7Y026	US9426	21010-JA10A	US6198
116 200 17 01	US9231	21010-8J000	US9427	21010-JK00A	US6198
117 200 33 01	US9230	21010-09W25	US9198	21010-JK00C	US6198
117 200 38 01	US9176	21010-12G26	US9104	21010-M66Y6	US9010
119 200 15 01	US9315	21010-12G28	US9104	21010-M6626	US9010
119 200 21 01	US9346	21010-16A85	US9044	21010-N5829	US9031
120 200 11 01	US9277	21010-16AY5	US9044	21010-N5885	US9031
211 835 02 64	US11009	21010-17C28	US9110	21010-N8527	US9008
271 200 02 01	US6030	21010-17S27	US9011	21010-P7586	US9011
272 200 04 01	US6075	21010-17SY7	US9011	21010-P7589	US9011
272 200 04 91	US6075	21010-22P25	US9201	21010-U6727	US9008
272 200 09 01	US6142	21010-30R05	US9162	21010-V5528	US9063
273 200 02 01	US6235	21010-30R06	US9162	21010-VV227	US8978
275 200 01 01	US6273			92516-EA50B	US11005



WATER PUMP CROSS REFERENCE



WATER PUMPS

Nissan (cont'd.)		Renault (cont'd.)		Suzuki (cont'd.)	
B1010-0P529	US9268	8982 775055	US3408	17400-66811	US9385
B1010-0W00J	US9338	9641117180	US8973	17400-73001	US9227
B1010-1G20A	US6218	Saab		17400-73002	US9227
B1010-1KC0A	US8104	12 56 6029	US8932	17400-73003	US9227
B1010-1KC0B	US8104	12 60 0767	US6009	17400-73012	US9227
B1010-1P128	US9388	12 60 0767	US6009-T	17400-73013	US9227
B1010-3HC0A	US6687	12 62 0226	US5097	17400-73810	US9227
B1010-3LM0A	US6218	12 63 0084	US5092	17400-73811	US9227
B1010-16E03	US9074	24 57 6952	US5097	17400-73812	US9227
B1010-22P27	US9201	32 00 5905	US9223	17400-73820	US9232
B1010-40F27	US9206	32 00 5906	US9215	17400-77810	US9342
B1010-67U28	US9304	32 01 0616	US9223	17400-77812	US9342
B1010-AL50B	US9426	59 58 061	US5079	17400-77813	US9342
B1010-ED00A	US6687	59 60 414	US9307	17400-77815	US9342
B1010-EN20B	US6218	75 07 460	US9108	17400-77816	US9342
B1010-ET00A	US6218	88 17 900	US9108	17400-78820	US9232
B1010-F461B	US9427	88 21 944	US5079	17400-78821	US9232
B1010-JK00A	US6198	88 22 710	US9307	17400-78890	US6292
B1010-JK00C	US6198	88 22 793	US9307	17400-78891	US6292
B1010-JK20A	US8164	89 01 8166	US64	17400-78892	US6292
BA010-06E26	US9116	89 01 8166	US64-T	17400-78893	US6292
BA010-80W89	US9031	92 14 9009	US8932	17400-82824	US5058
BA010-D0126	US9114	93 16 6829	US9307	17400-82850	US5058
BA010-H7289	US9026	93 17 8602	US5092	17400-82851	US5058
BA010-M6626	US9010	93 18 1118	US5092	17400-83811	US5029
BA010-N8527	US9008	93 19 5308	US5092	17400-83815	US5029
BA010-V5589	US9063	93 21 670	US9107	17400-85830	US9385
Peugeot		93 21 688	US9264	17400-85831	US9385
1201 31	US9193	95 71 1081	US8932	17401-78812	US8932
1201-47	US8936	Smart		Toyota	
1201-A2	US8937	132 200 02 01	US8121	161A0-29015	US6682
1201-E3	US8936	Sterling		161A0-39015	US6682
1201-E5	US8937	26526500010	US9097	161A0-39025	US6211
1201-F5	US8954	Subaru		16100-0H010	US9414
1202 82	US9193	21110 AA016	US9161	16100-0H040	US8970
1202 97	US9193	21110 AA017	US9161	16100-0H050	US8970
1207-18	US8936	21110 AA025	US9080	16100-64H05	US9059
1207-23	US8936	21110 AA026	US9080	16100-09170	US9376
Porsche		21110 AA050	US9025	16100-09200	US9257
060 121 010 X	US9177	21110 AA060	US9025	16100-09201	US9257
060 121 011	US9177	21110 AA070	US9093	16100-09440	US6047
928 106 015 11	US9242	21110 AA110	US9109	16100-09441	US6047
928 106 015 20	US9241	21110 AA360	US9421	16100-09442	US6047
928 106 015 22	US9242	21110 AA510	US6692	16100-09470	US6037
944 106 021 09	US9245	21110 AA690	US9384	16100-09471	US6037
944 106 021 13	US9245	21111 AA007	US9223	16100-09490	US6197
944 106 021 22	US9245	21111 AA026	US9215	16100-09491	US6197
951 106 021 01	US9245	21111 AA033	US9254	16100-09515	US6252
951 106 021 08	US9245	21111 AA065	US9255	16100-09525	US6336
951 106 021 10	US9245	21111 AA110	US9223	16100-09560	US6232
955 106 011 00	US9471	21111 AA230	US9472	16100-09690	US8150
996 106 011 53	US9475	21111 AA240	US9215	16100-19016	US9015
996 106 011 55	US9475	21111 AA250	US9255	16100-19017-77	US9015
996 106 011 57	US9475	21111 AA280	US6049	16100-19025	US9028
997 101 011 02	US9475	21111 AA290	US6160	16100-19027	US9045
997 106 011 02	US9475	21111 AA320	US6049	16100-19028-77	US9045
997 106 011 05	US9475	21114 AA051	US6160	16100-19056	US9064
997 106 011 06	US9475	21118 KA000	US9486	16100-19066	US9086
997 106 011 70	US9475	21135 KA000	US9486	16100-19066-84	US9086
997 106 011 71	US9475	Suzuki		16100-19166	US9064
997 106 011 72	US9475	17400-60D01	US8928	16100-25012	US9012
Renault		17400-70B00	US8928	16100-25012-84	US9012
7701 457 670	US9301	17400-78J00	US8932	16100-26022	US9018
7701 462 809	US8914	17400-82Z00	US9426	16100-26022-84	US9018
7701 463 111	US8914	17400-85Z00	US8925	16100-26023	US9018
7701 463 397	US8914	17400-85Z01	US9342	16100-28020	US9018
7701 505 397	US9301	17400-85Z02	US8925	16100-28020-77	US9018
7701 452155	US9282	17400-86Z00	US6241	16100-28041	US9414
7701 457416	US9282	17400-86Z03	US6241	16100-29026	US1006
7701 462085	US3406	17400-60812	US5048	16100-29047	US9021
7701 463182	US3410	17400-60813	US5048	16100-29048	US9021
7701 479043	US8921	17400-60815	US5048	16100-29055	US1006
7701 502962	US9282	17400-61820	US9374	16100-29085	US9306
7702 001510	US9282	17400-66810	US9385	16100-29145	US9405
				16100-29146	US9405

Toyota (cont'd.)		Toyota (cont'd.)		Volkswagen / Audi (cont'd.)	
16100-29156	US9406	16110-19185	US9272	06F 121 011 X	US6022
16100-29156-83	US9406	16110-19205	US9271	06H 121 026 AB	US9047
16100-29157	US9406	16110-26020	US9016	06H 121 026 AB	US9047-2
16100-29157-83	US9406	16110-26020-84	US9016	06H 121 026 AF	US9047
16100-29415-83	US9405	16110-26021	US9018	06H 121 026 AF	US9047-2
16100-39316	US9017	16110-26021-84	US9018	06H 121 026 BA	US9047
16100-39317	US9017	16110-28010	US9018	06H 121 026 BA	US9047-2
16100-39317-77	US9017	16110-28010-77	US9018	06H 121 026 CF	US9047
16100-39346-83	US9141	16110-38020	US9005	06H 121 026 CF	US9047-2
16100-39435	US6143	16110-38022	US9027	06H 121 026 CQ	US9047
16100-39436	US6143	16110-38022-77	US9027	06H 121 026 CQ	US9047-2
16100-39456	US6047	16110-45070	US9180	06H 121 026 DD	US9047
16100-39465	US6232	16110-49025	US9170	06H 121 026 DD	US9047-2
16100-39466	US6232	16110-49026-77	US9170	06J 121 026 J	US9047
16100-39495	US6197	16110-49097	US9292	06J 121 026 J	US9047-2
16100-39496	US6197	16110-49115	US9256	06J 121 026 M	US9047
16100-39505	US6338	16110-49116	US9256	06J 121 026 M	US9047-2
16100-39506	US6338	16110-49125	US9292	06K 121 011 B	US8124
16100-39515	US6252	16110-49126	US9292	06K 121 011 C	US8124
16100-39545	US6599	16110-49156	US9395	7B0 121 011	US6231
16100-39555	US6336	16110-61081	US9337	7B0 121 011 A	US8951
16100-39615	US8150	16110-61081-77	US9337	7B0 121 011 B	US8981
16100-49095	US9181	16110-61180	US9155	7B0 121 011 BXRMM	US8981
16100-49655	US9040N	16110-69035	US9048	7B0 121 011 C	US6231
16100-49656-77	US9040N	16110-69036-77	US9048	7B0 121 011 D	US8951
16100-49776	US9100	16110-79026-83	US9099	7B0 121 011 E	US8981
16100-49805-83	US9100	16110-79095	US9140	7B0 121 011 F	US6231
16100-49837-83	US9256	16110-79115	US9140	7B0 121 011 G	US8981
16100-50023-83	US9257	16120-41060	US9180	07D 121 005 R	US8111
16100-59127	US9094	16120-42011	US9180	07D 121 008 A	US8111
16100-59129	US9094	16290-21011	US11013	07K 121 011 B	US6050
16100-59137	US9200	87200-33010	US11012	07K 121 011 BX	US6050
16100-59139	US9200	87200-47030	US11011	07L 121 014 F	US6702
16100-59275-83	US9257	SU003-00401	US9384	021 121 004	US9262
16100-59276	US9257	Volkswagen / Audi		021 121 004 A	US9262
16100-60080	US9078	1K0 965 561 G	US11017	021 121 004 AX	US9262
16100-61012	US9189	1K0 965 561 J	US11008	021 121 004 X	US9262
16100-61041	US9189	03C 121 005 B	US8996	022 121 011	US9471
16100-61070	US9493	03C 121 005 C	US8996	022 121 011 A	US6221
16100-61080	US9493	03C 121 005 D	US8996	022 121 011 B	US6221
16100-61130	US9189	03C 121 005 N	US8977	022 121 011 V	US9471
16100-69085	US9059	03C 121 008 J	US8108	022 121 011 X	US9471
16100-69255	US9155	3D0 965 561 D	US11004	025 121 010 AX	US9061
16100-69275	US9059	03L 121 011 B	US6034	025 121 010 CX	US9150
16100-69325	US9269	03L 121 011 BX	US6034	026 121 005 C	US9065
16100-69385	US9320	03L 121 011 G	US6034	026 121 005 G	US9065
16100-69398-83	US9324	03L 121 011 GX	US6034	026 121 005 H	US9065
16100-69455-83	US9258	03L 121 011 H	US8108	026 121 005 JX	US9065
16100-69465-83	US9142	03L 121 011 HX	US8108	026 121 005 L	US9401
16100-69475-83	US9145	03L 121 011 P	US8108	026 121 010 DX	US9066
16100-69485-83	US9291	06A 121 011 F	US9377	030 121 005 N	US8949
16100-69495-83	US9291	06A 121 011 L	US9377	030 121 005 NV	US8949
16100-69535	US9325	06A 121 011 LX	US9377	030 121 005 NX	US8949
16100-79036	US9092	06A 121 011 T	US9377	030 121 008 D	US8949
16100-79036-77	US9092	06A 121 011 TX	US9377	030 121 008 DX	US8949
16100-79165-83	US9216	06A 121 012	US9377	030 131 005 T	US8949
16100-79445-83	US9293	06A 121 012 E	US9377	034 121 004	US9171
16100-WB001	US6700	06A 121 012 G	US9377	034 121 004 X	US9171
16110-15020	US9046	06A 121 012 GX	US9377	035 121 004 A	US9052
16110-15085	US9046	06A 121 012 X	US9377	035 121 004 AX	US9052
16110-16020-84	US9076	06C 121 004 H	US9429	036 121 005 B	US8976
16110-19025	US9045	06C 121 004 HX	US9429	036 121 005 E	US8976
16110-19026	US9045	06E121 018 B	US6249	036 121 005 Q	US8976
16110-19036	US9046	06E 121 005 D	US6146	037 121 005 B	US9065
16110-19036-84	US9046	06E 121 005 F	US6146	037 121 005 C	US9065
16110-19046	US9057	06E 121 005 G	US6249	037 121 010 C	US9065
16110-19047-77	US9057	06E 121 005 N	US6146	037 121 010 CX	US9065
16110-19065-84	US9098	06E 121 005 P	US6249	038 121 011 A	US9378
16110-19076	US9057	06E 121 008 N	US6146	038 121 011 AX	US9378
16110-19086	US9057	06E 121 008 P	US6249	038 121 011 G	US6034
16110-19106	US9334	06E 121 018 A	US6146	038 121 011 GX	US6034
16110-19115	US9076	06E 121 018 AX	US6146	038 121 011 J	US9378
16110-19146	US9271	06E 121 018 B	US6249	038 121 011 JX	US9378
16110-19155	US9075	06E 121 018 D	US6146	045 121 011 F	US6212
16110-19176	US9272	06F 121 011	US6022	045 121 011 H	US6212

Volkswagen / Audi (cont'd.)











050 121 010 CX	US9401
054 121 004 A	US9279
054 121 004 AX	US9279
068 121 005 A	US9065
068 121 005 B	US9066
068 121 005 C	US9066
069 121 005 D	US9071
074 121 005 M	US9274
074 121 005 N	US9274
077 121 004 A	US9226
077 121 004 F	US9362
077 121 004 G	US9226
077 121 004 HX	US9362
077 121 004 M	US9410
077 121 004 MX	US9410
077 121 004 N	US9410
077 121 004 NX	US9410
077 121 004 P	US9410
077 121 004 PX	US9410
078 121 004 C	US9263
078 121 004 CX	US9263
078 121 004 H	US9333
078 121 004 HX	US9333
078 121 004 J	US9333
078 121 004 JX	US9333
078 121 004 QX	US9333
078 121 006	US9333
078 121 006 A	US9446
078 121 006 AX	US9446
078 121 006 X	US9333
078 965 561	US11003
079 121 010 D	US6000
079 121 011 H	US6000
079 121 011 Q	US6000
079 121 012 B	US6000
079 121 012 D	US6000
079 121 012 K	US6702
079 121 013 P	US6702
079 121 013 T	US6702
079 121 014 D	US6000
079 121 014 F	US6702
251 965 561 B	US11034

Volvo

270681-0	US9049
271275-0	US9068
271855-0	US9339
271975-0	US9068
271985-0	US9339
271986-0	US9339
272474-0	US9339
272481-0	US9339
275619-0	US9049
461094-0	US9077
1218096-0	US9147
1218158-0	US9146
1257185-0	US9071
8694626-0	US9339
8694627-0	US9339
8694628-0	US9340
8694630-0	US9456
30650751-0	US9339
30684432-0	US9339
30731384-0	US6276
30751700-0	US9339
31219000	US9382
31293303-0	US8134

			
US43N	US52	US61	US63
			
US64	US64-T	US65	US65N
			
US65N-T	US65-T	US66	US67
			
US72	US73	US76	US77
			
US78	US79	US85	US99

Note: The photos or illustrations shown above are for reference purposes only. It does not suggest or imply that all the referenced pumps are manufactured by US Motor Works.

 US127	 US310	 US470	 US488
 US670	 US713	 US723	 US773
 US819	 US821	 US835	 US843
 US850	 US855	 US861	 US895
 US896	 US898	 US898H	 US907

Note: The photos or illustrations shown above are for reference purposes only. It does not suggest or imply that all the referenced pumps are manufactured by US Motor Works.



US919



US926



US927



US932



US953



US953H



US960



US964



US975



US981



US984



US984H



US986



US1002



US1002H



US1006



US1010



US1012



US1018



US1018H

Note: The photos or illustrations shown above are for reference purposes only. It does not suggest or imply that all the referenced pumps are manufactured by US Motor Works.

 <p style="text-align: center; background-color: black; color: white; padding: 2px;">US1021</p>	 <p style="text-align: center; background-color: black; color: white; padding: 2px;">US1028</p>	 <p style="text-align: center; background-color: black; color: white; padding: 2px;">US1028H</p>	 <p style="text-align: center; background-color: black; color: white; padding: 2px;">US1040</p>
 <p style="text-align: center; background-color: black; color: white; padding: 2px;">US1042</p>	 <p style="text-align: center; background-color: black; color: white; padding: 2px;">US1044</p>	 <p style="text-align: center; background-color: black; color: white; padding: 2px;">US1045</p>	 <p style="text-align: center; background-color: black; color: white; padding: 2px;">US1046</p>
 <p style="text-align: center; background-color: black; color: white; padding: 2px;">US1047</p>	 <p style="text-align: center; background-color: black; color: white; padding: 2px;">US1052</p>	 <p style="text-align: center; background-color: black; color: white; padding: 2px;">US1053</p>	 <p style="text-align: center; background-color: black; color: white; padding: 2px;">US1053H</p>
 <p style="text-align: center; background-color: black; color: white; padding: 2px;">US1061</p>	 <p style="text-align: center; background-color: black; color: white; padding: 2px;">US1069</p>	 <p style="text-align: center; background-color: black; color: white; padding: 2px;">US1070</p>	 <p style="text-align: center; background-color: black; color: white; padding: 2px;">US1075</p>
 <p style="text-align: center; background-color: black; color: white; padding: 2px;">US1075H</p>	 <p style="text-align: center; background-color: black; color: white; padding: 2px;">US1077</p>	 <p style="text-align: center; background-color: black; color: white; padding: 2px;">US1082</p>	 <p style="text-align: center; background-color: black; color: white; padding: 2px;">US1083</p>

Note: The photos or illustrations shown above are for reference purposes **only**. It does not suggest or imply that all the referenced pumps are manufactured by US Motor Works.

 US1088	 US1096	 US1099	 US1100
 US1107	 US1109	 US1109H	 US1110
 US1114	 US1120	 US1120H	 US1121
 US1121H	 US1124	 US1127	 US1137
 US1137H	 US3400	 US3401	 US3401H

Note: The photos or illustrations shown above are for reference purposes only. It does not suggest or imply that all the referenced pumps are manufactured by US Motor Works.

 US3403	 US3404	 US3406	 US3408
 US3409	 US3410	 US3411	 US3412
 US3413	 US3414	 US3705	 US4002
 US4003	 US4005	 US4014	 US4014H
 US4016	 US4018	 US4020	 US4022

Note: The photos or illustrations shown above are for reference purposes **only**. It does not suggest or imply that all the referenced pumps are manufactured by US Motor Works.

 US4023	 US4024	 US4024H	 US4030N
 US4033	 US4034	 US4035	 US4037
 US4038	 US4038H	 US4039	 US4040
 US4041	 US4042	 US4044	 US4044H
 US4048	 US4049	 US4050	 US4051

Note: The photos or illustrations shown above are for reference purposes only. It does not suggest or imply that all the referenced pumps are manufactured by US Motor Works.

 <p style="text-align: center;">US4052</p>	 <p style="text-align: center;">US4052H</p>	 <p style="text-align: center;">US4053</p>	 <p style="text-align: center;">US4054</p>
 <p style="text-align: center;">US4055</p>	 <p style="text-align: center;">US4056</p>	 <p style="text-align: center;">US4057</p>	 <p style="text-align: center;">US4059</p>
 <p style="text-align: center;">US4060</p>	 <p style="text-align: center;">US4061</p>	 <p style="text-align: center;">US4062</p>	 <p style="text-align: center;">US4065</p>
 <p style="text-align: center;">US4066</p>	 <p style="text-align: center;">US4068</p>	 <p style="text-align: center;">US4069</p>	 <p style="text-align: center;">US4070</p>
 <p style="text-align: center;">US4077</p>	 <p style="text-align: center;">US4078</p>	 <p style="text-align: center;">US4079</p>	 <p style="text-align: center;">US4081</p>

Note: The photos or illustrations shown above are for reference purposes **only**. It does not suggest or imply that all the referenced pumps are manufactured by US Motor Works.

 US4082	 US4083	 US4086	 US4087
 US4088	 US4089	 US4090	 US4091
 US4091-2	 US4093	 US4094	 US4095
 US4096	 US4097	 US4098	 US4099
 US4101	 US4102	 US4103	 US4104





















Note: The photos or illustrations shown above are for reference purposes only. It does not suggest or imply that all the referenced pumps are manufactured by US Motor Works.

 <p style="text-align: center;">US4105</p>	 <p style="text-align: center;">US4106</p>	 <p style="text-align: center;">US4107</p>	 <p style="text-align: center;">US4108</p>
 <p style="text-align: center;">US4109</p>	 <p style="text-align: center;">US4113</p>	 <p style="text-align: center;">US4114</p>	 <p style="text-align: center;">US4115</p>
 <p style="text-align: center;">US4118</p>	 <p style="text-align: center;">US4119</p>	 <p style="text-align: center;">US4121</p>	 <p style="text-align: center;">US4123</p>
 <p style="text-align: center;">US4124</p>	 <p style="text-align: center;">US4125</p>	 <p style="text-align: center;">US4126</p>	 <p style="text-align: center;">US4128</p>
 <p style="text-align: center;">US4129</p>	 <p style="text-align: center;">US4132</p>	 <p style="text-align: center;">US4132-2</p>	 <p style="text-align: center;">US5000</p>

Note: The photos or illustrations shown above are for reference purposes **only**. It does not suggest or imply that all the referenced pumps are manufactured by US Motor Works.

 <p>US5000P</p>	 <p>US5001</p>	 <p>US5003</p>	 <p>US5004</p>
 <p>US5006</p>	 <p>US5007</p>	 <p>US5008</p>	 <p>US5010</p>
 <p>US5012</p>	 <p>US5013</p>	 <p>US5014</p>	 <p>US5014P</p>
 <p>US5015</p>	 <p>US5016</p>	 <p>US5016H</p>	 <p>US5017</p>
 <p>US5019</p>	 <p>US5019H</p>	 <p>US5020</p>	 <p>US5022</p>







Note: The photos or illustrations shown above are for reference purposes only. It does not suggest or imply that all the referenced pumps are manufactured by US Motor Works.

 <p style="text-align: center; background-color: black; color: white; padding: 2px;">US5023</p>	 <p style="text-align: center; background-color: black; color: white; padding: 2px;">US5027</p>	 <p style="text-align: center; background-color: black; color: white; padding: 2px;">US5028</p>	 <p style="text-align: center; background-color: black; color: white; padding: 2px;">US5029</p>
 <p style="text-align: center; background-color: black; color: white; padding: 2px;">US5030</p>	 <p style="text-align: center; background-color: black; color: white; padding: 2px;">US5031</p>	 <p style="text-align: center; background-color: black; color: white; padding: 2px;">US5032</p>	 <p style="text-align: center; background-color: black; color: white; padding: 2px;">US5033</p>
 <p style="text-align: center; background-color: black; color: white; padding: 2px;">US5035</p>	 <p style="text-align: center; background-color: black; color: white; padding: 2px;">US5036</p>	 <p style="text-align: center; background-color: black; color: white; padding: 2px;">US5037</p>	 <p style="text-align: center; background-color: black; color: white; padding: 2px;">US5038</p>
 <p style="text-align: center; background-color: black; color: white; padding: 2px;">US5038H</p>	 <p style="text-align: center; background-color: black; color: white; padding: 2px;">US5040</p>	 <p style="text-align: center; background-color: black; color: white; padding: 2px;">US5041</p>	 <p style="text-align: center; background-color: black; color: white; padding: 2px;">US5043</p>
 <p style="text-align: center; background-color: black; color: white; padding: 2px;">US5045</p>	 <p style="text-align: center; background-color: black; color: white; padding: 2px;">US5048</p>	 <p style="text-align: center; background-color: black; color: white; padding: 2px;">US5049</p>	 <p style="text-align: center; background-color: black; color: white; padding: 2px;">US5049H</p>

Note: The photos or illustrations shown above are for reference purposes **only**. It does not suggest or imply that all the referenced pumps are manufactured by US Motor Works.

 US5050	 US5051	 US5054	 US5056
 US5057	 US5058	 US5062	 US5063
 US5064	 US5066	 US5067	 US5068
 US5069	 US5070	 US5072	 US5073
 US5074	 US5075	 US5076	 US5077

Note: The photos or illustrations shown above are for reference purposes only. It does not suggest or imply that all the referenced pumps are manufactured by US Motor Works.

 US5077H	 US5078	 US5079	 US5081
 US5084	 US5085	 US5086	 US5087
 US5089	 US5089H	 US5090	 US5092
 US5097	 US5099	 US6000	 US6001
 US6003	 US6006	 US6007	 US6008

Note: The photos or illustrations shown above are for reference purposes **only**. It does not suggest or imply that all the referenced pumps are manufactured by US Motor Works.



US6009



US6009-T



US6018



US6020



US6022



US6023



US6030



US6034



US6037



US6038



US6046



US6047



US6048



US6049



US6050



US6056



US6075



US6142



US6143



US6144

Note: The photos or illustrations shown above are for reference purposes only. It does not suggest or imply that all the referenced pumps are manufactured by US Motor Works.

			
US6145	US6146	US6149	US6152
			
US6154	US6155	US6156	US6159
			
US6160	US6184	US6186	US6197
			
US6198	US6211	US6212	US6213
			
US6215	US6216	US6217	US6218



Note: The photos or illustrations shown above are for reference purposes **only**. It does not suggest or imply that all the referenced pumps are manufactured by US Motor Works.

 US6219	 US6220	 US6221	 US6222
 US6223	 US6227	 US6228	 US6229
 US6231	 US6232	 US6233	 US6235
 US6238	 US6240	 US6241	 US6242
 US6244	 US6247	 US6249	 US6250





Note: The photos or illustrations shown above are for reference purposes only. It does not suggest or imply that all the referenced pumps are manufactured by US Motor Works.

 US6251	 US6252	 US6273	 US6276
 US6287	 US6292	 US6295	 US6336
 US6338	 US6341	 US6349	 US6350
 US6599	 US6654	 US6657	 US6662
 US6680	 US6681	 US6682	 US6687

Note: The photos or illustrations shown above are for reference purposes **only**. It does not suggest or imply that all the referenced pumps are manufactured by US Motor Works.

 US6689	 US6692	 US6693	 US6699
 US6700	 US6702	 US6703	 US6708
 US7100	 US7101	 US7104	 US7105
 US7106	 US7108	 US7110	 US7110H
 US7111	 US7113	 US7114	 US7115





















Note: The photos or illustrations shown above are for reference purposes only. It does not suggest or imply that all the referenced pumps are manufactured by US Motor Works.

 US7117	 US7118	 US7120	 US7121
 US7121-2	 US7122	 US7124	 US7126
 US7127	 US7128	 US7129	 US7131
 US7135	 US7136	 US7137	 US7139
 US7140	 US7141	 US7145	 US7145HN

Note: The photos or illustrations shown above are for reference purposes **only**. It does not suggest or imply that all the referenced pumps are manufactured by US Motor Works.

			
US7145N	US7146	US7148	US7150
			
US7151	US7152	US7153	US7156
			
US7158	US7159	US7160	US7161
			
US7162	US7163	US7164	US7165
			
US7167	US7168	US7169	US8102

Note: The photos or illustrations shown above are for reference purposes only. It does not suggest or imply that all the referenced pumps are manufactured by US Motor Works.

 US8103	 US8104	 US8105	 US8106
 US8107	 US8108	 US8109	 US8111
 US8112	 US8114	 US8115	 US8116
 US8117	 US8118	 US8119	 US8120
 US8121	 US8123	 US8124	 US8125

Note: The photos or illustrations shown above are for reference purposes **only**. It does not suggest or imply that all the referenced pumps are manufactured by US Motor Works.

 US8134	 US8135	 US8136	 US8137
 US8138	 US8139	 US8140	 US8141
 US8141P	 US8141P-T	 US8141-T	 US8142
 US8142-T	 US8143	 US8144	 US8145
 US8146	 US8147	 US8148	 US8149





















Note: The photos or illustrations shown above are for reference purposes only. It does not suggest or imply that all the referenced pumps are manufactured by US Motor Works.

			
US8150	US8151	US8152	US8153
			
US8154	US8155	US8157	US8158
			
US8159	US8160	US8161	US8162
			
US8163	US8164	US8908	US8910
			
US8914	US8916	US8917	US8918

Note: The photos or illustrations shown above are for reference purposes **only**. It does not suggest or imply that all the referenced pumps are manufactured by US Motor Works.

			
US8920	US8921	US8922	US8925
			
US8926	US8927	US8928	US8931
			
US8932	US8933	US8934	US8935
			
US8936	US8937	US8938	US8939
			
US8940	US8944	US8945	US8946

Note: The photos or illustrations shown above are for reference purposes only. It does not suggest or imply that all the referenced pumps are manufactured by US Motor Works.

 <p style="text-align: center;">US8948</p>	 <p style="text-align: center;">US8949</p>	 <p style="text-align: center;">US8951</p>	 <p style="text-align: center;">US8952</p>
 <p style="text-align: center;">US8954</p>	 <p style="text-align: center;">US8955</p>	 <p style="text-align: center;">US8956</p>	 <p style="text-align: center;">US8959</p>
 <p style="text-align: center;">US8960</p>	 <p style="text-align: center;">US8963</p>	 <p style="text-align: center;">US8967</p>	 <p style="text-align: center;">US8968</p>
 <p style="text-align: center;">US8970</p>	 <p style="text-align: center;">US8971</p>	 <p style="text-align: center;">US8972</p>	 <p style="text-align: center;">US8973</p>
 <p style="text-align: center;">US8974</p>	 <p style="text-align: center;">US8975</p>	 <p style="text-align: center;">US8976</p>	 <p style="text-align: center;">US8977</p>

Note: The photos or illustrations shown above are for reference purposes **only**. It does not suggest or imply that all the referenced pumps are manufactured by US Motor Works.

			
US8978	US8979	US8980	US8981
			
US8982	US8983	US8984	US8984-2
			
US8985	US8987	US8990	US8996
			
US8998	US8999	US9003	US9005
			
US9008	US9009	US9010	US9011

Note: The photos or illustrations shown above are for reference purposes only. It does not suggest or imply that all the referenced pumps are manufactured by US Motor Works.

 US9012	 US9015	 US9016	 US9017
 US9018	 US9020	 US9021	 US9025
 US9026	 US9027	 US9028	 US9029
 US9031	 US9033	 US9034	 US9035
 US9040N	 US9041	 US9043N	 US9044

Note: The photos or illustrations shown above are for reference purposes **only**. It does not suggest or imply that all the referenced pumps are manufactured by US Motor Works.

			
US9045	US9046	US9047	US9047-2
			
US9048	US9049	US9050	US9052
			
US9053	US9056	US9057	US9058
			
US9059	US9060	US9061	US9063
			
US9064	US9065	US9065-2	US9066

Note: The photos or illustrations shown above are for reference purposes only. It does not suggest or imply that all the referenced pumps are manufactured by US Motor Works.

			
US9067	US9068	US9069	US9071
			
US9074	US9075	US9076	US9077
			
US9078	US9080	US9082	US9083
			
US9084	US9085	US9086	US9092
			
US9093	US9093	US9094	US9097

Note: The photos or illustrations shown above are for reference purposes **only**. It does not suggest or imply that all the referenced pumps are manufactured by US Motor Works.

			
US9098	US9099	US9099-2	US9100
			
US9102	US9104	US9105	US9106
			
US9107	US9108	US9109	US9110
			
US9111	US9114	US9115	US9116
			
US9117	US9119	US9120	US9122



















Note: The photos or illustrations shown above are for reference purposes only. It does not suggest or imply that all the referenced pumps are manufactured by US Motor Works.

 US9128	 US9129	 US9130	 US9131
 US9132	 US9133	 US9134	 US9140
 US9141	 US9142	 US9145	 US9146
 US9147	 US9149	 US9150	 US9152
 US9153	 US9154	 US9155	 US9160

Note: The photos or illustrations shown above are for reference purposes **only**. It does not suggest or imply that all the referenced pumps are manufactured by US Motor Works.

 US9161	 US9162	 US9163	 US9165
 US9166	 US9167	 US9168	 US9170
 US9171	 US9172	 US9173	 US9175
 US9176	 US9177	 US9179	 US9180
 US9181	 US9189	 US9193	 US9198



















Note: The photos or illustrations shown above are for reference purposes only. It does not suggest or imply that all the referenced pumps are manufactured by US Motor Works.

 <p style="text-align: center; background-color: black; color: white; padding: 2px;">US9200</p>	 <p style="text-align: center; background-color: black; color: white; padding: 2px;">US9201</p>	 <p style="text-align: center; background-color: black; color: white; padding: 2px;">US9202</p>	 <p style="text-align: center; background-color: black; color: white; padding: 2px;">US9203</p>
 <p style="text-align: center; background-color: black; color: white; padding: 2px;">US9206</p>	 <p style="text-align: center; background-color: black; color: white; padding: 2px;">US9207</p>	 <p style="text-align: center; background-color: black; color: white; padding: 2px;">US9208</p>	 <p style="text-align: center; background-color: black; color: white; padding: 2px;">US9209</p>
 <p style="text-align: center; background-color: black; color: white; padding: 2px;">US9211</p>	 <p style="text-align: center; background-color: black; color: white; padding: 2px;">US9212</p>	 <p style="text-align: center; background-color: black; color: white; padding: 2px;">US9213</p>	 <p style="text-align: center; background-color: black; color: white; padding: 2px;">US9214</p>
 <p style="text-align: center; background-color: black; color: white; padding: 2px;">US9215</p>	 <p style="text-align: center; background-color: black; color: white; padding: 2px;">US9216</p>	 <p style="text-align: center; background-color: black; color: white; padding: 2px;">US9218</p>	 <p style="text-align: center; background-color: black; color: white; padding: 2px;">US9219</p>
 <p style="text-align: center; background-color: black; color: white; padding: 2px;">US9220</p>	 <p style="text-align: center; background-color: black; color: white; padding: 2px;">US9221</p>	 <p style="text-align: center; background-color: black; color: white; padding: 2px;">US9222</p>	 <p style="text-align: center; background-color: black; color: white; padding: 2px;">US9223</p>

Note: The photos or illustrations shown above are for reference purposes **only**. It does not suggest or imply that all the referenced pumps are manufactured by US Motor Works.

			
US9224	US9225	US9226	US9227
			
US9228	US9230	US9231	US9232
			
US9234	US9236	US9237	US9238
			
US9239	US9241	US9242	US9245
			
US9250	US9251	US9252	US9253

Note: The photos or illustrations shown above are for reference purposes only. It does not suggest or imply that all the referenced pumps are manufactured by US Motor Works.

 <p style="text-align: center; background-color: black; color: white; padding: 2px;">US9254</p>	 <p style="text-align: center; background-color: black; color: white; padding: 2px;">US9255</p>	 <p style="text-align: center; background-color: black; color: white; padding: 2px;">US9256</p>	 <p style="text-align: center; background-color: black; color: white; padding: 2px;">US9257</p>
 <p style="text-align: center; background-color: black; color: white; padding: 2px;">US9258</p>	 <p style="text-align: center; background-color: black; color: white; padding: 2px;">US9259</p>	 <p style="text-align: center; background-color: black; color: white; padding: 2px;">US9260</p>	 <p style="text-align: center; background-color: black; color: white; padding: 2px;">US9261</p>
 <p style="text-align: center; background-color: black; color: white; padding: 2px;">US9262</p>	 <p style="text-align: center; background-color: black; color: white; padding: 2px;">US9263</p>	 <p style="text-align: center; background-color: black; color: white; padding: 2px;">US9264</p>	 <p style="text-align: center; background-color: black; color: white; padding: 2px;">US9268</p>
 <p style="text-align: center; background-color: black; color: white; padding: 2px;">US9269</p>	 <p style="text-align: center; background-color: black; color: white; padding: 2px;">US9270</p>	 <p style="text-align: center; background-color: black; color: white; padding: 2px;">US9271</p>	 <p style="text-align: center; background-color: black; color: white; padding: 2px;">US9272</p>
 <p style="text-align: center; background-color: black; color: white; padding: 2px;">US9272-2</p>	 <p style="text-align: center; background-color: black; color: white; padding: 2px;">US9273</p>	 <p style="text-align: center; background-color: black; color: white; padding: 2px;">US9274</p>	 <p style="text-align: center; background-color: black; color: white; padding: 2px;">US9274-20</p>

Note: The photos or illustrations shown above are for reference purposes **only**. It does not suggest or imply that all the referenced pumps are manufactured by US Motor Works.



US9275



US9276



US9277



US9278



US9279



US9280



US9282



US9284



US9288



US9289



US9291



US9292



US9293



US9299



US9300



US9301



US9304



US9305



US9306



US9307

Note: The photos or illustrations shown above are for reference purposes only. It does not suggest or imply that all the referenced pumps are manufactured by US Motor Works.

			
US9309	US9310	US9311	US9313
			
US9314	US9315	US9318	US9320
			
US9321	US9324	US9325	US9327
			
US9328	US9332	US9333	US9334
			
US9337	US9338	US9339	US9340



















Note: The photos or illustrations shown above are for reference purposes **only**. It does not suggest or imply that all the referenced pumps are manufactured by US Motor Works.

			
US9342	US9343	US9344	US9345
			
US9346	US9348	US9349	US9351
			
US9352	US9353	US9354	US9356
			
US9359	US9360	US9362	US9364
			
US9365	US9368	US9369	US9371





















Note: The photos or illustrations shown above are for reference purposes only. It does not suggest or imply that all the referenced pumps are manufactured by US Motor Works.

			
US9374	US9375	US9376	US9377
			
US9378	US9379	US9380	US9382
			
US9383	US9384	US9385	US9388
			
US9389	US9393	US9394	US9395
			
US9399	US9401	US9402	US9403

Note: The photos or illustrations shown above are for reference purposes **only**. It does not suggest or imply that all the referenced pumps are manufactured by US Motor Works.

			
US9405	US9406	US9410	US9414
			
US9415	US9416	US9419	US9421
			
US9426	US9427	US9427-2	US9429
			
US9434	US9440	US9446	US9448
			
US9449	US9450	US9456	US9460

Note: The photos or illustrations shown above are for reference purposes only. It does not suggest or imply that all the referenced pumps are manufactured by US Motor Works.

			
US9461	US9462	US9463	US9464
			
US9465	US9467	US9468	US9470
			
US9471	US9472	US9473	US9474
			
US9475	US9480	US9486	US9488
			
US9489	US9489-2	US9493	US9494

Note: The photos or illustrations shown above are for reference purposes **only**. It does not suggest or imply that all the referenced pumps are manufactured by US Motor Works.

			
US9495	US9496	US11001	US11002
			
US11003	US11004	US11005	US11006
			
US11007	US11008	US11009	US11011
			
US11012	US11013	US11014	US11015
			
US11017	US11024	US11034	

Note: The photos or illustrations shown above are for reference purposes only. It does not suggest or imply that all the referenced pumps are manufactured by US Motor Works.

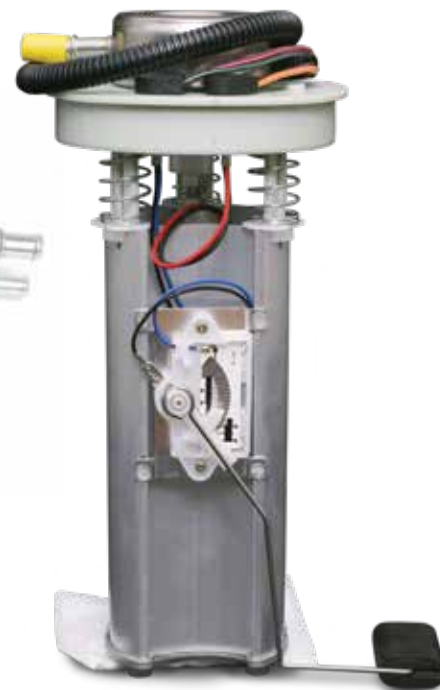

Product Development

With our 6 simple steps in new product development process, US Motor Works sits in the driver's seat when it comes to quick and precise product development. From product definition to design, production planning and preparations, prototype production and final production run, it's a mere 120 days or less. US Motor Work's OPEX mentality enables us to be on the leading edge of product development.



E.I.T. Electronic Information Technology

US Motor Works utilizes proprietary Electronic Information Technology as a communication and information platform for new product releases, bulletins, technical updates and general client correspondence. USMW E.I.T. is internet based with 24/7 365 days a year access to keep our clients up to date in the most efficient and expedient format possible.

As part of our E.I.T. Platform we have also added the Pro Tech Center. The US Motor Works PRO Tech Center is designed to keep you up to date with the latest articles, product releases, tech tips and videos.



A.E.T.S. Advanced Engineering & Technical Support

US Motor Works has created an engineering and technical environment from the design process to the final production product. Starting with CAD/CAM 3-D projections, computerized testing, a complete manufacturing plan and ending with a reliable distribution network. US Motor Works is able to track and control all related design, quality processes and packaging with specifications and manufacturing excellence in mind.



Manufacturing

Our State-of-the-art manufacturing utilizes our four principles; Supply Chain (improved flow), Quality Management (robust quality assurance), Production (pull & flow and 5S) and Measurements by KPI's (Key performance indicators). With these manufacturing principles and our continuous improvement ideology under the OPEX umbrella, US Motor Works continues to be the front runner among the industry leaders.



In-House Marketing & Graphic Design

Our In-house marketing and graphic design department helps to ensure our branding is at the forefront of the automotive industry. Working closely with category managers allows us to create powerful advertisement campaigns, marketing sales tools and educational pieces.

Along with the printed media, our team also works on a digital platform via brand specific websites and social media. Through social media we are able to connect with the end users and get genuine testimony of our products, thus making each brand recognizable and a name they can trust.





Trusted by professionals around the world

US Motor Works, LLC and its employees are committed to providing an extensive line of consistent high quality products and the finest customer service and satisfaction.

95

- US Motor Works Established in Commerce, Ca.

97

- Scaled up Manufacturing of Water Pumps to 30,000/Month

99

- Moved to a 30,000 sq. ft. facility in Cerritos, Ca.
- Purchased Fan Clutch Division

05

- Entered Joint Venture with Chinese Casting Manufacturer

06

- 40% Annual growth
- Expanded Facility to 50,000 sq. ft.

07

- Production reached 1,000,000 Water Pumps per year
- Opened Engineering Facility in China

08

- Development & Distribution of Electric Fuel Pumps

09

- Moved to a 80,000 sq. ft. facility in Santa Fe Springs, Ca.

10

- Became ISO 9001:2008 Certified

11

- Timing Kits w/ Water Pumps added to the product line
- Approved Vendor by APA & Vipar HD

12

- Launched HD product lines
- Approved Vendor by ADN Silver
- Expanded the facility to 100,000 sq. ft.

13

- Approved Vendor by Alliance & ADN Gold

14

- Expanded HD offering into Oil Pumps & Mechanical Transfer Pumps

15

- Celebrated 20th Anniversary
- First Automotive aftermarket company certified as ISO 9001:2015
- AASA top 100 Automotive Aftermarket suppliers

16

- Purchased Pacer Performance, est.1965
- Derale Performance, est.1975
- Introduced Max Cooling Kits
- USMW Professional Series undergoes re-branding
- Expanded Facility adding 50,000 sq. ft of Manufacturing & Warehouse

17

- Campaign launch for USMW HD
- Operating out of two facilities in CA (Los Angeles & Santa Fe Springs)
- More than 150,000 SQ FT of Manufacturing and Distribution

18

- Performance Division certified as ISO 9001:2015
- Introduction of mechanical fuel pumps to the line
- Auto Care Association recognizes Max Cooling Kit as an official part type (56846) water pump with fan clutch

...

Learn more about performance engine cooling we have.