



2017 CATALOG



AUTOMOTIVE/OFFROAD CONTENTS



| | |
|---|----|
| LED LIGHTS | |
| Cannon Series | 32 |
| Transporter Series | 34 |
| Optimus Series | 36 |
| Solo Pod Series | 38 |
| LIGHT BARS | |
| PX [Prime Xtreme]. | 46 |
| XPR-S | 47 |
| XPR | 48 |
| LPX [Lo-Pro Prime Xtreme] | 49 |
| Xmitter | 50 |
| Chaser Rear LED System | 51 |
| LED HEADLIGHTS | |
| Vortex | 57 |
| VEHICLE SPECIFIC KITS | |
| Jeep JK | 61 |
| Ford Raptor/F-Series | 62 |
| Dodge, Toyota, GMC, Chevrolet | 63 |
| Polaris RZR, Yamaha YXZ | 64 |
| HID Lighting | 66 |
| Halogen Lighting | 68 |
| AUTOMOTIVE ACCESSORIES | |
| Polycarbonate Light Covers | 72 |
| Accent Lighting | 74 |
| Subaqua | 76 |
| Borg Smart Lighting | 76 |
| Mounting Accessories | 78 |



INDUSTRIAL CONTENTS

| | |
|------------------------------------|-------------------------|
| HEAVY DUTY AND MEDIUM DUTY | |
| 86 | PitMaster |
| 88 | Ripper |
| 90 | Solstice Prime |
| 92 | Shockwave |
| 94 | Protex [ATEX] |
| 96 | Utility Market Xtreme |
| 98 | Dura |
| INDUSTRIAL SOLUTIONS | |
| 102 | BT Heavy Industrial |
| 104 | BT Light Industrial |
| MARITIME | |
| 109 | Maritime PitMaster |
| 110 | Maritime Ripper |
| 111 | Maritime Explorer |
| LUCENT ENGINEERED SOLUTIONS | |
| 114 | 10W Junction Box Light |
| 115 | 60W Junction Box Light |
| 115 | High Bay Light |
| 116 | Cube LED PMX |
| 118 | Cube LED Shockwave |
| INDUSTRIAL ACCESSORIES | |
| 120 | Construction Area Light |
| 121 | Video Extreme Light |
| 121 | Utility Flood |
| 122 | Strobe Beacons |
| 123 | LED Vehicle ID Board |
| 123 | Mini Incident Response |



VISION X LIGHTING

DESIGN, MANUFACTURE AND DELIVER
THE ULTIMATE LIGHTING SOLUTION



VISION X HISTORY

Since 1997, Vision X has been providing the lighting solutions demanded by the market as well as innovating the next step for lighting. With the release of the HID series in late 2005, Vision X was the first to provide an HID internal ballast and starter to the mass market, simplifying installation and reducing external components. Again in 2008, Vision X revolutionized lighting with the LED bar originally produced for NASA's Back to the Moon Mission. Since then, Vision X has continued innovation with the Solo Pod - which gives as many lumens as a headlight from a single 2" x 2" housing - and heavy duty LED lighting for use in mining, industrial, and commercial applications. At Vision X, we are constantly striving to live up to our company motto of "Lighting Evolved."



QUALITY AS A PRIORITY

PRODUCT TESTING

| | | | |
|--|--|--|--|
| <p>CONSUMPTION/INPUT RANGE</p> <p>All products are put on a digital power meter to test that it is consuming the correct amount of power, checking for any electrical faults.</p> | <p>LONG TERM DURABILITY</p> <p>Products are then switched on and off 20,000 times repeatedly to ensure that they remain functional after all testing.</p> | <p>SUBMERSION/AGING</p> <p>Once products are assembled every product is run through a submersion (water dunk test), then placed onto an aging rack and powered up for 30 minutes.</p> | <p>THERMAL IMPACT</p> <p>Products are placed in a -40°C chamber for 30 minutes, and then placed in a 80°C chamber for an additional 30 minutes. Products are then left on for 72 hours.</p> |
| <p>PHOTOMETRIC</p> <p>Lights are tested in the Goniophotometer to model the beam pattern and depict the overall light output.</p> | <p>TEMPERATURE AND HUMIDITY</p> <p>Products are placed in a 60°C, 94% humidity chamber and left operational for 72 hours. Afterwards, products are inspected for moisture and damage.</p> | <p>INGRESS</p> <p>Products are sprayed from close distances with 80-100 BAR water pressure to verify the Ingress Protection rating, ensuring they are sealed properly.</p> | <p>VIBRATION</p> <p>Products are placed on the vibration shock for 4 hours to test that they can withstand the rated vibration standard. Products tested at 60 Grms are performed off-site.</p> |

HIGH LEVEL CERTIFICATIONS

| | |
|--|---|
| <p>PHOTO BIOLOGICAL</p> <p>IEC 62471 Ensures that light output has safe levels of UV exposure for both skin and eyes.</p> | <p>E-MARK</p> <p>E European Regulatory certification for on highway use.</p> |
| <p>ROHS</p> <p>RoHS Ensures no use of restricted hazardous materials in products such as lead, mercury, cadmium, PBB, PBDE, and Phthalate.</p> | <p>ADR 13/00</p> <p>ADR Products which are in compliance with the Australian Design Rules (ADR).</p> |
| <p>DOT</p> <p>DOT US Department of Transportation certified for on road use.</p> | <p>IP RATING</p> <p>IP-69K Ingress Protection rates protection against outside elements. First number is solids, second is liquids.</p> |
| <p>UL</p> <p>UL UL Certification is recognized around the world as a way to ensure standards.</p> | <p>CE</p> <p>CE CE is a mandatory conformity mark for products in the European Economic Area.</p> |
| <p>ATEX 94 (94/9/EC)</p> <p>Ex The ATEX 94 certification is given to electronic equipment that is resistant to flame and explosion.</p> | <p>EMC</p> <p>emc EMC and EMI certifies that a product does not interfere with other electrical products. This includes CISPR 25 Certifications</p> |

VISION X LIGHTING

ENGINEERED SOLUTION PROCESS

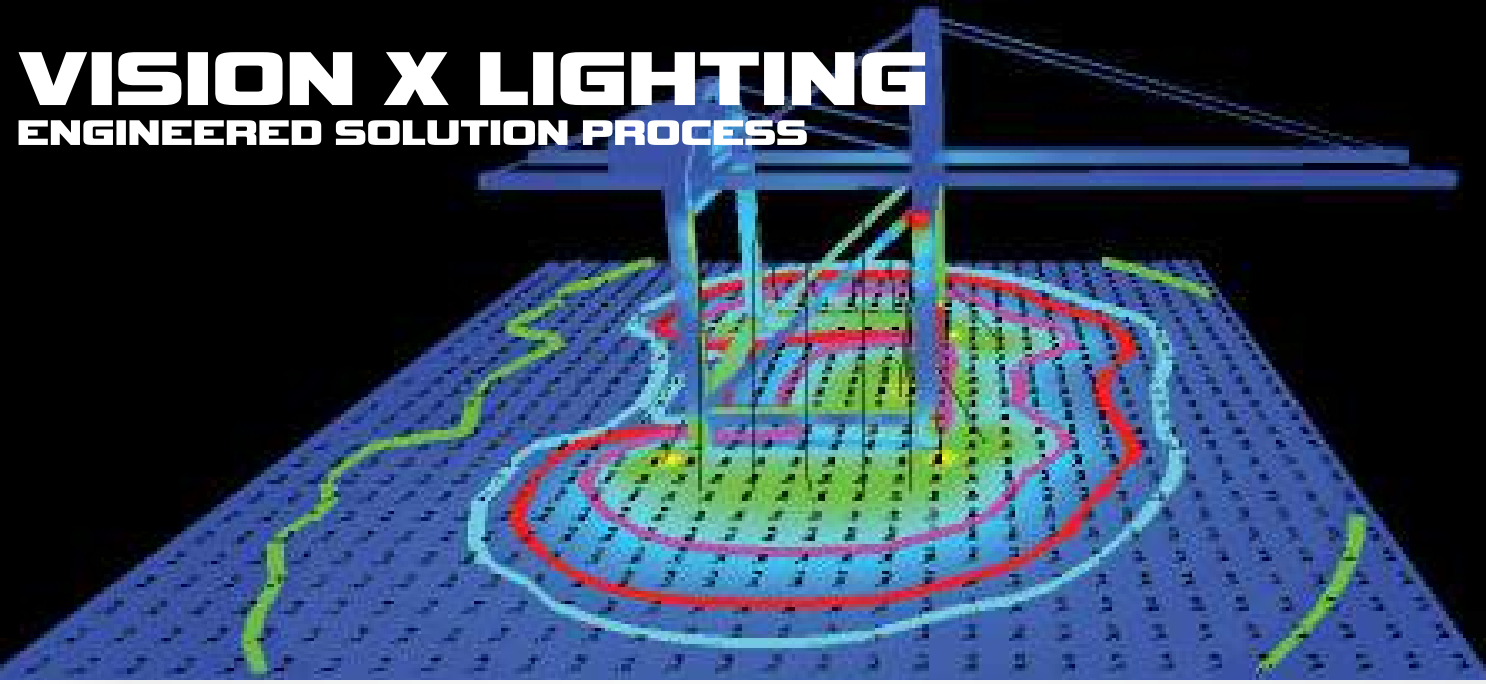

CONTINUOUS IMPROVEMENT

ISO
Vision X Meets ISO 9001,
ISO 14001 Standards

HAZCOM
Certified HAZCOM
Program

20
Years of Experience
with Finding Lighting
Solutions

140
Vision X Lighting is
Currently Active in 140
Countries Worldwide

ECOPROFIT
Award Winning Factory
for Environmental
Responsibility

**Photo
Biological**
All Lights are Photo Biologically
Tested Safe for Human Skin and Eyes

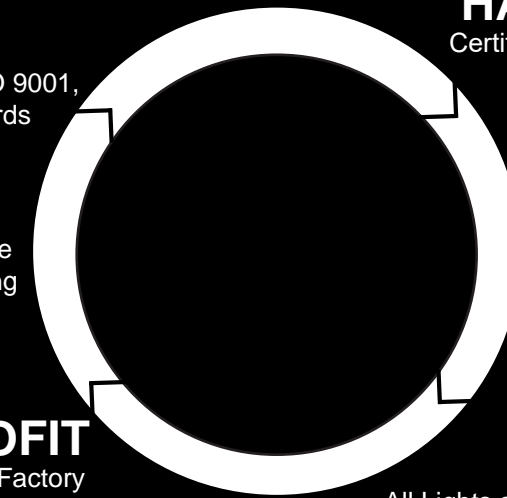

2D BLUEPRINT

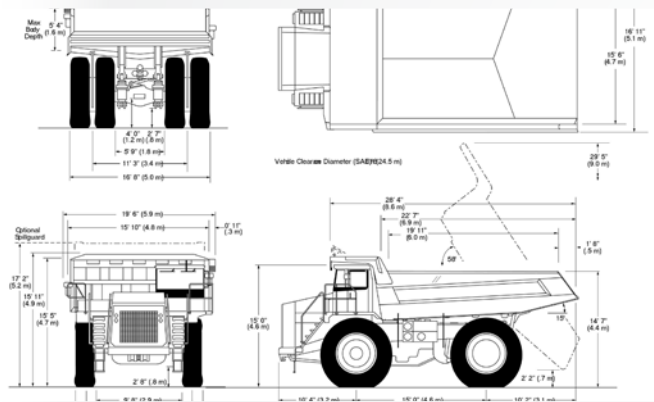

Vision X begins a project by requesting the list of machines that will needed to be retrofitted. Then gathering the technical information for those machines.

3D MODEL



A 3D Model is then built to match the customers exact specifications. This model is then carried over into the rendering.

SIMULATION RENDER

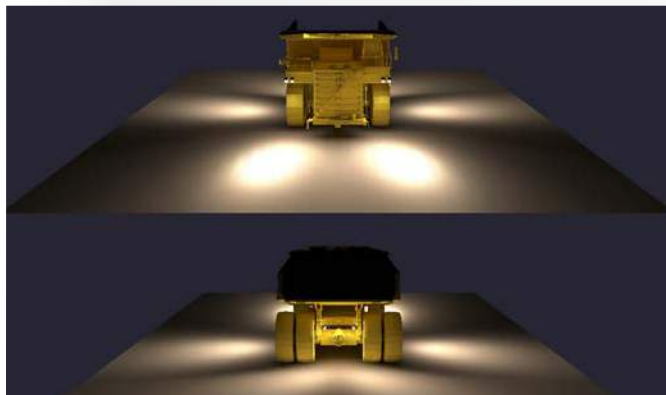

Prior to implementing a lighting solution, Vision X creates a simulation rendering of the intended result to help envision if the final product will meet lighting requirements.

SOLUTION

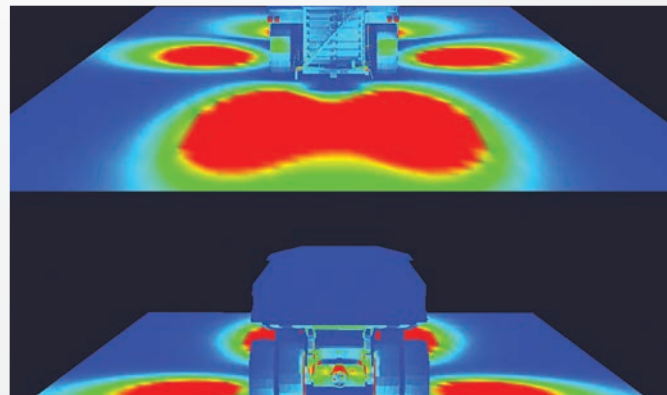

Vision X creates a complete breakdown of what the customer needs to meet their specific requirements for safety.

ENGINEERED PRODUCT DEVELOPMENT

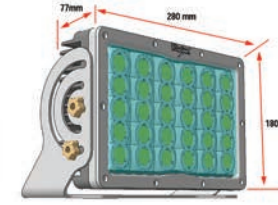
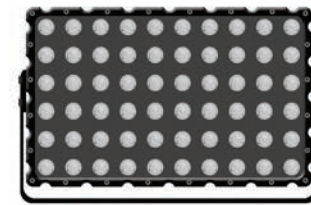

Vision X works with our customers around the world, our sponsorship partners and the world's leading LED manufacturers continuously to imagine new products for use in many applications. We strive to be the solution provider for any lighting need by continuously improving existing product and imagining new product.

PATENTED PRODUCT PROTECTION



Vision X ensures the protection of our products by acquiring patents and trademarks worldwide. This gives us the ability to fight "knock-off" products worldwide so that our customers can be assured they are buying Vision X Genuine products.



UTV | SXS

ROOF LIGHT BARS



CHASER REAR LED



HEADLIGHT UPGRADES



A-PILLAR LIGHTS



BUMPER LIGHTS



ACCESSORIES



ROOF MOUNTED LIGHT BARS

THE XPR-S IS THE ULTIMATE RACE LIGHT BAR

All New IRIS Reflectors | XPR-21S Shines 3,281' of Useable Light | Available 5" to 51" Lengths



ITEM #: XPR-21S
PART #: 9897424

| ITEM # | PART # | APPLICATION |
|---------|---------|-----------------------|
| XPR-15S | 9897400 | Stock cages 30" |
| XPR-21S | 9897424 | Aftermarket Cages 40" |

See Page 47 for Complete XPR-S Details

XPR FEATURES TILTED REFLECTORS FOR A MIXED BEAM

Multiple Mounting Options Included | Highest Quality 10-Watt LED | Available 5" to 51" Lengths



ITEM #: XPR-21M
PART #: 9891668

| ITEM # | PART # | FITS |
|---------|---------|-----------------------|
| XPR-15M | 9891644 | Stock cages 30" |
| XPR-21M | 9891668 | Aftermarket Cages 40" |

See Page 48 for Complete XPR Details

HEADLIGHT UPGRADES

POLARIS RZR HEADLIGHT KIT

For Select 2008+ Models | Available in Black, Chrome, White and Halo Models | Plug and Play Installation



ITEM #: XIL-OEHL14RZROPR
PART #: 9897516

| ITEM # | PART # | FITS | KIT INCLUDES |
|--------------------|---------|-----------|----------------------------|
| XIL-OEHL14RZROPR | 9897516 | 2014+ RZR | Brackets, 4 Optimus Lights |
| XIL-OEHL08RZR900OP | 9898582 | 2008+ RZR | Brackets, 4 Optimus Lights |

See Page 64 for Complete RZR Headlight Details

YAMAHA YXZ HEADLIGHT KIT

For Select 2015+ Models | 1 Kit for Low Beam 2nd Kit Optional for High Beam | Plug and Play Installation

| ITEM # | PART # | FITS | KIT INCLUDES |
|-------------------|---------|-----------|---------------------------|
| XIL-OEHL15YXZCPZ1 | 9899114 | 2015+ YXZ | Brackets, 2 Cannon Lights |

View our website for complete application information

BUMPER LIGHTS

DURA SERIES BUMPER LIGHT FOR UTVS

Add 4,244 Raw Lumens to Your UTV | Simple Single Stud Mounting | Adjustable Bracket for Easy Aiming



ITEM #: DURA-410KIT Shown
PART #: 9891187

| ITEM # | PART # | APPLICATION | KIT INCLUDES |
|-------------|---------|---------------|----------------------|
| DURA-410KIT | 9891187 | Spot Beam Kit | 2 Lights and Harness |

See Page 99 for Complete DURA Details

BUMPER LIGHT BARS FOR UTVS

Available in Flood or Spot Beams | Also Available with Amber LEDs | Add Light to Your Front Bumper



ITEM #: XIL-LP610A Shown
PART #: 9888071

| ITEM # | PART # | APPLICATION | INCLUDES |
|------------|---------|---------------|-----------------------|
| XIL-LPX610 | 9118758 | 9" Spot Beam | Light Bar and Harness |
| XIL-LPX640 | 9120737 | 9" Flood Beam | Light Bar and Harness |
| XIL-LP610A | 9888071 | 9" Amber Spot | Light Bar and Harness |

See Page 49 for Complete Lo Pro Details

CHASER REAR LED SYSTEM

RECREATIONAL CHASER BAR

Low Profile Design | Running & Brake Lights In Single Bar | Red/Amber/White/Amber/Red Configuration



ITEM #: XIL-CBSR27 Shown
PART #: 9897202

| ITEM # | PART # | APPLICATION |
|------------|---------|------------------|
| XIL-CBSR21 | 9897196 | Recreational 28" |
| XIL-CBSR27 | 9897202 | Recreational 28" |

See Page 51 for Complete Chaser Details

RACER CHASER BAR

Low Profile Design | Running & Brake Lights In Single Bar | Feature Blue Warning Light



ITEM #: XIL-CBSX27 Shown
PART #: 9897196

| ITEM # | PART # | APPLICATION |
|------------|---------|------------------|
| XIL-CBSX21 | 9897219 | Racer Xtreme 28" |
| XIL-CBSX27 | 9897226 | Racer Xtreme 35" |

See Page 51 for Complete Chaser Details

A-PILLAR LIGHTING

4.5" LED LIGHT CANNON

Multiple Mounting Options | Lightweight Hybrid Housing | Plug and Play Installation



ITEM #: CTL-CPZ110KIT Shown
PART #: 9151069

| ITEM # | PART # | KIT INCLUDES |
|-----------------|---------|---|
| CTL-CPZ110KIT | 9151069 | 2 x 25-Watt LED Light Cannons and Harness |
| CTL-CPZ110XPKIT | 9893365 | 2 x 40-Watt LED Light Cannons and Harness |

See Page 33 for Complete Cannon Details

SNAP-ON COVERS FOR CANNONS CHANGE BEAM AND COLOR

Clear Covers to Protect | Red Covers for Sand | Amber Covers for Fog and Debris



| ITEM # | PART # | APPLICATION |
|------------|---------|------------------|
| PCV-CP1RCB | 9893235 | Red Combo Beam |
| PCV-CP1BL | 9157450 | Black Protective |

See Page 72 for Complete Polycarbonate Cover Details

ACCESSORIES

PRO POD UNDER GLOW LIGHTING

Add Color to Your UTV | Extremely Low Power Consumption | Add Light to Your Front Bumper



ITEM #: XIL-PDW Shown
PART #: 9136127

| ITEM # | PART # | COLOR |
|---------|---------|-------|
| XIL-PDA | 9136219 | Amber |
| XIL-PDB | 9136301 | Blue |
| XIL-PDG | 9136394 | Green |

| ITEM # | PART # | COLOR |
|---------|---------|-------|
| XIL-PDR | 9136486 | Red |
| XIL-PDW | 9136127 | White |

See Page 74 for Complete Pro Pod Details

SECURITY HARDWARE

Secure Your Lights and Accessories



DURA MINI

2.75" Universal Flood Light



MINI SOLO

1.7" Pod Available in Colors



View our Website for Complete Range of Accessories



JEEP

HEADLIGHT UPGRADES



FOG LIGHT UPGRADES



WINDSHIELD LIGHT BAR



HOOD MOUNT



A-PILLAR



ACCESSORIES

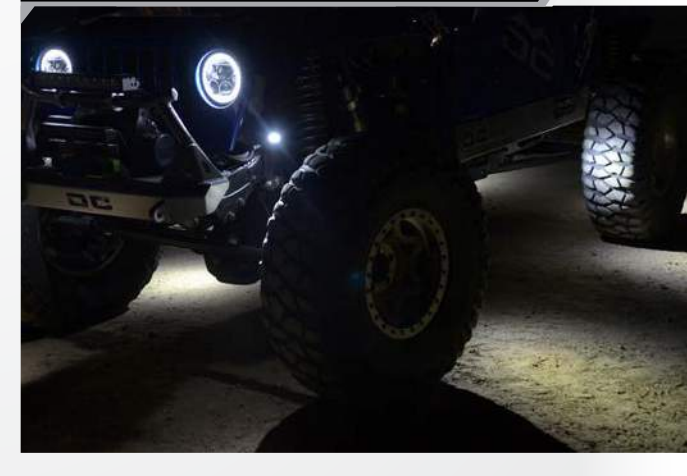

HEADLIGHT UPGRADES



PLUG AND PLAY HEADLIGHT UPGRADE FOR JEEP HEADLIGHTS
Works With Canbus | Multiple LEDs Fill in Roadway | Long Range High Beams

| ITEM # | PART # | APPLICATION |
|---------------|---------|------------------------------------|
| XIL-7RDKITJK | 9892733 | Jeep Headlight Chrome Finish |
| XIL-7RDBKITJK | 9892825 | Jeep Headlight Black Chrome Finish |

ITEM #: XIL-7RDKITJK
PART #: 9892733

See Page 56 for Complete Vortex Details



WINDSHIELD LIGHT BARS

XMITTER PRIME XTREME MAX LIGHT OUTPUT LIGHT BAR
Mixed Beam for Wide Pattern | Mount Using End Caps Or Feet | Wiring Included



| ITEM # | PART # | INCLUDES |
|-----------------|---------|---|
| XIL-PX90M | 9132792 | 50" Mixed Beam PX Light Bar |
| XIL-OEW0713JKV2 | 9888422 | Windshield Light Bar Mounting Brackets Only |

ITEM #: XIL-PX90M
PART #: 9132792

See Page 46 for Complete PX Details

XPR LONG DISTANCE LIGHT BAR
Tilted Reflectors for Wide Pattern | Mount Using End Caps Or Feet | Wiring Included



| ITEM # | PART # | INCLUDES |
|-----------------|---------|---|
| XPR-27M | 9891682 | 50" Tilted Reflector XPR Light Bar |
| XIL-OEW0713JKV2 | 9888422 | Windshield Light Bar Mounting Brackets Only |

ITEM #: XPR-27M Shown
PART #: 9891682

See Page 48 for Complete XPR Details

A-PILLAR LIGHTING



JEEP A-PILLAR BRACKETS AND 4.5" LED LIGHT CANNON KITS
Multiple Mounting Options | Lightweight Hybrid Housing | Plug and Play Installation

| ITEM # | PART # | KIT INCLUDES |
|-------------------|---------|---|
| XIL-OEA0713JKCPZ1 | 9888415 | Brackets for Jeep JK and 2x 4.5" Light Cannon |
| XIL-OEA9706TJCPZ1 | 9892795 | Brackets for Jeep TJ and 2x 4.5" Light Cannon |

ITEM #: XIL-OEA0713JKCPZ1 Shown
PART #: 9888415

See Page 61 for Complete Vx Spec Details

SNAP-ON COVERS FOR CANNONS CHANGE BEAM AND COLOR
Clear Covers to Protect | Red Covers for Sand | Amber Covers for Fog and Debris

| ITEM # | PART # | APPLICATION |
|------------|---------|-----------------------------|
| PCV-CP1RCB | 9893235 | 4.5" Red Combo Beam Cover |
| PCV-CP1BL | 9157450 | 4.5" Black Protective Cover |



See Page 72 for Complete Polycarbonate Cover Details

FOG LIGHT UPGRADES



ITEM #: XIL-OE1012JKOPR Shown
PART #: 9154756

2007 AND UP JEEP JK FOG LIGHTS
No Drilling Required | Direct Plug-And-Play With Factory Wiring | Dramatically Increased Visibility

| ITEM # | PART # | APPLICATION |
|--------------------|---------|--|
| XIL-OE0709JKV2OPR | 9145754 | 07-09 Jeep JK Fog Light Upgrade |
| XIL-OE0709JKV2OPRH | 9891811 | 07-09 Jeep JK Fog Light Upgrade Lights with Halo |
| XIL-OE1012JKV2OPR | 9154756 | 2010+ Jeep JK Fog Light Upgrade |
| XIL-OE1012JKV2OPRH | 9891828 | 2010+ Jeep JK Fog Light Upgrade with Halo |



ITEM #: XIL-OE13JKXOPRH Shown
PART #: 9892474

JEEP JK X FOG LIGHTS
No Drilling Required | Direct Plug-And-Play With Factory Wiring | Dramatically Increased Visibility

| ITEM # | PART # | APPLICATION |
|-----------------|---------|---|
| XIL-OE13JKXOPR | 9891088 | 2013+ Jeep JK X Fog Light Upgrade |
| XIL-OE13JKXOPRH | 9892474 | 2013+ Jeep JK X Fog Light Upgrade with Halo |

See Page 60 for Complete VxSpec Details

HOOD MOUNT



ITEM #: XIL-OEH0713JKPX36 Shown
PART #: 9891002

HOOD MOUNT KITS FOR JEEP JK
No Drill Installation | Bracket Holds up to 24" Light Bar | Adds Up to 19,008 lm

| ITEM # | PART # | APPLICATION |
|--------------------|---------|--|
| XIL-OEH0713JKPX36 | 9891002 | Bracket with 21" XIL-PX3610 Light Bar For Max Light Output |
| XIL-OEH0713JKXPI12 | 9891019 | Bracket with 24" XPI-12M Light Bar For Long Distance |

See Page 60 for Complete VxSpec Details



ACCESSORIES



ITEM #: HIL-STW Shown
PART #: 4005419

SECURITY HARDWARE
Secure Your Lights and Accessories



TANTRUM 8 POD UNDERCARRIAGE LIGHTING KITS
Add Color to Your Jeep | Includes Wireless Remote | 4 Pods with 10' Cords 4 Pods with 20' Cords

| ITEM # | PART # | COLOR |
|---------|---------|-------|
| HIL-STA | 4005662 | Amber |
| HIL-STB | 4005372 | Blue |
| HIL-STG | 4005396 | Green |

| ITEM # | PART # | COLOR |
|---------|---------|-------|
| HIL-STM | 4005679 | Multi |
| HIL-STR | 4005389 | Red |
| HIL-STW | 4005419 | White |

See Page 75 for Complete Tantrum Details

DURA MINI
2.75" Universal Flood Light



PRO POD
Available in Multiple Colors



View our Website for Complete Range of Accessories



TRUCK

FOG LIGHT UPGRADES



BUMPER LIGHT BARS



A-PILLAR LIGHTS



DRIVING LIGHTS



ROOF LIGHT BARS



ACCESSORIES



FOG LIGHT UPGRADES



ITEM #: XIL-OE9913FSDDURA
PART #: 9891200

FORD TRUCKS PLUG AND PLAY LED FOG LIGHT UPGRADE KITS

| ITEM # | PART # | APPLICATION |
|-------------------|---------|--|
| XIL-OE9913FSDDURA | 9891200 | 99-16 Ford Superduty Fog Light Using 2 x DURA-410 Lights |
| XIL-OE10FROP | 9133515 | 10-14 Ford Raptor Fog Light Using 4 x XIL-OP110 Lights |
| XIL-OE10FROPH | 9892450 | 10-14 Ford Raptor Fog Light Using 4 x Halo XIL-OPH115 Lights |

DODGERAM TRUCKS PLUG AND PLAY LED FOG LIGHT UPGRADE KITS

| ITEM # | PART # | APPLICATION |
|--------------------|---------|--|
| XIL-OE0913DROP | 9888552 | 10-16 Dodge Ram Fog Light Using 2 x XIL-OP110 Lights |
| XIL-OE0913DROP1MX2 | 9890685 | 10-16 Dodge Ram Fog Light Using 4 x Optimus Lights |
| XIL-OE0210DRUMX | 9133065 | 02-10 Dodge Ram Fog Light Using 2 x XIL-UMX4010 Lights |

GM TRUCKS PLUG AND PLAY LED FOG LIGHT UPGRADE KITS

| ITEM # | PART # | APPLICATION |
|-------------------|---------|--|
| XIL-OE0711GSUMX | 9133157 | 07-13 GMC Sierra Fog Light Using 2 x XIL-UMX4010 Lights |
| XIL-OE0711CSS1100 | 9120829 | 07-13 Chevrolet Silverado Fog Light Using 4 x XIL-S1100 Lights |

TOYOTA TRUCKS PLUG AND PLAY LED FOG LIGHT UPGRADE KITS

| ITEM # | PART # | APPLICATION |
|-----------------|---------|--|
| XIL-OE0711TTUMX | 9133249 | 07-14 Toyota Tundra Fog Light Using 2 x XIL-UMX4010 Lights |

View our website for complete application information



ITEM #: XIL-OE0711GSUMX
PART #: 9133157

A-PILLAR LIGHTS



ITEM #: CTL-CPZ110KIT Shown
PART #: 9151069

4.5" LED LIGHT CANNON

Multiple Mounting Options | Lightweight Hybrid Housing | Plug and Play Installation

| ITEM # | PART # | KIT INCLUDES |
|-----------------|---------|--|
| CTL-CPZ110KIT | 9151069 | 2 x 4.5" 25-Watt LED Light Cannons and Harness |
| CTL-CPZ110XPKIT | 9893365 | 2 x 4.5" 40-Watt LED Light Cannons and Harness |

See Page 33 for Complete Cannon Details

SNAP-ON COVERS FOR CANNONS CHANGE BEAM AND COLOR

Clear Covers to Protect | Red Covers for Sand | Amber Covers for Fog and Debris

| ITEM # | PART # | APPLICATION |
|------------|---------|----------------------------------|
| PCV-CP1RCB | 9893235 | Red Combo Beam for 4.5" Cannon |
| PCV-CP1BL | 9157450 | Black Protective for 4.5" Cannon |

See Page 72 for Complete Polycarbonate Cover Details



ROOF LIGHT BARS



ITEM #: XPR-27M Shown
PART #: 9891682

50" XPR LONG DISTANCE LIGHT BAR WITH TILTED REFLECTORS

Tilted Reflectors for Wide Pattern | Mount Using End Caps Or Feet | Wiring Included

| ITEM # | PART # | APPLICATION |
|---------|---------|------------------------------------|
| XPR-27M | 9891682 | 50" Tilted Reflector XPR Light Bar |

See Page 48 for Complete XPR Details

50" XMITTER PRIME XTREME MAX LIGHT OUTPUT LIGHT BAR

Mixed Beam for Wide Pattern | Mount Using End Caps Or Feet | Wiring Included

| ITEM # | PART # | FITS |
|-----------|---------|-----------------------------|
| XIL-PX90M | 9132792 | 50" Mixed Beam PX Light Bar |

See Page 46 for Complete PX Details



ITEM #: XIL-PX90M Shown
PART #: 9132792

BUMPER LIGHT BARS



ITEM #: XIL-OEB09F150PX36 Shown
PART #: 9891156

FORD TRUCKS PLUG AND PLAY LED FOG LIGHT UPGRADE KITS

| ITEM # | PART # | APPLICATION |
|----------------------|---------|---|
| XIL-OEB09F150PX36 | 9891156 | 09-14 Ford F150 Using 1 x XIL-PX3610 Light Bar |
| XIL-OEB09F150ECO | 9891170 | 09-14 Ford F150 Eco-Boost Using 2 x XIL-PX610 Light Bar |
| XIL-OEB10FRPX3610 | 9887357 | 10-14 Ford Raptor Using 1 x XIL-PX3610 Light Bar |
| XIL-OEB0810FSDPX3610 | 9891842 | 08-10 Ford Superduty Using 1 x XIL-PX3610 Light Bar |
| XIL-OEB0810FSDXPI12M | 9892306 | 08-10 Ford Superduty Using 1 x XPI-12M Light Bar |
| XIL-OEB1114FSDPX3610 | 9891873 | 11-16 Ford Superduty Using 1 x XIL-PX3610 Light Bar |
| XIL-OEB1114FSDXPI12M | 9892290 | 11-16 Ford Superduty Using 1 x XPI-12M Light Bar |

DODGERAM TRUCKS PLUG AND PLAY LED FOG LIGHT UPGRADE KITS

| ITEM # | PART # | APPLICATION |
|---------------------|---------|--------------------------------------|
| XIL-OEB0913DRPX3610 | 9889245 | 10-16 Dodge Ram Using 1 x XIL-PX3610 |

View our website for complete application information



ITEM #: XIL-OEB0913DRPX3610 Shown
PART #: 9889245

DRIVING LIGHTS



ITEM #: CTL-CPZ610KIT Shown
PART #: 9888545

6.7" LED LIGHT CANNON

Multiple Mounting Options | 25 Lights in 1 With Snap on Covers | Wiring Included

| ITEM # | PART # | APPLICATION |
|---------------|---------|---|
| CTL-CPZ610KIT | 9888545 | Two 50-Watt Single Source LED Long Distance 6.7" Lights |

See Page 33 for Complete Cannon Details

6.7" TRANSPORTER 18 LED DRIVING LIGHT

Smooth Beam Pattern to Fill Roadway | Color Changing Covers | Wiring Included

| ITEM # | PART # | APPLICATION |
|-------------|---------|--|
| CTL-TPX1810 | 9111018 | 90 Watt 6.7" Light with 10° Spot Beam Pattern |
| CTL-TPX1840 | 9111193 | 90 Watt 6.7" Light with 40° Flood Beam Pattern |

See Page 34 for Complete Transporter Details



ITEM #: CTL-TPX1810 Shown
PART #: 9111018

ACCESSORIES



ITEM #: XIL-SRECEIVERDURAMX2 Shown
PART #: 9899121

RECEIVER TOW MOUNT KIT FOR REVERSE FLOOD LIGHTS

Wire to Reverse or Separate Switch | Weatherproof Lights For Boat Launching | Multiple Lights Available

| ITEM # | PART # | APPLICATION |
|----------------------|---------|---|
| XIL-SRECEIVERDURAMX2 | 9899121 | Receiver Light Kit with Bracket, 2 x DURA-M460, Harness |
| XIL-SRECEIVERS1101X2 | 4008595 | Receiver Light Kit with Bracket, 2 x XIL-S1101, Harness |

See Page 78 for Complete Mounting Solutions Details

WINCH MOUNT
Light Bar Mount Plate for Winch



FLUSH MOUNT LIGHTS
DURA FLUSH



BORG MODULE
Bluetooth Controller for Prime Drive



View our Website for Complete Range of Accessories

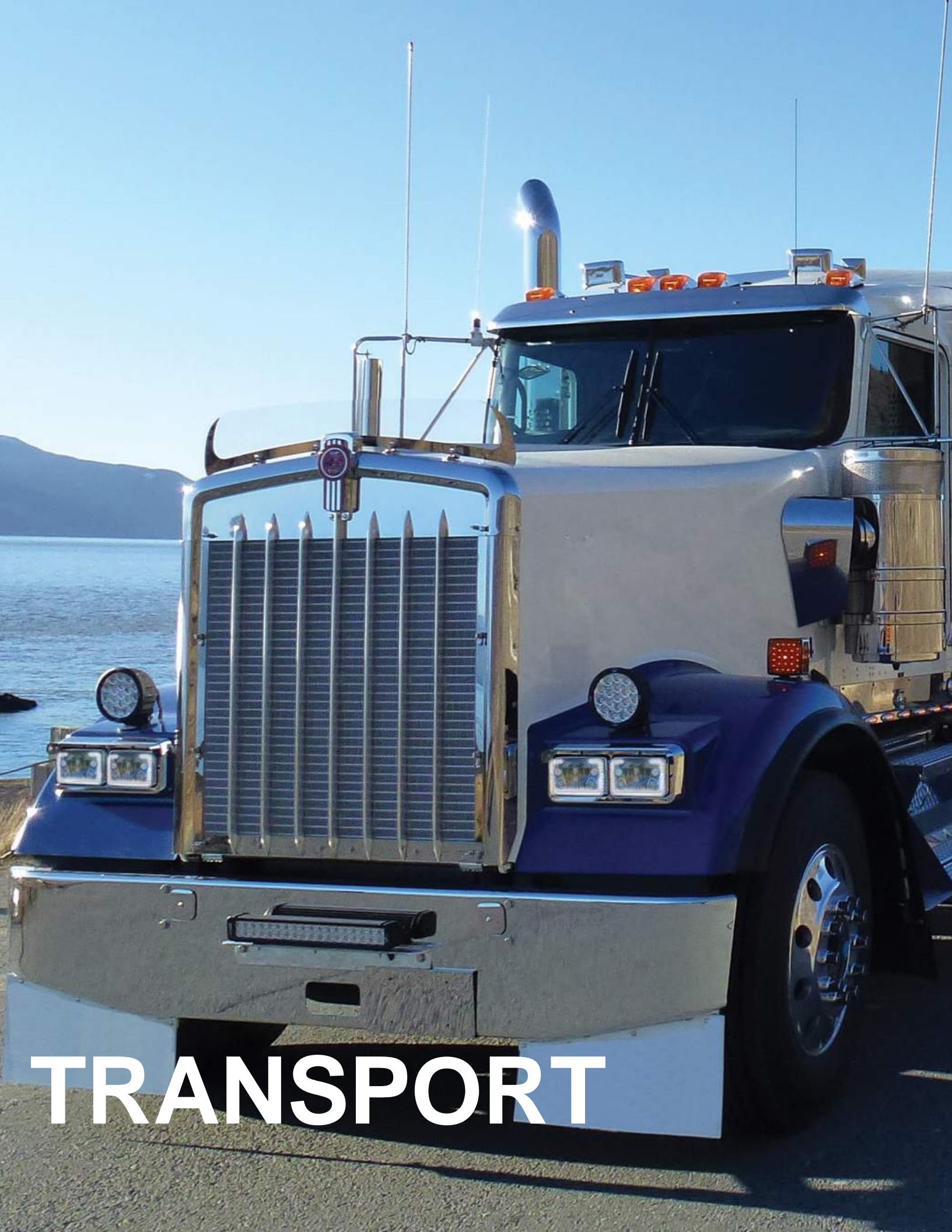

HEADLIGHT UPGRADES



BUMPER LIGHTS



BUMPER LIGHT BARS



CAB-OVER



LOAD LIGHTS



ACCESSORIES



TRANSPORT

HEADLIGHT UPGRADES

4X6" DUAL BEAM HEADLIGHT LED UPGRADE KIT

High and Low Beam in Single Housing | IRIS Reflectors for Long Distance High Beams | Bright Halo



ITEM #: XIL-46DBKIT
PART #: 9897837

| ITEM # | PART # | APPLICATION |
|-------------|---------|--|
| XIL-46DKIT | 9897820 | Pair of Polished Chrome Face 4x6" LED Headlights |
| XIL-46DBKIT | 9897837 | Pair of Black Chrome Face 4x6" LED Headlights |

See Page 56 for Complete Headlight Details

7" HEADLIGHT LED UPGRADE KIT

Additional LEDs To Fill in Roadway | IRIS Reflectors for Long Distance High Beams | Bright Halo



ITEM #: XIL-7RDKIT
PART #: 9891224

| ITEM # | PART # | APPLICATION |
|-------------|---------|--|
| XIL-7RDKIT | 9891224 | Pair of Polished Chrome Face 7" LED Headlights |
| XIL-7RDBKIT | 9892443 | Pair of Black Chrome Face 7" LED Headlights |

See Page 56 for Complete Headlight Details

BUMPER LIGHT BARS

XMITTER PRIME XTREME MAXIMUM LIGHT OUTPUT LIGHT BAR

Full Range Fills in Road Way | Multiple Mounting Options | Wiring Included



ITEM #: XIL-PX3610
PART #: 9117041

| ITEM # | PART # | APPLICATION |
|------------|---------|-----------------------------|
| XIL-PX3610 | 9117041 | 20" Spot Beam LED Light Bar |
| XIL-PX5410 | 9117225 | 30" Spot Beam LED Light Bar |

See Page 46 for Complete PX Details

XPR-S XTREME LONG DISTANCE LIGHT BAR

IRIS Reflector for Long Range Light | Dual Mounting Options Included | Wiring Included



ITEM #: XPR-12S Shown
PART #: 9897394

| ITEM # | PART # | INCLUDES |
|---------|---------|---|
| XPR-12S | 9897394 | 24" XPR-S Light Bar Producing 2,461 ft of Usable Light |
| XPR-15S | 9897400 | 29" XPR-S Light Bar Production 2,784 ft of Usable Light |

See Page 47 for Complete XPR-S Details

LOAD LIGHTS

UTILITY MARKET SERIES 35-WATT LED WORK LIGHT

Single Stud Mounting | Available in Round or Square Housing | Durable Polycarbonate Lens



ITEM #: XIL-UMX4060 Shown
PART #: 9118307

| ITEM # | PART # | APPLICATION |
|-------------|---------|---|
| XIL-UMX4060 | 9118307 | 4" Round LED Work Light 60° Flood Beam |
| XIL-UMX4460 | 9118482 | 4" Square LED Work Light 60° Flood Beam |

See Page 97 for Complete UMX Details

DURA SERIES 30 AND 20 WATT LED WORK LIGHTS

Single Stud Mounting | Two Sizes Available | Durable Polycarbonate Lens



ITEM #: DURA-660 Shown
PART #: 9888385

| ITEM # | PART # | APPLICATION |
|----------|---------|--|
| DURA-460 | 9141527 | 4" Square 20-Watt Work Light 60° Flood Beam |
| DURA-660 | 9888385 | 5" Rectangular 30-Watt Work Light 60° Flood Beam |

See Page 99 for Complete DURA Details

BUMPER LIGHTS

6.7" LED LIGHT CANNON

Multiple Mounting Options | 25 Lights in 1 With Snap on Covers | Wiring Included



ITEM #: CTL-CPZ610KIT Shown
PART #: 9888545

| ITEM # | PART # | APPLICATION |
|---------------|---------|---|
| CTL-CPZ610KIT | 9888545 | Two 50-Watt Single Source LED Long Distance 6.7" Lights |

See Page 33 for Complete Cannon Details

6.7" TRANSPORTER 18 LED DRIVING LIGHT

Smooth Beam Pattern to Fill Roadway | Color Changing Covers | Wiring Included



ITEM #: CTL-TPX1810 Shown
PART #: 9111018

| ITEM # | PART # | APPLICATION |
|-------------|---------|--|
| CTL-TPX1810 | 9111018 | 90 Watt 6.7" Light with 10° Spot Beam Pattern |
| CTL-TPX1840 | 9111193 | 90 Watt 6.7" Light with 40° Flood Beam Pattern |

See Page 34 for Complete Transporter Details

CAB-OVER

8.7" LED LIGHT CANNON

Multiple Mounting Options | 25 Lights in 1 With Snap on Covers | Lights Up 3,280 ft of Usable Light



ITEM #: CTL-CPZ810KIT Shown
PART #: 9890074

| ITEM # | PART # | APPLICATION |
|---------------|---------|---|
| CTL-CPZ810KIT | 9890074 | Two 90-Watt Single Source LED Long Distance 8.7" Lights |

See Page 33 for Complete Cannon Details

SNAP-ON COVERS FOR 8.7" CANNONS CHANGE BEAM AND COLOR

Black Street Legal Cover | Amber Covers for Snow | Combo Cover for Best of Both Beams



| ITEM # | PART # | APPLICATION |
|-------------|---------|-----------------------------|
| PCV-8500YCB | 9893211 | 8.7" Amber Combo Beam Cover |
| PCV-8500Y | 4002791 | 8.7" Amber Spot Cover |
| PCV-8500BL | 9890876 | 8.7" Black Protective Cover |

See Page 72 for Complete Polycarbonate Cover Details

ACCESSORIES

PRO POD UNDER GLOW LIGHTING

Add Color to Your UTV | Durable PC Lens for Any Application | Add Accent Light Anywhere



ITEM #: XIL-PDW Shown
PART #: 9136127

| ITEM # | PART # | COLOR |
|---------|---------|-------|
| XIL-PDA | 9136219 | Amber |
| XIL-PDB | 9136301 | Blue |
| XIL-PDG | 9136394 | Green |

| ITEM # | PART # | COLOR |
|---------|---------|-------|
| XIL-PDR | 9136486 | Red |
| XIL-PDW | 9136127 | White |

See Page 74 for Complete Pro Pod Details

SECURITY HARDWARE

Secure Your Lights and Accessories



DURA MINI

2.75" Universal Flood Light



UTILITY FLOOD

Available in Multiple Colors



View our Website for Complete Range of Accessories



MOTORCYCLE

7" HEADLIGHTS



5.75" HEADLIGHTS



ROAD GLIDE HEADLIGHTS



PASSING LAMPS



BAG LIGHTS

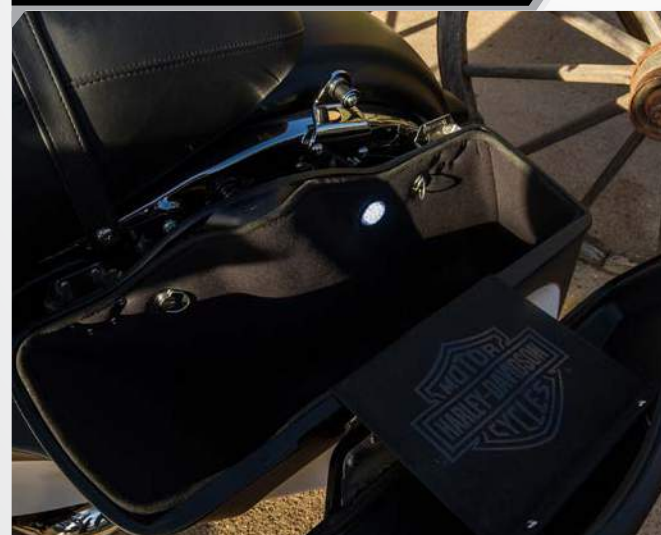

ACCESSORIES



7" ROUND LED HEADLIGHT

DOT APPROVED LED HEADLIGHT WITH BRIGHT LED HALO RING
Multiple LEDs Fill In Roadway | Polycarbonate Lens | Dramatically Improves Safety



ITEM #: XMC-7RD Shown
PART #: 9892061

| | | |
|--------------------------------------|--|--|
| BEAM MODES Halo, Low, High | WEIGHT 2.20 lb / 1.00 kg | DIMENSIONS 6.96" x 6.96" x 3.86" |
| RAW LUMENS 4,210 lm (ea) | REFLECTOR FINISH Polished Chrome, Black Chrome | METRIC 177mm x 177mm x 97.8mm |



| ITEM # | PART # | FINISH | QTY |
|----------|---------|-----------------|--------|
| XMC-7RD | 9892061 | Polished Chrome | Single |
| XMC-7RDB | 9895291 | Black Chrome | Single |

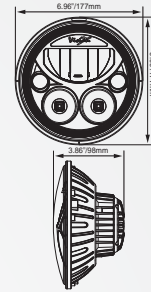

Replaces OEM 68342-05A, 67700032, 67700243

View Our Website For Complete Application Chart

5.75" ROUND LED HEADLIGHT

DOT APPROVED LED HEADLIGHT WITH BRIGHT LED HALO RING
Multiple LEDs Fill In Roadway | Polycarbonate Lens | Dramatically Improves Safety



ITEM #: XMC-575RD Shown
PART #: 9895628

| | | |
|--------------------------------------|--|--|
| BEAM MODES Halo, Low, High | WEIGHT 1.95 lb / 0.88 kg | DIMENSIONS 5.65" x 5.65" x 2.88" |
| RAW LUMENS 4,210 lm (ea) | REFLECTOR FINISH Polished Chrome, Black Chrome | METRIC 146mm x 146mm x 73mm |



| ITEM # | PART # | FINISH | QTY |
|------------|---------|-----------------|--------|
| XMC-575RD | 9895628 | Polished Chrome | Single |
| XMC-575RDB | 9895659 | Black Chrome | Single |

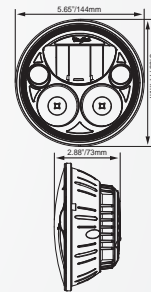

Replaces OEM 68297-05A, 67700144A

View Our Website For Complete Application Chart

BAG LIGHTS

LOW CONSUMPTION COMPARTMENT LIGHTING FOR TRUNKS, BAGS, SADDLES
Two Light Kit | 40 Inch Power Cord With Flush Switch Included | Water & Dust Proof



ITEM #: XMC-BKW2 Shown
PART #: 9895246

| | | |
|-----------------------------------|---|--|
| BEAM MODES Frosted Lens | WARRANTY Extended | DIMENSIONS 2.7" x 2.7" x 0.87" |
| RAW LUMENS 280 lm (kit) | WEIGHT 0.20 lb / 0.09 kg (ea) | METRIC 68.5mm x 68.5mm x 21mm |



| ITEM # | PART # | WIRING | QTY |
|----------|---------|----------------------|----------|
| XMC-BKW2 | 9895246 | 40" Cord With Switch | Two Pods |

5.75" OVAL ROAD GLIDE KIT

2004-2013 HARLEY-DAVIDSON ROAD GLIDE DIRECT REPLACEMENT
Multiple LEDs Fill In Roadway | Polycarbonate Lens | Dramatically Improves Safety



ITEM #: XMC-575ODKIT Shown
PART #: 9895673

| | | |
|--------------------------------------|--|--|
| BEAM MODES Halo, Low, High | WEIGHT 2.20 lb / 1.00 kg | DIMENSIONS 6.96" x 6.96" x 3.85" |
| RAW LUMENS 8,420 lm | REFLECTOR FINISH Polished Chrome, Black Chrome | METRIC 177mm x 177mm x 97.8mm |



| ITEM # | PART # | FINISH | QTY |
|---------------|---------|-----------------|-----|
| XMC-575ODKIT | 9895673 | Polished Chrome | Kit |
| XMC-575ODBKIT | 9895697 | Black Chrome | Kit |

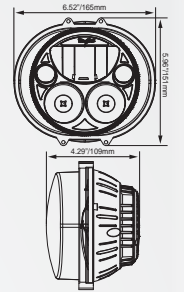

Replaces OEM 67700109, 67775-01C

View Our Website For Complete Application Chart

MOTORCYCLE PASSING LAMP

FIVE TIMES BRIGHTER THAN HALOGEN PASSING LAMPS
Multisurface Reflector | Polycarbonate Lens | Dramatically Improves Safety



ITEM #: XMC-45RDKIT Shown
PART #: 9897844

| | | |
|-------------------------------------|--|--|
| BEAM MODES Driving | WEIGHT 2.20 lb / 1.00 kg | DIMENSIONS 4.49" x 4.49" x 2.24" |
| RAW LUMENS 2,104 lm (kit) | REFLECTOR FINISH Polished Chrome, Black Chrome | METRIC 114mm x 114mm x 57mm |



| ITEM # | PART # | FINISH | QTY |
|--------------|---------|-----------------|---------|
| XMC-45RDKIT | 9897844 | Polished Chrome | Kit (2) |
| XMC-45RDBKIT | 9897851 | Black Chrome | Kit (2) |

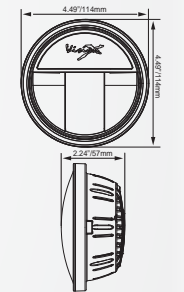

ACCESSORIES

OPTIMUS ROUND LED DRIVING LIGHT
Single Bolt Mounting | Capable of 883 ft of Usable Light | Available In Halo and Non-Halo Models



ITEM #: XIL-OPRH115KIT Shown
PART #: 9891729

| ITEM # | PART # | FINISH | QTY |
|----------------|---------|-----------------|---------|
| XIL-OPRH115KIT | 9891729 | Black, Halo | Kit (2) |
| XIL-OPRH110KIT | 9141251 | Black, Non-Halo | Kit (2) |

See Page 36 for Complete Optimus Details

BILLET CLAMPS
Universal 0.75" - 3.00" Tube Mounting



WIRING
Bike Specific Wiring Available



PRO POD
Available in Multiple Colors



When we released the 25 watt 4.5" LED Light Cannon, no one expected us to double the size shortly after being on the market for one year. Enter the 8.7" LED Light Cannon. This massive single source LED excels at long range distances, shining up to 3,280 feet of usable light all from a 90 watt Luminus Premium LED. With the addition of the 50 watt 6.7" Cannon, that boasts a respectable 2,500 feet of usable light, there's a Light Cannon option for everyone. With the available snap-on covers, you can easily turn any Cannon into 25 different lights.

UNMATCHED

DISTANCE + VERSATILITY + VALUE



LED LIGHTS

Vision X Automotive/Offroad LED lighting runs at a 6000K temperature for intense, bright white light for increased visibility and safety. LED technology has many advantages over traditional lighting options, including low power consumption, no voltage spike at start-up, 50,000 hour life span, and increased durability with the absence of a bulb.

25 LIGHTS IN ONE!



With Snap-On Covers

AUTOMOTIVE/OFFROAD LED LIGHT CANNONS

ABOUT THE CANNON SERIES

The LED Light Cannon Series from Vision X is unmatched by any other fixture on the market. By utilizing Vision X's IRIS Reflector Technology and top binned Single-Source Luminus LEDs, the Cannon Series can produce up to 3,280 feet of usable light.

Each Light Cannon is 25 Lights In One with the help of the available polycarbonate snap-on covers that can alter the beam pattern and change the color of the Cannon. Tackle any weather condition with the proper color cover, or quickly change your spot cover to a flood cover for a wider beam when necessary.

The Light Cannon Series is sold as a single fixture, or as a complete Light Kit consisting of two lights and a dual wiring harness with lighted rocker switch.



25 LIGHTS IN ONE

SPOT COMBO EURO ELLIPTICAL FLOOD WIDE FLOOD

CLEAR COVERS

Unbreakable, dust resistant protection to protect the light from debris and particulates. Recommended for users who wish to maintain original light color.



RED COVERS

Reduces light temperature and glare back in order to enhance penetration in dust and air particulates. Ideal for vehicles in extreme dust conditions.



BLUE COVERS

Increases lighting distance when used in snow conditions by reflecting the blue light off the snow. Recommended for vehicles in heavy winter conditions.



AMBER COVERS

Battles fog conditions by reducing the amount of blue light. Mimics classic Halogen color temperature. Great for driving in dust at high speeds.



BLACKOUT COVERS

Covers the fixture with a solid black protective cover with a high contrast "X" logo. Required in select states for on-road use.



BIG-CHIP SINGLE SOURCE LEDs

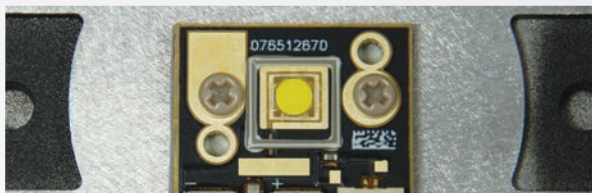

Luminus LEDs

Most LEDs on the market today are composed of smaller LEDs combined together to make one large unit. With the LED Light Cannon Series, Vision X uses larger Single Source LEDs that are one diode, capable of producing more light and a brighter source.

Light Kits Available

Each size of LED Light Cannon is available in a two light kit that includes a dual wiring harness and a lighted rocker switch.



8.7" 90-WATT LIGHT CANNON



ITEM #: CTL-CPZ810 Shown
PART #: 9890852

90-WATT SINGLE SOURCE LED PRODUCES 3,280' OF USABLE LIGHT
Lightweight Hybrid Housing | Long Range IRIS Reflectors | Snap-On Covers Change Beam Pattern

| | | |
|------------------------------------|------------------------------------|---|
| BEAM PATTERNS 10° | WEIGHT 10.36 lb / 4.7 kg | DIMENSIONS 8.71" x 10.58" x 4.57" |
| RAW LUMENS 5,800 lm (ea) | DISTANCE TO 1 LUX 3,280' | METRIC 221mm x 269mm x 116mm |



| ITEM # | PART # | QTY | BEAM |
|---------------|---------|-----|------|
| CTL-CPZ810 | 9890852 | 1 | 10° |
| CTL-CPZ810KIT | 9890074 | 2 | 10° |

*Additional Part Numbers & Technical Information On Page 40

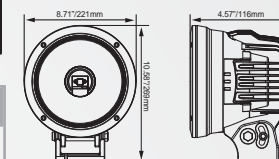

6.7" 50-WATT LIGHT CANNON



ITEM #: CTL-CPZ610 Shown
PART #: 9888538

50-WATT SINGLE SOURCE LED PRODUCES 2,500' OF USABLE LIGHT
Lightweight Hybrid Housing | Long Range IRIS Reflectors | Snap-On Covers Change Beam Pattern

| | | |
|------------------------------------|------------------------------------|--|
| BEAM PATTERNS 10°, 20° | WEIGHT 5.51 lb / 2.5 kg | DIMENSIONS 6.69" x 8.82" x 6.31" |
| RAW LUMENS 3,200 lm (ea) | DISTANCE TO 1 LUX 2,500' | METRIC 170mm x 224mm x 160mm |

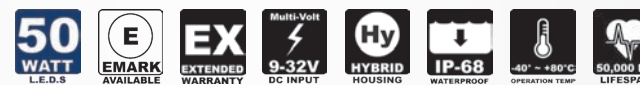

| ITEM # | PART # | QTY | BEAM |
|---------------|---------|-----|------|
| CTL-CPZ610 | 9888538 | 1 | 10° |
| CTL-CPZ610KIT | 9888545 | 2 | 10° |
| CTL-CPZ620 | 9891736 | 1 | 20° |
| CTL-CPZ620KIT | 9891743 | 2 | 20° |

*Additional Part Numbers & Technical Information On Page 40

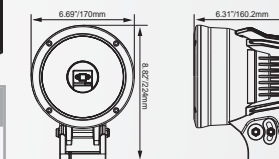

4.5" 40-WATT LIGHT CANNON XP



XTREME PERFORMANCE 40-WATT SINGLE SOURCE LED PRODUCES 1,100' OF USEABLE LIGHT
10° Beam Pattern | Polycarbonate Covers Available (Round) | Two Light Kits Available

| | | |
|------------------------------------|------------------------------------|--|
| BEAM PATTERNS 10° | WEIGHT 2.02 lb / 0.92 kg | DIMENSIONS 4.72" x 5.75" x 4.35" |
| RAW LUMENS 3,000 lm (ea) | DISTANCE TO 1 LUX 1,115' | METRIC 120mm x 147mm x 110mm |



| ITEM # | PART # | QTY | BEAM |
|-----------------|---------|-----|------|
| CTL-CPZ110XP | 9893259 | 1 | 10° |
| CTL-CPZ110XPKIT | 9893365 | 2 | 10° |

*Additional Part Numbers & Technical Information On Page 40

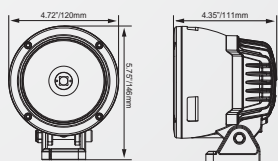

ITEM #: CTL-CPZ110XP Shown
PART #: 9893259
*Lights Available with Black Bezels

4.5" 25-WATT LIGHT CANNON



ITEM #: CTL-CPZ110 Shown
PART #: 9150970

25-WATT SINGLE SOURCE LED PRODUCES 1,000' OF USABLE LIGHT
Lightweight Hybrid Housing | Long Range IRIS Reflectors | Snap-On Covers Change Beam Pattern

| | | |
|------------------------------------|------------------------------------|--|
| BEAM PATTERNS 10° | WEIGHT 2.02 lb / 0.92 kg | DIMENSIONS 4.72" x 5.75" x 4.35" |
| RAW LUMENS 2,500 lm (ea) | DISTANCE TO 1 LUX 1,000' | METRIC 120mm x 147mm x 110mm |

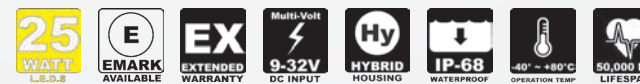

| ITEM # | PART # | QTY | BEAM |
|---------------|---------|-----|------|
| CTL-CPZ110 | 9150970 | 1 | 10° |
| CTL-CPZ110KIT | 9151069 | 2 | 10° |

*Additional Part Numbers & Technical Information On Page 40

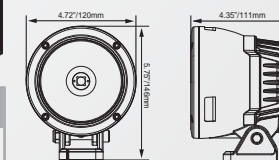

AUTOMOTIVE/OFFROAD TRANSPORTER SERIES

ABOUT THE TRANSPORTER SERIES

The Transporter Series utilizes high powered 5-watt LEDs to provide intense light output for commercial applications. The Transporter Series is ideal for long-haul Trucking and Transport applications because the 50,000 hour lifespan takes away from unscheduled fleet maintenance like bulb replacement, etc.

Additionally, brighter driving conditions for operators ensures greater safety and reliability for drivers on the road. Proper lighting can reduce the amount of time it takes for a load to be delivered and can also reduce the chances for an accident on roadways affected by harsh conditions.

COVERS AVAILABLE



ADVANCED MOUNTING



KNURLED AIMING KNOBS

The Transporter Series can be precisely adjusted to any angle within 15° thanks to the knurled adjustment knobs located at the base of the fixture.

LIGHTED ROCKER HARNES



INCLUDED HARNES

The Transporter Series comes packaged with a single light wiring harness with lighted rocker switch for activation and a weatherproof Deutsch connector, ensuring the longevity of the light. Mounting and wiring is a breeze so you'll be out on the road in no time.

RECESSED OPTICS



SMOOTH BEAM PATTERN

Each Transporter produces a smooth and even beam pattern due to the recessed reflectors that are precisely angled to achieve an effective beam pattern for on-road driving.

TRANSPORTER 18 LED



ITEM #: CTL-TPX1810 Shown
PART #: 9111018

90-WATT LED LIGHT FOR LONG-HAUL TRUCK AND TRANSPORT
Eighteen 5-Watt LEDs | Protective Polycarbonate Covers Available | Truck and Transport Ready

| | | |
|------------------------------------|-----------------------------------|--|
| BEAM PATTERNS 10°, 40° | WEIGHT 6.17 lb / 2.8 kg | DIMENSIONS 6.42" x 7.19" x 4.57" |
| RAW LUMENS 9,504 lm (ea) | DISTANCE TO 1 LUX 840' | METRIC 171mm x 183mm x 116mm |

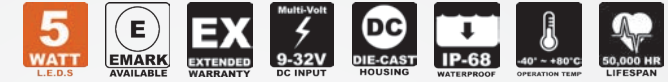

| ITEM # | PART # | QTY | BEAM |
|-------------|---------|-----|------|
| CTL-TPX1810 | 9111018 | 1 | 10° |
| CTL-TPX1840 | 9111193 | 1 | 40° |

*Additional Part Numbers & Technical Information On Page 40

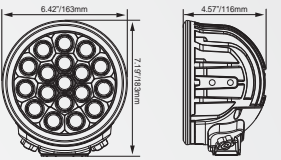

TRANSPORTER 12 LED



ITEM #: CTL-TPX1210 Shown
PART #: 9110561

60-WATT LED LIGHT FOR LONG-HAUL TRUCK AND TRANSPORT
Twelve 5-Watt LEDs | Protective Polycarbonate Covers Available | Truck and Transport Ready

| | | |
|------------------------------------|-----------------------------------|--|
| BEAM PATTERNS 10°, 40° | WEIGHT 5.95 lb / 2.7 kg | DIMENSIONS 6.42" x 7.19" x 4.57" |
| RAW LUMENS 6,336 lm (ea) | DISTANCE TO 1 LUX 778' | METRIC 171mm x 183mm x 116mm |

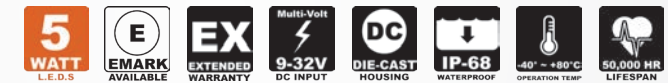

| ITEM # | PART # | QTY | BEAM |
|-------------|---------|-----|------|
| CTL-TPX1210 | 9110561 | 1 | 10° |
| CTL-TPX1240 | 9110745 | 1 | 40° |

*Additional Part Numbers & Technical Information On Page 40

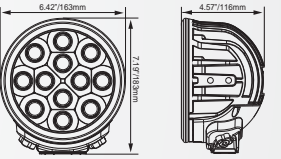

TRANSPORTER 9 LED



ITEM #: CTL-TPX910 Shown
PART #: 9110110

LED LIGHT FOR LONG-HAUL TRUCK AND TRANSPORT
Nine 5-Watt LEDs | Protective Polycarbonate Covers Available | E-Mark Approved Fixture

| | | |
|------------------------------------|-----------------------------------|--|
| BEAM PATTERNS 10°, 40° | WEIGHT 5.95 lb / 2.7 kg | DIMENSIONS 6.42" x 7.19" x 4.57" |
| RAW LUMENS 4,752 lm (ea) | DISTANCE TO 1 LUX 656' | METRIC 163mm x 183mm x 116mm |



| ITEM # | PART # | QTY | BEAM |
|------------|---------|-----|------|
| CTL-TPX910 | 9110110 | 1 | 10° |
| CTL-TPX940 | 9110295 | 1 | 40° |

*Additional Part Numbers & Technical Information On Page 40

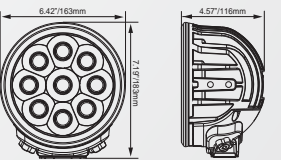

AUTOMOTIVE/OFFROAD OPTIMUS SERIES

ABOUT THE OPTIMUS SERIES

By combining Single-Source LEDs with Vision X's IRIS Reflector Technology, the Optimus Series is capable of reaching powerful distances from a small housing. The Optimus is available in three different beam patterns, allowing users to choose between distance or spread.

Kits consisting of two lights and a wiring harness are available for each member of the Optimus family, and each is also available in Black, Chrome or White housing colors.

The Optimus Series is often used in Vision X Vehicle Specific Kits, to see the available options and to learn more please see page 60.

COVERS AVAILABLE

TWO LIGHT KIT



- Black
- White
- Chrome

COMPLETE KIT

Each model in the Optimus Series can be purchased in a complete lighting kit consisting of two fixtures, a dual-wiring harness, and necessary mounting. Everything you need to explore the night.



OPTIMUS HALO

LONG-RANGE 10-WATT LED WITH BRIGHT LED HALO RING
15° Beam Pattern | Polycarbonate Covers Available (Round) | Two Light Kits Available



| | | |
|------------------------------------|------------------------------------|--|
| BEAM PATTERNS 15° | WEIGHT 1.37 lb / 0.62 kg | ROUND DIMENSIONS 3.62 x 3.62 x 3.79"/92 x 92 x 96mm |
| RAW LUMENS 1,052 lm (ea) | DISTANCE TO 1 LUX 680' | SQUARE DIMENSIONS 2.99 x 2.99 x 3.79"/76 x 76 x 97mm |



| ITEM # | PART # | QTY | HOUSING | ITEM # | PART # | QTY | HOUSING |
|-------------|---------|-----|---------|----------------|---------|-----|---------|
| XIL-OPRH115 | 9891712 | 1 | Round | XIL-OPRH115KIT | 9891729 | 2 | Round |
| XIL-OPH115 | 9891699 | 1 | Square | XIL-OPH115KIT | 9891705 | 2 | Square |

*Additional Part Numbers & Technical Information On Page 41

Round
ITEM #: XIL-OPRH115 Shown
PART #: 9891712

Square
ITEM #: XIL-OPH115 Shown
PART #: 9891699

OPTIMUS SINGLE



ITEM #: XIL-OP110 Shown
PART #: 9123882

10-WATT UNIVERSAL LED DRIVING LIGHT PRODUCES ULTIMATE DISTANCE
Compact 3.0" Housing | High-Strength Adjustable Trunnion Mount | Two Light Kits Available

| | | |
|---------------------------------------|------------------------------------|--|
| BEAM PATTERNS 10°, 20°, 60° | WEIGHT 1.37 lb / 0.62 kg | DIMENSIONS 2.99" x 2.99" x 3.82" |
| RAW LUMENS 1,052 lm (ea) | DISTANCE TO 1 LUX 883' | METRIC 76mm x 80.5mm x 97mm |



| ITEM # | PART # | QTY | BEAM | ITEM # | PART # | QTY | BEAM |
|-----------|---------|-----|------|--------------|---------|-----|------|
| XIL-OP110 | 9123882 | 1 | 10° | XIL-OP110KIT | 9124421 | 2 | 10° |
| XIL-OP120 | 9130002 | 1 | 20° | XIL-OP120KIT | 9138015 | 2 | 20° |
| XIL-OP160 | 9124063 | 1 | 60° | XIL-OP160KIT | 9137926 | 2 | 60° |

*Additional Part Numbers & Technical Information On Page 41

OPTIMUS ROUND



ITEM #: XIL-OPR110 Shown
PART #: 9140896

10-WATT UNIVERSAL LED DRIVING LIGHT PRODUCES ULTIMATE DISTANCE
Compact 3.0" Housing | Snap-On Color & Beam Changing Covers | Two Light Kits Available

| | | |
|---------------------------------------|------------------------------------|--|
| BEAM PATTERNS 10°, 20°, 60° | WEIGHT 1.53 lb / 0.69 kg | DIMENSIONS 3.62" x 3.62" x 3.82" |
| RAW LUMENS 1,052 lm (ea) | DISTANCE TO 1 LUX 883' | METRIC 92mm x 92mm x 97mm |



| ITEM # | PART # | QTY | BEAM | ITEM # | PART # | QTY | BEAM |
|------------|---------|-----|------|---------------|---------|-----|------|
| XIL-OPR110 | 9140896 | 1 | 10° | XIL-OPR110KIT | 9141251 | 2 | 10° |
| XIL-OPR120 | 9141077 | 1 | 20° | XIL-OPR120KIT | 9141343 | 2 | 20° |
| XIL-OPR160 | 9141169 | 1 | 60° | XIL-OPR160KIT | 9141435 | 2 | 60° |

*Additional Part Numbers & Technical Information On Page 41



VIEW COVERS
Page 72

OPTIMUS DUAL



ITEM #: XIL-OP210 Shown
PART #: 9123882

20-WATT UNIVERSAL LED DRIVING LIGHT PRODUCES ULTIMATE DISTANCE
Power Of Two Optimus In One | Available In Kits | High-Strength Adjustable Trunnion Mount

| | | |
|---------------------------------------|------------------------------------|--|
| BEAM PATTERNS 10°, 20°, 60° | WEIGHT 2.25 lb / 1.02 kg | DIMENSIONS 5.83" x 3.82" x 4.80" |
| RAW LUMENS 2,104 lm (ea) | DISTANCE TO 1 LUX 1,240' | METRIC 148mm x 97mm x 122mm |



| ITEM # | PART # | QTY | BEAM | ITEM # | PART # | QTY | BEAM |
|-----------|---------|-----|------|--------------|---------|-----|------|
| XIL-OP210 | 9123882 | 1 | 10° | XIL-OP210KIT | 9125053 | 2 | 10° |
| XIL-OP220 | 9124605 | 1 | 20° | XIL-OP220KIT | 9137834 | 2 | 20° |
| XIL-OP260 | 9136660 | 1 | 60° | XIL-OP260KIT | 9137742 | 2 | 60° |

*Additional Part Numbers & Technical Information On Page 41

AUTOMOTIVE/OFFROAD SOLO POD SERIES

ABOUT THE SOLO SERIES

Compact yet powerful, the Solo Pod Series from Vision X provides intense light output from a small housing. Each Solo produces the equal light output of a pair of headlights from a modern vehicle.

The Solstice Solo excels at multiple applications thanks to the wide selection of different beam patterns. Perfect for dirt bikes, reverse lights, marine lights, or rock lights - the applications are endless.

Additionally, there are multiple accessories that can further extend the versatility of the Solstice Solo.

OMNI-LINK CONNECTORS



ENDLESS CONFIGURATIONS

With the Omni-Link Connector, simply connect Solstice Solo Pods together to create unique lengths and configurations, as well as add numerous accessories for various applications.

FLEXIBLE MOUNTING



SINGLE-BOLT MOUNTING SYSTEM

The Solstice Solo uses a single-bolt mounting system with an adjustable aiming system allowing for precision aiming in hard to reach spots.

ACCESSORIES

FLUSH MOUNT
3" Flush Mount Adapter



HANDLE
Pistol Grip Handle



HANDLE BAR CLAMP
0.75" - 1.25" Mounting



See page 80 for complete accessory details.

SOLO PRIME POD



ITEM #: XIL-SP110 Shown
PART #: 4008830

ULTIMATE 10-WATT LED POD FOR UNIVERSAL APPLICATIONS
Omni-Link Interlocking System | Electronic Thermal Management | Flush Mount Bracket Available

| | | |
|---------------------------------------|------------------------------------|--|
| BEAM PATTERNS 10°, 20°, 40° | WEIGHT 0.70 lb / 0.32 kg | DIMENSIONS 2.17" x 3.35" x 2.36" |
| RAW LUMENS 1,052 lm (ea) | DISTANCE TO 1 LUX 279' | METRIC 55mm x 85mm x 60mm |

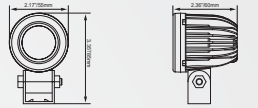

| ITEM # | PART # | BEAM |
|-----------|---------|------|
| XIL-SP110 | 4008830 | 10° |
| XIL-SP120 | 4009882 | 20° |
| XIL-SP140 | 4009899 | 40° |

*Additional Part Numbers & Technical Information On Page 42

SOLSTICE SOLO



ITEM #: XIL-S1110 Shown
PART #: 9888156

COMPACT 10-WATT LED FOR UNIVERSAL APPLICATIONS
Omni-Link Interlocking System | Small 2" Die-Cast Housing | Flush Mount Bracket Available

| | | |
|--|------------------------------------|--|
| BEAM PATTERNS 10°, 30°, 60°, 30°x65° | WEIGHT 0.76 lb / 0.34 kg | DIMENSIONS 2.05" x 3.24" x 2.44" |
| RAW LUMENS 1,052 lm (ea) | DISTANCE TO 1 LUX 255' | METRIC 52mm x 82mm x 62mm |

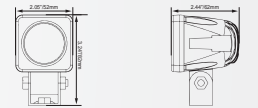

| ITEM # | PART # | BEAM |
|-----------|---------|------|
| XIL-S1110 | 9888156 | 10° |
| XIL-S1130 | 9888163 | 30° |
| XIL-S1160 | 9888170 | 60° |

*Additional Part Numbers & Technical Information On Page 42

MINI SOLO POD



ITEM #: XIL-MX110 Shown
PART #: 9113531

COMPACT 5-WATT LED PERFECT FOR TIGHT SPOTS
Omni-Link Interlocking System | Ultra Compact Housing | Mounting Accessories

| | | |
|--|------------------------------------|--|
| BEAM PATTERNS 10°, 25°, 40°, 60°, 90°, 30°x65° | WEIGHT 0.40 lb / 0.18 kg | DIMENSIONS 1.69" x 2.58" x 2.38" |
| RAW LUMENS 528 lm (ea) | DISTANCE TO 1 LUX 195' | METRIC 43mm x 65mm x 61mm |

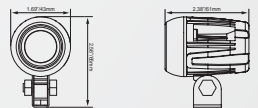

| ITEM # | PART # | BEAM |
|-----------|---------|------|
| XIL-MX110 | 9113531 | 10° |
| XIL-MX140 | 9113715 | 40° |
| XIL-MX160 | 9113807 | 60° |

*Additional Part Numbers & Technical Information On Page 42



LED LIGHT CANNON

| ITEM # | PART # | QTY | BEAM | WEIGHT | RAW LUMENS | EFFECTIVE LUMENS | INPUT VOLTS | WATTS | AMP DRAW |
|-----------------|---------|-----|------|----------|------------|------------------|-------------|-------|----------|
| CTL-CPZ110 | 9150970 | 1 | 10° | 2.02 lb | 2,500 lm | 1,750 lm | 9-32V | 25 | 2.08A |
| CTL-CPZ110KIT | 9151069 | 2 | | 4.04 lb | 5,000 lm | 3,500 lm | | | |
| CTL-CPZ110XP | 9893259 | 1 | 10° | 2.02 lb | 3,000 lm | 2,100 lm | 9-32V | 40 | 3.33A |
| CTL-CPZ110XPKIT | 9893365 | 2 | | 4.04 lb | 6,000 lm | 4,200 lm | | | |
| CTL-CPZ610 | 9888538 | 1 | 10° | 5.51 lb | 3,200 lm | 2,240 lm | 9-32V | 50 | 4.17A |
| CTL-CPZ610KIT | 9888545 | 2 | | 11.02 lb | 6,400 lm | 4,480 lm | | | |
| CTL-CPZ620 | 9891736 | 1 | 20° | 5.51 lb | 3,200 lm | 2,240 lm | 9-32V | 50 | 4.17A |
| CTL-CPZ620KIT | 9891743 | 2 | | 11.02 lb | 6,400 lm | 4,480 lm | | | |
| CTL-CPZ810 | 9890852 | 1 | 10° | 10.36 lb | 5,800 lm | 4,060 lm | 9-32V | 90 | 7.5A |
| CTL-CPZ810KIT | 9890074 | 2 | | 20.72 lb | 11,600 lm | 8,120 lm | | | |

CTL-CPZ110 | 9150970 - 10° BEAM

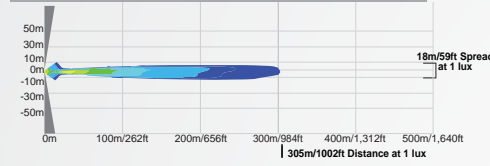

CTL-CPZ110XP | 9893259 - 10° BEAM

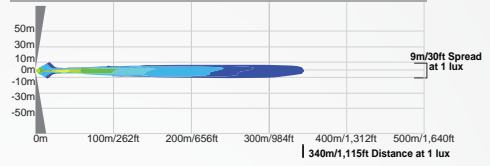

CTL-CPZ610 | 9888538 - 10° BEAM

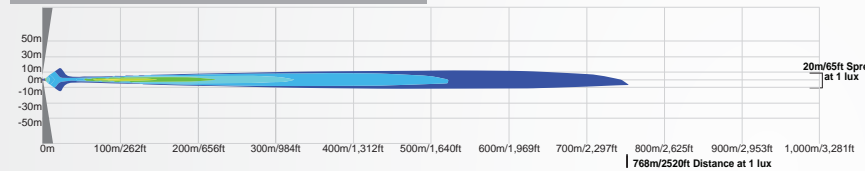

CTL-CPZ810 | 9890852 - 10° BEAM

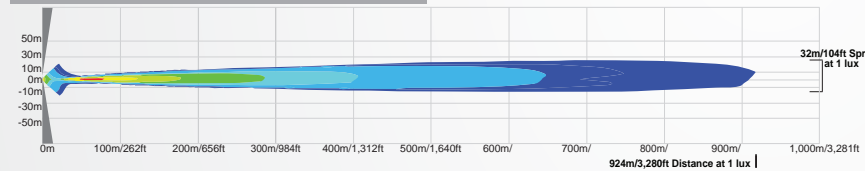

TRANSPORTER

| ITEM # | PART # | # OF LEDS | BEAM | WEIGHT | RAW LUMENS | EFFECTIVE LUMENS | INPUT VOLTS | WATTS | AMP DRAW |
|-------------|---------|-----------|------|---------|------------|------------------|-------------|-------|----------|
| CTL-TPX910 | 9110110 | 9 | 10° | 5.95 lb | 4,752 lm | 3,330 lm | 9-32V | 45 | 3.75A |
| CTL-TPX940 | 9110295 | 9 | 40° | 5.95 lb | 4,752 lm | 3,330 lm | 9-32V | 45 | 3.75A |
| CTL-TPX1210 | 9110561 | 12 | 10° | 6.17 lb | 6,336 lm | 4,440 lm | 9-32V | 60 | 5A |
| CTL-TPX1240 | 9110745 | 12 | 40° | 6.17 lb | 6,336 lm | 4,440 lm | 9-32V | 60 | 5A |
| CTL-TPX1810 | 9111018 | 18 | 10° | 6.61 lb | 9,504 lm | 6,660 lm | 9-32V | 90 | 7.5A |
| CTL-TPX1840 | 9111193 | 18 | 40° | 6.61 lb | 9,504 lm | 6,660 lm | 9-32V | 90 | 7.5A |

CTL-TPX1810 | 9111018 - 10° BEAM

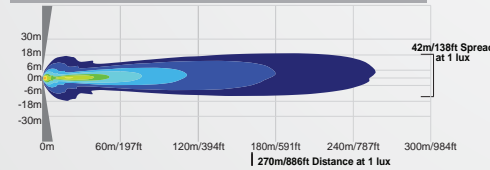

CTL-TPX1840 | 9111193 - 40° BEAM

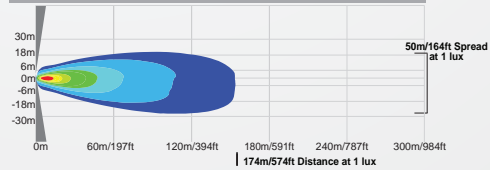

OPTIMUS

| ITEM # | PART # | QTY | HOUSING | BEAM | WEIGHT | RAW LUMENS | EFFECTIVE LUMENS | INPUT VOLTS | WATTS | AMP DRAW |
|----------------|---------|-----|--------------|------|---------|------------|------------------|-------------|-------|----------|
| XIL-OPH115 | 9891699 | 1 | Black | 10° | 1.37 lb | 1,052 lm | 736 lm | 9-32V | 10 | 0.83A |
| XIL-OPH115KIT | 9891705 | 2 | | | 2.74 lb | 2,104 lm | 1,473 lm | | | |
| XIL-OPRH115 | 9891712 | 1 | Black | 10° | 1.53 lb | 1,052 lm | 736 lm | 9-32V | 10 | 0.83A |
| XIL-OPRH115KIT | 9891729 | 2 | | | 3.06 lb | 2,104 lm | 1,473 lm | | | |
| XIL-OP110 | 9123882 | 1 | Black | 20° | 1.37 lb | 1,052 lm | 736 lm | 9-32V | 10 | 0.83A |
| XIL-OP110KIT | 9124421 | 2 | | | 2.74 lb | 2,104 lm | 1,473 lm | | | |
| XIL-OP120 | 9130002 | 1 | Black | 10° | 1.37 lb | 1,052 lm | 736 lm | 9-32V | 10 | 0.83A |
| XIL-OP120KIT | 9138015 | 2 | | | 2.74 lb | 2,104 lm | 1,473 lm | | | |
| XIL-OP160 | 9124063 | 1 | Black | 10° | 1.37 lb | 1,052 lm | 736 lm | 9-32V | 10 | 0.83A |
| XIL-OP160KIT | 9137926 | 2 | | | 2.74 lb | 2,104 lm | 1,473 lm | | | |
| XIL-OP110W | 9124513 | 1 | White Chrome | 10° | 1.37 lb | 1,052 lm | 736 lm | 9-32V | 10 | 0.83A |
| XIL-OP110C | 9124247 | 1 | | | 2.74 lb | 2,104 lm | 1,473 lm | | | |
| XIL-OP120W | 9139005 | 1 | White Chrome | 20° | 1.37 lb | 1,052 lm | 736 lm | 9-32V | 10 | 0.83A |
| XIL-OP120C | 9139098 | 1 | | | 2.74 lb | 2,104 lm | 1,473 lm | | | |
| XIL-OP160W | 9139364 | 1 | White Chrome | 60° | 1.37 lb | 1,052 lm | 736 lm | 9-32V | 10 | 0.83A |
| XIL-OP160C | 9139272 | 1 | | | 2.74 lb | 2,104 lm | 1,473 lm | | | |
| XIL-OPR110 | 9140896 | 1 | Black | 10° | 1.53 lb | 1,052 lm | 736 lm | 9-32V | 10 | 0.83A |
| XIL-OPR110KIT | 9141251 | 2 | | | 3.06 lb | 2,104 lm | 1,473 lm | | | |
| XIL-OPR120 | 9141077 | 1 | Black | 10° | 1.53 lb | 1,052 lm | 736 lm | 9-32V | 10 | 0.83A |
| XIL-OPR120KIT | 9141343 | 2 | | | 3.06 lb | 2,104 lm | 1,473 lm | | | |
| XIL-OPR160 | 9141169 | 1 | Black | 10° | 1.53 lb | 1,052 lm | 736 lm | 9-32V | 10 | 0.83A |
| XIL-OPR160KIT | 9141435 | 2 | | | 3.06 lb | 2,104 lm | 1,473 lm | | | |
| XIL-OPR110W | 9149172 | 1 | White Chrome | 10° | 1.53 lb | 1,052 lm | 736 lm | 9-32V | 10 | 0.83A |
| XIL-OPR110C | 9149080 | 1 | | | 3.06 lb | 2,104 lm | 1,473 lm | | | |
| XIL-OPR120W | 9149356 | 1 | White Chrome | 20° | 1.53 lb | 1,052 lm | 736 lm | 9-32V | 10 | 0.83A |
| XIL-OPR120C | 9149264 | 1 | | | 3.06 lb | 2,104 lm | 1,473 lm | | | |
| XIL-OPR160W | 9149530 | 1 | White Chrome | 60° | 1.53 lb | 1,052 lm | 736 lm | 9-32V | 10 | 0.83A |
| XIL-OPR160C | 9149448 | 1 | | | 3.06 lb | 2,104 lm | 1,473 lm | | | |
| XIL-OP210 | 9124605 | 1 | Black | 10° | 2.25 lb | 2,104 lm | 1,473 lm | 9-32V | 20 | 1.67A |
| XIL-OP210KIT | 9125053 | 2 | | | 4.5 lb | 4,208 lm | 2,946 lm | | | |
| XIL-OP220 | 9139548 | 1 | Black | 20° | 2.25 lb | 2,104 lm | 1,473 lm | 9-32V | 20 | 1.67A |
| XIL-OP220KIT | 9137834 | 2 | | | 4.5 lb | 4,208 lm | 2,946 lm | | | |
| XIL-OP260 | 9136660 | 1 | Black | 60° | 2.25 lb | 2,104 lm | 1,473 lm | 9-32V | 20 | 1.67A |
| XIL-OP260KIT | 9137742 | 2 | | | 4.5 lb | 4,208 lm | 2,946 lm | | | |
| XIL-OP210W | 9124964 | 1 | White Chrome | 10° | 2.25 lb | 2,104 lm | 1,473 lm | 9-32V | 20 | 1.67A |
| XIL-OP210C | 9124698 | 1 | | | 4.5 lb | 4,208 lm | 2,946 lm | | | |
| XIL-OP220W | 9139630 | 1 | White Chrome | 20° | 2.25 lb | 2,104 lm | 1,473 lm | 9-32V | 20 | 1.67A |
| XIL-OP220C | 9166636 | 1 | | | 4.5 lb | 4,208 lm | 2,946 lm | | | |
| XIL-OP260W | 9139722 | 1 | White Chrome | 60° | 2.25 lb | 2,104 lm | 1,473 lm | 9-32V | 20 | 1.67A |
| XIL-OP260C | 9159348 | 1 | | | 4.5 lb | 4,208 lm | 2,946 lm | | | |

XIL-OP110 | 9123882 - 10° BEAM

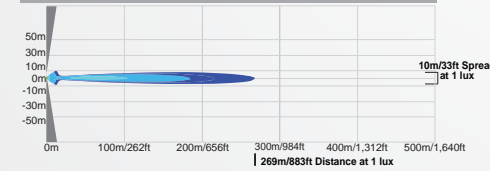

XIL-OP160 | 9124063 - 60° BEAM

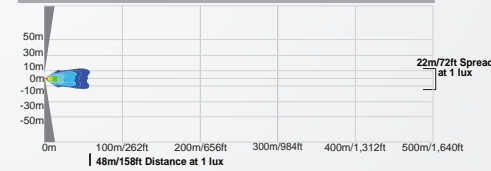

XIL-OP210 | 9124605 - 10° BEAM

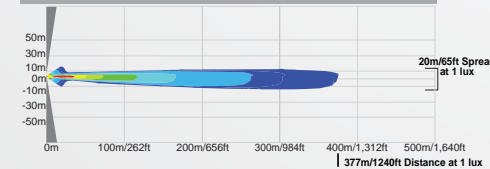

XIL-OP260 | 9139548 - 60° BEAM

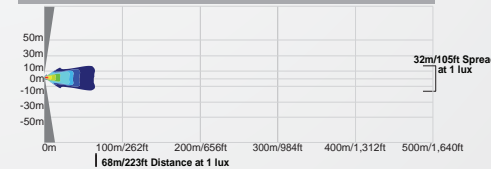

SOLO PRIME

| ITEM # | PART # | HOUSING | BEAM | WEIGHT | RAW LUMENS | EFFECTIVE LUMENS | INPUT VOLTS | WATTS | AMP DRAW |
|------------|---------|---------|------|---------|------------|------------------|-------------|-------|----------|
| XIL-SP110 | 4008830 | Black | 10° | 0.70 lb | 1,052 lm | 736 lm | 9-32V | 10 | 0.83A |
| XIL-SP110W | 4008847 | White | 10° | 0.70 lb | 1,052 lm | 736 lm | 9-32V | 10 | 0.83A |
| XIL-SP120 | 4009882 | Black | 20° | 0.70 lb | 1,052 lm | 736 lm | 9-32V | 10 | 0.83A |
| XIL-SP120W | 4008854 | White | 20° | 0.70 lb | 1,052 lm | 736 lm | 9-32V | 10 | 0.83A |
| XIL-SP140 | 4009899 | Black | 40° | 0.70 lb | 1,052 lm | 736 lm | 9-32V | 10 | 0.83A |
| XIL-SP140W | 4008861 | White | 40° | 0.70 lb | 1,052 lm | 736 lm | 9-32V | 10 | 0.83A |

XIL-SP110 | 4008830 - 10° BEAM

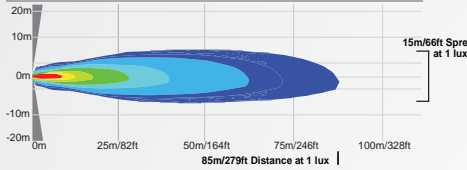

XIL-SP120 | 4009882 - 20° BEAM

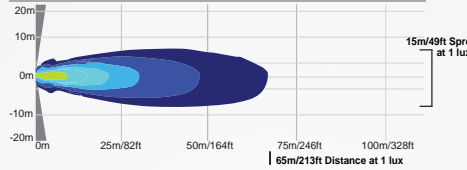

XIL-SP140 | 4009899 - 40° BEAM

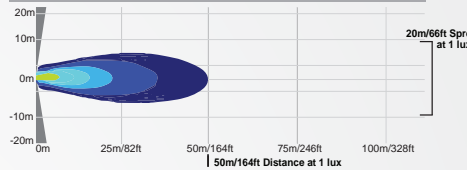

SOLSTICE SOLO

| ITEM # | PART # | HOUSING | BEAM | WEIGHT | RAW LUMENS | EFFECTIVE LUMENS | INPUT VOLTS | WATTS | AMP DRAW |
|---------------|---------|---------|---------|---------|------------|------------------|-------------|-------|----------|
| XIL-S1110 | 9888156 | Black | 10° | 0.76 lb | 1,052 lm | 736 lm | 9-32V | 10 | 0.83A |
| XIL-S1110W | 9888194 | White | 10° | 0.76 lb | 1,052 lm | 736 lm | 9-32V | 10 | 0.83A |
| XIL-S1130 | 9888163 | Black | 30° | 0.76 lb | 1,052 lm | 736 lm | 9-32V | 10 | 0.83A |
| XIL-S1130W | 9888200 | White | 30° | 0.76 lb | 1,052 lm | 736 lm | 9-32V | 10 | 0.83A |
| XIL-S1160 | 9888170 | Black | 60° | 0.76 lb | 1,052 lm | 736 lm | 9-32V | 10 | 0.83A |
| XIL-S1160W | 9888217 | White | 60° | 0.76 lb | 1,052 lm | 736 lm | 9-32V | 10 | 0.83A |
| XIL-S11e3065 | 9888187 | Black | 30°x65° | 0.76 lb | 1,052 lm | 736 lm | 9-32V | 10 | 0.83A |
| XIL-S11e3065W | 9888224 | White | 30°x65° | 0.76 lb | 1,052 lm | 736 lm | 9-32V | 10 | 0.83A |

XIL-S1110 | 9888156 - 10° BEAM

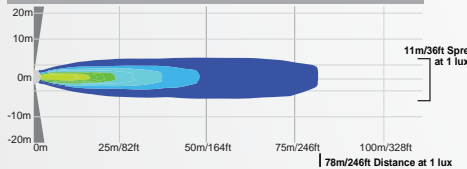

XIL-S1130 | 9888163 - 30° BEAM

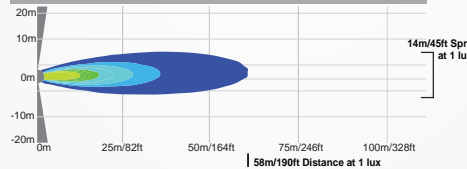

XIL-S1160 | 9888170 - 60° BEAM

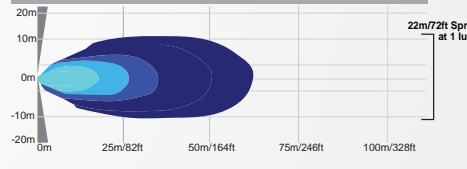

MINI SOLO

| ITEM # | PART # | HOUSING | BEAM | WEIGHT | RAW LUMENS | EFFECTIVE LUMENS | INPUT VOLTS | WATTS | AMP DRAW |
|-----------|---------|---------|------|---------|------------|------------------|-------------|-------|----------|
| XIL-MX110 | 9113531 | Black | 10° | 0.40 lb | 528 lm | 368 lm | 9-32V | 5 | 0.42A |
| XIL-MX140 | 9113715 | Black | 40° | 0.40 lb | 528 lm | 368 lm | 9-32V | 5 | 0.42A |
| XIL-MX160 | 9113807 | Black | 60° | 0.40 lb | 528 lm | 368 lm | 9-32V | 5 | 0.42A |

XIL-MX110 | 9113531 - 10° BEAM

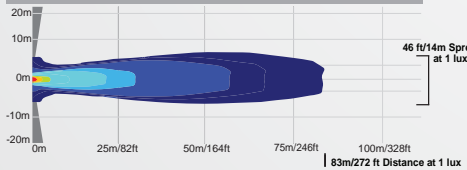

XIL-MX140 | 9113715 - 40° BEAM

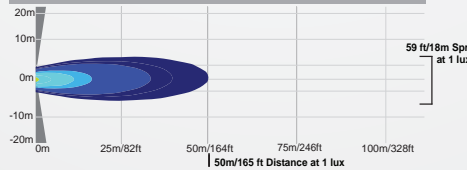

XIL-MX160 | 9113807 - 60° BEAM

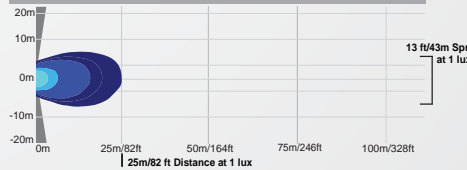



LED LIGHT BARS

Vision X LED Light Bars come in a variety of sizes from 4" all the way to 52". Our LED Light Bars have an extruded 6061 aluminum housing and are created from top-binned, perfectly crafted LEDs for a durable and highly effective LED lighting solution.

XMITTER PRIME XTREME

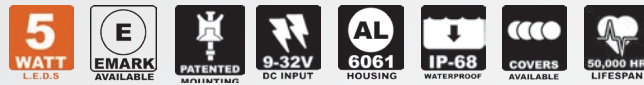

BRIGHTEST LIGHT BAR ON THE MARKET

- Full Range Fills In Road Way
- Plug And Play Harness Included
- PWM Integrated Dimming Circuitry
- 90% Efficiency Next Generation LED
- Electronic Thermal Management & Dimming

| | |
|---|------------------------------|
| BEAM PATTERNS 10°, 40°, Mixed | WARRANTY Extended |
| HEIGHT 3.75" / 95mm | WIDTH 3.31" / 84mm |

END CAP MOUNTS



ITEM #: XIL-PECM Shown
PART #: 9889191

2D VIEW

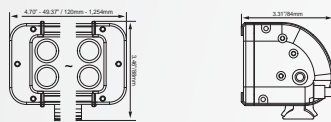

AVAILABLE IN AMBER



| LENGTH | ITEM # | PART # | BEAM | ITEM # | PART # | BEAM | ITEM # | PART # | BEAM |
|------------------|------------|---------|----------|------------|---------|-----------|-----------|---------|-------|
| 4.70" / 120mm | XIL-PX610 | 9117409 | 10° Spot | XIL-PX640 | 9117492 | 40° Flood | XIL-PX6M | 9894850 | Mixed |
| 7.90" / 201mm | XIL-PX1210 | 9115603 | 10° Spot | XIL-PX1240 | 9115696 | 40° Flood | XIL-PX12M | 9894751 | Mixed |
| 11.10" / 282mm | XIL-PX1810 | 9115788 | 10° Spot | XIL-PX1840 | 9115870 | 40° Flood | XIL-PX18M | 9887890 | Mixed |
| 17.50" / 444mm | XIL-PX3010 | 9116860 | 10° Spot | XIL-PX3040 | 9116952 | 40° Flood | XIL-PX30M | 9123431 | Mixed |
| 20.60" / 525mm | XIL-PX3610 | 9117041 | 10° Spot | XIL-PX3640 | 9117133 | 40° Flood | XIL-PX36M | 9894836 | Mixed |
| 30.20" / 768mm | XIL-PX5410 | 9117225 | 10° Spot | XIL-PX5440 | 9117317 | 40° Flood | XIL-PX54M | 9153223 | Mixed |
| 39.80" / 1,011mm | XIL-PX7210 | 9117584 | 10° Spot | XIL-PX7240 | 9117676 | 40° Flood | XIL-PX72M | 9153490 | Mixed |
| 49.37" / 1,254mm | XIL-PX9010 | 9887036 | 10° Spot | XIL-PX9040 | 9887043 | 40° Flood | XIL-PX90M | 9132792 | Mixed |

*Additional Part Numbers & Technical Information On Page 52

XPR-S



UPGRADED FOR UNSURPASSED DISTANCE

- Halo Models Available
- Dual Mounting Standard
- Plug And Play Harness Included
- 40-95% More Distance than XPR Series
- Upgraded IRIS Reflector Technology With 10 Watt LED

| | |
|---|------------------------------|
| BEAM PATTERNS Straight (6.5°) | WARRANTY Extended |
| HEIGHT 3.75" / 95mm | WIDTH 3.19" / 81mm |

END CAP MOUNTS



ITEM #: XPI-EM Shown
PART #: 9892917

2D VIEW

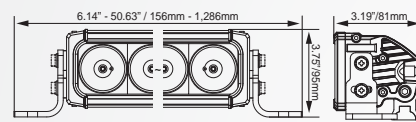

| ITEM # | PART # | LENGTH | BEAM |
|---------|---------|----------------|----------|
| XPR-3S | 9897462 | 6.14" / 156 mm | Straight |
| XPR-6S | 9897479 | 11.46"/291mm | Straight |
| XPR-9S | 9897455 | 18.80"/476mm | Straight |
| XPR-12S | 9897394 | 24.06"/611mm | Straight |
| XPR-15S | 9897400 | 29.37"/746mm | Straight |
| XPR-18S | 9897417 | 34.69"/881mm | Straight |
| XPR-21S | 9897424 | 40.00"/1,016mm | Straight |
| XPR-27S | 9897448 | 50.63"/1,286mm | Straight |

*Additional Part Numbers & Technical Information On Page 51

SIDE WING MOUNTS INCLUDED



DUAL MOUNTING INCLUDED
Each XPR comes packaged with dual side-wing mounts as well as patented feet mounts. Amount of feet mounts vary by length of the light bar.

XPR



IRIS REFLECTORS FOR ULTIMATE DISTANCE

- Dual Mounting Standard
- 5-Watt XPI Light Bar Available
- Plug And Play Harness Included
- IRIS Reflector Technology With 10 Watt LED
- New Lifespan-Boosting Heat Sink Technology

| | |
|--|------------------------------|
| BEAM PATTERNS Straight, Tilted | WARRANTY Extended |
| HEIGHT 3.75" / 95mm | WIDTH 3.19" / 81mm |

END CAP MOUNTS



ITEM #: XPI-EM Shown
PART #: 9892917

2D VIEW

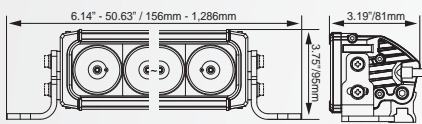

| ITEM # | PART # | LENGTH | BEAM |
|---------|---------|-----------------|----------|
| XPR-3 | 9891606 | 6.05" / 153.7mm | Straight |
| XPR-6 | 9891613 | 11.46"/291mm | Straight |
| XPR-9M | 9891620 | 18.80"/476mm | Tilted |
| XPR-12M | 9891637 | 24.06"/611mm | Tilted |
| XPR-15M | 9891644 | 29.37"/746mm | Tilted |
| XPR-18M | 9891651 | 34.69"/881mm | Tilted |
| XPR-21M | 9891668 | 40.00"/1,016mm | Tilted |
| XPR-27M | 9891682 | 50.63"/1,286mm | Tilted |

SIDE WING MOUNTS INCLUDED



DUAL MOUNTING INCLUDED

Each XPR comes packaged with dual side-wing mounts as well as patented feet mounts. Amount of feet mounts vary by length of the light bar.

XMITTER LOW PRO XTREME



XTREME OUTPUT IN A COMPACT LIGHT BAR

- Sleek Low Profile Design
- 90% Efficiency Next Gen LED
- Plug And Play Harness Included
- PWM Integrated Dimming Circuitry
- Electronic Thermal Management & Dimming

| | |
|---|------------------------------|
| BEAM PATTERNS 10°, 40°, Mixed | WARRANTY Extended |
| HEIGHT 2.06" / 52mm | WIDTH 2.45" / 62mm |

END CAP MOUNTS



ITEM #: XIL-LPECM Shown
PART #: 9888811

2D VIEW

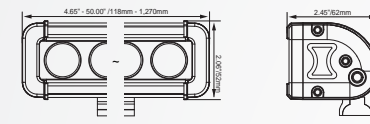

| LENGTH | ITEM # | PART # | BEAM |
|------------------|-------------|---------|----------|
| 4.65" / 118mm | XIL-LPX310 | 4000759 | 10° Spot |
| 8.43" / 214mm | XIL-LPX610 | 9118758 | 10° Spot |
| 12.21" / 310mm | XIL-LPX910 | 4000773 | 10° Spot |
| 19.77" / 502mm | XIL-LPX1510 | 9114613 | 10° Spot |
| 31.11" / 790mm | XIL-LPX2410 | 9121901 | 10° Spot |
| 34.89" / 886mm | XIL-LPX2710 | 9114972 | 10° Spot |
| 42.44" / 1,078mm | XIL-LPX3310 | 9115153 | 10° Spot |
| 50.00" / 1,270mm | XIL-LPX3910 | 9128115 | 10° Spot |

| ITEM # | PART # | BEAM |
|-------------|---------|-----------|
| XIL-LPX340 | 4000766 | 40° Flood |
| XIL-LPX640 | 9120737 | 40° Flood |
| XIL-LPX940 | 4000780 | 40° Flood |
| XIL-LPX1540 | 9114705 | 40° Flood |
| XIL-LPX2440 | 9132884 | 40° Flood |
| XIL-LPX2740 | 9115061 | 40° Flood |
| XIL-LPX3340 | 9115245 | 40° Flood |
| XIL-LPX3940 | 9132976 | 40° Flood |

| ITEM # | PART # | BEAM |
|------------|---------|-------|
| XIL-LPX6M | 9153407 | Mixed |
| XIL-LPX15M | 9897042 | Mixed |
| XIL-LPX24M | 9889351 | Mixed |
| XIL-LPX39M | 9892252 | Mixed |

*Additional Part Numbers & Technical Information On Page 53

XMITTER

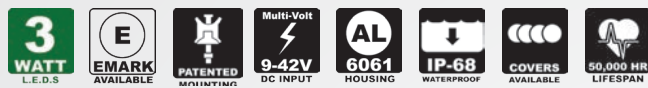

| | |
|-------------------------------------|------------------------------|
| BEAM PATTERNS Euro, Flood | WARRANTY Extended |
| HEIGHT 2.76" / 69mm | WIDTH 3.00" / 76mm |

END CAP MOUNTS



ITEM #: XIL-ECM Shown
PART #: 9888781

2D VIEW

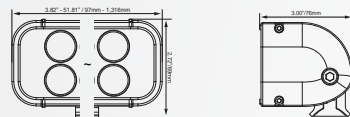

ORIGINAL LIGHT BAR WITH SEAMLESS BEAM

- Seamless Beam Pattern
- Plug and Play Harness Included
- Weatherproof Deutsch Connector
- Used by NASA, Border Patrol, and Pro Racers
- Infrared, Amber, Red Blue, and Green Available



| ITEM # | PART # | LENGTH | BEAM |
|----------|---------|------------------|------|
| XIL-40 | 4006270 | 4.00" / 101.6mm | Euro |
| XIL-80 | 4006287 | 5.80" / 147.6mm | Euro |
| XIL-120 | 4006294 | 7.80" / 198.4mm | Euro |
| XIL-200 | 4006300 | 11.80" / 300mm | Euro |
| XIL-320 | 4006317 | 17.60" / 446mm | Euro |
| XIL-400 | 4006324 | 21.70" / 550mm | Euro |
| XIL-600 | 4006331 | 31.80" / 808mm | Euro |
| XIL-800 | 4006348 | 41.80" / 1,062mm | Euro |
| XIL-1000 | 4006355 | 51.80" / 1,316mm | Euro |

| ITEM # | PART # | LENGTH | BEAM |
|----------|---------|------------------|-------|
| XIL-41 | 4007529 | 4.00" / 101.6mm | Flood |
| XIL-81 | 4007581 | 5.80" / 147.6mm | Flood |
| XIL-121 | 4007369 | 7.80" / 198.4mm | Flood |
| XIL-201 | 4007468 | 11.80" / 300mm | Flood |
| XIL-321 | 4007482 | 17.60" / 446mm | Flood |
| XIL-401 | 4007505 | 21.70" / 550mm | Flood |
| XIL-601 | 4007543 | 31.80" / 808mm | Flood |
| XIL-801 | 4007567 | 41.80" / 1,062mm | Flood |
| XIL-1001 | 4007345 | 51.80" / 1,316mm | Flood |

*Additional Part Numbers & Technical Information On Page 53

CHASER BARS



| | |
|-------------------------------|------------------------------|
| BEAM PATTERNS 60° | WARRANTY Extended |
| HEIGHT 2.06" / 52mm | WIDTH 2.45" / 62mm |

END CAP MOUNTS



ITEM #: XIL-LPECM Shown
PART #: 9888811

LOW PROFILE REAR LED CHASER BAR SYSTEM

- Sleek Low Profile Design
- High Output Color LEDs
- Racer Models Include Blue LEDs
- Running and Brake Lights in Single Bar
- Red, Amber, and White LEDs in Single Housing



| ITEM # | PART # | LENGTH | USE |
|------------|---------|----------------|------------|
| XIL-CBSR21 | 9897196 | 27.33" / 694mm | Recreation |
| XIL-CBSR27 | 9897202 | 34.89" / 886mm | Recreation |

| ITEM # | PART # | LENGTH | USE |
|------------|---------|----------------|------|
| XIL-CBSX21 | 9897219 | 27.33" / 694mm | Race |
| XIL-CBSX27 | 9897226 | 34.89" / 886mm | Race |

XPR-S TECHNICAL DATA

| ITEM # | PART # | LEDS | BEAM | LENGTH | WEIGHT | RAW LUMENS | EFFECTIVE LUMENS | INPUT VOLTS | WATTS | AMP DRAW |
|---------|---------|------|----------|----------------|----------------|------------|------------------|-------------|-------|----------|
| XPR-3S | 9897462 | 3 | Straight | 6.14"/156mm | 1.80lb/0.82kg | 3,237 lm | 2,266 lm | 11-32V | 30 | 2.5A |
| XPR-6S | 9897479 | 6 | Straight | 11.46"/291mm | 3.40lb/1.54kg | 6,474 lm | 4,531 lm | 11-32V | 60 | 5A |
| XPR-9S | 9897455 | 9 | Straight | 18.80"/476mm | 5.10lb/2.31kg | 9,711 lm | 6,798 lm | 11-32V | 60 | 5A |
| XPR-12S | 9897394 | 12 | Straight | 24.06"/611mm | 6.90lb/3.13kg | 12,948 lm | 9,064 lm | 11-32V | 90 | 10A |
| XPR-15S | 9897400 | 15 | Straight | 29.37"/746mm | 8.70lb/3.95kg | 16,185 lm | 11,330 lm | 11-32V | 150 | 12.5A |
| XPR-18S | 9897417 | 18 | Straight | 34.69"/881mm | 9.80lb/4.45kg | 19,422 lm | 13,595 lm | 11-32V | 180 | 15A |
| XPR-21S | 9897424 | 21 | Straight | 40.00"/1,016mm | 11.60lb/5.26kg | 22,659 lm | 15,861 lm | 11-32V | 210 | 17.5A |
| XPR-27S | 9897448 | 27 | Straight | 50.63"/1,286mm | 15.22lb/6.90kg | 29,133 lm | 20,393 lm | 11-32V | 270 | 22.5A |

XPR-27S | 9891682 - Straight Beam

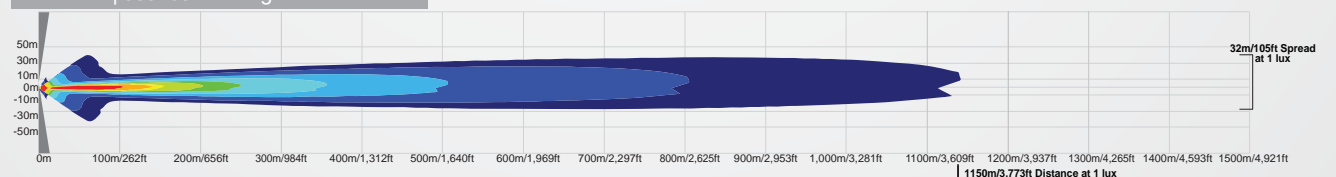

XMITTER PRIME XTREME

| ITEM # | PART # | LEDS | BEAM | LENGTH | WEIGHT | RAW LUMENS | EFFECTIVE LUMENS | INPUT VOLTS | WATTS | AMP DRAW |
|------------|---------|------|-------|----------------|----------------|------------|------------------|-------------|-------|----------|
| XIL-PX610 | 9117409 | | 10° | | | | | | | |
| XIL-PX640 | 9117492 | 6 | 40° | 4.70"/120mm | 2.65lb/1.2kg | 3,168 lm | 2,220 lm | 9-32V | 30 | 2.5A |
| XIL-PX6M | 9894850 | | Mixed | | | | | | | |
| XIL-PX1210 | 9115603 | | 10° | | | | | | | |
| XIL-PX1240 | 9115696 | 12 | 40° | 7.90"/201mm | 5.29lb/2.4kg | 6,336 lm | 4,440 lm | 9-32V | 60 | 5A |
| XIL-PX12M | 9894751 | | Mixed | | | | | | | |
| XIL-PX1810 | 9115788 | | 10° | | | | | | | |
| XIL-PX1840 | 9115870 | 18 | 40° | 11.10"/282mm | 6.61lb/3.0kg | 9,504 lm | 6,660 lm | 9-32V | 90 | 7.5A |
| XIL-PX18M | 9887890 | | Mixed | | | | | | | |
| XIL-PX3010 | 9116860 | | 10° | | | | | | | |
| XIL-PX3040 | 9116952 | 30 | 40° | 17.50"/444mm | 9.25lb/4.5kg | 15,840 lm | 11,100 lm | 9-32V | 150 | 12.5A |
| XIL-PX30M | 9123431 | | Mixed | | | | | | | |
| XIL-PX3610 | 9117041 | | 10° | | | | | | | |
| XIL-PX3640 | 9117133 | 36 | 40° | 20.60"/525mm | 10.58lb/4.8kg | 19,008 lm | 13,320 lm | 9-32V | 180 | 15A |
| XIL-PX36M | 9894836 | | Mixed | | | | | | | |
| XIL-PX5410 | 9117225 | | 10° | | | | | | | |
| XIL-PX5440 | 9117317 | 54 | 40° | 30.20"/768mm | 14.55lb/6.6kg | 28,512 lm | 19,980 lm | 9-32V | 270 | 22.5A |
| XIL-PX54M | 9153223 | | Mixed | | | | | | | |
| XIL-PX7210 | 9117584 | | 10° | | | | | | | |
| XIL-PX7240 | 9117676 | 72 | 40° | 39.80"/1,011mm | 18.51lb/8.4kg | 38,016 lm | 26,640 lm | 9-32V | 360 | 30A |
| XIL-PX72M | 9153490 | | Mixed | | | | | | | |
| XIL-PX9010 | 9887036 | | 10° | | | | | | | |
| XIL-PX9040 | 9887043 | 90 | 40° | 49.37"/1,254mm | 22.49lb/10.2kg | 47,520 lm | 33,300 lm | 9-32V | 450 | 37.5A |
| XIL-PX90M | 9132792 | | Mixed | | | | | | | |

XIL-PX1810 | 9115788 - 10° BEAM

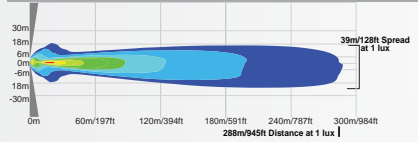

XIL-PX1840 | 9115870 - 40° BEAM

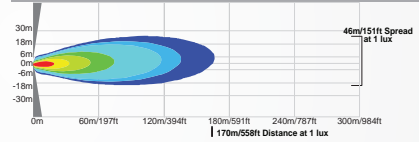

XPR

| ITEM # | PART # | LEDS | BEAM | LENGTH | WEIGHT | RAW LUMENS | EFFECTIVE LUMENS | INPUT VOLTS | WATTS | AMP DRAW |
|---------|---------|------|----------|----------------|----------------|------------|------------------|-------------|-------|----------|
| XPR-3 | 9891606 | 3 | Straight | 6.14"/156mm | 1.80lb/0.82kg | 3,237 lm | 2,266 lm | 11-32V | 30 | 2.5A |
| XPR-6 | 9891613 | 6 | Straight | 11.46"/291mm | 3.40lb/1.54kg | 6,474 lm | 4,531 lm | 11-32V | 60 | 5A |
| XPR-9M | 9891620 | 9 | Tilted | 18.80"/476mm | 5.10lb/2.31kg | 9,711 lm | 6,798 lm | 11-32V | 60 | 5A |
| XPR-12M | 9891637 | 12 | Tilted | 24.06"/611mm | 6.90lb/3.13kg | 12,948 lm | 9,064 lm | 11-32V | 90 | 7.5A |
| XPR-15M | 9891644 | 15 | Tilted | 29.37"/746mm | 8.70lb/3.95kg | 16,185 lm | 11,330 lm | 11-32V | 150 | 12.5A |
| XPR-18M | 9891651 | 18 | Tilted | 34.69"/881mm | 9.80lb/4.45kg | 19,422 lm | 13,595 lm | 11-32V | 180 | 15A |
| XPR-21M | 9891668 | 21 | Tilted | 40.00"/1,016mm | 11.60lb/5.26kg | 22,659 lm | 15,861 lm | 11-32V | 210 | 17.5A |
| XPR-27M | 9891682 | 27 | Tilted | 50.63"/1,286mm | 15.22lb/6.90kg | 29,133 lm | 20,393 lm | 11-32V | 270 | 22.5A |

XPR-27M | 9891682 - Tilted Beam

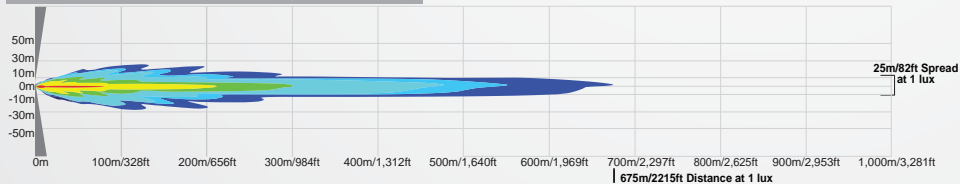

XMITTER LOW PROFILE XTREME

| ITEM # | PART # | LEDS | BEAM | LENGTH | WEIGHT | RAW LUMENS | EFFECTIVE LUMENS | INPUT VOLTS | WATTS | AMP DRAW |
|-------------|---------|------|-------|----------------|--------------|------------|------------------|-------------|-------|----------|
| XIL-LPX310 | 4000759 | | 10° | | | | | | | |
| XIL-LPX340 | 4000766 | 3 | 40° | 4.65"/118mm | 1.21lb/0.5kg | 1,584 lm | 1,110 lm | 9-32V | 15 | 1.25A |
| XIL-LPX610 | 9118758 | | 10° | | | | | | | |
| XIL-LPX640 | 9120737 | 6 | 40° | 8.43"/214mm | 2.00lb/0.9kg | 3,168 lm | 2,220 lm | 9-32V | 30 | 2.5A |
| XIL-LPX6M | 9153407 | | Mixed | | | | | | | |
| XIL-LPX910 | 4000773 | | 10° | | | | | | | |
| XIL-LPX940 | 4000780 | 9 | 40° | 12.21"/310mm | 2.84lb/1.3kg | 4,752 lm | 3,330 lm | 9-32V | 45 | 3.75A |
| XIL-LPX1510 | 9114613 | | 10° | | | | | | | |
| XIL-LPX1540 | 9114705 | 15 | 40° | 19.77"/502mm | 4.45lb/2.0kg | 7,920 lm | 5,550 lm | 9-32V | 75 | 6.25A |
| XIL-LPX15M | 9897042 | | Mixed | | | | | | | |
| XIL-LPX2410 | 9121901 | | 10° | | | | | | | |
| XIL-LPX2440 | 9132884 | 24 | 40° | 31.11"/790mm | 6.05lb/2.7kg | 12,672 lm | 8,880 lm | 9-32V | 120 | 10A |
| XIL-LPX24M | 9889351 | | Mixed | | | | | | | |
| XIL-LPX2710 | 9114972 | | 10° | | | | | | | |
| XIL-LPX2740 | 9115061 | 27 | 40° | 34.89"/886mm | 7.67lb/3.5kg | 14,256 lm | 9,990 lm | 9-32V | 135 | 11.25A |
| XIL-LPX3310 | 9115153 | | 10° | | | | | | | |
| XIL-LPX3340 | 9115245 | 33 | 40° | 42.44"/1,078mm | 9.26lb/4.2kg | 17,424 lm | 12,210 lm | 9-32V | 165 | 13.75A |
| XIL-LPX3910 | 9128115 | | 10° | | | | | | | |
| XIL-LPX3940 | 9132976 | 39 | 40° | 50.00"/1,270mm | 10.9lb/4.9kg | 20,592 lm | 14,430 lm | 9-32V | 195 | 16.25A |
| XIL-LPX39M | 9892252 | | Mixed | | | | | | | |

XIL-LPX910 | 4000773 - 10° BEAM

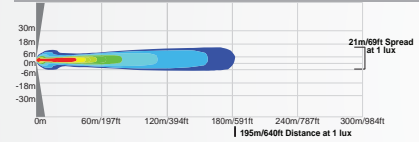

XIL-LPX940 | 4000780 - 40° BEAM

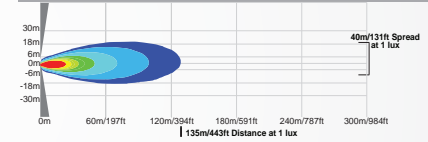

XMITTER

| ITEM # | PART # | LEDS | BEAM | LENGTH | WEIGHT | RAW LUMENS | EFFECTIVE LUMENS | INPUT VOLTS | WATTS | AMP DRAW |
|----------|---------|------|------------|----------------|----------------|------------|------------------|-------------|-------|----------|
| XIL-40 | 4006270 | | Euro Flood | | | | | | | |
| XIL-41 | 4007529 | 4 | Euro Flood | 4.00"/101.6mm | 1.26lb/0.57kg | 720 lm | 396 lm | 9-42V | 12 | 1.25A |
| XIL-80 | 4006287 | | Euro Flood | | | | | | | |
| XIL-81 | 4007581 | 8 | Euro Flood | 5.80"/147.6mm | 2.09lb/0.95kg | 1,440 lm | 792 lm | 9-42V | 24 | 2.5A |
| XIL-120 | 4006294 | | Euro Flood | | | | | | | |
| XIL-121 | 4007369 | 12 | Euro Flood | 7.80"/198.4mm | 2.65lb/1.2kg | 2,160 lm | 1,188 lm | 9-42V | 36 | 3.75A |
| XIL-200 | 4006300 | | Euro Flood | | | | | | | |
| XIL-201 | 4007468 | 20 | Euro Flood | 11.80"/300mm | 3.64lb/1.65kg | 3,600 lm | 1,980 lm | 9-42V | 60 | 6.25A |
| XIL-320 | 4006317 | | Euro Flood | | | | | | | |
| XIL-321 | 4007482 | 32 | Euro Flood | 17.60"/446mm | 5.51lb/2.5kg | 5,760 lm | 3,168 lm | 9-42V | 96 | 10A |
| XIL-400 | 4006324 | | Euro Flood | | | | | | | |
| XIL-401 | 4007505 | 40 | Euro Flood | 21.70"/550mm | 6.61lb/3.0kg | 7,200 lm | 3,960 lm | 9-42V | 120 | 11.25A |
| XIL-600 | 4006331 | | Euro Flood | | | | | | | |
| XIL-601 | 4007543 | 60 | Euro Flood | 31.80"/808mm | 9.59lb/4.35kg | 10,800 lm | 5,940 lm | 9-42V | 180 | 13.75A |
| XIL-800 | 4006348 | | Euro Flood | | | | | | | |
| XIL-801 | 4007567 | 80 | Euro Flood | 41.80"/1,062mm | 12.46lb/5.65kg | 14,400 lm | 7,920 lm | 9-42V | 240 | 16.25A |
| XIL-1000 | 4006355 | | Euro Flood | | | | | | | |
| XIL-1001 | 4007345 | 100 | Euro Flood | 51.80"/1,316mm | 14.55lb/6.60kg | 18,000 lm | 9,900 lm | 9-42V | 300 | 16.25A |

XIL-200 | 4006317 - EURO BEAM

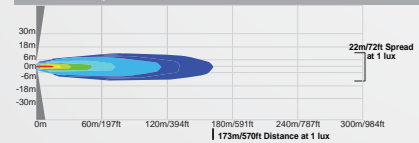

XIL-201 | 4007468 - FLOOD BEAM



NEXT LEVEL

STYLE + OUTPUT + RELIABILITY



WIDE SPREAD
LOW BEAM

BRIGHT LED
HALO RING

LONG RANGE
HIGH BEAMS

MULTIPLE LEDs
FILL IN ROADWAY



HALO



LOW



HIGH



ALSO AVAILABLE IN
BLACK CHROME

E-MARK & ADR MODELS AVAILABLE

LED HEADLIGHTS

Take your desire for high powered LEDs to the streets with the DOT Approved Vortex LED Headlight. The Vortex boasts halo, low, and high beam modes and a robust aluminum polycarbonate hybrid housing. E-Mark and ADR approved models also available.

AUTOMOTIVE/OFFROAD VORTEX LED HEADLIGHTS

ABOUT THE VORTEX

The DOT Approved Vortex LED Headlight leads the LED Headlight industry in both style and performance. With an integrated LED Halo Ring, the Vortex is sure to turn heads while also delivering a dramatically improved night driving experience over factory headlights. The Vortex is currently available in 7" Round and 5.75" Round with more models on the way, each available with a Polished Chrome finish or a Black Chrome finish.

ADR and E-MARK Approved models are available for those who live in Australia and Europe. We spent the time to get the certification and pass all regulations so that you can enjoy your Vortex LED Headlight regardless of location.

Multiple direct plug-and-play accessories are available that help give you the most out of your Vortex LED Headlight.

7" E-MARK APPROVED MODELS



XIL-7RELKIT
Special models for Left-hand and Right-hand driving regulations are available with E-Mark Approval in the 7" Round housing..

MULTIPLE LEDS

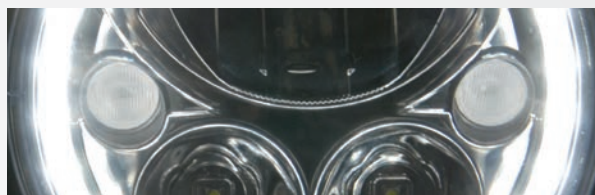

MULTIPLE LEDS FILL IN ROADWAY
Vision X integrated two LEDs with flood optics into the sides of the fixture in order to provide ample peripheral lighting by filling in the sides of the roadway in between the vehicle and the low beam.

BEAM MODES



HALO / LOW / HIGH
The Vortex has three beam modes that each serve a different purpose. The Halo works as a daytime running light while the Low and High beams handle the job of providing you with light output.



ACCESSORIES



ITEM #: P-HLH4 Shown
PART #: 9895475
For Offroad Vehicles Only

ITEM #: P-HLCBA Shown
PART #: 9892757

IMPROVE PERFORMANCE
For those looking to take their Vortex LED Headlight to the next level we recommend the following accessories.

| ITEM # | PART # | PURPOSE | QTY |
|---------|---------|--|-----|
| P-HLH4 | 9895475 | Engages all three beam modes simultaneously to dramatically increase visibility and light output | 1 |
| P-HLCBA | 9892757 | Levels electrical current to remove electrical interference from vehicle and eliminate flickering in the light | 1 |

7" ROUND LED HEADLIGHT



ITEM #: XIL-7RD Shown
PART #: 9891217
Replaces OEM Part # H6017/H6024

DOT APPROVED LED HEADLIGHT WITH BRIGHT LED HALO RING
Multiple LEDs Fill In Roadway | Polycarbonate Lens | E-Mark & ADR Models Available

| BEAM MODES | WEIGHT | DIMENSIONS |
|------------------------------------|--|---------------------------------------|
| Halo, Low, High | 2.20 lb / 1.00 kg | 6.96" x 6.96" x 3.86" |
| RAW LUMENS 4,210 lm (ea) | REFLECTOR FINISH Polished Chrome, Black Chrome | METRIC 177mm x 177mm x 98mm |



| ITEM # | PART # | FINISH | QTY |
|-------------|---------|-----------------|-----|
| XIL-7RD | 9891217 | Polished Chrome | 1 |
| XIL-7RDKIT | 9891224 | Polished Chrome | 2 |
| XIL-7RDB | 9892436 | Black Chrome | 1 |
| XIL-7RDBKIT | 9892443 | Black Chrome | 2 |

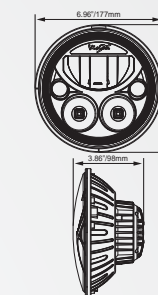

5.75" ROUND LED HEADLIGHT



ITEM #: XIL-575RD Shown
PART #: 9895604
Replaces OEM Part # H5001/H5006

DOT APPROVED LED HEADLIGHT WITH BRIGHT LED HALO RING
Multiple LEDs Fill In Roadway | Polycarbonate Lens | Perfect For Classic Cars

| BEAM MODES | WEIGHT | DIMENSIONS |
|------------------------------------|--|---------------------------------------|
| Halo, Low, High | 1.95 lb / 0.88 kg | 5.65" x 5.65" x 2.88" |
| RAW LUMENS 4,210 lm (ea) | REFLECTOR FINISH Polished Chrome, Black Chrome | METRIC 144mm x 144mm x 73mm |



| ITEM # | PART # | FINISH | QTY |
|---------------|---------|-----------------|-----|
| XIL-575RD | 9895604 | Polished Chrome | 1 |
| XIL-575RDKIT | 9895611 | Polished Chrome | 2 |
| XIL-575RDB | 9895635 | Black Chrome | 1 |
| XIL-575RDBKIT | 9895642 | Black Chrome | 2 |

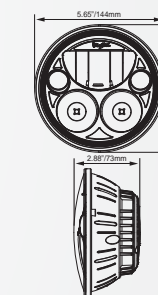

4X6" LED HEADLIGHT



ITEM #: XIL-46D Shown
PART #: 9897806
Replaces OEM Part # H4656/H4651

DOT APPROVED LED HEADLIGHT WITH BRIGHT LED HALO RING
Multiple LEDs Fill In Roadway | Dual All In One High and Low Beam | Perfect For Truck and Transport

| BEAM MODES | WEIGHT | DIMENSIONS |
|------------------------------------|--|---------------------------------------|
| Halo, Low, High | 1.95 lb / 0.88 kg | 6.57" x 3.94" x 3.29" |
| RAW LUMENS 4,210 lm (ea) | REFLECTOR FINISH Polished Chrome, Black Chrome | METRIC 167mm x 100mm x 84mm |



| ITEM # | PART # | FINISH | QTY |
|-------------|---------|-----------------|-----|
| XIL-46D | 9897806 | Polished Chrome | 1 |
| XIL-46DKIT | 9897820 | Polished Chrome | 2 |
| XIL-46DB | 9897813 | Black Chrome | 1 |
| XIL-46DBKIT | 9897837 | Black Chrome | 2 |

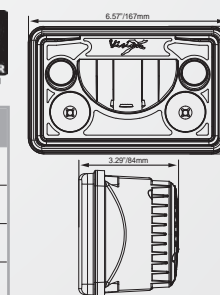

JEEP JK SPECIFIC KIT



DIRECT REPLACEMENT LED HEADLIGHT KIT FOR JEEP JK
Works with Canbus | Simple Installation | Multiple LEDs Fill In Roadway

| | | |
|--------------------------------------|--|--|
| BEAM MODES Halo, Low, High | WEIGHT 4.40 lb / 2.00 kg | DIMENSIONS 6.96" x 6.96" x 3.86" |
| RAW LUMENS 8,420 lm (kit) | REFLECTOR FINISH Polished Chrome, Black Chrome | METRIC 177mm x 177mm x 98mm |

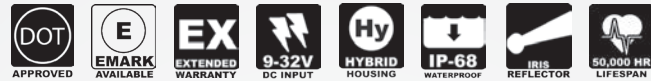

| ITEM # | PART # | FINISH | QTY |
|---------------|---------|-----------------|-----|
| XIL-7RDKITJK | 9892733 | Polished Chrome | 2 |
| XIL-7RDBKITJK | 9892825 | Black Chrome | 2 |

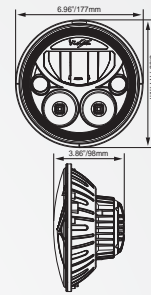

ITEM #: XIL-7RDKITJK Shown
PART #: 9892733

Replaces OEM Part # H6017/H6024

Replaces Chrysler OEM Part # 55078148AB, 55078149AB, 55078148AC, 55078149AC

View Our Website For Complete Application Chart

XMC 7" ROUND LED HEADLIGHT



DOT APPROVED LED HEADLIGHT WITH BRIGHT LED HALO RING
Multiple LEDs Fill In Roadway | Polycarbonate Lens | Dramatically Improves Safety

| | | |
|--------------------------------------|--|--|
| BEAM MODES Halo, Low, High | WEIGHT 2.20 lb / 1.00 kg | DIMENSIONS 6.96" x 6.96" x 3.86" |
| RAW LUMENS 4,210 lm (ea) | REFLECTOR FINISH Polished Chrome, Black Chrome | METRIC 177mm x 177mm x 98mm |



| ITEM # | PART # | FINISH | QTY |
|----------|---------|-----------------|-----|
| XMC-7RD | 9892061 | Polished Chrome | 1 |
| XMC-7RDB | 9895291 | Black Chrome | 1 |

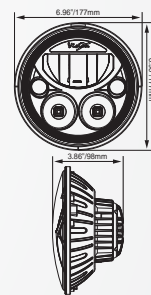

ITEM #: XMC-7RD Shown
PART #: 9892061

Replaces OEM Part # 68342-05A, 67700032, 67700243

View Our Website For Complete Application Chart



XMC 5.75" ROUND LED HEADLIGHT



DOT APPROVED LED HEADLIGHT WITH BRIGHT LED HALO RING
Multiple LEDs Fill In Roadway | Polycarbonate Lens | Dramatically Improves Safety

| | | |
|--------------------------------------|--|--|
| BEAM MODES Halo, Low, High | WEIGHT 1.95 lb / 0.88 kg | DIMENSIONS 5.65" x 5.65" x 2.88" |
| RAW LUMENS 4,210 lm (ea) | REFLECTOR FINISH Polished Chrome, Black Chrome | METRIC 144mm x 144mm x 73mm |



| ITEM # | PART # | FINISH | QTY |
|------------|---------|-----------------|--------|
| XMC-575RD | 9895628 | Polished Chrome | Single |
| XMC-575RDB | 9895659 | Black Chrome | Single |

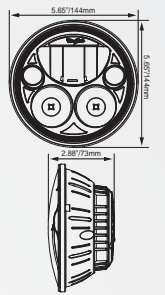

ITEM #: XMC-575RD Shown
PART #: 9895628

Replaces OEM Part # 68297-05A, 67700144A

View Our Website For Complete Application Chart

XMC 5.75" OVAL ROAD GLIDE



2004-2013 HARLEY-DAVIDSON ROAD GLIDE DIRECT REPLACEMENT
Multiple LEDs Fill In Roadway | Polycarbonate Lens | Dramatically Improves Safety

| | | |
|--------------------------------------|--|--|
| BEAM MODES Halo, Low, High | WEIGHT 2.20 lb / 1.00 kg | DIMENSIONS 6.52" x 5.96" x 4.29" |
| RAW LUMENS 8,420 lm (kit) | REFLECTOR FINISH Polished Chrome, Black Chrome | METRIC 165mm x 151mm x 109mm |



| ITEM # | PART # | FINISH | QTY |
|---------------|---------|-----------------|-----|
| XMC-575ODKIT | 9895673 | Polished Chrome | Kit |
| XMC-575ODBKIT | 9895697 | Black Chrome | Kit |

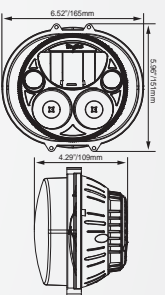

ITEM #: XMC-575ODKIT Shown
PART #: 9895673

Replaces OEM Part # 67700109, 67775-01C

View Our Website For Complete Application Chart

XMC PASSING LAMP



FIVE TIME BRIGHTER THAN HALOGEN PASSING LAMPS
Multisurface Reflector | Polycarbonate Lens | Dramatically Improves Safety

| | | |
|-------------------------------------|--|--|
| BEAM MODES Driving | WEIGHT 2.20 lb / 1.00 kg | DIMENSIONS 4.49" x 4.49" x 2.24" |
| RAW LUMENS 2,104 lm (kit) | REFLECTOR FINISH Polished Chrome, Black Chrome | METRIC 114mm x 114mm x 57mm |



| ITEM # | PART # | FINISH | QTY |
|--------------|---------|-----------------|-----|
| XMC-45RDKIT | 9897844 | Polished Chrome | 1 |
| XMC-45RDBKIT | 9897851 | Black Chrome | 1 |

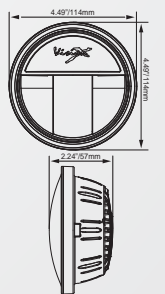

ITEM #: XMC-45RDKIT Shown
PART #: 9897844



VEHICLE SPECIFIC KITS

Vision X offers vehicle specific lighting application and mounting options for most truck makes and models, allowing for effortless installation with our direct replacement fitting.



JEEP KITS

ABOUT JEEP JK KITS

Adding custom lighting takes any Jeep to the next level. Vision X makes easy to install custom kits for Jeep JK vehicles. All kits feature no-drilling installation, and are easily installed in a matter of minutes.



VORTEX 7" LED HEADLIGHT

PAGE 58

Check out the Vortex 7" LED Headlight featuring an intense halo ring on page 56 and 58. This powerful headlight is the perfect addition to any Jeep. Exclusive Jeep JK LED headlight kit includes 2 canbus adapters to eliminate electrical interference between vehicle and light.



AVAILABLE JEEP LED KITS



Factory Fog Light Upgrade Kit
 - 883' Of Usable Light per Light
 - 7x Brighter Than Factory
 - Direct Replacement

ITEM #: XIL-OE1012JKV2OPR Shown
 PART #: 9154756



Windshield Mount for Light Bars
 - Mount 50" LED Light Bars
 - Easy Installation
 - No Drilling

ITEM #: XIL-OEW0713JKV2 Shown
 PART #: 9888422



Hood Mount for Light Bars
 - Maintains Factory Appearance
 - For Up To 20" LED Light Bar
 - Adds Up To 19,008 Lumens

ITEM #: XIL-OEH0713JKPX36 Shown
 PART #: 9891002



A-Pillar Light Mount
 - Perfect For Cannon Or Optimus
 - Long Range Projection
 - No Drilling Required

ITEM #: XIL-OEA0713JKCPZ1 Shown
 PART #: 9888415

VORTEX HEADLIGHT UPGRADE

DOT Approved Lighting Fixture | Bright LED Halo Ring | Multiple LEDs Fill In Roadway

| ITEM # | PART # | REPLACES | KIT INCLUDES | REFERENCE |
|---------------|---------|---------------------|---|-----------|
| XIL-7RDKITJK | 9892733 | 7" ROUND HEADLIGHT | Chrome LED Headlights (2), Canbus Adapter (2) | PAGE 58 |
| XIL-7RDBKITJK | 9892825 | 7" ROUND HEADLIGHTS | Black Chrome LED Headlights (2), Canbus Adapter (2) | PAGE 58 |

DIRECT REPLACEMENT LED UPGRADES

No Drilling Necessary | Direct Plug-And-Play With Factory Wiring | Dramatically Increase Visibility

| ITEM # | PART # | APPLICATION | YEAR FITS | KIT INCLUDES | REFERENCE |
|-------------------|---------|--------------------|-----------------|--------------------------------------|-----------|
| XIL-OE0709JKV2 | 9145662 | LED FOG LIGHTS | 07-09 JEEP JK | Brackets, Connectors | - |
| XIL-OE1012JKV2 | 9154664 | LED FOG LIGHTS | 10-17 JEEP JK | Brackets, Connectors | - |
| XIL-OE0709JKV2OPR | 9145754 | LED FOG LIGHTS | 07-09 JEEP JK | Brackets, (2) XIL-OPR110, Connectors | PAGE 37 |
| XIL-OE1012JKV2OPR | 9154756 | LED FOG LIGHTS | 10-17 JEEP JK | Brackets, (2) XIL-OPR110, Connectors | PAGE 37 |
| XIL-OE13JKX | 9891064 | LED FOG LIGHTS | 13-17 JEEP JK-X | Brackets, Connectors | - |
| XIL-OEW0713JKV2 | 9888422 | WINDSHIELD MOUNT | 07-17 JEEP JK | Brackets | - |
| XIL-OEH0713PX36 | 9891002 | HOOD LIGHT BAR | 07-17 JEEP JK | Brackets, (1) XIL-PX3610, Harness | PAGE 46 |
| XIL-OEH0713JKXP12 | 9891019 | HOOD LIGHT BAR | 07-17 JEEP JK | Brackets, (1) XPI-12M | PAGE 48 |
| XIL-OEA0713JK | 9888392 | A-PILLAR FOG LIGHT | 07-17 JEEP JK | Brackets | - |
| XIL-OEA0713JKOP1 | 9888408 | A-PILLAR FOG LIGHT | 07-17 JEEP JK | Brackets, (2) XIL-OP110, Harness | PAGE 37 |
| XIL-OEA0713JKCPZ1 | 9888415 | A-PILLAR FOG LIGHT | 07-17 JEEP JK | Brackets, (2) CTL-CPZ110, Harness | PAGE 33 |
| XIL-OEA9706TJCPZ1 | 9892795 | A-PILLAR FOG LIGHT | 97-06 JEEP TJ | Brackets, (2) CTL-CPZ110, Harness | PAGE 33 |
| XIL-OEA9706TJOPH | 9892818 | A-PILLAR FOG LIGHT | 97-06 JEEP TJ | Brackets, (2) XIL-OPH115, Harness | PAGE 36 |

FORD RAPTOR KITS

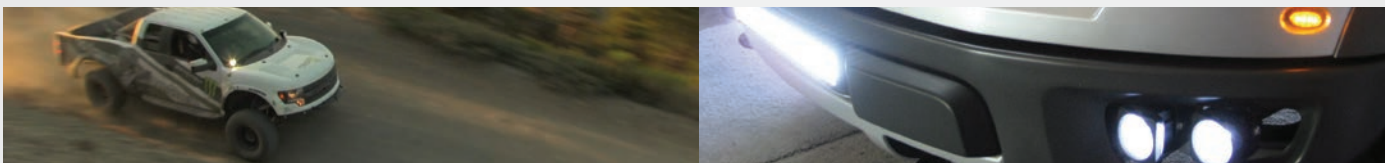

Factory Fog Light Upgrade Kit
ITEM #: XIL-OE10FROP Shown
PART #: 9133515



Bumper Mount for Light Bars
ITEM #: XIL-OEB10FRPX3610 Shown
PART #: 9887357

FACTORY FOG LIGHT UPGRADE KIT

Lights, Mounts, Wiring | 7x Brighter Than Headlight | Direct Fit In Factory Opening

| ITEM # | PART # | FITS | KIT INCLUDES | REFERENCE |
|---------------|---------|-------------------|--|-----------|
| XIL-OE10FR | 9160870 | 10-14 FORD RAPTOR | BRACKET, FACTORY INTEGRATION HARNESS | - |
| XIL-OE10FROP | 9133515 | 10-14 FORD RAPTOR | BRACKETS, (4) XIL-OP110, INTEGRATED HARNESS | PAGE 37 |
| XIL-OE10FROPH | 9892450 | 10-14 FORD RAPTOR | BRACKETS, (4) XIL-OPH115, INTEGRATED HARNESS | PAGE 37 |

BUMPER MOUNT FOR LIGHT BARS

Lights, Mounts, Wiring | Fits Directly into Factory Bumper | Add Up to 19,008 Lumens

| ITEM # | PART # | FITS | KIT INCLUDES | REFERENCE |
|-------------------|---------|-------------------|--|-----------|
| XIL-OEB10FR | 9887340 | 10-14 FORD RAPTOR | BRACKETS, FACTORY INTEGRATION HARNESS | - |
| XIL-OEB10FRPX3610 | 9887357 | 10-14 FORD RAPTOR | BRACKETS, (1) XIL-PX3610, INTEGRATED HARNESS | PAGE 46 |

FORD F SERIES KITS



Factory Fog Light Upgrade Kit
ITEM #: XIL-OE9913FSDDURA Shown
PART #: 9891200



Bumper Mount for Light Bars
ITEM #: XIL-OEB09F150PX36 Shown
PART #: 9891156

FACTORY FOG LIGHT UPGRADE KIT

Drastically Increase Light Output | 99-16 Ford Super Duty Models | Direct Fit In Factory Bumper

| ITEM # | PART # | FITS | KIT INCLUDES | REFERENCE |
|-------------------|---------|-----------------------|------------------------------------|-----------|
| XIL-OE9913FSD | 9891194 | 99-16 FORD SUPER DUTY | BRACKET, CONNECTORS | - |
| XIL-OE9913FSDDURA | 9891200 | 99-16 FORD SUPER DUTY | BRACKETS, (2) DURA-410, CONNECTORS | PAGE 99 |

BUMPER MOUNT FOR LIGHT BARS

EcoBoost Edition Available | Add Up To 19,008 Lumens | Direct Fit In Factory Bumper

| ITEM # | PART # | FITS | KIT INCLUDES | REFERENCE |
|--------------------|---------|-----------------|--|-----------|
| XIL-OEB09F150 | 9891057 | 09-14 FORD F150 | BRACKET | - |
| XIL-OEB09F150PX36 | 9891156 | 09-14 FORD F150 | BRACKET, XIL-PX3610, WIRING HARNESS | PAGE 46 |
| XIL-OEB09F150LPX15 | 9891163 | 09-14 FORD F150 | BRACKET, XIL-LPX1510, WIRING HARNESS | PAGE 49 |
| XIL-OEB09F150ECO | 9891170 | 09-14 FORD F150 | BRACKET, (2) XIL-PX610, WIRING HARNESS | PAGE 46 |

DODGE RAM KITS



ITEM #: XIL-OE0913DROP1MX2 Shown
PART #: 9890685

FACTORY FOG LIGHT UPGRADE KIT

Lights, Mounts, Wiring | Available for 02-14 Dodge Ram Models | Direct Fog Light Replacement

| ITEM # | PART # | FITS | KIT INCLUDES |
|--------------------|---------|-----------------|--|
| XIL-OE0210DR | 4002333 | 02-08 DODGE RAM | BRACKETS, PLUG & PLAY CONNECTORS |
| XIL-OE0210DRUMX | 9133065 | 02-08 DODGE RAM | BRACKETS, (2) XIL-UMX4010, CONNECTORS |
| XIL-OE0913DR | 9889221 | 09-14 DODGE RAM | BRACKETS, CONNECTORS |
| XIL-OE0913DROP | 9888552 | 09-14 DODGE RAM | BRACKETS, (2) XIL-OP110, CONNECTORS |
| XIL-OE0913DROP1MX2 | 9890685 | 09-14 DODGE RAM | BRACKETS, (2) XIL-OP110, (2)XIL-OP120 CONNECTORS |



ITEM #: XIL-OEB0913DRPX3610 Shown
PART #: 9889245

BUMPER MOUNT FOR LIGHT BARS

Lights, Mounts, Wiring | Add Up to 19,008 Lumens | Direct Fit In Factory Bumper

| ITEM # | PART # | FITS | KIT INCLUDES |
|---------------------|---------|-----------------|--------------------------------------|
| XIL-OEB0913DR | 9889238 | 10-14 DODGE RAM | BRACKETS, CONNECTORS |
| XIL-OEB0913DRPX3610 | 9889245 | 10-14 DODGE RAM | BRACKETS, XIL-PX3610, WIRING HARNESS |

TOYOTA TUNDRA KITS



ITEM #: XIL-OE0711TTUMX Shown
PART #: 9133249

FACTORY FOG LIGHT UPGRADE KIT

Lights, Mounts, Wiring | 7x Brighter Than Headlight | Direct Fog Light Replacement

| ITEM # | PART # | FITS | KIT INCLUDES |
|-----------------|---------|--------------|---------------------------------------|
| XIL-OE0711TT | 4002296 | 07-13 TUNDRA | BRACKET, CONNECTORS |
| XIL-OE0711TTUMX | 9133249 | 07-13 TUNDRA | BRACKETS, (2) XIL-UMX4010, CONNECTORS |

GMC SIERRA KITS



ITEM #: XIL-OE0711GSUMX Shown
PART #: 9133157

FACTORY FOG LIGHT UPGRADE KIT

Lights, Mounts, Wiring | Bolts Directly To Factory Mounting | 7x Brighter Than Headlight

| ITEM # | PART # | FITS | KIT INCLUDES |
|-----------------|---------|------------------|---|
| XIL-OE0711GS | 4002388 | 07-13 GMC SIERRA | BRACKET |
| XIL-OE0711GSUMX | 9133157 | 07-13 GMC SIERRA | BRACKETS, (2) XIL-UMX4010, T-TAP CONNECTORS |

CHEVROLET SILVERADO KITS



ITEM #: XIL-OE0711CSS1100 Shown
PART #: 9120829

FACTORY FOG LIGHT UPGRADE KIT

Lights, Mounts, Wiring | Bolts Directly To Factory Mounting | 7x Brighter Than Headlight

| ITEM # | PART # | FITS | KIT INCLUDES |
|-------------------|---------|-----------------|---|
| XIL-OE0711CS | 4002340 | 07-13 SILVERADO | BRACKETS*, T-TAP CONNECTORS |
| XIL-OE0711CSS1100 | 9120829 | 07-13 SILVERADO | BRACKETS, (4) XIL-S1100, T-TAP CONNECTORS |

POLARIS RZR KITS



Twin LED Headlight System
ITEM #: XIL-OEHL08RZR900OP Shown
PART #: 9898582



A Pillar Mounting Brackets
ITEM #: XIL-OEAD08RZR0PR Shown
PART #: 9898940



D Pillar Mounting Brackets
ITEM #: XIL-OED08RZR0PR Shown
PART #: 9898988

TWIN LED HEADLIGHT SYSTEM FOR POLARIS RZR

08+ Models | Halo Models Available | Plug and Play Wiring Included | Maintains Separate High / Low Beam Operation

| ITEM # | PART # | LIGHTS INCLUDED | KIT INCLUDES |
|---------------------|---------|----------------------|--|
| XIL-OEHL08RZR900 | 9898643 | No | Left and Right Brackets, 2 Wiring Adapters |
| XIL-OEHL08RZR900OP | 9898582 | Yes, Black Housing | 4x XIL-OP110 Lights, Left and Right Brackets, 2 Wiring Adapters |
| XIL-OEHL08RZR900OPC | 9898599 | Yes, Chrome Housing | 4x XIL-OP110C Lights, Left and Right Brackets, 2 Wiring Adapters |
| XIL-OEHL08RZR900OPW | 9898629 | Yes, White Housing | 4x XIL-OP110W Lights, Left and Right Brackets, 2 Wiring Adapters |
| XIL-OEHL08RZR900OPH | 9898605 | Yes, Black with Halo | 4x XIL-OPH115 Lights, Left and Right Brackets, 2 Wiring Adapters |

TWIN LED HEADLIGHT SYSTEM FOR POLARIS RZR 1000

14+ Models | Halo Models Available | Plug and Play Wiring Included | Maintains Separate High / Low Beam Operation

| ITEM # | PART # | LIGHTS INCLUDED | KIT INCLUDES |
|-------------------|---------|----------------------|---|
| XIL-OEHL14RZR | 9897509 | No | Left and Right Brackets, 2 Wiring Adapters |
| XIL-OEHL14RZR0PR | 9897516 | Yes, Black Housing | 4x XIL-OPR110 Lights, Left and Right Brackets, 2 Wiring Adapters |
| XIL-OEHL14RZR0PRC | 9898490 | Yes, Chrome Housing | 4x XIL-OPR110C Lights, Left and Right Brackets, 2 Wiring Adapters |
| XIL-OEHL14RZR0PRW | 9898513 | Yes, White Housing | 4x XIL-OPR110W Lights, Left and Right Brackets, 2 Wiring Adapters |
| XIL-OEHL14RZR0PRH | 9898520 | Yes, Black with Halo | 4x XIL-OPRH115 Lights, Left and Right Brackets, 2 Wiring Adapters |

A-PILLAR LIGHT MOUNTS FOR OPTIMUS 2008+ POLARIS RZR

08+ Models | Single and Dual Light Brackets Available | Harness Included with Lights

| ITEM # | PART # | LIGHTS INCLUDED | KIT INCLUDES |
|------------------|---------|--------------------|--|
| XIL-OEAS08RZR | 9898957 | No | Left and Right Brackets |
| XIL-OEAS08RZR0PR | 9898964 | Yes, Black Housing | 2x XIL-OPR110 Lights, Left and Right Single Light Brackets, Harness |
| XIL-OEAD08RZR | 9898933 | No | Left and Right Brackets |
| XIL-OEAD08RZR0PR | 9898940 | Yes, Black Housing | 4x XIL-OPR110 Lights, Left and Right Dual Light Brackets, 2x Harness |

D-PILLAR LIGHT MOUNTS FOR OPTIMUS 2008+ POLARIS RZR

08+ Models | Light is Adjustable Once Mounted | Harness Included with Lights

| ITEM # | PART # | LIGHTS INCLUDED | KIT INCLUDES |
|-----------------|---------|--------------------|---|
| XIL-OED08RZR | 9898971 | No | Left and Right Brackets |
| XIL-OED08RZR0PR | 9898988 | Yes, Black Housing | 2x XIL-OPR110 Lights, Left and Right Single Light Brackets, Harness |

YAMAHA YXZ

YAMAHA YXZ HEADLIGHT KIT

For Select 2015+ Models | 1 Kit for Low Beam 2nd Kit Optional for High Beam | Plug and Play Installation

| ITEM # | PART # | LIGHTS INCLUDED | KIT INCLUDES |
|-------------------|---------|--------------------|---------------------------|
| XIL-OEHL15YXZCPZ1 | 9899114 | Yes, Black Housing | Brackets, 2 Cannon Lights |

VIEW OUR WEBSITE FOR COMPLETE APPLICATION GUIDE AND THE NEWEST PRODUCTS





HID LIGHTING

Vision X continues to offer high quality HID lighting solutions, providing over 2,500 hours of intense illumination and a die-cast 6061 aluminum housing for a reliable and durable lighting solution.

ABOUT THE XP SERIES

The Xtreme Performance HID was engineered with input from Baja 1000 winning racers to further enhance the race proven Vision X HID series. Each light includes a weatherproof Deutsch Connector with Plug-and-Play Harness and features a durable lightweight polycarbonate lens.

The HID XP Series is currently trusted by professional rally teams in the United States and Canada.

Internal Ballast & Starter

The ballast takes the standard 12V input power and increases this to the 32,000V that the bulb operates at and the starter is used to ignite the bulb. Vision X uses all internal components for an all-in-one package

LONG RANGE PROJECTION

The XP Series is capable of producing long range distances of up to 1,200 meters of usable light from the 8.7" model and 1,000 meters from the 6.7" housing.



8.7" HID XP



ITEM #: HID-8550XP Shown
PART #: 9119922

1200 METERS OF LIGHT FOR UNMATCHED DISTANCE
Polycarbonate Lens | Die-Cast Aluminum Housing | Internal Ballast & Starter

| | | |
|--------------------------------------|-------------------------------------|--|
| BEAM PATTERNS Spot, Euro | WARRANTY Extended | DIMENSIONS 8.70" x 9.09" x 5.55" |
| RAW LUMENS 5,000 lm (ea) | EFFECTIVE LUMENS 3,500 lm | METRIC 221mm x 231mm x 141mm |
| WATTAGE / AMPS 50W / 4.17A | VIBRATION RATING 8.6 Grms | WEIGHT 6.20 lb / 2.81 kg |

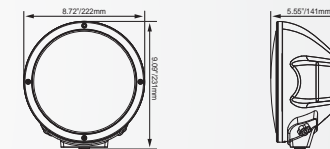
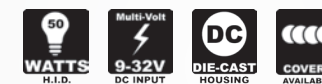

| ITEM # | PART # | FINISH |
|------------|---------|--------|
| HID-8550XP | 9119922 | Euro |
| HID-8552XP | 4000490 | Spot |

6.7" HID XP



ITEM #: HID-6552XP Shown
PART #: 4000483

1000 METERS OF USABLE LIGHT
Polycarbonate Lens | Die-Cast Aluminum Housing | Internal Ballast & Starter

| | | |
|--------------------------------------|--|---|
| BEAM PATTERNS Spot | WARRANTY Extended | DIMENSIONS 6.7" x 7.00" x 6.30" |
| RAW LUMENS 5,000 lm (ea) | EFFECTIVE LUMENS 3,500 lm (ea) | METRIC 170mm x 178mm x 160mm |
| WATTAGE / AMPS 50W / 4.17A | VIBRATION RATING 8.6 Grms | WEIGHT 4.00 lb / 1.81 kg |

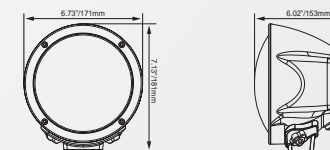
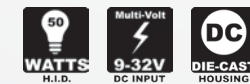

| ITEM # | PART # | BEAM |
|------------|---------|------|
| HID-6552XP | 4000483 | Spot |



HALOGEN LIGHTING

With various bulbs and headlight products, Vision X caters to your needs when upgrading or replacing your bulbs or headlights.

AUTOMOTIVE/OFFROAD HALOGEN HEADLIGHT BULBS

DIRECT REPLACEMENT

Increase brightness by up to 50% with the Vision X headlight bulbs. Vision X headlight bulbs provide a super white, more natural light for increased visibility and safety. With three lines to choose from, we offer the perfect mix of cost and performance for any driver.

DOT APPROVED

Unlike other Halogen Bulbs on the market, Vision X D Series bulbs are DOT Approved. Enhance your night time driving experience while cooperating with all laws and regulations.

LIFETIME WARRANTY

Vision X D Series bulbs feature a Lifetime Limited Warranty. Meaning you never have to buy another set of bulbs.



D SERIES HALOGEN BULBS

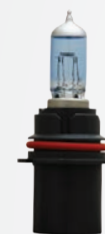

VX-D9004
4001527



VX-D9005
4001534



VX-D9006
4001558



VX-D9007
4001572



VX-DH1
4001589



VX-DH3
4001596



VX-DH4
4001602



VX-DH7
4001619



VX-DH10
4001633

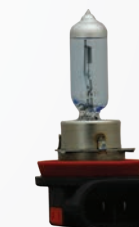

VX-DH11
4001657

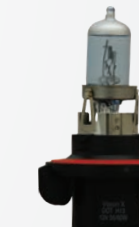

VX-DH13
4001664



| ITEM # | PART # | REPLACES | WATTS | FILAMENT |
|----------|---------|----------|-------|----------|
| VX-D9004 | 4001527 | 9004 | 65/45 | DUAL |
| VX-D9005 | 4001534 | 9005 | 65 | SINGLE |
| VX-D9006 | 4001558 | 9006 | 55 | SINGLE |
| VX-D9007 | 4001572 | 9007 | 65/55 | DUAL |
| VX-DH1 | 4001589 | H1 | 55 | SINGLE |
| VX-DH3 | 4001596 | H3 | 66 | SINGLE |
| VX-DH4 | 4001602 | H4 | 60/55 | DUAL |
| VX-DH7 | 4001619 | H7 | 55 | SINGLE |
| VX-DH10 | 4001633 | H10 | 42 | SINGLE |
| VX-DH11 | 4001657 | H11 | 55 | SINGLE |
| VX-DH13 | 4001664 | H13 | 55/60 | DUAL |

7" SEALED BEAM



ITEM #: VX-7RD Shown
PART #: 4004047

OEM REPLACEMENT HEADLIGHT
Hardened Borosilicate Glass Lens | High/Low Beam | DOT Approved

| | | |
|--|---|--|
| BULB TYPE H4 (Not Included) | WARRANTY Standard | DIMENSIONS 5.00" x 7.00" x 4.50" |
| VISION X BULB AVAILABLE VX-DH4 / VX-LH4 / VX-HH4 | OEM CROSS REFERENCE H6017 / H6024 | METRIC 127mm x 178mm x 114mm |
| CERTIFICATION DOT Approved | BEAM MODE High/Low | WEIGHT 3.40 lb / 1.54 kg |

| ITEM # | PART # | QUANTITY |
|--------|---------|----------|
| VX-7RD | 4004047 | 2 |

5.75" SEALED BEAM



ITEM #: VX-575 Shown
PART #: 4004030

OEM REPLACEMENT HEADLIGHT
Hardened Borosilicate Glass Lens | High/Low Beam | DOT Approved

| | | |
|--|---|--|
| BULB TYPE 9007 (Not Included) | WARRANTY Standard | DIMENSIONS 5.75" x 5.75" x 3.13" |
| VISION X BULB AVAILABLE VX-D9007/VX-L9007/VX-H9007 | OEM CROSS REFERENCE H5001 / H5006 | METRIC 146mm x 146mm x 80mm |
| CERTIFICATION DOT Approved | BEAM MODE High/Low | WEIGHT 1.50 lb / 0.68 kg |

| ITEM # | PART # | QUANTITY |
|--------|---------|----------|
| VX-575 | 4004030 | 2 |

5" X 7" SEALED BEAM



ITEM #: VX-57 Shown
PART #: 4004023

OEM REPLACEMENT HEADLIGHT
Hardened Borosilicate Glass Lens | High/Low Beam | DOT Approved

| | | |
|--|-------------------------------------|--|
| BULB TYPE H4 (Not Included) | WARRANTY Standard | DIMENSIONS 5.00" x 7.00" x 4.50" |
| VISION X BULB AVAILABLE VX-DH4 / VX-LH4 / VX-HH4 | OEM CROSS REFERENCE H6054 | METRIC 127mm x 178mm x 114mm |
| CERTIFICATION DOT Approved | BEAM MODE High/Low | WEIGHT 3.40 lb / 1.54 kg |

| ITEM # | PART # | QUANTITY |
|--------|---------|----------|
| VX-57 | 4004023 | 2 |

4" X 6" SEALED BEAM



ITEM #: VX-46 Shown
PART #: 4004016

OEM REPLACEMENT HEADLIGHT
Hardened Borosilicate Glass Lens | High/Low Beam | DOT Approved

| | | |
|--|---|--|
| BULB TYPE 9007 (Not Included) | WARRANTY Standard | DIMENSIONS 4.00" x 6.00" x 4.25" |
| VISION X BULB AVAILABLE VX-D9007/VX-L9007/VX-H9007 | OEM CROSS REFERENCE H4656 / H4651 | METRIC 102mm x 152mm x 108mm |
| CERTIFICATION DOT Approved | BEAM MODE High/Low | WEIGHT 2.00 lb / 0.91 kg |

| ITEM # | PART # | QUANTITY |
|--------|---------|----------|
| VX-46 | 4004016 | 2 |



AUTOMOTIVE ACCESSORIES

Vision X provides an assortment of automotive accessories including accent lights, mounting solutions, and light covers for that extra detail you've been looking for.

POLYCARBONATE LIGHT COVERS

ABOUT POLYCARBONATE LIGHT COVERS

Vision X polycarbonate translucent covers not only protect your light, but they also improve vision in dust, fog, or snow. Another benefit of adding a cover is the capability to change your beam pattern. All covers are made with a UV Protective Coating to prevent fading. Each cover is finished with a glow in the dark printed "X" for a unique look at night when the lights are off.



COVER COLORS

CLEAR
Unbreakable, dust resistant protection to protect the light from debris and particulate. Without changing light color or performance.

BLACKOUT
Covers the fixture with a solid black protective cover with a high contrast "X" logo. Required in select states for on-road use.

AMBER
Battles fog conditions by reducing the amount of blue light. Mimics classic Halogen color temperature. Great for driving in dust at high speeds.

BLUE
Increases lighting distance when used in snow conditions by reflecting the blue light off the snow. Recommended for vehicles in heavy winter conditions.

RED
Reduces light temperature and glare back in order to enhance penetration in dust and air particulate. Ideal for vehicles in extreme dust conditions.

COVER BEAMS

SPOT
Spot covers maintain original lighting beam pattern while protecting the lens from harmful debris.

COMBO
Combo covers combine the distance of a spot cover with the peripheral illumination of a euro cover.

EURO *ELLIPTICAL
Euro covers illuminate peripherals while losing some distance effectiveness.
*Reduces left peripheral illumination for oncoming traffic.

FLOOD *WIDE FLOOD
Wide Flood covers illuminate a wide field of view in exchange for distance effectiveness.
* Flood covers is the vertical beam equivalent to flood covers.

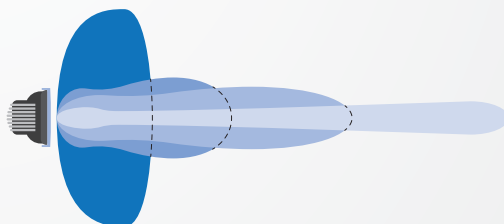

OPTIMUS ROUND & OPTIMUS HALO ROUND

| ITEM # | PART # | COLOR | BEAM |
|-------------|---------|-------|------------|
| PCV-OPR1 | 9889528 | CLEAR | SPOT |
| PCV-OPR1B | 9889559 | BLUE | SPOT |
| PCV-OPR1Y | 9889740 | AMBER | SPOT |
| PCV-OPR1R | 9889719 | RED | SPOT |
| PCV-OPR1EU | 9889535 | CLEAR | EURO |
| PCV-OPR1BEU | 9889566 | BLUE | EURO |
| PCV-OPR1YEU | 9889757 | AMBER | EURO |
| PCV-OPR1REU | 9889726 | RED | EURO |
| PCV-OPR1FL | 9889542 | CLEAR | FLOOD |
| PCV-OPR1BFL | 9889573 | BLUE | FLOOD |
| PCV-OPR1YFL | 9889764 | AMBER | FLOOD |
| PCV-OPR1RFL | 9889733 | RED | FLOOD |
| PCV-OPR1WF | 9890944 | CLEAR | WIDE FLOOD |
| PCV-OPR1BWF | 9890906 | BLUE | WIDE FLOOD |
| PCV-OPR1YWF | 9890968 | AMBER | WIDE FLOOD |
| PCV-OPR1RWF | 9890937 | RED | WIDE FLOOD |
| PCV-OPR1EL | 9890913 | CLEAR | ELLIPTICAL |
| PCV-OPR1BEL | 9890890 | BLUE | ELLIPTICAL |
| PCV-OPR1YEL | 9890951 | AMBER | ELLIPTICAL |
| PCV-OPR1REL | 9890920 | RED | ELLIPTICAL |
| PCV-OPR1BL | 9889580 | BLACK | PROTECTIVE |

* Compatible with all beam patterns

6.7 LED LIGHT CANNON

| ITEM # | PART # | COLOR | BEAM |
|-------------|---------|-------|------------|
| PCV-6500 | 4003248 | CLEAR | SPOT |
| PCV-6500B | 4003569 | BLUE | SPOT |
| PCV-6500Y | 4002784 | AMBER | SPOT |
| PCV-6500R | 4004689 | RED | SPOT |
| PCV-6500CB | 9895703 | CLEAR | COMBO |
| PCV-6500BCB | 9895710 | BLUE | COMBO |
| PCV-6500YCB | 9895734 | AMBER | COMBO |
| PCV-6500RCB | 9893198 | RED | COMBO |
| PCV-6500EU | 9888453 | CLEAR | EURO |
| PCV-6500BEU | 9888460 | BLUE | EURO |
| PCV-6500YEU | 9888484 | AMBER | EURO |
| PCV-6500REU | 9888477 | RED | EURO |
| PCV-6500FL | 9888491 | CLEAR | FLOOD |
| PCV-6500BFL | 9888507 | BLUE | FLOOD |
| PCV-6500YFL | 9888521 | AMBER | FLOOD |
| PCV-6500RFL | 9888514 | RED | FLOOD |
| PCV-6500WF | 9888771 | CLEAR | WIDE FLOOD |
| PCV-6500BWF | 9889788 | BLUE | WIDE FLOOD |
| PCV-6500YWF | 9889801 | AMBER | WIDE FLOOD |
| PCV-6500RWF | 9889795 | RED | WIDE FLOOD |
| PCV-6500EL | 9890616 | CLEAR | ELLIPTICAL |
| PCV-6500BEL | 9890609 | BLUE | ELLIPTICAL |
| PCV-6500YEL | 9890630 | AMBER | ELLIPTICAL |
| PCV-6500REL | 9890623 | RED | ELLIPTICAL |
| PCV-6500BL | 9160245 | BLACK | PROTECTIVE |

* Also compatible with Transporter and HID-8500

LOW PROFILE XTREME

| ITEM # | PART # | FITS | COLOR | BEAM |
|------------|---------|------------|-------|------------|
| PCV-LP3BL | 9155296 | XIL-LPX3* | BLACK | PROTECTIVE |
| PCV-LP6BL | 9155388 | XIL-LPX6* | BLACK | PROTECTIVE |
| PCV-LP9BL | 9135946 | XIL-LPX9* | BLACK | PROTECTIVE |
| PCV-LP15BL | 9155470 | XIL-LPX15* | BLACK | PROTECTIVE |
| PCV-LP18BL | 9135762 | XIL-LPX18* | BLACK | PROTECTIVE |
| PCV-LP24BL | 9155654 | XIL-LPX24* | BLACK | PROTECTIVE |
| PCV-LP33BL | 9155838 | XIL-LPX33* | BLACK | PROTECTIVE |
| PCV-LP36BL | 9155920 | XIL-LPX36* | BLACK | PROTECTIVE |
| PCV-LP3Y | 9165103 | XIL-LPX3* | AMBER | SPOT |
| PCV-LP6Y | 9165196 | XIL-LPX6* | AMBER | SPOT |
| PCV-LP9Y | 9136035 | XIL-LPX9* | AMBER | SPOT |
| PCV-LP15Y | 9164564 | XIL-LPX15* | AMBER | SPOT |
| PCV-LP18Y | 9135854 | XIL-LPX18* | AMBER | SPOT |
| PCV-LP24Y | 9164748 | XIL-LPX24* | AMBER | SPOT |
| PCV-LP33Y | 9164922 | XIL-LPX33* | AMBER | SPOT |
| PCV-LP36Y | 9165011 | XIL-LPX36* | AMBER | SPOT |

* Compatible with all beam patterns

4.5 LED LIGHT CANNON

| ITEM # | PART # | COLOR | BEAM |
|------------|---------|-------|------------|
| PCV-CP1 | 9151151 | CLEAR | SPOT |
| PCV-CP1B | 9157184 | BLUE | SPOT |
| PCV-CP1Y | 9157726 | AMBER | SPOT |
| PCV-CP1R | 9162492 | RED | SPOT |
| PCV-CP1CB | 9893228 | CLEAR | COMBO |
| PCV-CP1BCB | 9893242 | BLUE | COMBO |
| PCV-CP1YCB | 9893259 | AMBER | COMBO |
| PCV-CP1RCB | 9893235 | RED | COMBO |
| PCV-CP1EU | 9151243 | CLEAR | EURO |
| PCV-CP1BEU | 9157276 | BLUE | EURO |
| PCV-CP1YEU | 9157818 | AMBER | EURO |
| PCV-CP1REU | 9157542 | RED | EURO |
| PCV-CP1FL | 9151335 | CLEAR | FLOOD |
| PCV-CP1BFL | 9157368 | BLUE | FLOOD |
| PCV-CP1YFL | 9157900 | AMBER | FLOOD |
| PCV-CP1RFL | 9157634 | RED | FLOOD |
| PCV-CP1WF | 9890562 | CLEAR | WIDE FLOOD |
| PCV-CP1BWF | 9890654 | BLUE | WIDE FLOOD |
| PCV-CP1YWF | 9890586 | AMBER | WIDE FLOOD |
| PCV-CP1RWF | 9890883 | RED | WIDE FLOOD |
| PCV-CP1EL | 9890661 | CLEAR | ELLIPTICAL |
| PCV-CP1BEL | 9890647 | BLUE | ELLIPTICAL |
| PCV-CP1YEL | 9890579 | AMBER | ELLIPTICAL |
| PCV-CP1REL | 9890678 | RED | ELLIPTICAL |
| PCV-CP1BL | 9157450 | BLACK | PROTECTIVE |

8.7 LED LIGHT CANNON

| ITEM # | PART # | COLOR | BEAM |
|-------------|---------|-------|------------|
| PCV-8500 | 4003255 | CLEAR | SPOT |
| PCV-8500B | 4003583 | BLUE | SPOT |
| PCV-8500Y | 4002791 | AMBER | SPOT |
| PCV-8500R | 4003576 | RED | SPOT |
| PCV-8500CB | 9893182 | CLEAR | COMBO |
| PCV-8500BCB | 9893204 | BLUE | COMBO |
| PCV-8500YCB | 9893211 | AMBER | COMBO |
| PCV-8500RCB | 9893198 | RED | COMBO |
| PCV-8500EU | 9890128 | CLEAR | EURO |
| PCV-8500BEU | 9890098 | BLUE | EURO |
| PCV-8500YEU | 9890470 | AMBER | EURO |
| PCV-8500REU | 9890432 | RED | EURO |
| PCV-8500FL | 9890135 | CLEAR | FLOOD |
| PCV-8500BFL | 9890104 | BLUE | FLOOD |
| PCV-8500YFL | 9890487 | AMBER | FLOOD |
| PCV-8500RFL | 9890449 | RED | FLOOD |
| PCV-8500WF | 9890463 | CLEAR | WIDE FLOOD |
| PCV-8500BWF | 9890111 | BLUE | WIDE FLOOD |
| PCV-8500YWF | 9890142 | AMBER | WIDE FLOOD |
| PCV-8500RWF | 9890456 | RED | WIDE FLOOD |
| PCV-8500EL | 9890081 | CLEAR | ELLIPTICAL |
| PCV-8500BEL | 9890869 | BLUE | ELLIPTICAL |
| PCV-8500YEL | 9890159 | AMBER | ELLIPTICAL |
| PCV-8500REL | 9890425 | RED | ELLIPTICAL |
| PCV-8500BL | 9890876 | BLACK | PROTECTIVE |

* Also compatible with HID-8500

XMITTER PRIME XTREME

| ITEM # | PART # | FITS | COLOR | BEAM |
|-----------|---------|-----------|-------|------------|
| PCV-P6BL | 9156019 | XIL-PX6* | BLACK | PROTECTIVE |
| PCV-P12BL | 9156101 | XIL-PX12* | BLACK | PROTECTIVE |
| PCV-P18BL | 9156194 | XIL-PX18* | BLACK | PROTECTIVE |
| PCV-P30BL | 9156378 | XIL-PX30* | BLACK | PROTECTIVE |
| PCV-P36BL | 9156460 | XIL-PX36* | BLACK | PROTECTIVE |
| PCV-P54BL | 9156736 | XIL-PX54* | BLACK | PROTECTIVE |
| PCV-P72BL | 9157009 | XIL-PX72* | BLACK | PROTECTIVE |
| PCV-P90BL | 9888064 | XIL-PX90* | BLACK | PROTECTIVE |
| PCV-P6Y | 9166186 | XIL-PX6* | AMBER | SPOT |
| PCV-P12Y | 9165288 | XIL-PX12* | AMBER | SPOT |
| PCV-P18Y | 9165370 | XIL-PX18* | AMBER | SPOT |
| PCV-P30Y | 9165554 | XIL-PX30* | AMBER | SPOT |
| PCV-P36Y | 9165646 | XIL-PX36* | AMBER | SPOT |
| PCV-P54Y | 9165912 | XIL-PX54* | AMBER | SPOT |
| PCV-P72Y | 9166278 | XIL-PX72* | AMBER | SPOT |
| PCV-P90Y | 9887883 | XIL-PX90* | AMBER | SPOT |

* Compatible with all beam patterns

LED ACCENT LIGHTING

ABOUT ACCENT LIGHTING

Vision X offers a diverse line of accent pod lighting. Easily attract attention to your vehicle with the wide variety of colors. Each durable pod accepts 9-32 volt input and features a strong black housing. Ideal for professional grade applications and weekend enthusiasts alike.



Reinforced Mounting
Vision X Pro Pod LEDs each feature four equally distant mounting holes, allowing the light to be securely fastened to a large variety of surfaces and letting you put the light where it needs to be.

UNIVERSAL PRO PODS

LED POD PERFECT FOR ROCK LIGHTING OR COMPARTMENT LIGHTING
Impact Resistant Lens | Weatherproof Housing for All Conditions | 3' Cord



| | | |
|---|-----------------------------|-------------------------------------|
| COLORS Amber, Blue, Green, Red, White | WARRANTY Extended | DIMENSIONS 1.76" Diameter |
| RAW LUMENS 140 lm (ea) | HOUSING Aluminum | METRIC 45mm Diameter |

ITEM #: XIL-PDW Shown
PART #: 9136127

| ITEM # | PART # | COLOR |
|---------|---------|-------|
| XIL-PDA | 9136219 | Amber |
| XIL-PDB | 9136301 | Blue |
| XIL-PDG | 9136394 | Green |

| ITEM # | PART # | COLOR |
|---------|---------|-------|
| XIL-PDR | 9136486 | Red |
| XIL-PDW | 9136127 | White |

UNIVERSAL PODS

COLORED LED LIGHTING FOR ANY APPLICATION
Impact Resistant Acrylic Lens | Weatherproof Housing for All Conditions | 10' Cord



| | | |
|---|-----------------------------|-------------------------------------|
| COLORS Amber, Blue, Green, Red, White | WARRANTY Standard | DIMENSIONS 1.25" Diameter |
| RAW LUMENS 70 lm (ea) | HOUSING Aluminum | METRIC 32mm Diameter |

ITEM #: HIL-DW Shown
PART #: 4004054

| ITEM # | PART # | COLOR |
|--------|---------|-------|
| HIL-DA | 4004078 | Amber |
| HIL-DB | 4004139 | Blue |
| HIL-DG | 4004146 | Green |

| ITEM # | PART # | COLOR |
|--------|---------|-------|
| HIL-DR | 4004061 | Red |
| HIL-DW | 4004054 | White |



TANTRUM

RUGGED LED STROBE OR ROCK LIGHT KIT

Wireless Remote | Multi-Speed Scanning and Flash Control | 4 Pods with 10' Cords 4 Pods with 20' Cords



ITEM #: HIL-STB Shown
PART #: 4005372

| | | |
|--|-----------------------------|-------------------------------------|
| COLORS Amber, Blue, Green, Multi, Red, White | WARRANTY Standard | DIMENSIONS 1.25" Diameter |
| RAW LUMENS 560 lm (kit) | HOUSING Aluminum | METRIC 32mm Diameter |



| ITEM # | PART # | COLOR |
|---------|---------|-------|
| HIL-STA | 4005662 | Amber |
| HIL-STB | 4005372 | Blue |
| HIL-STG | 4005396 | Green |

| ITEM # | PART # | COLOR |
|---------|---------|-------|
| HIL-STM | 4005679 | Multi |
| HIL-STR | 4005389 | Red |
| HIL-STW | 4005419 | White |

STRIP LIGHT

TOUCH ACTIVATED OR STANDARD COMMERCIAL DESIGN
Universal Application | Touch Activated Model Available | Compact Design



ITEM #: XIL-ST7.5 Shown
PART #: 9167626



ITEM #: XIL-ST12 Shown
PART #: 9141701

| | | |
|---|------------------------------|-----------------------------|
| ACTIVATION MODES Touch On/Off, Hard-wired | WARRANTY Standard | HEIGHT 0.92"/23mm |
| RAW LUMENS 141-328 lm (ea) | LENGTH 7.4", 11.9" | DEPTH 0.59"/15mm |

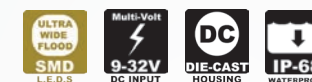

| ITEM # | PART # | MODE | LENGTH | ITEM # | PART # | MODE | LENGTH |
|-----------|---------|-------|--------------|-----------|---------|----------|--------------|
| XIL-ST7.5 | 9167626 | Touch | 7.4"/189 mm | XIL-SL7.5 | 9167534 | Standard | 7.4"/189 mm |
| XIL-ST12 | 9141701 | Touch | 11.9"/303 mm | XIL-SL12 | 9141794 | Standard | 11.9"/303 mm |

LED BAGGER LIGHT KIT

LOW CONSUMPTION COMPARTMENT LIGHTING FOR TRUNKS, BAGS, SADDLES
Two Light Kit | 40 Inch Power Cord With Flush Switch Included | Water & Dust Proof



ITEM #: XMC-BKW2 Shown
PART #: 9895246

| | | |
|-----------------------------------|---|-------------------------------------|
| BEAM MODES Frosted Lens | WARRANTY Extended | DIMENSIONS 1.76" Diameter |
| RAW LUMENS 280 lm (kit) | WEIGHT 0.20 lb / 0.09 kg (ea) | METRIC 45mm Diameter |



| ITEM # | PART # | WIRING | QTY |
|----------|---------|----------------------|----------------|
| XMC-BKW2 | 9895246 | 40" Cord With Switch | Two White Pods |

XMC HEADLIGHT ACCESSORIES



ITEM #: P-HLH4 Shown
PART #: 9895475



ITEM #: XMC-H42H9H11 Shown
PART #: 9892900



ITEM #: XMC-H42DELPHI Shown
PART #: 9892894

6 LED SUBAQUA



ITEM #: XIL-U625W Shown
PART #: 9897578

UNDERWATER LED MODULE FOR OE TRANSOM INTEGRATION
Transom LED Light | New Model Produces Twice As Much Light | Multiple Colors Available

| | | |
|------------------------------------|---|--|
| SUBMERSIBLE 100'/30m | WARRANTY Extended | DIMENSIONS 4.13" x 4.13" x 1.25" |
| RAW LUMENS 1,366 lm (ea) | COLORS Amber, Blue, Green, Red, White | METRIC 105mm x 105mm x 33mm |

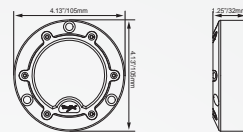

| ITEM # | PART # | COLOR | BEAM |
|-----------|---------|-------|------|
| XIL-U625A | 9897967 | Amber | 25° |
| XIL-U625B | 9897554 | Blue | 25° |
| XIL-U625G | 9897561 | Green | 25° |
| XIL-U625R | 9897585 | Red | 25° |
| XIL-U625W | 9897578 | White | 25° |

BORG SMART LIGHTING APP

KEY FEATURES

- Take control of your Vision X Prime Drive Lights via bluetooth connection
- Monitor humidity, temperature, voltage, and other valuable data
- Remotely set strobing and power levels via mobile device
- Currently available for iOS and Android Devices
- Simple On-Off Power Function
- Real Time Two-Way Data
- 32 Bit Processing

ABOUT THE BORG

Vision X is constantly leading the LED Lighting industry by taking the "next-step" in technology and products. The Borg is just that. A simple adaption for any Vision X Light that is equipped with Prime Drive Technology can be transformed from a simple on/off product, to an experience in itself.

Everything from strobing intervals to light intensity can be controlled by your smartphone via bluetooth connection. Additionally, you'll have the power to see valuable data relayed from your LED Light such as humidity, temperature, voltage, RSSI, and elevation. Even further, you can track your g-force level and acceleration with only a few taps.

Unlock the full potential of your Vision X LED by equipping it with Borg!



ITEM #: XIL-PXB36M Shown
PART #: 9893266

BLUETOOTH CONNECTION FOR PRIME DRIVE LIGHTS

BORG CONTROL MODULE

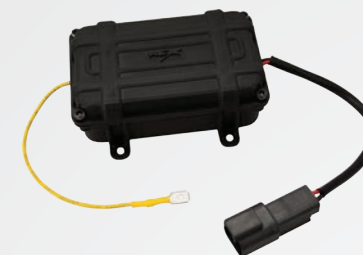

ITEM #: XIL-BORGPC Shown
PART #: 9893273

CONTROL MODULE FOR ANY PRIME DRIVE LIGHT

Connects to Prime Drive Wire | Add Bluetooth Control | App Available in

- Take control of your Vision X Prime Drive Lights via bluetooth connection
- Monitor humidity, temperature, voltage, and other valuable data
- Remotely set strobing and power levels via mobile device
- Currently available for iOS and Android Devices
- Simple On-Off Power Function
- Real Time Two-Way Data
- 32 Bit Processing

| ITEM # | PART # | WORKS WITH |
|------------|---------|-------------|
| XIL-BORGPC | 9893273 | Prime Drive |

PRIME DIMMER

PUSH BUTTON OR DIAL DIMMER FOR PRIME LIGHTS

Push Button Dimmer | Designed for Prime Drive Lights | Dial Knob Dimmer



ITEM #: XIL-PDIMMERB Shown
PART #: 4009264

| ITEM # | PART # | CONTROL | DIMMER RANGE | CORD LENGTH |
|--------------|---------|-------------|--------------|---------------|
| XIL-PDIMMER | 4009257 | Dial Knob | 50%-100% | 5.50"/139.7mm |
| XIL-PDIMMERB | 4009264 | Button Knob | 50% & 100% | 5.50"/139.7mm |

BATTERY PACKS

RECHARGEABLE POWER SOURCE FOR VISION X LIGHTS

Long Life Battery | Compatible with 12V Lights | Compact & Lightweight

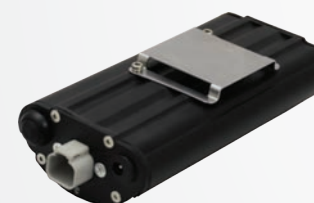

ITEM #: XPC-B30 Shown
PART #: 9130095

| ITEM # | PART # | MAX LOAD | CAPACITY | SOLO RUN TIME | WEIGHT |
|---------|---------|----------|----------|---------------|---------|
| XPC-B22 | 4009080 | 5A | 2.2Ah | 3 Hours | 1.15 lb |
| XPC-B30 | 9130095 | 5A | 3.1Ah | 5 Hours | 1.15 lb |
| XPC-B65 | 4009097 | 8A | 6.5Ah | 6 Hours | 1.00 lb |
| XPC-B86 | 4000339 | 10A | 8.6Ah | 13 Hours | 2.00 lb |

UNIVERSAL HARNESSES

UNIVERSAL WIRING HARNESS

30A 12V Relay Included | Lighted Rocker Switch | Weatherproof Deutsch Connectors



ITEM #: P-HARNESS.2XIL Shown
PART #: 4006201

| ITEM # | PART # | CONNECTORS | APPLICATION |
|----------------|---------|-------------------|--------------------------|
| P-HARNESS.2XIL | 4006201 | Terminals | 2 Light Harness |
| P-HARNESS.XIL | 4006195 | Terminals | 1 Light Harness |
| P-HARNESS.HO | 9888354 | Terminals | High Amp 1 Light Harness |
| P-DY2M1F | 4006263 | Deutsch DT Series | Y Adapter |
| P-UCA | 4006218 | Cigarette Adapter | Cigarette Power Cord |

LED MOUNTING SOLUTIONS

Vision X offers a variety of mounts and adapters to help you put light in more places. Each adapter allows you to add lights to spots that are normally out-of-bounds with these simple mounting solutions. Series includes extra mounting options for light bars.



LICENSE PLATE MOUNT

LICENSE PLATE MOUNT

Holds Any LED Bar Up To 20" | Easily Installs Behind License Plate | Powder Coated



| ITEM # | PART # | INCLUDED |
|--------------------|---------|---------------------------------------|
| XIL-LICENSEP | 4000308 | Bracket |
| XIL-LICENSEPLPX910 | 9887012 | Bracket, XIL-LPX910 LED Bar & Harness |

ITEM #: XIL-LICENSEPLPX910 Shown
PART #: 9887012

TOW HITCH MOUNT

TOW HITCH MOUNT

Machined 6061 Aluminum | 2 Bolt Mount for Hitches | Use With Solo Pods Or Dura Mini



| ITEM # | PART # | INCLUDED |
|----------------------|---------|------------------------|
| XIL-SRECEIVER | 4000322 | Bracket |
| XIL-SRECEIVERDURAMX2 | 9899121 | Bracket, 2 x DURA-M460 |
| XIL-SRECEIVERS1101X2 | 4008595 | Bracket, 2 x XIL-S1101 |

ITEM #: XIL-SRECEIVERS1101X2 Shown
PART #: 4008595

[View Website for Application Details](#)



SOLO FLUSH MOUNT



ITEM #: XIL-SFLUSHV2 Shown
PART #: 9887777

4" FLUSH MOUNT FOR SOLSTICE SOLO POD

Install Flush Into A 2.75" Hole | Ideal for Ceiling Mounts | Black Anodized Finish

| ITEM # | PART # | DIAMETER | APPLICATION |
|--------------|---------|----------------|-------------|
| XIL-SFLUSH | 4000315 | 3.68"/93.47 mm | Front Mount |
| XIL-SFLUSHV2 | 9887777 | 3.68"/93.47 mm | Light Mount |
| XIL-SFLUSH4 | 4008243 | 4.00"/101.6 mm | Front Mount |

MAGNETIC BASE



ITEM #: P-UMB Shown
PART #: 4006225
Lights Not Included

UNIVERSAL TEMPORARY LIGHT MOUNT

Secure Light Temporarily | Multiple to Support Large Lights | Protective Rubber Boot

| ITEM # | PART # | PULL | INCLUDED |
|----------|---------|----------------|----------------------|
| P-UMB.95 | 4009127 | 95 lb/43.09 kg | Magnet & Sleeve |
| P-UMB.65 | 4009110 | 65 lb/29.48 kg | Magnet & Sleeve |
| P-UMB | 4006225 | 75 lb/34.02 kg | Magnet & Rubber Boot |

DURA FLUSH MOUNTS



ITEM #: DURA-460FLUSH Shown
PART #: 9892993

FLUSH MOUNT FOR DURA SERIES

Install Flush | Ideal for Bumpers | Black Powdercoat Finish

| ITEM # | PART # | INCLUDES |
|----------------|---------|---------------------------------|
| DURA-M460FLUSH | 9899138 | Bracket, DURA Mini Flush Light |
| DURA-460FLUSH | 9892993 | Bracket, DURA 4 LED Flush Light |
| DURA-660FLUSH | 9893006 | Bracket, DURA 6 LED Flush Light |

END CAP MOUNTS



ITEM #: XIL-PECM Shown
PART #: 9889191

END CAP MOUNTS FOR LIGHT BARS

M10x1.5 20mm Thread | Sold In Pairs | Ideal For Roof Mounting

| ITEM # | PART # | DESIGNED FOR |
|-----------|---------|---------------------|
| XIL-LPECM | 9888811 | Xmitter Low Profile |
| XIL-PECM | 9889191 | Xmitter Prime |
| XPI-EM | 9892917 | XPR & XPI |
| XIL-ECM | 9888781 | Xmitter |

OPTIMUS HANDLE



ITEM #: XIL-OP2HANDLE Shown
PART #: 9887098

OPTIMUS HANDLE FOR PORTABLE APPLICATIONS

Sure-Grip form | Convenient Handle for use with Optimus Series | Portable Application

| ITEM # | PART # | FITS | COLOR |
|---------------|---------|--------------------------------|-------|
| XIL-OP1HANDLE | 9890173 | Optimus Single & Optimus Round | Black |
| XIL-OP2HANDLE | 9887098 | Optimus Dual | Black |

XIL-UM HANDLE



ITEM #: P-UM40HANDLE Shown
PART #: 9144498

UTILITY MARKET LIGHT ACCESSORY FOR ADDITIONAL APPLICATIONS

Sure-Grip form | Convenient Handle for use with UM Series | Portable Application

| ITEM # | PART # | FITS |
|--------------|---------|------------------|
| P-UM40HANDLE | 9888361 | UM40xx & UMX40xx |
| P-UMHANDLE | 9887111 | UM44xx & UMX44xx |

SOLO MOUNTS



Various Solo Mounts Shown

SOLO MOUNTS

Combine with Vision X Battery Packs | Portable On-The-Go Lighting | Extends Applications

| ITEM # | PART # | USE |
|----------------|---------|---------------------------|
| XIL-SHANDLE | 4002685 | Pistol Grip Handle |
| XIL-SHELMET | 4002753 | Helmets |
| XIL-SHANDLEBAR | 4002746 | Handlebars |
| XIL-SCLAMP | 9117942 | Tube Mounting 0.75"-1.25" |
| XIL-SCOMBO | 4002739 | Helmets + Handlebars |

MINI SOLO MOUNTS



Various Mini Solo Mounts Shown

MINI SOLO MOUNTS

Combine with Vision X Battery Packs | Portable On-The-Go Lighting | Extends Applications

| ITEM # | PART # | USE |
|-----------------|---------|---------------------------|
| XIL-MXHANDLEBAR | 9145570 | Handlebars |
| XIL-MXHELMET | 9145488 | Helmets |
| XIL-MXCOMBO | 9145396 | Helmets + Handlebars |
| XIL-MXCLAMP | 9119205 | Tube Mounting 0.75"-1.25" |

TUBE CLAMP MOUNTS



ITEM #: XIL-C175 Shown
PART #: 9897240

360° TUBE FRAME MOUNT SYSTEM FOR LIGHTS, LIGHT BARS, AND MORE
Includes All Rubber Gasket and Hardware | Anodized Aluminum | Sold in Pairs

| ITEM # | PART # | DIAMETER |
|----------|---------|------------|
| XIL-C075 | 9897325 | 0.75"/19mm |
| XIL-C100 | 9897301 | 1.00"/25mm |
| XIL-C125 | 9897288 | 1.25"/32mm |
| XIL-C150 | 9897264 | 1.50"/38mm |
| XIL-C175 | 9897240 | 1.75"/45mm |
| XIL-C200 | 9893372 | 2.00"/50mm |
| XIL-C225 | 9893389 | 2.25"/57mm |
| XIL-C250 | 9893396 | 2.50"/64mm |
| XIL-C300 | 9893402 | 3.00"/76mm |

SECURITY BOLTS



ITEM #: XIL-SB0820 Shown
PART #: 9893426

SECURITY HARDWARE REDUCES THEFT BY REQUIRING SPECIAL TOOL TO REMOVE
Fit Virtually Any Bolt | 304 Stainless Steel Construction | Sold as 2 Bolts with 1 Tool

| ITEM # | PART # | SIZE | POPULAR APPLICATIONS |
|------------|---------|---------|---|
| XIL-SB0615 | 9893440 | M6 X 15 | L Bracket Mounting Bolt to Side of Light for XPR - XPI Light Bars |
| XIL-SB0620 | 9893457 | M6 X 20 | Bracket to Light bolts Horizon Series |
| XIL-SB0815 | 9893419 | M8 X 15 | Bracket to Light bolts for Optimus Series, DURA Series |
| XIL-SB0820 | 9893426 | M8 X 20 | Bracket to Light on PitMaster Series |
| XIL-SB0825 | 9893433 | M8 X 25 | Any M8 x 25 Bolt |

SECURITY NUTS



ITEM #: XIL-SN08 Shown
PART #: 9893488

SECURITY HARDWARE REDUCES THEFT BY REQUIRING SPECIAL TOOL TO REMOVE
Fit Virtually Any Nut | Carbon Steel Construction | Sold as 2 Nuts with 1 Tool

| ITEM # | PART # | SIZE | POPULAR APPLICATIONS |
|----------|---------|------|---|
| XIL-SN06 | 9897349 | M6 | Fits to mounting bolts for UF32 - Solo Pods (SP100 - S1100 - MX Solo) - Dura Mini - Light Bar Mounting Feet (Xmitter, PX, LPX, XPI, XPR Series) |
| XIL-SN08 | 9893488 | M8 | Fits to mounting bolts for All Optimus, Dura Series. Fits to bracket to light bolts for 4.7" Cannon and UMX Series |
| XIL-SN10 | 9893471 | M10 | Fits to mounting bolts for 8.7" - 6.7" - 4.7" Cannon Series - Dual Optimus - TPX Series - UMX Series |
| XIL-SN12 | 9893464 | M12 | Any M12 Mounting Hardware |





INDUSTRIAL SOLUTIONS

HEAVY DUTY | MEDIUM DUTY | HEAVY INDUSTRIAL | LIGHT INDUSTRIAL
MARITIME | STRUCTURAL | INDUSTRIAL ACCESSORIES



SOLUTION PROCESS

Vision X offers complete lighting solutions tailored to the exact needs of your location. This allows you to know prior to purchasing exactly what each light package will do for you. Letting you know in confidence that the lights will meet all the OSHA/MSHA and any other requirements that you may need.

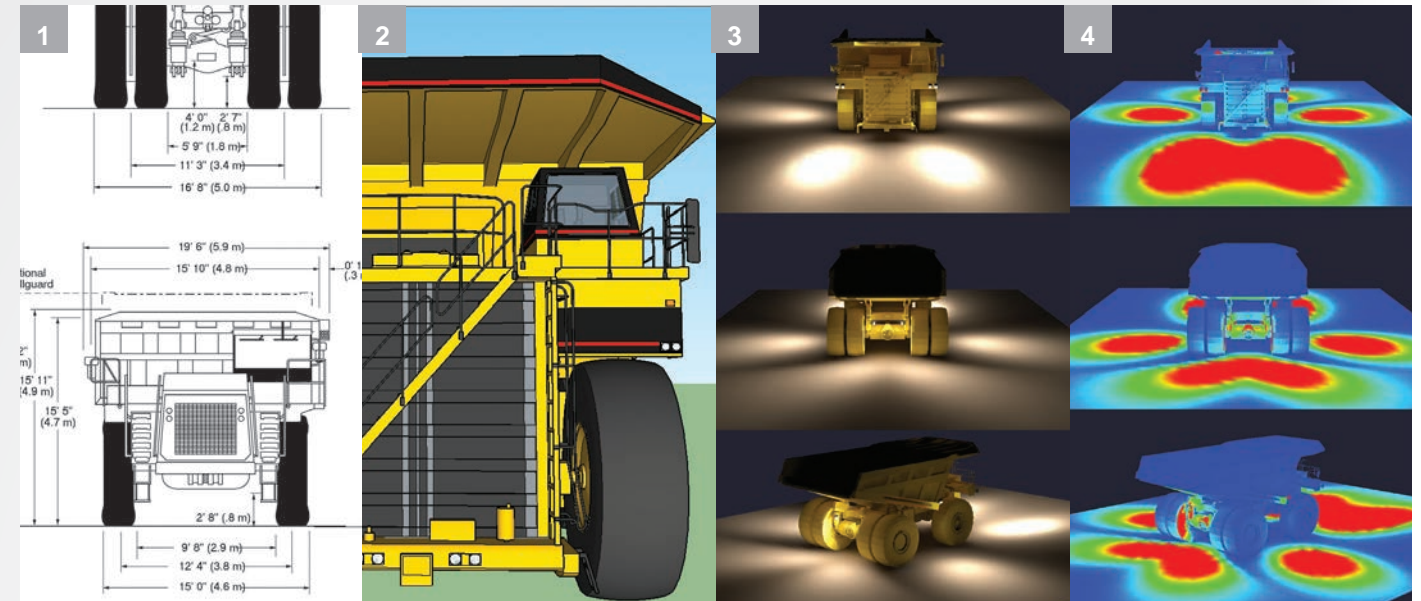

2D BLUEPRINT
Vision X begins a project by requesting the list of machines that will be needed to be retrofitted. Then gathering the technical information for those machines.

3D MODEL
A 3D Model is then built to match the customer exact specifications. This model is then carried over into the rendering.

SIMULATION RENDER
Prior to implementing a lighting solution, Vision X creates a simulation rendering of the intended result to help envision if the final product will meet lighting requirements.

SOLUTION
Vision X creates a complete breakdown of what the customer needs to meet their specific requirements for safety.

FIT OUT GUIDES AVAILABLE

|  CAT D11 DOZER |  CATERPILLAR 994F WHEEL LOADER |  CATERPILLAR 797F DUMP TRUCK |
|--|---|---|
|  <ul style="list-style-type: none"> MIL-RPX1240T 4.5' x 7' Rectangle LED Work Light MIL-RPX1280T 4.5' x 7' Rectangle LED Work Light |  <ul style="list-style-type: none"> MIL-SP520 4" Square Spot LED Work Light MIL-SP540 4" Square Flood LED Work Light MIL-SP140 2" Round Flood LED Flood Light |  <ul style="list-style-type: none"> MIL-SP520 4" Square Spot LED Work Light MIL-SP540 4" Square Flood LED Work Light MIL-SP140 2" Round Flood LED Flood Light |
| <p>Vision X Lighting Mining Services P: 1-800-994-4460 E: mining@visionxusa.com Copyright 2014 Vision X Lighting</p> | <p>Vision X Lighting Mining Services P: 1-800-994-4460 E: mining@visionxusa.com Copyright 2010 Vision X Lighting</p> | <p>Vision X Lighting Mining Services P: 1-800-994-4460 E: mining@visionxusa.com Copyright 2010 Vision X Lighting</p> |

HEAVY & MEDIUM DUTY SOLUTIONS

INDUSTRIAL/HEAVY DUTY PITMASTER SERIES

ABOUT THE PITMASTER

HARSH ENVIRONMENT 500 & 1000 WATT HPS REPLACEMENT

The PitMaster has earned its reputation for being the ultimate Heavy Duty LED light from the combination of its die-cast aluminum housing, unbreakable polycarbonate lens, integrated deutsch connector, reinforced gasketed bezel, and a strengthened trunnion mounting bracket.

Designed to outshine and outlast the competition, the PitMaster features advanced electronic technology like Pulse Width Modulation, Electronic Thermal Management, and a Redundant Circuit Design (60 LED) that allows the fixture to function even if half of the light should fail for unknown reasons. This is part of the effort by Vision X to ensure that the PitMaster exceeds half engine life on mining vehicles.

FOR USE WITH

- UNDERGROUND JUMBOS & DRILL RIGS
- HARSH ENVIRONMENT STRUCTURAL
- HYDRAULIC AND ROPE SHOVELS
- WORKOVER DRILL RIGS
- LIGHT PLANT RETROFIT
- LIGHT POLES
- WASH BAYS

REDUNDANT CIRCUIT DESIGN



FAILSAFE FIXTURE

The PitMaster 30 & 60 each have five and ten internal circuits respectively for redundancy. If one circuit fails, other circuits continue to function allowing equipment to operate until preventive maintenance eliminating unscheduled maintenance and downtime.

INCREASED PERFORMANCE OVER HPS



Each PitMaster delivers 30% more light to effective work area over high-pressure sodium and metal-halide fixtures, while consuming only 30% of the energy.

PACKAGES & MOUNTS

ADAPTIVE MOUNTING

Multiple mounting options are available for the PitMaster 30 and PitMaster 60 such as hanging mounts, flush mounts, and application specific mounts crafted from hardened steel. Also, Vision X can create custom brackets or mounting for your specific needs. Give us a call for further information.

SURFACE MOUNT



ITEM #: P-PMX30HANGINGMOUNT Shown
PART #: 9131085

COBRA HEAD POLE MOUNT



ITEM #: P-PMX30COBRAHEADMOUNT Shown
PART #: 9130996

HANGING MOUNT



ITEM #: P-PMX30HANGINGMOUNT Shown
PART #: 9131177

AC PACKAGES

Packages are also available for purchase and include the fixture, a power supply, necessary mounting, and a junction box to protect the wiring from weather. The AC Power Inverter changes the PitMaster Input Voltage from 11-65V DC to 90-277V AC for a wider range.

| ITEM # | PART # | APPLICATION | PACKAGE INCLUDES | VOLTAGE |
|----------------|---------|-----------------|--|------------|
| CXA-PMX3060HPS | 9887388 | High Bay | MIL-PMX3060, XPC-PS150-24, P-PMX30HANGINGMOUNT, P-JBOXAC | 90-277V AC |
| CXA-PMX3060FPS | 9887395 | Low Bay | MIL-PMX3060, XPC-PS150-24, P-PMX30FLUSHMOUNT, P-JBOXAC | 90-277V AC |
| CXA-PMX3060CPS | 9887401 | Street Lighting | MIL-PMX3060, XPC-PS150-24, P-PMX30COBRAHEADMOUNT, P-JBOXAC | 90-277V AC |
| CXA-PMX3060PS | 9887418 | Structural | MIL-PMX3060, XPC-PS150-24, P-JBOXAC | 90-277V AC |
| CXA-PMX6060HPS | 9887425 | High Bay | MIL-PMX6060, [2] XPC-PS150-24, P-PMX60HPLATE, [2] P-JBOXAC | 90-277V AC |
| CXA-PMX6060PS | 9887432 | Structural | MIL-PMX6060, [2] XPC-PS150-24, [2] P-JBOXAC | 90-277V AC |
| CXA-PMX3090WPS | 9893280 | Wall Pack | MIL-PMX6090, [2] XPC-PS150-24, P-PMX30WALLPACK, [2] P-JBOXAC | 90-277V AC |

PITMASTER 60

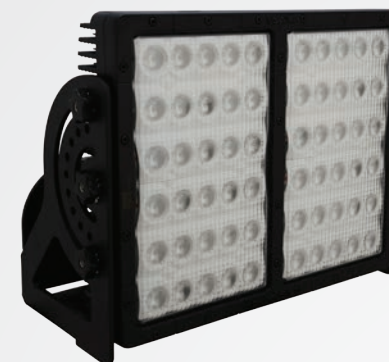

ITEM #: MIL-PMX6060 Shown
PART #: 9113357

1000-WATT METAL HALIDE REPLACEMENT LIGHT
Increases Operator Safety | 360° Fully Adjustable Mounting System | Prime Drive Equipped

| BEAM PATTERNS | WARRANTY | DIMENSIONS |
|--|---|--|
| 10°, 25°, 40°, 60°, 90°, 30°x65° | Extended | 15.07" x 11.54" x 6.87" |
| RAW LUMENS 31,680 lm (ea) | EFFECTIVE LUMENS 22,200 lm (ea) | METRIC 383mm x 293mm x 175mm |
| WATTAGE / AMPS 300W / 25A @12V | VIBRATION RATING 60 Grms | WEIGHT 26.46 lb / 12.0 kg |



| ITEM # | PART # | QTY | BEAM | ITEM # | PART # | QTY | BEAM |
|-------------|---------|-----|------|-------------|---------|-----|------|
| MIL-PMX6010 | 9113081 | 1 | 10° | MIL-PMX6060 | 9113357 | 1 | 60° |
| MIL-PMX6040 | 9113265 | 1 | 40° | MIL-PMX6090 | 9139906 | 1 | 90° |

BEAM PATTERN

MIL-PMX6060 | 9113357 - 60° Beam

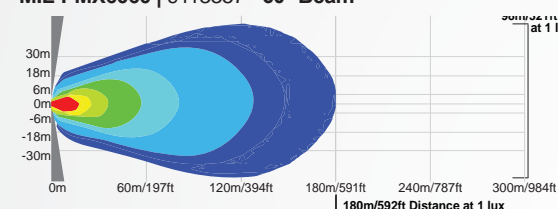

2D VIEW

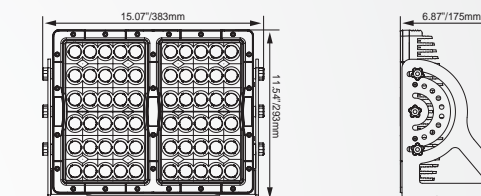

PITMASTER 30



ITEM #: MIL-PMX3060 Shown
PART #: 9112909

400/500-WATT METAL HALIDE REPLACEMENT LIGHT
Increases Operator Safety | 360° Fully Adjustable Mounting System | Prime Drive Equipped

| BEAM PATTERNS | WARRANTY | DIMENSIONS |
|--|---|--|
| 10°, 25°, 40°, 60°, 90°, 30°x65° | Extended | 11.96" x 7.52" x 4.94" |
| RAW LUMENS 15,840 lm (ea) | EFFECTIVE LUMENS 11,100 lm (ea) | METRIC 297mm x 191mm x 126mm |
| WATTAGE / AMPS 150W / 12.5A @12V | VIBRATION RATING 60 Grms | WEIGHT 12.34 lb / 5.6 kg |



| ITEM # | PART # | QTY | BEAM | ITEM # | PART # | QTY | BEAM |
|-------------|---------|-----|------|-------------|---------|-----|------|
| MIL-PMX3010 | 9112633 | 1 | 10° | MIL-PMX3060 | 9112909 | 1 | 60° |
| MIL-PMX3040 | 9112817 | 1 | 40° | MIL-PMX3090 | 9138107 | 1 | 90° |

BEAM PATTERN

MIL-PMX3060 | 9112909 - 60° Beam

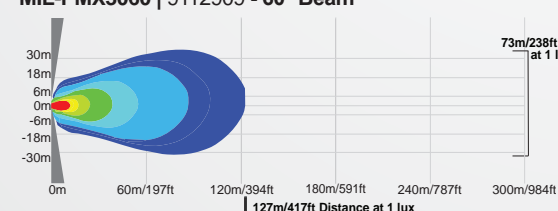

2D VIEW

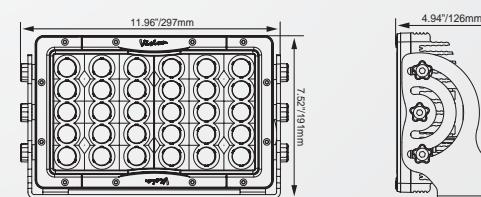

INDUSTRIAL/HEAVY DUTY RIPPER SERIES

ABOUT THE RIPPER

DESIGNED SPECIFICALLY FOR TRACKED DOZERS, WILL LAST IN ANY APPLICATION.

Built to last. The Ripper Series from Vision X is the hardest working LED fixture you'll find on the market. Rated at 60Grms, the Ripper is capable of standing up to intense amounts of vibration and still perform like it is its first day on the job.

The Ripper is a direct replacement for HID and Halogen fixtures on heavy vibration commercial and industrial machinery. It features Prime Drive ETM (Electronic Thermal Management) that controls the LED temperature to ensure a prolonged LED lifespan. Additionally, the unique vertical and horizontal channeled heat sink increases heat dissipation and further prolongs the lifespan of the light.

FOR USE WITH

HARSH ENVIRONMENT STRUCTURAL RUBBER TIRE & TRACK DOZERS STANCHION LIGHT POLES WORKOVER DRILL RIGS HYDRAULIC SHOVELS WASH BAYS

RIPPER SERIES MOUNTING



DUAL MOUNTING

Each Ripper comes packaged with a fully-adjustable Trunnion mount with isolated rubber shock absorbers. Combined with the standard Suspension mount, the Ripper can operate in intense vibration applications.

VARIETY OF OPTICS



BEAM PATTERNS

The Ripper 12 and 20 LED lights are available in a large variety of beam patterns, each excelling in specific applications. Currently, 10°, 25°, 40°, 60°, and 90° beam patterns are available.

RIPPER 20 LED



ITEM #: MIL-RXP2060T Shown
PART #: 9114439

60 Grms RATED FOR HIGH VIBRATION 100-WATT WORK LIGHT
Dual Mounting System | High Vibration Light | OE Upgrade

| | | |
|--|--|--|
| BEAM PATTERNS 10°, 25°, 40°, 60°, 90°, 30°x65° | WARRANTY Extended | DIMENSIONS 6.61" x 6.97" x 4.05" |
| RAW LUMENS 10,560 lm (ea) | EFFECTIVE LUMENS 7,400 lm (ea) | METRIC 168mm x 1177mm x 103mm |
| WATTAGE / AMPS 100W / 8.34A @12V | VIBRATION RATING 60 Grms | WEIGHT 7.50 lb / 3.4 kg |



| ITEM # | PART # | QTY | BEAM |
|--------------|---------|-----|------|
| MIL-RXP2010T | 9114163 | 1 | 10° |
| MIL-RXP2040T | 9114347 | 1 | 40° |

| ITEM # | PART # | QTY | BEAM |
|--------------|---------|-----|------|
| MIL-RXP2060T | 9114439 | 1 | 60° |
| MIL-RXP2090T | 9138640 | 1 | 90° |

BEAM PATTERN

MIL-RXP2060T | 9114439 - 60° Beam

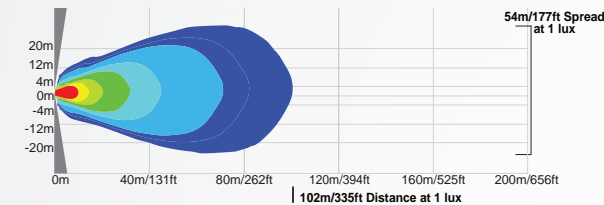

2D VIEW

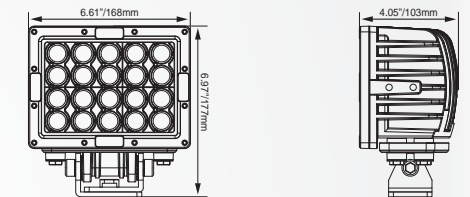

RIPPER 12 LED



ITEM #: MIL-RXP1260T Shown
PART #: 4009998

60 Grms RATED FOR HIGH VIBRATION 60-WATT WORK LIGHT
Dual Mounting System | High Vibration Light | OE Upgrade

| | | |
|--|--|--|
| BEAM PATTERNS 10°, 25°, 40°, 60°, 90°, 30°x65° | WARRANTY Extended | DIMENSIONS 4.72" x 6.93" x 4.05" |
| RAW LUMENS 6,336 lm (ea) | EFFECTIVE LUMENS 4,440 lm (ea) | METRIC 120mm x 6.93mm x 103mm |
| WATTAGE / AMPS 60W / 5.0A @12V | VIBRATION RATING 60 Grms | WEIGHT 5.51 lb / 2.5 kg |



| ITEM # | PART # | QTY | BEAM |
|--------------|---------|-----|------|
| MIL-RXP1210T | 4009974 | 1 | 10° |
| MIL-RXP1240T | 4009981 | 1 | 40° |

| ITEM # | PART # | QTY | BEAM |
|--------------|---------|-----|------|
| MIL-RXP1260T | 4009998 | 1 | 60° |
| MIL-RXP1290T | 9138558 | 1 | 90° |

BEAM PATTERN

MIL-RXP1260T | 4009998 - 60° Beam

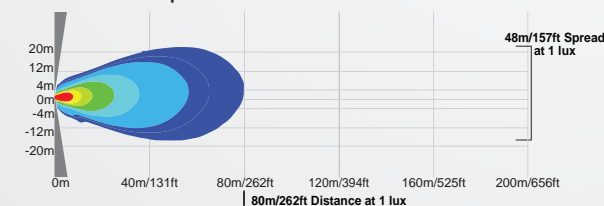

2D VIEW

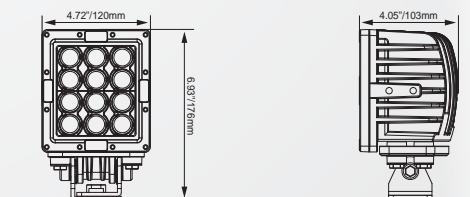

INDUSTRIAL/HEAVY DUTY SOLSTICE PRIME SERIES

ABOUT THE SOLSTICE PRIME

DESIGNED FOR HEAVY DUTY FLEETS, OE FITMENT DESIGN

The Solstice Prime Series from Vision X combines traditional form factor and single-bolt mounting with the energy-efficient benefits of LED for the ultimate OE upgrade option for commercial and industrial vehicles that use HID and Halogen fixtures.

The Solstice Prime Series is available in 5 LED or 7 LED models, and each feature Prime Drive ETM (Electronic Thermal Management) that controls the LED temperature to ensure a prolonged LED lifespan. Additionally, the unique vertical channeled heat sink increases heat dissipation and further prolongs the lifespan.

FOR USE WITH

- UNDERGROUND HAUL TRUCKS
- OPEN PIT HAUL TRUCKS
- MISC WHITE IRON
- WATER TRUCKS
- EXCAVATORS
- GRADERS
- LOADERS
- MUCKER

SOLSTICE PRIME MOUNTING



TRUNNION BRACKET

The Vision X Solstice Prime comes equipped with a full-adjustable 105° Trunnion Bracket that can be easily tuned with a 5mm allen wrench for the optical angle for the most direct and efficient light. Additionally, each bolt on the bracket uses isolated rubber shock absorbers to minimize vibration.

ETM & REDUNDANT CIRCUITRY



ETM & PRIME DRIVE

Integrated Electronic Thermal Management helps prolong the life of the LEDs by regulating heat levels. Redundant circuit design allows partial light operation until preventative maintenance.

SOLSTICE PRIME 7 LED



ITEM #: XIL-SP740 Shown
PART #: 4009875

OE UPGRADE FOR HEAVY DUTY COMMERCIAL & INDUSTRIAL APPLICATIONS
105° Adjustable Trunnion Bracket | PMW Integrated Dimming | Vertical Fins Maximize Heat Dissipation

| | | |
|---|--|--|
| BEAM PATTERNS 20°, 40° | WARRANTY Extended | DIMENSIONS 7.17" x 6.89" x 3.17" |
| RAW LUMENS 7,364 lm (ea) | EFFECTIVE LUMENS 5,155 lm (ea) | METRIC 182mm x 175mm x 81mm |
| WATTAGE / AMPS 70W / 5.84A @12V | VIBRATION RATING 15.6 Grms | WEIGHT 4.52 lb / 2.05 kg |



| ITEM # | PART # | QTY | BEAM | ITEM # | PART # | QTY | BEAM |
|-----------|---------|-----|------|-----------|---------|-----|------|
| XIL-SP720 | 4009868 | 1 | 20° | XIL-SP740 | 4009875 | 1 | 40° |

BEAM PATTERN

XIL-SP740 | 4009875 - 40° Beam

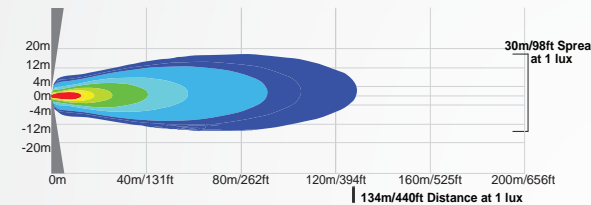

2D VIEW

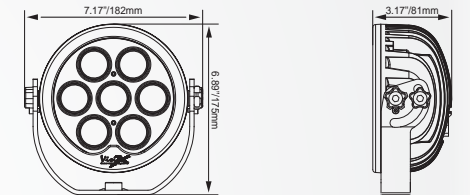

SOLSTICE PRIME 5 LED



ITEM #: XIL-SP540 Shown
PART #: 4009851

OE UPGRADE FOR HEAVY DUTY COMMERCIAL & INDUSTRIAL APPLICATIONS
105° Adjustable Trunnion Bracket | PMW Integrated Dimming | Vertical Fins Maximize Heat Dissipation

| | | |
|---|--|--|
| BEAM PATTERNS 20°, 40° | WARRANTY Extended | DIMENSIONS 5.83" x 4.92" x 3.11" |
| RAW LUMENS 5,260 lm (ea) | EFFECTIVE LUMENS 3,682 lm (ea) | METRIC 148mm x 125mm x 79mm |
| WATTAGE / AMPS 50W / 4.17A @12V | VIBRATION RATING 15.6 Grms | WEIGHT 3.09 lb / 1.4 kg |



| ITEM # | PART # | QTY | BEAM | ITEM # | PART # | QTY | BEAM |
|-----------|---------|-----|------|-----------|---------|-----|------|
| XIL-SP520 | 4009844 | 1 | 20° | XIL-SP540 | 4009851 | 1 | 40° |

BEAM PATTERN

XIL-SP540 | 4009851 - 40° Beam

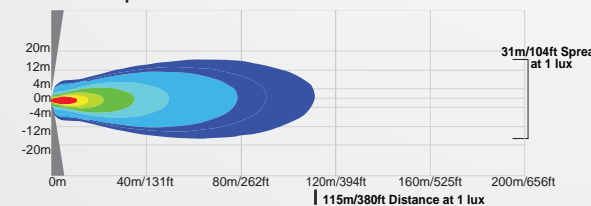

2D VIEW

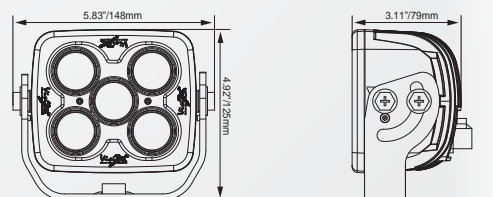

INDUSTRIAL/HEAVY DUTY DC CUBE SERIES

ABOUT THE SHOCKWAVE

REPLACES FLUORESCENT FIXTURES IN HARSH ENVIRONMENTS

The Vision X Shockwave excels at being a durable fluorescent upgrade for flat mount applications. The Shockwave was designed to replace fluorescent tubes in heavy commercial and industrial work environments.

Each Shockwave has the option of using a Frosted lens that diffuse the light to help reduce shadow areas. Additionally, multiple mounting options are available, including a Flush, and standard brackets.

Fluorescent tubes often break and need replacement. With the Shockwave Series, you can save on unscheduled maintenance with 50,000 hours of LED life for a brighter, longer-lasting light.

SHOCKWAVE SINGLE



SHOCKWAVE SINGLE SERIES

The single panel LED Shockwave produces a 120° beam spread, rugged industrial design, and universal mounting options.

FLUORESCENT REPLACEMENT

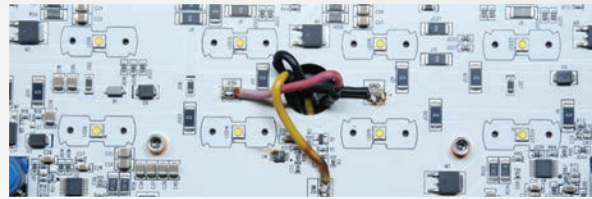

FOR HARSH CONDITION MACHINERY

We designed the Shockwave Series to replace ineffective fluorescent fixtures on heavy duty machinery. With the Shockwave, you get more output for much less power.

SHOCKWAVE DUAL



SHOCKWAVE DUAL SERIES

The Dual Shockwave off axis panels produces a 150° beam spread with Integrated Electronic Thermal Management (ETM) and low power consumption.

DC CUBE SHOCKWAVE



ITEM #: MIL-CSWD1296 (top) & MIL-CSWS2496 Shown
PART #: 9898995 & 9899046

2D VIEW

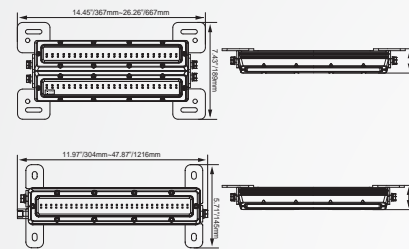

PREMIUM FLUORESCENT REPLACEMENT WITH 210° FULL-SPREAD BEAM PATTERN
High Efficacy CUBE LEDs | Power Supply Packages Available | Clear Bezel For Wider Dispersion

| | | |
|---|--------------------------------------|---|
| BEAM PATTERNS 180°, 210° | WARRANTY Extended | DIMENSIONS 12" 24" 36" 48" |
| TESTED LUMENS Up to 43,392 lm | INPUT VOLTAGE 9-32V DC | METRIC 304mm 608mm 912mm 1216mm |
| WATTAGE / AMPS Up to 384W / 32A @12V DC | VIBRATION RATING 15.6 Grms | WEIGHT Varies by Model |



| ITEM # | PART # | LENGTH | LEDS | RAW LUMENS | WATTS | AMP DRAW | WEIGHT |
|---------------|---------|------------|------|------------|-------|----------|---------|
| MIL-CSWS1248 | 9899039 | Single 12" | 48 | 5,424 LM | 48 | 4A | 3.1 LB |
| MIL-CSWS2496 | 9899046 | Single 24" | 96 | 10,848 LM | 96 | 8A | 6.2 LB |
| MIL-CSWS36144 | 9899053 | Single 36" | 144 | 16,272 LM | 144 | 12A | 9.2 LB |
| MIL-CSWS48192 | 9899060 | Single 48" | 192 | 21,696 LM | 192 | 16A | 12.2 LB |

| ITEM # | PART # | LENGTH | LENS | RAW LUMENS | WATTS | AMP DRAW | WEIGHT |
|---------------|---------|----------|-------|------------|-------|----------|----------|
| MIL-CSWD1296 | 9898995 | Dual 12" | Clear | 10,848 lm | 96 | 8A | 5.80 LB |
| MIL-CSWD24192 | 9899008 | Dual 24" | Clear | 21,696 lm | 192 | 16A | 11.60 LB |
| MIL-CSWD36288 | 9899015 | Dual 36" | Clear | 32,544 LM | 288 | 24A | 17.00 LB |
| MIL-CSWD48384 | 9899022 | Dual 48" | Clear | 43,392 LM | 384 | 32A | 22.60 LB |

DC SHOCKWAVE



ITEM #: MIL-SWD2440 (Top) & MIL-SWS1210 Shown
PART #: 9126043 & 9150611

2D VIEW

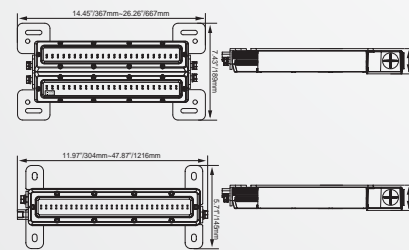

MODULAR LED UPGRADE FOR FLUORESCENT LIGHTS
Power Supply & Mounts Available | Frosted or Clear Lens | Direct Fluorescent Replacement

| | | |
|---|---|---|
| BEAM PATTERNS Ultra Wide 120°, 150° | WARRANTY Extended | DIMENSIONS 12" 24" 36" 48" |
| RAW LUMENS Up to 7,000 lm | EFFECTIVE LUMENS Up to 4,900 lm | METRIC 304mm 608mm 912mm 1216mm |
| WATTAGE / AMPS 10-80W / 0.83-6.67A @12V | VIBRATION RATING 15.6 Grms | WEIGHT 3.1 - 22.6 lbs |



| ITEM # | PART # | LENGTH | LENS | RAW LUMENS | WATTS | AMP DRAW | WEIGHT |
|-------------|---------|----------|-------|------------|-------|----------|---------|
| MIL-SWD1220 | 9125954 | Dual 12" | Clear | 1,750 lm | 20 | 1.67A | 5.8 lb |
| MIL-SWD2440 | 9126043 | Dual 24" | Clear | 3,500 lm | 40 | 3.34A | 11.6 lb |
| MIL-SWD3660 | 9126135 | Dual 36" | Clear | 5,250 lm | 60 | 5.0A | 17.0 lb |
| MIL-SWD4880 | 9126227 | Dual 48" | Clear | 7,000 lm | 80 | 6.67A | 22.6 lb |

| ITEM # | PART # | LENGTH | LENS | RAW LUMENS | WATTS | AMP DRAW | WEIGHT |
|-------------|---------|------------|-------|------------|-------|----------|---------|
| MIL-SWS1210 | 9125596 | Single 12" | Clear | 875 lm | 10 | 0.83A | 3.1 lb |
| MIL-SWS2420 | 9125688 | Single 24" | Clear | 1,750 lm | 20 | 1.67A | 6.2 lb |
| MIL-SWS3630 | 9125770 | Single 36" | Clear | 2,625 lm | 30 | 2.50A | 9.2 lb |
| MIL-SWS4840 | 9125862 | Single 48" | Clear | 3,500 lm | 40 | 3.34A | 12.2 lb |

INDUSTRIAL/HEAVY DUTY PROTEX LIGHT

ABOUT THE PROTEX

ATEX APPROVED FOR FLAMMABLE ENVIRONMENTS

The Protex Flameproof Light fixture from Vision X provides you with a powerful and energy efficient alternative to traditional hazardous lights. The Protex offers a compact design making it the perfect replacement for older fixtures that are too bulky or require high maintenance. The Protex is designed to be mounted on the interior or exterior for area illumination.

This fixture features 18 High Output 3-Watt LEDs for a total of forty watts, and has an integrated 85-264V AC input range. The Die-Cast Aluminum Housing combined with a soda-lime glass lens allow the light to operate in any environment.

FOR USE WITH

- FUEL DELIVERY SYSTEMS
- FRACKING DRILL RIGS
- OIL PLATFORMS
- OIL REFINERIES
- TANK FARMS

ATEX 95 APPROVAL



DIRECTIVE 94/9/EC

The Vision X Protex fixture has undergone extensive product testing and has earned the ATEX 94 certification to become a flameproof electrical equipment.

FLAME/EXPLOSION CERTIFICATIONS



CE 0575 EX II 2G Ex d II B T5 Gb

Zone 1 – Gases, Mists, Vapors. Occasional, Present
 Zone 2 – Gases, Mists, Vapors. Only present for a short period
 EX d – Prevents transmission of the explosion outside
 II B – For Complete list of explosion group examples see ATEX 94/9/EC



PROTEX FLAMEPROOF LIGHT



ITEM #: MIL-EXP1860 Shown
 PART #: 9895956

40-WATT FLAMEPROOF ATEX 94/9/EC CERTIFIED LED FIXTURE
 Soda-Lime Glass (15.0t) Lens | Integrated 85-264V AC Power Input | Single Stud Mounting System

| | | |
|---|--|---|
| BEAM PATTERNS 10°, 25°, 60° | WARRANTY Extended | DIMENSIONS 10.04" x 6.89" x 8.15" |
| RAW LUMENS 3,500 lm (ea) | EFFECTIVE LUMENS 2,450 lm (ea) | METRIC 255mm x 175mm x 207mm |
| WATTAGE / AMPS @110V AC 40W / 0.36A | VIBRATION RATING 15.6 Grms | WEIGHT 21.16 lb / 9.16 kg |



| ITEM # | PART # | QTY | BEAM | ITEM # | PART # | QTY | BEAM |
|-------------|---------|-----|------|-------------|---------|-----|------|
| MIL-EXP1810 | 9895925 | 1 | 10° | MIL-EXP1860 | 9895956 | 1 | 60° |

BEAM PATTERN

MIL-EXP1860 | 9895956 - 60° Beam

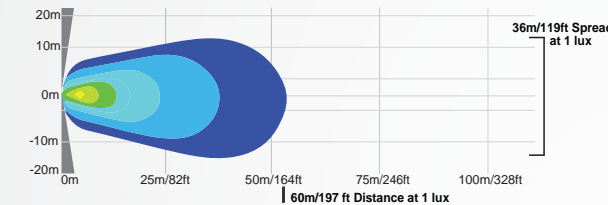

2D VIEW

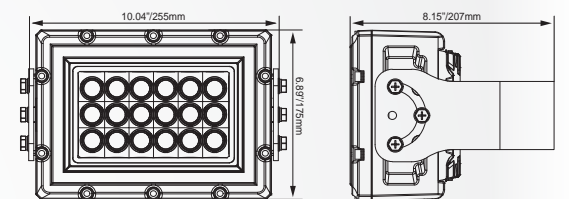

INDUSTRIAL/MEDIUM DUTY UTILITY MARKET XTREME

ABOUT THE UMX SERIES

OEM/AFTERMARKET REPLACEMENT LIGHTING FOR HALOGEN/HID

The UMX Series excels in a multitude of applications and is a premium OE upgrade for commercial and industrial applications. Both the UMX Round and the UMX Square are capable of delivering greatly increased output and a smoother beam pattern than comparable halogen fixtures.

The UMX is used everywhere from large-scale mining sites to commercial fog light applications that take advantage of the available 10° beam pattern.

Over 528 raw lumens come out of each LED inside the UMX, making it a leader in the 5-Watt LED field.

FOR USE WITH

- AGRICULTURAL EQUIPMENT
- AIRPORT EQUIPMENT
- GARBAGE TRUCKS
- FLEET VEHICLES
- SERVICE BODIES
- EXCAVATORS
- SWEEPERS
- WRECKERS

REDUCED ENERGY CONSUMPTION



3-WATT MODEL AVAILABLE

For those looking for less power draw, the less powerful UM Series is available in the same housings as the UMX. The UM Series utilizes 3-watt LEDs to draw only 21 watts.

FACTORY REPLACEMENT FIXTURE



REPLACES OEM HALOGEN & HID

The UMX Series features a single stud mount allowing it to replace OEM fixtures with ease, including integrated Deutsch plug mated to factory wiring on most equipment manufacturers.

ROUND UTILITY MARKET XTREME



ITEM #: XIL-UMX4060 Shown
PART #: 9118307

XTREME LIGHT OUTPUT OE UPGRADE FOR COMMERCIAL & INDUSTRIAL
Die-Cast Aluminum Housing | Reduced Energy Consumption | 3-Watt Model Available

| | | |
|--|--|--|
| BEAM PATTERNS 10°, 25°, 40°, 60°, 90°, 30°x65° | WARRANTY Extended | DIMENSIONS 4.49" x 5.47" x 2.99" |
| RAW LUMENS 3,696 lm (ea) | EFFECTIVE LUMENS 2,590 lm (ea) | METRIC 114mm x 139mm x 76mm |
| WATTAGE / AMPS 70W / 3.8A @12V | VIBRATION RATING 15.6 Grms | WEIGHT 2.43 lb / 1.1 kg |



| ITEM # | PART # | QTY | BEAM |
|-------------|---------|-----|------|
| XIL-UMX4010 | 4004719 | 1 | 10° |
| XIL-UMX4040 | 9118215 | 1 | 40° |
| XIL-UMX4060 | 9118307 | 1 | 60° |

BEAM PATTERN

XIL-UMX4060 | 9118307 - 60° Beam

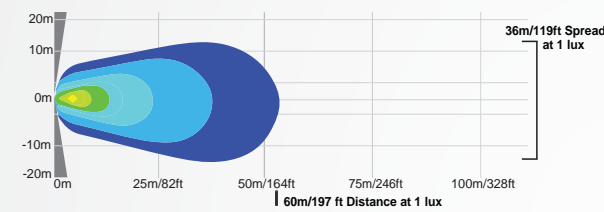

2D VIEW

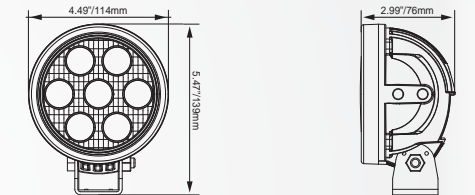

SQUARE UTILITY MARKET XTREME



ITEM #: XIL-UMX4460 Shown
PART #: 9118482

XTREME LIGHT OUTPUT OE UPGRADE FOR COMMERCIAL & INDUSTRIAL
Die-Cast Aluminum Housing | Reduced Energy Consumption | 3-Watt Model Available

| | | |
|--|--|--|
| BEAM PATTERNS 10°, 25°, 40°, 60°, 90°, 30°x65° | WARRANTY Extended | DIMENSIONS 4.72" x 6.22" x 3.12" |
| RAW LUMENS 3,696 lm (ea) | EFFECTIVE LUMENS 2,590 lm (ea) | METRIC 120mm x 158mm x 79mm |
| WATTAGE / AMPS 70W / 3.8A @12V | VIBRATION RATING 15.6 Grms | WEIGHT 2.63 lb / 1.2 kg |



| ITEM # | PART # | QTY | BEAM |
|-------------|---------|-----|------|
| XIL-UMX4410 | 4004726 | 1 | 10° |
| XIL-UMX4440 | 9118390 | 1 | 40° |
| XIL-UMX4460 | 9118482 | 1 | 60° |

BEAM PATTERN

XIL-UMX4460 | 9118482 - 60° Beam

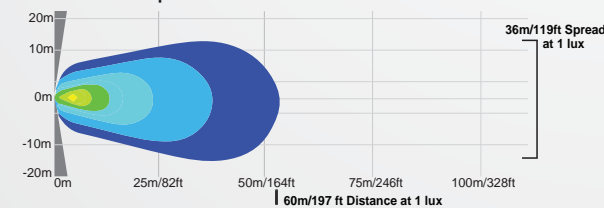

2D VIEW

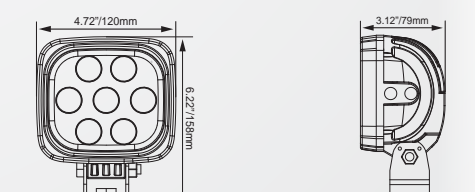

INDUSTRIAL/MEDIUM DUTY DURALUX SERIES

ABOUT THE DURALUX SERIES

OEM/AFTERMARKET REPLACEMENT LIGHTING FOR HALOGEN/HID

The Duralux Series gives more output than 100-Watt Halogen lights while drawing much less power and reducing wear on associated components. Additionally, the Duralux was designed with fleet vehicles in mind, reducing cost, energy consumption, and boosting output at an attractive price.

Available in three different housing sizes and three different beam patterns, the Duralux Series is one of the most adaptive fixtures made by Vision X. The Die-Cast Aluminum housing combines durability with afford-ability for a wide variety of applications.

For those with limited space, the 12-Watt DURA Mini (DURA-M460) produces 2,000 raw lumens while only drawing 1.0 amperage at 12V.

FOR USE WITH

- AGRICULTURAL EQUIPMENT
- AIRPORT EQUIPMENT
- GARBAGE TRUCKS
- FLEET VEHICLES
- SERVICE BODIES
- EXCAVATORS
- SWEEPERS
- WRECKERS

DURA MINI



ITEM #: DURA-M460 Shown
PART #: 9895499



ULTIMATE COMPACT FIXTURE FOR UNIVERSAL APPLICATIONS

60° Flood Beam Pattern | IP-69K Waterproof/High Pressure Spray | 1.0 Amp Draw At 12V

| | | |
|-------------------------------------|--|--|
| BEAM PATTERNS 60° | WARRANTY Extended | DIMENSIONS 2.75" x 3.62" x 1.94" |
| RAW LUMENS 2,000 lm (ea) | EFFECTIVE LUMENS 950 lm (ea) | METRIC 70mm x 92mm x 49mm |
| WATTAGE / AMPS 12W / 1.0A | VIBRATION RATING 15.6 Grms | WEIGHT 0.88 lb / 0.40 kg |



| ITEM # | PART # | QTY | BEAM |
|-----------|---------|-----|------|
| DURA-M460 | 9895499 | 1 | 60° |

BEAM PATTERN

DURA-M460 | 9895499 - 60° Beam

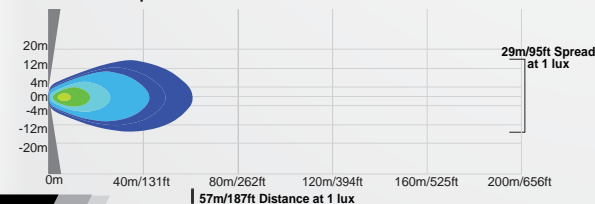

2D VIEW

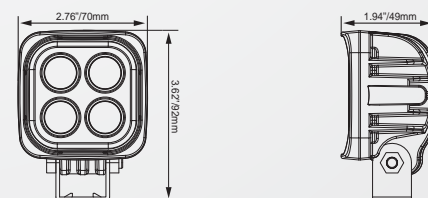

TWO LIGHT KITS



AVAILABLE DURALUX KITS

Currently, the Dura 6 LED and Dura 4 LED are available in two light kits with a dual wiring harness with 10°, 40°, or 60° optics at an affordable price.

FLUSH BRACKETS AVAILABLE



PROFESSIONAL MOUNTING SOLUTION

Extend the application range of the DURA with the addition of a Flush Mounting Bracket.

DURA-660FLUSH | 9893006
DURA-460FLUSH | 9892993

DURALUX 6 LED



ITEM #: DURA-660 Shown
PART #: 9888385

30-WATT HIGH PERFORMANCE UNIVERSAL LED LIGHT
Minimal Amperage Draw | 150-Watt Halogen Comparable Fixture | Durable Die-Cast Housing

| | | |
|--|--|--|
| BEAM PATTERNS 10°, 25°, 40°, 60°, 90°, 30°x65° | WARRANTY Extended | DIMENSIONS 5.38" x 4.19" x 2.72" |
| RAW LUMENS 3,696 lm (ea) | EFFECTIVE LUMENS 2,590 lm (ea) | METRIC 139mm x 107mm x 69mm |
| WATTAGE / AMPS 30W / 2.5A @12V | VIBRATION RATING 15.6 Grms | WEIGHT 2.63 lb / 1.2 kg |



| ITEM # | PART # | QTY | BEAM |
|-------------|---------|-----|------|
| DURA-610 | 9891125 | 1 | 10° |
| DURA-610KIT | 9891309 | 2 | 10° |

| ITEM # | PART # | QTY | BEAM |
|----------|---------|-----|------|
| DURA-640 | 9888378 | 1 | 40° |
| DURA-660 | 9888385 | 1 | 60° |

BEAM PATTERN

DURA-610 | 9891125 - 10° Beam

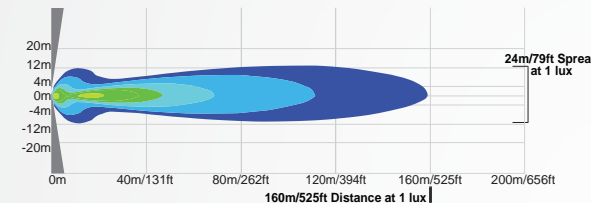

2D VIEW

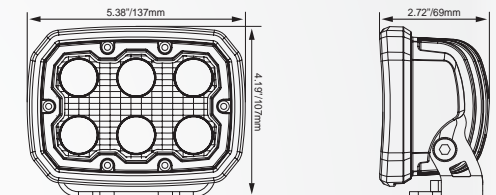

DURALUX 4 LED



ITEM #: DURA-460 Shown
PART #: 9141527

20-WATT HIGH PERFORMANCE UNIVERSAL LED LIGHT
Minimal Amperage Draw | 100-Watt Halogen Comparable Fixture | Durable Die-Cast Housing

| | | |
|--|--|--|
| BEAM PATTERNS 10°, 25°, 40°, 60°, 90°, 30°x65° | WARRANTY Extended | DIMENSIONS 3.94" x 4.24" x 2.57" |
| RAW LUMENS 2,112 lm (ea) | EFFECTIVE LUMENS 1,480 lm (ea) | METRIC 100mm x 107mm x 65mm |
| WATTAGE / AMPS 20W / 1.6A @12V | VIBRATION RATING 15.6 Grms | WEIGHT 1.50 lb / 0.68 kg |



| ITEM # | PART # | QTY | BEAM |
|-------------|---------|-----|------|
| DURA-410 | 9891132 | 1 | 10° |
| DURA-410KIT | 9891187 | 2 | 10° |

| ITEM # | PART # | QTY | BEAM |
|----------|---------|-----|------|
| DURA-440 | 9141619 | 1 | 40° |
| DURA-460 | 9141527 | 1 | 60° |

BEAM PATTERN

DURA-410 | 9891132 - 10° Beam

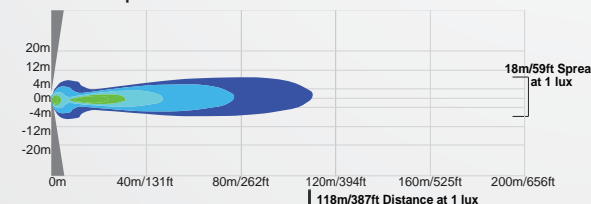

2D VIEW

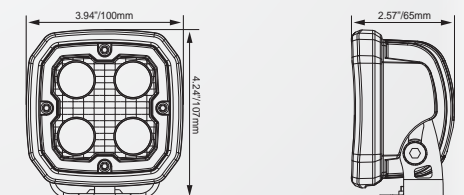

INDUSTRIAL SOLUTIONS

Marine grade anti corrosive coating

BT Series lights polyester powder coating is designed for the exterior environment offering excellent long term light and weather resistance. Its marine grade anti-corrosive coating has passed multiple chemical and durability tests including:

Salt Spray AS3715 2.5.10 (1000 hours)

Exterior durability AS3715 (12 months continuous exposure)

Long life - 50,000 hours

Using Pulse Width Modulation (PWM), the LEDs are being turned on and off at a frequency quicker than the human eye can detect. This technology allows the LEDs to be driven hard whilst still achieving a long life span of 50,000 hours.

CISPR 25 - Class 1 rated

To limit the RF noise that your work light introduces into electronics/radios, enabling better communication.

Outstanding light output

The latest LEDs provide a mass volume of light where you need it most. The color temperature of LED is closer to that of sunlight which reduces eye strain and enables excellent peripheral vision.

Moulded DT connectors

Any product is only as good as its components and Deutsch's moulded DT connectors are manufactured from high quality materials selected for their ability to withstand years of environmental exposure.

Reverse polarity protection

BT Series lights will not sustain accidental damage if the polarity to the light is reversed by incorrect installation.

IP69K rated

The IP69K rating ensures that the work lights are dust tight with no ingress of particulates and protected against high pressure, high temperature wash downs.

Electronic thermal management

In an extraordinary situation where the light is subjected to massive heat overload, a self protection protocol is engaged to reduce the light output, until such time as the heat overload retreats to normal parameters.



HEAVY INDUSTRIAL BT HEAVY INDUSTRIAL SERIES

ABOUT THE BT HEAVY INDUSTRIAL SERIES

UPGRADED STAINLESS STEEL TRUNNION BRACKET FOR MINING

The BT Heavy Industrial Series offers outstanding light output in a functional design utilizing a forward rake trunnion bracket, with integrated aiming markings on the sides and base of the bracket. Utilizing the aiming system in conjunction with 3d fit outs to ensure the correct light for any environment. As well as increasing safety, be keeping light out of other operators. High quality construction and components enable the BT Heavy Industrial Series to withstand vibration up to 60Gms. Built-in reverse polarity protection helps prevent accidental damage caused by incorrect installation. Electronic thermal management ensures that if the light is subjected to massive heat overload, that a self protection protocol is engaged to reduce the light output, until such time as the heat overload retreats to normal parameters.



LIGHT INDUSTRIAL BT LIGHT INDUSTRIAL SERIES

ABOUT THE BT LIGHT INDUSTRIAL SERIES

OEM/AFTERMARKET REPLACEMENT LIGHTING FOR HALOGEN/HID

The BT Light Industrial Series offers outstanding light output in a functional design which can be easily adjusted, with either of the supplied trunnion or single bolt bracket options. High quality construction and components enable the BT Light Industrial Series to withstand vibration up to 21Gms. Built-in reverse polarity protection helps prevent accidental damage caused by incorrect installation. Electronic thermal management ensures that if the light is subjected to massive heat overload, that a self protection protocol is engaged to reduce the light output, until such time as the heat overload retreats to normal parameters.

BHB 20



400 / 500-WATT METAL HALIDE REPLACEMENT FIXTURE
 Forward Rake Trunnion Bracket | Aiming System on Bracket | Reverse Polarity Protection

| | | |
|--|---|--|
| BEAM PATTERNS 10°, 25°, 40°, 60°, 90°, 30°x65° | WARRANTY Extended | DIMENSIONS 9.42" x 6.81" x 4.92" |
| RAW LUMENS 16,000 lm (ea) | EFFECTIVE LUMENS 11,270 lm (ea) | METRIC 239mm x 173mm x 125mm |
| WATTAGE / AMPS 140W / 11.66A @12V | VIBRATION RATING 60 Grms | WEIGHT 9.25 lb / 4.20 kg |



| ITEM # | PART # | QTY | BEAM | ITEM # | PART # | QTY | BEAM |
|-----------|---------|-----|------|-----------|---------|-----|------|
| BHB072025 | 9898223 | 1 | 25° | BHB072060 | 9898247 | 1 | 60° |
| BHB072040 | 9898230 | 2 | 40° | BHB072090 | 9898254 | 1 | 90° |

BEAM PATTERN

BHB072040 | 9898230 - 40° Beam

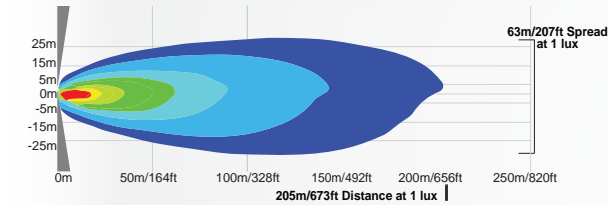

2D VIEW

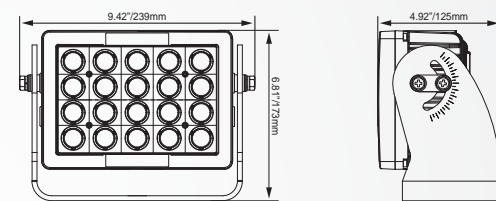

BHB 12



1000-WATT Halogen Equivalent
 Forward Rake Trunnion Bracket | Aiming System on Bracket | Reverse Polarity Protection

| | | |
|--|--|--|
| BEAM PATTERNS 10°, 25°, 40°, 60°, 90°, 30°/65° | WARRANTY Extended | DIMENSIONS 6.95" x 5.20" x 4.02" |
| RAW LUMENS 9,600 lm (ea) | EFFECTIVE LUMENS 6,697 lm (ea) | METRIC 177mm x 132mm x 102mm |
| WATTAGE / AMPS 84W / 7.0A @12V | VIBRATION RATING 60 Grms | WEIGHT 4.96 lb / 2.25 kg |



| ITEM # | PART # | QTY | BEAM | ITEM # | PART # | QTY | BEAM |
|------------|---------|-----|------|------------|---------|-----|------|
| BHB071225L | 9898162 | 1 | 25° | BHB071260L | 9898186 | 1 | 60° |
| BHB071240L | 9898179 | 2 | 40° | BHB071290L | 9898193 | 1 | 90° |

BEAM PATTERN

BHB071240L | 9898179 - 40° Beam

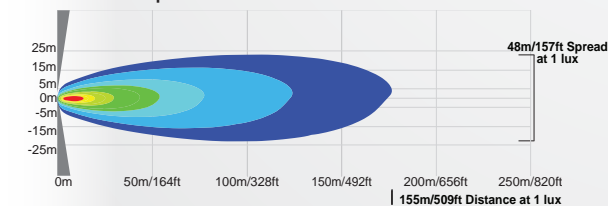

2D VIEW

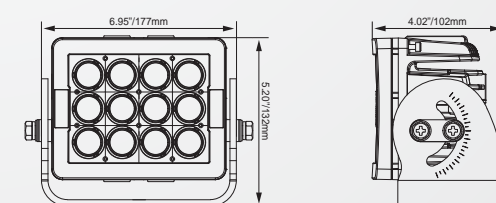

BHB 9



700-WATT Halogen Equivalent
 Forward Rake Trunnion Bracket | Aiming System on Bracket | Reverse Polarity Protection

| | | |
|--|--|--|
| BEAM PATTERNS 10°, 25°, 40°, 60°, 90°, 30°x65° | WARRANTY Extended | DIMENSIONS 6.08" x 5.20" x 3.33" |
| RAW LUMENS 7,200 lm (ea) | EFFECTIVE LUMENS 5,734 lm (ea) | METRIC 154mm x 132mm x 85mm |
| WATTAGE / AMPS 63W / 5.26A @12V | VIBRATION RATING 60 Grms | WEIGHT 3.96 lb / 1.80 kg |



| ITEM # | PART # | QTY | BEAM | ITEM # | PART # | QTY | BEAM |
|-----------|---------|-----|------|-----------|---------|-----|------|
| BHB070925 | 9898049 | 1 | 25° | BHB070960 | 9898063 | 1 | 60° |
| BHB070940 | 9898056 | 2 | 40° | BHB070990 | 9898070 | 1 | 90° |

BEAM PATTERN

BHB070940 | 9898056 - 40° Beam

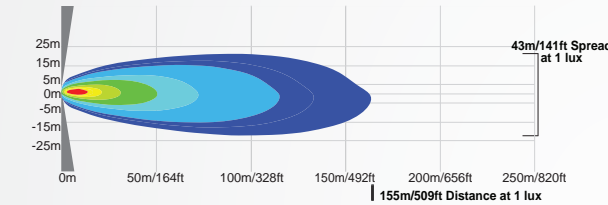

2D VIEW

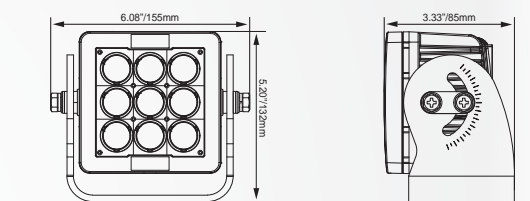

BHB 5



400-WATT Halogen Equivalent
 Forward Rake Trunnion Bracket | Aiming System on Bracket | Reverse Polarity Protection

| | | |
|--|--|--|
| BEAM PATTERNS 10°, 25°, 40°, 60°, 90°, 30°x65° | WARRANTY Extended | DIMENSIONS 4.86" x 4.41" x 3.98" |
| RAW LUMENS 4,000 lm (ea) | EFFECTIVE LUMENS 3,305 lm (ea) | METRIC 123mm x 112mm x 101mm |
| WATTAGE / AMPS 35W / 2.92A @12V | VIBRATION RATING 60 Grms | WEIGHT 2.20 lb / 1.00 kg |



| ITEM # | PART # | QTY | BEAM | ITEM # | PART # | QTY | BEAM |
|-----------|---------|-----|------|-----------|---------|-----|------|
| BHB070525 | 9897981 | 1 | 25° | BHB070560 | 9898001 | 1 | 60° |
| BHB070540 | 9897998 | 2 | 40° | BHB070590 | 9898018 | 1 | 90° |

BEAM PATTERN

BHB070540 | 9897998 - 40° Beam

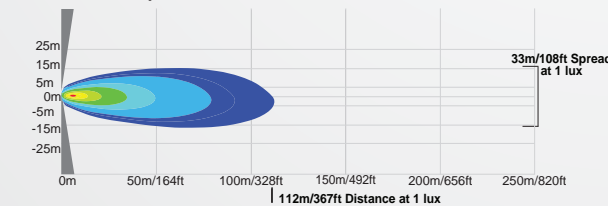

2D VIEW

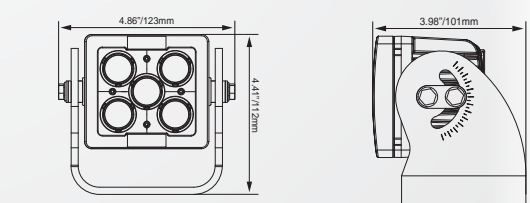

BLB 20



400 / 500-WATT METAL HALIDE REPLACEMENT FIXTURE
Dual Mounting Brackets Included | Multiple Mounting Points on Light | Reverse Polarity Protection

| | | |
|--|---|--|
| BEAM PATTERNS 10°, 25°, 40°, 60°, 90°, 30°x65° | WARRANTY Extended | DIMENSIONS 9.42" x 5.55" x 4.13" |
| RAW LUMENS 16,000 lm (ea) | EFFECTIVE LUMENS 11,270 lm (ea) | METRIC 239mm x 141mm x 105mm |
| WATTAGE / AMPS 140W / 11.66A @12V | VIBRATION RATING 21.2 Grms | WEIGHT 9.25 lb / 4.20 kg |



| ITEM # | PART # | QTY | BEAM | ITEM # | PART # | QTY | BEAM |
|-----------|---------|-----|------|-----------|---------|-----|------|
| BLB072025 | 9898223 | 1 | 25° | BLB072060 | 9898247 | 1 | 60° |
| BLB072040 | 9898230 | 2 | 40° | | | | |

BEAM PATTERN

BLB072040 | 9898230 - 40° Beam

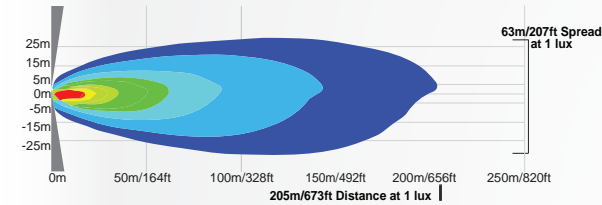

2D VIEW

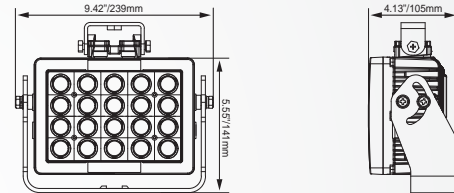

BLB 12



1000-WATT Halogen Equivalent
Dual Mounting Brackets Included | Multiple Mounting Points on Light | Reverse Polarity Protection

| | | |
|--|--|--|
| BEAM PATTERNS 10°, 25°, 40°, 60°, 90°, 30°/65° | WARRANTY Extended | DIMENSIONS 6.95" x 5.22" x 3.54" |
| RAW LUMENS 9,600 lm (ea) | EFFECTIVE LUMENS 6,697 lm (ea) | METRIC 177mm x 133mm x 90mm |
| WATTAGE / AMPS 84W / 7.0A @12V | VIBRATION RATING 21.2 Grms | WEIGHT 4.96 lb / 2.25 kg |



| ITEM # | PART # | QTY | BEAM | ITEM # | PART # | QTY | BEAM |
|------------|---------|-----|------|------------|---------|-----|------|
| BLB071225L | 9898162 | 1 | 25° | BLB071260L | 9898186 | 1 | 60° |
| BLB071240L | 9893877 | 2 | 40° | BLB071290L | 9898193 | 1 | 90° |

BEAM PATTERN

BLB071240L | 9898117 - 40° Beam

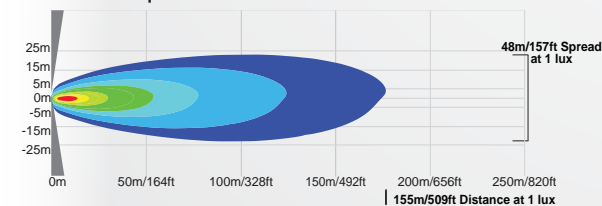

2D VIEW

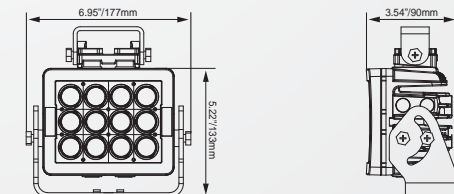

BLB 9



700-WATT Halogen Equivalent
Dual Mounting Brackets Included | Multiple Mounting Points on Light | Reverse Polarity Protection

| | | |
|--|--|--|
| BEAM PATTERNS 10°, 25°, 40°, 60°, 90°, 30°x65° | WARRANTY Extended | DIMENSIONS 6.08" x 5.12" x 3.33" |
| RAW LUMENS 7,200 lm (ea) | EFFECTIVE LUMENS 5,734 lm (ea) | METRIC 155mm x 130mm x 85mm |
| WATTAGE / AMPS 63W / 5.26A @12V | VIBRATION RATING 21.2 Grms | WEIGHT 3.96 lb / 1.80 kg |



| ITEM # | PART # | QTY | BEAM | ITEM # | PART # | QTY | BEAM |
|-----------|---------|-----|------|-----------|---------|-----|------|
| BLB070925 | 9898049 | 1 | 25° | BLB070960 | 9898063 | 1 | 60° |
| BLB070940 | 9898056 | 2 | 40° | BLB070990 | 9898070 | 1 | 90° |

BEAM PATTERN

BLB070940 | 9898056 - 40° Beam

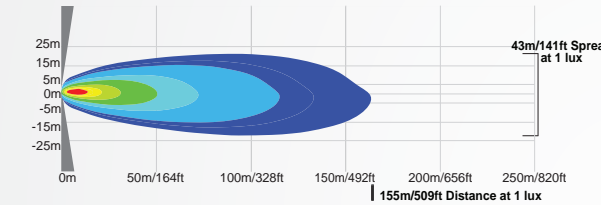

2D VIEW

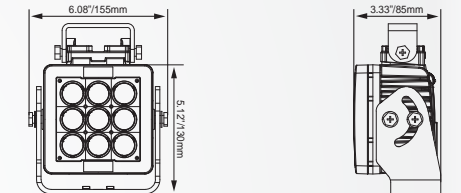

BLB 5



400-WATT Halogen Equivalent
Dual Mounting Brackets Included | Multiple Mounting Points on Light | Reverse Polarity Protection

| | | |
|--|--|--|
| BEAM PATTERNS 10°, 25°, 40°, 60°, 90°, 30°x65° | WARRANTY Extended | DIMENSIONS 4.86" x 3.94" x 3.98" |
| RAW LUMENS 4,000 lm (ea) | EFFECTIVE LUMENS 3,305 lm (ea) | METRIC 123mm x 100mm x 101mm |
| WATTAGE / AMPS 35W / 2.92A @12V | VIBRATION RATING 21.2 Grms | WEIGHT 2.20 lb / 1.00 kg |



| ITEM # | PART # | QTY | BEAM | ITEM # | PART # | QTY | BEAM |
|-----------|---------|-----|------|-----------|---------|-----|------|
| BLB070525 | 9897981 | 1 | 25° | BLB070560 | 9898001 | 1 | 60° |
| BLB070540 | 9897998 | 2 | 40° | BLB070590 | 9898018 | 1 | 90° |

BEAM PATTERN

BLB070540 | 9897998 - 40° Beam

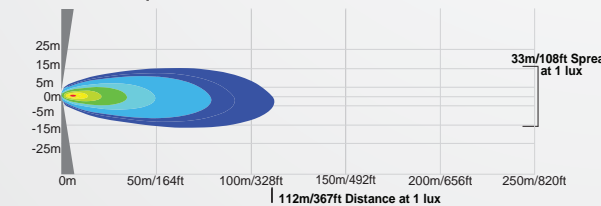

2D VIEW

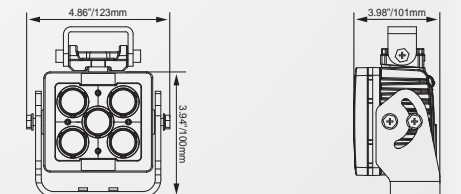



SOLUTION PROCESS

Vision X creates a solution for your ship or shore lighting needs while using a product specific range designed for the harsh environment of saltwater. This is done through above ground copper circuit boards, stainless steel brackets, and a marine grade coating. Using this environment specific range to create a complete proven solution.

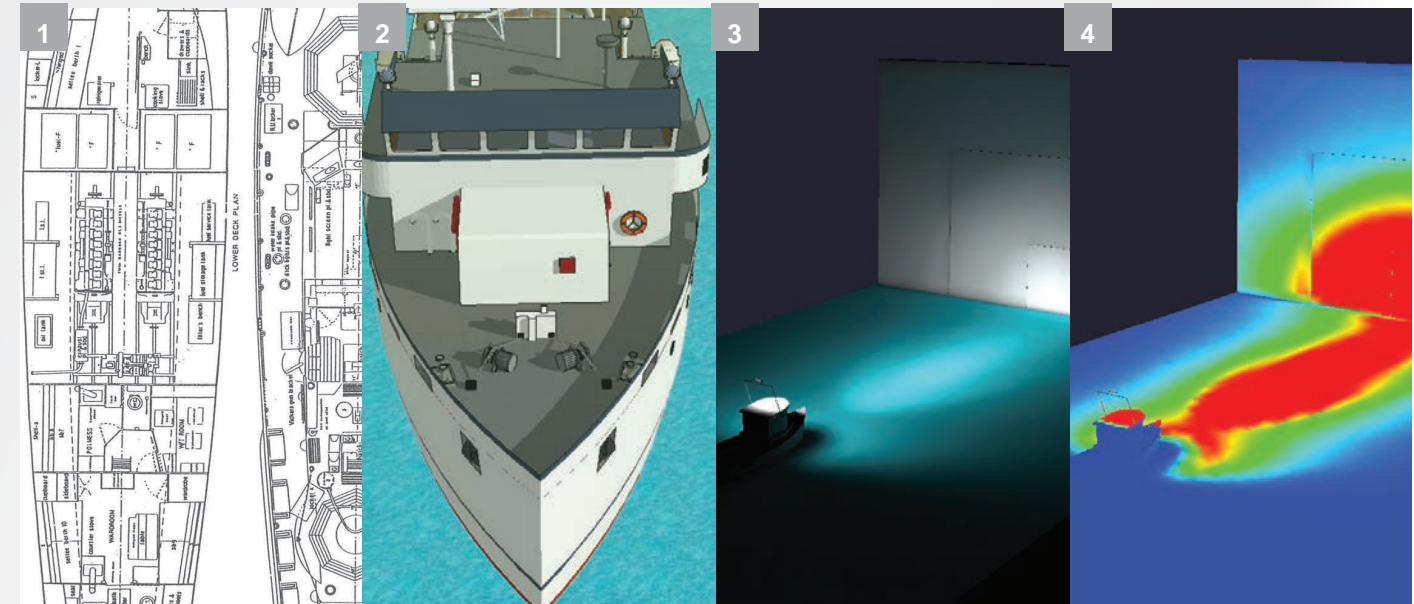

2D BLUEPRINT

Vision X begins a project by gathering information from the customer and the exact areas of the boat that need to be illuminated to what Lux/FC requirements.

3D MODEL

A 3D Model is then built to match the requirements requested and dropped into a realistic aquatic or port environment to ensure the light is where you need it.

SIMULATION RENDER

Prior to implementing a lighting solution, Vision X creates a simulation rendering of the intended result to help envision if the final product will resolve the problem.

SOLUTION

Vision X is able to create a solution that proves our lights are able to get you the spread and distance you need on the shore or on the ship.

CASE STUDIES / FIT OUT GUIDES AVAILABLE

Case Study - Port Lighting
Innovative LED Lighting Helps Shipping Port Increase Energy Efficiency and Light Output

Vision X Lighting helped shipping port to increase energy efficiency and reduce environmental impact at their large container ship docking terminal by upgrading their existing inefficient lighting fixtures to premium LED technology.

By switching to Vision X LED lighting, shipping port was able to increase energy efficiency by about 65% while also increasing light output by 20%. This upgrade is actively helping reduce the shipping port footprint while also ensuring a safe, well-lit workplace.

About The Port Project
Shipping port, headquartered in Houston, Texas is the operator of a large precast manufacturing plant located just outside of Miami, Georgia. A precast is a material that is used in the oil industry to keep reduced hydraulic fracture open. The sprawling Port Miller facility produces concentrated precast material for a wide variety of oil drilling and hydraulic fracturing ("fracking") operations. Shipping port was interested in upgrading their facility's older, inefficient lights with Vision X Lighting's premium LED lighting fixtures.

The Project at Hand
The plant containing the large Port Miller precast plant covers over 60 acres. A large proportion of the site, as well as the interior of all plant structures, need to be kept well lit at all times to ensure a safe and productive work environment. Previously this task was accomplished by large amounts of inefficient, older technology fixtures. Not only did these fixtures waste large amounts of energy, they also provided less lighting output and poor coverage compared to that afforded by newer Vision X LED technologies.

Developing A Solution
In order to fulfil Port Cerant's desire to reduce the high energy consumption of their precast plant's lighting systems while also increasing light output, Vision X developed a plug and play retrofit solution for existing fixtures. In this way all lighting fixtures were easily replaced while continuing to utilize existing hardware and wiring. This applied to all previously existing light fixtures, from large 1000-watt high bay lights in the facility's crude shed to 400-watt well packs to smaller, lower-voltage fixtures inside of plant structures.

Vision X Lighting - Auburn, MA | www.visionx.com | 888-489-9820

RTG CRANE

4 x Outside of North Arm (Aiming Straight Down)
4 x Outside of South Arm (Aiming Straight Down)

4 x One on the Outside of Each Leg (12' High Aiming Straight Down)

Vision X Lighting
P: 1-888-489-9820 E: info@visionxusa.com
Copyright 2014 Vision X Lighting

TXLC-976

2x Rear Facing (Blackout)
2x Facing Inboard Turret Lock

4x Forward Facing (Blackout)
2x Forward Facing at 45° Out Board

Vision X Lighting Mining Services
P: 1-888-489-9820 E: mining@visionxusa.com
Copyright 2014 Vision X Lighting

MARITIME SOLUTIONS

Vision X Marine lighting is specially manufactured to prevent effects of corrosion caused by close proximity to saltwater, along with special electronics for use in or near saltwater.

INDUSTRIAL MARITIME SOLUTIONS

ABOUT THE MARITIME SERIES

The Vision X Marine line provides the ideal solution for watercraft of all sizes. From commercial freight ships to fishing vessels, we carry lighting designed specifically for the maritime market. Each electronics board used in the Maritime line is constructed from copper and are above ground to remove corrosion issues typically common in saltwater applications.

Additionally, the marine grade gloss coating reduces wear from constant barrage of saltwater while at sea, ensuring the light performs day in and day out. The heavy duty stainless steel bracket combines maximum strength with a bracket that won't deteriorate over time.

Maritime products operate at a 5000K color temperature, giving the light a warmer feel.

ABOVE GROUND MARITIME



SALTWATER PROTECTION

The unique gloss coating used on Maritime products from Vision X greatly reduces the dramatic impact that saltwater has on traditional lighting fixture housings.

STAINLESS STEEL BRACKET

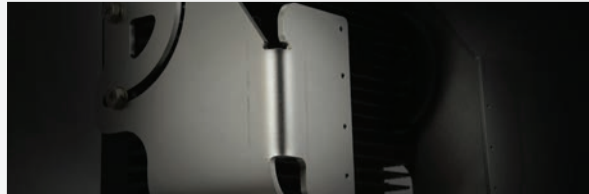

INCLUDED MOUNTING

The each fixture in the MAR Series from Vision X comes equipped with a high-strength stainless steel bracket that gives the light extra protection against saltwater corrosion.

COPPER BOARD

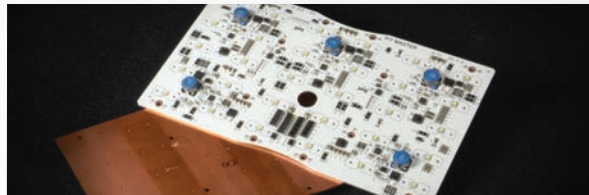

ANTI-CORROSION

The Maritime products from Vision X feature an above ground copper electronic board to eliminate any chance of corrosion.



MARITIME PITMASTER 60



ITEM #: MAR-PMX6060 Shown
PART #: 9892078

1000-WATT METAL HALIDE REPLACEMENT LIGHT FOR MARINE APPLICATIONS
Stainless Steel Bracket | AC Versions Available | Prime Drive Technology

| | | |
|--|---|--|
| BEAM PATTERNS 10°, 25°, 40°, 60°, 90°, 30°x65° | WARRANTY Extended | DIMENSIONS 15.07" x 11.54" x 6.87" |
| RAW LUMENS 31,680 lm (ea) | EFFECTIVE LUMENS 22,200 lm (ea) | METRIC 383mm x 293mm x 175mm |
| WATTAGE / AMPS 300W / 25A @12V | VIBRATION RATING 60 Grms | WEIGHT 32.4 lb / 14.7 kg |



| ITEM # | PART # | QTY | BEAM |
|-------------|---------|-----|------|
| MAR-PMX6040 | 9892382 | 1 | 40° |
| MAR-PMX6060 | 9892078 | 1 | 60° |
| MAR-PMX6090 | 9893013 | 1 | 90° |

BEAM PATTERN

MAR-PMX6060 | 9892078 - 60° Beam

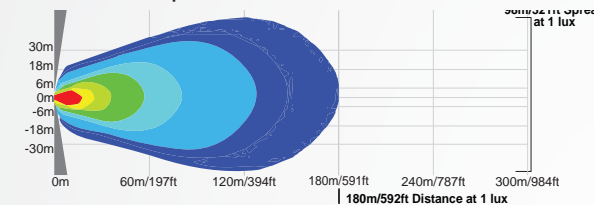

2D VIEW

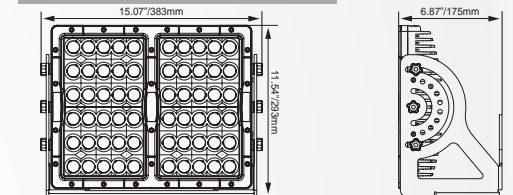

MARITIME PITMASTER 30



ITEM #: MAR-PMX3060 Shown
PART #: 9892085

400/500-WATT METAL HALIDE REPLACEMENT LIGHT FOR MARINE APPLICATIONS
Stainless Steel Bracket | AC Versions Available | Prime Drive Technology

| | | |
|--|---|---|
| BEAM PATTERNS 10°, 25°, 40°, 60°, 90°, 30°x65° | WARRANTY Extended | DIMENSIONS 11.96" x 7.52" x 4.94" |
| RAW LUMENS 15,840 lm (ea) | EFFECTIVE LUMENS 11,100 lm (ea) | METRIC 297mm x 191mm x 126mm |
| WATTAGE / AMPS 150W / 12.5A @12V | VIBRATION RATING 60 Grms | WEIGHT 16.1 lb / 7.3 kg |



| ITEM # | PART # | QTY | BEAM |
|-------------|---------|-----|------|
| MAR-PMX3040 | 9892412 | 1 | 40° |
| MAR-PMX3060 | 9892085 | 1 | 60° |
| MAR-PMX3090 | 9892573 | 1 | 90° |

BEAM PATTERN

MAR-PMX3060 | 9892085 - 60° Beam

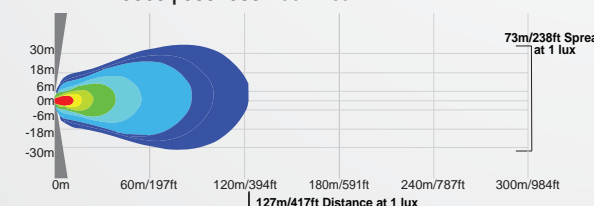

2D VIEW

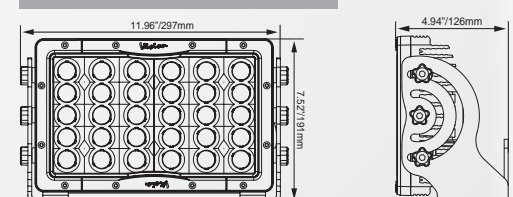

MARITIME RIPPER 20



ITEM #: MAR-RXP2060 Shown
PART #: 9892108

STAINLESS STEEL BRACKET WITH UPGRADED ELECTRONICS FOR MARINE USE
60 Grms High Vibration Rating | Single Bolt Mounting | Stainless Steel Trunnion Bracket

| | | |
|--|--|--|
| BEAM PATTERNS 10°, 25°, 40°, 60°, 90°, 30°x65° | WARRANTY Extended | DIMENSIONS 8.26" x 6.24" x 4.05" |
| RAW LUMENS 10,560 lm (ea) | EFFECTIVE LUMENS 7,400 lm (ea) | METRIC 210mm x 159mm x 103mm |
| WATTAGE / AMPS 100W / 8.34A @12V | VIBRATION RATING 60 Grms | WEIGHT 8.4 lb / 38 kg |



| ITEM # | PART # | QTY | BEAM |
|-------------|---------|-----|------|
| MAR-RXP2040 | 9893020 | 1 | 40° |
| MAR-RXP2060 | 9892108 | 1 | 60° |

BEAM PATTERN

MAR-RXP2060 | 9892108 - 60° Beam

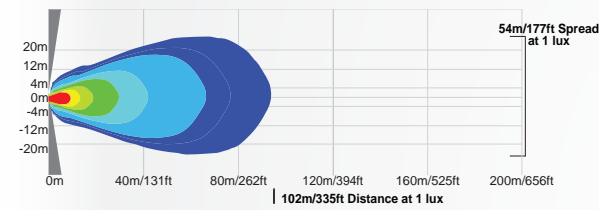

2D VIEW

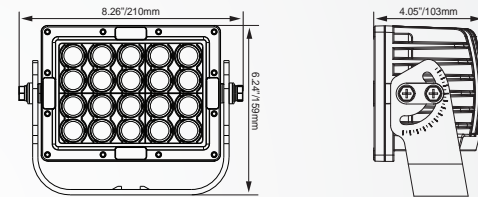

MARITIME RIPPER 12



ITEM #: MAR-RXP1260 Shown
PART #: 9892092

STAINLESS STEEL BRACKET WITH UPGRADED ELECTRONICS FOR MARINE USE
60 Grms High Vibration Rating | Single Bolt Mounting | Stainless Steel Trunnion Bracket

| | | |
|--|--|--|
| BEAM PATTERNS 10°, 25°, 40°, 60°, 90°, 30°x65° | WARRANTY Extended | DIMENSIONS 6.06" x 6.28" x 4.05" |
| RAW LUMENS 6,336 lm (ea) | EFFECTIVE LUMENS 4,440 lm (ea) | METRIC 154mm x 160mm x 103mm |
| WATTAGE / AMPS 60W / 5.0A @12V | VIBRATION RATING 60 Grms | WEIGHT 5.51 lb / 2.5 kg |



| ITEM # | PART # | QTY | BEAM |
|-------------|---------|-----|------|
| MAR-RXP1240 | 9893037 | 1 | 40° |
| MAR-RXP1260 | 9892092 | 1 | 60° |

BEAM PATTERN

MAR-RXP1260 | 9892092 - 60° Beam

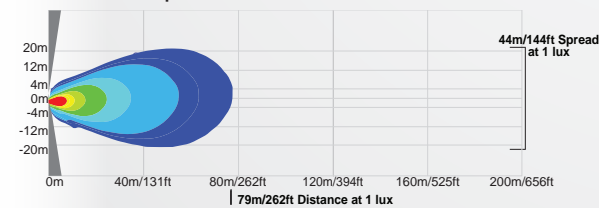

2D VIEW

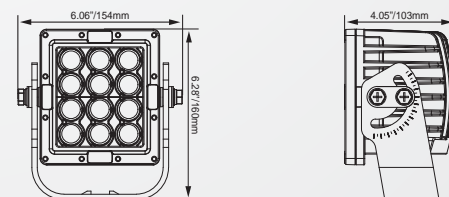

MARINE EXPLORER 7



ITEM #: MIL-EPX760 Shown
PART #: 9892115

STAINLESS STEEL BRACKET WITH UPGRADED ELECTRONICS FOR MARINE USE
Stainless Steel Trunnion Bracket | Single Bolt Mounting | CISPR 25 Rated For Marine Use

| | | |
|--|--|--|
| BEAM PATTERNS 10°, 25°, 40°, 60°, 90°, 30°x65° | WARRANTY Extended | DIMENSIONS 6.43" x 5.50" x 3.12" |
| RAW LUMENS 3,696 lm (ea) | EFFECTIVE LUMENS 2,590 lm (ea) | METRIC 163mm x 140mm x 79mm |
| WATTAGE / AMPS 35W / 2.9A @12V | VIBRATION RATING 15.6 Grms | WEIGHT 4.0 lb / 1.81 kg |



| ITEM # | PART # | QTY | BEAM |
|------------|---------|-----|------|
| MAR-EPX740 | 9893044 | 1 | 40° |
| MAR-EPX760 | 9892115 | 1 | 60° |

BEAM PATTERN

MAR-EPX760 | 9892115 - 60° Beam

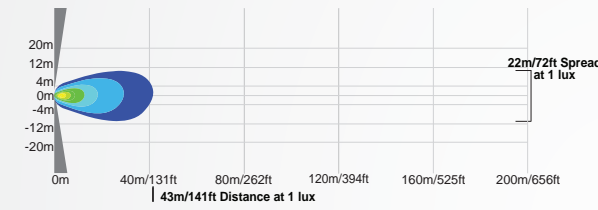

2D VIEW

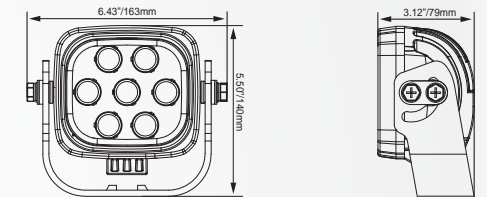



SOLUTION PROCESS

Vision X goes above the expectation to create a solution for the specific needs of its customers. A digital rendering of accurate light output can be requested for specific projects to help demonstrate the effectiveness of our products and help you visualize the solution before purchasing.

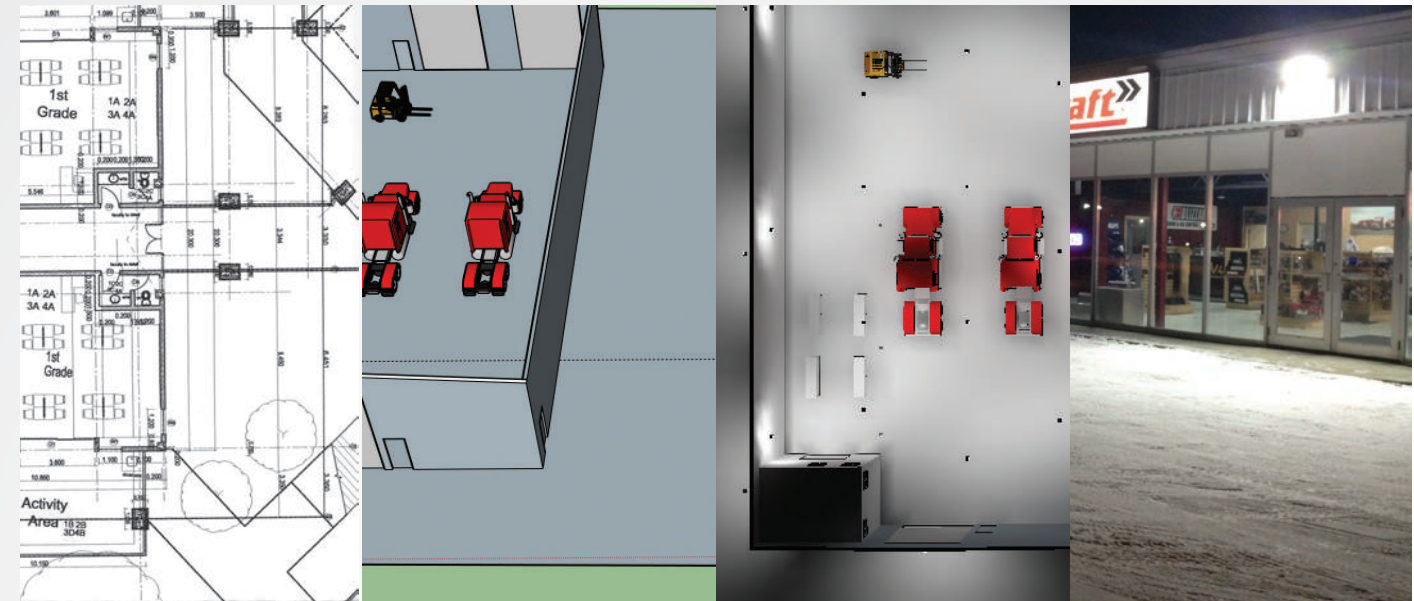

2D BLUEPRINT

Vision X begins a project by gathering information and details that will be used to digitally create the project in order to accurately portray the solution.

3D MODEL

A 3D Model is then built to-scale in order for lighting fixtures to be rendered and placed accordingly. This model is then carried over into the rendering.

SIMULATION RENDER

Prior to implementing a lighting solution, Vision X creates a simulation rendering of the intended result to help envision if the final product will resolve the problem.

SOLUTION

Vision X creates a cost effective solution that provides ample light output while saving energy and valuable time.

CASE STUDIES AVAILABLE

Case Study - Affordable Used Cars Lot

Innovative LED Lighting Technology Helps Alaskan Car Dealer Reduce Costs and Eliminate Light Pollution

Vision X Lighting solutions helped Affordable Used Cars to increase their energy efficiency and reduce light pollution onto neighboring city streets at one of their largest car lots in Fairbanks, Alaska.

By switching from old inefficient lighting technologies to Vision X premium LED lighting technology in 12 of the lot's lighting fixtures, Affordable Used Cars was able to save 136,500 kWh and \$5,500 a year while increasing light output by 30%. The increase in energy efficiency is also preventing the release of 9 metric tons of greenhouse gas emissions from Alaskan coal-fired power plants every year.

About The Project
The Affordable Used Cars lot is located in Fairbanks, Alaska. In an effort to improve light output in the lot, reduce energy inefficiency and cut costs, Affordable Used Cars was interested in replacing its older fixtures with Vision X's LED technology.

The Project At Hand
The Affordable Used Cars lot covers nearly 170,000 square feet, almost all of which is required to be well lit for long periods of time. Lighting requirements are even higher in the winter, when it is dark even during normal day time hours. Previously the lot was accomplished by a lot of 121 old inefficient fixtures that experienced chronic problems, including projecting light onto city streets, which prevented safety from being gained. All together the old fixtures consumed about 216,500 kWh of electricity per year, which results in Alaska high energy costs translated an expense of \$54,800 a year.

Developing A Solution
To identify the problems and alleviate the unnecessary costs being incurred at the Affordable Used Cars lot, Vision X developed a comprehensive lighting solution. All 121 of the old 400-watt fixtures were removed and replaced with easy to install remote LED systems that could be simply bolted onto existing hardware present on the lighting poles. The problem of projecting light onto city streets was also reduced by utilizing special Vision X LED fixtures equipped with digital lenses on the poles designed to limit. Special Vision X LED fixtures used power supplies also helped guarantee safety from operations in the harsh Alaskan climate.

Energy and Cost Savings
In total the upgrade to Vision X LED technology increased energy efficiency by 60% and reduced electrical consumption of the lot by 136,500 kWh a year, which has been reduced utility costs by about \$5,500 a year. The reduction in energy costs alone will result in the cost of the upgrade being recouped in under two years, as well as 140,000 lbs of total savings in 5 years. Affordable Used Cars also received a rebate from the local power utility for going through with this upgrade, according to \$20,000 and a new surplus of nearly 110,000 in 5 years.

Case Study - Van Cours Automotive

Innovative LED Lighting Technology Helps a Washington State Auto Dealer Cut Costs and Improve Light Output

Vision X Lighting solutions is looking into helping Van Cours Automotive increase their energy efficiency, reduce utility costs and improve light output at their shop location in South Hill, WA just outside of Tacoma.

By switching from old inefficient lighting technologies to Vision X premium LED lighting technology in 12 of its existing lighting fixtures, Van Cours will be able to save 131,100 kWh and \$4,800 a year. The increase in energy efficiency will also prevent the release of 9 metric tons of greenhouse gas emissions every year. Vision X LED technology also outputs 30% more light and provides better lighting coverage than the older technology currently in use.

About The Project
The Van Cours Automotive location is an auto detailing workshop located just outside of Tacoma, WA. In an effort to reduce energy inefficiency as well as improve light output and light coverage around the shop's exterior Van Cours is interested in replacing its older fixtures with Vision X LED technology.

The Project At Hand
The lot for which the Van Cours Automotive store is situated covers nearly 15,400 square feet, a sizable amount of which needs to be kept lit during regular hours for security purposes. Currently this task is being performed by inefficient 400W fixtures mounted in walk-in or high poles adjacent to the street. All together the current fixtures consume about 21,000 kWh of electricity per year, which at typical Washington energy rates translates to about \$5,000 a year.

Developing A Solution
To increase light output and the security throughout the lot and alleviate the unnecessary costs being incurred at the Van Cours Automotive store, Vision X developed a comprehensive lighting solution. All 12 of the old 400-watt fixtures will be removed and replaced with easy to install 150-watt LED systems. These LED fixtures are a plug and play solution that can be bolted onto existing fixture locations and plugged into existing hardware. A 3D rendering of the store was also prepared by Vision X to determine what the upgrade would look like.

Energy and Cost Savings
All told the upgrade to Vision X LED technology will increase energy efficiency by 60% and reduce electrical consumption of the store by 131,100 kWh a year, which will result in reduced utility costs by about \$4,800 a year. The reduction in energy costs alone will result in the cost of the upgrade being recouped in just under one year, as well as producing 123,000 lbs of total savings in 5 years.

Case Study - Intermountain Medical Center

Innovative LED Lighting Technology Helps Leading Medical Center Improve Efficiency

Vision X Lighting helped Utah's leading medical campus reduce their carbon energy footprint by 207 metric tons every year with premium LED lighting.

Intermountain Medical Center reduced their annual energy cost by switching to LED lighting saving \$48,705.00 annually just from reworking 278 parking lot light pole fixtures alone. Other projects included walkway lighting and a complete parking garage retrofit.

About The Project
Intermountain Medical Center in Murray Utah is regarded as one of the nation's leading medical centers providing top of the line medical care to individuals from all over the nation. Prior to being retrofitted with LED lighting fixtures, IMC had high consumption 400-watt halogen and metal halide fixtures for their parking lot lighting. Interested in lowering their energy consumption and reducing their carbon footprint, the medical center looked towards Vision X Lighting to replace their existing fixtures with premium LED lighting technology.

The Issue At Hand
Over 800,000 square feet of parking space was using inefficient lighting technology that was increasing the facility's annual energy cost. The Medical Center already had lighting structures in place in the form of light poles and parking garage walls, and wanted to life-cycle the existing infrastructure with a green solution. In addition to upgrading operating cost, Intermountain Medical Center was concerned about their carbon footprint and cost to retrofit. The existing 400-watt lighting fixtures had a duty operation cost of \$21,533 that the medical center felt unnecessary with today's lighting options.

Developing A Solution
In order to fulfill the demands from the Intermountain Medical Center, Vision X was able to develop a plug and play retrofit solution that removed the "leg" of their existing pole-mounted cobra head and replace them with remote, reducing the energy consumption from 400 watts to 150 watts. In addition to the parking lot lighting, walk way lighting was upgraded in the same fashion as well as the parking garage lighting from their two fluorescent to LED fixtures. All applications increased light of the ground by over 30% compared to the fluorescent and metal halide fixtures, and total energy consumption by over 60%.

The LED fixtures implemented by Vision X saved the Intermountain Medical Center \$48,705.00 for each building in annual energy costs. Over the average life of the LED fixtures, Intermountain Medical Center will save \$1,000,750 in energy expenses required to power their light poles.

In addition to more light output, the "compact ratio" or spread of lighting between fixtures was improved while reducing light pollution into the atmosphere.

LUCENT ENGINEERED SOLUTIONS

AC LED lighting solutions for harsh environments with greatly lower annual power consumption and increased efficiency to provide more light output for a more eco-friendly alternative to HPS and metal halide lighting.

INDUSTRIAL LUCENT ENGINEERED SOLUTIONS

ABOUT LUCENT AC TECHNOLOGY

Vision X is able to provide professional solutions due to the effectiveness of CUBE LED Technology. CUBE LEDs differ from standard diodes primarily in size and output per watt. A CUBE LED has a larger surface area, allowing more light to be emitted per individual watt. Additionally, having a larger surface area gives the LED a much wider beam pattern, allowing more lux to illuminate a full 180° wide-spread area.

For larger applications, the PMX Series of AC lights have multiple beam patterns available, and currently produce 106 lumens per watt making them very efficient.

EASE OF INSTALLATION



BUILT IN CONNECTIONS

The Lucent Range of AC products was designed with installation and mounting as key requirements. These products feature multiple mounting options and each features multiple 3/4" NPT threaded connections. So power can be supplied via conduit, or mounted easily as well as additional connections can be passed through the junction box.

HIGH EFFICACY

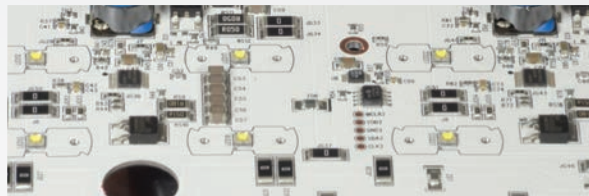

HIGH EFFICACY

Lucent Engineered Solution AC products from Vision X are ideal for structural applications because of the 117 lumen per watt ratio.

AC INTEGRATED



110-277V AC BUILT IN

Structural solutions from Vision X are bundled with power supplies that allow for a 110V-277V AC Power input range, as well as junction boxes to protect the electrical connections.

JUNCTION BOX LIGHT 10W



ITEM #: LSGSM40180 Shown
PART #: LUC-40-1K-10-UD-LV-BL-5K

10-WATT UL C CERTIFIED LED FLOOD LIGHT

Frosted Lens for Smooth Beam | Integrated 110-277V AC Power Input | Conduit or Flush Mounting System

| | | |
|---|-------------------------------------|--|
| BEAM PATTERNS Frosted Lens | WARRANTY Extended | DIMENSIONS 4.41" x 4.41" x 3.94" |
| TESTED LUMENS 1,050 lm | INPUT VOLTAGE 110-277V AC | METRIC 112mm x 112mm x 100mm |
| WATTAGE / AMPS @110V AC 10W / 0.09A | VIBRATION RATING 8.7 Grms | WEIGHT 2.05 lb / 0.93 kg |



| ITEM # | QTY |
|------------|-----|
| LSGSM40180 | 1 |

BEAM PATTERN

LSGSM40180 - 180° Beam

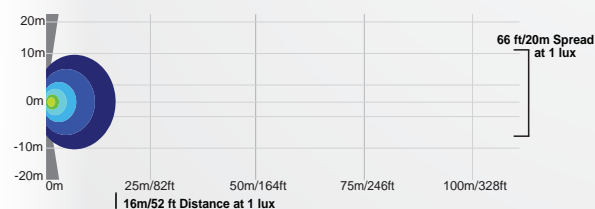

2D VIEW

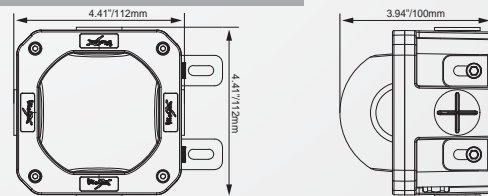

JUNCTION BOX LIGHT 60W



ITEM #: LSG0160180 Shown
PART #: LUC-60-6k-60-UD-LV-BL-5K

LOW MOUNT OR WALL PACK LED LIGHT FIXTURE

High Efficacy CUBE LEDs | Integrated 110-277V AC Power Input | Integrated NPT For Conduit Installation

| | | |
|---|--------------------------------------|---|
| BEAM PATTERNS 180° | WARRANTY Extended | DIMENSIONS 11.34" x 7.09" x 2.95" |
| TESTED LUMENS 5,294 lm | INPUT VOLTAGE 110-277V AC | METRIC 288mm x 180mm x 75mm |
| WATTAGE / AMPS @110V AC 60W / 0.55A | VIBRATION RATING 15.6 Grms | WEIGHT 8.38 lb / 3.8 kg |



| ITEM # | HOUSING COLOR |
|------------|---------------|
| LSG0160180 | Gray |

BEAM PATTERN

LSG0160180 - 180° Beam

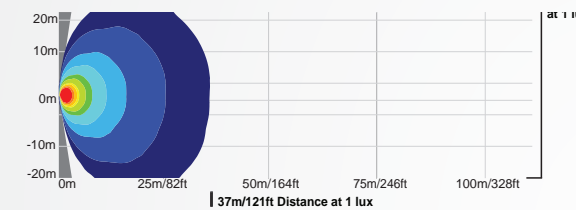

2D VIEW

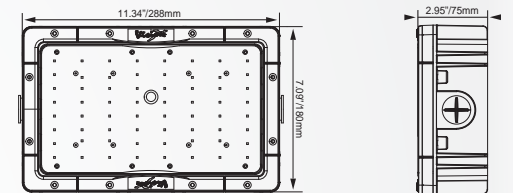

HIGH BAY LIGHT



ITEM #: LSG063060 Shown
PART #: LUC-30-15K-150-FD-LV-BL-5K

HARSH ENVIRONMENT 500-WATT AND 1000-WATT REPLACEMENT FIXTURES

Harsh Environment PC Lens | Integrated 90-264V AC Power Input | Multiple Mounting Options

| | | |
|--|--------------------------------------|---|
| BEAM PATTERNS 25°, 40°, 60°, 90° | WARRANTY Extended | DIMENSIONS 11.38" x 6.88" x 8.46" |
| TESTED LUMENS 15,368 lm | INPUT VOLTAGE 110-277V AC | METRIC 363mm x 297mm x 174.5mm |
| WATTAGE / AMPS @110V AC 180W / 1.63A | VIBRATION RATING 15.6 Grms | WEIGHT 29.17 lb / 13.23 kg |



| ITEM # | LEDS | TESTED LUMENS | BEAM PATTERN |
|-----------|------|---------------|--------------|
| LSG063060 | 30 | 15,368 lm | 60° |
| LSG066060 | 60 | 29,185 lm | 60° |

BEAM PATTERN

LSG063060 - 60° Beam

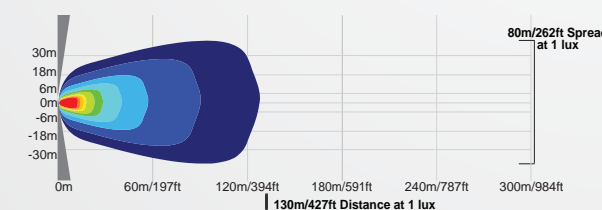

2D VIEW

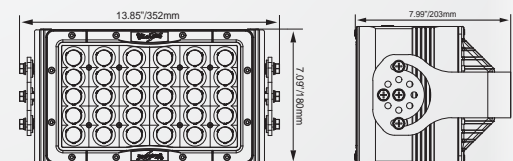

INDUSTRIAL CUBE SERIES

ABOUT CUBE LED TECHNOLOGY

Vision X is able to provide professional solutions due to the effectiveness of CUBE LED Technology. CUBE LEDs differ from standard diodes primarily in size and output per watt. A CUBE LED has a larger surface area, allowing more light to be emitted per individual watt. Additionally, having a larger surface area gives the LED a much wider beam pattern, allowing more lux to illuminate a more wide-spread area.

Currently, Vision X CUBE LEDs output an impressive 117 lumens per watt, making them the ideal LED for structural applications.

HIGH TEMP GLASS



HEAT RESISTANT

The optional Soda-Lime Glass lens helps protect the LEDs, as well as internal components, from extreme heat. Vision X recommends Soda-Lime Glass for applications that require intense heat.

117 LUMENS PER WATT

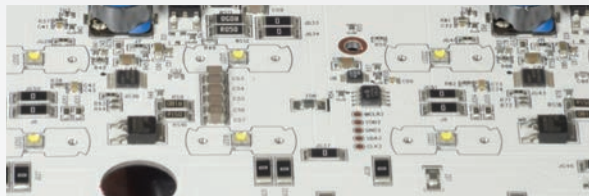

HIGH EFFICACY

CUBE LEDs from Vision X are ideal for structural applications because of the 117 lumen per watt ratio. We're able to get more light output for a lower cost than standard LEDs.

PACKAGES



INTEGRATED POWER SUPPLIES

Structural solutions from Vision X are bundled with power supplies that allow for a 110V-277V AC Power input range, as well as junction boxes to protect the electrical connections.



CUBE PITMASTER 320 LED



ITEM #: CPM320PE Shown
PART #: 9893051

320 CUBE LEDs FOR 37,440 LUMENS & UNMATCHED BEAM SPREAD
High Efficacy CUBE LEDs | AC Power Supplies Included | High-Temp Glass Lens Option

| | | |
|---|--------------------------------------|--|
| BEAM PATTERNS 180° | WARRANTY Extended | DIMENSIONS 14.21" x 11.54" x 8.40" |
| TESTED LUMENS 37,440 lm (ea) | VIBRATION RATING 15.6 Grms | METRIC 361mm x 293mm x 213mm |
| WATTAGE / AMPS @110V AC 320W / 2.9A | INPUT VOLTAGE 110-277V AC | WEIGHT 29.17 lb / 13.23 kg |



| ITEM # | PART # | LEDS | LENS | WEIGHT |
|-----------|---------|------|-----------------|------------------|
| CPM320PE | 9893051 | 320 | Polycarbonate | 26.46 lb / 12 kg |
| CPM320GPE | 9893068 | 320 | High-Temp Glass | 26.46 lb / 12 kg |

BEAM PATTERN

CPM320PE | 9893051 - 180° Beam

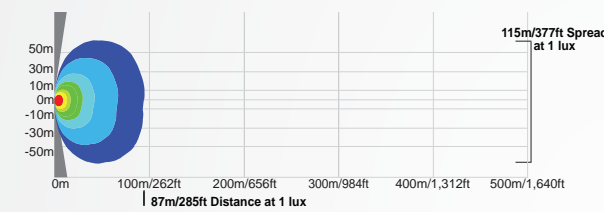

2D VIEW

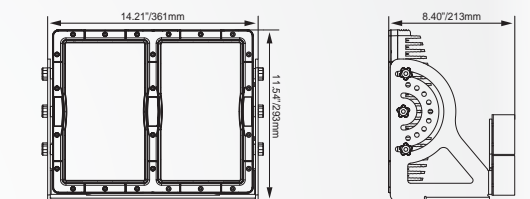

CUBE PITMASTER 160 LED



ITEM #: CPM160PE Shown
PART #: 9893075

160 CUBE LEDs FOR 18,720 LUMENS & UNMATCHED BEAM SPREAD
High Efficacy CUBE LEDs | AC Power Supplies Included | High-Temp Glass Lens Option

| | | |
|--|--------------------------------------|---|
| BEAM PATTERNS 180° | WARRANTY Extended | DIMENSIONS 11.96" x 7.52" x 6.46" |
| TESTED LUMENS 18,720 lm (ea) | VIBRATION RATING 15.6 Grms | METRIC 297mm x 191mm x 164mm |
| WATTAGE / AMPS @110V AC 160W / 1.45A | INPUT VOLTAGE 110-277V AC | WEIGHT 15.05 lb / 6.82 kg |



| ITEM # | PART # | LEDS | LENS | WEIGHT |
|-----------|---------|------|-----------------|-------------------|
| CPM160PE | 9893075 | 160 | Polycarbonate | 12.34 lb / 5.6 kg |
| CPM160GPE | 9893082 | 160 | High-Temp Glass | 12.34 lb / 5.6 kg |

BEAM PATTERN

CPM160PE | 9893075 - 180° Beam

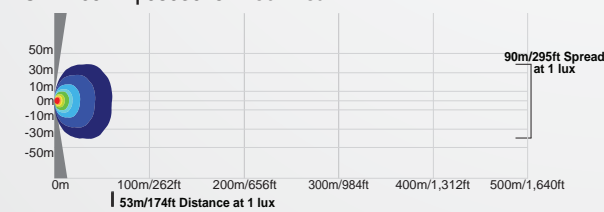

2D VIEW

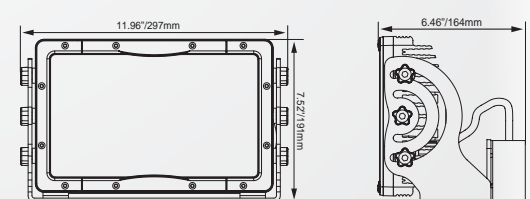

CUBE SHOCKWAVE DUAL

PREMIUM FLUORESCENT REPLACEMENT WITH 210° FULL-SPREAD BEAM PATTERN
High Efficacy CUBE LEDs | Power Supply Included | Clear Bezel For Wider Dispersion



ITEM #: CSWD192PE Shown
PART #: 9893105

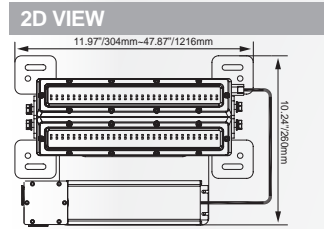

| | | |
|--|--------------------------------------|-----------------------------------|
| BEAM PATTERNS 210° | WARRANTY Extended | DIMENSIONS 12" 24" |
| TESTED LUMENS 10,848 lm 21,696 lm | INPUT VOLTAGE 110-277V AC | METRIC 304mm 608mm |
| WATTAGE / AMPS @110V AC 96W / 0.87A 192W / 1.75A | VIBRATION RATING 15.6 Grms | WEIGHT 5.8 lb 11.6 lb |



| ITEM # | PART # | LENGTH | LEDS | RAW LUMENS | WATTS | AMP DRAW | WEIGHT |
|-----------|---------|----------|------|------------|-------|----------|----------|
| CSWD96PE | 9893099 | Dual 12" | 96 | 10,848 lm | 96 | 2A | 5.80 lb |
| CSWD192PE | 9893105 | Dual 24" | 192 | 21,696 lm | 192 | 4A | 11.60 lb |

MOUNTING SOLUTIONS

Multiple mounting solutions have been created for a variety of applications in which the CUBE LED technology excels.

Additionally, Vision X can create custom mounting to suit your applications and help lower the cost of retrofitting a project with LED Lighting.

Flat Mount



Hanging Mount



Cobra Head Pole Mount



Wall Pack Mount



| ITEM # | PART # | FITS | APPLICATION | MATERIAL |
|-----------------------|---------|--------------|--|----------|
| P-PMX30FLUSHMOUNT | 9131085 | PitMaster 30 | For Use In Low Bay Applications | Steel |
| P-PMX30HANGINGMOUNT | 9131177 | PitMaster 30 | For Hanging Mount Applications | Steel |
| P-PMX30COBRAHEADMOUNT | 9130996 | PitMaster 30 | For Street Lighting Or Light Pole Applications | Steel |
| P-PMX60HPLATE | 9893150 | PitMaster 60 | For Hanging Mount Applications | Steel |

CUBE SHOCKWAVE SINGLE

PREMIUM FLUORESCENT REPLACEMENT WITH 180° FULL-SPREAD BEAM PATTERN
High Efficacy CUBE LEDs | Power Supply Included | Clear Bezel For Wider Dispersion



ITEM #: CSWS192 Shown
PART #: 9893143

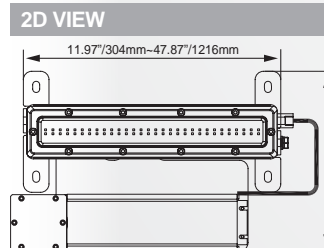

| | | |
|--|--------------------------------------|---|
| BEAM PATTERNS 180° | WARRANTY Extended | DIMENSIONS 12" 24" 36" 48" |
| TESTED LUMENS 5,424 10,848 16,272 21,696 | INPUT VOLTAGE 110-277V AC | METRIC 304mm 608mm 912mm 1216mm |
| WATTAGE / AMPS @110V AC 92-371W / 0.84-3.37A | VIBRATION RATING 15.6 Grms | WEIGHT 3.1 lb 6.2 lb 9.2 lb 12.2 lb |



| ITEM # | PART # | LENGTH | LEDS | RAW LUMENS | WATTS | AMP DRAW | WEIGHT |
|-----------|---------|------------|------|------------|-------|----------|---------|
| CSWS48PE | 9893112 | Single 12" | 48 | 5,424 lm | 48 | 0.44A | 3.1 lb |
| CSWS96PE | 9893129 | Single 24" | 96 | 10,848 lm | 96 | 0.87A | 6.2 lb |
| CSWS144PE | 9893136 | Single 36" | 144 | 16,272 lm | 144 | 1.31A | 9.2 lb |
| CSWS192PE | 9893143 | Single 48" | 192 | 21,696 lm | 192 | 1.75A | 12.2 lb |





INDUSTRIAL ACCESSORIES

Vision X offers various accessories including vehicle ID boards, LED reflector utility lights, and the new addition of our video extreme LED light.

CONSTRUCTION / ROADWORK AREA LIGHT



ITEM #: PVR2CSWD96AC Shown
PART #: 9898384

POLE-MOUNTED PORTABLE LED LIGHT SOLUTION

Includes 5' to 9' Extendable Pole | Flexible Ball Joints | Folds into Included Storage Case

| | | |
|--|--------------------------------------|---|
| BEAM PATTERN 210° | WARRANTY Extended | LIGHT DIMENSIONS 11.81" x 4.65" x 1.89" |
| TESTED LUMENS 21,696 lm | INPUT VOLTAGE 110-277V AC | LIGHT METRIC 300mm x 118mm x 48mm |
| WATTAGE / AMPS @110V AC 192W / 1.74A | VIBRATION RATING 15.6 Grms | MAXIMUM POLE EXTENSION 9' / 2.4m |



| ITEM # | PART # |
|--------------|---------|
| PVR2CSWD96AC | 9898384 |



UTILITY FLOOD



ITEM #: XIL-UF32 Shown
PART #: 4001824

LIGHTWEIGHT UTILITY LED LIGHT WITH 120° FLOOD PATTERN
0.5A Amp Draw At 12V | Available In White, Amber, Blue, Green, Red | Universal Applications

| | | |
|------------------------------------|--|---|
| BEAM PATTERNS 120° | WARRANTY Extended | DIMENSIONS 3.4" x 1.9" x 0.9" |
| RAW LUMENS 500 lm (ea) | EFFECTIVE LUMENS 456 lm (ea) | METRIC 86mm x 48mm x 23mm |
| WATTAGE / AMPS 6W / 0.5A | VIBRATION RATING 8.6 Grms | WEIGHT 0.41 lb / 0.19 kg |



| ITEM # | PART # | COLOR | ITEM # | PART # | COLOR |
|-----------|---------|-------|-----------|---------|--------|
| XIL-UF32 | 4001824 | White | XIL-UF32G | 9121277 | Green |
| XIL-UF32A | 9119298 | Amber | XIL-UF32R | 9121369 | Red |
| XIL-UF32B | 9121185 | Blue | XIL-UF32P | 9135045 | Purple |

AVAILABLE COLORS



VIDEO EXTREME LIGHT



ITEM #: VEL-4460CA72SS Shown
PART #: 9889856

ILLUMINATES AREA WHILE SIMULTANEOUSLY PROVIDING LIVE VIDEO FEED
Kit Available With 7" Monitor (VEL-CAMMON7KIT) | Glare Blocking Shield | Infrared Model Available

| | | |
|-------------------------------------|--|---|
| BEAM PATTERNS 60° | WARRANTY Extended | DIMENSIONS 4.71" x 6.28" x 3.14" |
| RAW LUMENS 3,168 lm (ea) | EFFECTIVE LUMENS 2,590 lm (ea) | METRIC 119.6mm x 159.5mm x 79.7mm |
| WATTAGE / AMPS 30W / 2.5A | VIBRATION RATING 15.6 Grms | WEIGHT 2.43 lb / 1.1 kg |



| ITEM # | PART # | TYPE | ITEM # | PART # | LED TYPE |
|----------------|---------|-------|----------------------|---------|----------|
| VEL-4460CA72SS | 9889856 | White | VEL-4460CA72SS.IR850 | 9889863 | Infrared |
| VEL-CAMMON7KIT | 9892863 | White | VEL-M7 (7" Monitor) | 9889870 | - |

BEAM PATTERN

VEL-4460CA72SS | 9889856 - 60° Beam

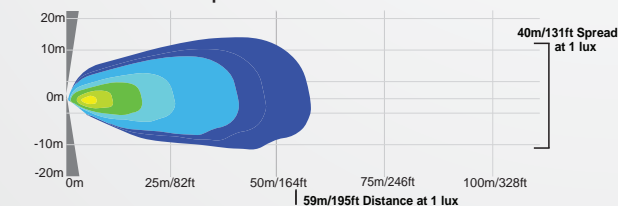

2D VIEW

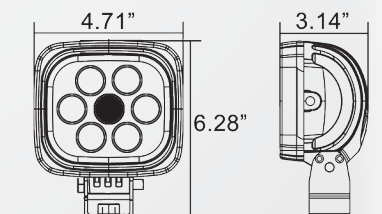

HEAVY DUTY LED BEACON



ITEM #: MIL-HDBA Shown
PART #: 9895123

180 LED HEAVY DUTY STROBING SAFETY BEACON
360° Visibility | Rugged Die-Cast Aluminum Housing | Shatterproof Polycarbonate Lens

| | | |
|---|--------------------------------------|--|
| LEDS 180 | WARRANTY Extended | DIMENSIONS 5.31" x 5.12" x 5.31" |
| AREA OF EFFECT Full 360° Visibility | FLASH TYPE Dual | METRIC 135mm x 130mm x 135mm |
| WATTAGE / AMPS 36W / 3.0A | VIBRATION RATING 15.6 Grms | WEIGHT 2.96 lb / 1.34 kg |



| ITEM # | PART # | COLOR |
|----------|---------|-------|
| MIL-HDBA | 9895123 | Amber |
| MIL-HDBB | 9893167 | Blue |
| MIL-HDBG | 9895314 | Green |

| ITEM # | PART # | COLOR |
|----------|---------|-------|
| MIL-HDBR | 9893174 | Red |
| MIL-HDBW | 9895130 | White |

36 LED STROBE BEACON (9V)



ITEM #: XIL-UBB36A Shown
PART #: 9895147

3 TIMES THE OUTPUT OVER STANDARD LED BEACONS
Powered By 2x 9V Batteries | Magnetic Base | Available In Five Colors

| | | |
|---|--------------------------------------|--|
| LEDS 36 | WARRANTY Extended | DIMENSIONS 5.25" x 3.81" x 2.86" |
| AREA OF EFFECT Full 360° Visibility | FLASH TYPE Dual | METRIC 133mm x 97mm x 73mm |
| WATTAGE / AMPS 7.2W / 0.8A @9V | VIBRATION RATING 15.6 Grms | WEIGHT 0.44 lb / 0.2 kg |



| ITEM # | PART # | COLOR |
|------------|---------|-------|
| XIL-UBB36A | 9895147 | Amber |
| XIL-UBB36B | 9895161 | Blue |
| XIL-UBB36G | 9895185 | Green |

| ITEM # | PART # | COLOR |
|------------|---------|-------|
| XIL-UBB36R | 9895345 | Red |
| XIL-UBB36W | 9895369 | White |

36 LED STROBE BEACON



ITEM #: XIL-UB36A Shown
PART #: 9895321

3 TIMES THE OUTPUT OVER STANDARD LED BEACONS
Weatherproof Deutsch Connector | Magnetic Base | Available In Five Colors

| | | |
|---|--------------------------------------|--|
| LEDS 36 | WARRANTY Extended | DIMENSIONS 5.25" x 3.81" x 2.86" |
| AREA OF EFFECT Full 360° Visibility | FLASH TYPE Dual | METRIC 133mm x 97mm x 73mm |
| WATTAGE / AMPS 7.2W / 0.8A @9V | VIBRATION RATING 15.6 Grms | WEIGHT 0.44 lb / 0.2 kg |

| ITEM # | PART # | COLOR |
|-----------|---------|-------|
| XIL-UB36A | 9895321 | Amber |
| XIL-UB36B | 9895154 | Blue |
| XIL-UB36G | 9895178 | Green |

| ITEM # | PART # | COLOR |
|-----------|---------|-------|
| XIL-UB36R | 9895338 | Red |
| XIL-UB36W | 9895352 | White |

LED VEHICLE ID BOARD



ITEM #: MIL-ID03R & MIL-ID02A Shown
PART #: 9892184 & 9892207

ALLOWS FOR QUICK VEHICLE IDENTIFICATION IN ANY WEATHER CONDITION
195 Crisp LEDs Per Digit | Magnetic Sensor To Change Digits | Engineered For 24/7 Operation

| ITEM # | PART # | DIGITS | COLOR |
|-----------|---------|--------|-------|
| MIL-ID03A | 9892719 | 3 | Amber |
| MIL-ID03R | 9892184 | 3 | Red |

| ITEM # | PART # | DIGITS | COLOR |
|-----------|---------|--------|-------|
| MIL-ID02A | 9892207 | 2 | Amber |
| MIL-ID02R | 9892191 | 2 | Red |

3-DIGIT 2D VIEW

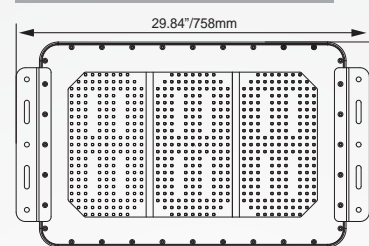

2-DIGIT 2D VIEW

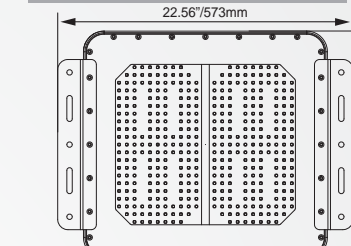

MINI INCIDENT RESPONSE CASE



ITEM #: XLS-M2DURA460BP Shown
PART #: 9891026

PORTABLE EMERGENCY SCENE LIGHTING

Deploys In 30 Seconds Without Tools | Self-Contained Power Cell | 12 Hour Run Time

| | | |
|-----------------------------------|--------------------------------|--|
| POLE LENGTH 96" / 2.44m | WARRANTY Standard | DIMENSIONS 17.5" x 25" x 8" |
| RUN TIME Up To 12 Hours | CHARGE TIME 10 Hours | METRIC 445mm x 635mm x 203mm |

| ITEM # | PART # | LIGHTS INCLUDED | RAW LUMENS | RUN TIME |
|-----------------|---------|-----------------|------------|-----------|
| XLS-M2DURA460BP | 9891026 | 2x DURA-460 | 5,916 lm | 12 Hours |
| XLS-M4S1160BP | 9891033 | 4x XIL-S1160 | 1,720 lm | 12 Hours |
| XLS-M2UMX4460BP | 9891040 | 2x XIL-UMX4460 | 6,902 lm | 7.5 Hours |

INDUSTRIAL / MARINE DOME LIGHT



ITEM #: XIL-DL5RW Shown
PART #: 9898704

| | | |
|---|-------------------------------------|--|
| BEAM PATTERNS 180° | WARRANTY Extended | DIMENSIONS 6.81" x 6.81" x 1.18" |
| RAW LUMENS 452 lm (ea) | EFFECTIVE LUMENS 316 lm | METRIC 173mm x 173mm x 30mm |
| WATTAGE / AMPS 4W / 0.33A @12V DC | VIBRATION RATING 8.6 Grms | WEIGHT 0.60 lb / 270g |



| ITEM # | PART # | QTY | COLORS |
|-----------|---------|-----|---------------|
| XIL-DL5RW | 9898704 | 1 | WHITE AND RED |