

TRUCK STORAGE EQUIPMENT



UNMATCHED PROTECTION



# WHAT DO THE MOST ADMIRABLE TRADESMEN AND CONTRACTORS HAVE IN COMMON?



## WEATHER GUARD® TRUCK EQUIPMENT



**YOU KNOW THE ONES.** Just like you, they understand that being at the top goes beyond skill and talent. It's about projecting competence every step of the way. It starts with buying the best possible truck. From there, it's all about fitting it with the stylish, organized security of WEATHER GUARD® Truck Boxes, Ladder Racks, Cab Protectors and In-Bed Storage Solutions. WEATHER GUARD® Truck Equipment. *The Ultimate in Protection.*



**THE DEFENDER SERIES** is an affordable line of truck boxes built with the professional grade durability, security, and weather resistance you expect from the WEATHER GUARD® brand.



# TABLE OF CONTENTS

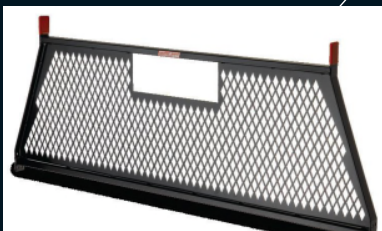

<b>WEATHER GUARD® TRUCK BOXES. . . . .</b>	<b>4</b>
▪ Saddle Boxes . . . . .	4
Lighted Boxes . . . . .	6
Cross Boxes . . . . .	8
Pork Chop Boxes . . . . .	9
All-Purpose Chests . . . . .	10
Lo-Side Boxes . . . . .	12
Hi-Side Boxes . . . . .	14
Super-Side Boxes . . . . .	16
Truck Box Accessories . . . . .	17
Gear Up™ Truck Fit Guide . . . . .	18
<b>DEFENDER SERIES™ . . . . .</b>	<b>20</b>
▪ Saddle Boxes . . . . .	21
Side Boxes/Universal Chests . . . . .	22
Truck Fit Guide . . . . .	23
<b>UNDERBED BOXES . . . . .</b>	<b>24</b>
▪ Steel Underbed Boxes . . . . .	24
Aluminum Underbed Boxes . . . . .	25
<b>IN-BED STORAGE SOLUTIONS . . . . .</b>	<b>26</b>
▪ PACK RAT® Drawer Units . . . . .	26
BED RAT® Sliding Platform . . . . .	29
Transfer Tanks/Accessories . . . . .	30
<b>BED-MOUNTED SOLUTIONS . . . . .</b>	<b>32</b>
▪ Steel Truck Rack . . . . .	32
ATR® – Aluminum Truck Racks . . . . .	34
Service Body Ladder Racks . . . . .	35
WEEKENDER® Truck Rack . . . . .	36
▪ PROTECT-A-RAIL® Cab Protectors/ . . . . .	37
Mounting Accessories . . . . .	37
Truck Rack Upfit Guide . . . . .	39
<b>CONFIGURATIONS GUIDE. . . . .</b>	<b>40</b>
<b>REPLACEMENT PARTS . . . . .</b>	<b>41</b>



## LIMITED LIFETIME WARRANTY

### WEATHER GUARD® IS THE ULTIMATE IN PROTECTION OF SADDLE BOXES

Like you, WEATHER GUARD® Saddle Boxes keep getting better and better. Now with more options and features than ever. Like industry-leading security with our exclusive tamper-resistant EXTREME PROTECTION™ LOCK. WEATHER GUARD® Saddle Boxes are the most popular truck storage option due to ease of installation, maximum bed clearance, and of course legendary durability. Constructed of either steel or aluminum diamond plate and finished with an ARMOR TUF® Powder Coat in Clear, Gloss Black, or Textured Black that lasts for years and looks great.

#### ALUMINUM DIAMOND PLATE



Clear ARMOR TUF® Powder Coat



Textured Black ARMOR TUF® Powder Coat



Gloss Black ARMOR TUF® Powder Coat

#### STEEL



Brite White ARMOR TUF® Powder Coat



Gloss Black ARMOR TUF® Powder Coat

Choice Options: X = 0 (Clear) or X = 3 (Bright White) or X = 5 (Gloss Black) or X = 52 (Textured Black)

## THE ULTIMATE IN PROTECTION

### Maximum Durability

- 1 ARMOR TUF® Powder Coat Protection
- 2 Heavy Gauge Five Piece Welded Construction *puts strength where it is needed most*
- 3 Welded Gas Strut Shields *Aluminum shield protects gas strut from damage*

### Extreme Security

- 4 EXTREME PROTECTION™ LOCK *tamper-resistant retracting lock helps protect against break-ins*
- 5 Dual Stage Automotive Rotary Latch and Heavy Duty Looped Strikers *provide extreme security*
- 6 Heavy Duty C-Channel Reinforced Lid Construction and Lid Overlap *Aluminum C-Channels welded into lid provide added pry resistance*

### Ultimate Weather Resistance

- 7 Automotive D-Shaped Ribbed Rubber Weather Stripping *keeps its shape even after years of service*
- 8 Lid Cover Overlap *prevents direct water intrusion*

## INTEGRATED FEATURES

Convenient attachment points *secures materials and tools in pickup bed*

Sliding Steel Tray

Removable Parts Bin

UNMATCHED PROTECTION

# SADDLE BOXES



## FULL-SIZE STANDARD

11.3 CUBIC FEET

### ALUMINUM

127-0-02 127-52-02

127-5-02

Ship Weight: 86 Lbs.

### STEEL

126-3-02

126-5-02

Ship Weight: 133 Lbs.



## FULL-SIZE EXTRA WIDE

15.3 CUBIC FEET

### ALUMINUM

117-0-02 117-52-02

117-5-02

Ship Weight: 105 Lbs.

### STEEL

116-3-02

116-5-02

Ship Weight: 160 Lbs.

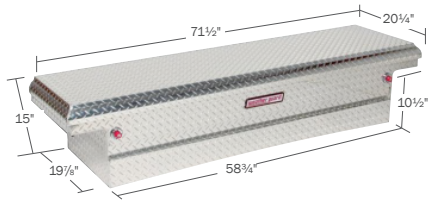

## FULL-SIZE LOW PROFILE

8.8 CUBIC FEET

### ALUMINUM

121-0-01 121-52-01

121-5-01

Ship Weight: 122 Lbs.

### STEEL

120-3-01

120-5-01

Ship Weight: 122 Lbs.

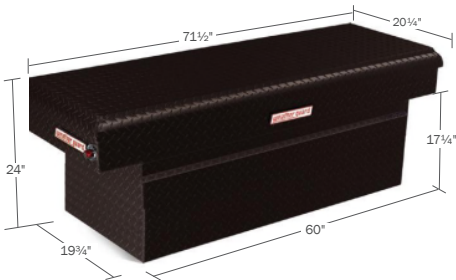

## FULL-SIZE EXTRA DEEP

15.1 CUBIC FEET

### ALUMINUM

123-0-01

123-5-01

Ship Weight: 94 Lbs.

### STEEL

128-3-01

Ship Weight: 148 Lbs.



## COMPACT STANDARD

6.4 CUBIC FEET

NOTE: This product has different dimensions for ALUMINUM and STEEL.

### ALUMINUM

154-0-01

154-5-01

Ship Weight: 68 Lbs.

### STEEL

156-3-01

Ship Weight: 100 Lbs.



## COMPACT LOW-PROFILE

8.7 CUBIC FEET

### ALUMINUM

131-0-01

131-5-01

Ship Weight: 76 Lbs.

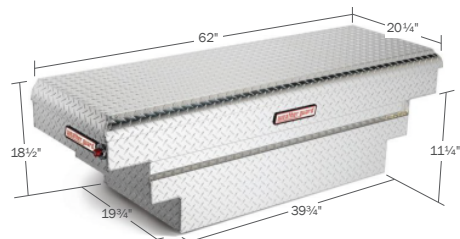

## COMPACT DEEP

8.9 CUBIC FEET

### ALUMINUM

137-0-01

137-5-01

Ship Weight: 79 Lbs.

### STEEL

136-3-01

Ship Weight: 115 Lbs.

# LIGHTED BOXES

## WIRED FOR WORK.



**AVAILABLE NOW**  
**LIGHTED BOXES & LIGHT UPGRADE KITS**

### DURABLE

*Designed for all phases of the job*

- 1 Sealed automotive grade OEM connectors
- 2 Integrated bezel protects LEDs from impact
- 3 Water proof and dust proof – meets IP66 requirement
- 4 Long life LEDs – lamp life of minimum 20,000 hrs continuous use

### VISIBILITY

*Long Lasting Design*

- 5 600 Lumens total = 40 watt incandescent bulb
- 6 160 degree viewing angle to cover full box when lit
- 7 Frosted light diffuser, eliminates hot spots or glare
- 8 Lights placed in rear and pointed at the body to minimize shadows

### EASY INSTALL

*Solution that works for your truck*

- 9 Quick connect, easy install wiring harness. 30 min install
- 10 Automatic magnetic switch
- 11 Does not void warranty to your vehicle
- 12 Supports all full size trucks and all major OEM builders
- 13 Upgradability & Flexibility

**weather guard**

**LIGHTED BOXES**

with **PowerSync** Technology

5 Magnetic switch

4 Impact resistant bezel

1 Quick connect easy to install wiring harness

2 Built w/ OEM Automotive grade connectors with weather seal

3 Frosted LEDs

6

**weather guard**

# LIGHTED BOXES

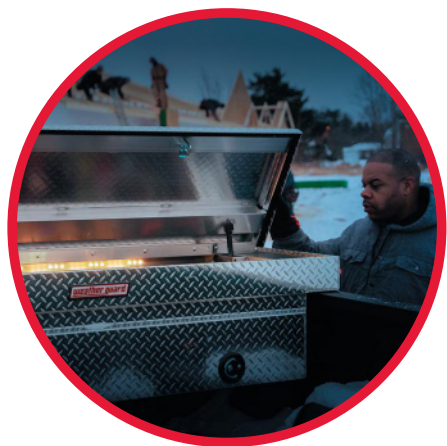

**Brilliant, dependable lighting so you can find what you're looking for any time of day...or night!**

- Supports all full size trucks in North America
- Easy to install Wiring Harness
- Automotive OEM grade connectors with weather seal
- Integrated protective aluminum bezel
- Ultra bright LED (600 lumens total)
- Long-lasting and low power consumption (20,000-35,000 hrs)
- Wide light dispersion with 160° viewing angle for maximum visibility
- Frosted light diffuser
- Meets IP66 requirement







## 127 SADDLE BOX with Integrated Lighting

SKU	PRODUCT	FINISH	WIRING HARNESS
127-0-02LS	Lighted 127 Saddle Box	Clear	Standard Wiring Harness
127-0-02LF	Lighted 127 Saddle Box	Clear	Fuse Box Wiring Harness

SKU	PRODUCT	FINISH	WIRING HARNESS
127-52-02LS	Lighted 127 Saddle Box	Textured Matte Black	Standard Wiring Harness
127-52-02LF	Lighted 127 Saddle Box	Textured Matte Black	Fuse Box Wiring Harness

## LIGHT UPGRADE KITS for Standard WG 127 Saddle Box

	SKU	PRODUCT	FINISH	WIRING HARNESS		SKU	PRODUCT	FINISH	WIRING HARNESS
	827-0-02LS	Lights upgrade kit for 127	Clear	Standard Wiring Harness		827-52-02LS	Lights upgrade kit for 127	Textured Matte Black	Standard Wiring Harness
	827-0-02LF	Lights upgrade kit for 127	Clear	Fuse Box Wiring Harness		827-52-02LF	Lights upgrade kit for 127	Textured Matte Black	Fuse Box Wiring Harness

UNMATCHED PROTECTION

# CROSS BOXES



## CROSS BOX KEY FEATURES

- 1 **EXTREME PROTECTION™ LOCK** tamper-resistant retracting lock helps protect against break-ins
- 2 Two independent covers access from either side of truck
- 3 Dual Stage Automotive Rotary Latch and Heavy Duty Looped Strikers provide extreme security
- 4 Heavy Duty C-Channel Reinforced Lid Construction for maximum durability
- 5 Automotive D-Shaped Ribbed Rubber Weather Stripping keep its shape even after years of service
- 6 ARMOR TUF® Powder Coat Protection
- 7 Heavy Gauge Five Piece Welded Construction puts strength where it is needed most

## LIMITED LIFETIME WARRANTY

### QUICK ACCESS FROM EITHER SIDE OF THE TRUCK BED

WEATHER GUARD® Cross Boxes allow access from either side of the truck with two independent covers. A productivity-aiding plus is an automotive-style latch that allows you to pop each cover open with one hand. These rugged, versatile boxes are available in steel with a Brite White or Gloss Black ARMOR TUF® Powder Coat, or in aluminum diamond plate (Clear or Gloss Black) and a full weather seal keeps out the elements. Cross Boxes can be used in combination with Lo-Side or Super-Lo Boxes for even more storage.

### FULL-SIZE ! 11.3 CUBIC

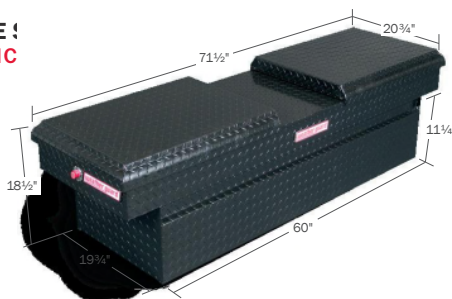

#### ALUMINUM

- 124-0-01
  - 124-5-01
- Ship Weight: 78 Lbs.

#### STEEL

- 125-3-01
  - 125-5-01
- Ship Weight: 122 Lbs.

### FULL-SIZE EXTRA WIDE 15.3 CUBIC

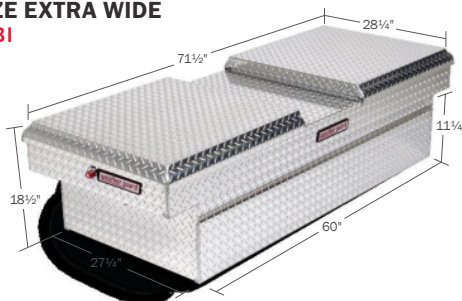

#### ALUMINUM

- 114-0-01
  - 114-5-01
- Ship Weight: 92 Lbs.

#### STEEL

- 115-3-01
- Ship Weight: 150 Lbs.



# PORK CHOP BOXES

## PORK CHOP BOX KEY FEATURES

- 1 **EXTREME PROTECTION™ LOCK**  
tamper-resistant retracting lock helps protect against break-ins
- 2 **90° Cover opening**  
for easy access
- 3 **Heavy Duty C-Channel Reinforced Lid Construction**  
for maximum durability
- 4 **Automotive D-Shaped Ribbed Rubber Weather Stripping**  
keeps its shape even after years of service
- 5 **ARMOR TUF® Powder Coat Protection**



**LIMITED LIFETIME WARRANTY**

### DRIVER/PASSENGER-SIDE STANDARD 2.1 CUBIC FEET

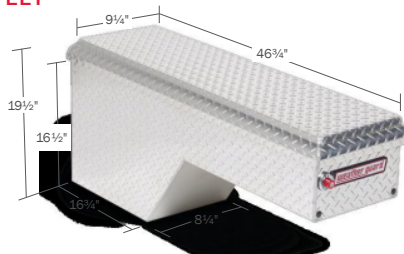

#### ALUMINUM

- 170-0-01 (driver)
- 171-0-01 (passenger)
- 170-5-01 (driver)
- 171-5-01 (passenger)

Ship Weight: 36 Lbs.

#### STEEL

- 160-3-01 (driver)
- 161-3-01 (passenger)

Ship Weight: 53 Lbs.

### DRIVER/PASSENGER-SIDE WIDE 3.4 CUBIC FEET

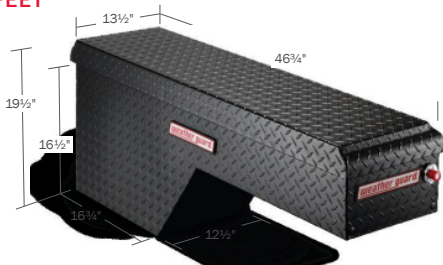

#### ALUMINUM Ship Weight: 42 Lbs.

- 172-0-01 (driver)
- 173-0-01 (passenger)
- 172-5-01 (driver)
- 173-5-01 (passenger)

Ship Weight: 66 Lbs.

#### STEEL

- 162-3-01 (driver)
- 163-3-01 (passenger)

## MAKING USE OF SPACE AROUND THE WHEEL WELLS

WEATHER GUARD® has figured out a way to make use of otherwise unutilized truck bed space above and behind the wheel wells with these uniquely shaped boxes. They establish a great location for storing small parts and hand tools to which you often need quick, easy access. They're constructed of either steel—protected with a Brite White ARMOR TUF® Powder Coat finish—or aluminum diamond plate (Clear or Gloss Black). Pork Chop Boxes leave plenty of room in the truck bed for hauling around your weekend toys.

UNMATCHED PROTECTION

# ALL PURPOSE CHESTS



## ALL PURPOSE CHESTS KEY FEATURES

- 1 EXTREME PROTECTION™ LOCK  
*tamper-resistant retracting lock helps protect against break-ins*
- 2 90° Cover opening for easy access
- 3 Heavy Duty C-Channel Reinforced Lid Construction  
*for maximum durability*
- 4 Dual Stage Automotive Rotary Latch and Heavy Duty Looped Strikers provide extreme security
- 5 Unique Offset Hinges allows chest to lie flat against truck
- 6 Automotive D-Shaped Ribbed Rubber Weather Stripping keeps its shape even after years of service
- 7 Sliding Steel Tray  
*all chests except compact*

**LIMITED LIFETIME WARRANTY**

## A LOW-RIDER WORK HORSE

Maximize your visibility with All-Purpose Chests that sit below the bedrail, accommodating tonneau covers and lids. An angled body design allows the chest to fit in fifth-wheel trailer configurations. The cover opens to 90° for maximum access using a unique offset hinge design that still allows installation flush against the truck cab. For durability, they're built of steel and finished with Brite White or Gloss Black ARMOR TUF® Powder Coat, or diamond plate aluminum (Clear, Gloss Black, or Textured Black).

### ALUMINUM DIAMOND PLATE



Clear ARMOR TUF® Powder Coat



Textured Black ARMOR TUF® Powder Coat



Gloss Black ARMOR TUF® Powder Coat



Brite White ARMOR TUF® Powder Coat

### STEEL



Brite White ARMOR TUF® Powder Coat





Gloss Black ARMOR TUF® Powder Coat

Choice Options: X = 0 (Clear) or X = 3 (Brite White) or X = 5 (Gloss Black) or X = 52 (Textured Black)

**COMPACT**  
6.0 CUBIC FEET



**ALUMINUM**

-  644-0-01
  -  644-5-01
- Ship Weight: 37 Lbs.

**STEEL**

-  645-3-01
- Ship Weight: 67 Lbs.

**FULL/COMPACT**  
10.0 CUBIC FEET



**ALUMINUM**

-  674-0-01
  -  674-5-01
  -  674-52-01
- Ship Weight: 43 Lbs.



**STEEL**

-  675-3-01
- Ship Weight: 80 Lbs.

**FULL/COMPACT**  
12.0 CUBIC FEET



**ALUMINUM**

-  654-0-01
  -  654-5-01
- Ship Weight: 52 Lbs.

**STEEL**

-  655-3-01
  -  655-5-01
- Ship Weight: 94 Lbs.



**FULL-SIZE STANDARD**  
13.1 CUBIC FEET



**ALUMINUM**

-  664-0-01
  -  664-5-01
  -  664-52-01
- Ship Weight: 57 Lbs.



**STEEL**

-  665-3-01
  -  665-5-01
- Ship Weight: 112 Lbs.

**FULL-SIZE EXTRA WIDE**  
18.6 CUBIC FEET



**ALUMINUM**

-  684-0-01
  -  684-5-01
- Ship Weight: 71 Lbs.

**STEEL**

-  685-3-01
- Ship Weight: 134 Lbs.

UNMATCHED PROTECTION

# LO-SIDE BOXES

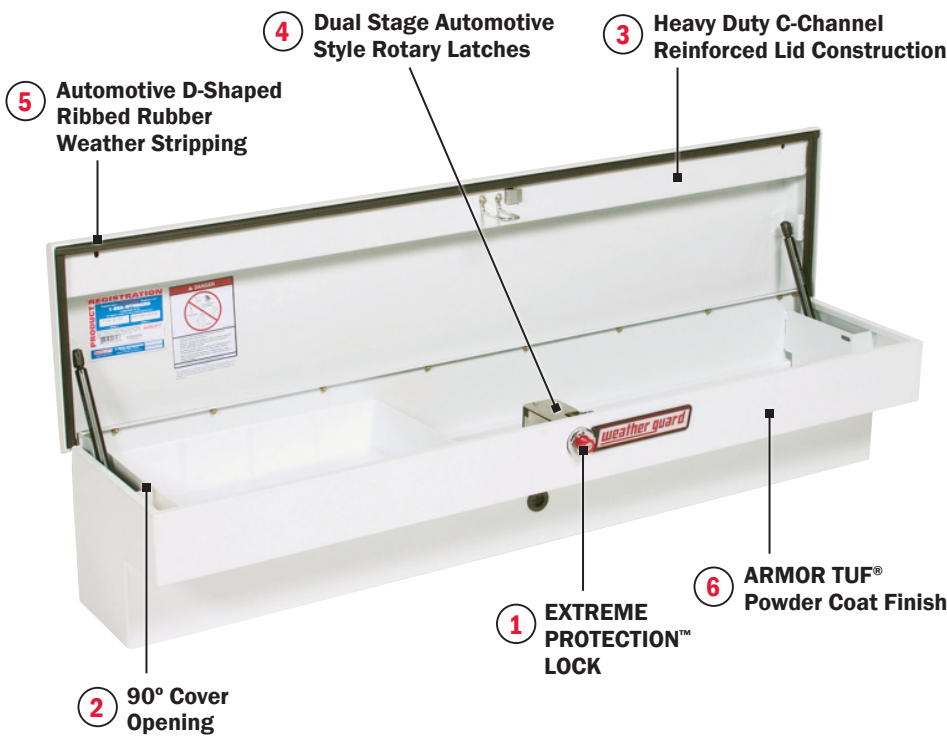

## LO-SIDE BOXES KEY FEATURES

- 1 **EXTREME PROTECTION™ LOCK** tamper-resistant retracting lock helps protect against break-ins
- 2 90° Cover opening for easy access
- 3 Heavy Duty C-Channel Reinforced Lid Construction for maximum durability
- 4 Dual Stage Automotive Rotary Latch and Heavy Duty Looped Strikers provide extreme security
- 5 Automotive D-Shaped Ribbed Rubber Weather Stripping keeps its shape even after years of service
- 6 ARMOR TUF® Powder Coat Protection

## LIMITED LIFETIME WARRANTY

### QUICK ACCESS FROM THE BEDRAILS

WEATHER GUARD® Lo-Side Boxes mount over the bedrails of your truck and keep critical tools and parts at your fingertips. Their easy installation utilizes mounting brackets that do not require drilling into the rails. The design and location on the truck bed aren't the only attributes that keep you productive—you can get inside with just one hand using an automotive-style latch. The durable Lo-Side is available in steel, and protected by an ARMOR TUF® Powder Coat finish in either Brite White or Gloss Black, or diamond plate aluminum (Clear, Brite White, Gloss Black, and Textured Black). The Lo-Side from WEATHER GUARD® can also be used separately or in combination with Cross Boxes or Saddle Boxes.

#### ALUMINUM DIAMOND PLATE



Brite White  
ARMOR TUF®  
Powder Coat



Clear ARMOR TUF®  
Powder Coat



Gloss Black  
ARMOR TUF®  
Powder Coat



Textured Black  
ARMOR TUF®  
Powder Coat

#### STEEL



Brite White  
ARMOR TUF®  
Powder Coat



Gloss Black  
ARMOR TUF®  
Powder Coat

Choice Options: X = 0 (Clear) or X = 3 (Brite White) or X = 5 (Gloss Black) or X = 52 (Textured Black)

**LO SIDE SHORT**

ALUMINUM  
STEEL

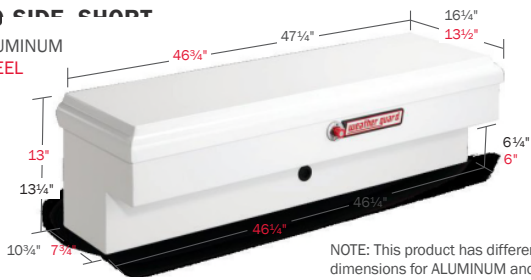

NOTE: This product has different dimensions for ALUMINUM and STEEL.

**ALUMINUM 3.4 CUBIC FEET**

- 184-3-01
- 184-0-01
- 184-5-01
- 184-52-01

Ship Weight: 46 Lbs.

**STEEL 3.2 CUBIC FEET**

- 185-3-01

Ship Weight: 63 Lbs.

**LO SIDE STANDARD**

ALUMINUM  
STEEL

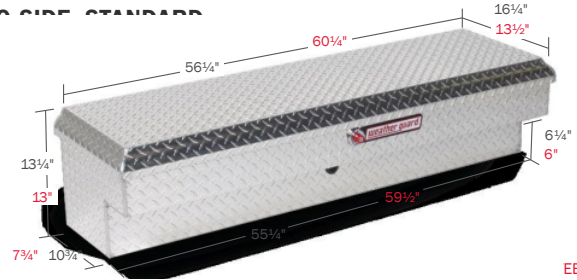

EEL

**ALUMINUM 4.1 CUBIC FEET**

- 174-0-01
- 174-52-01
- 174-5-01

Ship Weight: 53 Lbs.

**STEEL 4.5 CUBIC FEET**

- 175-3-01

Ship Weight: 81 Lbs.

**LO SIDE LONG**

ALUMINUM  
STEEL

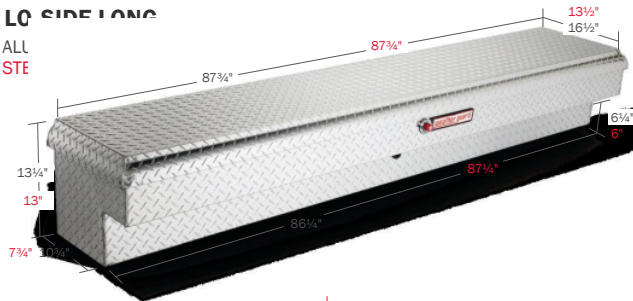

**ALUMINUM 6.4 CUBIC FEET**

- 164-0-01
- 164-5-01

Ship Weight: 74 Lbs.

**STEEL 6.2 CUBIC FEET**

- 165-3-01

Ship Weight: 108 Lbs.

**LOW PROFILE SIDE SHORT 3.2**

ALUMINUM

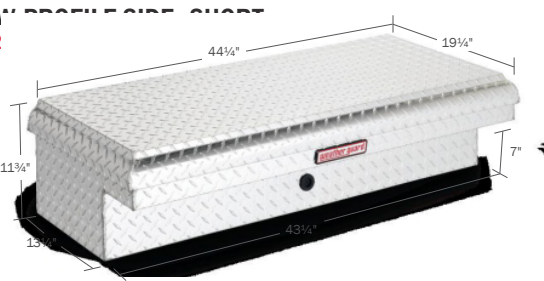

**ALUMINUM**

- 180-0-01 (DRIVER)
- 181-0-01 (PASSENGER)

Ship Weight: 41 Lbs.

**ALUMINUM**

- 180-5-01 (DRIVER)
- 181-5-01 (PASSENGER)

Ship Weight: 41 Lbs.

**LOW-PROFILE SIDE-STANDARD 4.3 CUBIC FEET**

ALUMINUM



**ALUMINUM**

- 178-0-01 (DRIVER)
- 179-0-01 (PASSENGER)

Ship Weight: 46 Lbs.

**ALUMINUM**

- 178-5-01 (DRIVER)
- 179-5-01 (PASSENGER)

Ship Weight: 46 Lbs.

**SUPER-LO-SHORT 4.5 CUBIC FEET**

STEEL



**STEEL**

- 186-3-01

Ship Weight: 72 Lbs.

**SUPER-LO-STANDARD 6.5 CUBIC FEET**

STEEL



**STEEL**

- 176-3-01
- 176-5-01

Ship Weight: 94 Lbs.

**SUPER-LO-LONG**

STEEL



**STEEL**

- 166-3-01

Ship Weight: 128 Lbs.

UNMATCHED PROTECTION

# HI-SIDE BOXES

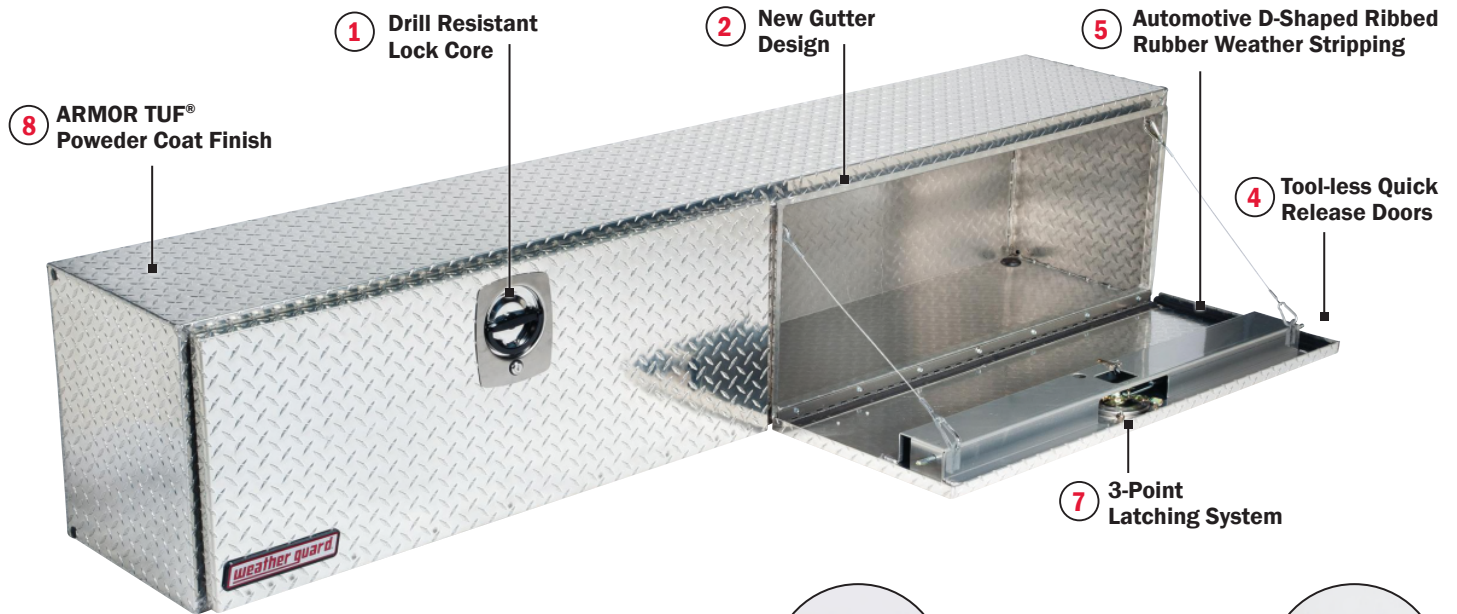

3 Removable Parts Bin



6 Convenient Attachment Points



## LIMITED LIFETIME WARRANTY

### ADDING STORAGE WHILE PRESERVING BED SPACE

Even the best can get better. That's why we keep pushing our engineers to top themselves. And so they have. Now our class-leading WEATHER GUARD® Hi-Side Truck Boxes deliver even greater protection from the elements, from vandalism. WEATHER GUARD® Hi-Sides are built to outlast the competition, just like you—hard-working construction pros, skilled tradespeople, field service and municipal workers who need quick access to valuable tools, equipment and parts while keeping the truck bed open for supplies. You never stop. Neither do we.

### WARNING

Hi-Side Boxes cannot be installed to truck racks. Support legs included with box is required for installation.

HI-SIDE  
5.6 CUBIC FEET



#### ALUMINUM

- 346-0-02
- 346-5-02

Ship Weight: 45 Lbs.

#### STEEL

- 246-3-02

Ship Weight: 76 Lbs.

Door Opening Measures:  
12 3/4" H x 42" W

HI-SIDE  
7.9 CUBIC FEET



#### ALUMINUM

- 364-0-02
- 364-5-02

Ship Weight: 60 Lbs.

#### STEEL

- 264-3-02

Ship Weight: 101 Lbs.

Door Opening Measures:  
12 3/4" H x 29" W

## HI-SIDE BOXES KEY FEATURES

- 1 Drill resistant lock core helps protect against break-ins
- 2 Gutter design channels rain and snow off box to keep contents dry
- 3 Removable parts bin keeps small items organized
- 4 Tool-less quick release doors adjust from 90° to 180° with QuickClips, no tools required
- 5 Automotive D-Shaped Ribbed Rubber Weather Stripping keeps its shape even after years of service
- 6 Convenient attachment point secures materials and tools in pickup bed
- 7 3-Point Latching System helps protect against theft and weather
- 8 **ARMOR TUF®**  
Powder Coat Protection

## RECOMMENDED ACCESSORIES

Adjustable Shelf  
Accessory (pg. 15)



Parts Cabinet  
Accessory (pg. 15)



**HI-SIDE**  
8.9 CUBIC FEET



**ALUMINUM**  
372-0-02  
372-5-02  
Ship Weight: 64 Lbs.

**Door Opening Measures:**  
12 3/4"H x 33"W

**HI-SIDE**  
8.9 CUBIC FEET



**STEEL**  
272-3-02  
Ship Weight: 109 Lbs.

**Door Opening Measures:**  
12 3/4"H x 33"W

**HI-SIDE**  
11.1 CUBIC FEET



**ALUMINUM**  
390-0-02  
390-5-02  
Ship Weight: 74 Lbs.

**Door Opening Measures:**  
12 3/4"H x 42"W

**HI-SIDE**  
11.1 CUBIC FEET



**STEEL**  
290-3-02  
Ship Weight: 129 Lbs.

**Door Opening Measures:**  
12 3/4"H x 42"W

**HI-SIDE**  
11.8 CUBIC FEET



**ALUMINUM**  
396-0-02  
396-5-02  
Ship Weight: 79 Lbs.

**Door Opening Measures:**  
12 3/4"H x 45"W

**HI-SIDE**  
11.8 CUBIC FEET



**STEEL**  
296-3-02  
Ship Weight: 136 Lbs.

**Door Opening Measures:**  
12 3/4"H x 45"W

# UNMATCHED PROTECTION

# SUPER-SIDE BOXES

## SUPER-SIZE YOUR STORAGE

Super-Side versions of the WEATHER GUARD® Hi-Side are available—whether you choose the steel or diamond plate aluminum version—with all of the same features that the Hi-Sides offer. A Super-Side version of the steel Hi-Side is available, providing an extra 2 inches of height and 3 inches of depth. A Jumbo Super-Side version of the steel Hi-Side is also available, with 6 more inches of width and 6 more inches of height for a whopping 21.4 cubic feet capacity. An extra-large Super-Side version of the aluminum Hi-Side is available, too, with an extra 2 inches of height and 3 inches of depth.

## LIMITED LIFETIME WARRANTY

### ALUMINUM DIAMOND PLATE

 Gloss Black ARMOR TUF® Powder Coat

 Clear ARMOR TUF® Powder Coat

 Textured Black ARMOR TUF® Powder Coat

### STEEL

 Brite White ARMOR TUF® Powder Coat

 Gloss Black ARMOR TUF® Powder Coat

#### Choice Options:

X = 0 (Clear) or  
 X = 3 (Brite White) or  
 X = 5 (Gloss Black) or  
 X = 52 (Textured Black)

### SUPER-SIDE 7.7 CUBIC FEET



#### ALUMINUM

 347-0-02

 347-5-02

Ship Weight: 50 Lbs.

#### STEEL

 247-3-02

Ship Weight: 86 Lbs.

Door Opening Measures:  
14 3/4" H x 42" W

### SUPER-SIDE 10.8 CUBIC FEET



#### ALUMINUM

 365-0-02

 365-5-02

Ship Weight: 65 Lbs.

#### STEEL

 265-3-02

Ship Weight: 114 Lbs.

Door Opening Measures:  
14 3/4" H x 29" W

### SUPER-SIDE 15.2 CUBIC FEET



#### ALUMINUM

 391-0-02

 391-5-02

 391-52-02

Ship Weight: 83 Lbs.

#### STEEL

 291-3-02

Ship Weight: 147 Lbs.

Door Opening Measures:  
14 3/4" H x 42" W

### JUMBO SUPER-SIDE 21.4 CUBIC FEET



#### STEEL

 297-3-02

Ship Weight: 174 Lbs.

Door Opening Measures:  
20 3/4" H x 45" W



# TRUCK BOX ACCESSORIES

KEEP YOUR TOOLS AND EQUIPMENT ORGANIZED AND EASY TO ACCESS

## ACCESSORY TOOL BOX

**610** – Plastic Tool Box  
Ship Weight: 3 Lbs.

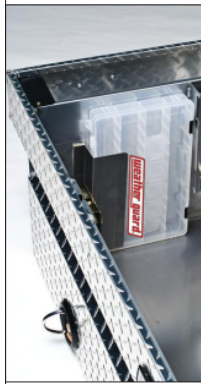

## ACCESSORY PARTS BIN FOR SADDLE BOXES

**618** – Accessory Parts Box  
Ship Weight: 2 Lbs.

**NEW WEATHER GUARD® Parts Box** fits into enhanced (-02) Saddle Boxes.

**FITS:** 116-X-02, 117-X-02, 126-X-02 and 127-X-02

## ACCESSORY TRAY FOR LO-SIDE & SUPER-LO BOXES

**911** – Tray  
Ship Weight: 9 Lbs.



## STEEL DIVIDER TRAY

**613-3** – 19¼”L x 14”W  
Ship Weight: 14 Lbs.

**FITS:** 124-X-01, 125-X-01, 126-X-02, 127-X-02, 137-X-01, 154-X-01, 156-X-01, 654-X-01, 664-X-01, 675-X-01, 677-X-01, 678-X-01, 679-X-01

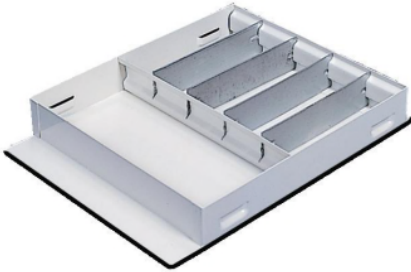

## STEEL DIVIDER TRAY

**614-3** – 26½”L x 14⅝”W  
Ship Weight: 14 Lbs.

**FITS:** 114-X-01, 115-X-01, 116-X-02, 117-X-02, 684-X-01, 685-X-01



## STEEL DIVIDER TRAY

**615** – 19¼”L x 14”W  
Ship Weight: 14 Lbs.

**FITS:** 121-X-01, 123-X-01, 124-X-01, 126-X-02, 127-X-02, 128-X-01, 131-X-01, 136-X-01, 137-X-01, 154-X-01, 156-X-01, 654-X-01, 655-X-01, 664-X-01, 665-X-01, 674-X-01, 675-X-01



## STEEL DIVIDER TRAY

**617** – 26½”L x 14”W  
Ship Weight: 14 Lbs.

**FITS:** 114-X-01, 115-X-01, 116-X-02, 117-X-02, 684-X-01, 685-X-01



## STEEL TOTE TRAY

**619-3** – 18½”L x 9”W x 3”H  
Ship Weight: 8 Lbs.

**FITS:** 126-X-02, 127-X-02, 136-X-01, 154-X-01, 156-X-01



## STEEL TOTE TRAY

**620-3** – 25½”L x 9”W x 3”H  
Ship Weight: 14 Lbs.

**FITS:** 116-X-02, 117-X-02

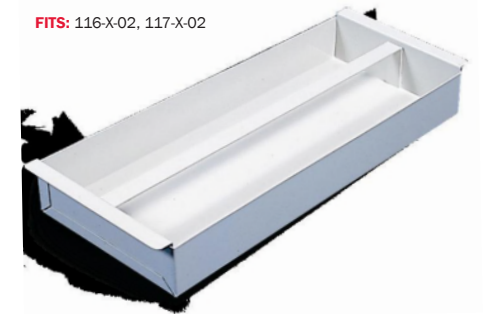

## TRAYS

**200-3** – 41½”L x 9½”W  
Ship Weight: 17 Lbs.

**202-3** – 24”L x 9½”W  
Ship Weight: 12 Lbs.

16-gauge steel with adjustable dividers; bolts to back wall of cabinet.



Shown in Hi-Side Box

## PARTS CABINET

**201-3** – 32½”L x 11¾”H  
Ship Weight: 28 Lbs.

All steel cabinets feature removable partitions; bolts through bottom of box. Not intended for use with 264-X-02 and 272-X-02.

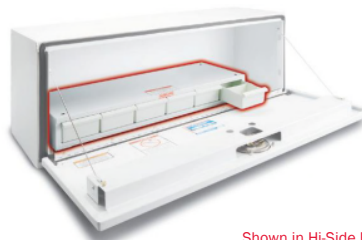

Shown in Hi-Side Box

## WATCHMAN® IV SINGLE-PADLOCK LOCK SYSTEM

**9036-3**  
Ship Weight: 93 Lbs.

**FOR INSIDE USE ONLY!** Use in conjunction with a pickup cap or other type of enclosure and bolt it to the truck bed.



# GEAR UP™ TRUCK FIT GUIDE

Aluminum Boxes available in Brite White, Clear or Gloss Black ARMOR TUF® Powder Coat.

Steel Boxes available in Brite White and Textured Black ARMOR TUF® Powder Coat.

Coating Choice Options: **X=0** (Clear) or **X=3** (Brite White) or **X=5** (Gloss Black) or **X=52** (Textured Black).

Not all coating choices available on all models.

SADDLE BOXES	ALUMINUM	STEEL	5' FLEETSIDE		6' FLEETSIDE		5 1/2' FLEETSIDE		6' FLEETSIDE		8' FLEETSIDE		5' BED	6 1/2' BED	5'7" BED	6' BED	8' BED	6' STYLESIDE	7' STYLESIDE
			CHEVROLET COLORADO		CHEVROLET SILVERADO*														
FULL-SIZE EXTRA WIDE		116-X-02					•	•							•	•	•		
		117-X-02					•	•							•	•	•		
FULL-SIZE EXTRA DEEP		128-X-01					•	•									•		
		123-X-01					•	•									•		
FULL-SIZE STANDARD		126-X-02					•	•							•	•	•		
		127-X-02					•	•							•	•	•		
FULL-SIZE LOW-PROFILE		120-X-01			•	•	•								•	•	•		
		121-X-01			•	•	•								•	•	•		
COMPACT - DEEP		136-3-01	•	•									•	•				•	•
		137-X-01	•	•									•	•				•	•
COMPACT - STANDARD		156-X-01	•	•									•	•				•	•
		154-X-01	•	•									•	•				•	•
COMPACT - LOW-PROFILE		131-X-01	•	•								•	•					•	•
<b>CROSS BOXES</b>																			
FULL-SIZE EXTRA WIDE		115-3-01					•	•							•	•	•		
		114-X-01					•	•							•	•	•		
FULL-SIZE STANDARD		125-X-01			•	•	•								•	•	•		
		124-X-01			•	•	•								•	•	•		
<b>ALL-PURPOSE CHESTS</b>																			
COMPACT		645-X-01	•	•	•	•	•					•	•	•	•	•	•	•	•
		644-X-01	•	•	•	•	•					•	•	•	•	•	•	•	•
FULL/COMPACT		655-3-01					•	•					•				•		
		654-X-01					•	•					•				•		
FULL-SIZE STANDARD		655-X-01					•	•									•		
		664-X-01					•	•									•		
FULL/COMPACT		675-3-01			•	•	•						•	•	•	•	•	•	•
		674-X-01			•	•	•						•	•	•	•	•	•	•
FULL-SIZE EXTRA WIDE		685-3-01						•									•		
		684-X-01						•									•		

\* Newer truck models available with aluminum beds are compatible with the WEATHER GUARD® truck boxes and chests in the table. Follow installation instructions for mounting to aluminum beds and use mounting components included with the truck box.

NOTE: THIS GUIDE APPLIES TO 2005 AND NEWER MODEL YEAR VEHICLES.  
 YOU SHOULD MEASURE YOUR VEHICLE TO MAKE SURE YOUR WEATHER GUARD® TRUCK BOX WILL FIT.

5½' STYLESIDE		6½' STYLESIDE		6½' FLARESIDE		8' STYLESIDE		6½' STYLESIDE		8' STYLESIDE		5' FLEETSIDE		6' FLEETSIDE		5½' FLEETSIDE		6' FLEETSIDE		8' FLEETSIDE		5' BED		6' BED		6' BED		8' BED		4½' BED		6' BED		5½' BED		6½' BED			
FORD F150*						FORD F250*						GMC CANYON		GMC SIERRA*				TOYOTA TACOMA		TOYOTA TUNDRA				NISSAN FRONTIER		NISSAN TITAN													
•	•		•	•	•											•	•																		•	•			
•	•		•	•	•											•	•																		•	•			
			•		•											•	•																			•			
			•		•											•	•																				•		
•	•		•	•	•											•	•									•	•									•	•		
•	•		•	•	•											•	•								•	•											•	•	
•	•	•	•	•	•											•	•								•	•											•	•	
•	•	•	•	•	•											•	•								•	•												•	•
												•	•											•	•														
												•	•											•	•														
												•	•											•	•														
												•	•											•	•														
												•	•											•	•														

•	•		•	•	•											•	•																			•	•			
•	•		•	•	•											•	•																				•	•		
•	•		•	•	•											•	•								•	•												•	•	
•	•		•	•	•											•	•								•	•													•	•

•	•	•	•	•	•																																		
•	•	•	•	•	•																																		
			•	•	•																																		
			•	•	•																																		
			•	•	•																																		
•	•	•	•	•	•																																		
•	•	•	•	•	•																																		
			•	•	•																																		
			•	•	•																																		

# weather guard®

## DEFENDER SERIES

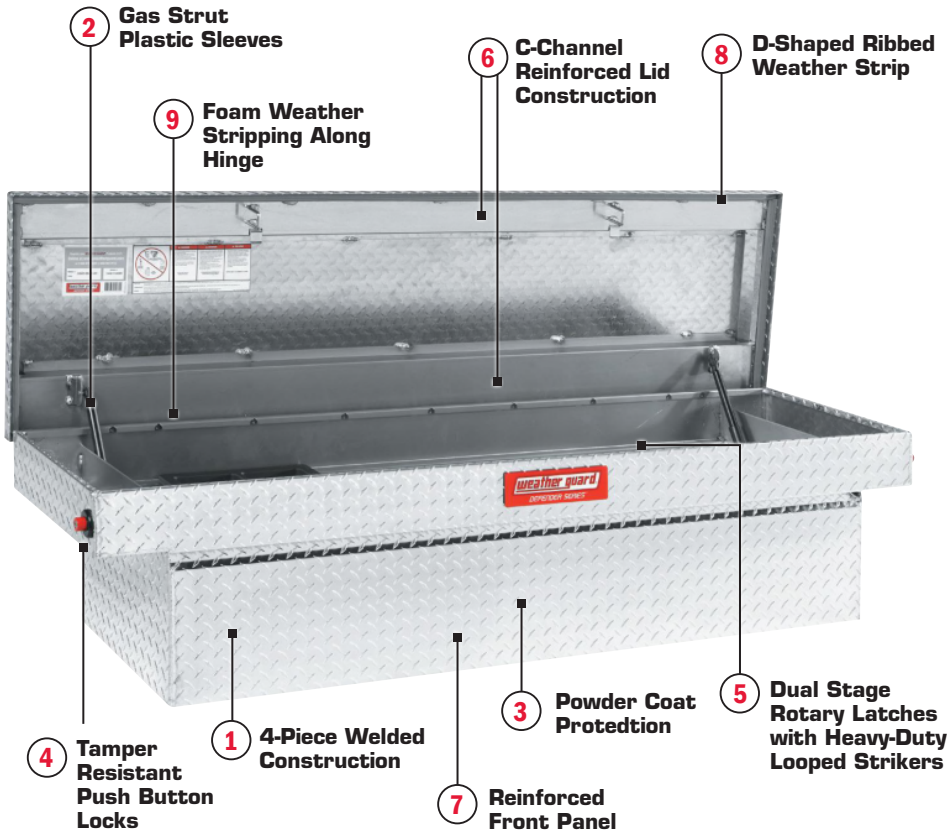

## PROFESSIONAL GRADE PROTECTION

### PROFESSIONAL DURABILITY

- 1 4-Piece Welded Construction**  
Puts more strength where it is needed most
- 2 Gas Strut Plastic Sleeves**  
Prevents basic damage from sliding materials in the box
- 3 Powder Coat Protection**  
Available in Black

### HEAVY DUTY SECURITY

- 4 Tamper Resistant Push Button Locks**  
Drill resistant through key hole
- 5 Two Dual Stage Rotary Latches with Heavy-Duty Looped Strikers**  
Secures lid closed and resists pry-in  
Looped Striker with steel reinforcement is bolted to heavy-duty C-channel
- 6 C-Channel Reinforced Lid Construction**  
Heavy-duty aluminum welded into lid resists pry-ins
- 7 Reinforced Front Panel**  
Rigid front panel resists pry-in

### CLASSIC WEATHER RESISTANCE

- 8 D-Shaped Ribbed weather strip**
- 9 Foam Weather Stripping along hinge completes 4 sided weather resistance**

### INTEGRATED FEATURES

- Plastic Parts Sliding Tray
- No-Crimp/No-Drill Mounting Hardware
- Built-in Side Compartments

# 7 YEAR WARRANTY

## INTRODUCING THE DEFENDER SERIES™

a new affordable line of truck boxes built with the professional grade durability, security, and weather resistance you expect from the WEATHER GUARD® brand. Now there is a WEATHER GUARD® for every truck and user out there.

### ALUMINUM DIAMOND PLATE



Uncoated



Black Powder Coat

PROFESSIONAL GRADE PROTECTION  
**SADDLE BOXES/CROSS BOXES**

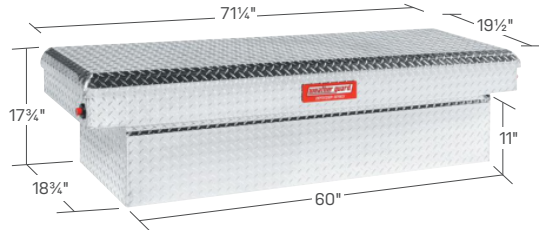

**FULL SIZE TRUCK  
STANDARD SADDLE**  
**10.7 CUBIC FEET**

- 300105-9-01
- 300105-53-01

Approximate  
Ship Weight: 56 lbs

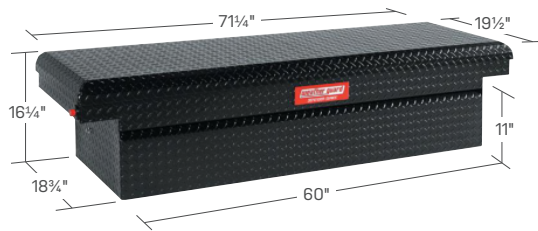

**FULL SIZE TRUCK  
LOW PROFILE SADDLE**  
**9.5 CUBIC FEET**

- 300106-9-01
- 300106-53-01

Approximate  
Ship Weight: 56 lbs

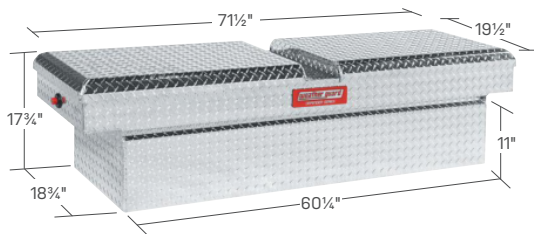

**FULL SIZE TRUCK  
STANDARD CROSS**  
**10.2 CUBIC FEET**

- 300207-9-01
- 300207-53-01

Approximate  
Ship Weight: 56 lbs

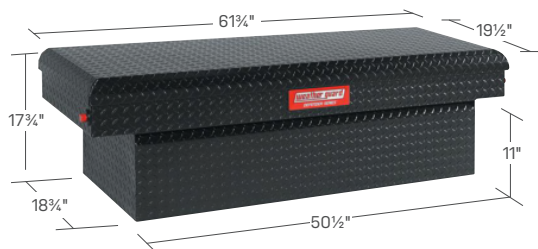

**COMPACT TRUCK  
STANDARD SADDLE**  
**9 CUBIC FEET**

- 300104-9-01
- 300104-53-01

Approximate  
Ship Weight: 56 lbs

PROFESSIONAL GRADE PROTECTION

# SIDE BOXES/UNIVERSAL CHESTS

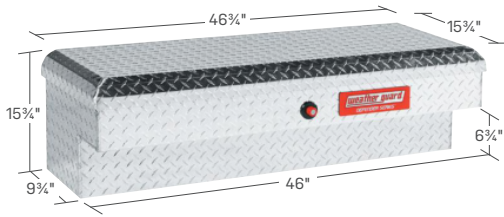

**48" SHORT LO-SIDE**  
**12.5 CUBIC FEET**

- 300304-9-01
- 300304-53-01

Approximate Ship Weight: 39 lbs

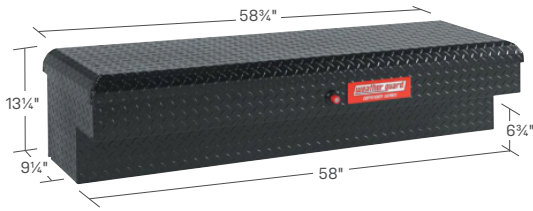

**60" STANDARD LO-SIDE**  
**9.3 CUBIC FEET**

- 300300-9-01
- 300300-53-01

Approximate Ship Weight: 47 lbs

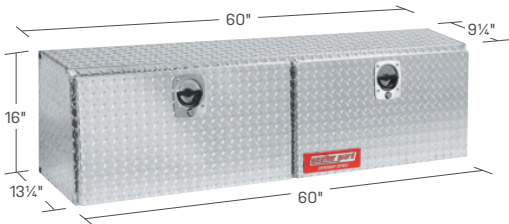

**60" HI-SIDE BOXES**  
**3.3 CUBIC FEET**

- 300302-9-01
- 300302-53-01

Approximate Ship Weight: 45 lbs

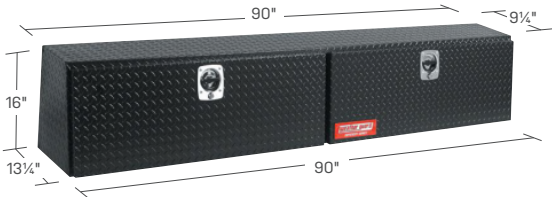

**90" HI-SIDE BOXES**  
**9 CUBIC FEET**

- 300303-9-01
- 300303-53-01

Approximate Ship Weight: 57 lbs

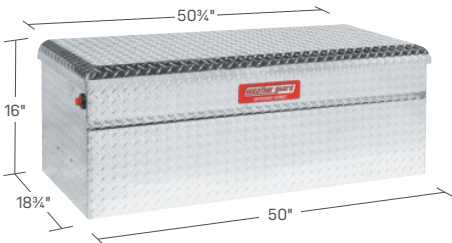

**50" UNIVERSAL CHEST**  
**18.8 CUBIC FEET**

- 300401-9-01
- 300401-53-01

Approximate Ship Weight: 46 lbs

ALSO AVAILABLE

**72" LONG LO-SIDE**  
**5.3 CUBIC FEET**

- 300301-9-01
- 300301-53-01

**36" UNDERBED**  
**7.1 CUBIC FEET**

- 300500-9-01
- 300500-53-01

**48" UNDERBED**  
**9.5 CUBIC FEET**

- 300501-9-01
- 300501-53-01

# DEFENDER SERIES™ TRUCK FIT GUIDE

## STEP 1 Determine Your Vehicle Type

COMPACT TRUCK	FULL SIZE TRUCK		
COMPACT BED	SHORT BED	STANDARD BED	LONG BED
5-½' (66") or 6-½' (78")	5-½' (66")	6-½' (78")	8' (96")

## STEP 2 Choose a Saddle Box, Cross Box, or Universal Chest

COMPACT TRUCK	FULL SIZE TRUCK		
COMPACT BED	SHORT BED	STANDARD BED	LONG BED
<b>Compact Standard 20"w</b> 300104-XX-01	Full Size Standard 20"w 300105-XX-01	Full Size Standard 20"w 300105-XX-01	Full Size Standard 20"w 300105-XX-01
	Full Size Low Profile 20"w 300106-XX-01	Full Size Low Profile 20"w 300106-XX-01	Full Size Low Profile 20"w 300106-XX-01
	Full Size Cross Box 20"w 300207-XX-01	Full Size Cross Box 20"w 300207-XX-01	Full Size Cross Box 20"w 300207-XX-01
	Universal Chest 19.5"w 300401-XX-01	Universal Chest 19.5"w 300401-XX-01	Universal Chest 19.5"w 300401-XX-01

## STEP 3 Choose Color



Uncoated  
300XXX-9-01



Powder Coated Black  
300XXX-53-01

## STEP 4 Add Side Boxes in Combination with Saddle/Cross Boxes

Determine remaining bed rail length on vehicle and choose front eh following.  
Include 3" of buffer space for box spacing, tail gate clearance, and lid clearance.

COMPACT TRUCK		FULL SIZE TRUCK					
COMPACT BED		SHORT BED		STANDARD BED		LONG BED	
Low-Side Combo	High-Side Combo	Low-Side Combo	High-Side Combo	Low-Side Combo	High-Side Combo	Low-Side Combo	High-Side Combo
<b>48" Only</b> 300304-XX-01	<b>N/A</b>	Combo of Saddle/Cross & Side Box Not Available		<b>48" Only</b> 300304-XX-01	<b>N/A</b>	<b>48", 60", 72"</b> 300304-XX-01 300300-XX-01 300301-XX-01	<b>60"</b> 300302-XX-01
Side Boxes Only		Side Boxes Only		Side Boxes Only		Side Boxes Only	
<b>48", 60", 72"</b> 300304-XX-01 300300-XX-01 300301-XX-01	<b>60" Only</b> 300302-XX-01	<b>48", 60"</b> 300304-XX-01 300300-XX-01	<b>60"</b> 300302-XX-01	<b>48", 60", 72"</b> 300304-XX-01 300300-XX-01 300301-XX-01	<b>N/A</b>	<b>48", 60" 72"</b> 300304-XX-01 300300-XX-01 300301-XX-01	<b>60", 90"</b> 300302-XX-01 300303-XX-01

UNMATCHED PROTECTION

# STEEL UNDERBED BOXES



## WIDE SELECTION OF SIZES FOR YOUR NEEDS

WEATHER GUARD® Steel Underbed Boxes come in three size groupings: compact, standard and jumbo. A Brite White or Gloss Black ARMOR TUF® Powder Coat enhances the durability of these boxes' heavy-gauge steel. Steel Underbed Boxes are supplied with an aluminum door and hinge for superior resistance to rust and corrosion.

## STEEL UNDERBED BOX KEY FEATURES

- 1 Gutter design & weather stripping easy and positive door closure that protects against the elements
- 2 3-point latching system for optimum security and weather resistance
- 3 Stainless Steel D Handle for easy and positive door closure, and added protection against break-ins
- 4 Tool-less quick release drop down door full and easy access, adjusts from 90° to 180°
- 5 Automotive D-Shaped Ribbed Rubber Weather Stripping keeps its shape even after years of service
- 6 ARMOR TUF® Powder Coat Protection

## LIMITED LIFETIME WARRANTY

### COMPACT UNDERBED



#### 2.3 CUBIC FEET

- 525-3-02
  - 525-5-02
- Ship Weight: 45 Lbs.  
Door Opening Measures:  
10½"H × 22½"W

### STANDARD UNDERBED



#### 4.5 CUBIC FEET

- 524-3-02
  - 524-5-02
- Ship Weight: 45 Lbs.  
(24½"L × 18¼"W × 18½"H)  
Door Opening Measures:  
14½"H × 22½"W

#### 5.6 CUBIC FEET

- 530-3-02
  - 530-5-02
- Ship Weight: 70 Lbs.  
(30½"L × 18¼"W × 18½"H)  
Door Opening Measures:  
14½"H × 28½"W

#### 6.7 CUBIC FEET

- 536-3-02
  - 536-5-02 (Shown)
- Ship Weight: 82 Lbs.  
Door Opening Measures:  
14½"H × 34¾"W

#### 9.1 CUBIC FEET

- 548-3-02
  - 548-5-02
- Ship Weight: 100 Lbs.  
(48½"L × 18¼"W × 18½"H)  
Door Opening Measures:  
14½"H × 46¼"W

#### 11.2 CUBIC FEET

- 560-3-02
  - 560-5-02
- Ship Weight: 135 Lbs.  
(60½"L × 18¼"W × 18½"H)  
Door Opening Measures:  
14½"H × 58¼"W

### JUMBO UNDERBED



#### 12.1 CUBIC FEET

- 538-3-02 (Shown)
  - 538-5-02
- Ship Weight: 111 Lbs.  
(36½"L × 24¼"W × 24½"H)  
Door Opening Measures:  
20½"H × 34¼"W

#### 16.2 CUBIC FEET

- 550-3-02
  - 550-5-02
- Ship Weight: 145 Lbs.  
(48½"L × 24¼"W × 24½"H)  
Door Opening Measures:  
20½"H × 46¼"W

#### 20.2 CUBIC FEET

- 562-5-02
- Ship Weight: 181 Lbs.  
(60½"L × 24¼"W × 24½"H)  
Door Opening Measures:  
20½"H × 58¼"W



# ALUMINUM UNDERBED BOXES



## DURABILITY AT LIGHTER WEIGHT

WEATHER GUARD® Aluminum Underbed Boxes are available in compact, standard and jumbo versions to meet your specific needs. Clear or Gloss Black ARMOR TUF® Powder Coat finishes extend the ruggedness of the diamond plate aluminum.



**TOOL-LESS QUICK RELEASE DROP DOWN DOOR**



**WEATHER STRIPPING** protects contents from the weather.

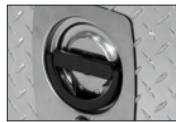

**STAINLESS STEEL D HANDLE** With Drill-resistant Lock Core

**LIMITED LIFETIME WARRANTY**

## ALUMINUM UNDERBED BOX KEY FEATURES

- 1** Gutter design & weather stripping easy and positive door closure that protects against the elements
- 2** 3-point latching system for optimum security and weather resistance
- 3** Stainless Steel D Handle for easy and positive door closure, and added protection against break-ins
- 4** Tool-less quick release drop down door full and easy access, adjusts from 90° to 180°
- 5** Automotive D-Shaped Ribbed Rubber Weather Stripping keeps its shape even after years of service
- 6** ARMOR TUF® Powder Coat Protection

### COMPACT UNDERBED



**2.4 CUBIC FEET**

622-0-02

622-5-02

Ship Weight: 24 Lbs.

Door Opening Measures:  
9¼"H × 19¼"W

### STANDARD UNDERBED

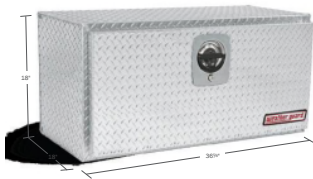

**4.3 CUBIC FEET**

627-0-02

Ship Weight: 35 Lbs.  
(24½"L × 18¼"W × 18"H)

Door Opening Measures:  
13½"H × 19¼"W

**5.4 CUBIC FEET**

631-0-02

631-5-02

Ship Weight: 42 Lbs.  
(30½"L × 18"W × 18"H)

Door Opening Measures:  
13½"H × 25¼"W

**6.5 CUBIC FEET**

636-0-02 (Shown)

636-5-02

Ship Weight: 47 Lbs.  
(36½"L × 18"W × 18"H)

Door Opening Measures:  
13½"H × 34¼"W

**8.6 CUBIC FEET**

648-0-02

Ship Weight: 62 Lbs.  
(48½"L × 18"W × 18"H)

Door Opening Measures:  
13½"H × 43¼"W

**11.2 CUBIC FEET**

660-0-02

660-5-02

Ship Weight: 135 Lbs.  
(60½"L × 18"W × 18"H)

Door Opening Measures:  
13½"H × 55¼"W

### JUMBO UNDERBED



**12.2 CUBIC FEET**

638-0-02

Ship Weight: 65 Lbs.  
(36½"L × 24"W × 24"H)

Door Opening Measures:  
19½"H × 31¼"W

**16 CUBIC FEET**

650-0-02

Ship Weight: 81 Lbs.  
(48½"L × 24"W × 24"H)

Door Opening Measures:  
19½"H × 43¼"W

**20 CUBIC FEET**

662-0-02 (Shown)

Ship Weight: 100 Lbs.  
(60½"L × 24"W × 24"H)

Door Opening Measures:  
19½"H × 55¼"W

IN-BED STORAGE

# PACK RAT® DRAWER UNITS

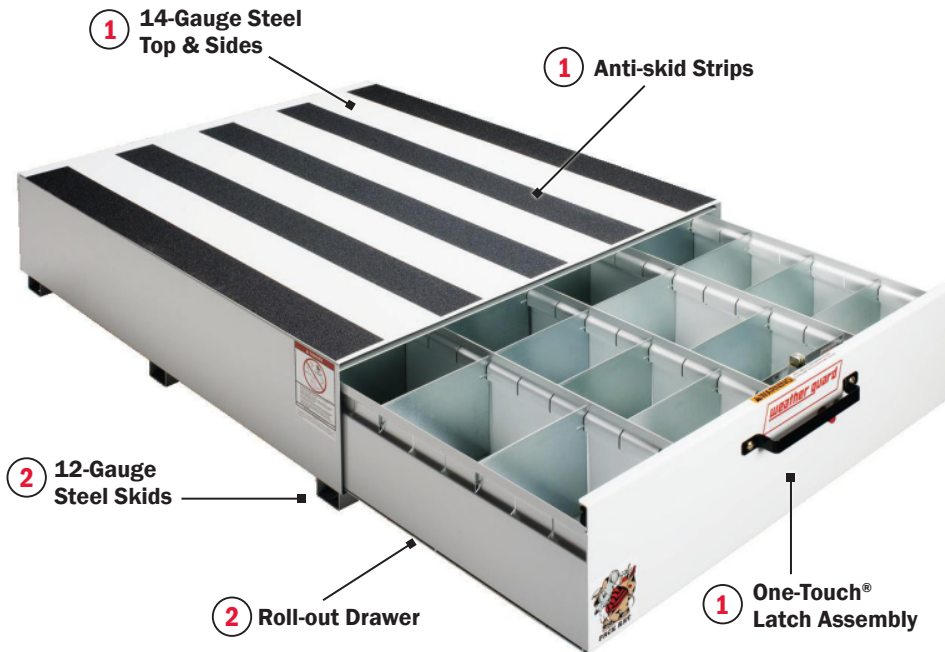

## PACK RAT® DRAWER UNIT KEY FEATURES

- 1 14-Gauge steel top and sides allows 750 lb load rating
- 2 Drawer load rating 425 lbs. evenly distributed
- 3 12-Gauge steel skirts for extra strength
- 4 Anti-skid strips provide traction for workboots
- 5 One-Touch® latch assembly easy, one-hand operation
- 6 Roll-out drawer easy access and organization
- 7 Limited Lifetime Warranty unparalleled quality

## LIMITED LIFETIME WARRANTY

### HEAVY-DUTY STORAGE KEEPS BED SPACE OPEN AND YOU ORGANIZED

The Heavy-Duty PACK RAT® drawer units can be mounted inside the rear of the vehicle and give you easy access to large tools and supplies while leaving floor space open. These rugged units are constructed of 14-gauge steel on the top and sides, giving you a 750 pound load rating and placing them among the sturdiest items in the back of your truck.

#### STANDARD DRAWER UNIT 305-3



**1 COMPARTMENTS,  
6 DIVIDERS.**

Each Drawer Compartment: 5"H x 9 3/4"W x 45"L

Ship Weight: 106 Lbs.

#### STANDARD DRAWER UNIT 306-3



**2 COMPARTMENTS,  
12 DIVIDERS.**

Each Drawer Compartment: 5"H x 9 3/4"W x 45"L

Ship Weight: 179 Lbs.

# PACK RAT® DRAWER UNITS

## STANDARD DRAWER UNIT

**307-3**



**3 COMPARTMENTS,  
18 DIVIDERS.**

**Each Drawer Compartment: 5"H x 9 3/4"W x 45"L**

*Ship Weight: 247 Lbs.*

## STANDARD DRAWER UNIT

**308-3 (white)  
308-5 (black)**

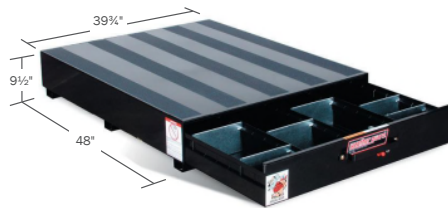

**4 COMPARTMENTS,  
24 DIVIDERS.**

**Each Drawer Compartment: 5"H x 9 3/4"W x 45"L**

*Ship Weight: 322 Lbs.*

## STANDARD DRAWER UNIT

**335-3**



**1 COMPARTMENT,  
6 DIVIDERS.**

**Each Drawer Compartment: 8 1/2"H x 9 3/4"W x 45"L**

*Ship Weight: 130 Lbs.*

## STANDARD DRAWER UNIT

**336-3**



**2 COMPARTMENTS,  
12 DIVIDERS.**

**Each Drawer Compartment: 8 1/2"H x 9 3/4"W x 45"L**

*Ship Weight: 210 Lbs.*

## STANDARD DRAWER UNIT

**337-3**



**3 COMPARTMENTS,  
18 DIVIDERS.**

**Each Drawer Compartment: 8 1/2"H x 9 3/4"W x 45"L**

*Ship Weight: 294 Lbs.*

## STANDARD DRAWER UNIT

**338-3 (white)  
338-5 (black)**

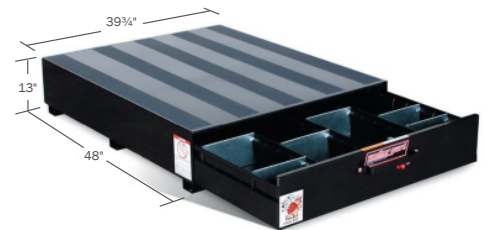

**4 COMPARTMENTS,  
24 DIVIDERS.**

**Each Drawer Compartment: 8 1/2"H x 9 3/4"W x 45"L**

*Ship Weight: 383 Lbs.*

IN-BED STORAGE

# PACK RAT® DRAWER UNITS

**EXTRA-WIDE COMPARTMENT**

**304-3**



**2 COMPARTMENTS,  
6 DIVIDERS.**

**Small Compartment:** 5"H x 9 3/4"W x 45"L  
**Large Compartment:** 5"H x 19 1/2"W x 45"L

Ship Weight: 220 Lbs.

**EXTRA-WIDE COMPARTMENT**

**334-3**



**2 COMPARTMENTS,  
6 DIVIDERS.**

**Small Compartment:** 8 1/2"H x 9 3/4"W x 45"L  
**Large Compartment:** 5"H x 19 1/2"W x 21"L

Ship Weight: 245 Lbs.

**SHORT DRAWER UNIT**

**301-3**

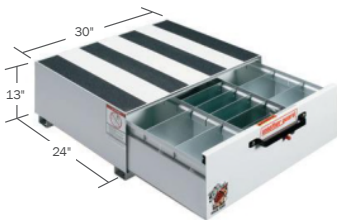

**3 COMPARTMENTS,  
12 DIVIDERS.**

**Each Drawer Compartment:** 8 1/2"H x 9 3/4"W x 21"L

Ship Weight: 169 Lbs.

**SHORT DRAWER UNIT**

**303-3**

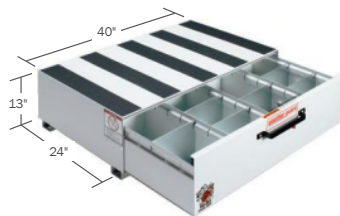

**4 COMPARTMENTS,  
12 DIVIDERS.**

**Each Drawer Compartment:** 8 1/2"H x 9 3/4"W x 21"L

Ship Weight: 217 Lbs.

**STANDARD DRAWER UNIT**

**312-3**



**3 COMPARTMENTS,  
12 DIVIDERS.**

**Each Drawer Compartment:** 5"H x 9 3/4"W x 21"L

Ship Weight: 151 Lbs.

**DRAWER DIVIDERS 300**

**DRAWER DIVIDERS 302**

# BED RAT® SLIDING PLATFORM

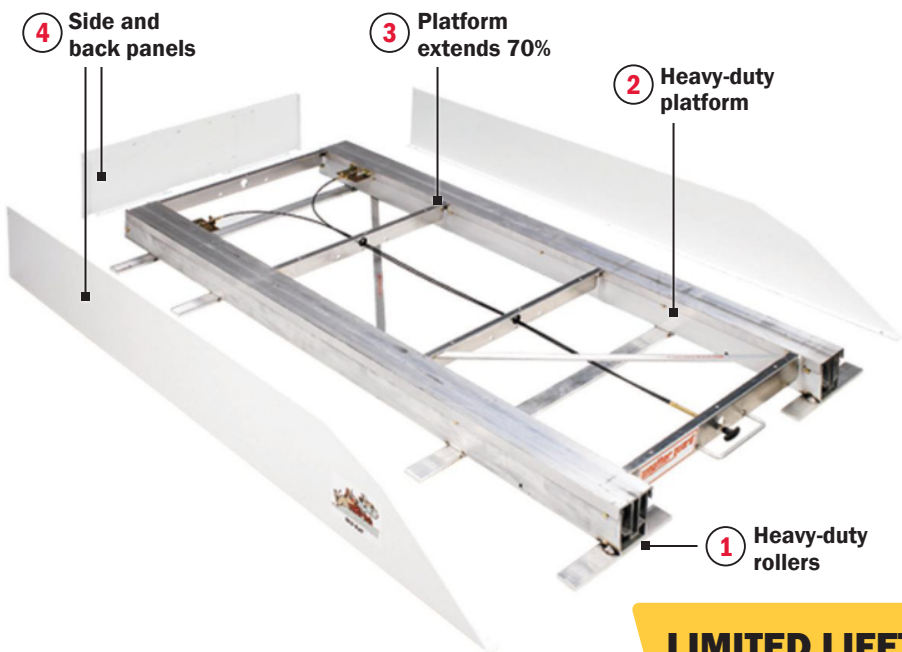

**LIMITED LIFETIME WARRANTY**

## BED RAT® KEY FEATURES

- 1 Heavy duty rollers support maximum loads
- 2 Heavy duty platform supports 750 lbs.
- 3 Platform extends 70% easy access, large work area
- 4 Side and back pack panels keep items from rolling off
- 5 Limited Lifetime Warranty unparalleled quality

**GAIN IN EXTRA WORK SPACE FROM THE BED** Grabbing tools or parts as you need them during the course of a project is always easier when they're elevated. The BED RAT® Sliding Platform from WEATHER GUARD® works with PACK RAT® Drawer Unit allowing you to pull items toward you from the cargo area, either from the side or rear of the vehicle, creating an additional work space.

### BED RAT® SLIDING PLATFORM

**3100**

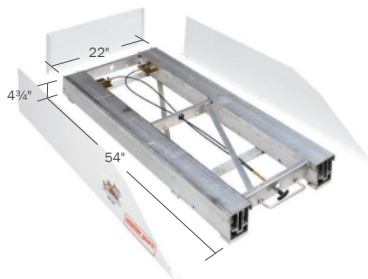

54"L x 22"W x 4¾"H

**FITS:** Chevy City Express, Express, Colorado, Silverado 1500, Silverado 2500/3500. Dodge Dakota. Ford E-Series, F-150, F-250/F-350, Ranger, Transit, Transit Connect, Transit Connect 2020-2013. GMC Canyon, Savana, Sierra 1500, Sierra 2500/3500. Mercedes Metris, Mercedes Sprinter. Nissan Frontier, Nissan NV, NV200, Titan. Ram 1500, 2500/3500, ProMaster, ProMaster City. Toyota Tundra.

Ship Weight: 107.5 Lbs.

### BED RAT® SLIDING PLATFORM

**3200**

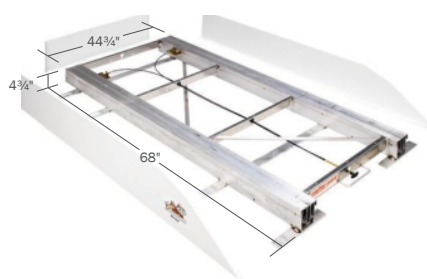

68"L x 44¾"W x 4¾"H

**FITS:** Chevy City Express, Express, Colorado, Silverado 1500, Silverado 2500/3500. Ford E-Series, F-150, F-250/F-350, Transit. GMC Canyon, Savana, Sierra 1500, Sierra 2500/3500. Mercedes Sprinter. Nissan Frontier, Nissan NV, Nissan Titan. Ram 1500, 2500/3500, ProMaster. Toyota Tundra.

Ship Weight: 144 Lbs.

### BED RAT® SLIDING PLATFORM

**3400**

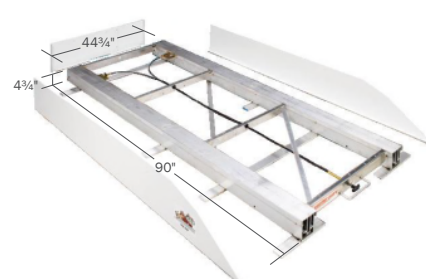

90"L x 44¾"W x 4¾"H

**FITS:** Chevy City Express, Express, Silverado 1500, Silverado 2500/3500. Ford E-Series, F-150, F-250/F-350, Transit. GMC Savana, Sierra 1500, Sierra 2500/3500. Mercedes Sprinter. Nissan NV, Nissan Titan. Ram 1500, 2500/3500, ProMaster. Toyota Tundra.

Ship Weight: 179.5 Lbs.

# IN-BED STORAGE TRANSFER TANKS

1 Vented Filter Cap

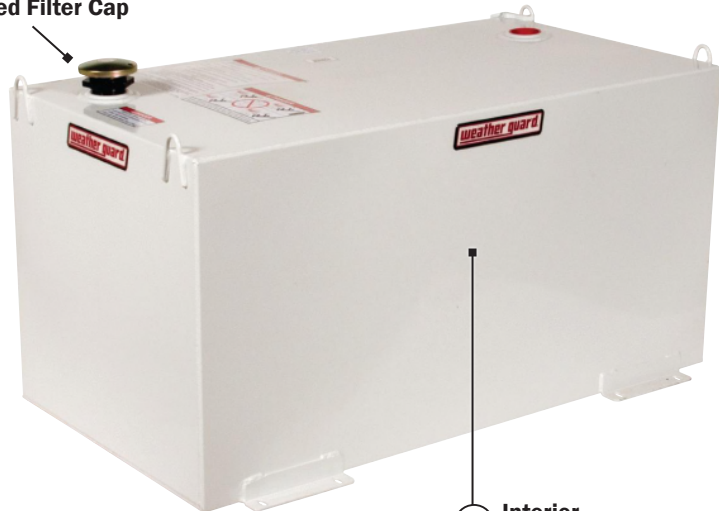

2 Interior Baffle Design

## TRANSFER TANK KEY FEATURES

- 1 Vented filler cap prevents excessive pressure build-up
- 2 Interior baffle design reduces fuel movement
- 3 Limited Lifetime Warranty for peace of mind

## LIMITED LIFETIME WARRANTY

### FOR TRANSPORTING DIESEL FUEL

WEATHER GUARD® Transfer tanks offer a safer mode of transporting diesel fuel to your jobsite and beyond. L-shaped tanks are designed to be used with Cross Boxes and Saddle Boxes only; rectangular tanks are designed for full-size pickup trucks.

Ranging in capacity from 40-110 gallons, WEATHER GUARD® Transfer Tanks feature full arc-welded, heavy 14-gauge steel construction for long-lasting durability. The interior baffle design reduces fuel movement and provides extra tank reinforcement. The lockable vented filler cap prevents excessive pressure build-up

and the threaded filler neck accepts standard 2" threaded pipe. Installation is easy using the heavy-duty lifting loops and secure plate-steel flange bed mounting points. All tanks are protected with Brite White or Gloss Black ARMOR TUF® Powder Coat Finish for years of durability, and backed by a Limited Lifetime Warranty.

#### STEEL TRANSFER TANK 50 GAL. CAPACITY

- 350-3-01
- 350-5-01



For compact pickups. May be used in combination with WEATHER GUARD® Cross and Saddle Boxes.

Ship Weight: 131 Lbs.

#### STEEL TRANSFER TANK 75 GAL. CAPACITY

- 352-3-01
- 352-5-01

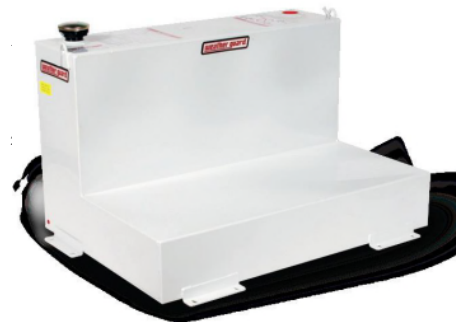

For full-size short-bed pickups. May be used in combination with WEATHER GUARD® Cross and Saddle Boxes.

Ship Weight: 164 Lbs.

# TRANSFER TANKS

## STEEL TRANSFER TANK 90 GAL. CAPACITY

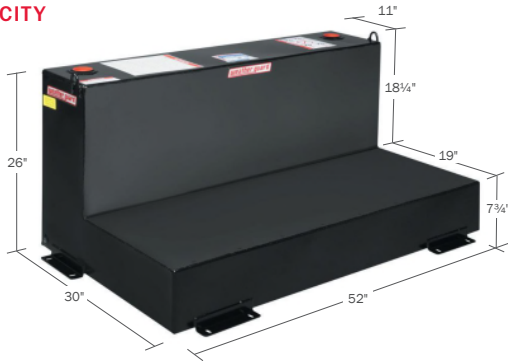

-  354-3-01
-  354-5-01



For full-size pickups. May be used in combination with WEATHER GUARD® Cross and Saddle Boxes.

Ship Weight: 185 Lbs.

## STEEL TRANSFER TANK 40 GAL. CAPACITY

-  351-3-01
-  351-5-01

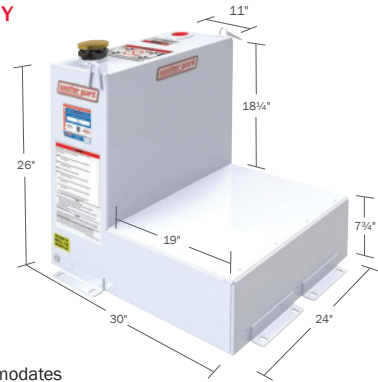

L-shape design accommodates saddle box.

Ship Weight: 118 Lbs.

## STEEL TRANSFER TANK 100 GAL. CAPACITY



-  358-3-01
-  358-5-01



For full-size pickups.

Ship Weight: 152 Lbs.

## STEEL TRANSFER TANK 45 GAL. CAPACITY

-  357-3-01
-  357-5-01



Designed for most full-size and compact pickups.

Ship Weight: 94 Lbs.

## STEEL TRANSFER TANK 110 GAL. CAPACITY



-  360-3-01
-  360-5-01



For full-size pickups. May be used in combination with WEATHER GUARD® Cross and Saddle Boxes.

Ship Weight: 219 Lbs.

## STEEL TRANSFER TANK 50 GAL. CAPACITY

-  359-3-01
-  359-5-01

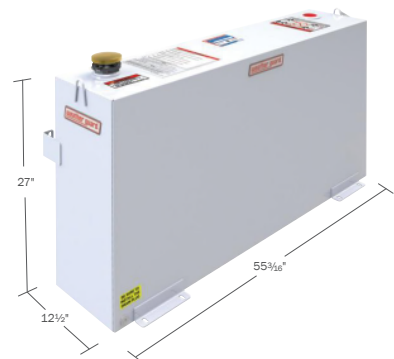

Designed for most full-size pickups.

Ship Weight: 142 Lbs.

# STEEL TRUCK RACK



**NO-DRILL INSTALL**



**WELDED AIRFOIL INCLUDED**

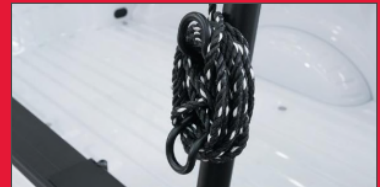

**MAXIMUM TIE DOWN POINTS**

- Fits all full size trucks
- 1,000 lb. weight rated – evenly distributed
- Compatible with Weather Guard truck boxes





# STEEL TRUCK RACK

## FULL SIZE STEEL TRUCK RACK

1275-52-02



## COMPACT STEEL TRUCK RACK

1345-52-02

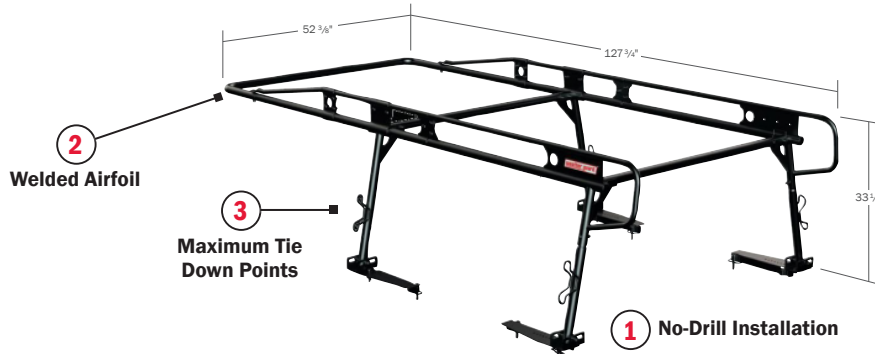

## STEEL TRUCK RACK KEY FEATURES

- 1 No-Drill Installation**  
Installs in less than an hour (15-20 minutes to assemble /30 minutes to install)
- 2 Welded Airfoil Included**  
No need to purchase an accessory, helps deflect wind
- 3 Maximum Tie Down Points**  
4 areas allow for additional tie down points on rack legs for items on rack

## ACCESSORIES

### FULL-SIZE CAB PROTECTOR

1059-52-01

Mounting points line up with pre-drilled holes on Full Size Steel Truck Rack Front legs

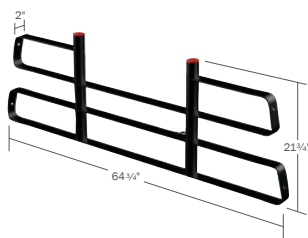

Matte Black Finish  
Matches Compact Steel Truck Rack

Ship Weight: 61 Lbs.

### COMPACT CAB PROTECTOR

1058-52-01

Mounting points line up with pre-drilled holes on Compact Steel Truck Rack Front legs

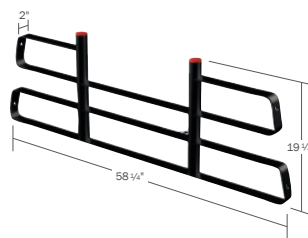

Matte Black Finish  
Matches Compact Steel Truck Rack

Ship Weight: 61 Lbs.

### RATCHET STRAPS

1057-52-01

Works with the 1275-52-02 & 1345-52-02 various tie down points

Installation requires product to be drilled into truck rack and is permanently installed to the rack

Quick release button retracts the straps automatically for easy slowing when not in use

Straps rated to 1,000 lbs

### INCLUDES:

Set of 2 ratchet straps, mounting bracket, and mounting hardware



### FULL-SIZE ACCESSORY CROSS MEMBER

1290-52-01

No-Drill Installation utilizes locking pins (same as rear cross member on rack)

Matte Black Finish  
Matches Compact Steel Truck Rack

Ship Weight: 15.5 Lbs.

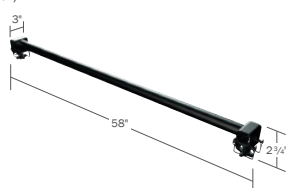

### COMPACT ACCESSORY CROSS MEMBER

1390-52-01

No-Drill Installation utilizes locking pins (same as rear cross member on rack)

Matte Black Finish  
Matches Compact Steel Truck Rack

Ship Weight: 9.1 Lbs.



## BED-MOUNTED SOLUTIONS

# ATR<sup>®</sup> ALUMINUM TRUCK RACK

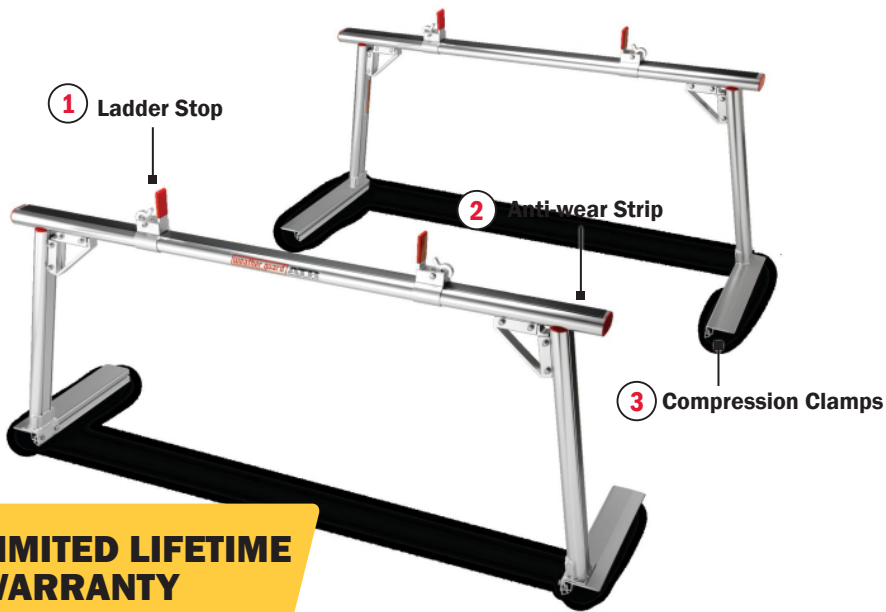

## ATR<sup>®</sup> ALUMINUM TRUCK RACK KEY FEATURES

- 1 Ladder stop**  
easy to adjust, secures ladder/materials
- 2 Anti-wear strip**  
protects ladders and materials
- 3 Compression clamps**  
easily secures rack to top of truck bed
- 4 Triple-wall reinforcement**  
rigidity, durability
- 5 Limited Lifetime Warranty**  
for peace of mind

**LIMITED LIFETIME WARRANTY**

### FOR FULL-SIZE PICKUPS LOAD CAPACITY 800 LBS.



**INCLUDES:**  
4 uprights, 4 mounting bases,  
2 cross members, 4 ladder stops

Ship Weight: 68 Lbs.

### FOR COMPACT PICKUPS LOAD CAPACITY 800 LBS.



**1**  
**IN**  
4 uprights, 4 mounting bases,  
2 cross members, 4 ladder stops

Ship Weight: 61 Lbs.

## SECURE TRANSIT AND STORAGE

There are a couple of aspects of security above the truck bed. You need to keep your ladders and equipment secure both in transit and in storage. The WEATHER GUARD<sup>®</sup> ATR (Aluminum Truck Rack) comes in versions that fit either compact or full-size pickups and are constructed with several design extras sure to provide years of secure transit and storage, no matter what your specific needs are.

### ACCESSORY SIDE RAILS



**1211**  
For full-size pickups with 6.5' beds and all compact pickups.

**INCLUDES:**  
2 side rails  
1 front cross member

Ship Weight: 46 Lbs.

### ACCESSORY SIDE RAILS



**1210**  
For full-size pickups with 8' beds.

**INCLUDES:**  
2 side rails  
1 front cross member

Ship Weight: 52 Lbs.

### ACCESSORY CROSS MEMBER



**1215**  
**FITS:** 1210 and 1211  
Accessory Side Rails only.

Ship Weight: 12 Lbs.

### ACCESSORY QUICK RELEASE

**1218**  
Allows quick removal of rear cross member (2 each.)

**FITS:** 1210 and 1211  
Accessory Side Rails only.

Ship Weight: 2 Lbs.



# STEEL SERVICE BODY RACK

## KEY FEATURES

- 1 WEATHER GUARD® Truck Equipment offers the same quality and durability on our Steel Service Body Rack as on our other field-proven racks.

**NOTE:** Do not mount on aluminum, plastic, fiberglass or top-opening service body trucks: Mount only on steel service bodies.

### STEEL SERVICE BODY RACK LOAD CAPACITY 1000 LBS.

**1225**

For full-size steel service bodies.

**INCLUDES:** legs, side rails and cross members.

Ship Weight: 233 Lbs.



**LIMITED LIFETIME WARRANTY**

# ALUMINUM SERVICE BODY RACK

## KEY FEATURES

- 1 The WEATHER GUARD® Aluminum Service Body Rack is designed to make loading or unloading a ladder a "one-person" job.
- 2 Front post adjusts in height and swivels to allow for easy positioning of ladder during removal or placement
- 3 Both posts have a wide mounting

**NOTE:** Do not mount on an aluminum plastic or fiberglass service body. Mount on steel service body only.

### ALUMINUM SERVICE BODY RACK LOAD CAPACITY 200 LBS.

**1425-3**

For full-size and compact service body trucks on both driver and passenger sides.

Front post adjusts 21 $\frac{3}{16}$ "-35 $\frac{3}{16}$ "

Rear post is stationary at 21 $\frac{3}{16}$ " (shown left)

Front post adjusts 16"-30"

Rear post is stationary at 16 $\frac{1}{4}$ " (shown right)

Ship Weight: 22 Lbs.

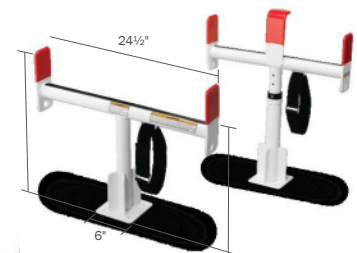

**LIMITED LIFETIME WARRANTY**

# WEEKENDER<sup>®</sup> TRUCK RACK



## KEY FEATURES

- 1** Easy on, easy off for that occasional need to carry a ladder or long material.
- 2** Uprights should be removed when not in use.
- 3** Adjustable, tubular steel pockets bolt into the side of the truck bed. A set-screw holds the upright in place.
- 4** Load bar is adjustable to accommodate the varied widths of ladders.
- 5** Constructed of 1½" x 1½", 14-gauge wall steel tubing.
- 6** Joints are fully arc-welded.
- 7** Mounting bracket allows WEEKENDER<sup>®</sup> Truck Rack to be installed on driver side or curb side of truck.
- 8** If installing to an aluminum bed, please purchase the 70322 Aluminum Upfit Kit.

**LIMITED LIFETIME  
WARRANTY**



**ANGULAR**  
LOAD CAPACITY 250 LBS.

**1475**

For '95 and newer pickup  
Chevy, Dodge, Ford and  
Toyota Tundra.

Ship Weight: 52 Lbs.



**HORIZONTAL**  
LOAD CAPACITY 250

**1450**

For '95 and newer pickups,  
Chevy, Dodge, Ford and  
Toyota Tundra.

Ship Weight: 56 Lbs.

# PROTECT-A-RAIL® CAB PROTECTORS/ACCESSORIES

## FOR COMPACT PICKUPS

**1910-3-01 (white)**  
**1910-5-01 (black)**

Steel Screen cab protector mounts to the bed of a mini pickup. Installation hardware provided.

**1909-3-01 (white)**  
**1909-5-01 (black)**

Punched steel screen cab protector. (Requires separate purchase of Installation Kit.)

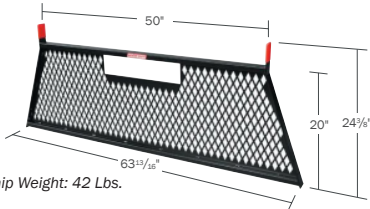
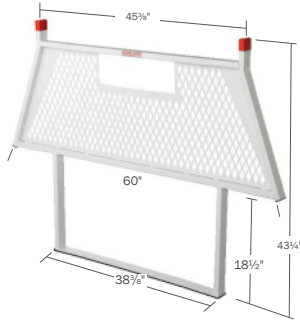

Ship Weight: 42 Lbs.

## FOR FULL-SIZE PICKUPS

**1905-0-02**

Aluminum frame cab protector. Features a lightweight extruded aluminum frame with 14-gauge steel louvers. (Requires separate purchase of Installation Kit.)

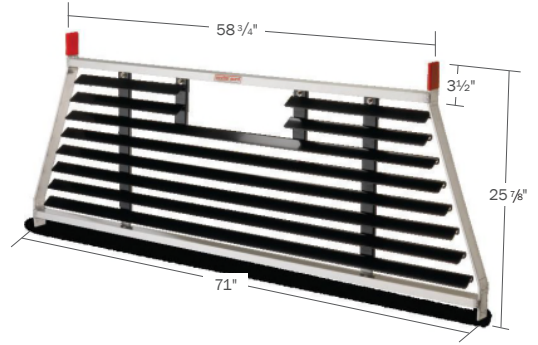

Ship Weight: 33 Lbs.

## FOR FULL-SIZE PICKUPS

**1907-0-02**

Aluminum frame cab protector. Features a lightweight extruded aluminum frame. (Requires separate purchase of Installation Kit.)

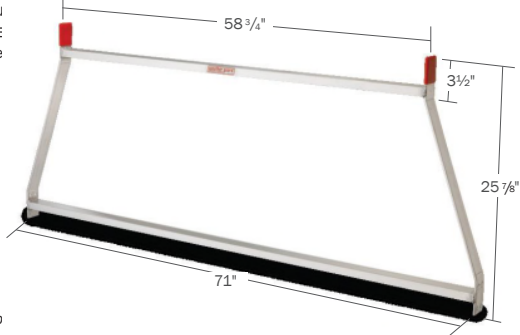

Ship Weight: 19 Lb

## FOR FULL-SIZE PICKUPS

**1904-3-02 (white)**  
**1904-5-02 (black)**

Steel louvered cab protector. Features a steel frame and 14-gauge steel louvers. (Requires separate purchase of Installation Kit.)

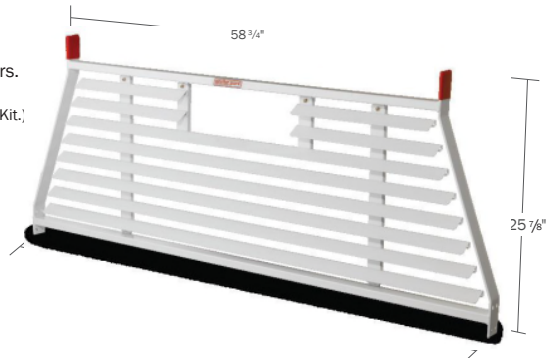

Ship Weight: 46 Lbs.

## FOR FULL-SIZE PICKUPS

**1906-3-02 (white)**  
**1906-5-02 (black)**

Punched steel screen cab protector. (Requires separate purchase of Installation Kit.)

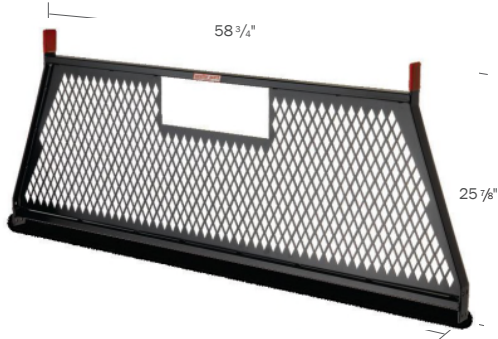

Ship Weight: 33 Lbs.

## FOR FULL-SIZE PICKUPS

**1908**

Heavy-duty cab protector. (Requires separate purchase of Installation Kit.)

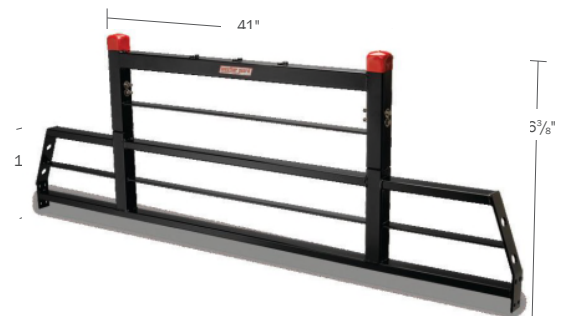

Ship Weight: 46 Lbs.

## ACCESSORIES FOR MOUNTING WARNING LIGHTS & LADDERS FOR 1908

**1917**  
Ladder mount extension.  
Ship Weight: 5 Lbs.



**1918**  
7½" round base.  
Ship Weight: 2 Lbs.



**1920**  
9½" x 17" rectangular base.  
Ship Weight: 6 Lbs.



**1919**  
7½" side mount round base.  
Ship Weight: 3 Lbs.



## INSTALLATION KITS

All full-size & 1909-X-01 PROTECT-A-RAIL® Cab protector models require separate purchase of Installation Kit. Each kit is designed to custom fit your vehicle.

**CHEVROLET/GMC** **1916-3, 1916-5**  
'99 and newer Chevy Silverado/  
GMC Sierra  
Ship Weight: 14 Lbs.

**1914-3, 1914-5**  
'00 and older CK  
Ship Weight: 13 Lbs.

**1927-3-01, 1927-5-01**  
'15 and newer Chevy Colorado/  
GMC Canyon  
Will not fit GM & Chevy 3500 HD.

**RAM** **1912-3-01, 1912-5-01**  
'94 and newer  
Ship Weight: 13 Lbs.

**1921-3-01, 1921-5-01**  
Crew Cab with short bed

**NISSAN** **1929-3-01, 1929-5-01**  
'16 and newer Nissan  
Frontier

**FORD** **1913-3, 1913-5**  
'97 and newer Ford F-150, 2007 and  
newer Toyota Tundra  
Ship Weight: 15 Lbs.

**1915-3-01, 1915-5-01**  
'99 to '16 Super Duty F-250/F-350  
'96 and older F-150/F-250/F-350  
Ship Weight: 14 Lbs.

**1925-3-01, 1925-5-01**  
'17 Super Duty F-250/F-350



Mounting Bracket

## ALUMINUM CONDUIT CARRIER

Keep your conduit safe, secure and clean with our lightweight and durable Conduit Carrier.

**237**  
Conduit Carrier  
Ship Weight: 40 Lbs.

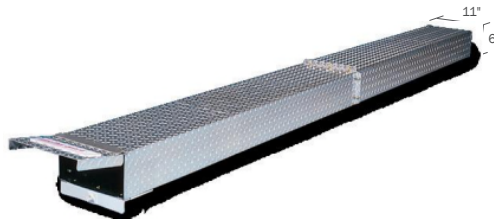

**238**  
6" Extension  
Ship Weight: 4 Lbs.

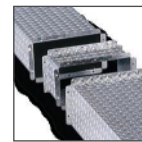

6" Extension

## MAKE-YOUR-OWN CONDUIT CARRIER

**239**  
PVC not included. Separately purchase a section of standard 6" PVC (9ASTM D2665) plastic drain pipe. Coordinate the length of the PVC with the length of conduit you'll be carrying.



Ship Weight: 4 Lbs.

# TRUCK RACK UPFIT GUIDE

				TRUCK RACKS				
				1200	1205	1450	1475	1275-52-02
BRAND	MODEL	BED SIZE	BED STYLE	FULL SIZE ATR	COMPACT ATR	WEEKENDER HORIZONTAL RACK	WEEKENDER ANGLED RACK	FULL SIZE STEEL TRUCK RACK
CHEVROLET	COLORADO	5'	FLEETSIDE		•			
CHEVROLET	COLORADO	6'	FLEETSIDE		•	•	•	
CHEVROLET	SILVERADO	5½'	FLEETSIDE	•		• +70021	• +70021	•
CHEVROLET	SILVERADO	6'	FLEETSIDE	•		• +70021	• +70021	•
CHEVROLET	SILVERADO	8'	FLEETSIDE	•		• +70021	• +70021	•
DODGE	DAKOTA	5'	BED		•	•	•	
DODGE	DAKOTA	6½'	BED		•			
RAM	1500/ 2500/ 3500	6'	BED	•		•	•	•
RAM	1500/ 2500/ 3500	8'	BED	•		•	•	•
FORD	RANGER	6'	STYLESIDE		•	•	•	
FORD	RANGER	7'	STYLESIDE		•	•	•	
FORD	F150	5½'	STYLESIDE	•		•	•	•
FORD	F150	6½'	STYLESIDE	•		•	•	•
FORD	F150	6½'	FLARESIDE	•		•	•	•
FORD	F150	8'	STYLESIDE	•		•	•	•
FORD	SUPER DUTY	6½'	STYLESIDE	•		•	•	•
FORD	SUPER DUTY	8'	STYLESIDE	•		•	•	•
FORD 2017 & NEWER	SUPER DUTY	8'	STYLESIDE					•
GMC	CANYON	5'	FLEETSIDE		•			
GMC	CANYON	6'	FLEETSIDE		•			
GMC	SIERRA	5½'	FLEETSIDE	•		• +70021	• +70021	•
GMC	SIERRA	6'	FLEETSIDE	•		• +70021	• +70021	•
GMC	SIERRA	8'	FLEETSIDE	•		• +70021	• +70021	•
TOYOTA	TACOMA	5'	BED		•			
TOYOTA	TACOMA	6'	BED		•			
TOYOTA	TUNDRA	6'	BED	•		•	•	•
TOYOTA	TUNDRA	8'	BED	•		•	•	•
NISSAN	FRONTIER	4½'	BED		•			
NISSAN	FRONTIER	6'	BED		•			
NISSAN	TITAN	5½'	BED	•				•
NISSAN	TITAN	6½'	BED	•				•

# CONFIGURATIONS GUIDE



## FULL SIZE CONTRACTOR UPFIT

### LO-SIDE BOXES (2)

174-0-01 (page 11)

### ATR®

1200 (page 30), 1210 Rails (page 30)

### PACK RAT®

338-3 (page 25)

### SADDLE BOX

127-0-02 (page 5)



## STEEL TRUCK RACK UPFIT

### STEEL TRUCK RACK

1275-52-02 (page 30)

### SADDLE BOX

127-52-02 (page 5)

### CAB PROTECTOR

1059-52-01 (page 36)



## TRANSFER TANK UPFIT

### PROTECT-A-RAIL®

1908 (page 35)

### TRANSFER TANK

354-3-01 (page 29)

### SADDLE BOX

126-3-02 (page 5)



# REPLACEMENT PARTS

## LOCKS

### 7838-2PK – EXTREME PROTECTION® Retrofit Lock Kit

Dual Locks fit current and retro fit older Cross, Saddle, Lo-Side, Pork Chop Boxes

### 7748-1PK – EXTREME PROTECTION® Replacement Lock Kit

Single Lock for Current Cross, Saddle, Lo-Side, Pork chop & All-Purpose Chests



### 7081-1PK – Paddle-Handle Latch & Lock Kit

**FITS:** Older Hi-Sides, current aluminum Underbeds, older steel Underbeds

### 7106-1PK – Striker Plate Kit

**FITS:** Three generations Cross, Saddle, Lo-Side, Pork Chop, All-Purpose Chests



## CABLES

### 7069-2PK – 14" Cables

**FITS:** All standard-size steel and aluminum Hi-Sides

### 7071-2PK – 16" Cables

**FITS:** All steel & Aluminum Super-Side Boxes except 297-3 Jumbo Super-Side. Any 18" high Underbeds, current aluminum and old-style steel



## PAINT

### 886-1CN – White Aerosol Touch-up paint

For touchup on all WEATHER GUARD® White Products

### 887-1CN – Black Aerosol Touch-up paint

For touchup on all WEATHER GUARD® Black Products



## BLIND FASTENERS

### 7998-20PK – 1/4" Blind Fasteners (20)

Rigid fastening on sheet metal, fiberglass and plastic

### 999-20PK – 3/16" Blind Fasteners (20)

Rigid fastening on sheet metal, fiberglass and plastic

### 7998-10PK – 1/4" Blind Fasteners (10)

Rigid fastening on sheet metal, fiberglass and plastic

### 999-10PK – 3/16" Blind Fasteners (10)

Rigid fastening on sheet metal, fiberglass and plastic



## FILL CAP

### 355-1PK – Fill Cap

**FITS:** Transfer Tanks



## GAS SPRINGS 2PK



### 7009-2PK

**FITS:** 121-X-01, 123-X-01, 123, 123-X, 127-X-01, 127, 127-X, R-127, 131-X-01, 137-X-01, 137, 137-X, 147-X-01, 154-X-01, 6212-5.

### 7249-2PK

**FITS:** 117-X-01, 117, 117-X, R-117, 126-X-01, 126-X, R-126, 128-X-01, 128-X.

### 7917-2PK

**FITS:** 114-X-01, 114, 114-X, 114-B, 124-X-01, 124, 124-X, 124-B, 134, 134-X, 134-B, 153, 153-X, 153-B, 159, 159-X, 159-B, 191, 193.

### 900-2PK

**FITS:** 125-X-01, 125-X, R-125, R-125-B, 135-X, R-135, 155-X, R-155.

### 7095-2PK

**FITS:** 160-X-01, 161-X-01, 164-X-01, 165-X-01, 166-X-01, 170-X-01, 170, 170-X, 171-X-01, 171, 171-X, 172-X-01, 172, 172-X, 173-X-01, 173, 173-X, 174-X-01, 175-X-01, 184-X-01, 185-X-01, 186-X-01, 644-X-01, 645-X-01, 654-X-01, 654, 654-X, 654-B, 655-X-01, 664-X-01, 664-X, 664, 664-B, 674-X-01, 674-X, 674, 674-B, 675-X-01.

### 7096-2PK

**FITS:** 162-X-01, 163-X-01, 166-X-01, 665-X-01, 665-X, 665-B.

### 7248-2PK

**FITS:** 116-3, 116-5, R-116.

### 7250-2PK

**FITS:** 136-X-01, 136-X, R-136, 156-X-01, 156-X, R-156.

### 7250-2PK

**FITS:** 116-X-01, 158-X, R-158.

### 7252-2PK

**FITS:** 154, 154-X, R-154.

### 7900-2PK

**FITS:** 115-X-01, 115-X, R-115, 157-X, R-157.

### 7902-2PK

**FITS:** 165-X-01, 176-X-01, 655, 655-X, 675, 675-X, 684-X-01, 684, 684-X.

### 7904-2PK

**FITS:** 685-X-01, 685-X.

### 918-2PK

**FITS:** 162-X, 162, 163-X, 163.

### 932-2PK

**FITS:** 165-X, 186-X, 630, 630-X.

### 932-2PK

**FITS:** 160-X, 160, 161-X, 161, 164, 164-X, R-164, R-164-B, 175-X, 185-X, 624, 624-X.

### 7010-2PK

**FITS:** 174, 174-X, R-174, R-174-B, 184, R-184, R-184-B.

### 7011-2PK

**FITS:** 176-X.

### 7901-2PK

**FITS:** 166-X.

### 921-4PK – Ball Studs 4-Pack

Fits all KNAACK® & WEATHER GUARD® Gas Springs



\*Model Number Color Coating:  
X = 0 (Clear), 3 (White), 5 (Black)