

WeatherTech®

Industry Leader in Vehicle Accessories

Distributor Catalog

2015





What Matters to You?

Today, America needs fresh leadership to lead us as a nation out of this economic crisis. Leadership must come not only from our political leaders but also from the average citizen. The exporting of American jobs is a trend that must be stopped and reversed. When I walk into my local hardware store, I typically find 85% of the goods for sale are manufactured 7,000 miles away. Recognizable American brands have been forced by shortsighted management and buyers at large national chains to build factories overseas just to save a lousy \$.50 on a tape measure. To these ruthless buyers, it is all about the money. Rarely are product quality, the political system, human rights, animal rights and environmental costs to the planet considered, not to mention the cost to our society of exporting not only jobs, but an entire factory!

At MacNeil Automotive, we are doing our part for the American economy and for our 300 million fellow citizens and neighbors. My philosophy is that if my neighbor doesn't have a job, sooner or later I won't have a job either. For example, we used to have our All-Weather Floor Mats manufactured in England by a company that used antiquated, inefficient equipment. They made a decent floor mat for us, but we thought we could build a better floor mat for our customers using modern American technology, American raw materials and skilled American workers. So in 2007 we transferred all of our floor mat manufacturing back to the United States. Today, we build the best fitting, highest quality automotive floor mats in the world, right here in America.

Our machine shop is equipped with 26 CNC machining centers including four 4 axis mills and one 5 axis mill that produce between 30 to 50 injection and thermoforming molds per month. We have one shift of highly skilled American Journeymen, toolmakers and apprentices, but our machines run 24 hours a day, 7 days a week. There is not a more efficient tool and mold making operation in the world - and guess what, it's right here in America.

Furthermore, most of our CNC mills are manufactured in Oxnard, CA by Haas. Our 1,000 ton injection molding machines are made in Bolton, Ontario of American and Canadian components. Our thermoforming machinery is made in Carol Stream, IL. The raw steel and aluminum billets which make up our tooling are sourced from American steel aluminum mills such as Vista Metals in Fontana, CA. The raw materials that make up our All-Weather Floor Mats, FloorLiners, Cargo Liners and

MudFlaps are manufactured in Paulding, OH; Greenville, OH; Wichita, KS; and Jasper, TN. Our forklifts are made in Columbus, IN and Greene, NY. Our warehouse racking is manufactured in Melrose Park, IL.

At MacNeil Automotive, we are also very aware of sustainability and our responsibility to the environment. We are proactive in controlling waste and recycling all of the unused raw materials from the manufacture of our tooling and products including: aluminum, steel, rubber, TPO, TPE, paper and cardboard.

As you can see, we are as for our consumer and OEM clients as we are passionate about supporting the American economy, preserving the American industrial infrastructure, and keeping the "money" in our family, a family of 300 plus million people from all over America.

Our commitment and dedication to our customer is further exemplified by our certification to ISO 9001:2008 Quality Management Standards with the additional Automotive Qualification ISO/TS 16949:2009. This ensures our customers of the highest quality products as well as the systems necessary to continually exceed expectations in every regard.

Life is simple; be good to your fellow man, be kind to animals and the environment, and place building a quality product, supporting your country and your fellow American worker before profit. And, one last thing - let's all do our best to balance family time with work time as our children are the future of America.

Sincerely,





Contents

INTERIOR FLOOR PROTECTION

FloorLiner™	6
All-Weather Floor Mats	10
AVM® All-Vehicle Mat	14

CARGO & TRUNK PROTECTION

Cargo Liners	18
AVM® Universal Cargo Mat	22
TechLiner® & Tailgate TechLiner®	26
UnderLiner®	30
CargoTech®	31

DEFLECTORS

Side Window Deflectors	32
Sunroof Wind Deflector	36
Stone & Bug Deflector	38

EXTERIOR PROTECTION

No-Drill MudFlaps	40
BumpStep®	44
Billet BumpStep®	45
Hockey Team BumpStep®	46

LICENSE PLATE FRAMES

Billet Aluminum Plate Frame	48
Motorcycle Billet Aluminum Plate Frame	49
ClearCover®, ClearFrame™, PlateFrame®, StainlessFrame™ & BumpFrame™	50

FLOOR TILE

TechFloor™	52
------------	----

AUTO DETAILING AND CLEANING PRODUCTS

TechCare® and Accessories	56
---------------------------	----

ADDITIONAL ACCESSORIES

OutdoorMat™	58
-------------	----

IndoorMat™	59
------------	----

BootTray™	59
-----------	----

RackSack®	60
-----------	----

Pet Barrier	61
-------------	----

WeatherTech® BatteryCharger	62
-----------------------------	----

TechShade®	63
------------	----

Car Covers	64
------------	----

LampGard®	68
-----------	----

Gift Bag	68
----------	----

RACING APPAREL

WeatherTech® Racing Apparel	66
-----------------------------	----



Proudly Designed, Engineered
and Manufactured with American
Made Tooling in the USA



Available for Cars, Trucks, SUVs and Minivans



WeatherTech's designers and engineers have worked tirelessly to develop the most advanced vehicle protection system available today. The WeatherTech® FloorLiner™ lines the interior carpet up the front, back and even up the sides of the vehicle's footwell. This ultimate protection helps to provide the assurance that a vehicle will maintain the long-lasting comfort and interior appearance that an owner wants from their investment.

PERFECT FIT for every vehicle and protects the front, back and even up the sides

Channels that carry fluids away

Lower reservoir that holds fluids and debris

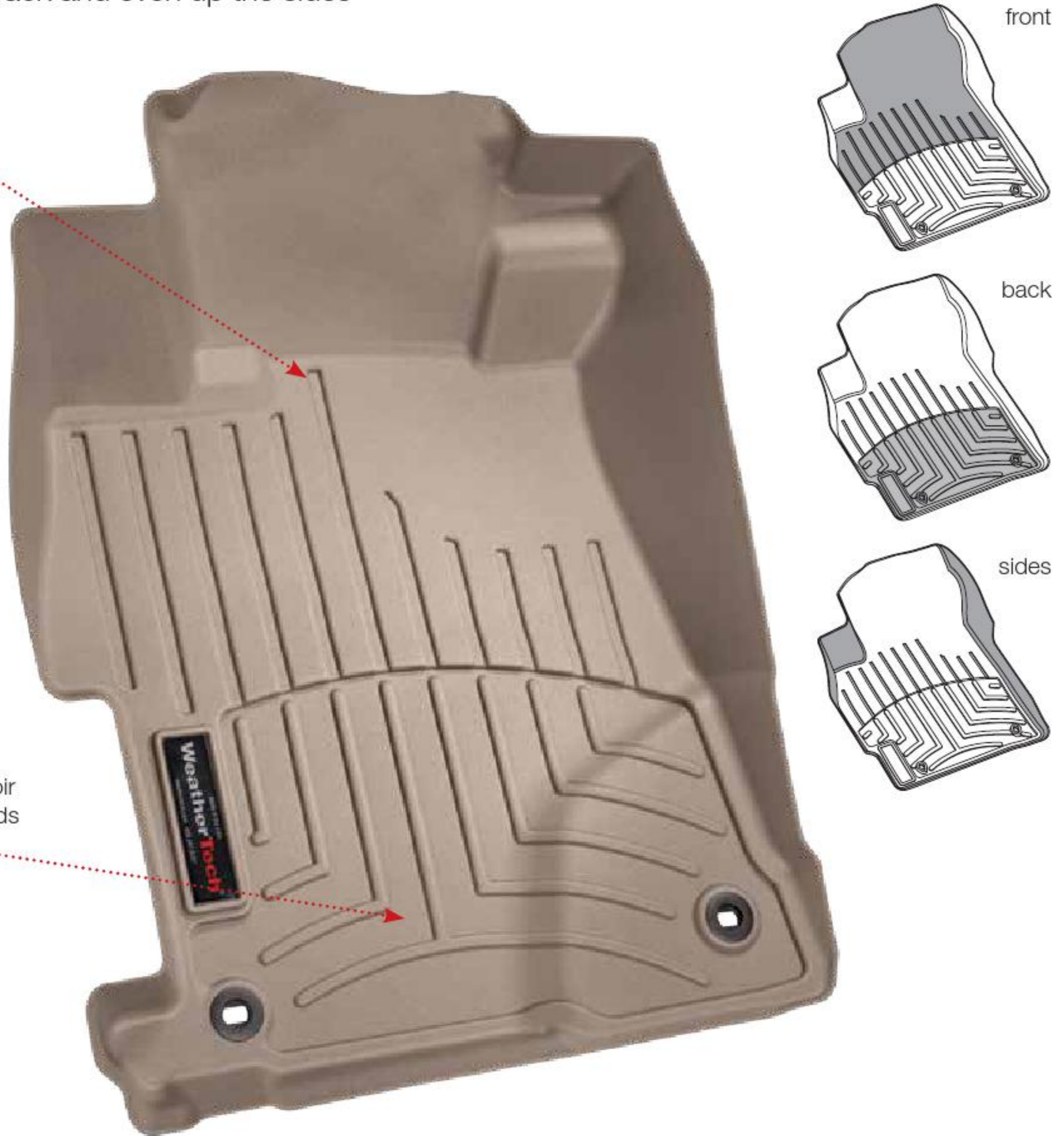

Each and every designed FloorLiner™ application goes through an intense series of measurements, fittings, design and mold creation before it will become available on the accessories market. Starting with 3D laser measurements of the interior surfaces, raw data of each vehicle is collected and processed. Designers utilize this data to create a 3D prototype part that is fitted into the vehicle and, if necessary, make adjustments until the fit of the product fits seamlessly to the contours of the vehicle. A mold is then machined out of aircraft grade aluminum and water cooled to maintain a consistent production quality.

The WeatherTech® FloorLiner™ provides a custom-fit solution to spills, debris, tracked in weather and more. Made from a patented multilayer material, FloorLiners provide a rigid core for strength that helps to retain their custom-fit shape, while offering a soft tactile top surface that feels comfortable underfoot. Specially designed channels carry fluid and debris to a lower reservoir, away from shoes and clothing. Easy to clean and easy to install. Available for cars, trucks, SUVs and minivans in black, tan and grey.



Proudly Designed, Engineered
and Manufactured with American
Made Tooling in the USA

All-Weather Floor Mat



Available for Cars, Trucks, SUVs and Minivans



CUSTOM FIT

to the shape of the vehicle

Deeply sculpted channels designed to trap water, road salt, mud and sand



Anti-skid ridges prevent shifting in your vehicle



The WeatherTech® All-Weather Floor Mats have deeply sculpted channels designed to trap water, road salt, mud and sand. Our proprietary engineered odorless resin ensures that these mats will not curl, crack or harden in sub-zero weather. All-Weather Floor Mats have anti-skid ridges to prevent shifting in your vehicle, and come with a protective non-stick finish to make cleanup quick and easy.

WeatherTech® All-Weather Floor Mats are manufactured in America to meet ISO 9001 standards and FMVSS302 standards – your assurance of quality. Choose from black, tan or grey to complement virtually any interior color. Available for cars, trucks, minivans and SUVs.



Proudly Designed, Engineered
and Manufactured with American
Made Tooling in the USA



Available for Cars, Trucks, SUVs and Minivans



These mats have been specifically trimmed for these vehicles

Good, Better, Best – what is the right choice for you when it comes to vehicle floor protection? Naturally, the WeatherTech® FloorLiner™ offers the best possible protection for your vehicle, followed by the WeatherTech® All-Weather Floor Mat coming in second on the protection scale; both offering custom-fit protection for virtually all popular vehicles. However, for car owners on a budget, the WeatherTech® All-Vehicle Mat (AVM®) offers a good option to fit their specific needs, with a trim-to-fit feature for customization.

driver

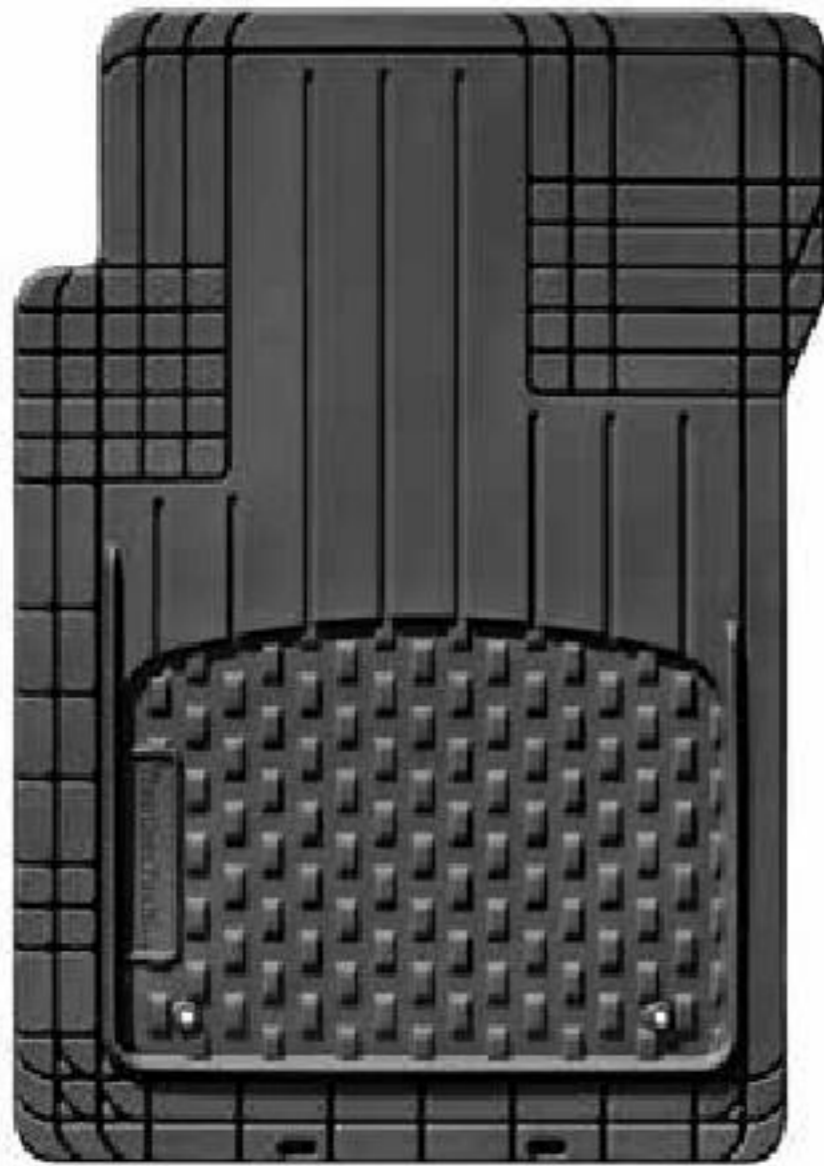

passenger

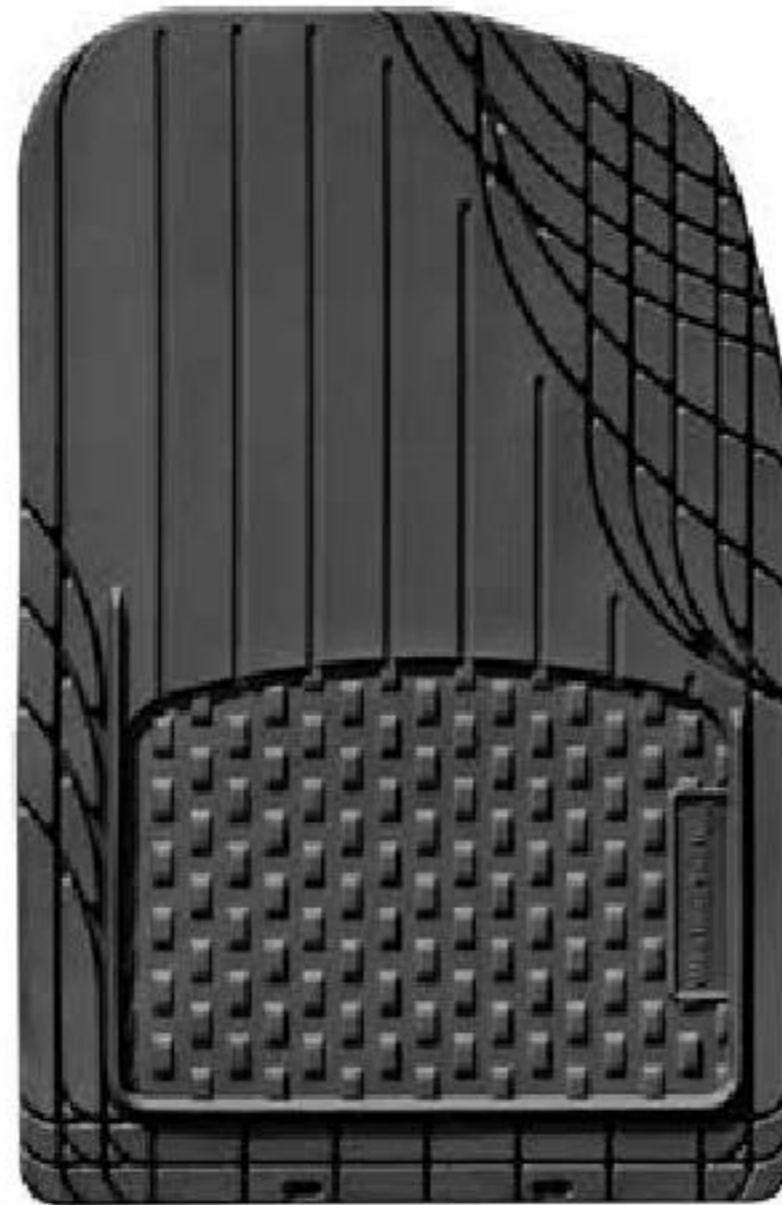

rear



rear



Patented MatGrip® retention device

The WeatherTech® AVM® is the evolution of the “Universal” All-Weather Floor Mat. It is the most technologically advanced universal trim-to-fit mat made today, with a unique shape for the driver and passenger floor.

Our product designers measured many different shapes and sizes of vehicles to determine the best sizes needed for an ideal fit, indicated for customization by trim lines on the mat. The combination of the high quality materials and easy to use trim lines ensures the AVM® maintains the desirable attributes expected of a WeatherTech® product.

AVM® Trim-to-Fit™ Mats feature a tall outer ridge and reservoir to help trap fluids and debris from the vehicle's flooring. The AVM® is made from an advanced thermoplastic elastomer (TPE) that is odorless, non-toxic and stays flexible in even the coldest of temperatures.

To ensure proper safety, the AVM® features the patented MatGrip® retention device, as well as molded-in nibs for a secure mat-to-floor interface. Available in black, tan or grey.

Remember – before you place your order, this is a trim-to-fit universal-type floor mat. If you wish to have a custom mat for your vehicle, please see our FloorLiner™ or All-Weather Floor Mats.



Proudly Designed, Engineered
and Manufactured with American
Made Tooling in the USA



Available for Car Trunks, SUVs and Minivans



DIGITALLY DESIGNED

to fit your vehicle



Features a raised lip to keep spills, dirt and grease off your vehicle's interior



Textured finish that helps to keep cargo from shifting

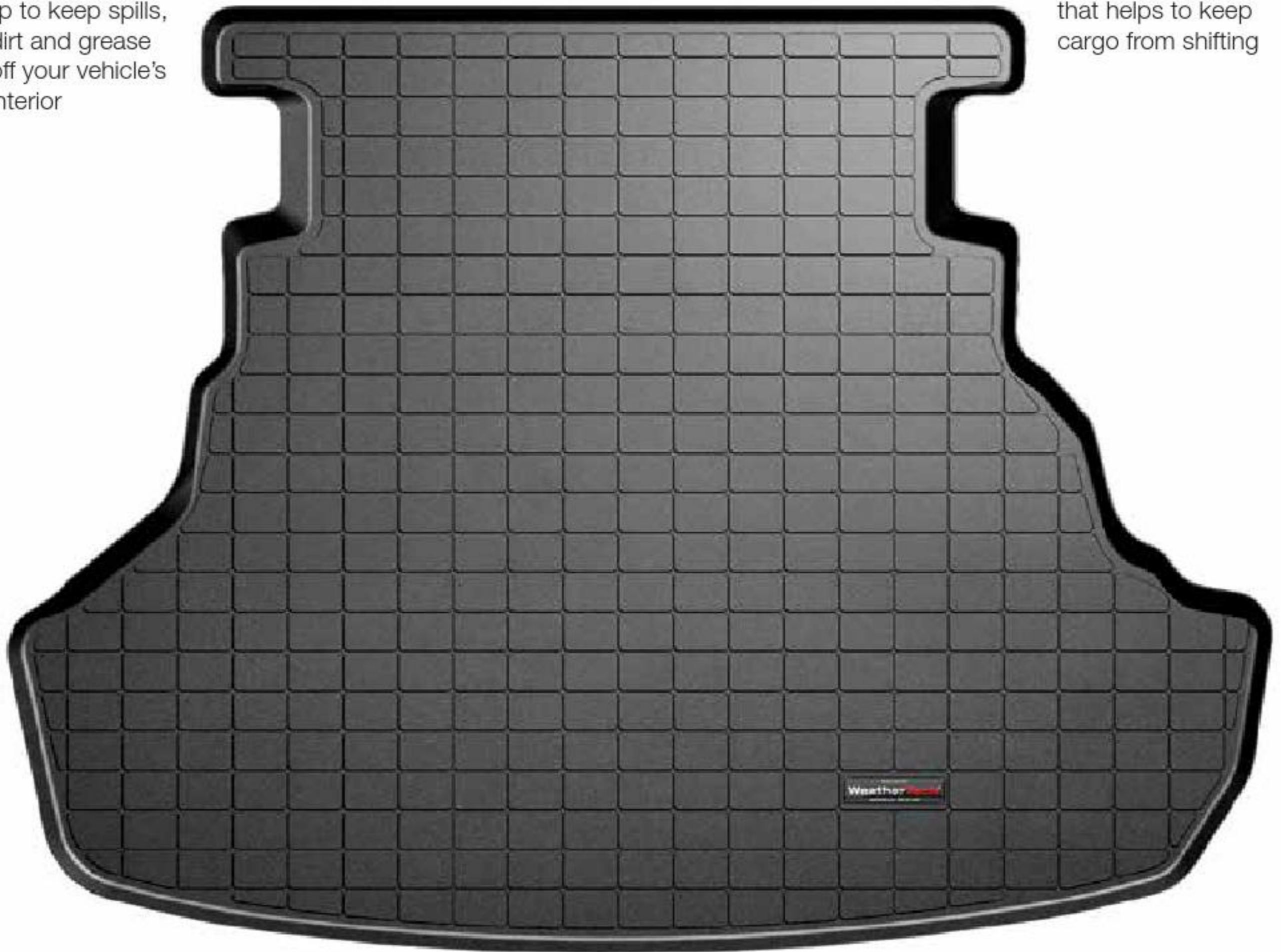

WeatherTech® Cargo Liners provide complete trunk and cargo area protection. Our Cargo Liners are digitally designed to fit your vehicle and feature a raised lip to keep spills, dirt and grease off your vehicle's interior, protecting your investment from normal wear and tear.

Made from a proprietary custom blended TPE that is not only wear resistant, but also remains flexible under

temperature extremes. WeatherTech® Cargo Liners feature a textured finish that helps to keep cargo from shifting. Perfect for hauling just about anything from gardening supplies to construction materials, even the family pet.

WeatherTech® Cargo Liners meet FMVSS302 standards. Available for car trunks, minivans and SUVs in black, tan or grey.



Proudly Designed, Engineered
and Manufactured with American
Made Tooling in the USA

AVM® Universal Cargo Mat



Available for Car Trunks, SUVs and Minivans



These mats have been specifically trimmed for these vehicles

Universal Protection, WeatherTech® AVM® Cargo Mats protect your investment from normal wear and tear. Intelligent design, combined with trim lines allow for a truly custom fit. An outer ridge and inner reservoir contain and keep fluid away from the vehicle's interior. Made from a soft, flexible rubber compound that will not curl, crack or harden even in sub-zero temperatures. Textured finished and raised areas help prevent cargo from shifting. Perfect for hauling just about anything

from gardening supplies to construction materials, even the family pet.

Our commitment to the environment and sustainable design, led to the development of our advanced rubber compound that is an OEM approved, virtually odorless material that contains no harmful PVCs, cadmium, or lead and is 100% recyclable! Available in black, tan or grey.

TRIM-TO-FIT™

Length from 27½" - 36"

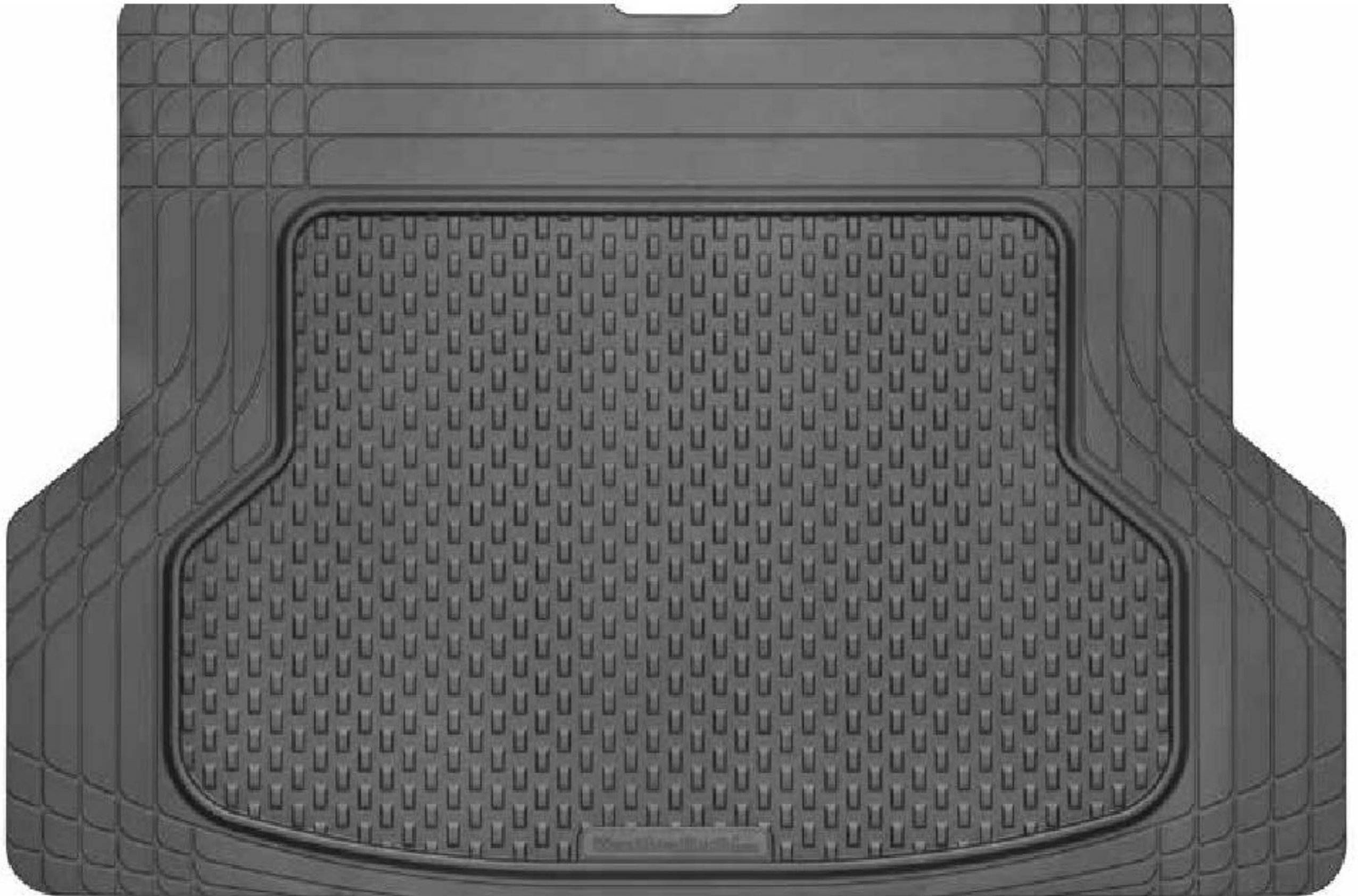

TRIM-TO-FIT™

Width from 41" - 53"



Tall outer ridge and inner reservoir contain fluid and debris



Trim lines allow for a truly custom fit



Maintains flexibility



Proudly Designed, Engineered
and Manufactured with American
Made Tooling in the USA

TechLiner® & Tailgate TechLiner®



Available for Most Popular Pick-Up Trucks

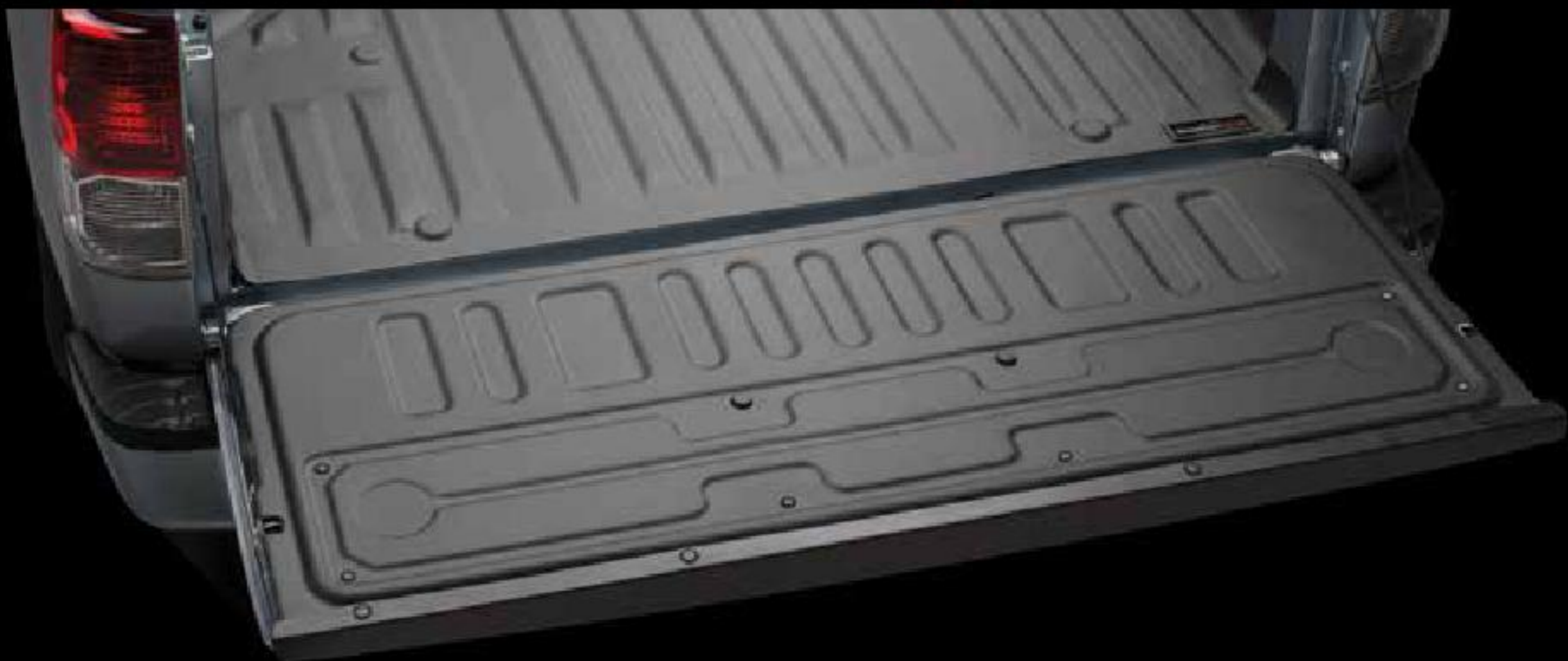

EASIEST TO INSTALL PICK-UP BED PROTECTION – PERIOD!

Custom fits to the contours of
the truck bed

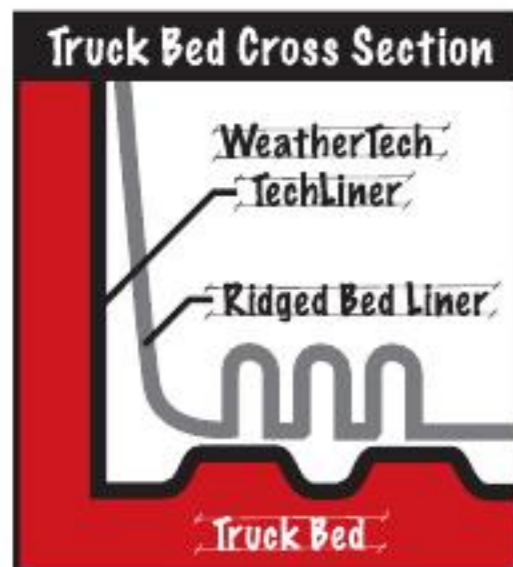

Works well under rigid
bed liners to protect
against paint wear



WeatherTech® TechLiner® is the easiest to install, custom-fit solution for protecting and preserving pick-up truck beds – PERIOD! TechLiner® armors your investment against scratches, dents and paint damage by seamlessly lining the truck bed and tailgate. The liner's "soft touch" material helps to prevent cargo from shifting yet provides ease to loading/unloading.

Made from a 100% recyclable and odorless thermoplastic elastomer; TechLiner® is durable, flexible and UV resistant. Custom-fit for each application, the liner securely fits the exact contours of the truck bed. Will not crack, break or warp in even extreme temperatures.

TechLiner® can be placed underneath a rigid high-sided liner to provide additional protection against paint damage. It is also ideal for users of truck caps and transporting pets. Installation takes only minutes, without the need

for drilling or use of chemical applications. TechLiner® is secured to the truck bed with the use of Velcro® discs that allow for an effortless fit and the ability to remove the liner if necessary. Additional tailgate piece available.

- Easiest to install pick-up bed protection – PERIOD!
- Fits to the exact contours of application
- No-messy sprays or drilling needed
- 100% recyclable, odorless material
- Flexible and durable
- Chemical and UV resistant

UnderLiner®

So you just purchased your shiny new pick-up truck and you intend to do some seriously heavy duty hauling. Your next stop will be to outfit your new vehicle with nothing but the best accessories - WeatherTech® FloorLiners™ – check, WeatherTech® MudFlaps – check. You passed on the WeatherTech® TechLiner® because you really have your mind set on a “drop-in” bed liner for the full protection you feel you need, but wait! Did you consider protecting the bed of your truck from the ravages of the rigid bed liner rubbing against the painted surface?

Introducing UnderLiner® – digitally designed to perfectly match the contours of your specific pick-up truck bed. The UnderLiner® provides added protection by creating a .065" thick semi-soft protective barrier between the rigid drop-in bed liner and the painted surface of your truck bed.





The CargoTech® system integrates with the WeatherTech® Cargo Liner, standard carpeted surface of a car trunk, or SUV cargo area. Aids in securing large or unusually shaped items, such as grocery bags or plants. Molded from two different materials, the WeatherTech® CargoTech® system couples a durable plastic “fence” with a super-grippy underside to ensure goods remain stable. Sold as a set-of-four.





WeatherTech
800.411.6287 weathertech.com



Available for Cars, Trucks, SUVs and Minivans



Side Window Deflectors

WeatherTech® Side Window Deflectors offer fresh air enjoyment with an original equipment look. They are crafted from the finest 3mm acrylic material available.

Installed within the window channel, installation is quick and easy, without the need for exterior tape. WeatherTech® Side Window Deflectors are precision

machined to perfectly fit your vehicle. These low profile window deflectors help to reduce wind noise and allow interior heat to escape. Our light tinted Side Window Deflectors are the only deflectors in the world made with a D.O.T. (U.S. Department of Transportation) approved glazing material. Available in light and dark tint.

SLEEK, LOW PROFILE DESIGN

Installs in-channel





The WeatherTech® Sunroof Wind Deflector provides significant reduction of in-cabin wind noise and air turbulence. It is crafted from the finest 4mm thick, tinted cast acrylic that fits the sunroof opening precisely; held securely in place with the MagiClip™ vehicle specific fastening system. To protect your vehicle's finish, the unique AirCushion™ gasket seals the edge of the deflector. WeatherTech® Sunroof Wind Deflector's sleek and sophisticated look is a great addition to any vehicle.



VEHICLE SPECIFIC DESIGN



MagiClip™
fastening system



AirCushion™ gasket

Sleek and low profile, the WeatherTech® Easy-On® Stone & Bug Deflector is aerodynamically designed to provide excellent protection against stone chips and bug stains.

Made from aerospace-grade acrylic, it is virtually indestructible and extremely scratch resistant. Attaches easily to most SUVs, trucks, minivans or cars using either a 3M® brand automotive adhesive tape or fasteners that use existing holes in the vehicle's hood. No drilling is required. A beautiful and protective addition to any vehicle.



Sleek and low profile



Aerodynamic design



Stone & Bug Deflector





Proudly Designed, Engineered
and Manufactured with American
Made Tooling in the USA



Available for Trucks and SUVs



Dually No-Drill MudFlap

**Perfect
DigitalFit®**

No-Drill MudFlaps

MOUNTS-IN-MINUTES™

Engineered specifically for each application



Installs without wheel/tire removal

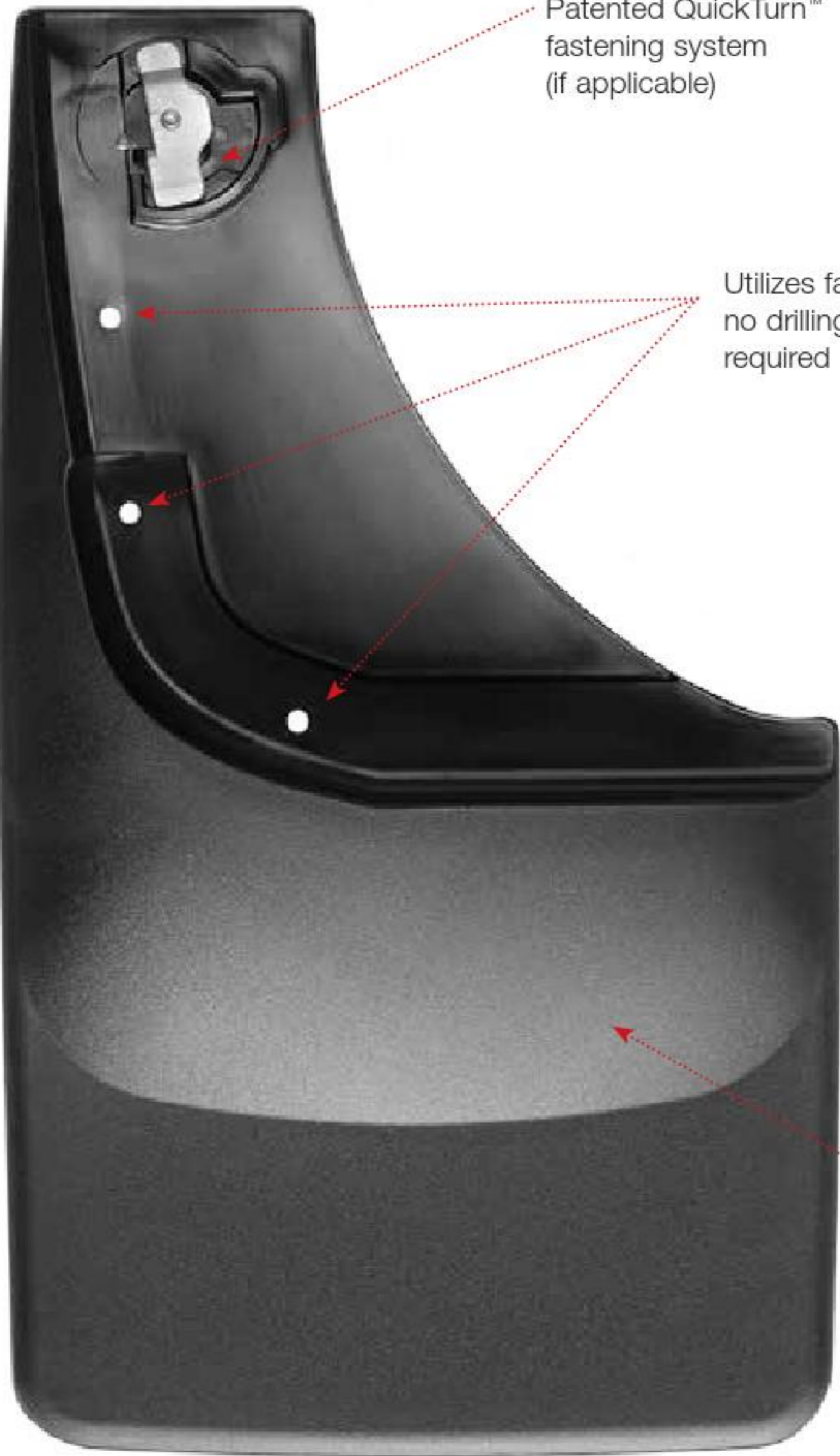

The WeatherTech® No-Drill MudFlap set literally “mounts-in-minutes™” (in most applications) without the need for wheel/tire removal, and most importantly - without the need for drilling into the vehicle’s fragile painted metal surface! Contoured specifically for each application and molded from a proprietary thermoplastic resin. Featuring the patented QuickTurn™ hardened stainless steel fastening system.

The WeatherTech® No-Drill MudFlap provides protection for your vehicle’s most vulnerable rust area; protecting the fender and rocker panel from stone chips, slush, dirt and debris.

BumpStep®

Introducing the injection molded WeatherTech® BumpStep® and yes, it is proudly made in America! It is the best step-bumper protector available, next to our Solid Aluminum Billet BumpStep®.

We made the tooling for the injection molded BumpStep® in our tool room located in Downers Grove, IL by American Machinists on American made CNC machines.

BumpStep® is molded out of a proprietary resin in our manufacturing facility located in Bolingbrook, IL, and fits any vehicle with a standard 2" receiver hitch.

Why get a BumpStep®? Well, it's simple, protection against bumps, dents and scratches to your vehicle's bumper. Careless drivers can bump, knock, and crash without care into your back bumper. With the BumpStep®, you will have the reassurance of bumper protection from other motorist's mistakes and small accidents from backing up.

As a vehicle owner that takes pride in your investment, scratches and dents to your bumper are as much of an eyesore as a ding to your door.

As the "step" portion of its name describes, BumpStep® also allows you to safely stand on the step (up to a 300lb max) for every day tasks such as loading a roof rack, racking a bike or washing the upper area of your vehicle.

PROTECTION AGAINST BUMPS from other motorists, while parallel parking or at a traffic light



WeatherTech®
Hitch Pin (sold separately)



Allows you to safely stand on the step (up to a 300lb max)

Billet BumpStep®

It's HEAVY! It's HANDMADE in America! It's SOLID aluminum. It's COOL, and it's the best bumper protector/step you can buy.

We make the Billet BumpStep® in our tool room in Downers Grove by American Machinists on American made CNC machines.

Made in very limited quantities, we start with a 36.5 pound solid billet of aluminum. Many hours are then spent sculpting the Billet BumpStep® in multiple CNC machines. Custom fixtures had to be made, programs written and specialized cutters purchased, all to make the best bumper protector/step in the world.

Fits any vehicle with a standard 2" receiver hitch. The aluminum is hard-anodized for corrosion resistance and scratch protection.

WeatherTech®
Stainless Hitch Pin

- Theft deterrent design
- Solid 304 stainless steel



(sold separately)





BumpStep®





Protect your vehicle and support your favorite team with the WeatherTech® BumpStep®, featuring high quality NHL® team designs. These fan favorite accessories help protect your vehicle's bumper from unwanted dents and scratches from small accidents. BumpStep® also provides an excellent “step” utility to your vehicle.



NHL and the NHL Shield are registered trademarks of the National Hockey League. All NHL logos and marks and NHL team logos and marks depicted herein are the property of the NHL and the respective teams and may not be reproduced without the prior written consent of NHL Enterprises, L.P. © NHL 2015. All Rights Reserved.

Billet Aluminum Plate Frame

Introducing the WeatherTech® Solid Billet Aluminum License Plate Frame. We make no excuses for the price, but there are also no excuses for the superb American crafted quality either. This is a solid billet license plate frame for car collectors or for true car enthusiast only.

Today, they are made one at a time right in the WeatherTech® tooling facility in Downers Grove, Illinois. Furthermore they are made on an American made CNC milling machine and the machining time approaches two hours which includes real 3D machining. Even the cutters used to shape the metal are American made.

None of this is inexpensive and therefore the price is what it is as our American machinists receive fair American wages, they are created on American made CNC machinery using American raw materials with American made cutters, and we use American sourced finishing of the billet aluminum.

If you want the finest billet license plate frame on the planet and you want one made right here in America, look no further as you have found it at WeatherTech®. Available in three bullet proof anodized finishes: Clear Bright Silver, Titanium and Black. Handmade in extremely small batches.



Available in clear bright silver, titanium and black



High quality stainless steel universal fastener kit



Motorcycle Billet Aluminum Plate Frame



Available in clear bright silver, titanium and black



Introducing the WeatherTech® Solid Billet Aluminum Motorcycle License Plate Frame. We appreciate the lengths owners go to customize the appearance of their motorcycle and offer this unique and exclusive product to elevate your motorcycle's appearance above the rest.

We include everything you need to install, including the hex wrench. Attaches easily to the plate bracket with a set of four Stainless Steel Hex-Key bolts with self-locking flange nuts.

We make no excuses for the price, but there are also no excuses for the superb American crafted quality either. This is the solid billet license plate frame for motorcycle collectors or true motorcycle enthusiast. Today, they are made one at a time right in the WeatherTech® tooling facility in Downers Grove, Illinois. Individually made on an American made CNC milling machine, taking close to two hours to make (which includes real 3D machining). Even the cutters used to shape the metal are American made. None of this is inexpensive and therefore the price is what it is as our American Machinists receive fair American wages, they are made on American made CNC machinery using American raw materials with American made cutters, and we use American sourced finishing of the billet aluminum.



License Plate Frames



The WeatherTech® ClearCover® license plate cover is made from the virtually indestructible UV-stable Lupillon 3000. The one piece lens and gasket design allows for easy installation. The Multi-Flex™ gasket seals moisture out, and a stepped lip design fits the license plate snugly. The WeatherTech® ClearCover® has many colors to choose from, and will complement any vehicle.

AVAILABLE COLOR OPTIONS: Black, White/Black, Red/Black, Chrome/Black, Brushed Stainless/Black, Red, Hot Pink, Purple, Navy Blue, White, Kelly Green, Orange, Yellow, Beluga Grey, Golden Yellow, Blue, Green



The WeatherTech® ClearFrame™ license plate frame has all of the features of the ClearCover® in a frame. It is made from virtually indestructible UV-stable Lupillon 3000. The one piece frame and gasket design allows for easy installation. The Multi-Flex™ Gasket seats against plate snugly preventing vibration or rattling. The WeatherTech® ClearFrame™ has many styles to choose from, and will complement any vehicle.

AVAILABLE COLOR OPTIONS: Black, White/Black, Red/Black, Chrome/Black, Brushed Stainless/Black, Red, Hot Pink, Purple, Navy Blue, White, Kelly Green, Orange, Yellow, Beluga Grey, Golden Yellow, Blue, Green



The WeatherTech® PlateFrame® features a solid one-piece design and is made from ABS Natural Platable Grade Plastic. This specific grade of ABS thermoplastic material is virtually indestructible, with optimum resistance to weathering.

AVAILABLE COLOR OPTION: Black



Manufactured in America from highly polished T-304 Stainless Steel, the StainlessFrame™ will surely make a statement on any car you own. PlateSpacer™ gasket supports and keeps plate away from car body. Comes complete with clever caps that hide the mounting hardware.



The WeatherTech® BumpFrame™ is made 3/4" thick to provide an extra barrier of protection for the front bumper of your vehicle. With its impact resistant design and materials; it takes the every day bumps, mistakes of other drivers and parking mishaps away from your bumper.



Proudly Designed, Engineered
and Manufactured with American
Made Tooling in the USA



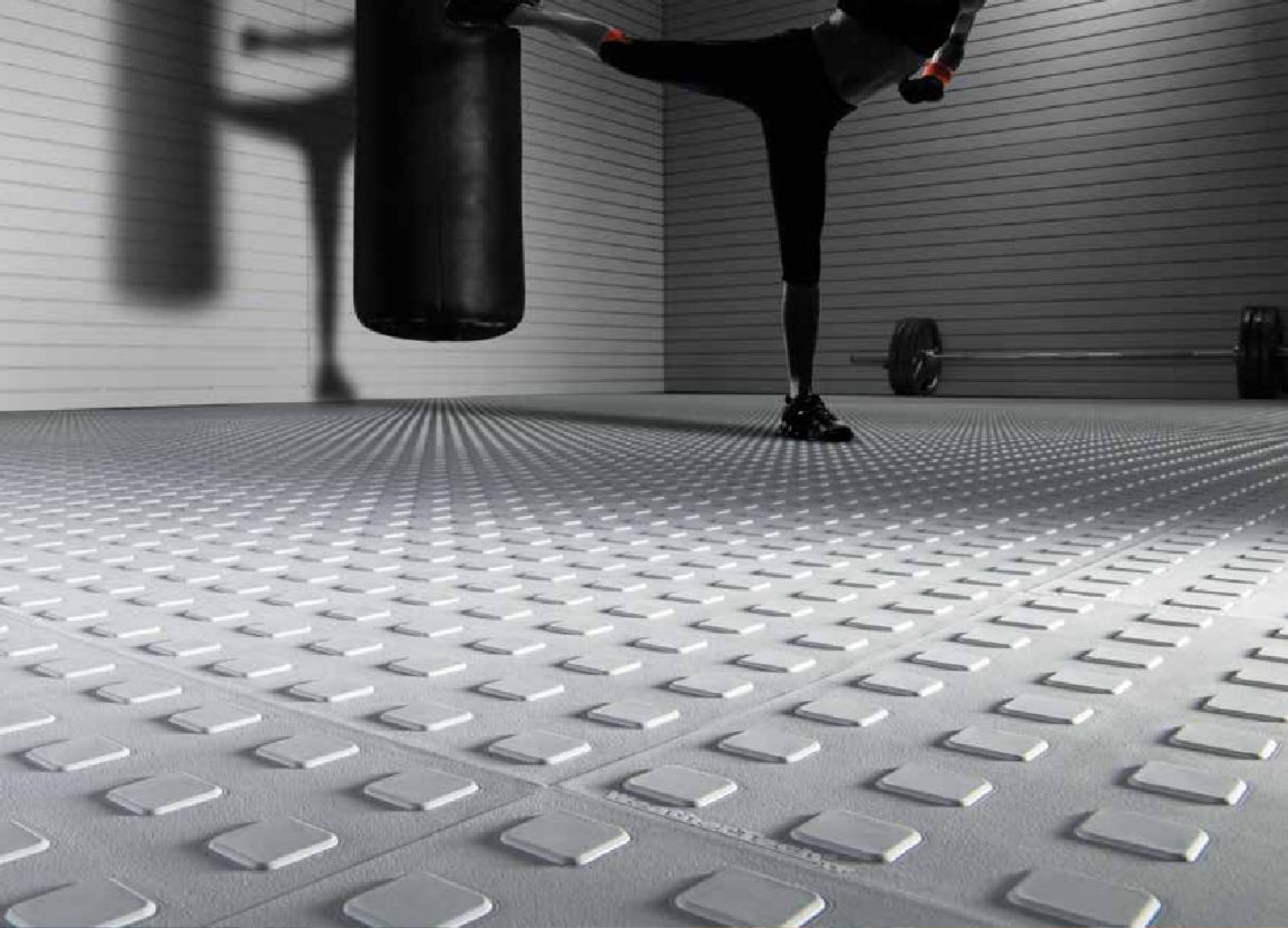

Available in a variety of colors, borders available only in black

Available Styles

Premium with TractionSquares™

The first modular floor tiles to offer two distinctly different materials molded into one tile. Our revolutionary TwoShot™ process (patent pending) offers an extremely rugged and low profile polypropylene plastic tile with non-slip thermoplastic elastomer TractionSquares™. A soft touch underside offers incredible grip to virtually any floor.

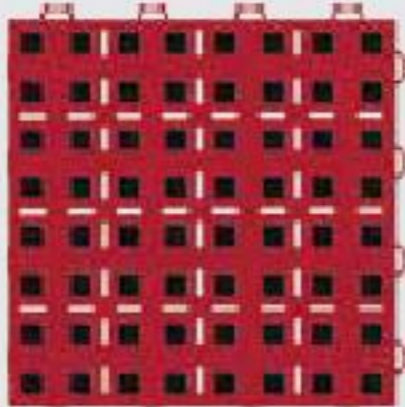

Premium Flow-Thru with TractionSquares™



Premium with TractionSquares™

Solid with Raised Squares

A solid polypropylene tile that features raised squares for traction and style. Combine with Premium or Smooth tiles for unlimited options.



Solid Flow-Thru with Raised Squares



Solid with Raised Squares

Smooth Surface

A solid polypropylene tile that features a flat, smooth surface design for a clean appearance. Combine with Premium or Solid tiles for unlimited options.



Smooth Surface Flow-Thru



Smooth Surface

TechFloor™

Easily Assembled by Hand!

Available in 6 tile styles, 6 tile sizes, and 5 border components to allow fast wall-to-wall installation without the need to cut or trim.

Easily assembled and disassembled by hand using a snap together loop & tab system. No professional installation or special tools required!

Tiles are available in a variety of colors, borders available only in black. Use a single color or create custom patterns by using multiple color and border options.

Multi-Use

Designed to withstand the daily wear and tear of virtually any floor:

- Garage
- Laundry Room
- Shop
- Basement
- Mud Room
- Workout Room
- Play Area
- Trade Show Flooring

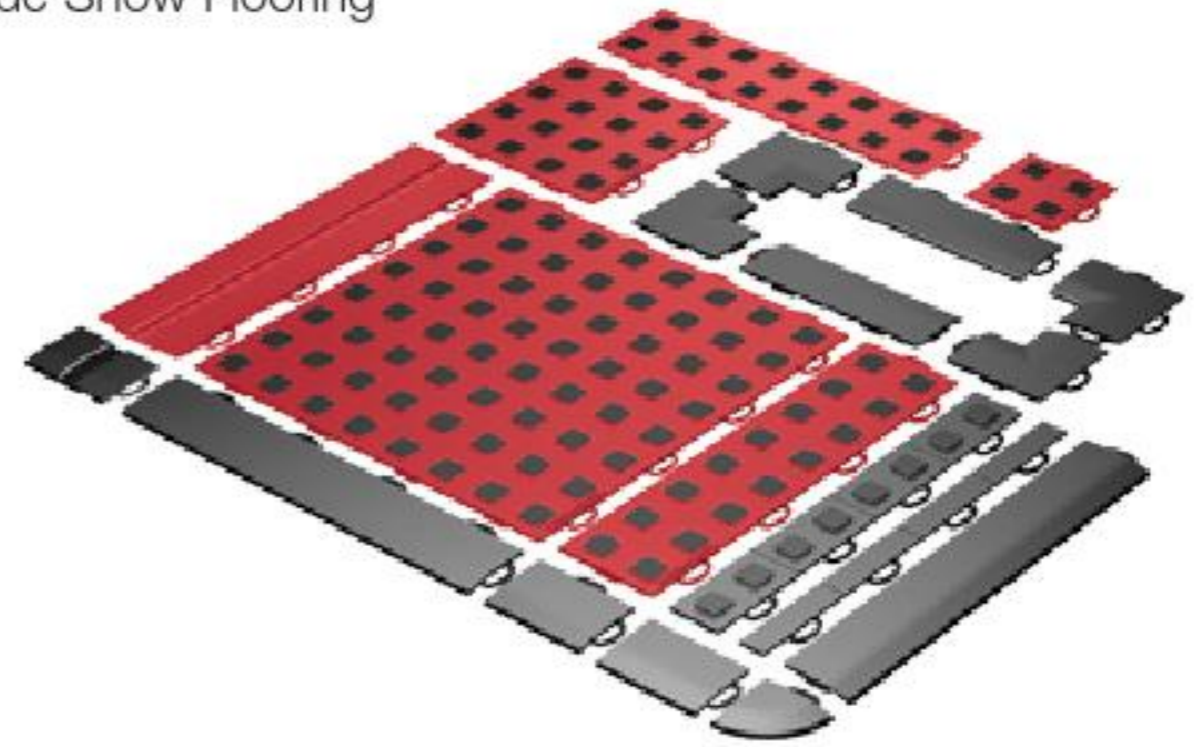

TechFloor™ Tile System Components

Floor Tiles	Trim Tiles	Expansion Tiles	Beveled Edges	Beveled Edge Corners
12" X 12"	¾" X 12"	3" X 12" Expansion Joint	2" X 3" with Tabs	Inside Tab-Tab
6" X 6"	1½" X 12"	2" X 3" Beveled Edge Expansion Joint	2" X 6" with Tabs	Inside Tab-Loop
3" X 3"			2" X 12" with Tabs	Inside Loop-Loop
3" X 12" Left Loop			2" X 3" with Loops	Inside Loop-Tab
3" X 12" Right Loop			2" X 6" with Loops	2" X 2" Border Corner
			2" X 12" with Loops	

TechCare®

WeatherTech® TechCare® is a complete line of automotive care and cleaning products. Developed with dedication to sustainability and superior care, TechCare® products are made from only the highest quality of ingredients and advanced formulas. The TechCare® line of care products provide the ultimate clean and professional finish expected of the WeatherTech® name.



FLOORLINER™ & FLOORMAT CLEANER

- Removes scuff marks and stains
- Lifts sand and dirt for easy removal
- Dissolves grease and oil stains



FLOORLINER™ & FLOORMAT PROTECTOR

- Helps to prevent staining
- Slip resistant finish
- Creates long-lasting, "Like New" appearance



INTERIOR DETAILER

- Spray-on, wipe away formula removes dirt & dust
- Use on virtually all non-glass interior surface
- Helps to eliminate odors



LEATHER CONDITIONER with Aloe Vera

- Matte Finish
- Contains Aloe Vera for moisturizing and enhancing
- Guards against UVA and UVB
- Contains spot & stain blocker



CARPET CLEANER with SpotTech™

- Stain repellent and remover
- Contains wetting agent to loosen dirt and oil stains
- Enhances anti-staining properties



INTERIOR GLASS CLEANER with Anti-Fog

- Specifically for automotive interiors
- Prevents fogging from temperature variations
- Does not leave streaks or film



ACID-FREE WHEEL CLEANER

- Acid-free, biodegradable formula
- For virtually all wheel types
- Removes road grime and brake dust on contact



HEAVY DUTY WHEEL CLEANER

- Non-acid formula for virtually all wheel type
- Quickly cleans extreme brake dust and grime buildup
- Changes to a red/purple color when working



GENTLE CAR™ SHAMPOO

- Non-corrosive
- Highly concentrated
- Safe for virtually all paint finishes
- Removes bugs, tar, grease and oil



TIRE GLOSS with Cross-Link Action™

- Promotes Cross-Link Action™ with rubber for a stronger bond
- High gloss appearance
- Easy, spray on and walk away



WAX-PREP CLAY GEL CLEANER

- Pre-cleaner that preps surface for waxing
- Removes imbedded impurities in finish
- Provides a glossy & smooth finish



CARNAUBA GEL WAX

- Provides durable, high gloss finish
- Helps to remove minor blemishes
- For use on paint, chrome, or fiberglass
- Contains natural Carnauba wax



QUIKTECH™ DETAILER with Carnauba Wax

- Easy on and off application
- Enhances appearance of automotive, motorcycle, watercraft and aircraft finishes
- Contains natural Carnauba wax



EXTERIOR GLASS CLEANER with Repel

- Non-streaking, ammonia-free
- Removes bugs, dirt and debris
- Adds water repellency



Made in the USA





GRIT GUARD® WASHING SYSTEM

- Roll & lock wheels
- Grit Guard® insert
- Gamma Seal® Lid
- Removable cushion top
- Sturdy rolling dolly



MICROFIBER APPLICATOR & CLOTHS

- A. Microfiber Applicator Pad
- B. Super White Microfiber Cleaning Cloth
- C. Microfiber Finishing Cloth & Quick Detailer
- D. Microfiber Waffle Weave Drying Towel



THE ABSORBER® XL

- Super absorbent
- Soft and scratch free
- Resistant to most chemicals
- Machine washable
- Resistant to mold & mildew
- Handy tube for protection
- Product dimensions: 29" x 18"
- Use for: vehicles, boats, personal drying, dogs, household chores and more!

OutdoorMat™



An outdoor mat is never JUST an outdoor mat when it is designed, engineered and manufactured by WeatherTech®. We took the same technology that we use for our precision engineered automotive accessories and developed a premium OutdoorMat™ to fit the needs of busy doorways.

Made from 100% recyclable resin, the WeatherTech® OutdoorMat™ features a specially designed scraper edge combined with semi-rigid cones to remove debris from shoes. Perimeter vents surround the edges to allow liquids to drain from the mat with ease. Its robust design enables the OutdoorMat™ to stay-put and lay-flat. The attractive appearance of the WeatherTech® OutdoorMat™ makes it the perfect and exceptionally functional accessory for any doorway - from busy businesses to a household of outdoor lovers, it will stand the test!



Colors:
brown, grey,
black and tan

Sizes:
24" x 39"
30" x 48"
30" x 60"

IndoorMat™



With comfort and protection in mind, the WeatherTech® IndoorMat™ was designed to fit the needs of any doorway. Place the mat in the entrance of the family mudroom to conquer soccer cleats and rainboots; front door to collect visitor's leaf crunching debris; or business lobby to catch the leftovers of customer's walking through puddles. Developed from the same digital technology that WeatherTech® is known for, the IndoorMat™ entry mat is made from a 100% recyclable resin.

It features a fully wrapped raised lip perimeter to contain any fluid, dirt, etc to protect your floor from tracked-in messes. Engineered with a specially designed pattern that is comfortable to walk on, but is strong enough to hold shoes up from the bottom of the mat where dirt and fluids are retained. Easy to clean and easy to move, the WeatherTech® IndoorMat™ is the ideal mat for indoor entryways.

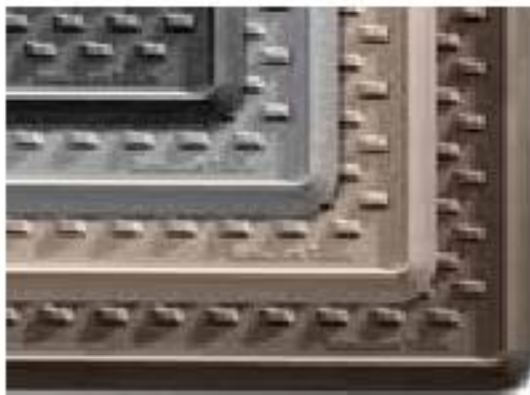

Colors:
brown, grey,
black and tan

Sizes:
24" x 39"
30" x 48"
30" x 60"



BootTray™

Finding an attractive solution for storing muddy, wet or snow covered shoes can often be difficult in your home. Standard door mats don't hold any liquid, towels on the floor in the mud room just look sloppy and no one wants to step into cold, wet boots that have been tossed in the garage to dry off! The BootTray™ is made from a strong, yet flexible TPE material that is durable for even the most rough and tumble household entry. The BootTray™ is engineered to keep mud, snow, water and dirt contained and features channels that keep the mess away from your shoes, allowing them to dry. Measuring at 16"x 36", the BootTray™ easily holds four large pairs of boots/shoes.

Colors:
brown, grey, black
and tan

Size: 16" X 36"

RackSack®

The WeatherTech® RackSack® expands your cargo carrying capacity a whopping 13 cubic feet and measures 39" x 32" x 18". Made of heavy-duty 1800 Denier Oxford fabric that is tear resistant and water repellent.

Features include swivel straps that mount to the crossbar or side rails of an existing roof rack, patented Roll and Wrap™ tabs to prevent flapping straps, ITW Nexus™ Connectors and a soft felt bottom to protect your vehicle's finish from scratching.



Release connectors



Swivel strap



2-Way zipper



Roll and Wrap™ strap



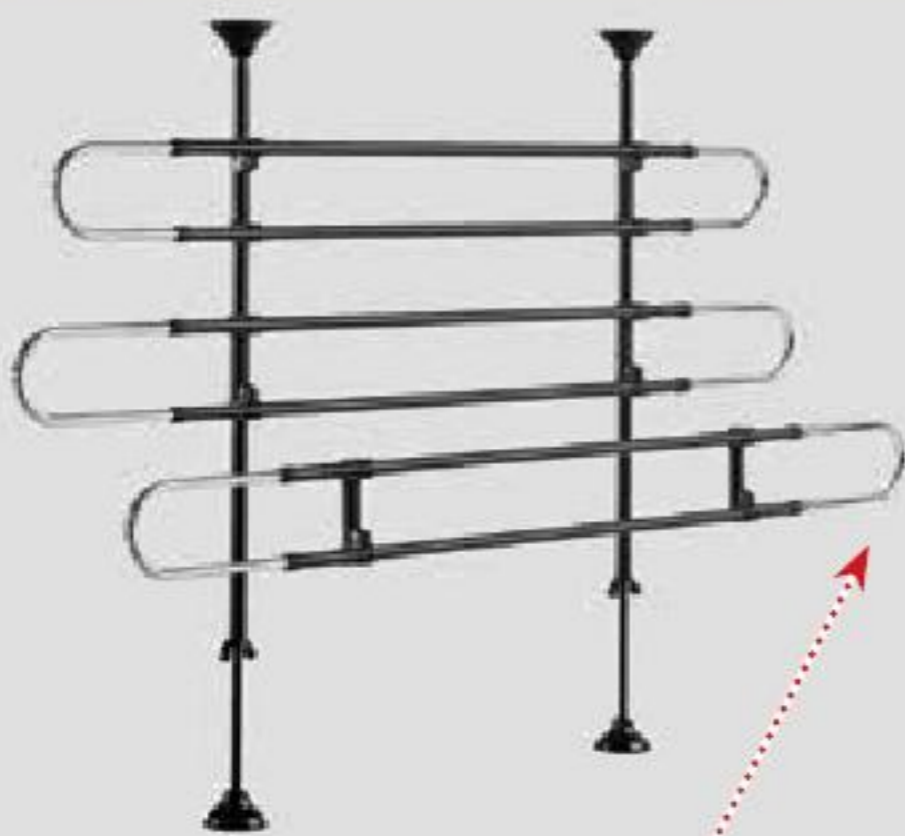

OPTIONAL EXTENSION

Tubing Size	1/2", 5/8" & 3/4" Steel
Total Weight	7.3 lbs.
Max Height	42" (w/out extension) 51" (w/extension)
Max Width	66"

Keep those paws and claws off the upholstery. The WeatherTech® Pet Barrier is adjustable, expandable and keeps pets safely in the rear of your vehicle.

The heavy-duty 5/8" diameter telescopic tubing installs easily without tools or drilling. The barrier adjusts vertically and horizontally to suit any vehicle and any pet. "No-Mar" rubber coated components protect your interior and ensure a rattle-free installation. An optional extension is available for minivans, or vehicles with folding seats.

WeatherTech® BatteryCharger



Temporary connectors (included)

Permanent connectors (included)

Weatherproof connector for quick hook-ups (included)



WeatherTech® BatteryCharger

The WeatherTech® BatteryCharger is simply the best charger made for the long term maintenance of your vehicle's battery. Exclusively designed for keeping your battery in prime condition while vehicle is not in use.

The perfect solution for your collector car, seasonal vehicle, or special vehicle. The WeatherTech® BatteryCharger monitors your battery's condition and only when necessary, uses a 4-Step charging method to keep your battery in tip-top shape! Can stay connected to the vehicle for months.

Keep the Sun and Heat Out



TechShade®

Perfect for any season, the WeatherTech® TechShade® can warm or cool your vehicle. Reflective film chases the sun away in summer. Then, the reverse side absorbs the heat for those cold winter months. When not in use the TechShade® is easily removed, rolled and secured with a Velcro® tab. The TechShade® is custom fit for each vehicle.

Indoor Custom-Fit Car Cover



Designed to Form-Fit® the exact contours of the make and model of your vehicle. A car that warrants space in your indoor storage areas, deserves the luxury of protection provided by the WeatherTech® Indoor Custom-Fit Car Cover. Especially designed for those vehicles that warrant an additional step of superior care and protection, perfect for those vehicles that are not daily drivers. Providing total vehicle protection, the car cover helps to shield the vehicle from settling sediment, moisture, scratches and other minor hazards that exist in a typical garage/storage space.

- Long-lasting fabric memory
- Form-Fit® around vehicle's contours
- Breathable to prevent vapors/moisture trapping
- Soft, plush interior lining
- Sewn in vehicle ID tag on front of cover. Easily find the correct cover!
- Designed for indoor use only
- Available in 6 colors
- 2 storage bags included

AVAILABLE COLORS



Dark Blue



Black



Bright Red



Charcoal Grey



Silver Grey



Hunter Green



Outdoor Custom-Fit Car Cover



Designed to provide years of protection against the harsh effects, in any climate, of the sun. UV rays have a permanent effect on the paint and finish of a vehicle, Outdoor Custom-Fit Car Covers feature a Sunbrella® enhanced acrylic fiber material that helps prevent this damage. With long-lasting strength and water resistance, these car covers defy color fading and resist rot due to extended exposure to the elements.

- High performance, long-lasting material
- UV resistant, withstands harshest sun climates
- Water resistant
- Designed for outdoor use
- Available in 3 colors
- Front labeled for easy install
- Sewn in vehicle ID tag in front of Cover. Easily find the correct cover!
- 2 storage bags included

Custom-fit to hug the natural contours and shape, the cover prevents sediment, water, and other outdoor materials from resting on the vehicle.

AVAILABLE COLORS



Pacific Blue



Cadet Grey



Toast





Inspired by our championship winning race car driver, Cooper MacNeil, WeatherTech's in-house design team created the featured t-shirt line art and photo renderings based on actual photographs of the winning vehicle.

SUPPORT THE WEATHERTECH® RACING TEAM
High quality t-shirts Made in USA

ADULT SHORT SLEEVE SHIRTS

- Multiple graphics to choose from
- High quality, super soft material
- Available in S-XXL



Color: White



Color: White or Black



Color: White or Black



Color: White or Black



FADED WT RACING LOGO
Hoodie - Unisex
Adult XS-XXL
Color: Grey



COOPER MACNEIL HAT
2 Sizes

LampGard®



Protect your lights with the WeatherTech® LampGard®. Designed to specifically fit vehicle headlamps, fog lamps and turn indicators. Each LampGard® is computer die-cut to fit specific vehicles. Made from an

optically clear urethane, the LampGard® protects your lights from cracking, scratching and pitting. Easy to follow instructions.

Gift Bag

Make the perfect gift even better with this worry-free wrapping, a gift bag exclusively made to fit around the WeatherTech® FloorLiner™ boxes.

Made from high quality materials, can be re-used for other needs.

Available in red and black.

