



**WESTSTAR**  
EST 1986

**2016**  
EDITION

MOTOR MOUNTS  
TORQUE STRUTS  
DRIVE SHAFT SUPPORTS  
TRANSMISSION MOUNTS

2016 APPLICATION CATALOG &  
INTERCHANGE (WES2016)



**30**

YEARS  
OF QUALITY  
YOU CAN TRUST

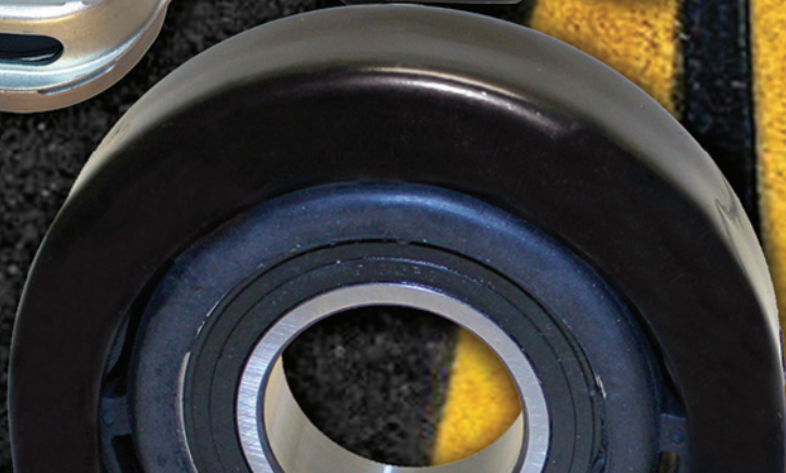



*Thank you for choosing Westar Distribution, LLC for your Engine, Transmission, and Center Support Mount needs.*

**Our History:**

- 1986 - Westar incorporated in an initial warehouse 1,500 square feet, in Columbia, MD.
- 1989 - Westar moved into a 5,000 square foot facility in Jessup, MD
- 1992 – Westar expanded into a 19,000 square foot facility in Laurel, MD
- 2000 – Westar grew into a 60,000 square foot facility back in Jessup, MD
- 2011 – We relocated into our current 187,000 square foot facility in Columbia, MD

Westar incorporated a solid business model to ensure that any customer that aligns with Westar grows with us and becomes successful.

1. **Branding** – A whole new marketing effort was set up to allow Westar’s customers to be informed about what’s going on with our engine mounts and to make sure they are ahead of the game.
2. **Quality** – Amazing Product Quality reduces the customer’s returns and establishes a positive reputation in the market. All of our factories are required to obtain and adhere to the stringent requirements of such industry standards as ISO, QS, and TS.
3. **Coverage** – Great coverage and research allows Westar to ensure our customers have legitimate full line coverage of engine mounts along with the capability to make sure they are always stocking the right parts.
4. **Price** – Competitive Pricing allows Westar’s customers to grow and compete at the highest level.
5. **Performance** – Delivering amazing fill rate on all orders placed with Westar at amazing delivery time!

# NEW PART NUMBERS

PART #	APPLICATION	YEAR	PART #	APPLICATION	YEAR
DS-5236	BMW PASSENGER CAR	2010-02	EM-3190	DODGE VAN L5 Cyl 2.7	2006-03
	BMW SPORT UTILITY	2011-04		FREIGHTLINER L5 Cyl 2.7	2006-03
DS-6024	BMW PASSENGER CAR	2012-04	EM-3192	BUICK SPORT UTILITY V6 Cyl 3.6	2008
	BMW SPORT UTILITY	2012		BUICK SPORT UTILITY V6 Cyl 3.6	2008
DS-6037	BMW PASSENGER CAR	2012-07		BUICK SPORT UTILITY V6 Cyl 3.6	2008
DS-6042	AUDI SPORTS UTILITY	2012-07	EM-3193	FORD PASSENGER CAR L4 Cyl 1.5	2013-11
	PORSCHE	2010-03	EM-3194	BUICK PASSENGER CAR L4 Cyl 2.4	2014-10
	VOLKSWAGEN SPORT UTILITY	2012-04		CHEVROLET PASSENGER CAR L4 Cyl 2.4	2013
DS-6066	CHEVROLET SPORT UTILITY V6 Cyl 3.4	2007-02	EM-3195	BUICK PASSENGER CAR V6 Cyl 3.0	2013-10
	PONTIAC SPORT UTILITY V6 Cyl 3.4	2006		CADILLAC PASSENGER CAR V6 Cyl	2014-13
	SATURN SUV L4 Cyl 2.2	2007-02		CADILLAC SPORT UTILITY V6 Cyl 3.0	2011-10
DS-6068	CHEVROLET TRUCK	2012-04		CHEVROLET PASSENGER CAR L4 Cyl 2.0	2013
	GMC TRUCK	2012-04	EM-3196	BUICK PASSENGER CAR L4, V6 Cyl 2.4	2013-10
	ISUZU TRUCK	2006		CADILLAC PASSENGER CAR V6 Cyl	2014-13
DS-6069	HONDA SPORT UTILITY	2006-02		CADILLAC SPORT UTILITY V6 Cyl 2.8	2011-10
DS-6071	DODGE TRUCK	2006-03		CHEVROLET PASSENGER CAR L4 Cyl 2.0	2013
	NISSAN TRUCK	2012-05	EM-3197	BUICK PASSENGER CAR L4 Cyl 2.0	2013-11
DS-6072	TOYOTA SPORT UTILITY	2005-01		CADILLAC SPORT UTILITY V6 Cyl 2.8	2011-10
DS-6076	FORD SPORT UTILITY	2007-01	EM-3198	BUICK PASSENGER CAR L4 Cyl 2.4	2012-10
	MAZDA SPORT UTILITY	2006-01	EM-3199	BUICK PASSENGER CAR L4 Cyl 2.4	2013-10
	MERCURY SPORT UTILITY	2007-05	EM-3200	BUICK PASSENGER CAR V6 Cyl 3.5	2012-10
DS-6079	CHEVROLET SPORT UTILITY	2010-04	EM-3201	BUICK PASSENGER CAR L4 Cyl 2.0	2013-11
	CHEVROLET TRUCK	2004-04		CADILLAC SPORT UTILITY V6 Cyl 2.8	2011-10
	DODGE TRUCK	2002-98	EM-3202	CHEVROLET PASSENGER CAR L4 Cyl 1.4	2014-11
	DODGE VAN	2003-02	EM-4000	CHEVROLET SPORT UTILITY V8 Cyl 4.8	2009-07
	GMC SPORT UTILITY	2005-95		CHEVROLET TRUCK V8 Cyl 4.8	2013-08
	GMC TRUCK	2004-94		GMC SPORT UTILITY V8 Cyl 4.8	2009-07
DS-6085	LEXUS PASSENGER CAR	2010-98		GMC TRUCK V8 Cyl 4.8	2013-08
DS-6086	LEXUS PASSENGER CAR	2005-95	EM-4001	HUMMER V8 Cyl 6.5	2006-02
DS-6100	CHRYSLER PASSENGER CAR	2012-06	EM-4002	DODGE TRUCK V8 Cyl 4.7	2008-06
	DODGE PASSENGER CAR	2012-08	EM-4003	CHRYSLER VAN L4 Cyl 2.4	2002-01
DS-6104	DODGE VAN	2013-07		DODGE VAN L4 Cyl 2.4	2002-01
	FREIGHTLINER	2009-07	EM-4004	CHRYSLER VAN L4 Cyl 2.4	2003
	MERCEDES-BENZ VAN	2013-10		DODGE VAN L4 Cyl 2.4	2007-03
DS-6105	DODGE VAN	2013-07	EM-4005	FORD PASSENGER CAR V6 Cyl 3.0	1995-89
	FREIGHTLINER	2009-07	EM-4006	DODGE TRUCK V8 Cyl 5.7	2007-06
	MERCEDES-BENZ VAN	2013-10	EM-4007	DODGE TRUCK V8 Cyl 5.7	2007-06
DS-6106	DODGE VAN	2013-07	EM-4012	CHRYSLER VAN V6 Cyl 4.0	2010-08
	FREIGHTLINER	2009-07		DODGE VAN V6 Cyl 4.0	2015-08
	MERCEDES-BENZ VAN	2013-10		RAM VAN V6 Cyl 3.6	2015-12
DS-6107	DODGE VAN	2013-07		VOLKSWAGEN VAN V6 Cyl	2014-11
	FREIGHTLINER	2009-07	EM-4013	CHRYSLER VAN V6 Cyl 3.3	2010-08
	MERCEDES-BENZ VAN	2013-10		DODGE VAN V6 Cyl 3.3	2010-08
DS-6109	DODGE TRUCK	2005-03		VOLKSWAGEN VAN V6 Cyl 3.8	2010-09
DS-6111	MITSUBISHI SPORT UTILITY	2006-03	EM-4015	HUMMER L5 Cyl 3.5	2010-06
DS-6112	MITSUBISHI SPORT UTILITY	2006-03	EM-4016	HUMMER L5 Cyl 3.5	2010-06
EM-3156	CHRYSLER VAN V6 Cyl 3.3	2010-08	EM-4017	CHEVROLET SPORT UTILITY V8 Cyl 4.8	2009-07
	DODGE VAN V6 Cyl 3.3	2010-08		CHEVROLET TRUCK V8 Cyl 4.8	2013-07
	VOLKSWAGEN VAN V6 Cyl 3.8	2010-09		GMC SPORT UTILITY V8 Cyl 4.8	2009-07
EM-3157	DODGE PASSENGER CAR L4 Cyl 2.4	2009-07		GMC TRUCK V8 Cyl 4.8	2013-08
	JEEP SPORT UTILITY L4 Cyl 2.4	2009-07	EM-4018	DODGE TRUCK L6, V10 Cyl 5.9	2005-03
	MITSUBISHI SPORT UTILITY L4 Cyl 2.4	2011-08	EM-4019	DODGE SPORT UTILITY L4 Cyl 2.4	2010-09
EM-3158	BUICK PASSENGER CAR V6 Cyl 3.9	2011-09		FORD SPORT UTILITY L4, V6 Cyl 2.5	2012-05
EM-3159	CADILLAC PASSENGER CAR V6 Cyl 3.6	2007-04		MAZDA SPORT UTILITY L4 Cyl 2.3	2008-05
EM-3160	PONTIAC PASSENGER CAR L4 Cyl 2.0	2009-07		MERCURY SPORT UTILITY L4 Cyl 2.3	2008-05
	SATURN PASSENGER CAR L4 Cyl 2.0	2010-07	EM-4022	FORD SPORT UTILITY V10 Cyl 6.8	2005-00
EM-3161	PONTIAC PASSENGER CAR L4 Cyl 2.0	2010-07		FORD TRUCK V10 Cyl 6.8	2004-99
	SATURN PASSENGER CAR L4 Cyl 2.4	2010-07	EM-4027	CHEVROLET PASSENGER CAR V6, L4 Cyl	2010-07
EM-3162	CADILLAC PASSENGER CAR V6 Cyl 3.2	2004-03		PONTIAC PASSENGER CAR L4 Cyl 2.4	2010-09
EM-3165	DODGE SPORT UTILITY L4, V6 Cyl	2010-09		SATURN PASSENGER CAR L4 Cyl 2.4	2008
EM-3166	BUICK PASSENGER CAR V8 Cyl 4.6	2011-06	EM-4028	FORD PASSENGER CAR V6 Cyl 3.0	2007-05
	CADILLAC PASSENGER CAR V8 Cyl 4.6	2011-06		MERCURY PASSENGER CAR V6 Cyl 3.0	2007-05
EM-3167	CHRYSLER PASSENGER CAR V6, L4 Cyl	2013-07	EM-4029	FORD PASSENGER CAR V6, V8 Cyl 4.0	2015-05
	DODGE PASSENGER CAR L4 Cyl 2.4	2010-08	EM-4033	FORD SPORT UTILITY V6 Cyl 3.0	2012-05
EM-3168	CHRYSLER PASSENGER CAR L4, V6 Cyl	2013-07		MAZDA SPORT UTILITY L4 Cyl 2.3	2008-05
	DODGE PASSENGER CAR V6 Cyl 3.5	2010-08		MERCURY SPORT UTILITY V6 Cyl 3.0	2008-05
EM-3172	CHEVROLET TRUCK V8 Cyl 4.8	2012-07	EM-4034	FORD PASSENGER CAR L4, V6 Cyl 2.3	2012-06
	GMC TRUCK V8 Cyl 4.8	2012-07		LINCOLN PASSENGER CAR V6 Cyl 3.0	2006
EM-3175	CHEVROLET VAN V8 Cyl 5.3	2012-03		MERCURY PASSENGER CAR L4 Cyl 2.3	2009-06
	GMC VAN V8 Cyl 5.3	2010-03	EM-4035	BUICK SPORT UTILITY V6 Cyl 3.6	2014-09
EM-3177	CHEVROLET VAN V6 Cyl 4.3	2012-03		CHEVROLET SPORT UTILITY V6 Cyl 3.6	2012-09
	GMC VAN V6 Cyl 4.3	2012-03		GMC SPORT UTILITY V6 Cyl 3.6	2012-09
EM-3179	CHRYSLER PASSENGER CAR L4 Cyl 2.4	2007-03		SATURN SUV V6 Cyl	2010-09
EM-3183	DODGE SPORT UTILITY L4, V6 Cyl	2012-09	EM-4036	BUICK SPORT UTILITY V6 Cyl 3.6	2012-09
EM-3189	DODGE VAN L5 Cyl 2.7	2006-03		CHEVROLET SPORT UTILITY V6 Cyl 3.6	2012-09
	FREIGHTLINER L5 Cyl 2.7	2006-03		GMC SPORT UTILITY V6 Cyl 3.6	2012-09
				SATURN SUV V6 Cyl	2010-09

# NEW PART NUMBERS

PART #	APPLICATION	YEAR	PART #	APPLICATION	YEAR
EM-3190	DODGE VAN L5 Cyl 2.7	2006-03	EM-4037	BUICK SPORT UTILITY V6 Cyl 3.6	2014-09
	FREIGHTLINER L5 Cyl 2.7	2006-03		CHEVROLET SPORT UTILITY V6 Cyl 3.6	2012-09
EM-3192	BUICK SPORT UTILITY V6 Cyl 3.6	2008		GMC SPORT UTILITY V6 Cyl 3.6	2012-09
	BUICK SPORT UTILITY V6 Cyl 3.6	2008		SATURN SUV V6 Cyl	2010-09
	BUICK SPORT UTILITY V6 Cyl 3.6	2008	EM-4038	FORD TRUCK V8 Cyl 4.6	2008-05
EM-3193	FORD PASSENGER CAR L4 Cyl 1.5	2013-11	EM-4039	FORD TRUCK V8 Cyl 4.6	2008-05
EM-3194	BUICK PASSENGER CAR L4 Cyl 2.4	2014-10	EM-4040	FORD PASSENGER CAR V6 Cyl 3.5	2009-08
	CHEVROLET PASSENGER CAR L4 Cyl 2.4	2013		FORD SPORT UTILITY V6 Cyl 3.5	2013-09
EM-3195	BUICK PASSENGER CAR V6 Cyl 3.0	2013-10		LINCOLN PASSENGER CAR V6 Cyl 3.7	2012-09
	CADILLAC PASSENGER CAR V6 Cyl	2014-13		LINCOLN SPORT UTILITY V6 Cyl 3.7	2013-10
	CADILLAC SPORT UTILITY V6 Cyl 3.0	2011-10		MERCURY PASSENGER CAR V6 Cyl 3.5	2013-08
	CHEVROLET PASSENGER CAR L4 Cyl 2.0	2013	EM-4041	JEEP SPORT UTILITY V6 Cyl 3.8	2011-07
EM-3196	BUICK PASSENGER CAR L4, V6 Cyl	2013-10	EM-4042	CHRYSLER VAN V6 Cyl 3.8	2010-08
	CADILLAC PASSENGER CAR V6 Cyl	2014-13		DODGE VAN V6 Cyl 3.3	2010-08
	CADILLAC SPORT UTILITY V6 Cyl 2.8	2011-10		VOLKSWAGEN VAN V6 Cyl 3.8	2010-09
	CHEVROLET PASSENGER CAR L4 Cyl 2.0	2013	EM-4043	JEEP SPORT UTILITY V6 Cyl 3.8	2011-07
EM-3197	BUICK PASSENGER CAR L4 Cyl 2.0	2013-11	EM-4044	FORD PASSENGER CAR L4, V6 Cyl	2009-06
	CADILLAC SPORT UTILITY V6 Cyl 2.8	2011-10		LINCOLN PASSENGER CAR V6 Cyl 3.0	2006
EM-3198	BUICK PASSENGER CAR L4 Cyl 2.4	2012-10		MERCURY PASSENGER CAR L4 Cyl 2.3	2009-06
EM-3199	BUICK PASSENGER CAR L4 Cyl 2.4	2013-10	EM-4045	CHEVROLET PASSENGER CAR L4 Cyl 2.4	2012-08
EM-3200	BUICK PASSENGER CAR V6 Cyl 3.5	2012-10		SATURN PASSENGER CAR L4 Cyl 2.4	2009
EM-3201	BUICK PASSENGER CAR L4 Cyl 2.0	2013-11	EM-4046	CHEVROLET PASSENGER CAR L4 Cyl 2.4	2012-08
	CADILLAC SPORT UTILITY V6 Cyl 2.8	2011-10		SATURN PASSENGER CAR L4 Cyl 2.4	2009
EM-3202	CHEVROLET PASSENGER CAR L4 Cyl 1.4	2014-11	EM-4047	CHEVROLET PASSENGER CAR L4, V6 Cyl	2010-04
EM-4000	CHEVROLET SPORT UTILITY V8 Cyl 4.8	2009-07		PONTIAC PASSENGER CAR L4 Cyl 2.4	2010-09
	CHEVROLET TRUCK V8 Cyl 4.8	2013-08		SATURN PASSENGER CAR L4 Cyl 2.4	2009
	GMC SPORT UTILITY V8 Cyl 4.8	2009-07	EM-4049	CHEVROLET PASSENGER CAR L4 Cyl 1.4	2014-11
	GMC TRUCK V8 Cyl 4.8	2013-08	EM-4050	CHRYSLER VAN V6 Cyl	2015-11
EM-4001	HUMMER V8 Cyl 6.5	2006-02		DODGE VAN V6 Cyl	2015-11
EM-4002	DODGE TRUCK V8 Cyl 4.7	2008-06		RAM VAN V6 Cyl 3.6	2015-12
EM-4003	CHRYSLER VAN L4 Cyl 2.4	2002-01		VOLKSWAGEN VAN V6 Cyl	2014-11
	DODGE VAN L4 Cyl 2.4	2002-01	EM-4051	FORD SPORT UTILITY L4 Cyl 2.3	2012-05
EM-4004	CHRYSLER VAN L4 Cyl 2.4	2003		MERCURY SPORT UTILITY L4 Cyl 2.3	2008-06
	DODGE VAN L4 Cyl 2.4	2007-03	EM-4055	FORD PASSENGER CAR V6 Cyl 3.5	2012-10
EM-4005	FORD PASSENGER CAR V6 Cyl 3.0	1995-89		FORD SPORT UTILITY V6 Cyl 3.5	2012-10
EM-4006	DODGE TRUCK V8 Cyl 5.7	2007-06		LINCOLN SPORT UTILITY V6 Cyl 3.5	2014-10
EM-4007	DODGE TRUCK V8 Cyl 5.7	2007-06	EM-4056	FORD PASSENGER CAR V6 Cyl 3.5	2012-10
EM-4012	CHRYSLER VAN V6 Cyl 4.0	2010-08		FORD SPORT UTILITY V6 Cyl 3.5	2012-10
	DODGE VAN V6 Cyl 4.0	2015-08		LINCOLN SPORT UTILITY V6 Cyl 3.5	2014-10
	RAM VAN V6 Cyl 3.6	2015-12	EM-4057	FORD PASSENGER CAR L4 Cyl 2.0	2012-11
	VOLKSWAGEN VAN V6 Cyl	2014-11		FORD SPORT UTILITY L4 Cyl 2.0	2014-13
EM-4013	CHRYSLER VAN V6 Cyl 3.3	2010-08	EM-4058	FORD PASSENGER CAR L4 Cyl 2.5	2012-10
	DODGE VAN V6 Cyl 3.3	2010-08		MERCURY PASSENGER CAR L4 Cyl 2.5	2011-10
	VOLKSWAGEN VAN V6 Cyl 3.8	2010-09	EM-4059	FORD PASSENGER CAR V6 Cyl 3.5	2012-10
EM-4015	HUMMER L5 Cyl 3.5	2010-06		LINCOLN PASSENGER CAR V6 Cyl 3.5	2012-10
EM-4016	HUMMER L5 Cyl 3.5	2010-06	EM-4060	DODGE TRUCK L6 Cyl 5.9	2008-06
EM-4017	CHEVROLET SPORT UTILITY V8 Cyl 4.8	2009-07	EM-4063	SATURN SUV V6 Cyl	2010-08
	CHEVROLET TRUCK V8 Cyl 4.8	2013-07	EM-4064	SATURN SUV L4 Cyl 2.4	2010-08
	GMC SPORT UTILITY V8 Cyl 4.8	2009-07	EM-4070	FORD PASSENGER CAR L4 Cyl 2.0	2014-13
	GMC TRUCK V8 Cyl 4.8	2013-08	EM-4071	FORD SPORT UTILITY L4, V6 Cyl 2.3	2012-05
EM-4018	DODGE TRUCK L6, V10 Cyl 5.9	2005-03		MAZDA SPORT UTILITY L4 Cyl 2.3	2008-05
EM-4019	DODGE SPORT UTILITY L4 Cyl 2.4	2010-09		MERCURY SPORT UTILITY L4 Cyl 2.3	2008-05
	FORD SPORT UTILITY L4, V6 Cyl	2012-05	EM-4073	CHEVROLET TRUCK V6 Cyl 4.3	2013-07
	MAZDA SPORT UTILITY L4 Cyl 2.3	2008-05		GMC TRUCK V6 Cyl 4.3	2013-07
	MERCURY SPORT UTILITY L4 Cyl 2.3	2008-05	EM-4077	CHRYSLER VAN V6 Cyl	2013-11
EM-4022	FORD SPORT UTILITY V10 Cyl 6.8	2005-00		DODGE VAN V6 Cyl	2013-11
	FORD TRUCK V10 Cyl 6.8	2004-99	EM-4078	CHEVROLET SPORT UTILITY V6 Cyl 3.6	2009-08
EM-4027	CHEVROLET PASSENGER CAR V6, L4 Cyl	2010-07	EM-4079	CHEVROLET SPORT UTILITY V6 Cyl 3.8	2009-08
	PONTIAC PASSENGER CAR L4 Cyl 2.4	2010-09	EM-4080	BUICK PASSENGER CAR L4 Cyl 2.0	2014-13
	SATURN PASSENGER CAR L4 Cyl 2.4	2008		CHEVROLET PASSENGER CAR L4 Cyl 1.4	2014-11
EM-4028	FORD PASSENGER CAR V6 Cyl 3.0	2007-05	EM-4081	FORD SPORT UTILITY V6, L4 Cyl 3.5	2014-07
	MERCURY PASSENGER CAR V6 Cyl 3.0	2007-05		LINCOLN SPORT UTILITY V6 Cyl 3.5	2010-07
EM-4029	FORD PASSENGER CAR V6, V8 Cyl 4.0	2015-05	EM-4082	FORD PASSENGER CAR L4 Cyl 2.0	2011-08
EM-4033	FORD SPORT UTILITY V6 Cyl 3.0	2012-05	EM-4094	CHRYSLER PASSENGER CAR L4, V6 Cyl	2015-07
	MAZDA SPORT UTILITY L4 Cyl 2.3	2008-05		CHRYSLER VAN V6 Cyl 4.0	2010-08
	MERCURY SPORT UTILITY V6 Cyl 3.0	2008-05		DODGE PASSENGER CAR L4 Cyl 2.4	2010-08
EM-4034	FORD PASSENGER CAR L4, V6 Cyl	2012-06		DODGE VAN V6 Cyl	2015-11
	LINCOLN PASSENGER CAR V6 Cyl 3.0	2006		RAM VAN V6 Cyl 3.6	2015-12
	MERCURY PASSENGER CAR L4 Cyl 2.3	2009-06		VOLKSWAGEN VAN V6 Cyl 3.8	2010-09
EM-4035	BUICK SPORT UTILITY V6 Cyl 3.6	2014-09	EM-4095	FORD SPORT UTILITY V6, V8 Cyl 4.0	2010-06
	CHEVROLET SPORT UTILITY V6 Cyl 3.6	2012-09	EM-4096	HUMMER L5 Cyl 3.5	2010-06
	GMC SPORT UTILITY V6 Cyl 3.6	2012-09	EM-4097	FORD SPORT UTILITY V8 Cyl 5.4	2006-05
	SATURN SUV V6 Cyl	2010-09		LINCOLN SPORT UTILITY V8 Cyl 5.4	2006-03
EM-4036	BUICK SPORT UTILITY V6 Cyl 3.6	2012-09	EM-4099	FORD SPORT UTILITY V8 Cyl 5.4	2006-05
	CHEVROLET SPORT UTILITY V6 Cyl 3.6	2012-09		LINCOLN SPORT UTILITY V8 Cyl 5.4	2006-04
	GMC SPORT UTILITY V6 Cyl 3.6	2012-09	EM-4100	JEEP SPORT UTILITY V8 Cyl 4.7	2009-06
	SATURN SUV V6 Cyl	2010-09			

# NEW PART NUMBERS

PART #	APPLICATION	YEAR	PART #	APPLICATION	YEAR
EM-4101	DODGE SPORT UTILITY V6 Cyl 3.7	2011-07	EM-5793	HONDA PASSENGER CAR V6 Cyl 3.5	2013-08
	JEEP SPORT UTILITY V6 Cyl 3.7	2012-08		HONDA VAN V6 Cyl 3.5	2010-08
EM-4102	JEEP SPORT UTILITY V6 Cyl 3.7	2010-06	EM-5794	ACURA PASSENGER CAR L4 Cyl 1.7	2005-01
EM-4103	JEEP SPORT UTILITY V6 Cyl 3.7	2010-05		HONDA PASSENGER CAR L4 Cyl 1.7	2005-01
EM-4104	JEEP SPORT UTILITY V6 Cyl 3.7	2010-05	EM-5795	HONDA VAN V6 Cyl 3.5	2007-05
EM-4105	JEEP SPORT UTILITY V8 Cyl 4.7	2009-06	EM-5796	MINI L4 Cyl 1.6	2006-03
EM-4106	FORD SPORT UTILITY V6, V8 Cyl 4.0	2010-06	EM-5797	MINI L4 Cyl 1.6	2006-03
	MERCURY SPORT UTILITY V6 Cyl 4.0	2010-06	EM-5798	MINI L4 Cyl 1.6	2006-03
EM-4108	CHEVROLET VAN V8 Cyl 5.3	2014-03	EM-5799	TOYOTA PASSENGER CAR L4 Cyl 2.2	1995-91
	GMC VAN V8 Cyl 5.3	2014-03	EM-5800	LEXUS SPORT UTILITY V6 Cyl 3.3	2006-04
EM-4110	FORD PASSENGER CAR L4 Cyl	2014-12	EM-5801	LEXUS PASSENGER CAR L6 Cyl 3.0	2005-02
EM-4112	CHRYSLER PASSENGER CAR V6 Cyl	2014-11	EM-5802	TOYOTA PASSENGER CAR L4 Cyl 2.0	1995-91
	DODGE PASSENGER CAR V6 Cyl	2013-11	EM-5804	LEXUS PASSENGER CAR V6 Cyl 3.0	2001-99
EM-4113	CHRYSLER PASSENGER CAR V6 Cyl	2014-11	EM-5805	TOYOTA PASSENGER CAR L4 Cyl 2.2	1995-91
	DODGE PASSENGER CAR V6 Cyl	2013-11	EM-5807	TOYOTA SPORT UTILITY V8 Cyl 4.7	2004-01
EM-4117	FORD SPORT UTILITY L4 Cyl 2.3	2011-05	EM-5808	TOYOTA SPORT UTILITY V8 Cyl 4.7	2004-01
	MAZDA SPORT UTILITY L4 Cyl 2.3	2008-05	EM-5809	LEXUS PASSENGER CAR V6 Cyl 3.0	2001-99
	MERCURY SPORT UTILITY L4 Cyl 2.3	2008-05	EM-5810	TOYOTA PASSENGER CAR L4 Cyl 1.6 1988	1988
EM-4120	FORD SPORT UTILITY L4 Cyl 2.0	2014-12	EM-5812	ISUZU SPORT UTILITY L4 Cyl 2.2	2003-98
EM-4126	PONTIAC PASSENGER CAR L4 Cyl 2.0	2009-07	EM-5813	HONDA SPORT UTILITY V6 Cyl 3.2	2004-01
	SATURN PASSENGER CAR L4 Cyl 2.0	2010-07		ISUZU SPORT UTILITY V6 Cyl 3.5	2004-02
EM-4127	CHRYSLER PASSENGER CAR V6 Cyl 3.5	2008-07	EM-5814	HONDA SPORT UTILITY V6 Cyl 3.2	2000-98
	CHRYSLER VAN V6, L4 Cyl 3.3	2013-07		ISUZU SPORT UTILITY V6 Cyl 3.2	2000-98
	DODGE PASSENGER CAR V6 Cyl 3.5	2010-09	EM-5815	NISSAN PASSENGER CAR L4 Cyl 1.4 1978-76	1978-76
	DODGE VAN V6 Cyl 3.3	2010-08	EM-5817	NISSAN PASSENGER CAR L4 Cyl 2.5	2006-02
	VOLKSWAGEN VAN V6 Cyl 3.8	2010-09	EM-5818	NISSAN PASSENGER CAR V6 Cyl 3.5	2006-05
EM-4129	CHEVROLET PASSENGER CAR L4 Cyl 1.8	2014-11		NISSAN SPORT UTILITY V6 Cyl 3.5	2007-03
EM-5746	CHEVROLET PASSENGER CAR V6 Cyl 3.9	2009-08		NISSAN VAN V6 Cyl 3.5	2009-04
EM-5747	VOLVO PASSENGER CAR L5 Cyl 2.4	2000-98	EM-5819	TOYOTA PASSENGER CAR L4 Cyl 1.8	1997-94
	VOLVO PASSENGER CAR L5 Cyl 2.3	2000-98	EM-5825	MINI L4 Cyl 1.6	2006-02
EM-5748	NISSAN PASSENGER CAR V6 Cyl 3.5	2008-04	EM-5827	TOYOTA PASSENGER CAR L4 Cyl 1.5	2011-06
EM-5749	TOYOTA VAN L4 Cyl 2.2	1989-87	EM-5832	TOYOTA PASSENGER CAR L4 Cyl 1.5	2003-01
EM-5750	TOYOTA PASSENGER CAR L4 Cyl 2.4	2011-07	EM-5834	TOYOTA PASSENGER CAR V6 Cyl 3.5	2014-07
EM-5751	TOYOTA PASSENGER CAR L4 Cyl 2.2	1995-91	EM-5835	TOYOTA VAN V6 Cyl 3.3	2006-04
EM-5752	TOYOTA PASSENGER CAR L6 Cyl 3.0	1998-93	EM-5837	LEXUS SPORT UTILITY V6 Cyl 3.3	2006-04
EM-5753	TOYOTA PASSENGER CAR L4 Cyl 2.2	1999-94		TOYOTA SPORT UTILITY V6 Cyl 3.3	2007-04
EM-5754	TOYOTA TRUCK V6 Cyl 4.0	2006-05	EM-5840	HONDA VAN V6 Cyl 3.5	2007-05
EM-5755	TOYOTA SPORT UTILITY V6 Cyl 3.0	2003-01	EM-5844	MINI L4 Cyl 1.6	2006-02
EM-5756	TOYOTA PASSENGER CAR L4 Cyl 2.2	1995-91	EM-5846	NISSAN PASSENGER CAR V6 Cyl 3.0	2001-00
EM-5757	TOYOTA PASSENGER CAR L4 Cyl 2.4	2011-02	EM-5855	AUDI PASSENGER CAR V8, V6, V10, L4 Cyl 4.0	2011-02
EM-5758	TOYOTA PASSENGER CAR V6 Cyl 3.0	2003-00	EM-5856	MINI L4 Cyl 1.6	2011-08
EM-5759	TOYOTA PASSENGER CAR L4 Cyl 1.8	2005-00		MINI L4 Cyl 1.6	2012-07
EM-5761	TOYOTA PASSENGER CAR L4 Cyl 1.6	1992-90	EM-5857	MINI L4 Cyl 1.6	2011-08
EM-5762	TOYOTA PASSENGER CAR L4 Cyl 2.0	1989-88	EM-5858	MINI L4 Cyl 1.6	2011-08
EM-5763	TOYOTA PASSENGER CAR L4 Cyl 2.2	1993-90	EM-5859	MINI L4 Cyl 1.6	2011-08
EM-5764	TOYOTA PASSENGER CAR L6 Cyl 3.0	1998-95	EM-5860	MINI L4 Cyl 1.6	2008-02
EM-5766	TOYOTA SPORT UTILITY V6 Cyl 3.0	2003-01	EM-5861	LEXUS SPORT UTILITY V6 Cyl 3.5	2009-07
EM-5767	TOYOTA PASSENGER CAR L4 Cyl 2.0	1995-91	EM-5863	MAZDA PASSENGER CAR L4 Cyl 2.3	2011-10
EM-5768	LEXUS PASSENGER CAR L6 Cyl 3.0	1997-92	EM-5864	MAZDA PASSENGER CAR L4 Cyl 2.0	2011-10
EM-5769	LEXUS PASSENGER CAR L6 Cyl 3.0	2000-98		MAZDA VAN L4 Cyl 2.5	2012
	TOYOTA PASSENGER CAR L6 Cyl 3.0	1998-92	EM-5865	NISSAN PASSENGER CAR L4 Cyl 2.5	2013-07
EM-5770	NISSAN PASSENGER CAR L4 Cyl 2.4	1992-90	EM-5866	NISSAN SPORT UTILITY V6 Cyl 3.5	2012-09
EM-5771	NISSAN PASSENGER CAR L4 Cyl 1.6	1992-91		NISSAN VAN V6 Cyl 3.5	2015-11
EM-5772	NISSAN PASSENGER CAR V6 Cyl 3.5	2006-02	EM-5867	NISSAN PASSENGER CAR V6 Cyl 3.5	2014-07
EM-5773	NISSAN PASSENGER CAR L4 Cyl 2.5	2006-02	EM-5869	NISSAN PASSENGER CAR V6 Cyl 3.5	2014-07
EM-5774	INFINITI PASSENGER CAR V6 Cyl 3.0	1999-98	EM-5870	NISSAN PASSENGER CAR V6 Cyl 3.5	2014-07
EM-5775	NISSAN PASSENGER CAR L4 Cyl 2.5	2006-02	EM-5871	HONDA SPORT UTILITY L4 Cyl 2.4	2011-02
EM-5776	INFINITI PASSENGER CAR V6 Cyl 3.5	2006-04	EM-5872	HONDA PASSENGER CAR L4 Cyl 1.5	2012-09
	INFINITI SPORT UTILITY V6 Cyl 3.5	2008-03	EM-5873	SUZUKI PASSENGER CAR L4 Cyl 2.3	2007-04
EM-5777	NISSAN PASSENGER CAR V6 Cyl 3.0	1994-92	EM-5874	TOYOTA VAN V6 Cyl 3.3	2006-04
EM-5778	NISSAN SPORT UTILITY V6 Cyl 3.0	1989	EM-5875	HONDA PASSENGER CAR V6 Cyl 3.5	2013-08
	NISSAN TRUCK V6 Cyl 3.0	1989-86	EM-5876	MINI L4 Cyl 1.6	2006-02
EM-5779	NISSAN PASSENGER CAR V6 Cyl 3.0	1994-89	EM-5877	BMW SPORT UTILITY L6, V8 Cyl 3.0	2006-00
EM-5780	NISSAN TRUCK L4 Cyl 2.4	1989-86	EM-5879	AUDI SPORTS UTILITY V6 Cyl 3.0	2012-07
EM-5781	NISSAN PASSENGER CAR L4 Cyl 1.6	2011-09		VOLKSWAGEN SPORT UTILITY V6 Cyl 3.0	2012-09
EM-5782	NISSAN PASSENGER CAR L4 Cyl 2.0	2010-07	EM-5881	HYUNDAI PASSENGER CAR V8 Cyl 4.6	2010-09
EM-5783	MAZDA VAN L4 Cyl 2.3	2010-06	EM-5882	HYUNDAI PASSENGER CAR V8 Cyl 4.6	2010-09
	MAZDA PASSENGER CAR L4 Cyl 2.5	2013-04	EM-5884	BMW PASSENGER CAR L6 Cyl 3.0	2011-04
EM-5784	ACURA PASSENGER CAR L4 Cyl 2.4	2012-08	EM-5885	BMW PASSENGER CAR L6 Cyl 3.0	2011-04
	HONDA PASSENGER CAR L4 Cyl 2.4	2012-08	EM-5886	BMW PASSENGER CAR L6 Cyl 3.0	2012-06
EM-5785	HONDA PASSENGER CAR L4 Cyl 1.5	2013-09	EM-5887	BMW PASSENGER CAR L4 Cyl 2.0	2013-12
EM-5786	HONDA PASSENGER CAR L4 Cyl 2.0	2009-00		BMW SPORT UTILITY L4 Cyl 2.0	2013
EM-5787	ACURA PASSENGER CAR V6 Cyl 3.2	2008-03	EM-5888	BMW PASSENGER CAR L4 Cyl 2.0	2013-12
	HONDA PASSENGER CAR V6 Cyl 3.0	2007-06		BMW SPORT UTILITY L4 Cyl 2.0	2013
EM-5789	ACURA PASSENGER CAR L4 Cyl 2.4	2008-06	EM-5889	BMW SPORT UTILITY L6 Cyl 2.5	2006-04
EM-5792	HONDA PASSENGER CAR L4 Cyl 1.5	2013-09	EM-5890	BMW SPORT UTILITY L6 Cyl 2.5	2010-04

# NEW PART NUMBERS

PART #	APPLICATION	YEAR	PART #	APPLICATION	YEAR
EM-5892	LAND ROVER SPORT UTILITY V8 Cyl 4.2	2012-06	EM-5968	NISSAN PASSENGER CAR L4 Cyl 1.6	2013-12
EM-5893	LAND ROVER SPORT UTILITY V8 Cyl 4.2	2009-06	EM-5969	NISSAN PASSENGER CAR L4 Cyl 1.6	2015-12
EM-5894	LAND ROVER SPORT UTILITY V8 Cyl 4.2	2009-06	EM-5970	LEXUS PASSENGER CAR L4 Cyl 1.8	2013-11
EM-5895	LAND ROVER SPORT UTILITY V8 Cyl 4.4	2005-03		TOYOTA PASSENGER CAR L4 Cyl 1.8	2013-10
EM-5896	LAND ROVER SPORT UTILITY V8 Cyl 4.4	2005-03	EM-5971	SUBARU PASSENGER CAR H4 Cyl 2.5	2009-05
EM-5900	TOYOTA VAN V6 Cyl 3.3	2006-04		SUBARU SPORT UTILITY H4 Cyl 2.5	2010-05
EM-5901	TOYOTA SPORT UTILITY V8 Cyl 4.6	2013-07	EM-5973	SCION VAN L4 Cyl 2.4	2014-08
	TOYOTA TRUCK V8 Cyl 4.6	2012-10	EM-5976	LEXUS PASSENGER CAR V8 Cyl 4.3	2006-04
EM-5902	TOYOTA SPORT UTILITY V8 Cyl 5.7	2013-07	EM-5978	ACURA PASSENGER CAR V6 Cyl 3.5	2008-07
	TOYOTA TRUCK V8 Cyl 4.6	2012-10	EM-5980	MITSUBISHI PASSENGER CAR L4 Cyl 2.4	2012-06
EM-5903	HONDA SPORT UTILITY V6 Cyl 3.5	2008-06	EM-5982	TOYOTA SPORT UTILITY L4 Cyl 2.4	2008-06
EM-5904	HONDA VAN V6 Cyl 3.5	2010-08	EM-5983	SUBARU PASSENGER CAR H4 Cyl 2.5	2009-05
EM-5905	NISSAN PASSENGER CAR L4 Cyl 2.5	2012-07		SUBARU SPORT UTILITY H4 Cyl 2.5	2010-05
EM-5906	HONDA PASSENGER CAR L4 Cyl 1.3	2011-06	EM-5984	ACURA PASSENGER CAR V6 Cyl 3.2	2008-04
EM-5907	MITSUBISHI PASSENGER CAR V6 Cyl 3.5	2004-99	EM-5986	SCION PASSENGER CAR L4 Cyl 2.4	2010-05
EM-5908	TOYOTA SPORT UTILITY V6 Cyl 3.4	2001-96	EM-5988	SCION PASSENGER CAR L4 Cyl 2.4	2010-05
EM-5909	MAZDA PASSENGER CAR L4 Cyl 1.5	2012-11	EM-5990	HONDA PASSENGER CAR L4 Cyl 1.8	2013-12
EM-5910	TOYOTA TRUCK L4 Cyl 2.7	2015-05	EM-5992	ACURA SPORT UTILITY V6 Cyl 3.7	2013-07
EM-5911	INFINITI PASSENGER CAR V6 Cyl 3.5	2008-04	EM-5993	VOLVO PASSENGER CAR L5 Cyl 2.3	2007-98
	INFINITI SPORT UTILITY V6 Cyl 3.5	2012-03		VOLVO SPORT UTILITY L5 Cyl 2.5	2006-03
EM-5912	MITSUBISHI SPORT UTILITY L4 Cyl 2.4	2006-03	EM-5994	ACURA PASSENGER CAR V6 Cyl 3.5	2008-07
EM-5913	ACURA SPORT UTILITY L4 Cyl 2.3	2012-07		ACURA SPORT UTILITY V6 Cyl 3.7	2009-07
EM-5914	NISSAN SPORT UTILITY V6 Cyl 3.5	2012-08	EM-7000	VOLKSWAGEN PASSENGER CAR L4 Cyl 1.8	2006-99
	NISSAN VAN V6 Cyl 3.5	2012-11	EM-7004	MAZDA SPORT UTILITY V6 Cyl 3.7	2012-10
EM-5915	ACURA PASSENGER CAR V6 Cyl	2014-03	EM-7006	KIA PASSENGER CAR L4 Cyl 2.0	2013-10
	HONDA PASSENGER CAR L4 Cyl 2.4	2012-03	EM-7007	SUBARU PASSENGER CAR H4 Cyl 2.2	1996-92
EM-5916	SCION PASSENGER CAR L4 Cyl 2.4	2010-05	EM-7010	TOYOTA TRUCK L4 Cyl 2.7	2015-05
EM-5917	ACURA PASSENGER CAR V6, L4 Cyl	2014-03	EM-7011	TOYOTA SPORT UTILITY L4 Cyl 2.4	2005-04
	HONDA PASSENGER CAR V6 Cyl 3.5	2014-08	EM-7015	SCION PASSENGER CAR L4 Cyl 1.8	2013-08
EM-5918	TOYOTA TRUCK V8 Cyl 4.7	2004-00	EM-7017	MITSUBISHI SPORT UTILITY V6 Cyl 3.0	1996-95
EM-5919	TOYOTA SPORT UTILITY V8 Cyl 4.7	2007-05	EM-7021	VOLKSWAGEN PASSENGER CAR L4 Cyl 2.0	2014-09
EM-5921	LEXUS PASSENGER CAR L6 Cyl 3.0	2005-98	EM-7030	AUDI PASSENGER CAR L4 Cyl 1.8	2006-02
EM-5922	MINI L4 Cyl 1.6	2006-04	EM-7039	LEXUS SPORT UTILITY V6 Cyl 3.3	2006-04
EM-5923	MAZDA VAN L4 Cyl 2.3	2010-06		TOYOTA SPORT UTILITY V6 Cyl 3.3	2010-04
EM-5924	MITSUBISHI PASSENGER CAR L4 Cyl 2.0	2011-08	EM-7042	SCION PASSENGER CAR L4 Cyl 1.8	2013-08
EM-5925	HONDA VAN V6 Cyl 3.5	2010-08	EM-7043	MAZDA PASSENGER CAR L4 Cyl 2.3	2009-07
EM-5927	MITSUBISHI SPORT UTILITY V6 Cyl 3.0	2012-07	EM-7051	KIA SPORT UTILITY V6 Cyl 3.8	2010-07
EM-5928	MITSUBISHI SPORT UTILITY V6 Cyl 3.0	2012-07	EM-8701	NISSAN PASSENGER CAR L4 Cyl 1.6	1998-91
EM-5929	MITSUBISHI PASSENGER CAR V6 Cyl 3.0	1996-93	EM-9487	HONDA PASSENGER CAR L4 Cyl 1.8	2011-06
EM-5930	TOYOTA PASSENGER CAR L4 Cyl 1.5	2011-06	EM-9488	ACURA PASSENGER CAR L4 Cyl 2.4	2010-09
EM-5931	CHEVROLET PASSENGER CAR L4 Cyl 2.0	2010-04		HONDA PASSENGER CAR L4 Cyl 2.4	2012-09
	SUZUKI PASSENGER CAR L4 Cyl 2.0	2008-04	EM-9489	MITSUBISHI PASSENGER CAR L4 Cyl 2.0	2011-08
EM-5932	CHEVROLET PASSENGER CAR L4 Cyl 2.0	2010-04	EM-9490	HONDA PASSENGER CAR L4 Cyl 2.0	2009-00
	SUZUKI PASSENGER CAR L4 Cyl 2.0	2008-04	EM-9491	PONTIAC PASSENGER CAR L4 Cyl 2.4	2010-09
EM-5933	CHEVROLET PASSENGER CAR L4 Cyl 2.0	2010-04		TOYOTA PASSENGER CAR L4 Cyl 2.4	2011-09
	SUZUKI PASSENGER CAR L4 Cyl 2.0	2008-04	EM-9494	TOYOTA SPORT UTILITY V6 Cyl 4.0	2012-03
EM-5934	VOLKSWAGEN PASSENGER CAR L4 Cyl 2.0	2011-09		TOYOTA TRUCK V6 Cyl 4.0	2012-05
EM-5935	VOLKSWAGEN PASSENGER CAR L4 Cyl 2.0	2014-09	EM-9495	TOYOTA PASSENGER CAR L4 Cyl 2.2	1999-94
EM-5936	HYUNDAI PASSENGER CAR L4 Cyl 2.4	2010-09	EM-9496	HONDA SPORT UTILITY L4 Cyl 2.4	2011-07
EM-5937	INFINITI PASSENGER CAR V6 Cyl 3.0	1996	EM-9497	SCION VAN L4 Cyl 2.4	2014-08
	NISSAN PASSENGER CAR V6 Cyl 3.0	2001-95		TOYOTA SPORT UTILITY L4 Cyl 2.4	2008-06
EM-5938	NISSAN SPORT UTILITY L4 Cyl 2.5	2007-05	EM-9498	TOYOTA SPORT UTILITY L4 Cyl 2.5	2012-09
EM-5940	TOYOTA SPORT UTILITY L4 Cyl 2.4	2008-06	EM-9499	TOYOTA SPORT UTILITY V8 Cyl 4.7	2009-03
EM-5941	LEXUS PASSENGER CAR L6 Cyl 3.0	2005-98	EM-9500	TOYOTA TRUCK L4 Cyl 2.7	2015-05
EM-5942	LEXUS PASSENGER CAR V8 Cyl 4.0	2000-96	EM-9502	TOYOTA SPORT UTILITY L4 Cyl 2.4	2005-04
EM-5943	MAZDA PASSENGER CAR L4 Cyl 2.3	2008-06	EM-9504	TOYOTA PASSENGER CAR L4 Cyl 2.4	2003-02
EM-5944	SCION PASSENGER CAR L4 Cyl 1.8	2013-08	EM-9506	NISSAN SPORT UTILITY V6 Cyl 4.0	2013-05
EM-5945	SUBARU PASSENGER CAR H4 Cyl 2.5	2013-12		NISSAN TRUCK V6 Cyl 4.0	2012-05
	SUBARU SPORT UTILITY H4 Cyl 2.5	2014		NISSAN VAN V6 Cyl 4.0	2013-12
EM-5947	SAAB PASSENGER CAR L4 Cyl 2.3	2002-94	EM-9507	MAZDA SPORT UTILITY V6, L4 Cyl 3.5	2009-07
EM-5949	TOYOTA VAN V6 Cyl 3.5	2010-07	EM-9509	TOYOTA SPORT UTILITY V6 Cyl 3.5	2012-06
EM-5950	LEXUS PASSENGER CAR L6 Cyl 3.0	1997-93	EM-9510	MITSUBISHI PASSENGER CAR L4, V6 Cyl	2012-06
EM-5951	SUZUKI PASSENGER CAR L4 Cyl 2.0	2013-10		MITSUBISHI SPORT UTILITY V6 Cyl 3.8	2008-04
EM-5952	LEXUS PASSENGER CAR V8 Cyl 4.3	2006-01	EM-9511	LEXUS SPORT UTILITY V8 Cyl 4.7	2007-03
EM-5953	NISSAN PASSENGER CAR L4 Cyl 2.5	2012-07		TOYOTA SPORT UTILITY V8 Cyl 4.7	2009-03
	NISSAN SPORT UTILITY L4 Cyl 2.5	2012-08	EM-9512	HONDA SPORT UTILITY V6 Cyl 3.5	2014-09
EM-5954	ACURA SPORT UTILITY L4 Cyl 2.0	2015-13		HONDA VAN V6 Cyl 3.5	2013-11
	HONDA SPORT UTILITY L4 Cyl 2.4	2015-12	EM-9513	TOYOTA SPORT UTILITY L4 Cyl 2.5	2012-06
EM-5958	HONDA SPORT UTILITY L4 Cyl 2.4	2014-12	EM-9514	LEXUS PASSENGER CAR L4 Cyl 1.8	2013-11
EM-5959	SUBARU PASSENGER CAR H4 Cyl 2.0	2013-12		TOYOTA PASSENGER CAR L4 Cyl 1.8	2013-10
	SUBARU SPORT UTILITY H4 Cyl 2.5	2013	EM-9515	TOYOTA TRUCK V6 Cyl 3.4	2004-95
EM-5960	SUBARU PASSENGER CAR H4 Cyl 2.0	2013-12	EM-9516	HONDA PASSENGER CAR V6 Cyl 3.5	2012-08
	SUBARU SPORT UTILITY H4 Cyl 2.5	2013	EM-9517	NISSAN PASSENGER CAR L4 Cyl 2.4	1997-93
EM-5962	NISSAN SPORT UTILITY V6 Cyl 3.5	2007-03	EM-9518	TOYOTA SPORT UTILITY L4 Cyl 2.4	2012-06
EM-5963	LEXUS PASSENGER CAR V6, V8 Cyl 3.0	2012-06	EM-9519	TOYOTA SPORT UTILITY V8 Cyl 4.7	2009-08
EM-5964	TOYOTA SPORT UTILITY V6 Cyl 3.5	2012-06		TOYOTA TRUCK V8 Cyl 4.7	2009-07
EM-5967	LEXUS PASSENGER CAR V8 Cyl 4.3	2003-01			

## NEW PART NUMBERS

PART #	APPLICATION	YEAR	PART #	APPLICATION	YEAR
EM-9520	NISSAN SPORT UTILITY V6 Cyl 4.0	2014-05			
	NISSAN TRUCK V6 Cyl 4.0	2015-05			
EM-9522	TOYOTA SPORT UTILITY V8 Cyl 4.6	2011-08			
	TOYOTA TRUCK V8 Cyl 4.6	2011-10			
EM-9523	TOYOTA TRUCK V6 Cyl 4.0	2012-07			
EM-9525	TOYOTA PASSENGER CAR L4 Cyl 1.8	2006-00			
EM-9526	MAZDA PASSENGER CAR L4 Cyl 2.3	2009-07			
EM-9527	MAZDA VAN V6 Cyl 2.5	2006-00			
EM-9530	HONDA VAN V6 Cyl 3.5	2010-07			
EM-9531	NISSAN PASSENGER CAR L4 Cyl 2.0	2001-00			
EM-9534	MAZDA PASSENGER CAR L4 Cyl 2.0	2011-10			
	MAZDA VAN L4 Cyl 2.5	2012			
EM-9535	TOYOTA PASSENGER CAR V6 Cyl 3.5	2007-05			
EM-9536	MAZDA PASSENGER CAR V6 Cyl 3.0	2008-03			
EM-9537	MAZDA SPORT UTILITY V6, L4 Cyl 3.5	2014-07			
EM-9538	TOYOTA SPORT UTILITY V6 Cyl 3.5	2011-08			
EM-9539	MAZDA PASSENGER CAR L4 Cyl 2.3	2008-03			
EM-9541	TOYOTA PASSENGER CAR L4 Cyl 1.8	2005-00			
EM-9542	HONDA PASSENGER CAR L4 Cyl 2.0	2010-06			
EM-9543	TOYOTA TRUCK V6 Cyl 4.0	2006-05			
EM-9544	NISSAN PASSENGER CAR L4 Cyl 2.5	2011-07			
EM-9545	NISSAN PASSENGER CAR V6 Cyl 3.5	2012-08			
EM-9546	TOYOTA VAN V6 Cyl 3.5	2009-07			
EM-9547	NISSAN PASSENGER CAR V6 Cyl 3.5	2006-02			
EM-9548	NISSAN VAN V6 Cyl 3.5	2008-04			
EM-9549	TOYOTA SPORT UTILITY L4 Cyl 2.4	2012-06			
EM-9550	TOYOTA SPORT UTILITY V6 Cyl 3.5	2012-06			
EM-9551	NISSAN PASSENGER CAR V6 Cyl 3.5	2012-08			
EM-9552	SUBARU SPORT UTILITY H4 Cyl 2.5	2006-03			
EM-9553	HONDA PASSENGER CAR L4 Cyl 1.3	2011-06			
EM-9554	HONDA PASSENGER CAR L4, V6 Cyl 2.4	2013-08			
EM-9558	AUDI PASSENGER CAR V6 Cyl 3.2	2011-05			
EM-9559	SUBARU SPORT UTILITY H4 Cyl 2.5	2006-03			
	SUBARU PASSENGER CAR H4 Cyl 2.5	2014-00			
	SUBARU SPORT UTILITY 6 Cyl 3.0	2007-06			
EM-9560	SUBARU PASSENGER CAR H4 Cyl 2.5	2009-05			
	SUBARU SPORT UTILITY H4 Cyl 2.5	2009-05			
EM-9562	MERCEDES-BENZ PASSENGER CAR V6 Cyl 3	2005-03			
EM-9566	SUBARU PASSENGER CAR H4 Cyl 2.5	2009-07			
	SUBARU SPORT UTILITY H4 Cyl 2.5	2009-05			
EM-9570	SUBARU PASSENGER CAR H4 Cyl 1.8	1994-90			
EM-9572	TOYOTA PASSENGER CAR L4 Cyl 2.4	2003-02			
EM-9573	NISSAN PASSENGER CAR L4 Cyl 2.5	2006-02			
EM-9574	TOYOTA PASSENGER CAR L4 Cyl 1.8	2005-00			
EM-9575	NISSAN PASSENGER CAR V6 Cyl 3.5	2006-04			
EM-9576	TOYOTA PASSENGER CAR L4 Cyl 2.4	2003-02			
EM-9577	NISSAN PASSENGER CAR V6 Cyl 3.5	2004-02			
EM-9579	VOLVO PASSENGER CAR L6 Cyl 2.8	2005-99			
	VOLVO SPORT UTILITY L6 Cyl 2.9	2005-03			
EM-9580	VOLVO PASSENGER CAR L6 Cyl 2.9	2003-99			
	VOLVO SPORT UTILITY L6 Cyl 2.9	2005-99			
EM-9587	TOYOTA VAN V6 Cyl 3.5	2014-11			
EM-9588	TOYOTA PASSENGER CAR L4 Cyl 2.5	2014-10			
EM-9589	NISSAN PASSENGER CAR V6 Cyl 3.5	2003-02			
EM-9593	TOYOTA PASSENGER CAR V6 Cyl 3.5	2015-09			
EM-9594	HONDA TRUCK V6 Cyl 3.5	2011-09			
EM-9595	TOYOTA VAN V6 Cyl 3.5	2014-11			
EM-9599	TOYOTA SPORT UTILITY V6 Cyl 4.0	2014-03			
	TOYOTA TRUCK V6 Cyl 4.0	2011-05			
EM-9601	LEXUS PASSENGER CAR V6 Cyl 3.5	2015-07			
EM-9610	TOYOTA PASSENGER CAR L5 Cyl 2.7	2013-09			
	TOYOTA SPORT UTILITY L4 Cyl 2.7	2012-09			
EM-9612	SCION PASSENGER CAR L4 Cyl 1.8	2013-08			
EM-9613	SUZUKI SPORT UTILITY V6, L4 Cyl	2011-06			
EM-9617	HONDA PASSENGER CAR L4 Cyl 1.3	2011-06			
EM-9619	TOYOTA SPORT UTILITY L4 Cyl 2.7	2010			
EM-9634	INFINITI PASSENGER CAR V6 Cyl 3.0	2004-00			

## Re-Number & Consolidate

Old Part #	New Part #	Old Part #	New Part #	Old Part #	New Part #
DS-5233	DS-5225	EM-5194	EM-5199	EM-5408	EM-9464
EM-2215	EM-2268	EM-5195	EM-9242	EM-5409	EM-9468
EM-2244	EM-2287	EM-5196	EM-9211	EM-5410	EM-9472
EM-2529	EM-2497	EM-5197	EM-2748	EM-5412	EM-9249
EM-2544	EM-2531	EM-5199	EM-8189	EM-5413	EM-9279
EM-2648	EM-2815	EM-5201	EM-8418	EM-5414	EM-9246
EM-2694	EM-2812	EM-5202	EM-9477	EM-5415	EM-9229
EM-2694S	EM-2812S	EM-5203	EM-9212	EM-5416	EM-9215
EM-2865	EM-2822	EM-5204	EM-9235	EM-5417	EM-9214
EM-2877	EM-2622	EM-5205	EM-9231	EM-5418	EM-9280
EM-2906	EM-2987	EM-5207	EM-9227	EM-5419	EM-9299
EM-2937	EM-2853	EM-5210	EM-8164	EM-5421	EM-8792
EM-2946	EM-2960	EM-5211	EM-9226	EM-5429	EM-3128
EM-2976	EM-2624	EM-5217	EM-9003	EM-5430	EM-3115
EM-3181	EM-5085	EM-5220	EM-2832	EM-5431	EM-2949
EM-5044	EM-9049	EM-5322	EM-9209	EM-5433	EM-9274
EM-5045	EM-9025	EM-5323	EM-9219	EM-5435	EM-9289
EM-5059	EM-3006	EM-5324	EM-9204	EM-5438	EM-9265
EM-5066	EM-9185	EM-5325	EM-9202	EM-5442	EM-9247
EM-5071	EM-9275	EM-5327	EM-9288	EM-5443	EM-9451
EM-5076	EM-2896	EM-5328	EM-9217	EM-5444	EM-3113
EM-5082	EM-9394	EM-5330	EM-9205	EM-5447	EM-9289
EM-5086	EM-3095	EM-5331	EM-9254	EM-5451	EM-5032
EM-5088	EM-9174	EM-5333	EM-9219	EM-5463	EM-9294
EM-5090	EM-3124	EM-5334	EM-9253	EM-5469	EM-9247
EM-5095	EM-3066	EM-5336	EM-9492	EM-5470	EM-9433
EM-5099	EM-9056	EM-5337	EM-8068	EM-5478	EM-8209
EM-5102	EM-5098	EM-5338	EM-8492	EM-5479	EM-2748
EM-5115	EM-2940	EM-5339	EM-8062	EM-5486	EM-9404
EM-5116	EM-2941	EM-5341	EM-9441	EM-5496	EM-9307
EM-5122	EM-8786	EM-5342	EM-9255	EM-5497	EM-9366
EM-5123	EM-8790	EM-5344	EM-9252	EM-5498	EM-9314
EM-5124	EM-9331	EM-5345	EM-9248	EM-5499	EM-9312
EM-5125	EM-8783	EM-5346	EM-3088	EM-5504	EM-2927
EM-5126	EM-9367	EM-5347	EM-3129	EM-5505	EM-9281
EM-5127	EM-9373	EM-5348	EM-9384	EM-5506	EM-8243
EM-5128	EM-9376	EM-5351	EM-3093	EM-5520	EM-9424
EM-5135	EM-9031	EM-5355	EM-9222	EM-5522	EM-5661
EM-5137	EM-9359	EM-5357	EM-9196	EM-5523	EM-2928
EM-5139	EM-9351	EM-5360	EM-3124	EM-5524	EM-2947
EM-5153	EM-9221	EM-5361	EM-8200	EM-5525	EM-2947
EM-5154	EM-9195	EM-5363	EM-9466	EM-5529	EM-9244
EM-5157	EM-9072	EM-5364	EM-2817	EM-5531	EM-9372
EM-5158	EM-8578	EM-5365	EM-9469	EM-5532	EM-9364
EM-5160	EM-9203	EM-5366	EM-9297	EM-5534	EM-9296
EM-5164	EM-9033	EM-5368	EM-9168	EM-5535	EM-9410
EM-5167	EM-9010	EM-5369	EM-2620	EM-5536	EM-9337
EM-5168	EM-9200	EM-5386	EM-9300	EM-5538	EM-9326
EM-5169	EM-9442	EM-5389	EM-9271	EM-5539	EM-9382
EM-5172	EM-8964	EM-5390	EM-9273	EM-5540	EM-9380
EM-5183	EM-5026	EM-5391	EM-9276	EM-5541	EM-9374
EM-5184	EM-8568	EM-5393	EM-9272	EM-5542	EM-9378
EM-5185	EM-8665	EM-5395	EM-3110	EM-5543	EM-9336
EM-5192	EM-9388	EM-5402	EM-9410	EM-5544	EM-9320



## Re-Number & Consolidate

Old Part #	New Part #	Old Part #	New Part #	Old Part #	New Part #
EM-5545	EM-9338	EM-5626	EM-9339	EM-8216	EM-2410
EM-5546	EM-9322	EM-5627	EM-9341	EM-8268	EM-8103
EM-5547	EM-9306	EM-5628	EM-9361	EM-8305	EM-2406
EM-5548	EM-9306	EM-5629	EM-9349	EM-8341	EM-9055
EM-5549	EM-9368	EM-5630	EM-9309	EM-8347	EM-8002
EM-5550	EM-9325	EM-5631	EM-9377	EM-8381	EM-2409
EM-5552	EM-3104	EM-5632	EM-9360	EM-8486	EM-8393
EM-5555	EM-8643	EM-5633	EM-9321	EM-8505	EM-2731
EM-5557	EM-8887	EM-5634	EM-9310	EM-8569	EM-8568
EM-5558	EM-8604	EM-5635	EM-9313	EM-8585	EM-8205
EM-5560	EM-9228	EM-5636	EM-9315	EM-8610	EM-2815
EM-5562	EM-8074	EM-5637	EM-9316	EM-8633	EM-8230
EM-5564	EM-9285	EM-5638	EM-9318	EM-8637	EM-8224
EM-5565	EM-9286	EM-5639	EM-9344	EM-8642	EM-8393
EM-5566	EM-9213	EM-5640	EM-9370	EM-8647	EM-8164
EM-5567	EM-9220	EM-5641	EM-9348	EM-8702	EM-8150
EM-5568	EM-9205	EM-5642	EM-9335	EM-8703	EM-2855
EM-5569	EM-9216	EM-5643	EM-9323	EM-8706	EM-2856
EM-5571	EM-9437	EM-5644	EM-9362	EM-8707	EM-2857
EM-5572	EM-9387	EM-5648	EM-9454	EM-8708	EM-2854
EM-5573	EM-9206	EM-5666	EM-3151	EM-8712	EM-8041
EM-5576	EM-8108	EM-5667	EM-3150	EM-8714	EM-8042
EM-5577	EM-3087	EM-5668	EM-9092	EM-8720	EM-8719
EM-5579	EM-3147	EM-5687	EM-2818	EM-8726	EM-8727
EM-5580	EM-3097	EM-5695	EM-3130	EM-8737	EM-8044
EM-5581	EM-3094	EM-5696	EM-3131	EM-8785	EM-8783
EM-5584	EM-3121	EM-5697	EM-3132	EM-8808	EM-8681
EM-5585	EM-3122	EM-5698	EM-3134	EM-8810	EM-8296
EM-5586	EM-3090	EM-5699	EM-3137	EM-8922	EM-8921
EM-5589	EM-3138	EM-5740	EM-9205	EM-8924	EM-8923
EM-5590	EM-3091	EM-5745	EM-9434	EM-8927	EM-8921
EM-5592	EM-3092	EM-5765	EM-5143	EM-8942	EM-8943
EM-5593	EM-3111	EM-5788	EM-9413	EM-8946	EM-8945
EM-5594	EM-3120	EM-5803	EM-9197	EM-9006	EM-8795
EM-5595	EM-3118	EM-5806	EM-9418	EM-9009S	EM-9009
EM-5604	EM-9334	EM-5811	EM-9037	EM-9036	EM-2985
EM-5605	EM-9342	EM-5833	EM-9599	EM-9052	EM-9018
EM-5606	EM-9330	EM-5836	EM-9546	EM-9069	EM-8261
EM-5607	EM-9311	EM-5852	EM-5515	EM-9075	EM-8895
EM-5611	EM-9261	EM-5853	EM-5322	EM-9097	EM-9003
EM-5613	EM-9263	EM-5854	EM-9467	EM-9126	EM-2910
EM-5614	EM-9402	EM-5878	EM-5877	EM-9135	EM-8681
EM-5615	EM-9258	EM-7005	EM-9497	EM-9243	EM-9240
EM-5618	EM-9324	EM-8043	EM-8042	EM-9243S	EM-9240
EM-5619	EM-9353	EM-8052	EM-8579	EM-9247S	EM-9247
EM-5620	EM-9345	EM-8064	EM-2651	EM-9276S	EM-9276
EM-5621	EM-9375	EM-8069	EM-8063	EM-9321	EM-9317
EM-5622	EM-9355	EM-8070	EM-2815	EM-9398	EM-9066
EM-5623	EM-9340	EM-8112	EM-8100	EM-9399	EM-9168
EM-5624	EM-9308	EM-8139	EM-2740	EM-9493	EM-5155
EM-5625	EM-9354	EM-8143	EM-8310	EM-9561	EM-9559

## DISCONTINUED / OBSOLETE

PART #	PART #	PART #
EM-2411	EM-5503	EM-8136
EM-2729	EM-5508	EM-8158
EM-5212	EM-5516	EM-8159
EM-5221	EM-5570	EM-8498
EM-5274	EM-5650	EM-8500
EM-5466	EM-5652	EM-8504
EM-5472	EM-5671	EM-8625
EM-5477	EM-5735	EM-8634
EM-5480	EM-8114S	

## ABBREVIATIONS

2WD ..... 2 Wheel Drive  
 4WD ..... 4 Wheel Drive  
 ABS..... Antilock Brake System  
 A/C ..... Air Conditioning  
 A/T ..... Automatic Transmission  
 AWD ..... All Wheel Drive  
 BBL ..... Barrel  
 BEF ..... Before  
 CC ..... Cubic Centimeters  
 CONV ..... Convertible  
 DSL ..... Diesel  
 EFI ..... Electronic Fuel Injection  
 ENG ..... Engine  
 EXC ..... Excluding  
 FI ..... Fuel Injection  
 F/T ..... Full Time  
 FWD ..... Front Wheel Drive  
 GVWR ...Gross Vehicle Weight Rating  
 H ..... Hydraulic  
 HP ..... Horsepower  
 INC ..... Includes  
 L&R ..... Left and Right Hand

LH ..... Left Hand  
 LIMO ..... Limosine  
 LONG ..... Longitudinal  
 LOW ..... Lower  
 M/T ..... Manual Transmission  
 N/A ..... Not Applicable  
 PASS ..... Passanger  
 P/S ..... Power Steering  
 P/T ..... Part Time  
 PWR ..... Power  
 RH ..... Right Hand  
 SER ..... Series  
 STD ..... Standard  
 SUSP ..... Suspension  
 T/C ..... Turbo Charge  
 T/H ..... Turbo Hydromatic  
 T/M ..... Trans-O-Matic  
 TRANS ..... Transmission  
 UPR ..... Upper  
 W/ ..... With  
 W/O ..... Without

### **General Motors**

#### **Automatic Transmission**

M29 ..... PA  
 M30 ..... 4L60E  
 M33 ..... Hybrid 4L60E  
 M38 ..... THM350C  
 M40 ..... THM400C  
 M74 ..... 5 Speed Allison  
 MD8 ..... 700R4  
 MT1 ..... THMF4  
 MV4 ..... THM350C  
 MW9 ..... THM2004R

#### **Ford Automatic Transmission**

AOD ..... Automatic Overdrive  
 C3 ..... 3 Speed Automatic  
 C4 ..... 3 Speed Automatic  
 C5 ..... Speed Automatic  
 C6 ..... speed Automatic  
 CM ..... Cruise-O-Matic

# BODY MOUNTS AND BODY BUSHINGS

## FORD / LINCOLN / MERCURY

### Body Mounts for Taurus and Sable 1986 thru 1995

#### FRONT KIT Part No. BB-5500

Includes:  
Mount, Washer, Bolt  
Plate Nut and Rubber Plug

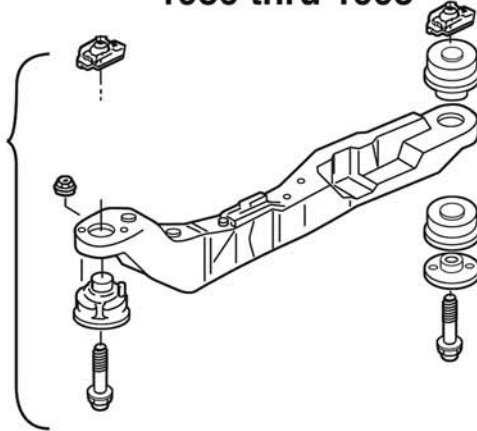

#### REAR KIT Part No. BB-5501

Includes:  
Upper Mount, Lower Mount  
Washers, Bolt  
Plate Nut and Rubber Plug

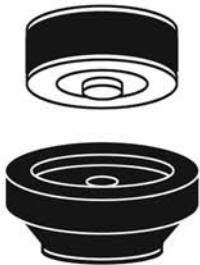

### Chassis Body Bushings for Crown Victoria, Town Car, Grand Marquis

Part No. BB-5502 – 1 Bushing Kit per box

## GENERAL MOTORS BODY MOUNT BUSHINGS

### Part No. BB-5503

Replaces O.E.M. No. 348080 - 4 required

Make	Model	Year	Position
<b>BUICK</b>	Estatewagon	1982 - 1996	3 & 4
	Regal	1985 - 1987	3 & 4
	Riviera	1982 - 1985	3 & 4
	Electra	1982 - 1984	1 & 3
Chevrolet	Caprice Sedan	1985 - 1996	1 & 3
	Stationwagon	1982 - 1996	3 & 4

Make	Model	Year	Position
<b>OLDSMOBILE</b>	Custom Cruiser	1982 - 1992	3 & 4
	Regency 98	1982 - 1984	1 & 3
	Toronado	1982 - 1985	3 & 4
<b>PONTIAC</b>	Bonneville	1982 - 1984	1 & 3
	Parisienne	1985 - 1986	1 & 3
	Safari	1982 - 1989	3 & 4

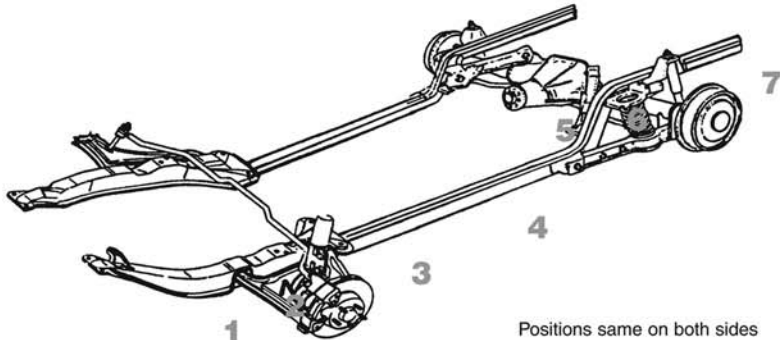
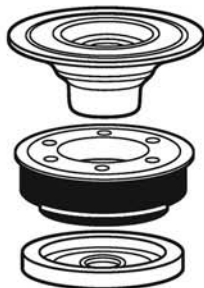

Positions same on both sides

# EM-5000 UNIVERSAL

## GENERAL MOTORS TRANSMISSION MOUNT



Replaces Most (85%) General Motors Rear Wheel Drive Single-Stud and Two-Hole Transmission Mounts on 4cyl., 6cyl. and 8 cyl. Engines (fits over 100 million vehicles now on the road)

### *Replaces these Westar parts*

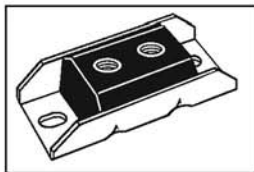

EM-2143

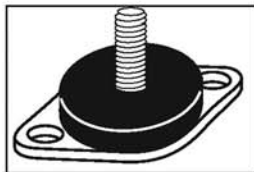

EM-2150

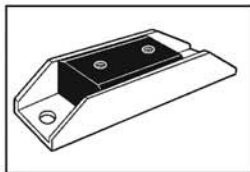

EM-2215

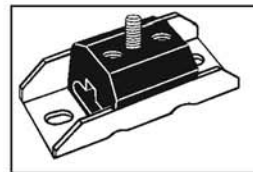

EM-2360

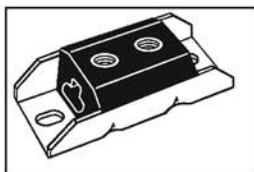

EM-2378

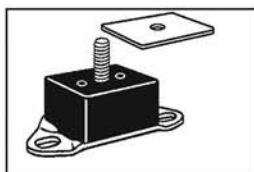

EM-2510

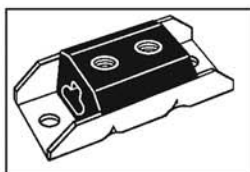

EM-2268

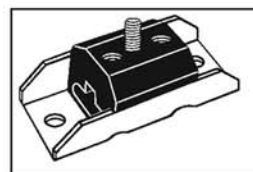

EM-2288

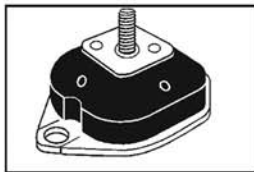

EM-2374

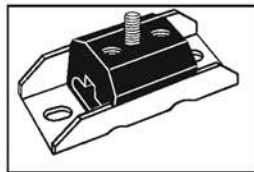

EM-2659

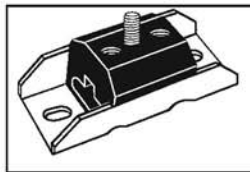

EM-2773

**Original Design or Universal—  
Westar has what you need!**

# Engine, Transmission, And Torque Strut Mounts

CYL	ENG. SIZE	YEAR	LOCATION	DESCRIPTION	QTY	ENGINE	TORQUE STRUT	TRANSMISSION
<b>ACURA PASSENGER CAR</b>								
<b>CL</b>								
L4	L4 2.2L 2156cc	1997	Front	Auto	1	EM-8026		
			Front	Manual	1	EM-8432		
			LH Front		1	EM-8404		
			Rear	Auto; w/ Solenoid	1	EM-8984		
			Rear	Auto; w/o Solenoid	1	EM-8011		
			Rear	Manual	1	EM-8009		
			Trans	Auto	1			EM-8002
	L4 2.3L 2254cc	1998-99	Front	Auto	1	EM-8026		
			Front	Manual	1	EM-8432		
			LH Front		1	EM-8404		
			Rear	Auto; w/ Solenoid	1	EM-8984		
			Rear	Auto; w/o Solenoid	1	EM-8011		
			Rear	Manual	1	EM-8009		
			Trans	Auto	1			EM-8002
V6	V6 3.0L 2997cc	1997-99	Front		1	EM-9178		
			Rear		1	EM-5471		
			Trans		1			EM-8896
	V6 3.2L 3210cc	2001-03	Front		1	EM-9441		
			Rear		1	EM-9149		
			Right		1	EM-8974		
Trans	Auto	1			EM-8898			
<b>CSX</b>								
L4	L4 2.0L 1998cc	2006-09 2006-10	RH Front		1	EM-9282		
			Torq Str - Lower		1		EM-9386	
			Torq Str - Upper		1		EM-9385	
<b>EL</b>								
L4	L4 1.7L 1668cc	2001-05	Trans	Auto; Exc. CVT	1			EM-5794
			Trans	Manual	1			EM-9204
<b>INTEGRA</b>								
L4	L4 1.6L 1590cc	1986-89	Rear	Auto; After Chassis #GS000960	1	EM-9084		
			Rear	Manual	1	EM-9084		
			Trans	Auto	1			EM-8018
			Trans	Manual	1			EM-8018
	L4 1.7L	1992-93	Trans	Manual	1			EM-5385
	L4 1.7L 1678cc		Front		1	EM-8823		
			LH Front		1	EM-8981		
	L4 1.8L 1797cc	1997-01 1994-96 1997-01 1994-96 1997-01 1994-96 1997-01 1994-96 1997-01 1994-96	Front	GS-R & Type-R	1	EM-8434		
			Front	GS-R	1	EM-8824		
			LH Front	GS-R & Type-R	1	EM-8435		
			LH Front Lower	GS-R	1	EM-8893		
			LH Front Upper	GS-R & Type-R	1	EM-8894		
			LH Front Upper	GS-R	1	EM-8894		
			Rear	GS-R & Type-R	1	EM-8010		
			Rear	GS-R	1	EM-8010		
			Trans	GS-R & Type-R; Manual	1			EM-8329
			Trans	GS-R; Manual	1			EM-8329
	L4 1.8L 1834cc	1997-01 1994-96 1992-93	Front	exc. GS-R & Type-R; Auto	1	EM-8575		
			Front	exc. GS-R & Type-R; Manual 5 Spd	1	EM-8824		
			Front	exc. GS-R; Auto	1	EM-8575		
Front			exc. GS-R; Manual	1	EM-8824			
Front	Auto	1	EM-8860					

# Engine, Transmission, And Torque Strut Mounts

CYL	ENG. SIZE	YEAR	LOCATION	DESCRIPTION	QTY	ENGINE	TORQUE STRUT	TRANSMISSION	
<b>ACURA PASSENGER CAR (continued)</b>									
<b>INTEGRA (continued)</b>									
L4	L4 1.8L 1834cc	1992-93	Front	Manual	1	EM-8823			
		1990-91	Front	Auto	1	EM-8860			
			Front	Manual	1	EM-8823			
		1992-93	LH Front		1	EM-9169			
		1990-91	LH Front		1	EM-8981			
		1997-01	LH Front Lower	exc. GS-R & Type-R; Auto		1	EM-8709		
			LH Front Lower	exc. GS-R & Type-R; Manual 5 Spd		1	EM-8893		
		1994-96	LH Front Lower	exc. GS-R; Auto		1	EM-8709		
			LH Front Lower	exc. GS-R; Manual		1	EM-8893		
		1997-01	LH Front Upper	exc. GS-R & Type-R		1	EM-8894		
		1994-96	LH Front Upper	exc. GS-R		1	EM-8894		
		1997-01	Rear	exc. GS-R & Type-R; Auto		1	EM-8897		
			Rear	exc. GS-R & Type-R; Manual 5 Spd		1	EM-8010		
		1994-96	Rear	exc. GS-R		1	EM-8010		
		1992-93	Rear	Auto		1	EM-8895		
			Rear	Manual		1	EM-8895		
		1990-91	Rear	Auto		1	EM-8895		
			Rear	Manual		1	EM-8895		
		1997-01	Trans	exc. GS-R & Type-R; Auto		1			EM-8330
			Trans	exc. GS-R & Type-R; Manual		1			EM-8329
1994-96	Trans	exc. GS-R & Type-R; Auto		1			EM-8330		
	Trans	exc. GS-R & Type-R; Manual		1			EM-8329		
1990-93	Trans			1			EM-8980		
	Trans	Manual		1			EM-5385		
<b>LEGEND</b>									
V6	V6 2.5L 2494cc	1986	Front		1	EM-9043			
		1987	Rear		1	EM-9110			
		1986-87	Torq Str - Front	Insert Only		1		EM-8614	
			Torq Str - Rear	Insert Only		1		EM-8615	
	V6 2.7L	1987-90	Trans		1			EM-5379	
	V6 2.7L 2675cc	1989-90	Front	Vibration Damper		1	EM-5382		
		1987-88	Front	Vibration Damper		1	EM-5382		
		1989-90	RH Front			1	EM-9043		
		1987-88	RH Front			1	EM-9043		
			Rear			1	EM-9110		
		1987-90	Torq Str - Front	Insert Only		1		EM-8614	
		Torq Str - Rear	Insert Only		1		EM-8615		
	V6 3.2L 3206cc	1993-95	Front Lower			2	EM-9067		
			RH Front			2	EM-8992		
		1991-92	RH Front			1	EM-9083		
		1993-95	Rear			1	EM-8037		
1991-92		Trans	Manual		1			EM-9054	
	Trans	Manual		1			EM-9054		
<b>NSX</b>									
V6	V6 3.0L 2977cc	1991-05	RH Front		1	EM-9030			
	V6 3.2L 3179cc	1997-05	RH Front		1	EM-9030			
<b>RL</b>									
V6	V6 3.5L 3471cc	2005-08	Rear		1	EM-5984			
<b>RSX</b>									
L4	L4 2.0L 1998cc	2002-06	Front	Auto	1	EM-9066			
			Front	Manual	1	EM-9424			
			RH Front		1	EM-9413			
			Rear	Auto	1	EM-9175			

# Engine, Transmission, And Torque Strut Mounts

CYL	ENG. SIZE	YEAR	LOCATION	DESCRIPTION	QTY	ENGINE	TORQUE STRUT	TRANSMISSION
<b>ACURA PASSENGER CAR (continued)</b>								
<b>RSX (continued)</b>								
L4	L4 2.0L 1998cc	2002-06	Rear	Manual	1	EM-9396		
		2006	Trans	Auto	1			EM-9205
			Trans	Manual	1			EM-9433
		2002-05	Trans	Auto	1			EM-9205
			Trans	Manual, Exc. Type S	1			EM-9433
<b>TL</b>								
V6	V6 3.2L 3206cc	1997-98	Center Lower		2	EM-8037		
			L & R Front Lower		2	EM-8992		
		V6 3.2L 3210cc	2007-08 2004-06 2000-03 1999 2007-08 2004-06 2000-03 1999 2007-08 2004-06 2000-03 1999 2007-08 2004-06 2000-03	Front	Auto	1	EM-9247	
	Front			Auto	1	EM-9247		
	Front			Hydraulic Mount	1	EM-9441		
	Front				1	EM-9185		
	RH Front				1	EM-8974		
	Rear				1	EM-5984		
	Rear				1	EM-5984		
	Rear				1	EM-9149		
	Rear				1	EM-9149		
	Right			Auto	1	EM-9297		
	Right			Auto	1	EM-9297		
	Right			Manual	1	EM-5787		
	Right				1	EM-8974		
	Trans - Front			Auto	1		EM-5744	
	Trans - Front			Manual	1		EM-9458	
	Trans - Front		1		EM-8898			
	Trans - Front	Auto	1		EM-8898			
	Trans - Rear	Auto	1		EM-9220			
	Trans - Rear		1		EM-8986			
	Trans - Rear	Auto	1		EM-8986			
	Trans - Upper	Auto	1		EM-5978			
	V6 3.5L	2007-08	Front	Auto	1	EM-9247		
			Rear		1	EM-5984		
			Right	Auto	1	EM-9297		
			Right	Manual	1	EM-5787		
			Trans - Front	Manual	1		EM-5744	
			Trans - Lower		1		EM-9459	
			Trans - Lower	Auto	1		EM-5994	
			Trans - Upper		1		EM-9463	
			Trans - Upper	Auto	1		EM-5978	
	V6 3.7L	2009-14	Trans - Lower		1		EM-9459	
Trans - Upper				1		EM-9463		
<b>TSX</b>								
L4	L4 2.4L	2009-10	Front		1	EM-9488		
			LH Rear	Auto	1	EM-9443		
			RH Front		1	EM-9457		
		2004-08	Trans - Front	Auto	1		EM-9426	
			Trans - Front	Manual	1		EM-9152	
			Trans - Rear	Auto	1		EM-9438	
	Trans - Rear	Manual	1		EM-9440			
	L4 2.4L 2354cc	2006-08 2004-05 2006-08 2004-05 2006-08 2004-05 2009-12	Front	Auto	1	EM-5789		
			Front	Auto	1	EM-9247		
			RH Front		1	EM-9297		
			RH Front		1	EM-9297		
			Rear	Hydraulic Mount	1	EM-9194		
			Rear	Hydraulic Mount	1	EM-9194		
Trans - Lower			Auto	1		EM-9428		

# Engine, Transmission, And Torque Strut Mounts

CYL	ENG. SIZE	YEAR	LOCATION	DESCRIPTION	QTY	ENGINE	TORQUE STRUT	TRANSMISSION
<b>ACURA PASSENGER CAR (continued)</b>								
<b>TSX (continued)</b>								
L4	L4 2.4L 2354cc	2009-12	Trans - Lower	Manual	1			EM-9417
			Trans - Upper		1			EM-5784
V6	V6 3.5L 3471cc	2010-12	Right		1	EM-9467		
			Trans - Lower		1			EM-9439
<b>ACURA SPORT UTILITY</b>								
<b>ILX</b>								
L4	L4 2.0L 1997cc	2013-15	Torq Str - Front		1		EM-5954	
<b>MDX</b>								
V6	V6 3.5L	2005-06	Front	Hydraulic Mount	1	EM-9441		
		2003-04	Front	Hydraulic Mount	1	EM-9441		
		2001-02	Front	Hydraulic Mount	1	EM-9441		
		2005-06	RH Front	w/o Counter Weight	1	EM-9299		
		2003-04	RH Front	w/o Counter Weight	1	EM-9299		
		2001-02	RH Front		1	EM-9389		
		2005-06	Rear		1	EM-9300		
		2003-04	Rear		1	EM-9300		
		2001-02	Rear		1	EM-9300		
		2003-06	Trans - Front		1			EM-9301
	2001-02	Trans - Front	Auto	1			EM-8898	
		Trans - LH Rear	Auto	1			EM-8986	
		2003-06	Trans - Rear	1			EM-9298	
V6 3.7L	2007-13	Rear		1	EM-9451			
		Right		1	EM-5992			
		2007-09	Trans		1			EM-5994
<b>RDX</b>								
L4	L4 2.3L	2007-12	Torq Str - Upper		1		EM-5913	
<b>SLX</b>								
V6	V6 3.2L 3165cc	1996-97	LH Front	4WD	1	EM-8351		
			RH Front	4WD	1	EM-8352		
			Trans	4WD	1			EM-9142
	V6 3.5L 3494cc	1998-99	LH Front	4WD	1	EM-8351		
			RH Front	4WD	1	EM-8352		
			Trans	4WD	1			EM-9142
<b>ZDX</b>								
V6	V6 3.7L	2010-13	Rear		1	EM-9451		
<b>AMERICAN MOTORS PASSENGER CAR</b>								
<b>AMBASSADOR</b>								
L6	L6 3.8L 232ci	1965-70	L & R Front		2	EM-2280		
		1967-70	Trans	Auto	1			EM-2317
			Trans	Manual	1			EM-2317
	L6 4.2L 258ci	1971	L & R Front		2	EM-2330		
			Trans	Auto	1			EM-2317
			Trans	Manual	1			EM-2317
V8	V8 4.7L 287ci	1966-67	L & R Front		2	EM-2351		
	V8 4.8L 290ci	1967-69	L & R Front		2	EM-2351		
	V8 5.0L 304ci	1974	L & R Front		2	EM-2351		
		1970-72	L & R Front		2	EM-2351		
		1973	LH Front		1	EM-2722		
			RH Front		1	EM-2351		
		1972-74	Trans	Auto	1			EM-2453
	Trans		Manual	1			EM-2453	
V8 5.6L 343ci	1967-69	L & R Front		2	EM-2351			
V8 5.9L 360ci	1974	L & R Front		2	EM-2351			



# Engine, Transmission, And Torque Strut Mounts

CYL	ENG. SIZE	YEAR	LOCATION	DESCRIPTION	QTY	ENGINE	TORQUE STRUT	TRANSMISSION
<b>AMERICAN MOTORS PASSENGER CAR (continued)</b>								
<b>AMBASSADOR (continued)</b>								
V8	V8 5.9L 360ci	1970-72	L & R Front		2	EM-2351		
		1973	LH Front		1	EM-2722		
			RH Front		1	EM-2351		
		1972-74	Trans	Auto		1		
	Trans		Manual		1			EM-2453
	V8 6.4L 390ci	1968-70	L & R Front		2	EM-2351		
	V8 6.6L 401ci	1974	L & R Front		2	EM-2351		
		1971-72	L & R Front		2	EM-2351		
			LH Front		1	EM-2722		
		1973	RH Front		1	EM-2351		
Trans			Auto		1			EM-2453
Trans	Manual		1			EM-2453		
<b>AMERICAN</b>								
L6	L6 3.2L 196ci	1960-63	L & R Front	OEM Design	2	EM-2150@		
			Trans - L & R	OEM Design	2			EM-2150 @
	L6 3.3L 199ci	1966-68	L & R Front		2	EM-2280		
			Trans		1			EM-2310
<b>AMX</b>								
L6	L6 4.2L 258ci	1978-80	L & R Front		2	EM-2330		
			Trans	Auto	1			EM-2454
		1979-80	Trans	Manual	1			EM-2454
			Trans	Auto	1			EM-2373
			Trans	Manual	1			EM-2373
<b>CLASSIC</b>								
L6	L6 3.8L 232ci	1964-65	L & R Front		2	EM-2280		
<b>CONCORD</b>								
L4	L4 2.5L 151ci	1980-82	L & R Front		2	EM-2446		
			Trans	Auto	1			EM-2453
			Trans	Manual	1			EM-2453
L6	L6 3.8L 232ci	1978-79	L & R Front		2	EM-2330		
			Trans	Auto	1			EM-2454
			Trans	Manual	1			EM-2454
	L6 4.2L 258ci	1978-83	L & R Front		2	EM-2330		
			Trans	Auto	1			EM-2454
			Trans	Manual	1			EM-2454
V8	V8 5.0L 304ci	1978-79	L & R Front		2	EM-2351		
			Trans	Auto	1			EM-2454
			Trans	Manual	1			EM-2454
<b>EAGLE</b>								
L4	L4 2.5L 151ci	1981-84	L & R Front		2	EM-2330		
L6	L6 4.2L 258ci	1980-88	L & R Front		2	EM-2330		
			Trans	Manual	1			EM-2921
<b>GREMLIN</b>								
L6	L6 3.3L 199ci	1970	L & R Front		2	EM-2280		
			Trans	Auto	1			EM-2317
			Trans	Manual	1			EM-2317
	L6 3.8L 232ci	1973-78	L & R Front		2	EM-2330		
			L & R Front		2	EM-2280		
		1975-78	Trans	Auto; w/ Calif. Emissions	1			EM-2454
			Trans	Auto; w/ Federal Emissions	1			EM-2373
			Trans	Manual	1			EM-2454
		1971-74	Trans	Auto; w/ Calif. Emissions	1			EM-2454
			Trans	Auto; w/ Federal Emissions	1			EM-2373
Trans	Manual	1			EM-2317			

# Engine, Transmission, And Torque Strut Mounts

CYL	ENG. SIZE	YEAR	LOCATION	DESCRIPTION	QTY	ENGINE	TORQUE STRUT	TRANS-MISSION
<b>AMERICAN MOTORS PASSENGER CAR (continued)</b>								
<b>GREMLIN (continued)</b>								
L6	L6 3.8L 232ci	1970	Trans	Auto	1			EM-2317
			Trans	Manual	1			EM-2317
	L6 4.2L 258ci	1973-78	L & R Front		2	EM-2330		
			1971-72	L & R Front		2	EM-2280	
		1973-78	Trans	Auto; w/ Calif. Emissions	1			EM-2454
			Trans	Auto; w/ Federal Emissions	1			EM-2373
			Trans	Manual	1			EM-2454
		1971-72	Trans	Auto	1			EM-2317
Trans	Manual		1			EM-2317		
V8	V8 5.0L 304ci	1972-76	L & R Front		2	EM-2351		
		1975-76	Trans	Auto	1			EM-2454
			Trans	Manual	1			EM-2454
		1972-74	Trans	Auto	1			EM-2317
			Trans	Manual	1			EM-2317
<b>HORNET</b>								
L6	L6 3.3L 199ci	1970	L & R Front		2	EM-2280		
			Trans	Auto	1			EM-2317
			Trans	Manual	1			EM-2317
	L6 3.8L 232ci	1973-77	L & R Front		2	EM-2330		
			1970-72	L & R Front		2	EM-2280	
		1975-77	Trans	Auto; w/ Calif. Emissions	1			EM-2454
			Trans	Auto; w/ Federal Emissions	1			EM-2373
			Trans	Manual	1			EM-2454
		1971-74	Trans	Auto; w/ Calif. Emissions	1			EM-2454
			Trans	Auto; w/ Federal Emissions	1			EM-2373
			Trans	Manual	1			EM-2317
		1970	Trans	Auto	1			EM-2317
	Trans		Manual	1			EM-2317	
	L6 4.2L 258ci	1973-77	L & R Front		2	EM-2330		
			1971-72	L & R Front		2	EM-2280	
		1973-77	Trans	w/ Calif. Emissions	1			EM-2454
			Trans	w/ Federal Emissions	1			EM-2373
			Trans	Manual	1			EM-2454
		1971-72	Trans	Auto	1			EM-2317
			Trans	Manual	1			EM-2317
<b>JAVELIN</b>								
L6	L6 3.8L 232ci	1973-74	L & R Front		2	EM-2330		
		1968-72	L & R Front		2	EM-2280		
		1973-74	Trans	Auto	1			EM-2373
			Trans	Manual	1			EM-2317
		1968-72	Trans	Auto	1			EM-2373
			Trans	Manual	1			EM-2317
	L6 4.2L 258ci	1973-74	L & R Front		2	EM-2330		
		1971-72	L & R Front		2	EM-2280		
		1973-74	Trans		1			EM-2373
			Trans	Manual	1			EM-2317
		1972	Trans	Auto	1			EM-2373
			Trans	Manual	1			EM-2317
		1971	Trans	Auto	1			EM-2373
Trans	Manual		1			EM-2317		
V8	V8 4.8L 290ci	1968-69	L & R Front		2	EM-2351		
<b>MARLIN</b>								
L6	L6 3.8L 232ci	1965-67	L & R Front		2	EM-2280		
			Trans	Auto	1			EM-2317
			Trans	Manual	1			EM-2317
V8	V8 4.8L 290ci	1967	L & R Front		2	EM-2351		

# Engine, Transmission, And Torque Strut Mounts

CYL	ENG. SIZE	YEAR	LOCATION	DESCRIPTION	QTY	ENGINE	TORQUE STRUT	TRANS-MISSION
<b>AMERICAN MOTORS PASSENGER CAR (continued)</b>								
<b>MATADOR</b>								
L6	L6 3.8L 232ci	1973-74	L & R Front		2	EM-2330		
		1971-72	L & R Front		2	EM-2280		
		1973-74	Trans	Auto	1			EM-2453
			Trans	Manual	1			EM-2453
		1971-72	Trans	Auto	1			EM-2317
			Trans	Manual	1			EM-2317
	L6 4.2L 258ci	1973-78	L & R Front		2	EM-2330		
		1971-72	L & R Front		2	EM-2280		
		1973-78	Trans	Auto	1			EM-2373
			Trans	Manual	1			EM-2373
1971-72	Trans	Auto	1			EM-2317		
	Trans	Manual	1			EM-2317		
V8	V8 5.0L 304ci	1974	L & R Front		2	EM-2351		
			Trans	Auto	1		EM-2453	
			Trans	Manual	1		EM-2453	
	V8 5.9L 360ci	1974	L & R Front		2	EM-2351		
			Trans	Auto	1		EM-2453	
			Trans	Manual	1		EM-2453	
	V8 6.6L 401ci	1974	L & R Front		2	EM-2351		
			Trans	Auto	1		EM-2453	
			Trans	Manual	1		EM-2453	
<b>PACER</b>								
L6	L6 3.8L 232ci	1975-78	L & R Front		2	EM-2330		
			Trans	Auto	1		EM-2373	
			Trans	Manual	1		EM-2373	
	L6 4.2L 258ci	1979-80	Trans	Auto	1		EM-2373	
			Trans	Manual	1		EM-2373	
V8	V8 5.0L 304ci	1979	L & R Front		2	EM-2351		
			Trans	Auto	1		EM-2453	
			Trans	Manual	1		EM-2453	
<b>REBEL</b>								
V8	V8 4.8L 290ci	1967-69	L & R Front		2	EM-2351		
			Trans	Auto	1		EM-2317	
			Trans	Manual	1		EM-2317	
<b>SPIRIT</b>								
L4	L4 2.5L 151ci	1980-82	L & R Front		2	EM-2446		
			Trans	Auto	1		EM-2453	
			Trans	Manual	1		EM-2454	
L6	L6 3.8L 232ci	1979	L & R Front		2	EM-2330		
			Trans	Auto	1		EM-2453	
			Trans	Manual	1		EM-2454	
	L6 4.2L 258ci	1979-83	L & R Front		2	EM-2330		
			Trans	Auto	1		EM-2454	
			Trans	Manual	1		EM-2454	
<b>AUDI PASSENGER CAR</b>								
<b>80</b>								
L4	L4 2.0L 1983cc	1988-90	Center Front		1	EM-5485		
			L & R Front	Auto	2	EM-9109		
			L & R Front	Manual	2	EM-2421		
			Trans	Auto; 3 Spd	1		EM-8831	
L5	L5 2.3L 2309cc	1991-92	L & R Front		2	EM-8663		
			Trans		1		EM-9046	

# Engine, Transmission, And Torque Strut Mounts

CYL	ENG. SIZE	YEAR	LOCATION	DESCRIPTION	QTY	ENGINE	TORQUE STRUT	TRANS-MISSION
<b>AUDI PASSENGER CAR (continued)</b>								
<b>80 QUATTRO</b>								
L5	L5 2.3L 2309cc	1988-92	Center Front		1	EM-5485		
			L & R Front		2	EM-8663		
			Trans	Manual	1			EM-9046
<b>90</b>								
L4	L4 2.0L 1983cc	1988	L & R Front	Auto	2	EM-2421		
			L & R Front	Manual	2	EM-9109		
			Trans	Auto; 3 Spd	1			EM-8831
L5	L5 2.3L 2309cc	1988-91	Center Front		1	EM-5485		
			L & R Front		2	EM-8663		
			Trans		1			EM-8831
V6	V6 2.8L	1993-95	Trans		1			EM-5432
	V6 2.8L 2771cc	1993-95	Center Front		1	EM-5485		
			LH Front		1	EM-8828		
			RH Front		1	EM-8829		
<b>90 QUATTRO</b>								
L5	L5 2.3L 2309cc	1988-91	Center Front		1	EM-5485		
			L & R Front		2	EM-8663		
			Trans	Manual	1			EM-9046
V6	V6 2.8L	1993-95	Trans		1			EM-5432
	V6 2.8L 2771cc	1993-95	Center Front		1	EM-5485		
			LH Front		1	EM-8828		
			RH Front		1	EM-8829		
<b>100</b>								
L5	L5 2.3L 2309cc	1989-91	L & R Front		2	EM-8663		
			Trans	Auto	1			EM-9046
			Trans	Manual	1			EM-9046
V6	V6 2.8L 2771cc	1992-94	Center Front		1	EM-5675		
			LH Front		1	EM-9004		
			RH Front		1	EM-9005		
			Trans	Auto	2			EM-9102
			Trans	Manual	2			EM-9102
<b>100 QUATTRO</b>								
L5	L5 2.3L 2309cc	1989-91	L & R Front		2	EM-8663		
			Trans	Manual	1			EM-9046
V6	V6 2.8L 2771cc	1992-94	Center Front		1	EM-5675		
			LH Front		1	EM-9004		
			RH Front		1	EM-9005		
			Trans - L & R		2			EM-9102
<b>200</b>								
L5	L5 2.2L 2226cc	1989-91	L & R Front		2	EM-8663		
			Trans	Auto	1			EM-9046
			Trans	Manual	1			EM-9046
<b>200 QUATTRO</b>								
L5	L5 2.2L 2226cc	1989-91	L & R Front		2	EM-8663		
			Trans	Manual	1			EM-9046
<b>4000</b>								
L4	L4 1.6L 1588cc	1980	L & R Front		2	EM-2421		
	L4 1.6L 1588cc Diesel	1982-83	Trans	Auto	1			EM-8221
			Trans	Manual	1			EM-9093
	L4 1.6L 1588cc	1980	Trans		1			EM-8623
	L4 1.7L 1715cc	1981-83	L & R Front		2	EM-2421		
			Trans	Auto	1			EM-8221
			Trans	Manual	1			EM-9093

# Engine, Transmission, And Torque Strut Mounts

CYL	ENG. SIZE	YEAR	LOCATION	DESCRIPTION	QTY	ENGINE	TORQUE STRUT	TRANS-MISSION	
<b>AUDI PASSENGER CAR (continued)</b>									
<b>4000CS QUATTRO</b>									
L5	L5 2.2L 2226cc	1986-87	L & R Front		2	EM-8663			
			Trans	Manual	1		EM-9046		
<b>4000S</b>									
L4	L4 1.8L 1780cc	1984-87	L & R Front		2	EM-2421			
			Trans	Auto	1		EM-8221		
			Trans	Manual	1		EM-9093		
L5	L5 2.2L 2226cc	1985-86	L & R Front		2	EM-8663			
<b>4000S QUATTRO</b>									
L4	L4 1.8L 1780cc	1984-87	Trans	Manual	1			EM-9093	
L5	L5 2.2L 2226cc	1985	L & R Front		2	EM-8663			
<b>5000</b>									
L5	L5 2.2L 2144cc	1978-88	L & R Front		2	EM-8663			
			Trans	Auto	1		EM-9046		
			Trans	Manual	1		EM-9046		
<b>5000 QUATTRO</b>									
L5	L5 2.2L 2226cc	1986-88	L & R Front		2	EM-8663			
			Trans		1		EM-9089		
	L5 2.3L 2309cc	1987-88	L & R Front		2	EM-8663			
			Trans	Manual	1		EM-9046		
<b>A3</b>									
L4	1.8L 1780 cc L4	1998-01	RH Front	Hydraulic Mount; Mexican Vehicle	1	EM-9092			
			Rear	Mexican Vehicle	1	EM-9208			
			Trans	Hydraulic Mount; Mexican Vehicle	1		EM-9101		
	L4 2.0L	1997-01	RH Front	Mexican Vehicle; Hydraulic Mount	1	EM-9092			
			Rear	Mexican Vehicle	1	EM-9208			
			2006-09	Trans	Manual	1		EM-9262	
			1997-01	Trans	Mexican Vehicle; Hydraulic Mount	1		EM-9101	
	L4 2.0L 1968cc Diesel	2010-11	Front		1	EM-9402			
			LH Front		1	EM-9259			
			Lower Rear		1	EM-9260			
			RH Front		1	EM-9257			
			Rear		1	EM-9283			
	L4 2.0L 1984cc	2010-12	Front	Gas	1	EM-9092			
		2006-09	Front		1	EM-9092			
		2010-12	LH Front	Gas	1	EM-9259			
		2006-09	LH Front		1	EM-9259			
		2010-12	LH Front Upper	Gas	1	EM-9263			
		2006-09	LH Front Upper		1	EM-9263			
		2010-12	Lower Rear	Gas	1	EM-9260			
		2006-09	Lower Rear		1	EM-9260			
		2010-12	RH Front	Gas	1	EM-9257			
		2006-09	RH Front		1	EM-9257			
	2010-12	Rear	Gas	1	EM-9283				
	2006-09	Rear		1	EM-9283				
	<b>A3 QUATTRO</b>								
	V6	V6 3.2L	2006-09	LH Front		1	EM-9259		
				LH Front Upper		1	EM-9263		
				RH Front		1	EM-9257		
Right					1	EM-9405			

# Engine, Transmission, And Torque Strut Mounts

CYL	ENG. SIZE	YEAR	LOCATION	DESCRIPTION	QTY	ENGINE	TORQUE STRUT	TRANSMISSION	
<b>AUDI PASSENGER CAR (continued)</b>									
<b>A4</b>									
L4	L4 1.8L	2002-06	LH Front		1	EM-8997			
			RH Front		1	EM-7030			
		2005-06	Trans	Auto; CVT		1			EM-8999
		2003-04	Trans	Auto		1			EM-8999
		2002	Trans	Auto		1			EM-8999
	L4 1.8L 1781cc	2002-05	LH Front			1	EM-8997		
		1997-01	LH Front			1	EM-8998		
			RH Front			1	EM-8997		
		2002-05	Trans	Differential Mount		2			EM-5855
		1997-01	Trans	Auto		1			EM-8999
	Trans		Manual		1			EM-8999	
	L4 2.0L	2005-07	L & R Front			2	EM-9403		
			LH Rear			1	EM-8997		
			Trans	Manual		1			EM-9287
L4 2.0L 1984cc	2005-09	Trans	Differential Mount		2			EM-5855	
V6	V6 2.8L	2000-01	Trans - L & R		2			EM-9258	
	V6 2.8L 2771cc	1996-01	Center Front		1	EM-8830			
			L & R Front		2	EM-8997			
		1996-99	Trans	Auto		2			EM-8999
			Trans	Manual		2			EM-8999
	V6 3.0L	2002-05	LH Front			1	EM-5517		
		2003-05	Trans - L & R			2			EM-8999
		2002	Trans - L & R			2			EM-9258
	V6 3.0L 2976cc	2002-05	Trans	Differential Mount		2			EM-5855
	V6 3.1L 3123cc	2006-08	Trans	Differential Mount		2			EM-5855
V6 3.2L	2006-08	LH Front			1	EM-5517			
		Trans - L & R			2			EM-9258	
<b>A4 QUATTRO</b>									
L4	L4 1.8L	2002-05	LH Front		1	EM-8997			
		2002	Trans - L & R		2			EM-9258	
	L4 1.8L 1781cc	1997-01	LH Front			1	EM-8998		
			RH Front			1	EM-8997		
			Trans - LH	Manual		1			EM-8999
			Trans - RH			1			EM-8999
		2002-05	Trans	Differential Mount		2			EM-5855
	L4 2.0L	2005-06	LH Rear			1	EM-8997		
		2007-08	Rear			1	EM-8997		
		2005-06	Trans - LH	Auto		1			EM-9258
			Trans - RH Rear	Auto		1			EM-9258
		2007-08	Trans			1			EM-9287
		2005-06	Trans	Manual		1			EM-9287
L4 2.0L 1984cc	2005-09	Trans	Differential Mount		2			EM-5855	
V6	V6 2.8L	2000-01	Trans - L & R	Auto	2			EM-9258	
			Trans	Manual	2			EM-8999	
	V6 2.8L 2771cc	1996-01	Front Center			1	EM-8830		
			L & R Front			2	EM-8997		
		1996-99	Trans	Manual		2			EM-8999
	V6 3.0L	2002-05	LH Front			1	EM-5517		
		2003-05	Trans - L & R			2			EM-8999
		2002	Trans - L & R			2			EM-9258
	V6 3.0L 2976cc	2002-06	Trans	Differential Mount		2			EM-5855
	V6 3.1L 3123cc	2005-09	Trans	Differential Mount		2			EM-5855
V6 3.2L	2006-08	LH Front			1	EM-5517			
	2005-08	Trans - L & R	Auto		2			EM-9258	

# Engine, Transmission, And Torque Strut Mounts

CYL	ENG. SIZE	YEAR	LOCATION	DESCRIPTION	QTY	ENGINE	TORQUE STRUT	TRANSMISSION	
<b>AUDI PASSENGER CAR (continued)</b>									
<b>A6</b>									
V6	V6 2.8L	2000-01	Trans - L & R		2			EM-9258	
	V6 2.8L 2771cc	1998-01	Center Front		1	EM-8830			
		1995-97	Center Front		1	EM-5675			
		1998-01	L & R Front		2	EM-8997			
		1995-97	LH Front		1	EM-9004			
			RH Front		1	EM-9005			
	V6 3.0L 2976cc	2002-04	Trans		1			EM-9102	
			L & R Front		2	EM-8998			
	V6 3.1L 3123cc	2006-11	Trans		2			EM-8999	
			Differential Mount		1			EM-5855	
V6 3.2L	2006-10	LH Front		1	EM-9406				
		RH Front		1	EM-9407				
		Trans		1			EM-9558		
<b>A6 QUATTRO</b>									
V6	V6 2.7L	2000-04	L & R Front		2	EM-8997			
			Trans - L & R		2			EM-9258	
	V6 2.8L 2771cc	2000-01	Trans - L & R		2			EM-9258	
			Center Front		1	EM-8830			
			Center Front		1	EM-5675			
			L & R Front		2	EM-8998			
			1995-97	LH Front		1	EM-9004		
				RH Front		1	EM-9005		
	V6 3.0L 2976cc	2002-04	Trans		1			EM-9102	
			L & R Front		2	EM-8997			
	V6 3.0L 2995cc	2009-11	Trans		1			EM-8999	
			Differential Mount		2			EM-5855	
			Trans		1			EM-9558	
V6 3.2L	2006-08	LH Front		1	EM-9406				
		RH Front		1	EM-9407				
		Trans		1			EM-9558		
V8	V8 4.2L	2000-04	Center Front		1	EM-8999			
		2005-11	Trans		2			EM-5855	
<b>ALLROAD QUATTRO</b>									
V6	V6 2.7L	2001-05	Center Front Lower		1	EM-5485			
			L & R Front		2	EM-8997			
			Trans		2			EM-9258	
V8	V8 4.2L	2003-05	Trans		1			EM-9258	
<b>CABRIOLET</b>									
V6	V6 2.8L	1994-98	Trans		1			EM-5432	
	V6 2.8L 2771cc	1994-98	LH Front		1	EM-8828			
			RH Front		1	EM-8829			
<b>COUPE</b>									
L5	L5 2.2L 2144cc	1981-87	L & R Front		2	EM-8663			
	L5 2.3L 2309cc	1987	L & R Front		2	EM-8663			
			Trans		1			EM-9046	
<b>COUPE QUATTRO</b>									
L5	L5 2.3L 2309cc	1990-91	L & R Front		2	EM-8663			
			Trans		1			EM-9046	
<b>FOX</b>									
L4	L4 1.5L 1471cc	1973-74	L & R Front		2	EM-2421			
			Trans		1			EM-8221	
	L4 1.6L 1588cc	1975-79	L & R Front		2	EM-2421			
Trans			1			EM-8221			

# Engine, Transmission, And Torque Strut Mounts

CYL	ENG. SIZE	YEAR	LOCATION	DESCRIPTION	QTY	ENGINE	TORQUE STRUT	TRANSMISSION
<b>AUDI PASSENGER CAR (continued)</b>								
<b>FOX (continued)</b>								
L4	L4 1.6L 1588cc	1975-79	Trans	Manual	1			EM-8623
<b>RS4</b>								
V8	V8 4.2L	2007-08	Trans	Differential Mount	2			EM-5855
<b>S4</b>								
L5	L5 2.2L 2226cc	1992-94	L & R Front		2	EM-8663		
			Trans	Manual	1			EM-9089
V6	V6 2.7L 2671cc	2000-02	L & R Front		2	EM-8997		
			Trans	Auto	2			EM-8999
			Trans	Manual	2			EM-8999
V8	V8 4.2L	2004-09	Trans	Differential Mount	2			EM-5855
<b>S6</b>								
L5	L5 2.2L 2226cc	1995-97	L & R Front		2	EM-8663		
			Trans	Manual	1			EM-9089
V10	V10 5.2L 5204cc	2007-11	Trans	Differential Mount	2			EM-5855
<b>TT</b>								
L4	L4 2.0L	2008-09	Front		1	EM-9092		
<b>TT QUATTRO</b>								
L4	L4 2.0L	2009	Front		1	EM-9092		
V6	V6 3.2L	2004-06	Rear		1	EM-9208		
		2008-09	Right		1	EM-9405		
		2004-06	Right		1	EM-9261		
<b>AUDI SPORTS UTILITY</b>								
<b>Q7</b>								
V6	V6 3.0L	2008-12	L & R Front		2	EM-5879		
	V6 3.6L	2007-10	L & R Front		2	EM-5879		
<b>BMW PASSENGER CAR</b>								
<b>125I</b>								
L6	L6 3.0L	2009-10	L & R Front	Mexico	2	EM-5886		
<b>130I</b>								
L6	L6 3.0L	2006-10	L & R Front	Mexico	2	EM-5886		
<b>128I</b>								
L6	L6 3.0L	2008-12	L & R Front		2	EM-5886		
		2008-10	Trans	Auto	1			EM-9096
			Trans	Manual	1			EM-9096
<b>135I</b>								
		2008-12	L & R Front		2	EM-5886		
L6	L6 3.0L	2008-10	Trans	Auto	1			EM-9096
			Trans	Manual	1			EM-9096
<b>1 SERIES M</b>								
L6	L6 3.0L	2011	L & R Front		2	EM-5886		
<b>3.0Si</b>								
L6	L6 3.0L 2985cc	1975-76	Trans	Manual	1			EM-8594
		1971	Trans	Manual	1			EM-8594
<b>318I</b>								
L4	L4 1.8L	1992-95	Trans	Auto	1			EM-9096
	L4 1.8L 1766cc	1984-85	L & R Front		2	EM-9111		
	L4 1.8L 1796cc	1994-95	L & R Front	Hydraulic Mount	2	EM-9003		
	L4 1.9L 1796cc	1996-99	L & R Front	Hydraulic Mount	2	EM-9003		



# Engine, Transmission, And Torque Strut Mounts

CYL	ENG. SIZE	YEAR	LOCATION	DESCRIPTION	QTY	ENGINE	TORQUE STRUT	TRANS-MISSION	
<b>BMW PASSENGER CAR (continued)</b>									
<b>318IS</b>									
L4	L4 1.8L	1993-95	Trans		1			EM-9096	
	L4 1.8L 1796cc	1994-95	L & R Front	Hydraulic Mount	2	EM-9003			
	L4 1.9L	1996-97	Trans		1			EM-9096	
	L4 1.9L 1895cc	1996-99	L & R Front	Hydraulic Mount	2	EM-9003			
<b>318TI</b>									
L4	L4 1.8L	1995	Trans	Auto	1			EM-9096	
	Trans		Manual	1			EM-9096		
	L4 1.8L 1796cc	1995	L & R Front	Hydraulic Mount	2	EM-9003			
	L4 1.9L	1996-97	Trans	Auto	1			EM-9096	
			Trans	Manual	1			EM-9096	
L4 1.9L 1895cc	1996-99	L & R Front	Hydraulic Mount	2	EM-9003				
<b>320I</b>									
L4	L4 1.8L	1980-83	Trans		1			EM-8592	
	L4 2.0L 1990cc	1977-79	Trans	Auto	1			EM-8592	
			Trans	Manual	1			EM-8592	
<b>323CI</b>									
L6	L6 2.5L	2000	L & R Front	Hydraulic Mount; 2WD	2	EM-9003			
<b>323I</b>									
L6	L6 2.5L	2006-07	L & R Front	Hydraulic Mount; RWD	2	EM-9003			
		1998-00	L & R Front	Hydraulic Mount; RWD	2	EM-9003			
		2006-11	Trans	Auto	1			EM-9096	
			Trans	Manual	1			EM-9096	
		1999-00	Trans	Auto	1			EM-9096	
	Trans		Manual	1			EM-9096		
L6 2.5L 2494cc	2001	L & R Front	Mexican Vehicle; Hydraulic Mount; RWD	2	EM-9003				
<b>323IS</b>									
L6	L6 2.5L	1998-99	L & R Front	Hydraulic Mount; 2WD	2	EM-9003			
			Trans	Auto	1			EM-9096	
			Trans	Manual	1			EM-9096	
<b>325</b>									
L6	L6 2.7L	1986-88	L & R Front		2	EM-9404			
	L6 2.7L 2693cc	1986-87	Trans	Auto	1			EM-9107	
			Trans	Manual	1			EM-9098	
<b>325CI</b>									
L6	L6 2.5L	2001-06	L & R Front	Hydraulic Mount; 2WD	2	EM-9003			
<b>325E</b>									
L6	L6 2.7L	1984-87	Front		1	EM-9094			
	L6 2.7L 2693cc	1984-87	Trans	Auto	1			EM-9107	
			Trans	Manual	1			EM-9098	
<b>325I</b>									
L6	L6 2.5L	1994-95	Trans	Auto	1			EM-9096	
			Trans	Manual	1			EM-9096	
	L6 2.5L 2494cc	2001-05	L & R Front	Hydraulic Mount	2	EM-9003			
			L & R Front		2	EM-9003			
			L & R Front		2	EM-9404			
			1992-93	Trans - LH	Auto	1			EM-9104
				Trans - RH	Auto	1			EM-9100
			1987-91	Trans	Manual	2			EM-9096
				Trans	Auto	1			EM-9107
	L6 3.0L	2011	L & R Front	Mexico	2	EM-5886			
			L & R Front		2	EM-5886			

# Engine, Transmission, And Torque Strut Mounts

CYL	ENG. SIZE	YEAR	LOCATION	DESCRIPTION	QTY	ENGINE	TORQUE STRUT	TRANSMISSION	
<b>BMW PASSENGER CAR (continued)</b>									
<b>325IC</b>									
L6	L6 2.5L	1991-95	L & R Front	Hydraulic Mount; After 10/91	2	EM-9003			
		1987-90	L & R Front		2	EM-9404			
<b>325IS</b>									
L6	L6 2.5L	1992-95	L & R Front		2	EM-9003			
		1991	L & R Front	after 10/91	2	EM-9003			
			L & R Front	before 10/91	2	EM-9404			
		1994-95	Trans	Auto		1			EM-9096
			Trans	Manual		1			EM-9096
	L6 2.5L 2494cc	1987-90	L & R Front			2	EM-9404		
		1992-93	Trans - LH	Auto		1			EM-9104
			Trans - RH	Auto		1			EM-9100
			Trans	Manual		2			EM-9096
		1991	Trans	Auto		1			EM-9107
			Trans	Manual		1			EM-9098
		1987-90	Trans	Auto		1			EM-9107
			Trans	Manual		1			EM-9098
	<b>325IX</b>								
L6	L6 2.5L	1988-91	Front	before 10/91	1	EM-5340			
			Trans	Auto	1			EM-9107	
			Trans	Manual	1			EM-9098	
<b>325XI</b>									
L6	L6 2.5L	2001-05	LH Front	Hydraulic Mount; AWD	2	EM-9003			
<b>328CI</b>									
L6	L6 2.8L 2793cc	2000	Trans - LH	Auto	1			EM-9104	
			Trans - RH	Auto	1			EM-9100	
<b>328I</b>									
L6	L6 2.8L 2793cc	2007-12	L & R Front		2	EM-5886			
		1996-00	Trans - LH	Auto	1			EM-9104	
	Trans - RH		Auto	1			EM-9100		
	L6 3.0L 2996cc		2007-12	Trans	Auto	1			EM-9096
		Trans		Manual	1			EM-9096	
<b>328IC</b>									
L6	L6 2.8L 2793cc	1996-99	Trans - LH	Auto	1			EM-9104	
			Trans - RH	Auto	1			EM-9100	
<b>328IS</b>									
L6	L6 2.8L 2793cc	1996-99	Trans - LH	Auto	1			EM-9104	
			Trans - RH	Auto	1			EM-9100	
<b>330I</b>									
L6	L6 3.0L	2001-06	L & R Front	Hydraulic Mount	2	EM-9003			
<b>330CI</b>									
L6	L6 3.0L	2001-06	L & R Front	Hydraulic Mount	2	EM-9003			
<b>335I</b>									
		2007-12	L & R Front		2	EM-5886			
<b>330XI</b>									
L6	L6 3.0L	2001-05	LH Front	Hydraulic Mount; AWD	2	EM-9003			
<b>335D</b>									
L6	L6 3.0L	2009-11	Trans	Auto	1			EM-9096	
<b>335I</b>									
L6	L6 3.0L	2007-12	Trans		1			EM-9096	
			Trans	Auto	1			EM-9096	

# Engine, Transmission, And Torque Strut Mounts

CYL	ENG. SIZE	YEAR	LOCATION	DESCRIPTION	QTY	ENGINE	TORQUE STRUT	TRANSMISSION		
<b>BMW PASSENGER CAR (continued)</b>										
<b>335IS</b>										
L6	L6 3.0L	2011-12	Trans	Manual	1			EM-9096		
<b>524TD</b>										
L6	L6 2.4L 2443cc Diesel	1985-86	Trans		1			EM-9095		
<b>525I</b>										
L6	L6 2.5L	2001-03	L & R Front	Hydraulic Mount	2	EM-9276				
		2006-09	LH Front	Mexico	1	EM-5884				
		2004-05	LH Front			1	EM-5884			
		2006-09	RH Front	Mexico		1	EM-5885			
		2004-05	RH Front			1	EM-5885			
		2001-05	Trans - LH	Auto			1			EM-9104
			Trans - RH	Auto			1			EM-9100
			Trans - RH	Manual			1			EM-9100
		L6 2.5L 2494cc	1989-95	L & R Front	Manual		2	EM-9099		
	1991-95		Trans - LH	Auto		1			EM-9104	
			Trans - RH	Auto		1			EM-9100	
			Trans - RH	Manual		1			EM-9100	
	1989-90		Trans - RH	Auto		1			EM-9100	
	Trans	Manual		1				EM-9096		
	L6 3.0L 2996cc	2010	LH Front	Mexico		1	EM-5884			
2006-07		LH Front			1	EM-5884				
2010		RH Front	Mexico		1	EM-5885				
2006-07		RH Front			1	EM-5885				
<b>525IT</b>										
L6	L6 2.5L	1993	Trans - LH	Auto	1			EM-9104		
			Trans - RH		1		EM-9100			
	L6 2.5L 2494cc	1993	L & R Front		2	EM-9099				
<b>528E</b>										
L6	L6 2.7L 2693cc	1982-88	Trans	Manual	1			EM-9105		
<b>528I</b>										
L6	L6 2.8L	1997-00	L & R Front	Hydraulic Mount	2	EM-9276				
		1979-81	L & R Front		2	EM-5491				
	L6 2.8L 2793cc	1997-00	Trans	Manual	1			EM-9103		
	L6 3.0L 2996cc	2008-11	LH Front			1	EM-5884			
			RH Front			1	EM-5885			
<b>530I</b>										
L6	L6 3.0L	2001-03	L & R Front	Hydraulic Mount	2	EM-9276				
	L6 3.0L 2985cc	1975-78	Trans	Auto	1			EM-8594		
			Trans	Manual	1			EM-8594		
	L6 3.0L 2996cc	2008-10	LH Front	Mexico		1	EM-5884			
		2004-07	LH Front			1	EM-5884			
		2008-10	RH Front	Mexico		1	EM-5885			
		2004-07	RH Front			1	EM-5885			
V8	V8 3.0L	1994-95	LH Front		1	EM-9274				
			RH Front		1	EM-9273				
<b>533I</b>										
L6	L6 3.2L 3210cc	1984	Trans	Auto	1			EM-9095		
			Trans	Manual	1			EM-9096		
		1983	Trans	Auto		1			EM-8594	
			Trans	Manual		1			EM-9090	
<b>535I</b>										
L6	L6 3.0L	2008-11	LH Front		1	EM-5884				
			RH Front		1	EM-5885				
	L6 3.5L 3430cc	1989-93	L & R Front	Hydraulic Mount	2	EM-9275				

# Engine, Transmission, And Torque Strut Mounts

CYL	ENG. SIZE	YEAR	LOCATION	DESCRIPTION	QTY	ENGINE	TORQUE STRUT	TRANSMISSION
<b>BMW PASSENGER CAR (continued)</b>								
<b>535I (continued)</b>								
L6	L6 3.5L 3430cc	1987-93	Trans	Auto	1			EM-9094
			Trans	Manual	1		EM-9096	
		1985-86	Trans	Auto	1		EM-9090	
<b>535IS</b>								
L6	L6 3.5L 3430cc	1988	Trans	Auto	1			EM-9094
			Trans	Manual	1		EM-9096	
<b>540I</b>								
V8	V8 4.4L	1997-03	LH Front		1	EM-9271		
			RH Front		1	EM-9272		
	V8 4.4L 4398cc	1997-03	Trans	Manual	1		EM-9103	
	W8 4.0L	1994-95	LH Front		1	EM-9274		
			RH Front		1	EM-9273		
<b>630CSI</b>								
L6	L6 3.0L	1978	Trans		2			EM-8594
<b>633CSI</b>								
L6	L6 3.2L	1978-82	L & R Front		2	EM-5491		
		L6 3.2L 3210cc	1984	Trans	Manual	1		EM-9096
		1983	Trans	Auto	1		EM-8594	
<b>635CSI</b>								
L6	L6 3.5L 3430cc	1985-89	Trans	Manual	1			EM-9098
<b>733I</b>								
L6	L6 3.2L	1978-79	Rear		1	EM-5218		
			L6 3.2L 3210cc	1980-84	Rear		1	EM-5218
			1983-84	Trans	Auto	1		EM-9090
				Trans	Manual	1		EM-9096
			1978-82	Trans	Auto	1		EM-9090
				Trans	Manual	1		EM-9090
<b>735I</b>								
L6	L6 3.5L	1985-87	LH Front		1	EM-5070		
			RH Front		1	EM-5069		
	L6 3.5L 3430cc	1988-92	L & R Front	Hydraulic Mount	2	EM-9275		
			Trans	Auto	1		EM-9094	
			1985-87	Trans	Manual	1		EM-9096
				Trans	Auto	1		EM-9090
			Trans	Manual	1		EM-9098	
<b>735IL</b>								
L6	L6 3.5L 3430cc	1988-92	L & R Front	Hydraulic Mount	2	EM-9275		
			Trans		1		EM-9096	
			Trans	Auto	1		EM-9094	
<b>740I</b>								
V8	V8 4.0L 3982cc	1993-95	LH Front		1	EM-9274		
			RH Front		1	EM-9273		
		1994-95	Trans		1		EM-9096	
	V8 4.4L	1997-01	LH Front		1	EM-9271		
			RH Front		1	EM-9272		
V8 4.4L 4398cc	1997-01	Trans		1		EM-9096		
<b>740IL</b>								
V8	V8 4.0L 3982cc	1994-95	Trans		1			EM-9096
	V8 4.4L	1997-01	LH Front		1	EM-9271		
			RH Front		1	EM-9272		
	V8 4.4L 4398cc	1996-01	Trans		1		EM-9096	
	V8 4.0L	1993-95	LH Front		1	EM-9274		

# Engine, Transmission, And Torque Strut Mounts

CYL	ENG. SIZE	YEAR	LOCATION	DESCRIPTION	QTY	ENGINE	TORQUE STRUT	TRANS-MISSION
<b>BMW PASSENGER CAR (continued)</b>								
<b>740IL (continued)</b>								
V8	W8 4.0L	1993-95	RH Front		1	EM-9273		
<b>750IL</b>								
V12	V12 5.0L 4988cc	1988-94	Trans	Auto	1			EM-9094
	V12 5.4L	1995-01	Left		1	EM-9271		
			Right		1	EM-9272		
<b>840CI</b>								
V8	W8 4.4L	1996-97	LH Front		1	EM-9274		
			RH Front		1	EM-9273		
	W8 4.0L	1994-95	LH Front		1	EM-9274		
			RH Front		1	EM-9273		
			Trans	Auto	1			EM-9094
<b>850CI</b>								
V12	V12 5.0L 4988cc	1993-94	Trans	Auto	1			EM-9094
	V12 5.4L	1995-97	Trans	Auto	1			EM-9094
<b>850CSI</b>								
V12	V12 5.6L 5576cc	1994-95	Trans	Manual	1			EM-9094
<b>850I</b>								
V12	V12 5.0L 4988cc	1991-92	Trans		1			EM-9094
<b>1600</b>								
L4	L4 1.6L 1573cc	1967-71	LH Front		1	EM-5067		
			RH Front		1	EM-5068		
<b>2000</b>								
L4	L4 2.0L	1970	LH Front		1	EM-5067		
			RH Front		1	EM-5068		
			Trans	Auto	1			EM-8593
			Trans	Manual	1			EM-8592
<b>2002</b>								
L4	L4 2.0L 1990cc	1966-76	LH Front		1	EM-5067		
			RH Front		1	EM-5068		
			Trans	Auto	1			EM-8593
			Trans	Manual	1			EM-8592
<b>L6</b>								
L6	L6 3.5L 3430cc	1987	Trans	Auto	1			EM-9096
<b>L7</b>								
L6	L6 3.5L 3430cc	1986-87	Trans	Auto	1			EM-9096
<b>M3</b>								
L6	L6 3.0L	1994-95	L & R Front		2	EM-9003		
			Trans	Auto	1			EM-9096
			Trans	Manual	1			EM-9096
	L6 3.2L	2001-06 1996-99	L & R Front		2	EM-9003		
			L & R Front		2	EM-9003		
V8	W8 4.0L	2008-09	L & R Front		2	EM-9003		
<b>M5</b>								
L6	L6 3.5L 3453cc	1988	Trans	Manual	1			EM-9096
	L6 3.6L	1991-93	L & R Front		2	EM-9275		
	L6 3.6L 3553cc	1991-93	Trans	Manual	1			EM-9096
V8	W8 5.0L 4941cc	2000-03	Trans	Manual	2			EM-9103
<b>Z3</b>								
L4	L4 1.9L	1999	Trans	Mexican Vehicle	1			EM-9096
		1996-98	Trans		1			EM-9096
	L4 1.9L 1895cc	1999	L & R Front	Mexican Vehicle; Hydraulic Mount	2	EM-9003		

# Engine, Transmission, And Torque Strut Mounts

CYL	ENG. SIZE	YEAR	LOCATION	DESCRIPTION	QTY	ENGINE	TORQUE STRUT	TRANSMISSION	
<b>BMW PASSENGER CAR (continued)</b>									
<b>Z3 (continued)</b>									
L4	L4 1.9L 1895cc	1996-98	L & R Front	Hydraulic Mount	2	EM-9003			
L6	L6 2.5L	1999-02	L & R Front		2	EM-9003			
	L6 2.8L	1999-00	L & R Front		2	EM-9003			
	L6 3.0L	2001-02	L & R Front		2	EM-9003			
	L6 3.2L	1999-02	L & R Front		2	EM-9003			
<b>Z4</b>									
L4	L4 2.0L 1997cc	2012-13	LH Front		1	EM-5888			
			RH Front		1	EM-5887			
L6	L6 3.0L	2009-11	L & R Front		2	EM-5886			
<b>BMW SPORT UTILITY</b>									
<b>X1</b>									
L4	L4 2.0L 1997cc	2013	LH Front		1	EM-5888			
			RH Front		1	EM-5887			
<b>X3</b>									
L6	L6 2.5L 2494cc	2004-06	Left		1	EM-5889			
			Right		1	EM-5890			
	L6 3.0L 2996cc	2004-06	Left		1	EM-5889			
			Right		1	EM-5890			
		2004-06	Right		1	EM-5890			
<b>X5</b>									
L6	L6 3.0L	2001-06	L & R Front		2	EM-5877			
V8	V8 4.4L 4398cc	2000-06	L & R Front		2	EM-5877			
	V8 4.6L	2002-03	L & R Front		2	EM-5877			
	V8 4.8L	2004-06	L & R Front		2	EM-5877			
<b>BUICK PASSENGER CAR</b>									
<b>ALLURE</b>									
V6	V6 3.6L 217ci	2005-07	Right		1	EM-2987			
			Torq Str - Front	Brkt to Radiator Support; LH & RH Front	2		EM-3088		
			Torq Str - Front	Complete Unit; LH & RH Front	2		EM-2866		
			Torq Str - Front	Insert Only; LH & RH Front	2		EM-2716		
	V6 3.8L 231ci	2005-08	Trans		1			EM-2818	
			Right		1	EM-2987			
			Torq Str - Front	Brkt to Radiator Support; LH & RH Front	2		EM-3088		
			Torq Str - Front	Complete Unit; LH & RH Front	2		EM-2866		
			Torq Str - Front	Insert Only; LH & RH Front	2		EM-2716		
			Trans		1			EM-2818	
V8	V8 5.3L	2008-09	Front		1	EM-3093			
			Rear		1	EM-2990			
			Torq Str - Front	Bracket Support to Radiator	1		EM-3104		
			Torq Str - Front	Complete Unit	1		EM-2866		
			Torq Str - Front	Insert Only; LH & RH Front	2		EM-2716		
			Trans - Rear		1			EM-2990	
<b>APOLLO</b>									
L6	L6 4.1L 250ci	1973-75	L & R Front		2	EM-2292			
		1975	Trans		1			EM-2360 @	
		1973-74	Trans		1			EM-2378 @	
V8	V8 4.3L 260ci	1975	L & R Front		2	EM-2328			
			Trans		1			EM-2288 @	
V8	V8 5.7L 350ci	1973-75	L & R Front		2	EM-2281			
			1975	Trans	Auto; THM350 (M38)	1			EM-2288 @
				Trans	Manual	1			EM-2288 @

# Engine, Transmission, And Torque Strut Mounts

CYL	ENG. SIZE	YEAR	LOCATION	DESCRIPTION	QTY	ENGINE	TORQUE STRUT	TRANSMISSION	
<b>BUICK PASSENGER CAR (continued)</b>									
<b>APOLLO (continued)</b>									
V8	V8 5.7L 350ci	1973-74	Trans	Auto; THM350	1			EM-2378 @	
			Trans	Auto; THM400	1		EM-2360 @		
			Trans	Manual	1		EM-2378 @		
<b>CENTURION</b>									
V8	V8 5.7L 350ci	1972-73	L & R Front		2	EM-2281			
			Trans	Auto; THM350	1		EM-2288 @		
			Trans	Auto; THM400	1		EM-2268 @		
	V8 7.5L 455ci	1971-73	L & R Front		2	EM-2291			
			Trans		1			EM-2288 @	
<b>CENTURY</b>									
L4	L4 2.2L 134ci	1993-96	RH Front		1	EM-2548'			
		1995-96	Torq Str - Front	Complete Unit	1		EM-2866		
			Torq Str - Front	Insert	1		EM-2716		
		1993-94	Torq Str - Front		1		EM-2609		
	1993-96	Trans		1			EM-2543		
	L4 2.5L 2474cc	1985-92	RH Front		1	EM-2548'			
		1982-84	RH Front		1	EM-2472			
		1982-92	Torq Str - Front		1		EM-2396		
		1982-84	Trans - Front	Auto	1			EM-2467	
		1989-92	Trans		1			EM-2543	
		1985-88	Trans	Auto	1			EM-2543	
			Trans	Manual	1			EM-2543	
	V6	V6 2.8L 173ci	1985-89	RH Front		1	EM-2548'		
			1983-84	RH Front		1	EM-2472		
1986-89			Torq Str - Front		1		EM-2396		
1983-85			Torq Str - Front		1		EM-2490		
1989			Trans - Front	Auto	1			EM-2467	
1984-88			Trans - Front	Auto	1			EM-2466	
			Trans - Front	Manual	1			EM-2467	
1983			Trans - Front	Auto	1			EM-2467	
			Trans - Rear	Auto	1			EM-2467	
V6 3.0L 181ci		1985	RH Front		1	EM-2548'			
		1982-84	RH Front		1	EM-2472			
		1982-85	Torq Str - Front		1		EM-2490		
			Trans - Front	Auto	1			EM-2467	
V6 3.1L 189ci		1994-96	Front		1	EM-2548'			
	1997-05	RH Front		1	EM-2796'				
		Torq Str - Front	Brkt to Radiator Support	1		EM-2901			
		Torq Str - Front	Complete Unit	1		EM-2866			
		Torq Str - Front	Insert Only	1		EM-2716			
	1995-96	Torq Str - Front	Insert	1		EM-2716			
	1994	Torq Str - Front		1		EM-2396			
	1994-96	Trans - LH Front		1			EM-2466		
		Trans - LH Rear		1			EM-2467		
1997-05	Trans		1			EM-2818			
V6 3.2L 196ci	1978-79	LH Front		1	EM-2382				
		RH Front		1	EM-2384				
		Trans	Auto	1		EM-2379			
		Trans	Manual	1		EM-2379			
V6 3.3L 204ci	1989-93	RH Front		1	EM-2548'				
		Torq Str - Front		1		EM-2396			
		Trans - LH Front		1		EM-2466			
		Trans - LH Rear		1		EM-2467			
V6 3.8L 231ci	1975-81	LH Front		1	EM-2382				
	1985-88	RH Front		1	EM-2548'				

# Engine, Transmission, And Torque Strut Mounts

CYL	ENG. SIZE	YEAR	LOCATION	DESCRIPTION	QTY	ENGINE	TORQUE STRUT	TRANSMISSION
<b>BUICK PASSENGER CAR (continued)</b>								
<b>CENTURY (continued)</b>								
V6	V6 3.8L 231ci	1984	RH Front		1	EM-2472		
		1975-81	RH Front		1	EM-2384		
		1987-88	Torq Str - Front		1		EM-2396	
		1984-86	Torq Str - Front		1		EM-2490	
		1984-88	Trans - Front	Auto	1			EM-2466
			Trans - Front	Manual	1			EM-2467
			Trans - Rear	Auto	1			EM-2467
		1978-81	Trans	Auto	1			EM-2379
			Trans	Manual	1			EM-2379
		1975-77	Trans	Auto	1			EM-2379
	Trans		Manual; OEM Design	1			EM-2360 @	
	V6 4.3L 260ci Diesel	1982-85	Front		1	EM-2472		
		1984-85	Torq Str - Front		1		EM-2490	
		1982-83	Torq Str - Front		1		EM-2396	
1982-85		Trans - Front	Auto	1			EM-2467	
V8	V8 4.3L 265ci	1980-81	L & R Front		2	EM-2387		
			Trans	Auto	1		EM-2393	
			Trans	Manual	1		EM-2393	
	V8 4.4L 267ci	1981	L & R Front		2	EM-2387		
			Trans	Auto	1		EM-2393	
			Trans	Manual	1		EM-2393	
	V8 4.9L 301ci	1979-80	L & R Front		2	EM-2387		
			Trans	Auto	1		EM-2360 @	
			Trans	Manual	1		EM-2360 @	
	V8 5.0L 305ci	1977-81	L & R Front		2	EM-2292		
		1979-81	Trans	Auto	1		EM-2393	
			Trans	Manual	1		EM-2393	
		1977-78	Trans	Auto	1		EM-2360 @	
	Trans		Manual	1		EM-2360 @		
	V8 5.7L 350ci	1978-79	L & R Front		2	EM-2292		
			1977	L & R Front	VIN H; VIN J	2	EM-2281	
		1973-76	L & R Front	VIN R	2	EM-2328		
			L & R Front		2	EM-2281		
		1979	Trans	Auto	1			EM-2393
			Trans	Manual	1			EM-2393
		1978	Trans	Auto	1			EM-2360 @
			Trans	Manual	1			EM-2360 @
		1977	Trans	Auto; THM200 (M29); THM350 (M38); VIN R	1			EM-2337
			Trans	Auto; THM400-475 (M40); VIN R	1			EM-2360 @
Trans			VIN L	1			EM-2360 @	
Trans			Auto; VIN H, VIN J	1			EM-2394	
Trans			Manual; VIN H, VIN J	1			EM-2394	
1976		Trans	Auto	1			EM-2394	
		Trans	Manual	1			EM-2394	
1975		Trans	Auto	1			EM-2394	
	1973-74	Trans	Auto	1		EM-2394		
V8 5.7L 350ci Diesel	1981	Trans	Auto	1		EM-2360 @		
		Trans	Manual	1		EM-2360 @		
V8 6.6L 403ci	1977	L & R Front		2	EM-2328			
		Trans		1		EM-2337		
V8 7.5L 455ci	1973-74	L & R Front		2	EM-2291			
		Trans	OEM Design	1		EM-2288 @		



# Engine, Transmission, And Torque Strut Mounts

CYL	ENG. SIZE	YEAR	LOCATION	DESCRIPTION	QTY	ENGINE	TORQUE STRUT	TRANSMISSION	
<b>BUICK PASSENGER CAR (continued)</b>									
<b>ELECTRA</b>									
V6	V6 3.0L 181ci	1985	RH Front	1st Design	1	EM-2630			
			RH Front	Hydraulic Mount; 2nd Design	1	EM-2551*			
			Trans - LH Front		1			EM-2537	
			Trans - LH Rear		1			EM-2568	
			Trans - RH Rear	1st Design	1			EM-2663	
			Trans - RH Rear	2nd Design	1			EM-2664	
			Trans - RH Rear	Hydraulic Mount; 3rd Design	1			EM-2556*	
	V6 3.8L 231ci	1986-90	RH Front	Hydraulic Mount; 2nd Design	1	EM-2551*			
			1985	RH Front	1st Design	1	EM-2630		
			RH Front	Hydraulic Mount; 2nd Design	1	EM-2551*			
		1987-90	Trans - LH Front		1			EM-2537	
		1985-86	Trans - LH Front		1			EM-2537	
		1987-90	Trans - LH Rear		1			EM-2568	
		1985-86	Trans - LH Rear		1			EM-2568	
		1987-90	Trans - RH Rear	Hydraulic Mount; 3rd Design	1			EM-2556*	
		1985-86	Trans - RH Rear	1st Design	1			EM-2663	
			Trans - RH Rear	2nd Design	1			EM-2664	
	Trans - RH Rear		Hydraulic Mount; 3rd Design	1			EM-2556*		
	V6 4.1L 252ci	1980-84	LH Front		1	EM-2382			
			RH Front		1	EM-2384			
			Trans		1			EM-2379	
	V6 4.3L 260ci Diesel	1985	Front	1st Design	1	EM-2630			
			Front	Hydraulic Mount; 2nd Design	1	EM-2551*			
			Trans - LH Front		1			EM-2537	
			Trans - LH Rear		1			EM-2568	
			Trans - RH Rear	Hydraulic Mount; 2nd Design	1			EM-2556*	
	V8	V8 4.9L 301ci	1980	L & R Front		2	EM-2387		
				Trans	OEM Design	1			EM-2360 @
V8 5.0L 252ci		1981-87	L & R Front		2	EM-2328			
V8 5.0L 307ci		1981-89	Trans	OEM Design	1			EM-2360 @	
V8 5.7L 350 ci Gas		1981	L & R Front		2	EM-2281			
			1978-80	L & R Front	VIN R	2	EM-2328		
			L & R Front	VIN X	2	EM-2281			
V8 5.7L 350ci		1977	L & R Front	VIN H; VIN J	2	EM-2281			
			L & R Front	VIN R	2	EM-2328			
		1978-80	Trans	Auto; THM350 (M38); VIN R	1			EM-2360 @	
			Trans	Auto; THM350 (M38); VIN X,	1			EM-2394	
			Trans	Auto; THM400-475 (M40); VIN X	1			EM-2360 @	
		1977	Trans	Auto; THM350 (M38); VIN R	1			EM-2360 @	
Trans			Auto; THM400-475 (M40); VIN H; VIN J	1			EM-2394		
V8 5.7L 350ci Diesel		1980-85	L & R Front		2	EM-2328			
			Trans	VIN N; OEM Design	1			EM-2360 @	
V8 6.6L 401ci		1961-66	L & R Front		2	EM-2219			
		1959-60	Trans		1			EM-2070	
V8 6.6L 403ci		1977-79	L & R Front		2	EM-2328			
			Trans	OEM Design	1			EM-2360 @	
V8 7.0L 425ci		1965-66	L & R Front		2	EM-2219			
V8 7.0L 430ci		1967-69	L & R Front		2	EM-2291			
			Trans	OEM Design	1			EM-2378 @	
V8 7.5L 455ci		1970-76	L & R Front		2	EM-2291			
		1976	Trans	OEM Design	1			EM-2360 @	
		1973-75	Trans	OEM Design	1			EM-2374 @	
		1970-72	Trans	OEM Design	1			EM-2378 @	

# Engine, Transmission, And Torque Strut Mounts

CYL	ENG. SIZE	YEAR	LOCATION	DESCRIPTION	QTY	ENGINE	TORQUE STRUT	TRANSMISSION			
<b>BUICK PASSENGER CAR (continued)</b>											
<b>ESTATE WAGON</b>											
V8	V8 5.7L GAS	1978-80	L & R Front	VIN R	2	EM-2328					
			L & R Front	VIN X	2	EM-2281					
	V8 5.7L 350ci	1977	1973	L & R Front		2	EM-2328				
				L & R Front	VIN H	2	EM-2328				
				L & R Front	VIN J	2	EM-2281				
				L & R Front	VIN J	2	EM-2281				
				L & R Front		2	EM-2328				
				1978-79	Trans	Auto; THM350 (M38); VIN X,		1			EM-2394
					Trans	Auto; THM400-475 (M40); VIN R		1			EM-2360 @
					Trans	Auto; THM400-475 (M40); VIN X		1			EM-2360 @
					Trans	Auto; THM350 (M38); VIN R		1			EM-2288 @
				1977	Trans	Auto; THM400 (M40)		1			EM-2360 @
	1973	Trans	VIN H; OEM Design		1			EM-2360 @			
		Trans	VIN J		1			EM-2394			
	1972	Trans	VIN J		1			EM-2394			
		Trans	OEM Design		1			EM-2360 @			
	V8 6.6L 403ci	1977-79	L & R Front		2	EM-2328					
			Trans	OEM Design	1			EM-2360 @			
	V8 7.5L 455ci	1970-76	1976	L & R Front		2	EM-2291				
				Trans	OEM Design	1			EM-2360 @		
Trans				OEM Design	1			EM-2374 @			
Trans				OEM Design	1			EM-2378 @			
<b>GRAN SPORT</b>											
V8	V8 6.6L 401ci	1965-67	L & R Front		2	EM-2219					
<b>GS</b>											
V8	V8 5.7L 350ci	1970-72	L & R Front		2	EM-2281					
			Trans		1			EM-2394			
<b>GS 350</b>											
V8	V8 5.7L 350ci	1968-69	L & R Front		2	EM-2281					
			Trans	Auto	1			EM-2394			
			Trans	Manual	1			EM-2394			
<b>GS 400</b>											
V8	V8 6.6L 400ci	1968-69	L & R Front		2	EM-2291					
			Trans		1			EM-2378 @			
<b>INVICTA</b>											
V8	V8 6.6L 401ci	1959-63	L & R Front		2	EM-2219					
			Trans		1			EM-2070			
<b>LACROSSE</b>											
L4	L4 2.4L 145ci	2010-12	Right		1	EM-3198					
			Trans - Center		1			EM-3199			
			Trans - Front		1			EM-3194			
			Trans - Rear	FWD	1			EM-3196			
V6	V6 3.0L 182ci	2010	Right		1	EM-3200					
			Trans - Front		1			EM-3195			
V6	V6 3.6L 217ci	2005-08	RH Front		1	EM-2987					
			2010-12	Right		1	EM-3200				
		2005-08	Torq Str - Front	Brkt to Radiator Support; LH & RH Front	2			EM-3088			
			Torq Str - Front	Complete Unit; LH & RH Front	2			EM-2866			
			Torq Str - Front	Insert Only; LH & RH Front	2			EM-2716			
		2010-13	Trans - Front		1				EM-3195		
Trans - Rear	FWD		1				EM-3196				

# Engine, Transmission, And Torque Strut Mounts

CYL	ENG. SIZE	YEAR	LOCATION	DESCRIPTION	QTY	ENGINE	TORQUE STRUT	TRANSMISSION
<b>BUICK PASSENGER CAR (continued)</b>								
<b>LACROSSE (continued)</b>								
V6	V6 3.6L 217ci	2005-08	Trans		1			EM-2818
	V6 3.8L 231ci	2005-09	RH Front		1	EM-2987		
			Torq Str - Front	Brkt to Radiator Support; LH & RH Front	2		EM-3088	
			Torq Str - Front	Complete Unit; LH & RH Front	2		EM-2866	
			Torq Str - Front	Insert Only; LH & RH Front	2		EM-2716	
		Trans		1			EM-2818	
V8	V8 5.3L	2008-09	Front		1	EM-3093		
			Rear		1	EM-2990		
			Torq Str - Front	Brkt to Radiator Support; LH & RH Front	2		EM-3104	
			Torq Str - Front	Complete Unit; LH & RH Front	2		EM-2866	
			Trans		1			EM-5661
<b>LESABRE</b>								
L6	L6 4.1L	1970	Trans		1			EM-2378 @
V6	V6 3.0L 181ci	1986	Front	1st Design	1	EM-2630		
			Front	Hydraulic Mount; 2nd Design	1	EM-2551*		
			Trans - LH Front		1			EM-2537
			Trans - LH Rear		1			EM-2568
			Trans - RH Rear	1st Design	1			EM-2663
			Trans - RH Rear	2nd Design	1			EM-2664
			Trans - RH Rear	Hydraulic Mount; 3rd Design	1			EM-2556 *
	V6 3.8L 231ci	1976-85 2000-05 1992-99 1987-91 1986	LH Front		1	EM-2382		
			RH Front		1	EM-2896*		
			RH Front		1	EM-2801		
			RH Front	Hydraulic Mount; 2nd Design	1	EM-2551*		
			RH Front	1st Design	1	EM-2630		
			RH Front	Hydraulic Mount; 2nd Design	1	EM-2551*		
			RH Front		1	EM-2384		
			Torq Str - Front		1		EM-2662	
			Trans - Center		1			EM-2895 *
			Trans - LH Front		1			EM-2897 *
			Trans - LH Front	Shock Mount	1			EM-2881
			Trans - LH Front		1			EM-2800
			Trans - LH Front		1			EM-2537
			Trans - LH Front		1			EM-2537
			Trans - LH Rear		1			EM-2898
			Trans - LH Rear		1			EM-2778
			Trans - LH Rear		1			EM-2823 *
			Trans - LH Rear		1			EM-2568
	Trans - LH Rear		1			EM-2568		
	Trans - RH Rear	Hydraulic Mount; 3rd Design	1			EM-2556 *		
	1986	Trans - RH Rear	1st Design	1		EM-2663		
		Trans - RH Rear	2nd Design	1		EM-2664		
		Trans - RH Rear	Hydraulic Mount; 3rd Design	1		EM-2556 *		
	1976-85	Trans		1			EM-2379	
	V6 4.1L 252ci	1980-84	LH Front		1	EM-2382		
			RH Front		1	EM-2384		
			Trans		1			EM-2379
	V8	V8 4.4L 267ci	1982	L & R Front		2	EM-2292	
Trans					1			EM-2360 @
V8 4.9L 300ci		1965	L & R Front		2	EM-2350		
V8 4.9L 301ci		1977-80	L & R Front		2	EM-2387		
			Trans		1			EM-2360 @
V8 5.0L 305ci	1978	L & R Front		2	EM-2292			
		Trans		1			EM-2360 @	

# Engine, Transmission, And Torque Strut Mounts

CYL	ENG. SIZE	YEAR	LOCATION	DESCRIPTION	QTY	ENGINE	TORQUE STRUT	TRANSMISSION
<b>BUICK PASSENGER CAR (continued)</b>								
<b>LESABRE (continued)</b>								
V8	V8 5.0L 307ci	1981-90	L & R Front		2	EM-2328		
			Trans		1		EM-2360 @	
	V8 5.6L 340ci	1966-67	L & R Front		2	EM-2350		
			Trans	Auto	1		EM-2268 @	
			Trans	Manual	1		EM-2378 @	
	V8 5.7L	1968-70	Trans		1		EM-2534	
	V8 5.7L 350 ci Gas	1978-80	L & R Front	VIN R	2	EM-2328		
			L & R Front	VIN X	2	EM-2281		
	V8 5.7L 350ci	1977	L & R Front	VIN H; VIN J	2	EM-2281		
			L & R Front	VIN R	2	EM-2328		
		1972-76	L & R Front	VIN H; VIN J	2	EM-2281		
			L & R Front		2	EM-2281		
		1978-80	Trans	Auto; THM350 (M38); VIN X,	1		EM-2394	
			Trans	Auto; THM400-475 (M40); VIN X	1		EM-2360 @	
			Trans	VIN R	1		EM-2360 @	
		1977	Trans	VIN J	1		EM-2394	
			Trans	VIN R	1		EM-2360 @	
		1975-76	Trans	Auto; THM350	1		EM-2394	
		1972-74	Trans	VIN H	1		EM-2378 @	
	Trans		VIN J	1		EM-2394		
	V8 5.7L 350ci Diesel	1980-85	L & R Front		2	EM-2328		
			Trans		1		EM-2360 @	
	V8 6.0L 364ci	1959-61	L & R Front		2	EM-2219		
	V8 6.6L 364ci	1960-64	L & R Front		2	EM-2219		
	V8 6.6L 400ci	1975	L & R Front		2	EM-2291		
	V8 6.6L 403ci	1977-78	L & R Front		2	EM-2328		
			Trans		1		EM-2360 @	
V8 7.0L 425ci	1964	L & R Front		2	EM-2219			
V8 7.5L 455ci	1970-76	L & R Front		2	EM-2291			
		Trans		1		EM-2360 @		
	1973-75	Trans		1		EM-2374 @		
		Trans		1		EM-2378 @		
<b>LUCERNE</b>								
V6	V6 3.8L	2006-08	Front		1	EM-3148		
			Rear		1	EM-3146		
			Torq Str - Front		1		EM-3139	
			Trans	Auto	1		EM-3153	
	V6 3.9L	2009-11	Front		1	EM-3158		
			Rear		1	EM-3146		
			Torq Str - Front		1		EM-3139	
			Trans	Auto	1		EM-3153	
V8	V8 4.6L	2006-11	Front		1	EM-3166		
			Torq Str - Right		1		EM-3140	
			Trans	Auto	1		EM-3153	
<b>PARK AVENUE</b>								
V6	V6 3.8L	1999	Trans - LH Front		1			EM-2897 *
			Trans - LH Rear		1		EM-2898	
	V6 3.8L 231ci	1997-99	LH Front		1	EM-3126		
			2000-05	RH Front	Hydraulic Mount	1	EM-2896*	
			1997-99	RH Front	RH Front	1	EM-5074	
			1991-96	RH Front		1	EM-2801	
				Torq Str - Front		1		EM-2662
			2000-05	Trans - Center		1		EM-2895 *
Trans - LH Front		1			EM-2897 *			

# Engine, Transmission, And Torque Strut Mounts

CYL	ENG. SIZE	YEAR	LOCATION	DESCRIPTION	QTY	ENGINE	TORQUE STRUT	TRANSMISSION	
<b>BUICK PASSENGER CAR (continued)</b>									
<b>PARK AVENUE (continued)</b>									
V6	V6 3.8L 231ci	1994-96	Trans - LH Front	Shock Mount	1			EM-2881	
		1991-93	Trans - LH Front		1			EM-2800	
		2000-05	Trans - LH Rear		1			EM-2898	
		1994-96	Trans - LH Rear	VIN K; VIN L		1			EM-2778
		1991-93	Trans - LH Rear		1			EM-2823	
		1997-98	Trans - Rear	Complete Unit		1			EM-5075
					Trans - Rear	Insert Only	1		
<b>REATTA</b>									
V6	V6 3.8L 231ci	1988-91	RH Front		1	EM-2943			
			Torq Str - Front		1		EM-2662		
		1991	Trans - LH		1			EM-2779	
		1989-90	Trans - LH		1			EM-2779	
		1988	Trans - LH		1			EM-2779	
		1989-90	Trans - RH		1			EM-2691	
<b>REGAL</b>									
L4	L4 2.0L 122ci	2011-13	Trans - Center		1			EM-3201	
			Trans - Front		1			EM-3197	
			Trans - Rear		1			EM-3196	
	L4 2.0L 122ci	2011-12	Right		1	EM-3198			
	L4 2.4L 145ci	2011-12	Right		1	EM-3198			
			2011-13	Trans - Center		1			EM-3199
				Trans - Front		1			EM-3194
	Trans - Rear			1			EM-3196		
	V6	V6 2.8L 173ci	1988-89	RH Front		1	EM-2660		
Torq Str - Front				LH & RH Front	2		EM-2609		
Trans					1			EM-2620	
V6 3.1L 189ci		1994-96	Front		1	EM-2796			
			1989-93	Front		1	EM-2660		
			1995-96	Torq Str - Front	Brkt to Radiator Support; LH & RH Front	2			EM-2901
		Torq Str - Front		Complete Unit; LH & RH Front; 2nd Design	2			EM-2866	
		Torq Str - Front		Insert; LH & RH Front; 2nd Design	2			EM-2716	
		1994	Torq Str - Front	Brkt to Radiator Support; LH & RH Front	2			EM-2901	
			Torq Str - Front	Complete Unit; LH & RH Front; 2nd Design	2			EM-2866	
			Torq Str - Front	Insert; LH & RH Front; 2nd Design	2			EM-2716	
			Torq Str - Left	1st Design	1			EM-2609	
		1989-93	Torq Str - Left	1st Design	1			EM-2609	
		1994	Torq Str - Right	1st Design	1			EM-2609	
		1989-93	Torq Str - Right	1st Design	1			EM-2609	
1994-96		Trans	Auto	1			EM-2712		
1989-93		Trans		1			EM-2620		
V6 3.2L 196ci		1978-79	LH Front		1	EM-2382			
			RH Front		1	EM-2384			
			Trans	Auto	1			EM-2379	
			Trans	Manual	1			EM-2379	
V6 3.8L 189ci	1996-04	RH Front		1	EM-2796				
V6 3.8L 231ci	1975-87	LH Front		1	EM-2382				
	1993-95	RH Front		1	EM-2697				
	1990-92	RH Front		1	EM-2697				
	1975-87	RH Front		1	EM-2384				

# Engine, Transmission, And Torque Strut Mounts

CYL	ENG. SIZE	YEAR	LOCATION	DESCRIPTION	QTY	ENGINE	TORQUE STRUT	TRANSMISSION
<b>BUICK PASSENGER CAR (continued)</b>								
<b>REGAL (continued)</b>								
V6	V6 3.8L 231ci	1993-95	RH Rear		1	EM-2676		
		1990-92	RH Rear		1	EM-2763		
		1996-04	Torq Str - Front	Brkt to Radiator Support; LH & RH Front	2		EM-3088	
			Torq Str - Front	Complete Unit; LH & RH Front	2		EM-2866	
			Torq Str - Front	Insert; LH & RH Front	2		EM-2716	
		1990-95	Torq Str - Front		1		EM-2609	
		1997-04	Trans		1			EM-2818
		1994-96	Trans		1			EM-2712
		1990-93	Trans		1			EM-2620
		1980-87	Trans		1			EM-2379
	1976-79	Trans	Auto	1			EM-2379	
		Trans	Manual	1			EM-2379	
	1975	Trans		1			EM-2379	
	V6 4.1L 252ci	1982-84	LH Front		1	EM-2382		
			RH Front		1	EM-2384		
Trans				1		EM-2360 @		
V6 4.3L 260ci Diesel	1982-84	L & R Front		2	EM-2292			
	1983-84	Trans		1			EM-2360 @	
V8	V8 4.3L 265ci	1980-81	L & R Front		2	EM-2387		
			Trans		1		EM-2391	
	V8 4.4L 267ci	1981-82	L & R Front		2	EM-2387		
			Trans	Auto	1		EM-2393	
	V8 4.9L 301ci	1979-80	L & R Front		2	EM-2387		
			Trans	Auto	1		EM-2393	
	V8 5.0L 305ci	1982-87	L & R Front		2	EM-2292		
			L & R Front		2	EM-2292		
		1982-87	Trans		1		EM-2360 @	
		1980	Trans	Auto	1		EM-2360 @	
		1977-79	Trans	Auto	1		EM-2360 @	
	Trans		Manual	1		EM-2360 @		
	V8 5.0L 307ci	1986-87	L & R Front		2	EM-2328		
	V8 5.7L 350ci	1977	L & R Front	VIN H	2	EM-2281		
			L & R Front	VIN L	2	EM-2292		
L & R Front			VIN R	2	EM-2328			
1973-76		L & R Front	VIN H; VIN J	2	EM-2281			
		Trans	Auto; VIN H	1		EM-2394		
		Trans	Auto; VIN L	1		EM-2393		
		Trans	Manual; VIN H	1		EM-2394		
1975-76		Trans	Manual; VIN L	1		EM-2393		
		Trans		1		EM-2394		
		Trans	Auto	1		EM-2394		
1973-74	Trans	Manual	1		EM-2394			
V8 5.7L 350ci Diesel	1985	L & R Front	VIN N	2	EM-2328			
	1982-83	L & R Front	VIN N	2	EM-2328			
	1985	Trans		1		EM-2360 @		
	1982-83	Trans		1		EM-2360 @		
V8 7.5L 455ci	1973-74	L & R Front		2	EM-2291			
		Trans		1		EM-2374 @		
<b>RIVIERA</b>								
V6	V6 3.8L 231ci	1979-85	L & R Front		2	EM-2777		
		1986-91	RH Front		1	EM-2943		
		1988-93	Torq Str - Front		1		EM-2662	
		1995-98	Trans - Front		1			EM-3127
		1991	Trans - LH		1			EM-2779
		1989-90	Trans - LH		1			EM-2779

# Engine, Transmission, And Torque Strut Mounts

CYL	ENG. SIZE	YEAR	LOCATION	DESCRIPTION	QTY	ENGINE	TORQUE STRUT	TRANSMISSION	
<b>BUICK PASSENGER CAR (continued)</b>									
<b>RIVIERA (continued)</b>									
V6	V6 3.8L 231ci	1986-88	Trans - LH		1			EM-2671	
		1982-85	Trans - LH		1			EM-2495	
		1979-81	Trans - LH		1			EM-2497	
		1989-90	Trans - RH		1			EM-2691	
		1982-85	Trans - RH		1			EM-2494	
		1979-81	Trans - RH		1			EM-2494	
		1995-98	Trans - Rear	Complete Unit	1			EM-5075	
			Trans - Rear	Insert Only	1			EM-3065	
		1999	Trans		1			EM-2898	
	V6 4.1L 252ci	1981-84	L & R Front		2	EM-2777			
		1982-84	Trans - LH		1			EM-2495	
		1981	Trans - LH		1			EM-2497	
		1982-84	Trans - RH		1			EM-2494	
		1981	Trans - RH		1			EM-2494	
	V8	V8 5.0L 307ci	1980-85	L & R Front		2	EM-2629		
1982-85			Trans - LH		1			EM-2495	
1980-81			Trans - LH		1			EM-2497	
1982-85			Trans - RH		1			EM-2494	
1980-81			Trans - RH		1			EM-2494	
V8 5.7L 350ci		1977-78	L & R Front		2	EM-2328			
V8 5.7L 350ci Diesel		1981-85	L & R Front		2	EM-2629			
			Trans - LH		1			EM-2495	
			Trans - RH		1			EM-2494	
V8 6.6L 401ci		1963-65	L & R Front		2	EM-2219			
V8 6.6L 403ci		1977-78	L & R Front		2	EM-2328			
			L & R Rear		2	EM-5388			
			Trans		1			EM-2360 @	
V8 7.0L 425ci		1963-66	L & R Front		2	EM-2219			
V8 7.0L 430ci		1967-69	RH Front		1	EM-2291			
V8 7.5L 455ci		1970-76	L & R Front		2	EM-2291			
			Trans		1			EM-2360 @	
			Trans		1			EM-2374 @	
	Trans			1			EM-2378 @		
<b>ROADMASTER</b>									
V8	V8 5.0L 305ci	1991	L & R Front		2	EM-2292			
			Trans		1			EM-2360 @	
	V8 5.7L 350ci	1992-96	L & R Front		2	EM-2292			
			Trans		1			EM-2394	
	1992-93	Trans		1			EM-2360 @		
<b>SKYHAWK</b>									
L4	L4 1.8L 112ci	1985-86	RH Front		1	EM-2538			
			1983-84	RH Front		1	EM-2496		
				1982	RH Front	Auto; 3 Spd; Vin G; w/ Air	1	EM-2474	
			RH Front		Auto; 3 Spd; VIN G; w/o Air	1	EM-2506		
			RH Front		Auto; 4 Spd; VIN G; w/o Air	1	EM-2524		
			RH Front		Manual; 4 Spd; VIN G; w/ Air	1	EM-2473		
		1985-86	RH Rear		1	EM-2477			
			1983-84	RH Rear		1	EM-2477		
		1982		RH Rear		1	EM-2477		
		1982-86	Torq Str - Front	Lateral	1		EM-2492		
			Torq Str - Front	Longitudinal	1		EM-2528		
		1985-86	Trans	Complete Unit	1			EM-2601	
	1982-84	Trans	Auto; Insert	1			EM-2720		
		Trans	Manual; Insert	1			EM-2720		
	L4 2.0L 122ci	1985-89	RH Front		1	EM-2538			
			1983-84	RH Front	Auto w/o Air	1	EM-2506		

# Engine, Transmission, And Torque Strut Mounts

CYL	ENG. SIZE	YEAR	LOCATION	DESCRIPTION	QTY	ENGINE	TORQUE STRUT	TRANSMISSION	
<b>BUICK PASSENGER CAR (continued)</b>									
<b>SKYHAWK (continued)</b>									
L4	L4 2.0L 122ci	1983-84	RH Front	Auto; w/ Air	1	EM-2474			
			RH Front	Manual; w/ Air	1	EM-2473			
			RH Front	Manual; w/o Air	1	EM-2524			
		1985-89	RH Rear		1	EM-2477			
		1983-84	RH Rear		1	EM-2477			
		1989	Torq Str - Rear	Longitudinal	1		EM-2528		
		1983-88	Torq Str - Rear	Lateral	1		EM-2492		
			Torq Str - Rear	Longitudinal	1		EM-2528		
		1985-89	Trans	Auto	1			EM-2601	
			Trans	Manual	1			EM-2601	
1983-84	Trans	Auto; Insert	1			EM-2720			
	Trans	Manual; Insert	1			EM-2720			
V6	V6 3.8L 231ci	1975-80	LH Front		1	EM-2382			
			RH Front		1	EM-2384			
		1978	Trans	Auto; VIN 2	1			EM-2379	
			Trans	Manual	1			EM-2393	
		1976-77	Trans	Auto	1			EM-2353	
			Trans	Manual	1			EM-2353	
		1975	Trans	Auto	1			EM-2353	
		V6 3.8L 3800cc	1978-80	Trans		1			EM-2393
				Trans	Auto; VIN A	1			EM-2393
		<b>SKYLARK</b>							
L4	L4 2.3L 138ci	1992-95	RH Front	Complete Unit	1	EM-5031'			
			RH Front	Insert	1	EM-2803'			
		1988-91	RH Front		1	EM-2859'			
			RH Rear		1	EM-2952			
		1995	Torq Str - Front		1		EM-2814		
		1992-94	Torq Str - Front		1		EM-2782		
		1992-95	Trans		1			EM-2715	
		L4 2.4L 146ci	1996-98	RH Front	Complete Unit	1	EM-5031'		
				RH Front	Insert	1	EM-2803'		
				Torq Str - Front		1		EM-2814	
	Trans				1			EM-2715	
	L4 2.5L 2474cc	1986-91	RH Front		1	EM-2538			
			RH Front		1	EM-2548'			
			RH Front		1	EM-2472			
			RH Front		1	EM-2505			
			RH Rear		1	EM-2477			
			Torq Str - Front		1		EM-2396		
			Torq Str - Front		1		EM-2396		
			Torq Str - Rear		1		EM-2528		
			Trans - Front	Auto	1			EM-2466	
			Trans - Front	Manual	1			EM-2467	
			Trans - Rear	Auto	1			EM-2467	
			Trans	Auto	1			EM-2601	
			Trans	Auto	1			EM-2601	
			Trans	Manual	1			EM-2601	
			Trans	Auto	1			EM-2543	
			Trans	Manual	1			EM-2543	
	L6	L6 4.1L 250ci	1968-71	L & R Front		2	EM-2292		
				Trans	Auto	1			EM-2378 @
				Trans	Manual	1			EM-2378 @
V6	V6 2.8L 173ci	1985	RH Front		1	EM-2548'			
			RH Front		1	EM-2472			
			RH Front		1	EM-2505			
			Torq Str - Front		1		EM-2396		



# Engine, Transmission, And Torque Strut Mounts

CYL	ENG. SIZE	YEAR	LOCATION	DESCRIPTION	QTY	ENGINE	TORQUE STRUT	TRANSMISSION	
<b>BUICK PASSENGER CAR (continued)</b>									
<b>SKYLARK (continued)</b>									
V6	V6 2.8L 173ci	1980-85	Trans - Front	Auto	1			EM-2466	
			Trans - Front	Manual	1			EM-2467	
			Trans - Rear	Auto	1			EM-2467	
	V6 3.0L 181ci	1986-88	RH Front		1	EM-2626			
			RH Rear		1	EM-2477			
			Torq Str - Rear		1		EM-2528		
			Trans	Auto	1			EM-2601	
			Trans	Manual	1			EM-2601	
	V6 3.1L 189ci	1994-98	RH Front	Insert	1	EM-2803'			
			Torq Str - Front		1		EM-2814		
			Torq Str - Front		1		EM-2782		
			Trans		1			EM-2715	
	V6 3.3L 204ci	1992-93	RH Front	Insert	1	EM-2803'			
			RH Front		1	EM-2626			
		1989-91	RH Rear		1	EM-2477			
			Torq Str - Front		1		EM-2782		
		1989-91	Torq Str - Rear		1		EM-2528		
			Trans		1			EM-2715	
	V6 3.8L 231ci	1975-79	LH Front		1	EM-2382			
			RH Front		1	EM-2384			
		1979	Trans	Auto	1			EM-2394	
			Trans	Manual	1			EM-2394	
		1976-78	Trans	Auto	1			EM-2394	
		1975	Trans	Auto; OEM Design	1			EM-2288 @	
	V8	V8 3.5L 215ci	1961-63	L & R Front		2	EM-2219		
		V8 4.3L 260ci	1975-76	L & R Front		2	EM-2328		
		Trans		Auto	1			EM-2360 @	
V8 4.9L 301ci		1977	L & R Front		2	EM-2387			
			Trans	Auto	1			EM-2360 @	
			Trans	Manual	1			EM-2360 @	
V8 5.0L 305ci		1977-79	L & R Front		2	EM-2292			
			Trans	Auto	1			EM-2360 @	
			Trans	Manual	1			EM-2360 @	
V8 5.6L 340ci		1966-67	L & R Front		2	EM-2350			
			Trans	Auto	1			EM-2378 @	
			Trans	Manual	1			EM-2378 @	
V8 5.7L 350ci		1977-79	L & R Front		2	EM-2292			
			L & R Front		2	EM-2281			
		1977-79	L & R Front		2	EM-2281			
			Trans	Auto	1			EM-2360 @	
		1975-76	Trans	Manual	1			EM-2360 @	
			Trans	Auto; THM350 (M38); VIN H	1			EM-2288 @	
			Trans	Auto; THM350 (M38); VIN J	1			EM-2394	
			Trans	Manual; OEM Design	1			EM-2288 @	
		1971-72	Trans	Auto; THM350 (M38); OEM Design	1			EM-2378 @	
			Trans	Auto; THM400-475 (M40) OEM Design	1			EM-2268 @	
Trans			Manual	1			EM-2378 @		
Trans			Auto; THM350 (M38); OEM Design	1			EM-2378 @		
1968-70		Trans	Auto; THM350 (M38); OEM Design	1			EM-2378 @		
		Trans	Manual	1			EM-2378 @		
V8 6.6L 400ci		1968	L & R Front		2	EM-2291			
V8 6.6L 401ci	1965-67	L & R Front		2	EM-2219				
V8 7.5L 455ci	1970-72	L & R Front		2	EM-2291				

# Engine, Transmission, And Torque Strut Mounts

CYL	ENG. SIZE	YEAR	LOCATION	DESCRIPTION	QTY	ENGINE	TORQUE STRUT	TRANSMISSION
<b>BUICK PASSENGER CAR (continued)</b>								
<b>SKYLARK (continued)</b>								
V8	V8 7.5L 455ci	1970-72	Trans	OEM Design	1			EM-2374 @
<b>SOMERSET</b>								
L4	L4 2.5L 2474cc	1985-87	RH Front		1	EM-2538		
			RH Rear		1	EM-2477		
			Torq Str - Rear		1		EM-2528	
			Trans	Auto	1			EM-2601
			Trans	Manual	1			EM-2601
V6	V6 3.0L 181ci	1985-87	RH Front		1	EM-2626		
			RH Rear		1	EM-2477		
		1986-87	Torq Str - Rear		1		EM-2528	
			Torq Str - Rear		1		EM-2528	
		1985-87	Trans	Auto	1			EM-2601
			Trans	Manual	1			EM-2601
<b>SPECIAL</b>								
L6	L6 4.1L 250ci	1968-69	L & R Front		2	EM-2292		
			Trans		1			EM-2378 @
V6	V6 3.2L 198ci	1962-63	L & R Front		2	EM-2218		
V8	V8 3.5L 215ci	1961-63	L & R Front		2	EM-2218		
	V8 5.7L 350ci	1968-69	L & R Front		2	EM-2281		
<b>SPORTWAGON</b>								
V8	V8 5.6L 340ci	1966-67	L & R Front		2	EM-2350		
			Trans	Manual	1			EM-2378 @
	V8 5.7L 350ci	1968-72	L & R Front		2	EM-2281		
	V8 6.6L 400ci	1968	L & R Front		2	EM-2291		
<b>SUPER</b>								
V8	V8 5.3L 322ci	1953-56	Trans		1			EM-2070
<b>VERANO</b>								
L4	L4 2.0L 122ci	2013-14	Trans - Front		1			EM-3194
			Trans - Rear		1			EM-4080
	L4 2.4L 145ci	2012-14	Trans - Front		1			EM-3194
			Trans - Rear		1			EM-4080
<b>WILDCAT</b>								
V8	V8 6.6L 401ci	1963-66	L & R Front		2	EM-2219		
	V8 7.0L 425ci	1964-66	L & R Front		2	EM-2219		
	V8 7.0L 430ci	1967-69	L & R Front		2	EM-2291		
			Trans	Auto	1			EM-2378 @
			Trans	Manual	1			EM-2378 @
<b>BUICK SPORT UTILITY</b>								
<b>ENCLAVE</b>								
V6	V6 3.6L	2009-12	Torq Str - Right		1		EM-3141	
		2008	Torq Str - Right	Bracket Only	1		EM-3143	
			Torq Str - Right	Strut	1		EM-3133	
	V6 3.6L 217ci	2009-14	Front		1	EM-4037		
			2008	Front		1	EM-3192	
		2009-14	Rear		1	EM-4035		
			2008	Rear		1	EM-3192	
		2009-12	Trans		1			EM-4036
		2008	Trans		1			EM-3192
		<b>RAINIER</b>						
L6	L6 4.2L 256ci	2004-07	L & R Front		2	EM-3021'		
			Trans		1			EM-3027
V8	V8 5.3L	2004-07	LH Front		1	EM-5694		

# Engine, Transmission, And Torque Strut Mounts

CYL	ENG. SIZE	YEAR	LOCATION	DESCRIPTION	QTY	ENGINE	TORQUE STRUT	TRANSMISSION
<b>BUICK SPORT UTILITY (continued)</b>								
<b>RAINIER (continued)</b>								
V8	V8 5.3L	2004-07	RH Front		1	EM-5693		
<b>RENDEZVOUS</b>								
V6	V6 3.4L 207ci	2002-05	RH Front	AWD; When Current Stock is Depleted, Re-order EM-2987	1	EM-2906*		
			RH Front	FWD	1	EM-2987		
			Torq Str - Front	Brkt to Radiator Support; LH & RH Front	2		EM-2900	
			Torq Str - Front	Complete Unit; LH & RH Front	2		EM-2899	
			Torq Str - Front	Insert Only; LH & RH Front	2		EM-2716	
			Trans		1			EM-2818
	V6 3.5L 213ci	2006-07	RH Front		1	EM-2987		
			RH Front	When Stock is Depleted, Re-order EM-2987	1	EM-2906*		
			Torq Str - Front	Brkt to Radiator Support; LH & RH Front	2		EM-2900	
			Torq Str - Front	Complete Unit; LH & RH Front	2		EM-2899	
			Torq Str - Front	Insert Only; LH & RH Front	2		EM-2716	
			Trans		1			EM-2818
	V6 3.6L 217ci	2004-06	RH Front		1	EM-2987		
			RH Front	When Stock is Depleted, Re-order EM-2987	1	EM-2906*		
			Torq Str - Front	Brkt to Radiator Support; LH & RH Front	2		EM-2900	
			Torq Str - Front	Complete Unit; LH & RH Front	2		EM-2899	
			Torq Str - Front	Insert Only; LH & RH Front	2		EM-2716	
			Trans		1			EM-2818
<b>BUICK VAN</b>								
<b>TERRAZA</b>								
V6	V6 3.5L 213ci	2005-06	RH Front	AWD; When Current Stock is Depleted, Re-order EM-2987	1	EM-2906*		
			RH Front	FWD	1	EM-2987		
			Torq Str - Front	Brkt to Radiator Support; LH & RH Front	2		EM-2900	
			Torq Str - Front	Complete Unit; LH & RH Front	2		EM-2899	
			Torq Str - Front	Insert Only; LH & RH Front	2		EM-2716	
			Trans		1			EM-2818
	V6 3.9L 3880cc	2007	RH Front		1	EM-2987		
			RH Front	When Stock is Depleted, Re-order EM-2987	1	EM-2906*		
		2006	RH Front	AWD	1	EM-2987		
			RH Front	AWD; When Current Stock is Depleted, Re-order EM-2987	1	EM-2906*		
		2006-07	Torq Str - Front	Brkt to Radiator Support; LH & RH Front	2		EM-2900	
			Torq Str - Front	Complete Unit; LH & RH Front	2		EM-3090	
			Torq Str - Front	Insert Only; LH & RH Front	2		EM-2716	
			Trans		1			EM-2818
<b>CADILLAC PASSENGER CAR</b>								
<b>60 SPECIAL</b>								
V8	V8 4.9L	1993	RH Front	Hydraulic Mount	1	EM-2551*		

# Engine, Transmission, And Torque Strut Mounts

CYL	ENG. SIZE	YEAR	LOCATION	DESCRIPTION	QTY	ENGINE	TORQUE STRUT	TRANSMISSION			
<b>CADILLAC PASSENGER CAR (continued)</b>											
<b>ALLANTE</b>											
V8	V8 4.1L 250ci	1987-88	RH Front		1	EM-2892'					
			Trans - Center		1			EM-2779 *			
			Trans - RH Rear		1			EM-2691			
	V8 4.5L 273ci	1989-92	RH Front		1	EM-2892'					
			Torq Str - Front		1		EM-2662				
			Trans - Center		1				EM-2779 *		
			1989	Trans - LH		1			EM-2779 *		
			1990-92	Trans - RH Rear		1			EM-2691		
	V8 4.6L 281ci	1993	RH Front		1	EM-2838'					
			Torq Str - Front		1		EM-2781				
			Torq Str - Front		1		EM-2780				
			Trans - LH		1				EM-2893 *		
Trans - RH				1				EM-2837 *			
<b>BROUGHAM</b>											
V8	V8 5.0L	1987-90	L & R Front		2	EM-2387					
			Trans	Auto; THM200-R4 (MW9)	1			EM-2394			
			Trans	Auto; THM400 (M40)	1			EM-2374 @			
	V8 5.0L 305ci	1991-92	Trans	w/ Armored Body	1			EM-2374 @			
			Trans	w/o Armored Body	1			EM-2394			
<b>CALAIS</b>											
V8	V8 7.0L 429ci	1965-67	L & R Front		2	EM-2296					
	V8 7.7L 472ci	1968-74	L & R Front		2	EM-2296					
			Trans		1			EM-2320			
	V8 8.2L 500ci	1975-76	L & R Front		2	EM-2470					
Trans				1			EM-2320				
<b>CTS</b>											
V6	V6 2.8L	2005-07	L & R Front		2	EM-3149					
			Trans		1			EM-3159			
	V6 3.2L	2003-04	L & R Front		2	EM-3149					
			Trans	Auto	1			EM-3123			
			Trans	Manual	1			EM-3162			
	V6 3.6L	2005-07	L & R Front		2	EM-3149					
V6 3.6L 217ci	2004-07	Trans		1			EM-3159				
<b>CIMARRON</b>											
L4	L4 1.8L 112ci	1982	RH Front	Auto; w/ Air	1	EM-2474					
			RH Front	Auto; w/o Air	1	EM-2506					
			RH Front	Manual; w/ Air	1	EM-2473					
			RH Front	Manual; w/o Air	1	EM-2524					
			RH Rear		1	EM-2477					
			Torq Str - Rear	Lateral	1		EM-2492				
			Torq Str - Rear	Longitudinal	1		EM-2528				
			Trans	Auto; Insert	1			EM-2720			
			Trans	Manual; Insert	1			EM-2720			
			L4 2.0L 122ci	1985-86	RH Front		1	EM-2538			
					1983-84	RH Front	Auto	1	EM-2474		
						RH Front	Manual	1	EM-2473		
					1985-86	RH Rear		1	EM-2477		
	1983-84	RH Rear				1	EM-2477				
	1983-86	Torq Str - Rear			Lateral	1		EM-2492			
		Torq Str - Rear			Longitudinal	1		EM-2528			
	1985-86	Trans	Auto	1			EM-2601				
		Trans	Manual	1			EM-2601				
	1983-84	Trans	Auto; Insert	1			EM-2720				
		Trans	Manual; Insert	1			EM-2720				
V6	V6 2.8L 173ci	1985-88	RH Front		1	EM-2538					

# Engine, Transmission, And Torque Strut Mounts

CYL	ENG. SIZE	YEAR	LOCATION	DESCRIPTION	QTY	ENGINE	TORQUE STRUT	TRANSMISSION
<b>CADILLAC PASSENGER CAR (continued)</b>								
<b>CIMARRON (continued)</b>								
V6	V6 2.8L 173ci	1985-88	RH Rear	Auto	1	EM-2477		
			RH Rear	Manual	1	EM-2708		
			Torq Str - Rear	Lateral	1		EM-2492	
			Torq Str - Rear	Longitudinal	1		EM-2528	
			Trans	Auto	1			EM-2601
			Trans	Manual	1			EM-2601
<b>COMMERCIAL CHASSIS</b>								
V8	V8 7.0L 425ci	1977-79	L & R Front		2	EM-2387		
			Trans		1			EM-2374 @
	V8 8.2L 500ci	1975-76	L & R Front		2	EM-2470		
			Trans		1			EM-2320
<b>CONCOURS</b>								
V8	V8 4.6L 281ci	1994-99	RH Front		1	EM-2838'		
		1997-99	Trans - LH		1			EM-2932 *
		1994-96	Trans - LH		1			EM-2893 *
		1997-99	Trans - RH		1			EM-2837 *
		1994-96	Trans - RH		1			EM-2837 *
<b>DTS</b>								
V8	V8 4.6L	2006-11	Torq Str - Right		1		EM-3140	
	V8 4.6L 281ci	2006-11	Front		1	EM-3166		
			Trans		1			EM-3153
<b>DEVILLE</b>								
V6	V6 4.1L 252ci	1980-82	LH Front	w/o Wires	1	EM-2382		
			RH Front		1	EM-2384		
			Trans		1			EM-2379
	V6 4.3L 260ci Diesel	1985	RH Front	1st Design	1	EM-2630		
			RH Front	Hydraulic Mount; 2nd Design	1	EM-2553'		
			Trans - LH Front		1			EM-2800
			Trans - LH Rear		1			EM-2568
V8	V8 4.1L 250ci	1982-84	L & R Front	RWD	2	EM-2387		
		1987	RH Front	Hydraulic Mount; 3rd Design	1	EM-2553'		
		1986	RH Front	1st Design, Non-Hyd	1	EM-2630		
			RH Front	Hydraulic Mount; 3rd Design	1	EM-2553'		
		1985	RH Front	Solid Mount; 1st. Design	1	EM-2630		
		1985-87	Trans - LH Front		1			EM-2537
			Trans - LH Rear		1			EM-2568
	1982-84	Trans	RWD	1			EM-2907	
	V8 4.5L 273ci	1988-90	RH Front		1	EM-2551'		
			Trans - LH Front		1			EM-2537
			Trans - LH Rear		1			EM-2568
			Trans - RH Rear		1			EM-2556 *
	V8 4.6L 281ci	2000-05	1996-99	RH Front		1	EM-2896'	
1994-99			Torq Str - Front		1		EM-2781	
			Torq Str - Front		1		EM-2780	
2000-05			Trans - Center		1			EM-2895 *
1997-99			Trans - LH		1			EM-2932 *
1996			Trans - LH		1			EM-2893 *
2000-05			Trans - LH Front		1			EM-3020 *
			Trans - LH Rear		1			EM-2898
1997-99			Trans - RH		1			EM-2837 *
1996			Trans - RH		1			EM-2837 *
V8 4.9L 300ci	1994-95	1991-93	RH Front		1	EM-2836'		
			RH Front		1	EM-2551'		

# Engine, Transmission, And Torque Strut Mounts

CYL	ENG. SIZE	YEAR	LOCATION	DESCRIPTION	QTY	ENGINE	TORQUE STRUT	TRANSMISSION
<b>CADILLAC PASSENGER CAR (continued)</b>								
<b>DEVILLE (continued)</b>								
V8	V8 4.9L 300ci	1994-95	Torq Str - Front		1		EM-2662	
			Trans - LH		1		EM-2620	
		1991-93	Trans - LH Front		1		EM-2800	
			Trans - LH Rear		1		EM-2568	
		1994-95	Trans - RH		1		EM-2951	
	1991-93	Trans - RH Rear		1		EM-2821		
	V8 5.7L 350ci Diesel	1979-84	L & R Front		2	EM-2387		
			Trans		1		EM-2773 @	
	V8 6.0L 368ci	1980-81	L & R Front		2	EM-2387		
			Trans		1		EM-2499	
		1980	Trans		1		EM-2374 @	
	V8 6.4L 390ci	1959-63	L & R Front		2	EM-2238		
	V8 7.0L 425ci	1977-79	L & R Front		2	EM-2387		
			Trans		1		EM-2374 @	
	V8 7.0L 429ci	1965-67	L & R Front		2	EM-2274		
1964			L & R Front		2	EM-2238		
V8 7.7L 472ci	1968-74	L & R Front		2	EM-2296			
		Trans		1		EM-2320		
V8 8.2L 500ci	1974-76	L & R Front		2	EM-2470			
		Trans		1		EM-2320		
<b>ELDORADO</b>								
V6	V6 4.1L 252ci	1981-82	L & R Front		2	EM-2777		
			Trans - LH		1		EM-2495	
			Trans - RH		1		EM-2494	
V8	V8 4.1L 250ci	1982-85	L & R Front		2	EM-2629		
			1986-87	RH Front		1	EM-2892'	
		1987	Trans - LH		1		EM-2783	
		1986	Trans - LH		1		EM-2783	
		1982-85	Trans - LH		1		EM-2497	
		1987	Trans - RH		1		EM-2691	
	1982-85	Trans - RH		1		EM-2498		
	V8 4.5L 273ci	1988-90	RH Front		1	EM-2892'		
			Torq Str - Front		1		EM-2662	
			Trans - LH		1		EM-2779	
			Trans - RH		1		EM-2691	
	V8 4.6L 281ci	1993-02	RH Front		1	EM-2838'		
			Torq Str - Front		1		EM-2781	
			Torq Str - Front		1		EM-2780	
		1997-02	Trans - LH		1		EM-2932	
		1993-96	Trans - LH		1		EM-2893	
		1997-02	Trans - RH		1		EM-2837	
	1993-96	Trans - RH		1		EM-2837		
	V8 4.9L 300ci	1992-93	RH Front		1	EM-2836'		
			1991	RH Front		1	EM-2892'	
		1991-93	Torq Str - Front		1		EM-2662	
1992-93		Trans - LH		1		EM-2620		
1991		Trans - LH		1		EM-2779		
1992-93	Trans - RH		1		EM-2951			
V8 5.7L 350ci Diesel	1981-85	L & R Front		2	EM-2629			
		1982-85	Trans - LH		1		EM-2497	
	1981	Trans - LH		1		EM-2495		
	1982-85	Trans - RH		1		EM-2498		
	1981	Trans - RH		1		EM-2494		
V8 6.0L 365ci	1957-58	L & R Front		2	EM-2238			
V8 6.0L 368ci	1981	LH Front		1	EM-2629			
		Trans - LH		1		EM-2495		

# Engine, Transmission, And Torque Strut Mounts

CYL	ENG. SIZE	YEAR	LOCATION	DESCRIPTION	QTY	ENGINE	TORQUE STRUT	TRANSMISSION
<b>CADILLAC PASSENGER CAR (continued)</b>								
<b>ELDORADO (continued)</b>								
V8	V8 6.0L 368ci	1981	Trans - RH		1			EM-2494
	V8 6.4L 390ci	1959-63	L & R Front		2	EM-2238		
	V8 7.0L 425ci	1977-78	L & R Front		2	EM-2296		
	V8 7.0L 429ci	1964-66	L & R Front		2	EM-2274		
	V8 8.2L 500ci	1973-76	L & R Front		2	EM-2296		
<b>FLEETWOOD</b>								
V6	V6 4.1L 252ci	1980-82	LH Front		1	EM-2382		
			RH Front		1	EM-2384		
			Trans		1			EM-2379
	V6 4.3L 260ci Diesel	1985	RH Front	1st Design	1	EM-2630		
			RH Front	Hydraulic Mount; 2nd Design	1	EM-2553'		
Trans - LH Front				1			EM-2800	
	Trans - LH Rear			1			EM-2568	
V8	V8 4.1L 250ci	1982-87	L & R Front		2	EM-2387		
			Trans		1			EM-2907
	V8 4.5L 273ci	1988-90	RH Front		1	EM-2551'		
			Trans - LH Front		1			EM-2537
			Trans - LH Rear		1			EM-2568
			Trans - RH Rear		1			EM-2556
	V8 4.9L 300ci	1991-92	RH Front		1	EM-2551'		
			Trans - LH Front		1			EM-2800
			Trans - LH Rear		1			EM-2568
			Trans - RH Rear		1			EM-2821
	V8 5.0L 307ci	1986	L & R Front		2	EM-2387		
			Trans	Auto	1			EM-2394
	V8 5.7L 350ci	1993-96	L & R Front		2	EM-2292		
		1990-96	Trans	w/ Armored Body	1			EM-2374 @
			Trans	w/o Armored Body	1			EM-2394
	V8 5.7L 350ci Diesel	1979-85	L & R Front		2	EM-2387		
			Trans		1			EM-2773 @
	V8 6.0L 368ci	1980-84	L & R Front		2	EM-2387		
		1982-84	Trans		1			EM-2374 @
		1981	Trans		1			EM-2499
1980		Trans		1			EM-2374 @	
V8 7.0L 425ci	1977-79	L & R Front		2	EM-2387			
		Trans		1			EM-2374 @	
V8 7.0L 429ci	1965-67	L & R Front		2	EM-2274			
V8 7.7L 472ci	1968-74	L & R Front		2	EM-2296			
		Trans		1			EM-2320	
V8 8.2L 500ci	1974-76	L & R Front		2	EM-2470			
		Trans		1			EM-2320	
<b>SEVILLE</b>								
V6	V6 4.1L 252ci	1981-82	L & R Front		2	EM-2777		
			Trans - LH		1			EM-2495
			Trans - RH		1			EM-2494
V8	V8 4.1L 250ci	1982-85	L & R Front		2	EM-2629		
		1986-87	RH Front		1	EM-2892'		
		1987	Trans - LH		1			EM-2783
		1986	Trans - LH		1			EM-2783
		1982-85	Trans - LH		1			EM-2497
		1987	Trans - RH		1			EM-2691
		1986	Trans - RH		1			EM-2498
		1982-85	Trans - RH		1			EM-2498
		V8 4.5L 273ci	1988-90	RH Front		1	EM-2892'	
	Torq Str - Front				1			EM-2662

# Engine, Transmission, And Torque Strut Mounts

CYL	ENG. SIZE	YEAR	LOCATION	DESCRIPTION	QTY	ENGINE	TORQUE STRUT	TRANSMISSION
<b>CADILLAC PASSENGER CAR (continued)</b>								
<b>SEVILLE (continued)</b>								
V8	V8 4.5L 273ci	1988-90	Trans - LH		1			EM-2779 *
			Trans - RH		1			EM-2691
V8	V8 4.6L 281ci	1998-04	RH Front		1	EM-2896*		
		1993-97	RH Front		1	EM-2838*		
		1993-99	Torq Str - Front		1		EM-2781	
			Torq Str - Front		1		EM-2780	
		1998-04	Trans - Center		1			EM-2895 *
		1997	Trans - LH		1			EM-2932 *
		1993-96	Trans - LH		1			EM-2893 *
		1998-04	Trans - LH Front		1			EM-3083 *
		1997	Trans - RH		1			EM-2837 *
		1993-96	Trans - RH		1			EM-2837 *
		1998-04	Trans - Rear		1			EM-3068
V8	V8 4.9L 300ci	1992-93	RH Front		1	EM-2836*		
		1991	RH Front		1	EM-2892*		
		1991-93	Torq Str - Front		1		EM-2662	
		1992-93	Trans - LH		1			EM-2620
		1991	Trans - LH		1			EM-2779 *
		1992-93	Trans - RH		1			EM-2951
V8	V8 5.7L GAS	1978-80	L & R Front		2	EM-2292		
V8	V8 5.7L 350ci	1976-80	Trans	Gas	1			EM-2360 @
V8	V8 5.7L 350ci Diesel	1978-85	L & R Front		2	EM-2629		
		1982-85	Trans - LH		1			EM-2497
		1981	Trans - LH		1			EM-2495
		1982-85	Trans - RH		1			EM-2498
		1981	Trans - RH		1			EM-2494
		1979-80	Trans		1			EM-2360 @
V8	V8 6.0L 368ci	1980-81	LH Front		1	EM-2629		
		1981	Trans - LH		1			EM-2495
			Trans - RH		1			EM-2494
<b>SERIES 75 FLEETWOOD</b>								
V8	V8 6.0L 365ci	1957-58	L & R Front		2	EM-2238		
V8	V8 6.4L 390ci	1959-63	L & R Front		2	EM-2238		
<b>STS</b>								
V6	V6 3.6L	2005-10	L & R Front		2	EM-3149		
V8	V8 4.4L	2006-09	Trans		1			EM-5665
<b>XTS</b>								
V6	V6 3.6L 217ci	2013-14	Trans - Front	FWD	1			EM-3195
			Trans - Rear		1			EM-3196
<b>XLR</b>								
V8	V8 4.4L	2006-09	Trans - L & R		2			EM-5660
	V8 4.6L	2004-09	Trans - L & R		2			EM-5660
<b>CADILLAC SPORT UTILITY</b>								
<b>SRX</b>								
V6	V6 2.8L 2792cc	2010-11	Trans - Center		1			EM-3201
			Trans - Front		1			EM-3197
			Trans - Rear	FWD	1			EM-3196
	V6 3.0L 182ci	2010-11	Trans - Front		1			EM-3195
			Trans - Rear	FWD	1			EM-3196
	V6 3.6L	2004-09	LH Front		1	EM-3149		
V6 3.6L 217ci	2012-13	Trans - Front		1			EM-3195	
		Trans - Rear	FWD	1			EM-3196	
V8	V8 4.6L	2007-09	Trans	AWD	1			EM-5664



# Engine, Transmission, And Torque Strut Mounts

CYL	ENG. SIZE	YEAR	LOCATION	DESCRIPTION	QTY	ENGINE	TORQUE STRUT	TRANSMISSION	
<b>CADILLAC SPORT UTILITY (continued)</b>									
<b>SRX (continued)</b>									
V8	V8 4.6L	2007-09	Trans	RWD	1			EM-5662	
		2004-06	Trans	RWD	1			EM-5662	
<b>ESCALADE</b>									
V8	V8 5.3L 325ci	2002-05	L & R Front		2	EM-2909			
			Trans	AWD & 4WD	1			EM-2638	
			Trans	RWD	1			EM-2817	
	V8 5.7L 350ci	1999-00 2000	L & R Front		2	EM-2637			
			Trans	4WD	1			EM-2638	
			Trans	RWD	1			EM-2817	
	V8 6.0L	2009-13 2009-10	L & R Front	Complete Unit	2	EM-5583			
			Trans	AWD	1			EM-2638	
			Trans	RWD	1			EM-2817	
	V8 6.0L 364ci	2002-06 2002	L & R Front		2	EM-2909			
			Trans	AWD	1			EM-2638	
			Trans	RWD	1			EM-2817	
	V8 6.2L	2007-14	L & R Front	Complete Unit	2	EM-5583			
			Trans	AWD	1			EM-2638	
			Trans	RWD	1			EM-2817	
	<b>ESCALADE ESV</b>								
	V8	V8 6.0L	2009-10	Trans	AWD	1			EM-2638
				Trans	RWD	1			EM-2817
2003-06			Trans	AWD	1			EM-2638	
V8 6.0L 364ci		2003-06	L & R Front		2	EM-2909			
V8 6.2L		2007-14	L & R Front	Complete Unit	2	EM-5583			
			Trans	AWD	1			EM-2638	
		2008-14	Trans	RWD	1		EM-2817		
		2007	Trans	AWD	1		EM-2638		
<b>ESCALADE EXT</b>									
V8	V8 6.0L	2003-06	Trans	AWD	1			EM-2638	
	V8 6.0L 364ci	2003-06	L & R Front		2	EM-2909			
	V8 6.2L	2007-13	L & R Front	Complete Unit	2	EM-5583			
			Trans	AWD	1			EM-2638	
<b>CHEVROLET PASSENGER CAR</b>									
<b>AVEO5</b>									
L4	L4 1.6L	2007-08	Front	Hydraulic Mount	1	EM-3113			
			Torq Str - Front		1		EM-3114		
			Trans		1			EM-3115	
<b>AVEO</b>									
L4	L4 1.6L	2004-08	Torq Str - Front		1		EM-3114		
			Trans		1			EM-3115	
	L4 1.6L 98ci	2004-08	Front	Hydraulic Mount	1	EM-3113			
<b>DEVILLE (MEXICAN VEHICLE)</b>									
V8	V8 4.6L 281ci	1993	LH Front	Hydraulic Mount	1	EM-2893			
			RH Front	Hydraulic Mount	1	EM-2838			
			Torq Str - Front		1		EM-2781		
			Torq Str - Front		1		EM-2780		
			Trans - RH	Hydraulic Mount	1			EM-2837	
	V8 4.9L 300ci	1996-97	RH Front	Hydraulic Mount	1	EM-2836			
			Torq Str - Front		1		EM-2662		
			Trans - LH		1		EM-2620		

# Engine, Transmission, And Torque Strut Mounts

CYL	ENG. SIZE	YEAR	LOCATION	DESCRIPTION	QTY	ENGINE	TORQUE STRUT	TRANSMISSION	
<b>CHEVROLET PASSENGER CAR (continued)</b>									
<b>DEVILLE (MEXICAN VEHICLE) (continued)</b>									
V8	V8 4.9L 300ci	1996-97	Trans - RH		1			EM-2951	
<b>BEL AIR</b>									
L6	L6 3.6L 217ci	1950-51	L & R Front	Manual	2	EM-2053			
		1952	L & R Front		2	EM-2092			
			Lower						
			L & R Front	Upper		2	EM-2091		
		1950-51	Trans - L & R	Manual	2			EM-2057	
	L6 3.8L 230ci	1965	L & R Front			2	EM-2284		
		1963-64	L & R Front			2	EM-2231		
		1963-65	Trans	Auto		1			EM-2378 @
			Trans	Manual		1			EM-2378 @
	L6 3.9L 235ci	1958-62	L & R Front			2	EM-2231		
			1955-57	L & R Front	Large	2	EM-2123		
			L & R Front	Small		2	EM-2122		
			Trans - LH	Auto		1			EM-2127
			Trans - LH	Manual		1			EM-2124
			Trans - RH	Auto		1			EM-2126
			Trans - RH	Manual		1			EM-2125
		1958-62	Trans	Auto		1			EM-2378 @
			Trans	Manual		1			EM-2378 @
		L6 3.9L 236ci	1950-54	L & R Front	Lower		2	EM-2092	
	L & R Front			Upper		2	EM-2091		
	L6 4.1L 250ci	1973	L & R Front			2	EM-2292		
		1965-72	L & R Front			2	EM-2284		
		1973	Trans	Auto		1			EM-2360 @
			Trans	Manual		1			EM-2337
		1965-72	Trans	Auto		1			EM-2360 @
	Trans		Manual		1			EM-2378 @	
	V8	V8 4.3L 265ci	1955-57	L & R Front	Large	2	EM-2123		
L & R Front				Small	2	EM-2122			
Trans - LH				Auto		1			EM-2127
Trans - LH				Manual		1			EM-2124
Trans - RH				Auto		1			EM-2126
Trans - RH				Manual		1			EM-2125
V8 4.4L 267ci		1981	L & R Front			2	EM-2292		
			Trans	Auto		1			EM-2360 @
			Trans	Manual		1			EM-2360 @
V8 4.6L 283ci		1965-67	L & R Front			2	EM-2142		
		1957-64	L & R Front			2	EM-2267		
		1965-67	LH Front	Power Steering Bracket		1	EM-2278		
		1958-67	Trans	Auto; Powerglide		1			EM-2143
Trans			Manual		1			EM-2378 @	
V8 5.0L 305ci		1981	L & R Front			2	EM-2292		
			Trans	Auto		1			EM-2360 @
			Trans	Manual		1			EM-2360 @
V8 5.0L 307ci		1968	L & R Front			2	EM-2142		
			Trans	Auto		1			EM-2378 @
			Trans	Manual		1			EM-2378 @
V8 5.4L 327ci		1962-69	L & R Front			2	EM-2267		
			Trans	Auto		1			EM-2268 @
			Trans	Manual		1			EM-2378 @
V8 5.7L 348ci		1958-60	L & R Front			2	EM-2267		
		1958-61	Trans	Auto; 3 Spd		1			EM-2378 @

# Engine, Transmission, And Torque Strut Mounts

CYL	ENG. SIZE	YEAR	LOCATION	DESCRIPTION	QTY	ENGINE	TORQUE STRUT	TRANSMISSION	
<b>CHEVROLET PASSENGER CAR (continued)</b>									
<b>BEL AIR (continued)</b>									
V8	V8 5.7L 348ci	1958-61	Trans	Auto; Powerglide	1			EM-2143	
			Trans	Manual	1			EM-2378 @	
	V8 5.7L 350ci	1973-75	L & R Front		2	EM-2292			
			1969-72	L & R Front		2	EM-2283		
		1975	Trans	Auto	1			EM-2337	
		1974	Trans	Auto	1			EM-2294	
			Trans	Manual	1			EM-2294	
		1969-73	Trans	Auto; Powerglide	1			EM-2294	
			Trans	Auto; THM400	1			EM-2337	
	Trans		Manual	1			EM-2268 @		
	V8 6.5L 396ci	1966-69	L & R Front		2	EM-2283			
			1969	Trans		1		EM-2295	
		1966-68	Trans	Auto	1			EM-2378 @	
			Trans	Manual	1			EM-2378 @	
	V8 6.6L 400ci	1974-75	L & R Front		2	EM-2292			
			1973	L & R Front		2	EM-2395		
		1972	L & R Front	VIN R	2	EM-2395			
		1970-71	L & R Front		2	EM-2283			
		1974-75	Trans	Auto	1			EM-2294	
			Trans	Auto	1			EM-2337	
		1971-73	Trans	Manual	1			EM-2294	
			1970	Trans	Auto	1		EM-2268 @	
			Trans	Manual	1		EM-2378 @		
	V8 6.6L 402ci	1972	L & R Front	VIN S	2	EM-2283			
	V8 6.7L 409ci	1961-65	L & R Front		2	EM-2285			
			Trans	Auto, 3 Speed	1			EM-2378 @	
			Trans	Auto; Powerglide	1			EM-2143	
			Trans	Manual	1			EM-2378 @	
	V8 7.0L 427ci	1966-69	L & R Front		2	EM-2283			
			1968-69	Trans		1		EM-2295	
		1966-67	Trans	Auto	1			EM-2268 @	
			Trans	Manual	1			EM-2378 @	
	V8 7.4L 454ci	1973-75	L & R Front		2	EM-2395			
			1970-72	L & R Front		2	EM-2283		
		1975	Trans	Auto	1			EM-2294	
		1971-74	Trans	Auto	1			EM-2294	
			Trans	Manual	1			EM-2294	
		1970	Trans	Auto	1			EM-2378 @	
	Trans		Manual	1			EM-2378 @		
	<b>BERETTA</b>								
	L4	L4 2.0L 122ci	1987-89	RH Front		1	EM-2538		
				RH Rear		1	EM-2477		
Torq Str - Rear					1		EM-2528		
Trans					1			EM-2601	
Trans				Manual	1			EM-2601	
L4 2.2L 134ci		1992-96	RH Front	Complete Unit	1	EM-5031'			
			RH Front	Insert	1	EM-2803'			
		1990-91	RH Front		1	EM-2538			
			RH Rear		1	EM-2477			
		1995-96	Torq Str - Front	Auto	1		EM-2814		
			Torq Str - Front	Manual	1		EM-2782		
		1992-94	Torq Str - Front	Auto	1		EM-2782		
		1990-91	Torq Str - Rear		1		EM-2528		
		1992-96	Trans	Auto	1			EM-2715	
		1990-91	Trans		1			EM-2601	
			Trans	Manual	1			EM-2601	

# Engine, Transmission, And Torque Strut Mounts

CYL	ENG. SIZE	YEAR	LOCATION	DESCRIPTION	QTY	ENGINE	TORQUE STRUT	TRANSMISSION	
<b>CHEVROLET PASSENGER CAR (continued)</b>									
<b>BERETTA (continued)</b>									
L4	L4 2.3L 140ci	1992-94	RH Front	Complete Unit	1	EM-5031'			
			RH Front	Insert	1	EM-2803'			
		1990-91	RH Front		1	EM-2859'			
			RH Rear		1	EM-2952			
		1992-94	Torq Str - Front		1		EM-2782		
1990-91	Trans	Manual; Insert	1			EM-2766			
V6	V6 2.8L 173ci	1987-89	RH Front		1	EM-2538			
			RH Rear	Auto	1	EM-2477			
			RH Rear	Manual	1	EM-2708			
			Torq Str - Front	Lateral	1		EM-2492		
			Torq Str - Front	Longitudinal	1		EM-2528		
			Trans		1			EM-2601	
			Trans	Manual	1			EM-2601	
	V6 3.1L 189ci	1994-96	RH Front	Insert	1	EM-2803'			
			1992-93	RH Front	Complete Unit	1	EM-5028'		
				RH Front	Insert	1	EM-2803'		
		1990-91	RH Front		1	EM-2538			
			RH Rear	Auto	1	EM-2477			
			RH Rear	Manual	1	EM-2708			
		1995-96	Torq Str - Front	Auto	1		EM-2814		
		1992-94	Torq Str - Front		1		EM-2782		
		1990-91	Torq Str - Rear		1		EM-2528		
		1992-96	Trans - Front	Manual	1			EM-5033	
			Trans - Rear	Manual	1			EM-5032	
			Trans	Auto	1			EM-2715	
			1990-91	Trans	Auto	1		EM-2601	
1990-91	Trans	Manual	1		EM-2601				
<b>BISCAYNE</b>									
L6	L6 3.8L 230ci	1965	L & R Front		2	EM-2284			
		1963-64	L & R Front		2	EM-2231			
		1963-65	Trans		1			EM-2378 @	
	L6 3.9L 235ci	1958-62	L & R Front		2	EM-2231			
		1958-59	Trans		1			EM-2378 @	
	L6 4.1L 250ci	1965-72	L & R Front		2	EM-2284			
			Trans	Auto	1		EM-2360 @		
Trans			Manual	1		EM-2378 @			
V8	V8 4.6L 283ci	1965-67	L & R Front		2	EM-2142			
		1958-64	L & R Front		2	EM-2267			
		1965-67	LH Front	Power Steering Bracket	1	EM-2278			
		1958-67	Trans	Auto; Powerglide	1		EM-2143		
			Trans	Manual	1		EM-2378 @		
	V8 5.0L 307ci	1968	L & R Front		2	EM-2142			
			Trans		1		EM-2378 @		
	V8 5.4L 327ci	1962-69	L & R Front		2	EM-2267			
			Trans	Auto	1		EM-2268 @		
			Trans	Manual	1		EM-2378 @		
	V8 5.7L 348ci	1958-61	L & R Front		2	EM-2267			
			Trans	Auto; 3 Spd	1		EM-2378 @		
			Trans	Auto; Powerglide	1		EM-2143		
			Trans	Manual	1		EM-2378 @		
	V8 5.7L 350ci	1969-72	L & R Front		2	EM-2283			
			Trans	Auto; Powerglide	1		EM-2294		
			Trans	Auto; THM400	1		EM-2337		
			Trans	Manual	1		EM-2268 @		
V8 6.5L 396ci	1966-69	L & R Front		2	EM-2283				
	1969	Trans		1		EM-2295			

# Engine, Transmission, And Torque Strut Mounts

CYL	ENG. SIZE	YEAR	LOCATION	DESCRIPTION	QTY	ENGINE	TORQUE STRUT	TRANSMISSION	
<b>CHEVROLET PASSENGER CAR (continued)</b>									
<b>BISCAYNE (continued)</b>									
V8	V8 6.5L 396ci	1966-68	Trans		1			EM-2378 @	
	V8 6.6L 400ci	1972	L & R Front		2	EM-2395			
		1970-71	L & R Front		2	EM-2283			
		1971-72	Trans	Auto		1			EM-2337
			Trans	Manual		1			EM-2294
		1970	Trans	Auto		1			EM-2268 @
			Trans	Manual		1			EM-2378 @
	V8 6.6L 402ci	1971-72	L & R Front		2	EM-2283			
			Trans	Auto; THM350	1			EM-2378 @	
			Trans	Auto; THM400	1			EM-2268 @	
	V8 6.7L 409ci	1961-65	L & R Front		2	EM-2285			
			Trans	Auto; 3 Spd	1			EM-2378 @	
			Trans	Auto; Powerglide	1			EM-2143	
			Trans	Manual	1			EM-2378 @	
	V8 7.0L 427ci	1966-69	L & R Front		2	EM-2283			
		1968-69	Trans		1			EM-2295	
		1966-67	Trans	Auto		1			EM-2268 @
			Trans	Manual		1			EM-2378 @
	V8 7.4L 454ci	1970-72	L & R Front		2	EM-2283			
			Trans		1			EM-2294	
Trans				1			EM-2378 @		
<b>BROOKWOOD</b>									
L6	L6 4.1L 250ci	1969	L & R Front		2	EM-2267			
			Trans		1			EM-2378 @	
V8	V8 5.7L 350ci	1969-72	L & R Front		2	EM-2283			
			Trans	Auto; Powerglide	1			EM-2294	
			Trans	Auto; Turbo-Hydramatic	1			EM-2337	
			Trans	Manual	1			EM-2268 @	
	V8 6.6L 400ci	1972	L & R Front	VIN R	1	EM-2395			
			L & R Front		2	EM-2283			
			Trans		1			EM-2337	
			Trans	Auto; THM350 (M38)	1			EM-2378 @	
			Trans	Auto; THM400 (M40)	1			EM-2268 @	
	V8 6.6L 402ci	1972	L & R Front	VIN S	2	EM-2283			
Trans			Auto; THM350 (M38)	1			EM-2378 @		
<b>CAMARO</b>									
L4	L4 2.5L 2474cc	1982-86	LH Front		1	EM-2549			
			RH Front		1	EM-2550			
		1984-86	Trans	Auto		1			EM-2392
			Trans	Manual; 5 Spd		1			EM-2393
		1983	Trans	Auto; 3 Spd		1			EM-2392
			Trans	Manual; 4 Spd		1			EM-2392
			Trans	Manual; 5 Spd		1			EM-2393
		1982	Trans	Auto; 3 Spd		1			EM-2392
			Trans	Manual; 4 Spd		1			EM-2392
		L6	L6 3.8L 230ci	1967-69	L & R Front		2	EM-2142	
Trans	Auto				1			EM-2378 @	
Trans	Manual				1			EM-2378 @	
L6 4.1L 250ci	1973-79		L & R Front		2	EM-2292			
			L & R Front		2	EM-2284			
	1967-70		L & R Front		2	EM-2267			
			Trans	Auto		1			EM-2360 @
	1976-79		Trans	Manual		1			EM-2360 @
			Trans	Auto		1			EM-2378 @
1975	Trans	Manual		1			EM-2337		

# Engine, Transmission, And Torque Strut Mounts

CYL	ENG. SIZE	YEAR	LOCATION	DESCRIPTION	QTY	ENGINE	TORQUE STRUT	TRANSMISSION
<b>CHEVROLET PASSENGER CAR (continued)</b>								
<b>CAMARO (continued)</b>								
L6	L6 4.1L 250ci	1967-74	Trans	Auto	1			EM-2378 @
			Trans	Manual	1			EM-2378 @
V6	V6 2.8L 173ci	1982-89	L & R Front		2	EM-2436		
		1988-89	Trans	Auto	1			EM-2394
		1982-87	Trans		1			EM-2394
	V6 3.1L 189ci	1990-92	L & R Front		2	EM-2436		
			Trans	Auto	1			EM-2394
	V6 3.4L 207ci	1993-95	L & R Front		2	EM-2436		
			Trans		1			EM-2880 *
	V6 3.8L 229ci	1980-81	L & R Front		2	EM-2436		
			Trans		1			EM-2360 @
	V6 3.8L 231ci	1995-02 1980-81 1995-02 1980-81 1995-02 1980-81	LH Front		1	EM-2436		
			LH Front		1	EM-2382		
			RH Front		1	EM-2878		
			RH Front		1	EM-2384		
			Trans		1			EM-2880 *
			Trans	Auto	1			EM-2379
V8	V8 4.4L 267ci	1980-81	L & R Front		2	EM-2292		
			Trans	Auto	1			EM-2360 @
V8 5.0L 302ci	1969-73 1967-68	L & R Front		2	EM-2267			
		L & R Front		2	EM-2285			
		Trans	Auto	1			EM-2268 @	
V8 5.0L 305ci	1976-92 1982-92 1976-81	Trans	Manual	1			EM-2378 @	
		L & R Front		2	EM-2292			
		Trans	Auto	1			EM-2394	
V8 5.0L 307 ci	1969-73	Trans	Auto	1			EM-2360 @	
		Trans	Manual	1			EM-2360 @	
		Trans	Auto	1			EM-2378 @	
V8 5.4L 327ci	1967-69	L & R Front		2	EM-2267			
		Trans	Auto	1			EM-2378 @	
		Trans	Manual	1			EM-2378 @	
V8 5.7L	1998-02	Trans	Manual	1			EM-3125	
V8 5.7L 350ci	1998-02 1987-92 1972-81 1970-71 1967-69 1993-97 1994-97 1993 1987-92 1976-81 1975 1974 1973	L & R Front		2	EM-3064			
		L & R Front		2	EM-2292			
		L & R Front	Hi-Perf Engine	2	EM-2395			
		L & R Front	Std Engine	2	EM-2292			
		L & R Front		2	EM-2267			
		L & R Front		2	EM-2285			
		LH Front		1	EM-3045			
		RH Front		1	EM-3046			
		Trans	Auto	1			EM-2817	
		Trans	Manual	1			EM-2394	
		Trans		1			EM-2394	
		Trans	Auto; 4 Spd	1			EM-2360 @	
		Trans	Manual; 5 Spd	1			EM-2360 @	
		Trans	Auto	1			EM-2360 @	
		Trans	Manual	1			EM-2360 @	
		Trans	Auto	1			EM-2268 @	
		Trans	Manual	1			EM-2378 @	
		Trans	Auto	1			EM-2378 @	
Trans	Manual	1			EM-2378 @			
Trans	Auto	1			EM-2378 @			
Trans	Manual	1			EM-2378 @			

# Engine, Transmission, And Torque Strut Mounts

CYL	ENG. SIZE	YEAR	LOCATION	DESCRIPTION	QTY	ENGINE	TORQUE STRUT	TRANSMISSION	
<b>CHEVROLET PASSENGER CAR (continued)</b>									
<b>CAMARO (continued)</b>									
V8	V8 5.7L 350ci	1967-72	Trans	Auto; THM400	1			EM-2268 @	
			Trans	Manual	1			EM-2378 @	
	V8 6.5L 396ci	1967-70	L & R Front		2	EM-2283			
			Trans	Auto; THM350	1			EM-2378 @	
			Trans	Auto; THM400	1			EM-2268 @	
			Trans	Manual	1			EM-2378 @	
	V8 6.6L 402ci	1970-72	L & R Front		2	EM-2283			
			Trans	Auto; THM350	1			EM-2378 @	
			Trans	Auto; THM400	1			EM-2268 @	
			Trans	Manual	1			EM-2378 @	
<b>CAPRICE</b>									
L6	L6 4.1L 250ci	1977-79	L & R Front		2	EM-2292			
		1967-69	L & R Front		2	EM-2284			
		1977-79	Trans		1			EM-2360 @	
		1967-69	Trans	Auto	1			EM-2360 @	
			Trans	Manual	1			EM-2378 @	
V6	V6 3.8L 229ci	1980-84	L & R Front		2	EM-2436			
		1983-84	Trans		1			EM-2360 @	
		1980-82	Trans		1			EM-2379	
	V6 3.8L 231ci	1980-85	LH Front		1	EM-2382			
			RH Front		1	EM-2384			
			Trans		1			EM-2379	
	V6 4.3L 262ci	1988-93	L & R Front		2	EM-2627			
			L & R Front		2	EM-2436			
			Trans		1			EM-2360 @	
	V8	V8 4.3L 265ci	1994-96	L & R Front		2	EM-2292		
Trans					1			EM-2394	
V8 4.4L 267ci		1980-82	L & R Front		2	EM-2292			
			Trans		1			EM-2360 @	
V8 4.6L 283ci		1966-67	L & R Front		2	EM-2267			
			Trans	Auto; Powerglide	1			EM-2143	
V8 5.0L 305ci		1977-93	L & R Front		2	EM-2292			
			Trans	Auto	1			EM-2360 @	
			1979-84	Trans	Auto	1			EM-2337
			1977-78	Trans		1			EM-2360 @
V8 5.0L 307ci		1986-90	L & R Front		2	EM-2328			
			Trans	Auto	1			EM-2360 @	
V8 5.4L 327ci		1966-69	L & R Front		2	EM-2142			
			Trans		1			EM-2268 @	
V8 5.7L		1986-93	Trans		1			EM-2360 @	
V8 5.7L 350 ci Gas		1980	L & R Front		2	EM-2292			
V8 5.7L 350ci		1986-96	L & R Front		2	EM-2292			
			L & R Front		2	EM-2292			
			L & R Front		2	EM-2283			
			Trans		1			EM-2394	
			Trans	Auto	1			EM-2337	
			Trans	Auto	1			EM-2294	
	Trans		Manual	1			EM-2294		
	Trans		Auto	1			EM-2295		
	Trans		Manual	1			EM-2295		
V8 5.7L 350ci Diesel	1980-85	L & R Front	VIN N	2	EM-2328				
		Trans		1			EM-2360 @		
		Trans	Auto	1			EM-2360 @		
V8 6.5L 396ci	1968-69	L & R Front		2	EM-2283				
		L & R Front		2	EM-2283				

# Engine, Transmission, And Torque Strut Mounts

CYL	ENG. SIZE	YEAR	LOCATION	DESCRIPTION	QTY	ENGINE	TORQUE STRUT	TRANSMISSION	
<b>CHEVROLET PASSENGER CAR (continued)</b>									
<b>CAPRICE (continued)</b>									
V8	V8 6.5L 396ci	1969	Trans	Auto	1			EM-2295	
		1966-68	Trans	Auto	1			EM-2378 @	
	V8 6.6L 400ci	1972-76	L & R Front			2	EM-2395		
		1970-71	L & R Front			2	EM-2283		
		1975-76	Trans	Auto		1			EM-2294
		1971-74	Trans	Auto		1			EM-2294
			Trans	Manual		1			EM-2294
		1970	Trans			1			EM-2378 @
	V8 6.6L 402ci	1971-72	L & R Front			2	EM-2283		
			Trans	Auto; THM350		1			EM-2378 @
			Trans	Auto; THM400		1			EM-2268 @
	V8 7.0L 427ci	1966-69	L & R Front			2	EM-2283		
		1968-69	Trans			1			EM-2295
		1966-67	Trans	Auto		1			EM-2268 @
			Trans	Manual		1			EM-2378 @
	V8 7.4L 454ci	1973-76	L & R Front			2	EM-2395		
		1970-72	L & R Front			2	EM-2283		
		1975-76	Trans	Auto		1			EM-2294
		1971-74	Trans	Auto		1			EM-2294
			Trans	Manual		1			EM-2294
1970		Trans			1			EM-2378 @	
<b>CAVALIER</b>									
L4	L4 1.8L 112ci	1982	RH Front	Auto; w/ Air		1	EM-2474		
			RH Front	Auto; w/o Air		1	EM-2506		
			RH Front	Manual; w/ Air		1	EM-2473		
			RH Front	Manual; w/o Air		1	EM-2524		
			RH Rear			1	EM-2477		
			Torq Str - Rear	Lateral		1		EM-2492	
			Torq Str - Rear	Longitudinal		1		EM-2528	
			Trans	Auto; Insert		1			EM-2720
			Trans	Manual; Insert		1			EM-2720
	L4 2.0L 122ci	1985-89	RH Front			1	EM-2538		
			1983-84	RH Front	Auto; w/ Air		1	EM-2474	
		1985-89	RH Front	Auto; w/o Air		1	EM-2506		
			RH Front	Manual; w/ Air		1	EM-2473		
			RH Front	Manual; w/o Air		1	EM-2524		
			RH Rear			1	EM-2477		
		1983-84	RH Rear			1	EM-2477		
		1987-89	Torq Str - Rear			1		EM-2528	
		1983-86	Torq Str - Rear	Lateral		1		EM-2492	
			Torq Str - Rear	Longitudinal		1		EM-2528	
		1985-89	Trans	Auto		1			EM-2601
			Trans	Manual		1			EM-2601
	1983-84	Trans	Auto; Insert		1			EM-2720	
		Trans	Manual; Insert		1			EM-2720	
	L4 2.2L 134ci	1995-02	RH Front	OHV; Complete Unit		1	EM-5026		
			RH Front	OHV; Insert		1	EM-2803		
		1990-94	RH Front			1	EM-2538		
			RH Rear			1	EM-2477		
		1995-05	Torq Str - Front			1		EM-2798	
		1990-94	Torq Str - Rear			1		EM-2528	
		1995-05	Trans - Front	Manual; Insert		1			EM-2923
			Trans - Rear	Manual; Insert		1			EM-2924
			Trans	Auto		1			EM-2820
		1990-94	Trans	Auto		1			EM-2601
Trans	Manual			1			EM-2601		



# Engine, Transmission, And Torque Strut Mounts

CYL	ENG. SIZE	YEAR	LOCATION	DESCRIPTION	QTY	ENGINE	TORQUE STRUT	TRANSMISSION		
<b>CHEVROLET PASSENGER CAR (continued)</b>										
<b>CAVALIER (continued)</b>										
L4	L4 2.2L 2198cc	2002-05	RH Front	DOHC	1	EM-3128				
		1995	RH Front	Insert	1	EM-2803'				
			Torq Str - Front		1		EM-2798			
			Trans - Front	Manual; Insert	1			EM-2923		
			Trans - Rear	Manual; Insert	1			EM-2924		
	Trans	Auto	1			EM-2820				
	L4 2.4L 146ci	1996-02	RH Front	Insert	1	EM-2803'				
			Torq Str - Front		1		EM-2798			
			Trans - Front	Manual; Insert	1			EM-2923		
			Trans - Rear	Manual; Insert	1			EM-2924		
			Trans	Auto	1			EM-2820		
	V6	V6 2.8L 173ci	1987-89	RH Front		1	EM-2538			
			1985-86	RH Front		1	EM-2538			
			1987-89	RH Rear	Auto	1	EM-2477			
RH Rear				Manual	1	EM-2708				
1985-86			RH Rear		1	EM-2477				
1985-89			Torq Str - Front	Lateral	1		EM-2492			
			Torq Str - Front	Longitudinal	1		EM-2528			
			Trans	Auto	1			EM-2601		
		Trans	Manual	1			EM-2601			
V6 3.1L 189ci		1990-94	RH Front		1	EM-2538				
			RH Rear	Auto	1	EM-2477				
			RH Rear	Manual	1	EM-2708				
			Torq Str - Rear		1		EM-2528			
			Trans	Auto	1			EM-2601		
	Trans		Manual	1			EM-2601			
<b>CELEBRITY</b>										
L4	L4 2.5L 2474cc	1985-90	RH Front		1	EM-2548'				
		1982-84	RH Front		1	EM-2472				
		1982-90	Torq Str - Front		1		EM-2396			
		1985-86	Trans - Front	Manual; 4 Spd	1			EM-2466		
		1982-84	Trans - Front	Auto	1			EM-2467		
		1985-86	Trans - Rear	Manual; 4 Spd	1			EM-2467		
		1987-90	Trans	Auto	1			EM-2543		
		1985-86	Trans	Auto; MD9	1			EM-2543		
		V6	V6 2.8L 173ci	1985-89	Front		1	EM-2548'		
				1982-84	Front		1	EM-2472		
1982-89	Torq Str - Front				1		EM-2396			
1989	Trans - Front			Auto	1			EM-2466		
	Trans - Front			Manual	1			EM-2467		
1984-86	Trans - Front			Auto	1			EM-2466		
	Trans - Front			Manual	1			EM-2467		
1982-83	Trans - Front			Auto	1			EM-2467		
1987-88	Trans - LH Front			Auto	1			EM-2466		
	Trans - LH Front			Manual	1			EM-2762		
	Trans - LH Rear			Auto	1			EM-2467		
	Trans - LH Rear			Manual	1			EM-2467		
1989	Trans - Rear			Auto	1			EM-2467		
1984-86	Trans - Rear		Auto	1			EM-2467			
V6 3.1L 189ci	1990		RH Front		1	EM-2548'				
			Torq Str - Front		1		EM-2396			
			Trans - LH Front		1			EM-2466		
			Trans - LH Rear		1			EM-2467		
			V6 4.3L 260ci Diesel	1982-85	RH Front		1	EM-2472		
		Torq Str - Front				1		EM-2396		
		Trans - Front	Auto	1			EM-2467			

# Engine, Transmission, And Torque Strut Mounts

CYL	ENG. SIZE	YEAR	LOCATION	DESCRIPTION	QTY	ENGINE	TORQUE STRUT	TRANSMISSION	
<b>CHEVROLET PASSENGER CAR (continued)</b>									
<b>CENTURY (MEXICAN VEHICLE)</b>									
L4	L4 2.2L 134ci	1995	RH Front	Hydraulic Mount	1	EM-2548'			
			Torq Str - Front	Complete Unit	1		EM-2866		
			Torq Str - Front	Insert Only	1		EM-2716		
			Trans		1			EM-2543	
V6	V6 2.8L 173ci	1985-90	RH Front	Hydraulic Mount	1	EM-2548'			
			1983-84	RH Front		1	EM-2472		
		1983-90	Torq Str - Front		1		EM-2396		
			Trans - LH Front		1			EM-2466	
			Trans - LH Rear		1			EM-2467	
	V6 3.1L 189ci	1995-96	RH Front	Hydraulic Mount	1	EM-2548'			
			1994	RH Front	Hydraulic Mount	1	EM-2548'		
			1989-93	RH Front	Hydraulic Mount	1	EM-2660'		
		1994	Torq Str - Front		1		EM-2396		
			Torq Str - Front		1		EM-2609		
			Torq Str - Front	Complete Unit	1		EM-2866		
			Torq Str - Front	Insert Only	1		EM-2716		
			Trans - LH Front		1			EM-2466	
			1994	Trans - LH Front		1			EM-2466
			1995-96	Trans - LH Rear		1			EM-2467
			1994	Trans - LH Rear		1			EM-2467
1989-93	Trans		1			EM-2620			
<b>CHEVELLE</b>									
L6	L6 3.2L 194ci	1964-66	L & R Front		2	EM-2284			
			Trans		1			EM-2378 @	
	L6 3.8L 230ci	1965-69	L & R Front		2	EM-2284			
			1964	L & R Front		2	EM-2231		
		1964-69	Trans		1			EM-2378 @	
	L6 4.1L 250ci	1973	L & R Front		2	EM-2292			
			1967-72	L & R Front		2	EM-2284		
		1973	Trans	Auto	1			EM-2360 @	
			Trans	Manual; 3 Spd	1			EM-2337	
			Trans	Manual; 4 Spd	1			EM-2294	
		1967-72	Trans	Auto	1			EM-2360 @	
	Trans		Manual; 3 Spd	1			EM-2378 @		
V8	V8 4.6L 283ci	1964-67	L & R Front		2	EM-2142			
			Trans	Auto	1			EM-2268 @	
			Trans	Manual	1			EM-2378 @	
	V8 5.0L 307ci	1968-73	L & R Front		2	EM-2142			
			Trans	Manual	1			EM-2378 @	
	V8 5.4L 327ci	1964-68	L & R Front		2	EM-2142			
			Trans		1			EM-2378 @	
	V8 5.7L 350ci	1973	L & R Front		2	EM-2292			
			1969-72	L & R Front		2	EM-2283		
		1973	Trans	Auto	1			EM-2360 @	
			Trans	Manual; 3 Spd	1			EM-2360 @	
			Trans	Manual; 4 Spd	1			EM-2294	
		1969-72	Trans		1			EM-2295	
	V8 6.5L 396ci	1968-69	L & R Front		2	EM-2283			
			1966-67	L & R Front		2	EM-2285		
		1966-69	Trans	Auto; THM350	1			EM-2378 @	
			Trans	Auto; THM400	1			EM-2268 @	
	V8 6.6L 400ci	1970-71	Trans	Manual	1			EM-2378 @	
			L & R Front		2	EM-2283			
			Trans	Auto; THM350	1			EM-2378 @	
			Trans	Auto; THM400	1			EM-2295	

# Engine, Transmission, And Torque Strut Mounts

CYL	ENG. SIZE	YEAR	LOCATION	DESCRIPTION	QTY	ENGINE	TORQUE STRUT	TRANSMISSION
<b>CHEVROLET PASSENGER CAR (continued)</b>								
<b>CHEVELLE (continued)</b>								
V8	V8 6.6L 400ci	1970-71	Trans	Manual	1			EM-2378 @
	V8 6.6L 402ci	1972	L & R Front		1	EM-2283		
		1970	L & R Front		2	EM-2283		
		1972	Trans		1			EM-2378 @
			Trans	Auto; THM350		1		EM-2378 @
			Trans	Auto; THM400		1		EM-2268 @
		1970	Trans	Auto; THM350		1		EM-2378 @
	Trans		Auto; THM400		1		EM-2268 @	
	Trans		Manual		1		EM-2378 @	
	V8 7.4L 454ci	1973	L & R Front		2	EM-2395		
		1970-72	L & R Front		2	EM-2283		
		1973	Trans		1			EM-2360 @
		1970-72	Trans		1			EM-2294
<b>CHEVETTE</b>								
L4	L4 1.4L 1393cc	1976-77	L & R Front		2	EM-2381		
			Trans		1		EM-2391	
	L4 1.6L 98ci	1976-87	L & R Front		2	EM-2381		
			Trans		1		EM-2391	
	L4 1.8L 1819cc Diesel	1981-86	L & R Front		2	EM-2381		
Trans				1		EM-2391		
<b>CHEVY (MEXICAN VEHICLE)</b>								
L4	L4 1.4L	1994-96	LH Front	Bushing	1	EM-2656		
		1997-03	Rear	Bushing	1	EM-2657		
	L4 1.6L 98ci	1994-96	LH Front	Bushing	1	EM-2656		
		1997-03	Rear	Bushing	1	EM-2657		
<b>CHEVY C2 (MEXICAN VEHICLE)</b>								
L4	L4 1.6L 98ci	2004-09	Rear	Bushing	1	EM-2657		
<b>CHEVY II / NOVA (PRE 1968)</b>								
L4	L4 2.5L 153ci	1968	Trans	Auto; THM400	1			EM-2268 @
			Trans	Manual	1		EM-2378 @	
		1962-67	Trans	Auto	1		EM-2378 @	
			Trans	Manual	1		EM-2378 @	
L6	L6 3.2L 194ci	1962-67	L & R Front		2	EM-2231		
		1962-66	Trans	Auto	1		EM-2378 @	
			Trans	Manual	1		EM-2378 @	
	L6 3.8L	1968	L & R Front		2	EM-2231		
	L6 3.8L 230ci	1964-66	L & R Front		2	EM-2231		
		1968	Trans	Auto; THM400	1		EM-2268 @	
		1964-66	Trans	Auto	1		EM-2378 @	
	Trans		Manual	1		EM-2378 @		
	L6 4.1L 250ci	1967-68	L & R Front		2	EM-2284		
			Trans	Auto	1		EM-2378 @	
Trans			Manual	1		EM-2378 @		
V8	V8 4.6L 283ci	1963-67	L & R Front		2	EM-2267		
			Trans	Auto	1		EM-2378 @	
			Trans	Manual	1		EM-2378 @	
	V8 5.0L 307ci	1968	L & R Front		2	EM-2142		
			Trans	Auto	1		EM-2268 @	
			Trans	Manual	1		EM-2378 @	
	V8 5.4L 327ci	1965-68	L & R Front		2	EM-2142		
			Trans	Auto	1		EM-2378 @	
			Trans	Manual	1		EM-2378 @	
	V8 5.7L 350ci	1968	L & R Front		2	EM-2283		
Trans				1		EM-2295		

# Engine, Transmission, And Torque Strut Mounts

CYL	ENG. SIZE	YEAR	LOCATION	DESCRIPTION	QTY	ENGINE	TORQUE STRUT	TRANSMISSION
<b>CHEVROLET PASSENGER CAR (continued)</b>								
<b>CHEVY II / NOVA (PRE 1968) (continued)</b>								
V8	V8 6.5L 396ci	1968			1	EM-2285		
			Trans	Auto; THM350	1			EM-2378 @
			Trans	Auto; THM400	1			EM-2268 @
			Trans	Manual	1			EM-2378 @
<b>CITATION</b>								
L4	L4 2.5L 2474cc	1985	RH Front		1	EM-2548'		
		1982-84	RH Front		1	EM-2472		
		1980-81	RH Front		1	EM-2505		
		1980-85	Torq Str - Front		1		EM-2396	
		1985	Trans - Front	Manual	1			EM-2466
		1980-84	Trans - Front	Auto	1			EM-2466
			Trans - Front	Manual	1			EM-2467
		1985	Trans - Rear	Manual	1			EM-2467
		1980-84	Trans - Rear	Auto	1			EM-2467
		1985	Trans	Auto	1			EM-2543
V6	V6 2.8L 173ci	1985	RH Front		1	EM-2548'		
		1982-84	RH Front		1	EM-2472		
		1980-81	RH Front		1	EM-2505		
		1980-85	Torq Str - Front		1		EM-2396	
			Trans - Front	Auto	1			EM-2466
			Trans - Front	Manual	1			EM-2467
			Trans - Rear	Auto	1			EM-2467
<b>CITATION II (MEXICAN VEHICLE)</b>								
V6	V6 2.8L 173ci	1986	RH Front	Hydraulic Mount	1	EM-2548'		
			Torq Str - Front		1		EM-2396	
			Trans - Front	Auto	1			EM-2466
			Trans - Front	Manual	1			EM-2467
			Trans - Rear	Auto	1			EM-2467
<b>CLASSIC</b>								
L4	L4 2.2L	2004-05	Right		1	EM-3129		
	L4 2.2L 2198cc	2004-05	Trans - Center		1			EM-2874
			Trans - LH Front	Complete Unit	1			EM-3070
			Trans - LH Front	Insert Only	1			EM-5422
			Trans - LH Rear	Complete Unit	1			EM-5078
			Trans - LH Rear	Insert Only	1			EM-2875
<b>COBALT</b>								
L4	L4 2.0L	2008-09	RH Front		1	EM-3108		
		2005-07	RH Front	Manual	1	EM-3108		
		2009-10	Trans - Upper		1			EM-3092
		2008	Trans - Upper	Auto	1			EM-3092
		2005-07	Trans - Upper		1			EM-3092
		L4 2.2L	2005-10	RH Front	Auto	1	EM-3109	
	RH Front			Manual	1	EM-3108		
	L4 2.2L 2198cc	2005-10	Trans - Front	Auto	1			EM-3086
			Trans - Rear	Auto	1			EM-3043
	L4 2.4L	2006-08	RH Front	Auto	1	EM-3109		
			RH Front	Manual	1	EM-3108		
	L4 2.4L 145ci	2006-08	Trans - Front	Auto	1			EM-3086
			Trans - Rear	Auto	1			EM-3043
	<b>CORSICA</b>							
L4	L4 2.0L 122ci	1987-89	RH Front		1	EM-2538		
			RH Rear		1	EM-2477		
		1987-88	Torq Str - Rear		1		EM-2528	
		1987-89	Trans	Auto	1			EM-2601

# Engine, Transmission, And Torque Strut Mounts

CYL	ENG. SIZE	YEAR	LOCATION	DESCRIPTION	QTY	ENGINE	TORQUE STRUT	TRANSMISSION			
<b>CHEVROLET PASSENGER CAR (continued)</b>											
<b>CORSICA (continued)</b>											
L4	L4 2.0L 122ci	1987-89	Trans	Manual	1			EM-2601			
	L4 2.2L 134ci	1992-96	RH Front	Insert	1	EM-2803'					
		1990-91	RH Front		1	EM-2538					
			RH Rear		1	EM-2477					
		1995-96	Torq Str - Front	Auto		1		EM-2814			
			Torq Str - Front	Manual		1		EM-2782			
		1992-94	Torq Str - Front	Auto		1		EM-2782			
			Torq Str - Front	Manual		1		EM-2782			
		1990-91	Torq Str - Rear			1		EM-2528			
	1992-96	Trans	Auto		1			EM-2715			
1990-91	Trans	Auto		1			EM-2601				
	Trans	Manual		1			EM-2601				
V6	V6 2.8L 173ci	1987-89	RH Front		1	EM-2538					
			RH Rear	Auto	1	EM-2477					
			RH Rear	Manual	1	EM-2708					
			Torq Str - Rear	Lateral	1		EM-2492				
			Torq Str - Rear	Longitudinal	1		EM-2528				
			Trans	Auto	1			EM-2601			
			Trans	Manual	1			EM-2601			
			V6 3.1L 189ci	1994-96	RH Front	Insert	1	EM-2803'			
	1992-93	RH Front			Complete Unit	1	EM-5028'				
		RH Front			Insert	1	EM-2803'				
	1990-91	RH Front				1	EM-2538				
		RH Rear			Auto	1	EM-2477				
		RH Rear			Manual	1	EM-2708				
	1995-96	Torq Str - Front			Auto	1		EM-2814			
	1992-94	Torq Str - Front			Auto	1		EM-2782			
	1990-91	Torq Str - Rear				1		EM-2528			
	1992-96	Trans - Front			Manual	1			EM-5033		
		Trans - Rear			Manual	1			EM-5032		
		Trans			Auto	1			EM-2715		
	1990-91	Trans			Auto	1			EM-2601		
		Trans			Manual	1			EM-2601		
	<b>CORVETTE</b>										
	L6	L6 3.9L 236ci			1953-55	L & R Front Lower		2	EM-2092		
	V8	V8 4.3L 265ci			1955-56	L & R Front Lower		2	EM-2092		
		V8 4.6L 283ci			1957-60	L & R Front Lower		2	EM-2092		
		V8 5.0L 305ci	1980	L & R Front		2	EM-2292				
Trans					1			EM-2360 @			
V8 5.4L 327ci		1962-68	L & R Front		2	EM-2285					
			Trans	Auto	1			EM-2378 @			
			Trans	Manual	1			EM-2378 @			
V8 5.7L 350ci		1997-04	L & R Front		2	EM-2993'					
		1992-96	L & R Front		2	EM-2902'					
		1984-91	L & R Front		2	EM-2713					
		1969-82	L & R Front		2	EM-2249					
		1982	Trans		1			EM-2268 @			
		1979-81	Trans	Auto	1			EM-2268 @			
			Trans	Manual	1			EM-2378 @			
		1969-78	Trans	Auto	1			EM-2378 @			
	Trans	Manual	1			EM-2378 @					
V8 6.0L	2005-07	L & R Front		2	EM-5674						
		Trans		1			EM-5660				

# Engine, Transmission, And Torque Strut Mounts

CYL	ENG. SIZE	YEAR	LOCATION	DESCRIPTION	QTY	ENGINE	TORQUE STRUT	TRANSMISSION
<b>CHEVROLET PASSENGER CAR (continued)</b>								
<b>CORVETTE (continued)</b>								
V8	V8 6.2L	2009-10	L & R Front	w/ Supercharger	2	EM-5673		
			L & R Front	w/o Supercharger	2	EM-5674		
		2008	L & R Front		2	EM-5674		
		2008-10	Trans		1			EM-5660
	V8 7.0L	2009-10	L & R Front		2	EM-5674		
			L & R Front		2	EM-2993'		
		2006-10	Trans		1			EM-5660
	V8 7.0L 427ci	1966-69	L & R Front		2	EM-2283		
			Trans	Auto	1			EM-2295
		1968-69	Trans	Manual	1			EM-2295
			Trans	Auto	1			EM-2268 @
			Trans	Manual	1			EM-2378 @
	V8 7.4L 454ci	1970-74	L & R Front		2	EM-2249		
			Trans	Auto	1			EM-2268 @
			Trans	Manual	1			EM-2378 @
<b>CRUZE</b>								
L4	L4 1.4L	2011-14	Trans - Front	Auto	1			EM-3202
			Trans - Front	Manual	1			EM-4080
	L4 1.8L 110ci	2011-14	Trans - Center	Auto	1			EM-4129
			Trans - Front	Auto	1			EM-3202
			Trans - Front	Manual	1			EM-4080
<b>CUTLASS (MEXICAN VEHICLE)</b>								
L4	L4 2.2L 134ci	1994-96	RH Front	Hydraulic Mount	1	EM-2548'		
			Torq Str - Front	Complete Unit	1		EM-2866	
			Torq Str - Front	Insert	1		EM-2716	
			Trans		1			EM-2543
V6	V6 2.8L 173ci	1986-89	RH Front	Hydraulic Mount	1	EM-2548'		
			Torq Str - Front		1		EM-2396	
			Trans - LH Front		1			EM-2466
			Trans - LH Rear		1			EM-2467
	V6 3.1L 189ci	1995-96	RH Front	Hydraulic Mount	1	EM-2548'		
			RH Front	Hydraulic Mount	1	EM-2660'		
		1995-96	Torq Str - Front		1		EM-2609	
			Torq Str - Front	Complete Unit	1		EM-2866	
			Torq Str - Front	Insert	1		EM-2716	
			Trans - LH Front		1			EM-2466
1986-93	Trans - LH Rear		1			EM-2467		
	Trans		1			EM-2620		
<b>DEL RAY</b>								
L6	L6 3.9L 235ci	1958	L & R Front		2	EM-2231		
			Trans		1			EM-2378 @
V8	V8 4.6L 283ci	1958	L & R Front		2	EM-2142		
			Trans	Auto; Powerglide	1			EM-2143
			Trans	Manual	1			EM-2378 @
	V8 5.7L 348ci	1958	L & R Front		2	EM-2267		
			Trans	Auto; Powerglide	1			EM-2143
			Trans	Manual	1			EM-2378 @
<b>FIREBIRD TRANS AM (MEXICAN VEHICLE)</b>								
V8	V8 5.7L 350ci	1998-02	L & R Front		2	EM-3064		
		1997	LH Front		1	EM-3045		
			RH Front		1	EM-3046		
			Trans		1			EM-2817

# Engine, Transmission, And Torque Strut Mounts

CYL	ENG. SIZE	YEAR	LOCATION	DESCRIPTION	QTY	ENGINE	TORQUE STRUT	TRANSMISSION
<b>CHEVROLET PASSENGER CAR (continued)</b>								
<b>HHR</b>								
L4	L4 2.0L	2008-10	RH Front	Auto	1	EM-3109		
			RH Front	Manual	1	EM-3108		
		2008-09	Trans - Front	Auto	1			EM-3043
			Trans - Rear	Manual	1			EM-3092
	L4 2.2L	2006-10	RH Front	Auto	1	EM-3109		
			RH Front	Manual	1	EM-3108		
	L4 2.2L 2189cc	2006-10	Trans - Front	Auto	1			EM-3086
			Trans - Rear	Auto	1			EM-3043
	L4 2.4L	2006-10	RH Front	Auto	1	EM-3109		
			RH Front	Manual	1	EM-3108		
Trans - Front			Auto	1			EM-3086	
Trans - Rear			Auto	1			EM-3043	
<b>IMPALA</b>								
L6	L6 3.8L 230ci	1965	L & R Front		2	EM-2284		
		1963-64	L & R Front		2	EM-2231		
		1963-65	Trans		1			EM-2378 @
	L6 3.9L 235ci	1961-62	L & R Front		2	EM-2231		
			L & R Front		2	EM-2231		
			Trans		1			EM-2378 @
	L6 4.1L 250ci	1977-79	L & R Front		2	EM-2292		
			L & R Front		2	EM-2292		
			L & R Front		2	EM-2284		
			Trans		1			EM-2360 @
		1977	Trans		1			EM-2337
			Trans	Auto	1			EM-2360 @
			Trans	Manual; 3 Spd	1			EM-2337
	1965-72	Trans	Manual; 4 Spd	1			EM-2294	
		Trans	Auto	1			EM-2360 @	
Trans		Manual	1			EM-2378 @		
Trans		Manual	1			EM-2378 @		
V6	V6 3.4L 207ci	2000-05	Right		1	EM-2987		
			Torq Str - Front	Brkt to Radiator Support; LH & RH Front	2		EM-2901	
			Torq Str - Front	Complete Unit; LH & RH Front	2		EM-2866	
			Torq Str - Front	Insert; LH & RH Front	2		EM-2716	
			Trans		1			EM-2818
	V6 3.5L	2006-10	Torq Str - Front	Bracket Support to Radiator	2		EM-3104	
			Torq Str - Front	Complete Unit	2		EM-3090	
	V6 3.5L 3490cc	2006-10	Right		1	EM-2987		
			Trans		1			EM-2818
	V6 3.8L	2004-05	Torq Str - Front	Brkt to Radiator Support	1		EM-3088	
			Torq Str - Front	Complete Unit	1		EM-2866	
			Torq Str - Front	Insert; LH & RH Front	2		EM-2716	
	V6 3.8L 229ci	1980-84	L & R Front		2	EM-2436		
			Trans		1			EM-2360 @
			Trans		1			EM-2379
	V6 3.8L 231 ci	2000-05	Trans		1			EM-2712
	V6 3.8L 231ci	1980-85	LH Front		1	EM-2382		
			RH Front		1	EM-2796		
		1980-85	RH Front		1	EM-2384		
			Torq Str - Front	Brkt to Radiator Support	2		EM-3088	
		2000-03	Torq Str - Front	Complete Unit; LH & RH Front	2		EM-2866	
Torq Str - Front			Insert; LH & RH Front	2		EM-2716		
1980-85	Trans		1			EM-2379		
	2006-10	Torq Str - Front	Brkt to Radiator Support	2		EM-3104		
Torq Str - Front		Complete Unit; LH & RH Front	2		EM-3090			

# Engine, Transmission, And Torque Strut Mounts

CYL	ENG. SIZE	YEAR	LOCATION	DESCRIPTION	QTY	ENGINE	TORQUE STRUT	TRANSMISSION	
<b>CHEVROLET PASSENGER CAR (continued)</b>									
<b>IMPALA (continued)</b>									
V6	V6 3.9L 3880cc	2006-10	Front		1	EM-2987			
		2008-09	Trans	exc. Police Cars	1			EM-2712 *	
			Trans	Police Cars	1			EM-5746	
		2006-07	Trans			1		EM-2712 *	
	V6 4.3L 262ci	1985	L & R Front		2	EM-2436			
			Trans		1			EM-2360 @	
V8	V8 4.4L 267ci	1980-82	L & R Front		2	EM-2292			
			Trans		1		EM-2360 @		
	V8 4.6L 283ci	1965-67	L & R Front		2	EM-2142			
			1959-64	L & R Front		2	EM-2267		
				Trans	Auto; Powerglide	1		EM-2143	
			Trans	Manual	1		EM-2378 @		
	V8 5.0L 305ci	1977-85	L & R Front		2	EM-2292			
			1985	Trans	Auto	1		EM-2360 @	
			1979-84	Trans	Auto	1		EM-2337	
			1977-78	Trans	Auto	1		EM-2360 @	
	V8 5.0L 307ci	1968	L & R Front		2	EM-2142			
	V8 5.3L	2006-09	Front		1	EM-3093			
			Rear		1	EM-2990			
			Torq Str - Front	Brkt to Radiator Support	2		EM-3104		
			Torq Str - Front	Complete Unit	2		EM-3090		
			Trans		1		EM-5661		
	V8 5.4L 327ci	1962-69	L & R Front		2	EM-2142			
			Trans	Auto	1		EM-2268 @		
			Trans	Manual	1		EM-2378 @		
	V8 5.7L	1994-96	L & R Front		2	EM-2292			
	V8 5.7L 348ci	1959-61	L & R Front		2	EM-2267			
			Trans	Auto; Powerglide	1		EM-2143		
			Trans	Auto; Turbo-Hydrumatic	1		EM-2378 @		
			Trans	Manual	1		EM-2378 @		
	V8 5.7L 350 ci Gas	1980-85	L & R Front		2	EM-2292			
	V8 5.7L 350ci	1973-79	L & R Front		2	EM-2292			
			1969-72	L & R Front		2	EM-2283		
			1994-96	Trans		1		EM-2394	
			1980-85	Trans	Gas; Auto	1		EM-2360 @	
			1975-79	Trans		1		EM-2337	
			1974	Trans	Auto	1		EM-2294	
				Trans	Manual	1		EM-2294	
1971-73			Trans	Auto; Powerglide	1		EM-2294		
			Trans	Auto; Turbo-Hydrumatic	1		EM-2337		
			Trans	Manual	1		EM-2268 @		
1969-70			Trans	Auto; Powerglide	1		EM-2294		
	Trans	Manual	1		EM-2268 @				
V8 5.7L 350ci Diesel	1980-85	L & R Front	VIN N	2	EM-2328				
		Trans	Auto	1		EM-2360 @			
V8 6.5L 396ci	1968-69	L & R Front		2	EM-2283				
		1969	Trans		1		EM-2295		
		1968	Trans		1		EM-2378 @		
V8 6.6L 400ci	1972-76	L & R Front		2	EM-2395				
		1971	L & R Front		2	EM-2283			
	1975-76	Trans	Auto	1		EM-2294			
	1971-74	Trans	Auto	1		EM-2294			
		Trans	Manual	1		EM-2294			
	1970	Trans	Auto	1		EM-2268 @			
V8 6.6L 402ci	1971-72	L & R Front		2	EM-2283				
		Trans	Auto; THM350 (M38)	1		EM-2378 @			



# Engine, Transmission, And Torque Strut Mounts

CYL	ENG. SIZE	YEAR	LOCATION	DESCRIPTION	QTY	ENGINE	TORQUE STRUT	TRANSMISSION	
<b>CHEVROLET PASSENGER CAR (continued)</b>									
<b>IMPALA (continued)</b>									
V8	V8 6.6L 402ci	1971-72	Trans	Auto; THM400 (M40)	1			EM-2268 @	
	V8 6.7L 409ci	1961-65	L & R Front		2	EM-2285			
			Trans	Auto; 3 Spd	1			EM-2378 @	
			Trans	Auto; Powerglide	1			EM-2143	
			Trans	Manual	1			EM-2378 @	
	V8 7.0L 427ci	1966-69	L & R Front		2	EM-2283			
			Trans		1			EM-2295	
		1966-67	Trans	Auto	1			EM-2268 @	
			Trans	Manual	1			EM-2378 @	
	V8 7.4L 454ci	1973-76	L & R Front		2	EM-2395			
		1970-72	L & R Front		2	EM-2283			
		1975-76	Trans	Auto	1			EM-2294	
		1971-74	Trans	Auto	1			EM-2294	
		1970	Trans	Manual	1			EM-2294	
			1970	Trans		1			EM-2378 @
<b>IMPALA SS</b>									
V6	V8 3.8L	2004-05	Torq Str - Front	Brkt to Radiator Support	1		EM-3088		
			Torq Str - Front	Complete Unit	1		EM-2866		
			Torq Str - Front	Insert; LH & RH Front	2		EM-2716		
V8	V8 5.7L 350ci	1994-96	L & R Front		2	EM-2292			
			Trans		1			EM-2394	
<b>JOY (MEXICAN VEHICLE)</b>									
L4	L4 1.4L	1994-96	LH Front	Bushing	1	EM-2656			
	L4 1.6L 98ci	1994-96	LH Front	Bushing	1	EM-2656			
		1997-08	Rear	Bushing	1	EM-2657			
<b>KINGSWOOD</b>									
V8	V8 5.7L 350ci	1969-72	L & R Front		2	EM-2283			
			Trans	Auto	1			EM-2295	
			Trans	Manual	1			EM-2295	
	V8 6.6L 400ci	1972	L & R Front		2	EM-2395			
			1971-72	L & R Front		2	EM-2283		
			1970-71	L & R Front		2	EM-2283		
			1971-72	Trans	Auto	1			EM-2294
				Trans	Manual	1			EM-2294
	1970	Trans		1			EM-2268 @		
	V8 6.6L 402ci	1971-72	Trans	Auto; THM350	1			EM-2378 @	
			Trans	Auto; THM400	1			EM-2268 @	
			Trans	Manual	1			EM-2378 @	
	V8 7.4L 454ci	1972	L & R Front		2	EM-2395			
		1970	L & R Front		2	EM-2283			
		1972	Trans	Auto	1			EM-2294	
Trans			Manual	1			EM-2294		
1970		Trans	Auto	1			EM-2378 @		
		1970	Trans	Manual	1			EM-2378 @	
<b>LAGUNA</b>									
V8	V8 5.0L 305ci	1976	L & R Front		2	EM-2292			
			Trans	Auto	1			EM-2360 @	
			Trans	Manual	1			EM-2360 @	
	V8 5.7L 350ci	1973-76	L & R Front		2	EM-2292			
			1975-76	Trans		1			EM-2337
			1974	Trans		1			EM-2294
			1973	Trans		1			EM-2268 @
	V8 6.6L 400ci	1974-76	L & R Front		2	EM-2292			
			1976	Trans	Auto, M40 (THM400)	1			EM-2353

# Engine, Transmission, And Torque Strut Mounts

CYL	ENG. SIZE	YEAR	LOCATION	DESCRIPTION	QTY	ENGINE	TORQUE STRUT	TRANSMISSION	
<b>CHEVROLET PASSENGER CAR (continued)</b>									
<b>LAGUNA (continued)</b>									
V8	V8 6.6L 400ci	1976	Trans	Auto; THM350 (M38)	1			EM-2360 @	
			Trans	Manual	1			EM-2378 @	
		1974-75	Trans	Auto; THM350 (M38)	1			EM-2360 @	
			Trans	Auto; THM400 (M40)	1			EM-2353	
			Trans	Manual	1			EM-2378 @	
	V8 7.4L 454ci	1973-74	L & R Front		2	EM-2395			
Trans			Auto	1			EM-2360 @		
Trans			Manual	1			EM-2360 @		
<b>LUMINA</b>									
L4	L4 2.2L 2180cc	1993	RH Front	Insert	1	EM-2803'			
			Torq Str - Front		1		EM-2782		
			Trans	Auto	1			EM-2715	
	L4 2.5L 2474cc	1990-92	Front		1	EM-2660'			
			Torq Str - Front		1		EM-2609		
Trans				1			EM-2620		
V6	V6 3.1L 189ci	1995-01	RH Front		1	EM-2796'			
		1990-94	RH Front		1	EM-2660'			
		1995-01	Torq Str - Front	Brkt to Radiator Support	1			EM-2901	
			Torq Str - Front	Complete Unit	1			EM-2866	
			Torq Str - Front	Insert Only	1			EM-2716	
		1990-94	Torq Str - Front		1		EM-2609		
		1991-93	Trans - Front	Manual	1				EM-2466
			Trans - Rear	Auto	1				EM-2620
		1995-01	Trans		1				EM-2712 *
		1994	Trans	Auto	1				EM-2620
	1991-93	Trans	Manual	1				EM-2467	
	1990	Trans		1				EM-2620	
	V6 3.4L 189ci	1994-97	Trans	Auto	1			EM-2712 *	
	V6 3.4L 207ci	1991-97	RH Front		1	EM-2555'			
			RH Rear		1	EM-2676			
Torq Str - Front			Auto	1		EM-2799			
1992-93			Trans	Auto	1			EM-2620	
1991	Trans	Auto	1				EM-2712 *		
V6 3.8L 231ci	1998-99	RH Front		1	EM-2796'				
		Torq Str - Front	Brkt to Radiator Support	1		EM-2901			
		Torq Str - Front	Complete Unit	1		EM-2866			
		Torq Str - Front	Insert Only	1		EM-2716			
		Trans		1			EM-2712 *		
<b>MALIBU</b>									
L4	L4 2.0L 122ci	2013	Trans - Front		1			EM-3195	
			Trans - Rear		1			EM-3196	
	L4 2.2L	2004-05	2006-08	Front		1	EM-3129		
			2008	Right		1	EM-3117		
		2008	Trans - Center		1			EM-4047	
			Trans - LH Front		1			EM-5659	
			Trans - RH Rear	1st Design - Stamped Part	1			EM-3094	
	L4 2.2L 2198cc	2006-07	Trans - Center		1			EM-4047	
		2004-05	Trans - Center		1			EM-4047	
		2006-07	Trans - LH Front		1			EM-5659	
		2004-05	Trans - LH Front		1			EM-5659	
		2006-07	Trans - LH Rear		1			EM-3094	
		2004-05	Trans - LH Rear		1			EM-3094	
	L4 2.4L 145ci	2009-12	2008	RH Front	Exc. Hybrid	1	EM-3118		
			2008	Right		1	EM-3117		
2009-10		Trans - Center	Auto; 4 Spd	1			EM-4047		

# Engine, Transmission, And Torque Strut Mounts

CYL	ENG. SIZE	YEAR	LOCATION	DESCRIPTION	QTY	ENGINE	TORQUE STRUT	TRANSMISSION
<b>CHEVROLET PASSENGER CAR (continued)</b>								
<b>MALIBU (continued)</b>								
L4	L4 2.4L 145ci	2008	Trans - Center	Auto; 4 Spd	1			EM-4047
		2013	Trans - Front		1			EM-3194
		2011-12	Trans - Front		1			EM-4046
		2009-10	Trans - Front	Auto; 4 Spd	1			EM-4027
			Trans - Front	Auto; 6 Spd	1			EM-4046
		2008	Trans - Front	Auto; 4 Spd	1			EM-4027
			Trans - Front	Auto; 6 Spd	1			EM-4046
		2011-12	Trans - Rear		1			EM-4045
		2009-10	Trans - Rear	Auto; 6 Spd	1			EM-4045
	2008	Trans - Rear	Auto; 4 Spd; 1st Design Stamped Part	1			EM-3094	
		Trans - Rear	Auto; 6 Spd	1			EM-4045	
	L4 2.4L 146ci	1997-99	RH Front		1	EM-2876		
		1999	Trans - Center	Auto	1			EM-2874
		1997-98	Trans - Center	Auto	1			EM-2874
		1999	Trans - LH Front	Auto; Complete Unit	1			EM-5079
			Trans - LH Rear	Auto; Complete Unit	1			EM-5078
			Trans - LH Rear	Auto; Insert	1			EM-2875
	L4 2.5L 153ci	2013	Trans - Rear		1			EM-3196
	L6	L6 3.2L 194ci	1964-66	L & R Front		2	EM-2284	
Trans				Auto	1			EM-2378 @
Trans				Manual	1			EM-2378 @
L6 3.8L 230ci		1964-67	L & R Front		2	EM-2284		
			Trans	Auto	1			EM-2378 @
			Trans	Manual	1			EM-2378 @
L6 4.1L 250ci		1973-77	L & R Front		2	EM-2292		
		1967	L & R Front		2	EM-2284		
		1976-77	Trans	Auto	1			EM-2337
			Trans	Manual; 3 Spd	1			EM-2337
		1973-75	Trans	Auto	1			EM-2360 @
			Trans	Manual; 3 Spd	1			EM-2337
		1967	Trans	Auto	1			EM-2360 @
Trans			Manual	1			EM-2378 @	
V6		V6 3.1L 189ci	2002-03	Front	Made in Lansing, MI	1	EM-2933	
	2001		Front	Made in Lansing, MI	1	EM-2933		
			Front	Made in Oklahoma City	1	EM-2876		
			Front	Made in Oklahoma City	1	EM-2876		
	1997-00		Front	Made in Oklahoma City	1	EM-2876		
	1999-03		Trans - Center		1			EM-2874
	1997-98		Trans - Center	Auto	1			EM-2874
	1999-03		Trans - LH Front	Complete Unit	1			EM-5079
			Trans - LH Rear	Complete Unit	1			EM-5078
		Trans - LH Rear	Insert	1			EM-2875	
	V6 3.3L 200ci	1978-79	LH Front		1	EM-2382		
			RH Front		1	EM-2384		
		1979	Trans	Notchback	1			EM-2393
			Trans	Coupe	1			EM-2353
			Trans		1			EM-2393
		1978	Trans	Auto	1			EM-2353
	Trans		Manual	1			EM-2353	
	V6 3.5L	2004-10	RH Front	Hydraulic Mount	1	EM-3097		
	V6 3.5L 213ci	2008-10	Trans - Center		1			EM-3096
			Trans - Center		1			EM-3096
			Trans - Front		1			EM-4027
Trans - Front				1			EM-5659	
Trans - LH Rear				1			EM-3094	
V6 3.5L 3498cc	2006-07	Trans - Center		1			EM-3096	

# Engine, Transmission, And Torque Strut Mounts

CYL	ENG. SIZE	YEAR	LOCATION	DESCRIPTION	QTY	ENGINE	TORQUE STRUT	TRANSMISSION
<b>CHEVROLET PASSENGER CAR (continued)</b>								
<b>MALIBU (continued)</b>								
V6	V6 3.5L 3498cc	2006-07	Trans - Front		1			EM-5659
			Trans - LH Rear		1			EM-3094
	V6 3.6L	2008-10	Front	Hydraulic Mount	1	EM-3097		
		2008-12	Trans - Center		1			EM-3135
	V6 3.8L 229ci	1980-83	L & R Front		2	EM-2436		
			Trans	Auto	1			EM-2379
	V6 3.8L 231ci	1978-83	LH Front		1	EM-2382		
			RH Front		1	EM-2384		
		1982-83	Trans	Auto	1			EM-2379
		1978-81	Trans	Auto	1			EM-2379
	V6 3.9L	2006-07	Trans	Manual	1			EM-2379
			Front	Hydraulic Mount	1	EM-3097		
			Trans - Center	Hydraulic Mount	1			EM-3112
	V6 4.3L 260ci	1982-83	L & R Front		2	EM-2292		
V6 4.3L 260ci Diesel	1982-83	Trans		1			EM-2360 @	
V8	V8 4.4L 267ci	1979-82	L & R Front		2	EM-2292		
			1982	Trans	Auto	1		EM-2360 @
			1979-81	Trans	Auto	1		EM-2360 @
				Trans	Manual	1		EM-2360 @
	V8 4.6L 283ci	1964-67	L & R Front		2	EM-2142		
			Trans	Auto; Powerglide	1		EM-2143	
			Trans	Manual	1		EM-2378 @	
	V8 5.0L 305ci	1976-83	L & R Front		2	EM-2292		
			1982-83	Trans	Auto	1		EM-2337
		1979-81	Trans	Auto	1		EM-2337	
			Trans	Manual	1		EM-2337	
		1976-78	Trans	Auto	1		EM-2360 @	
	1976-78	Trans	Manual	1		EM-2360 @		
	V8 5.0L 307ci	1973	L & R Front		2	EM-2142		
			Trans	Auto	1		EM-2378 @	
			Trans	Manual	1		EM-2378 @	
	V8 5.4L 327ci	1964-67	L & R Front		2	EM-2142		
			Trans	Auto	1		EM-2378 @	
			Trans	Manual	1		EM-2378 @	
	V8 5.7L 350ci	1973-81	L & R Front		2	EM-2292		
			Trans	Auto	1		EM-2360 @	
			Trans	Manual	1		EM-2360 @	
	V8 5.7L 350ci Diesel	1982-83	L & R Front		2	EM-2328		
			Trans		1		EM-2360 @	
	V8 6.5L 396ci	1966-67	L & R Front		2	EM-2285		
			Trans	Auto	1		EM-2378 @	
			Trans	Manual	1		EM-2378 @	
	V8 6.6L 400ci	1974-76	L & R Front		2	EM-2292		
1976			Trans	Auto	1		EM-2353	
1974-75		Trans	Manual	1		EM-2353		
		Trans	Auto; THM350 (M38)	1		EM-2360 @		
		Trans	Auto; THM400 (M40)	1		EM-2353		
1974-75	Trans	Manual	1		EM-2360 @			
V8 7.4L 454ci	1973-75	L & R Front		2	EM-2395			
		Trans	Auto	1		EM-2360 @		
		Trans	Manual	1		EM-2360 @		
<b>METRO</b>								
L3	L3 1.0L 993cc	1998-00	Front		1	EM-5608		
			Rear		1	EM-8277		
			Torq Str - Rear		1		EM-8658	

# Engine, Transmission, And Torque Strut Mounts

CYL	ENG. SIZE	YEAR	LOCATION	DESCRIPTION	QTY	ENGINE	TORQUE STRUT	TRANSMISSION
<b>CHEVROLET PASSENGER CAR (continued)</b>								
<b>METRO (continued)</b>								
L3	L3 1.0L 993cc	1998-00	Trans		1			EM-8277
L4	L4 1.3L L4 1.3L 1295cc	1998-01	Front		1	EM-5608		
		1992	Front		1	EM-8517		
			Torq Str - Front	Auto	1		EM-8658	
		1998-01	Torq Str - Rear	Auto	1		EM-8658	
			Trans		1			EM-8277
1992	Trans		1			EM-8277		
<b>MONTE CARLO</b>								
V6	V6 3.1L 189ci	1995-99	RH Front		1	EM-2796*		
			Torq Str - Front	Brkt to Radiator Support	1		EM-2901	
			Torq Str - Front	Complete Unit	1		EM-2866	
			Torq Str - Front	Insert	1		EM-2716	
			Trans		1			EM-2712 *
	V6 3.3L 200ci	1978-79	LH Front		1	EM-2382		
			RH Front		1	EM-2384		
			Trans	Auto	1			EM-2353
			Trans	Manual	1			EM-2353
	V6 3.4L 207ci	2000-05	RH Front		1	EM-2796*		
			1995-97	RH Front		1	EM-2555*	
				RH Rear		1	EM-2676	
		2000-05	Torq Str - Front		1		EM-2799	
			Torq Str - Front	Bracket Support to Radiator	1		EM-2901	
			Torq Str - Front	Complete Unit	1		EM-2866	
			Torq Str - Front	Insert Only	1		EM-2716	
				Trans		1		EM-2712 *
	1995-97	Trans		1			EM-2712 *	
	V6 3.5L	2006-07	Torq Str - Front	Brkt to Radiator Support; LH & RH Front	2		EM-3104	
			Torq Str - Front	Complete Unit; LH & RH Front	2		EM-3090	
			Torq Str - Front	Insert Only; LH & RH Front	2		EM-2716	
	V6 3.5L 3490cc	2006-07	Front		1	EM-2987		
			Trans		1			EM-2818
	V6 3.8L 229ci	1980-84	L & R Front		2	EM-2436		
			Trans	Auto	1			EM-2379
	V6 3.8L 231ci	1978-87	LH Front		1	EM-2382		
		1998-05	RH Front		1	EM-2796*		
		1978-87	RH Front		1	EM-2384		
		1998-05	Torq Str - Front	Brkt to Radiator Support	1		EM-3088	
			Torq Str - Front	Complete Unit	1		EM-2866	
			Torq Str - Front	Insert Only	1		EM-2716	
			Trans		1			EM-2712 *
		1982-87	Trans		1			EM-2379
1978-81	Trans	Auto	1			EM-2379		
V6 3.9L	2006	Torq Str - Front		1		EM-3090		
		Torq Str - Front	Bracket Only	2		EM-3104		
V6 3.9L 3880cc	2006	Front		1	EM-2987			
		Trans	Hydraulic Mount	1			EM-2712 *	
		Trans	Solid Mount; Bushing	1			EM-2712S	
V6 4.3L 260ci	1982-83	L & R Front		2	EM-2292			
V6 4.3L 260ci Diesel	1982-83	Trans		1			EM-2360 @	
V6 4.3L 262ci	1985-88	L & R Front		2	EM-2436			
		Trans		1			EM-2379	
V8	V8 4.4L 267ci	1979-82	L & R Front		2	EM-2292		
		Trans	Auto	1			EM-2360 @	
	V8 5.0L 305ci	1976-88	L & R Front		2	EM-2292		
1980-88		Trans	Auto	1			EM-2360 @	

# Engine, Transmission, And Torque Strut Mounts

CYL	ENG. SIZE	YEAR	LOCATION	DESCRIPTION	QTY	ENGINE	TORQUE STRUT	TRANSMISSION
<b>CHEVROLET PASSENGER CAR (continued)</b>								
<b>MONTE CARLO (continued)</b>								
V8	V8 5.0L 305ci	1976-79	Trans	Auto	1			EM-2360 @
			Trans	Manual	1			EM-2360 @
	V8 5.3L	2006-07	Front		1	EM-3093		
			Rear		1	EM-2990		
			Torg Str - Front		1		EM-3090	
			Torg Str - Front	Bracket Only	2		EM-3104	
			Trans		1			EM-5661
	V8 5.7L 350ci	1973-77	L & R Front		2	EM-2292		
			L & R Front		2	EM-2283		
		1970-72	Trans	Auto	1			EM-2360 @
			Trans	Manual	1			EM-2360 @
	V8 5.7L 350ci Diesel	1982-84	Trans		1			EM-2295
			L & R Front		2	EM-2328		
	V8 6.6L 400ci	1974-76	L & R Front		2	EM-2292		
			L & R Front		2	EM-2283		
		1976	Trans	Auto	1			EM-2360 @
			Trans	Manual	1			EM-2360 @
		1974-75	Trans	Auto, M40 (THM400)	1			EM-2353
			Trans	Auto; THM350 (M38)	1			EM-2360 @
		1970-73	Trans	Auto; THM350	1			EM-2378 @
			Trans	Auto; THM400	1			EM-2295
			Trans	Manual	1			EM-2378 @
	V8 6.6L 402ci	1970-72	L & R Front		2	EM-2283		
			Trans	Auto; THM350	1			EM-2378 @
			Trans	Auto; THM400	1			EM-2268 @
			Trans	Manual	1			EM-2378 @
	V8 7.4L 454ci	1973-75	L & R Front		2	EM-2395		
			L & R Front		2	EM-2283		
1973-75		Trans	Auto	1			EM-2360 @	
		Trans	Manual	1			EM-2360 @	
1970-72		Trans		1			EM-2294	
<b>MONZA</b>								
L4	L4 1.6L 98ci	1994-96	LH Front	Mexican Vehicle; Bushing	1	EM-2656		
			Rear	Mexican Vehicle; Bushing	1	EM-2657		
	L4 2.3L 140ci	1975-77	LH Front		1	EM-2357		
			RH Front		1	EM-2356		
		1976-77	Trans	Auto	1			EM-2353
			Trans	Manual	1			EM-2288 @
	1975	Trans	Auto	1			EM-2353	
		Trans	Manual	1			EM-2353	
	L4 2.5L 2474cc	1978-80	L & R Front		2	EM-2446		
			Trans	Auto	1			EM-2531
Trans			Manual	1			EM-2531	
V6	V6 3.2L 196ci	1978-79	L & R Front		2	EM-2436		
			Trans	Auto	1			EM-2379
			Trans	Manual	1			EM-2379
	V6 3.8L 231ci	1978-80	LH Front		1	EM-2382		
			RH Front		1	EM-2384		
		1980	Trans	Auto	1			EM-2353
			Trans	Manual	1			EM-2467
		1978-79	Trans	Auto	1			EM-2353
	Trans		Manual	1			EM-2353	
	V8	V8 4.3L 262ci	1975-76	Trans	Auto	1		
Trans				Manual	1			EM-2353
V8 5.0L 305ci		1976-79	Trans	Auto	1			EM-2353

# Engine, Transmission, And Torque Strut Mounts

CYL	ENG. SIZE	YEAR	LOCATION	DESCRIPTION	QTY	ENGINE	TORQUE STRUT	TRANS-MISSION	
<b>CHEVROLET PASSENGER CAR (continued)</b>									
<b>MONZA (continued)</b>									
V8	V8 5.0L 305ci	1976-79	Trans	Manual	1			EM-2353	
<b>NOVA</b>									
L4	L4 1.6L 1588cc	1985-88	Front		1	EM-2674			
			RH Front		1	EM-8233			
			Rear	Auto	1	EM-2688			
			Trans	Manual	1			EM-8648	
	L4 2.5L	1969	Trans		1			EM-2378 @	
			Trans		1			EM-2268 @	
L4 2.5L 153ci	1970	Trans		1				EM-2378 @	
		Trans	Auto	1				EM-2378 @	
L6	L6 3.8L 230ci	1969-70	L & R Front		2	EM-2284			
			Trans		1			EM-2378 @	
			Trans	Auto	1			EM-2378 @	
	L6 4.1L 250ci	1973-79	L & R Front		2	EM-2292			
			1969-72	L & R Front		2	EM-2284		
		1978-79	Trans	Auto	1				EM-2360 @
			Trans	Manual	1				EM-2360 @
		1976-77	Trans	Auto	1				EM-2337
			Trans	Manual	1				EM-2337
		1973-75	Trans	Auto	1				EM-2360 @
			Trans	Manual	1				EM-2337
	1969-72	Trans	Auto	1				EM-2360 @	
		Trans	Manual	1				EM-2378 @	
	V8	V8 4.3L 262ci	1975	L & R Front		2	EM-2292		
Trans				Auto	1			EM-2360 @	
Trans				Manual	1			EM-2360 @	
V8 5.0L 305ci		1976-79	L & R Front		2	EM-2292			
			Trans	Auto	1			EM-2360 @	
			Trans	Manual	1			EM-2360 @	
V8 5.0L 307ci		1969-73	L & R Front		2	EM-2142			
			Trans	Auto; OEM Design	1			EM-2268 @	
			Trans	Manual; OEM Design	1			EM-2378 @	
V8 5.7L		1969	L & R Front		1	EM-2283			
			Trans	Auto	1			EM-2295	
			Trans	Manual	1			EM-2295	
V8 5.7L 350ci		1973-79	L & R Front		2	EM-2292			
			1972	L & R Front		2	EM-2283		
		1970-71	L & R Front		2	EM-2142			
			Trans	Auto	1				EM-2360 @
		1976-79	Trans	Manual	1				EM-2360 @
			1975	Trans		1			EM-2268 @
1970-74		Trans		1				EM-2378 @	
		Trans	Auto	1				EM-2378 @	
V8 6.5L 396ci	1970	L & R Front		2	EM-2283				
		Trans		1			EM-2378 @		
		Trans	Auto	1			EM-2378 @		
V8 6.6L 402ci	1970	L & R Front		2	EM-2283				
		Trans		1			EM-2378 @		
		Trans	Auto; THM350	1			EM-2378 @		
		Trans	Auto; THM400	1			EM-2268 @		
<b>OPTRA</b>									
L4	L4 2.0L 1998cc	2008-10	Right	Mexican Vehicle	1	EM-5931			
		2004-07	Right		1	EM-5931			
		2006-10	Torq Str - Lower	Mexico	1			EM-5933	
		2004-07	Torq Str - Lower	Canada	1			EM-5933	

# Engine, Transmission, And Torque Strut Mounts

CYL	ENG. SIZE	YEAR	LOCATION	DESCRIPTION	QTY	ENGINE	TORQUE STRUT	TRANSMISSION
<b>CHEVROLET PASSENGER CAR (continued)</b>								
<b>OPTRA (continued)</b>								
L4	L4 2.0L 1998cc	2006-10	Torq Str - Right	Mexico	1		EM-5932	
		2004-07	Torq Str - Right	Canada	1		EM-5932	
<b>ONE-FIFTY SERIES</b>								
V8	V8 4.3L 265ci	1955-57	L & R Front	Large	2	EM-2123		
			L & R Front	Small	2	EM-2122		
			Trans - LH	Auto	1			EM-2127
			Trans - LH	Manual	1			EM-2124
			Trans - RH	Auto	1			EM-2126
			Trans - RH	Manual	1			EM-2125
	V8 4.6L 283ci	1957	L & R Front		2	EM-2142		
			Trans	Auto; Powerglide	1			EM-2143
			Trans	Manual	1			EM-2378 @
<b>POP (MEXICAN VEHICLE)</b>								
L4	L4 1.4L	1994-96	LH Front	Bushing	1	EM-2656		
		1997-08	Rear	Bushing	1	EM-2657		
	L4 1.6L 98ci	1994-96	LH Front	Bushing	1	EM-2656		
		1997-08	Rear	Bushing	1	EM-2657		
<b>PRIZM</b>								
L4	L4 1.8L 110ci	1998-02	Front	Auto	1	EM-8870		
			Front	Manual	1	EM-8966		
			RH Front		1	EM-8850		
			Rear	Auto	1	EM-8851		
			Trans	Auto; 3 Spd	1			EM-8872
			Trans	Auto; 4 Spd	1			EM-8873
			Trans	Manual	1			EM-9474
<b>SPECTRUM</b>								
L4	L4 1.5L	1985-88	Torq Str - Front	Complete Unit	1		EM-8438	
			Torq Str - Front	Insert Only	1		EM-8539	
	L4 1.5L 1471cc	1985-88	Front	Manual; w/o Turbo	1	EM-8442		
			RH Front	w/o Turbo	1	EM-8439		
			Rear		1	EM-8826		
			Trans	Auto	1			EM-8439
			Trans	Manual	1			EM-8439
<b>SPRINT</b>								
L3	L3 1.0L	1991	LH Front	Auto	1	EM-5591		
			LH Front	Manual	1	EM-8517		
		1989-90	LH Front	Auto	1	EM-5591		
			LH Front	Manual	1	EM-8517		
		1991	RH Front	Auto; To 3-1-1991	1	EM-5733		
			RH Front	Manual	1	EM-8514		
		1989-90	RH Front	Auto	1	EM-5733		
			RH Front	Manual	1	EM-8514		
		1991	Rear	Manual	1	EM-8294		
		1989-90	Rear	Manual	1	EM-8294		
		1989-91	Torq Str - Front		1			EM-8521
			Torq Str - Rear	Auto	1			EM-8658
			Torq Str - Rear	Manual	1			EM-8524
	Trans			1			EM-8277	
	L3 1.0L 993cc	1987-88	Front		1	EM-8283		
			Front	Auto	1	EM-8162		
			Front	Manual	1	EM-8489		
			Rear	Manual	1	EM-8294		
			Rear	Manual	1	EM-8294		
1985-88			Torq Str - Front	Manual	1		EM-8521	
1985-88	Torq Str - Rear	Auto	1		EM-8658			



# Engine, Transmission, And Torque Strut Mounts

CYL	ENG. SIZE	YEAR	LOCATION	DESCRIPTION	QTY	ENGINE	TORQUE STRUT	TRANS-MISSION
<b>CHEVROLET PASSENGER CAR (continued)</b>								
<b>SPRINT (continued)</b>								
L3	L3 1.0L 993cc	1985-88	Torg Str - Rear	Manual	1		EM-8524	
		1987-88	Trans	Manual	1			EM-8282
		1985-86	Trans	Manual; 5 Spd	1			EM-8282
<b>SUNFIRE (MEXICAN VEHICLE)</b>								
L4	L4 2.2L 134ci	1994	RH Front	Bushing	1	EM-2803'		
			RH Front	Complete Unit	1	EM-5026'		
			RH Front	Solid Mount; Bushing	1	EM-2803		
			Trans - LH Front	Manual; Bushing	1			EM-2923
			Trans - LH Rear	Manual; Bushing	1			EM-2924
			Trans	Auto, Complete Unit	1			EM-2820
<b>SWING (MEXICAN VEHICLE)</b>								
L4	L4 1.4L	1994-96	LH Front	Bushing	1	EM-2656		
	L4 1.6L 98ci	1994-96	LH Front	Bushing	1	EM-2656		
		1997-08	Rear	Bushing	1	EM-2657		
<b>TOWNSMAN</b>								
V8	V8 5.7L 350ci	1969-72	L & R Front		2	EM-2283		
			Trans	Auto	1			EM-2294
		1971-72	Trans	Manual	1			EM-2294
			Trans	Auto	1			EM-2295
			Trans	Manual	1			EM-2295
	V8 6.6L 400ci	1972	L & R Front	VIN R	2	EM-2395		
			L & R Front		2	EM-2283		
		1971	Trans	Auto	1			EM-2294
			Trans	Manual	1			EM-2294
	V8 6.6L 402ci	1972	L & R Front	VIN S	2	EM-2283		
			Trans	Auto; THM350	1			EM-2378 @
			Trans	Auto; THM400	1			EM-2268 @
			Trans	Manual	1			EM-2378 @
	V8 7.4L 454ci	1972	L & R Front		2	EM-2283		
			L & R Front		2	EM-2283		
		1970	Trans	Auto	1			EM-2294
Trans			Manual	1			EM-2294	
Trans				1			EM-2294	
<b>TWO-TEN SERIES</b>								
V8	V8 4.3L 265ci	1955-57	L & R Front	Large	2	EM-2123		
			L & R Front	Small	2	EM-2122		
			Trans - LH	Auto	1			EM-2127
			Trans - LH	Manual	1			EM-2124
			Trans - RH	Auto	1			EM-2126
			Trans - RH	Manual	1			EM-2125
	V8 4.6L 283ci	1957	L & R Front		2	EM-2142		
			Trans	Auto; Powerglide	1			EM-2143
			Trans	Manual	1			EM-2378 @
<b>VAGONETA (MEXICAN VEHICLE)</b>								
L4	L4 1.6L 98ci	2000-02	Rear	Bushing	1	EM-2657		
<b>VECTRA (MEXICAN VEHICLE)</b>								
L4	L4 2.2L 134ci	2003-05	Front		1	EM-3129		
			Trans - Center		1			EM-2874
			Trans - LH Front	Complete Unit	1			EM-3070
			Trans - LH Front	Insert Only	1			EM-5422
			Trans - LH Rear	Complete Unit	1			EM-5078
			Trans - LH Rear	Insert Only	1			EM-2875

# Engine, Transmission, And Torque Strut Mounts

CYL	ENG. SIZE	YEAR	LOCATION	DESCRIPTION	QTY	ENGINE	TORQUE STRUT	TRANSMISSION	
<b>CHEVROLET PASSENGER CAR (continued)</b>									
<b>VEGA</b>									
L4	L4 2.0L 122ci	1975-76	LH Front		1	EM-2357			
			RH Front		1	EM-2356			
			Trans	Auto	1			EM-2353	
			Trans	Manual	1			EM-2353	
	L4 2.3L 140ci	1971-77	LH Front		1	EM-2357			
			RH Front		1	EM-2356			
		1976-77	Trans	Auto	1			EM-2353	
			Trans	Manual	1			EM-2288 @	
		1971-75	Trans	Auto	1			EM-2353	
			Trans	Manual	1			EM-2353	
<b>CHEVROLET SPORT UTILITY</b>									
<b>AVALANCHE</b>									
V8	V8 5.3L	2007-13	L & R Front	Complete Unit	2	EM-5583			
			Trans	Auto; 4WD	1			EM-2638	
			Trans	Auto; RWD	1			EM-2817	
	V8 6.0L	2007-09	L & R Front	Complete Unit	2	EM-5583			
			Trans	Auto; 4WD	1			EM-2638	
			Trans	Auto; RWD	1			EM-2817	
<b>AVALANCHE 1500</b>									
V8	V8 5.3L 323ci	2002-06	L & R Front	w/Heat Shield	2	EM-5423			
			L & R Front	w/o Heat Shield	2	EM-2909			
			Trans	4WD	1			EM-2638	
			Trans	RWD, Base model, LS, LT and Z66	1			EM-2817	
			Trans	RWD, Z71	1			EM-2638	
<b>AVALANCHE 2500</b>									
V8	V8 8.1L	2002-06	L & R Front		2	EM-5353			
	V8 8.1L 496ci	2006	Trans	4WD	1			EM-2638	
		2002-05	Trans		1			EM-2638	
<b>EQUINOX</b>									
V6	V6 3.4L	2005-09	RH Front		1	EM-3110			
	V6 3.4L 207ci	2007-09	Trans - Front		1			EM-3082	
		2005-06	Trans - Front		1			EM-3082	
		2007-09	Trans - Rear		1			EM-3069	
		2005-06	Trans - Rear		1			EM-3069	
			Trans - Upper		1			EM-5475	
	V6 3.6L 217ci	2008-09	Front		1	EM-3154			
			Rear		1	EM-3154			
			Right		1	EM-4078			
			Trans		1			EM-4079	
<b>K5 BLAZER</b>									
L6	L6 4.1L	1982	Trans - Lower	Auto; 4WD	2			EM-2108	
			Trans - Lower	Manual; 4WD	2			EM-2108	
		1977-81	Trans - Lower	Auto; 4WD	2			EM-2108	
			Trans - Lower	Manual; 4WD	2			EM-2108	
		1975-76	Trans - Lower	Auto; 4WD	2			EM-2108	
			Trans - Lower	Manual; 4WD	2			EM-2108	
		1982	Trans - Upper	Auto; 4WD	2			EM-2107	
			Trans - Upper	Manual; 4WD	2			EM-2378 @	
		1977-81	Trans - Upper	Auto; 4WD	2			EM-2107	
			Trans - Upper	Manual; 4WD	2			EM-2378 @	
		1975-76	Trans - Upper	Auto; 4WD	2			EM-2107	
			Trans - Upper	Manual; 4WD	2			EM-2378 @	
		1982	Trans	Auto; THM350C (MV4)	1			EM-2268 @	
					THM700-R4/4L60 (MD8); RW				

# Engine, Transmission, And Torque Strut Mounts

CYL	ENG. SIZE	YEAR	LOCATION	DESCRIPTION	QTY	ENGINE	TORQUE STRUT	TRANSMISSION
<b>CHEVROLET SPORT UTILITY (continued)</b>								
<b>K5 BLAZER (continued)</b>								
L6	L6 4.1L	1982	Trans	Auto; THM400 (M40); RWD	1			EM-2378 @
		1977-81	Trans	Auto; THM350 (M38); RWD	1			EM-2268 @
			Trans	Auto; THM400 (M40); RWD	1			EM-2378 @
		1975-76	Trans	Auto; THM350 (M38); RWD	1			EM-2378 @
V8	V8 5.7L	1983-84	Trans - Lower	Auto; 4WD	2			EM-2108
			Trans - Lower	Manual; 4WD	2			EM-2108
			Trans - Upper	Auto; 4WD	2			EM-2107
			Trans - Upper	Manual; 4WD	2			EM-2392
		1985-86	Trans	Auto	1			EM-2638
			Trans	Manual	1			EM-2638
		1983-84	Trans	Auto; RWD	1			EM-2392
		V8 6.2L	1982-84	Trans - Lower	Auto; 4WD	2		
	Trans - Lower			Manual; 4WD	2			EM-2108
	Trans - Upper			Auto; 4WD	2			EM-2107
	Trans			Auto	1			EM-2638
	1985-86	Trans	Manual	1			EM-2638	
		Trans - Lower	Auto; 4WD	2			EM-2108	
	V8 6.6L	1975-79	Trans - Lower	Manual; 4WD	2			EM-2108
			Trans - Upper	Auto; 4WD	2			EM-2107
			Trans - Lower	Auto; 4WD	2			EM-2108
V8 7.4L	1976-78	Trans - Lower	Manual; 4WD	2			EM-2108	
		Trans - Upper	Auto; 4WD	2			EM-2107	
		Trans - Lower	Auto; 4WD	2			EM-2108	
<b>BLAZER</b>								
L6	L6 4.1L 250ci	1973-82	L & R Front		2	EM-2292		
		1969-72	L & R Front		2	EM-2282		
		1973-74	Trans - L & R Lower	4WD 4WD	2			EM-2108
			Trans - L & R Lower	4WD 4WD	2			EM-2108
		1973-74	Trans - L & R Upper	4WD 4WD	2			EM-2107
			Trans - L & R Upper	4WD 4WD	2			EM-2107
		1973-74	Trans	Auto; THM350 (M38) THM350C (MV4); RWD	1			EM-2378 @
			Trans	Auto; THM400 (M40); RWD	1			EM-2268 @
			Trans	Manual; RWD	1			EM-2378 @
		1969-72	Trans	Auto; THM350 (M38) THM350C (MV4); RWD	1			EM-2378 @
			Trans	Manual; RWD	1			EM-2378 @
		L6 4.8L 292ci	1973	L & R Front		2	EM-2292	
	L & R Front				2	EM-2282		
	1973		Trans - L & R Lower	4WD 4WD	2			EM-2108
			Trans - L & R Lower	4WD 4WD	2			EM-2108
	1973		Trans - L & R Upper	4WD 4WD	2			EM-2107
			Trans - L & R Upper	4WD 4WD	2			EM-2107
	1973		Trans	Auto; THM350 (M38); RWD	1			EM-2378 @
			Trans	Auto; THM400 (M40); RWD	1			EM-2268 @
			Trans	Manual; RWD	1			EM-2378 @
	1970		Trans	Auto; THM350 (M38); RWD	1			EM-2378 @
			Trans	Auto; THM400 (M40); RWD	1			EM-2268 @
			Trans	Manual; RWD	1			EM-2378 @

# Engine, Transmission, And Torque Strut Mounts

CYL	ENG. SIZE	YEAR	LOCATION	DESCRIPTION	QTY	ENGINE	TORQUE STRUT	TRANSMISSION
<b>CHEVROLET SPORT UTILITY (continued)</b>								
<b>BLAZER (continued)</b>								
V6	V6 4.3L 262ci	1996-05	L & R Front		2	EM-2802		
		1995	L & R Front	4WD	2	EM-2802		
			L & R Front	RWD	2	EM-2627		
			Trans	Auto; 4WD	1			EM-2638
		2002-05	Trans	Auto; RWD	1			EM-2394
			Trans	Manual; 4WD	1			EM-2638
			Trans	Manual; RWD	1			EM-2394
			Trans	Auto; 4WD	1			EM-2638
		1995-01	Trans	Auto; RWD	1			EM-2394
			Trans	Manual; 4WD	1			EM-2638
Trans	Manual; RWD		1			EM-2394		
Trans	Manual; RWD		1			EM-2394		
V8	V8 5.0L 305ci	1977-87	L & R Front		2	EM-2292		
		1987	Trans - L & R Lower	4WD 4WD	2			EM-2108
			Trans - L & R Upper	4WD 4WD	2			EM-2107
		Trans	Auto; THM180C (MD2) THM400 (MD38); 4WD	1			EM-2638	
	V8 5.0L 307ci	1973	L & R Front		2	EM-2292		
		1969-72	L & R Front		2	EM-2282		
		1969-73	Trans - L & R Lower	4WD 4WD	2			EM-2108
			Trans - L & R Upper	4WD 4WD	2			EM-2107
		Trans	Auto; Powerglide	1			EM-2378 @	
		Trans	Auto; THM350 (M38) THM350C (MV4); RWD	1			EM-2378 @	
		Trans	Auto; THM400 (M40); RWD	1			EM-2268 @	
		Trans	Manual; RWD	1			EM-2378 @	
	V8 5.7L 350ci	1990-94	L & R Front	4WD	2	EM-2637		
			L & R Front	RWD	2	EM-2621		
		1988-89	L & R Front	4WD	2	EM-2637		
		1973-87	L & R Front		2	EM-2292		
1969-72		L & R Front		2	EM-2282			
		Trans - L & R Lower	4WD 4WD	2			EM-2108	
1969-74		Trans - L & R Upper	4WD 4WD	2			EM-2107	
		Trans	RWD	1			EM-2360 @	
		Trans	Auto; 4WD	1			EM-2638	
1990-91		Trans	Manual; 4WD	1			EM-2638	
		Trans	Auto; 4WD	1			EM-2638	
		Trans	Auto; RWD	1			EM-2392	
1987-89		Trans	Manual; 4WD	1			EM-2638	
		Trans	Manual; RWD	1			EM-2392	
1987-89		Trans	Auto; 4WD	1			EM-2638	
		Trans	Manual; 4WD	1			EM-2638	
1969-74		Trans	Auto; THM350 (M38); RWD	1			EM-2378 @	
		Trans	Auto; THM400 (M40); RWD	1			EM-2268 @	
	Trans	Manual; RWD	1			EM-2378 @		
V8 6.2L 379ci Diesel	1988-91	L & R Front		2	EM-2637			
	1984-87	L & R Front		2	EM-2395			
	1982-83	L & R Front		2	EM-2292			
	1987-91	Trans	Auto; 4WD	1			EM-2638	
Trans		Manual; 4WD	1			EM-2638		
V8 6.5L 395ci Diesel	1994	L & R Front	4WD	2	EM-2637			
		Trans	Auto; 4WD	1			EM-2638	

# Engine, Transmission, And Torque Strut Mounts

CYL	ENG. SIZE	YEAR	LOCATION	DESCRIPTION	QTY	ENGINE	TORQUE STRUT	TRANSMISSION	
<b>CHEVROLET SPORT UTILITY (continued)</b>									
<b>BLAZER (continued)</b>									
V8	V8 6.5L 395ci Diesel	1994	Trans	Manual; 4WD	1			EM-2638	
	V8 6.6L 400ci	1975-79	L & R Front		2	EM-2292			
	V8 7.4L 454ci	1976-78	L & R Front		2	EM-2292			
		1973	L & R Front		2	EM-2395			
			Trans - L & R Lower		2			EM-2108	
Trans - L & R Upper		2				EM-2107			
<b>C10/C1500 SUBURBAN</b>									
L6	L6 4.1L 250ci	1973-80	L & R Front		2	EM-2292			
		1968-72	L & R Front		2	EM-2282			
		1973-80	Trans	Auto; THM350 (M38) THM350C (MV4); RWD	1			EM-2378 @	
			Trans	Auto; THM400-475 (M40)	1			EM-2268 @	
			Trans	Manual	1			EM-2378 @	
	1968-72	Trans		1			EM-2378 @		
	L6 4.8L 292ci	1973-74	L & R Front		2	EM-2292			
		1968-71	L & R Front		2	EM-2282			
		1973-74	Trans	Auto; THM350 (M38)	1			EM-2378 @	
			Trans	Auto; THM400-475 (M40)	1			EM-2268 @	
			Trans	Manual	1			EM-2378 @	
		1968-71	Trans	Auto; THM350 (M38)	1			EM-2378 @	
			Trans	Manual	1			EM-2378 @	
		V8	V8 5.0L 305ci	1976-86	L & R Front		2	EM-2292	
	1985-86			Trans	Auto; THM400-475 (M40)	1			EM-2513
Trans				Auto; THM700R4 (MD8)	1			EM-2392	
1982-84	Trans			Auto; THM400-475 (M40)	1			EM-2513	
	Trans			Auto; THM700R4 (MD8)	1			EM-2392	
	Trans			Manual	1			EM-2392	
1976-81	Trans			Auto; THM350 (M38) THM350C (MV4)	1			EM-2378 @	
	Trans			Auto; THM400-475 (M40)	1			EM-2268 @	
	Trans			Manual	1			EM-2378 @	
V8 5.0L 307ci	1973		L & R Front		2	EM-2292			
	1968-72		L & R Front		2	EM-2282			
	1968-73		Trans	Auto; Powerglide	1			EM-2378 @	
			Trans	Auto; THM350 (M38)	1			EM-2378 @	
			Trans	Auto; THM400-475 (M40)	1			EM-2268 @	
Trans	Manual		1			EM-2378 @			
V8 5.4L 327ci	1968		L & R Front		2	EM-2282			
	Trans		Auto; THM350 (M38)	1			EM-2378 @		
	Trans		Auto; THM400-475 (M40)	1			EM-2268 @		
Trans	Manual	1			EM-2378 @				
V8 5.7L 350ci	1992-99	L & R Front		2	EM-2621				
	1973-86	L & R Front		2	EM-2292				
	1969-72	L & R Front		2	EM-2282				
	1994-99	Trans		1			EM-2817		
	1992-93	Trans		1			EM-2360 @		
	1985-86	Trans	Auto; THM350C (MV4) THM700R4 (MD8)	1			EM-2392		
		Trans	Auto; THM400 (M40)	1			EM-2513		
	1982-84	Trans	Auto; THM350C (MV4) THM700R4 (MD8)	1			EM-2392		
Trans	Auto; THM400 (M40)	1			EM-2513				
Trans	Manual	1			EM-2392				

# Engine, Transmission, And Torque Strut Mounts

CYL	ENG. SIZE	YEAR	LOCATION	DESCRIPTION	QTY	ENGINE	TORQUE STRUT	TRANSMISSION	
<b>CHEVROLET SPORT UTILITY (continued)</b>									
<b>C10/C1500 SUBURBAN (continued)</b>									
V8	V8 5.7L 350ci	1969-81	Trans	Auto; THM350 (M38)	1			EM-2378 @	
			Trans	Auto; THM400-475 (M40)	1			EM-2268 @	
			Trans	Manual	1			EM-2378 @	
	V8 6.2L 379ci Diesel	1984-86 1982-83 1983-86 1982	L & R Front		2	EM-2395			
			L & R Front		2	EM-2292			
			Trans	Auto; THM400-475 (M40)	1			EM-2515	
			Trans	Auto; THM700R4 (MD8)	1			EM-2393	
			Trans	Auto; THM700R4 (MD8)	1			EM-2392	
	V8 6.5L 395ci Diesel	1995-99	L & R Front		2	EM-2621			
			Trans		1			EM-2817	
	V8 6.6L 402ci	1970-72	L & R Front		2	EM-2283			
			Trans	Auto; THM350 (M38)	1			EM-2378 @	
			Trans	Auto; THM400-475 (M40)	1			EM-2268 @	
			Trans	Manual	1			EM-2378 @	
	V8 7.4L 454ci	1973-80	L & R Front		2	EM-2395			
			Trans	Auto; THM350 (M38)	1			EM-2378 @	
			Trans	Auto; THM400-475 (M40)	1			EM-2268 @	
			Trans	Manual	1			EM-2378 @	
<b>C20/C2500 SUBURBAN</b>									
L6	L6 4.1L 250ci	1973-74 1968-72 1973-74 1968-72	L & R Front		2	EM-2292			
			L & R Front		2	EM-2282			
			Trans	Auto; THM350 (M38) THM350C (MV4)	1			EM-2378 @	
			Trans	Auto; THM400-475 (M40)	1			EM-2268 @	
			Trans	Manual	1			EM-2378 @	
			Trans	Auto; THM350 (M38) THM350C (MV4)	1			EM-2378 @	
	L6 4.8L 292ci	1973-82 1968-72 1982 1968-81	L & R Front		2	EM-2292			
			L & R Front		2	EM-2282			
			Trans	Auto; THM350C (MV4)	1			EM-2378 @	
			Trans	Auto; THM400 (M40)	1			EM-2513	
			Trans	Auto; THM700-R4/4L60 (MD8)	1			EM-2268 @	
			Trans	Manual	1			EM-2378 @	
			Trans	Auto; THM350 (M38)	1			EM-2378 @	
			Trans	Auto; THM400-475 (M40)	1			EM-2268 @	
			Trans	Manual	1			EM-2378 @	
	V8	V8 5.0L 305ci	1976-86 1985-86 1982-84 1976-81	L & R Front		2	EM-2292		
				Trans	Auto; THM350C; THM400	1			EM-2513
				Trans	Auto; THM700-R4/4L60 (MD8)	1			EM-2392
Trans				Auto; THM400-475 (M40)	1			EM-2513	
Trans				Auto; THM700R4 (MD8)	1			EM-2392	
Trans				Manual	1			EM-2392	
Trans				Auto; THM350 (M38) THM350C (MV4); RWD	1			EM-2378 @	
Trans				Auto; THM400-475 (M40)	1			EM-2268 @	
Trans				Manual	1			EM-2378 @	
V8 5.0L 307ci		1973 1968-72 1968-73	L & R Front		2	EM-2292			
			L & R Front		2	EM-2282			
			Trans	Auto; Powerglide	1			EM-2378 @	
			Trans	Auto; THM400-475 (M40)	1			EM-2268 @	
V8 5.4L 327ci		1968	L & R Front		2	EM-2282			
			Trans	Auto; THM350 (M38)	1			EM-2378 @	
			Trans	Auto; THM400-475 (M40)	1			EM-2268 @	
			Trans	Manual	1			EM-2378 @	

# Engine, Transmission, And Torque Strut Mounts

CYL	ENG. SIZE	YEAR	LOCATION	DESCRIPTION	QTY	ENGINE	TORQUE STRUT	TRANSMISSION	
<b>CHEVROLET SPORT UTILITY (continued)</b>									
<b>C20/C2500 SUBURBAN (continued)</b>									
V8	V8 5.4L 327ci	1968	Trans	Manual	1			EM-2378 @	
	V8 5.7L 350ci	1992-99	L & R Front		2	EM-2621			
		1973-86	L & R Front		2	EM-2292			
		1969-72	L & R Front		2	EM-2282			
		1994-99	Trans		1			EM-2817	
		1992-93	Trans		1			EM-2360 @	
		1985-86	Trans	Auto; THM350C (MV4) THM700-R4/4L60 (MD8)		1			EM-2392
			Trans	Auto; THM400 (M40)		1			EM-2513
		1982-84	Trans	Auto; THM350C (MV4) THM700-R4/4L60 (MD8)		1			EM-2392
			Trans	Auto; THM400 (M40)		1			EM-2513
			Trans	Manual		1			EM-2392
		1969-81	Trans	Auto; THM350 (M38)		1			EM-2378 @
			Trans	Auto; THM400-475 (M40)		1			EM-2268 @
			Trans	Manual		1			EM-2378 @
	V8 6.2L 379ci Diesel	1984-86	L & R Front		2	EM-2395			
		1982-83	L & R Front		2	EM-2292			
		1983-86	Trans	Auto; THM400-475 (M40)		1			EM-2515
			Trans	Auto; THM700R4 (MD8)		1			EM-2393
	1982	Trans	Auto; THM700R4 (MD8)		1			EM-2392	
	V8 6.5L 395ci Diesel	1994-99	L & R Front		2	EM-2621			
			Trans		1			EM-2817	
	V8 6.6L 400ci	1976-80	L & R Front		2	EM-2292			
			Trans		1			EM-2378 @	
	V8 6.6L 402ci	1970-72	L & R Front		2	EM-2283			
			Trans	Auto; THM350 (M38)		1			EM-2378 @
			Trans	Auto; THM400-475 (M40)		1			EM-2268 @
			Trans	Manual		1			EM-2378 @
	V8 7.4L 454ci	1973-86	L & R Front		2	EM-2395			
		1996-99	Trans		1			EM-2817	
		1992-95	Trans		1			EM-2360 @	
		1986	Trans	Auto; THM400 (M40)		1			EM-2513
			Trans	Auto; THM700-R4/4L60 (MD8)		1			EM-2392
		1985	Trans	Auto; THM400 (M40)		1			EM-2513
			Trans	Auto; THM700-R4/4L60 (MD8)		1			EM-2392
		1982-84	Trans	Auto; THM350C (MV4)		1			EM-2378 @
			Trans	Auto; THM400 (M40)		1			EM-2513
			Trans	Auto; THM700-R4/4L60 (MD8)		1			EM-2392
			Trans	Manual		1			EM-2392
		1973-81	Trans	Auto; THM350 (M38)		1			EM-2378 @
			Trans	Auto; THM400-475 (M40)		1			EM-2268 @
Trans			Manual		1			EM-2378 @	
<b>K10/K1500 SUBURBAN</b>									
L6	L6 4.1L 250ci	1973-80	L & R Front		2	EM-2292			
		1968-72	L & R Front		2	EM-2282			
		1968-80	Trans - Lower	Auto		2			EM-2108
			Trans - Lower	Manual		2			EM-2108
			Trans - Upper	Auto		2			EM-2107
V8	V8 5.0L 250ci	1976-84	Trans - Lower	Auto		2		EM-2108	
			Trans - Lower	Manual		2		EM-2108	
			Trans - Upper	Auto		2		EM-2107	
	V8 5.0L 305ci	1976-86	L & R Front		2	EM-2292			
			1985-86	Trans	Auto		1		EM-2638
	V8 5.0L 307ci	1973	L & R Front		2	EM-2292			
			1968-72	L & R Front		2	EM-2282		

# Engine, Transmission, And Torque Strut Mounts

CYL	ENG. SIZE	YEAR	LOCATION	DESCRIPTION	QTY	ENGINE	TORQUE STRUT	TRANSMISSION
<b>CHEVROLET SPORT UTILITY (continued)</b>								
<b>K10/K1500 SUBURBAN (continued)</b>								
V8	V8 5.0L 307ci	1968-73	Trans - L & R Lower		2			EM-2108
			Trans - L & R Upper		2			EM-2107
	V8 5.4L 327ci	1968	L & R Front		2	EM-2282		
			Trans - L & R Lower		2			EM-2108
			Trans - L & R Upper		2			EM-2107
	V8 5.7L 350ci	1992-99	L & R Front		2	EM-2637		
		1973-86	L & R Front		2	EM-2292		
		1969-72	L & R Front		2	EM-2282		
		1969-84	Trans - Lower	Auto	2			EM-2108
			Trans - Lower	Manual	2			EM-2108
			Trans - Upper	Auto	2			EM-2107
		1992-99	Trans	Auto	1			EM-2638
	1985-86	Trans	Auto	1			EM-2638	
	V8 6.2L 379ci Diesel	1984-86	L & R Front		2	EM-2395		
		1982-83	L & R Front		2	EM-2292		
		1982-84	Trans - Lower	Auto	2			EM-2108
			Trans - Lower	Manual	2			EM-2108
			Trans - Upper	Auto	2			EM-2107
	1985-86	Trans	Auto	1			EM-2638	
	V8 6.5L 395ci Diesel	1995-99	L & R Front		2	EM-2637		
Trans			Auto	1			EM-2638	
V8 6.5L 396ci	1968-69	L & R Front		2	EM-2283			
		Trans		1			EM-2378 @	
V8 6.6L 400ci	1975-79	L & R Front		2	EM-2292			
		Trans - Lower	Auto	2			EM-2108	
		Trans - Lower	Manual	2			EM-2108	
		Trans - Upper	Auto	2			EM-2107	
V8 6.6L 402ci	1970-72	L & R Front		2	EM-2283			
		Trans		1			EM-2378 @	
<b>K20/K2500 SUBURBAN</b>								
L6	L6 4.1L 250ci	1973-74	L & R Front		2	EM-2292		
		1968-72	L & R Front		2	EM-2282		
	L6 4.8L 292ci	1973-82	L & R Front		2	EM-2292		
		1968-72	L & R Front		2	EM-2282		
		1968-82	Trans - Lower	Auto	2			EM-2108
Trans - Lower	Manual		2			EM-2108		
Trans - Upper	Auto		2			EM-2107		
V8	V8 5.0L 305ci	1985-86	L & R Front		2	EM-2292		
		1977-78	L & R Front		2	EM-2292		
			Trans - Lower	Auto	2			EM-2108
			Trans - Lower	Manual	2			EM-2108
			Trans - Upper	Auto	2			EM-2107
	1985-86	Trans	Auto	1			EM-2638	
	V8 5.0L 307ci	1973	L & R Front		2	EM-2292		
		1968-72	L & R Front		2	EM-2282		
		1968-73	Trans - L & R Lower		2			EM-2108
			Trans - L & R Upper		2			EM-2107
	V8 5.7L 350ci	1992-99	L & R Front		2	EM-2637		
1973-86		L & R Front		2	EM-2292			
1969-72		L & R Front		2	EM-2282			
1969-84		Trans - Lower	Auto	2			EM-2108	



# Engine, Transmission, And Torque Strut Mounts

CYL	ENG. SIZE	YEAR	LOCATION	DESCRIPTION	QTY	ENGINE	TORQUE STRUT	TRANSMISSION	
<b>CHEVROLET SPORT UTILITY (continued)</b>									
<b>K20/K2500 SUBURBAN (continued)</b>									
V8	V8 5.7L 350ci	1969-84	Trans - Lower	Manual	2			EM-2108	
			Trans - Upper	Auto	2			EM-2107	
		1992-99	Trans	Auto	1				EM-2638
			1985-86	Trans	Auto	1			EM-2638
	V8 6.2L 379ci Diesel	1984-86	L & R Front		2	EM-2395			
			1982-83	L & R Front		2	EM-2292		
		1982-84	Trans - Lower	Auto	2			EM-2108	
			Trans - Lower	Manual	2			EM-2108	
			Trans - Upper	Auto	2			EM-2107	
	1985-86	Trans	Auto	1			EM-2638		
	V8 6.5L 395ci Diesel	1994-99	L & R Front		2	EM-2637			
			Trans	Auto	1			EM-2638	
	V8 6.6L 400ci	1975-80	L & R Front		2	EM-2292			
			Trans - Lower	Auto	2			EM-2108	
			Trans - Lower	Manual	2			EM-2108	
			Trans - Upper	Auto	2			EM-2107	
	V8 7.4L 454ci	1992-99	L & R Front		2	EM-2637			
			1985	L & R Front		2	EM-2395		
		1973	L & R Front		2	EM-2395			
			Trans - Lower	Auto	2			EM-2108	
Trans - Lower			Manual	2			EM-2108		
Trans - Upper			Auto	2			EM-2107		
1992-99		Trans	Auto	1			EM-2638		
		1985	Trans	Auto	1			EM-2638	
<b>R10/R1500 SUBURBAN</b>									
V8	V8 5.0L 305ci	1987	L & R Front		2	EM-2292			
			Trans	Auto; THM400-475 (M40)	1			EM-2513	
			Trans	Auto; THM700R4 (MD8)	1			EM-2392	
	V8 5.7L 350ci	1989-91	L & R Front		2	EM-2621			
			1987-88	L & R Front		2	EM-2621		
		1991	Trans	Auto; 4L80E (MT1)	1			EM-2513	
			Trans	Auto; THM700-R4/4L60 (MD8)	1			EM-2392	
		1989-90	Trans	Auto; THM400 (M40)	1			EM-2513	
			Trans	Auto; THM700-R4/4L60 (MD8)	1			EM-2392	
		1987-88	Trans	Auto; THM400 (M40)	1			EM-2513	
			Trans	Auto; THM700-R4/4L60 (MD8)	1			EM-2392	
	V8 6.2L 379ci Diesel	1989-91	L & R Front		2	EM-2395			
			1987-88	L & R Front		2	EM-2395		
		1991	Trans	Auto; 4L80E (MT1)	1			EM-2513	
			Trans	Auto; THM700-R4/4L60 (MD8)	1			EM-2392	
		1989-90	Trans	Auto; THM400 (M40)	1			EM-2513	
			Trans	Auto; THM700-R4/4L60 (MD8)	1			EM-2392	
		1987-88	Trans	Auto; THM400-475 (M40)	1			EM-2515	
Trans			Auto; THM700R4 (MD8)	1			EM-2393		
<b>R20/R2500 SUBURBAN</b>									
V8	V8 5.7L 350ci	1989-91	L & R Front		2	EM-2621			
			1987-88	L & R Front		2	EM-2621		
		1991	Trans	Auto; 4L80E (MT1)	1			EM-2513	
			Trans	Auto; THM700-R4/4L60 (MD8)	1			EM-2392	
		1989-90	Trans	Auto; THM400 (M40)	1			EM-2513	
			Trans	Auto; THM700-R4/4L60 (MD8)	1			EM-2392	
		1987-88	Trans	Auto; THM400 (M40)	1			EM-2513	
			Trans	Auto; THM700-R4/4L60 (MD8)	1			EM-2392	
	V8 6.2L 379ci Diesel	1989-91	L & R Front		2	EM-2395			
			1987-88	L & R Front		2	EM-2395		
1991	Trans	Auto; 4L80E (MT1)	1			EM-2513			

# Engine, Transmission, And Torque Strut Mounts

CYL	ENG. SIZE	YEAR	LOCATION	DESCRIPTION	QTY	ENGINE	TORQUE STRUT	TRANSMISSION	
<b>CHEVROLET SPORT UTILITY (continued)</b>									
<b>R20/R2500 SUBURBAN (continued)</b>									
V8	V8 6.2L 379ci Diesel	1991	Trans	Auto; THM700-R4/4L60 (MD8)	1			EM-2392	
		1989-90	Trans	Auto; THM400 (M40)	1			EM-2515	
			Trans	Auto; THM700-R4/4L60 (MD8)	1			EM-2393	
		1987-88	Trans	Auto; THM400 (M40)	1			EM-2515	
			Trans	Auto; THM700-R4/4L60 (MD8)	1			EM-2393	
	V8 7.4L 454ci	1989-91	L & R Front			2	EM-2395		
		1987-88	L & R Front			2	EM-2395		
		1989-91	Trans			1			EM-2515
1987-88		Trans	Auto; THM700-R4/4L60 (MD8)		1			EM-2515	
<b>S10 BLAZER</b>									
L4	L4 1.9L	1984	Trans	Auto; 2WD	1			EM-2531	
			Trans	Auto; 4WD	1			EM-2638	
			Trans	Manual; 2WD	1			EM-2531	
			Trans	Manual; 4WD	1			EM-2638	
	L4 1.9L 119ci	1983-84	L & R Front			2	EM-2381		
			1983	Trans	Auto; 2WD	1			EM-2771
				Trans	Auto; 4WD	1			EM-2638
				Trans	Manual; 2WD	1			EM-2771
	L4 2.0L	1984	Trans	Auto; 2WD		1			EM-2531
			Trans	Auto; 4WD		1			EM-2638
			Trans	Manual; 2WD		1			EM-2531
			Trans	Manual; 4WD		1			EM-2638
	L4 2.0L 122ci	1983-84	LH Front			1	EM-2755		
			RH Front			1	EM-2756		
		1983	Trans	Auto; 2WD		1			EM-2772
			Trans	Auto; 4WD		1			EM-2638
	Trans		Manual; 2WD		1			EM-2772	
	L4 2.2L 134ci Diesel	1984	LH Front			1	EM-2549		
			RH Front			1	EM-2550		
			Trans	Auto; 2WD		1			EM-2531
			Trans	Manual; 2WD		1			EM-2531
	L4 2.5L 2474cc	1985-88	LH Front			1	EM-2549		
			RH Front			1	EM-2550		
		1988	Trans	2WD		1			EM-2508
			Trans	Auto; 4WD		1			EM-2638
			Trans	Manual; 4WD		1			EM-2638
		1985-87	Trans	Auto; 2WD		1			EM-2531
			Trans	Auto; 4WD		1			EM-2638
			Trans	Manual; 2WD		1			EM-2531
			Trans	Manual; 4WD		1			EM-2638
	V6	V6 2.8L 173ci	1983-89	L & R Front		2	EM-2436		
			1988-89	Trans	Auto; 2WD	1			EM-2508
				Trans	Manual; 2WD	1			EM-2508
Trans				Auto; 2WD	1			EM-2531	
1984-87			Trans	Auto; 4WD	1			EM-2638	
			Trans	Manual; 2WD	1			EM-2531	
			Trans	Manual; 4WD	1			EM-2638	
			Trans	Auto; 2WD	1			EM-2772	
1983			Trans	Auto; 4WD	1			EM-2638	
			Trans	Manual; 2WD	1			EM-2772	
			Trans	Manual; 4WD	1			EM-2638	
			Trans	Manual; 4WD	1			EM-2638	
V6 4.3L 262ci		1988-94	L & R Front			2	EM-2627		
			Trans	Auto; 2WD		1			EM-2508
			Trans	Auto; 4WD		1			EM-2638
			Trans	Manual; 2WD		1			EM-2508

# Engine, Transmission, And Torque Strut Mounts

CYL	ENG. SIZE	YEAR	LOCATION	DESCRIPTION	QTY	ENGINE	TORQUE STRUT	TRANSMISSION
<b>CHEVROLET SPORT UTILITY (continued)</b>								
<b>S10 BLAZER (continued)</b>								
V6	V6 4.3L 262ci	1988-94	Trans	Manual; 4WD	1			EM-2638
<b>SUBURBAN</b>								
L6	L6 4.1L 250ci	1966-67	L & R Front		2	EM-2282		
			Trans	Auto; THM350 (M38) THM350C (MV4); RWD	1			EM-2378 @
			Trans	Manual; 2WD	1			EM-2378 @
<b>SUBURBAN 1500</b>								
V8	V8 5.3L	2007-14	L & R Front	Complete Unit	2	EM-5583		
			Trans	2WD	1			EM-2817
			Trans	4WD	1			EM-2638
		2006	Trans	RWD	1			EM-2817
	V8 5.3L 323ci	2000-06	L & R Front		2	EM-2909		
		2000-03	Trans	2WD	1			EM-2817
			Trans	4WD	1			EM-2638
	V8 6.0L	2007-09	L & R Front	Complete Unit	2	EM-5583		
			Trans	4WD; Auto	1			EM-2638
			Trans	Auto; 2WD	1			EM-2817
<b>SUBURBAN 2500</b>								
V8	V8 6.0L	2007-13	L & R Front	Complete Unit	2	EM-5583		
			Trans	4WD; Auto	1			EM-2638
			Trans	Auto; 2WD	1			EM-2817
		2004-06	Trans	RWD, Auto	1			EM-2817
	V8 6.0L 364ci	2000-06	L & R Front		2	EM-2909		
		2000-03	Trans	Auto; 2WD	1			EM-2817
			Trans	Auto; 4WD	1			EM-2638
	V8 8.1L	2005-06	L & R Front		2	EM-5353		
		2001-03	L & R Front		2	EM-5353		
<b>TAHOE</b>								
V8	V8 4.8L 294ci	2000-06	L & R Front		2	EM-2909		
		2007-09	LH Front	2WD	1	EM-4000		
			RH Front		1	EM-4017		
		2000-09	Trans	2WD	1			EM-2817
			Trans	4WD	1			EM-2638
	V8 5.3L	2007-14	Trans	2WD	1			EM-2817
			Trans	4WD	1			EM-2638
	V8 5.3L 323ci	2007-14	L & R Front		2	EM-5583		
		2000-05	L & R Front		2	EM-2909		
			Trans		1			EM-2638
	V8 5.3L 325ci	2007	L & R Front		2	EM-5583		
		2006	L & R Front		2	EM-2909		
	V8 5.7L 350ci	1995-00	L & R Front	4WD	2	EM-2637		
			L & R Front	RWD	2	EM-2621		
		1997-00	Trans	2WD	1			EM-2817
			Trans	4WD	1			EM-2638
		1995-96	Trans	Auto; 2WD	1			EM-2817
			Trans	Auto; 4WD	1			EM-2638
			Trans	Manual; 2WD	1			EM-2817
			Trans	Manual; 4WD	1			EM-2638
	V8 6.0L	2008-13	Trans	2WD	1			EM-2817
			Trans	4WD	1			EM-2638
	V8 6.0L 364ci	2008-13	L & R Front		2	EM-5583		
	V8 6.2L	2009	Trans	2WD	1			EM-2817
			Trans	4WD	1			EM-2638
	V8 6.2L 378ci	2008-09	L & R Front		2	EM-5583		
	V8 6.5L 395ci Diesel	1995-99	L & R Front	4WD	2	EM-2637		

# Engine, Transmission, And Torque Strut Mounts

CYL	ENG. SIZE	YEAR	LOCATION	DESCRIPTION	QTY	ENGINE	TORQUE STRUT	TRANSMISSION
<b>CHEVROLET SPORT UTILITY (continued)</b>								
<b>TAHOE (continued)</b>								
V8	V8 6.5L 395ci Diesel	1995-99	L & R Front	RWD	2	EM-2621		
			Trans	Auto; 2WD	1		EM-2817	
			Trans	Auto; 4WD	1		EM-2638	
<b>TRAVERSE</b>								
V6	V6 3.6L	2009-12	Torq Str - Right		1		EM-3141	
			Trans		1		EM-4036	
	V6 3.6L 217ci	2009-12	Front		1	EM-4037		
			Rear		1	EM-4035		
<b>TRACKER</b>								
L4	L4 1.6L 1588cc	1999-00	L & R Front		2	EM-9240		
		1998	L & R Front		2	EM-8568		
		1999-00	Torq Str - Front	Auto; 4 Spd; 4WD	1		EM-8657	
			Torq Str - Front	Manual; 4WD	1		EM-8657	
		1998	Torq Str - Front	Auto; 3L30 (M65) 3 Spd 4WD	1		EM-8656	
			Torq Str - Front	Auto; 4 Spd; 4WD	1		EM-8657	
			Torq Str - Front	Manual; 4WD	1		EM-8657	
	1998-00	Trans		1			EM-8825	
	L4 2.0L 122ci	1999-03	L & R Front		2	EM-9240		
			Trans	Auto	1		EM-9241	
			Trans	Manual	1		EM-8825	
V6	V6 2.5L 2500cc	2001-04	L & R Front		2	EM-9240		
			Trans		1		EM-8825	
<b>TRAILBLAZER</b>								
L6	L6 4.2L 256ci	2002-08	L & R Front		2	EM-3021*		
		2002-09	Trans	Auto	1		EM-3027	
V8	V8 5.3L	2006-08	LH Front		1	EM-5694		
			RH Front		1	EM-5693		
<b>TRAILBLAZER EXT</b>								
L6	L6 4.2L 256ci	2002-06	L & R Front		2	EM-3021*		
			Trans	Auto	1		EM-3027	
V8	V8 5.3L	2005-06	LH Front		1	EM-5694		
			RH Front		1	EM-5693		
<b>V10/V1500 SUBURBAN</b>								
V8	V8 5.7L 350ci	1989-91	L & R Front	4WD	2	EM-2637		
		1988	L & R Front	4WD	2	EM-2637		
		1987	L & R Front	4WD	2	EM-2292		
		1989-91	Trans	Auto	1		EM-2638	
		1987-88	Trans	Auto	1		EM-2638	
			Trans	Manual	1		EM-2638	
	V8 6.2L 379ci Diesel	1989-91	L & R Front	4WD	2	EM-2637		
		1988	L & R Front	4WD	2	EM-2637		
		1987	L & R Front	4WD	2	EM-2395		
		1989-91	Trans	Auto	1		EM-2638	
		1987-88	Trans	Auto	1		EM-2638	
			Trans	Manual	1		EM-2638	
		<b>V20/V2500 SUBURBAN</b>						
V8	V8 5.7L 350ci	1989-91	L & R Front	4WD	2	EM-2637		
		1988	L & R Front	4WD	2	EM-2637		
		1987	L & R Front	4WD	2	EM-2292		
		1989-91	Trans	Auto	1		EM-2638	
		1987-88	Trans	Auto	1		EM-2638	
			Trans	Manual	1		EM-2638	
	V8 6.2L 379ci Diesel	1989-91	L & R Front	4WD	2	EM-2637		
		1988	L & R Front	4WD	2	EM-2637		

# Engine, Transmission, And Torque Strut Mounts

CYL	ENG. SIZE	YEAR	LOCATION	DESCRIPTION	QTY	ENGINE	TORQUE STRUT	TRANSMISSION
<b>CHEVROLET SPORT UTILITY (continued)</b>								
<b>V20/V2500 SUBURBAN (continued)</b>								
V8	V8 6.2L 379ci Diesel	1987	L & R Front	4WD	2	EM-2395		
		1989-91	Trans	Auto	1			EM-2638
		1987-88	Trans	Auto	1			EM-2638
			Trans	Manual	1			EM-2638
	V8 7.4L 454ci	1990	L & R Front	4WD	2	EM-2637		
		1988	L & R Front	4WD	2	EM-2637		
		1987	L & R Front	4WD	2	EM-2395		
		1990	Trans	Auto	1			EM-2638
		1987-88	Trans	Auto	1			EM-2638
			Trans	Manual	1			EM-2638
<b>CHEVROLET TRUCK</b>								
<b>C10/C1500 P/U</b>								
L6	L6 3.8L 230ci	1963-66	L & R Front		2	EM-2282		
	L6 3.9L 235ci	1961-62	L & R Front		2	EM-2142		
			Trans		1			EM-2378 @
	L6 4.1L 250ci	1973-84	L & R Front		2	EM-2292		
		1966-72	L & R Front		2	EM-2282		
		1982-84	Trans		1			EM-2392
			Trans	Auto; THM350 (M38) THM350C (MV4)	1			EM-2378 @
		1973-81	Trans	Auto; THM400-475 (M40)	1			EM-2268 @
			Trans	Manual	1			EM-2378 @
			Trans	Auto; THM350 (M38) THM350C (MV4)	1			EM-2378 @
		1966-72	Trans	Manual	1			EM-2378 @
	Trans		Manual	1			EM-2378 @	
	L6 4.8L 292ci	1973-80	L & R Front		2	EM-2292		
		1963-71	L & R Front		2	EM-2282		
		1973-80	Trans	Auto; THM350 (M38)	1			EM-2378 @
			Trans	Auto; THM400-475 (M40)	1			EM-2268 @
			Trans	Manual	1			EM-2378 @
		1963-71	Trans	Auto; THM350 (M38)	1			EM-2378 @
	Trans		Manual	1			EM-2378 @	
	V6	V6 4.3L 262ci	1988-95	L & R Front		2	EM-2436	
1985-86			L & R Front		2	EM-2436		
1996-98			LH Front		1	EM-3028		
			RH Front		1	EM-3044		
1991-95			Trans		1			EM-2817
			Trans	Auto	1			EM-2394
1988-90			Trans	Manual	1			EM-2394
			Trans	Auto, 3 Spd	1			EM-2510 @
1985-86			Trans	Auto, 4 Spd	1			EM-2394
			Trans	Manual	1			EM-2394
			Trans	Auto	1			EM-2394
			Trans	Manual	1			EM-2394
V8	V8 4.6L 283ci	1963-67	L & R Front		2	EM-2282		
		1961-62	L & R Front		2	EM-2267		
		1961-67	Trans - L & R Lower	Manual Manual	2			EM-2108
			Trans - L & R Upper	Manual Manual	2			EM-2107
			Trans	Auto	1			EM-2378 @
	V8 5.0L	1982-86	LH Front		1	EM-2292		
	V8 5.0L 305ci	1988-99	L & R Front		2	EM-2621		
		1976-81	L & R Front		2	EM-2292		
1999	Trans	Auto; 2WD	1			EM-2817		

# Engine, Transmission, And Torque Strut Mounts

CYL	ENG. SIZE	YEAR	LOCATION	DESCRIPTION	QTY	ENGINE	TORQUE STRUT	TRANSMISSION	
<b>CHEVROLET TRUCK (continued)</b>									
<b>C10/C1500 P/U (continued)</b>									
V8	V8 5.0L 305ci	1996-98	Trans	Auto; 2WD	1			EM-2817	
			Trans	Manual; 2WD	1			EM-2817	
		1992-95	Trans		1			EM-2360 @	
		1990-91	Trans	Auto; THM700R4 (MD8)	1			EM-2392	
			Trans	Manual	1			EM-2392	
		1988-89	Trans	Auto; THM400-475 (M40)	1			EM-2513	
			Trans	Auto; THM700R4 (MD8)	1			EM-2392	
			Trans	Manual	1			EM-2392	
		1982-86	Trans	Auto; THM350C (MV4) THM700R4 (MD8)	1			EM-2392	
			Trans	Auto; THM400-475 (M40)	1			EM-2513	
			Trans	Manual	1			EM-2392	
		1976-81	Trans	Auto; THM350 (M38) THM350C (MV4)	1			EM-2378 @	
			Trans	Auto; THM400-475 (M40)	1			EM-2268 @	
			Trans	Manual	1			EM-2378 @	
	Trans		Manual	1			EM-2378 @		
	V8 5.0L 307ci		1973	L & R Front		2	EM-2292		
			1968-72	L & R Front		2	EM-2282		
			1968-73	Trans	Auto; THM350 (M38)	1			EM-2378 @
				Trans	Auto; THM400-475 (M40)	1			EM-2268 @
				Trans	Manual	1			EM-2378 @
	V8 5.4L 327ci	1966-68	L & R Front		2	EM-2282			
			Trans	Auto; THM350 (M38)	1			EM-2378 @	
			Trans	Auto; THM400-475 (M40)	1			EM-2268 @	
			Trans	Manual	1			EM-2378 @	
	V8 5.7L 350 ci Gas	1979-81	L & R Front		2	EM-2292			
	V8 5.7L 350ci		1988-99	L & R Front		2	EM-2621		
			1973-78	L & R Front		2	EM-2292		
			1969-72	L & R Front		2	EM-2282		
			1982-86	LH Front		1	EM-2292		
			1999	Trans	Auto; 2WD	1			EM-2817
			1996-98	Trans	Auto; 2WD	1			EM-2817
				Trans	Manual; 2WD	1			EM-2817
				1995	Trans	Auto; 2WD	1		
1994			Trans	Manual; 2WD	1			EM-2817	
			Trans	Auto; 2WD; 1st Design	1			EM-2360 @	
			Trans	Auto; 2WD; 2nd Design	1			EM-2817	
1992-93			Trans	Manual	1			EM-2360 @	
			Trans	Auto; THM700R4 (MD8)	1			EM-2392	
			Trans	Manual	1			EM-2392	
1988-90			Trans	Auto; THM400 (M40); RWD	1			EM-2513	
			Trans	Auto; THM700-R4/4L60 (MD8) RWD	1			EM-2392	
			Trans	Manual; RWD	1			EM-2392	
1982-86			Trans	Auto; THM350 (M38) THM700R4 (MD8)	1			EM-2392	
			Trans	Auto; THM400-475 (M40)	1			EM-2513	
			Trans	Manual	1			EM-2392	
1975-81			Trans	Auto; THM350 (M33); THM350 (M38); OEM Design	1			EM-2378 @	
			Trans	Auto; THM400-475 (M40)	1			EM-2268 @	
			Trans	Manual	1			EM-2378 @	
V8 5.7L 350ci Diesel			1979-81	L & R Front		2	EM-2328		
				Trans	Auto; THM350 (M38)	1			EM-2378 @
				Trans	Auto; THM400-475 (M40)	1			EM-2268 @

# Engine, Transmission, And Torque Strut Mounts

CYL	ENG. SIZE	YEAR	LOCATION	DESCRIPTION	QTY	ENGINE	TORQUE STRUT	TRANSMISSION	
<b>CHEVROLET TRUCK (continued)</b>									
<b>C10/C1500 P/U (continued)</b>									
V8	V8 5.7L 350ci Diesel	1979-81	Trans	Manual	1			EM-2378 @	
	V8 6.2L 379ci Diesel	1988-93	L & R Front		2	EM-2621			
		1984-86	L & R Front		2	EM-2395			
		1982-83	L & R Front		2	EM-2292			
		1992-93	Trans		1			EM-2360 @	
		1991	Trans	Auto; THM700-R4/4L60 (MD8)		1			EM-2392
			Trans	Manual		1			EM-2392
		1989	Trans	Auto; THM400 (M40)		1			EM-2513
			Trans	Auto; THM700-R4/4L60 (MD8)		1			EM-2392
			Trans	Manual		1			EM-2392
		1988-90	Trans	Auto; THM400 (M40)		1			EM-2513
			Trans	Auto; THM700-R4/4L60 (MD8)		1			EM-2392
			Trans	Manual; 4 Spd		1			EM-2393
			Trans	Manual; 5 Spd		1			EM-2392
		1988	Trans	Auto; THM400 (M40)		1			EM-2513
			Trans	Auto; THM700-R4/4L60 (MD8)		1			EM-2392
	Trans		Manual; 4 Spd		1			EM-2393	
	Trans		Manual; 5 Spd		1			EM-2392	
	1983-86	Trans	Auto; THM400-475 (M40)		1			EM-2515	
		Trans	Auto; THM700R4 (MD8)		1			EM-2393	
		Trans	Manual		1			EM-2393	
	1982	Trans	Auto		1			EM-2393	
		Trans	Manual		1			EM-2392	
	V8 6.5L 395ci Diesel	1994-98	L & R Front		2	EM-2621			
			Trans	Auto; 2WD	1			EM-2817	
			Trans	Manual; 2WD	1			EM-2817	
	V8 6.6L 400ci	1976-80	L & R Front		2	EM-2292			
			Trans	Auto; THM350 (M38)	1			EM-2378 @	
			Trans	Auto; THM400-475 (M40)	1			EM-2268 @	
			Trans	Manual	1			EM-2378 @	
	V8 6.6L 402ci	1970-72	L & R Front		2	EM-2283			
			Trans	Auto; THM350 (M38)	1			EM-2378 @	
			Trans	Auto; THM400-475 (M40)	1			EM-2268 @	
Trans			Manual	1			EM-2378 @		
V8 7.4L 454ci	1990-93	L & R Front		2	EM-2621				
	1973-80	L & R Front		2	EM-2395				
	1992-93	Trans		1			EM-2360 @		
	1990-91	Trans		1			EM-2392		
	1973-80	Trans	Auto; THM350 (M38)		1			EM-2378 @	
		Trans	Auto; THM400-475 (M40)		1			EM-2268 @	
Trans	Manual		1			EM-2378 @			
<b>C20/C2500 P/U</b>									
L6	L6 3.8L 230ci	1963-65	L & R Front		2	EM-2282			
	L6 3.9L 235ci	1961-62	L & R Front		2	EM-2142			
			Trans		1			EM-2378 @	
	L6 4.1L 250ci	1973-84	L & R Front		2	EM-2292			
		1966-72	L & R Front		2	EM-2282			
		1982-84	Trans		1			EM-2392	
		1973-81	Trans	Auto; THM350 (M38)		1			EM-2378 @
			Trans	THM350C (MV4)					
			Trans	Auto; THM400-475 (M40)		1			EM-2268 @
		1966-72	Trans	Manual		1			EM-2378 @
	Trans		Auto; THM350 (M38)		1			EM-2378 @	
	Trans	THM350C (MV4)							
Trans	Manual		1			EM-2378 @			
L6 4.8L 292ci	1973-86	L & R Front		2	EM-2292				

# Engine, Transmission, And Torque Strut Mounts

CYL	ENG. SIZE	YEAR	LOCATION	DESCRIPTION	QTY	ENGINE	TORQUE STRUT	TRANSMISSION
<b>CHEVROLET TRUCK (continued)</b>								
<b>C20/C2500 P/U (continued)</b>								
L6	L6 4.8L 292ci	1963-72	L & R Front		2	EM-2282		
		1983-86	Trans	Auto; THM400-475 (M40)	1			EM-2513
			Trans	Auto; THM700R4 (MD8)	1			EM-2392
			Trans	Manual	1			EM-2392
		1982	Trans	Auto; THM350C (MV4)	1			EM-2378 @
			Trans	Auto; THM400 (M40)	1			EM-2513
			Trans	Auto; THM700-R4/4L60 (MD8)	1			EM-2392
			Trans	Manual	1			EM-2378 @
		1973-81	Trans	Auto; THM350 (M38)	1			EM-2378 @
			Trans	Auto; THM400-475 (M40)	1			EM-2268 @
			Trans	Manual	1			EM-2378 @
		1963-72	Trans	Auto; THM350 (M38)	1			EM-2378 @
Trans	Auto; THM400-475 (M40)		1			EM-2268 @		
V6	V6 4.3L 262ci	1988-95	L & R Front		2	EM-2436		
		1985-86	L & R Front		2	EM-2436		
		1992-95	Trans		1			EM-2394
		1991	Trans	Auto; 4L80E THM700-R4/4L60 (MD8)	1			EM-2394
			Trans	Manual	1			EM-2394
		1988-90	Trans	Auto; THM400 (M40)	1			EM-2510 @
			Trans	Auto; THM700-R4/4L60 (MD8)	1			EM-2394
			Trans	Manual	1			EM-2394
		1985-86	Trans		1			EM-2394
		V8	V8 4.6L 283ci	1963-67	L & R Front		2	EM-2282
1961-62	L & R Front				2	EM-2267		
1961-67	Trans - L & R Lower			Manual Manual	2			EM-2108
	Trans - L & R Upper			Manual Manual	2			EM-2107
	Trans			Auto	1			EM-2378 @
V8 5.0L 305ci	1988-98		L & R Front		2	EM-2621		
	1977-86		L & R Front		2	EM-2292		
	1996-98		Trans	Auto; 2WD	1			EM-2817
			Trans	Manual; 2WD	1			EM-2817
	1992-95		Trans		1			EM-2360 @
	1990-91		Trans		1			EM-2392
	1988-89		Trans	Auto; THM400-475 (M40)	1			EM-2513
			Trans	Auto; THM700R4 (MD8)	1			EM-2392
			Trans	Manual	1			EM-2392
	1982-86		Trans	Auto; THM350C (MV4) THM700R4 (MD8)	1			EM-2392
			Trans	Auto; THM400-475 (M40)	1			EM-2513
			Trans	Manual	1			EM-2392
			Trans	Auto; THM350 (M38)	1			EM-2378 @
	1977-81		Trans	Auto; THM400 (M40)	1			EM-2268 @
			Trans	Manual	1			EM-2378 @
Trans		Auto; THM350 (M38)	1			EM-2378 @		
V8 5.0L 307ci	1973	L & R Front		2	EM-2292			
	1968-72	L & R Front		2	EM-2282			
	1968-73	Trans	Auto; THM350 (M38)	1			EM-2378 @	
		Trans	Auto; THM400-475 (M40)	1			EM-2268 @	
		Trans	Manual	1			EM-2378 @	
V8 5.4L 327ci	1966-68	L & R Front		2	EM-2282			
		Trans	Auto; THM350 (M38)	1			EM-2378 @	
		Trans	Auto; THM400-475 (M40)	1			EM-2268 @	
		Trans	Manual	1			EM-2378 @	
V8 5.7L	1985-86	LH Front		1	EM-2292			



# Engine, Transmission, And Torque Strut Mounts

CYL	ENG. SIZE	YEAR	LOCATION	DESCRIPTION	Q T Y	ENGINE	TORQUE STRUT	TRANS- MISSION	
<b>CHEVROLET TRUCK (continued)</b>									
<b>C20/C2500 P/U (continued)</b>									
V8	V8 5.7L 350ci	1988-00	L & R Front		2	EM-2621			
		1973-84	L & R Front		2	EM-2292			
		1969-72	L & R Front		2	EM-2282			
		1996-00	Trans	Auto; 2WD		1			EM-2817
			Trans	Manual; 2WD		1			EM-2817
		1995	Trans	Auto; 4L80E (MT1)		1			EM-2817
			Trans	Manual		1			EM-2360 @
		1994	Trans	Auto; 4L60E (M30)		1			EM-2360 @
			Trans	Auto; 4L80E (MT1)		1			EM-2817
			Trans	Manual		1			EM-2360 @
		1992-93	Trans			1			EM-2360 @
		1991	Trans			1			EM-2392
		1988-90	Trans	Auto; THM400-475 (M40)		1			EM-2513
			Trans	Auto; THM700R4 (MD8)		1			EM-2392
			Trans	Manual		1			EM-2392
		1982-86	Trans	Auto; THM350C (MV4) THM700-R4/4L60 (MD8)		1			EM-2392
			Trans	Auto; THM400 (M40)		1			EM-2513
			Trans	Manual		1			EM-2392
	1975-81	Trans	Auto; THM350 (M38)		1			EM-2378 @	
		Trans	Auto; THM400-475 (M40)		1			EM-2268 @	
		Trans	Manual		1			EM-2378 @	
	V8 6.2L 379ci Diesel	1988-93	L & R Front			2	EM-2621		
		1984-86	L & R Front			2	EM-2395		
		1982-83	L & R Front			2	EM-2292		
		1992-93	Trans			1			EM-2360 @
		1991	Trans	Auto; THM700-R4/4L60 (MD8)		1			EM-2392
			Trans	Manual		1			EM-2392
		1989-90	Trans	Auto; 4L80E THM700-R4/4L60 (MD8)		1			EM-2392
			Trans	Auto; THM400 (M40)		1			EM-2513
			Trans	Manual		1			EM-2392
		1988	Trans	Auto; THM400 (M40)		1			EM-2513
			Trans	Auto; THM700-R4/4L60 (MD8)		1			EM-2392
			Trans	Manual; 4 Spd		1			EM-2393
			Trans	Manual; 5 Spd		1			EM-2392
		1983-86	Trans	Auto; THM400-475 (M40)		1			EM-2515
			Trans	Auto; THM700R4 (MD8)		1			EM-2393
	Trans		Manual		1			EM-2393	
	1982	Trans			1			EM-2392	
	V8 6.5L 395ci Diesel	1992-00	L & R Front			2	EM-2621		
		1995-00	Trans	Auto; 2WD		1			EM-2817
			Trans	Manual; 2WD		1			EM-2817
		1992-94	Trans			1			EM-2360 @
	V8 6.5L 396ci	1968-69	L & R Front			2	EM-2283		
V8 6.6L 400ci	1976-80	L & R Front			2	EM-2292			
		Trans	Auto; THM350 (M38)		1			EM-2378 @	
		Trans	Auto; THM400-475 (M40)		1			EM-2268 @	
		Trans	Manual		1			EM-2378 @	
V8 6.6L 402ci	1970-71	L & R Front			2	EM-2283			
		Trans			1			EM-2378 @	
V8 7.4L 454ci	1991-00	L & R Front			2	EM-2621			
	1973-86	L & R Front			2	EM-2395			
	1996-00	Trans	Auto; 2WD		1			EM-2817	
		Trans	Manual; 2WD		1			EM-2817	
	1992-95	Trans			1			EM-2360 @	

# Engine, Transmission, And Torque Strut Mounts

CYL	ENG. SIZE	YEAR	LOCATION	DESCRIPTION	QTY	ENGINE	TORQUE STRUT	TRANS-MISSION		
<b>CHEVROLET TRUCK (continued)</b>										
<b>C20/C2500 P/U (continued)</b>										
V8	V8 7.4L 454ci	1991	Trans		1			EM-2392		
		1982-86	Trans	Auto; THM350C; THM400	1			EM-2513		
			Trans	Auto; THM700R4 (MD8)	1			EM-2392		
			Trans	Manual	1			EM-2392		
		1973-81	Trans	Auto; THM350 (M38)	1			EM-2378 @		
			Trans	Auto; THM400-475 (M40)	1			EM-2268 @		
Trans	Manual		1			EM-2378 @				
<b>C30/C3500 P/U</b>										
L6	L6 3.8L 230ci	1964-65	L & R Front		2	EM-2282				
	L6 3.9L 235ci	1961-62	L & R Front		2	EM-2142				
			Trans		1			EM-2378 @		
	L6 4.1L 250ci	1978-80	L & R Front		2	EM-2292				
			L & R Front		2	EM-2292				
		1966-72	L & R Front		2	EM-2282				
			1978-80	Trans	Auto; THM350 (M38) THM350C (MV4)	1			EM-2378 @	
				Trans	Auto; THM400-475 (M40)	1			EM-2268 @	
		1973-75	Trans	Manual		1			EM-2378 @	
				Auto; THM350 (M38) THM350C (MV4)		1			EM-2378 @	
				Auto; THM400-475 (M40)		1			EM-2268 @	
			1966-72	Trans	Manual		1			EM-2378 @
				Trans			1			EM-2378 @
	L6 4.8L 292ci	1973-86	L & R Front		2	EM-2292				
			L & R Front		2	EM-2282				
		1983-86	Trans	Auto; THM400-475 (M40)		1			EM-2513	
			Trans	Auto; THM700R4 (MD8)		1			EM-2392	
			Trans	Manual		1			EM-2392	
		1982	Trans	Auto; THM350C (MV4)		1			EM-2378 @	
				Auto; THM400 (M40)		1			EM-2513	
			Trans	Auto; THM700-R4/4L60 (MD8)		1			EM-2392	
				Manual		1			EM-2378 @	
		1973-81	Trans	Auto; THM350 (M38)		1			EM-2378 @	
				Auto; THM400-475 (M40)		1			EM-2268 @	
				Manual		1			EM-2378 @	
		1963-72	Trans			1			EM-2378 @	
	V8	V8 4.6L 283ci	1963-67	L & R Front		2	EM-2282			
1961-62			L & R Front		2	EM-2267				
1961-67			Trans - L & R Lower	Manual Manual		2			EM-2108	
			Trans - L & R Upper	Manual Manual		2			EM-2107	
			Trans	Auto		1			EM-2378 @	
V8 5.0L 305ci		1986	L & R Front		2	EM-2292				
			L & R Front		2	EM-2292				
		1986	Trans	Auto; THM350C (MV4) THM700R4 (MD8)		1			EM-2392	
			Trans	Auto; THM400-475 (M40)		1			EM-2513	
			Trans	Manual		1			EM-2392	
		1978-79	Trans	Auto; THM350 (M38) THM350C (MV4)		1			EM-2378 @	
Auto; THM400-475 (M40)					1			EM-2268 @		
Manual					1			EM-2378 @		
V8 5.0L 307ci	1973	L & R Front		2	EM-2292					
	1968-72	L & R Front		2	EM-2282					

# Engine, Transmission, And Torque Strut Mounts

CYL	ENG. SIZE	YEAR	LOCATION	DESCRIPTION	QTY	ENGINE	TORQUE STRUT	TRANS-MISSION
<b>CHEVROLET TRUCK (continued)</b>								
<b>C30/C3500 P/U (continued)</b>								
V8	V8 5.0L 307ci	1968-73	Trans	Auto; THM350 (M38)	1			EM-2378 @
			Trans	Auto; THM400-475 (M40)	1			EM-2268 @
			Trans	Manual	1			EM-2378 @
	V8 5.4L 327ci	1966-68	L & R Front			2	EM-2282	
Trans			Auto; THM350 (M38)	1			EM-2378 @	
Trans			Auto; THM400-475 (M40)	1			EM-2268 @	
Trans			Manual	1			EM-2378 @	
V8 5.7L	1984-86	LH Front		1	EM-2292			
V8 5.7L GAS	1973-83	L & R Front		2	EM-2292			
	1969-72	L & R Front		2	EM-2282			
V8 5.7L 350ci	1988-00	L & R Front		2	EM-2621			
		Trans	Auto; 2WD	1			EM-2817	
	1994	Trans	Manual; 2WD	1			EM-2817	
		Trans	C309, 1st Design	1			EM-2360 @	
		Trans	C314 & C318, 15,000 GVW	1			EM-2638	
	1991-93	Trans	Auto; RWD	1			EM-2360 @	
		Trans	Manual; RWD	1			EM-2360 @	
	1988-90	Trans	Auto; THM400 (M40)	1			EM-2513	
		Trans	Auto; THM700-R4/4L60 (MD8)	1			EM-2392	
		Trans	Manual; 131.5WB (C309)	1			EM-2392	
		Trans	Manual; 155.5WB (C309) 159.5WB (C314)	1			EM-2638	
	1982-86	Trans	Auto; THM350 (M38) THM700R4 (MD8)	1			EM-2392	
		Trans	Auto; THM400-475 (M40)	1			EM-2513	
		Trans	Manual	1			EM-2392	
	1975-81	Trans	Auto; THM350 (M38)	1			EM-2378 @	
		Trans	Auto; THM400-475 (M40)	1			EM-2268 @	
	Trans	Manual	1			EM-2378 @		
V8 6.2L 379ci Diesel	1988-93	L & R Front		2	EM-2621			
		L & R Front		2	EM-2395			
	1982-83	L & R Front		2	EM-2292			
	1992-93	Trans		1			EM-2360 @	
	1991	Trans	Auto; 4L80E THM700-R4/4L60 (MD8)	1			EM-2392	
		Trans	Manual	1			EM-2392	
	1989-90	Trans	Auto; THM400 (M40)	1			EM-2513	
		Trans	Auto; THM700-R4/4L60 (MD8)	1			EM-2392	
		Trans	Manual	1			EM-2392	
	1988	Trans	Auto; THM400-475 (M40)	1			EM-2513	
		Trans	Auto; THM700R4 (MD8)	1			EM-2392	
		Trans	Manual; 4 Spd	1			EM-2393	
	1983-86	Trans	Manual; 5 Spd	1			EM-2392	
		Trans	Auto; THM400-475 (M40)	1			EM-2515	
Trans		Auto; THM700R4 (MD8)	1			EM-2393		
1982	Trans	Manual	1			EM-2393		
V8 6.5L 395ci Diesel	1992-00	L & R Front		2	EM-2621			
		Trans	Auto; 2WD	1			EM-2817	
	1995-00	Trans	Manual; 2WD	1			EM-2817	
		Trans		1			EM-2360 @	
V8 6.5L 396ci	1968-69	L & R Front		2	EM-2283			
V8 6.6L 400ci	1976-79	L & R Front		2	EM-2292			
		Trans	Auto; THM350 (M38)	1			EM-2378 @	
Trans	Auto; THM400-475 (M40)	1			EM-2268 @			

# Engine, Transmission, And Torque Strut Mounts

CYL	ENG. SIZE	YEAR	LOCATION	DESCRIPTION	QTY	ENGINE	TORQUE STRUT	TRANSMISSION	
<b>CHEVROLET TRUCK (continued)</b>									
<b>C30/C3500 P/U (continued)</b>									
V8	V8 6.6L 400ci	1976-79	Trans	Manual	1			EM-2378 @	
	V8 6.6L 402ci	1970-71	L & R Front		2	EM-2283			
			Trans	Auto; THM350 (M38)	1			EM-2378 @	
			Trans	Auto; THM400-475 (M40)	1			EM-2268 @	
			Trans	Manual	1			EM-2378 @	
	V8 6.7L 409ci	1964-65	L & R Front		2	EM-2285			
		1962	L & R Front		2	EM-2285			
	V8 7.4L 454ci	1988-00	L & R Front		2	EM-2621			
		1973-86	L & R Front		2	EM-2395			
		1996-00	Trans	Auto; 4L80-E 4 Spd	1				EM-2817
			Trans	Manual, FleetSide	1				EM-2817
			Trans	Manual; 135.5WB (C310), 159.5WB (C314), 183.5WB (C318)	1				EM-2638
		1992-95	Trans		1			EM-2360 @	
		1990-91	Trans		1			EM-2392	
		1988-89	Trans	Auto; THM400 (M40)	1				EM-2513
			Trans	Auto; THM700R4 (MD8)	1				EM-2392
		1982-86	Trans	Manual	1				EM-2392
			Trans	Auto; THM400 (M40)	1				EM-2513
			Trans	Auto; THM700R4 (MD8)	1				EM-2392
	1973-81	Trans	Manual	1				EM-2392	
Trans		Auto; THM350 (M38)	1				EM-2378 @		
Trans		Auto; THM400-475 (M40)	1				EM-2268 @		
V8 8.1L 496ci	2001-02	Trans		1			EM-2378 @		
		Trans	Mexican Vehicle; Manual; 2WD	1			EM-2817		
<b>C75</b>									
	V6 5.2L	1966-72	Center Front		1	EM-2041			
			Trans - L & R Lower	Manual	2			EM-2163	
			Trans - L & R Upper	Manual	2			EM-2162	
<b>COLORADO</b>									
L4	L4 2.8L	2004-06	LH Front		1	EM-3121			
			RH Front		1	EM-3120			
	L4 2.8L 2770cc	2004-06	Trans	2WD w/ Z71	1			EM-2638	
			Trans	2WD w/o Z71	1			EM-3122	
			Trans	4WD	1			EM-2638	
	L4 2.9L	2010	LH Front		1	EM-3121			
			RH Front		1	EM-3120			
		2007-09	LH Front		1	EM-3121			
			RH Front		1	EM-3120			
	2007-10	Trans	2WD	1			EM-3122		
Trans		4WD	1			EM-2638			
L5	L5 3.5L	2004-06	LH Front		1	EM-3121			
			RH Front		1	EM-3120			
		2006	Trans	4WD	1			EM-2638	
	L5 3.5L 3460cc	2004-05	Trans	2WD w/ Z71	1			EM-2638	
			Trans	2WD w/o Z71	1			EM-3122	
			Trans	4WD	1			EM-2638	
	L5 3.7L	2007-10	LH Front		1	EM-3121			
			RH Front		1	EM-3120			
			Trans	2WD	1			EM-3122	
			Trans	4WD	1			EM-2638	

# Engine, Transmission, And Torque Strut Mounts

CYL	ENG. SIZE	YEAR	LOCATION	DESCRIPTION	QTY	ENGINE	TORQUE STRUT	TRANSMISSION	
<b>CHEVROLET TRUCK (continued)</b>									
<b>EL CAMINO</b>									
L6	L6 3.2L 194ci	1964-65	L & R Front		2	EM-2284			
			Trans		1			EM-2378 @	
	L6 3.8L 230ci	1964-69	L & R Front		2	EM-2231			
	L6 4.1L 250ci	1975-77	L & R Front		2	EM-2292			
			1973	L & R Front		2	EM-2292		
		1967-72	L & R Front		2	EM-2284			
			1976-77	Trans	Auto	1			EM-2360 @
		1973-75	Trans	Manual; 3 Spd	1			EM-2337	
			Trans	Auto	1			EM-2360 @	
			Trans	Manual; 3 Spd	1			EM-2337	
			Trans	Manual; 4 Spd	1			EM-2294	
	1967-72	Trans	Auto	1			EM-2360 @		
		Trans	Manual	1			EM-2378 @		
V6	V6 3.3L 200ci	1978-79	LH Front		1	EM-2382			
			RH Front		1	EM-2384			
			Trans		1		EM-2353		
	V6 3.8L 229ci	1980-84	L & R Front		2	EM-2436			
			Trans	Auto	1		EM-2379		
		1980-81	Trans	Auto	1		EM-2379		
			Trans	Manual	1		EM-2379		
	V6 3.8L 231ci	1978-84	LH Front		1	EM-2382			
			RH Front		1	EM-2384			
		1982-84	Trans	Auto	1		EM-2379		
			Trans	Auto	1		EM-2379		
			Trans	Manual	1		EM-2379		
	V6 4.3L 262ci	1985-87	L & R Front		2	EM-2436			
			Trans	Auto	1		EM-2379		
	V8	V8 4.4L 267ci	1979-82	L & R Front		2	EM-2292		
				1982	Trans	Auto	1		EM-2360 @
1979-81			Trans	Auto	1		EM-2360 @		
			Trans	Manual	1		EM-2360 @		
V8 4.6L 283ci		1964-67	L & R Front		2	EM-2142			
			Trans	Auto	1		EM-2268 @		
			Trans	Manual	1		EM-2378 @		
V8 5.0L 305ci		1976-87	L & R Front		2	EM-2292			
			Trans	Auto	1		EM-2360 @		
		1976-81	Trans	Auto	1		EM-2337		
			Trans	Manual	1		EM-2337		
V8 5.0L 307ci		1968-73	L & R Front		2	EM-2142			
			Trans	Auto	1		EM-2378 @		
			Trans	Manual	1		EM-2378 @		
V8 5.4L 327ci		1966-68	L & R Front		2	EM-2142			
			Trans	Auto	1		EM-2378 @		
			Trans	Manual	1		EM-2378 @		
V8 5.7L 348ci		1959-60	L & R Front		2	EM-2267			
			Trans	Auto; Powerglide	1		EM-2268 @		
			Trans	Manual	1		EM-2378 @		
V8 5.7L 350ci		1973-79	L & R Front		2	EM-2292			
			1969-72	L & R Front		2	EM-2282		
		1979	Trans	Auto; THM200 (M29) THM200C (MV9); THM350 (M38)	1		EM-2378 @		
	Trans		Manual	1		EM-2378 @			
	1976-78	Trans	Auto; THM200 (M29); THM350 (M38)	1		EM-2378 @			
		Trans	Manual	1		EM-2378 @			

# Engine, Transmission, And Torque Strut Mounts

CYL	ENG. SIZE	YEAR	LOCATION	DESCRIPTION	QTY	ENGINE	TORQUE STRUT	TRANSMISSION	
<b>CHEVROLET TRUCK (continued)</b>									
<b>EL CAMINO (continued)</b>									
V8	V8 5.7L 350ci	1975	Trans	Auto; THM350 (M38)	1			EM-2378 @	
			Trans	Auto; THM400 (M40)	1			EM-2268 @	
			Trans	Manual	1				EM-2378 @
		1969-74	Trans	Auto; THM350 (M38)	1				EM-2378 @
			Trans	Auto; THM400 (M40)	1				EM-2268 @
			Trans	Manual	1				EM-2378 @
	V8 5.7L 350ci Diesel	1983-84	L & R Front		2	EM-2328			
			Trans		1			EM-2360 @	
	V8 6.5L 396ci	1968-70	L & R Front		2	EM-2283			
			1966-67	L & R Front		2	EM-2285		
		1966-70	Trans	Auto; THM350 (M38)	1				EM-2378 @
			Trans	Auto; THM400 (M40)	1				EM-2268 @
	V8 6.6L 400ci	1974-76	L & R Front		2	EM-2292			
			1970-72	L & R Front		2	EM-2283		
		1974-76	Trans	Auto	1				EM-2360 @
			Trans	Manual	1				EM-2360 @
		1970-72	Trans	Auto	1				EM-2378 @
			Trans	Manual	1				EM-2378 @
	V8 7.4L 454ci	1973-74	L & R Front		2	EM-2395			
			1970-72	L & R Front		2	EM-2283		
1973-74		Trans	Auto	1				EM-2360 @	
		Trans	Manual	1				EM-2360 @	
1970-72		Trans		1				EM-2294	
<b>K10/K1500 P/U</b>									
L6	L6 3.8L 230ci	1964-65	L & R Front		2	EM-2282			
			L & R Rear Lower		2	EM-2108			
			L & R Rear Upper		2	EM-2107			
	L6 3.9L 235ci	1961-62	L & R Front		2	EM-2142			
			L & R Rear Lower		2	EM-2108			
			L & R Rear Upper		2	EM-2107			
	L6 4.1L 250ci	1973-84	L & R Front		2	EM-2292			
			1970-72	L & R Front		2	EM-2282		
		1966-67	L & R Front		2	EM-2282			
			Trans - L & R Lower		2				EM-2108
			Trans - L & R Upper		2				EM-2107
		1970-84	Trans - Lower	Auto	2				EM-2108
			Trans - Lower	Manual	2				EM-2108
	Trans - Upper		Auto	2				EM-2107	
	L6 4.8L 292ci	1979-80	L & R Front		2	EM-2292			
		1975-76	L & R Front		2	EM-2292			
		1964-66	L & R Front		2	EM-2282			
			Trans - L & R Lower		2				EM-2108
			Trans - L & R Upper		2				EM-2107
		1979-80	Trans - Lower	Auto	2				EM-2108
Trans - Lower			Manual	2				EM-2108	
1975-76		Trans - Lower	Auto	2				EM-2108	
	Trans - Lower	Manual	2				EM-2108		

## Engine, Transmission, And Torque Strut Mounts

CYL	ENG. SIZE	YEAR	LOCATION	DESCRIPTION	Q T Y	ENGINE	TORQUE STRUT	TRANS- MISSION
<b>CHEVROLET TRUCK (continued)</b>								
<b>K10/K1500 P/U (continued)</b>								
L6	L6 4.8L 292ci	1979-80	Trans - Upper	Auto	2			EM-2107
		1975-76	Trans - Upper	Auto	2			EM-2107
V6	V6 4.3L 262ci	1988-95	L & R Front		2	EM-2436		
		1985-86	L & R Front		2	EM-2436		
		1998	Trans	Auto	1			EM-2638
			Trans	Manual	1			EM-2638
		1988-97	Trans	Auto	1			EM-2638
			Trans	Manual	1			EM-2638
		1985-86	Trans	Auto	1			EM-2638
			Trans	Manual	1			EM-2638
V8	V8 4.6L 283ci	1963-67	L & R Front		2	EM-2282		
		1961-62	L & R Front		2	EM-2267		
		1963-67	Trans - L & R Lower		2			EM-2108
			Trans - L & R Upper		2			EM-2107
	V8 5.0L 305ci	1988-99	L & R Front		2	EM-2637		
		1981-86	L & R Front		2	EM-2292		
		1977-79	L & R Front		2	EM-2292		
		1981-84	Trans - Lower	Auto	2			EM-2108
			Trans - Lower	Manual	2			EM-2108
		1977-79	Trans - Lower	Auto	2			EM-2108
			Trans - Lower	Manual	2			EM-2108
		1981-84	Trans - Upper	Auto	2			EM-2107
		1977-79	Trans - Upper	Auto	2			EM-2107
		1999	Trans	Auto	1			EM-2638
		1988-98	Trans	Auto	1			EM-2638
			Trans	Manual	1			EM-2638
		1985-86	Trans	Auto	1			EM-2638
	Trans		Manual	1			EM-2638	
	V8 5.0L 307ci	1968-69	L & R Front		2	EM-2282		
			Trans - L & R Lower		2			EM-2108
			Trans - L & R Upper		2			EM-2107
	V8 5.4L 327ci	1966-68	L & R Front		2	EM-2282		
			Trans - L & R Lower		2			EM-2108
			Trans - L & R Upper		2			EM-2107
	V8 5.7L 350ci	1988-99	L & R Front		2	EM-2637		
		1973-86	L & R Front		2	EM-2292		
		1969-72	L & R Front		2	EM-2282		
		1969-84	Trans - Lower	Auto	2			EM-2108
			Trans - Lower	Manual	2			EM-2108
			Trans - Upper	Auto	2			EM-2107
		1999	Trans	Auto	1			EM-2638
		1988-98	Trans	Auto	1			EM-2638
			Trans	Manual	1			EM-2638
1985-86		Trans	Auto	1			EM-2638	
		Trans	Manual	1			EM-2638	
V8 6.2L 379ci Diesel	1988-93	L & R Front		2	EM-2637			
	1984-86	L & R Front		2	EM-2395			
	1982-83	L & R Front		2	EM-2292			
	1982-84	Trans - Lower	Auto	2			EM-2108	
		Trans - Lower	Manual	2			EM-2108	
		Trans - Upper	Auto	2			EM-2107	

# Engine, Transmission, And Torque Strut Mounts

CYL	ENG. SIZE	YEAR	LOCATION	DESCRIPTION	QTY	ENGINE	TORQUE STRUT	TRANSMISSION	
<b>CHEVROLET TRUCK (continued)</b>									
<b>K10/K1500 P/U (continued)</b>									
V8	V8 6.2L 379ci Diesel	1988-93	Trans	Auto	1			EM-2638	
			Trans	Manual	1			EM-2638	
		1985-86	Trans	Auto	1				EM-2638
			Trans	Manual	1				EM-2638
	V8 6.5L 395ci Diesel	1994-98	L & R Front		2	EM-2637			
			Trans	Auto	1			EM-2638	
			Trans	Manual	1			EM-2638	
	V8 6.6L 400ci	1975-80	L & R Front		2	EM-2292			
			Trans - Lower	Auto	2			EM-2108	
			Trans - Lower	Manual	2			EM-2108	
			Trans - Upper	Auto	2			EM-2107	
	V8 7.4L 454ci	1979-80	L & R Front		2	EM-2395			
			L & R Front		2	EM-2395			
		1974	L & R Front		2	EM-2395			
			Trans - Lower	Auto	2			EM-2108	
		1979-80	Trans - Lower	Manual	2			EM-2108	
			Trans - Lower	Auto	2			EM-2108	
		1976	Trans - Lower	Auto	2			EM-2108	
			Trans - Lower	Manual	2			EM-2108	
		1974	Trans - Lower	Auto	2			EM-2108	
Trans - Lower			Manual	2			EM-2108		
1979-80	Trans - Upper	Auto	2			EM-2107			
	Trans - Upper	Auto	2			EM-2107			
1974	Trans - Upper	Auto	2			EM-2107			
	Trans - Upper	Auto	2			EM-2107			
<b>K20/K2500 P/U</b>									
L6	L6 3.8L 230ci	1964-65	L & R Front		2	EM-2282			
			L & R Rear Lower		2	EM-2108			
			L & R Rear Upper		2	EM-2107			
	L6 3.9L 235ci	1961-62	L & R Front		2	EM-2142			
			Trans - L & R Lower		2			EM-2108	
			Trans - L & R Upper		2			EM-2107	
	L6 4.1L 250ci	1978-80	L & R Front		2	EM-2292			
			L & R Front		2	EM-2292			
		1966-72	L & R Front		2	EM-2282			
			Trans - L & R Lower		2			EM-2108	
		1978-80	Trans - L & R Upper		2			EM-2107	
			Trans - Lower	Auto	2			EM-2108	
		1966-76	Trans - Lower	Manual	2			EM-2108	
	Trans - Upper		Auto	2			EM-2107		
	L6 4.8L 292ci	1973-86	L & R Front		2	EM-2292			
			L & R Front		2	EM-2282			
		1964-67	L & R Front		2	EM-2282			
			Trans - L & R Lower		2			EM-2108	
			Trans - L & R Upper		2			EM-2107	
		1970-84	Trans - Lower	Auto	2			EM-2108	
Trans - Lower			Manual	2			EM-2108		
Trans - Upper			Auto	2			EM-2107		
1985-86	Trans	Auto	1			EM-2638			
	Trans	Manual	1			EM-2638			
V6	V6 4.3L 262ci	1988-95	L & R Front		2	EM-2436			



# Engine, Transmission, And Torque Strut Mounts

CYL	ENG. SIZE	YEAR	LOCATION	DESCRIPTION	QTY	ENGINE	TORQUE STRUT	TRANSMISSION
<b>CHEVROLET TRUCK (continued)</b>								
<b>K20/K2500 P/U (continued)</b>								
V6	V6 4.3L 262ci	1985	L & R Front		2	EM-2436		
		1988-95	Trans	Auto	1			EM-2638
			Trans	Manual	1			EM-2638
		1985	Trans	Auto	1			EM-2638
			Trans	Manual	1			EM-2638
V8	V8 4.6L 283ci	1963-67	L & R Front		2	EM-2282		
		1961-62	L & R Front		2	EM-2267		
		1963-67	Trans - L & R Lower		2			EM-2108
		1961-62	Trans - L & R Lower		2			EM-2108
		1963-67	Trans - L & R Upper		2			EM-2107
		1961-62	Trans - L & R Upper		2			EM-2107
		V8 5.0L 305ci	1998	L & R Front		2	EM-2637	
	1988-95		L & R Front		2	EM-2637		
	1985		L & R Front		2	EM-2292		
	1980		L & R Front		2	EM-2292		
	1977-78		L & R Front		2	EM-2292		
			Trans - Lower	Auto	2			EM-2108
			Trans - Lower	Manual	2			EM-2108
	1977-78		Trans - Lower	Auto	2			EM-2108
			Trans - Lower	Manual	2			EM-2108
	1980		Trans - Upper	Auto	2			EM-2107
	1977-78		Trans - Upper	Auto	2			EM-2107
	1998		Trans	Auto	1			EM-2638
			Trans	Manual	1			EM-2638
	1988-95		Trans	Auto	1			EM-2638
			Trans	Manual	1			EM-2638
	1985		Trans	Auto	1			EM-2638
		Trans	Manual	1			EM-2638	
	V8 5.0L 307ci	1968-69	L & R Front		2	EM-2282		
			Trans - L & R Lower		2			EM-2108
			Trans - L & R Upper		2			EM-2107
	V8 5.4L 327ci	1966-68	L & R Front		2	EM-2282		
			Trans - L & R Lower		2			EM-2108
			Trans - L & R Upper		2			EM-2107
	V8 5.7L 348ci	1961	Trans	Auto; Powerglide	1			EM-2268 @
			Trans	Manual	1			EM-2378 @
	V8 5.7L 350ci	1988-00	L & R Front		2	EM-2637		
		1973-86	L & R Front		2	EM-2292		
1969-72		L & R Front		2	EM-2282			
1969-84		Trans - Lower	Auto	2			EM-2108	
		Trans - Lower	Manual	2			EM-2108	
1988-00		Trans	Auto	1			EM-2638	
		Trans	Manual	1			EM-2638	
1985-86		Trans	Auto	1			EM-2638	
		Trans	Manual	1			EM-2638	
V8 6.2L 379ci Diesel	1988-93	L & R Front		2	EM-2637			
	1984-86	L & R Front		2	EM-2395			
	1982-83	L & R Front		2	EM-2292			
	1982-84	Trans - Lower	Auto	2			EM-2108	

# Engine, Transmission, And Torque Strut Mounts

CYL	ENG. SIZE	YEAR	LOCATION	DESCRIPTION	QTY	ENGINE	TORQUE STRUT	TRANSMISSION	
<b>CHEVROLET TRUCK (continued)</b>									
<b>K20/K2500 P/U (continued)</b>									
V8	V8 6.2L 379ci Diesel	1982-84	Trans - Lower	Manual	2			EM-2108	
		1988-93	Trans	Auto	1			EM-2638	
			Trans	Manual	1			EM-2638	
			Trans	Auto	1			EM-2638	
		1985-86	Trans	Auto	1			EM-2638	
	Trans		Manual	1			EM-2638		
	V8 6.5L 395ci Diesel		1992-00	L & R Front		2	EM-2637		
		Trans	Auto	1				EM-2638	
		Trans	Manual	1				EM-2638	
	V8 6.6L 400ci	1975-80	L & R Front		2	EM-2292			
			Trans - Lower	Auto	2			EM-2108	
			Trans - Lower	Manual	2			EM-2108	
			Trans - Upper	Auto	2			EM-2107	
	V8 6.7L 409ci	1964-65	Trans	Auto; Powerglide	1			EM-2268 @	
			Trans	Manual	1			EM-2378 @	
		1962	Trans	Auto; Powerglide	1			EM-2268 @	
			Trans	Manual	1			EM-2378 @	
	V8 7.4L 454ci	1991-00	L & R Front		2	EM-2637			
			L & R Front		2	EM-2395			
		1976-78	L & R Front		2	EM-2395			
		1973-74	L & R Front		2	EM-2395			
		1980	Trans - L & R Lower		2				EM-2108
			Trans - L & R Upper		2				EM-2107
		1976-78	Trans - Lower	Auto	2				EM-2108
			Trans - Lower	Manual	2				EM-2108
		1973-74	Trans - Lower	Auto	2				EM-2108
			Trans - Lower	Manual	2				EM-2108
		1976-78	Trans - Upper	Auto	2				EM-2107
1973-74		Trans - Upper	Auto	2				EM-2107	
1991-00		Trans	Auto	1				EM-2638	
Trans	Manual	1					EM-2638		
<b>K30/K3500 P/U</b>									
L6	L6 4.1L 250ci	1973-74	L & R Front		2	EM-2292			
		1968-72	L & R Front		2	EM-2282			
		1968-74	Trans - Lower	Auto	2				EM-2108
			Trans - Lower	Manual	2				EM-2108
			Trans - Upper	Auto	2				EM-2107
	L6 4.8L 292ci	1977-86	L & R Front		2	EM-2292			
		1973-74	L & R Front		2	EM-2292			
		1968-72	L & R Front		2	EM-2282			
		1977-84	Trans - Lower	Auto	2				EM-2108
			Trans - Lower	Manual	2				EM-2108
		1968-74	Trans - Lower	Auto	2				EM-2108
			Trans - Lower	Manual	2				EM-2108
		1977-84	Trans - Upper	Auto	2			EM-2107	
		1968-74	Trans - Upper	Auto	2			EM-2107	
		1985-86	Trans	Auto	1				EM-2638
	Trans		Manual	1				EM-2638	
	V8	V8 5.0L 307ci	1973	L & R Front		2	EM-2292		
1968-72			L & R Front		2	EM-2282			
1968-73			Trans - Lower	Auto	2				EM-2108
			Trans - Lower	Manual	2				EM-2108
			Trans - Upper	Auto	2				EM-2107
V8 5.7L 350ci		1988-00	L & R Front		2	EM-2637			
	1977-86	L & R Front		2	EM-2292				

# Engine, Transmission, And Torque Strut Mounts

CYL	ENG. SIZE	YEAR	LOCATION	DESCRIPTION	QTY	ENGINE	TORQUE STRUT	TRANSMISSION
<b>CHEVROLET TRUCK (continued)</b>								
<b>K30/K3500 P/U (continued)</b>								
V8	V8 5.7L 350ci	1973-74	L & R Front		2	EM-2292		
		1969-72	L & R Front		2	EM-2282		
		1977-84	Trans - Lower	Auto	2			EM-2108
			Trans - Lower	Manual	2			EM-2108
		1969-74	Trans - Lower	Auto	2			EM-2108
			Trans - Lower	Manual	2			EM-2108
		1977-84	Trans - Upper	Auto	2			EM-2107
			Trans	Auto	1			EM-2638
		1988-00	Trans	Manual	1			EM-2638
			1985-86	Trans	Auto	1		EM-2638
			Trans	Manual	1		EM-2638	
	V8 6.2L 379ci Diesel	1988-93	L & R Front		2	EM-2637		
		1984-86	L & R Front		2	EM-2395		
		1982-83	L & R Front		2	EM-2292		
		1982-84	Trans - Lower	Auto	2			EM-2108
			Trans - Lower	Manual	2			EM-2108
			Trans - Upper	Auto	2			EM-2107
		1988-93	Trans	Auto	1			EM-2638
			Trans	Manual	1			EM-2638
		1985-86	Trans	Auto	1			EM-2638
			Trans	Manual	1			EM-2638
	V8 6.5L 395ci Diesel	1992-00	L & R Front		2	EM-2637		
			Trans	Auto	1		EM-2638	
			Trans	Manual	1		EM-2638	
	V8 6.6L 400ci	1977-80	L & R Front		2	EM-2292		
			Trans - Lower	Auto	2		EM-2108	
			Trans - Lower	Manual	2		EM-2108	
			Trans - Upper	Auto	2		EM-2107	
	V8 6.6L 402ci	1970-71	L & R Front		2	EM-2283		
			Trans - Lower	Auto	2		EM-2108	
			Trans - Lower	Manual	2		EM-2108	
			Trans - Upper	Auto	2		EM-2107	
	V8 7.4L 454ci	1988-00	L & R Front		2	EM-2637		
		1980-86	L & R Front		2	EM-2395		
		1977	L & R Front		2	EM-2395		
		1973-74	L & R Front		2	EM-2395		
		1980-84	Trans - Lower	Auto	2			EM-2108
			Trans - Lower	Manual	2			EM-2108
		1977	Trans - Lower	Auto	2			EM-2108
			Trans - Lower	Manual	2			EM-2108
		1973-74	Trans - Lower	Auto	2			EM-2108
			Trans - Lower	Manual	2			EM-2108
1980-84		Trans - Upper	Auto	2		EM-2107		
1977		Trans - Upper	Auto	2		EM-2107		
1973-74		Trans - Upper	Auto	2		EM-2107		
1988-00		Trans	Auto	1			EM-2638	
		Trans	Manual	1			EM-2638	
1985-86		Trans	Auto	1			EM-2638	
		Trans	Manual	1			EM-2638	
<b>LLV (POSTAL VEHICLE)</b>								
L4	L4 2.2L 134ci	1994-95	L & R Front	Insert	2	EM-2819		
			Trans		1		EM-2508	
	L4 2.5L 2474cc	1987-93	LH Front		1	EM-2549		
			RH Front		1	EM-2550		
			Trans		1		EM-2508	

# Engine, Transmission, And Torque Strut Mounts

CYL	ENG. SIZE	YEAR	LOCATION	DESCRIPTION	QTY	ENGINE	TORQUE STRUT	TRANSMISSION
<b>CHEVROLET TRUCK (continued)</b>								
<b>LUV PICKUP</b>								
L4	L4 1.8L 111ci	1972-82	LH Front		1	EM-2563		
			RH Front		1	EM-2562		
			Trans	Auto	1			EM-2567
			Trans	Manual	1			EM-2567
	L4 2.2L 134ci Diesel	1981-82	LH Front		1	EM-8048		
			RH Front		1	EM-8049		
Trans				1			EM-8586	
<b>R10 PICKUP</b>								
V6	V6 4.3L 262ci	1987	L & R Front		2	EM-2436		
			Trans	Auto; THM700R4 (MD8)	1			EM-2394
			Trans	Manual	1			EM-2394
V8	V8 5.0L 305ci	1987	L & R Front		2	EM-2292		
			Trans	Auto	1			EM-2513
			Trans	Manual	1			EM-2392
	V8 5.7L 350ci	1987	L & R Front		2	EM-2292		
			Trans		1			EM-2392
	V8 6.2L 379ci Diesel	1987	L & R Front		2	EM-2395		
			Trans	Auto; THM400-475 (M40)	1			EM-2515
			Trans	Auto; THM700R4 (MD8)	1			EM-2393
			Trans	Manual	1			EM-2393
<b>R20/R2500 P/U</b>								
L6	L6 4.8L 292ci	1987-88	L & R Front		2	EM-2292		
			Trans	Auto	1			EM-2513
			Trans	Manual	1			EM-2392
V6	V6 4.3L 262ci	1987	L & R Front		2	EM-2436		
			Trans	Auto; THM700R4 (MD8)	1			EM-2394
			Trans	Manual	1			EM-2394
V8	V8 5.0L 305ci	1987	L & R Front		2	EM-2292		
			Trans	Auto	1			EM-2513
			Trans	Manual	1			EM-2392
	V8 5.7L 350ci	1987-88	L & R Front		2	EM-2292		
			Trans		1			EM-2392
	V8 6.2L 379ci Diesel	1989	L & R Front		2	EM-2395		
			L & R Front		2	EM-2395		
			Trans	Auto; THM400-475 (M40)	1			EM-2515
		1987-88	Trans	Auto; THM700R4 (MD8)	1			EM-2393
			Trans	Manual	1			EM-2393
			Trans	Auto; THM400-475 (M40)	1			EM-2515
		1987-88	Trans	Auto; THM700R4 (MD8)	1			EM-2393
			Trans	Manual	1			EM-2393
			Trans	Manual	1			EM-2393
	V8 7.4L 454ci	1989	L & R Front		2	EM-2395		
			L & R Front		2	EM-2395		
		1989	Trans	Auto; THM400 (M40)	1			EM-2513
			Trans	Auto; THM700R4 (MD8)	1			EM-2392
Trans			Manual	1			EM-2392	
1987-88		Trans	Auto; THM400-475 (M40)	1			EM-2513	
	Trans	Auto; THM700R4 (MD8)	1			EM-2392		
Trans	Manual	1			EM-2392			
<b>R30/R3500 P/U</b>								
L6	L6 4.8L 292ci	1987-88	L & R Front		2	EM-2292		
			Trans	Auto	1			EM-2513
			Trans	Manual	1			EM-2392
V8	V8 5.7L 350ci	1987-91	L & R Front		2	EM-2292		
			Trans		1			EM-2392
			Trans		1			EM-2392
	V8 6.2L 379ci Diesel	1989-91	L & R Front		2	EM-2395		

# Engine, Transmission, And Torque Strut Mounts

CYL	ENG. SIZE	YEAR	LOCATION	DESCRIPTION	QTY	ENGINE	TORQUE STRUT	TRANSMISSION	
<b>CHEVROLET TRUCK (continued)</b>									
<b>R30/R3500 P/U (continued)</b>									
V8	V8 6.2L 379ci Diesel	1987-88	L & R Front		2	EM-2395			
		1991	Trans	Auto; THM700-R4/4L60 (MD8)	1			EM-2393	
			Trans	Manual	1			EM-2393	
		1989-90	Trans	Auto; THM400 (M40)	1			EM-2515	
			Trans	Auto; THM700-R4/4L60 (MD8)	1			EM-2393	
			Trans	Manual	1			EM-2393	
		1987-88	Trans	Auto; THM400-475 (M40)	1			EM-2515	
			Trans	Auto; THM700R4 (MD8)	1			EM-2393	
			Trans	Manual	1			EM-2393	
	V8 7.4L 454ci	1989-91	L & R Front		2	EM-2395			
			Trans	Auto	1			EM-2513	
			Trans	Manual	1			EM-2392	
		1987-88	Trans	Auto	1			EM-2513	
			Trans	Manual	1			EM-2392	
<b>S10 PICKUP</b>									
L4	L4 1.9L 119ci	1982-85	L & R Front		2	EM-2381			
		1983-85	Trans	Auto; 2WD	1			EM-2531	
			Trans	Auto; 4WD	1			EM-2638	
			Trans	Manual; 2WD	1			EM-2531	
			Trans	Manual; 4WD	1			EM-2638	
		1982	Trans	Auto; 2WD	1			EM-2771	
			Trans	Manual; 2WD	1			EM-2771	
		L4 2.0L 122ci	1983-84	LH Front		1	EM-2755		
				RH Front		1	EM-2756		
			1984	Trans	Auto; 2WD	1			EM-2531
	Trans			Auto; 4WD	1			EM-2638	
	Trans			Manual; 2WD	1			EM-2531	
	Trans			Manual; 4WD	1			EM-2638	
	1983		Trans	Auto; 2WD	1			EM-2772	
			Trans	Auto; 4WD	1			EM-2638	
			Trans	Manual; 2WD	1			EM-2772	
			Trans	Manual; 4WD	1			EM-2638	
	L4 2.2L 134ci	1994-03	L & R Front	Insert	2	EM-2819			
			LH Front	Complete Unit	1	EM-5426			
			RH Front	Complete Unit	1	EM-5350			
		1998-03	Trans	Auto	1			EM-2957	
			Trans	Manual	1			EM-2957	
		1994-97	Trans	Auto	1			EM-2957	
			Trans	Manual	1			EM-2956	
	L4 2.2L 134ci Diesel	1983-85	LH Front		1	EM-2549			
			RH Front		1	EM-2550			
			Trans	Auto; 2WD	1			EM-2531	
			Trans	Manual; 2WD	1			EM-2531	
	L4 2.5L 2474cc	1985-93	LH Front		1	EM-2549			
RH Front				1	EM-2550				
1988-93		Trans	Auto; 2WD	1			EM-2508		
		Trans	Manual; 2WD	1			EM-2508		
1985-87		Trans	Auto; 2WD	1			EM-2531		
		Trans	Manual; 2WD	1			EM-2531		
V6	V6 2.8L 173ci	1982-93	L & R Front		2	EM-2436			
		1988-93	Trans	Auto; 2WD	1			EM-2508	
			Trans	Auto; 4WD	1			EM-2638	
			Trans	Manual; 2WD	1			EM-2508	
			Trans	Manual; 4WD	1			EM-2638	
		1984-87	Trans	Auto; 2WD	1			EM-2531	
			Trans	Auto; 4WD	1			EM-2638	
			Trans	Manual; 2WD	1			EM-2531	

# Engine, Transmission, And Torque Strut Mounts

CYL	ENG. SIZE	YEAR	LOCATION	DESCRIPTION	QTY	ENGINE	TORQUE STRUT	TRANSMISSION	
<b>CHEVROLET TRUCK (continued)</b>									
<b>S10 PICKUP (continued)</b>									
V6	V6 2.8L 173ci	1984-87	Trans	Manual; 4WD	1			EM-2638	
		1983	Trans	Auto; 2WD	1			EM-2772	
			Trans	Auto; 4WD	1			EM-2638	
			Trans	Manual; 2WD	1			EM-2772	
			Trans	Manual; 4WD	1			EM-2638	
			Trans	Auto; 2WD	1			EM-2771	
	1982	Trans	Manual; 2WD	1			EM-2771		
	V6 4.3L 262ci	1996-04	L & R Front			2	EM-2802		
		1988-95	L & R Front			2	EM-2627		
		2004	Trans	Auto; 4WD		1			EM-2638
		1995-03	Trans	Auto; 4WD		1			EM-2638
			Trans	Auto; RWD		1			EM-2394
			Trans	Manual; 4WD		1			EM-2638
			Trans	Manual; RWD		1			EM-2394
			1988-94	Trans	Auto; 2WD		1		
		Trans	Auto; 4WD		1				EM-2638
		Trans	Manual; 2WD		1				EM-2508
		Trans	Manual; 4WD		1				EM-2638
<b>SILVERADO 1500</b>									
V6	V6 4.3L	2006-13	Trans	4WD	1			EM-2638	
			Trans	RWD	1			EM-2817	
	V6 4.3L 262ci	2007-13	L & R Front			2	EM-4073		
		1999-06	L & R Front			2	EM-2994		
		1999-05	Trans	4WD		1			EM-2638
Trans	RWD			1			EM-2817		
V8	V8 4.8L	2007-12	Trans	4WD	1			EM-3172	
			Trans	RWD	1			EM-2817	
	V8 4.8L 294ci	2007	L & R Front	Classic Body Style		2	EM-2909		
		1999-06	L & R Front			2	EM-2909		
		2008-13	LH Front			1	EM-4000		
		2007	LH Front	New Body Style		1	EM-4000		
		2008-13	RH Front			1	EM-4017		
		2007	RH Front	New Body Style		1	EM-4017		
		1999-06	Trans	4WD		1			EM-2638
			Trans	RWD		1			EM-2817
	V8 5.3L	2004-05	L & R Front	Complete Unit; Hybrid; RWD		2	EM-5423		
			L & R Front	Exc. Hybrid; RWD		2	EM-2909		
		2005	Trans	Auto, 4WD, Hybrid		1			EM-2638
	V8 5.3L 323ci	2010-12	L & R Front			2	EM-5583		
		2008-09	L & R Front			2	EM-5583		
		2006	L & R Front	Mexican Vehicle; Complete Unit		2	EM-5423		
		1999-03	L & R Front			2	EM-2909		
		1999-04	Trans	4WD		1			EM-2638
			Trans	RWD		1			EM-2817
	V8 5.3L 325ci	2007	L & R Front	Gas; New Body Style		2	EM-5583		
			L & R Front	Gas; Old Body Style		2	EM-2909		
		2006-07	L & R Front	Hybrid; Hybrid		2	EM-5423		
		2006	L & R Front	Gas; Exc. Hybrid; RWD		2	EM-2909		
		2006-14	Trans	4WD		1			EM-2638
			Trans	RWD		1			EM-2817
	V8 6.0L 364ci	2008-12	L & R Front			2	EM-5583		
		2003-07	L & R Front			2	EM-2909		
		2009-13	Trans	4WD		1			EM-2638
			Trans	RWD		1			EM-2817
		2006-08	Trans	4WD		1			EM-2638
			Trans	RWD		1			EM-2817

## Engine, Transmission, And Torque Strut Mounts

CYL	ENG. SIZE	YEAR	LOCATION	DESCRIPTION	QTY	ENGINE	TORQUE STRUT	TRANSMISSION	
<b>CHEVROLET TRUCK (continued)</b>									
<b>SILVERADO 1500 (continued)</b>									
V8	V8 6.0L 364ci	2003-05	Trans		1			EM-2638	
	V8 6.2L	2009-14	Trans	4WD	1			EM-2638	
			Trans	RWD	1		EM-2817		
	V8 6.2L 376ci	2009-12	L & R Front	Complete Unit	2	EM-5583			
<b>SILVERADO 1500 HD</b>									
V8	V8 6.0L 364ci	2001-07	L & R Front		2	EM-2909			
		2005-07	Trans	2WD	1			EM-2817	
			Trans	4WD	1			EM-2638	
		2001-03	Trans	2WD		1			EM-2817
			Trans	4WD		1			EM-2638
<b>SILVERADO 2500</b>									
V8	V8 5.3L 323ci	2001-05	L & R Front	Mexican Vehicle	2	EM-2909			
		1999-00	L & R Front		2	EM-2909			
		2001-05	Trans	Mexican Vehicle	1			EM-2817	
		1999-00	Trans	4WD		1			EM-2638
			Trans	RWD		1			EM-2817
	V8 5.3L 325ci	2006-08	L & R Front	Mexican Vehicle	2	EM-5074			
	V8 5.3L 5328cc	2006-09	Trans	Mexican Vehicle	1			EM-2817	
	V8 6.0L 364ci	1999-04	L & R Front	w/Heat Shield	2	EM-5423			
			L & R Front	w/o Heat Shield	2	EM-2909			
			Trans	2WD	1			EM-2817	
			Trans	4WD	1			EM-2638	
	<b>SILVERADO 2500 HD</b>								
V8	V8 6.0L	2007-14	Trans	Auto; 4WD	1			EM-2638	
			Trans	Auto; RWD	1			EM-2817	
			Trans	Manual; 4WD	1			EM-2638	
			Trans	Manual; RWD	1			EM-2817	
	V8 6.0L 364ci	2008-10	L & R Front	Complete Unit	2	EM-5583			
			2001-07	L & R Front	w/Heat Shield	2	EM-5423		
				L & R Front	w/o Heat Shield	2	EM-2909		
		2001-06	Trans	Auto; 4WD		1			EM-2638
			Trans	Auto; RWD		1			EM-2817
			Trans	Manual; 4WD		1			EM-2638
			Trans	Manual; RWD		1			EM-2817
	V8 6.6L 400ci Diesel	2001-10	LH Front		1	EM-3102			
			RH Front	Complete Unit	1	EM-5582			
			RH Front	w/o Heat Shield	1	EM-3102			
			2001-06	Trans		1			EM-2638
	V8 8.1L	2001-07	L & R Front		2	EM-5353			
	V8 8.1L 496ci	2001-07	Trans		1			EM-2638	
	<b>SILVERADO 3500</b>								
	V8	V8 5.3L 323ci	2004-05	L & R Front	Mexican Vehicle	2	EM-2909		
Trans				Mexican Vehicle	1			EM-2817	
V8 5.3L 325ci		2006-07	L & R Front	Mexican Vehicle	2	EM-2909			
V8 5.3L 5328cc		2006-09	Trans	Mexican Vehicle	1			EM-2817	
V8 6.0L 364ci		2001-07	L & R Front	w/Heat Shield	2	EM-5423			
			L & R Front	w/o Heat Shield	2	EM-2909			
		2007	Trans	4WD		1			EM-2638
			Trans	RWD		1			EM-2817
V8 6.6L 400ci Diesel		2001-07	Left	Complete Unit	1	EM-5582			
			Left	w/o Heat Shield	1	EM-3102			
			Right		1	EM-3102			
			Trans	2WD	1			EM-2638	
V8 8.1L		2001-07	L & R Front		2	EM-5353			
V8 8.1L 496ci		2001-07	Trans		1			EM-2638	

# Engine, Transmission, And Torque Strut Mounts

CYL	ENG. SIZE	YEAR	LOCATION	DESCRIPTION	QTY	ENGINE	TORQUE STRUT	TRANSMISSION
<b>CHEVROLET TRUCK (continued)</b>								
<b>SILVERADO 3500 HD</b>								
V8	V8 6.0L	2007-14	Trans	4WD	1			EM-2638
			Trans	RWD	1			EM-2817
	V8 6.0L 364ci	2007-10	L & R Front		2	EM-5583		
	V8 6.6L	2007-14	Trans		1			EM-2638
	V8 6.6L 400ci Diesel	2007-10	LH Front		1	EM-3102		
			RH Front	Complete Unit	1	EM-5582		
		RH Front	w/o Heat Shield	1	EM-3102			
<b>TRUCK</b>								
L6	L6 3.5L 216ci	1942-53	Center Front		1	EM-2007		
			Trans - L & R	Manual, 1st Design	1			EM-2060
			Trans - L & R	Manual, 3rd Design	1			EM-2073
	L6 3.9L 235ci	1960	L & R Front		2	EM-2142		
			Trans	Auto	1			EM-2378 @
		1953-58	Trans	Large	1			EM-2123
		Trans	Small	1			EM-2122	
<b>V10 PICKUP</b>								
V6	V6 4.3L 262ci	1987	L & R Front		2	EM-2436		
			Trans	Auto	1			EM-2638
			Trans	Manual	1			EM-2638
V8	V8 5.0L 305ci	1987	L & R Front		2	EM-2292		
			Trans	Auto	1			EM-2638
			Trans	Manual	1			EM-2638
	V8 5.7L 350ci	1987	L & R Front		2	EM-2292		
			Trans	Auto	1			EM-2638
			Trans	Manual	1			EM-2638
V8 6.2L 379ci Diesel	1987	L & R Front		2	EM-2395			
		Trans	Auto	1			EM-2638	
		Trans	Manual	1			EM-2638	
<b>V20 PICKUP</b>								
L6	L6 4.8L 292ci	1987	L & R Front		2	EM-2292		
			Trans	Auto	1			EM-2638
			Trans	Manual	1			EM-2638
V8	V8 5.7L 350ci	1987	L & R Front		2	EM-2292		
			Trans	Auto	1			EM-2638
			Trans	Manual	1			EM-2638
	V8 6.2L 379ci Diesel	1987	L & R Front		2	EM-2395		
			Trans	Auto	1			EM-2638
			Trans	Manual	1			EM-2638
<b>V30/V3500 P/U</b>								
V8	V8 5.7L 350ci	1989-91	L & R Front		2	EM-2292		
		1987-88	L & R Front		2	EM-2292		
		1989-91	Trans	Auto	1			EM-2638
			Trans	Manual	1			EM-2638
		1987-88	Trans	Auto	1			EM-2638
			Trans	Manual	1			EM-2638
	V8 6.2L 379ci Diesel	1989-91	L & R Front		2	EM-2395		
			Trans	Auto	1			EM-2638
			Trans	Manual	1			EM-2638
V8 7.4L 454ci	1989-91	L & R Front		2	EM-2395			
		1987-91	Trans	Auto	1			EM-2513
		Trans	Manual	1			EM-2392	



# Engine, Transmission, And Torque Strut Mounts

CYL	ENG. SIZE	YEAR	LOCATION	DESCRIPTION	QTY	ENGINE	TORQUE STRUT	TRANSMISSION
<b>CHEVROLET VAN</b>								
<b>ASTRO</b>								
L4	L4 2.5L 2474cc	1985-90	LH Front		1	EM-2549		
			RH Front		1	EM-2550		
		1990	Trans	Auto	1			EM-2508
		1985-89	Trans	Auto	1			EM-2508
Trans	Manual		1			EM-2508		
V6	V6 4.3L 262ci	1985-05	L & R Front		2	EM-2436		
		1996-05	Trans		1			EM-2879
		1994-95	Trans	Auto; RWD	1			EM-2879
			Trans	Auto; AWD	1			EM-5392
		1990-93	Trans	2WD	1			EM-2394
			Trans	AWD	1			EM-2950
		1985-89	Trans	Auto	1			EM-2508
			Trans	Manual	1			EM-2508
<b>EXPRESS 1500</b>								
V6	V6 4.3L	1997-02	Trans		1			EM-2817
		1996	Trans		1			EM-2816
	V6 4.3L 262ci	2003-12	L & R Front		2	EM-3177		
		1999-02	L & R Front		2	EM-2621		
V8	V8 5.0L	1996-98	Trans		1			EM-2816
	V8 5.0L 305ci	1999-02	L & R Front		2	EM-2621		
			Trans		1		EM-2817	
	V8 5.3L	2003-12	L & R Front	RWD	2	EM-5354		
			LH Front	AWD	1	EM-3175		
			RH Front	AWD	1	EM-5354		
			2003-14	Trans	AWD	1		
	V8 5.7L 350ci	1999-02	Trans	RWD	1			EM-3098
L & R Front				2	EM-2621			
			Trans		1		EM-2817	
<b>EXPRESS 2500</b>								
V6	V6 4.3L 262ci	2003-05	L & R Front		2	EM-5354		
		1996-02	L & R Front		2	EM-2621		
		1999-02	Trans		1			EM-2817
V8	V8 4.8L	2003-10	L & R Front		2	EM-5354		
		2003-14	Trans	2WD	1			EM-3098
	V8 5.0L 305ci	1999-02	L & R Front		2	EM-2621		
			Trans		1		EM-2816	
	V8 5.3L	2003-05	Trans	RWD	1		EM-3098	
			Trans	AWD	1		EM-4108	
	V8 5.3L 323ci	2003-05	L & R Front	RWD	2	EM-5354		
			LH Front	AWD	1	EM-3175		
			RH Front	AWD	1	EM-5354		
	V8 5.7L	1996-98	Trans		1			EM-2816
	V8 5.7L 350ci	1999-02	L & R Front		2	EM-2621		
			Trans		1		EM-2817	
	V8 6.0L	2003-10	L & R Front	RWD	2	EM-5354		
2006-14			Trans	RWD	1		EM-3098	
2003-05			Trans	RWD	1		EM-3098	
			Trans	AWD	1		EM-4108	
V8 6.5L 395ci Diesel	1999-02	L & R Front		2	EM-2621			
		Trans		1		EM-2816		
V8 6.6L 400ci Diesel	2006-09	Trans	Turbo	1			EM-5663	
<b>EXPRESS 3500</b>								
V8	V8 4.8L	2005-10	L & R Front		2	EM-5354		
		2005-14	Trans		1			EM-3098
	V8 5.7L 350ci	1999-02	L & R Front		2	EM-2621		
			Trans	Auto; 4L80E (MT1)	1		EM-2817	

# Engine, Transmission, And Torque Strut Mounts

CYL	ENG. SIZE	YEAR	LOCATION	DESCRIPTION	QTY	ENGINE	TORQUE STRUT	TRANSMISSION	
<b>CHEVROLET VAN (continued)</b>									
<b>EXPRESS 3500 (continued)</b>									
V8	V8 6.0L	2003-10	L & R Front		2	EM-5354			
		2003-14	Trans - Front		1			EM-3098	
	V8 6.5L 395ci Diesel	1999-02	L & R Front		2	EM-2621			
			Trans		1			EM-2816	
	V8 6.6L 400ci Diesel	2006-09	Trans	Turbo	1			EM-5663	
	V8 7.4L 454ci	1999-00	L & R Front		2	EM-2621			
			Trans		1			EM-2816	
V8 8.1L 496ci	2001-02	L & R Front		2	EM-2621				
		Trans		1			EM-2816		
<b>G10/G1500 VAN</b>									
L4	L4 2.5L 153ci	1964-65	L & R Front		2	EM-2282			
L6	L6 3.2L 194ci	1964-66	L & R Front		2	EM-2282			
			L & R Rear Lower	Manual Manual	2	EM-2108			
			L & R Rear Upper	Manual Manual	2	EM-2107			
	L6 4.1L 250ci	1971-84	1967-70	L & R Front		2	EM-2292		
				L & R Front		2	EM-2282		
		1983-84	Trans	Auto; THM400 (M40)	1			EM-2515	
			Trans	Auto; THM700-R4/4L60 (MD8)	1			EM-2393	
			Trans	Manual	1			EM-2393	
		1982	Trans	Auto; THM350 (M38) THM350C (MV4)	1			EM-2378 @	
			Trans	Auto; THM400 (M40)	1			EM-2268 @	
			Trans	Manual	1			EM-2378 @	
		1977-81	Trans	Auto; THM350 (M38)	1			EM-2378 @	
			Trans	Auto; THM400 (M40)	1			EM-2268 @	
			Trans	Manual	1			EM-2378 @	
1975-76	Trans	Auto; THM350 (M38)	1			EM-2378 @			
	Trans	Manual	1			EM-2378 @			
V6	V6 4.3L 262ci	1998	L & R Front		2	EM-2621			
		1997	L & R Front		2	EM-2621			
		1985-96	L & R Front		2	EM-2436			
		1991-95	Trans		1			EM-2817	
		1990	Trans	Auto; THM400 (M40)	1			EM-2515	
			Trans	Auto; THM700-R4/4L60 (MD8)	1			EM-2394	
		1985-89	Trans	Auto; THM400-475 (M40)	1			EM-2515	
			Trans	Auto; THM700R4 (MD8)	1			EM-2508	
			Trans	Manual	1			EM-2508	
V8	V8 5.0L 305ci	1998	L & R Front		2	EM-2621			
		1996-97	L & R Front		2	EM-2621			
		1977-95	L & R Front		2	EM-2292			
		1991-95	Trans		1			EM-2816	
		1983-90	Trans	Auto; 4 Spd	1			EM-2393	
			Trans	Auto; THM400-475 (M40)	1			EM-2515	
			Trans	Manual	1			EM-2393	
		1977-82	Trans	Auto, THM350 (M38), THM350C (MV4)	1			EM-2378 @	
			Trans	Auto; THM400-475 (M40)	1			EM-2268 @	
	Trans		Manual	1			EM-2378 @		
	V8 5.0L 307ci	1972-73	L & R Front		2	EM-2292			
		1968-71	L & R Front		2	EM-2282			
		1968-73	Trans	Auto, THM350 (M38)	1			EM-2378 @	
			Trans	Auto; THM400-475 (M40)	1			EM-2268 @	
	1968-73	Trans	Manual	1			EM-2378 @		
V8 5.7L 350ci	1998	L & R Front		2	EM-2621				

## Engine, Transmission, And Torque Strut Mounts

CYL	ENG. SIZE	YEAR	LOCATION	DESCRIPTION	QTY	ENGINE	TORQUE STRUT	TRANSMISSION	
<b>CHEVROLET VAN (continued)</b>									
<b>G10/G1500 VAN (continued)</b>									
V8	V8 5.7L 350ci	1996-97	L & R Front		2	EM-2621			
		1970-93	L & R Front		2	EM-2292			
		1992-93	Trans	Auto		1			EM-2816
		1991	Trans	Auto; THM700-R4/4L60 (MD8)		1			EM-2817
		1990	Trans	Auto; THM400-475 (M40)		1			EM-2515
			Trans	Auto; THM700R4 (MD8)		1			EM-2394
		1983-89	Trans	Auto; THM400-475 (M40)		1			EM-2515
			Trans	Auto; THM700R4 (MD8)		1			EM-2393
			Trans	Manual		1			EM-2393
			Trans	Auto; THM400-475 (M40)		1			EM-2515
			Trans	Auto; THM700R4 (MD8)		1			EM-2393
		1982	Trans	Manual		1			EM-2393
			Trans	Auto; THM350C (MV4)		1			EM-2378 @
			Trans	Auto; THM400 (M40)		1			EM-2268 @
		1977-81	Trans	Manual		1			EM-2378 @
			Trans	Auto, THM350 (M38)		1			EM-2378 @
			Trans	Auto; THM400 (M40)		1			EM-2268 @
		1975-76	Trans	Manual		1			EM-2378 @
			Trans	Auto, THM350 (M38)		1			EM-2378 @
			Trans	Manual		1			EM-2378 @
<b>G20/G2500 VAN</b>									
L6	L6 4.1L 250ci	1971-84	L & R Front		2	EM-2292			
		1968-70	L & R Front		2	EM-2282			
		1983-84	Trans	Auto, 4 Spd		1			EM-2393
			Trans	Auto; THM400-475 (M40)		1			EM-2515
		1982	Trans	Manual		1			EM-2393
			Trans	Auto; THM350C (MV4)		1			EM-2378 @
			Trans	Auto; THM400 (M40)		1			EM-2268 @
		1975-81	Trans	Manual		1			EM-2378 @
			Trans	Auto, THM350 (M38)		1			EM-2378 @
			Trans	Auto; THM400 (M40)		1			EM-2268 @
		1971-74	Trans	Manual		1			EM-2378 @
			Trans	Auto, THM350 (M38)		1			EM-2378 @
			Trans	Auto; THM400 (M40)		1			EM-2268 @
		1968-70	Trans	Manual		1			EM-2378 @
	Trans		Auto		1			EM-2378 @	
	L6 4.8L 292ci	1973-80	L & R Front		2	EM-2292			
		1971	L & R Front		2	EM-2282			
		1973-80	Trans	Auto		1			EM-2373
			Trans	Manual		1			EM-2268 @
		1971	Trans	Auto		1			EM-2378 @
Trans			Manual		1			EM-2268 @	
V6	V6 4.3L 262ci	1997-98	L & R Front		2	EM-2621			
		1985-95	L & R Front		2	EM-2436			
		1996	Trans		1			EM-2816	
		1991-95	Trans		1			EM-2817	
		1990	Trans	Auto; THM400-475 (M40)		1			EM-2515
			Trans	Auto; THM700R4 (MD8)		1			EM-2394
		1985-89	Trans	Auto; THM400-475 (M40)		1			EM-2515
			Trans	Auto; THM700R4 (MD8)		1			EM-2508
			Trans	Manual		1			EM-2508
		V8	V8 5.0L 305ci	1998	L & R Front		2	EM-2621	
1996-97	L & R Front				2	EM-2621			
1977-95	L & R Front				2	EM-2292			

# Engine, Transmission, And Torque Strut Mounts

CYL	ENG. SIZE	YEAR	LOCATION	DESCRIPTION	Q T Y	ENGINE	TORQUE STRUT	TRANS- MISSION		
<b>CHEVROLET VAN (continued)</b>										
<b>G20/G2500 VAN (continued)</b>										
V8	V8 5.0L 305ci	1991-95	Trans		1			EM-2816		
		1983-90	Trans	Auto, 4 Spd	1			EM-2393		
Trans			Auto; THM400-475 (M40)	1			EM-2515			
Trans			Manual	1			EM-2393			
1977-82		Trans	Auto, THM350 (M38), THM350C (MV4)	1			EM-2378 @			
		Trans	Auto; THM400-475 (M40)	1			EM-2268 @			
	Trans	Manual	1			EM-2378 @				
V8 5.0L 307ci	1968-69 1968-73	L & R Front			2	EM-2282				
		Trans	Auto		1			EM-2378 @		
		Trans	Manual		1			EM-2378 @		
V8 5.7L 350ci	1998 1996-97 1970-95	L & R Front			2	EM-2621				
		L & R Front			2	EM-2621				
		L & R Front			2	EM-2292				
	1993-95	Trans	Auto; 4L60E (M30)			1			EM-2816	
		Trans	Auto; THM700-R4/4L60 (MD8)			1			EM-2816	
		Trans	Auto; THM700-R4/4L60 (MD8)			1			EM-2817	
		1990	Trans	Auto; THM400-475 (M40)			1			EM-2515
			Trans	Auto; THM700R4 (MD8)			1			EM-2394
		1987-89	Trans	Auto; THM400-475 (M40)			1			EM-2515
			Trans	Auto; THM700R4 (MD8)			1			EM-2393
			Trans	Auto; THM400-475 (M40)			1			EM-2515
		1983-86	Trans	Auto; THM400-475 (M40)			1			EM-2515
			Trans	Auto; THM700R4 (MD8)			1			EM-2393
			Trans	Manual			1			EM-2393
	1982	Trans	Auto; THM350C (MV4)			1			EM-2378 @	
		Trans	Auto; THM400 (M40)			1			EM-2268 @	
		Trans	Manual			1			EM-2378 @	
	1979-81	Trans	Auto, THM350 (M38)			1			EM-2378 @	
		Trans	Auto; THM400 (M40)			1			EM-2268 @	
		Trans	Manual			1			EM-2378 @	
	1975-78 1971-74	Trans				1			EM-2378 @	
		Trans	Auto			1			EM-2378 @	
	V8 6.2L 379ci Diesel	1983-93 1992-93 1991 1990 1983-89	L & R Front			2	EM-2292			
Trans					1			EM-2817		
Trans			Auto; THM700-R4/4L60 (MD8)			1			EM-2394	
Trans			Auto; THM400 (M40)			1			EM-2515	
Trans			Auto; THM700-R4/4L60 (MD8)			1			EM-2394	
Trans			Auto; THM400-475 (M40)			1			EM-2515	
Trans			Auto; THM700R4 (MD8)			1			EM-2393	
V8 6.5L 395ci Diesel	1998 1997 1994-96 1998 1994-95	L & R Front			2	EM-2621				
		L & R Front			2	EM-2621				
		L & R Front			2	EM-2292				
		Trans			1			EM-2816		
		Trans			1			EM-2816		
V8 6.6L 400ci	1975-80	L & R Front			2	EM-2292				
		Trans	Auto, THM350 (M38)		1			EM-2378 @		
		Trans	Auto; THM400-475 (M40)		1			EM-2268 @		
		Trans	Manual		1			EM-2378 @		
V8 7.4L 454ci	1976	L & R Front			2	EM-2395				
		Trans	Auto		1			EM-2268 @		
		Trans	Manual		1			EM-2378 @		

# Engine, Transmission, And Torque Strut Mounts

CYL	ENG. SIZE	YEAR	LOCATION	DESCRIPTION	QTY	ENGINE	TORQUE STRUT	TRANS-MISSION	
<b>CHEVROLET VAN (continued)</b>									
<b>G30/G3500 VAN</b>									
L6	L6 4.1L 250ci	1976-84	L & R Front		2	EM-2292			
		1971-74	L & R Front		2	EM-2292			
		1983-84	Trans	Auto, 4 Spd		1			EM-2393
			Trans	Auto; THM400-475 (M40)		1			EM-2515
			Trans	Manual		1			EM-2393
		1982	Trans	Auto; THM350C (MV4)		1			EM-2378 @
			Trans	Auto; THM400 (M40)		1			EM-2268 @
			Trans	Manual		1			EM-2378 @
		1976-81	Trans	Auto, THM350 (M38)		1			EM-2378 @
			Trans	Auto; THM400 (M40)		1			EM-2268 @
			Trans	Manual		1			EM-2378 @
		1971-74	Trans	Auto, THM350 (M38)		1			EM-2378 @
	Trans		Auto; THM400-475 (M40)		1			EM-2268 @	
	Trans		Manual		1			EM-2378 @	
	L6 4.8L 292ci	1974-79	L & R Front		2	EM-2292			
		1971-72	L & R Front		2	EM-2282			
		1974-79	Trans	Auto		1			EM-2373
			Trans	Manual		1			EM-2268 @
		1971-72	Trans	Auto		1			EM-2378 @
	Trans		Manual		1			EM-2268 @	
V6	V6 4.3L 262ci	1985-95	L & R Front		2	EM-2436			
		1991-95	Trans		1			EM-2817	
		1990	Trans	Auto; THM400-475 (M40)		1			EM-2515
			Trans	Auto; THM700R4 (MD8)		1			EM-2394
		1985-89	Trans	Auto; THM400-475 (M40)		1			EM-2515
			Trans	Auto; THM700R4 (MD8)		1			EM-2508
Trans	Manual		1			EM-2508			
V8	V8 5.0L 305ci	1985	L & R Front		2	EM-2292			
		1982	L & R Front		2	EM-2292			
		1978-79	L & R Front		2	EM-2292			
		1985	Trans	Auto, 4 Spd		1			EM-2393
			Trans	Auto; THM400-475 (M40)		1			EM-2515
			Trans	Manual		1			EM-2393
		1982	Trans	Auto, THM350 (M38), THM350C (MV4)		1			EM-2378 @
			Trans	Auto; THM400-475 (M40)		1			EM-2268 @
			Trans	Manual		1			EM-2378 @
		1978-79	Trans	Auto, THM350 (M38), THM350C (MV4)		1			EM-2378 @
			Trans	Auto; THM400-475 (M40)		1			EM-2268 @
			Trans	Manual		1			EM-2378 @
	V8 5.7L 350ci	1998	L & R Front		2	EM-2621			
		1996-97	L & R Front		2	EM-2621			
		1971-95	L & R Front		2	EM-2292			
		1992-95	Trans		1			EM-2816	
		1991	Trans	Auto, 4L60E (M30). THM-R2 (MT1)		1			EM-2816
			Trans	Auto; THM700R4 (MD8)		1			EM-2817
		1990	Trans	Auto; THM400-475 (M40)		1			EM-2515
			Trans	Auto; THM700R4 (MD8)		1			EM-2394
1987-89	Trans	Auto; THM400-475 (M40)		1			EM-2515		
	Trans	Auto; THM700R4 (MD8)		1			EM-2393		
1983-86	Trans	Auto; THM400 (M40)		1			EM-2515		
	Trans	Auto; THM700R4 (MD8)		1			EM-2393		
	Trans	Manual		1			EM-2393		
1982	Trans	Auto; THM350C (MV4)		1			EM-2378 @		

# Engine, Transmission, And Torque Strut Mounts

CYL	ENG. SIZE	YEAR	LOCATION	DESCRIPTION	QTY	ENGINE	TORQUE STRUT	TRANSMISSION
<b>CHEVROLET VAN (continued)</b>								
<b>G30/G3500 VAN (continued)</b>								
V8	V8 5.7L 350ci	1982	Trans	Auto; THM400 (M40)	1			EM-2268 @
			Trans	Manual	1			EM-2378 @
		1979-81	Trans	Auto, THM350 (M38)	1			EM-2378 @
			Trans	Auto; THM400 (M40)	1			EM-2268 @
			Trans	Manual	1			EM-2378 @
	1971-78	Trans		1			EM-2378 @	
		Trans		1			EM-2378 @	
	V8 6.2L 379ci Diesel	1983-93	L & R Front		2	EM-2292		
			Trans		1			EM-2816
		1991	Trans	Auto; THM-R2 (MT1) 4L80E	1			EM-2816
			Trans	Auto; THM700R4 (MD8)	1			EM-2817
		1983-90	Trans	Auto; THM400-475 (M40)	1			EM-2515
			Trans	Auto; THM700R4 (MD8)	1			EM-2393
	1983-90	Trans	Manual	1			EM-2393	
		Trans	Manual	1			EM-2393	
	V8 6.5L 395ci Diesel	1998	L & R Front		2	EM-2621		
			L & R Front		2	EM-2621		
		1996	L & R Front		2	EM-2621		
			L & R Front		2	EM-2292		
		1998	Trans		1			EM-2816
			Trans		1			EM-2816
	V8 6.6L 400ci	1975-80	L & R Front		2	EM-2292		
			Trans	Auto, THM350 (M38)	1			EM-2378 @
		Trans	Auto; THM400-475 (M40)	1			EM-2268 @	
		Trans	Manual	1			EM-2378 @	
	V8 7.4L 454ci	1998	L & R Front		2	EM-2621		
			L & R Front		2	EM-2621		
		1988-96	L & R Front		2	EM-2292		
			L & R Front		2	EM-2395		
		1992-96	Trans		1			EM-2816
Trans				1			EM-2816	
1988-89		Trans	Auto; THM400 (M40)	1			EM-2515	
		Trans	Auto	1			EM-2268 @	
1973-76	Trans	Manual	1			EM-2378 @		
<b>LUMINA APV</b>								
V6	V6 3.1L 189ci	1990-95	RH Front		1	EM-2548'		
			Torq Str - Front		1		EM-2396	
			Trans - LH Front		1			EM-2466
			Trans - LH Rear		1			EM-2467
	V6 3.4L 207ci	1996	RH Front		1	EM-2548'		
			Torq Str - Front	Insert	1		EM-2716	
			Trans - LH Front		1			EM-2466
			Trans - LH Rear		1			EM-2467
	V6 3.8L 231ci	1992-95	RH Front		1	EM-2548'		
			Torq Str - Front		1		EM-2396	
			Trans - LH Front		1			EM-2466
			Trans - LH Rear		1			EM-2467
<b>P10 VAN</b>								
L4	L4 2.5L 153ci	1963-65	Trans - L & R Lower		2			EM-2108
			Trans - L & R Upper		2			EM-2107
L6	L6 4.1L 250ci	1973-74	L & R Front		2	EM-2292		
			L & R Front		2	EM-2282		
		1968-74	Trans		1			EM-2378 @
	L6 4.8L 292ci	1975-80	L & R Front		2	EM-2292		
Trans			Auto	1			EM-2378 @	

# Engine, Transmission, And Torque Strut Mounts

CYL	ENG. SIZE	YEAR	LOCATION	DESCRIPTION	QTY	ENGINE	TORQUE STRUT	TRANSMISSION		
<b>CHEVROLET VAN (continued)</b>										
<b>P10 VAN (continued)</b>										
L6	L6 4.8L 292ci	1975-80	Trans	Manual	1			EM-2268 @		
V8	V8 5.0L 305ci	1979	L & R Front		2	EM-2292				
			Trans	Auto	1			EM-2268 @		
V8	V8 5.7L 350ci	1975-78	L & R Front		2	EM-2292				
			1973	L & R Front		2	EM-2292			
		1977-78	Trans	Auto; THM400	1			EM-2268 @		
			Trans	Manual	1			EM-2378 @		
		1975	Trans	Auto, M40	1			EM-2268 @		
			Trans	Manual	1			EM-2378 @		
		1973	Trans	Auto; THM400	1			EM-2268 @		
			Trans	Manual	1			EM-2378 @		
		V8	V8 6.6L 400ci	1977	L & R Front		2	EM-2292		
					Trans	Auto	1			EM-2268 @
Trans	Manual				1			EM-2378 @		
V8	V8 7.4L 454ci	1973	L & R Front		2	EM-2395				
			Trans	Auto; THM400	1			EM-2268 @		
			Trans	Manual	1			EM-2373		
<b>P20 VAN</b>										
L6	L6 4.1L 250ci	1970-74	Trans		1			EM-2378 @		
			L6 4.8L 292ci	1973-89	L & R Front		2	EM-2292		
					1968-72	L & R Front		2	EM-2282	
			1985-89	1968-84	Trans	Auto	1			EM-2513
					Trans	Manual	1			EM-2392
					Trans	Auto	1			EM-2378 @
			Trans	Manual	1			EM-2268 @		
V8	V8 5.0L 307ci	1968-69	L & R Front		2	EM-2282				
			Trans	Auto	1			EM-2268 @		
			Trans	Manual	1			EM-2378 @		
	V8	V8 5.7L 350ci	1973-89	L & R Front		2	EM-2292			
				1970-72	L & R Front		2	EM-2282		
			1985-89	Trans	Auto	1			EM-2513	
				Trans	Manual	1			EM-2392	
			1970-84	Trans	Auto	1			EM-2268 @	
	Trans	Manual	1			EM-2378 @				
	V8	V8 6.2L 379ci Diesel	1982-89	L & R Front		2	EM-2292			
				Trans	Auto	1			EM-2513	
				Trans	Manual	1			EM-2392	
	V8	V8 7.4L 454ci	1979	L & R Front		2	EM-2395			
				1976	L & R Front		2	EM-2395		
			1973	L & R Front		2	EM-2395			
1970-71				L & R Front		2	EM-2395			
1979			Trans	Auto	1			EM-2513		
			Trans	Manual	1			EM-2378 @		
1976			Trans	Auto	1			EM-2268 @		
			Trans	Manual	1			EM-2378 @		
1973			Trans	Auto	1			EM-2268 @		
			Trans	Manual	1			EM-2378 @		
1970-71	Trans	Auto	1			EM-2268 @				
Trans	Manual	1			EM-2378 @					
<b>P30 VAN</b>										
L4	L4 3.9L 239ci Diesel	1990-91	Trans		1			EM-2513		
L6	L6 4.1L 250ci	1979	L & R Front		2	EM-2292				
			1976	L & R Front		2	EM-2292			
				1973-74	L & R Front		2	EM-2292		

# Engine, Transmission, And Torque Strut Mounts

CYL	ENG. SIZE	YEAR	LOCATION	DESCRIPTION	QTY	ENGINE	TORQUE STRUT	TRANSMISSION		
<b>CHEVROLET VAN (continued)</b>										
<b>P30 VAN (continued)</b>										
L6	L6 4.1L 250ci	1970-72	L & R Front		2	EM-2282				
		1979	Trans		1			EM-2378 @		
		1976	Trans			1			EM-2378 @	
		1970-74	Trans			1			EM-2378 @	
	L6 4.8L 292ci	1973-89	L & R Front			2	EM-2292			
		1968-72	L & R Front			2	EM-2282			
		1985-89	Trans	Auto		1			EM-2513	
			Trans	Manual		1			EM-2392	
		1983-84	Trans	Auto		1			EM-2513	
			Trans	Manual		1			EM-2268 @	
		1968-82	Trans	Auto		1			EM-2378 @	
			Trans	Manual		1			EM-2268 @	
	V6	V6 4.3L 262ci	1990-99	L & R Front		2	EM-2436			
			1992-99	Trans	Manual; 5 Spd	1			EM-2922	
1991			Trans	Auto		1			EM-2510 @	
			Trans	Manual; 5 Spd		1			EM-2922	
1990			Trans	Auto		1			EM-2510 @	
			Trans	Manual; 4 Spd		1			EM-2515	
V8	V8 5.0L 307ci	1968-69	L & R Front		2	EM-2282				
			Trans	Auto		1			EM-2268 @	
			Trans	Manual		1			EM-2378 @	
	V8 5.7L 350ci	1973-99	L & R Front			2	EM-2292			
		1970-72	L & R Front			2	EM-2282			
		1992-99	Trans	Auto		1			EM-2392	
			Trans	Manual		1			EM-2922	
		1991	Trans	Auto		1			EM-2392	
			Trans	Manual; 5 Spd		1			EM-2922	
		1985-90	Trans	Auto		1			EM-2513	
			Trans	Manual		1			EM-2392	
	1970-84	Trans	Auto		1			EM-2268 @		
		Trans	Manual		1			EM-2378 @		
	V8 6.2L 379ci Diesel	1982-93	L & R Front			2	EM-2292			
			Trans			1			EM-2922	
			1982-90	Trans	Auto		1			EM-2513
				Trans	Manual		1			EM-2392
	V8 6.5L 395ci Diesel	1994-99	L & R Front			2	EM-2292			
			Trans			1			EM-2922	
	V8 6.6L 400ci	1976	L & R Front			2	EM-2292			
			Trans	Auto		1			EM-2268 @	
			Trans	Manual		1			EM-2378 @	
	V8 7.4L 454ci	1998-99	L & R Front			2	EM-2621			
		1973-97	L & R Front			2	EM-2395			
		1970-71	L & R Front			2	EM-2395			
		1991-99	Trans			1			EM-2922	
		1981-90	Trans	Auto		1			EM-2513	
			Trans	Manual		1			EM-2393	
		1979-80	Trans	Auto		1			EM-2513	
			Trans	Manual		1			EM-2373	
1973-78		Trans	Auto		1			EM-2268 @		
		Trans	Manual		1			EM-2373		
<b>UPLANDER</b>										
V6	V6 3.5L 213ci	2005-06	RH Front	AWD	1	EM-2987				
			RH Front	AWD; When Current Stock is Depleted, Re-order EM-2987	1	EM-2906'				
			RH Front	FWD	1	EM-2987				
			Torq Str - Front	Brkt to Radiator Support; LH & RH Front	2		EM-2900			



# Engine, Transmission, And Torque Strut Mounts

CYL	ENG. SIZE	YEAR	LOCATION	DESCRIPTION	QTY	ENGINE	TORQUE STRUT	TRANSMISSION	
<b>CHEVROLET VAN (continued)</b>									
<b>UPLANDER (continued)</b>									
V6	V6 3.5L 213ci	2005-06	Torq Str - Front	Complete Unit; LH & RH Front	2		EM-2899		
			Torq Str - Front	Insert Only; LH & RH Front	2		EM-2716		
			Trans	Auto	1			EM-2818	
	V6 3.9L 3880cc	2006-07 2006-09	RH Front			1	EM-2987		
			Torq Str - Front	Brkt to Radiator Support; LH & RH Front	2		EM-2900		
			Torq Str - Front	Complete Unit; LH & RH Front	2		EM-2899		
			Torq Str - Front	Insert Only; LH & RH Front	2		EM-2716		
		Trans	Auto	1			EM-2818		
<b>VENTURE</b>									
V6	V6 3.4L 207ci	2005	RH Front		1	EM-2796			
			2003-04	RH Front	AWD	1	EM-2987		
		1997-02	RH Front	AWD; When Current Stock is Depleted, Re-order EM-2987	1	EM-2906			
			RH Front	FWD	1	EM-2796			
		1997-05	Torq Str - Front	Brkt to Radiator Support; LH & RH Front	2		EM-2900		
			Torq Str - Front	Complete Unit; LH & RH Front	2		EM-2899		
			Torq Str - Front	Insert; LH & RH Front	2		EM-2716		
			Trans		1			EM-2818	
<b>CHRYSLER PASSENGER CAR</b>									
<b>CROSSFIRE</b>									
V6	V6 3.2L	2004-08	Trans		1			EM-9268	
<b>200</b>									
L4	L4 2.4L 2360cc	2012-13	Front	Complete Unit	1	EM-3152			
			Front	Insert	1	EM-4094			
		2011	Front	Complete Unit	1	EM-3152			
			Front	Insert	1	EM-4094			
		2012-13	RH Front		1	EM-3167			
		2011	RH Front		1	EM-3167			
		2012-13	Rear	Auto; 4 Spd	1	EM-3168			
		2011	Rear		1	EM-3168			
2011-13	Trans	Bushing	1			EM-4127			
V6	V6 3.6L 220ci	2011-14	Front		1	EM-4113			
			Right		1	EM-4112			
		2011-13	Trans	Bushing	1			EM-4127	
<b>300</b>									
V6	V6 2.7L	2005-10	L & R Front		2	EM-5588			
			Trans		1		EM-5587		
	V6 3.5L 3497cc	2005-10 2005-07	L & R Front	RWD	2	EM-5588			
			Trans	RWD	1		EM-5587		
	V6 3.5L 3518cc	2008-10 2006-07	L & R Front	Mexican Vehicle	1	EM-5588			
			Trans	Mexican Vehicle	1		EM-5587		
V8	V8 5.7L	2005-10	Trans	RWD	1		EM-5587		
			V8 5.7L 345ci	L & R Front		2	EM-3138		
		L & R Front	When Stock is Depleted, Re-order EM-3138	2	EM-5589				
	V8 6.1L	2005-10	L & R Front		2	EM-3138			
			L & R Front	When Stock is Depleted, Re-order EM-3138	2	EM-5589			
			Trans	RWD	1		EM-5587		
	V8 6.3L 383ci	1962-65 1966			1	EM-2228			
L & R Front				2	EM-2250				

# Engine, Transmission, And Torque Strut Mounts

CYL	ENG. SIZE	YEAR	LOCATION	DESCRIPTION	QTY	ENGINE	TORQUE STRUT	TRANSMISSION			
<b>CHRYSLER PASSENGER CAR (continued)</b>											
<b>300 (continued)</b>											
V8	V8 6.3L 383ci	1962-65	LH Front		1	EM-2228					
		1962-66	Trans	Auto	1			EM-2272			
	V8 6.8L 413ci	1959-65	LH Front		1	EM-2228					
			RH Front		1	EM-2227					
			Trans		1			EM-2272			
	V8 7.2L 440ci	1966-71	L & R Front		2	EM-2250					
			Trans	Complete Unit	1			EM-2340			
		1969-71	Trans	Insert	1			EM-2525			
			1966-68	Trans		1			EM-2272		
<b>300M</b>											
V6	V6 3.5L 3497cc	1999-04	L & R Front		2	EM-2903'					
			Trans		1			EM-2908			
<b>ASPEN</b>											
V8	V8 4.7L	2007-09	Trans		1			EM-3066			
	V8 5.7L	2007-09	Trans		1			EM-3066			
<b>CIRRUS</b>											
L4	L4 2.0L 1996cc	2000	Front		1	EM-2958					
			RH Front		1	EM-2841'					
			Rear		1	EM-3089					
			Trans - Center	Auto	1			EM-2842 *			
			Trans	Manual	1			EM-2842 *			
	L4 2.4L 2429cc	1995-97	Bushing Kit	Cradle Insert Kit (2 pieces) Recommended	1	EM-5178					
			2000	Front		1	EM-2958				
			1995-97	Front	Cradle-Insert	1	EM-2980				
			2000	RH Front		1	EM-2841'				
			1995-97	RH Front		1	EM-2841'				
			2000	Rear		1	EM-2945				
			1995-97	Rear	Cradle-Insert	1	EM-3011				
			2000	Trans	Auto	1			EM-2842 *		
				Trans	Manual	1			EM-2842 *		
			1995-97	Trans	Auto	1			EM-2842 *		
			V6	V6 2.5L 2497cc	1995-97	Bushing Kit	Cradle Insert Kit (2 pieces) Recommended	1	EM-5178		
						1998-00	Front		1	EM-2958	
						1995-97	Front	Cradle-Insert	1	EM-2980	
						1998-00	RH Front		1	EM-2841'	
1995-97	RH Front					1	EM-2841'				
1998-00	Rear					1	EM-2945				
1995-97	Rear	Cradle-Insert				1	EM-3011				
1999-00	Trans	Auto				1			EM-2842 *		
	Trans	Manual				1			EM-2842 *		
1995-98	Trans	Auto				1			EM-2842 *		
<b>CONCORDE</b>											
V6	V6 2.7L 2700cc	1998-04	LH Front		1	EM-2942'					
			RH Front		1	EM-2903'					
			Trans		1			EM-2908			
	V6 3.2L 3200cc	1998-01	L & R Front		2	EM-2903'					
			Trans		1			EM-2908			
	V6 3.3L 201ci	1996	L & R Front		2	EM-5020'					
			1993-95	L & R Front		2	EM-2795'				
			1993-96	Trans		1			EM-2810		
	V6 3.5L 3497cc	2002-04	L & R Front		2	EM-2903'					
			1996-97	L & R Front		2	EM-5020'				

# Engine, Transmission, And Torque Strut Mounts

CYL	ENG. SIZE	YEAR	LOCATION	DESCRIPTION	QTY	ENGINE	TORQUE STRUT	TRANSMISSION
<b>CHRYSLER PASSENGER CAR (continued)</b>								
<b>CONCORDE (continued)</b>								
V6	V6 3.5L 3497cc	1993-95	L & R Front		2	EM-2795*		
		2002-04	Trans		1			EM-2908
		1993-97	Trans		1			EM-2810
<b>CONQUEST</b>								
L4	L4 2.6L 2555cc	1987-89	Trans	Manual	1			EM-2730
<b>CORDOBA</b>								
L6	L6 3.7L 3687cc	1980-83	LH Front	Complete Unit	1	EM-2324		
			LH Front	Insert Only	1	EM-2376		
			RH Front	Complete Unit	1	EM-2323		
			RH Front	Insert Only	1	EM-2376		
			Trans	Complete Unit	1			EM-2340
			Trans	Complete Unit - HD	1			EM-2512
			Trans	Insert Only	1			EM-2525
V8	V8 5.2L 318ci	1975-80	L & R Front	Insert Only	2	EM-2369		
			1981-83	LH Front	Complete Unit	1	EM-2326	
		LH Front		Insert Only	1	EM-2369		
		RH Front		Complete Unit	1	EM-2325		
		RH Front		Insert Only	1	EM-2369		
		Trans		Insert	1			EM-2525
		Trans		Complete Unit	1			EM-2340
		1975-80	Trans	Complete Unit - HD	1			EM-2512
	Trans		Insert Only	1			EM-2525	
	V8 5.9L 360ci	1975-79	LH Front	Complete Unit	1	EM-2326		
			LH Front	Insert Only	1	EM-2369		
			RH Front	Complete Unit	1	EM-2325		
			RH Front	Insert Only	1	EM-2369		
			Trans	Complete Unit	1			EM-2340
Trans			Complete Unit - HD	1			EM-2512	
Trans			Insert Only	1			EM-2525	
V8 6.6L 400ci	1975-78	L & R Front	Complete Unit	2	EM-5476			
		L & R Front	Insert Only	2	EM-2369			
		Trans	Complete Unit - HD	1			EM-2512	
		Trans	Insert Only	1			EM-2525	
<b>DAYTONA</b>								
L4	L4 2.2L 135ci	1984-89	Front		1	EM-2493		
		1992-93	RH Front		1	EM-2600		
		1984-89	RH Front		1	EM-2600		
		1992-93	Trans		1			EM-2618
		1984-89	Trans		1			EM-2617
		L4 2.5L 2507cc	1992	Front		1	EM-2615	
	1990-91		Front		1	EM-2493		
	1987		Front		1	EM-2493		
	1992		RH Front		1	EM-2616		
	1990-91		RH Front		1	EM-2616		
	1987		RH Front		1	EM-2600		
	1990-92		Trans		1			EM-2618
	1989		Trans		1			EM-2617
	V6	V6 3.0L 2972cc	1990-93	Front		1	EM-2615	
RH Front				Hydraulic Mount	1	EM-2711		
RH Front				Solid Mount; Bushing	1	EM-2616		
Trans					1			EM-2618
<b>DYNASTY</b>								
V6	V6 3.0L 2972cc	1989-90	Front		1	EM-2615		
			RH Front	Hydraulic Mount	1	EM-2711		
			RH Front	Solid Mount; Bushing	1	EM-2616		

# Engine, Transmission, And Torque Strut Mounts

CYL	ENG. SIZE	YEAR	LOCATION	DESCRIPTION	QTY	ENGINE	TORQUE STRUT	TRANSMISSION
<b>CHRYSLER PASSENGER CAR (continued)</b>								
<b>DYNASTY (continued)</b>								
V6	V6 3.0L 2972cc	1990	Trans		1			EM-2824 *
		1989	Trans		1			EM-2618
	V6 3.3L 201ci	1991-93	Front		1	EM-2615		
			RH Front	Hydraulic Mount	1	EM-2711		
			RH Front	Solid Mount; Bushing	1	EM-2616		
			Trans	1			EM-2824 *	
<b>E CLASS</b>								
L4	L4 2.2L 135ci	1983-84	Front		1	EM-2447		
			RH Front		1	EM-2600		
			Torq Str - Front		1		EM-2491	
		1984	Trans	Auto	1			EM-2617
		1983	Trans	Auto	1			EM-2600
	L4 2.6L 2555cc	1983-84	Front		1	EM-2493		
			RH Front		1	EM-2600		
			1984	Trans	Auto	1		
1983			Trans	Auto	1			EM-2600
<b>EXECUTIVE LIMOUSINE</b>								
L4	L4 2.6L 2555cc	1985	Front		1	EM-2493		
			RH Front		1	EM-2600		
			Trans		1		EM-2617	
<b>EXECUTIVE SEDAN</b>								
L4	L4 2.6L 2555cc	1983-84	Front		1	EM-2493		
			RH Front		1	EM-2600		
			Trans		1		EM-2617	
<b>FIFTH AVENUE</b>								
L6	L6 3.7L 3687cc	1983	LH Front	Complete Unit	1	EM-2324		
			LH Front	Insert Only	1	EM-2376		
			RH Front	Complete Unit	1	EM-2323		
			RH Front	Insert Only	1	EM-2376		
			Trans	Complete Unit	1		EM-2340	
			Trans	Complete Unit - HD	1		EM-2512	
			Trans	Insert Only	1		EM-2525	
V8	V8 5.2L 318ci	1983-89	LH Front	Complete Unit	1	EM-2326		
			LH Front	Insert Only	1	EM-2369		
			RH Front	Complete Unit	1	EM-2325		
			RH Front	Insert Only	1	EM-2369		
			Trans	Complete Unit	1		EM-2340	
			Trans	Complete Unit - HD	1		EM-2512	
			Trans	Insert Only	1		EM-2525	
<b>IMPERIAL</b>								
V6	V6 3.3L 201ci	1990-91	Front		1	EM-2615		
			RH Front		1	EM-2711		
			Trans		1		EM-2824 *	
	V6 3.8L 230ci	1991-93	Front		1	EM-2615		
			RH Front		1	EM-2711		
			Trans		1		EM-2824 *	
V8	V8 5.2L 318ci	1981-83	LH Front	Complete Unit	1	EM-2326		
			LH Front	Insert Only	1	EM-2369		
			RH Front	Complete Unit	1	EM-2325		
			RH Front	Insert Only	1	EM-2369		
			Trans	Complete Unit	1		EM-2340	
			Trans	Complete Unit - HD	1		EM-2512	
	Trans	Insert Only	2		EM-2525			
	V8 6.8L 413ci	1959-65	LH Front		1	EM-2228		
RH Front				1	EM-2227			

# Engine, Transmission, And Torque Strut Mounts

CYL	ENG. SIZE	YEAR	LOCATION	DESCRIPTION	QTY	ENGINE	TORQUE STRUT	TRANSMISSION	
<b>CHRYSLER PASSENGER CAR (continued)</b>									
<b>IMPERIAL (continued)</b>									
V8	V8 7.2L 440ci	1974-75	L & R Front	Complete Unit	2	EM-5476			
			L & R Front	Insert Only	2	EM-2369			
		1966-73	L & R Front			2	EM-2250		
		1969-75	Trans	Complete Unit	1			EM-2340	
			Trans	Insert Only	1			EM-2525	
		1966-68	Trans	Auto	1			EM-2272	
			Trans	Manual	1			EM-2272	
<b>INTREPID</b>									
V6	V6 2.7L 2700cc	2002-04	LH Front		1	EM-2942'			
			1998-01	LH Front		1	EM-2942'		
		2002-04	RH Front		1	EM-2903'			
			1998-01	RH Front		1	EM-2903'		
		2002-04	Trans		1			EM-2908	
			1998-01	Trans		1		EM-2908	
	V6 3.2L 3200cc	1998-01	L & R Front		2	EM-2903'			
			Trans		1		EM-2908		
	V6 3.3L 201ci	1993-96	L & R Front		2	EM-2795'			
			1993-97	Trans		1		EM-2810	
	V6 3.5L 3497cc	2003-04	L & R Front		2	EM-2903'			
			1993-97	L & R Front		2	EM-2795'		
		2003-04	Trans		1			EM-2905	
			1993-97	Trans		1		EM-2810	
<b>LASER</b>									
L4	L4 2.2L 135ci	1984-86	Front		1	EM-2493			
			RH Front		1	EM-2600			
			Torq Str - Front	Manual	1		EM-2491		
			Trans		1			EM-2617	
	L4 2.5L 2507cc	1986	Front		1	EM-2493			
			RH Front		1	EM-2600			
			Torq Str - Front		1		EM-2491		
			Trans		1			EM-2617	
<b>LEBARON</b>									
L4	L4 2.2L 135ci	1983-90	Front		1	EM-2493			
			1982	Front		1	EM-2447		
		1983-90	RH Front		1	EM-2600			
			1982	RH Front		1	EM-2600		
		1984-90	Trans	Auto	1			EM-2617	
			Trans	Manual	1			EM-2617	
		1982-83	Trans	Auto	1			EM-2600	
			Trans	Manual	1			EM-2600	
		L4 2.5L 2507cc	1990-93	Front		1	EM-2615		
				1986-89	Front		1	EM-2493	
	1990-93		RH Front	Hydraulic Mount	1	EM-2711			
			RH Front	Solid Mount; Bushing	1	EM-2616			
	1986-89		RH Front		1	EM-2600			
			Trans	Auto	1			EM-2618	
	1990-93		Trans	Manual	1			EM-2618	
			1986-89	Trans	Auto	1		EM-2617	
	1986-89	Trans	Manual	1			EM-2617		
		L4 2.6L 2555cc	1982-85	Front		1	EM-2493		
	RH Front				1	EM-2600			
	1985		Trans	Auto	1			EM-2617	
1984			Trans	Auto	1		EM-2617		
1984	Trans		Manual	1			EM-2617		
	1982-83		Trans	Auto	1		EM-2600		

# Engine, Transmission, And Torque Strut Mounts

CYL	ENG. SIZE	YEAR	LOCATION	DESCRIPTION	QTY	ENGINE	TORQUE STRUT	TRANSMISSION
<b>CHRYSLER PASSENGER CAR (continued)</b>								
<b>LEBARON (continued)</b>								
L4	L4 2.6L 2555cc	1982-83	Trans	Manual	1			EM-2600
L6	L6 3.7L 3687cc	1978-81	LH Front	Complete Unit	1	EM-2324		
			LH Front	Insert Only	1	EM-2376		
			RH Front	Complete Unit	1	EM-2323		
			RH Front	Insert Only	1	EM-2376		
			Trans	Auto; Complete Unit	1			EM-2512
			Trans	Auto; Insert Only	1			EM-2525
V6	V6 3.0L 2972cc	1992-95	Front		1	EM-2615		
			Front		1	EM-2615		
		1992-95	RH Front	Hydraulic Mount	1	EM-2711		
			RH Front	Solid Mount; Bushing	1	EM-2616		
		1990-91	RH Front	Solid Mount; Bushing	1	EM-2616		
		1994	Trans	Auto	1			EM-2618
		1990-93	Trans	Auto	1			EM-2618
			Trans	Manual	1			EM-2618
V8	V8 5.2L 318ci	1977-81	LH Front	Complete Unit	1	EM-2326		
			LH Front	Insert Only	1	EM-2369		
			RH Front	Complete Unit	1	EM-2325		
			RH Front	Insert Only	1	EM-2369		
			Trans	Auto; Complete Unit	1			EM-2340
			Trans	Auto; Complete Unit; HD Pkg.	1			EM-2512
			Trans	Auto; Insert Only	1			EM-2525
	V8 5.9L 360ci	1978-79	LH Front	Complete Unit	1	EM-2326		
			LH Front	Insert Only	1	EM-2369		
			RH Front	Complete Unit	1	EM-2325		
			RH Front	Insert Only	1	EM-2369		
			Trans	Complete Unit	1			EM-2340
			Trans	Complete Unit - HD	1			EM-2339
			Trans	Insert for EM-2512	1			EM-2525
<b>LHS</b>								
V6	V6 3.5L 3497cc	1999-01	L & R Front		2	EM-2903'		
		1996-97	L & R Front		2	EM-5020'		
		1994-95	L & R Front		2	EM-2795'		
		1999-01	Trans		1			EM-2908
		1994-97	Trans		1			EM-2810
<b>NEON</b>								
L4	L4 2.0L	2002	Trans	Auto	1			EM-3124
			Trans	Manual	1			EM-3050
		2000-01	Trans	Auto	1			EM-2975
			Trans	Manual	1			EM-3050
	L4 2.0L 1996cc	2000-02	LH Rear Upper		1	EM-2948		
			RH Front Lower		1	EM-2949		
	Rear			1	EM-2947			
<b>NEW YORKER</b>								
L4	L4 2.2L 135ci	1983-88	Front		1	EM-2493		
			RH Front		1	EM-2600		
		1983-84	Torq Str - Front	w/o Turbo	1		EM-2491	
		1984-88	Trans		1			EM-2617
		1983	Trans		1			EM-2600
	L4 2.5L 2507cc	1986-87	Front		1	EM-2493		
			RH Front		1	EM-2600		
			Torq Str - Front		1		EM-2491	
			Trans		1			EM-2617
	L4 2.6L 2555cc	1983-85	Front		1	EM-2493		
			RH Front		1	EM-2600		
	1984-85	Trans		1			EM-2617	

# Engine, Transmission, And Torque Strut Mounts

CYL	ENG. SIZE	YEAR	LOCATION	DESCRIPTION	QTY	ENGINE	TORQUE STRUT	TRANSMISSION	
<b>CHRYSLER PASSENGER CAR (continued)</b>									
<b>NEW YORKER (continued)</b>									
L4	L4 2.6L 2555cc	1983	Trans		1			EM-2600	
L6	L6 3.7L 3687cc	1982	LH Front	Complete Unit	1	EM-2324			
			LH Front	Insert Only	1	EM-2376			
			RH Front	Complete Unit	1	EM-2323			
			RH Front	Insert Only	1	EM-2376			
			Trans	Complete Unit	1			EM-2340	
			Trans	Complete Unit - HD	1			EM-2512	
			Trans	Insert Only	1			EM-2525	
V6	V6 3.0L 2972cc	1989	Front		1	EM-2615			
			1988	Front		1	EM-2615		
			1989	RH Front		1	EM-2711		
			1988	RH Front		1	EM-2600		
			1988-89	Trans		1			EM-2617
	V6 3.3L 201ci	1990-93	Front		1	EM-2615			
			RH Front		1	EM-2711			
			Trans		1			EM-2824	
	V6 3.5L 3497cc	1996	L & R Front		2	EM-5020			
			1994-95	L & R Front		2	EM-2795		
			1994-96	Trans		1			EM-2810
	V6 3.8L 230ci	1991-93	Front		1	EM-2615			
			RH Front		1	EM-2711			
			Trans		1			EM-2824	
	V8	V8 5.2L 318ci	1979-82	LH Front	Complete Unit	1	EM-2326		
LH Front				Insert Only	1	EM-2369			
RH Front				Complete Unit	1	EM-2325			
RH Front				Insert Only	1	EM-2369			
Trans				Complete Unit	1			EM-2340	
Trans				Complete Unit - HD	1			EM-2512	
Trans				Insert Only	1			EM-2525	
V8 5.9L 360ci		1977-80	LH Front	Complete Unit	1	EM-2326			
			LH Front	Insert Only	1	EM-2369			
			RH Front	Complete Unit	1	EM-2325			
			RH Front	Insert Only	1	EM-2369			
			Trans	Complete Unit	1			EM-2340	
			Trans	Complete Unit - HD	1			EM-2512	
			Trans	Insert Only	1			EM-2525	
V8 6.6L 400ci		1975-78	L & R Front	Insert Only	2	EM-2369			
			Trans	Complete Unit	1			EM-2512	
			Trans	Insert Only	1			EM-2525	
V8 6.8L 413ci		1959-65	LH Front		1	EM-2228			
			RH Front		1	EM-2227			
			Trans		1			EM-2272	
V8 7.2L 440ci		1974-78	L & R Front	Complete Unit	2	EM-5476			
			L & R Front	Insert Only	2	EM-2369			
		1966-73	L & R Front		2	EM-2250			
		1969-78	Trans	Complete Unit	1			EM-2340	
			Trans	Insert Only	1			EM-2525	
		1966-68	Trans	Auto	1			EM-2272	
			Trans	Manual	1			EM-2272	
<b>NEWPORT</b>									
L6		L6 3.7L 3687cc	1979-81	LH Front	Complete Unit	1	EM-2324		
				LH Front	Insert Only	1	EM-2376		
	RH Front			Complete Unit	1	EM-2323			
	RH Front			Insert Only	1	EM-2376			
	Trans			Complete Unit	1			EM-2340	
	Trans			Complete Unit - HD	1			EM-2512	

# Engine, Transmission, And Torque Strut Mounts

CYL	ENG. SIZE	YEAR	LOCATION	DESCRIPTION	QTY	ENGINE	TORQUE STRUT	TRANS-MISSION
<b>CHRYSLER PASSENGER CAR (continued)</b>								
<b>NEWPORT (continued)</b>								
L6	L6 3.7L 3687cc	1979-81	Trans	Insert Only	1			EM-2525
V8	V8 5.2L 318ci	1979-81	LH Front	Complete Unit	1	EM-2326		
			LH Front	Insert Only	1	EM-2369		
			RH Front	Complete Unit	1	EM-2325		
			RH Front	Insert Only	1	EM-2369		
			Trans	Complete Unit	1			EM-2340
			Trans	Complete Unit - HD	1			EM-2512
			Trans	Insert Only	1			EM-2525
	V8 5.9L 360ci	1971-72	L & R Front		2	EM-2250		
			1974-80	LH Front	Complete Unit	1	EM-2326	
		LH Front		Insert Only	1	EM-2369		
		RH Front		Complete Unit	1	EM-2325		
		RH Front		Insert Only	1	EM-2369		
		Trans		Complete Unit	1			EM-2340
		Trans		Complete Unit - HD	1			EM-2512
		Trans		Insert Only	1			EM-2525
		1971-72		Trans	Complete Unit	1		
			Trans	Complete Unit - HD	1			EM-2512
	Trans		Insert Only	1			EM-2525	
	V8 5.9L 361ci	1961-64	Trans	Auto	1			EM-2272
			Trans	Manual	1			EM-2272
	V8 6.3L 383ci	1966-71	L & R Front		2	EM-2250		
1965			LH Front		1	EM-2228		
			RH Front		1	EM-2227		
1969-71		Trans	Auto; Complete Unit	1			EM-2512	
		Trans	Auto; Insert Only	1			EM-2525	
		Trans	Manual; Complete Unit	1			EM-2512	
		Trans	Manual; Insert Only	1			EM-2525	
1965-68		Trans	Auto	1			EM-2272	
		Trans	Manual	1			EM-2272	
V8 6.6L 400ci	1972-78	L & R Front	Insert Only	2	EM-2369			
		Trans	Complete Unit	1			EM-2512	
		Trans	Insert Only	1			EM-2525	
V8 6.8L 413ci	1962-64	LH Front		1	EM-2228			
	1959-60	LH Front		1	EM-2228			
	1962-64	RH Front		1	EM-2227			
	1959-60	RH Front		1	EM-2227			
	1962-64	Trans	Auto	1			EM-2272	
		Trans	Manual	1			EM-2272	
	1959-60	Trans	Auto	1			EM-2272	
		Trans	Manual	1			EM-2272	
V8 7.2L 440ci	1974-78	L & R Front	Complete Unit	2	EM-5476			
		L & R Front	Insert Only	2	EM-2369			
	1966-73	L & R Front		2	EM-2250			
		1972-78	Trans	Complete Unit	1			EM-2340
	Trans		Insert Only	1			EM-2525	
	Trans		Complete Unit	1			EM-2340	
	1969-71	Trans	Auto; Insert Only	1			EM-2525	
		Trans	Manual; Insert Only	1			EM-2525	
		1966-68	Trans	Auto	1			EM-2272
	Trans		Manual	1			EM-2272	
	<b>PT CRUISER</b>							
L4	L4 2.4L	2010	Front Lower	w/o Turbo	1	EM-2949		
		2008-09	Front Lower	Turbo	1	EM-5692		
			Front Lower	w/o Turbo	1	EM-2949		
		2007	Front Lower	Turbo	1	EM-5692		
			Front Lower	w/o Turbo	1	EM-2949		



# Engine, Transmission, And Torque Strut Mounts

CYL	ENG. SIZE	YEAR	LOCATION	DESCRIPTION	QTY	ENGINE	TORQUE STRUT	TRANSMISSION		
<b>CHRYSLER PASSENGER CAR (continued)</b>										
<b>PT CRUISER (continued)</b>										
L4	L4 2.4L	2004-06	Front Lower	Turbo	1	EM-5692				
			Front Lower	w/o Turbo	1	EM-2949				
		2003	Front Lower	Turbo	1	EM-5692				
			Front Lower	w/o Turbo	1	EM-2949				
		2001-02	Front Lower		1	EM-2949				
		2010	RH Front Upper		1	EM-2948				
		2008-09	RH Front Upper		1	EM-2948				
			RH Front Upper	Auto	1	EM-2948				
		2004-06	RH Front Upper	Manual	1	EM-5080				
			RH Front Upper	Auto	1	EM-2948				
		2003	RH Front Upper	Manual	1	EM-5080				
			RH Front Upper	Auto	1	EM-2948				
		2001-02	RH Front Upper	Manual	1	EM-5080				
			RH Front Upper	Auto	1	EM-2948				
		2010	Right		1	EM-2947				
		2008-09	Right		1	EM-2947				
		2007	Right		1	EM-2947				
		2004-06	Right		1	EM-2947				
		2003	Right		1	EM-2947				
		2001-02	Right		1	EM-2947				
2003-07	Trans	Non Turbo	1			EM-3026				
	Trans	Turbo	1			EM-3179				
<b>SEBRING</b>										
L4	L4 2.0L 1996cc	1995-99	Front		1	EM-8670				
			RH Front		1	EM-5081				
			Rear	Auto	1	EM-9394				
			Rear	Manual, Complete Unit	1	EM-8798				
			Rear	Manual; Bushing	1	EM-5420				
			Trans	Auto	1			EM-9174		
			Trans	Manual	1			EM-8793		
	L4 2.4L 2351cc SOH					1	EM-9160			
						1	EM-9160			
						1	EM-9160			
						1	EM-9184			
						1	EM-9184			
						1	EM-9184			
						1	EM-9161			
					Auto	1	EM-9161			
					Manual	1	EM-9485			
						1	EM-9161			
					Trans	Auto, Coupe	1			EM-9162
					Trans	Auto, Coupe	1			EM-9162
					Trans	Manual; Coupe	1			EM-5452
				Trans	Auto, Coupe	1			EM-9162	
	L4 2.4L 2360cc	2007-10	Front	Complete Unit	1	EM-3152				
			Front	Insert	1	EM-4094				
			RH Front		1	EM-3167				
			Rear		1	EM-3168				
			Trans	Bushing	1			EM-4127		
			Trans	Complete Unit	1			EM-3155		
	L4 2.4L 2429cc	1996-97	Bushing Kit	Cradle Insert Kit (2 pieces) Recommended	1	EM-5178				
	L4 2.4L 2429cc DOH				1	EM-3034				
	L4 2.4L 2429cc	1998	Front		1	EM-2958				
		1996-97	Front	Cradle Insert	1	EM-2980				
	L4 2.4L 2429cc DOH				1	EM-2841				

# Engine, Transmission, And Torque Strut Mounts

CYL	ENG. SIZE	YEAR	LOCATION	DESCRIPTION	QTY	ENGINE	TORQUE STRUT	TRANSMISSION	
<b>CHRYSLER PASSENGER CAR (continued)</b>									
<b>SEBRING (continued)</b>									
L4	L4 2.4L 2429cc	1998	RH Front		1	EM-2841*			
		1996-97	RH Front		1	EM-2841*			
		L4 2.4L 2429cc DOH				1	EM-3049		
	L4 2.4L 2429cc	1998	Rear			1	EM-2945		
		1996-97	Rear	Cradle Insert		1	EM-3011		
		2006	Trans	Convertible & Sedan		1			EM-2842 *
		2001-05	Trans	DOHC; Convertible & Sedan		1			EM-2842 *
		2006	Trans			1			EM-2842 *
		2001-05	Trans	DOHC		1			EM-2842 *
	V6	V6 2.5L	1996-97	Trans	Hydraulic Mount; JX; JXi	1			EM-2842 *
1998-00			Trans	LX; LXi	1			EM-9174	
1996-97			Trans	Solid Mount; LX, LXi	1			EM-9174	
			Trans		1			EM-2842 *	
1995			Trans	LX; LXi	1			EM-9174	
V6 2.5L 2497cc		1996-00	Bushing Kit	Convertible, Cradle Insert Kit (2 pcs) Recommended	1	EM-5178			
			Front	Convertible, Cradle Insert	1	EM-2980			
			Front	Coupe	1	EM-8670			
		1995	Front	Coupe	1	EM-8670			
		1996-00	RH Front	Convertible	1	EM-2841*			
			Rear	Convertible, Cradle Insert	1	EM-3011			
			Rear	Coupe	1	EM-9392			
V6 2.7L		2007-10	Front	Complete Unit	1	EM-3152			
			Front	Insert	1	EM-4094			
			RH Front		1	EM-3167			
			Rear		1	EM-3168			
V6 2.7L 2700cc		2002-06	Front		1	EM-3034			
			Front		1	EM-3034			
		2002-06	RH Front		1	EM-2841*			
			Rear		1	EM-3049			
		2001	Rear		1	EM-3049			
		2007-09	Trans	Bushing	1			EM-4127	
			Trans	Complete Unit	1			EM-3155	
		2005-06	Trans	Auto	1			EM-2842 *	
		2001-04	Trans	Auto	1			EM-2842 *	
			Trans	Manual	1			EM-2842 *	
V6 3.0L		2004-05	Trans - LH	Auto, Limited Coupe	1			EM-9384	
		2003	Trans	Auto, LX Coupe	1			EM-9384	
		2001-02	Trans	Auto, LXi Coupe	1			EM-9384	
V6 3.0L 2972cc		2001-05	LH Front		1	EM-5159			
			LH Rear		1	EM-5349			
			RH Front		1	EM-9187			
V6 3.5L		2007-10	Front	Complete Unit	1	EM-3152			
			Front	Insert	1	EM-4094			
			RH Front		1	EM-3167			
			Rear		1	EM-3168			
V6 3.5L 3497cc		2009-10	Trans	Bushing	1			EM-4127	
			Trans	Bushing	1			EM-4127	
		2007-08	Trans	Complete Unit	1			EM-3155	
<b>TC MASERATI</b>									
L4	L4 2.2L 135ci	1990	RH Front		1	EM-2711			
		1989	RH Front		1	EM-5083			
		1989-90	Trans		1			EM-2617	
V6	V6 3.0L 2972cc	1990-91	Front		1	EM-2493			
			Trans		1			EM-2617	

# Engine, Transmission, And Torque Strut Mounts

CYL	ENG. SIZE	YEAR	LOCATION	DESCRIPTION	QTY	ENGINE	TORQUE STRUT	TRANSMISSION	
<b>CHRYSLER PASSENGER CAR (continued)</b>									
<b>TOWN &amp; COUNTRY</b>									
L4	L4 2.2L 135ci	1982-88	Front		1	EM-2493			
			RH Front		1	EM-2600			
		1984-88	Trans		1			EM-2617	
		1982-83	Trans		1			EM-2600	
	L4 2.5L 2507cc	1986-88	Front		1	EM-2493			
			RH Front		1	EM-2600			
			Torq Str - Front		1		EM-2491		
			Trans		1			EM-2617	
	L4 2.6L 2555cc	1984-85	Front		1	EM-2493			
			1982	Front		1	EM-2493		
			1984-85	RH Front		1	EM-2600		
			1982	RH Front		1	EM-2600		
			1984-85	Trans		1			EM-2617
	1982	Trans		1			EM-2600		
	L6	L6 3.7L 3687cc	1978-81	LH Front	Complete Unit	1	EM-2324		
LH Front				Insert Only	1	EM-2376			
RH Front				Complete Unit	1	EM-2323			
RH Front				Insert Only	1	EM-2376			
Trans				Complete Unit	1			EM-2340	
Trans				Complete Unit - HD	1			EM-2512	
Trans				Insert Only	1			EM-2525	
V8	V8 5.2L 318ci	1978-81	LH Front	Complete Unit	1	EM-2326			
			LH Front	Insert Only	1	EM-2369			
			RH Front	Complete Unit	1	EM-2325			
			RH Front	Insert Only	1	EM-2369			
			Trans	Complete Unit	1			EM-2340	
			Trans	Complete Unit - HD	1			EM-2512	
			Trans	Insert Only	1			EM-2525	
	V8 5.9L 360ci	1978-79	LH Front	Complete Unit	1	EM-2326			
			LH Front	Insert Only	1	EM-2369			
			RH Front	Complete Unit	1	EM-2325			
			RH Front	Insert Only	1	EM-2369			
			Trans	Complete Unit	1			EM-2340	
			Trans	Complete Unit - HD	1			EM-2512	
			Trans	Insert Only	1			EM-2525	
	V8 6.3L 383ci	1965-71	L & R Front		2	EM-2250			
		1969-71	Trans	Complete Unit - HD	1			EM-2512	
			Trans	Insert Only	1			EM-2525	
		1965-68	Trans		1			EM-2272	
	V8 6.6L 400ci	1975-77	L & R Front	Complete Unit	2	EM-5476			
			L & R Front	Insert Only	2	EM-2369			
		1972	L & R Front		2	EM-2250			
1975-77		Trans	Complete Unit - HD	1			EM-2512		
		Trans	Insert Only	1			EM-2525		
1972		Trans	Complete Unit	1			EM-2340		
		Trans	Insert	1			EM-2525		
V8 6.8L 413ci	1959-65	LH Front		1	EM-2228				
		RH Front		1	EM-2227				
		Trans		1			EM-2272		
V8 7.2L 440ci	1974-77	L & R Front	Complete Unit	2	EM-5476				
		L & R Front	Insert Only	2	EM-2369				
	1968-73	L & R Front		2	EM-2250				
	1969-77	Trans	Complete Unit	1			EM-2340		
		Trans	Insert	1			EM-2525		
1968	Trans		1			EM-2272			

# Engine, Transmission, And Torque Strut Mounts

CYL	ENG. SIZE	YEAR	LOCATION	DESCRIPTION	QTY	ENGINE	TORQUE STRUT	TRANS-MISSION	
<b>CHRYSLER SUV</b>									
<b>PACIFICA</b>									
V6	V6 3.5L 3497cc	2004-06	Front		1	EM-3084'			
			Rear		1	EM-3084'			
			Right		1	EM-5085			
			Torq Str - Rear	FWD	1		EM-3095		
	V6 3.8L	2005-06	Front	AWD	1	EM-3084'			
			Front	FWD	1	EM-3084'			
			2007-08	L & R Front		2	EM-3147		
			2005-06	Rear	AWD	1	EM-3084'		
			2007-08	Right		1	EM-5085		
			2007-08	L & R Front		2	EM-3147		
<b>CHRYSLER VAN</b>									
<b>GRAND VOYAGER</b>									
V6	V6 3.0L 2972cc	2000	RH Front	Complete Unit	1	EM-2959			
			RH Front	Insert	1	EM-2844			
			Trans - Center	Complete Unit	1			EM-2984	
			Trans - Center	Insert	1			EM-2845	
			Trans - LH Front	Complete Unit	1			EM-2960	
			Trans - LH Front	Insert	1			EM-2849	
			Trans - LH Rear	Complete Unit	1			EM-3017	
			Trans - LH Rear	Insert	1			EM-2849	
	V6 3.3L 201ci	2000	RH Front	Complete Unit	1	EM-2959			
			RH Front	Insert	1	EM-2844			
			Trans - Center	Complete Unit	1			EM-2984	
			Trans - Center	Insert	1			EM-2845	
			Trans - LH Front	Complete Unit	1			EM-2960	
			Trans - LH Front	Insert	1			EM-2849	
			Trans - LH Rear	Complete Unit	1			EM-3017	
			Trans - LH Rear	Insert	1			EM-2849	
<b>TOWN &amp; COUNTRY</b>									
V6	V6 3.3L 201ci	2008-10	Front	Complete Unit	1	EM-3156			
			Front	Insert	1	EM-4094			
		1990-93	Front		1	EM-2615			
		2005-07	RH Front	Hydraulic Mount; FWD	1	EM-2926'			
		2001-04	RH Front	Hydraulic Mount; FWD	1	EM-2926'			
		1996-00	RH Front	Complete Unit	1	EM-2959			
			RH Front	Insert	1	EM-2844			
		1990-93	RH Front	Hydraulic Mount	1	EM-2711			
			RH Front	Rubber Mount	1	EM-2616			
		2001-07	Trans - Center		1			EM-2925	
		1996-00	Trans - Center	Complete Unit	1			EM-2984	
			Trans - Center	Insert Only	1			EM-2845	
		2001-07	Trans - LH Front		1			EM-2928	
		1996-00	Trans - LH Front	Complete Unit	1			EM-2960	
			Trans - LH Front	Insert Only	1			EM-2849	
		2001-07	Trans - LH Rear		1			EM-2927	
		1996-00	Trans - LH Rear	Complete Unit	1			EM-3017	
			Trans - LH Rear	Insert Only	1			EM-2849	
		2008-10	Trans	Bushing	1			EM-4127	
			Trans	Complete Unit	1			EM-4013	
	1990-93	Trans		1			EM-2618		
	V6 3.6L 220ci	2011-15	Front	Complete Unit	1	EM-4050			
			Front	Insert	1	EM-4094			
			Front	Complete Unit	1	EM-4050			
Front			Insert	1	EM-4094				
Right				1	EM-4012				

# Engine, Transmission, And Torque Strut Mounts

CYL	ENG. SIZE	YEAR	LOCATION	DESCRIPTION	QTY	ENGINE	TORQUE STRUT	TRANS-MISSION
<b>CHRYSLER VAN (continued)</b>								
<b>TOWN &amp; COUNTRY (continued)</b>								
V6	V6 3.6L 220ci	2011-15	Right		1	EM-4012		
		2011-13	Trans		1			EM-4077
	V6 3.8L 230ci	2008-10	Front	Complete Unit	1	EM-3156		
			Front	Insert	1	EM-4094		
		1994-95	Front	FWD	1	EM-2615		
		2005-07	RH Front	Hydraulic Mount; FWD	1	EM-2926		
		2001-04	RH Front	Hydraulic Mount; FWD	1	EM-2926		
		1996-00	RH Front	Complete Unit; FWD	1	EM-2959		
			RH Front	Insert Only; FWD	1	EM-2844		
		1994-95	RH Front	FWD, Solid Mount	1	EM-2616		
			RH Front	Hydraulic Mount; FWD	1	EM-2711		
		2008-10	Rear		1	EM-4042		
		2001-07	Trans - Center		1			EM-2925
		1996-00	Trans - Center	Complete Unit	1			EM-2984
			Trans - Center	Insert Only	1			EM-2845
		2001-07	Trans - LH Front		1			EM-2928
		1996-00	Trans - LH Front	Complete Unit	1			EM-2960
			Trans - LH Front	Insert Only	1			EM-2849
		2001-07	Trans - LH Rear		1			EM-2927
		1996-00	Trans - LH Rear	Complete Unit	1			EM-3017
	Trans - LH Rear		Insert Only	1			EM-2849	
	2008-10	Trans	Bushing	1			EM-4127	
		Trans	Complete Unit	1			EM-4013	
	1994-95	Trans		1			EM-2618	
		V6 4.0L 3952cc 241ci	2008-10	Front	Complete Unit	1	EM-3156	
	Front			Insert	1	EM-4094		
	Rear			1	EM-4042			
	Right			1	EM-4012			
Trans	Bushing		1			EM-4127		
Trans	Complete Unit		1			EM-4013		
<b>VOYAGER</b>								
L4	L4 2.4L	2003	Trans		1			EM-2927
		2001-02	Trans		1			EM-2927
	L4 2.4L 2429cc	2003	Front		1	EM-2928		
			2001-02	Front		1	EM-2928	
		2003	Left		1	EM-2925		
			Right		1	EM-4004		
		2001-02	Right		1	EM-4003		
		2000	Trans - Center	Auto, Complete Unit	1			EM-2984
			Trans - Center	Auto; Insert	1			EM-2845
			Trans - LH Front	Auto, Complete Unit	1			EM-2960
	Trans - LH Front		Auto; Insert	1			EM-2849	
	2000	Trans - LH Rear	Auto, Complete Unit	1			EM-3017	
V6	V6 3.0L 2972cc	2000	RH Front	Complete Unit	1	EM-2959		
			RH Front	Insert	1	EM-2844		
			Trans - Center	Complete Unit	1			EM-2984
			Trans - Center	Insert	1			EM-2845
			Trans - LH Front	Complete Unit	1			EM-2960
			Trans - LH Front	Insert	1			EM-2849
			Trans - LH Rear	Complete Unit	1			EM-3017
			Trans - LH Rear	Insert	1			EM-2849
			V6 3.3L 201ci	2001-03	RH Front		1	EM-2926
	2000	RH Front			Complete Unit	1	EM-2959	
	2001-03	RH Front		Insert Only	1	EM-2844		
		Trans - Center			1			EM-2925
	2000	Trans - Center		Complete Unit	1			EM-2984

# Engine, Transmission, And Torque Strut Mounts

CYL	ENG. SIZE	YEAR	LOCATION	DESCRIPTION	QTY	ENGINE	TORQUE STRUT	TRANS-MISSION
<b>CHRYSLER VAN (continued)</b>								
<b>VOYAGER (continued)</b>								
V6	V6 3.3L 201ci	2000	Trans - Center	Insert	1			EM-2845
		2001-03	Trans - LH Front		1			EM-2928
		2000	Trans - LH Front	Complete Unit	1			EM-2960
			Trans - LH Front	Insert	1			EM-2849
		2001-03	Trans - LH Rear		1			EM-2927
		2000	Trans - LH Rear	Complete Unit	1			EM-3017
Trans - LH Rear	Insert		1			EM-2849		
<b>DAEWOO PASSENGER CAR</b>								
<b>LANOS</b>								
L4	L4 1.6L 1588cc	1999-02	Front	Auto	1	EM-8920		
			Front	Manual	1	EM-2658		
			Rear		1	EM-2657		
			Trans	Auto	1			EM-8915
			Trans	Manual	1			EM-2656
<b>LEGANZA</b>								
L4	L4 2.2L 2200cc	1999-02	Front		1	EM-8916		
			RH Front		1	EM-8918		
			Rear		1	EM-8917		
			Trans	Auto	1			EM-8923
			Trans	Manual	1			EM-8923
<b>NUBIRA</b>								
L4	L4 2.0L 1998cc	2000-02	Torq Str - Front		1		EM-8919	
			L4 2.0L 2000cc	2000-02	RH Front	Auto	1	EM-8928
	1999	RH Front	Manual	1	EM-8929			
		RH Front	Auto	1	EM-8928			
	2000-02	RH Front	Manual	1	EM-8929			
		Rear		1	EM-8921			
	1999	Rear		1	EM-8921			
		2000-02	Trans	Auto	1			EM-8926
	1999	Trans	Manual	1			EM-8925	
	1999	Trans	Auto	1			EM-8931	
1999	Trans	Manual	1			EM-8930		
<b>DAIHATSU PASSENGER CAR</b>								
<b>CHARADE</b>								
L3	L3 1.0L	1991-92	Trans	Auto	1			EM-8655
			Trans	Manual	1			EM-8653
	L3 1.0L 993cc	1991-92	Front		1	EM-8652		
			Rear		1	EM-8654		
L4	L4 1.3L 1295cc	1989-92	RH Front		1	EM-8652		
			Rear		1	EM-8654		
			Trans	Auto	1			EM-8655
			Trans	Manual	1			EM-8653
<b>DAIHATSU SPORT UTILITY</b>								
<b>ROCKY</b>								
L4	L4 1.6L 1589cc	1990-92	L & R Front		2	EM-8811		
			Trans	Manual	1			EM-8812

# Engine, Transmission, And Torque Strut Mounts

CYL	ENG. SIZE	YEAR	LOCATION	DESCRIPTION	QTY	ENGINE	TORQUE STRUT	TRANSMISSION
<b>DODGE PASSENGER CAR</b>								
<b>330</b>								
V8	V8 5.2L 318ci	1963-64	LH Front		1	EM-2228		
			RH Front		1	EM-2227		
			Trans		1			EM-2302
	V8 6.3L 383ci	1964	LH Front		1	EM-2227		
			RH Front		1	EM-2228		
			Trans		1			EM-2302
	V8 6.8L 413ci	1963	LH Front		1	EM-2227		
			RH Front		1	EM-2228		
			Trans		1			EM-5087
<b>400</b>								
L4	L4 2.2L 135ci	1982-83	Front		1	EM-2493		
			RH Front		1	EM-2600		
			Torq Str - Front	Manual	1		EM-2491	
			Trans	Auto	1			EM-2600
			Trans	Manual	1			EM-2600
	L4 2.6L 2555cc	1982-83	Front		1	EM-2493		
			RH Front		1	EM-2600		
			Trans	Auto	1			EM-2600
			Trans	Manual	1			EM-2600
			<b>440</b>					
V8	V8 5.2L 318ci	1963-64	LH Front		1	EM-2227		
			RH Front		1	EM-2228		
	V8 6.3L 383ci	1964	LH Front		1	EM-2227		
			RH Front		1	EM-2228		
			Trans		1			EM-2302
	V8 6.8L 413ci	1963	LH Front		1	EM-2227		
			RH Front		1	EM-2228		
<b>600</b>								
L4	L4 2.2L 135ci	1983-88	Front		1	EM-2493		
			RH Front		1	EM-2600		
			Torq Str - Front	Manual	1		EM-2491	
		1984-88	Trans	Auto	1			EM-2617
			Trans	Manual	1			EM-2617
		1983	Trans	Auto	1			EM-2600
			Trans	Manual	1			EM-2600
	L4 2.5L 2507cc	1986-88	Front		1	EM-2493		
			RH Front		1	EM-2600		
			Trans	Auto	1			EM-2617
			Trans	Manual	1			EM-2617
	L4 2.6L 2555cc	1983-85	Front		1	EM-2493		
			RH Front		1	EM-2600		
		1984-85	Trans	Auto	1			EM-2617
			Trans	Manual	1			EM-2617
		1983	Trans	Auto	1			EM-2600
			Trans	Manual	1			EM-2600
<b>880</b>								
V8	V8 5.2L 318ci	1963-64	LH Front		1	EM-2227		
			RH Front		1	EM-2228		
			Trans		1			EM-2302
	V8 6.3L 383ci	1963-64	LH Front		1	EM-2227		
			RH Front		1	EM-2228		
			Trans		1			EM-2302
	V8 6.8L 413ci	1963	LH Front		1	EM-2227		
			RH Front		1	EM-2228		
			Trans		1			EM-5087

# Engine, Transmission, And Torque Strut Mounts

CYL	ENG. SIZE	YEAR	LOCATION	DESCRIPTION	QTY	ENGINE	TORQUE STRUT	TRANSMISSION			
<b>DODGE PASSENGER CAR (continued)</b>											
<b>ARIES</b>											
L4	L4 2.2L 135ci	1982-89	Front		1	EM-2493					
			1981	Front	Auto	1	EM-2493				
		1982-89	Front	Manual; 4 Spd	1	EM-2493					
			RH Front		1	EM-2600					
		1981	RH Front		1	EM-2600					
		1981-87	Torq Str - Front	Manual	1		EM-2491				
		1984-89	Trans	Auto	1			EM-2617			
			Trans	Manual	1			EM-2617			
		1981-83	Trans	Auto	1			EM-2600			
			Trans	Manual	1			EM-2600			
	L4 2.5L 2507cc	1986-89	Front		1	EM-2493					
			RH Front		1	EM-2600					
			Torq Str - Front	Manual	1		EM-2491				
			Trans	Auto	1			EM-2617			
	1981-85	Trans	Manual	1			EM-2617				
		Trans	Auto	1	EM-2493						
	L4 2.6L 2555cc	1984-85	RH Front		1	EM-2600					
			Trans	Auto	1			EM-2617			
		1981-83	Trans	Manual	1			EM-2617			
			Trans	Auto	1			EM-2600			
Trans	Manual	1			EM-2600						
<b>ASPEN</b>											
L6	L6 3.7L 3687cc	1976-80	LH Front	Complete Unit	1	EM-2324					
			LH Front	Insert Only	1	EM-2376					
			RH Front	Complete Unit	1	EM-2323					
			RH Front	Insert Only	1	EM-2376					
			Trans	Auto; Complete Unit	1			EM-2340			
			Trans	Auto; Complete Unit; HD Pkg.	1			EM-2512			
			Trans	Auto; Insert	1			EM-2525			
			Trans	Manual; Complete Unit	1			EM-2340			
			Trans	Manual; Complete Unit; HD Pkg.	1			EM-2512			
			Trans	Manual; Insert	1			EM-2525			
			V8	V8 5.2L 318ci	1976-80	LH Front	Complete Unit	1	EM-2326		
						LH Front	Insert Only	1	EM-2369		
						RH Front	Complete Unit	1	EM-2325		
RH Front	Insert Only	1				EM-2369					
Trans	Auto; Complete Unit	1						EM-2340			
Trans	Auto; Complete Unit; HD Pkg.	1						EM-2512			
Trans	Auto; Insert	1						EM-2525			
Trans	Manual; Complete Unit	1						EM-2340			
Trans	Manual; Complete Unit; HD Pkg.	1						EM-2512			
Trans	Manual; Insert	1						EM-2525			
V8 5.9L 360ci	1976-80	LH Front		Complete Unit	1	EM-2326					
		LH Front		Insert Only	1	EM-2369					
		RH Front		Complete Unit	1	EM-2325					
RH Front	Insert Only	1	EM-2369								
Trans	Auto; Complete Unit	1			EM-2340						
Trans	Auto; Complete Unit; HD Pkg.	1			EM-2512						
Trans	Auto; Insert	1			EM-2525						
Trans	Manual; Complete Unit	1			EM-2340						
Trans	Manual; Complete Unit; HD Pkg.	1			EM-2512						
Trans	Manual; Insert	1			EM-2525						



# Engine, Transmission, And Torque Strut Mounts

CYL	ENG. SIZE	YEAR	LOCATION	DESCRIPTION	QTY	ENGINE	TORQUE STRUT	TRANSMISSION	
<b>DODGE PASSENGER CAR (continued)</b>									
<b>AVENGER</b>									
L4	L4 2.0L 1996cc	1995-99	Front		1	EM-8670			
			RH Front		1	EM-5081			
			Rear		1	EM-9394			
			Trans	Auto	1			EM-9174	
			Trans	Manual	1			EM-8793	
	L4 2.4L 2360cc	2008-10	Front	Complete Unit	1	EM-3152			
			Front	Insert	1	EM-4094			
			2011-13	RH Front		1	EM-3167		
			2008-10	RH Front		1	EM-3167		
			2011-13	Rear		1	EM-3168		
			2008-10	Rear		1	EM-3168		
			2011-13	Trans	Bushing	1			EM-4127
			2008-09	Trans	Bushing	1			EM-4127
			2008-09	Trans	Complete Unit	1			EM-3155
V6	V6 2.5L 2497cc	1995-00	Front		1	EM-5089			
			Rear	Complete Unit	1	EM-9392			
			Trans		1			EM-9174	
	V6 2.7L 2700cc	2008-10	Front	Complete Unit	1	EM-3152			
			Front	Insert	1	EM-4094			
			RH Front		1	EM-3167			
			Rear		1	EM-3168			
			2008-09	Trans	Bushing	1			EM-4127
			2008-09	Trans	Complete Unit	1			EM-3155
	V6 3.5L	2008-10	Front	Complete Unit	1	EM-3152			
			Front	Insert	1	EM-4094			
			RH Front		1	EM-3167			
			Rear		1	EM-3168			
			2009-10	Trans	Bushing	1			EM-4127
	V6 3.6L 220ci	2011-13	Front		1	EM-4113			
			Right		1	EM-4112			
	<b>CALIBER</b>								
	L4	L4 1.8L	2007-09	Front		1	EM-3131		
RH Front					1	EM-3130			
Rear					1	EM-3132			
Trans				Auto; CVT	1			EM-3134	
Trans				Manual	1			EM-3137	
L4 2.0L		2007-09	Front		1	EM-3131			
			RH Front		1	EM-3130			
			Rear		1	EM-3145			
L4 2.4L		2009	Front		1	EM-3131			
			2007-08	Front		1	EM-3131		
		2009	RH Front		1	EM-3130			
			RH Front		1	EM-3130			
		2009	Rear	Auto; CVT	1	EM-3145			
			Rear	Manual	1	EM-3132			
			2007-08	Rear	Auto (CVT); AWD	1	EM-3157		
		2007-08	Rear	Auto (CVT); FWD	1	EM-3145			
			Rear	Manual	1	EM-3132			
2007-09		Trans	Auto; CVT	1			EM-3134		
		Trans	Manual	1			EM-3137		
<b>CHALLENGER</b>									
L4	L4 1.6L 1597cc	1978-79	L & R Front		2	EM-2731			
			Trans	Auto	1			EM-8544	
			Trans	Manual	1			EM-8544	
	L4 2.6L 2555cc	1978-83	L & R Front		2	EM-2731			
Trans				1			EM-2730		

# Engine, Transmission, And Torque Strut Mounts

CYL	ENG. SIZE	YEAR	LOCATION	DESCRIPTION	QTY	ENGINE	TORQUE STRUT	TRANSMISSION	
<b>DODGE PASSENGER CAR (continued)</b>									
<b>CHALLENGER (continued)</b>									
L6	L6 3.2L 198ci	1970-71	LH Front		1	EM-2275			
			RH Front		1	EM-2277			
			Trans	Auto; Complete Unit	1			EM-2340	
			Trans	Auto; Insert	1			EM-2525	
			Trans	Manual; Complete Unit	1			EM-2340	
				Trans	Manual; Insert	1			EM-2525
	L6 3.7L 3687cc	1970-72	LH Front		1	EM-2275			
			RH Front		1	EM-2277			
			Trans	Auto; Complete Unit	1			EM-2512	
			Trans	Auto; Insert	1			EM-2525	
Trans			Manual; Complete Unit	1			EM-2512		
			Trans	Manual; Insert	1			EM-2525	
V6	V6 3.5L 3497cc	2009-10	L & R Front		2	EM-5588			
V8	V8 5.2L 318ci	1970-74	L & R Front		2	EM-2250			
			Trans	Auto; Complete Unit	1			EM-2340	
			Trans	Auto; Complete Unit; HD Pkg.	1			EM-2512	
			Trans	Auto; Insert	1			EM-2525	
			Trans	Manual; Complete Unit	1			EM-2340	
			Trans	Manual; Complete Unit; HD Pkg.	1			EM-2512	
				Trans	Manual; Insert	1			EM-2525
	V8 5.6L 340ci	1970-73	L & R Front		2	EM-2250			
			Trans	Auto; Complete Unit	1			EM-2340	
			Trans	Auto; Insert	1			EM-2525	
			Trans	Manual; Complete Unit	1			EM-2340	
				Trans	Manual; Complete Unit	1			EM-2525
	V8 5.7L	2009-10	L & R Front		2	EM-3138			
			L & R Front	When Stock is Depleted, Re-order EM-3138	2	EM-5589			
	V8 5.7L 345ci	2009-10	Trans		1			EM-5587	
	V8 5.9L 360ci	1974	L & R Front		2	EM-2250			
			Trans	Auto; Complete Unit	1			EM-2340	
			Trans	Auto; Complete Unit; HD Pkg.	1			EM-2512	
			Trans	Auto; Insert	1			EM-2525	
Trans			Manual; Complete Unit	1			EM-2340		
Trans			Manual; Complete Unit; HD Pkg.	1			EM-2512		
			Trans	Manual; Insert	1			EM-2525	
V8 6.1L	2008-10	L & R Front		2	EM-3138				
		L & R Front	When Stock is Depleted, Re-order EM-3138	2	EM-5589				
		Trans		1			EM-5587		
V8 6.3L 383ci	1970-71	L & R Front		2	EM-2250				
		Trans	Auto	1			EM-2272		
		Trans	Manual	1			EM-2272		
V8 7.0L 426ci	1970-71	LH Front		1	EM-2227				
		RH Front		1	EM-2228				
		Trans	Auto; Complete Unit	1			EM-2512		
		Trans	Auto; Insert	1			EM-2525		
		Trans	Manual; Complete Unit	1			EM-2512		
			Trans	Manual; Insert	1			EM-2525	
V8 7.2L 440ci	1970-71	L & R Front		2	EM-2250				
		Trans		1			EM-2272		

# Engine, Transmission, And Torque Strut Mounts

CYL	ENG. SIZE	YEAR	LOCATION	DESCRIPTION	QTY	ENGINE	TORQUE STRUT	TRANSMISSION		
<b>DODGE PASSENGER CAR (continued)</b>										
<b>CHARGER</b>										
L4	L4 1.6L 1595cc	1984	Front		1	EM-2493				
			RH Front		1	EM-2600				
			Torq Str - Front	Manual	1		EM-2491			
			Trans	Auto	1			EM-2617		
			Trans	Manual	1			EM-2617		
	L4 2.2L 135ci	1985-87	Front	exc Shelby	1	EM-2493				
			Front	Shelby	1	EM-2447				
		1983-84	Front		1	EM-2493				
		1985-87	RH Front		1	EM-2600				
		1983-84	RH Front		1	EM-2600				
		1983-87	Torq Str - Front	Manual	1		EM-2491			
		1984-87	Trans	Auto	1			EM-2617		
			Trans	Manual	1			EM-2617		
		1983	Trans	Auto	1			EM-2600		
			Trans	Manual	1			EM-2600		
		L6	L6 3.7L 3687cc	1976	LH Front	Complete Unit	1	EM-2324		
					LH Front	Insert Only	1	EM-2376		
1973-74	LH Front			Complete Unit	1	EM-2324				
	LH Front			Insert Only	1	EM-2376				
1968-72	LH Front				1	EM-2275				
1976	RH Front			Complete Unit	1	EM-2323				
	RH Front			Insert Only	1	EM-2376				
1973-74	RH Front			Complete Unit	1	EM-2323				
	RH Front			Insert Only	1	EM-2376				
1968-72	RH Front				1	EM-2277				
	Trans			Auto; Complete Unit	1			EM-2512		
1976	Trans			Auto; Insert	1			EM-2525		
	Trans			Auto; Complete Unit	1			EM-2512		
1970-74	Trans			Auto; Insert	1			EM-2525		
	Trans			Manual; Complete Unit	1			EM-2512		
1968-69	Trans			Manual; Insert	1			EM-2525		
	Trans			Auto	1			EM-2272		
1976	Trans	Manual	1			EM-2272				
	Trans	Manual	1			EM-2272				
V6	V6 2.7L 2700cc	2006-10	L & R Front		2	EM-5588				
			Trans		1		EM-5587			
	V6 3.5L	2006-10	L & R Front	RWD	2	EM-5588				
	V6 3.5L 3497cc	2006-07	Trans	US & Canada	1		EM-5587			
	V6 3.5L 3518cc	2006-07	Trans	Mexican Vehicle	1		EM-5587			
V8	V8 4.5L 273ci	1966	L & R Front		2	EM-2250				
			Trans	Auto	1		EM-2272			
	V8 5.2L 318ci	1972	L & R Front		2	EM-2250				
			LH Front	Complete Unit	1	EM-2326				
		1973-78	LH Front	Insert Only	1	EM-2369				
			RH Front	Complete Unit	1	EM-2325				
			RH Front	Insert Only	1	EM-2369				
			Trans	Auto; Complete Unit	1		EM-2340			
		1975-78	Trans	Auto; Complete Unit; HD Pkg.	1		EM-2512			
			Trans	Auto; Insert	1		EM-2525			
			Trans	Auto; Complete Unit	1		EM-2340			
		1972-74	Trans	Auto; Complete Unit; HD Pkg.	1		EM-2512			
			Trans	Auto; Insert	1		EM-2525			
			Trans	Manual; Complete Unit	1		EM-2340			
	Trans		Manual; Complete Unit; HD Pkg.	1		EM-2512				
	Trans		Manual; Insert	1		EM-2525				
	1967-71	Trans	Auto	1		EM-2272				
Trans		Manual	1		EM-2272					

# Engine, Transmission, And Torque Strut Mounts

CYL	ENG. SIZE	YEAR	LOCATION	DESCRIPTION	QTY	ENGINE	TORQUE STRUT	TRANSMISSION
<b>DODGE PASSENGER CAR (continued)</b>								
<b>CHARGER (continued)</b>								
V8	V8 5.6L 340ci	1971-72	L & R Front		2	EM-2250		
		1973	LH Front	Complete Unit	1	EM-2326		
			LH Front	Insert Only	1	EM-2369		
			RH Front	Complete Unit	1	EM-2325		
			RH Front	Insert Only	1	EM-2369		
			1971-73	Trans	Auto; Complete Unit	1		
		Trans		Auto; Complete Unit; HD Pkg.	1			EM-2512
		Trans		Auto; Insert	1			EM-2525
		Trans		Manual; Complete Unit	1			EM-2340
		Trans		Manual; Complete Unit; HD Pkg.	1			EM-2512
	V8 5.7L	2007-10	L & R Front		2	EM-3138		
			L & R Front	When Stock is Depleted, Re-order EM-3138	2	EM-5589		
		2006	L & R Front		2	EM-3138		
			L & R Front	When Stock is Depleted, Re-order EM-3138	2	EM-5589		
		2006-10	Trans		1			EM-5587
	V8 5.9L 360ci	1974-78	LH Front	Complete Unit	1	EM-2326		
			LH Front	Insert Only	1	EM-2369		
			RH Front	Complete Unit	1	EM-2325		
			RH Front	Insert Only	1	EM-2369		
			Trans	Auto; Complete Unit	1			EM-2340
			Trans	Auto; Complete Unit; HD Pkg.	1			EM-2512
V8 6.1L	2006-10	L & R Front		2	EM-3138			
		L & R Front	When Stock is Depleted, Re-order EM-3138	2	EM-5589			
		Trans		1			EM-5587	
V8 6.3L 383ci	1967-71	L & R Front		2	EM-2250			
		Trans	Auto	1			EM-2272	
		Trans	Manual	1			EM-2272	
V8 6.6L 400ci	1974-78	L & R Front	Complete Unit	1	EM-5476			
		L & R Front	Insert Only	2	EM-2369			
	1972-73	L & R Front		2	EM-2250			
		1975-78	Trans	Auto; Complete Unit	1			EM-2340
			Trans	Auto; Complete Unit; HD Pkg.	1			EM-2512
	Trans		Auto; Insert	1			EM-2525	
	1972-74	Trans	Auto; Complete Unit	1			EM-2340	
		Trans	Auto; Complete Unit; HD Pkg.	1			EM-2512	
		Trans	Auto; Insert	1			EM-2525	
		Trans	Manual; Complete Unit	1			EM-2340	
		Trans	Manual; Complete Unit; HD Pkg.	1			EM-2512	
V8 7.0L 426ci	1967-71	Trans	Manual; Insert	1			EM-2525	
		LH Front		1	EM-2227			
		RH Front		1	EM-2228			
		Trans	Auto; Complete Unit	1			EM-2512	
		Trans	Auto; Insert	1			EM-2525	
		Trans	Manual; Complete Unit	1			EM-2512	
V8 7.2L 440ci	1967-74	Trans	Manual; Insert	1			EM-2525	
		L & R Front		2	EM-2250			
		Trans	Auto; Complete Unit	1			EM-2340	
		Trans	Auto; Complete Unit; HD Pkg.	1			EM-2512	
			Trans	Auto; Insert	1		EM-2525	
			Trans	Manual; Complete Unit	1		EM-2340	

# Engine, Transmission, And Torque Strut Mounts

CYL	ENG. SIZE	YEAR	LOCATION	DESCRIPTION	QTY	ENGINE	TORQUE STRUT	TRANSMISSION
<b>DODGE PASSENGER CAR (continued)</b>								
<b>CHARGER (continued)</b>								
V8	V8 7.2L 440ci	1967-74	Trans	Manual; Complete Unit; HD Pkg.	1			EM-2512
			Trans	Manual; Insert	1			EM-2525
<b>COLT</b>								
L4	L4 1.4L 1410cc	1979-84	LH Front		1	EM-8205		
		1980-84	Trans	Auto	1			EM-8545
			Trans	Manual	1			EM-2730
		1979	Trans	Manual	1			EM-2730
	L4 1.5L 1468cc	1994	Front	Auto	1	EM-8097		
			Front	Manual	1	EM-8100		
		1993	Front	Auto	1	EM-8097		
			Front	Manual	1	EM-8100		
		1991-92	Front	Auto	1	EM-2673		
			Front	Manual	1	EM-8107		
		1989-90	Front	Auto	1	EM-2673		
			Front	Manual	1	EM-8107		
		1985-88	Front	Auto	1	EM-8235		
			Front	Manual	1	EM-8103		
		1994	RH Front	w/ Power Steering	1	EM-8238		
			RH Front	w/o Power Steering	1	EM-8206		
		1993	RH Front	w/ Power Steering	1	EM-8238		
			RH Front	w/o Power Steering	1	EM-8206		
		1991-92	RH Front		1	EM-8108		
			RH Front	Hatchback	1	EM-8108		
		1989-90	RH Front	Station Wagon	1	EM-8242		
			RH Front		1	EM-8875		
		1985-88	Rear	Manual	1	EM-8818		
			Rear	Manual	1	EM-8818		
		1991-92	Rear	Auto	1	EM-8796		
		1985-88	Rear		1	EM-8267		
		1993-94	Trans	Auto	1			EM-8582
			Trans	Manual	1			EM-8099
		1989-92	Trans	Auto	1			EM-8584
			Trans	Manual	1			EM-8669
		1987-88	Trans	Sedan	1			EM-8242
		1985-86	Trans	Auto	1			EM-8875
	Trans		Manual; Insert	1			EM-8552	
	L4 1.6L 1597cc	1989-90	Front	Auto	1	EM-2673		
			Front	Manual	1	EM-8107		
		1985-88	Front	Auto	1	EM-8253		
			Front	Manual	1	EM-8231		
		1971-84	L & R Front		2	EM-2731		
		1989-90	RH Front	Auto	1	EM-8584		
			RH Front	Manual	1	EM-8060		
		1985-88	RH Front	Auto	1	EM-8205		
			RH Front	Manual	1	EM-8242		
		1989-90	Rear	Auto	1	EM-8102		
			Rear	Manual	1	EM-8102		
			Trans		1			EM-8108
		1985-88	Trans	w/ Manual Steering	1			EM-8232
			Trans	w/ Power Steering	1			EM-8556
		1981-84	Trans		1			EM-8545
		1980	Trans	Auto	1			EM-8502
			Trans	Manual	1			EM-8503
1978-79		Trans	Manual	1			EM-8503	
1975-77		Trans	Auto	1			EM-8502	
		Trans	Manual	1			EM-8503	

# Engine, Transmission, And Torque Strut Mounts

CYL	ENG. SIZE	YEAR	LOCATION	DESCRIPTION	QTY	ENGINE	TORQUE STRUT	TRANSMISSION
<b>DODGE PASSENGER CAR (continued)</b>								
<b>COLT (continued)</b>								
L4	L4 1.6L 1597cc	1971-74	Trans	Auto	1			EM-8502
			Trans	Manual	1			EM-8503
	L4 1.8L 1754cc	1989-90	Front	Auto	1	EM-8235		
			Front	Manual	1	EM-8231		
	L4 1.8L 1834cc	1994	Front	Auto	1	EM-8239		
			Front	Manual	1	EM-8098		
		1993	Front	Auto	1	EM-8097		
			Front	Manual	1	EM-8098		
		1992	Front	Auto	1	EM-8097		
			Front	Manual	1	EM-8098		
		1994	RH Front	Sedan	1	EM-8099		
		1993	RH Front	Sedan	1	EM-8099		
		1992	RH Front		1	EM-8099		
		1994	Rear	Auto, Sedan	1	EM-8100		
			Rear	Manual, After 6/3/92	1	EM-9057		
			Rear	Manual, Before 6/3/92	1	EM-8100		
		1993	Rear	Auto, Sedan	1	EM-8100		
	Rear		Manual, After 6/3/92	1	EM-9057			
	Rear		Manual, Before 6/3/92	1	EM-8100			
	1992	Rear	Auto	1	EM-8100			
Rear		Manual, After 6/3/92	1	EM-9057				
Rear		Manual, Before 6/3/92	1	EM-8100				
1993-94	Trans	Sedan; w/o Power Steering	1				EM-9147	
L4 2.0L	1974-77	Trans		1			EM-8502	
L4 2.0L 1995cc	1984-91	RH Front	Auto	1	EM-8807			
L4 2.4L 2351cc	1993-94	Rear	Auto	1	EM-8690			
		Rear	Manual	1	EM-8689			
		Trans	Sedan; w/o Power Steering	1			EM-8686	
<b>CONQUEST</b>								
L4	L4 2.6L 2555cc	1984-86	Trans	Manual	1			EM-2730
<b>CORONET</b>								
L6	L6 3.7L 225ci	1967-72	LH Front		1	EM-2275		
			RH Front		1	EM-2277		
		1967-69	Trans	Auto	1			EM-2272
			Trans	Manual	1			EM-2272
	L6 3.7L 3687cc	1973-76	LH Front	Complete Unit	1	EM-2324		
			LH Front	Insert Only	1	EM-2376		
			RH Front	Complete Unit	1	EM-2323		
			RH Front	Insert Only	1	EM-2376		
		1970-76	Trans	Auto; Complete Unit	1			EM-2512
			Trans	Auto; Insert	1			EM-2525
			Trans	Manual; Complete Unit	1			EM-2512
			Trans	Manual; Insert	1			EM-2525
	L6 3.8L 230ci	1953-56	Center Front		1	EM-2018		
		1949-52	Center Front		1	EM-2018		
1953-56		L & R Rear		2	EM-2014			
V8	V8 4.5L 273ci	1966-68	L & R Front		2	EM-2250		
		1965	LH Front		1	EM-2227		
			RH Front		1	EM-2228		
		1966-68	Trans	Auto	1			EM-2272
			Trans	Manual	1			EM-2272
	V8 5.2L 318ci	1967-72	L & R Front		2	EM-2250		
		1973-76	LH Front	Complete Unit	1	EM-2326		
			LH Front	Insert Only	1	EM-2369		
1965-66		LH Front		1	EM-2227			
1973-76	RH Front	Complete Unit	1	EM-2325				

# Engine, Transmission, And Torque Strut Mounts

CYL	ENG. SIZE	YEAR	LOCATION	DESCRIPTION	QTY	ENGINE	TORQUE STRUT	TRANSMISSION
<b>DODGE PASSENGER CAR (continued)</b>								
<b>CORONET (continued)</b>								
V8	V8 5.2L 318ci	1973-76	RH Front	Insert Only	1	EM-2369		
		1965-66	RH Front		1	EM-2228		
		1972-76	Trans	Auto; Complete Unit	1			EM-2340
			Trans	Auto; Complete Unit; HD Pkg.	1			EM-2512
			Trans	Auto; Insert	1			EM-2525
			Trans	Manual; Complete Unit	1			EM-2340
			Trans	Manual; Complete Unit; HD Pkg.	1			EM-2512
			Trans	Manual; Insert	1			EM-2525
		1965-71	Trans	Auto	1			EM-2272
			Trans	Manual	1			EM-2272
V8	V8 5.6L 340ci	1972-73	LH Front	Complete Unit	1	EM-2326		
			LH Front	Insert Only	1	EM-2369		
			RH Front	Complete Unit	1	EM-2325		
			RH Front	Insert Only	1	EM-2369		
			Trans	Auto; Complete Unit	1			EM-2340
			Trans	Auto; Insert	1			EM-2525
			Trans	Manual; Complete Unit	1			EM-2340
			Trans	Manual; Insert	1			EM-2525
V8	V8 5.9L 360ci	1973-76	L & R Front	Insert Only	2	EM-2369		
			LH Front	Complete Unit	1	EM-2326		
			RH Front	Complete Unit	1	EM-2325		
			Trans	Auto; Complete Unit	1			EM-2340
			Trans	Auto; Complete Unit; HD Pkg.	1			EM-2512
			Trans	Auto; Insert	1			EM-2525
			Trans	Manual; Complete Unit	1			EM-2340
			Trans	Manual; Complete Unit; HD Pkg.	1			EM-2512
V8	V8 6.3L 383ci	1967-71	L & R Front		2	EM-2250		
			Trans	Auto	1			EM-2272
			Trans	Manual	1			EM-2272
V8	V8 6.6L 400ci	1974-76	L & R Front	Complete Unit	2	EM-5476		
			L & R Front	Insert	2	EM-2369		
		1972-73 1972-76	L & R Front		2	EM-2250		
			Trans	Auto; Complete Unit	1			EM-2340
			Trans	Auto; Complete Unit; HD Pkg.	1			EM-2512
			Trans	Auto; Insert	1			EM-2525
			Trans	Manual; Complete Unit	1			EM-2340
			Trans	Manual; Complete Unit; HD Pkg.	1			EM-2512
Trans	Manual; Insert	1			EM-2525			
V8	V8 6.8L 413ci	1965	LH Front		1	EM-2227		
			RH Front		1	EM-2228		
V8	V8 7.0L 426ci	1965-70	LH Front		1	EM-2227		
			RH Front		1	EM-2228		
			Trans	Auto; Complete Unit	1			EM-2512
			Trans	Auto; Insert	1			EM-2525
			Trans	Manual; Complete Unit	1			EM-2512
Trans	Manual; Insert	1			EM-2525			
V8	V8 7.2L 440ci	1972-76	L & R Front		2	EM-2250		
		1967-70	L & R Front		2	EM-2250		
		1972-76	Trans	Auto	1			EM-2272
			Trans	Manual	1			EM-2272
		1967-70	Trans	Auto	1			EM-2272
Trans	Manual	1			EM-2272			

# Engine, Transmission, And Torque Strut Mounts

CYL	ENG. SIZE	YEAR	LOCATION	DESCRIPTION	QTY	ENGINE	TORQUE STRUT	TRANSMISSION	
<b>DODGE PASSENGER CAR (continued)</b>									
<b>CUSTOM</b>									
V8	V8 6.3L 383ci	1963-65	LH Front		1	EM-2227			
			RH Front		1	EM-2228			
			Trans		1			EM-2302	
	V8 6.8L 413ci	1965	LH Front		1	EM-2227			
			RH Front		1	EM-2228			
			Trans		1			EM-2302	
<b>DART</b>									
L6	L6 2.8L 170ci	1967-69	LH Front		1	EM-2265			
			1961-66	LH Front		1	EM-2303		
		1967-69	RH Front		1	EM-2264			
			1961-66	RH Front		1	EM-2304		
		1966-69	Trans	Auto	1			EM-2272	
			Trans	Manual	1			EM-2272	
	L6 3.2L 198ci	1973-74	LH Front	Complete Unit	1	EM-2324			
			LH Front	Insert Only	1	EM-2376			
		1970-72	LH Front		1	EM-2265			
			1973-74	RH Front	Complete Unit	1	EM-2323		
		1970-72	RH Front	Insert Only	1	EM-2376			
			1973-74	RH Front		1	EM-2264		
		1973-74	Trans	Auto; Complete Unit	1			EM-2340	
			Trans	Auto; Insert	1			EM-2525	
			Trans	Manual; Complete Unit	1			EM-2340	
			Trans	Manual; Insert	1			EM-2525	
			1970-72	Trans	Auto	1			EM-2272
				Trans	Manual	1			EM-2272
	L6 3.7L 3687cc	1973-76	LH Front	Complete Unit	1	EM-2324			
			LH Front	Insert Only	1	EM-2376			
		1967-72	LH Front		1	EM-2265			
			1960-66	LH Front		1	EM-2303		
		1973-76	RH Front	Complete Unit	1	EM-2323			
			RH Front	Insert Only	1	EM-2376			
		1967-72	RH Front		1	EM-2264			
			1960-66	RH Front		1	EM-2304		
		1973-76	Trans	Auto; Complete Unit	1			EM-2512	
			Trans	Auto; Insert	1			EM-2525	
			Trans	Manual; Complete Unit	1			EM-2512	
			Trans	Manual; Insert	1			EM-2525	
			1962-72	Trans	Auto	1			EM-2272
				Trans	Manual	1			EM-2272
V8	V8 4.5L 273ci	1964-69	L & R Front		2	EM-2266			
			1969	Trans	Auto	1		EM-2272	
			Trans	Manual	1			EM-2272	
	V8 5.2L 318ci	1968-72	L & R Front		2	EM-2266			
			1973-76	LH Front	Complete Unit	1	EM-2326		
		LH Front		Insert Only	1	EM-2369			
		RH Front		Complete Unit	1	EM-2325			
		RH Front		Insert Only	1	EM-2369			
		1974-76	Trans	Auto; Complete Unit	1			EM-2340	
			Trans	Auto; Complete Unit; HD Pkg.	1			EM-2512	
			Trans	Auto; Insert	1			EM-2525	
			Trans	Manual; Complete Unit	1			EM-2340	
			Trans	Manual; Complete Unit; HD Pkg.	1			EM-2512	
			Trans	Manual; Insert	1			EM-2525	
		1968-73	Trans	Auto	1			EM-2272	
	Trans		Manual	1			EM-2272		
	V8 5.6L 340ci	1968-73	L & R Front		2	EM-2266			



# Engine, Transmission, And Torque Strut Mounts

CYL	ENG. SIZE	YEAR	LOCATION	DESCRIPTION	QTY	ENGINE	TORQUE STRUT	TRANSMISSION	
<b>DODGE PASSENGER CAR (continued)</b>									
<b>DART (continued)</b>									
V8	V8 5.6L 340ci	1968-73	Trans	Auto	1			EM-2272	
			Trans	Manual	1			EM-2272	
	V8 5.9L 360ci	1974-76	LH Front	Complete Unit	1	EM-2326			
			LH Front	Insert Only	1	EM-2369			
			RH Front	Complete Unit	1	EM-2325			
			RH Front	Insert Only	1	EM-2369			
			Trans	Auto; Complete Unit	1			EM-2340	
			Trans	Auto; Complete Unit; HD Pkg.	1			EM-2512	
			Trans	Auto; Insert	1			EM-2525	
			Trans	Manual; Complete Unit	1			EM-2340	
			Trans	Manual; Complete Unit; HD Pkg.	1			EM-2512	
			Trans	Manual; Insert	1			EM-2525	
	V8 6.3L 383ci	1967-69	L & R Front		2	EM-2250			
			Trans	Auto	1			EM-2272	
			Trans	Manual	1			EM-2272	
V8 6.8L 413ci	1965	LH Front		1	EM-2227				
		RH Front		1	EM-2228				
<b>DAYTONA</b>									
L4	L4 2.2L 135ci	1992-93	Front		1	EM-2615			
			1990	Front		1	EM-2493		
		1984-89	Front		1	EM-2493			
			1992-93	RH Front		1	EM-2616		
		1990	RH Front		1	EM-2616			
		1984-89	RH Front		1	EM-2600			
		1984-86	Torq Str - Front	Manual	1		EM-2491		
		1992-93	Trans	Manual	1			EM-2618	
		1990	Trans	Auto	1			EM-2618	
			Trans	Manual	1			EM-2618	
		1984-89	Trans	Auto	1			EM-2617	
			Trans	Manual	1			EM-2617	
		L4 2.5L 2507cc	1992-93	Front		1	EM-2615		
				1990-91	Front		1	EM-2493	
	1986-89		Front		1	EM-2493			
	1992-93		RH Front		1	EM-2616			
	1990-91		RH Front		1	EM-2616			
	1986-89		RH Front		1	EM-2600			
	1986		Torq Str - Front	Manual	1		EM-2491		
	1990-93		Trans	Auto	1			EM-2618	
			Trans	Manual	1			EM-2618	
	1986-89		Trans	Auto	1			EM-2617	
		Trans	Manual	1			EM-2617		
	V6	V6 3.0L 2972cc	1990-93	Front		1	EM-2615		
RH Front				Hydraulic Mount	1	EM-2711			
RH Front				Solid Mount; Bushing	1	EM-2616			
Trans				Auto	1			EM-2618	
Trans				Manual	1			EM-2618	
<b>DIPLOMAT</b>									
L6	L6 3.7L 3687cc	1978-83	LH Front	Complete Unit	1	EM-2324			
			LH Front	Insert Only	1	EM-2376			
			RH Front	Complete Unit	1	EM-2323			
			RH Front	Insert Only	1	EM-2376			
			Trans	Complete Unit	1			EM-2340	
			Trans	Complete Unit - HD	1			EM-2512	
V8	V8 5.2L 318ci	1977-89	LH Front	Complete Unit	1	EM-2326			
			LH Front	Insert Only	1	EM-2369			

# Engine, Transmission, And Torque Strut Mounts

CYL	ENG. SIZE	YEAR	LOCATION	DESCRIPTION	QTY	ENGINE	TORQUE STRUT	TRANSMISSION	
<b>DODGE PASSENGER CAR (continued)</b>									
<b>DIPLOMAT (continued)</b>									
V8	V8 5.2L 318ci	1977-89	RH Front	Complete Unit	1	EM-2325			
			RH Front	Insert Only	1	EM-2369			
		1979-89	Trans	Complete Unit	1			EM-2340	
			Trans	Complete Unit - HD	1			EM-2512	
			Trans	Insert	1			EM-2525	
		1977-78	Trans	Complete Unit	1			EM-2340	
			Trans	Complete Unit - HD	1			EM-2512	
			Trans	Auto; Insert	1			EM-2525	
			Trans	Manual; Insert	1			EM-2525	
	V8 5.9L 360ci	1978-79	LH Front	Complete Unit	1	EM-2326			
			LH Front	Insert Only	1	EM-2369			
			RH Front	Complete Unit	1	EM-2325			
			RH Front	Insert Only	1	EM-2369			
			Trans	Complete Unit	1			EM-2340	
			Trans	Complete Unit - HD	1			EM-2512	
Trans	Insert	1			EM-2525				
<b>DYNASTY</b>									
L4	L4 2.5L 2507cc	1988-93	Front		1	EM-2615			
			RH Front		1	EM-2711			
		1990-93	Trans	Auto; 4 Spd	1			EM-2824 *	
		1988-89	Trans	Auto	1			EM-2617	
V6	V6 3.0L 2972cc	1988-93	Front		1	EM-2615			
			RH Front		1	EM-2711			
		1990-93	Trans		1			EM-2824 *	
		1988-89	Trans		1			EM-2617	
	V6 3.3L 201ci	1990-93	Front		1	EM-2615			
			RH Front		1	EM-2711			
Trans		1			EM-2824 *				
<b>INTREPID</b>									
V6	V6 2.7L 2700cc	1998-04	LH Front		1	EM-2942*			
			RH Front		1	EM-2903*			
			Trans		1			EM-2908	
	V6 3.2L 3200cc	1998-01	L & R Front		2	EM-2903*			
			Trans		1			EM-2908	
	V6 3.3L 201ci	1996-97	L & R Front		2	EM-5020*			
			1993-95	L & R Front		2	EM-2795*		
			1993-97	Trans		1			EM-2810
	V6 3.5L 3497cc	2000-04	L & R Front		2	EM-2903*			
			1996-97	L & R Front		2	EM-5020*		
			1993-95	L & R Front		2	EM-2795*		
			2000-04	Trans		1			EM-2908
	1993-97	Trans		1			EM-2810		
<b>LANCER</b>									
L4	L4 2.2L 135ci	1985-89	Front		1	EM-2493			
			RH Front		1	EM-2600			
		1985-87	Torq Str - Front	Manual	1		EM-2491		
		1985-89	Trans	Auto	1			EM-2617	
	L4 2.5L 2507cc	1986-89	Trans	Manual	1			EM-2617	
			Front		1	EM-2493			
			RH Front		1	EM-2600			
			Torq Str - Front	Manual	1		EM-2491		
1986-89	Trans	Auto	1			EM-2617			
Trans	Manual	1			EM-2617				
L6	L6 2.8L 170ci	1962	LH Front		1	EM-2303			
	L6 3.7L 3687cc	1962	LH Front		1	EM-2303			

# Engine, Transmission, And Torque Strut Mounts

CYL	ENG. SIZE	YEAR	LOCATION	DESCRIPTION	QTY	ENGINE	TORQUE STRUT	TRANSMISSION
<b>DODGE PASSENGER CAR (continued)</b>								
<b>LANCER (continued)</b>								
L6	L6 3.7L 3687cc	1962	Trans		1			EM-2272
<b>MAGNUM</b>								
V6	V6 2.7L	2005-07	Trans	RWD	1			EM-5587
	V6 2.7L 2700cc	2005-08	L & R Front		2	EM-5588		
	V6 3.5L	2005-08	L & R Front	RWD	2	EM-5588		
2005-07		Trans	RWD	1			EM-5587	
V8	V8 5.2L 318ci	1978-79	LH Front	Complete Unit	1	EM-2326		
			LH Front	Insert Only	1	EM-2369		
			RH Front	Complete Unit	1	EM-2325		
			RH Front	Insert Only	1	EM-2369		
			Trans	Complete Unit	1			EM-2340
			Trans	Complete Unit - HD	1			EM-2512
			Trans	Insert	1			EM-2525
	V8 5.7L	2005-08	L & R Front		2	EM-3138		
			L & R Front	When Stock is Depleted, Re-order EM-3138	2	EM-5589		
			2005-07	Trans	RWD	1		
	V8 5.9L 360ci	1978-79	LH Front	Complete Unit	1	EM-2326		
			LH Front	Insert Only	1	EM-2369		
			RH Front	Complete Unit	1	EM-2325		
			RH Front	Insert Only	1	EM-2369		
			Trans	Complete Unit	1			EM-2340
Trans			Complete Unit - HD	1			EM-2512	
V8 6.1L	2006-07	Trans	RWD	1			EM-5587	
		V8 6.6L 400ci	1978	L & R Front	Insert Only	2	EM-2369	
				Trans	Complete Unit	1		
Trans	Complete Unit - HD			1			EM-2512	
			Trans	Insert	1			EM-2525
<b>MIRADA</b>								
L6	L6 3.7L 3687cc	1980-83	LH Front	Complete Unit	1	EM-2324		
			LH Front	Insert Only	1	EM-2376		
			RH Front	Complete Unit	1	EM-2323		
			RH Front	Insert Only	1	EM-2376		
			Trans	Complete Unit	1			EM-2340
			Trans	Complete Unit - HD	1			EM-2512
			Trans	Insert	1			EM-2525
V8	V8 5.2L 318ci	1980-83	LH Front	Complete Unit	1	EM-2326		
			LH Front	Insert Only	1	EM-2369		
			RH Front	Complete Unit	1	EM-2325		
			RH Front	Insert Only	1	EM-2369		
			Trans	Complete Unit	1			EM-2340
			Trans	Complete Unit - HD	1			EM-2512
	Trans	Insert	1			EM-2525		
	V8 5.9L 360ci	1980	LH Front	Complete Unit	1	EM-2326		
			LH Front	Insert Only	1	EM-2369		
			RH Front	Complete Unit	1	EM-2325		
			RH Front	Insert Only	1	EM-2369		
			Trans	Complete Unit	1			EM-2340
			Trans	Complete Unit - HD	1			EM-2512
Trans			Insert	1			EM-2525	
<b>MONACO</b>								
L6	L6 3.7L 3687cc	1977-78	LH Front	Complete Unit	1	EM-2324		
			LH Front	Insert Only	1	EM-2376		
			RH Front	Complete Unit	1	EM-2323		
			RH Front	Insert Only	1	EM-2376		

# Engine, Transmission, And Torque Strut Mounts

CYL	ENG. SIZE	YEAR	LOCATION	DESCRIPTION	QTY	ENGINE	TORQUE STRUT	TRANSMISSION	
<b>DODGE PASSENGER CAR (continued)</b>									
<b>MONACO (continued)</b>									
L6	L6 3.7L 3687cc	1977-78	Trans	Auto; Complete Unit	1			EM-2340	
			Trans	Auto; Complete Unit; HD Pkg.	1			EM-2512	
			Trans	Auto; Insert	1			EM-2525	
V8	V8 5.2L 318ci	1975-78	LH Front	Complete Unit	1	EM-2326			
			LH Front	Insert Only	1	EM-2369			
			RH Front	Complete Unit	1	EM-2325			
			RH Front	Insert Only	1	EM-2369			
			Trans	Auto; Complete Unit	1			EM-2340	
			Trans	Auto; Complete Unit; HD Pkg.	1			EM-2512	
			Trans	Auto; Insert	1			EM-2525	
	V8 5.9L 360ci	1971-73	1974-78	L & R Front		2	EM-2250		
				LH Front	Complete Unit	1	EM-2326		
				LH Front	Insert Only	1	EM-2369		
				RH Front	Complete Unit	1	EM-2325		
		1971-73	RH Front	Insert Only	1	EM-2369			
			Trans	Auto; Complete Unit	1			EM-2340	
			Trans	Auto; Complete Unit; HD Pkg.	1			EM-2512	
Trans			Auto; Insert	1			EM-2525		
V8 6.3L 383ci	1965-71	L & R Front		2	EM-2250				
	1966-71	Trans	Auto	1			EM-2272		
		Trans	Manual	1			EM-2272		
V8 6.6L 400ci	1974-78	L & R Front	Complete Unit	1	EM-5476				
		L & R Front	Insert Only	2	EM-2369				
		L & R Front		2	EM-2250				
	1975-78	Trans	Auto; Complete Unit	1			EM-2340		
		Trans	Auto; Complete Unit; HD Pkg.	1			EM-2512		
		Trans	Auto; Insert	1			EM-2525		
	1972-74	Trans	Auto; Complete Unit	1			EM-2340		
		Trans	Auto; Complete Unit; HD Pkg.	1			EM-2512		
		Trans	Auto; Insert	1			EM-2525		
		Trans	Manual; Complete Unit	1			EM-2340		
		Trans	Manual; Complete Unit; HD Pkg.	1			EM-2512		
V8 6.8L 413ci	1965	LH Front		1	EM-2227				
		RH Front		1	EM-2228				
V8 7.2L 440ci	1974-78	L & R Front	Insert Only	2	EM-2369				
	1966-73	L & R Front		2	EM-2250				
<b>NEON</b>									
L4	L4 2.0L 1996cc	1995-99	Front	Complete Unit	1	EM-2867			
			Front	Insert	1	EM-2846			
			RH Front	Complete Unit	1	EM-2979			
			RH Front	Insert	1	EM-2847			
		2003-05	RH Front Lower	Auto	1	EM-2949			
		2000-02	RH Front Lower		1	EM-2949			
		2003-05	RH Front Upper	Auto	1	EM-2948			
		2000-02	RH Front Upper		1	EM-2948			
		2003-05	RH Rear	Auto	1	EM-2947			
		2000-02	RH Rear		1	EM-2947			
		2002-05	Trans	Auto	1			EM-3124	
			Trans	Manual	1			EM-3050	
		2000-01	Trans	Auto	1			EM-2975	
			Trans	Manual	1			EM-3050	
		1995-99	Trans	Auto; Complete Unit	1			EM-5052	
Trans	Auto; Insert		1			EM-2848			

# Engine, Transmission, And Torque Strut Mounts

CYL	ENG. SIZE	YEAR	LOCATION	DESCRIPTION	QTY	ENGINE	TORQUE STRUT	TRANSMISSION	
<b>DODGE PASSENGER CAR (continued)</b>									
<b>NEON (continued)</b>									
L4	L4 2.0L 1996cc	1995-99	Trans	Manual; Complete Unit	1			EM-5052	
			Trans	Manual; Insert	1		EM-2848		
	L4 2.4L 2429cc	2003-05	Front Lower		1	EM-5692			
			Rear		1	EM-2947			
<b>OMNI</b>									
L4	L4 1.6L 1595cc	1983-86	Front		1	EM-2493			
			RH Front		1	EM-2600			
			Torq Str - Front	Manual	1		EM-2491		
		1984-86	Trans	Auto	1			EM-2617	
			Trans	Manual	1			EM-2617	
			Trans	Auto	1			EM-2600	
		1983	Trans	Auto	1			EM-2600	
			Trans	Manual	1			EM-2600	
		L4 1.7L 105ci	1978-83	Front	Complete Unit	1	EM-2733		
				Front	Insert Only	1	EM-2447		
	RH Front				1	EM-2600			
	1981-83		Torq Str - Front	Manual	1		EM-2491		
			Trans	Auto	1			EM-2600	
	1978-80		Trans	Manual	1			EM-2600	
			Trans	Auto; Complete Unit	1			EM-2734	
			Trans	Auto; Insert Only	1			EM-2721	
	L4 2.2L 135ci	1981-90	Trans	Manual; Complete Unit	1			EM-2734	
			Trans	Manual; Insert Only	1			EM-2721	
			Front		1	EM-2493			
		1984-90	RH Front		1	EM-2600			
Torq Str - Front			Manual	1		EM-2491			
Trans			Auto	1			EM-2617		
Trans			Manual	1			EM-2617		
Trans			Auto	1			EM-2600		
Trans			Manual	1			EM-2600		
<b>POLARA</b>									
L6	L6 3.7L 3687cc	1970-71	LH Front		1	EM-2275			
			RH Front		1	EM-2276			
			Trans	Auto; Complete Unit	1			EM-2512	
			Trans	Auto; Insert	1			EM-2525	
			Trans	Manual; Complete Unit	1			EM-2512	
			Trans	Manual; Insert	1			EM-2525	
V8	V8 5.2L 318ci	1967-72	L & R Front		2	EM-2250			
			1973	LH Front		1	EM-2326		
		1960-66	LH Front		1	EM-2228			
			1973	RH Front		1	EM-2325		
		1960-66	RH Front		1	EM-2227			
			Trans	Auto; Complete Unit	1			EM-2340	
			Trans	Auto; Insert	1			EM-2525	
			Trans	Manual; Complete Unit	1			EM-2340	
			Trans	Manual; Insert	1			EM-2525	
			Trans	Auto	1			EM-2272	
		1966-70	Trans	Manual	1			EM-2272	
			V8 5.9L 360ci	1971-73	L & R Front		2	EM-2250	
	V8 6.3L 383ci	1966-71	Trans	Auto	1			EM-2272	
			Trans	Manual	1			EM-2272	
	V8 6.6L 400ci	1962-65	L & R Front		2	EM-2250			
			LH Front		1	EM-2228			
		1963-71	RH Front		1	EM-2227			
			Trans	Auto	1			EM-2272	
Trans	Manual	1			EM-2272				

# Engine, Transmission, And Torque Strut Mounts

CYL	ENG. SIZE	YEAR	LOCATION	DESCRIPTION	QTY	ENGINE	TORQUE STRUT	TRANSMISSION	
<b>DODGE PASSENGER CAR (continued)</b>									
<b>POLARA (continued)</b>									
V8	V8 6.6L 400ci	1972-73	Trans	Auto; Complete Unit	1			EM-2340	
			Trans	Auto; Complete Unit; HD Pkg.	1			EM-2512	
			Trans	Auto; Insert	1				EM-2525
			Trans	Manual; Complete Unit	1				EM-2340
			Trans	Manual; Complete Unit; HD Pkg.	1				EM-2512
			Trans	Manual; Insert	1				EM-2525
	V8 6.8L 413ci	1963-65	LH Front		1	EM-2227			
			RH Front		1	EM-2228			
	V8 7.0L 426ci	1964-67	LH Front		1	EM-2227			
			RH Front		1	EM-2228			
			Trans	Auto; Complete Unit	1				EM-2512
			Trans	Auto; Insert	1				EM-2525
	V8 7.2L 440ci	1966-73	Trans	Manual; Complete Unit	1				EM-2512
			Trans	Manual; Insert	1				EM-2525
			L & R Front		2	EM-2250			
			Trans	Auto; Complete Unit	1				EM-2340
			Trans	Auto; Complete Unit; HD Pkg.	1				EM-2512
			Trans	Auto; Insert	1				EM-2525
	<b>ROYAL MONACO</b>								
	V8	V8 5.2L 318ci	1975-77	LH Front	Complete Unit	1	EM-2326		
				LH Front	Insert Only	1	EM-2369		
RH Front				Complete Unit	1	EM-2325			
RH Front				Insert Only	1	EM-2369			
Trans				Complete Unit	1				EM-2340
Trans				Complete Unit - HD	1				EM-2512
Trans				Insert	1				EM-2525
V8 5.9L 360ci		1975-77	LH Front	Complete Unit	1	EM-2326			
			LH Front	Insert Only	1	EM-2369			
			RH Front	Complete Unit	1	EM-2325			
			RH Front	Insert Only	1	EM-2369			
			Trans	Complete Unit	1				EM-2340
			Trans	Complete Unit - HD	1				EM-2512
V8 6.6L 400ci		1975-77	L & R Front	Complete Unit	2	EM-5476			
			L & R Front	Insert Only	2	EM-2369			
			Trans	Complete Unit	1				EM-2340
			Trans	Complete Unit - HD	1				EM-2512
			Trans	Insert	1				EM-2525
<b>SHADOW</b>									
L4		L4 2.2L 135ci	1991-94	Front		1	EM-2615		
			1987-90	Front		1	EM-2493		
	1991-94		RH Front		1	EM-2616			
	1987-90		RH Front		1	EM-2600			
	1987		Torq Str - Front	Manual	1		EM-2491		
	1991-94		Trans	Auto	1			EM-2618	
			Trans	Manual	1			EM-2618	
	1987-90		Trans	Auto	1			EM-2617	
		Trans	Manual	1			EM-2617		
	L4 2.5L 2507cc	1991-94	Front		1	EM-2615			
		1988-90	Front		1	EM-2493			
1991-94		RH Front		1	EM-2616				

# Engine, Transmission, And Torque Strut Mounts

CYL	ENG. SIZE	YEAR	LOCATION	DESCRIPTION	QTY	ENGINE	TORQUE STRUT	TRANS-MISSION		
<b>DODGE PASSENGER CAR (continued)</b>										
<b>SHADOW (continued)</b>										
L4	L4 2.5L 2507cc	1988-90	RH Front		1	EM-2600				
		1990-94	Trans	Auto	1			EM-2618		
			Trans	Manual	1			EM-2618		
		1988-89	Trans	Auto	1			EM-2617		
			Trans	Manual	1			EM-2617		
V6	V6 3.0L 2972cc	1992-94	Front		1	EM-2615				
			RH Front		1	EM-2711				
		1994	Trans	Auto	1			EM-2618		
			Trans	Manual	1			EM-2618		
		<b>SPIRIT</b>								
L4	L4 2.2L 135ci	1991-92	Front		1	EM-2615				
			RH Front		1	EM-2616				
			Trans		1			EM-2618		
	L4 2.5L 2507cc	1990-95	Front		1	EM-2615				
			1989	Front		1	EM-2615			
		1990-95	RH Front		1	EM-2616				
			1989	RH Front		1	EM-2600			
		1990-95	Trans	Auto	1			EM-2618		
			Trans	Manual	1			EM-2618		
		1989	Trans	Auto	1			EM-2617		
			Trans	Manual	1			EM-2617		
		V6	V6 3.0L 2972cc	1992-95	Front		1	EM-2615		
				1990-91	Front		1	EM-2615		
				1989	Front		1	EM-2615		
1992-95	RH Front			Hydraulic Mount; NOT INTERCHANABLE WITH NON HYDRAULIC	1	EM-2711				
1990-91	RH Front				1	EM-2616				
1989	RH Front				1	EM-2600				
1990-95	Trans			Auto	1			EM-2618		
	Trans			Manual	1			EM-2618		
1989	Trans			Auto	1			EM-2617		
	Trans			Manual	1			EM-2617		
<b>ST. REGIS</b>										
L6	L6 3.7L 3687cc	1979-81	LH Front	Complete Unit	1	EM-2324				
			LH Front	Insert Only	1	EM-2376				
			RH Front	Complete Unit	1	EM-2323				
			RH Front	Insert Only	1	EM-2376				
			Trans	Complete Unit	1			EM-2340		
			Trans	Complete Unit - HD	1			EM-2512		
			Trans	Insert Only	1			EM-2525		
V8	V8 5.2L 318ci	1979-81	LH Front	Complete Unit	1	EM-2326				
			LH Front	Insert Only	1	EM-2369				
			RH Front	Complete Unit	1	EM-2325				
			RH Front	Insert Only	1	EM-2369				
			Trans	Complete Unit	1			EM-2340		
			Trans	Complete Unit - HD	1			EM-2512		
			Trans	Insert Only	1			EM-2525		
	V8 5.9L 360ci	1979-80	LH Front	Complete Unit	1	EM-2326				
			LH Front	Insert Only	1	EM-2369				
			RH Front	Complete Unit	1	EM-2325				
			RH Front	Insert Only	1	EM-2369				
			Trans	Complete Unit	1			EM-2340		
			Trans	Complete Unit - HD	1			EM-2512		
			Trans	Insert Only	1			EM-2525		

# Engine, Transmission, And Torque Strut Mounts

CYL	ENG. SIZE	YEAR	LOCATION	DESCRIPTION	QTY	ENGINE	TORQUE STRUT	TRANSMISSION
<b>DODGE PASSENGER CAR (continued)</b>								
<b>STEALTH</b>								
V6	V6 3.0L	1991-96	Front	FWD	1	EM-9191		
<b>STRATUS</b>								
L4	L4 2.0L 1996cc	2001-06	Trans	Mexican Vehicle	1			EM-3124
	L4 2.0L 1996cc	1995-97	Bushing Kit	Cradle Insert Kit (2 pieces) Recommended	1	EM-5178		
		1998-00	Front		1	EM-2958		
		1995-97	Front	Cradle Insert	1	EM-2980		
		1998-00	RH Front		1	EM-2841*		
		1995-97	RH Front		1	EM-2841*		
		1998-00	Rear		1	EM-3089		
		1995-97	Rear	Cradle Insert	1	EM-3011		
		1995-00	Trans	Auto	1			EM-2842 *
	L4 2.4L 2351cc SOH				1	EM-9160		
					1	EM-9184		
				Auto	1	EM-9161		
				Manual	1	EM-9485		
			Trans	Auto, Coupe	1			EM-9162
			Trans	Manual; Coupe	1			EM-5452
	L4 2.4L 2429cc	1995-99	Bushing Kit	Cradle Insert Kit (2 pieces) Recommended	1	EM-5178		
	L4 2.4L 2429cc DOH				1	EM-3034		
					1	EM-3034		
	L4 2.4L 2429cc	2000	Front		1	EM-2958		
		1995-99	Front	Cradle Insert	1	EM-2980		
	L4 2.4L 2429cc DOH				1	EM-2841*		
					1	EM-2841*		
	L4 2.4L 2429cc	2000	RH Front		1	EM-2841*		
		1995-99	RH Front		1	EM-2841*		
	L4 2.4L 2429cc DOH				1	EM-3049		
					1	EM-3049		
	L4 2.4L 2429cc	2000	Rear		1	EM-2945		
		1995-99	Rear	Cradle Insert	1	EM-3011		
		2006	Trans	Auto	1			EM-2842 *
	L4 2.4L 2429cc DOH		Trans	Auto	1			EM-2842 *
			Trans	Manual	1			EM-2842 *
	L4 2.4L 2429cc	1995-00	Trans	Auto	1			EM-2842 *
			Trans	Manual	1			EM-2842 *
V6	V6 2.5L 2497cc	1995-97	Bushing Kit	Cradle Insert Kit (2 pieces) Recommended	1	EM-5178		
		1999-00	Front		1	EM-2958		
		1995-97	Front	Cradle Insert	1	EM-2980		
		1999-00	RH Front		1	EM-2841*		
		1995-97	RH Front		1	EM-2841*		
		1999-00	Rear		1	EM-2945		
		1995-97	Rear	Cradle Insert	1	EM-3011		
		1996-00	Trans	Auto	1			EM-2842 *
			Trans	Manual	1			EM-2842 *
		1995	Trans	Auto	1			EM-2842 *
	V6 2.7L 2700cc	2001-06	Front		1	EM-3034		
			RH Front		1	EM-2841*		
			Rear		1	EM-3049		
		2006	Trans	Auto	1			EM-2842 *
		2001-05	Trans	Auto	1			EM-2842 *
			Trans	Manual	1			EM-2842 *
	V6 3.0L	2003-05	Trans - LH	Auto, R/T Coupe	1			EM-9384



# Engine, Transmission, And Torque Strut Mounts

CYL	ENG. SIZE	YEAR	LOCATION	DESCRIPTION	QTY	ENGINE	TORQUE STRUT	TRANS-MISSION
<b>DODGE PASSENGER CAR (continued)</b>								
<b>STRATUS (continued)</b>								
V6	V6 3.0L	2001-02	Trans	Auto, SE & R/T Coupe	1			EM-9384
	V6 3.0L 2972cc	2001-05	LH Front		1	EM-5159		
			LH Rear		1	EM-5349		
			RH Front		1	EM-9187		
<b>VERNA (MEXICAN VEHICLE)</b>								
L4	L4 1.5L 1493cc	2005-06	Front	Auto	1	EM-9253		
			Front	Manual	1	EM-8938		
			RH Front	Manual	1	EM-9255		
			Rear	Manual	1	EM-9254		
			Trans - LH	Manual	1			EM-8253
	L4 1.6L 1599cc	2006	Front	Auto	1	EM-9253		
			Front	Manual	1	EM-8938		
		2004-05	Front		1	EM-9253		
			2006	RH Front	Manual	1	EM-9255	
		2004-05	Rear	Manual	1	EM-9254		
			Trans - LH		1			EM-8253
			Trans - LH	Auto	1			EM-8253
<b>DODGE SPORT UTILITY</b>								
<b>DURANGO</b>								
V6	V6 3.7L 226ci	2004-09	Trans		1			EM-3066
	V6 3.9L 239ci	1998-99	LH Front		1	EM-2963		
			RH Front		1	EM-2962		
			Trans		1			EM-2858
V8	V8 4.7L 285ci	2004-09	Trans	Auto; 4WD	1			EM-3066
	V8 4.7L 287ci	2000-03	LH Front	4WD	1	EM-3005		
			LH Front	RWD	1	EM-3035		
			RH Front	4WD	1	EM-3006		
			RH Front	RWD	1	EM-3036		
			Trans	Auto; 2WD	1			EM-2992
			Trans	Auto; 4WD	1			EM-2858
	V8 5.2L 318ci	1999-00	LH Front	4WD	1	EM-2963		
			LH Front	RWD	1	EM-2917		
		1998	LH Front		1	EM-2963		
			1999-00	RH Front	4WD	1	EM-2962	
		1998	RH Front	RWD	1	EM-3067		
			RH Front		1	EM-2962		
		1999-00	Trans	Auto; 4WD	1			EM-2858
			Trans	Auto; RWD	1			EM-2992
	1998	Trans	Auto; 4WD	1			EM-2858	
V8 5.7L 345ci	2004-09	Trans		1			EM-3066	
V8 5.9L 360ci	2000-03	LH Front		1	EM-3005			
		LH Front		1	EM-2963			
		RH Front		1	EM-3006			
		RH Front		1	EM-2962			
		Trans		1			EM-2858	
<b>JOURNEY</b>								
L4	L4 2.4L	2009-10	Front		1	EM-3165		
			Rear		1	EM-4019		
			Right		1	EM-3183		
V6	V6 3.5L	2009-10	Front		1	EM-3165		
		2011-12	Right		1	EM-3183		

# Engine, Transmission, And Torque Strut Mounts

CYL	ENG. SIZE	YEAR	LOCATION	DESCRIPTION	QTY	ENGINE	TORQUE STRUT	TRANSMISSION		
<b>DODGE SPORT UTILITY (continued)</b>										
<b>NITRO</b>										
V6	V6 3.7L 226ci	2007-11	LH Front		1	EM-4101				
<b>RAIDER</b>										
L4	L4 2.6L 2555cc	1987-89	L & R Front		2	EM-2731				
		1987-88	Trans	Auto	1			EM-8096		
			Trans	Manual	1			EM-8248		
V6	V6 3.0L 2972cc	1989	L & R Front		2	EM-8235				
<b>RAMCHARGER</b>										
L6	L6 3.7L 3687cc	1979-80	L & R Front		2	EM-2469				
		1974-78	L & R Front		2	EM-2265				
		1974-80	Trans - Lower	4WD	1		EM-2668			
			Trans - Upper	4WD	1		EM-2667			
			Trans	Auto; Complete Unit; 2WD	1		EM-2512			
			Trans	Auto; Insert; 2WD	1		EM-2525			
			Trans	Manual; Complete Unit; 2WD	1		EM-2512			
			Trans	Manual; Insert; 2WD	1		EM-2525			
V8	V8 5.2L 318ci	1979-93	L & R Front		2	EM-2469				
		1974-78	L & R Front		2	EM-2265				
		1990-93	Trans - Lower	Auto; 4WD	2		EM-2668			
			Trans - Lower	Manual; 4WD	2		EM-2668			
		1974-89	Trans - Lower	Auto; 4WD	2		EM-2668			
			Trans - Lower	Manual; 4WD	2		EM-2668			
		1990-93	Trans - Upper	Auto; 4WD	2		EM-2667			
			Trans - Upper	Manual; 4WD	2		EM-2624			
		1974-89	Trans - Upper	Auto; 4WD	2		EM-2667			
			Trans - Upper	Manual; 4WD	2		EM-2512			
		1990-93	Trans	Auto; 2WD	1		EM-2624			
			1974-89	Trans	Auto; Complete Unit; 2WD	1		EM-2525		
			Trans	Auto; Insert; 2WD	1		EM-2512			
			Trans	Manual; Complete Unit; 2WD	1		EM-2525			
		V8	V8 5.9L 360ci	1984-93	L & R Front		2	EM-2469		
				1979-81	L & R Front		2	EM-2469		
1974-78	L & R Front				2	EM-2265				
1990-93	Trans - Lower			Auto; 4WD	2		EM-2668			
	Trans - Lower			Manual; 4WD	2		EM-2668			
1984-89	Trans - Lower			Auto; 4WD	2		EM-2668			
	Trans - Lower			Manual; 4WD	2		EM-2668			
1974-81	Trans - Lower			Auto; 4WD	2		EM-2668			
	Trans - Lower			Manual; 4WD	2		EM-2668			
1990-93	Trans - Upper			Auto; 4WD	2		EM-2667			
	Trans - Upper			Manual; 4WD	2		EM-2624			
1984-89	Trans - Upper			Auto; 4WD	2		EM-2667			
	Trans - Upper			Manual; 4WD	2		EM-2512			
1974-81	Trans - Upper			Auto; 4WD	2		EM-2667			
	Trans - Upper			Manual; 4WD	2		EM-2512			
1990-93	Trans			Auto; 2WD	1		EM-2624			
1984-89	Trans			Auto; Complete Unit; 2WD	1		EM-2525			
	Trans			Auto; Insert; 2WD	1		EM-2512			
	Trans			Manual; Complete Unit; 2WD	1		EM-2525			
1974-81	Trans			Auto; Complete Unit; 2WD	1		EM-2525			
	Trans			Auto; Insert; 2WD	1		EM-2512			
	Trans			Manual; Complete Unit; 2WD	1		EM-2525			
V8	V8 6.6L 400ci			1976-78	L & R Front		2	EM-2265		
					Trans	Auto; Complete Unit	1		EM-2512	
		Trans	Auto; Insert Only		1		EM-2525			
		Trans	Manual; Complete Unit		1		EM-2512			
		Trans	Manual; Insert Only		1		EM-2525			

# Engine, Transmission, And Torque Strut Mounts

CYL	ENG. SIZE	YEAR	LOCATION	DESCRIPTION	QTY	ENGINE	TORQUE STRUT	TRANSMISSION	
<b>DODGE SPORT UTILITY (continued)</b>									
<b>RAMCHARGER (continued)</b>									
V8	V8 7.2L 440ci	1974-78	L & R Front		2	EM-2265			
			Trans	Auto; Complete Unit	1			EM-2512	
			Trans	Auto; Insert Only	1				EM-2525
			Trans	Manual; Complete Unit	1				EM-2512
			Trans	Manual; Insert Only	1				EM-2525
<b>DODGE TRUCK</b>									
<b>D50 PICKUP</b>									
L4	L4 2.0L 1995cc	1982	LH Front	RWD	1	EM-2731			
			1979-81	LH Front		1	EM-2731		
		1982	RH Front		1	EM-2731			
			1979-81	RH Front		1	EM-2731		
		1982	Trans	4WD		1			EM-8248
			Trans	Auto; 2WD		1			EM-8111
			Trans	Manual; 2WD		1			EM-8111
		1979-81	Trans	Auto; 2WD		1			EM-8111
			Trans	Manual; 2WD		1			EM-8111
		L4 2.6L 2555cc	1982	LH Front	RWD	1	EM-2731		
	1979-81			LH Front		1	EM-2731		
	1982		RH Front		1	EM-2731			
			1979-81	RH Front		1	EM-2731		
	1982		Trans	4WD		1			EM-8248
			Trans	RWD		1			EM-8111
1979-81			Trans		1			EM-8111	
<b>D100 PICKUP</b>									
L6	L6 2.8L 170ci	1963-65	L & R Front		2	EM-2235			
			L6 3.2L 198ci	1970-71	L & R Front		2	EM-2266	
	Trans	Auto; Complete Unit	1				EM-2512		
	Trans	Auto; Insert Only	1				EM-2525		
	Trans	Manual; Complete Unit	1				EM-2512		
	Trans	Manual; Insert Only	1				EM-2525		
	L6 3.7L 3687cc	1986-87	L & R Front		2	EM-2469			
			1972-79	L & R Front		2	EM-2265		
		1969-71	L & R Front		2	EM-2266			
		1968	L & R Front		2	EM-2235			
		1963-67	L & R Front		2	EM-2235			
			1986-87	Trans	Auto; Complete Unit	1			EM-2512
		Trans	Auto; Insert Only	1			EM-2525		
		Trans	Manual; Complete Unit	1			EM-2512		
		Trans	Manual; Insert Only	1			EM-2525		
		1969-79	Trans	Auto; Complete Unit	1			EM-2512	
	Trans		Auto; Insert Only	1			EM-2525		
	Trans	Manual; Complete Unit	1			EM-2512			
	Trans	Manual; Insert Only	1			EM-2525			
	L6 4.0L 243ci Diesel	1979	L & R Front		2	EM-2469			
L & R Front				2	EM-2265				
V6	V6 3.9L 239ci	1988-89	L & R Front		2	EM-2469			
			Trans	Auto	1			EM-2624	
			Trans	Manual	1			EM-2624	
V8	V8 5.2L 318ci	1986-89	L & R Front		2	EM-2469			
			1979	L & R Front		2	EM-2469		
		1972-78	L & R Front		2	EM-2265			
			1968-71	L & R Front		2	EM-2235		
		1963-67	L & R Front		2	EM-2235			
			1988-89	Trans	Auto	1			EM-2624
		Trans	Manual	1			EM-2624		
		1986-87	Trans	Auto; Complete Unit	1			EM-2512	

# Engine, Transmission, And Torque Strut Mounts

CYL	ENG. SIZE	YEAR	LOCATION	DESCRIPTION	QTY	ENGINE	TORQUE STRUT	TRANSMISSION	
<b>DODGE TRUCK (continued)</b>									
<b>D100 PICKUP (continued)</b>									
V8	V8 5.2L 318ci	1986-87	Trans	Auto; Insert Only	1			EM-2525	
			Trans	Manual; Complete Unit	1			EM-2512	
			Trans	Manual; Insert Only	1			EM-2525	
		1969-79	Trans	Auto; Complete Unit	1			EM-2512	
			Trans	Auto; Insert Only	1			EM-2525	
			Trans	Manual; Complete Unit	1			EM-2512	
	V8 5.9L 360ci	1986-88	L & R Front		2	EM-2469			
			1979	L & R Front		2	EM-2469		
		1971-78	L & R Front		2	EM-2265			
			1988	Trans	Auto	1			EM-2624
		1986-87	Trans	Manual	1			EM-2624	
			Trans	Auto; Complete Unit	1			EM-2512	
		1972-79	Trans	Auto; Insert Only	1			EM-2525	
			Trans	Manual; Complete Unit	1			EM-2512	
			Trans	Manual; Insert Only	1			EM-2525	
			Trans	Auto; Complete Unit	1			EM-2512	
			Trans	Auto; Insert Only	1			EM-2525	
			Trans	Manual; Complete Unit	1			EM-2512	
	V8 6.3L 383ci	1968-71	L & R Front		2	EM-2235			
			1963-67	L & R Front		2	EM-2235		
		1963-67	Trans - L & R		2			EM-2302	
			Trans - L & R		2			EM-2302	
		V8 6.6L 400ci	1976-78	L & R Front		2	EM-2265		
				1972-74	L & R Front		2	EM-2265	
			1971	L & R Front		2	EM-2235		
				Trans	Auto; Complete Unit	1			EM-2512
			1972-74	Trans	Auto; Insert Only	1			EM-2525
				Trans	Manual; Complete Unit	1			EM-2512
				Trans	Manual; Insert Only	1			EM-2525
				Trans	Auto; Complete Unit	1			EM-2512
	V8 7.2L 440ci		1973-78	L & R Front		2	EM-2265		
				Trans	Auto; Complete Unit	1			EM-2512
		Trans	Auto; Insert Only	1			EM-2525		
		Trans	Manual; Complete Unit	1			EM-2512		
		Trans	Manual; Insert Only	1			EM-2525		
		<b>D150 PICKUP</b>							
	L6	L6 3.7L 3687cc	1982-87	L & R Front		2	EM-2469		
				1977-81	L & R Front		2	EM-2265	
			1977-87	Trans	Auto; Complete Unit	1			EM-2512
				Trans	Auto; Insert Only	1			EM-2525
				Trans	Manual; Complete Unit	1			EM-2512
				Trans	Manual; Insert Only	1			EM-2525
L6 4.0L 243ci Diesel		1979-80	L & R Front		2	EM-2469			
		1978	L & R Front		2	EM-2265			
V6		V6 3.9L 239ci	1988-93	L & R Front		2	EM-2469		
				Trans	Auto	1			EM-2624
	Trans		Manual	1			EM-2624		
V8	V8 5.2L 318ci	1979-93	L & R Front		2	EM-2469			
			1977-78	L & R Front		2	EM-2265		
		1988-93	Trans	Auto	1			EM-2624	
			Trans	Manual	1			EM-2624	
		1977-87	Trans	Auto; Complete Unit	1			EM-2512	

# Engine, Transmission, And Torque Strut Mounts

CYL	ENG. SIZE	YEAR	LOCATION	DESCRIPTION	QTY	ENGINE	TORQUE STRUT	TRANSMISSION		
<b>DODGE TRUCK (continued)</b>										
<b>D150 PICKUP (continued)</b>										
V8	V8 5.2L 318ci	1977-87	Trans	Auto; Insert Only	1			EM-2525		
			Trans	Manual; Complete Unit	1			EM-2512		
			Trans	Manual; Insert Only	1			EM-2525		
	V8 5.9L 360ci	1993	L & R Front			2	EM-2469			
						2	EM-2469			
						2	EM-2469			
						2	EM-2265			
						2	EM-2265			
		1988-91	Trans	Auto		1			EM-2624	
				Manual		1			EM-2624	
				Auto		1			EM-2624	
		1984-87	Trans	Auto; Complete Unit		1			EM-2512	
				Auto; Insert Only		1			EM-2525	
				Manual; Complete Unit		1			EM-2512	
		1977-82	Trans	Manual; Insert Only		1			EM-2525	
				Auto; Complete Unit		1			EM-2512	
				Auto; Insert Only		1			EM-2525	
				Manual; Complete Unit		1			EM-2512	
	Manual; Insert Only				1			EM-2525		
	V8 6.6L 400ci	1977-78	L & R Front		2	EM-2265				
			Trans	Auto; Complete Unit	1			EM-2512		
			Trans	Auto; Insert Only	1			EM-2525		
			Trans	Manual; Complete Unit	1			EM-2512		
	V8 7.2L 440ci	1978	Trans	Manual; Insert Only	1			EM-2525		
			L & R Front		2	EM-2265				
			Trans	Auto; Complete Unit	1			EM-2512		
			Trans	Auto; Insert Only	1			EM-2525		
	L6	L6 3.7L 3687cc	1972-80	L & R Front		2	EM-2265			
				L & R Front		2	EM-2266			
				L & R Front		2	EM-2235			
				L & R Front		2	EM-2235			
			1969-80	Trans	Auto; Complete Unit		1			EM-2512
					Auto; Insert Only		1			EM-2525
Manual; Complete Unit						1			EM-2512	
Manual; Insert Only						1			EM-2525	
L6 4.0L 243ci Diesel			1980	L & R Front		2	EM-2469			
			1978	L & R Front		2	EM-2265			
V8	V8 5.2L 318ci	1979-80	L & R Front		2	EM-2469				
			L & R Front		2	EM-2265				
			L & R Front		2	EM-2235				
			L & R Front		2	EM-2235				
			Trans	Auto; Complete Unit	1			EM-2512		
		1969-80	Trans	Auto; Insert Only		1			EM-2525	
				Manual; Complete Unit		1			EM-2512	
				Manual; Insert Only		1			EM-2525	
				L & R Front		2	EM-2469			
				L & R Front		2	EM-2265			
	V8 5.9L 360ci	1971-80	Trans	Auto; Complete Unit	1			EM-2512		
			Trans	Auto; Insert Only	1			EM-2525		
			Trans	Manual; Complete Unit	1			EM-2512		
			Trans	Manual; Insert Only	1			EM-2525		
L & R Front				2	EM-2235					
V8 6.3L 383ci	1968-71	L & R Front		2	EM-2235					
		L & R Front		2	EM-2235					
		Trans - L & R		2			EM-2302			

# Engine, Transmission, And Torque Strut Mounts

CYL	ENG. SIZE	YEAR	LOCATION	DESCRIPTION	QTY	ENGINE	TORQUE STRUT	TRANSMISSION
<b>DODGE TRUCK (continued)</b>								
<b>D200 PICKUP (continued)</b>								
V8	V8 6.6L 400ci	1972-78	L & R Front		2	EM-2265		
		1971	L & R Front		2	EM-2235		
		1972-78	Trans	Auto; Complete Unit	1			EM-2512
			Trans	Auto; Insert Only	1			EM-2525
			Trans	Manual; Complete Unit	1			EM-2512
			Trans	Manual; Insert Only	1			EM-2525
	V8 7.2L 440ci	1973-78	L & R Front		2	EM-2265		
			Trans	Auto; Complete Unit	1		EM-2512	
			Trans	Auto; Insert Only	1		EM-2525	
			Trans	Manual; Complete Unit	1		EM-2512	
			Trans	Manual; Insert Only	1		EM-2525	
<b>D250 PICKUP</b>								
L6	L6 3.7L 3687cc	1982-87	L & R Front		2	EM-2469		
		1981	L & R Front		2	EM-2265		
		1981-87	Trans	Auto; Complete Unit	1			EM-2512
			Trans	Auto; Insert Only	1			EM-2525
			Trans	Manual; Complete Unit	1			EM-2512
			Trans	Manual; Insert Only	1			EM-2525
	L6 5.9L 359ci Diesel	1989-93	L & R Front		2	EM-2710		
			Trans	Auto	1		EM-2624	
			Trans	Manual	1		EM-2624	
V6	V6 3.9L 239ci	1988-93	L & R Front		2	EM-2469		
			Trans	Auto	1		EM-2624	
			Trans	Manual	1		EM-2624	
V8	V8 5.2L 318ci	1981-93	L & R Front		2	EM-2469		
			Trans	Auto	1		EM-2624	
			Trans	Manual	1		EM-2624	
		1981-87	Trans	Auto; Complete Unit	1			EM-2512
			Trans	Auto; Insert Only	1			EM-2525
			Trans	Manual; Complete Unit	1			EM-2512
			Trans	Manual; Insert Only	1			EM-2525
			Trans	Auto; Complete Unit	1			EM-2512
			Trans	Auto; Insert Only	1			EM-2525
	V8 5.9L 360ci	1984-93	L & R Front		2	EM-2469		
			L & R Front		2	EM-2469		
			Trans	Auto	1		EM-2624	
		1984-87	Trans	Manual	1		EM-2624	
			Trans	Auto; Complete Unit	1		EM-2512	
			Trans	Auto; Insert Only	1		EM-2525	
			Trans	Manual; Complete Unit	1		EM-2512	
			Trans	Manual; Insert Only	1		EM-2525	
			Trans	Auto; Complete Unit	1		EM-2512	
1981-82	Trans	Auto; Insert Only	1			EM-2525		
	Trans	Manual; Complete Unit	1			EM-2512		
	Trans	Manual; Insert Only	1			EM-2525		
<b>D300 PICKUP</b>								
L6	L6 3.7L 3687cc	1972-78	L & R Front		2	EM-2265		
		1969-71	L & R Front		2	EM-2266		
		1968	L & R Front		2	EM-2235		
			L & R Front		2	EM-2235		
		1963-67	L & R Front		2	EM-2235		
		1975-78	Trans	Auto; Complete Unit	1			EM-2512
			Trans	Auto; Insert Only	1			EM-2525
		1969-74	Trans	Auto; Complete Unit	1			EM-2512
			Trans	Auto; Insert Only	1			EM-2525
			Trans	Manual; Complete Unit	1			EM-2512
			Trans	Manual; Insert Only	1			EM-2525
			Trans	Manual; Insert Only	1			EM-2525
V8	V8 5.2L 318ci	1972-80	L & R Front		2	EM-2265		

# Engine, Transmission, And Torque Strut Mounts

CYL	ENG. SIZE	YEAR	LOCATION	DESCRIPTION	QTY	ENGINE	TORQUE STRUT	TRANSMISSION	
<b>DODGE TRUCK (continued)</b>									
<b>D300 PICKUP (continued)</b>									
V8	V8 5.2L 318ci	1968-71	L & R Front		2	EM-2235			
		1963-67	L & R Front		2	EM-2235			
		1975-80	Trans	Auto; Complete Unit	1			EM-2512	
			Trans	Auto; Insert Only	1			EM-2525	
		1969-74	Trans	Auto; Complete Unit	1			EM-2512	
			Trans	Auto; Insert Only	1			EM-2525	
			Trans	Manual; Complete Unit	1			EM-2512	
	Trans		Manual; Insert Only	1			EM-2525		
	V8 5.9L 360ci	1979-80	L & R Front		2	EM-2469			
		1971-78	L & R Front		2	EM-2265			
		1975-80	Trans	Auto; Complete Unit	1			EM-2512	
			Trans	Auto; Insert Only	1			EM-2525	
		1971-74	Trans	Auto; Complete Unit	1			EM-2512	
			Trans	Auto; Insert Only	1			EM-2525	
			Trans	Manual; Complete Unit	1			EM-2512	
	V8 6.3L 383ci	1968-71	L & R Front		2	EM-2235			
		1963-67	L & R Front		2	EM-2235			
	V8 6.6L 400ci	1963-68	Trans - L & R		2			EM-2302	
		1972-78	L & R Front		2	EM-2265			
		1972-74	L & R Front		2	EM-2265			
	V8 7.2L 440ci	1971	L & R Front		2	EM-2235			
		1976-78	Trans	Auto; Complete Unit	1			EM-2512	
			Trans	Auto; Insert Only	1			EM-2525	
		1972-74	Trans	Auto; Complete Unit	1			EM-2512	
			Trans	Auto; Insert Only	1			EM-2525	
			Trans	Manual; Complete Unit	1			EM-2512	
		V8 7.2L 440ci	1973-78	L & R Front		2	EM-2265		
			1975-78	Trans	Auto; Complete Unit	1			EM-2512
Trans				Auto; Insert Only	1			EM-2525	
1973-74			Trans	Auto; Complete Unit	1			EM-2512	
	Trans		Auto; Insert Only	1			EM-2525		
Trans	Manual; Complete Unit	1			EM-2512				
Trans	Manual; Insert Only	1			EM-2525				
<b>D350 PICKUP</b>									
L6	L6 5.9L 359ci Diesel	1989-93	L & R Front		2	EM-2710			
		1992-93	Trans - L & R Lower		1			EM-2667	
			Trans - L & R Upper		1			EM-2668	
V8	V8 5.2L 318ci	1981-83	L & R Front		2	EM-2469			
		Trans	Auto; Complete Unit	1			EM-2512		
		Trans	Auto; Insert Only	1			EM-2525		
		Trans	Manual; Complete Unit	1			EM-2512		
	V8 5.9L 360ci	1981-83	Trans	Manual; Insert Only	1			EM-2525	
			L & R Front		2	EM-2469			
			Trans	Auto	1			EM-2624	
			Trans	Manual	1			EM-2624	
		1981-87	Trans	Auto; Complete Unit	1			EM-2512	
			Trans	Auto; Insert Only	1			EM-2525	
			Trans	Manual; Complete Unit	1			EM-2512	
			Trans	Manual; Insert Only	1			EM-2525	

# Engine, Transmission, And Torque Strut Mounts

CYL	ENG. SIZE	YEAR	LOCATION	DESCRIPTION	QTY	ENGINE	TORQUE STRUT	TRANSMISSION		
<b>DODGE TRUCK (continued)</b>										
<b>D400 PICKUP</b>										
V8	V8 5.9L 360ci	1979-81	L & R Front		2	EM-2469				
		1978	L & R Front		2	EM-2265				
		1978-81	Trans	Auto; Complete Unit	1			EM-2512		
			Trans	Auto; Insert Only	1			EM-2525		
			Trans	Manual; Complete Unit	1			EM-2512		
			Trans	Manual; Insert Only	1			EM-2525		
	V8 7.2L 440ci	1978	L & R Front		2	EM-2265				
			Trans	Auto; Complete Unit	1		EM-2512			
			Trans	Auto; Insert Only	1		EM-2525			
			Trans	Manual; Complete Unit	1		EM-2512			
			Trans	Manual; Insert Only	1		EM-2525			
	<b>D450 PICKUP</b>									
	V8	V8 5.9L 360ci	1979-81	L & R Front		2	EM-2469			
			1978	L & R Front		2	EM-2265			
1978-81			Trans	Auto; Complete Unit	1			EM-2512		
			Trans	Auto; Insert Only	1			EM-2525		
			Trans	Manual; Complete Unit	1			EM-2512		
			Trans	Manual; Insert Only	1			EM-2525		
V8 7.2L 440ci		1978	L & R Front		2	EM-2265				
			Trans	Auto; Complete Unit	1		EM-2512			
			Trans	Auto; Insert Only	1		EM-2525			
			Trans	Manual; Complete Unit	1		EM-2512			
			Trans	Manual; Insert Only	1		EM-2525			
<b>DAKOTA</b>										
L4		L4 2.2L 135ci	1987-88	LH Front	Complete Unit	1	EM-2914			
				LH Front	Insert Only	1	EM-2981			
	RH Front			Complete Unit	1	EM-2913				
	RH Front			Insert Only	1	EM-2981				
	Trans			Auto; 2WD	1		EM-2624			
	Trans			Manual; 2WD	1		EM-2624			
	L4 2.5L 2507cc	1989-96	LH Front	Complete Unit	1	EM-2914				
			LH Front	Insert Only	1	EM-2981				
			RH Front	Complete Unit	1	EM-2913				
			RH Front	Insert Only	1	EM-2981				
		1997-02	Trans	Auto; 2WD	1		EM-2624			
			Trans	Manual; 2WD	1		EM-2624			
		1989-96	Trans	Auto; 2WD	1		EM-2624			
			Trans	Manual; 2WD	1		EM-2624			
		V6	V6 3.7L 226ci	2004	LH Front	4WD	1	EM-2963		
					RH Front	4WD	1	EM-2962		
	Trans				4WD	1		EM-2858		
	V6 3.9L 239ci		1991-96	L & R Front	RWD	2	EM-2652			
1987-90			L & R Front	RWD	2	EM-2652				
1997-03			LH Front	4WD	1	EM-2963				
		LH Front	RWD	1	EM-2918					
1991-96		LH Front	4WD	1	EM-2955					
1987-90		LH Front	4WD	1	EM-5092					
1997-03		RH Front	4WD	1	EM-2962					
		RH Front	RWD	1	EM-3004					
1991-96		RH Front	4WD	1	EM-2961					
1987-90	RH Front	4WD	1	EM-2944						
1994-96	Trans - L & R Lower	Manual; 4WD Manual; 4WD	2		EM-2667					
1992-93	Trans - L & R Lower	Manual; 4WD Manual; 4WD	2		EM-2667					
1987-91	Trans - L & R Lower	Auto; 4WD Auto; 4WD	2		EM-2667					



# Engine, Transmission, And Torque Strut Mounts

CYL	ENG. SIZE	YEAR	LOCATION	DESCRIPTION	QTY	ENGINE	TORQUE STRUT	TRANSMISSION
<b>DODGE TRUCK (continued)</b>								
<b>DAKOTA (continued)</b>								
V6	V6 3.9L 239ci	1994-96	Trans - L & R Upper	Manual; 4WD Manual; 4WD	2			EM-2668
		1992-93	Trans - L & R Upper	Manual; 4WD Manual; 4WD	2			EM-2668
		1987-91	Trans - L & R Upper	Auto; 4WD Auto; 4WD	2			EM-2668
		1997-03	Trans	Auto; 2WD	1			EM-2624
			Trans	Auto; 4WD	1			EM-2858
			Trans	Manual; 2WD	1			EM-2624
			Trans	Manual; 4WD	1			EM-2858
		1994-96	Trans	Auto; 2WD	1			EM-2624
			Trans	Auto; 4WD	1			EM-2858
			Trans	Manual; 2WD	1			EM-2954
		1992-93	Trans	Auto; 2WD	1			EM-2624
			Trans	Manual; 2WD	1			EM-2954
		1987-91	Trans	Auto; 2WD	1			EM-2624
			Trans	Manual; 2WD	1			EM-2624
V8	V8 4.7L 285ci	2002-04	LH Front	4WD	1	EM-3005		
			LH Front	RWD	1	EM-3035		
			RH Front	4WD	1	EM-3006		
			RH Front	RWD	1	EM-3036		
			Trans	Auto; 2WD	1		EM-2992	
			Trans	Auto; 4WD	1		EM-2858	
			Trans	Manual; 2WD	1		EM-2992	
			Trans	Manual; 4WD	1		EM-2858	
	V8 4.7L 287ci	2000-01	LH Front	4WD	1	EM-3005		
			LH Front	RWD	1	EM-3035		
			RH Front	4WD	1	EM-3006		
			RH Front	RWD	1	EM-3036		
			Trans	Auto; 2WD	1		EM-2992	
			Trans	Auto; 4WD	1		EM-2858	
			Trans	Manual; 2WD	1		EM-2992	
			Trans	Manual; 4WD	1		EM-2858	
	V8 5.2L 318ci	1990-96 1989 1997-99 1990-96 1997-99 1990-96 1990-91 1994-96 1992-93 1994-96 1992-93 1997-99 1994-96 1992-93 1990-91	L & R Front	RWD	2	EM-2652		
			L & R Front	RWD	2	EM-2652		
			LH Front	4WD	1	EM-2963		
			LH Front	RWD	1	EM-2917		
			LH Front	4WD	1	EM-2953		
			RH Front	4WD	1	EM-2962		
RH Front			RWD	1	EM-3067			
RH Front			4WD	1	EM-2983			
Trans - L & R Lower			4WD 4WD	2		EM-2667		
Trans - L & R Upper			4WD 4WD	2		EM-2668		
Trans - Lower			Manual; 4WD	2		EM-2667		
Trans - Upper			2WD	1		EM-2954		
Trans - Upper			Manual; 4WD	2		EM-2624		
Trans			Auto; 2WD	1		EM-2991		
Trans			Auto; 4WD	1		EM-2858		
Trans			Manual; 2WD	1		EM-2991		
Trans	Manual; 4WD	1		EM-2858				
Trans	Manual; 4WD	2		EM-2570				
Trans	Auto; 2WD	1		EM-2570				
Trans	Auto; 4WD	1		EM-2624				
Trans	Auto; 2WD	1		EM-2624				

# Engine, Transmission, And Torque Strut Mounts

CYL	ENG. SIZE	YEAR	LOCATION	DESCRIPTION	QTY	ENGINE	TORQUE STRUT	TRANSMISSION
<b>DODGE TRUCK (continued)</b>								
<b>DAKOTA (continued)</b>								
V8	V8 5.2L 318ci	1990-91	Trans	Manual; 2WD	1			EM-2624
		1989	Trans	Auto; 2WD	1			EM-2624
	V8 5.9L 360ci	2001-03	LH Front	4WD	1	EM-3005		
			LH Front	RWD	1	EM-2917		
		2000	LH Front	4WD	1	EM-2963		
			LH Front	RWD	1	EM-2917		
		1998-99	LH Front	RWD	1	EM-2917		
		2001-03	RH Front	4WD	1	EM-3006		
			RH Front	RWD	1	EM-3067		
		2000	RH Front	4WD	1	EM-2962		
			RH Front	RWD	1	EM-3067		
		1998-99	RH Front	RWD	1	EM-3067		
		2003	Trans	2WD	1			EM-2991
		2000-02	Trans	2WD	1			EM-2991
Trans	Auto; 4WD		1			EM-2858		
Trans	Manual; 4WD		1			EM-2858		
1998-99	Trans		2WD	1		EM-2991		
<b>POWER RAM 50</b>								
L4	L4 2.0L 1997cc	1983-84	RH Front		1	EM-2731		
			Trans	4WD	1		EM-8248	
	L4 2.3L 2346cc Diesel	1983-85	LH Front		1	EM-8205		
			Trans	4WD	1		EM-8096	
	L4 2.6L 2555cc	1983-86	RH Front		1	EM-2731		
Trans			4WD	1		EM-8248		
<b>RAM 50</b>								
L4	L4 2.0L 1995cc	1987-89	L & R Front	RWD	2	EM-2731		
			RH Front	4WD	1	EM-2731		
	L4 2.0L 1997cc	1983-86	L & R Front		2	EM-2731		
			Trans	2WD	1		EM-8111	
		1987-89	Trans	Auto; 4WD	1		EM-8248	
			Trans	Manual; 4WD	1		EM-8248	
	1983-86	Trans	2WD	1		EM-8111		
		L4 2.3L 2346cc Diesel	1983-85	LH Front		1	EM-8205	
	RH Front				1	EM-8205		
	Trans			2WD	1		EM-8556	
	L4 2.4L 2351cc	1990-93	L & R Front	RWD	2	EM-2731		
			LH Front	4WD	1	EM-8205		
			RH Front	4WD	1	EM-2731		
			Trans	Auto; 2WD	1		EM-9199	
			Trans	Auto; 4WD	1		EM-9070	
			Trans	Manual; 2WD	1		EM-8111	
			Trans	Manual; 4WD	1		EM-8244	
	L4 2.6L 2555cc	1987-89	L & R Front	RWD	2	EM-2731		
			L & R Front		2	EM-2731		
		1987-89	LH Front	4WD	1	EM-8205		
RH Front			4WD	1	EM-2731			
Trans			2WD	1		EM-8111		
Trans			4WD	1		EM-8096		
1983-86		Trans	Auto; 2WD	1		EM-8556		
		Trans	Manual; 2WD	1		EM-8556		
V6	V6 3.0L 2972cc	1990-91	Trans	Auto	1		EM-9070	
			Trans	Manual	1		EM-8243	

# Engine, Transmission, And Torque Strut Mounts

CYL	ENG. SIZE	YEAR	LOCATION	DESCRIPTION	QTY	ENGINE	TORQUE STRUT	TRANSMISSION
<b>DODGE TRUCK (continued)</b>								
<b>RAM 1500 PICKUP</b>								
V6	V6 3.7L 226ci	2002-05	Trans	Auto	1			EM-3066
			Trans	Manual	1			EM-3066
	V6 3.9L 239ci	1997-01	LH Front		1	EM-2829		
			RH Front		1	EM-2830		
		1994-01	Trans		1			EM-2624
V8	V8 4.7L 287ci	2002-05	LH Front	4WD	1	EM-3073		
			RH Front	4WD	1	EM-3074		
		2006-08	Trans	4WD	1			EM-4002
			2002-05	Trans	Auto; 4WD	1		
			Trans	Manual; 4WD	1			EM-3066
		V8 5.2L 318ci	1994-01	LH Front		1	EM-2829	
	RH Front				1	EM-2830		
	Trans			Auto	1			EM-2852
	Trans			Manual	1			EM-2852
	V8 5.7L 345ci	2006-07	LH Front	Insert; 2WD	1	EM-4006		
			2003-05	LH Front	4WD	1	EM-3073	
		2006-07	RH Front	Insert; 2WD	1	EM-4007		
			2003-05	RH Front	4WD	1	EM-3074	
		2006-08	Trans	4WD; Auto	1			EM-4002
			2003-05	Trans	Auto	1		
		Trans		Manual	1			EM-3066
	V8 5.9L 360ci	2002-03	LH Front	4WD	1	EM-3073		
			1996-01	LH Front		1	EM-2829	
		1994-95	LH Front		1	EM-2829		
			2002-03	RH Front	4WD	1	EM-3074	
1996-01		RH Front		1	EM-2830			
		1994-95	RH Front		1	EM-2830		
2002-03			Trans	Auto	1			EM-3066
			Trans	Manual	1			EM-3066
1994-01		Trans	Auto	1			EM-2852	
		Trans	Manual	1			EM-2852	
<b>RAM 2500 PICKUP</b>								
L6	L6 5.9L 359ci Diesel	2003-05	L & R Front		2	EM-4018		
			2006-08	Trans	Auto; RWD	1		
		Trans		Manual; RWD	1			EM-4060
		2003-05	Trans	Auto	1			EM-3066
			Trans	Manual	1			EM-3066
		1994-02	Trans	Auto	1			EM-2852
Trans	Manual		1			EM-2852		
V8	V8 5.2L 318ci	1994-96	LH Front		1	EM-2829		
			RH Front		1	EM-2830		
		1996	Trans	Auto	1			EM-2852
			Trans	Manual	1			EM-2852
	V8 5.9L 360ci	2002	LH Front	4WD	1	EM-3073		
			1994-01	LH Front		1	EM-2829	
		2002	RH Front	4WD	1	EM-3074		
			1994-01	RH Front		1	EM-2830	
		2001-02	Trans	Auto	1			EM-2852
			Trans	Manual	1			EM-2852
1994-00	Trans	Auto	1			EM-2852		
	Trans	Manual	1			EM-2852		
V10	V10 8.0L	2003	L & R Front		2	EM-4018		
	V10 8.0L 7990cc	1994-02	LH Front		1	EM-2829		
			RH Front		1	EM-2830		
		1994-03	Trans	Auto	1			EM-2852
Trans	Manual		1			EM-2852		

# Engine, Transmission, And Torque Strut Mounts

CYL	ENG. SIZE	YEAR	LOCATION	DESCRIPTION	QTY	ENGINE	TORQUE STRUT	TRANSMISSION
<b>DODGE TRUCK (continued)</b>								
<b>RAM 3500 PICKUP</b>								
L6	L6 5.9L	2003-05	L & R Front		2	EM-4018		
	L6 5.9L 359ci Diesel	2006-08	Trans	Auto; RWD	1			EM-4060
			Trans	Manual; RWD	1			EM-4060
		2003-05	Trans	Auto	1			EM-3066
			Trans	Manual	1			EM-3066
		1994-02	Trans	Auto	1			EM-2852
Trans	Manual		1			EM-2852		
V8	V8 5.9L	2002	LH Front		1	EM-2829		
			RH Front	4WD	1	EM-3074		
	V8 5.9L 360ci	1994-01	LH Front	Gas	1	EM-2829		
			RH Front	Gas	1	EM-2830		
		2001-02	Trans	Auto	1			EM-2852
			Trans	Manual	1			EM-2852
		1994-00	Trans	Auto	1			EM-2852
			Trans	Manual	1			EM-2852
V10	V10 8.0L	2003	L & R Front		2	EM-4018		
	V10 8.0L 7990cc	1994-02	LH Front		1	EM-2829		
			RH Front		1	EM-2830		
		1994-03	Trans	Auto	1			EM-2852
			Trans	Manual	1			EM-2852
<b>RAMPAGE</b>								
L4	L4 2.2L 135ci	1982-84	Front		1	EM-2447		
			RH Front		1	EM-2600		
		1984	Trans		1			EM-2617
		1982-83	Trans	Auto	1			EM-2600
<b>RD200 PICKUP</b>								
V8	V8 5.2L 318ci	1980	L & R Front		2	EM-2469		
		1979	L & R Front		2	EM-2469		
		1978	L & R Front		2	EM-2265		
		1980	Trans	Complete Unit	1			EM-2512
			Trans	Insert Only	1			EM-2525
		1978-79	Trans	Complete Unit	1			EM-2512
			Trans	Insert Only	1			EM-2525
		V8 5.9L 360ci	1980	L & R Front		2	EM-2469	
	L & R Front				2	EM-2469		
	1978		L & R Front		2	EM-2265		
			Trans	Complete Unit	1			EM-2512
	1978-79		Trans	Insert Only	1			EM-2525
			Trans	Complete Unit	1			EM-2512
	Trans	Insert Only	1			EM-2525		
<b>W100 PICKUP</b>								
L6	L6 3.7L 3687cc	1986-87	L & R Front		2	EM-2469		
		1972-77	L & R Front		2	EM-2265		
		1969-71	L & R Front		2	EM-2266		
		1968	L & R Front		2	EM-2235		
		1986-87	Trans - Lower	Auto	2			EM-2668
			Trans - Lower	Manual	2			EM-2668
		1974-77	Trans - Lower	Auto	2			EM-2668
			Trans - Lower	Manual	2			EM-2668
		1986-87	Trans - Upper	Auto	2			EM-2667
		1974-77	Trans - Upper	Auto	2			EM-2667
		1969-73	Trans	Auto; Complete Unit	1			EM-2512
			Trans	Auto; Insert Only	1			EM-2525
			Trans	Manual; Complete Unit	1			EM-2512
			Trans	Manual; Insert Only	1			EM-2525
		V6	V6 3.9L 239ci	1989	L & R Front		2	EM-2469

# Engine, Transmission, And Torque Strut Mounts

CYL	ENG. SIZE	YEAR	LOCATION	DESCRIPTION	QTY	ENGINE	TORQUE STRUT	TRANSMISSION
<b>DODGE TRUCK (continued)</b>								
<b>W100 PICKUP (continued)</b>								
V6	V6 3.9L 239ci	1989	Trans - Lower	Auto	2			EM-2668
			Trans - Lower	Manual	2			EM-2668
			Trans - Upper	Auto	2			EM-2667
V8	V8 5.2L 318ci	1986-89	L & R Front		2	EM-2469		
		1972-77	L & R Front		2	EM-2265		
		1969-71	L & R Front		2	EM-2266		
		1968	L & R Front		2	EM-2235		
		1963-67	L & R Front		2	EM-2235		
		1986-89	Trans - Lower	Auto	2			EM-2668
			Trans - Lower	Manual	2			EM-2668
		1974-77	Trans - Lower	Auto	2			EM-2668
			Trans - Lower	Manual	2			EM-2668
		1986-89	Trans - Upper	Auto	2			EM-2667
		1974-77	Trans - Upper	Auto	2			EM-2667
		1972-73	Trans	Auto; Complete Unit	1			EM-2512
			Trans	Auto; Insert Only	1			EM-2525
	Trans		Manual; Complete Unit	1			EM-2512	
	Trans		Manual; Insert Only	1			EM-2525	
	V8 5.9L 360ci	1986-88	L & R Front		2	EM-2469		
		1972-77	L & R Front		2	EM-2265		
		1986-88	Trans - Lower	Auto	2			EM-2668
			Trans - Lower	Manual	2			EM-2668
		1972-77	Trans - Lower	Auto	2			EM-2668
Trans - Lower			Manual	2			EM-2668	
1986-88		Trans - Upper	Auto	2			EM-2667	
1972-77	Trans - Upper	Auto	2			EM-2667		
V8 6.3L 383ci	1969-71	L & R Front		2	EM-2235			
V8 6.6L 400ci	1974-77	L & R Front		2	EM-2265			
	1971	L & R Front		2	EM-2235			
		Trans	Auto; Complete Unit	1			EM-2512	
		Trans	Auto; Insert Only	1			EM-2525	
		Trans	Manual; Complete Unit	1			EM-2512	
Trans	Manual; Insert Only	1			EM-2525			
1971	Trans		1			EM-2235		
V8 7.2L 440ci	1974-77	L & R Front		2	EM-2265			
		Trans	Auto; Complete Unit	1			EM-2512	
		Trans	Auto; Insert Only	1			EM-2525	
		Trans	Manual; Complete Unit	1			EM-2512	
		Trans	Manual; Insert Only	1			EM-2525	
<b>W150 PICKUP</b>								
L6	L6 3.7L 3687cc	1982-87	L & R Front		2	EM-2469		
		1978-81	L & R Front		2	EM-2265		
		1978-87	Trans - Lower	Auto	2			EM-2668
			Trans - Lower	Manual	2			EM-2668
			Trans - Upper	Auto	2			EM-2667
	L6 4.0L 243ci Diesel	1979	L & R Front		2	EM-2469		
1978	L & R Front		2	EM-2265				
V6	V6 3.9L 239ci	1989-93	L & R Front		2	EM-2469		
		Trans - Lower	Auto	2			EM-2668	
		Trans - Lower	Manual	2			EM-2668	
		Trans - Upper	Auto	2			EM-2667	
V8	V8 5.2L 318ci	1979-93	L & R Front		2	EM-2469		
		1977-78	L & R Front		2	EM-2265		
		1977-93	Trans - Lower	Auto	2			EM-2668
			Trans - Lower	Manual	2			EM-2668
	Trans - Upper		Auto	2			EM-2667	
V8 5.9L 360ci	1993	L & R Front		2	EM-2469			

# Engine, Transmission, And Torque Strut Mounts

CYL	ENG. SIZE	YEAR	LOCATION	DESCRIPTION	QTY	ENGINE	TORQUE STRUT	TRANSMISSION
<b>DODGE TRUCK (continued)</b>								
<b>W150 PICKUP (continued)</b>								
V8	V8 5.9L 360ci	1984-91	L & R Front		2	EM-2469		
		1979-81	L & R Front		2	EM-2469		
		1977-78	L & R Front		2	EM-2265		
		1993	Trans - Lower	Auto	2			EM-2668
			Trans - Lower	Manual	2			EM-2668
		1977-91	Trans - Lower	Auto	2			EM-2668
			Trans - Lower	Manual	2			EM-2668
	1993	Trans - Upper	Auto	2			EM-2667	
		1977-91	Trans - Upper	Auto	2		EM-2667	
	V8 6.6L 400ci	1977-78	L & R Front		2	EM-2265		
			Trans	Auto; Complete Unit	1			EM-2512
			Trans	Auto; Insert Only	1			EM-2525
			Trans	Manual; Complete Unit	1			EM-2512
			Trans	Manual; Insert Only	1			EM-2525
V8 7.2L 440ci	1978	L & R Front		2	EM-2265			
		Trans	Auto; Complete Unit	1			EM-2512	
		Trans	Auto; Insert Only	1			EM-2525	
		Trans	Manual; Complete Unit	1			EM-2512	
		Trans	Manual; Insert Only	1			EM-2525	
<b>W200 PICKUP</b>								
L6	L6 3.7L 3687cc	1972-80	L & R Front		2	EM-2265		
		1969-71	L & R Front		2	EM-2266		
		1974-80	Trans - Lower	Auto	2			EM-2668
			Trans - Lower	Manual	2			EM-2668
			Trans - Upper	Auto	2			EM-2667
		1972-73	Trans	Auto; Complete Unit	1			EM-2512
			Trans	Auto; Insert Only	1			EM-2525
			Trans	Manual; Complete Unit	1			EM-2512
	Trans		Manual; Insert Only	1			EM-2525	
	L6 4.0L 243ci Diesel	1979	L & R Front		2	EM-2469		
		1978	L & R Front		2	EM-2265		
V8	V8 5.2L 318ci	1979-80	L & R Front		2	EM-2469		
		1972-78	L & R Front		2	EM-2265		
		1969-71	L & R Front		2	EM-2235		
		1963-67	L & R Front		2	EM-2235		
		1974-80	Trans - Lower	Auto	2			EM-2668
			Trans - Lower	Manual	2			EM-2668
			Trans - Upper	Auto	2			EM-2667
		1972-73	Trans	Auto; Complete Unit	1			EM-2512
			Trans	Auto; Insert Only	1			EM-2525
			Trans	Manual; Complete Unit	1			EM-2512
			Trans	Manual; Insert Only	1			EM-2525
	V8 5.9L 360ci	1979-80	L & R Front		2	EM-2469		
		1972-78	L & R Front		2	EM-2265		
		1971	L & R Front		2	EM-2235		
		1972-80	Trans - Lower	Auto	2			EM-2668
			Trans - Lower	Manual	2			EM-2668
		Trans - Upper	Auto	2			EM-2667	
	V8 6.3L 383ci	1969-71	L & R Front		2	EM-2235		
	V8 6.6L 400ci	1976-78	L & R Front		2	EM-2265		
L & R Front				2	EM-2265			
L & R Front				2	EM-2235			
Trans			Auto; Complete Unit	1			EM-2512	
Trans			Auto; Insert Only	1			EM-2525	
Trans			Manual; Complete Unit	1			EM-2512	
	Trans	Manual; Insert Only	1			EM-2525		
	1974	Trans	Auto; Complete Unit	1			EM-2512	

# Engine, Transmission, And Torque Strut Mounts

CYL	ENG. SIZE	YEAR	LOCATION	DESCRIPTION	QTY	ENGINE	TORQUE STRUT	TRANSMISSION
<b>DODGE TRUCK (continued)</b>								
<b>W200 PICKUP (continued)</b>								
V8	V8 6.6L 400ci	1974	Trans	Auto; Insert Only	1			EM-2525
			Trans	Manual; Complete Unit	1			EM-2512
			Trans	Manual; Insert Only	1			EM-2525
	V8 7.2L 440ci	1974-78	L & R Front		2	EM-2265		
			Trans	Auto; Complete Unit	1			EM-2512
			Trans	Auto; Insert Only	1			EM-2525
			Trans	Manual; Complete Unit	1			EM-2512
			Trans	Manual; Insert Only	1			EM-2525
<b>W250 PICKUP</b>								
L6	L6 5.9L 359ci Diesel	1989-93	L & R Front		2	EM-2710		
			Trans - Lower	Auto	2			EM-2668
			Trans - Lower	Manual	2			EM-2668
			Trans - Upper	Auto	2			EM-2667
V8	V8 5.2L 318ci	1981-93	L & R Front		2	EM-2469		
		1985-93	Trans - Lower	Auto	2			EM-2668
			Trans - Lower	Manual	2			EM-2668
		1981-84	Trans - Lower	Auto	2			EM-2668
			Trans - Lower	Manual	2			EM-2668
		1985-93	Trans - Upper	Auto	2			EM-2667
	1981-84	Trans - Upper	Auto	2			EM-2667	
	V8 5.9L 360ci	1984-93	L & R Front		2	EM-2469		
		1981-82	L & R Front		2	EM-2469		
		1984-93	Trans - Lower	Auto	2			EM-2668
			Trans - Lower	Manual	2			EM-2668
		1981-82	Trans - Lower	Auto	2			EM-2668
Trans - Lower			Manual	2			EM-2668	
1984-93	Trans - Upper	Auto	2			EM-2667		
1981-82	Trans - Upper	Auto	2			EM-2667		
<b>W300 PICKUP</b>								
L6	L6 3.7L 3687cc	1972-78	L & R Front		2	EM-2265		
		1969-71	L & R Front		2	EM-2266		
		1968	L & R Front		2	EM-2235		
		1974-78	Trans - Lower	Auto	2			EM-2668
			Trans - Lower	Manual	2			EM-2668
			Trans - Upper	Auto	2			EM-2667
		1972-73	Trans	Auto; Complete Unit	1			EM-2512
			Trans	Auto; Insert Only	1			EM-2525
			Trans	Manual; Complete Unit	1			EM-2512
			Trans	Manual; Insert Only	1			EM-2525
V8	V8 5.2L 318ci	1980	L & R Front		2	EM-2469		
		1972-78	L & R Front		2	EM-2265		
		1969-71	L & R Front		2	EM-2266		
		1968	L & R Front		2	EM-2235		
		1963-67	L & R Front		2	EM-2235		
		1980	Trans - Lower	Auto	2			EM-2668
		1974-78	Trans - Lower	Auto	2			EM-2668
			Trans - Lower	Manual	2			EM-2668
		1980	Trans - Upper	Auto	2			EM-2667
		1974-78	Trans - Upper	Auto	2			EM-2667
		1972-73	Trans	Auto; Complete Unit	1			EM-2512
			Trans	Auto; Insert Only	1			EM-2525
			Trans	Manual; Complete Unit	1			EM-2512
			Trans	Manual; Insert Only	1			EM-2525
V8 5.9L 360ci	1979-80	L & R Front		2	EM-2469			
	1972-78	L & R Front		2	EM-2265			
	1971	L & R Front		2	EM-2235			

# Engine, Transmission, And Torque Strut Mounts

CYL	ENG. SIZE	YEAR	LOCATION	DESCRIPTION	QTY	ENGINE	TORQUE STRUT	TRANSMISSION	
<b>DODGE TRUCK (continued)</b>									
<b>W300 PICKUP (continued)</b>									
V8	V8 5.9L 360ci	1980	Trans - Lower	Auto	2			EM-2668	
		1972-79	Trans - Lower	Auto	2			EM-2668	
			Trans - Lower	Manual	2			EM-2668	
			Trans - Upper	Auto	2			EM-2667	
		1972-79	Trans - Upper	Auto	2			EM-2667	
	V8 6.3L 383ci	1971	L & R Front		2	EM-2235			
		1968-69	L & R Front		2	EM-2235			
	V8 6.6L 400ci	1976-78	L & R Front		2	EM-2265			
			Trans	Auto; Complete Unit	1			EM-2512	
			Trans	Auto; Insert Only	1			EM-2525	
			Trans	Manual; Complete Unit	1			EM-2512	
			Trans	Manual; Insert Only	1			EM-2525	
	V8 7.2L 440ci	1975-78	L & R Front		2	EM-2265			
			Trans	Auto; Complete Unit	1			EM-2512	
			Trans	Auto; Insert Only	1			EM-2525	
Trans			Manual; Complete Unit	1			EM-2512		
Trans			Manual; Insert Only	1			EM-2525		
<b>W350 PICKUP</b>									
L6	L6 5.9L 359ci Diesel	1989-93	L & R Front		2	EM-2710			
			Trans - Lower	Auto	2			EM-2668	
			Trans - Lower	Manual	2			EM-2668	
			Trans - Upper	Auto	2			EM-2667	
V8	V8 5.2L 318ci	1982-83	L & R Front		2	EM-2469			
			Trans - Lower	Auto	2			EM-2668	
			Trans - Lower	Manual	2			EM-2668	
			Trans - Upper	Auto	2			EM-2667	
	V8 5.9L 360ci	1981-93	L & R Front		2	EM-2469			
			Trans - Lower	Auto	2			EM-2668	
			Trans - Lower	Manual	2			EM-2668	
			Trans - Upper	Auto	2			EM-2667	
<b>DODGE VAN</b>									
<b>A100</b>									
L6	L6 2.8L 170ci	1964-66	LH Front		1	EM-2235			
			RH Front		1	EM-2234			
	L6 3.7L 3687cc	1964-66	LH Front		1	EM-2235			
			RH Front		1	EM-2234			
V8	V8 4.5L 273ci	1964-66	L & R Front		2	EM-2338			
	V8 5.2L 318ci	1970	L & R Front		2	EM-2338			
<b>A108 VAN</b>									
L6	L6 2.8L 170ci	1967-69	LH Front		1	EM-2235			
			RH Front		1	EM-2234			
	L6 3.2L 198ci	1970	LH Front		1	EM-2235			
			RH Front		1	EM-2234			
	L6 3.7L 225ci	1967-70	LH Front		1	EM-2235			
			RH Front		1	EM-2234			
<b>B100 VAN</b>									
L6	L6 3.2L 198ci	1971	LH Front		1	EM-2235			
			RH Front		1	EM-2234			
			Trans	Auto; Complete Unit	1			EM-2512	
			Trans	Auto; Insert	1			EM-2525	
			Trans	Manual; Complete Unit	1			EM-2512	
	L6 3.7L 225ci	1971	L & R Front		2	EM-2266			
			Trans	Auto; Complete Unit	1			EM-2512	
			1971-80	Trans	Auto; Insert	1			EM-2525
				Trans	Auto; Insert	1			EM-2525



# Engine, Transmission, And Torque Strut Mounts

CYL	ENG. SIZE	YEAR	LOCATION	DESCRIPTION	QTY	ENGINE	TORQUE STRUT	TRANSMISSION
<b>DODGE VAN (continued)</b>								
<b>B100 VAN (continued)</b>								
L6	L6 3.7L 225ci	1971-80	Trans	Manual; Complete Unit	1			EM-2512
			Trans	Manual; Insert	1			EM-2525
	L6 3.7L 3687cc	1979-80	L & R Front		2	EM-2469		
		1972-78	L & R Front		2	EM-2265		
V8	V8 5.2L 318ci	1979-80	L & R Front		2	EM-2469		
		1972-78	L & R Front		2	EM-2265		
		1971	L & R Front		2	EM-2266		
		1971-80	Trans	Auto; Complete Unit	1			EM-2512
			Trans	Auto; Insert	1			EM-2525
			Trans	Manual; Complete Unit	1			EM-2512
			Trans	Manual; Insert	1			EM-2525
		V8 5.9L 360ci	1976-78	L & R Front		2	EM-2265	
	1972-74		L & R Front		2	EM-2265		
	1971		L & R Front		2	EM-2266		
	1976-78		Trans	Auto; Complete Unit	1			EM-2512
			Trans	Auto; Insert	1			EM-2525
			Trans	Manual; Complete Unit	1			EM-2512
		Trans	Manual; Insert	1			EM-2525	
1971-74	Trans	Auto; Complete Unit	1			EM-2512		
	Trans	Auto; Insert	1			EM-2525		
	Trans	Manual; Complete Unit	1			EM-2512		
	Trans	Manual; Insert	1			EM-2525		
V8 7.2L 440ci	1974	L & R Front		2	EM-2265			
		Trans	Auto; Complete Unit	1			EM-2512	
		Trans	Auto; Insert	1			EM-2525	
		Trans	Manual; Complete Unit	1			EM-2512	
		Trans	Manual; Insert	1			EM-2525	
<b>B150 VAN</b>								
L6	L6 3.7L 3687cc	1981-87	L & R Front		2	EM-2469		
			Trans	Auto; Complete Unit	1			EM-2512
			Trans	Auto; Insert	1			EM-2525
			Trans	Manual; Complete Unit	1			EM-2512
			Trans	Manual; Insert	1			EM-2525
V6	V6 3.9L 239ci	1994	L & R Front		2	EM-2469		
		1992-93	L & R Front		2	EM-2652		
		1988-91	L & R Front		2	EM-2469		
		1994	Trans		1			EM-2624
		1992-93	Trans	Auto	1			EM-2624
			Trans	Manual	1			EM-2982
		1988-91	Trans	Auto	1			EM-2624
			Trans	Manual	1			EM-2624
V8	V8 5.2L 318ci	1981-94	L & R Front		2	EM-2469		
		1994	Trans	Auto	1			EM-2624
		1988-93	Trans	Auto	1			EM-2624
			Trans	Manual	1			EM-2624
		1981-87	Trans	Auto; Complete Unit	1			EM-2512
			Trans	Auto; Insert	1			EM-2525
			Trans	Manual; Complete Unit	1			EM-2512
			Trans	Manual; Insert	1			EM-2525
<b>B200 VAN</b>								
L6	L6 3.2L 198ci	1971	L & R Front		2	EM-2266		
			Trans	Auto; Complete Unit	1			EM-2512
			Trans	Auto; Insert	1			EM-2525
			Trans	Manual; Complete Unit	1			EM-2512
	Trans	Manual; Insert	1			EM-2525		
	L6 3.7L 225ci	1979-80	L & R Front		2	EM-2469		

# Engine, Transmission, And Torque Strut Mounts

CYL	ENG. SIZE	YEAR	LOCATION	DESCRIPTION	QTY	ENGINE	TORQUE STRUT	TRANSMISSION
<b>DODGE VAN (continued)</b>								
<b>B200 VAN (continued)</b>								
L6	L6 3.7L 225ci	1971	L & R Front		2	EM-2266		
		1971-80	Trans	Auto; Complete Unit	1			EM-2512
			Trans	Auto; Insert	1			EM-2525
			Trans	Manual; Complete Unit	1			EM-2512
			Trans	Manual; Insert	1			EM-2525
L6 3.7L 3687cc	1972-78	L & R Front		2	EM-2265			
V8	V8 5.2L 318ci	1979-80	L & R Front		2	EM-2469		
		1972-78	L & R Front		2	EM-2265		
		1971	L & R Front		2	EM-2266		
		1971-80	Trans	Auto; Complete Unit	1			EM-2512
			Trans	Auto; Insert	1			EM-2525
			Trans	Manual; Complete Unit	1			EM-2512
			Trans	Manual; Insert	1			EM-2525
	V8 5.9L 360ci	1979-80	L & R Front		2	EM-2469		
		1972-78	L & R Front		2	EM-2265		
		1971	L & R Front		2	EM-2266		
		1971-80	Trans	Auto; Complete Unit	1			EM-2512
			Trans	Auto; Insert	1			EM-2525
			Trans	Manual; Complete Unit	1			EM-2512
			Trans	Manual; Insert	1			EM-2525
	V8 6.6L 400ci	1976-78	L & R Front		2	EM-2265		
		1974	L & R Front		2	EM-2265		
		1976-78	Trans	Auto; Complete Unit	1			EM-2512
			Trans	Auto; Insert	1			EM-2525
			Trans	Manual; Complete Unit	1			EM-2512
Trans			Manual; Insert	1			EM-2525	
1974		Trans	Auto; Complete Unit	1			EM-2512	
		Trans	Auto; Insert	1			EM-2525	
		Trans	Manual; Complete Unit	1			EM-2512	
		Trans	Manual; Insert	1			EM-2525	
	V8 7.2L 440ci	1974-78	L & R Front		2	EM-2265		
	<b>B250 VAN</b>							
L6	L6 3.7L 3687cc	1981-87	L & R Front		2	EM-2469		
			Trans	Complete Unit	1		EM-2512	
			Trans	Insert Only	1		EM-2525	
V6	V6 3.9L 239ci	1994	L & R Front		2	EM-2469		
		1992-93	L & R Front		2	EM-2652		
		1988-91	L & R Front		2	EM-2469		
		1994	Trans		1		EM-2624	
		1992-93	Trans		1		EM-2624	
		1988-91	Trans		1		EM-2624	
V8	V8 5.2L 318ci	1981-94	L & R Front		2	EM-2469		
		1988-94	Trans		1		EM-2624	
		1981-87	Trans	Complete Unit	1		EM-2512	
			Trans	Insert Only	1		EM-2525	
			V8 5.9L 360ci	1981-94	L & R Front		2	EM-2469
	1988-94	Trans		1		EM-2624		
	1981-87	Trans	Complete Unit	1		EM-2512		
		Trans	Insert Only	1		EM-2525		
	<b>B300 VAN</b>							
L6	L6 3.7L 225ci	1971	L & R Front		2	EM-2266		
		1971-80	Trans	Auto; Complete Unit	1			EM-2512
			Trans	Auto; Insert	1			EM-2525
			Trans	Manual; Complete Unit	1			EM-2512
			Trans	Manual; Insert	1			EM-2525
L6 3.7L 3687cc	1979-80	L & R Front		2	EM-2469			

# Engine, Transmission, And Torque Strut Mounts

CYL	ENG. SIZE	YEAR	LOCATION	DESCRIPTION	QTY	ENGINE	TORQUE STRUT	TRANSMISSION
<b>DODGE VAN (continued)</b>								
<b>B300 VAN (continued)</b>								
L6	L6 3.7L 3687cc	1972-78	L & R Front		2	EM-2265		
V8	V8 5.2L 318ci	1979-80	L & R Front		2	EM-2469		
		1972-78	L & R Front		2	EM-2265		
		1971	L & R Front		2	EM-2266		
		1971-80	Trans	Auto; Complete Unit	1			EM-2512
			Trans	Auto; Insert	1			EM-2525
			Trans	Manual; Complete Unit	1			EM-2512
			Trans	Manual; Insert	1			EM-2525
		V8 5.9L 360ci	1979-80	L & R Front		2	EM-2469	
	1972-78		L & R Front		2	EM-2265		
	1971		L & R Front		2	EM-2266		
	1971-80		Trans	Auto; Complete Unit	1			EM-2512
			Trans	Auto; Insert	1			EM-2525
			Trans	Manual; Complete Unit	1			EM-2512
			Trans	Manual; Insert	1			EM-2525
	V8 6.6L 400ci		1976-78	L & R Front		2	EM-2265	
		Trans		Auto; Complete Unit	1		EM-2512	
Trans		Auto; Insert		1		EM-2525		
Trans		Manual; Complete Unit		1		EM-2512		
Trans		Manual; Insert		1		EM-2525		
V8 7.2L 440ci	1975-78	L & R Front		2	EM-2265			
<b>B350 VAN</b>								
V8	V8 5.2L 318ci	1981-94	L & R Front		2	EM-2469		
		1988-94	Trans		1			EM-2624
		1981-87	Trans	Complete Unit	1			EM-2512
			Trans	Insert Only	1			EM-2525
	V8 5.9L 360ci	1981-94	L & R Front		2	EM-2469		
		1988-94	Trans		1			EM-2624
		1981-87	Trans	Complete Unit	1			EM-2512
			Trans	Insert Only	1			EM-2525
<b>B1500 VAN</b>								
V6	V6 3.9L 239ci	1995-98	L & R Front		2	EM-2469		
			Trans		1			EM-2624
V8	V8 5.2L 318ci	1995-98	L & R Front		2	EM-2469		
			Trans		1			EM-2624
	V8 5.9L 360ci	1998	L & R Front		2	EM-2469		
			Trans		1			EM-2624
<b>B2500 VAN</b>								
V6	V6 3.9L 239ci	1995-97	L & R Front		2	EM-2469		
			Trans		1			EM-2624
V8	V8 5.2L 318ci	1995-98	L & R Front		2	EM-2469		
			Trans		1			EM-2624
	V8 5.9L 360ci	1995-98	L & R Front		2	EM-2469		
			Trans		1			EM-2624
<b>B3500 VAN</b>								
V8	V8 5.2L 318ci	1995-98	L & R Front		2	EM-2469		
			Trans		1			EM-2624
	V8 5.9L 360ci	1995-98	L & R Front		2	EM-2469		
			Trans		1			EM-2624
<b>CARAVAN</b>								
L4	L4 2.2L 135ci	1984-87	Front		1	EM-2493		
			RH Front		1	EM-2600		
			Torq Str - Front	Manual	1			EM-2491
			Trans		1			EM-2617
	L4 2.4L	2003-07	Trans - Rear		1			EM-2927

# Engine, Transmission, And Torque Strut Mounts

CYL	ENG. SIZE	YEAR	LOCATION	DESCRIPTION	QTY	ENGINE	TORQUE STRUT	TRANSMISSION	
<b>DODGE VAN (continued)</b>									
<b>CARAVAN (continued)</b>									
L4	L4 2.4L	2001-02	Trans - Rear		1			EM-2927	
	L4 2.4L 2429cc	2003-07	Front		1	EM-2928			
		2001-02	Front		1	EM-2928			
		2003-07	Left		1	EM-2925			
			RH Front		1	EM-4004			
		2001-02	RH Front		1	EM-4003			
	L4 2.4L 2429cc	1996-00	Front		1	EM-2928			
			RH Front	Complete Unit	1	EM-2959			
			RH Front	Insert	1	EM-2844			
			Trans - Center	Auto, Complete Unit	1		EM-2984		
			Trans - Center	Auto; Insert	1		EM-2845		
			Trans - LH Front	Auto, Complete Unit	1		EM-2960		
			Trans - LH Rear	Auto, Complete Unit	1		EM-3017		
			Trans - LH Rear	Auto; Insert	1		EM-2849		
	L4 2.5L 2507cc	1991-95	Front		1	EM-2615			
			1988-90	Front		1	EM-2493		
			1991-95	RH Front		1	EM-2616		
			1988-90	RH Front		1	EM-2600		
			1991-95	Trans		1		EM-2618	
			1988-90	Trans		1		EM-2617	
	L4 2.6L 2555cc	1984-87	Front		1	EM-2493			
			RH Front		1	EM-2600			
			Trans		1		EM-2617		
	V6	V6 3.0L 2972cc	1990-95	Front		1	EM-2615		
			1987-89	Front		1	EM-2493		
			1996-00	RH Front	Complete Unit	1	EM-2959		
				RH Front	Insert	1	EM-2844		
1990-95			RH Front	Hydraulic Mount	1	EM-2711			
			RH Front	Rubber Mount	1	EM-2616			
1987-89			RH Front		1	EM-2600			
				Trans - Center	Auto, Complete Unit	1		EM-2984	
Trans - Center			Auto; Insert	1		EM-2845			
Trans - LH Front			Auto, Complete Unit	1		EM-2960			
Trans - LH Front			Auto; Insert	1		EM-2849			
Trans - LH Rear			Auto, Complete Unit	1		EM-3017			
Trans - LH Rear			Auto; Insert	1		EM-2849			
1990-95			Trans	Auto	1		EM-2618		
1987-89		Trans	Auto	1		EM-2617			
V6 3.3L 201ci		1990-95	Front	FWD	1	EM-2615			
			2001-06	RH Front		1	EM-2926		
		1996-00	RH Front	Complete Unit	1	EM-2959			
			RH Front	Insert	1	EM-2844			
		1990-95	RH Front	FWD, Solid Mount	1	EM-2616			
			RH Front	Hydraulic Mount; FWD	1	EM-2711			
		2001-07	Trans - Center		1		EM-2925		
		1996-00	Trans - Center	Auto, Complete Unit	1		EM-2984		
			Trans - Center	Auto; Insert	1		EM-2845		
		2001-07	Trans - LH Front		1		EM-2928		
		1996-00	Trans - LH Front	Auto, Complete Unit	1		EM-2960		
			Trans - LH Front	Auto; Insert	1		EM-2849		
		2001-07	Trans - LH Rear		1		EM-2927		
		1996-00	Trans - LH Rear	Auto, Complete Unit	1		EM-3017		
			Trans - LH Rear	Auto; Insert	1		EM-2849		
	1991-95	Trans		1		EM-2618			
1990	Trans	FWD	1		EM-2618				
V6 3.8L 230ci	1996-99	RH Front	Complete Unit	1	EM-2959				
		RH Front	Insert	1	EM-2844				

# Engine, Transmission, And Torque Strut Mounts

CYL	ENG. SIZE	YEAR	LOCATION	DESCRIPTION	QTY	ENGINE	TORQUE STRUT	TRANS-MISSION	
<b>DODGE VAN (continued)</b>									
<b>CARAVAN (continued)</b>									
V6	V6 3.8L 230ci	1996-99	Trans - Center	Auto, Complete Unit	1			EM-2984	
			Trans - Center	Auto; Insert	1			EM-2845	
			Trans - LH Front	Auto, Complete Unit	1			EM-2960	
			Trans - LH Front	Auto; Insert	1			EM-2849	
			Trans - LH Rear	Auto, Complete Unit	1			EM-3017	
			Trans - LH Rear	Auto; Insert	1			EM-2849	
<b>GRAND CARAVAN</b>									
L4	L4 2.4L 2429cc	1996-97	RH Front	Complete Unit	1	EM-2959			
			RH Front	Insert	1	EM-2844			
			Trans - Center	Auto, Complete Unit	1			EM-2984	
			Trans - Center	Auto; Insert	1			EM-2845	
			Trans - LH Front	Auto, Complete Unit	1			EM-2960	
			Trans - LH Front	Auto; Insert	1			EM-2849	
			Trans - LH Rear	Auto, Complete Unit	1			EM-3017	
			Trans - LH Rear	Auto; Insert	1			EM-2849	
	L4 2.5L 2507cc	1988	Front		1	EM-2493			
			RH Front		1	EM-2600			
			Trans		1			EM-2617	
	V6	V6 3.0L 181ci	1992-95	Front		1	EM-2615		
				RH Front	Hydraulic Mount	1	EM-2711		
				RH Front	Rubber Mount	1	EM-2616		
Trans					1			EM-2618	
V6 3.0L 2972cc		1988-89	Front		1	EM-2493			
			1996-00	RH Front	Complete Unit	1	EM-2959		
				RH Front	Insert	1	EM-2844		
		1988-89	RH Front		1	EM-2600			
			1996-00	Trans - Center	Complete Unit	1			EM-2984
				Trans - Center	Insert	1			EM-2845
				Trans - LH Front	Complete Unit	1			EM-2960
				Trans - LH Front	Insert	1			EM-2849
		1988-89	Trans - LH Rear	Complete Unit	1			EM-3017	
			Trans - LH Rear	Insert	1			EM-2849	
			Trans		1			EM-2617	
V6 3.3L 201ci		2008-10	Front	Complete Unit	1	EM-3156			
			Front	Insert	1	EM-4094			
		1990-95	Front		1	EM-2615			
		2005-07	RH Front	FWD	1	EM-2926			
		2001-04	RH Front	Hydraulic Mount; FWD	1	EM-2926			
		1996-00	RH Front	FWD, Complete Unit	1	EM-2959			
			RH Front	FWD, Insert Only	1	EM-2844			
		1990-95	RH Front	Hydraulic Mount	1	EM-2711			
			RH Front	Rubber Mount	1	EM-2616			
		2008-10	Rear		1	EM-4042			
		2005-07	Trans - Center	FWD	1			EM-2925	
		2004	Trans - Center		1			EM-2925	
		2001-03	Trans - Center	FWD	1			EM-2925	
		1996-00	Trans - Center	FWD, Auto, Complete Unit	1			EM-2984	
			Trans - Center	FWD, Auto, Insert Only	1			EM-2845	
		2005-07	Trans - LH Front	FWD	1			EM-2928	
		2004	Trans - LH Front		1			EM-2928	
		2001-03	Trans - LH Front	Auto, Complete Unit; AWD	1			EM-2960	
	Trans - LH Front		Auto; Insert; AWD	1			EM-2849		
	Trans - LH Front		FWD	1			EM-2928		
	1996-00	Trans - LH Front	Auto, Complete Unit	1			EM-2960		
		Trans - LH Front	Auto; Insert	1			EM-2849		
	2005-07	Trans - LH Rear	FWD	1			EM-2927		
	2004	Trans - LH Rear		1			EM-2927		

# Engine, Transmission, And Torque Strut Mounts

CYL	ENG. SIZE	YEAR	LOCATION	DESCRIPTION	QTY	ENGINE	TORQUE STRUT	TRANSMISSION
<b>DODGE VAN (continued)</b>								
<b>GRAND CARAVAN (continued)</b>								
V6	V6 3.3L 201ci	2001-03	Trans - LH Rear	Auto; Complete Unit; AWD	1			EM-3017
			Trans - LH Rear	Auto; Insert; AWD	1			EM-2849
			Trans - LH Rear	FWD	1			EM-2927
		1996-00	Trans - LH Rear	Auto, Complete Unit	1			EM-3017
			Trans - LH Rear	Auto; Insert	1			EM-2849
		2008-10	Trans	Bushing	1			EM-4127
			Trans	Complete Unit	1			EM-4013
		1991-95	Trans		1			EM-2618
			1990	Trans	FWD	1		EM-2618
		V6 3.6L 220ci	2011-15	Front	Complete Unit	1	EM-4050	
	Front			Insert	1	EM-4094		
	Front			Complete Unit	1	EM-4050		
	Front			Insert	1	EM-4094		
	Right				1	EM-4012		
	Right				1	EM-4012		
	2011-13	Trans		1			EM-4077	
	V6 3.8L 230ci	2008-10	Front	Complete Unit	1	EM-3156		
			Front	Insert	1	EM-4094		
		1994-95	Front	FWD	1	EM-2615		
		2005-07	RH Front	FWD	1	EM-2926		
		2001-04	RH Front	Hydraulic Mount; FWD	1	EM-2926		
		1996-00	RH Front	FWD, Complete Unit	1	EM-2959		
			RH Front	FWD, Insert Only	1	EM-2844		
		1994-95	RH Front	FWD, Solid Mount	1	EM-2616		
			RH Front	Hydraulic Mount; FWD	1	EM-2711		
		2008-10	Rear		1	EM-4042		
		2005-07	Trans - Center	Auto; FWD	1			EM-2925
		2001-04	Trans - Center	Auto; FWD	1			EM-2925
		1996-00	Trans - Center	FWD, Auto, Complete Unit	1			EM-2984
			Trans - Center	FWD, Auto, Insert Only	1			EM-2845
		2005-07	Trans - LH Front	Auto; FWD	1			EM-2928
		2001-04	Trans - LH Front	Auto; Complete Unit; AWD	1			EM-2960
			Trans - LH Front	Auto; FWD	1			EM-2928
			Trans - LH Front	Auto; Insert; AWD	1			EM-2849
		1996-00	Trans - LH Front	Auto, Complete Unit	1			EM-2960
			Trans - LH Front	Auto; Insert	1			EM-2849
		2005-07	Trans - LH Rear	Auto; FWD	1			EM-2927
		2001-04	Trans - LH Rear	Auto; Complete Unit; AWD	1			EM-3017
			Trans - LH Rear	Auto; FWD	1			EM-2927
			Trans - LH Rear	Auto; Insert; AWD	1			EM-2849
		1996-00	Trans - LH Rear	Auto, Complete Unit	1			EM-3017
			Trans - LH Rear	Auto; Insert	1			EM-2849
2008-10		Trans	Bushing	1			EM-4127	
		Trans	Complete Unit	1			EM-4013	
1994-95		Trans		1			EM-2618	
V6 4.0L 3952cc 241ci		2008-10	Front	Complete Unit	1	EM-3156		
			Front	Insert	1	EM-4094		
			Rear		1	EM-4042		
			Right		1	EM-4012		
			Trans	Bushing	1			EM-4127
	Trans		Complete Unit	1			EM-4013	
<b>MINI RAM</b>								
L4	L4 2.2L 135ci	1984-87	Front		1	EM-2493		
			RH Front		1	EM-2600		
			Torq Str - Front	Manual	1		EM-2491	
			Trans	Auto	1			EM-2617
			Trans	Manual	1			EM-2617

# Engine, Transmission, And Torque Strut Mounts

CYL	ENG. SIZE	YEAR	LOCATION	DESCRIPTION	QTY	ENGINE	TORQUE STRUT	TRANS-MISSION
<b>DODGE VAN (continued)</b>								
<b>MINI RAM (continued)</b>								
L4	L4 2.5L 2507cc	1987-88	Front		1	EM-2493		
			RH Front		1	EM-2600		
			Trans	Auto	1			EM-2617
			Trans	Manual	1			EM-2617
	L4 2.6L 2555cc	1984-87	Front		1	EM-2493		
			RH Front		1	EM-2600		
			Trans	Auto	1			EM-2617
			Trans	Manual	1			EM-2617
V6	V6 3.0L 2972cc	1987-88	Front		1	EM-2493		
			RH Front		1	EM-2600		
			Trans	Auto	1			EM-2617
			Trans	Manual	1			EM-2617
<b>RAM 1500 VAN</b>								
V6	V6 3.9L 239ci	1999-03	L & R Front		2	EM-2469		
			Trans		1			EM-2852
V8	V8 5.2L 318ci	1999-03	L & R Front		2	EM-2469		
			Trans		1			EM-2852
	V8 5.9L 360ci	1999-03	L & R Front		2	EM-2469		
			Trans		1			EM-2852
<b>RAM 2500 VAN</b>								
V8	V8 5.2L 318ci	1999-03	L & R Front		2	EM-2469		
			Trans		1			EM-2852
	V8 5.9L 360ci	1999-03	L & R Front		2	EM-2469		
			Trans		1			EM-2852
<b>RAM 3500 VAN</b>								
V8	V8 5.2L 318ci	1999-03	L & R Front		2	EM-2469		
			Trans		1			EM-2852
	V8 5.9L 360ci	1999-03	L & R Front		2	EM-2469		
			Trans		1			EM-2852
<b>ROYAL MINI RAM</b>								
L4	L4 2.2L 135ci	1984-87	Front		1	EM-2493		
			RH Front		1	EM-2600		
			Trans	Auto	1			EM-2617
			Trans	Manual	1			EM-2617
	L4 2.6L 2555cc	1984-87	Front		1	EM-2493		
			RH Front		1	EM-2600		
			Trans	Auto	1			EM-2617
			Trans	Manual	1			EM-2617
V6	V6 3.0L 2972cc	1987	Front		1	EM-2493		
			RH Front		1	EM-2600		
			Trans	Auto	1			EM-2617
			Trans	Manual	1			EM-2617
<b>SPRINTER 2500</b>								
L5	L5 2.7L 2687cc 165ci	2003-06	L & R Front		2	EM-3190		
			Trans		1			EM-3189
<b>EAGLE PASSENGER CAR</b>								
<b>SUMMIT</b>								
L4	L4 1.5L 1468cc	1996	Front	Auto	1	EM-8239		
			Front	Manual	1	EM-8098		
		1995	Front		1	EM-8239		
			Front	Auto	1	EM-8239		
		1994	Front	Manual	1	EM-8098		
			Front	Auto	1	EM-8097		
		1993	Front	Auto	1	EM-8097		
			Front	Manual	1	EM-8098		

# Engine, Transmission, And Torque Strut Mounts

CYL	ENG. SIZE	YEAR	LOCATION	DESCRIPTION	QTY	ENGINE	TORQUE STRUT	TRANSMISSION
<b>EAGLE PASSENGER CAR (continued)</b>								
<b>SUMMIT (continued)</b>								
L4	L4 1.5L 1468cc	1989-92	Front	Auto	1	EM-2673		
			Front	Manual	1	EM-8107		
		1996	LH Front	Power Str	1	EM-8238		
			LH Front	w/o Power Streering	1	EM-8206		
		1995	LH Front	Power Str	1	EM-8238		
			LH Front	w/o Power Streering	1	EM-8206		
		1994	LH Front	Power Str	1	EM-8238		
			LH Front	w/o Power Streering	1	EM-8206		
		1993	LH Front	Power Str	1	EM-8238		
			LH Front	w/o Power Streering	1	EM-8206		
		1989-92	LH Front		1	EM-8108		
			Rear		1	EM-8100		
		1995	Rear		1	EM-8100		
			Rear	Auto	1	EM-8100		
		1994	Rear	Manual	1	EM-8100		
			Rear	Auto	1	EM-8100		
		1993	Rear	Manual	1	EM-8100		
			Rear	Auto	1	EM-8100		
		1989-92	Rear	Auto	1	EM-8102		
			Rear	Manual	1	EM-8102		
		1996	Trans	Auto; Coupe & Sedan	1			EM-8582
	Trans		Manual; Coupe & Sedan	1			EM-8099	
	1995	Trans	Auto; Coupe & Sedan	1			EM-8582	
	1993-94	Trans	Auto; Coupe & Sedan	1			EM-8582	
		Trans	Manual; Coupe & Sedan	1			EM-8099	
	1991-92	Trans	Auto; Sedan; Hatchback	1			EM-8584	
		Trans	Manual; Sedan; Hatchback	1			EM-8669	
	1989-90	Trans	Auto; Sedan	1			EM-8584	
		Trans	Manual; Sedan	1			EM-8669	
	L4 1.6L 1597cc	1989-90	Front	Auto	1	EM-2673		
			Front	Manual	1	EM-8107		
			LH Front		1	EM-8108		
			Rear	Auto	1	EM-8102		
Rear			Manual	1	EM-8102			
Trans			Auto	1			EM-8584	
Trans			Manual	1			EM-8669	
L4 1.8L 1834cc	1996	Front	Auto	1	EM-8818			
		Front	Manual	1	EM-8098			
	1995	Front		1	EM-8818			
		Front	Auto	1	EM-8239			
	1994	Front	Manual	1	EM-8098			
		Front	Auto	1	EM-8097			
	1992-93	Front	Manual	1	EM-8098			
		Front	Auto	1	EM-8690			
	1996	LH Front	Auto	1	EM-8690			
		LH Front	Manual	1	EM-8689			
	1995	LH Front		1	EM-8690			
		LH Front	Auto	1	EM-8690			
	1994	LH Front	Manual, Pwr Str	1	EM-9147			
		LH Front	Auto	1	EM-8690			
	1992-93	LH Front	Manual, Pwr Str	1	EM-9147			
		LH Front	Auto	1	EM-8100			
	1996	Rear		1	EM-8100			
		Rear	Auto	1	EM-8100			
	1995	Rear	Manual	1	EM-8100			
		Rear	Auto	1	EM-8100			
1994	Rear	Auto	1	EM-8100				
	Rear	Manual	1	EM-8100				
1992-93	Rear	Auto	1	EM-8100				
	Trans	Auto; Coupe & Sedan	1			EM-8619		
1996	Trans	Manual; Wagon; FWD	1			EM-8686		
	Trans	Auto; Coupe & Sedan	1			EM-8619		



# Engine, Transmission, And Torque Strut Mounts

CYL	ENG. SIZE	YEAR	LOCATION	DESCRIPTION	QTY	ENGINE	TORQUE STRUT	TRANSMISSION
<b>EAGLE PASSENGER CAR (continued)</b>								
<b>SUMMIT (continued)</b>								
L4	L4 1.8L 1834cc	1992-94	Trans	Auto; Sedan; Hatchback	1			EM-8619
			Trans	Auto; Wagon; 2WD	1			EM-8881
			Trans	Manual; Sedan; Hatchback	1			EM-8099
			Trans	Manual; Wagon; 2WD	1			EM-8686
	L4 2.4L 2351cc	1996	Front	Auto	1	EM-8687		
			Front	Manual	1	EM-8688		
		1995	Front		1	EM-8687		
		1992-94	Front	Auto	1	EM-8102		
			Front	Manual	1	EM-8821		
		1996	LH Front		1	EM-8820		
		1995	LH Front		1	EM-8820		
		1996	Rear	Auto	1	EM-8690		
			Rear	Manual	1	EM-8689		
		1995	Rear		1	EM-8690		
		1996	Trans	Auto	1			EM-8881
			Trans	Manual	1			EM-8686
		1995	Trans	Auto	1			EM-8881
		1992-94	Trans	Auto	1			EM-8881
			Trans	Manual	1			EM-8686
		<b>TALON</b>						
L4	L4 1.8L 1755cc	1993-94	Front		1	EM-8103		
			LH Front		1	EM-9056		
			Rear	Auto	1	EM-8104		
			Rear	Manual	1	EM-5098		
			Trans	Auto	1			EM-8700
			Trans	Manual	1			EM-8686
	L4 2.0L 1997cc	1997-98	Front		1	EM-8670		
			Front		1	EM-8670		
		1993-94	Front	FWD	1	EM-8103		
			Front	TSi; Auto; AWD	1	EM-8559		
			Front	TSi; Manual; AWD	1	EM-9078		
		1991-92	Front	FWD	1	EM-8103		
			Front	TSi; Auto; AWD	1	EM-8559		
			Front	TSi; Manual; AWD	1	EM-9078		
		1990	Front	FWD	1	EM-8103		
			Front	TSi; Manual; AWD	1	EM-9078		
		1997-98	LH Front		1	EM-8792		
		1995-96	LH Front		1	EM-8792		
		1993-94	LH Front	TSi; Auto; AWD	1	EM-9206		
		1991-92	LH Front	TSi; Auto; AWD	1	EM-9206		
		1990	LH Front		1	EM-9206		
		1997-98	RH Front		1	EM-5081		
		1995-96	RH Front		1	EM-9198		
		1997-98	Rear	Auto	1	EM-9039		
			Rear	Manual	1	EM-8798		
		1995-96	Rear	Auto	1	EM-9039		
		1993-94	Rear	Auto; FWD	1	EM-8104		
			Rear	Manual; FWD	1	EM-5098		
			Rear	TSi; Auto; AWD	1	EM-8104		
			Rear	TSi; Manual; AWD	1	EM-5101		
		1991-92	Rear	Auto; AWD	1	EM-8104		
			Rear	Manual; FWD	1	EM-5098		
			Rear	TSi; Auto; AWD	1	EM-8104		
			Rear	TSi; Manual; AWD	1	EM-5101		
		1990	Rear	Auto; FWD	1	EM-8104		
			Rear	Manual; FWD	1	EM-5098		
			Rear	TSi; Manual; AWD	1	EM-5101		

# Engine, Transmission, And Torque Strut Mounts

CYL	ENG. SIZE	YEAR	LOCATION	DESCRIPTION	QTY	ENGINE	TORQUE STRUT	TRANSMISSION		
<b>EAGLE PASSENGER CAR (continued)</b>										
<b>TALON (continued)</b>										
L4	L4 2.0L 1997cc	1995-98	Trans	Exc. TSi Auto	1			EM-9174		
			Trans	Auto; TSi	1			EM-9058		
			Trans	Exc. TSi Manual	1				EM-9174	
			Trans	Manual; TSi	1				EM-8793	
		1990-94	Trans	Auto, w/ Spd Cntrl, w/o ABS	1				EM-8700	
			Trans	AWD, Manual, w/o Spd Cntrl	1				EM-8686	
			Trans	Manual; AWD; w/ Std Brakes	1				EM-8686	
<b>VISION</b>										
V6	V6 3.3L 201ci	1993-97	L & R Front		2	EM-2795'				
			Trans		1			EM-2810		
	V6 3.5L 3497cc	1993-97	L & R Front		2	EM-2795'				
			Trans		1			EM-2810		
<b>FORD PASSENGER CAR</b>										
<b>ASPIRE</b>										
L4	L4 1.3L 1295cc	1994-97	Trans - Front	Manual	1			EM-5104		
			Trans - Rear		1			EM-5103		
<b>CLUB</b>										
V8	V8 4.5L 272ci	1955-57	L & R Front		2	EM-2110				
<b>CONTOUR</b>										
L4	L4 2.0L 1989cc	1998-00	Front	Auto; Complete Unit	1	EM-5521				
			Front	Auto; Insert	1	EM-2885				
			Front	Manual; Insert	1	EM-2978				
		1995-97	Front	Auto; Complete Unit	1	EM-5596				
			Front	Auto; Insert	1	EM-2886				
			Front	Manual; Insert	1	EM-2978				
		1998-00	RH Front		1	EM-2890'				
		1995-97	RH Front	Complete Unit	1	EM-2889				
			RH Front	Insert Only	1	EM-5105				
		1998-00	Trans - Front	Auto, Complete Unit	1			EM-2873		
			Trans - Front	Auto; Insert	1			EM-5106		
		1995-97	Trans - Front	Auto, Complete Unit	1			EM-2873		
			Trans - Front	Auto; Insert	1			EM-5106		
		1998-00	Trans - Rear	Auto; Insert	1			EM-2888		
		1995-97	Trans - Rear	Auto, Complete Unit	1			EM-5107		
			Trans - Rear	Auto; Insert	1			EM-2887		
		1998-00	Trans	Manual; Complete Unit	2			EM-3119		
		1995-97	Trans	Manual; Complete Unit	2			EM-3119		
		V6	V6 2.5L 2450cc	1998-00	Front	Auto; Insert	1	EM-2885		
					Front	Manual; Insert	1	EM-2888		
1995-97	Front			Auto; Complete Unit	1	EM-5596				
	Front			Auto; Insert	1	EM-2886				
	Front			Manual; Insert	1	EM-2978				
1998-00	RH Front			Complete Unit	1	EM-5352				
1995-97	RH Front			Complete Unit	1	EM-2889				
	RH Front			Insert Only	1	EM-5105				
1998-00	Trans - Front			Auto; Complete Unit	1			EM-2873		
	Trans - Front			Auto; Insert	1			EM-5106		
1995-97	Trans - Front			Auto; Complete Unit; Att. to Fender Apron	1			EM-2873		
	Trans - Front			Auto; Insert; Att. to Fender Apron	1			EM-5106		
	Trans - Front			Auto; Insert; Attached to Crossmember	1			EM-2887		
1998-00	Trans - Rear	Auto; Insert	1			EM-2888				

# Engine, Transmission, And Torque Strut Mounts

CYL	ENG. SIZE	YEAR	LOCATION	DESCRIPTION	QTY	ENGINE	TORQUE STRUT	TRANSMISSION
<b>FORD PASSENGER CAR (continued)</b>								
<b>CONTOUR (continued)</b>								
V6	V6 2.5L 2450cc	1995-97	Trans - Rear	Auto; Complete Unit; Att. to Crossmember	1			EM-5107
			Trans - Rear	Manual; Complete Unit	1		EM-3119	
		1998-00	Trans	Manual; Complete Unit	2		EM-3119	
<b>COUGAR (MEXICAN VEHICLE)</b>								
V6	V6 3.8L 232ci	1986-97	L & R Front	Hydraulic Mount	2	EM-2661'		
			Trans	Hydraulic Mount	1		EM-2707	
<b>COUNTRY SEDAN</b>								
V8	V8 4.5L 272ci	1955-57	L & R Front		2	EM-2110		
	V8 5.8L 351ci	1969-74	L & R Front		2	EM-2287		
			Trans	Auto	1		EM-2311	
			Trans	Manual	1		EM-2311	
			Trans		1		EM-2242	
	V8 5.8L 352ci	1963-65	Trans		1		EM-2242	
	V8 6.4L 390ci	1969-71	LH Front		1	EM-2271		
			LH Front		1	EM-2241		
			LH Front		1	EM-2223		
			RH Front		1	EM-2270		
			RH Front		1	EM-2240		
			RH Front		1	EM-2222		
			Trans	Auto	1		EM-2242	
	Trans	Manual	1		EM-2242			
	V8 6.6L 400ci	1971-74	LH Front		1	EM-2359		
			RH Front		1	EM-2358		
			Trans		1		EM-2345	
	V8 7.0L 428ci	1969-73	Trans	AOD	1		EM-2345	
			Trans	CM (C-4/C-6)	1		EM-2311	
	V8 7.0L 429ci	1969-73	LH Front		1	EM-2368		
RH Front				1	EM-2367			
V8 7.5L 460ci	1972-74	LH Front		1	EM-2368			
		RH Front		1	EM-2367			
		Trans		1		EM-2345		
<b>COUNTRY SQUIRE</b>								
L6	L6 2.8L 170ci	1966-67	L & R Front		2	EM-2333		
			1962-65	LH Front		1	EM-2226	
			RH Front		1	EM-2225		
		1962-67	Trans		1		EM-2253	
	L6 3.3L 200ci	1966-67	L & R Front		2	EM-2333		
1963-67			Trans		1		EM-2253	
L6 3.9L 240ci	1965-67	Trans		1		EM-2242		
V8	V8 3.9L 239ci	1954	L & R Front		2	EM-2110		
	V8 4.3L 260ci	1963-64	LH Front		1	EM-2220		
			RH Front		1	EM-2221		
			Trans		1		EM-2242	
	V8 4.5L 272ci	1955-57	L & R Front		2	EM-2110		
	V8 4.7L 289ci	1965-67	L & R Front		2	EM-2287		
			1963-64	LH Front		1	EM-2220	
			RH Front		1	EM-2221		
		1963-67	Trans		1		EM-2242	
	V8 4.8L 292ci	1959-62	L & R Front		2	EM-2141		
		1958	L & R Front		2	EM-2110		
	V8 5.0L 302ci	1968-72	L & R Front		2	EM-2287		
			1987-91	LH Front		1	EM-2438	
			RH Front		1	EM-2437		
			Trans		1		EM-2464	
1969-72		Trans		1		EM-2311		
1968		Trans		1		EM-2242		

# Engine, Transmission, And Torque Strut Mounts

CYL	ENG. SIZE	YEAR	LOCATION	DESCRIPTION	Q T Y	ENGINE	TORQUE STRUT	TRANS- MISSION			
<b>FORD PASSENGER CAR (continued)</b>											
<b>COUNTRY SQUIRE (continued)</b>											
V8	V8 5.8L 351ci	1969-74	L & R Front		2	EM-2287					
			Trans		1			EM-2311			
V8	V8 5.8L 352ci	1965-67 1958-64 1965-67 1958-64 1963-67	LH Front		1	EM-2241					
			LH Front		1	EM-2223					
			RH Front		1	EM-2240					
			RH Front		1	EM-2222					
			Trans		1			EM-2242			
V8	V8 6.4L 390ci	1969-71 1968 1963-64 1969-71 1968 1963-64 1968-71	LH Front		1	EM-2271					
			LH Front		1	EM-2241					
			LH Front		1	EM-2223					
			RH Front		1	EM-2270					
			RH Front		1	EM-2240					
			Trans		1	EM-2222					
V8	V8 6.6L 400ci	1971-74	LH Front		1	EM-2359					
			RH Front		1	EM-2358					
			Trans		1			EM-2345			
V8	V8 7.0L	1964	LH Front		1	EM-2223					
			RH Front		1	EM-2222					
V8	V8 7.0L 427ci	1966 1964-66	LH Front		1	EM-2241					
			RH Front		1	EM-2240					
			Trans		1			EM-2242			
V8	V8 7.0L 428ci	1968-69	LH Front		1	EM-2241					
			RH Front		1	EM-2240					
			Trans		1			EM-2242			
V8	V8 7.0L 429ci	1973 1969-72 1973 1969-72 1969-73	LH Front		1	EM-2368					
			LH Front		1	EM-2724					
			RH Front		1	EM-2367					
			RH Front		1	EM-2723					
			Trans	AOD	1			EM-2345			
			Trans	CM (C-4/C-6)	1			EM-2311			
V8	V8 7.5L	1972-74	LH Front		1	EM-2368					
			RH Front		1	EM-2367					
V8	V8 7.5L 460ci	1972-78	Trans		1			EM-2345			
<b>CROWN VICTORIA</b>											
V8	V8 4.6L 281ci	2003-09 1998-02 1992-97 2003-09 1998-02 1992-97 2003-09 1998-02 1993-97 1992	LH Front		1	EM-3025					
			LH Front		1	EM-2861					
			LH Front		1	EM-2807					
			RH Front		1	EM-3024					
			RH Front		1	EM-2860					
			RH Front		1	EM-2806					
			Trans		1			EM-3038			
			Trans		1			EM-2822			
			Trans	exc. Police Cars	1			EM-2822			
			Trans	Police Cars	1			EM-2448			
			Trans	After 2/5/92, exc. Police Cars	1			EM-2822			
			Trans	Police Cars	1			EM-2448			
			V8	V8 5.0L 302ci	1987-91	LH Front		1	EM-2438		
						RH Front		1	EM-2437		
						Trans		1			EM-2464
V8	V8 5.8L 351ci	1987-91	LH Front		1	EM-2438					
			RH Front		1	EM-2437					
			Trans		1			EM-2464			

# Engine, Transmission, And Torque Strut Mounts

CYL	ENG. SIZE	YEAR	LOCATION	DESCRIPTION	QTY	ENGINE	TORQUE STRUT	TRANS-MISSION
<b>FORD PASSENGER CAR (continued)</b>								
<b>CUSTOM</b>								
L6	L6 3.7L	1949-51	Front		1	EM-5465		
V8	V8 3.9L	1949-52	Front		1	EM-5465		
<b>CUSTOM 500</b>								
L6	L6 3.9L 240ci	1968-72	L & R Front		2	EM-2319		
		1969-72	Trans		1			EM-2311
		1968	Trans	Auto	1			EM-2242
			Trans	Manual	1			EM-2242
V8	V8 4.7L 289ci	1965-67	L & R Front		2	EM-2287		
		1968	Trans		1			EM-2242
			Trans	Manual	1			EM-2242
	V8 4.8L 292ci	1957	L & R Front		2	EM-2110		
	V8 5.0L 302ci	1968-72	L & R Front		2	EM-2287		
		1969-72	Trans		1			EM-2311
		1968	Trans	Auto	1			EM-2242
	Trans		Manual	1			EM-2242	
	V8 5.8L 351ci	1969-77	L & R Front		2	EM-2287		
		1975-77	Trans	Auto	1			EM-2311
		1969-74	Trans	Auto	1			EM-2311
			Trans	Manual	1			EM-2242
	V8 5.8L 352ci	1965-66	LH Front		1	EM-2241		
		1964	LH Front		1	EM-2223		
		1965-66	RH Front		1	EM-2240		
		1964	RH Front		1	EM-2222		
		1964-66	Trans	Auto	1			EM-2242
			Trans	Manual	1			EM-2242
	V8 6.4L 390ci	1969-71	LH Front		1	EM-2271		
		1968	LH Front		1	EM-2241		
		1964	LH Front		1	EM-2223		
		1969-71	RH Front		1	EM-2270		
		1968	RH Front		1	EM-2240		
		1964	RH Front		1	EM-2222		
			Trans	Auto	1			EM-2242
		Trans	Manual	1			EM-2242	
	V8 6.6L 400ci	1971-77	LH Front		1	EM-2359		
			RH Front		1	EM-2358		
		1974-77	Trans		1			EM-2345
		1971-73	Trans	Auto	1			EM-2345
			Trans	Manual	1			EM-2345
	V8 7.0L 427ci	1968	Trans	Auto	1			EM-2242
			Trans	Manual	1			EM-2242
	V8 7.0L 428ci	1969-70	LH Front		1	EM-2241		
		1968	LH Front		1	EM-2241		
		1969-70	RH Front		1	EM-2240		
		1968	RH Front		1	EM-2240		
		1969-70	Trans	Auto	1			EM-2242
			Trans	Manual	1			EM-2242
	V8 7.0L 429ci	1973	LH Front		1	EM-2368		
		1969-72	LH Front		1	EM-2723		
		1973	RH Front		1	EM-2367		
		1969-72	RH Front		1	EM-2724		
		1969-73	Trans	AOD	1			EM-2345
			Trans	CM (C-4/C-6)	1			EM-2311
	V8 7.5L 460ci	1973-76	LH Front		1	EM-2368		
			RH Front		1	EM-2367		
		1974-76	Trans	Auto	1			EM-2345
		1973	Trans	Auto	1			EM-2345
			Trans	Manual	1			EM-2345

# Engine, Transmission, And Torque Strut Mounts

CYL	ENG. SIZE	YEAR	LOCATION	DESCRIPTION	QTY	ENGINE	TORQUE STRUT	TRANSMISSION		
<b>FORD PASSENGER CAR (continued)</b>										
<b>CUSTOMLINE</b>										
V8	V8 4.5L 272ci	1955-56	L & R Front		2	EM-2110				
<b>C-MAX</b>										
L4	L4 2.0L 122ci	2013-14	Trans - Upper		1			EM-4070		
<b>DELUXE</b>										
L6	L6 3.7L	1949-51	Front		1	EM-5465				
V8	V8 3.9L	1949-51	Front		1	EM-5465				
	V8 3.9L 239ci	1946-48	L & R Front Lower		2	EM-2010				
<b>ELITE</b>										
V8	V8 5.8L 351ci	1975-76	L & R Front		2	EM-2287				
			Trans		1			EM-2311		
V8	V8 6.6L 400ci	1975-76	LH Front		1	EM-2359				
			RH Front		1	EM-2358				
			Trans		1			EM-2345		
V8	V8 7.5L 460ci	1975-76	LH Front		1	EM-2368				
			RH Front		1	EM-2367				
			Trans		1			EM-2345		
<b>ESCORT</b>										
L4	L4 1.6L 1598cc	1984-85	Front		1	EM-2559				
			1981-83	Front	Auto	1	EM-2461			
				Front	Manual	1	EM-2460			
		1984-85	RH Front		1	EM-2558				
			1981-83	RH Front		1	EM-2459			
		1984-85	Trans	Auto		1			EM-2632	
			Trans	Manual; 4 Spd		1			EM-2634	
			Trans	Manual; 5 Spd		1			EM-2665	
		1981-83	Trans	Auto		1			EM-2463	
			Trans	Manual		1			EM-2463	
		L4 1.8L 112ci	1994-96	Front	Auto		1	EM-2910		
				Front	Manual		1	EM-2651		
	1991-93		Front		1	EM-2651				
	1994-96		LH Rear		1	EM-2650				
	1991-93		LH Rear		1	EM-2650				
	1994-96		RH Front		1	EM-2649				
	1991-93		RH Front		1	EM-2649				
	1991-96		Trans	Auto		1			EM-2815	
		Trans	Manual		1			EM-2815		
	L4 1.9L 116ci	1991-96	Front		1	EM-2651				
			1988-90	Front		1	EM-2559			
		1987	Front		1	EM-2559				
		1986	Front		1	EM-2559				
		1985	Front		1	EM-2559				
		1987	LH Front	Auto; w/ EFI		1	EM-5063			
		1986	LH Front	Auto; w/ EFI		1	EM-5063			
			LH Front	Auto; w/o EFI		1	EM-5064			
		1985	LH Front	Auto		1	EM-5063			
		1991-96	LH Rear		1	EM-2650				
			RH Front		1	EM-2649				
		1988-90	RH Front		1	EM-2558				
		1987	RH Front		1	EM-2558				
		1986	RH Front	Auto; w/o EFI		1	EM-2558			
1985		RH Front		1	EM-2558					
1991-96		Trans	Auto		1			EM-2815		
		Trans	Manual		1			EM-2815		
1985-90		Trans	Auto		1			EM-2632		

# Engine, Transmission, And Torque Strut Mounts

CYL	ENG. SIZE	YEAR	LOCATION	DESCRIPTION	QTY	ENGINE	TORQUE STRUT	TRANSMISSION		
<b>FORD PASSENGER CAR (continued)</b>										
<b>ESCORT (continued)</b>										
L4	L4 1.9L 116ci	1985-90	Trans	Manual; 4 Spd	1			EM-2634		
			Trans	Manual; 5 Spd	1			EM-2665		
	L4 2.0L 1989cc	2001-02	2000	Front	Auto	1	EM-2910*			
				Front	Manual	1	EM-2651			
			1998-99	Front	LX; Manual	1	EM-2651			
				Front	LX; Auto	1	EM-2910*			
			1997	Front	Auto	1	EM-2910*			
				Front	Manual	1	EM-2651			
			L4 2.0L 1989cc Diesel	1984-87	LH Front	Auto; Complete Unit	1	EM-5063		
					LH Front	Insert; All	1	EM-2559		
	LH Front	Manual; Complete Unit			1	EM-5065				
	L4 2.0L 1989cc	2001-02	RH Front		1	EM-2649				
			2000	RH Front	LX	1	EM-2649			
			1998-99	RH Front		1	EM-2649			
			1997	RH Front		1	EM-2649			
		2001-02	Rear	Auto	1	EM-2911				
			Rear	Manual	1	EM-2912				
			2000	Rear	LX; Manual	1	EM-2912			
			Rear	LX; Auto	1	EM-2911				
		1998-99	Rear	Auto	1	EM-2911				
			Rear	Manual	1	EM-2912				
			1997	Rear	Auto	1	EM-2911			
			Rear	Manual	1	EM-2912				
		1997-02	Trans	Auto	1			EM-2843		
			Trans	Manual	1			EM-2843		
	<b>EXP</b>									
L4	L4 1.6L 1598cc	1984-85	Front	Front	1	EM-2559				
			1982-83	Front	Auto	1	EM-2461			
		1984-85	RH Front	RH Front	1	EM-2558				
			1982-83	RH Front	RH Front	1	EM-2459			
		1984-86	Trans	Auto	1			EM-2632		
			Trans	Manual; 4 Spd	1			EM-2634		
			Trans	Manual; 5 Spd	1			EM-2665		
		1982-83	Trans	Auto	1			EM-2463		
	Trans		Manual	1			EM-2463			
	L4 1.9L 116ci	1986-88	Front		1	EM-2559				
			RH Front		1	EM-2558				
			Trans	Auto	1			EM-2632		
			Trans	Manual	1			EM-2665		
	<b>FAIRLANE</b>									
L6	L6 2.8L 170ci	1966	L & R Front		2	EM-2333				
		1963-65	LH Front		1	EM-2226				
			RH Front		1	EM-2225				
		1963-64	Trans	Auto	1			EM-2253		
	Trans		Manual	1			EM-2253			
	L6 3.3L 200ci	1966-68	L & R Front		2	EM-2333				
		1965-68	Trans	Auto	1			EM-2253		
Trans			Manual	1			EM-2253			
V8	V8 4.5L 272ci	1955-57	L & R Front		2	EM-2110				
	V8 4.7L 289ci	1964-68	L & R Front		2	EM-2257				
			Trans	Auto	1			EM-2253		
			Trans	Manual	1			EM-2253		
V8 5.0L 302ci	1968-70	L & R Front		2	EM-2257					

# Engine, Transmission, And Torque Strut Mounts

CYL	ENG. SIZE	YEAR	LOCATION	DESCRIPTION	QTY	ENGINE	TORQUE STRUT	TRANSMISSION	
<b>FORD PASSENGER CAR (continued)</b>									
<b>FAIRLANE (continued)</b>									
V8	V8 5.0L 302ci	1968-70	Trans	Auto	1			EM-2253	
			Trans	Manual	1			EM-2253	
	V8 5.8L 351ci	1969-70	L & R Front		2	EM-2287			
			Trans	Auto	1			EM-2311	
			Trans	Manual	1			EM-2311	
	V8 6.4L 390ci	1968-69	LH Front		1	EM-2241			
			RH Front		1	EM-2240			
		1966-69	Trans	Auto	1			EM-2253	
			Trans	Manual	1			EM-2253	
	V8 7.0L 427ci	1966-68	LH Front		1	EM-2241			
			RH Front		1	EM-2240			
			Trans	Auto	1			EM-2253	
Trans			Manual	1			EM-2253		
<b>FAIRMONT</b>									
L4	L4 2.3L 140ci	1978-83	LH Front		1	EM-2458			
			RH Front		1	EM-2457			
			Trans	Auto	1			EM-2388	
			Trans	Manual	1			EM-2388	
L6	L6 3.3L 200ci	1978-83	L & R Front		2	EM-2385			
			Trans	Auto	1			EM-2388	
		1982-83	Trans	Manual	1			EM-2388	
			Trans	Auto, C3	1			EM-2389	
		1980-81	Trans	Auto; C4	1			EM-2388	
			Trans	Manual	1			EM-2389	
		1978-79	Trans		1			EM-2389	
			Trans	Manual	1			EM-2389	
V8	V8 4.2L 255ci	1980-82	LH Front		1	EM-2458			
			RH Front		1	EM-2457			
			Trans	Auto	1			EM-2388	
			Trans	Manual	1			EM-2388	
	V8 5.0L 302ci	1978-79	LH Front		1	EM-2458			
			RH Front		1	EM-2457			
			Trans	Auto	1			EM-2388	
			Trans	Manual	1			EM-2388	
<b>FALCON</b>									
L6	L6 2.4L 144ci	1962	L & R Front	Before 7/4/62	2	EM-2170			
		1960-61	L & R Front		2	EM-2170			
		1963-64	LH Front		1	EM-2226			
		1962	LH Front	After 7/4/62	1	EM-2226			
		1963-64	RH Front		1	EM-2225			
		1962	RH Front	After 7/4/62	1	EM-2225			
		1960-61	Trans	w/ Cantelever	1			EM-2172	
			Trans	w/o Cantelever	1			EM-2172	
		1962-64	Trans	Auto	1			EM-2253	
			Trans	Manual	1			EM-2253	
		1960-61	Trans		1			EM-2171	
			Trans		1			EM-2171	
		L6 2.8L 170ci	1966-69	L & R Front		2	EM-2333		
				1962	L & R Front	Before 7/4/62	2	EM-2170	
			1960-61	L & R Front		2	EM-2170		
			1963-65	LH Front		1	EM-2226		
	1962		LH Front	After 7/4/62	1	EM-2226			
	1963-65		RH Front		1	EM-2225			
	1962		RH Front	After 7/4/62	1	EM-2225			
	1960-61		Trans	w/ Cantelever	1			EM-2172	
		Trans	w/o Cantelever	1			EM-2172		



# Engine, Transmission, And Torque Strut Mounts

CYL	ENG. SIZE	YEAR	LOCATION	DESCRIPTION	QTY	ENGINE	TORQUE STRUT	TRANSMISSION
<b>FORD PASSENGER CAR (continued)</b>								
<b>FALCON (continued)</b>								
L6	L6 2.8L 170ci	1962-65	Trans	Auto	1			EM-2253
			Trans	Manual	1			EM-2253
		1960-61	Trans		1			EM-2171
			Trans		1			EM-2171
	L6 3.3L 200ci	1966-70	L & R Front		2	EM-2333		
			1963-65	LH Front		1	EM-2226	
			RH Front		1	EM-2225		
		1966-70	Trans	Auto	1			EM-2253
			Trans	Manual	1			EM-2253
		1963-65	Trans		1			EM-2171
V8	V8 4.3L 260ci	1963-64	LH Front		1	EM-2220		
			RH Front		1	EM-2221		
			Trans		1		EM-2171	
	V8 4.7L 289ci	1966-68	L & R Front		2	EM-2257		
			1964-65	LH Front	exc Convertible	1	EM-2220	
			RH Front	exc Convertible	1	EM-2221		
		1966-68	Trans	Auto	1			EM-2253
			Trans	Manual	1			EM-2253
	1964-65	Trans		1			EM-2171	
	V8 5.0L 302ci	1968-70	L & R Front		2	EM-2257		
			Trans	Auto	1			EM-2253
			Trans	Manual	1			EM-2253
	<b>FESTIVA</b>							
L4	L4 1.3L 1295cc	1990-93	Front	Manual	1	EM-2654		
			RH Front	Auto	1	EM-8511		
			RH Front	Manual	1	EM-2655		
		1988-89	RH Front	Manual	1	EM-2655		
		1988-93	Trans	Manual	1			EM-2653
<b>FIESTA</b>								
L4	L4 1.6L 1596cc	2011-13	Torq Str - Rear		1		EM-3193	
<b>FIVE HUNDRED</b>								
V6	V6 3.0L 183ci	2005-07	Front		1	EM-3079*		
			Rear		1	EM-3080*		
			Torq Str - Upper	Insert Only	1		EM-4028	
<b>FOCUS</b>								
L4	L4 2.0L 121ci	2012-14	Torq Str - Front	Electric Vehicle	1		EM-4110	
		2008-09	Torq Str - Front		1		EM-3087	
		2013	RH Front	To 2/4/13; Insert	1	EM-3103		
		2012	RH Front	Insert	1	EM-3103		
		2008-11	RH Front	Auto; Complete Unit	1	EM-4082		
			RH Front	Insert	1	EM-3103		
		2005-07	RH Front		1	EM-3103		
		2013-14	Torq Str - Front	Exc. ST Model	1		EM-4057	
			Torq Str - Front	ST Model Only - Per Ford TSB	1		EM-4110	
		2011-12	Torq Str - Front		1		EM-4057	
		L4 2.0L 1989cc DOH			exc SVT	1	EM-3003*	
					SVT	1	EM-3085*	
	L4 2.0L 1989cc SOH			SOHC	1	EM-2938*		
	L4 2.0L 1989cc DOH			DOHC	1	EM-3003*		
	L4 2.0L 1989cc	2000-07	Torq Str - Rear		1		EM-2939	
			2000-11	Trans	Auto	1		EM-2986
			Trans	Manual	1		EM-2986	
L4 2.3L	2003-07	RH Front		1	EM-3103			
		Torq Str - Rear		1		EM-3100		
L4 2.3L 140ci	2007	Trans	Auto	1		EM-2986		

# Engine, Transmission, And Torque Strut Mounts

CYL	ENG. SIZE	YEAR	LOCATION	DESCRIPTION	QTY	ENGINE	TORQUE STRUT	TRANSMISSION
<b>FORD PASSENGER CAR (continued)</b>								
<b>FOCUS (continued)</b>								
L4	L4 2.3L 140ci	2007	Trans	Manual	1			EM-2986
		2005-06	Trans	Manual	1			EM-2986
		2003-04	Trans	Auto	1			EM-2986
			Trans	Manual	1			EM-2986
<b>FREESTYLE</b>								
V6	V6 3.0L	2005-07	LH Front		1	EM-3080*		
			RH Front		1	EM-3079*		
	V6 3.0L 183ci	2005-07	Torq Str - Upper	Insert Only	1		EM-4028	
<b>FUSION</b>								
L4	L4 2.3L	2006-08	Torq Str - Front		1		EM-3107	
	L4 2.3L 140ci	2006-09	Right		1	EM-4044		
			Trans		1		EM-4034	
	L4 2.5L 153ci	2010-12	Torq Str - Front	Hybrid	1		EM-4058	
Trans			Gas; Manual	1		EM-4034		
V6	V6 3.0L	2007-09	Torq Str - Front	AWD	1		EM-3105	
			Torq Str - Front	FWD	1		EM-3107	
		2006	Torq Str - Front		1		EM-3107	
			Torq Str - Front		1		EM-3105	
	V6 3.0L 183ci	2006-09	Right		1	EM-4044		
			Trans		1		EM-4034	
	V6 3.5L	2010-12	Torq Str - Front		1		EM-4059	
<b>GALAXIE</b>								
L6	L6 3.9L 240ci	1965-67	L & R Front		2	EM-2319		
			Trans	Auto	1		EM-2242	
			Trans	Manual	1		EM-2242	
V8	V8 4.3L 260ci	1964	LH Front		1	EM-2220		
			RH Front		1	EM-2221		
			Trans	Auto	1		EM-2242	
			Trans	Manual	1		EM-2242	
	V8 4.7L 289ci	1965-67	L & R Front		2	EM-2287		
			1963-64	LH Front		1	EM-2220	
		1963-67	RH Front		1	EM-2221		
			Trans	Auto	1		EM-2242	
			Trans	Manual	1		EM-2242	
	V8 5.8L 352ci	1959-62	L & R Front		2	EM-2141		
		1965-66	LH Front		1	EM-2241		
		1963-64	LH Front		1	EM-2223		
		1965-66	RH Front		1	EM-2240		
		1963-64	RH Front		1	EM-2222		
			Trans	Auto	1		EM-2242	
1959-66	Trans	Manual	1		EM-2242			
	V8 6.4L 390ci	1962	L & R Front		2	EM-2141		
1963-64		LH Front		1	EM-2223			
		RH Front		1	EM-2222			
1962-67		Trans	Auto	1		EM-2242		
	Trans	Manual	1		EM-2242			
V8 7.0L 427ci	1965-67	LH Front		1	EM-2241			
		RH Front		1	EM-2240			
		Trans	Auto	1		EM-2242		
		Trans	Manual	1		EM-2242		
V8 7.0L 428ci	1966-67	Trans	Auto	1		EM-2242		
		Trans	Manual	1		EM-2242		

# Engine, Transmission, And Torque Strut Mounts

CYL	ENG. SIZE	YEAR	LOCATION	DESCRIPTION	QTY	ENGINE	TORQUE STRUT	TRANSMISSION	
<b>FORD PASSENGER CAR (continued)</b>									
<b>GALAXIE 500</b>									
L6	L6 3.9L 240ci	1968-72	L & R Front		2	EM-2319			
		1969-72	Trans		1			EM-2311	
		1968	Trans	Auto		1			EM-2242
			Trans	Manual		1			EM-2242
V8	V8 5.0L 302ci	1968-72	L & R Front		2	EM-2287			
		1969-72	Trans	Auto	1			EM-2311	
			Trans	Manual	1			EM-2311	
		1968	Trans	Auto	1			EM-2242	
			Trans	Manual	1			EM-2242	
		V8 5.8L 351ci	1969-72	L & R Front		2	EM-2287		
			1969-74	Trans	Auto	1			EM-2311
				Trans	Manual	1			EM-2311
	V8 6.4L 390ci	1969-71	LH Front		1	EM-2271			
			1968	LH Front		1	EM-2241		
		1969-71	RH Front		1	EM-2270			
			1968	RH Front		1	EM-2240		
		1968-71	Trans	Auto	1			EM-2242	
			Trans	Manual	1			EM-2242	
	V8 6.6L 400ci	1971-74	LH Front		1	EM-2359			
			RH Front		1	EM-2358			
			Trans	Auto	1			EM-2345	
			Trans	Manual	1			EM-2345	
	V8 7.0L 427ci	1968	LH Front		1	EM-2241			
			RH Front		1	EM-2240			
			Trans	Auto	1			EM-2242	
			Trans	Manual	1			EM-2242	
	V8 7.0L 428ci	1969	LH Front		1	EM-2271			
		1968	LH Front		1	EM-2241			
1969		RH Front		1	EM-2270				
1968		RH Front		1	EM-2240				
1968-69		Trans	Auto	1			EM-2242		
		Trans	Manual	1			EM-2242		
V8 7.0L 429ci	1969-73	LH Front		1	EM-2368				
		RH Front		1	EM-2367				
		Trans	CM (C-4/C-6)	1			EM-2311		
		Trans	FMX (AOD)	1			EM-2345		
		Trans	Auto	1			EM-2345		
V8 7.5L 460ci	1973-74	Trans	Auto	1			EM-2345		
		Trans	Manual	1			EM-2345		
<b>GHIA (MEXICAN VEHICLE)</b>									
L4	L4 2.3L	1990-91	LH Front	Auto; Bracket Only	1	EM-5063			
			LH Front	Manual; Bracket Only	1	EM-5065			
			RH Front		1	EM-2558			
			Trans	Auto; Hydraulic Mount	1			EM-2696	
			Trans	Manual	1			EM-2665	
V6	V6 3.0L	1992-94	LH Front		1	EM-2804			
			RH Front		1	EM-2805			
			Trans	Auto; Hydraulic Mount	1			EM-2696	
			Trans	Manual	1			EM-2665	
<b>GRAND MARQUIS (MEXICAN VEHICLE)</b>									
V8	V8 4.6L 281ci	1998-01	LH Front		1	EM-2861			
		1995-97	LH Front		1	EM-2807			
		1998-01	RH Front		1	EM-2860			
		1995-97	RH Front		1	EM-2806			
		1998-01	Trans		1			EM-2822	
		1993-97	Trans		1			EM-2822	

# Engine, Transmission, And Torque Strut Mounts

CYL	ENG. SIZE	YEAR	LOCATION	DESCRIPTION	QTY	ENGINE	TORQUE STRUT	TRANSMISSION
<b>FORD PASSENGER CAR (continued)</b>								
<b>GRAN TORINO</b>								
L6	L6 4.1L 250ci	1973-74	Trans		1			EM-2347
		1972	Trans	Auto	1			EM-2253
			Trans	Manual	1			EM-2253
V8	V8 5.0L 302ci	1972-74	LH Front		1	EM-2370		
			RH Front		1	EM-2371		
		1973-74	Trans	C4	1			EM-2372
			Trans	FMX (AOD)	1			EM-2347
			Trans	Manual	1			EM-2347
		1972	Trans		1			EM-2372
	V8 5.8L 351ci	1975-76	L & R Front	Modified Engine	2	EM-2371		
			L & R Front	Windsor Engine	2	EM-2370		
		1972-74	LH Front		1	EM-2371		
	V8 6.6L 400ci	1972-76	RH Front		1	EM-2370		
			Trans		1			EM-2347
			Trans		1			EM-2347
V8 7.0L 429ci	1972-73	LH Front		1	EM-2367			
		RH Front		1	EM-2723			
		Trans		1			EM-2253	
V8 7.5L 460ci	1974-76	Trans		1			EM-2347	
<b>GRANADA</b>								
L4	L4 2.3L 140ci	1981-82	LH Front		1	EM-2458		
			RH Front		1	EM-2457		
			Trans	Auto	1			EM-2388
			Trans	Manual	1			EM-2388
L6	L6 3.3L 200ci	1981-82	L & R Front	Column Shift	2	EM-2776		
			L & R Front	Floor Shift	2	EM-2385		
		1975	L & R Front		2	EM-2341		
			LH Front		1	EM-2434		
		1976-77	RH Front		1	EM-2433		
			Trans	Auto	1			EM-2388
		1982	Trans	Manual	1			EM-2388
			Trans	Auto	1			EM-2389
	1981	Trans	Auto	1			EM-2389	
		Trans	Manual	1			EM-2389	
	1975-77	Trans	Auto	1			EM-2253	
		Trans	Manual	1			EM-2253	
L6	L6 4.1L 250ci	1975	L & R Front		2	EM-2341		
		1976-80	LH Front		1	EM-2434		
			RH Front		1	EM-2433		
		1975-80	Trans	Auto	1			EM-2253
			Trans	Manual	1			EM-2253
V6	V6 3.8L 232ci	1982	LH Front		1	EM-2500		
			RH Front		1	EM-2501		
			Trans	Auto	1			EM-2389
			Trans	Manual	1			EM-2389
V8	V8 4.2L 255ci	1981	LH Front		1	EM-2500		
		1980	LH Front		1	EM-2504		
		1981	RH Front		1	EM-2501		
		1980	RH Front		1	EM-2503		
		1980-81	Trans	Auto	1			EM-2388
			Trans	Manual	1			EM-2388
	V8 5.0L 302ci	1976-80	LH Front		1	EM-2504		
			RH Front		1	EM-2503		
		1975-80	Trans	Auto	1			EM-2253
			Trans	Manual	1			EM-2253
V8 5.8L 351ci	1975-77	LH Front		1	EM-2504			

# Engine, Transmission, And Torque Strut Mounts

CYL	ENG. SIZE	YEAR	LOCATION	DESCRIPTION	QTY	ENGINE	TORQUE STRUT	TRANS-MISSION
<b>FORD PASSENGER CAR (continued)</b>								
<b>GRANADA (continued)</b>								
V8	V8 5.8L 351ci	1975-77	RH Front		1	EM-2503		
			Trans	Auto	1		EM-2253	
			Trans	Manual	1		EM-2253	
<b>LTD</b>								
L4	L4 2.3L 140ci	1983-86	LH Front		1	EM-2458		
			RH Front		1	EM-2457		
			Trans	Auto	1		EM-2388	
L6	L6 3.3L 200ci	1983	RH Front		1	EM-2341		
			Trans	Auto	1		EM-2388	
			Trans	Manual	1		EM-2388	
V6	V6 3.8L 232ci	1986	LH Front		1	EM-2682		
		1985	LH Front	After 12/1/84	1	EM-2682		
			LH Front	Before 12/1/84	1	EM-2500		
		1983-84	LH Front		1	EM-2500		
		1986	RH Front		1	EM-2683		
		1985	RH Front	After 12/1/84	1	EM-2683		
			RH Front	Before 12/1/84	1	EM-2501		
		1983-84	RH Front		1	EM-2501		
		1985-86	Trans	Auto	1		EM-2388	
		1984	Trans	Auto	1		EM-2388	
		1983	Trans	Auto	1		EM-2388	
Trans	Manual	1		EM-2388				
V8	V8 4.2L 255ci	1981-82	LH Front		1	EM-2438		
			RH Front		1	EM-2437		
			Trans		1		EM-2464	
	V8 4.7L 289ci	1967-68	L & R Front		2	EM-2287		
			Trans	Auto	1		EM-2242	
			Trans	Manual	1		EM-2242	
	V8 5.0L 302ci	1977-78	L & R Front		2	EM-2287		
			1968-72	L & R Front		2	EM-2287	
				LH Front		1	EM-2438	
			1979-86	RH Front		1	EM-2437	
				Trans		1		EM-2464
			1968-72	Trans	Auto	1		EM-2311
	Trans	Manual	1		EM-2311			
	V8 5.8L 351ci	1969-78	L & R Front		2	EM-2287		
			1979-86	LH Front		1	EM-2438	
		RH Front			1	EM-2437		
		Trans			1		EM-2464	
		1975-78	Trans	Auto	1		EM-2311	
		1972-74	Trans	Auto	1		EM-2311	
			Trans	Manual	1		EM-2311	
		1970-71	Trans	Auto	1		EM-2242	
			Trans	Manual	1		EM-2242	
		1969	Trans	Auto	1		EM-2311	
			Trans	Manual	1		EM-2311	
	V8 6.4L 390ci	1969-71	LH Front		1	EM-2271		
		1968	LH Front		1	EM-2241		
		1969-71	RH Front		1	EM-2270		
		1968	RH Front		1	EM-2240		
1965-71		Trans		1		EM-2253		
V8 6.6L 400ci	1971-78	LH Front		1	EM-2359			
		RH Front		1	EM-2358			
		Trans		1		EM-2345		
V8 7.0L 427ci	1965-68	LH Front		1	EM-2241			
		RH Front		1	EM-2240			
		Trans	Auto	1		EM-2242		

# Engine, Transmission, And Torque Strut Mounts

CYL	ENG. SIZE	YEAR	LOCATION	DESCRIPTION	QTY	ENGINE	TORQUE STRUT	TRANSMISSION		
<b>FORD PASSENGER CAR (continued)</b>										
<b>LTD (continued)</b>										
V8	V8 7.0L 427ci	1965-68	Trans	Manual	1			EM-2242		
		1969	LH Front		1	EM-2271				
	V8 7.0L 428ci	1967-68	LH Front			1	EM-2241			
		1969	RH Front			1	EM-2270			
		1967-68	RH Front			1	EM-2240			
			Trans	Auto			1			EM-2242
		Trans	Manual			1			EM-2242	
		V8 7.0L 429ci	1973	LH Front			1	EM-2368		
	1969-72		LH Front			1	EM-2723			
	1973		RH Front			1	EM-2367			
	1969-72		RH Front			1	EM-2724			
	1969-73		Trans	AOD			1			EM-2345
			Trans	CM (C-4/C-6)			1			EM-2311
	V8 7.5L 460ci	1972-78	LH Front			1	EM-2368			
			RH Front			1	EM-2367			
Trans					1			EM-2345		
<b>LTD II</b>										
V8	V8 5.0L 302ci	1977-79	LH Front		1	EM-2371				
			RH Front		1	EM-2370				
			Trans		1			EM-2388		
	V8 5.8L 351ci	1977-79	LH Front	Modified Engine		1	EM-2365			
			LH Front	Windsor Engine		1	EM-2370			
			RH Front	Modified Engine		1	EM-2364			
			RH Front	Windsor Engine		1	EM-2371			
			Trans			1			EM-2464	
<b>MAINLINE</b>										
V8	V8 4.5L 272ci	1955-56	L & R Front		2	EM-2110				
	V8 5.1L 312ci	1956	L & R Front		2	EM-2110				
<b>MAVERICK</b>										
L6	L6 2.8L 170ci	1970-72	L & R Front		2	EM-2333				
			Trans	Auto		1			EM-2253	
			Trans	Manual		1			EM-2253	
	L6 3.3L 200ci	1973-77	L & R Front			2	EM-2341			
			1970-72	L & R Front		2	EM-2333			
			1970-77	Trans	Auto		1			EM-2253
				Trans	Manual		1			EM-2253
	L6 4.1L 250ci	1973-77	L & R Front			2	EM-2341			
			1970-72	L & R Front		2	EM-2333			
			1970-77	Trans	Auto		1			EM-2253
Trans	Manual			1			EM-2253			
V8	V8 5.0L 302ci	1971-77	L & R Front		2	EM-2316				
			Trans	Auto		1			EM-2253	
			Trans	Manual		1			EM-2253	
<b>MUSTANG</b>										
L4	L4 2.3L 140ci	1987-93	LH Front		1	EM-5109				
		1983-86	LH Front	exc Convertible	1	EM-2458				
		1979-82	LH Front		1	EM-2458				
		1987-93	RH Front		1	EM-5108				
		1983-86	RH Front	exc. Convertible	1	EM-2457				
		1979-82	RH Front		1	EM-2457				
		1987-93	Trans	Auto			1			EM-2707
			Trans	Manual			1			EM-2388
		1983-86	Trans	Auto			1			EM-2388
			Trans	Manual			1			EM-2388
		1979-82	Trans	Auto		1			EM-2565	

# Engine, Transmission, And Torque Strut Mounts

CYL	ENG. SIZE	YEAR	LOCATION	DESCRIPTION	QTY	ENGINE	TORQUE STRUT	TRANSMISSION	
<b>FORD PASSENGER CAR (continued)</b>									
<b>MUSTANG (continued)</b>									
L4	L4 2.3L 140ci	1979-82	Trans	Manual	1			EM-2388	
L6	L6 3.3L 200ci	1979-82	L & R Front		2	EM-2385			
		1967-70	L & R Front		2	EM-2333			
		1964-66	LH Front		1	EM-2226			
			RH Front		1	EM-2225			
		1982	Trans	Auto	1			EM-2388	
			Trans	Manual	1			EM-2388	
		1979-81	Trans		1			EM-2389	
		1964-70	Trans	Auto	1			EM-2253	
			Trans	Manual	1			EM-2253	
		L6 4.1L 250ci	1969-73	Trans	Auto	1		EM-2253	
Trans	Manual			1		EM-2253			
V6	V6 2.8L 171ci	1979	LH Front		1	EM-2458			
			RH Front		1	EM-2457			
			Trans	Auto	1		EM-2388		
			Trans	Manual	1		EM-2388		
	V6 3.7L 227ci	2011-15	L & R Front		2	EM-4029			
	V6 3.8L 232ci	1996-04	LH Front		1	EM-2904			
			1994-95	LH Front		1	EM-2998		
			1985-86	LH Front	exc Convertible	1	EM-2683		
			1984	LH Front	Convertible	1	EM-2683		
				LH Front	Coupe	1	EM-2682		
			1983	LH Front	Convertible	1	EM-2683		
				LH Front	Coupe; Hatchback	1	EM-2500		
			1996-04	RH Front		1	EM-2905		
			1994-95	RH Front		1	EM-2997		
			1985-86	RH Front	exc Convertible	1	EM-2683		
			1984	RH Front	Convertible	1	EM-2683		
				RH Front	Coupe	1	EM-2683		
			1983	RH Front	Convertible	1	EM-2501		
				RH Front	Coupe; Hatchback	1	EM-2501		
			1996	Trans	After 11/7/95	1			EM-2707 *
				Trans	Before 11/7/95	1			EM-2707 *
			1999-04	Trans		1			EM-5380
			1997-98	Trans		1			EM-2784
			1996	Trans		1			EM-2784
				Trans		1			EM-2784
	1994-95	Trans	Auto	1			EM-2707 *		
		Trans	Manual	1			EM-2707 *		
	1985-86	Trans	Auto; C5	1			EM-2389		
	1983-84	Trans	C3 & C5	1			EM-2389		
	V6 3.9L 238ci	2004	LH Front		1	EM-2904			
			RH Front		1	EM-2905			
			Trans		1		EM-5380		
	V6 4.0L 245ci	2005-10	L & R Front		2	EM-4029			
V8	V8 4.2L 255ci	1980-82	LH Front		1	EM-2458			
			RH Front		1	EM-2457			
			Trans	Auto	1		EM-2388		
			Trans	Manual	1		EM-2388		
V8 4.3L 260ci	1964	LH Front		1	EM-2220				
		RH Front		1	EM-2221				
		Trans		1		EM-2171			
V8 4.6L 281ci	2005-10	L & R Front		2	EM-4029				
		1998-04	LH Front	w/o Appearance Group	1	EM-3002			
			RH Front	w/o Appearance Group	1	EM-3001			
		1999-04	Trans	Exc. Cobra SVT	1			EM-5380	
1996-98	Trans		1			EM-2784			

# Engine, Transmission, And Torque Strut Mounts

CYL	ENG. SIZE	YEAR	LOCATION	DESCRIPTION	QTY	ENGINE	TORQUE STRUT	TRANSMISSION	
<b>FORD PASSENGER CAR (continued)</b>									
<b>MUSTANG (continued)</b>									
V8	V8 4.7L 289ci	1967-68	L & R Front		2	EM-2257			
		1966	L & R Front	After 3/66	2	EM-2257			
			LH Front	Before 3/66	1	EM-2220			
		1964-65	LH Front			1	EM-2220		
		1966	RH Front	Before 3/66		1	EM-2221		
		1964-65	RH Front			1	EM-2221		
			1964-68	Trans	Auto		1		
		Trans	Manual		1			EM-2253	
	V8 5.0L 302ci	1973	L & R Front	Convertible		2	EM-2286		
			L & R Front	Coupe		2	EM-2257		
		1968-72	L & R Front			2	EM-2257		
		1993-95	LH Front			1	EM-2725		
		1992	LH Front	Convertible		1	EM-2725		
			LH Front	Exc. Convertible Before 2/20/1992		1	EM-2682		
		1985-91	LH Front	Convertible		1	EM-2725		
		1984	LH Front	Convertible		1	EM-2725		
			LH Front	Coupe		1	EM-2682		
		1982-83	LH Front			1	EM-2458		
		1979	LH Front			1	EM-2458		
		1993-95	RH Front			1	EM-2726		
		1992	RH Front	Convertible		1	EM-2726		
			RH Front	Exc. Convertible Before 2/20/1992		1	EM-2683		
		1985-91	RH Front	Convertible		1	EM-2726		
		1984	RH Front	Convertible		1	EM-2726		
			RH Front	Coupe		1	EM-2683		
		1982-83	RH Front			1	EM-2457		
		1979	RH Front			1	EM-2457		
		1994-95	Trans			1			EM-2784
		1987-93	Trans	Auto		1			EM-2388
			Trans	Manual		1			EM-2388
		1982-85	Trans	Auto		1			EM-2388
			Trans	Manual		1			EM-2388
		1979	Trans	Auto		1			EM-2388
			Trans	Manual		1			EM-2388
		1968-73	Trans	Auto		1			EM-2253
	Trans		Auto		1			EM-2253	
	Trans		Manual		1			EM-2253	
	V8 5.8L 351ci	1969-73	L & R Front	exc Convertible		2	EM-2257		
			Trans	Auto		1			EM-2253
			Trans	Manual		1			EM-2253
	V8 6.4L 390ci	1967-69	L & R Front			2	EM-2257		
			Trans	Auto		1			EM-2253
Trans			Manual		1			EM-2253	
V8 7.0L 428ci	1970	L & R Front			2	EM-2257			
		LH Front			1	EM-2241			
	1968-69	RH Front			1	EM-2240			
		Trans	Auto		1			EM-2253	
		Trans	Manual		1			EM-2253	
V8 7.0L 429ci	1969-71	LH Front			1	EM-2724			
		RH Front			1	EM-2723			
		Trans	Auto		1			EM-2253	
		Trans	Manual		1			EM-2253	



# Engine, Transmission, And Torque Strut Mounts

CYL	ENG. SIZE	YEAR	LOCATION	DESCRIPTION	QTY	ENGINE	TORQUE STRUT	TRANSMISSION			
<b>FORD PASSENGER CAR (continued)</b>											
<b>MUSTANG II</b>											
L4	L4 2.0L 1989cc	1974	L & R Front		2	EM-2363					
			Trans	Auto	1			EM-2346			
			Trans	Manual	1			EM-2346			
	L4 2.3L 140ci	1974-78	L & R Front		2	EM-2344					
			Trans	Auto	1			EM-2565			
			Trans	Manual	1			EM-2565			
V6	V6 2.8L 171ci	1974-78	LH Front		1	EM-2344					
		1975-78	Trans	Auto	1			EM-2566			
			Trans	Manual	1			EM-2566			
		1974	Trans	Auto	1			EM-2388			
			Trans	Manual	1			EM-2388			
V8	V8 5.0L 302ci	1975-78	Trans	Auto	1			EM-2566			
			Trans	Manual	1			EM-2566			
<b>MYSTIQUE (MEXICAN VEHICLE)</b>											
L4	L4 2.0L	1994-97	Front	Auto; Insert Only	1	EM-2866					
			RH Front	Complete Unit	1	EM-2899					
			RH Front	Insert Only	1	EM-5105					
			Trans - Front	Complete Unit	1			EM-2873			
			Trans - Front	Insert Only	1			EM-5106			
			Trans - Front	Manual; Complete Unit	1			EM-5381			
			Trans - Rear	Mexican Vehicle; Complete Unit; Auto	1			EM-5107			
			Trans - Rear	Mexican Vehicle; Insert Only Auto	1			EM-2887			
			L4 2.5L	1998-00	1998-00	Front	Auto; Insert Only	1	EM-2885		
					1995-97	Front	Auto; Insert Only	1	EM-2886		
	1998-00	RH Front			Hydraulic Mount	1	EM-5352				
	1995-97	RH Front			Complete Unit	1	EM-2889				
	1995-97	RH Front			Insert Only	1	EM-5105				
	1998-00	Trans - Front			Auto; Complete Unit	1			EM-2873		
	1998-00	Trans - Front			Auto; Insert Only	1			EM-5106		
	1995-97	Trans - Front			Auto; Complete Unit	1			EM-2873		
	1995-97	Trans - Front			Auto; Insert Only	1			EM-5106		
	1998-00	Trans - Rear			Auto; Insert Only	1			EM-2888		
	1995-97	Trans - Rear			Auto; Complete Unit	1			EM-5107		
	1995-97	Trans - Rear	Auto; Insert Only	1			EM-2887				
	<b>PARK LANE WAGON</b>										
V8	V8 4.5L 272ci	1956	L & R Front		2	EM-2110					
<b>PINTO</b>											
L4	L4 1.6L 1598cc	1971-73	L & R Front		2	EM-2363					
			Trans	Auto	1			EM-2471			
			Trans	Manual	1			EM-2471			
	L4 2.0L 1989cc	1971-74	1973-74	L & R Front		2	EM-2363				
				Trans	Auto	1			EM-2346		
			1972	Trans	Manual	1			EM-2346		
				Trans	Auto	1			EM-2471		
				Trans	Manual	1			EM-2471		
	L4 2.3L 140ci	1974-80	L & R Front		2	EM-2344					
			Trans	Auto	1			EM-2346			
			Trans	Manual	1			EM-2346			
	V6	V6 2.8L 171ci	1975-79	L & R Front		2	EM-2344				
Trans				Auto	1			EM-2346			
Trans				Manual	1			EM-2346			

# Engine, Transmission, And Torque Strut Mounts

CYL	ENG. SIZE	YEAR	LOCATION	DESCRIPTION	QTY	ENGINE	TORQUE STRUT	TRANS-MISSION
<b>FORD PASSENGER CAR (continued)</b>								
<b>PROBE</b>								
L4	L4 2.0L 1989cc	1994-97	Front	Auto	1	EM-5155		
			Front	Manual	1	EM-8073		
		1993	Front	Auto	1	EM-5110		
			Front	Manual	1	EM-8073		
		1994-97	RH Front		1	EM-8074		
		1993	RH Front		1	EM-8074		
		1994-97	Rear	Auto	1	EM-8691		
			Rear	Manual	1	EM-8456		
		1993	Rear	Auto	1	EM-8075		
			Rear	Manual	1	EM-8456		
		1994-97	Trans - Center Lower	Auto	1			EM-9087
			Trans - Center Lower	Manual	1			EM-9082
	1993	Trans - Center Lower	Auto	1			EM-9087	
		Trans - Center Lower	Manual	1			EM-9082	
	1994-97	Trans - Upper	Auto	1			EM-8691	
	1993	Trans - Upper	Auto	1			EM-8075	
		Trans - Upper	Manual	1			EM-8456	
	L4 2.2L 133ci	1989-92	Front	Auto; GL; LX	1	EM-8083		
			Front	Manual	1	EM-8085		
			RH Front	GL, LX	1	EM-9131		
RH Front			Manual; GT	1	EM-8086			
Rear			Auto; GL; LX	1	EM-8087			
Rear			GT	1	EM-8080			
Rear			Manual; GL; LX	1	EM-8088			
Trans			Auto	1			EM-8516	
Trans	Manual	1			EM-8089			
V6	V6 2.5L 2450cc	1993-97	Front		1	EM-8073		
			LH Rear	Auto	1	EM-8075		
			LH Rear	Manual	1	EM-8456		
			Trans - Center Lower	Auto	1			EM-9087
	Trans - Center Lower	Manual	1			EM-9082		
	V6 3.0L 182ci	1990-92	Front	Manual	1	EM-8085		
Rear				1	EM-8087			
<b>RANCH WAGON</b>								
V8	V8 4.5L 272ci	1955-57	L & R Front		2	EM-2110		
<b>SABLE (MEXICAN VEHICLE)</b>								
V6	V6 3.0L 182ci	2000-01	RH Front	Hydraulic Mount	1	EM-2894'		
			1997-99	RH Front	Hydraulic Mount; DOHC	1	EM-2934'	
		1996	RH Front	Hydraulic Mount	1	EM-2934'		
		2000-01	RH Rear	DOHC	1	EM-2862		
		1997-99	RH Rear	DOHC	1	EM-2862		
		1996	RH Rear		1	EM-2862		
		2000-01	Torg Str - Rear		1			EM-2872
			Trans	Hydraulic Mount	1			EM-2974 *
	1996-99	Trans	Hydraulic Mount	1			EM-2717 *	
	V6 3.8L 232ci	1995	RH Front	Hydraulic Mount	1	EM-2812'		
RH Rear			Hydraulic Mount	1	EM-2813'			
Trans			Hydraulic Mount	1			EM-2717 *	

# Engine, Transmission, And Torque Strut Mounts

CYL	ENG. SIZE	YEAR	LOCATION	DESCRIPTION	QTY	ENGINE	TORQUE STRUT	TRANSMISSION
<b>FORD PASSENGER CAR (continued)</b>								
<b>SCORPIO (MEXICAN VEHICLE)</b>								
L4	L4 2.3L	1989	LH Front		1	EM-5109		
			RH Front		1	EM-5108		
			Trans	Auto; Hydraulic Mount	1			EM-2707
			Trans	Manual	1			EM-2784
<b>SKYLINER</b>								
V8	V8 4.5L 272ci	1955-57	L & R Front		2	EM-2110		
<b>SUNLINER</b>								
V8	V8 4.5L 272ci	1955-57	L & R Front		2	EM-2110		
<b>SUPER DELUXE</b>								
V8	V8 3.9L 239ci	1946-48	L & R Front Upper		2	EM-2009		
<b>TAURUS X</b>								
V6	V6 3.5L	2008-09	RH Front		1	EM-5427		
			Torq Str - Rear		1		EM-3142	
			Trans - Upper		1			EM-4040
<b>TAURUS</b>								
L4	L4 2.5L 153ci	1986-91	RH Front		1	EM-2692		
			RH Rear		1	EM-2770		
		1988-91	Trans	Auto	1			EM-2686
		1986-87	Trans	Auto	1			EM-2687
V6	V6 3.0L	2006-07	RH Front		1	EM-2894'		
			RH Rear		1	EM-2973'		
			Torq Str - Rear		1		EM-3099	
		2004-05	Torq Str - Rear	OHV; VIN2; VINU	1		EM-3099	
	V6 3.0L 182ci	2000-05	RH Front	DOHC	1	EM-2894'		
			RH Front	OHV	1	EM-2894'		
		1996-99	RH Front	DOHC	1	EM-2934'		
			RH Front	OHV	1	EM-2789'		
		1994-95	RH Front	exc SHO	1	EM-2790'		
		1993	RH Front	OHV	1	EM-2792'		
		1991-92	RH Front	OHV	1	EM-2791'		
		1986-90	RH Front	VIN U	1	EM-2623		
		2000-05	RH Rear	DOHC	1	EM-2862		
			RH Rear	OHV	1	EM-2973'		
		1996-99	RH Rear	DOHC	1	EM-2862		
			RH Rear	Hydraulic Mount; OHV	1	EM-2840'		
		1994-95	RH Rear	exc SHO	1	EM-2788'		
		1993	RH Rear	OHV	1	EM-2788'		
		1991-92	RH Rear	OHV	1	EM-2788'		
		1986-90	RH Rear	VIN U	1	EM-2622		
		2000-03	Torq Str - Rear		1		EM-2872	
		2000-07	Trans	Auto	1			EM-2974
		1990-99	Trans	Auto	1			EM-2717
		1988-89	Trans	Auto	1			EM-2686
	1986-87	Trans		1			EM-2687	
	V6 3.0L 182ci SHO Engine	1989-95	RH Front	VIN Y	1	EM-4005		
				VIN Y	1	EM-4005		
				VIN Y	1	EM-2964		
			Trans	Manual	1			EM-2717
	V6 3.2L 195ci SHO Engine	1993-95	Front		1	EM-2967'		
					1	EM-2967'		
			Trans	Auto	1	EM-2968'		EM-2717

# Engine, Transmission, And Torque Strut Mounts

CYL	ENG. SIZE	YEAR	LOCATION	DESCRIPTION	QTY	ENGINE	TORQUE STRUT	TRANSMISSION		
<b>FORD PASSENGER CAR (continued)</b>										
<b>TAURUS (continued)</b>										
V6	V6 3.5L	2013-14	Torq Str - Front	Turbo	1		EM-4056			
		2010-12	Torq Str - Front	Turbo	1		EM-4056			
		2008-09	Torq Str - Front	Exc. SHO	1		EM-3142			
		2013-14	Torq Str - Rear	Turbo	1		EM-4055			
		2010-12	Torq Str - Rear	Non Turbo	1		EM-3142			
			Torq Str - Rear	Turbo	1		EM-4055			
	V6 3.5L 213ci	2010-12	RH Front	Non Turbo	1	EM-5427				
		2008-09	RH Front		1	EM-5427				
		2010-13	Trans - Upper	Non Turbo	1			EM-4040		
		2008-09	Trans - Upper		1			EM-4040		
	V6 3.8L 232ci	1989-95	RH Front		1	EM-2812'				
		1988	RH Front		1	EM-2812'				
		1989-95	RH Rear		1	EM-2813'				
		1988	RH Rear		1	EM-2813'				
1988-95		Trans		1			EM-2717			
V8	V8 3.4L 207ci	1996-99	Front		1	EM-2934'				
			Rear		1	EM-2862				
			Trans		1			EM-2717		
<b>TEMPO</b>										
L4	L4 2.0L 1989cc Diesel	1984-86	Front	Manual; w/ Bracket	1	EM-5065				
			Front	Manual; w/o Bracket	1	EM-2559				
			LH Front	Auto; w/ Bracket	1	EM-5063				
	L4 2.3L 140ci	1992-94	1986-91	Front	Auto	1	EM-2804			
				Front	Manual	1	EM-2559			
				Front	Manual	1	EM-2559			
		1984-85	1986-91	1984-85	Front	Auto	1	EM-2558		
					LH Front	Auto; w/ Bracket	1	EM-5063		
					LH Front	Manual; w/ Bracket	1	EM-5065		
		1992-94	1986-91	1984-85	RH Front		1	EM-2805		
					RH Front		1	EM-2558		
					RH Front		1	EM-2558		
		1986-94	1984-85	1986-94	Trans	Auto	1		EM-2696	
					Trans	Manual; 5 Spd	1		EM-2665	
					Trans	Auto	1		EM-2632	
		1984-85	1986-94	1984-85	Trans	Manual; 4 Spd	1		EM-2634	
Trans	Manual; 5 Spd				1		EM-2665			
V6	V6 3.0L 182ci	1992-94	LH Front	Auto; Attached To Transaxle	1	EM-2804				
			Trans	Auto	1		EM-2696			
			Trans	Manual	1		EM-2665			
<b>THUNDERBIRD</b>										
L4	L4 2.3L 140ci	1983-84	LH Front		1	EM-5109				
			RH Front		1	EM-5108				
		1985-88	Trans	Auto	1			EM-2707		
			Trans	Manual	1			EM-2707		
		1983-84	Trans	Auto	1			EM-2388		
			Trans	Manual	1			EM-2388		
L6	L6 3.3L 200ci	1980-82	L & R Front		2	EM-2776				
		1982	Trans	Auto; AOT	1		EM-2784			
			Trans	Auto; C5	1		EM-2389			
		1981	Trans	Auto	1		EM-2389			
V6	V6 3.8L 232ci	1986-97	L & R Front		2	EM-2661'				
		1983-85	LH Front		1	EM-2682				
		1982	LH Front		1	EM-2500				
		1983-85	RH Front		1	EM-2683				
		1982	RH Front		1	EM-2501				

# Engine, Transmission, And Torque Strut Mounts

CYL	ENG. SIZE	YEAR	LOCATION	DESCRIPTION	QTY	ENGINE	TORQUE STRUT	TRANSMISSION		
<b>FORD PASSENGER CAR (continued)</b>										
<b>THUNDERBIRD (continued)</b>										
V6	V6 3.8L 232ci	1996-97	Trans	Auto	1			EM-2707		
		1989-95	Trans	Auto	1			EM-2707		
			Trans	Manual	1			EM-2707		
V8	V8 3.9L 242ci	2002-05	Trans		1			EM-3063		
	V8 4.2L 255ci	1980-82	LH Front	w/ Shake Condition	1	EM-2725				
			LH Front	w/o Shake Condition	1	EM-2500				
			RH Front	w/ Shake Condition	1	EM-2726				
			RH Front	w/o Shake Condition	1	EM-2501				
			Trans	Auto	1		EM-2388			
	V8 4.6L 281ci	1994-97	L & R Front		2	EM-2995				
			Trans	Auto	1		EM-2707			
			Trans	Auto	1		EM-2707			
	V8 4.8L	1955	L & R Front		2	EM-2110				
	V8 4.8L 292ci	1956-58	Center Front Lower		1	EM-2120				
	V8 5.0L 302ci	1991-93 1986-88 1977-79 1983-85 1980-81 1983-85 1980-81 1991-93 1983-88 1980-81 1977-79	L & R Front		2	EM-2995				
			L & R Front		2	EM-2661				
			L & R Front		2	EM-2371				
			LH Front		1	EM-2682				
			LH Front	Shake Condition	1	EM-2725				
			LH Front	w/o Shake Condition	1	EM-2500				
			RH Front		1	EM-2683				
			RH Front	Shake Condition	1	EM-2726				
			RH Front	w/o Shake Condition	1	EM-2501				
			Trans	Auto	1		EM-2707			
			Trans	Auto	1		EM-2388			
	V8 5.1L 312ci	1956-57	L & R Front		2	EM-2110				
			V8 5.8L 351ci	1977-79	LH Front	Modified Engine	1	EM-2365		
					LH Front	Windsor Engine	1	EM-2370		
					RH Front	Modified Engine	1	EM-2364		
					RH Front	Windsor Engine	1	EM-2371		
	Trans	Auto	1		EM-2464					
	V8 6.4L 390ci	1967-68	LH Front		1	EM-2241				
RH Front				1	EM-2240					
1961-66		Trans	Auto	1		EM-2242				
		Trans	Manual	1		EM-2242				
V8 6.6L 400ci	1977-78	LH Front		1	EM-2365					
		RH Front		1	EM-2364					
		Trans	Auto	1		EM-2464				
V8 7.0L 428ci	1966-67	LH Front		1	EM-2241					
		RH Front		1	EM-2240					
V8 7.0L 429ci	1968-73	LH Front		1	EM-2724					
		RH Front		1	EM-2723					
V8 7.5L 460ci	1972-75	LH Front		1	EM-2368					
		RH Front		1	EM-2367					
	1972-76	Trans		1		EM-2345				
<b>TORINO</b>										
L6	L6 4.1L 250ci	1969-71	L & R Front	Convertible	2	EM-2333				
		1973-74	Trans	Auto	1			EM-2347		
			Trans	Manual	1			EM-2347		
		1969-72	Trans	Auto	1			EM-2253		
			Trans	Manual	1			EM-2253		
V8	V8 4.7L 289ci	1968	L & R Front		2	EM-2257				
			Trans	Auto	1		EM-2253			

# Engine, Transmission, And Torque Strut Mounts

CYL	ENG. SIZE	YEAR	LOCATION	DESCRIPTION	QTY	ENGINE	TORQUE STRUT	TRANS-MISSION	
<b>FORD PASSENGER CAR (continued)</b>									
<b>TORINO (continued)</b>									
V8	V8 4.7L 289ci	1968	Trans	Manual	1			EM-2253	
	V8 5.0L 302ci	1968-71	L & R Front		2	EM-2257			
			LH Front		1	EM-2370			
		1972-74	RH Front		1	EM-2371			
			Trans	Auto	1			EM-2347	
		1972	Trans	Manual	1			EM-2347	
			Trans	Auto	1			EM-2372	
		1968-71	Trans	Manual	1			EM-2372	
			Trans	Auto	1			EM-2253	
		V8 5.8L 351ci	1975-76	L & R Front	Modified Engine	2	EM-2371		
				L & R Front	Windsor Engine	2	EM-2370		
	1969-71		L & R Front		2	EM-2257			
			LH Front		1	EM-2371			
	1972-74		RH Front		1	EM-2370			
			Trans		1			EM-2347	
	1972-74		Trans	Auto	1			EM-2347	
			Trans	Manual	1			EM-2347	
	1969-71		Trans	Auto	1			EM-2253	
			Trans	Manual	1			EM-2253	
	V8 6.4L 390ci	1968-69	LH Front		1	EM-2241			
			RH Front		1	EM-2240			
			Trans	Auto	1			EM-2253	
			Trans	Manual	1			EM-2253	
	V8 6.6L 400ci	1972-76	LH Front		1	EM-2365			
			RH Front		1	EM-2364			
			Trans		1			EM-2372	
	V8 7.0L 428ci	1968-69	LH Front		1	EM-2241			
			RH Front		1	EM-2240			
Trans			Auto	1			EM-2253		
Trans			Manual	1			EM-2253		
V8 7.0L 429ci	1970-73	LH Front		1	EM-2367				
		RH Front		1	EM-2723				
V8 7.5L 460ci	1973-76	Trans		1			EM-2372		
<b>VAGONETA (MEXICAN VEHICLE)</b>									
L4	L4 1.6L	1996-97	Front		1	EM-2651			
			RH Front		1	EM-2649			
			Rear	Complete Unit	1	EM-2650			
			Trans		1			EM-2815	
<b>VICTORIA</b>									
V8	V8 4.5L 272ci	1955-57	L & R Front		2	EM-2110			
<b>FORD SPORT UTILITY</b>									
<b>BRONCO</b>									
L6	L6 2.8L 170ci	1967-72	L & R Front		2	EM-2319			
			Trans		1			EM-2348	
	L6 3.9L 240ci	1967	LH Front		1	EM-2332			
			RH Front		1	EM-2331			
			Trans		1			EM-2349	
	L6 4.9L 300ci	1989-92	L & R Front		2	EM-2698			
			1985-88	LH Front		1	EM-2636		
			1980-84	LH Front		1	EM-2442		
			1985-88	RH Front		1	EM-2635		
			1980-84	RH Front		1	EM-2441		
1988-92	Trans	Auto	1			EM-2557			
	Trans	Manual	1			EM-2557			

# Engine, Transmission, And Torque Strut Mounts

CYL	ENG. SIZE	YEAR	LOCATION	DESCRIPTION	QTY	ENGINE	TORQUE STRUT	TRANSMISSION	
<b>FORD SPORT UTILITY (continued)</b>									
<b>BRONCO (continued)</b>									
L6	L6 4.9L 300ci	1987	Trans	Auto	1			EM-2557	
			Trans	Manual	1			EM-2557	
		1985-86	Trans	Auto	1				EM-2448
			Trans	Manual	1				EM-2448
		1980-84	Trans	Auto	1				EM-2448
			Trans	Manual	1			EM-2448	
V8	V8 4.7L 289ci	1966-68	L & R Front		2	EM-2329			
			Trans		1			EM-2348	
	V8 5.0L 302ci	1987-96	L & R Front		2	EM-2564			
			1980-86	L & R Front		2	EM-2329		
		1968-77	L & R Front		2	EM-2329			
		1994-96	Trans	Auto	1				EM-2884
			Trans	Manual	1				EM-2884
		1987-93	Trans	Auto	1				EM-2557
			Trans	Manual	1				EM-2557
		1985-86	Trans	Auto	1				EM-2448
			Trans	Manual	1				EM-2448
		1980-84	Trans	Auto	1				EM-2448
			Trans	Manual	1				EM-2448
		1968-77	Trans	Auto	1				EM-2448
			Trans	Manual	1				EM-2448
		V8 5.8L 351ci	1987-96	L & R Front		2	EM-2564		
	1983-86			L & R Front		2	EM-2329		
	1980-82		L & R Front		2	EM-2329			
	1978-79		L & R Front	Windsor Engine	2	EM-2329			
			LH Front	Modified Engine	1	EM-2445			
			RH Front	Modified Engine	1	EM-2444			
	1996		Trans	Auto	1				EM-2970
			Trans	Manual	1				EM-2970
	1994-95		Trans		1			EM-2870	
	1988-93		Trans	Auto	1				EM-2557
			Trans	Manual	1				EM-2557
	1985-86		Trans	Auto	1				EM-2448
			Trans	Manual	1				EM-2448
	1980-84		Trans	Auto	1				EM-2448
		Trans	Manual	1				EM-2448	
	V8 6.6L 400ci	1978-79	LH Front		1	EM-2445			
			RH Front		1	EM-2444			
			Trans	Auto	1			EM-2349	
Trans			Manual	1			EM-5111		
<b>BRONCO II</b>									
V6	V6 2.8L 171ci	1984-85	LH Front		1	EM-2940			
			RH Front		1	EM-2941			
	V6 2.9L 177ci	1986-90	LH Front	4WD	1	EM-2643			
			LH Front	RWD	1	EM-2642			
			RH Front		1	EM-2641			
			Trans	Auto	1			EM-2639	
			Trans	Manual	1			EM-2639	
<b>EDGE</b>									
L4	L4 2.0L 122ci	2012-14	Torq Str - Rear		1		EM-3142		
			Trans		1			EM-4081	
V6	V6 3.5L	2007-14	RH Front		1	EM-5427			
		2007-10	Torq Str - Front		1		EM-3144		
	V6 3.5L 213ci	2011-14	Torq Str - Rear		1		EM-3142		
		2007-14	Trans		1			EM-4081	
V6 3.7L 227ci	2011-14	RH Front		1	EM-5427				

# Engine, Transmission, And Torque Strut Mounts

CYL	ENG. SIZE	YEAR	LOCATION	DESCRIPTION	QTY	ENGINE	TORQUE STRUT	TRANSMISSION
<b>FORD SPORT UTILITY (continued)</b>								
<b>EDGE (continued)</b>								
V6	V6 3.7L 227ci	2011-14	Torq Str - Rear		1		EM-3142	
			Trans		1			EM-4081
<b>ESCAPE</b>								
L4	L4 2.0L 121ci	2013-14	Torq Str - Front		1		EM-4057	
	L4 2.0L 1989cc	2001-04	RH Front		1	EM-3056*		
			Rear		1	EM-3057*		
			Trans	Auto	1			EM-3037
	L4 2.3L	2005-08	Trans	Auto	1			EM-4117
	L4 2.3L 140ci	2005-08	LH Front	Gas	1	EM-4071		
			LH Front	Hybrid	1	EM-4071		
			Rear	Gas	1	EM-4019		
			Torq Str - Rear	Hybrid; Hybrid	1		EM-4051	
	L4 2.5L	2009-11	LH Front	Gas	1	EM-4071		
			Rear	Gas	1	EM-4019		
	L4 2.5L 2488cc	2009-12	Torq Str - Rear	Hybrid	1		EM-4051	
		2009-11	Trans	Auto	1			EM-4117
V6	V6 3.0L 182ci	2001-04	Front		1	EM-3056*		
			Trans		1			EM-3037
	V6 3.0L 183ci	2009-12	Front		1	EM-4033		
		2005-08	Front		1	EM-4071		
		2009-12	LH Front		1	EM-4071		
			Rear	FWD	1	EM-4019		
		2005-08	Rear		1	EM-4019		
			Right		1	EM-4033		
<b>EXCURSION</b>								
V8	V8 5.4L	2000-05	LH Front		1	EM-5424		
			RH Front	4WD	1	EM-5425		
	V8 5.4L 330ci	2000-05	Trans	Auto; w/o Damper	1			EM-2884
	V8 7.3L 445ci Diesel	2000-03	Trans	Auto; w/o Damper	1			EM-2884
V10	V10 6.8L 415ci	2000-05	Left	4WD	1	EM-4022		
		2000-04	Trans	Auto; w/o Damper	1			EM-2884
<b>EXPEDITION</b>								
V8	V8 4.6L	1997-02	LH Front	4WD	1	EM-2972		
			LH Front	RWD	1	EM-2832		
			RH Front		1	EM-2835		
	V8 4.6L 281ci	2004	Left		1	EM-4097		
		2003	Left		1	EM-4097		
		1997-04	Trans		1			EM-2870
	V8 5.4L 330ci	2005-06	LH Front		1	EM-4097		
		2004	LH Front		1	EM-4097		
		2003	LH Front		1	EM-4097		
		1999-02	LH Front	4WD	1	EM-2972		
			LH Front	RWD	1	EM-2832		
		1997-98	LH Front	4WD	1	EM-2972		
			LH Front	RWD	1	EM-2832		
		2005-06	RH Front		1	EM-4099		
		2004	RH Front		1	EM-4099		
		1999-02	RH Front		1	EM-2835		
		1997-98	RH Front	4WD	1	EM-2834		
			RH Front	RWD	1	EM-2835		
		1997-04	Trans		1			EM-2870
<b>EXPLORER</b>								
L4	L4 2.0L 122ci	2012-14	Torq Str - Front		1		EM-4120	
V6	V6 4.0L	2006-10	LH Front		1	EM-4106		
			RH Front		1	EM-3048		



# Engine, Transmission, And Torque Strut Mounts

CYL	ENG. SIZE	YEAR	LOCATION	DESCRIPTION	QTY	ENGINE	TORQUE STRUT	TRANSMISSION
<b>FORD SPORT UTILITY (continued)</b>								
<b>EXPLORER (continued)</b>								
V6	V6 4.0L	2006-10	Trans	4WD	1			EM-4095
			Trans	RWD	1			EM-3062
	V6 4.0L 245ci	2002-05 1997-01 1995-96 1991-94 2002-05 1997-01 1995-96 1991-94 2005 2004 2002-03 1991-01	LH Front		1	EM-3047		
			LH Front		1	EM-2851		
			LH Front		1	EM-2869		
			LH Front		1	EM-2643		
			RH Front		1	EM-3048		
			RH Front		1	EM-2850		
			RH Front		1	EM-2850		
			RH Front		1	EM-2641		
			Trans	4WD	1			EM-3061
			Trans	RWD	1			EM-3062
			Trans	AWD & 4WD	1			EM-3061
			Trans	RWD	1			EM-3062
			Trans	4WD	1			EM-3061
			Trans	RWD	1			EM-3062
Trans	Auto	1			EM-2639			
Trans	Manual	1			EM-2639			
V8	V8 4.6L	2007-10	LH Front		1	EM-4106		
			RH Front		1	EM-3048		
		2006-10	Trans	4WD	1			EM-4095
			Trans	RWD	1			EM-3062
	V8 4.6L 281ci	2002-06	LH Front		1	EM-3047		
			RH Front		1	EM-3048		
		2004-05	Trans	AWD & 4WD	1			EM-3061
			Trans	RWD	1			EM-3062
		2002-03	Trans	4WD	1			EM-3061
			Trans	RWD	1			EM-3062
	V8 5.0L 302ci	1996-01	LH Front		1	EM-3000		
			RH Front		1	EM-2999		
Trans				1			EM-2868	
<b>FLEX</b>								
V6	V6 3.5L	2013-14	Torq Str - Front	Turbo	1		EM-4056	
			Torq Str - Front	Non Turbo	1		EM-3142	
		2010-12	Torq Str - Front	Turbo	1		EM-4056	
			Torq Str - Front	Non Turbo	1		EM-3142	
		2013-14	Torq Str - Rear	Turbo	1		EM-4055	
			Torq Str - Rear	Turbo	1		EM-4055	
	V6 3.5L 213ci	2009-13	RH Front	Non Turbo	1	EM-5427		
	V6 3.5L 3456cc	2009-13	Trans - Upper	Non Turbo	1			EM-4040
<b>EXPLORER SPORT TRAC</b>								
V6	V6 4.0L	2007-10	RH Front		1	EM-3048		
	V6 4.0L 245ci	2001-05	LH Front		1	EM-2851		
			RH Front		1	EM-2850		
		2001-07	Trans	2WD	1			EM-2868
			Trans	4WD	1			EM-2639
V8	V8 4.6L	2007-10	RH Front		1	EM-3048		
<b>FORD TRUCK</b>								
<b>B SERIES</b>								
	L6 6.7L 408ci Diesel	1987-89	L & R Front		2	EM-2462		
			Trans	Auto	2			EM-2769
			Trans	Manual	2			EM-2769
V8	V8 10.4L 636ci	1983-87	Trans	Auto	1			EM-2753
			Trans	Manual	1			EM-2752

# Engine, Transmission, And Torque Strut Mounts

CYL	ENG. SIZE	YEAR	LOCATION	DESCRIPTION	QTY	ENGINE	TORQUE STRUT	TRANSMISSION
<b>FORD TRUCK (continued)</b>								
<b>C SERIES</b>								
V8	V8 10.4L 636ci	1978-82	Trans	Auto	1			EM-2753
			Trans	Manual	1			EM-2752
<b>COURIER SEDAN DELIVERY</b>								
V8	V8 4.4L	1955-57	L & R Front		2	EM-2110		
<b>COURIER</b>								
L4	L4 1.8L 110ci	1972-79	LH Front		1	EM-2775		
			RH Front		1	EM-2774		
		1975-79	Trans		1			EM-2759
		1972-74	Trans	Auto	1			EM-2759
			Trans	Manual	1			EM-2759
	L4 2.0L 1989cc	1981-82	LH Front		1	EM-2775		
			1979	LH Front		1	EM-2775	
		1981-82	RH Front		1	EM-2774		
			1979	RH Front		1	EM-2774	
		1981-82	Trans		1			EM-2759
			1979	Trans		1		EM-2759
	L4 2.3L 140ci	1977-82	LH Front		1	EM-2775		
			RH Front		1	EM-2774		
			Trans		1			EM-2759
<b>F SERIES</b>								
L6	L6 3.7L 223ci	1957-59	L & R Front Lower		2	EM-2048		
			L & R Front Upper		2	EM-2050		
			Trans - L & R Lower		2			EM-2121
			Trans - L & R Upper		2			EM-2119
	L6 3.7L 226ci	1949-50	Front		1	EM-5465		
V8	V8 3.9L 239ci	1948-51	L & R Front Lower		2	EM-2010		
			L & R Front Upper		2	EM-2009		
		1953-55	Trans - Lower		1			EM-2121
			Trans - Upper		1			EM-2119
	V8 4.5L 272ci	1957	L & R Front Lower		2	EM-2048		
			L & R Front Upper		2	EM-2050		
			Trans - L & R Lower		2			EM-2121
			Trans - L & R Upper		2			EM-2119
	V8 4.8L 292ci	1957-59	L & R Front Lower		2	EM-2048		
			L & R Front Upper		2	EM-2050		
<b>F53 STRIPPED CHASSIS</b>								
V8	V8 7.5L 460ci	1996-97	L & R Front		2	EM-2709		
		1988-97	Trans	Manual	1			EM-2966
<b>F59 STRIPPED CHASSIS</b>								
V8	V8 7.3L 445ci Diesel	1988-94	LH Front		1	EM-2765		
			RH Front		1	EM-2764		
		1989-93	Trans	Auto	1			EM-2557
			Trans	Manual	1			EM-2557

# Engine, Transmission, And Torque Strut Mounts

CYL	ENG. SIZE	YEAR	LOCATION	DESCRIPTION	QTY	ENGINE	TORQUE STRUT	TRANSMISSION	
<b>FORD TRUCK (continued)</b>									
<b>F59 STRIPPED CHASSIS (continued)</b>									
V8	V8 7.3L 445ci Diesel	1988	Trans	Manual	1			EM-2557	
<b>F-100 PICKUP</b>									
L6	L6 3.6L 223ci	1957-64	L & R Front Lower		2	EM-2048			
			L & R Front Upper		2	EM-2050			
		1954-64	Trans - L & R Lower		2			EM-2121	
			Trans - L & R Upper		2			EM-2119	
	L6 3.9L 240ci	1965-75	LH Front		1	EM-2332			
			LH Front		1	EM-2332			
		1965-75	RH Front		1	EM-2331			
			RH Front		1	EM-2331			
		1953-55	Trans - L & R Lower		2			EM-2121	
			Trans - L & R Upper		2			EM-2119	
		1965-66	Trans - Lower	4WD	1			EM-2306	
			Trans - Upper	4WD	1			EM-2305	
		1967-74	Trans	4WD	1			EM-2349	
			Trans	Auto; C4; 2WD	1			EM-2327	
			Trans	Auto; C6; 2WD	1			EM-2362	
			Trans	Manual; 2WD	1			EM-2327	
		1965-66	Trans	Auto; C4; 2WD	1			EM-2327	
			Trans	Auto; C6; 2WD	1			EM-2362	
	Trans	Manual; 2WD	1			EM-2327			
	L6 4.9L 300ci	1974-83	LH Front		1	EM-2442			
			LH Front		1	EM-2332			
		1974-83	RH Front		1	EM-2441			
			RH Front		1	EM-2331			
		1980-83	Trans	Auto; 2WD	1			EM-2448	
			Trans	Manual; 2WD	1			EM-2448	
		1976-79	Trans	Auto	1			EM-2349	
		1973-75	Trans	Auto	1			EM-2349	
			Trans	Manual	1			EM-2349	
		1965-72	Trans	4WD	1			EM-2349	
			Trans	Auto; 2WD	1			EM-2362	
	Trans	Manual; 2WD	1			EM-2327			
	V6	V6 3.8L 232ci	1982-83	LH Front		1	EM-2728		
				RH Front		1	EM-2727		
Trans			Auto; 2WD	1			EM-2448		
Trans			Manual; 2WD	1			EM-2448		
V8	V8 3.9L 239ci	1953-55	Center Front Lower		1	EM-2120			
	V8 4.2L 255ci	1981-82	L & R Front		2	EM-2329			
			Trans	Auto	1		EM-2448		
			Trans	Manual	1		EM-2448		
	V8 4.4L 272ci	1956-58	Trans - L & R Lower		2		EM-2121		
			Trans - L & R Upper		2		EM-2119		
	V8 4.8L 292ci	1960-64	L & R Front Lower		2	EM-2048			
			L & R Front Upper		2	EM-2050			
			Trans - L & R Lower		2		EM-2121		

# Engine, Transmission, And Torque Strut Mounts

CYL	ENG. SIZE	YEAR	LOCATION	DESCRIPTION	Q T Y	ENGINE	TORQUE STRUT	TRANS- MISSION	
<b>FORD TRUCK (continued)</b>									
<b>F-100 PICKUP (continued)</b>									
V8	V8 4.8L 292ci	1960-64	Trans - L & R Upper		2			EM-2119	
	V8 5.0L 302ci	1969-83	L & R Front		2	EM-2329			
		1980-83	Trans	Auto		1			EM-2448
			Trans	Manual		1			EM-2448
		1979	Trans	Auto; C6		1			EM-2327
		1977-78	Trans	Auto; C4		1			EM-2362
			Trans	Auto; C6		1			EM-2327
		1976	Trans	Auto; C4		1			EM-2362
			Trans	Auto; C6		1			EM-2327
			Trans	Auto; FMX		1			EM-2349
		1975	Trans	Auto; C4		1			EM-2362
			Trans	Auto; C6		1			EM-2327
			Trans	Auto; FMX		1			EM-2349
			Trans	Manual		1			EM-2349
		1973-74	Trans			1			EM-2327
		1972	Trans	4WD		1			EM-2327
			Trans	Auto; C6; 2WD		1			EM-2327
	Trans		Manual; 2WD		1			EM-2327	
	1969-71	Trans	4WD		1			EM-2327	
		Trans	Manual; 2WD		1			EM-2327	
	V8 5.8L 351ci	1981	L & R Front			2	EM-2329		
		1977-79	LH Front			1	EM-2445		
			RH Front			1	EM-2444		
		1981	Trans	Auto		1			EM-2448
			Trans	Manual		1			EM-2448
	1977-79	Trans	Auto		1			EM-2448	
	V8 5.8L 352ci	1966-67	LH Front			1	EM-2290		
			RH Front			1	EM-2289		
			Trans			1			EM-2327
	V8 5.9L 360ci	1968-76	LH Front			1	EM-2290		
			RH Front			1	EM-2289		
		1976	Trans	Auto; 4WD		1			EM-2751
			Trans	Auto; RWD		1			EM-2349
		1975	Trans	RWD		1			EM-2349
			Trans	Auto; 4WD		1			EM-2751
			Trans	Manual; 4WD		1			EM-2349
		1973-74	Trans	RWD		1			EM-2349
			Trans	Auto; 4WD		1			EM-2751
			Trans	Manual; 4WD		1			EM-2349
	1969-72	Trans	Auto		1			EM-2349	
		Trans	Manual		1			EM-2349	
	1968	Trans	4WD		1			EM-2349	
	V8 6.4L 390ci	1968-76	LH Front			1	EM-2290		
			RH Front			1	EM-2289		
		1976	Trans	Auto		1			EM-2349
		1970-75	Trans	Auto		1			EM-2349
			Trans	Manual		1			EM-2327
1968-69		Trans	Auto		1			EM-2349	
	Trans	Manual		1			EM-2349		
V8 6.6L 400ci	1977-79	LH Front			1	EM-2445			
		RH Front			1	EM-2444			
		Trans	Auto; 2WD		1			EM-2327	
V8 7.5L 460ci	1979	L & R Front			2	EM-2502			
	1973-77	L & R Front			2	EM-2502			
	1979	Trans	Auto		1			EM-2349	
	1976-77	Trans	Auto		1			EM-2349	

## Engine, Transmission, And Torque Strut Mounts

CYL	ENG. SIZE	YEAR	LOCATION	DESCRIPTION	QTY	ENGINE	TORQUE STRUT	TRANSMISSION
<b>FORD TRUCK (continued)</b>								
<b>F-100 PICKUP (continued)</b>								
V8	V8 7.5L 460ci	1973-75	Trans	Auto	1			EM-2349
			Trans	Manual	1			EM-2349
<b>F-150 HERITAGE</b>								
V6	V6 4.2L	2004	LH Front		1	EM-2831		
			RH Front		1	EM-2833		
			Trans	Auto	1			EM-2871
			Trans	Manual	1			EM-2871
V8	V8 4.6L	2004	LH Front	4WD	1	EM-2972		
			LH Front	RWD, Auto	1	EM-2832		
			LH Front	RWD, Manual	1	EM-5732		
			RH Front		1	EM-2835		
			Trans	Auto; 4WD	1			EM-2871
			Trans	Manual; 4WD	1			EM-2871
	V8 5.4L	2004	LH Front	4WD	1	EM-2972		
			LH Front	RWD	1	EM-2832		
			LH Front	RWD, Manual	1	EM-5732		
			RH Front		1	EM-2835		
<b>F-150 PICKUP</b>								
L6	L6 4.9L 300ci	1989-93	L & R Front		2	EM-2698*		
			1994-96	LH Front		1	EM-2636	
		1985-88	LH Front		1	EM-2636		
		1975-84	LH Front		1	EM-2442		
		1994-96	RH Front		1	EM-2635		
		1985-88	RH Front		1	EM-2635		
		1975-84	RH Front		1	EM-2441		
		1996	Trans	Auto	1			EM-2970
			Trans	Manual	1			EM-2970
		1994-95	Trans	Auto	1			EM-2884
			Trans	Manual	1			EM-2884
		1987-93	Trans	Auto	1			EM-2557
			Trans	Manual	1			EM-2557
		1985-86	Trans	Auto	1			EM-2448
			Trans	Manual	1			EM-2448
		1980-84	Trans	Auto; 2WD	1			EM-2448
			Trans	Manual; 2WD	1			EM-2448
1975-79	Trans		1			EM-2349		
V6	V6 4.2L 256ci	1997-03	LH Front	Auto	1	EM-2831		
			RH Front	Auto	1	EM-2833		
			Trans	Auto	1			EM-2871
			Trans	Manual	1			EM-2871
V8	V8 4.6L	2006-08	Trans	Auto; 4WD	1			EM-3136
			Trans	Manual; 4WD	1			EM-3136
		2005	Trans	Auto; 4WD	1			EM-3136
	V8 4.6L 281ci	1998-03	LH Front	4WD	1	EM-2972		
			LH Front	RWD, Auto	1	EM-2832		
			LH Front	RWD, Manual	1	EM-5732		
		1997	LH Front	2WD	1	EM-2972		
			LH Front	Auto; 4WD	1	EM-2972		
			LH Front	Manual; 4WD	1	EM-2832		
		2005-08	Left		1	EM-4038		
		2004	Left		1	EM-3151		
	1998-03	RH Front		1	EM-2835			
	1997	RH Front	2WD & 4WD	1	EM-2835			
	2005-08	Right		1	EM-4039			
	2004	Right		1	EM-3150			
	Trans	2WD	1			EM-2870		

# Engine, Transmission, And Torque Strut Mounts

CYL	ENG. SIZE	YEAR	LOCATION	DESCRIPTION	QTY	ENGINE	TORQUE STRUT	TRANSMISSION		
<b>FORD TRUCK (continued)</b>										
<b>F-150 PICKUP (continued)</b>										
V8	V8 4.6L 281ci	2004	Trans	Auto; 4WD	1			EM-2871		
		1997-03	Trans	2WD	1			EM-2870		
			Trans	Auto; 4WD	1			EM-2871		
			Trans	Manual; 4WD	1			EM-2871		
	V8 5.0L 302ci	1987-96	L & R Front			2	EM-2564			
		1975-86	L & R Front			2	EM-2329			
		1996	Trans	Auto		1			EM-2970	
			Trans	Manual		1			EM-2970	
		1994-95	Trans	Auto		1			EM-2884	
			Trans	Manual		1			EM-2884	
		1987-93	Trans	Auto		1			EM-2557	
			Trans	Manual		1			EM-2557	
		1985-86	Trans	4WD, exc. Auto - AOD		1			EM-2448	
			Trans	Auto; 2WD		1			EM-2448	
			Trans	Manual; 2WD		1			EM-2448	
			Trans	Manual; 4WD		1			EM-2448	
		1980-84	Trans	Auto		1			EM-2448	
			Trans	Manual		1			EM-2448	
		1979	Trans	Auto; C6		1			EM-2327	
			Trans	Manual; 4WD		1			EM-2327	
			Trans	Manual; RWD		1			EM-2349	
		1977-78	Trans	Auto; C4		1			EM-2362	
			Trans	Auto; C6		1			EM-2327	
			Trans	Manual; 4WD		1			EM-2327	
			Trans	Manual; RWD		1			EM-2349	
		1976	Trans	Auto; C6		1			EM-2327	
			Trans	Manual; 4WD		1			EM-2327	
			Trans	Manual; RWD		1			EM-2349	
		1975	Trans	Auto; C6		1			EM-2327	
			Trans	Manual		1			EM-2349	
		V8 5.4L 330ci	1997-98	LH Front	4WD		1	EM-2972		
				LH Front	RWD		1	EM-2832		
	1997-03		LH Front	4WD		1	EM-2972			
			LH Front	RWD, Auto		1	EM-2832			
			LH Front	RWD, Manual		1	EM-5732			
	2005-08		Left			1	EM-4038			
	2004		Left			1	EM-3151			
	1997-98		RH Front			1	EM-2835			
	1997-03		RH Front			1	EM-2835			
	2005-08		Right			1	EM-4039			
	2004		Right			1	EM-3150			
	2004-08		Trans	2WD		1			EM-2884	
			Trans	4WD		1			EM-3136	
	1997-03		Trans	Auto; 2WD		1			EM-2870	
			Trans	Auto; 4WD		1			EM-2871	
			Trans	Manual; 2WD		1			EM-2870	
		Trans	Manual; 4WD		1			EM-2871		
	V8 5.8L 351ci	1987-96	L & R Front			2	EM-2564			
		1980-86	L & R Front			2	EM-2329			
		1977-79	LH Front			1	EM-2445			
			RH Front			1	EM-2444			
		1996	Trans	Auto; 2WD		1			EM-2969	
			Trans	Auto; 4WD		1			EM-2970	
Trans			Manual; 2WD		1			EM-2969		
Trans			Manual; 4WD		1			EM-2970		
1994-95		Trans	Auto		1			EM-2969		
	Trans	Manual		1			EM-2969			

# Engine, Transmission, And Torque Strut Mounts

CYL	ENG. SIZE	YEAR	LOCATION	DESCRIPTION	QTY	ENGINE	TORQUE STRUT	TRANSMISSION	
<b>FORD TRUCK (continued)</b>									
<b>F-150 PICKUP (continued)</b>									
V8	V8 5.8L 351ci	1987-93	Trans	Auto	1			EM-2557	
			Trans	Manual	1			EM-2557	
		1980-86	Trans	Auto	1				EM-2448
			Trans	Manual	1				EM-2448
			Trans	Auto; 2WD	1				EM-2448
	V8 5.9L 360ci	1975-76	LH Front		1	EM-2290			
			RH Front		1	EM-2289			
		1976	Trans	RWD	1				EM-2349
			Trans	Auto; 4WD	1				EM-2751
			Trans	Manual; 4WD	1				EM-2349
	1975	Trans		1				EM-2349	
		V8 6.4L 390ci	1975-76	LH Front		1	EM-2290		
				RH Front		1	EM-2289		
	Trans		Auto	1				EM-2349	
	V8 6.6L 400ci	1977-79	LH Front		1	EM-2445			
			RH Front		1	EM-2444			
			Trans		1				EM-2327
	V8 6.9L 420ci Diesel	1984	Trans	Auto	1				EM-2448
			Trans	Manual	1				EM-2448
	V8 7.5L 460ci	1975-79	L & R Front		2	EM-2502			
Trans				1				EM-2349	
<b>F-250 PICKUP</b>									
L6	L6 3.6L 223ci	1957-64	L & R Front Lower		2	EM-2048			
			L & R Front Upper		2	EM-2050			
		1954-64	Trans - L & R Lower		2				EM-2121
			Trans - L & R Upper		2				EM-2119
	L6 3.9L 240ci	1967-74	LH Front		1	EM-2332			
		1965-66	LH Front	RWD	1	EM-2332			
		1967-74	RH Front		1	EM-2331			
		1965-66	RH Front	RWD	1	EM-2331			
			Trans - L & R Lower	4WD 4WD	2				EM-2306
			Trans - L & R Upper	4WD 4WD	2				EM-2305
		1967-74	Trans	2WD	1				EM-2327
			Trans	4WD	1				EM-2349
	1965-66	Trans	2WD	1				EM-2327	
	L6 4.9L 300ci	1989-93	L & R Front		2	EM-2698			
		1994-96	LH Front		1	EM-2636			
		1985-88	LH Front		1	EM-2636			
		1974-84	LH Front		1	EM-2442			
		1965-73	LH Front		1	EM-2332			
		1994-96	RH Front		1	EM-2635			
		1985-88	RH Front		1	EM-2635			
		1974-84	RH Front		1	EM-2441			
		1965-73	RH Front		1	EM-2331			
		1996	Trans	Auto	1				EM-2970
			Trans	Manual	1				EM-2970
		1994-95	Trans	Auto	1				EM-2884
			Trans	Manual	1				EM-2884
	1987-93	Trans	Auto	1				EM-2557	
Trans		Manual	1				EM-2557		

# Engine, Transmission, And Torque Strut Mounts

CYL	ENG. SIZE	YEAR	LOCATION	DESCRIPTION	QTY	ENGINE	TORQUE STRUT	TRANSMISSION	
<b>FORD TRUCK (continued)</b>									
<b>F-250 PICKUP (continued)</b>									
L6	L6 4.9L 300ci	1980-86	Trans	Auto	1			EM-2448	
			Trans	Manual	1			EM-2448	
		1973-79	Trans	Auto	1				EM-2349
			Trans	Manual	1				EM-2349
		1965-72	Trans	4WD	1				EM-2349
			Trans	Auto; 2WD	1				EM-2362
			Trans	Manual; 2WD	1			EM-2327	
V8	V8 3.9L 239ci	1953-55	Center Front Lower		1	EM-2120			
	V8 4.6L 281ci	1997-99	LH Front		1	EM-2832			
			RH Front		1	EM-2835			
			Trans	Auto; 4WD	1			EM-2871	
			Trans	Manual; 4WD	1			EM-2871	
	V8 4.8L 292ci	1960-64	L & R Front Lower		2	EM-2048			
			L & R Front Upper		2	EM-2050			
			Trans - L & R Lower		2			EM-2119	
			Trans - L & R Upper		2			EM-2121	
	V8 5.0L 302ci	1987-96	L & R Front		2	EM-2564			
		1972-86	L & R Front		2	EM-2329			
		1996	Trans	Auto; 2WD	1			EM-2884	
			Trans	Auto; 4WD	1			EM-2970	
			Trans	Manual; 2WD	1			EM-2884	
			Trans	Manual; 4WD	1			EM-2970	
		1994-95	Trans	Auto	1			EM-2884	
			Trans	Manual	1			EM-2884	
		1987-93	Trans	Auto	1			EM-2557	
			Trans	Manual	1			EM-2557	
		1985-86	Trans	4WD, exc. Auto - AOD	1			EM-2448	
			Trans	Auto; 2WD	1			EM-2448	
			Trans	Manual; 2WD	1			EM-2448	
			Trans	Manual; 4WD	1			EM-2448	
		1980-84	Trans	Auto	1			EM-2448	
			Trans	Manual	1			EM-2448	
		1978-79	Trans	Auto; C6	1			EM-2362	
			Trans	Manual; 4WD	1			EM-2327	
			Trans	Manual; RWD	1			EM-2349	
		1977	Trans	Auto; C4	1			EM-2349	
			Trans	Auto; C6	1			EM-2362	
			Trans	Manual; 4WD	1			EM-2327	
			Trans	Manual; RWD	1			EM-2349	
1975-76		Trans	Auto; C6	1			EM-2362		
	Trans	Manual; 4WD	1			EM-2327			
1973-74	Trans	Manual; RWD	1			EM-2349			
	Trans	Auto; Cruise-O-Matic; 4WD	1			EM-2349			
	Trans	Auto; RWD	1			EM-2362			
	Trans	Manual; 4WD	1			EM-2327			
1972	Trans	Manual; RWD	1			EM-2349			
	Trans		1			EM-2327			
V8 5.4L 330ci	1997-99	LH Front	4WD	1	EM-2972				
		LH Front	RWD	1	EM-2832				
		RH Front		1	EM-2835				
		Trans	Auto; 2WD	1			EM-2870		
		Trans	Auto; 4WD	1			EM-2871		



## Engine, Transmission, And Torque Strut Mounts

CYL	ENG. SIZE	YEAR	LOCATION	DESCRIPTION	QTY	ENGINE	TORQUE STRUT	TRANSMISSION
<b>FORD TRUCK (continued)</b>								
<b>F-250 PICKUP (continued)</b>								
V8	V8 5.4L 330ci	1997-99	Trans	Manual; 2WD	1			EM-2870
			Trans	Manual; 4WD	1		EM-2871	
	V8 5.8L 351ci	1987-97	L & R Front		2	EM-2564		
			L & R Front		2	EM-2329		
			LH Front		1	EM-2445		
			RH Front		1	EM-2444		
		1994-95	Trans	Auto	1			EM-2969
			Trans	Manual	1			EM-2969
		1987-93	Trans	Auto	1			EM-2557
			Trans	Manual	1			EM-2557
	1980-86	Trans	Auto	1			EM-2448	
		Trans	Manual	1			EM-2448	
	V8 5.8L 352ci	1966-67	LH Front		1	EM-2290		
			RH Front		1	EM-2289		
			Trans		1		EM-2327	
	V8 5.9L 360ci	1968-76	LH Front		1	EM-2290		
			RH Front		1	EM-2289		
		1973-76	Trans	2WD	1			EM-2349
			Trans	Auto; 4WD	1			EM-2751
			Trans	Manual; 4WD	1			EM-2349
		1969-72	Trans	Auto	1			EM-2349
			Trans	Manual	1			EM-2349
	1968	Trans	4WD	1			EM-2349	
	V8 6.4L 390ci	1968-76	LH Front		1	EM-2290		
			RH Front		1	EM-2289		
		1970-76	Trans	Auto; 2WD	1			EM-2349
			Trans	Auto; 4WD	1			EM-2751
			Trans	Manual; 2WD	1			EM-2327
			Trans	Manual; 4WD	1			EM-2349
	1968-69	Trans	2WD	1			EM-2349	
	V8 6.6L 400ci	1977-82	LH Front		1	EM-2445		
			RH Front		1	EM-2444		
		1980-82	Trans	Auto; 2WD	1			EM-2448
			Trans	Manual; 2WD	1			EM-2448
		1977-79	Trans	2WD	1			EM-2327
	Trans		Auto; 4WD	1			EM-2349	
	V8 6.9L 420ci Diesel	1987	Trans		1			EM-2557
		1983-86	Trans	Auto; 2WD	1			EM-2448
			Trans	Manual; 2WD	1			EM-2448
	V8 7.3L 445ci Diesel	1988-97	LH Front		1	EM-2765		
			RH Front		1	EM-2764		
		1988-93	Trans	Auto	1			EM-2557
			Trans	Manual	1			EM-2557
	V8 7.5L 460ci	1983-97	L & R Front		2	EM-2709		
		1973-79	L & R Front		2	EM-2502		
			Trans	Auto; 2WD	1			EM-2970
		1996-97	Trans	Auto; 4WD	1			EM-2557
			Trans	Manual; 2WD	1			EM-2970
			Trans	Manual; 4WD	1			EM-2557
		1987-95	Trans		1			EM-2557
		1983-86	Trans	Auto	1			EM-2448
			Trans	Manual	1			EM-2448
1973-79		Trans	Auto	1			EM-2349	
	Trans	Manual	1			EM-2349		

# Engine, Transmission, And Torque Strut Mounts

CYL	ENG. SIZE	YEAR	LOCATION	DESCRIPTION	QTY	ENGINE	TORQUE STRUT	TRANSMISSION	
<b>FORD TRUCK (continued)</b>									
<b>F-250 SUPER DUTY PICKUP</b>									
V8	V8 5.4L 330ci	1999-04	LH Front		1	EM-5424			
			RH Front		1	EM-5425			
		1999-07	Trans	2WD	1			EM-2884	
			Trans	4WD	1			EM-2971	
	V8 7.3L 445ci Diesel	1999-03	LH Front		1	EM-3029			
			RH Front		1	EM-3030			
			Trans	Auto; 2WD	1			EM-2884	
			Trans	Auto; 4WD	1			EM-2971	
			Trans	Manual; 2WD	1			EM-2884	
			Trans	Manual; 4WD	1			EM-2971	
V10	V10 6.8L 415ci	1999-04	Left		1	EM-4022			
		1999-07	Trans	2WD	1			EM-2884	
			Trans	4WD	1			EM-2971	
<b>F-350 PICKUP</b>									
L6	L6 3.6L 223ci	1957-64	L & R Front Lower		2	EM-2048			
			L & R Front Upper		2	EM-2050			
		1954-64	Trans - L & R Lower		2			EM-2121	
			Trans - L & R Upper		2			EM-2119	
	L6 3.9L 240ci	1965-74	LH Front		1	EM-2332			
			RH Front		1	EM-2331			
		1965-66	Trans - L & R Lower	4WD 4WD	2			EM-2306	
			Trans - L & R Upper	4WD 4WD	2			EM-2305	
		1967-74	Trans	2WD	1			EM-2327	
			Trans	4WD	1			EM-2349	
	1965-66	Trans	2WD	1			EM-2327		
	L6 4.9L 300ci	1989-93	L & R Front		2	EM-2698			
		1994-96	LH Front		1	EM-2636			
		1985-88	LH Front		1	EM-2636			
		1974-84	LH Front		1	EM-2442			
		1965-73	LH Front		1	EM-2332			
		1994-96	RH Front		1	EM-2635			
		1985-88	RH Front		1	EM-2635			
		1974-84	RH Front		1	EM-2441			
		1965-73	RH Front		1	EM-2331			
		1996	Trans	Auto		1			EM-2970
			Trans	Manual		1			EM-2970
		1994-95	Trans	Auto		1			EM-2884
			Trans	Manual		1			EM-2884
		1987-93	Trans	Auto		1			EM-2557
			Trans	Manual		1			EM-2557
		1980-86	Trans	Auto		1			EM-2448
	Trans		Manual		1			EM-2448	
	1973-79	Trans	Auto		1			EM-2349	
		Trans	Manual		1			EM-2349	
	1965-72	Trans	4WD		1			EM-2349	
		Trans	Auto; 2WD		1			EM-2362	
		Trans	Manual; 2WD		1			EM-2327	
	V8	V8 3.9L 239ci	1953-55	Center Front Lower		1	EM-2120		
		V8 4.8L 292ci	1960-64	L & R Front Lower		2	EM-2048		

# Engine, Transmission, And Torque Strut Mounts

CYL	ENG. SIZE	YEAR	LOCATION	DESCRIPTION	QTY	ENGINE	TORQUE STRUT	TRANSMISSION
<b>FORD TRUCK (continued)</b>								
<b>F-350 PICKUP (continued)</b>								
V8	V8 4.8L 292ci	1960-64	L & R Front Upper		2	EM-2050		
		1961-64	Trans - L & R Lower		2			EM-2121
			Trans - L & R Upper		2			EM-2119
V8	V8 5.0L 302ci	1972-80	L & R Front		2	EM-2329		
		1980	Trans	Auto	1			EM-2448
			Trans	Manual	1			EM-2448
		1975-79	Trans	Auto	1			EM-2362
			Trans	Manual	1			EM-2349
		1973-74	Trans	4WD, Auto - C5	1			EM-2327
			Trans	Auto; C6; 2WD	1			EM-2327
			Trans	Auto; Cruise-O-Matic; 4WD	1			EM-2349
			Trans	Manual; 2WD	1			EM-2349
				Trans	Manual; 4WD	1		EM-2327
		1972	Trans		1		EM-2327	
V8	V8 5.8L 351ci	1987-97	L & R Front		2	EM-2564		
		1980-86	L & R Front		2	EM-2329		
		1977-79	LH Front		1	EM-2445		
			RH Front		1	EM-2444		
		1994-95	Trans	Auto	1			EM-2969
			Trans	Manual	1			EM-2969
		1987-93	Trans	Auto	1			EM-2557
			Trans	Manual	1			EM-2557
		1980-86	Trans	Auto	1			EM-2448
			Trans	Manual	1			EM-2448
V8	V8 5.8L 352ci	1966-67	LH Front		1	EM-2290		
			RH Front		1	EM-2289		
			Trans		1		EM-2327	
V8	V8 5.9L 360ci	1968-76	LH Front		1	EM-2290		
			RH Front		1	EM-2289		
		1973-76	Trans	2WD	1			EM-2349
		1969-72	Trans		1			EM-2349
		1968	Trans	4WD	1			EM-2349
V8	V8 6.4L 390ci	1968-76	LH Front		1	EM-2290		
			RH Front		1	EM-2289		
		1970-76	Trans	Auto; 2WD	1			EM-2349
			Trans	Manual; 2WD	1			EM-2327
		1968-69	Trans	2WD	1			EM-2349
V8	V8 6.6L 400ci	1977-82	LH Front		1	EM-2445		
			RH Front		1	EM-2444		
		1980-82	Trans	Auto; 2WD	1			EM-2448
			Trans	Manual; 2WD	1			EM-2448
		1979	Trans	RWD	1			EM-2327
			Trans	Auto; 4WD	1			EM-2349
				Trans	Manual; 4WD	1		EM-5111
		1977-78	Trans		1		EM-2327	
V8	V8 6.9L 420ci Diesel	1987	Trans		1			EM-2557
		1983-86	Trans	Auto; 2WD	1			EM-2448
			Trans	Manual; 2WD	1			EM-2448
V8	V8 7.3L 445ci Diesel	1988-97	LH Front		1	EM-2765		
			RH Front		1	EM-2764		
		1988-93	Trans	Auto	1			EM-2557
			Trans	Manual	1			EM-2557
V8	V8 7.5L 460ci	1983-97	L & R Front		2	EM-2709		
		1973-79	L & R Front		2	EM-2502		

# Engine, Transmission, And Torque Strut Mounts

CYL	ENG. SIZE	YEAR	LOCATION	DESCRIPTION	QTY	ENGINE	TORQUE STRUT	TRANSMISSION	
<b>FORD TRUCK (continued)</b>									
<b>F-350 PICKUP (continued)</b>									
V8	V8 7.5L 460ci	1996-97	Trans	Auto; 2WD	1			EM-2970	
			Trans	Auto; 4WD	1			EM-2557	
			Trans	Manual; 2WD	1			EM-2970	
			Trans	Manual; 4WD	1			EM-2557	
		1987-95	Trans	Auto		1			EM-2557
			Trans	Manual		1			EM-2557
		1983-86	Trans	Auto		1			EM-2448
			Trans	Manual		1			EM-2448
		1973-79	Trans	Auto		1			EM-2349
			Trans	Manual		1			EM-2349
<b>F-350 SUPER DUTY PICKUP</b>									
V8	V8 5.4L 330ci	1999-04	LH Front		1	EM-5424			
			RH Front		1	EM-5425			
		1999-07	Trans	2WD		1			EM-2884
			Trans	4WD		1			EM-2971
	V8 7.3L 445ci Diesel	1999-03	LH Front		1	EM-3029			
			RH Front		1	EM-3030			
			Trans	Auto; 2WD	1			EM-2884	
			Trans	Auto; 4WD	1			EM-2971	
			Trans	Manual; 2WD	1			EM-2884	
			Trans	Manual; 4WD	1			EM-2971	
V10	V10 6.8L 415ci	1999-04	Left		1	EM-4022			
		1999-07	Trans	2WD	1			EM-2884	
			Trans	4WD	1			EM-2971	
<b>F SUPER DUTY</b>									
V8	V8 7.5L	1996	Trans	Manual	1			EM-2970	
		1990-95	Trans	Auto	1			EM-2557	
<b>F-450 SUPER DUTY PICKUP</b>									
V8	V8 7.3L 445ci Diesel	1999-03	LH Front		1	EM-3029			
		1990-97	LH Front		1	EM-2765			
		1999-03	RH Front		1	EM-3030			
		1990-97	RH Front		1	EM-2764			
		1999-03	Trans	Auto; 2WD		1			EM-2884
			Trans	Auto; 4WD		1			EM-2971
			Trans	Manual; 2WD		1			EM-2884
			Trans	Manual; 4WD		1			EM-2971
		1990-93	Trans		1			EM-2557	
	V8 7.5L 460ci	1990-97	L & R Front		2	EM-2709			
		1997	Trans	2WD	1			EM-2557	
V10	V10 6.8L 415ci	1999-04	Left		1	EM-4022			
		1999-07	Trans	2WD	1			EM-2884	
			Trans	4WD	1			EM-2971	
<b>F-500 PICKUP</b>									
V8	V8 5.4L 330ci	1975-77	L & R Front Lower		2	EM-2298			
			L & R Front Upper		2	EM-2297			
			Trans - Lower	Manual	2			EM-2306	
	V8 5.9L 360ci	1975-77	L & R Front Lower		2	EM-2298			
			L & R Front Upper		2	EM-2297			
			Trans		1			EM-2750	

# Engine, Transmission, And Torque Strut Mounts

CYL	ENG. SIZE	YEAR	LOCATION	DESCRIPTION	QTY	ENGINE	TORQUE STRUT	TRANSMISSION	
<b>FORD TRUCK (continued)</b>									
<b>F-550 SUPER DUTY PICKUP</b>									
V8	V8 7.3L 445ci Diesel	1999-03	LH Front		1	EM-3029			
			RH Front		1	EM-3030			
		2000-03	Trans	Auto; 2WD		1			EM-2884
			Trans	Auto; 4WD		1			EM-2971
			Trans	Manual; 2WD		1			EM-2884
			Trans	Manual; 4WD		1			EM-2971
		1999	Trans	Manual; 2WD		1			EM-2884
Trans	Manual; 4WD			1			EM-2971		
V10	V10 6.8L 415ci	1999-04	Left		1	EM-4022			
		1999-07	Trans	2WD	1			EM-2884	
			Trans	4WD	1			EM-2971	
<b>F600</b>									
	L6 6.7L 408ci Diesel	1987-93	Trans	Auto	2			EM-2769	
			Trans	Manual	2			EM-2769	
<b>F700</b>									
	L6 6.7L 408ci Diesel	1987-93	Trans	Auto	2			EM-2769	
			Trans	Manual	2			EM-2769	
<b>F600</b>									
L6	L6 5.9L 359ci	1993	L & R Front		2	EM-2462			
<b>F700</b>									
L6	L6 5.9L 359ci	1993	L & R Front		2	EM-2462			
<b>F600</b>									
L6	L6 5.9L 359ci Diesel	1993-94	Trans	Auto	2			EM-2769	
			Trans	Manual	2			EM-2769	
<b>F700</b>									
L6	L6 5.9L 359ci Diesel	1993-94	Trans	Auto	2			EM-2769	
			Trans	Manual	2			EM-2769	
<b>F600</b>									
L6	L6 6.6L Diesel	1987-93	L & R Front		2	EM-2462			
<b>F700</b>									
L6	L6 6.6L Diesel	1987-93	L & R Front		2	EM-2462			
<b>L500</b>									
V8		1970-78	Trans - L & R Upper	Manual Manual	1			EM-2299	
<b>L600</b>									
V8		1970-78	Trans - L & R Upper	Manual Manual	1			EM-2299	
<b>L700</b>									
V8		1970-78	Trans - L & R Upper	Manual Manual	1			EM-2299	
<b>L800</b>									
V8		1970-78	Trans - L & R Upper	Manual Manual	1			EM-2299	
<b>LOBO (MEXICAN VEHICLE)</b>									
V8	V8 4.6L 281ci	2004	LH Front	Mexican Vehicle; RWD	1	EM-2832			
			RH Front	Mexican Vehicle	1	EM-2835			
			Trans	RWD	1			EM-2870	
	V8 5.4L	2002-04	LH Front	Mexican Vehicle; RWD	1	EM-2832			
			2001	LH Front	Mexican Vehicle; RWD	1	EM-2832		
			1993-00	LH Front	Mexican Vehicle; 4WD	1	EM-2972		
			LH Front	Mexican Vehicle; RWD	1	EM-2832			

# Engine, Transmission, And Torque Strut Mounts

CYL	ENG. SIZE	YEAR	LOCATION	DESCRIPTION	QTY	ENGINE	TORQUE STRUT	TRANSMISSION
<b>FORD TRUCK (continued)</b>								
<b>LOBO (MEXICAN VEHICLE) (continued)</b>								
V8	V8 5.4L	2002-04	RH Front	Mexican Vehicle	1	EM-2835		
		2001	RH Front	Mexican Vehicle	1	EM-2835		
		1993-00	RH Front	Mexican Vehicle	1	EM-2835		
		2002-04	Trans	4WD	1			EM-2871
		2001	Trans	RWD	1			EM-2870
<b>RANCHERO</b>								
L6	L6 2.4L 144ci	1960-64	LH Front		1	EM-2226		
			RH Front		1	EM-2225		
			Trans	Auto	1			EM-2253
			Trans	Manual	1			EM-2253
	L6 2.8L 170ci	1964-65	LH Front		1	EM-2226		
			LH Front		1	EM-2226		
			RH Front		1	EM-2225		
			RH Front		1	EM-2225		
			Trans	Auto	1			EM-2253
			Trans	Manual	1			EM-2253
			Trans	Auto	1			EM-2253
			Trans	Manual	1			EM-2253
	L6 3.3L 200ci	1964-68	L & R Front		2	EM-2333		
			Trans	Auto	1			EM-2253
			Trans	Manual	1			EM-2253
	L6 4.1L 250ci	1973	Trans	Auto	1			EM-2347
			Trans	Manual	1			EM-2347
		1969-72	Trans	Auto	1			EM-2253
			Trans	Manual	1			EM-2253
V8	V8 4.7L 289ci	1966-67	L & R Front		2	EM-2286		
			LH Front		1	EM-2220		
		1965	RH Front		1	EM-2221		
			Trans	Auto	1			EM-2253
			Trans	Manual	1			EM-2253
	V8 4.8L 292ci	1957-59	L & R Front Lower		2	EM-2048		
			L & R Front Upper		2	EM-2050		
	V8 5.0L 302ci	1968-71	L & R Front		2	EM-2257		
			LH Front		1	EM-2504		
		1973-74	LH Front		1	EM-2370		
			LH Front		1	EM-2371		
		1977-79	RH Front		1	EM-2503		
			RH Front		1	EM-2371		
		1972	RH Front		1	EM-2370		
			Trans	Auto	1			EM-2253
		1973-74	Trans	Auto; AOD	1			EM-2347
			Trans	Auto; FX	1			EM-2372
			Trans	Manual	1			EM-2347
		1972	Trans	Auto	1			EM-2372
			Trans	Manual	1			EM-2372
1968-71	Trans	Auto	1			EM-2253		
	Trans	Manual	1			EM-2253		
V8 5.8L 351ci	1969-71	L & R Front		2	EM-2286			
		LH Front		1	EM-2370			
	1972-79	RH Front		1	EM-2371			
		Trans	Auto	1			EM-2464	
		Trans	Auto	1			EM-2347	
1972-76	Trans	Manual	1			EM-2347		

# Engine, Transmission, And Torque Strut Mounts

CYL	ENG. SIZE	YEAR	LOCATION	DESCRIPTION	QTY	ENGINE	TORQUE STRUT	TRANSMISSION	
<b>FORD TRUCK (continued)</b>									
<b>RANCHERO (continued)</b>									
V8	V8 5.8L 351ci	1969-71	Trans	Auto	1			EM-2253	
			Trans	Manual	1			EM-2253	
	V8 6.4L 390ci	1967-69	LH Front		1	EM-2241			
			RH Front		1	EM-2240			
			Trans	Auto	1			EM-2253	
			Trans	Manual	1			EM-2253	
	V8 6.6L 400ci	1972-78	LH Front		1	EM-2365			
			RH Front		1	EM-2364			
		1977-78	Trans		1			EM-2464	
		1972-76	Trans	Auto	1			EM-2372	
			Trans	Manual	1			EM-2372	
	V8 7.0L 428ci	1968-69	LH Front		1	EM-2241			
			RH Front		1	EM-2240			
		1968-73	Trans	Auto	1			EM-2253	
			Trans	Manual	1			EM-2253	
	V8 7.0L 429ci	1970-73	LH Front		1	EM-2723			
			RH Front		1	EM-2724			
	V8 7.5L 460ci	1974-77	Trans	Auto	1			EM-2372	
Trans			Manual	1			EM-2372		
<b>RANGER</b>									
L4	L4 2.0L 1989cc	1988	L & R Front		2	EM-2698'			
		1985-87	LH Front		1	EM-2786			
		1983-84	LH Front		1	EM-2941			
		1985-87	RH Front		1	EM-2785			
		1983-84	RH Front		1	EM-2940			
		1988	Trans	Auto	1			EM-2639	
			Trans	Manual	1			EM-2639	
		1986-87	Trans		1			EM-2631	
			Trans	Manual	1			EM-2631	
		1985	Trans		1			EM-2631	
			Trans	Manual	1			EM-2631	
		L4 2.3L 140ci	1988-97	L & R Front		2	EM-2698'		
				L & R Front	Gas; Auto; RWD	2	EM-2698'		
			2001-11	LH Front		1	EM-3078		
	1985-87		LH Front	Gas; 4WD	1	EM-2786			
			LH Front	Gas; Manual; RWD	1	EM-2786			
	1983-84		LH Front		1	EM-2941			
	2001-11		RH Front		1	EM-5377			
			RH Front	Gas; 4WD	1	EM-2785			
	1985-87		RH Front	Gas; Manual; RWD	1	EM-2785			
			RH Front		1	EM-2940			
	2001-09		Trans	Auto	1			EM-2639	
			Trans	Manual	1			EM-2639	
	1995-97		Trans	Auto	1			EM-2639	
			Trans	Manual	1			EM-2639	
	1991-94		Trans	Auto	1			EM-2639	
			Trans	Manual	1			EM-2639	
	1990		Trans	Auto	1			EM-2639	
			Trans	Manual	1			EM-2639	
	1988-89		Trans	Auto; 4WD	1			EM-2639	
			Trans	Auto; Regular Cab; 2WD	1			EM-2631	
			Trans	Manual; 4WD	1			EM-2639	
			Trans	Manual; Regular Cab; 2WD	1			EM-2639	
	1985-87	Trans	Auto	1			EM-2639		
Trans		Manual	1			EM-2639			
L4 2.3L 140ci Diesel	1985-87	LH Front	4WD	1	EM-2786				

# Engine, Transmission, And Torque Strut Mounts

CYL	ENG. SIZE	YEAR	LOCATION	DESCRIPTION	QTY	ENGINE	TORQUE STRUT	TRANS-MISSION	
<b>FORD TRUCK (continued)</b>									
<b>RANGER (continued)</b>									
L4	L4 2.3L 140ci Diesel	1985-87	Trans	Auto	1			EM-2639	
			Trans	Manual	1			EM-2639	
	L4 2.5L 153ci	1998-99	L & R Front		2	EM-2853			
			LH Front	2WD	1	EM-2853			
			LH Front	4WD	1	EM-2853			
		2000-01	RH Front	4WD	1	EM-2853			
			1998-01	Trans	Auto	1			EM-2639
				Trans	Manual	1			EM-2639
	V6	V6 2.8L 171ci	1983-85	LH Front	4WD	1	EM-2940		
				RH Front	2WD	1	EM-2941		
RH Front				4WD	1	EM-2941			
V6 2.9L 177ci		1986-92	LH Front	4WD	1	EM-2643			
			LH Front	RWD	1	EM-2642			
			RH Front		1	EM-2641			
			Trans	Auto	1			EM-2639	
V6 3.0L		2000-01	Trans	Manual	1			EM-2639	
			L & R Front	RWD	2	EM-2853			
			LH Front	4WD	1	EM-2851			
V6 3.0L 182ci		2005-08	RH Front	4WD	1	EM-2936			
			L & R Front	RWD	2	EM-2853			
			L & R Front	RWD	2	EM-2853			
		2002-04	L & R Front	RWD	2	EM-2853			
			L & R Front	RWD	2	EM-2853			
		1995-97	L & R Front	RWD	2	EM-2643			
			LH Front	4WD	1	EM-2851			
		1998-99	LH Front	RWD	1	EM-2853			
			LH Front	4WD	1	EM-2643			
		1995-97	LH Front	4WD	1	EM-2643			
			LH Front	4WD	1	EM-2643			
		1991-94	LH Front	RWD	1	EM-2642			
			LH Front	RWD	1	EM-2642			
		1998-99	RH Front	4WD	1	EM-2936			
RH Front			RWD	1	EM-2853				
1995-97		RH Front	4WD	1	EM-2640				
		RH Front	4WD	1	EM-2640				
1991-94		RH Front	4WD	1	EM-2640				
	RH Front	4WD	1	EM-2640					
V6 4.0L 245ci	1999-11	Trans	Auto	1			EM-2639		
		Trans	Manual	1			EM-2639		
	1998	LH Front	4WD	1	EM-2851				
		LH Front	4WD	1	EM-2851				
	1990-97	LH Front	4WD	1	EM-2643				
		LH Front	RWD	1	EM-2642				
	1999-11	RH Front	4WD	1	EM-2935				
		RH Front	RWD	1	EM-2853				
	1998	RH Front	4WD	1	EM-2850				
		RH Front	RWD	1	EM-2853				
	1990-97	RH Front	4WD	1	EM-2641				
		RH Front	RWD	1	EM-2641				
	1990-09	Trans	Auto	1			EM-2639		
		Trans	Manual	1			EM-2639		
<b>FORD VAN</b>									
<b>AEROSTAR</b>									
L4	L4 2.3L 140ci	1986-87	Trans	Auto	1			EM-2633	
			Trans	Manual	1			EM-2633	
V6	V6 2.8L 171ci	1986	Trans	Auto	1			EM-2633	
			Trans	Manual	1			EM-2633	
	V6 3.0L 182ci	1986-97	LH Front		1	EM-2646			
			RH Front		1	EM-2645			
		1995-97	Trans	Auto	1			EM-2639	
1989-94	Trans	Auto	1			EM-2639			



# Engine, Transmission, And Torque Strut Mounts

CYL	ENG. SIZE	YEAR	LOCATION	DESCRIPTION	QTY	ENGINE	TORQUE STRUT	TRANSMISSION	
<b>FORD VAN (continued)</b>									
<b>AEROSTAR (continued)</b>									
V6	V6 3.0L 182ci	1989-94	Trans	Manual	1			EM-2639	
		1986-88	Trans	Auto	1			EM-2633	
			Trans	Manual	1			EM-2633	
	V6 4.0L 245ci	1990-97	LH Front		1	EM-2646			
			RH Front		1	EM-2644			
		1995-97	Trans	Auto	1			EM-2639	
		1990-94	Trans	Auto	1			EM-2639	
			Trans	Manual	1			EM-2639	
<b>CLUB WAGON</b>									
V8	V8 6.0L 363ci Diesel	2004-05	LH Front	Turbo	1	EM-5551			
			RH Front	Turbo	1	EM-5578			
<b>E-100 ECONOLINE</b>									
L6	L6 2.8L 170ci	1968-71	Trans		1			EM-2307	
	L6 3.9L 240ci	1968-74	LH Front		1	EM-2332			
			RH Front		1	EM-2331			
			1973-74	Trans	Auto	1			EM-2362
				Trans	Manual	1			EM-2327
			1968-72	Trans		1			EM-2327
	L6 4.9L 300ci	1977-83	LH Front		1	EM-2442			
			LH Front		1	EM-2332			
			RH Front		1	EM-2441			
			RH Front		1	EM-2331			
			1980-83	Trans	Auto	1			EM-2448
				Trans	Manual	1			EM-2448
			1977-79	Trans	Auto	1			EM-2448
				Trans	Manual	1			EM-2448
			1975-76	Trans	Auto	1			EM-2372
			1972-74	Trans	Auto	1			EM-2362
	Trans	Manual		1			EM-2327		
V8	V8 5.0L 302ci	1968-74	L & R Front		2	EM-2329			
			LH Front		1	EM-2440			
		1975	LH Front		1	EM-2440			
			RH Front		1	EM-2439			
		1979-83	RH Front		1	EM-2439			
			Trans	Auto	1			EM-2448	
		1979-83	Trans	Manual	1			EM-2448	
			1975	Trans	Auto	1		EM-2448	
		1975	Trans	Manual	1			EM-2448	
			1968-74	Trans	Auto	1		EM-2362	
		1968-74	Trans	Manual	1			EM-2327	
			V8 5.8L 351ci	1975-83	LH Front		1	EM-2440	
	RH Front				1	EM-2439			
	Trans	Auto			1			EM-2448	
	Trans	Manual			1			EM-2448	
	Trans	Manual			1			EM-2448	
	V8 7.5L 460ci	1978	L & R Front		2	EM-2536			
<b>E-150 ECONOLINE</b>									
L6	L6 4.9L 300ci	1985-96	LH Front		1	EM-2636			
		1977-84	LH Front		1	EM-2442			
		1975-76	LH Front		1	EM-2332			
		1985-96	RH Front		1	EM-2635			
		1977-84	RH Front		1	EM-2441			
		1975-76	RH Front		1	EM-2331			
		1990-96	Trans	Auto	1			EM-2557	
		1988-89	Trans	Auto	1			EM-2557	
			Trans	Manual	1			EM-2557	
		1980-87	Trans	Auto	1			EM-2448	

# Engine, Transmission, And Torque Strut Mounts

CYL	ENG. SIZE	YEAR	LOCATION	DESCRIPTION	QTY	ENGINE	TORQUE STRUT	TRANSMISSION	
<b>FORD VAN (continued)</b>									
<b>E-150 ECONOLINE (continued)</b>									
L6	L6 4.9L 300ci	1980-87	Trans	Manual	1			EM-2448	
		1977-79	Trans	Auto	1			EM-2448	
			Trans	Manual	1			EM-2448	
			Trans	Auto	1			EM-2448	
			Trans	Manual	1			EM-2448	
1975-76	Trans	Auto	1			EM-2372			
V6	V6 4.2L 256ci	1997-03	LH Front		1	EM-3059			
			RH Front		1	EM-3060			
		2003	Trans	Auto	1			EM-2557	
		1997-03	Trans	Auto	1			EM-2557	
V8	V8 4.6L 281ci	1997-13	LH Front		1	EM-2930			
			RH Front		1	EM-2929			
		1997-11	Trans	Auto	1			EM-2557	
	V8 5.0L 302ci	1979-96	LH Front		1	EM-2440			
			LH Front		1	EM-2440			
			RH Front		1	EM-2439			
			RH Front		1	EM-2439			
			Trans	Auto	1		EM-2557		
			Trans	Auto	1		EM-2448		
			Trans	Auto	1		EM-2448		
			Trans	Manual	1		EM-2448		
			Trans	Auto	1		EM-2448		
	Trans	Manual	1		EM-2448				
	V8 5.4L 330ci	1997-13	LH Front		1	EM-2930			
			RH Front		1	EM-2929			
			1997-11	Trans	Auto	1		EM-2557	
	V8 5.8L 351ci	1975-96	LH Front		1	EM-2440			
			RH Front		1	EM-2439			
			Trans	Auto	1		EM-2557		
			Trans	Auto	1		EM-2448		
			Trans	Auto	1		EM-2448		
	V8 6.9L 420ci Diesel	1984	LH Front		1	EM-2768			
			RH Front		1	EM-2767			
Trans			Auto	1		EM-2448			
V8 7.5L 460ci	1976-80	L & R Front		2	EM-2536				
		1980	Trans	Auto	1		EM-2448		
			Trans	Manual	1		EM-2448		
<b>E-200 ECONOLINE</b>									
L6	L6 2.8L 170ci	1968-70	Trans		1			EM-2307	
			L6 3.9L 240ci	1968-74	LH Front		1	EM-2332	
					RH Front		1	EM-2331	
			1973-74	Trans	Auto	1		EM-2362	
				Trans	Manual	1		EM-2327	
	1968-72	Trans		1		EM-2327			
		L6 4.9L 300ci	1972-74	LH Front		1	EM-2332		
RH Front				1	EM-2331				
Trans	Auto			1		EM-2362			
V8	V8 5.0L 302ci	1968-74	L & R Front		2	EM-2329			
			1969-74	Trans	Auto	1		EM-2362	
				Trans	Manual	1		EM-2327	
<b>E-250 ECONOLINE</b>									
L6	L6 4.9L 300ci	1985-96	LH Front		1	EM-2636			
		1977-84	LH Front		1	EM-2442			
		1975-76	LH Front		1	EM-2332			
		1985-96	RH Front		1	EM-2635			

# Engine, Transmission, And Torque Strut Mounts

CYL	ENG. SIZE	YEAR	LOCATION	DESCRIPTION	QTY	ENGINE	TORQUE STRUT	TRANSMISSION		
<b>FORD VAN (continued)</b>										
<b>E-250 ECONOLINE (continued)</b>										
L6	L6 4.9L 300ci	1977-84	RH Front		1	EM-2441				
		1975-76	RH Front		1	EM-2331				
		1988-96	Trans	Auto		1			EM-2557	
		1983-87	Trans	Auto		1			EM-2448	
		1977-82	Trans	Auto		1			EM-2448	
			Trans	Manual		1			EM-2448	
	1975-76	Trans	Auto		1			EM-2372		
V6	V6 4.2L 256ci	1997-03	LH Front		1	EM-3059				
			RH Front		1	EM-3060				
			Trans	Auto		1			EM-2557	
V8	V8 4.6L 281ci	2003-13	LH Front		1	EM-2930				
			RH Front		1	EM-2929				
			2003-11	Trans	Auto		1			EM-2557
	V8 5.0L 302ci		1979-91	LH Front		1	EM-2440			
			1975	LH Front		1	EM-2440			
			1979-91	RH Front		1	EM-2439			
			1975	RH Front		1	EM-2439			
			1983-91	Trans	Auto		1			EM-2448
			1979-82	Trans	Auto		1			EM-2448
				Trans	Manual		1			EM-2448
			1975	Trans	Auto		1			EM-2448
		Trans	Manual		1			EM-2448		
	V8 5.4L 330ci		1997-13	LH Front		1	EM-2930			
				RH Front		1	EM-2929			
				1997-11	Trans	Auto		1		
	V8 5.8L 351ci		1975-96	LH Front		1	EM-2440			
				RH Front		1	EM-2439			
			1992-96	Trans	Auto		1			EM-2557
			1984-91	Trans	Auto		1			EM-2448
			1983	Trans	Auto		1			EM-2448
1975-82			Trans	Auto		1			EM-2448	
	Trans	Manual		1			EM-2448			
V8 6.6L 400ci		1980-82	LH Front		1	EM-2754				
			Trans	Auto		1			EM-2448	
			Trans	Manual		1			EM-2448	
V8 6.9L 420ci Diesel		1983-87	LH Front		1	EM-2768				
			RH Front		1	EM-2767				
			Trans	Auto		1			EM-2448	
V8 7.3L 445ci Diesel		1988-91	LH Front		1	EM-2768				
			RH Front		1	EM-2767				
			Trans	Auto		1			EM-2557	
V8 7.5L 460ci		1975-91	L & R Front		2	EM-2536				
		1988-91	Trans	Auto		1			EM-2557	
		1980-87	Trans	Auto		1			EM-2448	
		1980-82	Trans	Auto		1			EM-2448	
	Trans	Manual		1			EM-2448			
<b>E-250 SUPER DUTY</b>										
V8	V8 5.4L 330ci	2004-05	LH Front		1	EM-2930				
			RH Front		1	EM-2929				
			Trans		1			EM-2557		
<b>E-300 ECONOLINE</b>										
L6	L6 2.8L 170ci	1969-70	Trans		1			EM-2307		
	L6 3.9L 240ci	1968-74	LH Front		1	EM-2332				
			RH Front		1	EM-2331				
		1973-74	Trans	Auto		1			EM-2362	
	Trans	Manual		1			EM-2327			

# Engine, Transmission, And Torque Strut Mounts

CYL	ENG. SIZE	YEAR	LOCATION	DESCRIPTION	QTY	ENGINE	TORQUE STRUT	TRANSMISSION	
<b>FORD VAN (continued)</b>									
<b>E-300 ECONOLINE (continued)</b>									
L6	L6 3.9L 240ci	1968-72	Trans		1			EM-2327	
	L6 4.9L 300ci	1972-74	LH Front		1	EM-2332			
			RH Front		1	EM-2331			
			Trans	Auto	1			EM-2362	
V8	V8 5.0L 302ci	1968-74	L & R Front		2	EM-2329			
		1969-74	Trans	Auto	1			EM-2362	
			Trans	Manual	1			EM-2327	
<b>E-350 ECONOLINE</b>									
L6	L6 4.9L 300ci	1985-96	LH Front		1	EM-2636			
		1977-84	LH Front		1	EM-2442			
		1975-76	LH Front		1	EM-2332			
		1985-96	RH Front		1	EM-2635			
		1977-84	RH Front		1	EM-2441			
		1975-76	RH Front		1	EM-2331			
		1988-96	Trans	Auto		1			EM-2557
		1985-87	Trans	Auto		1			EM-2448
		1980-84	Trans	Auto		1			EM-2448
			Trans	Manual		1			EM-2448
		1977-79	Trans	Auto		1			EM-2448
			Trans	Manual		1			EM-2448
		1975-76	Trans	Auto		1			EM-2372
V8	V8 5.0L 302ci	1979-82	LH Front		1	EM-2440			
		1975	LH Front		1	EM-2440			
		1979-82	RH Front		1	EM-2439			
		1975	RH Front		1	EM-2439			
		1979-82	Trans	Auto		1			EM-2448
			Trans	Manual		1			EM-2448
		1975	Trans	Auto		1			EM-2448
			Trans	Manual		1			EM-2448
	V8 5.4L 330ci	1997-07	LH Front		1	EM-2930			
			RH Front		1	EM-2929			
		1997-05	Trans	Auto		1		EM-2557	
	V8 5.8L 351ci	1975-96	LH Front		1	EM-2440			
			RH Front		1	EM-2439			
		1992-96	Trans	Auto		1		EM-2557	
		1985-91	Trans	Auto		1		EM-2448	
		1975-84	Trans	Auto		1			EM-2448
	Trans		Manual		1			EM-2448	
	V8 6.0L 363ci	2004-05	Trans		1			EM-2557	
	V8 6.0L 363ci Diesel	2004-05	LH Front	Turbo		1	EM-5551		
			RH Front	Turbo		1	EM-5578		
V8 6.6L 400ci	1980-82	LH Front			1	EM-2754			
		Trans	Auto		1			EM-2448	
		Trans	Manual		1			EM-2448	
V8 6.9L 420ci Diesel	1983-87	LH Front			1	EM-2768			
		RH Front			1	EM-2767			
	1985-87	Trans	Auto		1			EM-2448	
	1983-84	Trans	Auto		1			EM-2448	
Trans		Manual		1			EM-2448		
V8 7.3L 445ci Diesel	1988-03	LH Front			1	EM-2768			
		RH Front			1	EM-2767			
	1988-00	Trans	Auto		1			EM-2557	
V8 7.5L 460ci	1975-96	L & R Front			2	EM-2536			
		Trans	Auto		1			EM-2557	
		Trans	Auto		1			EM-2557	
		Trans	Auto		1			EM-2448	
		Trans	Auto		1			EM-2448	

# Engine, Transmission, And Torque Strut Mounts

CYL	ENG. SIZE	YEAR	LOCATION	DESCRIPTION	QTY	ENGINE	TORQUE STRUT	TRANSMISSION	
<b>FORD VAN (continued)</b>									
<b>E-350 ECONOLINE (continued)</b>									
V8	V8 7.5L 460ci	1980-84	Trans	Manual	1			EM-2448	
V10	V10 6.8L 415ci	2005	Trans	Auto	1			EM-2557	
		1997-03	Trans	Auto	1			EM-2557	
<b>E-350 SUPER DUTY</b>									
V8	V8 5.4L 330ci	2004-13	LH Front		1	EM-2930			
			RH Front		1	EM-2929			
		2004-12	Trans	Auto	1			EM-2557	
		V8 6.0L 363ci	2004-10	Trans		1			EM-2557
	V8 6.0L 363ci Diesel	2004-10	LH Front	Turbo	1	EM-5551			
RH Front			Turbo	1	EM-5578				
V10	V10 6.8L 415ci	2006-13	Trans		1			EM-2557	
<b>E-450 SUPER DUTY</b>									
V8	V8 5.4L 330ci	2000-13	LH Front		1	EM-2930			
			RH Front		1	EM-2929			
		2006-13	Trans		1			EM-2557	
		2004	Trans		1			EM-2557	
		V8 6.0L 363ci	2004-07	Trans		1			EM-2557
	V8 6.0L 363ci Diesel	2004-10	LH Front	Turbo	1	EM-5551			
			RH Front	Turbo	1	EM-5578			
	V8 7.3L 445ci Diesel	2000-03	LH Front		1	EM-2768			
			RH Front		1	EM-2767			
Trans			Auto	1			EM-2557		
V10	V10 6.8L 415ci	2000-13	Trans	Auto	1			EM-2557	
<b>E-550 SUPER DUTY</b>									
V8	V8 7.3L 445ci Diesel	2003	LH Front		1	EM-2768			
			RH Front		1	EM-2767			
			Trans	Auto	1			EM-2557	
V10	V10 6.8L 415ci	2003	Trans		1			EM-2557	
<b>E SUPER DUTY</b>									
V8	V8 5.4L 330ci	2000-02	LH Front		1	EM-2930			
		1997-99	LH Front		1	EM-2930			
		2000-02	RH Front		1	EM-2929			
		1997-99	RH Front		1	EM-2929			
		2000-02	Trans	Auto	1			EM-2557	
		1997-99	Trans		1			EM-2557	
	V8 5.8L 351ci	1996	LH Front		1	EM-2440			
			RH Front		1	EM-2439			
			Trans	Auto	1			EM-2557	
	V8 7.3L 445ci Diesel	2000-02	LH Front		1	EM-2768			
			1996-99	LH Front		1	EM-2768		
			2000-02	RH Front		1	EM-2767		
			1996-99	RH Front		1	EM-2767		
			2000-02	Trans	Auto	1			EM-2557
			1996-99	Trans	Auto	1			EM-2557
	V10	V10 6.8L 415ci	2000-02	Trans	Auto	1			EM-2557
1997-99			Trans	Auto	1			EM-2557	
<b>FREESTAR</b>									
V6	V6 3.9L	2004-07	Torq Str - Rear		1		EM-3101		
			Trans		1			EM-3106	
	V6 3.9L 238ci	2004-07	RH Front		1	EM-3075*			
			RH Rear		1	EM-3076*			
	V6 4.2L	2004-07	Torq Str - Rear		1		EM-3101		
			Trans		1			EM-3106	
V6 4.2L 256ci	2004-07	RH Front		1	EM-3075*				
		RH Rear		1	EM-3076*				

# Engine, Transmission, And Torque Strut Mounts

CYL	ENG. SIZE	YEAR	LOCATION	DESCRIPTION	QTY	ENGINE	TORQUE STRUT	TRANSMISSION
<b>FORD VAN (continued)</b>								
<b>P350 MICROBUS (MEXICAN VEHICLE)</b>								
V8	V8 5.0L 302ci	1989-91	LH Front		1	EM-2440		
			RH Front		1	EM-2439		
			Trans		1			EM-2347
	V8 5.8L 351ci	1986-97	LH Front		1	EM-5440		
			RH Front		1	EM-2439		
			Trans		1			EM-8887
<b>TRANSIT CONNECT</b>								
L4	L4 2.0L 121ci	2010-13	RH Front		1	EM-3103		
			Torq Str - Rear		1		EM-2939	
			Trans		1			EM-2986
<b>WINDSTAR</b>								
V6	V6 3.0L 182ci	1995-00	RH Front		1	EM-2623		
			RH Rear		1	EM-2622		
			Trans		1			EM-2686
	V6 3.8L 232ci	1999-03 1996-98 1995 1999-03 1996-98 1995 1999-03 1997-98 1995-96	RH Front		1	EM-2931		
			RH Front		1	EM-2915		
			RH Front		1	EM-2812'		
			RH Rear		1	EM-2813'		
			RH Rear		1	EM-2813'		
			RH Rear		1	EM-2813'		
			Trans		1			EM-2717 *
			Trans		1			EM-2977
			Trans		1			EM-2717 *
			<b>FREIGHTLINER</b>					
<b>SPRINTER 2500</b>								
L5	L5 2.7L 2687cc 165ci	2003-06	L & R Front		2	EM-3190		
			Trans		1			EM-3189
<b>GEO PASSENGER CAR</b>								
<b>METRO</b>								
L3	L3 1.0L	1991	Front	Manual	1	EM-8517		
		1989-90	Front	Manual	1	EM-8517		
		1991	LH Front	Auto	1	EM-5591		
		1989-90	LH Front	Auto	1	EM-5591		
		1991	RH Front	Auto; To 3-1-1991	1	EM-5733		
			RH Front	Manual	1	EM-8514		
		1989-90	RH Front	Auto	1	EM-5733		
			RH Front	Manual	1	EM-8514		
		1991	Rear	Manual	1	EM-8294		
		1989-90	Rear	Manual	1	EM-8294		
	L3 1.0L 993cc	1995-97 1992-94	Front	Manual	1	EM-8517		
			Front	Manual	1	EM-8517		
			LH Front	Auto	1	EM-5591		
			Torq Str - Rear	Auto	1		EM-8658	
			Trans	Auto	1			EM-8314
			Trans	Manual	1			EM-8277
			Trans	Manual	1			
L4	L4 1.3L 1295cc	1992-97	Front		1	EM-5608		
			Rear		1	EM-8277		
		1995-97	Torq Str - Front		1		EM-8658	
			Trans		1			EM-8277
<b>PRIZM</b>								
L4	L4 1.6L 1588cc	1993-97	Front	Auto	1	EM-8177		
			Front	Manual	1	EM-8180		
			Front	Auto	1	EM-8180		

# Engine, Transmission, And Torque Strut Mounts

CYL	ENG. SIZE	YEAR	LOCATION	DESCRIPTION	QTY	ENGINE	TORQUE STRUT	TRANSMISSION	
<b>GEO PASSENGER CAR (continued)</b>									
<b>PRIZM (continued)</b>									
L4	L4 1.6L 1588cc	1989-92	Front	Manual	1	EM-8181			
		1993-97	RH Front		1	EM-8178			
		1989-92	RH Front			1	EM-8183		
		1993-97	Rear			1	EM-8179		
		1989-92	Rear		Auto	1	EM-8185		
			Rear		Manual	1	EM-8187		
		1993-97	Trans			1			EM-8191
	1989-92	Trans		Auto	1			EM-8188	
	L4 1.8L	1996-97	Trans		Auto	1			EM-8415
			Trans		Manual	1			EM-8191
	L4 1.8L 1788cc	1993-97	Front		Auto	1	EM-8177		
			Front		Manual	1	EM-8180		
			RH Front			1	EM-8178		
Rear					1	EM-8179			
1993-95			Trans		Manual	1			EM-8191
<b>SPECTRUM</b>									
L4	L4 1.5L	1989	Trans		1			EM-8976	
			Trans		1			EM-8976	
	L4 1.5L 1471cc	1989	Front		1	EM-8442			
			RH Front		1	EM-8439			
<b>GEO SPORT UTILITY</b>									
<b>TRACKER</b>									
L4	L4 1.6L 1588cc	1989-97	L & R Front		2	EM-8568			
		1996-97	Torq Str - Front	Auto; 3 Spd; 4WD	1		EM-8657		
			Torq Str - Front	Auto; 4 Spd; 4WD	1		EM-8656		
		1989-95	Torq Str - Front	Auto; 3 Spd; 4WD	1		EM-8657		
			Torq Str - Front	Manual	1		EM-8657		
	1989-97	Trans			1			EM-8825	
L4 1.6L 1590cc 97ci	1995	Torq Str - Front	Auto	1		EM-8657			
<b>GMC SPORT UTILITY</b>									
<b>ACADIA</b>									
V6	V6 3.6L	2009-12	Torq Str - Right		1		EM-3141		
		2007-08	Torq Str - Right	Bracket Only	1		EM-3143		
			Torq Str - Right	Strut	1		EM-3133		
	V6 3.6L 217ci	2009-12	Front		1	EM-4037			
			Rear		1	EM-4035			
			Trans		1			EM-4036	
<b>C15/C1500 SUBURBAN</b>									
L6	L6 4.1L 250ci	1973-80	L & R Front		2	EM-2292			
		1968-72	L & R Front		2	EM-2282			
		1973-80	Trans	Auto; THM350 (M38)	1			EM-2378 @	
				THM350C (MV4)					
			Trans	Auto; THM400	1			EM-2268 @	
			Trans	Manual	1			EM-2378 @	
		1968-72	Trans	Auto; THM350 (M38)	1			EM-2378 @	
				THM350C (MV4)					
	Trans		Manual	1			EM-2378 @		
	L6 4.8L 292ci	1973-74	L & R Front		2	EM-2292			
			L & R Front		2	EM-2282			
1973-74		Trans	Auto; THM350	1			EM-2378 @		
			Auto; THM400	1			EM-2268 @		
			Manual	1			EM-2378 @		
1968-71	Trans		1			EM-2378 @			
V8	V8 5.0L 305ci	1976-86	L & R Front		2	EM-2292			

# Engine, Transmission, And Torque Strut Mounts

CYL	ENG. SIZE	YEAR	LOCATION	DESCRIPTION	QTY	ENGINE	TORQUE STRUT	TRANSMISSION			
<b>GMC SPORT UTILITY (continued)</b>											
<b>C15/C1500 SUBURBAN (continued)</b>											
V8	V8 5.0L 305ci	1986	Trans	Auto; THM350 (M38) THM700R4 (MD8)	1			EM-2392			
			Trans	Auto; THM400 (M40)	1			EM-2513			
		1985	Trans	Auto; THM400 (M40)	1				EM-2513		
			Trans	Auto; THM700-R4/4L60 (MD8)	1				EM-2392		
		1982-84	Trans	Auto; THM350 (M38) THM700R4 (MD8)	1				EM-2392		
			Trans	Auto; THM400 (M40)	1				EM-2513		
			Trans	Manual	1				EM-2392		
		1976-81	Trans	Auto; THM350 (M38) THM350C (MV4)	1				EM-2378 @		
			Trans	Auto; THM400	1				EM-2268 @		
			Trans	Manual	1				EM-2378 @		
		V8 5.0L 307ci	V8 5.0L 307ci	1973	L & R Front		2	EM-2292			
				1968-72	L & R Front		2	EM-2282			
				1968-73	Trans	Auto; THM350	1				EM-2378 @
					Trans	Auto; THM400	1				EM-2268 @
Trans	Manual				1				EM-2378 @		
V8 5.4L 327ci	V8 5.4L 327ci	1968	L & R Front		2	EM-2282					
			Trans	Auto; THM350 (M38) THM350C (MV4)	1			EM-2378 @			
		Trans	Auto; THM400	1				EM-2268 @			
			Manual	1				EM-2378 @			
V8 5.7L 350 ci Gas	1979-81	L & R Front		2	EM-2292						
V8 5.7L 350ci	V8 5.7L 350ci	1992-99	L & R Front		2	EM-2621					
			L & R Front		2	EM-2292					
		1973-78	L & R Front		2	EM-2292					
			L & R Front		2	EM-2282					
		1969-72	L & R Front		2	EM-2282					
		1994-99	Trans		1			EM-2817			
		1992-93	Trans		1			EM-2360 @			
		1986	Trans	Auto; THM350 (M38) THM700R4 (MD8)	1				EM-2392		
			Trans	Auto; THM400 (M40)	1				EM-2513		
		1985	Trans	Auto; THM400 (M40)	1				EM-2513		
			Trans	Auto; THM700-R4/4L60 (MD8)	1				EM-2392		
		1982-84	Trans	Auto; THM350 (M38) THM700R4 (MD8)	1				EM-2392		
			Trans	Auto; THM400 (M40)	1				EM-2513		
			Trans	Manual	1				EM-2392		
1973-81	Trans	Auto; THM350	1				EM-2378 @				
	Trans	Auto; THM400	1				EM-2268 @				
	Trans	Manual	1				EM-2378 @				
V8 5.7L 350ci Diesel	V8 5.7L 350ci Diesel	1979-81	L & R Front	VIN Z	2	EM-2328					
			Trans	Auto; THM350	1			EM-2378 @			
			Trans	Auto; THM400	1				EM-2268 @		
			Trans	Manual	1				EM-2378 @		
V8 6.2L 379ci Diesel	V8 6.2L 379ci Diesel	1984-86	L & R Front		2	EM-2395					
			L & R Front		2	EM-2292					
		1983-86	Trans	Auto; THM400	1				EM-2515		
			Trans	Auto; THM700-R4/4L60 (MD8)	1				EM-2393		
1982	Trans		1				EM-2392				
V8 6.5L 395ci Diesel	V8 6.5L 395ci Diesel	1995-99	L & R Front		2	EM-2621					
			Trans		1			EM-2817			
V8 6.6L 402ci	V8 6.6L 402ci	1970-72	L & R Front		2	EM-2283					
			Trans	Auto; THM350	1			EM-2378 @			
			Trans	Auto; THM400	1				EM-2268 @		



# Engine, Transmission, And Torque Strut Mounts

CYL	ENG. SIZE	YEAR	LOCATION	DESCRIPTION	QTY	ENGINE	TORQUE STRUT	TRANS-MISSION		
<b>GMC SPORT UTILITY (continued)</b>										
<b>C15/C1500 SUBURBAN (continued)</b>										
V8	V8 6.6L 402ci	1970-72	Trans	Manual	1			EM-2378 @		
	V8 7.4L 454ci	1973-80	L & R Front		2	EM-2395				
			Trans	Auto; THM350	1			EM-2378 @		
			Trans	Auto; THM400	1			EM-2268 @		
			Trans	Manual	1			EM-2378 @		
<b>C25/C2500 SUBURBAN</b>										
L6	L6 4.1L 250ci	1973-74	L & R Front		2	EM-2292				
		1968-72	L & R Front		2	EM-2282				
		1973-74	Trans	Auto; THM350 (M38) THM350C (MV4)	1			EM-2378 @		
			Trans	Auto; THM400	1			EM-2268 @		
			Trans	Manual	1			EM-2378 @		
			1968-72	Trans		1			EM-2378 @	
	L6 4.8L 292ci	1984	L & R Front		2	EM-2292				
		1973-82	L & R Front		2	EM-2292				
		1968-72	L & R Front		2	EM-2282				
			Trans	Auto; THM400	1			EM-2513		
			Trans	Auto; THM700-R4/4L60 (MD8)	1			EM-2392		
		1968-81	Trans	Manual	1			EM-2392		
			Trans	Auto; THM350	1			EM-2378 @		
			Trans	Auto; THM400	1			EM-2268 @		
			Trans	Manual	1			EM-2378 @		
		V8	V8 5.0L 305ci	1982-86	L & R Front		2	EM-2292		
				1977-78	L & R Front		2	EM-2292		
				1986	Trans	Auto; THM350C (MV4)	1			EM-2392
					Trans	Auto; THM400 (M40)	1			EM-2513
				1985	Trans	Auto; THM400 (M40)	1			EM-2513
1982-84	Trans			Auto; THM350C (MV4)	1			EM-2392		
	Trans			Auto; THM400 (M40)	1			EM-2513		
1977-78	Trans			Auto; THM350 (M38)	1			EM-2378 @		
	Trans			Auto; THM400	1			EM-2268 @		
	Trans			Manual	1			EM-2378 @		
V8 5.0L 307ci	1973			L & R Front		2	EM-2292			
	1968-72			L & R Front		2	EM-2282			
			Trans	Auto; Powerglide	1			EM-2378 @		
			Trans	Auto; THM400	1			EM-2268 @		
			Trans	Manual	1			EM-2378 @		
V8 5.4L 327ci	1968		L & R Front		2	EM-2282				
			Trans	Auto; THM350	1			EM-2378 @		
			Trans	Auto; THM400	1			EM-2268 @		
			Trans	Manual	1			EM-2378 @		
V8 5.7L 350 ci Gas	1980		L & R Front		2	EM-2292				
V8 5.7L 350ci	1992-99		L & R Front		2	EM-2621				
	1981-86		L & R Front		2	EM-2292				
	1974-79		L & R Front		2	EM-2292				
	1969-72		L & R Front		2	EM-2282				
	1994-99		Trans		1			EM-2817		
	1992-93		Trans		1			EM-2360 @		
	1985-86		Trans	Auto; THM350 (M38) THM700R4 (MD8)	1			EM-2392		
			Trans	Auto; THM400 (M40)	1			EM-2513		
			1982-84	Trans	Auto; THM350 (M38) THM700R4 (MD8)	1			EM-2392	
	Trans			Auto; THM400 (M40)	1			EM-2513		
	Trans	Manual	1			EM-2392				

# Engine, Transmission, And Torque Strut Mounts

CYL	ENG. SIZE	YEAR	LOCATION	DESCRIPTION	QTY	ENGINE	TORQUE STRUT	TRANSMISSION
<b>GMC SPORT UTILITY (continued)</b>								
<b>C25/C2500 SUBURBAN (continued)</b>								
V8	V8 5.7L 350ci	1974-81	Trans	Auto; THM350	1			EM-2378 @
			Trans	Auto; THM400	1		EM-2268 @	
			Trans	Manual	1		EM-2378 @	
V8	V8 5.7L 350ci Diesel	1980	L & R Front	VIN Z	2	EM-2328		
			Trans	Auto; THM350	1		EM-2378 @	
			Trans	Auto; THM400	1		EM-2268 @	
			Trans	Manual	1		EM-2378 @	
V8	V8 6.2L 379ci Diesel	1984-86	L & R Front		2	EM-2395		
			L & R Front		2	EM-2292		
		1982-86	Trans	Auto; THM400	1		EM-2515	
			Trans	Auto; THM700R4 (MD8)	1		EM-2393	
V8	V8 6.5L 395ci Diesel	1994-99	L & R Front		2	EM-2621		
			Trans		1		EM-2817	
V8	V8 6.6L 400ci	1980	L & R Front		2	EM-2292		
			L & R Front		2	EM-2292		
		1980	Trans	Auto; THM350	1		EM-2378 @	
			Trans	Auto; THM400	1		EM-2268 @	
			Trans	Manual	1		EM-2378 @	
1978	Trans		1		EM-2378 @			
V8	V8 6.6L 402ci	1970-72	L & R Front		2	EM-2283		
			Trans	Auto; THM350	1		EM-2378 @	
			Trans	Auto; THM400	1		EM-2268 @	
			Trans	Manual	1		EM-2378 @	
V8	V8 7.4L 454ci	1992-99	L & R Front		2	EM-2621		
			L & R Front		2	EM-2395		
		1974-86	Trans		1		EM-2817	
			Trans		1		EM-2360 @	
		1984-86	Trans	Auto; THM400 (M40)	1		EM-2513	
			Trans	Auto; THM700-R4/4L60 (MD8)	1		EM-2392	
		1982-84	Trans	Auto; THM400 (M40)	1		EM-2513	
			Trans	Auto; THM700-R4/4L60 (MD8)	1		EM-2392	
			Trans	Manual	1		EM-2392	
		1974-81	Trans	Auto; THM350	1		EM-2378 @	
			Trans	Auto; THM400	1		EM-2268 @	
Trans	Manual	1		EM-2378 @				
<b>ENVOY</b>								
L6	L6 4.2L 256ci	2002-09	L & R Front		2	EM-3021*		
			Trans		1		EM-3027	
V8	V8 5.3L	2005-09	LH Front		1	EM-5694		
			RH Front		1	EM-5693		
<b>ENVOY XL / XUV</b>								
L6	L6 4.2L 256ci	2006	L & R Front		2	EM-3021*		
			Trans		1		EM-3027	
V8	V8 5.3L	2005-06	LH Front		1	EM-5694		
			RH Front		1	EM-5693		
<b>JIMMY</b>								
L6	L6 4.1L 250ci	1973-82	L & R Front		2	EM-2292		
			L & R Front		2	EM-2282		
		1975-76	Trans - L & R Lower	4WD 4WD	2		EM-2108	
			Trans - L & R Upper	4WD 4WD	2		EM-2107	
			Trans - Lower	Auto; 4WD	2		EM-2108	
		1982	Trans - Lower	Manual; 4WD	2		EM-2108	
			Trans - Lower	Auto; 4WD	2		EM-2108	

# Engine, Transmission, And Torque Strut Mounts

CYL	ENG. SIZE	YEAR	LOCATION	DESCRIPTION	QTY	ENGINE	TORQUE STRUT	TRANS-MISSION	
<b>GMC SPORT UTILITY (continued)</b>									
<b>JIMMY (continued)</b>									
L6	L6 4.1L 250ci	1977-81	Trans - Lower	Manual; 4WD	2			EM-2108	
		1970-74	Trans - Lower	Auto; 4WD	2			EM-2108	
			Trans - Lower	Manual; 4WD	2			EM-2108	
			1982	Trans - Upper	Auto; 4WD	2			EM-2107
		1977-81	Trans - Upper	Manual; 4WD	2			EM-2392	
			Trans - Upper	Auto; 4WD	2			EM-2107	
		1970-74	Trans - Upper	Manual; 4WD	2			EM-2378 @	
			Trans - Upper	Auto; 4WD	2			EM-2107	
		1982	Trans	Auto; THM350C (MV4); 2WD	1			EM-2392	
			1977-81	Trans	Auto; THM350 (M38) THM350C (MV4); RWD	1			EM-2268 @
		1975-76	Trans	Auto; THM400 (M40); 2WD	1			EM-2378 @	
			Trans	Auto; M40; 2WD	1			EM-2268 @	
			Trans	Auto; THM350 (M38) THM350C (MV4); RWD	1			EM-2378 @	
		1970-74	Trans	Manual; 2WD	1			EM-2378 @	
			Trans	Auto; THM350 (M38) THM350C (MV4); RWD	1			EM-2268 @	
			Trans	Auto; THM400 (M40); 2WD	1			EM-2378 @	
		L6 4.8L 292ci	1973	L & R Front			2	EM-2292	
				Trans - Lower	Auto; 4WD	2			EM-2108
	Trans - Lower			Manual; 4WD	2			EM-2108	
	Trans - Upper			Auto; 4WD	2			EM-2107	
	Trans - Upper			Manual; 4WD	2			EM-2378 @	
	Trans			Auto; THM350 (M38); 2WD	1			EM-2268 @	
	V6	V6 4.3L 262ci	1996-05	L & R Front		2	EM-2802		
			1995	L & R Front		2	EM-2627		
2002-05			Trans	Auto; 4WD	1			EM-2638	
1995-01			Trans	Auto; 4WD	1			EM-2638	
			Trans	Auto; RWD	1			EM-2394	
			Trans	Manual; 4WD	1			EM-2638	
			Trans	Manual; RWD	1			EM-2394	
V8	V8 5.0L 305ci	1977-87	L & R Front		2	EM-2292			
		1983-84	Trans - Lower	Auto; 4WD	2			EM-2108	
			Trans - Lower	Manual; 4WD	2			EM-2108	
		1977-82	Trans - Lower	Auto; 4WD	2			EM-2108	
			Trans - Lower	Manual; 4WD	2			EM-2108	
		1983-84	Trans - Upper	Auto; 4WD	2			EM-2107	
			Trans - Upper	Manual; 4WD	2			EM-2513	
		1977-82	Trans - Upper	Auto; 4WD	2			EM-2107	
			1985-87	Trans	Auto; 4WD	1			EM-2638
		1983-84	Trans	Manual; 4WD	1			EM-2638	
			Trans	Auto; THM400 (M40); RWD	1			EM-2392	
		Trans	Auto; THM700-R4/4L60 (MD8) RWD	1			EM-2392		
		V8 5.0L 307ci	1970-72	L & R Front			2	EM-2282	
				Trans - Lower	Auto; 4WD	2			EM-2108
	Trans - Lower			Manual; 4WD	2			EM-2108	
	Trans - Upper			Auto; 4WD	2			EM-2107	
	Trans - Upper	Manual; 4WD	2			EM-2268 @			
	V8 5.7L 350ci	1988-91	L & R Front	4WD		2	EM-2637		
			1973-87	L & R Front		2	EM-2292		
			1970-72	L & R Front		2	EM-2282		
1982-84			Trans - Lower	Auto; 4WD	2			EM-2108	

# Engine, Transmission, And Torque Strut Mounts

CYL	ENG. SIZE	YEAR	LOCATION	DESCRIPTION	QTY	ENGINE	TORQUE STRUT	TRANS-MISSION	
<b>GMC SPORT UTILITY (continued)</b>									
<b>JIMMY (continued)</b>									
V8	V8 5.7L 350ci	1982-84	Trans - Lower	Manual; 4WD	2			EM-2108	
		1977-81	Trans - Lower	Auto; 4WD	2			EM-2108	
			Trans - Lower	Manual; 4WD	2				EM-2108
		1975-76	Trans - Lower	Auto; 4WD	2				EM-2108
			Trans - Lower	Manual; 4WD	2				EM-2108
		1970-74	Trans - Lower	Auto; 4WD	2				EM-2108
			Trans - Lower	Manual; 4WD	2				EM-2108
		1982-84	Trans - Upper	Auto; 4WD	2				EM-2107
			Trans - Upper	Manual; 4WD	2				EM-2392
		1977-81	Trans - Upper	Auto; 4WD	2				EM-2107
			Trans - Upper	Manual; 4WD	2				EM-2378 @
		1975-76	Trans - Upper	Auto; 4WD	2				EM-2107
			Trans - Upper	Manual; 4WD	2				EM-2268 @
		1970-74	Trans - Upper	Auto; 4WD	2				EM-2107
			Trans - Upper	Manual; 4WD	2				EM-2378 @
		1985-91	Trans	Auto; 4WD	1				EM-2638
			Trans	Manual; 4WD	1				EM-2638
		1982-84	Trans	Auto; THM350 (M38) THM700R4 (MD8); 2WD	1				EM-2513
			Trans	Auto; THM400 (M40); 2WD	1				EM-2392
		1977-81	Trans	Auto; THM350 (M38); 2WD	1				EM-2268 @
		Trans	Auto; THM400 (M40); 2WD	1				EM-2378 @	
	1975-76	Trans	Auto, M40; 2WD	1				EM-2378 @	
		Trans	Auto; THM350 (M38); 2WD	1				EM-2378 @	
	1970-74	Trans	Auto; THM350 (M38); 2WD	1				EM-2268 @	
		Trans	Auto; THM400 (M40); 2WD	1				EM-2378 @	
		V8 6.2L 379ci Diesel	1988-91	L & R Front		2	EM-2637		
			1984-87	L & R Front		2	EM-2395		
			1982-83	L & R Front		2	EM-2292		
			1982-84	Trans - Lower	Auto; 4WD	2			EM-2108
				Trans - Lower	Manual; 4WD	2			EM-2108
				Trans - Upper	Auto; 4WD	2			EM-2107
			Trans - Upper	Manual; 4WD	2			EM-2393	
		1985-91	Trans	Auto; 4WD	1			EM-2638	
		Trans	Manual; 4WD	1			EM-2638		
	V8 7.4L 454ci	1976	L & R Front		2	EM-2292			
			Trans - Lower	Auto; 4WD	2			EM-2108	
			Trans - Lower	Manual; 4WD	2			EM-2108	
			Trans - Upper	Auto; 4WD	2			EM-2107	
<b>K15/K1500 SUBURBAN</b>									
L6	L6 4.1L 250ci	1973-80	L & R Front		2	EM-2292			
		1968-72	L & R Front		2	EM-2282			
		1968-80	Trans - Lower	Auto	2			EM-2108	
			Trans - Lower	Manual	2			EM-2108	
		Trans - Upper	Auto	2			EM-2107		
	L6 4.8L 292ci	1968	L & R Front		2	EM-2282			
			Trans - Lower	Auto	2			EM-2108	
			Trans - Lower	Manual	2			EM-2108	
		Trans - Upper	Auto	2			EM-2107		
V8	V8 5.0L 305ci	1977-85	L & R Front		2	EM-2292			
		1985	Trans - Lower	Auto	2			EM-2108	
		1977-84	Trans - Lower	Auto	2			EM-2108	
			Trans - Lower	Manual	2			EM-2108	
		1985	Trans - Upper	Auto	2			EM-2107	
	1977-84	Trans - Upper	Auto	2			EM-2107		
	V8 5.0L 307ci	1973	L & R Front		2	EM-2292			

# Engine, Transmission, And Torque Strut Mounts

CYL	ENG. SIZE	YEAR	LOCATION	DESCRIPTION	QTY	ENGINE	TORQUE STRUT	TRANSMISSION		
<b>GMC SPORT UTILITY (continued)</b>										
<b>K15/K1500 SUBURBAN (continued)</b>										
V8	V8 5.0L 307ci	1970-72	L & R Front		2	EM-2282				
		1968	L & R Front		2	EM-2282				
		1970-73	Trans - Lower	Auto		2			EM-2108	
			Trans - Lower	Manual		2			EM-2108	
		1968	Trans - Lower	Auto		2			EM-2108	
			Trans - Lower	Manual		2			EM-2108	
	1970-73	Trans - Upper	Auto		2			EM-2107		
		1968	Trans - Upper	Auto		2		EM-2107		
	V8 5.7L 350ci	1992-99	L & R Front		2	EM-2637				
		1973-86	L & R Front		2	EM-2292				
		1969-72	L & R Front		2	EM-2282				
		1969-84	Trans - Lower	Auto		2			EM-2108	
			Trans - Lower	Manual		2			EM-2108	
			Trans - Upper	Auto		2			EM-2107	
	1992-99	Trans	Auto		1			EM-2638		
	1985-86	Trans	Auto		1			EM-2638		
	V8 6.2L 379ci Diesel	1984-86	L & R Front		2	EM-2395				
		1982-83	L & R Front		2	EM-2292				
		1982-84	Trans - Lower	Auto		2			EM-2108	
			Trans - Lower	Manual		2			EM-2108	
		1985-86	Trans		1			EM-2638		
V8 6.5L 395ci Diesel	1995-99	L & R Front		2	EM-2637					
		Trans	Auto		1			EM-2638		
V8 6.6L 400ci	1975-79	L & R Front		2	EM-2292					
		Trans - Lower	Auto		2			EM-2108		
		Trans - Lower	Manual		2			EM-2108		
		Trans - Upper	Auto		2			EM-2107		
<b>K25/K2500 SUBURBAN</b>										
L6	L6 4.1L 250ci	1973-74	L & R Front		2	EM-2292				
		1968-72	L & R Front		2	EM-2282				
		1968-74	Trans - Lower	Auto		2			EM-2108	
			Trans - Lower	Manual		2			EM-2108	
	L6 4.8L 292ci	1973-84	L & R Front		2	EM-2292				
		1968-72	L & R Front		2	EM-2282				
		1968-84	Trans - Lower	Auto		2			EM-2108	
			Trans - Lower	Manual		2			EM-2108	
		Trans - Upper	Auto		2			EM-2107		
V8	V8 5.0L 305ci	1977-78	L & R Front		2	EM-2292				
			Trans - Lower	Auto		2			EM-2108	
			Trans - Lower	Manual		2			EM-2108	
			Trans - Upper	Auto		2			EM-2107	
	V8 5.0L 307ci	1973	L & R Front		2	EM-2292				
			1968-72	L & R Front		2	EM-2282			
			1968-73	Trans - Lower	Auto		2			EM-2108
				Trans - Lower	Manual		2			EM-2108
			Trans - Upper	Auto		2			EM-2107	
	V8 5.7L 350ci	1992-99	L & R Front		2	EM-2637				
		1973-86	L & R Front		2	EM-2292				
		1969-72	L & R Front		2	EM-2282				
		1969-84	Trans - Lower	Auto		2			EM-2108	
			Trans - Lower	Manual		2			EM-2108	
			Trans - Upper	Auto		2			EM-2107	
		1992-99	Trans	Auto		1			EM-2638	
	1985-86	Trans	Auto		1			EM-2638		
	V8 6.2L 379ci Diesel	1984-86	L & R Front		2	EM-2395				

# Engine, Transmission, And Torque Strut Mounts

CYL	ENG. SIZE	YEAR	LOCATION	DESCRIPTION	QTY	ENGINE	TORQUE STRUT	TRANSMISSION	
<b>GMC SPORT UTILITY (continued)</b>									
<b>K25/K2500 SUBURBAN (continued)</b>									
V8	V8 6.2L 379ci Diesel	1982-83	L & R Front		2	EM-2292			
		1982-84	Trans - Lower	Auto	2			EM-2108	
			Trans - Lower	Manual	2			EM-2108	
			Trans - Upper	Auto	2			EM-2107	
	1985-86	Trans	Auto	1			EM-2638		
	V8 6.5L 395ci Diesel	1994-99	L & R Front		2	EM-2637			
			Trans	Auto	1			EM-2638	
	V8 6.6L 400ci	1975-80	L & R Front		2	EM-2292			
			Trans - Lower	Auto	2			EM-2108	
			Trans - Lower	Manual	2			EM-2108	
			Trans - Upper	Auto	2			EM-2107	
	V8 7.4L 454ci	1992-99	L & R Front		2	EM-2637			
			L & R Front		2	EM-2395			
		1977	Trans - Lower	Auto	2			EM-2108	
Trans - Lower			Manual	2			EM-2108		
Trans - Upper			Auto	2			EM-2107		
1992-99		Trans	Auto	1			EM-2638		
<b>R1500 SUBURBAN</b>									
V8	V8 5.0L 305ci	1987	L & R Front		2	EM-2292			
			Trans		1			EM-2392	
	V8 5.7L 350ci	1989-91	L & R Front		2	EM-2621			
			Trans	Auto; THM700R4 (MD8)	1			EM-2392	
			1987-90	Trans	Auto; THM400	1			EM-2513
				Trans	Auto; THM700R4 (MD8)	1			EM-2392
	V8 6.2L 379ci Diesel	1987-91	L & R Front		2	EM-2395			
			Trans	Auto; THM700-R4/4L60 (MD8)	1			EM-2393	
			1987-90	Trans	Auto; THM400 (M40)	1			EM-2515
				Trans	Auto; THM700-R4/4L60 (MD8)	1			EM-2393
<b>R2500 SUBURBAN</b>									
V8	V8 5.7L 350ci	1989-91	L & R Front		2	EM-2621			
			Trans	Auto; THM700R4 (MD8)	1			EM-2392	
			1987-90	Trans	Auto; THM400	1			EM-2513
				Trans	Auto; THM700R4 (MD8)	1			EM-2392
	V8 6.2L 379ci Diesel	1987-91	L & R Front		2	EM-2395			
			1991	Trans	Auto; 4L80E (MT1)	1			EM-2515
				Trans	Auto; THM700R4 (MD8)	1			EM-2393
				Trans	Auto; THM400 (M40)	1			EM-2515
			1987-90	Trans	Auto; THM700R4 (MD8)	1			EM-2393
				Trans	Auto; THM700R4 (MD8)	1			EM-2393
V8 7.4L 454ci	1987-91	L & R Front		2	EM-2395				
		Trans		1			EM-2515		
<b>S15 JIMMY</b>									
L4	L4 1.9L 119ci	1983-84	L & R Front		2	EM-2381			
			1984	Trans	Auto; 2WD	1			EM-2531
		Trans		Auto; 4WD	1			EM-2638	
		Trans		Manual; 2WD	1			EM-2531	
		Trans		Manual; 4WD	1			EM-2638	
		1983		Trans	Auto; 2WD	1			EM-2771
				Trans	Auto; 4WD	1			EM-2638
				Trans	Manual; 2WD	1			EM-2771
				Trans	Manual; 4WD	1			EM-2638
		L4 2.0L 122ci	1983-84	LH Front		1	EM-2755		
	RH Front				1	EM-2756			
	1984		Trans	Manual; 2WD	1			EM-2531	
			Trans	4WD	1			EM-2638	
	Trans		1			EM-2531			
Trans	Auto; 2WD	1			EM-2531				

# Engine, Transmission, And Torque Strut Mounts

CYL	ENG. SIZE	YEAR	LOCATION	DESCRIPTION	QTY	ENGINE	TORQUE STRUT	TRANSMISSION
<b>GMC SPORT UTILITY (continued)</b>								
<b>S15 JIMMY (continued)</b>								
L4	L4 2.0L 122ci	1983	Trans	Auto; 2WD	1			EM-2772
			Trans	Auto; 4WD	1			EM-2638
			Trans	Manual; 2WD	1			EM-2772
			Trans	Manual; 4WD	1			EM-2638
	L4 2.5L 2474cc	1985-88	LH Front		1	EM-2549		
			RH Front		1	EM-2550		
		1988	Trans	Auto; 2WD	1			EM-2508
			Trans	Auto; 4WD	1			EM-2638
			Trans	Manual; 2WD	1			EM-2508
			Trans	Manual; 4WD	1			EM-2638
		1985-87	Trans	Auto; 2WD	1			EM-2531
			Trans	Auto; 4WD	1			EM-2638
			Trans	Manual; 2WD	1			EM-2531
			Trans	Manual; 4WD	1			EM-2638
V6	V6 2.8L 173ci	1983-89	L & R Front		2	EM-2436		
		1988-89	Trans	Auto; 2WD	1			EM-2508
			Trans	Manual; 2WD	1			EM-2508
		1984-87	Trans	Auto; 2WD	1			EM-2531
			Trans	Manual; 2WD	1			EM-2531
		1983	Trans	Auto; 2WD	1			EM-2772
			Trans	Auto; 4WD	1			EM-2638
			Trans	Manual; 2WD	1			EM-2772
			Trans	Manual; 4WD	1			EM-2638
		V6 4.3L 262ci	1988-94	L & R Front		2	EM-2627	
	Trans			Auto; 2WD	1			EM-2508
	Trans			Auto; 4WD	1			EM-2638
	Trans			Manual; 2WD	1			EM-2508
				Trans	Manual; 4WD	1		
<b>SUBURBAN</b>								
L6	L6 4.1L 250ci	1966-67	L & R Front		2	EM-2282		
			Trans	2WD	1			EM-2378 @
<b>TYPHOON</b>								
V6	V6 4.3L 262ci	1992-93	L & R Front		2	EM-2627		
			Trans	AWD	1			EM-2638
<b>V1500 SUBURBAN</b>								
V8	V8 5.7L 350ci	1988-91	L & R Front		2	EM-2637		
		1987	L & R Front		2	EM-2292		
		1989-91	Trans	Auto	1			EM-2638
		1987-88	Trans	Auto	1			EM-2638
			Trans	Manual	1			EM-2638
	V8 6.2L 379ci Diesel	1988-91	L & R Front		2	EM-2637		
		1987	L & R Front		2	EM-2395		
		1989-91	Trans	Auto	1			EM-2638
		1987-88	Trans	Auto	1			EM-2638
			Trans	Manual	1			EM-2638
<b>V2500 SUBURBAN</b>								
V8	V8 5.7L 350ci	1989-91	L & R Front		2	EM-2637		
			Trans	Auto	1			EM-2638
		1987-88	Trans	Auto	1			EM-2638
			Trans	Manual	1			EM-2638
	V8 6.2L 379ci Diesel	1988-91	L & R Front		2	EM-2637		
		1987	L & R Front		2	EM-2395		
		1989-91	Trans	Auto	1			EM-2638
		1987-88	Trans	Auto	1			EM-2638
			Trans	Manual	1			EM-2638

# Engine, Transmission, And Torque Strut Mounts

CYL	ENG. SIZE	YEAR	LOCATION	DESCRIPTION	QTY	ENGINE	TORQUE STRUT	TRANSMISSION	
<b>GMC SPORT UTILITY (continued)</b>									
<b>YUKON</b>									
V8	V8 4.8L 294ci	2001-06	L & R Front		2	EM-2909			
		2007-09	LH Front	2WD	1	EM-4000			
			RH Front		1	EM-4017			
		2000-09	Trans	2WD		1			EM-2817
			Trans	4WD		1			EM-2638
	V8 5.3L	2007-12	L & R Front	Complete Unit	2	EM-5583			
	V8 5.3L 323ci	2001-05	L & R Front		2	EM-2909			
			Trans	2WD	1			EM-2817	
			Trans	4WD	1			EM-2638	
	V8 5.3L 5328cc	2005-06	L & R Front		2	EM-2909			
			Trans	2WD	1			EM-2817	
			Trans	4WD	1			EM-2638	
	V8 5.7L 350ci	1992-99	L & R Front	4WD	2	EM-2637			
			L & R Front	RWD	2	EM-2621			
		1997-99	Trans	4WD	1			EM-2638	
			Trans	RWD	1			EM-2817	
		1995-96	Trans	Auto; 2WD	1			EM-2817	
			Trans	Auto; 4WD	1			EM-2638	
			Trans	Manual; 2WD	1			EM-2817	
		1992-94	Trans	Manual; 4WD	1			EM-2638	
			Trans	RWD	1			EM-2360 @	
	Trans		Auto; 4WD	1			EM-2638		
	V8 6.0L	2008-13	L & R Front	Complete Unit	2	EM-5583			
			Trans	4WD; Auto	1			EM-2638	
			Trans	Auto; 2WD	1			EM-2817	
	V8 6.0L 364ci	2001-04	L & R Front		2	EM-2909			
	V8 6.2L	2007-14	L & R Front	Complete Unit	2	EM-5583			
			Trans	AWD	1			EM-2638	
	V8 6.5L 395ci Diesel	1994-97	L & R Front	4WD	2	EM-2637			
			L & R Front	RWD	2	EM-2621			
		1997	Trans	Auto; 2WD	1			EM-2817	
			Trans	Auto; 4WD	1			EM-2638	
		1994-96	Trans	Auto; 2WD	1			EM-2817	
Trans			Auto; 4WD	1			EM-2638		
Trans			Manual; 2WD	1			EM-2817		
Trans		Manual; 4WD	1			EM-2638			
<b>YUKON XL 1500</b>									
V8	V8 5.3L	2007-12	L & R Front	Complete Unit	2	EM-5583			
		2007-14	Trans	Auto; 2WD	1			EM-2817	
			Trans	Auto; 4WD	1			EM-2638	
		2006	Trans	Auto; 2WD	1			EM-2817	
	V8 5.3L 323ci	2000-06	L & R Front		2	EM-2909			
			Trans	2WD	1			EM-2817	
			Trans	4WD	1			EM-2638	
	V8 6.0L	2007-09	L & R Front	Complete Unit	2	EM-5583			
			Trans	2WD	1			EM-2817	
			Trans	4WD	1			EM-2638	
V8 6.2L	2007-14	Trans	AWD	1			EM-2638		
V8 6.2L 378ci	2007-14	L & R Front	Complete Unit	2	EM-5583				
<b>YUKON XL 2500</b>									
V8	V8 6.0L	2007-12	L & R Front	Complete Unit	2	EM-5583			
	V8 6.0L 364ci	2000-06	L & R Front		2	EM-2909			
			Trans	2WD	1			EM-2817	
			Trans	4WD	1			EM-2638	
V8 8.1L	2001-06	L & R Front		2	EM-5353				



# Engine, Transmission, And Torque Strut Mounts

CYL	ENG. SIZE	YEAR	LOCATION	DESCRIPTION	QTY	ENGINE	TORQUE STRUT	TRANSMISSION
<b>GMC SPORT UTILITY (continued)</b>								
<b>YUKON XL 2500 (continued)</b>								
V8	V8 8.1L 496ci	2001-06	Trans		1			EM-2638
<b>GMC TRUCK</b>								
<b>1000 SERIES</b>								
L6	L6 3.8L 230ci	1964-65	L & R Front		2	EM-2282		
			Trans - L & R Lower	4WD 4WD	1			EM-2108
			Trans - L & R Upper	4WD 4WD	1			EM-2107
V6	V6 5.0L 305ci	1961-65	Trans - L & R Lower	4WD 4WD	1			EM-2108
			Trans - L & R Upper	4WD 4WD	1			EM-2107
<b>1500 SERIES</b>								
L6	L6 3.8L 230ci	1964-65	L & R Front		2	EM-2282		
			Trans - L & R Lower	4WD 4WD	1			EM-2108
			Trans - L & R Upper	4WD 4WD	1			EM-2107
V6	V6 5.0L 305ci	1961-65	Trans - L & R Lower	4WD 4WD	1			EM-2108
			Trans - L & R Upper	4WD 4WD	1			EM-2107
<b>2500 SERIES</b>								
L6	L6 3.8L 230ci	1964-65	L & R Front		2	EM-2282		
			Trans - L & R Lower	4WD 4WD	1			EM-2108
			Trans - L & R Upper	4WD 4WD	1			EM-2107
V6	V6 5.0L 305ci	1961-63	Trans - L & R Lower	4WD 4WD	1			EM-2108
			Trans - L & R Upper	4WD 4WD	1			EM-2107
<b>C15/C1500 PICKUP</b>								
L6	L6 3.8L 230ci	1966	L & R Front		2	EM-2282		
	L6 4.1L 250ci	1973-84	L & R Front		2	EM-2292		
		1966-72	L & R Front		2	EM-2282		
		1982-84	Trans		1			EM-2392
		1973-81	Trans	Auto; THM350 (M38) THM350C (MV4)	1			EM-2378 @
			Trans	Auto; THM400 (M40)	1			EM-2268 @
			Trans	Manual	1			EM-2378 @
		1966-72	Trans		1			EM-2378 @
	L6 4.8L 292ci	1973-80	L & R Front		2	EM-2292		
		1966-71	L & R Front		2	EM-2282		
		1973-80	Trans	Auto; THM350 (M38)	1			EM-2378 @
			Trans	Auto; THM400 (M40)	1			EM-2268 @
			Trans	Manual	1			EM-2378 @
		1966-71	Trans		1			EM-2378 @
V6	V6 4.3L 262ci	1988-95	L & R Front		2	EM-2436		
		1985-86	L & R Front		2	EM-2436		
		1996-98	LH Front		1	EM-3028		
			RH Front		1	EM-3044		
			Trans		1			EM-2817
		1991-95	Trans	Auto	1			EM-2394

# Engine, Transmission, And Torque Strut Mounts

CYL	ENG. SIZE	YEAR	LOCATION	DESCRIPTION	QTY	ENGINE	TORQUE STRUT	TRANS-MISSION	
<b>GMC TRUCK (continued)</b>									
<b>C15/C1500 PICKUP (continued)</b>									
V6	V6 4.3L 262ci	1991-95	Trans	Manual	1			EM-2394	
		1988-90	Trans	Auto; THM400 (M40)	1			EM-2510 @	
			Trans	Auto; THM700-R4/4L60 (MD8)	1			EM-2394	
			Trans	Manual	1			EM-2394	
		1985-86	Trans	Auto	1			EM-2394	
	Trans		Manual	1			EM-2394		
	V6 5.0L 305ci	1967	Trans - L & R Lower			2			EM-2108
			Trans - L & R Upper			2			EM-2107
	V8	V8 4.6L 283ci	1967	L & R Front		2	EM-2282		
				Trans - L & R Lower	Manual	2			EM-2108
Trans - L & R Upper				Manual	2			EM-2107	
Trans				Auto	1			EM-2378 @	
V8 5.0L	1982-86	LH Front		1	EM-2292				
V8 5.0L 305ci	1988-99	L & R Front			2	EM-2621			
	1976-81	L & R Front			2	EM-2292			
	1999	Trans	Auto; 2WD		1			EM-2817	
	1996-98	Trans	Auto; 2WD		1			EM-2817	
		Trans	Manual; 2WD		1			EM-2817	
	1992-95	Trans			1			EM-2360 @	
	1991	Trans	Auto; THM700-R4/4L60 (MD8)		1			EM-2392	
		Trans	Manual		1			EM-2392	
	1988-90	Trans	Auto; 4L80E THM700-R4/4L60 (MD8)		1			EM-2392	
		Trans	Auto; THM400 (M40)		1			EM-2513	
		Trans	Manual		1			EM-2392	
	1982-86	Trans	Auto; THM350C (MV4) THM700-R4/4L60 (MD8)		1			EM-2392	
		Trans	Auto; THM400 (M40)		1			EM-2513	
		Trans	Manual		1			EM-2392	
	1976-81	Trans	Auto; THM350 (M38) THM350C (MV4)		1			EM-2378 @	
		Trans	Auto; THM400 (M40)		1			EM-2268 @	
Trans		Manual		1			EM-2378 @		
Trans		Manual		1			EM-2378 @		
V8 5.0L 307ci	1973	L & R Front			2	EM-2292			
	1968-72	L & R Front			2	EM-2282			
	1968-73	Trans	Auto; THM350 (M38)		1			EM-2378 @	
		Trans	Auto; THM400 (M40)		1			EM-2268 @	
		Trans	Manual		1			EM-2378 @	
V8 5.4L 327ci	1967-68	L & R Front			2	EM-2282			
		Trans	Auto; THM350 (M38)		1			EM-2378 @	
		Trans	Auto; THM400 (M40)		1			EM-2268 @	
		Trans	Manual		1			EM-2378 @	
V8 5.7L 350 ci Gas	1979-81	L & R Front			2	EM-2292			
V8 5.7L 350ci	1988-99	L & R Front			2	EM-2621			
	1973-78	L & R Front			2	EM-2292			
	1969-72	L & R Front			2	EM-2282			
	1982-86	LH Front			1	EM-2292			
	1999	Trans	Auto; 2WD		1			EM-2817	
	1996-98	Trans	Auto; 2WD		1			EM-2817	
		Trans	Manual; 2WD		1			EM-2817	
	1992-95	Trans			1			EM-2360 @	
	1991	Trans			1			EM-2392	

# Engine, Transmission, And Torque Strut Mounts

CYL	ENG. SIZE	YEAR	LOCATION	DESCRIPTION	QTY	ENGINE	TORQUE STRUT	TRANSMISSION	
<b>GMC TRUCK (continued)</b>									
<b>C15/C1500 PICKUP (continued)</b>									
V8	V8 5.7L 350ci	1988-90	Trans	Auto; THM400 (M40)	1			EM-2513	
			Trans	Auto; THM700R4 (MD8)	1			EM-2392	
			Trans	Manual	1			EM-2392	
		1986	Trans	Auto; THM350C (MV4) THM700-R4/4L60 (MD8)	1				EM-2392
			Trans	Auto; THM400 (M40)	1				EM-2513
			Trans	Manual	1				EM-2392
		1985	Trans	Auto; THM400 (M40)	1				EM-2513
			Trans	Auto; THM700R4 (MD8)	1				EM-2392
			Trans	Manual	1				EM-2392
		1982-84	Trans	Auto; THM350C (MV4) THM700-R4/4L60 (MD8)	1				EM-2392
			Trans	Auto; THM400 (M40)	1				EM-2513
			Trans	Manual	1				EM-2392
		1979-81	Trans	Auto; THM350 (M38)	1				EM-2378 @
			Trans	Auto; THM400 (M40)	1				EM-2268 @
			Trans	Manual	1				EM-2378 @
	V8 5.7L 350ci Diesel	1979-81	L & R Front	VIN Z	2	EM-2328			
	V8 6.2L 379ci Diesel	1988-93	L & R Front		2	EM-2621			
		1984-86	L & R Front		2	EM-2395			
		1982-83	L & R Front		2	EM-2292			
		1992-93	Trans		1			EM-2360 @	
		1991	Trans	Auto; THM700-R4/4L60 (MD8)	1				EM-2392
			Trans	Manual	1				EM-2392
		1989-90	Trans	Auto; THM400 (M40)	1				EM-2513
			Trans	Auto; THM700-R4/4L60 (MD8)	1				EM-2392
			Trans	Manual	1				EM-2392
		1988	Trans	Auto; THM400 (M40)	1				EM-2513
			Trans	Auto; THM700-R4/4L60 (MD8)	1				EM-2392
			Trans	Manual; 4 Spd	1				EM-2393
			Trans	Manual; 5 Spd	1				EM-2392
		1983-86	Trans	Auto; THM400 (M40)	1				EM-2515
			Trans	Auto; THM700-R4/4L60 (MD8)	1				EM-2393
	Trans		Manual	1				EM-2393	
	1982	Trans	Auto; THM400 (M40)	1				EM-2515	
Trans		Auto; THM700-R4/4L60 (MD8)	1				EM-2392		
Trans		Manual	1				EM-2392		
V8 6.5L 395ci Diesel	1994-97	RH Front		1	EM-2621				
		Trans	Auto; 2WD	1			EM-2817		
		Trans	Manual; 2WD	1			EM-2817		
V8 6.6L 400ci	1978-80	L & R Front		2	EM-2292				
		Trans - LH	Auto; THM400 (M40)	1			EM-2268 @		
	1978-80	Trans	Auto; THM350 (M38)	1				EM-2378 @	
		Trans	Auto; THM400 (M40)	1				EM-2268 @	
		Trans	Manual	1				EM-2378 @	
	1976	Trans	Auto; THM350 (M38)	1				EM-2378 @	
		Trans	Manual	1				EM-2378 @	
V8 6.6L 402ci	1970-72	L & R Front		2	EM-2283				
		Trans	Auto; THM350 (M38)	1			EM-2378 @		
		Trans	Auto; THM400 (M40)	1			EM-2268 @		
		Trans	Manual	1			EM-2378 @		
V8 7.4L 454ci	1973-80	L & R Front		2	EM-2395				
		Trans	Auto; THM350 (M38)	1			EM-2378 @		
		Trans	Auto; THM400 (M40)	1			EM-2268 @		
		Trans	Manual	1			EM-2378 @		

# Engine, Transmission, And Torque Strut Mounts

CYL	ENG. SIZE	YEAR	LOCATION	DESCRIPTION	QTY	ENGINE	TORQUE STRUT	TRANSMISSION	
<b>GMC TRUCK (continued)</b>									
<b>C25/C2500 PICKUP</b>									
L6	L6 3.8L 230ci	1966	L & R Front		2	EM-2282			
		1973-84	L & R Front		2	EM-2292			
	L6 4.1L 250ci	1966-72	L & R Front			2	EM-2282		
		1982-84	Trans			1			EM-2392
		1973-81	Trans	Auto; THM350 (M38)		1			EM-2378 @
			Trans	THM350C (MV4)					
			Trans	Auto; THM400 (M40)		1			EM-2268 @
		Trans	Manual		1			EM-2378 @	
		1966-72	Trans			1			EM-2378 @
	L6 4.8L	1982-86	LH Front		1	EM-2292			
	L6 4.8L 292ci	1973-81	L & R Front			2	EM-2292		
		1966-72	L & R Front			2	EM-2282		
		1986	Trans	Auto; THM350C (MV4) THM700-R4/4L60 (MD8)		1			EM-2392
			Trans	Auto; THM400 (M40)		1			EM-2513
			Trans	Manual		1			EM-2392
		1985	Trans	Auto; THM400 (M40)		1			EM-2513
			Trans	Auto; THM700R4 (MD8)		1			EM-2392
			Trans	Manual		1			EM-2392
		1983-84	Trans	Auto; THM350C (MV4) THM700-R4/4L60 (MD8)		1			EM-2392
			Trans	Auto; THM400 (M40)		1			EM-2513
			Trans	Manual		1			EM-2392
		1982	Trans	Auto; THM350C (MV4) THM700-R4/4L60 (MD8)		1			EM-2392
			Trans	Auto; THM400 (M40)		1			EM-2513
			Trans	Manual		1			EM-2378 @
		1973-81	Trans	Auto; THM350 (M38)		1			EM-2378 @
			Trans	Auto; THM400 (M40)		1			EM-2268 @
			Trans	Manual		1			EM-2378 @
		1966-72	Trans			1			EM-2378 @
		V6	V6 4.3L 262ci	1988-95	L & R Front		2	EM-2436	
1985-86	L & R Front				2	EM-2436			
1991-95	Trans					1		EM-2394	
1988-90	Trans			Auto; THM400 (M40)		1			EM-2510 @
	Trans			Auto; THM700-R4/4L60 (MD8)		1			EM-2394
Trans	Manual				1			EM-2394	
1985-86	Trans				1		EM-2394		
V6 5.0L 305ci	1967		Trans - L & R Lower			2			EM-2108
			Trans - L & R Upper			2			EM-2107
V8	V8 4.6L 283ci		1967	L & R Front	C-40 Thru C-85	2	EM-2309		
		Trans - L & R Lower	Manual		2			EM-2108	
		Trans - L & R Upper	Manual		2			EM-2107	
		Trans	Auto		1			EM-2378 @	
	V8 5.0L 305ci	1988-98	L & R Front			2	EM-2621		
		1977-86	L & R Front			2	EM-2292		
		1996-98	Trans			1			EM-2817
		1992-95	Trans			1			EM-2360 @
		1990-91	Trans			1			EM-2392
		1988-89	Trans	Auto; THM400 (M40)		1			EM-2513
			Trans	Auto; THM700-R4/4L60 (MD8)		1			EM-2392
	Trans	Manual		1				EM-2392	

# Engine, Transmission, And Torque Strut Mounts

CYL	ENG. SIZE	YEAR	LOCATION	DESCRIPTION	QTY	ENGINE	TORQUE STRUT	TRANSMISSION
<b>GMC TRUCK (continued)</b>								
<b>C25/C2500 PICKUP (continued)</b>								
V8	V8 5.0L 305ci	1982-86	Trans	Auto; THM350C (MV4) THM700-R4/4L60 (MD8)	1			EM-2392
			Trans	Auto; THM400 (M40)	1			EM-2513
			Trans	Manual	1			EM-2392
		1977-81	Trans	Auto; THM350 (M38) THM350C (MV4)	1			EM-2378 @
			Trans	Auto; THM400 (M40)	1			EM-2268 @
			Trans	Manual	1			EM-2378 @
	V8 5.0L 307ci	1973	L & R Front		2	EM-2292		
			L & R Front		2	EM-2282		
		1968-73	Trans	Auto; THM350 (M38)	1			EM-2378 @
			Trans	Auto; THM400 (M40)	1			EM-2268 @
			Trans	Manual	1			EM-2378 @
	V8 5.4L 327ci	1967-68	L & R Front		2	EM-2282		
			Trans	Auto; THM350 (M38)	1			EM-2378 @
			Trans	Auto; THM400 (M40)	1			EM-2268 @
			Trans	Manual	1			EM-2378 @
	V8 5.7L	1985-86	LH Front		1	EM-2292		
	V8 5.7L 350ci	1988-00	L & R Front		2	EM-2621		
			L & R Front		2	EM-2292		
		1969-72	L & R Front		2	EM-2282		
			Trans	Auto; 2WD	1			EM-2817
		Trans	Manual; 2WD	1			EM-2817	
		1992-94	Trans		1			EM-2360 @
		1991	Trans	Auto; THM700-R4/4L60 (MD8)	1			EM-2392
			Trans	Manual	1			EM-2392
		1988-90	Trans	Auto; THM400 (M40)	1			EM-2513
			Trans	Auto; THM700-R4/4L60 (MD8)	1			EM-2392
			Trans	Manual	1			EM-2392
		1986	Trans	Auto; THM350C (MV4) THM700-R4/4L60 (MD8)	1			EM-2392
			Trans	Auto; THM400 (M40)	1			EM-2513
			Trans	Manual	1			EM-2392
		1985	Trans	Auto; THM400 (M40)	1			EM-2513
			Trans	Auto; THM700-R4/4L60 (MD8)	1			EM-2392
			Trans	Manual	1			EM-2392
1982-84		Trans	Auto; THM350C (MV4) THM700-R4/4L60 (MD8)	1			EM-2392	
		Trans	Auto; THM400 (M40)	1			EM-2513	
		Trans	Manual	1			EM-2392	
1973-81		Trans	Auto; THM350 (M38)	1			EM-2378 @	
		Trans	Auto; THM400 (M40)	1			EM-2268 @	
		Trans	Manual	1			EM-2378 @	
V8 6.2L 379ci Diesel	1988-93	L & R Front		2	EM-2621			
		L & R Front		2	EM-2395			
	1982-83	L & R Front		2	EM-2292			
	1992-93	Trans		1			EM-2360 @	
	1991	Trans	Auto; 4L80E THM700-R4/4L60 (MD8)	1			EM-2392	
		Trans	Manual	1			EM-2392	
	1989-90	Trans	Auto; THM400 (M40)	1			EM-2515	
		Trans	Auto; THM700-R4/4L60 (MD8)	1			EM-2392	
		Trans	Manual	1			EM-2392	
	1988	Trans	Auto; THM400 (M40)	1			EM-2515	
Trans		Auto; THM700-R4/4L60 (MD8)	1			EM-2392		
Trans	Manual; 4 Spd	1			EM-2393			

# Engine, Transmission, And Torque Strut Mounts

CYL	ENG. SIZE	YEAR	LOCATION	DESCRIPTION	QTY	ENGINE	TORQUE STRUT	TRANSMISSION	
<b>GMC TRUCK (continued)</b>									
<b>C25/C2500 PICKUP (continued)</b>									
V8	V8 6.2L 379ci Diesel	1988	Trans	Manual; 5 Spd	1			EM-2392	
		1983-86	Trans	Auto; THM400 (M40)	1			EM-2515	
			Trans	Auto; THM700-R4/4L60 (MD8)	1			EM-2393	
			Trans	Manual	1			EM-2393	
			Trans		1			EM-2392	
	V8 6.5L 395ci Diesel	1992-00	L & R Front			2	EM-2621		
		1995-00	Trans	Auto; 2WD		1			EM-2817
			Trans	Manual; 2WD		1			EM-2817
		1992-94	Trans			1			EM-2360 @
	V8 6.6L 400ci	1976-79	L & R Front			2	EM-2292		
			Trans	Auto; THM350 (M38)		1			EM-2378 @
			Trans	Auto; THM400 (M40)		1			EM-2268 @
			Trans	Manual		1			EM-2378 @
	V8 6.6L 402ci	1970-72	L & R Front			2	EM-2283		
			Trans	Auto; THM350 (M38)		1			EM-2378 @
			Trans	Auto; THM400 (M40)		1			EM-2268 @
			Trans	Manual		1			EM-2378 @
	V8 7.4L 454ci	1991-00	L & R Front			2	EM-2621		
		1973-86	L & R Front			2	EM-2395		
		1996-00	Trans	Auto; 2WD		1			EM-2817
			Trans	Manual; 2WD		1			EM-2817
		1992-95	Trans			1			EM-2360 @
		1991	Trans			1			EM-2392
		1982-86	Trans	Auto; THM400 (M40)		1			EM-2513
			Trans	Auto; THM700-R4/4L60 (MD8)		1			EM-2392
			Trans	Manual		1			EM-2392
		1973-81	Trans	Auto; THM350 (M38)		1			EM-2378 @
			Trans	Auto; THM400 (M40)		1			EM-2268 @
Trans	Manual		1			EM-2378 @			
<b>C35/C3500 PICKUP</b>									
L6	L6 4.1L 250ci	1978-80	L & R Front		2	EM-2292			
		1973-75	L & R Front		2	EM-2292			
		1967-72	L & R Front		2	EM-2282			
		1978-80	Trans	Auto; THM350 (M38) THM350C (MV4)		1			EM-2378 @
			Trans	Auto; THM400		1			EM-2268 @
			Trans	Manual		1			EM-2378 @
		1973-75	Trans	Auto; THM350 (M38) THM350C (MV4)		1			EM-2378 @
			Trans	Auto; THM400		1			EM-2268 @
			Trans	Manual		1			EM-2378 @
		1967-72	Trans			1			EM-2378 @
	L6 4.8L 292ci	1973-86	L & R Front			2	EM-2292		
		1967-72	L & R Front			2	EM-2282		
		1983-86	Trans	Auto; THM400		1			EM-2513
			Trans	Auto; THM700-R4/4L60 (MD8)		1			EM-2392
			Trans	Manual		1			EM-2392
		1982	Trans	Auto; THM350C (MV4)		1			EM-2378 @
			Trans	Auto; THM400 (M40)		1			EM-2513
Trans	Auto; THM700-R4/4L60 (MD8)			1			EM-2392		
1973-81	Trans	Manual		1			EM-2378 @		
	Trans	Auto; THM350		1			EM-2378 @		
	Trans	Auto; THM400		1			EM-2268 @		
1967-72	Trans			1			EM-2378 @		

# Engine, Transmission, And Torque Strut Mounts

CYL	ENG. SIZE	YEAR	LOCATION	DESCRIPTION	QTY	ENGINE	TORQUE STRUT	TRANSMISSION
<b>GMC TRUCK (continued)</b>								
<b>C35/C3500 PICKUP (continued)</b>								
V8	V8 4.6L 283ci	1967	L & R Front		2	EM-2282		
			Trans - L & R Lower	Manual Manual	2			EM-2108
			Trans - L & R Upper	Manual Manual	2			EM-2107
			Trans	Auto	1			EM-2378 @
V8	V8 5.0L 305ci	1986	L & R Front		2	EM-2292		
			1978	L & R Front		2	EM-2292	
		1986	Trans	Auto; THM400	1			EM-2513
			Trans	Auto; THM700-R4/4L60 (MD8)	1			EM-2392
			Trans	Manual	1			EM-2392
		1978	Trans	Auto; THM350 (M38) THM350C (MV4)	1			EM-2378 @
			Trans	Auto; THM400	1			EM-2268 @
			Trans	Manual	1			EM-2378 @
V8	V8 5.0L 307ci	1973	L & R Front		2	EM-2292		
			1968-72	L & R Front		2	EM-2282	
		1968-73	Trans	Auto; THM350	1			EM-2378 @
			Trans	Auto; THM400	1			EM-2268 @
V8	V8 5.4L 327ci	1967-68	L & R Front		2	EM-2282		
			Trans	Auto; THM350	1			EM-2378 @
			Trans	Auto; THM400	1			EM-2268 @
V8	V8 5.7L	1984-86	LH Front		1	EM-2292		
			V8 5.7L 350ci	1988-00	L & R Front		2	EM-2621
V8	V8 5.7L 350ci	1973-83	L & R Front		2	EM-2292		
			1969-72	L & R Front		2	EM-2282	
		1994	Trans	C309, 2nd Design	1			EM-2817
			Trans	C314 & C318, 15,000 GVW	1			EM-2638
		1995-00	Trans	Auto; 2WD	1			EM-2817
			Trans	Manual; 2WD	1			EM-2817
		1994	Trans		1			EM-2360 @
			Trans		1			EM-2360 @
			Trans	C309, 1st Design	1			EM-2817
		1992-93	Trans	Auto; RWD	1			EM-2360 @
			Trans	Manual; RWD	1			EM-2360 @
		1991	Trans	Auto; THM700-R4/4L60 (MD8)	1			EM-2392
			Trans	Manual, C309	1			EM-2392
			Trans	Manual, C310	1			EM-2360 @
			Trans	Manual, C314 & C318	1			EM-2638
		1988-90	Trans	Auto; THM400	1			EM-2513
			Trans	Auto; THM700-R4/4L60 (MD8)	1			EM-2392
			Trans	Manual, C309	1			EM-2392
			Trans	Manual, C310	1			EM-2360 @
		1986	Trans	Manual, C314 & C318	1			EM-2638
			Trans	Auto; THM350C (MV4) THM700-R4/4L60 (MD8)	1			EM-2392
			Trans	Auto; THM400 (M40)	1			EM-2513
			Trans	Manual	1			EM-2392
		1985	Trans	Auto; THM400 (M40)	1			EM-2513
			Trans	Auto; THM700-R4/4L60 (MD8)	1			EM-2392
			Trans	Manual	1			EM-2392
		1982-84	Trans	Auto; THM350C (MV4) THM700-R4/4L60 (MD8)	1			EM-2392
			Trans	Auto; THM400 (M40)	1			EM-2513

# Engine, Transmission, And Torque Strut Mounts

CYL	ENG. SIZE	YEAR	LOCATION	DESCRIPTION	QTY	ENGINE	TORQUE STRUT	TRANSMISSION		
<b>GMC TRUCK (continued)</b>										
<b>C35/C3500 PICKUP (continued)</b>										
V8	V8 5.7L 350ci	1982-84	Trans	Manual	1			EM-2392		
		1973-81	Trans	Auto; THM350	1			EM-2378 @		
			Trans	Auto; THM400	1			EM-2268 @		
			Trans	Manual	1			EM-2378 @		
	V8 6.2L 379ci Diesel	1988-93	L & R Front			2	EM-2621			
		1984-86	L & R Front			2	EM-2395			
		1982-83	L & R Front			2	EM-2292			
		1992-93	Trans			1			EM-2360 @	
		1991	Trans	Auto; 4L80E THM700-R4/4L60 (MD8)			1			EM-2392
			Trans	Manual			1			EM-2392
		1988-90	Trans	Auto; THM400 (M40)			1			EM-2513
			Trans	Auto; THM700-R4/4L60 (MD8)			1			EM-2392
			Trans	Manual			1			EM-2392
		1983-86	Trans	Auto; MD8			1			EM-2393
			Trans	Auto; THM400			1			EM-2515
			Trans	Manual			1			EM-2393
		1982	Trans			1			EM-2393	
		V8 6.5L 395ci Diesel	1992-02	L & R Front			2	EM-2621		
	1995-02		Trans	Auto; 2WD		1			EM-2817	
			Trans	Manual; 2WD		1			EM-2817	
	1992-94		Trans			1			EM-2360 @	
	V8 6.6L 400ci	1976-79	L & R Front			2	EM-2292			
			Trans	Auto; THM350		1			EM-2378 @	
			Trans	Auto; THM400		1			EM-2268 @	
			Trans	Manual		1			EM-2378 @	
	V8 6.6L 402ci	1970-72	L & R Front			2	EM-2283			
			Trans	Auto; THM350		1			EM-2378 @	
			Trans	Auto; THM400		1			EM-2268 @	
			Trans	Manual		1			EM-2378 @	
	V8 7.4L 454ci	1988-00	L & R Front			2	EM-2621			
		1973-86	L & R Front			2	EM-2395			
		1996-00	Trans	Auto; 4L80E (MT1)		1			EM-2817	
			Trans	Manual, C310, C314 & C318		1			EM-2638	
			Trans	Manual, FleetSide		1			EM-2817	
		1992-95	Trans			1			EM-2360 @	
		1988-91	Trans			1			EM-2392	
		1982-86	Trans	Auto; THM400			1			EM-2513
			Trans	Auto; THM700-R4/4L60 (MD8)			1			EM-2392
			Trans	Manual			1			EM-2392
		1973-81	Trans	Auto; THM350			1			EM-2378 @
	Trans		Auto; THM400			1			EM-2268 @	
	Trans		Manual			1			EM-2378 @	
	V8 8.1L 496ci	2001-02	Trans	Auto; THM-R2 (MT1) 4L80E		1			EM-2817	
Trans			Manual		1			EM-2817		
<b>CABALLERO</b>										
V6	V6 3.3L 200ci	1978-79	LH Front		1	EM-2382				
			RH Front		1	EM-2384				
			Trans		1			EM-2353		
	V6 3.8L 229ci	1980-84	L & R Front			2	EM-2436			
			Trans			1			EM-2360 @	
			1982	Trans	Auto		1			EM-2379
			1980-81	Trans	Auto		1			EM-2379
	Trans	Manual			1			EM-2379		
	V6 3.8L 231ci	1978-84	LH Front			1	EM-2382			
RH Front					1	EM-2384				



# Engine, Transmission, And Torque Strut Mounts

CYL	ENG. SIZE	YEAR	LOCATION	DESCRIPTION	QTY	ENGINE	TORQUE STRUT	TRANSMISSION
<b>GMC TRUCK (continued)</b>								
<b>CABALLERO (continued)</b>								
V6	V6 3.8L 231ci	1982-84	Trans	Auto	1			EM-2379
		1978-81	Trans	Auto	1			EM-2379
			Trans	Manual	1			EM-2379
	V6 4.3L 262ci	1985-87	L & R Front		2	EM-2436		
			Trans	Auto	1			EM-2379
V8	V8 4.4L 267ci	1980-82	L & R Front		2	EM-2292		
		1982	Trans	Auto	1			EM-2360 @
			Trans	Auto	1			EM-2360 @
			Trans	Manual	1			EM-2360 @
	V8 5.0L 305ci	1978-87	L & R Front		2	EM-2292		
			Trans		1			EM-2360 @
		1978-81	Trans	Auto	1			EM-2337
			Trans	Manual	1			EM-2337
	V8 5.7L 350ci	1978-79	L & R Front		2	EM-2292		
			Trans	Auto	1			EM-2378 @
			Trans	Manual	1			EM-2378 @
	V8 5.7L 350ci Diesel	1983-84	L & R Front		2	EM-2328		
Trans				1			EM-2360 @	
<b>CANYON</b>								
L4	L4 2.8L	2004-06	LH Front		1	EM-3121		
			RH Front		1	EM-3120		
		2006	Trans	4WD	1			EM-2638
			2004-05	Trans	2WD	1		EM-3122
				Trans	4WD	1		EM-2638
	L4 2.9L	2007-10	LH Front		1	EM-3121		
			RH Front		1	EM-3120		
			Trans	2WD	1		EM-3122	
			Trans	4WD	1		EM-2638	
L5	L5 3.5L	2004-06	LH Front		1	EM-3121		
			RH Front		1	EM-3120		
		2006	Trans	4WD	1		EM-2638	
	L5 3.5L 3460cc	2004-05	Trans	2WD	1		EM-3122	
			Trans	4WD	1		EM-2638	
	L5 3.7L	2007-10	LH Front		1	EM-3121		
			RH Front		1	EM-3120		
			Trans	2WD	1		EM-3122	
			Trans	4WD	1		EM-2638	
<b>K15/K1500 PICKUP</b>								
L6	L6 4.1L 250ci	1973-84	L & R Front		2	EM-2292		
		1967-72	L & R Front		2	EM-2282		
		1967-84	Trans - Lower	Auto	2			EM-2108
			Trans - Lower	Manual	2			EM-2108
			Trans - Upper	Auto	2			EM-2107
	L6 4.8L 292ci	1979-80	L & R Front		2	EM-2292		
			1975-76	L & R Front		2	EM-2292	
		1967	L & R Front		2	EM-2282		
			Trans - L & R Lower		2			EM-2108
			Trans - L & R Upper		2			EM-2107
		1979-80	Trans - Lower	Auto	2			EM-2108
			Trans - Lower	Manual	2			EM-2108
		1975-76	Trans - Lower	Auto	2			EM-2108
			Trans - Lower	Manual	2			EM-2108
		1979-80	Trans - Upper	Auto	2			EM-2107
		1975-76	Trans - Upper	Auto	2			EM-2107

# Engine, Transmission, And Torque Strut Mounts

CYL	ENG. SIZE	YEAR	LOCATION	DESCRIPTION	QTY	ENGINE	TORQUE STRUT	TRANSMISSION	
<b>GMC TRUCK (continued)</b>									
<b>K15/K1500 PICKUP (continued)</b>									
V6	V6 4.3L 262ci	1988-95	L & R Front		2	EM-2436			
		1985-86	L & R Front		2	EM-2436			
		1998	Trans	Auto		1			EM-2638
			Trans	Manual		1			EM-2638
		1988-97	Trans	Auto		1			EM-2638
			Trans	Manual		1			EM-2638
		1985-86	Trans	Auto		1			EM-2638
Trans	Manual			1			EM-2638		
V8	V8 4.6L 283ci	1967	L & R Front		2	EM-2282			
			Trans - Lower	Auto		2		EM-2108	
			Trans - Lower	Manual		2		EM-2108	
			Trans - Upper	Auto		2		EM-2107	
	V8 5.0L 305ci	1988-99	L & R Front		2	EM-2637			
			L & R Front		2	EM-2292			
			L & R Front		2	EM-2292			
			1981-84	Trans - Lower	Auto		2		EM-2108
				Trans - Lower	Manual		2		EM-2108
			1977-79	Trans - Lower	Auto		2		EM-2108
				Trans - Lower	Manual		2		EM-2108
			1981-84	Trans - Upper	Auto		2		EM-2107
				Trans - Upper	Auto		2		EM-2107
			1999	Trans	Auto		1		EM-2638
			1988-98	Trans	Auto		1		EM-2638
				Trans	Manual		1		EM-2638
			1985-86	Trans	Auto		1		EM-2638
	Trans	Manual			1		EM-2638		
	V8 5.0L 307ci	1968-70	L & R Front		2	EM-2282			
			Trans - Lower	Auto		2		EM-2108	
			Trans - Lower	Manual		2		EM-2108	
			Trans - Upper	Auto		2		EM-2107	
	V8 5.7L 350ci	1988-99	L & R Front		2	EM-2637			
			L & R Front		2	EM-2292			
			L & R Front		2	EM-2282			
			1969-84	Trans - Lower	Auto		2		EM-2108
				Trans - Lower	Manual		2		EM-2108
				Trans - Upper	Auto		2		EM-2107
			1999	Trans	Auto		1		EM-2638
			1988-98	Trans	Auto		1		EM-2638
				Trans	Manual		1		EM-2638
			1985-86	Trans	Auto		1		EM-2638
				Trans	Manual		1		EM-2638
	V8 6.2L 379ci Diesel	1988-93	L & R Front		2	EM-2637			
			L & R Front		2	EM-2395			
			L & R Front		2	EM-2292			
			1982-84	Trans - Lower	Auto		2		EM-2108
				Trans - Lower	Manual		2		EM-2108
				Trans - Upper	Auto		2		EM-2107
1988-93			Trans	Auto		1		EM-2638	
			Trans	Manual		1		EM-2638	
1985-86			Trans	Auto		1		EM-2638	
			Trans	Manual		1		EM-2638	
V8 6.5L 395ci Diesel	1994-98	L & R Front		2	EM-2637				
		Trans	Auto		1		EM-2638		
		Trans	Manual		1		EM-2638		
V8 6.6L 400ci	1975-80	L & R Front		2	EM-2292				
		Trans - Lower	Auto		2		EM-2108		
		Trans - Lower	Manual		2		EM-2108		

# Engine, Transmission, And Torque Strut Mounts

CYL	ENG. SIZE	YEAR	LOCATION	DESCRIPTION	QTY	ENGINE	TORQUE STRUT	TRANSMISSION		
<b>GMC TRUCK (continued)</b>										
<b>K15/K1500 PICKUP (continued)</b>										
V8	V8 6.6L 400ci	1975-80	Trans - Upper	Auto	2			EM-2107		
	V8 7.4L 454ci	1979-80	L & R Front		2	EM-2395				
		1976	L & R Front		2	EM-2395				
		1979-80	Trans - Lower	Auto	2			EM-2108		
			Trans - Lower	Manual	2			EM-2108		
		1976	Trans - Lower	Auto	2			EM-2108		
			Trans - Lower	Manual	2			EM-2108		
		1979-80	Trans - Upper	Auto	2			EM-2107		
1976	Trans - Upper	Auto	2			EM-2107				
<b>K25/K2500 PICKUP</b>										
L6	L6 4.1L 250ci	1973-80	L & R Front		2	EM-2292				
		1967-72	L & R Front		2	EM-2282				
		1978	Trans - Lower	Auto	2			EM-2108		
			Trans - Lower	Manual	2			EM-2108		
		1973-80	Trans - Lower	Auto	2			EM-2108		
			Trans - Lower	Manual	2			EM-2108		
		1967-76	Trans - Lower	Auto	2			EM-2108		
			Trans - Lower	Manual	2			EM-2108		
		1978	Trans - Upper	Auto	2			EM-2107		
		1973-80	Trans - Upper	Auto	2			EM-2107		
		1967-76	Trans - Upper	Auto	2			EM-2107		
		L6 4.8L 292ci	1973-86	L & R Front		2	EM-2292			
			1970-72	L & R Front		2	EM-2282			
			1967	L & R Front		2	EM-2282			
	1970-84		Trans - Lower	Auto	2			EM-2108		
			Trans - Lower	Manual	2			EM-2108		
	1967		Trans - Lower	Auto	2			EM-2108		
			Trans - Lower	Manual	2			EM-2108		
	1970-84		Trans - Upper	Auto	2			EM-2107		
	1967		Trans - Upper	Auto	2			EM-2107		
	1985-86		Trans	Auto	1			EM-2638		
			Trans	Manual	1			EM-2638		
	V6		V6 4.3L 262ci	1988-95	L & R Front		2	EM-2436		
				1985	L & R Front		2	EM-2436		
				1988-95	Trans	Auto	1			EM-2638
		Trans			Manual	1			EM-2638	
		1985		Trans	Auto	1			EM-2638	
				Trans	Manual	1			EM-2638	
V8		V8 4.6L 283ci		1967	L & R Front		2	EM-2282		
	Trans - Lower		Auto		2		EM-2108			
	Trans - Lower		Manual		2		EM-2108			
	Trans - Upper		Auto		2		EM-2107			
	V8 5.0L 305ci	1998	L & R Front		2	EM-2637				
			1988-95	L & R Front		2	EM-2637			
			1977-78	L & R Front		2	EM-2292			
		Trans - Lower		Auto	2		EM-2108			
		Trans - Lower		Manual	2		EM-2108			
		Trans - Upper		Auto	2		EM-2107			
		1998	Trans	Auto	1		EM-2638			
			Trans	Manual	1		EM-2638			
			1988-95	Trans	Auto	1		EM-2638		
		Trans		Manual	1		EM-2638			
	V8 5.0L 307ci	1968-70	L & R Front		2	EM-2282				
			Trans - Lower	Auto	2		EM-2108			
			Trans - Lower	Manual	2		EM-2108			
			Trans - Upper	Auto	2		EM-2107			
	V8 5.7L 350ci	1988-00	L & R Front		2	EM-2637				

# Engine, Transmission, And Torque Strut Mounts

CYL	ENG. SIZE	YEAR	LOCATION	DESCRIPTION	QTY	ENGINE	TORQUE STRUT	TRANS-MISSION	
<b>GMC TRUCK (continued)</b>									
<b>K25/K2500 PICKUP (continued)</b>									
V8	V8 5.7L 350ci	1973-86	L & R Front		2	EM-2292			
		1969-72	L & R Front		2	EM-2282			
		1969-84	Trans - Lower	Auto	2			EM-2108	
			Trans - Lower	Manual	2			EM-2108	
			Trans - Upper	Auto	2			EM-2107	
		1988-00	Trans	Auto	1			EM-2638	
			Trans	Manual	1			EM-2638	
		1985-86	Trans	Auto	1			EM-2638	
	Trans		Manual	1			EM-2638		
	V8 6.2L 379ci Diesel	1988-93	L & R Front		2	EM-2637			
		1984-86	L & R Front		2	EM-2395			
		1982-83	L & R Front		2	EM-2292			
		1982-84	Trans - Lower	Auto	2			EM-2108	
			Trans - Lower	Manual	2			EM-2108	
			Trans - Upper	Auto	2			EM-2107	
		1988-93	Trans	Auto	1			EM-2638	
			Trans	Manual	1			EM-2638	
		1985-86	Trans	Auto	1			EM-2638	
			Trans	Manual	1			EM-2638	
	V8 6.5L 395ci Diesel	1992-00	L & R Front		2	EM-2637			
			Trans	Auto	1		EM-2638		
			Trans	Manual	1		EM-2638		
	V8 6.6L 400ci	1975-80	L & R Front		2	EM-2292			
			Trans - Lower	Auto	2		EM-2108		
			Trans - Lower	Manual	2		EM-2108		
			Trans - Upper	Auto	2		EM-2107		
	V8 7.4L 454ci	1991-00	L & R Front		2	EM-2637			
		1976-78	L & R Front		2	EM-2395			
		1973-74	L & R Front		2	EM-2395			
		1976-78	Trans - Lower	Auto	2			EM-2108	
			Trans - Lower	Manual	2			EM-2108	
		1973-74	Trans - Lower	Auto	2			EM-2108	
			Trans - Lower	Manual	2			EM-2108	
1976-78		Trans - Upper	Auto	2			EM-2107		
1973-74		Trans - Upper	Auto	2			EM-2107		
1991-00		Trans	Auto	1			EM-2638		
	Trans	Manual	1			EM-2638			
<b>K35/K3500 PICKUP</b>									
L6	L6 4.1L 250ci	1973-74	L & R Front		2	EM-2292			
		1968-72	L & R Front		2	EM-2282			
		1968-74	Trans - Lower	Auto	2			EM-2108	
			Trans - Lower	Manual	2			EM-2108	
			Trans - Upper	Auto	2			EM-2107	
	L6 4.8L 292ci	1977-86	L & R Front		2	EM-2292			
		1973-74	L & R Front		2	EM-2292			
		1968-72	L & R Front		2	EM-2282			
		1977-84	Trans - Lower	Auto	2			EM-2108	
			Trans - Lower	Manual	2			EM-2108	
		1968-74	Trans - Lower	Auto	2			EM-2108	
			Trans - Lower	Manual	2			EM-2108	
		1977-84	Trans - Upper	Auto	2			EM-2107	
		1968-74	Trans - Upper	Auto	2			EM-2107	
		1985-86	Trans	Auto	1			EM-2638	
	Trans		Manual	1			EM-2638		
	V8	V8 5.0L 307ci	1973	L & R Front		2	EM-2292		
			1968-72	L & R Front		2	EM-2282		
1968-73			Trans - Lower	Auto	2			EM-2108	

# Engine, Transmission, And Torque Strut Mounts

CYL	ENG. SIZE	YEAR	LOCATION	DESCRIPTION	QTY	ENGINE	TORQUE STRUT	TRANSMISSION
<b>GMC TRUCK (continued)</b>								
<b>K35/K3500 PICKUP (continued)</b>								
V8	V8 5.0L 307ci	1968-73	Trans - Lower	Manual	2			EM-2108
			Trans - Upper	Auto	2			EM-2107
	V8 5.7L 350ci	1988-00 1977-86 1973-74 1969-72 1977-84 1969-74 1977-84 1969-74 1988-00 1985-86	L & R Front		2	EM-2637		
			L & R Front		2	EM-2292		
			L & R Front		2	EM-2292		
			L & R Front		2	EM-2282		
			Trans - Lower	Auto	2			EM-2108
			Trans - Lower	Manual	2			EM-2108
			Trans - Lower	Auto	2			EM-2108
			Trans - Lower	Manual	2			EM-2108
			Trans - Upper	Auto	2			EM-2107
			Trans - Upper	Auto	2			EM-2107
			Trans	Auto	1			EM-2638
			Trans	Manual	1			EM-2638
			Trans	Auto	1			EM-2638
	Trans	Manual	1			EM-2638		
	V8 6.2L 379ci Diesel	1988-93 1984-86 1982-83 1982-84 1988-93 1985-86	L & R Front		2	EM-2637		
			L & R Front		2	EM-2395		
			L & R Front		2	EM-2292		
			Trans - Lower	Auto	2			EM-2108
			Trans - Lower	Manual	2			EM-2108
			Trans - Upper	Auto	2			EM-2107
			Trans	Auto	1			EM-2638
			Trans	Manual	1			EM-2638
			Trans	Auto	1			EM-2638
			Trans	Manual	1			EM-2638
	V8 6.5L 395ci Diesel	1992-00	L & R Front		2	EM-2637		
			Trans	Auto	1			EM-2638
			Trans	Manual	1			EM-2638
	V8 6.6L 400ci	1977-80	L & R Front		2	EM-2292		
			Trans - Lower	Auto	2			EM-2108
			Trans - Lower	Manual	2			EM-2108
			Trans - Upper	Auto	2			EM-2107
	V8 7.4L 454ci	1988-00 1979-86 1973-74 1979-84 1973-74 1979-84 1973-74 1988-00 1985-86	L & R Front		2	EM-2637		
			L & R Front		2	EM-2395		
			L & R Front		2	EM-2395		
			Trans - Lower	Auto	2			EM-2108
			Trans - Lower	Manual	2			EM-2108
			Trans - Lower	Auto	2			EM-2108
			Trans - Lower	Manual	2			EM-2108
			Trans - Upper	Auto	2			EM-2107
			Trans - Upper	Auto	2			EM-2107
			Trans	Auto	1			EM-2638
Trans			Manual	1			EM-2638	
Trans			Auto	1			EM-2638	
Trans			Manual	1			EM-2638	
<b>R1500 PICKUP</b>								
V6	V6 4.3L 262ci	1987	L & R Front		2	EM-2436		
			Trans	Auto; THM700-R4/4L60 (MD8)	1			EM-2394
			Trans	Manual	1			EM-2394
V8	V8 5.0L 305ci	1987	L & R Front		2	EM-2292		
			Trans	Auto	1			EM-2513
			Trans	Manual	1			EM-2392
	V8 5.7L 350ci	1987	L & R Front		2	EM-2292		
			Trans		1			EM-2392
	V8 6.2L 379ci Diesel	1987	L & R Front		2	EM-2395		
Trans			Auto; THM400	1			EM-2515	

# Engine, Transmission, And Torque Strut Mounts

CYL	ENG. SIZE	YEAR	LOCATION	DESCRIPTION	QTY	ENGINE	TORQUE STRUT	TRANSMISSION	
<b>GMC TRUCK (continued)</b>									
<b>R1500 PICKUP (continued)</b>									
V8	V8 6.2L 379ci Diesel	1987	Trans	Auto; THM700-R4/4L60 (MD8)	1			EM-2393	
			Trans	Manual	1			EM-2393	
<b>R2500 PICKUP</b>									
L6	L6 4.8L 292ci	1987-88	L & R Front		2	EM-2292			
			Trans	Auto	1			EM-2513	
			Trans	Manual	1			EM-2392	
V6	V6 4.3L 262ci	1987	L & R Front		2	EM-2436			
			Trans	Auto; THM700-R4/4L60 (MD8)	1			EM-2394	
			Trans	Manual	1			EM-2394	
V8	V8 5.0L 305ci	1987	L & R Front		2	EM-2292			
			Trans	Auto	1			EM-2513	
			Trans	Manual	1			EM-2392	
	V8 5.7L 350ci	1988-89	1987	L & R Front		2	EM-2621		
				L & R Front		2	EM-2292		
		1988-89	Trans	Auto; THM400 (M40)	1			EM-2513	
			Trans	Auto; THM700-R4/4L60 (MD8)	1			EM-2392	
			Trans	Manual, FleetSide 164.5WB	1			EM-2392	
			Trans	Auto; THM180C (MD2) THM700-R4/4L60 (MD8)	1			EM-2392	
	1987	Trans	Auto; THM400 (M40)	1			EM-2513		
		Trans	Manual, FleetSide; 131.5WB	1			EM-2360 @		
		Trans	Manual; StepSide; 164.5WB	1			EM-2392		
	V8 6.2L 379ci Diesel	1987-89	L & R Front		2	EM-2395			
			Trans	Auto; THM400	1			EM-2515	
			Trans	Auto; THM700-R4/4L60 (MD8)	1			EM-2393	
Trans			Manual	1			EM-2393		
V8 7.4L 454ci	1987-89	L & R Front		2	EM-2395				
		Trans	Auto; THM400	1			EM-2513		
		Trans	Auto; THM700-R4/4L60 (MD8)	1			EM-2392		
		Trans	Manual	1			EM-2392		
<b>R3500 PICKUP</b>									
L6	L6 4.8L 292ci	1987-88	L & R Front		2	EM-2292			
			Trans	Auto	1			EM-2513	
			Trans	Manual	1			EM-2392	
V8	V8 5.7L 350ci	1987-91	L & R Front		2	EM-2292			
			Trans		1			EM-2392	
	V8 6.2L 379ci Diesel	1987-91	L & R Front		2	EM-2395			
			Trans	Auto; THM700-R4/4L60 (MD8)	1			EM-2393	
	Trans	Manual	1			EM-2393			
	V8 7.4L 454ci	1987-91	L & R Front		2	EM-2395			
Trans			Auto	1			EM-2513		
Trans			Manual	1			EM-2392		
<b>S15 PICKUP</b>									
L4	L4 1.9L 119ci	1982-85	L & R Front		2	EM-2381			
			Trans	Auto; 2WD	1			EM-2531	
		1984-85	Trans	Auto; 4WD	1			EM-2638	
			Trans	Manual; 2WD	1			EM-2531	
			Trans	Manual; 4WD	1			EM-2638	
			Trans	Auto; 2WD	1			EM-2771	
		1983	Trans	Auto; 4WD	1			EM-2638	
			Trans	Manual; 2WD	1			EM-2771	
			Trans	Manual; 4WD	1			EM-2638	
			Trans	Auto; 2WD	1			EM-2771	
	1982	Trans	Manual; 2WD	1			EM-2771		
		Trans	Manual; 2WD	1			EM-2771		
	L4 2.0L 122ci	1983-84	LH Front		1	EM-2755			
RH Front				1	EM-2756				

# Engine, Transmission, And Torque Strut Mounts

CYL	ENG. SIZE	YEAR	LOCATION	DESCRIPTION	QTY	ENGINE	TORQUE STRUT	TRANSMISSION
<b>GMC TRUCK (continued)</b>								
<b>S15 PICKUP (continued)</b>								
L4	L4 2.0L 122ci	1984	Trans	Auto; 2WD	1			EM-2531
			Trans	Auto; 4WD	1			EM-2638
			Trans	Manual; 2WD	1			EM-2531
			Trans	Manual; 4WD	1			EM-2638
		1983	Trans	Auto; 2WD	1			EM-2772
			Trans	Auto; 4WD	1			EM-2638
			Trans	Manual; 2WD	1			EM-2772
			Trans	Manual; 4WD	1			EM-2638
	L4 2.2L 134ci Diesel	1984-85	LH Front		1	EM-2549		
			RH Front		1	EM-2550		
			Trans	Auto; 2WD	1			EM-2531
			Trans	Manual; 2WD	1			EM-2531
	L4 2.5L 2474cc	1985-90	LH Front		1	EM-2549		
			RH Front		1	EM-2550		
		1988-90	Trans	Auto; 2WD	1			EM-2508
			Trans	Manual; 2WD	1			EM-2508
1985-87		Trans	Auto; 2WD	1			EM-2531	
		Trans	Manual; 2WD	1			EM-2531	
V6	V6 2.8L 173ci	1982-90	L & R Front		2	EM-2436		
			1983	Trans	Manual; 4WD	1		EM-2638
		1988-90	Trans	Auto; 2WD	1			EM-2508
			Trans	Auto; 4WD	1			EM-2638
			Trans	Manual; 2WD	1			EM-2508
			Trans	Manual; 4WD	1			EM-2638
			1984-87	Trans	Auto; 2WD	1		EM-2531
		1983	Trans	Auto; 4WD	1			EM-2638
			Trans	Manual; 2WD	1			EM-2531
			Trans	Manual; 4WD	1			EM-2638
			Trans		1			EM-2772
			Trans	2WD	1			EM-2772
			Trans	Auto; 4WD	1			EM-2638
		1982	Trans	Auto; 2WD	1			EM-2771
	Trans		Manual; 2WD	1			EM-2771	
	V6 4.3L 262ci	1988-90	L & R Front		2	EM-2627		
			Trans	Auto; 2WD	1			EM-2508
			Trans	Auto; 4WD	1			EM-2638
			Trans	Manual; 2WD	1			EM-2508
			Trans	Manual; 4WD	1			EM-2638
Trans			Manual; 4WD	1			EM-2638	
<b>SIERRA 1500</b>								
V6	V6 4.3L	2008-09	Trans	2WD	1			EM-2817
			Trans	4WD	1			EM-2638
		2007	Trans	Classic SL and Classic WT, 4WD	1			EM-2638
			Trans	Classic SL and Classic WT, RWD	1			EM-2817
	V6 4.3L 262ci	2007-13	L & R Front		2	EM-4073		
			1999-06	L & R Front		2	EM-2994	
		2007-12	Trans	2WD	1			EM-2817
			Trans	4WD	1			EM-2638
V8	V8 4.8L	2007-12	Trans	4WD	1			EM-3172
			Trans	RWD	1			EM-2817
	V8 4.8L 294ci	2007	L & R Front	Classic Body Style	2	EM-2909		
		1999-06	L & R Front		2	EM-2909		
		2008-13	LH Front		1	EM-4000		
		2007	LH Front	New Body Style	1	EM-4000		
2008-13	RH Front		1	EM-4017				

# Engine, Transmission, And Torque Strut Mounts

CYL	ENG. SIZE	YEAR	LOCATION	DESCRIPTION	QTY	ENGINE	TORQUE STRUT	TRANSMISSION
<b>GMC TRUCK (continued)</b>								
<b>SIERRA 1500 (continued)</b>								
V8	V8 4.8L 294ci	2007	RH Front	New Body Style	1	EM-4017		
		1999-06	Trans	2WD	1			EM-2817
			Trans	4WD	1			EM-2638
	V8 5.3L 323ci	1999-05	L & R Front		2	EM-2909		
			Trans	2WD	1			EM-2817
			Trans	4WD	1			EM-2638
	V8 5.3L 325ci	2007-13	L & R Front	Complete Unit	2	EM-5583		
		2006-07	L & R Front		2	EM-2909		
		2006-14	Trans	2WD	1			EM-2817
			Trans	4WD	1			EM-2638
	V8 6.0L 364ci	2007-12	L & R Front	Complete Unit	2	EM-5583		
		2002-07	L & R Front		2	EM-2909		
		2005-13	Trans	2WD	1			EM-2817
			Trans	4WD	1			EM-2638
		2002-04	Trans	AWD	1			EM-2638
	V8 6.2L 376ci	2007-12	L & R Front		2	EM-5583		
2009-14		Trans	4WD	1			EM-2638	
		Trans	RWD	1			EM-2817	
2007-08		Trans	AWD	1			EM-2638	
		Trans	RWD	1			EM-2817	
<b>SIERRA 1500 HD</b>								
V8	V8 6.0L	2001-03	Trans	2WD	1			EM-2817
			Trans	4WD	1			EM-2638
	V8 6.0L 364ci	2001-07 2005-07	L & R Front		2	EM-2909		
			Trans	2WD	1			EM-2817
			Trans	4WD	1			EM-2638
<b>SIERRA 2500</b>								
V8	V8 5.3L 323ci	1999-00	L & R Front		2	EM-2909		
			Trans	2WD	1			EM-2817
			Trans	4WD	1			EM-2638
	V8 6.0L 364ci	1999-04	L & R Front	w/Heat Shield	2	EM-5423		
			L & R Front	w/o Heat Shield	2	EM-2909		
			Trans	2WD	1			EM-2817
			Trans	4WD	1			EM-2638
<b>SIERRA 2500 HD</b>								
V8	V8 6.0L 364ci	2008-10	L & R Front	Complete Unit	2	EM-5583		
		2001-07	L & R Front	w/Heat Shield	2	EM-5423		
			L & R Front	w/o Heat Shield	2	EM-2909		
		2007-14	Trans	4WD	1			EM-2638
			Trans	RWD	1			EM-2817
		2001-06	Trans	4WD	1			EM-2638
			Trans	RWD	1			EM-2817
	V8 6.6L 400ci Diesel	2001-10	Left	Complete Unit	1	EM-5582		
			Left	w/o Heat Shield	1	EM-3102		
			Right		1	EM-3102		
	V8 8.1L	2001-07	L & R Front		2	EM-5353		
Trans				1			EM-2638	
<b>SIERRA 3500</b>								
V8	V8 6.0L	2004-07	Trans	4WD	1			EM-2638
	V8 6.0L 364ci	2001-07	L & R Front	w/Heat Shield	2	EM-5423		
			L & R Front	w/o Heat Shield	2	EM-2909		
		2001-03	Trans	2WD	1			EM-2817
	V8 6.6L 400ci Diesel	2001-07	Trans	4WD	1			EM-2638
LH Front				1	EM-3102			



# Engine, Transmission, And Torque Strut Mounts

CYL	ENG. SIZE	YEAR	LOCATION	DESCRIPTION	QTY	ENGINE	TORQUE STRUT	TRANSMISSION	
<b>GMC TRUCK (continued)</b>									
<b>SIERRA 3500 (continued)</b>									
V8	V8 6.6L 400ci Diesel	2001-07	RH Front	Complete Unit	1	EM-5582			
			RH Front	w/o Heat Shield	1	EM-3102			
			Trans		1			EM-2638	
	V8 8.1L	2001-07	L & R Front		2	EM-5353			
	V8 8.1L 496ci	2001-07	Trans		1			EM-2638	
<b>SIERRA 3500 HD</b>									
V8	V8 6.0L	2007-14	Trans	4WD	1			EM-2638	
			Trans	RWD	1			EM-2817	
	V8 6.0L 364ci	2007-10	L & R Front	Complete Unit	2	EM-5583			
	V8 6.6L 400ci Diesel	2007-10	LH Front		1	EM-3102			
			RH Front	Complete Unit	1	EM-5582			
			RH Front	w/o Heat Shield	1	EM-3102			
	Trans			1			EM-2638		
<b>SIERRA C3</b>									
V8	V8 6.0L 364ci	2001	L & R Front		2	EM-2909			
			Trans	AWD	1			EM-2638	
<b>SONOMA</b>									
L4	L4 2.2L 134ci	1994-03	L & R Front	Insert	2	EM-2819			
			LH Front	Complete Unit	1	EM-5426			
			RH Front	Complete Unit	1	EM-5350			
		1998-03	Trans	Auto	1			EM-2957	
			Trans	Manual	1			EM-2957	
		1994-97	Trans	Auto	1			EM-2957	
	Trans		Manual	1			EM-2956		
	L4 2.5L 2474cc	1991-93	LH Front		1	EM-2549			
			RH Front		1	EM-2550			
			Trans	Auto; 2WD	1			EM-2508	
			Trans	Manual; 2WD	1			EM-2508	
	V6	V6 2.8L 173ci	1991-93	L & R Front		2	EM-2436		
				Trans	Auto; 2WD	1			EM-2508
				Trans	Auto; 4WD	1			EM-2638
Trans				Manual; 2WD	1			EM-2508	
Trans				Manual; 4WD	1			EM-2638	
V6 4.3L 262ci		1996-04	L & R Front		2	EM-2802			
			1991-95	L & R Front		2	EM-2627		
			2004	Trans	Auto	1			EM-2638
		1995-03	Trans	Auto; 4WD	1			EM-2638	
			Trans	Auto; RWD	1			EM-2394	
			Trans	Manual; 4WD	1			EM-2638	
			Trans	Manual; RWD	1			EM-2394	
			1991-94	Trans	Auto; 2WD	1			EM-2508
				Trans	Auto; 4WD	1			EM-2638
		Trans		Manual; 2WD	1			EM-2508	
			Trans	Manual; 4WD	1			EM-2638	
		<b>SPRINT</b>							
L6	L6 4.1L 250ci	1975-77	L & R Front		2	EM-2284			
		1971-72	L & R Front		2	EM-2284			
		1975-77	Trans		1			EM-2378 @	
		1971-72	Trans		1			EM-2378 @	
V8	V8 5.0L 305ci	1976-77	L & R Front		2	EM-2292			
			Trans		1			EM-2513	
	V8 5.7L 350ci	1973-77	L & R Front		2	EM-2292			
			1971-72	L & R Front		2	EM-2282		
			1976-77	Trans	Auto	1			EM-2378 @
			Trans	Manual	1			EM-2378 @	

# Engine, Transmission, And Torque Strut Mounts

CYL	ENG. SIZE	YEAR	LOCATION	DESCRIPTION	QTY	ENGINE	TORQUE STRUT	TRANSMISSION	
<b>GMC TRUCK (continued)</b>									
<b>SPRINT (continued)</b>									
V8	V8 5.7L 350ci	1971-75	Trans	Auto; THM350	1			EM-2378 @	
			Trans	Auto; THM400	1			EM-2268 @	
			Trans	Manual	1			EM-2378 @	
	V8 6.6L 400ci	1976	L & R Front		2	EM-2292			
			Trans		1			EM-2378 @	
	V8 7.4L 454ci	1973-75	1971-72	L & R Front		2	EM-2395		
				L & R Front		2	EM-2283		
1973-75		Trans		1			EM-2360 @		
1971-72		Trans		1			EM-2294		
<b>SYCLONE</b>									
V6	V6 4.3L 262ci	1991	L & R Front		2	EM-2627			
			Trans	AWD	1			EM-2638	
<b>V1500 PICKUP</b>									
V6	V6 4.3L 262ci	1987	L & R Front		2	EM-2436			
			Trans	Auto	1			EM-2638	
			Trans	Manual	1			EM-2638	
V8	V8 5.0L 305ci	1987	L & R Front		2	EM-2292			
			Trans	Auto	1			EM-2638	
			Trans	Manual	1			EM-2638	
	V8 5.7L 350ci	1987	L & R Front		2	EM-2292			
			Trans	Auto	1			EM-2638	
			Trans	Manual	1			EM-2638	
V8 6.2L 379ci Diesel	1987	L & R Front		2	EM-2395				
		Trans	Auto	1			EM-2638		
		Trans	Manual	1			EM-2638		
<b>V2500 PICKUP</b>									
L6	L6 4.8L 292ci	1987	L & R Front		2	EM-2292			
			Trans	Auto	1			EM-2638	
			Trans	Manual	1			EM-2638	
V8	V8 5.7L 350ci	1987	L & R Front		2	EM-2292			
			Trans	Auto	1			EM-2638	
			Trans	Manual	1			EM-2638	
	V8 6.2L 379ci Diesel	1987	L & R Front		2	EM-2395			
			Trans	Auto	1			EM-2638	
			Trans	Manual	1			EM-2638	
<b>V3500 PICKUP</b>									
L6	L6 4.8L 292ci	1987-88	L & R Front		2	EM-2292			
			Trans	Auto	1			EM-2638	
			Trans	Manual	1			EM-2638	
V8	V8 5.7L 350ci	1987-91	L & R Front		2	EM-2292			
			Trans	Auto	1			EM-2638	
			Trans	Manual	1			EM-2638	
	V8 6.2L 379ci Diesel	1987-91	L & R Front		2	EM-2395			
			Trans	Auto	1			EM-2638	
			Trans	Manual	1			EM-2638	
	V8 7.4L 454ci	1987-91	L & R Front		2	EM-2395			
			Trans	Auto	1			EM-2513	
			Trans	Manual	1			EM-2392	

# Engine, Transmission, And Torque Strut Mounts

CYL	ENG. SIZE	YEAR	LOCATION	DESCRIPTION	QTY	ENGINE	TORQUE STRUT	TRANSMISSION
<b>GMC VAN</b>								
<b>G1000 SERIES</b>								
L6	L6 3.2L 194ci	1966	L & R Front		2	EM-2282		
			L & R Rear	Manual	2	EM-2108		
			Lower	Manual				
			L & R Rear	Manual	2	EM-2107		
			Upper	Manual				
<b>G15/G1500 VAN</b>								
L6	L6 4.1L 250ci	1971-84	L & R Front		2	EM-2292		
		1967-70	L & R Front		2	EM-2282		
		1983-84	Trans	Auto; THM400 (M40)	1			EM-2515
			Trans	Auto; THM700-R4/4L60 (MD8)	1			EM-2393
			Trans	Manual	1			EM-2393
		1982	Trans	Auto; THM350 (M38)	1			EM-2378 @
				THM350C (MV4)				
			Trans	Auto; THM400 (M40)	1			EM-2268 @
			Trans	Manual	1			EM-2378 @
		1977-81	Trans	Auto; THM350 (M38)	1			EM-2378 @
			Trans	Auto; THM400 (M40)	1			EM-2268 @
			Trans	Manual	1			EM-2378 @
		1975-76	Trans	Auto; THM350 (M38)	1			EM-2378 @
			Trans	Manual	1			EM-2378 @
		1971-74	Trans	Auto	1			EM-2378 @
			Trans	Manual	1			EM-2378 @
		1967-70	Trans	Auto	1			EM-2378 @
Trans	Manual		1			EM-2378 @		
V6	V6 4.3L 262ci	1997-98	L & R Front		2	EM-2621		
		1985-96	L & R Front		2	EM-2436		
		1997-98	Trans		1			EM-2817
		1996	Trans		1			EM-2816
		1991-95	Trans		1			EM-2817
		1990	Trans	Auto; THM400	1			EM-2515
			Trans	Auto; THM700-R4/4L60 (MD8)	1			EM-2394
		1985-89	Trans	Auto; THM400	1			EM-2515
			Trans	Auto; THM700-R4/4L60 (MD8)	1			EM-2508
			Trans	Manual	1			EM-2508
V8	V8 5.0L 305ci	1996-98	L & R Front		2	EM-2621		
		1977-95	L & R Front		2	EM-2292		
		1991-98	Trans		1			EM-2816
		1983-90	Trans	Auto; THM400	1			EM-2515
			Trans	Auto; THM700-R4/4L60 (MD8)	1			EM-2393
			Trans	Manual	1			EM-2393
		1977-82	Trans	Auto; THM350 (M38)	1			EM-2378 @
				THM350C (MV4)				
			Trans	Auto; THM400	1			EM-2268 @
			Trans	Manual	1			EM-2378 @
	V8 5.0L 307ci	1972-73	L & R Front		2	EM-2292		
		1968-71	L & R Front		2	EM-2282		
		1968-73	Trans	Auto; THM350	1			EM-2378 @
			Trans	Auto; THM400	1			EM-2268 @
		Trans	Manual	1			EM-2378 @	
	V8 5.7L 350ci	1996-98	L & R Front		2	EM-2621		
			L & R Front		2	EM-2292		
		1993	Trans	Auto, 4L60E (M30)	1			EM-2816
		1992	Trans	Auto; THM700-R4/4L60 (MD8)	1			EM-2817
1991		Trans	Auto; THM700-R4/4L60 (MD8)	1			EM-2817	
		Trans	Auto; THM-R2 (MT1)	1			EM-2816	
1990		Trans	Auto; THM400 (M40)	1			EM-2515	

# Engine, Transmission, And Torque Strut Mounts

CYL	ENG. SIZE	YEAR	LOCATION	DESCRIPTION	QTY	ENGINE	TORQUE STRUT	TRANSMISSION	
<b>GMC VAN (continued)</b>									
<b>G15/G1500 VAN (continued)</b>									
V8	V8 5.7L 350ci	1990	Trans	Auto; THM700-R4/4L60 (MD8)	1			EM-2394	
		1987-89	Trans	Auto; THM400 (M40)	1			EM-2515	
			Trans	Auto; THM700-R4/4L60 (MD8)	1			EM-2393	
			Trans	Manual	1			EM-2393	
		1986	Trans	Auto; THM350C (MV4) THM700-R4/4L60 (MD8)	1			EM-2393	
			Trans	Auto; THM400 (M40)	1			EM-2515	
			Trans	Manual	1			EM-2393	
		1985	Trans	Auto; THM400-475 (M40)	1			EM-2515	
			Trans	Auto; THM700-R4/4L60 (MD8)	1			EM-2393	
			Trans	Manual	1			EM-2393	
		1984	Trans	Auto; THM350C (MV4)	1			EM-2393	
			Trans	Auto; THM400 (M40)	1			EM-2515	
			Trans	Auto; THM700-R4/4L60 (MD8)	1			EM-2393	
			Trans	Manual	1			EM-2393	
		1983	Trans	Auto; THM400 (M40)	1			EM-2515	
			Trans	Auto; THM700-R4/4L60 (MD8)	1			EM-2393	
			Trans	Manual	1			EM-2393	
		1982	Trans	Auto; THM350C (MV4)	1			EM-2378 @	
			Trans	Auto; THM400 (M40)	1			EM-2268 @	
			Trans	Manual	1			EM-2378 @	
		1979-81	Trans	Auto; THM350 (M38)	1			EM-2378 @	
	Trans		Auto; THM400 (M40)	1			EM-2268 @		
	Trans		Manual	1			EM-2378 @		
	1971-78	Trans	Auto	1			EM-2378 @		
		Trans	Manual	1			EM-2378 @		
	V8 6.6L 400ci	1979	L & R Front			2	EM-2292		
		1976	L & R Front			2	EM-2292		
		1979	Trans	Auto; THM350	1			EM-2378 @	
			Trans	Auto; THM400	1			EM-2268 @	
			Trans	Manual	1			EM-2378 @	
		1976	Trans	Auto	1			EM-2378 @	
			Trans	Manual	1			EM-2378 @	
	<b>G25/G2500 VAN</b>								
L6	L6 4.1L 250ci	1978-84	L & R Front		2	EM-2292			
		1971-74	L & R Front		2	EM-2292			
		1967-70	L & R Front		2	EM-2282			
		1983-84	Trans	Auto; THM400	1			EM-2515	
			Trans	Auto; THM700-R4/4L60 (MD8)	1			EM-2393	
			Trans	Manual	1			EM-2393	
		1982	Trans	Auto; THM350C (MV4)	1			EM-2378 @	
			Trans	Auto; THM400 (M40)	1			EM-2268 @	
			Trans	Manual	1			EM-2378 @	
		1978-81	Trans	Auto; THM350 (M38)	1			EM-2378 @	
			Trans	Auto; THM400 (M40)	1			EM-2268 @	
			Trans	Manual	1			EM-2378 @	
		1971-74	Trans	Auto; THM350	1			EM-2378 @	
			Trans	Auto; THM400	1			EM-2268 @	
	Trans		Manual	1			EM-2378 @		
	1967-70	Trans		1			EM-2378 @		
	L6 4.8L 292ci	1974-78	L & R Front			2	EM-2292		
Trans			Auto	1			EM-2373		
Trans			Manual	1			EM-2268 @		
V6	V6 4.3L 262ci	1998	L & R Front		2	EM-2621			
		1985-95	L & R Front		2	EM-2436			

# Engine, Transmission, And Torque Strut Mounts

CYL	ENG. SIZE	YEAR	LOCATION	DESCRIPTION	QTY	ENGINE	TORQUE STRUT	TRANSMISSION	
<b>GMC VAN (continued)</b>									
<b>G25/G2500 VAN (continued)</b>									
V6	V6 4.3L 262ci	1998	Trans		1			EM-2817	
		1991-95	Trans		1			EM-2817	
		1990	Trans	Auto; THM400	1		EM-2515		
			Trans	Auto; THM700-R4/4L60 (MD8)	1		EM-2394		
		1985-89	Trans	Auto; THM400	1		EM-2515		
			Trans	Auto; THM700-R4/4L60 (MD8)	1		EM-2508		
			Trans	Manual	1		EM-2508		
V8	V8 5.0L 305ci	1996-98	L & R Front		2	EM-2621			
		1977-95	L & R Front		2	EM-2292			
		1991-98	Trans		1		EM-2816		
		1983-90	Trans	Auto; THM400	1		EM-2515		
			Trans	Auto; THM700-R4/4L60 (MD8)	1		EM-2393		
			Trans	Manual	1		EM-2393		
		1977-82	Trans	Auto; THM350 (M38)	1		EM-2378 @		
				THM350C (MV4)					
			Trans	Auto; THM400	1		EM-2268 @		
			Trans	Manual	1		EM-2378 @		
	V8 5.0L 307ci	1972-73	L & R Front		2	EM-2292			
		1968-71	L & R Front		2	EM-2282			
		1968-73	Trans	Auto; THM350	1		EM-2378 @		
			Trans	Auto; THM400	1		EM-2268 @		
			Trans	Manual	1		EM-2378 @		
	V8 5.7L 350ci	1996-98	L & R Front		2	EM-2621			
		1970-95	L & R Front		2	EM-2292			
		1993-95	Trans	Auto, 4L60E (M30)	1		EM-2816		
		1991-92	Trans	Auto; THM700-R4/4L60 (MD8)	1		EM-2817		
		1983-90	Trans	Auto; THM400	1		EM-2515		
			Trans	Auto; THM700-R4/4L60 (MD8)	1		EM-2393		
			Trans	Manual	1		EM-2393		
		1982	Trans	Auto; THM350C (MV4)	1		EM-2378 @		
			Trans	Auto; THM400 (M40)	1		EM-2268 @		
			Trans	Manual	1		EM-2378 @		
			1979-81	Trans	Auto; THM350 (M38)	1		EM-2378 @	
		Trans		Auto; THM400 (M40)	1		EM-2268 @		
		Trans		Manual	1		EM-2378 @		
		1970-78	Trans		1		EM-2378 @		
		V8 6.2L 379ci Diesel	1983-93	L & R Front		2	EM-2292		
			1992-93	Trans		1		EM-2817	
	1990-91		Trans	Auto; THM700-R4/4L60 (MD8)	1		EM-2394		
	1983-89		Trans	Auto; THM400	1		EM-2515		
Trans			Auto; THM700-R4/4L60 (MD8)	1		EM-2393			
Trans			Manual	1		EM-2393			
V8 6.5L 395ci Diesel	1997-98		L & R Front		2	EM-2621			
	1994-96	L & R Front		2	EM-2292				
	1994-98	Trans		1		EM-2816			
V8 6.6L 400ci	1975-80	L & R Front		2	EM-2292				
		Trans	Auto; THM350	1		EM-2378 @			
		Trans	Auto; THM400	1		EM-2268 @			
		Trans	Manual	1		EM-2378 @			
<b>G35/G3500 VAN</b>									
L6	L6 4.1L 250ci	1982-84	L & R Front		2	EM-2292			
		1978-79	L & R Front		2	EM-2292			
		1971-74	L & R Front		2	EM-2292			
		1983-84	Trans	Auto; THM400	1		EM-2515		
			Trans	Auto; THM700-R4/4L60 (MD8)	1		EM-2393		
			Trans	Manual	1		EM-2393		

# Engine, Transmission, And Torque Strut Mounts

CYL	ENG. SIZE	YEAR	LOCATION	DESCRIPTION	QTY	ENGINE	TORQUE STRUT	TRANSMISSION	
<b>GMC VAN (continued)</b>									
<b>G35/G3500 VAN (continued)</b>									
L6	L6 4.1L 250ci	1982	Trans	Auto; THM350C (MV4)	1			EM-2378 @	
			Trans	Auto; THM400 (M40)	1			EM-2268 @	
			Trans	Manual	1				EM-2378 @
		1978-79	Trans	Auto; THM350	1				EM-2378 @
			Trans	Auto; THM400	1				EM-2268 @
			Trans	Manual	1				EM-2378 @
		1971-74	Trans	Auto; THM350	1				EM-2378 @
			Trans	Auto; THM400	1				EM-2268 @
			Trans	Manual	1				EM-2378 @
	L6 4.8L 292ci	1974-78	L & R Front		2	EM-2292			
			Trans	Auto	1			EM-2373	
Trans			Manual	1			EM-2268 @		
V6	V6 4.3L 262ci	1985-95	L & R Front		2	EM-2436			
		1991-95	Trans		1			EM-2817	
		1990	Trans	Auto; THM400	1			EM-2515	
			Trans	Auto; THM700-R4/4L60 (MD8)	1			EM-2394	
		1985-89	Trans	Auto; THM400	1			EM-2515	
			Trans	Auto; THM700-R4/4L60 (MD8)	1			EM-2508	
			Trans	Manual	1			EM-2508	
V8	V8 5.0L 305ci	1981	L & R Front		2	EM-2292			
			Trans	Auto; THM350 (M38) THM350C (MV4)	1			EM-2378 @	
			Trans	Auto; THM400	1			EM-2268 @	
			Trans	Manual	1			EM-2378 @	
	V8 5.7L 350ci	1996-98	L & R Front		2	EM-2621			
		1971-95	L & R Front		2	EM-2292			
		1993-96	Trans	Auto; 4L80E (MT1)	1			EM-2816	
		1991-92	Trans	Auto; THM700-R4/4L60 (MD8)	1			EM-2817	
		1990	Trans	Auto; THM700-R4/4L60 (MD8)	1			EM-2394	
			Trans	Auto; THM400 (M40)	1			EM-2515	
		1983-89	Trans	Auto; THM400	1			EM-2515	
			Trans	Auto; THM700-R4/4L60 (MD8)	1			EM-2393	
			Trans	Manual	1			EM-2393	
		1982	Trans	Auto; THM350C (MV4)	1			EM-2378 @	
			Trans	Auto; THM400 (M40)	1			EM-2268 @	
			Trans	Manual	1			EM-2378 @	
		1979-81	Trans	Auto; THM350 (M38)	1			EM-2378 @	
			Trans	Auto; THM400 (M40)	1			EM-2268 @	
			Trans	Manual	1			EM-2378 @	
	1971-78	Trans		1			EM-2378 @		
	V8 6.2L 379ci Diesel	1983-93	L & R Front		2	EM-2292			
		1992-93	Trans		1			EM-2816	
		1991	Trans	Auto; THM700-R4/4L60 (MD8)	1			EM-2394	
		1990	Trans	Auto; THM400	1			EM-2515	
			Trans	Auto; THM700-R4/4L60 (MD8)	1			EM-2394	
		1983-89	Trans	Auto; THM400	1			EM-2515	
			Trans	Auto; THM700-R4/4L60 (MD8)	1			EM-2393	
	Trans	Manual	1			EM-2393			
	V8 6.5L 395ci Diesel	1997-98	L & R Front		2	EM-2621			
		1994-96	L & R Front		2	EM-2292			
		1994-98	Trans		1			EM-2816	
	V8 6.6L 400ci	1975-80	L & R Front		2	EM-2292			
			Trans	Auto; THM350	1			EM-2378 @	
Trans			Auto; THM400	1			EM-2268 @		
Trans			Manual	1			EM-2378 @		
V8 7.4L 454ci	1997-98	L & R Front		2	EM-2621				

# Engine, Transmission, And Torque Strut Mounts

CYL	ENG. SIZE	YEAR	LOCATION	DESCRIPTION	QTY	ENGINE	TORQUE STRUT	TRANSMISSION
<b>GMC VAN (continued)</b>								
<b>G35/G3500 VAN (continued)</b>								
V8	V8 7.4L 454ci	1988-96	L & R Front		2	EM-2292		
		1990-98	Trans	MT1	1			EM-2816
		1988-89	Trans			1		
<b>P15/P1500 VAN</b>								
L6	L6 4.1L 250ci	1973-74	L & R Front		2	EM-2292		
		1968-72	L & R Front		2	EM-2282		
		1968-74	Trans	2WD	1			EM-2378 @
	L6 4.8L 292ci	1975-80	L & R Front		2	EM-2292		
			Trans	Auto; 2WD	1		EM-2378 @	
V8	V8 7.4L 454ci	1979	L & R Front		2	EM-2395		
			Trans	Auto; 2WD	1		EM-2513	
			Trans	Manual; 2WD	1		EM-2378 @	
<b>P25/P2500 VAN</b>								
L6	L6 4.1L 250ci	1973-74	L & R Front		2	EM-2292		
		1972	L & R Front		2	EM-2282		
		1970	L & R Front		2	EM-2282		
		1967	L & R Front		2	EM-2282		
		1972-74	Trans	2WD	1			EM-2378 @
		1970	Trans	2WD	1			EM-2378 @
		1967	Trans	2WD	1			EM-2378 @
	L6 4.8L 292ci	1973-89	L & R Front		2	EM-2292		
			L & R Front		2	EM-2282		
		1985-89	Trans	Auto; 2WD	1			EM-2513
			Trans	Manual; 2WD	1			EM-2392
		1983-84	Trans	Auto; 2WD	1			EM-2513
			Trans	Manual; 2WD	1			EM-2268 @
		1970-82	Trans	Auto; 2WD	1			EM-2378 @
			Trans	Manual; 2WD	1			EM-2268 @
V8	V8 5.7L 350ci	1973-89	L & R Front		2	EM-2292		
			L & R Front		2	EM-2282		
		1985-89	Trans	2WD	1			EM-2392
			Trans	2WD	1			EM-2378 @
	V8 6.2L 379ci Diesel	1982-89	L & R Front		2	EM-2292		
			Trans	Auto; 2WD	1		EM-2513	
Trans	Manual; 2WD	1		EM-2392				
<b>P35/P3500 VAN</b>								
L4	L4 3.9L 239ci Diesel	1989-91	Trans	2WD	1			EM-2513
L6	L6 4.1L 250ci	1973-74	L & R Front		2	EM-2292		
		1970-72	L & R Front		2	EM-2282		
		1967	L & R Front		2	EM-2282		
		1970-74	Trans	2WD	1			EM-2378 @
		1967	Trans	2WD	1			EM-2378 @
	L6 4.8L 292ci	1973-89	L & R Front		2	EM-2292		
			L & R Front		2	EM-2282		
		1985-89	Trans	Auto; 2WD	1			EM-2513
			Trans	Manual; 2WD	1			EM-2392
		1983-84	Trans	Auto; 2WD	1			EM-2513
Trans	Manual; 2WD		1			EM-2268 @		
1970-82	Trans	Auto; 2WD	1			EM-2378 @		
	Trans	Manual; 2WD	1			EM-2268 @		
V6	V6 4.3L 262ci	1990-99	L & R Front		2	EM-2436		
			Trans	RWD	1		EM-2922	
			Trans	Auto	1		EM-2510 @	
			Trans	Manual; 5 Spd	1		EM-2922	

# Engine, Transmission, And Torque Strut Mounts

CYL	ENG. SIZE	YEAR	LOCATION	DESCRIPTION	QTY	ENGINE	TORQUE STRUT	TRANSMISSION
<b>GMC VAN (continued)</b>								
<b>P35/P3500 VAN (continued)</b>								
V6	V6 4.3L 262ci	1990	Trans	Auto	1			EM-2510 @
			Trans	Manual; 4 Spd	1			EM-2515
V8	V8 5.7L 350ci	1973-99	L & R Front		2	EM-2292		
		1970-72	L & R Front		2	EM-2282		
		1991-99	Trans	Auto	1			EM-2392
			Trans	Manual; 5 Spd	1			EM-2922
		1985-90	Trans	Auto; 2WD	1			EM-2513
			Trans	Manual; 2WD	1			EM-2392
		1970-84	Trans	Auto; 2WD	1			EM-2268 @
			Trans	Manual; 2WD	1			EM-2378 @
	V8 6.2L 379ci Diesel	1982-93	L & R Front		2	EM-2292		
		1991-93	Trans	Auto	1			EM-2922
			Trans	Manual; 5 Spd	1			EM-2922
		1982-90	Trans	Auto; 2WD	1			EM-2513
	Trans		Manual; 2WD	1			EM-2392	
	V8 6.5L 395ci Diesel	1994-99	L & R Front		2	EM-2292		
			Trans	2WD	1			EM-2922
	V8 7.4L 454ci	1998-99	L & R Front		2	EM-2621		
		1973-97	L & R Front		2	EM-2395		
		1991-99	Trans	2WD	1			EM-2922
1985-90		Trans	Auto; 2WD	1			EM-2513	
		Trans	Manual; 2WD	1			EM-2393	
1981-84		Trans	Auto; 2WD	1			EM-2513	
1979-80		Trans	Auto; 2WD	1			EM-2513	
1973-78		Trans	Manual; 2WD	1			EM-2378 @	
		Trans	Auto; 2WD	1			EM-2268 @	
1973-78	Trans	Manual; 2WD	1			EM-2378 @		
<b>SAFARI</b>								
L4	L4 2.5L 2474cc	1985-90	LH Front		1	EM-2549		
			RH Front		1	EM-2550		
		1990	Trans	Auto	1			EM-2508
		1985-89	Trans	Auto	1			EM-2508
Trans	Manual		1			EM-2508		
V6	V6 4.3L 262ci	1985-05	L & R Front		2	EM-2436		
		1994-05	Trans		1			EM-2879
		1990-93	Trans	2WD	1			EM-2394
			Trans	AWD	1			EM-2950
		1985-89	Trans	Auto	1			EM-2508
			Trans	Manual	1			EM-2508
<b>SAVANA 1500</b>								
V6	V6 4.3L 262ci	2003-12	L & R Front		2	EM-3177		
		1999-02	L & R Front		2	EM-2621		
V8	V8 5.0L 305ci	1999-02	L & R Front		2	EM-2621		
			Trans		1			EM-2816
	V8 5.3L	2003-10	L & R Front	RWD	2	EM-5354		
			LH Front	AWD	1	EM-3175		
			RH Front	AWD	1	EM-5354		
		2003-14	Trans	RWD	1			EM-3098
	Trans		AWD	1			EM-4108	
	V8 5.7L 350ci	1999-02	L & R Front		2	EM-2621		
Trans				1			EM-2817	
<b>SAVANA 2500</b>								
V6	V6 4.3L 262ci	1999-02	L & R Front		2	EM-2621		
			Trans		1			EM-2817
V8	V8 4.8L	2006-07	L & R Front	RWD	2	EM-5354		



# Engine, Transmission, And Torque Strut Mounts

CYL	ENG. SIZE	YEAR	LOCATION	DESCRIPTION	QTY	ENGINE	TORQUE STRUT	TRANSMISSION
<b>GMC VAN (continued)</b>								
<b>SAVANA 2500 (continued)</b>								
V8	V8 4.8L	2003-05	L & R Front	RWD	2	EM-5354		
			LH Front	AWD	1	EM-3175		
			RH Front	AWD	1	EM-5354		
			2003-10	Trans	RWD	1		EM-3098
	V8 5.0L 305ci	1999-02	L & R Front		2	EM-2621		
			Trans		1		EM-2816	
	V8 5.3L	2003-05	Trans	RWD	1		EM-3098	
			Trans	AWD	1		EM-2638	
	V8 5.7L 350ci	1999-02	L & R Front		2	EM-2621		
			Trans		1		EM-2817	
	V8 6.0L	2003-10	L & R Front	RWD	2	EM-5354		
		2006-14	Trans - Front		1		EM-3098	
		2003-05	Trans	RWD	1		EM-3098	
				Trans	AWD	1		EM-2638
	V8 6.5L 395ci Diesel	1999-02	L & R Front		2	EM-2621		
Trans				1		EM-2816		
V8 6.6L 400cc Turbo Diesel	2006-09	L & R Front	Turbo	1		EM-5663		
		Trans	Turbo	1		EM-5663		
<b>SAVANA 3500</b>								
V8	V8 4.8L	2006-07	L & R Front	RWD	2	EM-5354		
		2006-09	Trans	RWD	1		EM-3098	
	V8 5.7L 350ci	1999-02	L & R Front		2	EM-2621		
			Trans		1		EM-2817	
	V8 6.0L	2003-10	L & R Front		2	EM-5354		
		2003-14	Trans		1		EM-3098	
	V8 6.5L 395ci Diesel	1999-02	L & R Front		2	EM-2621		
			Trans		1		EM-2816	
	V8 6.6L	2006-09	Trans	Turbo	1		EM-5663	
	V8 7.4L 454ci	1999-00	L & R Front		2	EM-2621		
			Trans	Auto	1		EM-2816	
V8 8.1L 496ci	2001-02	L & R Front		2	EM-2621			
		Trans	Auto	1		EM-2816		
<b>HONDA PASSENGER CAR</b>								
<b>ACCORD CROSSTOUR</b>								
V6	V6 3.5L 3471cc	2010-11	Front		1	EM-5793		
			Trans - Lower		1		EM-9439	
			Trans - Upper		1		EM-9516	
<b>ACCORD</b>								
L4	L4 1.6L 1599cc	1976-78	Rear		1	EM-8660		
			Trans		1		EM-8825	
	L4 1.8L 1751cc	1982-83	Front		1	EM-8012		
		1979-81	Front		1	EM-2451		
		1982-83	Rear		1	EM-8012		
		1979-81	Rear		1	EM-8660		
		1982-83	Torq Str - Front	Insert	1		EM-8614	
			Torq Str - Front	Tube	1		EM-8802	
		1979-81	Torq Str - Front	Insert	1		EM-8293	
		1982-83	Torq Str - Rear	Insert	1		EM-8615	
		1982	Trans - Lower		1		EM-8031	
		1979-81	Trans - Lower	Auto	1		EM-2452	
			Trans - Lower	Manual	1		EM-2452	
		1982	Trans - Upper	Auto	1		EM-8022	
		1979-81	Trans - Upper	Auto	1		EM-8022	
	1983	Trans		1		EM-8031		
	L4 1.8L 1829cc	1984-85	Front		1	EM-8574		

# Engine, Transmission, And Torque Strut Mounts

CYL	ENG. SIZE	YEAR	LOCATION	DESCRIPTION	QTY	ENGINE	TORQUE STRUT	TRANSMISSION	
<b>HONDA PASSENGER CAR (continued)</b>									
<b>ACCORD (continued)</b>									
L4	L4 1.8L 1829cc	1984-85	Rear		1	EM-8574			
			Torq Str - Front	Insert	1		EM-8614		
			Torq Str - Rear	Insert	1		EM-8615		
			Trans	Auto	1			EM-8014	
			Trans	Manual	1			EM-8012	
L4	L4 2.0L 1955cc	1989	Front	Vibration Damper	1	EM-5382			
			1986-88	Front	Vibration Damper	1	EM-5382		
			1989	Front Center	Auto	1	EM-5371		
			1986-88	Front Center	Auto	1	EM-5371		
			1989	LH Front		1	EM-8019		
			1986-88	LH Front		1	EM-8019		
			1989	RH Front		1	EM-9128		
			1986-88	RH Front		1	EM-8005		
			1989	Rear		1	EM-8014		
			1986-88	Rear		1	EM-8014		
			1986-89	Torq Str - Front	Insert	1		EM-8614	
				Torq Str - Front	Tube	1		EM-8025	
				Torq Str - Rear	Insert	1		EM-8615	
L4	L4 2.2L 2156cc	1996-97	Front	Auto	1	EM-8026			
			Front	Manual	1	EM-8432			
		1994-95	Front	Auto	1	EM-8026			
			Front	Manual	1	EM-8432			
		1996-97	LH Front		1	EM-8404			
		1994-95	LH Front		1	EM-8404			
		1990-93	LH Front		1	EM-8016			
			Rear	Auto; w/ Solenoid Valve	1	EM-8984			
			Rear	Auto; w/o Solenoid Valve	1	EM-8011			
			Rear	Manual; DX; LX	1	EM-8228			
		1994-95	Rear	Manual; EX	1	EM-8009			
			Rear	Auto; w/ Solenoid Valve	1	EM-8984			
			Rear	Auto; w/o Solenoid Valve	1	EM-8011			
			Rear	Manual; DX; LX	1	EM-9137			
		1990-93	Rear	Manual; EX	1	EM-8009			
			Rear	Auto; w/ Solenoid Valve	1	EM-8984			
			Rear	Auto; w/o Solenoid Valve	1	EM-8011			
			Rear	Manual; DX; LX	1	EM-9137			
		1991-93	Rear	Manual; EX	1	EM-8009			
			Torq Str - Front		1		EM-8024		
		1996-97	Trans	Auto	1			EM-8002	
			Trans	Manual	1			EM-9055	
		1994-95	Trans	Auto	1			EM-8002	
Trans	Manual		1			EM-9055			
1990-93	Trans	Auto	1			EM-8002			
	Trans	Manual	1			EM-8002			
L4	L4 2.3L 2254cc	1998-02	Front		1	EM-8801			
			LH Front		1	EM-8899			
			Rear	Auto	1	EM-8845			
			Rear	Manual	1	EM-8849			
		2000-02	Trans	Auto	1			EM-8983	
			Trans	Manual	1			EM-8971	
		1998-99	Trans	Auto	1			EM-8799	
Trans	Manual		1			EM-8971			
L4	L4 2.4L 2354cc	2009-12	Front		1	EM-9488			
			2003-07	Front	Hydraulic Mount; Auto	1	EM-9247		
			2009-12	LH Rear	Auto	1	EM-9443		
				LH Rear	Manual	1	EM-9554		
			2008	LH Rear	Auto	1	EM-9443		

# Engine, Transmission, And Torque Strut Mounts

CYL	ENG. SIZE	YEAR	LOCATION	DESCRIPTION	QTY	ENGINE	TORQUE STRUT	TRANSMISSION	
<b>HONDA PASSENGER CAR (continued)</b>									
<b>ACCORD (continued)</b>									
L4	L4 2.4L 2354cc	2008	LH Rear	Manual	1	EM-9554			
		2003-07	Rear	Hydraulic Mount	1	EM-9194			
		2009-12	Right		1	EM-9457			
		2008	Right	Auto	1	EM-9457			
		2003-07	Right	Auto	1	EM-9297			
			Trans - Front	Auto	1			EM-9426	
			Trans - Front	Manual	1			EM-9152	
		2008-12	Trans - Lower	Auto	1			EM-9428	
			Trans - Lower	Manual	1			EM-9417	
		2003-07	Trans - Rear	Auto	1			EM-9438	
			Trans - Rear	Manual	1			EM-9225	
		2008-12	Trans - Upper	Auto	1			EM-5784	
		V6	V6 2.7L 2675cc	1995-97	Front		1	EM-9178	
RH Front					1	EM-8900			
Rear					1	EM-5471			
Trans					1			EM-8896	
V6 3.0L 2977cc	2003-05		Front	Gas; Hydraulic Mount; Auto	1	EM-9247			
			Rear	Gas; Hydraulic Mount	1	EM-9451			
			Right	Gas; Auto	1	EM-9297			
			Right	Gas; Manual	1	EM-5787			
	2003-04		Trans - Front	Auto	1			EM-9215	
			Trans - Front	Auto; EX	1			EM-9409	
	2005		Trans - Front Upper	Bracket Only Bracket Only	1			EM-9220	
			2003-04	Trans - Front Upper		1		EM-9220	
	2005		Trans - Rear	Auto	1			EM-9214	
			Trans - Rear	Manual	1			EM-9434	
	2003-04		Trans - Rear	Auto	1			EM-9214	
			Trans - Rear	Manual	1			EM-9434	
	2005		Trans	Auto; EX	1			EM-9409	
Trans			Auto; LX & SE	1			EM-9215		
V6 3.0L 2997cc	2006-07		Front	Gas; Auto	1	EM-9247			
			1998-02	Front		1	EM-9185		
				RH Front		1	EM-8974		
			2006-07	Rear	Gas	1	EM-9451		
			1998-02	Rear		1	EM-9149		
			2006-07	Right	Gas; Auto	1	EM-9297		
				Right	Gas; Manual	1	EM-5787		
				Trans - Front	Auto	1			EM-9214
			1998-02	Trans - Front		1			EM-8898
			2006-07	Trans - Front Upper	Bracket Only Bracket Only	1			EM-9220
				Trans - Rear	Auto	1			EM-9434
			1998-02	Trans - Rear		1			EM-8986
V6 3.5L 3471cc	2008-13		Front	Sedan	1	EM-5793			
			Rear	Auto	1	EM-5875			
			Rear	Manual	1	EM-9554			
		Right		1	EM-9467				
	2008-12	Trans - Lower	Auto	1			EM-9439		
		Trans - Lower	Manual	1			EM-9450		
		Trans - Upper	Auto	1			EM-9516		
<b>CIVIC</b>									
L4	L4 1.2L 1237cc	1973-79	L & R Front		2	EM-2449			
			Torq Str - Front	Insert	1		EM-8029		
	L4 1.3L 1335cc	1981	Front	Auto	1	EM-2451			
			1980-83	Torq Str - Front		1		EM-8525	

# Engine, Transmission, And Torque Strut Mounts

CYL	ENG. SIZE	YEAR	LOCATION	DESCRIPTION	QTY	ENGINE	TORQUE STRUT	TRANS-MISSION	
<b>HONDA PASSENGER CAR (continued)</b>									
<b>CIVIC (continued)</b>									
L4	L4 1.3L 1335cc	1980-83	Trans - Lower		1			EM-8012	
			Trans - Upper		1			EM-8031	
	L4 1.3L 1339cc	2006-11	RH Front		1	EM-5906			
			2003-05	Rear		1	EM-8973		
		2006-11	Right		1	EM-5376			
			Torq Str - Rear		1		EM-9553		
	L4 1.3L 1342cc	1984-87	Trans		1			EM-9617	
			Front	Front	1	EM-8018			
			RH Front		1	EM-8402			
			Trans	Auto	1			EM-8004	
	L4 1.5L 1487cc	1980-83	Trans	Manual	1			EM-8004	
			Front		1	EM-8012			
			1975-79	L & R Front		2	EM-2449		
			1984-87	LH Front		1	EM-8402		
			Rear		1	EM-8004			
			1980-83	Rear		1	EM-8012		
			1976-79	Torq Str - Front	Insert	1		EM-8029	
			1984-87	Trans	Auto	1			EM-8004
			Trans	Manual	1			EM-8018	
			1980-83	Trans	Auto	1			EM-8031
	L4 1.5L 1493cc	1980-83	Trans	Manual	1			EM-8031	
			Front		1	EM-8575			
			1992-93	Front		1	EM-8575		
			1988-91	Front	Auto	1	EM-8431		
				Front	Manual	1	EM-8411		
			1988-91	LH Front		1	EM-8020		
			1994-95	LH Front Lower		1	EM-8435		
			1992-93	LH Front Lower		1	EM-8435		
			1994-95	LH Front Upper	CX	1	EM-9136		
				LH Front Upper	LIFT	1	EM-8021		
				LH Front Upper	VX	1	EM-8894		
			1992-93	LH Front Upper	CX, DX, LX	1	EM-9136		
			1992-93	LH Front Upper	VX	1	EM-8021		
			1994-95	Rear		1	EM-8010		
			1992-93	Rear		1	EM-8010		
			1988-91	Rear	Auto	1	EM-8007		
				Rear	Manual	1	EM-8006		
			1994-95	Trans	Auto; DX; LX	1			EM-8572
				Trans	Manual; DX; LX	1			EM-8329
			1992-93	Trans	Auto; DX; LX	1			EM-8330
	Trans	CX		1			EM-8495		
	Trans	Manual; DX; LX; VX		1			EM-8329		
	1988-91	Trans	Auto	1			EM-8001		
		Trans	Manual	1			EM-8034		
	L4 1.6L 1590cc	1996-00	Front		1	EM-8575			
			1989-91	Front	Auto	1	EM-8431		
			1989-91	Front	Manual	1	EM-8411		
			1988	Front	Manual	1	EM-8411		
			1994-95	LH Front	Auto	1	EM-8431		
				LH Front	Manual	1	EM-8435		
			1989-91	LH Front	Manual	1	EM-8020		
			1988	LH Front	Manual	1	EM-8020		
			1996-00	LH Front Lower		1	EM-8435		
1994-95			LH Front Lower		1	EM-8435			
1992-93			LH Front Lower		1	EM-8435			
1994-95			LH Front Upper	Coupe	1	EM-8894			
	LH Front Upper	Sedan	1	EM-8021					

# Engine, Transmission, And Torque Strut Mounts

CYL	ENG. SIZE	YEAR	LOCATION	DESCRIPTION	QTY	ENGINE	TORQUE STRUT	TRANSMISSION
<b>HONDA PASSENGER CAR (continued)</b>								
<b>CIVIC (continued)</b>								
L4	L4 1.6L 1590cc	1992-93	LH Front Upper		1	EM-8021		
			LH Front Upper		1	EM-9136		
		1996-00	LH Rear Upper		1	EM-8710		
		1994-95	RH Front	Auto	1	EM-8575		
			RH Front	Manual	1	EM-8434		
		1992-93	RH Front		1	EM-8575		
			RH Front	Auto	1	EM-8575		
			RH Front	Manual	1	EM-8434		
		1989-91	RH Front	Auto	1	EM-8001		
			RH Front	Manual	1	EM-8034		
		1988	RH Front	Manual	1	EM-8034		
		1996-00	Rear		1	EM-8010		
		1994-95	Rear		1	EM-8010		
		1992-93	Rear		1	EM-8010		
		1989-91	Rear	Auto	1	EM-8007		
			Rear	Manual	1	EM-8006		
		1988	Rear	Manual	1	EM-8006		
			Trans	Auto	1			EM-8300
		2000	Trans	Manual	1			EM-8300
			Trans	Auto	1			EM-8300
		1999	Trans	Manual	1			EM-8300
			Trans	Auto	1			EM-8300
		1997-98	Trans	Auto	1			EM-8300
			Trans	Manual	1			EM-8300
		L4 1.6L 1590cc D16Y Eng.	1996-00	Trans	Auto; HX w/CVT	1		EM-5449
				Trans	Auto; HX w/CVT	1		EM-5449
		L4 1.6L 1590cc	1996	Trans	Auto	1		EM-8300
				Trans	Manual	1		EM-8300
			1994-95	Trans	Auto	1		EM-8572
				Trans	Manual	1		EM-8329
			1992-93	Trans	Auto	1		EM-8330
				Trans	Manual	1		EM-8329
			1989-91	Trans	Auto	1		EM-8001
	Trans			Manual	1		EM-8034	
	1988	Trans	Manual	1		EM-8034		
	L4 1.6L 1595cc	1999-00	Trans	SI	1		EM-8300	
	L4 1.7L 1668cc	2005	Front	Auto	1	EM-8988		
			Front	Manual	1	EM-8975		
		2004	Front	Auto	1	EM-8988		
			Front	Manual	1	EM-8975		
		2002-03	Front	Auto	1	EM-8988		
			Front	Manual	1	EM-8975		
		2001	Front	Auto	1	EM-8988		
			Front	Manual	1	EM-8975		
		2005	LH Front	Auto	1	EM-9016		
			LH Front	Manual	1	EM-9277		
		2004	LH Front	DX, EX, LX	1	EM-9016		
LH Front			HX, Manual	1	EM-9016			
LH Front			HX; Automatic CVT	1	EM-9277			
2002-03		LH Front		1	EM-9016			
2001		LH Front		1	EM-9277			
2005		Rear		1	EM-8973			
2004		Rear		1	EM-8973			
2002-03		Rear		1	EM-8973			
2001		Rear		1	EM-8973			
2003-05		Trans	Auto; CVT	1			EM-9470	
		Trans	Auto; Exc. CVT	1			EM-5794	
		Trans	Manual, EX & LX	1			EM-9479	

# Engine, Transmission, And Torque Strut Mounts

CYL	ENG. SIZE	YEAR	LOCATION	DESCRIPTION	QTY	ENGINE	TORQUE STRUT	TRANSMISSION	
<b>HONDA PASSENGER CAR (continued)</b>									
<b>CIVIC (continued)</b>									
L4	L4 1.7L 1668cc	2003-05	Trans	Manual; SLW Trans.	1			EM-9204	
		2001-02	Trans	Auto; CVT	1			EM-9470	
			Trans	Auto; Exc. CVT	1			EM-5794	
			Trans	Manual	1			EM-9204	
	L4 1.8L	2006-11	Front		1	EM-9280			
	L4 1.8L 1799cc	2006-11	Torq Str - Lower	Auto	1		EM-9218		
			Torq Str - Lower	Manual	1		EM-9487		
			Torq Str - Upper	Auto	1		EM-9213		
			Torq Str - Upper	Manual	1		EM-5689		
		2012-13	Trans	Auto	1			EM-5990	
		2006-11	Trans	Auto	1			EM-9216	
	Trans		Manual	1			EM-9216		
	L4 2.0L 1998cc	2006-10	Front		1	EM-9542			
		2002-05	Front		1	EM-9424			
		2006-10	RH Front		1	EM-9282			
		2002-05	RH Front		1	EM-9413			
			Rear		1	EM-9396			
		2006-10	Torq Str - Lower	Lower	1		EM-9386		
			Torq Str - Upper	Upper	1		EM-9385		
		2005	Trans	SI	1			EM-9433	
2002-04	Trans	Si; SiR	1			EM-9433			
<b>CIVIC DEL SOL</b>									
L4	L4 1.5L 1493cc	1993-95	LH Front		1	EM-8435			
			LH Rear	After VIN PS003627	1	EM-8021			
			LH Rear	Before VIN PS003627	1	EM-9136			
			RH Front		1	EM-8575			
			Rear		1	EM-8010			
		1994-95	Trans	Auto	1			EM-8572	
			Trans	Manual	1			EM-8329	
		1993	Trans	Auto	1			EM-8330	
			Trans	Manual	1			EM-8329	
		L4 1.6L 1590cc	1996-97	Front		1	EM-8575		
	LH Front Lower			Auto	1	EM-8431			
	LH Front Lower			Manual	1	EM-8435			
	1993		LH Front Lower		1	EM-8435			
			1996-97	LH Front Upper	S, After VIN PS003627	1	EM-8021		
				LH Front Upper	S, Before VIN PS003627	1	EM-9136		
	1993		LH Front Upper	SI	1	EM-8894			
			LH Front Upper	SI, After VIN PS001140	1	EM-8021			
	LH Front Upper		SI, Before VIN PS001140	1	EM-9136				
	1994-95		RH Front	Auto	1	EM-8435			
	1993		RH Front	Auto	1	EM-8575			
			RH Front	Manual	1	EM-8434			
	1996-97		Rear	Rear	1	EM-8010			
	1994-95		Rear	Rear	1	EM-8010			
	1993		Rear		1	EM-8010			
			1994-97	Trans	Auto	1			EM-8572
	Trans			Manual	1			EM-8329	
	1993		Trans	Auto	1			EM-8330	
			Trans	Manual	1			EM-8329	
	<b>CRX</b>								
	L4	L4 1.3L 1342cc	1984	Trans - Rear		1			EM-8004
L4 1.5L 1487cc		1984-87	Trans	Auto	1			EM-8004	
			Trans	Manual	1			EM-8018	
L4 1.5L 1493cc		1988-91	Front	Auto	1	EM-8431			
	Front		Manual	1	EM-8411				

# Engine, Transmission, And Torque Strut Mounts

CYL	ENG. SIZE	YEAR	LOCATION	DESCRIPTION	QTY	ENGINE	TORQUE STRUT	TRANSMISSION
<b>HONDA PASSENGER CAR (continued)</b>								
<b>CRX (continued)</b>								
L4	L4 1.5L 1493cc	1988-91	LH Front		1	EM-8020		
			Rear	Auto	1	EM-8007		
			Rear	Manual	1	EM-8006		
			Trans	Auto	1			EM-8001
			Trans	Manual	1			EM-8034
	L4 1.6L 1590cc	1988-91	Front		1	EM-8411		
			LH Front		1	EM-8020		
			Rear		1	EM-8006		
			Trans	Manual	1			EM-8034
<b>CR-Z</b>								
L4	L4 1.5L 1497cc	2011-13	Torq Str - Left	Manual	1		EM-5792	
<b>FIT</b>								
L4	L4 1.5L	2007-08	Front	Manual	1	EM-9250		
			Rear		1	EM-9437		
			Trans	Auto	1			EM-9285
			Trans	Manual	1			EM-9286
	L4 1.5L 1497cc	2009-12 2009-13	Front		1	EM-5872		
			Torq Str - Rear	Auto	1		EM-5785	
			Torq Str - Rear	Manual	1		EM-5792	
<b>PRELUDE</b>								
L4	L4 1.8L 1751cc	1979-82	Front		1	EM-2451		
			Side		1	EM-2452		
	L4 1.8L 1829cc	1983-87	L & R Front		2	EM-8014		
			Rear	Auto	1	EM-8660		
			Rear	Manual	1	EM-8014		
			Side		1	EM-8014		
			Torq Str - Front	Insert	1		EM-8614	
			Torq Str - Rear	Insert	1		EM-8615	
			Trans	Auto	1			EM-8031
			Trans	Manual	1			EM-8031
	L4 2.0L	1985-87	Trans		1			EM-5400
	L4 2.0L 1955cc	1985-87	L & R Front		2	EM-8005		
			Rear		1	EM-8014		
			Torq Str - Front	Insert	1		EM-8614	
			Torq Str - Rear	Insert	1		EM-8615	
	L4 2.0L 1958cc	1988	Front		1	EM-9172		
		1990-91	LH Front		1	EM-5510		
		1989	LH Front		1	EM-5510		
		1990-91	RH Front	Auto	1	EM-8497		
			RH Front	Manual	1	EM-8030		
		1989	RH Front	Auto	1	EM-8497		
			RH Front	Manual	1	EM-8030		
		1988	RH Front	Auto	1	EM-8497		
			RH Front	Manual	1	EM-8030		
		1990-91	Rear	Auto	1	EM-8349		
			Rear	Manual	1	EM-8008		
		1989	Rear	Auto	1	EM-8349		
			Rear	Manual	1	EM-8008		
	1988	Rear		1	EM-8008			
	1988-91	Trans	Auto	1			EM-8987	
		Trans	Manual	1			EM-8374	
	L4 2.2L 2156cc	1997-01 1992-96	Front		1	EM-8806		
			Front	Auto	1	EM-8859		
			Front	Manual	1	EM-8806		
		1997-01 1992-96	LH Front		1	EM-9150		
			LH Front		1	EM-9085		

# Engine, Transmission, And Torque Strut Mounts

CYL	ENG. SIZE	YEAR	LOCATION	DESCRIPTION	QTY	ENGINE	TORQUE STRUT	TRANSMISSION		
<b>HONDA PASSENGER CAR (continued)</b>										
<b>PRELUDE (continued)</b>										
L4	L4 2.2L 2156cc	1997-01	Rear		1	EM-9137				
		1992-96	Rear		1	EM-8008				
		1997-01	Trans	Auto		1			EM-9183	
		1995-96	Trans	Auto		1			EM-8002	
			Trans	Manual		1			EM-9055	
		1992-94	Trans	Auto		1			EM-8002	
	Trans		Manual		1			EM-9055		
	L4 2.3L 2259cc	1992-96	Front			1	EM-8806			
			LH Front			1	EM-9085			
			Rear			1	EM-8008			
		1995-96	Trans	Auto		1			EM-8002	
			Trans	Manual		1			EM-9055	
		1992-94	Trans	Auto		1			EM-8002	
			Trans	Manual		1			EM-9055	
<b>S2000</b>										
L4	L4 2.0L 1997cc	2000-03	L & R Front		2	EM-5786				
			Trans		2			EM-9490		
	L4 2.2L	2004-09	L & R Front		2	EM-5786				
			Trans		2			EM-9490		
<b>HONDA SPORT UTILITY</b>										
<b>CR-V</b>										
L4	L4 2.0L 1972cc	1997	Front		1	EM-8709				
		1998-01	LH Front	Auto	1	EM-8982				
			LH Front	Manual	1	EM-8710				
		1997	LH Front		1	EM-8982				
		1998-01	Rear	Auto	1	EM-8897				
			Rear	Manual	1	EM-8010				
		1997	Rear		1	EM-8897				
		1997-01	Trans	4WD		1			EM-8300	
		L4 2.4L 2354cc	2006	Front	Auto		1	EM-9066		
			2002-05	Front	Auto		1	EM-9066		
	Front			Manual		1	EM-9424			
	Front			Manual; When Stock is Depleted, Re-order EM-9424		1	EM-9424			
	2007-11		RH Front		1	EM-9496				
	2006		RH Front		1	EM-9139				
	2002-05		RH Front		1	EM-9139				
	2006		Rear	Auto	1	EM-9168				
			Rear	Manual	1	EM-9175				
	2002-05		Rear	Auto	1	EM-9168				
			Rear	Manual	1	EM-9175				
	2012-14		Right		1	EM-5958				
	2007-11		Torq Str - Right		1		EM-9303			
			Torq Str - Right		1		EM-9302			
	2012-15		Torq Str - Upper		1		EM-5954			
	2009		Trans	US & Mexico Built	1			EM-9397		
	2008		Trans		1			EM-9397		
	2007		Trans	EX & LX	1			EM-9433		
			Trans	EX-L	1			EM-9397		
	2003-06		Trans	Auto	1			EM-9205		
			Trans	Manual	1			EM-9433		
	2002-11		Trans		2			EM-5871		
	2002		Trans	Auto	1			EM-9205		
			Trans	Manual	1			EM-9433		



# Engine, Transmission, And Torque Strut Mounts

CYL	ENG. SIZE	YEAR	LOCATION	DESCRIPTION	QTY	ENGINE	TORQUE STRUT	TRANSMISSION	
<b>HONDA SPORT UTILITY (continued)</b>									
<b>ELEMENT</b>									
L4	L4 2.4L	2003-11	Trans	4WD	2			EM-5871	
		2007-09	Torq Str - Right	Lower	1		EM-9303		
			Torq Str - Right	Upper	1		EM-9302		
			Trans	Auto	1			EM-9473	
			Trans	Manual	1			EM-9433	
		2003-06	Trans	Auto	1			EM-9473	
	Trans		Manual	1			EM-9433		
	L4 2.4L 2354cc	2010-11	Front	FWD	1	EM-9066			
			2007-09	Front	FWD	1	EM-9066		
			2010-11	RH Front		1	EM-9445		
			2007-09	RH Front		1	EM-9445		
			2010-11	Rear		1	EM-9168		
			2007-09	Rear		1	EM-9168		
	L4 2.4L 2400cc	2003-06	Front		1	EM-9066			
			RH Front		1	EM-9445			
Rear				1	EM-9168				
<b>PASSPORT</b>									
L4	L4 2.6L 2559cc	1996	LH Front		1	EM-8499			
		1994-95	LH Front		1	EM-9141			
		1996	RH Front		1	EM-8352			
		1994-95	RH Front		1	EM-9140			
		1994-96	Trans	Manual	1			EM-8586	
V6	V6 3.2L	1998-02	Trans	Auto; 2WD	1			EM-5609	
			Trans	Manual; 2WD	1			EM-5610	
	V6 3.2L 3165cc	2001-02	LH Front		1	EM-5813			
			1998-00	LH Front		1	EM-8351		
			1996-97	LH Front		1	EM-8351		
			1994-95	LH Front		1	EM-8445		
			1998-00	RH Front		1	EM-5814		
			1996-97	RH Front		1	EM-8352		
			1994-95	RH Front		1	EM-9144		
			1994-97	Trans	Auto; 4WD	1			EM-9142
				Trans	Auto; RWD	1			EM-8586
		Trans	Manual; RWD	1			EM-8586		
<b>PILOT</b>									
V6	V6 3.5L	2006-08	Front	AWD	1	EM-9441			
			Front	FWD	1	EM-5903			
		2005	Front		1	EM-9441			
		2003-04	Front		1	EM-9441			
		2009-10	RH Front		1	EM-9411			
		2006-08	RH Front	w/o Counter Weight	1	EM-9299			
		2005	RH Front	w/o Counter Weight	1	EM-9299			
		2003-04	RH Front		1	EM-9389			
		2006-08	Rear		1	EM-9300			
		2005	Rear		1	EM-9300			
		2003-04	Rear		1	EM-9300			
		2006-08	Trans - Front		1			EM-9301	
		2005	Trans - Front	Auto	1			EM-8898	
		2003-04	Trans - Front	Auto	1			EM-8898	
		2006-08	Trans - Rear		1			EM-9298	
		2005	Trans - Rear	Auto	1			EM-8986	
		2003-04	Trans - Rear	Auto	1			EM-8986	
		2009-14	Trans		1			EM-9512	

# Engine, Transmission, And Torque Strut Mounts

CYL	ENG. SIZE	YEAR	LOCATION	DESCRIPTION	QTY	ENGINE	TORQUE STRUT	TRANS-MISSION			
<b>HONDA TRUCK</b>											
<b>RIDGELINE</b>											
V6	V6 3.5L 3471cc	2009-11	Front	Hydraulic Mount	1	EM-9441					
		2006-08	Front	Hydraulic Mount	1	EM-9441					
		2009-11	Rear			1	EM-9300				
		2006-08	Rear			1	EM-9300				
		2009-11	Trans - Front			1			EM-9594		
		2006-08	Trans - Front			1			EM-9301		
<b>HONDA VAN</b>											
<b>WAGOVAN</b>											
L4	L4 1.5L	1984-87	Front		1	EM-8018					
			Rear		1	EM-2451					
			Trans		1			EM-8004			
<b>ODYSSEY</b>											
L4	L4 2.2L 2156cc	1995-97	Front		1	EM-8026					
			LH Front		1	EM-8404					
			Rear	w/ Solenoid Valve	1	EM-8984					
			Rear	w/o Solenoid Valve	1	EM-8011					
				Trans		1			EM-8002		
	L4 2.3L 2234cc	1998	Front		1	EM-8026					
			LH Front		1	EM-8404					
			Rear	w/ Solenoid Valve	1	EM-8984					
			Rear	w/o Solenoid Valve	1	EM-8011					
			V6	V6 3.5L	2008-10	Front	i-VTEC Engine	1	EM-5793		
						Front	VTEC Engine	1	EM-5925		
					2007	Front	i-VTEC Engine	1	EM-5840		
Front						VTEC Engine	1	EM-9247			
2005-06	Front	i-VTEC Engine	1		EM-5840						
	Front	VTEC Engine	1		EM-9247						
2011-13	RH Front		1		EM-9415						
2008-10	RH Front		1		EM-9415						
2007	RH Front		1		EM-9415						
2005-06	RH Front		1		EM-9411						
2008-10	Rear	i-VTEC Engine	1		EM-5904						
	Rear	VTEC Engine	1		EM-9431						
2007	Rear	i-VTEC Engine	1		EM-5795						
	Rear	VTEC Engine	1		EM-9431						
2005-06	Rear	i-VTEC Engine	1		EM-5795						
	Rear	VTEC Engine	1		EM-9431						
2007-10	Trans - Front		1				EM-9530				
2005-06	Trans - Front		1				EM-8898				
2007-10	Trans - Rear		1				EM-9427				
2005-06	Trans - Rear		1				EM-9423				
2011-13	Trans	Auto; 5 Spd	1			EM-9512					
V6 3.5L 3474cc	1999-04	Front		1	EM-9441						
		RH Front		1	EM-8974						
		Rear		1	EM-9202						
		Trans - Front	Auto	1			EM-8898				
		Trans - Rear	Auto	1			EM-8986				
<b>HUMMER</b>											
<b>H3</b>											
L5	L5 3.5L 3460cc	2006	LH Front		1	EM-4015					
			RH Front		1	EM-4016					
			Trans		1			EM-4096			
	L5 3.7L	2007-10	LH Front		1	EM-4015					
			RH Front		1	EM-4016					
			Trans		1			EM-4096			

# Engine, Transmission, And Torque Strut Mounts

CYL	ENG. SIZE	YEAR	LOCATION	DESCRIPTION	QTY	ENGINE	TORQUE STRUT	TRANSMISSION
<b>HUMMER (continued)</b>								
<b>H1</b>								
V8	V8 6.5L 395ci Diesel	2002-04	Front		2	EM-4001		
	V8 6.6L	2006	Front		2	EM-4001		
<b>H2</b>								
V8	V8 6.0L 364ci	2003-07	L & R Front		2	EM-2909		
		2003-06	Trans		1			EM-2638
<b>HYUNDAI PASSENGER CAR</b>								
<b>ACCENT</b>								
L4	L4 1.5L 1495cc	2000-02	Front	Manual	1	EM-8958		
		1997-99	Front	Auto	1	EM-8747		
			Front	Manual	1	EM-8746		
		1996	Front	Auto	1	EM-8748		
			Front	Manual	1	EM-8750		
		1995	Front	Auto	1	EM-8680		
			Front	Manual	1	EM-8676		
		2000-02	LH Front		1	EM-8936		
		1997-99	LH Front		1	EM-8715		
		1996	LH Front		1	EM-8715		
		1995	LH Front	Complete Unit	1	EM-8253		
			LH Front	Insert Only	1	EM-8560		
		2000-02	Rear		1	EM-8937		
		1997-99	Rear		1	EM-8751		
		1996	Rear		1	EM-8677		
		1995	Rear		1	EM-8677		
		2001-02	Trans	Manual	1			EM-8938
		2000	Trans	Auto	1			EM-8939
			Trans	Manual	1			EM-8938
		1997-99	Trans	Auto	1			EM-8727
			Trans	Manual	1			EM-8724
		1996	Trans	Auto	1			EM-8727
			Trans	Manual	1			EM-8725
		1995	Trans	Auto	1			EM-8679
			Trans	Manual	1			EM-8678
	L4 1.6L	2003-05	Front	Auto	1	EM-9253		
			Front	Manual	1	EM-9255		
		2001-02	Front	Auto	1	EM-8935		
			Front	Manual	1	EM-8958		
		2006-09	Front Lower		1	EM-9309		
			Front Upper		1	EM-9324		
		2003-05	LH Front		1	EM-8940		
		2001-02	LH Front		1	EM-8940		
		2006-09	Rear		1	EM-9310		
		2003-05	Rear	Auto	1	EM-9352		
			Rear	Manual	1	EM-9254		
		2001-02	Rear		1	EM-8937		
		2006-09	Trans		1			EM-9308
		2003-05	Trans	Auto	1			EM-9296
			Trans	Manual	1			EM-9295
	L4 1.6L 1600cc	2001-02	Trans	Auto	1			EM-8941
			Trans	Manual	1			EM-8938
<b>AZERA</b>								
V6	V6 3.3L	2007-10	Front		1	EM-9317		
			Front	When Stock is Depleted, Re-order EM-9317	1	EM-9321		
			RH Front	Complete Unit	1	EM-9353		
			RH Front	Insert Only	1	EM-9340		

# Engine, Transmission, And Torque Strut Mounts

CYL	ENG. SIZE	YEAR	LOCATION	DESCRIPTION	QTY	ENGINE	TORQUE STRUT	TRANSMISSION
<b>HYUNDAI PASSENGER CAR (continued)</b>								
<b>AZERA (continued)</b>								
V6	V6 3.3L	2007-10	Rear		1	EM-9354		
			Trans		1		EM-9370	
	V6 3.8L	2006-10	Front		1	EM-9317		
			Front	When Stock is Depleted, Re-order EM-9317	1	EM-9321		
			RH Front	Complete Unit	1	EM-9353		
			RH Front	Insert Only	1	EM-9340		
			Rear		1	EM-9354		
			Trans		1		EM-9370	
<b>ELANTRA</b>								
L4	L4 1.6L 1596cc	1994-95	Front	Auto	1	EM-8596		
			Front	Manual	1	EM-8759		
		1992-93	Front	Auto	1	EM-8596		
			Front	Manual	1	EM-8759		
		1994-95	LH Front	Auto	1	EM-8255		
			LH Front	Manual	1	EM-8718		
		1992-93	LH Front	Auto	1	EM-8255		
			LH Front	Manual	1	EM-8716		
		1994-95	Rear	Auto	1	EM-8774		
			Rear	Manual	1	EM-8771		
		1992-93	Rear	Auto	1	EM-8774		
			Rear	Manual	1	EM-8771		
		1994-95	Trans	Auto	1		EM-8040	
			Trans	Manual	1		EM-8731	
		1992-93	Trans	Auto	1		EM-8040	
			Trans	Manual	1		EM-8730	
	L4 1.8L 1795cc	1996-98	Front		1	EM-8762		
			RH Front		1	EM-8719		
			Rear	Auto	1	EM-8778		
			Rear	Manual	1	EM-8775		
			Trans	Auto	1		EM-8734	
			Trans	Manual	1		EM-8733	
	L4 1.8L 1836cc	1994-95	Front	Auto	1	EM-8042		
			Front	Manual	1	EM-8760		
		1993	Front	Auto	1	EM-8042		
			Front	Manual	1	EM-8760		
		1994-95	LH Front	Auto	1	EM-8717		
			LH Front	Manual	1	EM-8718		
		1993	LH Front	Auto	1	EM-8255		
			LH Front	Manual	1	EM-8716		
		1994-95	Rear	Auto	1	EM-8774		
			Rear	Manual	1	EM-8772		
		1993	Rear	Auto	1	EM-8774		
			Rear	Manual	1	EM-8772		
		1994-95	Trans	Auto	1		EM-8732	
			Trans	Manual	1		EM-8731	
		1993	Trans	Auto	1		EM-8732	
			Trans	Manual	1		EM-8730	
	L4 2.0L	2011	Front	Auto	1	EM-9357		
			Front	Manual	1	EM-9377		
		2009-10	Front	Auto; Exc. Touring Edition	1	EM-9360		
			Front	Auto; Touring Edition	1	EM-9357		
			Front	Manual	1	EM-9377		
		2007-08	Front	Auto	1	EM-9360		
			Front	Manual	1	EM-9377		
		2011	RH Front		1	EM-9345		
		2009-10	RH Front		1	EM-9345		

# Engine, Transmission, And Torque Strut Mounts

CYL	ENG. SIZE	YEAR	LOCATION	DESCRIPTION	QTY	ENGINE	TORQUE STRUT	TRANSMISSION
<b>HYUNDAI PASSENGER CAR (continued)</b>								
<b>ELANTRA (continued)</b>								
L4	L4 2.0L	2007-08	RH Front		1	EM-9345		
		2011	Rear		1	EM-9316		
		2009-10	Rear		1	EM-9316		
		2007-08	Rear		1	EM-9316		
		2007-09	Trans		1			EM-9339
	L4 2.0L 1975cc	2001-06	Front	Auto	1	EM-8943		
			Front	Manual	1	EM-8943		
		1999-00	Front	Auto	1	EM-8764		
			Front	Manual	1	EM-8762		
		2001-06	RH Front		1	EM-8944		
		1999-00	RH Front		1	EM-8719		
		2001-06	Rear	Auto	1	EM-8945		
			Rear	Manual	1	EM-8945		
		1999-00	Rear	Auto	1	EM-8778		
			Rear	Manual	1	EM-8775		
2001-06	Trans	Auto	1			EM-9376		
	Trans	Manual	1			EM-8947		
1999-00	Trans	Auto	1			EM-8734		
			Trans	Manual	1		EM-8733	
<b>EXCEL</b>								
L4	L4 1.5L	1986-89	Torq Str - Front	Complete Unit; Auto	1		EM-8932	
			Torq Str - Front	Complete Unit; Manual	1		EM-8045	
			Torq Str - Front	Insert Only; Large (70mm) Bushing	1		EM-5453	
			Torq Str - Front	Insert Only; Small (50mm) Bushing	1		EM-5398	
	L4 1.5L 1468cc	1990-94	Front		1	EM-8103		
			Front		1	EM-8933		
		1986-89	LH Front		1	EM-8039		
			Rear		1	EM-8672		
		1986-89	Rear	Auto	1	EM-8803		
			Torq Str - Front		1		EM-8047	
		1990-94	Trans	Auto	1			EM-8675
			Trans	Manual	1			EM-8674
		1986-89	Trans	Auto	1			EM-8934
<b>GENESIS</b>								
V6	V6 3.8L	2009	L & R Front		2	EM-9344		
			Trans	Auto, After 5-1-08	1		EM-9356	
			Trans	Auto, Before 4-30-08	1		EM-9350	
V8	V8 4.6L	2009-10	LH Front		1	EM-5881		
			RH Front		1	EM-5882		
<b>SCOUPE</b>								
L4	L4 1.5L	1991-92	Torq Str - Right	Manual	1		EM-8047	
			Front		1	EM-8103		
	L4 1.5L 1468cc	1991-92	RH Front	Auto	1	EM-8675		
			RH Front	Manual	1	EM-8674		
			Rear		1	EM-8672		
			Trans	Auto	1		EM-8039	
			Trans	Manual	1		EM-8039	
			L4 1.5L 1495cc	1993-95	Front	Auto	1	EM-8596
	Front	Manual			1	EM-8759		
	RH Front				1	EM-8254		
	Rear	Auto			1	EM-8752		
	Rear	Manual			1	EM-8753		
	Trans	Auto			1		EM-8728	
Trans	Manual	1				EM-8729		

# Engine, Transmission, And Torque Strut Mounts

CYL	ENG. SIZE	YEAR	LOCATION	DESCRIPTION	QTY	ENGINE	TORQUE STRUT	TRANSMISSION
<b>HYUNDAI PASSENGER CAR (continued)</b>								
<b>SONATA</b>								
L4	L4 2.0L 1997cc	1998	Front	Auto	1	EM-8788		
			Front	Manual	1	EM-8788		
		1997	Front	Auto	1	EM-8788		
			Front	Manual	1	EM-8788		
		1995-96	Front	Auto	1	EM-8597		
		1992-94	Front	Auto	1	EM-8599		
			Front	Manual	1	EM-8598		
		1998	LH Front	Auto	1	EM-8721		
			LH Front	Manual	1	EM-8790		
		1997	LH Front	Auto	1	EM-8721		
			LH Front	Manual	1	EM-8790		
		1995-96	LH Front		1	EM-8595		
		1992-94	LH Front	Auto	1	EM-8736		
			LH Front	Manual	1	EM-9206		
		1998	Rear	Auto	1	EM-8781		
			Rear	Manual	1	EM-8782		
		1997	Rear	Auto	1	EM-8781		
			Rear	Manual	1	EM-8782		
		1995-96	Rear	Auto	1	EM-8781		
			Rear	Manual	1	EM-8780		
	1992-94	Rear	Auto	1	EM-8041			
		Rear	Manual	1	EM-8041			
	1997-98	Trans	Auto	1			EM-8741	
		Trans	Manual	1			EM-8791	
	1995-96	Trans	Auto	1			EM-8741	
		Trans	Manual	1			EM-8738	
	1992-94	Trans	Auto	1			EM-8757	
		Trans	Manual	1			EM-8755	
	L4 2.4L	2009-10	Front		1	EM-9317		
			Front		1	EM-9317		
		2006-08	RH Front	Complete Unit	1	EM-9353		
			RH Front	Insert Only	1	EM-9340		
		2009-10	Rear		1	EM-9318		
2006-08		Rear		1	EM-9318			
2009-10		Right	Complete Unit	1	EM-5936			
		Trans	Auto	1			EM-9381	
		Trans	Manual	1			EM-9361	
2006-08		Trans		1			EM-9361	
	Trans	Auto	1			EM-9373		
2002-05	Trans	Manual	1			EM-9367		
	Trans	Manual	1			EM-9367		
L4 2.4L 2351cc	2002-05	Front	Auto	1	EM-8769			
		Front	Manual	1	EM-8770			
	1999-01	Front		1	EM-8768			
		Front		1	EM-8042			
	1989-91	LH Front		1	EM-8044			
		RH Front		1	EM-8722			
	1999-01	RH Front		1	EM-8722			
	2002-05	Rear		1	EM-8783			
	1999-01	Rear		1	EM-8783			
	1989-91	Rear		1	EM-8041			
	1999-01	Trans	Auto	1			EM-8744	
		Trans	Manual	1			EM-8743	
	1989-91	Trans	Auto	1			EM-8756	
		Trans	Manual	1			EM-8754	
V6	V6 2.5L 2493cc	1999-01	Front	Auto	1	EM-8769		
			Front	Manual	1	EM-8768		
			RH Front		1	EM-8723		

# Engine, Transmission, And Torque Strut Mounts

CYL	ENG. SIZE	YEAR	LOCATION	DESCRIPTION	QTY	ENGINE	TORQUE STRUT	TRANSMISSION
<b>HYUNDAI PASSENGER CAR (continued)</b>								
<b>SONATA (continued)</b>								
V6	V6 2.5L 2493cc	1999-01	Rear		1	EM-8783		
			Trans	Auto	1		EM-8745	
			Trans	Manual	1		EM-8743	
	V6 2.7L 2656cc	2004-05 2002-03 2004-05 2002-03 2004-05 2002-03 2002-03 2002-03 2002-03 2002-03 2002-03	Front		1	EM-8769		
			Front	Auto	1	EM-8769		
			Front	Manual	1	EM-8770		
			RH Front		1	EM-8723		
			RH Front		1	EM-8723		
			Rear		1	EM-8783		
			Rear	Auto	1	EM-8784		
			Rear	Manual	1	EM-8783		
			Trans	Auto	1		EM-9373	
			Trans	Manual	1		EM-9367	
			Trans	Manual; When Stock is Depleted, Re-order EM-9367	1		EM-5126	
			Trans	When Stock is Depleted, Re-order EM-9373	1		EM-5127	
	V6 3.0L 2972cc	1997-98 1995-96 1992-94 1990-91 1997-98 1995-96 1992-94 1990-91 1997-98 1995-96 1992-94 1990-91 1996-98 1995 1992-94 1990-91	Front		1	EM-8597		
			Front		1	EM-8597		
			Front		1	EM-8680		
			Front		1	EM-2673		
			LH Front		1	EM-8787		
			LH Front		1	EM-8786		
			LH Front		1	EM-8742		
			LH Front		1	EM-8740		
			Rear		1	EM-9365		
			Rear		1	EM-9365		
			Rear		1	EM-8041		
			Rear		1	EM-8041		
			Trans		1		EM-8789	
			Trans		1		EM-8791	
			Trans		1		EM-8756	
	Trans		1		EM-8758			
	V6 3.3L	2009-10 2006-08 2009-10 2006-08 2009-10 2006-08 2006-10	Front		1	EM-9317		
			Front	When Stock is Depleted, Re-order EM-9317	1	EM-9321		
Front				1	EM-9317			
Front			When Stock is Depleted, Re-order EM-9317	1	EM-9321			
RH Front			Complete Unit	1	EM-9363			
RH Front			Complete Unit	1	EM-9353			
Rear				1	EM-9318			
Rear				1	EM-9318			
Trans				1		EM-9370		
<b>TIBURON</b>								
L4	L4 1.8L 1795cc	1997	Front		1	EM-8762		
			RH Front		1	EM-8719		
			Rear	Auto	1	EM-8778		
			Rear	Manual	1	EM-8775		
			Trans	Auto	1		EM-8734	
			Trans	Manual	1		EM-8733	
	L4 2.0L 1975cc	2007-08 2006 2003-05 1998-01 1997	Front		1	EM-8943		
			Front		1	EM-8943		
			Front		1	EM-8943		
			Front	Auto	1	EM-8764		
			Front	Manual	1	EM-8762		
			Front		1	EM-8762		

# Engine, Transmission, And Torque Strut Mounts

CYL	ENG. SIZE	YEAR	LOCATION	DESCRIPTION	QTY	ENGINE	TORQUE STRUT	TRANSMISSION
<b>HYUNDAI PASSENGER CAR (continued)</b>								
<b>TIBURON (continued)</b>								
L4	L4 2.0L 1975cc	2007-08	RH Front		1	EM-9372		
		2006	RH Front		1	EM-9379		
		2003-05	RH Front		1	EM-8944		
		1998-01	RH Front		1	EM-8719		
		1997	RH Front		1	EM-8719		
		2007-08	RH Rear	Manual	1	EM-5533		
		2006	RH Rear	Manual	1	EM-5533		
		2003-05	RH Rear	Manual	1	EM-5533		
		2007-08	Rear		1	EM-8945		
		2006	Rear		1	EM-8945		
		2003-05	Rear		1	EM-8945		
		1998-01	Rear	Auto	1	EM-8778		
			Rear	Manual	1	EM-8775		
		1997	Rear	Auto	1	EM-8778		
			Rear	Manual	1	EM-8775		
			2003-08	Trans	Auto	1		
		Trans	Manual	1			EM-9376	
	1997-01	Trans	Auto	1			EM-8734	
		Trans	Manual	1			EM-8733	
V6	V6 2.7L	2007-08	Front		1	EM-9307		
			RH Front		1	EM-9372		
			Rear	Auto	1	EM-9314		
			Rear	Manual	1	EM-8945		
		2005-08	Trans	Auto	1			EM-9366
			Trans	Manual; 5 Spd	1			EM-9369
	Trans		Manual; 6 Spd	1			EM-9364	
	V6 2.7L 2656cc	2005-06	Front		1	EM-9307		
			2003-04	Front		1	EM-9307	
		2005-06	RH Front	Auto	1	EM-9372		
			RH Front	Manual	1	EM-9358		
		2003-04	RH Front	Auto	1	EM-9372		
			RH Front	Manual	1	EM-9358		
			RH Rear	Manual	1	EM-5533		
		2005-06	Rear	Auto	1	EM-9314		
			Rear	Manual	1	EM-8945		
2003-04		Rear	Auto	1	EM-9314			
	Rear	Manual	1	EM-8945				
	Trans	Auto	1			EM-9366		
	Trans	Manual	1			EM-8947		
<b>XG300</b>								
V6	V6 3.0L 2972cc	2001	Front		1	EM-8948		
			RH Front		1	EM-8949		
			Rear		1	EM-8950		
			Trans		1			EM-8951
<b>XG350</b>								
V6	V6 3.5L 3500cc	2002-05	Front		1	EM-8948		
			RH Front		1	EM-8949		
			Rear		1	EM-8950		
			Trans		1			EM-8951



# Engine, Transmission, And Torque Strut Mounts

CYL	ENG. SIZE	YEAR	LOCATION	DESCRIPTION	QTY	ENGINE	TORQUE STRUT	TRANS-MISSION	
<b>HYUNDAI SPORT UTILITY</b>									
<b>SANTA FE</b>									
L4	L4 2.4L	2004-06	Front	Auto	1	EM-8952			
			Front	Manual	1	EM-8953			
			RH Front		1	EM-8954			
	L4 2.4L 2351cc	2001-03	Front	Auto	1	EM-8952			
			Front	Manual	1	EM-8953			
			RH Front		1	EM-8954			
			Rear	Auto	1	EM-8955			
V6	V6 2.7L	2007-09	Front	Manual	1	EM-9348			
			RH Front		1	EM-9355			
			Rear		1	EM-9315			
	V6 2.7L 2656cc	2001-06	RH Front		1	EM-8954			
			Rear		1	EM-8955			
			Trans	4WD	1			EM-8957	
				Trans	FWD	1			EM-8956
	V6 3.3L	2007-09	Front		1	EM-9348			
			RH Front		1	EM-9355			
			Rear		1	EM-9315			
	V6 3.5L	2003-06	Front		1	EM-9371			
			Rear		1	EM-8955			
		2010-12	Right		1	EM-9355			
<b>TUCSON</b>									
L4	L4 2.0L	2005-09	Front		1	EM-9322			
			RH Front		1	EM-9368			
			Rear		1	EM-9306			
			Trans	Auto	1			EM-9374	
			Trans	Manual	1			EM-9380	
V6	V6 2.7L	2005-09	Front		1	EM-9338			
			RH Front		1	EM-9368			
			Rear		1	EM-9306			
			2005-08	Trans	Auto	1			EM-9378
<b>VERACRUZ</b>									
V6	V6 3.8L	2007-12	Front		1	EM-9348			
			RH Front		1	EM-9355			
			Rear	AWD	1	EM-9315			
			Trans	Auto	1			EM-9341	
<b>HYUNDAI VAN</b>									
<b>ENTOURAGE</b>									
V6	V6 3.8L	2007-08	Front		1	EM-9375			
			RH Front		1	EM-9343			
			Rear		1	EM-9347			
			Trans		1			EM-9349	
<b>INFINITI PASSENGER CAR</b>									
<b>G20</b>									
L4	L4 2.0L	1999-02	Trans	Auto	1			EM-9224	
		1991-96	Trans	Auto	1			EM-9288	
			Trans	Manual	1			EM-5332	
	L4 2.0L 1998cc	1991-96	Front	Auto	1	EM-8858			
			RH Front	Auto	1	EM-5131			
			RH Front	Manual	1	EM-5468			
	L4 2.0L 2000cc	1999-02	Front		1	EM-8682			
			Rear		1	EM-8681			

# Engine, Transmission, And Torque Strut Mounts

CYL	ENG. SIZE	YEAR	LOCATION	DESCRIPTION	QTY	ENGINE	TORQUE STRUT	TRANSMISSION
<b>INFINITI PASSENGER CAR (continued)</b>								
<b>G35</b>								
V6	V6 3.5L 3498cc	2004-06	L & R Front	2 Door	1	EM-9180		
			L & R Front	Sedan; 2WD	1	EM-9416		
		2003	L & R Front	Coupe	1	EM-9180		
			L & R Front	Sedan	1	EM-9416		
		2004-06	LH Front	Sedan; AWD	1	EM-5776		
			RH Front	Sedan; AWD	1	EM-9416		
		2004-08	Trans	AWD	1			EM-5911
			Trans	RWD	1			EM-9464
			Trans	RWD; When Stock is Depleted, Re-order EM-9464	1			EM-5408
2003	Trans	RWD	1			EM-9464		
	Trans	RWD; When Stock is Depleted, Re-order EM-9464	1			EM-5408		
<b>I30</b>								
V6	V6 3.0L	2000-01	Front	w/ Wires	1	EM-5670		
			Front	w/o Wires	1	EM-5132		
			RH Front		1	EM-9031		
			Rear	w/ Wires	1	EM-5655		
			Rear	w/o Wires	1	EM-9634		
	V6 3.0L 2988cc	1998-99	Front	Auto, w/ Wires	1	EM-5670		
			Front	Auto. w/o Wires	1	EM-5132		
		1996-97	Front	Auto, w/ Wires	1	EM-5670		
			Front	Auto. w/o Wires	1	EM-5132		
		1998-99	RH Front		1	EM-9031		
			RH Front		1	EM-9031		
		1998-99	Rear	Auto	1	EM-5774		
			Rear	Manual	1	EM-8866		
		1996-97	Rear		1	EM-8866		
		2000-01	Trans		1			EM-8959
		1997-99	Trans	Auto	1			EM-8959
			Trans	Manual	1			EM-9035
		1996	Trans	Auto	1			EM-5937
			Trans	Manual	1			EM-9035
		<b>I35</b>						
V6	V6 3.5L 3498cc	2002-04	Front	w/ Wires	1	EM-5670		
			Front	w/o Wires	1	EM-5132		
			RH Front		1	EM-9031		
			Rear	w/ Wires	1	EM-5655		
			Rear	w/o Wires	1	EM-9634		
			Trans		1			EM-8959
<b>M35</b>								
V6	V6 3.5L 3498cc	2006-10	Trans	AWD	1			EM-5911
<b>M45</b>								
V8	V8 4.5L	2003-04	Trans	RWD	1			EM-9464
			Trans	RWD; When Stock is Depleted, Re-order EM-9464	1			EM-5408
<b>Q45</b>								
V8	V8 4.5L	2002-06	Trans		1			EM-9464
			Trans	When Stock is Depleted, Re-order EM-9464	1			EM-5408

# Engine, Transmission, And Torque Strut Mounts

CYL	ENG. SIZE	YEAR	LOCATION	DESCRIPTION	QTY	ENGINE	TORQUE STRUT	TRANSMISSION
<b>INFINITI SPORT UTILITY</b>								
<b>EX35</b>								
V6	V6 3.5L 3498cc	2008-12	Trans	AWD	1			EM-5911
<b>FX35</b>								
V6	V6 3.5L	2003-08	L & R Front	2WD	2	EM-9416		
			LH Front	AWD	1	EM-5776		
			RH Front	AWD	1	EM-9416		
			Trans	AWD	1			EM-5911
			Trans	RWD	1			EM-9464
Trans	RWD; When Stock is Depleted, Re-order EM-9464	1			EM-5408			
<b>QX4</b>								
V6	V6 3.3L 3275cc	1997-00	L & R Front		2	EM-8311		
			Trans	Auto; 4WD	1			EM-9038
	V6 3.5L 3498cc	2001-03	L & R Front		2	EM-9408		
			Trans	Auto; 4WD	1			EM-9395
Trans	Auto; RWD	1			EM-8322			
<b>QX56</b>								
V8	V8 5.6L	2004-09	L & R Front		2	EM-5404		
		2004-13	Trans	4WD	1			EM-5407
			Trans	RWD	1			EM-5406
<b>ISUZU PASSENGER CAR</b>								
<b>I-MARK</b>								
L4	L4 1.5L	1985-89	Front		1	EM-8442		
			Rear		1	EM-8826		
	L4 1.5L 1471cc	1985-89	Torq Str - Front	Complete Unit	1		EM-8438	
			Torq Str - Front	Insert Only	1		EM-8539	
			Trans	Auto	1			EM-8439
			Trans	Manual	1			EM-8439
	L4 1.6L	1989	Torq Str - Front	Complete Unit	1		EM-8438	
			Torq Str - Front	Insert Only	1		EM-8539	
	L4 1.6L 1588cc	1989	Front		1	EM-8442		
			RH Front		1	EM-8439		
			Trans		1			EM-8976
			Trans		1			EM-8976
	L4 1.8L 1817cc Diesel	1981-84	LH Front		1	EM-8621		
LH Front				1	EM-8621			
<b>ISUZU SPORT UTILITY</b>								
<b>AMIGO</b>								
L4	L4 2.2L 2180cc	1998-00	LH Front		1	EM-8351		
			RH Front		1	EM-5812		
			Trans	Auto; 2WD	1			EM-5609
			Trans	Auto; 4WD	1			EM-9142
			Trans	Manual; 4WD	1			EM-9143
	L4 2.3L	1989-91	Trans	Manual; 4WD	1			EM-9143
			L4 2.3L 2254cc	1989-93	LH Front		1	EM-8576
	RH Front		1		EM-8579			
		1992-93	Trans	Manual; 4WD	1			EM-9143
	L4 2.6L	1989-91	Trans	Manual; 4WD	1			EM-9143
	L4 2.6L 2559cc	1989-94	LH Front		1	EM-8576		
RH Front				1	EM-8579			
Trans			Manual; 4WD	1			EM-9143	
V6	V6 3.2L	1998-00	Trans	RWD	1			EM-8586
	V6 3.2L 3165cc	1998-00	RH Front		1	EM-5814		

# Engine, Transmission, And Torque Strut Mounts

CYL	ENG. SIZE	YEAR	LOCATION	DESCRIPTION	QTY	ENGINE	TORQUE STRUT	TRANSMISSION	
<b>ISUZU SPORT UTILITY (continued)</b>									
<b>ASCENDER</b>									
L6	L6 4.2L 256ci	2003-08	L & R Front	Hydraulic Mount; RWD	2	EM-3021*			
		2003-07	Trans		1			EM-3027	
<b>AXIOM</b>									
V6	V6 3.5L	2002-04	Trans	RWD	1			EM-5609	
	V6 3.5L 3494cc	2002-04	LH Front		1	EM-5813			
<b>RODEO SPORT</b>									
L4	L4 2.2L	2001-03	Trans	Auto	1			EM-5609	
			Trans	Manual	1			EM-5610	
	L4 2.2L 2180cc	2001-03	LH Front		1	EM-8351			
			RH Front		1	EM-5812			
V6	V6 3.2L	2001-03	Trans	Auto; 2WD	1			EM-5609	
			Trans	Manual; 2WD	1			EM-5610	
<b>RODEO</b>									
L4	L4 2.2L 2180cc	1998-03	LH Front		1	EM-8351			
			RH Front		1	EM-5812			
			Trans	Auto	1			EM-5609	
			Trans	Manual	1			EM-5610	
	L4 2.6L 2559cc	1996-97	1995	LH Front		1	EM-8499		
				LH Front	After 5/95	1	EM-8499		
		1991-94	1995	LH Front	Before 5/95	1	EM-9141		
				LH Front		1	EM-9141		
		1996-97	1995	RH Front		1	EM-8352		
				RH Front	After 5/95	1	EM-8352		
		1991-94	1995	RH Front	Before 5/95	1	EM-9140		
				RH Front		1	EM-9140		
		1991-97		Trans	Auto; 2WD	1			EM-8586
				Trans	Manual; 2WD	1			EM-8586
V6	V6 3.1L 3137cc	1991-92	LH Front		1	EM-9141			
			RH Front		1	EM-9140			
			Trans	Auto; 2WD	1			EM-8586	
			Trans	Manual; 2WD	1			EM-8586	
	V6 3.2L	1998-04	Trans	Manual; 4WD	1			EM-9143	
			Trans	Auto; 2WD	1			EM-5609	
	V6 3.2L 3165cc	2001-04	1996-97	Trans	Manual; 2WD	1			EM-5610
				LH Front		1	EM-5813		
		1995	1993-94	LH Front		1	EM-8351		
				LH Front		1	EM-8351		
		1996-97	1995	LH Front		1	EM-8445		
				RH Front		1	EM-5814		
		1993-94	1993-97	RH Front		1	EM-8352		
				RH Front	After 5/95	1	EM-8352		
		1993-94	1993-97	RH Front	Before 5/95	1	EM-9144		
				RH Front	4WD	1	EM-9144		
		1993-97		Trans	RWD	1	EM-8579		
				Trans	Auto; 4WD	1			EM-9142
		V6 3.5L	2004	Trans	Auto; 2WD	1			EM-8586
				Trans	Manual; 2WD	1			EM-8586
	V6 3.5L 3494cc	2004	Trans	Auto; 2WD	1			EM-5609	
			Trans	Manual; 2WD	1			EM-5610	
L4	L4 1.9L 1949cc	1984-85	LH Front		1	EM-8053			
			RH Front		1	EM-8054			
L4 2.2L 2238cc Diesel	1986	1986	Trans	Manual	1			EM-8586	
			L & R Front		2	EM-8048			
<b>TROOPER</b>									

## Engine, Transmission, And Torque Strut Mounts

CYL	ENG. SIZE	YEAR	LOCATION	DESCRIPTION	QTY	ENGINE	TORQUE STRUT	TRANSMISSION
<b>ISUZU SPORT UTILITY (continued)</b>								
<b>TROOPER (continued)</b>								
L4	L4 2.2L 2238cc Diesel	1987	LH Front		1	EM-8576		
		1984	LH Front		1	EM-8048		
		1987	RH Front		1	EM-8579		
		1984	RH Front		1	EM-8049		
		1987	Trans	Manual	1			EM-8586
		1986	Trans	Manual; 4WD	1			EM-9138
		1984	Trans	Manual; 4WD	1			EM-9138
	L4 2.3L 2254cc	1987	LH Front		1	EM-8576		
		1986	LH Front		1	EM-8053		
		1987	RH Front		1	EM-8579		
		1986	RH Front		1	EM-8054		
		1987	Trans	Manual	1			EM-8586
	L4 2.6L 2559cc	1988-91	LH Front		1	EM-8576		
			RH Front		1	EM-8579		
			Trans	Manual	1			EM-8586
V6	V6 2.8L 2827cc	1989-91	Trans	Auto	1			EM-9143
			Trans	Manual	1			EM-9143
			LH Front		1	EM-8351		
	V6 3.2L 3165cc	1992-95	LH Front		1	EM-8445		
			RH Front		1	EM-8352		
			RH Front		1	EM-9144		
			Trans	Auto	1			EM-9142
	V6 3.5L	1998-99	LH Front		1	EM-8351		
			RH Front		1	EM-8352		
	V6 3.5L 3475cc	2000-02	LH Front	4WD	1	EM-8351		
RH Front			4WD	1	EM-8352			
Trans			Auto; 4WD; w/o Torque Control	1			EM-9142	
<b>VEHICROSS</b>								
V6	V6 3.5L 3475cc	1999-01	LH Front		1	EM-8351		
			RH Front		1	EM-8352		
<b>ISUZU TRUCK</b>								
<b>HOMBRE</b>								
L4	L4 2.2L 2180cc	1996-00	L & R Front	Insert	2	EM-2819		
			LH Front	Complete Unit	1	EM-5426		
			RH Front	Complete Unit	1	EM-5350		
		1998-00	Trans	Auto	1			EM-2957
			Trans	Manual	1			EM-2957
		1996-97	Trans	Auto; RWD	1			EM-2957
			Trans	Manual; RWD	1			EM-2956
V6	V6 4.3L 4294cc	1997-00	L & R Front		2	EM-2802		
			Trans	Auto; 4WD	1			EM-2638
		1998-00	Trans	Auto; RWD	1			EM-2394
			Trans	Manual; 4WD	1			EM-2638
			Trans	Auto; RWD	1			EM-2394
		1997	Trans	Manual; RWD	1			EM-2394
<b>I-350</b>								
L5	L5 3.5L 3460cc	2006	Trans		1			EM-2638
<b>PICKUP</b>								
L4	L4 1.8L 1817cc	1981-82	LH Front		1	EM-8053		
			RH Front		1	EM-8054		
			Trans	Manual; 2WD	1			EM-8586
	L4 1.9L 1949cc	1983-87	LH Front		1	EM-8053		
			RH Front		1	EM-8054		
			Trans	Auto; 2WD	1			EM-8586

# Engine, Transmission, And Torque Strut Mounts

CYL	ENG. SIZE	YEAR	LOCATION	DESCRIPTION	QTY	ENGINE	TORQUE STRUT	TRANSMISSION
<b>ISUZU TRUCK (continued)</b>								
<b>PICKUP (continued)</b>								
L4	L4 1.9L 1949cc	1983-87	Trans	Manual; 2WD	1			EM-8586
	L4 2.2L 2238cc Diesel	1987	L & R Front		2	EM-8577		
		1981-86	LH Front		1	EM-8048		
			RH Front		1	EM-8049		
		1982-87	Trans	Auto; 2WD	1			EM-8586
			Trans	Manual; 2WD	1			EM-8586
	1981	Trans	Manual; 2WD	1			EM-8586	
	L4 2.3L	1986-87	LH Front	4WD	1	EM-8576		
			LH Front	RWD	1	EM-8053		
			RH Front	4WD	1	EM-8579		
			RH Front	RWD	1	EM-8054		
		1988-92	Trans	Manual; 4WD	1			EM-9143
	L4 2.3L 2254cc	1988-92	LH Front		1	EM-8576		
			RH Front		1	EM-8579		
		1986-87	Trans	4WD	1			EM-9143
			Trans	Auto; 2WD	1			EM-8586
		Trans	Manual; 2WD	1			EM-8586	
	L4 2.6L 2559cc	1995	LH Front		1	EM-8576		
		1994	LH Front	Built in Japan	1	EM-8576		
			LH Front	Built in USA	1	EM-9141		
		1988-93	LH Front	Built in USA	1	EM-8576		
		1995	RH Front		1	EM-8579		
		1994	RH Front	Built in Japan	1	EM-8579		
			RH Front	Built in USA	1	EM-9140		
		1988-93	RH Front	Built in USA	1	EM-8579		
		1995	Trans	Manual; 4WD	1			EM-8586
		1988-94	Trans	Auto; 4WD	1			EM-8586
	Trans		Manual; 4WD	1			EM-8586	
V6	V6 3.1L 3137cc	1991-94	LH Front		1	EM-9141		
			RH Front		1	EM-9140		
			Trans	Auto; 2WD	1			EM-9143
			Trans	Manual; 2WD	1			EM-9143
<b>ISUZU VAN</b>								
<b>OASIS</b>								
L4	L4 2.2L 2156cc	1996-97	Front		1	EM-8026		
			LH Front		1	EM-8404		
			Rear	w/ Solenoid Valve	1	EM-8984		
			Rear	w/o Solenoid Valve	1	EM-8011		
			Trans	Auto	1			EM-8002
	L4 2.3L 2234cc	1998-99	Trans	Auto	1			EM-8002
	L4 2.3L 2254cc	1998-99	Front		1	EM-8026		
			LH Front		1	EM-8404		
			Rear	w/ Solenoid Valve	1	EM-8984		
			Rear	w/o Solenoid Valve	1	EM-8011		
<b>JAGUAR</b>								
<b>S-TYPE</b>								
V6	V6 3.0L 183ci	2000-02	L & R Front		2	EM-3077*		
			Trans		1			EM-3063
V8	V8 4.0L 3996cc	2000-02	L & R Front		2	EM-3077*		
			Trans		1			EM-3063
	V8 4.2L 4196cc	2003-05	L & R Front		2	EM-3077*		
			Trans		1			EM-3063

# Engine, Transmission, And Torque Strut Mounts

CYL	ENG. SIZE	YEAR	LOCATION	DESCRIPTION	QTY	ENGINE	TORQUE STRUT	TRANSMISSION	
<b>JEEP SPORT UTILITY</b>									
<b>CHEROKEE</b>									
L4	L4 2.1L 126ci Diesel	1985-87	L & R Front		2	EM-2569			
			Trans	Auto	1			EM-2625	
			Trans	Manual	1			EM-2570	
	L4 2.5L 150ci	1992-00 1991 1984-90 1992-00 1991 1984-90 1997-00 1991-96 1990 1987-89 1986 1984-85		LH Front		1	EM-2569		
				LH Front		1	EM-2569		
				LH Front		1	EM-2569		
				RH Front		1	EM-2571		
				RH Front		1	EM-2920		
				RH Front		1	EM-2571		
				Trans	Auto	1			EM-2570
				Trans	Manual; Cushion	1			EM-5383
				Trans	Auto	1			EM-2570
				Trans	Manual; Cushion	1			EM-5383
				Trans	Auto	1			EM-2625
				Trans	Manual; Aisin Trans.	1			EM-5383
				Trans	Auto	1			EM-2625
				Trans	Manual; Aisin Trans.	1			EM-5383
				Trans	Manual; Peugeot Trans.	1			EM-2570
				Trans	Auto	1			EM-2625
				Trans	Manual; Aisin Trans.	1			EM-5383
	Trans	Manual; Borg Warner Trans.	1			EM-2570			
	L6	L6 4.0L	2000-01	Trans		1			EM-5428
		L6 4.0L 242ci	2000-01 1997-99 1987-96 1997-99 1987-96	L & R Front	exc RH Drive	2	EM-2572		
L & R Front				exc RH Drive	2	EM-2572			
L & R Front				RH Drive	2	EM-2919			
L & R Front					2	EM-2572			
Trans				exc Peugeot Transmission	1			EM-2625	
Trans				Manual; Cushion	1			EM-5383	
Trans				exc Peugeot Transmission	1			EM-2625	
Trans		Manual; Cushion	1			EM-5383			
L6 4.2L 258ci		1978-83 1977 1974-76 1974-83	L & R Front	w/ Interlock	2	EM-2330			
			L & R Front	w/ Interlock	2	EM-2330			
			L & R Front	w/o Interlock	2	EM-2280			
			L & R Front	w/o Interlock	2	EM-2280			
	Trans		Auto	1			EM-2693		
Trans	Manual	1			EM-2693				
V6	V6 2.8L 173ci	1984-86	L & R Front		2	EM-2569			
			Trans	Auto	1			EM-2570	
			Trans	Manual; Cushion	1			EM-5383	
V8	V8 5.9L 360ci	1974-83	L & R Front		2	EM-2351			
			Trans	Auto	1			EM-2693	
			Trans	Manual	1			EM-2693	
<b>CJ3</b>									
L4	L4 2.2L	1959-60	Trans	Manual; 4 Spd	1			EM-5401	
	L4 2.2L 134ci	1959-60	L & R Front		2	EM-2040			
<b>CJ5A</b>									
L4	L4 2.2L	1966-68	Trans	Manual; 4 Spd	1			EM-5401	
<b>CJ5</b>									
L4	L4 2.2L	1968-71	Trans	Manual; 4 Spd	1			EM-5401	
		1959-60	Trans	Manual; 4 Spd	1			EM-5401	
	L4 2.2L 134ci	1968-71	L & R Front		2	EM-2040			
		1959-60	L & R Front		2	EM-2040			
	L4 2.5L 151ci	1980-83	L & R Front		2	EM-2446			
			Trans	Auto	1			EM-2921	

# Engine, Transmission, And Torque Strut Mounts

CYL	ENG. SIZE	YEAR	LOCATION	DESCRIPTION	QTY	ENGINE	TORQUE STRUT	TRANSMISSION
<b>JEEP SPORT UTILITY (continued)</b>								
<b>CJ5 (continued)</b>								
L4	L4 2.5L 151ci	1980-83	Trans	Manual	1			EM-2693
L6	L6 3.8L 232ci L6 4.2L 258ci	1972-78	L & R Front		2	EM-2330		
		1978-83	L & R Front	w/ Interlock	2	EM-2330		
		1977	L & R Front	w/ Interlock	2	EM-2330		
			L & R Front	w/o Interlock	2	EM-2280		
		1972-76	L & R Front	w/o Interlock	2	EM-2280		
		1972-83	Trans	Auto	1			EM-2693
			Trans	Manual	1		EM-2693	
V8	V8 5.0L 304ci	1972-81	L & R Front		2	EM-2351		
			Trans	Auto	1		EM-2693	
			Trans	Manual	1		EM-2693	
<b>CJ6</b>								
L4	L4 2.2L	1968-71	Trans	Manual; 4 Spd	1			EM-5401
		1959-60	Trans	Manual; 4 Spd	1			EM-5401
	L4 2.2L 134ci	1968-71	L & R Front		2	EM-2040		
		1959-60	L & R Front		2	EM-2040		
L6	L6 3.8L 232ci	1972-75	L & R Front		2	EM-2280		
	L6 4.2L 258ci	1972-75	L & R Front	w/o Interlock	2	EM-2280		
		1974-75	Trans	Auto	1		EM-2693	
			Trans	Manual	1		EM-2693	
V8	V8 5.0L 304ci	1972-75	L & R Front		2	EM-2351		
			Trans	Auto	1		EM-2693	
			Trans	Manual	1		EM-2693	
<b>CJ6A</b>								
L4	L4 2.2L	1966-68	Trans	Manual; 4 Spd	1			EM-5401
<b>CJ7</b>								
L4	L4 2.5L 151ci	1980-86	L & R Front		2	EM-2446		
			Trans	Auto	1		EM-2921	
			Trans	Manual	1		EM-2693	
L6	L6 3.8L 232ci L6 4.2L 258ci	1976-78 1976-86	L & R Front		2	EM-2330		
			L & R Front	w/ Interlock	2	EM-2330		
			Trans	Auto	1		EM-2693	
			Trans	Manual	1		EM-2693	
V8	V8 5.0L 304ci	1976-81	L & R Front		2	EM-2351		
			Trans	Auto	1		EM-2693	
			Trans	Manual	1		EM-2693	
<b>COMANCHE</b>								
L4	L4 2.1L 126ci Diesel	1986-87	L & R Front		2	EM-2569		
			Trans	Auto	1		EM-2625	
			Trans	Manual	1		EM-2570	
	L4 2.5L 150ci	1992	LH Front		1	EM-2569		
		1991	LH Front		1	EM-2569		
		1986-90	LH Front		1	EM-2569		
		1992	RH Front		1	EM-2571		
		1991	RH Front		1	EM-2920		
		1986-90	RH Front		1	EM-2571		
		1991-92	Trans	Auto	1		EM-2570	
			Trans	Manual; Cushion	1		EM-5383	
		1986-90	Trans	Auto	1		EM-2625	
			Trans	Manual	1		EM-2570	
L6	L6 4.0L 242ci	1987-92	L & R Front		2	EM-2572		
			Trans	exc Peugeot Transmission	1		EM-2625	
			Trans	Manual; Cushion	1		EM-5383	
V6	V6 2.8L 173ci	1986	L & R Front		2	EM-2569		
			Trans	Auto	1		EM-2570	



# Engine, Transmission, And Torque Strut Mounts

CYL	ENG. SIZE	YEAR	LOCATION	DESCRIPTION	QTY	ENGINE	TORQUE STRUT	TRANSMISSION	
<b>JEEP SPORT UTILITY (continued)</b>									
<b>COMANCHE (continued)</b>									
V6	V6 2.8L 173ci	1986	Trans	Manual; Cushion	1			EM-5383	
<b>COMMANDER</b>									
V6	V6 3.7L 226ci	2006-10	LH Front		1	EM-4103			
			RH Front		1	EM-4104			
V8	V8 4.7L 287ci	2006-09	LH Front		1	EM-4100			
			RH Front		1	EM-4105			
<b>COMPASS</b>									
L4	L4 2.0L	2007-09	Front		1	EM-3131			
			RH Front		1	EM-3130			
			Rear		1	EM-3145			
		L4 2.4L	2007-08	Trans		1			EM-3134
	2007-09		Front		1	EM-3131			
			RH Front		1	EM-3130			
			Rear	4WD	1	EM-3157			
		Rear	FWD	1	EM-3145				
<b>GRAND CHEROKEE</b>									
L6	L6 4.0L 242ci	1999-04	LH Front		1	EM-3019			
			1993-98	LH Front		1	EM-2794		
		1999-04	RH Front		1	EM-3039			
			1993-98	RH Front		1	EM-2793		
		1999-04	Trans	2WD		1			EM-2988
			Trans	4WD		1			EM-3051
		1996-98	Trans			1			EM-2828
		1995	Trans	Auto		1			EM-2864
		1993-94	Trans	Auto		1			EM-2864
			Trans	Manual		1			EM-2863
V6	V6 3.7L 226ci	2005-10	LH Front		1	EM-4103			
			RH Front		1	EM-4104			
V8	V8 4.7L 285ci	2002-05	Trans	2WD	1			EM-3018	
			Trans	4WD	1			EM-3013	
	V8 4.7L 287ci	2006-09	LH Front		1	EM-4100			
			1999-05	LH Front		1	EM-3012		
			2006-09	RH Front		1	EM-4105		
			1999-05	RH Front		1	EM-3008		
			2000-01	Trans		1			EM-3018
	V8 5.2L 318ci	1993-98	LH Front		1	EM-2809			
			RH Front		1	EM-2808			
			1997-98	Trans		1			EM-2828
			1993-96	Trans		1			EM-2863
	V8 5.9L 360ci	1998	LH Front		1	EM-2916			
			RH Front		1	EM-2808			
Trans				1			EM-2828		
<b>GRAND WAGONEER</b>									
L6	L6 4.2L 258ci	1984-86	L & R Front		2	EM-2330			
			Trans	Auto	1			EM-2693	
			Trans	Manual	1			EM-2693	
V8	V8 5.2L 318ci	1993	L & R Front		2	EM-2351			
			Trans	Auto	1			EM-2693	
			Trans	Manual	1			EM-2693	
	V8 5.9L 360ci	1984-91	L & R Front		2	EM-2351			
			Trans	Auto	1			EM-2693	
		Trans	Manual	1			EM-2693		

# Engine, Transmission, And Torque Strut Mounts

CYL	ENG. SIZE	YEAR	LOCATION	DESCRIPTION	QTY	ENGINE	TORQUE STRUT	TRANS-MISSION	
<b>JEEP SPORT UTILITY (continued)</b>									
<b>LIBERTY</b>									
L4	L4 2.4L 148ci	2002-05	LH Front		1	EM-3009			
			RH Front		1	EM-3010			
			Trans		1			EM-3016	
V6	V6 3.7L 226ci	2008-12 2002-05	LH Front		1	EM-4101			
			LH Front		1	EM-3015			
			RH Front		1	EM-3014			
		2004-05	Trans	Auto; 2WD	1			EM-3054	
			Trans	Auto; 4WD	1			EM-3055	
			Trans	Manual	1			EM-3054	
		2002-03	Trans	Auto; 2WD	1			EM-3053	
			Trans	Auto; 4WD	1			EM-3007	
			Trans	Manual; 2WD	1			EM-3052	
			Trans	Manual; 4WD	1			EM-3055	
<b>PATRIOT</b>									
L4	L4 2.0L	2007-09	Front		1	EM-3131			
			RH Front		1	EM-3130			
			Rear		1	EM-3145			
	L4 2.4L	2007-09	Front		1	EM-3131			
			RH Front		1	EM-3130			
			Rear	4WD	1	EM-3157			
			Rear	FWD	1	EM-3145			
			Trans	Auto; CVT	1			EM-3134	
			Trans	Manual	1			EM-3137	
<b>SCRAMBLER</b>									
L4	L4 2.5L 151ci	1981-85	L & R Front		2	EM-2446			
			Trans	Auto	1			EM-2921	
			Trans	Manual	1			EM-2693	
L6	L6 4.2L 258ci	1981-85	L & R Front		2	EM-2330			
			Trans	Auto	1			EM-2693	
			Trans	Manual	1			EM-2693	
<b>WAGONEER</b>									
L4	L4 2.1L 126ci Diesel	1985	L & R Front		2	EM-2569			
			Trans	Auto	1			EM-2625	
			Trans	Manual	1			EM-2570	
	L4 2.5L 150ci	1984-87	LH Front		1	EM-2569			
			RH Front		1	EM-2571			
			Trans	Auto	1			EM-2625	
			Trans	Manual	1			EM-2570	
	L6	L6 3.8L 230ci	1963-67	L & R Front		2	EM-2279		
		L6 3.8L 232ci	1971	L & R Front		2	EM-2279		
L6 4.0L 242ci		1987-90	L & R Front		2	EM-2572			
			Trans	exc Peugeot Transmission	1			EM-2625	
			Trans	Manual; Cushion	1			EM-5383	
L6 4.2L 258ci		1980-83 1972-73 1980-83 1972-73	L & R Front	w/ Interlock	2	EM-2330			
			L & R Front	w/o Interlock	2	EM-2280			
			Trans	Auto	1			EM-2693	
			Trans	Manual	1			EM-2693	
	Trans			1			EM-2268 @		
V6	V6 2.8L 173ci	1984-86	L & R Front		2	EM-2569			
			Trans	Auto	1			EM-2693	
			Trans	Manual; Cushion	1			EM-5383	
V8	V8 5.9L 360ci	1972-83	L & R Front		2	EM-2351			
			Trans	Auto	1			EM-2693	
			Trans	Manual	1			EM-2693	

# Engine, Transmission, And Torque Strut Mounts

CYL	ENG. SIZE	YEAR	LOCATION	DESCRIPTION	QTY	ENGINE	TORQUE STRUT	TRANS-MISSION	
<b>JEEP SPORT UTILITY (continued)</b>									
<b>WRANGLER</b>									
L4	L4 2.4L 148ci	2003-06	L & R Front		2	EM-2883			
			Trans	Auto	1			EM-2882	
			Trans	Manual	1			EM-2882	
	L4 2.5L 150ci	1997-02 1987-90 1991-95	1997-02 1987-90 1991-95	L & R Front		2	EM-2883		
				L & R Front		2	EM-2569		
				LH Front		1	EM-2569		
				RH Front		1	EM-2920		
				Trans	Auto	1			EM-2882
				Trans	Manual	1			EM-2882
				Trans	Auto	1			EM-2628
				Trans	Manual	1			EM-2628
				L6	L6 4.0L 242ci	1997-06 1991-95	L & R Front		2
L & R Front		2	EM-2572						
Trans	Auto	1						EM-2882	
Trans	Manual	1						EM-2882	
Trans	Auto	1						EM-2628	
Trans	Manual	1						EM-2628	
L6 4.2L 258ci	1987-90	L & R Front			2	EM-2572			
		Trans	Auto		1			EM-2628	
		Trans	Manual		1			EM-2628	
V6	V6 3.8L 231ci	2007-11	L & R Front	Bushing	1	EM-4041			
			Trans	Auto	1			EM-4043	
			Trans	Manual	1			EM-4043	
<b>JEEP TRUCK</b>									
<b>FC150</b>									
L4	L4 2.2L 134ci	1958-62	L & R Front		2	EM-2040			
			Trans - Lower	Transfer Case	1			EM-2009	
			Trans - Upper	Transfer Case	1			EM-2010	
<b>J10</b>									
L6	L6 4.2L 258ci	1974-87	L & R Front		2	EM-2330			
			Trans		1			EM-2268 @	
V8	V8 5.9L 360ci	1974-88	L & R Front		2	EM-2351			
			Trans	Auto	1			EM-2693	
			Trans	Manual	1			EM-2693	
<b>J20</b>									
L6	L6 4.2L 258ci	1974-76	L & R Front		2	EM-2330			
			Trans	Auto	1			EM-2693	
			Trans	Manual	1			EM-2693	
V8	V8 5.9L 360ci	1974-88	L & R Front		2	EM-2351			
			Trans	Auto	1			EM-2693	
			Trans	Manual	1			EM-2693	
<b>JEEPSTER</b>									
L4	L4 2.2L	1949-51	L & R Front		2	EM-2040			
			Trans - L & R		2			EM-2039	
<b>KIA PASSENGER CAR</b>									
<b>AMANTI</b>									
V6	V6 3.5L 3497cc	2004-06	Front		1	EM-8948			
			RH Front		1	EM-8949			
			Rear		1	EM-8950			
			Trans		1			EM-5121	
	V6 3.8L	2007-09	Front		1	EM-9317			
			Front	When Stock is Depleted, Re-order EM-9317	1	EM-9321			
			RH Front		1	EM-9332			

# Engine, Transmission, And Torque Strut Mounts

CYL	ENG. SIZE	YEAR	LOCATION	DESCRIPTION	QTY	ENGINE	TORQUE STRUT	TRANSMISSION	
<b>KIA PASSENGER CAR (continued)</b>									
<b>AMANTI (continued)</b>									
V6	V6 3.8L	2007-09	Rear		1	EM-9330			
			Trans	Auto	1			EM-9333	
<b>FORTE5</b>									
L4	L4 2.0L 1998cc	2012-13	Rear	Manual	1	EM-7006			
<b>FORTE</b>									
L4	L4 2.0L 1998cc	2010-13	Rear	Manual	1	EM-7006			
<b>FORTE KOUP</b>									
L4	L4 2.0L 1998cc	2010-13	Rear	Manual	1	EM-7006			
<b>FORTE5</b>									
L4	L4 2.0L 1998cc	2012-13	Right		1	EM-9345			
<b>FORTE</b>									
L4	L4 2.0L 1998cc	2010-13	Right		1	EM-9345			
<b>FORTE KOUP</b>									
L4	L4 2.0L 1998cc	2010-13	Right		1	EM-9345			
<b>FORTE5</b>									
L5	L4 2.4L	2012-13	Right		1	EM-9345			
<b>FORTE</b>									
L5	L4 2.4L	2010-13	Right		1	EM-9345			
<b>FORTE KOUP</b>									
L5	L4 2.4L	2010-13	Right		1	EM-9345			
<b>MAGENTIS</b>									
L4	L4 2.4L	2009-10	Front	Manual	1	EM-9311			
		2006-08	Front		1	EM-9311			
		2005	Front		1	EM-8770			
		2009-10	RH Front		1	EM-9335			
		2006-08	RH Front		1	EM-9335			
		2009-10	Rear		1	EM-9323			
		2006-08	Rear		1	EM-9323			
		2005	Rear		1	EM-8783			
		2006-10	Trans		1			EM-9334	
		2005	Trans	Auto	1			EM-9373	
		2001-04	Trans	Auto	1			EM-9373	
		2001-04	Trans	Manual	1			EM-9367	
		L4 2.4L 2351cc	2001-04	Front		1	EM-8770		
				RH Front		1	EM-8722		
Rear				1	EM-8783				
V6	V6 2.5L 2500cc	2001	Front		1	EM-8769			
			Rear		1	EM-8784			
	V6 2.7L	2007-10	RH Front		1	EM-9335			
			2005-06	RH Front		1	EM-9335		
	V6 2.7L 2700cc	2002-04	Front		1	EM-8769			
			Rear		1	EM-8784			
<b>OPTIMA</b>									
L4	L4 2.4L	2009-10	Front	Manual	1	EM-9311			
		2007-08	Front	Auto	1	EM-9311			
		2006	Front	From 9-17-2006	1	EM-9311			
			Front	To 9-17-2006	1	EM-8770			
		2001-05	Front		1	EM-8770			
		2009-10	RH Front		1	EM-9335			
		2007-08	RH Front		1	EM-9335			
		2006	RH Front	From 9-17-2006	1	EM-9335			

## Engine, Transmission, And Torque Strut Mounts

CYL	ENG. SIZE	YEAR	LOCATION	DESCRIPTION	QTY	ENGINE	TORQUE STRUT	TRANSMISSION	
<b>KIA PASSENGER CAR (continued)</b>									
<b>OPTIMA (continued)</b>									
L4	L4 2.4L	2006	RH Front	To 9-17-2006	1	EM-8722			
		2001-05	RH Front		1	EM-8722			
		2009-10	Rear		1	EM-9323			
		2007-08	Rear		1	EM-9323			
		2006	Rear	From 9-17-2006	1	EM-9323			
			Rear	To 9-17-2006	1	EM-8783			
		2001-05	Rear		1	EM-8783			
		2009-10	Trans		1			EM-9334	
		2007-10	Trans		1			EM-9334	
		2006	Trans	Auto; 4 Spd	1			EM-9373	
			Trans	Auto; 5 Spd	1			EM-9334	
			Trans	Manual	1			EM-9367	
	2005	Trans	Auto; 4 Spd	1			EM-9373		
		Trans	Manual	1			EM-9367		
	L4 2.4L 2351cc	2001-04	Trans	Auto	1			EM-9373	
Trans		Manual	1				EM-9367		
V6	V6 2.5L 2500cc	2001	Front		1	EM-8769			
			RH Front		1	EM-8723			
			Rear		1	EM-8784			
			Trans		1			EM-9373	
			Trans	When Stock is Depleted, Re-order EM-9373	1			EM-5127	
	V6 2.7L	2006	2007-09	Front		1	EM-9323		
			RH Front		1	EM-9335			
			2006	RH Front		1	EM-9335		
			2002-06	Trans	Auto	1			EM-9373
	V6 2.7L 2656cc	2002-05	Front		1	EM-8769			
			RH Front		1	EM-8723			
			Rear		1	EM-8784			
<b>RIO5</b>									
L4	L4 1.6L	2006-08	Trans		1			EM-9308	
	L4 1.6L 1599cc	2006-08	Front Lower		1	EM-9309			
			Front Upper		1	EM-9324			
		2009	Rear	Auto	1	EM-9310			
		2006-08	Rear	Auto	1	EM-9310			
<b>RIO</b>									
L4	L4 1.5L	2001-02	Trans - Front	Manual	1			EM-5738	
	L4 1.5L 1493cc	2001-02	Front		1	EM-8914			
			RH Front		1	EM-8913			
			Rear		1	EM-8914			
	L4 1.6L	2003-05	Trans - Front	Manual	1			EM-5738	
		2006-09	Trans		1			EM-9308	
	L4 1.6L 1594cc	2006-09	Front Lower		1	EM-9309			
			Front Upper		1	EM-9324			
			Rear		1	EM-9310			
	L4 1.6L 1599cc	2003-05	Front		1	EM-8914			
			RH Front		1	EM-9346			
Rear				1	EM-8914				
<b>RONDO</b>									
L4	L4 2.4L	2007-10	Front		1	EM-9311			
			RH Front		1	EM-9335			
			Rear		1	EM-9323			
			Trans	Auto	1			EM-9342	
V6	V6 2.7L	2007-10	RH Front		1	EM-9335			
			Rear		1	EM-9323			

# Engine, Transmission, And Torque Strut Mounts

CYL	ENG. SIZE	YEAR	LOCATION	DESCRIPTION	QTY	ENGINE	TORQUE STRUT	TRANS-MISSION	
<b>KIA PASSENGER CAR (continued)</b>									
<b>SEPHIA</b>									
L4	L4 1.6L 1597cc	1994-97	Front		1	EM-8903			
			RH Front		1	EM-8609			
			Rear	Auto	1	EM-8612			
			Rear	Manual	1	EM-8611			
			Trans		1			EM-2815	
	L4 1.8L 1793cc	1998-01	Front	Auto	1	EM-8906			
			Front	Manual	1	EM-8904			
			RH Front		1	EM-8902			
			Rear	Auto	1	EM-8908			
			Rear	Manual	1	EM-8905			
		2001	Trans	Auto	1			EM-8907	
		2001	Trans	Manual	1			EM-8910	
		1998-00	Trans	Auto	1			EM-8912	
	L4 1.8L 1839cc	1995-97	Front		1	EM-8903			
			RH Front		1	EM-8609			
			Rear		1	EM-8612			
			Trans		1			EM-2815	
<b>SPECTRA</b>									
L4	L4 1.8L	2003-04	Front	Auto	1	EM-8906			
			Front	Manual	1	EM-8904			
			RH Front		1	EM-8902			
			Rear	Manual	1	EM-8905			
	L4 1.8L 1793cc	2000-02	Front	Auto	1	EM-8906			
			Front	Manual	1	EM-8904			
			RH Front		1	EM-8902			
			Rear	Auto	1	EM-8908			
			Rear	Manual	1	EM-8905			
		2000-04	Trans	Auto	1			EM-8907	
				Trans	Manual	1			EM-8910
	L4 2.0L	2006-09	Front	Auto	1	EM-9362			
			Front	Manual	1	EM-9312			
		2004-05	Front		1	EM-9312			
		2006-09	Front Upper	Bracket Only	1	EM-9328			
		2004-05	Front Upper	Bracket Only	1	EM-9328			
		2006-09	RH Front		1	EM-9325			
		2004-05	RH Front		1	EM-9325			
		2006-09	Rear	Auto	1	EM-9313			
			Rear	Manual	1	EM-9313			
		2004-05	Rear	Auto	1	EM-9326			
			Rear	Manual	1	EM-9313			
2006-09		Rear Upper	Bracket Only	1	EM-9327				
2004-05	Rear Upper	Bracket Only	1	EM-9327					
2004-09	Trans	Auto	1			EM-9337			
	Trans	Manual	1			EM-9319			
<b>SPECTRA5</b>									
L4	L4 2.0L	2007-09	Front	Auto	1	EM-9362			
			Front	Manual	1	EM-9312			
		2005-06	Front	Manual	1	EM-9312			
		2007-09	Front Upper	Bracket Only	1	EM-9328			
		2005-06	Front Upper	Bracket Only	1	EM-9328			
		2007-09	RH Front		1	EM-9325			
		2005-06	RH Front	Manual	1	EM-9325			
		2007-09	Rear	Auto	1	EM-9313			
			Rear	Manual	1	EM-9313			
		2005-06	Rear	Auto	1	EM-9326			

# Engine, Transmission, And Torque Strut Mounts

CYL	ENG. SIZE	YEAR	LOCATION	DESCRIPTION	QTY	ENGINE	TORQUE STRUT	TRANS-MISSION	
<b>KIA PASSENGER CAR (continued)</b>									
<b>SPECTRA5 (continued)</b>									
L4	L4 2.0L	2005-06	Rear	Manual	1	EM-9313			
		2007-09	Rear Upper	Bracket Only	1	EM-9327			
		2005-06	Rear Upper	Bracket Only	1	EM-9327			
		2005-09	Trans	Auto	1			EM-9337	
		2005-09	Trans	Manual	1			EM-9319	
<b>KIA SPORT UTILITY</b>									
<b>BORREGO</b>									
V6	V6 3.8L	2009-10	L & R Front		2	EM-9329			
			Trans		1			EM-7051	
V8	V8 4.6L	2009-10	L & R Front		2	EM-9329			
<b>SORENTO</b>									
V6	V6 3.3L	2008-09	Trans	Auto; 4WD	1			EM-9320	
			Trans	Manual; 4WD	1			EM-9320	
			Trans	Manual; RWD	1			EM-7051	
	V6 3.5L	2011-13	Right		1	EM-9355			
			2005-06	Trans	Auto	1			EM-9320
				Trans	Manual; 4WD	1			EM-9336
			2004	Trans	Auto	1			EM-9336
				Trans	Manual; 4WD	1			EM-9336
			2003	Trans	Auto	1			EM-9336
	V6 3.5L 3497cc	2003-06	L & R Front		2	EM-9331			
			L & R Front	When Stock is Depleted, Re-order EM-9331	2	EM-5124			
	V6 3.8L	2007-09	L & R Front		2	EM-9329			
			Trans	Auto; 4WD	1			EM-9320	
			Trans	Manual; 4WD	1			EM-9320	
			Trans	Manual; RWD	1			EM-7051	
<b>SPORTAGE</b>									
L4	L4 2.0L	2005-09	Front		1	EM-9322			
			RH Front		1	EM-9368			
			Rear		1	EM-9306			
			Trans	Auto	1			EM-9374	
			Trans	Manual	1			EM-9380	
	L4 2.0L 1998cc	1995-02	LH Front		1	EM-8607			
			RH Front		1	EM-8606			
			Trans - LH	Auto; 4WD	1			EM-8901	
			Trans - LH	Manual; 4WD	1			EM-8901	
			Trans	Auto	1			EM-8608	
			Trans	Manual	1			EM-8608	
	V6	V6 2.7L	2005-09	Front		1	EM-9338		
				RH Front		1	EM-9368		
Rear					1	EM-9306			
Trans					1			EM-9378	
<b>KIA VAN</b>									
<b>SEDONA</b>									
V6	V6 3.5L	2014	Rear		1	EM-9347			
		2011-12	Rear		1	EM-9347			
		2002-05	Trans		1			EM-5482	
	V6 3.5L 3497cc	2002-05	Front		1	EM-9351			
			Rear		1	EM-9359			
			Right		1	EM-5526			
	V6 3.8L	2010	Front		1	EM-9375			
			2006-09	Front		1	EM-9375		
				RH Front		1	EM-9343		

# Engine, Transmission, And Torque Strut Mounts

CYL	ENG. SIZE	YEAR	LOCATION	DESCRIPTION	QTY	ENGINE	TORQUE STRUT	TRANSMISSION	
<b>KIA VAN (continued)</b>									
<b>SEDONA (continued)</b>									
V6	V6 3.8L	2006-09	Rear		1	EM-9347			
		2006-14	Trans	Auto	1			EM-9349	
<b>LAND ROVER SPORT UTILITY</b>									
<b>RANGE ROVER SPORT</b>									
V8	V8 4.2L 4196cc	2006-09	L & R Front		2	EM-5892			
	V8 4.4L	2006-09	L & R Front		2	EM-5892			
	V8 5.0L 305 ci	2010-12	L & R Front		2	EM-5892			
<b>RANGE ROVER</b>									
V8	V8 4.2L 4196cc	2006-09	LH Front		1	EM-5893			
			RH Front		1	EM-5894			
	V8 4.4L	2006-09	LH Front		1	EM-5893			
			LH Front		1	EM-5895			
			RH Front		1	EM-5894			
			RH Front		1	EM-5896			
<b>LEXUS PASSENGER CAR</b>									
<b>CT200H</b>									
L4	L4 1.8L 1798cc	2011-13	Front		1	EM-9514			
			Right		1	EM-5970			
<b>ES250</b>									
V6	V6 2.5L 2508cc	1990-91	LH Front	Auto	1	EM-8193			
			LH Front	Manual	1	EM-8192			
			RH Front	Manual	1	EM-8207			
			Rear		1	EM-8197			
			Trans - Center		1			EM-8208	
<b>ES300</b>									
V6	V6 3.0L	1999-01	Front	w/ Variable Timing	1	EM-5804			
			Front	w/o Variable Timing	1	EM-8967			
		2002-03	RH Front		1	EM-9239			
			Rear		1	EM-9421			
		2002-03	Torq Str - Front		1		EM-9197		
			Trans	w/ Variable Timing	1			EM-5809	
		1999-01	Trans	w/o Variable Timing	1			EM-8644	
			Trans	w/o Variable Timing	1			EM-8644	
		V6 3.0L 2959cc	1997-98	Front	w/o Variable Timing	1	EM-8967		
				Front	Auto	1	EM-8965		
	1992-93		Front	Manual	1	EM-8207			
			Rear	Insert Only	1	EM-8699			
	1992-93		Rear		1	EM-8398			
			Torq Str - Front	Auto	1		EM-8697		
	1992-96		Torq Str - Front	Auto	1		EM-8201		
			Trans	Auto, w/o Variable Timing	1			EM-8644	
	1992-93		Trans	Manual	1			EM-8529	
			V6 3.0L 2995cc	1994-96	Front		1	EM-8711	
	Rear				1	EM-8398			
	2002-03	1994-96	Trans - LH		1			EM-9165	
Trans			Auto, w/o Variable Timing	1			EM-8644		
<b>ES330</b>									
V6	V6 3.3L	2004-06	RH Rear		1	EM-9212			
			Torq Str - Front		1		EM-9197		
	V6 3.3L 3300cc	2004-06	Trans		1			EM-9165	



# Engine, Transmission, And Torque Strut Mounts

CYL	ENG. SIZE	YEAR	LOCATION	DESCRIPTION	QTY	ENGINE	TORQUE STRUT	TRANSMISSION
<b>LEXUS PASSENGER CAR (continued)</b>								
<b>ES350</b>								
V6	V6 3.5L	2007-12	RH Front		1	EM-9238		
	V6 3.5L 3456cc	2007-15	Torg Str - Rear		1		EM-9601	
		2007-14	Trans		1			EM-9236
<b>GS300</b>								
L6	L6 3.0L	1993-97	L & R Front	Hydraulic Mount	2	EM-5399		
		1998-05	Trans		1			EM-5941
		1993-97	Trans		1			EM-5950
	L6 3.0L 2997cc	1998-05	L & R Front	Hydraulic Mount	2	EM-5921		
V6	L6 3.0L	2006	Trans	RWD	1			EM-5963
<b>GS350</b>								
V6	L6 3.5L	2007-11	Trans	RWD	1			EM-5963
<b>GS400</b>								
V8	V8 4.0L 3969cc	1998-00	L & R Front	Hydraulic Mount	2	EM-5142		
	W8 4.0L	1998-00	Trans		1			EM-5403
<b>GS430</b>								
V8	V8 4.3L	2001-05	Trans		1			EM-5403
	V8 4.3L 4293cc	2001-05	L & R Front	Hydraulic Mount	2	EM-5142		
		2006-07	Trans		1			EM-5963
<b>IS250</b>								
V6	V6 2.5L	2006-12	Trans	Auto; RWD	1			EM-5963
<b>IS300</b>								
L6	L6 3.0L	2001-05	L & R Front	Hydraulic Mount	2	EM-5921		
		2002-05	Trans		1			EM-5941
			Trans	Manual	1			EM-5801
		2001	Trans	Auto	1			EM-5941
<b>IS350</b>								
V6	V6 2.5L	2006-12	Trans	RWD	1			EM-5963
<b>LS400</b>								
V8	V8 4.0L 3967cc	1990-95	Trans		1			EM-5144
	V8 4.0L 3969cc	1990-00	L & R Front		2	EM-5143		
		1996-00	Trans		1			EM-5942
<b>LS430</b>								
V8	V8 4.3L 4293cc	2001-06	L & R Front		2	EM-5952		
		2004-06	Trans		1			EM-5976
		2001-03	Trans		1			EM-5967
<b>SC300</b>								
L6	L6 3.0L	1992-00	L & R Front		2	EM-5367		
	L6 3.0L 2997cc	1998-00	Trans	Auto	1			EM-5769
		1992-97	Trans	Auto	1			EM-5769
			Trans	Manual	1			EM-5768
<b>SC430</b>								
V8	V8 4.3L	2002-10	Trans		1			EM-5403
<b>LEXUS SPORT UTILITY</b>								
<b>GX470</b>								
V8	V8 4.7L 4663cc	2003-09	L & R Front		2	EM-5649		
		2003-07	Trans		1			EM-9511
<b>LX450</b>								
L6	L6 4.5L 4477cc	1996-97	L & R Front		2	EM-8353		
			Trans		1			EM-8395

# Engine, Transmission, And Torque Strut Mounts

CYL	ENG. SIZE	YEAR	LOCATION	DESCRIPTION	QTY	ENGINE	TORQUE STRUT	TRANSMISSION
<b>LEXUS SPORT UTILITY (continued)</b>								
<b>LX470</b>								
V8	V8 4.7L 4663cc	1998-07	L & R Front		2	EM-9050		
			Trans		1			EM-8991
<b>RX300</b>								
V6	V6 3.0L 2995cc	1999-03	Front		1	EM-9173		
			Rear	AWD	1	EM-9179		
			Rear	FWD	1	EM-9192		
			Torq Str - Front		1		EM-8995	
			Trans		1			EM-9073
<b>RX330</b>								
V6	V6 3.3L	2004-06	Front	4WD; Built in Japan	1	EM-5800		
			RH Front		1	EM-9212		
			Rear	AWD	1	EM-7039		
			Rear	FWD	1	EM-5837		
			Torq Str - Front		1		EM-9227	
	V6 3.3L 3300cc	2004-06	Trans		1			EM-9165
<b>RX350</b>								
V6	V6 3.5L 3456cc	2010-15	RH Front		1	EM-9238		
			2007-09	RH Front		1	EM-9238	
		2007-09	Rear	FWD; Japan Built	1	EM-7039		
			Torq Str - Front		1		EM-5861	
		2010-15	Trans		1			EM-9236
		2007-09	Trans		1			EM-9165
<b>RX400H</b>								
V6	V6 3.3L	2006-08	RH Front		1	EM-9212		
			Torq Str - Rear	AWD	1		EM-9232	
	V6 3.3L 3300cc	2006-08	Trans		1			EM-9165
<b>RX450H</b>								
V6	V6 3.5L 3456cc	2010-15	Right		1	EM-9238		
<b>LINCOLN PASSENGER CAR</b>								
<b>MKS</b>								
V6	V6 3.7L	2009-13	RH Front		1	EM-5427		
		2009-11	Torq Str - Rear		1		EM-3142	
		2009-12	Trans - Upper		1			EM-4040
<b>CONTINENTAL</b>								
V6	V6 3.8L 232ci	1988-94	RH Front		1	EM-2812'		
			RH Rear		1	EM-2813'		
			Trans		1			EM-2717'
V8	V8 4.6L	1998-02	Torq Str - Rear		1		EM-3111	
			V8 4.6L 281ci	2001-02	RH Front	1	EM-2996'	
	V8 4.6L 281ci	1998-02	RH Front	1	EM-2996'			
		1995-97	RH Front	1	EM-2996'			
		2001-02	RH Rear	1	EM-2813'			
		1995-97	RH Rear	Hydraulic Mount	1	EM-5148		
	V8 5.0L 302ci	1980-87	Trans		1			EM-2717'
			LH Front		1	EM-2725		
			RH Front		1	EM-2726		
	V8 5.8L 351ci	1980	Trans		1			EM-2679
LH Front				1	EM-2438			
RH Front				1	EM-2437			
V8 6.6L 400ci	1977-79	Trans		1			EM-2464	
		LH Front		1	EM-2749			
V8 7.0L 430ci	1958-65	Trans		1			EM-2619	
		L & R Front		2	EM-2141			

# Engine, Transmission, And Torque Strut Mounts

CYL	ENG. SIZE	YEAR	LOCATION	DESCRIPTION	QTY	ENGINE	TORQUE STRUT	TRANS-MISSION	
<b>LINCOLN PASSENGER CAR (continued)</b>									
<b>CONTINENTAL (continued)</b>									
V8	V8 7.5L 460ci	1968-78	RH Front		1	EM-2749			
			Trans		1			EM-2619	
	V8 7.6L 462ci	1966-68	L & R Front		2	EM-2141			
<b>LS</b>									
V6	V6 3.0L 182ci	2000-05	L & R Front		2	EM-3077*			
			Trans		1			EM-3063	
V8	V8 3.9L 242ci	2000-06	L & R Front		2	EM-3077*			
			Trans		1			EM-3063	
<b>MARK III</b>									
V8	V8 7.5L 460ci	1968-71	LH Front		1	EM-2367			
			RH Front		1	EM-2723			
			Trans		1			EM-2619	
	V8 7.6L 462ci	1968	L & R Front		2	EM-2141			
<b>MARK IV</b>									
V8	V8 7.5L 460ci	1972-76	LH Front		1	EM-2367			
			RH Front		1	EM-2723			
			Trans		1			EM-2619	
<b>MARK V</b>									
V8	V8 6.6L 400ci	1977-79	LH Front		1	EM-2365			
			RH Front		1	EM-2364			
			Trans		1			EM-2619	
	V8 7.5L 460ci	1977-78	LH Front		1	EM-2367			
			RH Front		1	EM-2723			
	Trans		1			EM-2619			
<b>MARK VI</b>									
V8	V8 5.0L 302ci	1980-83	LH Front		1	EM-2438			
			RH Front		1	EM-2437			
			Trans		1			EM-2464	
	V8 5.8L 351ci	1980	LH Front		1	EM-2438			
			RH Front		1	EM-2437			
	Trans		1			EM-2464			
<b>MARK VII</b>									
V8	V8 5.0L 302ci	1984-92	LH Front	Std Suspension	1	EM-2725			
			RH Front	Std Suspension	1	EM-2726			
			Trans		1			EM-2679	
<b>MARK VIII</b>									
V8	V8 4.6L 281ci	1993-98	L & R Front		2	EM-5048*			
<b>MKZ</b>									
V6	V6 3.5L 213ci	2010-12	Torq Str - Front		1		EM-4059		
		2007-09	Torq Str - Front	FWD	1		EM-3107		
<b>TOWN CAR</b>									
V8	V8 4.6L	2009	LH Front		1	EM-3025			
			RH Front		1	EM-3024			
	V8 4.6L 281ci	2003-08	LH Front		1	EM-3071*			
			1998-02	LH Front		1	EM-2861		
			1991-97	LH Front		1	EM-2807		
			2003-08	RH Front		1	EM-3072*		
			1998-02	RH Front		1	EM-2860		
			1991-97	RH Front		1	EM-2806		
			2003-09	Trans		1			EM-3038
			1998-02	Trans		1			EM-2822
	1992-97	Trans		1			EM-2822		
	V8 5.0L 302ci	1982-90	LH Front		1	EM-2438			

# Engine, Transmission, And Torque Strut Mounts

CYL	ENG. SIZE	YEAR	LOCATION	DESCRIPTION	QTY	ENGINE	TORQUE STRUT	TRANSMISSION
<b>LINCOLN PASSENGER CAR (continued)</b>								
<b>TOWN CAR (continued)</b>								
V8	V8 5.0L 302ci	1982-90	RH Front		1	EM-2437		
		1982-85	Trans	before 1/28/82	1			EM-2464
<b>ZEPHYR</b>								
V6	V6 3.0L 183ci	2006	Right		1	EM-4044		
			Torq Str - Front		1		EM-3107	
			Trans		1			EM-4034
<b>VERSAILLES</b>								
V8	V8 5.0L 302ci	1977-80	LH Front		1	EM-2504		
			RH Front		1	EM-2503		
			Trans		1			EM-2253
	V8 5.8L 351ci	1977	LH Front		1	EM-2504		
			RH Front		1	EM-2503		
			Trans	Auto	1			EM-2253
<b>LINCOLN SPORT UTILITY</b>								
<b>MKX</b>								
V6	V6 3.5L	2007-10	RH Front		1	EM-5427		
			Torq Str - Rear		1		EM-3144	
	V6 3.5L 213ci	2007-10	Trans		1			EM-4081
	V6 3.7L 227ci	2011-13	RH Front		1	EM-5427		
		2011-14	Torq Str - Rear		1		EM-3142	
2011-13	Trans		1			EM-4081		
<b>MKT</b>								
V6	V6 3.5L 213ci	2010-13	Torq Str - Front	Turbo	1		EM-4056	
			Torq Str - Rear	Turbo	1		EM-4055	
	V6 3.7L	2010-12	RH Front		1	EM-5427		
		2010-13	Torq Str - Front		1		EM-3142	
	V6 3.7L 227ci	2010-13	Trans - Upper	Non Turbo	1			EM-4040
<b>NAVIGATOR</b>								
V8	V8 5.4L	2005-06	LH Front		1	EM-4097		
		2004	LH Front		1	EM-4097		
		2003	LH Front		1	EM-4097		
		2005-06	RH Front		1	EM-4099		
		2004	RH Front		1	EM-4099		
		V8 5.4L 330ci	2000-02	LH Front	4WD	1	EM-2972	
	LH Front			RWD	1	EM-2832		
	1998-99		LH Front	4WD	1	EM-2972		
			LH Front	RWD	1	EM-2832		
	2000-02		RH Front		1	EM-2835		
			1998-99	RH Front	4WD	1	EM-2834	
	RH Front			RWD	1	EM-2835		
	2006		Trans	RWD	1			EM-2971
	2005		Trans	RWD	1			EM-2971
	1998-04	Trans	2WD	1			EM-2870	
<b>LINCOLN TRUCK</b>								
<b>MARK LT</b>								
V8	V8 5.4L	2006-08	Trans	4WD	1			EM-3136
	V8 5.4L 330ci	2006-08	Left	Gas	1	EM-3151		
			Right	Gas	1	EM-3150		
<b>BLACKWOOD</b>								
V8	V8 5.4L 330ci	2002	LH Front		1	EM-2972		
			RH Front		1	EM-2835		
			Trans		1			EM-2870

# Engine, Transmission, And Torque Strut Mounts

CYL	ENG. SIZE	YEAR	LOCATION	DESCRIPTION	QTY	ENGINE	TORQUE STRUT	TRANS-MISSION	
<b>MAZDA PASSENGER CAR</b>									
<b>2</b>									
L4	L4 1.5L	2011-12	Torq Str - Rear	Manual	1		EM-5909		
<b>3</b>									
L4	L4 2.0L	2011-13	RH Front	Insert Only	1	EM-3103			
		2004-10	RH Front	Complete Unit	1	EM-5375			
			RH Front	Insert Only	1	EM-3103			
		2011-13	Rear	Mount	1	EM-9222			
		2004-10	Rear	Mount	1	EM-9222			
		2010-11	Trans	Auto				EM-5864	
			Trans	Manual				EM-9534	
		2004-09	Trans					EM-9196	
		L4 2.0L 2000cc	2004-13	Torq Str - Rear		1		EM-5783	
		L4 2.3L	2007-09	RH Front	Complete Unit	1	EM-5362		
				RH Front	Insert Only	1	EM-3103		
			2004-06	RH Front	Complete Unit; w/o Turbo	1	EM-5362		
				RH Front	Insert Only; w/o Turbo	1	EM-3103		
			2010-13	Rear	Mount	1	EM-9222		
			2007-09	Rear	Mount	1	EM-9222		
			2004-06	Rear		1	EM-9222		
			2007-09	Trans	Auto; w/ Turbo	1			EM-9526
				Trans	Auto; w/o Turbo	1			EM-9196
				Trans	Manual; w/ Turbo	1			EM-7043
			Trans	Manual; w/o Turbo	1			EM-9196	
		2004-06	Trans	Auto	1			EM-9196	
			Trans	Manual	1			EM-9196	
		L4 2.3L 2260cc	2004-09	Torq Str - Rear		1		EM-5783	
			2010-11	Trans		1			EM-5863
		L4 2.5L	2010-13	Rear		1	EM-9222		
		L4 2.5L 2488cc	2010-13	Torq Str - Rear		1		EM-5783	
			2010-11	Trans	Auto	1			EM-5864
			Trans	Manual	1			EM-9534	
<b>6</b>									
L4	L4 2.3L 2260cc	2003-08	RH Front	Auto; i Sedan	1	EM-9182			
		2006-08	Torq Str - Rear		1		EM-5943		
		2003-05	Torq Str - Rear		1		EM-9195		
		2003-08	Trans		1			EM-9539	
V6	V6 3.0L 2968cc	2003-08	RH Front		1	EM-5152			
			Torq Str - Rear		1		EM-9221		
			Trans		1			EM-9536	
<b>323</b>									
L4	L4 1.6L 1597cc	1988-89	Front		1	EM-8065			
		1986-87	Front	Auto	1	EM-8065			
			Front	Manual	1	EM-8101			
		1990-94	RH Front		1	EM-9131			
		1988-89	RH Front	Auto	1	EM-8234			
			RH Front	Manual	1	EM-8060			
		1986-87	RH Front	Auto	1	EM-8234			
			RH Front	Manual	1	EM-8262			
		1990-94	Rear		1	EM-8453			
		1988-89	Rear		1	EM-2650			
		1986-87	Rear	Manual	1	EM-8068			
			Trans - Front	Manual; FWD	1			EM-8068	
		1990	Trans	Auto	1			EM-8223	
		1988-89	Trans	w/o Turbo	1			EM-8068	
		1986-87	Trans	Auto; FWD	1			EM-8424	
		L4 1.8L 1839cc	1990-91	RH Front		1	EM-8609		
				Trans	Auto	1			EM-2815

# Engine, Transmission, And Torque Strut Mounts

CYL	ENG. SIZE	YEAR	LOCATION	DESCRIPTION	QTY	ENGINE	TORQUE STRUT	TRANSMISSION	
<b>MAZDA PASSENGER CAR (continued)</b>									
<b>323 (continued)</b>									
L4	L4 1.8L 1839cc	1990-91	Trans	Manual	1			EM-2650	
<b>626</b>									
L4	L4 2.0L	2000	Front	Auto	1	EM-5155			
			Front	Manual	1	EM-9478			
			RH Front		1	EM-9469			
			Rear	Auto	1	EM-9481			
			Rear	Manual	1	EM-9480			
		1983-85	Trans	Auto	1			EM-5378	
				Trans	Manual	1		EM-8082	
	L4 2.0L 1970cc	1983	1983	Front		1	EM-8080		
			1979-82	L & R Front		2	EM-8055		
			1983	RH Front	Auto	1	EM-8077		
				RH Front	Manual	1	EM-8514		
				Rear		1	EM-8078		
		1979-82	Trans		1			EM-8512	
	L4 2.0L 1991cc	2001-02	Front	Auto	1	EM-9466			
			Front	Manual	1	EM-9478			
		1994-97	Front	Auto	1	EM-5155			
			Front	Manual	1	EM-8073			
		1993	Front		1	EM-8073			
			LH Front	Auto	1	EM-5155			
		1998-99	LH Front	Manual	1	EM-9478			
				RH Front	Auto	1	EM-9469		
		2001-02	RH Front	Auto	1	EM-8074			
				RH Front	Manual	1	EM-8074		
		1998-99	RH Front		1	EM-8074			
			1994-97	RH Front		1	EM-8074		
		1993	RH Front		1	EM-8074			
			2001-02	Rear	Auto	1	EM-8075		
			Rear	Manual	1	EM-8456			
		1998-99	Rear	Auto	1	EM-9481			
			Rear	Manual	1	EM-9480			
		1994-97	Rear	Auto	1	EM-9476			
			Rear	Manual	1	EM-8456			
		1993	Rear	Auto	1	EM-8075			
			Rear	Manual	1	EM-8456			
		1998-02	Trans - Center	Auto	1			EM-9087	
			Lower	Auto					
		Trans - Center	Manual	1			EM-9082		
		Lower	Manual						
	1994-97	Trans - Center	Auto	1			EM-9087		
		Lower	Auto						
	1998-02	Trans - Upper	Auto	1			EM-8691		
	1994-97	Trans - Upper	Auto	1			EM-8691		
		Trans	Manual	1			EM-8457		
	1993	Trans	Auto	1			EM-8460		
		Trans	Manual	1			EM-8457		
	L4 2.0L 1998cc Diesel	1984-85	Front	Auto; LX	1	EM-8077			
			Front	DX	1	EM-8080			
Front			LX, Manual	1	EM-8514				
L4 2.0L 1998cc	1984-85	Front	Auto; LX	1	EM-8077				
		Front	DX	1	EM-8080				
		Front	LX, Manual	1	EM-8514				
	1986-87	LH Front		1	EM-8080				
L4 2.0L 1998cc Diesel	1984-85	RH Front		1	EM-8077				
L4 2.0L 1998cc	1984-85	RH Front		1	EM-8077				
	1986-87	Rear		1	EM-8078				
L4 2.0L 1998cc Diesel	1984-85	Rear		1	EM-8078				

# Engine, Transmission, And Torque Strut Mounts

CYL	ENG. SIZE	YEAR	LOCATION	DESCRIPTION	QTY	ENGINE	TORQUE STRUT	TRANSMISSION
<b>MAZDA PASSENGER CAR (continued)</b>								
<b>626 (continued)</b>								
L4	L4 2.0L 1998cc	1984-85	Rear		1	EM-8078		
		1986-87	Trans - Rear	Auto	1			EM-5378
			Trans	Manual	1			EM-8091
	L4 2.2L 2184cc	1991-92	Front	Auto	1	EM-8083		
		1988-90	Front	Auto	1	EM-8083		
			Front	Manual	1	EM-8085		
		1991-92	RH Front		1	EM-8086		
		1988-90	RH Front		1	EM-8086		
		1991-92	Rear	Auto	1	EM-8087		
			Rear	Manual	1	EM-8088		
		1988-90	Rear	Auto	1	EM-8087		
			Rear	Manual	1	EM-8088		
		1990-92	Trans	Auto	1			EM-8516
			Trans	Manual	1			EM-8462
		1988-89	Trans	Auto	1			EM-5156
Trans	Manual		1			EM-8089		
V6	V6 2.5L 2497cc	1998-02	Front	Auto	1	EM-8073		
			Front	Manual	1	EM-9478		
		1993-97	Front		1	EM-8073		
		1998-02	RH Front		1	EM-8074		
		1993-97	RH Front		1	EM-8074		
		1998-02	Rear	Manual	1	EM-8456		
			Rear	Auto	1	EM-8075		
		1993-97	Rear	Manual	1	EM-8456		
			Trans - Center Lower	Auto	1			EM-9087
		1993-97	Trans - Center Lower	Auto	1			EM-9087
			Trans - Center Lower	Manual	1			EM-9082
			Trans - Upper	Auto	1			EM-8460
1998-02	Trans	Manual	1			EM-8457		
<b>808</b>								
L4	L4 1.6L 1587cc	1972-77	Trans		1			EM-2759
<b>929</b>								
V6	V6 3.0L	1992-95	Front		1	EM-5658		
		1988-89	Trans		1			EM-5563
<b>GLC</b>								
L4	L4 1.4L 1415cc	1979-80	Rear		1	EM-8095		
			Trans	Auto	1		EM-8512	
			Trans	Manual	1		EM-8512	
	L4 1.5L 1490cc	1983-85	Front		1	EM-8059		
		1981-82	Front		1	EM-8056		
		1983-85	RH Front		1	EM-8259		
		1981-82	RH Front		1	EM-8060		
		1983-85	Rear		1	EM-8424		
			Rear		1	EM-8424		
		1981-85	Torq Str - Front	Control Arm	1			EM-8425
			Torq Str - Rear	Control Arm	1			EM-8563
		1983-85	Trans	Auto	1			EM-8061
			Trans	Manual	1			EM-8061
		1981-82	Trans	Auto	1			EM-8263
			Trans	Manual	1			EM-8061

# Engine, Transmission, And Torque Strut Mounts

CYL	ENG. SIZE	YEAR	LOCATION	DESCRIPTION	QTY	ENGINE	TORQUE STRUT	TRANSMISSION	
<b>MAZDA PASSENGER CAR (continued)</b>									
<b>MIATA - MX5</b>									
L4	L4 1.6L 1597cc	1990-93	L & R Front		2	EM-8909			
	L4 1.8L 1839cc	1999-05	L & R Front		2	EM-8909			
		1994-97	L & R Front		2	EM-8909			
<b>MILLENNIA</b>									
V6	V6 2.3L 2254cc	1995-02	Front		1	EM-9007			
			RH Front		1	EM-9017			
			Rear		1	EM-9008			
			Trans		1			EM-8863	
	V6 2.5L 2497cc	1997-02	1995-96	Front		1	EM-8864		
				Front		1	EM-9007		
				RH Front		1	EM-9021		
				RH Front		1	EM-9021		
				Rear		1	EM-9008		
				Rear		1	EM-9008		
	1995-02	Trans		1			EM-8862		
<b>MX-3</b>									
L4	L4 1.6L 1597cc	1994-96	Front	Auto	1	EM-2910			
		1992-93	Front		1	EM-2651			
		1994-96	RH Front		1	EM-8609			
		1992-93	RH Front		1	EM-9131			
		1994-96	Rear	Manual	1	EM-8453			
		1992-93	Rear		1	EM-2815			
		1992-96	Trans	Manual	1			EM-2650	
V6	V6 1.8L 1597cc	1994	Front		1	EM-2651			
			RH Front		1	EM-8609			
			Rear		1	EM-2815			
	V6 1.8L 1845cc	1992-93	1992-94	Front		1	EM-2651		
				RH Front		1	EM-8813		
				Rear		1	EM-2815		
				Trans		1			EM-2650
<b>MX-6</b>									
L4	L4 2.0L 1991cc	1994-97	Front	Auto	1	EM-5155			
			Front	Manual	1	EM-8073			
		1993	Front	Auto	1	EM-5110			
			Front	Manual	1	EM-8073			
		1994-97	RH Front		1	EM-8074			
			RH Front		1	EM-8074			
		1994-97	Rear	Auto	1	EM-9476			
			Rear	Manual	1	EM-8456			
		1993	Rear	Auto	1	EM-8075			
			Rear	Manual	1	EM-8456			
		1994-97	Trans	Auto	1			EM-8691	
			Trans	Manual	1			EM-8457	
		1993	Trans	Auto	1			EM-8460	
			Trans	Manual	1			EM-8457	
	L4 2.2L 2184cc	1990-92	1988-89	Front	Auto	1	EM-8083		
				Front	Manual	1	EM-8085		
		1988-89	Front	Auto	1	EM-8083			
			Front	Manual	1	EM-8085			
		1990-92	RH Front		1	EM-8086			
			RH Front	LIFT	1	EM-8086			
1990-92		Rear	Auto	1	EM-8087				
		Rear	Manual; Exc. GT	1	EM-8088				
1988-89	Rear	Manual; GT	1	EM-9130					
	Rear	Auto; DX; LX	1	EM-8087					
	Rear	Manual; DX; LX	1	EM-8088					



# Engine, Transmission, And Torque Strut Mounts

CYL	ENG. SIZE	YEAR	LOCATION	DESCRIPTION	QTY	ENGINE	TORQUE STRUT	TRANSMISSION	
<b>MAZDA PASSENGER CAR (continued)</b>									
<b>MX-6 (continued)</b>									
L4	L4 2.2L 2184cc	1988-89	Rear	Manual; GT	1	EM-9130			
		1992	Trans	Auto	1			EM-8516	
			Trans	Manual	1			EM-9064	
		1988-91	Trans	Auto	1			EM-8516	
			Trans	Manual	1			EM-8462	
V6	V6 2.5L 2497cc	1994-97	Front		1	EM-8073			
		1993	Front		1	EM-8073			
		1994-97	Rear	Auto	1	EM-8075			
			Rear	Manual	1	EM-8456			
		1993	Rear	Auto	1	EM-8075			
			Rear	Manual	1	EM-8456			
		1993-97	Trans	Auto	1			EM-8460	
			Trans	Manual	1			EM-8457	
<b>PROTEGE</b>									
L4	L4 1.5L 1489cc	1995-98	Front	Auto	1	EM-8513			
			Front	Manual	1	EM-8062			
			RH Front		1	EM-8740			
			Rear		1	EM-8261			
			Trans		1			EM-8063	
	L4 1.6L 1589cc	1999-01	Front		1	EM-8885			
			RH Front		1	EM-8884			
		2001-03	Rear	Auto	1	EM-8889			
		1999-01	Rear	Auto	1	EM-8889			
			Rear	Manual	1	EM-8886			
			Trans	Auto	1			EM-8978	
			Trans	Manual	1			EM-8977	
	L4 1.8L 1839cc	1999-00	Front		1	EM-8885			
		1995-98	Front	Auto	1	EM-8513			
			Front	Manual	1	EM-8062			
		1990-94	LH Front		1	EM-2815			
		1999-00	RH Front		1	EM-9072			
		1995-98	RH Front		1	EM-8740			
		1990-94	RH Front		1	EM-2649			
		1999-00	Rear		1	EM-8882			
		1995-98	Rear		1	EM-8261			
		1990-94	Rear	Auto	1	EM-2650			
			Rear	Manual	1	EM-8453			
		1999-00	Trans	Auto	1			EM-8978	
			Trans	Manual	1			EM-8977	
		1996-98	Trans	Auto	1			EM-8063	
		1995	Trans	Auto	1			EM-8063	
			Trans	Manual	1			EM-8063	
		1990-94	Trans	Auto	1			EM-2815	
			Trans	Manual	1			EM-2815	
		L4 2.0L 2000cc	2003	Front		1	EM-8885		
			2001-02	Front		1	EM-8885		
	2003		RH Front	Auto	1	EM-9072			
	2001-02		RH Front	Auto	1	EM-9072			
	2003		Rear	Auto	1	EM-8882			
	2001-02		Rear	Auto	1	EM-8882			
	2001-03		Trans	Auto	1			EM-8978	
	<b>RX-7</b>								
	R2	R2 1.1L 1146cc	1979-85	L & R Front		2	EM-8055		
				Trans	Auto	1			EM-8512
Trans				Manual	1			EM-8095	
	R2 1.3L 1308cc	1986-91	L & R Front		2	EM-8424			

# Engine, Transmission, And Torque Strut Mounts

CYL	ENG. SIZE	YEAR	LOCATION	DESCRIPTION	QTY	ENGINE	TORQUE STRUT	TRANSMISSION
<b>MAZDA PASSENGER CAR (continued)</b>								
<b>RX-7 (continued)</b>								
R2	R2 1.3L 1308cc	1984-85	L & R Front		2	EM-8055		
		1986-91	Trans	Coupe	2			EM-8068
			Trans		2			EM-8068
		1984-85	Trans	Manual	1			EM-8095
<b>MAZDA SPORT UTILITY</b>								
<b>CX-7</b>								
L4	L4 2.3L 2260cc	2007-09	Torg Str - Rear		1		EM-9507	
		2007-12	Trans		1			EM-9537
<b>CX-9</b>								
V6	V6 3.5L 3456cc	2007	Torg Str - Rear		1		EM-9507	
			Trans		1		EM-9537	
	V6 3.7L	2010-12	Right		1	EM-7004		
		2008-09	Torg Str - Rear		1		EM-9507	
		2008-14	Trans		1			EM-9537
<b>NAVAJO</b>								
V6	V6 4.0L 4016cc	1991-94	LH Front		1	EM-2643		
			RH Front		1	EM-2641		
		1992-94	Trans	Auto	1			EM-2639
			Trans	Manual	1			EM-2639
<b>TRIBUTE</b>								
L4	L4 2.0L 1991cc	2001-04	RH Front		1	EM-3056*		
			Rear		1	EM-3057*		
			Trans	Auto	1		EM-3037	
	L4 2.3L	2005-08	Trans	Auto	1		EM-4117	
	L4 2.3L 140ci	2005-08	Front	Gas	1	EM-4033		
			LH Front	Gas	1	EM-4071		
			Rear	Gas	1	EM-4019		
	L4 2.5L	2009-11	LH Front	Gas	1	EM-4071		
			Rear	Gas	1	EM-4019		
	L4 2.5L 2488cc	2009-11	Trans	Auto	1		EM-4117	
V6	V6 3.0L	2001-04	Front		1	EM-3056*		
			RH Front		1	EM-3057*		
			Trans	Auto	1		EM-3037	
	V6 3.0L 183ci	2009-11	Front		1	EM-4033		
		2005-08	Front		1	EM-4033		
		2009-11	LH Front		1	EM-4071		
		2005-08	LH Front		1	EM-4071		
		2009-11	Rear	FWD	1	EM-4019		
2005-08	Rear		1	EM-4019				
<b>MAZDA TRUCK</b>								
<b>B1600</b>								
L4	L4 1.6L 1586cc	1972-76	LH Front		1	EM-2775		
			RH Front		1	EM-2774		
			Rear		1	EM-8095		
			Trans	Manual	1		EM-8079	
<b>B1800</b>								
L4	L4 1.8L 1796cc	1977-78	LH Front		1	EM-2775		
			RH Front		1	EM-2774		
			Trans	Manual	1		EM-8079	

# Engine, Transmission, And Torque Strut Mounts

CYL	ENG. SIZE	YEAR	LOCATION	DESCRIPTION	QTY	ENGINE	TORQUE STRUT	TRANS-MISSION
<b>MAZDA TRUCK (continued)</b>								
<b>B2000</b>								
L4	L4 2.0L 1970cc	1979-84	LH Front		1	EM-2775		
			RH Front		1	EM-2774		
			Trans	Manual	1			EM-8095
	L4 2.0L 1998cc	1986-87	L & R Front		2	EM-8094		
			Trans	Manual	1			EM-8095
<b>B2200</b>								
L4	L4 2.2L 2184cc	1987-93	L & R Front		2	EM-8094		
			Trans	Manual	1			EM-8095
	L4 2.2L 2209cc Diesel	1982-84	LH Front		1	EM-2775		
			RH Front		1	EM-2774		
			Trans		1			EM-8079
<b>B2300</b>								
L4	L4 2.3L	2001-09	LH Front		1	EM-3078		
			RH Front		1	EM-5377		
			Trans	Auto	1			EM-2639
			Trans	Manual	1			EM-2639
	L4 2.3L 2295cc	1994-97	L & R Front		2	EM-2698		
			Trans	Auto	1			EM-2639
			Trans	Manual	1			EM-2639
<b>B2500</b>								
L4	L4 2.5L 2492cc	1998-01	RH Front		1	EM-2853		
			Trans	Auto	1			EM-2639
			Trans	Manual	1			EM-2639
<b>B2600</b>								
L4	L4 2.6L 2555cc	1987-88	L & R Front		2	EM-8084		
			Trans	2WD	1			EM-8095
		1987-89	Trans	Manual	1			EM-8095
	L4 2.6L 2606cc	1989-93	L & R Front		2	EM-8578		
			1990-93	Trans	Manual	1		
<b>B3000</b>								
V6	V6 3.0L 2954cc	1998-07	L & R Front		2	EM-2853		
			Trans	Auto	1			EM-2639
			Trans	Manual	1			EM-2639
	V6 3.0L 2983cc	1994-96	LH Front	4WD	1	EM-2643		
			LH Front	RWD	1	EM-2643		
			RH Front	4WD	1	EM-2641		
			RH Front	RWD	1	EM-2640		
			Trans	Auto	1			EM-2639
			Trans	Manual	1			EM-2639
<b>B4000</b>								
V6	V6 4.0L	2005-09	LH Front	4WD	1	EM-2851		
			RH Front	4WD	1	EM-2935		
	V6 4.0L 4016cc	1994-97	LH Front	4WD	1	EM-2643		
			LH Front	RWD	1	EM-2642		
		1998-04	RH Front	4WD	1	EM-2935		
			RH Front	RWD	1	EM-2853		
		1994-97	RH Front	4WD	1	EM-2641		
			RH Front	RWD	1	EM-2641		
		1994-08	Trans	Auto	1			EM-2639
			Trans	Manual	1			EM-2639

# Engine, Transmission, And Torque Strut Mounts

CYL	ENG. SIZE	YEAR	LOCATION	DESCRIPTION	QTY	ENGINE	TORQUE STRUT	TRANSMISSION	
<b>MAZDA VAN</b>									
<b>5</b>									
L4	L4 2.3L	2006-10	RH Front	Complete Unit	1	EM-5362			
			RH Front	Insert Only	1	EM-3103			
			Rear	Auto; Bracket; with Bushing	1	EM-5783			
			Rear	Mount	1	EM-9222			
	L4 2.3L 2260cc	2006-10	Trans	Auto	1			EM-5923	
			Trans	Manual	1			EM-5923	
	L4 2.5L 2488cc	2012	Trans	Auto	1			EM-5864	
Trans			Manual	1			EM-9534		
<b>MPV</b>									
L4	L4 2.6L 2606cc	1989-94	L & R Front		2	EM-8093			
			1992-94	Trans	4WD	1		EM-8814	
		1989-91	Trans	RWD	1		EM-8693		
			Trans	Manual	1		EM-8693		
V6	V6 2.5L	2000-01	Front		1	EM-9468			
			Rear		1	EM-9472			
	V6 2.5L 2497cc	2000-01	Trans		1		EM-9527		
	V6 3.0L	2002-06	Front		1	EM-9468			
			Left		1	EM-9461			
			Rear		1	EM-9472			
	V6 3.0L 183ci	2002-06	Trans		1		EM-9527		
	V6 3.0L 2954cc	1996-98	L & R Front		2	EM-8868			
L & R Front				2	EM-8093				
1989-98		Trans	2WD	1		EM-8693			
		Trans	4WD	1		EM-8814			
<b>MERCEDES-BENZ PASSENGER CAR</b>									
<b>190D</b>									
L4	L4 2.2L 2197cc Diesel	1984-85	L & R Front	Auto	2	EM-9270			
			L & R Front	Manual	2	EM-9269			
			Trans	Auto	1		EM-9266		
L5	L5 2.5L	1988-89	Trans	Auto	1		EM-9266		
			1987	Trans	Auto; w/o Turbo	1		EM-9266	
			1986	Trans		1		EM-9266	
	L5 2.5L 2497cc Diesel	1988-89	L & R Front		2	EM-8662			
			1987	L & R Front	Turbo	2	EM-8836		
			L & R Front	w/o Turbo	2	EM-8662			
L5 2.5L 2497cc	1986	L & R Front		2	EM-8662				
<b>190DT</b>									
L5	L5 2.5L	1987	L & R Front	Turbo	2	EM-8836			
			Trans		1		EM-8632		
<b>190E</b>									
L4	L4 2.3L 2299cc	1991-93	L & R Front		2	EM-8662			
			1984-88	L & R Front		2	EM-8662		
		1991-93	Trans	Auto	1		EM-9266		
L6	L6 2.6L 2599cc	1987-93	L & R Front		2	EM-8662			
<b>230</b>									
L4	L4 2.3L 2307cc	1974-78	L & R Front		2	EM-8630			
		1974	Trans	Manual	1		EM-8629		
<b>240D</b>									
L4	L4 2.4L 2404cc Diesel	1974-83	L & R Front		2	EM-8229			
<b>260E</b>									
L6	L6 2.6L 2599cc	1987-89	L & R Front		2	EM-8662			
			Trans	Auto	1		EM-9266		

## Engine, Transmission, And Torque Strut Mounts

CYL	ENG. SIZE	YEAR	LOCATION	DESCRIPTION	QTY	ENGINE	TORQUE STRUT	TRANSMISSION
<b>MERCEDES-BENZ PASSENGER CAR (continued)</b>								
<b>280CE</b>								
L6	L6 2.8L 2746cc	1978-81	L & R Front		2	EM-8662		
			Trans		1			EM-8631
<b>280E</b>								
L6	L6 2.8L 2746cc	1977-81	L & R Front		2	EM-8662		
			Trans		1			EM-8631
<b>300CD</b>								
L5	L5 3.0L 3005cc Diesel	1978-81	Trans		1			EM-8631
<b>300CDT</b>								
L5	L5 3.0L 3005cc Diesel	1982-85	L & R Front		2	EM-8229		
			Trans		1			EM-8631
<b>300CE</b>								
L6	L6 3.0L	1988-89	Trans		1			EM-8632
	L6 3.0L 2962cc	1988-93	L & R Front		2	EM-8662		
		1990-92	Trans	Auto	1			EM-9266
	L6 3.2L 3199cc	1993	L & R Front		2	EM-8662		
Trans				1			EM-9266	
<b>300D</b>								
L5	L5 2.5L 2497cc Diesel	1990-93	L & R Front		2	EM-8836		
			Trans	Auto	1			EM-9266
	L5 3.0L 3005cc Diesel	1975-81	Trans		1			EM-8629
L6	L6 3.0L 2998cc Diesel	1987	L & R Front		2	EM-8662		
			Trans		1			EM-9266
<b>300DT</b>								
L5	L5 3.0L 3005cc Diesel	1982-85	L & R Front		2	EM-8229		
			Trans	Auto	1			EM-8230
<b>300E</b>								
L6	L6 2.6L 2599cc	1992	Trans	Auto	1			EM-9266
	L6 2.8L 2799cc	1993	L & R Front		2	EM-8662		
			Trans	Auto	1			EM-9091
	L6 3.0L 2962cc	1986-93	L & R Front		2	EM-8662		
			Trans		1			EM-8632
L6 3.2L 3199cc	1993	L & R Front		2	EM-8662			
		Trans	Auto	1			EM-9266	
<b>300SD</b>								
L5	L5 3.0L 3005cc Diesel	1978-85	L & R Front		2	EM-8229		
			Trans	Auto	1			EM-8629
L6	L6 3.4L 3449cc	1992-93	L & R Front		2	EM-8662		
	L6 3.4L 3449cc Diesel	1992-93	Trans		1			EM-9002
<b>300SDL</b>								
L6	L6 3.0L 2998cc Diesel	1986-87	L & R Front		2	EM-8229		
			Trans	Auto	1			EM-9266
<b>300SE</b>								
L6	L6 3.0L 2962cc	1988-91	LH Front		1	EM-8630		
			RH Front		1	EM-5374		
			Trans	Auto	1			EM-8230
	L6 3.2L 3199cc	1992-93	Trans		1			EM-9002
<b>300SEL</b>								
L6	L6 3.0L 2962cc	1988-91	LH Front		1	EM-8630		
			RH Front		1	EM-5374		
			Trans	Auto	1			EM-8230

# Engine, Transmission, And Torque Strut Mounts

CYL	ENG. SIZE	YEAR	LOCATION	DESCRIPTION	QTY	ENGINE	TORQUE STRUT	TRANSMISSION
<b>MERCEDES-BENZ PASSENGER CAR (continued)</b>								
<b>300SL</b>								
L6	L6 3.0L 2962cc	1990-93	L & R Front		2	EM-8834		
			Trans		1			EM-9266
<b>300TD</b>								
L5	L5 3.0L 3005cc Diesel	1979-81	L & R Front		2	EM-8229		
			Trans	Auto	1			EM-8631
<b>300TE</b>								
L6	L6 3.0L 2962cc	1988-93	L & R Front		2	EM-8662		
			Trans	Auto	1			EM-9266
	L6 3.2L 3199cc	1993	L & R Front		2	EM-8662		
			Trans		1			EM-8632
<b>350SD</b>								
L6	L6 3.4L 3449cc Diesel	1991	Trans	Auto	1			EM-9266
<b>350SDL</b>								
L6	L6 3.4L 3449cc Diesel	1990-91	Trans	Auto	1			EM-9266
<b>380SE</b>								
V8	V8 3.8L 3839cc	1984-85	L & R Front		2	EM-8229		
			Trans		1			EM-8230
<b>380SEC</b>								
V8	V8 3.8L 3839cc	1982-83	L & R Front		2	EM-8229		
			Trans		1			EM-8230
<b>380SEL</b>								
V8	V8 3.8L 3839cc	1981-83	L & R Front		2	EM-8229		
			Trans	Auto	1			EM-8230
<b>380SL</b>								
V8	V8 3.8L 3839cc	1981-85	Trans	Auto	1			EM-8629
<b>380SLC</b>								
V8	V8 3.8L 3839cc	1981	Trans		1			EM-8629
<b>400E</b>								
V8	V8 4.2L 4196cc	1992-93	L & R Front		2	EM-8834		
<b>400SE</b>								
V8	V8 4.2L 4196cc	1992	LH Front		1	EM-8834		
			Trans		1			EM-9002
<b>400SEL</b>								
V8	V8 4.2L 4196cc	1993	LH Front		1	EM-8834		
			Trans		1			EM-9002
<b>420SEL</b>								
V8	V8 4.2L 4196cc	1986-91	L & R Front		2	EM-8229		
			Trans		1			EM-8230
<b>450SE</b>								
V8	V8 4.5L 4520cc	1973-76	Trans		1			EM-8629
<b>450SEL</b>								
V8	V8 4.5L 4520cc	1973-80	Trans		1			EM-8629
<b>450SL</b>								
V8	V8 4.5L 4520cc	1973-80	Trans		1			EM-8629
<b>450SLC</b>								
V8	V8 4.5L 4520cc	1973-80	Trans		1			EM-8629

## Engine, Transmission, And Torque Strut Mounts

CYL	ENG. SIZE	YEAR	LOCATION	DESCRIPTION	QTY	ENGINE	TORQUE STRUT	TRANSMISSION
<b>MERCEDES-BENZ PASSENGER CAR (continued)</b>								
<b>500E</b>								
V8	V8 5.0L 4973cc DOH				2	EM-8834		
<b>500SEC</b>								
V8	V8 5.0L 4973cc DOH				2	EM-8834		
					2	EM-8229		
					1			EM-9002
			Trans		1			EM-8230
<b>500SEL</b>								
V8	V8 5.0L 4973cc DOH				2	EM-8229		
					1	EM-8834		
					1			EM-9002
			Trans	Auto	1			EM-8230
<b>500SL</b>								
V8	V8 5.0L 4973cc DOH				2	EM-8835		
					1			EM-9266
<b>560SEC</b>								
V8	V8 5.6L 5547cc	1986-91	L & R Front		2	EM-8229		
			Trans	Auto	1		EM-8230	
<b>560SEL</b>								
V8	V8 5.6L 5547cc	1986-91	L & R Front		2	EM-8229		
			Trans	Auto	1		EM-8230	
<b>600SEC</b>								
V12	V12 6.0L 5987cc	1993	L & R Front		2	EM-8838		
			Trans	Auto	1		EM-9002	
<b>600SEL</b>								
V12	V12 6.0L 5987cc	1992-93	L & R Front		2	EM-8838		
			Trans	Auto	1		EM-9002	
<b>600SL</b>								
V12	V12 6.0L 5987cc	1993	L & R Front		2	EM-8838		
<b>C32 AMG</b>								
V6	V6 3.2L	2002-04	L & R Front		1	EM-5434		
			Trans	Auto	1		EM-9268	
<b>C43 AMG</b>								
V8	V8 4.3L	1998-00	Trans	Auto	1			EM-9268
<b>C55 AMG</b>								
V8	V8 5.4L	2005-06	L & R Front		2	EM-5434		
	V8 5.5L	2005-06	Trans	Auto	1			EM-9268
<b>C220</b>								
L4	L4 2.2L 2199cc	1994-96	L & R Front		2	EM-8832		
			Trans	Auto	1		EM-9091	
<b>C230</b>								
L4	L4 1.8L	2003-05	Trans		1			EM-9268
	L4 1.8L 1796cc	2003-05	L & R Front		2	EM-5734		
	L4 2.3L	1999-00	Trans		1			EM-9268
	L4 2.3L 2295cc	1997-02	L & R Front		2	EM-8832		
V6	V6 2.5L	2006-07	Trans		1			EM-9268
<b>C240</b>								
V6	V6 2.6L	2001-05	Trans		1			EM-9268

# Engine, Transmission, And Torque Strut Mounts

CYL	ENG. SIZE	YEAR	LOCATION	DESCRIPTION	QTY	ENGINE	TORQUE STRUT	TRANS-MISSION	
<b>MERCEDES-BENZ PASSENGER CAR (continued)</b>									
<b>C280</b>									
L6	L6 2.8L 2799cc	1994-96	Trans		1			EM-9091	
V6	V6 2.8L	1998-00	Trans	Auto	1			EM-9268	
	V6 3.0L	2006-07	Trans		1			EM-9268	
<b>C350</b>									
V6	V6 3.5L	2006-08	Trans	US & Canada	1			EM-9268	
	V6 3.5L 3498cc	2008-11	L & R Front	RWD	2	EM-5859			
		2010-11	Trans	RWD	1			EM-5858	
<b>C300</b>									
V6	V6 3.0L	2008-11	L & R Front	RWD	2	EM-5859			
		2010-11	Trans	RWD	1			EM-5858	
<b>C320</b>									
V6	V6 3.2L	2001-05	Trans		1			EM-9268	
<b>CL55 AMG</b>									
V8	V8 5.5L	2001-06	L & R Front		2	EM-5434			
			Trans	Auto	1			EM-9268	
<b>CL65 AMG</b>									
V12	V12 6.0L	2005-09	Trans		1			EM-9268	
<b>CL500</b>									
V8	V8 5.0L 4966cc SOH		Trans		1			EM-9268	
			Trans	Mexican Vehicle	1			EM-9268	
			V8 5.0L 4973cc DOH			2	EM-5434		
						2	EM-8835		
		Trans		1			EM-9268		
<b>CL600</b>									
V12	V12 5.5L	2003-09	Trans	Auto	1			EM-9268	
	V12 5.8L	2001-02	Trans	Auto	1			EM-9268	
	V12 6.0L	1998-99	Trans		1			EM-9268	
	V12 6.0L 5987cc	1998-99	L & R Front		2	EM-8838			
<b>CLK550</b>									
V8	V8 5.5L	2007-09	L & R Front		2	EM-5434			
			Trans		1			EM-9268	
<b>CLK55 AMG</b>									
V8	V8 5.5L	2004-06	L & R Front		2	EM-5434			
		2001-06	Trans	Auto	1			EM-9268	
<b>CLK320</b>									
V6	V6 3.2L	1998-05	Trans	Auto	1			EM-9268	
<b>CLK430</b>									
V8	V8 4.3L	1999-03	Trans	Auto	1			EM-9268	
<b>CLK500</b>									
V8	V8 5.0L	2003-06	Trans	Auto	1			EM-9268	
<b>CLK63 AMG</b>									
V8	V8 6.2L	2007-08	L & R Front		2	EM-5434			
<b>CLS500</b>									
V8	V8 5.0L	2006	Trans		1			EM-9268	
<b>CLS550</b>									
V8	V8 5.5L	2010-12	Trans	RWD	1			EM-5858	



# Engine, Transmission, And Torque Strut Mounts

CYL	ENG. SIZE	YEAR	LOCATION	DESCRIPTION	QTY	ENGINE	TORQUE STRUT	TRANSMISSION
<b>MERCEDES-BENZ PASSENGER CAR (continued)</b>								
<b>E250</b>								
V6	V6 3.5L 3498cc	2011	L & R Front	Mexico	2	EM-5859		
<b>E300D</b>								
L6	L6 3.0L 2996cc Diesel	1995-99	L & R Front		2	EM-8832		
<b>E350</b>								
V6	V6 3.5L 3498cc	2010-11	L & R Front		2	EM-5859		
			Trans	RWD	1			EM-5858
<b>E320</b>								
L6	L6 3.2L	2004-06	Trans	Auto	1			EM-9268
		1998-03	Trans	Exc. 4-Matic	1			EM-9268
		1996-97	Trans	Auto	1			EM-9268
	L6 3.2L 3199cc	1996-97	L & R Front		2	EM-5394		
		1994-95	L & R Front		2	EM-8662		
	L6 3.2L 3222cc Diesel	2005-06	Trans	Auto	1			EM-9266
V6	V6 3.0L 2987cc Diese		Trans	Auto	1			EM-9268
V6	V6 3.2L	2003-05	LH Front		1	EM-9562		
			RH Front		1	EM-9562		
		1998-02	RH Front	AWD	1	EM-8832		
<b>E420</b>								
V8	V8 4.2L	1997	Trans	Auto	1			EM-9268
	V8 4.2L 4196cc	1994-95	L & R Front		2	EM-8834		
<b>E55 AMG</b>								
V8	V8 5.5L	1999-06	Trans	Auto	1			EM-9268
<b>E550</b>								
V8	V8 5.5L	2010-11	Trans	RWD	1			EM-5858
<b>E500</b>								
V8	V8 5.0L	2003-06	Trans	Auto	1			EM-9268
	V8 5.0L 4973cc DOH				2	EM-8834		
<b>G55 AMG</b>								
V8	V8 5.5L	2003-09	Trans		1			EM-9268
<b>G500</b>								
V8	V8 5.0L	2002-06	Trans		1			EM-9268
<b>S55 AMG</b>								
V8	V8 5.5L	2001-06	Trans	Auto	1			EM-9268
<b>S320</b>								
L6	L6 3.2L	1997-99	Trans	Auto	1			EM-9268
		L6 3.2L 3199cc	1994-99	L & R Front	2	EM-8838		
			1994-96	Trans		1		EM-9002
<b>S350</b>								
L6	L6 3.4L 3449cc	1994-95	L & R Front		2	EM-8662		
<b>S350D</b>								
L6	L6 3.4L 3449cc Diesel	1994-95	Trans		1			EM-9002
<b>S420</b>								
V8	V8 4.2L V8 4.2L 4196cc	1996-99	Trans	Auto	1			EM-9268
		1996-99	LH Front		1	EM-8835		
		1994-95	LH Front		1	EM-8834		
			RH Front		1	EM-8662		
			Trans	Auto	1			EM-9002

# Engine, Transmission, And Torque Strut Mounts

CYL	ENG. SIZE	YEAR	LOCATION	DESCRIPTION	QTY	ENGINE	TORQUE STRUT	TRANS-MISSION
<b>MERCEDES-BENZ PASSENGER CAR (continued)</b>								
<b>S430</b>								
V8	V8 4.3L	2000-06	Trans		1			EM-9268
<b>S550</b>								
V8	V8 5.5L	2007-09	Trans		1			EM-9268
<b>S500</b>								
V8	V8 5.0L	1996-06	Trans	Auto	1			EM-9268
	V8 5.0L 4973cc DOH				2	EM-8835		
			Trans		1			EM-9002
<b>S600</b>								
V12	V12 5.5L	2003-09	Trans		1			EM-9268
	V12 5.8L	2001-02	Trans	Auto	1			EM-9268
	V12 6.0L	1996-99	Trans	Auto	1			EM-9268
	V12 6.0L 5987cc	1994-99	L & R Front		2	EM-8838		
1994-95		Trans		1			EM-9002	
<b>S65 AMG</b>								
V12	V12 6.0L	2006-09	Trans		1			EM-9268
<b>SL65 AMG</b>								
V12	V12 6.0L	2005-09	Trans		1			EM-9268
<b>SL320</b>								
L6	L6 3.2L	1997	Trans	Auto	1			EM-9268
	L6 3.2L 3199cc	1994-97	L & R Front		2	EM-8834		
		1994-96	Trans	Auto	1			EM-9266
<b>SL500</b>								
V8	V8 5.0L	1998	L & R Front		2	EM-8838		
		1996-06	Trans	Auto	1			EM-9268
	V8 5.0L 4973cc DOH				2	EM-8835		
			Trans	Auto	1			EM-9266
<b>SL600</b>								
V12	V12 5.5L	2004-09	Trans		1			EM-9268
	V12 6.0L	1996-02	Trans	Auto	1			EM-9268
	V12 6.0L 5987cc	1994-02	L & R Front		2	EM-8838		
<b>SLK32 AMG</b>								
V6	V6 3.2L	2002-04	Trans		1			EM-9268
<b>SLK300</b>								
V6	V6 3.0L	2009-11	Trans		1			EM-5858
<b>SLK55 AMG</b>								
V8	V8 5.5L	2010-11	Trans		1			EM-5858
		2005-09	Trans		1			EM-9268
<b>SLK280</b>								
V6	V6 3.0L	2006-08	Trans		1			EM-5858
<b>SLK350</b>								
V6	V6 3.5L 3498cc	2005-11	Trans		1			EM-5858
<b>SLK230</b>								
L4	L4 2.3L	2000-04	Trans	Auto	1			EM-9268
		1998-99	Trans		1			EM-5737
	L4 2.3L 2295cc	1998-99	L & R Front		2	EM-8832		
<b>SLR MCLAREN</b>								
V8	V8 5.5L	2005-09	Trans		1			EM-9268

## Engine, Transmission, And Torque Strut Mounts

CYL	ENG. SIZE	YEAR	LOCATION	DESCRIPTION	QTY	ENGINE	TORQUE STRUT	TRANSMISSION
<b>MERCEDES-BENZ PASSENGER CAR (continued)</b>								
<b>SLK320</b>								
V6	V6 3.2L	2001-04	Trans		1			EM-9268
<b>MERCEDES-BENZ SPORT UTILITY</b>								
<b>ML320</b>								
V6	V6 3.2L	1998-03	L & R Front		2	EM-9265		
			Trans		1			EM-9267
<b>ML350</b>								
V6	V6 3.7L	2003-05	L & R Front		2	EM-9265		
			Trans	Auto	1			EM-9267
<b>ML430</b>								
V8	V8 4.3L	1999-01	L & R Front		2	EM-9265		
<b>ML500</b>								
V8	V8 5.0L	2002-05	L & R Front		2	EM-9265		
			Trans		1			EM-9267
<b>MERCURY PASSENGER CAR</b>								
<b>BOBCAT</b>								
L4	L4 2.3L 140ci	1975-80	L & R Front		2	EM-2344		
			Trans	Auto	1			EM-2346
			Trans	Manual	1			EM-2346
V6	V6 2.8L 171ci	1975-79	L & R Front		2	EM-2344		
			Trans	Auto	1			EM-2346
			Trans	Manual	1			EM-2346
<b>BROUGHAM</b>								
V8	V8 6.7L 410ci	1967	LH Front		1	EM-2241		
			RH Front		1	EM-2240		
			Trans		1			EM-2242
	V8 7.0L 427ci	1967	LH Front		1	EM-2241		
			RH Front		1	EM-2240		
			Trans		1			EM-2242
<b>CALIENTE</b>								
L6	L6 3.3L 200ci	1966-67	L & R Front		2	EM-2333		
		1964-65	LH Front		1	EM-2226		
			RH Front		1	EM-2225		
		1966-67	Trans		1			EM-2253
V8	V8 4.3L 260ci	1964	LH Front		1	EM-2220		
			RH Front		1	EM-2221		
	V8 4.7L 289ci	1966-67	L & R Front		2	EM-2257		
		1964-65	LH Front		1	EM-2220		
			RH Front		1	EM-2221		
		1966-67	Trans		1			EM-2253
	V8 6.4L 390ci	1966-67	Trans		1			EM-2253
	V8 7.0L 427ci	1965	LH Front		1	EM-2241		
			RH Front		1	EM-2240		
<b>CAPRI</b>								
L4	L4 1.6L 1598cc	1971-72	L & R Front		2	EM-2363		
		1971	Trans	Auto	1			EM-2471
			Trans	Manual	1			EM-2471
	L4 2.0L 1989cc	1971-74	L & R Front		2	EM-2363		
		1973-74	Trans	Auto	1			EM-2346
			Trans	Manual	1			EM-2346
		1972	Trans	After 10/1/72	1			EM-2346
			Trans	Before 10/1/72	1			EM-2471
		1971	Trans	Auto	1			EM-2471

# Engine, Transmission, And Torque Strut Mounts

CYL	ENG. SIZE	YEAR	LOCATION	DESCRIPTION	QTY	ENGINE	TORQUE STRUT	TRANSMISSION	
<b>MERCURY PASSENGER CAR (continued)</b>									
<b>CAPRI (continued)</b>									
L4	L4 2.0L 1989cc	1971	Trans	Manual	1			EM-2471	
	L4 2.3L 140ci	1979-86	LH Front	w/o Turbo	1	EM-2458			
		1976-77	LH Front		1	EM-2458			
		1979-86	RH Front	w/o Turbo	1	EM-2457			
		1976-77	RH Front		1	EM-2457			
		1979-85	Trans	Auto	1			EM-2388	
			Trans	Manual	1			EM-2388	
		1976-77	Trans	Auto	1			EM-2388	
			Trans	Manual	1		EM-2388		
L6	L6 3.3L 200ci	1979-82	L & R Front		2	EM-2385			
		1982	Trans	Auto	1			EM-2388	
			Trans	Manual	1			EM-2388	
		1979-81	Trans	Auto	1			EM-2389	
			Trans	Manual	1			EM-2389	
V6	V6 2.8L 171ci	1976-77	L & R Front		2	EM-2344			
		1974	L & R Front		2	EM-2344			
		1979	LH Front		1	EM-2458			
			RH Front		1	EM-2457			
			Trans	Auto	1			EM-2388	
			Trans	Manual	1			EM-2388	
		1976-77	Trans		1			EM-2566	
		1974	Trans		1			EM-2566	
		V6 3.8L 232ci	1985-86	LH Front		1	EM-2682		
			1984	LH Front	After 12/1/83	1	EM-2682		
	LH Front			Before 12/1/83	1	EM-2500			
	1983		LH Front		1	EM-2500			
	1985-86		RH Front		1	EM-2683			
	1984		RH Front	After 12/1/83	1	EM-2683			
			RH Front	Before 12/1/83	1	EM-2501			
	1983		RH Front		1	EM-2501			
	1985-86		Trans	Auto; C5	1			EM-2389	
			Trans	Manual	1			EM-2389	
	1983-84	Trans	Auto; C3 & C5 Canada	1			EM-2389		
		Trans	Auto; C3 & C5 US	1			EM-2388		
Trans		Manual	1			EM-2389			
V8	V8 4.2L 255ci	1980-82	LH Front		1	EM-2458			
			RH Front		1	EM-2457			
			Trans	Auto	1			EM-2388	
			Trans	Manual	1			EM-2388	
		V8 5.0L 302ci	1985-86	LH Front		1	EM-2682		
	1984		LH Front	After 12/1/83	1	EM-2682			
			LH Front	Before 12/1/83	1	EM-2458			
	1982-83		LH Front		1	EM-2458			
	1979		LH Front		1	EM-2458			
	1985-86		RH Front		1	EM-2683			
	1984		RH Front	After 12/1/83	1	EM-2683			
			RH Front	Before 12/1/83	1	EM-2457			
	1982-83		RH Front		1	EM-2457			
	1979		RH Front		1	EM-2457			
	1982-86		Trans	Auto	1			EM-2388	
			Trans	Manual	1			EM-2388	
	1979		Trans	Auto	1			EM-2388	
			Trans	Manual	1			EM-2388	

## Engine, Transmission, And Torque Strut Mounts

CYL	ENG. SIZE	YEAR	LOCATION	DESCRIPTION	QTY	ENGINE	TORQUE STRUT	TRANSMISSION	
<b>MERCURY PASSENGER CAR (continued)</b>									
<b>COLONY PARK</b>									
V8	V8 4.8L 292ci	1961-62	L & R Front		2	EM-2141			
	V8 5.0L 302ci	1984-91	LH Front		1	EM-2438			
		1979-82	LH Front		1	EM-2438			
		1984-91	RH Front		1	EM-2437			
		1979-82	RH Front		1	EM-2437			
		1984-91	Trans		1			EM-2464	
		1979-82	Trans		1			EM-2464	
	V8 5.1L 312ci	1959-60	L & R Front		2	EM-2141			
	V8 5.8L 351ci	1979-81	LH Front		1	EM-2438			
		1971-73	LH Front		1	EM-2359			
		1979-81	RH Front		1	EM-2437			
		1971-73	RH Front		1	EM-2358			
		1979-81	Trans		1			EM-2464	
		1971-73	Trans	Auto	1			EM-2345	
				Trans	Manual	1		EM-2345	
	V8 5.8L 352ci	1961-62	L & R Front		2	EM-2141			
	V8 6.4L 390ci	1969-70	LH Front		1	EM-2271			
		1967-68	LH Front		1	EM-2241			
		1962-64	LH Front		1	EM-2226			
		1969-70	RH Front		1	EM-2270			
		1967-68	RH Front		1	EM-2240			
		1962-64	RH Front		1	EM-2225			
		1969-70	Trans	Auto	1			EM-2345	
					Trans	Manual	1		EM-2345
		1965-68	Trans	Auto	1			EM-2242	
					Trans	Manual	1		EM-2242
		1962-64	Trans		1			EM-2349	
		V8 6.6L 400ci	1971-76	LH Front		1	EM-2359		
	RH Front				1	EM-2358			
	1971-74		Trans	Auto	1			EM-2345	
			Trans	Manual	1			EM-2345	
	V8 6.7L 410ci	1966-67	LH Front		1	EM-2241			
			RH Front		1	EM-2240			
			Trans		1			EM-2242	
	V8 7.0L 427ci	1965-67	LH Front		1	EM-2241			
			RH Front		1	EM-2240			
	V8 7.0L 428ci	1966-68	LH Front		1	EM-2241			
			RH Front		1	EM-2240			
			Trans		1			EM-2242	
	V8 7.0L 429ci	1969-73	LH Front		1	EM-2368			
			RH Front		1	EM-2367			
			Trans	Auto	1			EM-2345	
Trans			Manual	1			EM-2345		
V8 7.5L 460ci	1976	LH Front		1	EM-2368				
	1972-74	LH Front		1	EM-2368				
	1976	RH Front		1	EM-2367				
	1972-74	RH Front		1	EM-2367				
		Trans	Auto	1			EM-2345		
		Trans	Manual	1			EM-2345		
<b>COMET</b>									
L6	L6 2.4L 144ci	1962	L & R Front	Before 5/7/62	2	EM-2170			
		1960-61	L & R Front		2	EM-2170			
		1963	LH Front		1	EM-2226			
		1962	LH Front	After 5/7/62	1	EM-2226			
		1963	RH Front		1	EM-2225			
		1962	RH Front	After 5/7/62	1	EM-2225			
		1960-61	Trans	w/ Cantelever	1			EM-2172	

# Engine, Transmission, And Torque Strut Mounts

CYL	ENG. SIZE	YEAR	LOCATION	DESCRIPTION	QTY	ENGINE	TORQUE STRUT	TRANSMISSION
<b>MERCURY PASSENGER CAR (continued)</b>								
<b>COMET (continued)</b>								
L6	L6 2.4L 144ci	1960-61	Trans	w/o Cantelever	1			EM-2172
		1962-63	Trans		1			EM-2171
		1960-61	Trans		1			EM-2171
			Trans		1			EM-2171
	L6 2.8L 170ci	1971-72	L & R Front		2	EM-2333		
			1962	L & R Front	Before 5/7/62	2	EM-2170	
		1961	L & R Front		2	EM-2170		
		1963-64	LH Front		1	EM-2226		
		1962	LH Front	After 5/7/62	1	EM-2226		
		1963-64	RH Front		1	EM-2225		
		1962	RH Front	After 5/7/62	1	EM-2225		
		1961	Trans	w/ Cantelever	1			EM-2172
			Trans	w/o Cantelever	1			EM-2172
		1971-72	Trans	Auto	1			EM-2253
			Trans	Manual	1			EM-2253
		1962-64	Trans		1			EM-2171
		1961	Trans		1			EM-2171
			Trans		1			EM-2171
	L6 3.3L 200ci	1971-77	L & R Front		2	EM-2341		
			1966-68	L & R Front		2	EM-2333	
		1964-65	LH Front		1	EM-2226		
			RH Front		1	EM-2225		
		1971-77	Trans	Auto	1			EM-2253
			Trans	Manual	1			EM-2253
		1966-68	Trans	Auto	1			EM-2253
			Trans	Manual	1			EM-2253
	1964-65	Trans		1			EM-2171	
	L6 4.1L 250ci	1973-77	L & R Front		2	EM-2341		
		1971-72	L & R Front		2	EM-2333		
		1969	L & R Front		2	EM-2333		
		1971-77	Trans	Auto	1			EM-2253
			Trans	Manual	1			EM-2253
		1969	Trans	Auto	1			EM-2253
	Trans	Manual	1				EM-2253	
	V8	V8 4.3L 260ci	1963-64	LH Front		1	EM-2220	
			RH Front		1	EM-2221		
V8 4.7L 289ci		1966-67	L & R Front	Convertible	2	EM-2286		
			L & R Front	Coupe	2	EM-2257		
		1964-65	LH Front		1	EM-2220		
			RH Front		1	EM-2221		
1966-67		Trans	Auto	1			EM-2253	
		Trans	Manual	1			EM-2253	
		1964-65	Trans		1		EM-2171	
V8 5.0L 302ci		1971-77	L & R Front		2	EM-2316		
			1968-69	L & R Front		2	EM-2286	
		1971-77	Trans	Auto	1			EM-2253
			Trans	Manual	1			EM-2253
		1968-69	Trans	Auto	1			EM-2253
Trans			Manual	1			EM-2253	
V8 6.4L 390ci		1968-69	LH Front		1	EM-2241		
			RH Front		1	EM-2240		
		1966-69	Trans	Auto	1			EM-2253
Trans		Manual	1				EM-2253	
V8 7.0L 427ci		1965-67	LH Front		1	EM-2241		
			RH Front		1	EM-2240		
		Trans	Auto	1			EM-2253	
			Manual	1			EM-2253	

# Engine, Transmission, And Torque Strut Mounts

CYL	ENG. SIZE	YEAR	LOCATION	DESCRIPTION	QTY	ENGINE	TORQUE STRUT	TRANSMISSION			
<b>MERCURY PASSENGER CAR (continued)</b>											
<b>COMMUTER</b>											
V8	V8 5.1L 312ci	1957-60	L & R Front		2	EM-2141					
	V8 5.8L 352ci	1961	L & R Front		2	EM-2141					
	V8 6.7L 410ci	1966-67	LH Front		1	EM-2241					
			RH Front		1	EM-2240					
			Trans		1			EM-2242			
	V8 7.0L 427ci	1966-68	LH Front		1	EM-2241					
			RH Front		1	EM-2240					
Trans				1			EM-2242				
<b>COUGAR</b>											
L4	L4 2.0L 1989cc	1999-02	Front	Auto; Insert	1	EM-2885					
			Front	Manual; Insert	1	EM-2888					
			RH Front		1	EM-2890					
		2002	Trans - LH		1			EM-2873			
		1999-01	Trans - LH		1			EM-2873			
			Trans - Rear	Auto; Insert	1			EM-2888			
	L4 2.3L 140ci	1984	LH Front		1	EM-5109					
			LH Front		1	EM-2457					
			RH Front		1	EM-5108					
			RH Front		1	EM-2458					
			1985-86	Trans	Auto	1			EM-2707		
				Trans	Manual	1			EM-2707		
			1984	Trans	Auto	1			EM-2388		
			1981	Trans	Auto	1			EM-2388		
L6	L6 3.3L 200ci	1981-82	L & R Front	Column Shift	2	EM-2776					
			L & R Front	Floor Shift	2	EM-2385					
		1980	L & R Front		2	EM-2776					
			Trans	Auto; C5	1			EM-2388			
		1981	Trans	XR7	1			EM-2389			
			Trans	Auto; C3	1			EM-2389			
		1980	Trans	Auto; C4	1			EM-2388			
			Trans	Auto	1			EM-2388			
		V6	V6 2.5L 2450cc	1999-02	LH Front	Auto; Insert	1	EM-2885			
					LH Front	Manual; Insert	1	EM-2888			
RH Front	Complete Unit				1	EM-5352					
Trans - Front	Auto; Complete Unit; Att. to Fender Apron				1			EM-2888			
Trans - Front	Auto; Insert; Att. to Fender Apron				1			EM-3119			
V6 3.8L 232ci	1986-97				L & R Front		2	EM-2661			
			LH Front		1	EM-2682					
			LH Front		1	EM-2500					
			RH Front		1	EM-2683					
			RH Front		1	EM-2501					
			Trans	Auto	1			EM-2707			
			Trans	Auto	1			EM-2707			
			Trans	Manual	1			EM-2707			
			Trans	Auto; C5	1			EM-2389			
			Trans	Auto; AOT	1			EM-2388			
			Trans	Auto; C5	1			EM-2389			
			1982	Trans	Auto	1			EM-2388		
			V8	V8 4.2L 255ci	1980-82	LH Front	w/ Shake Condition	1	EM-2725		
						LH Front	w/o Shake Condition	1	EM-2500		
RH Front	w/ Shake Condition					1	EM-2726				
RH Front	w/o Shake Condition	1				EM-2501					
Trans	Auto	1						EM-2388			

# Engine, Transmission, And Torque Strut Mounts

CYL	ENG. SIZE	YEAR	LOCATION	DESCRIPTION	QTY	ENGINE	TORQUE STRUT	TRANSMISSION
<b>MERCURY PASSENGER CAR (continued)</b>								
<b>COUGAR (continued)</b>								
V8	V8 4.6L 281ci	1994-97	L & R Front		2	EM-5048		
			Trans	Auto	1		EM-2707	
V8	V8 4.7L 289ci	1967-68	L & R Front		2	EM-2257		
			Trans	Auto	1		EM-2253	
			Trans	Manual	1		EM-2253	
V8	V8 5.0L 302ci	1991-93	L & R Front		2	EM-2995		
			1986-88	L & R Front		2	EM-2661	
		1983-85	LH Front		1	EM-2682		
			LH Front	w/ Shake Condition	1	EM-2725		
		1980-81	LH Front	w/o Shake Condition	1	EM-2500		
			LH Front		1	EM-2371		
		1983-85	RH Front		1	EM-2683		
			RH Front	w/ Shake Condition	1	EM-2726		
		1980-81	RH Front	w/o Shake Condition	1	EM-2501		
			RH Front		1	EM-2370		
		1991-93	Trans	Auto	1		EM-2707	
		1987-88	Trans	Auto	1		EM-2388	
		1985-86	Trans	Auto	1		EM-2388	
		1983-84	Trans	Auto	1		EM-2388	
		1977-81	Trans	Auto	1		EM-2388	
V8	V8 5.8L 351ci	1969-72	L & R Front		2	EM-2257		
			1977-79	LH Front	Modified Engine	1	EM-2365	
		1974-76	LH Front	Cleveland Engine; Windsor Engine	1	EM-2371		
			LH Front	Modified Engine	1	EM-2365		
		1973	LH Front	Windsor Engine	1	EM-2371		
		1977-79	RH Front	Modified Engine	1	EM-2364		
		1974-76	RH Front	Cleveland Engine; Windsor Engine	1	EM-2370		
			RH Front	Modified Engine	1	EM-2364		
		1973	RH Front	Windsor Engine	1	EM-2370		
		1977-79	Trans	Auto	1		EM-2464	
		1975-76	Trans	Auto; Modified Engine	1		EM-2464	
			Trans	Auto; C4; Windsor Engine	1		EM-2372	
		1974	Trans	Auto; C6	1		EM-2347	
			Trans	Modified Engine	1		EM-2464	
		1974	Trans	Auto; AOD; Windsor & Cleveland Engines	1		EM-2347	
Trans	Auto; C4; Windsor & Cleveland Engines		1		EM-2372			
1969-73	Trans	Auto	1		EM-2253			
	Trans	Manual	1		EM-2253			
V8	V8 6.4L 390ci	1967-69	L & R Front		2	EM-2257		
			Trans	Auto	1		EM-2253	
			Trans	Manual	1		EM-2253	
V8	V8 6.6L 400ci	1973-78	LH Front		1	EM-2365		
			RH Front		1	EM-2364		
		1977-78	Trans	Auto	1		EM-2464	
		1973-76	Trans		1		EM-2372	
V8	V8 7.0L 427ci	1968	L & R Front		2	EM-2257		
			Trans	Auto	1		EM-2253	
			Trans	Manual	1		EM-2253	
V8	V8 7.0L 428ci	1968-70	L & R Front		2	EM-2257		
			Trans	Auto	1		EM-2253	
			Trans	Manual	1		EM-2253	
V8	V8 7.0L 429ci	1970-71	LH Front		1	EM-2724		
			RH Front		1	EM-2723		



# Engine, Transmission, And Torque Strut Mounts

CYL	ENG. SIZE	YEAR	LOCATION	DESCRIPTION	QTY	ENGINE	TORQUE STRUT	TRANSMISSION	
<b>MERCURY PASSENGER CAR (continued)</b>									
<b>COUGAR (continued)</b>									
V8	V8 7.0L 429ci	1970-71	Trans	Auto	1			EM-2253	
			Trans	Manual	1			EM-2253	
	V8 7.5L 460ci	1973-76	Trans		1			EM-2372	
<b>COUNTRY CRUISER</b>									
V8	V8 5.1L 312ci	1959-60	L & R Front		2	EM-2141			
<b>CUSTOM</b>									
V8	V8 5.1L 312ci	1956	L & R Front		2	EM-2141			
<b>GRAND MARQUIS</b>									
V8	V8 4.2L 255ci	1981-82	LH Front		1	EM-2438			
			RH Front		1	EM-2437			
			Trans		1			EM-2464	
	V8 4.6L 281ci	2003-10 1998-02 1992-97 2003-10 1998-02 1992-97 2003-10 1998-02 1993-97 1992		LH Front		1	EM-3025		
				LH Front		1	EM-2861		
				LH Front		1	EM-2807		
				RH Front		1	EM-3024		
				RH Front		1	EM-2860		
				RH Front		1	EM-2806		
				Trans		1			EM-3038
				Trans		1			EM-2822
				Trans		1			EM-2822
	Trans	After 2/5/92	1			EM-2822			
		Before 2/5/92	1			EM-2448			
	V8 5.0L 302ci	1979-91	LH Front		1	EM-2438			
			RH Front		1	EM-2437			
			Trans		1			EM-2464	
	V8 5.8L 351ci	1983-89 1978-81 1983-89 1978-81 1983-89 1978-81		LH Front		1	EM-2438		
				LH Front		1	EM-2359		
				RH Front		1	EM-2437		
				RH Front		1	EM-2358		
				Trans		1			EM-2464
	Trans		1			EM-2345			
	V8 6.6L 400ci	1975-78	LH Front		1	EM-2359			
			RH Front		1	EM-2358			
			Trans		1			EM-2345	
	V8 7.5L 460ci	1975-78	LH Front		1	EM-2368			
RH Front				1	EM-2367				
Trans				1			EM-2345		
<b>LN7</b>									
L4	L4 1.6L 1598cc	1982-83	Front	Auto	1	EM-2461			
			Front	Manual	1	EM-2460			
			RH Front	RH Front	1	EM-2459			
			Trans	Auto	1			EM-2463	
			Trans	Manual	1			EM-2463	
<b>LYNX</b>									
L4	L4 1.6L 1598cc	1984-85 1981-83 1984-85 1981-83 1984-85 1981-83 1984-85 1981-83	Front		1	EM-2559			
			Front	Auto	1	EM-2461			
			Front	Manual	1	EM-2460			
			RH Front		1	EM-2558			
			RH Front		1	EM-2459			
			Trans	Auto	1			EM-2632	
				Manual; 4 Spd	1			EM-2634	
				Manual; 5 Spd	1			EM-2665	
			Trans	Auto	1			EM-2463	
				Manual	1			EM-2463	
			L4 1.9L 116ci	1985-87	Front		1	EM-2559	

# Engine, Transmission, And Torque Strut Mounts

CYL	ENG. SIZE	YEAR	LOCATION	DESCRIPTION	QTY	ENGINE	TORQUE STRUT	TRANSMISSION
<b>MERCURY PASSENGER CAR (continued)</b>								
<b>LYNX (continued)</b>								
L4	L4 1.9L 116ci	1985-87	LH Front	Auto	1	EM-5063		
			LH Front	Manual	1	EM-5064		
			RH Front		1	EM-2558		
			Trans	Auto	1			EM-2632
			Trans	Manual	1			EM-2665
	L4 2.0L 1989cc Diesel	1984	Front	Manual; 4 Spd	1	EM-2559		
			LH Front	Auto	1	EM-5063		
LH Front			Manual; 4 Spd	1	EM-5065			
LH Front			Manual; 5 Spd	1	EM-5064			
<b>MARAUDER</b>								
V8	V8 4.6L 281ci	2003-04	LH Front		1	EM-3024		
			RH Front		1	EM-3025		
			Trans		1			EM-3038
	V8 6.4L 390ci	1969-70 1967 1963-64 1969-70 1967 1963-64 1969-70	LH Front		1	EM-2271		
			LH Front		1	EM-2241		
			LH Front		1	EM-2226		
			RH Front		1	EM-2270		
			RH Front		1	EM-2240		
			RH Front		1	EM-2225		
			Trans	Auto	1			EM-2345
			Trans	Manual	1			EM-2345
	V8 7.0L 427ci	1965	LH Front		1	EM-2241		
			RH Front		1	EM-2240		
			LH Front		1	EM-2368		
	V8 7.0L 429ci	1969-70	RH Front		1	EM-2367		
			Trans	Auto	1			EM-2345
			Trans	Manual	1			EM-2345
Trans			Manual	1			EM-2345	
<b>MARQUIS</b>								
L4	L4 2.3L 140ci	1983-86	LH Front		1	EM-2458		
			RH Front		1	EM-2457		
			Trans		1			EM-2388
L6	L6 3.3L 200ci	1983	Trans		1			EM-2388
V6	V6 3.8L 232ci	1985-86	LH Front		1	EM-2682		
			LH Front	After 12/1/83	1	EM-2682		
		1984	LH Front	Before 12/1/83	1	EM-2500		
			LH Front		1	EM-2500		
		1985-86	RH Front		1	EM-2683		
			RH Front	After 12/1/83	1	EM-2683		
		1984	RH Front	Before 12/1/83	1	EM-2501		
			RH Front		1	EM-2501		
		1985-86	Trans	Auto	1			EM-2388
		1983-84	Trans	Auto	1			EM-2388
V8	V8 4.2L 255ci	1981-82	LH Front		1	EM-2504		
			RH Front		1	EM-2503		
			Trans	Auto	1			EM-2253
	V8 5.0L 302ci	1985 1979-82 1985 1979-82 1985 1979-82	LH Front		1	EM-2682		
			LH Front		1	EM-2682		
			RH Front		1	EM-2683		
			RH Front		1	EM-2683		
			Trans		1			EM-2388
			Trans		1			EM-2388
	V8 5.8L 351ci	1971-73 1978-81	L & R Front		2	EM-2287		
			LH Front		1	EM-2438		
			RH Front		1	EM-2437		
			Trans		1			EM-2464

# Engine, Transmission, And Torque Strut Mounts

CYL	ENG. SIZE	YEAR	LOCATION	DESCRIPTION	QTY	ENGINE	TORQUE STRUT	TRANSMISSION
<b>MERCURY PASSENGER CAR (continued)</b>								
<b>MARQUIS (continued)</b>								
V8	V8 5.8L 351ci	1971-73	Trans	Auto	1			EM-2345
			Trans	Manual	1			EM-2345
V8	V8 6.4L 390ci	1968-70	LH Front		1	EM-2241		
			RH Front		1	EM-2240		
			Trans		1			EM-2253
V8	V8 6.6L 400ci	1971-78	LH Front		1	EM-2359		
			RH Front		1	EM-2358		
		1975-78	Trans	Auto	1			EM-2345
		1971-74	Trans	Auto	1			EM-2345
V8	V8 6.7L 410ci	1967	Trans	Manual	1			EM-2345
			LH Front		1	EM-2241		
			RH Front		1	EM-2240		
V8	V8 7.0L 427ci	1967	Trans		1			EM-2242
			LH Front		1	EM-2241		
			RH Front		1	EM-2240		
V8	V8 7.0L 428ci	1967-69	Trans		1			EM-2242
			LH Front		1	EM-2241		
			RH Front		1	EM-2240		
V8	V8 7.0L 429ci	1969-73	Trans		1			EM-2242
			LH Front		1	EM-2368		
			RH Front		1	EM-2367		
V8	V8 7.5L 460ci	1972-78	Trans	Auto	1			EM-2345
			Trans	Manual	1			EM-2345
		1975-78	LH Front		1	EM-2368		
			RH Front		1	EM-2367		
1972-74	Trans	Auto	1			EM-2345		
	Trans	Manual	1			EM-2345		
<b>MEDALIST</b>								
V8	V8 5.1L 312ci	1956-58	L & R Front		2	EM-2141		
<b>METEOR</b>								
L6	L6 2.8L 170ci	1961-63	LH Front		1	EM-2226		
			RH Front		1	EM-2225		
			Trans	Auto	1			EM-2349
			Trans	Manual	1			EM-2349
V8	V8 3.6L 221ci	1962-63	Trans	Auto	1			EM-2349
			Trans	Manual	1			EM-2349
<b>MILAN</b>								
L4	L4 2.3L	2006-09	Torq Str - Front	FWD	1		EM-3107	
	L4 2.3L 140ci	2006-09	Right		1	EM-4044		
			Trans		1			EM-4034
	L4 2.5L	2010-11	Torq Str - Front	Hybrid	1		EM-4058	
	L4 2.5L 153ci	2010-11	Trans	Manual	1			EM-4034
V6	V6 3.0L	2007-10	Torq Str - Front	AWD	1		EM-3105	
			Torq Str - Front	FWD	1		EM-3107	
		2006	Torq Str - Front	FWD	1		EM-3107	
	V6 3.0L 183ci	2006-09	Right		1	EM-4044		
			Trans		1			EM-4034
<b>MONARCH</b>								
L6	L6 3.3L 200ci	1975-77	L & R Front		2	EM-2341		
			Trans	Auto	1			EM-2253
			Trans	Manual	1			EM-2253
	L6 4.1L 250ci	1975	L & R Front		2	EM-2341		
			1976-80	LH Front		1	EM-2434	
			RH Front		1	EM-2433		

# Engine, Transmission, And Torque Strut Mounts

CYL	ENG. SIZE	YEAR	LOCATION	DESCRIPTION	QTY	ENGINE	TORQUE STRUT	TRANSMISSION	
<b>MERCURY PASSENGER CAR (continued)</b>									
<b>MONARCH (continued)</b>									
L6	L6 4.1L 250ci	1975-80	Trans	Auto	1			EM-2253	
			Trans	Manual	1			EM-2253	
V8	V8 4.2L 255ci	1980	LH Front		1	EM-2504			
			RH Front		1	EM-2503			
			Trans	Auto	1			EM-2253	
			Trans	Manual	1			EM-2253	
	V8 5.0L 302ci	1976-80	LH Front		1	EM-2504			
			RH Front		1	EM-2503			
		1975-80	Trans	Auto	1			EM-2253	
			Trans	Manual	1			EM-2253	
	V8 5.8L 351ci	1975-77	LH Front		1	EM-2504			
			RH Front		1	EM-2503			
Trans			Auto	1			EM-2253		
Trans			Manual	1			EM-2253		
<b>MONTCCLAIR</b>									
V8	V8 5.1L 312ci	1956-60	L & R Front		2	EM-2141			
	V8 6.4L 390ci	1967-68	LH Front		1	EM-2241			
		1964	LH Front		1	EM-2226			
		1967-68	RH Front		1	EM-2240			
		1964	RH Front		1	EM-2225			
		1965-68	Trans		1			EM-2242	
	V8 6.7L 410ci	1966-67	LH Front		1	EM-2241			
			RH Front		1	EM-2240			
			Trans		1			EM-2242	
	V8 7.0L 427ci	1965-68	LH Front		1	EM-2241			
RH Front				1	EM-2240				
Trans				1			EM-2242		
<b>MONTEGO</b>									
L6	L6 4.1L 250ci	1969-74	L & R Front		2	EM-2333			
			Trans	Auto	1			EM-2253	
			Trans	Manual	1			EM-2253	
V6	V6 3.0L 183ci	2005-07	LH Front		1	EM-3080*			
			RH Front		1	EM-3079*			
			Torq Str - Upper	Insert Only	1			EM-4028	
			Trans	FWD	1			EM-3080 *	
V8	V8 5.0L 302ci	1971-74	LH Front		1	EM-2371			
			RH Front		1	EM-2370			
		1973-74	Trans	Auto; C4	1			EM-2347	
			Trans	Auto; Cruise-O-Matic	1			EM-2372	
		1971-72	Trans	Auto	1			EM-2253	
			Trans	Manual	1			EM-2253	
		V8 5.8L 351ci	1969-71	L & R Front	Convertible	2	EM-2286		
				L & R Front	Coupe	2	EM-2257		
	1975-76		LH Front	VIN H	1	EM-2365			
	1972-74		LH Front	VIN Q	1	EM-2371			
	1975-76		RH Front	VIN H	1	EM-2364			
	1972-74		RH Front	VIN Q	1	EM-2370			
	1975-76		Trans	Auto; C4	1			EM-2372	
			Trans	Auto; FMX	1			EM-2347	
	1974	Trans	Modified Engine	1			EM-2345		
		Trans	Auto; AOD; Cleveland Engine	1			EM-2347		
Trans		Auto; C4; Cleveland Engine	1			EM-2372			
Trans		Manual; Cleveland Engine	1			EM-2347			
1972-73		Trans	Auto; AOD; Cleveland Engine	1			EM-2347		
	Trans	Auto; C4; Cleveland Engine	1			EM-2372			
	Trans	Manual; Cleveland Engine	1			EM-2347			

# Engine, Transmission, And Torque Strut Mounts

CYL	ENG. SIZE	YEAR	LOCATION	DESCRIPTION	QTY	ENGINE	TORQUE STRUT	TRANSMISSION
<b>MERCURY PASSENGER CAR (continued)</b>								
<b>MONTEGO (continued)</b>								
V8	V8 5.8L 351ci	1969-71	Trans	Auto	1			EM-2253
			Trans	Manual	1			EM-2253
V8	V8 6.4L 390ci	1968-69	LH Front		1	EM-2241		
			RH Front		1	EM-2240		
			Trans	Auto	1			EM-2253
			Trans	Manual	1			EM-2253
V8	V8 6.6L 400ci	1972-76	LH Front		1	EM-2365		
			RH Front		1	EM-2364		
			Trans		1			EM-2372
V8	V8 7.0L 428ci	1968-69	LH Front		1	EM-2241		
			RH Front		1	EM-2240		
			Trans	Auto	1			EM-2253
			Trans	Manual	1			EM-2253
V8	V8 7.0L 429ci	1970-73	L & R Front		2	EM-2257		
			Trans	Auto	1			EM-2253
			Trans	Manual	1			EM-2253
V8	V8 7.5L 460ci	1973-76	LH Front		1	EM-2368		
			RH Front		1	EM-2367		
			Trans		1			EM-2345
<b>MONTEREY</b>								
V8	V8 5.1L 312ci	1956-60	L & R Front		2	EM-2141		
	V8 5.8L 351ci	1971-73	L & R Front		2	EM-2287		
Trans			Auto	1			EM-2311	
Trans			Manual	1			EM-2311	
V8 6.6L 400ci			1971-74	LH Front		1	EM-2359	
	RH Front			1	EM-2358			
	Trans	Auto		1			EM-2345	
	Trans	Manual		1			EM-2345	
V8	V8 6.7L 410ci	1966-67	LH Front		1	EM-2241		
			RH Front		1	EM-2240		
			Trans		1			EM-2242
V8	V8 7.0L 427ci	1965-67	LH Front		1	EM-2241		
			RH Front		1	EM-2240		
			Trans	Auto	1			EM-2242
			Trans	Manual	1			EM-2242
V8	V8 7.0L 428ci	1966-70	LH Front		1	EM-2241		
			RH Front		1	EM-2240		
			Trans	Auto	1			EM-2242
			Trans	Manual	1			EM-2242
V8	V8 7.0L 429ci	1969-73	LH Front		1	EM-2368		
			RH Front		1	EM-2367		
			Trans	Auto	1			EM-2345
			Trans	Manual	1			EM-2345
V8	V8 7.5L 460ci	1972-74	LH Front		1	EM-2368		
			RH Front		1	EM-2367		
			Trans	Auto	1			EM-2345
			Trans	Manual	1			EM-2345
<b>MYSTIQUE</b>								
L4	L4 2.0L 1989cc	1998-00	Front	Auto; Complete Unit	1	EM-5521		
			Front	Auto; Insert	1	EM-2885		
			Front	Manual; Insert	1	EM-2888		
		1995-97	Front	Auto; Complete Unit	1	EM-5596		
			Front	Auto; Insert	1	EM-2886		
			Front	Manual; Insert	1	EM-2978		
		1998-00	RH Front		1	EM-2890		
		1995-97	RH Front		1	EM-2889		

# Engine, Transmission, And Torque Strut Mounts

CYL	ENG. SIZE	YEAR	LOCATION	DESCRIPTION	QTY	ENGINE	TORQUE STRUT	TRANS-MISSION	
<b>MERCURY PASSENGER CAR (continued)</b>									
<b>MYSTIQUE (continued)</b>									
L4	L4 2.0L 1989cc	1998-00	Trans - Front	Auto, Complete Unit	1			EM-2873	
			Trans - Front	Auto; Insert	1			EM-5106	
		1995-97	Trans - Front	Auto, Complete Unit	1				EM-2873
			Trans - Front	Auto; Insert	1				EM-5106
		1998-00	Trans - Rear	Auto; Insert	1				EM-2888
		1995-97	Trans - Rear	Auto, Complete Unit	1				EM-5107
			Trans - Rear	Auto; Insert	1				EM-2887
		1998-00	Trans	Manual; Complete Unit	2				EM-3119
1995-97	Trans	Manual; Complete Unit	2				EM-3119		
V6	V6 2.5L 2450cc	1998-00	Front	Auto; Insert Only	1	EM-2885			
			Front	Manual; Insert Only	1	EM-2888			
		1995-97	Front	Auto; Complete Unit	1	EM-5596			
			Front	Auto; Insert	1	EM-2886			
		1998-00	Front	Manual; Insert	1	EM-2978			
			RH Front	Complete Unit	1	EM-5352			
		1995-97	RH Front	Insert Only	1	EM-5105			
			RH Front	Complete Unit	1	EM-2889			
		1998-00	RH Front	Insert	1	EM-5105			
			Trans - Front	Auto, Complete Unit	1				EM-2873
		1995-97	Trans - Front	Auto; Insert	1				EM-5106
			Trans - Front	Auto, Complete Unit	1				EM-2873
		1998-00	Trans - Front	Auto; Insert	1				EM-5106
			Trans - Rear	Auto; Insert	1				EM-2888
		1995-97	Trans - Rear	Auto, Complete Unit	1				EM-5107
			Trans - Rear	Auto; Insert	1				EM-2885
		1998-00	Trans	Manual; Complete Unit	2				EM-3119
		1995-97	Trans	Manual; Complete Unit	2				EM-3119
<b>PARK LANE</b>									
V8	V8 6.7L 410ci	1966-67	LH Front		1	EM-2241			
			RH Front		1	EM-2240			
			Trans		1			EM-2242	
	V8 7.0L 427ci	1966-68	LH Front		1	EM-2241			
			RH Front		1	EM-2240			
			Trans		1			EM-2242	
<b>SABLE</b>									
L4	L4 2.5L 153ci	1986	RH Front		1	EM-2692			
			RH Rear		1	EM-2770			
			Trans		1			EM-2687	
V6	V6 3.0L 182ci	2000-05	RH Front	Hydraulic Mount; DOHC	1	EM-2894*			
			RH Front	Hydraulic Mount; OHV	1	EM-2894*			
		1996-99	RH Front	Hydraulic Mount; DOHC	1	EM-2934*			
			RH Front	Hydraulic Mount; OHV	1	EM-2789*			
		1994-95	RH Front		1	EM-2790*			
		1993	RH Front		1	EM-2792*			
		1991-92	RH Front		1	EM-2791*			
		1986-90	RH Front		1	EM-2623			
		1996-99	RH Rear	Hydraulic Mount; DOHC	1	EM-2862			
			RH Rear	Hydraulic Mount; OHV	1	EM-2840*			
		1994-95	RH Rear		1	EM-2788*			
		1993	RH Rear		1	EM-2788*			
		1991-92	RH Rear		1	EM-2788*			
		1986-90	RH Rear		1	EM-2622			
		2000-03	Torq Str - Rear		1			EM-2872	
		2000-05	Trans		1				EM-2974 *
1990-99	Trans		1				EM-2717 *		

# Engine, Transmission, And Torque Strut Mounts

CYL	ENG. SIZE	YEAR	LOCATION	DESCRIPTION	QTY	ENGINE	TORQUE STRUT	TRANSMISSION
<b>MERCURY PASSENGER CAR (continued)</b>								
<b>SABLE (continued)</b>								
V6	V6 3.0L 182ci	1988-89	Trans		1			EM-2686
		1986-87	Trans		1			EM-2687
	V6 3.5L	2008-09	Torq Str - Rear		1		EM-3142	
	V6 3.5L 213ci	2008-09	RH Front		1	EM-5427		
			Trans - Upper		1			EM-4040
	V6 3.8L 232ci	1988-95	RH Front		1	EM-2812'		
			RH Rear		1	EM-2813'		
Trans				1			EM-2717	
<b>TOPAZ</b>								
L4	L4 2.0L 1989cc Diesel	1984-86	LH Front	Manual	1	EM-5065		
		L4 2.3L 140ci	1992-94	Front		1	EM-2804	
	1986-91		Front	Auto; Hydraulic Mount	1	EM-2696'		
			Front	Manual	1	EM-2559		
	1984-85		Front		1	EM-2559		
			LH Front	Auto	1	EM-5063		
			LH Front	Manual	1	EM-5065		
	1992-94		RH Front		1	EM-2805		
	1986-91		RH Front		1	EM-2558		
	1984-85		RH Front		1	EM-2558		
	1986-94		Trans	Auto; Hydraulic Mount	1			EM-2696
			Trans	Manual	1			EM-2665
	1984-85		Trans	Auto	1			EM-2632
		Trans	Manual; 4 Spd	1			EM-2634	
Trans		Manual; 5 Spd	1			EM-2665		
V6	V6 3.0L 182ci	1992-94	LH Front	Auto; Attached To Transaxle	1	EM-2804		
			Trans	Auto; Hydraulic Mount	1			EM-2696
			Trans	Manual	1			EM-2665
<b>TRACER</b>								
L4	L4 1.6L	1987-89	Trans		1			EM-8068
	L4 1.6L 1598cc	1987-89	LH Front	Manual	1	EM-8060		
			RH Front	Auto	1	EM-8234		
	L4 1.8L 112ci	1994-96	Front	Auto; Hydraulic Mount	1	EM-2910'		
			Front	Manual	1	EM-2651		
		1991-93	Front		1	EM-2651		
		1994-96	LH Rear		1	EM-2650		
		1991-93	LH Rear		1	EM-2650		
		1994-96	RH Front		1	EM-2650		
		1991-93	RH Front		1	EM-2649		
		1991-96	Trans	Auto	1			EM-2815
	Trans		Manual	1			EM-2815	
	L4 1.9L 116ci	1991-96	Front		1	EM-2651		
			LH Rear		1	EM-2650		
			RH Front		1	EM-2649		
			Trans	Auto	1			EM-2815
			Trans	Manual	1			EM-2815
	L4 2.0L 1989cc	1997-99	Front	Auto; Hydraulic Mount	1	EM-2910'		
			Front	Manual	1	EM-2651		
			RH Front		1	EM-2649		
			Rear	Auto	1	EM-2912		
			Rear	Manual	1	EM-2911		
			Trans	Auto	1			EM-2843
Trans			Manual	1			EM-2843	

# Engine, Transmission, And Torque Strut Mounts

CYL	ENG. SIZE	YEAR	LOCATION	DESCRIPTION	QTY	ENGINE	TORQUE STRUT	TRANSMISSION	
<b>MERCURY PASSENGER CAR (continued)</b>									
<b>VOYAGER</b>									
V8	V8 5.1L 312ci	1957-59	L & R Front		2	EM-2141			
<b>ZEPHYR</b>									
L4	L4 2.3L 140ci	1978-83	LH Front		1	EM-2458			
			RH Front		1	EM-2457			
			Trans	Auto	1			EM-2388	
			Trans	Manual	1			EM-2388	
L6	L6 3.3L 200ci	1978-83	L & R Front		2	EM-2385			
			Trans	Auto	1			EM-2388	
			Trans	Manual	1			EM-2388	
V8	V8 4.2L 255ci	1980-82	LH Front		1	EM-2458			
			RH Front		1	EM-2457			
			Trans	Auto	1			EM-2388	
			Trans	Manual	1			EM-2388	
	V8 5.0L 302ci	1978-79	LH Front		1	EM-2458			
			RH Front		1	EM-2457			
			Trans	Auto	1			EM-2388	
			Trans	Manual	1			EM-2388	
<b>MERCURY SPORT UTILITY</b>									
<b>MARINER</b>									
L4	L4 2.3L	2005-08	Trans	Auto	1			EM-4117	
	L4 2.3L 140ci	2005-08	LH Front	Gas	1	EM-4071			
			Rear	Gas	1	EM-4019			
		2006-08	Torq Str - Rear	Hybrid	1		EM-4051		
	L4 2.5L	2009-11	LH Front	Gas	1	EM-4071			
			Rear	Gas	1	EM-4019			
	L4 2.5L 2488cc	2009-11	Torq Str - Rear	Hybrid	1		EM-4051		
			Trans	Auto	1			EM-4117	
	V6	V6 3.0L 182ci	2005-08	Front		1	EM-4033		
				LH Front		1	EM-4071		
Rear				FWD	1	EM-4019			
V6 3.0L 183ci		2009-11	Front		1	EM-4033			
			LH Front		1	EM-4071			
			Rear	FWD	1	EM-4019			
<b>MOUNTAINEER</b>									
V6	V6 4.0L	2006-10	LH Front		1	EM-4106			
			RH Front		1	EM-3048			
			Trans	RWD	1			EM-3062	
	V6 4.0L 245ci	2002-05	LH Front		1	EM-3047			
			1998-01	LH Front		1	EM-2851		
			2002-05	RH Front		1	EM-3048		
			1998-01	RH Front		1	EM-2850		
			2002-05	Trans	AWD	1			EM-3061
			2002-05	Trans	RWD	1			EM-3062
			1998-01	Trans		1			EM-2639
V8	V8 4.6L	2006-10	LH Front		1	EM-4106			
			RH Front		1	EM-3048			
			2006-07	Trans	RWD	1			EM-3062
	V8 4.6L 281ci	2002-03	LH Front		1	EM-3047			
			LH Front	RWD	1	EM-3047			
			RH Front		1	EM-3048			
			RH Front	RWD	1	EM-3048			
			2002-05	Trans	AWD	1			EM-3061
			2002-05	Trans	RWD	1			EM-3062
	V8 5.0L 302ci	1997-01	LH Front		1	EM-3000			
RH Front				1	EM-2999				



# Engine, Transmission, And Torque Strut Mounts

CYL	ENG. SIZE	YEAR	LOCATION	DESCRIPTION	QTY	ENGINE	TORQUE STRUT	TRANSMISSION
<b>MERCURY SPORT UTILITY (continued)</b>								
<b>MOUNTAINEER (continued)</b>								
V8	V8 5.0L 302ci	1997-01	Trans		1			EM-2868
<b>MERCURY VAN</b>								
<b>MONTEREY</b>								
V6	V6 4.2L	2004-07	Torq Str - Front		1		EM-3101	
			Trans		1		EM-3106	
	V6 4.2L 256ci	2004-07	LH Front		1	EM-3075		
			RH Front		1	EM-3076		
<b>VILLAGER</b>								
V6	V6 3.0L 182ci	1993-98	Front		1	EM-2855		
			LH Rear		1	EM-2856		
			RH Rear		1	EM-2857		
			Trans		1		EM-2854	
	V6 3.3L 3275cc	1999-02	Front		1	EM-2989		
			LH Rear		1	EM-2985		
			RH Rear		1	EM-2857		
			Trans		1		EM-2854	
<b>MG PASSENGER CAR</b>								
<b>MIDGET</b>								
L4	L4 1.3L 1275cc	1967-74	LH Front		1	EM-2736		
			RH Front		1	EM-2735		
<b>MGA</b>								
L4	L4 1.5L 1493cc	1956-59	LH Front		1	EM-2736		
			RH Front		1	EM-2735		
<b>MGB</b>								
L4	L4 1.8L 1798cc	1963-74	LH Front		1	EM-2736		
			RH Front		1	EM-2735		
<b>MINI</b>								
<b>COOPER</b>								
L4	L4 1.6L	2002-08	Torq Str - Rear		1		EM-5860	
			L4 1.6L 1600cc	2005-06	Front		1	EM-5922
	L4 1.6L 1600cc	2004	Front	From 12/03	1	EM-5922		
			RH Rear		1	EM-5844		
			RH Rear		1	EM-5844		
			RH Rear		1	EM-5844		
<b>MINI PASSENGER CAR</b>								
<b>3000GT</b>								
V6	V6 3.0L	1994-99	Front	FWD	1	EM-9191		
		1992-93	Front	FWD	1	EM-9191		
		1991	Front	FWD	1	EM-9191		
<b>CORDIA</b>								
L4	L4 1.8L 1795cc	1984-88	Front Lower		1	EM-8270		
			1983	Front Lower		1	EM-8270	
		1983-88	Rear	Auto; 3 Spd	1	EM-8271		
			Rear	Manual	1	EM-8506		
			Torq Str - Front	Manual, Complete Unit	1		EM-8272	
			Torq Str - Front	Manual, Insert	1		EM-5739	
	Trans	Manual; 5 Spd	1			EM-8510		
	L4 2.0L 1997cc	1984-88	Front	Manual	1	EM-8270		
			Front Upper	Auto	1	EM-8105		
			Torq Str - Front	Manual	1		EM-8867	
Trans			Auto	1			EM-8807	

# Engine, Transmission, And Torque Strut Mounts

CYL	ENG. SIZE	YEAR	LOCATION	DESCRIPTION	QTY	ENGINE	TORQUE STRUT	TRANS-MISSION
<b>MITSUBISHI PASSENGER CAR (continued)</b>								
<b>CORDIA (continued)</b>								
L4	L4 2.0L 1997cc	1984-88	Trans	Manual; 5 Spd	1			EM-8510
<b>DIAMANTE</b>								
V6	V6 3.0L	1992-93	Trans		1			EM-5574
	V6 3.0L 2972cc	1996	Front		1	EM-5929		
		1993-95	Front	Sedan	1	EM-5929		
			Front	Wagon	1	EM-8667		
		1996	Rear		1	EM-8668		
		1993-95	Rear		1	EM-8668		
	V6 3.5L	1997-04	Trans		1			EM-9387
	V6 3.5L 3497cc	1999-04	Front		1	EM-9193		
		1997-98	Front		1	EM-9193		
		1999-04	RH Front		1	EM-9189		
		1997-98	RH Front		1	EM-9189		
		1999-04	Rear		1	EM-5907		
		1997-98	Rear		1	EM-5575		
<b>ECLIPSE</b>								
L4	L4 1.8L 1755cc	1990-94	Front		1	EM-8103		
			LH Front		1	EM-9056		
			Rear	Auto	1	EM-8104		
			Rear	Manual	1	EM-5098		
			Trans	Auto; w/o Cruise Control	1		EM-8700	
			Trans	Manual; w/o Cruise Control	1		EM-8686	
	L4 2.0L 1997cc	1995-99	Front		1	EM-8670		
			1990-94	Front	Auto; AWD	1	EM-8559	
		1995-99	Front	FWD	1	EM-8103		
			Front	Manual; AWD	1	EM-9078		
			LH Front	Auto; AWD	1	EM-9206		
			RH Front	Turbo	1	EM-8792		
			RH Front	w/o Turbo	1	EM-9198		
			Rear	Auto	1	EM-9394		
		1990-94	Rear	Manual	1	EM-8798		
			Rear	Auto	1	EM-8104		
			Rear	Manual, AWD	1	EM-5101		
			Rear	Manual, FWD	1	EM-5098		
			1995-99	Trans	Auto; w/ Turbo	1		EM-9058
			Trans	Auto; w/o Turbo	1		EM-9174	
		1995-99	Trans	Manual; w/ Turbo	1		EM-8793	
			Trans	Manual; w/o Turbo	1		EM-9174	
			1990-94	Trans	Auto; w/o Cruise Control	1		EM-8700
			Trans	Manual; w/o Cruise Control	1		EM-8686	
	L4 2.4L	2006-12	Trans	Auto	1		EM-9304	
			Trans	Manual	1		EM-5980	
	L4 2.4L 2351cc	2000-05	Front	Auto	1	EM-9160		
			Front	Manual	1	EM-5159		
		1996-99	Front		1	EM-8670		
			LH Front		1	EM-8792		
		2000-05	RH Front		1	EM-9184		
			Rear	Auto	1	EM-9161		
			Rear	Manual	1	EM-9485		
			Rear	Auto	1	EM-9394		
		1996-99	Rear	Manual	1	EM-8798		
			2000-05	Trans	Auto	1		EM-9162
		Trans	Manual	1		EM-5452		
		1996-99	Trans	Auto	1		EM-8797	
			Trans	Manual	1		EM-8793	
		L4 2.4L 2378cc	2006-12	Front		1	EM-9305	

# Engine, Transmission, And Torque Strut Mounts

CYL	ENG. SIZE	YEAR	LOCATION	DESCRIPTION	QTY	ENGINE	TORQUE STRUT	TRANSMISSION	
<b>MITSUBISHI PASSENGER CAR (continued)</b>									
<b>ECLIPSE (continued)</b>									
L4	L4 2.4L 2378cc	2006-12	RH Front		1	EM-9281			
			Rear	Auto	1	EM-9382			
			Rear	Manual	1	EM-9510			
V6	V6 3.0L	2000-05	Trans - LH	Auto	1			EM-9384	
	V6 3.0L 2972cc	2000-05	Front		1	EM-5159			
			LH Rear		1	EM-5349			
			RH Front		1	EM-9187			
	V6 3.8L 3828cc	2010-12 2006-09	Front		1	EM-9305			
			Front		1	EM-9305			
			RH Front		1	EM-9278			
Rear				1	EM-9382				
<b>GALANT</b>									
L4	L4 2.0L 1997cc	1993	Front	FWD	1	EM-8103			
		1991-92	Front	AWD	1	EM-9078			
			Front	FWD	1	EM-8103			
			Front	AWD; GSX	1	EM-9078			
		1990	Front	FWD	1	EM-8103			
			Front	FWD	1	EM-8103			
		1989	Front		1	EM-8103			
		1993	LH Front	FWD	1	EM-9071			
		1991-92	LH Front	Auto; AWD; GSX	1	EM-8559			
			LH Front	FWD w/ DOHC	1	EM-8790			
			LH Front	FWD w/ SOHC	1	EM-9071			
			LH Front	VR-4	1	EM-9206			
		1990	LH Front	AWD; GSX	1	EM-8281			
			LH Front	BASE; LS	1	EM-9071			
			LH Front	GS	1	EM-8790			
		1989	LH Front	FWD w/ DOHC	1	EM-8790			
			LH Front	FWD w/ SOHC	1	EM-9071			
		1993	Rear	Auto; FWD	1	EM-8105			
			Rear	Manual; FWD	1	EM-8104			
		1991-92	Rear	Auto; AWD	1	EM-8104			
			Rear	Manual; AWD	1	EM-8105			
			Rear	Manual; FWD	1	EM-5098			
		1990	Rear	Auto; FWD	1	EM-8105			
			Rear	AWD; GSX	1	EM-8105			
			Rear	Manual; FWD	1	EM-8104			
			Rear	Auto; FWD	1	EM-8105			
		1989	Rear	Auto; FWD	1	EM-8105			
			Rear	Manual; FWD	1	EM-5098			
		1993	Trans	Auto; FWD	1			EM-8694	
			Trans	Manual; FWD	1			EM-8106	
		1990-92	Trans	AWD	1			EM-8106	
			Trans	Auto; FWD	1			EM-8694	
			Trans	Manual; FWD	1			EM-8106	
			Trans	Auto; FWD	1			EM-8694	
		1989	Trans	Auto; FWD	1			EM-8694	
			Trans	Manual; FWD	1			EM-8106	
		L4 2.4L	2004-07	Front		1	EM-9305		
				RH Front		1	EM-9281		
				Rear		1	EM-9382		
			2004-09	Trans		1			EM-9304
L4 2.4L 2351cc	1999-03	Front		1	EM-9160				
	1985-87	Front		1	EM-8292				
	1994-98	LH Front		1	EM-8792				
	1985-87	LH Front		1	EM-8292				
	1999-03	RH Front		1	EM-9184				
	1994-98	RH Front	Auto	1	EM-9203				
		RH Front	Manual	1	EM-8670				
	1999-03	Rear	Auto	1	EM-9161				

# Engine, Transmission, And Torque Strut Mounts

CYL	ENG. SIZE	YEAR	LOCATION	DESCRIPTION	QTY	ENGINE	TORQUE STRUT	TRANSMISSION	
<b>MITSUBISHI PASSENGER CAR (continued)</b>									
<b>GALANT (continued)</b>									
L4	L4 2.4L 2351cc	1994-98	Rear	Auto	1	EM-9161			
			Rear	Manual	1	EM-8798			
		1985-87	Rear	HD Suspension	1	EM-5098			
			Rear	Std Suspension	1	EM-8105			
		1999-03	Trans	Auto	1			EM-9162	
		1994-98	Trans	Auto	1			EM-8797	
	Trans		Manual	1			EM-8793		
	L4 2.4L 2378cc	2009-12 2008	Front		1	EM-9305			
			Front		1	EM-9305			
			Rear		1	EM-9382			
V6	V6 3.0L	1999-03	Trans - LH		1			EM-9384	
	V6 3.0L 2972cc	1999-03	Front		1	EM-5159			
			LH Rear		1	EM-5349			
			RH Front		1	EM-9187			
	V6 3.8L	2008-09	Front		1	EM-9305			
			RH Front		1	EM-9278			
			Rear		1	EM-9382			
			2004-06	Trans		1			EM-9383
	V6 3.8L 3800cc	2004-07	Front		1	EM-9305			
			RH Front		1	EM-9278			
Rear				1	EM-9154				
<b>LANCER</b>									
L4	L4 2.0L	2008-11	Front	Turbo	1	EM-5856			
			Front	w/o Turbo	1	EM-3131			
			RH Front	w/o Turbo	1	EM-3130			
			Rear	Turbo, Manual	1	EM-5924			
			Rear	Turbo; Automatic Dual Clutch	1	EM-9489			
			Rear	w/o Turbo	1	EM-3132			
		2007	Trans	Mexican Vehicle; Manual	1			EM-8817	
		L4 2.0L 1997cc Turbo	2005-06 2002-04	Rear	Manual	1	EM-5876		
				Rear	Auto	1	EM-9170		
				Rear	Manual	1	EM-5876		
	L4 2.0L 1998cc	2005-06	Trans	Manual	1			EM-9088	
			Trans	Auto; CVT; w/o Turbo	1			EM-3134	
	L4 2.0L 1999cc Non-Turbo	2008-13	Trans	Manual	1			EM-3137	
			2005-06	Auto		1		EM-5825	
				Trans	Auto	1		EM-5825	
	L4 2.0L 2000cc	2002-04	Trans	Manual	1			EM-9088	
			Trans	Auto	1			EM-5825	
	L4 2.0L Non Turbo	2007 2002-06 2007 2002-06 2007 2002-06	Front		1	EM-9181			
			Front		1	EM-9181			
			RH Front		1	EM-9188			
			RH Front		1	EM-9188			
			Rear	Auto	1	EM-9170			
			Rear	Auto	1	EM-9170			
			Rear	Manual	1	EM-5876			
			Trans	Manual	1			EM-3137	
	L4 2.4L	2009-13	Trans	Manual	1			EM-3137	
	L4 2.4L 2360cc	2009-11	Front	w/o Turbo	1	EM-3131			
			RH Front		1	EM-3130			
	L4 2.4L 2400cc	2004-06	Rear	Auto	1	EM-9170			
			Rear	Manual	1	EM-5876			
			Trans	Auto	1			EM-5825	
			Trans	Manual	1			EM-9088	

# Engine, Transmission, And Torque Strut Mounts

CYL	ENG. SIZE	YEAR	LOCATION	DESCRIPTION	QTY	ENGINE	TORQUE STRUT	TRANS-MISSION
<b>MITSUBISHI PASSENGER CAR (continued)</b>								
<b>MIRAGE</b>								
L4	L4 1.5L 1468cc	1999-02	Front	Auto	1	EM-8818		
			Front	Manual	1	EM-9037		
		1997-98	Front	Auto	1	EM-8818		
			Front	Manual	1	EM-9037		
		1995-96	Front		1	EM-8100		
		1993-94	Front	Auto	1	EM-8097		
			Front	Manual	1	EM-8100		
		1989-92	Front	Auto	1	EM-2673		
			Front	Manual	1	EM-8107		
		1987-88	Front	Complete Unit	1	EM-8103		
			Front	Insert Only	1	EM-8553		
		1986	Front	Auto	1	EM-8235		
			Front	Manual	1	EM-8103		
		1985	Front	Auto	1	EM-8235		
			Front	Manual	1	EM-8103		
		1989-92	LH Front		1	EM-8108		
		1987-88	LH Front		1	EM-8619		
		1986	LH Front	w/o Power Steering	1	EM-8232		
		1985	LH Front	w/ Power Steering	1	EM-8556		
			LH Front	w/o Power Steering	1	EM-8232		
		1999-02	RH Front		1	EM-9068		
		1997-98	RH Front		1	EM-8853		
		1995-96	RH Front	w/ Power Steering	1	EM-8238		
			RH Front	w/o Power Steering	1	EM-8206		
		1993-94	RH Front	w/ Power Steering	1	EM-8238		
			RH Front	w/o Power Steering	1	EM-8206		
		1999-02	Rear	Auto	1	EM-8819		
			Rear	Manual	1	EM-9059		
		1997-98	Rear	Auto	1	EM-8819		
			Rear	Manual	1	EM-9059		
		1995-96	Rear		1	EM-8100		
		1993-94	Rear	Auto	1	EM-8100		
			Rear	Manual	1	EM-8100		
		1989-92	Rear		1	EM-8102		
		1987-88	Rear	Auto	1	EM-8266		
			Rear	Manual	1	EM-8554		
		1986	Rear		1	EM-8267		
		1985	Rear		1	EM-8267		
		1997-02	Trans	Auto	1			EM-8879
			Trans	Manual	1			EM-8880
		1993-96	Trans	Auto	1			EM-8582
			Trans	Manual	1			EM-8099
		1989-92	Trans	Auto	1			EM-8584
			Trans	Manual	1			EM-8669
		1987-88	Trans	Auto	1			EM-8205
			Trans	Manual	1			EM-8242
		1985-86	Trans	Auto	1			EM-8875
			Trans	Manual; 4 Spd	1			EM-8107
	Trans		Manual; 5 Spd	1			EM-8552	
	L4 1.6L 1597cc	1991-92	Front	Auto	1	EM-2673		
Front			Manual	1	EM-8107			
1989		Front		1	EM-2673			
1987-88		Front	Auto	1	EM-8235			
		Front	Manual	1	EM-8103			
1985-86		Front	Auto	1	EM-8235			
		Front	Manual	1	EM-8103			
1991-92		LH Front		1	EM-9207			

# Engine, Transmission, And Torque Strut Mounts

CYL	ENG. SIZE	YEAR	LOCATION	DESCRIPTION	QTY	ENGINE	TORQUE STRUT	TRANSMISSION	
<b>MITSUBISHI PASSENGER CAR (continued)</b>									
<b>MIRAGE (continued)</b>									
L4	L4 1.6L 1597cc	1989	LH Front		1	EM-9207			
		1991-92	Rear		1	EM-8102			
		1989	Rear		1	EM-8102			
		1987-88	Rear		1	EM-8267			
		1985-86	Rear		1	EM-8267			
		1989-92	Trans		1			EM-8584	
		1987-88	Trans	Manual	1			EM-8242	
		1985-86	Trans	Auto	1			EM-8875	
				Trans	Manual; Insert	1		EM-8552	
		L4 1.8L 1834cc	1997-02	Front	Auto	1	EM-8818		
			Front	Manual	1	EM-9037			
	1995-96		Front		1	EM-8100			
	1993-94		Front	Auto	1	EM-8097			
			Front	Manual	1	EM-8100			
	1997-02		RH Front		1	EM-8877			
			Rear	Auto	1	EM-8819			
			Rear	Manual	1	EM-9059			
	1995-96		Rear	Auto	1	EM-8100			
			Rear	Manual	1	EM-9057			
	1993-94		Rear	Auto	1	EM-8100			
			Rear	Manual	1	EM-9057			
	1997-02		Trans	Auto	1			EM-8816	
	Trans		Manual	1			EM-8817		
1993-96	Trans	Auto	1			EM-8619			
	Trans	Manual	1			EM-8099			
<b>PRECIS</b>									
L4	L4 1.5L 1468cc	1990-94	Front		1	EM-8103			
		1987-89	Front		1	EM-8933			
		1990-94	LH Front		1	EM-8039			
			Rear		1	EM-8672			
		1987-89	Rear	Auto	1	EM-8803			
		1990-94	Torq Str - Front		1		EM-8047		
		1987-89	Torq Str - Front	Complete Unit; Auto	1		EM-8932		
			Torq Str - Front	Complete Unit; Manual	1		EM-8045		
			Torq Str - Front	Insert Only; Large (70mm) Bushing	1		EM-5453		
			Torq Str - Front	Insert Only; Small (50mm) Bushing	1		EM-5398		
		1990-94	Trans	Auto	1			EM-8675	
			Trans	Manual	1			EM-8674	
1987-89	Trans	Auto	1			EM-8934			
<b>SIGMA</b>									
V6	V6 3.0L 2972cc	1989-90	Trans	Auto	1			EM-2730	
<b>STARION</b>									
L4	L4 2.6L 2555cc	1983-89	Front		1	EM-2731			
			Rear		1	EM-8205			
		1989	Trans	Manual	1			EM-2730	
		1984-88	Trans	Auto	1			EM-8292	
			Trans	Manual	1			EM-2730	
1983	Trans	Manual	1			EM-2730			
<b>TREDIA</b>									
L4	L4 1.8L 1795cc	1984-88	Front Lower	Insert	1	EM-8270			
			Front Lower		1	EM-8803			
		1983	Rear	Auto	1	EM-8271			
			Rear	Manual	1	EM-8506			

# Engine, Transmission, And Torque Strut Mounts

CYL	ENG. SIZE	YEAR	LOCATION	DESCRIPTION	QTY	ENGINE	TORQUE STRUT	TRANSMISSION
<b>MITSUBISHI PASSENGER CAR (continued)</b>								
<b>TREDIA (continued)</b>								
L4	L4 1.8L 1795cc	1983-88	Torq Str - Front	Manual, Complete Unit	1		EM-8272	
			Torq Str - Front	Manual, Insert	1		EM-5739	
		1984-88	Trans	Manual; 5 Spd	1			EM-8510
	L4 2.0L 1997cc	1984-88	Front	Manual	1	EM-8270		
			Front Upper	Auto	1	EM-8105		
			Torq Str - Front	Manual	1		EM-8867	
			Trans	Auto	1			EM-8807
		Trans	Manual; 5 Spd	1			EM-8510	
<b>MITSUBISHI SPORT UTILITY</b>								
<b>ENDEAVOR</b>								
V6	V6 3.8L 3828cc	2010-11	Front		1	EM-9305		
		2004-08	Front		1	EM-9305		
		2010-11	Rear		1	EM-9510		
		2004-08	Rear		1	EM-9510		
		2010-11	Trans	Auto	1			EM-9383
		2004-08	Trans	Auto	1			EM-9383
<b>MONTERO</b>								
L4	L4 2.6L 2555cc	1983-89	L & R Front		2	EM-2731		
			Trans	Auto; 4WD	1			EM-8096
			Trans	Manual; 4WD	1			EM-8248
V6	V6 3.0L 2972cc	1995-96	L & R Front		2	EM-8878		
		1994	L & R Front	After 6/94	2	EM-8876		
			L & R Front	Before 6/94	2	EM-8205		
		1992-93	L & R Front		2	EM-8205		
		1996	Trans	Auto	1			EM-7017
			Trans	Manual	1			EM-7017
		1995	Trans	Auto	1			EM-8695
			Trans	Manual	1			EM-7017
		1992-94	Trans	Auto; 4WD	1			EM-8244
			Trans	Manual; 4WD	1			EM-8243
	V6 3.5L	2001-02	Trans	Auto	1			EM-9201
	V6 3.5L 3497cc	2001-02	L & R Front		2	EM-9186		
			L & R Front		2	EM-8878		
L & R Front				2	EM-8876			
Trans			Auto	1			EM-8695	
V6 3.8L	2003-06	Trans	Auto	1			EM-9201	
V6 3.8L 3797cc	2003-06	L & R Front	4WD	2	EM-9186			
<b>MONTERO SPORT</b>								
V6	V6 3.0L 2972cc	2000-03 1997-99	Trans	4WD	1			EM-8695
			Trans	4WD; Manual; Transfer Case	1			EM-8696
			Trans	Auto; 2WD	1			EM-8111
			Trans	Auto; 4WD	1			EM-8695
			Trans	Manual; 2WD	1			EM-8111
			Trans	Manual; 4WD	1			EM-8243
	V6 3.5L 3497cc	1999	LH Front		1	EM-8876		
			RH Front		1	EM-8878		
			Trans	2WD	1			EM-8111
<b>OUTLANDER</b>								
L4	L4 2.4L	2008-11	Trans		1			EM-3134
		2003-06	Trans		1			EM-5797
	L4 2.4L 2351cc	2003-06	Front		1	EM-5796		
			Rear	Auto; FWD	1	EM-9153		
			Rear	AWD	1	EM-5912		
			Right		1	EM-5798		
	L4 2.4L 2360cc	2008-11	Front		1	EM-5856		

# Engine, Transmission, And Torque Strut Mounts

CYL	ENG. SIZE	YEAR	LOCATION	DESCRIPTION	QTY	ENGINE	TORQUE STRUT	TRANS-MISSION
<b>MITSUBISHI SPORT UTILITY (continued)</b>								
<b>OUTLANDER (continued)</b>								
L4	L4 2.4L 2360cc	2008-11	Rear	AWD	1	EM-3157		
			Rear	FWD	1	EM-3145		
			Right		1	EM-5857		
V6	V6 3.0L	2007-12	Front		1	EM-5856		
			Right		1	EM-5927		
			Trans		1			EM-5928
<b>MITSUBISHI TRUCK</b>								
<b>MIGHTY MAX</b>								
L4	L4 2.0L 1997cc	1987-89	L & R Front		2	EM-2731		
			1983-86	RH Front		1	EM-2731	
		1987-89		Trans	Auto; 2WD	1		
			Trans	Auto; 4WD	1			EM-8096
			Trans	Manual; 2WD	1			EM-8556
			Trans	Manual; 4WD	1			EM-8096
		1986	Trans	Auto; 2WD	1			EM-8556
			Trans	Auto; 4WD	1			EM-8248
			Trans	Manual; 2WD	1			EM-8556
			Trans	Manual; 4WD	1			EM-8248
		1984-85	Trans	Auto; 2WD	1			EM-8556
			Trans	Manual; 2WD	1			EM-8556
		1983	Trans	Auto; 2WD	1			EM-8556
			Trans	Auto; 4WD	1			EM-8248
			Trans	Manual; 2WD	1			EM-8556
			Trans	Manual; 4WD	1			EM-8248
	L4 2.3L 2346cc Diesel	1983-85	LH Front		1	EM-8205		
			Trans	Auto; 2WD	1			EM-8556
			Trans	Auto; 4WD	1			EM-8096
			Trans	Manual; 2WD	1			EM-8556
	L4 2.4L 2351cc	1990-96	L & R Front		2	EM-2731		
			Trans	Auto; 2WD	1			EM-9199
			Trans	Manual	1			EM-8111
			Trans	Manual; 4WD	1			EM-8096
	L4 2.6L 2555cc	1987-89	L & R Front		2	EM-2731		
			1983-86	RH Front		1	EM-2731	
		1987-89		Trans	Auto; 2WD	1		
			Trans	Auto; 4WD	1			EM-8096
Trans			Manual; 2WD	1			EM-8111	
Trans			Manual; 4WD	1			EM-8096	
1983-86		Trans	4WD	1			EM-8248	
		Trans	Auto; 2WD	1			EM-8556	
Trans	Manual; 2WD	1			EM-8556			
V6	V6 3.0L 2972cc	1992-94	L & R Front		2	EM-2731		
		1991	L & R Front		2	EM-2731		
		1990	L & R Front		2	EM-2731		
		1992-94	Rear	4WD	1	EM-8696		
		1991	Rear	4WD, After 3/91	1	EM-8696		
		1990-94	Trans	Auto; 2WD	1			EM-9199
			Trans	Auto; 4WD	1			EM-8111
			Trans	Manual; 2WD	1			EM-8111
Trans	Manual; 4WD	1			EM-8111			



# Engine, Transmission, And Torque Strut Mounts

CYL	ENG. SIZE	YEAR	LOCATION	DESCRIPTION	QTY	ENGINE	TORQUE STRUT	TRANSMISSION	
<b>MITSUBISHI VAN</b>									
<b>EXPO</b>									
L4	L4 2.4L 2351cc	1993-95	Front	FWD	1	EM-8688			
			1992	Front	Auto; AWD	1	EM-8687		
				Front	Auto; FWD	1	EM-8102		
				Front	Manual; AWD	1	EM-8688		
				Front	Manual; FWD	1	EM-8821		
		1993-95	LH Front		1	EM-8820			
			1992	LH Front		1	EM-8820		
		1993-95		Rear	Auto; FWD	1	EM-8690		
			Rear	Manual; FWD	1	EM-8689			
		1992	Rear	FWD	1	EM-8689			
			Rear	Manual; AWD	1	EM-8689			
		1993-95	Trans	Auto; FWD	1			EM-8822	
			1992	Trans	Auto; FWD	1			EM-8881
		Trans		Manual; AWD	1			EM-8686	
Trans	Manual; FWD	1				EM-8686			
<b>EXPO LRV</b>									
L4	L4 1.8L 1834cc	1992-93	Front	Auto; AWD	1	EM-8100			
			Front	FWD	1	EM-9057			
			LH Front	Manual; AWD	1	EM-8685			
			Rear	Auto; AWD	1	EM-8690			
			Rear	Manual; FWD	1	EM-8689			
		1993-94	Trans	Auto	1			EM-8822	
			1992	Trans	Auto; FWD	1			EM-8881
		Trans		Manual; FWD	1			EM-8696	
		L4 2.4L 2351cc		1993-94	Front	FWD	1	EM-9057	
			LH Front		FWD	1	EM-8685		
	Rear		Auto; FWD		1	EM-8690			
	Rear		Manual; FWD		1	EM-8689			
				Trans	Auto	1			EM-8822
	<b>VAN</b>								
L4	L4 2.4L 2351cc	1987-90	LH Front		1	EM-8466			
			RH Front		1	EM-8467			
			Trans		1			EM-8556	
<b>NISSAN PASSENGER CAR</b>									
<b>200SX</b>									
L4	L4 1.6L 1597cc	1995-98	Front	Manual	1	EM-8130			
			RH Front		1	EM-8122			
			Rear	Auto	1	EM-8132			
			Rear	Manual	1	EM-8701			
			Trans	Auto	1			EM-8150	
			Trans	Manual	1			EM-8683	
	L4 1.8L 1809cc	1984	Trans - LH	Auto	1			EM-9049	
			Trans - RH	Auto	1			EM-9025	
		1985-86	Trans		1			EM-2488	
			1984	Trans	Manual	1			EM-2488
	L4 2.0L	1995-98	Trans		1			EM-8891	
	L4 2.0L 1952cc	1980-81	L & R Front		2	EM-2680			
			1977-79	L & R Front		2	EM-2405		
				Trans	Auto	1			EM-2487
				Trans	Manual	1			EM-2487
	L4 2.0L 1974cc	1984-88	Trans - LH	Auto	1			EM-9049	
			Trans - RH	Auto	1			EM-9025	
			Trans	Manual	1			EM-2488	
	L4 2.0L 1998cc	1995-98	Front	Manual	1	EM-8130			
			RH Front		1	EM-8307			

# Engine, Transmission, And Torque Strut Mounts

CYL	ENG. SIZE	YEAR	LOCATION	DESCRIPTION	QTY	ENGINE	TORQUE STRUT	TRANSMISSION
<b>NISSAN PASSENGER CAR (continued)</b>								
<b>200SX (continued)</b>								
L4	L4 2.0L 1998cc	1995-98	Rear	Auto	1	EM-8132		
			Rear	Manual	1	EM-8701		
	L4 2.2L 2187cc	1982-83	L & R Front		2	EM-2680		
			Trans		1			EM-2488
V6	V6 3.0L 2960cc	1987-88	L & R Front		2	EM-8600		
			Trans	Auto	1			EM-5162
			Trans	Manual	1			EM-2488
<b>210</b>								
L4	L4 1.2L 1237cc	1979-82	L & R Front		2	EM-2681		
			Trans	Manual	1			EM-2489
	L4 1.4L 1393cc	1979-82	L & R Front		2	EM-2681		
			Trans	Manual	1			EM-2489
	L4 1.5L 1488cc	1980-82	L & R Front		2	EM-2681		
			Trans	Manual	1			EM-2489
<b>240SX</b>								
L4	L4 2.4L 2389cc	1989-98	L & R Front		2	EM-8296		
		1989-94	Trans	Manual	1			EM-8323
<b>240Z</b>								
L6	L6 2.4L 2393cc	1970-73	L & R Front		2	EM-2401		
			Trans	Auto	1			EM-2487
			Trans	Manual	1			EM-2487
<b>280ZX</b>								
L6	L6 2.8L 2753cc	1979-83	L & R Front		2	EM-2401		
			Trans	Auto	1			EM-2741
			Trans	Manual	1			EM-2741
<b>300ZX</b>								
V6	V6 3.0L 2960cc	1990-96	L & R Front	Coupe	2	EM-9044		
		1984-89	L & R Front		2	EM-9009		
		1990-96	Rear	Turbo	1	EM-5561		
		1984-89	Trans		1			EM-8963
<b>310</b>								
L4	L4 1.4L 1393cc	1979-80	LH Front		1	EM-9033		
			RH Front		1	EM-9033		
			Trans		1			EM-5163
	L4 1.5L 1488cc	1981-82	LH Front		1	EM-9033		
			RH Front		1	EM-9033		
			Trans		1			EM-5163
<b>350Z</b>								
V6	V6 3.5L	2009	L & R Front		2	EM-9180		
		2003-08	L & R Front		2	EM-9180		
		2009	Trans		1			EM-9464
			Trans	When Stock is Depleted, Re-order EM-9464	1			EM-5408
		2003-08	Trans		1			EM-9464
			Trans	When Stock is Depleted, Re-order EM-9464	1			EM-5408
<b>510</b>								
L4	L4 1.6L 1595cc	1968-73	L & R Front		2	EM-2533		
		1981	L & R Front		2	EM-2456		
	1978-80	LH Front		1	EM-2456			
		RH Front		1	EM-2680			
		1978-81	Trans		1			EM-2488

# Engine, Transmission, And Torque Strut Mounts

CYL	ENG. SIZE	YEAR	LOCATION	DESCRIPTION	QTY	ENGINE	TORQUE STRUT	TRANSMISSION	
<b>NISSAN PASSENGER CAR (continued)</b>									
<b>610</b>									
L4	L4 1.8L 1770cc	1973	L & R Front		2	EM-2405			
			Trans		1			EM-2487	
	L4 2.0L 1952cc	1974-76	L & R Front		2	EM-2405			
			Trans		1			EM-2487	
<b>710</b>									
L4	L4 1.8L 1770cc	1974	L & R Front		2	EM-2404			
			Trans		1			EM-2487	
	L4 2.0L 1952cc	1975-77	L & R Front		2	EM-2404			
			Trans		1			EM-2487	
<b>810</b>									
L6	L6 2.4L 2393cc	1981	L & R Front		2	EM-8138			
		1978-80	L & R Front		2	EM-2456			
		1978-81	Trans		2			EM-2742	
	L6 2.8L 2793cc Diesel	1981	L & R Front		2	EM-8138			
			Trans		1			EM-2487	
<b>1200</b>									
L4	L4 1.2L 1171cc	1971-73	L & R Front		2	EM-2402			
			Trans		1			EM-8115	
<b>1600</b>									
L4	L4 1.6L	1966-70	L & R Front		2	EM-2403			
<b>2000</b>									
L4	L4 2.0L 1982cc	1968-70	L & R Front		2	EM-2533			
			Trans		1			EM-2487	
<b>ALTIMA</b>									
L4	L4 2.4L 2389cc	2000-01	Front		1	EM-8682			
		1996-99	Front		1	EM-8682			
		1993-95	Front		1	EM-8682			
		2000-01	RH Front		1	EM-8994			
		1996-99	RH Front	Auto, Complete Unit		1	EM-8704		
			RH Front	Auto; Insert Only		1	EM-5502		
			RH Front	Manual		1	EM-8994		
		1993-95	RH Front	Auto, Complete Unit		1	EM-8704		
			RH Front	Auto; Insert Only		1	EM-5502		
		2000-01	Rear	Auto		1	EM-8681		
		1996-99	Rear	Auto		1	EM-8681		
		1993-95	Rear	Auto		1	EM-8681		
		1998-01	Trans	Auto		1			EM-8705
		1993-97	Trans	Auto		1			EM-8705
	Trans		Manual		1			EM-9517	
	L4 2.5L 2500cc	2002-06	Front		1	EM-9167			
			RH Front		1	EM-9190			
		2012-13	Rear		1	EM-9446			
		2007-11	Rear	Hybrid		1	EM-9544		
		2002-06	Rear	w/o Wires		1	EM-9209		
		2012-13	Right			1	EM-5865		
		2007-11	Right	Gas		1	EM-5865		
			Right	Hybrid		1	EM-5865		
		2007-13	Torq Str - Front			1		EM-9444	
		2007-12	Trans	Auto; CVT		1			EM-9465
		2005-06	Trans	Auto		1			EM-5817
2003-04		Trans	Auto		1			EM-5817	
2002	Trans	Auto		1			EM-5817		
V6	V6 3.5L 3498cc	2007-12	Front		1	EM-5869			
		2005-06	Front	Auto, w/ Wires		1	EM-5672		

# Engine, Transmission, And Torque Strut Mounts

CYL	ENG. SIZE	YEAR	LOCATION	DESCRIPTION	QTY	ENGINE	TORQUE STRUT	TRANSMISSION	
<b>NISSAN PASSENGER CAR (continued)</b>									
<b>ALTIMA (continued)</b>									
V6	V6 3.5L 3498cc	2005-06	Front	Auto; w/o Wires	1	EM-9252			
			Front	Manual, w/o Wires	1	EM-5772			
		2004	Front	Auto, w/ Wires	1	EM-5672			
			Front	Auto; w/o Wires	1	EM-9252			
			Front	Manual, w/o Wires	1	EM-5772			
		2002-03	Front	Auto, w/ Wires	1	EM-5672			
			Front	Auto; w/o Wires	1	EM-9252			
			Front	Manual, w/o Wires	1	EM-5772			
		2007-12	Rear			1	EM-5870		
		2005-06	Rear	Auto; 5 Spd; w/Wires	1	EM-5818			
			Rear	Manual	1	EM-9547			
		2004	Rear	Auto; w/o Wires	1	EM-9248			
			Rear	Manual, w/o Wires	1	EM-9547			
		2002-03	Rear	Auto; w/o Wires	1	EM-9248			
			Rear	Manual, w/o Wires	1	EM-9547			
		2007-12	Right			1	EM-5867		
		2005-06	Right			1	EM-9223		
		2004	Right			1	EM-9223		
		2002-03	Right			1	EM-9223		
		2008-12	Torq Str - Rear			1		EM-9551	
Torq Str - Right				1		EM-9545			
Trans	Auto; CVT		1				EM-9460		
2007	Trans	Auto; CVT	1				EM-9460		
2005-06	Trans	Auto	1				EM-9410		
	Trans	Manual	1				EM-9575		
2002-04	Trans	Auto	1				EM-9219		
	Trans	Manual	1				EM-9577		
<b>ALMERA (MEXICAN VEHICLE)</b>									
L4	L4 1.8L	2001-02	RH Front		1	EM-9200			
			Rear		1	EM-9166			
			Trans		1			EM-9217	
<b>B210</b>									
L4	L4 1.3L 1288cc	1974	L & R Front		2	EM-2400			
			L & R Front		2	EM-2403			
		1974	Trans	Auto	1			EM-2760	
			Trans	Manual	1			EM-5165	
		L4 1.4L 1393cc	1978	L & R Front		2	EM-2681		
	1975-77		L & R Front		2	EM-2400			
	1978		Trans	Manual	1			EM-2489	
	1975-77		Trans	Manual, 2 Door	1			EM-8117	
		Trans	Manual; 4 Door	1			EM-5166		
<b>CEFIRO (MEXICAN VEHICLE)</b>									
V6	V6 3.0L	1997	Front	Auto; w/o Wires	1	EM-5132			
			Front	Auto; w/Wires	1	EM-5670			
			Front	Manual	1	EM-8865			
			RH Front		1	EM-9031			
			Rear		1	EM-8866			
			Trans	Auto	1			EM-8959	
			Trans	Manual	1			EM-9035	
<b>CUBE</b>									
L4	L4 1.8L	2009	RH Front		1	EM-5656			
		2009-10	Torq Str - Rear		1		EM-9228		
			Torq Str - Right		1		EM-9422		
		2009	Trans		1			EM-9230	

# Engine, Transmission, And Torque Strut Mounts

CYL	ENG. SIZE	YEAR	LOCATION	DESCRIPTION	QTY	ENGINE	TORQUE STRUT	TRANSMISSION	
<b>NISSAN PASSENGER CAR (continued)</b>									
<b>F10</b>									
L4	L4 1.4L 1393cc	1976-78	L & R Front		2	EM-8138			
			Trans		1			EM-5815	
<b>HIKARI (MEXICAN VEHICLE)</b>									
L4	L4 1.6L	1987-92	RH Front		1	EM-8304			
			Rear		1	EM-8324			
			Torq Str - Front		1		EM-8125		
			Torq Str - Rear		1		EM-8133		
			Trans		1			EM-8121	
<b>INFINITI I30 (MEXICAN VEHICLE)</b>									
V6	V6 3.0L	2000-01	Front	w/ Wires	1	EM-5670			
			Front	w/o Wires	1	EM-5132			
		1998-99	Front	w/ Wires	1	EM-5670			
			Front	w/o Wires	1	EM-5132			
		2000-01	1998-99	RH Front		1	EM-9031		
				RH Front		1	EM-9031		
		2000-01	1998-99	Rear	Manual	1	EM-8866		
				Trans		1			EM-8959
		1998-99		Trans	Auto	1			EM-8959
				Trans	Manual	1			EM-9035
<b>LUCINO (MEXICAN VEHICLE)</b>									
L4	L4 1.6L	1996-00	Front		1	EM-8130			
			RH Front		1	EM-8122			
			Rear	Auto	1	EM-8132			
			Rear	Manual; Complete Unit	1	EM-8154			
			Rear	Manual; Insert Only	1	EM-8152			
		1999-00	Trans	Auto	1			EM-8150	
			Trans	Manual	1			EM-8148	
		1996-98	Trans	Auto	1			EM-8150	
	Trans		Manual	1			EM-8891		
	L4 2.0L	2000	Front	Manual	1	EM-8130			
			RH Front		1	EM-8307			
			Rear		1	EM-8132			
			Trans		1			EM-8891	
<b>MAXIMA</b>									
L6	L6 2.4L 2393cc	1982-84	L & R Front		2	EM-8138			
			Trans	Manual	1			EM-2487	
	L6 2.8L 2793cc Diesel	1982-83	L & R Front		2	EM-8138			
			Trans		1			EM-2487	
V6	V6 3.0L 2960cc	1992-94	Front	DOHC	1	EM-9048			
			Front	SOHC	1	EM-8600			
		1989-91	1985-88	Front		1	EM-8600		
				Front	Auto	1	EM-8605		
		1992-94	1989-91	Front	Manual	1	EM-8962		
				LH Front	Auto	1	EM-8601		
		1989-91	1992-94	LH Front	Manual	1	EM-9010		
				LH Front	Auto	1	EM-8601		
		1992-94	1989-91	LH Front	Manual	1	EM-9010		
				LH Rear	Auto - DOHC	1	EM-5777		
		1989-91	1992-94	LH Rear	Manual - DOHC	1	EM-5779		
				LH Rear	SOHC	1	EM-8603		
		1985-88	1992-94	LH Rear	Auto	1	EM-8603		
				LH Rear	Manual	1	EM-5779		
		1985-88	1992-94	RH Front		1	EM-8140		
				RH Rear	DOHC	1	EM-9171		
			RH Rear	SOHC	1	EM-8602			

# Engine, Transmission, And Torque Strut Mounts

CYL	ENG. SIZE	YEAR	LOCATION	DESCRIPTION	QTY	ENGINE	TORQUE STRUT	TRANSMISSION	
<b>NISSAN PASSENGER CAR (continued)</b>									
<b>MAXIMA (continued)</b>									
V6	V6 3.0L 2960cc	1989-91	RH Rear	Auto	1	EM-8602			
		1985-88	Rear		1	EM-8141			
		1992-94	Trans	Auto, DOHC	1			EM-9176	
			Trans	Auto, SOHC	1			EM-8601	
			Trans	Manual	1			EM-9010	
		1989-91	Trans	Auto	1			EM-8601	
			Trans	Manual	1			EM-9010	
		1985-88	Trans	Auto	1			EM-8604	
			Trans	Manual	1			EM-8604	
		V6 3.0L 2988cc	2000-01	Front	Auto, GXE & SE	1	EM-5670		
				Front	Manual	1	EM-8865		
			1997-99	Front	Auto; GLE; SE w/ Wires	1	EM-5670		
	Front			Auto; GLE; SE; w/o Wires	1	EM-5132			
	Front			Auto; GXE	1	EM-8865			
	1996		Front	Manual, SE & GLE	1	EM-8865			
			Front	Auto, GXE	1	EM-8865			
			Front	Auto, w/ Wires; GLE and SE from 2/96	1	EM-5670			
	1995		Front	Auto; GLE; SE; w/o Wires	1	EM-5132			
			Front	Manual	1	EM-8865			
			Front	Auto, GXE	1	EM-8865			
	2000-01		Front	Manual	1	EM-8865			
			RH Front	Auto, GXE & SE	1	EM-9251			
	1997-99		RH Front	GLE	1	EM-9251			
			RH Front	Manual, GXE & SE	1	EM-9031			
			RH Front		1	EM-9031			
	2000-01		Rear	Auto	1	EM-5846			
			Rear	Manual	1	EM-8866			
	1997-99		Rear		1	EM-8866			
	1996		Rear		1	EM-8866			
	1995		Rear		1	EM-8866			
	2000-01		Trans	Auto	1			EM-5937	
			Trans	Manual	1			EM-9035	
	1997-99		Trans	Auto	1			EM-5937	
			Trans	Manual	1			EM-9035	
	1995-96		Trans		1			EM-9035	
			Trans	Auto	1			EM-5937	
	V6 3.5L 3498cc		2009-14	Front		1	EM-5869		
			2007-08	Front	w/ Wires	1	EM-5672		
				Front	w/o Wires	1	EM-9252		
		2006	Front	w/ Wires	1	EM-5672			
			Front	w/o Wires	1	EM-9252			
		2004-05	Front	w/ Wires	1	EM-5672			
Front			w/o Wires	1	EM-9252				
2003		Front	Auto; w/o Wires	1	EM-5132				
		Front	Auto; w/Wires	1	EM-5670				
		Front	Manual	1	EM-8865				
2002		Front		1	EM-8865				
2007-08		RH Front		1	EM-9223				
2006		RH Front		1	EM-9223				
2004-05		RH Front		1	EM-9223				
2003		RH Front	Auto	1	EM-9031				
		RH Front	Manual	1	EM-9031				
2002		RH Front	Auto	1	EM-9031				
2009-14		Rear		1	EM-5870				
2007-08		Rear	w/ Wires	1	EM-5748				
2006		Rear	Auto; From 6/06	1	EM-5748				

# Engine, Transmission, And Torque Strut Mounts

CYL	ENG. SIZE	YEAR	LOCATION	DESCRIPTION	QTY	ENGINE	TORQUE STRUT	TRANSMISSION			
<b>NISSAN PASSENGER CAR (continued)</b>											
<b>MAXIMA (continued)</b>											
V6	V6 3.5L 3498cc	2006	Rear	Auto; to 6/06	1	EM-5818					
			Rear	Manual	1	EM-9547					
		2004-05	Rear	Auto; w/ Wires; SE	1	EM-5818					
			Rear	Auto; w/ Wires; SL	1	EM-5748					
			Rear	Manual	1	EM-9547					
		2003	Rear	Auto	1	EM-5411					
			Rear	Manual	1	EM-8866					
		2002	Rear	Auto	1	EM-5411					
		2009-14	Right		1	EM-5867					
		2009-12	Torq Str - Rear	Torque Strut Buffer	1		EM-9551				
			Torq Str - Right		1		EM-9545				
			Trans		1			EM-9460			
		2007-08	Trans		1			EM-9414			
		2005-06	Trans	Auto & CVT	1			EM-9410			
			Trans	Manual	1			EM-9575			
		2004	Trans	Auto; 4 Spd	1			EM-9219			
			Trans	Auto; 5 Spd	1			EM-9410			
			Trans	Manual	1			EM-9575			
2002-03	Trans	Auto	1			EM-8959					
	Trans	Manual	1			EM-9589					
<b>MULTI</b>											
L4	L4 2.0L	1986-88	LH Front		1	EM-5500					
<b>NX</b>											
L4	L4 1.6L 1597cc	1991-93	Front	Manual	1	EM-8130					
			LH Front		1	EM-8427					
			RH Front		1	EM-8122					
			Rear	Auto	1	EM-8132					
			Rear	Manual	1	EM-8701					
			Trans	Auto	1			EM-8150			
	L4 2.0L 1998cc	1991-93	Front	Manual	1	EM-8130					
			RH Front	Auto	1	EM-8290					
			RH Front	Manual	1	EM-8427					
			Rear	Auto	1	EM-8132					
			Rear	Manual	1	EM-8701					
			Trans		1			EM-8149			
			<b>PRIMERA (MEXICAN VEHICLE)</b>								
			L4	L4 2.0L	1992	Front		1	EM-8858		
RH Front		1				EM-5131					
Rear		1				EM-8681					
Trans	Auto	1						EM-9288			
Trans	Manual	1						EM-5332			
<b>PULSAR</b>											
L4	L4 1.6L 1597cc	1983	RH Front		1	EM-8118					
			Rear		1	EM-8119					
			Torq Str - Front		1		EM-8120				
			Torq Str - Rear		1		EM-8142				
			Trans	Auto	1			EM-8151			
			Trans	Manual	1			EM-8121			
<b>PULSAR NX</b>											
L4	L4 1.5L 1488cc	1983-84	LH Front		1	EM-8151					
			RH Front		1	EM-8118					
			Torq Str - Front	Auto	1		EM-8142				
			Torq Str - Rear	Auto	1		EM-8284				
			Trans	Auto	1			EM-8119			

# Engine, Transmission, And Torque Strut Mounts

CYL	ENG. SIZE	YEAR	LOCATION	DESCRIPTION	QTY	ENGINE	TORQUE STRUT	TRANS-MISSION	
<b>NISSAN PASSENGER CAR (continued)</b>									
<b>PULSAR NX (continued)</b>									
L4	L4 1.5L 1488cc	1983-84	Trans	Manual	1			EM-8121	
		1988-90	LH Rear	Auto	1	EM-8324			
			LH Rear	Manual	1	EM-8154			
		1987	LH Rear	Manual	1	EM-8154			
		1988-90	RH Front		1	EM-8304			
		1987	RH Front		1	EM-8304			
		1983-86	RH Front		1	EM-8118			
		1987-90	Torq Str - Front		1		EM-8125		
		1983-86	Torq Str - Front		1		EM-8142		
		1987-90	Torq Str - Rear		1		EM-8133		
	1983-86	Torq Str - Rear		1		EM-8284			
	1988-90	Trans	Auto	1				EM-8128	
		Trans	Manual	1				EM-8312	
		1987	Trans	Manual	1			EM-8312	
		1983-86	Trans	Auto	1			EM-8151	
		Trans	Manual	1				EM-8121	
	L4 1.8L 1809cc	1988-89	RH Front		1	EM-9134			
			Torq Str - Front		1		EM-8125		
			Torq Str - Rear		1		EM-8133		
			Trans		1			EM-8312	
<b>SAKURA (MEXICAN VEHICLE)</b>									
L4	L4 1.8L	1985-87	Trans - LH	Auto	1			EM-9049	
			Trans - RH	Auto	1			EM-9025	
			Trans	Manual	1			EM-2488	
<b>SENTRA</b>									
L4	L4 1.5L 1488cc	1982-83	Front	Auto	1	EM-8151			
			Front	Manual	1	EM-8118			
			Torq Str - Front	Auto	1		EM-8142		
			Torq Str - Rear	Auto	1		EM-8284		
			Trans	Auto	1			EM-8119	
			Trans	Manual	1			EM-8121	
	L4 1.6L 1597cc	2000	Front	Mexican Vehicle	1	EM-8130			
			1995-99	Front	Manual	1	EM-8130		
			1991-94	Front	Manual	1	EM-8130		
			2000	RH Front	Mexican Vehicle	1	EM-8122		
			1995-99	RH Front		1	EM-8122		
			1991-94	RH Front		1	EM-8427		
			1989-90	RH Front	Complete Unit	1	EM-8304		
			RH Front	Insert Only	1	EM-8295			
			1987-88	RH Front		1	EM-8304		
			1983-86	RH Front		1	EM-8118		
			2000	Rear	Mexican Vehicle; Auto	1	EM-8132		
				Rear	Mexican Vehicle; Bushing	1	EM-8152		
				Rear	Mexican Vehicle; Manual	1	EM-8154		
			1995-99	Rear	Auto	1	EM-8132		
			1991-94	Rear		1	EM-8132		
			1989-90	Rear	Auto	1	EM-8324		
				Rear	Manual, Complete Unit	1	EM-8154		
				Rear	Manual; Insert Only	1	EM-8152		
			1987-88	Rear	Auto	1	EM-8324		
				Rear	Manual, Complete Unit	1	EM-8154		
				Rear	Manual; Insert Only	1	EM-8152		
			1983-86	Rear		1	EM-8119		
			1989-90	Torq Str - Front		1		EM-8125	
			1987-88	Torq Str - Front		1		EM-8125	
			1983-86	Torq Str - Front		1		EM-8142	



# Engine, Transmission, And Torque Strut Mounts

CYL	ENG. SIZE	YEAR	LOCATION	DESCRIPTION	QTY	ENGINE	TORQUE STRUT	TRANSMISSION		
<b>NISSAN PASSENGER CAR (continued)</b>										
<b>SENTRA (continued)</b>										
L4	L4 1.6L 1597cc	1987-88	Torq Str - Rear		1		EM-8133			
		1983-86	Torq Str - Rear		1		EM-8284			
		2000	Trans	Mexican Vehicle; Auto	1				EM-8150	
			Trans	Mexican Vehicle; Manual	1				EM-8891	
		1995-99	Trans	Auto	1				EM-8150	
			Trans	Manual, Made in Mexico	1				EM-8149	
			Trans	Manual; Made in U.S.A.	1				EM-8683	
		1993-94	Trans	Auto; 4 Spd	1				EM-8150	
			Trans	Manual; 5 Spd	1				EM-8149	
		1991-92	Trans	Auto; 3 Spd	1				EM-5771	
			Trans	Auto; 4 Spd	1				EM-8150	
			Trans	Manual; 4 Spd	1				EM-8148	
		1990	Trans	Manual; 5 Spd	1				EM-8149	
			Trans	FWD; Auto; FWD	1				EM-8128	
			Trans	FWD; Manual; FWD	1				EM-8274	
		1989	Trans	4WD; Auto; 4WD	1				EM-8317	
			Trans	Auto; FWD	1				EM-8128	
		1987-88	Trans	Manual; FWD	1				EM-8274	
			Trans	Auto	1				EM-8128	
		1986	Trans	Manual; After 10/1986	1				EM-8312	
			Trans	Manual; Before 10/1986	1				EM-5501	
			Trans	Auto	1				EM-8151	
		1983-85	Trans	Manual; After 10/1986	1				EM-8312	
			Trans	Manual; Before 10/1986	1				EM-8121	
		L4 1.8L	2000-06	Trans	Auto	1			EM-8151	
				Trans	Manual	1			EM-8121	
		L4 1.8L 1809cc	2000-06	Front		1	EM-9200			
				RH Front		1	EM-9229			
	Rear				1	EM-9166				
	L4 2.0L	2007-10	Torq Str - Left		1		EM-9456			
			Torq Str - Rear		1		EM-9228			
		2007-12	Trans	Manual	1			EM-9448		
	L4 2.0L 1997cc	2007-10	RH Front		1	EM-5782				
	L4 2.0L 1998cc	2000-01	Front	Auto	1	EM-9200				
			Front	Manual	1	EM-8130				
			Front	Manual	1	EM-8130				
		1998-99	RH Front		1	EM-8307				
			RH Front		1	EM-8307				
		2000-01	Rear	Auto	1	EM-9166				
			Rear	Auto	1	EM-8132				
		2000-01	Rear	Manual	1	EM-8701				
			Right	Auto	1	EM-9531				
		1998-99	Trans	Auto, Made in Japan	1				EM-8150	
			Trans	Auto, Made in US	1				EM-8149	
			Trans	Manual, Made in Japan	1				EM-8891	
		1991-94	Trans	Auto	1				EM-8149	
	Trans		Manual	1				EM-8149		
L4 2.5L	2007-12	Torq Str - Left		1		EM-9453				
		Torq Str - Rear		1		EM-9452				
	2002-06	Trans	Auto	1				EM-9471		
Trans		Manual	1				EM-5775			
L4 2.5L 2500cc	2004-06	Front	Auto	1	EM-9442					
		Front	Manual	1	EM-5405					
	2002-03	Front	Auto	1	EM-9442					
		Front	Manual	1	EM-5405					

# Engine, Transmission, And Torque Strut Mounts

CYL	ENG. SIZE	YEAR	LOCATION	DESCRIPTION	QTY	ENGINE	TORQUE STRUT	TRANSMISSION
<b>NISSAN PASSENGER CAR (continued)</b>								
<b>SENTRA (continued)</b>								
L4	L4 2.5L 2500cc	2004-06	RH Front		1	EM-5773		
		2002-03	RH Front	Manual	1	EM-5773		
		2004-06	Rear		1	EM-9573		
		2002-03	Rear		1	EM-9573		
		2007-12	Right		1	EM-5953		
			Trans	Manual	1			EM-5905
<b>STANZA</b>								
L4	L4 2.0L 1974cc	1982-86	Front		1	EM-9020		
		1987-89	LH Front		1	EM-5500		
			RH Front		1	EM-5171		
		1982-86	RH Front	Complete Unit	1	EM-8135		
			RH Front	Insert Only	1	EM-5387		
		1987-89	Rear	Auto	1	EM-8961		
			Rear	Manual	1	EM-8319		
		1982-86	Rear	Auto	1	EM-9040		
			Rear	Manual	1	EM-9042		
		1987-89	Torq Str - Front		1		EM-8133	
		1982-86	Torq Str - Front		1		EM-5170	
		1987-89	Torq Str - Rear		1		EM-8137	
		1989	Trans	Auto	1			EM-8303
			Trans	Manual; Hatchback; Sedan	1			EM-5481
		1987-88	Trans	Auto	1			EM-8303
			Trans	Manual; Hatchback; Sedan	1			EM-5481
			Trans	Manual; Wagon	1			EM-9041
	1982-86	Trans	Auto	1			EM-9028	
		Trans	Manual	1			EM-9028	
	L4 2.4L 2389cc	1990-92	Front		1	EM-8874		
RH Front				1	EM-8846			
Rear			Auto, After 6/90	1	EM-8681			
Trans			Auto	1		EM-5770		
Trans			Manual	1		EM-8887		
<b>TIIDA (MEXICAN VEHICLE)</b>								
L4	L4 1.8L	2007-08	RH Front		1	EM-5656		
		2007-11	Torq Str - Front		1		EM-9422	
			Torq Str - Rear		1		EM-9228	
		2007-08	Trans		1			EM-9230
<b>TSUBAME (MEXICAN VEHICLE)</b>								
L4	L4 1.5L	1985	RH Front		1	EM-8118		
			Torq Str - Front		1		EM-8142	
			Torq Str - Rear		1		EM-8284	
			Trans		1		EM-8119	
	L4 1.6L	1995-04	Front		1	EM-8130		
			RH Front		1	EM-8122		
			Rear	Auto	1	EM-8132		
			Rear	Manual; Complete Unit	1	EM-8154		
			Rear	Manual; Insert Only	1	EM-8152		
		1999-04	Trans	Auto	1		EM-8150	
			Trans	Manual	1		EM-8148	
		1995-98	Trans	Auto	1		EM-8150	
	Trans		Manual	1		EM-8150		
<b>VERSA NOTE</b>								
L4	L4 1.6L 1598cc	2014-15	Trans	Auto	1			EM-5969
			Trans	Manual	1			EM-5969

# Engine, Transmission, And Torque Strut Mounts

CYL	ENG. SIZE	YEAR	LOCATION	DESCRIPTION	QTY	ENGINE	TORQUE STRUT	TRANSMISSION	
<b>NISSAN PASSENGER CAR (continued)</b>									
<b>VERSA</b>									
L4	L4 1.6L 1598cc	2009-11	RH Front		1	EM-5781			
		2012-13	Torq Str - Lower		1		EM-5968		
		2009-11	Torq Str - Rear		1		EM-9228		
		2012-15	Trans	Auto		1			EM-5969
			Trans	Manual		1			EM-5969
		2009-11	Trans	Auto		1			EM-9230
	Trans		Manual		1			EM-9230	
	L4 1.8L	2007-12	RH Front		1	EM-5656			
	L4 1.8L 1798cc	2012	Torq Str - Lower		1		EM-5968		
			Torq Str - Rear		1		EM-9228		
		2007-12	Torq Str - Right		1		EM-9422		
			Trans	Auto		1			EM-9230
Trans			Manual		1			EM-9230	
<b>TSURU (MEXICAN VEHICLE)</b>									
L4	L4 1.5L	1985-87	RH Front		1	EM-8118			
			Torq Str - Front		1		EM-8142		
			Torq Str - Rear		1		EM-8284		
			Trans		1			EM-8119	
	L4 1.6L	1998-08 1995-97 1992-94 1998-08 1995-97 1992-94 1985-91 1998-08 1995-97 1992-94 1985-91 1999-08 1998 1995-97 1985-91	1998-08 1995-97 1992-94 1998-08 1995-97 1992-94 1985-91 1998-08 1995-97 1992-94 1985-91 1999-08 1998 1995-97 1985-91	Front		1	EM-8130		
				Front		1	EM-8130		
				Front		1	EM-8130		
				RH Front		1	EM-8122		
				RH Front		1	EM-8122		
				RH Front	Complete Unit	1	EM-8427		
				RH Front		1	EM-8304		
				Rear	Auto	1	EM-8132		
					Manual; Complete Unit	1	EM-8154		
					Manual; Insert Only	1	EM-8152		
				Rear	Auto	1	EM-8132		
					Manual; Complete Unit	1	EM-8154		
					Manual; Insert Only	1	EM-8152		
				Rear	Manual; Complete Unit	1	EM-8154		
					Manual; Insert Only	1	EM-8152		
				Rear	Manual; Complete Unit	1	EM-8154		
					Manual; Insert Only	1	EM-8152		
				Torq Str - Front		1		EM-8125	
						1		EM-8133	
				Trans	Auto	1			EM-8150
	Manual	1				EM-8148			
	Trans	Complete Unit	1			EM-8149			
	Trans	Complete Unit	1			EM-8149			
	Trans		1			EM-8121			
	L4 2.0L	1995-96	Front	Manual	1	EM-8130			
			RH Front		1	EM-8307			
			Rear		1	EM-8132			
			Trans		1			EM-8891	
	<b>NISSAN SPORT UTILITY</b>								
	<b>ARMADA</b>								
	V8	V8 5.6L	2005-09	L & R Front		2	EM-5404		
			2005-13	Trans	AWD & 4WD	1			EM-5407
Trans				RWD	1			EM-5406	
<b>MURANO</b>									
V6	V6 3.5L	2009-12	Trans		1			EM-5914	
		2008	Trans	Mexico	1			EM-5914	
		2003-07	Trans		1			EM-9414	
	V6 3.5L 3498cc	2003-07	Front	AWD; w/o Wires	1	EM-9256			

# Engine, Transmission, And Torque Strut Mounts

CYL	ENG. SIZE	YEAR	LOCATION	DESCRIPTION	QTY	ENGINE	TORQUE STRUT	TRANS-MISSION	
<b>NISSAN SPORT UTILITY (continued)</b>									
<b>MURANO (continued)</b>									
V6	V6 3.5L 3498cc	2003-07	Front	FWD, w/o Wires	1	EM-9252			
			Front	FWD, w/Wires	1	EM-5672			
			RH Front		1	EM-9223			
			Rear	AWD; w/ Wires	1	EM-5962			
			Rear	AWD; w/o Wires	1	EM-5441			
			Rear	FWD, w/o Wires	1	EM-9248			
		Rear	FWD, w/Wires	1	EM-5818				
		2009-12	Right		1	EM-5866			
<b>ROGUE</b>									
L4	L4 2.5L 2500cc	2008-12	Right		1	EM-5953			
			Torq Str - Left		1		EM-9453		
			Torq Str - Rear		1		EM-9452		
<b>PATHFINDER</b>									
L4	L4 2.4L 2389cc	1987-88	L & R Front		2	EM-8276			
			Trans		1			EM-8124	
V6	V6 3.0L 2960cc	1987-95	L & R Front		2	EM-8114			
			1989	Trans - LH	Auto; 2WD	1			EM-8124
			1989	Trans - RH	4WD	1			EM-8124
		1990-95	Trans	Auto	1			EM-8124	
			Trans	Manual	1			EM-8124	
		1989	Trans	Auto; 2WD	1			EM-5778	
			Trans	Manual; 2WD	1			EM-2719	
		1987-88	Trans	Auto; 4WD	1			EM-8124	
			Trans	Manual; 4WD	1			EM-8124	
		V6 3.3L 3275cc	1996-00	L & R Front	Before 1/00	2	EM-8311		
				Trans	2WD	1			EM-8322
				Trans	Auto; 4WD	1			EM-9038
			1996	Trans	Manual; 4WD	1			EM-9011
				Trans	Auto; 4WD	1			EM-9108
				Trans	Auto; RWD	1			EM-8322
	1996	Trans	Manual; RWD	1			EM-8322		
V6 3.5L 3498cc	2001-04	L & R Front		2	EM-9408				
		Trans	Auto; 4WD	1			EM-9395		
	2003-04	Trans	Auto; RWD	1			EM-8322		
		Trans	Auto; 4WD	1			EM-9395		
	2001-02	Trans	Auto; RWD	1			EM-8322		
		Trans	Manual; 4WD	1			EM-9011		
		Trans	Manual; RWD	1			EM-8322		
V6 4.0L 3954cc	2006-12	L & R Front		2	EM-9506				
		Trans	4WD	1			EM-9520		
	2005-12	Trans	RWD	1			EM-9482		
V8	V8 5.6L 5552cc	2008-10	L & R Front		2	EM-5404			
			2004	L & R Front		2	EM-5404		
		2008-12	Trans	4WD	1			EM-5407	
			Trans	RWD	1			EM-5406	
		2004	Trans	4WD	1			EM-5407	
			Trans	RWD	1			EM-5406	
<b>X-TRAIL</b>									
L4	L4 2.5L 2500cc	2005-07	Front		1	EM-9442			
			RH Front		1	EM-5173			
			Rear	AWD	1	EM-5174			
			Rear	FWD	1	EM-5938			
		2005-06	Trans	Manual; Canada	1			EM-5175	

# Engine, Transmission, And Torque Strut Mounts

CYL	ENG. SIZE	YEAR	LOCATION	DESCRIPTION	QTY	ENGINE	TORQUE STRUT	TRANSMISSION	
<b>NISSAN SPORT UTILITY (continued)</b>									
<b>XTERRA</b>									
L4	L4 2.4L 2389cc	2000-04	LH Front		1	EM-9012			
			RH Front		1	EM-8276			
			Trans		1			EM-8964	
V6	V6 3.3L 3275cc	2000-04	L & R Front		2	EM-8960			
			Trans	Auto; 2WD	1			EM-5556	
			Trans	Auto; 4WD	1			EM-8964	
			Trans	Manual; 2WD	1			EM-5556	
			Trans	Manual; 4WD	1			EM-8964	
	V6 4.0L	2005-12 2005-14	L & R Front		2	EM-9506			
			Trans	4WD	1			EM-9520	
			Trans	Auto; RWD	1			EM-9482	
	Trans	Manual; RWD	1			EM-9482			
<b>NISSAN TRUCK</b>									
<b>521 PICKUP</b>									
L4	L4 1.6L 1595cc	1970-72	L & R Front		2	EM-2404			
			Trans	2WD	1			EM-2742	
<b>620 PICKUP</b>									
L4	L4 1.6L 1595cc	1972-73	L & R Front		2	EM-2404			
			Trans	Auto; 2WD	1			EM-2742	
			Trans	Manual; 2WD	1			EM-2742	
	L4 1.8L 1770cc	1974	L & R Front		2	EM-2404			
			Trans	2WD	1			EM-2742	
			Trans	Auto; 2WD	1			EM-2742	
			Trans	Manual; 2WD	1			EM-2742	
	L4 2.0L 1952cc	1975-79	LH Front		1	EM-2532			
			RH Front		1	EM-2533			
			Trans	2WD	1			EM-2742	
			Trans	Auto; 2WD	1			EM-2742	
			Trans	Manual; 2WD	1			EM-2742	
	<b>720 PICKUP</b>								
L4	L4 2.0L 1952cc	1983-85	LH Front		1	EM-2740			
			1980	LH Front	4WD	1	EM-8310		
		1983-85	LH Front	RWD	1	EM-2740			
			RH Front		1	EM-8566			
		1980	RH Front	4WD	1	EM-8144			
			RH Front	RWD	1	EM-8566			
		1984-85	Trans	Auto	1			EM-2742	
			Trans	Manual	1			EM-2742	
		1983	Trans	Manual	1			EM-2742	
		1980	Trans	Auto	1			EM-2742	
			Trans	Manual	1			EM-2742	
		L4 2.2L 2164cc Diesel	1981-83	LH Front		1	EM-8145		
				RH Front		1	EM-8146		
				Trans	Auto	1			EM-2742
	Trans			Manual	1			EM-2742	
	Trans			Auto	1			EM-2742	
	L4 2.2L 2187cc	1983	L & R Front	4WD	2	EM-8310			
			LH Front	RWD	1	EM-2740			
		1981-82	LH Front	4WD	1	EM-8310			
			LH Front	RWD	1	EM-2740			
		1983	RH Front	RWD	1	EM-8566			
		1981-82	RH Front	RWD	1	EM-8566			
		L4 2.4L 2389cc	1986	L & R Front	4WD	2	EM-8276		
	L & R Front			RWD	2	EM-2718			

# Engine, Transmission, And Torque Strut Mounts

CYL	ENG. SIZE	YEAR	LOCATION	DESCRIPTION	QTY	ENGINE	TORQUE STRUT	TRANSMISSION	
<b>NISSAN TRUCK (continued)</b>									
<b>720 PICKUP (continued)</b>									
L4	L4 2.4L 2389cc	1983-85	L & R Front	4WD	2	EM-8310			
			LH Front	RWD	1	EM-2740			
			RH Front	RWD	1	EM-8566			
		1986	Trans	Auto; 4WD	1			EM-8124	
			Trans	Manual; 4WD	1			EM-8124	
			Trans	Manual; RWD	1			EM-2719	
	1983-85	Trans	Auto	1			EM-2742		
		Trans	Manual	1			EM-2742		
	L4 2.5L 2488cc Diesel	1983-86	LH Front		1	EM-8157			
			Trans	Auto; 2WD	1		EM-2742		
Trans			Manual; 2WD	1		EM-2742			
<b>D21 PICKUP</b>									
L4	L4 2.4L 2389cc	1986-94	L & R Front	4WD	2	EM-8276			
			L & R Front	RWD	2	EM-2718			
		1986-89	Trans - RH	Auto; 2WD	1			EM-5780	
			1990-94	Trans	Auto; 2WD	1		EM-8328	
				Trans	Auto; 4WD	1		EM-8124	
		Trans		Manual; 2WD	1		EM-2719		
		1986-89	Trans	Manual; 4WD	1		EM-8124		
			Trans	Auto; 4WD	1		EM-8124		
			Trans	Manual; 2WD	1		EM-2719		
			Trans	Manual; 4WD	1		EM-8124		
Trans	Manual; 4WD		1		EM-8124				
V6	V6 3.0L 2960cc	1986-94	L & R Front		2	EM-8114			
			Trans - LH	Auto; 2WD	1		EM-8124		
		1986-89	Trans - RH	Auto; 2WD	1		EM-5778		
			1990-94	Trans	Auto	1		EM-2719	
		1986-89		Trans	Manual	1		EM-8124	
			Trans	4WD	1		EM-8124		
Trans	Manual; 2WD	1		EM-2719					
<b>FRONTIER</b>									
L4	L4 2.4L 2389cc	1998-04	LH Front		1	EM-9012			
			RH Front		1	EM-8276			
			Trans	Auto; 2WD	1		EM-2719		
			Trans	Auto; 4WD	1		EM-8964		
			Trans	Manual; 2WD	1		EM-2719		
			Trans	Manual; 4WD	1		EM-8964		
	L4 2.5L	2005-11	L & R Front		1	EM-9483			
			Trans	RWD	1		EM-9482		
	V6	V6 3.3L 3275cc	1999-04	L & R Front		2	EM-8960		
				Trans	Auto; 2WD	1		EM-5556	
2000-04			Trans	Auto; 4WD	1		EM-8964		
			Trans	Manual; 2WD	1		EM-5556		
			Trans	Manual; 4WD	1		EM-8964		
1999		Trans		1		EM-8964			
V6 4.0L		2005-12	L & R Front		2	EM-9506			
			Trans	4WD	1		EM-9520		
	2005-15	Trans	RWD	1		EM-9482			
<b>PICKUP</b>									
L4	L4 1.8L	1985-94	L & R Front	Mexican Vehicle; 4WD Mexican Vehicle	2	EM-8310			
			LH Front	Mexican Vehicle; RWD Mexican Vehicle	1	EM-2740			
			RH Front	Mexican Vehicle; RWD Mexican Vehicle	1	EM-2533			
			Trans	Mexican Vehicle	1		EM-2742		
	L4 2.4L	1998-02	L & R Front	RWD; Mexican Vehicle	2	EM-2718			

# Engine, Transmission, And Torque Strut Mounts

CYL	ENG. SIZE	YEAR	LOCATION	DESCRIPTION	QTY	ENGINE	TORQUE STRUT	TRANS-MISSION
<b>NISSAN TRUCK (continued)</b>								
<b>PICKUP (continued)</b>								
L4	L4 2.4L	1998-02	Trans	RWD; Mexican Vehicle	1			EM-2719
			1997	Trans	Auto; 4WD	1		EM-2742
		1995-97	Trans	Auto; RWD	1		EM-8328	
			Trans	Manual; 4WD	1		EM-8124	
			Trans	Manual; RWD	1		EM-2719	
	L4 2.4L 2389cc	1995-97	L & R Front	4WD	2	EM-8276		
			L & R Front	RWD	2	EM-2718		
		1994-96	Trans	4WD	1		EM-8124	
Trans	RWD		1		EM-2719			
V6	V6 3.0L 2960cc	1995-96	L & R Front		2	EM-8114		
			Trans	4WD	1		EM-8124	
			Trans	RWD	1		EM-2719	
<b>TITAN</b>								
V8	V8 5.6L	2004-10	L & R Front		2	EM-5404		
			2004-13	Trans	4WD	1		EM-5407
		2004-13	Trans	RWD	1		EM-5406	
<b>NISSAN VAN</b>								
<b>AXXESS</b>								
L4	L4 2.4L	1991-92	Torq Str - Front	4WD	1		EM-8133	
			L4 2.4L 2389cc	1993-95	Front	Manual	1	EM-8874
	L4 2.4L 2389cc	1991-92	Front	Manual; FWD	1	EM-8874		
		1990	Front	Manual; FWD	1	EM-8874		
		1993-95	Rear		1	EM-8681		
		1991-92	Rear	FWD	1	EM-8681		
		1990	Rear	FWD	1	EM-8681		
		1990-95	Trans	Auto; FWD	1		EM-8887	
		<b>ICHI (MEXICAN VEHICLE)</b>						
L4	L4 1.8L	1988-94	L & R Front		2	EM-2456		
			Trans		1		EM-2487	
<b>NV1500</b>								
V6	V6 4.0L 3954cc	2012-13	L & R Front		2	EM-9506		
<b>NV2500</b>								
V6	V6 4.0L 3954cc	2012-13	L & R Front		2	EM-9506		
<b>NV3500</b>								
V6	V6 4.0L 3954cc	2012-13	L & R Front		2	EM-9506		
<b>NV2500</b>								
V8	V8 5.6L 5552cc	2012-13	Trans		1			EM-5406
<b>NV3500</b>								
V8	V8 5.6L 5552cc	2012-13	Trans		1			EM-5406
<b>QUEST</b>								
V6	V6 3.0L 2960cc	1993-98	Front		1	EM-2855		
			RH Front		1	EM-2856		
			Rear		1	EM-2857		
			Trans		1		EM-2854	
	V6 3.3L 3275cc	1999-02	Front		1	EM-2989		
			LH Rear		1	EM-2985		
			RH Rear		1	EM-2857		
			Trans		1		EM-2854	
	V6 3.5L 3498cc	2009	Front	w/ Wires	1	EM-5672		
			Front	w/o Wires	1	EM-9252		
		2007-08	Front	w/ Wires	1	EM-5672		
			Front	w/o Wires	1	EM-9252		

# Engine, Transmission, And Torque Strut Mounts

CYL	ENG. SIZE	YEAR	LOCATION	DESCRIPTION	QTY	ENGINE	TORQUE STRUT	TRANSMISSION	
<b>NISSAN VAN (continued)</b>									
<b>QUEST (continued)</b>									
V6	V6 3.5L 3498cc	2004-06	Front	w/ Wires	1	EM-5672			
			Front	w/o Wires	1	EM-9252			
		2009	RH Front			1	EM-9223		
		2007-08	RH Front			1	EM-9223		
		2004-06	RH Front			1	EM-9223		
		2009	Rear	w/ Wires	1	EM-5818			
			Rear	w/o Wires	1	EM-9248			
		2007-08	Rear	w/o Wires	1	EM-9548			
		2004-06	Rear	4 spd A/T; w/ Wires	1	EM-5818			
			Rear	4 spd A/T; w/o Wires	1	EM-9248			
			Rear	5 spd A/T; w/o Wires	1	EM-9548			
		2011-15	Right		1	EM-5866			
		2011-12	Trans		1			EM-5914	
		2007-09	Trans	Auto	1			EM-9410	
2004-06	Trans	Auto; 4 Spd	1			EM-9219			
	Trans	Auto; 5 Spd	1			EM-9410			
<b>VAN</b>									
L4	L4 2.4L	1987-88	Trans	Manual	1			EM-5481	
	L4 2.4L 2389cc	1987-88	LH Front		1	EM-5500			
			Rear		1	EM-8303			
<b>AD (MEXICAN VEHICLE)</b>									
L4	L4 1.6L	1990-91	RH Front		1	EM-8304			
			Rear		1	EM-8324			
			Torq Str - Front		1		EM-8125		
			Torq Str - Rear		1		EM-8133		
			Trans		1		EM-8121		
	L4 2.0L	1991	Front	Manual	1	EM-8130			
			RH Front	Auto	1	EM-8307			
			RH Front	Manual	1	EM-8427			
			Rear	Manual	1	EM-8132			
			Trans	Auto	1		EM-8149		
			Trans	Manual	1		EM-8891		
<b>OLDSMOBILE PASSENGER CAR</b>									
<b>98</b>									
V6	V6 3.0L 181ci	1985	RH Front	1st Design	1	EM-2630			
			RH Front	Hydraulic Mount; 2nd Design	1	EM-2551*			
			Trans - LH Front		1		EM-2537		
			Trans - LH Rear		1		EM-2568		
			Trans - RH Rear	1st Design - 3 Stud	1		EM-2663		
			Trans - RH Rear	2nd Design - 4 Stud	1		EM-2664		
			Trans - RH Rear	Hydraulic Mount; 3rd Design	1		EM-2556 *		
			V6 3.8L 231ci	1991-96	RH Front		1	EM-2801	
	RH Front	Hydraulic Mount; 2nd Design			1	EM-2551*			
	RH Front	1st Design			1	EM-2630			
	RH Front	Hydraulic Mount; 2nd Design			1	EM-2551*			
	Torq Str - Front				1		EM-2662		
	Trans - LH Front	Shock Mount			1		EM-2881		
	Trans - LH Front				1		EM-2800		
	Trans - LH Front				1		EM-2537		
	Trans - LH Front				1		EM-2537		
	Trans - LH Rear				1		EM-2778		
	Trans - LH Rear				1		EM-2823 *		
	Trans - LH Rear				1		EM-2568		
	Trans - LH Rear				1		EM-2568		
	Trans - RH Rear	Hydraulic Mount; 3rd Design			1		EM-2556 *		



# Engine, Transmission, And Torque Strut Mounts

CYL	ENG. SIZE	YEAR	LOCATION	DESCRIPTION	QTY	ENGINE	TORQUE STRUT	TRANSMISSION
<b>OLDSMOBILE PASSENGER CAR (continued)</b>								
<b>98 (continued)</b>								
V6	V6 3.8L 231ci	1985-86	Trans - RH Rear	1st Design - 3 Stud	1			EM-2663
			Trans - RH Rear	2nd Design - 4 Stud	1		EM-2664	
			Trans - RH Rear	Hydraulic Mount; 3rd Design	1		EM-2556	
	V6 4.1L 252ci	1981-83	LH Front		1	EM-2382		
			RH Front		1	EM-2384		
			Trans		1		EM-2379	
	V6 4.3L 260ci Diesel	1985	Front	1st Design	1	EM-2630		
			Front	Hydraulic Mount; 2nd Design	1	EM-2551		
			Trans - LH Front		1		EM-2537	
			Trans - LH Rear		1		EM-2568	
			Trans - RH Rear	Hydraulic Mount; 2nd Design	1		EM-2556	
	V8	V8 5.0L 307ci	1980-84	L & R Front		2	EM-2328	
Trans					1		EM-2360 @	
V8 5.7L GAS		1977-80	L & R Front		2	EM-2328		
			VIN H		2	EM-2328		
V8 5.7L 350ci		1972-73	L & R Front	VIN H	2	EM-2328		
			1977-80	Trans	Gas	1		EM-2360 @
			1972-73	Trans	Auto; THM350 (M38)	1		EM-2288 @
			Trans	Auto; THM400 (M40)	1		EM-2360 @	
V8 5.7L 350ci Diesel		1978-84	L & R Front		2	EM-2328		
			Trans		1		EM-2360 @	
V8 6.5L 394ci		1960-64	Trans - LH		1		EM-2216	
			Trans - RH		1		EM-2217	
V8 6.6L 400ci		1975-79	L & R Front		2	EM-2328		
			1975	Trans	Auto; THM400 (M40)	1		EM-2360 @
V8 6.6L 403ci		1977-79	Trans	Auto; THM350 (M38)	1		EM-2288 @	
			Trans	Auto; THM400-475 (M40)	1		EM-2360 @	
V8 7.0L 425ci		1965-67	LH Front		1	EM-2263		
			RH Front		1	EM-2262		
			Trans		1		EM-2378 @	
V8 7.5L 455ci		1971-76	L & R Front		2	EM-2328		
			1968-70	LH Front		1	EM-2263	
			RH Front		1	EM-2262		
	1976	Trans	Auto; THM350 (M38)	1		EM-2337		
		Trans	Auto; THM400-475 (M40)	1		EM-2360 @		
	1975	Trans	Auto; THM400 (M40)	1		EM-2360 @		
	1971-74	Trans	Auto	1		EM-2337		
1968-70	Trans	Auto; THM350 (M38)	1		EM-2378 @			
<b>442</b>								
V8	V8 5.7L 350ci	1968-70	L & R Front		2	EM-2261		
			Trans	Auto	1		EM-2378 @	
			Trans	Manual	1		EM-2378 @	
	V8 6.6L 400ci	1965-69	L & R Front		2	EM-2328		
			Trans	Auto	1		EM-2378 @	
			Trans	Manual	1		EM-2378 @	
	V8 7.5L 455ci	1971	L & R Front		2	EM-2328		
			1968-70	LH Front		1	EM-2263	
			RH Front		1	EM-2262		
		1971	Trans		1		EM-2337	
1968-70		Trans	Auto	1		EM-2378 @		
	Trans	Manual	1		EM-2378 @			
<b>ACHIEVA</b>								
L4	L4 2.3L 138ci	1992-95	RH Front	Complete Unit	1	EM-5031		
			RH Front	Insert Only	1	EM-2803		
		1995	Torq Str - Front	Auto	1		EM-2814	
			Torq Str - Front	Manual	1		EM-2782	

# Engine, Transmission, And Torque Strut Mounts

CYL	ENG. SIZE	YEAR	LOCATION	DESCRIPTION	QTY	ENGINE	TORQUE STRUT	TRANSMISSION
<b>OLDSMOBILE PASSENGER CAR (continued)</b>								
<b>ACHIEVA (continued)</b>								
L4	L4 2.3L 138ci	1992-94	Torq Str - Front		1		EM-2782	
		1992-95	Trans - LH Front	Insert	1			EM-2923
			Trans	Auto	1			EM-2715
	L4 2.4L	1997-98	Trans	NL Body, Auto	1			EM-2715
	L4 2.4L 146ci	1996-98	RH Front	Complete Unit	1	EM-5031'		
			RH Front	Insert Only	1	EM-2803'		
		1998	Torq Str - Front	Auto	1		EM-2814	
		1996-97	Torq Str - Front	Auto	1		EM-2814	
			Torq Str - Front	Manual	1		EM-2782	
		1996	Trans - Front	Manual; Bushing	1			EM-2874
Trans - Rear			Manual; Bushing	1			EM-2875	
Trans	Auto		1			EM-2715		
V6	V6 3.1L 189ci	1994-98	RH Front	Insert	1	EM-2803'		
		1995-98	Torq Str - Front		1		EM-2814	
		1994	Torq Str - Front		1		EM-2782	
		1994-98	Trans		1			EM-2715
	V6 3.3L 204ci	1992-93	RH Front	Insert	1	EM-2803'		
			Torq Str - Front		1		EM-2782	
			Trans		1			EM-2715
<b>ALERO</b>								
L4	L4 2.2L	2002-04	Right		1	EM-3129		
	L4 2.2L 2198cc	2002-04	Trans - Center		1			EM-2874
			Trans - LH Front	Complete Unit	1			EM-3070
			Trans - LH Front	Insert Only	1			EM-5422
			Trans - LH Rear	Complete Unit	1			EM-5078
			Trans - LH Rear	Insert Only	1			EM-2875
	L4 2.4L 146ci	1999-01	RH Front		1	EM-2933'		
			Trans - Center	Auto	1			EM-2874
			Trans - LH Front	Auto; Complete Unit	1			EM-5079
			Trans - LH Rear	Auto; Complete Unit	1			EM-5078
Trans - LH Rear			Auto; Insert	1			EM-2875	
V6	V6 3.4L 207ci	1999-04	Front		1	EM-2933'		
			Trans - Center	Auto	1			EM-2874
			Trans - LH Front	Auto; Complete Unit	1			EM-5079
			Trans - LH Front	Auto; Insert	1			EM-2875
			Trans - LH Rear	Auto; Complete Unit	1			EM-5078
			Trans - LH Rear	Auto; Insert	1			EM-2875
<b>AURORA</b>								
V6	V6 3.5L 214ci	2001-02	Trans - Center		1			EM-2895 *
			Trans - LH Rear		1			EM-2898
			Trans		1			EM-2897 *
V8	V8 4.0L 244ci	2001-03	Front		1	EM-2896'		
		1999	Front		1	EM-3083'		
		2001-03	Trans - Center		1			EM-2895 *
		1999	Trans - Center		1			EM-2895 *
		1997-98	Trans - Center		1			EM-2895 *
		2001-03	Trans - LH Front		1			EM-3020 *
		1999	Trans - LH Front		1			EM-3083 *
		2001-03	Trans - LH Rear		1			EM-2898
		1999	Trans - LH Rear		1			EM-3068
		1997-98	Trans - LH Rear	Complete Unit	1			EM-5075
			Trans - LH Rear	Insert Only	1			EM-3065
		1995-96	Trans - LH Rear	Complete Unit	1			EM-5075
			Trans - LH Rear	Insert Only	1			EM-3065

# Engine, Transmission, And Torque Strut Mounts

CYL	ENG. SIZE	YEAR	LOCATION	DESCRIPTION	QTY	ENGINE	TORQUE STRUT	TRANSMISSION
<b>OLDSMOBILE PASSENGER CAR (continued)</b>								
<b>CALAIS</b>								
L4	L4 2.5L 2474cc	1985-87	RH Front		1	EM-2538		
			RH Rear		1	EM-2477		
			Torq Str - Rear		1		EM-2528	
			Trans		1			EM-2601
V6	V6 3.0L 181ci	1985-87	RH Front		1	EM-2626		
			RH Rear		1	EM-2477		
			Torq Str - Rear		1		EM-2528	
			Trans		1			EM-2601
<b>CUSTOM CRUISER</b>								
V8	V8 5.0L 305ci	1991-92	L & R Front		2	EM-2292		
	V8 5.0L 307ci	1980-90	L & R Front		2	EM-2328		
		1980-92	Trans		1			EM-2360 @
	V8 5.7L 350ci	1992	L & R Front		2	EM-2292		
		1977-80	L & R Front	Gas	2	EM-2328		
		1973	L & R Front		2	EM-2328		
		1992	Trans		1			EM-2360 @
		1977-80	Trans	Gas	1			EM-2360 @
		1973	Trans		1			EM-2360 @
	V8 5.7L 350ci Diesel	1978-83	L & R Front		2	EM-2328		
			Trans		1			EM-2360 @
	V8 6.6L 400ci	1975	L & R Front		2	EM-2375		
			Trans		1			EM-2374 @
	V8 6.6L 403ci	1977-79	L & R Front		2	EM-2328		
Trans			Auto; THM350	1			EM-2288 @	
Trans			Auto; THM400	1			EM-2360 @	
V8 7.5L 455ci	1971-76	L & R Front		2	EM-2328			
		Trans	Auto; THM350	1			EM-2337	
	1976	Trans	Auto; THM400	1			EM-2360 @	
		Trans	Auto; THM350	1			EM-2337	
<b>CUTLASS</b>								
L6	L6 4.1L 250ci	1975-76	L & R Front		2	EM-2292		
		1968-71	L & R Front		2	EM-2284		
		1975-76	Trans	Auto	1			EM-2360 @
			Trans	Manual	1			EM-2337
		1968-71	Trans	Auto	1			EM-2378 @
			Trans	Manual	1			EM-2378 @
V6	V6 3.1L 189ci	1997-99	RH Front		1	EM-2876*		
			Trans - Center		1			EM-2874
			Trans - LH Front	Complete Unit	1			EM-5079
			Trans - LH Front	Insert Only	1			EM-2875
			Trans - LH Rear		1			EM-5078
			Trans - LH Rear	Insert Only	1			EM-2875
	V6 3.8L 231ci	1977-81	LH Front		1	EM-2382		
			RH Front		1	EM-2384		
		1978-81	Trans	Auto	1			EM-2392
			Trans	Manual	1			EM-2379
	1977	Trans		1			EM-2337	
	V8 5.7L 350ci	1980	Trans	Gas	1			EM-2360 @
	V8	V8 4.3L 260ci	1975-81	L & R Front		2	EM-2328	
Trans				Auto	1			EM-2360 @
Trans				Manual	1			EM-2337
V8 4.4L 267ci		1981	L & R Front		2	EM-2292		
			Trans		1			EM-2360 @
V8 5.0L 305ci	1985-87	L & R Front		2	EM-2292			
	1978-80	L & R Front		2	EM-2292			

# Engine, Transmission, And Torque Strut Mounts

CYL	ENG. SIZE	YEAR	LOCATION	DESCRIPTION	QTY	ENGINE	TORQUE STRUT	TRANSMISSION
<b>OLDSMOBILE PASSENGER CAR (continued)</b>								
<b>CUTLASS (continued)</b>								
V8	V8 5.0L 305ci	1985-87	Trans		1			EM-2360 @
		1978-80	Trans		1			EM-2360 @
	V8 5.0L 307ci	1985-87	L & R Front		2	EM-2328		
			Trans		1		EM-2360 @	
	V8 5.4L 330ci	1964-67	LH Front		1	EM-2263		
			RH Front		1	EM-2262		
			Trans	Auto	1		EM-2378 @	
			Trans	Manual	1		EM-2378 @	
	V8 5.7L GAS	1980	L & R Front		2	EM-2328		
			L & R Front	VIN L	2	EM-2292		
		1979	L & R Front	Vin N & R	2	EM-2328		
			L & R Front	VIN L	2	EM-2292		
	V8 5.7L 350ci	1976-77	L & R Front	VIN R	2	EM-2328		
			L & R Front		2	EM-2328		
		1968-73	L & R Front		2	EM-2261		
			Trans	Auto	1		EM-2360 @	
		1978-79	Trans	Manual	1		EM-2392	
			Trans	Auto; THM200 (M29) THM250C (M31)	1		EM-2360 @	
		1976-77	Trans	Auto; THM350 (M38)	1		EM-2378 @	
			Trans	Manual; 3 Spd	1		EM-2337	
			Trans	Auto; THM350	1		EM-2378 @	
		1973-75	Trans	Auto; THM350	1		EM-2378 @	
			Trans	Auto; THM400	1		EM-2360 @	
			Trans	Manual; 3 Spd	1		EM-2337	
		1968-72	Trans	Auto; THM350	1		EM-2378 @	
	Trans		Auto; THM400	1		EM-2268 @		
	Trans		Manual; 3 Spd	1		EM-2378 @		
	V8 5.7L 350ci Diesel	1979-81	L & R Front		2	EM-2328		
		1980-81	Trans	VIN N	1			EM-2531
	V8 6.6L 400ci	1965-68	L & R Front		2	EM-2328		
			Trans	Auto	1		EM-2378 @	
			Trans	Manual	1		EM-2378 @	
	V8 6.6L 403ci	1977	L & R Front		2	EM-2328		
Trans			Auto	1		EM-2288 @		
V8 7.5L 455ci	1971-76	L & R Front		2	EM-2328			
		LH Front		1	EM-2263			
	1970	RH Front		1	EM-2262			
		Trans	Auto; THM350 (M38)	1		EM-2337		
	1971-75	Trans	Auto; THM350 (M38)	1		EM-2337		
		Trans	Auto; THM400 (M40)	1		EM-2360 @		
	1970	Trans	Auto; THM350 (M38)	1		EM-2378 @		
Trans	Auto; THM400 (M40)	1		EM-2360 @				
<b>CUTLASS CALAIS</b>								
L4	L4 2.3L 138ci	1988-91	RH Front		1	EM-2859'		
			RH Rear		1	EM-2952		
			Trans	Insert; Auto	1		EM-3058	
			Trans	Manual; Insert	1		EM-2766	
	L4 2.3L 140ci	1989-91	RH Front		1	EM-2859'		
			RH Rear		1	EM-2952		
			Torq Str - Rear		1		EM-2528	
			Trans	Manual; Insert	1		EM-2766	
	L4 2.5L 2474cc	1988-91	RH Front		1	EM-2538		
			RH Rear		1	EM-2477		
			Torq Str - Rear		1		EM-2528	
			Trans		1		EM-2601	
			Trans		1		EM-2601	

# Engine, Transmission, And Torque Strut Mounts

CYL	ENG. SIZE	YEAR	LOCATION	DESCRIPTION	QTY	ENGINE	TORQUE STRUT	TRANSMISSION
<b>OLDSMOBILE PASSENGER CAR (continued)</b>								
<b>CUTLASS CALAIS (continued)</b>								
V6	V6 3.0L 181ci	1988	RH Front		1	EM-2626		
			RH Rear		1	EM-2477		
			Torq Str - Rear		1		EM-2528	
			Trans		1			EM-2601
	V6 3.3L 204ci	1989-91	RH Front		1	EM-2626		
			RH Rear		1	EM-2477		
			Torq Str - Rear		1		EM-2528	
			Trans		1			EM-2601
	V6 3.8L 231ci	1978-84	LH Front		1	EM-2382		
			RH Front		1	EM-2384		
		1980-84	Trans	Auto	1			EM-2379
		1978-79	Trans	Auto	1			EM-2379
			Trans	Manual; 3 Spd	1			EM-2379
Trans	Manual; 5 Spd	1			EM-2392			
V6 4.3L 260ci Diesel	1982-84	L & R Front		2	EM-2292			
		Trans		1			EM-2360 @	
V8	V8 4.3L 260ci	1978-82	L & R Front		2	EM-2328		
		1980-82	Trans	Auto	1			EM-2360 @
		1978-79	Trans	Auto	1			EM-2360 @
			Trans	Manual	1			EM-2392
	V8 4.3L 260ci Diesel	1979	L & R Front		2	EM-2328		
			Trans	Auto	1			EM-2360 @
			Trans	Manual	1			EM-2392
	V8 4.4L 267ci	1982	L & R Front		2	EM-2292		
			Trans		1			EM-2360 @
	V8 5.0L 305ci	1984	L & R Front		2	EM-2292		
		1978-80	L & R Front		2	EM-2292		
		1984	Trans		1			EM-2360 @
		1980	Trans	Auto	1			EM-2360 @
		1978-79	Trans	Auto	1			EM-2360 @
	Trans		Manual	1			EM-2360 @	
	V8 5.0L 307ci	1982-84	L & R Front		2	EM-2328		
			Trans		1			EM-2360 @
	V8 5.7L 350 ci Gas	1979-80	L & R Front		2	EM-2328		
	V8 5.7L 350ci	1979-80	Trans	Gas; Auto	1			EM-2360 @
V8 5.7L 350ci Diesel	1980-84	L & R Front		2	EM-2328			
		Trans		1			EM-2360 @	
<b>CUTLASS CIERA</b>								
L4	L4 2.2L 134ci	1993-94	Front		1	EM-2548*		
		1995-96	Torq Str - Front	Complete Unit	1		EM-2866	
			Torq Str - Front	Insert Only	1		EM-2716	
		1993-94	Torq Str - Front		1		EM-2609	
			Trans		1			EM-2543
	L4 2.5L 2474cc	1985-92	Front		1	EM-2548*		
		1982-84	Front		1	EM-2472		
		1982-92	Torq Str - Front		1		EM-2396	
		1982-84	Trans - LH Front		1			EM-2466
			Trans - LH Rear		1			EM-2467
1985-92	Trans		1			EM-2543		
V6 3.1L 189ci	1995-96	Torq Str - Front	Complete Unit	2		EM-2866		
		Torq Str - Front	Insert Only; LH & RH Front	2		EM-2716		
V6	V6 2.8L 173ci	1985-89	Front		1	EM-2548*		
		1982-84	Front		1	EM-2472		
		1982-89	Torq Str - Front		1		EM-2396	
			Trans - LH Front		1			EM-2466
			Trans - LH Rear		1			EM-2467

# Engine, Transmission, And Torque Strut Mounts

CYL	ENG. SIZE	YEAR	LOCATION	DESCRIPTION	QTY	ENGINE	TORQUE STRUT	TRANSMISSION	
<b>OLDSMOBILE PASSENGER CAR (continued)</b>									
<b>CUTLASS CIERA (continued)</b>									
V6	V6 3.0L 181ci	1985	Front		1	EM-2548'			
		1982-84	Front		1	EM-2472			
		1982-85	Torq Str - Front		1		EM-2396		
			Trans - LH Front		1			EM-2466	
			Trans - LH Rear		1			EM-2467	
	V6 3.1L 189ci	1994	Front		1	EM-2548'			
			Torq Str - Front		1		EM-2396		
			Trans - LH Front		1			EM-2466	
			Trans - LH Rear		1			EM-2467	
	V6 3.3L 204ci	1989-93	Front		1	EM-2548'			
			Torq Str - Front		1		EM-2396		
			Trans - LH Front		1			EM-2466	
			Trans - LH Rear		1			EM-2467	
	V6 3.8L 231ci	1985-88	Front		1	EM-2548'			
			1984	Front		1	EM-2472		
		1987-88	Torq Str - Front		1		EM-2396		
			1984-86	Torq Str - Front		1		EM-2490	
			1984-88	Trans - LH Front		1			EM-2466
	Trans - LH Rear			1			EM-2467		
	V6 4.3L 260ci Diesel	1982-85	Front		1	EM-2472			
			Torq Str - Front		1		EM-2396		
Trans - LH Front				1			EM-2466		
Trans - LH Rear				1			EM-2467		
<b>CUTLASS CRUISER</b>									
L4	L4 2.5L 2474cc	1987-90	Torq Str - Front		1		EM-2396		
V6	V6 2.8L 173ci	1987-89	Torq Str - Front		1		EM-2396		
	V6 3.1L 189ci	1994	Torq Str - Front		1		EM-2396		
	V6 3.3L 204ci	1989-93	Torq Str - Front		1		EM-2396		
	V6 3.8L 231ci	1978-83	LH Front		1	EM-2382			
			RH Front		1	EM-2384			
Trans				1			EM-2379		
V8	V8 4.3L 260ci	1978-82	L & R Front		2	EM-2328			
			Trans		1			EM-2360 @	
	V8 4.3L 260ci Diesel	1979	L & R Front		2	EM-2328			
			Trans		1			EM-2360 @	
	V8 4.4L 267ci	1982	L & R Front		2	EM-2292			
			Trans		1			EM-2360 @	
	V8 5.0L 305ci	1982-83	L & R Front		2	EM-2292			
			1980	L & R Front		2	EM-2292		
		1982-83	Trans		1			EM-2360 @	
			1980	Trans		1			EM-2360 @
	V8 5.0L 307ci	1981-83	L & R Front		2	EM-2328			
Trans				1			EM-2360 @		
V8 5.7L GAS	1980	L & R Front		2	EM-2328				
V8 5.7L 350ci	1980	Trans		1			EM-2360 @		
V8 5.7L 350ci Diesel	1980-83	L & R Front		2	EM-2328				
		Trans		1			EM-2531		
<b>CUTLASS SALON</b>									
V8	V8 4.3L	1978-81	Trans	Auto	1			EM-2360 @	
			Trans	Manual	1			EM-2337	
		1975-77	Trans	Auto	1			EM-2360 @	
			Trans	Manual	1			EM-2337	
	V8 4.3L 260ci	1975-81	L & R Front		2	EM-2328			
	V8 5.0L 305ci	1978-80	L & R Front		2	EM-2292			
	V8 5.7L	1975-76	Trans	Auto; THM200 (M29) THM250C (M31)	1			EM-2360 @	

# Engine, Transmission, And Torque Strut Mounts

CYL	ENG. SIZE	YEAR	LOCATION	DESCRIPTION	QTY	ENGINE	TORQUE STRUT	TRANSMISSION
<b>OLDSMOBILE PASSENGER CAR (continued)</b>								
<b>CUTLASS SALON (continued)</b>								
V8	V8 5.7L	1975-76	Trans	Auto; THM350 (M38)	1			EM-2378 @
			Trans	Auto; THM400 (M40)	1			EM-2360 @
			Trans	Manual; 3 Spd	1			
	V8 5.7L GAS	1979	L & R Front		2	EM-2328		
	V8 5.7L 350ci Diesel	1985	L & R Front		2	EM-2328		
		1980-81	L & R Front		2	EM-2328		
	V8 7.5L	1976	Trans	Auto; THM350 (M38)	1			EM-2337
			Trans	Auto; THM350 (M38)	1			EM-2337
Trans			Auto; THM400 (M40)	1			EM-2360 @	
<b>CUTLASS SUPREME</b>								
L4	L4 2.3L 138ci	1990-91	Front		1	EM-2796'		
			Torq Str - Front		1		EM-2396	
			Trans	Auto	1			EM-2620
L6	L6 4.1L 250ci	1975-76	L & R Front		2	EM-2292		
			Trans	Auto	1			EM-2360 @
			Trans	Manual	1			EM-2337
V6	V6 2.8L 173ci	1988-89	Front		1	EM-2660'		
			Torq Str - Front	Auto	1		EM-2609	
			Torq Str - Front	Manual	1		EM-5177	
			Torq Str - Front		1		EM-2609	
			Trans	Auto	1			EM-2620
	V6 3.1L 189ci	1994-97	RH Front		1	EM-2796'		
			1989-93	RH Front		1	EM-2660'	
		1994-97	Torq Str - Front	Brkt to Radiator Support; LH & RH Front	2			EM-2901
			Torq Str - Front	Complete Unit; LH & RH Front 2nd Design	2			EM-2866
		Torq Str - Front	LH & RH Front, 1st Design	2			EM-2609	
		Torq Str - Front	LH & RH Front, 2nd Design, Insert Only	2			EM-2716	
		1989-93	Torq Str - Front	LH & RH Front	2			EM-2609
		1994-97	Trans		1			EM-2712 '
	1989-93	Trans		1			EM-2620	
	V6 3.4L 207ci	1991-96	RH Front		1	EM-2555'		
			RH Rear		1	EM-2676		
			Torq Str - Front		1		EM-2799	
		1994-96	Trans	Auto	1			EM-2712 '
1993		Trans	Auto	1			EM-2620	
1991-92	Trans	Auto	1			EM-2712 '		
V6 3.8L 231ci	1977-87	LH Front		1	EM-2382			
		RH Front		1	EM-2384			
	1982-87	Trans		1			EM-2379	
	1978-81	Trans	Auto	1			EM-2379	
	1977	Trans		1			EM-2337	
V6 4.3L 260ci Diesel	1982-84	L & R Front		2	EM-2292			
		Trans		1			EM-2360 @	
V8	V8 4.3L 260ci	1975-82	L & R Front		2	EM-2328		
			Trans	Auto	1			EM-2360 @
			Trans	Auto	1			EM-2360 @
			Trans	Manual	1			EM-2392
			Trans	Auto	1			EM-2360 @
			Trans	Manual	1			EM-2337
	V8 4.3L 260ci Diesel	1979	L & R Front		2	EM-2328		
	V8 4.4L 267ci	1982	L & R Front		2	EM-2292		
			Trans	Auto	1			EM-2360 @
	V8 5.0L 305ci	1985-87	L & R Front		2	EM-2292		

# Engine, Transmission, And Torque Strut Mounts

CYL	ENG. SIZE	YEAR	LOCATION	DESCRIPTION	QTY	ENGINE	TORQUE STRUT	TRANSMISSION	
<b>OLDSMOBILE PASSENGER CAR (continued)</b>									
<b>CUTLASS SUPREME (continued)</b>									
V8	V8 5.0L 305ci	1983	L & R Front		2	EM-2292			
		1978-80	L & R Front		2	EM-2292			
		1985-87	Trans	Auto		1			EM-2360 @
		1983	Trans	Auto		1			EM-2360 @
		1980	Trans	Auto		1			EM-2360 @
		1978-79	Trans	Auto		1			EM-2360 @
				Trans	Manual	1			EM-2360 @
	V8 5.0L 307ci	1982-88	L & R Front			2	EM-2328		
			Trans			1			EM-2360 @
	V8 5.7L 350ci	1974-80	L & R Front	Gas		2	EM-2328		
		1972-73	L & R Front			2	EM-2261		
		1980	Trans	Gas; Auto		1			EM-2360 @
		1977-79	Trans	Gas; Auto		1			EM-2360 @
			Trans	Gas; Manual		1			EM-2360 @
		1975-76	Trans	Auto; THM350 (M38)		1			EM-2378 @
			Trans	Manual		1			EM-2378 @
		1973-74	Trans	Auto; THM350 (M38)		1			EM-2378 @
			Trans	Auto; THM400 (M40)		1			EM-2360 @
	1972	Trans	Auto; THM350 (M38)		1			EM-2378 @	
		Trans	Auto; THM400 (M40)		1			EM-2268 @	
	V8 5.7L 350ci Diesel	1979-85	L & R Front			2	EM-2328		
			Trans	Auto		1			EM-2360 @
	V8 6.6L 403ci	1977	L & R Front			2	EM-2328		
Trans			Auto; THM350 (M38)		1			EM-2288 @	
Trans			Manual		1			EM-2337	
V8 7.5L 455ci	1971-76	L & R Front			2	EM-2328			
		Trans	Auto; THM350 (M38)		1			EM-2337	
<b>DELMONT 88</b>									
V8	V8 5.4L	1967	LH Front		1	EM-2263			
			RH Front		1	EM-2262			
	V8 5.4L 330ci	1967	Trans	Auto		1			EM-2378 @
			Trans	Manual		1			EM-2378 @
	V8 5.7L	1968	LH Front			1	EM-2263		
			RH Front			1	EM-2262		
	V8 5.7L 350ci	1968	Trans	Auto		1			EM-2378 @
			Trans	Manual		1			EM-2378 @
	V8 7.0L	1967	LH Front			1	EM-2263		
			RH Front			1	EM-2262		
	V8 7.0L 425ci	1967	Trans	Auto		1			EM-2378 @
			Trans	Manual		1			EM-2378 @
<b>DELTA 88</b>									
V6	V6 3.0L 181ci	1986	Front	1st Design	1	EM-2630			
			Front	Hydraulic Mount; 2nd Design	1	EM-2551*			
			Trans - LH Front		1			EM-2537	
			Trans - LH Rear		1			EM-2568	
			Trans - RH Rear	1st Design - 3 Stud	1			EM-2663	
			Trans - RH Rear	2nd Design - 4 Stud	1			EM-2664	
			Trans - RH Rear	Hydraulic Mount; 3rd Design	1			EM-2556 *	
	V6 3.8L 231ci	1977-85	LH Front			1	EM-2382		
			1992-99	RH Front		1	EM-2801		
			1987-91	RH Front	Hydraulic Mount; 2nd Design	1	EM-2551*		
			1986	RH Front	1st Design	1	EM-2630		
				RH Front	Hydraulic Mount; 2nd Design	1	EM-2551*		
			1977-85	RH Front		1	EM-2384		
1992-99	Torq Str - Front		1		EM-2662				



# Engine, Transmission, And Torque Strut Mounts

CYL	ENG. SIZE	YEAR	LOCATION	DESCRIPTION	QTY	ENGINE	TORQUE STRUT	TRANS-MISSION
<b>OLDSMOBILE PASSENGER CAR (continued)</b>								
<b>DELTA 88 (continued)</b>								
V6	V6 3.8L 231ci	1994-99	Trans - LH Front	Shock Mount	1			EM-2881
		1992-93	Trans - LH Front		1			EM-2800
		1987-91	Trans - LH Front		1			EM-2537
		1986	Trans - LH Front		1			EM-2537
		1994-99	Trans - LH Rear		1			EM-2778
		1992-93	Trans - LH Rear		1			EM-2823
		1987-91	Trans - LH Rear		1			EM-2568
		1986	Trans - LH Rear		1			EM-2568
		1987-91	Trans - RH Rear	Hydraulic Mount; 3rd Design	1			EM-2556
		1986	Trans - RH Rear	1st Design - 3 Stud	1			EM-2663
			Trans - RH Rear	2nd Design - 4 Stud	1			EM-2664
			Trans - RH Rear	Hydraulic Mount; 3rd Design	1			EM-2556
		1977-85	Trans		1			EM-2379
V8	V8 4.3L 260ci	1977-82	L & R Front		2	EM-2328		
			Trans		1		EM-2360 @	
	V8 4.4L 267ci	1981-82	L & R Front		2	EM-2292		
			Trans		1		EM-2360 @	
	V8 4.9L 301ci	1979	L & R Front		2	EM-2387		
			Trans		1		EM-2360 @	
	V8 5.0L 307ci	1980-85	L & R Front		2	EM-2328		
			Trans		1		EM-2360 @	
	V8 5.4L 330ci	1967	LH Front		1	EM-2263		
			RH Front		1	EM-2262		
			Trans	Auto	1		EM-2378 @	
			Trans	Manual	1		EM-2378 @	
	V8 5.7L GAS	1978-80	L & R Front		2	EM-2328		
	V8 5.7L 350ci	1977	L & R Front		2	EM-2292		
		1971-76	L & R Front		2	EM-2328		
		1968-70	LH Front		1	EM-2263		
			RH Front		1	EM-2262		
		1977-80	Trans	Gas	1		EM-2360 @	
		1976	Trans		1		EM-2337	
		1974-75	Trans		1		EM-2374 @	
		1971-73	Trans		1		EM-2337	
		1968-70	Trans	Auto	1		EM-2378 @	
			Trans	Manual	1		EM-2378 @	
	V8 5.7L 350ci Diesel	1978-85	L & R Front		2	EM-2328		
			Trans		1		EM-2360 @	
	V8 6.6L 400ci	1975-79	L & R Front		2	EM-2328		
			Trans	Auto; THM350	1		EM-2288 @	
			Trans	Auto; THM400	1		EM-2360 @	
	V8 7.0L 425ci	1965-67	LH Front		1	EM-2263		
			RH Front		1	EM-2262		
			Trans	Auto	1		EM-2378 @	
			Trans	Manual	1		EM-2378 @	
	V8 7.5L 455ci	1971-76	L & R Front		2	EM-2328		
1968-70			LH Front		1	EM-2263		
		RH Front		1	EM-2262			
1976		Trans	Auto; THM350	1		EM-2337		
		Trans	Auto; THM400	1		EM-2360 @		
1971-75		Trans	Auto; THM350	1		EM-2337		
1968-70		Trans	Auto	1		EM-2378 @		
	Trans	Manual	1		EM-2378 @			

# Engine, Transmission, And Torque Strut Mounts

CYL	ENG. SIZE	YEAR	LOCATION	DESCRIPTION	QTY	ENGINE	TORQUE STRUT	TRANSMISSION	
<b>OLDSMOBILE PASSENGER CAR (continued)</b>									
<b>DYNAMIC</b>									
V8	V8 6.5L 394ci	1960-64	Trans - LH		1			EM-2216	
			Trans - RH		1		EM-2217		
	V8 7.0L 425ci	1965-66	LH Front		1	EM-2263			
			RH Front		1	EM-2262			
			Trans		1		EM-2378 @		
<b>F85</b>									
L6	L6 3.7L 225ci	1964-65	L & R Front		2	EM-2261			
			Trans	Auto	1		EM-2378 @		
			Trans	Manual	1		EM-2378 @		
	L6 4.1L 250ci	1966-71	L & R Front		2	EM-2284			
			Trans	Auto	1		EM-2378 @		
			Trans	Manual	1		EM-2378 @		
V8	V8 3.5L 215ci	1961-63	L & R Front		2	EM-2218			
	V8 5.4L 330ci	1964-67	L & R Front		2	EM-2261			
			Trans	Auto	1		EM-2378 @		
				Trans	Manual	1		EM-2378 @	
	V8 5.7L 350ci	1968-72	L & R Front		2	EM-2261			
			Trans	Auto	1		EM-2378 @		
			Trans	Manual	1		EM-2378 @		
	V8 7.5L 455ci	1970-72	L & R Front		2	EM-2328			
			Trans	Auto	1		EM-2378 @		
			Trans	Manual	1		EM-2378 @		
<b>FIESTA</b>									
V8	V8 6.5L 394ci	1960-63	Trans - LH		1			EM-2216	
			Trans - RH		1		EM-2217		
<b>FIRENZA</b>									
L4	L4 1.8L 112ci	1985-86	RH Front		1	EM-2538			
		1983-84	RH Front		1	EM-2496			
		1982	RH Front	Auto; 3 Spd; Vin G; w/ Air	1	EM-2474			
			RH Front	Auto; 3 Spd; VIN G; w/o Air	1	EM-2506			
			RH Front	Manual; Code G; w/ Air	1	EM-2473			
			RH Front	Manual; Code G; w/o Air	1	EM-2524			
			RH Front	VIN 0	1	EM-2496			
		1985-86	RH Rear		1	EM-2477			
		1983-84	RH Rear		1	EM-2477			
		1982	RH Rear		1	EM-2477			
		1982-86	Torq Str - Rear	Lateral	1		EM-2492		
			Torq Str - Rear	Longitudinal	1		EM-2528		
	1985-86	Trans	Auto	1			EM-2601		
		Trans	Manual	1			EM-2601		
	1982-84	Trans	Auto; Insert	1			EM-2720		
		Trans	Manual; Insert	1			EM-2720		
	L4 2.0L 121ci	1987-88	RH Front		1	EM-2538			
			RH Rear		1	EM-2477			
			Torq Str - Rear		1		EM-2528		
	L4 2.0L 122ci	1985-88	RH Front		1	EM-2538			
			1983-84	RH Front	Auto w/o Air	1	EM-2506		
				RH Front	Auto; w/ Air	1	EM-2474		
				RH Front	Manual; w/ Air	1	EM-2473		
			RH Front	Manual; w/o Air	1	EM-2524			
		1985-88	RH Rear		1	EM-2477			
		1983-84	RH Rear		1	EM-2477			
		1983-86	Torq Str - Rear	Lateral	1		EM-2492		
Torq Str - Rear			Longitudinal	1		EM-2528			
1983-88		Trans	Auto	1			EM-2601		

# Engine, Transmission, And Torque Strut Mounts

CYL	ENG. SIZE	YEAR	LOCATION	DESCRIPTION	QTY	ENGINE	TORQUE STRUT	TRANSMISSION			
<b>OLDSMOBILE PASSENGER CAR (continued)</b>											
<b>FIRENZA (continued)</b>											
L4	L4 2.0L 122ci	1983-88	Trans	Manual	1			EM-2601			
V6	V6 2.8L 173ci	1985-87	RH Front		1	EM-2538					
			RH Rear	Auto	1	EM-2477					
			RH Rear	Manual	1	EM-2708					
			Torq Str - Rear	Lateral	1		EM-2492				
			Torq Str - Rear	Longitudinal	1		EM-2528				
			Trans	Auto	1			EM-2601			
			Trans	Manual	1			EM-2601			
<b>INTRIGUE</b>											
V6	V6 3.5L 214ci	1999-02	Front	Hydraulic Mount	1	EM-3093					
			RH Rear		1	EM-2990					
			Torq Str - Front	Brkt to Radiator Support	1		EM-3088				
			Torq Str - Front	Complete Unit	1		EM-2899				
			Torq Str - Front	Insert	1		EM-2716				
			Trans - LH		1			EM-2712			
			Trans - LH		1			EM-2712S			
	V6 3.8L 231ci	1998-99	Front		1	EM-2796					
			Torq Str - Front	Brkt to Radiator Support; LH & RH Front	2		EM-3088				
			Torq Str - Front	Insert; LH & RH Front	2		EM-2716				
			Trans		1			EM-2712			
			<b>JETFIRE</b>								
			V8	V8 3.5L 215ci	1962-63	L & R Front		2	EM-2218		
<b>JETSTAR 88</b>											
V8	V8 5.4L 330ci	1964-66	LH Front		1	EM-2263					
			RH Front		1	EM-2262					
			Trans	Auto	1			EM-2378 @			
			Trans	Manual	1			EM-2378 @			
	V8 6.5L 394ci	1964	Trans - LH		1			EM-2216			
			Trans - RH		1			EM-2217			
	V8 7.0L 425ci	1965	LH Front		1	EM-2263					
			RH Front		1	EM-2262					
			Trans	Auto	1			EM-2378 @			
			Trans	Manual	1			EM-2378 @			
	<b>LSS</b>										
V6	V6 3.8L 231ci	1996-99	RH Front		1	EM-2801					
			Torq Str - Front		1		EM-2662				
			Trans - LH Front		1			EM-2881			
			Trans - LH Rear		1			EM-2778			
<b>OMEGA</b>											
L4	L4 2.5L 2474cc	1982-84	RH Front		1	EM-2472					
		1980-81	RH Front		1	EM-2505					
		1980-84	Torq Str - Front		1		EM-2396				
			Trans - Front	Auto	1			EM-2466			
			Trans - Front	Manual	1			EM-2467			
			Trans - Rear	Auto	1			EM-2467			
		L6	L6 4.1L 250ci	1973-76	L & R Front		2	EM-2292			
1976	Trans			Auto	1			EM-2360 @			
	Trans			Manual	1			EM-2378 @			
1973-75	Trans			Auto	1			EM-2378 @			
	Trans	Manual	1			EM-2378 @					
V6	V6 2.8L 173ci	1982-84	RH Front		1	EM-2472					
		1980-81	RH Front		1	EM-2505					
		1980-84	Torq Str - Front		1		EM-2396				

# Engine, Transmission, And Torque Strut Mounts

CYL	ENG. SIZE	YEAR	LOCATION	DESCRIPTION	QTY	ENGINE	TORQUE STRUT	TRANSMISSION
<b>OLDSMOBILE PASSENGER CAR (continued)</b>								
<b>OMEGA (continued)</b>								
V6	V6 2.8L 173ci	1980-84	Trans - Front	Auto	1			EM-2466
			Trans - Front	Manual	1			EM-2467
			Trans - Rear	Auto	1			EM-2467
	V6 3.8L 231ci	1977-79	LH Front		1	EM-2382		
			RH Front		1	EM-2384		
		1978-79	Trans	Auto	1			EM-2393
			Trans	Manual	1			EM-2394
		1977	Trans	Auto	1			EM-2394
	Trans	Manual; 3 Spd	1			EM-2394		
	V8	V8 4.3L 260ci	1975-77	L & R Front		2	EM-2328	
Trans				Auto	1		EM-2360 @	
Trans				Manual	1		EM-2360 @	
V8 5.0L 305ci		1977-79	L & R Front		2	EM-2292		
			Trans	Auto	1		EM-2360 @	
			Trans	Manual	1		EM-2360 @	
V8 5.7L 350ci		1973-79	L & R Front		2	EM-2292		
			Trans	Auto	1		EM-2360 @	
			Trans	Manual	1		EM-2360 @	
<b>REGENCY</b>								
V6	V6 3.8L 231ci	1997-98	Front		1	EM-2801		
			Torq Str - Front		1		EM-2662	
			Trans - LH Front		1		EM-2881	
			Trans - LH Rear		1		EM-2778	
<b>STARFIRE</b>								
L4	L4 2.3L 140ci	1976-77	LH Front		1	EM-2357		
			RH Front		1	EM-2356		
			Trans	Auto	1		EM-2353	
			Trans	Manual	1		EM-2353	
	L4 2.5L 2474cc	1978-80	L & R Front		2	EM-2446		
			1980	Trans	Auto	1		EM-2531
		1978-79	Trans	Manual; 4 Spd	1		EM-2531	
			Trans	Auto	1		EM-2531	
			Trans	Manual; 4 Spd	1		EM-2531	
			Trans	Manual; 5 Spd	1		EM-2353	
V6	V6 3.8L 231ci	1975-80	LH Front		1	EM-2382		
			RH Front		1	EM-2384		
		1978-80	Trans	Auto	1		EM-2393	
			Trans	Manual; 5 Spd	1		EM-2393	
		1975-77	Trans	Auto	1		EM-2353	
			Trans	Manual	1		EM-2353	
V8	V8 5.0L 305ci	1977-79	L & R Front		2	EM-2292		
			Trans	Auto	1		EM-2360 @	
			Trans	Manual	1		EM-2360 @	
	V8 6.5L 394ci	1961-64	Trans - LH		1		EM-2216	
			Trans - RH		1		EM-2217	
	V8 7.0L 425ci	1965-66	L & R Front		2	EM-2261		
			Trans	Auto	1		EM-2378 @	
			Trans	Manual	1		EM-2378 @	
<b>SUPER 88</b>								
V8	V8 6.5L 394ci	1960-64	Trans - LH		1			EM-2216
			Trans - RH		1		EM-2217	

# Engine, Transmission, And Torque Strut Mounts

CYL	ENG. SIZE	YEAR	LOCATION	DESCRIPTION	QTY	ENGINE	TORQUE STRUT	TRANSMISSION
<b>OLDSMOBILE PASSENGER CAR (continued)</b>								
<b>TORONADO</b>								
V6	V6 3.8L 231ci	1986-91	Front		1	EM-2943		
		1988-92	Torq Str - Front		1		EM-2662	
		1989-91	Trans - LH		1			EM-2779
		1986-88	Trans - LH		1			EM-2671
		1989-91	Trans - RH		1			EM-2691
	V6 4.1L 252ci	1981-84	L & R Front		2	EM-2777		
			Trans - LH		1		EM-2495	
			Trans - RH		1		EM-2494	
	V8	V8 5.0L 307ci	1980-85	L & R Front		2	EM-2629	
1982-85			Trans - LH		1			EM-2495
1981			Trans - LH		1			EM-2497
1982-85			Trans - RH		1			EM-2494
1981			Trans - RH		1			EM-2494
V8 5.7L 350ci Diesel		1981-85	L & R Front		2	EM-2629		
			Trans - LH		1		EM-2495	
			Trans - RH		1		EM-2494	
V8 6.6L 403ci		1977-78	L & R Front		2	EM-2328		
		1978	Trans - LH Rear		1			EM-5450
		1977	Trans - LH Rear		1			EM-5450
V8 7.0L 425ci		1966-67	LH Front		1	EM-2263		
			RH Front		1	EM-2262		
			Trans		1		EM-2378 @	
V8 7.5L 455ci		1971-76	L & R Front		2	EM-2328		
			LH Front		1	EM-2263		
		1968-70	RH Front		1	EM-2262		
			Trans - LH Rear		1		EM-5450	
	1974		Trans - LH Rear		1		EM-5450	
1971-73	Trans	Auto; THM350 (M38)	1			EM-2337		
<b>VISTA CRUISER</b>								
L6	L6 3.7L 225ci	1964-65	Trans	Auto	1			EM-2378 @
			Trans	Manual	1			EM-2378 @
V8	V8 4.9L 301ci	1978-79	Trans	Auto	1			EM-2393
			Trans	Manual	1			EM-2392
	V8 5.4L 330ci	1964-67	LH Front		1	EM-2263		
			RH Front		1	EM-2262		
			Trans	Auto	1		EM-2378 @	
			Trans	Manual	1		EM-2378 @	
	V8 5.7L 350ci	1974-75	L & R Front		2	EM-2328		
			1968-73	L & R Front		2	EM-2261	
		1975	Trans	Auto; THM350 (M38)	1		EM-2378 @	
			Trans	Auto; THM400 (M40)	1		EM-2360 @	
		1973-74	Trans	Auto; THM350 (M38)	1		EM-2378 @	
			Trans	Auto; THM400 (M40)	1		EM-2360 @	
		1968-72	Trans	Manual	1		EM-2337	
			Trans	Auto; THM350	1		EM-2378 @	
	V8 6.6L 400ci	1968-69	Trans	Auto; THM400	1		EM-2268 @	
			Trans	Manual	1		EM-2378 @	
			L & R Front		2	EM-2328		
	V8 7.5L 455ci	1971-75	L & R Front		2	EM-2328		
1970			LH Front		1	EM-2263		
1971-75			RH Front		1	EM-2262		
1971-75		Trans	Auto; THM350	1		EM-2337		
		Trans	Auto; THM400	1		EM-2360 @		
1970		Trans	Auto; THM350	1		EM-2378 @		

# Engine, Transmission, And Torque Strut Mounts

CYL	ENG. SIZE	YEAR	LOCATION	DESCRIPTION	QTY	ENGINE	TORQUE STRUT	TRANSMISSION
<b>OLDSMOBILE PASSENGER CAR (continued)</b>								
<b>VISTA CRUISER (continued)</b>								
V8	V8 7.5L 455ci	1970	Trans	Auto; THM400	1			EM-2360 @
<b>OLDSMOBILE SPORT UTILITY</b>								
<b>BRAVADA</b>								
L6	L6 4.2L 256ci	2002-04	L & R Front		2	EM-3021*		
			Trans		1			EM-3027
V6	V6 4.3L 262ci	1996-01	L & R Front		2	EM-2802		
		1991-94	L & R Front		2	EM-2627		
		1996-01	Trans		1			EM-2638
		1991-94	Trans		1			EM-2638
<b>OLDSMOBILE VAN</b>								
<b>SILHOUETTE</b>								
V6	V6 3.1L 189ci	1990-94	Front		1	EM-2548*		
			Torq Str - Front		1		EM-2396	
			Trans - LH Front		1			EM-2466
			Trans - LH Rear		1			EM-2467
	V6 3.4L 207ci	1997-04	Front		1	EM-2796*		
		1996	Front		1	EM-2548*		
		1997-04	Torq Str - Front	Brkt to Radiator Support; LH & RH Front	2		EM-2900	
			Torq Str - Front	Complete Unit; LH & RH Front	2		EM-2899	
			Torq Str - Front	Insert Only; LH & RH Front	2		EM-2716	
		1996	Torq Str - Front	Complete Unit	1		EM-2866	
			Torq Str - Front	Insert Only	1		EM-2716	
			Trans - LH Front		1			EM-2466
			Trans - LH Rear		1			EM-2467
		1997-04	Trans		1			EM-2818
	V6 3.8L 231ci	1992-95	Front		1	EM-2548*		
			Torq Str - Front		1		EM-2396	
			Trans - LH Front		1			EM-2466
			Trans - LH Rear		1			EM-2467
<b>PLYMOUTH PASSENGER CAR</b>								
<b>ACCLAIM</b>								
L4	L4 2.5L 2507cc	1990-95	Front		1	EM-2615		
		1989	Front		1	EM-2615		
		1990-95	RH Front		1	EM-2616		
		1989	RH Front		1	EM-2600		
		1994-95	Trans	Auto	1			EM-2618
		1993	Trans	Auto	1			EM-2618
			Trans	Manual	1			EM-2618
		1989	Trans	Auto	1			EM-2617
			Trans	Manual	1			EM-2617
V6	V6 3.0L 2972cc	1990-95	Front		1	EM-2615		
		1989	Front		1	EM-2615		
		1990-95	RH Front	Hydraulic Mount	1	EM-2711		
			RH Front	Rubber Mount	1	EM-2616		
		1989	RH Front		1	EM-2600		
		1994-95	Trans	Auto	1			EM-2618
		1990-93	Trans	Auto	1			EM-2618
			Trans	Manual	1			EM-2618
		1989	Trans	Auto	1			EM-2617

# Engine, Transmission, And Torque Strut Mounts

CYL	ENG. SIZE	YEAR	LOCATION	DESCRIPTION	QTY	ENGINE	TORQUE STRUT	TRANSMISSION			
<b>PLYMOUTH PASSENGER CAR (continued)</b>											
<b>ARROW</b>											
L4	L4 1.6L 1597cc	1976-80	L & R Front		2	EM-2731					
			Trans		1			EM-8502			
	L4 2.0L 1997cc	1976-78	L & R Front		2	EM-2731					
			Trans		1			EM-8503			
	L4 2.6L 2555cc	1979-80	L & R Front		2	EM-2731					
			Rear		1	EM-8556					
			Trans		1			EM-8503			
<b>BARRACUDA</b>											
L6	L6 3.2L 198ci	1970-71	LH Front		1	EM-2275					
			RH Front		1	EM-2277					
			Trans	Auto; Complete Unit	1			EM-2512			
			Trans	Auto; Insert Only	1			EM-2525			
			Trans	Manual; Complete Unit	1			EM-2512			
			Trans	Manual; Insert Only	1			EM-2525			
	L6 3.7L 3687cc	1970-72	1970-72	LH Front		1	EM-2275				
				LH Front		1	EM-2265				
		1965-69	1970-72	RH Front		1	EM-2276				
				RH Front		1	EM-2264				
		1970-72	1970-72	Trans	Auto; Complete Unit	1			EM-2512		
				Trans	Auto; Insert Only	1			EM-2525		
				Trans	Manual; Complete Unit	1			EM-2512		
				Trans	Manual; Insert Only	1			EM-2525		
				1965-69	1970-72	Trans	Auto	1			EM-2272
						Trans	Manual	1			EM-2272
		V8	V8 4.5L 273ci	1967	L & R Front		2	EM-2266			
					1964-66	L & R Front		2	EM-2338		
Trans	Auto					1			EM-2272		
1964-67	Trans				Manual	1			EM-2272		
V8 5.2L 318ci	1970-74		1970-74	L & R Front		2	EM-2250				
				L & R Front		2	EM-2266				
	1970-74		1970-74	Trans	Auto; Complete Unit	1			EM-2340		
				Trans	Auto; Complete Unit; HD Pkg.	1			EM-2512		
				Trans	Auto; Insert Only	1			EM-2525		
				Trans	Manual; Complete Unit	1			EM-2340		
				Trans	Manual; Complete Unit; HD Pkg.	1			EM-2512		
				Trans	Manual; Insert Only	1			EM-2525		
	1968-69		1970-74	Trans	Auto	1			EM-2272		
				Trans	Manual	1			EM-2272		
V8 5.6L 340ci	1968-73		1968-73	L & R Front		2	EM-2250				
				Trans	Auto; Complete Unit	1			EM-2340		
				Trans	Auto; Complete Unit; HD Pkg.	1			EM-2512		
				Trans	Auto; Insert Only	1			EM-2525		
				Trans	Manual; Complete Unit	1			EM-2340		
				Trans	Manual; Complete Unit; HD Pkg.	1			EM-2512		
				Trans	Manual; Insert Only	1			EM-2525		
V8 5.9L 360ci	1974		1974	L & R Front		2	EM-2250				
				Trans	Auto; Complete Unit	1			EM-2340		
				Trans	Auto; Complete Unit; HD Pkg.	1			EM-2512		
		Trans		Auto; Insert Only	1			EM-2525			
		Trans		Manual; Complete Unit	1			EM-2340			
		Trans		Manual; Complete Unit; HD Pkg.	1			EM-2512			
		Trans		Manual; Insert Only	1			EM-2525			
V8 6.3L 383ci	1967-71	1967-71	L & R Front		2	EM-2250					
			Trans	Auto	1			EM-2272			

# Engine, Transmission, And Torque Strut Mounts

CYL	ENG. SIZE	YEAR	LOCATION	DESCRIPTION	QTY	ENGINE	TORQUE STRUT	TRANSMISSION	
<b>PLYMOUTH PASSENGER CAR (continued)</b>									
<b>BARRACUDA (continued)</b>									
V8	V8 6.3L 383ci	1967-71	Trans	Manual	1			EM-2272	
<b>BELVEDERE</b>									
L6	L6 3.6L 218ci	1953-54	Front Center		1	EM-2018			
			Trans - L & R Upper		2			EM-2014	
	L6 3.7L 3687cc	1965-70	LH Front		1	EM-2275			
			1962-64 LH Front		1	EM-2235			
			1965-70 RH Front		1	EM-2276			
			1962-64 RH Front		1	EM-2234			
1962-70	Trans	Auto	1			EM-2272			
	Trans	Manual	1			EM-2272			
V8	V8 4.5L 273ci	1966-68	L & R Front		2	EM-2250			
		1964-65	LH Front		1	EM-2228			
			RH Front		1	EM-2227			
		1966-68	Trans	Auto	1			EM-2272	
			Trans	Manual	1			EM-2272	
	1964-65	Trans		1			EM-5087		
		V8 5.2L 317ci	1958-70	Trans	Auto	1		EM-2272	
	Trans			Manual	1		EM-2272		
	V8 5.2L 318ci	1965-70	L & R Front		2	EM-2250			
			1962-64	LH Front		1	EM-2228		
				RH Front		1	EM-2227		
	V8 6.3L 383ci	1966-70	L & R Front		2	EM-2250			
			1960-65	LH Front		1	EM-2228		
				RH Front		1	EM-2227		
		1966-70	Trans	Auto	1			EM-2272	
			Trans	Manual	1			EM-2272	
	1960-65	Trans		1			EM-5087		
		V8 7.0L 426ci	1963-67	L & R Front		2	EM-2250		
Trans	Auto			1		EM-2272			
Trans	Manual			1		EM-2272			
V8 7.2L 440ci	1966-67	L & R Front		2	EM-2250				
		Trans	Complete Unit	1		EM-2340			
		Trans	Complete Unit - HD	1		EM-2512			
		Trans	Insert Only	1		EM-2525			
<b>BREEZE</b>									
L4	L4 2.0L 1996cc	1996-97	Bushing Kit	Cradle Insert Kit - Front & Rear	1	EM-5178			
		1998-00	Front		1	EM-2958			
		1996-97	Front	Cradle-Insert	1	EM-2980			
		1998-00	RH Front		1	EM-2841*			
		1996-97	RH Front		1	EM-2841*			
		1998-00	Rear		1	EM-3089			
		1996-97	Rear	Cradle-Insert	1	EM-3011			
		1996-00	Trans	Auto	1			EM-2842 *	
			Trans	Manual	1			EM-2842 *	
		L4 2.4L 2429cc	1998-99	Bushing Kit	Cradle Insert Kit (2 pieces) Recommended	1	EM-5178		
				2000	Front		1	EM-2958	
	1998-99		Front	Cradle-Insert	1	EM-2980			
	2000		RH Front		1	EM-2841*			
	1998-99		RH Front		1	EM-2841*			
	2000		Rear		1	EM-2945			
	1998-99		Rear	Cradle-Insert	1	EM-3011			
	1998-00		Trans	Auto	1			EM-2842 *	
		Trans	Manual	1			EM-2842 *		



# Engine, Transmission, And Torque Strut Mounts

CYL	ENG. SIZE	YEAR	LOCATION	DESCRIPTION	QTY	ENGINE	TORQUE STRUT	TRANSMISSION
<b>PLYMOUTH PASSENGER CAR (continued)</b>								
<b>CARAVELLE</b>								
L4	L4 2.2L 135ci	1983-88	Front		1	EM-2493		
			RH Front		1	EM-2600		
		1985-88	Torq Str - Front		1		EM-2491	
		1984-86	Trans	Auto	1			EM-2617
		1983	Trans	Auto	1			EM-2600
				Trans	Manual	1		EM-2600
	L4 2.5L 2507cc	1986-88	Front		1	EM-2493		
			RH Front		1	EM-2600		
			Torq Str - Front		1		EM-2491	
			Trans	Auto	1			EM-2617
	L4 2.6L 2555cc	1983-85	Front		1	EM-2493		
			RH Front		1	EM-2600		
		1984-85	Trans	Auto	1			EM-2617
		1983	Trans	Auto	1			EM-2600
				Trans	Manual	1		EM-2600
L6	L6 3.7L 3687cc	1978-83	LH Front	Complete Unit	1	EM-2324		
			LH Front	Insert Only	1	EM-2376		
			RH Front	Complete Unit	1	EM-2323		
			RH Front	Insert Only	1	EM-2376		
			Trans	Complete Unit	1			EM-2340
			Trans	Complete Unit - HD	1			EM-2512
			Trans	Insert Only	1			EM-2525
V8	V8 5.2L 318ci	1978-88	LH Front	Complete Unit	1	EM-2326		
			LH Front	Insert Only	1	EM-2369		
			RH Front	Complete Unit	1	EM-2325		
			RH Front	Insert Only	1	EM-2369		
		1978-89	Trans	Complete Unit	1			EM-2340
			Trans	Complete Unit - HD	1			EM-2512
				Trans	Insert Only	1		EM-2525
	V8 5.9L 360ci	1978-79	LH Front	Complete Unit	1	EM-2326		
			LH Front	Insert Only	1	EM-2369		
			RH Front	Complete Unit	1	EM-2325		
RH Front			Insert Only	1	EM-2369			
			Trans	Complete Unit	1		EM-2340	
			Trans	Complete Unit - HD	1		EM-2512	
			Trans	Insert Only	1		EM-2525	
<b>CHAMP</b>								
L4	L4 1.4L 1410cc	1979-82	L & R Front		2	EM-8542		
			Trans	Auto	1			EM-8548
			Trans	Manual	1			EM-8542
	L4 1.6L 1597cc	1979-82	RH Front		1	EM-8803		
			Trans	Auto	1			EM-8545
			Trans	Manual	1		EM-8544	
<b>COLT</b>								
L4	L4 1.4L 1410cc	1979-84	LH Front		1	EM-8205		
			RH Front		1	EM-2731		
			Trans		1			EM-2730
	L4 1.5L 1468cc	1993-94	Front		1	EM-8100		
			Front	Auto	1	EM-2673		
		1989-92	Front	Manual	1	EM-8107		
			Front	Auto	1	EM-8235		
		1987-88	Front	Manual	1	EM-8103		
			Front	Auto	1	EM-8235		
		1985-86	Front	Manual	1	EM-8103		
			Front	Auto	1	EM-8235		
		1993-94	RH Front	w/ Power Steering	1	EM-8238		
	RH Front		w/o Power Steering	1	EM-8206			

# Engine, Transmission, And Torque Strut Mounts

CYL	ENG. SIZE	YEAR	LOCATION	DESCRIPTION	QTY	ENGINE	TORQUE STRUT	TRANS-MISSION		
PLYMOUTH PASSENGER CAR (continued)										
COLT (continued)										
L4	L4 1.5L 1468cc	1989-92	RH Front		1	EM-8108				
		1987-88	RH Front		1	EM-8242				
		1985-86	RH Front		1	EM-8232				
		1993-94	Rear	Auto		1	EM-8100			
			Rear	Manual		1	EM-8818			
		1989-92	Rear		1	EM-8102				
		1987-88	Rear		1	EM-8267				
		1985-86	Rear		1	EM-8267				
		1993-94	Trans	Auto		1			EM-8582	
			Trans	Manual		1			EM-8099	
		1989-92	Trans	Auto		1			EM-8584	
			Trans	Manual		1			EM-8669	
		1987-88	Trans		1			EM-8242		
		1985-86	Trans	Auto		1			EM-8575	
			Trans	Manual; Insert		1			EM-8552	
		L4 1.6L 1597cc	1989-90	Front	Auto		1	EM-2673		
				Front	Manual		1	EM-8107		
			1985-88	Front	Auto		1	EM-8235		
				Front	Manual		1	EM-8103		
			1982-84	Front		1	EM-8803			
	1981		Front		1	EM-8803				
	1976-80		L & R Front		2	EM-2731				
	1989-90		Rear		1	EM-8102				
	1985-88		Rear		1	EM-8267				
	1982-84		Rear	Auto		1	EM-8803			
			Rear	Manual		1	EM-8542			
	1981		Rear		1	EM-8542				
	1989-90		Trans	Auto		1			EM-8584	
			Trans	Manual		1			EM-8669	
	1987-88		Trans		1			EM-8242		
	1985-86		Trans	w/ Manual Steering		1			EM-8232	
			Trans	w/ Power Steering		1			EM-8556	
	1981-84		Trans		1			EM-8545		
	1976-80		Trans	Manual		1			EM-8542	
	L4 1.8L 1754cc		1989-90	Front	Auto		1	EM-8103		
		Front		Manual		1	EM-8103			
		Torq Str - Front		Manual		1		EM-8867		
	L4 1.8L 1834cc	1993-94	Front	Auto		1	EM-8097			
			Front	Manual		1	EM-9057			
		1992	Front	Auto		1	EM-8690			
			Front	Manual		1	EM-8100			
		1993-94	RH Front	Auto		1	EM-8238			
			RH Front	Manual		1	EM-9147			
		1992	RH Front	Auto		1	EM-8238			
			RH Front	Manual		1	EM-9147			
		1993-94	Rear	Auto		1	EM-8690			
			Rear	Manual		1	EM-8689			
		1992	Rear	Auto		1	EM-8690			
			Rear	Manual		1	EM-8689			
		1993-94	Trans	Auto		1			EM-8619	
			Trans	Manual		1			EM-8686	
		1992	Trans	Auto		1			EM-8881	
			Trans	Manual		1			EM-8686	
		L4 2.0L 1997cc	1984-91	RH Front	Auto		1	EM-8270		
				Trans	Auto		1			EM-8807
				Trans	Manual		1			EM-8510
				Trans	Auto		1			EM-8510

# Engine, Transmission, And Torque Strut Mounts

CYL	ENG. SIZE	YEAR	LOCATION	DESCRIPTION	QTY	ENGINE	TORQUE STRUT	TRANSMISSION		
<b>PLYMOUTH PASSENGER CAR (continued)</b>										
<b>COLT (continued)</b>										
L4	L4 2.0L 1997cc	1984	Trans	Manual	1			EM-8807		
	L4 2.4L 2351cc	1993-94	Front	Auto; FWD	1	EM-8102				
			Front	Manual; FWD	1	EM-8821				
			RH Front		1	EM-8820				
		1992	RH Front		1	EM-8820				
		1993-94	Rear	Auto; FWD	1	EM-8690				
			Rear	Manual; FWD	1	EM-8689				
		1994	Trans	Auto; FWD	1			EM-8822		
			Trans	Manual; FWD	1			EM-8686		
		1993	Trans	Auto; FWD	1			EM-8881		
			Trans	Manual; AWD	1			EM-8686		
			Trans	Manual; FWD	1			EM-8686		
		1992	Trans	Auto; FWD	1			EM-8881		
			Trans	Manual; AWD	1			EM-8686		
			Trans	Manual; FWD	1			EM-8686		
L4 2.6L 2555cc	1978-80	L & R Front		2	EM-2731					
		Trans		1			EM-2730			
<b>CONCORD</b>										
L6	L6 3.6L 218ci	1951-52	Trans - L & R Upper		2			EM-2014		
<b>CONQUEST</b>										
L4	L4 2.6L 2555cc	1984-86	LH Front		1	EM-8205				
			RH Front		1	EM-2731				
			Trans	Manual	1			EM-2730		
<b>CRANBROOK</b>										
L6	L6 3.6L 218ci	1951-53	Trans - L & R Upper		2			EM-2014		
<b>CUDA</b>										
V8	V8 5.2L 318ci	1972-74	L & R Front		2	EM-2250				
			Trans	Auto; Complete Unit	1			EM-2340		
			Trans	Auto; Complete Unit; HD Pkg.	1			EM-2512		
			Trans	Auto; Insert Only	1			EM-2525		
			Trans	Manual; Complete Unit	1			EM-2340		
			Trans	Manual; Complete Unit; HD Pkg.	1			EM-2512		
			Trans	Manual; Insert Only	1			EM-2525		
			V8 5.6L 340ci	1970-73	L & R Front		2	EM-2250		
					Trans	Auto; Complete Unit	1			EM-2340
					Trans	Auto; Complete Unit; HD Pkg.	1			EM-2512
					Trans	Auto; Insert Only	1			EM-2525
					Trans	Manual; Complete Unit	1			EM-2340
	Trans	Manual; Complete Unit; HD Pkg.			1			EM-2512		
	V8 5.9L 360ci	1974	L & R Front		2	EM-2250				
			Trans	Auto; Complete Unit	1			EM-2340		
			Trans	Auto; Complete Unit; HD Pkg.	1			EM-2512		
			Trans	Auto; Insert Only	1			EM-2525		
			Trans	Manual; Complete Unit	1			EM-2340		
			Trans	Manual; Complete Unit; HD Pkg.	1			EM-2512		
	V8 6.3L 383ci	1970-71	L & R Front		2	EM-2250				
			Trans		1			EM-2272		
			Trans	Manual; Insert Only	1			EM-2525		
	V8 7.0L 426ci	1970-71	L & R Front		2	EM-2250				

# Engine, Transmission, And Torque Strut Mounts

CYL	ENG. SIZE	YEAR	LOCATION	DESCRIPTION	QTY	ENGINE	TORQUE STRUT	TRANSMISSION	
<b>PLYMOUTH PASSENGER CAR (continued)</b>									
<b>CUDA (continued)</b>									
V8	V8 7.0L 426ci	1970-71	Trans	Auto	1			EM-2272	
			Trans	Manual	1			EM-2272	
	V8 7.2L 440ci	1970-71	L & R Front		2	EM-2250			
			Trans	Auto; Complete Unit	1			EM-2340	
			Trans	Auto; Complete Unit; HD Pkg.	1			EM-2512	
			Trans	Auto; Insert Only	1			EM-2525	
			Trans	Manual; Complete Unit	1			EM-2340	
			Trans	Manual; Complete Unit; HD Pkg.	1			EM-2512	
Trans	Manual; Insert Only	1			EM-2525				
<b>DUSTER</b>									
L6	L6 3.2L 198ci	1973-74	LH Front	Complete Unit	1	EM-2324			
			LH Front	Insert Only	2	EM-2376			
		1970-72	LH Front		1	EM-2265			
		1973-74	RH Front	Complete Unit	1	EM-2323			
			RH Front	Insert Only	2	EM-2376			
		1970-72	RH Front		1	EM-2264			
		1973-74	Trans	Auto; Complete Unit	1			EM-2340	
			Trans	Auto; Complete Unit; HD Pkg.	1			EM-2512	
			Trans	Auto; Insert Only	1			EM-2525	
			Trans	Manual; Complete Unit	1			EM-2340	
			Trans	Manual; Complete Unit; HD Pkg.	1			EM-2512	
			Trans	Manual; Insert Only	1			EM-2525	
		1970-72	Trans	Auto	1			EM-2272	
			Trans	Manual	1			EM-2272	
	L6 3.7L 3687cc		1973-76	LH Front	Complete Unit	1	EM-2324		
				LH Front	Insert Only	2	EM-2376		
		1970-72	LH Front		1	EM-2275			
		1973-76	RH Front	Complete Unit	1	EM-2323			
			RH Front	Insert Only	2	EM-2376			
		1970-72	RH Front		1	EM-2276			
		1973-76	Trans	Auto; Complete Unit	1			EM-2340	
			Trans	Auto; Complete Unit; HD Pkg.	1			EM-2512	
	Trans		Auto; Insert Only	1			EM-2525		
	Trans		Manual; Complete Unit	1			EM-2340		
	Trans		Manual; Complete Unit; HD Pkg.	1			EM-2512		
	Trans		Manual; Insert Only	1			EM-2525		
	1970-72	Trans	Auto	1			EM-2272		
		Trans	Manual	1			EM-2272		
V8	V8 5.2L 318ci	1970-72	L & R Front		2	EM-2266			
			1973-76	LH Front	Complete Unit	1	EM-2326		
		LH Front		Insert Only	2	EM-2369			
		RH Front		Complete Unit	1	EM-2325			
		RH Front		Insert Only	2	EM-2369			
		Trans		Auto; Complete Unit	1			EM-2340	
		Trans		Auto; Complete Unit; HD Pkg.	1			EM-2512	
		Trans		Auto; Insert Only	1			EM-2525	
		Trans		Manual; Complete Unit	1			EM-2340	
		Trans	Manual; Complete Unit; HD Pkg.	1			EM-2512		
		Trans	Manual; Insert Only	1			EM-2525		
		1970-72	Trans	Auto	1			EM-2272	
			Trans	Manual	1			EM-2272	
			V8 5.6L 340ci	1970-73	LH Front	Complete Unit	1	EM-2326	
	LH Front				Insert Only	2	EM-2369		

# Engine, Transmission, And Torque Strut Mounts

CYL	ENG. SIZE	YEAR	LOCATION	DESCRIPTION	QTY	ENGINE	TORQUE STRUT	TRANSMISSION	
<b>PLYMOUTH PASSENGER CAR (continued)</b>									
<b>DUSTER (continued)</b>									
V8	V8 5.6L 340ci	1970-73	RH Front	Complete Unit	1	EM-2325			
			RH Front	Insert Only	2	EM-2369			
			Trans	Auto; Complete Unit	1			EM-2340	
			Trans	Auto; Complete Unit; HD Pkg.	1			EM-2512	
			Trans	Auto; Insert Only	1			EM-2525	
			Trans	Manual; Complete Unit	1			EM-2340	
			Trans	Manual; Complete Unit; HD Pkg.	1			EM-2512	
			Trans	Manual; Insert Only	1			EM-2525	
	V8 5.9L 360ci	1974-76	LH Front	Complete Unit	1	EM-2326			
			LH Front	Insert Only	2	EM-2369			
			RH Front	Complete Unit	1	EM-2325			
			RH Front	Insert Only	2	EM-2369			
			Trans	Auto; Complete Unit	1			EM-2340	
			Trans	Auto; Complete Unit; HD Pkg.	1			EM-2512	
			Trans	Auto; Insert Only	1			EM-2525	
			Trans	Manual; Complete Unit	1			EM-2340	
Trans			Manual; Complete Unit; HD Pkg.	1			EM-2512		
Trans			Manual; Insert Only	1			EM-2525		
<b>EXPO</b>									
L4	L4 2.2L 135ci	1987-89	Front		1	EM-2493			
			RH Front		1	EM-2600			
			Trans		1			EM-2617	
<b>FURY</b>									
L6	L6 3.7L 3687cc	1975-78	LH Front	Complete Unit	1	EM-2324			
			LH Front	Insert Only	2	EM-2376			
		1970	LH Front		1	EM-2275			
			LH Front		1	EM-2275			
		1975-78	RH Front	Complete Unit	1	EM-2323			
			RH Front	Insert Only	2	EM-2376			
		1970	RH Front		1	EM-2276			
			RH Front		1	EM-2276			
		1975-78	Trans	Auto; Complete Unit	1			EM-2340	
			Trans	Auto; Complete Unit; HD Pkg.	1			EM-2512	
			Trans	Auto; Insert Only	1			EM-2525	
			Trans	Manual; Complete Unit	1			EM-2340	
			Trans	Manual; Complete Unit; HD Pkg.	1			EM-2512	
			Trans	Manual; Insert Only	1			EM-2525	
			Trans	Auto	1			EM-2272	
		1970	Trans	Manual	1			EM-2272	
			Trans	Auto	1			EM-2272	
		1968	Trans	Auto	1			EM-2272	
Trans	Manual		1			EM-2272			
V8	V8 4.5L 273ci	1964-65	LH Front		1	EM-2228			
			RH Front		1	EM-2227			
			Trans	Auto	1			EM-2272	
			Trans	Manual	1			EM-2272	
	V8 5.2L 318ci	1967-73	1975-78	L & R Front		2	EM-2250		
				LH Front	Complete Unit	1	EM-2326		
		LH Front	Insert Only	2	EM-2369				
		RH Front	Complete Unit	1	EM-2325				
		RH Front	Insert Only	2	EM-2369				
		Trans	Auto; Complete Unit	1			EM-2340		
1975-78	Trans	Auto; Complete Unit; HD Pkg.	1			EM-2512			
	Trans	Auto; Insert Only	1			EM-2525			

# Engine, Transmission, And Torque Strut Mounts

CYL	ENG. SIZE	YEAR	LOCATION	DESCRIPTION	QTY	ENGINE	TORQUE STRUT	TRANSMISSION
<b>PLYMOUTH PASSENGER CAR (continued)</b>								
<b>FURY (continued)</b>								
V8	V8 5.2L 318ci	1975-78	Trans	Manual; Complete Unit	1			EM-2340
			Trans	Manual; Complete Unit; HD Pkg.	1			EM-2512
			Trans	Manual; Insert Only	1			EM-2525
		1971-73	Trans	Auto; Complete Unit	1			EM-2340
			Trans	Auto; Complete Unit; HD Pkg.	1			EM-2512
			Trans	Auto; Insert Only	1			EM-2525
			Trans	Manual; Complete Unit	1			EM-2340
			Trans	Manual; Complete Unit; HD Pkg.	1			EM-2512
		1967-70	Trans	Manual; Insert Only	1			EM-2525
			Trans	Auto	1			EM-2272
			Trans	Manual	1		EM-2272	
V8 5.9L 360ci	1971-73	1974-78	L & R Front		2	EM-2250		
			LH Front	Complete Unit	1	EM-2326		
			LH Front	Insert Only	2	EM-2369		
			RH Front	Complete Unit	1	EM-2325		
			RH Front	Insert Only	2	EM-2369		
	1971-78	Trans	Auto; Complete Unit	1			EM-2340	
		Trans	Auto; Complete Unit; HD Pkg.	1			EM-2512	
		Trans	Auto; Insert Only	1			EM-2525	
		Trans	Manual; Complete Unit	1			EM-2340	
		Trans	Manual; Complete Unit; HD Pkg.	1			EM-2512	
			Trans	Manual; Insert Only	1		EM-2525	
V8 5.9L 361ci	1966	1960-65	L & R Front		2	EM-2250		
			LH Front		1	EM-2228		
			RH Front		1	EM-2227		
	1966	Trans	Auto	1			EM-2272	
		Trans	Manual	1			EM-2272	
V8 6.3L 383ci	1966-71	1960-65	L & R Front		2	EM-2250		
			LH Front		1	EM-2228		
			RH Front		1	EM-2227		
	1960-71	Trans	Auto	1			EM-2272	
		Trans	Manual	1			EM-2272	
V8 6.6L 400ci	1972	1973-78	L & R Front		2	EM-2250		
			LH Front	Complete Unit	1	EM-2326		
			LH Front	Insert Only	2	EM-2369		
			RH Front	Complete Unit	1	EM-2325		
			RH Front	Insert Only	2	EM-2369		
	1972-78	Trans	Auto; Complete Unit	1			EM-2340	
		Trans	Auto; Complete Unit; HD Pkg.	1			EM-2512	
		Trans	Auto; Insert Only	1			EM-2525	
		Trans	Manual; Complete Unit	1			EM-2340	
		Trans	Manual; Complete Unit; HD Pkg.	1			EM-2512	
			Trans	Manual; Insert Only	1		EM-2525	
V8 7.0L 426ci	1966	1963-65	L & R Front		2	EM-2250		
			LH Front		1	EM-2228		
			RH Front		1	EM-2227		
	1963-66	Trans	Auto	1			EM-2272	
		Trans	Manual	1			EM-2272	
V8 7.2L 440ci	1967-73	1974-78	L & R Front		2	EM-2250		
			LH Front	Complete Unit	1	EM-2326		
			LH Front	Insert Only	2	EM-2369		
			RH Front	Complete Unit	1	EM-2325		
			RH Front	Insert Only	2	EM-2369		

# Engine, Transmission, And Torque Strut Mounts

CYL	ENG. SIZE	YEAR	LOCATION	DESCRIPTION	QTY	ENGINE	TORQUE STRUT	TRANSMISSION
<b>PLYMOUTH PASSENGER CAR (continued)</b>								
<b>FURY (continued)</b>								
V8	V8 7.2L 440ci	1969-78	Trans	Auto; Complete Unit	1			EM-2340
			Trans	Auto; Insert Only	1			EM-2525
			Trans	Manual; Complete Unit	1			EM-2340
			Trans	Manual; Insert Only	1			EM-2525
<b>FURY I</b>								
L6	L6 3.7L 3687cc	1973	LH Front	Complete Unit	1	EM-2324		
			LH Front	Insert Only	2	EM-2376		
		1968-72	LH Front		1	EM-2275		
			1973	RH Front	Complete Unit	1	EM-2323	
		1968-72	RH Front	Insert Only	2	EM-2376		
			1973	RH Front		1	EM-2276	
		1973	Trans	Auto; Complete Unit	1			EM-2340
			Trans	Auto; Complete Unit; HD Pkg.	1			EM-2512
			Trans	Auto; Insert Only	1			EM-2525
			Trans	Manual; Complete Unit	1			EM-2340
			Trans	Manual; Complete Unit; HD Pkg.	1			EM-2512
			Trans	Manual; Insert Only	1			EM-2525
			1968-72	Trans		1		
		V8	V8 5.2L 318ci	1968-73	L & R Front		2	EM-2250
1971-73	Trans				Auto; Complete Unit	1		EM-2340
1971-73	Trans			Auto; Complete Unit; HD Pkg.	1		EM-2512	
	Trans			Auto; Insert Only	1		EM-2525	
	Trans			Manual; Complete Unit	1		EM-2340	
	Trans			Manual; Complete Unit; HD Pkg.	1		EM-2512	
	Trans			Manual; Insert Only	1		EM-2525	
1968-70	Trans			1		EM-2272		
V8 5.9L 360ci	1971-73		L & R Front		2	EM-2250		
			1974	LH Front	Complete Unit	1	EM-2326	
	1971-73		LH Front	Insert Only	2	EM-2369		
			RH Front	Complete Unit	1	EM-2325		
			RH Front	Insert Only	2	EM-2369		
		Trans	Auto; Complete Unit	1		EM-2340		
		Trans	Auto; Complete Unit; HD Pkg.	1		EM-2512		
		Trans	Auto; Insert Only	1		EM-2525		
Trans	Manual; Complete Unit	1		EM-2340				
Trans	Manual; Complete Unit; HD Pkg.	1		EM-2512				
V8 6.3L 383ci	1968-71	L & R Front		2	EM-2250			
		Trans		1		EM-2272		
V8 6.6L 400ci	1972	L & R Front		2	EM-2250			
		1973-74	LH Front	Complete Unit	1	EM-2326		
	LH Front		Insert Only	2	EM-2369			
	RH Front		Complete Unit	1	EM-2325			
	RH Front		Insert Only	2	EM-2369			
	1972-74	Trans	Auto; Complete Unit	1		EM-2340		
		Trans	Auto; Complete Unit; HD Pkg.	1		EM-2512		
		Trans	Auto; Insert Only	1		EM-2525		
		Trans	Manual; Complete Unit	1		EM-2340		
		Trans	Manual; Complete Unit; HD Pkg.	1		EM-2512		
Trans		Manual; Insert Only	1		EM-2525			
V8 7.2L 440ci	1968-73	L & R Front		2	EM-2250			
		Trans	Auto; Complete Unit	1		EM-2340		
		Trans	Auto; Complete Unit; HD Pkg.	1		EM-2512		

# Engine, Transmission, And Torque Strut Mounts

CYL	ENG. SIZE	YEAR	LOCATION	DESCRIPTION	QTY	ENGINE	TORQUE STRUT	TRANS-MISSION	
<b>PLYMOUTH PASSENGER CAR (continued)</b>									
<b>FURY I (continued)</b>									
V8	V8 7.2L 440ci	1968-73	Trans	Auto; Insert Only	1			EM-2525	
			Trans	Manual; Complete Unit	1			EM-2340	
			Trans	Manual; Complete Unit; HD Pkg.	1			EM-2512	
			Trans	Manual; Insert Only	1			EM-2525	
<b>FURY II</b>									
L6	L6 3.7L 3687cc	1968-70	LH Front		1	EM-2275			
			RH Front		1	EM-2276			
			Trans		1			EM-2272	
V8	V8 5.2L 318ci	1968-73	L & R Front		2	EM-2250			
			1971-73	Trans	Auto; Complete Unit	1			EM-2340
		1971-73	Trans	Auto; Complete Unit; HD Pkg.	1			EM-2512	
			Trans	Auto; Insert Only	1			EM-2525	
			Trans	Manual; Complete Unit	1			EM-2340	
			Trans	Manual; Complete Unit; HD Pkg.	1			EM-2512	
			Trans	Manual; Insert Only	1			EM-2525	
	1968-70	Trans		1			EM-2272		
	V8 5.9L 360ci	1971-73	L & R Front		2	EM-2250			
			1974	LH Front	Complete Unit	1	EM-2326		
				LH Front	Insert Only	2	EM-2369		
				RH Front	Complete Unit	1	EM-2325		
		RH Front		Insert Only	2	EM-2369			
1971-74		Trans	Auto; Complete Unit	1			EM-2340		
		Trans	Auto; Complete Unit; HD Pkg.	1			EM-2512		
		Trans	Auto; Insert Only	1			EM-2525		
		Trans	Manual; Complete Unit	1			EM-2340		
		Trans	Manual; Complete Unit; HD Pkg.	1			EM-2512		
	Trans	Manual; Insert Only	1			EM-2525			
V8 6.3L 383ci	1968-71	L & R Front		2	EM-2250				
		Trans		1			EM-2272		
V8 6.6L 400ci	1972	L & R Front		2	EM-2250				
		1973-74	LH Front	Complete Unit	1	EM-2326			
	LH Front		Insert Only	2	EM-2369				
	RH Front		Complete Unit	1	EM-2325				
	RH Front		Insert Only	2	EM-2369				
	1972-74	Trans	Auto; Complete Unit	1			EM-2340		
		Trans	Auto; Complete Unit; HD Pkg.	1			EM-2512		
		Trans	Auto; Insert Only	1			EM-2525		
		Trans	Manual; Complete Unit	1			EM-2340		
		Trans	Manual; Complete Unit; HD Pkg.	1			EM-2512		
	Trans	Manual; Insert Only	1			EM-2525			
V8 7.2L 440ci	1974	L & R Front	Insert Only	2	EM-2369				
		1968-73	L & R Front		2	EM-2250			
	1968-74		Trans	Auto; Complete Unit	1			EM-2340	
			Trans	Auto; Complete Unit; HD Pkg.	1			EM-2512	
	Trans		Auto; Insert Only	1			EM-2525		
	Trans		Manual; Complete Unit	1			EM-2340		
	Trans		Manual; Complete Unit; HD Pkg.	1			EM-2512		
	Trans	Manual; Insert Only	1			EM-2525			



# Engine, Transmission, And Torque Strut Mounts

CYL	ENG. SIZE	YEAR	LOCATION	DESCRIPTION	QTY	ENGINE	TORQUE STRUT	TRANSMISSION
<b>PLYMOUTH PASSENGER CAR (continued)</b>								
<b>FURY III</b>								
L6	L6 3.7L 3687cc	1968-71	LH Front		1	EM-2275		
			RH Front		1	EM-2276		
			Trans		1			EM-2272
V8	V8 5.2L 318ci	1968-73	L & R Front		2	EM-2250		
		1971-73	Trans	Auto; Complete Unit	1			EM-2340
			Trans	Auto; Complete Unit; HD Pkg.	1			EM-2512
			Trans	Auto; Insert Only	1			EM-2525
			Trans	Manual; Complete Unit	1			EM-2340
			Trans	Manual; Complete Unit; HD Pkg.	1			EM-2512
			Trans	Manual; Insert Only	1			EM-2525
		1968-70	Trans		1			EM-2272
	V8 5.9L 360ci	1971-73	L & R Front		2	EM-2250		
		1974	LH Front	Complete Unit	1	EM-2326		
			LH Front	Insert Only	2	EM-2369		
			RH Front	Complete Unit	1	EM-2325		
			RH Front	Insert Only	2	EM-2369		
		1971-74	Trans	Auto; Complete Unit	1			EM-2340
			Trans	Auto; Complete Unit; HD Pkg.	1			EM-2512
			Trans	Auto; Insert Only	1			EM-2525
			Trans	Manual; Complete Unit	1			EM-2340
			Trans	Manual; Complete Unit; HD Pkg.	1			EM-2512
	Trans		Manual; Insert Only	1			EM-2525	
	V8 6.3L 383ci	1968-71	L & R Front		2	EM-2250		
			Trans		1			EM-2272
V8 6.6L 400ci	1972	L & R Front		2	EM-2250			
	1973-74	LH Front		1	EM-2326			
		LH Front	Insert Only	2	EM-2369			
		RH Front		1	EM-2325			
		RH Front	Insert Only	2	EM-2369			
		Trans	Auto; Complete Unit	1			EM-2340	
	1972-74	Trans	Auto; Complete Unit; HD Pkg.	1			EM-2512	
		Trans	Auto; Insert Only	1			EM-2525	
		Trans	Manual; Complete Unit	1			EM-2340	
		Trans	Manual; Complete Unit; HD Pkg.	1			EM-2512	
Trans		Manual; Insert Only	1			EM-2525		
V8 7.2L 440ci	1974	L & R Front	Insert Only	2	EM-2369			
	1968-73	L & R Front		2	EM-2250			
	1968-74	Trans	Auto; Complete Unit	1			EM-2340	
		Trans	Auto; Complete Unit; HD Pkg.	1			EM-2512	
		Trans	Auto; Insert Only	1			EM-2525	
		Trans	Manual; Complete Unit	1			EM-2340	
		Trans	Manual; Complete Unit; HD Pkg.	1			EM-2512	
		Trans	Manual; Insert Only	1			EM-2525	
<b>GRAN FURY</b>								
L6	L6 3.7L 3687cc	1980-83	LH Front	Complete Unit	1	EM-2324		
			LH Front	Insert Only	2	EM-2376		
			RH Front	Complete Unit	1	EM-2323		
			RH Front	Insert Only	2	EM-2376		
			Trans	Complete Unit	1			EM-2340
			Trans	Complete Unit - HD	1			EM-2512
			Trans	Insert Only	1			EM-2525
V8	V8 5.2L 318ci	1972-73	L & R Front		2	EM-2250		
		1980-89	LH Front	Complete Unit	1	EM-2326		

# Engine, Transmission, And Torque Strut Mounts

CYL	ENG. SIZE	YEAR	LOCATION	DESCRIPTION	QTY	ENGINE	TORQUE STRUT	TRANSMISSION	
<b>PLYMOUTH PASSENGER CAR (continued)</b>									
<b>GRAN FURY (continued)</b>									
V8	V8 5.2L 318ci	1980-89	LH Front	Insert Only	2	EM-2369			
			1975-77	LH Front	Complete Unit	1	EM-2326		
				LH Front	Insert Only	2	EM-2369		
		1980-89	RH Front	Complete Unit	1	EM-2325			
			RH Front	Insert Only	2	EM-2369			
				1975-77	RH Front	Complete Unit	1	EM-2325	
		1980-89	Trans	RH Front	Insert Only	2	EM-2369		
				Complete Unit	1		EM-2340		
				Complete Unit - HD	1		EM-2512		
			1975-77	Insert Only	1		EM-2525		
				Complete Unit	1		EM-2340		
				Complete Unit - HD	1		EM-2512		
		1972-73	Trans	Insert Only	1		EM-2525		
				Complete Unit	1		EM-2340		
				Complete Unit - HD	1		EM-2512		
	Trans		Insert Only	1		EM-2525			
			Complete Unit	1		EM-2340			
			Complete Unit - HD	1		EM-2512			
	V8 5.9L 360ci	1972-73	L & R Front		2	EM-2250			
			1980	LH Front	Complete Unit	1	EM-2326		
				LH Front	Insert Only	2	EM-2369		
		1974-77	LH Front	Complete Unit	1	EM-2326			
			LH Front	Insert Only	2	EM-2369			
				1980	RH Front	Complete Unit	1	EM-2325	
		1980	RH Front	Insert Only	2	EM-2369			
				1974-77	RH Front	Complete Unit	1	EM-2325	
			RH Front	Insert Only	2	EM-2369			
		1980		Trans	Complete Unit	1		EM-2340	
				Complete Unit - HD	1		EM-2512		
			Insert Only	1		EM-2525			
		1972-77	Trans	Complete Unit	1		EM-2340		
				Complete Unit - HD	1		EM-2512		
				Insert Only	1		EM-2525		
	1972		L & R Front		2	EM-2250			
			1973-77	LH Front	Complete Unit	1	EM-2326		
				LH Front	Insert Only	2	EM-2369		
RH Front	Complete Unit	1		EM-2325					
1972-77	RH Front	Insert Only	2	EM-2369					
		Trans	Complete Unit	1		EM-2340			
		Complete Unit - HD	1		EM-2512				
Trans	Insert Only	1		EM-2525					
V8 6.6L 400ci	V8 7.2L 440ci	1972	L & R Front		2	EM-2250			
			1973-77	LH Front	Complete Unit	1	EM-2326		
				LH Front	Insert Only	2	EM-2369		
		1972-77	RH Front	Complete Unit	1	EM-2325			
			RH Front	Insert Only	2	EM-2369			
				Trans	Complete Unit	1		EM-2340	
	Complete Unit - HD	1		EM-2512					
	Insert Only	1		EM-2525					
	V8 6.3L 383ci	1972	L & R Front		2	EM-2250			
			1973-77	LH Front	Complete Unit	1	EM-2326		
				LH Front	Insert Only	2	EM-2369		
		1972-77	RH Front	Complete Unit	1	EM-2325			
RH Front			Insert Only	2	EM-2369				
			Trans	Complete Unit	1		EM-2340		
Complete Unit - HD	1		EM-2512						
Insert Only	1		EM-2525						
<b>GTX</b>									
V8	V8 4.5L 273ci	1967	L & R Front		2	EM-2266			
			Trans	Auto	1		EM-2272		
			Trans	Manual	1		EM-2272		
		V8 5.2L 318ci	1967-68	L & R Front		2	EM-2266		
				Trans	Auto	1		EM-2272	
				Trans	Manual	1		EM-2272	
	V8 6.3L 383ci	1967-68	L & R Front		2	EM-2250			
			Trans	Auto	1		EM-2272		
			Trans	Manual	1		EM-2272		

# Engine, Transmission, And Torque Strut Mounts

CYL	ENG. SIZE	YEAR	LOCATION	DESCRIPTION	QTY	ENGINE	TORQUE STRUT	TRANSMISSION	
<b>PLYMOUTH PASSENGER CAR (continued)</b>									
<b>GTX (continued)</b>									
V8	V8 7.0L 426ci	1967-71	L & R Front		2	EM-2250			
			Trans	Auto	1			EM-2272	
			Trans	Manual	1			EM-2272	
	V8 7.2L 440ci	1967-71	L & R Front		2	EM-2250			
			Trans	Complete Unit	1			EM-2340	
			Trans	Complete Unit - HD	1			EM-2512	
			Trans	Insert Only	1			EM-2525	
<b>HORIZON</b>									
L4	L4 1.6L 1595cc	1983-86	Front		1	EM-2493			
			RH Front		1	EM-2600			
			Torq Str - Front	Manual	1		EM-2491		
		1984-86	Trans	Auto	1			EM-2617	
			Trans	Manual	1			EM-2617	
		1983	Trans	Auto	1			EM-2600	
			Trans	Manual	1			EM-2600	
		L4 1.7L 105ci	1978-83	Front	Complete Unit	1	EM-2733		
				Front	Insert Only	1	EM-2447		
	RH Front				1	EM-2600			
	1981-83		Trans	Auto	1			EM-2600	
			Trans	Manual	1			EM-2600	
	1978-80		Trans	Complete Unit	1			EM-2734	
			Trans	Insert Only	1			EM-2721	
			Trans	Manual; Complete Unit	1			EM-2734	
				Trans	Manual; Insert Only	1			EM-2721
	L4 2.2L 135ci	1982-90	Front		1	EM-2493			
			1981	Front		1	EM-2447		
		1982-90	RH Front		1	EM-2600			
		1981	RH Front		1	EM-2600			
		1984-87	Torq Str - Front	Manual	1		EM-2491		
			Trans	Auto	1			EM-2617	
		1984-90	Trans	Manual	1			EM-2617	
			1981-83	Trans	Auto	1		EM-2600	
				Trans	Manual	1		EM-2600	
<b>LASER</b>									
L4	L4 1.8L 1755cc	1990-94	Front		1	EM-8103			
			LH Front		1	EM-9056			
			Rear	Auto	1	EM-5098			
			Rear	Manual	1	EM-8104			
			Trans	Auto	1			EM-8700	
			Trans	Manual	1			EM-8686	
	L4 2.0L 1997cc	1992-94	Front	Auto; AWD	1	EM-8559			
			Front	FWD	1	EM-8103			
			Front	Manual; AWD	1	EM-9078			
		1990-91	Front	FWD	1	EM-8103			
		1992-94	LH Front		1	EM-9206			
		1990-91	LH Front		1	EM-9206			
		1992-94	Rear	Auto; AWD	1	EM-8104			
			Rear	Auto; FWD	1	EM-8104			
			Rear	Manual; AWD	1	EM-5101			
			Rear	Manual; FWD	1	EM-5098			
		1990-91	Rear	Auto; FWD	1	EM-8104			
			Rear	Manual; FWD	1	EM-5098			
		1990-94	Trans	Auto	1			EM-8700	

# Engine, Transmission, And Torque Strut Mounts

CYL	ENG. SIZE	YEAR	LOCATION	DESCRIPTION	QTY	ENGINE	TORQUE STRUT	TRANSMISSION
<b>PLYMOUTH PASSENGER CAR (continued)</b>								
<b>NEON</b>								
L4	L4 2.0L 1996cc	1995-99	Front	Complete Unit	1	EM-2867		
			Front	Insert	1	EM-2846		
		2000-01	LH Rear Upper	Auto	1	EM-2948		
		1995-99	RH Front	Complete Unit	1	EM-2979		
			RH Front	Insert	1	EM-2847		
		2000-01	RH Front Lower		1	EM-2949		
			Rear		1	EM-2947		
			Trans	Auto	1			EM-2975
		1995-99	Trans	Manual	1			EM-3050
			Trans	Auto, Complete Unit	1			EM-5052
			Trans	Auto; Insert	1			EM-2848
			Trans	Manual, Complete Unit	1			EM-5180
Trans	Manual; Insert		1			EM-2848		
<b>PROWLER</b>								
V6	V6 3.5L 3497cc	1997-99	Trans		1			EM-2810
<b>RELIANT</b>								
L4	L4 2.2L 135ci	1982-89	Front		1	EM-2493		
			1981	Front	Auto	1	EM-2447	
		1981	Front	Manual; 4 Spd	1	EM-2493		
			Front	Manual; 5 Spd	1	EM-2447		
			1982-89	RH Front		1	EM-2600	
		1981	RH Front	RH Front	1	EM-2600		
		1981-87	Torq Str - Front	Manual	1		EM-2491	
		1984-89	Trans	Auto	1			EM-2617
			Trans	Manual	1			EM-2617
		1981-83	Trans	Auto	1			EM-2600
			Trans	Manual	1			EM-2600
		L4 2.5L 2507cc	1986-89	Front		1	EM-2493	
	RH Front				1	EM-2600		
	Torq Str - Front			Manual	1		EM-2491	
	Trans			Auto	1			EM-2617
	Trans			Manual	1			EM-2617
	L4 2.6L 2555cc	1981-85	Front		1	EM-2493		
			RH Front		1	EM-2600		
		1984-85	Trans	Auto	1			EM-2617
			Trans	Manual	1			EM-2617
1981-83		Trans	Auto	1			EM-2600	
		Trans	Manual	1			EM-2600	
<b>ROADRUNNER</b>								
V8	V8 4.5L 273ci	1968	L & R Front		2	EM-2250		
			Trans		1			EM-2272
	V8 5.2L 318ci	1972-74	L & R Front		2	EM-2250		
			1968	L & R Front		2	EM-2250	
		1975	LH Front	Complete Unit	1	EM-2326		
			LH Front	Insert Only	2	EM-2369		
			RH Front	Complete Unit	1	EM-2325		
			RH Front	Insert Only	2	EM-2369		
			Trans	Auto; Complete Unit	1			EM-2340
		1972-75	Trans	Auto; Complete Unit; HD Pkg.	1			EM-2512
			Trans	Auto; Insert Only	1			EM-2525
			Trans	Manual; Complete Unit	1			EM-2340
	Trans		Manual; Complete Unit; HD Pkg.	1			EM-2512	
	1968	Trans	Manual; Insert Only	1			EM-2525	
	1968	Trans		1			EM-2272	
	V8 5.6L 340ci	1971-73	L & R Front		2	EM-2250		

# Engine, Transmission, And Torque Strut Mounts

CYL	ENG. SIZE	YEAR	LOCATION	DESCRIPTION	QTY	ENGINE	TORQUE STRUT	TRANSMISSION	
<b>PLYMOUTH PASSENGER CAR (continued)</b>									
<b>ROADRUNNER (continued)</b>									
V8	V8 5.6L 340ci	1971-73	Trans	Auto; Complete Unit	1			EM-2340	
			Trans	Auto; Complete Unit; HD Pkg.	1			EM-2512	
			Trans	Auto; Insert Only	1			EM-2525	
			Trans	Manual; Complete Unit	1			EM-2340	
			Trans	Manual; Complete Unit; HD Pkg.	1			EM-2512	
			Trans	Manual; Insert Only	1			EM-2525	
	V8 5.9L 360ci	1974-75	LH Front	Complete Unit	1	EM-2326			
			LH Front	Insert Only	2	EM-2369			
			RH Front	Complete Unit	1	EM-2325			
			RH Front	Insert Only	2	EM-2369			
			Trans	Auto; Complete Unit	1			EM-2340	
			Trans	Auto; Complete Unit; HD Pkg.	1			EM-2512	
			Trans	Auto; Insert Only	1			EM-2525	
			Trans	Manual; Complete Unit	1			EM-2340	
			Trans	Manual; Complete Unit; HD Pkg.	1			EM-2512	
			Trans	Manual; Insert Only	1			EM-2525	
	V8 6.3L 383ci	1968-71	L & R Front		2	EM-2250			
			Trans	Auto	1			EM-2272	
			Trans	Manual	1			EM-2272	
	V8 6.6L 400ci	1972	L & R Front		2	EM-2250			
		1973-75	LH Front	Complete Unit	1	EM-2326			
			LH Front	Insert Only	2	EM-2369			
			RH Front	Complete Unit	1	EM-2325			
			RH Front	Insert Only	2	EM-2369			
		1972-75	Trans	Auto; Complete Unit	1			EM-2340	
			Trans	Auto; Complete Unit; HD Pkg.	1			EM-2512	
			Trans	Auto; Insert Only	1			EM-2525	
			Trans	Manual; Complete Unit	1			EM-2340	
			Trans	Manual; Complete Unit; HD Pkg.	1			EM-2512	
		Trans	Manual; Insert Only	1			EM-2525		
		V8 7.0L 426ci	1968-71	L & R Front		2	EM-2250		
				Trans	Auto	1			EM-2272
	Trans			Manual	1			EM-2272	
V8 7.2L 440ci	1969-72	L & R Front		2	EM-2250				
	1973-74	LH Front	Complete Unit	1	EM-2326				
		LH Front	Insert Only	2	EM-2369				
		RH Front	Complete Unit	1	EM-2325				
		RH Front	Insert Only	2	EM-2369				
	1969-74	Trans	Auto; Complete Unit	1			EM-2340		
		Trans	Auto; Complete Unit; HD Pkg.	1			EM-2512		
		Trans	Auto; Insert Only	1			EM-2525		
		Trans	Manual; Complete Unit	1			EM-2340		
		Trans	Manual; Complete Unit; HD Pkg.	1			EM-2512		
Trans	Manual; Insert Only	1			EM-2525				
<b>SAPPORO</b>									
L4	L4 1.6L 1597cc	1978-79	Front		1	EM-8542			
			Trans	Auto	1			EM-8545	
			Trans	Manual	1			EM-8542	
	L4 2.6L 2555cc	1978-83	L & R Front		2	EM-2731			
			Trans		1			EM-2730	

# Engine, Transmission, And Torque Strut Mounts

CYL	ENG. SIZE	YEAR	LOCATION	DESCRIPTION	QTY	ENGINE	TORQUE STRUT	TRANSMISSION	
<b>PLYMOUTH PASSENGER CAR (continued)</b>									
<b>SATELLITE</b>									
L6	L6 3.7L 3687cc	1973-74	LH Front	Complete Unit	1	EM-2324			
			LH Front	Insert Only	2	EM-2369			
		1971-72	LH Front		1	EM-2275			
			LH Front		1	EM-2275			
		1973-74	RH Front	Complete Unit	1	EM-2323			
			RH Front	Insert Only	2	EM-2376			
		1971-72	RH Front		1	EM-2276			
			RH Front		1	EM-2276			
		1971-74	Trans	Auto; Complete Unit	1			EM-2340	
			Trans	Auto; Complete Unit; HD Pkg.	1			EM-2512	
			Trans	Auto; Insert Only	1			EM-2525	
			Trans	Manual; Complete Unit	1			EM-2340	
			Trans	Manual; Complete Unit; HD Pkg.	1			EM-2512	
			Trans	Manual; Insert Only	1			EM-2525	
1966-67	Trans		1			EM-2272			
V8	V8 4.5L 273ci	1965-68	L & R Front		2	EM-2250			
			Trans		1			EM-2272	
	V8 5.2L 318ci	1965-74	1971-74	L & R Front		2	EM-2250		
				Trans	Auto; Complete Unit	1			EM-2340
				Trans	Auto; Complete Unit; HD Pkg.	1			EM-2512
				Trans	Auto; Insert Only	1			EM-2525
				Trans	Manual; Complete Unit	1			EM-2340
				Trans	Manual; Complete Unit; HD Pkg.	1			EM-2512
		Trans	Manual; Insert Only	1			EM-2525		
	1965-69	Trans		1			EM-2272		
	V8 5.6L 340ci	1972	L & R Front		2	EM-2250			
			Trans	Auto; Complete Unit	1			EM-2340	
			Trans	Auto; Complete Unit; HD Pkg.	1			EM-2512	
			Trans	Auto; Insert Only	1			EM-2525	
			Trans	Manual; Complete Unit	1			EM-2340	
			Trans	Manual; Complete Unit; HD Pkg.	1			EM-2512	
			Trans	Manual; Insert Only	1			EM-2525	
	V8 5.9L 360ci	1974	L & R Front		2	EM-2250			
			Trans	Auto; Complete Unit	1			EM-2340	
			Trans	Auto; Complete Unit; HD Pkg.	1			EM-2512	
			Trans	Auto; Insert Only	1			EM-2525	
			Trans	Manual; Complete Unit	1			EM-2340	
			Trans	Manual; Complete Unit; HD Pkg.	1			EM-2512	
			Trans	Manual; Insert Only	1			EM-2525	
	V8 6.3L 383ci	1965-71	L & R Front		2	EM-2250			
			Trans	Auto	1			EM-2272	
			Trans	Manual	1			EM-2272	
	V8 6.6L 400ci	1972	1973-74	L & R Front		2	EM-2250		
				LH Front	Complete Unit	1	EM-2326		
1972-74		LH Front	Insert Only	2	EM-2369				
		RH Front	Complete Unit	1	EM-2325				
		RH Front	Insert Only	2	EM-2369				
		Trans	Auto; Complete Unit	1			EM-2340		
		Trans	Auto; Complete Unit; HD Pkg.	1			EM-2512		
Trans		Auto; Insert Only	1			EM-2525			
Trans		Manual; Complete Unit	1			EM-2340			
Trans	Manual; Complete Unit; HD Pkg.	1			EM-2512				

# Engine, Transmission, And Torque Strut Mounts

CYL	ENG. SIZE	YEAR	LOCATION	DESCRIPTION	QTY	ENGINE	TORQUE STRUT	TRANSMISSION	
<b>PLYMOUTH PASSENGER CAR (continued)</b>									
<b>SATELLITE (continued)</b>									
V8	V8 6.6L 400ci	1972-74	Trans	Manual; Insert Only	1			EM-2525	
	V8 7.0L 426ci	1965-67	L & R Front		2	EM-2250			
			Trans		1			EM-2272	
	V8 7.2L 440ci	1974	L & R Front	Insert Only	2	EM-2369			
			1966-67	L & R Front		2	EM-2250		
		1974	Trans	Auto; Complete Unit	1				EM-2340
			Trans	Auto; Complete Unit; HD Pkg.	1				EM-2512
			Trans	Auto; Insert Only	1				EM-2525
			Trans	Manual; Complete Unit	1				EM-2340
			Trans	Manual; Complete Unit; HD Pkg.	1				EM-2512
			Trans	Manual; Insert Only	1				EM-2525
		1966-67	Trans	Auto; Complete Unit	1				EM-2340
			Trans	Auto; Complete Unit; HD Pkg.	1				EM-2512
			Trans	Auto; Insert Only	1				EM-2525
			Trans	Manual; Complete Unit	1				EM-2340
			Trans	Manual; Complete Unit; HD Pkg.	1				EM-2512
	Trans	Manual; Insert Only	1				EM-2525		
<b>SCAMP</b>									
L4	L4 2.2L 135ci	1983	Front		1	EM-2493			
			RH Front		1	EM-2600			
			Torq Str - Front	Manual	1		EM-2491		
			Trans	Auto	1			EM-2600	
			Trans	Manual	1			EM-2600	
L6	L6 3.2L 198ci	1973-74	LH Front	Complete Unit	1	EM-2324			
			LH Front	Insert Only	2	EM-2369			
		1971-72	LH Front		1	EM-2265			
			1973-74	RH Front	Complete Unit	1	EM-2323		
		1973-74	RH Front	Insert Only	2	EM-2376			
			1971-72	RH Front		1	EM-2264		
		1973-74	Trans	Auto; Complete Unit	1			EM-2340	
			Trans	Auto; Complete Unit; HD Pkg.	1			EM-2512	
			Trans	Auto; Insert Only	1			EM-2525	
			Trans	Manual; Complete Unit	1			EM-2340	
	Trans		Manual; Complete Unit; HD Pkg.	1			EM-2512		
	Trans	Manual; Insert Only	1			EM-2525			
	1971-72	Trans		1			EM-2272		
	L6 3.7L 3687cc	1973-76	LH Front	Complete Unit	1	EM-2324			
			LH Front	Insert Only	2	EM-2369			
		1971-72	LH Front		1	EM-2265			
			1973-76	RH Front	Complete Unit	1	EM-2323		
		1973-76	RH Front	Insert Only	2	EM-2376			
			1971-72	RH Front		1	EM-2264		
		1973-76	Trans	Auto; Complete Unit	1			EM-2340	
Trans			Auto; Complete Unit; HD Pkg.	1			EM-2512		
Trans			Auto; Insert Only	1			EM-2525		
Trans			Manual; Complete Unit	1			EM-2340		
Trans	Manual; Complete Unit; HD Pkg.		1			EM-2512			
Trans	Manual; Insert Only	1			EM-2525				
1971-72	Trans		1			EM-2272			
V8	V8 5.2L 318ci	1971-72	L & R Front		2	EM-2266			
			1973-76	LH Front	Complete Unit	1	EM-2326		
		1973-76	LH Front	Insert Only	2	EM-2369			
			RH Front	Complete Unit	1	EM-2325			

# Engine, Transmission, And Torque Strut Mounts

CYL	ENG. SIZE	YEAR	LOCATION	DESCRIPTION	QTY	ENGINE	TORQUE STRUT	TRANSMISSION	
<b>PLYMOUTH PASSENGER CAR (continued)</b>									
<b>SCAMP (continued)</b>									
V8	V8 5.2L 318ci	1973-76	RH Front	Insert Only	2	EM-2369			
		1971-76	Trans	Auto; Complete Unit	1			EM-2340	
			Trans	Auto; Complete Unit; HD Pkg.	1			EM-2512	
			Trans	Auto; Insert Only	1			EM-2525	
			Trans	Manual; Complete Unit	1			EM-2340	
			Trans	Manual; Complete Unit; HD Pkg.	1			EM-2512	
Trans	Manual; Insert Only	1			EM-2525				
<b>SUNDANCE</b>									
L4	L4 2.2L 135ci	1991-94	Front		1	EM-2615			
		1990	Front		1	EM-2493			
		1987-89	Front		1	EM-2493			
		1991-94	RH Front		1	EM-2616			
		1990	RH Front		1	EM-2616			
		1987-89	RH Front		1	EM-2600			
		1987	Torq Str - Front	Manual		1		EM-2491	
		1990-94	Trans	Auto		1			EM-2618
			Trans	Manual		1			EM-2618
		1987-89	Trans	Auto		1			EM-2617
			Trans	Manual		1			EM-2617
		L4 2.5L 2507cc	1991-94	Front		1	EM-2615		
	1988-90		Front		1	EM-2493			
	1991-94		RH Front		1	EM-2616			
	1988-90		RH Front		1	EM-2600			
	1990-94		Trans	Auto		1			EM-2618
			Trans	Manual		1			EM-2618
	1988-89	Trans	Auto		1			EM-2617	
Trans		Manual		1			EM-2617		
V6	V6 3.0L 2972cc	1992-94	Front		1	EM-2615			
			RH Front	Hydraulic Mount	1	EM-2711			
			RH Front	Rubber Mount	1	EM-2616			
			Trans	Auto	1			EM-2618	
			Trans	Manual	1			EM-2618	
<b>TURISMO</b>									
L4	L4 1.6L 1595cc	1984-85	Trans	Auto	1			EM-2617	
			Trans	Manual	1			EM-2617	
	L4 1.6L 1597cc	1983-85	Front		1	EM-2493			
			RH Front		1	EM-2600			
			Torq Str - Front	Manual	1		EM-2491		
	1983	Trans	Auto		1			EM-2600	
Trans		Manual		1			EM-2600		
<b>VALIANT</b>									
L6	L6 2.8L 170ci	1967-69	LH Front		1	EM-2265			
		1960-66	LH Front		1	EM-2303			
		1967-69	RH Front		1	EM-2264			
		1960-66	RH Front		1	EM-2304			
		1960-69	Trans	Auto		1			EM-2272
			Trans	Manual		1			EM-2272
	L6 3.2L 198ci	1973-74	LH Front	Complete Unit	1	EM-2324			
			LH Front	Insert Only	2	EM-2369			
		1970-72	LH Front		1	EM-2265			
			RH Front	Complete Unit	1	EM-2323			
		1973-74	RH Front	Insert Only	2	EM-2376			
			RH Front		1	EM-2264			
		1970-72	Trans	Auto; Complete Unit	1			EM-2340	
Trans	Auto; Complete Unit; HD Pkg.		1			EM-2512			



# Engine, Transmission, And Torque Strut Mounts

CYL	ENG. SIZE	YEAR	LOCATION	DESCRIPTION	QTY	ENGINE	TORQUE STRUT	TRANSMISSION	
<b>PLYMOUTH PASSENGER CAR (continued)</b>									
<b>VALIANT (continued)</b>									
L6	L6 3.2L 198ci	1973-74	Trans	Auto; Insert Only	1			EM-2525	
			Trans	Manual; Complete Unit	1			EM-2340	
			Trans	Manual; Complete Unit; HD Pkg.	1			EM-2512	
			Trans	Manual; Insert Only	1			EM-2525	
		1970-72	Trans	Auto	1			EM-2272	
			Trans	Manual	1			EM-2272	
	L6 3.7L 3687cc	1973-76	LH Front	Complete Unit	1	EM-2324			
			LH Front	Insert Only	2	EM-2369			
		1965-72	LH Front		1	EM-2265			
		1961	LH Front		1	EM-2235			
		1973-76	RH Front	Complete Unit	1	EM-2323			
			RH Front	Insert Only	2	EM-2376			
		1965-72	RH Front		1	EM-2264			
		1961	RH Front		1	EM-2234			
		1973-76	Trans	Auto; Complete Unit	1			EM-2340	
			Trans	Auto; Complete Unit; HD Pkg.	1			EM-2512	
			Trans	Auto; Insert Only	1			EM-2525	
			Trans	Manual; Complete Unit	1			EM-2340	
			Trans	Manual; Complete Unit; HD Pkg.	1			EM-2512	
			Trans	Manual; Insert Only	1			EM-2525	
			1965-72	Trans	Auto	1			EM-2272
				Trans	Manual	1			EM-2272
		1961	Trans	Auto	1			EM-2272	
			Trans	Manual	1			EM-2272	
	V8	V8 4.5L 273ci	1966-69	L & R Front		2	EM-2266		
			1964-65	LH Front		1	EM-2228		
				RH Front		1	EM-2227		
			1964-69	Trans	Auto	1			EM-2272
Trans				Manual	1			EM-2272	
V8 5.2L 318ci			1968-72	L & R Front		2	EM-2266		
		1973-76	LH Front	Complete Unit	1	EM-2326			
			LH Front	Insert Only	2	EM-2369			
			RH Front	Complete Unit	1	EM-2325			
			RH Front	Insert Only	2	EM-2369			
			Trans	Auto; Complete Unit	1		EM-2340		
			Trans	Auto; Complete Unit; HD Pkg.	1		EM-2512		
			Trans	Auto; Insert Only	1		EM-2525		
			Trans	Manual; Complete Unit	1		EM-2340		
		1973-76	Trans	Manual; Complete Unit; HD Pkg.	1		EM-2512		
			Trans	Manual; Insert Only	1		EM-2525		
			1968-72	Trans	Auto	1		EM-2272	
				Trans	Manual	1		EM-2272	
			V8 5.9L 360ci	1976	LH Front	Complete Unit	1	EM-2326	
LH Front					Insert Only	2	EM-2369		
RH Front	Complete Unit	1			EM-2325				
RH Front	Insert Only	2			EM-2369				
Trans	Auto; Complete Unit	1				EM-2340			
Trans	Auto; Complete Unit; HD Pkg.	1				EM-2512			
Trans	Auto; Insert Only	1				EM-2525			
Trans	Manual; Complete Unit	1				EM-2340			
Trans	Manual; Complete Unit; HD Pkg.	1				EM-2512			
Trans	Manual; Insert Only	1				EM-2525			

# Engine, Transmission, And Torque Strut Mounts

CYL	ENG. SIZE	YEAR	LOCATION	DESCRIPTION	QTY	ENGINE	TORQUE STRUT	TRANSMISSION
<b>PLYMOUTH PASSENGER CAR (continued)</b>								
<b>VIP</b>								
V8	V8 5.2L 318ci	1967	L & R Front		2	EM-2250		
			Trans		1		EM-2272	
	V8 6.3L 383ci	1967	L & R Front		2	EM-2250		
			Trans		1		EM-2272	
	V8 7.2L 440ci	1967	L & R Front		2	EM-2250		
			Trans	Complete Unit	1		EM-2340	
Trans			Complete Unit - HD	1		EM-2512		
			Trans	Insert Only	1		EM-2525	
<b>VOLARE</b>								
L6	L6 3.7L 3687cc	1976-80	LH Front	Complete Unit	1	EM-2324		
			LH Front	Insert Only	2	EM-2369		
			RH Front	Complete Unit	1	EM-2323		
			RH Front	Insert Only	2	EM-2376		
		1980	Trans	Auto; Complete Unit	1		EM-2340	
			Trans	Auto; Complete Unit; HD Pkg.	1		EM-2512	
			Trans	Auto; Insert Only	1		EM-2525	
			Trans	Manual; Complete Unit	1		EM-2340	
			Trans	Manual; Complete Unit; HD Pkg.	1		EM-2512	
			Trans	Manual; Insert Only	1		EM-2525	
			1979	Trans	Manual; Complete Unit	1		EM-2340
		Trans		Manual; Complete Unit; HD Pkg.	1		EM-2512	
		Trans		Manual; Insert Only	1		EM-2525	
		1976-78	Trans	Auto; Complete Unit	1		EM-2340	
			Trans	Auto; Complete Unit; HD Pkg.	1		EM-2512	
			Trans	Auto; Insert Only	1		EM-2525	
			Trans	Manual; Complete Unit	1		EM-2340	
			Trans	Manual; Complete Unit; HD Pkg.	1		EM-2512	
			Trans	Manual; Insert Only	1		EM-2525	
		V8	V8 5.2L 318ci	1976-80	LH Front	Complete Unit	1	EM-2326
LH Front	Insert Only				2	EM-2369		
RH Front	Complete Unit				1	EM-2325		
RH Front	Insert Only				2	EM-2369		
1980	Trans			Auto; Complete Unit	1		EM-2340	
	Trans			Auto; Complete Unit; HD Pkg.	1		EM-2512	
	Trans			Auto; Insert Only	1		EM-2525	
	Trans			Manual; Complete Unit	1		EM-2340	
	Trans			Manual; Complete Unit; HD Pkg.	1		EM-2512	
	Trans			Manual; Insert Only	1		EM-2525	
1979	Trans			Manual; Complete Unit	1		EM-2340	
	Trans			Manual; Complete Unit; HD Pkg.	1		EM-2512	
	Trans			Manual; Insert Only	1		EM-2525	
1976-78	Trans			Auto; Complete Unit	1		EM-2340	
	Trans			Auto; Complete Unit; HD Pkg.	1		EM-2512	
	Trans			Auto; Insert Only	1		EM-2525	
	Trans			Manual; Complete Unit	1		EM-2340	
	Trans			Manual; Complete Unit; HD Pkg.	1		EM-2512	
	Trans			Manual; Insert Only	1		EM-2525	
1976-79	LH Front			Complete Unit	1	EM-2326		
	LH Front	Insert Only	2	EM-2369				
	RH Front	Complete Unit	1	EM-2325				
	RH Front	Insert Only	2	EM-2369				

## Engine, Transmission, And Torque Strut Mounts

CYL	ENG. SIZE	YEAR	LOCATION	DESCRIPTION	QTY	ENGINE	TORQUE STRUT	TRANSMISSION	
<b>PLYMOUTH PASSENGER CAR (continued)</b>									
<b>VOLARE (continued)</b>									
V8	V8 5.9L 360ci	1979	Trans	Manual; Complete Unit	1			EM-2340	
			Trans	Manual; Complete Unit; HD Pkg.	1			EM-2512	
			Trans	Manual; Insert Only	1			EM-2525	
		1976-78	Trans	Auto; Complete Unit	1			EM-2340	
			Trans	Auto; Complete Unit; HD Pkg.	1			EM-2512	
			Trans	Auto; Insert Only	1			EM-2525	
			Trans	Manual; Complete Unit	1			EM-2340	
			Trans	Manual; Complete Unit; HD Pkg.	1			EM-2512	
			Trans	Manual; Insert Only	1			EM-2525	
<b>PLYMOUTH SUV</b>									
<b>TRAILDUSTER</b>									
L6	L6 3.7L 3687cc	1979-80	L & R Front		2	EM-2469			
		1975-78	L & R Front		2	EM-2265			
		1975-80	Trans - Lower	4WD	2			EM-2668	
			Trans - Upper	Complete Unit; 2WD	1			EM-2340	
			Trans	Complete Unit; HD; 2WD	1			EM-2512	
			Trans	Insert Only; 2WD	1			EM-2525	
			Trans	4WD	2			EM-2667	
V8	V8 5.2L 318ci	1979-81	L & R Front		2	EM-2469			
		1974-78	L & R Front		2	EM-2265			
		1974-81	Trans - L & R Lower	4WD 4WD	2			EM-2668	
			Trans - L & R Upper	4WD 4WD	2			EM-2667	
			Trans	Complete Unit; 2WD	1			EM-2340	
		Trans	Complete Unit; HD; 2WD	1			EM-2512		
		Trans	Insert Only; 2WD	1			EM-2525		
		V8 5.9L 360ci	1979-81	L & R Front		2	EM-2469		
			1974-78	L & R Front		2	EM-2265		
	1974-81		Trans - L & R Lower	4WD 4WD	2			EM-2668	
			Trans - L & R Upper	4WD 4WD	2			EM-2667	
			Trans	Complete Unit; 2WD	1			EM-2340	
			Trans	Complete Unit; HD; 2WD	1			EM-2512	
			Trans	Insert Only; 2WD	1			EM-2525	
	V8 6.6L 400ci	1976-78	L & R Front		2	EM-2265			
			Trans	Complete Unit	1			EM-2340	
			Trans	Complete Unit - HD	1			EM-2512	
			Trans	Insert Only	1			EM-2525	
			V8 7.2L 440ci	1974-78	L & R Front		2	EM-2265	
Trans					Complete Unit	1			EM-2340
Trans	Complete Unit - HD	1					EM-2512		
Trans	Insert Only	1			EM-2525				
<b>PLYMOUTH TRUCK</b>									
<b>ARROW PICKUP</b>									
L4	L4 2.0L 1997cc	1979-82	L & R Front		2	EM-2731			
			Trans		1			EM-8503	
	L4 2.6L 2555cc	1982	1979-81	L & R Front		2	EM-2731		
				L & R Front		2	EM-2731		
			1982	Rear		1	EM-8248		
			1979-81	Rear		1	EM-8556		
			1979-82	Trans	exc Optional	1			EM-8503

# Engine, Transmission, And Torque Strut Mounts

CYL	ENG. SIZE	YEAR	LOCATION	DESCRIPTION	QTY	ENGINE	TORQUE STRUT	TRANSMISSION	
<b>PLYMOUTH TRUCK (continued)</b>									
<b>ARROW PICKUP (continued)</b>									
L4	L4 2.6L 2555cc	1979-82	Trans	Optional	1			EM-2730	
<b>PLYMOUTH VAN</b>									
<b>GRAND VOYAGER</b>									
L4	L4 2.4L 2429cc	1996-97	RH Front	Complete Unit	1	EM-2959			
			RH Front	Insert	1	EM-2844			
			Trans - Center	Auto, Complete Unit	1			EM-2984	
			Trans - Center	Auto; Insert	1			EM-2845	
			Trans - LH Front	Auto, Complete Unit	1			EM-2960	
			Trans - LH Front	Auto; Insert	1			EM-2849	
			Trans - LH Rear	Auto, Complete Unit	1			EM-3017	
			Trans - LH Rear	Auto; Insert	1			EM-2849	
	L4 2.5L 2507cc	1988	Front		1	EM-2493			
			RH Front		1	EM-2600			
			Trans		1			EM-2617	
	<b>PB150 VAN</b>								
	L6	L6 3.7L 3687cc	1981-83	L & R Front		2	EM-2469		
<b>PB100 VAN</b>									
L6	L6 3.7L 3687cc	1979-80	L & R Front		2	EM-2469			
		1974-78	L & R Front		2	EM-2265			
<b>PB150 VAN</b>									
L6	L6 3.7L 3687cc	1981-83	Trans	Complete Unit	1			EM-2512	
			Trans	Insert Only	1			EM-2525	
<b>PB100 VAN</b>									
L6	L6 3.7L 3687cc	1974-80	Trans	Complete Unit	1			EM-2512	
			Trans	Insert Only	1			EM-2525	
<b>GRAND VOYAGER</b>									
V6	V6 3.0L 2972cc	1992-95	Front		1	EM-2615			
		1988-89	Front		1	EM-2493			
		1997-00	RH Front	Complete Unit	1	EM-2959			
			RH Front	Insert	1	EM-2844			
		1992-95	RH Front	Hydraulic Mount	1	EM-2711			
			RH Front	w/ Rubber Mount	1	EM-2616			
		1988-89	RH Front		1	EM-2600			
			Trans - Center	Auto, Complete Unit	1			EM-2984	
		Trans - Center	Auto; Insert	1			EM-2845		
		Trans - LH Front	Auto, Complete Unit	1			EM-2960		
		Trans - LH Front	Auto; Insert	1			EM-2849		
		Trans - LH Rear	Auto, Complete Unit	1			EM-3017		
		Trans - LH Rear	Auto; Insert	1			EM-2849		
		1992-95	Trans		1			EM-2618	
		1988-89	Trans		1			EM-2617	
		V6 3.3L 201ci	1990-95	Front		1	EM-2615		
				1996-00	RH Front	Complete Unit	1	EM-2959	
			1990-95	RH Front	Insert	1	EM-2844		
	RH Front			Hydraulic Mount	1	EM-2711			
	1996-00		RH Front	w/ Rubber Mount	1	EM-2616			
			Trans - Center	Auto, Complete Unit	1			EM-2984	
	Trans - Center		Auto; Insert	1			EM-2845		
	Trans - LH Front		Auto, Complete Unit	1			EM-2960		
	Trans - LH Front		Auto; Insert	1			EM-2849		
	Trans - LH Rear		Auto, Complete Unit	1			EM-3017		
	Trans - LH Rear	Auto; Insert	1			EM-2849			
	1990-95	Trans		1			EM-2618		
	V6 3.8L 230ci	1994-95	Front	FWD	1	EM-2615			

# Engine, Transmission, And Torque Strut Mounts

CYL	ENG. SIZE	YEAR	LOCATION	DESCRIPTION	QTY	ENGINE	TORQUE STRUT	TRANSMISSION
<b>PLYMOUTH VAN (continued)</b>								
<b>GRAND VOYAGER (continued)</b>								
V6	V6 3.8L 230ci	1999	RH Front	Complete Unit	1	EM-2959		
			RH Front	Insert Only	1	EM-2844		
		1994-95	RH Front	FWD, Rubber Mount	1	EM-2616		
			RH Front	Hydraulic Mount; FWD	1	EM-2711		
		1999	Trans - Center	Auto, Complete Unit	1			EM-2984
			Trans - Center	Auto; Insert	1			EM-2845
			Trans - LH Front	Auto, Complete Unit	1			EM-2960
			Trans - LH Front	Auto; Insert	1			EM-2849
			Trans - LH Rear	Auto, Complete Unit	1			EM-3017
			Trans - LH Rear	Auto; Insert	1			EM-2849
1994-95	Trans		1			EM-2618		
<b>PB150 VAN</b>								
V8	V8 5.2L 318ci	1981-83	L & R Front		2	EM-2469		
<b>PB100 VAN</b>								
V8	V8 5.2L 318ci	1979-80	L & R Front		2	EM-2469		
		1974-78	L & R Front		2	EM-2265		
<b>PB150 VAN</b>								
V8	V8 5.2L 318ci	1981-83	Trans	Complete Unit	1			EM-2512
			Trans	Insert Only	1			EM-2525
<b>PB100 VAN</b>								
V8	V8 5.2L 318ci	1974-80	Trans	Complete Unit	1			EM-2512
			Trans	Insert Only	1			EM-2525
	V8 5.9L 360ci	1974-78	L & R Front		2	EM-2265		
			Trans	Complete Unit	1			EM-2512
			Trans	Insert Only	1			EM-2525
<b>PB200 VAN</b>								
L6	L6 3.7L 3687cc	1980	L & R Front		2	EM-2469		
			1974-78	L & R Front		2	EM-2265	
		1974-80	Trans	Complete Unit	1			EM-2512
			Trans	Insert Only	1			EM-2525
V8	V8 5.2L 318ci	1979-80	L & R Front		2	EM-2469		
		1974-78	L & R Front		2	EM-2265		
		1974-80	Trans	Complete Unit	1			EM-2512
			Trans	Insert Only	1			EM-2525
	V8 5.9L 360ci	1979-80	L & R Front		2	EM-2469		
		1974-78	L & R Front		2	EM-2265		
		1974-80	Trans	Complete Unit	1			EM-2512
			Trans	Insert Only	1			EM-2525
	V8 6.6L 400ci	1976-78	L & R Front		2	EM-2265		
			Trans	Complete Unit	1			EM-2512
			Trans	Insert Only	1			EM-2525
			L & R Front		2	EM-2265		
V8 7.2L 440ci	1976-78	L & R Front		2	EM-2265			
		Trans	Complete Unit	1			EM-2512	
		Trans	Insert Only	1			EM-2525	
		L & R Front		2	EM-2265			
<b>PB250 VAN</b>								
L6	L6 3.7L 3687cc	1981-83	L & R Front		2	EM-2469		
			Trans	Complete Unit	1			EM-2512
			Trans	Insert Only	1			EM-2525
V8	V8 5.2L 318ci	1981-83	L & R Front		2	EM-2469		
			Trans	Complete Unit	1			EM-2512
			Trans	Insert Only	1			EM-2525
	V8 5.9L 360ci	1981	L & R Front		2	EM-2469		
			Trans	Complete Unit	1			EM-2512
			Trans	Insert Only	1			EM-2525

# Engine, Transmission, And Torque Strut Mounts

CYL	ENG. SIZE	YEAR	LOCATION	DESCRIPTION	QTY	ENGINE	TORQUE STRUT	TRANS-MISSION	
<b>PLYMOUTH VAN (continued)</b>									
<b>PB300 VAN</b>									
V8	V8 5.2L 318ci	1979-80	L & R Front		2	EM-2469			
		1974-78	L & R Front		2	EM-2265			
		1974-80	Trans	Complete Unit	1			EM-2512	
			Trans	Insert Only	1			EM-2525	
	V8 5.9L 360ci	1979-80	L & R Front		2	EM-2469			
		1974-78	L & R Front		2	EM-2265			
		1974-80	Trans	Complete Unit	1			EM-2512	
			Trans	Insert Only	1			EM-2525	
	V8 6.6L 400ci	1976-78	L & R Front		2	EM-2265			
			Trans	Complete Unit	1		EM-2512		
			Trans	Insert Only	1		EM-2525		
	V8 7.2L 440ci	1976-78	L & R Front		2	EM-2265			
Trans			Complete Unit	1		EM-2512			
Trans			Insert Only	1		EM-2525			
<b>PB350 VAN</b>									
V8	V8 5.2L 318ci	1981-83	L & R Front		2	EM-2469			
			Trans	Complete Unit	1		EM-2512		
			Trans	Insert Only	1		EM-2525		
	V8 5.9L 360ci	1981-83	L & R Front		2	EM-2469			
			Trans	Complete Unit	1		EM-2512		
			Trans	Insert Only	1		EM-2525		
<b>VOYAGER</b>									
L4	L4 2.2L 135ci	1984-87	Front		1	EM-2493			
			RH Front		1	EM-2600			
		1984-86	Torq Str - Front	Manual	1		EM-2491		
			1984-87	Trans	Auto	1		EM-2617	
				Trans	Manual	1		EM-2617	
	L4 2.4L 2429cc	1996-00	RH Front	Complete Unit	1	EM-2959			
			RH Front	Insert	1	EM-2844			
			Trans - Center	Auto, Complete Unit	1		EM-2984		
			Trans - Center	Auto; Insert	1		EM-2845		
			Trans - LH Front	Auto, Complete Unit	1		EM-2960		
			Trans - LH Front	Auto; Insert	1		EM-2849		
			Trans - LH Rear	Auto, Complete Unit	1		EM-3017		
			Trans - LH Rear	Auto; Insert	1		EM-2849		
			L4 2.5L 2507cc	1991-95	Front		1	EM-2615	
	1987-90	Front				1	EM-2493		
	1991-95	RH Front				1	EM-2616		
	1987-90	RH Front				1	EM-2600		
	1991-95	Trans				1		EM-2618	
	1987-90	Trans			Auto	1		EM-2617	
	L4 2.6L 2555cc	1984-87	Trans	Manual	1		EM-2617		
			Front		1	EM-2493			
			RH Front		1	EM-2600			
			Trans	Auto	1		EM-2617		
			Trans	Manual	1		EM-2617		
	V6	V6 3.0L 2972cc	1990-95	Front		1	EM-2615		
				1987-89	Front		1	EM-2493	
			1997-00	RH Front	Complete Unit	1	EM-2959		
RH Front				Insert	1	EM-2844			
1990-95			RH Front	Hydraulic Mount	1	EM-2711			
			RH Front	Rubber Mount	1	EM-2616			
1987-89			RH Front		1	EM-2600			
1996-99			Trans - Center	Auto, Complete Unit	1		EM-2984		
			Trans - Center	Auto; Insert	1		EM-2845		
			Trans - LH Front	Auto, Complete Unit	1		EM-2960		

# Engine, Transmission, And Torque Strut Mounts

CYL	ENG. SIZE	YEAR	LOCATION	DESCRIPTION	QTY	ENGINE	TORQUE STRUT	TRANS-MISSION	
<b>PLYMOUTH VAN (continued)</b>									
<b>VOYAGER (continued)</b>									
V6	V6 3.0L 2972cc	1996-99	Trans - LH Front	Auto; Insert	1			EM-2849	
			Trans - LH Rear	Auto, Complete Unit	1			EM-3017	
			Trans - LH Rear	Auto; Insert	1			EM-2849	
		1990-95	Trans		1			EM-2618	
		1987-89	Trans		1			EM-2617	
	V6 3.3L 201ci	1991-95	Front			1	EM-2615		
			1996-00	RH Front	Complete Unit	1	EM-2959		
		1991-95	RH Front	Insert	1	EM-2844			
			RH Front	Hydraulic Mount	1	EM-2711			
		1996-00	RH Front	w/ Rubber Mount	1	EM-2616			
			Trans - Center	Auto, Complete Unit	1				EM-2984
			Trans - Center	Auto; Insert	1				EM-2845
			Trans - LH Front	Auto, Complete Unit	1				EM-2960
			Trans - LH Front	Auto; Insert	1				EM-2849
			Trans - LH Rear	Auto, Complete Unit	1				EM-3017
			Trans - LH Rear	Auto; Insert	1				EM-2849
		1991-95	Trans		1			EM-2618	
	V6 3.8L 230ci	1998-99	RH Front	Complete Unit	1	EM-2959			
			RH Front	Insert Only	1	EM-2844			
		Trans - Center	Auto, Complete Unit	1				EM-2984	
		Trans - Center	Auto; Insert	1				EM-2845	
		Trans - LH Front	Auto, Complete Unit	1				EM-2960	
		Trans - LH Front	Auto; Insert	1				EM-2849	
		Trans - LH Rear	Auto, Complete Unit	1				EM-3017	
		Trans - LH Rear	Auto; Insert	1				EM-2849	
	<b>PONTIAC PASSENGER CAR</b>								
	<b>6000</b>								
L4	L4 2.5L 2474cc	1985-91	RH Front		1	EM-2548'			
			1982-84	RH Front		1	EM-2472		
		1982-91	Torq Str - Front		1			EM-2396	
			1982-84	Trans - LH Front		1			EM-2466
		1989-91	Trans - LH Rear		1				EM-2467
			Trans		1				EM-2543
		1986-88	Trans	Auto	1				EM-2543
			Trans	Manual	1				EM-2543
		1985	Trans	Auto	1				EM-2543
V6	V6 2.8L 173ci	1985-89	RH Front		1	EM-2548'			
			1982-84	RH Front		1	EM-2472		
		1982-89	Torq Str - Front	Auto	1			EM-2396	
		1989	Trans - LH Front		1				EM-2466
		1987-88	Trans - LH Front	Auto	1				EM-2466
			Trans - LH Front	Manual	1				EM-2762
		1982-86	Trans - LH Front		1				EM-2466
		1989	Trans - LH Rear		1				EM-2467
		1987-88	Trans - LH Rear		1				EM-2467
	1982-86	Trans - LH Rear		1				EM-2467	
	V6 3.1L 189ci	1988-91	RH Front		1	EM-2548'			
			Torq Str - Front		1			EM-2396	
			Trans - LH Front		1				EM-2466
			Trans - LH Rear		1				EM-2467
	V6 4.3L 260ci Diesel	1982-85	RH Front		1	EM-2472			
Torq Str - Front				1			EM-2490		
Trans - LH Front				1				EM-2466	
Trans - LH Rear				1				EM-2467	

# Engine, Transmission, And Torque Strut Mounts

CYL	ENG. SIZE	YEAR	LOCATION	DESCRIPTION	QTY	ENGINE	TORQUE STRUT	TRANSMISSION
<b>PONTIAC PASSENGER CAR (continued)</b>								
<b>ACADIAN</b>								
L4	L4 1.4L 1393cc	1976-77	L & R Front		2	EM-2381		
			Trans		1		EM-2391	
	L4 1.6L 1606cc	1976-87	L & R Front		2	EM-2381		
			Trans		1		EM-2391	
L4 1.8L 1819cc Diesel	1981-86	L & R Front		2	EM-2381			
		Trans		1		EM-2391		
<b>ASTRE</b>								
L4	L4 2.3L 140ci	1975-77	LH Front		1	EM-2357		
			RH Front		1	EM-2356		
			Trans	Auto	1		EM-2353	
			Trans	Manual	1		EM-2353	
	L4 2.5L 2474cc	1977	L & R Front		2	EM-2446		
			L & R Rear	OEM Design	2	EM-2374@		
			Trans	Auto	1		EM-2531	
Trans	Manual	1		EM-2531				
<b>BONNEVILLE</b>								
V6	V6 3.8L 231ci	1980-86 2000-05 1992-99 1987-91 1980-86 1992-99 2000-05 1994-99 1992-93 1987-91 2000-05 1994-99 1992-93 1987-91 1980-86	LH Front		1	EM-2382		
			RH Front		1	EM-2896*		
			RH Front		1	EM-2801		
			RH Front		1	EM-2551*		
			RH Front		1	EM-2384		
			Torq Str - Front		1		EM-2662	
			Trans - Center		1			EM-2895 *
			Trans - LH Front		1			EM-2897 *
			Trans - LH Front	Shock Mount	1			EM-2881
			Trans - LH Front		1			EM-2800
			Trans - LH Front		1			EM-2537
			Trans - LH Rear		1			EM-2898
			Trans - LH Rear	VIN K; VIN L	1			EM-2778
			Trans - LH Rear		1			EM-2823 *
	Trans - LH Rear		1			EM-2568		
	Trans - RH Rear		1			EM-2556 *		
	Trans		1			EM-2379		
	V6 4.1L 252ci	1982	LH Front		1	EM-2382		
			RH Front		1	EM-2384		
			Trans		1		EM-2379	
V6 4.3L 262ci	1986	L & R Front		2	EM-2436			
		Trans		1		EM-2337		
V8	V8 4.3L 265ci	1980-81	L & R Front		2	EM-2387		
			Trans		1		EM-2379	
	V8 4.9L 301ci	1977-80 1978-80 1977	L & R Front		2	EM-2387		
			Trans		1		EM-2392	
			Trans		1		EM-2531	
	V8 5.0L 305ci	1983-86	L & R Front		2	EM-2292		
			Trans		1		EM-2393	
	V8 5.0L 307ci	1981	L & R Front		2	EM-2328		
			Trans		1		EM-2392	
	V8 5.7L GAS	1978-80	L & R Front	VIN R	2	EM-2328		
			L & R Front	VIN X	2	EM-2281		
	V8 5.7L 350ci	1977	L & R Front	VIN P	2	EM-2387		
			L & R Front	VIN R	2	EM-2328		
			Trans	Gas	1		EM-2392	
	V8 5.7L 350ci Diesel	1977	Trans	VIN P	1		EM-2531	
			L & R Front	VIN N	2	EM-2328		
Trans		1		EM-2360 @				
V8 6.4L 389ci	1965-66	L & R Front		2	EM-2254			



# Engine, Transmission, And Torque Strut Mounts

CYL	ENG. SIZE	YEAR	LOCATION	DESCRIPTION	QTY	ENGINE	TORQUE STRUT	TRANSMISSION	
<b>PONTIAC PASSENGER CAR (continued)</b>									
<b>BONNEVILLE (continued)</b>									
V8	V8 6.4L 389ci	1959-64	LH Front		1	EM-2204			
			RH Front		1	EM-2205			
		1965-66	Trans		1			EM-2321	
		1961-64	Trans	Manual	2			EM-2206	
	V8 6.6L 400ci	1973-78	1968-70	L & R Front		2	EM-2375		
				L & R Front		2	EM-2254		
		1971	LH Front		1	EM-2336			
			RH Front		1	EM-2335			
		1976-78	Trans	Auto	1			EM-2360 @	
		1975	Trans	Auto; THM400 (M40)	1			EM-2360 @	
		1973-74	Trans	Auto	1			EM-2360 @	
		1971	Trans	Auto; THM400	1			EM-2374 @	
	1968-70	Trans	Auto; THM400	1			EM-2321		
	V8 6.6L 403ci	1977-79	L & R Front		2	EM-2387			
			Trans		1			EM-2392	
	V8 6.9L 421ci	1965	1963-64	L & R Front		2	EM-2254		
				LH Front		1	EM-2204		
				RH Front		1	EM-2205		
	V8 7.0L 428ci	1967-69	L & R Front		2	EM-2254			
			Trans	Auto	1			EM-2268 @	
			Trans	Manual	1			EM-2378 @	
	V8 7.5L 455ci	1973-76	1970	L & R Front		2	EM-2375		
				L & R Front		2	EM-2254		
1971-72		LH Front		1	EM-2336				
		RH Front		1	EM-2335				
1973-76		Trans		1			EM-2360 @		
1971-72		Trans		1			EM-2374 @		
1970	Trans		1			EM-2321			
<b>CATALINA</b>									
L6	L6 4.1L 250ci	1977-79	L & R Front		2	EM-2292			
			Trans	Auto	1			EM-2378 @	
V6	V6 3.8L 231ci	1977-81	LH Front		1	EM-2382			
			RH Front		1	EM-2384			
			Trans		1			EM-2379	
V8	V8 4.3L 265ci	1980-81	L & R Front		2	EM-2387			
			Trans		1			EM-2379	
	V8 4.4L 267ci	1980-81	L & R Front		2	EM-2292			
			Trans	Auto	1			EM-2393	
	V8 4.9L 301ci	1977-80	L & R Front		2	EM-2387			
			1978-80	Trans		1		EM-2392	
			1977	Trans		1		EM-2531	
	V8 5.0L 305ci	1980-81	L & R Front		2	EM-2292			
			Trans	Auto	1			EM-2393	
	V8 5.0L 307ci	1981	L & R Front		2	EM-2328			
			Trans		1			EM-2392	
	V8 5.7L 350ci	1978-80	1977	L & R Front	VIN R	2	EM-2328		
				L & R Front	VIN X	2	EM-2281		
		1976	L & R Front	VIN P	2	EM-2387			
			L & R Front	VIN R	2	EM-2328			
1970-73		L & R Front	VIN M	2	EM-2387				
		LH Front		1	EM-2336				
RH Front			1	EM-2335					
1978-80		Trans	Gas; VIN R; VIN X	1			EM-2392		
1977		Trans	VIN P	1			EM-2531		
Trans		VIN R	1				EM-2392		
1976	Trans	VIN M	1			EM-2531			

# Engine, Transmission, And Torque Strut Mounts

CYL	ENG. SIZE	YEAR	LOCATION	DESCRIPTION	QTY	ENGINE	TORQUE STRUT	TRANSMISSION
<b>PONTIAC PASSENGER CAR (continued)</b>								
<b>CATALINA (continued)</b>								
V8	V8 5.7L 350ci	1970-73	Trans	Manual	1			EM-2288 @
	V8 5.7L 350ci Diesel	1980-81	L & R Front		2	EM-2328		
			Trans	VIN N	1		EM-2360 @	
	V8 6.4L 389ci	1965-66 1959-64	L & R Front		2	EM-2254		
			LH Front		1	EM-2204		
			RH Front		1	EM-2205		
		1965-66	Trans		1			EM-2321
		1961-64	Trans	Manual	2			EM-2206
	V8 6.6L 400ci	1973-78	L & R Front		2	EM-2375		
			L & R Front		2	EM-2254		
		1971-72	LH Front		1	EM-2336		
			RH Front		1	EM-2335		
		1978	Trans	Auto; THM350 (M38)	1			EM-2288 @
		1976-77	Trans	Auto; THM400-475 (M40)	1			EM-2360 @
		1975	Trans	Auto; THM400 (M40)	1			EM-2360 @
		1973-74	Trans	Auto	1			EM-2360 @
		1971-72	Trans	Auto; THM400	1			EM-2374 @
		1967-70	Trans	Auto; THM400	1			EM-2321
	V8 6.6L 403ci	1977-79	L & R Front		2	EM-2387		
			Trans		1		EM-2392	
	V8 6.9L 421ci	1965-66 1963-64	L & R Front		2	EM-2254		
			LH Front		1	EM-2204		
		1963-66	RH Front		1	EM-2205		
			Trans	Auto; THM400	1			EM-2321
			Trans	Manual	1			EM-2206
			V8 7.0L 428ci	1967-69	L & R Front		2	EM-2254
	Trans	Auto			1		EM-2268 @	
	Trans	Manual			1		EM-2378 @	
	V8 7.5L 455ci	1973-76 1970	L & R Front		2	EM-2375		
			L & R Front		2	EM-2254		
1971-72		LH Front		1	EM-2336			
		RH Front		1	EM-2335			
1973-76		Trans		1			EM-2360 @	
1971-72		Trans		1			EM-2374 @	
1970	Trans		1			EM-2321		
<b>EXECUTIVE</b>								
V8	V8 5.7L 350ci	1970	L & R Front		2	EM-2387		
			Trans		1		EM-2531	
	V8 6.6L 400ci	1967-70	L & R Front		2	EM-2254		
			Trans		1		EM-2321	
	V8 7.0L 428ci	1967-69	L & R Front		2	EM-2254		
			Trans	Auto	1		EM-2268 @	
			Trans	Manual	1		EM-2378 @	
	V8 7.5L 455ci	1970	L & R Front		2	EM-2254		
Trans				1		EM-2321		
<b>FIERO</b>								
L4	L4 2.5L 2474cc	1986-88 1984-85 1984-88	RH Front	Auto	1	EM-2548*		
			RH Front		1	EM-2472		
			Torq Str - Front		1		EM-2761	
		1984-88	Trans - LH Front	Auto	1			EM-2466
			Trans - LH Front	Manual	1			EM-2466
			Trans - LH Rear	Auto	1			EM-2467
			Trans - LH Rear	Manual	1			EM-2467
V6	V6 2.8L 173ci	1985-88	Front		1	EM-2472		
			Trans - LH Front	Auto	1		EM-2466	

# Engine, Transmission, And Torque Strut Mounts

CYL	ENG. SIZE	YEAR	LOCATION	DESCRIPTION	QTY	ENGINE	TORQUE STRUT	TRANSMISSION	
<b>PONTIAC PASSENGER CAR (continued)</b>									
<b>FIERO (continued)</b>									
V6	V6 2.8L 173ci	1985-88	Trans - LH Front	Manual	1			EM-2466	
			Trans - LH Rear	Auto	1		EM-2467		
			Trans - LH Rear	Manual	1		EM-2467		
<b>FIREBIRD</b>									
L4	L4 2.5L 2474cc	1982-86	LH Front		1	EM-2549			
			RH Front		1	EM-2550			
		1983-86	Trans	Auto	1			EM-2393	
			Trans	Manual	1			EM-2393	
		1982	Trans		1			EM-2531	
L6	L6 4.1L 250ci	1973-76	L & R Front		2	EM-2292			
		1968-72	L & R Front		2	EM-2284			
		1976	Trans		1			EM-2288 @	
		1968-75	Trans		1			EM-2378 @	
V6	V6 2.8L 173ci	1982-89	L & R Front		2	EM-2436			
		1988-89	Trans	Auto	1			EM-2394	
		1982-87	Trans	Auto	1			EM-2393	
			Trans	Manual	1			EM-2393	
	V6 3.1L 189ci	1990-92	L & R Front		2	EM-2436			
			Trans	Auto	1		EM-2394		
	V6 3.4L 207ci	1993-95	L & R Front		2	EM-2436			
			Trans	Auto	1		EM-2880 *		
			Trans	Manual	1		EM-2880 *		
	V6 3.8L 231ci	V6 3.8L 231ci	1995-02	LH Front		1	EM-2436		
			1977-81	LH Front		1	EM-2382		
			1995-02	RH Front		1	EM-2878		
			1989	RH Front		1	EM-2627		
			1977-81	RH Front		1	EM-2384		
			1995-02	Trans	Auto	1			EM-2880 *
				Trans	Manual	1			EM-2880 *
			1989	Trans	Auto	1			EM-2394
				Trans	Manual	1			EM-2394
			1977-81	Trans	Auto	1			EM-2394
	1977-81	Trans	Manual	1			EM-2394		
V8	V8 4.3L 265ci	1980-81	L & R Front		2	EM-2292			
			Trans		1		EM-2392		
	V8 4.4L 267ci	1981	L & R Front		2	EM-2292			
			Trans		1		EM-2392		
	V8 4.9L 301ci	1977-81	L & R Front		2	EM-2387			
			Trans		1		EM-2392		
	V8 5.0L 305ci	1977-92	L & R Front		2	EM-2292			
			Trans	Auto	1		EM-2394		
		1984-92	Trans	Manual	1		EM-2394		
			1977-83	Trans	Auto	1		EM-2392	
	1977-83	Trans	Manual	1		EM-2393			
	V8 5.3L 326ci	1967	LH Front		1	EM-2256			
			RH Front		1	EM-2255			
	V8 5.7L 350ci	V8 5.7L 350ci	1998-02	L & R Front		2	EM-3064		
			1987-92	L & R Front		2	EM-2292		
			1978-79	L & R Front		2	EM-2387		
			1977	L & R Front	VIN P	2	EM-2387		
L & R Front				VIN R	2	EM-2328			
1975-76			L & R Front		2	EM-2387			
1993-97			LH Front		1	EM-3045			
1968-74			LH Front		1	EM-2336			
1993-97			RH Front		1	EM-3046			
1968-74	RH Front		1	EM-2335					

# Engine, Transmission, And Torque Strut Mounts

CYL	ENG. SIZE	YEAR	LOCATION	DESCRIPTION	QTY	ENGINE	TORQUE STRUT	TRANS-MISSION
<b>PONTIAC PASSENGER CAR (continued)</b>								
<b>FIREBIRD (continued)</b>								
V8	V8 5.7L 350ci	1998-02	Trans	Manual	1			EM-3125
		1994-97	Trans		1			EM-2817
		1988-93	Trans	Auto	1			EM-2394
			Trans	Manual	1			EM-2394
		1987	Trans	Auto	1			EM-2392
			Trans	Manual	1			EM-2392
		1977-79	Trans		1			EM-2392
		1975-76	Trans		1			EM-2288 @
		1968-74	Trans	Auto; THM350	1			EM-2378 @
			Trans	Auto; THM400	1			EM-2268 @
	Trans		Manual	1			EM-2378 @	
	V8 6.6L 400ci	1975-79	L & R Front		2	EM-2387		
		1967-69	L & R Front		2	EM-2254		
		1970-74	LH Front		1	EM-2336		
			RH Front		1	EM-2335		
		1979	Trans	Auto; THM350 (M38)	1			EM-2378 @
			Trans	Manual	1			EM-2288 @
		1978	Trans	Auto; THM350 (M38)	1			EM-2378 @
			Trans	Manual	1			EM-2288 @
		1976-77	Trans	Auto; THM350 (M38)	1			EM-2378 @
			Trans	Auto; THM400-475 (M40)	1			EM-2268 @
			Trans	Manual	1			EM-2288 @
		1975	Trans	Auto; THM350 (M38)	1			EM-2378 @
			Trans	THM350C (MV4)				
			Trans	Auto; THM400 (M40)	1			EM-2268 @
		1967-74	Trans	Manual	1			EM-2288 @
			Trans	Auto; THM350	1			EM-2378 @
	Trans		Auto; THM400	1			EM-2268 @	
			Trans	Manual	1		EM-2378 @	
	V8 6.6L 403ci	1977-79	Trans		1			EM-2392
	V8 7.5L 455ci	1975-76	L & R Front		2	EM-2387		
		1971-74	LH Front		1	EM-2336		
			RH Front		1	EM-2335		
1975-76		Trans		1			EM-2288 @	
1971-74		Trans	Auto; THM350	1			EM-2378 @	
		Trans	Auto; THM400	1			EM-2268 @	
		Trans	Manual	1		EM-2378 @		
<b>FIREFLY</b>								
L3	L3 1.0L	1994	LH Front	Auto	1	EM-5591		
			LH Front	Manual	1	EM-8517		
		1991	LH Front	Auto	1	EM-5591		
			LH Front	Manual	1	EM-8517		
		1989-90	LH Front	Auto	1	EM-5591		
			LH Front	Manual	1	EM-8517		
		1991	RH Front	Auto; To 3-1-1991	1	EM-5733		
			RH Front	Manual	1	EM-8514		
		1989-90	RH Front	Auto	1	EM-5733		
			RH Front	Manual	1	EM-8514		
		1991	Rear	Manual	1	EM-8294		
1989-90	Rear	Manual	1	EM-8294				
L4	L4 1.3L	1994-00	Front		1	EM-5608		
		Rear		1	EM-8277			

# Engine, Transmission, And Torque Strut Mounts

CYL	ENG. SIZE	YEAR	LOCATION	DESCRIPTION	QTY	ENGINE	TORQUE STRUT	TRANS-MISSION			
<b>PONTIAC PASSENGER CAR (continued)</b>											
<b>G5</b>											
L4	L4 2.2L	2007-08	RH Front	Auto	1	EM-3109					
			RH Front	Manual	1	EM-3108					
			Trans - LH Front	Auto	1			EM-3081			
			Trans - Rear	Auto	1			EM-3086			
			Trans - Rear	Manual	1			EM-3043			
	L4 2.4L	2007-08	RH Front	Auto	1	EM-3109					
			RH Front	Manual	1	EM-3108					
			Trans - LH Front	Auto	1			EM-3081			
			Trans - Rear	Auto	1			EM-3086			
			Trans - Rear	Manual	1			EM-3043			
			<b>G6</b>								
			L4	L4 2.4L	2009	RH Front		1	EM-3118		
2006-08	RH Front				1	EM-3117					
2009-10	Trans - Center	Auto; 4 Spd			1			EM-4047			
2008	Trans - Center	Auto; 4 Spd			1			EM-4047			
2009-10	Trans - Front	Auto; 4 Spd			1			EM-4027			
2008	Trans - Front	Auto; 4 Spd			1			EM-4027			
	Trans - Rear	Auto; 4 Spd; 1st Design Stamped Part			1			EM-3094			
V6	V6 3.5L	2005-06			Right	Hydraulic Mount; Auto	1	EM-3097			
		2010	RH Front	Hydraulic Mount	1	EM-3097					
	V6 3.5L 213ci	2007-09	RH Front	Convertible	1	EM-3116					
			RH Front	Hydraulic Mount; Coupe & Sedan	1	EM-3097					
		2010	Trans - Center		1			EM-3096			
		2007-09	Trans - Center	Convertible	1			EM-4047			
			Trans - Center	Coupe & Sedan	1			EM-3096			
		2005-06	Trans - Center		1			EM-3096			
		2010	Trans - Front		1			EM-4027			
		2007-09	Trans - Front		1			EM-4027			
		2005-06	Trans - Front		1			EM-5659			
			Trans - LH Rear		1			EM-3094			
		V6 3.5L 3498cc	2005-07	Trans - Front	Mexican Vehicle	1			EM-5659		
				Trans - Rear	Mexican Vehicle	1			EM-3094		
		V6 3.6L	2007-09	RH Front	Hydraulic Mount	1	EM-3097				
				Trans - Center		1			EM-3135		
		V6 3.9L	2008-09	Front	Auto; Convertible	1	EM-3116				
				Front	Hydraulic Mount; Sedan Coupe	1	EM-3097				
				Front	Auto; Convertible	1	EM-3116				
			2006-07	Front	Auto; Hydraulic Mount; Sedan Coupe	1	EM-3097				
Front	Manual; Hydraulic Mount			1	EM-3097						
2006-08	Trans - Center			1			EM-3112				
<b>GRAND AM</b>											
L4	L4 2.0L 122ci	1987-89	RH Front		1	EM-2538					
			RH Rear		1	EM-2477					
			Torq Str - Rear	Lateral	1			EM-2492			
			Torq Str - Rear	Longitudinal	1			EM-2528			
			Trans	Auto	1			EM-2601			
			Trans	Manual	1			EM-2601			
			L4 2.2L 2198cc	2002-05	Right		1	EM-3129			
	Trans - Center				1			EM-2874			
	Trans - LH Front				1			EM-3070			
	Trans - LH Rear	Complete Unit			1			EM-5078			
	Trans - LH Rear	Insert Only			1			EM-2875			

# Engine, Transmission, And Torque Strut Mounts

CYL	ENG. SIZE	YEAR	LOCATION	DESCRIPTION	QTY	ENGINE	TORQUE STRUT	TRANSMISSION	
<b>PONTIAC PASSENGER CAR (continued)</b>									
<b>GRAND AM (continued)</b>									
L4	L4 2.3L 138ci	1992-95	RH Front	Complete Unit	1	EM-5031*			
			RH Front	Insert	1	EM-2803*			
		1988-91	RH Front		1	EM-2859*			
			RH Rear		1	EM-2952			
		1994-95	Torq Str - Front	Auto	1		EM-2814		
			Torq Str - Front	Manual	1		EM-2782		
		1992-93	Torq Str - Front		1		EM-2782		
		1988-91	Torq Str - Front		1		EM-2528		
		1992-95	Trans - LH Front	Manual; Insert	1			EM-2923	
			Trans - LH Rear	Auto	1			EM-2715	
			Trans - LH Rear	Manual; Insert	1			EM-2924	
		1988-91	Trans	Complete Unit; Auto	1			EM-3058	
	Trans		Insert Only; Manual	1			EM-2766		
	L4 2.4L 146ci	1999-01	Front		1	EM-2933*			
			1996-98	RH Front	Complete Unit	1	EM-5031*		
		RH Front		Insert	1	EM-2803*			
		Torq Str - Front		Auto	1		EM-2814		
		Torq Str - Front		Manual	1		EM-2782		
		1999-01	Trans - Center		1			EM-2874	
			Trans - LH Front	Complete Unit	1			EM-5079	
			Trans - LH Rear	Complete Unit	1			EM-5078	
			Trans - LH Rear	Insert	1			EM-2875	
		1996-98	Trans	Auto	1			EM-2715	
			Trans	Manual; Insert	1			EM-2766	
		L4 2.5L 2474cc	1985-91	RH Front		1	EM-2538		
	RH Rear				1	EM-2477			
	Torq Str - Rear				1		EM-2528		
	Trans			Auto	1			EM-2601	
	Trans			Manual	1			EM-2601	
	V6	V6 3.0L 181ci	1985-87	RH Front		1	EM-2626		
				RH Rear		1	EM-2477		
				Torq Str - Rear		1		EM-2528	
Trans				Auto	1			EM-2601	
Trans				Manual	1			EM-2601	
V6 3.1L 189ci		1994-98	RH Front	Insert	1	EM-2803*			
			Torq Str - Front		1		EM-2814		
			Torq Str - Front		1		EM-2782		
			Trans		1			EM-2715	
V6 3.3L 204ci		1992-93	RH Front	Insert	1	EM-2803*			
			Torq Str - Front		1		EM-2782		
			Trans		1			EM-2715	
V6 3.4L 207ci		1999-05	Front		1	EM-2933*			
			Trans - Center		1			EM-2874	
			Trans - Front	Complete Unit	1			EM-5079	
			Trans - Rear	Complete Unit	1			EM-5078	
			Trans - Rear	Insert	1			EM-2875	
V6 3.8L 231ci		1979	LH Front		1	EM-2382			
			RH Front		1	EM-2384			
			Trans		1			EM-2379	
V8		V8 4.9L 301ci	1978-80	L & R Front		2	EM-2387		
				1980	Trans	Auto	1		
			1978-79	Trans	Auto	1			EM-2393
				Trans	Manual	1			EM-2392
	V8 5.0L 305ci	1978-80	L & R Front		2	EM-2292			
			1980	Trans	Auto	1			EM-2393
		1978-79	Trans	Auto	1			EM-2393	
			Trans	Manual	1			EM-2393	

# Engine, Transmission, And Torque Strut Mounts

CYL	ENG. SIZE	YEAR	LOCATION	DESCRIPTION	QTY	ENGINE	TORQUE STRUT	TRANSMISSION	
<b>PONTIAC PASSENGER CAR (continued)</b>									
<b>GRAND AM (continued)</b>									
V8	V8 5.7L 350ci	1975	L & R Front		2	EM-2254			
		1973	L & R Front		2	EM-2254			
		1973-75	Trans		1			EM-2378 @	
	V8 6.6L 400ci	1973-75	L & R Front		2	EM-2292			
			Trans		1			EM-2288 @	
	V8 7.5L 455ci	1975	L & R Front		2	EM-2375			
			1973-74	LH Front		1	EM-2336		
				RH Front		1	EM-2335		
		1973-75	Trans	Auto; THM350		1			EM-2268 @
			Trans	Auto; THM400		1			EM-2360 @
Trans			Manual		1			EM-2360 @	
<b>GRAND LEMANS</b>									
L6	L6 4.1L 250ci	1975-77	L & R Front		2	EM-2292			
		1976-77	Trans		1			EM-2337	
		1975	Trans		1			EM-2288 @	
V6	V6 3.3L 200ci	1978-79	Trans		1			EM-2288 @	
	V6 3.8L 229ci	1980-81	L & R Front		2	EM-2436			
			Trans		1			EM-2378 @	
	V6 3.8L 231ci	1977-83	LH Front		1	EM-2382			
			RH Front		1	EM-2384			
			Trans		1			EM-2379	
	V6 4.1L 252ci	1982	LH Front		1	EM-2382			
			RH Front		1	EM-2384			
Trans				1			EM-2379		
V8	V8 4.3L 260ci	1976	L & R Front		2	EM-2328			
			Trans		1			EM-2393	
	V8 4.3L 265ci	1980-81	L & R Front		2	EM-2387			
			Trans		1			EM-2379	
	V8 4.4L 267ci	1979-82	L & R Front		2	EM-2292			
			Trans		1			EM-2393	
	V8 4.9L 301ci	1977-81	L & R Front		2	EM-2387			
		1979-81	Trans		1			EM-2393	
		1977	Trans		1			EM-2360 @	
	V8 5.0L 305ci	1976-83	L & R Front		2	EM-2292			
		1981-83	Trans		1			EM-2393	
		1976-80	Trans	Auto		1			EM-2393
			Trans	Manual		1			EM-2393
	V8 5.7L 350ci	1975-79	L & R Front		2	EM-2387			
			Trans		1			EM-2288 @	
	V8 5.7L 350ci Diesel	1982-83	L & R Front		2	EM-2328			
			Trans		1			EM-2360 @	
	V8 6.6L 400ci	1975-77	LH Front		1	EM-2256			
			RH Front		1	EM-2255			
			Trans		1			EM-2288 @	
V8 6.6L 403ci	1977	L & R Front		2	EM-2387				
		Trans		1			EM-2392		
V8 7.5L 455ci	1975-76	L & R Front		2	EM-2292				
	1976	Trans		1			EM-2268 @		
	1975	Trans		1			EM-2360 @		
<b>GRAND PRIX</b>									
L4	L4 2.3L 138ci	1990-91	Front		1	EM-2859'			
			Torq Str - Front	LH & RH Front	2		EM-2396		
			Trans	Auto	1			EM-2620	
V6	V6 2.8L 173ci	1988-89	Front		1	EM-2660'			
			Torq Str - Front	Auto	1		EM-2609		

# Engine, Transmission, And Torque Strut Mounts

CYL	ENG. SIZE	YEAR	LOCATION	DESCRIPTION	QTY	ENGINE	TORQUE STRUT	TRANSMISSION	
<b>PONTIAC PASSENGER CAR (continued)</b>									
<b>GRAND PRIX (continued)</b>									
V6	V6 2.8L 173ci	1988-89	Torq Str - Front	Manual	1		EM-5177		
			Torq Str - Front		1		EM-2609		
			Trans	Auto	1			EM-2620	
			Trans	Manual	1			EM-5181	
	V6 3.1L 189ci	1989-93	1989-93	Front		1	EM-2660		
			1994-03	RH Front		1	EM-2796		
		1995-03	Torq Str - Front	Auto, Complete Unit; LH & RH Front	2		EM-2866		
			Torq Str - Front	Brkt to Radiator Support; LH & RH Front	2		EM-2901		
			Torq Str - Front	Insert; LH & RH Front; Auto	2		EM-2716		
		1994	Torq Str - Front	Brkt to Radiator Support; LH & RH Front	2		EM-2901		
			Torq Str - Front	Complete Unit; LH & RH Front 1st Design	2		EM-2609		
			Torq Str - Front	Complete Unit; LH & RH Front 2nd Design	2		EM-2866		
			Torq Str - Front	Insert Only; LH & RH Front 2nd Design	2		EM-2716		
		1991-93	Torq Str - Front	Auto, LH & RH Front	2		EM-2609		
		1989-90	Torq Str - Front	Auto, LH & RH Front	2		EM-2609		
			Torq Str - Front	Manual	1		EM-5177		
			Torq Str - Front	Manual	1		EM-2609		
		1994-03	Trans	Auto	1			EM-2712	
		1991-93	Trans	Auto	1			EM-2620	
		1989-90	Trans	Auto	1			EM-2620	
	Trans		Manual	1			EM-5181		
	V6 3.4L 207ci	1991-96	RH Front		1	EM-2555			
			RH Rear		1	EM-2676			
			Torq Str - Front		1		EM-2799		
		1994-96	Trans	Auto	1			EM-2712	
		1992-93	Trans	Auto	1			EM-2620	
	1991	Trans	Auto	1			EM-2712		
	V6 3.8L 231ci	1997-03	1997-03	Front		1	EM-2796		
			1978-87	LH Front		1	EM-2382		
		2004-08	2004-08	RH Front		1	EM-2987		
			1978-87	RH Front		1	EM-2384		
		2004-08	Torq Str - Front	Brkt to Radiator Support; LH & RH Front	2		EM-3088		
			Torq Str - Front	Complete Unit; LH & RH Front	2		EM-2866		
			Torq Str - Front	Insert; LH & RH Front	2		EM-2716		
			Torq Str - Front	Brkt to Radiator Support; LH & RH Front	2		EM-2901		
		1997-03	Torq Str - Front	Complete Unit; LH & RH Front	2		EM-2866		
			Torq Str - Front	Insert; LH & RH Front	2		EM-2716		
			2007-08	Trans		1			EM-2818
		1997-06	Trans		1			EM-2712	
		1982-87	Trans		1			EM-2379	
	1978-81	Trans	Auto	1			EM-2379		
	V6 4.1L 252ci	1982	LH Front		1	EM-2382			
			RH Front		1	EM-2384			
			Trans	Auto	1		EM-2379		
	V6 4.3L 262ci	1986-87	L & R Front		2	EM-2436			
			Trans		1		EM-2337		
	V8	V8 4.3L 265ci	1980-81	L & R Front		2	EM-2387		
				Trans	Auto	1		EM-2379	
		V8 4.4L 267ci	1981-82	L & R Front		2	EM-2292		



# Engine, Transmission, And Torque Strut Mounts

CYL	ENG. SIZE	YEAR	LOCATION	DESCRIPTION	QTY	ENGINE	TORQUE STRUT	TRANSMISSION
<b>PONTIAC PASSENGER CAR (continued)</b>								
<b>GRAND PRIX (continued)</b>								
V8	V8 4.4L 267ci	1981-82	Trans	Auto	1			EM-2393
	V8 4.9L 301ci	1977-80	L & R Front		2	EM-2387		
		1980	Trans	Auto	1			EM-2393
		1978-79	Trans	Auto	1			EM-2393
			Trans	Manual	1			EM-2392
		1977	Trans	Auto	1			EM-2393
	V8 5.0L 305ci	1983-87	L & R Front		2	EM-2292		
		1978-80	L & R Front		2	EM-2292		
		1983-87	Trans	Auto	1			EM-2393
		1978-80	Trans	Auto	1			EM-2393
	V8 5.3L	2005-08	Front	Hydraulic Mount	1	EM-3093		
			Rear		1	EM-2990		
			Torq Str - Front	Brkt to Radiator Support	1		EM-3088	
			Torq Str - Front	Complete Unit	1		EM-3090	
			Torq Str - Front	Insert Only; LH & RH Front	2		EM-2716	
		Trans			1			EM-5661
	V8 5.7L 350ci	1977	L & R Front	VIN P	2	EM-2292		
			L & R Front	VIN R	2	EM-2328		
		1976-77	L & R Front		2	EM-2292		
			Trans	Auto; THM350	1			EM-2288 @
		Trans	Auto; THM400	1			EM-2360 @	
	V8 5.7L 350ci Diesel	1981-84	L & R Front		2	EM-2328		
			Trans		1			EM-2360 @
	V8 6.4L 389ci	1965-66	L & R Front		2	EM-2254		
			LH Front		1	EM-2204		
		1962-64	RH Front		1	EM-2205		
			Trans		1			EM-2321
	1962-64	Trans	Manual	2			EM-2206	
	V8 6.6L 400ci	1974-77	L & R Front		2	EM-2292		
		1970-73	LH Front		1	EM-2336		
		1968-69	LH Front		1	EM-2204		
		1970-73	RH Front		1	EM-2335		
		1968-69	RH Front		1	EM-2205		
		1976-77	Trans	Auto; THM350 (M38)	1			EM-2288 @
		1973-74	Trans	Auto	1			EM-2288 @
		1972	Trans	Auto	1			EM-2268 @
		1968-71	Trans	Auto	1			EM-2268 @
		Trans	Manual	1			EM-2378 @	
	V8 6.6L 403ci	1977	L & R Front		2	EM-2387		
			Trans	Auto; THM350 (M38)	1			EM-2288 @
			Trans	Auto; THM400-475 (M40)	1			EM-2392
	V8 6.9L 421ci	1963-66	LH Front		1	EM-2204		
			RH Front		1	EM-2205		
			Trans		1			EM-2206
	V8 7.0L 428ci	1967-69	L & R Front		2	EM-2254		
			Trans	Auto	1			EM-2268 @
			Trans	Manual	1			EM-2378 @
	V8 7.5L 455ci	1974-76	L & R Front		2	EM-2292		
		1970-73	LH Front		1	EM-2336		
			RH Front		1	EM-2335		
1976		Trans	Auto; THM350 (M38)	1			EM-2268 @	
		Trans	Auto; THM400-475 (M40)	1			EM-2360 @	
1975		Trans	Auto; THM350 (M38)	1			EM-2268 @	
1974		Trans	Auto; THM400 (M40)	1			EM-2360 @	
1970-73		Trans	Auto; THM350 (M38)	1			EM-2268 @	
	Trans	Auto; THM400 (M40)	1			EM-2360 @		

# Engine, Transmission, And Torque Strut Mounts

CYL	ENG. SIZE	YEAR	LOCATION	DESCRIPTION	Q T Y	ENGINE	TORQUE STRUT	TRANS- MISSION
<b>PONTIAC PASSENGER CAR (continued)</b>								
<b>GRAND PRIX (continued)</b>								
V8	V8 7.5L 455ci	1970-73	Trans	Manual	1			EM-2378 @
<b>GRAND SAFARI</b>								
V8	V8 4.9L 301ci	1977	L & R Front		2	EM-2387		
			Trans	Auto	1		EM-2392	
	V8 5.7L 350ci	1977	L & R Front		2	EM-2387		
			Trans		1		EM-2531	
	V8 6.6L 400ci	1973-76	L & R Front		2	EM-2375		
			1971	LH Front		1	EM-2336	
			RH Front		1	EM-2335		
		1977-78	Trans		1		EM-2392	
		1973-76	Trans		1		EM-2360 @	
		1971	Trans		1		EM-2374 @	
	V8 6.6L 403ci	1977-78	L & R Front		2	EM-2387		
	V8 7.5L 455ci	1973-76	L & R Front		2	EM-2375		
			1971-72	LH Front		1	EM-2336	
			RH Front		1	EM-2335		
1973-76		Trans		1		EM-2360 @		
1971-72		Trans		1		EM-2374 @		
<b>GRANDVILLE</b>								
V8	V8 6.6L 400ci	1975	L & R Front		2	EM-2292		
		1973	L & R Front		2	EM-2375		
		1975	Trans		1		EM-2360 @	
		1973	Trans		1		EM-2360 @	
	V8 7.5L 455ci	1973-75	L & R Front		2	EM-2375		
			1971-72	LH Front		1	EM-2336	
			RH Front		1	EM-2335		
		1973-75	Trans		1		EM-2360 @	
1971-72	Trans		1		EM-2374 @			
<b>GTO</b>								
V8	V8 5.3L 326ci	1965	LH Front		1	EM-2256		
			RH Front		1	EM-2255		
			Trans	Auto; THM350	1		EM-2378 @	
			Trans	Auto; THM400	1		EM-2268 @	
			Trans	Manual	1		EM-2378 @	
	V8 5.7L 350ci	2004	Trans		1		EM-5182	
	V8 6.0L 364ci	2005-06	Trans		1		EM-5182	
	V8 6.4L 389ci	1964-66	L & R Front		2	EM-2256		
			Trans	Auto	1		EM-2268 @	
	V8 6.6L 400ci	1967-73	LH Front		1	EM-2256		
			RH Front		1	EM-2255		
			Trans	Auto; THM350	1		EM-2378 @	
		1970-73	Trans	Auto; THM400	1		EM-2268 @	
			Trans	Manual	1		EM-2360 @	
			Trans	Manual	1		EM-2378 @	
V8 7.5L 455ci	1970-73	LH Front		1	EM-2336			
		RH Front		1	EM-2335			
		Trans	Auto	1		EM-2378 @		
<b>J2000</b>								
L4	L4 1.8L 112ci	1983-84	RH Front		1	EM-2496		
			1982	RH Front	Auto; 3 Spd; Vin G; w/ Air	1	EM-2474	
			RH Front	Auto; 3 Spd; VIN G; w/o Air	1	EM-2506		
			RH Front	Manual; Code G; w/ Air	1	EM-2473		
			RH Front	Manual; Code G; w/o Air	1	EM-2524		

## Engine, Transmission, And Torque Strut Mounts

CYL	ENG. SIZE	YEAR	LOCATION	DESCRIPTION	QTY	ENGINE	TORQUE STRUT	TRANSMISSION	
<b>PONTIAC PASSENGER CAR (continued)</b>									
<b>J2000 (continued)</b>									
L4	L4 1.8L 112ci	1982	RH Front	VIN 0	1	EM-2496			
		1983-84	RH Rear		1	EM-2477			
		1982	RH Rear	RH Rear	1	EM-2477			
		1982-84	Torq Str - Rear	Lateral	1		EM-2492		
			Torq Str - Rear	Longitudinal	1		EM-2528		
			Trans	Auto; Insert	1				EM-2720
	Trans		Manual; Insert	1				EM-2720	
	L4 2.0L 122ci	1983-84	RH Front	Auto w/o Air	1	EM-2506			
			RH Front	Auto; w/ Air	1	EM-2474			
			RH Front	Manual; w/ Air	1	EM-2473			
			RH Front	Manual; w/o Air	1	EM-2524			
			RH Rear		1	EM-2477			
			Torq Str - Rear	Lateral	1		EM-2492		
			Torq Str - Rear	Longitudinal	1		EM-2528		
Trans			Auto; Insert	1				EM-2720	
Trans	Manual; Insert	1				EM-2720			
<b>LEMANS</b>									
L4	L4 1.6L 1588cc	1990-93	Front		1	EM-2657			
		1988-89	Front		1	EM-2657			
		1990-93	RH Front		1	EM-2658			
		1988-89	RH Front	w/ Air	1	EM-2658			
			RH Front	w/o Air	1	EM-8225			
		1990-93	Rear		1	EM-2657			
		1988-89	Rear		1	EM-2657			
		1988-93	Trans	Auto	1			EM-2656	
	Trans		Manual	1			EM-2656		
	L4 2.0L 122ci	1990	Front		1	EM-2657			
			Front		1	EM-2656			
			RH Front		1	EM-2658			
			RH Front	w/ Air	1	EM-2658			
			Trans	Auto	1			EM-2656	
Trans			Manual	1			EM-2656		
L6	L6 3.5L 215ci	1964-65	LH Front		1	EM-2204			
			RH Front		1	EM-2205			
			Trans		1			EM-2378 @	
	L6 4.1L 250ci	1973-77	L & R Front		2	EM-2292			
			1968-72	L & R Front		2	EM-2284		
			1976-77	Trans		1			EM-2337
			1974-75	Trans		1			EM-2288 @
			1968-73	Trans		1			EM-2378 @
V6	V6 3.3L 200ci	1978-79	Trans		1			EM-2288 @	
	V6 3.8L 229ci	1980-81	L & R Front		2	EM-2436			
			Trans		1			EM-2378 @	
	V6 3.8L 231ci	1977-81	LH Front		1	EM-2382			
			RH Front		1	EM-2384			
		1978-81	Trans	Auto	1			EM-2379	
			Trans	Manual	1			EM-2379	
		1977	Trans		1			EM-2360 @	
V8	V8 4.3L 260ci	1976	L & R Front		2	EM-2328			
			Trans	Auto	1			EM-2393	
			Trans	Manual	1			EM-2393	
	V8 4.3L 265ci	1980-81	L & R Front		2	EM-2292			
			Trans	Auto	1			EM-2393	
			Trans	Manual	1			EM-2393	
	V8 4.4L 267ci	1979-81	L & R Front		2	EM-2292			
			Trans	Auto	1			EM-2393	

# Engine, Transmission, And Torque Strut Mounts

CYL	ENG. SIZE	YEAR	LOCATION	DESCRIPTION	QTY	ENGINE	TORQUE STRUT	TRANSMISSION		
<b>PONTIAC PASSENGER CAR (continued)</b>										
<b>LEMANS (continued)</b>										
V8	V8 4.4L 267ci	1979-81	Trans	Manual	1			EM-2393		
	V8 4.9L 301ci	1979-81	L & R Front		2	EM-2387				
		1977	L & R Front		2	EM-2387				
		1979-81	Trans	Auto		1			EM-2392	
			Trans	Manual		1			EM-2393	
		1977	Trans	Auto; THM400		1			EM-2360 @	
			Trans	Manual		1			EM-2393	
	V8 5.0L 305ci	1976-81	L & R Front		2	EM-2292				
			Trans	Auto	1			EM-2393		
			Trans	Manual	1			EM-2393		
	V8 5.3L 326ci	1964-67	LH Front		1	EM-2256				
		1963	LH Front		1	EM-2204				
		1964-67	RH Front		1	EM-2255				
		1963	RH Front		1	EM-2205				
			Trans	Auto; THM350		1			EM-2378 @	
		1964-67	Trans	Auto; THM400		1			EM-2268 @	
			Trans	Manual		1			EM-2378 @	
		1963	Trans		1			EM-2206		
	V8 5.7L	1977	L & R Front	VIN R	2	EM-2328				
	V8 5.7L 350ci	1978-79	L & R Front		2	EM-2292				
			L & R Front	VIN L; VIN P	2	EM-2387				
		1975-76	L & R Front		2	EM-2387				
			LH Front		1	EM-2256				
		1968-74	RH Front		1	EM-2255				
			Trans	Auto		1			EM-2393	
		1978-79	Trans	Manual		1			EM-2393	
			Trans	Auto; THM350 (M38); VIN P		1			EM-2288 @	
		1977	Trans	Auto; THM400-475 (M40); VIN P		1			EM-2360 @	
			Trans	Manual, Code P		1			EM-2288 @	
			Trans	Manual, Code R		1			EM-2392	
			Trans	Auto; THM350 (M38); VIN P		1			EM-2288 @	
		1976	Trans	Auto; THM400-475 (M40); VIN P		1			EM-2360 @	
			Trans	Manual, Code P		1			EM-2288 @	
			Trans	VIN M		1			EM-2394	
			Trans	Auto; THM350 (M38)		1			EM-2288 @	
		1975	Trans	Auto; THM400-475 (M40)		1			EM-2268 @	
			Trans	Manual		1			EM-2288 @	
			1968-74	Trans	Auto; M15		1			EM-2288 @
				Trans	Auto; THM350		1			EM-2378 @
	Trans			Auto; THM400		1			EM-2268 @	
	Trans	Manual		1			EM-2288 @			
	V8 6.4L 389ci	1965	L & R Front		2	EM-2254				
			LH Front		1	EM-2204				
			RH Front		1	EM-2205				
		1964-65	Trans	Auto		1			EM-2268 @	
			Trans	Manual		1			EM-2206	
	V8 6.6L 400ci	1968-77	LH Front		1	EM-2256				
RH Front				1	EM-2255					
1975-77		Trans		1			EM-2288 @			
1968-74		Trans		1			EM-2378 @			
V8 6.6L 403ci	1977	L & R Front		2	EM-2387					
		Trans		1			EM-2392			
V8 7.0L 428ci	1968-69	L & R Front		2	EM-2254					
		Trans	Auto	1			EM-2268 @			

# Engine, Transmission, And Torque Strut Mounts

CYL	ENG. SIZE	YEAR	LOCATION	DESCRIPTION	QTY	ENGINE	TORQUE STRUT	TRANSMISSION	
<b>PONTIAC PASSENGER CAR (continued)</b>									
<b>LEMANS (continued)</b>									
V8	V8 7.0L 428ci	1968-69	Trans	Manual	1			EM-2378 @	
	V8 7.5L 455ci	1976	L & R Front		2	EM-2292			
		1972-74	LH Front		1	EM-2336			
		1970	LH Front		1	EM-2336			
		1972-74	RH Front		1	EM-2335			
		1970	RH Front		1	EM-2335			
		1972-74	Trans	Auto; THM350		1			EM-2378 @
			Trans	Auto; THM400		1			EM-2268 @
	Trans		Manual		1			EM-2378 @	
1970	Trans		1			EM-2268 @			
<b>OPTIMA</b>									
L4	L4 1.6L 1606cc	1990-91	Front		1	EM-2657			
		1988-89	Front		1	EM-2657			
		1990-91	RH Front		1	EM-2658			
		1988-89	RH Front	w/ Air	1	EM-2658			
			RH Front	w/o Air	1	EM-8225			
		1990-91	Rear		1	EM-2657			
		1988-89	Rear		1	EM-2657			
	1988-91	Trans		1			EM-2656		
	L4 2.0L 122ci	1988-90	Front		1	EM-2657			
RH Front				1	EM-2658				
Trans				1			EM-2656		
<b>PARISIENNE</b>									
L6	L6 4.1L 250ci	1977-79	L & R Front		2	EM-2292			
			Trans		1			EM-2337	
V6	V6 3.8L 229ci	1980	L & R Front		2	EM-2436			
			Trans		1			EM-2360 @	
	V6 3.8L 231ci	1981-85	LH Front		1	EM-2382			
			RH Front		1	EM-2384			
			Trans		1			EM-2379	
V6 4.3L 262ci	1985-86	L & R Front		2	EM-2436				
		Trans		1			EM-2360 @		
V8	V8 4.3L 265ci	1981	L & R Front		2	EM-2387			
			Trans		1			EM-2379	
	V8 4.4L 267ci	1980-82	L & R Front		2	EM-2292			
			Trans	Auto	1			EM-2393	
			Trans	Manual	1			EM-2393	
	V8 5.0L 305ci	1977-86	L & R Front		2	EM-2292			
			Trans		1			EM-2360 @	
	V8 5.0L 307ci	1986	L & R Front		2	EM-2328			
			L & R Front		2	EM-2328			
		1981	Trans		1			EM-2360 @	
			Trans		1			EM-2360 @	
	V8 5.7L 350ci	1978-85	L & R Front	Gas	2	EM-2328			
			L & R Front		2	EM-2387			
		1980-85	Trans	Gas	1			EM-2360 @	
			Trans		1			EM-2392	
Trans				1			EM-2531		
V8 5.7L 350ci Diesel	1980-85	L & R Front		2	EM-2328				
		Trans		1			EM-2360 @		
V8 6.6L 400ci	1976	L & R Front		2	EM-2375				
		Trans		1			EM-2360 @		
V8 7.5L 455ci	1976	L & R Front		2	EM-2375				
		Trans		1			EM-2360 @		

# Engine, Transmission, And Torque Strut Mounts

CYL	ENG. SIZE	YEAR	LOCATION	DESCRIPTION	QTY	ENGINE	TORQUE STRUT	TRANSMISSION	
<b>PONTIAC PASSENGER CAR (continued)</b>									
<b>PHOENIX</b>									
L4	L4 2.5L 2474cc	1980-81	L & R Front		2	EM-2505			
		1977-78	L & R Front		2	EM-2446			
		1982-84	RH Front		1	EM-2472			
		1980-84	Torq Str - Front		1		EM-2396		
			Trans - Front	Auto	1			EM-2499	
			Trans - Front	Manual	1			EM-2467	
			Trans - Rear	Auto	1			EM-2467	
1977-78	Trans	Manual	1			EM-2531			
V6	V6 2.8L 173ci	1982-84	RH Front		1	EM-2472			
		1980-81	RH Front		1	EM-2505			
		1980-84	Torq Str - Front		1		EM-2396		
			Trans - Front	Auto	1			EM-2466	
			Trans - Front	Manual	1			EM-2467	
			Trans - Rear	Auto	1			EM-2467	
	V6 3.8L 231ci	1977-79	LH Front		1	EM-2382			
			RH Front		1	EM-2384			
		1978-79	Trans	Auto	1			EM-2379	
			Trans	Manual	1			EM-2379	
		1977	Trans	Auto; THM350 (M38)	1			EM-2379	
			Trans	Manual; 3 Spd	1			EM-2394	
			Trans	Manual; 5 Spd	1			EM-2531	
V8	V8 5.0L 305ci	1977-79	L & R Front		2	EM-2292			
			Trans	Auto	1		EM-2393		
			Trans	Manual	1		EM-2393		
	V8 5.7L 350ci	1977-79	L & R Front		2	EM-2292			
			Trans	Auto	1		EM-2393		
			Trans	Manual	1		EM-2393		
<b>SAFARI</b>									
L6	L6 4.1L 250ci	1968-70	L & R Front		2	EM-2284			
			Trans		1		EM-2378 @		
V8	V8 5.0L 307ci	1987-89	L & R Front		2	EM-2328			
			Trans		1		EM-2360 @		
	V8 5.7L 350ci	1968-70	LH Front		1	EM-2256			
			RH Front		1	EM-2255			
			Trans		1		EM-2378 @		
	V8 6.4L 389ci	1965	L & R Front		2	EM-2254			
		1961-64	LH Front		1	EM-2204			
			RH Front		1	EM-2205			
	1961-65	Trans - Front	Manual	2		EM-2206			
	V8 6.6L 400ci	1970	L & R Front		2	EM-2254			
V8 6.9L 421ci	1965	L & R Front		2	EM-2254				
	1963-64	LH Front		1	EM-2204				
			RH Front		1	EM-2205			
<b>SOLSTICE</b>									
L4	L4 2.0L 1998cc	2007-09	LH Front		1	EM-3160			
			RH Front	Re-use Old Heat Shield	1	EM-3160			
			Trans		1		EM-3161		
			Trans	Adapter	1		EM-4126		
	L4 2.4L 145ci	2007-09	LH Front		1	EM-3160			
			RH Front	Re-use Old Heat Shield	1	EM-3160			
			Trans		1		EM-3161		
			Trans	Adapter	1		EM-4126		

# Engine, Transmission, And Torque Strut Mounts

CYL	ENG. SIZE	YEAR	LOCATION	DESCRIPTION	QTY	ENGINE	TORQUE STRUT	TRANSMISSION	
<b>PONTIAC PASSENGER CAR (continued)</b>									
<b>STAR CHIEF</b>									
V8	V8 6.4L 389ci	1959-66	LH Front		1	EM-2204			
			RH Front		1	EM-2205			
		1962-64	Trans	Manual	1			EM-2206	
	V8 6.9L 421ci	1963-66	LH Front		1	EM-2204			
			RH Front		1	EM-2205			
		1963-64	Trans	Manual	1			EM-2206	
<b>SUNBIRD</b>									
L4	L4 1.8L 112ci	1985-86	RH Front		1	EM-2538			
			RH Rear		1	EM-2477			
			Torq Str - Rear	Lateral	1		EM-2492		
			Torq Str - Rear	Longitudinal	1		EM-2528		
			Trans	Auto	1			EM-2601	
			Trans	Manual, 4 Speed, Insert	1			EM-2720	
			Trans	Manual; 5 Spd	1			EM-2601	
	L4 2.0L 122ci	1985-94	RH Front		1	EM-2538			
			RH Rear		1	EM-2477			
		1992-94	Torq Str - Rear	Longitudinal	1		EM-2528		
			1986-91	Torq Str - Rear	Lateral	1		EM-2492	
				Torq Str - Rear	Longitudinal	1		EM-2528	
		1984-85	Torq Str - Rear	Lateral	1		EM-2492		
			Torq Str - Rear	Longitudinal	1		EM-2528		
		1985-94	Trans	Auto	1			EM-2601	
	Trans		Manual	1			EM-2601		
	L4 2.3L 140ci	1976-77	LH Front		1	EM-2357			
			RH Front		1	EM-2356			
			Trans	Auto	1			EM-2353	
			Trans	Manual	1			EM-2353	
	L4 2.5L 2474cc	1977-80	L & R Front		2	EM-2446			
			L & R Rear	OEM Design	2	EM-2374@			
			Trans	Auto	1			EM-2531	
			Trans	Manual	1			EM-2531	
	V6	V6 3.1L 189ci	1991-94	RH Front		1	EM-2538		
				RH Rear	Auto	1	EM-2477		
RH Rear				Manual	1	EM-2708			
Torq Str - Rear					1		EM-2528		
Trans				Auto	1			EM-2601	
Trans				Manual	1			EM-2601	
V6 3.8L 231ci		1976-80	LH Front		1	EM-2382			
			RH Front		1	EM-2384			
			Trans	Auto	1			EM-2353	
			Trans	Manual	1			EM-2353	
V8	V8 5.0L 305ci	1978-79	L & R Front		2	EM-2292			
			Trans	Auto	1			EM-2353	
			Trans	Manual	1			EM-2353	
<b>SUNBURST</b>									
L4	L4 1.5L 1471cc	1985-88	Front	Manual	1	EM-8442			
			RH Front		1	EM-8439			
			Trans		1			EM-8976	
<b>SUNFIRE</b>									
L4	L4 2.2L 134ci	1995-02	RH Front	OHV; Complete Unit	1	EM-5026*			
			RH Front	OHV; Insert	1	EM-2803*			
		1995-05	Torq Str - Front		1		EM-2798		
			Trans - LH Front	Manual; Insert	1			EM-2923	
			Trans - LH Rear	Manual; Insert	1			EM-2924	
	Trans	Auto	1			EM-2820			
	L4 2.2L 2198cc	2002-05	RH Front	DOHC	1	EM-3128			

# Engine, Transmission, And Torque Strut Mounts

CYL	ENG. SIZE	YEAR	LOCATION	DESCRIPTION	QTY	ENGINE	TORQUE STRUT	TRANSMISSION
<b>PONTIAC PASSENGER CAR (continued)</b>								
<b>SUNFIRE (continued)</b>								
L4	L4 2.3L 138ci	1995	RH Front	Insert	1	EM-2803'		
			Torq Str - Front		1		EM-2798	
			Trans - LH Front	Manual; Insert	1			EM-2923
			Trans - LH Rear	Manual; Insert	1			EM-2924
			Trans	Auto	1			EM-2820
	L4 2.4L 146ci	1996-02	RH Front	Insert	1	EM-2803'		
			Torq Str - Front		1		EM-2798	
			Trans - LH Front	Manual; Insert	1			EM-2923
			Trans - LH Rear	Manual; Insert	1			EM-2924
			Trans	Auto	1			EM-2820
<b>SUNRUNNER</b>								
L4	L4 1.6L 1588cc	1994-97	L & R Front		2	EM-8568		
			Trans		1			EM-8825
<b>T1000</b>								
L4	L4 1.6L 98ci	1981-87	L & R Front		2	EM-2381		
			Trans	Auto	1			EM-2391
			Trans	Manual	1			EM-2391
<b>TEMPEST</b>								
L4	L4 2.0L 122ci	1987-89	Front		1	EM-2538		
			Rear		1	EM-2477		
			Torq Str - Rear	Lateral	1		EM-2492	
			Torq Str - Rear	Longitudinal	1		EM-2528	
			Trans		1			EM-2657
	L4 2.2L 134ci	1990-91	Front		1	EM-2538		
			Rear		1	EM-2477		
			Torq Str - Front		1		EM-2528	
			Trans		1			EM-2601
L6	L6 3.5L 215ci	1964-65	LH Front		1	EM-2204		
			RH Front		1	EM-2205		
			Trans	Auto	1			EM-2378 @
	L6 4.1L 250ci	1968-70	L & R Front		2	EM-2284		
			Trans		1			EM-2378 @
V6	V6 3.1L 189ci	1990-91	Front		1	EM-2538		
			Rear		1	EM-2477		
			Torq Str - Front		1		EM-2528	
			Trans		1			EM-2601
V8	V8 5.3L 326ci	1964-67	LH Front		1	EM-2256		
			1963	LH Front		1	EM-2204	
		1964-67	RH Front		1	EM-2255		
			1963	RH Front		1	EM-2205	
		Trans		1			EM-2206	
	V8 5.7L 350ci	1968-70	LH Front		1	EM-2256		
			RH Front		1	EM-2255		
			Trans	Auto; THM350	1			EM-2378 @
			Trans	Auto; THM400	1			EM-2268 @
			Trans	Manual	1			EM-2288 @
	V8 6.4L 389ci	1961-64	LH Front		2	EM-2256		
			RH Front		1	EM-2255		
			Trans	Manual	2			EM-2206
	V8 6.6L 400ci	1968-70	LH Front		1	EM-2256		
			RH Front		1	EM-2255		
			Trans	Auto; THM350	1			EM-2378 @
			Trans	Auto; THM400	1			EM-2268 @
			Trans	Manual	1			EM-2378 @
	V8 7.0L 428ci	1969	L & R Front		2	EM-2254		



# Engine, Transmission, And Torque Strut Mounts

CYL	ENG. SIZE	YEAR	LOCATION	DESCRIPTION	QTY	ENGINE	TORQUE STRUT	TRANSMISSION	
<b>PONTIAC PASSENGER CAR (continued)</b>									
<b>TEMPEST (continued)</b>									
V8	V8 7.0L 428ci	1969	Trans	Auto	1			EM-2268 @	
			Trans	Manual	1			EM-2378 @	
<b>VENTURA</b>									
L4	L4 2.5L 2474cc	1977	L & R Front		2	EM-2446			
			Trans	Manual	1			EM-2531	
L6	L6 4.1L 250ci	1973-76	L & R Front		2	EM-2292			
		1971-72	L & R Front		2	EM-2284			
		1975-76	Trans		1			EM-2337	
		1971-74	Trans	Auto	1			EM-2378 @	
			Trans	Manual	1			EM-2378 @	
V6	V6 3.8L 231ci	1977	LH Front		1	EM-2382			
			RH Front		1	EM-2384			
			Trans	Auto; THM350 (M38)	1			EM-2379	
			Trans	Manual	1			EM-2394	
V8	V8 4.3L 260ci	1975-76	L & R Front		2	EM-2328			
			Trans	Auto	1			EM-2393	
			Trans	Manual	1			EM-2393	
	V8 4.9L 301ci	1977	L & R Front		2	EM-2387			
			Trans		1			EM-2392	
	V8 5.0L 305ci	1977	L & R Front		2	EM-2387			
			Trans		1			EM-2392	
	V8 5.0L 307ci	1971-72	L & R Front		2	EM-2267			
			Trans	Auto	1			EM-2378 @	
			Trans	Manual	1			EM-2378 @	
	V8 5.7L 350ci	1977	L & R Front	VIN L	2	EM-2292			
			L & R Front	VIN R	2	EM-2328			
		1976	L & R Front		2	EM-2281			
		1972-75	L & R Front		2	EM-2254			
		1977	Trans		1			EM-2392	
1976		Trans		1			EM-2394		
1972-75		Trans	Manual	1			EM-2394		
	Trans	Auto	1			EM-2378 @			
1972-75		Trans	Manual	1			EM-2378 @		
V8 6.4L 389ci	1960-61	LH Front		1	EM-2204				
		RH Front		1	EM-2205				
		Trans	Manual	2			EM-2206		
<b>VIBE</b>									
L4	L4 1.8L	2009-10	Trans	Auto	1			EM-9390	
	L4 1.8L 1794cc	2007	Front		1	EM-9158			
			2003-06	Front		1	EM-9158		
			2007	RH Front	Auto	1	EM-9164		
			2003-06	RH Front	Auto; FWD	1	EM-9164		
			2007	Rear	Auto	1	EM-9155		
				Rear	Manual	1	EM-9157		
			2003-06	Rear	Auto, AWD	1	EM-9418		
				Rear	Auto; FWD	1	EM-9155		
				Rear	Manual; FWD	1	EM-9157		
			2003-07		Trans	Exc. GT; Auto	1		
	Trans	Exc. GT; Manual			1			EM-9163	
	L4 1.8L 1795cc	2003-06	Front	GT	1	EM-9158			
			RH Front	GT	1	EM-9412			
			Rear	GT	1	EM-9157			
			Trans	GT; Manual	1			EM-9163	
	L4 1.8L 1798cc	2009-10	Front		1	EM-9391			
RH Front				1	EM-9449				
Rear				1	EM-9400				

# Engine, Transmission, And Torque Strut Mounts

CYL	ENG. SIZE	YEAR	LOCATION	DESCRIPTION	QTY	ENGINE	TORQUE STRUT	TRANSMISSION	
<b>PONTIAC PASSENGER CAR (continued)</b>									
<b>VIBE (continued)</b>									
L4	L4 2.4L	2009-10	Front		1	EM-9419			
			RH Front	AWD	1	EM-9447			
			Rear	AWD	1	EM-9436			
			Rear	FWD	1	EM-9491			
	L4 2.4L 2362cc	2009-10	Trans	Auto	1			EM-9462	
<b>WAVE</b>									
L4	L4 1.6L	2005-07	Torq Str - Front		1		EM-3114		
			Trans		1			EM-3113	
	L4 1.6L 1598cc	2005-07	Front	Hydraulic Mount	1	EM-3113			
<b>PONTIAC SPORT UTILITY</b>									
<b>AZTEK</b>									
V6	V6 3.4L 207ci	2001-05	RH Front	AWD	1	EM-2987			
			RH Front	AWD; When Current Stock is Depleted, Re-order EM-2987	1	EM-2906			
			RH Front	FWD	1	EM-2987			
			Torq Str - Front	Brkt to Radiator Support	1		EM-2900		
			Torq Str - Front	Complete Unit; LH & RH Front	2		EM-2899		
			Torq Str - Front	Insert; LH & RH Front	2		EM-2716		
			Trans		1			EM-2818	
<b>TORRENT</b>									
V6	V6 3.4L	2006-09	RH Front		1	EM-3110			
		2007-09	Trans - LH Front		1			EM-3082	
			Trans - LH Rear		1			EM-3069	
	V6 3.4L 207ci	2006	Trans - LH Front		1			EM-3082	
			Trans - LH Rear		1			EM-3069	
			Trans - Upper		1			EM-5475	
	V6 3.6L 217ci	2008-09	Trans - Center		1			EM-3154	
<b>PONTIAC VAN</b>									
<b>MONTANA</b>									
V6	V6 3.4L 207ci	1999-05	Front		1	EM-2796			
			Torq Str - Front	Brkt to Radiator Support	1		EM-2900		
			Torq Str - Front	Complete Unit; LH & RH Front	2		EM-2899		
			Torq Str - Front	Insert; LH & RH Front	2		EM-2716		
			Trans		1			EM-2818	
	V6 3.5L 213ci	2005-06	Front	AWD	1	EM-2987			
			LH Front	FWD	1	EM-2987			
			RH Front	AWD; When Current Stock is Depleted, Re-order EM-2987	1	EM-2906			
			Torq Str - Front	LH & RH Front	2		EM-2899		
			Trans	Auto	1			EM-2818	
	V6 3.9L 3880cc	2006	Front		1	EM-2987			
			Torq Str - Front		1		EM-2899		
			Torq Str - Rear		1		EM-2899		
			Trans	Auto	1			EM-2818	
<b>TRANS SPORT</b>									
V6	V6 3.1L 189ci	1990-95	Front	FWD	1	EM-2548			
			Torq Str - Front		1		EM-2396		
			Trans - LH Front		1			EM-2466	
			Trans - LH Rear		1			EM-2467	
	V6 3.4L 207ci	1997-98	1997-98	Front		1	EM-2796		
			1996	Front		1	EM-2548		
			1997-98	Torq Str - Front	Brkt to Radiator Support; LH & RH Front	2		EM-2900	

# Engine, Transmission, And Torque Strut Mounts

CYL	ENG. SIZE	YEAR	LOCATION	DESCRIPTION	QTY	ENGINE	TORQUE STRUT	TRANSMISSION
<b>PONTIAC VAN (continued)</b>								
<b>TRANS SPORT (continued)</b>								
V6	V6 3.4L 207ci	1997-98	Torq Str - Front	Complete Unit; LH & RH Front	2		EM-2899	
			Torq Str - Front	Insert; LH & RH Front	2		EM-2716	
		1996	Torq Str - Front	Insert	1		EM-2716	
			Trans - LH Front		1			EM-2466
			Trans - LH Rear		1			EM-2467
	V6 3.8L 231ci	1997-98	Trans		1		EM-2818	
			1992-95	Front		1	EM-2548*	
		Torq Str - Front			1		EM-2396	
		Trans - LH Front			1			EM-2466
		Trans - LH Rear		1			EM-2467	
<b>RAM VAN</b>								
<b>C/V (CARGO VAN)</b>								
V6	V6 3.6L 220ci	2012-15	Front	Complete Unit	1	EM-4050		
			Front	Insert	1	EM-4094		
			Right		1	EM-4012		
<b>RENAULT PASSENGER CAR</b>								
<b>LECAR</b>								
L4	L4 1.3L 1289cc	1977-79	LH Front		1	EM-2738		
			RH Front		1	EM-2737		
			Trans		1		EM-2739	
	L4 1.4L 1397cc	1980-83	LH Front		1	EM-2738		
			RH Front		1	EM-2737		
			Trans		1		EM-2739	
<b>R5</b>								
L4	L4 1.3L 1289cc	1976	LH Front		1	EM-2738		
			RH Front		1	EM-2737		
			Trans		1		EM-2739	
<b>SAAB PASSENGER CAR</b>								
<b>9-3</b>								
L4	L4 2.0L	1999-03	RH Front	Auto	1	EM-5617		
			RH Front	Manual	1	EM-5492		
			Rear	Auto	1	EM-9291		
		1999-02	Trans	Auto	1		EM-5372	
			Trans	Manual	1		EM-5947	
	L4 2.3L 2290cc	1999-02	RH Front	Manual	1	EM-5492		
			Trans	Manual	1		EM-5947	
<b>9-5</b>								
L4	L4 2.3L	1999-01	LH Front		1	EM-5436		
		2000-09	Torq Str - Front	Auto	1		EM-9292	
		1999	Torq Str - Front	Auto	1		EM-9290	
			Torq Str - Rear	Manual	1		EM-5437	
V6	V6 3.0L	1999-01	LH Front		1	EM-5436		
		2000-03	Torq Str - Front		1		EM-9292	
		1999	Torq Str - Rear	Auto	1		EM-9290	
			Torq Str - Rear	Manual	1		EM-5437	
<b>900</b>								
L4	L4 2.0L	1991-94	Front		1	EM-5461		
		1990	Front		1	EM-5461		
		1986-88	Front		1	EM-5397		
		1981-85	Front		1	EM-5397		
		1996-98	RH Front	Auto	1	EM-5617		
			RH Front	Manual	1	EM-5492		

# Engine, Transmission, And Torque Strut Mounts

CYL	ENG. SIZE	YEAR	LOCATION	DESCRIPTION	QTY	ENGINE	TORQUE STRUT	TRANSMISSION	
<b>SAAB PASSENGER CAR (continued)</b>									
<b>900 (continued)</b>									
L4	L4 2.0L	1991-94	RH Front		1	EM-5462			
		1990	RH Front		1	EM-5462			
		1986-88	RH Front		1	EM-5460			
		1981-85	RH Front		1	EM-5460			
		1996-98	Rear	Auto		1	EM-9291		
			Trans	Auto		1			EM-5372
			Trans	Manual		1			EM-5947
		1994-95	Trans	Auto		1			EM-5372
			Trans	Manual		1			EM-5947
	1981-88	Trans		1			EM-5488		
	L4 2.1L	1991-94	Front		1	EM-5461			
			RH Front		1	EM-5462			
		1994	Trans	Auto		1		EM-5372	
			Trans	Manual		1		EM-5947	
	L4 2.3L	1994-98	RH Front	Auto		1	EM-5617		
			RH Front	Manual		1	EM-5492		
			Rear	Auto		1	EM-9291		
1996-98		Trans	Auto		1			EM-5372	
		Trans	Manual		1			EM-5947	
1994-95		Trans	Auto		1			EM-5372	
	Trans	Manual		1			EM-5947		
V6	V6 2.5L	1996-97	RH Front	Auto	1	EM-5617			
		1994-95	RH Front	Auto	1	EM-5617			
			RH Front	Manual	1	EM-5492			
		1996-97	Trans	Auto	1			EM-5372	
<b>9000</b>									
L4	L4 2.0L	1986-89	Front		1	EM-9293			
		1990	LH Rear		1	EM-9289			
		1986-89	Rear		1	EM-9294			
		1986-90	Torq Str - Rear		1		EM-5373		
		1986-89	Trans	Auto	1			EM-5489	
	L4 2.3L	1990-98	Front		1	EM-5490			
			LH Rear		1	EM-9289			
			Torq Str - Rear		1		EM-5373		
		Trans		1			EM-5489		
V6	V6 3.0L	1995-97	Front		1	EM-5490			
			LH Rear		1	EM-9289			
			Trans		1			EM-5489	
<b>SAAB SUV</b>									
<b>9-7X</b>									
L6	L6 4.2L 256ci	2005-09	L & R Front		2	EM-3021*			
			Trans		1			EM-3027	
V8	V8 5.3L	2005-09	LH Front		1	EM-5694			
			RH Front		1	EM-5693			
<b>SATURN PASSENGER CAR</b>									
<b>ION</b>									
L4	L4 2.0L	2004-07	Front	Red Line	1	EM-3108			
		2005-07	Trans - Front	Red Line	1			EM-3092	
			Trans - Rear	Red Line	1			EM-3092	
	L4 2.2L	2003-07	Front	Auto	1	EM-3109			
			Front	Manual	1	EM-3108			
	L4 2.2L 2198cc	2003-04	Trans - Center	Auto	1			EM-5645	
			Trans - LH Front	Auto	1			EM-3041	
Trans - LH Front			Manual	1			EM-3042		

# Engine, Transmission, And Torque Strut Mounts

CYL	ENG. SIZE	YEAR	LOCATION	DESCRIPTION	QTY	ENGINE	TORQUE STRUT	TRANS-MISSION
<b>SATURN PASSENGER CAR (continued)</b>								
<b>ION (continued)</b>								
L4	L4 2.2L 2198cc	2003-04	Trans - LH Rear		1			EM-3043
		2005-07	Trans - Rear	Auto	1			EM-3086
<b>AURA</b>								
L4	L4 2.4L	2007-08	Front		1	EM-3117		
<b>ION</b>								
L4	L4 2.4L	2006-07	Front	Auto	1	EM-3109		
			Front	Manual	1	EM-3108		
<b>AURA</b>								
L4	L4 2.4L	2009	RH Front		1	EM-3118		
			Trans - Center	Auto; 4 Spd	1			EM-4047
			Trans - Front	Auto; 4 Spd	1			EM-4027
			Trans - Front	Auto; 6 Spd	1			EM-4046
		2008	Trans - Front	Auto; 4 Spd	1			EM-4027
		2007	Trans - LH Rear		1			EM-3094
		2009	Trans - Rear	Auto; 6 Spd	1			EM-4045
		2008	Trans - Rear	Auto; 4 Spd; 1st Design Stamped Part	1			EM-3094
V6	V6 3.5L	2007-08	Front	Hydraulic Mount	1	EM-3097		
		2008	Trans - Center		1			EM-3096
			Trans - Front		1			EM-4027
		2007	Trans - LH Front		1			EM-5659
	Trans - LH Rear			1			EM-3094	
	V6 3.6L	2007-09	Front	Hydraulic Mount	1	EM-3097		
Trans - Center				1			EM-3135	
<b>L100</b>								
L4	L4 2.2L 134ci	2001-02	RH Front	Auto	1	EM-3022'		
			RH Front	Manual	1	EM-3091		
			Rear	Auto	1	EM-3031		
			Trans	Auto	1			EM-3032
<b>L200</b>								
L4	L4 2.2L 134ci	2001-03	RH Front	Auto	1	EM-3022'		
			RH Front	Manual	1	EM-3091		
			Rear	Auto	1	EM-3031		
			Trans	Auto	1			EM-3032
<b>L300</b>								
L4	L4 2.2L 134ci	2004	LH Front		1	EM-3033'		
			RH Front		1	EM-3023'		
			Rear		1	EM-3031		
			Trans	Auto	1			EM-3032
V6	V6 3.0L	2001-05	Trans	Auto	1			EM-3032
	V6 3.0L 3000cc	2001-05	LH Front		1	EM-3033'		
			RH Front		1	EM-3023'		
			Rear		1	EM-3031		
<b>LS</b>								
L4	L4 2.2L	2000	RH Front	Auto	1	EM-3022'		
			RH Front	Manual	1	EM-3091		
			Rear	Auto	1	EM-3031		
			Trans	Auto	1			EM-3032
<b>LS1</b>								
L4	L4 2.2L	2000	Trans	Auto	1			EM-3032
	L4 2.2L 2198cc	2000	RH Front	Auto	1	EM-3022'		
			RH Front	Manual	1	EM-3091		
			Rear	Auto	1	EM-3031		

# Engine, Transmission, And Torque Strut Mounts

CYL	ENG. SIZE	YEAR	LOCATION	DESCRIPTION	QTY	ENGINE	TORQUE STRUT	TRANSMISSION
<b>SATURN PASSENGER CAR (continued)</b>								
<b>LS2</b>								
V6	V6 3.0L	2000	LH Front	Hydraulic Mount	1	EM-3033'		
			RH Front		1	EM-3023'		
			Rear	Auto	1	EM-3031		
			Trans	Auto	1			EM-3032
<b>LW1</b>								
L4	L4 2.2L	2000	RH Front		1	EM-3022'		
			Rear		1	EM-3031		
			Trans	Auto	1			EM-3032
<b>LW2</b>								
V6	V6 3.0L	2000	LH Front		1	EM-3033'		
			RH Front		1	EM-3023'		
			Rear		1	EM-3031		
			Trans	Auto	1			EM-3032
<b>LW200</b>								
L4	L4 2.2L	2001-03	RH Front	Auto	1	EM-3022'		
			RH Front	Manual	1	EM-3091		
			Rear	Auto	1	EM-3031		
			Trans	Auto	1			EM-3032
<b>LW300</b>								
L4	L4 2.2L	2001-03	Trans	Auto	1			EM-3032
V6	V6 3.0L	2001-03	LH Front		1	EM-3033'		
			RH Front		1	EM-3023'		
			Rear		1	EM-3031		
<b>SKY</b>								
L4	L4 2.0L 1998cc	2007-10	LH Front		1	EM-3160		
			RH Front	Re-use Old Heat Shield	1	EM-3160		
			Trans		1			EM-3161
			Trans	Adapter	1			EM-4126
	L4 2.4L 145ci	2007-10	LH Front		1	EM-3160		
			RH Front	Re-use Old Heat Shield	1	EM-3160		
			Trans		1			EM-3161
			Trans	Adapter	1			EM-4126
<b>SC</b>								
L4	L4 1.9L	1991-92	RH Front		1	EM-2827		
			1992	Torq Str - Front	1		EM-2825	
		1991-92	Torq Str - Rear	1		EM-2825		
			Trans	Auto	1			EM-2826
			Trans	Manual	1			EM-2826
<b>SC1</b>								
L4	L4 1.9L	1993-02	Torq Str - Front		1		EM-2825	
			Torq Str - Rear		1		EM-2825	
			Trans	Auto	1			EM-2826
			Trans	Manual	1			EM-2826
	L4 1.9L 116ci	1993-02	RH Front		1	EM-2827		
<b>SC2</b>								
L4	L4 1.9L	1993-02	RH Front		1	EM-2827		
			Torq Str - Front		1		EM-2825	
			Torq Str - Rear		1		EM-2825	
			Trans	Auto	1			EM-2826
			Trans	Manual	1			EM-2826

# Engine, Transmission, And Torque Strut Mounts

CYL	ENG. SIZE	YEAR	LOCATION	DESCRIPTION	QTY	ENGINE	TORQUE STRUT	TRANSMISSION
<b>SATURN PASSENGER CAR (continued)</b>								
<b>SL</b>								
L4	L4 1.9L	1992-02	RH Front		1	EM-2827		
			Torq Str - Front		1		EM-2825	
			Torq Str - Rear		1		EM-2825	
			Trans	Auto	1			EM-2826
			Trans	Manual	1			EM-2826
<b>SL1</b>								
L4	L4 1.9L	1992-02	RH Front		1	EM-2827		
			Torq Str - Front		1		EM-2825	
			Torq Str - Rear		1		EM-2825	
			Trans	Auto	1			EM-2826
			Trans	Manual	1			EM-2826
<b>SL2</b>								
L4	L4 1.9L	1992-02	RH Front		1	EM-2827		
			Torq Str - Front		1		EM-2825	
			Torq Str - Rear		1		EM-2825	
			Trans	Auto	1			EM-2826
			Trans	Manual	1			EM-2826
<b>SW1</b>								
L4	L4 1.9L	1993-99	Torq Str - Front		1		EM-2825	
			Torq Str - Rear		1		EM-2825	
			Trans		1			EM-2826
	L4 1.9L 116ci	1993-99	RH Front		1	EM-2827		
<b>SW2</b>								
L4	L4 1.9L	1993-01	RH Front		1	EM-2827		
			Torq Str - Front		1		EM-2825	
			Trans		1			EM-2826
<b>SATURN SUV</b>								
<b>OUTLOOK</b>								
V6	V6 3.6L	2009-10	Torq Str - Right		1		EM-3141	
		2007-08	Torq Str - Right	Bracket Only	1		EM-3143	
			Torq Str - Right	Strut	1		EM-3133	
	V6 3.6L 217ci	2009-10	Front		1	EM-4037		
			Rear		1	EM-4035		
			Trans		1			EM-4036
<b>VUE</b>								
L4	L4 2.2L	2002-07	RH Front		1	EM-3108		
	L4 2.4L	2008-10	Right		1	EM-3108		
			Trans - Upper		1			EM-4064
V6	V6 3.0L 181ci	2002-03	Trans - LH Rear		1			EM-3040
	V6 3.6L 217ci	2008-10	Trans - Rear		1			EM-4063
<b>SATURN VAN</b>								
<b>RELAY</b>								
V6	V6 3.5L 213ci	2005-06	Front	AWD	1	EM-2987		
			Front	FWD	1	EM-2987		
			RH Front	AWD; When Current Stock is Depleted, Re-order EM-2987	1	EM-2906		
			Torq Str - Front	Brkt to Radiator Support; LH & RH Front	2		EM-2900	
			Torq Str - Front	Complete Unit; LH & RH Front	2		EM-2899	
			Torq Str - Front	Insert Only; LH & RH Front	2		EM-2716	
			Trans		1			EM-2818
	V6 3.9L	2006-07	RH Front		1	EM-2987		
			Torq Str - Front	Brkt to Radiator Support; LH & RH Front	2		EM-2900	

# Engine, Transmission, And Torque Strut Mounts

CYL	ENG. SIZE	YEAR	LOCATION	DESCRIPTION	QTY	ENGINE	TORQUE STRUT	TRANSMISSION
<b>SATURN VAN (continued)</b>								
<b>RELAY (continued)</b>								
V6	V6 3.9L	2006-07	Torg Str - Front	Complete Unit; LH & RH Front	2		EM-2899	
			Torg Str - Front	Insert Only; LH & RH Front	2		EM-2716	
			Trans		1			EM-2818
<b>SCION PASSENGER CAR</b>								
<b>TC</b>								
L4	L4 2.4L	2005-10	Front		1	EM-9158		
			Rear	Auto	1	EM-5986		
			Rear	Manual	1	EM-5988		
			Right		1	EM-5916		
<b>XA</b>								
L4	L4 1.5L 1497cc	2004-06	RH Front		1	EM-9015		
			Rear		1	EM-8968		
			Trans	Auto	1		EM-9284	
			Trans	Manual	1		EM-8888	
<b>XD</b>								
L4	L4 1.8L 1798cc	2008-13	Torg Str - Rear L	Auto	1		EM-5944	
			Torg Str - Rear L	Manual	1		EM-9612	
			Torg Str - Upper	Auto	1		EM-7042	
			Trans	Auto	1		EM-7015	
<b>SCION VAN</b>								
<b>XB</b>								
L4	L4 1.5L 1497cc	2004-06	RH Front		1	EM-9015		
			Rear		1	EM-8968		
			Trans	Auto	1		EM-9284	
			Trans	Manual	1		EM-8888	
	L4 2.4L 2362cc	2008-14	Front		1	EM-9497		
			Right		1	EM-5973		
<b>SEAT</b>								
<b>ALTEA</b>								
L4	2.0L	2005-06	Front Lower	Mexican Vehicle	1	EM-9260		
			Front Upper	Mexican Vehicle	1	EM-9263		
			RH Front	Hydraulic Mount; Mexican Vehicle	1	EM-9092		
			Rear	Mexican Vehicle	1	EM-9283		
			Trans	Auto; Hydraulic Mount Mexican Vehicle	1		EM-9262	
<b>CORDOBA</b>								
L4	1.6L 1598cc	2000-02	Front	Auto; Mexican Vehicle	1	EM-8224		
			Front	Manual; Bracket Only; Mexican Vehicle	1	EM-5612		
			Front	Manual; Mexican Vehicle	1	EM-8224		
			RH Front	Mexican Vehicle	1	EM-8222		
			Trans	Mexican Vehicle	1		EM-8287	
<b>IBIZA</b>								
L4	1.6L 1598cc	2000-02	Front	Auto; Mexican Vehicle	1	EM-8224		
			Front	Manual; Bracket Only; Mexican Vehicle	1	EM-5612		
			Front	Manual; Mexican Vehicle	1	EM-8224		
			RH Front	Mexican Vehicle	1	EM-8222		
			Trans	Mexican Vehicle	1		EM-8287	
	1.8L GAS	2005-08	RH Front	Hydraulic Mount; Mexican Vehicle	1	EM-9092		



# Engine, Transmission, And Torque Strut Mounts

CYL	ENG. SIZE	YEAR	LOCATION	DESCRIPTION	QTY	ENGINE	TORQUE STRUT	TRANSMISSION			
<b>SEAT (continued)</b>											
<b>IBIZA (continued)</b>											
L4	1.8L GAS	2005-08	Rear	Mexican Vehicle	1	EM-9208					
		2005-06	Trans	Hydraulic Mount; Mexican Vehicle	1			EM-9101			
<b>LEON</b>											
L4	1.8L GAS	2001-06	RH Front	Hydraulic Mount; Mexican Vehicle	1	EM-9092					
			Rear	Mexican Vehicle	1	EM-9208					
			Trans	Hydraulic Mount; Mexican Vehicle	1			EM-9101			
	2.0L	2007-08	Front Lower	Mexican Vehicle	1	EM-9260					
			Front Upper	Mexican Vehicle	1	EM-9263					
			RH Front	Hydraulic Mount; Mexican Vehicle	1	EM-9092					
			Rear	Mexican Vehicle	1	EM-9283					
			Trans	Manual; Hydraulic Mount Mexican Vehicle	1			EM-9245			
			<b>TOLEDO</b>								
			L4	1.8L GAS	2002-05	RH Front	Hydraulic Mount; Mexican Vehicle	1	EM-9092		
Rear	Mexican Vehicle	1				EM-9208					
Trans	Hydraulic Mount; Mexican Vehicle	1						EM-9101			
<b>SUBARU PASSENGER CAR</b>											
<b>DL</b>											
H4	H4 1.6L 1595cc	1982-84	L & R Front		2	EM-8641					
		1976-84	Trans - L & R		2			EM-8665			
	H4 1.8L	1985-89	Torq Str - Front	Complete Unit	1		EM-5602				
			Torq Str - Front	Insert Only; Small Bushing	1		EM-5603				
		1986-87	Trans	Auto	1			EM-5599			
			Trans	Manual	2			EM-8640			
			1985	Trans	Manual	2			EM-8640		
	H4 1.8L 1781cc	1986-89	Front	Auto	1	EM-8641					
			1980-84	Front	Auto	1	EM-8661				
			Front	Manual	1	EM-8641					
		1986-89	Rear	Manual	1	EM-8640					
		1985	Rear	Manual	1	EM-8640					
		1980-84	Trans - L & R		2			EM-8665			
		1988-89	Trans	Manual	2			EM-8640			
<b>GL</b>											
H4	H4 1.6L 1595cc	1979-80	L & R Front		2	EM-8641					
		1986-87	Trans - Lower	Manual	2			EM-8665			
			Trans	Auto	2			EM-5186			
		1979-80	Trans	Auto	1			EM-8661			
			Trans	Manual	1			EM-8665			
	H4 1.8L	1985-89	Torq Str - Front	Complete Unit	1		EM-5602				
			Torq Str - Front	Insert Only; Small Bushing	1		EM-5603				
	H4 1.8L 1781cc	1985-89	Front		1	EM-8641					
			1980-84	Front	Auto	1	EM-8661				
				Front	Manual	1	EM-8641				
		1985-89	Rear	Manual	1	EM-8640					
		1980-84	Rear	Manual	1	EM-8665					
		1988-89	Trans	Manual, Hatchback	1			EM-8665			
			Trans	Manual; exc. Hatchback	2			EM-8640			
		1985-87	Trans	Auto	1			EM-5599			
			Trans	Manual, Hatchback	1			EM-8665			

# Engine, Transmission, And Torque Strut Mounts

CYL	ENG. SIZE	YEAR	LOCATION	DESCRIPTION	QTY	ENGINE	TORQUE STRUT	TRANSMISSION	
<b>SUBARU PASSENGER CAR (continued)</b>									
<b>GL (continued)</b>									
H4	H4 1.8L 1781cc	1985-87	Trans	Manual; exc. Hatchback	1			EM-8640	
		1980-84	Trans	Manual	1			EM-8665	
<b>GL-10</b>									
H4	H4 1.8L	1988-89	Torq Str - Front	Complete Unit	1		EM-5602		
			Torq Str - Front	Insert Only; Small Bushing	1		EM-5603		
<b>IMPREZA</b>									
H4	H4 1.8L 1781cc	1993-97	L & R Front		2	EM-9024			
			Torq Str - Front		1		EM-5187		
		1996-97	Trans - LH	Auto; AWD	1			EM-5189	
		1993-95	Trans - LH	Auto; AWD	1			EM-5189	
		1996-97	Trans - RH	Auto; AWD	1			EM-5188	
		1993-95	Trans - RH	Auto; AWD	1			EM-5188	
		1996-97	Trans	Manual; AWD	1			EM-5190	
		1993-95	Trans	Auto; FWD	1			EM-7007	
			Trans	Manual; AWD	1			EM-5190	
			Trans	Manual; FWD	1			EM-5597	
	H4 2.0L 1994cc	2002-05	L & R Front		2	EM-9023			
			LH Front	Auto; CVT	1	EM-5959			
		2012-13	RH Front	Auto; CVT	1	EM-5960			
			Trans		1			EM-5945	
		2002-05	Trans	Manual	1			EM-5515	
			Trans	Auto	1			EM-9074	
	H4 2.2L 2212cc	1996-01	L & R Front		2	EM-9023			
			1995	L & R Front	Auto	2	EM-9024		
			L & R Front	Manual	2	EM-9023			
			Rear	FWD	1	EM-5597			
		1995-98	Torq Str - Front		1		EM-5187		
		1995-99	Trans - LH	Auto	1			EM-5189	
			Trans - RH	Auto	1			EM-5188	
		2000-01	Trans	Auto	1			EM-9074	
			Trans	Manual; AWD	1			EM-5515	
		1995-99	Trans	Manual; AWD	1			EM-5515	
	H4 2.5L 2458cc	2008-11	L & R Front	Non Turbo	2	EM-9024			
		2002-07	L & R Front	AWD	2	EM-9024			
		1998-01	L & R Front	AWD	2	EM-9023			
		1998	Torq Str - Front		1		EM-5187		
		2008-11	Trans	Manual; 5 Spd	1			EM-5515	
		2002-07	Trans	Auto	1			EM-9074	
			Trans	Manual; 5 Spd	1			EM-5515	
1998-01		Trans	Auto	1			EM-9074		
	Trans	Manual	1			EM-5515			
<b>LEGACY</b>									
H4	H4 2.2L	1992-94	LH Front		1	EM-5601			
		1990-91	LH Front		1	EM-5601			
		1992-94	RH Front		1	EM-5600			
		1990-91	RH Front		1	EM-5600			
			Rear	FWD	1	EM-5597			
		1990-94	Torq Str - Front	Insert Only; Small Bushing	1		EM-5603		
		1992-94	Trans - LH	Auto; AWD	1			EM-5189	
			Trans - RH	Auto; AWD	1			EM-5188	
			Trans	Auto; FWD	1			EM-7007	
			Trans	Manual; AWD	1			EM-5515	
			Trans	Manual; FWD	1			EM-5597	
		1990-91	Trans	Manual	1			EM-5515	
		H4 2.2L 2212cc	1996-99	L & R Front	Auto	2	EM-9024		

# Engine, Transmission, And Torque Strut Mounts

CYL	ENG. SIZE	YEAR	LOCATION	DESCRIPTION	QTY	ENGINE	TORQUE STRUT	TRANSMISSION	
<b>SUBARU PASSENGER CAR (continued)</b>									
<b>LEGACY (continued)</b>									
H4	H4 2.2L 2212cc	1995	L & R Front	Auto; FWD	2	EM-9024			
			LH Front	LS, AWD, Auto	1	EM-5597			
			RH Front	LS, AWD, Auto	1	EM-5600			
		1999	Torq Str - Front	AWD	1		EM-5191		
		1997-98	Torq Str - Front	AWD	1		EM-5191		
		1995-96	Torq Str - Front	AWD	1		EM-5191		
			Torq Str - Front	FWD	1		EM-5187		
			Trans - LH	Auto; AWD	1			EM-5189	
			Trans - RH	Auto; AWD	1			EM-5188	
		1997-99	Trans	Auto; AWD	1			EM-9074	
			Trans	Manual	1			EM-5515	
		1995-96	Trans	Auto; FWD	1			EM-7007	
	Trans		Manual	1			EM-5515		
	H4 2.5L	1996-99	Trans	Auto	1			EM-9074	
			Trans	Manual	1			EM-5515	
	H4 2.5L 2458cc	2000-04	L & R Front		2	EM-9024			
					2	EM-9024			
		1996-99	L & R Front	Auto	2	EM-9024			
				Manual	2	EM-9023			
		2005-09	LH Front	Non Turbo	1	EM-5971			
				Turbo	1	EM-5971			
				Non Turbo	1	EM-5983			
				Turbo	1	EM-5983			
		1996-99	Torq Str - Front		1		EM-5191		
		2006-09	Torq Str - Rear		1		EM-9559		
		2000-05	Torq Str - Rear		1		EM-9559		
		2010-11	Trans	Manual	1			EM-5515	
		2007-09	Trans	Auto w/o Turbo	1			EM-9074	
				Manual; w/o Turbo	1			EM-5515	
				Turbo, Auto	1			EM-9560	
				Turbo, Manual	1			EM-9566	
		2005-06	Trans	Auto w/o Turbo	1			EM-9074	
				Manual; 5 Spd	1			EM-5515	
Turbo, Auto				1			EM-9560		
2000-04		Trans	Auto	1			EM-9074		
	Manual; 5 Spd		1			EM-5515			
L4 2.5L	2013	Trans	Auto	1			EM-5945		
<b>LOYALE</b>									
H4	H4 1.8L	1990-94	Torq Str - Front	Complete Unit	1		EM-5602		
			Torq Str - Front	Insert Only; Small Bushing	1		EM-5603		
	H4 1.8L 1781cc	1990-93	1994	Front		1	EM-5598		
				L & R Front		2	EM-8641		
			1990-93	L & R Front		2	EM-8641		
			1994	Rear		1	EM-8665		
			1990-93	Rear		1	EM-8665		
			1990-94	Trans - Center	Auto	1			EM-9570
				Trans	Manual	2			EM-8640
<b>RX</b>									
H4	H4 1.8L 1781cc	1986-89	Trans	Manual	2			EM-8640	
<b>STANDARD</b>									
H4	H4 1.6L 1595cc	1987	Front	Auto	1	EM-8661			
			RH Front		1	EM-8640			
		1985-86	RH Front		1	EM-8640			
		1980-84	RH Front		1	EM-8640			
		1987	Rear	Manual	1	EM-8641			
		1985-86	Rear	Manual	1	EM-8641			
		1980-84	Rear	Manual	1	EM-8641			

# Engine, Transmission, And Torque Strut Mounts

CYL	ENG. SIZE	YEAR	LOCATION	DESCRIPTION	QTY	ENGINE	TORQUE STRUT	TRANSMISSION		
<b>SUBARU PASSENGER CAR (continued)</b>										
<b>STANDARD (continued)</b>										
H4	H4 1.6L 1595cc	1980-87	Trans - L & R		1			EM-8665		
	H4 1.8L 1781cc	1987	L & R Front		2	EM-8641				
		1981-82	L & R Front		2	EM-8641				
			Trans	Auto		1			EM-5186	
			Trans	Manual		1			EM-8665	
<b>SVX</b>										
H6	H6 3.3L 3318cc	1992-97	Torq Str - Front		1		EM-5187			
<b>XT</b>										
H4	H4 1.8L	1985-89	Torq Str - Front	Complete Unit	1		EM-5602			
			Torq Str - Front	Insert Only; Small Bushing	1		EM-5603			
	H4 1.8L 1781cc	1985-91	Front		1	EM-8641				
			Trans	Auto	1			EM-5599		
			Trans	Manual	2			EM-8640		
H6	H6 2.7L	1988-91	Torq Str - Front	Insert Only; Small (50mm) Bushing	1		EM-5603			
<b>XV CROSSTREK</b>										
H4	H4 2.0L	2013	LH Front	Auto; CVT	1	EM-5959				
			RH Front	Auto; CVT	1	EM-5960				
		2013-14	Trans	Manual	1			EM-5515		
<b>SUBARU SPORT UTILITY</b>										
<b>BAJA</b>										
H4	H4 2.5L 2458cc	2003-06	L & R Front		2	EM-9024				
			Torq Str - Front		1		EM-9559			
			Torq Str - Front	When Stock is Depleted, Re-order EM-9559	1		EM-9561			
			Trans		1			EM-9552		
			Trans	Manual	1			EM-5515		
<b>BRAT</b>										
H4	H4 1.6L 1595cc	1978-80	L & R Front		2	EM-8641				
			Trans - L & R		1			EM-8665		
	H4 1.8L 1781cc	1982-87	Torq Str - Front	Insert Only; Small Bushing	1		EM-5603			
			1980-81	Rear	Manual	1	EM-8665			
			1984-87	Trans		1			EM-5186	
<b>FORESTER</b>										
H4	H4 2.5L 2458cc	2009-10	L & R Front	Non Turbo	2	EM-9024				
		2003-08	L & R Front		2	EM-9024				
		1998-02	L & R Front		2	EM-9023				
		2009-10	Left	Turbo		1	EM-5971			
			Right	Turbo		1	EM-5983			
		2002-08	Torq Str - Front		1		EM-5187			
		1998-01	Torq Str - Front	Complete Unit		1		EM-5191		
			Torq Str - Front	Insert Only; Small Bushing		1		EM-5603		
		2011-13	Trans	Turbo; Auto; AWD		1			EM-9074	
		2005-10	Trans	Auto; AWD		1			EM-9074	
			Trans	Manual		1			EM-5515	
			2004	Trans	Auto; AWD		1		EM-9074	
		2003	Trans	Manual; w/o Turbo		1			EM-5515	
			Trans	Turbo, Manual		1			EM-5515	
			Trans	Auto; AWD		1			EM-9074	
		1998-02	Trans	Manual; w/o Turbo		1			EM-5515	
			Trans	Auto; AWD		1			EM-9074	
			Trans	Manual		1			EM-5515	
			H4 2.5L 2498cc	2011-12	L & R Front	Non Turbo	2	EM-9024		

# Engine, Transmission, And Torque Strut Mounts

CYL	ENG. SIZE	YEAR	LOCATION	DESCRIPTION	QTY	ENGINE	TORQUE STRUT	TRANSMISSION
<b>SUBARU SPORT UTILITY (continued)</b>								
<b>FORESTER (continued)</b>								
H4	H4 2.5L 2498cc	2013	LH Front	Auto; Exc. Turbo	1	EM-5959		
			RH Front	Auto; Exc. Turbo	1	EM-5960		
		2014	Trans	CVT Trans.	1			EM-5945
			Trans	Manual	1			EM-5515
		2011-13	Trans	Non-Turbo; Auto; AWD	1			EM-9074
			Trans	Non-Turbo; Manual	1			EM-5515
<b>TRIBECA</b>								
	H6 3.6L 3630cc	2009-14	Torq Str - Rear		1		EM-9559	
6	H6 3.0L 3000cc	2006-07	Torq Str - Rear		1		EM-9559	
<b>OUTBACK</b>								
	H6 3.0L 3000cc	2005-09	Torq Str - Rear		1		EM-9559	
H4	H4 2.5L	2001-04	Torq Str - Front	Insert Only; Small (50mm) Bushing	1		EM-5603	
			H4 2.5L 2458cc	2000-04	L & R Front		2	EM-9024
	2005-09	Trans	Auto w/o Turbo	1			EM-9074	
		Trans	Manual; w/o Turbo	1			EM-5515	
		Trans	Turbo, Auto	1			EM-9560	
		Trans	Turbo, Manual	1			EM-9566	
	2000-04	Trans	Auto	1			EM-9074	
		Trans	Manual	1			EM-5515	
<b>SUZUKI PASSENGER CAR</b>								
<b>SA310</b>								
L3	L3 1.0L 993cc	1985	Trans - LH	Manual	1			EM-5457
<b>AERIO</b>								
L4	L4 2.0L 2000cc	2002-03	Front	Manual	1	EM-9022		
			RH Front		1	EM-9156		
			Trans	Auto	1			EM-9177
	L4 2.3L 2290cc	2004-07	Front	FWD	1	EM-5873		
			RH Front	Auto	1	EM-9156		
			RH Front	Manual	1	EM-5359		
			Rear	FWD	1	EM-9159		
			2004-06	Trans	Auto	1		
	Trans	Manual	1			EM-9177		
	<b>ESTEEM</b>							
L4	L4 1.6L 1590cc	1995-00	Front		1	EM-9022		
			RH Front		1	EM-9242		
			Rear	Auto	1	EM-8805		
			Rear	Manual	1	EM-8804		
			Trans	Auto	1			EM-8890
			Trans	Manual	1			EM-8890
	L4 1.8L 1790cc	1999-02	Front		1	EM-9022		
			RH Front		1	EM-5358		
			Rear		1	EM-8804		
			Trans		1			EM-8890
<b>FORENZA</b>								
L4	L4 2.0L 2000cc	2004-08	Right		1	EM-5931		
			Torq Str - Lower		1		EM-5933	
			Torq Str - Right		1		EM-5932	
<b>RENO</b>								
L4	L4 2.0L 1998cc	2005-08	Right		1	EM-5931		
			Torq Str - Lower		1		EM-5933	
			Torq Str - Right		1		EM-5932	

# Engine, Transmission, And Torque Strut Mounts

CYL	ENG. SIZE	YEAR	LOCATION	DESCRIPTION	QTY	ENGINE	TORQUE STRUT	TRANSMISSION
<b>SUZUKI PASSENGER CAR (continued)</b>								
<b>SA310</b>								
L3	L3 1.0L 993cc	1985	Front	Auto	1	EM-8283		
			Front	Manual	1	EM-8489		
			Rear	Manual	1	EM-8294		
			Torq Str - Front		1		EM-8521	
			Torq Str - Rear		1		EM-8524	
			Trans	Auto	1			EM-8522
			Trans	Manual	1			EM-8490
<b>SX4</b>								
L4	L4 2.0L 1995cc	2010-13	Front		1	EM-5951		
<b>SWIFT</b>								
L3	L3 1.0L 993cc	1992-94	Front		1	EM-8517		
			RH Front		1	EM-9133		
			Trans		1			EM-8277
L4	L4 1.3L 1298cc	1995-01	Front		1	EM-8517		
		1989-94	Front		1	EM-8517		
			RH Front		1	EM-9133		
		1995-01	Rear	Manual	1	EM-8277		
		1989-94	Rear	Auto w/ DOHC	1	EM-8277		
			Rear	Auto w/ SOHC	1	EM-8659		
			Rear	Manual	1	EM-8277		
		1989-01	Torq Str - Rear	Auto	1		EM-8658	
		1995-01	Trans	Auto	1			EM-8314
	Trans	Manual	1			EM-8314		
<b>SUZUKI SPORT UTILITY</b>								
<b>GRAND VITARA</b>								
L4	L4 2.4L	2009-11	Trans	Auto	1			EM-9613
			Trans	Manual	1			EM-9613
V6	V6 2.5L 2500cc	1999-05	L & R Front		2	EM-9240		
		1999-02	Trans		1			EM-8825
		2001-02	L & R Front		2	EM-9240		
	V6 2.7L 2737cc	2006-08	Trans	Auto	1			EM-9613
			Trans	Manual	1			EM-9613
		2001-02	Trans		1			EM-8825
V6 3.2L	2009-10	Trans	Auto	1			EM-9613	
<b>SAMURAI</b>								
L4	L4 1.3L 1325cc	1985-95	L & R Front		2	EM-8161		
			Trans	Manual	1			EM-8160
<b>SIDEKICK</b>								
L4	L4 1.3L 1325cc	1989	L & R Front		2	EM-8161		
			Torq Str - Front	2 Door	1		EM-8657	
			Trans	4WD	1			EM-8825
	L4 1.6L 1590cc	1991-98	L & R Front		2	EM-8568		
			L & R Front		2	EM-8568		
			Torq Str - Front	Auto	1		EM-8657	
			Torq Str - Front	Auto	1		EM-8657	
			Trans - LH		1			EM-8825
			Trans		1			EM-8825
	L4 1.8L 1840cc	1996-98	L & R Front		2	EM-8093		
		Trans		1			EM-8825	
<b>VITARA</b>								
L4	L4 1.6L 1590cc	1999-01	L & R Front		2	EM-9240		
		1999-02	Trans	Auto	1			EM-9241
	L4 2.0L 2000cc	1999-03	L & R Front		2	EM-9240		
		Trans	Auto	1			EM-9241	

# Engine, Transmission, And Torque Strut Mounts

CYL	ENG. SIZE	YEAR	LOCATION	DESCRIPTION	QTY	ENGINE	TORQUE STRUT	TRANSMISSION
<b>SUZUKI SPORT UTILITY (continued)</b>								
<b>VITARA (continued)</b>								
V6	V6 2.5L	2004	L & R Front		2	EM-9240		
	V6 2.5L 2500cc	2004	Trans	Auto	1			EM-8825
<b>X-90</b>								
L4	L4 1.6L 1590cc	1996-98	L & R Front		2	EM-8568		
			Torq Str - Front	Auto	1		EM-8656	
			Torq Str - Front	Manual	1		EM-8657	
			Trans - LH		1			EM-8825
<b>XL-7</b>								
V6	V6 2.7L 2737cc	2002-06	L & R Front		2	EM-9240		
		2005	Trans		1			EM-8825
<b>SUZUKI TRUCK</b>								
<b>FORSA</b>								
L3	L3 1.0L	1987-88	Trans - Front		1			EM-5483
			Trans - LH Rear		1			EM-5458
<b>TOYOTA PASSENGER CAR</b>								
<b>AVALON</b>								
V6	V6 3.0L 2995cc	2004	Front	Hydraulic Mount	1	EM-5384		
		2000-03	Front	Hydraulic Mount	1	EM-5384		
		1995-96	Front		1	EM-8711		
		2000-03	Rear		1	EM-9421		
		1997-99	Rear	Insert	1	EM-8699		
		1995-96	Rear		1	EM-8398		
		2004	Torq Str - Front		1		EM-9388	
		2000-03	Torq Str - Front		1		EM-9388	
		1997-99	Torq Str - Front		1		EM-8697	
		1995-96	Torq Str - Front		1		EM-8201	
		2004	Trans		1			EM-8644
		2000-03	Trans		1			EM-8644
		1997-99	Trans		1			EM-8644
		1995-96	Trans		1			EM-8644
	V6 3.5L 3456cc	2008-12	RH Front		1	EM-9238		
		2005-07	RH Front		1	EM-9238		
		2008-13	Torq Str - Front		1		EM-5834	
		2005-07	Torq Str - Rear		1		EM-9535	
		2008-14	Trans		1			EM-9236
		2005-07	Trans		1			EM-9165
<b>CAMRY</b>								
L4	L4 1.8L 1839cc Diesel	1985-86	Front		1	EM-8348		
		1984	Front		1	EM-8348		
			LH Front		1	EM-8189		
		1985-86	RH Front		1	EM-8368		
		1984	RH Front		1	EM-8368		
		1985-86	Rear		1	EM-9122		
		1984	Rear		1	EM-8493		
	L4 1.8L 1839cc	1985-86	Trans	Auto	1			EM-8189
	L4 2.0L 1974cc Diesel	1986	Front		1	EM-8368		
			RH Front		1	EM-8482		
			Rear		1	EM-9122		
	L4 2.0L 1995cc	1986	Front	Auto	1	EM-8195		
			Front	Manual	1	EM-2677		
		1985	Front	Auto	1	EM-8195		
			Front	Manual	1	EM-2677		
		1983-84	Front	Auto	1	EM-8195		
			Front	Manual	1	EM-2677		

# Engine, Transmission, And Torque Strut Mounts

CYL	ENG. SIZE	YEAR	LOCATION	DESCRIPTION	QTY	ENGINE	TORQUE STRUT	TRANSMISSION	
<b>TOYOTA PASSENGER CAR (continued)</b>									
<b>CAMRY (continued)</b>									
L4	L4 2.0L 1995cc	1986	RH Front		1	EM-9051			
		1985	RH Front		1	EM-9051			
		1983-84	RH Front		1	EM-9051			
		1986	Rear	Auto	1	EM-9122			
			Rear	Manual	1	EM-2678			
		1985	Rear	Auto, After 6/85	1	EM-9122			
			Rear	Manual	1	EM-2678			
		1983-84	Rear	Manual	1	EM-2678			
		1983-86	Trans	Auto; Canada	1			EM-9053	
			Trans	Auto; USA	1			EM-5335	
	Trans		Manual; Canada	1			EM-9053		
	L4 2.0L 1998cc	1991	Front	Auto; 4WD	1	EM-8192			
			Front	Auto; FWD	1	EM-8193			
			Front	Manual; FWD	1	EM-8194			
		1989-90	Front	Auto; 4WD	1	EM-8192			
			Front	Auto; FWD	1	EM-8193			
			Front	Manual; 4WD	1	EM-8195			
		1987-88	Front	Manual; FWD	1	EM-8194			
			Front	Auto	1	EM-8193			
		1991	Front	Manual	1	EM-8194			
			RH Front	4WD	1	EM-8196			
		1989-90	RH Front	FWD	1	EM-8207			
			RH Front	4WD	1	EM-8196			
		1987-88	RH Front	FWD	1	EM-8207			
			RH Front	4WD	1	EM-8196			
		1991	Rear	Auto; 4WD	1	EM-9127			
			Rear	FWD	1	EM-8197			
		1989-90	Rear	Auto; 4WD	1	EM-9127			
			Rear	FWD	1	EM-8197			
			Rear	Manual; 4WD	1	EM-8385			
		1987-88	Rear	Auto	1	EM-8198			
			Rear	Manual	1	EM-8406			
		1990-91	Trans - Center	Auto; FWD	1			EM-8208	
		1989	Trans - Center	Auto	1			EM-8208	
			Trans - Center	Manual	1			EM-8684	
		1987-88	Trans - Center	Auto	1			EM-8208	
			Trans - Center	Manual	1			EM-8195	
		1990-91	Trans	Auto; FWD	1			EM-8684	
			Trans	All Trac; Auto; 4WD	1			EM-8189	
		L4 2.2L 2164cc	1997-01	Front	All; Made in Japan	1	EM-8795		
				Front	Auto, Made in USA	1	EM-8795		
				Front	Manual, Made in USA	1	EM-8361		
			1992-96	Front	Auto	1	EM-8485		
				Front	Manual, Made in USA	1	EM-8361		
			1997-01	Rear	Auto	1	EM-8796		
				Rear	Manual	1	EM-8414		
			1992-96	Rear	Auto	1	EM-8209		
				Rear	Manual	1	EM-8414		
			1997-01	Torq Str - Front	Auto; RH Front	1			EM-8698
				Torq Str - Front	Manual; RH Front	1			EM-8200
			1992-96	Torq Str - Front	RH	1			EM-8200
	1992-01		Trans	Auto	1			EM-8979	
			Trans	Manual	1			EM-8529	
	L4 2.4L		2007-09	LH Front	Gas	1	EM-5742		
				RH Front	Gas	1	EM-9237		
				Torq Str - Front		1			EM-5750
				Torq Str - Rear		1			EM-9210



# Engine, Transmission, And Torque Strut Mounts

CYL	ENG. SIZE	YEAR	LOCATION	DESCRIPTION	QTY	ENGINE	TORQUE STRUT	TRANSMISSION	
<b>TOYOTA PASSENGER CAR (continued)</b>									
<b>CAMRY (continued)</b>									
L4	L4 2.4L	2007-11	Trans		1			EM-5757	
			Trans	Gas Engine	1			EM-9236	
		2002-03	Trans	Auto	1				EM-9165
			Trans	Manual, Made in Japan	1				EM-5757
			Trans	Manual, Made in USA	1				EM-5554
	L4 2.4L 2362cc	2007-09	Front	Hybrid	1	EM-5742			
			2002-06	Front		1	EM-9211		
		2010-11	RH Front		1	EM-5141			
			Right	Hybrid	1	EM-9237			
		2007-09	Right	Hybrid	1	EM-9237			
			2010-11	Torq Str - Front		1		EM-5750	
		2002-06	Torq Str - Front	Hybrid	1		EM-5750		
			Torq Str - Front	Made in Japan	1		EM-9148		
		2004-06	Torq Str - Rear		1		EM-9492		
			Trans	Auto, Made in USA	1				EM-9165
			Trans	Manual, Made in Japan	1				EM-5757
	L4 2.5L	2010-11	Trans	Manual, Made in USA	1			EM-9165	
			Front	Gas	1	EM-5742			
			Right	Gas	1	EM-9237			
		2010-14	Torq Str - Front	Gas	1		EM-9588		
		2010-11	Trans	Auto	1				EM-9236
	Trans		Manual	1				EM-9236	
	V6	V6 2.5L 2508cc	1988-91	Front	Auto	1	EM-8192		
Front				Manual	1	EM-8194			
RH Front					1	EM-9129			
Rear					1	EM-8197			
Trans					1			EM-8208	
V6 3.0L		1999-01	Front	Auto	1	EM-8967			
			2002-03	RH Front		1	EM-9239		
		1999-01	Rear	Auto; Insert Only	1	EM-8699			
			Rear	Manual	1	EM-8398			
		2004-06	Torq Str - Front		1		EM-9197		
2002-03		Torq Str - Front		1		EM-9197			
V6 3.0L 2959cc		1994-96	Front		1	EM-8711			
			1992-93	Front	Auto	1	EM-8965		
		1994-96	Front	Manual	1	EM-8207			
			Rear	Auto	1	EM-8398			
		1992-93	Rear		1	EM-8398			
			1992-96	Torq Str - Front		1		EM-8201	
		1997-01	Trans	Auto	1			EM-8644	
			Trans	Manual	1			EM-8529	
		1994-96	Trans	Auto	1			EM-8644	
			1993	Trans	Auto	1		EM-8644	
		1992	Trans	Manual	1			EM-8529	
			Trans	Auto	1			EM-8979	
			Trans	Manual	1			EM-8529	
V6 3.0L 2995cc		2004-06	Front		1	EM-9211			
			1997-98	Front	Auto	1	EM-8967		
		1997-01	Rear	Auto; Insert Only	1	EM-8699			
			Rear	Manual	1	EM-8398			
		1997-01	Torq Str - Front	Auto	1		EM-8697		
		2002-06	Trans	Auto, Made in USA	1			EM-9165	
V6 3.3L		2006	RH Front		1	EM-9212			
			2004-05	RH Front		1	EM-9212		
		2004-06	Torq Str - Front		1		EM-9197		
V6 3.3L 3300cc		2004-06	Trans	Auto	1			EM-9165	
V6 3.5L		2007-11	RH Front		1	EM-9238			

# Engine, Transmission, And Torque Strut Mounts

CYL	ENG. SIZE	YEAR	LOCATION	DESCRIPTION	QTY	ENGINE	TORQUE STRUT	TRANSMISSION
<b>TOYOTA PASSENGER CAR (continued)</b>								
<b>CAMRY (continued)</b>								
V6	V6 3.5L	2007-14	Trans		1			EM-9236
	V6 3.5L 3456cc	2007-14	Torq Str - Front		1		EM-5834	
<b>CARINA</b>								
L4	L4 1.6L 1588cc	1972-73	L & R Front		2	EM-2406		
			Trans	Auto	1			EM-2410
			Trans	Manual	1			EM-2409
<b>CELICA</b>								
L4	L4 1.6L 1587cc	1990-93	Front	Auto	1	EM-8639		
			Front	Manual	1	EM-8491		
			Rear	Auto	1	EM-8385		
			Rear	Manual	1	EM-9118		
	L4 1.8L 1762cc	1994-95	Front		1	EM-8848		
		1996-97	RH Front		1	EM-5819		
		1994-95	RH Front		1	EM-5819		
		1996-97	Rear	Auto	1	EM-9013		
			Rear	Manual	1	EM-8871		
		1994-95	Rear	Auto	1	EM-9013		
			Rear	Manual	1	EM-8871		
		1994-97	Trans		1			EM-8852
	L4 1.8L 1794cc	2000-05	Front	GT	1	EM-9484		
			Rear	GT	1	EM-9574		
			Right	GT	1	EM-9525		
			Trans		1			EM-9541
	L4 1.8L 1795cc	2000-05	Front	Auto	1	EM-9484		
			RH Front	Auto	1	EM-9525		
			RH Front	Manual	1	EM-5759		
			Rear	GTS	1	EM-9574		
			Trans		1			EM-9541
	L4 1.9L 1898cc	1971	RH Front		1	EM-2743		
			Trans	Auto	1			EM-2410
			Trans	Manual	1			EM-2409
	L4 2.0L 1968cc	1972-74	RH Front		1	EM-2743		
			Trans	Auto	1			EM-2410
			Trans	Manual	1			EM-2409
	L4 2.0L 1995cc	1986	Front	Auto	1	EM-8348		
			Front	Manual	1	EM-8195		
			Rear	Auto	1	EM-8407		
			Rear	Manual	1	EM-8385		
			Trans	Auto	1			EM-8970
	L4 2.0L 1998cc	1990-93	Front		1	EM-8213		
		1987-89	Front	Auto	1	EM-8348		
			Front	Manual	1	EM-8213		
		1990-93	RH Front	Insert Only	1	EM-5743		
		1987-89	RH Front		1	EM-8692		
		1990-93	Rear		1	EM-9119		
		1987-89	Rear	Auto	1	EM-8407		
			Rear	Manual	1	EM-9119		
		1986-89	Trans	Auto	1			EM-8970
	L4 2.0L Turbo	1988-89	Front	Manual; All Trac; Turbo	1	EM-8195		
			RH Front	Manual; All Trac; Turbo	1	EM-5762		
			Rear	Manual; All Trac; Turbo	1	EM-9119		
	L4 2.2L 2164cc	1994-99	Front		1	EM-5753		
		1990-93	Front	Auto	1	EM-8359		
			Front	Manual	1	EM-8213		
		1994-99	RH Front	exc Convertible	1	EM-8869		
		1990-93	RH Front	Coupe & Liftback	1	EM-5763		

## Engine, Transmission, And Torque Strut Mounts

CYL	ENG. SIZE	YEAR	LOCATION	DESCRIPTION	QTY	ENGINE	TORQUE STRUT	TRANSMISSION	
<b>TOYOTA PASSENGER CAR (continued)</b>									
<b>CELICA (continued)</b>									
L4	L4 2.2L 2164cc	1994-99	Rear	Auto	1	EM-9013			
			Rear	Manual	1	EM-8871			
		1990-93	Rear		1	EM-8413			
			1994-99	Trans	Auto	1			EM-9495
		Trans		Manual	1			EM-8852	
	L4 2.2L 2189cc	1975-80	L & R Front		2	EM-2407			
			Trans	Auto	1			EM-2410	
			Trans	Manual	1			EM-2410	
	L4 2.4L 2366cc	1981-85	L & R Front		2	EM-8162			
			Trans	Auto	1			EM-2410	
Trans			Manual	1			EM-2410		
L6	L6 2.8L 2754cc	1981-86	L & R Front		2	EM-8212			
<b>COROLLA</b>									
L4	L4 1.2L 1166cc	1969-79	LH Front		1	EM-2747			
			RH Front		1	EM-2748			
			Trans	Manual	1			EM-2408	
	L4 1.6L 1587cc	1993-97	Front		1	EM-8177			
			1990-92	Front	Auto	1	EM-8180		
				Front	Manual	1	EM-8181		
		1988-89	Front	Auto	1	EM-8180			
			Front	Manual	1	EM-8181			
		1986-87	Front	FWD	1	EM-8211			
		1984-85	Front	FWD	1	EM-8211			
		1983	Front	RWD	1	EM-8211			
		1986-87	L & R Front	RWD	2	EM-8210			
		1984-85	L & R Front	RWD	2	EM-8210			
		1993-97	RH Front		1	EM-8178			
		1990-92	RH Front		1	EM-8183			
		1988-89	RH Front		1	EM-9117			
		1986-87	RH Front	FWD	1	EM-8233			
		1984-85	RH Front	FWD	1	EM-8233			
		1983	RH Front	RWD	1	EM-8233			
		1993-97	Rear	Auto	1	EM-8179			
			Rear	Manual	1	EM-9116			
		1990-92	Rear	Auto; 3 Spd FWD	1	EM-8186			
			Rear	Auto; 4 Spd FWD	1	EM-8185			
			Rear	Manual; FWD	1	EM-8187			
		1988-89	Rear	Auto; 3 Spd FWD	1	EM-8186			
			Rear	Auto; 4 Spd FWD	1	EM-8185			
			Rear	Manual; FWD	1	EM-8187			
		1986-87	Rear	Auto; FWD	1	EM-2688			
			Rear	Manual; FWD	1	EM-8375			
		1984-85	Rear	Auto; FWD	1	EM-2688			
			Rear	Manual; FWD	1	EM-8492			
		1983	Rear	Auto; RWD	1	EM-2688			
			Rear	Manual; RWD	1	EM-8214			
		1990-92	Right	AWD	1	EM-5761			
		1992	Trans - Center	Under Trans	1			EM-8190	
		1989-91	Trans - Center	Under Trans	1			EM-8190	
	1988	Trans - Center	Under Trans	1			EM-8190		
	1989-91	Trans - LH	Auto; 4 Spd FWD	1			EM-8188		
		Trans - LH	Manual; FWD	1			EM-8188		
	1993-97	Trans		1			EM-8191		
	1992	Trans	Auto; 3 Spd FWD	1			EM-8188		
		Trans	Auto; 4 Spd FWD	1			EM-8643		
		Trans	Auto; AWD	1			EM-8643		
		Trans	Manual; AWD	1			EM-8643		

# Engine, Transmission, And Torque Strut Mounts

CYL	ENG. SIZE	YEAR	LOCATION	DESCRIPTION	QTY	ENGINE	TORQUE STRUT	TRANSMISSION
<b>TOYOTA PASSENGER CAR (continued)</b>								
<b>COROLLA (continued)</b>								
L4	L4 1.6L 1587cc	1992	Trans	Manual; FWD	1			EM-8188
		1989-91	Trans	Auto; 3 Spd	1			EM-8422
			Trans	Auto; 4 Spd FWD	1			EM-8643
			Trans	Auto; AWD	1			EM-8643
			Trans	Manual; AWD	1			EM-8643
			1988	Trans	Auto; 3 Spd FWD	1		
		Trans		Auto; 4 Spd FWD	1			EM-8643
		Trans		Auto; AWD	1			EM-8643
		Trans		FX	1			EM-5810
		Trans		Manual; AWD	1			EM-8643
		Trans		Manual; FWD	1			EM-8188
		Trans		Manual; GTS	1			EM-8422
		Trans		Auto; FWD	1			EM-9121
		1985-87	Trans	Auto; RWD	1			EM-2690
			Trans	Manual; FWD	1			EM-8648
			Trans	Manual; RWD	1			EM-9114
			1984	Trans	Auto; FWD	1		
		Trans		Manual; FWD	1			EM-8189
		Trans		Manual; RWD	1			EM-2409
		Trans		RWD, Auto	1			EM-2690
	1983	Trans	Auto; RWD	1			EM-2690	
		Trans	Manual; RWD	1			EM-2409	
	L4 1.6L 1588cc	1971-79	LH Front		1	EM-5473		
			RH Front		1	EM-2406		
			Trans	Auto	1			EM-2410
			Trans	Manual	1			EM-2409
	L4 1.8L	2009-11	Front	Auto, Made in USA	1	EM-9391		
			Front	Manual	1	EM-9391		
			RH Front		1	EM-9449		
			Rear		1	EM-9400		
		2009-13	Trans	Auto; Made in USA	1			EM-9390
			Trans	Manual, Made in USA	1			EM-9390
	L4 1.8L 1762cc	1993-97	Front	Auto	1	EM-8177		
			Front	Manual	1	EM-5198		
			RH Front		1	EM-8178		
			Rear	Auto	1	EM-8179		
			Rear	Manual	1	EM-9116		
		1996-97	Trans	Auto, Made in Japan	1			EM-9125
			Trans	Auto, Made in US	1			EM-8415
			Trans	Manual	1			EM-8191
		1993-95	Trans	Auto, Made in Japan	1			EM-9125
			Trans	Auto, Made in US	1			EM-8415
			Trans	MManual, Made in US	1			EM-8191
L4 1.8L 1770cc		1980-82	L & R Front		2	EM-8430		
	Trans		Auto	1			EM-2410	
	Trans		Manual	1			EM-2409	
L4 1.8L 1794cc	2005-08	Front		1	EM-9158			
	2003-04	Front	Auto	1	EM-9158			
	1998-02	Front	Auto	1	EM-8870			
		Front	Manual	1	EM-8177			
	2005-08	RH Front	Auto	1	EM-9164			
		RH Front	Manual, 5 Spd	1	EM-9164			
	2003-04	RH Front		1	EM-9164			
	1998-02	RH Front		1	EM-8850			
	2005-08	Rear	Auto	1	EM-9155			
		Rear	Manual	1	EM-9157			
	2003-04	Rear	Auto	1	EM-9155			

# Engine, Transmission, And Torque Strut Mounts

CYL	ENG. SIZE	YEAR	LOCATION	DESCRIPTION	QTY	ENGINE	TORQUE STRUT	TRANS-MISSION
<b>TOYOTA PASSENGER CAR (continued)</b>								
<b>COROLLA (continued)</b>								
L4	L4 1.8L 1794cc	2003-04	Rear	Manual	1	EM-9157		
		1998-02	Rear	Auto	1	EM-8851		
		2003-08	Trans	Auto	1			EM-9163
			Trans	Manual	1			EM-9163
		1998-02	Trans	Auto, 3 Spd	1			EM-8872
			Trans	Auto, 4 Spd	1			EM-8873
	Trans		Manual	1			EM-9474	
	L4 1.8L 1795cc	2005-06	RH Front		1	EM-9412		
			Trans	XRS; Manual	1			EM-9163
	L4 1.8L 1839cc Diesel	1985	Front	Auto	1	EM-8368		
			Front	Manual	1	EM-8491		
		1984	Front	Auto	1	EM-8368		
			Front	Manual	1	EM-8348		
		1985	RH Front		1	EM-8368		
		1984	RH Front		1	EM-8368		
		1985	Rear	Auto	1	EM-8401		
			Rear	Manual	1	EM-8400		
		1984	Rear	Auto	1	EM-8401		
			Rear	Manual	1	EM-8400		
	1984-85	Trans	Auto	1			EM-8189	
	L4 2.4L	2009-10	Front		1	EM-9419		
RH Front				1	EM-9447			
Rear				1	EM-9491			
2009		Torq Str - Left		1		EM-9210		
		Trans		1			EM-9236	
<b>CORONA</b>								
L4	L4 1.9L 1898cc	1967-71	L & R Front		2	EM-2407		
			Trans	Auto	1			EM-2410
			Trans	Manual	1			EM-2409
	L4 2.0L 1968cc	1972	L & R Front		2	EM-2407		
			LH Front		1	EM-2745		
			RH Front		1	EM-2743		
		1972-74	Trans	Auto	1			EM-2410
			Trans	Manual	1			EM-2409
	L4 2.2L 2189cc	1975-80	L & R Front		2	EM-2407		
			Trans	Auto	1			EM-2410
			Trans	Manual	1			EM-2410
	L4 2.4L 2366cc	1981-82	L & R Front		2	EM-2407		
			Trans	Auto	1			EM-2410
Trans			Manual	1			EM-2410	
<b>CRESSIDA</b>								
L6	L6 2.6L 2563cc	1978-80	L & R Front		2	EM-2744		
			Rear	Auto	1	EM-5200		
			Trans		1			EM-2690
	L6 2.8L 2754cc	1983-88	Front		1	EM-8212		
	L6 2.8L 2759cc	1981-82	Front		1	EM-2744		
			Trans		1			EM-2690
	L6 3.0L 2954cc	1989-92	L & R Front		2	EM-8344		
Trans				1			EM-2410	
<b>CROWN</b>								
L6	L6 2.3L	1967-70	Trans		1			EM-5456
	L6 2.6L	1971-72	LH Front		1	EM-5455		
		1967-70	LH Front		1	EM-5455		
		1971-72	RH Front		1	EM-5454		
		1967-70	RH Front		1	EM-5454		
1971-72	Trans		1			EM-5456		

# Engine, Transmission, And Torque Strut Mounts

CYL	ENG. SIZE	YEAR	LOCATION	DESCRIPTION	QTY	ENGINE	TORQUE STRUT	TRANSMISSION	
<b>TOYOTA PASSENGER CAR (continued)</b>									
<b>ECHO</b>									
L4	L4 1.5L 1497cc	2000-05	RH Front		1	EM-9015			
			Rear		1	EM-8968			
			Trans	Auto	1			EM-8883	
			Trans	Manual	1			EM-8888	
<b>MARK II</b>									
L6	L6 2.3L	1972	LH Front		1	EM-5455			
			RH Front		1	EM-5454			
	L6 2.3L 2253cc	1972	Trans		1			EM-5456	
	L6 2.6L	1973-76	LH Front		1	EM-5455			
			RH Front		1	EM-5454			
L6 2.6L 2563cc	1973-76	Trans		1			EM-5456		
<b>MATRIX</b>									
L4	L4 1.8L	2009-13	Trans	Auto	1			EM-9390	
			Trans	Manual	1			EM-9390	
	L4 1.8L 1794cc	2007	Front		1	EM-9158			
			2003-06	Front		1	EM-9158		
		2003-06	RH Front	AWD		1	EM-9525		
			RH Front	FWD		1	EM-9164		
			Rear	Auto; AWD		1	EM-9418		
			Rear	Auto; FWD		1	EM-9155		
		2003-08	Rear	Manual; FWD		1	EM-9157		
			Trans	Auto		1			EM-9163
	2003-06	Trans	Manual		1			EM-9163	
		L4 1.8L 1795cc	2003-06	Front	XRS	1	EM-9158		
	RH Front			XRS	1	EM-9412			
	Rear			XRS	1	EM-9157			
	2004-06	Trans	XRS; Manual		1			EM-9163	
		L4 1.8L 1798cc	2009-11	Front		1	EM-9391		
	RH Front				1	EM-9449			
	Rear				1	EM-9400			
	L4 2.4L	2009-11	Front		1	EM-9419			
			RH Front		1	EM-9447			
Rear			AWD	1	EM-9436				
Rear			FWD	1	EM-9491				
2009-10			Trans	Auto		1			EM-9462
			Trans	Manual, AWD		1			EM-9462
<b>MR2</b>									
L4	L4 1.6L 1587cc	1987-89	Front		1	EM-8339			
			1986	Front		1	EM-8339		
			1985	Front		1	EM-8339		
		1987-89	Rear	Auto		1	EM-8187		
			Rear	Manual		1	EM-8384		
		1986	Rear	Auto		1	EM-2685		
			Rear	Manual		1	EM-8384		
		1985	Rear	Auto		1	EM-2685		
			Rear	Manual, After 3/85		1	EM-8384		
			Rear	Manual, Before 3/85		1	EM-8339		
	L4 2.0L 1998cc	1991-95	Front		1	EM-5767			
			Right		1	EM-5802			
	L4 2.2L 2164cc	1991-95	Front	Auto	1	EM-5751			
			Front	Manual	1	EM-5799			
RH Front			Auto	1	EM-5756				
RH Front			Manual	1	EM-5805				

# Engine, Transmission, And Torque Strut Mounts

CYL	ENG. SIZE	YEAR	LOCATION	DESCRIPTION	QTY	ENGINE	TORQUE STRUT	TRANSMISSION			
<b>TOYOTA PASSENGER CAR (continued)</b>											
<b>PASEO</b>											
L4	L4 1.5L 1497cc	1996-99	RH Front		1	EM-8166					
		1995	RH Front		1	EM-8166					
		1992-94	RH Front		1	EM-8166					
		1996-99	Rear	Calif Emission		1	EM-8167				
		1995	Rear	Auto; Federal Emission		1	EM-8169				
			Rear	Calif Emission		1	EM-8167				
		1992-94	Rear	Auto		1	EM-8169				
			Rear	Manual		1	EM-8168				
		1996-99	Trans	Auto		1			EM-9123		
			Trans	Manual, Complete Unit		1			EM-8418		
			Trans	Manual, Insert		1			EM-5736		
		1992-95	Trans	Auto		1			EM-9123		
	Trans	Manual		1			EM-8170				
<b>PRIUS</b>											
L4	L4 1.5L	2004-09	Torq Str - Front		1		EM-9454				
		2001-03	Torq Str - Front		1		EM-9455				
		2004-09	Trans		1			EM-5647			
		2001-03	Trans	Made in USA	1			EM-9284			
	L4 1.5L 1497cc	2001-03	Right		1	EM-5832					
	L4 1.8L 1798cc	2010-13	Front		1	EM-9514					
			Right		1	EM-5970					
<b>PRIUS V</b>											
L4	L4 1.8L 1798cc	2012-13	Front		1	EM-9514					
			Right		1	EM-5970					
<b>SOLARA</b>											
L4	L4 2.2L 2164cc	1999-01	Front	Auto, Made in USA	1	EM-8795					
			Front	Manual, Made in USA	1	EM-8361					
			Rear	Auto	1	EM-8796					
			Rear	Manual	1	EM-8414					
			Torq Str - Front	Auto; RH Front	1		EM-8698				
			Trans	Auto	1			EM-8979			
			Trans	Manual	1			EM-8529			
			L4 2.4L	2007-08	Front		1	EM-9211			
					RH Front		1	EM-9237			
					Torq Str - Front		1		EM-9148		
					Torq Str - Rear		1		EM-9210		
					Trans		1			EM-5757	
	Trans	Auto			1			EM-9165			
	2002-03		Trans	Auto	1			EM-9576			
			Trans	Manual	1			EM-5554			
			L4 2.4L 2362cc	2004-06	Front		1	EM-9211			
					2002-03	Front		1	EM-9572		
					2004-06	RH Front		1	EM-5141		
					2002-03	RH Front		1	EM-9475		
		Torq Str - Front				1		EM-9504			
	2004-06	Torq Str - Front				1		EM-9148			
	2002-03	Torq Str - Rear				1		EM-9492			
	2004-06	Trans			Auto	1			EM-9165		
		Trans	Manual	1			EM-5757				
	V6	V6 3.0L 2995cc	2002-03	Front		1	EM-8967				
			1999-01	Front		1	EM-8967				
			2002-03	Rear	Auto; Insert Only	1	EM-8699				
1999-01			Rear	Auto; Insert Only	1	EM-8699					
			Rear	Manual	1	EM-8398					
2000-03			Torq Str - Front	Auto; Convertible	1		EM-5758				
			Torq Str - Front	Auto; Coupe	1		EM-8697				

# Engine, Transmission, And Torque Strut Mounts

CYL	ENG. SIZE	YEAR	LOCATION	DESCRIPTION	QTY	ENGINE	TORQUE STRUT	TRANSMISSION	
<b>TOYOTA PASSENGER CAR (continued)</b>									
<b>SOLARA (continued)</b>									
V6	V6 3.0L 2995cc	2000-03	Torq Str - Front	Manual	1		EM-8201		
		1999	Torq Str - Front	Auto	1		EM-8697		
			Torq Str - Front	Manual	1		EM-8201		
			Trans	Auto	1			EM-8644	
		1999-03	Trans	Manual	1			EM-8529	
	V6 3.3L	2004-08	RH Front		1	EM-9212			
V6 3.3L 3300cc	2004-08	Trans		1			EM-9165		
<b>STARLET</b>									
L4	L4 1.3L	1981-82	Trans		1			EM-8181	
	L4 1.3L 1290cc	1983-84	L & R Front	w/2 Mounting Studs	2	EM-8163			
			L & R Front	w/3 Mounting Studs	2	EM-5448			
		1981-82	LH Front		1	EM-2406			
			RH Front	w/2 Mounting Studs	1	EM-8163			
			RH Front	w/3 Mounting Studs	1	EM-5448			
1983-84	Trans		1			EM-2748			
<b>SUPRA</b>									
L6	L6 3.0L 2954cc	1990-92	L & R Front		2	EM-5653			
		1986-89	L & R Front		2	EM-9034			
		1990-92	Trans	Auto	1			EM-2410	
			Trans	Manual	1			EM-2410	
		1986-89	Trans		1			EM-8218	
	L6 3.0L 2997cc	1996-98	L & R Front		2	EM-5764			
		1995	L & R Front	After 5/95	2	EM-5764			
			L & R Front	Before 5/95	2	EM-5467			
		1993-94	L & R Front	Before 5/95	2	EM-5467			
		1993-98	Trans	Non Turbo	1			EM-5769	
		Trans	Turbo	1			EM-5752		
<b>TERCEL</b>									
L4	L4 1.5L 1452cc	1987-88	Front		1	EM-8363			
		1980-86	L & R Front		2	EM-8279			
		1987-88	RH Front		1	EM-8278			
			Rear	Auto	1	EM-8173			
			Rear	Manual	1	EM-8174			
		1987-90	Trans	Auto	1			EM-8176	
			Trans	Manual	1			EM-9124	
		1984-86	Trans	Auto	1			EM-2685	
			Trans	Manual	1			EM-8377	
		1980-83	Trans	Auto, After 6/83	1			EM-2685	
			Trans	Auto, Before 6/83	1			EM-8214	
			Trans	Manual	1			EM-8377	
		L4 1.5L 1456cc	1989-90	Front		1	EM-8363		
			1991-94	RH Front		1	EM-8166		
	1989-90		RH Front		1	EM-8278			
	1991-94		Rear	Auto	1	EM-9019			
			Rear	Manual	1	EM-8171			
			Rear	Manual; 5 Spd	1	EM-8167			
	1989-90		Rear		1	EM-8173			
	1991-94		Trans	Auto	1			EM-8175	
		Trans	Manual	1			EM-8170		
	L4 1.5L 1497cc	1995-99	RH Front		1	EM-8166			
			Rear		1	EM-8167			
		1999	Trans	Complete Unit	1			EM-8418	
			Trans	Insert	1			EM-5736	
		1998	Trans	Auto	1			EM-8175	
			Trans	Manual, Complete Unit	1			EM-8418	
		Trans	Manual, Insert	1			EM-5736		



# Engine, Transmission, And Torque Strut Mounts

CYL	ENG. SIZE	YEAR	LOCATION	DESCRIPTION	QTY	ENGINE	TORQUE STRUT	TRANSMISSION
<b>TOYOTA PASSENGER CAR (continued)</b>								
<b>TERCEL (continued)</b>								
L4	L4 1.5L 1497cc	1995-97	Trans	Auto, 3 Spd	1			EM-8175
			Trans	Auto, 4 Spd	1			EM-9123
			Trans	Manual, Complete Unit	1			EM-8418
			Trans	Manual, Insert	1			EM-5736
<b>VENZA</b>								
L4	L4 2.7L	2009-15	Front		1	EM-5742		
			Right		1	EM-9237		
		2009-13	Trans		1			EM-9236
L5	L4 2.7L		Torq Str - Right		1		EM-9610	
V6	V6 3.5L	2009-13	RH Front	Hydraulic Mount	1	EM-9238		
		2009-14	Trans		1			EM-9236
	V6 3.5L 3456cc	2009-15	Torq Str - Right		1		EM-9593	
<b>YARIS</b>								
L4	L4 1.5L	2012-14	RH Front	Auto	1	EM-5654		
			2007-11	RH Front	Auto	1	EM-5654	
		2007-09	RH Front	Manual	1	EM-9279		
			Rear	Auto	1	EM-9249		
			Torq Str - Rear	Manual	1		EM-9246	
	L4 1.5L 1497cc	2006-11	Trans	Auto	1			EM-5930
			Trans	Manual	1			EM-5827
<b>TOYOTA SPORT UTILITY</b>								
<b>4RUNNER</b>								
L4	L4 2.4L 2366cc	1990-95	L & R Front	4WD	2	EM-8162		
			L & R Front	RWD	2	EM-8164		
		1984-89	L & R Front		2	EM-8162		
			1991-95	Trans	Auto; 2WD	1		
		Trans		Auto; 4WD	1			EM-8165
		Trans		Manual; 2WD	1			EM-9113
		Trans		Manual; 4WD	1			EM-9113
		1990	Trans	Auto; 2WD	1			EM-8508
			Trans	Auto; 4WD	1			EM-8508
			Trans	Manual; 2WD	1			EM-9113
			Trans	Manual; 4WD	1			EM-9113
		1987-89	Trans	Auto; 4WD	1			EM-8388
			Trans	Manual; 4WD	1			EM-9113
		1984-86	Trans	Auto; 4WD	1			EM-8388
	L4 2.7L 2694cc	1996-00	L & R Front		2	EM-8164		
		2010	Trans	Auto	1			EM-9619
		1996-00	Trans	2WD	1			EM-8993
Trans			4WD	1			EM-8990	
V6	V6 3.0L 2959cc	1988-95	L & R Front		2	EM-8164		
			1995	Trans	Auto; 2WD	1		
		Trans		Auto; 4WD	1			EM-8508
		Trans		Manual; 2WD	1			EM-8165
		Trans		Manual; 4WD	1			EM-8165
		1993-94	Trans	Auto; 2WD	1			EM-9086
			Trans	Auto; 4WD	1			EM-9086
			Trans	Manual; 2WD	1			EM-8165
			Trans	Manual; 4WD	1			EM-8165
		1990-92	Trans	Auto; 2WD	1			EM-8508
			Trans	Auto; 4WD	1			EM-8508
			Trans	Manual; 2WD	1			EM-8165
			Trans	Manual; 4WD	1			EM-8165
	1988-89	Trans	4WD	1			EM-8508	
V6 3.4L 3378cc	1999-02	L & R Front		2	EM-9014			

# Engine, Transmission, And Torque Strut Mounts

CYL	ENG. SIZE	YEAR	LOCATION	DESCRIPTION	QTY	ENGINE	TORQUE STRUT	TRANSMISSION	
<b>TOYOTA SPORT UTILITY (continued)</b>									
<b>4RUNNER (continued)</b>									
V6	V6 3.4L 3378cc	1996-98	L & R Front	4WD	2	EM-8164			
			L & R Front	RWD	2	EM-8162			
		2002	Trans	Auto; 2WD	1			EM-8993	
		1999-01	Trans	Auto; 2WD	1			EM-8993	
			Trans	Manual; 2WD	1			EM-8993	
			Trans	Manual; 4WD	1			EM-5908	
		1996-98	Trans	Auto; 2WD	1			EM-2410	
	Trans		Manual; 2WD	1			EM-2410		
	Trans		Manual; 4WD	1			EM-5908		
	V6 4.0L	2003-13	L & R Front		2	EM-9599			
V6 4.0L 245ci	2003-12	Trans	4WD	1			EM-9494		
		Trans	RWD	1			EM-9425		
V8	V8 4.7L	2003-09	L & R Front		2	EM-5649			
	V8 4.7L 4663cc	2003-09	Trans	4WD	1			EM-9511	
			Trans	Auto; 2WD	1			EM-9499	
<b>FJ CRUISER</b>									
V6	V6 4.0L	2007-14	L & R Front		2	EM-9599			
	V6 4.0L 245ci	2007-12	Trans	4WD	1			EM-9494	
			Trans	RWD	1			EM-9425	
<b>HIGHLANDER</b>									
L4	L4 2.4L	2004-07	Torq Str - Front	AWD	1		EM-9233		
			Torq Str - Front	FWD	1		EM-9234		
		2001-03	Torq Str - Front	AWD	1		EM-9231		
			Torq Str - Front	FWD	1		EM-9235		
	L4 2.4L 2362cc	2001-07	Front		1	EM-9477			
			RH Front		1	EM-5141			
			Rear		1	EM-5741			
			Trans	Auto	1			EM-9165	
	L4 2.7L	2009-12	Front		1	EM-9237			
			Torq Str - Right		1		EM-9610		
			Trans		1			EM-9236	
	V6	V6 3.0L	2001-03	Rear	AWD	1	EM-5741		
				Rear	FWD	1	EM-5755		
Right				AWD	1	EM-5766			
Right				FWD	1	EM-9239			
V6 3.0L 2995cc		2001-03	Torq Str - Front	AWD, RH Front	1		EM-9227		
			Torq Str - Front	FWD, RH Front	1		EM-5206		
			Trans		1			EM-9165	
V6 3.3L		2006-07	Rear	AWD	1	EM-7039			
			Rear	FWD	1	EM-5837			
		2004-05	Rear	AWD	1	EM-7039			
			Rear	FWD	1	EM-5837			
		2006-07	Right	FWD	1	EM-9212			
		2004-05	Right	FWD	1	EM-9212			
		2006-07	Torq Str - Right	AWD	1		EM-9232		
			Torq Str - Right	FWD	1		EM-9227		
		2004-05	Torq Str - Right	FWD	1		EM-9227		
		2004-07	Trans		1			EM-9165	
V6 3.3L 3300cc		2008-10	RH Front		1	EM-9212			
			Rear	AWD	1	EM-7039			
	2004-06	Trans		1			EM-9165		
V6 3.5L 3456cc	2008-10	Rear	FWD; Japan Built	1	EM-7039				
	2008-11	Torq Str - Front		1		EM-9538			
	2014-15	Trans		1			EM-9236		

# Engine, Transmission, And Torque Strut Mounts

CYL	ENG. SIZE	YEAR	LOCATION	DESCRIPTION	QTY	ENGINE	TORQUE STRUT	TRANSMISSION	
<b>TOYOTA SPORT UTILITY (continued)</b>									
<b>LAND CRUISER</b>									
L4	L4 3.4L 3431cc Diesel	1983-85	L & R Front	After 1/82	2	EM-8488			
		1982	L & R Front	After 1/82	2	EM-8488			
			L & R Front	Before 1/82	2	EM-5208			
		1981	L & R Front			2	EM-5208		
		1984-85	Trans	Auto		1			EM-2410
			Trans	Manual		1			EM-2410
		1982-83	Trans	Manual		1			EM-2410
		1981	Trans	Auto		1			EM-2410
Trans	Manual			1			EM-2410		
L6	L6 3.9L 3878cc	1967-74	L & R Front		2	EM-8280			
			Trans	Auto	1			EM-8650	
			Trans	Manual	1			EM-8651	
	L6 4.0L 3956cc	1988-90	L & R Front		2	EM-8163			
			1991-92	LH Front		1	EM-8365		
		1988-90	RH Front		1	EM-8571			
			Trans		1			EM-8395	
	L6 4.2L	1975	Trans	Auto	1			EM-8393	
			L & R Front		2	EM-5370			
	L6 4.2L 4227cc	1981-87	L & R Front		2	EM-8163			
			1976-80	L & R Front		2	EM-8280		
		1985	Trans	After 11/84	1			EM-8392	
			Trans	Before 11/84	1			EM-8392	
		1986-87	Trans	Manual	1			EM-8393	
		1985	Trans		1			EM-8393	
			Trans		1			EM-8393	
		1981-84	Trans	Manual	1			EM-8392	
	1975-80	Trans	Manual	1			EM-8651		
	L6 4.5L 4477cc	1993-97	L & R Front		2	EM-8353			
			Trans		1			EM-8395	
V8	V8 4.7L 4663cc	1998-07	L & R Front		2	EM-9050			
		1998-03	Trans		1			EM-8991	
<b>RAV4</b>									
L4	L4 2.0L	2001-03	Front	Auto	1	EM-9081			
			Front	Manual	1	EM-5464			
			RH Front		1	EM-9432			
			Rear	Canada	1	EM-9393			
			Trans		1			EM-9420	
	L4 2.0L 1998cc	2004-05	1996-00	Front	Auto	1	EM-9081		
				Front	Auto	1	EM-8847		
				Front	Manual	1	EM-8848		
				RH Front		1	EM-8854		
		1998-00	1996-97	Rear		1	EM-8855		
				Trans	Auto	1			EM-9026
		L4 2.4L	2004-05	Trans	Manual	1			EM-9026
				Trans	Auto; AWD	1			EM-9061
				Trans	Auto; FWD	1			EM-5209
				Trans	Manual; AWD	1			EM-8856
	Trans			Manual; FWD	1			EM-8856	
	Front			Auto	1	EM-9081			
	L4 2.4L 2362cc	2006-08	Front	Manual	1	EM-5464			
			Rear	AWD	1	EM-9393			
			Rear	FWD	1	EM-9502			
			Right		1	EM-7011			
			Trans		1			EM-9420	
	L4 2.4L 2362cc	2006-08	Front		1	EM-9497			
Rear			4WD	1	EM-9518				
Rear			FWD	1	EM-9513				

# Engine, Transmission, And Torque Strut Mounts

CYL	ENG. SIZE	YEAR	LOCATION	DESCRIPTION	QTY	ENGINE	TORQUE STRUT	TRANSMISSION
<b>TOYOTA SPORT UTILITY (continued)</b>								
<b>RAV4 (continued)</b>								
L4	L4 2.4L 2362cc	2006-08	Right	4WD	1	EM-5940		
			Right	FWD	1	EM-5982		
			Trans		1			EM-9549
	L4 2.5L	2009-12	Front		1	EM-9498		
			Rear	4WD	1	EM-9518		
			Rear	FWD	1	EM-9513		
Trans				1			EM-9549	
V6	V6 3.5L 3456cc	2006-12	Front		1	EM-9509		
			Right		1	EM-5964		
			Trans	Auto	1			EM-9550
<b>SEQUOIA</b>								
V8	V8 4.6L	2010-12	LH Front		1	EM-5902		
			RH Front		1	EM-5901		
		2010-11	Trans	4WD	1			EM-9522
	V8 4.7L	2001-07	L & R Front		2	EM-5646		
	V8 4.7L 4663cc	2008-09	Trans	2WD	1			EM-9519
			2005-07	Trans	4WD	1		EM-5919
			2001-04	Trans	2WD	1		EM-5808
				Trans	4WD	1		EM-5807
	V8 5.7L	2008-13	LH Front		1	EM-5902		
			RH Front		1	EM-5901		
		2010-11	Trans	4WD	1			EM-9522
		2008-09	Trans	4WD	1			EM-9522
<b>TOYOTA TRUCK</b>								
<b>PICKUP</b>								
L4	L4 1.9L 1858cc	1970-71	L & R Front		2	EM-2407		
			Trans	Auto	1			EM-2409
			Trans	Manual	1			EM-2409
	L4 2.0L 1968cc	1972-74	L & R Front		2	EM-2407		
			Trans	Auto	1			EM-2409
			Trans	Manual	1			EM-2409
	L4 2.2L 2188cc Diesel	1983	L & R Front		2	EM-8488		
			1982	L & R Front	After 1/82	2	EM-8488	
		1981	L & R Front	Before 1/82	2	EM-5208		
			L & R Front		2	EM-5208		
		1981-83	Trans	2WD	1			EM-2410
			Trans	4WD	1			EM-8389
	L4 2.2L 2189cc	1975-80	L & R Front		2	EM-2407		
			1979-80	Trans	4WD	1		EM-8389
		1978	Trans	Auto; 2WD	1			EM-2410
			Trans	Manual; 4 Spd; 2WD	1			EM-2746
			Trans	Manual; 5 Spd; 2WD	1			EM-2410
			Trans	Auto; 2WD	1			EM-2410
		1975-77	Trans	Manual; 4 Spd; 2WD; After 8/78	1			EM-2746
			Trans	Manual; 4 Spd; 2WD; Before 8/78	1			EM-2409
			Trans	Manual; 5 Spd; 2WD	1			EM-2410
			Trans	Auto; RWD	1			EM-2410
	L4 2.4L 2366cc	1984-95	L & R Front		2	EM-8488		
			Trans - LH	Auto; 2WD	1			EM-2410
		1992-95	Trans	Auto; 4WD	1			EM-8165
			Trans	Manual; 4WD	1			EM-9113
		1990-91	Trans	2WD	1			EM-2410
Trans			Auto; 4WD	1			EM-8165	

# Engine, Transmission, And Torque Strut Mounts

CYL	ENG. SIZE	YEAR	LOCATION	DESCRIPTION	QTY	ENGINE	TORQUE STRUT	TRANSMISSION		
<b>TOYOTA TRUCK (continued)</b>										
<b>PICKUP (continued)</b>										
L4	L4 2.4L 2366cc	1990-91	Trans	Manual; 4WD	1			EM-9113		
		1989	Trans	2WD	1			EM-2410		
			Trans	Manual; 4WD	1			EM-9113		
			Trans	4WD	1			EM-8388		
		1987-88	Trans	Auto; 2WD	1			EM-2410		
			Trans	Manual; 2WD	1			EM-2410		
			Trans	Manual; 4WD	1			EM-2410		
		1984-86	Trans	Manual; 2WD	1			EM-2410		
			Trans	Manual; 4WD	1			EM-2690		
		1981-83	Trans	2WD	1			EM-2410		
	Trans		4WD	1			EM-8388			
	L4 2.4L 2446cc Diesel	1984-87	L & R Front			2	EM-8488			
			Trans	Auto; 2WD	1			EM-2410		
			Trans	Auto; 4WD	1			EM-8389		
Trans			Manual; 2WD	1			EM-2410			
Trans			Manual; 4WD	1			EM-8389			
V6	V6 3.0L 2959cc	1988-95	L & R Front	4WD	2	EM-8164				
			L & R Front	RWD	2	EM-8162				
		1990-95	Trans	Auto; 2WD	1			EM-9086		
			Trans	Auto; 4WD	1			EM-8508		
			Trans	Manual; 4WD	1			EM-8165		
		1988-89	Trans	Auto; 2WD	1			EM-9086		
			Trans	Auto; 4WD; After 4/89	1			EM-8508		
			Trans	Manual; 4WD	1			EM-8165		
		<b>T100</b>								
		L4	L4 2.7L 2694cc	1994-98	L & R Front		2	EM-8164		
V6	V6 3.0L 2959cc	1993-94	L & R Front	4WD	2	EM-9080				
			L & R Front	RWD	2	EM-9120				
			Trans	4WD	1			EM-8165		
			Trans	RWD, Auto	1			EM-2410		
			Trans	RWD, Manual	1			EM-8165		
	V6 3.4L 3378cc	1995-98	L & R Front	4WD	2	EM-9080				
			L & R Front	RWD	2	EM-9120				
			Trans	Auto; 4WD	1			EM-2410		
			Trans	Manual; 4WD	1			EM-8165		
			Trans	RWD, Auto	1			EM-2410		
<b>TACOMA</b>										
L4	L4 2.4L 2438cc	1995-04	L & R Front		2	EM-8164				
		2004	Trans	RWD	1			EM-2410		
		1998-03	Trans	2WD, w/ Pre-Runner	1			EM-8989		
			Trans	2WD, w/o Pre-Runner	1			EM-2410		
	L4 2.7L 2694cc	2005-15	L & R Front		2	EM-7010				
			L & R Front		2	EM-8164				
		2011-15	Trans	Auto; RWD	1			EM-9500		
			Trans	Manual; 4WD	1			EM-5910		
			Trans	Manual; RWD	1			EM-9500		
		2005-10	Trans	Auto; RWD	1			EM-9500		
			Trans	Manual; 4WD	1			EM-5910		
			Trans	Manual; RWD	1			EM-9500		
		1998-04	Trans	2WD, w/ Pre-Runner	1			EM-8989		
			Trans	2WD, w/o Pre-Runner	1			EM-2410		
V6	V6 3.4L 3378cc	2000-04	L & R Front		2	EM-9014				
		1995-99	L & R Front		2	EM-8162				
		1998-04	Trans	2WD, w/ Pre-Runner	1			EM-8996		
			Trans	2WD, w/o Pre-Runner	1			EM-2410		
			Trans	4WD; Auto	1			EM-9515		
Trans	Manual; 4WD	1			EM-9018					

# Engine, Transmission, And Torque Strut Mounts

CYL	ENG. SIZE	YEAR	LOCATION	DESCRIPTION	QTY	ENGINE	TORQUE STRUT	TRANSMISSION	
<b>TOYOTA TRUCK (continued)</b>									
<b>TACOMA (continued)</b>									
V6	V6 3.4L 3378cc	1995-97	Trans	4WD; Auto	1			EM-9515	
			Trans	RWD	1			EM-2410	
			Trans	Manual; 4WD	1			EM-9115	
	V6 4.0L	2005-11	L & R Front		2	EM-9599			
	V6 4.0L 245ci	2005-12	Trans	4WD	1			EM-9494	
			Trans	Auto; 2WD	1			EM-9430	
Trans			Manual; 2WD	1			EM-9429		
<b>TUNDRA</b>									
V6	V6 3.4L 3378cc	2000-04	L & R Front		2	EM-9079			
			Trans	2WD	1			EM-8993	
			Trans	Manual; 4WD	1			EM-9018	
	V6 4.0L	2005-06	L & R Front		2	EM-5754			
	V6 4.0L 4000cc	2005-06	Trans		1			EM-9523	
			Trans	2WD	1			EM-8993	
V8	V8 4.6L	2010-12	LH Front		1	EM-5902			
			RH Front		1	EM-5901			
		2010-11	Trans	4WD	1			EM-9522	
	V8 4.7L 4663cc	2000-07	L & R Front		2	EM-5646			
			Trans	2WD	1			EM-9519	
			Trans	2WD	1			EM-8993	
			Trans	4WD	1			EM-5918	
	V8 5.7L	2007-13	LH Front		1	EM-5902			
			RH Front		1	EM-5901			
2010-11		Trans	4WD	1			EM-9522		
		2008-09	Trans	4WD	1			EM-9522	
<b>TOYOTA VAN</b>									
<b>PREVIA</b>									
L4	L4 2.4L 2438cc	1996-97	RH Front		1	EM-8892			
			1994-95	RH Front		1	EM-8892		
			1991-93	RH Front		1	EM-8892		
		1994-95	1991-93	Rear	w/o Supercharger	1	EM-9027		
				Rear		1	EM-9027		
				Trans	Insert; w/ Supercharger	1			EM-9063
		1994-95	1991-93	Trans	Insert; w/ Supercharger	1			EM-9063
				Trans	Auto; w/o Supercharger	1			EM-9032
		1991-95	Trans	Auto; w/o Supercharger	1			EM-9032	
<b>SIENNA</b>									
L4	L4 2.7L	2011-12	Front		1	EM-9237			
		2011-13	Trans	Hydraulic Mount	1			EM-9236	
V6	V6 3.0L 2995cc	1998-03	RH Front		1	EM-5356			
			Rear	Insert	1	EM-8699			
			Torq Str - Front		1		EM-9226		
			Trans		1			EM-8644	
			Trans		1				
	V6 3.3L	2004-06	Front		1	EM-5900			
			Rear	AWD	1	EM-5741			
			Right		1	EM-9212			
			Torq Str - Front	AWD	1		EM-5874		
			Torq Str - Front	FWD	1		EM-5835		
	V6 3.3L 3300cc	2004-06	Trans	Auto	1			EM-9165	
	V6 3.5L	2007-09	Torq Str - Front	AWD	1			EM-9546	
			Torq Str - Front	FWD	1			EM-9546	
	V6 3.5L 3456cc	2007-10	Front		1	EM-5949			
			RH Front		1	EM-9238			
Rear			AWD	1	EM-5741				

# Engine, Transmission, And Torque Strut Mounts

CYL	ENG. SIZE	YEAR	LOCATION	DESCRIPTION	QTY	ENGINE	TORQUE STRUT	TRANSMISSION
<b>TOYOTA VAN (continued)</b>								
<b>SIENNA (continued)</b>								
V6	V6 3.5L 3456cc	2011-14	Torq Str - Rear	AWD	1		EM-9595	
			Torq Str - Rear	FWD	1		EM-9587	
			Trans		1			EM-9236
	V6 3.5L 3500cc	2007-10	Trans	Hydraulic Mount	1			EM-9165
		2007-09	RH Front	Mexican Vehicle	1	EM-9238		
			Trans	Mexican Vehicle; Hydraulic Mount	1			EM-9165
<b>VAN</b>								
L4	L4 2.0L 1998cc	1984-85	L & R Front		2	EM-2407		
			Rear		1	EM-8649		
	L4 2.2L 2237cc	1987-89	L & R Front		2	EM-9029		
			L & R Front		2	EM-9029		
			Rear	4WD	1	EM-5749		
			Trans	Auto	1			EM-8649
			Trans	Manual	1			EM-8649
<b>VAN WAGON</b>								
L4	L4 2.3L 2245cc	1988	L & R Front		2	EM-9029		
			Rear		1	EM-8649		
<b>VOLKSWAGEN PASSENGER CAR</b>								
<b>411</b>								
H4	H4 1.7L 1679cc	1971-72	L & R Front		2	EM-2415		
<b>412</b>								
H4	H4 1.7L 1679cc	1973-74	L & R Front		2	EM-2415		
	H4 1.8L 1795cc	1974	L & R Front		2	EM-2415		
<b>ATLANTIC (MEXICAN VEHICLE)</b>								
L4	1.6L	1978-84	Trans - Rear Lower		1			EM-2420
			Trans - Rear Upper		1			EM-2417
	L4 1.6L	1978-84	L & R Front		2	EM-9045		
	L4 1.7L	1978-86	L & R Front		2	EM-9045		
			Trans - Rear Lower		1			EM-2420
			Trans - Rear Upper		1			EM-2417
	L4 1.8L	1990-91	Front	8 Valve Engine	1	EM-8224		
			Front	8 Valve Engine	1	EM-8224		
			Front	GLI; 16 Valve Engine	1	EM-8224		
			Front	GLI; 16 Valve Engine; Bracket Only	1	EM-5612		
		1988-89	RH Front	8 Valve Engine	1	EM-8222		
			RH Rear	8 Valve Engine	1	EM-9001		
	1990-91	1988-89	Trans		1			EM-8236
Trans				1			EM-8236	
<b>BEEBLE</b>								
H4	H4 1.2L 1192cc	1955-66	L & R Rear		2	EM-2167		
			Trans	Manual	1			EM-2293
	H4 1.3L 1285cc	1966	L & R Rear		2	EM-2167		
			Trans	Manual	1			EM-2293
	H4 1.5L 1457cc	1967-69	Rear Inner		1	EM-2167		
			Rear Outer		1	EM-2414		
			Trans	Manual	1			EM-2293
H4 1.6L 1584cc	1970-79	L & R Rear		2	EM-2167			

# Engine, Transmission, And Torque Strut Mounts

CYL	ENG. SIZE	YEAR	LOCATION	DESCRIPTION	QTY	ENGINE	TORQUE STRUT	TRANSMISSION
<b>VOLKSWAGEN PASSENGER CAR (continued)</b>								
<b>BEETLE (continued)</b>								
H4	H4 1.6L 1584cc	1973-79	Trans - LH	Auto	1			EM-2419
			Trans - RH	Auto	1			EM-2418
			Trans	Manual	1			EM-8850
		1970-72	Trans	Manual	1			EM-2293
L4	L4 1.8L 1781cc	1999-05	RH Front		1	EM-9092		
			Rear	Auto	1	EM-9208		
			Trans		1			EM-9101
	L4 1.9L 1896cc Diesel	1998-03	RH Front		1	EM-9092		
			Rear	Auto	1	EM-9208		
			Trans	Manual	1			EM-9101
	L4 2.0L	2006-09	RH Front	Hydraulic Mount; Mexican Vehicle	1	EM-9092		
			Rear	Auto; Mexican Vehicle	1	EM-9208		
			Trans	Hydraulic Mount; Mexican Vehicle	1			EM-9101
	L4 2.0L 1984cc	1998-05	RH Front		1	EM-9092		
Rear				1	EM-9208			
Trans			Manual	1			EM-9101	
L5	L5 2.5L 2480cc	2006-07	Trans	Manual	1			EM-9101
<b>BORA (MEXICAN VEHICLE)</b>								
L4	L4 1.9L Diesel	2008	Front Lower		1	EM-9260		
			Front Upper		1	EM-9263		
			RH Front	Hydraulic Mount	1	EM-9092		
			Rear		1	EM-9283		
			Trans	Auto; Hydraulic Mount	1			EM-9262
L5	L5 2.5L	2006-08	Front Lower		1	EM-9260		
			Front Upper		1	EM-9263		
			LH Front		1	EM-9259		
			RH Front		1	EM-9257		
			Rear		1	EM-9283		
<b>BRASILIA (MEXICAN VEHICLE)</b>								
H4	H4 1.6L 1584cc	1974-83	L & R Front		2	EM-9045		
			Trans - Rear Lower		1			EM-2420
			Trans - Rear Upper		1			EM-2417
<b>CC</b>								
L4	L4 2.0L 1984cc	2009-11	Front		1	EM-9092		
			L & R Rear		2	EM-9401		
		2010-11	Trans	Auto (Dual Clutch)	1			EM-5935
			Trans	Manual	1			EM-5934
		2009	Trans	Auto	1			EM-5935
Trans	Manual		1			EM-5934		
V6	V6 3.6L	2009-11	Front		1	EM-9405		
			L & R Rear		2	EM-9401		
<b>CABRIO</b>								
L4	L4 1.8L	2003	RH Front	Mexico; Mexican Vehicle Hydraulic Mount	1	EM-9092		
			Rear	Mexico; Auto; Mexican Vehicle	1	EM-9208		
			Trans	Mexico; Mexican Vehicle Hydraulic Mount	1			EM-9101
	L4 2.0L 1984cc	2000-02	Front	Mexican Vehicle	1	EM-8617		
			Front	US Vehicle	1	EM-8664		
			Front		1	EM-8664		
			LH Rear		1	EM-8224		



# Engine, Transmission, And Torque Strut Mounts

CYL	ENG. SIZE	YEAR	LOCATION	DESCRIPTION	QTY	ENGINE	TORQUE STRUT	TRANSMISSION		
<b>VOLKSWAGEN PASSENGER CAR (continued)</b>										
<b>CABRIO (continued)</b>										
L4	L4 2.0L 1984cc	1995-99	LH Rear		1	EM-8224				
			2000-02	RH Front	Mexican Vehicle	1	EM-8616			
				RH Rear	Mexican Vehicle	1	EM-8589			
				RH Rear	US Vehicle	1	EM-8616			
		2000-02	RH Rear		1	EM-8616				
			Trans	US & Canada	1			EM-8287		
			Trans	Mexican Vehicle	1			EM-8236		
			Trans		1			EM-8287		
			1995-99	Trans	Auto	1			EM-8287	
				Trans	Manual	1			EM-8287	
<b>CABRIOLET</b>										
L4	L4 1.8L 1780cc	1985-93	Front	Insert	1	EM-9045				
			Front Center		1	EM-9077				
			Trans - Rear Lower		1			EM-2420		
			Trans - Rear Upper		1			EM-2417		
<b>CARIBE (MEXICAN VEHICLE)</b>										
L4	L4 1.6L	1972-84	L & R Front		2	EM-9045				
			Trans - Rear Lower		1			EM-2420		
			Trans - Rear Upper		1			EM-2417		
			L4 1.7L	1979-86	L & R Front		2	EM-9045		
					Trans - Rear Lower		1			EM-2420
					Trans - Rear Upper		1			EM-2417
	L4 1.8L	1990	1988-89	Front	8 Valve Engine	1	EM-8224			
				Front	8 Valve Engine	1	EM-8224			
				Front	GLI; 16 Valve Engine	1	EM-8224			
				Front	GLI; 16 Valve Engine; Bracket Only	1	EM-5612			
			1987	Front		1	EM-8224			
				Front	Bracket Only	1	EM-5612			
			1984-86	Front		1	EM-8224			
				Front	Bracket Only	1	EM-5612			
			1990	RH Front	8 Valve Engine	1	EM-8222			
				RH Front	8 Valve Engine	1	EM-8222			
			1987	RH Front	8 Valve Engine	1	EM-8222			
				RH Front	8 Valve Engine	1	EM-8222			
			1984-86	RH Front	8 Valve Engine	1	EM-8222			
				RH Rear	Hydraulic Mount; GLI; 16 Valve Engine	1	EM-9001			
1987	RH Rear	Hydraulic Mount; GLI; 16 Valve Engine	1	EM-9001						
	1984-90	Trans		1			EM-8236			
<b>CORRADO</b>										
L4	L4 1.8L 1780cc	1990-92	Front		1	EM-8224				
			LH Rear		1	EM-8236				
			RH Rear		1	EM-9001				
			Trans		1			EM-8287		
V6	V6 2.8L 2792cc	1992-95	Front		1	EM-9000				
			RH Rear		1	EM-9065				
			Trans	Auto	1			EM-8236		
			Trans	Manual	1			EM-8236		

# Engine, Transmission, And Torque Strut Mounts

CYL	ENG. SIZE	YEAR	LOCATION	DESCRIPTION	QTY	ENGINE	TORQUE STRUT	TRANS-MISSION	
<b>VOLKSWAGEN PASSENGER CAR (continued)</b>									
<b>CORSAR (MEXICAN VEHICLE)</b>									
L4	L4 1.8L	1984-91	Front		1	EM-8224			
			Front	Bracket Only	1	EM-5612			
			RH Front		1	EM-8222			
			RH Rear		1	EM-9001			
			Trans		1			EM-8287	
<b>DASHER</b>									
L4	L4 1.5L 1471cc Diesel	1979-80	L & R Front		2	EM-9109			
			Rear		1	EM-2421			
	L4 1.5L 1471cc	1974-75	Rear		1	EM-2421			
	L4 1.5L 1471cc Diesel	1979-80	Trans	Auto	1			EM-8221	
	L4 1.5L 1471cc	1974-75	Trans	Auto	1			EM-8221	
			Trans	Manual	1			EM-8623	
	L4 1.6L 1588cc Diesel	1981	L & R Front		2	EM-9109			
	L4 1.6L 1588cc	1976-80	L & R Front		2	EM-9109			
L4 1.6L 1588cc Diesel	1981	Trans		1			EM-8221		
L4 1.6L 1588cc	1976-80	Trans	Auto	1			EM-8221		
<b>DERBY (MEXICAN VEHICLE)</b>									
L4	L4 1.8L	1995-00	Front		1	EM-8617			
			2001-08	RH Front	Hydraulic Mount	1	EM-9092		
			1995-00	RH Front		1	EM-8616		
			2001-08	Rear		1	EM-9208		
				Trans	Hydraulic Mount	1			EM-9101
		Trans	Manual	1			EM-8236		
	L4 2.0L	2003	RH Front	Hydraulic Mount	1	EM-9092			
			Rear		1	EM-9208			
Trans			Hydraulic Mount	1			EM-9101		
<b>EOS</b>									
L4	L4 2.0L	2007-12	Front		1	EM-9092			
			LH Front		1	EM-9259			
			LH Front Upper		1	EM-9263			
			Lower Rear		1	EM-9260			
			RH Front		1	EM-9257			
			Rear		1	EM-9283			
V6	V6 3.2L	2007-08	LH Front Upper		1	EM-9263			
			Lower Rear		1	EM-9260			
			RH Front		1	EM-9257			
			Rear		1	EM-9283			
			Right		1	EM-9405			
<b>FASTBACK</b>									
H4	H4 1.6L 1584cc	1966-73	Rear		1	EM-2167			
			Trans		1			EM-2293	
<b>FOX</b>									
L4	L4 1.8L 1780cc	1987-93	L & R Front		2	EM-9109			
			Trans	Manual	1			EM-9093	
<b>GOLF</b>									
L4	L4 1.6L 1588cc Diesel	1985-92	Front	Bracket Only	1	EM-5612			
			Front	Hydraulic Mount	1	EM-8224			
			RH Front		1	EM-8222			
			Trans	Auto	1			EM-8236	
			Trans	Manual	1			EM-8236	
	L4 1.8L 1780cc	1990-92	Front	Auto, Before 3/1/91	1	EM-8224			
			Front	Manual; Bracket Only	1	EM-5612			
			Front	Manual; Mount Only	1	EM-8224			
		1987-89	Front	8 Valve Engine w/ Auto	1	EM-8224			

# Engine, Transmission, And Torque Strut Mounts

CYL	ENG. SIZE	YEAR	LOCATION	DESCRIPTION	QTY	ENGINE	TORQUE STRUT	TRANSMISSION
<b>VOLKSWAGEN PASSENGER CAR (continued)</b>								
<b>GOLF (continued)</b>								
L4	L4 1.8L 1780cc	1987-89	Front	8 Valve Engine w/ Manual	1	EM-8224		
			Front	GLI; 16 Valve Engine	1	EM-8224		
			Front	Manual; Bracket Only	1	EM-5612		
		1985-86	Front	8 Valve Engine w/ Auto	1	EM-8224		
			Front	8 Valve Engine w/ Manual	1	EM-8224		
			Front	Manual; Bracket Only	1	EM-5612		
		1990-92	RH Rear	Calif Emission, After VIN# 1GM20635	1	EM-8287		
			RH Rear	Calif Emission, Before VIN# 1GM20635	1	EM-9001		
			RH Rear	Federal Emission	1	EM-8222		
		1987-89	RH Rear	8 Valve Engine, Cal Emission, After VIN# 1GM20635	1	EM-8287		
			RH Rear	8 Valve Engine, Cal Emission, Before VIN# 1GM20635	1	EM-9001		
			RH Rear	8 Valve Engine, Fed Emission	1	EM-8222		
			RH Rear	GLI; 16 Valve Engine	1	EM-9001		
		1985-86	RH Rear	8 Valve Engine, Fed Emission	1	EM-8222		
	1985-98	Trans	Auto	1			EM-8236	
		Trans	Manual	1			EM-8236	
	L4 1.8L 1781cc	2000-06	RH Front		1	EM-9092		
			Rear	Auto	1	EM-9208		
			Trans	Auto	1			EM-7000
			Trans	Manual	1			EM-9101
	L4 1.8L 1788cc	1993-97	Front	Hydraulic Mount	1	EM-8224		
			Front	Manual; Bracket Only	1	EM-5612		
			RH Rear	8 Valve Engine, Cal Emission	1	EM-8589		
			RH Rear	8 Valve Engine, Fed Emission	1	EM-8222		
	L4 1.9L 1896cc Diesel	1995-97	Front		1	EM-8843		
			Front		1	EM-8843		
		1993	Front		1	EM-8843		
		1999-06	RH Front		1	EM-9092		
1994-96		RH Front		1	EM-9092			
1995-97		RH Rear		1	EM-5445			
1994-96		RH Rear		1	EM-5445			
1993		RH Rear		1	EM-5445			
1999-06		Rear		1	EM-9208			
		Trans	Auto	1			EM-7000	
		Trans	Manual	1			EM-9101	
1993-98		Trans	Auto	1			EM-8236	
		Trans	Manual	1			EM-8236	
L4 2.0L		2006	LH Front		1	EM-9259		
	LH Front Upper			1	EM-9263			
	Lower Rear			1	EM-9260			
	RH Front			1	EM-9092			
	Rear		Auto	1	EM-9208			
L4 2.0L 1984cc	1993-98	Front		1	EM-8617			
		Front	Manual; Bracket Only	1	EM-5612			
	2007	RH Front	Mexican Vehicle; Hydraulic Mount	1	EM-9092			
	1999-05	RH Front		1	EM-9092			
	1993-98	RH Front		1	EM-8616			
	1990-92	RH Front	Manual; GLI 16 Valve Engine	1	EM-9001			
	1999-05	Rear	Auto	1	EM-9208			
	1999-06	Trans	Auto	1			EM-9101	
		Trans	Manual	1			EM-9101	
	1993-98	Trans	Auto	1			EM-8236	

# Engine, Transmission, And Torque Strut Mounts

CYL	ENG. SIZE	YEAR	LOCATION	DESCRIPTION	QTY	ENGINE	TORQUE STRUT	TRANSMISSION	
<b>VOLKSWAGEN PASSENGER CAR (continued)</b>									
<b>GOLF (continued)</b>									
L4	L4 2.0L 1984cc	1993-98	Trans	Manual	1			EM-8236	
		1990-92	Trans	Manual	1			EM-8236	
V6	V6 2.8L	1999-05	Trans	Manual	1			EM-9101	
	V6 2.8L 2792cc	1995-98	Front		1	EM-9000			
		1999-05	RH Front		1	EM-9261			
		1995-98	RH Rear		1	EM-9065			
		1999-05	Rear		1	EM-9208			
		1995-98	Trans	Manual	1			EM-8236	
V6 3.2L	2004	RH Front		1	EM-9261				
<b>GTI</b>									
L4	L4 2.0L	2010-11	Front		1	EM-9092			
		2006-09	Front		1	EM-9092			
		2010-11	Front Lower		1	EM-9260			
			Front Upper		1	EM-9263			
		2006-09	Front Upper		1	EM-9263			
			LH Front		1	EM-9259			
			Lower Rear		1	EM-9260			
		2010-11	RH Front		1	EM-9257			
		2010-11	Rear		1	EM-9283			
		2006-09	Rear		1	EM-9283			
2010	Trans	Hydraulic Mount	1			EM-9262			
2009	Trans	Hydraulic Mount	1			EM-9262			
2006-08	Trans	Manual, Hydraulic Mount	1			EM-9262			
<b>JETTA</b>									
L4	L4 1.6L 1588cc Diesel	1989-92	Front	Bracket Only	1	EM-5612			
			Front	Hydraulic Mount	1	EM-8224			
		1981-88	L & R Front		2	EM-9045			
	L4 1.6L 1588cc	1980	L & R Front		2	EM-9045			
	L4 1.6L 1588cc Diesel	1989-92	RH Front		1	EM-8222			
			Trans	Auto	1		EM-8236		
			Trans	Manual	1		EM-8236		
		1981-88	Trans	Auto	1		EM-2420		
			Trans	Manual	1		EM-2420		
	L4 1.6L 1588cc	1980	Trans	Auto	1		EM-2420		
			Trans	Manual	1		EM-2420		
	L4 1.7L 1715cc	1981-84	L & R Front	Insert	2	EM-9045			
			Trans	Auto	1		EM-2420		
			Trans	Manual	1		EM-2420		
	L4 1.8L 1780cc	1990-92	Front	Auto	1	EM-8224			
			Front	Manual; Bracket Only	1	EM-5612			
			Front	Manual; Mount Only	1	EM-8224			
			1987-89	Front	Auto	1	EM-8224		
				Front	Manual; Bracket Only	1	EM-5612		
				Front	Manual; Mount Only	1	EM-8224		
		1984-86	Front	Auto	1	EM-8224			
			Front	Manual; Bracket Only	1	EM-5612			
			Front	Manual; Mount Only	1	EM-8224			
		1987-89	RH Rear	8 Valve Engine	1	EM-8222			
			RH Rear	GLI; 16 Valve Engine	1	EM-9001			
			1984-86	RH Rear		1	EM-8222		
	1984-95	Trans	Auto	1		EM-8236			
Trans		Manual	1		EM-8236				
2000-05		RH Front		1	EM-9092				
L4 1.8L 1781cc	2000-05	Rear	Auto	1	EM-9208				
		Trans	Auto; Bushing	1		EM-9264			
		Trans	Auto; Hydraulic Mount	1		EM-7000			
		Trans	Auto; Hydraulic Mount	1		EM-7000			

# Engine, Transmission, And Torque Strut Mounts

CYL	ENG. SIZE	YEAR	LOCATION	DESCRIPTION	QTY	ENGINE	TORQUE STRUT	TRANSMISSION
<b>VOLKSWAGEN PASSENGER CAR (continued)</b>								
<b>JETTA (continued)</b>								
L4	L4 1.8L 1781cc	2000-05	Trans	Manual; Bushing	1			EM-9264
			Trans	Manual; Hydraulic Mount	1			EM-9101
	L4 1.8L 1788cc	1993-95	Front	Auto	1	EM-8224		
			Front	Manual; Bracket Only	1	EM-5612		
			Front	Manual; Mount Only	1	EM-8224		
			Rear		1	EM-8222		
	L4 1.9L	1999	RH Front		1	EM-9092		
			Rear	Auto	1	EM-9208		
	L4 1.9L 1896cc Diesel	2005-06 1993-98 2007-08 2005-06 2007-08 2005-06 2007-08 2005-06 2007-08 2005-06 2000-04 2005-06 2007-08 2005-06 2000-04 1993-98 2007-08	Front		1	EM-9092		
			Front		1	EM-8843		
			Front Lower	Mexican Vehicle	1	EM-9260		
			Front Lower		1	EM-9260		
			Front Upper	Mexican Vehicle	1	EM-9263		
			LH Front	Mexican Vehicle	1	EM-9259		
			LH Front		1	EM-9259		
			RH Front	Mexican Vehicle	1	EM-9257		
			RH Front		1	EM-9257		
			RH Front		1	EM-9092		
			RH Rear		1	EM-9263		
			Rear	Mexican Vehicle	1	EM-9283		
			Rear		1	EM-9283		
			Rear	Auto	1	EM-9208		
			Rear	Hydraulic Mount	1	EM-9065		
			Trans	Mexican Vehicle; Manual Hydraulic Mount	1			EM-9245
			Trans	Auto; Hydraulic Mount	1			EM-7000
			Trans	Manual; Hydraulic Mount	1			EM-9101
			Trans	Insert	1			EM-9264
			Trans	Auto; Hydraulic Mount	1			EM-7000
	Trans	Manual; Hydraulic Mount	1			EM-9101		
	Trans	Auto	1			EM-8236		
	Trans	Manual	1			EM-8236		
	L4 2.0L 1968cc Diesel	2009-11	Front		1	EM-9402		
			LH Front		1	EM-9259		
			LH Front Lower		1	EM-9260		
			RH Front		1	EM-9257		
			Rear		1	EM-9283		
	2009	Trans		1			EM-9262	
	L4 2.0L 1984cc	2006-11 1993-98 1990-92 2006-11 1999-05 1993-98 1990-92 2006-11 1999-05 1993-98 1990-92 2006-11 1999-05 2006-09 1999-05	Front		1	EM-9092		
			Front		1	EM-8617		
			Front	Hydraulic Mount	1	EM-8224		
			Front	Manual; Bracket Only	1	EM-5612		
			LH Front		1	EM-9259		
			LH Front Upper		1	EM-9263		
			Lower Rear		1	EM-9260		
			RH Front		1	EM-9257		
			RH Front		1	EM-9092		
			RH Rear	Auto	1	EM-8616		
			RH Rear	Manual	1	EM-8616		
			RH Rear		1	EM-9001		
			Rear		1	EM-9283		
			Rear	Auto	1	EM-9208		
			Trans		1			EM-9262
			Trans	Auto; Bushing	1			EM-9264
Trans			Auto; Hydraulic Mount	1			EM-9101	
Trans	Manual; Bushing	1			EM-9264			
Trans	Manual; Hydraulic Mount	1			EM-9101			

# Engine, Transmission, And Torque Strut Mounts

CYL	ENG. SIZE	YEAR	LOCATION	DESCRIPTION	QTY	ENGINE	TORQUE STRUT	TRANSMISSION	
<b>VOLKSWAGEN PASSENGER CAR (continued)</b>									
<b>JETTA (continued)</b>									
L4	L4 2.0L 1984cc	1993-98	Trans	Auto	1			EM-8236	
			Trans	Manual	1			EM-8236	
		1990-92	Trans	Manual	1			EM-8236	
L5	L5 2.5L	2005-09	Front Lower		1	EM-9260			
			Front Upper		1	EM-9263			
			LH Front		1	EM-9259			
			RH Front	Bracket	1	EM-9257			
			Rear		1	EM-9283			
		2005-08	Trans	Manual, Hydraulic Mount	1			EM-9245	
V6	V6 2.8L	1999-04	Trans	Insert	1			EM-9264	
	V6 2.8L 2792cc	1994-98	Front		1	EM-9000			
		1999-04	RH Front		1	EM-9261			
		1994-98	RH Rear		1	EM-9065			
		1999-04	Rear		1	EM-9208			
		1994-98	Trans	Auto	1			EM-8236	
		1994-98	Trans	Manual	1			EM-8236	
<b>KARMANN GHIA</b>									
H4	H4 1.2L 1192cc	1956-65	Rear		1	EM-2167			
			Trans	Manual	1			EM-2293	
	H4 1.5L 1457cc	1967-69	Rear Inner		1	EM-2167			
			Rear Outer		1	EM-2414			
			Trans	Manual	1			EM-2293	
	H4 1.6L 1584cc	1970-74	L & R Rear		2	EM-2167			
Trans			Manual	1			EM-2293		
<b>PASSAT</b>									
L4	L4 1.8L	2004-05	Trans - L & R	AWD	2			EM-9258	
	L4 1.8L 1780cc	1991-93	Front		1	EM-8224			
			Rear	Auto	1	EM-8222			
			Rear	Manual	1	EM-9001			
			Trans		1			EM-8589	
	L4 1.8L 1781cc	1998-05	Center Front Lower		1	EM-5485			
			LH Front		1	EM-8998			
			RH Front		1	EM-8997			
		2001-03	Trans - LH	Auto	1			EM-8999	
			Trans - LH	Manual	1			EM-9106	
		1998-00	Trans - LH		1			EM-9106	
		2001-03	Trans - RH	Auto	1			EM-8999	
			Trans - RH	Manual	1			EM-8999	
		1998-00	Trans - RH		1			EM-8999	
		L4 1.9L 1896cc Diesel	1993-94	Front	Manual	1	EM-8224		
	1995-97			LH Front		1	EM-8998		
	1995-97			RH Front		1	EM-8997		
	1993-94		Trans - LH		1			EM-8236	
			Trans - RH	Auto	1			EM-8222	
	1995-97	Trans - RH	Manual	1			EM-9001		
	1995-97	Trans	Manual	2			EM-8999		
	L4 2.0L	2009-10	L & R Front		2	EM-9401			
	L4 2.0L 1967cc Diesel	2005	LH Front		1	EM-8998			
			RH Front		1	EM-8997			
		2004-05	Trans - LH	Manual	1			EM-9106	
			Trans - RH	Manual	1			EM-8999	
	2004-05	Trans	Auto	2			EM-8999		
L4 2.0L 1984cc	1995-96	Front		1	EM-8664				
		1990-94	Front		1	EM-8224			
	1995-96	RH Rear		1	EM-8616				

# Engine, Transmission, And Torque Strut Mounts

CYL	ENG. SIZE	YEAR	LOCATION	DESCRIPTION	QTY	ENGINE	TORQUE STRUT	TRANSMISSION
<b>VOLKSWAGEN PASSENGER CAR (continued)</b>								
<b>PASSAT (continued)</b>								
L4	L4 2.0L 1984cc	1990-94	RH Rear	Auto	1	EM-8222		
			RH Rear	Manual	1	EM-9001		
	L4 2.0L 1984cc Turbo	2006-08	Right		1	EM-9092		
	L4 2.0L 1984cc	1995-96	Trans - RH	Auto	1			EM-8589
			Trans	Manual	1			EM-8236
			1990-94	Trans	Auto	1		
Trans			Manual	1			EM-8589	
V6	V6 2.8L	2005	Trans - L & R	GLS & GLX 4 MOTIon	2			EM-9258
		2003-04	Trans - L & R	AWD	2			EM-9258
			Trans - L & R	FWD	2			EM-8999
			2001-02	Trans - L & R	Auto	2		
	V6 2.8L 2771cc	1998-05	Center Front Lower		1	EM-5485		
			L & R Front		2	EM-8997		
		1998-00	Trans	Manual	2			EM-8999
	V6 2.8L 2792cc	1993-97	Front		1	EM-9000		
			RH Front		1	EM-8616		
			Trans		1			EM-8236
	V6 3.6L	2012-14	Right		1	EM-9405		
		2006-09	Right		1	EM-9405		
W8	W8 4.0L	2002-04	Trans - L & R		1			EM-9258
<b>PASSAT CC</b>								
L4	L4 2.0L 1984cc	2009-10	Trans	Auto	1			EM-5935
			Trans	Manual	1			EM-5934
<b>POINTER (MEXICAN VEHICLE)</b>								
L4	L4 1.8L 1781cc	1998-08	L & R Front		2	EM-2421		
			Trans		1			EM-9093
	L4 2.0L	2000-03	L & R Front	GTI	2	EM-2421		
			Trans	GTI	1			EM-9093
<b>POLO (MEXICAN VEHICLE)</b>								
L4	L4 1.6L 1596cc	1996-97	Front		1	EM-5612		
			Front	Auto	1	EM-8224		
			Front	Manual	1	EM-8224		
			RH Front		1	EM-8222		
			Trans		1			EM-8287
<b>QUANTUM</b>								
L4	L4 1.6L 1588cc Diesel	1982-85	L & R Front		2	EM-2421		
	L4 1.7L 1715cc	1982-83	L & R Front		2	EM-2421		
	L4 1.8L 1780cc	1985	L & R Front		2	EM-9109		
L5	L5 2.2L 2144cc	1983-88	L & R Front		2	EM-8663		
	L5 2.2L 2226cc	1985-88	Trans		1			EM-9046
<b>R32</b>								
V6	V6 3.2L	2008	Front		1	EM-9405		
			LH Front		1	EM-9259		
			LH Front Upper		1	EM-9263		
			Lower Rear		1	EM-9260		
			RH Front		1	EM-9257		
<b>RABBIT</b>								
L4	L4 1.5L 1471cc Diesel	1977-80	Front	Insert	1	EM-9045		
	L4 1.5L 1471cc	1975-80	Front	Insert	1	EM-9045		
	L4 1.5L 1471cc Diesel	1977-80	Front Center		1	EM-9077		
	L4 1.5L 1471cc	1975-80	Front Center		1	EM-9077		
	L4 1.5L 1471cc Diesel	1977-80	Trans - Lower	Auto	1			EM-2420
			Trans - Lower	Manual	1			EM-2420

# Engine, Transmission, And Torque Strut Mounts

CYL	ENG. SIZE	YEAR	LOCATION	DESCRIPTION	QTY	ENGINE	TORQUE STRUT	TRANSMISSION	
<b>VOLKSWAGEN PASSENGER CAR (continued)</b>									
<b>RABBIT (continued)</b>									
L4	L4 1.5L 1471cc	1975-80	Trans - Lower	Auto	1			EM-2420	
			Trans - Lower	Manual	1			EM-2420	
	L4 1.5L 1471cc Diesel	1977-80	Trans - Upper	Auto	1			EM-2417	
	L4 1.5L 1471cc	1975-80	Trans - Upper	Auto	1			EM-2417	
	L4 1.6L 1588cc Diesel	1981-84	Front	Insert	1	EM-9045			
	L4 1.6L 1588cc	1980	Front	Insert	1	EM-9045			
			1976-77	Front	Insert	1	EM-9045		
	L4 1.6L 1588cc Diesel	1981-84	Front Center		1	EM-9077			
	L4 1.6L 1588cc	1980	Front Center		1	EM-9077			
			1976-77	Front Center		1	EM-9077		
	L4 1.6L 1588cc Diesel	1981-84	Trans - Lower	Auto	1			EM-2420	
			Trans - Lower	Manual	1			EM-2420	
	L4 1.6L 1588cc	1980	Trans - Lower	Auto	1			EM-2420	
			Trans - Lower	Manual	1			EM-2420	
			1976-77	Trans - Lower	Auto	1			EM-2420
			Trans - Lower	Manual	1			EM-2420	
	L4 1.6L 1588cc Diesel	1981-84	Trans - Upper	Auto	1			EM-2417	
	L4 1.6L 1588cc	1980	Trans - Upper	Auto	1			EM-2417	
			1976-77	Trans - Upper	Auto	1		EM-2417	
	L4 1.7L 1715cc	1981-84	Front	Insert	1	EM-9045			
Front Center				1	EM-9077				
Trans - Lower			Auto	1			EM-2420		
Trans - Lower			Manual	1			EM-2420		
Trans - Upper			Auto	1			EM-2417		
L4 1.8L 1780cc	1983-84	Front	Insert	1	EM-9045				
		Front Center		1	EM-9077				
		Trans - Lower	Manual	1			EM-2420		
L5	L5 2.5L	2006-09	LH Front		1	EM-9259			
			LH Front Upper		1	EM-9263			
			Lower Rear		1	EM-9260			
			RH Front	Bracket	1	EM-9257			
			Rear		1	EM-9283			
			Trans	Auto	1			EM-9245	
			Trans	Manual	1			EM-9245	
<b>RABBIT CONVERTIBLE</b>									
L4	L4 1.6L 1588cc	1980	Front	Insert	1	EM-9045			
			Front Center		1	EM-9077			
			Trans - Lower	Auto	1			EM-2420	
			Trans - Lower	Manual	1			EM-2420	
			Trans - Upper	Auto	1			EM-2417	
	L4 1.7L 1715cc	1981-83	Front	Insert	1	EM-9045			
			Front Center		1	EM-9077			
			Trans - Lower	Auto	1			EM-2420	
			Trans - Lower	Manual	1			EM-2420	
	L4 1.8L 1780cc	1984	Trans - Upper	Auto	1			EM-2417	
			Front	Insert	1	EM-9045			
			Front Center		1	EM-9077			
			Trans - Lower	Auto	1			EM-2420	
			Trans - Lower	Manual	1			EM-2420	
Trans - Upper	Auto	1			EM-2417				
<b>SAFARI (MEXICAN VEHICLE)</b>									
H4	H4 1.5L 1457cc	1960-73	L & R Front		2	EM-2167			
			Rear Outer		1	EM-2414			
			Trans		1			EM-2293	
L4	L4 1.6L	1974-80	L & R Rear		2	EM-2167			
			LH Rear		1	EM-2419			



# Engine, Transmission, And Torque Strut Mounts

CYL	ENG. SIZE	YEAR	LOCATION	DESCRIPTION	QTY	ENGINE	TORQUE STRUT	TRANSMISSION
<b>VOLKSWAGEN PASSENGER CAR (continued)</b>								
<b>SAFARI (MEXICAN VEHICLE) (continued)</b>								
L4	L4 1.6L	1974-80	RH Rear		1	EM-2418		
			Trans		1			EM-2293
<b>SANTANA (MEXICAN VEHICLE)</b>								
L4	L4 1.8L	1986	Front		1	EM-8224		
			Front	Bracket Only	1	EM-5612		
			RH Front	Auto	1	EM-8224		
			RH Rear	Manual, Hydraulic Mount	1	EM-9001		
			Trans		1			EM-8287
V6	V6 2.8L 2792cc	1997	Front		1	EM-9000		
			RH Front		1	EM-8616		
			RH Front	Bracket Only	1	EM-5612		
			Trans		1			EM-8236
<b>SEDAN (MEXICAN VEHICLE)</b>								
H4	H4 1.6L 1584cc	1997-04	L & R Rear		2	EM-2167		
L4	H4 1.6L 1584cc		Trans		1			EM-8857
<b>SCIROCCO</b>								
L4	L4 1.5L 1457cc	1978	L & R Front	Insert	2	EM-9045		
			Trans	Auto	1			EM-2420
			Trans	Manual	1			EM-2420
	L4 1.5L 1471cc	1975	L & R Front	Insert	2	EM-9045		
			Trans	Auto	1			EM-2420
			Trans	Manual	1			EM-2420
	L4 1.6L 1588cc	1979-80	L & R Front	Insert	2	EM-9045		
		1976-77	L & R Front	Insert	2	EM-9045		
		1979-80	Trans	Auto	1			EM-2420
			Trans	Manual	1			EM-2420
		1976-77	Trans	Auto	1			EM-2420
			Trans	Manual	1			EM-2420
	L4 1.7L 1715cc	1981-83	L & R Front	Insert	2	EM-9045		
			Trans	Auto	1			EM-2420
			Trans	Manual	1			EM-2420
	L4 1.8L 1780cc	1984-89	Front	Insert	1	EM-9045		
			Front Center	Insert	1	EM-9077		
		1989	Trans	Auto	1			EM-2420
			Trans	Manual	1			EM-2420
		1988	Trans	Manual	1			EM-2420
		1984-87	Trans	Auto	1			EM-2420
			Trans	Manual	1			EM-2420
<b>SQUAREBACK</b>								
H4	H4 1.6L 1584cc	1966-73	Rear		1	EM-2167		
			Trans		1			EM-2293
<b>SUPER BEETLE</b>								
H4	H4 1.6L 1584cc	1971-75	L & R Rear		2	EM-2167		
			Trans - LH		1			EM-2419
			Trans - RH		1			EM-8857
		1976-80	Trans		1			EM-8857
		1971-75	Trans		1			EM-2418
<b>TIGUAN</b>								
L4	L4 2.0L	2009-14	L & R Front		2	EM-9401		
			Right		1	EM-7021		
	L4 2.0L 1984cc	2009-14	Trans		1			EM-5935

# Engine, Transmission, And Torque Strut Mounts

CYL	ENG. SIZE	YEAR	LOCATION	DESCRIPTION	QTY	ENGINE	TORQUE STRUT	TRANSMISSION
<b>VOLKSWAGEN PASSENGER CAR (continued)</b>								
<b>VARIANT (MEXICAN VEHICLE)</b>								
H4	H4 1.3L 1285cc	1986	L & R Rear		2	EM-2167		
			Trans		1			EM-2293
<b>THING</b>								
H4	H4 1.6L 1584cc	1973-74	LH Rear		1	EM-2419		
			RH Rear		1	EM-2418		
<b>VARIANT (MEXICAN VEHICLE)</b>								
L4	L4 1.6L	1986	L & R Rear		2	EM-2167		
			Trans		1			EM-2293
	L4 1.8L	1986	L & R Rear		2	EM-2167		
			Trans		1			EM-2293
<b>VENTO (MEXICAN VEHICLE)</b>								
L4	L4 1.9L Diesel	1995	Front	Mexican Vehicle	1	EM-8617		
			Front	Mexican Vehicle; Bracket Only	1	EM-5612		
			RH Rear	Hydraulic Mount; Mexican Vehicle	1	EM-5445		
			Trans		1			EM-8236
	L4 2.0L	1993-95	Front		1	EM-8617		
			Front	Bracket Only	1	EM-5612		
			RH Front	Auto	1	EM-8222		
			RH Front	Bracket Only	1	EM-5612		
			RH Front	Manual	1	EM-8616		
			RH Rear	Hydraulic Mount	1	EM-9001		
Trans		1			EM-8236			
<b>VOLKSWAGEN SPORT UTILITY</b>								
<b>TOUAREG</b>								
V6	V6 3.0L	2009-12	L & R Front		2	EM-5879		
	V6 3.6L	2007-12	L & R Front		2	EM-5879		
<b>VOLKSWAGEN TRUCK</b>								
<b>HORMIGA (MEXICAN VEHICLE)</b>								
6 &	H4 1.6L 1584cc	1976-79	L & R Front		2	EM-2167		
			Rear Inner		1	EM-2415		
			Rear Outer		1	EM-2414		
H4	H4 1.6L 1584cc		Trans		1			EM-2293
<b>POINTER PICKUP (MEXICAN VEHICLE)</b>								
L4	L4 1.8L 1781cc	1999-07	L & R Front		2	EM-2421		
			Trans		1			EM-9093
<b>RABBIT PICKUP</b>								
L4	L4 1.5L 1457cc	1980	Front	Insert	1	EM-9045		
			Front Center		1	EM-9077		
			Trans - Rear Lower		1			EM-2420
			Trans - Rear Upper		1			EM-2417
	L4 1.6L 1588cc	1980-83	Front	Insert	1	EM-9045		
			Front Center		1	EM-9077		
			Trans - Rear Lower		1			EM-2420
			Trans - Rear Upper		1			EM-2417
	L4 1.7L 1715cc	1981-83	Front	Insert	1	EM-9045		
			Front Center		1	EM-9077		
			Trans - Rear Lower		1			EM-2420
			Trans - Rear Upper		1			EM-2417

# Engine, Transmission, And Torque Strut Mounts

CYL	ENG. SIZE	YEAR	LOCATION	DESCRIPTION	QTY	ENGINE	TORQUE STRUT	TRANSMISSION
<b>VOLKSWAGEN TRUCK (continued)</b>								
<b>RABBIT PICKUP (continued)</b>								
L4	L4 1.7L 1715cc	1981-83	Trans - Rear Upper		1			EM-2417
<b>VOLKSWAGEN VAN</b>								
<b>COMBI (MEXICAN VEHICLE)</b>								
H4	H4 1.6L 1584cc	1972-88	L & R Rear		2	EM-2167		
			Rear Inner		1	EM-2415		
			Rear Outer		1	EM-2414		
			Trans		1			EM-2293
L4	L4 1.8L	1995-01	L & R Front		2	EM-2421		
<b>EUROVAN</b>								
L5	L5 2.4L	1993-97	Front	Hydraulic Mount	1	EM-5446		
			RH Front		1	EM-5527		
	L5 2.5L	1992-96	Front	Hydraulic Mount	1	EM-5446		
			RH Front		1	EM-5527		
V6	L5 2.5L 2459cc	1992-96	Trans		1			EM-5213
V6	V6 2.8L	1997-03	RH Front		1	EM-5527		
	V6 2.8L 2792cc	1997-03	Trans		1			EM-5213
<b>PANEL (MEXICAN VEHICLE)</b>								
H4	H4 1.6L 1584cc	1973-88	L & R Rear		2	EM-2167		
			Rear Inner		1	EM-2415		
			Rear Outer		1	EM-2414		
			Trans		1			EM-2293
	H4 1.8L 1781cc	1988-01	L & R Front		2	EM-2421		
<b>ROUTAN</b>								
V6	V6 3.6L 220ci	2011-14	Front	Complete Unit	1	EM-4050		
			Front	Insert	1	EM-4094		
			Right		1	EM-4012		
	V6 3.8L	2009-10	Front	Complete Unit	1	EM-3156		
			Front	Insert	1	EM-4094		
			Rear		1	EM-4042		
			Trans	Bushing	1			EM-4127
			Trans	Complete Unit	1			EM-4013
	V6 4.0L 3952cc 241ci	2009-10	Front	Complete Unit	1	EM-3156		
			Front	Insert	1	EM-4094		
			Rear		1	EM-4042		
			Trans	Bushing	1			EM-4127
			Trans	Complete Unit	1			EM-4013
<b>TRANSPORTER</b>								
H4	H4 1.2L 1192cc	1954-64	Rear		1	EM-2167		
			Rear Inner		1	EM-2415		
			Rear Outer		1	EM-2414		
			Trans		1			EM-2293
	H4 1.5L 1457cc	1963-67	Rear		1	EM-2167		
			Rear Inner		1	EM-2415		
			Rear Outer		1	EM-2414		
			Trans		1			EM-2293
	H4 1.6L 1584cc	1968-71	L & R Rear		2	EM-2413		
			Trans		1			EM-2167
	H4 1.7L 1679cc	1972-73	Rear Inner		1	EM-2415		
			Rear Outer		1	EM-2414		
			Trans		1			EM-2167
	H4 1.8L 1795cc	1974-75	Rear Inner		1	EM-2415		
			Rear Outer		1	EM-2414		
			Trans		1			EM-2167

# Engine, Transmission, And Torque Strut Mounts

CYL	ENG. SIZE	YEAR	LOCATION	DESCRIPTION	QTY	ENGINE	TORQUE STRUT	TRANSMISSION
<b>VOLKSWAGEN VAN (continued)</b>								
<b>TRANSPORTER (continued)</b>								
H4	H4 1.9L 1915cc	1985	Rear Inner		1	EM-2415		
			Rear Outer		1	EM-2414		
			Trans		1			EM-2167
	H4 2.0L 1970cc	1976-79	Rear Inner		1	EM-2415		
			Rear Outer		1	EM-2414		
			Trans		1			EM-2167
H4 2.1L 2109cc	1986-91	RH Front Inner		1	EM-9076			
L5	L5 2.4L	1993-94	Trans		1			EM-5213
	L5 2.5L	1992-93	Front	Hydraulic Mount	1	EM-5446		
			RH Front		1	EM-5527		
	L5 2.5L 2459cc	1992-93	Trans		1			EM-5213
<b>VANAGON</b>								
L4	L4 1.6L 1588cc Diesel	1982-84	L & R Front		2	EM-9076		
			Rear		1	EM-5484		
	L4 1.6L 1588cc	1982-84	Trans		1			EM-5213
<b>VOLVO PASSENGER CAR</b>								
<b>142</b>								
L4	L4 2.0L 1990cc	1969-74	L & R Front		2	EM-2424		
			Trans	Auto	1			EM-2425
			Trans	Manual	1			EM-2425
<b>144</b>								
L4	L4 2.0L 1990cc	1969-74	L & R Front		2	EM-2424		
			Trans	Auto	1			EM-2425
			Trans	Manual	1			EM-2425
<b>145</b>								
L4	L4 2.0L 1990cc	1969-74	L & R Front		2	EM-2424		
			Trans	Auto	1			EM-2425
			Trans	Manual	1			EM-2425
<b>164</b>								
L6	L6 3.0L	1970-75	Rear		1	EM-5459		
	L6 3.0L 2980cc	1975	Trans	Auto	1			EM-2425
		1970-74	Trans	Auto	1			EM-2425
			Trans	Manual	1			EM-2425
<b>240</b>								
L4	L4 2.3L 2316cc	1990-93	LH Front		1	EM-2426		
			RH Front		1	EM-2429		
			Trans	Auto w/o Air	1			EM-2428
			Trans	Auto; w/ Air	1			EM-8800
			Trans	Manual	1			EM-5214
<b>242</b>								
L4	L4 2.0L 1990cc	1975	L & R Front		2	EM-2427		
			Trans		1			EM-2428
	L4 2.1L 2127cc	1976-84	L & R Front		2	EM-2426		
			Trans	Auto	1			EM-8800
			Trans	Manual w/ Overdrive	1			EM-2428
			Trans	Manual w/o Overdrive	1			EM-8800
	L4 2.3L 2316cc	1981-84	L & R Front		2	EM-2429		
			Trans	Auto	1			EM-8800
			Trans	Manual w/ Overdrive	1			EM-2428
			Trans	Manual w/o Overdrive	1			EM-8800

## Engine, Transmission, And Torque Strut Mounts

CYL	ENG. SIZE	YEAR	LOCATION	DESCRIPTION	QTY	ENGINE	TORQUE STRUT	TRANSMISSION
<b>VOLVO PASSENGER CAR (continued)</b>								
<b>244</b>								
L4	L4 2.0L 1990cc	1975	L & R Front		2	EM-2427		
			Trans	Auto	1			EM-2428
			Trans	Manual	1			EM-2428
	L4 2.1L 2127cc	1976-84	L & R Front		2	EM-2426		
			Trans	Auto	1			EM-8800
			Trans	Manual w/ Overdrive	1			EM-2428
			Trans	Manual w/o Overdrive	1			EM-8800
	L4 2.3L 2316cc	1981-89	LH Front		1	EM-2426		
			RH Front		1	EM-2429		
			Trans		1			EM-5214
L6	L6 2.4L 2383cc Diesel	1982-84	Trans	Auto	1			EM-2428
			Trans	Manual	1			EM-2428
<b>245</b>								
L4	L4 2.0L 1990cc	1975	L & R Front		2	EM-2427		
			Trans	Auto	1			EM-2428
			Trans	Manual	1			EM-2428
	L4 2.1L 2127cc	1985 1983-84 1976-82 1985 1983-84 1976-82 1976-85	LH Front		1	EM-2426		
			LH Front		1	EM-2426		
			LH Front		1	EM-2426		
			RH Front		1	EM-2429		
			RH Front	w/ Turbo	1	EM-2429		
			RH Front	w/o Turbo	1	EM-2426		
			RH Front		1	EM-2426		
			Trans	Auto	1			EM-8800
			Trans	Manual w/ Overdrive	1			EM-2428
	Trans	Manual w/o Overdrive	1			EM-8800		
	L4 2.3L 2316cc	1981-89	LH Front		1	EM-2426		
			RH Front		1	EM-2429		
			Trans	Auto	1			EM-2428
			Trans	Manual	1			EM-2428
L6	L6 2.4L 2383cc Diesel	1982-84	Trans	Auto	1			EM-2428
			Trans	Manual	1			EM-2428
<b>262</b>								
V6	V6 2.7L 2673cc	1979	L & R Front		2	EM-2689		
			L & R Front		2	EM-2689		
	V6 2.8L 2849cc	1980-81	Trans	Auto	1			EM-8800
			Trans	Manual	1			EM-2428
<b>264</b>								
L4	L4 2.1L 2127cc	1980-81	L & R Front		2	EM-2426		
			Trans		1			EM-2428
L6	L6 2.4L 2383cc Diesel	1980-81	Trans		1			EM-2428
V6	V6 2.7L 2673cc	1976-79	L & R Front		2	EM-2689		
			L & R Front		2	EM-2689		
	V6 2.8L 2849cc	1980-82	Trans	Auto	1			EM-8800
			Trans	Manual	1			EM-2428
<b>265</b>								
L6	L6 2.4L 2383cc Diesel	1980	Trans		1			EM-2428
V6	V6 2.7L 2673cc	1976-79	L & R Front		2	EM-2689		
			L & R Front		2	EM-2689		
	V6 2.8L 2849cc	1980-81	Trans	Auto	1			EM-8800
			Trans	Manual	1			EM-2428

# Engine, Transmission, And Torque Strut Mounts

CYL	ENG. SIZE	YEAR	LOCATION	DESCRIPTION	QTY	ENGINE	TORQUE STRUT	TRANSMISSION	
<b>VOLVO PASSENGER CAR (continued)</b>									
<b>740</b>									
L4	L4 2.3L 2316cc SOH			SOHC	2	EM-8622			
	L4 2.3L 2316cc DOH			DOHC	2	EM-8794			
	L4 2.3L 2316cc SOH				2	EM-8622			
						2	EM-2684		
	L4 2.3L 2316cc	1985-92	Trans	Auto; w/ Turbo	1			EM-2675	
			Trans	Auto; w/o Turbo	1			EM-2428	
			Trans	Manual; w/ Turbo	1			EM-2675	
	Trans		Manual; w/o Turbo	1			EM-2428		
L6	L6 2.4L 2377cc Diesel	1985-86	LH Front		1	EM-9047			
			RH Front		1	EM-9062			
		1986	Trans	Auto	1			EM-2428	
			Trans	Manual	1			EM-2428	
<b>745</b>									
L4	L4 2.3L 2316cc	1985	L & R Front		2	EM-2684			
			Trans	Auto	1		EM-2428		
			Trans	Manual	1		EM-2428		
L6	L6 2.4L 2383cc Diesel	1985	LH Front		1	EM-9047			
			RH Front		1	EM-9062			
			Trans	Auto	1		EM-2428		
			Trans	Manual	1		EM-2428		
<b>760</b>									
L4	L4 2.3L 2316cc SOH				2	EM-8622			
					2	EM-2684			
			Trans	Auto	1		EM-2675		
			Trans	Auto	1		EM-2675		
			Trans	Manual	1		EM-2675		
			Trans	Auto	1		EM-2428		
			Trans	Manual	1		EM-2428		
			Trans	Auto	1		EM-2428		
L6	L6 2.4L 2377cc Diesel	1985	LH Front		1	EM-2426			
			RH Front		1	EM-5669			
			Trans	Auto	1		EM-2675		
			Trans	Manual	1		EM-2675		
	L6 2.4L 2383cc Diesel	1983-84	LH Front		1	EM-2426			
			RH Front		1	EM-5669			
			Trans	Auto	1		EM-2675		
V6	V6 2.8L 2849cc	1985	L & R Front	Before Chassis# 164577	2	EM-8620			
			1983-84	L & R Front	Before Chassis# 164577	2	EM-8620		
		1986-90	LH Front	After Chassis# 164577	1	EM-9047			
		1985	LH Front	After Chassis# 164577	1	EM-9047			
		1986-90	RH Front	After Chassis# 164577	1	EM-9062			
		1985	RH Front	After Chassis# 164577	1	EM-9062			
		1988-90	Trans	Auto	1		EM-8800		
		1985-87	Trans	Auto	1		EM-8800		
	Trans	Manual	1		EM-8800				
	1983-84	Trans	Auto	1		EM-8800			
<b>780</b>									
L4	L4 2.3L 2316cc	1989-91	L & R Front		2	EM-8622			
			Trans	Auto	1		EM-2675		
V6	V6 2.8L 2849cc	1987-90	LH Front		1	EM-9047			
			RH Front		1	EM-9062			
			Trans	Auto	1		EM-8800		

# Engine, Transmission, And Torque Strut Mounts

CYL	ENG. SIZE	YEAR	LOCATION	DESCRIPTION	QTY	ENGINE	TORQUE STRUT	TRANSMISSION
<b>VOLVO PASSENGER CAR (continued)</b>								
<b>850</b>								
L5	L5 2.3L 2319cc	1994-97	LH Front		1	EM-9145		
			RH Front		1	EM-5215		
		1996-97	Trans		1			EM-5216
			1994-95	Trans		1		EM-8985
	L5 2.4L 2435cc	1993-97	LH Front		1	EM-9145		
			RH Front		1	EM-5215		
		1996-97	Trans		1			EM-5216
			1993-95	Trans		1		EM-8985
<b>940</b>								
L4	L4 2.3L 2316cc	1994-95	L & R Front		2	EM-8622		
		1991-93	L & R Front	Turbo; Turbo	2	EM-8622		
		1991-92	L & R Front	Non-Turbo; w/o Turbo	2	EM-8794		
	L4 2.3L 2316cc SOH		Trans	Auto	1			EM-2675
			Trans	Auto; w/o Turbo	1			EM-2675
			Trans	Turbo	1			EM-2428
	L4 2.3L 2316cc DOH		Trans	Auto; w/o Turbo	1			EM-2675
	L4 2.3L 2316cc SOH		Trans	Turbo	1			EM-2428
<b>960</b>								
L6	L6 2.9L	1994-97	Trans		1			EM-5487
		1992-93	Trans		1			EM-2428
	L6 2.9L 2917cc	1992-97	L & R Front		2	EM-5396		
<b>1800</b>								
L4	L4 2.0L 1990cc	1969-73	L & R Front		2	EM-2424		
			Trans		1			EM-2425
<b>C70</b>								
L5	L5 2.3L 2319cc	1998-04	Front Upper		1	EM-5528		
			LH Front		1	EM-9145		
			RH Front		1	EM-5215		
			Right		1	EM-5993		
			Trans		1			EM-5216
	L5 2.4L	1998	LH Front		1	EM-9145		
			RH Front		1	EM-5215		
	L5 2.4L 2435cc	1999-04	Front Upper		1	EM-5528		
			LH Front		1	EM-9145		
			RH Front		1	EM-5215		
			Right		1	EM-5993		
			1998-04	Trans		1		
	<b>DL</b>							
L4	L4 2.1L 2127cc	1984	LH Front		1	EM-2426		
			RH Front		1	EM-2429		
			Trans	Auto	1			EM-2428
			Trans	Manual	1			EM-2428
<b>GLE</b>								
L4	L4 2.3L 2316cc	1984	LH Front		1	EM-2426		
			RH Front		1	EM-2429		
			Trans		1			EM-2428
<b>S40</b>								
L4	L4 1.9L	2001-04	Front		1	EM-5494		
			2000	Front		1	EM-5495	
		2001-04	RH Rear		1	EM-5518		
			RH Upper		1	EM-5495		
		2000	Rear		1	EM-5440		
			Rear		1	EM-5439		

# Engine, Transmission, And Torque Strut Mounts

CYL	ENG. SIZE	YEAR	LOCATION	DESCRIPTION	QTY	ENGINE	TORQUE STRUT	TRANS-MISSION
<b>VOLVO PASSENGER CAR (continued)</b>								
<b>S60</b>								
L5	L5 2.3L	2001-04	Torq Str - Lower		1		EM-5530	
	L5 2.3L 2319cc Turbo	2001-04	Front	Hydraulic Mount	1	EM-9244		
			Front Upper		1	EM-5528		
			L & R Front	Hydraulic Mount	2	EM-9244		
			Right		1	EM-5993		
	L5 2.4L	2009	Front Upper		1	EM-5528		
		2001-08	Front Upper		1	EM-5528		
			L & R Front	Hydraulic Mount	2	EM-9244		
		2009	Rear Upper		1	EM-5616		
		2001-09	Torq Str - Lower		1		EM-5530	
	L5 2.5L	2009	Front Upper		1	EM-5528		
		2003-08	Front Upper		1	EM-5528		
		2009	Rear Upper		1	EM-5616		
2003-09		Torq Str - Lower		1		EM-5530		
<b>S70</b>								
L5	L5 2.3L 2319cc	1998-00	Front Upper		1	EM-5528		
			LH Front		1	EM-9145		
			RH Front		1	EM-5215		
			Rear		1	EM-5747		
			Trans	FWD w/ 280mm Front Disc	1			EM-5216
	L5 2.4L 2435cc	1998-00	Front Upper		1	EM-5528		
			LH Front		1	EM-9145		
			RH Front		1	EM-5215		
			Rear		1	EM-5747		
			Trans	FWD w/ 280mm Front Disc	1			EM-5216
<b>S80</b>								
L5	L5 2.5L	2004-06	Front Upper		1	EM-5528		
			L & R Front	Hydraulic Mount	2	EM-9244		
			Right		1	EM-5993		
			Torq Str - Lower		1		EM-5530	
L6	L6 2.8L	1999-01	Front		1	EM-9244		
			Lower Rear		1	EM-9244		
			RH Front		1	EM-5553		
			Rear Upper		1	EM-9580		
			Torq Str - Lower		1		EM-9579	
	L6 2.9L	2004-05	Front		1	EM-9244		
			Lower Rear		1	EM-9244		
			RH Front		1	EM-5553		
			Rear Upper		1	EM-9580		
	L6 2.9L 2917cc	1999-05	Torq Str - Lower		1		EM-9579	
	L6 2.9L w/o Turbo	1999-03	Front		1	EM-9244		
			Lower Rear		1	EM-9244		
RH Front				1	EM-5553			
Rear Upper				1	EM-9580			
<b>S90</b>								
L6	L6 2.9L	1998	Front		1	EM-5396		
<b>V40</b>								
L4	L4 1.9L	2001-04	Front		1	EM-5494		
		2000	Front		1	EM-5495		
			RH Rear		1	EM-5518		
		2001-04	RH Upper		1	EM-5495		
			Rear		1	EM-5440		
		2000	Rear		1	EM-5439		



# Engine, Transmission, And Torque Strut Mounts

CYL	ENG. SIZE	YEAR	LOCATION	DESCRIPTION	QTY	ENGINE	TORQUE STRUT	TRANS-MISSION
<b>VOLVO PASSENGER CAR (continued)</b>								
<b>V70</b>								
L5	L5 2.3L	2001-04	Torq Str - Lower		1		EM-5530	
		1998-00	Trans	AWD	1			EM-5747
			Trans	FWD w/ 280mm Front Disc	1			EM-5216
	L5 2.3L 2319cc	2001-04	Front Upper		1	EM-5528		
		1998-00	Front Upper		1	EM-5528		
		2001-04	LH Front		1	EM-9145		
		1998-00	LH Front		1	EM-9145		
		2001-04	RH Front		1	EM-5215		
		1998-00	RH Front		1	EM-5215		
		Rear	AWD	1	EM-5747			
	L5 2.4L	2001-07	Front		1	EM-9244		
			Front Upper		1	EM-5528		
			Right		1	EM-5993		
			Torq Str - Lower		1		EM-5530	
		1998-00	Trans	AWD	1		EM-5747	
	Trans	FWD w/ 280mm Front Disc	1		EM-5216			
	L5 2.4L 2435cc	1998-00	Front Upper		1	EM-5528		
			LH Front		1	EM-9145		
			RH Front		1	EM-5215		
			Rear	AWD	1	EM-5747		
L5 2.5L	2003-07	Torq Str - Lower		1		EM-5530		
<b>V90</b>								
L6	L6 2.9L	1998	Front		1	EM-5396		
<b>VOLVO SPORT UTILITY</b>								
<b>XC70</b>								
L5	L5 2.5L 2521cc	2003-06	Front		1	EM-9244		
			Front Upper		1	EM-5528		
			Lower Rear	Hydraulic Mount	1	EM-5493		
			Rear		1	EM-9244		
			Right		1	EM-5993		
<b>XC90</b>								
L5	L5 2.5L 2521cc	2003-06	Front		1	EM-9244		
			Front Upper		1	EM-5528		
			Lower Rear	Hydraulic Mount	1	EM-5493		
			Rear		1	EM-9244		
			Right		1	EM-5993		
			Torq Str - Lower		1		EM-5530	
L6	L6 2.9L	2003-05	Front		1	EM-9244		
			Lower Rear		1	EM-9244		
			RH Front		1	EM-5553		
			Rear Upper		1	EM-9580		
	L6 2.9L 2917cc	2003-05	Torq Str - Lower		1		EM-9579	

## Drive Shaft Center Supports

Models	Years	Shaft Type / Series	Bearing Inside Diameter	Part No. Complete Assembly	Part No. Bushing Only
<b>AUDI SPORTS UTILITY</b>					
Q7	2007-12			DS-6042	
<b>BMW PASSENGER CAR</b>					
128I	2008-12		I.D. = 1.8111"	DS-6024	
135I	2008-12		I.D. = 1.8111"	DS-6037	
3.0SI	1975-76			DS-8626	
318I	1984-85			DS-8627	
320I	1977-83			DS-8626	
323I	2006-11		I.D. = 1.8111"	DS-6024	
325	1986			DS-8627	
325CI	2004-06		I.D. = 1.8111"	DS-6024	
325E	1984-86			DS-8627	
325ES	1986			DS-8627	
325I	2007	Mexican Vehicle	I.D. = 1.8111"	DS-6024	
	2004-06		I.D. = 1.8111"	DS-6024	
328I	2007-12		I.D. = 1.8111"	DS-6024	
328XI	2007-08		I.D. = 1.8111"	DS-6024	
335D	2009-11		I.D. = 1.349"	DS-6037	
335I	2007-12		I.D. = 1.8111"	DS-6037	
330XI	2004-06		I.D. = 1.8111"	DS-6024	
335IS	2011-12		I.D. = 1.349"	DS-6037	
335XI	2007-08		I.D. = 1.8111"	DS-6037	
525XI	2006-07			DS-5236	
525I	2002-07			DS-5236	
528I	2009-10			DS-5236	
	1979-81			DS-8626	
528XI	2008			DS-5236	
530XI	2006-07			DS-5236	
530I	2002-07			DS-5236	
533I	1983-84			DS-8626	
535I	2008-10			DS-5236	
	1987-88			DS-8626	
	1985-86			DS-8626	
535XI	2008			DS-5236	
633CSI	1978-84			DS-8626	
635CSI	1985-89			DS-8626	
733I	1978-84			DS-8626	
735I	1985-86			DS-8626	
M3	2011-12		I.D. = 1.349"	DS-6037	
M5	1988			DS-8626	
M6	2012		I.D. = 1.349"	DS-6037	
	1987-88			DS-8626	
<b>BMW SPORT UTILITY</b>					
X1	2012		I.D. = 1.8111"	DS-6024	
X3	2004-11			DS-5236	
<b>CHECKER PASSENGER CAR</b>					
TAXICAB	1969-74	Spicer 1260 thru 1410	I.D. = 1.3780 - 1.3775"	DS-6056	DS-6027
MARATHON	1968-82	Spicer 1260 thru 1410	I.D. = 1.3780 - 1.3775"	DS-6056	DS-6027
<b>CHEVROLET PASSENGER CAR</b>					
BEL AIR	1958-64	Spicer 1280	I.D. = 1.1811 - 1.1807"	DS-6035	
BISCAYNE	1958-64	Spicer 1280	I.D. = 1.1811 - 1.1807"	DS-6035	
CHEVELLE	1964	Spicer 1280	I.D. = 1.1811 - 1.1807"	DS-6035	
CHEVY II / NOVA (PRE	1962-64	Spicer 1280	I.D. = 1.1811 - 1.1807"	DS-6035	
CORVAIR	1960-64	Spicer 1280	I.D. = 1.1811 - 1.1807"	DS-6035	
CORVETTE	1958-64	Spicer 1280	I.D. = 1.1811 - 1.1807"	DS-6035	
DEL RAY	1958	Spicer 1280	I.D. = 1.1811 - 1.1807"	DS-6035	

## Drive Shaft Center Supports

Models	Years	Shaft Type / Series	Bearing Inside Diameter	Part No. Complete Assembly	Part No. Bushing Only
<b>CHEVROLET PASSENGER CAR (continued)</b>					
IMPALA	1959-64	Spicer 1280	I.D. = 1.1811 - 1.1807"	DS-6035	
MALIBU	1964	Spicer 1280	I.D. = 1.1811 - 1.1807"	DS-6035	
<b>CHEVROLET SPORT UTILITY</b>					
AVALANCHE 1500	2002-06	U-Shaped Bracket; w/ Studs; w/ Spacer Block	I.D. = 1.575" (40mm)	DS-6064	
		Wing Shaped Bracket	I.D. = 1.37" (35mm)	DS-6063	
AVALANCHE 2500	2002-06	U-Shaped Bracket; w/ Studs; w/ Spacer Block	I.D. = 1.575" (40mm)	DS-6064	
		Wing Shaped Bracket	I.D. = 1.37" (35mm)	DS-6063	
EQUINOX	2005-06	AWD		DS-6066	
BLAZER	1995-05	Spicer 1280 - 1310 - 1410 (Square Housing)	1.378" Bearing ID (35mm)	DS-6079	
C10/C1500 SUBURBAN	1992-99	Cleveland "O" Shaft	I.D. = 1.5748 - 1.5743"	DS-6053	DS-6027
		Spicer 1280-1310 End Yolk Style	I.D. = 1.1811 - 1.1807"	DS-6035	DS-6028
		Spicer 1280-1410 Slip Yolk Style	I.D. = 1.3780 - 1.3775"	DS-6056	DS-6027
		Spicer 1410, 1480	I.D. = 1.5748 - 1.5743"	DS-6038	
		Spicer 1550, 1650	I.D. = 1.7717 - 1.7712"	DS-6040	
		Spicer 1700, 1710	I.D. = 1.9685 - 1.9680"	DS-6048	
		Spicer 1800, 1850	I.D. = 2.3622 - 2.3616"	DS-6049	
	1968-86	Cleveland "O" Shaft	I.D. = 1.5748 - 1.5743"	DS-6053	DS-6027
		Spicer 1280-1310 End Yolk Style	I.D. = 1.1811 - 1.1807"	DS-6035	DS-6028
		Spicer 1280-1410 Slip Yolk Style	I.D. = 1.3780 - 1.3775"	DS-6056	DS-6027
		Spicer 1410, 1480	I.D. = 1.5748 - 1.5743"	DS-6038	
		Spicer 1550, 1650	I.D. = 1.7717 - 1.7712"	DS-6040	
		Spicer 1700, 1710	I.D. = 1.9685 - 1.9680"	DS-6048	
		Spicer 1800, 1850	I.D. = 2.3622 - 2.3616"	DS-6049	
C20/C2500 SUBURBAN	1992-99	Cleveland "O" Shaft	I.D. = 1.5748 - 1.5743"	DS-6053	DS-6027
		Spicer 1280-1310 End Yolk Style	I.D. = 1.1811 - 1.1807"	DS-6035	DS-6028
		Spicer 1280-1410 Slip Yolk Style	I.D. = 1.3780 - 1.3775"	DS-6056	DS-6027
		Spicer 1410, 1480	I.D. = 1.5748 - 1.5743"	DS-6038	
		Spicer 1550, 1650	I.D. = 1.7717 - 1.7712"	DS-6040	
		Spicer 1700, 1710	I.D. = 1.9685 - 1.9680"	DS-6048	
		Spicer 1800, 1850	I.D. = 2.3622 - 2.3616"	DS-6049	
	1968-86	Cleveland "O" Shaft	I.D. = 1.5748 - 1.5743"	DS-6053	DS-6027
		Spicer 1280-1310 End Yolk Style	I.D. = 1.1811 - 1.1807"	DS-6035	DS-6028
		Spicer 1280-1410 Slip Yolk Style	I.D. = 1.3780 - 1.3775"	DS-6056	DS-6027
		Spicer 1410, 1480	I.D. = 1.5748 - 1.5743"	DS-6038	
		Spicer 1550, 1650	I.D. = 1.7717 - 1.7712"	DS-6040	
		Spicer 1700, 1710	I.D. = 1.9685 - 1.9680"	DS-6048	
		Spicer 1800, 1850	I.D. = 2.3622 - 2.3616"	DS-6049	
K10/K1500 SUBURBAN	1992-99	Spicer 1280-1330	I.D. = 1.3780 - 1.3775"	DS-6056	DS-6027
		Spicer 1410, 1480	I.D. = 1.5748 - 1.5743"	DS-6038	
	1968-86	Spicer 1280-1330	I.D. = 1.3780 - 1.3775"	DS-6056	DS-6027
		Spicer 1410, 1480	I.D. = 1.5748 - 1.5743"	DS-6038	
K20/K2500 SUBURBAN	1992-99	Spicer 1280-1330	I.D. = 1.3780 - 1.3775"	DS-6056	DS-6027
		Spicer 1410, 1480	I.D. = 1.5748 - 1.5743"	DS-6038	
	1968-86	Spicer 1280-1330	I.D. = 1.3780 - 1.3775"	DS-6056	DS-6027
		Spicer 1410, 1480	I.D. = 1.5748 - 1.5743"	DS-6038	
R10/R1500 SUBURBAN	1989-91	Spicer 1280-1410	I.D. = 1.3780 - 1.3775"	DS-6056	DS-6027

## Drive Shaft Center Supports

Models	Years	Shaft Type / Series	Bearing Inside Diameter	Part No. Complete Assembly	Part No. Bushing Only
<b>CHEVROLET SPORT UTILITY (continued)</b>					
R10/R1500 SUBURBAN	1989-91	Spicer 1410, 1480	I.D. = 1.5748 - 1.5743"	DS-6038	
	1987-88	Spicer 1280-1410	I.D. = 1.3780 - 1.3775"	DS-6056	DS-6027
		Spicer 1410, 1480	I.D. = 1.5748 - 1.5743"	DS-6038	
R20/R2500 SUBURBAN	1989-91	Spicer 1280-1410	I.D. = 1.3780 - 1.3775"	DS-6056	DS-6027
		Spicer 1410, 1480	I.D. = 1.5748 - 1.5743"	DS-6038	
	1987-88	Spicer 1280-1410	I.D. = 1.3780 - 1.3775"	DS-6056	DS-6027
		Spicer 1410, 1480	I.D. = 1.5748 - 1.5743"	DS-6038	
S10 BLAZER SUBURBAN	1983-94	Spicer 1280-1410	I.D. = 1.3780 - 1.3775"	DS-6056	DS-6027
	1961-64	Spicer 1280	I.D. = 1.1811 - 1.1807"	DS-6035	
					DS-6054
					DS-6054
					DS-6054
					DS-6054
			DS-6054		
SUBURBAN 1500	2000-12	U-Shaped Bracket; w/ Studs; w/ Spacer Block	I.D. = 1.575" (40mm)	DS-6064	
		Wing Shaped Bracket	I.D. = 1.37" (35mm)	DS-6063	
SUBURBAN 2500	2000-12	U-Shaped Bracket; w/ Studs; w/ Spacer Block	I.D. = 1.575" (40mm)	DS-6064	
		Wing Shaped Bracket	I.D. = 1.37" (35mm)	DS-6063	
TAHOE	2000-12	U-Shaped Bracket; w/ Studs; w/ Spacer Block	I.D. = 1.575" (40mm)	DS-6064	
		Wing Shaped Bracket	I.D. = 1.37" (35mm)	DS-6063	
TRAILBLAZER	2002-03		1.378" Bearing ID (35mm)	DS-6079	
TRAILBLAZER EXT	2002-03		1.378" Bearing ID (35mm)	DS-6079	
<b>CHEVROLET TRUCK</b>					
C10/C1500 P/U	1988-99	Cleveland "O" Shaft	I.D. = 1.5748 - 1.5743"	DS-6053	DS-6027
		Spicer 1280-1310 End Yolk Style	I.D. = 1.1811 - 1.1807"	DS-6035	DS-6028
		Spicer 1280-1410 Slip Yolk Style	I.D. = 1.3780 - 1.3775"	DS-6056	DS-6027
		Spicer 1410, 1480	I.D. = 1.5748 - 1.5743"	DS-6038	
		Spicer 1550, 1650	I.D. = 1.7717 - 1.7712"	DS-6040	
		Spicer 1700, 1710	I.D. = 1.9685 - 1.9680"	DS-6048	
		Spicer 1800, 1850	I.D. = 2.3622 - 2.3616"	DS-6049	
	1965-86	Cleveland "O" Shaft	I.D. = 1.5748 - 1.5743"	DS-6053	DS-6027
		Spicer 1280-1310 End Yolk Style	I.D. = 1.1811 - 1.1807"	DS-6035	DS-6028
		Spicer 1280-1410 Slip Yolk Style	I.D. = 1.3780 - 1.3775"	DS-6056	DS-6027
		Spicer 1410, 1480	I.D. = 1.5748 - 1.5743"	DS-6038	
		Spicer 1550, 1650	I.D. = 1.7717 - 1.7712"	DS-6040	
		Spicer 1700, 1710	I.D. = 1.9685 - 1.9680"	DS-6048	
		Spicer 1800, 1850	I.D. = 2.3622 - 2.3616"	DS-6049	
	1961-64	Cleveland "O" Shaft	I.D. = 1.5748 - 1.5743"	DS-6053	DS-6027
		Spicer 1280	I.D. = 1.1811 - 1.1807"	DS-6035	DS-6028
		Spicer 1280-1310 End Yolk Style	I.D. = 1.1811 - 1.1807"	DS-6035	DS-6027
		Spicer 1280-1410 Slip Yolk Style	I.D. = 1.3780 - 1.3775"	DS-6056	
		Spicer 1410, 1480	I.D. = 1.5748 - 1.5743"	DS-6038	
		Spicer 1550, 1650	I.D. = 1.7717 - 1.7712"	DS-6040	
Spicer 1700, 1710		I.D. = 1.9685 - 1.9680"	DS-6048		
C20/C2500 P/U	1988-00	Cleveland "O" Shaft	I.D. = 1.5748 - 1.5743"	DS-6053	DS-6027
		Spicer 1280-1310 End Yolk Style	I.D. = 1.1811 - 1.1807"	DS-6035	DS-6028

## Drive Shaft Center Supports

Models	Years	Shaft Type / Series	Bearing Inside Diameter	Part No. Complete Assembly	Part No. Bushing Only	
<b>CHEVROLET TRUCK (continued)</b>						
C20/C2500 P/U	1988-00	Spicer 1280-1410 Slip Yolk Style	I.D. = 1.3780 - 1.3775"	DS-6056	DS-6027	
		Spicer 1410, 1480	I.D. = 1.5748 - 1.5743"	DS-6038		
		Spicer 1550, 1650	I.D. = 1.7717 - 1.7712"	DS-6040		
		Spicer 1700, 1710	I.D. = 1.9685 - 1.9680"	DS-6048		
	1965-86	Spicer 1800, 1850	I.D. = 2.3622 - 2.3616"	DS-6049		
		Cleveland "O" Shaft	I.D. = 1.5748 - 1.5743"	DS-6053	DS-6027	
		Spicer 1280-1310 End Yolk Style	I.D. = 1.1811 - 1.1807"	DS-6035	DS-6028	
		Spicer 1280-1410 Slip Yolk Style	I.D. = 1.3780 - 1.3775"	DS-6056	DS-6027	
		Spicer 1410, 1480	I.D. = 1.5748 - 1.5743"	DS-6038		
		Spicer 1550, 1650	I.D. = 1.7717 - 1.7712"	DS-6040		
		Spicer 1700, 1710	I.D. = 1.9685 - 1.9680"	DS-6048		
	1961-64	Spicer 1800, 1850	I.D. = 2.3622 - 2.3616"	DS-6049		
		Cleveland "O" Shaft	I.D. = 1.5748 - 1.5743"	DS-6053	DS-6027	
		Spicer 1280	I.D. = 1.1811 - 1.1807"	DS-6035	DS-6028	
		Spicer 1280-1310 End Yolk Style	I.D. = 1.1811 - 1.1807"	DS-6035	DS-6027	
		Spicer 1280-1410 Slip Yolk Style	I.D. = 1.3780 - 1.3775"	DS-6056		
		Spicer 1410, 1480	I.D. = 1.5748 - 1.5743"	DS-6038		
		Spicer 1550, 1650	I.D. = 1.7717 - 1.7712"	DS-6040		
		Spicer 1700, 1710	I.D. = 1.9685 - 1.9680"	DS-6048		
		Spicer 1800, 1850	I.D. = 2.3622 - 2.3616"	DS-6049		
		C30/C3500 P/U	2001-04	Mexico; Cleveland "O" Shaft	I.D. = 1.5748 - 1.5743"	DS-6053
	Mexico; Spicer 1280-1310 End Yolk Style			I.D. = 1.1811 - 1.1807"	DS-6035	DS-6028
	Mexico; Spicer 1280-1410 Slip Yolk Style			I.D. = 1.3780 - 1.3775"	DS-6056	DS-6027
	Mexico; Spicer 1410, 1480			I.D. = 1.5748 - 1.5743"	DS-6038	
Mexico; Spicer 1550, 1650	I.D. = 1.7717 - 1.7712"			DS-6040		
Mexico; Spicer 1700, 1710	I.D. = 1.9685 - 1.9680"			DS-6048		
1988-00	Mexico; Spicer 1800, 1850		I.D. = 2.3622 - 2.3616"	DS-6049		
	Cleveland "O" Shaft		I.D. = 1.5748 - 1.5743"	DS-6053	DS-6027	
	Spicer 1280-1310 End Yolk Style		I.D. = 1.1811 - 1.1807"	DS-6035	DS-6028	
	Spicer 1280-1410 Slip Yolk Style		I.D. = 1.3780 - 1.3775"	DS-6056	DS-6027	
	Spicer 1410, 1480		I.D. = 1.5748 - 1.5743"	DS-6038		
	Spicer 1550, 1650		I.D. = 1.7717 - 1.7712"	DS-6040		
	Spicer 1700, 1710		I.D. = 1.9685 - 1.9680"	DS-6048		
	Spicer 1800, 1850		I.D. = 2.3622 - 2.3616"	DS-6049		
1965-86	Cleveland "O" Shaft		I.D. = 1.5748 - 1.5743"	DS-6053	DS-6027	
	Spicer 1280-1310 End Yolk Style		I.D. = 1.1811 - 1.1807"	DS-6035	DS-6028	
	Spicer 1280-1410 Slip Yolk Style		I.D. = 1.3780 - 1.3775"	DS-6056	DS-6027	
	Spicer 1410, 1480		I.D. = 1.5748 - 1.5743"	DS-6038		
	Spicer 1550, 1650		I.D. = 1.7717 - 1.7712"	DS-6040		
	Spicer 1700, 1710		I.D. = 1.9685 - 1.9680"	DS-6048		
	Spicer 1800, 1850		I.D. = 2.3622 - 2.3616"	DS-6049		
1961-64	Cleveland "O" Shaft		I.D. = 1.5748 - 1.5743"	DS-6053	DS-6027	
	Spicer 1280		I.D. = 1.1811 - 1.1807"	DS-6035	DS-6028	
	Spicer 1280-1310 End Yolk Style		I.D. = 1.1811 - 1.1807"	DS-6035	DS-6027	
	Spicer 1280-1410 Slip Yolk Style	I.D. = 1.3780 - 1.3775"	DS-6056			

## Drive Shaft Center Supports

Models	Years	Shaft Type / Series	Bearing Inside Diameter	Part No. Complete Assembly	Part No. Bushing Only
<b>CHEVROLET TRUCK (continued)</b>					
C30/C3500 P/U	1961-64	Spicer 1410, 1480	I.D. = 1.5748 - 1.5743"	DS-6038	
		Spicer 1550, 1650	I.D. = 1.7717 - 1.7712"	DS-6040	
		Spicer 1700, 1710	I.D. = 1.9685 - 1.9680"	DS-6048	
		Spicer 1800, 1850	I.D. = 2.3622 - 2.3616"	DS-6049	
COLORADO	2004-12			DS-6068	
EL CAMINO	1964	Spicer 1280	I.D. = 1.1811 - 1.1807"	DS-6035	
	1959-60	Spicer 1280	I.D. = 1.1811 - 1.1807"	DS-6035	
K10/K1500 P/U	1988-99	Spicer 1280-1330	I.D. = 1.3780 - 1.3775"	DS-6056	DS-6027
		Spicer 1410, 1480	I.D. = 1.5748 - 1.5743"	DS-6038	
	1965-86	Spicer 1280-1330	I.D. = 1.3780 - 1.3775"	DS-6056	DS-6027
		Spicer 1410, 1480	I.D. = 1.5748 - 1.5743"	DS-6038	
	1961-64	Spicer 1280	I.D. = 1.1811 - 1.1807"	DS-6035	DS-6027
		Spicer 1280-1330	I.D. = 1.3780 - 1.3775"	DS-6056	
		Spicer 1410, 1480	I.D. = 1.5748 - 1.5743"	DS-6038	
K20/K2500 P/U	1988-00	Spicer 1280-1330	I.D. = 1.3780 - 1.3775"	DS-6056	DS-6027
		Spicer 1410, 1480	I.D. = 1.5748 - 1.5743"	DS-6038	
	1965-86	Spicer 1280-1330	I.D. = 1.3780 - 1.3775"	DS-6056	DS-6027
		Spicer 1410, 1480	I.D. = 1.5748 - 1.5743"	DS-6038	
	1961-64	Spicer 1280	I.D. = 1.1811 - 1.1807"	DS-6035	DS-6027
		Spicer 1280-1330	I.D. = 1.3780 - 1.3775"	DS-6056	
		Spicer 1410, 1480	I.D. = 1.5748 - 1.5743"	DS-6038	
K30/K3500 P/U	1988-00	Spicer 1280-1330	I.D. = 1.3780 - 1.3775"	DS-6056	DS-6027
		Spicer 1410, 1480	I.D. = 1.5748 - 1.5743"	DS-6038	
	1977-86	Spicer 1280-1330	I.D. = 1.3780 - 1.3775"	DS-6056	DS-6027
		Spicer 1410, 1480	I.D. = 1.5748 - 1.5743"	DS-6038	
	1968-74	Spicer 1280-1330	I.D. = 1.3780 - 1.3775"	DS-6056	DS-6027
		Spicer 1410, 1480	I.D. = 1.5748 - 1.5743"	DS-6038	
R10 PICKUP	1987	Spicer 1280-1410	I.D. = 1.3780 - 1.3775"	DS-6056	DS-6027
		Spicer 1410, 1480	I.D. = 1.5748 - 1.5743"	DS-6038	
R20/R2500 P/U	1989	Spicer 1280-1410	I.D. = 1.3780 - 1.3775"	DS-6056	DS-6027
		Spicer 1410, 1480	I.D. = 1.5748 - 1.5743"	DS-6038	
	1987-88	Spicer 1280-1410	I.D. = 1.3780 - 1.3775"	DS-6056	DS-6027
		Spicer 1410, 1480	I.D. = 1.5748 - 1.5743"	DS-6038	
R30/R3500 P/U	1989-91	Spicer 1280-1410	I.D. = 1.3780 - 1.3775"	DS-6056	DS-6027
		Spicer 1410, 1480	I.D. = 1.5748 - 1.5743"	DS-6038	
	1987-88	Spicer 1280-1410	I.D. = 1.3780 - 1.3775"	DS-6056	DS-6027
		Spicer 1410, 1480	I.D. = 1.5748 - 1.5743"	DS-6038	
S10 PICKUP	1994-04	Spicer 1280 - 1310 - 1410 (Square Housing)	1.378" Bearing ID (35mm)	DS-6079	
		Spicer 1280-1410 (Rounded Housing)	I.D. = 1.3780 - 1.3775"	DS-6056	
	1982-93	Spicer 1280-1410	I.D. = 1.3780 - 1.3775"	DS-6056	DS-6027
SILVERADO 1500	2007-12	U-Shaped Bracket; w/ Studs; w/ Spacer Block	I.D. = 1.575" (40mm)	DS-6064	
		U-Shaped Bracket; w/ Studs; w/ Spacer Block	I.D. = 1.575" (40mm)	DS-6064	
			Wing Shaped Bracket	I.D. = 1.37" (35mm)	DS-6063
SILVERADO 1500 HD	2001-07	U-Shaped Bracket; w/ Studs; w/ Spacer Block	I.D. = 1.575" (40mm)	DS-6064	
		Wing Shaped Bracket	I.D. = 1.37" (35mm)	DS-6063	
SILVERADO 2500	2000-04	U-Shaped Bracket; w/ Studs; w/ Spacer Block	I.D. = 1.575" (40mm)	DS-6064	
		Wing Shaped Bracket	I.D. = 1.37" (35mm)	DS-6063	
SILVERADO 2500 HD	2001-06	U-Shaped Bracket; w/ Studs; w/ Spacer Block	I.D. = 1.575" (40mm)	DS-6064	
		Wing Shaped Bracket	I.D. = 1.37" (35mm)	DS-6063	
SILVERADO 3500	2001-06	U-Shaped Bracket; w/ Studs; w/ Spacer Block	I.D. = 1.575" (40mm)	DS-6064	

## Drive Shaft Center Supports

Models	Years	Shaft Type / Series	Bearing Inside Diameter	Part No. Complete Assembly	Part No. Bushing Only	
<b>CHEVROLET TRUCK (continued)</b>						
SILVERADO 3500	2001-06	Wing Shaped Bracket	I.D. = 1.37" (35mm)	DS-6063		
<b>CHEVROLET VAN</b>						
G10/G1500 VAN	1998	Spicer 1280-1310 End Yolk Style	I.D. = 1.1811 - 1.1807"	DS-6035	DS-6028	
		Spicer 1280-1410 Slip Yolk Style	I.D. = 1.3780 - 1.3775"	DS-6056	DS-6027	
		Spicer 1410, 1480	I.D. = 1.5748 - 1.5743"	DS-6038		
	1965-97	Spicer 1280-1310 End Yolk Style	I.D. = 1.1811 - 1.1807"	DS-6035	DS-6028	
		Spicer 1280-1410 Slip Yolk Style	I.D. = 1.3780 - 1.3775"	DS-6056	DS-6027	
		Spicer 1410, 1480	I.D. = 1.5748 - 1.5743"	DS-6038		
	1964	Spicer 1280	I.D. = 1.1811 - 1.1807"	DS-6035	DS-6028	
		Spicer 1280-1310 End Yolk Style	I.D. = 1.1811 - 1.1807"	DS-6035	DS-6027	
		Spicer 1280-1410 Slip Yolk Style	I.D. = 1.3780 - 1.3775"	DS-6056		
		Spicer 1410, 1480	I.D. = 1.5748 - 1.5743"	DS-6038		
	G20/G2500 VAN	1998	Spicer 1280-1310 End Yolk Style	I.D. = 1.1811 - 1.1807"	DS-6035	DS-6028
			Spicer 1280-1410 Slip Yolk Style	I.D. = 1.3780 - 1.3775"	DS-6056	DS-6027
Spicer 1410, 1480			I.D. = 1.5748 - 1.5743"	DS-6038		
1967-97		Spicer 1280-1310 End Yolk Style	I.D. = 1.1811 - 1.1807"	DS-6035	DS-6028	
		Spicer 1280-1410 Slip Yolk Style	I.D. = 1.3780 - 1.3775"	DS-6056	DS-6027	
		Spicer 1410, 1480	I.D. = 1.5748 - 1.5743"	DS-6038		
G30/G3500 VAN	1998	Spicer 1280-1310 End Yolk Style	I.D. = 1.1811 - 1.1807"	DS-6035	DS-6028	
		Spicer 1280-1410 Slip Yolk Style	I.D. = 1.3780 - 1.3775"	DS-6056	DS-6027	
		Spicer 1410, 1480	I.D. = 1.5748 - 1.5743"	DS-6038		
	1971-97	Spicer 1280-1310 End Yolk Style	I.D. = 1.1811 - 1.1807"	DS-6035	DS-6028	
		Spicer 1280-1410 Slip Yolk Style	I.D. = 1.3780 - 1.3775"	DS-6056	DS-6027	
		Spicer 1410, 1480	I.D. = 1.5748 - 1.5743"	DS-6038		
P10 VAN	1962-64	Spicer 1280	I.D. = 1.1811 - 1.1807"	DS-6035		
<b>CHRYSLER PASSENGER CAR</b>						
300	2006-12			DS-6100		
<b>DODGE PASSENGER CAR</b>						
CHALLENGER	2008-12			DS-6100		
CHARGER	2006-12			DS-6100		
MAGNUM	2006-08			DS-6100		
<b>DODGE TRUCK</b>						
D50 PICKUP	1979-82				DS-8549	
D100 PICKUP	1986-89	Spicer 1260, 1410	I.D. = 1.3780 - 1.3775"	DS-6056	DS-6027	
		Spicer 1480, 1550	I.D. = 1.5748 - 1.5743"	DS-6038		
		Spicer 1610, 1650	I.D. = 1.7717 - 1.7712"	DS-6040		
		Spicer 1700, 1710	I.D. = 1.9685 - 1.9680"	DS-6048		
		Spicer 1800, 1850	I.D. = 2.3622 - 2.3616"	DS-6049		
	1968-79	Spicer 1260, 1410	I.D. = 1.3780 - 1.3775"	DS-6056	DS-6027	
		Spicer 1480, 1550	I.D. = 1.5748 - 1.5743"	DS-6038		
		Spicer 1610, 1650	I.D. = 1.7717 - 1.7712"	DS-6040		

## Drive Shaft Center Supports

Models	Years	Shaft Type / Series	Bearing Inside Diameter	Part No. Complete Assembly	Part No. Bushing Only
<b>DODGE TRUCK (continued)</b>					
D100 PICKUP	1968-79	Spicer 1700, 1710	I.D. = 1.9685 - 1.9680"	DS-6048	
		Spicer 1800, 1850	I.D. = 2.3622 - 2.3616"	DS-6049	
	1960-67	Spicer 1260, 1410	I.D. = 1.3780 - 1.3775"	DS-6056	DS-6027
		Spicer 1480, 1550	I.D. = 1.5748 - 1.5743"	DS-6038	
		Spicer 1610, 1650	I.D. = 1.7717 - 1.7712"	DS-6040	
		Spicer 1700, 1710	I.D. = 1.9685 - 1.9680"	DS-6048	
D150 PICKUP	1977-93	Spicer 1800, 1850	I.D. = 2.3622 - 2.3616"	DS-6049	
		Spicer 1260, 1410	I.D. = 1.3780 - 1.3775"	DS-6056	DS-6027
		Spicer 1480, 1550	I.D. = 1.5748 - 1.5743"	DS-6038	
		Spicer 1610, 1650	I.D. = 1.7717 - 1.7712"	DS-6040	
		Spicer 1700, 1710	I.D. = 1.9685 - 1.9680"	DS-6048	
D200 PICKUP	1968-80	Spicer 1800, 1850	I.D. = 2.3622 - 2.3616"	DS-6049	
		Spicer 1260, 1410	I.D. = 1.3780 - 1.3775"	DS-6056	DS-6027
		Spicer 1480, 1550	I.D. = 1.5748 - 1.5743"	DS-6038	
		Spicer 1610, 1650	I.D. = 1.7717 - 1.7712"	DS-6040	
		Spicer 1700, 1710	I.D. = 1.9685 - 1.9680"	DS-6048	
	1960-67	Spicer 1800, 1850	I.D. = 2.3622 - 2.3616"	DS-6049	
		Spicer 1260, 1410	I.D. = 1.3780 - 1.3775"	DS-6056	DS-6027
		Spicer 1480, 1550	I.D. = 1.5748 - 1.5743"	DS-6038	
		Spicer 1610, 1650	I.D. = 1.7717 - 1.7712"	DS-6040	
		Spicer 1700, 1710	I.D. = 1.9685 - 1.9680"	DS-6048	
D250 PICKUP	1981-93	Spicer 1800, 1850	I.D. = 2.3622 - 2.3616"	DS-6049	
		Spicer 1260, 1410	I.D. = 1.3780 - 1.3775"	DS-6056	DS-6027
		Spicer 1480, 1550	I.D. = 1.5748 - 1.5743"	DS-6038	
		Spicer 1610, 1650	I.D. = 1.7717 - 1.7712"	DS-6040	
		Spicer 1700, 1710	I.D. = 1.9685 - 1.9680"	DS-6048	
D300 PICKUP	1968-80	Spicer 1800, 1850	I.D. = 2.3622 - 2.3616"	DS-6049	
		Spicer 1260, 1410	I.D. = 1.3780 - 1.3775"	DS-6056	DS-6027
		Spicer 1480, 1550	I.D. = 1.5748 - 1.5743"	DS-6038	
		Spicer 1610, 1650	I.D. = 1.7717 - 1.7712"	DS-6040	
		Spicer 1700, 1710	I.D. = 1.9685 - 1.9680"	DS-6048	
	1960-67	Spicer 1800, 1850	I.D. = 2.3622 - 2.3616"	DS-6049	
		Spicer 1260, 1410	I.D. = 1.3780 - 1.3775"	DS-6056	DS-6027
		Spicer 1480, 1550	I.D. = 1.5748 - 1.5743"	DS-6038	
		Spicer 1610, 1650	I.D. = 1.7717 - 1.7712"	DS-6040	
		Spicer 1700, 1710	I.D. = 1.9685 - 1.9680"	DS-6048	
D350 PICKUP	1981-93	Spicer 1800, 1850	I.D. = 2.3622 - 2.3616"	DS-6049	
		Spicer 1260, 1410	I.D. = 1.3780 - 1.3775"	DS-6056	DS-6027
		Spicer 1480, 1550	I.D. = 1.5748 - 1.5743"	DS-6038	
		Spicer 1610, 1650	I.D. = 1.7717 - 1.7712"	DS-6040	
		Spicer 1700, 1710	I.D. = 1.9685 - 1.9680"	DS-6048	
D400 PICKUP	1978-81	Spicer 1800, 1850	I.D. = 2.3622 - 2.3616"	DS-6049	
		Spicer 1260, 1410	I.D. = 1.3780 - 1.3775"	DS-6056	DS-6027
		Spicer 1480, 1550	I.D. = 1.5748 - 1.5743"	DS-6038	
		Spicer 1610, 1650	I.D. = 1.7717 - 1.7712"	DS-6040	
		Spicer 1700, 1710	I.D. = 1.9685 - 1.9680"	DS-6048	
D450 PICKUP	1978-81	Spicer 1800, 1850	I.D. = 2.3622 - 2.3616"	DS-6049	
		Spicer 1260, 1410	I.D. = 1.3780 - 1.3775"	DS-6056	DS-6027
		Spicer 1480, 1550	I.D. = 1.5748 - 1.5743"	DS-6038	
		Spicer 1610, 1650	I.D. = 1.7717 - 1.7712"	DS-6040	
		Spicer 1700, 1710	I.D. = 1.9685 - 1.9680"	DS-6048	
D500	1957	Spicer 1800, 1850	I.D. = 2.3622 - 2.3616"	DS-6049	
		Spicer 1260, 1410	I.D. = 1.3780 - 1.3775"	DS-6056	DS-6027
		Spicer 1480, 1550	I.D. = 1.5748 - 1.5743"	DS-6038	
		Spicer 1610, 1650	I.D. = 1.7717 - 1.7712"	DS-6040	
		Spicer 1700, 1710	I.D. = 1.9685 - 1.9680"	DS-6048	
D501	1957	Spicer 1800, 1850	I.D. = 2.3622 - 2.3616"	DS-6049	
		Spicer 1260, 1410	I.D. = 1.3780 - 1.3775"	DS-6056	DS-6027



## Drive Shaft Center Supports

Models	Years	Shaft Type / Series	Bearing Inside Diameter	Part No. Complete Assembly	Part No. Bushing Only	
<b>DODGE TRUCK (continued)</b>						
D501	1957	Spicer 1480, 1550	I.D. = 1.5748 - 1.5743"	DS-6038		
		Spicer 1610, 1650	I.D. = 1.7717 - 1.7712"	DS-6040		
		Spicer 1700, 1710	I.D. = 1.9685 - 1.9680"	DS-6048		
		Spicer 1800, 1850	I.D. = 2.3622 - 2.3616"	DS-6049		
DAKOTA	2005	Square Housing	1.378" Bearing ID (35mm)	DS-6079		
	2003-04			DS-6071		
	1998-02	Square Housing; 1.378" Bearing ID (35mm)	1.378" Bearing ID (35mm)	DS-6079		
	1987-98		I.D. = 1.3780 - 1.3775"	DS-6056	DS-6027	
RAM 50	1983-85		I.D. = 1.1811"	DS-8549		
	1987-91			DS-5224		
RAM 1500 PICKUP	2007-10	Square Housing	1.378" Bearing ID (35mm)	DS-6079		
	2004-06	Square Housing; 1.378" Bearing ID (35mm)	1.378" Bearing ID (35mm)	DS-6079		
		U-Shaped Housing		DS-6071		
	2003	Square Housing	1.378" Bearing ID (35mm)	DS-6079		
	1994-02	Spicer 1260, 1410	I.D. = 1.3780 - 1.3775"	DS-6056	DS-6027	
		Spicer 1480, 1550	I.D. = 1.5748 - 1.5743"	DS-6038		
		Spicer 1610, 1650	I.D. = 1.7717 - 1.7712"	DS-6040		
		Spicer 1700, 1710	I.D. = 1.9685 - 1.9680"	DS-6048		
		Spicer 1800, 1850	I.D. = 2.3622 - 2.3616"	DS-6049		
		w/ Dana 60, 70, 80	I.D. = 1.575	DS-6065		
RAM 2500 PICKUP	2006			DS-6071		
	2003-05	Square Housing; 1.378" Bearing ID (35mm)	1.378" Bearing ID (35mm)	DS-6079		
		Square Housing; 1.575" Bearing ID (40mm)	1.575" Bearing I.D. (40mm)	DS-6109		
	1994-02	Spicer 1260, 1410	I.D. = 1.3780 - 1.3775"	DS-6056	DS-6027	
		Spicer 1480, 1550	I.D. = 1.5748 - 1.5743"	DS-6038		
		Spicer 1610, 1650	I.D. = 1.7717 - 1.7712"	DS-6040		
		Spicer 1700, 1710	I.D. = 1.9685 - 1.9680"	DS-6048		
		Spicer 1800, 1850	I.D. = 2.3622 - 2.3616"	DS-6049		
	RAM 3500 PICKUP	2006			DS-6071	
		2003-05	Square Housing; 1.378" Bearing ID (35mm)	1.378" Bearing ID (35mm)	DS-6079	
Square Housing; 1.575" Bearing ID (40mm)			1.575" Bearing I.D. (40mm)	DS-6109		
1994-02		Spicer 1260, 1410	I.D. = 1.3780 - 1.3775"	DS-6056	DS-6027	
		Spicer 1480, 1550	I.D. = 1.5748 - 1.5743"	DS-6038		
		Spicer 1610, 1650	I.D. = 1.7717 - 1.7712"	DS-6040		
		Spicer 1700, 1710	I.D. = 1.9685 - 1.9680"	DS-6048		
		Spicer 1800, 1850	I.D. = 2.3622 - 2.3616"	DS-6049		
W100 PICKUP		1986-89	Spicer 1260, 1410	I.D. = 1.3780 - 1.3775"	DS-6056	DS-6027
			Spicer 1480, 1550	I.D. = 1.5748 - 1.5743"	DS-6038	
	Spicer 1610, 1650		I.D. = 1.7717 - 1.7712"	DS-6040		
	Spicer 1700, 1710		I.D. = 1.9685 - 1.9680"	DS-6048		
	Spicer 1800, 1850		I.D. = 2.3622 - 2.3616"	DS-6049		
	1968-77	Spicer 1260, 1410	I.D. = 1.3780 - 1.3775"	DS-6056	DS-6027	
		Spicer 1480, 1550	I.D. = 1.5748 - 1.5743"	DS-6038		
		Spicer 1610, 1650	I.D. = 1.7717 - 1.7712"	DS-6040		
		Spicer 1700, 1710	I.D. = 1.9685 - 1.9680"	DS-6048		
		Spicer 1800, 1850	I.D. = 2.3622 - 2.3616"	DS-6049		
	1960-67	Spicer 1260, 1410	I.D. = 1.3780 - 1.3775"	DS-6056	DS-6027	
		Spicer 1480, 1550	I.D. = 1.5748 - 1.5743"	DS-6038		
		Spicer 1610, 1650	I.D. = 1.7717 - 1.7712"	DS-6040		
		Spicer 1700, 1710	I.D. = 1.9685 - 1.9680"	DS-6048		
		Spicer 1800, 1850	I.D. = 2.3622 - 2.3616"	DS-6049		
W150 PICKUP	1977-93	Spicer 1260, 1410	I.D. = 1.3780 - 1.3775"	DS-6056	DS-6027	

## Drive Shaft Center Supports

Models	Years	Shaft Type / Series	Bearing Inside Diameter	Part No. Complete Assembly	Part No. Bushing Only
<b>DODGE TRUCK (continued)</b>					
W150 PICKUP	1977-93	Spicer 1480, 1550	I.D. = 1.5748 - 1.5743"	DS-6038	
		Spicer 1610, 1650	I.D. = 1.7717 - 1.7712"	DS-6040	
		Spicer 1700, 1710	I.D. = 1.9685 - 1.9680"	DS-6048	
		Spicer 1800, 1850	I.D. = 2.3622 - 2.3616"	DS-6049	
W200 PICKUP	1969-80	Spicer 1260, 1410	I.D. = 1.3780 - 1.3775"	DS-6056	DS-6027
		Spicer 1480, 1550	I.D. = 1.5748 - 1.5743"	DS-6038	
		Spicer 1610, 1650	I.D. = 1.7717 - 1.7712"	DS-6040	
		Spicer 1700, 1710	I.D. = 1.9685 - 1.9680"	DS-6048	
	1960-67	Spicer 1800, 1850	I.D. = 2.3622 - 2.3616"	DS-6049	
		Spicer 1260, 1410	I.D. = 1.3780 - 1.3775"	DS-6056	DS-6027
		Spicer 1480, 1550	I.D. = 1.5748 - 1.5743"	DS-6038	
		Spicer 1610, 1650	I.D. = 1.7717 - 1.7712"	DS-6040	
		Spicer 1700, 1710	I.D. = 1.9685 - 1.9680"	DS-6048	
		Spicer 1800, 1850	I.D. = 2.3622 - 2.3616"	DS-6049	
W250 PICKUP	1981-93	Spicer 1260, 1410	I.D. = 1.3780 - 1.3775"	DS-6056	DS-6027
		Spicer 1480, 1550	I.D. = 1.5748 - 1.5743"	DS-6038	
		Spicer 1610, 1650	I.D. = 1.7717 - 1.7712"	DS-6040	
		Spicer 1700, 1710	I.D. = 1.9685 - 1.9680"	DS-6048	
W300 PICKUP	1968-80	Spicer 1800, 1850	I.D. = 2.3622 - 2.3616"	DS-6049	
		Spicer 1260, 1410	I.D. = 1.3780 - 1.3775"	DS-6056	DS-6027
		Spicer 1480, 1550	I.D. = 1.5748 - 1.5743"	DS-6038	
		Spicer 1610, 1650	I.D. = 1.7717 - 1.7712"	DS-6040	
	1960-67	Spicer 1700, 1710	I.D. = 1.9685 - 1.9680"	DS-6048	
		Spicer 1800, 1850	I.D. = 2.3622 - 2.3616"	DS-6049	
		Spicer 1260, 1410	I.D. = 1.3780 - 1.3775"	DS-6056	DS-6027
		Spicer 1480, 1550	I.D. = 1.5748 - 1.5743"	DS-6038	
		Spicer 1610, 1650	I.D. = 1.7717 - 1.7712"	DS-6040	
		Spicer 1700, 1710	I.D. = 1.9685 - 1.9680"	DS-6048	
W350 PICKUP	1981-93	Spicer 1800, 1850	I.D. = 2.3622 - 2.3616"	DS-6049	
		Spicer 1260, 1410	I.D. = 1.3780 - 1.3775"	DS-6056	DS-6027
		Spicer 1480, 1550	I.D. = 1.5748 - 1.5743"	DS-6038	
		Spicer 1610, 1650	I.D. = 1.7717 - 1.7712"	DS-6040	
		Spicer 1700, 1710	I.D. = 1.9685 - 1.9680"	DS-6048	
<b>DODGE VAN</b>					
RAM 1500 VAN	2002-03		1.378" Bearing ID (35mm)	DS-6079	
RAM 2500 VAN	2003		1.378" Bearing ID (35mm)	DS-6079	
RAM 3500 VAN	1999-03	Square Housing	1.378" Bearing ID (35mm)	DS-6079	
SPRINTER 2500	2007-09	1-Piece Shaft; w/ Shims		DS-6105	
		1-Piece Shaft; w/o Shims		DS-6104	
		2- & 3-Piece Shaft; w/ Shims Slider Section		DS-6107	
		2- & 3-Piece Shaft; w/o Shims Slider Section		DS-6106	
SPRINTER 3500	2007-09	1-Piece Shaft; w/ Shims		DS-6105	
		1-Piece Shaft; w/o Shims		DS-6104	
		2- & 3-Piece Shaft; w/ Shims Slider Section		DS-6107	
		2- & 3-Piece Shaft; w/o Shims Slider Section		DS-6106	
<b>FORD SPORT UTILITY</b>					
ESCAPE	2001-07			DS-6076	
EXPLORER	1991-98	Spicer 1210	I.D. = 1.1811 - 1.1807"	DS-6062	

## Drive Shaft Center Supports

Models	Years	Shaft Type / Series	Bearing Inside Diameter	Part No. Complete Assembly	Part No. Bushing Only
<b>FORD TRUCK</b>					
F SERIES	1957-59	Cleveland "O" Shaft	I.D. = 1.5000 - 1.4945"	DS-6051	DS-6027
		Cleveland "R" & "S" Shaft	I.D. = 1.3740 - 1.3745"	DS-6050	DS-6027
		Spicer 1210, 1310	I.D. = 1.3780 - 1.3775"	DS-6056	
		Spicer 1280, 1410	I.D. = 1.3780 - 1.3775"	DS-6056	
		Spicer 1410	I.D. = 1.5748 - 1.5743"	DS-6053	
		Spicer 1480, 1550	I.D. = 1.5748 - 1.5743"	DS-6038	
		Spicer 1610, 1650	I.D. = 1.7717 - 1.7712"	DS-6040	
		Spicer 1700, 1710	I.D. = 1.9685 - 1.9680"	DS-6048	
		Spicer 1800, 1850	I.D. = 2.3622 - 2.3616"	DS-6049	
w/ Cleveland "O" Shaft	I.D. = 1.5748 - 1.5743"	DS-6053			
F-100 PICKUP	1960-83	Spicer 1280, 1410	I.D. = 1.3780 - 1.3775"	DS-6056	DS-6027
		Spicer 1480, 1550	I.D. = 1.5748 - 1.5743"	DS-6038	
F-150 PICKUP	1977-98	Spicer 1280, 1410	I.D. = 1.3780 - 1.3775"	DS-6056	DS-6027
		Spicer 1480, 1550	I.D. = 1.5748 - 1.5743"	DS-6038	
	1976	Spicer 1280, 1410	I.D. = 1.3780 - 1.3775"	DS-6056	DS-6027
		Spicer 1480, 1550	I.D. = 1.5748 - 1.5743"	DS-6038	
	1975	Spicer 1280, 1410	I.D. = 1.3780 - 1.3775"	DS-6056	DS-6027
Spicer 1480, 1550		I.D. = 1.5748 - 1.5743"	DS-6038		
F-250 PICKUP	1960-98	Spicer 1280, 1410	I.D. = 1.3780 - 1.3775"	DS-6056	DS-6027
		Spicer 1480, 1550	I.D. = 1.5748 - 1.5743"	DS-6038	
F-250 SUPER DUTY PIC	2007-10	1.575" Bearing ID (40mm) 2.25" Center Line Height	I.D. = 1.5748 - 1.5743"	DS-6038	
		2006	1.575" Bearing ID (40mm) 2.25" Center Line Height	I.D. = 1.5748 - 1.5743"	DS-6038
	2005	1.575" Bearing ID (40mm) 2.25" Center Line Height	I.D. = 1.5748 - 1.5743"	DS-6038	
	2003-04	1.575" Bearing ID (40mm) 2.25" Center Line Height	I.D. = 1.5748 - 1.5743"	DS-6038	
		1999-02	1.575" Bearing ID (40mm) 2.25" Center Line Height	I.D. = 1.5748 - 1.5743"	DS-6038
F-350 PICKUP	1960-97	Spicer 1280, 1410	I.D. = 1.3780 - 1.3775"	DS-6056	DS-6027
		Spicer 1480, 1550	I.D. = 1.5748 - 1.5743"	DS-6038	
F-350 SUPER DUTY PIC	1999-02	1.575" Bearing ID (40mm) 2.25" Center Line Height	I.D. = 1.5748 - 1.5743"	DS-6038	
		2004-07	1.575" Bearing ID (40mm) 2.25" Center Line Height	I.D. = 1.5748 - 1.5743"	DS-6038
F-450 SUPER DUTY PIC	2006-07	1.575" Bearing ID (40mm) 2.25" Center Line Height	I.D. = 1.5748 - 1.5743"	DS-6038	
		2004-05	1.575" Bearing ID (40mm) 2.25" Center Line Height	I.D. = 1.5748 - 1.5743"	DS-6038
	1999-03	1.575" Bearing ID (40mm) 2.25" Center Line Height	I.D. = 1.5748 - 1.5743"	DS-6038	
		1990-97	Cleveland "O" Shaft	I.D. = 1.5000 - 1.4945"	DS-6051
	Cleveland "R" & "S" Shaft		I.D. = 1.3740 - 1.3745"	DS-6050	
	Spicer 1210, 1310		I.D. = 1.3780 - 1.3775"	DS-6056	
	Spicer 1410		I.D. = 1.5748 - 1.5743"	DS-6053	
	Spicer 1480, 1550		I.D. = 1.5748 - 1.5743"	DS-6038	
Spicer 1610, 1650	I.D. = 1.7717 - 1.7712"		DS-6040		
Spicer 1700, 1710	I.D. = 1.9685 - 1.9680"	DS-6048			
Spicer 1800, 1850	I.D. = 2.3622 - 2.3616"	DS-6049			
w/ Cleveland "O" Shaft	I.D. = 1.5748 - 1.5743"	DS-6053			
F-500 PICKUP	1975-77	Cleveland "O" Shaft	I.D. = 1.5000 - 1.4945"	DS-6051	DS-6027
		Cleveland "R" & "S" Shaft	I.D. = 1.3740 - 1.3745"	DS-6050	
		Spicer 1210, 1310	I.D. = 1.3780 - 1.3775"	DS-6056	
		Spicer 1410	I.D. = 1.5748 - 1.5743"	DS-6053	
		Spicer 1480, 1550	I.D. = 1.5748 - 1.5743"	DS-6038	
		Spicer 1610, 1650	I.D. = 1.7717 - 1.7712"	DS-6040	
		Spicer 1700, 1710	I.D. = 1.9685 - 1.9680"	DS-6048	

## Drive Shaft Center Supports

Models	Years	Shaft Type / Series	Bearing Inside Diameter	Part No. Complete Assembly	Part No. Bushing Only
<b>FORD TRUCK (continued)</b>					
F-500 PICKUP	1975-77	Spicer 1800, 1850 w/ Cleveland "O" Shaft	I.D. = 2.3622 - 2.3616" I.D. = 1.5748 - 1.5743"	DS-6049 DS-6053	
F-550 SUPER DUTY PIC	1999-07	1.575" Bearing ID (40mm) 2.25" Center Line Height	I.D. = 1.5748 - 1.5743"	DS-6038	
RANGER	1990-98	Spicer 1210	I.D. = 1.1811 - 1.1807"	DS-6062	
	1986-89	Spicer 1210	I.D. = 1.2573 - 1.2568"	DS-6061	
<b>FORD VAN</b>					
E-100 ECONOLINE	1968-83	Spicer 1280, 1410	I.D. = 1.3780 - 1.3775"	DS-6056	DS-6027
		Spicer 1480, 1550	I.D. = 1.5748 - 1.5743"	DS-6038	
E-150 ECONOLINE	1975-98	Spicer 1280, 1410	I.D. = 1.3780 - 1.3775"	DS-6056	DS-6027
		Spicer 1480, 1550	I.D. = 1.5748 - 1.5743"	DS-6038	
E-200 ECONOLINE	1968-74	Spicer 1280, 1410	I.D. = 1.3780 - 1.3775"	DS-6056	DS-6027
		Spicer 1480, 1550	I.D. = 1.5748 - 1.5743"	DS-6038	
E-250 ECONOLINE	1975-98	Spicer 1280, 1410	I.D. = 1.3780 - 1.3775"	DS-6056	DS-6027
		Spicer 1480, 1550	I.D. = 1.5748 - 1.5743"	DS-6038	
E-250 SUPER DUTY	2004-05	1.575" Bearing ID (40mm) 2.25" Center Line Height	I.D. = 1.5748 - 1.5743"	DS-6038	
E-300 ECONOLINE	1968-74	Spicer 1280, 1410	I.D. = 1.3780 - 1.3775"	DS-6056	DS-6027
		Spicer 1480, 1550	I.D. = 1.5748 - 1.5743"	DS-6038	
E-350 ECONOLINE	1975-98	Spicer 1280, 1410	I.D. = 1.3780 - 1.3775"	DS-6056	DS-6027
		Spicer 1480, 1550	I.D. = 1.5748 - 1.5743"	DS-6038	
E-350 SUPER DUTY	2004-10	1.575" Bearing ID (40mm) 2.25" Center Line Height	I.D. = 1.5748 - 1.5743"	DS-6038	
E-450 SUPER DUTY	2000-13	1.575" Bearing ID (40mm) 2.25" Center Line Height	I.D. = 1.5748 - 1.5743"	DS-6038	
<b>FREIGHTLINER</b>					
SPRINTER 2500	2007-09	1-Piece Shaft; w/ Shims		DS-6105	
		1-Piece Shaft; w/o Shims		DS-6104	
		2- & 3-Piece Shaft; w/ Shims Slider Section		DS-6107	
		2- & 3-Piece Shaft; w/o Shims Slider Section		DS-6106	
SPRINTER 3500	2007-09	1-Piece Shaft; w/ Shims		DS-6105	
		1-Piece Shaft; w/o Shims		DS-6104	
		2- & 3-Piece Shaft; w/ Shims Slider Section		DS-6107	
		2- & 3-Piece Shaft; w/o Shims Slider Section		DS-6106	
<b>GMC SPORT UTILITY</b>					
C15/C1500 SUBURBAN	1992-99	Cleveland "O" Shaft	I.D. = 1.5748 - 1.5743"	DS-6053	DS-6027
		Spicer 1280-1310 End Yolk Style	I.D. = 1.1811 - 1.1807"	DS-6035	DS-6028
		Spicer 1280-1410 Slip Yolk Style	I.D. = 1.3780 - 1.3775"	DS-6056	DS-6027
		Spicer 1410, 1480	I.D. = 1.5748 - 1.5743"	DS-6038	
		Spicer 1550, 1650	I.D. = 1.7717 - 1.7712"	DS-6040	
		Spicer 1700, 1710	I.D. = 1.9685 - 1.9680"	DS-6048	
		Spicer 1800, 1850	I.D. = 2.3622 - 2.3616"	DS-6049	
		1968-86	Cleveland "O" Shaft	I.D. = 1.5748 - 1.5743"	DS-6053
	Spicer 1280-1310 End Yolk Style		I.D. = 1.1811 - 1.1807"	DS-6035	DS-6028
	Spicer 1280-1410 Slip Yolk Style		I.D. = 1.3780 - 1.3775"	DS-6056	DS-6027
	Spicer 1410, 1480		I.D. = 1.5748 - 1.5743"	DS-6038	
	Spicer 1550, 1650		I.D. = 1.7717 - 1.7712"	DS-6040	
	Spicer 1700, 1710		I.D. = 1.9685 - 1.9680"	DS-6048	

## Drive Shaft Center Supports

Models	Years	Shaft Type / Series	Bearing Inside Diameter	Part No. Complete Assembly	Part No. Bushing Only
<b>GMC SPORT UTILITY (continued)</b>					
C15/C1500 SUBURBAN	1968-86	Spicer 1800, 1850	I.D. = 2.3622 - 2.3616"	DS-6049	
C25/C2500 SUBURBAN	1992-99	Cleveland "O" Shaft	I.D. = 1.5748 - 1.5743"	DS-6053	DS-6027
		Spicer 1280-1310 End Yolk Style	I.D. = 1.1811 - 1.1807"	DS-6035	DS-6028
		Spicer 1280-1410 Slip Yolk Style	I.D. = 1.3780 - 1.3775"	DS-6056	DS-6027
		Spicer 1410, 1480	I.D. = 1.5748 - 1.5743"	DS-6038	
		Spicer 1550, 1650	I.D. = 1.7717 - 1.7712"	DS-6040	
		Spicer 1700, 1710	I.D. = 1.9685 - 1.9680"	DS-6048	
		Spicer 1800, 1850	I.D. = 2.3622 - 2.3616"	DS-6049	
	1968-86	Cleveland "O" Shaft	I.D. = 1.5748 - 1.5743"	DS-6053	DS-6027
		Spicer 1280-1310 End Yolk Style	I.D. = 1.1811 - 1.1807"	DS-6035	DS-6028
		Spicer 1280-1410 Slip Yolk Style	I.D. = 1.3780 - 1.3775"	DS-6056	DS-6027
		Spicer 1410, 1480	I.D. = 1.5748 - 1.5743"	DS-6038	
		Spicer 1550, 1650	I.D. = 1.7717 - 1.7712"	DS-6040	
		Spicer 1700, 1710	I.D. = 1.9685 - 1.9680"	DS-6048	
		Spicer 1800, 1850	I.D. = 2.3622 - 2.3616"	DS-6049	
ENVOY	2002-03		1.378" Bearing ID (35mm)	DS-6079	
ENVOY XL / XUV	2002-03		1.378" Bearing ID (35mm)	DS-6079	
JIMMY	1995-05	Spicer 1280 - 1310 - 1410 (Square Housing)	1.378" Bearing ID (35mm)	DS-6079	
K15/K1500 SUBURBAN	1992-99	Spicer 1280-1330	I.D. = 1.3780 - 1.3775"	DS-6056	DS-6027
		Spicer 1410, 1480	I.D. = 1.5748 - 1.5743"	DS-6038	
	1968-86	Spicer 1280-1330	I.D. = 1.3780 - 1.3775"	DS-6056	DS-6027
		Spicer 1410, 1480	I.D. = 1.5748 - 1.5743"	DS-6038	
K25/K2500 SUBURBAN	1992-99	Spicer 1280-1330	I.D. = 1.3780 - 1.3775"	DS-6056	DS-6027
		Spicer 1410, 1480	I.D. = 1.5748 - 1.5743"	DS-6038	
	1968-86	Spicer 1280-1330	I.D. = 1.3780 - 1.3775"	DS-6056	DS-6027
		Spicer 1410, 1480	I.D. = 1.5748 - 1.5743"	DS-6038	
R1500 SUBURBAN	1987-91	Spicer 1280-1410	I.D. = 1.3780 - 1.3775"	DS-6056	DS-6027
		Spicer 1410, 1480	I.D. = 1.5748 - 1.5743"	DS-6038	
R2500 SUBURBAN	1987-91	Spicer 1280-1410	I.D. = 1.3780 - 1.3775"	DS-6056	DS-6027
		Spicer 1410, 1480	I.D. = 1.5748 - 1.5743"	DS-6038	
S15 JIMMY	1994-04	Spicer 1280 - 1310 - 1410 (Square Housing)	1.378" Bearing ID (35mm)	DS-6079	
	1983-94	Spicer 1280-1410	I.D. = 1.3780 - 1.3775"	DS-6056	DS-6027
SUBURBAN	1967				DS-6054
	1965				DS-6054
	1967				DS-6054
					DS-6054
YUKON	2000-12	U-Shaped Bracket; w/ Studs; w/ Spacer Block	I.D. = 1.575" (40mm)	DS-6064	
		Wing Shaped Bracket	I.D. = 1.37" (35mm)	DS-6063	
YUKON XL 1500	2000-12	U-Shaped Bracket; w/ Studs; w/ Spacer Block	I.D. = 1.575" (40mm)	DS-6064	
		Wing Shaped Bracket	I.D. = 1.37" (35mm)	DS-6063	
YUKON XL 2500	2000-12	U-Shaped Bracket; w/ Studs; w/ Spacer Block	I.D. = 1.575" (40mm)	DS-6064	
		Wing Shaped Bracket	I.D. = 1.37" (35mm)	DS-6063	
<b>GMC TRUCK</b>					
C15/C1500 PICKUP	1988-99	Cleveland "O" Shaft	I.D. = 1.5748 - 1.5743"	DS-6053	DS-6027
		Spicer 1280-1310 End Yolk Style	I.D. = 1.1811 - 1.1807"	DS-6035	DS-6028
		Spicer 1280-1410 Slip Yolk Style	I.D. = 1.3780 - 1.3775"	DS-6056	DS-6027

## Drive Shaft Center Supports

Models	Years	Shaft Type / Series	Bearing Inside Diameter	Part No. Complete Assembly	Part No. Bushing Only
<b>GMC TRUCK (continued)</b>					
C15/C1500 PICKUP	1988-99	Spicer 1410, 1480	I.D. = 1.5748 - 1.5743"	DS-6038	
		Spicer 1550, 1650	I.D. = 1.7717 - 1.7712"	DS-6040	
		Spicer 1700, 1710	I.D. = 1.9685 - 1.9680"	DS-6048	
		Spicer 1800, 1850	I.D. = 2.3622 - 2.3616"	DS-6049	
	1966-86	Cleveland "O" Shaft	I.D. = 1.5748 - 1.5743"	DS-6053	DS-6027
		Spicer 1280-1310 End Yolk Style	I.D. = 1.1811 - 1.1807"	DS-6035	DS-6028
		Spicer 1280-1410 Slip Yolk Style	I.D. = 1.3780 - 1.3775"	DS-6056	DS-6027
		Spicer 1410, 1480	I.D. = 1.5748 - 1.5743"	DS-6038	
		Spicer 1550, 1650	I.D. = 1.7717 - 1.7712"	DS-6040	
		Spicer 1700, 1710	I.D. = 1.9685 - 1.9680"	DS-6048	
C25/C2500 PICKUP	1988-00	Cleveland "O" Shaft	I.D. = 1.5748 - 1.5743"	DS-6053	DS-6027
		Spicer 1280-1310 End Yolk Style	I.D. = 1.1811 - 1.1807"	DS-6035	DS-6028
		Spicer 1280-1410 Slip Yolk Style	I.D. = 1.3780 - 1.3775"	DS-6056	DS-6027
		Spicer 1410, 1480	I.D. = 1.5748 - 1.5743"	DS-6038	
		Spicer 1550, 1650	I.D. = 1.7717 - 1.7712"	DS-6040	
		Spicer 1700, 1710	I.D. = 1.9685 - 1.9680"	DS-6048	
	1966-86	Cleveland "O" Shaft	I.D. = 1.5748 - 1.5743"	DS-6053	DS-6027
		Spicer 1280-1310 End Yolk Style	I.D. = 1.1811 - 1.1807"	DS-6035	DS-6028
		Spicer 1280-1410 Slip Yolk Style	I.D. = 1.3780 - 1.3775"	DS-6056	DS-6027
		Spicer 1410, 1480	I.D. = 1.5748 - 1.5743"	DS-6038	
C35/C3500 PICKUP	1988-02	Cleveland "O" Shaft	I.D. = 1.5748 - 1.5743"	DS-6053	DS-6027
		Spicer 1280-1310 End Yolk Style	I.D. = 1.1811 - 1.1807"	DS-6035	DS-6028
		Spicer 1280-1410 Slip Yolk Style	I.D. = 1.3780 - 1.3775"	DS-6056	DS-6027
		Spicer 1410, 1480	I.D. = 1.5748 - 1.5743"	DS-6038	
		Spicer 1550, 1650	I.D. = 1.7717 - 1.7712"	DS-6040	
		Spicer 1700, 1710	I.D. = 1.9685 - 1.9680"	DS-6048	
	1967-86	Cleveland "O" Shaft	I.D. = 1.5748 - 1.5743"	DS-6053	DS-6027
		Spicer 1280-1310 End Yolk Style	I.D. = 1.1811 - 1.1807"	DS-6035	DS-6028
		Spicer 1280-1410 Slip Yolk Style	I.D. = 1.3780 - 1.3775"	DS-6056	DS-6027
		Spicer 1410, 1480	I.D. = 1.5748 - 1.5743"	DS-6038	
CANYON	2004-12			DS-6068	
K15/K1500 PICKUP	1988-99	Spicer 1280-1330	I.D. = 1.3780 - 1.3775"	DS-6056	DS-6027
		Spicer 1410, 1480	I.D. = 1.5748 - 1.5743"	DS-6038	
	1966-86	Spicer 1280-1330	I.D. = 1.3780 - 1.3775"	DS-6056	DS-6027
		Spicer 1410, 1480	I.D. = 1.5748 - 1.5743"	DS-6038	
K25/K2500 PICKUP	1988-00	Spicer 1280-1330	I.D. = 1.3780 - 1.3775"	DS-6056	DS-6027
		Spicer 1410, 1480	I.D. = 1.5748 - 1.5743"	DS-6038	
	1967-86	Spicer 1280-1330	I.D. = 1.3780 - 1.3775"	DS-6056	DS-6027
		Spicer 1410, 1480	I.D. = 1.5748 - 1.5743"	DS-6038	

## Drive Shaft Center Supports

Models	Years	Shaft Type / Series	Bearing Inside Diameter	Part No. Complete Assembly	Part No. Bushing Only
<b>GMC TRUCK (continued)</b>					
K35/K3500 PICKUP	1988-00	Spicer 1280-1330	I.D. = 1.3780 - 1.3775"	DS-6056	DS-6027
		Spicer 1410, 1480	I.D. = 1.5748 - 1.5743"	DS-6038	
	1977-86	Spicer 1280-1330	I.D. = 1.3780 - 1.3775"	DS-6056	DS-6027
		Spicer 1410, 1480	I.D. = 1.5748 - 1.5743"	DS-6038	
	1967-74	Spicer 1280-1330	I.D. = 1.3780 - 1.3775"	DS-6056	DS-6027
		Spicer 1410, 1480	I.D. = 1.5748 - 1.5743"	DS-6038	
R1500 PICKUP	1987	Spicer 1280-1410	I.D. = 1.3780 - 1.3775"	DS-6056	DS-6027
Spicer 1410, 1480		I.D. = 1.5748 - 1.5743"	DS-6038		
R2500 PICKUP	1987-89	Spicer 1280-1410	I.D. = 1.3780 - 1.3775"	DS-6056	DS-6027
Spicer 1410, 1480		I.D. = 1.5748 - 1.5743"	DS-6038		
R3500 PICKUP	1987-91	Spicer 1280-1410	I.D. = 1.3780 - 1.3775"	DS-6056	DS-6027
		Spicer 1410, 1480	I.D. = 1.5748 - 1.5743"	DS-6038	
S15 PICKUP	1982-90	Spicer 1280-1410	I.D. = 1.3780 - 1.3775"	DS-6056	DS-6027
SIERRA 1500	2007-12	U-Shaped Bracket; w/ Studs; w/ Spacer Block	I.D. = 1.575" (40mm)	DS-6064	
		U-Shaped Bracket; w/ Studs; w/ Spacer Block	I.D. = 1.575" (40mm)	DS-6064	
	Wing Shaped Bracket	I.D. = 1.37" (35mm)	DS-6063		
SIERRA 1500 HD	2001-07	U-Shaped Bracket; w/ Studs; w/ Spacer Block	I.D. = 1.575" (40mm)	DS-6064	
		Wing Shaped Bracket	I.D. = 1.37" (35mm)	DS-6063	
SIERRA 2500	1999-04	U-Shaped Bracket; w/ Studs; w/ Spacer Block	I.D. = 1.575" (40mm)	DS-6064	
		Wing Shaped Bracket	I.D. = 1.37" (35mm)	DS-6063	
SIERRA 2500 HD	2001-06	U-Shaped Bracket; w/ Studs; w/ Spacer Block	I.D. = 1.575" (40mm)	DS-6064	
		Wing Shaped Bracket	I.D. = 1.37" (35mm)	DS-6063	
SIERRA 3500	2001-06	U-Shaped Bracket; w/ Studs; w/ Spacer Block	I.D. = 1.575" (40mm)	DS-6064	
		Wing Shaped Bracket	I.D. = 1.37" (35mm)	DS-6063	
SIERRA C3	2001	U-Shaped Bracket; w/ Studs; w/ Spacer Block	I.D. = 1.575" (40mm)	DS-6064	
		Wing Shaped Bracket	I.D. = 1.37" (35mm)	DS-6063	
SONOMA	1994-04	Spicer 1280 - 1310 - 1410 (Square Housing)	1.378" Bearing ID (35mm)	DS-6079	
<b>GMC VAN</b>					
G1000 SERIES	1964-66	Spicer 1280-1310 End Yolk Style	I.D. = 1.1811 - 1.1807"	DS-6035	DS-6028
		Spicer 1280-1410 Slip Yolk Style	I.D. = 1.3780 - 1.3775"	DS-6056	DS-6027
		Spicer 1410, 1480	I.D. = 1.5748 - 1.5743"	DS-6038	
G15/G1500 VAN	1967-98	Spicer 1280-1310 End Yolk Style	I.D. = 1.1811 - 1.1807"	DS-6035	DS-6028
		Spicer 1280-1410 Slip Yolk Style	I.D. = 1.3780 - 1.3775"	DS-6056	DS-6027
		Spicer 1410, 1480	I.D. = 1.5748 - 1.5743"	DS-6038	
G25/G2500 VAN	1967-98	Spicer 1280-1310 End Yolk Style	I.D. = 1.1811 - 1.1807"	DS-6035	DS-6028
		Spicer 1280-1410 Slip Yolk Style	I.D. = 1.3780 - 1.3775"	DS-6056	DS-6027
		Spicer 1410, 1480	I.D. = 1.5748 - 1.5743"	DS-6038	
G35/G3500 VAN	1971-98	Spicer 1280-1310 End Yolk Style	I.D. = 1.1811 - 1.1807"	DS-6035	DS-6028
		Spicer 1280-1410 Slip Yolk Style	I.D. = 1.3780 - 1.3775"	DS-6056	DS-6027
		Spicer 1410, 1480	I.D. = 1.5748 - 1.5743"	DS-6038	
	1967	Spicer 1280-1310 End Yolk Style	I.D. = 1.1811 - 1.1807"	DS-6035	DS-6028

# Drive Shaft Center Supports

Models	Years	Shaft Type / Series	Bearing Inside Diameter	Part No. Complete Assembly	Part No. Bushing Only
<b>GMC VAN (continued)</b>					
G35/G3500 VAN	1967	Spicer 1280-1410 Slip Yolk Style	I.D. = 1.3780 - 1.3775"	DS-6056	DS-6027
		Spicer 1410, 1480	I.D. = 1.5748 - 1.5743"	DS-6038	
<b>HONDA SPORT UTILITY</b>					
CR-V	2002-06			DS-6069	
	1997-01			DS-5235	
PASSPORT	1994-98			DS-5222	
<b>INFINITI PASSENGER CAR</b>					
J30	1993-97			DS-8474	
M30	1990-92			DS-8474	
<b>INTERNATIONAL</b>					
4000 Series	2002	Cleveland "R" & "S" Shaft	I.D. = 1.3740 - 1.3745"	DS-6050	
		Cleveland "U" Shaft		DS-6052	
		Spicer 1260	I.D. = 1.1811 - 1.1807"	DS-6035	
		Spicer 1280 - 1310 - 1410 & Cleveland S55	I.D. = 1.3780 - 1.3775"	DS-6056	
		Spicer 1480 - 1550 & Mechanics 6C	I.D. = 1.5748 - 1.5743"	DS-6038	
		Spicer 1610 - 1650 & Mechanics 7C	I.D. = 1.7717 - 1.7712"	DS-6040	
		Spicer 1700 - 1710 & Mechanics 8C	I.D. = 1.9685 - 1.9680"	DS-6048	
		Spicer 1800 - 1850	I.D. = 2.3622 - 2.3616"	DS-6049	
3000 Series	1996-02	Cleveland "R" & "S" Shaft	I.D. = 1.3740 - 1.3745"	DS-6050	
		Cleveland "U" Shaft		DS-6052	
		Spicer 1260	I.D. = 1.1811 - 1.1807"	DS-6035	
		Spicer 1280 - 1310 - 1410 & Cleveland S55	I.D. = 1.3780 - 1.3775"	DS-6056	
		Spicer 1480 - 1550 & Mechanics 6C	I.D. = 1.5748 - 1.5743"	DS-6038	
		Spicer 1610 - 1650 & Mechanics 7C	I.D. = 1.7717 - 1.7712"	DS-6040	
		Spicer 1700 - 1710 & Mechanics 8C	I.D. = 1.9685 - 1.9680"	DS-6048	
		Spicer 1800 - 1850	I.D. = 2.3622 - 2.3616"	DS-6049	
2000 Series	1990-02	Cleveland "R" & "S" Shaft	I.D. = 1.3740 - 1.3745"	DS-6050	
		Cleveland "U" Shaft		DS-6052	
		Spicer 1260	I.D. = 1.1811 - 1.1807"	DS-6035	
		Spicer 1280 - 1310 - 1410 & Cleveland S55	I.D. = 1.3780 - 1.3775"	DS-6056	
		Spicer 1480 - 1550 & Mechanics 6C	I.D. = 1.5748 - 1.5743"	DS-6038	
		Spicer 1610 - 1650 & Mechanics 7C	I.D. = 1.7717 - 1.7712"	DS-6040	
		Spicer 1700 - 1710 & Mechanics 8C	I.D. = 1.9685 - 1.9680"	DS-6048	
		Spicer 1800 - 1850	I.D. = 2.3622 - 2.3616"	DS-6049	
1000 Series	1986-02	Cleveland "R" & "S" Shaft	I.D. = 1.3740 - 1.3745"	DS-6050	
		Cleveland "U" Shaft		DS-6052	
		Spicer 1260	I.D. = 1.1811 - 1.1807"	DS-6035	
		Spicer 1280 - 1310 - 1410 & Cleveland S55	I.D. = 1.3780 - 1.3775"	DS-6056	
		Spicer 1480 - 1550 & Mechanics 6C	I.D. = 1.5748 - 1.5743"	DS-6038	
		Spicer 1610 - 1650 & Mechanics 7C	I.D. = 1.7717 - 1.7712"	DS-6040	



## Drive Shaft Center Supports

Models	Years	Shaft Type / Series	Bearing Inside Diameter	Part No. Complete Assembly	Part No. Bushing Only
<b>INTERNATIONAL (continued)</b>					
1000 Series	1986-02	Spicer 1700 - 1710 & Mechanics 8C	I.D. = 1.9685 - 1.9680"	DS-6048	
		Spicer 1800 - 1850	I.D. = 2.3622 - 2.3616"	DS-6049	
ALL MODELS	1993-97	Cleveland "R" & "S" Shaft	I.D. = 1.3740 - 1.3745"	DS-6050	
		Cleveland "U" Shaft		DS-6052	
		Spicer 1260	I.D. = 1.1811 - 1.1807"	DS-6035	
		Spicer 1280 - 1310 - 1410 & Cleveland S55	I.D. = 1.3780 - 1.3775"	DS-6056	
		Spicer 1480 - 1550 & Mechanics 6C	I.D. = 1.5748 - 1.5743"	DS-6038	
		Spicer 1610 - 1650 & Mechanics 7C	I.D. = 1.7717 - 1.7712"	DS-6040	
		Spicer 1700 - 1710 & Mechanics 8C	I.D. = 1.9685 - 1.9680"	DS-6048	
		Spicer 1800 - 1850	I.D. = 2.3622 - 2.3616"	DS-6049	
<b>ISUZU SPORT UTILITY</b>					
RODEO	1991-97			DS-5223	
<b>ISUZU TRUCK</b>					
HOMBRE	1996-99	Spicer 1280, 1310, 1330, 1410	I.D. = 1.3780 - 1.3775"	DS-6056	DS-6027
I-290	2007-08			DS-6068	
I-370	2007-08			DS-6068	
I-280	2006			DS-6068	
I-350	2006			DS-6068	
PICKUP	1987-95	Complete Unit; 2WD		DS-8591	DS-8538
	1981-86	2WD		DS-8535	
<b>LEXUS PASSENGER CAR</b>					
ES300	1992-97			DS-8509	
GS300	1999-05			DS-6085	
	1993-97			DS-8509	
GS400	1998-00			DS-6085	
GS430	2001-07			DS-6085	
IS300	2001-05			DS-6086	
LS400	1995-00			DS-6086	
LS430	2001-06			DS-6085	
SC430	2002-10			DS-6085	
<b>MAZDA SPORT UTILITY</b>					
TRIBUTE	2001-06			DS-6076	
<b>MAZDA TRUCK</b>					
B1600	1972-76	2WD		DS-8565	
B2200	1988-93	2WD		DS-8551	DS-5234
	1987	2WD		DS-8550	DS-5234
	1982-84	2WD		DS-8550	
B2600	1987-93	4WD			DS-5234
B3000	1994-96	2WD		DS-8551	
<b>MERCEDES-BENZ PASSENGER CAR</b>					
190	1964-65	2WD		DS-8636	
190D	1984-89				DS-5232
190E	1984-89				DS-5232
280	1973-76			DS-8635	
280C	1973-76			DS-8635	
280CE	1978-79			DS-8635	
280E	1977-79			DS-8635	
280S	1975-76			DS-8635	
280SE	1977-79			DS-8635	

## Drive Shaft Center Supports

















Models	Years	Shaft Type / Series	Bearing Inside Diameter	Part No. Complete Assembly	Part No. Bushing Only
<b>MERCEDES-BENZ PASSENGER CAR (continued)</b>					
280SE	1972-73			DS-8635	
280SEL	1972-73			DS-8635	
300CDT	1984-85			DS-8634	
300CE	1988-89			DS-8634	
300D	1987			DS-8634	
300DT	1987			DS-8634	
	1984-85			DS-8634	
300E	1986-89			DS-8634	
300SD	1984-85			DS-8634	
300SDL	1986-87			DS-8634	
300SE	1988-89			DS-8634	
300SEL	1988-89			DS-8634	
300TDT	1987			DS-8634	
	1984-85			DS-8634	
300TE	1988-89			DS-8634	
380SE	1984-85			DS-8634	
380SL	1984-85			DS-8634	
<b>MERCEDES-BENZ VAN</b>					
SPRINTER 2500	2010-13	1-Piece Shaft; w/ Shims		DS-6105	
		1-Piece Shaft; w/o Shims		DS-6104	
		2- & 3-Piece Shaft; w/ Shims Slider Section		DS-6107	
		2- & 3-Piece Shaft; w/o Shims Slider Section		DS-6106	
SPRINTER 3500	2010-13	1-Piece Shaft; w/ Shims		DS-6105	
		1-Piece Shaft; w/o Shims		DS-6104	
		2- & 3-Piece Shaft; w/ Shims Slider Section		DS-6107	
		2- & 3-Piece Shaft; w/o Shims Slider Section		DS-6106	
<b>MERCURY SPORT UTILITY</b>					
MARINER	2005-07			DS-6076	
<b>MITSUBISHI TRUCK</b>					
MIGHTY MAX	1990-92	2WD		DS-8318	
	1983-89		I.D. = 1.1811"	DS-8549	
<b>NISSAN PASSENGER CAR</b>					
240SX	1989-95	RWD		DS-8474	
MAXIMA	1982-84	RWD		DS-8474	
<b>NISSAN SPORT UTILITY</b>					
PATHFINDER	1989-95	2WD		DS-8474	
		4WD		DS-8473	
	1987-88	4WD		DS-8473	
<b>NISSAN TRUCK</b>					
620 PICKUP	1973-79	2WD		DS-8475	
720 PICKUP	1986	2WD		DS-8474	
		4WD		DS-8473	
	1980-85	2WD		DS-8472	
D21 PICKUP	1986-93	2WD		DS-8474	
		4WD		DS-8473	
FRONTIER	1991-93			DS-8473	
	2005-12			DS-6071	
PICKUP	1998-04			DS-8474	
		1994-95	2WD	DS-8474	
		4WD		DS-8473	

## Drive Shaft Center Supports

Models	Years	Shaft Type / Series	Bearing Inside Diameter	Part No. Complete Assembly	Part No. Bushing Only
<b>NISSAN TRUCK (continued)</b>					
PICKUP	1994-96			DS-8473	
<b>PLYMOUTH TRUCK</b>					
ARROW PICKUP	1979-82		I.D. = 1.1811"	DS-8549	
<b>PONTIAC SPORT UTILITY</b>					
TORRENT	2006	AWD		DS-6066	
<b>PORSCHE</b>					
CAYENNE	2003-10			DS-6042	
<b>SATURN SUV</b>					
VUE	2002-07	AWD		DS-6066	
	2004-07	AWD		DS-6066	
	2002-03	AWD		DS-6066	
<b>TOYOTA PASSENGER CAR</b>					
CELICA	1982-85			DS-8468	
COROLLA	1980-87	RWD			DS-8531
CORONA	1982	RWD		DS-8468	
CRESSIDA	1985-88			DS-8588	
	1983-84	RWD		DS-8587	
	1979-80	RWD		DS-8587	
SUPRA	1986-87			DS-8588	
	1985			DS-8588	
	1982-84	RWD		DS-8468	
TERCEL	1983-88	4WD		DS-8468	
<b>TOYOTA SPORT UTILITY</b>					
4RUNNER	1984-88			DS-8470	
	1989-95			DS-5231	
LAND CRUISER	1984-90			DS-8470	
RAV4	2001-05			DS-6072	
	1996-00			DS-5230	
<b>TOYOTA TRUCK</b>					
PICKUP	1984-87	2WD		DS-8532	
		4WD		DS-8470	
	1979-83			DS-8469	
				DS-8533	
	1989-95	2WD		DS-8533	
		4WD		DS-8471	
1988	2WD		DS-8532		
	4WD		DS-8470		
T100	1995-98	2WD		DS-5225	
		4WD		DS-5226	
	1993-94			DS-5225	
TACOMA	1995-03	2WD		DS-5225	
		4WD		DS-5227	
TUNDRA	2000-06	2WD		DS-5225	
		4WD		DS-5227	
<b>TOYOTA VAN</b>					
SIENNA	2011-13			DS-5229	
<b>VOLKSWAGEN SPORT UTILITY</b>					
TOUAREG	2004-12			DS-6042	

# BUYER'S GUIDE

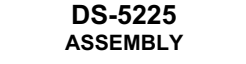
## NUMERICAL LISTING - ILLUSTRATIONS

 <p><b>DS-5222 ASSEMBLY</b></p> <p>HONDA SPORT UTILITY ..... 1994-98</p>	 <p><b>DS-5226 ASSEMBLY</b></p> <p>TOYOTA TRUCK ..... 1995-98</p>	 <p><b>DS-5230 ASSEMBLY</b></p> <p>TOYOTA SPORT UTILITY ..... 1996-00</p>	 <p><b>DS-5236 (NEW) ASSEMBLY</b></p> <p>BMW PASSENGER CAR ..... 2002-10 BMW SPORT UTILITY ..... 2004-11</p>
 <p><b>DS-5223 ASSEMBLY</b></p> <p>ISUZU SPORT UTILITY ..... 1991-97</p>	 <p><b>DS-5227 ASSEMBLY</b></p> <p>TOYOTA TRUCK ..... 1995-06</p>	 <p><b>DS-5231 ASSEMBLY</b></p> <p>TOYOTA SPORT UTILITY ..... 1989-95</p>	 <p><b>DS-6024 (NEW) ASSEMBLY</b></p> <p>BMW PASSENGER CAR ..... 2004-12 BMW SPORT UTILITY ..... 2012</p>
 <p><b>DS-5224 ASSEMBLY</b></p> <p>DODGE TRUCK ..... 1987-91</p>	 <p><b>DS-5228 ASSEMBLY FRONT</b></p> <p>LEXUS SPORT UTILITY ..... 2001-13 TOYOTA SPORT UTILITY ..... 2001-13</p>	 <p><b>DS-5232 BUSHINGS</b></p> <p>MERCEDES-BENZ PASSENGER CAR ..... 1984-89</p>	 <p><b>DS-6027 BUSHINGS</b></p> <p>CHEVROLET PASSENGER CAR .... 1968-82 CHEVROLET SPORT UTILITY .... 1968-99 CHEVROLET TRUCK ..... 1961-04 CHEVROLET VAN ..... 1964-98 DODGE TRUCK ..... 1957-02 FORD TRUCK ..... 1957-98 FORD VAN ..... 1968-98 GMC SPORT UTILITY ..... 1968-99 GMC TRUCK ..... 1966-02 GMC VAN ..... 1964-98 ISUZU TRUCK ..... 1996-99</p>
 <p><b>DS-5225 ASSEMBLY</b></p> <p>TOYOTA TRUCK ..... 1993-06</p>	 <p><b>DS-5229 ASSEMBLY REAR</b></p> <p>LEXUS SPORT UTILITY ..... 2001-13 TOYOTA SPORT UTILITY ..... 2001-13</p>	 <p><b>DS-5234 BUSHINGS</b></p> <p>MAZDA TRUCK ..... 1987-93</p>	 <p><b>DS-6028 BUSHINGS</b></p> <p>CHEVROLET SPORT UTILITY .... 1968-99 CHEVROLET TRUCK ..... 1961-04 CHEVROLET VAN ..... 1964-98 GMC SPORT UTILITY ..... 1968-99</p>
 <p><b>DS-5225 ASSEMBLY</b></p> <p>TOYOTA TRUCK ..... 1993-06</p>	 <p><b>DS-5235 ASSEMBLY</b></p> <p>HONDA SPORT UTILITY ..... 1997-01</p>	<p><b>(Continued Next Page)</b></p>	

# BUYER'S GUIDE

## NUMERICAL LISTING - ILLUSTRATIONS

### DS-6028 (Continued)

GMC TRUCK ..... 1966-02  
 GMC VAN ..... 1964-98



### DS-6035 ASSEMBLY

CHEVROLET PASSENGER  
 CAR ..... 1958-64  
 CHEVROLET SPORT UTILITY ..... 1961-99  
 CHEVROLET TRUCK ..... 1959-04  
 CHEVROLET VAN ..... 1962-98  
 GMC SPORT UTILITY ..... 1968-99  
 GMC TRUCK ..... 1966-02  
 GMC VAN ..... 1964-98  
 INTERNATIONAL ..... 1986-02



### DS-6037 (NEW) ASSEMBLY

BMW PASSENGER CAR ..... 2007-12



### DS-6038 ASSEMBLY

CHEVROLET SPORT UTILITY ..... 1968-99  
 CHEVROLET TRUCK ..... 1961-04  
 CHEVROLET VAN ..... 1964-98  
 DODGE TRUCK ..... 1957-02  
 FORD TRUCK ..... 1957-10  
 FORD VAN ..... 1968-13  
 GMC SPORT UTILITY ..... 1968-99  
 GMC TRUCK ..... 1966-02  
 GMC VAN ..... 1964-98  
 INTERNATIONAL ..... 1986-02



### DS-6040 ASSEMBLY

CHEVROLET SPORT UTILITY ..... 1968-99  
 CHEVROLET TRUCK ..... 1961-04  
 DODGE TRUCK ..... 1957-02  
 FORD TRUCK ..... 1957-97  
 GMC SPORT UTILITY ..... 1968-99  
 GMC TRUCK ..... 1966-02  
 INTERNATIONAL ..... 1986-02



### DS-6042 (NEW) ASSEMBLY

AUDI SPORTS UTILITY ..... 2007-12  
 PORSCHE ..... 2003-10  
 VOLKSWAGEN SPORT  
 UTILITY ..... 2004-12



### DS-6048 ASSEMBLY

CHEVROLET SPORT UTILITY ..... 1968-99  
 CHEVROLET TRUCK ..... 1961-04  
 DODGE TRUCK ..... 1957-02  
 FORD TRUCK ..... 1957-97  
 GMC SPORT UTILITY ..... 1968-99  
 GMC TRUCK ..... 1966-02  
 INTERNATIONAL ..... 1986-02



### DS-6049 ASSEMBLY

CHEVROLET SPORT UTILITY ..... 1968-99  
 CHEVROLET TRUCK ..... 1961-04  
 DODGE TRUCK ..... 1957-02  
 FORD TRUCK ..... 1957-97  
 GMC SPORT UTILITY ..... 1968-99  
 GMC TRUCK ..... 1966-02  
 INTERNATIONAL ..... 1986-02



### DS-6050 ASSEMBLY

FORD TRUCK ..... 1957-97  
 INTERNATIONAL ..... 1986-02



### DS-6051 ASSEMBLY

FORD TRUCK ..... 1957-97



### DS-6052 ASSEMBLY

INTERNATIONAL ..... 1986-02



### DS-6053 ASSEMBLY

CHEVROLET SPORT UTILITY ..... 1968-99  
 CHEVROLET TRUCK ..... 1961-04  
 FORD TRUCK ..... 1957-97  
 GMC SPORT UTILITY ..... 1968-99  
 GMC TRUCK ..... 1966-02



### DS-6054 BUSHINGS

CHEVROLET SPORT UTILITY ..... 1965-67  
 GMC SPORT UTILITY ..... 1965-67

# BUYER'S GUIDE

## NUMERICAL LISTING - ILLUSTRATIONS

 <p style="text-align: center;"><b>DS-6056 ASSEMBLY</b></p> <table style="width: 100%; border-collapse: collapse;"> <tr><td>CHEVROLET PASSENGER CAR</td><td>.....</td><td>1968-82</td></tr> <tr><td>CHEVROLET SPORT UTILITY</td><td>.....</td><td>1968-99</td></tr> <tr><td>CHEVROLET TRUCK</td><td>.....</td><td>1961-04</td></tr> <tr><td>CHEVROLET VAN</td><td>.....</td><td>1964-98</td></tr> <tr><td>DODGE TRUCK</td><td>.....</td><td>1957-02</td></tr> <tr><td>FORD TRUCK</td><td>.....</td><td>1957-98</td></tr> <tr><td>FORD VAN</td><td>.....</td><td>1968-98</td></tr> <tr><td>GMC SPORT UTILITY</td><td>.....</td><td>1968-99</td></tr> <tr><td>GMC TRUCK</td><td>.....</td><td>1966-02</td></tr> <tr><td>GMC VAN</td><td>.....</td><td>1964-98</td></tr> <tr><td>INTERNATIONAL</td><td>.....</td><td>1986-02</td></tr> <tr><td>ISUZU TRUCK</td><td>.....</td><td>1996-99</td></tr> </table>	CHEVROLET PASSENGER CAR	.....	1968-82	CHEVROLET SPORT UTILITY	.....	1968-99	CHEVROLET TRUCK	.....	1961-04	CHEVROLET VAN	.....	1964-98	DODGE TRUCK	.....	1957-02	FORD TRUCK	.....	1957-98	FORD VAN	.....	1968-98	GMC SPORT UTILITY	.....	1968-99	GMC TRUCK	.....	1966-02	GMC VAN	.....	1964-98	INTERNATIONAL	.....	1986-02	ISUZU TRUCK	.....	1996-99	 <p style="text-align: center;"><b>DS-6063 ASSEMBLY</b></p> <table style="width: 100%; border-collapse: collapse;"> <tr><td>CHEVROLET SPORT UTILITY</td><td>.....</td><td>2000-12</td></tr> <tr><td>CHEVROLET TRUCK</td><td>.....</td><td>1999-07</td></tr> <tr><td>GMC SPORT UTILITY</td><td>.....</td><td>2000-12</td></tr> <tr><td>GMC TRUCK</td><td>.....</td><td>1999-07</td></tr> </table>	CHEVROLET SPORT UTILITY	.....	2000-12	CHEVROLET TRUCK	.....	1999-07	GMC SPORT UTILITY	.....	2000-12	GMC TRUCK	.....	1999-07	 <p style="text-align: center;"><b>DS-6068 (NEW) ASSEMBLY</b></p> <table style="width: 100%; border-collapse: collapse;"> <tr><td>CHEVROLET TRUCK</td><td>.....</td><td>2004-12</td></tr> <tr><td>GMC TRUCK</td><td>.....</td><td>2004-12</td></tr> <tr><td>ISUZU TRUCK</td><td>.....</td><td>2006-08</td></tr> </table>	CHEVROLET TRUCK	.....	2004-12	GMC TRUCK	.....	2004-12	ISUZU TRUCK	.....	2006-08	 <p style="text-align: center;"><b>DS-6076 (NEW) ASSEMBLY</b></p> <table style="width: 100%; border-collapse: collapse;"> <tr><td>FORD SPORT UTILITY</td><td>.....</td><td>2001-07</td></tr> <tr><td>MAZDA SPORT UTILITY</td><td>.....</td><td>2001-06</td></tr> <tr><td>MERCURY SPORT UTILITY</td><td>.....</td><td>2005-07</td></tr> </table>	FORD SPORT UTILITY	.....	2001-07	MAZDA SPORT UTILITY	.....	2001-06	MERCURY SPORT UTILITY	.....	2005-07
CHEVROLET PASSENGER CAR	.....	1968-82																																																																			
CHEVROLET SPORT UTILITY	.....	1968-99																																																																			
CHEVROLET TRUCK	.....	1961-04																																																																			
CHEVROLET VAN	.....	1964-98																																																																			
DODGE TRUCK	.....	1957-02																																																																			
FORD TRUCK	.....	1957-98																																																																			
FORD VAN	.....	1968-98																																																																			
GMC SPORT UTILITY	.....	1968-99																																																																			
GMC TRUCK	.....	1966-02																																																																			
GMC VAN	.....	1964-98																																																																			
INTERNATIONAL	.....	1986-02																																																																			
ISUZU TRUCK	.....	1996-99																																																																			
CHEVROLET SPORT UTILITY	.....	2000-12																																																																			
CHEVROLET TRUCK	.....	1999-07																																																																			
GMC SPORT UTILITY	.....	2000-12																																																																			
GMC TRUCK	.....	1999-07																																																																			
CHEVROLET TRUCK	.....	2004-12																																																																			
GMC TRUCK	.....	2004-12																																																																			
ISUZU TRUCK	.....	2006-08																																																																			
FORD SPORT UTILITY	.....	2001-07																																																																			
MAZDA SPORT UTILITY	.....	2001-06																																																																			
MERCURY SPORT UTILITY	.....	2005-07																																																																			
 <p style="text-align: center;"><b>DS-6061 ASSEMBLY</b></p> <p>FORD TRUCK ..... 1986-89</p>	 <p style="text-align: center;"><b>DS-6064 ASSEMBLY</b></p> <table style="width: 100%; border-collapse: collapse;"> <tr><td>CHEVROLET SPORT UTILITY</td><td>.....</td><td>2000-12</td></tr> <tr><td>CHEVROLET TRUCK</td><td>.....</td><td>1999-12</td></tr> <tr><td>GMC SPORT UTILITY</td><td>.....</td><td>2000-12</td></tr> <tr><td>GMC TRUCK</td><td>.....</td><td>1999-12</td></tr> </table>	CHEVROLET SPORT UTILITY	.....	2000-12	CHEVROLET TRUCK	.....	1999-12	GMC SPORT UTILITY	.....	2000-12	GMC TRUCK	.....	1999-12	 <p style="text-align: center;"><b>DS-6069 (NEW) ASSEMBLY</b></p> <p>HONDA SPORT UTILITY ..... 2002-06</p>	 <p style="text-align: center;"><b>DS-6079 (NEW) ASSEMBLY</b></p> <table style="width: 100%; border-collapse: collapse;"> <tr><td>CHEVROLET SPORT UTILITY</td><td>.....</td><td>1995-05</td></tr> <tr><td>CHEVROLET TRUCK</td><td>.....</td><td>1994-04</td></tr> <tr><td>DODGE TRUCK</td><td>.....</td><td>1998-10</td></tr> <tr><td>DODGE VAN</td><td>.....</td><td>1999-03</td></tr> <tr><td>GMC SPORT UTILITY</td><td>.....</td><td>1994-05</td></tr> <tr><td>GMC TRUCK</td><td>.....</td><td>1994-04</td></tr> </table>	CHEVROLET SPORT UTILITY	.....	1995-05	CHEVROLET TRUCK	.....	1994-04	DODGE TRUCK	.....	1998-10	DODGE VAN	.....	1999-03	GMC SPORT UTILITY	.....	1994-05	GMC TRUCK	.....	1994-04																																				
CHEVROLET SPORT UTILITY	.....	2000-12																																																																			
CHEVROLET TRUCK	.....	1999-12																																																																			
GMC SPORT UTILITY	.....	2000-12																																																																			
GMC TRUCK	.....	1999-12																																																																			
CHEVROLET SPORT UTILITY	.....	1995-05																																																																			
CHEVROLET TRUCK	.....	1994-04																																																																			
DODGE TRUCK	.....	1998-10																																																																			
DODGE VAN	.....	1999-03																																																																			
GMC SPORT UTILITY	.....	1994-05																																																																			
GMC TRUCK	.....	1994-04																																																																			
 <p style="text-align: center;"><b>DS-6062 ASSEMBLY</b></p> <table style="width: 100%; border-collapse: collapse;"> <tr><td>FORD SPORT UTILITY</td><td>.....</td><td>1991-98</td></tr> <tr><td>FORD TRUCK</td><td>.....</td><td>1990-98</td></tr> </table>	FORD SPORT UTILITY	.....	1991-98	FORD TRUCK	.....	1990-98	 <p style="text-align: center;"><b>DS-6065 ASSEMBLY</b></p> <p>DODGE TRUCK ..... 1994-02</p>	 <p style="text-align: center;"><b>DS-6071 (NEW) ASSEMBLY</b></p> <table style="width: 100%; border-collapse: collapse;"> <tr><td>DODGE TRUCK</td><td>.....</td><td>2003-06</td></tr> <tr><td>NISSAN TRUCK</td><td>.....</td><td>2005-12</td></tr> </table>	DODGE TRUCK	.....	2003-06	NISSAN TRUCK	.....	2005-12	 <p style="text-align: center;"><b>DS-6085 (NEW) ASSEMBLY</b></p> <p>LEXUS PASSENGER CAR ..... 1998-10</p>																																																						
FORD SPORT UTILITY	.....	1991-98																																																																			
FORD TRUCK	.....	1990-98																																																																			
DODGE TRUCK	.....	2003-06																																																																			
NISSAN TRUCK	.....	2005-12																																																																			
 <p style="text-align: center;"><b>DS-6066 (NEW) ASSEMBLY</b></p> <table style="width: 100%; border-collapse: collapse;"> <tr><td>CHEVROLET SPORT UTILITY</td><td>.....</td><td>2005-06</td></tr> <tr><td>PONTIAC SPORT UTILITY</td><td>.....</td><td>2006</td></tr> <tr><td>SATURN SUV</td><td>.....</td><td>2002-07</td></tr> </table>	CHEVROLET SPORT UTILITY	.....	2005-06	PONTIAC SPORT UTILITY	.....	2006	SATURN SUV	.....	2002-07	 <p style="text-align: center;"><b>DS-6072 (NEW) ASSEMBLY</b></p> <p>TOYOTA SPORT UTILITY ..... 2001-05</p>	 <p style="text-align: center;"><b>DS-6086 (NEW) ASSEMBLY</b></p> <p>LEXUS PASSENGER CAR ..... 1995-05</p>																																																										
CHEVROLET SPORT UTILITY	.....	2005-06																																																																			
PONTIAC SPORT UTILITY	.....	2006																																																																			
SATURN SUV	.....	2002-07																																																																			

# BUYER'S GUIDE

## NUMERICAL LISTING - ILLUSTRATIONS



**DS-6100 (NEW)  
ASSEMBLY**

CHRYSLER PASSENGER  
CAR ..... 2006-12  
DODGE PASSENGER CAR ..... 2006-12



**DS-6107 (NEW)  
ASSEMBLY**

DODGE VAN ..... 2007-09  
FREIGHTLINER ..... 2007-09  
MERCEDES-BENZ VAN ..... 2010-13



**DS-8318  
ASSEMBLY**

MITSUBISHI TRUCK ..... 1990-92



**DS-8471  
ASSEMBLY**

TOYOTA TRUCK ..... 1989-95



**DS-6104 (NEW)  
ASSEMBLY**

DODGE VAN ..... 2007-09  
FREIGHTLINER ..... 2007-09  
MERCEDES-BENZ VAN ..... 2010-13



**DS-6109 (NEW)  
ASSEMBLY**

DODGE TRUCK ..... 2003-05



**DS-8468  
ASSEMBLY**

TOYOTA PASSENGER CAR ..... 1982-88



**DS-8472  
ASSEMBLY**

NISSAN TRUCK ..... 1980-85



**DS-6105 (NEW)  
ASSEMBLY**

DODGE VAN ..... 2007-09  
FREIGHTLINER ..... 2007-09  
MERCEDES-BENZ VAN ..... 2010-13



**DS-6111 (NEW)  
ASSEMBLY  
FRONT**

MITSUBISHI SPORT UTILITY ..... 2003-06



**DS-6112 (NEW)  
ASSEMBLY  
REAR**

MITSUBISHI SPORT UTILITY ..... 2003-06



**DS-8469  
ASSEMBLY**

TOYOTA TRUCK ..... 1979-83



**DS-8473  
ASSEMBLY**

NISSAN SPORT UTILITY ..... 1987-95  
NISSAN TRUCK ..... 1986-96



**DS-6106 (NEW)  
ASSEMBLY**

DODGE VAN ..... 2007-09  
FREIGHTLINER ..... 2007-09  
MERCEDES-BENZ VAN ..... 2010-13



**DS-8470  
ASSEMBLY**

TOYOTA SPORT UTILITY ..... 1984-90  
TOYOTA TRUCK ..... 1984-88



**DS-8474  
ASSEMBLY**

INFINITI PASSENGER CAR ..... 1990-97  
NISSAN PASSENGER CAR ..... 1982-95  
NISSAN SPORT UTILITY ..... 1989-95  
NISSAN TRUCK ..... 1986-04

# BUYER'S GUIDE

## NUMERICAL LISTING - ILLUSTRATIONS

 <p><b>DS-8475 ASSEMBLY</b></p> <p>NISSAN TRUCK ..... 1973-79</p>	 <p><b>DS-8533 ASSEMBLY</b></p> <p>TOYOTA TRUCK ..... 1989-95</p>	 <p><b>DS-8550 ASSEMBLY</b></p> <p>MAZDA TRUCK ..... 1982-87</p>	 <p><b>DS-8588 ASSEMBLY</b></p> <p>TOYOTA PASSENGER CAR ..... 1985-88</p>
 <p><b>DS-8509 ASSEMBLY</b></p> <p>LEXUS PASSENGER CAR ..... 1992-97</p>	 <p><b>DS-8535 ASSEMBLY</b></p> <p>ISUZU TRUCK ..... 1981-86</p>	 <p><b>DS-8551 ASSEMBLY</b></p> <p>MAZDA TRUCK ..... 1988-96</p>	 <p><b>DS-8591 ASSEMBLY</b></p> <p>ISUZU TRUCK ..... 1987-95</p>
 <p><b>DS-8531 BUSHINGS</b></p> <p>TOYOTA PASSENGER CAR ..... 1980-87</p>	 <p><b>DS-8538 BUSHINGS</b></p> <p>ISUZU TRUCK ..... 1987-95</p>	 <p><b>DS-8565 ASSEMBLY</b></p> <p>MAZDA TRUCK ..... 1972-76</p>	 <p><b>DS-8626 ASSEMBLY</b></p> <p>BMW PASSENGER CAR ..... 1975-89</p>
 <p><b>DS-8532 ASSEMBLY</b></p> <p>TOYOTA TRUCK ..... 1984-88</p>	 <p><b>DS-8549 BUSHINGS ASSEMBLY</b></p> <p>DODGE TRUCK ..... 1979-85</p> <p>MITSUBISHI TRUCK ..... 1983-89</p> <p>PLYMOUTH TRUCK ..... 1979-82</p>	 <p><b>DS-8587 ASSEMBLY</b></p> <p>TOYOTA PASSENGER CAR ..... 1979-84</p>	 <p><b>DS-8627 ASSEMBLY</b></p> <p>BMW PASSENGER CAR ..... 1984-86</p>



# BUYER'S GUIDE

## NUMERICAL LISTING - ILLUSTRATIONS



**DS-8634  
ASSEMBLY**

MERCEDES-BENZ  
PASSENGER CAR ..... 1984-89



**EM-2009  
MOUNT-ENGINE  
L & R Front Upper**

FORD PASSENGER CAR ..... 1946-48  
FORD TRUCK ..... 1948-51



**EM-2018  
MOUNT-ENGINE  
Center Front**

DODGE PASSENGER CAR ..... 1949-56



**EM-2041  
MOUNT-ENGINE  
Center Front**

CHEVROLET TRUCK ..... 1966-72

**MOUNT-TRANSMISSION  
Lower**

JEEP TRUCK ..... 1958-62

**MOUNT-ENGINE  
Front Center**

PLYMOUTH PASSENGER  
CAR ..... 1953-54



**DS-8635  
ASSEMBLY**

MERCEDES-BENZ  
PASSENGER CAR ..... 1972-79



**EM-2010  
MOUNT-ENGINE  
L & R Front Lower**

FORD PASSENGER CAR ..... 1946-48  
FORD TRUCK ..... 1948-51



**EM-2039  
MOUNT-TRANSMISSION  
L & R**

JEEP TRUCK ..... 1949-51



**EM-2048  
MOUNT-ENGINE  
L & R Front Lower**

FORD TRUCK ..... 1957-64



**DS-8636  
ASSEMBLY**

MERCEDES-BENZ  
PASSENGER CAR ..... 1964-65



**EM-2014  
MOUNT-ENGINE  
L & R Rear**

DODGE PASSENGER CAR ..... 1953-56



**EM-2040  
MOUNT-ENGINE  
L & R Front**

JEEP SPORT UTILITY ..... 1959-71  
JEEP TRUCK ..... 1949-62



**EM-2050  
MOUNT-ENGINE  
L & R Front Upper**

FORD TRUCK ..... 1957-64

**MOUNT-TRANSMISSION  
L & R Upper**

PLYMOUTH PASSENGER  
CAR ..... 1951-54



**EM-2007  
MOUNT-ENGINE  
Center Front**

CHEVROLET TRUCK ..... 1942-53

# BUYER'S GUIDE

## NUMERICAL LISTING - ILLUSTRATIONS

 <p style="text-align: center;"><b>EM-2053</b> <b>MOUNT-ENGINE</b> <b>L &amp; R Front</b></p> <p>CHEVROLET PASSENGER CAR ..... 1950-51</p>	 <p style="text-align: center;"><b>EM-2073</b> <b>MOUNT-TRANSMISSION</b> <b>L &amp; R</b></p> <p>CHEVROLET TRUCK ..... 1942-53</p>	<p><b>EM-2107 (Continued)</b></p> <p>GMC VAN ..... 1966</p> <p style="text-align: center;"><b>MOUNT-TRANSMISSION</b> <b>L &amp; R Upper</b></p> <p>CHEVROLET SPORT UTILITY ... 1968-74 CHEVROLET TRUCK ..... 1961-80 GMC TRUCK ..... 1967-84 CHEVROLET SPORT UTILITY ... 1968-87 CHEVROLET TRUCK ..... 1961-84 CHEVROLET VAN ..... 1963-65 GMC SPORT UTILITY ..... 1968-85 GMC TRUCK ..... 1961-84</p>	 <p style="text-align: center;"><b>EM-2119</b> <b>MOUNT-TRANSMISSION</b> <b>Upper</b></p> <p>FORD TRUCK ..... 1953-64</p>
 <p style="text-align: center;"><b>EM-2057</b> <b>MOUNT-TRANSMISSION</b> <b>L &amp; R</b></p> <p>CHEVROLET PASSENGER CAR ..... 1950-51</p>	 <p style="text-align: center;"><b>EM-2091</b> <b>MOUNT-ENGINE</b> <b>L &amp; R Front Upper</b></p> <p>CHEVROLET PASSENGER CAR ..... 1950-54</p>	 <p style="text-align: center;"><b>EM-2108</b> <b>MOUNT-ENGINE</b> <b>L &amp; R Rear Lower</b></p> <p>CHEVROLET TRUCK ..... 1961-65 CHEVROLET VAN ..... 1964-66 GMC VAN ..... 1966</p> <p style="text-align: center;"><b>MOUNT-TRANSMISSION</b> <b>L &amp; R Lower</b></p> <p>CHEVROLET SPORT UTILITY ... 1968-87 CHEVROLET TRUCK ..... 1961-84 CHEVROLET VAN ..... 1963-65 GMC SPORT UTILITY ..... 1968-85 GMC TRUCK ..... 1961-84</p>	 <p style="text-align: center;"><b>EM-2120</b> <b>MOUNT-ENGINE</b> <b>Center Front Lower</b></p> <p>FORD PASSENGER CAR ..... 1956-58 FORD TRUCK ..... 1953-55</p>
 <p style="text-align: center;"><b>EM-2060</b> <b>MOUNT-TRANSMISSION</b> <b>L &amp; R</b></p> <p>CHEVROLET TRUCK ..... 1942-53</p>	 <p style="text-align: center;"><b>EM-2092</b> <b>MOUNT-ENGINE</b> <b>L &amp; R Front Lower</b></p> <p>CHEVROLET PASSENGER CAR ..... 1950-60</p>	 <p style="text-align: center;"><b>EM-2110</b> <b>MOUNT-ENGINE</b> <b>L &amp; R Front</b></p> <p>FORD PASSENGER CAR ..... 1954-58 FORD TRUCK ..... 1955-57</p>	 <p style="text-align: center;"><b>EM-2121</b> <b>MOUNT-TRANSMISSION</b> <b>Lower</b></p> <p>FORD TRUCK ..... 1953-64</p>
 <p style="text-align: center;"><b>EM-2070</b> <b>MOUNT-TRANSMISSION</b></p> <p>BUICK PASSENGER CAR ..... 1953-63</p>	 <p style="text-align: center;"><b>EM-2107</b> <b>MOUNT-ENGINE</b> <b>L &amp; R Rear Upper</b></p> <p>CHEVROLET TRUCK ..... 1961-65 CHEVROLET VAN ..... 1964-66</p> <p style="text-align: center;">(Continued Next Column)</p>	 <p style="text-align: center;"><b>EM-2122</b> <b>MOUNT-ENGINE</b> <b>L &amp; R Front</b></p> <p>CHEVROLET PASSENGER CAR ..... 1955-57</p> <p style="text-align: center;">(Continued Next Page)</p>	

# BUYER'S GUIDE

## NUMERICAL LISTING - ILLUSTRATIONS

**EM-2122 (Continued)**  
**MOUNT-TRANSMISSION**  
 Auto  
 CHEVROLET TRUCK ..... 1953-58



**EM-2126**  
**MOUNT-TRANSMISSION**  
 RH

CHEVROLET PASSENGER  
 CAR ..... 1955-57



**EM-2142**  
**MOUNT-ENGINE**  
 L & R Front

CHEVROLET PASSENGER  
 CAR ..... 1957-73  
 CHEVROLET TRUCK ..... 1960-73



**EM-2162**  
**MOUNT-TRANSMISSION**  
 L & R Upper

CHEVROLET TRUCK ..... 1966-72

**EM-2123**  
**MOUNT-ENGINE**  
 L & R Front

CHEVROLET PASSENGER  
 CAR ..... 1955-57

**MOUNT-TRANSMISSION**  
 Auto

CHEVROLET TRUCK ..... 1953-58



**EM-2127**  
**MOUNT-TRANSMISSION**  
 LH

CHEVROLET PASSENGER  
 CAR ..... 1955-57



**EM-2143 (NEW)**  
**MOUNT-TRANSMISSION**  
 Auto

CHEVROLET PASSENGER  
 CAR ..... 1957-67



**EM-2163**  
**MOUNT-TRANSMISSION**  
 L & R Lower

CHEVROLET TRUCK ..... 1966-72



**EM-2124**  
**MOUNT-TRANSMISSION**  
 LH

CHEVROLET PASSENGER  
 CAR ..... 1955-57



**EM-2141**  
**MOUNT-ENGINE**  
 L & R Front

FORD PASSENGER CAR ..... 1959-62  
 LINCOLN PASSENGER CAR ..... 1958-68  
 MERCURY PASSENGER CAR ... 1956-62



**EM-2150@**  
**MOUNT-ENGINE**  
 L & R Front

AMERICAN MOTORS  
 PASSENGER CAR ..... 1960-63

**MOUNT-TRANSMISSION**  
 L & R

AMERICAN MOTORS  
 PASSENGER CAR ..... 1960-63



**EM-2167**  
**MOUNT-ENGINE**  
 L & R Front

VOLKSWAGEN PASSENGER  
 CAR ..... 1960-73  
 VOLKSWAGEN TRUCK ..... 1976-79

**MOUNT-ENGINE**  
 Rear Inner

VOLKSWAGEN PASSENGER  
 CAR ..... 1955-04

**MOUNT-ENGINE**  
 Rear

VOLKSWAGEN VAN ..... 1954-88

**MOUNT-TRANSMISSION**

VOLKSWAGEN VAN ..... 1968-85

**EM-2125**  
**MOUNT-TRANSMISSION**  
 RH

CHEVROLET PASSENGER  
 CAR ..... 1955-57



# BUYER'S GUIDE

## NUMERICAL LISTING - ILLUSTRATIONS

 <p><b>EM-2170</b> <b>MOUNT-ENGINE</b> <b>L &amp; R Front</b></p> <p>FORD PASSENGER CAR ..... 1960-62 MERCURY PASSENGER CAR ... 1960-62</p>	 <p><b>EM-2204</b> <b>MOUNT-ENGINE</b> <b>LH Front</b></p> <p>PONTIAC PASSENGER CAR ..... 1959-69</p>	 <p><b>EM-2216</b> <b>MOUNT-TRANSMISSION</b> <b>LH</b></p> <p>OLDSMOBILE PASSENGER CAR ..... 1960-64</p>	 <p><b>EM-2220</b> <b>MOUNT-ENGINE</b> <b>LH Front</b></p> <p>FORD PASSENGER CAR ..... 1963-66 FORD TRUCK ..... 1965 MERCURY PASSENGER CAR ... 1963-65</p>
 <p><b>EM-2171</b> <b>MOUNT-TRANSMISSION</b> <b>Manual</b></p> <p>FORD PASSENGER CAR ..... 1960-65 <b>MOUNT-TRANSMISSION</b></p> <p>FORD TRUCK ..... 1965 MERCURY PASSENGER CAR ... 1960-65</p>	 <p><b>EM-2205</b> <b>MOUNT-ENGINE</b> <b>RH Front</b></p> <p>PONTIAC PASSENGER CAR ..... 1959-69</p>	 <p><b>EM-2217</b> <b>MOUNT-TRANSMISSION</b> <b>RH</b></p> <p>OLDSMOBILE PASSENGER CAR ..... 1960-64</p>	 <p><b>EM-2221</b> <b>MOUNT-ENGINE</b> <b>RH Front</b></p> <p>FORD PASSENGER CAR ..... 1963-66 FORD TRUCK ..... 1965 MERCURY PASSENGER CAR ... 1963-65</p>
 <p><b>EM-2172</b> <b>MOUNT-TRANSMISSION</b> <b>Manual</b></p> <p>FORD PASSENGER CAR ..... 1960-61 <b>MOUNT-TRANSMISSION</b> <b>Auto</b></p> <p>MERCURY PASSENGER CAR ... 1960-61</p>	 <p><b>EM-2206</b> <b>MOUNT-TRANSMISSION</b> <b>Front</b></p> <p>PONTIAC PASSENGER CAR ..... 1961-66 <b>MOUNT-TRANSMISSION</b> <b>Manual</b></p> <p>PONTIAC PASSENGER CAR ..... 1960-64</p>	 <p><b>EM-2218</b> <b>MOUNT-ENGINE</b> <b>L &amp; R Front</b></p> <p>BUICK PASSENGER CAR ..... 1961-63 OLDSMOBILE PASSENGER CAR ..... 1961-63</p>	 <p><b>EM-2222</b> <b>MOUNT-ENGINE</b> <b>RH Front</b></p> <p>FORD PASSENGER CAR ..... 1958-64</p>
		 <p><b>EM-2219</b> <b>MOUNT-ENGINE</b> <b>L &amp; R Front</b></p> <p>BUICK PASSENGER CAR ..... 1959-67</p>	

# BUYER'S GUIDE

## NUMERICAL LISTING - ILLUSTRATIONS



**EM-2223**  
MOUNT-ENGINE  
LH Front

FORD PASSENGER CAR ..... 1958-64



**EM-2227**  
MOUNT-ENGINE  
RH Front

CHRYSLER PASSENGER  
CAR ..... 1959-65  
DODGE PASSENGER CAR ..... 1960-71  
PLYMOUTH PASSENGER  
CAR ..... 1960-65



**EM-2234**  
MOUNT-ENGINE  
RH Front

DODGE VAN ..... 1964-71  
PLYMOUTH PASSENGER  
CAR ..... 1961-64



**EM-2240**  
MOUNT-ENGINE  
RH Front

FORD PASSENGER CAR ..... 1965-70  
FORD TRUCK ..... 1967-69  
MERCURY PASSENGER CAR ... 1965-70



**EM-2225**  
MOUNT-ENGINE  
RH Front

FORD PASSENGER CAR ..... 1962-66  
FORD TRUCK ..... 1960-65  
MERCURY PASSENGER CAR ... 1961-65



**EM-2228**  
MOUNT-ENGINE  
LH Front

CHRYSLER PASSENGER  
CAR ..... 1959-65  
DODGE PASSENGER CAR ..... 1960-71  
PLYMOUTH PASSENGER  
CAR ..... 1960-65



**EM-2235**  
MOUNT-ENGINE  
L & R Front

DODGE TRUCK ..... 1963-71  
**MOUNT-ENGINE  
LH Front**



**EM-2241**  
MOUNT-ENGINE  
LH Front

FORD PASSENGER CAR ..... 1965-70  
FORD TRUCK ..... 1967-69  
MERCURY PASSENGER CAR ... 1965-70



**EM-2226**  
MOUNT-ENGINE  
LH Front

FORD PASSENGER CAR ..... 1962-66  
FORD TRUCK ..... 1960-65  
MERCURY PASSENGER CAR ... 1961-65



**EM-2231**  
MOUNT-ENGINE  
L & R Front

CHEVROLET PASSENGER  
CAR ..... 1958-68  
CHEVROLET TRUCK ..... 1964-69

**MOUNT-TRANSMISSION**

DODGE TRUCK ..... 1971



**EM-2238**  
MOUNT-ENGINE  
L & R Front

CADILLAC PASSENGER CAR .... 1957-64



**EM-2242**  
MOUNT-TRANSMISSION  
Auto

FORD PASSENGER CAR ..... 1959-74  
**MOUNT-TRANSMISSION**

MERCURY PASSENGER CAR ... 1965-70

# BUYER'S GUIDE

## NUMERICAL LISTING - ILLUSTRATIONS



**EM-2249**  
MOUNT-ENGINE  
L & R Front

CHEVROLET PASSENGER  
CAR ..... 1969-82



**EM-2254**  
MOUNT-ENGINE  
L & R Front

PONTIAC PASSENGER CAR ..... 1965-75



**EM-2261**  
MOUNT-ENGINE  
L & R Front

OLDSMOBILE PASSENGER  
CAR ..... 1964-73

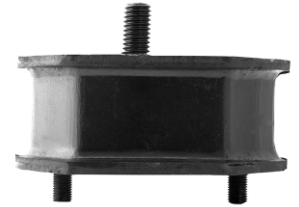

**EM-2264**  
MOUNT-ENGINE  
RH Front

DODGE PASSENGER CAR ..... 1967-72  
PLYMOUTH PASSENGER  
CAR ..... 1965-72



**EM-2250**  
MOUNT-ENGINE  
L & R Front

CHRYSLER PASSENGER  
CAR ..... 1965-73  
DODGE PASSENGER CAR ..... 1965-76  
PLYMOUTH PASSENGER  
CAR ..... 1963-74



**EM-2255**  
MOUNT-ENGINE  
RH Front

PONTIAC PASSENGER CAR ..... 1961-77



**EM-2262**  
MOUNT-ENGINE  
RH Front

OLDSMOBILE PASSENGER  
CAR ..... 1964-70



**EM-2265**  
MOUNT-ENGINE  
LH Front

DODGE PASSENGER CAR ..... 1967-72



**EM-2253**  
MOUNT-TRANSMISSION  
Manual

FORD PASSENGER CAR ..... 1962-80  
FORD TRUCK ..... 1960-79

**MOUNT-TRANSMISSION**  
Auto

LINCOLN PASSENGER CAR ..... 1977-80

**MOUNT-TRANSMISSION**  
Manual

MERCURY PASSENGER CAR ... 1965-82



**EM-2256**  
MOUNT-ENGINE  
LH Front

PONTIAC PASSENGER CAR ..... 1961-77



**EM-2263**  
MOUNT-ENGINE  
LH Front

OLDSMOBILE PASSENGER  
CAR ..... 1964-70

**MOUNT-ENGINE**  
L & R Front

DODGE SPORT UTILITY ..... 1974-78  
DODGE TRUCK ..... 1971-81  
DODGE VAN ..... 1972-78

**MOUNT-ENGINE**  
LH Front

PLYMOUTH PASSENGER  
CAR ..... 1965-72

**MOUNT-ENGINE**  
L & R Front

PLYMOUTH SUV ..... 1974-78  
PLYMOUTH VAN ..... 1974-78



**EM-2257**  
MOUNT-ENGINE  
L & R Front

FORD PASSENGER CAR ..... 1964-73  
FORD TRUCK ..... 1968-71  
MERCURY PASSENGER CAR ... 1966-73



**EM-2266**  
MOUNT-ENGINE  
L & R Front

DODGE PASSENGER CAR ..... 1964-73  
DODGE TRUCK ..... 1969-71  
DODGE VAN ..... 1971  
PLYMOUTH PASSENGER  
CAR ..... 1966-72

# BUYER'S GUIDE

## NUMERICAL LISTING - ILLUSTRATIONS

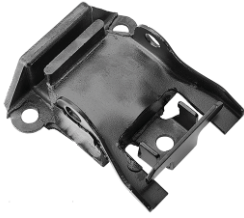

**EM-2267**  
**MOUNT-ENGINE**  
**L & R Front**

CHEVROLET PASSENGER  
CAR ..... 1957-73  
CHEVROLET TRUCK ..... 1959-62  
PONTIAC PASSENGER CAR ..... 1971-72

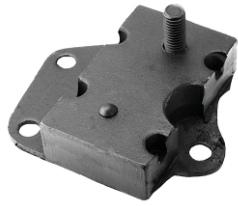

**EM-2270**  
**MOUNT-ENGINE**  
**RH Front**

FORD PASSENGER CAR ..... 1969-71  
MERCURY PASSENGER CAR ... 1969-70



**EM-2274**  
**MOUNT-ENGINE**  
**L & R Front**

CADILLAC PASSENGER CAR .... 1964-67

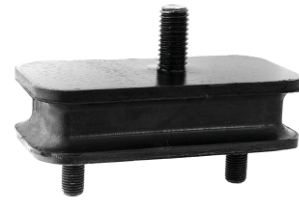

**EM-2277**  
**MOUNT-ENGINE**  
**RH Front**

DODGE PASSENGER CAR ..... 1967-72  
PLYMOUTH PASSENGER  
CAR ..... 1970-71



**EM-2268@**  
**MOUNT-TRANSMISSION**  
**Auto**

BUICK PASSENGER CAR ..... 1966-73  
CHEVROLET PASSENGER  
CAR ..... 1962-82  
CHEVROLET SPORT UTILITY .... 1968-82



**EM-2271**  
**MOUNT-ENGINE**  
**LH Front**

FORD PASSENGER CAR ..... 1969-71  
MERCURY PASSENGER CAR ... 1969-70

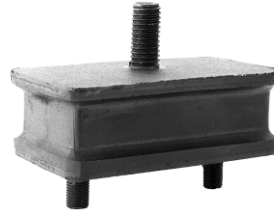

**EM-2275**  
**MOUNT-ENGINE**  
**LH Front**

DODGE PASSENGER CAR ..... 1967-72  
PLYMOUTH PASSENGER  
CAR ..... 1965-72



**EM-2278**  
**MOUNT-ENGINE**  
**LH Front**

CHEVROLET PASSENGER  
CAR ..... 1965-67

CHEVROLET TRUCK ..... 1959-81

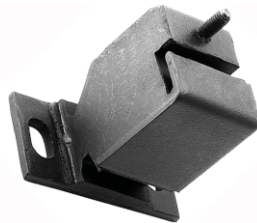

**EM-2272**  
**MOUNT-TRANSMISSION**  
**Auto**

CHRYSLER PASSENGER  
CAR ..... 1959-68

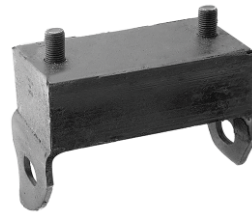

**EM-2276**  
**MOUNT-ENGINE**  
**RH Front**

DODGE PASSENGER CAR ..... 1970-71  
PLYMOUTH PASSENGER  
CAR ..... 1965-72



**EM-2279**  
**MOUNT-ENGINE**  
**L & R Front**

JEEP SPORT UTILITY ..... 1963-71

JEEP SPORT UTILITY ..... 1972-73  
JEEP TRUCK ..... 1974-87

OLDSMOBILE PASSENGER  
CAR ..... 1968-72  
PONTIAC PASSENGER CAR ..... 1964-77

DODGE PASSENGER CAR ..... 1962-76

PLYMOUTH PASSENGER  
CAR ..... 1958-72

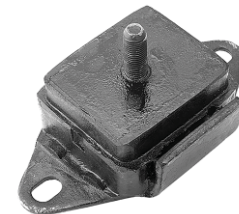

**EM-2280**  
**MOUNT-ENGINE**  
**L & R Front**

AMERICAN MOTORS  
PASSENGER CAR ..... 1964-72

(Continued Next Page)

# BUYER'S GUIDE

## NUMERICAL LISTING - ILLUSTRATIONS

### EM-2280 (Continued)

JEEP SPORT UTILITY ..... 1972-77



**EM-2281**  
**MOUNT-ENGINE**  
**L & R Front**

BUICK PASSENGER CAR ..... 1968-81  
PONTIAC PASSENGER CAR ..... 1976-80

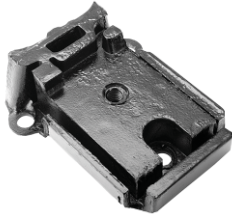

**EM-2282**  
**MOUNT-ENGINE**  
**L & R Front**

CHEVROLET SPORT UTILITY .... 1966-72  
CHEVROLET TRUCK ..... 1963-72  
CHEVROLET VAN ..... 1964-72  
GMC SPORT UTILITY ..... 1966-72  
GMC TRUCK ..... 1964-72  
GMC VAN ..... 1966-72



**EM-2283**  
**MOUNT-ENGINE**  
**L & R Front**

CHEVROLET PASSENGER  
CAR ..... 1966-74  
CHEVROLET SPORT UTILITY .... 1968-72  
CHEVROLET TRUCK ..... 1968-72  
GMC SPORT UTILITY ..... 1970-72  
GMC TRUCK ..... 1970-72



**EM-2284**  
**MOUNT-ENGINE**  
**L & R Front**

CHEVROLET PASSENGER  
CAR ..... 1964-72  
CHEVROLET TRUCK ..... 1964-72  
GMC TRUCK ..... 1971-77  
OLDSMOBILE PASSENGER  
CAR ..... 1966-71  
PONTIAC PASSENGER CAR ..... 1968-72

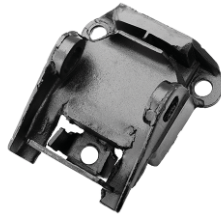

**EM-2285**  
**MOUNT-ENGINE**  
**L & R Front**

CHEVROLET PASSENGER  
CAR ..... 1961-69  
CHEVROLET TRUCK ..... 1962-67



**EM-2286**  
**MOUNT-ENGINE**  
**L & R Front**

FORD PASSENGER CAR ..... 1973  
FORD TRUCK ..... 1966-71  
MERCURY PASSENGER CAR ... 1966-71

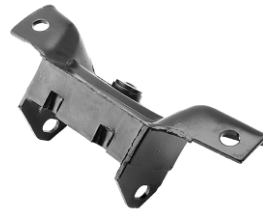

**EM-2287**  
**MOUNT-ENGINE**  
**L & R Front**

FORD PASSENGER CAR ..... 1965-78  
MERCURY PASSENGER CAR ... 1971-73

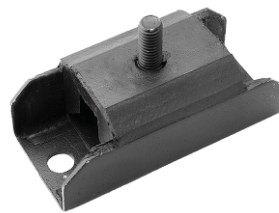

**EM-2288@**  
**MOUNT-TRANSMISSION**  
**Auto**

BUICK PASSENGER CAR ..... 1971-79

**MOUNT-TRANSMISSION**  
**Manual**

CHEVROLET PASSENGER  
CAR ..... 1976-77

**MOUNT-TRANSMISSION**  
**Auto**

OLDSMOBILE PASSENGER  
CAR ..... 1972-79

**MOUNT-TRANSMISSION**  
**Manual**

PONTIAC PASSENGER CAR ..... 1968-79



**EM-2289**  
**MOUNT-ENGINE**  
**RH Front**

FORD TRUCK ..... 1966-76



**EM-2290**  
**MOUNT-ENGINE**  
**LH Front**

FORD TRUCK ..... 1966-76



**EM-2291**  
**MOUNT-ENGINE**  
**L & R Front**

BUICK PASSENGER CAR ..... 1967-76



**EM-2292**  
**MOUNT-ENGINE**  
**L & R Front**

BUICK PASSENGER CAR ..... 1968-96  
CADILLAC PASSENGER CAR ... 1978-96  
CHEVROLET PASSENGER  
CAR ..... 1972-96  
CHEVROLET SPORT UTILITY .... 1973-87  
CHEVROLET TRUCK ..... 1973-91  
CHEVROLET VAN ..... 1970-99  
GMC SPORT UTILITY ..... 1973-87  
GMC TRUCK ..... 1973-91  
GMC VAN ..... 1970-99  
OLDSMOBILE PASSENGER  
CAR ..... 1973-92  
PONTIAC PASSENGER CAR ..... 1973-92



# BUYER'S GUIDE

## NUMERICAL LISTING - ILLUSTRATIONS



**EM-2293**  
**MOUNT-TRANSMISSION**  
**Manual**

VOLKSWAGEN PASSENGER CAR ..... 1955-88  
**MOUNT-TRANSMISSION**

VOLKSWAGEN TRUCK ..... 1976-79  
VOLKSWAGEN VAN ..... 1954-88



**EM-2296**  
**MOUNT-ENGINE**  
**L & R Front**

CADILLAC PASSENGER CAR .... 1965-78



**EM-2297**  
**MOUNT-ENGINE**  
**L & R Front Upper**

FORD TRUCK ..... 1975-77



**EM-2302**  
**MOUNT-TRANSMISSION**  
**MOUNT-TRANSMISSION**  
**L & R**

DODGE PASSENGER CAR ..... 1963-65

DODGE TRUCK ..... 1963-68



**EM-2303**  
**MOUNT-ENGINE**  
**LH Front**

DODGE PASSENGER CAR ..... 1960-66  
PLYMOUTH PASSENGER CAR ..... 1960-66



**EM-2304**  
**MOUNT-ENGINE**  
**RH Front**

DODGE PASSENGER CAR ..... 1960-66  
PLYMOUTH PASSENGER CAR ..... 1960-66



**EM-2305**  
**MOUNT-TRANSMISSION**  
**Upper**

FORD TRUCK ..... 1965-77



**EM-2306**  
**MOUNT-TRANSMISSION**  
**Lower**

FORD TRUCK ..... 1965-77



**EM-2307**  
**MOUNT-TRANSMISSION**

FORD VAN ..... 1968-71



**EM-2294**  
**MOUNT-TRANSMISSION**

CHEVROLET PASSENGER CAR ..... 1969-76  
CHEVROLET TRUCK ..... 1970-75  
GMC TRUCK ..... 1971-72



**EM-2295**  
**MOUNT-TRANSMISSION**  
**Auto**

CHEVROLET PASSENGER CAR ..... 1968-73



**EM-2298**  
**MOUNT-ENGINE**  
**L & R Front Lower**

FORD TRUCK ..... 1975-77



**EM-2299**  
**MOUNT-TRANSMISSION**  
**L & R Upper**

FORD TRUCK ..... 1970-78



**EM-2309**  
**MOUNT-ENGINE**  
**L & R Front**

GMC TRUCK ..... 1967

# BUYER'S GUIDE

## NUMERICAL LISTING - ILLUSTRATIONS

 <p style="text-align: center;"><b>EM-2310</b> <b>MOUNT-TRANSMISSION</b></p> <p>AMERICAN MOTORS PASSENGER CAR ..... 1966-68</p>	 <p style="text-align: center;"><b>EM-2319</b> <b>MOUNT-ENGINE</b> <b>L &amp; R Front</b></p> <p>FORD PASSENGER CAR ..... 1965-72 FORD SPORT UTILITY ..... 1967-72</p>	 <p style="text-align: center;"><b>EM-2324</b> <b>MOUNT-ENGINE</b> <b>LH Front</b></p> <p>CHRYSLER PASSENGER CAR ..... 1978-83 DODGE PASSENGER CAR ..... 1973-83 PLYMOUTH PASSENGER CAR ..... 1973-83</p>	 <p style="text-align: center;"><b>EM-2327</b> <b>MOUNT-TRANSMISSION</b> <b>Auto</b></p> <p>FORD TRUCK ..... 1965-79</p> <p style="text-align: center;"><b>MOUNT-TRANSMISSION</b></p> <p>FORD VAN ..... 1968-74</p>
 <p style="text-align: center;"><b>EM-2311</b> <b>MOUNT-TRANSMISSION</b> <b>Auto</b></p> <p>FORD PASSENGER CAR ..... 1968-78 MERCURY PASSENGER CAR ... 1971-73</p>	 <p style="text-align: center;"><b>EM-2320</b> <b>MOUNT-TRANSMISSION</b></p> <p>CADILLAC PASSENGER CAR .... 1968-76</p>	 <p style="text-align: center;"><b>EM-2325</b> <b>MOUNT-ENGINE</b> <b>RH Front</b></p> <p>CHRYSLER PASSENGER CAR ..... 1974-89 DODGE PASSENGER CAR ..... 1972-89 PLYMOUTH PASSENGER CAR ..... 1970-89</p>	 <p style="text-align: center;"><b>EM-2328</b> <b>MOUNT-ENGINE</b> <b>L &amp; R Front</b></p> <p>BUICK PASSENGER CAR ..... 1970-90 CHEVROLET PASSENGER CAR ..... 1980-90 CHEVROLET TRUCK ..... 1979-84 GMC SPORT UTILITY ..... 1979-81 GMC TRUCK ..... 1979-84 OLDSMOBILE PASSENGER CAR ..... 1965-90 PONTIAC PASSENGER CAR ..... 1975-89</p>
 <p style="text-align: center;"><b>EM-2316</b> <b>MOUNT-ENGINE</b> <b>L &amp; R Front</b></p> <p>FORD PASSENGER CAR ..... 1971-77 MERCURY PASSENGER CAR ... 1971-77</p>	 <p style="text-align: center;"><b>EM-2321</b> <b>MOUNT-TRANSMISSION</b></p> <p>PONTIAC PASSENGER CAR ..... 1963-70</p>	 <p style="text-align: center;"><b>EM-2326</b> <b>MOUNT-ENGINE</b> <b>LH Front</b></p> <p>CHRYSLER PASSENGER CAR ..... 1974-89 DODGE PASSENGER CAR ..... 1972-89 PLYMOUTH PASSENGER CAR ..... 1970-89</p>	 <p style="text-align: center;"><b>EM-2329</b> <b>MOUNT-ENGINE</b> <b>L &amp; R Front</b></p> <p>FORD SPORT UTILITY ..... 1966-86 FORD TRUCK ..... 1969-86 FORD VAN ..... 1968-74</p>
 <p style="text-align: center;"><b>EM-2317</b> <b>MOUNT-TRANSMISSION</b> <b>Manual</b></p> <p>AMERICAN MOTORS PASSENGER CAR ..... 1965-74</p>	 <p style="text-align: center;"><b>EM-2323</b> <b>MOUNT-ENGINE</b> <b>RH Front</b></p> <p>CHRYSLER PASSENGER CAR ..... 1978-83 DODGE PASSENGER CAR ..... 1973-83 PLYMOUTH PASSENGER CAR ..... 1973-83</p>		

# BUYER'S GUIDE

## NUMERICAL LISTING - ILLUSTRATIONS

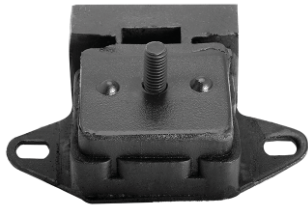

**EM-2330**  
MOUNT-ENGINE  
L & R Front

AMERICAN MOTORS  
PASSENGER CAR ..... 1971-88  
JEEP SPORT UTILITY ..... 1972-86  
JEEP TRUCK ..... 1974-87



**EM-2331**  
MOUNT-ENGINE  
RH Front

FORD SPORT UTILITY ..... 1967  
FORD TRUCK ..... 1965-75  
FORD VAN ..... 1968-76



**EM-2332**  
MOUNT-ENGINE  
LH Front

FORD SPORT UTILITY ..... 1967  
FORD TRUCK ..... 1965-75  
FORD VAN ..... 1968-76

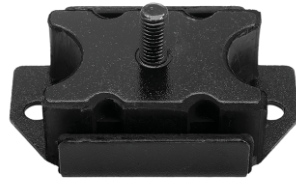

**EM-2333**  
MOUNT-ENGINE  
L & R Front

FORD PASSENGER CAR ..... 1966-72  
FORD TRUCK ..... 1964-68  
MERCURY PASSENGER CAR ... 1966-74



**EM-2335**  
MOUNT-ENGINE  
RH Front

PONTIAC PASSENGER CAR ..... 1968-74



**EM-2336**  
MOUNT-ENGINE  
LH Front

PONTIAC PASSENGER CAR ..... 1968-74



**EM-2337**  
MOUNT-TRANSMISSION  
Auto

BUICK PASSENGER CAR ..... 1977

(Continued Next Column)

### EM-2337 (Continued)

CHEVROLET PASSENGER  
CAR ..... 1969-84  
**MOUNT-TRANSMISSION  
Manual**

CHEVROLET TRUCK ..... 1973-81  
**MOUNT-TRANSMISSION  
Auto**

GMC TRUCK ..... 1978-81  
**MOUNT-TRANSMISSION**

OLDSMOBILE PASSENGER  
CAR ..... 1971-81  
PONTIAC PASSENGER CAR ..... 1975-87

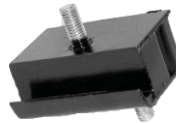

**EM-2338**  
MOUNT-ENGINE  
L & R Front

DODGE VAN ..... 1964-70  
PLYMOUTH PASSENGER  
CAR ..... 1964-66



**EM-2339**  
MOUNT-TRANSMISSION

CHRYSLER PASSENGER  
CAR ..... 1978-79



**EM-2340**  
MOUNT-TRANSMISSION  
Manual

CHRYSLER PASSENGER  
CAR ..... 1969-89  
**MOUNT-TRANSMISSION  
Manual**

(Continued Next Column)

### EM-2340 (Continued)

DODGE PASSENGER CAR ..... 1966-89  
**MOUNT-TRANSMISSION**

PLYMOUTH PASSENGER  
CAR ..... 1966-89  
PLYMOUTH SUV ..... 1974-81



**EM-2341**  
MOUNT-ENGINE  
L & R Front

FORD PASSENGER CAR ..... 1973-83  
MERCURY PASSENGER CAR ... 1971-77



**EM-2344**  
MOUNT-ENGINE  
LH Front

FORD PASSENGER CAR ..... 1974-80  
**MOUNT-ENGINE  
L & R Front**  
MERCURY PASSENGER CAR ... 1974-80



**EM-2345**  
MOUNT-TRANSMISSION  
Auto

FORD PASSENGER CAR ..... 1969-78  
**MOUNT-TRANSMISSION  
Manual**

MERCURY PASSENGER CAR ... 1969-81

# BUYER'S GUIDE

## NUMERICAL LISTING - ILLUSTRATIONS

 <p style="text-align: center;"><b>EM-2346</b> <b>MOUNT-TRANSMISSION</b> <b>Manual</b></p> <p>FORD PASSENGER CAR ..... 1973-80 <b>MOUNT-TRANSMISSION</b></p> <hr/> <p>MERCURY PASSENGER CAR ... 1972-80</p>	 <p style="text-align: center;"><b>EM-2349</b> <b>MOUNT-TRANSMISSION</b> <b>Auto</b></p> <p>FORD SPORT UTILITY ..... 1967-79 <b>MOUNT-TRANSMISSION</b></p> <hr/> <p>FORD TRUCK ..... 1965-79 <b>MOUNT-TRANSMISSION</b> <b>Manual</b></p> <hr/> <p>MERCURY PASSENGER CAR ... 1961-64</p>	 <p style="text-align: center;"><b>EM-2353</b> <b>MOUNT-TRANSMISSION</b> <b>Auto</b></p> <p>BUICK PASSENGER CAR ..... 1975-77 CHEVROLET PASSENGER CAR ..... 1971-80 <b>MOUNT-TRANSMISSION</b></p> <hr/> <p>CHEVROLET TRUCK ..... 1978-79 GMC TRUCK ..... 1978-79 <b>MOUNT-TRANSMISSION</b> <b>Manual</b></p> <hr/> <p>OLDSMOBILE PASSENGER CAR ..... 1975-79 <b>MOUNT-TRANSMISSION</b> <b>Auto</b></p> <hr/> <p>PONTIAC PASSENGER CAR ..... 1975-80</p>	 <p style="text-align: center;"><b>EM-2358</b> <b>MOUNT-ENGINE</b> <b>RH Front</b></p> <p>FORD PASSENGER CAR ..... 1971-78 MERCURY PASSENGER CAR ... 1971-81</p> <hr/>  <p style="text-align: center;"><b>EM-2359</b> <b>MOUNT-ENGINE</b> <b>LH Front</b></p> <p>FORD PASSENGER CAR ..... 1971-78 MERCURY PASSENGER CAR ... 1971-81</p> <hr/>  <p style="text-align: center;"><b>EM-2360@</b> <b>MOUNT-TRANSMISSION</b> <b>Auto</b></p> <p>BUICK PASSENGER CAR ..... 1970-93 <b>MOUNT-TRANSMISSION</b></p> <hr/> <p>CADILLAC PASSENGER CAR .... 1976-80 <b>MOUNT-TRANSMISSION</b> <b>Auto</b></p> <hr/> <p>CHEVROLET PASSENGER CAR ..... 1965-93 <b>MOUNT-TRANSMISSION</b></p> <hr/> <p>CHEVROLET SPORT UTILITY ... 1992-95 <b>MOUNT-TRANSMISSION</b> <b>Auto</b></p> <hr/> <p>CHEVROLET TRUCK ..... 1967-95 <b>MOUNT-TRANSMISSION</b></p> <hr/> <p>GMC SPORT UTILITY ..... 1992-95 <b>MOUNT-TRANSMISSION</b> <b>Auto</b></p> <p style="text-align: right;"><b>(Continued Next Page)</b></p>
 <p style="text-align: center;"><b>EM-2347</b> <b>MOUNT-TRANSMISSION</b> <b>Manual</b></p> <p>FORD PASSENGER CAR ..... 1972-76 <b>MOUNT-TRANSMISSION</b> <b>Manual</b></p> <hr/> <p>FORD TRUCK ..... 1972-76 <b>MOUNT-TRANSMISSION</b></p> <hr/> <p>FORD VAN ..... 1989-91 <b>MOUNT-TRANSMISSION</b> <b>Manual</b></p> <hr/> <p>MERCURY PASSENGER CAR ... 1972-76</p>	 <p style="text-align: center;"><b>EM-2350</b> <b>MOUNT-ENGINE</b> <b>L &amp; R Front</b></p> <p>BUICK PASSENGER CAR ..... 1965-67</p> <hr/>  <p style="text-align: center;"><b>EM-2351</b> <b>MOUNT-ENGINE</b> <b>L &amp; R Front</b></p> <p>AMERICAN MOTORS PASSENGER CAR ..... 1966-79 JEEP SPORT UTILITY ..... 1972-93 JEEP TRUCK ..... 1974-88</p>	 <p style="text-align: center;"><b>EM-2356</b> <b>MOUNT-ENGINE</b> <b>RH Front</b></p> <p>CHEVROLET PASSENGER CAR ..... 1971-77 OLDSMOBILE PASSENGER CAR ..... 1976-77 PONTIAC PASSENGER CAR ..... 1975-77</p> <hr/>  <p style="text-align: center;"><b>EM-2357</b> <b>MOUNT-ENGINE</b> <b>LH Front</b></p> <p>CHEVROLET PASSENGER CAR ..... 1971-77 OLDSMOBILE PASSENGER CAR ..... 1976-77 PONTIAC PASSENGER CAR ..... 1975-77</p>	 <p style="text-align: center;"><b>EM-2348</b> <b>MOUNT-TRANSMISSION</b></p> <p>FORD SPORT UTILITY ..... 1966-72</p>

# BUYER'S GUIDE

## NUMERICAL LISTING - ILLUSTRATIONS

### EM-2360 (Continued)

GMC TRUCK ..... 1973-95  
 OLDSMOBILE PASSENGER  
 CAR ..... 1970-92  
 PONTIAC PASSENGER CAR ..... 1970-89



**EM-2362**  
**MOUNT-TRANSMISSION**  
 Auto

FORD TRUCK ..... 1965-79  
 FORD VAN ..... 1968-74



**EM-2363**  
**MOUNT-ENGINE**  
 L & R Front

FORD PASSENGER CAR ..... 1971-74  
 MERCURY PASSENGER CAR ... 1971-74



**EM-2364**  
**MOUNT-ENGINE**  
 RH Front

FORD PASSENGER CAR ..... 1972-79  
 FORD TRUCK ..... 1972-78  
 LINCOLN PASSENGER CAR ..... 1977-79  
 MERCURY PASSENGER CAR ... 1972-79



**EM-2365**  
**MOUNT-ENGINE**  
 LH Front

FORD PASSENGER CAR ..... 1972-79  
 FORD TRUCK ..... 1972-78  
 LINCOLN PASSENGER CAR ..... 1977-79  
 MERCURY PASSENGER CAR ... 1972-79



**EM-2367**  
**MOUNT-ENGINE**  
 RH Front

FORD PASSENGER CAR ..... 1969-78

**EM-2366**  
**MOUNT-ENGINE**  
 LH Front

LINCOLN PASSENGER CAR ..... 1968-78

**EM-2368**  
**MOUNT-ENGINE**  
 RH Front

MERCURY PASSENGER CAR ... 1969-78



**EM-2368**  
**MOUNT-ENGINE**  
 LH Front

FORD PASSENGER CAR ..... 1969-78  
 MERCURY PASSENGER CAR ... 1969-78



**EM-2369**  
**MOUNT-ENGINE**  
 L & R Front

CHRYSLER PASSENGER  
 CAR ..... 1972-89

**EM-2370**  
**MOUNT-ENGINE**  
 LH Front

DODGE PASSENGER CAR ..... 1972-89

PLYMOUTH PASSENGER  
 CAR ..... 1970-89



**EM-2370**  
**MOUNT-ENGINE**  
 LH Front

FORD PASSENGER CAR ..... 1972-79

**EM-2371**  
**MOUNT-ENGINE**  
 RH Front

FORD TRUCK ..... 1972-79  
 MERCURY PASSENGER CAR ... 1971-79



**EM-2371**  
**MOUNT-ENGINE**  
 RH Front

FORD PASSENGER CAR ..... 1972-79

**EM-2372**  
**MOUNT-ENGINE**  
 LH Front

FORD TRUCK ..... 1972-79  
 MERCURY PASSENGER CAR ... 1971-79



**EM-2372**  
**MOUNT-TRANSMISSION**

FORD PASSENGER CAR ..... 1972-76

**EM-2373**  
**MOUNT-TRANSMISSION**  
 Manual

FORD TRUCK ..... 1972-77

**EM-2374**  
**MOUNT-TRANSMISSION**  
 Auto

FORD VAN ..... 1975-76  
 MERCURY PASSENGER CAR ... 1972-76



**EM-2373**  
**MOUNT-TRANSMISSION**  
 Auto

AMERICAN MOTORS  
 PASSENGER CAR ..... 1968-80

**EM-2374@**  
**MOUNT-TRANSMISSION**  
 Manual

CHEVROLET VAN ..... 1973-80

**EM-2374@**  
**MOUNT-TRANSMISSION**  
 Auto

GMC VAN ..... 1974-78



**EM-2374@**  
**MOUNT-ENGINE**  
 L & R Rear

PONTIAC PASSENGER CAR ..... 1977-80

BUICK PASSENGER CAR ..... 1973-75  
 CADILLAC PASSENGER CAR ..... 1980-84  
 OLDSMOBILE PASSENGER  
 CAR ..... 1974-75

(Continued Next Page)

# BUYER'S GUIDE

## NUMERICAL LISTING - ILLUSTRATIONS

### EM-2374 (Continued)

PONTIAC PASSENGER CAR ..... 1971-72  
 BUICK PASSENGER CAR ..... 1970-74  
 CADILLAC PASSENGER CAR ..... 1977-96

#### MOUNT-TRANSMISSION Auto

PONTIAC PASSENGER CAR ..... 1971-72



### EM-2375 MOUNT-ENGINE L & R Front

OLDSMOBILE PASSENGER CAR ... 1975  
 PONTIAC PASSENGER CAR ..... 1973-78



### EM-2376 MOUNT-ENGINE LH Front

CHRYSLER PASSENGER  
 CAR ..... 1978-83  
 DODGE PASSENGER CAR ..... 1973-83  
 PLYMOUTH PASSENGER  
 CAR ..... 1973-83



### EM-2378@ MOUNT-TRANSMISSION Manual

BUICK PASSENGER CAR ..... 1966-74

#### MOUNT-TRANSMISSION

CHEVROLET PASSENGER  
 CAR ..... 1957-81

#### MOUNT-TRANSMISSION Manual

(Continued Next Column)

### EM-2378 (Continued)

CHEVROLET SPORT UTILITY ... 1966-84  
 CHEVROLET TRUCK ..... 1959-82  
 CHEVROLET VAN ..... 1968-84

#### MOUNT-TRANSMISSION

GMC SPORT UTILITY ..... 1966-81

#### MOUNT-TRANSMISSION Auto

GMC TRUCK ..... 1966-82

#### MOUNT-TRANSMISSION

GMC VAN ..... 1967-84  
 OLDSMOBILE PASSENGER  
 CAR ..... 1964-77  
 PONTIAC PASSENGER CAR ..... 1964-81

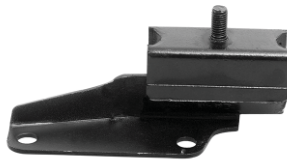

### EM-2379 MOUNT-TRANSMISSION

BUICK PASSENGER CAR ..... 1975-87  
 CADILLAC PASSENGER CAR ... 1980-82  
 CHEVROLET PASSENGER  
 CAR ..... 1978-88

#### MOUNT-TRANSMISSION Auto

CHEVROLET TRUCK ..... 1978-87  
 GMC TRUCK ..... 1978-87

#### MOUNT-TRANSMISSION Manual

OLDSMOBILE PASSENGER  
 CAR ..... 1977-87

#### MOUNT-TRANSMISSION

PONTIAC PASSENGER CAR ..... 1977-87



### EM-2381 MOUNT-ENGINE L & R Front

CHEVROLET PASSENGER  
 CAR ..... 1976-87  
 CHEVROLET SPORT UTILITY ... 1983-84  
 CHEVROLET TRUCK ..... 1982-85  
 GMC SPORT UTILITY ..... 1983-84  
 GMC TRUCK ..... 1982-85  
 PONTIAC PASSENGER CAR ..... 1976-87

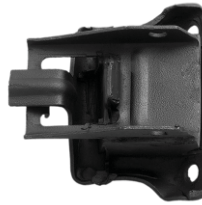

### EM-2382 MOUNT-ENGINE LH Front

BUICK PASSENGER CAR ..... 1975-87  
 CADILLAC PASSENGER CAR ... 1980-82  
 CHEVROLET PASSENGER  
 CAR ..... 1978-87  
 CHEVROLET TRUCK ..... 1978-84  
 GMC TRUCK ..... 1978-84  
 OLDSMOBILE PASSENGER  
 CAR ..... 1975-87  
 PONTIAC PASSENGER CAR ..... 1976-87

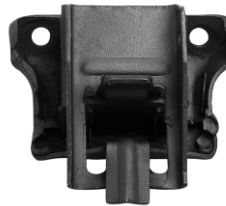

### EM-2384 MOUNT-ENGINE RH Front

BUICK PASSENGER CAR ..... 1975-87  
 CADILLAC PASSENGER CAR ... 1980-82  
 CHEVROLET PASSENGER  
 CAR ..... 1978-87  
 CHEVROLET TRUCK ..... 1978-84  
 GMC TRUCK ..... 1978-84  
 OLDSMOBILE PASSENGER  
 CAR ..... 1975-87  
 PONTIAC PASSENGER CAR ..... 1976-87



### EM-2385 MOUNT-ENGINE L & R Front

FORD PASSENGER CAR ..... 1978-83  
 MERCURY PASSENGER CAR ... 1978-83



### EM-2387 MOUNT-ENGINE L & R Front

BUICK PASSENGER CAR ..... 1977-82  
 CADILLAC PASSENGER CAR ... 1977-90  
 OLDSMOBILE PASSENGER CAR ... 1979  
 PONTIAC PASSENGER CAR ..... 1970-81



### EM-2388 MOUNT-TRANSMISSION Manual

FORD PASSENGER CAR ..... 1974-93

#### MOUNT-TRANSMISSION Auto

MERCURY PASSENGER CAR ... 1976-88

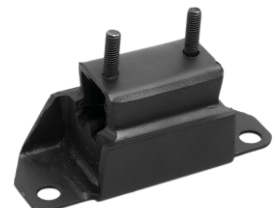

### EM-2389 MOUNT-TRANSMISSION

FORD PASSENGER CAR ..... 1978-86

#### MOUNT-TRANSMISSION Auto

MERCURY PASSENGER CAR ... 1979-86

# BUYER'S GUIDE

## NUMERICAL LISTING - ILLUSTRATIONS



**EM-2391**  
**MOUNT-TRANSMISSION**

BUICK PASSENGER CAR ..... 1980-81  
CHEVROLET PASSENGER CAR ..... 1976-87

**MOUNT-TRANSMISSION**  
**Auto**

PONTIAC PASSENGER CAR ..... 1976-87



**EM-2392**  
**MOUNT-TRANSMISSION**  
**Auto**

CHEVROLET PASSENGER CAR ..... 1982-86  
CHEVROLET SPORT UTILITY ..... 1982-91

**MOUNT-TRANSMISSION**  
**Manual**

CHEVROLET TRUCK ..... 1982-91  
CHEVROLET VAN ..... 1982-99

**MOUNT-TRANSMISSION**

GMC SPORT UTILITY ..... 1982-91

**MOUNT-TRANSMISSION**  
**Manual**

GMC TRUCK ..... 1982-91  
GMC VAN ..... 1982-99  
OLDSMOBILE PASSENGER CAR ..... 1978-81

**MOUNT-TRANSMISSION**

PONTIAC PASSENGER CAR ..... 1977-87



**EM-2393**  
**MOUNT-TRANSMISSION**  
**Manual**

BUICK PASSENGER CAR ..... 1977-82

**MOUNT-TRANSMISSION**  
**Auto**

CHEVROLET PASSENGER CAR ..... 1979-86  
CHEVROLET SPORT UTILITY ..... 1983-90

**MOUNT-TRANSMISSION**

CHEVROLET TRUCK ..... 1982-91

**MOUNT-TRANSMISSION**  
**Manual**

CHEVROLET VAN ..... 1981-90

**MOUNT-TRANSMISSION**  
**Auto**

GMC SPORT UTILITY ..... 1982-91

**MOUNT-TRANSMISSION**

GMC TRUCK ..... 1982-91

**MOUNT-TRANSMISSION**  
**Manual**

GMC VAN ..... 1983-90

**MOUNT-TRANSMISSION**  
**Auto**

OLDSMOBILE PASSENGER CAR ..... 1978-80  
PONTIAC PASSENGER CAR ..... 1975-87

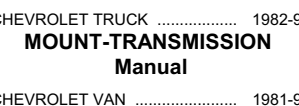

**EM-2394**  
**MOUNT-TRANSMISSION**  
**Manual**

BUICK PASSENGER CAR ..... 1977-82

**MOUNT-TRANSMISSION**  
**Auto**

CHEVROLET PASSENGER CAR ..... 1979-86  
CHEVROLET SPORT UTILITY ..... 1983-90

**MOUNT-TRANSMISSION**

CHEVROLET TRUCK ..... 1982-91

**MOUNT-TRANSMISSION**  
**Manual**

CHEVROLET VAN ..... 1981-90

**MOUNT-TRANSMISSION**  
**Auto**

GMC SPORT UTILITY ..... 1982-91

**MOUNT-TRANSMISSION**

GMC TRUCK ..... 1982-91

**MOUNT-TRANSMISSION**  
**Manual**

GMC VAN ..... 1983-90

**MOUNT-TRANSMISSION**  
**Auto**

OLDSMOBILE PASSENGER CAR ..... 1978-80  
PONTIAC PASSENGER CAR ..... 1975-87



**EM-2394**  
**MOUNT-TRANSMISSION**  
**Manual**

BUICK PASSENGER CAR ..... 1968-96

**MOUNT-TRANSMISSION**  
**Auto**

CADILLAC PASSENGER CAR ..... 1986-96  
CHEVROLET PASSENGER CAR ..... 1982-97

**MOUNT-TRANSMISSION**  
**Manual**

CHEVROLET SPORT UTILITY ..... 1995-05

(Continued Next Column)

**EM-2394 (Continued)**  
**MOUNT-TRANSMISSION**

CHEVROLET TRUCK ..... 1985-03

**MOUNT-TRANSMISSION**  
**Auto**

CHEVROLET VAN ..... 1990-93  
GMC SPORT UTILITY ..... 1995-01  
GMC TRUCK ..... 1985-03  
GMC VAN ..... 1990-93

**MOUNT-TRANSMISSION**  
**Manual**

ISUZU TRUCK ..... 1997-00

**MOUNT-TRANSMISSION**  
**Auto**

OLDSMOBILE PASSENGER CAR ..... 1977-79  
PONTIAC PASSENGER CAR ..... 1976-93



**EM-2395**  
**MOUNT-ENGINE**  
**L & R Front**

CHEVROLET PASSENGER CAR ..... 1972-81  
CHEVROLET SPORT UTILITY ..... 1973-91  
CHEVROLET TRUCK ..... 1973-91  
CHEVROLET VAN ..... 1970-97  
GMC SPORT UTILITY ..... 1973-91  
GMC TRUCK ..... 1973-91  
GMC VAN ..... 1973-97



**EM-2396**  
**Engine Torque Strut Mount**  
**Front**

BUICK PASSENGER CAR ..... 1980-94  
CHEVROLET PASSENGER CAR ..... 1980-94  
CHEVROLET VAN ..... 1990-95  
OLDSMOBILE PASSENGER CAR ..... 1980-94  
OLDSMOBILE VAN ..... 1990-95  
PONTIAC PASSENGER CAR ..... 1980-91  
PONTIAC VAN ..... 1990-95

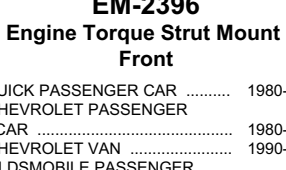

**EM-2400**  
**MOUNT-ENGINE**  
**L & R Front**

NISSAN PASSENGER CAR ..... 1974-77



**EM-2401**  
**MOUNT-ENGINE**  
**L & R Front**

NISSAN PASSENGER CAR ..... 1970-83



**EM-2402**  
**MOUNT-ENGINE**  
**L & R Front**

NISSAN PASSENGER CAR ..... 1971-73



**EM-2403**  
**MOUNT-ENGINE**  
**L & R Front**

NISSAN PASSENGER CAR ..... 1966-73



**EM-2400**  
**MOUNT-ENGINE**  
**L & R Front**

NISSAN PASSENGER CAR ..... 1974-77



**EM-2401**  
**MOUNT-ENGINE**  
**L & R Front**

NISSAN PASSENGER CAR ..... 1970-83

# BUYER'S GUIDE

## NUMERICAL LISTING - ILLUSTRATIONS

 <p><b>EM-2404</b> <b>MOUNT-ENGINE</b> <b>L &amp; R Front</b></p> <p>NISSAN PASSENGER CAR ..... 1974-77 NISSAN TRUCK ..... 1970-74</p>	 <p><b>EM-2408</b> <b>MOUNT-TRANSMISSION</b> <b>Manual</b></p> <p>TOYOTA PASSENGER CAR ..... 1969-79</p>	 <p><b>EM-2413</b> <b>MOUNT-ENGINE</b> <b>L &amp; R Rear</b></p> <p>VOLKSWAGEN VAN ..... 1968-71</p>	 <p><b>EM-2417</b> <b>MOUNT-TRANSMISSION-</b> <b>Rear Upper</b></p> <p>VOLKSWAGEN PASSENGER CAR ..... 1972-93 VOLKSWAGEN TRUCK ..... 1980-83</p>
 <p><b>EM-2405</b> <b>MOUNT-ENGINE</b> <b>L &amp; R Front</b></p> <p>NISSAN PASSENGER CAR ..... 1973-79</p>	 <p><b>EM-2409</b> <b>MOUNT-TRANSMISSION</b> <b>Manual</b></p> <p>TOYOTA PASSENGER CAR ..... 1967-84 TOYOTA TRUCK ..... 1970-78</p>	 <p><b>EM-2414</b> <b>MOUNT-ENGINE</b> <b>Rear Outer</b></p> <p>VOLKSWAGEN PASSENGER CAR ..... 1960-73 VOLKSWAGEN TRUCK ..... 1976-79 VOLKSWAGEN VAN ..... 1954-88</p>	 <p><b>EM-2418</b> <b>MOUNT-ENGINE</b> <b>RH Rear</b></p> <p>VOLKSWAGEN PASSENGER CAR ..... 1973-80</p>
 <p><b>EM-2406</b> <b>MOUNT-ENGINE</b> <b>L &amp; R Front</b></p> <p>TOYOTA PASSENGER CAR ..... 1971-82</p>	 <p><b>EM-2410</b> <b>MOUNT-TRANSMISSION</b> <b>Auto</b></p> <p>TOYOTA PASSENGER CAR ..... 1967-92</p>	 <p><b>EM-2415</b> <b>MOUNT-ENGINE</b> <b>L &amp; R Front</b></p> <p>VOLKSWAGEN PASSENGER CAR ..... 1971-74</p>	 <p><b>EM-2419</b> <b>MOUNT-ENGINE</b> <b>LH Rear</b></p> <p>VOLKSWAGEN PASSENGER CAR ..... 1973-80</p>
 <p><b>EM-2407</b> <b>MOUNT-ENGINE</b> <b>L &amp; R Front</b></p> <p>TOYOTA PASSENGER CAR ..... 1967-82 TOYOTA TRUCK ..... 1970-80 TOYOTA VAN ..... 1984-85</p>	 <p><b>EM-2410</b> <b>MOUNT-TRANSMISSION</b> <b>Manual</b></p> <p>TOYOTA SPORT UTILITY ..... 1981-98</p>	 <p><b>EM-2415</b> <b>MOUNT-ENGINE</b> <b>Rear Inner</b></p> <p>VOLKSWAGEN TRUCK ..... 1976-79 VOLKSWAGEN VAN ..... 1954-88</p>	 <p><b>EM-2419</b> <b>MOUNT-TRANSMISSION</b> <b>LH</b></p> <p>VOLKSWAGEN PASSENGER CAR ..... 1971-79</p>



# BUYER'S GUIDE

## NUMERICAL LISTING - ILLUSTRATIONS



**EM-2420**  
**MOUNT-TRANSMISSION**  
Auto

VOLKSWAGEN PASSENGER  
CAR ..... 1972-93

**MOUNT-TRANSMISSION-**  
**Rear Lower**

VOLKSWAGEN TRUCK ..... 1980-83



**EM-2421**  
**MOUNT-ENGINE**  
L & R Front

AUDI PASSENGER CAR ..... 1973-90  
VOLKSWAGEN PASSENGER  
CAR ..... 1982-08  
VOLKSWAGEN TRUCK ..... 1999-07  
VOLKSWAGEN VAN ..... 1988-01

**MOUNT-ENGINE**  
Rear

VOLKSWAGEN PASSENGER  
CAR ..... 1974-80



**EM-2424**  
**MOUNT-ENGINE**  
L & R Front

VOLVO PASSENGER CAR ..... 1969-74

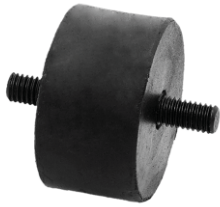

**EM-2425**  
**MOUNT-TRANSMISSION**  
Manual

VOLVO PASSENGER CAR ..... 1969-75



**EM-2426**  
**MOUNT-ENGINE**  
L & R Front

VOLVO PASSENGER CAR ..... 1976-93



**EM-2427**  
**MOUNT-ENGINE**  
L & R Front

VOLVO PASSENGER CAR ..... 1975



**EM-2428**  
**MOUNT-TRANSMISSION**

VOLVO PASSENGER CAR ..... 1975-93



**EM-2429**  
**MOUNT-ENGINE**  
L & R Front

VOLVO PASSENGER CAR ..... 1981-93

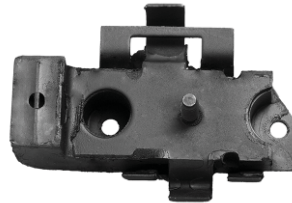

**EM-2433**  
**MOUNT-ENGINE**  
RH Front

FORD PASSENGER CAR ..... 1976-80  
MERCURY PASSENGER CAR ... 1976-80

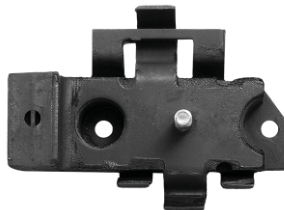

**EM-2434**  
**MOUNT-ENGINE**  
LH Front

FORD PASSENGER CAR ..... 1976-80  
MERCURY PASSENGER CAR ... 1976-80



**EM-2436**  
**MOUNT-ENGINE**  
L & R Front

CHEVROLET PASSENGER  
CAR ..... 1978-02

(Continued Next Column)

### EM-2436 (Continued)

CHEVROLET SPORT UTILITY	.....	1983-89
CHEVROLET TRUCK	.....	1980-95
CHEVROLET VAN	.....	1985-05
GMC SPORT UTILITY	.....	1983-89
GMC TRUCK	.....	1980-95
GMC VAN	.....	1985-05
PONTIAC PASSENGER CAR	.....	1980-02



**EM-2437**  
**MOUNT-ENGINE**  
RH Front

FORD PASSENGER CAR ..... 1979-91  
LINCOLN PASSENGER CAR ..... 1980-90  
MERCURY PASSENGER CAR ... 1978-91



**EM-2438**  
**MOUNT-ENGINE**  
LH Front

FORD PASSENGER CAR ..... 1979-91  
LINCOLN PASSENGER CAR ..... 1980-90  
MERCURY PASSENGER CAR ... 1978-91



**EM-2439**  
**MOUNT-ENGINE**  
RH Front

FORD VAN ..... 1975-97

# BUYER'S GUIDE

## NUMERICAL LISTING - ILLUSTRATIONS

 <p style="text-align: center;"><b>EM-2440</b> <b>MOUNT-ENGINE</b> <b>LH Front</b></p> <p>FORD VAN ..... 1975-96</p>	 <p style="text-align: center;"><b>EM-2445</b> <b>MOUNT-ENGINE</b> <b>LH Front</b></p> <p>FORD SPORT UTILITY ..... 1978-79 FORD TRUCK ..... 1977-82</p>	 <p style="text-align: center;"><b>EM-2448</b> <b>MOUNT-TRANSMISSION</b> <b>MOUNT-TRANSMISSION</b> <b>Auto</b></p> <p>FORD PASSENGER CAR ..... 1992-97</p> <p>FORD SPORT UTILITY ..... 1968-86 <b>MOUNT-TRANSMISSION</b> <b>Manual</b></p> <p>FORD TRUCK ..... 1977-86 <b>MOUNT-TRANSMISSION</b> <b>Auto</b></p> <p>FORD VAN ..... 1975-91 <b>MOUNT-TRANSMISSION</b></p> <p>MERCURY PASSENGER CAR ..... 1992</p>	 <p style="text-align: center;"><b>EM-2452</b> <b>MOUNT-ENGINE</b> <b>Side</b> <b>MOUNT-TRANSMISSION</b> <b>Lower</b></p> <p>HONDA PASSENGER CAR ..... 1979-82</p> <p>HONDA PASSENGER CAR ..... 1979-81</p>
 <p style="text-align: center;"><b>EM-2441</b> <b>MOUNT-ENGINE</b> <b>RH Front</b></p> <p>FORD SPORT UTILITY ..... 1980-84 FORD TRUCK ..... 1974-84 FORD VAN ..... 1977-84</p>	 <p style="text-align: center;"><b>EM-2446</b> <b>MOUNT-ENGINE</b> <b>L &amp; R Front</b></p> <p>AMERICAN MOTORS PASSENGER CAR ..... 1980-82 CHEVROLET PASSENGER CAR ..... 1978-80 JEEP SPORT UTILITY ..... 1980-86 OLDSMOBILE PASSENGER CAR ..... 1978-80 PONTIAC PASSENGER CAR ..... 1977-80</p>	 <p style="text-align: center;"><b>EM-2449</b> <b>MOUNT-ENGINE</b> <b>L &amp; R Front</b></p> <p>HONDA PASSENGER CAR ..... 1973-79</p>	 <p style="text-align: center;"><b>EM-2453</b> <b>MOUNT-TRANSMISSION</b> <b>Auto</b></p> <p>AMERICAN MOTORS PASSENGER CAR ..... 1972-82</p>
 <p style="text-align: center;"><b>EM-2442</b> <b>MOUNT-ENGINE</b> <b>LH Front</b></p> <p>FORD SPORT UTILITY ..... 1980-84 FORD TRUCK ..... 1974-84 FORD VAN ..... 1977-84</p>	 <p style="text-align: center;"><b>EM-2447</b> <b>MOUNT-ENGINE</b> <b>Front</b></p> <p>CHRYSLER PASSENGER CAR ..... 1982-84 DODGE PASSENGER CAR ..... 1978-87 DODGE TRUCK ..... 1982-84 PLYMOUTH PASSENGER CAR ..... 1978-83</p>	 <p style="text-align: center;"><b>EM-2451</b> <b>MOUNT-ENGINE</b> <b>Front</b> <b>MOUNT-ENGINE</b> <b>Rear</b></p> <p>HONDA PASSENGER CAR ..... 1979-82</p> <p>HONDA VAN ..... 1984-87</p>	 <p style="text-align: center;"><b>EM-2454</b> <b>MOUNT-TRANSMISSION</b> <b>Auto</b></p> <p>AMERICAN MOTORS PASSENGER CAR ..... 1971-83</p>
 <p style="text-align: center;"><b>EM-2444</b> <b>MOUNT-ENGINE</b> <b>RH Front</b></p> <p>FORD SPORT UTILITY ..... 1978-79 FORD TRUCK ..... 1977-82</p>			

# BUYER'S GUIDE

## NUMERICAL LISTING - ILLUSTRATIONS

 <p style="text-align: center;"><b>EM-2456</b> <b>MOUNT-ENGINE</b> <b>LH Front</b></p> <p>NISSAN PASSENGER CAR ..... 1978-81</p> <p style="text-align: center;"><b>EM-2457</b> <b>MOUNT-ENGINE</b> <b>RH Front</b></p> <p>FORD PASSENGER CAR ..... 1978-86 MERCURY PASSENGER CAR ... 1976-86</p>  <p style="text-align: center;"><b>EM-2458</b> <b>MOUNT-ENGINE</b> <b>LH Front</b></p> <p>FORD PASSENGER CAR ..... 1978-86 MERCURY PASSENGER CAR ... 1976-86</p>	 <p style="text-align: center;"><b>EM-2459</b> <b>MOUNT-ENGINE</b> <b>RH Front</b></p> <p>FORD PASSENGER CAR ..... 1981-83 MERCURY PASSENGER CAR ... 1981-83</p>  <p style="text-align: center;"><b>EM-2460</b> <b>MOUNT-ENGINE</b> <b>Front</b></p> <p>FORD PASSENGER CAR ..... 1981-83 MERCURY PASSENGER CAR ... 1981-83</p>  <p style="text-align: center;"><b>EM-2461</b> <b>MOUNT-ENGINE</b> <b>Front</b></p> <p>FORD PASSENGER CAR ..... 1981-83 MERCURY PASSENGER CAR ... 1981-83</p>  <p style="text-align: center;"><b>EM-2462</b> <b>MOUNT-ENGINE</b> <b>L &amp; R Front</b></p> <p>FORD TRUCK ..... 1987-93</p>	 <p style="text-align: center;"><b>EM-2463</b> <b>MOUNT-TRANSMISSION</b> <b>Manual</b></p> <p>FORD PASSENGER CAR ..... 1981-83</p> <p style="text-align: center;"><b>EM-2464</b> <b>MOUNT-TRANSMISSION</b> <b>Auto</b></p>  <p style="text-align: center;"><b>EM-2464</b> <b>MOUNT-TRANSMISSION</b> <b>Auto</b></p> <p>FORD PASSENGER CAR ..... 1977-91</p> <p>FORD TRUCK ..... 1977-79</p> <p style="text-align: center;"><b>EM-2466</b> <b>MOUNT-TRANSMISSION</b> <b>LH Front</b></p>  <p style="text-align: center;"><b>EM-2466</b> <b>MOUNT-TRANSMISSION</b> <b>LH Front</b></p> <p>BUICK PASSENGER CAR ..... 1980-96</p> <p>CHEVROLET PASSENGER CAR ..... 1980-96</p> <p>CHEVROLET VAN ..... 1990-96</p> <p>OLDSMOBILE PASSENGER CAR ..... 1980-94</p> <p>OLDSMOBILE VAN ..... 1990-96</p> <p>OLDSMOBILE VAN ..... 1980-94</p> <p>OLDSMOBILE VAN ..... 1990-96</p> <p style="text-align: center;">(Continued Next Column)</p>	<p><b>EM-2466 (Continued)</b></p> <p>PONTIAC PASSENGER CAR ..... 1980-91 PONTIAC VAN ..... 1990-96</p>  <p style="text-align: center;"><b>EM-2467</b> <b>MOUNT-TRANSMISSION</b> <b>Manual</b></p> <p>CHEVROLET PASSENGER CAR ..... 1980</p> <p style="text-align: center;"><b>EM-2469</b> <b>MOUNT-ENGINE</b> <b>L &amp; R Front</b></p>  <p style="text-align: center;"><b>EM-2469</b> <b>MOUNT-ENGINE</b> <b>L &amp; R Front</b></p> <p>DODGE SPORT UTILITY ..... 1979-93 DODGE TRUCK ..... 1979-93 DODGE VAN ..... 1979-03 PLYMOUTH SUV ..... 1979-81 PLYMOUTH VAN ..... 1979-83</p>
---	--	--	---

# BUYER'S GUIDE

## NUMERICAL LISTING - ILLUSTRATIONS

 <p style="text-align: center;"><b>EM-2470</b> <b>MOUNT-ENGINE</b> <b>L &amp; R Front</b></p> <p>CADILLAC PASSENGER CAR .... 1974-76</p>	 <p style="text-align: center;"><b>EM-2473</b> <b>MOUNT-ENGINE</b> <b>RH Front</b></p> <p>BUICK PASSENGER CAR ..... 1982-84            CADILLAC PASSENGER CAR .... 1982-84            CHEVROLET PASSENGER CAR ..... 1982-84            OLDSMOBILE PASSENGER CAR ..... 1982-84            PONTIAC PASSENGER CAR ..... 1982-84</p>	 <p style="text-align: center;"><b>EM-2487</b> <b>MOUNT-TRANSMISSION</b> <b>Manual</b></p> <p>NISSAN PASSENGER CAR ..... 1968-84</p>	<p><b>EM-2490 (Continued)</b></p> <p>OLDSMOBILE PASSENGER CAR ..... 1984-86            PONTIAC PASSENGER CAR ..... 1982-85</p> 
 <p style="text-align: center;"><b>EM-2471</b> <b>MOUNT-TRANSMISSION</b> <b>Manual</b></p> <p>FORD PASSENGER CAR ..... 1971-73</p>	 <p style="text-align: center;"><b>EM-2474</b> <b>MOUNT-ENGINE</b> <b>RH Front</b></p> <p>BUICK PASSENGER CAR ..... 1982-84            CADILLAC PASSENGER CAR .... 1982-84            CHEVROLET PASSENGER CAR ..... 1982-84            OLDSMOBILE PASSENGER CAR ..... 1982-84            PONTIAC PASSENGER CAR ..... 1982-84</p>	 <p style="text-align: center;"><b>EM-2488</b> <b>MOUNT-TRANSMISSION</b></p> <p>NISSAN PASSENGER CAR ..... 1978-88</p>	<p style="text-align: center;"><b>EM-2491</b> <b>Engine Torque Strut Mount</b> <b>Front</b></p> <p>CHRYSLER PASSENGER CAR ..... 1983-88            DODGE PASSENGER CAR ..... 1981-90            DODGE VAN ..... 1984-87            PLYMOUTH PASSENGER CAR ..... 1981-89            PLYMOUTH VAN ..... 1984-86</p> 
 <p style="text-align: center;"><b>EM-2472</b> <b>MOUNT-ENGINE</b> <b>RH Front</b></p> <p>BUICK PASSENGER CAR ..... 1982-85            CHEVROLET PASSENGER CAR ..... 1982-85            OLDSMOBILE PASSENGER CAR ..... 1982-85            PONTIAC PASSENGER CAR ..... 1982-88</p>	 <p style="text-align: center;"><b>EM-2477</b> <b>MOUNT-ENGINE</b> <b>RH Rear</b></p> <p>BUICK PASSENGER CAR ..... 1982-91            CADILLAC PASSENGER CAR .... 1982-88            CHEVROLET PASSENGER CAR ..... 1982-94            OLDSMOBILE PASSENGER CAR ..... 1982-91            PONTIAC PASSENGER CAR ..... 1982-94</p>	 <p style="text-align: center;"><b>EM-2489</b> <b>MOUNT-TRANSMISSION</b> <b>Manual</b></p> <p>NISSAN PASSENGER CAR ..... 1978-82</p>	<p style="text-align: center;"><b>EM-2492</b> <b>Engine Torque Strut Mount</b> <b>Front</b></p> <p>BUICK PASSENGER CAR ..... 1982-86            CHEVROLET PASSENGER CAR ..... 1985-89</p> <p style="text-align: center;"><b>Engine Torque Strut Mount</b> <b>Rear</b></p> <p>BUICK PASSENGER CAR ..... 1983-88            CADILLAC PASSENGER CAR .... 1982-88            CHEVROLET PASSENGER CAR ..... 1982-89            OLDSMOBILE PASSENGER CAR ..... 1982-87            PONTIAC PASSENGER CAR ..... 1982-91</p> 
 <p style="text-align: center;"><b>EM-2470</b> <b>MOUNT-ENGINE</b> <b>L &amp; R Front</b></p> <p>CADILLAC PASSENGER CAR .... 1974-76</p>	 <p style="text-align: center;"><b>EM-2473</b> <b>MOUNT-ENGINE</b> <b>RH Front</b></p> <p>BUICK PASSENGER CAR ..... 1982-84            CADILLAC PASSENGER CAR .... 1982-84            CHEVROLET PASSENGER CAR ..... 1982-84            OLDSMOBILE PASSENGER CAR ..... 1982-84            PONTIAC PASSENGER CAR ..... 1982-84</p>	 <p style="text-align: center;"><b>EM-2487</b> <b>MOUNT-TRANSMISSION</b> <b>Manual</b></p> <p>NISSAN PASSENGER CAR ..... 1968-84</p>	<p style="text-align: center;"><b>EM-2490</b> <b>Engine Torque Strut Mount</b> <b>Front</b></p> <p>BUICK PASSENGER CAR ..... 1982-86</p> <p style="text-align: center;"><b>(Continued Next Column)</b></p>
 <p style="text-align: center;"><b>EM-2471</b> <b>MOUNT-TRANSMISSION</b> <b>Manual</b></p> <p>FORD PASSENGER CAR ..... 1971-73</p>	 <p style="text-align: center;"><b>EM-2474</b> <b>MOUNT-ENGINE</b> <b>RH Front</b></p> <p>BUICK PASSENGER CAR ..... 1982-84            CADILLAC PASSENGER CAR .... 1982-84            CHEVROLET PASSENGER CAR ..... 1982-84            OLDSMOBILE PASSENGER CAR ..... 1982-84            PONTIAC PASSENGER CAR ..... 1982-84</p>	 <p style="text-align: center;"><b>EM-2488</b> <b>MOUNT-TRANSMISSION</b></p> <p>NISSAN PASSENGER CAR ..... 1978-88</p>	<p style="text-align: center;"><b>EM-2493</b> <b>MOUNT-ENGINE</b> <b>Front</b></p> <p>CHRYSLER PASSENGER CAR ..... 1982-91</p> <p style="text-align: center;"><b>(Continued Next Page)</b></p>

# BUYER'S GUIDE

## NUMERICAL LISTING - ILLUSTRATIONS

### EM-2493 (Continued)

DODGE PASSENGER CAR ..... 1981-91  
 DODGE VAN ..... 1984-90  
 PLYMOUTH PASSENGER  
 CAR ..... 1981-90  
 PLYMOUTH VAN ..... 1984-90



### EM-2494 MOUNT-TRANSMISSION RH

BUICK PASSENGER CAR ..... 1979-85  
 CADILLAC PASSENGER CAR .... 1981-82  
 OLDSMOBILE PASSENGER  
 CAR ..... 1981-85



### EM-2495 MOUNT-TRANSMISSION LH

BUICK PASSENGER CAR ..... 1981-85  
 CADILLAC PASSENGER CAR .... 1981-82  
 OLDSMOBILE PASSENGER  
 CAR ..... 1981-85

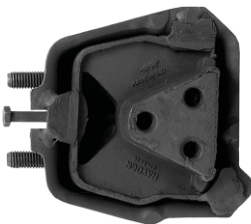

### EM-2496 MOUNT-ENGINE RH Front

BUICK PASSENGER CAR ..... 1983-84  
 OLDSMOBILE PASSENGER  
 CAR ..... 1982-84  
 PONTIAC PASSENGER CAR ..... 1982-84



### EM-2497 MOUNT-TRANSMISSION LH

BUICK PASSENGER CAR ..... 1979-81  
 CADILLAC PASSENGER CAR .... 1982-85  
 OLDSMOBILE PASSENGER CAR ... 1981



### EM-2498 MOUNT-TRANSMISSION RH

CADILLAC PASSENGER CAR .... 1982-86



### EM-2499 MOUNT-TRANSMISSION Front

PONTIAC PASSENGER CAR .... 1980-84

### MOUNT-TRANSMISSION

CADILLAC PASSENGER CAR ..... 1981

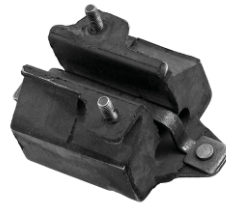

### EM-2500 MOUNT-ENGINE LH Front

FORD PASSENGER CAR ..... 1980-85  
 MERCURY PASSENGER CAR ... 1980-84

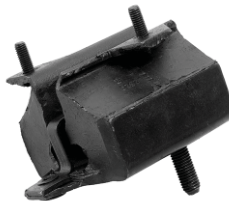

### EM-2501 MOUNT-ENGINE RH Front

FORD PASSENGER CAR ..... 1980-85  
 MERCURY PASSENGER CAR ... 1980-84



### EM-2502 MOUNT-ENGINE L & R Front

FORD TRUCK ..... 1973-79



### EM-2503 MOUNT-ENGINE RH Front

FORD PASSENGER CAR ..... 1975-80  
 FORD TRUCK ..... 1977-79

(Continued Next Column)

### EM-2503 (Continued)

LINCOLN PASSENGER CAR ..... 1977-80  
 MERCURY PASSENGER CAR ... 1975-82



### EM-2504 MOUNT-ENGINE LH Front

FORD PASSENGER CAR ..... 1975-80  
 FORD TRUCK ..... 1977-79  
 LINCOLN PASSENGER CAR ..... 1977-80  
 MERCURY PASSENGER CAR ... 1975-82



### EM-2505 MOUNT-ENGINE RH Front

BUICK PASSENGER CAR ..... 1980-81  
 CHEVROLET PASSENGER  
 CAR ..... 1980-81  
 OLDSMOBILE PASSENGER  
 CAR ..... 1980-81

### MOUNT-ENGINE L & R Front

PONTIAC PASSENGER CAR ..... 1980-81



### EM-2506 MOUNT-ENGINE RH Front

BUICK PASSENGER CAR ..... 1982-84  
 CADILLAC PASSENGER CAR ..... 1982  
 CHEVROLET PASSENGER  
 CAR ..... 1982-84  
 OLDSMOBILE PASSENGER  
 CAR ..... 1982-84  
 PONTIAC PASSENGER CAR ..... 1982-84

# BUYER'S GUIDE

## NUMERICAL LISTING - ILLUSTRATIONS



**EM-2508**  
**MOUNT-TRANSMISSION**  
Auto

CHEVROLET SPORT UTILITY ..... 1988-94  
CHEVROLET TRUCK ..... 1987-95

**MOUNT-TRANSMISSION**  
**Manual**

CHEVROLET VAN ..... 1985-90

**MOUNT-TRANSMISSION**  
Auto

GMC SPORT UTILITY ..... 1988-94

**MOUNT-TRANSMISSION**  
**Manual**

GMC TRUCK ..... 1988-94  
GMC VAN ..... 1985-90



**EM-2510@**  
**MOUNT-TRANSMISSION**  
Auto

CHEVROLET TRUCK ..... 1988-90  
CHEVROLET VAN ..... 1990-91  
GMC TRUCK ..... 1988-90  
GMC VAN ..... 1990-91



**EM-2512**  
**MOUNT-TRANSMISSION**  
Auto

CHRYSLER PASSENGER  
CAR ..... 1969-89

**MOUNT-TRANSMISSION**  
**Manual**

DODGE PASSENGER CAR ..... 1964-89  
DODGE SPORT UTILITY ..... 1974-89

(Continued Next Column)

**EM-2512 (Continued)**  
**MOUNT-TRANSMISSION**  
Auto

DODGE TRUCK ..... 1969-87  
DODGE VAN ..... 1971-87  
PLYMOUTH PASSENGER  
CAR ..... 1966-89

**MOUNT-TRANSMISSION**

PLYMOUTH SUV ..... 1974-81  
PLYMOUTH VAN ..... 1974-83



**EM-2513**  
**MOUNT-TRANSMISSION**  
Auto

CHEVROLET SPORT UTILITY ..... 1982-91  
CHEVROLET TRUCK ..... 1982-91  
CHEVROLET VAN ..... 1979-91  
GMC SPORT UTILITY ..... 1982-90

**MOUNT-TRANSMISSION**

GMC TRUCK ..... 1976-91

**MOUNT-TRANSMISSION**  
Auto

GMC VAN ..... 1979-91



**EM-2515**  
**MOUNT-TRANSMISSION**  
Auto

CHEVROLET SPORT UTILITY ..... 1983-91  
CHEVROLET TRUCK ..... 1983-90  
CHEVROLET VAN ..... 1983-90  
GMC SPORT UTILITY ..... 1982-91  
GMC TRUCK ..... 1982-90  
GMC VAN ..... 1983-90



**EM-2524**  
**MOUNT-ENGINE**  
RH Front

BUICK PASSENGER CAR ..... 1982-84  
CADILLAC PASSENGER CAR ..... 1982  
CHEVROLET PASSENGER  
CAR ..... 1982-84  
OLDSMOBILE PASSENGER  
CAR ..... 1982-84  
PONTIAC PASSENGER CAR ..... 1982-84



**EM-2525**  
**MOUNT-TRANSMISSION**  
Auto

CHRYSLER PASSENGER  
CAR ..... 1969-89  
DODGE PASSENGER CAR ..... 1964-89

**MOUNT-TRANSMISSION**  
Auto

DODGE SPORT UTILITY ..... 1974-89

**MOUNT-TRANSMISSION**  
**Manual**

DODGE TRUCK ..... 1969-87

**MOUNT-TRANSMISSION**  
Auto

DODGE VAN ..... 1971-87  
PLYMOUTH PASSENGER  
CAR ..... 1966-89

**MOUNT-TRANSMISSION**

PLYMOUTH SUV ..... 1974-81  
PLYMOUTH VAN ..... 1974-83



**EM-2528**  
**Engine Torque Strut Mount**  
Front

BUICK PASSENGER CAR ..... 1982-86  
CHEVROLET PASSENGER  
CAR ..... 1985-89  
PONTIAC PASSENGER CAR ..... 1988-91

**Engine Torque Strut Mount**  
Rear

BUICK PASSENGER CAR ..... 1983-91  
CADILLAC PASSENGER CAR ..... 1982-88  
CHEVROLET PASSENGER  
CAR ..... 1982-94  
OLDSMOBILE PASSENGER  
CAR ..... 1982-91  
PONTIAC PASSENGER CAR ..... 1982-94



**EM-2531**  
**MOUNT-TRANSMISSION**  
Manual

CHEVROLET PASSENGER  
CAR ..... 1978-80  
CHEVROLET SPORT UTILITY ..... 1984-87

**MOUNT-TRANSMISSION**  
Auto

CHEVROLET TRUCK ..... 1983-87  
GMC SPORT UTILITY ..... 1984-87  
GMC TRUCK ..... 1984-87

**MOUNT-TRANSMISSION**  
**Manual**

OLDSMOBILE PASSENGER  
CAR ..... 1978-83

**MOUNT-TRANSMISSION**

PONTIAC PASSENGER CAR ..... 1970-82

# BUYER'S GUIDE

## NUMERICAL LISTING - ILLUSTRATIONS

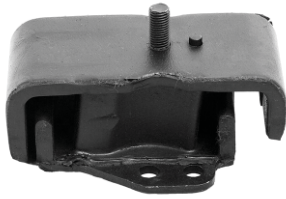

**EM-2532**  
MOUNT-ENGINE  
LH Front

NISSAN TRUCK ..... 1975-79



**EM-2537**  
MOUNT-TRANSMISSION  
LH Front

BUICK PASSENGER CAR ..... 1985-91  
CADILLAC PASSENGER CAR .... 1985-90  
OLDSMOBILE PASSENGER  
CAR ..... 1985-91  
PONTIAC PASSENGER CAR ..... 1987-91



**EM-2548\***  
MOUNT-ENGINE  
RH Front

BUICK PASSENGER CAR ..... 1985-96  
CHEVROLET PASSENGER  
CAR ..... 1985-96  
CHEVROLET VAN ..... 1990-96

**MOUNT-ENGINE  
Front**

OLDSMOBILE PASSENGER  
CAR ..... 1985-94  
OLDSMOBILE VAN ..... 1990-96

**MOUNT-ENGINE  
RH Front**

PONTIAC PASSENGER CAR ..... 1985-91

**MOUNT-ENGINE  
Front**

PONTIAC VAN ..... 1990-96



**EM-2550**  
MOUNT-ENGINE  
RH Front

CHEVROLET PASSENGER  
CAR ..... 1982-86  
CHEVROLET SPORT UTILITY .... 1984-88  
CHEVROLET TRUCK ..... 1983-93  
CHEVROLET VAN ..... 1985-90  
GMC SPORT UTILITY ..... 1985-88  
GMC TRUCK ..... 1984-93  
GMC VAN ..... 1985-90  
PONTIAC PASSENGER CAR ..... 1982-86

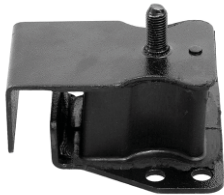

**EM-2533**  
MOUNT-ENGINE  
L & R Front

NISSAN PASSENGER CAR ..... 1968-73

**MOUNT-ENGINE  
RH Front**

NISSAN TRUCK ..... 1975-94



**EM-2538**  
MOUNT-ENGINE  
RH Front

BUICK PASSENGER CAR ..... 1985-91  
CADILLAC PASSENGER CAR .... 1985-88  
CHEVROLET PASSENGER  
CAR ..... 1985-94  
OLDSMOBILE PASSENGER  
CAR ..... 1985-91  
PONTIAC PASSENGER CAR ..... 1985-94



**EM-2549**  
MOUNT-ENGINE  
LH Front

CHEVROLET PASSENGER  
CAR ..... 1982-86  
CHEVROLET SPORT UTILITY .... 1984-88  
CHEVROLET TRUCK ..... 1983-93  
CHEVROLET VAN ..... 1985-90  
GMC SPORT UTILITY ..... 1985-88  
GMC TRUCK ..... 1984-93  
GMC VAN ..... 1985-90  
PONTIAC PASSENGER CAR ..... 1982-86



**EM-2551\***  
MOUNT-ENGINE  
RH Front

BUICK PASSENGER CAR ..... 1985-91  
CADILLAC PASSENGER CAR .... 1988-93  
OLDSMOBILE PASSENGER  
CAR ..... 1985-91  
PONTIAC PASSENGER CAR ..... 1987-91



**EM-2534**  
MOUNT-TRANSMISSION

BUICK PASSENGER CAR ..... 1968-70



**EM-2543**  
MOUNT-TRANSMISSION  
Auto

BUICK PASSENGER CAR ..... 1985-96  
CHEVROLET PASSENGER  
CAR ..... 1985-96

**MOUNT-TRANSMISSION**

OLDSMOBILE PASSENGER  
CAR ..... 1985-94  
PONTIAC PASSENGER CAR ..... 1985-91



**EM-2536**  
MOUNT-ENGINE  
L & R Front

FORD VAN ..... 1975-96



**EM-2553\***  
MOUNT-ENGINE  
RH Front

CADILLAC PASSENGER CAR .... 1985-87

# BUYER'S GUIDE

## NUMERICAL LISTING - ILLUSTRATIONS

 <p style="text-align: center;"><b>EM-2555*</b> <b>MOUNT-ENGINE</b> <b>RH Front</b></p> <p>CHEVROLET PASSENGER CAR ..... 1991-97            OLDSMOBILE PASSENGER CAR ..... 1991-96            PONTIAC PASSENGER CAR ..... 1991-96</p>	 <p style="text-align: center;"><b>EM-2558</b> <b>MOUNT-ENGINE</b> <b>RH Front</b></p> <p>FORD PASSENGER CAR ..... 1984-91            MERCURY PASSENGER CAR ... 1984-91</p>	 <p style="text-align: center;"><b>EM-2563</b> <b>MOUNT-ENGINE</b> <b>LH Front</b></p> <p>CHEVROLET TRUCK ..... 1972-82</p>	<p><b>EM-2566 (Continued)</b>            MERCURY PASSENGER CAR ... 1974-77</p>  <p style="text-align: center;"><b>EM-2567</b> <b>MOUNT-TRANSMISSION</b> <b>Auto</b></p> <p>CHEVROLET TRUCK ..... 1972-82</p>
 <p style="text-align: center;"><b>EM-2556*</b> <b>MOUNT-TRANSMISSION</b> <b>RH Rear</b></p> <p>BUICK PASSENGER CAR ..... 1985-91            CADILLAC PASSENGER CAR .... 1988-90            OLDSMOBILE PASSENGER CAR ..... 1985-91            PONTIAC PASSENGER CAR ..... 1987-91</p>	 <p style="text-align: center;"><b>EM-2559</b> <b>MOUNT-ENGINE</b> <b>LH Front</b></p> <p>FORD PASSENGER CAR ..... 1984-91</p> <p style="text-align: center;"><b>MOUNT-ENGINE</b> <b>Front</b></p> <p>MERCURY PASSENGER CAR ... 1984-91</p>	 <p style="text-align: center;"><b>EM-2564</b> <b>MOUNT-ENGINE</b> <b>L &amp; R Front</b></p> <p>FORD SPORT UTILITY ..... 1987-96            FORD TRUCK ..... 1987-97</p>	 <p style="text-align: center;"><b>EM-2568</b> <b>MOUNT-TRANSMISSION</b> <b>LH Rear</b></p> <p>BUICK PASSENGER CAR ..... 1985-91            CADILLAC PASSENGER CAR .... 1985-93            OLDSMOBILE PASSENGER CAR ..... 1985-91            PONTIAC PASSENGER CAR ..... 1987-91</p>
 <p style="text-align: center;"><b>EM-2557</b> <b>MOUNT-TRANSMISSION</b> <b>Manual</b></p> <p>FORD SPORT UTILITY ..... 1987-93</p> <p style="text-align: center;"><b>MOUNT-TRANSMISSION</b></p> <p>FORD TRUCK ..... 1987-97</p> <p style="text-align: center;"><b>MOUNT-TRANSMISSION</b> <b>Auto</b></p> <p>FORD VAN ..... 1988-13</p>	 <p style="text-align: center;"><b>EM-2562</b> <b>MOUNT-ENGINE</b> <b>RH Front</b></p> <p>CHEVROLET TRUCK ..... 1972-82</p>	 <p style="text-align: center;"><b>EM-2565</b> <b>MOUNT-TRANSMISSION</b> <b>Auto</b></p> <p>FORD PASSENGER CAR ..... 1974-82</p>	 <p style="text-align: center;"><b>EM-2569</b> <b>MOUNT-ENGINE</b> <b>L &amp; R Front</b></p> <p>JEEP SPORT UTILITY ..... 1984-00</p>
		 <p style="text-align: center;"><b>EM-2566</b> <b>MOUNT-TRANSMISSION</b> <b>Auto</b></p> <p>FORD PASSENGER CAR ..... 1975-78</p> <p style="text-align: center;"><b>MOUNT-TRANSMISSION</b></p> <p style="text-align: center;">(Continued Next Column)</p>	



# BUYER'S GUIDE

## NUMERICAL LISTING - ILLUSTRATIONS



**EM-2570**  
**MOUNT-TRANSMISSION**  
Auto

DODGE TRUCK ..... 1992-96  
**MOUNT-TRANSMISSION**  
Manual

JEEP SPORT UTILITY ..... 1984-00



**EM-2600**  
**MOUNT-ENGINE**  
RH Front

CHRYSLER PASSENGER  
CAR ..... 1982-93  
DODGE PASSENGER CAR ..... 1978-90  
DODGE TRUCK ..... 1982-84  
DODGE VAN ..... 1984-90  
PLYMOUTH PASSENGER  
CAR ..... 1978-90  
PLYMOUTH VAN ..... 1984-90

**MOUNT-TRANSMISSION**



**EM-2609**  
**Engine Torque Strut Mount**  
Front

BUICK PASSENGER CAR ..... 1988-95  
CHEVROLET PASSENGER  
CAR ..... 1986-94  
OLDSMOBILE PASSENGER  
CAR ..... 1988-97

**Engine Torque Strut**  
Front Left

PONTIAC PASSENGER CAR ..... 1988-94



**EM-2617**  
**MOUNT-TRANSMISSION**  
Auto

CHRYSLER PASSENGER  
CAR ..... 1983-91

**MOUNT-TRANSMISSION**  
Manual

DODGE PASSENGER CAR ..... 1984-90

**MOUNT-TRANSMISSION**

DODGE TRUCK ..... 1984  
DODGE VAN ..... 1984-90

**MOUNT-TRANSMISSION**  
Auto

PLYMOUTH PASSENGER  
CAR ..... 1984-90  
PLYMOUTH VAN ..... 1984-90



**EM-2571**  
**MOUNT-ENGINE**  
RH Front

JEEP SPORT UTILITY ..... 1984-00



**EM-2601**  
**MOUNT-TRANSMISSION**  
Auto

CHRYSLER PASSENGER  
CAR ..... 1982-83  
DODGE PASSENGER CAR ..... 1981-83  
DODGE TRUCK ..... 1982-83  
PLYMOUTH PASSENGER  
CAR ..... 1981-83  
CHRYSLER PASSENGER  
CAR ..... 1982-83  
DODGE PASSENGER CAR ..... 1982-83  
PLYMOUTH PASSENGER CAR ..... 1983



**EM-2615**  
**MOUNT-ENGINE**  
Front

CHRYSLER PASSENGER  
CAR ..... 1988-95  
CHRYSLER VAN ..... 1990-95  
DODGE PASSENGER CAR ..... 1988-95  
DODGE VAN ..... 1990-95  
PLYMOUTH PASSENGER  
CAR ..... 1989-95  
PLYMOUTH VAN ..... 1990-95



**EM-2618**  
**MOUNT-TRANSMISSION**  
Auto

CHRYSLER PASSENGER  
CAR ..... 1989-94

**MOUNT-TRANSMISSION**

CHRYSLER VAN ..... 1990-95

**MOUNT-TRANSMISSION**  
Manual

DODGE PASSENGER CAR ..... 1990-95

**MOUNT-TRANSMISSION**

DODGE VAN ..... 1990-95

**MOUNT-TRANSMISSION**  
Auto

PLYMOUTH PASSENGER  
CAR ..... 1990-95

**MOUNT-TRANSMISSION**

PLYMOUTH VAN ..... 1990-95



**EM-2572**  
**MOUNT-ENGINE**  
L & R Front

JEEP SPORT UTILITY ..... 1987-01

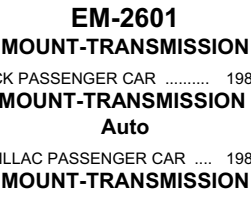

**EM-2616**  
**MOUNT-ENGINE**  
RH Front

BUICK PASSENGER CAR ..... 1985-91

**MOUNT-TRANSMISSION**  
Auto

CADILLAC PASSENGER CAR ..... 1985-88

**MOUNT-TRANSMISSION**

CHEVROLET PASSENGER  
CAR ..... 1985-94

**MOUNT-TRANSMISSION**  
Auto

OLDSMOBILE PASSENGER  
CAR ..... 1983-91

**MOUNT-TRANSMISSION**  
Manual

PONTIAC PASSENGER CAR ..... 1985-94



**EM-2616**  
**MOUNT-ENGINE**  
RH Front

CHRYSLER PASSENGER  
CAR ..... 1989-95  
CHRYSLER VAN ..... 1990-95  
DODGE PASSENGER CAR ..... 1990-95  
DODGE VAN ..... 1990-95  
PLYMOUTH PASSENGER  
CAR ..... 1990-95  
PLYMOUTH VAN ..... 1990-95

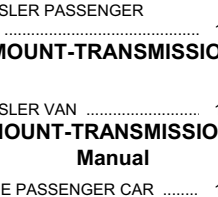

**EM-2618**  
**MOUNT-TRANSMISSION**  
Auto

CHRYSLER PASSENGER  
CAR ..... 1989-94

**MOUNT-TRANSMISSION**

CHRYSLER VAN ..... 1990-95

**MOUNT-TRANSMISSION**  
Manual

DODGE PASSENGER CAR ..... 1990-95

**MOUNT-TRANSMISSION**

DODGE VAN ..... 1990-95

**MOUNT-TRANSMISSION**  
Auto

PLYMOUTH PASSENGER  
CAR ..... 1990-95

**MOUNT-TRANSMISSION**

PLYMOUTH VAN ..... 1990-95

# BUYER'S GUIDE

## NUMERICAL LISTING - ILLUSTRATIONS

 <p style="text-align: center;"><b>EM-2619</b> <b>MOUNT-TRANSMISSION</b></p> <p>LINCOLN PASSENGER CAR ..... 1968-79</p>	 <p style="text-align: center;"><b>EM-2622</b> <b>MOUNT-ENGINE</b> <b>RH Rear</b></p> <p>FORD PASSENGER CAR ..... 1986-90 FORD VAN ..... 1995-00 MERCURY PASSENGER CAR ... 1986-90</p>	 <p style="text-align: center;"><b>EM-2625</b> <b>MOUNT-TRANSMISSION</b> <b>Auto</b></p> <p>JEEP SPORT UTILITY ..... 1984-99</p>	 <p style="text-align: center;"><b>EM-2628</b> <b>MOUNT-TRANSMISSION</b> <b>Manual</b></p> <p>JEEP SPORT UTILITY ..... 1987-95</p>
 <p style="text-align: center;"><b>EM-2620</b> <b>MOUNT-TRANSMISSION</b> <b>MOUNT-TRANSMISSION</b> <b>LH</b></p> <p>BUICK PASSENGER CAR ..... 1988-93</p> <p>CADILLAC PASSENGER CAR .... 1992-95</p> <p style="text-align: center;"><b>MOUNT-TRANSMISSION</b> <b>Auto</b></p> <p>CHEVROLET PASSENGER CAR ..... 1986-97 OLDSMOBILE PASSENGER CAR ..... 1988-93</p> <p style="text-align: center;"><b>MOUNT-TRANSMISSION</b> <b>Auto</b></p> <p>PONTIAC PASSENGER CAR ..... 1988-93</p>	 <p style="text-align: center;"><b>EM-2623</b> <b>MOUNT-ENGINE</b> <b>RH Front</b></p> <p>FORD PASSENGER CAR ..... 1986-90 FORD VAN ..... 1995-00 MERCURY PASSENGER CAR ... 1986-90</p>	 <p style="text-align: center;"><b>EM-2626</b> <b>MOUNT-ENGINE</b> <b>RH Front</b></p> <p>BUICK PASSENGER CAR ..... 1985-91 OLDSMOBILE PASSENGER CAR ..... 1985-91 PONTIAC PASSENGER CAR ..... 1985-87</p>	 <p style="text-align: center;"><b>EM-2629</b> <b>MOUNT-ENGINE</b> <b>L &amp; R Front</b> <b>MOUNT-ENGINE</b> <b>LH Front</b></p> <p>BUICK PASSENGER CAR ..... 1980-85</p> <p>CADILLAC PASSENGER CAR .... 1978-85</p> <p style="text-align: center;"><b>MOUNT-ENGINE</b> <b>L &amp; R Front</b></p> <p>OLDSMOBILE PASSENGER CAR ..... 1980-85</p>
 <p style="text-align: center;"><b>EM-2621</b> <b>MOUNT-ENGINE</b> <b>L &amp; R Front</b></p> <p>CHEVROLET SPORT UTILITY ... 1987-00 CHEVROLET TRUCK ..... 1988-00 CHEVROLET VAN ..... 1996-02 GMC SPORT UTILITY ..... 1989-99 GMC TRUCK ..... 1988-02 GMC VAN ..... 1996-02</p>	 <p style="text-align: center;"><b>EM-2624</b> <b>MOUNT-TRANSMISSION</b> <b>Manual</b> <b>MOUNT-TRANSMISSION</b> <b>Auto</b></p> <p>DODGE SPORT UTILITY ..... 1990-93</p> <p>DODGE TRUCK ..... 1987-03 DODGE VAN ..... 1988-98</p>	 <p style="text-align: center;"><b>EM-2627</b> <b>MOUNT-ENGINE</b> <b>L &amp; R Front</b> <b>MOUNT-ENGINE</b> <b>RH Front</b></p> <p>CHEVROLET PASSENGER CAR ..... 1988-93 CHEVROLET SPORT UTILITY ... 1988-95 CHEVROLET TRUCK ..... 1988-95 GMC SPORT UTILITY ..... 1988-95 GMC TRUCK ..... 1988-95 OLDSMOBILE SPORT UTILITY .. 1991-94</p> <p>PONTIAC PASSENGER CAR ..... 1989</p>	 <p style="text-align: center;"><b>EM-2630</b> <b>MOUNT-ENGINE</b> <b>RH Front</b></p> <p>BUICK PASSENGER CAR ..... 1985-86 CADILLAC PASSENGER CAR .... 1985-86 OLDSMOBILE PASSENGER CAR ..... 1985-86</p>

# BUYER'S GUIDE

## NUMERICAL LISTING - ILLUSTRATIONS



**EM-2631**  
**MOUNT-TRANSMISSION**  
**Manual**

FORD TRUCK ..... 1985-89



**EM-2635**  
**MOUNT-ENGINE**  
**RH Front**

FORD SPORT UTILITY ..... 1985-88  
FORD TRUCK ..... 1985-96  
FORD VAN ..... 1985-96



**EM-2638**  
**MOUNT-TRANSMISSION**  
**Manual**

CADILLAC SPORT UTILITY ..... 1999-14  
CHEVROLET SPORT UTILITY .... 1983-14

**MOUNT-TRANSMISSION**  
**Manual**

CHEVROLET TRUCK ..... 1983-14

**MOUNT-TRANSMISSION**

GMC SPORT UTILITY ..... 1983-14

**MOUNT-TRANSMISSION**  
**Manual**

GMC TRUCK ..... 1983-14

**MOUNT-TRANSMISSION**  
**Auto**

GMC VAN ..... 2003-05

**MOUNT-TRANSMISSION**

HUMMER ..... 2003-06

**MOUNT-TRANSMISSION**  
**Auto**

ISUZU TRUCK ..... 1998-06

**MOUNT-TRANSMISSION**

OLDSMOBILE SPORT UTILITY .. 1991-01



**EM-2640**  
**MOUNT-ENGINE**  
**RH Front**

FORD TRUCK ..... 1991-97  
MAZDA TRUCK ..... 1994-96



**EM-2632**  
**MOUNT-TRANSMISSION**  
**Auto**

FORD PASSENGER CAR ..... 1984-90  
MERCURY PASSENGER CAR ... 1984-87



**EM-2636**  
**MOUNT-ENGINE**  
**LH Front**

FORD SPORT UTILITY ..... 1985-88  
FORD TRUCK ..... 1985-96  
FORD VAN ..... 1985-96

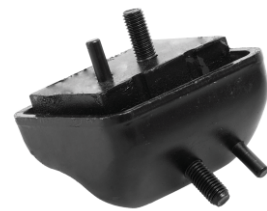

**EM-2641**  
**MOUNT-ENGINE**  
**RH Front**

FORD SPORT UTILITY ..... 1986-94  
FORD TRUCK ..... 1986-97  
MAZDA SPORT UTILITY ..... 1991-94  
MAZDA TRUCK ..... 1994-97

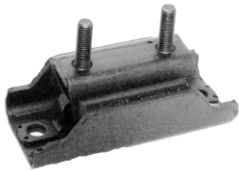

**EM-2633**  
**MOUNT-TRANSMISSION**  
**Auto**

FORD VAN ..... 1986-88



**EM-2637**  
**MOUNT-ENGINE**  
**L & R Front**

CADILLAC SPORT UTILITY ..... 1999-00  
CHEVROLET SPORT UTILITY .... 1988-00  
CHEVROLET TRUCK ..... 1988-00  
GMC SPORT UTILITY ..... 1988-99  
GMC TRUCK ..... 1988-00



**EM-2639**  
**MOUNT-TRANSMISSION**  
**Auto**

FORD SPORT UTILITY ..... 1986-07  
FORD TRUCK ..... 1985-09  
FORD VAN ..... 1989-97  
MAZDA SPORT UTILITY ..... 1992-94  
MAZDA TRUCK ..... 1994-09

**MOUNT-TRANSMISSION**

MERCURY SPORT UTILITY ..... 1998-01



**EM-2642**  
**MOUNT-ENGINE**  
**LH Front**

FORD SPORT UTILITY ..... 1986-90  
FORD TRUCK ..... 1986-97  
MAZDA TRUCK ..... 1994-97



**EM-2634**  
**MOUNT-TRANSMISSION**  
**Manual**

FORD PASSENGER CAR ..... 1984-90  
MERCURY PASSENGER CAR ... 1984-85

# BUYER'S GUIDE

## NUMERICAL LISTING - ILLUSTRATIONS

 <p style="text-align: center;"><b>EM-2643</b> <b>MOUNT-ENGINE</b> <b>LH Front</b></p> <p>FORD SPORT UTILITY ..... 1986-94            FORD TRUCK ..... 1986-97            MAZDA SPORT UTILITY ..... 1991-94            MAZDA TRUCK ..... 1994-97</p>	 <p style="text-align: center;"><b>EM-2649</b> <b>MOUNT-ENGINE</b> <b>RH Front</b></p> <p>FORD PASSENGER CAR ..... 1991-02            MAZDA PASSENGER CAR ..... 1990-94            MERCURY PASSENGER CAR ... 1991-99</p>	 <p style="text-align: center;"><b>EM-2652</b> <b>MOUNT-ENGINE</b> <b>L &amp; R Front</b></p> <p>DODGE TRUCK ..... 1987-96            DODGE VAN ..... 1992-93</p>	 <p style="text-align: center;"><b>EM-2656</b> <b>MOUNT-ENGINE</b> <b>LH Front</b></p> <p>CHEVROLET PASSENGER CAR ..... 1994-96</p> <p style="text-align: center;"><b>MOUNT-ENGINE</b> <b>Front</b></p> <p>PONTIAC PASSENGER CAR ..... 1989</p> <p style="text-align: center;"><b>MOUNT-TRANSMISSION</b> <b>Manual</b></p> <p>DAEWOO PASSENGER CAR ..... 1999-02            PONTIAC PASSENGER CAR ..... 1988-93</p>
 <p style="text-align: center;"><b>EM-2644</b> <b>MOUNT-ENGINE</b> <b>RH Front</b></p> <p>FORD VAN ..... 1990-97</p>	 <p style="text-align: center;"><b>EM-2650</b> <b>MOUNT-ENGINE</b> <b>RH Front</b></p> <p>MERCURY PASSENGER CAR ... 1994-96</p> <p style="text-align: center;"><b>MOUNT-ENGINE</b> <b>LH Rear</b></p> <p>FORD PASSENGER CAR ..... 1991-97</p> <p style="text-align: center;"><b>MOUNT-ENGINE</b> <b>Rear</b></p> <p>MAZDA PASSENGER CAR ..... 1988-94</p> <p style="text-align: center;"><b>MOUNT-ENGINE</b> <b>LH Rear</b></p> <p>MERCURY PASSENGER CAR ... 1991-96</p> <p style="text-align: center;"><b>MOUNT-TRANSMISSION</b> <b>Manual</b></p> <p>MAZDA PASSENGER CAR ..... 1992-96            MAZDA PASSENGER CAR ..... 1990-94</p>	 <p style="text-align: center;"><b>EM-2653</b> <b>MOUNT-TRANSMISSION</b> <b>Manual</b></p> <p>FORD PASSENGER CAR ..... 1988-93</p>	 <p style="text-align: center;"><b>EM-2657</b> <b>MOUNT-ENGINE</b> <b>Front</b></p> <p>PONTIAC PASSENGER CAR ..... 1988-93</p> <p style="text-align: center;"><b>MOUNT-ENGINE</b> <b>Rear</b></p> <p>CHEVROLET PASSENGER CAR ..... 1997-09            DAEWOO PASSENGER CAR ..... 1999-02            PONTIAC PASSENGER CAR ..... 1988-93</p> <p style="text-align: center;"><b>MOUNT-TRANSMISSION</b></p> <p>PONTIAC PASSENGER CAR ..... 1987-89</p>
 <p style="text-align: center;"><b>EM-2645</b> <b>MOUNT-ENGINE</b> <b>RH Front</b></p> <p>FORD VAN ..... 1986-97</p>	 <p style="text-align: center;"><b>EM-2651</b> <b>MOUNT-ENGINE</b> <b>Front</b></p> <p>FORD PASSENGER CAR ..... 1991-02            MAZDA PASSENGER CAR ..... 1992-94            MERCURY PASSENGER CAR ... 1991-99</p>	 <p style="text-align: center;"><b>EM-2654</b> <b>MOUNT-ENGINE</b> <b>Front</b></p> <p>FORD PASSENGER CAR ..... 1990-93</p>	 <p style="text-align: center;"><b>EM-2658</b> <b>MOUNT-ENGINE</b> <b>Front</b></p> <p>DAEWOO PASSENGER CAR ..... 1999-02</p> <p style="text-align: center;"><b>MOUNT-ENGINE</b> <b>RH Front</b></p>
 <p style="text-align: center;"><b>EM-2646</b> <b>MOUNT-ENGINE</b> <b>LH Front</b></p> <p>FORD VAN ..... 1986-97</p>	 <p style="text-align: center;"><b>EM-2655</b> <b>MOUNT-ENGINE</b> <b>RH Front</b></p> <p>FORD PASSENGER CAR ..... 1988-93</p>	 <p style="text-align: center;"><b>EM-2658</b> <b>MOUNT-ENGINE</b> <b>Front</b></p> <p>DAEWOO PASSENGER CAR ..... 1999-02</p> <p style="text-align: center;"><b>MOUNT-ENGINE</b> <b>RH Front</b></p>	<p style="text-align: center;"><b>(Continued Next Page)</b></p>

# BUYER'S GUIDE

## NUMERICAL LISTING - ILLUSTRATIONS

### EM-2658 (Continued)

PONTIAC PASSENGER CAR ..... 1988-93



**EM-2660\***  
**MOUNT-ENGINE**  
**RH Front**

BUICK PASSENGER CAR ..... 1988-93

**MOUNT-ENGINE**  
**Front**

CHEVROLET PASSENGER CAR ..... 1986-94

OLDSMOBILE PASSENGER CAR ..... 1988-93

PONTIAC PASSENGER CAR ..... 1988-93



**EM-2661\***  
**MOUNT-ENGINE**  
**L & R Front**

FORD PASSENGER CAR ..... 1986-97

MERCURY PASSENGER CAR ... 1986-97



**EM-2662**  
**Engine Torque Strut Mount**  
**Front**

BUICK PASSENGER CAR ..... 1988-99

CADILLAC PASSENGER CAR .... 1988-95

CHEVROLET PASSENGER CAR ..... 1996-97

OLDSMOBILE PASSENGER CAR ..... 1988-99

PONTIAC PASSENGER CAR ..... 1992-99



**EM-2663**  
**MOUNT-TRANSMISSION**  
**RH Rear**

BUICK PASSENGER CAR ..... 1985-86

OLDSMOBILE PASSENGER CAR ..... 1985-86



**EM-2664**  
**MOUNT-TRANSMISSION**  
**RH Rear**

BUICK PASSENGER CAR ..... 1985-86

OLDSMOBILE PASSENGER CAR ..... 1985-86



**EM-2665**  
**MOUNT-TRANSMISSION**  
**Manual**

FORD PASSENGER CAR ..... 1984-94

MERCURY PASSENGER CAR ... 1984-94



**EM-2667**  
**MOUNT-TRANSMISSION**  
**Upper**

DODGE SPORT UTILITY ..... 1974-93

DODGE TRUCK ..... 1972-96

PLYMOUTH SUV ..... 1974-81



**EM-2668**  
**MOUNT-TRANSMISSION**  
**Lower**

DODGE SPORT UTILITY ..... 1974-93

DODGE TRUCK ..... 1972-96

PLYMOUTH SUV ..... 1974-81



**EM-2671**  
**MOUNT-TRANSMISSION**  
**LH**

BUICK PASSENGER CAR ..... 1986-88

OLDSMOBILE PASSENGER CAR ..... 1986-88



**EM-2673**  
**MOUNT-ENGINE**  
**Front**

DODGE PASSENGER CAR ..... 1989-92

EAGLE PASSENGER CAR ..... 1989-92

HYUNDAI PASSENGER CAR ..... 1990-91

MITSUBISHI PASSENGER CAR ..... 1989-92

PLYMOUTH PASSENGER CAR ..... 1989-92



**EM-2674**  
**MOUNT-ENGINE**  
**Front**

CHEVROLET PASSENGER CAR ..... 1985-88

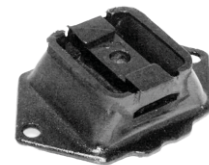



**EM-2675**  
**MOUNT-TRANSMISSION**  
**Manual**

VOLVO PASSENGER CAR ..... 1983-95

# BUYER'S GUIDE

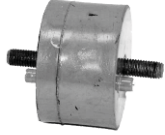
## NUMERICAL LISTING - ILLUSTRATIONS

 <p style="text-align: center;"><b>EM-2676</b> <b>MOUNT-ENGINE</b> <b>RH Rear</b></p> <p>BUICK PASSENGER CAR ..... 1993-95 CHEVROLET PASSENGER CAR ..... 1991-97 OLDSMOBILE PASSENGER CAR ..... 1991-96 PONTIAC PASSENGER CAR ..... 1991-96</p>	 <p style="text-align: center;"><b>EM-2679</b> <b>MOUNT-TRANSMISSION</b></p> <p>LINCOLN PASSENGER CAR ..... 1980-92</p>	<p><b>EM-2682 (Continued)</b></p> <p>FORD PASSENGER CAR ..... 1983-92 MERCURY PASSENGER CAR ... 1979-86</p>	 <p style="text-align: center;"><b>EM-2686</b> <b>MOUNT-TRANSMISSION</b> <b>Auto</b></p> <p>FORD PASSENGER CAR ..... 1988-91</p>
 <p style="text-align: center;"><b>EM-2677</b> <b>MOUNT-ENGINE</b> <b>Front</b></p> <p>TOYOTA PASSENGER CAR ..... 1983-86</p>	 <p style="text-align: center;"><b>EM-2680</b> <b>MOUNT-ENGINE</b> <b>RH Front</b></p> <p>NISSAN PASSENGER CAR ..... 1978-83</p>	 <p style="text-align: center;"><b>EM-2683</b> <b>MOUNT-ENGINE</b> <b>LH Front</b></p> <p>FORD PASSENGER CAR ..... 1983-92</p>	 <p style="text-align: center;"><b>EM-2687</b> <b>MOUNT-TRANSMISSION</b> <b>Auto</b></p> <p>FORD VAN ..... 1995-00 MERCURY PASSENGER CAR ... 1988-89</p>
 <p style="text-align: center;"><b>EM-2678</b> <b>MOUNT-ENGINE</b> <b>Rear</b></p> <p>TOYOTA PASSENGER CAR ..... 1983-86</p>	 <p style="text-align: center;"><b>EM-2681</b> <b>MOUNT-ENGINE</b> <b>L &amp; R Front</b></p> <p>NISSAN PASSENGER CAR ..... 1978-82</p>	 <p style="text-align: center;"><b>EM-2684</b> <b>MOUNT-ENGINE</b> <b>L &amp; R Front</b></p> <p>VOLVO PASSENGER CAR ..... 1984-86</p>	 <p style="text-align: center;"><b>EM-2688</b> <b>MOUNT-ENGINE</b> <b>Rear</b></p> <p>FORD PASSENGER CAR ..... 1986-87</p> <p>MERCURY PASSENGER CAR ... 1986-87</p>
 <p style="text-align: center;"><b>EM-2682</b> <b>MOUNT-ENGINE</b> <b>LH Front</b></p>	<p style="text-align: center;"><b>EM-2685</b> <b>MOUNT-ENGINE</b> <b>Rear</b></p> <p>TOYOTA PASSENGER CAR ..... 1985-86</p>	 <p style="text-align: center;"><b>EM-2685</b> <b>MOUNT-ENGINE</b> <b>Rear</b></p> <p>TOYOTA PASSENGER CAR ..... 1985-86</p>	 <p style="text-align: center;"><b>EM-2688</b> <b>MOUNT-ENGINE</b> <b>Rear</b></p> <p>CHEVROLET PASSENGER CAR ..... 1985-88 TOYOTA PASSENGER CAR ..... 1983-87</p>
<p><b>(Continued Next Column)</b></p>		<p style="text-align: center;"><b>MOUNT-TRANSMISSION</b> <b>Auto</b></p> <p>TOYOTA PASSENGER CAR ..... 1980-86</p>	

# BUYER'S GUIDE

## NUMERICAL LISTING - ILLUSTRATIONS

 <p style="text-align: center;"><b>EM-2689</b> <b>MOUNT-ENGINE</b> <b>L &amp; R Front</b></p> <p>VOLVO PASSENGER CAR ..... 1976-82</p>	 <p style="text-align: center;"><b>EM-2692</b> <b>MOUNT-ENGINE</b> <b>RH Front</b></p> <p>FORD PASSENGER CAR ..... 1986-91 MERCURY PASSENGER CAR ..... 1986</p>	 <p style="text-align: center;"><b>EM-2697*</b> <b>MOUNT-ENGINE</b> <b>RH Front</b></p> <p>BUICK PASSENGER CAR ..... 1990-95</p>	 <p style="text-align: center;"><b>EM-2708</b> <b>MOUNT-ENGINE</b> <b>RH Rear</b></p> <p>CADILLAC PASSENGER CAR .... 1985-88 CHEVROLET PASSENGER CAR ..... 1987-94 OLDSMOBILE PASSENGER CAR ..... 1985-87 PONTIAC PASSENGER CAR ..... 1991-94</p>
 <p style="text-align: center;"><b>EM-2690</b> <b>MOUNT-TRANSMISSION</b> <b>Auto</b></p> <p>TOYOTA PASSENGER CAR ..... 1978-87</p> <p style="text-align: center;"><b>MOUNT-TRANSMISSION</b> <b>Manual</b></p> <p>TOYOTA TRUCK ..... 1984-86</p>	 <p style="text-align: center;"><b>EM-2693</b> <b>MOUNT-TRANSMISSION</b> <b>Auto</b></p> <p>JEEP SPORT UTILITY ..... 1972-93</p> <p style="text-align: center;"><b>MOUNT-TRANSMISSION</b> <b>Manual</b></p> <p>JEEP TRUCK ..... 1974-88</p>	 <p style="text-align: center;"><b>EM-2698*</b> <b>MOUNT-ENGINE</b> <b>L &amp; R Front</b></p> <p>FORD SPORT UTILITY ..... 1989-92 FORD TRUCK ..... 1985-97 MAZDA TRUCK ..... 1994-97</p>	 <p style="text-align: center;"><b>EM-2709</b> <b>MOUNT-ENGINE</b> <b>L &amp; R Front</b></p> <p>FORD TRUCK ..... 1983-97</p>
 <p style="text-align: center;"><b>EM-2691</b> <b>MOUNT-TRANSMISSION</b> <b>RH</b></p> <p>BUICK PASSENGER CAR ..... 1989-90 CADILLAC PASSENGER CAR .... 1987-92 OLDSMOBILE PASSENGER CAR ..... 1989-91</p>	 <p style="text-align: center;"><b>EM-2696*</b> <b>MOUNT-ENGINE</b> <b>Front</b></p> <p>FORD PASSENGER CAR ..... 1986-91 MERCURY PASSENGER CAR ... 1986-91</p> <p style="text-align: center;"><b>MOUNT-TRANSMISSION</b> <b>Auto</b></p> <p>FORD PASSENGER CAR ..... 1990-94 FORD PASSENGER CAR ..... 1986-94 MERCURY PASSENGER CAR ... 1986-94</p>	 <p style="text-align: center;"><b>EM-2707*</b> <b>MOUNT-TRANSMISSION</b> <b>Auto</b></p> <p>FORD PASSENGER CAR ..... 1985-97 MERCURY PASSENGER CAR ... 1985-97</p>	 <p style="text-align: center;"><b>EM-2710</b> <b>MOUNT-ENGINE</b> <b>L &amp; R Front</b></p> <p>DODGE TRUCK ..... 1989-93</p>

# BUYER'S GUIDE

## NUMERICAL LISTING - ILLUSTRATIONS

 <p style="text-align: center;"><b>EM-2711</b> <b>MOUNT-ENGINE</b> <b>RH Front</b></p> <p>CHRYSLER PASSENGER CAR ..... 1989-95 CHRYSLER VAN ..... 1990-95 DODGE PASSENGER CAR ..... 1988-95 DODGE VAN ..... 1990-95 PLYMOUTH PASSENGER CAR ..... 1990-95 PLYMOUTH VAN ..... 1990-95</p>	 <p style="text-align: center;"><b>EM-2713</b> <b>MOUNT-ENGINE</b> <b>L &amp; R Front</b></p> <p>CHEVROLET PASSENGER CAR ..... 1984-91</p>	 <p style="text-align: center;"><b>EM-2716</b> <b>Engine Torque Strut Mount</b> <b>Front</b></p> <p>BUICK PASSENGER CAR ..... 1994-09 BUICK SPORT UTILITY ..... 2002-07 BUICK VAN ..... 2005-07 CHEVROLET PASSENGER CAR ..... 1994-07 CHEVROLET VAN ..... 1996-09</p>	<p><b>EM-2718 (Continued)</b></p> <p>NISSAN TRUCK ..... 1986-02</p>  <p style="text-align: center;"><b>EM-2719</b> <b>MOUNT-TRANSMISSION</b> <b>Manual</b></p> <p>NISSAN SPORT UTILITY ..... 1989 NISSAN TRUCK ..... 1986-04</p>
 <p style="text-align: center;"><b>EM-2712*</b> <b>MOUNT-TRANSMISSION</b> <b>Auto</b></p> <p>BUICK PASSENGER CAR ..... 1994-96</p> <p>CHEVROLET PASSENGER CAR ..... 1991-09 OLDSMOBILE PASSENGER CAR ..... 1991-02 PONTIAC PASSENGER CAR ..... 1991-06</p>	 <p style="text-align: center;"><b>EM-2714</b> <b>BODY MOUNT BUSHING KIT</b></p> <p>CHEVROLET PASSENGER CAR ..... 1986-93</p>	 <p style="text-align: center;"><b>EM-2717*</b> <b>MOUNT-TRANSMISSION</b> <b>Auto</b></p> <p>FORD PASSENGER CAR ..... 1988-99</p> <p>FORD VAN ..... 1995-03 LINCOLN PASSENGER CAR ..... 1988-02 MERCURY PASSENGER CAR ..... 1988-99</p>	 <p style="text-align: center;"><b>EM-2720</b> <b>MOUNT-TRANSMISSION</b> <b>Auto</b></p> <p>BUICK PASSENGER CAR ..... 1982-84</p> <p>CADILLAC PASSENGER CAR ..... 1982-84</p> <p>CHEVROLET PASSENGER CAR ..... 1982-84</p> <p>OLDSMOBILE PASSENGER CAR ..... 1982-84</p> <p>PONTIAC PASSENGER CAR ..... 1982-86</p>
 <p style="text-align: center;"><b>EM-2712S</b> <b>MOUNT-TRANSMISSION</b> <b>LH</b></p> <p>CHEVROLET PASSENGER CAR ..... 2006</p> <p>OLDSMOBILE PASSENGER CAR ..... 1999-02</p>	 <p style="text-align: center;"><b>EM-2715</b> <b>MOUNT-TRANSMISSION</b> <b>Auto</b></p> <p>BUICK PASSENGER CAR ..... 1992-95</p> <p>CHEVROLET PASSENGER CAR ..... 1992-96</p> <p>OLDSMOBILE PASSENGER CAR ..... 1992-95 PONTIAC PASSENGER CAR ..... 1992-93 BUICK PASSENGER CAR ..... 1994-98</p> <p>CHEVROLET PASSENGER CAR ..... 1992-96 OLDSMOBILE PASSENGER CAR ..... 1994-98</p> <p>PONTIAC PASSENGER CAR ..... 1992-98</p>	 <p style="text-align: center;"><b>EM-2718</b> <b>MOUNT-ENGINE</b> <b>L &amp; R Front</b></p>	 <p style="text-align: center;"><b>EM-2721</b> <b>MOUNT-TRANSMISSION</b> <b>Auto</b></p> <p>DODGE PASSENGER CAR ..... 1978-80 PLYMOUTH PASSENGER CAR ..... 1978-80</p>

(Continued Next Column)



# BUYER'S GUIDE

## NUMERICAL LISTING - ILLUSTRATIONS

 <p style="text-align: center;"><b>EM-2722</b> <b>MOUNT-ENGINE</b> <b>LH Front</b></p> <p>AMERICAN MOTORS PASSENGER CAR ..... 1973</p>	 <p style="text-align: center;"><b>EM-2725</b> <b>MOUNT-ENGINE</b> <b>LH Front</b></p> <p>FORD PASSENGER CAR ..... 1980-95 LINCOLN PASSENGER CAR ..... 1980-92 MERCURY PASSENGER CAR ... 1980-82</p>	 <p style="text-align: center;"><b>EM-2728</b> <b>MOUNT-ENGINE</b> <b>LH Front</b></p> <p>FORD TRUCK ..... 1982-83</p>	<p><b>EM-2731 (Continued)</b></p> <p>MITSUBISHI PASSENGER CAR ..... 1983-89</p> <p style="text-align: center;"><b>MOUNT-ENGINE</b> <b>L &amp; R Front</b></p> <p>MITSUBISHI SPORT UTILITY ..... 1983-89</p> <p style="text-align: center;"><b>MOUNT-ENGINE</b> <b>RH Front</b></p> <p>MITSUBISHI TRUCK ..... 1983-96</p> <p style="text-align: center;"><b>MOUNT-ENGINE</b> <b>L &amp; R Front</b></p> <p>PLYMOUTH PASSENGER CAR ..... 1976-86 PLYMOUTH TRUCK ..... 1979-82</p>
 <p style="text-align: center;"><b>EM-2723</b> <b>MOUNT-ENGINE</b> <b>RH Front</b></p> <p>FORD PASSENGER CAR ..... 1968-73</p> <p style="text-align: center;"><b>MOUNT-ENGINE</b> <b>LH Front</b></p> <p>FORD TRUCK ..... 1970-73</p> <p style="text-align: center;"><b>MOUNT-ENGINE</b> <b>RH Front</b></p> <p>LINCOLN PASSENGER CAR ..... 1968-78 MERCURY PASSENGER CAR ... 1970-71</p>	 <p style="text-align: center;"><b>EM-2726</b> <b>MOUNT-ENGINE</b> <b>RH Front</b></p> <p>FORD PASSENGER CAR ..... 1980-95 LINCOLN PASSENGER CAR ..... 1980-92 MERCURY PASSENGER CAR ... 1980-82</p>	 <p style="text-align: center;"><b>EM-2730</b> <b>MOUNT-TRANSMISSION</b> <b>Manual</b></p> <p>CHRYSLER PASSENGER CAR ..... 1987-89</p> <p style="text-align: center;"><b>MOUNT-TRANSMISSION</b></p> <p>DODGE PASSENGER CAR ..... 1978-86</p> <p style="text-align: center;"><b>MOUNT-TRANSMISSION</b> <b>Auto</b></p> <p>MITSUBISHI PASSENGER CAR ..... 1983-90</p> <p style="text-align: center;"><b>MOUNT-TRANSMISSION</b></p> <p>PLYMOUTH PASSENGER CAR ..... 1978-86 PLYMOUTH TRUCK ..... 1979-82</p>	 <p style="text-align: center;"><b>EM-2733</b> <b>MOUNT-ENGINE</b> <b>Front</b></p> <p>DODGE PASSENGER CAR ..... 1978-83 PLYMOUTH PASSENGER CAR ..... 1978-83</p>
 <p style="text-align: center;"><b>EM-2724</b> <b>MOUNT-ENGINE</b> <b>LH Front</b></p> <p>FORD PASSENGER CAR ..... 1968-73</p> <p style="text-align: center;"><b>MOUNT-ENGINE</b> <b>RH Front</b></p> <p>FORD TRUCK ..... 1970-73</p> <p style="text-align: center;"><b>MOUNT-ENGINE</b> <b>LH Front</b></p> <p>MERCURY PASSENGER CAR ... 1970-71</p>	 <p style="text-align: center;"><b>EM-2727</b> <b>MOUNT-ENGINE</b> <b>RH Front</b></p> <p>FORD TRUCK ..... 1982-83</p>	 <p style="text-align: center;"><b>EM-2731</b> <b>MOUNT-ENGINE</b> <b>L &amp; R Front</b></p> <p>DODGE PASSENGER CAR ..... 1971-84 DODGE SPORT UTILITY ..... 1987-89</p> <p style="text-align: center;"><b>MOUNT-ENGINE</b> <b>RH Front</b></p> <p>DODGE TRUCK ..... 1979-93</p> <p style="text-align: center;"><b>MOUNT-ENGINE</b> <b>Front</b></p> <p style="text-align: center;">(Continued Next Column)</p>	 <p style="text-align: center;"><b>EM-2734</b> <b>MOUNT-TRANSMISSION</b> <b>Manual</b></p> <p>DODGE PASSENGER CAR ..... 1978-80</p> <p style="text-align: center;"><b>MOUNT-TRANSMISSION</b> <b>Auto</b></p> <p>PLYMOUTH PASSENGER CAR ..... 1978-80</p>

# BUYER'S GUIDE

## NUMERICAL LISTING - ILLUSTRATIONS

 <p style="text-align: center;"><b>EM-2735</b> <b>MOUNT-ENGINE</b> <b>RH Front</b></p> <p>MG PASSENGER CAR ..... 1956-74</p>	 <p style="text-align: center;"><b>EM-2739</b> <b>MOUNT-TRANSMISSION</b> <b>Manual</b></p> <p>RENAULT PASSENGER CAR ..... 1976-83</p>	 <p style="text-align: center;"><b>EM-2743</b> <b>MOUNT-ENGINE</b> <b>RH Front</b></p> <p>TOYOTA PASSENGER CAR ..... 1971-74</p>	 <p style="text-align: center;"><b>EM-2747</b> <b>MOUNT-ENGINE</b> <b>LH Front</b></p> <p>TOYOTA PASSENGER CAR ..... 1969-79</p>
 <p style="text-align: center;"><b>EM-2736</b> <b>MOUNT-ENGINE</b> <b>LH Front</b></p> <p>MG PASSENGER CAR ..... 1956-74</p>	 <p style="text-align: center;"><b>EM-2740</b> <b>MOUNT-ENGINE</b> <b>LH Front</b></p> <p>NISSAN TRUCK ..... 1980-94</p>	 <p style="text-align: center;"><b>EM-2744</b> <b>MOUNT-ENGINE</b> <b>L &amp; R Front</b></p> <p>TOYOTA PASSENGER CAR ..... 1978-82</p>	 <p style="text-align: center;"><b>EM-2748</b> <b>MOUNT-ENGINE</b> <b>RH Front</b></p> <p>TOYOTA PASSENGER CAR ..... 1969-79</p>
 <p style="text-align: center;"><b>EM-2737</b> <b>MOUNT-ENGINE</b> <b>RH Front</b></p> <p>RENAULT PASSENGER CAR ..... 1976-83</p>	 <p style="text-align: center;"><b>EM-2741</b> <b>MOUNT-TRANSMISSION</b> <b>Auto</b></p> <p>NISSAN PASSENGER CAR ..... 1979-83</p>	 <p style="text-align: center;"><b>EM-2745</b> <b>MOUNT-ENGINE</b> <b>LH Front</b></p> <p>TOYOTA PASSENGER CAR ..... 1973-74</p>	 <p style="text-align: center;"><b>EM-2749</b> <b>MOUNT-ENGINE</b> <b>LH Front</b></p> <p>LINCOLN PASSENGER CAR ..... 1968-79</p>
 <p style="text-align: center;"><b>EM-2738</b> <b>MOUNT-ENGINE</b> <b>LH Front</b></p> <p>RENAULT PASSENGER CAR ..... 1976-83</p>	 <p style="text-align: center;"><b>EM-2742</b> <b>MOUNT-TRANSMISSION</b></p> <p>NISSAN PASSENGER CAR ..... 1978-81 NISSAN TRUCK ..... 1970-97</p>	 <p style="text-align: center;"><b>EM-2746</b> <b>MOUNT-TRANSMISSION</b> <b>Manual</b></p> <p>TOYOTA TRUCK ..... 1978-80</p>	

# BUYER'S GUIDE

## NUMERICAL LISTING - ILLUSTRATIONS



**EM-2750**  
**MOUNT-TRANSMISSION**

FORD TRUCK ..... 1975-77



**EM-2754**  
**MOUNT-ENGINE**  
**LH Front**

FORD VAN ..... 1980-82

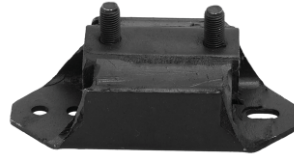

**EM-2759**  
**MOUNT-TRANSMISSION**

FORD TRUCK ..... 1972-82  
MAZDA PASSENGER CAR ..... 1972-77



**EM-2763**  
**MOUNT-ENGINE**  
**RH Rear**

BUICK PASSENGER CAR ..... 1990-92



**EM-2751**  
**MOUNT-TRANSMISSION**  
**Auto**

FORD TRUCK ..... 1970-76



**EM-2755**  
**MOUNT-ENGINE**  
**LH Front**

CHEVROLET SPORT UTILITY .... 1983-84  
CHEVROLET TRUCK ..... 1983-84  
GMC SPORT UTILITY ..... 1983-84  
GMC TRUCK ..... 1983-84



**EM-2760**  
**MOUNT-TRANSMISSION**  
**Auto**

NISSAN PASSENGER CAR ..... 1974



**EM-2764**  
**MOUNT-ENGINE**  
**RH Front**

FORD TRUCK ..... 1988-97



**EM-2752**  
**MOUNT-TRANSMISSION**  
**Manual**

FORD TRUCK ..... 1978-87



**EM-2756**  
**MOUNT-ENGINE**  
**RH Front**

CHEVROLET SPORT UTILITY .... 1983-84  
CHEVROLET TRUCK ..... 1983-84  
GMC SPORT UTILITY ..... 1983-84  
GMC TRUCK ..... 1983-84



**EM-2761**  
**Engine Torque Strut Mount**  
**Front**

PONTIAC PASSENGER CAR ..... 1984-88



**EM-2765**  
**MOUNT-ENGINE**  
**LH Front**

FORD TRUCK ..... 1988-97



**EM-2753**  
**MOUNT-TRANSMISSION**  
**Auto**

FORD TRUCK ..... 1978-87



**EM-2762**  
**MOUNT-TRANSMISSION**  
**LH Front**

CHEVROLET PASSENGER  
CAR ..... 1987-88  
PONTIAC PASSENGER CAR ..... 1987-88



**EM-2766**  
**MOUNT-TRANSMISSION**  
**Manual**

CHEVROLET PASSENGER  
CAR ..... 1990-91  
OLDSMOBILE PASSENGER  
CAR ..... 1988-91

(Continued Next Page)

# BUYER'S GUIDE

## NUMERICAL LISTING - ILLUSTRATIONS

### EM-2766 (Continued)

PONTIAC PASSENGER CAR ..... 1988-98



**EM-2767**  
**MOUNT-ENGINE**  
**RH Front**

FORD VAN ..... 1983-03



**EM-2768**  
**MOUNT-ENGINE**  
**LH Front**

FORD VAN ..... 1983-03



**EM-2769**  
**MOUNT-TRANSMISSION**  
**Manual**

FORD TRUCK ..... 1987-94



**EM-2770**  
**MOUNT-ENGINE**  
**RH Rear**

FORD PASSENGER CAR ..... 1986-91  
MERCURY PASSENGER CAR ..... 1986



**EM-2771**  
**MOUNT-TRANSMISSION**  
**Auto**

CHEVROLET SPORT UTILITY ..... 1983  
CHEVROLET TRUCK ..... 1982  
GMC SPORT UTILITY ..... 1983  
GMC TRUCK ..... 1982-83



**EM-2772**  
**MOUNT-TRANSMISSION**  
**Manual**

CHEVROLET SPORT UTILITY ..... 1983

**MOUNT-TRANSMISSION**  
**Auto**

CHEVROLET TRUCK ..... 1983  
GMC SPORT UTILITY ..... 1983  
GMC TRUCK ..... 1983



**EM-2773@**  
**MOUNT-TRANSMISSION**

CADILLAC PASSENGER CAR .... 1979-85



**EM-2774**  
**MOUNT-ENGINE**  
**RH Front**

FORD TRUCK ..... 1972-82  
MAZDA TRUCK ..... 1972-84



**EM-2775**  
**MOUNT-ENGINE**  
**LH Front**

FORD TRUCK ..... 1972-82  
MAZDA TRUCK ..... 1972-84



**EM-2776**  
**MOUNT-ENGINE**  
**L & R Front**

FORD PASSENGER CAR ..... 1980-82  
MERCURY PASSENGER CAR ... 1980-82



**EM-2777**  
**MOUNT-ENGINE**  
**L & R Front**

BUICK PASSENGER CAR ..... 1979-85  
CADILLAC PASSENGER CAR .... 1981-82  
OLDSMOBILE PASSENGER  
CAR ..... 1981-84



**EM-2778**  
**MOUNT-TRANSMISSION**  
**LH Rear**

BUICK PASSENGER CAR ..... 1994-99  
OLDSMOBILE PASSENGER  
CAR ..... 1994-99  
PONTIAC PASSENGER CAR .... 1994-99



**EM-2779\***  
**MOUNT-TRANSMISSION**  
**LH**

BUICK PASSENGER CAR ..... 1988-91  
**MOUNT-TRANSMISSION**  
**Center**

CADILLAC PASSENGER CAR .... 1987-92  
**MOUNT-TRANSMISSION**  
**LH**

OLDSMOBILE PASSENGER  
CAR ..... 1989-91

# BUYER'S GUIDE

## NUMERICAL LISTING - ILLUSTRATIONS

 <p style="text-align: center;"><b>EM-2780</b> Engine Torque Strut Front Right</p> <p>CADILLAC PASSENGER CAR ..... 1993-02 CHEVROLET PASSENGER CAR ..... 1993</p>	 <p style="text-align: center;"><b>EM-2783</b> MOUNT-TRANSMISSION LH</p> <p>CADILLAC PASSENGER CAR ..... 1986-87</p>	 <p style="text-align: center;"><b>EM-2788*</b> MOUNT-ENGINE RH Rear</p> <p>FORD PASSENGER CAR ..... 1991-95 MERCURY PASSENGER CAR ... 1991-95</p>	<p><b>EM-2791 (Continued)</b></p> <p>FORD PASSENGER CAR ..... 1991-92 MERCURY PASSENGER CAR ... 1991-92</p>  <p style="text-align: center;"><b>EM-2792*</b> MOUNT-ENGINE RH Front</p> <p>FORD PASSENGER CAR ..... 1993 MERCURY PASSENGER CAR ..... 1993</p>
 <p style="text-align: center;"><b>EM-2781</b> Engine Torque Strut Front Left</p> <p>CADILLAC PASSENGER CAR ..... 1993-02 CHEVROLET PASSENGER CAR ..... 1993</p>	 <p style="text-align: center;"><b>EM-2784</b> MOUNT-TRANSMISSION Auto</p> <p>FORD PASSENGER CAR ..... 1982-98</p>	 <p style="text-align: center;"><b>EM-2789*</b> MOUNT-ENGINE RH Front</p> <p>FORD PASSENGER CAR ..... 1996-99 MERCURY PASSENGER CAR ... 1996-99</p>	 <p style="text-align: center;"><b>EM-2793</b> MOUNT-ENGINE RH Front</p> <p>JEEP SPORT UTILITY ..... 1993-98</p>
 <p style="text-align: center;"><b>EM-2782</b> Engine Torque Strut Mount Front</p> <p>BUICK PASSENGER CAR ..... 1992-94 CHEVROLET PASSENGER CAR ..... 1992-96 OLDSMOBILE PASSENGER CAR ..... 1992-97 PONTIAC PASSENGER CAR ..... 1992-98</p>	 <p style="text-align: center;"><b>EM-2785</b> MOUNT-ENGINE RH Front</p> <p>FORD TRUCK ..... 1985-87</p>	 <p style="text-align: center;"><b>EM-2790*</b> MOUNT-ENGINE RH Front</p> <p>FORD PASSENGER CAR ..... 1994-95 MERCURY PASSENGER CAR ... 1994-95</p>	 <p style="text-align: center;"><b>EM-2794</b> MOUNT-ENGINE LH Front</p> <p>JEEP SPORT UTILITY ..... 1993-98</p>
 <p style="text-align: center;"><b>EM-2786</b> MOUNT-ENGINE LH Front</p> <p>FORD TRUCK ..... 1985-87</p>	 <p style="text-align: center;"><b>EM-2791*</b> MOUNT-ENGINE RH Front</p> <p style="text-align: center;">(Continued Next Column)</p>		

# BUYER'S GUIDE

## NUMERICAL LISTING - ILLUSTRATIONS



**EM-2795\***  
**MOUNT-ENGINE**  
**L & R Front**

CHRYSLER PASSENGER CAR .....	1993-97
DODGE PASSENGER CAR .....	1993-95
EAGLE PASSENGER CAR .....	1993-97

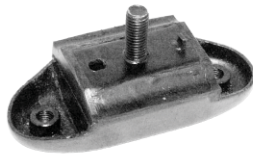

**EM-2797**  
**TORSION BAR MOUNT**  
**Front**

CHEVROLET SPORT UTILITY .....	1983-94
GMC SPORT UTILITY .....	1983-94
OLDSMOBILE SPORT UTILITY ..	1991-94



**EM-2800**  
**MOUNT-TRANSMISSION**  
**LH Front**

BUICK PASSENGER CAR .....	1991-93
CADILLAC PASSENGER CAR .....	1985-93
OLDSMOBILE PASSENGER CAR .....	1991-93
PONTIAC PASSENGER CAR .....	1992-93



**EM-2803\***  
**MOUNT-ENGINE**  
**RH Front**

BUICK PASSENGER CAR .....	1992-98
CHEVROLET PASSENGER CAR .....	1992-02
OLDSMOBILE PASSENGER CAR .....	1992-98
PONTIAC PASSENGER CAR .....	1992-02

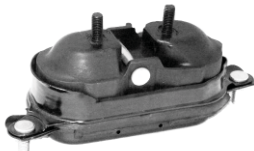

**EM-2796\***  
**MOUNT-ENGINE**  
**Front**

BUICK PASSENGER CAR .....	1994-05
---------------------------	---------

**MOUNT-ENGINE**  
**RH Front**

CHEVROLET PASSENGER CAR .....	1995-05
CHEVROLET VAN .....	1997-05

**MOUNT-ENGINE**  
**Front**

OLDSMOBILE PASSENGER CAR .....	1990-95
OLDSMOBILE VAN .....	1997-04

**MOUNT-ENGINE**  
**RH Front**

PONTIAC PASSENGER CAR .....	1994-03
-----------------------------	---------

**MOUNT-ENGINE**  
**Front**

PONTIAC VAN .....	1997-05
-------------------	---------



**EM-2798**  
**Engine Torque Strut Mount**  
**Front**

CHEVROLET PASSENGER CAR .....	1995-05
PONTIAC PASSENGER CAR .....	1995-05



**EM-2801**  
**MOUNT-ENGINE**  
**RH Front**

BUICK PASSENGER CAR .....	1991-99
OLDSMOBILE PASSENGER CAR .....	1991-99
PONTIAC PASSENGER CAR .....	1992-99



**EM-2804**  
**MOUNT-ENGINE**  
**Front**

FORD PASSENGER CAR .....	1992-94
MERCURY PASSENGER CAR .....	1992-94

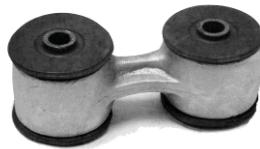

**EM-2799**  
**Engine Torque Strut Mount**  
**Front**

CHEVROLET PASSENGER CAR .....	1991-97
OLDSMOBILE PASSENGER CAR .....	1991-96
PONTIAC PASSENGER CAR .....	1991-96



**EM-2802**  
**MOUNT-ENGINE**  
**L & R Front**

CHEVROLET SPORT UTILITY .....	1995-05
CHEVROLET TRUCK .....	1996-04
GMC SPORT UTILITY .....	1996-05
GMC TRUCK .....	1996-04
ISUZU TRUCK .....	1997-00
OLDSMOBILE SPORT UTILITY ..	1996-01



**EM-2805**  
**MOUNT-ENGINE**  
**RH Front**

FORD PASSENGER CAR .....	1992-94
MERCURY PASSENGER CAR .....	1992-94

# BUYER'S GUIDE

## NUMERICAL LISTING - ILLUSTRATIONS

 <p style="text-align: center;"><b>EM-2806</b> <b>MOUNT-ENGINE</b> <b>RH Front</b></p> <p>FORD PASSENGER CAR ..... 1992-97 LINCOLN PASSENGER CAR ..... 1991-97 MERCURY PASSENGER CAR ... 1992-97</p>	 <p style="text-align: center;"><b>EM-2809</b> <b>MOUNT-ENGINE</b> <b>LH Front</b></p> <p>JEEP SPORT UTILITY ..... 1993-98</p>	 <p style="text-align: center;"><b>EM-2813*</b> <b>MOUNT-ENGINE</b> <b>RH Rear</b></p> <p>FORD PASSENGER CAR ..... 1988-95 FORD VAN ..... 1995-03 LINCOLN PASSENGER CAR ..... 1988-02 MERCURY PASSENGER CAR ... 1988-95</p>	<p><b>EM-2815 (Continued)</b></p> <p>MAZDA PASSENGER CAR ..... 1990-94 <b>MOUNT-TRANSMISSION</b> <b>Auto</b></p> <p>MERCURY PASSENGER CAR ... 1991-96 MAZDA PASSENGER CAR ..... 1990-91</p>
 <p style="text-align: center;"><b>EM-2807</b> <b>MOUNT-ENGINE</b> <b>LH Front</b></p> <p>FORD PASSENGER CAR ..... 1992-97 LINCOLN PASSENGER CAR ..... 1991-97 MERCURY PASSENGER CAR ... 1992-97</p>	 <p style="text-align: center;"><b>EM-2810</b> <b>MOUNT-TRANSMISSION</b></p> <p>CHRYSLER PASSENGER CAR ..... 1993-97 DODGE PASSENGER CAR ..... 1993-97 EAGLE PASSENGER CAR ..... 1993-97 PLYMOUTH PASSENGER CAR ..... 1997-99</p>	 <p style="text-align: center;"><b>EM-2814</b> <b>Engine Torque Strut Mount</b> <b>Front</b></p> <p>BUICK PASSENGER CAR ..... 1995-98 CHEVROLET PASSENGER CAR ..... 1995-96 OLDSMOBILE PASSENGER CAR ..... 1995-98 PONTIAC PASSENGER CAR ..... 1994-98</p>	 <p style="text-align: center;"><b>EM-2816</b> <b>MOUNT-TRANSMISSION</b></p> <p>CHEVROLET VAN ..... 1990-02 GMC VAN ..... 1990-02</p>
 <p style="text-align: center;"><b>EM-2808</b> <b>MOUNT-ENGINE</b> <b>RH Front</b></p> <p>JEEP SPORT UTILITY ..... 1993-98</p>	 <p style="text-align: center;"><b>EM-2812*</b> <b>MOUNT-ENGINE</b> <b>RH Front</b></p> <p>FORD PASSENGER CAR ..... 1988-95 FORD VAN ..... 1995 LINCOLN PASSENGER CAR ..... 1988-94 MERCURY PASSENGER CAR ... 1988-95</p>	 <p style="text-align: center;"><b>EM-2815</b> <b>MOUNT-ENGINE</b> <b>LH Front</b></p> <p>MAZDA PASSENGER CAR ..... 1990-94 <b>MOUNT-ENGINE</b> <b>Rear</b></p> <p>MAZDA PASSENGER CAR ..... 1992-94 <b>MOUNT-TRANSMISSION</b> <b>Auto</b></p> <p>FORD PASSENGER CAR ..... 1991-97 <b>MOUNT-TRANSMISSION</b></p> <p>KIA PASSENGER CAR ..... 1994-97 <b>MOUNT-TRANSMISSION</b> <b>Manual</b></p> <p style="text-align: center;">(Continued Next Column)</p>	 <p style="text-align: center;"><b>EM-2817</b> <b>MOUNT-TRANSMISSION</b> <b>Auto</b></p> <p>CADILLAC SPORT UTILITY ..... 2000-14 <b>MOUNT-TRANSMISSION</b> <b>Auto</b></p> <p>CHEVROLET PASSENGER CAR ..... 1994-97 <b>MOUNT-TRANSMISSION</b></p> <p>CHEVROLET SPORT UTILITY ... 1994-14 <b>MOUNT-TRANSMISSION</b> <b>Auto</b></p> <p>CHEVROLET TRUCK ..... 1994-14 <b>MOUNT-TRANSMISSION</b></p> <p>CHEVROLET VAN ..... 1991-02 GMC SPORT UTILITY ..... 1994-14 <b>MOUNT-TRANSMISSION</b> <b>Manual</b></p> <p>GMC TRUCK ..... 1994-14 <b>MOUNT-TRANSMISSION</b> <b>Auto</b></p> <p>GMC VAN ..... 1991-02 <b>MOUNT-TRANSMISSION</b></p> <p>PONTIAC PASSENGER CAR ..... 1994-97</p>

# BUYER'S GUIDE

## NUMERICAL LISTING - ILLUSTRATIONS



**EM-2818**  
**MOUNT-TRANSMISSION**

BUICK PASSENGER CAR ..... 1997-09  
 BUICK SPORT UTILITY ..... 2002-07  
 BUICK VAN ..... 2005-07  
 CHEVROLET PASSENGER  
 CAR ..... 2000-10  
 CHEVROLET VAN ..... 1997-09  
 OLDSMOBILE VAN ..... 1997-04  
 PONTIAC PASSENGER CAR ..... 2007-08  
 PONTIAC SPORT UTILITY ..... 2001-05  
 PONTIAC VAN ..... 1997-06

**MOUNT-TRANSMISSION**  
**Auto**

SATURN VAN ..... 2005-07



**EM-2819**  
**MOUNT-ENGINE**  
**L & R Front**

CHEVROLET TRUCK ..... 1994-03  
 GMC TRUCK ..... 1994-03  
 ISUZU TRUCK ..... 1996-00



**EM-2820**  
**MOUNT-TRANSMISSION**  
**Auto**

CHEVROLET PASSENGER  
 CAR ..... 1994-05  
 PONTIAC PASSENGER CAR ..... 1995-05



**EM-2821\***  
**MOUNT-TRANSMISSION**  
**RH Rear**

CADILLAC PASSENGER CAR ..... 1991-93



**EM-2822**  
**MOUNT-TRANSMISSION**

FORD PASSENGER CAR ..... 1992-02  
 LINCOLN PASSENGER CAR ..... 1992-02  
 MERCURY PASSENGER CAR ..... 1992-02



**EM-2823\***  
**MOUNT-TRANSMISSION**  
**LH Rear**

BUICK PASSENGER CAR ..... 1991-93  
 OLDSMOBILE PASSENGER  
 CAR ..... 1991-93  
 PONTIAC PASSENGER CAR ..... 1992-93



**EM-2824\***  
**MOUNT-TRANSMISSION**

CHRYSLER PASSENGER  
 CAR ..... 1990-93

**MOUNT-TRANSMISSION**  
**Auto**

DODGE PASSENGER CAR ..... 1990-93



**EM-2825**  
**Engine Torque Strut Mount**  
**Front**

SATURN PASSENGER CAR ..... 1992-02

**Engine Torque Strut Mount**  
**Rear**

SATURN PASSENGER CAR ..... 1992-02



**EM-2826**  
**MOUNT-TRANSMISSION**  
**Auto**

SATURN PASSENGER CAR ..... 1991-02



**EM-2827**  
**MOUNT-ENGINE**  
**RH Front**

SATURN PASSENGER CAR ..... 1991-02



**EM-2828**  
**MOUNT-TRANSMISSION**

JEEP SPORT UTILITY ..... 1996-98



**EM-2829**  
**MOUNT-ENGINE**  
**LH Front**

DODGE TRUCK ..... 1994-02



**EM-2830**  
**MOUNT-ENGINE**  
**RH Front**

DODGE TRUCK ..... 1994-02



# BUYER'S GUIDE

## NUMERICAL LISTING - ILLUSTRATIONS



**EM-2831**  
MOUNT-ENGINE  
LH Front

FORD TRUCK ..... 1997-04



**EM-2835**  
MOUNT-ENGINE  
RH Front

FORD SPORT UTILITY ..... 1997-02  
FORD TRUCK ..... 1993-04  
LINCOLN SPORT UTILITY ..... 1998-02  
LINCOLN TRUCK ..... 2002



**EM-2838\***  
MOUNT-ENGINE  
RH Front

CADILLAC PASSENGER CAR .... 1993-02  
CHEVROLET PASSENGER CAR ..... 1993



**EM-2842\***  
MOUNT-TRANSMISSION  
Center

CHRYSLER PASSENGER  
CAR ..... 1995-06

**MOUNT-TRANSMISSION  
Auto**

DODGE PASSENGER CAR ..... 1995-06  
PLYMOUTH PASSENGER  
CAR ..... 1996-00



**EM-2832**  
MOUNT-ENGINE  
LH Front

FORD SPORT UTILITY ..... 1997-02  
FORD TRUCK ..... 1993-04  
LINCOLN SPORT UTILITY ..... 1998-02



**EM-2836\***  
MOUNT-ENGINE  
RH Front

CADILLAC PASSENGER CAR .... 1992-95  
CHEVROLET PASSENGER  
CAR ..... 1996-97



**EM-2840\***  
MOUNT-ENGINE  
RH Rear

FORD PASSENGER CAR ..... 1996-99  
MERCURY PASSENGER CAR ... 1996-99



**EM-2843**  
MOUNT-TRANSMISSION  
Auto

FORD PASSENGER CAR ..... 1997-02

**MOUNT-TRANSMISSION  
Manual**

MERCURY PASSENGER CAR ... 1997-99



**EM-2833**  
MOUNT-ENGINE  
RH Front

FORD TRUCK ..... 1997-04



**EM-2837\***  
MOUNT-TRANSMISSION  
RH

CADILLAC PASSENGER CAR .... 1993-02  
CHEVROLET PASSENGER CAR ..... 1993



**EM-2841\***  
MOUNT-ENGINE  
RH Front

CHRYSLER PASSENGER  
CAR ..... 1995-06  
DODGE PASSENGER CAR ..... 1995-06  
PLYMOUTH PASSENGER  
CAR ..... 1996-00



**EM-2844**  
MOUNT-ENGINE  
RH Front

CHRYSLER VAN ..... 1996-00  
DODGE VAN ..... 1996-00  
PLYMOUTH VAN ..... 1996-00



**EM-2834**  
MOUNT-ENGINE  
RH Front

FORD SPORT UTILITY ..... 1997-98  
LINCOLN SPORT UTILITY ..... 1998-99

# BUYER'S GUIDE

## NUMERICAL LISTING - ILLUSTRATIONS

 <p style="text-align: center;"><b>EM-2845</b> <b>MOUNT-TRANSMISSION</b> Center</p> <p>CHRYSLER VAN ..... 1996-00 <b>MOUNT-TRANSMISSION</b> DODGE VAN ..... 1996-00 <b>MOUNT-TRANSMISSION</b> PLYMOUTH VAN ..... 1996-00</p>	 <p style="text-align: center;"><b>EM-2848</b> <b>MOUNT-TRANSMISSION</b> Auto</p> <p>DODGE PASSENGER CAR ..... 1995-99 <b>MOUNT-TRANSMISSION</b> Manual PLYMOUTH PASSENGER CAR ..... 1995-99</p>	 <p style="text-align: center;"><b>EM-2851</b> <b>MOUNT-ENGINE</b> LH Front</p> <p>FORD SPORT UTILITY ..... 1997-05 FORD TRUCK ..... 1998-11 MAZDA TRUCK ..... 2005-09 MERCURY SPORT UTILITY ..... 1998-01</p>	 <p style="text-align: center;"><b>EM-2854</b> <b>MOUNT-TRANSMISSION</b></p> <p>MERCURY VAN ..... 1993-02 NISSAN VAN ..... 1993-02</p>
 <p style="text-align: center;"><b>EM-2846</b> <b>MOUNT-ENGINE</b> Front</p> <p>DODGE PASSENGER CAR ..... 1995-99 PLYMOUTH PASSENGER CAR ..... 1995-99</p>	 <p style="text-align: center;"><b>EM-2849</b> <b>MOUNT-TRANSMISSION</b> LH Front</p> <p>CHRYSLER VAN ..... 1996-00 <b>MOUNT-TRANSMISSION</b> DODGE VAN ..... 1996-04 <b>MOUNT-TRANSMISSION</b> PLYMOUTH VAN ..... 1996-00 <b>MOUNT-TRANSMISSION</b> LH Rear CHRYSLER VAN ..... 1996-00 <b>MOUNT-TRANSMISSION</b> DODGE VAN ..... 1996-04 <b>MOUNT-TRANSMISSION</b> PLYMOUTH VAN ..... 1996-00</p>	 <p style="text-align: center;"><b>EM-2852</b> <b>MOUNT-TRANSMISSION</b> Auto</p> <p>DODGE TRUCK ..... 1994-03 <b>MOUNT-TRANSMISSION</b> DODGE VAN ..... 1999-03</p>	 <p style="text-align: center;"><b>EM-2855</b> <b>MOUNT-ENGINE</b> Front</p> <p>MERCURY VAN ..... 1993-98 NISSAN VAN ..... 1993-98</p>
 <p style="text-align: center;"><b>EM-2847</b> <b>MOUNT-ENGINE</b> RH Front</p> <p>DODGE PASSENGER CAR ..... 1995-99 PLYMOUTH PASSENGER CAR ..... 1995-99</p>	 <p style="text-align: center;"><b>EM-2850</b> <b>MOUNT-ENGINE</b> RH Front</p> <p>FORD SPORT UTILITY ..... 1995-05 FORD TRUCK ..... 1998 MERCURY SPORT UTILITY ..... 1998-01</p>	 <p style="text-align: center;"><b>EM-2853</b> <b>MOUNT-ENGINE</b> L &amp; R Front</p> <p>FORD TRUCK ..... 1998-11 MAZDA TRUCK ..... 1998-07</p>	 <p style="text-align: center;"><b>EM-2856</b> <b>MOUNT-ENGINE</b> RH Front</p> <p>NISSAN VAN ..... 1993-98 <b>MOUNT-ENGINE</b> LH Rear MERCURY VAN ..... 1993-98</p>

# BUYER'S GUIDE

## NUMERICAL LISTING - ILLUSTRATIONS



**EM-2857**  
**MOUNT-ENGINE**  
**RH Rear**

MERCURY VAN ..... 1993-02  
**MOUNT-ENGINE**  
**Rear**  
NISSAN VAN ..... 1993-02



**EM-2860**  
**MOUNT-ENGINE**  
**RH Front**

FORD PASSENGER CAR ..... 1998-02  
LINCOLN PASSENGER CAR ..... 1998-02  
MERCURY PASSENGER CAR ... 1998-02



**EM-2863**  
**MOUNT-TRANSMISSION**  
**Manual**

JEEP SPORT UTILITY ..... 1993-96



**EM-2867**  
**MOUNT-ENGINE**  
**Front**

DODGE PASSENGER CAR ..... 1995-99  
PLYMOUTH PASSENGER  
CAR ..... 1995-99



**EM-2858**  
**MOUNT-TRANSMISSION**  
**MOUNT-TRANSMISSION**  
**Auto**

DODGE SPORT UTILITY ..... 1998-03  
**MOUNT-TRANSMISSION**  
**Auto**  
DODGE TRUCK ..... 1994-04

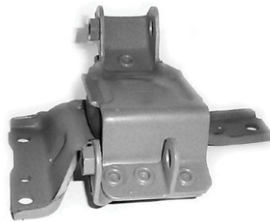

**EM-2861**  
**MOUNT-ENGINE**  
**LH Front**

FORD PASSENGER CAR ..... 1998-02  
LINCOLN PASSENGER CAR ..... 1998-02  
MERCURY PASSENGER CAR ... 1998-02



**EM-2864**  
**MOUNT-TRANSMISSION**  
**Auto**

JEEP SPORT UTILITY ..... 1993-95

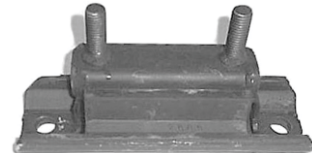

**EM-2868**  
**MOUNT-TRANSMISSION**

FORD SPORT UTILITY ..... 1996-07  
MERCURY SPORT UTILITY ..... 1997-01



**EM-2859\***  
**MOUNT-ENGINE**  
**RH Front**

BUICK PASSENGER CAR ..... 1988-91  
CHEVROLET PASSENGER  
CAR ..... 1990-91  
OLDSMOBILE PASSENGER  
CAR ..... 1988-91  
PONTIAC PASSENGER CAR ..... 1988-91



**EM-2862**  
**MOUNT-ENGINE**  
**RH Rear**

FORD PASSENGER CAR ..... 1996-05  
MERCURY PASSENGER CAR ... 1996-99



**EM-2866**  
**MOUNT-ENGINE**  
**Front**

FORD PASSENGER CAR ..... 1994-97  
**Engine Torque Strut Mount**

BUICK PASSENGER CAR ..... 1994-09  
CHEVROLET PASSENGER  
CAR ..... 1994-05  
OLDSMOBILE PASSENGER  
CAR ..... 1994-97  
OLDSMOBILE VAN ..... 1996  
PONTIAC PASSENGER CAR ..... 1994-08



**EM-2869**  
**MOUNT-ENGINE**  
**LH Front**

FORD SPORT UTILITY ..... 1995-96



**EM-2870**  
**MOUNT-TRANSMISSION**

FORD SPORT UTILITY ..... 1994-04

(Continued Next Page)

# BUYER'S GUIDE

## NUMERICAL LISTING - ILLUSTRATIONS

### EM-2870 (Continued)

#### MOUNT-TRANSMISSION Auto

FORD TRUCK ..... 1997-04  
**MOUNT-TRANSMISSION**

LINCOLN SPORT UTILITY ..... 1998-04  
LINCOLN TRUCK ..... 2002



#### EM-2871 MOUNT-TRANSMISSION

FORD TRUCK ..... 1997-04



#### EM-2872 Engine Torque Strut Mount Rear

FORD PASSENGER CAR ..... 2000-03  
MERCURY PASSENGER CAR ... 2000-03



#### EM-2873 MOUNT-TRANSMISSION Front

FORD PASSENGER CAR ..... 1994-00  
MERCURY PASSENGER CAR ... 1995-02



#### EM-2874 MOUNT-TRANSMISSION Center

CHEVROLET PASSENGER  
CAR ..... 1997-05  
OLDSMOBILE PASSENGER  
CAR ..... 1996-04  
PONTIAC PASSENGER CAR ..... 1999-05



#### EM-2875 MOUNT-TRANSMISSION LH Front

OLDSMOBILE PASSENGER  
CAR ..... 1997-04

#### MOUNT-TRANSMISSION LH Rear

CHEVROLET PASSENGER  
CAR ..... 1999-05  
OLDSMOBILE PASSENGER  
CAR ..... 1996-04  
PONTIAC PASSENGER CAR ..... 1999-05



#### EM-2876\* MOUNT-ENGINE RH Front

CHEVROLET PASSENGER  
CAR ..... 1997-01  
OLDSMOBILE PASSENGER  
CAR ..... 1997-99

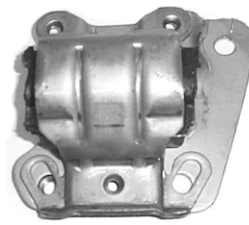

#### EM-2878 MOUNT-ENGINE RH Front

CHEVROLET PASSENGER  
CAR ..... 1995-02  
PONTIAC PASSENGER CAR ..... 1995-02



#### EM-2879\* MOUNT-TRANSMISSION

CHEVROLET VAN ..... 1994-05  
GMC VAN ..... 1994-05

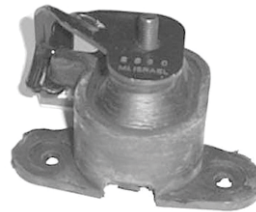

#### EM-2880\* MOUNT-TRANSMISSION MOUNT-TRANSMISSION Auto

CHEVROLET PASSENGER  
CAR ..... 1993-02  
PONTIAC PASSENGER CAR ..... 1993-02

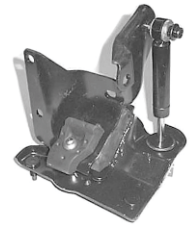

#### EM-2881 MOUNT-TRANSMISSION LH Front

BUICK PASSENGER CAR ..... 1994-99  
OLDSMOBILE PASSENGER  
CAR ..... 1994-99  
PONTIAC PASSENGER CAR ..... 1994-99

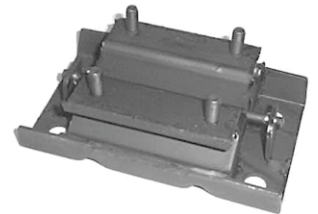

#### EM-2882 MOUNT-TRANSMISSION Manual

JEEP SPORT UTILITY ..... 1997-06



#### EM-2883 MOUNT-ENGINE L & R Front

JEEP SPORT UTILITY ..... 1997-06

# BUYER'S GUIDE

## NUMERICAL LISTING - ILLUSTRATIONS

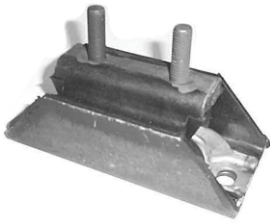

**EM-2884**  
**MOUNT-TRANSMISSION**  
Auto

FORD SPORT UTILITY ..... 1994-05  
FORD TRUCK ..... 1994-08

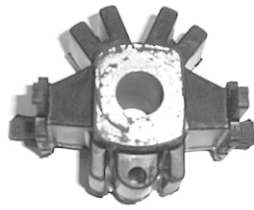

**EM-2887**  
**MOUNT-TRANSMISSION**  
Front

FORD PASSENGER CAR ..... 1995-97  
**MOUNT-TRANSMISSION**  
Rear

FORD PASSENGER CAR ..... 1994-97  
**MOUNT-TRANSMISSION**  
Rear

MERCURY PASSENGER CAR ... 1995-97



**EM-2890\***  
**MOUNT-ENGINE**  
RH Front

FORD PASSENGER CAR ..... 1998-00  
MERCURY PASSENGER CAR ... 1998-02



**EM-2894\***  
**MOUNT-ENGINE**  
RH Front

FORD PASSENGER CAR ..... 2000-07  
MERCURY PASSENGER CAR ... 2000-05



**EM-2885**  
**MOUNT-ENGINE**  
Front

FORD PASSENGER CAR ..... 1998-00  
MERCURY PASSENGER CAR ... 1998-02

**MOUNT-TRANSMISSION**  
Rear

MERCURY PASSENGER CAR ... 1995-97

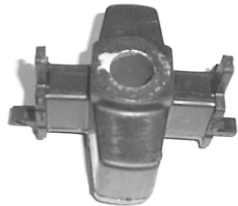

**EM-2888**  
**MOUNT-ENGINE**  
Front

FORD PASSENGER CAR ..... 1998-00  
MERCURY PASSENGER CAR ... 1998-02

**MOUNT-TRANSMISSION**  
Rear

FORD PASSENGER CAR ..... 1998-00

**MOUNT-TRANSMISSION**

MERCURY PASSENGER CAR ... 1998-02



**EM-2892\***  
**MOUNT-ENGINE**  
RH Front

CADILLAC PASSENGER CAR ... 1986-92



**EM-2895\***  
**MOUNT-TRANSMISSION**  
Center

BUICK PASSENGER CAR ..... 2000-05  
CADILLAC PASSENGER CAR ... 1998-05  
OLDSMOBILE PASSENGER  
CAR ..... 1997-03  
PONTIAC PASSENGER CAR ..... 2000-05

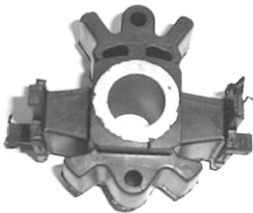

**EM-2886**  
**MOUNT-ENGINE**  
Front

FORD PASSENGER CAR ..... 1995-97  
MERCURY PASSENGER CAR ... 1995-97



**EM-2889**  
**MOUNT-ENGINE**  
RH Front

FORD PASSENGER CAR ..... 1995-97  
MERCURY PASSENGER CAR ... 1995-97



**EM-2893\***  
**MOUNT-ENGINE**  
LH Front

CHEVROLET PASSENGER CAR ..... 1993

**MOUNT-TRANSMISSION**  
LH

CADILLAC PASSENGER CAR ... 1993-96



**EM-2896\***  
**MOUNT-ENGINE**  
RH Front

BUICK PASSENGER CAR ..... 2000-05  
CADILLAC PASSENGER CAR ... 1998-05

**MOUNT-ENGINE**  
Front

OLDSMOBILE PASSENGER  
CAR ..... 2001-03

**MOUNT-ENGINE**  
RH Front

PONTIAC PASSENGER CAR ..... 2000-05

# BUYER'S GUIDE

## NUMERICAL LISTING - ILLUSTRATIONS

 <p style="text-align: center;"><b>EM-2897*</b> <b>MOUNT-TRANSMISSION</b> <b>LH Front</b></p> <p>BUICK PASSENGER CAR ..... 1999-05 <b>MOUNT-TRANSMISSION</b> <b>Auto</b></p> <p>OLDSMOBILE PASSENGER CAR ..... 2001-02 <b>MOUNT-TRANSMISSION</b> <b>LH Front</b></p> <p>PONTIAC PASSENGER CAR ..... 2000-05</p>	<p><b>EM-2899 (Continued)</b></p> <p>PONTIAC VAN ..... 1997-06 SATURN VAN ..... 2005-07 <b>Engine Torque Strut Mount</b> <b>Rear</b></p> <p>PONTIAC VAN ..... 2006</p>  <p style="text-align: center;"><b>EM-2900</b> <b>Engine Torque Strut Mount</b> <b>Front</b></p> <p>BUICK SPORT UTILITY ..... 2002-07 BUICK VAN ..... 2005-07 CHEVROLET VAN ..... 1997-09 OLDSMOBILE VAN ..... 1997-04 PONTIAC SPORT UTILITY ..... 2001-05 PONTIAC VAN ..... 1997-05 SATURN VAN ..... 2005-07</p>	 <p style="text-align: center;"><b>EM-2903*</b> <b>MOUNT-ENGINE</b> <b>L &amp; R Front</b></p> <p>CHRYSLER PASSENGER CAR ..... 1998-04 DODGE PASSENGER CAR ..... 1998-04</p>	 <p style="text-align: center;"><b>EM-2907</b> <b>MOUNT-TRANSMISSION</b></p> <p>CADILLAC PASSENGER CAR .... 1982-87</p>
 <p style="text-align: center;"><b>EM-2898</b> <b>MOUNT-TRANSMISSION</b></p> <p>BUICK PASSENGER CAR ..... 1999 <b>MOUNT-TRANSMISSION</b> <b>LH Rear</b></p> <p>BUICK PASSENGER CAR ..... 1999-05 CADILLAC PASSENGER CAR .... 2000-05 OLDSMOBILE PASSENGER CAR ..... 2001-03 PONTIAC PASSENGER CAR ..... 2000-05</p>	 <p style="text-align: center;"><b>EM-2901</b> <b>Engine Torque Strut Mount</b> <b>Front</b></p> <p>BUICK PASSENGER CAR ..... 1994-05 CHEVROLET PASSENGER CAR ..... 1995-05 OLDSMOBILE PASSENGER CAR ..... 1994-97 PONTIAC PASSENGER CAR ..... 1994-03</p>	 <p style="text-align: center;"><b>EM-2904</b> <b>MOUNT-ENGINE</b> <b>LH Front</b></p> <p>FORD PASSENGER CAR ..... 1996-04</p>	 <p style="text-align: center;"><b>EM-2908</b> <b>MOUNT-TRANSMISSION</b></p> <p>CHRYSLER PASSENGER CAR ..... 1998-04 DODGE PASSENGER CAR ..... 1998-04</p>
 <p style="text-align: center;"><b>EM-2899</b> <b>MOUNT-ENGINE</b> <b>RH Front</b></p> <p>FORD PASSENGER CAR ..... 1994-97 <b>Engine Torque Strut Mount</b> <b>Front</b></p> <p>BUICK SPORT UTILITY ..... 2002-07 BUICK VAN ..... 2005-06 CHEVROLET VAN ..... 1997-09 OLDSMOBILE PASSENGER CAR ..... 1999-02 OLDSMOBILE VAN ..... 1997-04 PONTIAC SPORT UTILITY ..... 2001-05</p>	 <p style="text-align: center;"><b>EM-2902*</b> <b>MOUNT-ENGINE</b> <b>L &amp; R Front</b></p> <p>CHEVROLET PASSENGER CAR ..... 1992-96</p>	 <p style="text-align: center;"><b>EM-2905</b> <b>MOUNT-ENGINE</b> <b>RH Front</b></p> <p>FORD PASSENGER CAR ..... 1996-04 <b>MOUNT-TRANSMISSION</b></p> <p>CHRYSLER PASSENGER CAR ..... 2003-04</p>	 <p style="text-align: center;"><b>EM-2909</b> <b>MOUNT-ENGINE</b> <b>L &amp; R Front</b></p> <p>CADILLAC SPORT UTILITY ..... 2002-06 CHEVROLET SPORT UTILITY .... 2000-06 CHEVROLET TRUCK ..... 1999-07 GMC SPORT UTILITY ..... 2000-06 GMC TRUCK ..... 1999-07 HUMMER ..... 2003-07</p>
<p><b>(Continued Next Column)</b></p>		<p style="text-align: center;"><b>EM-2906*</b> <b>MOUNT-ENGINE</b> <b>RH Front</b></p> <p>BUICK SPORT UTILITY ..... 2002-07 BUICK VAN ..... 2005-07 CHEVROLET VAN ..... 2003-06 PONTIAC SPORT UTILITY ..... 2001-05 PONTIAC VAN ..... 2005-06 SATURN VAN ..... 2005-06</p>	

# BUYER'S GUIDE

## NUMERICAL LISTING - ILLUSTRATIONS



**EM-2910\***  
**MOUNT-ENGINE**  
**Front**

FORD PASSENGER CAR ..... 1994-02  
MAZDA PASSENGER CAR ..... 1994-96  
MERCURY PASSENGER CAR ... 1994-99



**EM-2913**  
**MOUNT-ENGINE**  
**RH Front**

DODGE TRUCK ..... 1987-96



**EM-2917**  
**MOUNT-ENGINE**  
**LH Front**

DODGE SPORT UTILITY ..... 1999-00  
DODGE TRUCK ..... 1997-03



**EM-2921**  
**MOUNT-TRANSMISSION**  
**Manual**

AMERICAN MOTORS  
PASSENGER CAR ..... 1980-88



**EM-2911**  
**MOUNT-ENGINE**  
**Rear**

FORD PASSENGER CAR ..... 1997-02  
MERCURY PASSENGER CAR ... 1997-99



**EM-2914**  
**MOUNT-ENGINE**  
**LH Front**

DODGE TRUCK ..... 1987-96



**EM-2918**  
**MOUNT-ENGINE**  
**LH Front**

DODGE TRUCK ..... 1997-03



**EM-2922**  
**MOUNT-TRANSMISSION**  
**Manual**

CHEVROLET VAN ..... 1991-99  
GMC VAN ..... 1991-99



**EM-2912**  
**MOUNT-ENGINE**  
**Rear**

FORD PASSENGER CAR ..... 1997-02  
MERCURY PASSENGER CAR ... 1997-99



**EM-2915**  
**MOUNT-ENGINE**  
**RH Front**

FORD VAN ..... 1996-98



**EM-2919**  
**MOUNT-ENGINE**  
**L & R Front**

JEEP SPORT UTILITY ..... 1997-99



**EM-2923**  
**MOUNT-TRANSMISSION**  
**Front**

CHEVROLET PASSENGER  
CAR ..... 1994-05



**EM-2916**  
**MOUNT-ENGINE**  
**LH Front**

JEEP SPORT UTILITY ..... 1998



**EM-2920**  
**MOUNT-ENGINE**  
**RH Front**

JEEP SPORT UTILITY ..... 1991-95

**MOUNT-TRANSMISSION**  
**LH Front**

OLDSMOBILE PASSENGER  
CAR ..... 1992-95

**MOUNT-TRANSMISSION**

PONTIAC PASSENGER CAR ..... 1992-05

# BUYER'S GUIDE

## NUMERICAL LISTING - ILLUSTRATIONS

 <p style="text-align: center;"><b>EM-2924</b> <b>MOUNT-TRANSMISSION</b> Rear</p> <p>CHEVROLET PASSENGER CAR ..... 1994-05</p> <p style="text-align: center;"><b>MOUNT-TRANSMISSION</b> LH Rear</p> <p>PONTIAC PASSENGER CAR ..... 1992-05</p>	 <p style="text-align: center;"><b>EM-2927</b> <b>MOUNT-TRANSMISSION</b> LH Rear</p> <p>CHRYSLER VAN ..... 2001-07 DODGE VAN ..... 2001-07</p>	 <p style="text-align: center;"><b>EM-2930</b> <b>MOUNT-ENGINE</b> LH Front</p> <p>FORD VAN ..... 1997-13</p>	<p><b>EM-2933 (Continued)</b></p> <p style="text-align: center;"><b>MOUNT-ENGINE</b> Front</p> <p>PONTIAC PASSENGER CAR ..... 1999-05</p>  <p style="text-align: center;"><b>EM-2934*</b> <b>MOUNT-ENGINE</b> RH Front</p> <p>FORD PASSENGER CAR ..... 1996-99 MERCURY PASSENGER CAR ... 1996-99</p>  <p style="text-align: center;"><b>EM-2935</b> <b>MOUNT-ENGINE</b> RH Front</p> <p>FORD TRUCK ..... 1999-11 MAZDA TRUCK ..... 1998-09</p>  <p style="text-align: center;"><b>EM-2936</b> <b>MOUNT-ENGINE</b> RH Front</p> <p>FORD TRUCK ..... 1998-01</p>	
 <p style="text-align: center;"><b>EM-2925</b> <b>MOUNT-ENGINE</b> Left</p> <p>CHRYSLER VAN ..... 2003 DODGE VAN ..... 2003-07</p> <p style="text-align: center;"><b>MOUNT-TRANSMISSION</b> Center</p> <p>CHRYSLER VAN ..... 2001-07 DODGE VAN ..... 2001-07</p>	 <p style="text-align: center;"><b>EM-2928</b> <b>MOUNT-ENGINE</b> Front</p> <p>CHRYSLER VAN ..... 2001-03 DODGE VAN ..... 1996-07</p> <p style="text-align: center;"><b>MOUNT-TRANSMISSION</b> LH Front</p> <p>CHRYSLER VAN ..... 2001-07 DODGE VAN ..... 2001-07</p>	 <p style="text-align: center;"><b>EM-2931</b> <b>MOUNT-ENGINE</b> RH Front</p> <p>FORD VAN ..... 1999-03</p>  <p style="text-align: center;"><b>EM-2932*</b> <b>MOUNT-TRANSMISSION</b> LH</p> <p>CADILLAC PASSENGER CAR .... 1997-02</p>  <p style="text-align: center;"><b>EM-2933*</b> <b>MOUNT-ENGINE</b> Front</p> <p>CHEVROLET PASSENGER CAR ..... 2001-03</p> <p style="text-align: center;"><b>MOUNT-ENGINE</b> RH Front</p> <p>OLDSMOBILE PASSENGER CAR ..... 1999-04</p> <p style="text-align: center;">(Continued Next Column)</p>	 <p style="text-align: center;"><b>EM-2926*</b> <b>MOUNT-ENGINE</b> RH Front</p> <p>CHRYSLER VAN ..... 2001-07 DODGE VAN ..... 2001-07</p>	 <p style="text-align: center;"><b>EM-2929</b> <b>MOUNT-ENGINE</b> RH Front</p> <p>FORD VAN ..... 1997-13</p>



# BUYER'S GUIDE

## NUMERICAL LISTING - ILLUSTRATIONS



**EM-2938\***  
**MOUNT-ENGINE**  
**RH Front**

FORD PASSENGER CAR ..... 2000-04



**EM-2939**  
**Engine Torque Strut Mount**  
**Rear**

FORD PASSENGER CAR ..... 2000-07  
FORD VAN ..... 2010-13



**EM-2940**  
**MOUNT-ENGINE**  
**LH Front**

FORD SPORT UTILITY ..... 1984-85  
FORD TRUCK ..... 1983-85



**EM-2941**  
**MOUNT-ENGINE**  
**RH Front**

FORD SPORT UTILITY ..... 1984-85  
FORD TRUCK ..... 1983-85



**EM-2942\***  
**MOUNT-ENGINE**  
**LH Front**

CHRYSLER PASSENGER  
CAR ..... 1998-04  
DODGE PASSENGER CAR ..... 1998-04



**EM-2943\***  
**MOUNT-ENGINE**  
**RH Front**

BUICK PASSENGER CAR ..... 1986-91  
**MOUNT-ENGINE**  
**Front**

OLDSMOBILE PASSENGER  
CAR ..... 1986-91



**EM-2944**  
**MOUNT-ENGINE**  
**RH Front**

DODGE TRUCK ..... 1987-90



**EM-2945**  
**MOUNT-ENGINE**  
**Rear**

CHRYSLER PASSENGER  
CAR ..... 1998-00  
DODGE PASSENGER CAR ..... 1999-00  
PLYMOUTH PASSENGER CAR ..... 2000



**EM-2947**  
**MOUNT-ENGINE**  
**Rear**

CHRYSLER PASSENGER  
CAR ..... 2000-10  
DODGE PASSENGER CAR ..... 2000-05  
PLYMOUTH PASSENGER  
CAR ..... 2000-01



**EM-2948**  
**MOUNT-ENGINE**  
**RH Front Upper**

CHRYSLER PASSENGER  
CAR ..... 2001-10  
DODGE PASSENGER CAR ..... 2000-05

**MOUNT-ENGINE**  
**LH Rear Upper**

CHRYSLER PASSENGER  
CAR ..... 2000-02  
PLYMOUTH PASSENGER  
CAR ..... 2000-01



**EM-2949**  
**MOUNT-ENGINE**  
**RH Front Lower**

CHRYSLER PASSENGER  
CAR ..... 2000-10  
DODGE PASSENGER CAR ..... 2000-05  
PLYMOUTH PASSENGER  
CAR ..... 2000-01



**EM-2950**  
**MOUNT-TRANSMISSION**

CHEVROLET VAN ..... 1990-93  
GMC VAN ..... 1990-93



**EM-2951**  
**MOUNT-TRANSMISSION**  
**RH**

CADILLAC PASSENGER CAR .... 1992-95  
CHEVROLET PASSENGER  
CAR ..... 1996-97

# BUYER'S GUIDE

## NUMERICAL LISTING - ILLUSTRATIONS

 <p style="text-align: center;"><b>EM-2952</b> <b>MOUNT-ENGINE</b> <b>RH Rear</b></p> <p>BUICK PASSENGER CAR ..... 1988-91            CHEVROLET PASSENGER CAR ..... 1990-91            OLDSMOBILE PASSENGER CAR ..... 1988-91            PONTIAC PASSENGER CAR ..... 1988-91</p>	 <p style="text-align: center;"><b>EM-2955</b> <b>MOUNT-ENGINE</b> <b>LH Front</b></p> <p>DODGE TRUCK ..... 1991-96</p>	 <p style="text-align: center;"><b>EM-2958</b> <b>MOUNT-ENGINE</b> <b>Front</b></p> <p>CHRYSLER PASSENGER CAR ..... 1998-00            DODGE PASSENGER CAR ..... 1998-00            PLYMOUTH PASSENGER CAR ..... 1998-00</p>	 <p style="text-align: center;"><b>EM-2961</b> <b>MOUNT-ENGINE</b> <b>RH Front</b></p> <p>DODGE TRUCK ..... 1991-96</p>
 <p style="text-align: center;"><b>EM-2953</b> <b>MOUNT-ENGINE</b> <b>LH Front</b></p> <p>DODGE TRUCK ..... 1990-96</p>	 <p style="text-align: center;"><b>EM-2956</b> <b>MOUNT-TRANSMISSION</b> <b>Manual</b></p> <p>CHEVROLET TRUCK ..... 1994-97            GMC TRUCK ..... 1994-97            ISUZU TRUCK ..... 1996-97</p>	 <p style="text-align: center;"><b>EM-2959</b> <b>MOUNT-ENGINE</b> <b>RH Front</b></p> <p>CHRYSLER VAN ..... 1996-00            DODGE VAN ..... 1996-00            PLYMOUTH VAN ..... 1996-00</p>	 <p style="text-align: center;"><b>EM-2962</b> <b>MOUNT-ENGINE</b> <b>RH Front</b></p> <p>DODGE SPORT UTILITY ..... 1998-00            DODGE TRUCK ..... 1997-04</p>
 <p style="text-align: center;"><b>EM-2954</b> <b>MOUNT-TRANSMISSION</b> <b>Manual</b></p> <p>DODGE TRUCK ..... 1992-96</p>	 <p style="text-align: center;"><b>EM-2957</b> <b>MOUNT-TRANSMISSION</b> <b>Auto</b></p> <p>CHEVROLET TRUCK ..... 1994-03            GMC TRUCK ..... 1994-03            ISUZU TRUCK ..... 1996-00</p>	 <p style="text-align: center;"><b>EM-2960</b> <b>MOUNT-TRANSMISSION</b> <b>LH Front</b></p> <p>CHRYSLER VAN ..... 1996-00            DODGE VAN ..... 1996-04            PLYMOUTH VAN ..... 1996-00</p>	 <p style="text-align: center;"><b>EM-2963</b> <b>MOUNT-ENGINE</b> <b>LH Front</b></p> <p>DODGE SPORT UTILITY ..... 1998-00            DODGE TRUCK ..... 1997-04</p>
			 <p style="text-align: center;"><b>EM-2964</b> <b>MOUNT-ENGINE</b> <b>RH Rear</b></p> <p>FORD PASSENGER CAR ..... 1989-95</p>

# BUYER'S GUIDE

## NUMERICAL LISTING - ILLUSTRATIONS

 <p style="text-align: center;"><b>EM-2965</b> <b>MOUNT-TRANSMISSION</b> <b>Manual</b></p> <p>FORD PASSENGER CAR ..... 1986-87</p>	 <p style="text-align: center;"><b>EM-2969</b> <b>MOUNT-TRANSMISSION</b> <b>Manual</b></p> <p>FORD TRUCK ..... 1994-96</p>	<p><b>EM-2972 (Continued)</b> LINCOLN TRUCK ..... 2002</p>  <p style="text-align: center;"><b>EM-2973*</b> <b>MOUNT-ENGINE</b> <b>RH Rear</b></p> <p>FORD PASSENGER CAR ..... 2000-07</p>	 <p style="text-align: center;"><b>EM-2977</b> <b>MOUNT-TRANSMISSION</b></p> <p>FORD VAN ..... 1997-98</p>
 <p style="text-align: center;"><b>EM-2966</b> <b>MOUNT-TRANSMISSION</b> <b>Manual</b></p> <p>FORD TRUCK ..... 1988-97</p>	 <p style="text-align: center;"><b>EM-2970</b> <b>MOUNT-TRANSMISSION</b> <b>Auto</b></p> <p>FORD SPORT UTILITY ..... 1996 FORD TRUCK ..... 1996-97</p>	 <p style="text-align: center;"><b>EM-2974*</b> <b>MOUNT-TRANSMISSION</b> <b>Auto</b></p> <p>FORD PASSENGER CAR ..... 2000-07</p>	 <p style="text-align: center;"><b>EM-2978</b> <b>MOUNT-ENGINE</b> <b>Front</b></p> <p>FORD PASSENGER CAR ..... 1995-00 MERCURY PASSENGER CAR ... 1995-97</p>
 <p style="text-align: center;"><b>EM-2967*</b> <b>MOUNT-ENGINE</b> <b>Front</b></p> <p>FORD PASSENGER CAR ..... 1993-95</p>	 <p style="text-align: center;"><b>EM-2971</b> <b>MOUNT-TRANSMISSION</b></p> <p>FORD TRUCK ..... 1999-07 LINCOLN SPORT UTILITY ..... 2005-06</p>	<p>FORD PASSENGER CAR ..... 2000-07</p> <p style="text-align: center;"><b>MOUNT-TRANSMISSION</b></p> <p>MERCURY PASSENGER CAR ... 2000-05</p>  <p style="text-align: center;"><b>EM-2975</b> <b>MOUNT-TRANSMISSION</b> <b>Auto</b></p> <p>CHRYSLER PASSENGER CAR ..... 2000-01 DODGE PASSENGER CAR ..... 2000-01 PLYMOUTH PASSENGER CAR ..... 2000-01</p>	 <p style="text-align: center;"><b>EM-2979</b> <b>MOUNT-ENGINE</b> <b>RH Front</b></p> <p>DODGE PASSENGER CAR ..... 1995-99 PLYMOUTH PASSENGER CAR ..... 1995-99</p>
 <p style="text-align: center;"><b>EM-2968*</b> <b>MOUNT-ENGINE</b> <b>Rear</b></p> <p>FORD PASSENGER CAR ..... 1993-95</p>	 <p style="text-align: center;"><b>EM-2972</b> <b>MOUNT-ENGINE</b> <b>LH Front</b></p> <p>FORD SPORT UTILITY ..... 1997-02 FORD TRUCK ..... 1993-04 LINCOLN SPORT UTILITY ..... 1998-02</p> <p style="text-align: center;">(Continued Next Column)</p>	<p style="text-align: center;"><b>EM-2975</b> <b>MOUNT-TRANSMISSION</b> <b>Auto</b></p> <p>CHRYSLER PASSENGER CAR ..... 2000-01 DODGE PASSENGER CAR ..... 2000-01 PLYMOUTH PASSENGER CAR ..... 2000-01</p>	 <p style="text-align: center;"><b>EM-2980</b> <b>MOUNT-ENGINE</b> <b>Front</b></p> <p>CHRYSLER PASSENGER CAR ..... 1995-00</p> <p style="text-align: center;">(Continued Next Page)</p>

# BUYER'S GUIDE

## NUMERICAL LISTING - ILLUSTRATIONS

### EM-2980 (Continued)

DODGE PASSENGER CAR ..... 1995-99  
 PLYMOUTH PASSENGER  
 CAR ..... 1996-99



**EM-2981**  
**MOUNT-ENGINE**  
**LH Front**

DODGE TRUCK ..... 1987-96

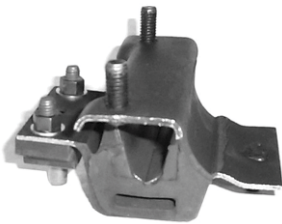

**EM-2982**  
**MOUNT-TRANSMISSION**  
**Manual**

DODGE VAN ..... 1992-93



**EM-2983**  
**MOUNT-ENGINE**  
**RH Front**

DODGE TRUCK ..... 1990-96



**EM-2984**  
**MOUNT-TRANSMISSION**  
**Center**

CHRYSLER VAN ..... 1996-00  
**MOUNT-TRANSMISSION**  
 DODGE VAN ..... 1996-00  
**MOUNT-TRANSMISSION**  
 PLYMOUTH VAN ..... 1996-00



**EM-2985**  
**MOUNT-ENGINE**  
**LH Rear**

MERCURY VAN ..... 1999-02  
 NISSAN VAN ..... 1999-02



**EM-2986**  
**MOUNT-TRANSMISSION**  
**Auto**

FORD PASSENGER CAR ..... 2000-11  
**MOUNT-TRANSMISSION**  
 FORD VAN ..... 2010-13



**EM-2987**  
**MOUNT-ENGINE**  
**RH Front**

BUICK PASSENGER CAR ..... 2005-09  
 BUICK SPORT UTILITY ..... 2002-07  
 BUICK VAN ..... 2005-07

**MOUNT-ENGINE**  
**Right**

CHEVROLET PASSENGER  
 CAR ..... 2000-10

**MOUNT-ENGINE**  
**RH Front**

CHEVROLET VAN ..... 2003-07  
 PONTIAC PASSENGER CAR ..... 2004-08  
 PONTIAC SPORT UTILITY ..... 2001-05

**MOUNT-ENGINE**  
**LH Front**

PONTIAC VAN ..... 2005-06

**MOUNT-ENGINE**  
**Front**

SATURN VAN ..... 2005-07



**EM-2988**  
**MOUNT-TRANSMISSION**

JEEP SPORT UTILITY ..... 1999-04



**EM-2989**  
**MOUNT-ENGINE**  
**Front**

MERCURY VAN ..... 1999-02  
 NISSAN VAN ..... 1999-02



**EM-2990**  
**MOUNT-ENGINE**  
**Rear**

BUICK PASSENGER CAR ..... 2008-09  
 CHEVROLET PASSENGER  
 CAR ..... 2006-09

**MOUNT-ENGINE**  
**RH Rear**

OLDSMOBILE PASSENGER  
 CAR ..... 1999-02

**MOUNT-ENGINE**  
**Rear**

PONTIAC PASSENGER CAR ..... 2005-08

**MOUNT-TRANSMISSION**

BUICK PASSENGER CAR ..... 2008-09



**EM-2991**  
**MOUNT-TRANSMISSION**  
**Manual**

DODGE TRUCK ..... 1997-03



**EM-2992**  
**MOUNT-TRANSMISSION**  
**Auto**

DODGE SPORT UTILITY ..... 1999-03  
 DODGE TRUCK ..... 2000-04

# BUYER'S GUIDE

## NUMERICAL LISTING - ILLUSTRATIONS

 <p style="text-align: center;"><b>EM-2993*</b> <b>MOUNT-ENGINE</b> <b>L &amp; R Front</b></p> <p>CHEVROLET PASSENGER CAR ..... 1997-08</p>	<p><b>EM-2996 (Continued)</b> LINCOLN PASSENGER CAR ..... 1995-02</p>  <p style="text-align: center;"><b>EM-2997</b> <b>MOUNT-ENGINE</b> <b>RH Front</b></p> <p>FORD PASSENGER CAR ..... 1994-95</p>	 <p style="text-align: center;"><b>EM-3000</b> <b>MOUNT-ENGINE</b> <b>LH Front</b></p> <p>FORD SPORT UTILITY ..... 1996-01 MERCURY SPORT UTILITY ..... 1997-01</p>	 <p style="text-align: center;"><b>EM-3004</b> <b>MOUNT-ENGINE</b> <b>RH Front</b></p> <p>DODGE TRUCK ..... 1997-03</p>
 <p style="text-align: center;"><b>EM-2994</b> <b>MOUNT-ENGINE</b> <b>L &amp; R Front</b></p> <p>CHEVROLET TRUCK ..... 1999-06 GMC TRUCK ..... 1999-06</p>	 <p style="text-align: center;"><b>EM-2998</b> <b>MOUNT-ENGINE</b> <b>LH Front</b></p> <p>FORD PASSENGER CAR ..... 1994-95</p>	 <p style="text-align: center;"><b>EM-3001</b> <b>MOUNT-ENGINE</b> <b>RH Front</b></p> <p>FORD PASSENGER CAR ..... 1998-04</p>	 <p style="text-align: center;"><b>EM-3005</b> <b>MOUNT-ENGINE</b> <b>LH Front</b></p> <p>DODGE SPORT UTILITY ..... 2000-03 DODGE TRUCK ..... 2000-04</p>
 <p style="text-align: center;"><b>EM-2995*</b> <b>MOUNT-ENGINE</b> <b>L &amp; R Front</b></p> <p>FORD PASSENGER CAR ..... 1991-97 MERCURY PASSENGER CAR ... 1991-93</p>	 <p style="text-align: center;"><b>EM-2999</b> <b>MOUNT-ENGINE</b> <b>RH Front</b></p> <p>FORD SPORT UTILITY ..... 1996-01 MERCURY SPORT UTILITY ..... 1997-01</p>	 <p style="text-align: center;"><b>EM-3002</b> <b>MOUNT-ENGINE</b> <b>LH Front</b></p> <p>FORD PASSENGER CAR ..... 1998-04</p>	 <p style="text-align: center;"><b>EM-3006</b> <b>MOUNT-ENGINE</b> <b>RH Front</b></p> <p>DODGE SPORT UTILITY ..... 2000-03 DODGE TRUCK ..... 2000-04</p>
 <p style="text-align: center;"><b>EM-2996*</b> <b>MOUNT-ENGINE</b> <b>RH Front</b></p> <p>(Continued Next Column)</p>		 <p style="text-align: center;"><b>EM-3003*</b> <b>MOUNT-ENGINE</b> <b>RH Front</b></p> <p>FORD PASSENGER CAR ..... 2000-04</p>	 <p style="text-align: center;"><b>EM-3007</b> <b>MOUNT-TRANSMISSION</b> <b>Auto</b></p> <p>JEEP SPORT UTILITY ..... 2002-03</p>

# BUYER'S GUIDE

## NUMERICAL LISTING - ILLUSTRATIONS

 <p><b>EM-3008</b> <b>MOUNT-ENGINE</b> <b>RH Front</b></p> <p>JEEP SPORT UTILITY ..... 1999-05</p>	 <p><b>EM-3012</b> <b>MOUNT-ENGINE</b> <b>LH Front</b></p> <p>JEEP SPORT UTILITY ..... 1999-05</p>	 <p><b>EM-3016</b> <b>MOUNT-TRANSMISSION</b></p> <p>JEEP SPORT UTILITY ..... 2002-05</p>	 <p><b>EM-3020*</b> <b>MOUNT-TRANSMISSION</b> <b>LH Front</b></p> <p>CADILLAC PASSENGER CAR .... 2000-05 OLDSMOBILE PASSENGER CAR ..... 2001-03</p>
 <p><b>EM-3009</b> <b>MOUNT-ENGINE</b> <b>LH Front</b></p> <p>JEEP SPORT UTILITY ..... 2002-05</p>	 <p><b>EM-3013</b> <b>MOUNT-TRANSMISSION</b></p> <p>JEEP SPORT UTILITY ..... 2002-05</p>	 <p><b>EM-3017</b> <b>MOUNT-TRANSMISSION</b> <b>LH Rear</b></p> <p>CHRYSLER VAN ..... 1996-00 DODGE VAN ..... 1996-04 PLYMOUTH VAN ..... 1996-00</p>	 <p><b>EM-3021*</b> <b>MOUNT-ENGINE</b> <b>L &amp; R Front</b></p> <p>BUICK SPORT UTILITY ..... 2004-07 CHEVROLET SPORT UTILITY .... 2002-08 GMC SPORT UTILITY ..... 2002-09 ISUZU SPORT UTILITY ..... 2003-08 OLDSMOBILE SPORT UTILITY .. 2002-04 SAAB SUV ..... 2005-09</p>
 <p><b>EM-3010</b> <b>MOUNT-ENGINE</b> <b>RH Front</b></p> <p>JEEP SPORT UTILITY ..... 2002-05</p>	 <p><b>EM-3014</b> <b>MOUNT-ENGINE</b> <b>RH Front</b></p> <p>JEEP SPORT UTILITY ..... 2002-05</p>	 <p><b>EM-3018</b> <b>MOUNT-TRANSMISSION</b></p> <p>JEEP SPORT UTILITY ..... 2000-05</p>	 <p><b>EM-3022*</b> <b>MOUNT-ENGINE</b> <b>RH Front</b></p> <p>SATURN PASSENGER CAR ..... 2000-03</p>
 <p><b>EM-3011</b> <b>MOUNT-ENGINE</b> <b>Rear</b></p> <p>CHRYSLER PASSENGER CAR ..... 1995-00 DODGE PASSENGER CAR ..... 1995-99 PLYMOUTH PASSENGER CAR ..... 1996-99</p>	 <p><b>EM-3015</b> <b>MOUNT-ENGINE</b> <b>LH Front</b></p> <p>JEEP SPORT UTILITY ..... 2002-05</p>	 <p><b>EM-3019</b> <b>MOUNT-ENGINE</b> <b>LH Front</b></p> <p>JEEP SPORT UTILITY ..... 1999-04</p>	

# BUYER'S GUIDE

## NUMERICAL LISTING - ILLUSTRATIONS



**EM-3023\***  
MOUNT-ENGINE  
RH Front

SATURN PASSENGER CAR ..... 2000-05



**EM-3026**  
MOUNT-TRANSMISSION

CHRYSLER PASSENGER  
CAR ..... 2003-07



**EM-3029**  
MOUNT-ENGINE  
LH Front

FORD TRUCK ..... 1999-03



**EM-3033\***  
MOUNT-ENGINE  
LH Front

SATURN PASSENGER CAR ..... 2000-05



**EM-3024**  
MOUNT-ENGINE  
RH Front

FORD PASSENGER CAR ..... 2003-09  
LINCOLN PASSENGER CAR ..... 2009  
MERCURY PASSENGER CAR ... 2003-10



**EM-3027**  
MOUNT-TRANSMISSION  
MOUNT-TRANSMISSION  
Auto

BUICK SPORT UTILITY ..... 2004-07

CHEVROLET SPORT UTILITY ... 2002-09

GMC SPORT UTILITY ..... 2002-07  
ISUZU SPORT UTILITY ..... 2003-07  
OLDSMOBILE SPORT UTILITY .. 2002-04  
SAAB SUV ..... 2005-09



**EM-3030**  
MOUNT-ENGINE  
RH Front

FORD TRUCK ..... 1999-03



**EM-3034**  
MOUNT-ENGINE  
Front

CHRYSLER PASSENGER  
CAR ..... 2001-06  
DODGE PASSENGER CAR ..... 2001-06



**EM-3025**  
MOUNT-ENGINE  
LH Front

FORD PASSENGER CAR ..... 2003-09  
LINCOLN PASSENGER CAR ..... 2009  
MERCURY PASSENGER CAR ... 2003-10



**EM-3028**  
MOUNT-ENGINE  
LH Front

CHEVROLET TRUCK ..... 1996-98  
GMC TRUCK ..... 1996-98



**EM-3031**  
MOUNT-ENGINE  
Rear

SATURN PASSENGER CAR ..... 2000-05



**EM-3035**  
MOUNT-ENGINE  
LH Front

DODGE SPORT UTILITY ..... 2000-03  
DODGE TRUCK ..... 2000-04



**EM-3032**  
MOUNT-TRANSMISSION  
Auto

SATURN PASSENGER CAR ..... 2000-05



**EM-3036**  
MOUNT-ENGINE  
RH Front

DODGE SPORT UTILITY ..... 2000-03

(Continued Next Page)

# BUYER'S GUIDE

## NUMERICAL LISTING - ILLUSTRATIONS

### EM-3036 (Continued)

DODGE TRUCK ..... 2000-04



**EM-3037**  
MOUNT-TRANSMISSION  
Auto

FORD SPORT UTILITY ..... 2001-04  
MAZDA SPORT UTILITY ..... 2001-04



**EM-3038**  
MOUNT-TRANSMISSION

FORD PASSENGER CAR ..... 2003-09  
LINCOLN PASSENGER CAR ..... 2003-09  
MERCURY PASSENGER CAR ..... 2003-10



**EM-3039**  
MOUNT-ENGINE  
RH Front

JEEP SPORT UTILITY ..... 1999-04



**EM-3040**  
MOUNT-TRANSMISSION  
LH Rear

SATURN SUV ..... 2002-03



**EM-3041**  
MOUNT-TRANSMISSION  
LH Front

SATURN PASSENGER CAR ..... 2003-04



**EM-3042**  
MOUNT-TRANSMISSION  
LH Front

SATURN PASSENGER CAR ..... 2003-04



**EM-3043**  
MOUNT-TRANSMISSION  
Rear

CHEVROLET PASSENGER  
CAR ..... 2005-10  
PONTIAC PASSENGER CAR ..... 2007-08

(Continued Next Column)

### EM-3043 (Continued)

**MOUNT-TRANSMISSION  
LH Rear**

SATURN PASSENGER CAR ..... 2003-04



**EM-3044**  
MOUNT-ENGINE  
RH Front

CHEVROLET TRUCK ..... 1996-98  
GMC TRUCK ..... 1996-98



**EM-3045**  
MOUNT-ENGINE  
LH Front

CHEVROLET PASSENGER  
CAR ..... 1993-97  
PONTIAC PASSENGER CAR ..... 1993-97



**EM-3046**  
MOUNT-ENGINE  
RH Front

CHEVROLET PASSENGER  
CAR ..... 1993-97  
PONTIAC PASSENGER CAR ..... 1993-97



**EM-3047**  
MOUNT-ENGINE  
LH Front

FORD SPORT UTILITY ..... 2002-06  
MERCURY SPORT UTILITY ..... 2002-05



**EM-3048**  
MOUNT-ENGINE  
RH Front

FORD SPORT UTILITY ..... 2002-10  
MERCURY SPORT UTILITY ..... 2002-10







**EM-3049**  
MOUNT-ENGINE  
Rear

CHRYSLER PASSENGER  
CAR ..... 2001-06  
DODGE PASSENGER CAR ..... 2001-06



# BUYER'S GUIDE

## NUMERICAL LISTING - ILLUSTRATIONS

 <p style="text-align: center;"><b>EM-3050</b> <b>MOUNT-TRANSMISSION</b> <b>Manual</b></p> <p>CHRYSLER PASSENGER CAR ..... 2000-02 DODGE PASSENGER CAR ..... 2000-05 PLYMOUTH PASSENGER CAR ..... 2000-01</p>	 <p style="text-align: center;"><b>EM-3054</b> <b>MOUNT-TRANSMISSION</b> <b>Auto</b></p> <p>JEEP SPORT UTILITY ..... 2004-05</p>	<p><b>EM-3057 (Continued)</b> <b>MOUNT-ENGINE</b> <b>Rear</b></p> <p>FORD SPORT UTILITY ..... 2001-04 MAZDA SPORT UTILITY ..... 2001-04</p> 	 <p style="text-align: center;"><b>EM-3061</b> <b>MOUNT-TRANSMISSION</b> <b>Auto</b></p> <p>FORD SPORT UTILITY ..... 2002-05 MERCURY SPORT UTILITY ..... 2002-05</p>
 <p style="text-align: center;"><b>EM-3051</b> <b>MOUNT-TRANSMISSION</b></p> <p>JEEP SPORT UTILITY ..... 1999-04</p>	 <p style="text-align: center;"><b>EM-3055</b> <b>MOUNT-TRANSMISSION</b> <b>Manual</b></p> <p>JEEP SPORT UTILITY ..... 2002-05</p>	<p style="text-align: center;"><b>EM-3058</b> <b>MOUNT-TRANSMISSION</b> <b>Auto</b></p> <p>OLDSMOBILE PASSENGER CAR ..... 1988-91 PONTIAC PASSENGER CAR ..... 1988-91</p> 	 <p style="text-align: center;"><b>EM-3062</b> <b>MOUNT-TRANSMISSION</b> <b>Auto</b></p> <p>FORD SPORT UTILITY ..... 2002-10 MERCURY SPORT UTILITY ..... 2002-10</p>
 <p style="text-align: center;"><b>EM-3052</b> <b>MOUNT-TRANSMISSION</b> <b>Manual</b></p> <p>JEEP SPORT UTILITY ..... 2002-03</p>	 <p style="text-align: center;"><b>EM-3056*</b> <b>MOUNT-ENGINE</b> <b>RH Front</b></p> <p>FORD SPORT UTILITY ..... 2001-04 MAZDA SPORT UTILITY ..... 2001-04</p>	<p style="text-align: center;"><b>EM-3059</b> <b>MOUNT-ENGINE</b> <b>LH Front</b></p> <p>FORD VAN ..... 1997-03</p> 	 <p style="text-align: center;"><b>EM-3063</b> <b>MOUNT-TRANSMISSION</b></p> <p>FORD PASSENGER CAR ..... 2002-05 JAGUAR ..... 2000-05 LINCOLN PASSENGER CAR ..... 2000-06</p>
 <p style="text-align: center;"><b>EM-3053</b> <b>MOUNT-TRANSMISSION</b> <b>Auto</b></p> <p>JEEP SPORT UTILITY ..... 2002-03</p>	 <p style="text-align: center;"><b>EM-3057*</b> <b>MOUNT-ENGINE</b> <b>RH Front</b></p> <p>MAZDA SPORT UTILITY ..... 2001-04</p> <p style="text-align: center;">(Continued Next Column)</p>	<p style="text-align: center;"><b>EM-3060</b> <b>MOUNT-ENGINE</b> <b>RH Front</b></p> <p>FORD VAN ..... 1997-03</p>	

# BUYER'S GUIDE

## NUMERICAL LISTING - ILLUSTRATIONS

 <p><b>EM-3064</b> <b>MOUNT-ENGINE</b> <b>L &amp; R Front</b></p> <p>CHEVROLET PASSENGER CAR ..... 1998-02 PONTIAC PASSENGER CAR ..... 1998-02</p>	 <p><b>EM-3067</b> <b>MOUNT-ENGINE</b> <b>RH Front</b></p> <p>DODGE SPORT UTILITY ..... 1999-00 DODGE TRUCK ..... 1997-03</p>	 <p><b>EM-3070</b> <b>MOUNT-TRANSMISSION</b> <b>LH Front</b></p> <p>CHEVROLET PASSENGER CAR ..... 2003-05 OLDSMOBILE PASSENGER CAR ..... 2002-04 PONTIAC PASSENGER CAR ..... 2002-05</p>	 <p><b>EM-3073</b> <b>MOUNT-ENGINE</b> <b>LH Front</b></p> <p>DODGE TRUCK ..... 2002-05</p>
 <p><b>EM-3065</b> <b>MOUNT-TRANSMISSION</b> <b>Rear</b></p> <p>BUICK PASSENGER CAR ..... 1995-98 <b>MOUNT-TRANSMISSION</b> <b>LH Rear</b></p> <p>OLDSMOBILE PASSENGER CAR ..... 1995-98</p>	 <p><b>EM-3068</b> <b>MOUNT-TRANSMISSION</b> <b>Rear</b></p> <p>CADILLAC PASSENGER CAR .... 1998-04 <b>MOUNT-TRANSMISSION</b> <b>LH Rear</b></p> <p>OLDSMOBILE PASSENGER CAR ... 1999</p>	 <p><b>EM-3071*</b> <b>MOUNT-ENGINE</b> <b>LH Front</b></p> <p>LINCOLN PASSENGER CAR ..... 2003-08</p>	 <p><b>EM-3074</b> <b>MOUNT-ENGINE</b> <b>RH Front</b></p> <p>DODGE TRUCK ..... 2002-05</p>
 <p><b>EM-3066</b> <b>MOUNT-TRANSMISSION</b></p> <p>CHRYSLER PASSENGER CAR ..... 2007-09 <b>MOUNT-TRANSMISSION</b> <b>Auto</b></p> <p>DODGE SPORT UTILITY ..... 2004-09 DODGE TRUCK ..... 2002-05</p>	 <p><b>EM-3069</b> <b>MOUNT-TRANSMISSION</b> <b>Rear</b></p> <p>CHEVROLET SPORT UTILITY .... 2005-09 <b>MOUNT-TRANSMISSION</b> <b>LH Rear</b></p> <p>PONTIAC SPORT UTILITY ..... 2006-09</p>	 <p><b>EM-3072*</b> <b>MOUNT-ENGINE</b> <b>RH Front</b></p> <p>LINCOLN PASSENGER CAR ..... 2003-08</p>	 <p><b>EM-3075*</b> <b>MOUNT-ENGINE</b> <b>RH Front</b></p> <p>FORD VAN ..... 2004-07 <b>MOUNT-ENGINE</b> <b>LH Front</b></p> <p>MERCURY VAN ..... 2004-07</p>

# BUYER'S GUIDE

## NUMERICAL LISTING - ILLUSTRATIONS

 <p style="text-align: center;"><b>EM-3076*</b> <b>MOUNT-ENGINE</b> <b>RH Front</b></p> <p>MERCURY VAN ..... 2004-07</p> <p style="text-align: center;"><b>MOUNT-ENGINE</b> <b>RH Rear</b></p> <p>FORD VAN ..... 2004-07</p>	 <p style="text-align: center;"><b>EM-3079*</b> <b>MOUNT-ENGINE</b> <b>Front</b></p> <p>FORD PASSENGER CAR ..... 2005-07</p> <p style="text-align: center;"><b>MOUNT-ENGINE</b> <b>RH Front</b></p> <p>MERCURY PASSENGER CAR ... 2005-07</p>	 <p style="text-align: center;"><b>EM-3082</b> <b>MOUNT-TRANSMISSION</b> <b>Front</b></p> <p>CHEVROLET SPORT UTILITY ... 2005-09</p> <p style="text-align: center;"><b>MOUNT-TRANSMISSION</b> <b>LH Front</b></p> <p>PONTIAC SPORT UTILITY ..... 2006-09</p>	 <p style="text-align: center;"><b>EM-3085*</b> <b>MOUNT-ENGINE</b> <b>RH Front</b></p> <p>FORD PASSENGER CAR ..... 2002-04</p>
 <p style="text-align: center;"><b>EM-3077*</b> <b>MOUNT-ENGINE</b> <b>L &amp; R Front</b></p> <p>JAGUAR ..... 2000-05</p> <p>LINCOLN PASSENGER CAR ..... 2000-06</p>	 <p style="text-align: center;"><b>EM-3080</b> <b>MOUNT-ENGINE</b> <b>LH Front</b></p> <p>FORD PASSENGER CAR ..... 2005-07</p> <p>MERCURY PASSENGER CAR ... 2005-07</p> <p style="text-align: center;"><b>MOUNT-ENGINE</b> <b>Rear</b></p> <p>FORD PASSENGER CAR ..... 2005-07</p> <p style="text-align: center;"><b>MOUNT-TRANSMISSION</b></p> <p>MERCURY PASSENGER CAR ... 2005-07</p>	 <p style="text-align: center;"><b>EM-3083*</b> <b>MOUNT-ENGINE</b> <b>Front</b></p> <p>OLDSMOBILE PASSENGER CAR ... 1999</p> <p style="text-align: center;"><b>MOUNT-TRANSMISSION</b> <b>LH Front</b></p> <p>CADILLAC PASSENGER CAR ... 1998-04</p> <p>OLDSMOBILE PASSENGER CAR ... 1999</p>	 <p style="text-align: center;"><b>EM-3086</b> <b>MOUNT-TRANSMISSION</b> <b>Rear</b></p> <p>CHEVROLET PASSENGER CAR ..... 2005-10</p> <p>PONTIAC PASSENGER CAR ..... 2007-08</p> <p style="text-align: center;"><b>MOUNT-TRANSMISSION</b></p> <p>SATURN PASSENGER CAR ..... 2005-07</p>
 <p style="text-align: center;"><b>EM-3078</b> <b>MOUNT-ENGINE</b> <b>LH Front</b></p> <p>FORD TRUCK ..... 2001-11</p> <p>MAZDA TRUCK ..... 2001-09</p>	 <p style="text-align: center;"><b>EM-3081</b> <b>MOUNT-TRANSMISSION</b> <b>Front</b></p> <p>CHEVROLET PASSENGER CAR ..... 2005-10</p> <p style="text-align: center;"><b>MOUNT-TRANSMISSION</b> <b>LH Front</b></p> <p>PONTIAC PASSENGER CAR ..... 2007-08</p>	 <p style="text-align: center;"><b>EM-3084*</b> <b>MOUNT-ENGINE</b> <b>Front</b></p> <p>CHRYSLER SUV ..... 2004-06</p> <p style="text-align: center;"><b>MOUNT-ENGINE</b> <b>Rear</b></p> <p>CHRYSLER SUV ..... 2004-06</p>	 <p style="text-align: center;"><b>EM-3087</b> <b>Engine Torque Strut Mount</b> <b>Front</b></p> <p>FORD PASSENGER CAR ..... 2008-09</p>

# BUYER'S GUIDE

## NUMERICAL LISTING - ILLUSTRATIONS

 <p style="text-align: center;"><b>EM-3088</b> Engine Torque Strut Mount Front</p> <p>BUICK PASSENGER CAR ..... 1996-09 CHEVROLET PASSENGER CAR ..... 1998-05 OLDSMOBILE PASSENGER CAR ..... 1998-02 PONTIAC PASSENGER CAR ..... 2004-08</p>	 <p style="text-align: center;"><b>EM-3091</b> MOUNT-ENGINE RH Front</p> <p>SATURN PASSENGER CAR ..... 2000-03</p>	 <p style="text-align: center;"><b>EM-3094</b> MOUNT-TRANSMISSION RH Rear</p> <p>CHEVROLET PASSENGER CAR ..... 2004-08</p>	 <p style="text-align: center;"><b>EM-3097</b> MOUNT-ENGINE RH Front</p> <p>CHEVROLET PASSENGER CAR ..... 2004-10</p>
 <p style="text-align: center;"><b>EM-3089</b> MOUNT-ENGINE Rear</p> <p>CHRYSLER PASSENGER CAR ..... 2000 DODGE PASSENGER CAR ..... 1998-00 PLYMOUTH PASSENGER CAR ..... 1998-00</p>	 <p style="text-align: center;"><b>EM-3092</b> MOUNT-TRANSMISSION Front</p> <p>SATURN PASSENGER CAR ..... 2005-07</p>	 <p style="text-align: center;"><b>EM-3095</b> Engine Torque Strut Mount Rear</p> <p>CHRYSLER SUV ..... 2004-06</p>	 <p style="text-align: center;"><b>EM-3098</b> MOUNT-TRANSMISSION Front</p> <p>CHEVROLET VAN ..... 2003-14 GMC VAN ..... 2003-14</p>
 <p style="text-align: center;"><b>EM-3090</b> Engine Torque Strut Mount Front</p> <p>BUICK VAN ..... 2006-07 CHEVROLET PASSENGER CAR ..... 2006-10 PONTIAC PASSENGER CAR ..... 2005-08</p>	 <p style="text-align: center;"><b>EM-3093</b> MOUNT-ENGINE Front</p> <p>BUICK PASSENGER CAR ..... 2008-09 CHEVROLET PASSENGER CAR ..... 2006-09 OLDSMOBILE PASSENGER CAR ..... 1999-02 PONTIAC PASSENGER CAR ..... 2005-08</p>	 <p style="text-align: center;"><b>EM-3096</b> MOUNT-TRANSMISSION Center</p> <p>CHEVROLET PASSENGER CAR ..... 2004-10 PONTIAC PASSENGER CAR ..... 2005-10 SATURN PASSENGER CAR ..... 2008</p>	 <p style="text-align: center;"><b>EM-3100</b> Engine Torque Strut Mount Rear</p> <p>FORD PASSENGER CAR ..... 2003-07</p>

# BUYER'S GUIDE

## NUMERICAL LISTING - ILLUSTRATIONS



**EM-3102**  
**MOUNT-ENGINE**  
**LH Front**

CHEVROLET TRUCK ..... 2001-10  
**MOUNT-ENGINE**  
**Right**  
GMC TRUCK ..... 2001-10



**EM-3105**  
**Engine Torque Strut Mount**  
**Front**

FORD PASSENGER CAR ..... 2007-12  
**Engine Torque Strut**  
**Front Right**  
MERCURY PASSENGER CAR ... 2007-10



**EM-3108**  
**MOUNT-ENGINE**  
**RH Front**

CHEVROLET PASSENGER  
CAR ..... 2005-10  
PONTIAC PASSENGER CAR ..... 2007-08  
**MOUNT-ENGINE**  
**Front**



**EM-3111**  
**Engine Torque Strut Mount**  
**Rear**

LINCOLN PASSENGER CAR ..... 1998-02



**EM-3103**  
**MOUNT-ENGINE**  
**RH Front**

FORD PASSENGER CAR ..... 2003-13  
FORD VAN ..... 2010-13  
MAZDA PASSENGER CAR ..... 2004-13  
MAZDA VAN ..... 2006-10



**EM-3106**  
**MOUNT-TRANSMISSION**

FORD VAN ..... 2004-07  
MERCURY VAN ..... 2004-07



**EM-3109**  
**MOUNT-ENGINE**  
**RH Front**

CHEVROLET PASSENGER  
CAR ..... 2005-10  
PONTIAC PASSENGER CAR ..... 2007-08  
**MOUNT-ENGINE**  
**Front**  
SATURN PASSENGER CAR ..... 2003-07



**EM-3112**  
**MOUNT-TRANSMISSION**  
**Center**

CHEVROLET PASSENGER  
CAR ..... 2006-07  
PONTIAC PASSENGER CAR ..... 2006-08



**EM-3104**  
**Engine Torque Strut Mount**  
**Front**

BUICK PASSENGER CAR ..... 2008-09  
CHEVROLET PASSENGER  
CAR ..... 2006-10



**EM-3107**  
**Engine Torque Strut Mount**  
**Front**

FORD PASSENGER CAR ..... 2006-09  
LINCOLN PASSENGER CAR ..... 2006-09  
**Engine Torque Strut**  
**Front Right**  
MERCURY PASSENGER CAR ... 2006-10



**EM-3110**  
**MOUNT-ENGINE**  
**RH Front**

CHEVROLET SPORT UTILITY ... 2005-09  
PONTIAC SPORT UTILITY ..... 2006-09

















**EM-3113**  
**MOUNT-ENGINE**  
**Front**

CHEVROLET PASSENGER  
CAR ..... 2004-08  
PONTIAC PASSENGER CAR ..... 2005-07  
**MOUNT-TRANSMISSION**

PONTIAC PASSENGER CAR ..... 2005-07

# BUYER'S GUIDE

## NUMERICAL LISTING - ILLUSTRATIONS

 <p style="text-align: center;"><b>EM-3114</b> Engine Torque Strut Front Right</p> <p>CHEVROLET PASSENGER CAR ..... 2004-08 PONTIAC PASSENGER CAR ..... 2005-07</p>	<p><b>EM-3117 (Continued)</b> <b>MOUNT-ENGINE RH Front</b></p> <p>PONTIAC PASSENGER CAR ..... 2006-08 <b>MOUNT-ENGINE Front</b></p> <p>SATURN PASSENGER CAR ..... 2007-08</p> 	 <p style="text-align: center;"><b>EM-3121</b> MOUNT-ENGINE LH Front</p> <p>CHEVROLET TRUCK ..... 2004-10 GMC TRUCK ..... 2004-10</p>	 <p style="text-align: center;"><b>EM-3125</b> MOUNT-TRANSMISSION Manual</p> <p>CHEVROLET PASSENGER CAR ..... 1998-02 PONTIAC PASSENGER CAR ..... 1998-02</p>
 <p style="text-align: center;"><b>EM-3115</b> MOUNT-TRANSMISSION</p> <p>CHEVROLET PASSENGER CAR ..... 2004-08</p>	<p style="text-align: center;"><b>EM-3118</b> MOUNT-ENGINE RH Front</p> <p>CHEVROLET PASSENGER CAR ..... 2009-12 PONTIAC PASSENGER CAR ..... 2009 SATURN PASSENGER CAR ..... 2009</p>	 <p style="text-align: center;"><b>EM-3122</b> MOUNT-TRANSMISSION</p> <p>CHEVROLET TRUCK ..... 2004-10 GMC TRUCK ..... 2004-10</p>	 <p style="text-align: center;"><b>EM-3126</b> MOUNT-ENGINE LH Front</p> <p>BUICK PASSENGER CAR ..... 1997-99</p>
 <p style="text-align: center;"><b>EM-3116</b> MOUNT-ENGINE Front</p> <p>PONTIAC PASSENGER CAR ..... 2006-09</p>	 <p style="text-align: center;"><b>EM-3119</b> MOUNT-TRANSMISSION Manual</p> <p>FORD PASSENGER CAR ..... 1998-00 <b>MOUNT-TRANSMISSION Rear</b></p> <p>FORD PASSENGER CAR ..... 1995-00 <b>MOUNT-TRANSMISSION Manual</b></p> <p>MERCURY PASSENGER CAR ... 1995-02</p>	 <p style="text-align: center;"><b>EM-3123</b> MOUNT-TRANSMISSION Auto</p> <p>CADILLAC PASSENGER CAR .... 2003-04</p>	 <p style="text-align: center;"><b>EM-3127</b> MOUNT-TRANSMISSION Front</p> <p>BUICK PASSENGER CAR ..... 1995-98</p>
 <p style="text-align: center;"><b>EM-3117</b> MOUNT-ENGINE Right</p> <p>CHEVROLET PASSENGER CAR ..... 2006-08</p>	 <p style="text-align: center;"><b>EM-3120</b> MOUNT-ENGINE RH Front</p> <p>CHEVROLET TRUCK ..... 2004-10 GMC TRUCK ..... 2004-10</p>	 <p style="text-align: center;"><b>EM-3124</b> MOUNT-TRANSMISSION Auto</p> <p>CHRYSLER PASSENGER CAR ..... 2002 DODGE PASSENGER CAR ..... 2001-06</p>	 <p style="text-align: center;"><b>EM-3128</b> MOUNT-ENGINE RH Front</p> <p>CHEVROLET PASSENGER CAR ..... 2002-05</p>
<p><b>(Continued Next Column)</b></p>			<p><b>(Continued Next Page)</b></p>

# BUYER'S GUIDE

## NUMERICAL LISTING - ILLUSTRATIONS

### EM-3128 (Continued)

PONTIAC PASSENGER CAR ..... 2002-05



### EM-3129 MOUNT-ENGINE Right

CHEVROLET PASSENGER  
CAR ..... 2003-05  
OLDSMOBILE PASSENGER  
CAR ..... 2002-04  
PONTIAC PASSENGER CAR ..... 2002-05



### EM-3130 MOUNT-ENGINE RH Front

DODGE PASSENGER CAR ..... 2007-09  
JEEP SPORT UTILITY ..... 2007-09  
MITSUBISHI PASSENGER  
CAR ..... 2008-11



### EM-3131 MOUNT-ENGINE Front

DODGE PASSENGER CAR ..... 2007-09  
JEEP SPORT UTILITY ..... 2007-09  
MITSUBISHI PASSENGER  
CAR ..... 2008-11



### EM-3132 MOUNT-ENGINE Rear

DODGE PASSENGER CAR ..... 2007-09  
MITSUBISHI PASSENGER  
CAR ..... 2008-11



### EM-3133 Engine Torque Strut Mount Right Upper

BUICK SPORT UTILITY ..... 2008  
GMC SPORT UTILITY ..... 2007-08  
SATURN SUV ..... 2007-08



### EM-3134 MOUNT-TRANSMISSION Auto

DODGE PASSENGER CAR ..... 2007-09  
**MOUNT-TRANSMISSION**

JEEP SPORT UTILITY ..... 2007-09  
**MOUNT-TRANSMISSION  
Auto**

MITSUBISHI PASSENGER  
CAR ..... 2008-13  
**MOUNT-TRANSMISSION**

MITSUBISHI SPORT UTILITY ..... 2008-11



### EM-3135 MOUNT-TRANSMISSION Center

CHEVROLET PASSENGER  
CAR ..... 2008-12  
PONTIAC PASSENGER CAR ..... 2007-09  
SATURN PASSENGER CAR ..... 2007-09

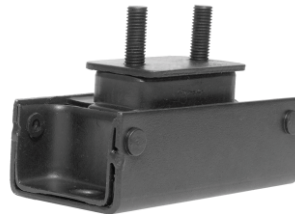

### EM-3136 MOUNT-TRANSMISSION Auto

FORD TRUCK ..... 2004-08  
**MOUNT-TRANSMISSION**

LINCOLN TRUCK ..... 2006-08



### EM-3137 MOUNT-TRANSMISSION Manual

DODGE PASSENGER CAR ..... 2007-09  
JEEP SPORT UTILITY ..... 2007-09  
MITSUBISHI PASSENGER  
CAR ..... 2008-13



### EM-3138 MOUNT-ENGINE L & R Front

CHRYSLER PASSENGER  
CAR ..... 2005-10  
DODGE PASSENGER CAR ..... 2005-10



### EM-3139 Engine Torque Strut Mount Front

BUICK PASSENGER CAR ..... 2006-11



### EM-3140 Engine Torque Strut Mount Right

BUICK PASSENGER CAR ..... 2006-11  
CADILLAC PASSENGER CAR ..... 2006-11



### EM-3141 Engine Torque Strut Mount Right Upper

BUICK SPORT UTILITY ..... 2009-12

(Continued Next Page)

# BUYER'S GUIDE

## NUMERICAL LISTING - ILLUSTRATIONS

### EM-3141 (Continued)

CHEVROLET SPORT UTILITY ..... 2009-12  
 GMC SPORT UTILITY ..... 2009-12  
 SATURN SUV ..... 2009-10



**EM-3142**  
**Engine Torque Strut Mount**  
**Front**

FORD PASSENGER CAR ..... 2008-09  
 FORD SPORT UTILITY ..... 2009-12  
 LINCOLN SPORT UTILITY ..... 2010-13

**Engine Torque Strut Mount**  
**Rear**

FORD PASSENGER CAR ..... 2008-12  
 FORD SPORT UTILITY ..... 2011-14  
 LINCOLN PASSENGER CAR ..... 2009-11  
 LINCOLN SPORT UTILITY ..... 2011-14  
 MERCURY PASSENGER CAR ... 2008-09



**EM-3143**  
**Engine Torque Strut Mount**  
**Right Upper**

BUICK SPORT UTILITY ..... 2008  
 GMC SPORT UTILITY ..... 2007-08  
 SATURN SUV ..... 2007-08



**EM-3144**  
**Engine Torque Strut**  
**Front Left**

FORD SPORT UTILITY ..... 2007-10

**Engine Torque Strut Mount**  
**Rear**

LINCOLN SPORT UTILITY ..... 2007-10



**EM-3145**  
**MOUNT-ENGINE**  
**Rear**

DODGE PASSENGER CAR ..... 2007-09  
 JEEP SPORT UTILITY ..... 2007-09  
 MITSUBISHI SPORT UTILITY ..... 2008-11



**EM-3146**  
**MOUNT-ENGINE**  
**Rear**

BUICK PASSENGER CAR ..... 2006-11



**EM-3147**  
**MOUNT-ENGINE**  
**L & R Front**

CHRYSLER SUV ..... 2007-08



**EM-3148**  
**MOUNT-ENGINE**  
**Front**

BUICK PASSENGER CAR ..... 2006-08



**EM-3149**  
**MOUNT-ENGINE**  
**L & R Front**

CADILLAC PASSENGER CAR ..... 2003-10  
**MOUNT-ENGINE**  
**LH Front**

CADILLAC SPORT UTILITY ..... 2004-09



**EM-3150**  
**MOUNT-ENGINE**  
**Right**

FORD TRUCK ..... 2004  
 LINCOLN TRUCK ..... 2006-08



**EM-3151**  
**MOUNT-ENGINE**  
**Left**

FORD TRUCK ..... 2004  
 LINCOLN TRUCK ..... 2006-08



**EM-3152**  
**MOUNT-ENGINE**  
**Front**

CHRYSLER PASSENGER  
 CAR ..... 2007-13  
 DODGE PASSENGER CAR ..... 2008-10



**EM-3153**  
**MOUNT-TRANSMISSION**  
**Auto**

BUICK PASSENGER CAR ..... 2006-11  
**MOUNT-TRANSMISSION**

CADILLAC PASSENGER CAR ..... 2006-11



**EM-3154**  
**MOUNT-ENGINE**  
**Front**

CHEVROLET SPORT UTILITY ..... 2008-09

**MOUNT-ENGINE**  
**Rear**

CHEVROLET SPORT UTILITY ..... 2008-09

**MOUNT-TRANSMISSION**  
**Center**

PONTIAC SPORT UTILITY ..... 2008-09



# BUYER'S GUIDE

## NUMERICAL LISTING - ILLUSTRATIONS



**EM-3155**  
**MOUNT-TRANSMISSION**

CHRYSLER PASSENGER CAR ..... 2007-10  
DODGE PASSENGER CAR ..... 2008-09



**EM-3156 (NEW)**  
**MOUNT-ENGINE**  
**Front**

CHRYSLER VAN ..... 2008-10  
DODGE VAN ..... 2008-10  
VOLKSWAGEN VAN ..... 2009-10



**EM-3157 (NEW)**  
**MOUNT-ENGINE**  
**Rear**

DODGE PASSENGER CAR ..... 2007-08  
JEEP SPORT UTILITY ..... 2007-09  
MITSUBISHI SPORT UTILITY ..... 2008-11



**EM-3158 (NEW)**  
**MOUNT-ENGINE**  
**Front**

BUICK PASSENGER CAR ..... 2009-11



**EM-3159 (NEW)**  
**MOUNT-TRANSMISSION**

CADILLAC PASSENGER CAR .... 2004-07



**EM-3160 (NEW)**  
**MOUNT-ENGINE**  
**RH Front**  
**MOUNT-ENGINE**  
**LH Front**

PONTIAC PASSENGER CAR ..... 2007-09  
SATURN PASSENGER CAR ..... 2007-10



**EM-3161 (NEW)**  
**MOUNT-TRANSMISSION**

PONTIAC PASSENGER CAR ..... 2007-09  
SATURN PASSENGER CAR ..... 2007-10



**EM-3162 (NEW)**  
**MOUNT-TRANSMISSION**  
**Manual**

CADILLAC PASSENGER CAR .... 2003-04



**EM-3165 (NEW)**  
**MOUNT-ENGINE**  
**Front**

DODGE SPORT UTILITY ..... 2009-10



**EM-3166 (NEW)**  
**MOUNT-ENGINE**  
**Front**

BUICK PASSENGER CAR ..... 2006-11  
CADILLAC PASSENGER CAR .... 2006-11



**EM-3167 (NEW)**  
**MOUNT-ENGINE**  
**RH Front**

CHRYSLER PASSENGER CAR ..... 2007-13  
DODGE PASSENGER CAR ..... 2008-13



**EM-3168 (NEW)**  
**MOUNT-ENGINE**  
**Rear**

CHRYSLER PASSENGER CAR ..... 2007-13  
**(Continued Next Column)**

### EM-3168 (Continued)

DODGE PASSENGER CAR ..... 2008-13

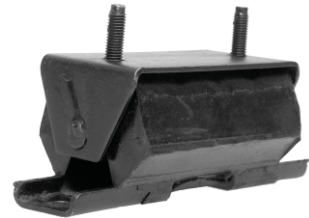

**EM-3172 (NEW)**  
**MOUNT-TRANSMISSION**

CHEVROLET TRUCK ..... 2007-12  
GMC TRUCK ..... 2007-12



**EM-3175 (NEW)**  
**MOUNT-ENGINE**  
**LH Front**

CHEVROLET VAN ..... 2003-12  
GMC VAN ..... 2003-10



**EM-3177 (NEW)**  
**MOUNT-ENGINE**  
**L & R Front**

CHEVROLET VAN ..... 2003-12  
GMC VAN ..... 2003-12

# BUYER'S GUIDE

## NUMERICAL LISTING - ILLUSTRATIONS

 <p style="text-align: center;"><b>EM-3179 (NEW)</b> <b>MOUNT-TRANSMISSION</b></p> <p>CHRYSLER PASSENGER CAR ..... 2003-07</p>	 <p style="text-align: center;"><b>EM-3192 (NEW)</b> <b>MOUNT-ENGINE</b> Front</p> <p>BUICK SPORT UTILITY ..... 2008</p> <p style="text-align: center;"><b>MOUNT-ENGINE</b> <b>Rear</b></p> <p>BUICK SPORT UTILITY ..... 2008</p> <p style="text-align: center;"><b>MOUNT-TRANSMISSION</b></p> <p>BUICK SPORT UTILITY ..... 2008</p>	<p><b>EM-3195 (Continued)</b></p> <p>BUICK PASSENGER CAR ..... 2010-13 CADILLAC PASSENGER CAR .... 2013-14 CADILLAC SPORT UTILITY ..... 2010-13 CHEVROLET PASSENGER CAR ..... 2013</p>  <p style="text-align: center;"><b>EM-3196 (NEW)</b> <b>MOUNT-TRANSMISSION</b> Rear</p> <p>BUICK PASSENGER CAR ..... 2010-13 CADILLAC PASSENGER CAR .... 2013-14 CADILLAC SPORT UTILITY ..... 2010-13 CHEVROLET PASSENGER CAR ..... 2013</p>	 <p style="text-align: center;"><b>EM-3200 (NEW)</b> <b>MOUNT-ENGINE</b> Right</p> <p>BUICK PASSENGER CAR ..... 2010-12</p>  <p style="text-align: center;"><b>EM-3201 (NEW)</b> <b>MOUNT-TRANSMISSION</b> Center</p> <p>BUICK PASSENGER CAR ..... 2011-13 CADILLAC SPORT UTILITY ..... 2010-11</p>  <p style="text-align: center;"><b>EM-3202 (NEW)</b> <b>MOUNT-TRANSMISSION</b> Front</p> <p>CHEVROLET PASSENGER CAR ..... 2011-14</p>  <p style="text-align: center;"><b>EM-4000 (NEW)</b> <b>MOUNT-ENGINE</b> LH Front</p> <p>CHEVROLET SPORT UTILITY .... 2007-09 CHEVROLET TRUCK ..... 2007-13 GMC SPORT UTILITY ..... 2007-09 GMC TRUCK ..... 2007-13</p>
 <p style="text-align: center;"><b>EM-3183 (NEW)</b> <b>MOUNT-ENGINE</b> Right</p> <p>DODGE SPORT UTILITY ..... 2009-12</p>  <p style="text-align: center;"><b>EM-3189 (NEW)</b> <b>MOUNT-TRANSMISSION</b></p> <p>DODGE VAN ..... 2003-06 FREIGHTLINER ..... 2003-06</p>	 <p style="text-align: center;"><b>EM-3193 (NEW)</b> <b>Engine Torque Strut Mount</b> Rear</p> <p>FORD PASSENGER CAR ..... 2011-13</p>  <p style="text-align: center;"><b>EM-3194 (NEW)</b> <b>MOUNT-TRANSMISSION</b> Front</p> <p>BUICK PASSENGER CAR ..... 2010-14 CHEVROLET PASSENGER CAR ..... 2013</p>  <p style="text-align: center;"><b>EM-3195 (NEW)</b> <b>MOUNT-TRANSMISSION</b> Front</p> <p style="text-align: center;">(Continued Next Column)</p>	 <p style="text-align: center;"><b>EM-3197 (NEW)</b> <b>MOUNT-TRANSMISSION</b> Front</p> <p>BUICK PASSENGER CAR ..... 2011-13 CADILLAC SPORT UTILITY ..... 2010-11</p>  <p style="text-align: center;"><b>EM-3198 (NEW)</b> <b>MOUNT-ENGINE</b> Right</p> <p>BUICK PASSENGER CAR ..... 2010-12</p>  <p style="text-align: center;"><b>EM-3199 (NEW)</b> <b>MOUNT-TRANSMISSION</b> Center</p> <p>BUICK PASSENGER CAR ..... 2010-13</p>	

# BUYER'S GUIDE

## NUMERICAL LISTING - ILLUSTRATIONS

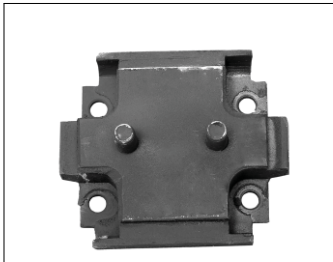

**EM-4001 (NEW)**  
MOUNT-ENGINE  
Front

HUMMER ..... 2002-06



**EM-4002 (NEW)**  
MOUNT-TRANSMISSION

DODGE TRUCK ..... 2006-08



**EM-4003 (NEW)**  
MOUNT-ENGINE  
Right

CHRYSLER VAN ..... 2001-02

**MOUNT-ENGINE  
RH Front**

DODGE VAN ..... 2001-02



**EM-4004 (NEW)**  
MOUNT-ENGINE  
Right

CHRYSLER VAN ..... 2003

(Continued Next Column)

**EM-4004 (Continued)**

**MOUNT-ENGINE  
RH Front**

DODGE VAN ..... 2003-07



**EM-4005 (NEW)**  
MOUNT-ENGINE  
RH Front

FORD PASSENGER CAR ..... 1989-95



**EM-4006 (NEW)**  
MOUNT-ENGINE  
LH Front

DODGE TRUCK ..... 2006-07



**EM-4007 (NEW)**  
MOUNT-ENGINE  
RH Front

DODGE TRUCK ..... 2006-07



**EM-4012 (NEW)**  
MOUNT-ENGINE  
Right

CHRYSLER VAN ..... 2008-15

DODGE VAN ..... 2008-15

RAM VAN ..... 2012-15

VOLKSWAGEN VAN ..... 2011-14



**EM-4013 (NEW)**  
MOUNT-TRANSMISSION

CHRYSLER VAN ..... 2008-10

DODGE VAN ..... 2008-10

VOLKSWAGEN VAN ..... 2009-10



**EM-4015 (NEW)**  
MOUNT-ENGINE  
LH Front

HUMMER ..... 2006-10



**EM-4016 (NEW)**  
MOUNT-ENGINE  
RH Front

(Continued Next Column)

**EM-4016 (Continued)**

HUMMER ..... 2006-10



**EM-4017 (NEW)**  
MOUNT-ENGINE  
RH Front

CHEVROLET SPORT UTILITY .... 2007-09

CHEVROLET TRUCK ..... 2007-13

GMC SPORT UTILITY ..... 2007-09

GMC TRUCK ..... 2007-13



**EM-4018 (NEW)**  
MOUNT-ENGINE  
L & R Front

DODGE TRUCK ..... 2003-05



**EM-4019 (NEW)**  
MOUNT-ENGINE  
Rear

DODGE SPORT UTILITY ..... 2009-10

FORD SPORT UTILITY ..... 2005-12

MAZDA SPORT UTILITY ..... 2005-11

MERCURY SPORT UTILITY ..... 2005-11

# BUYER'S GUIDE

## NUMERICAL LISTING - ILLUSTRATIONS

 <p style="text-align: center;"><b>EM-4022 (NEW)</b> <b>MOUNT-ENGINE</b> <b>Left</b></p> <p>FORD SPORT UTILITY ..... 2000-05 FORD TRUCK ..... 1999-04</p>	 <p style="text-align: center;"><b>EM-4029 (NEW)</b> <b>MOUNT-ENGINE</b> <b>L &amp; R Front</b></p> <p>FORD PASSENGER CAR ..... 2005-15</p>	<p><b>EM-4035 (Continued)</b></p> <p>CHEVROLET SPORT UTILITY ... 2009-12 GMC SPORT UTILITY ..... 2009-12 SATURN SUV ..... 2009-10</p>  <p style="text-align: center;"><b>EM-4036 (NEW)</b> <b>MOUNT-TRANSMISSION</b></p> <p>BUICK SPORT UTILITY ..... 2009-12 CHEVROLET SPORT UTILITY ... 2009-12 GMC SPORT UTILITY ..... 2009-12 SATURN SUV ..... 2009-10</p>	 <p style="text-align: center;"><b>EM-4039 (NEW)</b> <b>MOUNT-ENGINE</b> <b>Right</b></p> <p>FORD TRUCK ..... 2005-08</p>
 <p style="text-align: center;"><b>EM-4027 (NEW)</b> <b>MOUNT-TRANSMISSION</b> <b>Front</b></p> <p>CHEVROLET PASSENGER CAR ..... 2008-10 PONTIAC PASSENGER CAR ..... 2007-10 SATURN PASSENGER CAR ..... 2008-09</p>	 <p style="text-align: center;"><b>EM-4033 (NEW)</b> <b>MOUNT-ENGINE</b> <b>Right</b></p> <p>FORD SPORT UTILITY ..... 2005-12</p>	 <p style="text-align: center;"><b>EM-4037 (NEW)</b> <b>MOUNT-ENGINE</b> <b>Front</b></p> <p>BUICK SPORT UTILITY ..... 2009-14 CHEVROLET SPORT UTILITY ... 2009-12 GMC SPORT UTILITY ..... 2009-12 SATURN SUV ..... 2009-10</p>	 <p style="text-align: center;"><b>EM-4040 (NEW)</b> <b>MOUNT-TRANSMISSION</b> <b>Upper</b></p> <p>FORD PASSENGER CAR ..... 2008-13 FORD SPORT UTILITY ..... 2009-13 LINCOLN PASSENGER CAR ..... 2009-12 LINCOLN SPORT UTILITY ..... 2010-13 MERCURY PASSENGER CAR ... 2008-09</p>
 <p style="text-align: center;"><b>EM-4028 (NEW)</b> <b>Engine Torque Strut Mount</b> <b>Upper</b></p> <p>FORD PASSENGER CAR ..... 2005-07 MERCURY PASSENGER CAR ... 2005-07</p>	 <p style="text-align: center;"><b>EM-4034 (NEW)</b> <b>MOUNT-TRANSMISSION</b></p> <p>FORD PASSENGER CAR ..... 2006-12 LINCOLN PASSENGER CAR ..... 2006 MERCURY PASSENGER CAR ... 2006-11</p>	 <p style="text-align: center;"><b>EM-4038 (NEW)</b> <b>MOUNT-ENGINE</b> <b>Left</b></p> <p>FORD TRUCK ..... 2005-08</p>	 <p style="text-align: center;"><b>EM-4041 (NEW)</b> <b>MOUNT-ENGINE</b> <b>L &amp; R Front</b></p> <p>JEEP SPORT UTILITY ..... 2007-11</p>
 <p style="text-align: center;"><b>EM-4028 (NEW)</b> <b>Engine Torque Strut Mount</b> <b>Upper</b></p> <p>FORD PASSENGER CAR ..... 2005-07 MERCURY PASSENGER CAR ... 2005-07</p>	 <p style="text-align: center;"><b>EM-4035 (NEW)</b> <b>MOUNT-ENGINE</b> <b>Rear</b></p> <p>BUICK SPORT UTILITY ..... 2009-14</p> <p style="text-align: center;">(Continued Next Column)</p>	 <p style="text-align: center;"><b>EM-4038 (NEW)</b> <b>MOUNT-ENGINE</b> <b>Left</b></p> <p>FORD TRUCK ..... 2005-08</p>	 <p style="text-align: center;"><b>EM-4042 (NEW)</b> <b>MOUNT-ENGINE</b> <b>Rear</b></p> <p>CHRYSLER VAN ..... 2008-10 DODGE VAN ..... 2008-10 VOLKSWAGEN VAN ..... 2009-10</p>

# BUYER'S GUIDE

## NUMERICAL LISTING - ILLUSTRATIONS



**EM-4043 (NEW)**  
**MOUNT-TRANSMISSION**  
**Auto**

JEEP SPORT UTILITY ..... 2007-11



**EM-4047 (NEW)**  
**MOUNT-TRANSMISSION**  
**Center**

CHEVROLET PASSENGER  
CAR ..... 2004-10  
PONTIAC PASSENGER CAR ..... 2007-10  
SATURN PASSENGER CAR ..... 2009



**EM-4055 (NEW)**  
**Engine Torque Strut Mount**  
**Rear**

FORD PASSENGER CAR ..... 2010-14  
FORD SPORT UTILITY ..... 2010-14  
LINCOLN SPORT UTILITY ..... 2010-13



**EM-4059 (NEW)**  
**Engine Torque Strut Mount**  
**Front**

FORD PASSENGER CAR ..... 2010-12  
LINCOLN PASSENGER CAR ..... 2010-12



**EM-4044 (NEW)**  
**MOUNT-ENGINE**  
**Right**

FORD PASSENGER CAR ..... 2006-09  
LINCOLN PASSENGER CAR ..... 2006  
MERCURY PASSENGER CAR ... 2006-09



**EM-4049 (NEW)**  
**MOUNT-TRANSMISSION**  
**Front**

CHEVROLET PASSENGER  
CAR ..... 2011-14



**EM-4056 (NEW)**  
**Engine Torque Strut Mount**  
**Front**

FORD PASSENGER CAR ..... 2010-14  
FORD SPORT UTILITY ..... 2010-14  
LINCOLN SPORT UTILITY ..... 2010-13



**EM-4060 (NEW)**  
**MOUNT-TRANSMISSION**  
**Auto**

DODGE TRUCK ..... 2006-08



**EM-4045 (NEW)**  
**MOUNT-ENGINE**  
**Rear**

CHEVROLET PASSENGER  
CAR ..... 2008-12  
SATURN PASSENGER CAR ..... 2009

**EM-4050 (NEW)**  
**MOUNT-ENGINE**  
**Front**

CHRYSLER VAN ..... 2011-15  
DODGE VAN ..... 2011-15  
RAM VAN ..... 2012-15  
VOLKSWAGEN VAN ..... 2011-14



**EM-4057 (NEW)**  
**Engine Torque Strut Mount**  
**Front Lower**

FORD PASSENGER CAR ..... 2011-14  
FORD SPORT UTILITY ..... 2013-14



**EM-4063 (NEW)**  
**MOUNT-TRANSMISSION**  
**Rear**

SATURN SUV ..... 2008-10



**EM-4051 (NEW)**  
**Engine Torque Strut Mount**  
**Rear**

FORD SPORT UTILITY ..... 2005-12  
MERCURY SPORT UTILITY ..... 2006-11



**EM-4046 (NEW)**  
**MOUNT-TRANSMISSION**  
**Front**

CHEVROLET PASSENGER  
CAR ..... 2008-12  
SATURN PASSENGER CAR ..... 2009



**EM-4058 (NEW)**  
**Engine Torque Strut Mount**  
**Front**

FORD PASSENGER CAR ..... 2010-12  
MERCURY PASSENGER CAR ... 2010-11



**EM-4064 (NEW)**  
**MOUNT-TRANSMISSION**  
**Upper**

SATURN SUV ..... 2008-10

# BUYER'S GUIDE

## NUMERICAL LISTING - ILLUSTRATIONS

<p><b>EM-4070 (NEW)</b> <b>MOUNT-TRANSMISSION</b> Upper</p> <p>FORD PASSENGER CAR ..... 2013-14</p> 	 <p><b>EM-4078 (NEW)</b> <b>MOUNT-ENGINE</b> Right</p> <p>CHEVROLET SPORT UTILITY .... 2008-09</p>	 <p><b>EM-4082 (NEW)</b> <b>MOUNT-ENGINE</b> RH Front</p> <p>FORD PASSENGER CAR ..... 2008-11</p>	 <p><b>EM-4096 (NEW)</b> <b>MOUNT-TRANSMISSION</b></p> <p>HUMMER ..... 2006-10</p>
<p><b>EM-4071 (NEW)</b> <b>MOUNT-ENGINE</b> LH Front</p> <p>FORD SPORT UTILITY ..... 2005-12 MAZDA SPORT UTILITY ..... 2005-11 MERCURY SPORT UTILITY ..... 2005-11</p> 	 <p><b>EM-4079 (NEW)</b> <b>MOUNT-TRANSMISSION</b> Auto</p> <p>CHEVROLET SPORT UTILITY .... 2008-09</p>	 <p><b>EM-4094 (NEW)</b> <b>MOUNT-ENGINE</b> Front</p> <p>CHRYSLER PASSENGER CAR ..... 2007-13 CHRYSLER VAN ..... 2008-15 DODGE PASSENGER CAR ..... 2008-10 DODGE VAN ..... 2008-15 RAM VAN ..... 2012-15 VOLKSWAGEN VAN ..... 2009-14</p>	 <p><b>EM-4097 (NEW)</b> <b>MOUNT-ENGINE</b> LH Front</p> <p>FORD SPORT UTILITY ..... 2003-06 LINCOLN SPORT UTILITY ..... 2003-06</p>
<p><b>EM-4073 (NEW)</b> <b>MOUNT-ENGINE</b> L &amp; R Front</p> <p>CHEVROLET TRUCK ..... 2007-13 GMC TRUCK ..... 2007-13</p> 	 <p><b>EM-4080 (NEW)</b> <b>MOUNT-TRANSMISSION</b> Rear</p> <p>BUICK PASSENGER CAR ..... 2012-14 CHEVROLET PASSENGER CAR ..... 2011-14</p>	 <p><b>EM-4095 (NEW)</b> <b>MOUNT-TRANSMISSION</b></p> <p>FORD SPORT UTILITY ..... 2006-10</p>	 <p><b>EM-4099 (NEW)</b> <b>MOUNT-ENGINE</b> RH Front</p> <p>FORD SPORT UTILITY ..... 2004-06 LINCOLN SPORT UTILITY ..... 2004-06</p>
<p><b>EM-4077 (NEW)</b> <b>MOUNT-TRANSMISSION</b></p> <p>CHRYSLER VAN ..... 2011-13 DODGE VAN ..... 2011-13</p> 	 <p><b>EM-4081 (NEW)</b> <b>MOUNT-TRANSMISSION</b></p> <p>FORD SPORT UTILITY ..... 2007-14 LINCOLN SPORT UTILITY ..... 2007-13</p>	 <p><b>EM-4100 (NEW)</b> <b>MOUNT-ENGINE</b> LH Front</p> <p>JEEP SPORT UTILITY ..... 2006-09</p>	

# BUYER'S GUIDE

## NUMERICAL LISTING - ILLUSTRATIONS



**EM-4101 (NEW)**  
MOUNT-ENGINE  
LH Front

DODGE SPORT UTILITY ..... 2007-11  
JEEP SPORT UTILITY ..... 2008-12



**EM-4105 (NEW)**  
MOUNT-ENGINE  
RH Front

JEEP SPORT UTILITY ..... 2006-09



**EM-4112 (NEW)**  
MOUNT-ENGINE  
Right

CHRYSLER PASSENGER  
CAR ..... 2011-14  
DODGE PASSENGER CAR ..... 2011-13

**EM-4127 (NEW)**  
MOUNT-TRANSMISSION

CHRYSLER PASSENGER  
CAR ..... 2007-13  
CHRYSLER VAN ..... 2008-10  
DODGE PASSENGER CAR ..... 2008-13  
DODGE VAN ..... 2008-10  
VOLKSWAGEN VAN ..... 2009-10

**EM-4129 (NEW)**  
MOUNT-TRANSMISSION  
Center

CHEVROLET PASSENGER  
CAR ..... 2011-14



**EM-4102 (NEW)**  
DIFFERENTIAL MOUNT -  
FRONT

JEEP SPORT UTILITY ..... 2006-10



**EM-4106 (NEW)**  
MOUNT-ENGINE  
LH Front

FORD SPORT UTILITY ..... 2006-10  
MERCURY SPORT UTILITY ..... 2006-10



**EM-4113 (NEW)**  
MOUNT-ENGINE  
Front

CHRYSLER PASSENGER  
CAR ..... 2011-14  
DODGE PASSENGER CAR ..... 2011-13



**EM-5020\***  
MOUNT-ENGINE  
L & R Front

CHRYSLER PASSENGER  
CAR ..... 1996-97  
DODGE PASSENGER CAR ..... 1996-97



**EM-4103 (NEW)**  
MOUNT-ENGINE  
LH Front

JEEP SPORT UTILITY ..... 2005-10



**EM-4108 (NEW)**  
MOUNT-TRANSMISSION  
Auto

CHEVROLET VAN ..... 2003-14  
GMC VAN ..... 2003-14



**EM-4117 (NEW)**  
MOUNT-TRANSMISSION

FORD SPORT UTILITY ..... 2005-11  
MAZDA SPORT UTILITY ..... 2005-11  
MERCURY SPORT UTILITY ..... 2005-11



**EM-5026\***  
MOUNT-ENGINE  
RH Front

CHEVROLET PASSENGER  
CAR ..... 1994-02  
PONTIAC PASSENGER CAR ..... 1995-02



**EM-4104 (NEW)**  
MOUNT-ENGINE  
RH Front

JEEP SPORT UTILITY ..... 2005-10

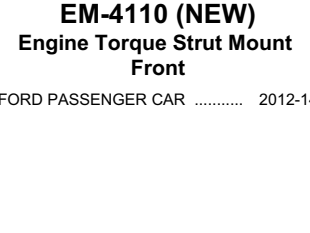

**EM-4110 (NEW)**  
Engine Torque Strut Mount  
Front

FORD PASSENGER CAR ..... 2012-14

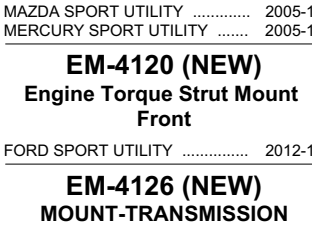

**EM-4120 (NEW)**  
Engine Torque Strut Mount  
Front

FORD SPORT UTILITY ..... 2012-14

**EM-4126 (NEW)**  
MOUNT-TRANSMISSION

PONTIAC PASSENGER CAR ..... 2007-09  
SATURN PASSENGER CAR ..... 2007-10

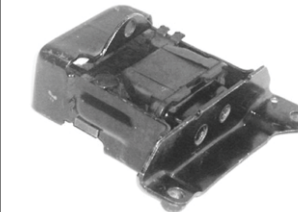

**EM-5028\***  
MOUNT-ENGINE  
RH Front

CHEVROLET PASSENGER  
CAR ..... 1992-93

# BUYER'S GUIDE

## NUMERICAL LISTING - ILLUSTRATIONS

 <p style="text-align: center;"><b>EM-5031*</b> <b>MOUNT-ENGINE</b> <b>RH Front</b></p> <p>BUICK PASSENGER CAR ..... 1992-98            CHEVROLET PASSENGER CAR ..... 1992-96            OLDSMOBILE PASSENGER CAR ..... 1992-98            PONTIAC PASSENGER CAR ..... 1992-98</p>	 <p style="text-align: center;"><b>EM-5048*</b> <b>MOUNT-ENGINE</b> <b>L &amp; R Front</b></p> <p>LINCOLN PASSENGER CAR ..... 1993-98            MERCURY PASSENGER CAR ... 1994-97</p>	 <p style="text-align: center;"><b>EM-5064</b> <b>MOUNT-ENGINE</b> <b>LH Front</b></p> <p>FORD PASSENGER CAR ..... 1986            MERCURY PASSENGER CAR ... 1984-87</p>	 <p style="text-align: center;"><b>EM-5069</b> <b>MOUNT-ENGINE</b> <b>RH Front</b></p> <p>BMW PASSENGER CAR ..... 1985-87</p>
 <p style="text-align: center;"><b>EM-5032</b> <b>MOUNT-TRANSMISSION</b> <b>Rear</b></p> <p>CHEVROLET PASSENGER CAR ..... 1992-96</p>	 <p style="text-align: center;"><b>EM-5052</b> <b>MOUNT-TRANSMISSION</b> <b>Manual</b></p> <p>DODGE PASSENGER CAR ..... 1995-99</p> <p style="text-align: center;"><b>MOUNT-TRANSMISSION</b> <b>Auto</b></p> <p>PLYMOUTH PASSENGER CAR ..... 1995-99</p>	 <p style="text-align: center;"><b>EM-5065</b> <b>MOUNT-ENGINE</b> <b>LH Front</b></p> <p>FORD PASSENGER CAR ..... 1984-91            MERCURY PASSENGER CAR ... 1984-86</p>	 <p style="text-align: center;"><b>EM-5070</b> <b>MOUNT-ENGINE</b> <b>LH Front</b></p> <p>BMW PASSENGER CAR ..... 1985-87</p>
 <p style="text-align: center;"><b>EM-5033</b> <b>MOUNT-TRANSMISSION</b> <b>Front</b></p> <p>CHEVROLET PASSENGER CAR ..... 1992-96</p>	 <p style="text-align: center;"><b>EM-5063</b> <b>MOUNT-ENGINE</b> <b>LH Front</b></p> <p>FORD PASSENGER CAR ..... 1984-91            MERCURY PASSENGER CAR ... 1984-87</p>	 <p style="text-align: center;"><b>EM-5067</b> <b>MOUNT-ENGINE</b> <b>LH Front</b></p> <p>BMW PASSENGER CAR ..... 1966-76</p>	 <p style="text-align: center;"><b>EM-5074</b> <b>MOUNT-ENGINE</b> <b>RH Front</b></p> <p>BUICK PASSENGER CAR ..... 1997-99</p> <p style="text-align: center;"><b>MOUNT-ENGINE</b> <b>L &amp; R Front</b></p> <p>CHEVROLET TRUCK ..... 2006-08</p>
 <p style="text-align: center;"><b>EM-5068</b> <b>MOUNT-ENGINE</b> <b>RH Front</b></p> <p>BMW PASSENGER CAR ..... 1966-76</p>			



# BUYER'S GUIDE

## NUMERICAL LISTING - ILLUSTRATIONS

 <p style="text-align: center;"><b>EM-5075</b> <b>MOUNT-TRANSMISSION</b> <b>Rear</b></p> <p>BUICK PASSENGER CAR ..... 1995-98 <b>MOUNT-TRANSMISSION</b> <b>LH Rear</b></p> <p>OLDSMOBILE PASSENGER CAR ..... 1995-98</p>	 <p style="text-align: center;"><b>EM-5080</b> <b>MOUNT-ENGINE</b> <b>RH Front Upper</b></p> <p>CHRYSLER PASSENGER CAR ..... 2001-07</p>	 <p style="text-align: center;"><b>EM-5085</b> <b>MOUNT-ENGINE</b> <b>Right</b></p> <p>CHRYSLER SUV ..... 2004-08</p>	 <p style="text-align: center;"><b>EM-5098</b> <b>MOUNT-ENGINE</b> <b>Rear</b></p> <p>EAGLE PASSENGER CAR ..... 1990-94 MITSUBISHI PASSENGER CAR ..... 1985-94 PLYMOUTH PASSENGER CAR ..... 1990-94</p>
 <p style="text-align: center;"><b>EM-5078</b> <b>MOUNT-TRANSMISSION</b> <b>LH Rear</b></p> <p>CHEVROLET PASSENGER CAR ..... 1999-05</p> <p>OLDSMOBILE PASSENGER CAR ..... 1997-04</p> <p>PONTIAC PASSENGER CAR ..... 1999-05</p>	 <p style="text-align: center;"><b>EM-5081</b> <b>MOUNT-ENGINE</b> <b>RH Front</b></p> <p>CHRYSLER PASSENGER CAR ..... 1995-99 DODGE PASSENGER CAR ..... 1995-99 EAGLE PASSENGER CAR ..... 1997-98</p>	 <p style="text-align: center;"><b>EM-5087</b> <b>MOUNT-TRANSMISSION</b></p> <p>DODGE PASSENGER CAR ..... 1963 PLYMOUTH PASSENGER CAR ..... 1960-65</p>	 <p style="text-align: center;"><b>EM-5101</b> <b>MOUNT-ENGINE</b> <b>Rear</b></p> <p>EAGLE PASSENGER CAR ..... 1990-94 MITSUBISHI PASSENGER CAR ..... 1990-94 PLYMOUTH PASSENGER CAR ..... 1992-94</p>
 <p style="text-align: center;"><b>EM-5079</b> <b>MOUNT-TRANSMISSION</b> <b>LH Front</b></p> <p>CHEVROLET PASSENGER CAR ..... 1999-03 OLDSMOBILE PASSENGER CAR ..... 1997-04 PONTIAC PASSENGER CAR ..... 1999-05</p>	 <p style="text-align: center;"><b>EM-5083</b> <b>MOUNT-ENGINE</b> <b>RH Front</b></p> <p>CHRYSLER PASSENGER CAR ..... 1989</p>	 <p style="text-align: center;"><b>EM-5089</b> <b>MOUNT-ENGINE</b> <b>Front</b></p> <p>DODGE PASSENGER CAR ..... 1995-00</p>	 <p style="text-align: center;"><b>EM-5103</b> <b>MOUNT-TRANSMISSION</b> <b>Rear</b></p> <p>FORD PASSENGER CAR ..... 1994-97</p>
 <p style="text-align: center;"><b>EM-5092</b> <b>MOUNT-ENGINE</b> <b>LH Front</b></p> <p>DODGE TRUCK ..... 1987-90</p>			

# BUYER'S GUIDE

## NUMERICAL LISTING - ILLUSTRATIONS

 <p><b>EM-5104</b> <b>MOUNT-TRANSMISSION</b> Front</p> <p>FORD PASSENGER CAR ..... 1994-97</p>	 <p><b>EM-5108</b> <b>MOUNT-ENGINE</b> RH Front</p> <p>FORD PASSENGER CAR ..... 1983-93 MERCURY PASSENGER CAR ..... 1984</p>	<p><b>EM-5111 (Continued)</b> FORD TRUCK ..... 1979</p>  <p><b>EM-5121</b> <b>MOUNT-TRANSMISSION</b></p> <p>KIA PASSENGER CAR ..... 2004-06</p>	 <p><b>EM-5132</b> <b>MOUNT-ENGINE</b> Front</p> <p>INFINITI PASSENGER CAR ..... 1996-04 NISSAN PASSENGER CAR ..... 1996-03</p>
 <p><b>EM-5105</b> <b>MOUNT-ENGINE</b> RH Front</p> <p>FORD PASSENGER CAR ..... 1994-97 MERCURY PASSENGER CAR ... 1995-00</p>	 <p><b>EM-5109</b> <b>MOUNT-ENGINE</b> LH Front</p> <p>FORD PASSENGER CAR ..... 1983-93 MERCURY PASSENGER CAR ..... 1984</p>	<p><b>EM-5124</b> <b>MOUNT-ENGINE</b> L &amp; R Front</p> <p>KIA SPORT UTILITY ..... 2003-06</p> <p><b>EM-5126</b> <b>MOUNT-TRANSMISSION</b> Manual</p> <p>HYUNDAI PASSENGER CAR ..... 2002-03</p> <p><b>EM-5127</b> <b>MOUNT-TRANSMISSION</b> Auto</p> <p>HYUNDAI PASSENGER CAR ..... 2002-03</p> <p><b>EM-5128</b> <b>MOUNT-TRANSMISSION</b></p> <p>KIA PASSENGER CAR ..... 2001</p>	 <p><b>EM-5141</b> <b>MOUNT-ENGINE</b> RH Front</p> <p>TOYOTA PASSENGER CAR ..... 2002-06 TOYOTA SPORT UTILITY ..... 2001-07</p>
 <p><b>EM-5106</b> <b>MOUNT-TRANSMISSION</b> Front</p> <p>FORD PASSENGER CAR ..... 1994-00 MERCURY PASSENGER CAR ... 1995-02</p>	 <p><b>EM-5110</b> <b>MOUNT-ENGINE</b> Front</p> <p>FORD PASSENGER CAR ..... 1993 MAZDA PASSENGER CAR ..... 1993</p>	 <p><b>EM-5131</b> <b>MOUNT-ENGINE</b> RH Front</p> <p>INFINITI PASSENGER CAR ..... 1991-96 NISSAN PASSENGER CAR ..... 1992</p>	 <p><b>EM-5142</b> <b>MOUNT-ENGINE</b> L &amp; R Front</p> <p>LEXUS PASSENGER CAR ..... 1998-05</p>
 <p><b>EM-5107</b> <b>MOUNT-TRANSMISSION</b> Rear</p> <p>FORD PASSENGER CAR ..... 1994-97 MERCURY PASSENGER CAR ... 1995-97</p>	 <p><b>EM-5111</b> <b>MOUNT-TRANSMISSION</b> Manual</p> <p>FORD SPORT UTILITY ..... 1978-79</p> <p><b>(Continued Next Column)</b></p>	 <p><b>EM-5143</b> <b>MOUNT-ENGINE</b> L &amp; R Front</p> <p>LEXUS PASSENGER CAR ..... 1990-00</p>	

# BUYER'S GUIDE

## NUMERICAL LISTING - ILLUSTRATIONS



**EM-5144**  
**MOUNT-TRANSMISSION**  
**Auto**

LEXUS PASSENGER CAR ..... 1990-95



**EM-5156**  
**MOUNT-TRANSMISSION**  
**Auto**

MAZDA PASSENGER CAR ..... 1988-89



**EM-5163**  
**MOUNT-TRANSMISSION**

NISSAN PASSENGER CAR ..... 1979-82



**EM-5171**  
**MOUNT-ENGINE**  
**RH Front**

NISSAN PASSENGER CAR ..... 1987-89



**EM-5148**  
**MOUNT-ENGINE**  
**RH Rear**

LINCOLN PASSENGER CAR ..... 1995-97



**EM-5159**  
**MOUNT-ENGINE**  
**LH Front**

CHRYSLER PASSENGER  
CAR ..... 2001-05  
DODGE PASSENGER CAR ..... 2001-05

**MOUNT-ENGINE**  
**Front**

MITSUBISHI PASSENGER  
CAR ..... 1999-05

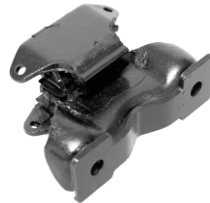

**EM-5165**  
**MOUNT-TRANSMISSION**  
**Manual**

NISSAN PASSENGER CAR ..... 1974



**EM-5173**  
**MOUNT-ENGINE**  
**RH Front**

NISSAN SPORT UTILITY ..... 2005-07



**EM-5152**  
**MOUNT-ENGINE**  
**RH Front**

MAZDA PASSENGER CAR ..... 2003-08



**EM-5162**  
**MOUNT-TRANSMISSION**  
**Auto**

NISSAN PASSENGER CAR ..... 1987-88

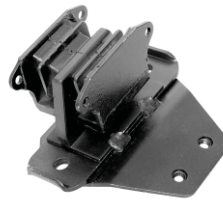

**EM-5166**  
**MOUNT-TRANSMISSION**  
**Manual**

NISSAN PASSENGER CAR ..... 1975-77



**EM-5174**  
**MOUNT-ENGINE**  
**Rear**

NISSAN SPORT UTILITY ..... 2005-07



**EM-5155**  
**MOUNT-ENGINE**  
**Front**

FORD PASSENGER CAR ..... 1994-97  
MAZDA PASSENGER CAR ..... 1994-00



**EM-5170**  
**Engine Torque Strut Mount**  
**Front**

NISSAN PASSENGER CAR ..... 1982-86



**EM-5175**  
**MOUNT-TRANSMISSION**  
**Manual**

NISSAN SPORT UTILITY ..... 2005-06

# BUYER'S GUIDE

## NUMERICAL LISTING - ILLUSTRATIONS

 <p><b>EM-5177</b> Engine Torque Strut Front Left</p> <p>OLDSMOBILE PASSENGER CAR ..... 1988-89 PONTIAC PASSENGER CAR ..... 1988-90</p>	 <p><b>EM-5181</b> MOUNT-TRANSMISSION Manual</p> <p>PONTIAC PASSENGER CAR ..... 1988-90</p>	 <p><b>EM-5187</b> Engine Torque Strut Mount Front</p> <p>SUBARU PASSENGER CAR ..... 1992-98 SUBARU SPORT UTILITY ..... 2002-08</p>	 <p><b>EM-5191</b> Engine Torque Strut Mount Front</p> <p>SUBARU PASSENGER CAR ..... 1995-99 SUBARU SPORT UTILITY ..... 1998-01</p>
 <p><b>EM-5178</b> MOUNT-ENGINE Bushing Kit</p> <p>CHRYSLER PASSENGER CAR ..... 1995-00 DODGE PASSENGER CAR ..... 1995-99 PLYMOUTH PASSENGER CAR ..... 1996-99</p>	 <p><b>EM-5182</b> MOUNT-TRANSMISSION</p> <p>PONTIAC PASSENGER CAR ..... 2004-06</p>	 <p><b>EM-5188</b> MOUNT-TRANSMISSION RH</p> <p>SUBARU PASSENGER CAR ..... 1992-99</p>	 <p><b>EM-5198</b> MOUNT-ENGINE Front</p> <p>TOYOTA PASSENGER CAR ..... 1993-97</p>
 <p><b>EM-5180</b> MOUNT-TRANSMISSION Manual</p> <p>PLYMOUTH PASSENGER CAR ..... 1995-99</p>	 <p><b>EM-5186</b> MOUNT-TRANSMISSION Auto</p> <p>SUBARU PASSENGER CAR ..... 1981-87 <b>MOUNT-TRANSMISSION</b></p> <p>SUBARU SPORT UTILITY ..... 1984-87</p>	 <p><b>EM-5189</b> MOUNT-TRANSMISSION LH</p> <p>SUBARU PASSENGER CAR ..... 1992-99</p>	 <p><b>EM-5200</b> MOUNT-ENGINE Rear</p> <p>TOYOTA PASSENGER CAR ..... 1978-80</p>
		 <p><b>EM-5190</b> MOUNT-TRANSMISSION Manual</p> <p>SUBARU PASSENGER CAR ..... 1993-97</p>	 <p><b>EM-5206</b> Engine Torque Strut Mount Front</p> <p>TOYOTA SPORT UTILITY ..... 2001-03</p>





# BUYER'S GUIDE

## NUMERICAL LISTING - ILLUSTRATIONS

 <p><b>EM-5208</b> <b>MOUNT-ENGINE</b> <b>L &amp; R Front</b></p> <p>TOYOTA SPORT UTILITY ..... 1981-82 TOYOTA TRUCK ..... 1981-82</p>	 <p><b>EM-5215</b> <b>MOUNT-ENGINE</b> <b>RH Front</b></p> <p>VOLVO PASSENGER CAR ..... 1993-04</p>	 <p><b>EM-5329</b> <b>RADIUS ARM BUSHING</b> <b>FRONT-LEFT</b></p> <p>HONDA PASSENGER CAR ..... 1992-93</p>	 <p><b>EM-5349</b> <b>MOUNT-ENGINE</b> <b>LH Rear</b></p> <p>CHRYSLER PASSENGER CAR ..... 2001-05 DODGE PASSENGER CAR ..... 2001-05 MITSUBISHI PASSENGER CAR ..... 1999-05</p>
 <p><b>EM-5209</b> <b>MOUNT-TRANSMISSION</b> <b>Auto</b></p> <p>TOYOTA SPORT UTILITY ..... 1996-97</p>	 <p><b>EM-5216</b> <b>MOUNT-TRANSMISSION</b></p> <p>VOLVO PASSENGER CAR ..... 1996-04</p>	 <p><b>EM-5332</b> <b>MOUNT-TRANSMISSION</b> <b>Manual</b></p> <p>INFINITI PASSENGER CAR ..... 1991-96 NISSAN PASSENGER CAR ..... 1992</p>	 <p><b>EM-5350</b> <b>MOUNT-ENGINE</b> <b>RH Front</b></p> <p>CHEVROLET TRUCK ..... 1994-03 GMC TRUCK ..... 1994-03 ISUZU TRUCK ..... 1996-00</p>
 <p><b>EM-5213</b> <b>MOUNT-TRANSMISSION</b></p> <p>VOLKSWAGEN VAN ..... 1982-03</p>	 <p><b>EM-5218</b> <b>MOUNT-ENGINE</b> <b>Rear</b></p> <p>BMW PASSENGER CAR ..... 1978-84</p>	 <p><b>EM-5335</b> <b>MOUNT-TRANSMISSION</b> <b>Auto</b></p> <p>TOYOTA PASSENGER CAR ..... 1983-86</p>	 <p><b>EM-5352</b> <b>MOUNT-ENGINE</b> <b>RH Front</b></p> <p>FORD PASSENGER CAR ..... 1998-00 MERCURY PASSENGER CAR ... 1998-02</p>
 <p><b>EM-5214</b> <b>MOUNT-TRANSMISSION</b></p> <p>VOLVO PASSENGER CAR ..... 1981-93</p>	 <p><b>EM-5326</b> <b>RADIUS ARM BUSHING</b> <b>FRONT-RIGHT</b></p> <p>HONDA PASSENGER CAR ..... 1992-93</p>	 <p><b>EM-5340</b> <b>MOUNT-ENGINE</b> <b>Front</b></p> <p>BMW PASSENGER CAR ..... 1988-91</p>	

# BUYER'S GUIDE

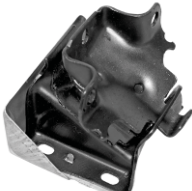
## NUMERICAL LISTING - ILLUSTRATIONS

 <p><b>EM-5353</b> <b>MOUNT-ENGINE</b> <b>L &amp; R Front</b></p> <p>CHEVROLET SPORT UTILITY ..... 2001-06            CHEVROLET TRUCK ..... 2001-07            GMC SPORT UTILITY ..... 2001-06            GMC TRUCK ..... 2001-07</p>	 <p><b>EM-5358</b> <b>MOUNT-ENGINE</b> <b>RH Front</b></p> <p>SUZUKI PASSENGER CAR ..... 1999-02</p>	 <p><b>EM-5370</b> <b>MOUNT-ENGINE</b> <b>L &amp; R Front</b></p> <p>TOYOTA SPORT UTILITY ..... 1975</p>	 <p><b>EM-5374</b> <b>MOUNT-ENGINE</b> <b>RH Front</b></p> <p>MERCEDES-BENZ PASSENGER CAR ..... 1988-91</p>
 <p><b>EM-5354</b> <b>MOUNT-ENGINE</b> <b>L &amp; R Front</b></p> <p>CHEVROLET VAN ..... 2003-12            GMC VAN ..... 2003-10</p>	 <p><b>EM-5359</b> <b>MOUNT-ENGINE</b> <b>RH Front</b></p> <p>SUZUKI PASSENGER CAR ..... 2004-07</p>	 <p><b>EM-5371</b> <b>MOUNT-ENGINE</b> <b>Front Center</b></p> <p>HONDA PASSENGER CAR ..... 1986-89</p>	 <p><b>EM-5375</b> <b>MOUNT-ENGINE</b> <b>RH Front</b></p> <p>MAZDA PASSENGER CAR ..... 2004-10</p>
 <p><b>EM-5356</b> <b>MOUNT-ENGINE</b> <b>RH Front</b></p> <p>TOYOTA VAN ..... 1998-03</p>	 <p><b>EM-5362</b> <b>MOUNT-ENGINE</b> <b>RH Front</b></p> <p>MAZDA PASSENGER CAR ..... 2004-09            MAZDA VAN ..... 2006-10</p>	 <p><b>EM-5372</b> <b>MOUNT-TRANSMISSION</b> <b>Auto</b></p> <p>SAAB PASSENGER CAR ..... 1994-02</p>	 <p><b>EM-5376</b> <b>MOUNT-ENGINE</b> <b>Right</b></p> <p>HONDA PASSENGER CAR ..... 2003-05</p>
 <p><b>EM-5367</b> <b>MOUNT-ENGINE</b> <b>L &amp; R Front</b></p> <p>LEXUS PASSENGER CAR ..... 1992-00</p>	 <p><b>EM-5373</b> <b>Engine Torque Strut Mount</b> <b>Rear</b></p> <p>SAAB PASSENGER CAR ..... 1986-98</p>	 <p><b>EM-5377</b> <b>MOUNT-ENGINE</b> <b>RH Front</b></p>	

(Continued Next Page)

# BUYER'S GUIDE

## NUMERICAL LISTING - ILLUSTRATIONS

### EM-5377 (Continued)

FORD TRUCK ..... 2001-11  
 MAZDA TRUCK ..... 2001-09



**EM-5378**  
**MOUNT-TRANSMISSION**  
 Rear

MAZDA PASSENGER CAR ..... 1983-87



**EM-5379**  
**MOUNT-TRANSMISSION**

ACURA PASSENGER CAR ..... 1987-90



**EM-5380**  
**MOUNT-TRANSMISSION**

FORD PASSENGER CAR ..... 1999-04



**EM-5381**  
**MOUNT-TRANSMISSION**  
 Front

FORD PASSENGER CAR ..... 1994-97



**EM-5382**  
**MOUNT-ENGINE**  
 Front

ACURA PASSENGER CAR ..... 1987-90  
 HONDA PASSENGER CAR ..... 1986-89



**EM-5383**  
**MOUNT-TRANSMISSION**  
 Manual

JEEP SPORT UTILITY ..... 1984-00



**EM-5384**  
**MOUNT-ENGINE**  
 Front

TOYOTA PASSENGER CAR ..... 2000-04



**EM-5385**  
**MOUNT-TRANSMISSION**  
 Manual

ACURA PASSENGER CAR ..... 1990-93



**EM-5387**  
**MOUNT-ENGINE**  
 RH Front

NISSAN PASSENGER CAR ..... 1982-86



**EM-5388**  
**MOUNT-ENGINE**  
 L & R Rear

BUICK PASSENGER CAR ..... 1977-78



**EM-5392**  
**MOUNT-TRANSMISSION**  
 Auto

CHEVROLET VAN ..... 1994-95



**EM-5394**  
**MOUNT-ENGINE**  
 L & R Front

MERCEDES-BENZ  
 PASSENGER CAR ..... 1996-97



**EM-5396**  
**MOUNT-ENGINE**  
 L & R Front

VOLVO PASSENGER CAR ..... 1992-98



**EM-5397**  
**MOUNT-ENGINE**  
 Front

SAAB PASSENGER CAR ..... 1981-88



**EM-5398**  
**Engine Torque Strut**  
 Front Right

HYUNDAI PASSENGER CAR ..... 1986-89  
 MITSUBISHI PASSENGER  
 CAR ..... 1987-89



**EM-5399**  
**MOUNT-ENGINE**  
 L & R Front

LEXUS PASSENGER CAR ..... 1993-97

# BUYER'S GUIDE

## NUMERICAL LISTING - ILLUSTRATIONS

 <p><b>EM-5400</b> <b>MOUNT-TRANSMISSION</b></p> <p>HONDA PASSENGER CAR ..... 1985-87</p>	 <p><b>EM-5405</b> <b>MOUNT-ENGINE</b> <b>Front</b></p> <p>NISSAN PASSENGER CAR ..... 2002-06</p>	 <p><b>EM-5411</b> <b>MOUNT-ENGINE</b> <b>Rear</b></p> <p>NISSAN PASSENGER CAR ..... 2002-03</p>	 <p><b>EM-5423</b> <b>MOUNT-ENGINE</b> <b>L &amp; R Front</b></p> <p>CHEVROLET SPORT UTILITY .... 2002-06 CHEVROLET TRUCK ..... 1999-07 GMC TRUCK ..... 1999-07</p>
 <p><b>EM-5401</b> <b>MOUNT-TRANSMISSION</b> <b>Manual</b></p> <p>JEEP SPORT UTILITY ..... 1959-71</p>	 <p><b>EM-5406</b> <b>MOUNT-TRANSMISSION</b></p> <p>INFINITI SPORT UTILITY ..... 2004-13 NISSAN SPORT UTILITY ..... 2004-13 NISSAN TRUCK ..... 2004-13 NISSAN VAN ..... 2012-13</p>	 <p><b>EM-5420</b> <b>MOUNT-ENGINE</b> <b>Rear</b></p> <p>CHRYSLER PASSENGER CAR ..... 1995-99</p>	 <p><b>EM-5424</b> <b>MOUNT-ENGINE</b> <b>LH Front</b></p> <p>FORD SPORT UTILITY ..... 2000-05 FORD TRUCK ..... 1999-04</p>
 <p><b>EM-5403</b> <b>MOUNT-TRANSMISSION</b></p> <p>LEXUS PASSENGER CAR ..... 1998-10</p>	 <p><b>EM-5407</b> <b>MOUNT-TRANSMISSION</b></p> <p>INFINITI SPORT UTILITY ..... 2004-13 NISSAN SPORT UTILITY ..... 2004-13 NISSAN TRUCK ..... 2004-13</p>	 <p><b>EM-5422</b> <b>MOUNT-TRANSMISSION</b> <b>LH Front</b></p> <p>CHEVROLET PASSENGER CAR ..... 2003-05 OLDSMOBILE PASSENGER CAR ..... 2002-04</p>	 <p><b>EM-5425</b> <b>MOUNT-ENGINE</b> <b>RH Front</b></p> <p>FORD SPORT UTILITY ..... 2000-05 FORD TRUCK ..... 1999-04</p>
 <p><b>EM-5404</b> <b>MOUNT-ENGINE</b> <b>L &amp; R Front</b></p> <p>INFINITI SPORT UTILITY ..... 2004-09 NISSAN SPORT UTILITY ..... 2004-10 NISSAN TRUCK ..... 2004-10</p>	<p><b>EM-5408</b> <b>MOUNT-TRANSMISSION</b></p> <p>INFINITI PASSENGER CAR ..... 2002-08 INFINITI SPORT UTILITY ..... 2003-08 NISSAN PASSENGER CAR ..... 2003-09</p>		



# BUYER'S GUIDE

## NUMERICAL LISTING - ILLUSTRATIONS



**EM-5426**  
**MOUNT-ENGINE**  
**LH Front**

CHEVROLET TRUCK ..... 1994-03  
GMC TRUCK ..... 1994-03  
ISUZU TRUCK ..... 1996-00



**EM-5432**  
**MOUNT-TRANSMISSION**

AUDI PASSENGER CAR ..... 1993-98



**EM-5439**  
**MOUNT-ENGINE**  
**Rear**

VOLVO PASSENGER CAR ..... 2000



**EM-5445**  
**MOUNT-ENGINE**  
**RH Rear**

VOLKSWAGEN PASSENGER CAR ..... 1993-97



**EM-5427**  
**MOUNT-ENGINE**  
**RH Front**

FORD PASSENGER CAR ..... 2008-12  
FORD SPORT UTILITY ..... 2007-14  
LINCOLN PASSENGER CAR ..... 2009-13  
LINCOLN SPORT UTILITY ..... 2007-13  
MERCURY PASSENGER CAR ..... 2008-09



**EM-5434**  
**MOUNT-ENGINE**  
**L & R Front**

MERCEDES-BENZ PASSENGER CAR ..... 2000-09



**EM-5440**  
**MOUNT-ENGINE**  
**LH Front**

FORD VAN ..... 1986-97



**EM-5446**  
**MOUNT-ENGINE**  
**Front**

VOLKSWAGEN VAN ..... 1992-97



**EM-5428**  
**MOUNT-TRANSMISSION**

JEEP SPORT UTILITY ..... 2000-01



**EM-5436**  
**MOUNT-ENGINE**  
**LH Front**

SAAB PASSENGER CAR ..... 1999-01



**EM-5441**  
**MOUNT-ENGINE**  
**Rear**

NISSAN SPORT UTILITY ..... 2003-07



**EM-5448**  
**MOUNT-ENGINE**  
**RH Front**

TOYOTA PASSENGER CAR ..... 1981-84



**EM-5437**  
**Engine Torque Strut Mount**  
**Rear**

SAAB PASSENGER CAR ..... 1999



**EM-5449**  
**MOUNT-TRANSMISSION**  
**Auto**

HONDA PASSENGER CAR ..... 1996-00

# BUYER'S GUIDE

## NUMERICAL LISTING - ILLUSTRATIONS

 <p style="text-align: center;"><b>EM-5450</b> <b>MOUNT-TRANSMISSION</b> <b>LH Rear</b></p> <p>OLDSMOBILE PASSENGER CAR ..... 1974-78</p>	 <p style="text-align: center;"><b>EM-5454</b> <b>MOUNT-ENGINE</b> <b>RH Front</b></p> <p>TOYOTA PASSENGER CAR ..... 1967-76</p>	 <p style="text-align: center;"><b>EM-5458</b> <b>MOUNT-TRANSMISSION</b> <b>LH Rear</b></p> <p>SUZUKI TRUCK ..... 1987-88</p>	 <p style="text-align: center;"><b>EM-5464</b> <b>MOUNT-ENGINE</b> <b>Front</b></p> <p>TOYOTA SPORT UTILITY ..... 2001-05</p>
 <p style="text-align: center;"><b>EM-5452</b> <b>MOUNT-TRANSMISSION</b> <b>Manual</b></p> <p>CHRYSLER PASSENGER CAR ..... 2003-04 DODGE PASSENGER CAR ..... 2001-05 MITSUBISHI PASSENGER CAR ..... 2000-05</p>	 <p style="text-align: center;"><b>EM-5455</b> <b>MOUNT-ENGINE</b> <b>LH Front</b></p> <p>TOYOTA PASSENGER CAR ..... 1967-76</p>	 <p style="text-align: center;"><b>EM-5459</b> <b>MOUNT-ENGINE</b> <b>Rear</b></p> <p>VOLVO PASSENGER CAR ..... 1970-75</p>	 <p style="text-align: center;"><b>EM-5465</b> <b>MOUNT-ENGINE</b> <b>Front</b></p> <p>FORD PASSENGER CAR ..... 1949-52 FORD TRUCK ..... 1949-50</p>
 <p style="text-align: center;"><b>EM-5453</b> <b>Engine Torque Strut</b> <b>Front Right</b></p> <p>HYUNDAI PASSENGER CAR ..... 1986-89 MITSUBISHI PASSENGER CAR ..... 1987-89</p>	 <p style="text-align: center;"><b>EM-5456</b> <b>MOUNT-TRANSMISSION</b></p> <p>TOYOTA PASSENGER CAR ..... 1967-76</p>	 <p style="text-align: center;"><b>EM-5460</b> <b>MOUNT-ENGINE</b> <b>RH Front</b></p> <p>SAAB PASSENGER CAR ..... 1981-88</p>	 <p style="text-align: center;"><b>EM-5467</b> <b>MOUNT-ENGINE</b> <b>L &amp; R Front</b></p> <p>TOYOTA PASSENGER CAR ..... 1993-95</p>
 <p style="text-align: center;"><b>EM-5457</b> <b>MOUNT-TRANSMISSION</b> <b>LH</b></p> <p>SUZUKI PASSENGER CAR ..... 1985</p>	 <p style="text-align: center;"><b>EM-5461</b> <b>MOUNT-ENGINE</b> <b>Front</b></p> <p>SAAB PASSENGER CAR ..... 1990-94</p>	 <p style="text-align: center;"><b>EM-5462</b> <b>MOUNT-ENGINE</b> <b>RH Front</b></p> <p>SAAB PASSENGER CAR ..... 1990-94</p>	 <p style="text-align: center;"><b>EM-5468</b> <b>MOUNT-ENGINE</b> <b>RH Front</b></p> <p>INFINITI PASSENGER CAR ..... 1991-96</p>

# BUYER'S GUIDE

## NUMERICAL LISTING - ILLUSTRATIONS



**EM-5471**  
**MOUNT-ENGINE**  
Rear

ACURA PASSENGER CAR ..... 1997-99  
HONDA PASSENGER CAR ..... 1995-97



**EM-5481**  
**MOUNT-TRANSMISSION**  
Manual

NISSAN PASSENGER CAR ..... 1987-89  
NISSAN VAN ..... 1987-88



**EM-5485**  
**MOUNT-ENGINE**  
Center Front

AUDI PASSENGER CAR ..... 1988-05



**EM-5490**  
**MOUNT-ENGINE**  
Front

SAAB PASSENGER CAR ..... 1990-98



**EM-5473**  
**MOUNT-ENGINE**  
LH Front

TOYOTA PASSENGER CAR ..... 1971-79



**EM-5482**  
**MOUNT-TRANSMISSION**

KIA VAN ..... 2002-05

VOLKSWAGEN PASSENGER  
CAR ..... 1998-05



**EM-5487**  
**MOUNT-TRANSMISSION**

VOLVO PASSENGER CAR ..... 1994-97



**EM-5491**  
**MOUNT-ENGINE**  
L & R Front

BMW PASSENGER CAR ..... 1978-82



**EM-5475**  
**MOUNT-TRANSMISSION**  
Upper

CHEVROLET SPORT UTILITY .... 2005-06  
PONTIAC SPORT UTILITY ..... 2006



**EM-5483**  
**MOUNT-TRANSMISSION**  
Front

SUZUKI TRUCK ..... 1987-88



**EM-5488**  
**MOUNT-TRANSMISSION**

SAAB PASSENGER CAR ..... 1981-88



**EM-5492**  
**MOUNT-ENGINE**  
RH Front

SAAB PASSENGER CAR ..... 1994-03



**EM-5476**  
**MOUNT-ENGINE**  
L & R Front

CHRYSLER PASSENGER  
CAR ..... 1974-78  
DODGE PASSENGER CAR ..... 1974-78



**EM-5484**  
**MOUNT-ENGINE**  
Rear

VOLKSWAGEN VAN ..... 1982-84



**EM-5489**  
**MOUNT-TRANSMISSION**  
Auto

SAAB PASSENGER CAR ..... 1986-98



**EM-5493**  
**MOUNT-ENGINE**  
Lower Rear

VOLVO SPORT UTILITY ..... 2003-06

# BUYER'S GUIDE

## NUMERICAL LISTING - ILLUSTRATIONS

 <p><b>EM-5494</b> <b>MOUNT-ENGINE</b> <b>Front</b></p> <p>VOLVO PASSENGER CAR ..... 2001-04</p>	 <p><b>EM-5502</b> <b>MOUNT-ENGINE</b> <b>RH Front</b></p> <p>NISSAN PASSENGER CAR ..... 1993-99</p>	 <p><b>EM-5518</b> <b>MOUNT-ENGINE</b> <b>RH Rear</b></p> <p>VOLVO PASSENGER CAR ..... 2000</p>	 <p><b>EM-5528</b> <b>MOUNT-ENGINE</b> <b>Front Upper</b></p> <p>VOLVO PASSENGER CAR ..... 1998-09 VOLVO SPORT UTILITY ..... 2003-06</p>
 <p><b>EM-5495</b> <b>MOUNT-ENGINE</b> <b>Front</b></p> <p>VOLVO PASSENGER CAR ..... 2000-04</p>	 <p><b>EM-5510</b> <b>MOUNT-ENGINE</b> <b>LH Front</b></p> <p>HONDA PASSENGER CAR ..... 1989-91</p>	 <p><b>EM-5521</b> <b>MOUNT-ENGINE</b> <b>Front</b></p> <p>FORD PASSENGER CAR ..... 1998-00 MERCURY PASSENGER CAR ... 1998-00</p>	 <p><b>EM-5530</b> <b>Engine Torque Strut Mount</b> <b>Lower</b></p> <p>VOLVO PASSENGER CAR ..... 2001-09 VOLVO SPORT UTILITY ..... 2003-06</p>
 <p><b>EM-5500</b> <b>MOUNT-ENGINE</b> <b>LH Front</b></p> <p>NISSAN PASSENGER CAR ..... 1986-89 NISSAN VAN ..... 1987-88</p>	 <p><b>EM-5515</b> <b>MOUNT-TRANSMISSION</b> <b>Manual</b></p> <p>SUBARU PASSENGER CAR ..... 1990-14 SUBARU SPORT UTILITY ..... 1998-14</p>	 <p><b>EM-5526</b> <b>MOUNT-ENGINE</b> <b>Right</b></p> <p>KIA VAN ..... 2002-05</p>	 <p><b>EM-5533</b> <b>MOUNT-ENGINE</b> <b>RH Rear</b></p> <p>HYUNDAI PASSENGER CAR ..... 2003-08</p>
 <p><b>EM-5501</b> <b>MOUNT-TRANSMISSION</b> <b>Manual</b></p> <p>NISSAN PASSENGER CAR ..... 1987-88</p>	 <p><b>EM-5517</b> <b>MOUNT-ENGINE</b> <b>LH Front</b></p> <p>AUDI PASSENGER CAR ..... 2002-08</p>	 <p><b>EM-5527</b> <b>MOUNT-ENGINE</b> <b>RH Front</b></p> <p>VOLKSWAGEN VAN ..... 1992-03</p>	 <p><b>EM-5551</b> <b>MOUNT-ENGINE</b> <b>LH Front</b></p> <p>FORD VAN ..... 2004-10</p>

# BUYER'S GUIDE

## NUMERICAL LISTING - ILLUSTRATIONS



**EM-5553**  
**MOUNT-ENGINE**  
**RH Front**

VOLVO PASSENGER CAR ..... 1999-05  
VOLVO SPORT UTILITY ..... 2003-05



**EM-5554**  
**MOUNT-TRANSMISSION**  
**Manual**

TOYOTA PASSENGER CAR ..... 2002-03



**EM-5556**  
**MOUNT-TRANSMISSION**  
**Manual**

NISSAN SPORT UTILITY ..... 2000-04  
NISSAN TRUCK ..... 2000-04



**EM-5561**  
**MOUNT-ENGINE**  
**Rear**

NISSAN PASSENGER CAR ..... 1990-96

**EM-5563**  
**MOUNT-TRANSMISSION**  
MAZDA PASSENGER CAR ..... 1988-89



**EM-5574**  
**MOUNT-TRANSMISSION**

MITSUBISHI PASSENGER  
CAR ..... 1992-93



**EM-5575**  
**MOUNT-ENGINE**  
**Rear**

MITSUBISHI PASSENGER  
CAR ..... 1997-98



**EM-5578**  
**MOUNT-ENGINE**  
**RH Front**

FORD VAN ..... 2004-10



**EM-5582**  
**MOUNT-ENGINE**  
**RH Front**

CHEVROLET TRUCK ..... 2001-10

**MOUNT-ENGINE**  
**Left**

GMC TRUCK ..... 2001-10



**EM-5583**  
**MOUNT-ENGINE**  
**L & R Front**

CADILLAC SPORT UTILITY ..... 2007-14  
CHEVROLET SPORT UTILITY ... 2007-14  
CHEVROLET TRUCK ..... 2007-12  
GMC SPORT UTILITY ..... 2007-14  
GMC TRUCK ..... 2007-13



**EM-5587**  
**MOUNT-TRANSMISSION**

CHRYSLER PASSENGER  
CAR ..... 2005-10  
DODGE PASSENGER CAR ..... 2005-10



**EM-5588**  
**MOUNT-ENGINE**  
**L & R Front**

CHRYSLER PASSENGER  
CAR ..... 2005-10  
DODGE PASSENGER CAR ..... 2005-10



**EM-5589**  
**MOUNT-ENGINE**  
**L & R Front**

CHRYSLER PASSENGER  
CAR ..... 2005-10  
DODGE PASSENGER CAR ..... 2005-10



**EM-5591**  
**MOUNT-ENGINE**  
**LH Front**

CHEVROLET PASSENGER  
CAR ..... 1989-91  
GEO PASSENGER CAR ..... 1989-94  
PONTIAC PASSENGER CAR ..... 1989-94



**EM-5596**  
**MOUNT-ENGINE**  
**Front**

FORD PASSENGER CAR ..... 1995-97  
MERCURY PASSENGER CAR ... 1995-97

# BUYER'S GUIDE

## NUMERICAL LISTING - ILLUSTRATIONS

 <p style="text-align: center;"><b>EM-5597</b> <b>MOUNT-ENGINE</b> <b>LH Front</b></p> <p>SUBARU PASSENGER CAR ..... 1995</p> <p style="text-align: center;"><b>MOUNT-ENGINE</b> <b>Rear</b></p> <p>SUBARU PASSENGER CAR ..... 1990-95</p> <p style="text-align: center;"><b>MOUNT-TRANSMISSION</b> <b>Manual</b></p> <p>SUBARU PASSENGER CAR ..... 1992-95</p>	 <p style="text-align: center;"><b>EM-5601</b> <b>MOUNT-ENGINE</b> <b>LH Front</b></p> <p>SUBARU PASSENGER CAR ..... 1990-94</p>	<p><b>EM-5608 (Continued)</b></p> <p>PONTIAC PASSENGER CAR ..... 1994-00</p>  <p style="text-align: center;"><b>EM-5609</b> <b>MOUNT-TRANSMISSION</b> <b>Auto</b></p> <p>HONDA SPORT UTILITY ..... 1998-02</p> <p style="text-align: center;"><b>MOUNT-TRANSMISSION</b></p> <p>ISUZU SPORT UTILITY ..... 1998-04</p>	 <p style="text-align: center;"><b>EM-5616</b> <b>MOUNT-ENGINE</b> <b>Rear Upper</b></p> <p>VOLVO PASSENGER CAR ..... 2009</p>
 <p style="text-align: center;"><b>EM-5598</b> <b>MOUNT-ENGINE</b> <b>Front</b></p> <p>SUBARU PASSENGER CAR ..... 1990-93</p> <p style="text-align: center;"><b>EM-5599</b> <b>MOUNT-TRANSMISSION</b> <b>Auto</b></p> <p>SUBARU PASSENGER CAR ..... 1985-91</p>	 <p style="text-align: center;"><b>EM-5602</b> <b>Engine Torque Strut Mount</b> <b>Front</b></p> <p>SUBARU PASSENGER CAR ..... 1985-94</p>	 <p style="text-align: center;"><b>EM-5610</b> <b>MOUNT-TRANSMISSION</b> <b>Manual</b></p> <p>HONDA SPORT UTILITY ..... 1998-02</p> <p>ISUZU SPORT UTILITY ..... 1998-04</p>	 <p style="text-align: center;"><b>EM-5617</b> <b>MOUNT-ENGINE</b> <b>RH Front</b></p> <p>SAAB PASSENGER CAR ..... 1994-03</p>
 <p style="text-align: center;"><b>EM-5600</b> <b>MOUNT-ENGINE</b> <b>RH Front</b></p> <p>SUBARU PASSENGER CAR ..... 1990-95</p>	 <p style="text-align: center;"><b>EM-5603</b> <b>Engine Torque Strut Mount</b> <b>Front</b></p> <p>SUBARU PASSENGER CAR ..... 1985-94</p> <p>SUBARU SPORT UTILITY ..... 1982-04</p>	 <p style="text-align: center;"><b>EM-5612</b> <b>MOUNT-ENGINE</b> <b>Front</b></p> <p>SEAT ..... 2000-02</p> <p>VOLKSWAGEN PASSENGER CAR ..... 1984-97</p>	 <p style="text-align: center;"><b>EM-5645</b> <b>MOUNT-TRANSMISSION</b> <b>Center</b></p> <p>SATURN PASSENGER CAR ..... 2003-04</p>
 <p style="text-align: center;"><b>EM-5608</b> <b>MOUNT-ENGINE</b> <b>Front</b></p> <p>CHEVROLET PASSENGER CAR ..... 1998-01</p> <p>GEO PASSENGER CAR ..... 1992-97</p> <p style="text-align: center;"><b>(Continued Next Column)</b></p>	 <p style="text-align: center;"><b>EM-5646</b> <b>MOUNT-ENGINE</b> <b>L &amp; R Front</b></p> <p>TOYOTA SPORT UTILITY ..... 2001-07</p> <p>TOYOTA TRUCK ..... 2000-07</p>		

# BUYER'S GUIDE

## NUMERICAL LISTING - ILLUSTRATIONS



**EM-5647**  
**MOUNT-TRANSMISSION**

TOYOTA PASSENGER CAR ..... 2004-09



**EM-5655**  
**MOUNT-ENGINE**  
**Rear**

INFINITI PASSENGER CAR ..... 2000-04



**EM-5659**  
**MOUNT-TRANSMISSION**  
**Front**

CHEVROLET PASSENGER CAR ..... 2004-08  
PONTIAC PASSENGER CAR ..... 2005-07

**MOUNT-TRANSMISSION**  
**LH Front**

SATURN PASSENGER CAR ..... 2007

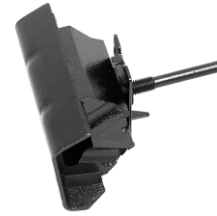

**EM-5663**  
**MOUNT-TRANSMISSION**

CHEVROLET VAN ..... 2006-09  
GMC VAN ..... 2006-09



**EM-5649**  
**MOUNT-ENGINE**  
**L & R Front**

LEXUS SPORT UTILITY ..... 2003-09  
TOYOTA SPORT UTILITY ..... 2003-09



**EM-5656**  
**MOUNT-ENGINE**  
**RH Front**

NISSAN PASSENGER CAR ..... 2007-12

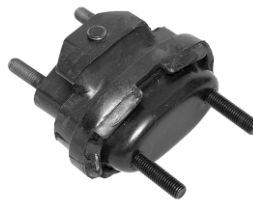

**EM-5660**  
**MOUNT-TRANSMISSION**  
**L & R**

CADILLAC PASSENGER CAR ..... 2004-09

**MOUNT-TRANSMISSION**

CHEVROLET PASSENGER CAR ..... 2005-10



**EM-5664**  
**MOUNT-TRANSMISSION**

CADILLAC SPORT UTILITY ..... 2007-09



**EM-5653**  
**MOUNT-ENGINE**  
**L & R Front**

TOYOTA PASSENGER CAR ..... 1990-92



**EM-5657**  
**MOUNT-TRANSMISSION**  
**Manual**

NISSAN PASSENGER CAR ..... 2000-06



**EM-5665**  
**MOUNT-TRANSMISSION**

CADILLAC PASSENGER CAR ..... 2006-09

**EM-5669**  
**MOUNT-ENGINE**  
**RH Front**

VOLVO PASSENGER CAR ..... 1983-85



**EM-5654**  
**MOUNT-ENGINE**  
**RH Front**

TOYOTA PASSENGER CAR ..... 2007-14



**EM-5658**  
**MOUNT-ENGINE**  
**Front**

MAZDA PASSENGER CAR ..... 1992-95

**EM-5661**  
**MOUNT-TRANSMISSION**

BUICK PASSENGER CAR ..... 2008-09  
CHEVROLET PASSENGER CAR ..... 2006-09  
PONTIAC PASSENGER CAR ..... 2005-08

**EM-5662**  
**MOUNT-TRANSMISSION**

CADILLAC SPORT UTILITY ..... 2004-09



**EM-5670**  
**MOUNT-ENGINE**  
**Front**

INFINITI PASSENGER CAR ..... 1996-04

(Continued Next Page)

# BUYER'S GUIDE

## NUMERICAL LISTING - ILLUSTRATIONS

**EM-5670 (Continued)**

NISSAN PASSENGER CAR ..... 1996-03



**EM-5672**  
**MOUNT-ENGINE**  
**Front**

NISSAN PASSENGER CAR ..... 2002-08  
NISSAN SPORT UTILITY ..... 2003-07  
NISSAN VAN ..... 2004-09

**EM-5673**  
**MOUNT-ENGINE**  
**L & R Front**

CHEVROLET PASSENGER  
CAR ..... 2009-10



**EM-5674**  
**MOUNT-ENGINE**  
**L & R Front**

CHEVROLET PASSENGER  
CAR ..... 2005-10



**EM-5675**  
**MOUNT-ENGINE**  
**Center Front**

AUDI PASSENGER CAR ..... 1992-97



**EM-5689**  
**Engine Torque Strut Mount**  
**Upper**

HONDA PASSENGER CAR ..... 2006-11



**EM-5692**  
**MOUNT-ENGINE**  
**Front Lower**

CHRYSLER PASSENGER  
CAR ..... 2003-09  
DODGE PASSENGER CAR ..... 2003-05



**EM-5693**  
**MOUNT-ENGINE**  
**RH Front**

BUICK SPORT UTILITY ..... 2004-07  
CHEVROLET SPORT UTILITY ..... 2005-08  
GMC SPORT UTILITY ..... 2005-09  
SAAB SUV ..... 2005-09



**EM-5694**  
**MOUNT-ENGINE**  
**LH Front**

BUICK SPORT UTILITY ..... 2004-07  
CHEVROLET SPORT UTILITY ..... 2005-08  
GMC SPORT UTILITY ..... 2005-09  
SAAB SUV ..... 2005-09



**EM-5732**  
**MOUNT-ENGINE**  
**LH Front**

FORD TRUCK ..... 1997-04



**EM-5733**  
**MOUNT-ENGINE**  
**RH Front**

CHEVROLET PASSENGER  
CAR ..... 1989-91  
GEO PASSENGER CAR ..... 1989-91  
PONTIAC PASSENGER CAR ..... 1989-91



**EM-5734**  
**MOUNT-ENGINE**  
**L & R Front**

MERCEDES-BENZ  
PASSENGER CAR ..... 2003-05



**EM-5736**  
**MOUNT-TRANSMISSION**  
**Manual**

TOYOTA PASSENGER CAR ..... 1995-99



**EM-5737**  
**MOUNT-TRANSMISSION**  
**Manual**

MERCEDES-BENZ  
PASSENGER CAR ..... 1998-99

**EM-5738**  
**MOUNT-TRANSMISSION**  
**Front**

KIA PASSENGER CAR ..... 2001-05



# BUYER'S GUIDE

## NUMERICAL LISTING - ILLUSTRATIONS



**EM-5739**  
Engine Torque Strut Mount  
Front

MITSUBISHI PASSENGER  
CAR ..... 1983-88



**EM-5741**  
MOUNT-ENGINE  
Rear

TOYOTA SPORT UTILITY ..... 2001-07  
TOYOTA VAN ..... 2004-10



**EM-5742**  
MOUNT-ENGINE  
LH Front

TOYOTA PASSENGER CAR ..... 2007-15

**EM-5743**  
MOUNT-ENGINE  
RH Front

TOYOTA PASSENGER CAR ..... 1990-93



**EM-5744**  
MOUNT-TRANSMISSION  
Front

ACURA PASSENGER CAR ..... 2004-08



**EM-5746 (NEW)**  
MOUNT-TRANSMISSION

CHEVROLET PASSENGER  
CAR ..... 2008-09



**EM-5747 (NEW)**  
MOUNT-ENGINE  
Rear

VOLVO PASSENGER CAR ..... 1998-00

**MOUNT-TRANSMISSION**

VOLVO PASSENGER CAR ..... 1998-00



**EM-5748 (NEW)**  
MOUNT-ENGINE  
Rear

(Continued Next Column)

**EM-5748 (Continued)**

NISSAN PASSENGER CAR ..... 2004-08



**EM-5749 (NEW)**  
MOUNT-ENGINE  
Rear

TOYOTA VAN ..... 1987-89



**EM-5750 (NEW)**  
Engine Torque Strut  
Front Right

TOYOTA PASSENGER CAR ..... 2007-11



**EM-5751 (NEW)**  
MOUNT-ENGINE  
Front

TOYOTA PASSENGER CAR ..... 1991-95

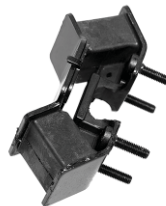

**EM-5752 (NEW)**  
MOUNT-TRANSMISSION  
Auto

TOYOTA PASSENGER CAR ..... 1993-98

**EM-5753 (NEW)**  
MOUNT-ENGINE  
Front

TOYOTA PASSENGER CAR ..... 1994-99



**EM-5754 (NEW)**  
MOUNT-ENGINE  
L & R Front

TOYOTA TRUCK ..... 2005-06



**EM-5755 (NEW)**  
MOUNT-ENGINE  
Rear

TOYOTA SPORT UTILITY ..... 2001-03



**EM-5756 (NEW)**  
MOUNT-ENGINE  
RH Front

TOYOTA PASSENGER CAR ..... 1991-95

# BUYER'S GUIDE

## NUMERICAL LISTING - ILLUSTRATIONS

 <p style="text-align: center;"><b>EM-5757 (NEW)</b> <b>MOUNT-TRANSMISSION</b> <b>Manual</b></p> <p>TOYOTA PASSENGER CAR ..... 2002-11</p>	 <p style="text-align: center;"><b>EM-5762 (NEW)</b> <b>MOUNT-ENGINE</b> <b>RH Front</b></p> <p>TOYOTA PASSENGER CAR ..... 1988-89</p>	 <p style="text-align: center;"><b>EM-5767 (NEW)</b> <b>MOUNT-ENGINE</b> <b>Front</b></p> <p>TOYOTA PASSENGER CAR ..... 1991-95</p>	 <p style="text-align: center;"><b>EM-5771 (NEW)</b> <b>MOUNT-TRANSMISSION</b> <b>Auto</b></p> <p>NISSAN PASSENGER CAR ..... 1991-92</p>
 <p style="text-align: center;"><b>EM-5758 (NEW)</b> <b>Engine Torque Strut Mount</b> <b>Front</b></p> <p>TOYOTA PASSENGER CAR ..... 2000-03</p>	 <p style="text-align: center;"><b>EM-5763 (NEW)</b> <b>MOUNT-ENGINE</b> <b>RH Front</b></p> <p>TOYOTA PASSENGER CAR ..... 1990-93</p>	 <p style="text-align: center;"><b>EM-5768 (NEW)</b> <b>MOUNT-TRANSMISSION</b> <b>Manual</b></p> <p>LEXUS PASSENGER CAR ..... 1992-97</p>	 <p style="text-align: center;"><b>EM-5772 (NEW)</b> <b>MOUNT-ENGINE</b> <b>Front</b></p> <p>NISSAN PASSENGER CAR ..... 2002-06</p>
 <p style="text-align: center;"><b>EM-5759 (NEW)</b> <b>MOUNT-ENGINE</b> <b>RH Front</b></p> <p>TOYOTA PASSENGER CAR ..... 2000-05</p>	 <p style="text-align: center;"><b>EM-5764 (NEW)</b> <b>MOUNT-ENGINE</b> <b>L &amp; R Front</b></p> <p>TOYOTA PASSENGER CAR ..... 1995-98</p>	 <p style="text-align: center;"><b>EM-5769 (NEW)</b> <b>MOUNT-TRANSMISSION</b> <b>Auto</b></p> <p>LEXUS PASSENGER CAR ..... 1992-00 TOYOTA PASSENGER CAR ..... 1993-98</p>	 <p style="text-align: center;"><b>EM-5773 (NEW)</b> <b>MOUNT-ENGINE</b> <b>RH Front</b></p> <p>NISSAN PASSENGER CAR ..... 2002-06</p>
 <p style="text-align: center;"><b>EM-5761 (NEW)</b> <b>MOUNT-ENGINE</b> <b>Right</b></p> <p>TOYOTA PASSENGER CAR ..... 1990-92</p>	 <p style="text-align: center;"><b>EM-5766 (NEW)</b> <b>MOUNT-ENGINE</b> <b>Right</b></p> <p>TOYOTA SPORT UTILITY ..... 2001-03</p>	 <p style="text-align: center;"><b>EM-5770 (NEW)</b> <b>MOUNT-TRANSMISSION</b> <b>Auto</b></p> <p>NISSAN PASSENGER CAR ..... 1990-92</p>	 <p style="text-align: center;"><b>EM-5774 (NEW)</b> <b>MOUNT-ENGINE</b> <b>Rear</b></p> <p>INFINITI PASSENGER CAR ..... 1998-99</p>

# BUYER'S GUIDE

## NUMERICAL LISTING - ILLUSTRATIONS



**EM-5775 (NEW)**  
MOUNT-TRANSMISSION  
Manual

NISSAN PASSENGER CAR ..... 2002-06



**EM-5779 (NEW)**  
MOUNT-ENGINE  
LH Rear

NISSAN PASSENGER CAR ..... 1989-94



**EM-5783 (NEW)**  
MOUNT-ENGINE  
Rear

MAZDA VAN ..... 2006-10  
**Engine Torque Strut Mount**

MAZDA PASSENGER CAR ..... 2004-13



**EM-5787 (NEW)**  
MOUNT-ENGINE  
Right

ACURA PASSENGER CAR ..... 2004-08  
HONDA PASSENGER CAR ..... 2003-07



**EM-5776 (NEW)**  
MOUNT-ENGINE  
LH Front

INFINITI PASSENGER CAR ..... 2004-06  
INFINITI SPORT UTILITY ..... 2003-08

**EM-5777 (NEW)**  
MOUNT-ENGINE  
LH Rear

NISSAN PASSENGER CAR ..... 1992-94



**EM-5780 (NEW)**  
MOUNT-TRANSMISSION  
RH

NISSAN TRUCK ..... 1986-89



**EM-5784 (NEW)**  
MOUNT-TRANSMISSION  
Upper

ACURA PASSENGER CAR ..... 2009-12  
**MOUNT-TRANSMISSION**

HONDA PASSENGER CAR ..... 2008-12



**EM-5789 (NEW)**  
MOUNT-ENGINE  
Front

ACURA PASSENGER CAR ..... 2006-08



**EM-5778 (NEW)**  
MOUNT-TRANSMISSION  
RH

NISSAN SPORT UTILITY ..... 1989  
NISSAN TRUCK ..... 1986-89



**EM-5781 (NEW)**  
MOUNT-ENGINE  
RH Front

NISSAN PASSENGER CAR ..... 2009-11



**EM-5785 (NEW)**  
Engine Torque Strut Mount  
Rear

HONDA PASSENGER CAR ..... 2009-13



**EM-5792 (NEW)**  
Engine Torque Strut Mount  
Rear

HONDA PASSENGER CAR ..... 2009-13



**EM-5782 (NEW)**  
MOUNT-ENGINE  
RH Front

NISSAN PASSENGER CAR ..... 2007-10



**EM-5786 (NEW)**  
MOUNT-ENGINE  
L & R Front

HONDA PASSENGER CAR ..... 2000-09



**EM-5793 (NEW)**  
MOUNT-ENGINE  
Front

HONDA PASSENGER CAR ..... 2008-13  
HONDA VAN ..... 2008-10

# BUYER'S GUIDE

## NUMERICAL LISTING - ILLUSTRATIONS

 <p><b>EM-5794 (NEW)</b> <b>MOUNT-TRANSMISSION</b> Auto</p> <p>ACURA PASSENGER CAR ..... 2001-05 HONDA PASSENGER CAR ..... 2001-05</p>	 <p><b>EM-5798 (NEW)</b> <b>MOUNT-ENGINE</b> Right</p> <p>MITSUBISHI SPORT UTILITY ..... 2003-06</p>	 <p><b>EM-5802 (NEW)</b> <b>MOUNT-ENGINE</b> Right</p> <p>TOYOTA PASSENGER CAR ..... 1991-95</p>	 <p><b>EM-5808 (NEW)</b> <b>MOUNT-TRANSMISSION</b></p> <p>TOYOTA SPORT UTILITY ..... 2001-04</p>
 <p><b>EM-5795 (NEW)</b> <b>MOUNT-ENGINE</b> Rear</p> <p>HONDA VAN ..... 2005-07</p>	 <p><b>EM-5799 (NEW)</b> <b>MOUNT-ENGINE</b> Front</p> <p>TOYOTA PASSENGER CAR ..... 1991-95</p>	 <p><b>EM-5804 (NEW)</b> <b>MOUNT-ENGINE</b> Front</p> <p>LEXUS PASSENGER CAR ..... 1999-01</p>	 <p><b>EM-5809 (NEW)</b> <b>MOUNT-TRANSMISSION</b></p> <p>LEXUS PASSENGER CAR ..... 1999-01</p> <p><b>EM-5810 (NEW)</b> <b>MOUNT-TRANSMISSION</b> Auto</p> <p>TOYOTA PASSENGER CAR ..... 1988</p>
 <p><b>EM-5796 (NEW)</b> <b>MOUNT-ENGINE</b> Front</p> <p>MITSUBISHI SPORT UTILITY ..... 2003-06</p>	 <p><b>EM-5800 (NEW)</b> <b>MOUNT-ENGINE</b> Front</p> <p>LEXUS SPORT UTILITY ..... 2004-06</p>	 <p><b>EM-5805 (NEW)</b> <b>MOUNT-ENGINE</b> RH Front</p> <p>TOYOTA PASSENGER CAR ..... 1991-95</p>	 <p><b>EM-5812 (NEW)</b> <b>MOUNT-ENGINE</b> RH Front</p> <p>ISUZU SPORT UTILITY ..... 1998-03</p>
 <p><b>EM-5797 (NEW)</b> <b>MOUNT-TRANSMISSION</b></p> <p>MITSUBISHI SPORT UTILITY ..... 2003-06</p>	 <p><b>EM-5801 (NEW)</b> <b>MOUNT-TRANSMISSION</b> Manual</p> <p>LEXUS PASSENGER CAR ..... 2002-05</p>	 <p><b>EM-5807 (NEW)</b> <b>MOUNT-TRANSMISSION</b></p> <p>TOYOTA SPORT UTILITY ..... 2001-04</p>	 <p><b>EM-5813 (NEW)</b> <b>MOUNT-ENGINE</b> LH Front</p> <p>HONDA SPORT UTILITY ..... 2001-02 ISUZU SPORT UTILITY ..... 2001-04</p>

# BUYER'S GUIDE

## NUMERICAL LISTING - ILLUSTRATIONS

 <p><b>EM-5814 (NEW)</b> <b>MOUNT-ENGINE</b> <b>RH Front</b></p> <p>HONDA SPORT UTILITY ..... 1998-00 ISUZU SPORT UTILITY ..... 1998-00</p>	 <p><b>EM-5819 (NEW)</b> <b>MOUNT-ENGINE</b> <b>RH Front</b></p> <p>TOYOTA PASSENGER CAR ..... 1994-97</p>	 <p><b>EM-5834 (NEW)</b> <b>Engine Torque Strut</b> <b>Front Right</b></p> <p>TOYOTA PASSENGER CAR ..... 2007-14</p>	 <p><b>EM-5844 (NEW)</b> <b>MOUNT-ENGINE</b> <b>RH Rear</b></p> <p>MINI ..... 2002-06</p>
 <p><b>EM-5815 (NEW)</b> <b>MOUNT-TRANSMISSION</b></p> <p>NISSAN PASSENGER CAR ..... 1976-78</p>	 <p><b>EM-5825 (NEW)</b> <b>MOUNT-TRANSMISSION</b> <b>Auto</b></p> <p>MITSUBISHI PASSENGER CAR ..... 2002-06</p>	 <p><b>EM-5835 (NEW)</b> <b>Engine Torque Strut Mount</b> <b>Front</b></p> <p>TOYOTA VAN ..... 2004-06</p>	 <p><b>EM-5846 (NEW)</b> <b>MOUNT-ENGINE</b> <b>Rear</b></p> <p>NISSAN PASSENGER CAR ..... 2000-01</p>
 <p><b>EM-5817 (NEW)</b> <b>MOUNT-TRANSMISSION</b> <b>Auto</b></p> <p>NISSAN PASSENGER CAR ..... 2002-06</p>	 <p><b>EM-5827 (NEW)</b> <b>MOUNT-TRANSMISSION</b> <b>Manual</b></p> <p>TOYOTA PASSENGER CAR ..... 2006-11</p>	 <p><b>EM-5837 (NEW)</b> <b>MOUNT-ENGINE</b> <b>Rear</b></p> <p>LEXUS SPORT UTILITY ..... 2004-06 TOYOTA SPORT UTILITY ..... 2004-07</p>	 <p><b>EM-5855 (NEW)</b> <b>DIFFERENTIAL MOUNT</b></p> <p>AUDI PASSENGER CAR ..... 2002-11</p>
 <p><b>EM-5818 (NEW)</b> <b>MOUNT-ENGINE</b> <b>Rear</b></p> <p>NISSAN PASSENGER CAR ..... 2004-06 NISSAN SPORT UTILITY ..... 2003-07 NISSAN VAN ..... 2004-09</p>	 <p><b>EM-5832 (NEW)</b> <b>MOUNT-ENGINE</b> <b>Right</b></p> <p>TOYOTA PASSENGER CAR ..... 2001-03</p>	 <p><b>EM-5840 (NEW)</b> <b>MOUNT-ENGINE</b> <b>Front</b></p> <p>HONDA VAN ..... 2005-07</p>	 <p><b>EM-5856 (NEW)</b> <b>MOUNT-ENGINE</b> <b>Front</b></p> <p>MITSUBISHI PASSENGER CAR ..... 2008-11 MITSUBISHI SPORT UTILITY ..... 2007-12</p>

# BUYER'S GUIDE

## NUMERICAL LISTING - ILLUSTRATIONS

<p><b>EM-5857 (NEW)</b> MOUNT-ENGINE Right</p> <p>MITSUBISHI SPORT UTILITY ..... 2008-11</p> 	 <p><b>EM-5861 (NEW)</b> Engine Torque Strut Mount Front</p> <p>LEXUS SPORT UTILITY ..... 2007-09</p>	 <p><b>EM-5866 (NEW)</b> MOUNT-ENGINE Right</p> <p>NISSAN SPORT UTILITY ..... 2009-12 NISSAN VAN ..... 2011-15</p>	 <p><b>EM-5871 (NEW)</b> DIFFERENTIAL MOUNT</p> <p>HONDA SPORT UTILITY ..... 2002-11</p>
<p><b>EM-5858 (NEW)</b> MOUNT-TRANSMISSION</p> <p>MERCEDES-BENZ PASSENGER CAR ..... 2005-12</p> 	 <p><b>EM-5863 (NEW)</b> MOUNT-TRANSMISSION</p> <p>MAZDA PASSENGER CAR ..... 2010-11</p>	 <p><b>EM-5867 (NEW)</b> MOUNT-ENGINE Right</p> <p>NISSAN PASSENGER CAR ..... 2007-14</p>	 <p><b>EM-5872 (NEW)</b> MOUNT-ENGINE Front</p> <p>HONDA PASSENGER CAR ..... 2009-12</p>
<p><b>EM-5859 (NEW)</b> MOUNT-ENGINE L &amp; R Front</p> <p>MERCEDES-BENZ PASSENGER CAR ..... 2008-11</p> 	 <p><b>EM-5864 (NEW)</b> MOUNT-TRANSMISSION Auto</p> <p>MAZDA PASSENGER CAR ..... 2010-11 MAZDA VAN ..... 2012</p>	 <p><b>EM-5869 (NEW)</b> MOUNT-ENGINE Front</p> <p>NISSAN PASSENGER CAR ..... 2007-14</p>	 <p><b>EM-5873 (NEW)</b> MOUNT-ENGINE Front</p> <p>SUZUKI PASSENGER CAR ..... 2004-07</p>
<p><b>EM-5860 (NEW)</b> Engine Torque Strut Mount Rear</p> <p>MINI ..... 2002-08</p> 	 <p><b>EM-5865 (NEW)</b> MOUNT-ENGINE Right</p> <p>NISSAN PASSENGER CAR ..... 2007-13</p>	 <p><b>EM-5870 (NEW)</b> MOUNT-ENGINE Rear</p> <p>NISSAN PASSENGER CAR ..... 2007-14</p>	 <p><b>EM-5874 (NEW)</b> Engine Torque Strut Mount Front</p> <p>TOYOTA VAN ..... 2004-06</p>

# BUYER'S GUIDE

## NUMERICAL LISTING - ILLUSTRATIONS



**EM-5875 (NEW)**  
MOUNT-ENGINE  
Rear

HONDA PASSENGER CAR ..... 2008-13



**EM-5881 (NEW)**  
MOUNT-ENGINE  
LH Front

HYUNDAI PASSENGER CAR ..... 2009-10



**EM-5886 (NEW)**  
MOUNT-ENGINE  
L & R Front

BMW PASSENGER CAR ..... 2006-12



**EM-5890 (NEW)**  
MOUNT-ENGINE  
Right

BMW SPORT UTILITY ..... 2004-10



**EM-5876 (NEW)**  
MOUNT-ENGINE  
Rear

MITSUBISHI PASSENGER  
CAR ..... 2002-06



**EM-5882 (NEW)**  
MOUNT-ENGINE  
RH Front

HYUNDAI PASSENGER CAR ..... 2009-10



**EM-5887 (NEW)**  
MOUNT-ENGINE  
RH Front

BMW PASSENGER CAR ..... 2012-13  
BMW SPORT UTILITY ..... 2013



**EM-5892 (NEW)**  
MOUNT-ENGINE  
L & R Front

LAND ROVER SPORT UTILITY .. 2006-12



**EM-5877 (NEW)**  
MOUNT-ENGINE  
L & R Front

BMW SPORT UTILITY ..... 2000-06



**EM-5884 (NEW)**  
MOUNT-ENGINE  
LH Front

BMW PASSENGER CAR ..... 2004-11



**EM-5888 (NEW)**  
MOUNT-ENGINE  
LH Front

BMW PASSENGER CAR ..... 2012-13  
BMW SPORT UTILITY ..... 2013



**EM-5893 (NEW)**  
MOUNT-ENGINE  
LH Front

LAND ROVER SPORT UTILITY .. 2006-09



**EM-5879 (NEW)**  
MOUNT-ENGINE  
L & R Front

AUDI SPORTS UTILITY ..... 2007-12  
VOLKSWAGEN SPORT  
UTILITY ..... 2007-12



**EM-5885 (NEW)**  
MOUNT-ENGINE  
RH Front

BMW PASSENGER CAR ..... 2004-11



**EM-5889 (NEW)**  
MOUNT-ENGINE  
Left

BMW SPORT UTILITY ..... 2004-06



**EM-5894 (NEW)**  
MOUNT-ENGINE  
RH Front

LAND ROVER SPORT UTILITY .. 2006-09

# BUYER'S GUIDE

## NUMERICAL LISTING - ILLUSTRATIONS

 <p style="text-align: center;"><b>EM-5895 (NEW)</b> <b>MOUNT-ENGINE</b> <b>LH Front</b></p> <p>LAND ROVER SPORT UTILITY .. 2003-05</p>	 <p style="text-align: center;"><b>EM-5902 (NEW)</b> <b>MOUNT-ENGINE</b> <b>LH Front</b></p> <p>TOYOTA SPORT UTILITY ..... 2008-13 TOYOTA TRUCK ..... 2007-13</p>	<p style="text-align: center;"><b>EM-5906 (NEW)</b> <b>MOUNT-ENGINE</b> <b>RH Front</b></p> <p>HONDA PASSENGER CAR ..... 2006-11</p>  <p style="text-align: center;"><b>EM-5907 (NEW)</b> <b>MOUNT-ENGINE</b> <b>Rear</b></p> <p>MITSUBISHI PASSENGER CAR ..... 1999-04</p>	 <p style="text-align: center;"><b>EM-5910 (NEW)</b> <b>MOUNT-TRANSMISSION</b> <b>Manual</b></p> <p>TOYOTA TRUCK ..... 2005-15</p>
 <p style="text-align: center;"><b>EM-5896 (NEW)</b> <b>MOUNT-ENGINE</b> <b>RH Front</b></p> <p>LAND ROVER SPORT UTILITY .. 2003-05</p>	 <p style="text-align: center;"><b>EM-5903 (NEW)</b> <b>MOUNT-ENGINE</b> <b>Front</b></p> <p>HONDA SPORT UTILITY ..... 2006-08</p>	 <p style="text-align: center;"><b>EM-5908 (NEW)</b> <b>MOUNT-TRANSMISSION</b> <b>Manual</b></p> <p>TOYOTA SPORT UTILITY ..... 1996-01</p>	 <p style="text-align: center;"><b>EM-5911 (NEW)</b> <b>MOUNT-TRANSMISSION</b></p> <p>INFINITI PASSENGER CAR ..... 2004-10 INFINITI SPORT UTILITY ..... 2003-12</p>
 <p style="text-align: center;"><b>EM-5900 (NEW)</b> <b>MOUNT-ENGINE</b> <b>Front</b></p> <p>TOYOTA VAN ..... 2004-06</p>	 <p style="text-align: center;"><b>EM-5904 (NEW)</b> <b>MOUNT-ENGINE</b> <b>Rear</b></p> <p>HONDA VAN ..... 2008-10</p>	 <p style="text-align: center;"><b>EM-5909 (NEW)</b> <b>Engine Torque Strut Mount</b> <b>Rear</b></p> <p>MAZDA PASSENGER CAR ..... 2011-12</p>	 <p style="text-align: center;"><b>EM-5912 (NEW)</b> <b>MOUNT-ENGINE</b> <b>Rear</b></p> <p>MITSUBISHI SPORT UTILITY ..... 2003-06</p>
 <p style="text-align: center;"><b>EM-5901 (NEW)</b> <b>MOUNT-ENGINE</b> <b>RH Front</b></p> <p>TOYOTA SPORT UTILITY ..... 2008-13 TOYOTA TRUCK ..... 2007-13</p>	 <p style="text-align: center;"><b>EM-5905 (NEW)</b> <b>MOUNT-TRANSMISSION</b> <b>Manual</b></p> <p>NISSAN PASSENGER CAR ..... 2007-12</p>		 <p style="text-align: center;"><b>EM-5913 (NEW)</b> <b>Engine Torque Strut Mount</b> <b>Upper</b></p> <p>ACURA SPORT UTILITY ..... 2007-12</p>



# BUYER'S GUIDE

## NUMERICAL LISTING - ILLUSTRATIONS



**EM-5914 (NEW)**  
**MOUNT-TRANSMISSION**

NISSAN SPORT UTILITY ..... 2008-12  
NISSAN VAN ..... 2011-12



**EM-5918 (NEW)**  
**MOUNT-TRANSMISSION**

TOYOTA TRUCK ..... 2000-04



**EM-5923 (NEW)**  
**MOUNT-TRANSMISSION**  
**Manual**

MAZDA VAN ..... 2006-10



**EM-5928 (NEW)**  
**MOUNT-TRANSMISSION**

MITSUBISHI SPORT UTILITY ..... 2007-12



**EM-5915 (NEW)**  
**SUBFRAME MOUNT**  
**FRONT RIGHT**

ACURA PASSENGER CAR ..... 2004-14  
HONDA PASSENGER CAR ..... 2003-14



**EM-5919 (NEW)**  
**MOUNT-TRANSMISSION**

TOYOTA SPORT UTILITY ..... 2005-07



**EM-5924 (NEW)**  
**MOUNT-ENGINE**  
**Rear**

MITSUBISHI PASSENGER CAR ..... 2008-11



**EM-5929 (NEW)**  
**MOUNT-ENGINE**  
**Front**

MITSUBISHI PASSENGER CAR ..... 1993-96



**EM-5916 (NEW)**  
**MOUNT-ENGINE**  
**Right**

SCION PASSENGER CAR ..... 2005-10



**EM-5921 (NEW)**  
**MOUNT-ENGINE**  
**L & R Front**

LEXUS PASSENGER CAR ..... 1998-05



**EM-5925 (NEW)**  
**MOUNT-ENGINE**  
**Front**

HONDA VAN ..... 2008-10



**EM-5930 (NEW)**  
**MOUNT-TRANSMISSION**  
**Auto**

TOYOTA PASSENGER CAR ..... 2006-11



**EM-5917 (NEW)**  
**SUBFRAME MOUNT**  
**FRONT LEFT**

ACURA PASSENGER CAR ..... 2004-14  
HONDA PASSENGER CAR ..... 2003-14



**EM-5922 (NEW)**  
**MOUNT-ENGINE**  
**Front**

MINI ..... 2004-06



**EM-5927 (NEW)**  
**MOUNT-ENGINE**  
**Right**

MITSUBISHI SPORT UTILITY ..... 2007-12



**EM-5931 (NEW)**  
**MOUNT-ENGINE**  
**Right**

CHEVROLET PASSENGER CAR ..... 2004-10  
SUZUKI PASSENGER CAR ..... 2004-08

# BUYER'S GUIDE

## NUMERICAL LISTING - ILLUSTRATIONS

 <p style="text-align: center;"><b>EM-5932 (NEW)</b> Engine Torque Strut Mount Right</p> <p>CHEVROLET PASSENGER CAR ..... 2004-10 SUZUKI PASSENGER CAR ..... 2004-08</p>	 <p style="text-align: center;"><b>EM-5935 (NEW)</b> MOUNT-TRANSMISSION Auto</p> <p>VOLKSWAGEN PASSENGER CAR ..... 2009-14</p>	 <p style="text-align: center;"><b>EM-5938 (NEW)</b> MOUNT-ENGINE Rear</p> <p>NISSAN SPORT UTILITY ..... 2005-07</p>	 <p style="text-align: center;"><b>EM-5943 (NEW)</b> Engine Torque Strut Mount Rear</p> <p>MAZDA PASSENGER CAR ..... 2006-08</p>
 <p style="text-align: center;"><b>EM-5933 (NEW)</b> Engine Torque Strut Mount Lower</p> <p>CHEVROLET PASSENGER CAR ..... 2004-10 SUZUKI PASSENGER CAR ..... 2004-08</p>	 <p style="text-align: center;"><b>EM-5936 (NEW)</b> MOUNT-ENGINE Right</p> <p>HYUNDAI PASSENGER CAR ..... 2009-10</p>	 <p style="text-align: center;"><b>EM-5940 (NEW)</b> MOUNT-ENGINE Right</p> <p>TOYOTA SPORT UTILITY ..... 2006-08</p>	 <p style="text-align: center;"><b>EM-5944 (NEW)</b> Engine Torque Strut Mount Rear Lower</p> <p>SCION PASSENGER CAR ..... 2008-13</p>
 <p style="text-align: center;"><b>EM-5934 (NEW)</b> MOUNT-TRANSMISSION Manual</p> <p>VOLKSWAGEN PASSENGER CAR ..... 2009-11</p>	 <p style="text-align: center;"><b>EM-5937 (NEW)</b> MOUNT-TRANSMISSION Auto</p> <p>INFINITI PASSENGER CAR ..... 1996 NISSAN PASSENGER CAR ..... 1995-01</p>	 <p style="text-align: center;"><b>EM-5941 (NEW)</b> MOUNT-TRANSMISSION Auto</p> <p>LEXUS PASSENGER CAR ..... 1998-05</p>	 <p style="text-align: center;"><b>EM-5945 (NEW)</b> MOUNT-TRANSMISSION Auto</p> <p>SUBARU PASSENGER CAR ..... 2012-13 SUBARU SPORT UTILITY ..... 2014</p>
 <p style="text-align: center;"><b>EM-5942 (NEW)</b> MOUNT-TRANSMISSION</p> <p>LEXUS PASSENGER CAR ..... 1996-00</p>		 <p style="text-align: center;"><b>EM-5947 (NEW)</b> MOUNT-TRANSMISSION Manual</p> <p>SAAB PASSENGER CAR ..... 1994-02</p>	

# BUYER'S GUIDE

## NUMERICAL LISTING - ILLUSTRATIONS



**EM-5949 (NEW)**  
MOUNT-ENGINE  
Front

TOYOTA VAN ..... 2007-10



**EM-5953 (NEW)**  
MOUNT-ENGINE  
Right

NISSAN PASSENGER CAR ..... 2007-12  
NISSAN SPORT UTILITY ..... 2008-12



**EM-5959 (NEW)**  
MOUNT-ENGINE  
LH Front

SUBARU PASSENGER CAR ..... 2012-13  
SUBARU SPORT UTILITY ..... 2013



**EM-5964 (NEW)**  
MOUNT-ENGINE  
Right

TOYOTA SPORT UTILITY ..... 2006-12



**EM-5950 (NEW)**  
MOUNT-TRANSMISSION

LEXUS PASSENGER CAR ..... 1993-97



**EM-5954 (NEW)**  
Engine Torque Strut Mount  
Front Upper

ACURA SPORT UTILITY ..... 2013-15  
Engine Torque Strut Mount  
Upper

HONDA SPORT UTILITY ..... 2012-15



**EM-5960 (NEW)**  
MOUNT-ENGINE  
RH Front

SUBARU PASSENGER CAR ..... 2012-13  
SUBARU SPORT UTILITY ..... 2013



**EM-5967 (NEW)**  
MOUNT-TRANSMISSION

LEXUS PASSENGER CAR ..... 2001-03



**EM-5951 (NEW)**  
MOUNT-ENGINE  
Front

SUZUKI PASSENGER CAR ..... 2010-13



**EM-5958 (NEW)**  
MOUNT-ENGINE  
Right

HONDA SPORT UTILITY ..... 2012-14



**EM-5962 (NEW)**  
MOUNT-ENGINE  
Rear

NISSAN SPORT UTILITY ..... 2003-07



**EM-5969 (NEW)**  
MOUNT-TRANSMISSION  
Manual

NISSAN PASSENGER CAR ..... 2012-15



**EM-5952 (NEW)**  
MOUNT-ENGINE  
L & R Front

LEXUS PASSENGER CAR ..... 2001-06



**EM-5963 (NEW)**  
MOUNT-TRANSMISSION  
Auto

LEXUS PASSENGER CAR ..... 2006-12



**EM-5970 (NEW)**  
MOUNT-ENGINE  
Right

LEXUS PASSENGER CAR ..... 2011-13  
TOYOTA PASSENGER CAR ..... 2010-13

# BUYER'S GUIDE

## NUMERICAL LISTING - ILLUSTRATIONS

 <p style="text-align: center;"><b>EM-5971 (NEW)</b> <b>MOUNT-ENGINE</b> <b>LH Front</b></p> <p>SUBARU PASSENGER CAR ..... 2005-09 <b>MOUNT-ENGINE</b> <b>Left</b> SUBARU SPORT UTILITY ..... 2009-10</p>	 <p style="text-align: center;"><b>EM-5980 (NEW)</b> <b>MOUNT-TRANSMISSION</b> <b>Manual</b></p> <p>MITSUBISHI PASSENGER CAR ..... 2006-12</p>	 <p style="text-align: center;"><b>EM-5984 (NEW)</b> <b>MOUNT-ENGINE</b> <b>Rear</b></p> <p>ACURA PASSENGER CAR ..... 2004-08</p>	 <p style="text-align: center;"><b>EM-5992 (NEW)</b> <b>MOUNT-ENGINE</b> <b>Right</b></p> <p>ACURA SPORT UTILITY ..... 2007-13</p>
 <p style="text-align: center;"><b>EM-5973 (NEW)</b> <b>MOUNT-ENGINE</b> <b>Right</b></p> <p>SCION VAN ..... 2008-14</p>	 <p style="text-align: center;"><b>EM-5982 (NEW)</b> <b>MOUNT-ENGINE</b> <b>Right</b></p> <p>TOYOTA SPORT UTILITY ..... 2006-08</p>	 <p style="text-align: center;"><b>EM-5986 (NEW)</b> <b>MOUNT-ENGINE</b> <b>Rear</b></p> <p>SCION PASSENGER CAR ..... 2005-10</p>	 <p style="text-align: center;"><b>EM-5993 (NEW)</b> <b>MOUNT-ENGINE</b> <b>Right</b></p> <p>VOLVO PASSENGER CAR ..... 1998-07 VOLVO SPORT UTILITY ..... 2003-06</p>
 <p style="text-align: center;"><b>EM-5976 (NEW)</b> <b>MOUNT-TRANSMISSION</b></p> <p>LEXUS PASSENGER CAR ..... 2004-06</p>	 <p style="text-align: center;"><b>EM-5983 (NEW)</b> <b>MOUNT-ENGINE</b> <b>RH Front</b></p> <p>SUBARU PASSENGER CAR ..... 2005-09 <b>MOUNT-ENGINE</b> <b>Right</b> SUBARU SPORT UTILITY ..... 2009-10</p>	 <p style="text-align: center;"><b>EM-5988 (NEW)</b> <b>MOUNT-ENGINE</b> <b>Rear</b></p> <p>SCION PASSENGER CAR ..... 2005-10</p>	 <p style="text-align: center;"><b>EM-5994 (NEW)</b> <b>MOUNT-TRANSMISSION</b> <b>Lower</b></p> <p>ACURA PASSENGER CAR ..... 2007-08 <b>MOUNT-TRANSMISSION</b> ACURA SPORT UTILITY ..... 2007-09</p>
 <p style="text-align: center;"><b>EM-5978 (NEW)</b> <b>MOUNT-TRANSMISSION</b> <b>Upper</b></p> <p>ACURA PASSENGER CAR ..... 2007-08</p>		 <p style="text-align: center;"><b>EM-5990 (NEW)</b> <b>MOUNT-TRANSMISSION</b> <b>Auto</b></p> <p>HONDA PASSENGER CAR ..... 2012-13</p>	

# BUYER'S GUIDE

## NUMERICAL LISTING - ILLUSTRATIONS



**EM-7000 (NEW)**  
MOUNT-TRANSMISSION  
Auto

VOLKSWAGEN PASSENGER  
CAR ..... 1999-06



**EM-7010 (NEW)**  
MOUNT-ENGINE  
L & R Front

TOYOTA TRUCK ..... 2005-15



**EM-7021 (NEW)**  
MOUNT-ENGINE  
Right

VOLKSWAGEN PASSENGER  
CAR ..... 2009-14



**EM-7043 (NEW)**  
MOUNT-TRANSMISSION  
Manual

MAZDA PASSENGER CAR ..... 2007-09



**EM-7004 (NEW)**  
MOUNT-ENGINE  
Right

MAZDA SPORT UTILITY ..... 2010-12



**EM-7011 (NEW)**  
MOUNT-ENGINE  
Right

TOYOTA SPORT UTILITY ..... 2004-05



**EM-7030 (NEW)**  
MOUNT-ENGINE  
RH Front

AUDI PASSENGER CAR ..... 2002-06



**EM-7051 (NEW)**  
MOUNT-TRANSMISSION

KIA SPORT UTILITY ..... 2007-10



**EM-7006 (NEW)**  
MOUNT-ENGINE  
Rear

KIA PASSENGER CAR ..... 2010-13



**EM-7015 (NEW)**  
MOUNT-TRANSMISSION  
Auto

SCION PASSENGER CAR ..... 2008-13



**EM-7039 (NEW)**  
MOUNT-ENGINE  
Rear

LEXUS SPORT UTILITY ..... 2004-09  
TOYOTA SPORT UTILITY ..... 2004-10



**EM-8001**  
MOUNT-ENGINE  
RH Front

HONDA PASSENGER CAR ..... 1989-91

**MOUNT-TRANSMISSION  
Auto**

HONDA PASSENGER CAR ..... 1988-91



**EM-7007 (NEW)**  
MOUNT-TRANSMISSION  
Auto

SUBARU PASSENGER CAR ..... 1992-96



**EM-7017 (NEW)**  
MOUNT-TRANSMISSION  
Manual

MITSUBISHI SPORT UTILITY ..... 1995-96



**EM-7042 (NEW)**  
Engine Torque Strut Mount  
Upper

SCION PASSENGER CAR ..... 2008-13



**EM-8002**  
MOUNT-TRANSMISSION  
Auto

ACURA PASSENGER CAR ..... 1997-99

(Continued Next Page)

# BUYER'S GUIDE

## NUMERICAL LISTING - ILLUSTRATIONS

**EM-8002 (Continued)**  
**MOUNT-TRANSMISSION**  
**Manual**  
 HONDA PASSENGER CAR ..... 1990-97  
**MOUNT-TRANSMISSION**  
 HONDA VAN ..... 1995-97  
**MOUNT-TRANSMISSION**  
**Auto**  
 ISUZU VAN ..... 1996-99



**EM-8004**  
**MOUNT-ENGINE**  
**Rear**

HONDA PASSENGER CAR ..... 1984-87  
**MOUNT-TRANSMISSION**  
 HONDA PASSENGER CAR ..... 1984-87  
**MOUNT-TRANSMISSION**  
 HONDA VAN ..... 1984-87



**EM-8005**  
**MOUNT-ENGINE**  
**L & R Front**

HONDA PASSENGER CAR ..... 1985-88



**EM-8006**  
**MOUNT-ENGINE**  
**Rear**

HONDA PASSENGER CAR ..... 1988-91



**EM-8007**  
**MOUNT-ENGINE**  
**Rear**

HONDA PASSENGER CAR ..... 1988-91



**EM-8008**  
**MOUNT-ENGINE**  
**Rear**

HONDA PASSENGER CAR ..... 1988-96



**EM-8009**  
**MOUNT-ENGINE**  
**Rear**

ACURA PASSENGER CAR ..... 1997-99  
 HONDA PASSENGER CAR ..... 1990-97



**EM-8010**  
**MOUNT-ENGINE**  
**Rear**

ACURA PASSENGER CAR ..... 1994-01  
 HONDA PASSENGER CAR ..... 1992-00  
 HONDA SPORT UTILITY ..... 1998-01



**EM-8011**  
**MOUNT-ENGINE**  
**Rear**

ACURA PASSENGER CAR ..... 1997-99  
 HONDA PASSENGER CAR ..... 1990-97  
 HONDA VAN ..... 1995-98  
 ISUZU VAN ..... 1996-99

**EM-8012**  
**MOUNT-ENGINE**  
**Front**

HONDA PASSENGER CAR ..... 1980-83

**MOUNT-ENGINE**  
**Rear**

HONDA PASSENGER CAR ..... 1980-83

**MOUNT-TRANSMISSION**  
**Lower**

HONDA PASSENGER CAR ..... 1980-83

**MOUNT-TRANSMISSION**  
**Manual**

HONDA PASSENGER CAR ..... 1984-85



**EM-8014**  
**MOUNT-ENGINE**  
**L & R Front**

HONDA PASSENGER CAR ..... 1983-87

**MOUNT-ENGINE**  
**Rear**

HONDA PASSENGER CAR ..... 1983-89

**MOUNT-TRANSMISSION**  
**Auto**

HONDA PASSENGER CAR ..... 1984-85



**EM-8016**  
**MOUNT-ENGINE**  
**LH Front**

HONDA PASSENGER CAR ..... 1990-93



**EM-8018**  
**MOUNT-ENGINE**  
**Front**

HONDA PASSENGER CAR ..... 1984-87  
 HONDA VAN ..... 1984-87

**MOUNT-TRANSMISSION**  
**Manual**

ACURA PASSENGER CAR ..... 1986-89  
 HONDA PASSENGER CAR ..... 1984-87

**MOUNT-TRANSMISSION**  
**Auto**

ACURA PASSENGER CAR ..... 1986-89

**MOUNT-TRANSMISSION**

HONDA PASSENGER CAR ..... 1984-87



**EM-8019**  
**MOUNT-ENGINE**  
**LH Front**

HONDA PASSENGER CAR ..... 1986-89

# BUYER'S GUIDE

## NUMERICAL LISTING - ILLUSTRATIONS

 <p style="text-align: center;"><b>EM-8020</b> <b>MOUNT-ENGINE</b> <b>LH Front</b></p> <p>HONDA PASSENGER CAR ..... 1988-91</p>	 <p style="text-align: center;"><b>EM-8024</b> <b>Engine Torque Strut Mount</b> <b>Front</b></p> <p>HONDA PASSENGER CAR ..... 1991-93</p>	<p style="text-align: center;"><b>EM-8030</b> <b>MOUNT-ENGINE</b> <b>RH Front</b></p> <p>HONDA PASSENGER CAR ..... 1988-91</p>  <p style="text-align: center;"><b>EM-8031</b> <b>MOUNT-TRANSMISSION</b> <b>Lower</b></p> <p>HONDA PASSENGER CAR ..... 1980-87</p>	 <p style="text-align: center;"><b>EM-8039</b> <b>MOUNT-ENGINE</b> <b>LH Front</b></p> <p>HYUNDAI PASSENGER CAR ..... 1990-94 MITSUBISHI PASSENGER CAR ..... 1990-94</p> <p style="text-align: center;"><b>MOUNT-TRANSMISSION</b> <b>Auto</b></p> <p>HYUNDAI PASSENGER CAR ..... 1991-92</p>
 <p style="text-align: center;"><b>EM-8021</b> <b>MOUNT-ENGINE</b> <b>LH Front Upper</b></p> <p>HONDA PASSENGER CAR ..... 1992-97</p> <p style="text-align: center;"><b>MOUNT-ENGINE</b> <b>LH Rear</b></p> <p>HONDA PASSENGER CAR ..... 1993-95</p>	 <p style="text-align: center;"><b>EM-8025</b> <b>Engine Torque Strut Mount</b> <b>Front</b></p> <p>HONDA PASSENGER CAR ..... 1986-89</p>	 <p style="text-align: center;"><b>EM-8034</b> <b>MOUNT-ENGINE</b> <b>RH Front</b></p> <p>HONDA PASSENGER CAR ..... 1988-91</p> <p style="text-align: center;"><b>MOUNT-TRANSMISSION</b> <b>Manual</b></p> <p>HONDA PASSENGER CAR ..... 1988-91</p>	 <p style="text-align: center;"><b>EM-8040</b> <b>MOUNT-TRANSMISSION</b> <b>Auto</b></p> <p>HYUNDAI PASSENGER CAR ..... 1992-95</p>
 <p style="text-align: center;"><b>EM-8022</b> <b>MOUNT-TRANSMISSION</b> <b>Upper</b></p> <p>HONDA PASSENGER CAR ..... 1979-82</p>	 <p style="text-align: center;"><b>EM-8026</b> <b>MOUNT-ENGINE</b> <b>Front</b></p> <p>ACURA PASSENGER CAR ..... 1997-99 HONDA PASSENGER CAR ..... 1994-97 HONDA VAN ..... 1995-98 ISUZU VAN ..... 1996-99</p>	 <p style="text-align: center;"><b>EM-8037</b> <b>MOUNT-ENGINE</b> <b>Rear</b></p> <p>ACURA PASSENGER CAR ..... 1993-98</p>	 <p style="text-align: center;"><b>EM-8041</b> <b>MOUNT-ENGINE</b> <b>Rear</b></p> <p>HYUNDAI PASSENGER CAR ..... 1989-94</p>
	 <p style="text-align: center;"><b>EM-8029</b> <b>Engine Torque Strut Mount</b> <b>Front</b></p> <p>HONDA PASSENGER CAR ..... 1973-79</p>		

# BUYER'S GUIDE

## NUMERICAL LISTING - ILLUSTRATIONS

 <p><b>EM-8042</b> <b>MOUNT-ENGINE</b> <b>Front</b></p> <p>HYUNDAI PASSENGER CAR ..... 1989-95</p>	 <p><b>EM-8048</b> <b>MOUNT-ENGINE</b> <b>LH Front</b></p> <p>CHEVROLET TRUCK ..... 1981-82 ISUZU SPORT UTILITY ..... 1984-86 ISUZU TRUCK ..... 1981-86</p>	 <p><b>EM-8054</b> <b>MOUNT-ENGINE</b> <b>RH Front</b></p> <p>ISUZU SPORT UTILITY ..... 1984-86 ISUZU TRUCK ..... 1981-87</p>	 <p><b>EM-8060</b> <b>MOUNT-ENGINE</b> <b>RH Front</b></p> <p>DODGE PASSENGER CAR ..... 1989-90 MAZDA PASSENGER CAR ..... 1981-89</p>
 <p><b>EM-8044</b> <b>MOUNT-ENGINE</b> <b>LH Front</b></p> <p>HYUNDAI PASSENGER CAR ..... 1989-91</p>	 <p><b>EM-8049</b> <b>MOUNT-ENGINE</b> <b>RH Front</b></p> <p>CHEVROLET TRUCK ..... 1981-82 ISUZU SPORT UTILITY ..... 1984 ISUZU TRUCK ..... 1981-86</p>	 <p><b>EM-8055</b> <b>MOUNT-ENGINE</b> <b>L &amp; R Front</b></p> <p>MAZDA PASSENGER CAR ..... 1979-85</p>	 <p><b>EM-8061</b> <b>MOUNT-TRANSMISSION</b> <b>Manual</b></p> <p>MAZDA PASSENGER CAR ..... 1981-85</p>
 <p><b>EM-8045</b> <b>Engine Torque Strut</b> <b>Front Right</b></p> <p>HYUNDAI PASSENGER CAR ..... 1986-89 MITSUBISHI PASSENGER CAR ..... 1987-89</p>	 <p><b>EM-8053</b> <b>MOUNT-ENGINE</b> <b>LH Front</b></p> <p>ISUZU SPORT UTILITY ..... 1984-86 ISUZU TRUCK ..... 1981-87</p>	 <p><b>EM-8056</b> <b>MOUNT-ENGINE</b> <b>Front</b></p> <p>MAZDA PASSENGER CAR ..... 1981-82</p>	 <p><b>EM-8062</b> <b>MOUNT-ENGINE</b> <b>Front</b></p> <p>MAZDA PASSENGER CAR ..... 1995-98</p>
 <p><b>EM-8047</b> <b>Engine Torque Strut Mount</b> <b>Front</b></p> <p>HYUNDAI PASSENGER CAR ..... 1990-94 MITSUBISHI PASSENGER CAR ..... 1990-94</p>		 <p><b>EM-8059</b> <b>MOUNT-ENGINE</b> <b>Front</b></p> <p>MAZDA PASSENGER CAR ..... 1983-85</p>	



# BUYER'S GUIDE

## NUMERICAL LISTING - ILLUSTRATIONS

 <p style="text-align: center;"><b>EM-8063</b> <b>MOUNT-TRANSMISSION</b> <b>Auto</b></p> <p>MAZDA PASSENGER CAR ..... 1995-98</p>	 <p style="text-align: center;"><b>EM-8073</b> <b>MOUNT-ENGINE</b> <b>Front</b></p> <p>FORD PASSENGER CAR ..... 1993-97 MAZDA PASSENGER CAR ..... 1993-02</p>	 <p style="text-align: center;"><b>EM-8077</b> <b>MOUNT-ENGINE</b> <b>Front</b></p> <p>MAZDA PASSENGER CAR ..... 1983-85</p>	<p><b>EM-8080 (Continued)</b> FORD PASSENGER CAR ..... 1989-92</p>  <p style="text-align: center;"><b>EM-8082</b> <b>MOUNT-TRANSMISSION</b> <b>Manual</b></p> <p>MAZDA PASSENGER CAR ..... 1983-85</p>
 <p style="text-align: center;"><b>EM-8065</b> <b>MOUNT-ENGINE</b> <b>Front</b></p> <p>MAZDA PASSENGER CAR ..... 1986-89</p>	 <p style="text-align: center;"><b>EM-8074</b> <b>MOUNT-ENGINE</b> <b>RH Front</b></p> <p>FORD PASSENGER CAR ..... 1993-97 MAZDA PASSENGER CAR ..... 1993-02</p>	 <p style="text-align: center;"><b>EM-8078</b> <b>MOUNT-ENGINE</b> <b>Rear</b></p> <p>MAZDA PASSENGER CAR ..... 1983-87</p>	 <p style="text-align: center;"><b>EM-8083</b> <b>MOUNT-ENGINE</b> <b>Front</b></p> <p>FORD PASSENGER CAR ..... 1989-92 MAZDA PASSENGER CAR ..... 1988-92</p>
 <p style="text-align: center;"><b>EM-8068</b> <b>MOUNT-ENGINE</b> <b>Rear</b></p> <p>MAZDA PASSENGER CAR ..... 1986-87</p> <p style="text-align: center;"><b>MOUNT-TRANSMISSION</b> <b>Front</b></p> <p>MAZDA PASSENGER CAR ..... 1986-91</p> <p style="text-align: center;"><b>MOUNT-TRANSMISSION</b> <b>Manual</b></p> <p>MAZDA PASSENGER CAR ..... 1986-91</p> <p style="text-align: center;"><b>MOUNT-TRANSMISSION</b></p> <p>MERCURY PASSENGER CAR ... 1987-89</p>	 <p style="text-align: center;"><b>EM-8075</b> <b>MOUNT-ENGINE</b> <b>Rear</b></p> <p>FORD PASSENGER CAR ..... 1993-97 MAZDA PASSENGER CAR ..... 1993-02</p> <p style="text-align: center;"><b>MOUNT-TRANSMISSION</b> <b>Upper</b></p> <p>FORD PASSENGER CAR ..... 1993</p>	 <p style="text-align: center;"><b>EM-8079</b> <b>MOUNT-TRANSMISSION</b> <b>Manual</b></p> <p>MAZDA TRUCK ..... 1972-84</p>	 <p style="text-align: center;"><b>EM-8084</b> <b>MOUNT-ENGINE</b> <b>L &amp; R Front</b></p> <p>MAZDA TRUCK ..... 1987-88</p>
		 <p style="text-align: center;"><b>EM-8080</b> <b>MOUNT-ENGINE</b> <b>Front</b></p> <p>MAZDA PASSENGER CAR ..... 1983-87</p> <p style="text-align: center;"><b>MOUNT-ENGINE</b> <b>Rear</b></p> <p style="text-align: center;">(Continued Next Column)</p>	 <p style="text-align: center;"><b>EM-8085</b> <b>MOUNT-ENGINE</b> <b>Front</b></p> <p style="text-align: center;">(Continued Next Page)</p>

# BUYER'S GUIDE

## NUMERICAL LISTING - ILLUSTRATIONS

### EM-8085 (Continued)

FORD PASSENGER CAR ..... 1989-92  
 MAZDA PASSENGER CAR ..... 1988-92



**EM-8086**  
**MOUNT-ENGINE**  
**RH Front**

FORD PASSENGER CAR ..... 1989-92  
 MAZDA PASSENGER CAR ..... 1988-92



**EM-8087**  
**MOUNT-ENGINE**  
**Rear**

FORD PASSENGER CAR ..... 1989-92  
 MAZDA PASSENGER CAR ..... 1988-92



**EM-8088**  
**MOUNT-ENGINE**  
**Rear**

FORD PASSENGER CAR ..... 1989-92  
 MAZDA PASSENGER CAR ..... 1988-92



**EM-8089**  
**MOUNT-TRANSMISSION**  
**Manual**

FORD PASSENGER CAR ..... 1989-92  
 MAZDA PASSENGER CAR ..... 1988-89



**EM-8091**  
**MOUNT-TRANSMISSION**  
**Manual**

MAZDA PASSENGER CAR ..... 1986-87



**EM-8093**  
**MOUNT-ENGINE**  
**L & R Front**

MAZDA VAN ..... 1989-95  
 SUZUKI SPORT UTILITY ..... 1996-98



**EM-8094**  
**MOUNT-ENGINE**  
**L & R Front**

MAZDA TRUCK ..... 1986-93

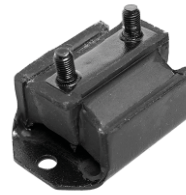

**EM-8095**  
**MOUNT-ENGINE**  
**Rear**

MAZDA PASSENGER CAR ..... 1979-80  
 MAZDA TRUCK ..... 1972-76

**MOUNT-TRANSMISSION**  
**Manual**

MAZDA PASSENGER CAR ..... 1979-85  
 MAZDA TRUCK ..... 1979-89  
 MAZDA PASSENGER CAR ..... 1984-85  
 MAZDA TRUCK ..... 1986-93

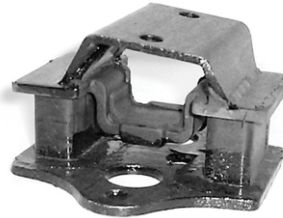

**EM-8096**  
**MOUNT-TRANSMISSION**  
**Auto**

DODGE SPORT UTILITY ..... 1987-88

**MOUNT-TRANSMISSION**

DODGE TRUCK ..... 1983-89

**MOUNT-TRANSMISSION**  
**Auto**

MITSUBISHI SPORT UTILITY ..... 1983-89

**MOUNT-TRANSMISSION**  
**Manual**

MITSUBISHI TRUCK ..... 1983-89



**EM-8097**  
**MOUNT-ENGINE**  
**Front**

DODGE PASSENGER CAR ..... 1992-94  
 EAGLE PASSENGER CAR ..... 1992-93  
 MITSUBISHI PASSENGER CAR ..... 1993-94

(Continued Next Column)

### EM-8097 (Continued)

PLYMOUTH PASSENGER CAR ..... 1993-94



**EM-8098**  
**MOUNT-ENGINE**  
**Front**

DODGE PASSENGER CAR ..... 1992-94  
 EAGLE PASSENGER CAR ..... 1992-96



**EM-8099**  
**MOUNT-ENGINE**  
**RH Front**

DODGE PASSENGER CAR ..... 1992-94

**MOUNT-TRANSMISSION**  
**Manual**

EAGLE PASSENGER CAR ..... 1996  
 MITSUBISHI PASSENGER CAR ..... 1993-96  
 PLYMOUTH PASSENGER CAR ..... 1993-94  
 DODGE PASSENGER CAR ..... 1993-94  
 EAGLE PASSENGER CAR ..... 1992-94  
 MITSUBISHI PASSENGER CAR ..... 1993-96



**EM-8100**  
**MOUNT-ENGINE**  
**Front**

DODGE PASSENGER CAR ..... 1993-94  
 MITSUBISHI PASSENGER CAR ..... 1993-96  
 MITSUBISHI VAN ..... 1992-93  
 PLYMOUTH PASSENGER CAR ..... 1992-94

**MOUNT-ENGINE**  
**Rear**

(Continued Next Page)

# BUYER'S GUIDE

## NUMERICAL LISTING - ILLUSTRATIONS

### EM-8100 (Continued)

DODGE PASSENGER CAR ..... 1992-94  
 EAGLE PASSENGER CAR ..... 1992-96  
 MITSUBISHI PASSENGER  
 CAR ..... 1993-96  
 PLYMOUTH PASSENGER  
 CAR ..... 1993-94

#### EM-8101 MOUNT-ENGINE Front

MAZDA PASSENGER CAR ..... 1986-87



#### EM-8102 MOUNT-ENGINE Front

EAGLE PASSENGER CAR ..... 1992-94  
 MITSUBISHI VAN ..... 1992  
 PLYMOUTH PASSENGER  
 CAR ..... 1993-94

#### MOUNT-ENGINE Rear

DODGE PASSENGER CAR ..... 1989-90  
 EAGLE PASSENGER CAR ..... 1989-92  
 MITSUBISHI PASSENGER  
 CAR ..... 1989-92  
 PLYMOUTH PASSENGER  
 CAR ..... 1989-92



#### EM-8103 MOUNT-ENGINE Front

DODGE PASSENGER CAR ..... 1985-88  
 EAGLE PASSENGER CAR ..... 1990-94  
 HYUNDAI PASSENGER CAR ..... 1990-94  
 MITSUBISHI PASSENGER  
 CAR ..... 1985-94  
 PLYMOUTH PASSENGER  
 CAR ..... 1985-94



#### EM-8104 MOUNT-ENGINE Rear

EAGLE PASSENGER CAR ..... 1990-94  
 MITSUBISHI PASSENGER  
 CAR ..... 1990-94  
 PLYMOUTH PASSENGER  
 CAR ..... 1990-94



#### EM-8105 MOUNT-ENGINE Front Upper

MITSUBISHI PASSENGER  
 CAR ..... 1984-88

#### MOUNT-ENGINE Rear

MITSUBISHI PASSENGER  
 CAR ..... 1985-93



#### EM-8106 MOUNT-TRANSMISSION Manual

MITSUBISHI PASSENGER  
 CAR ..... 1989-93



#### EM-8107 MOUNT-ENGINE Front

DODGE PASSENGER CAR ..... 1989-92  
 EAGLE PASSENGER CAR ..... 1989-92  
 MITSUBISHI PASSENGER  
 CAR ..... 1989-92  
 PLYMOUTH PASSENGER  
 CAR ..... 1989-92

#### MOUNT-TRANSMISSION Manual

MITSUBISHI PASSENGER  
 CAR ..... 1985-86



#### EM-8108 MOUNT-ENGINE RH Front

DODGE PASSENGER CAR ..... 1989-92

#### MOUNT-ENGINE LH Front

EAGLE PASSENGER CAR ..... 1989-92  
 MITSUBISHI PASSENGER  
 CAR ..... 1989-92

#### MOUNT-ENGINE RH Front

PLYMOUTH PASSENGER  
 CAR ..... 1989-92

#### MOUNT-TRANSMISSION

DODGE PASSENGER CAR ..... 1989-90



#### EM-8111 MOUNT-TRANSMISSION Auto

DODGE TRUCK ..... 1979-93  
 MITSUBISHI SPORT UTILITY ..... 1997-99  
 MITSUBISHI TRUCK ..... 1987-96



#### EM-8114 MOUNT-ENGINE L & R Front

NISSAN SPORT UTILITY ..... 1987-95  
 NISSAN TRUCK ..... 1986-96



#### EM-8115 MOUNT-TRANSMISSION

NISSAN PASSENGER CAR ..... 1971-73



#### EM-8117 MOUNT-TRANSMISSION Manual

NISSAN PASSENGER CAR ..... 1975-77

# BUYER'S GUIDE

## NUMERICAL LISTING - ILLUSTRATIONS

 <p><b>EM-8118</b> <b>MOUNT-ENGINE</b> <b>RH Front</b></p> <p>NISSAN PASSENGER CAR ..... 1982-87</p>	 <p><b>EM-8121</b> <b>MOUNT-TRANSMISSION</b> <b>Manual</b></p> <p>NISSAN PASSENGER CAR ..... 1982-92</p> <p><b>MOUNT-TRANSMISSION</b></p> <p>NISSAN VAN ..... 1990-91</p>	 <p><b>EM-8125</b> <b>Engine Torque Strut Mount</b> <b>Front</b></p> <p>NISSAN PASSENGER CAR ..... 1985-92</p> <p>NISSAN VAN ..... 1990-91</p>	 <p><b>EM-8133</b> <b>Engine Torque Strut Mount</b> <b>Front</b></p> <p>NISSAN PASSENGER CAR ..... 1987-89</p> <p>NISSAN VAN ..... 1991-92</p> <p><b>Engine Torque Strut Mount</b> <b>Rear</b></p> <p>NISSAN PASSENGER CAR ..... 1985-92</p> <p>NISSAN VAN ..... 1990-91</p>
 <p><b>EM-8119</b> <b>MOUNT-ENGINE</b> <b>Rear</b></p> <p>NISSAN PASSENGER CAR ..... 1983-86</p> <p><b>MOUNT-TRANSMISSION</b> <b>Auto</b></p> <p>NISSAN PASSENGER CAR ..... 1982-87</p>	 <p><b>EM-8122</b> <b>MOUNT-ENGINE</b> <b>RH Front</b></p> <p>NISSAN PASSENGER CAR ..... 1991-08</p>	 <p><b>EM-8128</b> <b>MOUNT-TRANSMISSION</b> <b>Auto</b></p> <p>NISSAN PASSENGER CAR ..... 1987-90</p>	 <p><b>EM-8135</b> <b>MOUNT-ENGINE</b> <b>RH Front</b></p> <p>NISSAN PASSENGER CAR ..... 1982-86</p>
 <p><b>EM-8120</b> <b>Engine Torque Strut Mount</b> <b>Front</b></p> <p>NISSAN PASSENGER CAR ..... 1983</p>	 <p><b>EM-8124</b> <b>MOUNT-TRANSMISSION</b> <b>MOUNT-TRANSMISSION</b> <b>Auto</b></p> <p>NISSAN SPORT UTILITY ..... 1987-95</p> <p>NISSAN TRUCK ..... 1986-97</p>	 <p><b>EM-8130</b> <b>MOUNT-ENGINE</b> <b>Front</b></p> <p>NISSAN PASSENGER CAR ..... 1991-08</p> <p>NISSAN VAN ..... 1991</p>	 <p><b>EM-8137</b> <b>Engine Torque Strut Mount</b> <b>Rear</b></p> <p>NISSAN PASSENGER CAR ..... 1987-89</p>
		 <p><b>EM-8132</b> <b>MOUNT-ENGINE</b> <b>Rear</b></p> <p>NISSAN PASSENGER CAR ..... 1991-08</p> <p>NISSAN VAN ..... 1991</p>	

# BUYER'S GUIDE

## NUMERICAL LISTING - ILLUSTRATIONS

 <p style="text-align: center;"><b>EM-8138</b> <b>MOUNT-ENGINE</b> <b>L &amp; R Front</b></p> <p>NISSAN PASSENGER CAR ..... 1976-84</p>	<p><b>EM-8142 (Continued)</b> NISSAN PASSENGER CAR ..... 1983</p>  <p style="text-align: center;"><b>EM-8144</b> <b>MOUNT-ENGINE</b> <b>RH Front</b></p> <p>NISSAN TRUCK ..... 1980</p>	 <p style="text-align: center;"><b>EM-8149</b> <b>MOUNT-TRANSMISSION</b> <b>Manual</b></p> <p>NISSAN PASSENGER CAR ..... 1991-99</p> <p style="text-align: center;"><b>MOUNT-TRANSMISSION</b> <b>Auto</b></p> <p>NISSAN VAN ..... 1991</p>	 <p style="text-align: center;"><b>EM-8152</b> <b>MOUNT-ENGINE</b> <b>Rear</b></p> <p>NISSAN PASSENGER CAR ..... 1987-08</p>
 <p style="text-align: center;"><b>EM-8140</b> <b>MOUNT-ENGINE</b> <b>RH Front</b></p> <p>NISSAN PASSENGER CAR ..... 1985-88</p>	 <p style="text-align: center;"><b>EM-8145</b> <b>MOUNT-ENGINE</b> <b>LH Front</b></p> <p>NISSAN TRUCK ..... 1981-83</p>	 <p style="text-align: center;"><b>EM-8150</b> <b>MOUNT-TRANSMISSION</b> <b>Auto</b></p> <p>NISSAN PASSENGER CAR ..... 1991-08</p>	 <p style="text-align: center;"><b>EM-8154</b> <b>MOUNT-ENGINE</b> <b>Rear</b></p> <p>NISSAN PASSENGER CAR ..... 1987-08</p>
 <p style="text-align: center;"><b>EM-8141</b> <b>MOUNT-ENGINE</b> <b>Rear</b></p> <p>NISSAN PASSENGER CAR ..... 1985-88</p>	 <p style="text-align: center;"><b>EM-8146</b> <b>MOUNT-ENGINE</b> <b>RH Front</b></p> <p>NISSAN TRUCK ..... 1981-83</p>	 <p style="text-align: center;"><b>EM-8151</b> <b>MOUNT-ENGINE</b> <b>Front</b></p> <p>NISSAN PASSENGER CAR ..... 1982-84</p> <p style="text-align: center;"><b>MOUNT-TRANSMISSION</b> <b>Auto</b></p> <p>NISSAN PASSENGER CAR ..... 1983-86</p>	 <p style="text-align: center;"><b>EM-8157</b> <b>MOUNT-ENGINE</b> <b>LH Front</b></p> <p>NISSAN TRUCK ..... 1983-86</p>
 <p style="text-align: center;"><b>EM-8142</b> <b>Engine Torque Strut Mount</b> <b>Front</b></p> <p>NISSAN PASSENGER CAR ..... 1982-87</p> <p style="text-align: center;"><b>Engine Torque Strut Mount</b> <b>Rear</b></p> <p>(Continued Next Column)</p>	 <p style="text-align: center;"><b>EM-8148</b> <b>MOUNT-TRANSMISSION</b> <b>Manual</b></p> <p>NISSAN PASSENGER CAR ..... 1991-08</p>	 <p style="text-align: center;"><b>EM-8160</b> <b>MOUNT-TRANSMISSION</b> <b>Manual</b></p> <p>SUZUKI SPORT UTILITY ..... 1985-95</p>	

# BUYER'S GUIDE

## NUMERICAL LISTING - ILLUSTRATIONS

 <p><b>EM-8161</b> <b>MOUNT-ENGINE</b> <b>L &amp; R Front</b></p> <p>SUZUKI SPORT UTILITY ..... 1985-95</p>	 <p><b>EM-8164</b> <b>MOUNT-ENGINE</b> <b>L &amp; R Front</b></p> <p>TOYOTA SPORT UTILITY ..... 1988-00 TOYOTA TRUCK ..... 1988-04</p>	 <p><b>EM-8168</b> <b>MOUNT-ENGINE</b> <b>Rear</b></p> <p>TOYOTA PASSENGER CAR ..... 1992-94</p>	 <p><b>EM-8173</b> <b>MOUNT-ENGINE</b> <b>Rear</b></p> <p>TOYOTA PASSENGER CAR ..... 1987-90</p>
 <p><b>EM-8162</b> <b>MOUNT-ENGINE</b> <b>Front</b></p> <p>CHEVROLET PASSENGER CAR ..... 1985-86</p> <p><b>MOUNT-ENGINE</b> <b>L &amp; R Front</b></p> <p>TOYOTA PASSENGER CAR ..... 1981-85 TOYOTA SPORT UTILITY ..... 1984-98 TOYOTA TRUCK ..... 1988-99</p>	 <p><b>EM-8165</b> <b>MOUNT-TRANSMISSION</b> <b>Manual</b></p> <p>TOYOTA SPORT UTILITY ..... 1990-95 TOYOTA TRUCK ..... 1988-98</p>	 <p><b>EM-8169</b> <b>MOUNT-ENGINE</b> <b>Rear</b></p> <p>TOYOTA PASSENGER CAR ..... 1992-95</p>	 <p><b>EM-8174</b> <b>MOUNT-ENGINE</b> <b>Rear</b></p> <p>TOYOTA PASSENGER CAR ..... 1987-90</p>
 <p><b>EM-8163</b> <b>MOUNT-ENGINE</b> <b>RH Front</b></p> <p>TOYOTA PASSENGER CAR ..... 1981-84</p> <p><b>MOUNT-ENGINE</b> <b>L &amp; R Front</b></p> <p>TOYOTA SPORT UTILITY ..... 1981-90</p>	 <p><b>EM-8166</b> <b>MOUNT-ENGINE</b> <b>RH Front</b></p> <p>TOYOTA PASSENGER CAR ..... 1991-99</p>	 <p><b>EM-8170</b> <b>MOUNT-TRANSMISSION</b> <b>Manual</b></p> <p>TOYOTA PASSENGER CAR ..... 1991-95</p>	 <p><b>EM-8175</b> <b>MOUNT-TRANSMISSION</b> <b>Auto</b></p> <p>TOYOTA PASSENGER CAR ..... 1991-98</p>
 <p><b>EM-8167</b> <b>MOUNT-ENGINE</b> <b>Rear</b></p> <p>TOYOTA PASSENGER CAR ..... 1991-99</p>	 <p><b>EM-8171</b> <b>MOUNT-ENGINE</b> <b>Rear</b></p> <p>TOYOTA PASSENGER CAR ..... 1991-94</p>	 <p><b>EM-8176</b> <b>MOUNT-TRANSMISSION</b> <b>Auto</b></p> <p>TOYOTA PASSENGER CAR ..... 1987-90</p>	

# BUYER'S GUIDE

## NUMERICAL LISTING - ILLUSTRATIONS



**EM-8177**  
**MOUNT-ENGINE**  
**Front**

GEO PASSENGER CAR ..... 1993-97  
TOYOTA PASSENGER CAR ..... 1993-02



**EM-8178**  
**MOUNT-ENGINE**  
**RH Front**

GEO PASSENGER CAR ..... 1993-97  
TOYOTA PASSENGER CAR ..... 1993-97



**EM-8179**  
**MOUNT-ENGINE**  
**Rear**

GEO PASSENGER CAR ..... 1993-97  
TOYOTA PASSENGER CAR ..... 1993-97



**EM-8180**  
**MOUNT-ENGINE**  
**Front**

GEO PASSENGER CAR ..... 1989-97

**(Continued Next Column)**

**EM-8180 (Continued)**

TOYOTA PASSENGER CAR ..... 1988-92



**EM-8181**  
**MOUNT-ENGINE**  
**Front**

GEO PASSENGER CAR ..... 1989-92  
TOYOTA PASSENGER CAR ..... 1988-92

**MOUNT-TRANSMISSION**

TOYOTA PASSENGER CAR ..... 1981-82



**EM-8183**  
**MOUNT-ENGINE**  
**RH Front**

GEO PASSENGER CAR ..... 1989-92  
TOYOTA PASSENGER CAR ..... 1990-92



**EM-8185**  
**MOUNT-ENGINE**  
**Rear**

GEO PASSENGER CAR ..... 1989-92  
TOYOTA PASSENGER CAR ..... 1988-92



**EM-8186**  
**MOUNT-ENGINE**  
**Rear**

TOYOTA PASSENGER CAR ..... 1988-92



**EM-8187**  
**MOUNT-ENGINE**  
**Rear**

GEO PASSENGER CAR ..... 1989-92  
TOYOTA PASSENGER CAR ..... 1987-92



**EM-8188**  
**MOUNT-TRANSMISSION**  
**MOUNT-TRANSMISSION**  
**LH**

GEO PASSENGER CAR ..... 1989-92  
TOYOTA PASSENGER CAR ..... 1988-92



**EM-8189**  
**MOUNT-ENGINE**  
**LH Front**

**(Continued Next Column)**

**EM-8189 (Continued)**

TOYOTA PASSENGER CAR ..... 1984

**MOUNT-TRANSMISSION**  
**Manual**

TOYOTA PASSENGER CAR ..... 1984-91



**EM-8191**  
**MOUNT-TRANSMISSION**  
**Center**

TOYOTA PASSENGER CAR ..... 1988-92



**EM-8191**  
**MOUNT-TRANSMISSION**  
**Manual**

GEO PASSENGER CAR ..... 1993-97  
TOYOTA PASSENGER CAR ..... 1993-97



**EM-8192**  
**MOUNT-ENGINE**  
**LH Front**

LEXUS PASSENGER CAR ..... 1990-91  
TOYOTA PASSENGER CAR ..... 1988-91

# BUYER'S GUIDE

## NUMERICAL LISTING - ILLUSTRATIONS

 <p style="text-align: center;"><b>EM-8193</b> <b>MOUNT-ENGINE</b> <b>LH Front</b></p> <p>LEXUS PASSENGER CAR ..... 1990-91 <b>MOUNT-ENGINE</b> <b>Front</b></p> <hr/> <p>TOYOTA PASSENGER CAR ..... 1987-91</p>	 <p style="text-align: center;"><b>EM-8196</b> <b>MOUNT-ENGINE</b> <b>RH Front</b></p> <p>TOYOTA PASSENGER CAR ..... 1987-91</p>	 <p style="text-align: center;"><b>EM-8201</b> <b>Engine Torque Strut</b> <b>Front Right</b></p> <p>LEXUS PASSENGER CAR ..... 1992-96 <b>Engine Torque Strut Mount</b> <b>Front</b></p> <hr/> <p>TOYOTA PASSENGER CAR ..... 1992-03</p>	 <p style="text-align: center;"><b>EM-8206</b> <b>MOUNT-ENGINE</b> <b>RH Front</b></p> <p>DODGE PASSENGER CAR ..... 1993-94 <b>MOUNT-ENGINE</b> <b>LH Front</b></p> <hr/> <p>EAGLE PASSENGER CAR ..... 1993-96 <b>MOUNT-ENGINE</b> <b>RH Front</b></p> <hr/> <p>MITSUBISHI PASSENGER CAR ..... 1993-96 PLYMOUTH PASSENGER CAR ..... 1993-94</p>
 <p style="text-align: center;"><b>EM-8194</b> <b>MOUNT-ENGINE</b> <b>Front</b></p> <p>TOYOTA PASSENGER CAR ..... 1987-91</p>	 <p style="text-align: center;"><b>EM-8197</b> <b>MOUNT-ENGINE</b> <b>Rear</b></p> <p>LEXUS PASSENGER CAR ..... 1990-91 TOYOTA PASSENGER CAR ..... 1988-91</p>	 <p style="text-align: center;"><b>EM-8205</b> <b>MOUNT-ENGINE</b> <b>LH Front</b></p> <p>DODGE PASSENGER CAR ..... 1979-88 DODGE TRUCK ..... 1983-93 <b>MOUNT-ENGINE</b> <b>L &amp; R Front</b></p> <hr/> <p>MITSUBISHI SPORT UTILITY ..... 1992-94 <b>MOUNT-ENGINE</b> <b>LH Front</b></p> <hr/> <p>MITSUBISHI TRUCK ..... 1983-85 PLYMOUTH PASSENGER CAR ..... 1979-86 <b>MOUNT-ENGINE</b> <b>Rear</b></p> <hr/> <p>MITSUBISHI PASSENGER CAR ..... 1983-89 <b>MOUNT-TRANSMISSION</b> <b>Auto</b></p> <hr/> <p>MITSUBISHI PASSENGER CAR ..... 1987-88</p>	 <p style="text-align: center;"><b>EM-8207</b> <b>MOUNT-ENGINE</b> <b>RH Front</b></p> <p>LEXUS PASSENGER CAR ..... 1990-93 TOYOTA PASSENGER CAR ..... 1989-93</p>
 <p style="text-align: center;"><b>EM-8195</b> <b>MOUNT-ENGINE</b> <b>Front</b></p> <p>TOYOTA PASSENGER CAR ..... 1983-90 <b>MOUNT-TRANSMISSION</b> <b>Manual</b></p> <hr/> <p>TOYOTA PASSENGER CAR ..... 1987-88</p>	 <p style="text-align: center;"><b>EM-8198</b> <b>MOUNT-ENGINE</b> <b>Rear</b></p> <p>TOYOTA PASSENGER CAR ..... 1987-88</p>	 <p style="text-align: center;"><b>EM-8200</b> <b>Engine Torque Strut Mount</b> <b>Front</b></p> <p>TOYOTA PASSENGER CAR ..... 1992-01</p>	 <p style="text-align: center;"><b>EM-8208</b> <b>MOUNT-TRANSMISSION</b> <b>Center</b></p> <p>LEXUS PASSENGER CAR ..... 1990-91 <b>MOUNT-TRANSMISSION</b></p> <hr/> <p>TOYOTA PASSENGER CAR ..... 1987-91</p>



# BUYER'S GUIDE

## NUMERICAL LISTING - ILLUSTRATIONS



**EM-8209**  
**MOUNT-ENGINE**  
**Rear**

TOYOTA PASSENGER CAR ..... 1992-96



**EM-8213**  
**MOUNT-ENGINE**  
**Front**

TOYOTA PASSENGER CAR ..... 1987-93



**EM-8221**  
**MOUNT-TRANSMISSION**  
**Auto**

AUDI PASSENGER CAR ..... 1973-87  
VOLKSWAGEN PASSENGER  
CAR ..... 1974-81



**EM-8224**  
**MOUNT-ENGINE**  
**Front**

SEAT ..... 2000-02  
VOLKSWAGEN PASSENGER  
CAR ..... 1984-97



**EM-8210**  
**MOUNT-ENGINE**  
**L & R Front**

TOYOTA PASSENGER CAR ..... 1984-87



**EM-8214**  
**MOUNT-ENGINE**  
**Rear**

TOYOTA PASSENGER CAR ..... 1983



**EM-8222**  
**MOUNT-ENGINE**  
**RH Front**

SEAT ..... 2000-02  
VOLKSWAGEN PASSENGER  
CAR ..... 1984-97



**EM-8225**  
**MOUNT-ENGINE**  
**RH Front**

PONTIAC PASSENGER CAR ..... 1988-89



**EM-8211**  
**MOUNT-ENGINE**  
**Front**

TOYOTA PASSENGER CAR ..... 1983-87



**EM-8218**  
**MOUNT-TRANSMISSION**

TOYOTA PASSENGER CAR ..... 1986-89

**MOUNT-ENGINE**  
**RH Rear**

VOLKSWAGEN PASSENGER  
CAR ..... 1984-97

**MOUNT-TRANSMISSION**  
**RH**

VOLKSWAGEN PASSENGER  
CAR ..... 1993-94



**EM-8223**  
**MOUNT-TRANSMISSION**  
**Auto**

MAZDA PASSENGER CAR ..... 1990



**EM-8228**  
**MOUNT-ENGINE**  
**Rear**

HONDA PASSENGER CAR ..... 1996-97



**EM-8212**  
**MOUNT-ENGINE**  
**Front**

TOYOTA PASSENGER CAR ..... 1981-88



**EM-8220**  
**MOUNT-TRANSMISSION**  
**Auto**

TOYOTA PASSENGER CAR ..... 1984

# BUYER'S GUIDE

## NUMERICAL LISTING - ILLUSTRATIONS

 <p style="text-align: center;"><b>EM-8229</b> <b>MOUNT-ENGINE</b> <b>L &amp; R Front</b></p> <p>MERCEDES-BENZ PASSENGER CAR ..... 1974-91</p>	<p><b>EM-8232 (Continued)</b></p> <p style="text-align: center;"><b>MOUNT-ENGINE</b> <b>RH Front</b></p> <p>PLYMOUTH PASSENGER CAR ..... 1985-86</p> <p style="text-align: center;"><b>MOUNT-TRANSMISSION</b></p> <p>DODGE PASSENGER CAR ..... 1985-88 PLYMOUTH PASSENGER CAR ..... 1985-86</p>  <p style="text-align: center;"><b>EM-8233</b> <b>MOUNT-ENGINE</b> <b>RH Front</b></p> <p>CHEVROLET PASSENGER CAR ..... 1985-88 TOYOTA PASSENGER CAR ..... 1983-87</p>	 <p style="text-align: center;"><b>EM-8236</b> <b>MOUNT-ENGINE</b> <b>LH Rear</b></p> <p>VOLKSWAGEN PASSENGER CAR ..... 1990-92</p> <p style="text-align: center;"><b>MOUNT-TRANSMISSION</b> <b>Auto</b></p> <p>VOLKSWAGEN PASSENGER CAR ..... 1992-97</p> <p style="text-align: center;"><b>MOUNT-TRANSMISSION</b> <b>LH</b></p> <p>VOLKSWAGEN PASSENGER CAR ..... 1984-02</p>	 <p style="text-align: center;"><b>EM-8242</b> <b>MOUNT-ENGINE</b> <b>RH Front</b></p> <p>DODGE PASSENGER CAR ..... 1985-90 PLYMOUTH PASSENGER CAR ..... 1987-88</p> <p style="text-align: center;"><b>MOUNT-TRANSMISSION</b></p> <p>DODGE PASSENGER CAR ..... 1987-88</p> <p style="text-align: center;"><b>MOUNT-TRANSMISSION</b> <b>Manual</b></p> <p>MITSUBISHI PASSENGER CAR ..... 1987-88</p> <p style="text-align: center;"><b>MOUNT-TRANSMISSION</b></p> <p>PLYMOUTH PASSENGER CAR ..... 1987-88</p>
 <p style="text-align: center;"><b>EM-8230</b> <b>MOUNT-TRANSMISSION</b></p> <p>MERCEDES-BENZ PASSENGER CAR ..... 1981-91</p>	 <p style="text-align: center;"><b>EM-8234</b> <b>MOUNT-ENGINE</b> <b>RH Front</b></p> <p>MAZDA PASSENGER CAR ..... 1986-89 MERCURY PASSENGER CAR ..... 1987-89</p>	 <p style="text-align: center;"><b>EM-8238</b> <b>MOUNT-ENGINE</b> <b>RH Front</b></p> <p>DODGE PASSENGER CAR ..... 1993-94</p> <p style="text-align: center;"><b>MOUNT-ENGINE</b> <b>LH Front</b></p> <p>EAGLE PASSENGER CAR ..... 1993-96</p> <p style="text-align: center;"><b>MOUNT-ENGINE</b> <b>RH Front</b></p> <p>MITSUBISHI PASSENGER CAR ..... 1993-96 PLYMOUTH PASSENGER CAR ..... 1992-94</p>	 <p style="text-align: center;"><b>EM-8243</b> <b>MOUNT-TRANSMISSION</b> <b>Manual</b></p> <p>DODGE TRUCK ..... 1990-91 MITSUBISHI SPORT UTILITY ..... 1992-99</p>
 <p style="text-align: center;"><b>EM-8231</b> <b>MOUNT-ENGINE</b> <b>Front</b></p> <p>DODGE PASSENGER CAR ..... 1985-90</p>	<p style="text-align: center;"><b>EM-8235</b> <b>MOUNT-ENGINE</b> <b>Front</b></p> <p>DODGE PASSENGER CAR ..... 1985-90</p> <p style="text-align: center;"><b>MOUNT-ENGINE</b> <b>L &amp; R Front</b></p> <p>DODGE SPORT UTILITY ..... 1989</p> <p style="text-align: center;"><b>MOUNT-ENGINE</b> <b>Front</b></p> <p>MITSUBISHI PASSENGER CAR ..... 1985-88 PLYMOUTH PASSENGER CAR ..... 1985-88</p>	 <p style="text-align: center;"><b>EM-8239</b> <b>MOUNT-ENGINE</b> <b>Front</b></p> <p>DODGE PASSENGER CAR ..... 1994 EAGLE PASSENGER CAR ..... 1994-96</p>	 <p style="text-align: center;"><b>EM-8244</b> <b>MOUNT-TRANSMISSION</b> <b>Manual</b></p> <p>DODGE TRUCK ..... 1990-93</p> <p style="text-align: center;"><b>MOUNT-TRANSMISSION</b> <b>Auto</b></p> <p>MITSUBISHI SPORT UTILITY ..... 1992-94</p>
<p>(Continued Next Column)</p>			

# BUYER'S GUIDE

## NUMERICAL LISTING - ILLUSTRATIONS

 <p style="text-align: center;"><b>EM-8248</b> <b>MOUNT-ENGINE</b> <b>Rear</b></p> <p>PLYMOUTH TRUCK ..... 1982 <b>MOUNT-TRANSMISSION</b> <b>Manual</b></p> <p>DODGE SPORT UTILITY ..... 1987-88 MITSUBISHI SPORT UTILITY ..... 1983-89 <b>MOUNT-TRANSMISSION</b></p> <p>MITSUBISHI TRUCK ..... 1983-86 DODGE TRUCK ..... 1982-89 <b>MOUNT-TRANSMISSION</b> <b>Manual</b></p> <p>MITSUBISHI TRUCK ..... 1983-86</p>	 <p style="text-align: center;"><b>EM-8255</b> <b>MOUNT-ENGINE</b> <b>LH Front</b></p> <p>HYUNDAI PASSENGER CAR ..... 1992-95</p>	 <p style="text-align: center;"><b>EM-8263</b> <b>MOUNT-TRANSMISSION</b> <b>Auto</b></p> <p>MAZDA PASSENGER CAR ..... 1981-82</p>	 <p style="text-align: center;"><b>EM-8270</b> <b>MOUNT-ENGINE</b> <b>Front Lower</b></p> <p>MITSUBISHI PASSENGER CAR ..... 1983-88 <b>MOUNT-ENGINE</b> <b>RH Front</b></p> <p>PLYMOUTH PASSENGER CAR ..... 1984-91</p>
 <p style="text-align: center;"><b>EM-8253</b> <b>MOUNT-ENGINE</b> <b>Front</b></p> <p>DODGE PASSENGER CAR ..... 1985-88 <b>MOUNT-ENGINE</b> <b>LH Front</b></p> <p>HYUNDAI PASSENGER CAR ..... 1995 <b>MOUNT-TRANSMISSION</b> <b>LH</b></p> <p>DODGE PASSENGER CAR ..... 2004-06</p>	 <p style="text-align: center;"><b>EM-8259</b> <b>MOUNT-ENGINE</b> <b>RH Front</b></p> <p>MAZDA PASSENGER CAR ..... 1983-85</p>	 <p style="text-align: center;"><b>EM-8266</b> <b>MOUNT-ENGINE</b> <b>Rear</b></p> <p>MITSUBISHI PASSENGER CAR ..... 1987-88</p>	 <p style="text-align: center;"><b>EM-8271</b> <b>MOUNT-ENGINE</b> <b>Rear</b></p> <p>MITSUBISHI PASSENGER CAR ..... 1983</p>
 <p style="text-align: center;"><b>EM-8254</b> <b>MOUNT-ENGINE</b> <b>RH Front</b></p> <p>HYUNDAI PASSENGER CAR ..... 1993-95</p>	 <p style="text-align: center;"><b>EM-8261</b> <b>MOUNT-ENGINE</b> <b>Rear</b></p> <p>MAZDA PASSENGER CAR ..... 1995-98</p>	 <p style="text-align: center;"><b>EM-8267</b> <b>MOUNT-ENGINE</b> <b>Rear</b></p> <p>DODGE PASSENGER CAR ..... 1985-88 MITSUBISHI PASSENGER CAR ..... 1985-88 PLYMOUTH PASSENGER CAR ..... 1985-88</p>	 <p style="text-align: center;"><b>EM-8272</b> <b>Engine Torque Strut Mount</b> <b>Front</b></p> <p>MITSUBISHI PASSENGER CAR ..... 1983-88</p>
 <p style="text-align: center;"><b>EM-8262</b> <b>MOUNT-ENGINE</b> <b>RH Front</b></p> <p>MAZDA PASSENGER CAR ..... 1986-87</p>			

# BUYER'S GUIDE

## NUMERICAL LISTING - ILLUSTRATIONS

 <p style="text-align: center;"><b>EM-8274</b> <b>MOUNT-TRANSMISSION</b> <b>Manual</b></p> <p>NISSAN PASSENGER CAR ..... 1989-90</p>	 <p style="text-align: center;"><b>EM-8278</b> <b>MOUNT-ENGINE</b> <b>RH Front</b></p> <p>TOYOTA PASSENGER CAR ..... 1987-90</p>	 <p style="text-align: center;"><b>EM-8282</b> <b>MOUNT-TRANSMISSION</b> <b>Manual</b></p> <p>CHEVROLET PASSENGER CAR ..... 1985-88</p>	<p><b>EM-8287 (Continued)</b> <b>MOUNT-TRANSMISSION</b></p> <p>SEAT ..... 2000-02 VOLKSWAGEN PASSENGER CAR ..... 1984-02</p> 
 <p style="text-align: center;"><b>EM-8276</b> <b>MOUNT-ENGINE</b> <b>L &amp; R Front</b></p> <p>NISSAN SPORT UTILITY ..... 1987-04 NISSAN TRUCK ..... 1986-04</p>	 <p style="text-align: center;"><b>EM-8279</b> <b>MOUNT-ENGINE</b> <b>L &amp; R Front</b></p> <p>TOYOTA PASSENGER CAR ..... 1980-86</p>	 <p style="text-align: center;"><b>EM-8283</b> <b>MOUNT-ENGINE</b> <b>Front</b></p> <p>CHEVROLET PASSENGER CAR ..... 1987-88 SUZUKI PASSENGER CAR ..... 1985</p>	<p style="text-align: center;"><b>EM-8290</b> <b>MOUNT-ENGINE</b> <b>RH Front</b></p> <p>NISSAN PASSENGER CAR ..... 1991-93</p> 
 <p style="text-align: center;"><b>EM-8277</b> <b>MOUNT-ENGINE</b> <b>Rear</b></p> <p>CHEVROLET PASSENGER CAR ..... 1998-00 GEO PASSENGER CAR ..... 1992-97 PONTIAC PASSENGER CAR ..... 1994-00 SUZUKI PASSENGER CAR ..... 1989-01</p> <p style="text-align: center;"><b>MOUNT-TRANSMISSION</b></p> <p>CHEVROLET PASSENGER CAR ..... 1989-01</p> <p style="text-align: center;"><b>MOUNT-TRANSMISSION</b> <b>Manual</b></p> <p>GEO PASSENGER CAR ..... 1989-97</p> <p style="text-align: center;"><b>MOUNT-TRANSMISSION</b></p> <p>SUZUKI PASSENGER CAR ..... 1992-94</p>	 <p style="text-align: center;"><b>EM-8280</b> <b>MOUNT-ENGINE</b> <b>L &amp; R Front</b></p> <p>TOYOTA SPORT UTILITY ..... 1967-80</p>	 <p style="text-align: center;"><b>EM-8284</b> <b>Engine Torque Strut Mount</b> <b>Rear</b></p> <p>NISSAN PASSENGER CAR ..... 1982-87</p>	<p style="text-align: center;"><b>EM-8292</b> <b>MOUNT-ENGINE</b> <b>Front</b></p> <p>MITSUBISHI PASSENGER CAR ..... 1985-87</p> <p style="text-align: center;"><b>MOUNT-TRANSMISSION</b> <b>Auto</b></p> <p>MITSUBISHI PASSENGER CAR ..... 1984-88</p> 
 <p style="text-align: center;"><b>EM-8281</b> <b>MOUNT-ENGINE</b> <b>LH Front</b></p> <p>MITSUBISHI PASSENGER CAR ..... 1990</p>	 <p style="text-align: center;"><b>EM-8287</b> <b>MOUNT-ENGINE</b> <b>RH Rear</b></p> <p>VOLKSWAGEN PASSENGER CAR ..... 1987-92</p> <p style="text-align: center;"><b>(Continued Next Column)</b></p>	 <p style="text-align: center;"><b>EM-8293</b> <b>Engine Torque Strut Mount</b> <b>Front</b></p> <p>HONDA PASSENGER CAR ..... 1979-81</p>	

# BUYER'S GUIDE

## NUMERICAL LISTING - ILLUSTRATIONS

 <p style="text-align: center;"><b>EM-8294</b> <b>MOUNT-ENGINE</b> Rear</p> <p>CHEVROLET PASSENGER CAR ..... 1985-91 GEO PASSENGER CAR ..... 1989-91 PONTIAC PASSENGER CAR ..... 1989-91 SUZUKI PASSENGER CAR ..... 1985</p>	 <p style="text-align: center;"><b>EM-8300</b> <b>MOUNT-TRANSMISSION</b></p> <p>HONDA PASSENGER CAR ..... 1996-00 HONDA SPORT UTILITY ..... 1997-01</p>	 <p style="text-align: center;"><b>EM-8307</b> <b>MOUNT-ENGINE</b> RH Front</p> <p>NISSAN PASSENGER CAR ..... 1991-00 NISSAN VAN ..... 1991</p>	<p><b>EM-8312 (Continued)</b> NISSAN PASSENGER CAR ..... 1986-90</p>  <p style="text-align: center;"><b>EM-8314</b> <b>MOUNT-TRANSMISSION</b> Auto</p> <p>GEO PASSENGER CAR ..... 1989-90 SUZUKI PASSENGER CAR ..... 1995-01</p>	
 <p style="text-align: center;"><b>EM-8295</b> <b>MOUNT-ENGINE</b> RH Front</p> <p>NISSAN PASSENGER CAR ..... 1989-90</p>	 <p style="text-align: center;"><b>EM-8303</b> <b>MOUNT-ENGINE</b> Rear</p> <p>NISSAN VAN ..... 1987-88 <b>MOUNT-TRANSMISSION</b> Auto</p> <p>NISSAN PASSENGER CAR ..... 1987-89</p>	 <p style="text-align: center;"><b>EM-8310</b> <b>MOUNT-ENGINE</b> LH Front</p> <p>NISSAN TRUCK ..... 1980-94</p>	 <p style="text-align: center;"><b>EM-8317</b> <b>MOUNT-TRANSMISSION</b> Auto</p> <p>NISSAN PASSENGER CAR ..... 1990</p>	
 <p style="text-align: center;"><b>EM-8296</b> <b>MOUNT-ENGINE</b> L &amp; R Front</p> <p>NISSAN PASSENGER CAR ..... 1989-98</p>	 <p style="text-align: center;"><b>EM-8304</b> <b>MOUNT-ENGINE</b> RH Front</p> <p>NISSAN PASSENGER CAR ..... 1985-92 NISSAN VAN ..... 1990-91</p>	 <p style="text-align: center;"><b>EM-8311</b> <b>MOUNT-ENGINE</b> L &amp; R Front</p> <p>INFINITI SPORT UTILITY ..... 1997-00 NISSAN SPORT UTILITY ..... 1996-00</p>	 <p style="text-align: center;"><b>EM-8319</b> <b>MOUNT-ENGINE</b> Rear</p> <p>NISSAN PASSENGER CAR ..... 1987-89</p>	
 <p style="text-align: center;"><b>EM-8312</b> <b>MOUNT-TRANSMISSION</b> Manual</p> <p style="text-align: center;">(Continued Next Column)</p>				

# BUYER'S GUIDE

## NUMERICAL LISTING - ILLUSTRATIONS



**EM-8322**  
**MOUNT-TRANSMISSION**  
Auto

INFINITI SPORT UTILITY ..... 2001-03  
**MOUNT-TRANSMISSION**  
NISSAN SPORT UTILITY ..... 1996-04

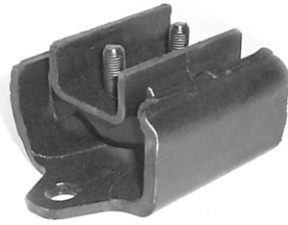

**EM-8328**  
**MOUNT-TRANSMISSION**  
Auto

NISSAN TRUCK ..... 1990-97



**EM-8339**  
**MOUNT-ENGINE**  
Front

TOYOTA PASSENGER CAR ..... 1985-89  
**MOUNT-ENGINE**  
Rear

TOYOTA PASSENGER CAR ..... 1985



**EM-8349**  
**MOUNT-ENGINE**  
Rear

HONDA PASSENGER CAR ..... 1989-91

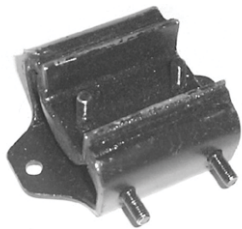

**EM-8323**  
**MOUNT-TRANSMISSION**  
Manual

NISSAN PASSENGER CAR ..... 1989-94



**EM-8329**  
**MOUNT-TRANSMISSION**  
Manual

ACURA PASSENGER CAR ..... 1994-01  
HONDA PASSENGER CAR ..... 1992-97



**EM-8344**  
**MOUNT-ENGINE**  
L & R Front

TOYOTA PASSENGER CAR ..... 1989-92



**EM-8351**  
**MOUNT-ENGINE**  
LH Front

ACURA SPORT UTILITY ..... 1996-99  
HONDA SPORT UTILITY ..... 1996-00  
ISUZU SPORT UTILITY ..... 1995-03



**EM-8324**  
**MOUNT-ENGINE**  
Rear

NISSAN PASSENGER CAR ..... 1985-92  
NISSAN VAN ..... 1990-91



**EM-8330**  
**MOUNT-TRANSMISSION**  
Auto

ACURA PASSENGER CAR ..... 1994-01  
HONDA PASSENGER CAR ..... 1992-93



**EM-8348**  
**MOUNT-ENGINE**  
Front

TOYOTA PASSENGER CAR ..... 1984-89

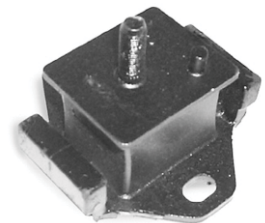

**EM-8352**  
**MOUNT-ENGINE**  
RH Front

ACURA SPORT UTILITY ..... 1996-99  
HONDA SPORT UTILITY ..... 1996-97  
ISUZU SPORT UTILITY ..... 1995-02

# BUYER'S GUIDE

## NUMERICAL LISTING - ILLUSTRATIONS

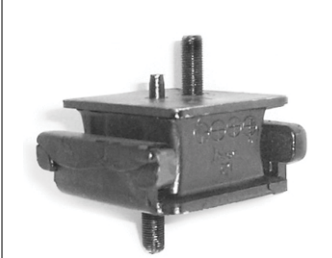

**EM-8353**  
MOUNT-ENGINE  
L & R Front

LEXUS SPORT UTILITY ..... 1996-97  
TOYOTA SPORT UTILITY ..... 1993-97



**EM-8363**  
MOUNT-ENGINE  
Front

TOYOTA PASSENGER CAR ..... 1987-90



**EM-8375**  
MOUNT-ENGINE  
Rear

TOYOTA PASSENGER CAR ..... 1986-87



**EM-8385 (Continued)**  
TOYOTA PASSENGER CAR ..... 1986-93

**EM-8388**  
MOUNT-TRANSMISSION  
Auto

TOYOTA SPORT UTILITY ..... 1984-89

**MOUNT-TRANSMISSION**

TOYOTA TRUCK ..... 1981-88



**EM-8359**  
MOUNT-ENGINE  
Front

TOYOTA PASSENGER CAR ..... 1990-93

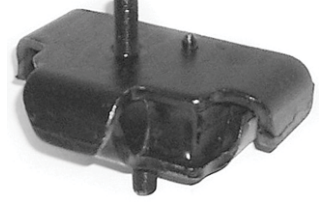

**EM-8365**  
MOUNT-ENGINE  
LH Front

TOYOTA SPORT UTILITY ..... 1991-92



**EM-8377**  
MOUNT-TRANSMISSION  
Manual

TOYOTA PASSENGER CAR ..... 1980-86



**EM-8389**  
MOUNT-TRANSMISSION

TOYOTA TRUCK ..... 1979-87



**EM-8361**  
MOUNT-ENGINE  
Front

TOYOTA PASSENGER CAR ..... 1992-01

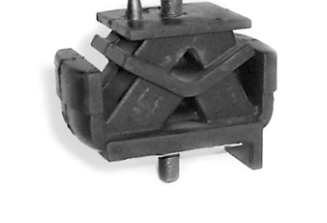

**EM-8368**  
MOUNT-ENGINE  
RH Front

TOYOTA PASSENGER CAR ..... 1984-86



**EM-8384**  
MOUNT-ENGINE  
Rear

TOYOTA PASSENGER CAR ..... 1985-89



**EM-8392**  
MOUNT-TRANSMISSION  
Manual

TOYOTA SPORT UTILITY ..... 1981-85

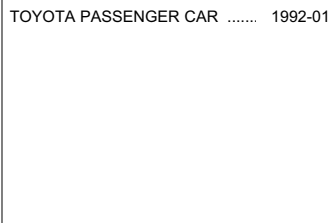

**EM-8374**  
MOUNT-TRANSMISSION  
Manual

HONDA PASSENGER CAR ..... 1988-91

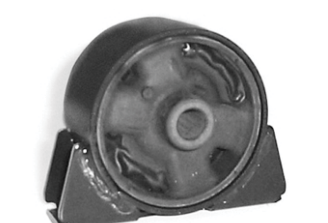

**EM-8385**  
MOUNT-ENGINE  
Rear

(Continued Next Column)

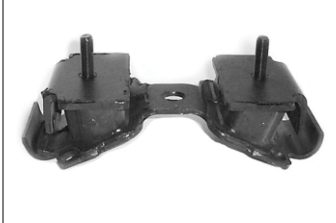

**EM-8393**  
MOUNT-TRANSMISSION  
Manual

TOYOTA SPORT UTILITY ..... 1985-90

# BUYER'S GUIDE

## NUMERICAL LISTING - ILLUSTRATIONS

 <p><b>EM-8395</b> <b>MOUNT-TRANSMISSION</b> LEXUS SPORT UTILITY ..... 1996-97 TOYOTA SPORT UTILITY ..... 1991-97</p>	 <p><b>EM-8402</b> <b>MOUNT-ENGINE</b> <b>RH Front</b> HONDA PASSENGER CAR ..... 1984-87</p>	 <p><b>EM-8411</b> <b>MOUNT-ENGINE</b> <b>Front</b> HONDA PASSENGER CAR ..... 1988-91</p>	 <p><b>EM-8418</b> <b>MOUNT-TRANSMISSION</b> <b>Manual</b> TOYOTA PASSENGER CAR ..... 1995-99</p>
 <p><b>EM-8398</b> <b>MOUNT-ENGINE</b> <b>Rear</b> LEXUS PASSENGER CAR ..... 1992-96 TOYOTA PASSENGER CAR ..... 1992-01</p>	 <p><b>EM-8404</b> <b>MOUNT-ENGINE</b> <b>LH Front</b> ACURA PASSENGER CAR ..... 1997-99 HONDA PASSENGER CAR ..... 1994-97 HONDA VAN ..... 1995-98 ISUZU VAN ..... 1996-99</p>	 <p><b>EM-8413</b> <b>MOUNT-ENGINE</b> <b>Rear</b> TOYOTA PASSENGER CAR ..... 1990-93</p>	 <p><b>EM-8422</b> <b>MOUNT-TRANSMISSION</b> <b>Auto</b> TOYOTA PASSENGER CAR ..... 1988-91</p>
 <p><b>EM-8400</b> <b>MOUNT-ENGINE</b> <b>Rear</b> TOYOTA PASSENGER CAR ..... 1984-85</p>	 <p><b>EM-8406</b> <b>MOUNT-ENGINE</b> <b>Rear</b> TOYOTA PASSENGER CAR ..... 1987-88</p>	 <p><b>EM-8414</b> <b>MOUNT-ENGINE</b> <b>Rear</b> TOYOTA PASSENGER CAR ..... 1992-01</p>	 <p><b>EM-8424</b> <b>MOUNT-ENGINE</b> <b>L &amp; R Front</b> MAZDA PASSENGER CAR ..... 1986-91</p>
 <p><b>EM-8401</b> <b>MOUNT-ENGINE</b> <b>Rear</b> TOYOTA PASSENGER CAR ..... 1984-85</p>	 <p><b>EM-8407</b> <b>MOUNT-ENGINE</b> <b>Rear</b> TOYOTA PASSENGER CAR ..... 1986-89</p>	 <p><b>EM-8415</b> <b>MOUNT-TRANSMISSION</b> <b>Auto</b> GEO PASSENGER CAR ..... 1996-97 TOYOTA PASSENGER CAR ..... 1993-97</p>	 <p><b>EM-8424</b> <b>MOUNT-ENGINE</b> <b>L &amp; R Front</b> MAZDA PASSENGER CAR ..... 1981-85 <b>MOUNT-TRANSMISSION</b> <b>Auto</b> MAZDA PASSENGER CAR ..... 1986-87</p>



# BUYER'S GUIDE

## NUMERICAL LISTING - ILLUSTRATIONS



**EM-8425**  
Engine Torque Strut Mount  
Front

MAZDA PASSENGER CAR ..... 1981-85



**EM-8432**  
MOUNT-ENGINE  
Front

ACURA PASSENGER CAR ..... 1997-99  
HONDA PASSENGER CAR ..... 1994-97



**EM-8438**  
Engine Torque Strut  
Front Left

CHEVROLET PASSENGER  
CAR ..... 1985-88  
ISUZU PASSENGER CAR ..... 1985-89



**EM-8445**  
MOUNT-ENGINE  
LH Front

HONDA SPORT UTILITY ..... 1994-95  
ISUZU SPORT UTILITY ..... 1992-95



**EM-8427**  
MOUNT-ENGINE  
RH Front

NISSAN PASSENGER CAR ..... 1991-94  
NISSAN VAN ..... 1991



**EM-8434**  
MOUNT-ENGINE  
Front

ACURA PASSENGER CAR ..... 1997-01

**MOUNT-ENGINE  
RH Front**

HONDA PASSENGER CAR ..... 1992-95



**EM-8439**  
MOUNT-ENGINE  
RH Front

CHEVROLET PASSENGER  
CAR ..... 1985-88  
GEO PASSENGER CAR ..... 1989  
ISUZU PASSENGER CAR ..... 1989  
PONTIAC PASSENGER CAR ..... 1985-88

**MOUNT-TRANSMISSION  
Auto**

CHEVROLET PASSENGER  
CAR ..... 1985-88  
ISUZU PASSENGER CAR ..... 1985-89



**EM-8453**  
MOUNT-ENGINE  
Rear

MAZDA PASSENGER CAR ..... 1990-96



**EM-8430**  
MOUNT-ENGINE  
L & R Front

TOYOTA PASSENGER CAR ..... 1980-82



**EM-8435**  
MOUNT-ENGINE  
LH Front

ACURA PASSENGER CAR ..... 1997-01

**MOUNT-ENGINE  
LH Front Lower**

HONDA PASSENGER CAR ..... 1992-00



**EM-8442**  
MOUNT-ENGINE  
Front

CHEVROLET PASSENGER  
CAR ..... 1985-88  
GEO PASSENGER CAR ..... 1989  
ISUZU PASSENGER CAR ..... 1985-89  
PONTIAC PASSENGER CAR ..... 1985-88



**EM-8456**  
MOUNT-ENGINE  
Rear

FORD PASSENGER CAR ..... 1993-97  
MAZDA PASSENGER CAR ..... 1993-02

**MOUNT-TRANSMISSION  
Upper**

FORD PASSENGER CAR ..... 1993















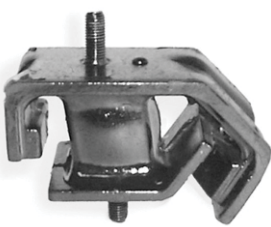

**EM-8431**  
MOUNT-ENGINE  
Front

HONDA PASSENGER CAR ..... 1988-97

# BUYER'S GUIDE

## NUMERICAL LISTING - ILLUSTRATIONS

 <p><b>EM-8457</b> <b>MOUNT-TRANSMISSION</b> Upper</p> <p>FORD PASSENGER CAR ..... 1994-97 <b>MOUNT-TRANSMISSION</b> Manual</p> <p>MAZDA PASSENGER CAR ..... 1993-02</p>	 <p><b>EM-8466</b> <b>MOUNT-ENGINE</b> LH Front</p> <p>MITSUBISHI VAN ..... 1987-90</p>	 <p><b>EM-8488</b> <b>MOUNT-ENGINE</b> L &amp; R Front</p> <p>TOYOTA SPORT UTILITY ..... 1982-85 TOYOTA TRUCK ..... 1982-95</p>	 <p><b>EM-8491</b> <b>MOUNT-ENGINE</b> Front</p> <p>TOYOTA PASSENGER CAR ..... 1985-93</p>
 <p><b>EM-8460</b> <b>MOUNT-TRANSMISSION</b> Auto</p> <p>MAZDA PASSENGER CAR ..... 1993-97</p>	 <p><b>EM-8467</b> <b>MOUNT-ENGINE</b> RH Front</p> <p>MITSUBISHI VAN ..... 1987-90</p>	 <p><b>EM-8489</b> <b>MOUNT-ENGINE</b> Front</p> <p>CHEVROLET PASSENGER CAR ..... 1985-86 SUZUKI PASSENGER CAR ..... 1985</p>	 <p><b>EM-8492</b> <b>MOUNT-ENGINE</b> Rear</p> <p>TOYOTA PASSENGER CAR ..... 1984-85</p>
 <p><b>EM-8462</b> <b>MOUNT-TRANSMISSION</b> Manual</p> <p>MAZDA PASSENGER CAR ..... 1988-92</p>	 <p><b>EM-8482</b> <b>MOUNT-ENGINE</b> RH Front</p> <p>TOYOTA PASSENGER CAR ..... 1986</p>	 <p><b>EM-8490</b> <b>MOUNT-TRANSMISSION</b> Manual</p> <p>SUZUKI PASSENGER CAR ..... 1985</p>	 <p><b>EM-8493</b> <b>MOUNT-ENGINE</b> Rear</p> <p>TOYOTA PASSENGER CAR ..... 1984</p>
	 <p><b>EM-8485</b> <b>MOUNT-ENGINE</b> Front</p> <p>TOYOTA PASSENGER CAR ..... 1992-96</p>		 <p><b>EM-8495</b> <b>MOUNT-TRANSMISSION</b> Auto</p> <p>HONDA PASSENGER CAR ..... 1992-93</p>

# BUYER'S GUIDE

## NUMERICAL LISTING - ILLUSTRATIONS



**EM-8497**  
**MOUNT-ENGINE**  
**RH Front**

HONDA PASSENGER CAR ..... 1988-91



**EM-8499**  
**MOUNT-ENGINE**  
**LH Front**

HONDA SPORT UTILITY ..... 1996  
ISUZU SPORT UTILITY ..... 1995-97



**EM-8502**  
**MOUNT-TRANSMISSION**

DODGE PASSENGER CAR ..... 1971-80  
PLYMOUTH PASSENGER CAR ..... 1976-80



**EM-8503**  
**MOUNT-TRANSMISSION**  
**Manual**

DODGE PASSENGER CAR ..... 1971-80

**EM-8503 (Continued)**  
**MOUNT-TRANSMISSION**

PLYMOUTH PASSENGER CAR ..... 1976-80  
PLYMOUTH TRUCK ..... 1979-82



**EM-8506**  
**MOUNT-ENGINE**  
**Rear**

MITSUBISHI PASSENGER CAR ..... 1983



**EM-8508**  
**MOUNT-TRANSMISSION**  
**Auto**

TOYOTA SPORT UTILITY ..... 1988-95  
TOYOTA TRUCK ..... 1988-95



**EM-8510**  
**MOUNT-TRANSMISSION**  
**Manual**

MITSUBISHI PASSENGER CAR ..... 1983-88  
PLYMOUTH PASSENGER CAR ..... 1984-91



**EM-8513**  
**MOUNT-ENGINE**  
**Front**

MAZDA PASSENGER CAR ..... 1995-98



**EM-8514**  
**MOUNT-ENGINE**  
**RH Front**

CHEVROLET PASSENGER CAR ..... 1989-91  
GEO PASSENGER CAR ..... 1989-91



**EM-8511**  
**MOUNT-ENGINE**  
**RH Front**

FORD PASSENGER CAR ..... 1990-93



**EM-8512**  
**MOUNT-TRANSMISSION**  
**Auto**

MAZDA PASSENGER CAR ..... 1979-85



**EM-8516**  
**MOUNT-TRANSMISSION**  
**Auto**

FORD PASSENGER CAR ..... 1989-92  
MAZDA PASSENGER CAR ..... 1988-92



**EM-8517**  
**MOUNT-ENGINE**  
**Front**

CHEVROLET PASSENGER CAR ..... 1989-92  
GEO PASSENGER CAR ..... 1989-97

(Continued Next Column)

**EM-8514 (Continued)**  
**MOUNT-ENGINE**  
**Front**

MAZDA PASSENGER CAR ..... 1983-85  
**MOUNT-ENGINE**  
**RH Front**

PONTIAC PASSENGER CAR ..... 1989-91



**EM-8516**  
**MOUNT-TRANSMISSION**  
**Auto**

FORD PASSENGER CAR ..... 1989-92  
MAZDA PASSENGER CAR ..... 1988-92



**EM-8517**  
**MOUNT-ENGINE**  
**Front**

CHEVROLET PASSENGER CAR ..... 1989-92  
GEO PASSENGER CAR ..... 1989-97

**MOUNT-ENGINE**  
**LH Front**

PONTIAC PASSENGER CAR ..... 1989-94  
**MOUNT-ENGINE**  
**Front**

SUZUKI PASSENGER CAR ..... 1989-01



**EM-8521**  
**Engine Torque Strut Mount**  
**Front**

CHEVROLET PASSENGER CAR ..... 1985-91  
SUZUKI PASSENGER CAR ..... 1985

(Continued Next Column)

(Continued Next Column)

# BUYER'S GUIDE

## NUMERICAL LISTING - ILLUSTRATIONS



**EM-8522**  
**MOUNT-TRANSMISSION**  
**Auto**

SUZUKI PASSENGER CAR ..... 1985



**EM-8524**  
**Engine Torque Strut Mount**  
**Rear**

CHEVROLET PASSENGER CAR ..... 1985-91  
SUZUKI PASSENGER CAR ..... 1985



**EM-8525**  
**Engine Torque Strut Mount**  
**Front**

HONDA PASSENGER CAR ..... 1980-83



**EM-8529**  
**MOUNT-TRANSMISSION**  
**Manual**

LEXUS PASSENGER CAR ..... 1992-93  
TOYOTA PASSENGER CAR ..... 1992-03



**EM-8539**  
**Engine Torque Strut**  
**Front Left**

CHEVROLET PASSENGER CAR ..... 1985-88  
ISUZU PASSENGER CAR ..... 1985-89

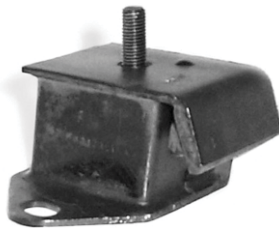

**EM-8542**  
**MOUNT-ENGINE**  
**L & R Front**

PLYMOUTH PASSENGER CAR ..... 1978-82

**MOUNT-ENGINE**  
**Rear**

PLYMOUTH PASSENGER CAR ..... 1981-84

**MOUNT-TRANSMISSION**  
**Manual**

PLYMOUTH PASSENGER CAR ..... 1976-80  
PLYMOUTH PASSENGER CAR ..... 1979-82

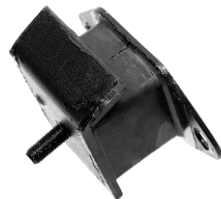

**EM-8544**  
**MOUNT-TRANSMISSION**  
**Manual**

DODGE PASSENGER CAR ..... 1978-79  
PLYMOUTH PASSENGER CAR ..... 1979-82



**EM-8545**  
**MOUNT-TRANSMISSION**  
**MOUNT-TRANSMISSION**  
**Auto**

DODGE PASSENGER CAR ..... 1980-84

PLYMOUTH PASSENGER CAR ..... 1978-84



**EM-8548**  
**MOUNT-TRANSMISSION**  
**Auto**

PLYMOUTH PASSENGER CAR ..... 1979-82



**EM-8552**  
**MOUNT-TRANSMISSION**  
**Manual**

DODGE PASSENGER CAR ..... 1985-86  
MITSUBISHI PASSENGER CAR ..... 1985-86  
PLYMOUTH PASSENGER CAR ..... 1985-86



**EM-8553**  
**MOUNT-ENGINE**  
**Front**

MITSUBISHI PASSENGER CAR ..... 1987-88



**EM-8554**  
**MOUNT-ENGINE**  
**Rear**

MITSUBISHI PASSENGER CAR ..... 1987-88



**EM-8556**  
**MOUNT-ENGINE**  
**LH Front**

MITSUBISHI PASSENGER CAR ..... 1985

**MOUNT-ENGINE**  
**Rear**

PLYMOUTH PASSENGER CAR ..... 1979-80  
PLYMOUTH TRUCK ..... 1979-81

**MOUNT-TRANSMISSION**

DODGE PASSENGER CAR ..... 1985-88  
DODGE TRUCK ..... 1983-86

**MOUNT-TRANSMISSION**  
**Auto**

MITSUBISHI TRUCK ..... 1983-89

**MOUNT-TRANSMISSION**

MITSUBISHI VAN ..... 1987-90  
PLYMOUTH PASSENGER CAR ..... 1985-86

# BUYER'S GUIDE

## NUMERICAL LISTING - ILLUSTRATIONS



**EM-8559**  
**MOUNT-ENGINE**  
**Front**

EAGLE PASSENGER CAR ..... 1991-94  
**MOUNT-ENGINE**  
**LH Front**  
 MITSUBISHI PASSENGER  
 CAR ..... 1990-94  
**MOUNT-ENGINE**  
**Front**  
 PLYMOUTH PASSENGER  
 CAR ..... 1992-94



**EM-8560**  
**MOUNT-ENGINE**  
**LH Front**

HYUNDAI PASSENGER CAR ..... 1995



**EM-8563**  
**Engine Torque Strut Mount**  
**Rear**

MAZDA PASSENGER CAR ..... 1981-85



**EM-8566**  
**MOUNT-ENGINE**  
**RH Front**

NISSAN TRUCK ..... 1980-85



**EM-8568**  
**MOUNT-ENGINE**  
**L & R Front**

CHEVROLET SPORT UTILITY ..... 1998  
 GEO SPORT UTILITY ..... 1989-97  
 PONTIAC PASSENGER CAR ..... 1994-97  
 SUZUKI SPORT UTILITY ..... 1989-98

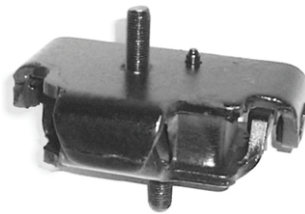

**EM-8571**  
**MOUNT-ENGINE**  
**RH Front**

TOYOTA SPORT UTILITY ..... 1991-92



**EM-8572**  
**MOUNT-TRANSMISSION**  
**Auto**

HONDA PASSENGER CAR ..... 1994-97



**EM-8574**  
**MOUNT-ENGINE**  
**Front**

HONDA PASSENGER CAR ..... 1984-85

**MOUNT-ENGINE**  
**Rear**

HONDA PASSENGER CAR ..... 1984-85



**EM-8575**  
**MOUNT-ENGINE**  
**Front**

ACURA PASSENGER CAR ..... 1994-01

HONDA PASSENGER CAR ..... 1992-00

**MOUNT-TRANSMISSION**  
**Auto**

PLYMOUTH PASSENGER  
 CAR ..... 1985-86



**EM-8576**  
**MOUNT-ENGINE**  
**LH Front**

ISUZU SPORT UTILITY ..... 1987-94

ISUZU TRUCK ..... 1986-95



**EM-8577**  
**MOUNT-ENGINE**  
**L & R Front**

ISUZU TRUCK ..... 1987



**EM-8578**  
**MOUNT-ENGINE**  
**L & R Front**

MAZDA TRUCK ..... 1989-93



**EM-8579**  
**MOUNT-ENGINE**  
**RH Front**

ISUZU SPORT UTILITY ..... 1987-94

ISUZU TRUCK ..... 1986-95



**EM-8582**  
**MOUNT-TRANSMISSION**  
**Auto**

DODGE PASSENGER CAR ..... 1993-94

EAGLE PASSENGER CAR ..... 1993-96

MITSUBISHI PASSENGER  
 CAR ..... 1993-96

(Continued Next Page)

# BUYER'S GUIDE

## NUMERICAL LISTING - ILLUSTRATIONS

### EM-8582 (Continued)

PLYMOUTH PASSENGER  
CAR ..... 1993-94



**EM-8584**  
**MOUNT-ENGINE**  
**RH Front**

DODGE PASSENGER CAR ..... 1989-90  
**MOUNT-TRANSMISSION**  
**Auto**

DODGE PASSENGER CAR ..... 1989-92  
EAGLE PASSENGER CAR ..... 1989-92  
MITSUBISHI PASSENGER  
CAR ..... 1989-92  
PLYMOUTH PASSENGER  
CAR ..... 1989-92

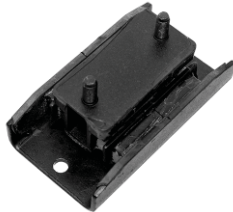

**EM-8586**  
**MOUNT-TRANSMISSION**

CHEVROLET TRUCK ..... 1981-82  
**MOUNT-TRANSMISSION**  
**Auto**

HONDA SPORT UTILITY ..... 1994-97  
**MOUNT-TRANSMISSION**  
**Manual**

ISUZU SPORT UTILITY ..... 1984-00  
ISUZU TRUCK ..... 1981-95



**EM-8589**  
**MOUNT-ENGINE**  
**RH Rear**

VOLKSWAGEN PASSENGER  
CAR ..... 1993-02

(Continued Next Column)

### EM-8589 (Continued)

#### MOUNT-TRANSMISSION

VOLKSWAGEN PASSENGER  
CAR ..... 1990-96

#### MOUNT-TRANSMISSION Manual

VOLKSWAGEN PASSENGER  
CAR ..... 1990-94



**EM-8592**  
**MOUNT-TRANSMISSION**  
**Manual**

BMW PASSENGER CAR ..... 1966-83



**EM-8593**  
**MOUNT-TRANSMISSION**  
**Auto**

BMW PASSENGER CAR ..... 1966-76

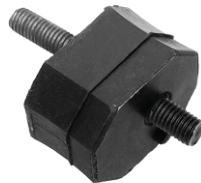

**EM-8594**  
**MOUNT-TRANSMISSION**  
**Manual**

BMW PASSENGER CAR ..... 1971-83



**EM-8595**  
**MOUNT-ENGINE**  
**LH Front**

HYUNDAI PASSENGER CAR ..... 1995-96



**EM-8599**  
**MOUNT-ENGINE**  
**Front**

HYUNDAI PASSENGER CAR ..... 1992-94



**EM-8596**  
**MOUNT-ENGINE**  
**Front**

HYUNDAI PASSENGER CAR ..... 1992-95



**EM-8600**  
**MOUNT-ENGINE**  
**Front**

NISSAN PASSENGER CAR ..... 1987-94



**EM-8597**  
**MOUNT-ENGINE**  
**Front**

HYUNDAI PASSENGER CAR ..... 1995-98



**EM-8601**  
**MOUNT-ENGINE**  
**LH Front**

NISSAN PASSENGER CAR ..... 1989-94  
**MOUNT-TRANSMISSION**  
**Auto**

NISSAN PASSENGER CAR ..... 1989-94



**EM-8598**  
**MOUNT-ENGINE**  
**Front**

HYUNDAI PASSENGER CAR ..... 1992-94

# BUYER'S GUIDE

## NUMERICAL LISTING - ILLUSTRATIONS



**EM-8602**  
MOUNT-ENGINE  
RH Rear

NISSAN PASSENGER CAR ..... 1989-94



**EM-8606**  
MOUNT-ENGINE  
RH Front

KIA SPORT UTILITY ..... 1995-02



**EM-8611**  
MOUNT-ENGINE  
Rear

KIA PASSENGER CAR ..... 1994-97



**EM-8616**  
MOUNT-ENGINE  
RH Front

VOLKSWAGEN PASSENGER  
CAR ..... 1993-02

**MOUNT-ENGINE  
RH Rear**

VOLKSWAGEN PASSENGER  
CAR ..... 1993-02



**EM-8603**  
MOUNT-ENGINE  
LH Rear

NISSAN PASSENGER CAR ..... 1989-94

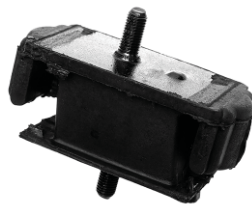

**EM-8607**  
MOUNT-ENGINE  
LH Front

KIA SPORT UTILITY ..... 1995-02



**EM-8612**  
MOUNT-ENGINE  
Rear

KIA PASSENGER CAR ..... 1994-97



**EM-8617**  
MOUNT-ENGINE  
Front

VOLKSWAGEN PASSENGER  
CAR ..... 1993-02



**EM-8604**  
MOUNT-TRANSMISSION  
Auto

NISSAN PASSENGER CAR ..... 1985-88



**EM-8608**  
MOUNT-TRANSMISSION  
Manual

KIA SPORT UTILITY ..... 1995-02



**EM-8614**  
Engine Torque Strut Mount  
Front

ACURA PASSENGER CAR ..... 1986-90  
HONDA PASSENGER CAR ..... 1982-89



**EM-8619**  
MOUNT-ENGINE  
LH Front

MITSUBISHI PASSENGER  
CAR ..... 1987-88

**MOUNT-TRANSMISSION  
Auto**

EAGLE PASSENGER CAR ..... 1992-96  
MITSUBISHI PASSENGER  
CAR ..... 1993-96  
PLYMOUTH PASSENGER  
CAR ..... 1993-94



**EM-8605**  
MOUNT-ENGINE  
Front

NISSAN PASSENGER CAR ..... 1985-88



**EM-8609**  
MOUNT-ENGINE  
RH Front

KIA PASSENGER CAR ..... 1994-97  
MAZDA PASSENGER CAR ..... 1990-96



**EM-8615**  
Engine Torque Strut Mount  
Rear

ACURA PASSENGER CAR ..... 1986-90  
HONDA PASSENGER CAR ..... 1982-89

# BUYER'S GUIDE

## NUMERICAL LISTING - ILLUSTRATIONS

 <p><b>EM-8620</b> <b>MOUNT-ENGINE</b> <b>L &amp; R Front</b></p> <p>VOLVO PASSENGER CAR ..... 1983-85</p>	 <p><b>EM-8629</b> <b>MOUNT-TRANSMISSION</b></p> <p>MERCEDES-BENZ PASSENGER CAR ..... 1973-85</p>	 <p><b>EM-8639</b> <b>MOUNT-ENGINE</b> <b>Front</b></p> <p>TOYOTA PASSENGER CAR ..... 1990-93</p>	 <p><b>EM-8643</b> <b>MOUNT-TRANSMISSION</b> <b>Auto</b></p> <p>TOYOTA PASSENGER CAR ..... 1988-92</p>
 <p><b>EM-8621</b> <b>MOUNT-ENGINE</b> <b>LH Front</b></p> <p>ISUZU PASSENGER CAR ..... 1981-84</p>	 <p><b>EM-8630</b> <b>MOUNT-ENGINE</b> <b>LH Front</b></p> <p>MERCEDES-BENZ PASSENGER CAR ..... 1974-91</p>	 <p><b>EM-8640</b> <b>MOUNT-ENGINE</b> <b>RH Front</b></p> <p>SUBARU PASSENGER CAR ..... 1980-87</p>	 <p><b>EM-8644</b> <b>MOUNT-TRANSMISSION</b> <b>Auto</b></p> <p>LEXUS PASSENGER CAR ..... 1992-01 TOYOTA PASSENGER CAR ..... 1993-04</p>
 <p><b>EM-8622</b> <b>MOUNT-ENGINE</b> <b>L &amp; R Front</b></p> <p>VOLVO PASSENGER CAR ..... 1987-95</p>	 <p><b>EM-8631</b> <b>MOUNT-TRANSMISSION</b></p> <p>MERCEDES-BENZ PASSENGER CAR ..... 1977-85</p>	<p><b>MOUNT-ENGINE</b> <b>Rear</b></p> <p>SUBARU PASSENGER CAR ..... 1985-89</p> <p><b>MOUNT-TRANSMISSION</b> <b>Manual</b></p> <p>SUBARU PASSENGER CAR ..... 1985-91 SUBARU PASSENGER CAR ..... 1985-94</p>	<p><b>MOUNT-TRANSMISSION</b></p> <p>TOYOTA VAN ..... 1998-03</p>
 <p><b>EM-8623</b> <b>MOUNT-TRANSMISSION</b> <b>Manual</b></p> <p>AUDI PASSENGER CAR ..... 1975-80 VOLKSWAGEN PASSENGER CAR ..... 1974-75</p>	 <p><b>EM-8632</b> <b>MOUNT-TRANSMISSION</b></p> <p>MERCEDES-BENZ PASSENGER CAR ..... 1986-93</p>	 <p><b>EM-8641</b> <b>MOUNT-ENGINE</b> <b>L &amp; R Front</b></p> <p>SUBARU PASSENGER CAR ..... 1979-94 SUBARU SPORT UTILITY ..... 1978-80</p> <p><b>MOUNT-ENGINE</b> <b>Rear</b></p> <p>SUBARU PASSENGER CAR ..... 1980-87</p>	 <p><b>EM-8648</b> <b>MOUNT-TRANSMISSION</b> <b>Manual</b></p> <p>CHEVROLET PASSENGER CAR ..... 1985-88 TOYOTA PASSENGER CAR ..... 1985-87</p>



# BUYER'S GUIDE

## NUMERICAL LISTING - ILLUSTRATIONS

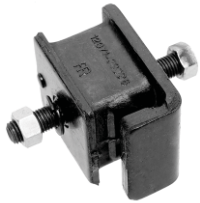

**EM-8649**  
**MOUNT-ENGINE**  
**Rear**

TOYOTA VAN ..... 1984-88  
**MOUNT-TRANSMISSION**  
**Auto**

TOYOTA VAN ..... 1986-89  
**MOUNT-TRANSMISSION**  
**Manual**

TOYOTA VAN ..... 1986-89



**EM-8650**  
**MOUNT-TRANSMISSION**  
**Auto**

TOYOTA SPORT UTILITY ..... 1967-74



**EM-8651**  
**MOUNT-TRANSMISSION**  
**Manual**

TOYOTA SPORT UTILITY ..... 1967-80



**EM-8652**  
**MOUNT-ENGINE**  
**Front**

DAIHATSU PASSENGER CAR ... 1989-92

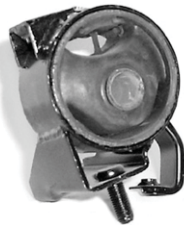

**EM-8653**  
**MOUNT-TRANSMISSION**  
**Manual**

DAIHATSU PASSENGER CAR ... 1989-92



**EM-8654**  
**MOUNT-ENGINE**  
**Rear**

DAIHATSU PASSENGER CAR ... 1989-92



**EM-8655**  
**MOUNT-TRANSMISSION**  
**Auto**

DAIHATSU PASSENGER CAR ... 1989-92



**EM-8656**  
**Engine Torque Strut Mount**  
**Front**

CHEVROLET SPORT UTILITY ..... 1998  
GEO SPORT UTILITY ..... 1996-97  
SUZUKI SPORT UTILITY ..... 1996-98



**EM-8657**  
**Engine Torque Strut Mount**  
**Front**

CHEVROLET SPORT UTILITY ... 1998-00  
GEO SPORT UTILITY ..... 1989-97  
SUZUKI SPORT UTILITY ..... 1989-98



**EM-8658**  
**Engine Torque Strut Mount**  
**Front**

CHEVROLET PASSENGER CAR ..... 1992  
GEO PASSENGER CAR ..... 1995-97  
**Engine Torque Strut Mount**  
**Rear**

CHEVROLET PASSENGER  
CAR ..... 1985-01  
GEO PASSENGER CAR ..... 1989-97  
SUZUKI PASSENGER CAR ..... 1989-01



**EM-8659**  
**MOUNT-ENGINE**  
**Rear**

SUZUKI PASSENGER CAR ..... 1989-94



**EM-8660**  
**MOUNT-ENGINE**  
**Rear**

HONDA PASSENGER CAR ..... 1976-87



**EM-8661**  
**MOUNT-ENGINE**  
**Front**

SUBARU PASSENGER CAR ..... 1980-87  
**MOUNT-TRANSMISSION**  
**Auto**

SUBARU PASSENGER CAR ..... 1979-80

# BUYER'S GUIDE

## NUMERICAL LISTING - ILLUSTRATIONS



**EM-8662**  
**MOUNT-ENGINE**  
**L & R Front**

MERCEDES-BENZ  
PASSENGER CAR ..... 1977-95



**EM-8663**  
**MOUNT-ENGINE**  
**L & R Front**

AUDI PASSENGER CAR ..... 1978-97  
VOLKSWAGEN PASSENGER  
CAR ..... 1983-88



**EM-8664**  
**MOUNT-ENGINE**  
**Front**

VOLKSWAGEN PASSENGER  
CAR ..... 1995-02



**EM-8665**  
**MOUNT-ENGINE**  
**Rear**

SUBARU PASSENGER CAR ..... 1980-94  
SUBARU SPORT UTILITY ..... 1980-87

**MOUNT-TRANSMISSION**  
**L & R**

SUBARU PASSENGER CAR ..... 1976-87  
SUBARU PASSENGER CAR ..... 1980-89  
SUBARU SPORT UTILITY ..... 1978-80



**EM-8667**  
**MOUNT-ENGINE**  
**Front**

MITSUBISHI PASSENGER  
CAR ..... 1993-95



**EM-8668**  
**MOUNT-ENGINE**  
**Rear**

MITSUBISHI PASSENGER  
CAR ..... 1993-96



**EM-8669**  
**MOUNT-TRANSMISSION**  
**Manual**

DODGE PASSENGER CAR ..... 1989-92  
EAGLE PASSENGER CAR ..... 1989-92  
MITSUBISHI PASSENGER  
CAR ..... 1989-92  
PLYMOUTH PASSENGER  
CAR ..... 1989-92



**EM-8670**  
**MOUNT-ENGINE**  
**Front**

CHRYSLER PASSENGER  
CAR ..... 1995-00  
DODGE PASSENGER CAR ..... 1995-99  
EAGLE PASSENGER CAR ..... 1995-98  
MITSUBISHI PASSENGER  
CAR ..... 1994-99



**EM-8672**  
**MOUNT-ENGINE**  
**Rear**

HYUNDAI PASSENGER CAR ..... 1990-94  
MITSUBISHI PASSENGER  
CAR ..... 1990-94



**EM-8674**  
**MOUNT-ENGINE**  
**RH Front**

HYUNDAI PASSENGER CAR ..... 1991-92

**MOUNT-TRANSMISSION**  
**Manual**

HYUNDAI PASSENGER CAR ..... 1990-94  
MITSUBISHI PASSENGER  
CAR ..... 1990-94



**EM-8675**  
**MOUNT-ENGINE**  
**RH Front**

HYUNDAI PASSENGER CAR ..... 1991-92

**MOUNT-TRANSMISSION**  
**Auto**

HYUNDAI PASSENGER CAR ..... 1990-94  
MITSUBISHI PASSENGER  
CAR ..... 1990-94



**EM-8676**  
**MOUNT-ENGINE**  
**Front**

HYUNDAI PASSENGER CAR ..... 1995

# BUYER'S GUIDE

## NUMERICAL LISTING - ILLUSTRATIONS



**EM-8677**  
**MOUNT-ENGINE**  
**Rear**

HYUNDAI PASSENGER CAR ..... 1995-96



**EM-8681**  
**MOUNT-ENGINE**  
**Rear**

INFINITI PASSENGER CAR ..... 1999-02  
NISSAN PASSENGER CAR ..... 1990-01  
NISSAN VAN ..... 1990-95



**EM-8685**  
**MOUNT-ENGINE**  
**LH Front**

MITSUBISHI VAN ..... 1992-94

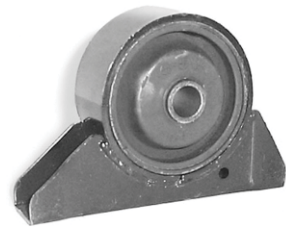

**EM-8688**  
**MOUNT-ENGINE**  
**Front**

EAGLE PASSENGER CAR ..... 1996  
MITSUBISHI VAN ..... 1992-95



**EM-8678**  
**MOUNT-TRANSMISSION**  
**Manual**

HYUNDAI PASSENGER CAR ..... 1995



**EM-8682**  
**MOUNT-ENGINE**  
**Front**

INFINITI PASSENGER CAR ..... 1999-02  
NISSAN PASSENGER CAR ..... 1993-01



**EM-8686**  
**MOUNT-TRANSMISSION**  
**Manual**

DODGE PASSENGER CAR ..... 1993-94  
EAGLE PASSENGER CAR ..... 1990-96  
MITSUBISHI PASSENGER  
CAR ..... 1990-94  
MITSUBISHI VAN ..... 1992  
PLYMOUTH PASSENGER  
CAR ..... 1990-94



**EM-8689**  
**MOUNT-ENGINE**  
**LH Front**

EAGLE PASSENGER CAR ..... 1996



**EM-8679**  
**MOUNT-TRANSMISSION**  
**Auto**

HYUNDAI PASSENGER CAR ..... 1995

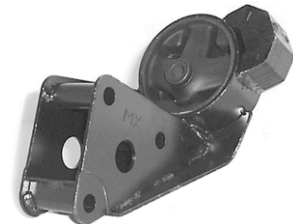

**EM-8683**  
**MOUNT-TRANSMISSION**  
**Manual**

NISSAN PASSENGER CAR ..... 1995-99



**EM-8687**  
**MOUNT-ENGINE**  
**Front**

EAGLE PASSENGER CAR ..... 1995-96  
MITSUBISHI VAN ..... 1992



**EM-8690**  
**MOUNT-ENGINE**  
**LH Front**

EAGLE PASSENGER CAR ..... 1992-96



**EM-8680**  
**MOUNT-ENGINE**  
**Front**

HYUNDAI PASSENGER CAR ..... 1992-95

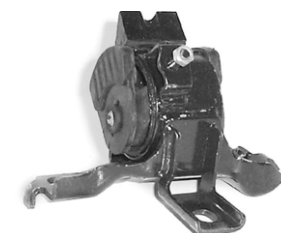

**EM-8684**  
**MOUNT-TRANSMISSION**  
**Auto**

TOYOTA PASSENGER CAR ..... 1989-91

PLYMOUTH PASSENGER CAR ..... 1992

**MOUNT-ENGINE**  
**Front**

**MOUNT-ENGINE**  
**Rear**

DODGE PASSENGER CAR ..... 1993-94  
EAGLE PASSENGER CAR ..... 1995-96  
MITSUBISHI VAN ..... 1992-95  
PLYMOUTH PASSENGER  
CAR ..... 1992-94

# BUYER'S GUIDE

## NUMERICAL LISTING - ILLUSTRATIONS

 <p style="text-align: center;"><b>EM-8691</b> <b>MOUNT-ENGINE</b> <b>Rear</b></p> <p>FORD PASSENGER CAR ..... 1994-97</p> <p style="text-align: center;"><b>MOUNT-TRANSMISSION</b> <b>Upper</b></p> <p>MAZDA PASSENGER CAR ..... 1994-97 FORD PASSENGER CAR ..... 1994-97 MAZDA PASSENGER CAR ..... 1998-02</p>	 <p style="text-align: center;"><b>EM-8694</b> <b>MOUNT-TRANSMISSION</b> <b>Auto</b></p> <p>MITSUBISHI PASSENGER CAR ..... 1989-93</p>	<p><b>EM-8697 (Continued)</b> <b>Engine Torque Strut Mount</b> <b>Front</b></p> <p>TOYOTA PASSENGER CAR ..... 1997-03</p>  <p style="text-align: center;"><b>EM-8698</b> <b>Engine Torque Strut Mount</b> <b>Front</b></p> <p>TOYOTA PASSENGER CAR ..... 1997-01</p>	 <p style="text-align: center;"><b>EM-8701 (NEW)</b> <b>MOUNT-ENGINE</b> <b>Rear</b></p> <p>NISSAN PASSENGER CAR ..... 1991-98</p>
 <p style="text-align: center;"><b>EM-8692</b> <b>MOUNT-ENGINE</b> <b>RH Front</b></p> <p>TOYOTA PASSENGER CAR ..... 1987-89</p>	 <p style="text-align: center;"><b>EM-8695</b> <b>MOUNT-TRANSMISSION</b> <b>Auto</b></p> <p>MITSUBISHI SPORT UTILITY ..... 1994-03</p>	 <p style="text-align: center;"><b>EM-8699</b> <b>MOUNT-ENGINE</b> <b>Rear</b></p> <p>LEXUS PASSENGER CAR ..... 1997-98 TOYOTA PASSENGER CAR ..... 1997-03 TOYOTA VAN ..... 1998-03</p>	 <p style="text-align: center;"><b>EM-8704</b> <b>MOUNT-ENGINE</b> <b>RH Front</b></p> <p>NISSAN PASSENGER CAR ..... 1993-99</p>
 <p style="text-align: center;"><b>EM-8693</b> <b>MOUNT-TRANSMISSION</b></p> <p>MAZDA VAN ..... 1989-98</p>	 <p style="text-align: center;"><b>EM-8696</b> <b>MOUNT-ENGINE</b> <b>Rear</b></p> <p>MITSUBISHI TRUCK ..... 1991-94</p> <p style="text-align: center;"><b>MOUNT-TRANSMISSION</b> <b>Manual</b></p> <p>MITSUBISHI SPORT UTILITY ..... 1997-99 MITSUBISHI VAN ..... 1992</p>	 <p style="text-align: center;"><b>EM-8700</b> <b>MOUNT-TRANSMISSION</b> <b>Auto</b></p> <p>EAGLE PASSENGER CAR ..... 1990-94 MITSUBISHI PASSENGER CAR ..... 1990-94 PLYMOUTH PASSENGER CAR ..... 1990-94</p>	 <p style="text-align: center;"><b>EM-8705</b> <b>MOUNT-TRANSMISSION</b> <b>Auto</b></p> <p>NISSAN PASSENGER CAR ..... 1993-01</p>
	 <p style="text-align: center;"><b>EM-8697</b> <b>Engine Torque Strut</b> <b>Front Right</b></p> <p>LEXUS PASSENGER CAR ..... 1997-01</p> <p style="text-align: center;"><b>(Continued Next Column)</b></p>		 <p style="text-align: center;"><b>EM-8709</b> <b>MOUNT-ENGINE</b> <b>LH Front Lower</b></p> <p>ACURA PASSENGER CAR ..... 1994-01</p> <p style="text-align: center;"><b>(Continued Next Page)</b></p>

# BUYER'S GUIDE

## NUMERICAL LISTING - ILLUSTRATIONS

**EM-8709 (Continued)**

**MOUNT-ENGINE  
Front**

HONDA SPORT UTILITY ..... 1997

**MOUNT-TRANSFER CASE**

HONDA SPORT UTILITY ..... 1998-01



**EM-8710  
MOUNT-ENGINE  
LH Front**

HONDA SPORT UTILITY ..... 1998-01

**MOUNT-ENGINE  
LH Rear Upper**

HONDA PASSENGER CAR ..... 1996-00



**EM-8711  
MOUNT-ENGINE  
Front**

LEXUS PASSENGER CAR ..... 1994-96

TOYOTA PASSENGER CAR ..... 1994-96



**EM-8715  
MOUNT-ENGINE  
LH Front**

HYUNDAI PASSENGER CAR ..... 1996-99



**EM-8716  
MOUNT-ENGINE  
LH Front**

HYUNDAI PASSENGER CAR ..... 1992-93



**EM-8717  
MOUNT-ENGINE  
LH Front**

HYUNDAI PASSENGER CAR ..... 1994-95



**EM-8718  
MOUNT-ENGINE  
LH Front**

HYUNDAI PASSENGER CAR ..... 1994-95



**EM-8719  
MOUNT-ENGINE  
RH Front**

HYUNDAI PASSENGER CAR ..... 1996-01



**EM-8721  
MOUNT-ENGINE  
LH Front**

HYUNDAI PASSENGER CAR ..... 1997-98



**EM-8722  
MOUNT-ENGINE  
RH Front**

HYUNDAI PASSENGER CAR ..... 1999-05

KIA PASSENGER CAR ..... 2001-06

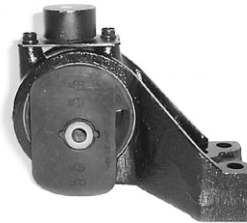

**EM-8723  
MOUNT-ENGINE  
RH Front**

HYUNDAI PASSENGER CAR ..... 1999-05

KIA PASSENGER CAR ..... 2001-05

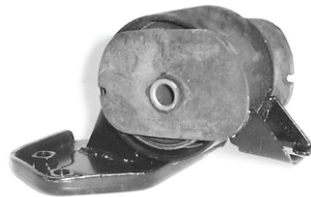

**EM-8724  
MOUNT-TRANSMISSION  
Manual**

HYUNDAI PASSENGER CAR ..... 1997-99



**EM-8725  
MOUNT-TRANSMISSION  
Manual**

HYUNDAI PASSENGER CAR ..... 1996



**EM-8727  
MOUNT-TRANSMISSION  
Auto**

HYUNDAI PASSENGER CAR ..... 1996-99

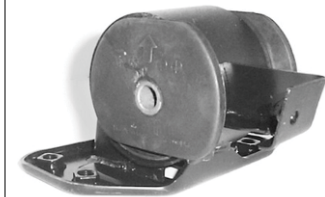

**EM-8728  
MOUNT-TRANSMISSION  
Auto**

HYUNDAI PASSENGER CAR ..... 1993-95









**EM-8729  
MOUNT-TRANSMISSION  
Manual**

HYUNDAI PASSENGER CAR ..... 1993-95

# BUYER'S GUIDE

## NUMERICAL LISTING - ILLUSTRATIONS

 <p><b>EM-8730</b> <b>MOUNT-TRANSMISSION</b> Manual</p> <p>HYUNDAI PASSENGER CAR ..... 1992-93</p>	 <p><b>EM-8733</b> <b>MOUNT-TRANSMISSION</b> Manual</p> <p>HYUNDAI PASSENGER CAR ..... 1996-01</p>	 <p><b>EM-8740</b> <b>MOUNT-ENGINE</b> LH Front</p> <p>HYUNDAI PASSENGER CAR ..... 1990-91</p>	 <p><b>EM-8743</b> <b>MOUNT-TRANSMISSION</b> Manual</p> <p>HYUNDAI PASSENGER CAR ..... 1999-01</p>
 <p><b>EM-8731</b> <b>MOUNT-TRANSMISSION</b> Manual</p> <p>HYUNDAI PASSENGER CAR ..... 1994-95</p>	 <p><b>EM-8734</b> <b>MOUNT-TRANSMISSION</b> Auto</p> <p>HYUNDAI PASSENGER CAR ..... 1996-01</p>	 <p><b>EM-8741</b> <b>MOUNT-TRANSMISSION</b> Auto</p> <p>HYUNDAI PASSENGER CAR ..... 1995-98</p>	 <p><b>EM-8744</b> <b>MOUNT-TRANSMISSION</b> Auto</p> <p>HYUNDAI PASSENGER CAR ..... 1999-01</p>
 <p><b>EM-8732</b> <b>MOUNT-TRANSMISSION</b> Auto</p> <p>HYUNDAI PASSENGER CAR ..... 1993-95</p>	 <p><b>EM-8736</b> <b>MOUNT-ENGINE</b> LH Front</p> <p>HYUNDAI PASSENGER CAR ..... 1992-94</p>	 <p><b>EM-8742</b> <b>MOUNT-ENGINE</b> LH Front</p> <p>HYUNDAI PASSENGER CAR ..... 1992-94</p>	 <p><b>EM-8745</b> <b>MOUNT-TRANSMISSION</b> Auto</p> <p>HYUNDAI PASSENGER CAR ..... 1999-01</p>
	 <p><b>EM-8738</b> <b>MOUNT-TRANSMISSION</b> Manual</p> <p>HYUNDAI PASSENGER CAR ..... 1995-96</p>		

# BUYER'S GUIDE

## NUMERICAL LISTING - ILLUSTRATIONS

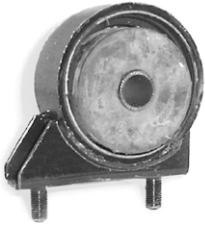

**EM-8746**  
MOUNT-ENGINE  
Front

HYUNDAI PASSENGER CAR ..... 1997-99



**EM-8750**  
MOUNT-ENGINE  
Front

HYUNDAI PASSENGER CAR ..... 1996



**EM-8754**  
MOUNT-TRANSMISSION  
Manual

HYUNDAI PASSENGER CAR ..... 1989-91



**EM-8757**  
MOUNT-TRANSMISSION  
Auto

HYUNDAI PASSENGER CAR ..... 1992-94



**EM-8747**  
MOUNT-ENGINE  
Front

HYUNDAI PASSENGER CAR ..... 1997-99



**EM-8751**  
MOUNT-ENGINE  
Rear

HYUNDAI PASSENGER CAR ..... 1997-99



**EM-8755**  
MOUNT-TRANSMISSION  
Manual

HYUNDAI PASSENGER CAR ..... 1992-94



**EM-8758**  
MOUNT-TRANSMISSION

HYUNDAI PASSENGER CAR ..... 1990-91



**EM-8748**  
MOUNT-ENGINE  
Front

HYUNDAI PASSENGER CAR ..... 1996



**EM-8752**  
MOUNT-ENGINE  
Rear

HYUNDAI PASSENGER CAR ..... 1993-95



**EM-8756**  
MOUNT-TRANSMISSION  
Auto

HYUNDAI PASSENGER CAR ..... 1989-94

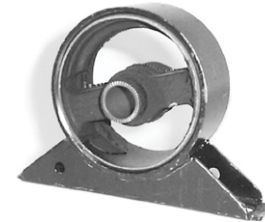

**EM-8759**  
MOUNT-ENGINE  
Front

HYUNDAI PASSENGER CAR ..... 1992-95

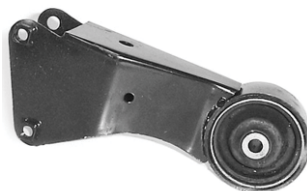

**EM-8753**  
MOUNT-ENGINE  
Rear

HYUNDAI PASSENGER CAR ..... 1993-95



**EM-8760**  
MOUNT-ENGINE  
Front

(Continued Next Page)

# BUYER'S GUIDE

## NUMERICAL LISTING - ILLUSTRATIONS

**EM-8760 (Continued)**

HYUNDAI PASSENGER CAR ..... 1993-95



**EM-8762**  
MOUNT-ENGINE  
Front

HYUNDAI PASSENGER CAR ..... 1996-01



**EM-8764**  
MOUNT-ENGINE  
Front

HYUNDAI PASSENGER CAR ..... 1998-01



**EM-8768**  
MOUNT-ENGINE  
Front

HYUNDAI PASSENGER CAR ..... 1999-01

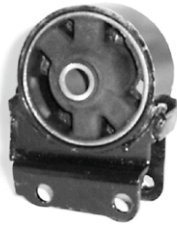

**EM-8769**  
MOUNT-ENGINE  
Front

HYUNDAI PASSENGER CAR ..... 1999-05  
KIA PASSENGER CAR ..... 2001-05



**EM-8770**  
MOUNT-ENGINE  
Front

HYUNDAI PASSENGER CAR ..... 2002-05  
KIA PASSENGER CAR ..... 2001-06

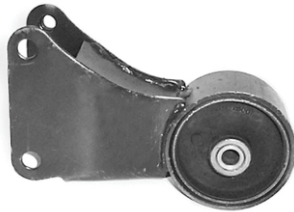

**EM-8771**  
MOUNT-ENGINE  
Rear

HYUNDAI PASSENGER CAR ..... 1992-95

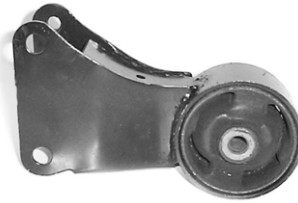

**EM-8772**  
MOUNT-ENGINE  
Rear

HYUNDAI PASSENGER CAR ..... 1993-95



**EM-8774**  
MOUNT-ENGINE  
Rear

HYUNDAI PASSENGER CAR ..... 1992-95



**EM-8775**  
MOUNT-ENGINE  
Rear

HYUNDAI PASSENGER CAR ..... 1996-01



**EM-8778**  
MOUNT-ENGINE  
Rear

HYUNDAI PASSENGER CAR ..... 1996-01



**EM-8780**  
MOUNT-ENGINE  
Rear

HYUNDAI PASSENGER CAR ..... 1995-96



**EM-8781**  
MOUNT-ENGINE  
Rear

HYUNDAI PASSENGER CAR ..... 1995-98



**EM-8782**  
MOUNT-ENGINE  
Rear

HYUNDAI PASSENGER CAR ..... 1997-98



# BUYER'S GUIDE

## NUMERICAL LISTING - ILLUSTRATIONS



**EM-8783**  
MOUNT-ENGINE  
Rear

HYUNDAI PASSENGER CAR ..... 1999-05  
KIA PASSENGER CAR ..... 2001-06



**EM-8784**  
MOUNT-ENGINE  
Rear

HYUNDAI PASSENGER CAR ..... 2002-03  
KIA PASSENGER CAR ..... 2001-05



**EM-8786**  
MOUNT-ENGINE  
LH Front

HYUNDAI PASSENGER CAR ..... 1995-96



**EM-8787**  
MOUNT-ENGINE  
LH Front

HYUNDAI PASSENGER CAR ..... 1997-98

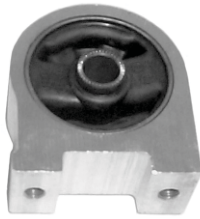

**EM-8788**  
MOUNT-ENGINE  
Front

HYUNDAI PASSENGER CAR ..... 1997-98



**EM-8789**  
MOUNT-TRANSMISSION

HYUNDAI PASSENGER CAR ..... 1996-98



**EM-8790**  
MOUNT-ENGINE  
LH Front

(Continued Next Column)

**EM-8790 (Continued)**

HYUNDAI PASSENGER CAR ..... 1997-98  
MITSUBISHI PASSENGER  
CAR ..... 1989-92



**EM-8791**  
MOUNT-TRANSMISSION  
Manual

HYUNDAI PASSENGER CAR ..... 1995-98

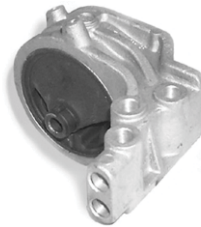

**EM-8792**  
MOUNT-ENGINE  
LH Front

EAGLE PASSENGER CAR ..... 1995-98

**MOUNT-ENGINE  
RH Front**

MITSUBISHI PASSENGER  
CAR ..... 1994-99

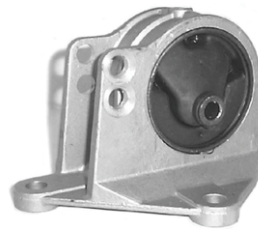

**EM-8793**  
MOUNT-TRANSMISSION  
Manual

CHRYSLER PASSENGER  
CAR ..... 1995-99  
DODGE PASSENGER CAR ..... 1995-99  
EAGLE PASSENGER CAR ..... 1995-98  
MITSUBISHI PASSENGER  
CAR ..... 1994-99



**EM-8794**  
MOUNT-ENGINE  
L & R Front

VOLVO PASSENGER CAR ..... 1989-92



**EM-8795**  
MOUNT-ENGINE  
Front

TOYOTA PASSENGER CAR ..... 1997-01



**EM-8796**  
MOUNT-ENGINE  
Rear

DODGE PASSENGER CAR ..... 1991-92  
TOYOTA PASSENGER CAR ..... 1997-01

# BUYER'S GUIDE

## NUMERICAL LISTING - ILLUSTRATIONS

 <p style="text-align: center;"><b>EM-8797</b> <b>MOUNT-TRANSMISSION</b> Auto</p> <p>MITSUBISHI PASSENGER CAR ..... 1994-99</p>	 <p style="text-align: center;"><b>EM-8800</b> <b>MOUNT-TRANSMISSION</b> Auto</p> <p>VOLVO PASSENGER CAR ..... 1976-93</p>	<p><b>EM-8803 (Continued)</b></p> <p>PLYMOUTH PASSENGER CAR ..... 1979-84</p> <p style="text-align: center;"><b>MOUNT-ENGINE</b> Rear</p> <p>HYUNDAI PASSENGER CAR ..... 1986-89 MITSUBISHI PASSENGER CAR ..... 1987-89 PLYMOUTH PASSENGER CAR ..... 1982-84</p>	 <p style="text-align: center;"><b>EM-8807</b> <b>MOUNT-ENGINE</b> RH Front</p> <p>DODGE PASSENGER CAR ..... 1984-91</p> <p style="text-align: center;"><b>MOUNT-TRANSMISSION</b> Auto</p> <p>MITSUBISHI PASSENGER CAR ..... 1984-88</p> <p style="text-align: center;"><b>MOUNT-TRANSMISSION</b> Manual</p> <p>PLYMOUTH PASSENGER CAR ..... 1984-91</p>
 <p style="text-align: center;"><b>EM-8798</b> <b>MOUNT-ENGINE</b> Rear</p> <p>CHRYSLER PASSENGER CAR ..... 1995-99 EAGLE PASSENGER CAR ..... 1997-98 MITSUBISHI PASSENGER CAR ..... 1994-99</p>	 <p style="text-align: center;"><b>EM-8801</b> <b>MOUNT-ENGINE</b> Front</p> <p>HONDA PASSENGER CAR ..... 1998-02</p>	 <p style="text-align: center;"><b>EM-8804</b> <b>MOUNT-ENGINE</b> Rear</p> <p>SUZUKI PASSENGER CAR ..... 1995-02</p>	 <p style="text-align: center;"><b>EM-8811</b> <b>MOUNT-ENGINE</b> L &amp; R Front</p> <p>DAIHATSU SPORT UTILITY ..... 1990-92</p>
 <p style="text-align: center;"><b>EM-8799</b> <b>MOUNT-TRANSMISSION</b> Auto</p> <p>HONDA PASSENGER CAR ..... 1998-99</p>	 <p style="text-align: center;"><b>EM-8802</b> <b>Engine Torque Strut Mount</b> Front</p> <p>HONDA PASSENGER CAR ..... 1982-83</p>	 <p style="text-align: center;"><b>EM-8805</b> <b>MOUNT-ENGINE</b> Rear</p> <p>SUZUKI PASSENGER CAR ..... 1995-00</p>	 <p style="text-align: center;"><b>EM-8812</b> <b>MOUNT-TRANSMISSION</b> Manual</p> <p>DAIHATSU SPORT UTILITY ..... 1990-92</p>
 <p style="text-align: center;"><b>EM-8803</b> <b>MOUNT-ENGINE</b> Front Lower</p> <p>MITSUBISHI PASSENGER CAR ..... 1983</p> <p style="text-align: center;"><b>MOUNT-ENGINE</b> RH Front</p> <p style="text-align: center;">(Continued Next Column)</p>	 <p style="text-align: center;"><b>EM-8806</b> <b>MOUNT-ENGINE</b> Front</p> <p>HONDA PASSENGER CAR ..... 1992-01</p>	 <p style="text-align: center;"><b>EM-8803</b> <b>MOUNT-ENGINE</b> Rear</p>	 <p style="text-align: center;"><b>EM-8812</b> <b>MOUNT-TRANSMISSION</b> Manual</p>

# BUYER'S GUIDE

## NUMERICAL LISTING - ILLUSTRATIONS



**EM-8813**  
**MOUNT-ENGINE**  
**RH Front**

MAZDA PASSENGER CAR ..... 1992-93



**EM-8817**  
**MOUNT-TRANSMISSION**  
**Manual**

MITSUBISHI PASSENGER  
CAR ..... 1997-07



**EM-8820**  
**MOUNT-ENGINE**  
**LH Front**

EAGLE PASSENGER CAR ..... 1995-96  
MITSUBISHI VAN ..... 1992-95



**EM-8823**  
**MOUNT-ENGINE**  
**Front**

ACURA PASSENGER CAR ..... 1990-93

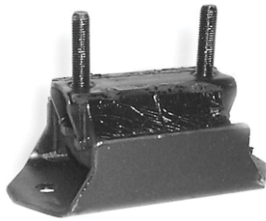

**EM-8814**  
**MOUNT-TRANSMISSION**

MAZDA VAN ..... 1989-98



**EM-8818**  
**MOUNT-ENGINE**  
**Front**

EAGLE PASSENGER CAR ..... 1995-96  
MITSUBISHI PASSENGER  
CAR ..... 1997-02

**MOUNT-ENGINE**  
**RH Front**

PLYMOUTH PASSENGER  
CAR ..... 1992-94

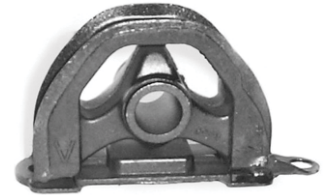

**EM-8824**  
**MOUNT-ENGINE**  
**Front**

ACURA PASSENGER CAR ..... 1994-01

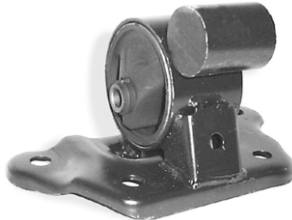

**EM-8816**  
**MOUNT-TRANSMISSION**  
**Auto**

MITSUBISHI PASSENGER  
CAR ..... 1997-02

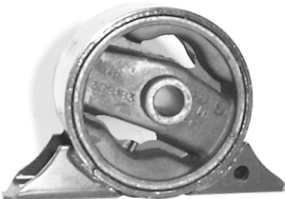

**EM-8819**  
**MOUNT-ENGINE**  
**Rear**

MITSUBISHI PASSENGER  
CAR ..... 1997-02



**EM-8821**  
**MOUNT-ENGINE**  
**Front**

EAGLE PASSENGER CAR ..... 1992-94  
MITSUBISHI VAN ..... 1992  
PLYMOUTH PASSENGER  
CAR ..... 1993-94



**EM-8825**  
**MOUNT-TRANSMISSION**

CHEVROLET SPORT UTILITY .... 1998-04  
GEO SPORT UTILITY ..... 1989-97  
HONDA PASSENGER CAR ..... 1976-78  
PONTIAC PASSENGER CAR ..... 1994-97  
SUZUKI SPORT UTILITY ..... 1989-05



**EM-8822**  
**MOUNT-TRANSMISSION**  
**Auto**

MITSUBISHI VAN ..... 1993-95  
PLYMOUTH PASSENGER CAR ..... 1994



**EM-8826**  
**MOUNT-ENGINE**  
**Rear**

CHEVROLET PASSENGER  
CAR ..... 1985-88  
ISUZU PASSENGER CAR ..... 1985-89

# BUYER'S GUIDE

## NUMERICAL LISTING - ILLUSTRATIONS

 <p><b>EM-8828</b> <b>MOUNT-ENGINE</b> <b>LH Front</b></p> <p>AUDI PASSENGER CAR ..... 1993-98</p>	 <p><b>EM-8831</b> <b>MOUNT-TRANSMISSION</b></p> <p>AUDI PASSENGER CAR ..... 1988-91</p>	 <p><b>EM-8835</b> <b>MOUNT-ENGINE</b> <b>L &amp; R Front</b></p> <p>MERCEDES-BENZ PASSENGER CAR ..... 1990-99</p>	 <p><b>EM-8843</b> <b>MOUNT-ENGINE</b> <b>Front</b></p> <p>VOLKSWAGEN PASSENGER CAR ..... 1993-98</p>
 <p><b>EM-8829</b> <b>MOUNT-ENGINE</b> <b>RH Front</b></p> <p>AUDI PASSENGER CAR ..... 1993-98</p>	 <p><b>EM-8832</b> <b>MOUNT-ENGINE</b> <b>L &amp; R Front</b></p> <p>MERCEDES-BENZ PASSENGER CAR ..... 1994-02</p>	 <p><b>EM-8836</b> <b>MOUNT-ENGINE</b> <b>L &amp; R Front</b></p> <p>MERCEDES-BENZ PASSENGER CAR ..... 1987-93</p>	 <p><b>EM-8845</b> <b>MOUNT-ENGINE</b> <b>Rear</b></p> <p>HONDA PASSENGER CAR ..... 1998-02</p>
 <p><b>EM-8830</b> <b>MOUNT-ENGINE</b> <b>Center Front</b></p> <p>AUDI PASSENGER CAR ..... 1996-01</p>	 <p><b>EM-8834</b> <b>MOUNT-ENGINE</b> <b>LH Front</b></p> <p>MERCEDES-BENZ PASSENGER CAR ..... 1990-97</p>	 <p><b>EM-8838</b> <b>MOUNT-ENGINE</b> <b>L &amp; R Front</b></p> <p>MERCEDES-BENZ PASSENGER CAR ..... 1992-02</p>	 <p><b>EM-8846</b> <b>MOUNT-ENGINE</b> <b>RH Front</b></p> <p>NISSAN PASSENGER CAR ..... 1990-92</p>

# BUYER'S GUIDE

## NUMERICAL LISTING - ILLUSTRATIONS



**EM-8847**  
**MOUNT-ENGINE**  
Front

TOYOTA SPORT UTILITY ..... 1996-00



**EM-8848**  
**MOUNT-ENGINE**  
Front

TOYOTA PASSENGER CAR ..... 1994-95  
TOYOTA SPORT UTILITY ..... 1996-00



**EM-8849**  
**MOUNT-ENGINE**  
Rear

HONDA PASSENGER CAR ..... 1998-02

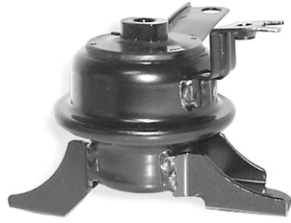

**EM-8850**  
**MOUNT-ENGINE**  
RH Front

CHEVROLET PASSENGER  
CAR ..... 1998-02  
TOYOTA PASSENGER CAR ..... 1998-02

**MOUNT-TRANSMISSION**  
Manual

VOLKSWAGEN PASSENGER  
CAR ..... 1973-79



**EM-8851**  
**MOUNT-ENGINE**  
Rear

CHEVROLET PASSENGER  
CAR ..... 1998-02  
TOYOTA PASSENGER CAR ..... 1998-02



**EM-8852**  
**MOUNT-TRANSMISSION**  
Manual

TOYOTA PASSENGER CAR ..... 1994-99



**EM-8853**  
**MOUNT-ENGINE**  
RH Front

MITSUBISHI PASSENGER  
CAR ..... 1997-98



**EM-8854**  
**MOUNT-ENGINE**  
RH Front

TOYOTA SPORT UTILITY ..... 1996-00

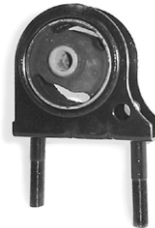

**EM-8855**  
**MOUNT-ENGINE**  
Rear

TOYOTA SPORT UTILITY ..... 1996-00



**EM-8856**  
**MOUNT-TRANSMISSION**  
Manual

TOYOTA SPORT UTILITY ..... 1996-97



**EM-8857**  
**MOUNT-TRANSMISSION**

VOLKSWAGEN PASSENGER  
CAR ..... 1971-04



**EM-8858**  
**MOUNT-ENGINE**  
Front

INFINITI PASSENGER CAR ..... 1991-96  
NISSAN PASSENGER CAR ..... 1992



**EM-8859**  
**MOUNT-ENGINE**  
Front

HONDA PASSENGER CAR ..... 1992-96



**EM-8860**  
**MOUNT-ENGINE**  
Front

ACURA PASSENGER CAR ..... 1990-93

# BUYER'S GUIDE

## NUMERICAL LISTING - ILLUSTRATIONS

 <p><b>EM-8862</b> <b>MOUNT-TRANSMISSION</b></p> <p>MAZDA PASSENGER CAR ..... 1995-02</p>	 <p><b>EM-8866</b> <b>MOUNT-ENGINE</b> <b>Rear</b></p> <p>INFINITI PASSENGER CAR ..... 1996-99 NISSAN PASSENGER CAR ..... 1995-03</p>	 <p><b>EM-8870</b> <b>MOUNT-ENGINE</b> <b>Front</b></p> <p>CHEVROLET PASSENGER CAR ..... 1998-02 TOYOTA PASSENGER CAR ..... 1998-02</p>	 <p><b>EM-8873</b> <b>MOUNT-TRANSMISSION</b> <b>Auto</b></p> <p>CHEVROLET PASSENGER CAR ..... 1998-02 TOYOTA PASSENGER CAR ..... 1998-02</p>
 <p><b>EM-8863</b> <b>MOUNT-TRANSMISSION</b></p> <p>MAZDA PASSENGER CAR ..... 1995-02</p>	 <p><b>EM-8867</b> <b>Engine Torque Strut Mount</b> <b>Front</b></p> <p>MINIBUS PASSENGER CAR ..... 1984-88 PLYMOUTH PASSENGER CAR ..... 1989-90</p>	 <p><b>EM-8871</b> <b>MOUNT-ENGINE</b> <b>Rear</b></p> <p>TOYOTA PASSENGER CAR ..... 1994-99</p>	 <p><b>EM-8874</b> <b>MOUNT-ENGINE</b> <b>Front</b></p> <p>NISSAN PASSENGER CAR ..... 1990-92 NISSAN VAN ..... 1990-95</p>
 <p><b>EM-8864</b> <b>MOUNT-ENGINE</b> <b>Front</b></p> <p>MAZDA PASSENGER CAR ..... 1997-02</p>	 <p><b>EM-8868</b> <b>MOUNT-ENGINE</b> <b>L &amp; R Front</b></p> <p>MAZDA VAN ..... 1996-98</p>	 <p><b>EM-8872</b> <b>MOUNT-TRANSMISSION</b> <b>Auto</b></p> <p>CHEVROLET PASSENGER CAR ..... 1998-02 TOYOTA PASSENGER CAR ..... 1998-02</p>	 <p><b>EM-8875</b> <b>MOUNT-ENGINE</b> <b>RH Front</b></p> <p>DODGE PASSENGER CAR ..... 1985-88</p>
 <p><b>EM-8865</b> <b>MOUNT-ENGINE</b> <b>Front</b></p> <p>INFINITI PASSENGER CAR ..... 1996-97 NISSAN PASSENGER CAR ..... 1995-03</p>	 <p><b>EM-8869</b> <b>MOUNT-ENGINE</b> <b>RH Front</b></p> <p>TOYOTA PASSENGER CAR ..... 1994-99</p>	<p><b>MOUNT-TRANSMISSION</b> <b>Auto</b></p> <p>DODGE PASSENGER CAR ..... 1985-86 MITSUBISHI PASSENGER CAR ..... 1985-86</p>	

# BUYER'S GUIDE

## NUMERICAL LISTING - ILLUSTRATIONS



**EM-8876**  
**MOUNT-ENGINE**  
**L & R Front**

MITSUBISHI SPORT UTILITY ..... 1994-99



**EM-8877**  
**MOUNT-ENGINE**  
**RH Front**

MITSUBISHI PASSENGER CAR ..... 1997-02



**EM-8878**  
**MOUNT-ENGINE**  
**L & R Front**

MITSUBISHI SPORT UTILITY ..... 1995-00



**EM-8879**  
**MOUNT-TRANSMISSION**  
**Auto**

(Continued Next Column)

**EM-8879 (Continued)**

MITSUBISHI PASSENGER CAR ..... 1997-02



**EM-8880**  
**MOUNT-TRANSMISSION**  
**Manual**

MITSUBISHI PASSENGER CAR ..... 1997-02



**EM-8881**  
**MOUNT-TRANSMISSION**  
**Auto**

EAGLE PASSENGER CAR ..... 1992-96  
 MITSUBISHI VAN ..... 1992  
 PLYMOUTH PASSENGER CAR ..... 1992-93



**EM-8882**  
**MOUNT-ENGINE**  
**Rear**

MAZDA PASSENGER CAR ..... 1999-03



**EM-8883**  
**MOUNT-TRANSMISSION**  
**Auto**

TOYOTA PASSENGER CAR ..... 2000-05



**EM-8884**  
**MOUNT-ENGINE**  
**RH Front**

MAZDA PASSENGER CAR ..... 1999-01



**EM-8885**  
**MOUNT-ENGINE**  
**Front**

MAZDA PASSENGER CAR ..... 1999-03



**EM-8886**  
**MOUNT-ENGINE**  
**Rear**

(Continued Next Column)

**EM-8886 (Continued)**

MAZDA PASSENGER CAR ..... 1999-01



**EM-8887**  
**MOUNT-TRANSMISSION**  
**Manual**

FORD VAN ..... 1986-87

**EM-8888**  
**MOUNT-TRANSMISSION**  
**Auto**

NISSAN PASSENGER CAR ..... 1990-92

NISSAN VAN ..... 1990-95



**EM-8888**  
**MOUNT-TRANSMISSION**  
**Manual**

SCION PASSENGER CAR ..... 2004-06  
 SCION VAN ..... 2004-06  
 TOYOTA PASSENGER CAR ..... 2000-05



**EM-8889**  
**MOUNT-ENGINE**  
**Rear**

MAZDA PASSENGER CAR ..... 1999-03

# BUYER'S GUIDE

## NUMERICAL LISTING - ILLUSTRATIONS

 <p><b>EM-8890</b> <b>MOUNT-TRANSMISSION</b></p> <p>SUZUKI PASSENGER CAR ..... 1995-02</p>	<p><b>EM-8893 (Continued)</b></p> <p>ACURA PASSENGER CAR ..... 1994-01</p>  <p><b>EM-8894</b> <b>MOUNT-ENGINE</b> <b>LH Front Upper</b></p> <p>ACURA PASSENGER CAR ..... 1994-01 HONDA PASSENGER CAR ..... 1994-97</p>	 <p><b>EM-8897</b> <b>MOUNT-ENGINE</b> <b>Rear</b></p> <p>ACURA PASSENGER CAR ..... 1997-01 HONDA SPORT UTILITY ..... 1997-01</p>	 <p><b>EM-8900</b> <b>MOUNT-ENGINE</b> <b>RH Front</b></p> <p>HONDA PASSENGER CAR ..... 1995-97</p>
 <p><b>EM-8891</b> <b>MOUNT-TRANSMISSION</b> <b>Manual</b></p> <p>NISSAN PASSENGER CAR ..... 1995-00 NISSAN VAN ..... 1991</p>	 <p><b>EM-8895</b> <b>MOUNT-ENGINE</b> <b>Rear</b></p> <p>ACURA PASSENGER CAR ..... 1990-93</p>	 <p><b>EM-8898</b> <b>MOUNT-TRANSMISSION</b> <b>Front</b></p> <p>ACURA PASSENGER CAR ..... 1999-03 ACURA SPORT UTILITY ..... 2001-02 HONDA PASSENGER CAR ..... 1998-02 HONDA SPORT UTILITY ..... 2003-05 HONDA VAN ..... 1999-06</p>	 <p><b>EM-8901</b> <b>MOUNT-TRANSMISSION</b> <b>LH</b></p> <p>KIA SPORT UTILITY ..... 1995-02</p>
 <p><b>EM-8892</b> <b>MOUNT-ENGINE</b> <b>RH Front</b></p> <p>TOYOTA VAN ..... 1991-97</p>	 <p><b>EM-8896</b> <b>MOUNT-TRANSMISSION</b></p> <p>ACURA PASSENGER CAR ..... 1997-99 HONDA PASSENGER CAR ..... 1995-97</p>	 <p><b>EM-8899</b> <b>MOUNT-ENGINE</b> <b>LH Front</b></p> <p>HONDA PASSENGER CAR ..... 1998-02</p>	 <p><b>EM-8902</b> <b>MOUNT-ENGINE</b> <b>RH Front</b></p> <p>KIA PASSENGER CAR ..... 1998-04</p>
 <p><b>EM-8893</b> <b>MOUNT-ENGINE</b> <b>LH Front Lower</b></p> <p>(Continued Next Column)</p>			



# BUYER'S GUIDE

## NUMERICAL LISTING - ILLUSTRATIONS

 <p><b>EM-8903</b> <b>MOUNT-ENGINE</b> <b>Front</b></p> <p>KIA PASSENGER CAR ..... 1994-97</p>	 <p><b>EM-8907</b> <b>MOUNT-TRANSMISSION</b> <b>Auto</b></p> <p>KIA PASSENGER CAR ..... 2000-04</p>	<p><b>EM-8910 (Continued)</b></p> <p>KIA PASSENGER CAR ..... 2000-04</p>  <p><b>EM-8911</b> <b>MOUNT-TRANSMISSION</b> <b>Manual</b></p> <p>KIA PASSENGER CAR ..... 1998-00</p>	 <p><b>EM-8914</b> <b>MOUNT-ENGINE</b> <b>Front</b></p> <p>KIA PASSENGER CAR ..... 2001-05</p> <p><b>EM-8915</b> <b>MOUNT-TRANSMISSION</b> <b>Auto</b></p> <p>DAEWOO PASSENGER CAR ..... 1999-02</p>
 <p><b>EM-8904</b> <b>MOUNT-ENGINE</b> <b>Front</b></p> <p>KIA PASSENGER CAR ..... 1998-04</p>	 <p><b>EM-8908</b> <b>MOUNT-ENGINE</b> <b>Rear</b></p> <p>KIA PASSENGER CAR ..... 1998-02</p>	 <p><b>EM-8912</b> <b>MOUNT-TRANSMISSION</b> <b>Auto</b></p> <p>KIA PASSENGER CAR ..... 1998-00</p>	 <p><b>EM-8916</b> <b>MOUNT-ENGINE</b> <b>Front</b></p> <p>DAEWOO PASSENGER CAR ..... 1999-02</p>
 <p><b>EM-8905</b> <b>MOUNT-ENGINE</b> <b>Rear</b></p> <p>KIA PASSENGER CAR ..... 1998-04</p>	 <p><b>EM-8909</b> <b>MOUNT-ENGINE</b> <b>L &amp; R Front</b></p> <p>MAZDA PASSENGER CAR ..... 1990-05</p>	 <p><b>EM-8913</b> <b>MOUNT-ENGINE</b> <b>RH Front</b></p> <p>KIA PASSENGER CAR ..... 2001-02</p>	 <p><b>EM-8917</b> <b>MOUNT-ENGINE</b> <b>Rear</b></p> <p>DAEWOO PASSENGER CAR ..... 1999-02</p>
 <p><b>EM-8906</b> <b>MOUNT-ENGINE</b> <b>Front</b></p> <p>KIA PASSENGER CAR ..... 1998-04</p>	 <p><b>EM-8910</b> <b>MOUNT-TRANSMISSION</b> <b>Manual</b></p> <p>(Continued Next Column)</p>		

# BUYER'S GUIDE

## NUMERICAL LISTING - ILLUSTRATIONS

 <p style="text-align: center;"><b>EM-8918</b> <b>MOUNT-ENGINE</b> <b>RH Front</b></p> <p>DAEWOO PASSENGER CAR ..... 1999-02</p>	 <p style="text-align: center;"><b>EM-8923</b> <b>MOUNT-TRANSMISSION</b> <b>Manual</b></p> <p>DAEWOO PASSENGER CAR ..... 1999-02</p>	<p><b>EM-8928 (Continued)</b></p> <p>DAEWOO PASSENGER CAR ..... 1999-02</p>  <p style="text-align: center;"><b>EM-8929</b> <b>MOUNT-ENGINE</b> <b>RH Front</b></p> <p>DAEWOO PASSENGER CAR ..... 1999-02</p>	 <p style="text-align: center;"><b>EM-8933</b> <b>MOUNT-ENGINE</b> <b>Front</b></p> <p>HYUNDAI PASSENGER CAR ..... 1986-89 MITSUBISHI PASSENGER CAR ..... 1987-89</p>
 <p style="text-align: center;"><b>EM-8919</b> <b>Engine Torque Strut Mount</b> <b>Front</b></p> <p>DAEWOO PASSENGER CAR ..... 2000-02</p>	 <p style="text-align: center;"><b>EM-8925</b> <b>MOUNT-TRANSMISSION</b> <b>Manual</b></p> <p>DAEWOO PASSENGER CAR ..... 2000-02</p>	 <p style="text-align: center;"><b>EM-8930</b> <b>MOUNT-TRANSMISSION</b> <b>Manual</b></p> <p>DAEWOO PASSENGER CAR ..... 1999</p>	 <p style="text-align: center;"><b>EM-8934</b> <b>MOUNT-TRANSMISSION</b> <b>Auto</b></p> <p>HYUNDAI PASSENGER CAR ..... 1986-89 MITSUBISHI PASSENGER CAR ..... 1987-89</p>
 <p style="text-align: center;"><b>EM-8920</b> <b>MOUNT-ENGINE</b> <b>Front</b></p> <p>DAEWOO PASSENGER CAR ..... 1999-02</p>	 <p style="text-align: center;"><b>EM-8926</b> <b>MOUNT-TRANSMISSION</b> <b>Auto</b></p> <p>DAEWOO PASSENGER CAR ..... 2000-02</p>	 <p style="text-align: center;"><b>EM-8931</b> <b>MOUNT-TRANSMISSION</b> <b>Auto</b></p> <p>DAEWOO PASSENGER CAR ..... 1999</p>	 <p style="text-align: center;"><b>EM-8935</b> <b>MOUNT-ENGINE</b> <b>Front</b></p> <p>HYUNDAI PASSENGER CAR ..... 2001-02</p>
 <p style="text-align: center;"><b>EM-8921</b> <b>MOUNT-ENGINE</b> <b>Rear</b></p> <p>DAEWOO PASSENGER CAR ..... 1999-02</p>	 <p style="text-align: center;"><b>EM-8928</b> <b>MOUNT-ENGINE</b> <b>RH Front</b></p> <p style="text-align: center;">(Continued Next Column)</p>	 <p style="text-align: center;"><b>EM-8932</b> <b>Engine Torque Strut</b> <b>Front Right</b></p> <p>HYUNDAI PASSENGER CAR ..... 1986-89 MITSUBISHI PASSENGER CAR ..... 1987-89</p>	

# BUYER'S GUIDE

## NUMERICAL LISTING - ILLUSTRATIONS

 <p><b>EM-8936</b> <b>MOUNT-ENGINE</b> <b>LH Front</b></p> <p>HYUNDAI PASSENGER CAR ..... 2000-02</p>	 <p><b>EM-8939</b> <b>MOUNT-TRANSMISSION</b> <b>Auto</b></p> <p>HYUNDAI PASSENGER CAR ..... 2000</p>	<p><b>EM-8943 (Continued)</b> HYUNDAI PASSENGER CAR ..... 2001-08</p>  <p><b>EM-8944</b> <b>MOUNT-ENGINE</b> <b>RH Front</b></p> <p>HYUNDAI PASSENGER CAR ..... 2001-06</p>	 <p><b>EM-8948</b> <b>MOUNT-ENGINE</b> <b>Front</b></p> <p>HYUNDAI PASSENGER CAR ..... 2001-05 KIA PASSENGER CAR ..... 2004-06</p>
 <p><b>EM-8937</b> <b>MOUNT-ENGINE</b> <b>Rear</b></p> <p>HYUNDAI PASSENGER CAR ..... 2000-02</p>	 <p><b>EM-8940</b> <b>MOUNT-ENGINE</b> <b>LH Front</b></p> <p>HYUNDAI PASSENGER CAR ..... 2001-05</p>	 <p><b>EM-8945</b> <b>MOUNT-ENGINE</b> <b>Rear</b></p> <p>HYUNDAI PASSENGER CAR ..... 2001-08</p>	 <p><b>EM-8949</b> <b>MOUNT-ENGINE</b> <b>RH Front</b></p> <p>HYUNDAI PASSENGER CAR ..... 2001-05 KIA PASSENGER CAR ..... 2004-06</p>
 <p><b>EM-8938</b> <b>MOUNT-ENGINE</b> <b>Front</b> <b>MOUNT-TRANSMISSION</b> <b>Manual</b></p> <p>DODGE PASSENGER CAR ..... 2005-06 HYUNDAI PASSENGER CAR ..... 2000-02</p>	 <p><b>EM-8941</b> <b>MOUNT-TRANSMISSION</b> <b>Auto</b></p> <p>HYUNDAI PASSENGER CAR ..... 2001-02</p>	 <p><b>EM-8947</b> <b>MOUNT-TRANSMISSION</b> <b>Manual</b></p> <p>HYUNDAI PASSENGER CAR ..... 2001-06</p>	 <p><b>EM-8950</b> <b>MOUNT-ENGINE</b> <b>Rear</b></p> <p>HYUNDAI PASSENGER CAR ..... 2001-05 KIA PASSENGER CAR ..... 2004-06</p>
	 <p><b>EM-8943</b> <b>MOUNT-ENGINE</b> <b>Front</b></p> <p>(Continued Next Column)</p>		

# BUYER'S GUIDE

## NUMERICAL LISTING - ILLUSTRATIONS

 <p><b>EM-8951</b> <b>MOUNT-TRANSMISSION</b> HYUNDAI PASSENGER CAR ..... 2001-05</p>	<p><b>EM-8954 (Continued)</b> HYUNDAI SPORT UTILITY ..... 2001-06</p>  <p><b>EM-8955</b> <b>MOUNT-ENGINE</b> <b>Rear</b> HYUNDAI SPORT UTILITY ..... 2001-06</p>	 <p><b>EM-8958</b> <b>MOUNT-ENGINE</b> <b>Front</b> HYUNDAI PASSENGER CAR ..... 2000-02</p>	 <p><b>EM-8961</b> <b>MOUNT-ENGINE</b> <b>Rear</b> NISSAN PASSENGER CAR ..... 1987-89</p>
 <p><b>EM-8952</b> <b>MOUNT-ENGINE</b> <b>Front</b> HYUNDAI SPORT UTILITY ..... 2001-06</p>	 <p><b>EM-8956</b> <b>MOUNT-TRANSMISSION</b> HYUNDAI SPORT UTILITY ..... 2001-06</p>	 <p><b>EM-8959</b> <b>MOUNT-TRANSMISSION</b> <b>Auto</b> INFINITI PASSENGER CAR ..... 1997-04</p>	 <p><b>EM-8962</b> <b>MOUNT-ENGINE</b> <b>Front</b> NISSAN PASSENGER CAR ..... 1985-88</p>
 <p><b>EM-8953</b> <b>MOUNT-ENGINE</b> <b>Front</b> HYUNDAI SPORT UTILITY ..... 2001-06</p>	 <p><b>EM-8957</b> <b>MOUNT-TRANSMISSION</b> HYUNDAI SPORT UTILITY ..... 2001-06</p>	 <p><b>EM-8960</b> <b>MOUNT-ENGINE</b> <b>L &amp; R Front</b> NISSAN SPORT UTILITY ..... 2000-04 NISSAN TRUCK ..... 1999-04</p>	 <p><b>EM-8963</b> <b>MOUNT-TRANSMISSION</b> NISSAN PASSENGER CAR ..... 1984-89</p>
 <p><b>EM-8954</b> <b>MOUNT-ENGINE</b> <b>RH Front</b>  (Continued Next Column)</p>			 <p><b>EM-8964</b> <b>MOUNT-TRANSMISSION</b> NISSAN SPORT UTILITY ..... 2000-04 <b>MOUNT-TRANSMISSION</b> <b>Auto</b> (Continued Next Page)</p>

# BUYER'S GUIDE

## NUMERICAL LISTING - ILLUSTRATIONS

**EM-8964 (Continued)**

NISSAN TRUCK ..... 1998-04



**EM-8965**  
**MOUNT-ENGINE**  
**Front**

LEXUS PASSENGER CAR ..... 1992-93  
TOYOTA PASSENGER CAR ..... 1992-93



**EM-8968**  
**MOUNT-ENGINE**  
**Rear**

SCION PASSENGER CAR ..... 2004-06  
SCION VAN ..... 2004-06  
TOYOTA PASSENGER CAR ..... 2000-05



**EM-8973**  
**MOUNT-ENGINE**  
**Rear**

HONDA PASSENGER CAR ..... 2001-05



**EM-8976**  
**MOUNT-TRANSMISSION**  
**Manual**

GEO PASSENGER CAR ..... 1989  
ISUZU PASSENGER CAR ..... 1989  
**MOUNT-TRANSMISSION**

PONTIAC PASSENGER CAR ..... 1985-88

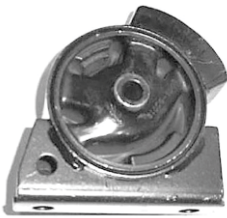

**EM-8966**  
**MOUNT-ENGINE**  
**Front**

CHEVROLET PASSENGER  
CAR ..... 1998-02

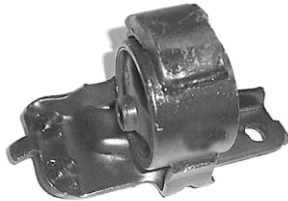

**EM-8970**  
**MOUNT-TRANSMISSION**  
**Auto**

TOYOTA PASSENGER CAR ..... 1986-89



**EM-8974**  
**MOUNT-ENGINE**  
**RH Front**

ACURA PASSENGER CAR ..... 1999-03  
HONDA PASSENGER CAR ..... 1998-02  
HONDA VAN ..... 1999-04



**EM-8977**  
**MOUNT-TRANSMISSION**  
**Manual**

MAZDA PASSENGER CAR ..... 1999-01



**EM-8967**  
**MOUNT-ENGINE**  
**Front**

LEXUS PASSENGER CAR ..... 1997-01  
TOYOTA PASSENGER CAR ..... 1997-03

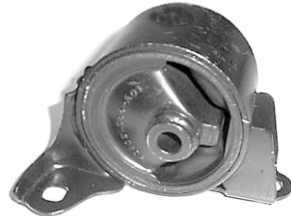

**EM-8971**  
**MOUNT-TRANSMISSION**  
**Manual**

HONDA PASSENGER CAR ..... 1998-02

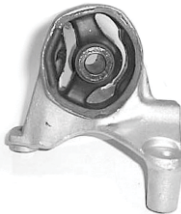

**EM-8975**  
**MOUNT-ENGINE**  
**Front**

HONDA PASSENGER CAR ..... 2001-05



**EM-8978**  
**MOUNT-TRANSMISSION**  
**Auto**

MAZDA PASSENGER CAR ..... 1999-03

# BUYER'S GUIDE

## NUMERICAL LISTING - ILLUSTRATIONS

 <p style="text-align: center;"><b>EM-8979</b> <b>MOUNT-TRANSMISSION</b> Auto</p> <p>TOYOTA PASSENGER CAR ..... 1992-01</p>	<p><b>EM-8982 (Continued)</b> HONDA SPORT UTILITY ..... 1997-01</p>  <p style="text-align: center;"><b>EM-8982</b> <b>MOUNT-ENGINE</b> LH Front</p> <p>(Continued Next Column)</p>	 <p style="text-align: center;"><b>EM-8986</b> <b>MOUNT-TRANSMISSION</b> Rear</p> <p>ACURA PASSENGER CAR ..... 1999-03</p>	 <p style="text-align: center;"><b>EM-8989</b> <b>MOUNT-TRANSMISSION</b></p> <p>TOYOTA TRUCK ..... 1998-04</p>
 <p style="text-align: center;"><b>EM-8980</b> <b>MOUNT-TRANSMISSION</b> Auto</p> <p>ACURA PASSENGER CAR ..... 1990-93</p>	<p>HONDA PASSENGER CAR ..... 2000-02</p>  <p style="text-align: center;"><b>EM-8983</b> <b>MOUNT-TRANSMISSION</b> Auto</p>	<p>ACURA SPORT UTILITY ..... 2001-02</p>  <p style="text-align: center;"><b>EM-8987</b> <b>MOUNT-TRANSMISSION</b> Auto</p> <p>HONDA PASSENGER CAR ..... 1998-02 HONDA SPORT UTILITY ..... 2003-05 HONDA VAN ..... 1999-04</p>	 <p style="text-align: center;"><b>EM-8990</b> <b>MOUNT-TRANSMISSION</b></p> <p>TOYOTA SPORT UTILITY ..... 1996-00</p>
 <p style="text-align: center;"><b>EM-8981</b> <b>MOUNT-ENGINE</b> LH Front</p> <p>ACURA PASSENGER CAR ..... 1990-93</p>	<p>ACURA PASSENGER CAR ..... 1997-99 HONDA PASSENGER CAR ..... 1990-97 HONDA VAN ..... 1995-98 ISUZU VAN ..... 1996-99</p>  <p style="text-align: center;"><b>EM-8984</b> <b>MOUNT-ENGINE</b> Rear</p>	<p>HONDA PASSENGER CAR ..... 1988-91</p>  <p style="text-align: center;"><b>EM-8988</b> <b>MOUNT-ENGINE</b> Front</p> <p>HONDA PASSENGER CAR ..... 2001-05</p>	 <p style="text-align: center;"><b>EM-8991</b> <b>MOUNT-TRANSMISSION</b></p> <p>LEXUS SPORT UTILITY ..... 1998-07 TOYOTA SPORT UTILITY ..... 1998-03</p>
 <p style="text-align: center;"><b>EM-8982</b> <b>MOUNT-ENGINE</b> LH Front</p>	<p>VOLVO PASSENGER CAR ..... 1993-95</p>  <p style="text-align: center;"><b>EM-8985</b> <b>MOUNT-TRANSMISSION</b></p>	 <p style="text-align: center;"><b>EM-8992</b> <b>MOUNT-ENGINE</b> RH Front</p> <p>ACURA PASSENGER CAR ..... 1993-98</p>	

# BUYER'S GUIDE

## NUMERICAL LISTING - ILLUSTRATIONS

 <p style="text-align: center;">EM-8993</p> <p style="text-align: center;"><b>EM-8993</b> <b>MOUNT-TRANSMISSION</b> <b>Manual</b></p> <p>TOYOTA SPORT UTILITY ..... 1996-02</p> <p style="text-align: center;"><b>MOUNT-TRANSMISSION</b></p> <p>TOYOTA TRUCK ..... 2000-06</p>	 <p style="text-align: center;">EM-8996</p> <p style="text-align: center;"><b>EM-8996</b> <b>MOUNT-TRANSMISSION</b></p> <p>TOYOTA TRUCK ..... 1998-04</p>	 <p style="text-align: center;">EM-8999</p> <p style="text-align: center;"><b>EM-8999</b> <b>MOUNT-ENGINE</b> <b>Center Front</b></p> <p>AUDI PASSENGER CAR ..... 2000-04</p> <p style="text-align: center;"><b>MOUNT-TRANSMISSION</b></p> <p style="text-align: center;"><b>Auto</b></p> <p>AUDI PASSENGER CAR ..... 1996-06</p> <p style="text-align: center;"><b>MOUNT-TRANSMISSION</b></p> <p style="text-align: center;"><b>RH</b></p> <p>VOLKSWAGEN PASSENGER CAR ..... 2001-04</p> <p style="text-align: center;"><b>MOUNT-TRANSMISSION</b></p> <p style="text-align: center;"><b>Auto</b></p> <p>AUDI PASSENGER CAR ..... 1996-05</p> <p style="text-align: center;"><b>MOUNT-TRANSMISSION</b></p> <p style="text-align: center;"><b>Manual</b></p> <p>VOLKSWAGEN PASSENGER CAR ..... 1995-05</p>	<p><b>EM-9001 (Continued)</b></p> <p style="text-align: center;"><b>MOUNT-ENGINE</b> <b>RH Rear</b></p> <p>VOLKSWAGEN PASSENGER CAR ..... 1984-95</p> <p style="text-align: center;"><b>MOUNT-TRANSMISSION</b> <b>RH</b></p> <p>VOLKSWAGEN PASSENGER CAR ..... 1993-94</p>
 <p style="text-align: center;">EM-8994</p> <p style="text-align: center;"><b>EM-8994</b> <b>MOUNT-ENGINE</b> <b>RH Front</b></p> <p>NISSAN PASSENGER CAR ..... 1996-01</p>	 <p style="text-align: center;">EM-8997</p> <p style="text-align: center;"><b>EM-8997</b> <b>MOUNT-ENGINE</b> <b>L &amp; R Front</b></p> <p>AUDI PASSENGER CAR ..... 1996-06</p> <p style="text-align: center;"><b>MOUNT-ENGINE</b> <b>RH Front</b></p> <p>VOLKSWAGEN PASSENGER CAR ..... 1995-05</p> <p style="text-align: center;"><b>MOUNT-ENGINE</b> <b>LH Rear</b></p> <p>AUDI PASSENGER CAR ..... 2005-08</p>	 <p style="text-align: center;">EM-9000</p> <p style="text-align: center;"><b>EM-9000</b> <b>MOUNT-ENGINE</b> <b>Front</b></p> <p>VOLKSWAGEN PASSENGER CAR ..... 1992-98</p>	 <p style="text-align: center;">EM-9002</p> <p style="text-align: center;"><b>EM-9002</b> <b>MOUNT-TRANSMISSION</b></p> <p>MERCEDES-BENZ PASSENGER CAR ..... 1992-96</p>
 <p style="text-align: center;">EM-8995</p> <p style="text-align: center;"><b>EM-8995</b> <b>Engine Torque Strut Mount</b> <b>Front</b></p> <p>LEXUS SPORT UTILITY ..... 1999-03</p>	 <p style="text-align: center;">EM-8998</p> <p style="text-align: center;"><b>EM-8998</b> <b>MOUNT-ENGINE</b> <b>LH Front</b></p> <p>AUDI PASSENGER CAR ..... 1997-04</p> <p>VOLKSWAGEN PASSENGER CAR ..... 1995-05</p>	 <p style="text-align: center;">EM-9001</p> <p style="text-align: center;"><b>EM-9001</b> <b>MOUNT-ENGINE</b> <b>RH Front</b></p> <p>VOLKSWAGEN PASSENGER CAR ..... 1990-92</p> <p style="text-align: center;">(Continued Next Column)</p>	 <p style="text-align: center;">EM-9003</p> <p style="text-align: center;"><b>EM-9003</b> <b>MOUNT-ENGINE</b> <b>L &amp; R Front</b></p> <p>BMW PASSENGER CAR ..... 1991-09</p>
 <p style="text-align: center;">EM-9004</p> <p style="text-align: center;"><b>EM-9004</b> <b>MOUNT-ENGINE</b> <b>LH Front</b></p> <p>AUDI PASSENGER CAR ..... 1992-97</p>			

# BUYER'S GUIDE

## NUMERICAL LISTING - ILLUSTRATIONS

 <p style="text-align: center;">EM-9005</p> <p style="text-align: center;"><b>EM-9005 MOUNT-ENGINE RH Front</b></p> <p>AUDI PASSENGER CAR ..... 1992-97</p>	 <p style="text-align: center;">EM-9009</p> <p style="text-align: center;"><b>EM-9009 MOUNT-ENGINE L &amp; R Front</b></p> <p>NISSAN PASSENGER CAR ..... 1984-89</p>	 <p style="text-align: center;">EM-9012</p> <p style="text-align: center;"><b>EM-9012 MOUNT-ENGINE LH Front</b></p> <p>NISSAN SPORT UTILITY ..... 2000-04 NISSAN TRUCK ..... 1998-04</p>	 <p style="text-align: center;">EM-9015</p> <p style="text-align: center;"><b>EM-9015 MOUNT-ENGINE RH Front</b></p> <p>SCION PASSENGER CAR ..... 2004-06 SCION VAN ..... 2004-06 TOYOTA PASSENGER CAR ..... 2000-05</p>
 <p style="text-align: center;">EM-9007</p> <p style="text-align: center;"><b>EM-9007 MOUNT-ENGINE Front</b></p> <p>MAZDA PASSENGER CAR ..... 1995-02</p>	 <p style="text-align: center;">EM-9010</p> <p style="text-align: center;"><b>EM-9010 MOUNT-ENGINE LH Front MOUNT-TRANSMISSION Manual</b></p> <p>NISSAN PASSENGER CAR ..... 1989-94 NISSAN PASSENGER CAR ..... 1989-91 NISSAN PASSENGER CAR ..... 1992-94</p>	 <p style="text-align: center;">EM-9013</p> <p style="text-align: center;"><b>EM-9013 MOUNT-ENGINE Rear</b></p> <p>TOYOTA PASSENGER CAR ..... 1994-99</p>	 <p style="text-align: center;">EM-9016</p> <p style="text-align: center;"><b>EM-9016 MOUNT-ENGINE LH Front</b></p> <p>HONDA PASSENGER CAR ..... 2002-05</p>
 <p style="text-align: center;">EM-9008</p> <p style="text-align: center;"><b>EM-9008 MOUNT-ENGINE Rear</b></p> <p>MAZDA PASSENGER CAR ..... 1995-02</p>	 <p style="text-align: center;">EM-9011</p> <p style="text-align: center;"><b>EM-9011 MOUNT-TRANSMISSION Manual</b></p> <p>NISSAN SPORT UTILITY ..... 1997-02</p>	 <p style="text-align: center;">EM-9014</p> <p style="text-align: center;"><b>EM-9014 MOUNT-ENGINE L &amp; R Front</b></p> <p>TOYOTA SPORT UTILITY ..... 1999-02 TOYOTA TRUCK ..... 2000-04</p>	 <p style="text-align: center;">EM-9017</p> <p style="text-align: center;"><b>EM-9017 MOUNT-ENGINE RH Front</b></p> <p>MAZDA PASSENGER CAR ..... 1995-02</p>



# BUYER'S GUIDE

## NUMERICAL LISTING - ILLUSTRATIONS

 <p>EM-9018</p> <p style="text-align: center;"><b>EM-9018</b> <b>MOUNT-TRANSMISSION</b> Manual</p> <p>TOYOTA TRUCK ..... 1998-04</p>	 <p>EM-9022</p> <p style="text-align: center;"><b>EM-9022</b> <b>MOUNT-ENGINE</b> Front</p> <p>SUZUKI PASSENGER CAR ..... 1995-03</p>	 <p>EM-9025</p> <p style="text-align: center;"><b>EM-9025</b> <b>MOUNT-TRANSMISSION</b> RH</p> <p>NISSAN PASSENGER CAR ..... 1984-88</p>	 <p>EM-9028</p> <p style="text-align: center;"><b>EM-9028</b> <b>MOUNT-TRANSMISSION</b> Auto</p> <p>NISSAN PASSENGER CAR ..... 1982-86</p>
 <p>EM-9019</p> <p style="text-align: center;"><b>EM-9019</b> <b>MOUNT-ENGINE</b> Rear</p> <p>TOYOTA PASSENGER CAR ..... 1991-94</p>	 <p>EM-9023</p> <p style="text-align: center;"><b>EM-9023</b> <b>MOUNT-ENGINE</b> L &amp; R Front</p> <p>SUBARU PASSENGER CAR ..... 1995-05 SUBARU SPORT UTILITY ..... 1998-02</p>	 <p>EM-9026</p> <p style="text-align: center;"><b>EM-9026</b> <b>MOUNT-TRANSMISSION</b> Auto</p> <p>TOYOTA SPORT UTILITY ..... 1998-00</p>	 <p>EM-9029</p> <p style="text-align: center;"><b>EM-9029</b> <b>MOUNT-ENGINE</b> L &amp; R Front</p> <p>TOYOTA VAN ..... 1986-89</p>
 <p>EM-9020</p> <p style="text-align: center;"><b>EM-9020</b> <b>MOUNT-ENGINE</b> Front</p> <p>NISSAN PASSENGER CAR ..... 1982-86</p>	 <p>EM-9024</p> <p style="text-align: center;"><b>EM-9024</b> <b>MOUNT-ENGINE</b> L &amp; R Front</p> <p>SUBARU PASSENGER CAR ..... 1993-11 SUBARU SPORT UTILITY ..... 2000-12</p>	 <p>EM-9027</p> <p style="text-align: center;"><b>EM-9027</b> <b>MOUNT-ENGINE</b> Rear</p> <p>TOYOTA VAN ..... 1991-95</p>	 <p>EM-9030</p> <p style="text-align: center;"><b>EM-9030</b> <b>MOUNT-ENGINE</b> RH Front</p> <p>ACURA PASSENGER CAR ..... 1991-05</p>
 <p>EM-9021</p> <p style="text-align: center;"><b>EM-9021</b> <b>MOUNT-ENGINE</b> RH Front</p> <p>MAZDA PASSENGER CAR ..... 1995-02</p>			 <p>EM-9031</p> <p style="text-align: center;"><b>EM-9031</b> <b>MOUNT-ENGINE</b> RH Front</p>

(Continued Next Page)

# BUYER'S GUIDE

## NUMERICAL LISTING - ILLUSTRATIONS

**EM-9031 (Continued)**

INFINITI PASSENGER CAR ..... 1996-04  
 NISSAN PASSENGER CAR ..... 1997-03



EM-9032

**EM-9032**  
**MOUNT-TRANSMISSION**  
 Auto

TOYOTA VAN ..... 1991-95



EM-9033

**EM-9033**  
**MOUNT-ENGINE**  
 LH Front

NISSAN PASSENGER CAR ..... 1979-82



EM-9034

**EM-9034**  
**MOUNT-ENGINE**  
 L & R Front

TOYOTA PASSENGER CAR ..... 1986-89



EM-9035

**EM-9035**  
**MOUNT-TRANSMISSION**  
 Manual

INFINITI PASSENGER CAR ..... 1996-99  
 NISSAN PASSENGER CAR ..... 1995-01



**EM-9037**  
**MOUNT-ENGINE**  
 Front

MITSUBISHI PASSENGER  
 CAR ..... 1997-02



EM-9038

**EM-9038**  
**MOUNT-TRANSMISSION**  
 Auto

INFINITI SPORT UTILITY ..... 1997-00  
 NISSAN SPORT UTILITY ..... 1997-00



EM-9039

**EM-9039**  
**MOUNT-ENGINE**  
 Rear

EAGLE PASSENGER CAR ..... 1995-98



EM-9040

**EM-9040**  
**MOUNT-ENGINE**  
 Rear

NISSAN PASSENGER CAR ..... 1982-86



EM-9041

**EM-9041**  
**MOUNT-TRANSMISSION**  
 Manual

NISSAN PASSENGER CAR ..... 1987-88



EM-9042

**EM-9042**  
**MOUNT-ENGINE**  
 Rear

NISSAN PASSENGER CAR ..... 1982-86



EM-9043

**EM-9043**  
**MOUNT-ENGINE**  
 RH Front

ACURA PASSENGER CAR ..... 1986-90

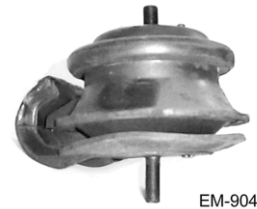

EM-9044

**EM-9044**  
**MOUNT-ENGINE**  
 L & R Front

NISSAN PASSENGER CAR ..... 1990-96



EM-9045

**EM-9045**  
**MOUNT-ENGINE**  
 L & R Front

VOLKSWAGEN PASSENGER  
 CAR ..... 1972-93

**MOUNT-ENGINE**  
 Front

VOLKSWAGEN TRUCK ..... 1980-83

# BUYER'S GUIDE

## NUMERICAL LISTING - ILLUSTRATIONS

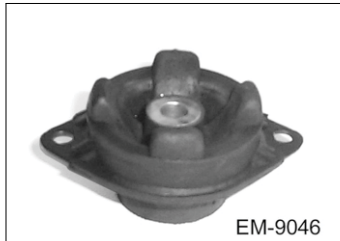

EM-9046

**EM-9046  
MOUNT-TRANSMISSION**

AUDI PASSENGER CAR ..... 1978-92  
VOLKSWAGEN PASSENGER  
CAR ..... 1985-88

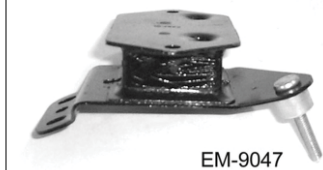

EM-9047

**EM-9047  
MOUNT-ENGINE  
LH Front**

VOLVO PASSENGER CAR ..... 1985-90



EM-9048

**EM-9048  
MOUNT-ENGINE  
Front**

NISSAN PASSENGER CAR ..... 1992-94



EM-9049

**EM-9049  
MOUNT-TRANSMISSION  
LH**

NISSAN PASSENGER CAR ..... 1984-88

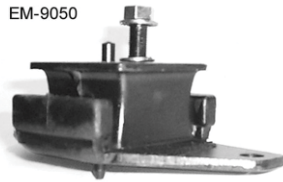

EM-9050

**EM-9050  
MOUNT-ENGINE  
L & R Front**

LEXUS SPORT UTILITY ..... 1998-07  
TOYOTA SPORT UTILITY ..... 1998-07



EM-9051

**EM-9051  
MOUNT-ENGINE  
RH Front**

TOYOTA PASSENGER CAR ..... 1983-86

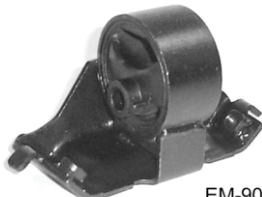

EM-9053

**EM-9053  
MOUNT-TRANSMISSION  
Auto**

TOYOTA PASSENGER CAR ..... 1983-86



EM-9054

**EM-9054  
MOUNT-TRANSMISSION  
Manual**

(Continued Next Column)

**EM-9054 (Continued)**

ACURA PASSENGER CAR ..... 1991-95



EM-9055

**EM-9055  
MOUNT-TRANSMISSION  
Manual**

ACURA PASSENGER CAR ..... 1997-99  
HONDA PASSENGER CAR ..... 1992-97



EM-9056

**EM-9056  
MOUNT-ENGINE  
LH Front**

EAGLE PASSENGER CAR ..... 1993-94  
MITSUBISHI PASSENGER  
CAR ..... 1990-94  
PLYMOUTH PASSENGER  
CAR ..... 1990-94



EM-9057

**EM-9057  
MOUNT-ENGINE  
Front**

MITSUBISHI VAN ..... 1992-94  
PLYMOUTH PASSENGER  
CAR ..... 1993-94

**MOUNT-ENGINE  
Rear**

DODGE PASSENGER CAR ..... 1992-94  
MITSUBISHI PASSENGER  
CAR ..... 1993-96



EM-9058

**EM-9058  
MOUNT-TRANSMISSION  
Auto**

EAGLE PASSENGER CAR ..... 1995-98  
MITSUBISHI PASSENGER  
CAR ..... 1995-99

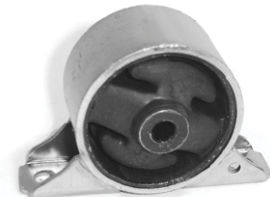

EM-9059

**EM-9059  
MOUNT-ENGINE  
Rear**

MITSUBISHI PASSENGER  
CAR ..... 1997-02



EM-9060

**EM-9060  
MOUNT-TRANSFER CASE  
Right**

DODGE TRUCK ..... 1983-93

# BUYER'S GUIDE

## NUMERICAL LISTING - ILLUSTRATIONS

 <p style="text-align: right; margin-right: 10px;">EM-9061</p> <p style="text-align: center;"><b>EM-9061</b> <b>MOUNT-TRANSMISSION</b> <b>Auto</b></p> <p>TOYOTA SPORT UTILITY ..... 1996-97</p>	 <p style="text-align: right; margin-right: 10px;">EM-9065</p> <p style="text-align: center;"><b>EM-9065</b> <b>MOUNT-ENGINE</b> <b>RH Rear</b></p> <p>VOLKSWAGEN PASSENGER CAR ..... 1992-98</p>	 <p style="text-align: right; margin-right: 10px;">EM-9068</p> <p style="text-align: center;"><b>EM-9068</b> <b>MOUNT-ENGINE</b> <b>RH Front</b></p> <p>MITSUBISHI PASSENGER CAR ..... 1999-02</p>	 <p style="text-align: right; margin-right: 10px;">EM-9072</p> <p style="text-align: center;"><b>EM-9072</b> <b>MOUNT-ENGINE</b> <b>RH Front</b></p> <p>MAZDA PASSENGER CAR ..... 1999-03</p>
 <p style="text-align: right; margin-right: 10px;">EM-9062</p> <p style="text-align: center;"><b>EM-9062</b> <b>MOUNT-ENGINE</b> <b>RH Front</b></p> <p>VOLVO PASSENGER CAR ..... 1985-90</p>	 <p style="text-align: right; margin-right: 10px;">EM-9066</p> <p style="text-align: center;"><b>EM-9066</b> <b>MOUNT-ENGINE</b> <b>Front</b></p> <p>ACURA PASSENGER CAR ..... 2002-06 HONDA SPORT UTILITY ..... 2002-11</p>	 <p style="text-align: right; margin-right: 10px;">EM-9070</p> <p style="text-align: center;"><b>EM-9070</b> <b>MOUNT-TRANSMISSION</b> <b>Auto</b></p> <p>DODGE TRUCK ..... 1990-93</p>	 <p style="text-align: right; margin-right: 10px;">EM-9073</p> <p style="text-align: center;"><b>EM-9073</b> <b>MOUNT-TRANSMISSION</b></p> <p>LEXUS SPORT UTILITY ..... 1999-03</p>
 <p style="text-align: right; margin-right: 10px;">EM-9063</p> <p style="text-align: center;"><b>EM-9063</b> <b>MOUNT-TRANSMISSION</b></p> <p>TOYOTA VAN ..... 1994-97</p>	 <p style="text-align: right; margin-right: 10px;">EM-9067</p> <p style="text-align: center;"><b>EM-9067</b> <b>MOUNT-ENGINE</b> <b>Front Lower</b></p> <p>ACURA PASSENGER CAR ..... 1993-95</p>	 <p style="text-align: right; margin-right: 10px;">EM-9071</p> <p style="text-align: center;"><b>EM-9071</b> <b>MOUNT-ENGINE</b> <b>LH Front</b></p> <p>MITSUBISHI PASSENGER CAR ..... 1989-93</p>	 <p style="text-align: right; margin-right: 10px;">EM-9074</p> <p style="text-align: center;"><b>EM-9074</b> <b>MOUNT-TRANSMISSION</b> <b>Auto</b></p> <p>SUBARU PASSENGER CAR ..... 1996-09 SUBARU SPORT UTILITY ..... 1998-13</p>
 <p style="text-align: right; margin-right: 10px;">EM-9064</p> <p style="text-align: center;"><b>EM-9064</b> <b>MOUNT-TRANSMISSION</b> <b>Manual</b></p> <p>MAZDA PASSENGER CAR ..... 1992</p>			

# BUYER'S GUIDE

## NUMERICAL LISTING - ILLUSTRATIONS

 <p><b>EM-9076</b></p> <p><b>EM-9076</b> <b>MOUNT-ENGINE</b> <b>Outer</b></p> <p>VOLKSWAGEN VAN ..... 1980-91</p>	 <p><b>EM-9079</b></p> <p><b>EM-9079</b> <b>MOUNT-ENGINE</b> <b>L &amp; R Front</b></p> <p>TOYOTA TRUCK ..... 2000-04</p>	 <p><b>EM-9082</b></p> <p><b>EM-9082</b> <b>MOUNT-TRANSMISSION</b> <b>Center Lower</b></p> <p>FORD PASSENGER CAR ..... 1993-97 MAZDA PASSENGER CAR ..... 1993-02</p>	 <p><b>EM-9085</b></p> <p><b>EM-9085</b> <b>MOUNT-ENGINE</b> <b>LH Front</b></p> <p>HONDA PASSENGER CAR ..... 1992-96</p>
 <p><b>EM-9077</b></p> <p><b>EM-9077</b> <b>MOUNT-ENGINE</b> <b>Front Center</b></p> <p>VOLKSWAGEN PASSENGER CAR ..... 1975-93 VOLKSWAGEN TRUCK ..... 1980-83</p>	 <p><b>EM-9080</b></p> <p><b>EM-9080</b> <b>MOUNT-ENGINE</b> <b>L &amp; R Front</b></p> <p>TOYOTA TRUCK ..... 1993-98</p>	 <p><b>EM-9083</b></p> <p><b>EM-9083</b> <b>MOUNT-ENGINE</b> <b>RH Front</b></p> <p>ACURA PASSENGER CAR ..... 1991-92</p>	 <p><b>EM-9086</b></p> <p><b>EM-9086</b> <b>MOUNT-TRANSMISSION</b> <b>Auto</b></p> <p>TOYOTA SPORT UTILITY ..... 1993-94 TOYOTA TRUCK ..... 1988-95</p>
 <p><b>EM-9078</b></p> <p><b>EM-9078</b> <b>MOUNT-ENGINE</b> <b>Front</b></p> <p>EAGLE PASSENGER CAR ..... 1990-94 MITSUBISHI PASSENGER CAR ..... 1990-94 PLYMOUTH PASSENGER CAR ..... 1992-94</p>	 <p><b>EM-9081</b></p> <p><b>EM-9081</b> <b>MOUNT-ENGINE</b> <b>Front</b></p> <p>TOYOTA SPORT UTILITY ..... 2001-05</p>	 <p><b>EM-9084</b></p> <p><b>EM-9084</b> <b>MOUNT-ENGINE</b> <b>Rear</b></p> <p>ACURA PASSENGER CAR ..... 1986-89</p>	 <p><b>EM-9087</b></p> <p><b>EM-9087</b> <b>MOUNT-TRANSMISSION</b> <b>Center Lower</b></p> <p>FORD PASSENGER CAR ..... 1993-97 MAZDA PASSENGER CAR ..... 1993-02</p>

# BUYER'S GUIDE

## NUMERICAL LISTING - ILLUSTRATIONS

 <p style="text-align: center;">EM-9088 <b>MOUNT-TRANSMISSION Manual</b> MITSUBISHI PASSENGER CAR ..... 2002-06</p>	 <p style="text-align: center;">EM-9091 <b>MOUNT-TRANSMISSION</b> MERCEDES-BENZ PASSENGER CAR ..... 1993-96</p>	 <p style="text-align: center;">EM-9094 <b>MOUNT-ENGINE Front</b> BMW PASSENGER CAR ..... 1984-87</p>	 <p style="text-align: center;">EM-9098 <b>MOUNT-TRANSMISSION Manual</b> BMW PASSENGER CAR ..... 1984-91</p>
 <p style="text-align: center;">EM-9089 <b>MOUNT-TRANSMISSION Manual</b> AUDI PASSENGER CAR ..... 1986-97</p>	 <p style="text-align: center;">EM-9092 <b>MOUNT-ENGINE Front</b> AUDI PASSENGER CAR ..... 1997-12</p>	 <p style="text-align: center;">EM-9095 <b>MOUNT-TRANSMISSION Auto</b> BMW PASSENGER CAR ..... 1987-97</p>	 <p style="text-align: center;">EM-9099 <b>MOUNT-ENGINE L &amp; R Front</b> BMW PASSENGER CAR ..... 1989-95</p>
 <p style="text-align: center;">EM-9090 <b>MOUNT-TRANSMISSION Manual</b> BMW PASSENGER CAR ..... 1978-87</p>	 <p style="text-align: center;">EM-9093 <b>MOUNT-TRANSMISSION Manual</b> AUDI PASSENGER CAR ..... 1981-87</p>	 <p style="text-align: center;">EM-9095 <b>MOUNT-TRANSMISSION Auto</b> BMW PASSENGER CAR ..... 1984-86</p>	 <p style="text-align: center;">EM-9100 <b>MOUNT-TRANSMISSION RH</b> BMW PASSENGER CAR ..... 1989-05</p>
	 <p style="text-align: center;">EM-9096 <b>MOUNT-TRANSMISSION Manual</b> VOLKSWAGEN PASSENGER CAR ..... 1987-08 VOLKSWAGEN TRUCK ..... 1999-07</p>	 <p style="text-align: center;">EM-9096 <b>MOUNT-TRANSMISSION Manual</b> BMW PASSENGER CAR ..... 1983-12</p>	

# BUYER'S GUIDE

## NUMERICAL LISTING - ILLUSTRATIONS

 <p style="text-align: center;">EM-9101</p> <p style="text-align: center;"><b>EM-9101</b> <b>MOUNT-TRANSMISSION</b></p> <p>AUDI PASSENGER CAR ..... 1997-01 SEAT ..... 2001-06</p> <p style="text-align: center;"><b>MOUNT-TRANSMISSION</b> <b>Manual</b></p> <p>VOLKSWAGEN PASSENGER CAR ..... 1998-09</p>	 <p style="text-align: center;">EM-9104</p> <p style="text-align: center;"><b>EM-9104</b> <b>MOUNT-TRANSMISSION</b> <b>LH</b></p> <p>BMW PASSENGER CAR ..... 1991-05</p>	 <p style="text-align: center;">EM-9107</p> <p style="text-align: center;"><b>EM-9107</b> <b>MOUNT-TRANSMISSION</b> <b>Auto</b></p> <p>BMW PASSENGER CAR ..... 1984-91</p>	 <p style="text-align: center;">EM-9111</p> <p style="text-align: center;"><b>EM-9111</b> <b>MOUNT-ENGINE</b> <b>L &amp; R Front</b></p> <p>BMW PASSENGER CAR ..... 1984-85</p>
 <p style="text-align: center;">EM-9102</p> <p style="text-align: center;"><b>EM-9102</b> <b>MOUNT-TRANSMISSION</b> <b>Auto</b></p> <p>AUDI PASSENGER CAR ..... 1992-97</p>	 <p style="text-align: center;">EM-9105</p> <p style="text-align: center;"><b>EM-9105</b> <b>MOUNT-TRANSMISSION</b> <b>Manual</b></p> <p>BMW PASSENGER CAR ..... 1982-88</p>	 <p style="text-align: center;">EM-9108</p> <p style="text-align: center;"><b>EM-9108</b> <b>MOUNT-TRANSMISSION</b> <b>Auto</b></p> <p>NISSAN SPORT UTILITY ..... 1996</p>	 <p style="text-align: center;">EM-9113</p> <p style="text-align: center;"><b>EM-9113</b> <b>MOUNT-TRANSMISSION</b> <b>Manual</b></p> <p>TOYOTA SPORT UTILITY ..... 1987-95 TOYOTA TRUCK ..... 1989-95</p>
 <p style="text-align: center;">EM-9103</p> <p style="text-align: center;"><b>EM-9103</b> <b>MOUNT-TRANSMISSION</b> <b>Manual</b></p> <p>BMW PASSENGER CAR ..... 1997-03</p>	 <p style="text-align: center;">EM-9106</p> <p style="text-align: center;"><b>EM-9106</b> <b>MOUNT-TRANSMISSION</b> <b>LH</b></p> <p>VOLKSWAGEN PASSENGER CAR ..... 1998-05</p>	 <p style="text-align: center;">EM-9109</p> <p style="text-align: center;"><b>EM-9109</b> <b>MOUNT-ENGINE</b> <b>L &amp; R Front</b></p> <p>AUDI PASSENGER CAR ..... 1988-90 VOLKSWAGEN PASSENGER CAR ..... 1976-93</p>	 <p style="text-align: center;">EM-9114</p> <p style="text-align: center;"><b>EM-9114</b> <b>MOUNT-TRANSMISSION</b> <b>Manual</b></p> <p>TOYOTA PASSENGER CAR ..... 1985-87</p>
 <p style="text-align: center;">EM-9110</p> <p style="text-align: center;"><b>EM-9110</b> <b>MOUNT-ENGINE</b> <b>Rear</b></p> <p>ACURA PASSENGER CAR ..... 1987-88</p>	 <p style="text-align: center;">EM-9115</p> <p style="text-align: center;"><b>EM-9115</b> <b>MOUNT-TRANSMISSION</b> <b>Manual</b></p> <p>TOYOTA TRUCK ..... 1995-97</p>	 <p style="text-align: center;">EM-9115</p> <p style="text-align: center;"><b>EM-9115</b> <b>MOUNT-TRANSMISSION</b> <b>Manual</b></p> <p>TOYOTA TRUCK ..... 1995-97</p>	 <p style="text-align: center;">EM-9115</p> <p style="text-align: center;"><b>EM-9115</b> <b>MOUNT-TRANSMISSION</b> <b>Manual</b></p> <p>TOYOTA TRUCK ..... 1995-97</p>

# BUYER'S GUIDE

## NUMERICAL LISTING - ILLUSTRATIONS

 <p style="text-align: center; margin-top: 10px;"><b>EM-9116</b> <b>MOUNT-ENGINE</b> <b>Rear</b></p> <p style="text-align: center; font-size: small;">TOYOTA PASSENGER CAR ..... 1993-97</p>	 <p style="text-align: center; margin-top: 10px;"><b>EM-9119</b> <b>MOUNT-ENGINE</b> <b>Rear</b></p> <p style="text-align: center; font-size: small;">TOYOTA PASSENGER CAR ..... 1987-93</p>	<p><b>EM-9122 (Continued)</b></p> <p style="font-size: x-small;">TOYOTA PASSENGER CAR ..... 1985-86</p>  <p style="text-align: center; margin-top: 10px;"><b>EM-9123</b> <b>MOUNT-TRANSMISSION</b> <b>Auto</b></p> <p style="text-align: center; font-size: x-small;">TOYOTA PASSENGER CAR ..... 1992-99</p>	 <p style="text-align: center; margin-top: 10px;"><b>EM-9127</b> <b>MOUNT-ENGINE</b> <b>Rear</b></p> <p style="text-align: center; font-size: small;">TOYOTA PASSENGER CAR ..... 1989-91</p>
 <p style="text-align: center; margin-top: 10px;"><b>EM-9117</b> <b>MOUNT-ENGINE</b> <b>RH Front</b></p> <p style="text-align: center; font-size: small;">TOYOTA PASSENGER CAR ..... 1988-89</p>	 <p style="text-align: center; margin-top: 10px;"><b>EM-9120</b> <b>MOUNT-ENGINE</b> <b>L &amp; R Front</b></p> <p style="text-align: center; font-size: small;">TOYOTA TRUCK ..... 1993-98</p>	 <p style="text-align: center; margin-top: 10px;"><b>EM-9124</b> <b>MOUNT-TRANSMISSION</b> <b>Manual</b></p> <p style="text-align: center; font-size: x-small;">TOYOTA PASSENGER CAR ..... 1987-90</p>	 <p style="text-align: center; margin-top: 10px;"><b>EM-9128</b> <b>MOUNT-ENGINE</b> <b>RH Front</b></p> <p style="text-align: center; font-size: small;">HONDA PASSENGER CAR ..... 1989</p>
 <p style="text-align: center; margin-top: 10px;"><b>EM-9118</b> <b>MOUNT-ENGINE</b> <b>Rear</b></p> <p style="text-align: center; font-size: small;">TOYOTA PASSENGER CAR ..... 1990-93</p>	 <p style="text-align: center; margin-top: 10px;"><b>EM-9121</b> <b>MOUNT-TRANSMISSION</b> <b>Auto</b></p> <p style="text-align: center; font-size: small;">TOYOTA PASSENGER CAR ..... 1985-87</p>	 <p style="text-align: center; margin-top: 10px;"><b>EM-9125</b> <b>MOUNT-TRANSMISSION</b> <b>Auto</b></p> <p style="text-align: center; font-size: x-small;">TOYOTA PASSENGER CAR ..... 1993-97</p>	 <p style="text-align: center; margin-top: 10px;"><b>EM-9129</b> <b>MOUNT-ENGINE</b> <b>RH Front</b></p> <p style="text-align: center; font-size: small;">TOYOTA PASSENGER CAR ..... 1988-91</p>
	 <p style="text-align: center; margin-top: 10px;"><b>EM-9122</b> <b>MOUNT-ENGINE</b> <b>Rear</b></p> <p style="text-align: center; font-size: small;">(Continued Next Column)</p>		 <p style="text-align: center; margin-top: 10px;"><b>EM-9130</b> <b>MOUNT-ENGINE</b> <b>Rear</b></p> <p style="text-align: center; font-size: small;">(Continued Next Page)</p>



# BUYER'S GUIDE

## NUMERICAL LISTING - ILLUSTRATIONS

### EM-9130 (Continued)

MAZDA PASSENGER CAR ..... 1988-92



EM-9131

#### EM-9131 MOUNT-ENGINE RH Front

FORD PASSENGER CAR ..... 1989-92  
MAZDA PASSENGER CAR ..... 1990-94



EM-9133

#### EM-9133 MOUNT-ENGINE RH Front

SUZUKI PASSENGER CAR ..... 1989-94



EM-9134

#### EM-9134 MOUNT-ENGINE RH Front

NISSAN PASSENGER CAR ..... 1988-89



EM-9136

#### EM-9136 MOUNT-ENGINE LH Front Upper

HONDA PASSENGER CAR ..... 1992-97

#### MOUNT-ENGINE LH Rear

HONDA PASSENGER CAR ..... 1993-95



EM-9137

#### EM-9137 MOUNT-ENGINE Rear

HONDA PASSENGER CAR ..... 1990-01

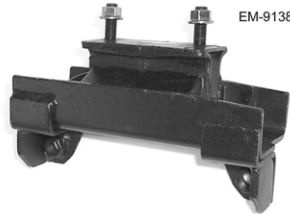

EM-9138

#### EM-9138 MOUNT-TRANSMISSION Manual

ISUZU SPORT UTILITY ..... 1984-86



EM-9139

#### EM-9139 MOUNT-ENGINE RH Front

HONDA SPORT UTILITY ..... 2002-06



EM-9140

#### EM-9140 MOUNT-ENGINE RH Front

HONDA SPORT UTILITY ..... 1994-95  
ISUZU SPORT UTILITY ..... 1991-95  
ISUZU TRUCK ..... 1991-94



EM-9141

#### EM-9141 MOUNT-ENGINE LH Front

HONDA SPORT UTILITY ..... 1994-95  
ISUZU SPORT UTILITY ..... 1991-95  
ISUZU TRUCK ..... 1991-94

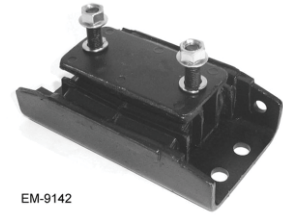

EM-9142

#### EM-9142 MOUNT-TRANSMISSION

ACURA SPORT UTILITY ..... 1996-99

#### MOUNT-TRANSMISSION Auto

HONDA SPORT UTILITY ..... 1994-97

#### MOUNT-TRANSMISSION

ISUZU SPORT UTILITY ..... 1992-02



#### EM-9143 MOUNT-TRANSMISSION Auto

ISUZU SPORT UTILITY ..... 1989-94

#### MOUNT-TRANSMISSION

ISUZU TRUCK ..... 1986-94















EM-9144

#### EM-9144 MOUNT-ENGINE RH Front

HONDA SPORT UTILITY ..... 1994-95  
ISUZU SPORT UTILITY ..... 1992-95

# BUYER'S GUIDE

## NUMERICAL LISTING - ILLUSTRATIONS

 <p><b>EM-9145</b> <b>MOUNT-ENGINE</b> <b>LH Front</b></p> <p>VOLVO PASSENGER CAR ..... 1993-04</p>	 <p><b>EM-9149</b> <b>MOUNT-ENGINE</b> <b>Rear</b></p> <p>ACURA PASSENGER CAR ..... 1999-03 HONDA PASSENGER CAR ..... 1998-02</p>	 <p><b>EM-9152</b> <b>MOUNT-TRANSMISSION</b> <b>Rear</b></p> <p>ACURA PASSENGER CAR ..... 2004-08 HONDA PASSENGER CAR ..... 2003-07</p>	 <p><b>EM-9155</b> <b>MOUNT-ENGINE</b> <b>Rear</b></p> <p>PONTIAC PASSENGER CAR ..... 2003-07 TOYOTA PASSENGER CAR ..... 2003-08</p>
 <p><b>EM-9147</b> <b>MOUNT-ENGINE</b> <b>LH Front</b></p> <p>EAGLE PASSENGER CAR ..... 1992-94</p> <p><b>MOUNT-ENGINE</b> <b>RH Front</b></p> <p>PLYMOUTH PASSENGER CAR ..... 1992-94</p> <p><b>MOUNT-TRANSMISSION</b> <b>Manual</b></p> <p>DODGE PASSENGER CAR ..... 1993-94</p>	 <p><b>EM-9150</b> <b>MOUNT-ENGINE</b> <b>LH Front</b></p> <p>HONDA PASSENGER CAR ..... 1997-01</p>	 <p><b>EM-9153</b> <b>MOUNT-ENGINE</b> <b>Rear</b></p> <p>MITSUBISHI SPORT UTILITY ..... 2003-06</p>	 <p><b>EM-9156</b> <b>MOUNT-ENGINE</b> <b>RH Front</b></p> <p>SUZUKI PASSENGER CAR ..... 2002-07</p>
 <p><b>EM-9148</b> <b>Engine Torque Strut</b> <b>Front Right</b></p> <p>TOYOTA PASSENGER CAR ..... 2002-08</p>	 <p><b>EM-9151</b> <b>MOUNT-TRANSMISSION</b> <b>Front</b></p> <p>HONDA PASSENGER CAR ..... 2003-07</p>	 <p><b>EM-9154</b> <b>MOUNT-ENGINE</b> <b>Rear</b></p> <p>MITSUBISHI PASSENGER CAR ..... 2004-07</p>	 <p><b>EM-9157</b> <b>MOUNT-ENGINE</b> <b>Rear</b></p> <p>PONTIAC PASSENGER CAR ..... 2003-07 TOYOTA PASSENGER CAR ..... 2003-08</p>

# BUYER'S GUIDE

## NUMERICAL LISTING - ILLUSTRATIONS



**EM-9158**  
**MOUNT-ENGINE**  
**Front**

PONTIAC PASSENGER CAR ..... 2003-07  
SCION PASSENGER CAR ..... 2005-10  
TOYOTA PASSENGER CAR ..... 2003-08



**EM-9161**  
**MOUNT-ENGINE**  
**Rear**

CHRYSLER PASSENGER  
CAR ..... 2001-05  
DODGE PASSENGER CAR ..... 2001-05  
MITSUBISHI PASSENGER  
CAR ..... 1994-05



**EM-9164**  
**MOUNT-ENGINE**  
**RH Front**

PONTIAC PASSENGER CAR ..... 2003-07  
TOYOTA PASSENGER CAR ..... 2003-08



**EM-9167**  
**MOUNT-ENGINE**  
**Front**

NISSAN PASSENGER CAR ..... 2002-06



**EM-9159**  
**MOUNT-ENGINE**  
**Rear**

SUZUKI PASSENGER CAR ..... 2004-07



**EM-9162**  
**MOUNT-TRANSMISSION**  
**Auto**

CHRYSLER PASSENGER  
CAR ..... 2001-05  
DODGE PASSENGER CAR ..... 2001-05  
MITSUBISHI PASSENGER  
CAR ..... 1999-05



**EM-9165**  
**MOUNT-TRANSMISSION**

LEXUS PASSENGER CAR ..... 2002-06  
LEXUS SPORT UTILITY ..... 2004-09

**MOUNT-TRANSMISSION**  
**Auto**

TOYOTA PASSENGER CAR ..... 2002-08  
TOYOTA SPORT UTILITY ..... 2001-07  
TOYOTA VAN ..... 2004-10



**EM-9168**  
**MOUNT-ENGINE**  
**Rear**

HONDA SPORT UTILITY ..... 2002-11



**EM-9160**  
**MOUNT-ENGINE**  
**Front**

CHRYSLER PASSENGER  
CAR ..... 2001-05  
DODGE PASSENGER CAR ..... 2001-05  
MITSUBISHI PASSENGER  
CAR ..... 1999-05



**EM-9163**  
**MOUNT-TRANSMISSION**  
**Auto**

PONTIAC PASSENGER CAR ..... 2003-07  
**MOUNT-TRANSMISSION**  
**Manual**  
TOYOTA PASSENGER CAR ..... 2003-08



**EM-9166**  
**MOUNT-ENGINE**  
**Rear**

NISSAN PASSENGER CAR ..... 2000-06















**EM-9169**  
**MOUNT-ENGINE**  
**LH Front**

ACURA PASSENGER CAR ..... 1992-93









# BUYER'S GUIDE

## NUMERICAL LISTING - ILLUSTRATIONS

 <p><b>EM-9170</b> <b>MOUNT-ENGINE</b> <b>Rear</b></p> <p>MITSUBISHI PASSENGER CAR ..... 2002-07</p>	 <p><b>EM-9173</b> <b>MOUNT-ENGINE</b> <b>Front</b></p> <p>LEXUS SPORT UTILITY ..... 1999-03</p>	 <p><b>EM-9176</b> <b>MOUNT-TRANSMISSION</b> <b>Auto</b></p> <p>NISSAN PASSENGER CAR ..... 1992-94</p>	 <p><b>EM-9179</b> <b>MOUNT-ENGINE</b> <b>Rear</b></p> <p>LEXUS SPORT UTILITY ..... 1999-03</p>
 <p><b>EM-9171</b> <b>MOUNT-ENGINE</b> <b>RH Rear</b></p> <p>NISSAN PASSENGER CAR ..... 1992-94</p>	 <p><b>EM-9174</b> <b>MOUNT-TRANSMISSION</b> <b>Auto</b></p> <p>CHRYSLER PASSENGER CAR ..... 1995-00</p> <p><b>MOUNT-TRANSMISSION</b></p> <p>DODGE PASSENGER CAR ..... 1995-00 EAGLE PASSENGER CAR ..... 1995-98</p> <p><b>MOUNT-TRANSMISSION</b> <b>Manual</b></p> <p>MITSUBISHI PASSENGER CAR ..... 1995-99</p>	 <p><b>EM-9177</b> <b>MOUNT-TRANSMISSION</b> <b>Auto</b></p> <p>SUZUKI PASSENGER CAR ..... 2002-06</p>	 <p><b>EM-9180</b> <b>MOUNT-ENGINE</b> <b>L &amp; R Front</b></p> <p>INFINITI PASSENGER CAR ..... 2003-06 NISSAN PASSENGER CAR ..... 2003-09</p>
 <p><b>EM-9172</b> <b>MOUNT-ENGINE</b> <b>Front</b></p> <p>HONDA PASSENGER CAR ..... 1988</p>	 <p><b>EM-9175</b> <b>MOUNT-ENGINE</b> <b>Rear</b></p> <p>ACURA PASSENGER CAR ..... 2002-06 HONDA SPORT UTILITY ..... 2002-06</p>	 <p><b>EM-9178</b> <b>MOUNT-ENGINE</b> <b>Front</b></p> <p>ACURA PASSENGER CAR ..... 1997-99 HONDA PASSENGER CAR ..... 1995-97</p>	 <p><b>EM-9181</b> <b>MOUNT-ENGINE</b> <b>Front</b></p> <p>MITSUBISHI PASSENGER CAR ..... 2002-07</p>
			 <p><b>EM-9182</b> <b>MOUNT-ENGINE</b> <b>RH Front</b></p> <p>MAZDA PASSENGER CAR ..... 2003-08</p>

# BUYER'S GUIDE

## NUMERICAL LISTING - ILLUSTRATIONS

 <p style="text-align: center;"><b>EM-9183</b> <b>MOUNT-TRANSMISSION</b> Auto</p> <p>HONDA PASSENGER CAR ..... 1997-01</p>	 <p style="text-align: center;"><b>EM-9186</b> <b>MOUNT-ENGINE</b> L &amp; R Front</p> <p>MITSUBISHI SPORT UTILITY ..... 2001-06</p>	 <p style="text-align: center;"><b>EM-9189</b> <b>MOUNT-ENGINE</b> RH Front</p> <p>MITSUBISHI PASSENGER CAR ..... 1997-04</p>	<p><b>EM-9192 (Continued)</b></p> <p>LEXUS SPORT UTILITY ..... 1999-03</p>  <p style="text-align: center;"><b>EM-9193</b> <b>MOUNT-ENGINE</b> Front</p> <p>MITSUBISHI PASSENGER CAR ..... 1997-04</p>
 <p style="text-align: center;"><b>EM-9184</b> <b>MOUNT-ENGINE</b> RH Front</p> <p>CHRYSLER PASSENGER CAR ..... 2001-05 DODGE PASSENGER CAR ..... 2001-05 MITSUBISHI PASSENGER CAR ..... 1999-05</p>	 <p style="text-align: center;"><b>EM-9187</b> <b>MOUNT-ENGINE</b> RH Front</p> <p>CHRYSLER PASSENGER CAR ..... 2001-05 DODGE PASSENGER CAR ..... 2001-05 MITSUBISHI PASSENGER CAR ..... 1999-05</p>	 <p style="text-align: center;"><b>EM-9190</b> <b>MOUNT-ENGINE</b> RH Front</p> <p>NISSAN PASSENGER CAR ..... 2002-06</p>	 <p style="text-align: center;"><b>EM-9194</b> <b>MOUNT-ENGINE</b> Rear</p> <p>ACURA PASSENGER CAR ..... 2004-08 HONDA PASSENGER CAR ..... 2003-07</p>
 <p style="text-align: center;"><b>EM-9185</b> <b>MOUNT-ENGINE</b> Front</p> <p>ACURA PASSENGER CAR ..... 1999 HONDA PASSENGER CAR ..... 1998-02</p>	 <p style="text-align: center;"><b>EM-9188</b> <b>MOUNT-ENGINE</b> RH Front</p> <p>MITSUBISHI PASSENGER CAR ..... 2002-07</p>	 <p style="text-align: center;"><b>EM-9191</b> <b>MOUNT-ENGINE</b> Front</p> <p>DODGE PASSENGER CAR ..... 1991-96 MITSUBISHI PASSENGER CAR ..... 1991-99</p>	 <p style="text-align: center;"><b>EM-9195</b> <b>Engine Torque Strut Mount</b> Rear</p> <p>MAZDA PASSENGER CAR ..... 2003-05</p>
 <p style="text-align: center;"><b>EM-9192</b> <b>MOUNT-ENGINE</b> Rear</p> <p style="text-align: center;">(Continued Next Column)</p>			





# BUYER'S GUIDE

## NUMERICAL LISTING - ILLUSTRATIONS

 <p style="text-align: center;"><b>EM-9196</b> <b>MOUNT-TRANSMISSION</b></p> <p>MAZDA PASSENGER CAR ..... 2004-09</p>	 <p style="text-align: center;"><b>EM-9200</b> <b>MOUNT-ENGINE</b> <b>Front</b></p> <p>NISSAN PASSENGER CAR ..... 2000-06</p>	 <p style="text-align: center;"><b>EM-9204</b> <b>MOUNT-TRANSMISSION</b> <b>Manual</b></p> <p>ACURA PASSENGER CAR ..... 2001-05 HONDA PASSENGER CAR ..... 2001-05</p>	 <p style="text-align: center;"><b>EM-9207</b> <b>MOUNT-ENGINE</b> <b>LH Front</b></p> <p>MITSUBISHI PASSENGER CAR ..... 1989-92</p>
 <p style="text-align: center;"><b>EM-9197</b> <b>Engine Torque Strut Mount</b> <b>Front</b></p> <p>LEXUS PASSENGER CAR ..... 2002-06</p> <p style="text-align: center;"><b>Engine Torque Strut</b> <b>Front Right</b></p> <p>TOYOTA PASSENGER CAR ..... 2002-06</p>	 <p style="text-align: center;"><b>EM-9201</b> <b>MOUNT-TRANSMISSION</b></p> <p>MITSUBISHI SPORT UTILITY ..... 2001-06</p>	 <p style="text-align: center;"><b>EM-9205</b> <b>MOUNT-TRANSMISSION</b> <b>Auto</b></p> <p>ACURA PASSENGER CAR ..... 2002-06 HONDA SPORT UTILITY ..... 2002-06</p>	 <p style="text-align: center;"><b>EM-9208</b> <b>MOUNT-ENGINE</b> <b>Rear</b></p> <p>AUDI PASSENGER CAR ..... 1997-06 SEAT ..... 2001-08 VOLKSWAGEN PASSENGER CAR ..... 1998-09</p>
 <p style="text-align: center;"><b>EM-9198</b> <b>MOUNT-ENGINE</b> <b>RH Front</b></p> <p>EAGLE PASSENGER CAR ..... 1995-96 MITSUBISHI PASSENGER CAR ..... 1995-99</p>	 <p style="text-align: center;"><b>EM-9202</b> <b>MOUNT-ENGINE</b> <b>Rear</b></p> <p>HONDA VAN ..... 1999-04</p>	 <p style="text-align: center;"><b>EM-9206</b> <b>MOUNT-ENGINE</b> <b>LH Front</b></p> <p>EAGLE PASSENGER CAR ..... 1990-94 HYUNDAI PASSENGER CAR ..... 1992-94 MITSUBISHI PASSENGER CAR ..... 1990-94 PLYMOUTH PASSENGER CAR ..... 1990-94</p>	 <p style="text-align: center;"><b>EM-9209</b> <b>MOUNT-ENGINE</b> <b>Rear</b></p> <p>NISSAN PASSENGER CAR ..... 2002-06</p>
 <p style="text-align: center;"><b>EM-9199</b> <b>MOUNT-TRANSMISSION</b> <b>Auto</b></p> <p>DODGE TRUCK ..... 1990-93 MITSUBISHI TRUCK ..... 1990-96</p>	 <p style="text-align: center;"><b>EM-9203</b> <b>MOUNT-ENGINE</b> <b>RH Front</b></p> <p>MITSUBISHI PASSENGER CAR ..... 1994-98</p>	 <p style="text-align: center;"><b>EM-9210</b> <b>Engine Torque Strut Mount</b> <b>Rear</b></p> <p>TOYOTA PASSENGER CAR ..... 2007-09</p>	

# BUYER'S GUIDE

## NUMERICAL LISTING - ILLUSTRATIONS

 <p style="text-align: center;"><b>EM-9211</b> <b>MOUNT-ENGINE</b> <b>Front</b></p> <p>TOYOTA PASSENGER CAR ..... 2002-08</p>	 <p style="text-align: center;"><b>EM-9214</b> <b>MOUNT-TRANSMISSION</b> <b>Rear</b></p> <p>HONDA PASSENGER CAR ..... 2003-07</p>	 <p style="text-align: center;"><b>EM-9217</b> <b>MOUNT-TRANSMISSION</b> <b>Auto</b></p> <p>NISSAN PASSENGER CAR ..... 2000-06</p>	<p><b>EM-9220 (Continued)</b> <b>MOUNT-TRANSMISSION</b> <b>Front Upper</b></p> <p>HONDA PASSENGER CAR ..... 2003-07</p> 
 <p style="text-align: center;"><b>EM-9212</b> <b>MOUNT-ENGINE</b> <b>RH Front</b></p> <p>LEXUS SPORT UTILITY ..... 2004-08 TOYOTA PASSENGER CAR ..... 2004-08</p>	 <p style="text-align: center;"><b>EM-9215</b> <b>MOUNT-TRANSMISSION</b> <b>Front</b></p> <p>ACURA PASSENGER CAR ..... 2004-06 HONDA PASSENGER CAR ..... 2003-07</p>	 <p style="text-align: center;"><b>EM-9218</b> <b>Engine Torque Strut Mount</b> <b>Lower</b></p> <p>HONDA PASSENGER CAR ..... 2006-11</p>	<p style="text-align: center;"><b>EM-9221</b> <b>Engine Torque Strut Mount</b> <b>Rear</b></p> <p>MAZDA PASSENGER CAR ..... 2003-08</p> 
 <p style="text-align: center;"><b>EM-9213</b> <b>Engine Torque Strut Mount</b> <b>Upper</b></p> <p>HONDA PASSENGER CAR ..... 2006-11</p>	 <p style="text-align: center;"><b>EM-9216</b> <b>MOUNT-TRANSMISSION</b> <b>Auto</b></p> <p>HONDA PASSENGER CAR ..... 2006-11</p>	 <p style="text-align: center;"><b>EM-9219</b> <b>MOUNT-TRANSMISSION</b> <b>Auto</b></p> <p>NISSAN PASSENGER CAR ..... 2002-04 NISSAN VAN ..... 2004-06</p>	<p style="text-align: center;"><b>EM-9222</b> <b>MOUNT-ENGINE</b> <b>Rear</b></p> <p>MAZDA PASSENGER CAR ..... 2004-13 MAZDA VAN ..... 2006-10</p> 
		 <p style="text-align: center;"><b>EM-9220</b> <b>MOUNT-TRANSMISSION</b> <b>Upper</b></p> <p>ACURA PASSENGER CAR ..... 2004-08</p>	<p style="text-align: center;"><b>EM-9223</b> <b>MOUNT-ENGINE</b> <b>Right</b></p> <p>NISSAN PASSENGER CAR ..... 2002-08</p> <p style="text-align: center;"><b>MOUNT-ENGINE</b> <b>RH Front</b></p> <p>NISSAN SPORT UTILITY ..... 2003-07 NISSAN VAN ..... 2004-09</p>

(Continued Next Column)

# BUYER'S GUIDE

## NUMERICAL LISTING - ILLUSTRATIONS

 <p><b>EM-9224</b> <b>MOUNT-TRANSMISSION</b> Auto</p> <p>INFINITI PASSENGER CAR ..... 1999-02</p>	 <p><b>EM-9228</b> <b>Engine Torque Strut Mount</b> Rear</p> <p>NISSAN PASSENGER CAR ..... 2007-12</p>	 <p><b>EM-9232</b> <b>Engine Torque Strut Mount</b> Right</p> <p>TOYOTA SPORT UTILITY ..... 2006-07</p>	 <p><b>EM-9236</b> <b>MOUNT-TRANSMISSION</b> Auto</p> <p>LEXUS PASSENGER CAR ..... 2007-14 LEXUS SPORT UTILITY ..... 2010-15</p>
 <p><b>EM-9225</b> <b>MOUNT-TRANSMISSION</b> Upper</p> <p>HONDA PASSENGER CAR ..... 2003-07</p>	 <p><b>EM-9229</b> <b>MOUNT-ENGINE</b> RH Front</p> <p>NISSAN PASSENGER CAR ..... 2000-06</p>	 <p><b>EM-9233</b> <b>Engine Torque Strut Mount</b> Front</p> <p>TOYOTA SPORT UTILITY ..... 2004-07</p>	 <p><b>EM-9237</b> <b>MOUNT-ENGINE</b> RH Front</p> <p>TOYOTA PASSENGER CAR ..... 2007-15</p>
 <p><b>EM-9226</b> <b>Engine Torque Strut Mount</b> Front</p> <p>TOYOTA VAN ..... 1998-03</p>	 <p><b>EM-9230</b> <b>MOUNT-TRANSMISSION</b></p> <p>NISSAN PASSENGER CAR ..... 2007-12</p>	 <p><b>EM-9234</b> <b>Engine Torque Strut Mount</b> Front</p> <p>TOYOTA SPORT UTILITY ..... 2004-07</p>	 <p><b>EM-9238</b> <b>MOUNT-ENGINE</b> RH Front</p> <p>TOYOTA SPORT UTILITY ..... 2009-12 TOYOTA VAN ..... 2011-12</p>
 <p><b>EM-9227</b> <b>Engine Torque Strut</b> Front Right</p> <p>LEXUS SPORT UTILITY ..... 2004-06</p>	 <p><b>EM-9231</b> <b>Engine Torque Strut</b> Front Right</p> <p>TOYOTA SPORT UTILITY ..... 2001-03</p>	 <p><b>EM-9235</b> <b>Engine Torque Strut</b> Front Right</p> <p>TOYOTA SPORT UTILITY ..... 2001-03</p>	 <p><b>EM-9233</b> <b>Engine Torque Strut Mount</b> Front</p> <p>TOYOTA PASSENGER CAR ..... 2007-12 LEXUS SPORT UTILITY ..... 2007-15 TOYOTA PASSENGER CAR ..... 2005-13 TOYOTA VAN ..... 2007-10</p>



# BUYER'S GUIDE

## NUMERICAL LISTING - ILLUSTRATIONS



**EM-9239**  
**MOUNT-ENGINE**  
**RH Front**

Lexus PASSENGER CAR ..... 2002-03  
TOYOTA PASSENGER CAR ..... 2002-03

**MOUNT-ENGINE**  
**Right**

TOYOTA SPORT UTILITY ..... 2001-03



**EM-9240**  
**MOUNT-ENGINE**  
**L & R Front**

CHEVROLET SPORT UTILITY .... 1999-04  
SUZUKI SPORT UTILITY ..... 1999-06



**EM-9241**  
**MOUNT-TRANSMISSION**

CHEVROLET SPORT UTILITY .... 1999-03  
SUZUKI SPORT UTILITY ..... 1999-03



**EM-9242**  
**MOUNT-ENGINE**  
**RH Front**

SUZUKI PASSENGER CAR ..... 1995-00



**EM-9244**  
**MOUNT-ENGINE**  
**L & R Front**

VOLVO PASSENGER CAR ..... 1999-08

**MOUNT-ENGINE**  
**Front**

VOLVO SPORT UTILITY ..... 2003-06

**MOUNT-ENGINE**  
**Lower Rear**

VOLVO PASSENGER CAR ..... 1999-05

**MOUNT-ENGINE**  
**Rear**

VOLVO SPORT UTILITY ..... 2003-06



**EM-9245**  
**MOUNT-TRANSMISSION**  
**Manual**

SEAT ..... 2007-08  
VOLKSWAGEN PASSENGER  
CAR ..... 2005-09



**EM-9246**  
**Engine Torque Strut Mount**  
**Rear**

TOYOTA PASSENGER CAR ..... 2007-09



**EM-9247**  
**MOUNT-ENGINE**  
**Front**

ACURA PASSENGER CAR ..... 2004-08  
HONDA PASSENGER CAR ..... 2003-07  
HONDA VAN ..... 2005-07



**EM-9248**  
**MOUNT-ENGINE**  
**Rear**

NISSAN PASSENGER CAR ..... 2002-04  
NISSAN SPORT UTILITY ..... 2003-07  
NISSAN VAN ..... 2004-09



**EM-9249**  
**MOUNT-ENGINE**  
**Rear**

TOYOTA PASSENGER CAR ..... 2007-11



**EM-9250**  
**MOUNT-ENGINE**  
**Front**

HONDA PASSENGER CAR ..... 2007-08



**EM-9251**  
**MOUNT-ENGINE**  
**RH Front**

NISSAN PASSENGER CAR ..... 2000-01















**EM-9252**  
**MOUNT-ENGINE**  
**Front**

NISSAN PASSENGER CAR ..... 2002-08  
NISSAN SPORT UTILITY ..... 2003-07  
NISSAN VAN ..... 2004-09

# BUYER'S GUIDE

## NUMERICAL LISTING - ILLUSTRATIONS

 <p><b>EM-9253</b> <b>MOUNT-ENGINE</b> <b>Front</b></p> <p>DODGE PASSENGER CAR ..... 2004-06 HYUNDAI PASSENGER CAR ..... 2003-05</p>	 <p><b>EM-9256</b> <b>MOUNT-ENGINE</b> <b>Front</b></p> <p>NISSAN SPORT UTILITY ..... 2003-07</p>	 <p><b>EM-9260</b> <b>MOUNT-ENGINE</b> <b>Front Lower</b></p> <p>SEAT ..... 2005-08</p>	 <p><b>EM-9263</b> <b>MOUNT-ENGINE</b> <b>LH Front Upper</b></p> <p>AUDI PASSENGER CAR ..... 2006-12</p>
 <p><b>EM-9254</b> <b>MOUNT-ENGINE</b> <b>Rear</b></p> <p>DODGE PASSENGER CAR ..... 2005-06 HYUNDAI PASSENGER CAR ..... 2003-05</p>	 <p><b>EM-9257</b> <b>MOUNT-ENGINE</b> <b>RH Front</b></p> <p>AUDI PASSENGER CAR ..... 2006-12 VOLKSWAGEN PASSENGER CAR ..... 2005-12</p>	<p><b>MOUNT-ENGINE</b> <b>LH Front Lower</b></p> <p>VOLKSWAGEN PASSENGER CAR ..... 2005-11</p> <p><b>MOUNT-ENGINE</b> <b>Lower Rear</b></p> <p>AUDI PASSENGER CAR ..... 2006-12 VOLKSWAGEN PASSENGER CAR ..... 2006-12</p>	<p><b>MOUNT-ENGINE</b> <b>Front Upper</b></p> <p>SEAT ..... 2005-08</p> <p><b>MOUNT-ENGINE</b> <b>LH Front Upper</b></p> <p>VOLKSWAGEN PASSENGER CAR ..... 2005-12</p> <p><b>MOUNT-ENGINE</b> <b>RH Rear</b></p> <p>VOLKSWAGEN PASSENGER CAR ..... 2005-06</p>
 <p><b>EM-9255</b> <b>MOUNT-ENGINE</b> <b>RH Front</b></p> <p>DODGE PASSENGER CAR ..... 2005-06</p> <p><b>MOUNT-ENGINE</b> <b>Front</b></p> <p>HYUNDAI PASSENGER CAR ..... 2003-05</p>	 <p><b>EM-9258</b> <b>MOUNT-TRANSMISSION</b> <b>RH Rear</b></p> <p>AUDI PASSENGER CAR ..... 2000-08</p> <p><b>MOUNT-TRANSMISSION</b> <b>L &amp; R</b></p> <p>VOLKSWAGEN PASSENGER CAR ..... 2001-05</p>	 <p><b>EM-9261</b> <b>MOUNT-ENGINE</b> <b>Right</b></p> <p>AUDI PASSENGER CAR ..... 2004-06</p> <p><b>MOUNT-ENGINE</b> <b>RH Front</b></p> <p>VOLKSWAGEN PASSENGER CAR ..... 1999-05</p>	 <p><b>EM-9264</b> <b>MOUNT-TRANSMISSION</b></p> <p>VOLKSWAGEN PASSENGER CAR ..... 1999-05</p>
 <p><b>EM-9259</b> <b>MOUNT-ENGINE</b> <b>LH Front</b></p> <p>AUDI PASSENGER CAR ..... 2006-12 VOLKSWAGEN PASSENGER CAR ..... 2005-12</p>	 <p><b>EM-9262</b> <b>MOUNT-TRANSMISSION</b> <b>Manual</b></p> <p>AUDI PASSENGER CAR ..... 2006-09</p> <p><b>MOUNT-TRANSMISSION</b> <b>Auto</b></p> <p>SEAT ..... 2005-06</p> <p><b>MOUNT-TRANSMISSION</b></p> <p>VOLKSWAGEN PASSENGER CAR ..... 2006-10</p>	 <p><b>EM-9265</b> <b>MOUNT-ENGINE</b> <b>L &amp; R Front</b></p> <p>MERCEDES-BENZ SPORT UTILITY ..... 1998-05</p>	

# BUYER'S GUIDE

## NUMERICAL LISTING - ILLUSTRATIONS



**EM-9266**  
**MOUNT-TRANSMISSION**

MERCEDES-BENZ  
PASSENGER CAR ..... 1984-96



**EM-9267**  
**MOUNT-TRANSMISSION**

MERCEDES-BENZ SPORT  
UTILITY ..... 1998-05



**EM-9268**  
**MOUNT-TRANSMISSION**

CHRYSLER PASSENGER  
CAR ..... 2004-08  
MERCEDES-BENZ  
PASSENGER CAR ..... 1996-09



**EM-9269**  
**MOUNT-ENGINE**  
**L & R Front**

MERCEDES-BENZ  
PASSENGER CAR ..... 1984-85



**EM-9270**  
**MOUNT-ENGINE**  
**L & R Front**

MERCEDES-BENZ  
PASSENGER CAR ..... 1984-85



**EM-9271**  
**MOUNT-ENGINE**  
**LH Front**

BMW PASSENGER CAR ..... 1995-03



**EM-9272**  
**MOUNT-ENGINE**  
**RH Front**

BMW PASSENGER CAR ..... 1995-03



**EM-9273**  
**MOUNT-ENGINE**  
**RH Front**

BMW PASSENGER CAR ..... 1993-97



**EM-9274**  
**MOUNT-ENGINE**  
**LH Front**

BMW PASSENGER CAR ..... 1993-97



**EM-9275**  
**MOUNT-ENGINE**  
**L & R Front**

BMW PASSENGER CAR ..... 1988-93



**EM-9276**  
**MOUNT-ENGINE**  
**L & R Front**

BMW PASSENGER CAR ..... 1997-03



**EM-9277**  
**MOUNT-ENGINE**  
**LH Front**

HONDA PASSENGER CAR ..... 2001-05



**EM-9278**  
**MOUNT-ENGINE**  
**RH Front**

MINI PASSENGER  
CAR ..... 2004-09



**EM-9279**  
**MOUNT-ENGINE**  
**RH Front**

TOYOTA PASSENGER CAR ..... 2007-11

# BUYER'S GUIDE

## NUMERICAL LISTING - ILLUSTRATIONS

 <p style="text-align: center;"><b>EM-9280</b> <b>MOUNT-ENGINE</b> <b>Front</b></p> <p>HONDA PASSENGER CAR ..... 2006-11</p>	<p><b>EM-9283 (Continued)</b></p> <p>SEAT ..... 2005-08 VOLKSWAGEN PASSENGER CAR ..... 2005-12</p>  <p style="text-align: center;"><b>EM-9284</b> <b>MOUNT-TRANSMISSION</b> <b>Auto</b></p> <p>SCION PASSENGER CAR ..... 2004-06 SCION VAN ..... 2004-06 TOYOTA PASSENGER CAR ..... 2001-03</p>	 <p style="text-align: center;"><b>EM-9287</b> <b>MOUNT-TRANSMISSION</b> <b>Manual</b></p> <p>AUDI PASSENGER CAR ..... 2005-08</p>	<p><b>EM-9290 (Continued)</b></p> <p>SAAB PASSENGER CAR ..... 1999</p>  <p style="text-align: center;"><b>EM-9291</b> <b>MOUNT-ENGINE</b> <b>Rear</b></p> <p>SAAB PASSENGER CAR ..... 1994-03</p>
 <p style="text-align: center;"><b>EM-9281</b> <b>MOUNT-ENGINE</b> <b>RH Front</b></p> <p>MITSUBISHI PASSENGER CAR ..... 2004-12</p>	 <p style="text-align: center;"><b>EM-9285</b> <b>MOUNT-TRANSMISSION</b> <b>Auto</b></p> <p>HONDA PASSENGER CAR ..... 2007-08</p>	 <p style="text-align: center;"><b>EM-9288</b> <b>MOUNT-TRANSMISSION</b> <b>Auto</b></p> <p>INFINITI PASSENGER CAR ..... 1991-96 NISSAN PASSENGER CAR ..... 1992</p>	 <p style="text-align: center;"><b>EM-9292</b> <b>Engine Torque Strut Mount</b> <b>Front</b></p> <p>SAAB PASSENGER CAR ..... 2000-09</p>
 <p style="text-align: center;"><b>EM-9282</b> <b>MOUNT-ENGINE</b> <b>RH Front</b></p> <p>ACURA PASSENGER CAR ..... 2006-09 HONDA PASSENGER CAR ..... 2006-10</p>	 <p style="text-align: center;"><b>EM-9286</b> <b>MOUNT-TRANSMISSION</b> <b>Manual</b></p> <p>HONDA PASSENGER CAR ..... 2007-08</p>	 <p style="text-align: center;"><b>EM-9289</b> <b>MOUNT-ENGINE</b> <b>LH Rear</b></p> <p>SAAB PASSENGER CAR ..... 1990-98</p>	 <p style="text-align: center;"><b>EM-9293</b> <b>MOUNT-ENGINE</b> <b>Front</b></p> <p>SAAB PASSENGER CAR ..... 1986-89</p>
 <p style="text-align: center;"><b>EM-9283</b> <b>MOUNT-ENGINE</b> <b>Rear</b></p> <p>AUDI PASSENGER CAR ..... 2006-12</p> <p style="text-align: center;">(Continued Next Column)</p>	<p style="text-align: center;">(Continued Next Column)</p>	 <p style="text-align: center;"><b>EM-9290</b> <b>Engine Torque Strut Mount</b> <b>Front</b></p> <p>SAAB PASSENGER CAR ..... 1999</p>  <p style="text-align: center;"><b>EM-9294</b> <b>MOUNT-ENGINE</b> <b>Rear</b></p> <p>SAAB PASSENGER CAR ..... 1986-89</p> <p style="text-align: center;">(Continued Next Column)</p>	<p style="text-align: center;">(Continued Next Column)</p>

# BUYER'S GUIDE

## NUMERICAL LISTING - ILLUSTRATIONS



**EM-9295**  
**MOUNT-TRANSMISSION**  
**Manual**

HYUNDAI PASSENGER CAR ..... 2003-05



**EM-9298**  
**MOUNT-TRANSMISSION**  
**Rear**

ACURA SPORT UTILITY ..... 2003-06  
HONDA SPORT UTILITY ..... 2006-08



**EM-9301**  
**MOUNT-TRANSMISSION**  
**Front**

ACURA SPORT UTILITY ..... 2003-06  
HONDA SPORT UTILITY ..... 2006-08  
HONDA TRUCK ..... 2006-08



**EM-9305**  
**MOUNT-ENGINE**  
**Front**

MITSUBISHI PASSENGER  
CAR ..... 2004-12  
MITSUBISHI SPORT UTILITY ..... 2004-11



**EM-9296**  
**MOUNT-TRANSMISSION**  
**Auto**

HYUNDAI PASSENGER CAR ..... 2003-05



**EM-9299**  
**MOUNT-ENGINE**  
**RH Front**

ACURA SPORT UTILITY ..... 2003-06  
HONDA SPORT UTILITY ..... 2005-08



**EM-9302**  
**Engine Torque Strut Mount**  
**Right Upper**

HONDA SPORT UTILITY ..... 2007-11



**EM-9306**  
**MOUNT-ENGINE**  
**Rear**

HYUNDAI SPORT UTILITY ..... 2005-09  
KIA SPORT UTILITY ..... 2005-09



**EM-9297**  
**MOUNT-ENGINE**  
**RH Front**

ACURA PASSENGER CAR ..... 2004-08



**EM-9300**  
**MOUNT-ENGINE**  
**Rear**

ACURA SPORT UTILITY ..... 2001-06  
HONDA SPORT UTILITY ..... 2003-08  
HONDA TRUCK ..... 2006-11



**EM-9303**  
**Engine Torque Strut Mount**  
**Right Lower**

HONDA SPORT UTILITY ..... 2007-11



**EM-9307**  
**MOUNT-ENGINE**  
**Front**

HYUNDAI PASSENGER CAR ..... 2003-08

**MOUNT-ENGINE**  
**Right**  
HONDA PASSENGER CAR ..... 2003-07  
HONDA PASSENGER CAR ..... 2003-07















**EM-9304**  
**MOUNT-TRANSMISSION**

MITSUBISHI PASSENGER  
CAR ..... 2004-12

# BUYER'S GUIDE

## NUMERICAL LISTING - ILLUSTRATIONS

 <p><b>EM-9308</b> <b>MOUNT-TRANSMISSION</b></p> <p>HYUNDAI PASSENGER CAR ..... 2006-09 KIA PASSENGER CAR ..... 2006-09</p>	 <p><b>EM-9311</b> <b>MOUNT-ENGINE</b> <b>Front</b></p> <p>KIA PASSENGER CAR ..... 2006-10</p>	 <p><b>EM-9314</b> <b>MOUNT-ENGINE</b> <b>Rear</b></p> <p>HYUNDAI PASSENGER CAR ..... 2003-08</p>	 <p><b>EM-9317</b> <b>MOUNT-ENGINE</b> <b>Front</b></p> <p>HYUNDAI PASSENGER CAR ..... 2006-10 KIA PASSENGER CAR ..... 2007-09</p>
 <p><b>EM-9309</b> <b>MOUNT-ENGINE</b> <b>Front Lower</b></p> <p>HYUNDAI PASSENGER CAR ..... 2006-09 KIA PASSENGER CAR ..... 2006-09</p>	 <p><b>EM-9312</b> <b>MOUNT-ENGINE</b> <b>Front</b></p> <p>KIA PASSENGER CAR ..... 2004-09</p>	 <p><b>EM-9315</b> <b>MOUNT-ENGINE</b> <b>Rear</b></p> <p>HYUNDAI SPORT UTILITY ..... 2007-12</p>	 <p><b>EM-9318</b> <b>MOUNT-ENGINE</b> <b>Rear</b></p> <p>HYUNDAI PASSENGER CAR ..... 2006-10</p>
 <p><b>EM-9310</b> <b>MOUNT-ENGINE</b> <b>Rear</b></p> <p>HYUNDAI PASSENGER CAR ..... 2006-09 KIA PASSENGER CAR ..... 2006-09</p>	 <p><b>EM-9313</b> <b>MOUNT-ENGINE</b> <b>Rear</b></p> <p>KIA PASSENGER CAR ..... 2004-09</p>	 <p><b>EM-9316</b> <b>MOUNT-ENGINE</b> <b>Rear</b></p> <p>HYUNDAI PASSENGER CAR ..... 2007-11</p>	 <p><b>EM-9319</b> <b>MOUNT-TRANSMISSION</b> <b>Manual</b></p> <p>KIA PASSENGER CAR ..... 2004-09</p>
			 <p><b>EM-9320</b> <b>MOUNT-TRANSMISSION</b> <b>Auto</b></p> <p>(Continued Next Page)</p>

# BUYER'S GUIDE

## NUMERICAL LISTING - ILLUSTRATIONS

### EM-9320 (Continued)

KIA SPORT UTILITY ..... 2005-09

#### EM-9321 MOUNT-ENGINE Front

HYUNDAI PASSENGER CAR ..... 2006-10  
KIA PASSENGER CAR ..... 2007-09



#### EM-9322 MOUNT-ENGINE Front

HYUNDAI SPORT UTILITY ..... 2005-09  
KIA SPORT UTILITY ..... 2005-09



#### EM-9323 MOUNT-ENGINE Front

KIA PASSENGER CAR ..... 2006

#### MOUNT-ENGINE Rear

KIA PASSENGER CAR ..... 2005-10



#### EM-9324 MOUNT-ENGINE Front Upper

HYUNDAI PASSENGER CAR ..... 2006-09  
KIA PASSENGER CAR ..... 2006-09



#### EM-9325 MOUNT-ENGINE RH Front

KIA PASSENGER CAR ..... 2004-09



#### EM-9326 MOUNT-ENGINE Rear

KIA PASSENGER CAR ..... 2004-06



#### EM-9327 MOUNT-ENGINE Rear Upper

KIA PASSENGER CAR ..... 2004-09



#### EM-9328 MOUNT-ENGINE Front Upper

KIA PASSENGER CAR ..... 2004-09



#### EM-9329 MOUNT-ENGINE L & R Front

KIA SPORT UTILITY ..... 2007-10



#### EM-9330 MOUNT-ENGINE Rear

KIA PASSENGER CAR ..... 2007-09



#### EM-9331 MOUNT-ENGINE L & R Front

(Continued Next Column)

### EM-9331 (Continued)

KIA SPORT UTILITY ..... 2003-06



#### EM-9332 MOUNT-ENGINE RH Front

KIA PASSENGER CAR ..... 2007-09



#### EM-9333 MOUNT-TRANSMISSION

KIA PASSENGER CAR ..... 2007-09















#### EM-9334 MOUNT-TRANSMISSION

KIA PASSENGER CAR ..... 2009-10  
KIA PASSENGER CAR ..... 2006-10

# BUYER'S GUIDE

## NUMERICAL LISTING - ILLUSTRATIONS

 <p><b>EM-9335</b> <b>MOUNT-ENGINE</b> <b>RH Front</b></p> <p>KIA PASSENGER CAR ..... 2005-10</p>	 <p><b>EM-9338</b> <b>MOUNT-ENGINE</b> <b>Front</b></p> <p>HYUNDAI SPORT UTILITY ..... 2005-09 KIA SPORT UTILITY ..... 2005-09</p>	 <p><b>EM-9341</b> <b>MOUNT-TRANSMISSION</b></p> <p>HYUNDAI SPORT UTILITY ..... 2007-12</p>	<p><b>EM-9344 (Continued)</b></p> <p>HYUNDAI PASSENGER CAR ..... 2009</p>  <p><b>EM-9344</b> <b>MOUNT-ENGINE</b> <b>L &amp; R Front</b></p>
 <p><b>EM-9336</b> <b>MOUNT-TRANSMISSION</b> <b>Manual</b></p> <p>KIA SPORT UTILITY ..... 2003-06</p>	 <p><b>EM-9339</b> <b>MOUNT-TRANSMISSION</b></p> <p>HYUNDAI PASSENGER CAR ..... 2007-09</p>	 <p><b>EM-9342</b> <b>MOUNT-TRANSMISSION</b></p> <p>KIA PASSENGER CAR ..... 2007-10</p>	<p><b>EM-9345</b> <b>MOUNT-ENGINE</b> <b>RH Front</b></p> <p>HYUNDAI PASSENGER CAR ..... 2007-11</p> <p><b>EM-9345</b> <b>MOUNT-ENGINE</b> <b>Right</b></p> <p>KIA PASSENGER CAR ..... 2010-13</p>
 <p><b>EM-9337</b> <b>MOUNT-TRANSMISSION</b> <b>Auto</b></p> <p>KIA PASSENGER CAR ..... 2004-09</p>	 <p><b>EM-9340</b> <b>MOUNT-ENGINE</b> <b>RH Front</b></p> <p>HYUNDAI PASSENGER CAR ..... 2006-10</p>	 <p><b>EM-9343</b> <b>MOUNT-ENGINE</b> <b>RH Front</b></p> <p>HYUNDAI VAN ..... 2007-08 KIA VAN ..... 2006-09</p>	 <p><b>EM-9346</b> <b>MOUNT-ENGINE</b> <b>RH Front</b></p> <p>KIA PASSENGER CAR ..... 2003-05</p>
		 <p><b>EM-9347</b> <b>MOUNT-ENGINE</b> <b>Rear</b></p> <p>HYUNDAI VAN ..... 2007-08 KIA VAN ..... 2006-14</p>	
		 <p><b>EM-9344</b> <b>MOUNT-ENGINE</b> <b>L &amp; R Front</b></p> <p>(Continued Next Column)</p>	



# BUYER'S GUIDE

## NUMERICAL LISTING - ILLUSTRATIONS

 <p><b>EM-9348</b> <b>MOUNT-ENGINE</b> <b>Front</b></p> <p>HYUNDAI SPORT UTILITY ..... 2007-12</p>	 <p><b>EM-9352</b> <b>MOUNT-ENGINE</b> <b>Rear</b></p> <p>HYUNDAI PASSENGER CAR ..... 2003-05</p>	 <p><b>EM-9355</b> <b>MOUNT-ENGINE</b> <b>RH Front</b></p> <p>HYUNDAI SPORT UTILITY ..... 2007-12</p> <p><b>MOUNT-ENGINE</b> <b>Right</b></p> <p>KIA SPORT UTILITY ..... 2011-13</p>	 <p><b>EM-9359</b> <b>MOUNT-ENGINE</b> <b>Rear</b></p> <p>KIA VAN ..... 2002-05</p>
 <p><b>EM-9349</b> <b>MOUNT-TRANSMISSION</b></p> <p>HYUNDAI VAN ..... 2007-08 KIA VAN ..... 2006-14</p>	 <p><b>EM-9353</b> <b>MOUNT-ENGINE</b> <b>RH Front</b></p> <p>HYUNDAI PASSENGER CAR ..... 2006-10</p>	 <p><b>EM-9356</b> <b>MOUNT-TRANSMISSION</b></p> <p>HYUNDAI PASSENGER CAR ..... 2009</p>	 <p><b>EM-9360</b> <b>MOUNT-ENGINE</b> <b>Front</b></p> <p>HYUNDAI PASSENGER CAR ..... 2007-10</p>
 <p><b>EM-9350</b> <b>MOUNT-TRANSMISSION</b></p> <p>HYUNDAI PASSENGER CAR ..... 2009</p>	 <p><b>EM-9354</b> <b>MOUNT-ENGINE</b> <b>Rear</b></p> <p>HYUNDAI PASSENGER CAR ..... 2006-10</p>	 <p><b>EM-9357</b> <b>MOUNT-ENGINE</b> <b>Front</b></p> <p>HYUNDAI PASSENGER CAR ..... 2009-11</p>	 <p><b>EM-9361</b> <b>MOUNT-TRANSMISSION</b> <b>Auto</b></p> <p>HYUNDAI PASSENGER CAR ..... 2006-10</p>
 <p><b>EM-9351</b> <b>MOUNT-ENGINE</b> <b>Front</b></p> <p>KIA VAN ..... 2002-05</p>		 <p><b>EM-9358</b> <b>MOUNT-ENGINE</b> <b>RH Front</b></p> <p>HYUNDAI PASSENGER CAR ..... 2003-06</p>	 <p><b>EM-9362</b> <b>MOUNT-ENGINE</b> <b>Front</b></p>

(Continued Next Page)

# BUYER'S GUIDE

## NUMERICAL LISTING - ILLUSTRATIONS

**EM-9362 (Continued)**

KIA PASSENGER CAR ..... 2006-09



**EM-9363**  
**MOUNT-ENGINE**  
**RH Front**

HYUNDAI PASSENGER CAR ..... 2009-10



**EM-9364**  
**MOUNT-TRANSMISSION**  
**Manual**

HYUNDAI PASSENGER CAR ..... 2005-08



**EM-9365**  
**MOUNT-ENGINE**  
**Rear**

HYUNDAI PASSENGER CAR ..... 1995-98



**EM-9366**  
**MOUNT-TRANSMISSION**

HYUNDAI PASSENGER CAR ..... 2003-08



**EM-9367**  
**MOUNT-TRANSMISSION**  
**Manual**

HYUNDAI PASSENGER CAR ..... 2002-05  
KIA PASSENGER CAR ..... 2001-06



**EM-9368**  
**MOUNT-ENGINE**  
**RH Front**

HYUNDAI SPORT UTILITY ..... 2005-09  
KIA SPORT UTILITY ..... 2005-09



**EM-9369**  
**MOUNT-TRANSMISSION**  
**Manual**

HYUNDAI PASSENGER CAR ..... 2005-08



**EM-9370**  
**MOUNT-TRANSMISSION**

HYUNDAI PASSENGER CAR ..... 2006-10



**EM-9371**  
**MOUNT-ENGINE**  
**Front**

HYUNDAI SPORT UTILITY ..... 2003-06



**EM-9372**  
**MOUNT-ENGINE**  
**RH Front**

HYUNDAI PASSENGER CAR ..... 2003-08



**EM-9373**  
**MOUNT-TRANSMISSION**  
**Auto**

HYUNDAI PASSENGER CAR ..... 2002-05  
KIA PASSENGER CAR ..... 2001-06



**EM-9374**  
**MOUNT-TRANSMISSION**  
**Auto**

HYUNDAI SPORT UTILITY ..... 2005-09  
KIA SPORT UTILITY ..... 2005-09



**EM-9375**  
**MOUNT-ENGINE**  
**Front**

HYUNDAI VAN ..... 2007-08  
KIA VAN ..... 2006-10

# BUYER'S GUIDE

## NUMERICAL LISTING - ILLUSTRATIONS



**EM-9376**  
**MOUNT-TRANSMISSION**

HYUNDAI PASSENGER CAR ..... 2001-08



**EM-9380**  
**MOUNT-TRANSMISSION**  
**Manual**

HYUNDAI SPORT UTILITY ..... 2005-09  
KIA SPORT UTILITY ..... 2005-09



**EM-9383**  
**MOUNT-TRANSMISSION**  
**Auto**

MITSUBISHI PASSENGER CAR ..... 2004-06  
MITSUBISHI SPORT UTILITY ..... 2004-11



**EM-9386**  
**Engine Torque Strut Mount**  
**Lower**

ACURA PASSENGER CAR ..... 2006-10  
HONDA PASSENGER CAR ..... 2006-10



**EM-9377**  
**MOUNT-ENGINE**  
**Front**

HYUNDAI PASSENGER CAR ..... 2007-11



**EM-9381**  
**MOUNT-TRANSMISSION**  
**Auto**

HYUNDAI PASSENGER CAR ..... 2009-10



**EM-9384**  
**MOUNT-TRANSMISSION**  
**LH**

CHRYSLER PASSENGER CAR ..... 2001-05  
DODGE PASSENGER CAR ..... 2001-05  
MITSUBISHI PASSENGER CAR ..... 1999-05



**EM-9387**  
**MOUNT-TRANSMISSION**

MITSUBISHI PASSENGER CAR ..... 1997-04



**EM-9378**  
**MOUNT-TRANSMISSION**

HYUNDAI SPORT UTILITY ..... 2005-08  
KIA SPORT UTILITY ..... 2005-09



**EM-9382**  
**MOUNT-ENGINE**  
**Rear**

MITSUBISHI PASSENGER CAR ..... 2004-12



**EM-9385**  
**Engine Torque Strut Mount**  
**Upper**

ACURA PASSENGER CAR ..... 2006-10  
HONDA PASSENGER CAR ..... 2006-10



**EM-9388**  
**Engine Torque Strut**  
**Front Right**

TOYOTA PASSENGER CAR ..... 2000-04



**EM-9379**  
**MOUNT-ENGINE**  
**RH Front**

HYUNDAI PASSENGER CAR ..... 2006



**EM-9389**  
**MOUNT-ENGINE**  
**RH Front**

ACURA SPORT UTILITY ..... 2001-02  
HONDA SPORT UTILITY ..... 2003-04

# BUYER'S GUIDE

## NUMERICAL LISTING - ILLUSTRATIONS

 <p style="text-align: center;"><b>EM-9390</b> <b>MOUNT-TRANSMISSION</b> <b>Auto</b></p> <p>PONTIAC PASSENGER CAR ..... 2009-10 TOYOTA PASSENGER CAR ..... 2009-13</p>	 <p style="text-align: center;"><b>EM-9393</b> <b>MOUNT-ENGINE</b> <b>Rear</b></p> <p>TOYOTA SPORT UTILITY ..... 2001-05</p>	 <p style="text-align: center;"><b>EM-9396</b> <b>MOUNT-ENGINE</b> <b>Rear</b></p> <p>ACURA PASSENGER CAR ..... 2002-06 HONDA PASSENGER CAR ..... 2002-05</p>	<p><b>EM-9401 (Continued)</b></p> <p>VOLKSWAGEN PASSENGER CAR ..... 2009-14</p> <p style="text-align: center;"><b>MOUNT-ENGINE</b> <b>L &amp; R Rear</b></p> <p>VOLKSWAGEN PASSENGER CAR ..... 2009-11</p> 
 <p style="text-align: center;"><b>EM-9391</b> <b>MOUNT-ENGINE</b> <b>Front</b></p> <p>PONTIAC PASSENGER CAR ..... 2009-10 TOYOTA PASSENGER CAR ..... 2009-11</p>	 <p style="text-align: center;"><b>EM-9394</b> <b>MOUNT-ENGINE</b> <b>Rear</b></p> <p>CHRYSLER PASSENGER CAR ..... 1995-99 DODGE PASSENGER CAR ..... 1995-99 MITSUBISHI PASSENGER CAR ..... 1995-99</p>	 <p style="text-align: center;"><b>EM-9397</b> <b>MOUNT-TRANSMISSION</b></p> <p>HONDA SPORT UTILITY ..... 2007-09</p>	<p style="text-align: center;"><b>EM-9402</b> <b>MOUNT-ENGINE</b> <b>Front</b></p> <p>AUDI PASSENGER CAR ..... 2010-11 VOLKSWAGEN PASSENGER CAR ..... 2009-11</p> 
 <p style="text-align: center;"><b>EM-9392</b> <b>MOUNT-ENGINE</b> <b>Rear</b></p> <p>CHRYSLER PASSENGER CAR ..... 1996-00 DODGE PASSENGER CAR ..... 1995-00</p>	 <p style="text-align: center;"><b>EM-9395</b> <b>MOUNT-TRANSMISSION</b> <b>Auto</b></p> <p>INFINITI SPORT UTILITY ..... 2001-03 NISSAN SPORT UTILITY ..... 2001-04</p>	 <p style="text-align: center;"><b>EM-9400</b> <b>MOUNT-ENGINE</b> <b>Rear</b></p> <p>PONTIAC PASSENGER CAR ..... 2009-10 TOYOTA PASSENGER CAR ..... 2009-11</p>	<p style="text-align: center;"><b>EM-9403</b> <b>MOUNT-ENGINE</b> <b>L &amp; R Front</b></p> <p>AUDI PASSENGER CAR ..... 2005-07</p> 
 <p style="text-align: center;"><b>EM-9401</b> <b>MOUNT-ENGINE</b> <b>L &amp; R Front</b></p> <p style="text-align: center;">(Continued Next Column)</p>			<p style="text-align: center;"><b>EM-9404</b> <b>MOUNT-ENGINE</b> <b>L &amp; R Front</b></p> <p>BMW PASSENGER CAR ..... 1986-92</p> 

# BUYER'S GUIDE

## NUMERICAL LISTING - ILLUSTRATIONS



**EM-9405**  
MOUNT-ENGINE  
Right

AUDI PASSENGER CAR ..... 2006-09

**MOUNT-ENGINE**  
Front

VOLKSWAGEN PASSENGER  
CAR ..... 2006-14



**EM-9406**  
MOUNT-ENGINE  
LH Front

AUDI PASSENGER CAR ..... 2006-10



**EM-9407**  
MOUNT-ENGINE  
RH Front

AUDI PASSENGER CAR ..... 2006-10



**EM-9408**  
MOUNT-ENGINE  
L & R Front

INFINITI SPORT UTILITY ..... 2001-03  
NISSAN SPORT UTILITY ..... 2001-04



**EM-9409**  
MOUNT-TRANSMISSION  
Front

HONDA PASSENGER CAR ..... 2003-05



**EM-9410**  
MOUNT-TRANSMISSION  
MOUNT-TRANSMISSION  
Auto

NISSAN PASSENGER CAR ..... 2004-06

NISSAN VAN ..... 2004-09



**EM-9411**  
MOUNT-ENGINE  
RH Front

HONDA SPORT UTILITY ..... 2009-10  
HONDA VAN ..... 2005-06



**EM-9412**  
MOUNT-ENGINE  
RH Front

PONTIAC PASSENGER CAR ..... 2003-06  
TOYOTA PASSENGER CAR ..... 2003-06



**EM-9413**  
MOUNT-ENGINE  
RH Front

ACURA PASSENGER CAR ..... 2002-06  
HONDA PASSENGER CAR ..... 2002-05



**EM-9414**  
MOUNT-TRANSMISSION

NISSAN PASSENGER CAR ..... 2007-08

(Continued Next Column)

**EM-9414 (Continued)**  
MOUNT-TRANSMISSION  
Auto

NISSAN SPORT UTILITY ..... 2003-07



**EM-9415**  
MOUNT-ENGINE  
RH Front

HONDA VAN ..... 2007-13



**EM-9416**  
MOUNT-ENGINE  
L & R Front

INFINITI PASSENGER CAR ..... 2003-06  
INFINITI SPORT UTILITY ..... 2003-08



**EM-9417**  
MOUNT-TRANSMISSION  
Lower

ACURA PASSENGER CAR ..... 2009-12  
HONDA PASSENGER CAR ..... 2008-12

# BUYER'S GUIDE

## NUMERICAL LISTING - ILLUSTRATIONS

 <p style="text-align: center;"><b>EM-9418</b> <b>MOUNT-ENGINE</b> Rear</p> <p>PONTIAC PASSENGER CAR ..... 2003-06 TOYOTA PASSENGER CAR ..... 2003-06</p>	 <p style="text-align: center;"><b>EM-9421</b> <b>MOUNT-ENGINE</b> Rear</p> <p>LEXUS PASSENGER CAR ..... 1999-01 TOYOTA PASSENGER CAR ..... 2000-03</p>	 <p style="text-align: center;"><b>EM-9425</b> <b>MOUNT-TRANSMISSION</b> Auto</p> <p>TOYOTA SPORT UTILITY ..... 2003-12</p>	<p><b>EM-9428 (Continued)</b></p> <p>ACURA PASSENGER CAR ..... 2009-12 HONDA PASSENGER CAR ..... 2008-12</p>  <p style="text-align: center;"><b>EM-9429</b> <b>MOUNT-TRANSMISSION</b> Manual</p> <p>TOYOTA TRUCK ..... 2005-12</p>
 <p style="text-align: center;"><b>EM-9419</b> <b>MOUNT-ENGINE</b> Front</p> <p>PONTIAC PASSENGER CAR ..... 2009-10 TOYOTA PASSENGER CAR ..... 2009-11</p>	 <p style="text-align: center;"><b>EM-9422</b> <b>Engine Torque Strut</b> Front Left</p> <p>NISSAN PASSENGER CAR ..... 2007-12</p>	 <p style="text-align: center;"><b>EM-9426</b> <b>MOUNT-TRANSMISSION</b> Front</p> <p>ACURA PASSENGER CAR ..... 2004-08 HONDA PASSENGER CAR ..... 2003-07</p>	 <p style="text-align: center;"><b>EM-9430</b> <b>MOUNT-TRANSMISSION</b> Auto</p> <p>TOYOTA TRUCK ..... 2005-12</p>
 <p style="text-align: center;"><b>EM-9420</b> <b>MOUNT-TRANSMISSION</b></p> <p>TOYOTA SPORT UTILITY ..... 2001-05</p>	 <p style="text-align: center;"><b>EM-9423</b> <b>MOUNT-TRANSMISSION</b> Rear</p> <p>HONDA VAN ..... 2005-06</p>	 <p style="text-align: center;"><b>EM-9427</b> <b>MOUNT-TRANSMISSION</b> Rear</p> <p>HONDA VAN ..... 2007-10</p>	 <p style="text-align: center;"><b>EM-9431</b> <b>MOUNT-ENGINE</b> Rear</p> <p>HONDA VAN ..... 2005-10</p>
 <p style="text-align: center;"><b>EM-9424</b> <b>MOUNT-ENGINE</b> Front</p> <p>ACURA PASSENGER CAR ..... 2002-06 HONDA PASSENGER CAR ..... 2002-05 HONDA SPORT UTILITY ..... 2002-05</p>	 <p style="text-align: center;"><b>EM-9428</b> <b>MOUNT-TRANSMISSION</b> Lower</p>	<p style="text-align: center;">(Continued Next Column)</p>	

# BUYER'S GUIDE

## NUMERICAL LISTING - ILLUSTRATIONS



**EM-9432**  
**MOUNT-ENGINE**  
**RH Front**

TOYOTA SPORT UTILITY ..... 2001-03



**EM-9435**  
**MOUNT-TRANSMISSION**  
**Front**

ACURA PASSENGER CAR ..... 2004-08



**EM-9439**  
**MOUNT-TRANSMISSION**  
**Lower**

ACURA PASSENGER CAR ..... 2010-12  
HONDA PASSENGER CAR ..... 2008-12



**EM-9442**  
**MOUNT-ENGINE**  
**Front**

NISSAN PASSENGER CAR ..... 2002-06  
NISSAN SPORT UTILITY ..... 2005-07



**EM-9433**  
**MOUNT-TRANSMISSION**  
**Manual**

ACURA PASSENGER CAR ..... 2002-06

HONDA PASSENGER CAR ..... 2002-05  
**MOUNT-TRANSMISSION**  
**Manual**

HONDA SPORT UTILITY ..... 2002-09



**EM-9436**  
**MOUNT-ENGINE**  
**Rear**

PONTIAC PASSENGER CAR ..... 2009-10  
TOYOTA PASSENGER CAR ..... 2009-11



**EM-9440**  
**MOUNT-TRANSMISSION**  
**Upper**

ACURA PASSENGER CAR ..... 2004-08



**EM-9443**  
**MOUNT-ENGINE**  
**LH Rear**

ACURA PASSENGER CAR ..... 2009-10  
HONDA PASSENGER CAR ..... 2008-12



**EM-9437**  
**MOUNT-ENGINE**  
**Rear**

HONDA PASSENGER CAR ..... 2007-08



**EM-9441**  
**MOUNT-ENGINE**  
**Front**

ACURA PASSENGER CAR ..... 2000-03  
ACURA SPORT UTILITY ..... 2001-06  
HONDA SPORT UTILITY ..... 2003-08  
HONDA TRUCK ..... 2006-11  
HONDA VAN ..... 1999-04



**EM-9444**  
**Engine Torque Strut Mount**  
**Front**

NISSAN PASSENGER CAR ..... 2007-13



**EM-9434**  
**MOUNT-TRANSMISSION**  
**Rear**

HONDA PASSENGER CAR ..... 2003-07



**EM-9438**  
**MOUNT-TRANSMISSION**  
**Rear**

ACURA PASSENGER CAR ..... 2004-08  
HONDA PASSENGER CAR ..... 2003-07



**EM-9445**  
**MOUNT-ENGINE**  
**RH Front**

HONDA SPORT UTILITY ..... 2003-11

# BUYER'S GUIDE

## NUMERICAL LISTING - ILLUSTRATIONS

 <p><b>EM-9446</b> <b>MOUNT-ENGINE</b> <b>Rear</b></p> <p>NISSAN PASSENGER CAR ..... 2012-13</p>	 <p><b>EM-9450</b> <b>MOUNT-TRANSMISSION</b> <b>Lower</b></p> <p>HONDA PASSENGER CAR ..... 2008-12</p>	 <p><b>EM-9454</b> <b>Engine Torque Strut Mount</b> <b>Front</b></p> <p>TOYOTA PASSENGER CAR ..... 2004-09</p>	<p><b>EM-9457 (Continued)</b> HONDA PASSENGER CAR ..... 2008-12</p>  <p><b>EM-9458</b> <b>MOUNT-TRANSMISSION</b> <b>Rear</b></p> <p>ACURA PASSENGER CAR ..... 2004-06</p>
 <p><b>EM-9447</b> <b>MOUNT-ENGINE</b> <b>RH Front</b></p> <p>PONTIAC PASSENGER CAR ..... 2009-10 TOYOTA PASSENGER CAR ..... 2009-11</p>	 <p><b>EM-9451</b> <b>MOUNT-ENGINE</b> <b>Rear</b></p> <p>ACURA SPORT UTILITY ..... 2007-13 HONDA PASSENGER CAR ..... 2003-07</p>	 <p><b>EM-9455</b> <b>Engine Torque Strut Mount</b> <b>Front</b></p> <p>TOYOTA PASSENGER CAR ..... 2001-03</p>	 <p><b>EM-9459</b> <b>MOUNT-TRANSMISSION</b> <b>Lower</b></p> <p>ACURA PASSENGER CAR ..... 2009-14</p>
 <p><b>EM-9448</b> <b>MOUNT-TRANSMISSION</b> <b>Manual</b></p> <p>NISSAN PASSENGER CAR ..... 2007-12</p>	 <p><b>EM-9452</b> <b>Engine Torque Strut Mount</b> <b>Rear</b></p> <p>NISSAN PASSENGER CAR ..... 2007-12 NISSAN SPORT UTILITY ..... 2008-12</p>	 <p><b>EM-9456</b> <b>Engine Torque Strut Mount</b> <b>Left</b></p> <p>NISSAN PASSENGER CAR ..... 2007-10</p>	 <p><b>EM-9457</b> <b>MOUNT-TRANSMISSION</b> <b>Upper</b></p> <p>HONDA PASSENGER CAR ..... 2008-12</p>
 <p><b>EM-9449</b> <b>MOUNT-ENGINE</b> <b>RH Front</b></p> <p>PONTIAC PASSENGER CAR ..... 2009-10 TOYOTA PASSENGER CAR ..... 2009-11</p>	 <p><b>EM-9453</b> <b>Engine Torque Strut Mount</b> <b>Left</b></p> <p>NISSAN PASSENGER CAR ..... 2007-12 NISSAN SPORT UTILITY ..... 2008-12</p>	 <p><b>EM-9457</b> <b>MOUNT-ENGINE</b> <b>RH Front</b></p> <p>ACURA PASSENGER CAR ..... 2009-10</p>	<p><b>EM-9460</b> <b>MOUNT-TRANSMISSION</b> <b>Auto</b></p> <p>NISSAN PASSENGER CAR ..... 2007-12</p>
		<p><b>EM-9457</b> <b>MOUNT-ENGINE</b> <b>Right</b></p> <p>(Continued Next Column)</p>	



# BUYER'S GUIDE

## NUMERICAL LISTING - ILLUSTRATIONS



**EM-9461**  
MOUNT-ENGINE  
Left

MAZDA VAN ..... 2002-06



**EM-9465**  
MOUNT-TRANSMISSION  
Auto

NISSAN PASSENGER CAR ..... 2007-12



**EM-9469**  
MOUNT-ENGINE  
RH Front

MAZDA PASSENGER CAR ..... 2000-02



**EM-9473**  
MOUNT-TRANSMISSION  
Auto

HONDA SPORT UTILITY ..... 2003-09



**EM-9462**  
MOUNT-TRANSMISSION  
Auto

PONTIAC PASSENGER CAR ..... 2009-10  
TOYOTA PASSENGER CAR ..... 2009-10



**EM-9466**  
MOUNT-ENGINE  
Front

MAZDA PASSENGER CAR ..... 2001-02



**EM-9470**  
MOUNT-TRANSMISSION  
Auto

HONDA PASSENGER CAR ..... 2001-05



**EM-9474**  
MOUNT-TRANSMISSION  
Manual

CHEVROLET PASSENGER  
CAR ..... 1998-02  
TOYOTA PASSENGER CAR ..... 1998-02



**EM-9463**  
MOUNT-TRANSMISSION  
Upper

ACURA PASSENGER CAR ..... 2009-14

**EM-9467**  
MOUNT-ENGINE  
Right

ACURA PASSENGER CAR ..... 2010-12  
HONDA PASSENGER CAR ..... 2008-13



**EM-9468**  
MOUNT-ENGINE  
Front

MAZDA VAN ..... 2000-06



**EM-9471**  
MOUNT-TRANSMISSION  
Auto

NISSAN PASSENGER CAR ..... 2002-06



**EM-9475**  
MOUNT-ENGINE  
RH Front

TOYOTA PASSENGER CAR ..... 2002-03



**EM-9464**  
MOUNT-TRANSMISSION

INFINITI PASSENGER CAR ..... 2002-08  
INFINITI SPORT UTILITY ..... 2003-08  
NISSAN PASSENGER CAR ..... 2003-09



**EM-9472**  
MOUNT-ENGINE  
Rear

MAZDA VAN ..... 2000-06

















**EM-9476**  
MOUNT-ENGINE  
Rear

MAZDA PASSENGER CAR ..... 1994-97

# BUYER'S GUIDE

## NUMERICAL LISTING - ILLUSTRATIONS

 <p><b>EM-9477</b> <b>MOUNT-ENGINE</b> <b>Front</b></p> <p>TOYOTA SPORT UTILITY ..... 2001-07</p>	 <p><b>EM-9481</b> <b>MOUNT-ENGINE</b> <b>Rear</b></p> <p>MAZDA PASSENGER CAR ..... 1998-00</p>	 <p><b>EM-9485</b> <b>MOUNT-ENGINE</b> <b>Rear</b></p> <p>CHRYSLER PASSENGER CAR ..... 2003-04 DODGE PASSENGER CAR ..... 2001-05 MITSUBISHI PASSENGER CAR ..... 2000-05</p>	 <p><b>EM-9490 (NEW)</b> <b>MOUNT-TRANSMISSION</b></p> <p>HONDA PASSENGER CAR ..... 2000-09</p>
 <p><b>EM-9478</b> <b>MOUNT-ENGINE</b> <b>LH Front</b></p> <p>MAZDA PASSENGER CAR ..... 1998-02</p>	 <p><b>EM-9482</b> <b>MOUNT-TRANSMISSION</b> <b>MOUNT-TRANSMISSION</b> <b>Manual</b></p> <p>NISSAN SPORT UTILITY ..... 2005-14 NISSAN TRUCK ..... 2005-15</p>	 <p><b>EM-9487 (NEW)</b> <b>Engine Torque Strut Mount</b> <b>Lower</b></p> <p>HONDA PASSENGER CAR ..... 2006-11</p>	 <p><b>EM-9491 (NEW)</b> <b>MOUNT-ENGINE</b> <b>Rear</b></p> <p>PONTIAC PASSENGER CAR ..... 2009-10 TOYOTA PASSENGER CAR ..... 2009-11</p>
 <p><b>EM-9479</b> <b>MOUNT-TRANSMISSION</b> <b>Manual</b></p> <p>HONDA PASSENGER CAR ..... 2003-05</p>	 <p><b>EM-9483</b> <b>MOUNT-ENGINE</b> <b>L &amp; R Front</b></p> <p>NISSAN TRUCK ..... 2005-11</p>	 <p><b>EM-9488 (NEW)</b> <b>MOUNT-ENGINE</b> <b>Front</b></p> <p>ACURA PASSENGER CAR ..... 2009-10 HONDA PASSENGER CAR ..... 2009-12</p>	 <p><b>EM-9492</b> <b>Engine Torque Strut Mount</b> <b>Rear</b></p> <p>TOYOTA PASSENGER CAR ..... 2002-06</p>
 <p><b>EM-9480</b> <b>MOUNT-ENGINE</b> <b>Rear</b></p> <p>MAZDA PASSENGER CAR ..... 1998-00</p>	 <p><b>EM-9484</b> <b>MOUNT-ENGINE</b> <b>Front</b></p> <p>TOYOTA PASSENGER CAR ..... 2000-05</p>	 <p><b>EM-9489 (NEW)</b> <b>MOUNT-ENGINE</b> <b>Rear</b></p> <p>MITSUBISHI PASSENGER CAR ..... 2008-11</p>	 <p><b>EM-9494 (NEW)</b> <b>MOUNT-TRANSMISSION</b></p> <p>TOYOTA SPORT UTILITY ..... 2003-12 TOYOTA TRUCK ..... 2005-12</p>

# BUYER'S GUIDE

## NUMERICAL LISTING - ILLUSTRATIONS



**EM-9495 (NEW)**  
**MOUNT-TRANSMISSION**  
Auto

TOYOTA PASSENGER CAR ..... 1994-99



**EM-9496 (NEW)**  
**MOUNT-ENGINE**  
RH Front

HONDA SPORT UTILITY ..... 2007-11



**EM-9497 (NEW)**  
**MOUNT-ENGINE**  
Front

SCION VAN ..... 2008-14  
TOYOTA SPORT UTILITY ..... 2006-08



**EM-9498 (NEW)**  
**MOUNT-ENGINE**  
Front

TOYOTA SPORT UTILITY ..... 2009-12



**EM-9499 (NEW)**  
**MOUNT-TRANSMISSION**

TOYOTA SPORT UTILITY ..... 2003-09



**EM-9500 (NEW)**  
**MOUNT-TRANSMISSION**  
Manual

TOYOTA TRUCK ..... 2005-15



**EM-9502 (NEW)**  
**MOUNT-ENGINE**  
Rear

TOYOTA SPORT UTILITY ..... 2004-05



**EM-9504 (NEW)**  
**Engine Torque Strut Mount**  
Front

TOYOTA PASSENGER CAR ..... 2002-03



**EM-9506 (NEW)**  
**MOUNT-ENGINE**  
L & R Front

NISSAN SPORT UTILITY ..... 2005-12  
NISSAN TRUCK ..... 2005-12  
NISSAN VAN ..... 2012-13

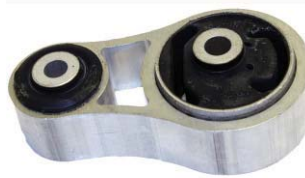

**EM-9507 (NEW)**  
**Engine Torque Strut Mount**  
Rear

MAZDA SPORT UTILITY ..... 2007-09



**EM-9509 (NEW)**  
**MOUNT-ENGINE**  
Front

TOYOTA SPORT UTILITY ..... 2006-12



**EM-9510 (NEW)**  
**MOUNT-ENGINE**  
Rear

MITSUBISHI PASSENGER  
CAR ..... 2006-12  
MITSUBISHI SPORT UTILITY ..... 2004-11



**EM-9511 (NEW)**  
**MOUNT-TRANSMISSION**

LEXUS SPORT UTILITY ..... 2003-07  
TOYOTA SPORT UTILITY ..... 2003-09



**EM-9512 (NEW)**  
**MOUNT-TRANSMISSION**

HONDA SPORT UTILITY ..... 2009-14  
HONDA VAN ..... 2011-13



**EM-9513 (NEW)**  
**MOUNT-ENGINE**  
Rear

TOYOTA SPORT UTILITY ..... 2006-12



















**EM-9514 (NEW)**  
**MOUNT-ENGINE**  
Front

LEXUS PASSENGER CAR ..... 2011-13  
TOYOTA PASSENGER CAR ..... 2010-13

# BUYER'S GUIDE

## NUMERICAL LISTING - ILLUSTRATIONS

 <p><b>EM-9515 (NEW) MOUNT-TRANSMISSION</b></p> <p>TOYOTA TRUCK ..... 1995-04</p>	 <p><b>EM-9519 (NEW) MOUNT-TRANSMISSION</b></p> <p>TOYOTA SPORT UTILITY ..... 2008-09 TOYOTA TRUCK ..... 2007-09</p>	 <p><b>EM-9525 (NEW) MOUNT-ENGINE RH Front</b></p> <p>TOYOTA PASSENGER CAR ..... 2000-06</p>	 <p><b>EM-9531 (NEW) MOUNT-ENGINE Right</b></p> <p>NISSAN PASSENGER CAR ..... 2000-01</p>
 <p><b>EM-9516 (NEW) MOUNT-TRANSMISSION Upper</b></p> <p>HONDA PASSENGER CAR ..... 2008-12</p>	 <p><b>EM-9520 (NEW) MOUNT-TRANSMISSION</b></p> <p>NISSAN SPORT UTILITY ..... 2005-14 NISSAN TRUCK ..... 2005-15</p>	 <p><b>EM-9526 (NEW) MOUNT-TRANSMISSION Auto</b></p> <p>MAZDA PASSENGER CAR ..... 2007-09</p>	 <p><b>EM-9534 (NEW) MOUNT-TRANSMISSION Manual</b></p> <p>MAZDA PASSENGER CAR ..... 2010-11 MAZDA VAN ..... 2012</p>
 <p><b>EM-9517 (NEW) MOUNT-TRANSMISSION Manual</b></p> <p>NISSAN PASSENGER CAR ..... 1993-97</p>	 <p><b>EM-9522 (NEW) MOUNT-TRANSMISSION</b></p> <p>TOYOTA SPORT UTILITY ..... 2008-11 TOYOTA TRUCK ..... 2008-11</p>	 <p><b>EM-9527 (NEW) MOUNT-TRANSMISSION</b></p> <p>MAZDA VAN ..... 2000-06</p>	 <p><b>EM-9535 (NEW) Engine Torque Strut Mount Rear</b></p> <p>TOYOTA PASSENGER CAR ..... 2005-07</p>
 <p><b>EM-9518 (NEW) MOUNT-ENGINE Rear</b></p> <p>TOYOTA SPORT UTILITY ..... 2006-12</p>	 <p><b>EM-9523 (NEW) MOUNT-TRANSMISSION</b></p> <p>TOYOTA TRUCK ..... 2007-12</p>	 <p><b>EM-9530 (NEW) MOUNT-TRANSMISSION Front</b></p> <p>HONDA VAN ..... 2007-10</p>	 <p><b>EM-9536 (NEW) MOUNT-TRANSMISSION Auto</b></p> <p>MAZDA PASSENGER CAR ..... 2003-08</p>

# BUYER'S GUIDE

## NUMERICAL LISTING - ILLUSTRATIONS



**EM-9537 (NEW)**  
**MOUNT-TRANSMISSION**

MAZDA SPORT UTILITY ..... 2007-14



**EM-9538 (NEW)**  
**Engine Torque Strut**  
**Front Right**

TOYOTA SPORT UTILITY ..... 2008-11



**EM-9539 (NEW)**  
**MOUNT-TRANSMISSION**

MAZDA PASSENGER CAR ..... 2003-08



**EM-9541 (NEW)**  
**MOUNT-TRANSMISSION**

TOYOTA PASSENGER CAR ..... 2000-05



**EM-9542 (NEW)**  
**MOUNT-ENGINE**  
**Front**

HONDA PASSENGER CAR ..... 2006-10



**EM-9543 (NEW)**  
**MOUNT-TRANSMISSION**  
**Manual**

TOYOTA TRUCK ..... 2005-06



**EM-9544 (NEW)**  
**MOUNT-ENGINE**  
**Rear**

NISSAN PASSENGER CAR ..... 2007-11



**EM-9545 (NEW)**  
**Engine Torque Strut Mount**  
**Right**

NISSAN PASSENGER CAR ..... 2008-12



**EM-9546 (NEW)**  
**Engine Torque Strut**  
**Front Right**

TOYOTA VAN ..... 2007-09



**EM-9547 (NEW)**  
**MOUNT-ENGINE**  
**Rear**

NISSAN PASSENGER CAR ..... 2002-06



**EM-9548 (NEW)**  
**MOUNT-ENGINE**  
**Rear**

NISSAN VAN ..... 2004-08



**EM-9549 (NEW)**  
**MOUNT-TRANSMISSION**

TOYOTA SPORT UTILITY ..... 2006-12



**EM-9550 (NEW)**  
**MOUNT-TRANSMISSION**  
**Auto**

TOYOTA SPORT UTILITY ..... 2006-12



**EM-9551 (NEW)**  
**Engine Torque Strut Mount**  
**Rear**

NISSAN PASSENGER CAR ..... 2008-12



**EM-9552 (NEW)**  
**MOUNT-TRANSMISSION**  
**Auto**

SUBARU SPORT UTILITY ..... 2003-06



**EM-9553 (NEW)**  
**Engine Torque Strut Mount**  
**Rear**

HONDA PASSENGER CAR ..... 2006-11

# BUYER'S GUIDE

## NUMERICAL LISTING - ILLUSTRATIONS

 <p><b>EM-9554 (NEW)</b> <b>MOUNT-ENGINE</b> <b>LH Rear</b></p> <p>HONDA PASSENGER CAR ..... 2008-13</p>	 <p><b>EM-9562 (NEW)</b> <b>MOUNT-ENGINE</b> <b>LH Front</b></p> <p>MERCEDES-BENZ PASSENGER CAR ..... 2003-05</p>	 <p><b>EM-9573 (NEW)</b> <b>MOUNT-ENGINE</b> <b>Rear</b></p> <p>NISSAN PASSENGER CAR ..... 2002-06</p>	 <p><b>EM-9577 (NEW)</b> <b>MOUNT-TRANSMISSION</b> <b>Manual</b></p> <p>NISSAN PASSENGER CAR ..... 2002-04</p>
 <p><b>EM-9558 (NEW)</b> <b>MOUNT-TRANSMISSION</b></p> <p>AUDI PASSENGER CAR ..... 2005-11</p>	 <p><b>EM-9566 (NEW)</b> <b>MOUNT-TRANSMISSION</b> <b>Manual</b></p> <p>SUBARU PASSENGER CAR ..... 2007-09 SUBARU SPORT UTILITY ..... 2005-09</p>	 <p><b>EM-9574 (NEW)</b> <b>MOUNT-ENGINE</b> <b>Rear</b></p> <p>TOYOTA PASSENGER CAR ..... 2000-05</p>	 <p><b>EM-9579 (NEW)</b> <b>Engine Torque Strut Mount</b> <b>Lower</b></p> <p>VOLVO PASSENGER CAR ..... 1999-05 VOLVO SPORT UTILITY ..... 2003-05</p>
 <p><b>EM-9559 (NEW)</b> <b>Engine Torque Strut Mount</b> <b>Front</b></p> <p>SUBARU SPORT UTILITY ..... 2003-06</p> <p><b>Engine Torque Strut Mount</b> <b>Rear</b></p> <p>SUBARU PASSENGER CAR ..... 2000-09 SUBARU SPORT UTILITY ..... 2005-14</p>	 <p><b>EM-9570 (NEW)</b> <b>MOUNT-TRANSMISSION</b> <b>Center</b></p> <p>SUBARU PASSENGER CAR ..... 1990-94</p>	 <p><b>EM-9575 (NEW)</b> <b>MOUNT-TRANSMISSION</b> <b>Manual</b></p> <p>NISSAN PASSENGER CAR ..... 2004-06</p>	 <p><b>EM-9580 (NEW)</b> <b>MOUNT-ENGINE</b> <b>Rear Upper</b></p> <p>VOLVO PASSENGER CAR ..... 1999-05 VOLVO SPORT UTILITY ..... 2003-05</p>
 <p><b>EM-9560 (NEW)</b> <b>MOUNT-TRANSMISSION</b> <b>Auto</b></p> <p>SUBARU PASSENGER CAR ..... 2005-09 SUBARU SPORT UTILITY ..... 2005-09</p>	 <p><b>EM-9572 (NEW)</b> <b>MOUNT-ENGINE</b> <b>Front</b></p> <p>TOYOTA PASSENGER CAR ..... 2002-03</p>	 <p><b>EM-9576 (NEW)</b> <b>MOUNT-TRANSMISSION</b> <b>Auto</b></p> <p>TOYOTA PASSENGER CAR ..... 2002-03</p>	 <p><b>EM-9587 (NEW)</b> <b>Engine Torque Strut Mount</b> <b>Rear</b></p> <p>TOYOTA VAN ..... 2011-14</p>
<p><b>EM-9561 (NEW)</b> <b>Engine Torque Strut Mount</b> <b>Front</b></p> <p>SUBARU SPORT UTILITY ..... 2003-06</p>			

# BUYER'S GUIDE

## NUMERICAL LISTING - ILLUSTRATIONS



**EM-9588 (NEW)**  
Engine Torque Strut  
Front Right

TOYOTA PASSENGER CAR ..... 2010-14



**EM-9595 (NEW)**  
Engine Torque Strut Mount  
Rear

TOYOTA VAN ..... 2011-14



**EM-9612 (NEW)**  
Engine Torque Strut Mount  
Rear Lower

SCION PASSENGER CAR ..... 2008-13



**EM-9634 (NEW)**  
MOUNT-ENGINE  
Rear

INFINITI PASSENGER CAR ..... 2000-04



**EM-9589 (NEW)**  
MOUNT-TRANSMISSION  
Manual

NISSAN PASSENGER CAR ..... 2002-03



**EM-9599 (NEW)**  
MOUNT-ENGINE  
L & R Front

TOYOTA SPORT UTILITY ..... 2003-14  
TOYOTA TRUCK ..... 2005-11



**EM-9613 (NEW)**  
MOUNT-TRANSMISSION  
Auto

SUZUKI SPORT UTILITY ..... 2006-11



**EM-9593 (NEW)**  
Engine Torque Strut Mount  
Right

TOYOTA PASSENGER CAR ..... 2009-15



**EM-9601 (NEW)**  
Engine Torque Strut Mount  
Rear

LEXUS PASSENGER CAR ..... 2007-15



**EM-9617 (NEW)**  
MOUNT-TRANSMISSION

HONDA PASSENGER CAR ..... 2006-11



**EM-9594 (NEW)**  
MOUNT-TRANSMISSION  
Front

HONDA TRUCK ..... 2009-11



**EM-9610 (NEW)**  
Engine Torque Strut Mount  
Right

TOYOTA PASSENGER CAR ..... 2009-13  
TOYOTA SPORT UTILITY ..... 2009-12



**EM-9619 (NEW)**  
MOUNT-TRANSMISSION  
Auto

TOYOTA SPORT UTILITY ..... 2010

# CROSS REFERENCE

Mfg Part No	Our Part	Mfg Part No	Our Part	Mfg Part No	Our Part	Mfg Part No	Our Part
<b>ANCHOR</b>		<b>ANCHOR (cont.)</b>		<b>ANCHOR (cont.)</b>		<b>ANCHOR (cont.)</b>	
2007	EM-2007	2250	EM-2250	2329	EM-2329	2406	EM-2406
2009	EM-2009	2253	EM-2253	2330	EM-2330	2407	EM-2407
2010	EM-2010	2254	EM-2254	2331	EM-2331	2408	EM-2408
2014	EM-2014	2255	EM-2255	2332	EM-2332	2409	EM-2409
2018	EM-2018	2256	EM-2256	2333	EM-2333	2410	EM-2410
2039	EM-2039	2257	EM-2257	2334	EM-2250	2413	EM-2413
2040	EM-2040	2258	EM-2253	2335	EM-2335	2414	EM-2414
2041	EM-2041	2261	EM-2261	2336	EM-2336	2415	EM-2415
2048	EM-2048	2262	EM-2262	2337	EM-2337	2417	EM-2417
2050	EM-2050	2263	EM-2263	2338	EM-2338	2418	EM-2418
2053	EM-2053	2264	EM-2264	2339	EM-2339	2419	EM-2419
2057	EM-2057	2265	EM-2265	2340	EM-2340	2420	EM-2420
2060	EM-2060	2266	EM-2266	2341	EM-2341	2421	EM-2421
2070	EM-2070	2267	EM-2267	2344	EM-2344	2424	EM-2424
2073	EM-2073	2268	EM-2268	2345	EM-2345	2425	EM-2425
2091	EM-2091	2270	EM-2270	2346	EM-2346	2426	EM-2426
2092	EM-2092	2271	EM-2271	2347	EM-2347	2427	EM-2427
2107	EM-2107	2272	EM-2272	2348	EM-2348	2428	EM-2428
2108	EM-2108	2273	EM-2296	2349	EM-2349	2429	EM-2429
2110	EM-2110	2274	EM-2274	2350	EM-2350	2433	EM-2433
2119	EM-2119	2275	EM-2275	2351	EM-2351	2434	EM-2434
2120	EM-2120	2276	EM-2276	2353	EM-2353	2435	EM-2436
2121	EM-2121	2277	EM-2277	2356	EM-2356	2436	EM-2436
2122	EM-2122	2278	EM-2278	2357	EM-2357	2437	EM-2437
2123	EM-2123	2279	EM-2279	2358	EM-2358	2438	EM-2438
2124	EM-2124	2280	EM-2280	2359	EM-2359	2439	EM-2439
2125	EM-2125	2281	EM-2281	2360	EM-2360	2440	EM-2440
2126	EM-2126	2282	EM-2282	2361	EM-2349	2441	EM-2441
2127	EM-2127	2283	EM-2283	2362	EM-2362	2442	EM-2442
2141	EM-2141	2284	EM-2284	2363	EM-2363	2444	EM-2444
2142	EM-2142	2285	EM-2285	2364	EM-2364	2445	EM-2445
2143	EM-2143	2286	EM-2257	2365	EM-2365	2446	EM-2446
2150	EM-2150	2286	EM-2286	2366	EM-2525	2447	EM-2447
2162	EM-2162	2287	EM-2287	2367	EM-2367	2448	EM-2448
2163	EM-2163	2288	EM-2288	2368	EM-2368	2449	EM-2449
2167	EM-2167	2289	EM-2289	2369	EM-2369	2450	EM-2451
2170	EM-2170	2290	EM-2290	2370	EM-2370	2451	EM-2451
2171	EM-2171	2291	EM-2291	2371	EM-2371	2452	EM-2452
2172	EM-2172	2292	EM-2292	2372	EM-2372	2453	EM-2453
2204	EM-2204	2293	EM-2293	2373	EM-2373	2454	EM-2454
2205	EM-2205	2294	EM-2294	2374	EM-2374	2455	EM-2600
2206	EM-2206	2295	EM-2295	2375	EM-2375	2456	EM-2456
2215	EM-2268	2296	EM-2296	2376	EM-2376	2457	EM-2457
2216	EM-2216	2297	EM-2297	2377	EM-2370	2458	EM-2458
2217	EM-2217	2298	EM-2298	2378	EM-2378	2459	EM-2459
2218	EM-2218	2299	EM-2299	2379	EM-2379	2460	EM-2460
2219	EM-2219	2300	EM-2512	2380	EM-2328	2461	EM-2461
2220	EM-2220	2301	EM-2301	2381	EM-2381	2462	EM-2462
2221	EM-2221	2302	EM-2302	2382	EM-2382	2463	EM-2463
2222	EM-2222	2303	EM-2303	2383	EM-2382	2464	EM-2464
2223	EM-2223	2304	EM-2304	2384	EM-2384	2465	EM-2436
2225	EM-2225	2305	EM-2305	2385	EM-2385	2466	EM-2466
2226	EM-2226	2306	EM-2306	2386	EM-2387	2467	EM-2467
2227	EM-2227	2307	EM-2307	2387	EM-2387	2468	EM-2469
2228	EM-2228	2309	EM-2309	2388	EM-2388	2469	EM-2469
2231	EM-2231	2310	EM-2310	2389	EM-2389	2470	EM-2470
2234	EM-2234	2311	EM-2311	2390	EM-2389	2471	EM-2471
2235	EM-2235	2314	EM-2369	2391	EM-2391	2472	EM-2472
2236	EM-2349	2316	EM-2316	2392	EM-2392	2473	EM-2473
2238	EM-2238	2317	EM-2317	2393	EM-2393	2474	EM-2474
2240	EM-2240	2319	EM-2319	2394	EM-2394	2475	EM-2549
2241	EM-2241	2320	EM-2320	2395	EM-2395	2476	EM-2550
2242	EM-2242	2321	EM-2321	2396	EM-2396	2477	EM-2477
2244	EM-2287	2323	EM-2323	2400	EM-2400	2478	EM-2381
2245	EM-2142	2324	EM-2324	2401	EM-2401	2479	EM-2457
2246	EM-2142	2325	EM-2325	2402	EM-2402	2480	EM-2458
2247	EM-2240	2326	EM-2326	2403	EM-2403	2481	EM-2457
2248	EM-2241	2327	EM-2327	2404	EM-2404	2482	EM-2457
2249	EM-2249	2328	EM-2328	2405	EM-2405	2483	EM-2458



# CROSS REFERENCE

Mfg Part No	Our Part	Mfg Part No	Our Part	Mfg Part No	Our Part	Mfg Part No	Our Part
<b>ANCHOR (cont.)</b>		<b>ANCHOR (cont.)</b>		<b>ANCHOR (cont.)</b>		<b>ANCHOR (cont.)</b>	
2484	EM-2458	2551SR	EM-2551S	2641	EM-2641	2712	EM-2712
2485	EM-2458	2552	EM-2551	2642	EM-2642	2712SR	EM-2712S
2486	EM-2458	2552SR	EM-2551S	2643	EM-2643	2713	EM-2713
2487	EM-2487	2553	EM-2553	2644	EM-2644	2714	EM-2714
2488	EM-2488	2553SR	EM-2553S	2645	EM-2645	2715	EM-2715
2489	EM-2489	2554	EM-2551	2646	EM-2646	2716	EM-2716
2490	EM-2490	2554SR	EM-2551S	2647	EM-2646	2717	EM-2717
2491	EM-2491	2555	EM-2555	2648	EM-2815	2717SR	EM-2717S
2492	EM-2492	2555SR	EM-2555S	2649	EM-2649	2718	EM-2718
2493	EM-2493	2556	EM-2556	2650	EM-2650	2719	EM-2719
2494	EM-2494	2556SR	EM-2556S	2651	EM-2651	2720	EM-2720
2495	EM-2495	2557	EM-2557	2652	EM-2652	2721	EM-2721
2496	EM-2496	2558	EM-2558	2653	EM-2653	2722	EM-2722
2497	EM-2497	2559	EM-2559	2654	EM-2654	2723	EM-2723
2498	EM-2498	2560	EM-2557	2655	EM-2655	2724	EM-2724
2499	EM-2499	2561	EM-2528	2656	EM-2656	2725	EM-2725
2500	EM-2500	2562	EM-2562	2657	EM-2657	2726	EM-2726
2501	EM-2501	2563	EM-2563	2658	EM-2658	2727	EM-2727
2502	EM-2502	2564	EM-2564	2660	EM-2660	2728	EM-2728
2503	EM-2503	2565	EM-2565	2660SR	EM-2660S	2730	EM-2730
2504	EM-2504	2566	EM-2566	2661	EM-2661	2731	EM-2731
2505	EM-2505	2567	EM-2567	2661SR	EM-2661S	2732	EM-2731
2506	EM-2506	2568	EM-2568	2662	EM-2662	2733	EM-2733
2507	EM-2395	2569	EM-2569	2663	EM-2663	2734	EM-2734
2508	EM-2508	2570	EM-2570	2664	EM-2664	2735	EM-2735
2509	EM-2436	2571	EM-2571	2665	EM-2665	2736	EM-2736
2510	EM-2510	2572	EM-2572	2666	EM-2639	2737	EM-2737
2511	EM-2466	2573	EM-2528	2667	EM-2667	2738	EM-2738
2512	EM-2512	2600	EM-2600	2668	EM-2668	2739	EM-2739
2513	EM-2513	2601	EM-2601	2669	EM-2657	2740	EM-2740
2514	EM-2515	2602	EM-2601	2670	EM-2658	2741	EM-2741
2515	EM-2515	2603	EM-2601	2671	EM-2671	2742	EM-2742
2516	EM-2394	2604	EM-2601	2672	EM-2394	2743	EM-2743
2517	EM-2292	2605	EM-2601	2673	EM-2673	2744	EM-2744
2518	EM-2501	2606	EM-2601	2674	EM-2674	2745	EM-2745
2519	EM-2500	2607	EM-2601	2675	EM-2675	2746	EM-2746
2520	EM-2501	2608	EM-2601	2676	EM-2676	2747	EM-2747
2521	EM-2500	2609	EM-2609	2677	EM-2677	2748	EM-2748
2522	EM-2501	2610	EM-2538	2678	EM-2678	2749	EM-2749
2523	EM-2500	2611	EM-2538	2679	EM-2679	2750	EM-2750
2524	EM-2524	2612	EM-2538	2680	EM-2680	2751	EM-2751
2525	EM-2525	2613	EM-2538	2681	EM-2681	2752	EM-2752
2526	EM-2528	2614	EM-2601	2682	EM-2682	2753	EM-2753
2527	EM-2528	2615	EM-2615	2683	EM-2683	2754	EM-2754
2528	EM-2528	2616	EM-2616	2684	EM-2684	2755	EM-2755
2529	EM-2497	2617	EM-2617	2685	EM-2685	2756	EM-2756
2530	EM-2388	2618	EM-2618	2686	EM-2686	2759	EM-2759
2531	EM-2531	2619	EM-2619	2687	EM-2687	2760	EM-2760
2532	EM-2532	2620	EM-2620	2688	EM-2688	2761	EM-2761
2533	EM-2533	2621	EM-2621	2689	EM-2689	2762	EM-2762
2534	EM-2534	2622	EM-2622	2690	EM-2690	2763	EM-2763
2535	EM-2436	2623	EM-2623	2691	EM-2691	2764	EM-2764
2536	EM-2536	2624	EM-2624	2692	EM-2692	2765	EM-2765
2537	EM-2537	2625	EM-2625	2693	EM-2693	2766	EM-2766
2538	EM-2538	2626	EM-2626	2694	EM-2812	2767	EM-2767
2539	EM-2538	2627	EM-2627	2695	EM-2813	2768	EM-2768
2540	EM-2538	2628	EM-2628	2696	EM-2696	2769	EM-2769
2541	EM-2538	2629	EM-2629	2696SR	EM-2696S	2770	EM-2770
2542	EM-2538	2630	EM-2630	2697	EM-2697	2771	EM-2771
2543	EM-2543	2631	EM-2631	2697SR	EM-2697S	2772	EM-2772
2544	EM-2531	2632	EM-2632	2698	EM-2698	2773	EM-2773
2545	EM-2457	2633	EM-2633	2698SR	EM-2698S	2774	EM-2774
2546	EM-2458	2634	EM-2634	2707	EM-2707	2775	EM-2775
2547	EM-2457	2635	EM-2635	2707SR	EM-2707S	2776	EM-2776
2548	EM-2548	2636	EM-2636	2708	EM-2708	2777	EM-2777
2548SR	EM-2548S	2637	EM-2637	2709	EM-2709	2778	EM-2778
2549	EM-2549	2638	EM-2638	2710	EM-2710	2779	EM-2779
2550	EM-2550	2639	EM-2639	2711	EM-2711	2780	EM-2780
2551	EM-2551	2640	EM-2640	2711SR	EM-2711S	2781	EM-2781

# CROSS REFERENCE

Mfg Part No	Our Part	Mfg Part No	Our Part	Mfg Part No	Our Part	Mfg Part No	Our Part
<b>ANCHOR (cont.)</b>		<b>ANCHOR (cont.)</b>		<b>ANCHOR (cont.)</b>		<b>ANCHOR (cont.)</b>	
2782	EM-2782	2837	EM-2837	2894	EM-2894	2948	EM-2948
2783	EM-2783	2837SR	EM-2837S	2894SR	EM-2894S	2949	EM-2949
2784	EM-2784	2838	EM-2838	2895	EM-2895	2950	EM-2950
2785	EM-2785	2838SR	EM-2838S	2895SR	EM-2895S	2951	EM-2951
2786	EM-2786	2839	EM-2838	2896	EM-2896	2952	EM-2952
2787	EM-2351	2840	EM-2840	2896SR	EM-2896S	2953	EM-2953
2788	EM-2788	2840SR	EM-2840S	2897	EM-2897	2954	EM-2954
2788SR	EM-2788S	2841	EM-2841	2897SR	EM-2897S	2955	EM-2955
2789	EM-2789	2841SR	EM-2841S	2898	EM-2898	2956	EM-2956
2789SR	EM-2789S	2842	EM-2842	2899	EM-2899	2957	EM-2957
2790	EM-2790	2842SR	EM-2842S	2900	EM-2900	2958	EM-2958
2790SR	EM-2790S	2843	EM-2843	2901	EM-2901	2959	EM-2959
2791	EM-2791	2844	EM-2844	2902	EM-2902	2960	EM-2960
2791SR	EM-2791S	2845	EM-2845	2902SR	EM-2902S	2961	EM-2961
2792	EM-2792	2846	EM-2846	2903	EM-2903	2962	EM-2962
2792SR	EM-2792S	2847	EM-2847	2903SR	EM-2903S	2963	EM-2963
2793	EM-2793	2848	EM-2848	2904	EM-2904	2964	EM-2964
2794	EM-2794	2849	EM-2849	2905	EM-2905	2965	EM-2965
2795	EM-2795	2850	EM-2850	2906	EM-2987	2966	EM-2966
2795SR	EM-2795S	2851	EM-2851	2906SR	EM-2906S	2967	EM-2967
2796	EM-2796	2852	EM-2852	2907	EM-2907	2967SR	EM-2967S
2796SR	EM-2796S	2853	EM-2853	2908	EM-2908	2968	EM-2968
2797	EM-2797	2854	EM-2854	2909	EM-2909	2968SR	EM-2968S
2798	EM-2798	2855	EM-2855	2910	EM-2910	2969	EM-2969
2799	EM-2799	2856	EM-2856	2910SR	EM-2910S	2970	EM-2970
2800	EM-2800	2857	EM-2857	2911	EM-2911	2971	EM-2971
2801	EM-2801	2858	EM-2858	2912	EM-2912	2972	EM-2972
2802	EM-2802	2859	EM-2859	2913	EM-2913	2973	EM-2973
2803	EM-2803	2859SR	EM-2859S	2914	EM-2914	2974	EM-2974
2803SR	EM-2803S	2860	EM-2860	2915	EM-2915	2974SR	EM-2974S
2804	EM-2804	2861	EM-2861	2916	EM-2916	2975	EM-2975
2805	EM-2805	2862	EM-2862	2917	EM-2917	2977	EM-2977
2806	EM-2806	2863	EM-2863	2918	EM-2918	2978	EM-2978
2807	EM-2807	2864	EM-2864	2919	EM-2919	2979	EM-2979
2808	EM-2808	2865	EM-2822	2920	EM-2920	2980	EM-2980
2809	EM-2809	2866	EM-2866	2921	EM-2921	2981	EM-2981
2810	EM-2810	2867	EM-2867	2922	EM-2922	2982	EM-2982
2811	EM-2817	2868	EM-2868	2923	EM-2923	2983	EM-2983
2812	EM-2812	2869	EM-2869	2924	EM-2924	2984	EM-2984
2812SR	EM-2812S	2870	EM-2870	2925	EM-2925	2985	EM-2985
2813	EM-2813	2871	EM-2871	2926	EM-2926	2986	EM-2986
2813SR	EM-2813S	2872	EM-2872	2926SR	EM-2926S	2987	EM-2987
2814	EM-2814	2873	EM-2873	2927	EM-2927	2987SR	EM-2987S
2815	EM-2815	2874	EM-2874	2928	EM-2928	2988	EM-2988
2816	EM-2816	2875	EM-2875	2929	EM-2929	2989	EM-2989
2817	EM-2817	2876	EM-2876	2930	EM-2930	2990	EM-2990
2818	EM-2818	2876SR	EM-2876S	2931	EM-2931	2991	EM-2991
2819	EM-2819	2877	EM-2622	2932	EM-2932	2992	EM-2992
2820	EM-2820	2878	EM-2878	2932SR	EM-2932S	2993	EM-2993
2821	EM-2821	2879	EM-2879	2933	EM-2933	2993SR	EM-2993S
2821SR	EM-2821S	2879SR	EM-2879S	2933SR	EM-2933S	2994	EM-2994
2822	EM-2822	2880	EM-2880	2934	EM-2934	2995	EM-2995
2823	EM-2823	2880SR	EM-2880S	2934SR	EM-2934S	2995SR	EM-2995S
2823SR	EM-2823S	2881	EM-2881	2935	EM-2935	2996	EM-2996
2824	EM-2824	2882	EM-2882	2936	EM-2936	2996SR	EM-2996S
2824SR	EM-2824S	2883	EM-2883	2937	EM-2853	2997	EM-2997
2825	EM-2825	2884	EM-2884	2938	EM-2938	2998	EM-2998
2826	EM-2826	2885	EM-2885	2938SR	EM-2938S	2999	EM-2999
2827	EM-2827	2886	EM-2886	2939	EM-2939	3000	EM-3000
2828	EM-2828	2887	EM-2887	2940	EM-2940	3001	EM-3001
2829	EM-2829	2888	EM-2888	2941	EM-2941	3002	EM-3002
2830	EM-2830	2889	EM-2889	2942	EM-2942	3003	EM-3003
2831	EM-2831	2890	EM-2890	2942SR	EM-2942S	3003SR	EM-3003S
2832	EM-2832	2890SR	EM-2890S	2943	EM-2943	3004	EM-3004
2833	EM-2833	2891	EM-2638	2943SR	EM-2943S	3005	EM-3005
2834	EM-2834	2892	EM-2892	2944	EM-2944	3006	EM-3006
2835	EM-2835	2892SR	EM-2892S	2945	EM-2945	3007	EM-3007
2836	EM-2836	2893	EM-2893	2946	EM-2960	3008	EM-3008
2836SR	EM-2836S	2893SR	EM-2893S	2947	EM-2947	3009	EM-3009

# CROSS REFERENCE

Mfg Part No	Our Part	Mfg Part No	Our Part	Mfg Part No	Our Part	Mfg Part No	Our Part
<b>ANCHOR (cont.)</b>		<b>ANCHOR (cont.)</b>		<b>ANCHOR (cont.)</b>		<b>ANCHOR (cont.)</b>	
3010	EM-3010	3071SR	EM-3071S	3133	EM-3133	3202	EM-3202
3011	EM-3011	3072	EM-3072	3134	EM-3134	3203	EM-4034
3012	EM-3012	3072SR	EM-3072S	3135	EM-3135	3204	EM-5377
3013	EM-3013	3073	EM-3073	3136	EM-3136	3205	EM-4040
3014	EM-3014	3074	EM-3074	3137	EM-3137	3206	EM-4038
3015	EM-3015	3075	EM-3075	3138	EM-3138	3207	EM-4039
3016	EM-3016	3075SR	EM-3075S	3139	EM-3139	3208	EM-4035
3017	EM-3017	3076	EM-3076	3140	EM-3140	3209	EM-4037
3018	EM-3018	3076SR	EM-3076S	3141	EM-3141	3210	EM-4033
3019	EM-3019	3077	EM-3077	3142	EM-3142	3211	EM-5583
3020	EM-3020	3077SR	EM-3077S	3143	EM-3143	3212	EM-4045
3020SR	EM-3020S	3078	EM-3078	3144	EM-3144	3213	EM-4046
3021	EM-3021	3079	EM-3079	3145	EM-3145	3214	EM-4057
3021SR	EM-3021S	3079SR	EM-3079S	3146	EM-3146	3215	EM-4019
3022	EM-3022	3080	EM-3080	3147	EM-3147	3217	EM-4050
3022SR	EM-3022S	3080SR	EM-3080S	3148	EM-3148	3218	EM-4055
3023	EM-3023	3081	EM-3081	3149	EM-3149	3219	EM-4056
3023SR	EM-3023S	3082	EM-3082	3150	EM-3150	3220	EM-4059
3024	EM-3024	3083	EM-3083	3151	EM-3151	3221	EM-4044
3025	EM-3025	3083SR	EM-3083S	3152	EM-3152	3222	EM-4071
3026	EM-3026	3084	EM-3084	3153	EM-3153	3227	EM-4077
3027	EM-3027	3084SR	EM-3084S	3154	EM-3154	3228	EM-4013
3028	EM-3028	3085	EM-3085	3155	EM-3155	3229	EM-4078
3029	EM-3029	3085SR	EM-3085S	3156	EM-3156	3230	EM-4079
3030	EM-3030	3086	EM-3086	3157	EM-3157	3231	EM-4073
3031	EM-3031	3087	EM-3087	3158	EM-3158	3232	EM-4000
3032	EM-3032	3088	EM-3088	3159	EM-3159	3233	EM-3142
3033	EM-3033	3089	EM-3089	3160	EM-3160	3234	EM-4080
3033SR	EM-3033S	3090	EM-3090	3161	EM-3161	3235	EM-4081
3034	EM-3034	3091	EM-3091	3162	EM-3162	3237	EM-4120
3035	EM-3035	3092	EM-3092	3163	EM-5587	3240	EM-4129
3036	EM-3036	3093	EM-3093	3164	EM-5380	3241	EM-4106
3037	EM-3037	3094	EM-3094	3165	EM-3165	3245	EM-4027
3038	EM-3038	3095	EM-3095	3166	EM-3166	3250	EM-4029
3039	EM-3039	3096	EM-3096	3167	EM-3167	3251	EM-5694
3040	EM-3040	3097	EM-3097	3168	EM-3168	3252	EM-5693
3041	EM-3041	3098	EM-3098	3169	EM-5692	3254	EM-4018
3042	EM-3042	3100	EM-3100	3170	EM-5588	3258	EM-4117
3043	EM-3043	3102	EM-3102	3171	EM-4002	3260	EM-2638
3044	EM-3044	3103	EM-3103	3172	EM-3172	3260	EM-4108
3045	EM-3045	3104	EM-3104	3173	EM-5424	3268	EM-4047
3046	EM-3046	3105	EM-3105	3174	EM-5425	6027	DS-6027
3047	EM-3047	3106	EM-3106	3175	EM-3175	6028	DS-6028
3048	EM-3048	3107	EM-3107	3176	EM-5353	6035	DS-6035
3049	EM-3049	3108	EM-3108	3177	EM-3177	6038	DS-6038
3050	EM-3050	3109	EM-3109	3178	EM-5354	6039	DS-6038
3051	EM-3051	3110	EM-3110	3179	EM-3179	6040	DS-6040
3052	EM-3052	3111	EM-3111	3180	EM-5427	6048	DS-6048
3053	EM-3053	3112	EM-3112	3181	EM-5085	6049	DS-6049
3054	EM-3054	3113	EM-3113	3182	EM-4028	6050	DS-6050
3055	EM-3055	3114	EM-3114	3183	EM-3183	6051	DS-6051
3056	EM-3056	3115	EM-3115	3184	EM-5659	6052	DS-6052
3056SR	EM-3056S	3116	EM-3116	3185	EM-5660	6053	DS-6053
3057	EM-3057	3117	EM-3117	3186	EM-4012	6056	DS-6056
3057SR	EM-3057S	3118	EM-3118	3187	EM-5661	6061	DS-6061
3058	EM-3058	3119	EM-3119	3188	EM-5428	6062	DS-6062
3059	EM-3059	3120	EM-3120	3189	EM-3189	6063	DS-6063
3060	EM-3060	3121	EM-3121	3190	EM-3190	6064	DS-6064
3061	EM-3061	3122	EM-3122	3191	EM-4036	6065	DS-6065
3062	EM-3062	3123	EM-3123	3192	EM-3192	6066	DS-6066
3063	EM-3063	3124	EM-3124	3193	EM-3193	6067	DS-6100
3064	EM-3064	3125	EM-3125	3194	EM-3194	6068	DS-6068
3065	EM-3065	3126	EM-3126	3195	EM-3195	6069	DS-6069
3066	EM-3066	3127	EM-3127	3196	EM-3196	6071	DS-6071
3067	EM-3067	3128	EM-3128	3197	EM-3197	6072	DS-6072
3068	EM-3068	3129	EM-3129	3198	EM-3198	6073	DS-5225
3069	EM-3069	3130	EM-3130	3199	EM-3199	6074	DS-5226
3070	EM-3070	3131	EM-3131	3200	EM-3200	6075	DS-5223
3071	EM-3071	3132	EM-3132	3201	EM-3201	6076	DS-6076

# CROSS REFERENCE

Mfg Part No	Our Part	Mfg Part No	Our Part	Mfg Part No	Our Part	Mfg Part No	Our Part
<b>ANCHOR (cont.)</b>		<b>ANCHOR (cont.)</b>		<b>ANCHOR (cont.)</b>		<b>ANCHOR (cont.)</b>	
6079	DS-6079	8057	EM-8068	8129	EM-8304	8201	EM-8201
6080	DS-6105	8058	EM-8095	8130	EM-8130	8205	EM-8205
6080	DS-6107	8059	EM-8059	8131	EM-8125	8206	EM-8206
6081	DS-6104	8060	EM-8060	8132	EM-8132	8207	EM-8207
6081	DS-6106	8061	EM-8061	8133	EM-8133	8208	EM-8208
6082	DS-5229	8062	EM-8062	8134	EM-8133	8209	EM-8209
6083	DS-5228	8063	EM-8063	8135	EM-8135	8210	EM-8210
6084	DS-5230	8064	EM-2651	8137	EM-8137	8211	EM-8211
6085	DS-6085	8065	EM-8065	8138	EM-8138	8212	EM-8212
6086	DS-6086	8066	EM-8609	8139	EM-2740	8213	EM-8213
6093	DS-6109	8068	EM-8068	8140	EM-8140	8214	EM-8214
8000	EM-8018	8069	EM-8063	8141	EM-8141	8218	EM-8218
8001	EM-8001	8070	EM-2815	8142	EM-8142	8219	EM-8211
8002	EM-8002	8071	EM-8063	8143	EM-8310	8220	EM-8220
8003	EM-8329	8073	EM-8073	8144	EM-8144	8221	EM-8221
8004	EM-8004	8074	EM-8074	8145	EM-8145	8221SR	EM-8221
8005	EM-8005	8075	EM-8075	8146	EM-8146	8222	EM-8222
8006	EM-8006	8076	EM-8080	8147	EM-8303	8223	EM-8223
8007	EM-8007	8077	EM-8077	8148	EM-8148	8224	EM-8224
8008	EM-8008	8078	EM-8078	8149	EM-8149	8224SR	EM-8224
8009	EM-8009	8079	EM-8079	8150	EM-8150	8225	EM-8225
8010	EM-8010	8080	EM-8080	8151	EM-8151	8226	EM-8102
8011	EM-8011	8081	EM-8082	8152	EM-8152	8227	EM-8223
8012	EM-8012	8082	EM-8082	8153	EM-8137	8228	EM-8228
8013	EM-8014	8083	EM-8083	8154	EM-8154	8229	EM-8229
8014	EM-8014	8084	EM-8084	8155	EM-8132	8230	EM-8230
8015	EM-8016	8085	EM-8085	8156	EM-8324	8231	EM-8231
8016	EM-8016	8086	EM-8086	8157	EM-8157	8232	EM-8232
8017	EM-8021	8087	EM-8087	8160	EM-8160	8233	EM-8233
8018	EM-8018	8088	EM-8088	8161	EM-8161	8234	EM-8234
8019	EM-8019	8089	EM-8089	8162	EM-8162	8235	EM-8235
8020	EM-8020	8090	EM-8516	8163	EM-8163	8236	EM-8236
8021	EM-8021	8091	EM-8091	8164	EM-8164	8236SR	EM-8236
8022	EM-8022	8092	EM-8080	8165	EM-8165	8237	EM-8224
8023	EM-8024	8093	EM-8093	8166	EM-8166	8238	EM-8238
8024	EM-8024	8094	EM-8094	8167	EM-8167	8239	EM-8239
8025	EM-8025	8095	EM-8095	8168	EM-8168	8240	EM-8431
8026	EM-8026	8096	EM-8096	8169	EM-8169	8241	EM-8073
8027	EM-8575	8097	EM-8097	8170	EM-8170	8242	EM-8242
8028	EM-8435	8098	EM-8098	8171	EM-8171	8243	EM-8243
8029	EM-8029	8099	EM-8099	8172	EM-8278	8244	EM-8244
8030	EM-8030	8100	EM-8100	8173	EM-8173	8245	EM-8424
8031	EM-8031	8101	EM-8101	8174	EM-8174	8246	EM-8517
8032	EM-8021	8102	EM-8102	8175	EM-8175	8247	EM-8004
8033	EM-8010	8103	EM-8103	8176	EM-8176	8248	EM-8248
8034	EM-8034	8104	EM-8104	8177	EM-8177	8249	EM-8031
8035	EM-8431	8105	EM-8105	8178	EM-8178	8250	EM-8014
8036	EM-8012	8106	EM-8106	8179	EM-8179	8251	EM-8014
8037	EM-8037	8107	EM-8107	8180	EM-8180	8252	EM-8019
8037SR	EM-8037	8108	EM-8108	8181	EM-8181	8253	EM-8253
8038	EM-8103	8109	EM-8103	8182	EM-8211	8254	EM-8254
8039	EM-8039	8111	EM-8111	8183	EM-8183	8255	EM-8255
8040	EM-8040	8112	EM-8100	8184	EM-8183	8256	EM-8586
8041	EM-8041	8113	EM-8065	8185	EM-8185	8257	EM-8586
8042	EM-8042	8114	EM-8114	8186	EM-8186	8258	EM-8586
8043	EM-8042	8115	EM-8115	8187	EM-8187	8259	EM-8259
8044	EM-8044	8116	EM-8132	8188	EM-8188	8260	EM-8424
8045	EM-8045	8117	EM-8117	8189	EM-8189	8261	EM-8261
8046	EM-8100	8118	EM-8118	8190	EM-8190	8262	EM-8262
8047	EM-8047	8119	EM-8119	8191	EM-8191	8263	EM-8263
8048	EM-8048	8120	EM-8120	8192	EM-8192	8264	EM-8080
8049	EM-8049	8121	EM-8121	8193	EM-8193	8265	EM-8094
8050	EM-8586	8122	EM-8122	8194	EM-8194	8266	EM-8266
8051	EM-8576	8123	EM-8124	8195	EM-8195	8267	EM-8267
8052	EM-8579	8124	EM-8124	8196	EM-8196	8268	EM-8103
8053	EM-8053	8125	EM-8125	8197	EM-8197	8269	EM-8584
8054	EM-8054	8126	EM-8304	8198	EM-8198	8270	EM-8270
8055	EM-8055	8127	EM-8133	8199	EM-8485	8271	EM-8271
8056	EM-8056	8128	EM-8128	8200	EM-8200	8272	EM-8272

# CROSS REFERENCE

Mfg Part No	Our Part	Mfg Part No	Our Part	Mfg Part No	Our Part	Mfg Part No	Our Part
<b>ANCHOR (cont.)</b>		<b>ANCHOR (cont.)</b>		<b>ANCHOR (cont.)</b>		<b>ANCHOR (cont.)</b>	
8273	EM-8324	8346	EM-8194	8418	EM-8418	8488	EM-8488
8274	EM-8274	8347	EM-8002	8419	EM-8191	8489	EM-8489
8275	EM-8312	8348	EM-8348	8420	EM-8643	8490	EM-8490
8276	EM-8276	8349	EM-8349	8421	EM-8415	8491	EM-8491
8277	EM-8277	8350	EM-8348	8422	EM-8422	8492	EM-8492
8278	EM-8278	8351	EM-8351	8423	EM-8021	8493	EM-8493
8279	EM-8279	8352	EM-8352	8424	EM-8424	8494	EM-8400
8280	EM-8280	8353	EM-8353	8425	EM-8425	8495	EM-8495
8281	EM-8281	8354	EM-8344	8426	EM-8034	8496	EM-8008
8282	EM-8282	8355	EM-8195	8427	EM-8427	8497	EM-8497
8283	EM-8283	8356	EM-8195	8428	EM-8120	8499	EM-8499
8284	EM-8284	8357	EM-8193	8429	EM-8177	8501	EM-2731
8285	EM-8142	8358	EM-8213	8430	EM-8430	8502	EM-8502
8286	EM-8181	8359	EM-8359	8431	EM-8431	8503	EM-8503
8287	EM-8287	8360	EM-8014	8432	EM-8432	8505	EM-2731
8288	EM-8411	8361	EM-8361	8433	EM-8435	8506	EM-8506
8289	EM-8431	8361SR	EM-8361	8434	EM-8434	8507	EM-8507
8290	EM-8290	8362	EM-8485	8435	EM-8435	8508	EM-8508
8291	EM-8619	8363	EM-8363	8436	EM-8435	8509	DS-8509
8292	EM-8292	8364	EM-8166	8437	EM-8435	8510	EM-8510
8293	EM-8293	8365	EM-8365	8438	EM-8438	8511	EM-8511
8294	EM-8294	8366	EM-8207	8439	EM-8439	8512	EM-8512
8295	EM-8295	8367	EM-8368	8440	EM-8439	8513	EM-8513
8296	EM-8296	8368	EM-8368	8441	EM-8586	8514	EM-8514
8298	EM-8304	8369	EM-8482	8442	EM-8442	8515	EM-8078
8299	EM-8001	8370	EM-8190	8443	EM-8586	8516	EM-8516
8300	EM-8300	8371	EM-8201	8444	EM-8579	8517	EM-8517
8301	EM-8304	8372	EM-8208	8445	EM-8445	8518	EM-8282
8302	EM-8304	8373	EM-8014	8446	EM-8579	8519	EM-8282
8303	EM-8303	8374	EM-8374	8447	EM-8576	8520	EM-8490
8304	EM-8304	8375	EM-8375	8448	EM-8586	8521	EM-8521
8305	EM-2406	8376	EM-8167	8449	EM-8586	8522	EM-8522
8306	EM-8034	8377	EM-8377	8450	EM-8586	8523	EM-8524
8307	EM-8307	8378	EM-8214	8451	EM-8352	8524	EM-8524
8308	EM-8307	8379	EM-8375	8452	EM-8586	8525	EM-8525
8309	EM-8427	8380	EM-8179	8453	EM-8453	8526	EM-8576
8310	EM-8310	8381	EM-2409	8454	EM-8609	8527	EM-8314
8311	EM-8311	8382	EM-2690	8455	EM-8073	8528	EM-8197
8312	EM-8312	8384	EM-8384	8456	EM-8456	8529	EM-8529
8313	EM-8312	8385	EM-8385	8457	EM-8457	8530	DS-8531
8314	EM-8314	8386	EM-8187	8458	EM-8073	8531	DS-8531
8315	EM-8149	8388	EM-8388	8459	EM-8073	8532	DS-8532
8316	EM-8312	8389	EM-8389	8460	EM-8460	8533	DS-8533
8317	EM-8317	8390	EM-8389	8461	EM-8075	8535	DS-8535
8318	DS-8318	8392	EM-8392	8462	EM-8462	8536	EM-8005
8319	EM-8319	8393	EM-8393	8463	EM-8087	8537	EM-8402
8320	EM-8149	8394	EM-8393	8464	EM-8086	8538	DS-8538
8321	EM-8133	8395	EM-8395	8465	EM-8516	8539	EM-8539
8322	EM-8322	8396	EM-8197	8466	EM-8466	8540	EM-8803
8323	EM-8323	8397	EM-8197	8467	EM-8467	8541	EM-8803
8324	EM-8324	8398	EM-8398	8468	DS-8468	8542	EM-8542
8325	EM-8324	8399	EM-8398	8469	DS-8469	8543	EM-8544
8326	EM-8324	8400	EM-8400	8470	DS-8470	8544	EM-8544
8327	EM-8324	8401	EM-8401	8471	DS-8471	8545	EM-8545
8328	EM-8328	8402	EM-8402	8472	DS-8472	8546	EM-8548
8329	EM-8329	8404	EM-8404	8473	DS-8473	8547	EM-8548
8330	EM-8330	8405	EM-8197	8474	DS-8474	8548	EM-8548
8331	EM-8130	8406	EM-8406	8475	DS-8475	8549	DS-8549
8332	EM-8130	8407	EM-8407	8477	EM-8075	8550	DS-8550
8335	EM-8178	8408	EM-8385	8478	EM-8055	8551	DS-8551
8336	EM-8194	8409	EM-8385	8479	EM-8142	8552	EM-8552
8337	EM-8278	8410	EM-8197	8480	EM-8304	8553	EM-8553
8338	EM-8278	8411	EM-8411	8481	EM-8192	8554	EM-8554
8339	EM-8339	8412	EM-8413	8482	EM-8482	8555	EM-8103
8340	EM-8180	8413	EM-8413	8483	EM-8368	8556	EM-8556
8341	EM-9055	8414	EM-8414	8484	EM-8348	8557	EM-8107
8343	EM-8164	8415	EM-8415	8485	EM-8485	8558	EM-8205
8344	EM-8344	8416	EM-8175	8485SR	EM-8485	8559	EM-8559
8345	EM-8002	8417	EM-8175	8487	EM-8197	8560	EM-8560

# CROSS REFERENCE

Mfg Part No	Our Part	Mfg Part No	Our Part	Mfg Part No	Our Part	Mfg Part No	Our Part
<b>ANCHOR (cont.)</b>		<b>ANCHOR (cont.)</b>		<b>ANCHOR (cont.)</b>		<b>ANCHOR (cont.)</b>	
8561	EM-8068	8632	EM-8632	8699	EM-8699	8770	EM-8770
8562	EM-8095	8633	EM-8230	8700	EM-8700	8771	EM-8771
8563	EM-8563	8634	DS-8634	8701	EM-8701	8772	EM-8772
8565	DS-8565	8635	DS-8635	8703	EM-2855	8773	EM-8774
8566	EM-8566	8636	DS-8636	8704	EM-8704	8774	EM-8774
8567	EM-8124	8637	EM-8224	8705	EM-8705	8775	EM-8775
8568	EM-8568	8637SR	EM-8224	8706	EM-2856	8776	EM-8775
8569	EM-8568	8638	EM-8663	8707	EM-2857	8777	EM-8778
8571	EM-8571	8639	EM-8639	8708	EM-2854	8778	EM-8778
8572	EM-8572	8640	EM-8640	8709	EM-8709	8779	EM-8778
8573	EM-8010	8641	EM-8641	8710	EM-8710	8780	EM-8780
8574	EM-8574	8642	EM-8393	8711	EM-8711	8781	EM-8781
8575	EM-8575	8643	EM-8643	8712	EM-8041	8782	EM-8782
8576	EM-8576	8644	EM-8644	8713	EM-8041	8783	EM-8783
8577	EM-8577	8645	EM-8389	8714	EM-8042	8784	EM-8784
8578	EM-8578	8646	EM-8196	8715	EM-8715	8785	EM-8783
8579	EM-8579	8647	EM-8164	8716	EM-8716	8786	EM-8786
8580	EM-8055	8648	EM-8648	8717	EM-8717	8787	EM-8787
8581	EM-8512	8649	EM-8649	8718	EM-8718	8788	EM-8788
8582	EM-8582	8650	EM-8650	8719	EM-8719	8789	EM-8789
8584	EM-8584	8651	EM-8651	8720	EM-8719	8790	EM-8790
8585	EM-8205	8652	EM-8652	8721	EM-8721	8791	EM-8791
8586	EM-8586	8653	EM-8653	8722	EM-8722	8792	EM-8792
8587	DS-8587	8654	EM-8654	8723	EM-8723	8793	EM-8793
8588	DS-8588	8655	EM-8655	8724	EM-8724	8794	EM-8794
8589	EM-8589	8656	EM-8656	8725	EM-8725	8795	EM-8795
8589SR	EM-8589	8657	EM-8657	8726	EM-8727	8795SR	EM-8795
8590	EM-8663	8658	EM-8658	8727	EM-8727	8796	EM-8796
8591	DS-8591	8659	EM-8659	8728	EM-8728	8796SR	EM-8796
8592	EM-8592	8660	EM-8660	8729	EM-8729	8797	EM-8797
8593	EM-8593	8661	EM-8661	8730	EM-8730	8798	EM-8798
8594	EM-8594	8662	EM-8662	8731	EM-8731	8799	EM-8799
8595	EM-8595	8662SR	EM-8662	8732	EM-8732	8800	EM-8800
8596	EM-8596	8663	EM-8663	8733	EM-8733	8801	EM-8801
8597	EM-8597	8663SR	EM-8663	8734	EM-8734	8802	EM-8802
8598	EM-8598	8664	EM-8664	8736	EM-8736	8803	EM-8803
8599	EM-8599	8665	EM-8665	8737	EM-8044	8804	EM-8804
8600	EM-8600	8666	EM-8165	8738	EM-8738	8805	EM-8805
8601	EM-8601	8667	EM-8667	8739	EM-8738	8806	EM-8806
8602	EM-8602	8668	EM-8668	8740	EM-8740	8807	EM-8807
8603	EM-8603	8669	EM-8669	8741	EM-8741	8808	EM-8681
8604	EM-8604	8670	EM-8670	8742	EM-8742	8809	EM-8296
8605	EM-8605	8672	EM-8672	8743	EM-8743	8810	EM-8296
8606	EM-8606	8673	EM-8672	8744	EM-8744	8810SR	EM-8296
8607	EM-8607	8674	EM-8674	8745	EM-8745	8811	EM-8811
8608	EM-8608	8675	EM-8675	8746	EM-8746	8812	EM-8812
8609	EM-8609	8676	EM-8676	8747	EM-8747	8813	EM-8813
8610	EM-2815	8677	EM-8677	8748	EM-8748	8814	EM-8814
8611	EM-8611	8678	EM-8678	8749	EM-8788	8815	EM-8093
8612	EM-8612	8679	EM-8679	8750	EM-8750	8816	EM-8816
8613	EM-8612	8680	EM-8680	8751	EM-8751	8817	EM-8817
8614	EM-8614	8681	EM-8681	8752	EM-8752	8818	EM-8818
8615	EM-8615	8682	EM-8682	8753	EM-8753	8819	EM-8819
8616	EM-8616	8683	EM-8683	8754	EM-8754	8820	EM-8820
8617	EM-8617	8684	EM-8684	8755	EM-8755	8821	EM-8821
8618	EM-8236	8685	EM-8685	8756	EM-8756	8822	EM-8822
8619	EM-8619	8686	EM-8686	8757	EM-8757	8823	EM-8823
8620	EM-8620	8687	EM-8687	8758	EM-8758	8824	EM-8824
8621	EM-8621	8688	EM-8688	8759	EM-8759	8825	EM-8825
8622	EM-8622	8689	EM-8689	8760	EM-8760	8826	EM-8826
8622SR	EM-8622	8690	EM-8690	8761	EM-8042	8827	EM-8663
8623	EM-8623	8691	EM-8691	8762	EM-8762	8828	EM-8828
8624	EM-8594	8692	EM-8692	8763	EM-8762	8828SR	EM-8828
8626	DS-8626	8693	EM-8693	8764	EM-8764	8829SR	EM-8829
8627	DS-8627	8694	EM-8694	8765	EM-8788	8829SR	EM-8829
8628	EM-8229	8695	EM-8695	8766	EM-8597	8830	EM-8830
8629	EM-8629	8696	EM-8696	8767	EM-8597	8831	EM-8831
8630	EM-8630	8697	EM-8697	8768	EM-8768	8832	EM-8832
8631	EM-8631	8698	EM-8698	8769	EM-8769	8832SR	EM-8832

# CROSS REFERENCE

Mfg Part No	Our Part	Mfg Part No	Our Part	Mfg Part No	Our Part	Mfg Part No	Our Part
<b>ANCHOR (cont.)</b>		<b>ANCHOR (cont.)</b>		<b>ANCHOR (cont.)</b>		<b>ANCHOR (cont.)</b>	
8833	EM-8832	8897	EM-8897	8962	EM-8962	9019	EM-9019
8834	EM-8834	8898	EM-8898	8963	EM-8963	9020	EM-9020
8834SR	EM-8834	8899	EM-8899	8964	EM-8964	9021	EM-9021
8835	EM-8835	8900	EM-8900	8965	EM-8965	9021SR	EM-9021
8835SR	EM-8835	8901	EM-8901	8965SR	EM-8965	9022	EM-9022
8836	EM-8836	8902	EM-8902	8966	EM-8966	9023	EM-9023
8836SR	EM-8836	8903	EM-8903	8967	EM-8967	9024	EM-9024
8837	EM-8834	8904	EM-8904	8968	EM-8968	9025	EM-9025
8837SR	EM-8834	8905	EM-8905	8969	EM-8644	9026	EM-9026
8838	EM-8838	8906	EM-8906	8970	EM-8970	9027	EM-9027
8838SR	EM-8838	8907	EM-8907	8971	EM-8971	9028	EM-9028
8839	EM-8832	8908	EM-8908	8972	EM-8008	9029	EM-9029
8840	EM-8832	8909	EM-8909	8973	EM-8973	9030	EM-9030
8841	EM-8616	8910	EM-8910	8974	EM-8974	9031	EM-9031
8842	EM-8616	8911	EM-8911	8975	EM-8975	9032	EM-9032
8843	EM-8843	8912	EM-8912	8976	EM-8976	9033	EM-9033
8844	EM-8616	8913	EM-8913	8977	EM-8977	9034	EM-9034
8845	EM-8845	8914	EM-8914	8978	EM-8978	9035	EM-9035
8846	EM-8846	8915	EM-8915	8979	EM-8979	9036	EM-2985
8847	EM-8847	8916	EM-8916	8980	EM-8980	9037	EM-9037
8848	EM-8848	8917	EM-8917	8981	EM-8981	9038	EM-9038
8849	EM-8849	8918	EM-8918	8982	EM-8982	9039	EM-9039
8850	EM-8850	8918SR	EM-8918	8983	EM-8983	9040	EM-9040
8851	EM-8851	8919	EM-8919	8984	EM-8984	9041	EM-9041
8852	EM-8852	8920	EM-8920	8984SR	EM-8984	9042	EM-9042
8853	EM-8853	8921	EM-8921	8985	EM-8985	9043	EM-9043
8854	EM-8854	8922	EM-8921	8986	EM-8986	9043SR	EM-9043
8855	EM-8855	8923	EM-8923	8987	EM-8987	9044	EM-9044
8856	EM-8856	8924	EM-8923	8988	EM-8988	9044SR	EM-9044
8857	EM-8857	8925	EM-8925	8989	EM-8989	9045	EM-9045
8858	EM-8858	8926	EM-8926	8990	EM-8990	9046	EM-9046
8859	EM-8859	8927	EM-8921	8991	EM-8991	9047	EM-9047
8860	EM-8860	8928	EM-8928	8992	EM-8992	9048	EM-9048
8861	EM-8460	8928SR	EM-8928	8993	EM-8993	9049	EM-9049
8862	EM-8862	8929	EM-8929	8994	EM-8994	9050	EM-9050
8863	EM-8863	8929SR	EM-8929	8995	EM-8995	9051	EM-9051
8864	EM-8864	8930	EM-8930	8996	EM-8996	9052	EM-9018
8865	EM-8865	8931	EM-8931	8997	EM-8997	9053	EM-9053
8866	EM-8866	8932	EM-8932	8997SR	EM-8997	9054	EM-9054
8867	EM-8867	8933	EM-8933	8998	EM-8998	9055	EM-9055
8868	EM-8868	8934	EM-8934	8998SR	EM-8998	9056	EM-9056
8869	EM-8869	8935	EM-8935	8999	EM-8999	9057	EM-9057
8870	EM-8870	8936	EM-8936	9000	EM-9000	9058	EM-9058
8871	EM-8871	8937	EM-8937	9001	EM-9001	9059	EM-9059
8872	EM-8872	8938	EM-8938	9001SR	EM-9001	9060	EM-9060
8873	EM-8873	8939	EM-8939	9002	EM-9002	9061	EM-9061
8874	EM-8874	8940	EM-8940	9003	EM-9003	9062	EM-9062
8875	EM-8875	8941	EM-8941	9003SR	EM-9003	9063	EM-9063
8876	EM-8876	8942	EM-8943	9004	EM-9004	9064	EM-9064
8877	EM-8877	8943	EM-8943	9004SR	EM-9004	9065	EM-9065
8878	EM-8878	8944	EM-8944	9005	EM-9005	9065SR	EM-9065
8879	EM-8879	8945	EM-8945	9005SR	EM-9005	9066	EM-9066
8880	EM-8880	8946	EM-8945	9006	EM-8795	9067	EM-9067
8881	EM-8881	8947	EM-8947	9006SR	EM-8795	9068	EM-9068
8882	EM-8882	8948	EM-8948	9007	EM-9007	9069	EM-8261
8883	EM-8883	8949	EM-8949	9007SR	EM-9007	9070	EM-9070
8884	EM-8884	8950	EM-8950	9008	EM-9008	9071	EM-9071
8885	EM-8885	8951	EM-8951	9008SR	EM-9008	9072	EM-9072
8886	EM-8886	8952	EM-8952	9009	EM-9009	9073	EM-9073
8887	EM-8887	8953	EM-8953	9010	EM-9010	9074	EM-9074
8888	EM-8888	8954	EM-8954	9011	EM-9011	9075	EM-8895
8889	EM-8889	8954SR	EM-8954	9012	EM-9012	9076	EM-9076
8890	EM-8890	8955	EM-8955	9013	EM-9013	9077	EM-9077
8891	EM-8891	8956	EM-8956	9014	EM-9014	9078	EM-9078
8892	EM-8892	8957	EM-8957	9015	EM-9015	9079	EM-9079
8893	EM-8893	8958	EM-8958	9016	EM-9016	9080	EM-9080
8894	EM-8894	8959	EM-8959	9017	EM-9017	9081	EM-9081
8895	EM-8895	8960	EM-8960	9017SR	EM-9017	9082	EM-9082
8896	EM-8896	8961	EM-8961	9018	EM-9018	9083	EM-9083

# CROSS REFERENCE

Mfg Part No	Our Part	Mfg Part No	Our Part	Mfg Part No	Our Part	Mfg Part No	Our Part
<b>ANCHOR (cont.)</b>		<b>ANCHOR (cont.)</b>		<b>ANCHOR (cont.)</b>		<b>ANCHOR (cont.)</b>	
9083SR	EM-9083	9145	EM-9145	9211	EM-9211	9280	EM-9280
9084	EM-9084	9145SR	EM-9145	9212	EM-9212	9281	EM-9281
9085	EM-9085	9146	EM-8207	9213	EM-9213	9282	EM-9282
9086	EM-9086	9146SR	EM-8207	9214	EM-9214	9283	EM-9283
9087	EM-9087	9147	EM-9147	9215	EM-9215	9284	EM-9284
9088	EM-9088	9148	EM-9148	9216	EM-9216	9285	EM-9285
9089	EM-9089	9149	EM-9149	9217	EM-9217	9286	EM-9286
9090	EM-9090	9150	EM-9150	9218	EM-9218	9287	EM-9287
9091	EM-9091	9151	EM-9151	9219	EM-9219	9288	EM-9288
9092	EM-9092	9152	EM-9152	9220	EM-9220	9289	EM-9289
9092SR	EM-9092	9153	EM-9153	9221	EM-9221	9290	EM-9290
9093	EM-9093	9154	EM-9154	9222	EM-9222	9291	EM-9291
9094	EM-9094	9155	EM-9155	9223	EM-9223	9292	EM-9292
9095	EM-9095	9156	EM-9156	9224	EM-9224	9293	EM-9293
9096	EM-9096	9157	EM-9157	9225	EM-9225	9294	EM-9294
9097	EM-9003	9158	EM-9158	9226	EM-9226	9295	EM-9295
9097SR	EM-9003	9159	EM-9159	9227	EM-9227	9296	EM-9296
9098	EM-9098	9160	EM-9160	9228	EM-9228	9297	EM-9297
9099	EM-9099	9161	EM-9161	9229	EM-9229	9298	EM-9298
9100	EM-9100	9162	EM-9162	9230	EM-9230	9299	EM-9299
9101	EM-9101	9163	EM-9163	9231	EM-9231	9300	EM-9300
9101SR	EM-9101	9164	EM-9164	9232	EM-9232	9301	EM-9301
9102	EM-9102	9165	EM-9165	9233	EM-9233	9302	EM-9302
9103	EM-9103	9165SR	EM-9165	9234	EM-9234	9303	EM-9303
9104	EM-9104	9166	EM-9166	9235	EM-9235	9304	EM-9304
9105	EM-9105	9167	EM-9167	9236	EM-9236	9305	EM-9305
9106	EM-9106	9168	EM-9168	9237	EM-9237	9306	EM-9306
9107	EM-9107	9169	EM-9169	9238	EM-9238	9307	EM-9307
9108	EM-9108	9170	EM-9170	9239	EM-9239	9308	EM-9308
9109	EM-9109	9171	EM-9171	9240	EM-9240	9309	EM-9309
9110	EM-9110	9172	EM-9172	9241	EM-9241	9310	EM-9310
9110SR	EM-9110	9173	EM-9173	9242	EM-9242	9311	EM-9311
9111	EM-9111	9174	EM-9174	9243	EM-9240	9312	EM-9312
9112	EM-2410	9175	EM-9175	9244	EM-9244	9313	EM-9313
9113	EM-9113	9176	EM-9176	9245	EM-9245	9314	EM-9314
9114	EM-9114	9177	EM-9177	9246	EM-9246	9315	EM-9315
9115	EM-9115	9178	EM-9178	9247	EM-9247	9316	EM-9316
9116	EM-9116	9179	EM-9179	9248	EM-9248	9317	EM-9317
9117	EM-9117	9180	EM-9180	9249	EM-9249	9318	EM-9318
9118	EM-9118	9181	EM-9181	9250	EM-9250	9319	EM-9319
9119	EM-8385	9182	EM-9182	9251	EM-9251	9320	EM-9320
9119	EM-9119	9183	EM-9183	9252	EM-9252	9321	EM-9317
9120	EM-9120	9184	EM-9184	9253	EM-9253	9322	EM-9322
9121	EM-9121	9185	EM-9185	9254	EM-9254	9323	EM-9323
9122	EM-9122	9186	EM-9186	9255	EM-9255	9324	EM-9324
9123	EM-9123	9187	EM-9187	9256	EM-9256	9325	EM-9325
9124	EM-9124	9188	EM-9188	9257	EM-9257	9326	EM-9326
9125	EM-9125	9189	EM-9189	9258	EM-9258	9327	EM-9327
9126	EM-2910	9190	EM-9190	9259	EM-9259	9328	EM-9328
9127	EM-9127	9191	EM-9191	9260	EM-9260	9329	EM-9329
9128	EM-9128	9192	EM-9192	9261	EM-9261	9330	EM-9330
9128SR	EM-9128	9193	EM-9193	9262	EM-9262	9331	EM-9331
9129	EM-9129	9194	EM-9194	9263	EM-9263	9332	EM-9332
9130	EM-9130	9195	EM-9195	9264	EM-9264	9333	EM-9333
9131	EM-9131	9196	EM-9196	9265	EM-9265	9334	EM-9334
9132	EM-2649	9197	EM-9197	9266	EM-9266	9335	EM-9335
9133	EM-9133	9198	EM-9198	9267	EM-9267	9336	EM-9336
9134	EM-9134	9199	EM-9199	9268	EM-9268	9337	EM-9337
9135	EM-8681	9200	EM-9200	9269	EM-9269	9338	EM-9338
9136	EM-9136	9201	EM-9201	9270	EM-9270	9339	EM-9339
9137	EM-8008	9202	EM-9202	9271	EM-9271	9340	EM-9340
9137	EM-9137	9203	EM-9203	9272	EM-9272	9341	EM-9341
9138	EM-9138	9204	EM-9204	9273	EM-9273	9342	EM-9342
9139	EM-9139	9205	EM-9205	9274	EM-9274	9343	EM-9343
9140	EM-9140	9206	EM-9206	9275	EM-9275	9344	EM-9344
9141	EM-9141	9207	EM-9207	9276	EM-9276	9345	EM-9345
9142	EM-9142	9208	EM-9208	9277	EM-9277	9346	EM-9346
9143	EM-9143	9209	EM-9209	9278	EM-9278	9347	EM-9347
9144	EM-9144	9210	EM-9210	9279	EM-9279	9348	EM-9348



# CROSS REFERENCE

Mfg Part No	Our Part	Mfg Part No	Our Part	Mfg Part No	Our Part	Mfg Part No	Our Part
<b>ANCHOR (cont.)</b>							
9349	EM-9349	9418	EM-9418	9486	EM-5689	9556	EM-5599
9350	EM-9350	9419	EM-9419	9487	EM-9487	9557	EM-5189
9351	EM-9351	9420	EM-9420	9488	EM-9488	9558	EM-9558
9352	EM-9352	9421	EM-9421	9489	EM-9489	9559	EM-9559
9353	EM-9353	9422	EM-9422	9490	EM-9490	9560	EM-9560
9354	EM-9354	9423	EM-9423	9491	EM-9491	9561	EM-9559
9355	EM-9355	9424	EM-9424	9492	EM-9492	9562	EM-9562
9356	EM-9356	9425	EM-9425	9493	EM-5155	9563	EM-5515
9357	EM-9357	9426	EM-9426	9494	EM-9494	9564	EM-8974
9358	EM-9358	9427	EM-9427	9495	EM-9495	9565	EM-5874
9359	EM-9359	9428	EM-9428	9496	EM-9496	9566	EM-9566
9360	EM-9360	9429	EM-9429	9497	EM-9497	9567	EM-5835
9361	EM-9361	9430	EM-9430	9498	EM-9498	9568	EM-7007
9362	EM-9362	9431	EM-9431	9499	EM-9499	9569	EM-5825
9363	EM-9363	9432	EM-9432	9500	EM-9500	9570	EM-9570
9364	EM-9364	9433	EM-9433	9501	EM-5349	9571	EM-5332
9365	EM-9365	9434	EM-9434	9502	EM-9502	9572	EM-9572
9366	EM-9366	9435	EM-9435	9503	EM-5781	9573	EM-9573
9367	EM-9367	9436	EM-9436	9504	EM-9504	9574	EM-9574
9368	EM-9368	9437	EM-9437	9505	EM-5646	9575	EM-9575
9369	EM-9369	9438	EM-9438	9506	EM-9506	9576	EM-9576
9370	EM-9370	9439	EM-9439	9507	EM-9507	9577	EM-9577
9371	EM-9371	9440	EM-9440	9508	EM-5384	9578	EM-5553
9372	EM-9372	9441	EM-9441	9509	EM-9509	9579	EM-9579
9373	EM-9373	9442	EM-9442	9510	EM-9510	9580	EM-9580
9374	EM-9374	9443	EM-9443	9511	EM-9511	9581	EM-5358
9375	EM-9375	9444	EM-9444	9512	EM-9512	9582	EM-5782
9376	EM-9376	9445	EM-9445	9513	EM-9513	9583	EM-5143
9377	EM-9377	9446	EM-9446	9514	EM-9514	9584	EM-5436
9378	EM-9378	9447	EM-9447	9515	EM-9515	9585	EM-5432
9379	EM-9379	9448	EM-9448	9516	EM-9516	9586	EM-5489
9380	EM-9380	9449	EM-9449	9517	EM-9517	9587	EM-9587
9381	EM-9381	9450	EM-9450	9518	EM-9518	9588	EM-9588
9382	EM-9382	9451	EM-9451	9519	EM-9519	9589	EM-9589
9383	EM-9383	9452	EM-9452	9520	EM-9520	9590	EM-5837
9384	EM-9384	9453	EM-9453	9521	EM-5407	9591	EM-5741
9385	EM-9385	9454	EM-9454	9522	EM-9522	9592	EM-5772
9386	EM-9386	9455	EM-9455	9523	EM-9523	9593	EM-9593
9387	EM-9387	9456	EM-9456	9524	EM-5656	9594	EM-9594
9388	EM-9388	9457	EM-9457	9525	EM-9525	9595	EM-9595
9389	EM-9389	9458	EM-9458	9526	EM-9526	9596	EM-5494
9390	EM-9390	9459	EM-5784	9527	EM-9527	9597	EM-5440
9391	EM-9391	9459	EM-9459	9528	EM-5404	9598	EM-5750
9392	EM-9392	9460	EM-9460	9529	EM-5411	9599	EM-9599
9393	EM-9393	9461	EM-9461	9530	EM-9530	9600	EM-5649
9394	EM-9394	9462	EM-9462	9531	EM-9531	9601	EM-9601
9395	EM-9395	9463	EM-9463	9533	EM-5785	9602	EM-5872
9396	EM-9396	9464	EM-9464	9534	EM-9534	9603	EM-5142
9397	EM-9397	9465	EM-9465	9535	EM-9535	9604	EM-5485
9398	EM-9066	9466	EM-9466	9536	EM-9536	9605	EM-5437
9399	EM-9168	9467	EM-9467	9537	EM-9537	9606	EM-5213
9400	EM-9400	9468	EM-9468	9538	EM-9538	9607	EM-5445
9401	EM-9401	9469	EM-9469	9539	EM-9539	9608	EM-5527
9402	EM-9402	9470	EM-9470	9540	EM-5864	9609	EM-5612
9403	EM-9403	9471	EM-9471	9541	EM-9541	9610	EM-9610
9404	EM-9404	9472	EM-9472	9542	EM-9542	9612	EM-9612
9405	EM-9405	9473	EM-9473	9543	EM-9543	9613	EM-9613
9406	EM-9406	9474	EM-9474	9544	EM-9544	9614	EM-5943
9407	EM-9407	9475	EM-9475	9545	EM-9545	9615	EM-5944
9408	EM-9408	9476	EM-9476	9546	EM-9546	9616	EM-5191
9409	EM-9409	9477	EM-9477	9547	EM-9547	9617	EM-9617
9410	EM-9410	9478	EM-9478	9548	EM-9548	9618	EM-5942
9411	EM-9411	9479	EM-9479	9549	EM-9549	9619	EM-9619
9412	EM-9412	9480	EM-9480	9550	EM-9550	9620	EM-5406
9413	EM-9413	9481	EM-9481	9551	EM-9551	9621	EM-5905
9414	EM-9414	9482	EM-9482	9552	EM-9552	9622	EM-5866
9415	EM-9415	9483	EM-9483	9553	EM-9553	9623	EM-5941
9416	EM-9416	9484	EM-9484	9554	EM-9554	9624	EM-5906
9417	EM-9417	9485	EM-9485	9555	EM-5188	9625	EM-5867

# CROSS REFERENCE

Mfg Part No	Our Part	Mfg Part No	Our Part	Mfg Part No	Our Part	Mfg Part No	Our Part
<b>ANCHOR (cont.)</b>		<b>ANCHOR (cont.)</b>		<b>BECK ARNLEY (cont.)</b>		<b>BECK ARNLEY (cont.)</b>	
9626	EM-5657	9703	EM-5993	104-0866	EM-2730	104-1056	EM-2656
9627	EM-5876	9704	EM-5930	104-0870	EM-8803	104-1057	EM-8166
9628	EM-5924	9705	EM-7021	104-0873	EM-8095	104-1058	EM-2654
9629	EM-5907	9707	EM-5757	104-0874	EM-8424	104-1059	EM-2688
9630	EM-5356	9709	EM-5983	104-0875	EM-8055	104-1060	EM-8233
9631	EM-5796	9713	EM-5672	104-0876	EM-8055	104-1061	EM-8220
9632	EM-5783	9714	EM-5748	104-0877	EM-8061	104-1063	EM-8189
9633	EM-5670	9714	EM-5818	104-0881	EM-2562	104-1063	EM-8375
9634	EM-5655	9716	EM-5885	104-0882	EM-8054	104-1063	EM-8492
9634	EM-9634	9727	EM-5528	104-0883	EM-8424	104-1065	EM-8140
9635	EM-5908	9734	EM-5827	104-0884	EM-8055	104-1065	EM-8605
9636	EM-5909	9737	EM-5793	104-0885	EM-8060	104-1066	EM-8604
9637	EM-5982	9738	EM-5846	104-0887	EM-2563	104-1067	EM-8140
9638	EM-5910	9742	EM-5990	104-0888	EM-8053	104-1067	EM-8141
9639	EM-5856	9775	EM-5922	104-0898	EM-2567	104-1068	EM-8140
9640	EM-5556	<b>BECK ARNLEY</b>		104-0902	EM-8230	104-1068	EM-8141
9641	EM-5911	101-3523	EM-8615	104-0907	EM-2407	104-1069	EM-8173
9642	EM-5912	101-3674	EM-8539	104-0909	EM-8389	104-1071	EM-8132
9643	EM-5526	101-3790	EM-8614	104-0910	EM-2532	104-1071	EM-8149
9644	EM-5403	101-4265	DS-8591	104-0911	EM-2449	104-1072	EM-8125
9645	EM-5859	101-4267	EM-8047	104-0912	EM-2451	104-1073	EM-8125
9646	EM-5844	101-7362	DS-6042	104-0913	EM-2451	104-1073	EM-8128
9646	EM-5860	104-0088	EM-2427	104-0915	EM-2680	104-1074	EM-8132
9647	EM-5452	104-0096	EM-2424	104-0916	EM-8135	104-1075	EM-9009
9648	EM-5754	104-0102	EM-8662	104-0920	EM-8604	104-1076	EM-8197
9649	EM-5963	104-0211	EM-2425	104-0923	EM-8117	104-1078	EM-8102
9650	EM-5600	104-0518	EM-2735	104-0928	EM-2489	104-1079	EM-8108
9650	EM-5601	104-0559	EM-2425	104-0929	EM-8118	104-1080	EM-8107
9651	EM-5913	104-0609	EM-2426	104-0930	EM-8121	104-1081	EM-2673
9652	EM-5819	104-0617	EM-2429	104-0930	EM-8151	104-1083	EM-8292
9653	EM-5600	104-0641	EM-2428	104-0931	EM-8146	104-1084	EM-8103
9653	EM-5601	104-0724	EM-8280	104-0932	EM-8145	104-1085	EM-8111
9654	EM-5877	104-0732	EM-2407	104-0935	EM-8119	104-1086	EM-8205
9655	EM-5884	104-0757	EM-2408	104-0958	EM-8210	104-1087	EM-2718
9656	EM-9096	104-0765	EM-2409	104-0959	EM-8279	104-1088	EM-8304
9657	EM-5795	104-0773	EM-2690	104-0961	EM-8212	104-1089	EM-8304
9659	EM-5914	104-0781	EM-8651	104-0964	EM-8213	104-1090	EM-8133
9660	EM-5971	104-0799	EM-8650	104-0967	EM-8214	104-1091	EM-8133
9661	EM-5903	104-0803	EM-2167	104-0968	EM-2685	104-1093	EM-8149
9662	EM-5904	104-0804	EM-2419	104-0970	EM-2690	104-1095	EM-8130
9663	EM-5921	104-0805	EM-2418	104-0978	EM-2417	104-1095	EM-8310
9665	EM-7000	104-0809	EM-2293	104-0990	EM-8229	104-1096	EM-8193
9668	EM-5940	104-0814	EM-8430	104-0996	EM-8229	104-1096	EM-8198
9669	EM-5973	104-0816	EM-8279	104-1003	EM-8230	104-1096	EM-8385
9671	EM-5968	104-0817	EM-2406	104-1021	EM-8224	104-1097	EM-8435
9675	EM-5970	104-0818	EM-2406	104-1022	EM-8222	104-1097	EM-8575
9676	EM-5744	104-0823	EM-2409	104-1023	EM-2421	104-1100	EM-8037
9677	EM-5976	104-0825	EM-2690	104-1030	EM-8224	104-1102	EM-8133
9678	EM-5969	104-0827	EM-2403	104-1031	EM-8142	104-1103	EM-8125
9679	EM-5916	104-0828	EM-2401	104-1031	EM-8284	104-1103	EM-8304
9680	EM-5742	104-0829	EM-2533	104-1032	EM-8620	104-1106	EM-8034
9681	EM-5967	104-0831	EM-2405	104-1033	EM-8622	104-1108	EM-8004
9682	EM-5886	104-0832	EM-2740	104-1034	EM-8119	104-1108	EM-8018
9683	EM-5877	104-0834	EM-2742	104-1034	EM-8142	104-1109	EM-8010
9684	EM-5144	104-0835	EM-2741	104-1036	EM-8103	104-1110	EM-8021
9685	EM-5964	104-0837	EM-8566	104-1038	EM-2684	104-1111	EM-8042
9687	EM-5978	104-0838	EM-8138	104-1040	EM-8045	104-1112	EM-8085
9689	EM-5840	104-0840	EM-2404	104-1041	EM-8047	104-1113	EM-8007
9690	EM-5994	104-0841	EM-2456	104-1042	EM-8039	104-1113	EM-8431
9691	EM-5980	104-0844	EM-8310	104-1043	EM-8044	104-1114	EM-8154
9692	EM-5902	104-0845	EM-2400	104-1044	EM-8211	104-1114	EM-8304
9693	EM-5901	104-0847	EM-2681	104-1045	EM-8042	104-1115	EM-8435
9694	EM-5900	104-0850	EM-2487	104-1047	EM-8080	104-1115	EM-8575
9695	EM-5792	104-0851	EM-2487	104-1048	EM-8080	104-1117	EM-2639
9696	EM-5875	104-0852	EM-2488	104-1049	EM-2653	104-1118	EM-8094
9697	EM-5986	104-0856	EM-2731	104-1050	EM-2655	104-1119	EM-8079
9698	EM-5758	104-0863	EM-8272	104-1051	EM-8453	104-1119	EM-8091
9701	EM-5988	104-0864	EM-8502	104-1054	EM-8065	104-1120	EM-8160
9702	EM-5530	104-0865	EM-8503	104-1055	EM-2658	104-1121	EM-8095

# CROSS REFERENCE

Mfg Part No	Our Part	Mfg Part No	Our Part	Mfg Part No	Our Part	Mfg Part No	Our Part
<b>BECK ARNLEY (cont.)</b>		<b>BECK ARNLEY (cont.)</b>		<b>BECK ARNLEY (cont.)</b>		<b>BECK ARNLEY (cont.)</b>	
104-1122	EM-8255	104-1217	EM-8183	104-1374	EM-8190	104-1525	EM-8801
104-1124	EM-8040	104-1219	EM-8137	104-1375	EM-8200	104-1527	EM-8670
104-1126	EM-8130	104-1220	EM-8603	104-1376	EM-8171	104-1528	EM-9074
104-1127	EM-8088	104-1221	EM-8601	104-1377	EM-8175	104-1554	EM-8722
104-1127	EM-8089	104-1222	EM-8093	104-1378	EM-8208	104-1583	EM-9367
104-1128	EM-8122	104-1226	EM-8568	104-1379	EM-8004	104-1585	EM-9373
104-1128	EM-8427	104-1229	EM-8287	104-1380	EM-8432	104-1588	EM-8683
104-1129	EM-8001	104-1229	EM-8431	104-1381	EM-8328	104-1589	EM-8062
104-1130	EM-8008	104-1230	EM-8287	104-1382	EM-8445	104-1590	EM-8513
104-1130	EM-8024	104-1230	EM-8411	104-1383	EM-9144	104-1591	EM-8261
104-1131	EM-8086	104-1230	EM-8431	104-1387	EM-8389	104-1592	EM-8074
104-1131	EM-8087	104-1233	EM-8576	104-1390	EM-8162	104-1597	EM-2855
104-1132	EM-8083	104-1233	EM-8579	104-1391	EM-8597	104-1600	EM-8884
104-1134	EM-8218	104-1235	EM-8576	104-1392	EM-8098	104-1601	EM-9018
104-1135	EM-8016	104-1249	EM-8166	104-1393	EM-8517	104-1602	EM-8261
104-1138	EM-8595	104-1250	EM-8711	104-1395	EM-8201	104-1603	EM-8882
104-1142	EM-8623	104-1253	EM-8644	104-1398	EM-8191	104-1604	EM-2854
104-1143	EM-8006	104-1271	EM-8167	104-1399	EM-8319	104-1606	EM-8885
104-1144	EM-2719	104-1273	EM-8056	104-1400	EM-8188	104-1607	EM-8866
104-1145	EM-8018	104-1275	EM-8617	104-1402	EM-9096	104-1608	EM-8704
104-1145	EM-8411	104-1277	EM-8107	104-1406	EM-8979	104-1611	EM-2857
104-1146	EM-8002	104-1278	EM-8552	104-1409	EM-8462	104-1614	EM-8978
104-1147	EM-8002	104-1281	EM-8586	104-1409	EM-9130	104-1618	EM-8977
104-1147	EM-8329	104-1284	EM-8167	104-1412	EM-9288	104-1623	EM-8740
104-1148	EM-8002	104-1286	EM-8174	104-1413	EM-8681	104-1625	EM-9035
104-1148	EM-8024	104-1287	EM-8073	104-1416	EM-8235	104-1627	EM-9031
104-1149	EM-8019	104-1290	EM-8086	104-1418	EM-8239	104-1628	EM-8404
104-1150	EM-2451	104-1314	EM-8554	104-1418	EM-8582	104-1634	EM-8801
104-1150	EM-8014	104-1315	EM-8105	104-1419	EM-8277	104-1635	EM-8849
104-1153	EM-8600	104-1316	EM-8082	104-1423	EM-8361	104-1636	EM-9139
104-1154	EM-8602	104-1319	EM-8026	104-1424	EM-8485	104-1638	EM-8975
104-1154	EM-8603	104-1322	EM-8467	104-1425	EM-8795	104-1639	EM-9066
104-1156	EM-8005	104-1324	EM-8100	104-1426	EM-8179	104-1640	EM-8845
104-1156	EM-8019	104-1324	EM-8238	104-1427	EM-8194	104-1643	EM-9085
104-1157	EM-8019	104-1325	EM-8097	104-1428	EM-8231	104-1644	EM-8988
104-1158	EM-8014	104-1326	EM-8099	104-1428	EM-8553	104-1646	EM-9145
104-1159	EM-8011	104-1327	EM-8619	104-1432	EM-8179	104-1647	EM-9003
104-1159	EM-8016	104-1328	EM-8206	104-1433	EM-8375	104-1648	EM-8699
104-1163	EM-5468	104-1329	EM-8244	104-1434	EM-8243	104-1653	EM-9351
104-1165	EM-8311	104-1333	EM-8681	104-1435	EM-8063	104-1660	EM-5494
104-1167	EM-8236	104-1335	EM-8705	104-1436	EM-8209	104-1661	EM-8997
104-1167	EM-8287	104-1337	EM-9023	104-1438	EM-8435	104-1662	EM-5372
104-1167	EM-8589	104-1341	EM-8068	104-1439	EM-8100	104-1665	EM-8973
104-1172	EM-8228	104-1342	EM-8586	104-1440	EM-8041	104-1667	EM-5155
104-1173	EM-9137	104-1343	EM-8087	104-1441	EM-9008	104-1669	EM-8848
104-1174	EM-8002	104-1343	EM-8516	104-1442	EM-8806	104-1670	EM-5617
104-1174	EM-8011	104-1344	EM-8075	104-1444	EM-9007	104-1671	EM-9229
104-1179	EM-8296	104-1345	EM-8075	104-1446	EM-8102	104-1672	EM-9271
104-1181	EM-8323	104-1346	EM-8073	104-1447	EM-8242	104-1675	EM-9272
104-1182	EM-8323	104-1346	EM-8457	104-1449	EM-8170	104-1677	EM-8850
104-1183	EM-8124	104-1347	EM-8456	104-1450	EM-8864	104-1679	EM-8870
104-1185	EM-8124	104-1349	EM-8193	104-1451	EM-9017	104-1682	EM-5528
104-1187	EM-8114	104-1350	EM-8190	104-1452	EM-8122	104-1683	EM-8968
104-1188	EM-8266	104-1351	EM-8164	104-1453	EM-8682	104-1685	EM-8872
104-1191	EM-8005	104-1356	EM-9055	104-1455	EM-8824	104-1686	EM-9168
104-1192	EM-8259	104-1357	EM-8001	104-1459	EM-9055	104-1687	EM-9205
104-1193	EM-8059	104-1358	EM-8034	104-1460	EM-8863	104-1688	EM-9166
104-1194	EM-8104	104-1359	EM-8312	104-1461	EM-8862	104-1689	EM-8974
104-1195	EM-8021	104-1361	EM-8068	104-1462	EM-8909	104-1692	EM-8967
104-1196	EM-8078	104-1362	EM-8185	104-1467	EM-8888	104-1693	EM-9184
104-1199	EM-8103	104-1363	EM-8175	104-1472	EM-8300	104-1694	EM-9165
104-1200	EM-8166	104-1365	EM-8418	104-1510	EM-8898	104-1695	EM-9148
104-1200	EM-8177	104-1366	EM-8021	104-1512	EM-8995	104-1696	EM-8937
104-1200	EM-8363	104-1367	EM-8643	104-1513	EM-9073	104-1707	EM-8769
104-1202	EM-8189	104-1369	EM-8181	104-1514	EM-8691	104-1712	EM-9200
104-1205	EM-8406	104-1370	EM-8180	104-1517	EM-2856	104-1714	EM-8855
104-1210	EM-8175	104-1371	EM-8186	104-1518	EM-8398	104-1716	EM-9101
104-1211	EM-8166	104-1372	EM-8183	104-1520	EM-8796	104-1717	EM-9188
104-1213	EM-8176	104-1373	EM-8187	104-1521	EM-8697	104-1718	EM-9217

# CROSS REFERENCE

Mfg Part No	Our Part	Mfg Part No	Our Part	Mfg Part No	Our Part	Mfg Part No	Our Part
<b>BECK ARNLEY (cont.)</b>		<b>BECK ARNLEY (cont.)</b>		<b>BECK ARNLEY (cont.)</b>		<b>CAR QUEST (cont.)</b>	
104-1719	EM-8851	104-1859	EM-5526	104-2042	EM-9447	31-2250	EM-2242
104-1725	EM-9155	104-1860	EM-5482	104-2047	EM-5173	31-2255	EM-2349
104-1726	EM-9162	104-1863	EM-9160	104-2060	EM-9219	31-2265	EM-2250
104-1727	EM-9158	104-1865	EM-9442	<b>CAR QUEST</b>		31-2266	EM-2272
104-1733	EM-9182	104-1866	EM-9304	31-1000	EM-2376	31-2267	EM-2338
104-1734	EM-9190	104-1867	EM-9382	31-1001	EM-2369	31-2268	EM-2304
104-1736	EM-9164	104-1873	EM-9291	31-1003	EM-2525	31-2271	EM-2321
104-1737	EM-9163	104-1879	EM-9258	31-1004	EM-2720	31-2273	EM-2254
104-1743	EM-8958	104-1880	EM-8999	31-1005	EM-2721	31-2274	EM-2256
104-1745	EM-8783	104-1883	EM-9384	31-1007	EM-2615	31-2275	EM-2255
104-1746	EM-8783	104-1884	EM-9058	31-1008	EM-2616	31-2276	EM-2350
104-1751	EM-8698	104-1885	EM-9058	31-1009	EM-2618	31-2280	EM-2534
104-1753	EM-9470	104-1886	EM-9198	31-1026	EM-3026	31-2281	EM-2262
104-1754	EM-8865	104-1887	EM-9247	31-2007	EM-2007	31-2284	EM-2253
104-1755	EM-9208	104-1890	EM-9213	31-2009	EM-2009	31-2286	EM-2333
104-1757	EM-9268	104-1891	EM-9487	31-2010	EM-2010	31-2288	EM-2290
104-1761	EM-9204	104-1892	EM-9216	31-2039	EM-2039	31-2289	EM-2289
104-1770	EM-5489	104-1893	EM-5689	31-2040	EM-2040	31-2293	EM-2264
104-1774	EM-5141	104-1894	EM-9280	31-2048	EM-2048	31-2295	EM-2351
104-1775	EM-8681	104-1895	EM-9215	31-2050	EM-2050	31-2296	EM-2266
104-1776	EM-9195	104-1896	EM-9220	31-2060	EM-2060	31-2304	EM-2263
104-1777	EM-5769	104-1897	EM-9247	31-2070	EM-2070	31-2305	EM-2281
104-1778	EM-9149	104-1898	EM-5405	31-2073	EM-2073	31-2308	EM-2267
104-1779	EM-5375	104-1900	EM-5775	31-2107	EM-2107	31-2308HD	EM-2267
104-1780	EM-3056	104-1902	EM-8797	31-2108	EM-2108	31-2313	EM-2261
104-1781	EM-3057	104-1903	EM-5750	31-2119	EM-2119	31-2315	EM-2309
104-1782	EM-9167	104-1904	EM-9249	31-2121	EM-2121	31-2316	EM-2277
104-1783	EM-5817	104-1905	EM-5930	31-2122	EM-2122	31-2317	EM-2275
104-1784	EM-9223	104-1906	EM-5827	31-2123	EM-2123	31-2319	EM-2301
104-1785	EM-9161	104-1909	EM-9541	31-2124	EM-2124	31-2322	EM-2283
104-1786	EM-9305	104-1910	EM-9150	31-2125	EM-2125	31-2323	EM-2317
104-1788	EM-5452	104-1911	EM-9137	31-2126	EM-2126	31-2327	EM-2310
104-1789	EM-8792	104-1912	EM-9183	31-2127	EM-2127	31-2328	EM-2403
104-1790	EM-9161	104-1915	EM-5672	31-2141	EM-2141	31-2331	EM-2271
104-1792	EM-9203	104-1916	EM-8986	31-2142	EM-2142	31-2332	EM-2270
104-1793	EM-9088	104-1924	EM-9393	31-2142HD	EM-2267	31-2334	EM-2297
104-1794	EM-8793	104-1925	EM-9239	31-2143	EM-2143	31-2335	EM-2298
104-1795	EM-8797	104-1926	EM-9441	31-2150	EM-2150	31-2336	EM-2299
104-1796	EM-9187	104-1927	EM-8529	31-2162	EM-2162	31-2338	EM-2305
104-1798	EM-5159	104-1928	EM-5407	31-2163	EM-2163	31-2339	EM-2306
104-1800	EM-5349	104-1929	EM-9471	31-2167	EM-2167	31-2342	EM-2257
104-1801	EM-9211	104-1930	EM-9248	31-2168	EM-2168	31-2343	EM-2268
104-1804	EM-9389	104-1932	EM-9573	31-2170	EM-2170	31-2344	EM-2279
104-1808	EM-9081	104-1934	EM-9420	31-2172	EM-2172	31-2345	EM-2316
104-1810	EM-8996	104-1937	EM-9539	31-2204	EM-2204	31-2346	EM-2296
104-1812	EM-8899	104-1938	EM-9539	31-2205	EM-2205	31-2350	EM-2265
104-1813	EM-5367	104-1946	EM-9317	31-2206	EM-2206	31-2352	EM-2311
104-1814	EM-9300	104-1951	EM-9318	31-2217	EM-2217	31-2353	EM-2288
104-1815	EM-5356	104-1952	EM-9411	31-2218	EM-2218	31-2356	EM-2512
104-1816	EM-5143	104-1953	EM-9415	31-2219	EM-2219	31-2357	EM-2323
104-1822	EM-2410	104-1956	EM-9432	31-2220	EM-2220	31-2358	EM-2324
104-1823	EM-9163	104-1957	EM-9371	31-2221	EM-2221	31-2359	EM-2325
104-1826	EM-8993	104-1958	EM-9477	31-2222	EM-2222	31-2361	EM-2292
104-1829	EM-9502	104-1959	EM-5757	31-2223	EM-2223	31-2363	EM-2291
104-1832	EM-3037	104-1960	EM-5742	31-2224	EM-2378	31-2365	EM-2320
104-1834	EM-9515	104-1961	EM-9466	31-2225	EM-2225	31-2366	EM-2295
104-1836	EM-9014	104-1962	EM-9469	31-2226	EM-2226	31-2367	EM-2328
104-1837	EM-9225	104-1965	EM-5384	31-2227	EM-2227	31-2370	EM-2370
104-1839	EM-9299	104-1966	EM-9462	31-2228	EM-2228	31-2372	EM-2329
104-1840	EM-9197	104-1968	EM-5900	31-2231	EM-2231	31-2373	EM-2722
104-1842	EM-9277	104-1970	EM-9248	31-2234	EM-2234	31-2374	EM-2351
104-1843	EM-9194	104-1970	EM-9547	31-2235	EM-2235	31-2375	EM-2345
104-1845	EM-8710	104-1971	EM-9431	31-2239HD	EM-2282	31-2377	EM-2353
104-1846	EM-8889	104-1972	EM-5670	31-2240	EM-2240	31-2378	EM-2331
104-1847	EM-9185	104-1993	EM-5495	31-2241	EM-2241	31-2379	EM-2332
104-1849	EM-9072	104-1997	EM-9209	31-2243HD	EM-2284	31-2380	EM-2375
104-1850	EM-9170	104-1999	EM-9280	31-2244	EM-2287	31-2381	EM-2356
104-1851	EM-3057	104-2001	EM-8982	31-2244HD	EM-2287	31-2382	EM-2357
104-1858	EM-9359	104-2009	EM-5773	31-2245	EM-2327	31-2384	EM-2344

# CROSS REFERENCE

Mfg Part No	Our Part	Mfg Part No	Our Part	Mfg Part No	Our Part	Mfg Part No	Our Part
<b>CAR QUEST (cont.)</b>		<b>CAR QUEST (cont.)</b>		<b>CAR QUEST (cont.)</b>		<b>CAR QUEST (cont.)</b>	
31-2385 .....	EM-2337	31-2914 .....	EM-2914	31-2975 .....	EM-2975	31-3062 .....	EM-2406
31-2386 .....	EM-2335	31-2915 .....	EM-2915	31-2977 .....	EM-2977	31-3063 .....	EM-2400
31-2387 .....	EM-2336	31-2916 .....	EM-2916	31-2978 .....	EM-2978	31-3064 .....	EM-2405
31-2388 .....	EM-2358	31-2917 .....	EM-2917	31-2979 .....	EM-2979	31-3065 .....	EM-2404
31-2389 .....	EM-2359	31-2918 .....	EM-2918	31-2980 .....	EM-2980	31-3066 .....	EM-2414
31-2390 .....	EM-2470	31-2919 .....	EM-2919	31-2981 .....	EM-2981	31-3067 .....	EM-2419
31-2391 .....	EM-2374	31-2920 .....	EM-2920	31-2982 .....	EM-2982	31-3068 .....	EM-2418
31-2393 .....	EM-2326	31-2921 .....	EM-2921	31-2983 .....	EM-2983	31-3069 .....	EM-2417
31-2511 .....	EM-2466	31-2922 .....	EM-2922	31-2984 .....	EM-2984	31-3071 .....	EM-2424
31-2537 .....	EM-2537	31-2923 .....	EM-2923	31-2985 .....	EM-2985	31-3072 .....	EM-2426
31-2538 .....	EM-2538	31-2924 .....	EM-2924	31-2986 .....	EM-2986	31-3073 .....	EM-2428
31-2868 .....	EM-2868	31-2925 .....	EM-2925	31-2987 .....	EM-2987S	31-3074 .....	EM-2425
31-2869 .....	EM-2869	31-2926 .....	EM-2926S	31-2987HY .....	EM-2987	31-3075 .....	EM-2415
31-2870 .....	EM-2870	31-2926HY .....	EM-2926	31-2988 .....	EM-2988	31-3076 .....	EM-2389
31-2871 .....	EM-2871	31-2927 .....	EM-2927	31-2989 .....	EM-2989	31-3077 .....	EM-2457
31-2872 .....	EM-2872	31-2928 .....	EM-2928	31-2990 .....	EM-2990	31-3078 .....	EM-2458
31-2873 .....	EM-2873	31-2929 .....	EM-2929	31-2991 .....	EM-2991	31-3080 .....	EM-2420
31-2874 .....	EM-2874	31-2930 .....	EM-2930	31-2992 .....	EM-2992	31-3081 .....	EM-2372
31-2875 .....	EM-2875	31-2931 .....	EM-2931	31-2993 .....	EM-2993S	31-3082 .....	EM-2385
31-2876 .....	EM-2876S	31-2932 .....	EM-2932S	31-2993HY .....	EM-2993	31-3083 .....	EM-2437
31-2876HY .....	EM-2876	31-2932HY .....	EM-2932	31-2994 .....	EM-2994	31-3084 .....	EM-2438
31-2878 .....	EM-2878	31-2933 .....	EM-2933S	31-2995 .....	EM-2995S	31-3086 .....	EM-2388
31-2879 .....	EM-2879S	31-2933HY .....	EM-2933	31-2995HY .....	EM-2995	31-3088 .....	EM-2462
31-2879HY .....	EM-2879	31-2934 .....	EM-2934S	31-2996 .....	EM-2996S	31-3089 .....	EM-2453
31-2880 .....	EM-2880S	31-2934HY .....	EM-2934	31-2996HY .....	EM-2996	31-3090 .....	EM-2454
31-2880HY .....	EM-2880	31-2935 .....	EM-2935	31-2997 .....	EM-2997	31-3091 .....	EM-2389
31-2881 .....	EM-2881	31-2936 .....	EM-2936	31-2998 .....	EM-2998	31-3093 .....	EM-2467
31-2882 .....	EM-2882	31-2938 .....	EM-2938S	31-2999 .....	EM-2999	31-3095 .....	EM-2505
31-2883 .....	EM-2883	31-2938HY .....	EM-2938	31-3000 .....	EM-2303	31-3096 .....	EM-2466
31-2884 .....	EM-2884	31-2939 .....	EM-2939	31-3002 .....	EM-3002	31-3097 .....	EM-2393
31-2885 .....	EM-2885	31-2940 .....	EM-2940	31-3003 .....	EM-3003S	31-3099 .....	EM-2531
31-2886 .....	EM-2886	31-2941 .....	EM-2941	31-3003HY .....	EM-3003	31-3103 .....	EM-2472
31-2887 .....	EM-2887	31-2942 .....	EM-2942S	31-3004 .....	EM-2373	31-3108 .....	EM-2436
31-2888 .....	EM-2888	31-2942HY .....	EM-2942	31-3005 .....	EM-3005	31-3112 .....	EM-2491
31-2889 .....	EM-2889	31-2943 .....	EM-2943S	31-3006 .....	EM-3006	31-3113 .....	EM-2490
31-2890 .....	EM-2890S	31-2943HY .....	EM-2943	31-3007 .....	EM-3007	31-3120 .....	EM-2567
31-2890HY .....	EM-2890	31-2944 .....	EM-2944	31-3008 .....	EM-3008	31-3121 .....	EM-2562
31-2892 .....	EM-2892S	31-2945 .....	EM-2945	31-3009 .....	EM-2340	31-3122 .....	EM-2563
31-2892HY .....	EM-2892	31-2947 .....	EM-2947	31-3010 .....	EM-3010	31-3136 .....	EM-2439
31-2893 .....	EM-2893S	31-2948 .....	EM-2948	31-3011 .....	EM-3011	31-3137 .....	EM-2440
31-2893HY .....	EM-2893	31-2949 .....	EM-2949	31-3014 .....	EM-2339	31-3138 .....	EM-2441
31-2894 .....	EM-2894S	31-2950 .....	EM-2950	31-3015 .....	EM-2341	31-3139 .....	EM-2442
31-2894HY .....	EM-2894	31-2951 .....	EM-2951	31-3017 .....	EM-2363	31-3141 .....	EM-2444
31-2895 .....	EM-2895S	31-2952 .....	EM-2952	31-3018 .....	EM-2346	31-3142 .....	EM-2445
31-2895HY .....	EM-2895	31-2953 .....	EM-2953	31-3019 .....	EM-2348	31-3144 .....	EM-2502
31-2896 .....	EM-2896S	31-2954 .....	EM-2954	31-3020 .....	EM-2384	31-3145 .....	EM-2448
31-2896HY .....	EM-2896	31-2955 .....	EM-2955	31-3021 .....	EM-2382	31-3147 .....	EM-2433
31-2897 .....	EM-2897S	31-2956 .....	EM-2956	31-3022 .....	EM-2387	31-3148 .....	EM-2434
31-2897HY .....	EM-2897	31-2957 .....	EM-2957	31-3024 .....	EM-2394	31-3152 .....	EM-2774
31-2898 .....	EM-2898	31-2958 .....	EM-2958	31-3025 .....	EM-2360	31-3153 .....	EM-2775
31-2899 .....	EM-2899	31-2959 .....	EM-2959	31-3026 .....	EM-2379	31-3159 .....	EM-2503
31-2900 .....	EM-2900	31-2960 .....	EM-2960	31-3030 .....	EM-2381	31-3160 .....	EM-2504
31-2901 .....	EM-2901	31-2961 .....	EM-2961	31-3033 .....	EM-2436	31-3161 .....	EM-2776
31-2902 .....	EM-2902S	31-2962 .....	EM-2962	31-3034 .....	EM-2436	31-3166 .....	EM-2500
31-2902HY .....	EM-2902	31-2963 .....	EM-2963	31-3036 .....	EM-2391	31-3167 .....	EM-2501
31-2903 .....	EM-2903S	31-2964 .....	EM-2964	31-3037 .....	EM-2531	31-3170 .....	EM-2459
31-2903HY .....	EM-2903	31-2965 .....	EM-2965	31-3038 .....	EM-2395	31-3171 .....	EM-2460
31-2904 .....	EM-2904	31-2966 .....	EM-2966	31-3042 .....	EM-2446	31-3172 .....	EM-2461
31-2905 .....	EM-2905	31-2967 .....	EM-2967S	31-3045 .....	EM-2370	31-3175 .....	EM-2501
31-2906 .....	EM-2906S	31-2967HY .....	EM-2967	31-3046 .....	EM-2370	31-3177 .....	EM-2501
31-2906HY .....	EM-2987	31-2968 .....	EM-2968S	31-3048 .....	EM-2471	31-3178 .....	EM-2500
31-2907 .....	EM-2907	31-2968HY .....	EM-2968	31-3049 .....	EM-2362	31-3179 .....	EM-2501
31-2908 .....	EM-2908	31-2969 .....	EM-2969	31-3054 .....	EM-2364	31-3180 .....	EM-2500
31-2909 .....	EM-2909	31-2970 .....	EM-2970	31-3055 .....	EM-2365	31-3182 .....	EM-2725
31-2910 .....	EM-2910S	31-2971 .....	EM-2971	31-3056 .....	EM-2368	31-3183 .....	EM-2726
31-2910HY .....	EM-2910	31-2972 .....	EM-2972	31-3057 .....	EM-2367	31-3187 .....	EM-2464
31-2911 .....	EM-2911	31-2973 .....	EM-2973	31-3058 .....	EM-2723	31-3188 .....	EM-2463
31-2912 .....	EM-2912	31-2974 .....	EM-2974S	31-3059 .....	EM-2724	31-3189 .....	EM-2679
31-2913 .....	EM-2913	31-2974HY .....	EM-2974	31-3060 .....	EM-2409	31-3190 .....	EM-2727

# CROSS REFERENCE

Mfg Part No	Our Part	Mfg Part No	Our Part	Mfg Part No	Our Part	Mfg Part No	Our Part
<b>CAR QUEST (cont.)</b>		<b>CAR QUEST (cont.)</b>		<b>CAR QUEST (cont.)</b>		<b>CAR QUEST (cont.)</b>	
31-3191	EM-2728	31-3438	EM-2506	31-3544	EM-2601	31-3614	EM-2777
31-3192	EM-2536	31-3439	EM-2524	31-3545	EM-2601	31-3616	EM-2778
31-3195	EM-2458	31-3440	EM-2477	31-3546	EM-2601	31-3617	EM-2548S
31-3200	EM-2447	31-3442	EM-2381	31-3547	EM-2601	31-3617HY	EM-2548
31-3201	EM-2600	31-3444	EM-2510	31-3548	EM-2601	31-3617HY	EM-2779
31-3202	EM-2730	31-3446	EM-2496	31-3549	EM-2623	31-3618	EM-2780
31-3203	EM-2731	31-3447	EM-2543	31-3550	EM-2622	31-3619	EM-2781
31-3204	EM-2731	31-3450	EM-2492	31-3551	EM-2687	31-3621	EM-2782
31-3206	EM-2733	31-3454	EM-2528	31-3552	EM-2686	31-3622	EM-2783
31-3208	EM-2734	31-3455	EM-2396	31-3553	EM-2644	31-3624	EM-2784
31-3234	EM-2469	31-3456	EM-2494	31-3554	EM-2645	31-3625	EM-2785
31-3245	EM-2493	31-3458	EM-2548S	31-3555	EM-2646	31-3626	EM-2786
31-3276	EM-2401	31-3458HY	EM-2548	31-3556	EM-2646	31-3629	EM-2639
31-3277	EM-2421	31-3459	EM-2495	31-3557	EM-2640	31-3630	EM-2673
31-3278	EM-2456	31-3460	EM-2755	31-3558	EM-2641	31-3631	EM-2675
31-3279	EM-2533	31-3461	EM-2756	31-3559	EM-2642	31-3632	EM-2693
31-3280	EM-2532	31-3464	EM-2382	31-3560	EM-2643	31-3633	EM-2697S
31-3281	EM-2410	31-3465	EM-2549	31-3561	EM-2652	31-3633HY	EM-2697
31-3282	EM-2429	31-3466	EM-2550	31-3562	EM-2620	31-3634	EM-2709
31-3283	EM-2449	31-3467	EM-2549	31-3563	EM-2637	31-3635	EM-2712S
31-3285	EM-2451	31-3468	EM-2550	31-3564	EM-2638	31-3635HY	EM-2712
31-3286	EM-2452	31-3469	EM-2497	31-3565	EM-2564	31-3636	EM-2713
31-3287	EM-2735	31-3500	EM-2280	31-3566	EM-2621	31-3638	EM-2715
31-3288	EM-2736	31-3501	EM-2330	31-3568	EM-2649	31-3639	EM-2716
31-3291	EM-2737	31-3502	EM-2570	31-3569	EM-2650	31-3640	EM-2718
31-3292	EM-2738	31-3503	EM-2661S	31-3570	EM-2651	31-3642	EM-2719
31-3293	EM-2739	31-3503HY	EM-2661	31-3571	EM-2665	31-3643	EM-2634
31-3297	EM-2680	31-3504	EM-2571	31-3572	EM-2717S	31-3644	EM-2791S
31-3300	EM-2740	31-3505	EM-2572	31-3572HY	EM-2717	31-3644HY	EM-2791
31-3302	EM-2681	31-3506	EM-2569	31-3573	EM-2660S	31-3645	EM-2792S
31-3305	EM-2741	31-3507	EM-2568	31-3573HY	EM-2660	31-3645HY	EM-2792
31-3306	EM-2742	31-3508	EM-2627	31-3574	EM-2691	31-3646	EM-2793
31-3307	EM-2488	31-3509	EM-2759	31-3575	EM-2671	31-3647	EM-2794
31-3308	EM-2487	31-3510	EM-2628	31-3576	EM-2761	31-3648	EM-2795S
31-3310	EM-2407	31-3511	EM-2617	31-3577	EM-2708	31-3648HY	EM-2795
31-3315	EM-2743	31-3512	EM-2625	31-3578	EM-2762	31-3649	EM-2796S
31-3316	EM-2744	31-3513	EM-2624	31-3579	EM-2763	31-3649HY	EM-2796
31-3317	EM-2745	31-3515	EM-2629	31-3580	EM-2764	31-3650	EM-2797
31-3318	EM-2408	31-3516	EM-2626	31-3581	EM-2765	31-3651	EM-2798
31-3320	EM-2746	31-3517	EM-2553S	31-3582	EM-2766	31-3652	EM-2799
31-3322	EM-2690	31-3517HY	EM-2553	31-3584	EM-2667	31-3653	EM-2800
31-3325	EM-2489	31-3518	EM-2555S	31-3585	EM-2668	31-3654	EM-2801
31-3327	EM-2747	31-3518HY	EM-2555	31-3586	EM-2710	31-3655	EM-2802
31-3328	EM-2748	31-3519	EM-2633	31-3587	EM-2653	31-3656	EM-2803S
31-3375	EM-2749	31-3520	EM-2557	31-3588	EM-2654	31-3656HY	EM-2803
31-3386	EM-2750	31-3521	EM-2639	31-3589	EM-2655	31-3657	EM-2804
31-3387	EM-2751	31-3522	EM-2557	31-3591	EM-2656	31-3658	EM-2805
31-3392	EM-2619	31-3523	EM-2632	31-3592	EM-2657	31-3659	EM-2806
31-3394	EM-2565	31-3524	EM-2609	31-3593	EM-2658	31-3660	EM-2807
31-3395	EM-2566	31-3525	EM-2551S	31-3594	EM-2767	31-3661	EM-2808
31-3396	EM-2752	31-3525HY	EM-2551	31-3595	EM-2768	31-3662	EM-2809
31-3397	EM-2753	31-3526	EM-2551S	31-3596	EM-2769	31-3663	EM-2810
31-3401	EM-2754	31-3526HY	EM-2551	31-3597	EM-2711S	31-3664	EM-2817
31-3408	EM-2458	31-3527	EM-2551S	31-3597HY	EM-2711	31-3665	EM-2812S
31-3409	EM-2457	31-3527HY	EM-2551	31-3598	EM-2770	31-3665HY	EM-2812
31-3411	EM-2457	31-3528	EM-2556S	31-3600	EM-2771	31-3666	EM-2813S
31-3412	EM-2682	31-3528HY	EM-2556	31-3601	EM-2676	31-3666HY	EM-2813
31-3413	EM-2683	31-3529	EM-2630	31-3602	EM-2664	31-3667	EM-2814
31-3414	EM-2558	31-3530	EM-2684	31-3603	EM-2663	31-3668	EM-2815
31-3415	EM-2559	31-3531	EM-2760	31-3604	EM-2692	31-3669	EM-2816
31-3418	EM-2696S	31-3532	EM-2685	31-3605	EM-2662	31-3670	EM-2817
31-3418HY	EM-2696	31-3535	EM-2636	31-3606	EM-2674	31-3671	EM-2818
31-3419	EM-2631	31-3536	EM-2635	31-3607	EM-2688	31-3672	EM-2819
31-3425	EM-2497	31-3538	EM-2600	31-3608	EM-2772	31-3673	EM-2820
31-3426	EM-2498	31-3539	EM-2499	31-3609	EM-2707S	31-3674	EM-2821S
31-3429	EM-2513	31-3540	EM-2601	31-3609HY	EM-2707	31-3674HY	EM-2821
31-3434	EM-2515	31-3541	EM-2601	31-3610	EM-2677	31-3675	EM-2822
31-3436	EM-2474	31-3542	EM-2601	31-3611	EM-2678	31-3676	EM-2823S
31-3437	EM-2473	31-3543	EM-2601	31-3613	EM-2773	31-3676HY	EM-2823

## CROSS REFERENCE

Mfg Part No	Our Part	Mfg Part No	Our Part	Mfg Part No	Our Part	Mfg Part No	Our Part
<b>CAR QUEST (cont.)</b>		<b>CAR QUEST (cont.)</b>		<b>CAR QUEST (cont.)</b>		<b>CAR QUEST (cont.)</b>	
31-3677	EM-2824S	31-5285	EM-3025	31-8049	EM-8049	31-8124	EM-8124
31-3677HY	EM-2824	31-5322	EM-3087	31-8050	EM-8586	31-8125	EM-8125
31-3678	EM-2657	31-5327	EM-5423	31-8051	EM-8576	31-8126	EM-8304
31-3679	EM-2698S	31-5353HY	EM-3147	31-8052	EM-8579	31-8127	EM-8133
31-3679HY	EM-2698	31-5358	EM-2927	31-8053	EM-8053	31-8128	EM-8128
31-3680	EM-2789S	31-5365	EM-5583	31-8054	EM-8054	31-8129	EM-8304
31-3680HY	EM-2789	31-5374	EM-3086	31-8055	EM-8055	31-8130	EM-8130
31-3681	EM-2790S	31-5376	EM-3100	31-8056	EM-8056	31-8131	EM-8125
31-3681HY	EM-2790	31-5382	EM-3098	31-8057	EM-8068	31-8132	EM-8132
31-3682	EM-2788S	31-5390	EM-2548	31-8058	EM-8095	31-8133	EM-8133
31-3682HY	EM-2788	31-5401	EM-5660	31-8059	EM-8059	31-8134	EM-8133
31-3683	EM-2394	31-5406	EM-5692	31-8060	EM-8060	31-8135	EM-8135
31-3935	EM-2825	31-5417	EM-3145	31-8061	EM-8061	31-8137	EM-8137
31-3936	EM-2826	31-6958	EM-5485	31-8062	EM-8062	31-8138	EM-8138
31-3937	EM-2827	31-7117	EM-9373	31-8063	EM-8063	31-8139	EM-2740
31-3938	EM-2828	31-7127	EM-9254	31-8065	EM-8065	31-8140	EM-8140
31-3939	EM-2829	31-7306	EM-5132	31-8066	EM-8609	31-8141	EM-8141
31-3940	EM-2830	31-7341	EM-9209	31-8068	EM-8068	31-8142	EM-8142
31-3941	EM-2831	31-7349	EM-5672	31-8071	EM-8063	31-8143	EM-8310
31-3942	EM-2832	31-7358	EM-5818	31-8073	EM-8073	31-8144	EM-8144
31-3943	EM-2833	31-7358	EM-9248	31-8074	EM-8074	31-8145	EM-8145
31-3945	EM-2835	31-8000	EM-8018	31-8075	EM-8075	31-8146	EM-8146
31-3946	EM-2836S	31-8001	EM-8001	31-8076	EM-8080	31-8147	EM-8303
31-3946HY	EM-2836	31-8002	EM-8002	31-8077	EM-8077	31-8148	EM-8148
31-3947	EM-2837S	31-8003	EM-8329	31-8078	EM-8078	31-8149	EM-8149
31-3947HY	EM-2837	31-8004	EM-8004	31-8079	EM-8079	31-8150	EM-8150
31-3948	EM-2838S	31-8005	EM-8005	31-8080	EM-8080	31-8151	EM-8151
31-3948HY	EM-2838	31-8006	EM-8006	31-8081	EM-8082	31-8152	EM-8152
31-3950	EM-2840S	31-8007	EM-8007	31-8082	EM-8082	31-8153	EM-8137
31-3950HY	EM-2840	31-8008	EM-8008	31-8083	EM-8083	31-8154	EM-8154
31-3951	EM-2841S	31-8009	EM-8009	31-8084	EM-8084	31-8155	EM-8132
31-3951HY	EM-2841	31-8010	EM-8010	31-8085	EM-8085	31-8156	EM-8324
31-3952	EM-2842S	31-8011	EM-8011	31-8086HY	EM-8086	31-8157	EM-8157
31-3952HY	EM-2842	31-8012	EM-8012	31-8087	EM-8087	31-8160	EM-8160
31-3953	EM-2843	31-8013	EM-8014	31-8088	EM-8088	31-8161	EM-8161
31-3954	EM-2844	31-8014	EM-8014	31-8089	EM-8089	31-8163	EM-8163
31-3955	EM-2845	31-8015	EM-8016	31-8090	EM-8516	31-8164	EM-8164
31-3956	EM-2846	31-8016	EM-8016	31-8091	EM-8091	31-8165	EM-8165
31-3957	EM-2847	31-8017	EM-8021	31-8092	EM-8080	31-8166	EM-8166
31-3958	EM-2848	31-8018	EM-8018	31-8093HY	EM-8093	31-8167	EM-8167
31-3959	EM-2849	31-8019	EM-8019	31-8094	EM-8094	31-8168	EM-8168
31-3960	EM-2854	31-8020	EM-8020	31-8095	EM-8095	31-8169	EM-8169
31-3961	EM-2855	31-8021	EM-8021	31-8096	EM-8096	31-8170	EM-8170
31-3962	EM-2857	31-8022	EM-8022	31-8097	EM-8097	31-8171	EM-8171
31-3963	EM-2850	31-8023	EM-8024	31-8098	EM-8098	31-8172	EM-8278
31-3964	EM-2851	31-8024	EM-8024	31-8099	EM-8099	31-8173	EM-8173
31-3965	EM-2852	31-8025	EM-8025	31-8100	EM-8100	31-8174	EM-8174
31-3966	EM-2853	31-8026	EM-8026	31-8101	EM-8101	31-8175	EM-8175
31-3967	EM-2856	31-8027	EM-8575	31-8102	EM-8102	31-8176	EM-8176
31-3968	EM-2858	31-8028	EM-8435	31-8103	EM-8103	31-8177	EM-8177
31-3969	EM-2859S	31-8029	EM-8029	31-8104	EM-8104	31-8178	EM-8178
31-3969HY	EM-2859	31-8031	EM-8031	31-8105	EM-8105	31-8179	EM-8179
31-3970	EM-2860	31-8032	EM-8021	31-8106	EM-8106	31-8180	EM-8180
31-3971	EM-2861	31-8033	EM-8010	31-8107	EM-8107	31-8181	EM-8181
31-3972	EM-2862	31-8034	EM-8034	31-8108	EM-8108	31-8182	EM-8211
31-3973	EM-2863	31-8035	EM-8431	31-8109	EM-8103	31-8183	EM-8183
31-3974	EM-2864	31-8036	EM-8012	31-8111	EM-8111	31-8184	EM-8183
31-3976	EM-2866	31-8037HY	EM-8037	31-8112	EM-8100	31-8185	EM-8185
31-3977	EM-2867	31-8038	EM-8103	31-8113	EM-8065	31-8186	EM-8186
31-3978	EM-3000	31-8039	EM-8039	31-8114	EM-8114	31-8187	EM-8187
31-3979	EM-3001	31-8040	EM-8040	31-8115	EM-8115	31-8188	EM-8188
31-3980	EM-3004	31-8041	EM-8041	31-8116	EM-8132	31-8189	EM-8189
31-3981	EM-3009	31-8042	EM-8042	31-8117	EM-8117	31-8190	EM-8190
31-4205	EM-9227	31-8043	EM-8042	31-8118	EM-8118	31-8191	EM-8191
31-4301	EM-9217	31-8044	EM-8044	31-8119	EM-8119	31-8192	EM-8192
31-4320	EM-9422	31-8045	EM-8045	31-8120	EM-8120	31-8193	EM-8193
31-4323	EM-5656	31-8046	EM-8100	31-8121	EM-8121	31-8194	EM-8194
31-4524	EM-9215	31-8047	EM-8047	31-8122	EM-8122	31-8195	EM-8195
31-4532	EM-9298	31-8048	EM-8048	31-8123	EM-8124	31-8196	EM-8196

# CROSS REFERENCE

Mfg Part No	Our Part	Mfg Part No	Our Part	Mfg Part No	Our Part	Mfg Part No	Our Part
CAR QUEST (cont.)		CAR QUEST (cont.)		CAR QUEST (cont.)		CAR QUEST (cont.)	
31-8197	EM-8197	31-8272	EM-8272	31-8346	EM-8194	31-8419	EM-8191
31-8198	EM-8198	31-8273	EM-8324	31-8347	EM-8002	31-8420	EM-8643
31-8199	EM-8485	31-8274	EM-8274	31-8348	EM-8348	31-8421	EM-8415
31-8200	EM-8200	31-8275	EM-8312	31-8349	EM-8349	31-8422	EM-8422
31-8201	EM-8201	31-8276	EM-8276	31-8350	EM-8348	31-8423	EM-8021
31-8205	EM-8205	31-8277	EM-8277	31-8351	EM-8351	31-8424	EM-8424
31-8206	EM-8206	31-8278	EM-8278	31-8352	EM-8352	31-8425	EM-8425
31-8207	EM-8207	31-8279	EM-8279	31-8353	EM-8353	31-8426	EM-8034
31-8208	EM-8208	31-8280	EM-8280	31-8354	EM-8344	31-8427	EM-8427
31-8209	EM-8209	31-8281	EM-8281	31-8355	EM-8195	31-8428	EM-8120
31-8210	EM-8210	31-8282	EM-8282	31-8356	EM-8195	31-8429	EM-8177
31-8211	EM-8211	31-8283	EM-8283	31-8357	EM-8193	31-8430	EM-8430
31-8212	EM-8212	31-8284	EM-8284	31-8358	EM-8213	31-8431	EM-8431
31-8213	EM-8213	31-8285	EM-8142	31-8359	EM-8359	31-8433	EM-8435
31-8214	EM-8214	31-8286	EM-8181	31-8360	EM-8014	31-8434	EM-8434
31-8218	EM-8218	31-8287	EM-8287	31-8361	EM-8361	31-8435	EM-8435
31-8219	EM-8211	31-8288	EM-8411	31-8362	EM-8485	31-8436	EM-8435
31-8220	EM-8220	31-8289	EM-8431	31-8363	EM-8363	31-8437	EM-8435
31-8221	EM-8221	31-8290	EM-8290	31-8364	EM-8166	31-8438	EM-8438
31-8222	EM-8222	31-8291	EM-8619	31-8365	EM-8365	31-8439	EM-8439
31-8223	EM-8223	31-8292	EM-8292	31-8366	EM-8207	31-8440	EM-8439
31-8224HY	EM-8224	31-8293	EM-8293	31-8367	EM-8368	31-8441	EM-8586
31-8225	EM-8225	31-8294	EM-8294	31-8368	EM-8368	31-8442	EM-8442
31-8226	EM-8102	31-8295	EM-8295	31-8369	EM-8482	31-8443	EM-8586
31-8227	EM-8223	31-8296	EM-8296	31-8370	EM-8190	31-8444	EM-8579
31-8228	EM-8228	31-8298	EM-8304	31-8371	EM-8201	31-8445	EM-8445
31-8229	EM-8229	31-8299	EM-8001	31-8372	EM-8208	31-8446	EM-8579
31-8230	EM-8230	31-8300	EM-8300	31-8373	EM-8014	31-8447	EM-8576
31-8231	EM-8231	31-8301	EM-8304	31-8374	EM-8374	31-8448	EM-8586
31-8232	EM-8232	31-8302	EM-8304	31-8375	EM-8375	31-8449	EM-8586
31-8233	EM-8233	31-8303	EM-8303	31-8376	EM-8167	31-8450	EM-8586
31-8234	EM-8234	31-8304	EM-8304	31-8377	EM-8377	31-8451	EM-8352
31-8235	EM-8235	31-8305	EM-2406	31-8378	EM-8214	31-8452	EM-8586
31-8236	EM-8236	31-8306	EM-8034	31-8379	EM-8375	31-8453	EM-8453
31-8237	EM-8224	31-8307	EM-8307	31-8380	EM-8179	31-8454	EM-8609
31-8238	EM-8238	31-8308	EM-8307	31-8381	EM-2409	31-8455	EM-8073
31-8239	EM-8239	31-8309	EM-8427	31-8382	EM-2690	31-8456	EM-8456
31-8240	EM-8431	31-8310	EM-8310	31-8384	EM-8384	31-8457	EM-8457
31-8241	EM-8073	31-8311	EM-8311	31-8385	EM-8385	31-8458	EM-8073
31-8242	EM-8242	31-8312	EM-8312	31-8386	EM-8187	31-8459	EM-8073
31-8243	EM-8243	31-8313	EM-8312	31-8387	EM-8389	31-8460	EM-8460
31-8244	EM-8244	31-8314	EM-8314	31-8389	EM-8389	31-8461	EM-8075
31-8245	EM-8424	31-8315	EM-8149	31-8390	EM-8389	31-8462	EM-8462
31-8246	EM-8517	31-8316	EM-8312	31-8392	EM-8392	31-8463	EM-8087
31-8247	EM-8004	31-8317	EM-8317	31-8393	EM-8393	31-8464	EM-8086
31-8248	EM-8248	31-8318	DS-8318	31-8394	EM-8393	31-8465	EM-8516
31-8249	EM-8031	31-8319	EM-8319	31-8395	EM-8395	31-8466	EM-8466
31-8250	EM-8014	31-8320	EM-8149	31-8396	EM-8197	31-8467	EM-8467
31-8251	EM-8014	31-8321	EM-8133	31-8397	EM-8197	31-8468	DS-8468
31-8252	EM-8019	31-8322	EM-8322	31-8398	EM-8398	31-8469	DS-8469
31-8253	EM-8253	31-8323	EM-8323	31-8399	EM-8398	31-8470	DS-8470
31-8254	EM-8254	31-8324	EM-8324	31-8400	EM-8400	31-8471	DS-8471
31-8255	EM-8255	31-8325	EM-8324	31-8401	EM-8401	31-8472	DS-8472
31-8256	EM-8586	31-8326	EM-8324	31-8402	EM-8402	31-8473	DS-8473
31-8257	EM-8586	31-8327	EM-8324	31-8404	EM-8404	31-8474	DS-8474
31-8258	EM-8586	31-8328	EM-8328	31-8405	EM-8197	31-8475	DS-8475
31-8259	EM-8259	31-8329	EM-8329	31-8406	EM-8406	31-8477	EM-8075
31-8260	EM-8424	31-8330	EM-8330	31-8407	EM-8407	31-8478	EM-8055
31-8261	EM-8261	31-8331	EM-8130	31-8408	EM-8385	31-8479	EM-8142
31-8262	EM-8262	31-8332	EM-8130	31-8409	EM-8385	31-8480	EM-8304
31-8263	EM-8263	31-8335	EM-8178	31-8410	EM-8197	31-8481	EM-8192
31-8264	EM-8080	31-8336	EM-8194	31-8411	EM-8411	31-8482	EM-8482
31-8265	EM-8094	31-8337	EM-8278	31-8412	EM-8413	31-8483	EM-8368
31-8266	EM-8266	31-8338	EM-8278	31-8413	EM-8413	31-8484	EM-8348
31-8267	EM-8267	31-8339	EM-8339	31-8414	EM-8414	31-8485	EM-8485
31-8268	EM-8103	31-8340	EM-8180	31-8415	EM-8415	31-8487	EM-8197
31-8269	EM-8584	31-8343	EM-8164	31-8416	EM-8175	31-8488	EM-8488
31-8270	EM-8270	31-8344	EM-8344	31-8417	EM-8175	31-8489	EM-8489
31-8271	EM-8271	31-8345	EM-8002	31-8418	EM-8418	31-8490	EM-8490



# CROSS REFERENCE

Mfg Part No	Our Part	Mfg Part No	Our Part	Mfg Part No	Our Part	Mfg Part No	Our Part
<b>CAR QUEST (cont.)</b>		<b>CAR QUEST (cont.)</b>		<b>CAR QUEST (cont.)</b>		<b>CAR QUEST (cont.)</b>	
31-8491	EM-8491	31-8565	DS-8565	31-8639	EM-8639	31-8711	EM-8711
31-8492	EM-8492	31-8566	EM-8566	31-8640	EM-8640	31-8712	EM-8041
31-8493	EM-8493	31-8567	EM-8124	31-8641	EM-8641	31-8713	EM-8041
31-8494	EM-8400	31-8568	EM-8568	31-8642	EM-8393	31-8714	EM-8042
31-8495	EM-8495	31-8569	EM-8568	31-8643	EM-8643	31-8715	EM-8715
31-8496	EM-8008	31-8571	EM-8571	31-8644	EM-8644	31-8716	EM-8716
31-8497	EM-8497	31-8572	EM-8572	31-8645	EM-8389	31-8717	EM-8717
31-8499	EM-8499	31-8573	EM-8010	31-8646	EM-8196	31-8718	EM-8718
31-8501	EM-2731	31-8574	EM-8574	31-8647	EM-8164	31-8719	EM-8719
31-8502	EM-8502	31-8575	EM-8575	31-8648	EM-8648	31-8720	EM-8719
31-8503	EM-8503	31-8576	EM-8576	31-8649	EM-8649	31-8721	EM-8721
31-8505	EM-2731	31-8577	EM-8577	31-8650	EM-8650	31-8722	EM-8722
31-8506	EM-8506	31-8578	EM-8578	31-8651	EM-8651	31-8723	EM-8723
31-8507	EM-8507	31-8579	EM-8579	31-8652	EM-8652	31-8724	EM-8724
31-8508	EM-8508	31-8580	EM-8055	31-8653	EM-8653	31-8725	EM-8725
31-8509	DS-8509	31-8581	EM-8512	31-8654	EM-8654	31-8726	EM-8727
31-8510	EM-8510	31-8582	EM-8582	31-8655	EM-8655	31-8727	EM-8727
31-8511	EM-8511	31-8584	EM-8584	31-8656	EM-8656	31-8728	EM-8728
31-8512	EM-8512	31-8585	EM-8205	31-8657	EM-8657	31-8729	EM-8729
31-8513	EM-8513	31-8586	EM-8586	31-8658	EM-8658	31-8730	EM-8730
31-8514	EM-8514	31-8587	DS-8587	31-8659	EM-8659	31-8731	EM-8731
31-8515	EM-8078	31-8588	DS-8588	31-8660	EM-8660	31-8732	EM-8732
31-8516	EM-8516	31-8589	EM-8589	31-8661	EM-8661	31-8733	EM-8733
31-8517	EM-8517	31-8590HY	EM-8663	31-8662HY	EM-8662	31-8734	EM-8734
31-8518	EM-8282	31-8591	DS-8591	31-8663HY	EM-8663	31-8736	EM-8736
31-8519	EM-8282	31-8592	EM-8592	31-8664	EM-8664	31-8737	EM-8044
31-8520	EM-8490	31-8593	EM-8593	31-8665	EM-8665	31-8738	EM-8738
31-8521	EM-8521	31-8594	EM-8594	31-8666	EM-8165	31-8739	EM-8738
31-8522	EM-8522	31-8595	EM-8595	31-8667	EM-8667	31-8740	EM-8740
31-8523	EM-8524	31-8596	EM-8596	31-8668	EM-8668	31-8741	EM-8741
31-8524	EM-8524	31-8597	EM-8597	31-8669	EM-8669	31-8742	EM-8742
31-8525	EM-8525	31-8598	EM-8598	31-8670	EM-8670	31-8743	EM-8743
31-8526	EM-8576	31-8599	EM-8599	31-8672	EM-8672	31-8744	EM-8744
31-8527	EM-8314	31-8600	EM-8600	31-8673	EM-8672	31-8745	EM-8745
31-8528	EM-8197	31-8601	EM-8601	31-8674	EM-8674	31-8746	EM-8746
31-8529	EM-8529	31-8602	EM-8602	31-8675	EM-8675	31-8747	EM-8747
31-8530	DS-8531	31-8603	EM-8603	31-8676	EM-8676	31-8748	EM-8748
31-8531	DS-8531	31-8604	EM-8604	31-8677	EM-8677	31-8749	EM-8788
31-8532	DS-8532	31-8605	EM-8605	31-8678	EM-8678	31-8750	EM-8750
31-8533	DS-8533	31-8606	EM-8606	31-8679	EM-8679	31-8751	EM-8751
31-8535	DS-8535	31-8607	EM-8607	31-8680	EM-8680	31-8752	EM-8752
31-8536	EM-8005	31-8608	EM-8608	31-8681	EM-8681	31-8753	EM-8753
31-8537	EM-8402	31-8609	EM-8609	31-8682	EM-8682	31-8754	EM-8754
31-8538	DS-8538	31-8611	EM-8611	31-8683	EM-8683	31-8755	EM-8755
31-8539	EM-8539	31-8612	EM-8612	31-8684	EM-8684	31-8756	EM-8756
31-8540	EM-8803	31-8613	EM-8612	31-8685	EM-8685	31-8757	EM-8757
31-8541	EM-8803	31-8614	EM-8614	31-8686	EM-8686	31-8758	EM-8758
31-8542	EM-8542	31-8615	EM-8615	31-8687	EM-8687	31-8759	EM-8759
31-8543	EM-8544	31-8616	EM-8616	31-8688	EM-8688	31-8760	EM-8760
31-8544	EM-8544	31-8617	EM-8617	31-8689	EM-8689	31-8761	EM-8042
31-8545	EM-8545	31-8618	EM-8236	31-8690	EM-8690	31-8762	EM-8762
31-8546	EM-8548	31-8619	EM-8619	31-8691	EM-8691	31-8763	EM-8762
31-8547	EM-8548	31-8620	EM-8620	31-8692	EM-8692	31-8764	EM-8764
31-8548	EM-8548	31-8621	EM-8621	31-8693	EM-8693	31-8765	EM-8788
31-8549	DS-8549	31-8622HY	EM-8622	31-8694	EM-8694	31-8766	EM-8597
31-8550	DS-8550	31-8623	EM-8623	31-8695	EM-8695	31-8767	EM-8597
31-8551	DS-8551	31-8624	EM-8594	31-8696	EM-8696	31-8768	EM-8768
31-8552	EM-8552	31-8626	DS-8626	31-8697	EM-8697	31-8769	EM-8769
31-8553	EM-8553	31-8627	DS-8627	31-8698	EM-8698	31-8770	EM-8770
31-8554	EM-8554	31-8628	EM-8229	31-8699	EM-8699	31-8771	EM-8771
31-8555	EM-8103	31-8629	EM-8629	31-8700	EM-8700	31-8772	EM-8772
31-8556	EM-8556	31-8630	EM-8630	31-8701	EM-8701	31-8773	EM-8774
31-8557	EM-8107	31-8631	EM-8631	31-8703	EM-2855	31-8774	EM-8774
31-8558	EM-8205	31-8632	EM-8632	31-8704	EM-8704	31-8775	EM-8775
31-8559	EM-8559	31-8633	EM-8230	31-8705	EM-8705	31-8776	EM-8775
31-8560	EM-8560	31-8634	DS-8634	31-8706	EM-2856	31-8777	EM-8778
31-8561	EM-8068	31-8635	DS-8635	31-8707	EM-2857	31-8778	EM-8778
31-8562	EM-8095	31-8636	DS-8636	31-8709	EM-8709	31-8779	EM-8778
31-8563	EM-8563	31-8638HY	EM-8663	31-8710	EM-8710	31-8780	EM-8780

# CROSS REFERENCE

Mfg Part No	Our Part	Mfg Part No	Our Part	Mfg Part No	Our Part	Mfg Part No	Our Part
<b>CAR QUEST (cont.)</b>		<b>CAR QUEST (cont.)</b>		<b>CAR QUEST (cont.)</b>		<b>CAR QUEST (cont.)</b>	
31-8781	EM-8781	31-8850	EM-8850	31-8919	EM-8919	31-8986	EM-8986
31-8782	EM-8782	31-8851	EM-8851	31-8920	EM-8920	31-8987	EM-8987
31-8783	EM-8783	31-8852	EM-8852	31-8921	EM-8921	31-8988	EM-8988
31-8784	EM-8784	31-8853	EM-8853	31-8922	EM-8921	31-8989	EM-8989
31-8785	EM-8783	31-8854	EM-8854	31-8923	EM-8923	31-8990	EM-8990
31-8786	EM-8786	31-8855	EM-8855	31-8924	EM-8923	31-8991	EM-8991
31-8787	EM-8787	31-8856	EM-8856	31-8925	EM-8925	31-8992	EM-8992
31-8788	EM-8788	31-8857	EM-8857	31-8926	EM-8926	31-8993	EM-8993
31-8789	EM-8789	31-8858	EM-8858	31-8927	EM-8921	31-8994	EM-8994
31-8790	EM-8790	31-8859	EM-8859	31-8928	EM-8928	31-8995	EM-8995
31-8791	EM-8791	31-8860	EM-8860	31-8929	EM-8929	31-8996	EM-8996
31-8792	EM-8792	31-8861	EM-8460	31-8930	EM-8930	31-8997HY	EM-8997
31-8793	EM-8793	31-8862	EM-8862	31-8931	EM-8931	31-8998HY	EM-8998
31-8794	EM-8794	31-8863	EM-8863	31-8932	EM-8932	31-8999	EM-8999
31-8795	EM-8795	31-8864	EM-8864	31-8933	EM-8933	31-9000	EM-9000
31-8796	EM-8796	31-8865	EM-8865	31-8934	EM-8934	31-9001HY	EM-9001
31-8797	EM-8797	31-8866	EM-8866	31-8935	EM-8935	31-9002	EM-9002
31-8798	EM-8798	31-8867	EM-8867	31-8936	EM-8936	31-9003HY	EM-9003
31-8799	EM-8799	31-8868	EM-8868	31-8937	EM-8937	31-9004HY	EM-9004
31-8800	EM-8800	31-8869	EM-8869	31-8938	EM-8938	31-9005HY	EM-9005
31-8801	EM-8801	31-8870	EM-8870	31-8939	EM-8939	31-9006HY	EM-8795
31-8802	EM-8802	31-8871	EM-8871	31-8940	EM-8940	31-9007HY	EM-9007
31-8803	EM-8803	31-8872	EM-8872	31-8941	EM-8941	31-9008HY	EM-9008
31-8804	EM-8804	31-8873	EM-8873	31-8942	EM-8943	31-9009HY	EM-9009
31-8805	EM-8805	31-8874	EM-8874	31-8943	EM-8943	31-9010	EM-9010
31-8806	EM-8806	31-8875	EM-8875	31-8944	EM-8944	31-9011	EM-9011
31-8807	EM-8807	31-8876	EM-8876	31-8945	EM-8945	31-9012	EM-9012
31-8808	EM-8681	31-8877	EM-8877	31-8946	EM-8945	31-9013	EM-9013
31-8809	EM-8296	31-8878	EM-8878	31-8947	EM-8947	31-9014	EM-9014
31-8810	EM-8296	31-8879	EM-8879	31-8948	EM-8948	31-9015	EM-9015
31-8811	EM-8811	31-8880	EM-8880	31-8949	EM-8949	31-9016	EM-9016
31-8812	EM-8812	31-8881	EM-8881	31-8950	EM-8950	31-9017HY	EM-9017
31-8813	EM-8813	31-8882	EM-8882	31-8951	EM-8951	31-9018	EM-9018
31-8814	EM-8814	31-8883	EM-8883	31-8952	EM-8952	31-9019	EM-9019
31-8815	EM-8093	31-8884	EM-8884	31-8953	EM-8953	31-9020	EM-9020
31-8816	EM-8816	31-8885	EM-8885	31-8954	EM-8954	31-9021HY	EM-9021
31-8817	EM-8817	31-8886	EM-8886	31-8954HY	EM-8954	31-9022	EM-9022
31-8818	EM-8818	31-8887	EM-8887	31-8955	EM-8955	31-9023	EM-9023
31-8819	EM-8819	31-8888	EM-8888	31-8956	EM-8956	31-9024	EM-9024
31-8820	EM-8820	31-8889	EM-8889	31-8957	EM-8957	31-9025	EM-9025
31-8821	EM-8821	31-8890	EM-8890	31-8958	EM-8958	31-9026	EM-9026
31-8822	EM-8822	31-8891	EM-8891	31-8959	EM-8959	31-9027	EM-9027
31-8823	EM-8823	31-8892	EM-8892	31-8960	EM-8960	31-9028	EM-9028
31-8824	EM-8824	31-8893	EM-8893	31-8961	EM-8961	31-9029	EM-9029
31-8825	EM-8825	31-8894	EM-8894	31-8962	EM-8962	31-9030	EM-9030
31-8826	EM-8826	31-8895	EM-8895	31-8963	EM-8963	31-9031	EM-9031
31-8827HY	EM-8663	31-8896	EM-8896	31-8964	EM-8964	31-9032	EM-9032
31-8828HY	EM-8828	31-8897	EM-8897	31-8965	EM-8965	31-9033	EM-9033
31-8829HY	EM-8829	31-8898	EM-8898	31-8966	EM-8966	31-9034	EM-9034
31-8830	EM-8830	31-8899	EM-8899	31-8967	EM-8967	31-9035	EM-9035
31-8831	EM-8831	31-8900	EM-8900	31-8967HY	EM-8967	31-9036	EM-2985
31-8832HY	EM-8832	31-8901	EM-8901	31-8968	EM-8968	31-9037	EM-9037
31-8833HY	EM-8832	31-8902	EM-8902	31-8969	EM-8644	31-9038	EM-9038
31-8834HY	EM-8834	31-8903	EM-8903	31-8970	EM-8970	31-9039	EM-9039
31-8835HY	EM-8835	31-8904	EM-8904	31-8971	EM-8971	31-9040	EM-9040
31-8836HY	EM-8836	31-8905	EM-8905	31-8972	EM-8008	31-9041	EM-9041
31-8837HY	EM-8834	31-8906	EM-8906	31-8973	EM-8973	31-9042	EM-9042
31-8838HY	EM-8838	31-8907	EM-8907	31-8974	EM-8974	31-9043HY	EM-9043
31-8839HY	EM-8832	31-8908	EM-8908	31-8975	EM-8975	31-9044HY	EM-9044
31-8840HY	EM-8832	31-8909	EM-8909	31-8976	EM-8976	31-9045	EM-9045
31-8841	EM-8616	31-8910	EM-8910	31-8977	EM-8977	31-9046	EM-9046
31-8842	EM-8616	31-8911	EM-8911	31-8978	EM-8978	31-9047	EM-9047
31-8843	EM-8843	31-8912	EM-8912	31-8979	EM-8979	31-9048	EM-9048
31-8844	EM-8616	31-8913	EM-8913	31-8980	EM-8980	31-9049	EM-9049
31-8845	EM-8845	31-8914	EM-8914	31-8981	EM-8981	31-9050	EM-9050
31-8846	EM-8846	31-8915	EM-8915	31-8982	EM-8982	31-9051	EM-9051
31-8847	EM-8847	31-8916	EM-8916	31-8983	EM-8983	31-9052	EM-9018
31-8848	EM-8848	31-8917	EM-8917	31-8984HY	EM-8984	31-9053	EM-9053
31-8849	EM-8849	31-8918	EM-8918	31-8985	EM-8985	31-9054	EM-9054

# CROSS REFERENCE

Mfg Part No	Our Part	Mfg Part No	Our Part	Mfg Part No	Our Part	Mfg Part No	Our Part
<b>CAR QUEST (cont.)</b>		<b>CAR QUEST (cont.)</b>		<b>CAR QUEST (cont.)</b>		<b>CAR QUEST (cont.)</b>	
31-9055	EM-9055	31-9125	EM-9125	31-9195	EM-2469	31-9270	DS-6051
31-9056	EM-9056	31-9126	EM-2910	31-9196	EM-2470	33-5364	EM-2949
31-9057	EM-9057	31-9127	EM-9127	31-9197	EM-2458	33-7139	EM-9312
31-9058	EM-9058	31-9128HY	EM-9128	31-9198	EM-2457	33-8341	EM-9055
31-9059	EM-9059	31-9129HY	EM-9129	31-9199	EM-2503	35-6027	DS-6027
31-9060	EM-9060	31-9130	EM-9130	31-9200	EM-2504	35-6028	DS-6028
31-9061	EM-9061	31-9131	EM-9131	31-9201	EM-2500	35-6035	DS-6035
31-9062	EM-9062	31-9132	EM-2649	31-9202	EM-2550	35-6036	DS-6056
31-9063	EM-9063	31-9133	EM-9133	31-9203	EM-2551S	35-6047	DS-6038
31-9064	EM-9064	31-9134	EM-9134	31-9204	EM-2562	35-6049	DS-6040
31-9065HY	EM-9065	31-9135	EM-8681	31-9205	EM-2563	35-6050	DS-6048
31-9066	EM-9066	31-9136	EM-9136	31-9206	EM-2538	35-6051	DS-6049
31-9067	EM-9067	31-9137	EM-9137	31-9207	EM-8225	35-6053	DS-6051
31-9068	EM-9068	31-9138	EM-9138	31-9208	EM-2660	35-6055	DS-6052
31-9069	EM-8261	31-9139	EM-9139	31-9209	EM-2717S	35-6058	DS-6053
31-9070	EM-9070	31-9140	EM-9140	31-9210	EM-2351	35-6061	DS-6061
31-9071	EM-9071	31-9141	EM-9141	31-9211	EM-8239	35-6062	DS-6062
31-9072	EM-9072	31-9142	EM-9142	31-9212	EM-2681	35-9277	EM-8402
31-9073	EM-9073	31-9143	EM-9143	31-9213	EM-8568	35-9278	EM-8497
31-9074	EM-9074	31-9144	EM-9144	31-9214	EM-8100	35-9279	EM-8662
31-9075	EM-8895	31-9145HY	EM-9145	31-9215	EM-8073	35-9280	EM-8266
31-9076	EM-9076	31-9146HY	EM-8207	31-9216	EM-2326	35-9281	EM-8979
31-9077	EM-9077	31-9147	EM-9147	31-9217	EM-3006	35-9282	EM-8485
31-9078	EM-9078	31-9148	EM-2835	31-9218	EM-2912	35-9283	EM-8485
31-9079	EM-9079	31-9149	EM-2696S	31-9220	EM-8107	35-9284	EM-8303
31-9080	EM-9080	31-9150	EM-8104	31-9221	EM-8100	35-9286	EM-2406
31-9081	EM-9081	31-9151	EM-2709	31-9222	EM-8238	35-9288	EM-8012
31-9082	EM-9082	31-9152	EM-2803S	31-9223	EM-8456	35-9289	EM-2681
31-9083HY	EM-9083	31-9153	EM-8010	31-9225	EM-8584	35-9292	EM-8803
31-9084	EM-9084	31-9154	EM-8100	31-9226	EM-8691	35-9293	EM-8200
31-9085	EM-9085	31-9155	EM-2959	31-9227	EM-8188	35-9294	EM-8208
31-9086	EM-9086	31-9156	EM-2902	31-9228	EM-3048	35-9295	EM-8643
31-9087	EM-9087	31-9157	EM-2903	31-9229	EM-2819	35-9296	EM-8175
31-9088	EM-9088	31-9158	EM-8239	31-9230	EM-2876	35-9297	EM-8209
31-9089	EM-9089	31-9159	EM-2493	31-9231HY	EM-2836	35-9298	EM-8681
31-9090	EM-9090	31-9160	EM-2829	31-9232HY	EM-2804	35-9299	EM-8006
31-9091	EM-9091	31-9161	EM-2838	31-9233	EM-2893	35-9300	EM-8665
31-9092HY	EM-9092	31-9162	EM-2859	31-9234	EM-2837S	35-9302	EM-2744
31-9093	EM-9093	31-9163	EM-2007	31-9237	EM-2073	35-9303	EM-8255
31-9094	EM-9094	31-9164	EM-2050	31-9238	EM-2126	35-9304	EM-8122
31-9095	EM-9095	31-9165	EM-2091	31-9239	EM-2127	35-9305	EM-8078
31-9096	EM-9096	31-9166	EM-2092	31-9240	EM-2268	35-9306	EM-8292
31-9097HY	EM-9003	31-9167	EM-2110	31-9241	EM-2171	35-9307	EM-5067
31-9098	EM-9098	31-9168	EM-2120	31-9242	EM-2216	35-9309	EM-8055
31-9099	EM-9099	31-9169	EM-2142	31-9243	EM-2217	35-9310	EM-8259
31-9100	EM-9100	31-9171	EM-2218	31-9244	EM-2349	35-9311	EM-8512
31-9101HY	EM-9101	31-9172	EM-2238	31-9245	EM-2253	35-9312	EM-8079
31-9102	EM-9102	31-9173	EM-2287	31-9246	EM-2288	35-9314	EM-8224
31-9103	EM-9103	31-9174	EM-2250	31-9247	EM-2294	35-9315	EM-9000
31-9104	EM-9104	31-9175	EM-2270	31-9248	EM-2302	35-9316	EM-9004
31-9105	EM-9105	31-9176	EM-2271	31-9249	EM-2307	35-9317	EM-9005
31-9106	EM-9106	31-9178	EM-2296	31-9250	EM-2372	35-9318	EM-8593
31-9107	EM-9107	31-9179	EM-2275	31-9251	EM-2349	35-9320	EM-8138
31-9108	EM-9108	31-9180	EM-2276	31-9252	EM-2525	35-9321	EM-8402
31-9109	EM-9109	31-9181	EM-2277	31-9253	EM-2374	35-9322	EM-8435
31-9110HY	EM-9110	31-9182	EM-2279	31-9254	EM-2388	35-9323	EM-8103
31-9111	EM-9111	31-9183	EM-2303	31-9255	EM-2392	35-9324	EM-8132
31-9112	EM-2410	31-9184	EM-2319	31-9256	EM-2471	35-9325	EM-8119
31-9113	EM-9113	31-9185	EM-2328	31-9257	EM-2508	35-9326	EM-8641
31-9114	EM-9114	31-9186	EM-2356	31-9259	EM-2565	35-9327	EM-8641
31-9115	EM-9115	31-9187	EM-2357	31-9260	EM-2712	35-9328	EM-8209
31-9116	EM-9116	31-9188	EM-2367	31-9261	EM-2750	35-9329	EM-8270
31-9117	EM-9117	31-9189	EM-2368	31-9262	EM-2751	35-9330	EM-8164
31-9118	EM-9118	31-9190	EM-2370	31-9263	EM-2730	35-9331	EM-8349
31-9120	EM-9120	31-9191	EM-2387	31-9264	EM-2857	35-9332	EM-8213
31-9121	EM-9121	31-9192	EM-2395	31-9265	EM-2858	35-9333	EM-8283
31-9122	EM-9122	31-9193	EM-2436	31-9267	EM-2884	35-9334	EM-8663
31-9123	EM-9123	31-9194	EM-2600	31-9268	EM-8503	35-9335	EM-8639
31-9124	EM-9124	31-9195	EM-2457	31-9269	EM-8544	35-9336	EM-8828

**CROSS REFERENCE**

Mfg Part No	Our Part	Mfg Part No	Our Part	Mfg Part No	Our Part	Mfg Part No	Our Part
<b>CAR QUEST (cont.)</b>		<b>CAR QUEST (cont.)</b>		<b>DEA (cont.)</b>		<b>DEA (cont.)</b>	
35-9337	EM-8829	33-10773	EM-3151	A2172	EM-2172	A2290	EM-2290
35-9338	EM-8832	33-10774	EM-3150	A2201	EM-5401	A2291	EM-2291
35-9339	EM-8834	33-10776	EM-3136	A2204	EM-2204	A2292	EM-2292
35-9340	EM-8834	33-10777	EM-3151	A2205	EM-2205	A2293	EM-2293
35-9341	EM-8836	33-10778	EM-3150	A2206	EM-2206	A2294	EM-2294
35-9342	EM-8834	33-10863	EM-9426	A2215	EM-2268	A2295	EM-2295
35-9343	EM-8838	33-10936	EM-4044	A2216	EM-2216	A2296	EM-2296
35-9344	EM-8832	33-10972	EM-5994	A2217	EM-2217	A2297	EM-2297
35-9345	EM-8193	33-11067	EM-9445	A2218	EM-2218	A2298	EM-2298
35-9346	EM-2409	33-11186	EM-4027	A2219	EM-2219	A2299	EM-2299
35-9348	EM-8063	33-11187	EM-5515	A2220	EM-2220	A2300	EM-2512
35-9349	EM-2742	33-11191	EM-4047	A2221	EM-2221	A2301	EM-2301
35-9350	EM-8644	33-11218	EM-4095	A2222	EM-2222	A2302	EM-2302
35-9351	EM-8277	33-11518	EM-3135	A2223	EM-2223	A2303	EM-2303
35-9352	EM-8041	33-11685	EM-4017	A2225	EM-2225	A2304	EM-2304
35-9353	EM-8303	33-11686	EM-9428	A2226	EM-2226	A2305	EM-2305
35-9354	EM-8140	33-11687	EM-5784	A2227	EM-2227	A2306	EM-2306
35-9355	EM-8140	33-11688	EM-4000	A2228	EM-2228	A2307	EM-2307
35-9356	EM-8374	33-11688	EM-4001	A2231	EM-2231	A2309	EM-2309
35-9357	EM-9095	33-11689	EM-4019	A2234	EM-2234	A2310	EM-2310
35-9358	EM-8593	33-11690	EM-9417	A2235	EM-2235	A2311	EM-2311
35-9359	EM-2487	33-11691	EM-5784	A2236	EM-2349	A2314	EM-2369
35-9360	EM-2487	33-11700	EM-5793	A2238	EM-2238	A2316	EM-2316
35-9362	EM-8214	33-11813	EM-4049	A2239	EM-2282	A2317	EM-2317
35-9363	EM-8018	33-12004	EM-3087	A2240	EM-2240	A2319	EM-2319
35-9364	EM-8151	37-10018	DS-6066	A2241	EM-2241	A2320	EM-2320
35-9365	EM-8218	37-10110	DS-6079	A2242	EM-2242	A2321	EM-2321
35-9366	EM-8222	37-10123	DS-6100	A2244	EM-2287	A2323	EM-2323
35-9367	EM-8586	37-10124	DS-6079	A2245	EM-2142	A2324	EM-2324
35-9368	EM-8586	<b>DEA</b>		A2246	EM-2142	A2325	EM-2325
35-9369	EM-8236	A2007	EM-2007	A2247	EM-2240	A2326	EM-2326
35-9370	EM-8672	A2009	EM-2009	A2248	EM-2241	A2327	EM-2327
35-9371	EM-9060	A2010	EM-2010	A2249	EM-2249	A2328	EM-2328
35-9374	EM-8614	A2014	EM-2014	A2250	EM-2250	A2329	EM-2329
33-10009	EM-9205	A2018	EM-2018	A2253	EM-2253	A2330	EM-2330
33-10080	EM-9247	A2039	EM-2039	A2254	EM-2254	A2331	EM-2331
33-10082	EM-5840	A2040	EM-2040	A2255	EM-2255	A2332	EM-2332
33-10085	EM-5795	A2041	EM-2041	A2256	EM-2256	A2333	EM-2333
33-10126	EM-9527	A2048	EM-2048	A2257	EM-2257	A2334	EM-2250
33-10133	EM-3037	A2050	EM-2050	A2258	EM-2253	A2335	EM-2335
33-10149	EM-5734	A2053	EM-2053	A2261	EM-2261	A2336	EM-2336
33-10189	EM-5844	A2055	EM-5465	A2262	EM-2262	A2337	EM-2337
33-10197	EM-5846	A2057	EM-2057	A2263	EM-2263	A2338	EM-2338
33-10292	EM-5672	A2060	EM-2060	A2264	EM-2264	A2339	EM-2339
33-10293	EM-5132	A2070	EM-2070	A2265	EM-2265	A2340	EM-2340
33-10294	EM-5818	A2073	EM-2073	A2266	EM-2266	A2341	EM-2341
33-10295	EM-5647	A2091	EM-2091	A2267	EM-2267	A2344	EM-2344
33-10296	EM-5649	A2092	EM-2092	A2268	EM-2268	A2345	EM-2345
33-10297	EM-5835	A2107	EM-2107	A2268C	EM-2268	A2346	EM-2346
33-10298	EM-9599	A2108	EM-2108	A2270	EM-2270	A2347	EM-2347
33-10300	EM-5837	A2110	EM-2110	A2271	EM-2271	A2348	EM-2348
33-10301	EM-9494	A2119	EM-2119	A2272	EM-2272	A2349	EM-2349
33-10302	EM-9420	A2120	EM-2120	A2273	EM-2274	A2350	EM-2350
33-10305	EM-9299	A2121	EM-2121	A2274	EM-2274	A2351	EM-2351
33-10306	EM-9427	A2122	EM-2122	A2275	EM-2275	A2353	EM-2353
33-10307	EM-9423	A2123	EM-2123	A2276	EM-2276	A2356	EM-2356
33-10308	EM-3096	A2124	EM-2124	A2277	EM-2277	A2357	EM-2357
33-10309	EM-4018	A2125	EM-2125	A2278	EM-2278	A2358	EM-2358
33-10310	EM-9313	A2126	EM-2126	A2279	EM-2279	A2359	EM-2359
33-10311	EM-9454	A2127	EM-2127	A2280	EM-2280	A2360	EM-2360
33-10312	EM-5861	A2141	EM-2141	A2281	EM-2281	A2361	EM-2349
33-10312	EM-9546	A2142	EM-2142	A2282	EM-2282	A2362	EM-2362
33-10313	EM-9538	A2143	EM-2143	A2283	EM-2283	A2363	EM-2363
33-10483	EM-4097	A2150	EM-2150	A2284	EM-2284	A2364	EM-2364
33-10509	EM-4022	A2162	EM-2162	A2285	EM-2285	A2365	EM-2365
33-10583	EM-5741	A2163	EM-2163	A2286	EM-2286	A2366	EM-2525
33-10749	EM-9507	A2167	EM-2167	A2287	EM-2287	A2367	EM-2367
33-10750	EM-9507	A2170	EM-2170	A2288	EM-2288	A2368	EM-2368
33-10772	EM-2884	A2171	EM-2171	A2289	EM-2289	A2369	EM-2369

# CROSS REFERENCE

Mfg Part No	Our Part	Mfg Part No	Our Part	Mfg Part No	Our Part	Mfg Part No	Our Part
DEA (cont.)		DEA (cont.)		DEA (cont.)		DEA (cont.)	
A2370	EM-2370	A2452	EM-2452	A2521	EM-2500	A2609	EM-2609
A2371	EM-2371	A2453	EM-2453	A2522	EM-2501	A2610	EM-2538
A2372	EM-2372	A2454	EM-2454	A2523	EM-2500	A2611	EM-2538
A2373	EM-2373	A2455	EM-2600	A2524	EM-2524	A2612	EM-2538
A2374	EM-2374	A2456	EM-2456	A2525	EM-2525	A2613	EM-2538
A2375	EM-2375	A2457	EM-2457	A2526	EM-2528	A2614	EM-2601
A2376	EM-2376	A2458	EM-2458	A2527	EM-2528	A2615	EM-2615
A2377	EM-2370	A2459	EM-2459	A2528	EM-2528	A2616	EM-2616
A2378	EM-2378	A2460	EM-2460	A2529	EM-2497	A2617	EM-2617
A2379	EM-2379	A2461	EM-2461	A2530	EM-2388	A2618	EM-2618
A2381	EM-2381	A2462	EM-2462	A2531	EM-2531	A2619	EM-2619
A2382	EM-2382	A2463	EM-2463	A2532	EM-2532	A2620	EM-2620
A2383	EM-2382	A2464	EM-2464	A2533	EM-2533	A2621	EM-2621
A2384	EM-2384	A2465	EM-2436	A2534	EM-2534	A2622	EM-2622
A2385	EM-2385	A2466	EM-2466	A2535	EM-2436	A2623	EM-2623
A2387	EM-2387	A2467	EM-2467	A2536	EM-2536	A2624	EM-2624
A2388	EM-2388	A2468	EM-2469	A2537	EM-2537	A2625	EM-2625
A2389	EM-2389	A2469	EM-2469	A2538	EM-2538	A2626	EM-2626
A2390	EM-2389	A2470	EM-2470	A2539	EM-2538	A2627	EM-2627
A2391	EM-2391	A2471	EM-2471	A2540	EM-2538	A2628	EM-2628
A2392	EM-2392	A2472	EM-2472	A2541	EM-2538	A2629	EM-2629
A2393	EM-2393	A2473	EM-2473	A2542	EM-2538	A2630	EM-2630
A2394	EM-2394	A2474	EM-2474	A2543	EM-2543	A2631	EM-2631
A2395	EM-2395	A2475	EM-2549	A2544	EM-2531	A2632	EM-2632
A2396	EM-2396	A2476	EM-2550	A2545	EM-2457	A2633	EM-2633
A2400	EM-2400	A2477	EM-2477	A2546	EM-2458	A2634	EM-2634
A2401	EM-2401	A2478	EM-2381	A2547	EM-2458	A2635	EM-2635
A2402	EM-2402	A2479	EM-2457	A2548	EM-2548S	A2636	EM-2636
A2403	EM-2403	A2480	EM-2458	A2548HY	EM-2548	A2637	EM-2637
A2404	EM-2404	A2481	EM-2457	A2549	EM-2549	A2638	EM-2638
A2405	EM-2405	A2482	EM-2457	A2550	EM-2550	A2639	EM-2639
A2406	EM-2406	A2483	EM-2458	A2551	EM-2551S	A2640	EM-2640
A2407	EM-2407	A2484	EM-2458	A2551HY	EM-2551	A2641	EM-2641
A2408	EM-2408	A2485	EM-2458	A2552	EM-2551S	A2642	EM-2642
A2409	EM-2409	A2486	EM-2458	A2552HY	EM-2551	A2643	EM-2643
A2410	EM-2410	A2487	EM-2487	A2553	EM-2553S	A2644	EM-2644
A2411	EM-9076	A2488	EM-2488	A2553HY	EM-2553	A2645	EM-2645
A2413	EM-2413	A2489	EM-2489	A2554	EM-2551S	A2646	EM-2646
A2414	EM-2414	A2490	EM-2490	A2554HY	EM-2551	A2647	EM-2646
A2415	EM-2415	A2491	EM-2491	A2555	EM-2555S	A2648	EM-2815
A2417	EM-2417	A2492	EM-2492	A2555HY	EM-2555	A2649	EM-2649
A2418	EM-2418	A2493	EM-2493	A2556	EM-2556S	A2650	EM-2650
A2419	EM-2419	A2494	EM-2494	A2556HY	EM-2556	A2651	EM-2651
A2420	EM-2420	A2495	EM-2495	A2557	EM-2557	A2652	EM-2652
A2421	EM-2421	A2496	EM-2496	A2558	EM-2558	A2653	EM-2653
A2424	EM-2424	A2497	EM-2497	A2559	EM-2559	A2654	EM-2654
A2425	EM-2425	A2498	EM-2498	A2560	EM-2557	A2655	EM-2655
A2426	EM-2426	A2499	EM-2499	A2561	EM-2528	A2656	EM-2656
A2427	EM-2427	A2500	EM-2500	A2562	EM-2562	A2657	EM-2657
A2428	EM-2428	A2501	EM-2501	A2563	EM-2563	A2658	EM-2658
A2429	EM-2429	A2502	EM-2502	A2564	EM-2564	A2660	EM-2660S
A2433	EM-2433	A2503	EM-2503	A2565	EM-2565	A2660HY	EM-2660
A2434	EM-2434	A2504	EM-2504	A2566	EM-2566	A2661	EM-2661S
A2435	EM-2436	A2505	EM-2505	A2567	EM-2567	A2661HY	EM-2661
A2436	EM-2436	A2506	EM-2506	A2568	EM-2568	A2662	EM-2662
A2437	EM-2437	A2507	EM-2395	A2569	EM-2569	A2663	EM-2663
A2438	EM-2438	A2508	EM-2508	A2570	EM-2570	A2664	EM-2664
A2439	EM-2439	A2509	EM-2436	A2571	EM-2571	A2665	EM-2665
A2440	EM-2440	A2510	EM-2510	A2572	EM-2572	A2666	EM-2639
A2441	EM-2441	A2511	EM-2466	A2573	EM-2528	A2667	EM-2667
A2442	EM-2442	A2512	EM-2512	A2600	EM-2600	A2668	EM-2668
A2444	EM-2444	A2513	EM-2513	A2601	EM-2601	A2669	EM-2657
A2445	EM-2445	A2514	EM-2515	A2602	EM-2601	A2670	EM-2658
A2446	EM-2446	A2515	EM-2515	A2603	EM-2601	A2671	EM-2671
A2447	EM-2447	A2516	EM-2394	A2604	EM-2601	A2672	EM-2394
A2448	EM-2448	A2517	EM-2292	A2605	EM-2601	A2673	EM-2673
A2449	EM-2449	A2518	EM-2501	A2606	EM-2601	A2674	EM-2674
A2450	EM-2451	A2519	EM-2500	A2607	EM-2601	A2675	EM-2675
A2451	EM-2451	A2520	EM-2501	A2608	EM-2601	A2676	EM-2676

# CROSS REFERENCE

Mfg Part No	Our Part	Mfg Part No	Our Part	Mfg Part No	Our Part	Mfg Part No	Our Part
DEA (cont.)		DEA (cont.)		DEA (cont.)		DEA (cont.)	
A2677	EM-2677	A2748	EM-2748	A2811	EM-2817	A2869	EM-2869
A2678	EM-2678	A2749	EM-2749	A2812	EM-2812S	A2870	EM-2870
A2679	EM-2679	A2750	EM-2750	A2812HY	EM-2812	A2871	EM-2871
A2680	EM-2680	A2751	EM-2751	A2813	EM-2813S	A2872	EM-2872
A2681	EM-2681	A2752	EM-2752	A2813HY	EM-2813	A2873	EM-2873
A2682	EM-2682	A2753	EM-2753	A2814	EM-2814	A2873HY	EM-2837
A2683	EM-2683	A2754	EM-2754	A2815	EM-2815	A2874	EM-2874
A2684	EM-2684	A2755	EM-2755	A2816	EM-2816	A2875	EM-2875
A2685	EM-2685	A2756	EM-2756	A2817	EM-2817	A2876	EM-2876S
A2686	EM-2686	A2759	EM-2759	A2818	EM-2818	A2876HY	EM-2876
A2687	EM-2687	A2760	EM-2760	A2818HD	EM-2818	A2878	EM-2878
A2688	EM-2688	A2761	EM-2761	A2819	EM-2819	A2879	EM-2879S
A2689	EM-2689	A2762	EM-2762	A2820	EM-2820	A2879HY	EM-2879
A2690	EM-2690	A2763	EM-2763	A2821	EM-2821S	A2880	EM-2880S
A2691	EM-2691	A2764	EM-2764	A2821HY	EM-2821	A2880HY	EM-2880
A2692	EM-2692	A2765	EM-2765	A2822	EM-2822	A2881	EM-2881
A2693	EM-2693	A2766	EM-2766	A2823	EM-2823S	A2882	EM-2882
A2694HY	EM-2812	A2767	EM-2767	A2823HY	EM-2823	A2883	EM-2883
A2695HY	EM-2813	A2768	EM-2768	A2824	EM-2824S	A2884	EM-2884
A2696	EM-2696S	A2769	EM-2769	A2824HY	EM-2824	A2885	EM-2885
A2696HY	EM-2696	A2770	EM-2770	A2825	EM-2825	A2886	EM-2886
A2697	EM-2697S	A2771	EM-2771	A2826	EM-2826	A2887	EM-2887
A2697HY	EM-2697	A2772	EM-2772	A2827	EM-2827	A2888	EM-2888
A2698	EM-2698S	A2773	EM-2773	A2828	EM-2828	A2889	EM-2889
A2698HY	EM-2698	A2774	EM-2774	A2829	EM-2829	A2890	EM-2890S
A2707	EM-2707S	A2775	EM-2775	A2830	EM-2830	A2890HY	EM-2890
A2707HY	EM-2707	A2776	EM-2776	A2831	EM-2831	A2892	EM-2892S
A2708	EM-2708	A2777	EM-2777	A2832	EM-2832	A2892HY	EM-2892
A2709	EM-2709	A2778	EM-2778	A2833	EM-2833	A2893	EM-2893S
A2710	EM-2710	A2779HY	EM-2779	A2834	EM-2834	A2893HY	EM-2893
A2711	EM-2711S	A2780	EM-2780	A2835	EM-2835	A2894	EM-2894S
A2711HY	EM-2711	A2781	EM-2781	A2836	EM-2836S	A2894HY	EM-2894
A2712	EM-2712S	A2782	EM-2782	A2836HY	EM-2836	A2895	EM-2895S
A2712HY	EM-2712	A2783	EM-2783	A2837	EM-2837S	A2895HY	EM-2895
A2713	EM-2713	A2784	EM-2784	A2837HY	EM-2837	A2896	EM-2896S
A2714	EM-2714	A2785	EM-2785	A2838	EM-2838S	A2896HY	EM-2896
A2715	EM-2715	A2786	EM-2786	A2838HY	EM-2838	A2897	EM-2897S
A2716	EM-2716	A2787	EM-2351	A2840	EM-2840S	A2897HY	EM-2897
A2717	EM-2717S	A2788	EM-2788S	A2840HY	EM-2840	A2898	EM-2898
A2717HY	EM-2717	A2788HY	EM-2788	A2841	EM-2841S	A2899	EM-2899
A2718	EM-2718	A2789	EM-2789S	A2841HY	EM-2841	A2900	EM-2900
A2719	EM-2719	A2789HY	EM-2789	A2842	EM-2842S	A2901	EM-2901
A2720	EM-2720	A2790	EM-2790S	A2842HY	EM-2842	A2902	EM-2902S
A2721	EM-2721	A2790HY	EM-2790	A2843	EM-2843	A2902HY	EM-2902
A2722	EM-2722	A2791	EM-2791S	A2844	EM-2844	A2903	EM-2903S
A2723	EM-2723	A2791HY	EM-2791	A2845	EM-2845	A2903HY	EM-2903
A2724	EM-2724	A2792	EM-2792S	A2846	EM-2846	A2904	EM-2904
A2725	EM-2725	A2792HY	EM-2792	A2847	EM-2847	A2905	EM-2905
A2726	EM-2726	A2793	EM-2793	A2848	EM-2848	A2906	EM-2987
A2727	EM-2727	A2794	EM-2794	A2849	EM-2849	A2907	EM-2907
A2728	EM-2728	A2795	EM-2795S	A2850	EM-2850	A2908	EM-2908
A2730	EM-2730	A2795HY	EM-2795	A2851	EM-2851	A2909	EM-2909
A2731	EM-2731	A2796	EM-2796S	A2852	EM-2852	A2910	EM-2910S
A2732	EM-2731	A2796HY	EM-2796	A2853	EM-2853	A2910HY	EM-2910
A2733	EM-2733	A2797	EM-2797	A2854	EM-2854	A2911	EM-2911
A2734	EM-2734	A2798	EM-2798	A2855	EM-2855	A2912	EM-2912
A2735	EM-2735	A2799	EM-2799	A2856	EM-2856	A2913	EM-2913
A2736	EM-2736	A2800	EM-2800	A2857	EM-2857	A2914	EM-2914
A2737	EM-2737	A2801	EM-2801	A2858	EM-2858	A2915	EM-2915
A2738	EM-2738	A2802	EM-2802	A2859	EM-2859S	A2916	EM-2916
A2739	EM-2739	A2803	EM-2803S	A2859HY	EM-2859	A2917	EM-2917
A2740	EM-2740	A2803HY	EM-2803	A2860	EM-2860	A2918	EM-2918
A2741	EM-2741	A2804	EM-2804	A2861	EM-2861	A2919	EM-2919
A2742	EM-2742	A2805	EM-2805	A2862	EM-2862	A2920	EM-2920
A2743	EM-2743	A2806	EM-2806	A2863	EM-2863	A2921	EM-2921
A2744	EM-2744	A2807	EM-2807	A2864	EM-2864	A2922	EM-2922
A2745	EM-2745	A2808	EM-2808	A2866	EM-2866	A2923	EM-2923
A2746	EM-2746	A2809	EM-2809	A2867	EM-2867	A2924	EM-2924
A2747	EM-2747	A2810	EM-2810	A2868	EM-2868	A2925	EM-2925

# CROSS REFERENCE

Mfg Part No	Our Part	Mfg Part No	Our Part	Mfg Part No	Our Part	Mfg Part No	Our Part
DEA (cont.)		DEA (cont.)		DEA (cont.)		DEA (cont.)	
A2926	EM-2926S	A2987HY	EM-2987	A4008	EM-5877	A4251	EM-9541
A2926HY	EM-2926	A2988	EM-2988	A4009	EM-5877	A4252	EM-8643
A2927	EM-2927	A2989	EM-2989	A4010	EM-5884	A4253	EM-5646
A2928	EM-2928	A2990	EM-2990	A4011	EM-5885	A4254	EM-5654
A2929	EM-2929	A2991	EM-2991	A4012	EM-5886	A4255	EM-9546
A2930	EM-2930	A2992	EM-2992	A4013	EM-5887	A4257	EM-5835
A2931	EM-2931	A2993	EM-2993S	A4014	EM-5888	A4258	EM-5874
A2932	EM-2932S	A2993HY	EM-2993	A4015	EM-5889	A4259	EM-9538
A2932HY	EM-2932	A2994	EM-2994	A4016	EM-5890	A4260	EM-9599
A2933	EM-2933	A2995	EM-2995	A4017	EM-5859	A4261	EM-5837
A2934	EM-2934S	A2996	EM-2996S	A4018	EM-5892	A4262	EM-7039
A2934HY	EM-2934	A2996HY	EM-2996	A4019	EM-5893	A4263	EM-9494
A2935	EM-2935	A2997	EM-2997	A4020	EM-5894	A4265	EM-9420
A2936	EM-2936	A2998	EM-2998	A4021	EM-5895	A4266	EM-9546
A2938	EM-2938S	A2999	EM-2999	A4022	EM-5896	A4267	EM-5901
A2938HY	EM-2938	A3000	EM-3000	A4026	EM-5922	A4268	EM-9599
A2939	EM-2939	A3001	EM-3001	A4029	EM-3189	A4269	EM-9210
A2940	EM-2940	A3002	EM-3002	A4030	EM-3190	A4270	EM-5900
A2941	EM-2941	A3003	EM-3003S	A4032	EM-5844	A4271	EM-9436
A2942	EM-2942S	A3003HY	EM-3003	A4038	EM-5993	A4272	EM-7010
A2942HY	EM-2942	A3004	EM-3004	A4200	EM-9192	A4273	EM-9421
A2943	EM-2943S	A3005	EM-3005	A4201	EM-9179	A4274	EM-5750
A2943HY	EM-2943	A3006	EM-3006	A4202	EM-9173	A4275	EM-9500
A2944	EM-2944	A3007	EM-3007	A4203	EM-9211	A4276	EM-5751
A2945	EM-2945	A3008	EM-3008	A4204	EM-9148	A4277	EM-5752
A2947	EM-2947	A3009	EM-3009	A4205	EM-9227	A4278	EM-5819
A2948	EM-2948	A3010	EM-3010	A4206	EM-5206	A4279	EM-5753
A2949	EM-2949	A3011	EM-3011	A4207	EM-9165	A4280	EM-5754
A2950	EM-2950	A3014	EM-3014	A4208	EM-8164	A4281	EM-5755
A2951	EM-2951	A3019	EM-3019	A4209	EM-9231	A4282	EM-5756
A2952	EM-2952	A3022	EM-3022	A4210	EM-9235	A4283	EM-5757
A2953	EM-2953	A3023	EM-3023	A4211	EM-5141	A4284	EM-5741
A2954	EM-2954	A3026	EM-3026	A4212	EM-9212	A4285	EM-5758
A2955	EM-2955	A3027	EM-3027	A4213	EM-5448	A4286	EM-5759
A2956	EM-2956	A3031	EM-3031	A4214	EM-5198	A4287	EM-9239
A2957	EM-2957	A3032	EM-3032	A4215	EM-9388	A4288	EM-9236
A2958	EM-2958	A3033	EM-3033	A4216	EM-9226	A4289	EM-5761
A2959	EM-2959	A3034	EM-3034	A4217	EM-8189	A4290	EM-5762
A2960	EM-2960	A3039	EM-3039	A4218	EM-9163	A4291	EM-7011
A2961	EM-2961	A3040	EM-3040	A4219	EM-9484	A4292	EM-5763
A2962	EM-2962	A3041	EM-3041	A4220	EM-9155	A4293	EM-5764
A2963	EM-2963	A3042	EM-3042	A4221	EM-9164	A4294	EM-5143
A2964	EM-2964	A3043	EM-3043	A4222	EM-9053	A4295	EM-9237
A2965	EM-2965	A3044	EM-3044	A4223	EM-5335	A4296	EM-5766
A2966	EM-2966	A3049	EM-3049	A4224	EM-5399	A4297	EM-5767
A2967	EM-2967S	A3052	EM-3052	A4225	EM-5384	A4298	EM-5768
A2967HY	EM-2967	A3054	EM-3054	A4226	EM-9492	A4299	EM-5769
A2968	EM-2968S	A3055	EM-3055	A4228	EM-8401	A4300	EM-8994
A2968HY	EM-2968	A3065	EM-3065	A4229	EM-5356	A4301	EM-9217
A2969	EM-2969	A3069	EM-3069	A4230	EM-9157	A4302	EM-9180
A2970	EM-2970	A3075HY	EM-3075	A4231	EM-5653	A4303	EM-9176
A2971	EM-2971	A3076HY	EM-3076	A4232	EM-5467	A4304	EM-9171
A2972	EM-2972	A3078	EM-3078	A4233	EM-8200	A4305	EM-9229
A2973	EM-2973	A3079HY	EM-3079	A4234	EM-5367	A4310	EM-5468
A2973HY	EM-2973	A3080HY	EM-3080	A4235HY	EM-5921	A4311	EM-8682
A2974	EM-2974S	A3081	EM-3081	A4236	EM-9197	A4312	EM-9230
A2974HY	EM-2974	A3082	EM-3082	A4237	EM-9249	A4313	EM-5405
A2975	EM-2975	A3085HY	EM-3085	A4238	EM-9279	A4314	EM-5556
A2977	EM-2977	A3415	EM-5063	A4240	EM-9234	A4315	EM-8887
A2978	EM-2978	A3416	EM-5064	A4241	EM-9233	A4316	EM-5770
A2979	EM-2979	A3417	EM-5065	A4242	EM-9232	A4317	EM-9442
A2980	EM-2980	A4000	EM-5518	A4243	EM-9284	A4318	EM-9228
A2981	EM-2981	A4001	EM-5528	A4244	EM-9246	A4319	EM-5561
A2982	EM-2982	A4002	EM-5553	A4245	EM-5403	A4320	EM-9422
A2983	EM-2983	A4003	EM-9244	A4246	EM-5647	A4321	EM-9414
A2984	EM-2984	A4004	EM-9580	A4247	EM-5554	A4322EL	EM-5655
A2985	EM-2985	A4005	EM-5734	A4248	EM-9454	A4323	EM-5656
A2986	EM-2986	A4006	EM-9579	A4249	EM-5749	A4324	EM-5657
A2987	EM-2987S	A4007	EM-5747	A4250	EM-5649	A4325	EM-9248

# CROSS REFERENCE

Mfg Part No	Our Part	Mfg Part No	Our Part	Mfg Part No	Our Part	Mfg Part No	Our Part
DEA (cont.)		DEA (cont.)		DEA (cont.)		DEA (cont.)	
A4325EL	EM-5748	A4510	EM-9151	A4583	EM-5795	A4703	EM-8930
A4326	EM-9573	A4511	EM-9204	A4583EL	EM-5795	A4704	EM-8923
A4327	EM-5771	A4512	EM-5385	A4584	EM-9428	A4705	EM-8919
A4328	EM-5772	A4513	EM-9183	A4585	EM-9617	A4706	EM-8915
A4329	EM-5773	A4514	EM-9169	A4587	EM-9415	A4707	EM-8921
A4330	EM-5774	A4515	EM-5449	A4588	EM-9385	A4708	EM-8917
A4331	EM-5775	A4516	EM-9194	A4589	EM-9386	A4709	EM-8923
A4332	EM-5776	A4517	EM-9297	A4590	EM-9435	A4711	EM-8918
A4333	EM-5777	A4518	EM-9202	A4591	EM-5915	A5003HY	EM-2943
A4334	EM-5778	A4519	EM-9441	A4593	EM-9440	A5006	EM-2959
A4335	EM-5779	A4520	EM-9172	A4594	EM-9438	A5007	EM-2964
A4336	EM-9448	A4521	EM-9178	A4595	EM-9496	A5009	EM-2911
A4338	EM-5780	A4522	EM-9128	A4596	EM-9426	A5011	EM-2940
A4339	EM-9446	A4522HY	EM-9128	A4597	EM-9417	A5012	EM-2941
A4340	EM-9465	A4523	EM-9300	A4598	EM-9397	A5013	EM-2912
A4342	EM-9471	A4524	EM-9215	A4599HY	EM-5984	A5017	EM-5067
A4343	EM-9482	A4525	EM-9214	A4600	EM-9174	A5018	EM-5068
A4344	EM-9506	A4526	EM-9247	A4601	EM-5081	A5020	EM-5087
A4345	EM-9456	A4526HY	EM-9247	A4602	EM-9184	A5021	EM-5392
A4347	EM-5781	A4527HY	EM-9451	A4603	EM-5159	A5024	EM-5148
A4348	EM-5782	A4528	EM-9433	A4604	EM-9394	A5024HY	EM-5148
A4349	EM-9483	A4529	EM-5471	A4605	EM-8685	A5026	EM-5473
A4350	EM-9444	A4530	EM-9280	A4606	EM-9188	A5028	EM-2901
A4351	EM-9452	A4531	EM-9301	A4607	EM-9154	A5029	EM-2900
A4352	EM-9453	A4532	EM-9298	A4608	EM-9153	A5030	EM-2945
A4353	EM-5865	A4533	EM-9299	A4610	EM-9485	A5031	EM-2920
A4354HY	EM-5867	A4534	EM-9218	A4611	EM-9384	A5034	EM-5450
A4355HY	EM-5869	A4535	EM-9302	A4612	EM-9162	A5035	EM-5388
A4356HY	EM-5870	A4536	EM-9303	A4613	EM-5420	A5095	EM-5111
A4357	EM-9577	A4537	EM-9285	A4614	EM-5349	A5101	EM-9064
A4359	EM-9589	A4538	EM-9286	A4615	EM-9186	A5102	EM-5353
A4361	EM-5969	A4539	EM-9277	A4616	EM-9187	A5103	EM-2620
A4400	EM-8909	A4540	EM-9282	A4617	EM-9170	A5104	EM-2817
A4401	EM-9469	A4541	EM-9250	A4618	EM-9189	A5106	EM-5083
A4402	EM-5375	A4542	EM-9225	A4619	EM-9191	A5109	EM-5354
A4403	EM-5362	A4543	EM-9213	A4620	EM-9193	A5117	EM-5108
A4404	EM-9196	A4544	EM-9220	A4621	EM-9161	A5118	EM-5109
A4405	EM-9222	A4545	EM-9205	A4622	EM-5452	A5123	EM-8068
A4406	EM-9466	A4546	EM-9216	A4623	EM-8792	A5132	EM-3125
A4407	EM-9461	A4547	EM-9487	A4624	EM-9305	A5137	EM-3021
A4408	EM-9468	A4548	EM-5689	A4625	EM-9199	A5151	EM-2979
A4409	EM-9527	A4549	EM-9424	A4626	EM-9201	A5169	EM-2910
A4410	EM-9472	A4550	EM-5510	A4627	EM-9278	A5181	EM-2951
A4411	EM-5909	A4551	EM-9389	A4628	EM-9281	A5182	EM-3029
A4413	EM-8074	A4552	EM-9437	A4629	EM-9382	A5183	EM-3030
A4414	EM-5923	A4553	EM-9431	A4630	EM-9383	A5198	EM-3053
A4415	EM-7043	A4555	EM-9411	A4631	EM-9387	A5199	EM-3035
A4416	EM-5563	A4557	EM-9427	A4632	EM-9206	A5200	EM-2972
A4417	EM-5658	A4558	EM-9530	A4633	EM-5574	A5203	EM-5103
A4418	EM-5783	A4559	EM-9423	A4634	EM-8243	A5204	EM-5104
A4419	EM-9507	A4561	EM-5784	A4635	EM-5575	A5205	EM-5177
A4420	EM-9534	A4562	EM-9490	A4637	EM-9207	A5207	EM-5105
A4421	EM-5864	A4563	EM-5785	A4638	EM-5927	A5208	EM-5383
A4422	EM-5863	A4564	EM-5786	A4639	EM-9304	A5209	EM-5107
A4423	EM-9536	A4565	EM-9488	A4640	EM-5796	A5211	EM-2960
A4424	EM-9539	A4566	EM-5787	A4641	EM-5797	A5212	EM-5052
A4425	EM-9537	A4567	EM-9413	A4642	EM-5798	A5213	EM-2899
A4435	EM-5943	A4568	EM-5789	A4643	EM-5928	A5214	EM-2977
A4500	EM-9137	A4570	EM-9443	A4644	EM-5857	A5215	EM-2915
A4501	EM-8374	A4572	EM-9457	A4645	EM-5876	A5216	EM-2931
A4502	EM-5400	A4573	EM-9445	A4646	EM-9088	A5217	EM-3002
A4503	EM-5376	A4574	EM-5792	A4647	EM-5929	A5218	EM-3001
A4504	EM-9168	A4575	EM-5793	A4648	EM-5856	A5219B	EM-5106
A4505	EM-9150	A4575EL	EM-5793	A4649	EM-5924	A5221	EM-5732
A4506	EM-9205	A4577	EM-9439	A4653	EM-5912	A5223	EM-5079
A4507	EM-9149	A4579	EM-9473	A4655	EM-7017	A5224	EM-2896
A4508	EM-9175	A4580	EM-5794	A4700	EM-8920	A5225	EM-2895
A4508	EM-9396	A4581	EM-5744	A4701	EM-8916	A5227	EM-2995
A4509	EM-9152	A4582	EM-9434	A4702	EM-8925	A5228	EM-2961



# CROSS REFERENCE

Mfg Part No	Our Part	Mfg Part No	Our Part	Mfg Part No	Our Part	Mfg Part No	Our Part
DEA (cont.)		DEA (cont.)		DEA (cont.)		DEA (cont.)	
A5229	EM-5181	A5319	EM-3070	A5405	EM-5664	A5476	EM-3157
A5231	EM-2952	A5320	EM-3045	A5406	EM-5692	A5478	EM-4060
A5232	EM-2902	A5322	EM-3087	A5407	EM-5665	A5479	EM-4049
A5233	EM-3017	A5323HY	EM-3093	A5408	EM-5693	A5481	EM-4071
A5234	EM-3068	A5324	EM-3110	A5409	EM-5694	A5482	EM-4012
A5235	EM-3083	A5325	EM-5475	A5410	EM-4018	A5485	EM-3136
A5236	EM-5075	A5326	EM-5377	A5411	EM-4051	A5486	EM-3183
A5237	EM-5074	A5327	EM-5423	A5412	EM-4019	A5487	EM-3165
A5238	EM-3059	A5329	EM-5551	A5413	EM-3151	A5489	EM-4127
A5239	EM-3060	A5330	EM-5578	A5413	EM-4097	A5490	EM-4022
A5240	EM-8670	A5338	EM-5424	A5414	EM-3150	A5491HY	EM-3166
A5241	EM-2958	A5339	EM-5425	A5414	EM-4099	A5492HY	EM-3158
A5242	EM-2974	A5341	EM-5426	A5415	EM-3130	A5493	EM-4013
A5243	EM-2973	A5342	EM-5427	A5416	EM-3131	A5494	EM-4043
A5248	EM-2939	A5346	EM-5428	A5417	EM-3145	A5495	EM-4082
A5251	EM-5080	A5347	EM-3128	A5418	EM-3134	A5497	EM-4101
A5253	EM-3063	A5348	EM-5476	A5419	EM-3137	A5499HY	EM-3192
A5254	EM-3077	A5350HY	EM-3113	A5420	EM-3152	A5500	EM-3202
A5260	EM-3050	A5351	EM-3115	A5420	EM-4050	A5501	EM-3194
A5261	EM-5078	A5353HY	EM-3147	A5421	EM-3154	A5502	EM-3196
A5263	EM-3104	A5354HY	EM-3097	A5422	EM-3177	A5503	EM-4045
A5265	EM-3067	A5355	EM-3094	A5423	EM-3132	A5504	EM-4046
A5271	EM-3038	A5356HY	EM-3096	A5424	EM-3136	A5505	EM-4079
A5272	EM-3071	A5357	EM-5659	A5425	EM-3142	A5506	EM-4078
A5273	EM-3072	A5358	EM-2927	A5426	EM-3143	A5507	EM-3193
A5274	EM-5026	A5359	EM-5582	A5427	EM-3127	A5508	EM-4129
A5275	EM-5031S	A5360	EM-3102	A5428	EM-3133	A5509	EM-4080
A5276	EM-5032	A5361	EM-2928	A5429	EM-4040	A5514	EM-3026
A5277	EM-5033	A5362	EM-2947	A5431	EM-3144	A5517	EM-3175
A5278	EM-5028	A5363	EM-2947	A5432	EM-4017	A5518	EM-4038
A5279	EM-5381	A5364	EM-2949	A5433	EM-4095	A5519	EM-4039
A5280	EM-3016	A5365	EM-5583	A5434	EM-3126	A5520	EM-4057
A5281	EM-3013	A5366	EM-3121	A5437	EM-3146	A5523	EM-4029
A5282	EM-3012	A5367	EM-3122	A5438	EM-3139	A5525	EM-4042
A5283	EM-5180	A5368	EM-5645	A5439	EM-3153	A5528	EM-4102
A5284	EM-3015	A5369	EM-3116	A5440	EM-4000	A5529	EM-4103
A5285	EM-3025	A5370	EM-3117	A5441	EM-4117	A5530	EM-3195
A5286	EM-3024	A5371	EM-3089	A5442HY	EM-5746	A5532	EM-3199
A5287	EM-3018	A5372	EM-3090	A5443	EM-3167	A5534	EM-4112
A5288	EM-3051	A5373	EM-3123	A5444	EM-3141	A5535	EM-3200
A5289	EM-3074	A5374	EM-3086	A5445	EM-4094	A5536	EM-3197
A5290	EM-3073	A5375	EM-3119	A5446	EM-4033	A5537	EM-3198
A5291	EM-3066	A5376	EM-3100	A5447	EM-4001	A5538	EM-3201
A5292	EM-3057	A5378	EM-3114	A5448	EM-4002	A5539	EM-3179
A5293	EM-3037	A5379	EM-3105	A5449	EM-4003	A5541	EM-4104
A5294	EM-2944	A5380	EM-3106	A5449HY	EM-4037	A5548HY	EM-4035
A5295	EM-3047	A5381	EM-3107	A5450	EM-4004	A5549HY	EM-4037
A5296	EM-3048	A5382	EM-3098	A5451	EM-4005	A5550	EM-4105
A5297	EM-3062	A5384	EM-3108	A5452	EM-4006	A5563	EM-4049
A5298	EM-3061	A5385	EM-3109	A5453	EM-4007	A5572	EM-4058
A5299	EM-3084	A5386HY	EM-3112	A5454HY	EM-3160	A5581	EM-4073
A5300	EM-5182	A5387	EM-3140	A5455HY	EM-3149	A5590	EM-4027
A5301	EM-3050	A5388	EM-5587	A5456HY	EM-3148	A5599	EM-4028
A5302HY	EM-3020	A5389	EM-5588	A5458HY	EM-4036	A6000	DS-8474
A5303	EM-3036	A5390HY	EM-3138	A5459	EM-3161	A6001	DS-8468
A5304	EM-3056	A5391	EM-5521	A5460HY	EM-3160	A6002	DS-8587
A5305	EM-5085	A5392	EM-3091	A5461	EM-3162	A6003	DS-8532
A5306	EM-3095	A5393	EM-5674	A5462	EM-4126	A6004	DS-8588
A5308	EM-3129	A5394	EM-5591	A5463	EM-9489	A6005	DS-8472
A5309	EM-3088	A5395	EM-3092	A5464	EM-4041	A6006	DS-8473
A5310	EM-5380	A5396	EM-3111	A5465	EM-3155	A6007	DS-8549
A5311	EM-3046	A5397	EM-3120	A5466	EM-3159	A6008	DS-8470
A5312	EM-3103	A5398	EM-3118	A5468	EM-4096	A6010	DS-8591
A5313	EM-3028	A5399	EM-5596	A5469	EM-3168	A6011	DS-8469
A5314	EM-3064	A5400	EM-5673	A5470	EM-4016	A6012	DS-8471
A5315	EM-5422	A5401	EM-5660	A5471	EM-4015	A6013	DS-8475
A5316	EM-5350	A5402	EM-5661	A5473	EM-4044	A6014	DS-8509
A5317HY	EM-5352	A5403	EM-5662	A5474	EM-4034	A6015	DS-8535
A5318	EM-3124	A5404	EM-5663	A5475	EM-4100	A6016	DS-8550

# CROSS REFERENCE

Mfg Part No	Our Part	Mfg Part No	Our Part	Mfg Part No	Our Part	Mfg Part No	Our Part
DEA (cont.)		DEA (cont.)		DEA (cont.)		DEA (cont.)	
A6017	DS-8551	A6126	EM-8039	A6211	EM-8195	A6285	EM-8377
A6019	DS-8565	A6127	EM-8047	A6213	EM-8233	A6286	EM-8389
A6020	DS-8626	A6128	EM-8040	A6215	EM-8181	A6288	EM-5200
A6021	DS-8634	A6129	EM-8253	A6216	EM-8197	A6290	EM-5456
A6022	DS-8635	A6130	EM-8255	A6217	EM-8198	A6291	EM-8650
A6023	DS-5232	A6131	EM-8597	A6218	EM-8210	A6292	EM-8392
A6024	DS-6024	A6132	EM-8599	A6219	EM-8186	A6293	EM-8214
A6025	DS-8627	A6133	EM-8598	A6220	EM-8185	A6294	EM-2748
A6027	DS-6027	A6134	EM-8041	A6221	EM-9117	A6295	EM-8375
A6028	DS-6028	A6135	EM-8786	A6222	EM-8193	A6297	EM-8492
A6029	DS-5230	A6136	EM-8790	A6223	EM-8188	A6298	EM-8395
A6030	DS-5223	A6137	EM-8759	A6224	EM-5810	A6299	EM-8393
A6031	DS-5234	A6138	EM-8596	A6225	EM-8187	A6301	EM-8303
A6032	DS-5235	A6139	EM-8676	A6226	EM-8187	A6302	EM-8137
A6034	DS-6109	A6140	EM-8680	A6227	EM-8180	A6303	EM-8125
A6035	DS-6035	A6142	EM-8103	A6228	EM-8183	A6304	EM-8133
A6037	DS-6037	A6142IN	EM-8553	A6230	EM-8192	A6305	EM-8142
A6038	DS-6038	A6143	EM-8042	A6231	EM-8194	A6306	EM-8284
A6039	DS-5236	A6144	EM-8741	A6232	EM-8201	A6307	EM-8154
A6040	DS-6040	A6145	EM-8738	A6233	EM-8190	A6308	EM-8304
A6042	DS-6042	A6146	EM-8764	A6234	EM-8190	A6309	EM-8304
A6048	DS-6048	A6147	EM-8762	A6235	EM-8200	A6310	EM-8304
A6049	DS-6049	A6148	EM-8780	A6236	EM-8422	A6311	EM-8148
A6050	DS-6050	A6149	EM-8781	A6237	EM-8430	A6312	EM-8149
A6051	DS-6051	A6150	EM-8932	A6238	EM-8344	A6313	EM-8427
A6052	DS-6052	A6151	EM-8672	A6239	EM-8175	A6314	EM-8133
A6053	DS-6053	A6152	EM-8752	A6240	EM-8171	A6315	EM-8135
A6056	DS-6056	A6153	EM-8677	A6241	EM-8166	A6316	EM-5170
A6061	DS-6061	A6154	EM-8751	A6242	EM-8179	A6318	EM-8137
A6062	DS-6062	A6156	EM-8736	A6243	EM-9116	A6320	EM-8604
A6063	DS-6063	A6157	EM-8721	A6244	EM-8170	A6321	EM-8605
A6064	DS-6064	A6158	EM-8255	A6245	EM-8176	A6323	EM-8140
A6065	DS-6065	A6160	EM-8254	A6246	EM-8361	A6324	EM-8701
A6066	DS-6066	A6161	EM-8734	A6246HY	EM-8361	A6325	EM-8132
A6067	DS-6079	A6162	EM-8941	A6247	EM-8414	A6326	EM-8128
A6069	DS-8538	A6163	EM-8044	A6248	EM-8208	A6329	EM-9040
A6070	DS-5226	A6164	EM-8936	A6249	EM-8363	A6330	EM-8141
A6071	DS-5225	A6165	EM-8674	A6250	EM-8166	A6331	EM-8130
A6072	DS-5234	A6166	EM-8675	A6251	EM-8398	A6333	EM-8118
A6085	DS-6111	A6167	EM-8678	A6252	EM-8711	A6334	EM-9049
A6086	DS-6112	A6169	EM-8719	A6253	EM-8209	A6335	EM-9025
A6087	DS-6100	A6170	EM-8595	A6254	EM-8207	A6336	EM-5171
A6089	DS-6076	A6171	EM-8775	A6255	EM-8162	A6338	EM-8600
A6091	DS-6072	A6172	EM-8756	A6256	EM-8979	A6339	EM-8601
A6093	DS-6085	A6176	EM-8742	A6257	EM-8644	A6340	EM-8602
A6094	DS-5229	A6178	EM-8745	A6258	EM-8191	A6341	EM-8603
A6100	EM-8803	A6179	EM-8746	A6259	EM-8415	A6342	EM-8704
A6101	EM-8744	A6180	EM-8748	A6260	EM-8178	A6343	EM-8705
A6103	EM-8747	A6181	EM-8937	A6261	EM-8177	A6344	EM-8114
A6104	EM-8715	A6182	EM-8940	A6264	EM-8278	A6344HY	EM-8114
A6105	EM-8716	A6185	EM-8935	A6265	EM-8279	A6345	EM-8682
A6106	EM-8717	A6186	EM-9296	A6267	EM-5454	A6346	EM-8681
A6107	EM-8718	A6187	EM-8791	A6268	EM-8212	A6347	EM-8124
A6108	EM-8722	A6188	EM-8743	A6270	EM-8165	A6348	EM-8276
A6109	EM-8723	A6189	EM-8750	A6271	EM-8168	A6349	EM-8324
A6110	EM-8938	A6190	EM-8753	A6272	EM-8169	A6350	EM-8295
A6112	EM-8939	A6191	EM-8754	A6273	EM-8174	A6351	EM-8121
A6113	EM-8727	A6192	EM-8755	A6274	EM-8508	A6352	EM-8151
A6114	EM-8728	A6193	EM-8757	A6275	EM-8207	A6353	EM-8566
A6115	EM-8729	A6194	EM-8758	A6276	EM-8213	A6354	EM-8312
A6116	EM-8730	A6195	EM-8790	A6277	EM-8485	A6355	EM-8296
A6117	EM-8731	A6196	EM-8944	A6277HY	EM-8485	A6356	EM-8138
A6118	EM-8732	A6198	EM-8957	A6278	EM-8375	A6357	EM-8310
A6119	EM-8733	A6199	EM-8956	A6279	EM-8488	A6358	EM-8152
A6121	EM-8934	A6204	EM-8648	A6280	EM-5370	A6359	EM-5165
A6122	EM-8045	A6206	EM-5042	A6281	EM-8280	A6360	EM-8117
A6123	EM-5453	A6208	EM-8173	A6282	EM-8163	A6361	EM-8119
A6124	EM-5398	A6209	EM-8218	A6283	EM-5455	A6363	EM-9033
A6125	EM-8044	A6210	EM-8189	A6284	EM-8181	A6364	EM-9033

# CROSS REFERENCE

Mfg Part No	Our Part	Mfg Part No	Our Part	Mfg Part No	Our Part	Mfg Part No	Our Part
DEA (cont.)		DEA (cont.)		DEA (cont.)		DEA (cont.)	
A6365	EM-8145	A6455	EM-9240	A6526	EM-8300	A6597	EM-9066
A6368	EM-5163	A6455HY	EM-9240	A6527	EM-8005	A6598	EM-8987
A6369	EM-5387	A6456	EM-8087	A6528	EM-8026	A6599	EM-9083
A6371	EM-9038	A6457	EM-8073	A6529	EM-8497	A6600	EM-2731
A6372	EM-8961	A6458	EM-8234	A6530	EM-8432	A6603	EM-8292
A6373	EM-5162	A6460	EM-8074	A6531	EM-8002	A6604	EM-8107
A6374	EM-8963	A6461	EM-8516	A6532	EM-5329	A6605	EM-8102
A6375	EM-8323	A6462	EM-8457	A6533	EM-9136	A6606	EM-8205
A6377	EM-8276	A6463	EM-8691	A6534	EM-8021	A6607	EM-8238
A6379	EM-8150	A6464	EM-8978	A6535	EM-8614	A6608	EM-8206
A6380	EM-8115	A6465	EM-8977	A6536	EM-8615	A6609	EM-5098
A6381	EM-8322	A6466	EM-8263	A6537	EM-8802	A6610	EM-8105
A6382	EM-8311	A6467	EM-8578	A6538	EM-8025	A6611	EM-8102
A6383	EM-8307	A6468	EM-5156	A6539	EM-8293	A6612	EM-8582
A6384	EM-8144	A6469	EM-8095	A6540	EM-8029	A6613	EM-8099
A6385	EM-8157	A6470	EM-8062	A6541	EM-5326	A6614	EM-8467
A6386	EM-8962	A6471	EM-8063	A6542	EM-9055	A6615	EM-8466
A6387	EM-8310	A6473	EM-9007	A6543	EM-5379	A6617	EM-8242
A6388	EM-8317	A6474	EM-8814	A6544	EM-8009	A6618	EM-8272
A6389	EM-5481	A6475	EM-8813	A6545	EM-8411	A6618IN	EM-5739
A6390	EM-9042	A6476	EM-9476	A6546	EM-9084	A6619	EM-8267
A6391	EM-9028	A6477	EM-9130	A6547	EM-8011	A6621	EM-8097
A6392	EM-9010	A6478	EM-8425	A6548	EM-8349	A6622	EM-8100
A6394	EM-8683	A6479	EM-8884	A6549	EM-8404	A6623	EM-8106
A6398	EM-8122	A6480	EM-5155	A6550	EM-8572	A6624	EM-8584
A6403	EM-8693	A6481	EM-9072	A6551	EM-8330	A6625	EM-8104
A6404	EM-8460	A6482	EM-8863	A6552	EM-8974	A6626	EM-8696
A6405	EM-8075	A6483	EM-8864	A6553	EM-8525	A6627	EM-8248
A6406	EM-8516	A6484	EM-8868	A6554	EM-9067	A6628	EM-8243
A6407	EM-8055	A6485	EM-8882	A6555	EM-8992	A6629	EM-8502
A6409	EM-8083	A6486	EM-8885	A6556	EM-8710	A6630	EM-8503
A6410	EM-8078	A6487	EM-9008	A6557	EM-8228	A6633	EM-8235
A6411	EM-8055	A6488	EM-8886	A6559	EM-8806	A6634	EM-8108
A6412	EM-8424	A6489	EM-8563	A6560	EM-9030	A6635	EM-8667
A6413	EM-8056	A6490	EM-8424	A6561	EM-8980	A6636	EM-8507
A6414	EM-8060	A6491	EM-9131	A6562	EM-9054	A6637	EM-8552
A6415	EM-8061	A6492	EM-9021	A6563	EM-8824	A6638	EM-8271
A6416	EM-8424	A6493	EM-9017	A6564	EM-8845	A6640	EM-8270
A6417	EM-8059	A6494	EM-9182	A6565	EM-8572	A6641	EM-8686
A6418	EM-8065	A6495	EM-5152	A6566	EM-9085	A6642	EM-8096
A6419	EM-8082	A6496	EM-9221	A6567	EM-5382	A6643	EM-8879
A6420	EM-8514	A6497	EM-9195	A6568	EM-8896	A6644	EM-8619
A6421	EM-8077	A6498	EM-5110	A6569	EM-8971	A6645	EM-8506
A6422	EM-8080	A6499	EM-5378	A6570	EM-8799	A6646	EM-8510
A6423	EM-8512	A6500	EM-8031	A6571	EM-8894	A6647	EM-9181
A6424	EM-8094	A6501	EM-8018	A6572	EM-8801	A6648	EM-9203
A6425	EM-8095	A6502	EM-8435	A6573	EM-8823	A6649	EM-8542
A6427	EM-8080	A6503	EM-8007	A6574	EM-8849	A6650	EM-8545
A6428	EM-8091	A6504	EM-8020	A6575	EM-8574	A6651	EM-8548
A6429	EM-8078	A6505	EM-8021	A6576	EM-8709	A6652	EM-8556
A6432	EM-8609	A6506	EM-8010	A6577	EM-8895	A6654	EM-8559
A6433	EM-8513	A6507	EM-8431	A6578	EM-8900	A6655	EM-8668
A6433HY	EM-8513	A6509	EM-8002	A6579	EM-8986	A6656	EM-8669
A6434	EM-8740	A6510	EM-8014	A6581	EM-5371	A6657	EM-8670
A6436	EM-8261	A6512	EM-8016	A6582	EM-8898	A6658	EM-9071
A6437	EM-8516	A6513	EM-8004	A6583	EM-8899	A6659	EM-8689
A6438	EM-8068	A6514	EM-8019	A6584	EM-8983	A6660	EM-8688
A6440	EM-9087	A6515	EM-8037	A6585	EM-8982	A6661	EM-8690
A6442	EM-8084	A6515HY	EM-8037	A6586	EM-8981	A6662	EM-8798
A6444	EM-8062	A6516	EM-8006	A6587	EM-8984	A6663	EM-8687
A6445	EM-9082	A6517	EM-8034	A6588	EM-8973	A6664	EM-8619
A6446	EM-8456	A6518	EM-8001	A6589	EM-8975	A6665	EM-8232
A6447	EM-8862	A6519	EM-8024	A6590	EM-8660	A6666	EM-8235
A6448	EM-8079	A6520	EM-8575	A6591	EM-9016	A6667	EM-8244
A6450	EM-8462	A6521	EM-8005	A6592	EM-9185	A6668	EM-9147
A6451	EM-8089	A6522	EM-8402	A6593	EM-9043	A6669	EM-8818
A6452	EM-8085	A6523	EM-8660	A6594	EM-9110	A6670	EM-8817
A6453	EM-8086	A6524	EM-8329	A6595	EM-8988	A6671	EM-8797
A6454	EM-8088	A6525	EM-8008	A6596	EM-9139	A6672	EM-8793

# CROSS REFERENCE

Mfg Part No	Our Part	Mfg Part No	Our Part	Mfg Part No	Our Part	Mfg Part No	Our Part
DEA (cont.)		DEA (cont.)		DEA (cont.)		DEA (cont.)	
A6673	EM-8792	A6767	EM-8906	A6855	EM-8054	A6952	EM-9093
A6674	EM-8685	A6768	EM-8904	A6856	EM-8053	A6953HY	EM-5445
A6675	EM-8807	A6769	EM-8905	A6857	EM-8049	A6954HY	EM-5446
A6676	EM-8820	A6770	EM-9359	A6858	EM-8048	A6955	EM-5484
A6677	EM-8700	A6771	EM-9351	A6859	EM-8586	A6957	EM-5675
A6678	EM-8821	A6772	EM-9331	A6860	EM-8439	A6958	EM-5485
A6679	EM-8695	A6773	EM-5121	A6861	EM-8442	A6959HY	EM-9245
A6680	EM-8853	A6774	EM-5482	A6862	EM-8579	A6960HY	EM-9262
A6681	EM-8111	A6775	EM-5526	A6863	EM-8576	A6961	EM-5432
A6682	EM-8867	A6776	EM-9337	A6864	EM-8576	A6962	EM-9283
A6683	EM-8875	A6777	EM-9334	A6865	EM-8438	A6964	EM-9257
A6684	EM-8876	A6778	EM-9342	A6866	EM-8577	A6965	EM-9259
A6685	EM-8877	A6779	EM-9330	A6867	EM-9142	A6966	EM-9260
A6686	EM-8878	A6780	EM-9311	A6868	EM-9140	A6967	EM-9287
A6687	EM-9056	A6781	EM-7007	A6870	EM-8351	A6968	EM-5612
A6688	EM-8881	A6791	EM-8812	A6871	EM-8499	A6969	EM-9263
A6690	EM-9060	A6793	EM-5738	A6872	EM-8539	A6970	EM-9264
A6691	EM-9057	A6795	EM-8811	A6873	EM-8621	A6971	EM-5527
A6692	EM-9070	A6796	EM-8655	A6874	EM-8586	A6972	EM-9092
A6693	EM-8694	A6797	EM-8654	A6875	EM-8352	A6973	EM-9092
A6694	EM-8822	A6798	EM-8653	A6877	EM-9138	A6974	EM-5517
A6695	EM-5101	A6799	EM-8652	A6878	EM-9143	A6975	EM-9258
A6696	EM-9078	A6800	EM-8160	A6879	EM-9141	A6976	EM-9406
A6697	EM-9068	A6801	EM-8283	A6880	EM-5733	A6977	EM-9407
A6698	EM-9058	A6802	EM-8161	A6882	EM-5609	A6978	EM-9401
A6699	EM-9160	A6803	EM-8659	A6883	EM-5610	A6979	EM-5855
A6700	EM-8665	A6804	EM-8489	A6883	EM-8586	A6980	EM-9403
A6701	EM-5186	A6805	EM-5457	A6884	EM-5812	A6981	EM-9402
A6702	EM-8641	A6806	EM-8568	A6885	EM-5813	A6982	EM-5934
A6703	EM-5187	A6807	EM-8825	A6886	EM-5814	A6984	EM-5935
A6704	EM-8640	A6808	EM-8277	A6900	EM-8224	A6985	EM-9558
A6706	EM-8661	A6809	EM-8517	A6901	EM-8236	A6987	EM-5879
A6707	EM-9559	A6810	EM-5483	A6902	EM-8222	A7000	EM-8794
A6708	EM-5188	A6811	EM-8524	A6903HY	EM-8224	A7001	EM-8800
A6709	EM-9024	A6812	EM-8314	A6904	EM-8221	A7002	EM-8620
A6710	EM-5189	A6813	EM-8568	A6905	EM-8857	A7004	EM-5459
A6712	EM-9023	A6814	EM-8517	A6906	EM-8589	A7005	EM-8622
A6713	EM-5190	A6815	EM-8656	A6907	EM-8287	A7006	EM-5214
A6714	EM-9074	A6816	EM-8657	A6908	EM-9000	A7007	EM-9145
A6716	EM-5191	A6817	EM-8294	A6909	EM-8663	A7008	EM-9111
A6717	EM-5597	A6818	EM-8658	A6910	EM-8616	A7009	EM-9062
A6718	EM-5598	A6819	EM-8282	A6911	EM-9004	A7010	EM-9047
A6719	EM-5599	A6820	EM-8521	A6912	EM-8623	A7011	EM-9094
A6721	EM-5600	A6821	EM-8804	A6912	EM-9077	A7012	EM-5069
A6722	EM-5601	A6822	EM-8093	A6913	EM-8663	A7013	EM-8985
A6723	EM-9559	A6823	EM-9242	A6914	EM-8663	A7014	EM-5669
A6724	EM-9552	A6824	EM-9022	A6915	EM-8617	A7015	EM-5737
A6725	EM-5602	A6825	EM-8890	A6916	EM-9046	A7016	EM-5616
A6726	EM-5603	A6826	EM-5458	A6917	EM-8829	A7017	EM-9095
A6727	EM-5515	A6827	EM-8568	A6918	EM-8831	A7018	EM-8594
A6730	EM-5983	A6828	EM-5358	A6919	EM-8830	A7019	EM-8593
A6731	EM-5971	A6829	EM-5359	A6920	EM-8828	A7020	EM-9099
A6732	EM-5960	A6830	EM-5951	A6921	EM-9005	A7021	EM-9003
A6733	EM-5959	A6833	EM-9613	A6922	EM-8997	A7022	EM-5218
A6750	EM-8912	A6835	EM-8522	A6923	EM-9106	A7023	EM-5216
A6752	EM-8612	A6836	EM-9156	A6924	EM-8999	A7024	EM-9002
A6753	EM-8611	A6837	EM-9159	A6925	EM-9102	A7025	EM-9105
A6754	EM-9346	A6838	EM-9177	A6926	EM-8998	A7026	EM-9096
A6755	EM-8911	A6839	EM-9241	A6927	EM-9065	A7028	EM-9098
A6756	EM-8902	A6840	EM-5608	A6929	EM-9092	A7029	EM-5215
A6757	EM-8914	A6841	EM-5931	A6930	EM-9101	A7030	EM-9099
A6759	EM-8913	A6842	EM-5932	A6932	EM-9001	A7031	EM-9404
A6760	EM-8606	A6844	EM-5933	A6933	EM-5213	A7032	EM-9271
A6761	EM-8607	A6845	EM-5873	A6934	EM-9076	A7033	EM-9272
A6762	EM-8608	A6850	EM-8586	A6935	EM-9208	A7034	EM-9273
A6763	EM-8901	A6851	EM-8976	A6936	EM-9261	A7035	EM-8592
A6764	EM-8910	A6852	EM-8445	A6937	EM-7030	A7036	EM-5396
A6765	EM-8908	A6853	EM-9144	A6950	EM-9045	A7037	EM-5487
A6766	EM-8907	A6854	EM-8049	A6951	EM-9109	A7038	EM-5397

# CROSS REFERENCE

Mfg Part No	Our Part	Mfg Part No	Our Part	Mfg Part No	Our Part	Mfg Part No	Our Part
DEA (cont.)		DEA (cont.)		DEA (cont.)		DEA (cont.)	
A7039	EM-5488	A7113	EM-8955	A7183	EM-9343	A7269	EM-8359
A7040	EM-5460	A7114	EM-8948	A7184	EM-9347	A7270	EM-8639
A7041	EM-5461	A7115	EM-8947	A7185	EM-9357	A7271	EM-9081
A7042	EM-5462	A7116	EM-8945	A7187	EM-9371	A7272	EM-8385
A7043	EM-9293	A7117	EM-9373	A7188	EM-9363	A7273	EM-9014
A7044	EM-9294	A7118	EM-8943	A7191	EM-5881	A7274	EM-8996
A7045	EM-5489	A7119	EM-8783	A7192	EM-5882	A7275	EM-8989
A7046	EM-5490	A7120	EM-8952	A7197	EM-5996	A7276	EM-9073
A7047	EM-5372	A7121	EM-8951	A7199	EM-9320	A7277	EM-9032
A7048	EM-9294	A7122	EM-9367	A7200	EM-8167	A7278	EM-9027
A7049	EM-5373	A7123	EM-9366	A7201	EM-8970	A7279	EM-8990
A7050	EM-8229	A7124	EM-8954	A7202	EM-8339	A7280	EM-8991
A7051	EM-8230	A7125	EM-9314	A7203	EM-8348	A7281	EM-9018
A7054	EM-8630	A7126	EM-9255	A7204	EM-8353	A7282	EM-9026
A7055	EM-8629	A7127	EM-9254	A7205	EM-8571	A7283	EM-9050
A7056	EM-8632	A7128	EM-8944	A7206	EM-8384	A7284	EM-9018
A7057	EM-8631	A7129	EM-8769	A7207	EM-9119	A7285	EM-9063
A7058	EM-8662	A7130	EM-9253	A7208	EM-8995	A7286	EM-9079
A7060	EM-8832	A7131	EM-9380	A7211	EM-8368	A7287	EM-9114
A7061	EM-8838	A7132	EM-9374	A7213	EM-8164	A7288	EM-9015
A7062	EM-8836	A7133	EM-9378	A7214	EM-8164	A7289	EM-5464
A7063	EM-8834	A7134	EM-9336	A7216	EM-9086	A7291	EM-9115
A7064	EM-5394	A7135	EM-7051	A7217	EM-9122	A7292	EM-9118
A7066	EM-9100	A7136	EM-9324	A7219	EM-8796	A7293	EM-9123
A7067	EM-9104	A7137	EM-9338	A7220	EM-8407	A7294	EM-5144
A7068	EM-9090	A7138	EM-9322	A7222	EM-8196	A7295	EM-9061
A7069	EM-9091	A7139	EM-9312	A7223	EM-9129	A7296	EM-5143
A7070	EM-9107	A7141	EM-9306	A7224	EM-8413	A7297	EM-5142
A7071	EM-9274	A7142	EM-9326	A7225	EM-8163	A7298	EM-9113
A7072HY	EM-9562	A7143	EM-9368	A7226	EM-8418	A7299	EM-9477
A7073	EM-5434	A7144	EM-9325	A7226IN	EM-5736	A7300	EM-8274
A7074	EM-5340	A7145	EM-9295	A7227	EM-8482	A7301	EM-9020
A7075	EM-9276	A7146	EM-9372	A7228	EM-8968	A7302	EM-8866
A7075HY	EM-9276	A7147	EM-9353	A7229	EM-9029	A7303	EM-8959
A7076	EM-5491	A7148	EM-9345	A7231	EM-8649	A7304	EM-9031
A7077	EM-5374	A7149	EM-9375	A7232	EM-8175	A7305	EM-8865
A7078	EM-9269	A7150	EM-9355	A7233	EM-8848	A7306	EM-5132
A7079	EM-9270	A7151	EM-9340	A7234	EM-8855	A7306EL	EM-5670
A7081	EM-9289	A7152	EM-9308	A7237	EM-8385	A7307	EM-5500
A7082	EM-5492	A7153	EM-9354	A7238	EM-8698	A7308	EM-8874
A7083	EM-9291	A7154	EM-9364	A7239	EM-8697	A7309	EM-8887
A7084	EM-5530	A7155	EM-9339	A7240	EM-5209	A7310	EM-8858
A7085	EM-9290	A7156	EM-9341	A7241	EM-8795	A7311	EM-8846
A7086	EM-9292	A7157	EM-9361	A7242	EM-8699	A7312	EM-5131
A7087	EM-5436	A7157	EM-9381	A7243	EM-8850	A7313	EM-5937
A7088	EM-5437	A7158	EM-9349	A7244	EM-8529	A7314	EM-9200
A7089	EM-9265	A7159	EM-9309	A7245	EM-8852	A7315	EM-9166
A7091HY	EM-5493	A7160	EM-9377	A7246	EM-9432	A7316	EM-5166
A7092	EM-5439	A7161	EM-9360	A7247	EM-8856	A7317	EM-5815
A7093HY	EM-9244	A7162	EM-9317	A7248	EM-8684	A7318	EM-9012
A7094	EM-5440	A7163	EM-5936	A7249	EM-8692	A7319	EM-8964
A7095	EM-9267	A7164	EM-9310	A7250	EM-5208	A7320	EM-2985
A7096	EM-5494	A7165	EM-9313	A7251	EM-9034	A7321	EM-9251
A7097	EM-5495	A7166	EM-9315	A7252	EM-8213	A7322	EM-9011
A7098	EM-9268	A7167	EM-9316	A7253	EM-8965	A7323HY	EM-9009
A7099	EM-5617	A7168	EM-9318	A7254	EM-8851	A7324	EM-9044
A7100	EM-8768	A7169	EM-9344	A7255	EM-8869	A7325	EM-9048
A7101	EM-9376	A7171	EM-9370	A7256	EM-8870	A7326	EM-9134
A7102	EM-8953	A7172	EM-5533	A7257	EM-8871	A7327	EM-5332
A7103	EM-8787	A7174	EM-9350	A7258	EM-8872	A7328	EM-9288
A7104	EM-8789	A7175	EM-9348	A7259	EM-8873	A7329	EM-8891
A7105	EM-8788	A7176	EM-9335	A7260	EM-8883	A7330	EM-9035
A7106	EM-8784	A7177	EM-9323	A7261	EM-8967	A7331	EM-9108
A7107	EM-8782	A7178	EM-9362	A7262	EM-8651	A7332HY	EM-8960
A7108	EM-8786	A7179	EM-9313	A7263	EM-8892	A7333	EM-9442
A7109	EM-8950	A7179	EM-9319	A7264	EM-8966	A7334	EM-8964
A7110	EM-8597	A7180	EM-9329	A7265	EM-9019	A7335	EM-5173
A7111	EM-8949	A7181	EM-9332	A7267	EM-8993	A7336	EM-5174
A7112	EM-9307	A7182	EM-9333	A7268	EM-9013	A7337	EM-5175

# CROSS REFERENCE

Mfg Part No	Our Part	Mfg Part No	Our Part	Mfg Part No	Our Part	Mfg Part No	Our Part
<b>DEA (cont.)</b>		<b>DEA (cont.)</b>		<b>HAYDEN (cont.)</b>		<b>HAYDEN (cont.)</b>	
A7338	EM-5411	A62034	EM-5861	31-1001	EM-2369	31-2268	EM-2304
A7340	EM-9167	A62035	EM-5949	31-1003	EM-2525	31-2271	EM-2321
A7341	EM-9209	A62037HY	EM-5916	31-1004	EM-2720	31-2273	EM-2254
A7342	EM-9190	A62038	EM-9498	31-1007	EM-2615	31-2274	EM-2256
A7343	EM-5817	A62040	EM-9543	31-1008	EM-2616	31-2275	EM-2255
A7344	EM-5938	A62042	EM-9015	31-1009	EM-2618	31-2276	EM-2350
A7345	EM-5501	A62044	EM-5827	31-2007	EM-2007	31-2281	EM-2262
A7346	EM-5502	A62044	EM-5930	31-2009	EM-2009	31-2284	EM-2253
A7347	EM-9219	A62045	EM-9595	31-2010	EM-2010	31-2286	EM-2333
A7348	EM-9223	A62046	EM-9518	31-2039	EM-2039	31-2287	EM-2257
A7349	EM-9252	A62047	EM-9519	31-2040	EM-2040	31-2288	EM-2290
A7349EL	EM-5672	A62049HY	EM-5940	31-2048	EM-2048	31-2289	EM-2289
A7351	EM-9410	A62050	EM-9513	31-2050	EM-2050	31-2293	EM-2264
A7352	EM-5905	A62051	EM-9523	31-2060	EM-2060	31-2295	EM-2351
A7353	EM-9256	A62052HY	EM-9175	31-2070	EM-2070	31-2296	EM-2266
A7354	EM-5441	A62053	EM-9514	31-2073	EM-2073	31-2304	EM-2263
A7355	EM-5404	A62055HY	EM-9525	31-2107	EM-2107	31-2305	EM-2281
A7356	EM-5406	A62056	EM-9550	31-2108	EM-2108	31-2308	EM-2267
A7357	EM-5407	A62057	EM-9509	31-2119	EM-2119	31-2308HD	EM-2267
A7358	EM-9248	A62058	EM-9593	31-2121	EM-2121	31-2312	EM-2238
A7358EL	EM-5818	A62060	EM-9601	31-2122	EM-2122	31-2312	EM-2274
A7359	EM-9464	A62061	EM-8854	31-2123	EM-2123	31-2313	EM-2261
A7360	EM-9416	A62062	EM-9588	31-2124	EM-2124	31-2315	EM-2309
A7361	EM-9460	A62063	EM-9158	31-2125	EM-2125	31-2316	EM-2277
A7362	EM-9551	A62063	EM-9412	31-2126	EM-2126	31-2317	EM-2275
A7363	EM-9545	A62064	EM-9549	31-2127	EM-2127	31-2319	EM-2301
A7364	EM-9544	A62065	EM-5963	31-2141	EM-2141	31-2322	EM-2283
A7365	EM-9531	A62066	EM-9576	31-2142	EM-2142	31-2323	EM-2317
A7366	EM-9520	A62068	EM-7015	31-2142HD	EM-2267	31-2327	EM-2310
A7367	EM-9517	A62069	EM-9497	31-2142HDL	EM-2278	31-2328	EM-2402
A7369	EM-5968	A62071	EM-5973	31-2143	EM-2143	31-2328	EM-2403
A7370	EM-5953	A62072	EM-5964	31-2150	EM-2150	31-2331	EM-2271
A7372	EM-5914	A62075	EM-7042	31-2162	EM-2162	31-2332	EM-2270
A7373EL	EM-5846	A62076	EM-9511	31-2163	EM-2163	31-2334	EM-2297
A7375	EM-5911	A62078	EM-9535	31-2167	EM-2167	31-2335	EM-2298
A8224	EM-8224	A62079	EM-9574	31-2168	EM-2293	31-2336	EM-2299
A62001	EM-5799	A62083HY	EM-5982	31-2170	EM-2170	31-2338	EM-2305
A62002	EM-5743	A62092	EM-5902	31-2172	EM-2172	31-2339	EM-2306
A62003	EM-5800	A62097	EM-5908	31-2204	EM-2204	31-2342	EM-2286
A62004	EM-5801	A65001HY	EM-5872	31-2205	EM-2205	31-2343	EM-2268
A62005	EM-5802	A65002	EM-9458	31-2206	EM-2206	31-2344	EM-2279
A62006	EM-9197	A65003	EM-9467	31-2217	EM-2217	31-2345	EM-2316
A62007	EM-5804	A65004	EM-9463	31-2218	EM-2218	31-2346	EM-2296
A62008	EM-5805	A65005	EM-9470	31-2219	EM-2219	31-2350	EM-2265
A62009	EM-5742	A65007	EM-9479	31-2220	EM-2220	31-2352	EM-2311
A62010	EM-9393	A65008	EM-9301	31-2221	EM-2221	31-2353	EM-2288
A62010	EM-9502	A65010	EM-5871	31-2222	EM-2222	31-2353	EM-2531
A62011	EM-9418	A65011	EM-9554	31-2223	EM-2223	31-2356	EM-2512
A62012	EM-9497	A65014	EM-9542	31-2224	EM-2378	31-2357	EM-2323
A62013	EM-5807	A65016	EM-5992	31-2225	EM-2225	31-2357	EM-2357
A62014	EM-5808	A65017EL	EM-5904	31-2226	EM-2226	31-2358	EM-2324
A62015	EM-9391	A65019	EM-5906	31-2227	EM-2227	31-2359	EM-2325
A62016	EM-9504	A65020	EM-9215	31-2228	EM-2228	31-2361	EM-2292
A62017	EM-5809	A65021	EM-5990	31-2231	EM-2231	31-2363	EM-2291
A62018	EM-9425	A65022	EM-5994	31-2234	EM-2234	31-2365	EM-2320
A62019	EM-8493	A65023HY	EM-5925	31-2235	EM-2235	31-2366	EM-2295
A62020	EM-9430	A65025	EM-5917	31-2239HD	EM-2282	31-2367	EM-2328
A62021	EM-9429	A65026EL	EM-5840	31-2240	EM-2240	31-2370	EM-2294
A62022	EM-9390	A65028EL	EM-5875	31-2241	EM-2241	31-2372	EM-2329
A62023	EM-9449	A65029	EM-9553	31-2243HD	EM-2284	31-2373	EM-2722
A62024	EM-9447	A65052	EM-5954	31-2244	EM-2287	31-2375	EM-2345
A62025	EM-5834	A65072	EM-5964	31-2244HD	EM-2287	31-2377	EM-2353
A62026	EM-9525	A65079	EM-9389	31-2245	EM-2327	31-2378	EM-2331
A62027	EM-9400	BC1F39060	EM-8740	31-2250	EM-2242	31-2379	EM-2332
A62028	EM-9419	<b>DORMAN</b>		31-2255	EM-2349	31-2380	EM-2375
A62029	EM-9455	A2609	EM-2609	31-2255	EM-2369	31-2381	EM-2356
A62030	EM-9491	<b>HAYDEN</b>		31-2265	EM-2250	31-2384	EM-2344
A62031	EM-9462	31-1000	EM-2376	31-2266	EM-2272	31-2385	EM-2337
A62033	EM-9158			31-2267	EM-2338	31-2386	EM-2335

# CROSS REFERENCE

Mfg Part No	Our Part	Mfg Part No	Our Part	Mfg Part No	Our Part	Mfg Part No	Our Part
<b>HAYDEN (cont.)</b>		<b>HAYDEN (cont.)</b>		<b>HAYDEN (cont.)</b>		<b>HAYDEN (cont.)</b>	
31-2387 .....	EM-2336	31-3084 .....	EM-2438	31-3281 .....	EM-2410	31-3501 .....	EM-2330
31-2388 .....	EM-2358	31-3086 .....	EM-2388	31-3282 .....	EM-2429	31-3502 .....	EM-2570
31-2389 .....	EM-2359	31-3088 .....	EM-2462	31-3283 .....	EM-2449	31-3503HY .....	EM-2661
31-2390 .....	EM-2470	31-3089 .....	EM-2453	31-3284 .....	EM-2451	31-3503SLD .....	EM-2661S
31-2391 .....	EM-2374	31-3090 .....	EM-2454	31-3285 .....	EM-2451	31-3504 .....	EM-2571
31-2393 .....	EM-2326	31-3091 .....	EM-2389	31-3286 .....	EM-2452	31-3505 .....	EM-2572
31-2511 .....	EM-2466	31-3093 .....	EM-2467	31-3297 .....	EM-2680	31-3506 .....	EM-2569
31-2534 .....	EM-2534	31-3095 .....	EM-2505	31-3300 .....	EM-2740	31-3506 .....	EM-2663
31-2537 .....	EM-2537	31-3096 .....	EM-2466	31-3302 .....	EM-2681	31-3507 .....	EM-2568
31-2538 .....	EM-2538	31-3097 .....	EM-2393	31-3305 .....	EM-2741	31-3508 .....	EM-2627
31-2539 .....	EM-2538	31-3097 .....	EM-2508	31-3306 .....	EM-2742	31-3510 .....	EM-2628
31-2540 .....	EM-2538	31-3099 .....	EM-2531	31-3307 .....	EM-2488	31-3511 .....	EM-2617
31-2541 .....	EM-2538	31-3103 .....	EM-2472	31-3308 .....	EM-2487	31-3512 .....	EM-2625
31-2542 .....	EM-2538	31-3108 .....	EM-2436	31-3310 .....	EM-2407	31-3513 .....	EM-2624
31-3000 .....	EM-2303	31-3112 .....	EM-2491	31-3315 .....	EM-2743	31-3515 .....	EM-2629
31-3004 .....	EM-2373	31-3113 .....	EM-2490	31-3316 .....	EM-2744	31-3516 .....	EM-2626
31-3006 .....	EM-2512	31-3120 .....	EM-2567	31-3317 .....	EM-2745	31-3517HY .....	EM-2553
31-3009 .....	EM-2340	31-3121 .....	EM-2562	31-3318 .....	EM-2408	31-3517SLD .....	EM-2553S
31-3014 .....	EM-2339	31-3121 .....	EM-2774	31-3320 .....	EM-2746	31-3518HY .....	EM-2555
31-3015 .....	EM-2341	31-3122 .....	EM-2563	31-3322 .....	EM-2690	31-3518SLD .....	EM-2555S
31-3017 .....	EM-2363	31-3136 .....	EM-2439	31-3325 .....	EM-2489	31-3519 .....	EM-2633
31-3018 .....	EM-2346	31-3137 .....	EM-2440	31-3325 .....	EM-2489	31-3520 .....	EM-2557
31-3019 .....	EM-2348	31-3138 .....	EM-2441	31-3375 .....	EM-2749	31-3520 .....	EM-2557
31-3020 .....	EM-2384	31-3139 .....	EM-2442	31-3386 .....	EM-2750	31-3521 .....	EM-2639
31-3021 .....	EM-2382	31-3141 .....	EM-2444	31-3387 .....	EM-2751	31-3523 .....	EM-2632
31-3022 .....	EM-2387	31-3142 .....	EM-2445	31-3392 .....	EM-2619	31-3523 .....	EM-2634
31-3024 .....	EM-2394	31-3144 .....	EM-2502	31-3394 .....	EM-2565	31-3524 .....	EM-2609
31-3025 .....	EM-2360	31-3144 .....	EM-2502	31-3395 .....	EM-2566	31-3525HY .....	EM-2551
31-3026 .....	EM-2379	31-3145 .....	EM-2448	31-3396 .....	EM-2752	31-3525SLD .....	EM-2551S
31-3030 .....	EM-2381	31-3147 .....	EM-2433	31-3397 .....	EM-2753	31-3526HY .....	EM-2551
31-3033 .....	EM-2436	31-3148 .....	EM-2434	31-3401 .....	EM-2754	31-3526SLD .....	EM-2551S
31-3034 .....	EM-2436	31-3153 .....	EM-2775	31-3408 .....	EM-2458	31-3527HY .....	EM-2551
31-3036 .....	EM-2391	31-3159 .....	EM-2503	31-3409 .....	EM-2457	31-3527SLD .....	EM-2551S
31-3037 .....	EM-2392	31-3160 .....	EM-2504	31-3410 .....	EM-2458	31-3528HY .....	EM-2556
31-3038 .....	EM-2395	31-3161 .....	EM-2776	31-3411 .....	EM-2457	31-3529 .....	EM-2630
31-3042 .....	EM-2446	31-3165 .....	EM-2458	31-3412 .....	EM-2682	31-3530 .....	EM-2684
31-3045 .....	EM-2370	31-3166 .....	EM-2500	31-3413 .....	EM-2683	31-3531 .....	EM-2760
31-3046 .....	EM-2370	31-3167 .....	EM-2501	31-3414 .....	EM-2558	31-3532 .....	EM-2685
31-3046 .....	EM-2371	31-3168 .....	EM-2457	31-3414 .....	EM-2558	31-3532 .....	EM-2685
31-3048 .....	EM-2471	31-3168 .....	EM-2457	31-3415 .....	EM-2559	31-3533 .....	EM-2636
31-3049 .....	EM-2362	31-3170 .....	EM-2459	31-3415 .....	EM-2559	31-3535 .....	EM-2636
31-3054 .....	EM-2364	31-3171 .....	EM-2460	31-3418 .....	EM-2696S	31-3536 .....	EM-2635
31-3055 .....	EM-2365	31-3172 .....	EM-2461	31-3418 .....	EM-2696S	31-3536 .....	EM-2635
31-3056 .....	EM-2368	31-3172 .....	EM-2461	31-3419 .....	EM-2631	31-3538 .....	EM-2600
31-3057 .....	EM-2367	31-3175 .....	EM-2501	31-3419 .....	EM-2631	31-3538 .....	EM-2600
31-3058 .....	EM-2723	31-3175 .....	EM-2501	31-3425 .....	EM-2497	31-3539 .....	EM-2499
31-3059 .....	EM-2724	31-3176 .....	EM-2500	31-3426 .....	EM-2498	31-3539 .....	EM-2499
31-3060 .....	EM-2409	31-3176 .....	EM-2500	31-3426 .....	EM-2498	31-3540 .....	EM-2601
31-3062 .....	EM-2406	31-3177 .....	EM-2501	31-3429 .....	EM-2513	31-3541 .....	EM-2601
31-3063 .....	EM-2400	31-3177 .....	EM-2501	31-3429 .....	EM-2515	31-3542 .....	EM-2601
31-3064 .....	EM-2405	31-3178 .....	EM-2500	31-3434 .....	EM-2515	31-3542 .....	EM-2601
31-3065 .....	EM-2404	31-3179 .....	EM-2501	31-3434 .....	EM-2515	31-3543 .....	EM-2601
31-3066 .....	EM-2414	31-3180 .....	EM-2500	31-3436 .....	EM-2474	31-3544 .....	EM-2601
31-3067 .....	EM-2419	31-3182 .....	EM-2725	31-3437 .....	EM-2473	31-3544 .....	EM-2601
31-3068 .....	EM-2418	31-3183 .....	EM-2726	31-3438 .....	EM-2506	31-3545 .....	EM-2601
31-3069 .....	EM-2417	31-3183 .....	EM-2726	31-3438 .....	EM-2506	31-3546 .....	EM-2601
31-3071 .....	EM-2424	31-3188 .....	EM-2463	31-3439 .....	EM-2524	31-3547 .....	EM-2601
31-3072 .....	EM-2426	31-3188 .....	EM-2463	31-3440 .....	EM-2477	31-3547 .....	EM-2601
31-3073 .....	EM-2428	31-3189 .....	EM-2679	31-3442 .....	EM-2381	31-3548 .....	EM-2601
31-3074 .....	EM-2425	31-3190 .....	EM-2727	31-3444 .....	EM-2510	31-3549 .....	EM-2623
31-3075 .....	EM-2415	31-3190 .....	EM-2727	31-3444 .....	EM-2510	31-3550 .....	EM-2622
31-3076 .....	EM-2389	31-3191 .....	EM-2728	31-3446 .....	EM-2496	31-3551 .....	EM-2687
31-3077 .....	EM-2457	31-3192 .....	EM-2536	31-3447 .....	EM-2543	31-3552 .....	EM-2686
31-3078 .....	EM-2458	31-3192 .....	EM-2536	31-3450 .....	EM-2492	31-3552 .....	EM-2686
31-3080 .....	EM-2420	31-3195 .....	EM-2458	31-3453 .....	EM-2528	31-3552 .....	EM-2688
31-3081 .....	EM-2347	31-3195 .....	EM-2458	31-3453 .....	EM-2528	31-3553 .....	EM-2644
31-3081 .....	EM-2372	31-3200 .....	EM-2447	31-3454 .....	EM-2528	31-3553 .....	EM-2644
31-3082 .....	EM-2385	31-3201 .....	EM-2600	31-3454 .....	EM-2528	31-3554 .....	EM-2645
31-3083 .....	EM-2437	31-3202 .....	EM-2730	31-3455 .....	EM-2396	31-3555 .....	EM-2646
		31-3203 .....	EM-2731	31-3456 .....	EM-2494	31-3555 .....	EM-2646
		31-3204 .....	EM-2731	31-3456HY .....	EM-2548	31-3556 .....	EM-2646
		31-3208 .....	EM-2734	31-3458SLD .....	EM-2548S	31-3557 .....	EM-2641
		31-3234 .....	EM-2469	31-3459 .....	EM-2495	31-3558 .....	EM-2641
		31-3245 .....	EM-2493	31-3460 .....	EM-2755	31-3559 .....	EM-2642
		31-3276 .....	EM-2401	31-3461 .....	EM-2756	31-3560 .....	EM-2643
		31-3277 .....	EM-2421	31-3461 .....	EM-2756	31-3561 .....	EM-2652
		31-3278 .....	EM-2456	31-3464 .....	EM-2382	31-3562 .....	EM-2620
		31-3279 .....	EM-2533	31-3467 .....	EM-2549	31-3563 .....	EM-2637
		31-3280 .....	EM-2532	31-3468 .....	EM-2550	31-3563 .....	EM-2637
				31-3469 .....	EM-2497	31-3564 .....	EM-2638
				31-3500 .....	EM-2280	31-3565 .....	EM-2564
						31-3566 .....	EM-2621

# CROSS REFERENCE

Mfg Part No	Our Part	Mfg Part No	Our Part	Mfg Part No	Our Part	Mfg Part No	Our Part
<b>HAYDEN (cont.)</b>		<b>NAPA (cont.)</b>		<b>NAPA (cont.)</b>		<b>NAPA (cont.)</b>	
31-3568	EM-2649	602-1020	EM-2040	602-1158	EM-2320	602-1324	EM-2533
31-3569	EM-2650	602-1021	EM-2039	602-1159	EM-2281	602-1325	EM-2532
31-3570	EM-2651	602-1023	EM-2057	602-1161	EM-2280	602-1334	EM-2565
31-3571	EM-2665	602-1026	EM-2219	602-1162	EM-2330	602-1340	EM-2619
31-3572HY	EM-2717	602-1027	EM-2053	602-1165	EM-2263	602-1343	EM-2744
31-3572SLD	EM-2717S	602-1028	EM-2381	602-1167	EM-2284	602-1345	EM-2681
31-3573HY	EM-2660	602-1030	EM-2091	602-1168	EM-2289	602-1346	EM-2469
31-3573SLD	EM-2660S	602-1034	EM-2107	602-1169	EM-2290	602-1350	EM-2429
31-3574	EM-2691	602-1035	EM-2108	602-1170	EM-2265	602-1355	EM-2615
31-3575	EM-2671	602-1038	EM-2110	602-1174	EM-2512	602-1356	EM-2616
31-3576	EM-2761	602-1039	EM-2120	602-1175	EM-2296	602-1357	EM-2623
31-3577	EM-2708	602-1040	EM-2119	602-1177	EM-2009	602-1358	EM-2626
31-3578	EM-2762	602-1041	EM-2121	602-1178	EM-2010	602-1361	EM-2629
31-3579	EM-2763	602-1044	EM-2122	602-1179	EM-2292	602-1362	EM-2630
31-3580	EM-2764	602-1045	EM-2123	602-1180	EM-2375	602-1363	EM-2635
31-3581	EM-2765	602-1046	EM-2124	602-1182	EM-2351	602-1364	EM-2636
31-3582	EM-2766	602-1047	EM-2125	602-1189	EM-2217	602-1365	EM-2637
31-3584	EM-2667	602-1050	DS-6027	602-1190	EM-2218	602-1369	EM-2493
31-3585	EM-2668	602-1054	EM-2142	602-1193	EM-2444	602-1370	EM-2436
31-3586	EM-2710	602-1058	EM-2141	602-1194	EM-2445	602-1373	EM-2436
31-3587	EM-2653	602-1059	EM-2204	602-1195	EM-2345	602-1375	EM-2421
31-3588	EM-2654	602-1061	EM-2206	602-1196	EM-2311	602-1376	EM-2456
31-3589	EM-2655	602-1063	EM-2364	602-1213	EM-2301	602-1377	EM-2446
31-3591	EM-2656	602-1064	EM-2365	602-1214	EM-2302	602-1379	EM-2436
31-3592	EM-2657	602-1066	EM-2162	602-1217	EM-2297	602-1380	EM-2437
31-3593	EM-2658	602-1067	EM-2163	602-1218	EM-2298	602-1381	EM-2438
31-3594	EM-2767	602-1068	EM-2170	602-1221	EM-2305	602-1382	EM-2433
31-3595	EM-2768	602-1069	EM-2172	602-1227	EM-2369	602-1383	EM-2434
31-3596	EM-2769	602-1078	EM-2150	602-1231	EM-2357	602-1384	EM-2449
31-3597HY	EM-2711	602-1086	EM-2319	602-1232	EM-2356	602-1387	EM-2447
31-3598	EM-2770	602-1087	DS-6028	602-1235	EM-2331	602-1389	EM-2382
31-3600	EM-2771	602-1090	EM-2309	602-1236	EM-2332	602-1390	EM-2382
31-3601	EM-2676	602-1091	EM-2316	602-1237	EM-2327	602-1391	EM-2459
31-3602	EM-2664	602-1094	EM-2350	602-1238	EM-2344	602-1392	EM-2460
31-3604	EM-2692	602-1102	EM-2462	602-1239	EM-2358	602-1393	EM-2461
31-3605	EM-2662	602-1104	EM-2267	602-1240	EM-2359	602-1483	EM-2506
31-3606	EM-2674	602-1105	EM-2231	602-1242	EM-2335	602-1484	EM-2524
31-3608	EM-2772	602-1106	EM-2267	602-1243	EM-2336	602-1486	EM-2496
31-3609	EM-2707S	602-1107	EM-2283	602-1250	EM-2363	602-1488	EM-2473
31-3610	EM-2677	602-1108	EM-2282	602-1251	EM-2395	602-1489	EM-2474
31-3611	EM-2678	602-1109	EM-2261	602-1252	EM-2371	602-1490	EM-2477
31-3613	EM-2773	602-1110	EM-2275	602-1253	EM-2370	602-1493	EM-2490
31-3614	EM-2777	602-1114	EM-2234	602-1254	EM-2341	602-1501	EM-2550
31-3616	EM-2778	602-1115	EM-2235	602-1255	EM-2400	602-1502	EM-2549
31-3617HY	EM-2548	602-1116	EM-2264	602-1258	EM-2424	602-1503	EM-2550
31-3618	EM-2780	602-1118	EM-2250	602-1259	EM-2426	602-1506	EM-2558
31-3619	EM-2781	602-1119	EM-2328	602-1260	EM-2367	602-1514	EM-2323
31-3621	EM-2782	602-1121	EM-2272	602-1262	EM-2414	602-1515	EM-2324
31-3623	EM-2709	602-1122	EM-2277	602-1263	EM-2417	602-1516	EM-2325
31-3624	EM-2784	602-1127	EM-2267	602-1264	EM-2415	602-1517	EM-2326
31-3625	EM-2785	602-1130	EM-2266	602-1265	EM-2329	602-1524	EM-2503
31-3626	EM-2786	602-1132	EM-2225	602-1266	EM-2600	602-1526	EM-2727
35-6027	DS-6027	602-1133	EM-2220	602-1268	EM-2376	602-1527	EM-2728
35-6028	DS-6028	602-1134	EM-2221	602-1280	EM-2562	602-1528	EM-2682
35-6035	DS-6035	602-1138	EM-2242	602-1281	EM-2563	602-1529	EM-2683
35-6036	DS-6056	602-1139	EM-2222	602-1284	EM-2439	602-1530	EM-2407
35-6047	DS-6038	602-1140	EM-2223	602-1285	EM-2440	602-1531	EM-2406
35-6049	DS-6040	602-1144	EM-2271	602-1286	EM-2441	602-1532	EM-2458
35-6050	DS-6048	602-1145	EM-2270	602-1287	EM-2442	602-1534	EM-2458
35-6051	DS-6049	602-1147	EM-2255	602-1288	EM-2502	602-1535	EM-2457
35-6053	DS-6051	602-1148	EM-2256	602-1297	EM-2457	602-1536	EM-2458
35-6054	DS-6050	602-1149	EM-2291	602-1298	EM-2458	602-1537	EM-2457
35-6055	DS-6052	602-1151	EM-2257	602-1300	EM-2396	602-1538	EM-2501
35-6058	DS-6053	602-1152	EM-2287	602-1310	EM-2609	602-1539	EM-2500
<b>NAPA</b>		602-1153	EM-2333	602-1311	EM-2825	602-1541	EM-2538
602-1006	EM-2384	602-1154	EM-2240	602-1313	EM-2872	602-1546	EM-2491
602-1009	EM-2387	602-1155	EM-2241	602-1321	EM-8200	602-1550	EM-2548
602-1015	EM-2014	602-1156	EM-2226	602-1322	EM-8137	602-1552	EM-2538
602-1017	EM-2385	602-1157	EM-2254	602-1323	EM-8142	602-1555	EM-2600



# CROSS REFERENCE

Mfg Part No	Our Part	Mfg Part No	Our Part	Mfg Part No	Our Part	Mfg Part No	Our Part
NAPA (cont.)		NAPA (cont.)		NAPA (cont.)		NAPA (cont.)	
602-1556	EM-2326	602-1670	EM-2402	602-1742	EM-2809	602-1837	EM-8141
602-1557	EM-2505	602-1671	EM-2403	602-1743	EM-2819	602-1839	EM-8161
602-1558	EM-2472	602-1672	EM-2427	602-1744	EM-2798	602-1840	EM-2407
602-1559	EM-2501	602-1673	EM-2381	602-1745	EM-2799	602-1841	EM-8278
602-1560	EM-2500	602-1674	EM-2662	602-1746	EM-2814	602-1842	EM-8173
602-1563	EM-2627	602-1675	EM-2658	602-1747	EM-2797	602-1843	EM-8177
602-1565	EM-2569	602-1676	EM-2673	602-1748	EM-8025	602-1844	EM-8178
602-1566	EM-2571	602-1677	EM-2674	602-1749	EM-8024	602-1845	EM-8180
602-1567	EM-2572	602-1678	EM-2676	602-1750	EM-8697	602-1846	EM-8181
602-1569	EM-2501	602-1679	EM-2680	602-1751	EM-8698	602-1847	EM-8211
602-1570	EM-2501	602-1680	EM-2685	602-1752	EM-9153	602-1848	EM-8183
602-1571	EM-2500	602-1681	EM-2686	602-1753	EM-9154	602-1849	EM-8183
602-1572	EM-2564	602-1682	EM-2687	602-1754	EM-9155	602-1850	EM-8185
602-1573	EM-2551	602-1683	EM-2688	602-1755	EM-9156	602-1851	EM-8186
602-1574	EM-2551	602-1684	EM-2689	602-1756	EM-9157	602-1852	EM-8192
602-1575	EM-2553	602-1685	EM-2697	602-1757	EM-9158	602-1853	EM-8193
602-1576	EM-2551	602-1686	EM-2698	602-1758	EM-9159	602-1854	EM-8194
602-1578	EM-2559	602-1687	EM-2708	602-1759	EM-9160	602-1855	EM-8195
602-1580	EM-2458	602-1688	EM-2709	602-1760	EM-9161	602-1856	EM-8197
602-1581	EM-2621	602-1689	EM-2713	602-1761	EM-9164	602-1857	EM-8198
602-1582	EM-2640	602-1691	EM-2716	602-1762	EM-8209	602-1858	EM-8210
602-1583	EM-2641	602-1692	EM-2718	602-1763	EM-8682	602-1859	EM-8211
602-1584	EM-2642	602-1693	EM-2722	602-1764	EM-8801	602-1860	EM-8213
602-1585	EM-2643	602-1694	EM-2723	602-1765	EM-8849	602-1861	EM-2678
602-1586	EM-2644	602-1695	EM-2724	602-1766	EM-8851	602-1862	EM-8222
602-1587	EM-2645	602-1696	EM-2726	602-1767	EM-8960	602-1863	EM-8224
602-1588	EM-2646	602-1698	EM-2733	602-1769	EM-8968	602-1864	EM-8229
602-1589	EM-2646	602-1699	EM-2736	602-1770	EM-8973	602-1865	EM-8233
602-1590	EM-2649	602-1700	EM-2737	602-1771	EM-8975	602-1866	EM-8224
602-1591	EM-2650	602-1701	EM-2738	602-1772	EM-8795	602-1867	EM-8239
602-1592	EM-2651	602-1702	EM-2740	602-1773	EM-9014	602-1868	EM-8259
602-1593	EM-2652	602-1703	EM-2743	602-1774	EM-9016	602-1869	EM-8278
602-1594	EM-2654	602-1704	EM-2745	602-1775	EM-9136	602-1870	EM-8279
602-1595	EM-2655	602-1705	EM-2749	602-1776	EM-9139	602-1871	EM-8282
602-1596	EM-2656	602-1706	EM-2755	602-1800	EM-8039	602-1872	EM-8283
602-1597	EM-2657	602-1707	EM-2756	602-1801	EM-8041	602-1873	EM-8307
602-1598	EM-2658	602-1708	EM-2396	602-1802	EM-8042	602-1875	EM-8178
602-1599	EM-2338	602-1709	EM-2763	602-1803	EM-8042	602-1876	EM-8278
602-1623	EM-2401	602-1710	EM-2776	602-1804	EM-8044	602-1878	EM-8348
602-1628	EM-2451	602-1711	EM-2777	602-1805	EM-8053	602-1879	EM-8363
602-1629	EM-2536	602-1712	EM-2778	602-1806	EM-8068	602-1881	EM-8197
602-1631	EM-2747	602-1713	EM-2780	602-1807	EM-8059	602-1882	EM-8406
602-1634	EM-2731	602-1714	EM-2781	602-1808	EM-2651	602-1883	EM-8177
602-1635	EM-2731	602-1715	EM-2782	602-1809	EM-8065	602-1884	EM-8430
602-1638	EM-2696	602-1716	EM-2785	602-1811	EM-8073	602-1885	EM-8605
602-1639	EM-2725	602-1717	EM-2351	602-1812	EM-8078	602-1886	EM-8600
602-1640	EM-2750	602-1718	EM-2775	602-1813	EM-8080	602-1887	EM-8568
602-1641	EM-2735	602-1719	EM-2413	602-1814	EM-8083	602-1888	EM-8574
602-1642	EM-2684	602-1720	EM-2748	602-1815	EM-8084	602-1890	EM-8576
602-1643	EM-2812	602-1721	EM-2774	602-1816	EM-8085	602-1891	EM-8431
602-1644	EM-2692	602-1722	EM-2404	602-1817	EM-8086	602-1892	EM-8407
602-1645	EM-2660	602-1723	EM-2405	602-1818	EM-8087	602-1893	EM-8276
602-1647	EM-2717	602-1725	EM-2789	602-1819	EM-8088	602-1894	EM-8212
602-1648	EM-2711	602-1726	EM-2790	602-1820	EM-8080	602-1895	EM-8151
602-1649	EM-2661	602-1727	EM-2791	602-1821	EM-8100	602-1897	EM-8094
602-1650	EM-2555	602-1728	EM-2792	602-1822	EM-8102	602-1898	EM-8007
602-1651	EM-2764	602-1729	EM-2795	602-1824	EM-8104	602-1899	EM-8018
602-1652	EM-2765	602-1730	EM-2796	602-1825	EM-8105	602-1900	EM-2451
602-1653	EM-2710	602-1731	EM-2801	602-1826	EM-8107	602-1901	EM-8014
602-1654	EM-2767	602-1732	EM-2803	602-1827	EM-8103	602-1902	EM-8002
602-1655	EM-2768	602-1733	EM-2812	602-1828	EM-8065	602-1903	EM-8005
602-1657	EM-2677	602-1734	EM-2793	602-1829	EM-8118	602-1904	EM-8517
602-1658	EM-2678	602-1735	EM-2794	602-1830	EM-8119	602-1905	EM-8001
602-1663	EM-2018	602-1736	EM-2802	602-1831	EM-8125	602-1906	EM-8006
602-1664	EM-2287	602-1737	EM-2804	602-1832	EM-8133	602-1909	EM-8047
602-1665	EM-2276	602-1738	EM-2805	602-1833	EM-8125	602-1910	EM-8122
602-1666	EM-2303	602-1739	EM-2806	602-1834	EM-8133	602-1911	EM-8132
602-1667	EM-2304	602-1740	EM-2807	602-1835	EM-8135	602-1912	EM-8152
602-1669	EM-2786	602-1741	EM-2808	602-1836	EM-8140	602-1913	EM-8164

# CROSS REFERENCE

Mfg Part No	Our Part	Mfg Part No	Our Part	Mfg Part No	Our Part	Mfg Part No	Our Part
NAPA (cont.)		NAPA (cont.)		NAPA (cont.)		NAPA (cont.)	
602-1914	EM-8187	602-2014	EM-8622	602-2087	EM-2983	602-2160	EM-8870
602-1917	EM-8234	602-2015	EM-8224	602-2088	EM-2985	602-2161	EM-8874
602-1921	EM-8310	602-2016	EM-8672	602-2089	EM-2987	602-2162	EM-8893
602-1923	EM-8411	602-2018	EM-8680	602-2090	EM-2989	602-2163	EM-8894
602-1925	EM-8566	602-2020	EM-2869	602-2091	EM-2990	602-2164	EM-8895
602-1926	EM-8578	602-2021	EM-2876	602-2092	EM-2993	602-2165	EM-8897
602-1927	EM-8579	602-2022	EM-2622	602-2093	EM-2994	602-2166	EM-8899
602-1928	EM-2939	602-2023	EM-2878	602-2094	EM-2995	602-2167	EM-8906
602-1929	EM-2968	602-2024	EM-2883	602-2095	EM-2996	602-2168	EM-8908
602-1939	EM-3011	602-2025	EM-2885	602-2096	EM-2997	602-2169	EM-8921
602-1940	EM-8614	602-2026	EM-2886	602-2097	EM-2998	602-2170	EM-8961
602-1941	EM-8615	602-2027	EM-2889	602-2098	EM-2999	602-2171	EM-8962
602-1942	EM-8427	602-2028	EM-2890	602-2099	EM-3000	602-2172	EM-8965
602-1943	EM-2894	602-2029	EM-2892	602-2100	EM-3001	602-2173	EM-8974
602-1944	EM-2896	602-2032	EM-2900	602-2101	EM-3002	602-2174	EM-8984
602-1945	EM-3012	602-2033	EM-2901	602-2102	EM-3003	602-2175	EM-8988
602-1946	EM-3014	602-2034	EM-2902	602-2103	EM-3004	602-2176	EM-8994
602-1947	EM-3015	602-2035	EM-2903	602-2104	EM-3005	602-2177	EM-9003
602-1948	EM-3019	602-2036	EM-2904	602-2105	EM-3006	602-2178	EM-9007
602-1950	EM-2866	602-2037	EM-2905	602-2106	EM-3008	602-2179	EM-9008
602-1951	EM-8201	602-2038	EM-2987	602-2107	EM-3009	602-2180	EM-9009
602-1953	EM-2850	602-2039	EM-2909	602-2108	EM-3010	602-2181	EM-9022
602-1954	EM-2851	602-2040	EM-2910	602-2109	EM-8008	602-2182	EM-9023
602-1955	EM-2853	602-2041	EM-2911	602-2110	EM-8010	602-2183	EM-9043
602-1956	EM-2856	602-2042	EM-2912	602-2111	EM-8011	602-2184	EM-9044
602-1957	EM-2859	602-2043	EM-2913	602-2112	EM-8021	602-2185	EM-8261
602-1958	EM-2860	602-2044	EM-2914	602-2113	EM-8074	602-2186	EM-8895
602-1959	EM-2861	602-2045	EM-2915	602-2114	EM-8075	602-2187	EM-9083
602-1960	EM-2867	602-2046	EM-2916	602-2116	EM-8167	602-2188	EM-2649
602-1961	EM-2827	602-2047	EM-2917	602-2117	EM-8296	602-2189	EM-8681
602-1962	EM-2829	602-2048	EM-2918	602-2118	EM-8361	602-2190	EM-9137
602-1963	EM-2830	602-2049	EM-2919	602-2119	EM-8404	602-2192	EM-8009
602-1964	EM-2831	602-2050	EM-2920	602-2121	EM-8435	602-2193	EM-8030
602-1965	EM-2832	602-2051	EM-2926	602-2122	EM-8456	602-2194	EM-8100
602-1966	EM-2833	602-2052	EM-2929	602-2123	DS-8471	602-2195	EM-8169
602-1967	EM-2834	602-2053	EM-2930	602-2124	EM-8491	602-2196	EM-8349
602-1968	EM-2835	602-2054	EM-2931	602-2125	EM-8513	602-2197	EM-8359
602-1969	EM-2836	602-2055	EM-2933	602-2126	EM-8612	602-2198	EM-8385
602-1970	EM-2838	602-2056	EM-2934	602-2127	EM-8617	602-2199	EM-8398
602-1971	EM-2841	602-2057	EM-2935	602-2130	EM-8164	602-2200	EM-8413
602-1972	EM-2842	602-2058	EM-2936	602-2131	EM-8662	602-2201	EM-8432
602-1973	EM-2844	602-2059	EM-2853	602-2132	EM-8677	602-2202	EM-8497
602-1974	EM-2846	602-2060	EM-2938	602-2133	EM-8687	602-2203	EM-8524
602-1975	EM-2847	602-2061	EM-2940	602-2134	EM-8692	602-2204	EM-8575
602-1976	EM-2849	602-2062	EM-2941	602-2135	EM-8699	602-2205	EM-8616
602-1977	EM-2854	602-2063	EM-2942	602-2136	EM-8701	602-2206	EM-8658
602-1978	EM-2855	602-2064	EM-2943	602-2137	EM-8710	602-2207	EM-8670
602-1979	EM-8004	602-2065	EM-2944	602-2138	EM-8711	602-2208	EM-8690
602-1980	EM-8026	602-2066	EM-2945	602-2139	EM-8740	602-2209	EM-8709
602-1982	EM-8037	602-2067	EM-2947	602-2140	EM-8597	602-2210	EM-8792
602-1984	EM-8068	602-2068	EM-2948	602-2141	EM-8774	602-2211	EM-8819
602-1985	EM-8093	602-2069	EM-2949	602-2142	EM-8781	602-2212	EM-8823
602-1986	EM-8097	602-2070	EM-2952	602-2143	EM-8788	602-2213	EM-8824
602-1987	EM-8114	602-2071	EM-2953	602-2144	EM-8795	602-2214	EM-8616
602-1990	EM-8166	602-2072	EM-2955	602-2145	EM-8796	602-2215	EM-8344
602-1991	EM-8171	602-2073	EM-2958	602-2146	EM-8798	602-2216	EM-8691
602-1992	EM-8179	602-2074	EM-2959	602-2147	EM-8803	602-2217	EM-3022
602-1993	EM-8196	602-2075	EM-2961	602-2148	EM-8806	602-2218	EM-3023
602-1995	EM-8207	602-2076	EM-2962	602-2149	EM-8681	602-2219	EM-3024
602-1996	EM-8235	602-2077	EM-2963	602-2150	EM-8818	602-2220	EM-3025
602-1998	EM-8253	602-2078	EM-2964	602-2151	EM-8820	602-2221	EM-3028
602-1999	EM-8304	602-2079	EM-2967	602-2152	EM-8845	602-2222	EM-3029
602-2005	EM-8402	602-2080	EM-2972	602-2153	EM-8846	602-2223	EM-3030
602-2007	EM-8485	602-2081	EM-2973	602-2154	EM-8850	602-2224	EM-3031
602-2009	EM-8584	602-2082	EM-2978	602-2155	EM-8858	602-2225	EM-3033
602-2010	EM-8596	602-2083	EM-2979	602-2156	EM-8860	602-2226	EM-3034
602-2011	EM-8602	602-2084	EM-2980	602-2157	EM-8864	602-2227	EM-3035
602-2012	EM-8603	602-2085	EM-2899	602-2158	EM-8865	602-2228	EM-3036
602-2013	EM-8609	602-2086	EM-2981	602-2159	EM-8866	602-2229	EM-3037

# CROSS REFERENCE

Mfg Part No	Our Part	Mfg Part No	Our Part	Mfg Part No	Our Part	Mfg Part No	Our Part
NAPA (cont.)		NAPA (cont.)		NAPA (cont.)		NAPA (cont.)	
602-2230	EM-3039	602-2301	EM-5141	602-2373	EM-9200	602-2449	EM-9031
602-2231	EM-3044	602-2302	EM-9212	602-2374	EM-9202	602-2450	EM-8150
602-2232	EM-3045	602-2303	EM-9223	602-2375	EM-9203	602-2451	EM-8959
602-2233	EM-3064	602-2304	EM-9226	602-2376	EM-9207	602-2452	EM-8882
602-2234	EM-3047	602-2305	EM-9227	602-2377	EM-9209	602-2453	EM-8997
602-2235	EM-3048	602-2306	EM-9228	602-2378	EM-9210	602-2454	EM-8778
602-2236	EM-3049	602-2307	EM-9231	602-2379	EM-9213	602-2455	EM-9116
602-2237	EM-3056	602-2308	EM-9232	602-2380	EM-9218	602-2456	EM-8277
602-2238	EM-3059	602-2309	EM-9233	602-2381	EM-9221	602-2457	EM-8855
602-2239	EM-3060	602-2310	EM-9234	602-2382	EM-9228	602-2458	EM-8992
602-2240	EM-3067	602-2311	EM-9235	602-2383	EM-9246	602-2459	EM-9015
602-2241	EM-9149	602-2312	EM-9237	602-2384	EM-9248	602-2460	EM-8978
602-2242	EM-9150	602-2313	EM-9238	602-2385	EM-9250	602-2461	EM-8982
602-2243	EM-9166	602-2314	EM-9239	602-2386	EM-9265	602-2462	EM-8884
602-2244	EM-9167	602-2315	EM-9240	602-2387	EM-9277	602-2463	EM-8871
602-2245	EM-9168	602-2316	EM-9242	602-2388	EM-9297	602-2464	EM-9092
602-2246	EM-9169	602-2318	EM-9240	602-2389	EM-9303	602-2465	EM-8002
602-2247	EM-9170	602-2319	EM-9247	602-2390	EM-9305	602-2466	EM-8832
602-2248	EM-9171	602-2320	EM-9249	602-2392	EM-9307	602-2468	EM-3128
602-2249	EM-9172	602-2321	EM-9251	602-2393	EM-9309	602-2469	EM-3129
602-2250	EM-9173	602-2322	EM-9252	602-2394	EM-9310	602-2470	EM-3130
602-2251	EM-9175	602-2323	EM-9253	602-2395	EM-9311	602-2471	EM-3131
602-2252	EM-9178	602-2324	EM-9254	602-2396	EM-9312	602-2472	EM-3132
602-2253	EM-9179	602-2325	EM-9255	602-2397	EM-9313	602-2473	EM-3133
602-2254	EM-9180	602-2326	EM-9256	602-2398	EM-9314	602-2474	EM-3138
602-2255	EM-9181	602-2327	EM-9257	602-2400	EM-9316	602-2475	EM-3139
602-2256	EM-9184	602-2328	EM-9259	602-2401	EM-9317	602-2476	EM-3140
602-2257	EM-9185	602-2329	EM-9260	602-2402	EM-9318	602-2477	EM-3141
602-2258	EM-9186	602-2330	EM-9261	602-2403	EM-9317	602-2478	EM-3142
602-2259	EM-9187	602-2331	EM-9263	602-2404	EM-9322	602-2479	EM-3143
602-2260	EM-9188	602-2332	EM-9269	602-2405	EM-9323	602-2480	EM-3145
602-2261	EM-9189	602-2333	EM-9270	602-2406	EM-9324	602-2481	EM-3146
602-2262	EM-9190	602-2334	EM-9271	602-2407	EM-9325	602-2482	EM-3147
602-2263	EM-9191	602-2335	EM-9272	602-2408	EM-9326	602-2483	EM-3148
602-2264	EM-9193	602-2336	EM-9273	602-2409	EM-9327	602-2484	EM-3149
602-2267	EM-3021	602-2337	EM-9274	602-2410	EM-9328	602-2485	EM-3150
602-2268	EM-3064	602-2338	EM-9275	602-2411	EM-9329	602-2486	EM-3151
602-2269	EM-3072	602-2339	EM-9276	602-2412	EM-9330	602-2487	EM-9385
602-2270	EM-3071	602-2340	EM-9278	602-2413	EM-9331	602-2488	EM-9386
602-2271	EM-3073	602-2341	EM-9279	602-2414	EM-9332	602-2489	EM-9388
602-2272	EM-3074	602-2342	EM-9280	602-2415	EM-9335	602-2490	EM-9389
602-2273	EM-3075	602-2343	EM-9281	602-2416	EM-9338	602-2491	EM-9391
602-2274	EM-3076	602-2344	EM-9282	602-2417	EM-9340	602-2492	EM-9392
602-2275	EM-3077	602-2345	EM-9283	602-2419	EM-9344	602-2493	EM-9393
602-2276	EM-3078	602-2346	EM-9288	602-2420	EM-9345	602-2494	EM-9394
602-2277	EM-3079	602-2347	EM-9289	602-2421	EM-9346	602-2495	EM-9396
602-2278	EM-3084	602-2348	EM-9290	602-2422	EM-9348	602-2496	EM-9066
602-2279	EM-3085	602-2349	EM-9291	602-2423	EM-9348	602-2497	EM-9168
602-2280	EM-9182	602-2350	EM-9292	602-2425	EM-9352	602-2498	EM-9400
602-2281	EM-9192	602-2351	EM-9293	602-2426	EM-9353	602-2499	EM-9401
602-2282	EM-9194	602-2352	EM-9294	602-2427	EM-9354	602-2500	EM-9402
602-2283	EM-9195	602-2353	EM-9299	602-2428	EM-9355	602-2501	EM-9403
602-2284	EM-3083	602-2354	EM-9300	602-2429	EM-9357	602-2502	EM-9404
602-2285	EM-3088	602-2355	EM-9302	602-2430	EM-9358	602-2503	EM-9405
602-2286	EM-3089	602-2356	EM-3087	602-2431	EM-9359	602-2504	EM-9406
602-2287	EM-3090	602-2357	EM-3091	602-2432	EM-9360	602-2505	EM-9407
602-2288	EM-3093	602-2358	EM-3095	602-2433	EM-9362	602-2506	EM-9408
602-2289	EM-3097	602-2359	EM-3100	602-2434	EM-9363	602-2507	EM-9411
602-2290	EM-3102	602-2360	EM-3107	602-2435	EM-9365	602-2508	EM-9412
602-2291	EM-3103	602-2362	EM-3109	602-2436	EM-9368	602-2509	EM-9413
602-2292	EM-3104	602-2363	EM-3110	602-2437	EM-9372	602-2510	EM-9415
602-2293	EM-3105	602-2364	EM-3111	602-2438	EM-9375	602-2511	EM-9416
602-2294	EM-3111	602-2365	EM-3112	602-2439	EM-9377	602-2512	EM-9418
602-2295	EM-3121	602-2366	EM-3113	602-2440	EM-9379	602-2513	EM-9419
602-2296	EM-9196	602-2367	EM-3114	602-2441	EM-9382	602-2514	EM-9421
602-2297	EM-9197	602-2368	EM-3116	602-2442	EM-9382	602-2515	EM-9422
602-2298	EM-9078	602-2369	EM-3117	602-2444	EM-8681	602-2516	EM-9424
602-2299	EM-9208	602-2370	EM-3118	602-2445	EM-8704	602-2517	EM-9431
602-2300	EM-9211	602-2371	EM-3120	602-2446	EM-8885	602-2518	EM-9432
		602-2372	EM-9198	602-2447	EM-8902		
				602-2448	EM-2985		

# CROSS REFERENCE

Mfg Part No	Our Part	Mfg Part No	Our Part	Mfg Part No	Our Part	Mfg Part No	Our Part
NAPA (cont.)		NAPA (cont.)		NAPA (cont.)		NAPA (cont.)	
602-2519	EM-9436	602-2599	EM-5674	602-2676	EM-9553	620-1107	EM-2392
602-2520	EM-9437	602-2601	EM-5692	602-2677	EM-9554	620-1108	EM-2389
602-2521	EM-9441	602-2602	EM-5693	602-2731	EM-4044	620-1109	EM-2497
602-2522	EM-9442	602-2603	EM-5694	612-1550	EM-2548S	620-1110	EM-2557
602-2523	EM-9443	602-2605	EM-4017	612-1574	EM-2551S	620-1111	EM-2556
602-2524	EM-9444	602-2606	EM-4000	612-1576	EM-2551S	620-1114	EM-2557
602-2525	EM-9445	602-2607	EM-5152	612-1638	EM-2696S	620-1121	EM-2620
602-2526	EM-9446	602-2608	EM-8021	612-1645	EM-2660S	620-1122	EM-2639
602-2527	EM-9447	602-2609	EM-5326	612-1648	EM-2711S	620-1123	EM-2815
602-2528	EM-9449	602-2610	EM-8568	612-1649	EM-2661S	620-1124	EM-2653
602-2529	EM-9451	602-2611	EM-5358	612-1650	EM-2555S	620-1141	EM-9161
602-2530	EM-3152	602-2612	EM-5445	612-1685	EM-2697S	620-1142	EM-9163
602-2531	EM-3154	602-2613	EM-5446	612-1686	EM-2698S	620-1184	EM-2488
602-2532	EM-3156	602-2614	EM-5485	612-1725	EM-2789S	620-1185	EM-2489
602-2533	EM-3157	602-2615	EM-5612	612-1726	EM-2790S	620-1186	EM-2495
602-2534	EM-9452	602-2616	EM-5527	612-1727	EM-2791S	620-1189	EM-2513
602-2535	EM-9453	602-2617	EM-5616	612-1728	EM-2792S	620-1194	EM-2537
602-2536	EM-9454	602-2621	EM-5436	612-1729	EM-2795S	620-1197	EM-2570
602-2537	EM-9455	602-2622	EM-5494	612-1730	EM-2796S	620-1198	EM-2628
602-2538	EM-9456	602-2623	EM-5495	612-1732	EM-2803S	620-1200	EM-2617
602-2539	EM-9457	602-2624	EM-5143	612-1733	EM-2812S	620-1201	EM-2618
602-2540	EM-9458	602-2625	EM-5142	612-1957	EM-2859S	620-1202	EM-2622
602-2541	EM-9461	602-2626	EM-5441	612-1969	EM-2836S	620-1203	EM-2624
602-2542	EM-9466	602-2629	EM-9579	620-1010	EM-2362	620-1204	EM-2625
602-2543	EM-9467	602-2630	EM-5835	620-1012	EM-2048	620-1205	EM-2631
602-2544	EM-9468	602-2632	EM-5191	620-1013	EM-2050	620-1206	EM-2632
602-2545	EM-9469	602-2633	EM-5437	620-1020	EM-2268	620-1207	EM-2633
602-2546	EM-9475	602-2634	EM-5673	620-1023	EM-2294	620-1208	EM-2634
602-2547	EM-9476	602-2635	EM-3158	620-1024	EM-2378	620-1209	EM-2638
602-2548	EM-9477	602-2636	EM-3160	620-1026	EM-2360	620-1212	EM-2409
602-2549	EM-9478	602-2637	EM-3165	620-1030	EM-2295	620-1214	EM-2746
602-2550	EM-9480	602-2638	EM-3166	620-1031	EM-2268	620-1219	EM-2679
602-2551	EM-9481	602-2639	EM-3167	620-1032	EM-2369	620-1220	EM-2739
602-2552	EM-9483	602-2640	EM-3168	620-1034	EM-2293	620-1221	EM-2667
602-2553	EM-9484	602-2641	EM-5692	620-1037	EM-2317	620-1222	EM-2668
602-2554	EM-9485	602-2642	EM-5588	620-1040	EM-2253	620-1223	EM-2769
602-2555	EM-5689	602-2643	EM-9497	620-1041	EM-2353	620-1224	EM-2770
602-2556	EM-9487	602-2644	EM-9498	620-1043	EM-2534	620-1225	EM-2707
602-2557	EM-9488	602-2645	EM-5349	620-1045	EM-2337	620-1226	EM-2349
602-2558	EM-9489	602-2646	EM-9502	620-1046	EM-2374	620-1227	EM-2306
602-2559	EM-9491	602-2647	EM-5781	620-1052	EM-2346	620-1228	EM-2307
602-2560	EM-9492	602-2648	EM-9504	620-1056	EM-2471	620-1229	EM-2762
602-2561	EM-5155	602-2649	EM-5646	620-1058	EM-2372	620-1230	EM-2348
602-2562	EM-9496	602-2650	EM-9506	620-1059	EM-2167	620-1231	EM-2408
602-2563	EM-5553	602-2651	EM-9507	620-1063	EM-2419	620-1232	EM-2499
602-2564	EM-9580	602-2652	EM-5384	620-1064	EM-2418	620-1234	EM-2663
602-2565	EM-5399	602-2653	EM-9509	620-1065	EM-2420	620-1235	EM-2664
602-2566	EM-5356	602-2654	EM-9510	620-1068	EM-2428	620-1236	EM-2665
602-2567	EM-5367	602-2655	EM-9513	620-1069	EM-2425	620-1237	EM-2657
602-2568	EM-5921	602-2656	EM-9514	620-1070	EM-2394	620-1238	EM-2675
602-2569	EM-5649	602-2657	EM-9518	620-1071	EM-2373	620-1239	EM-2690
602-2570	EM-5837	602-2658	EM-5656	620-1072	EM-2453	620-1240	EM-2691
602-2572	EM-5655	602-2659	EM-9525	620-1073	EM-2454	620-1241	EM-2693
602-2573	EM-9248	602-2660	EM-9526	620-1075	EM-2310	620-1242	EM-2712
602-2576	EM-5375	602-2661	EM-5404	620-1076	EM-2525	620-1243	EM-2715
602-2580	EM-5798	602-2662	EM-5411	620-1077	EM-2410	620-1244	EM-2719
602-2581	EM-5857	602-2663	EM-9531	620-1086	EM-2463	620-1245	EM-2720
602-2582	EM-5876	602-2664	EM-5132	620-1087	EM-2601	620-1246	EM-2721
602-2583	EM-5148	602-2665	EM-5785	620-1090	EM-2379	620-1247	EM-2730
602-2584	EM-5353	602-2666	EM-9535	620-1091	EM-2388	620-1248	EM-2734
602-2585	EM-5354	602-2667	EM-9537	620-1092	EM-2389	620-1249	EM-2741
602-2586	EM-5104	602-2668	EM-9538	620-1094	EM-2391	620-1251	EM-2759
602-2588	EM-5074	602-2669	EM-9542	620-1097	EM-2393	620-1252	EM-2760
602-2589	EM-5352	602-2670	EM-9544	620-1100	EM-2464	620-1253	EM-2766
602-2592	EM-5578	602-2671	EM-9545	620-1101	EM-2448	620-1254	EM-2771
602-2595	EM-5427	602-2672	EM-9546	620-1102	EM-2467	620-1255	EM-2772
602-2596	EM-2928	602-2673	EM-9547	620-1103	EM-2466	620-1256	EM-2773
602-2597	EM-2947	602-2674	EM-9548	620-1105	EM-2742	620-1257	EM-2548
602-2598	EM-5588	602-2675	EM-9551	620-1106	EM-2487	620-1258	EM-2783

# CROSS REFERENCE

Mfg Part No	Our Part	Mfg Part No	Our Part	Mfg Part No	Our Part	Mfg Part No	Our Part
<b>NAPA (cont.)</b>							
620-1259 .....	EM-2784	620-1340 .....	EM-2977	620-1538 .....	EM-2821	620-1611 .....	EM-3122
620-1260 .....	EM-2671	620-1341 .....	EM-2907	620-1539 .....	EM-2823	620-1612 .....	EM-3123
620-1261 .....	EM-2394	620-1342 .....	EM-2982	620-1540 .....	EM-2824	620-1613 .....	EM-3124
620-1262 .....	EM-2639	620-1343 .....	EM-2984	620-1541 .....	EM-2800	620-1614 .....	EM-9199
620-1263 .....	EM-2813	620-1344 .....	EM-2986	620-1542 .....	EM-2810	620-1615 .....	EM-9205
620-1264 .....	EM-2452	620-1345 .....	EM-2988	620-1543 .....	EM-2817	620-1616 .....	EM-9219
620-1265 .....	EM-8604	620-1346 .....	EM-2991	620-1544 .....	EM-2815	620-1617 .....	EM-9224
620-1267 .....	EM-8516	620-1347 .....	EM-2992	620-1545 .....	EM-2816	620-1618 .....	EM-9230
620-1268 .....	EM-8303	620-1348 .....	EM-3007	620-1546 .....	EM-2817	620-1619 .....	EM-9241
620-1269 .....	EM-8208	620-1349 .....	EM-2897S	620-1547 .....	EM-2818	620-1620 .....	EM-9245
620-1270 .....	EM-8124	620-1350 .....	EM-8063	620-1548 .....	EM-2820	620-1621 .....	EM-9262
620-1271 .....	EM-8188	620-1351 .....	EM-8329	620-1549 .....	EM-2822	620-1622 .....	EM-9264
620-1272 .....	EM-8176	620-1352 .....	EM-8330	620-1550 .....	EM-8103	620-1623 .....	EM-9266
620-1273 .....	EM-8160	620-1355 .....	EM-8907	620-1551 .....	EM-8045	620-1624 .....	EM-9267
620-1274 .....	EM-8128	620-1356 .....	EM-9082	620-1552 .....	EM-8095	620-1625 .....	EM-9268
620-1276 .....	EM-8082	620-1357 .....	EM-9086	620-1553 .....	EM-2815	620-1626 .....	EM-9284
620-1277 .....	EM-8019	620-1358 .....	EM-9087	620-1554 .....	EM-8080	620-1627 .....	EM-9286
620-1278 .....	EM-8022	620-1359 .....	EM-8034	620-1555 .....	EM-8077	620-1628 .....	EM-9287
620-1279 .....	EM-8020	620-1360 .....	EM-8300	620-1556 .....	EM-8079	620-1629 .....	EM-9295
620-1280 .....	EM-8016	620-1361 .....	EM-8328	620-1557 .....	EM-8121	620-1630 .....	EM-9296
620-1281 .....	EM-8031	620-1362 .....	EM-8460	620-1558 .....	EM-8130	620-1631 .....	EM-8165
620-1283 .....	EM-8091	620-1363 .....	EM-8684	620-1559 .....	EM-8214	620-1632 .....	EM-9055
620-1284 .....	EM-8095	620-1364 .....	EM-8693	620-1560 .....	EM-8238	620-1633 .....	EM-8799
620-1285 .....	EM-8175	620-1365 .....	EM-8694	620-1561 .....	EM-8312	620-1634 .....	EM-8872
620-1286 .....	EM-8190	620-1366 .....	EM-8700	620-1562 .....	EM-2568	620-1635 .....	EM-8873
620-1287 .....	EM-8209	620-1367 .....	EM-8705	620-1566 .....	EM-8324	620-1636 .....	EM-8888
620-1288 .....	EM-2410	620-1368 .....	EM-8797	620-1567 .....	EM-2690	620-1637 .....	EM-8898
620-1289 .....	EM-8424	620-1369 .....	EM-8825	620-1568 .....	EM-8422	620-1638 .....	EM-8971
620-1293 .....	EM-2852	620-1370 .....	EM-3013	620-1569 .....	EM-2898	620-1639 .....	EM-8979
620-1294 .....	EM-2858	620-1371 .....	EM-3016	620-1570 .....	EM-2868	620-1640 .....	EM-8983
620-1295 .....	EM-2862	620-1372 .....	EM-3017	620-1571 .....	EM-2870	620-1641 .....	EM-8986
620-1296 .....	EM-2863	620-1373 .....	EM-3018	620-1572 .....	EM-2871	620-1642 .....	EM-8993
620-1297 .....	EM-2864	620-1374 .....	EM-8415	620-1573 .....	EM-2873	620-1643 .....	EM-9018
620-1298 .....	EM-2822	620-1375 .....	EM-8643	620-1574 .....	EM-2874	620-1644 .....	EM-9101
620-1300 .....	EM-8106	620-1376 .....	EM-8644	620-1575 .....	EM-2875	620-1645 .....	EM-9113
620-1301 .....	EM-8111	620-1377 .....	EM-9142	620-1576 .....	EM-2879	620-1647 .....	EM-3086
620-1302 .....	EM-8150	620-1378 .....	EM-3026	620-1577 .....	EM-2880	620-1648 .....	EM-3094
620-1303 .....	EM-8191	620-1379 .....	EM-3027	620-1578 .....	EM-2881	620-1649 .....	EM-3098
620-1304 .....	EM-8236	620-1380 .....	EM-3032	620-1579 .....	EM-2882	620-1650 .....	EM-3112
620-1305 .....	EM-8323	620-1381 .....	EM-3038	620-1580 .....	EM-2884	620-1651 .....	EM-3115
620-1309 .....	EM-8063	620-1382 .....	EM-3040	620-1581 .....	EM-2887	620-1652 .....	EM-9201
620-1310 .....	EM-8529	620-1383 .....	EM-3041	620-1582 .....	EM-2888	620-1653 .....	EM-9204
620-1311 .....	EM-8586	620-1384 .....	EM-3042	620-1583 .....	EM-2638	620-1654 .....	EM-9214
620-1312 .....	EM-8601	620-1385 .....	EM-3043	620-1585 .....	EM-2893	620-1655 .....	EM-9215
620-1313 .....	EM-2815	620-1386 .....	EM-3050	620-1586 .....	EM-2895	620-1656 .....	EM-9216
620-1314 .....	EM-2908	620-1387 .....	EM-3051	620-1587 .....	EM-3061	620-1657 .....	EM-9217
620-1315 .....	EM-2921	620-1388 .....	EM-3052	620-1588 .....	EM-3062	620-1658 .....	EM-9220
620-1316 .....	EM-2922	620-1389 .....	EM-3053	620-1589 .....	EM-3066	620-1659 .....	EM-9222
620-1317 .....	EM-2923	620-1390 .....	EM-3054	620-1590 .....	EM-3068	620-1660 .....	EM-9225
620-1318 .....	EM-2924	620-1391 .....	EM-3055	620-1591 .....	EM-3069	620-1661 .....	EM-9236
620-1319 .....	EM-2925	620-1392 .....	EM-3057	620-1592 .....	EM-9148	620-1662 .....	EM-9258
620-1320 .....	EM-2927	620-1393 .....	EM-3058	620-1593 .....	EM-9151	620-1663 .....	EM-9285
620-1321 .....	EM-2928	620-1481 .....	EM-2498	620-1594 .....	EM-9152	620-1664 .....	EM-9298
620-1322 .....	EM-2932	620-1482 .....	EM-2497	620-1595 .....	EM-9165	620-1665 .....	EM-9301
620-1324 .....	EM-2960	620-1496 .....	EM-2528	620-1596 .....	EM-9174	620-1666 .....	EM-9304
620-1325 .....	EM-2950	620-1497 .....	EM-2492	620-1597 .....	EM-9176	620-1667 .....	EM-9308
620-1326 .....	EM-2951	620-1505 .....	EM-2543	620-1598 .....	EM-9177	620-1668 .....	EM-9319
620-1327 .....	EM-2954	620-1521 .....	EM-2567	620-1599 .....	EM-9183	620-1670 .....	EM-9333
620-1328 .....	EM-2956	620-1525 .....	EM-2826	620-1600 .....	EM-3020	620-1671 .....	EM-9334
620-1329 .....	EM-2957	620-1526 .....	EM-2828	620-1601 .....	EM-3063	620-1672 .....	EM-9336
620-1330 .....	EM-2960	620-1527 .....	EM-2837	620-1602 .....	EM-3065	620-1673 .....	EM-9337
620-1331 .....	EM-2965	620-1528 .....	EM-2638	620-1603 .....	EM-3070	620-1674 .....	EM-9339
620-1332 .....	EM-2966	620-1529 .....	EM-2840	620-1604 .....	EM-3080	620-1675 .....	EM-9341
620-1334 .....	EM-2969	620-1530 .....	EM-2843	620-1605 .....	EM-3081	620-1676 .....	EM-9342
620-1335 .....	EM-2970	620-1531 .....	EM-2845	620-1606 .....	EM-3082	620-1677 .....	EM-9349
620-1336 .....	EM-2971	620-1532 .....	EM-2848	620-1607 .....	EM-3092	620-1678 .....	EM-9350
620-1337 .....	EM-2974	620-1533 .....	EM-2857	620-1608 .....	EM-3096	620-1679 .....	EM-9356
620-1338 .....	EM-2975	620-1536 .....	EM-2788	620-1609 .....	EM-3106	620-1680 .....	EM-9361
620-1339 .....	EM-2624	620-1537 .....	EM-2813	620-1610 .....	EM-3119	620-1681 .....	EM-9364

# CROSS REFERENCE

Mfg Part No	Our Part	Mfg Part No	Our Part	Mfg Part No	Our Part	Mfg Part No	Our Part
<b>NAPA (cont.)</b>		<b>NAPA (cont.)</b>		<b>PIONEER (cont.)</b>		<b>PIONEER (cont.)</b>	
620-1682	EM-9366	620-1753	EM-2620	A5339	EM-5425	601097	EM-8065
620-1683	EM-9367	620-1754	EM-5103	A5341	EM-5426	601098	EM-8234
620-1684	EM-9369	620-1755	EM-5383	A5346	EM-5428	601105	EM-8209
620-1685	EM-9370	620-1757	EM-5033	A5347	EM-3128	601118	EM-8485
620-1686	EM-9373	620-1758	EM-5182	A5348	EM-5476	601141	EM-8389
620-1687	EM-9374	620-1760	EM-5475	A6953HY	EM-5445	601143	EM-9055
620-1688	EM-9376	620-1762	EM-5659	A7084	EM-5530	601146	EM-2690
620-1690	EM-9380	620-1763	EM-2927	A7087	EM-5436	601147	EM-8157
620-1691	EM-9381	620-1764	EM-5660	A7088	EM-5437	601151	EM-8456
620-1692	EM-9383	620-1765	EM-5661	A7092	EM-5439	601154	EM-8859
620-1693	EM-9384	620-1766	EM-5662	MB518393	EM-8281	601155	EM-8010
620-1695	EM-3125	620-1767	EM-5663	600000	EM-9000	601160	EM-8363
620-1696	EM-3126	620-1768	EM-5664	600001	EM-3001	601161	EM-8179
620-1697	EM-3127	620-1769	EM-5665	600012	EM-9012	601169	EM-8619
620-1698	EM-3134	620-1770	EM-4040	600013	EM-9013	601179	EM-2862
620-1699	EM-3135	620-1773	EM-5190	600014	EM-9014	601185	EM-2829
620-1700	EM-3136	620-1774	EM-5121	600015	EM-9015	601205	EM-2850
620-1701	EM-3137	620-1775	EM-5609	600016	EM-9016	601206	EM-2851
620-1702	EM-3144	620-1777	EM-5432	600019	EM-9019	601207	EM-2852
620-1703	EM-9387	620-1778	EM-5737	600022	EM-9022	601208	EM-2853
620-1704	EM-9390	620-1779	EM-5489	600024	EM-9024	601209	EM-2856
620-1705	EM-9395	620-1780	EM-5440	600031	EM-9031	601211	EM-2859S
620-1706	EM-9397	620-1781	EM-5144	600424	EM-8424	601218	EM-2866
620-1707	EM-9409	620-1782	EM-5406	600869	EM-2869	602007	EM-2007
620-1708	EM-9410	620-1786	EM-3159	600878	EM-2878	602009	EM-2009
620-1709	EM-9414	620-1787	EM-3161	600883	EM-2883	602010	EM-2010
620-1710	EM-9417	620-1788	EM-3162	600885	EM-2885	602040	EM-2040
620-1711	EM-9420	620-1789	EM-5587	600886	EM-2886	602041	EM-2041
620-1712	EM-9423	620-1790	EM-5380	600888	EM-2888	602048	EM-2048
620-1713	EM-9425	620-1791	EM-9499	600889	EM-2889	602050	EM-2050
620-1714	EM-9426	620-1792	EM-9500	600906	EM-8906	602053	EM-2053
620-1715	EM-9427	620-1793	EM-9511	600908	EM-8908	602091	EM-2091
620-1716	EM-9428	620-1794	EM-9512	600909	EM-8909	602092	EM-2092
620-1717	EM-9429	620-1795	EM-9515	600914	EM-8914	602107	EM-2107
620-1718	EM-9430	620-1796	EM-9516	600916	EM-8916	602108	EM-2108
620-1719	EM-9433	620-1797	EM-9517	600917	EM-8917	602110	EM-2110
620-1720	EM-9434	620-1798	EM-9519	600919	EM-8919	602120	EM-2120
620-1721	EM-9435	620-1799	EM-9520	600920	EM-8920	602122	EM-2122
620-1722	EM-9438	620-1800	EM-5407	600921	EM-8921	602123	EM-2123
620-1723	EM-9439	620-1801	EM-9522	600922	EM-8921	602141	EM-2141
620-1724	EM-9440	620-1802	EM-9523	600927	EM-8921	602142	EM-2142
620-1725	EM-9448	620-1803	EM-9527	601004	EM-2952	602150	EM-2150
620-1726	EM-9450	620-1804	EM-9530	601006	EM-8402	602167	EM-2167
620-1727	EM-3153	620-1805	EM-9534	601010	EM-8103	602170	EM-2170
620-1728	EM-3155	620-1806	EM-9536	601013	EM-8568	602204	EM-2204
620-1729	EM-5784	620-1807	EM-9539	601023	EM-8186	602205	EM-2205
620-1730	EM-9460	620-1808	EM-5864	601025	EM-8230	602215	EM-2268
620-1731	EM-9462	620-1809	EM-9541	601026	EM-8933	602218	EM-2218
620-1732	EM-9463	620-1810	EM-9543	601035	EM-8228	602219	EM-2219
620-1733	EM-9464	620-1811	EM-9549	601036	EM-8497	602220	EM-2220
620-1734	EM-9465	620-1812	EM-9550	601038	EM-2836	602221	EM-2221
620-1735	EM-9470	620-1813	EM-9552	601055	EM-8266	602222	EM-2222
620-1736	EM-9471	620-1828	EM-4034	601059	EM-8238	602223	EM-2223
620-1737	EM-9472	622-1111	EM-2556S	601061	EM-8206	602225	EM-2225
620-1738	EM-9473	622-1225	EM-2707S	601063	EM-8178	602226	EM-2226
620-1739	EM-9474	622-1242	EM-2712S	601064	EM-8211	602227	EM-2227
620-1740	EM-9479	622-1536	EM-2788S	601068	EM-8213	602228	EM-2228
620-1741	EM-9482	622-1537	EM-2813S	601071	EM-8195	602231	EM-2231
620-1742	EM-9490	622-1538	EM-2821S	601072	EM-8361	602234	EM-2234
620-1743	EM-9494	622-1539	EM-2823S	601074	EM-8278	602235	EM-2235
620-1744	EM-9495	622-1540	EM-2824S	601075	EM-8166	602238	EM-2238
620-1745	EM-5518	650-1184	EM-2714	601076	EM-8233	602240	EM-2240
620-1746	EM-5403	<b>PIONEER</b>		601080	EM-8375	602241	EM-2241
620-1747	EM-5647	A2834	EM-2834	601081	EM-8171	602244	EM-2287
620-1748	EM-5657	A2835	EM-2835	601082	EM-8492	602245	EM-2142
620-1749	EM-5449	A4000	EM-5518	601083	EM-8187	602246	EM-2142
620-1750	EM-9205	A4310	EM-5468	601084	EM-8179	602248	EM-2241
620-1751	EM-5452	A4622	EM-5452	601090	EM-8151	602249	EM-2267
620-1752	EM-5928	A5338	EM-5424	601092	EM-8274	602250	EM-2250

# CROSS REFERENCE

Mfg Part No	Our Part	Mfg Part No	Our Part	Mfg Part No	Our Part	Mfg Part No	Our Part
<b>PIONEER (cont.)</b>		<b>PIONEER (cont.)</b>		<b>PIONEER (cont.)</b>		<b>PIONEER (cont.)</b>	
602254	EM-2254	602371	EM-2371	602500	EM-2500	602661	EM-2661S
602255	EM-2255	602375	EM-2375	602501	EM-2501	602670	EM-2658
602256	EM-2256	602376	EM-2376	602502	EM-2502	602673	EM-2673
602257	EM-2257	602380	EM-2328	602503	EM-2503	602674	EM-2674
602261	EM-2261	602381	EM-2381	602504	EM-2504	602676	EM-2676
602262	EM-2262	602382	EM-2382	602505	EM-2505	602677	EM-2677
602263	EM-2263	602383	EM-2382	602506	EM-2506	602678	EM-2678
602264	EM-2264	602384	EM-2384	602507	EM-2395	602680	EM-2680
602265	EM-2265	602385	EM-2385	602509	EM-2436	602681	EM-2681
602266	EM-2266	602386	EM-2387	602518	EM-2501	602682	EM-2682
602267	EM-2267	602387	EM-2387	602519	EM-2500	602683	EM-2683
602270	EM-2270	602395	EM-2395	602520	EM-2501	602684	EM-2684
602271	EM-2271	602400	EM-2400	602521	EM-2500	602686	EM-2686
602273	EM-2296	602401	EM-2401	602522	EM-2501	602687	EM-2687
602274	EM-2274	602402	EM-2402	602523	EM-2500	602688	EM-2688
602275	EM-2275	602403	EM-2403	602524	EM-2524	602689	EM-2689
602276	EM-2276	602404	EM-2404	602532	EM-2532	602692	EM-2692
602277	EM-2277	602405	EM-2405	602533	EM-2533	602697	EM-2697
602278	EM-2278	602406	EM-2406	602535	EM-2436	602708	EM-2708
602279	EM-2279	602407	EM-2407	602536	EM-2536	602709	EM-2709
602280	EM-2280	602413	EM-2413	602540	EM-2538	602710	EM-2710
602281	EM-2281	602414	EM-2414	602546	EM-2458	602711	EM-2711
602282	EM-2282	602415	EM-2415	602547	EM-2457	602713	EM-2713
602283	EM-2283	602417	EM-2417	602548	EM-2548S	602717	EM-2717S
602284	EM-2284	602418	EM-2418	602549	EM-2549	602718	EM-2718
602285	EM-2267	602419	EM-2419	602550	EM-2550	602722	EM-2722
602286	EM-2257	602421	EM-2421	602551	EM-2551S	602723	EM-2723
602287	EM-2287	602424	EM-2424	602552	EM-2551S	602724	EM-2724
602289	EM-2289	602426	EM-2426	602553	EM-2553S	602725	EM-2725
602290	EM-2290	602427	EM-2427	602554	EM-2551S	602726	EM-2726
602291	EM-2291	602429	EM-2429	602555	EM-2555S	602727	EM-2727
602292	EM-2292	602433	EM-2433	602558	EM-2558	602728	EM-2728
602296	EM-2296	602434	EM-2434	602559	EM-2559	602731	EM-2731
602297	EM-2297	602435	EM-2436	602562	EM-2562	602732	EM-2731
602298	EM-2298	602436	EM-2436	602563	EM-2563	602733	EM-2733
602301	EM-2301	602437	EM-2437	602564	EM-2564	602735	EM-2735
602303	EM-2303	602438	EM-2438	602569	EM-2569	602736	EM-2736
602304	EM-2304	602439	EM-2439	602571	EM-2571	602737	EM-2737
602309	EM-2309	602440	EM-2440	602572	EM-2572	602738	EM-2738
602316	EM-2316	602441	EM-2441	602600	EM-2600	602740	EM-2740
602319	EM-2319	602442	EM-2442	602610	EM-2538	602743	EM-2743
602323	EM-2323	602444	EM-2444	602611	EM-2538	602744	EM-2744
602324	EM-2324	602445	EM-2445	602615	EM-2615	602745	EM-2745
602325	EM-2325	602446	EM-2446	602616	EM-2616	602747	EM-2747
602326	EM-2326	602447	EM-2447	602621	EM-2621	602748	EM-2748
602328	EM-2328	602449	EM-2449	602623	EM-2623	602749	EM-2749
602329	EM-2329	602450	EM-2451	602626	EM-2626	602754	EM-2754
602330	EM-2330	602451	EM-2451	602627	EM-2627	602755	EM-2755
602331	EM-2331	602455	EM-2600	602629	EM-2629	602756	EM-2756
602332	EM-2332	602456	EM-2456	602630	EM-2630	602763	EM-2763
602333	EM-2333	602458	EM-2458	602635	EM-2635	602764	EM-2764
602335	EM-2335	602459	EM-2459	602636	EM-2636	602765	EM-2765
602336	EM-2336	602460	EM-2460	602637	EM-2637	602767	EM-2767
602338	EM-2338	602461	EM-2461	602640	EM-2640	602768	EM-2768
602341	EM-2341	602462	EM-2462	602641	EM-2641	602774	EM-2774
602344	EM-2344	602465	EM-2436	602642	EM-2642	602775	EM-2775
602350	EM-2350	602469	EM-2469	602643	EM-2643	602776	EM-2776
602351	EM-2351	602470	EM-2470	602644	EM-2644	602777	EM-2777
602356	EM-2356	602472	EM-2472	602645	EM-2645	602785	EM-2785
602357	EM-2357	602473	EM-2473	602646	EM-2646	602786	EM-2786
602358	EM-2358	602474	EM-2474	602649	EM-2649	602787	EM-2351
602359	EM-2359	602477	EM-2477	602650	EM-2650	602791	EM-2791
602363	EM-2363	602479	EM-2457	602651	EM-2651	602792	EM-2731
602364	EM-2364	602480	EM-2458	602652	EM-2652	602793	EM-2793
602365	EM-2365	602481	EM-2457	602654	EM-2654	602794	EM-2794
602367	EM-2367	602483	EM-2458	602655	EM-2655	602801	EM-2801
602368	EM-2368	602484	EM-2458	602656	EM-2656	602802	EM-2802
602369	EM-2369	602493	EM-2493	602658	EM-2658	602805	EM-2805
602370	EM-2370	602496	EM-2496	602660	EM-2660S	602806	EM-2806

# CROSS REFERENCE

Mfg Part No	Our Part	Mfg Part No	Our Part	Mfg Part No	Our Part	Mfg Part No	Our Part
<b>PIONEER (cont.)</b>		<b>PIONEER (cont.)</b>		<b>PIONEER (cont.)</b>		<b>PIONEER (cont.)</b>	
602807	EM-2807	602962	EM-2962	607188	EM-8103	608135	EM-8135
602808	EM-2808	602963	EM-2963	607261	EM-8967	608138	EM-8138
602809	EM-2809	602964	EM-2964	607312	EM-8858	608139	EM-2740
602813	EM-8103	602972	EM-2972	608002	EM-8002	608140	EM-8140
602816	EM-8045	602978	EM-2978	608007	EM-8007	608143	EM-8310
602823	EM-8100	602979	EM-2979	608008	EM-8008	608145	EM-8145
602825	EM-8200	602980	EM-2980	608009	EM-8009	608146	EM-8146
602826	EM-8208	602981	EM-2981	608011	EM-8011	608147	EM-8303
602827	EM-8600	602983	EM-2983	608013	EM-8014	608161	EM-8161
602829	EM-8224	602985	EM-2985	608014	EM-8014	608164	EM-8164
602832	EM-8026	602989	EM-2989	608017	EM-8021	608166	EM-8166
602834	EM-2834	602990	EM-2990	608018	EM-8018	608167	EM-8167
602834	EM-8097	602994	EM-2994	608020	EM-8020	608168	EM-8168
602838	EM-8601	602997	EM-2997	608022	EM-8181	608169	EM-8169
602839	EM-8445	602998	EM-2998	608024	EM-8024	608173	EM-8173
602842	EM-8430	602999	EM-2999	608025	EM-8025	608174	EM-8174
602843	EM-8344	603000	EM-3000	608026	EM-8026	608177	EM-8177
602845	EM-8579	603002	EM-3002	608027	EM-8575	608178	EM-8178
602846	EM-2845	603004	EM-3004	608028	EM-8435	608179	EM-8179
602847	EM-8643	603005	EM-3005	608032	EM-8021	608180	EM-8180
602848	EM-8175	603006	EM-3006	608033	EM-8010	608182	EM-8211
602849	EM-8170	603008	EM-3008	608034	EM-8034	608183	EM-8183
602850	EM-8414	603009	EM-3009	608038	EM-8103	608185	EM-8185
602855	EM-8568	603010	EM-3010	608039	EM-8039	608194	EM-8194
602856	EM-8568	603011	EM-3011	608041	EM-8041	608195	EM-8195
602857	EM-8197	603305	EM-2741	608042	EM-8042	608196	EM-8196
602859	EM-8602	604319	EM-2835	608043	EM-8042	608205	EM-8205
602860	EM-8681	604324	EM-2832	608044	EM-8044	608206	EM-8424
602862	EM-8006	605091	EM-8622	608046	EM-8100	608207	EM-8207
602863	EM-8100	605142	EM-8104	608048	EM-8048	608209	EM-8209
602866	EM-8119	606128	EM-8040	608049	EM-8049	608210	EM-8210
602868	EM-8603	606129	EM-8677	608051	EM-8576	608211	EM-8211
602878	EM-8242	606130	EM-8255	608052	EM-8579	608212	EM-8212
602883	EM-8073	606131	EM-8595	608053	EM-8053	608213	EM-8213
602884	EM-8021	606133	EM-8598	608054	EM-8054	608222	EM-8222
602889	EM-8016	606138	EM-8596	608056	EM-8056	608225	EM-8225
602893	EM-8349	606139	EM-8676	608057	EM-8068	608226	EM-8102
602894	EM-8021	606140	EM-8680	608059	EM-8059	608229	EM-8229
602904	EM-2904	606307	EM-8154	608062	EM-8062	608231	EM-8231
602905	EM-2905	606310	EM-8304	608073	EM-8073	608233	EM-8233
602909	EM-2909	606313	EM-8122	608074	EM-8074	608235	EM-8235
602911	EM-2911	606331	EM-8130	608075	EM-8075	608237	EM-8224
602912	EM-2912	606400	EM-8063	608076	EM-8080	608238	EM-8238
602913	EM-2913	606401	EM-8609	608078	EM-8078	608239	EM-8239
602914	EM-2914	606408	EM-8648	608080	EM-8080	608242	EM-8242
602915	EM-2915	606409	EM-8083	608084	EM-8084	608253	EM-8253
602916	EM-2916	606410	EM-8077	608085	EM-8085	608254	EM-8254
602917	EM-2917	606452	EM-8085	608087	EM-8087	608259	EM-8259
602918	EM-2918	606453	EM-8086	608088	EM-8088	608260	EM-8424
602919	EM-2919	606500	EM-8012	608092	EM-8080	608261	EM-8261
602920	EM-2920	606507	EM-8431	608093	EM-8093	608262	EM-8262
602929	EM-2929	606514	EM-8019	608097	EM-8097	608266	EM-8266
602930	EM-2930	606521	EM-8005	608098	EM-8098	608267	EM-8267
602931	EM-2931	606523	EM-8008	608100	EM-8100	608270	EM-8270
602935	EM-2935	606603	EM-8292	608101	EM-8101	608271	EM-8271
602936	EM-2936	606604	EM-8107	608102	EM-8102	608276	EM-8276
602939	EM-2939	606610	EM-8559	608103	EM-8103	608277	EM-8277
602940	EM-2940	606611	EM-8108	608104	EM-8104	608279	EM-8279
602941	EM-2941	606614	EM-8467	608105	EM-8105	608281	EM-8281
602944	EM-2944	606615	EM-8466	608107	EM-8107	608282	EM-8282
602945	EM-2945	606700	EM-8091	608112	EM-8100	608283	EM-8283
602947	EM-2947	606772	EM-8055	608114	EM-8114	608286	EM-8181
602948	EM-2948	606773	EM-8055	608116	EM-8132	608287	EM-8287
602949	EM-2949	606776	EM-8060	608118	EM-8118	608294	EM-8294
602953	EM-2953	606785	EM-8094	608119	EM-8119	608296	EM-8296
602955	EM-2955	606786	EM-8079	608120	EM-8120	608298	EM-8304
602958	EM-2958	607033	EM-8163	608122	EM-8122	608305	EM-2406
602959	EM-2959	607092	EM-8566	608125	EM-8125	608307	EM-8307
602961	EM-2961	607162	EM-8144	608133	EM-8133	608310	EM-8310



# CROSS REFERENCE

Mfg Part No	Our Part	Mfg Part No	Our Part	Mfg Part No	Our Part	Mfg Part No	Our Part
<b>PIONEER (cont.)</b>		<b>PIONEER (cont.)</b>		<b>PIONEER (cont.)</b>		<b>PIONEER (cont.)</b>	
608311	EM-8311	608537	EM-8402	608716	EM-8716	608820	EM-8820
608319	EM-8319	608539	EM-8539	608717	EM-8717	608821	EM-8821
608324	EM-8324	608553	EM-8553	608718	EM-8718	608823	EM-8823
608331	EM-8130	608554	EM-8554	608719	EM-8719	608824	EM-8824
608332	EM-8130	608555	EM-8103	608720	EM-8719	608826	EM-8826
608339	EM-8339	608556	EM-8556	608721	EM-8721	608827	EM-8663
608340	EM-8180	608560	EM-8560	608722	EM-8722	608828	EM-8828
608343	EM-8164	608561	EM-8068	608723	EM-8723	608829	EM-8829
608344	EM-8344	608568	EM-8568	608736	EM-8736	608830	EM-8830
608348	EM-8348	608569	EM-8568	608737	EM-8044	608832	EM-8832
608349	EM-8349	608571	EM-8571	608742	EM-8742	608833	EM-8832
608350	EM-8348	608574	EM-8574	608746	EM-8746	608834	EM-8834
608351	EM-8351	608576	EM-8576	608747	EM-8747	608835	EM-8835
608352	EM-8352	608577	EM-8577	608748	EM-8748	608836	EM-8836
608353	EM-8353	608578	EM-8578	608749	EM-8788	608837	EM-8834
608355	EM-8195	608579	EM-8579	608750	EM-8750	608838	EM-8838
608358	EM-8213	608585	EM-8205	608751	EM-8751	608839	EM-8832
608359	EM-8359	608590	EM-8663	608752	EM-8752	608840	EM-8832
608360	EM-8014	608597	EM-8597	608753	EM-8753	608841	EM-8616
608362	EM-8485	608599	EM-8599	608759	EM-8759	608842	EM-8616
608365	EM-8365	608602	EM-8602	608760	EM-8760	608843	EM-8843
608368	EM-8368	608605	EM-8605	608762	EM-8762	608844	EM-8616
608375	EM-8375	608606	EM-8606	608763	EM-8762	608845	EM-8845
608378	EM-8214	608607	EM-8607	608764	EM-8764	608846	EM-8846
608380	EM-8179	608609	EM-8609	608765	EM-8788	608847	EM-8847
608384	EM-8384	608611	EM-8611	608766	EM-8597	608848	EM-8848
608385	EM-8385	608612	EM-8612	608768	EM-8768	608849	EM-8849
608396	EM-8197	608616	EM-8616	608769	EM-8769	608850	EM-8850
608398	EM-8398	608617	EM-8617	608770	EM-8770	608851	EM-8851
608399	EM-8398	608620	EM-8620	608771	EM-8771	608853	EM-8853
608400	EM-8400	608621	EM-8621	608772	EM-8772	608854	EM-8854
608401	EM-8401	608630	EM-8630	608773	EM-8774	608855	EM-8855
608402	EM-8402	608638	EM-8663	608774	EM-8774	608860	EM-8860
608404	EM-8404	608639	EM-8639	608775	EM-8775	608864	EM-8864
608406	EM-8406	608640	EM-8640	608776	EM-8775	608865	EM-8865
608407	EM-8407	608641	EM-8641	608777	EM-8778	608866	EM-8866
608411	EM-8411	608647	EM-8164	608778	EM-8778	608868	EM-8868
608413	EM-8413	608652	EM-8652	608779	EM-8778	608869	EM-8869
608434	EM-8434	608654	EM-8654	608780	EM-8780	608870	EM-8870
608435	EM-8435	608659	EM-8659	608781	EM-8781	608871	EM-8871
608437	EM-8435	608660	EM-8660	608782	EM-8782	608874	EM-8874
608442	EM-8442	608661	EM-8661	608783	EM-8783	608875	EM-8875
608444	EM-8579	608664	EM-8664	608784	EM-8784	608876	EM-8876
608445	EM-8445	608665	EM-8665	608785	EM-8783	608877	EM-8877
608447	EM-8576	608667	EM-8667	608786	EM-8786	608878	EM-8878
608451	EM-8352	608668	EM-8668	608787	EM-8787	608882	EM-8882
608456	EM-8456	608670	EM-8670	608788	EM-8788	608884	EM-8884
608461	EM-8075	608681	EM-8681	608790	EM-8790	608885	EM-8885
608481	EM-8192	608682	EM-8682	608792	EM-8792	608886	EM-8886
608482	EM-8482	608685	EM-8685	608794	EM-8794	608889	EM-8889
608483	EM-8368	608687	EM-8687	608795	EM-8795	608892	EM-8892
608484	EM-8348	608688	EM-8688	608796	EM-8796	608893	EM-8893
608485	EM-8485	608689	EM-8689	608797	EM-8797	608894	EM-8894
608488	EM-8488	608690	EM-8690	608798	EM-8798	608895	EM-8895
608489	EM-8489	608691	EM-8691	608801	EM-8801	608897	EM-8897
608491	EM-8491	608692	EM-8692	608802	EM-8802	608899	EM-8899
608493	EM-8493	608699	EM-8699	608803	EM-8803	608900	EM-8900
608494	EM-8400	608701	EM-8701	608804	EM-8804	608902	EM-8902
608496	EM-8008	608703	EM-2855	608805	EM-8805	608903	EM-8903
608499	EM-8499	608704	EM-8704	608806	EM-8806	608904	EM-8904
608501	EM-2731	608706	EM-2856	608807	EM-8807	608905	EM-8905
608502	EM-8502	608707	EM-2857	608808	EM-8681	608906	EM-8193
608505	EM-2731	608709	EM-8709	608809	EM-8296	608907	EM-8198
608513	EM-8513	608710	EM-8710	608810	EM-8296	608909	EM-8192
608514	EM-8514	608711	EM-8711	608811	EM-8811	608911	EM-8197
608517	EM-8517	608712	EM-8041	608813	EM-8813	608913	EM-2409
608523	EM-8524	608713	EM-8041	608814	EM-8814	608919	EM-8188
608526	EM-8576	608714	EM-8042	608818	EM-8818	608932	EM-8932
608527	EM-8314	608715	EM-8715	608819	EM-8819	608935	EM-8935

# CROSS REFERENCE

Mfg Part No	Our Part	Mfg Part No	Our Part	Mfg Part No	Our Part	Mfg Part No	Our Part
<b>PIONEER (cont.)</b>		<b>PIONEER (cont.)</b>		<b>PIONEER (cont.)</b>		<b>PIONEER (cont.)</b>	
608936	EM-8936	609068	EM-9068	612906	EM-2987	622039	EM-2039
608937	EM-8937	609069	EM-8261	612910	EM-2910	622057	EM-2057
608940	EM-8940	609071	EM-9071	612926	EM-2926	622060	EM-2060
608942	EM-8943	609072	EM-9072	612933	EM-2933	622070	EM-2070
608943	EM-8943	609075	EM-8895	612934	EM-2934	622073	EM-2073
608944	EM-8944	609076	EM-9076	612938	EM-2938	622119	EM-2119
608945	EM-8945	609077	EM-9077	612942	EM-2942	622121	EM-2121
608946	EM-8945	609078	EM-9078	612943	EM-2943	622124	EM-2124
608948	EM-8948	609079	EM-9079	612967	EM-2967	622125	EM-2125
608949	EM-8949	609080	EM-9080	612968	EM-2968	622126	EM-2126
608950	EM-8950	609081	EM-9081	612973	EM-2973	622127	EM-2127
608952	EM-8952	609084	EM-9084	612987	EM-2987	622143	EM-2268
608953	EM-8953	609085	EM-9085	612993	EM-2993	622162	EM-2162
608955	EM-8955	609099	EM-9099	612995	EM-2995	622163	EM-2163
608958	EM-8958	609109	EM-9109	612996	EM-2996	622171	EM-2171
608960	EM-8960	609111	EM-9111	613003	EM-3003	622172	EM-2172
608961	EM-8961	609117	EM-9117	618037	EM-8037	622206	EM-2206
608962	EM-8962	609118	EM-9118	618224	EM-8224	622216	EM-2216
608966	EM-8966	609119	EM-9119	618662	EM-8662	622217	EM-2217
608968	EM-8968	609120	EM-9120	618663	EM-8663	622236	EM-2349
608970	EM-8970	609122	EM-9122	618918	EM-8918	622242	EM-2242
608973	EM-8973	609126	EM-2910	618928	EM-8928	622253	EM-2253
608974	EM-8974	609127	EM-9127	618929	EM-8929	622258	EM-2253
608975	EM-8975	609130	EM-9130	618954	EM-8954	622268	EM-2268
608976	EM-8976	609131	EM-9131	618965	EM-8965	622272	EM-2272
608979	EM-8025	609132	EM-2649	618984	EM-8984	622288	EM-2288
608981	EM-8981	609133	EM-9133	618997	EM-8997	622293	EM-2293
608982	EM-8982	609134	EM-9134	618998	EM-8998	622294	EM-2294
608988	EM-8988	609135	EM-8681	619001	EM-9001	622295	EM-2295
608992	EM-8992	609136	EM-9136	619003	EM-9003	622299	EM-2299
608994	EM-8994	609137	EM-9137	619004	EM-9004	622302	EM-2302
609000	EM-2825	609139	EM-9139	619005	EM-9005	622305	EM-2305
609001	EM-2827	609140	EM-9140	619006	EM-8795	622306	EM-2306
609003	EM-2830	609141	EM-9141	619007	EM-9007	622307	EM-2307
609004	EM-2831	609144	EM-9144	619008	EM-9008	622310	EM-2310
609005	EM-2833	609185	EM-2876	619009	EM-9009	622311	EM-2311
609007	EM-2844	611014	EM-2892	619017	EM-9017	622314	EM-2349
609008	EM-2846	611038	EM-2836	619021	EM-9021	622317	EM-2317
609008	EM-2849	611110	EM-2859	619043	EM-9043	622320	EM-2320
609009	EM-2847	611180	EM-2841	619044	EM-9044	622321	EM-2321
609014	EM-2860	611191	EM-2838	619065	EM-9065	622327	EM-2327
609015	EM-2861	612548	EM-2548	619083	EM-9083	622337	EM-2337
609017	EM-2867	612551	EM-2551	619092	EM-9092	622339	EM-2339
609018	EM-2854	612552	EM-2551	619097	EM-9003	622340	EM-2340
609019	EM-2855	612553	EM-2553	619110	EM-9110	622345	EM-2345
609023	EM-9023	612554	EM-2551	619128	EM-9128	622346	EM-2346
609027	EM-9027	612555	EM-2555	619129	EM-9129	622347	EM-2347
609029	EM-9029	612660	EM-2660	619145	EM-9145	622348	EM-2348
609030	EM-9030	612661	EM-2661	619146	EM-8207	622349	EM-2349
609031	EM-2819	612697	EM-2697	620263	EM-8263	622353	EM-2353
609033	EM-9033	612698	EM-2698	620901	EM-8901	622360	EM-2360
609034	EM-9034	612711	EM-2711	620915	EM-8915	622361	EM-2349
609036	EM-2985	612717	EM-2717	621007	EM-8632	622362	EM-2362
609037	EM-9037	612788	EM-2788	621008	EM-8963	622366	EM-2525
609039	EM-9039	612789	EM-2789	621018	EM-8619	622372	EM-2372
609040	EM-9040	612790	EM-2790	621019	EM-8244	622373	EM-2373
609041	EM-9041	612791	EM-2791	621022	EM-8300	622374	EM-2374
609042	EM-9042	612792	EM-2792	621027	EM-8002	622378	EM-2378
609045	EM-9045	612795	EM-2795	621029	EM-8460	622379	EM-2379
609047	EM-9047	612796	EM-2796	621040	EM-2826	622388	EM-2388
609048	EM-9048	612803	EM-2803	621041	EM-2828	622389	EM-2389
609050	EM-9050	612804	EM-2804	621042	EM-2837	622390	EM-2389
609051	EM-9051	612812	EM-2812	621044	EM-2845	622391	EM-2391
609056	EM-9056	612813	EM-2813	621045	EM-2848	622392	EM-2392
609057	EM-9057	612890	EM-2890	621046	EM-2849	622393	EM-2393
609059	EM-9059	612894	EM-2894	621048	EM-2863	622394	EM-2394
609062	EM-9062	612896	EM-2896	621049	EM-2864	622408	EM-2408
609066	EM-9066	612902	EM-2902	621050	EM-2870	622409	EM-2409
609067	EM-9067	612903	EM-2903	622014	EM-2014	622410	EM-2410

# CROSS REFERENCE

Mfg Part No	Our Part	Mfg Part No	Our Part	Mfg Part No	Our Part	Mfg Part No	Our Part
<b>PIONEER (cont.)</b>		<b>PIONEER (cont.)</b>		<b>PIONEER (cont.)</b>		<b>PIONEER (cont.)</b>	
622420	EM-2420	622668	EM-2668	622928	EM-2928	628208	EM-8208
622425	EM-2425	622669	EM-2657	622950	EM-2950	628218	EM-8218
622428	EM-2428	622671	EM-2671	622951	EM-2951	628220	EM-8220
622448	EM-2448	622672	EM-2394	622954	EM-2954	628221	EM-8221
622452	EM-2452	622675	EM-2675	622956	EM-2956	628222	EM-8222
622453	EM-2453	622679	EM-2679	622957	EM-2957	628223	EM-8223
622454	EM-2454	622685	EM-2685	622960	EM-2960	628232	EM-8232
622463	EM-2463	622690	EM-2690	622965	EM-2965	628236	EM-8236
622464	EM-2464	622691	EM-2691	622966	EM-2966	628241	EM-8073
622466	EM-2466	622693	EM-2693	622969	EM-2969	628243	EM-8243
622467	EM-2467	622696	EM-2696S	622970	EM-2970	628244	EM-8244
622471	EM-2471	622707	EM-2707S	622971	EM-2971	628245	EM-8424
622487	EM-2487	622712	EM-2712	622975	EM-2975	628248	EM-8248
622488	EM-2488	622715	EM-2715	622977	EM-2977	628256	EM-8586
622489	EM-2489	622719	EM-2719	622982	EM-2982	628257	EM-8586
622494	EM-2494	622720	EM-2720	622984	EM-2984	628258	EM-8586
622495	EM-2495	622721	EM-2721	622986	EM-2986	628280	EM-8280
622497	EM-2497	622730	EM-2730	622988	EM-2988	628293	EM-8293
622498	EM-2498	622734	EM-2734	622991	EM-2991	628295	EM-8295
622499	EM-2499	622739	EM-2739	622992	EM-2992	628299	EM-8001
622508	EM-2508	622742	EM-2742	623007	EM-3007	628300	EM-8300
622510	EM-2510	622746	EM-2746	624108	EM-2871	628303	EM-8303
622511	EM-2466	622750	EM-2750	624113	EM-2843	628306	EM-8034
622512	EM-2512	622751	EM-2751	624120	EM-2873	628312	EM-8312
622513	EM-2513	622752	EM-2752	625152	EM-8462	628313	EM-8312
622514	EM-2515	622753	EM-2753	626120	EM-8672	628314	EM-8314
622515	EM-2515	622759	EM-2759	626134	EM-8041	628317	EM-8317
622525	EM-2525	622760	EM-2760	626208	EM-8176	628320	EM-8149
622529	EM-2497	622762	EM-2762	626209	EM-8218	628322	EM-8322
622530	EM-2388	622766	EM-2766	626320	EM-8604	628323	EM-8323
622531	EM-2531	622769	EM-2769	626322	EM-8141	628328	EM-8328
622534	EM-2534	622770	EM-2770	626324	EM-8149	628329	EM-8329
622537	EM-2537	622771	EM-2771	626325	EM-8150	628330	EM-8330
622543	EM-2543	622772	EM-2772	626450	EM-8516	628341	EM-9055
622544	EM-2531	622773	EM-2773	626508	EM-8374	628345	EM-8002
622556	EM-2556S	622778	EM-2778	627061	EM-8544	628347	EM-8002
622557	EM-2557	622783	EM-2783	627165	EM-8214	628377	EM-8377
622565	EM-2565	622784	EM-2784	627509	EM-8512	628387	EM-8389
622566	EM-2566	622797	EM-2797	628001	EM-8001	628389	EM-8389
622567	EM-2567	622800	EM-2800	628004	EM-8004	628392	EM-8392
622568	EM-2568	622810	EM-2810	628020	EM-8014	628393	EM-8393
622570	EM-2570	622811	EM-2817	628022	EM-8022	628395	EM-8395
622601	EM-2601	622815	EM-2815	628031	EM-8031	628415	EM-8415
622602	EM-2601	622816	EM-2816	628036	EM-8012	628418	EM-8418
622603	EM-2601	622817	EM-2817	628050	EM-8586	628419	EM-8191
622607	EM-2601	622818	EM-2818	628061	EM-8061	628420	EM-8643
622608	EM-2601	622819	EM-2819	628063	EM-8063	628421	EM-8415
622614	EM-2601	622820	EM-2820	628068	EM-8068	628422	EM-8422
622617	EM-2617	622822	EM-2822	628082	EM-8082	628427	EM-8427
622618	EM-2618	622823	EM-2823S	628089	EM-8089	628439	EM-8439
622619	EM-2619	622828	EM-8644	628095	EM-8095	628440	EM-8439
622620	EM-2620	622831	EM-8111	628096	EM-8096	628441	EM-8586
622622	EM-2622	622835	EM-8124	628099	EM-8099	628448	EM-8586
622624	EM-2624	622840	EM-8659	628106	EM-8106	628452	EM-8586
622625	EM-2625	622845	EM-2730	628111	EM-8111	628457	EM-8457
622628	EM-2628	622857	EM-2857	628115	EM-8115	628460	EM-8460
622631	EM-2631	622858	EM-2858	628117	EM-8117	628490	EM-8490
622632	EM-2632	622868	EM-2868	628121	EM-8121	628495	EM-8495
622633	EM-2633	622882	EM-2882	628128	EM-8128	628503	EM-8503
622634	EM-2634	622884	EM-2884	628148	EM-8148	628506	EM-8506
622638	EM-2638	622898	EM-2898	628149	EM-8149	628507	EM-8507
622639	EM-2639	622907	EM-2907	628151	EM-8151	628508	EM-8508
622653	EM-2653	622908	EM-2908	628152	EM-8152	628510	EM-8510
622657	EM-2657	622921	EM-2921	628160	EM-8160	628511	EM-8511
622663	EM-2663	622922	EM-2922	628165	EM-8165	628512	EM-8512
622664	EM-2664	622923	EM-2923	628175	EM-8175	628516	EM-8516
622665	EM-2665	622924	EM-2924	628189	EM-8189	628519	EM-8282
622666	EM-2639	622925	EM-2925	628190	EM-8190	628522	EM-8522
622667	EM-2667	622927	EM-2927	628191	EM-8191	628529	EM-8529

# CROSS REFERENCE

Mfg Part No	Our Part	Mfg Part No	Our Part	Mfg Part No	Our Part	Mfg Part No	Our Part
<b>PIONEER (cont.)</b>		<b>PIONEER (cont.)</b>		<b>PIONEER (cont.)</b>		<b>PIONEER (cont.)</b>	
628542	EM-8542	628793	EM-8793	629025	EM-9025	632799	EM-2799
628544	EM-8544	628799	EM-8799	629026	EM-9026	632814	EM-2814
628545	EM-8545	628800	EM-8800	629028	EM-9028	632815	EM-8200
628552	EM-8552	628812	EM-8812	629032	EM-9032	632817	DS-8538
628562	EM-8095	628816	EM-8816	629035	EM-9035	632826	EM-8045
628572	EM-8572	628817	EM-8817	629038	EM-9038	632872	EM-2872
628582	EM-8582	628822	EM-8822	629046	EM-9046	632899	EM-2899
628584	EM-8584	628825	EM-8825	629049	EM-9049	632900	EM-2900
628586	EM-8586	628831	EM-8831	629052	EM-9018	632901	EM-2901
628589	EM-8589	628852	EM-8852	629053	EM-9053	636318	EM-8133
628592	EM-8592	628856	EM-8856	629054	EM-9054	636519	EM-8024
628593	EM-8593	628857	EM-8857	629055	EM-9055	636740	EM-8615
628594	EM-8594	628862	EM-8862	629058	EM-9058	636741	EM-8614
628604	EM-8290	628863	EM-8863	629060	EM-9060	638045	EM-8045
628608	EM-8608	628872	EM-8872	629061	EM-9061	638047	EM-8047
628618	EM-8236	628873	EM-8873	629063	EM-9063	638137	EM-8137
628623	EM-8623	628879	EM-8879	629064	EM-9064	638142	EM-8142
628624	EM-8594	628880	EM-8880	629070	EM-9070	638153	EM-8133
628629	EM-8629	628881	EM-8881	629073	EM-9073	638201	EM-8201
628631	EM-8631	628883	EM-8883	629074	EM-9074	638284	EM-8284
628633	EM-8230	628887	EM-8887	629082	EM-9082	638428	EM-8120
628634	DS-8634	628888	EM-8888	629086	EM-9086	638479	EM-8142
628642	EM-8393	628890	EM-8890	629087	EM-9087	638697	EM-8697
628644	EM-8644	628891	EM-8891	629088	EM-9088	638698	EM-8698
628648	EM-8648	628896	EM-8896	629089	EM-9089	638867	EM-8867
628649	EM-8649	628898	EM-8898	629090	EM-9090	638995	EM-8995
628650	EM-8650	628907	EM-8907	629091	EM-9091	639020	EM-9020
628651	EM-8651	628910	EM-2875	629093	EM-9093	646027	DS-6027
628653	EM-8653	628910	EM-8910	629094	EM-9094	646028	DS-6028
628655	EM-8655	628911	EM-8911	629095	EM-9095	646035	DS-6035
628669	EM-8669	628912	EM-8912	629096	EM-9096	646038	DS-6038
628674	EM-8674	628913	EM-8913	629098	EM-9098	646040	DS-6040
628675	EM-8675	628915	EM-2874	629100	EM-9100	646048	DS-6048
628678	EM-8678	628923	EM-8923	629102	EM-9102	646049	DS-6049
628679	EM-8679	628924	EM-8923	629103	EM-9103	646051	DS-6051
628683	EM-8683	628925	EM-8925	629104	EM-9104	646052	DS-6052
628684	EM-8684	628926	EM-8926	629105	EM-9105	646053	DS-6053
628686	EM-8686	628930	EM-8930	629106	EM-9106	646056	DS-6056
628693	EM-8693	628931	EM-8931	629107	EM-9107	646061	DS-6061
628694	EM-8694	628934	EM-8934	629108	EM-9108	646062	DS-6062
628695	EM-8695	628938	EM-8938	629112	EM-2410	648318	DS-8318
628696	EM-8696	628939	EM-8939	629113	EM-9113	648425	EM-8425
628700	EM-8700	628941	EM-8941	629114	EM-9114	648468	DS-8468
628705	EM-8705	628947	EM-8947	629115	EM-9115	648469	DS-8469
628724	EM-8724	628951	EM-8951	629121	EM-9121	648470	DS-8470
628725	EM-8725	628956	EM-8956	629123	EM-9123	648471	DS-8471
628726	EM-8727	628957	EM-8957	629124	EM-9124	648472	DS-8472
628727	EM-8727	628959	EM-8959	629125	EM-9125	648473	DS-8473
628728	EM-8728	628964	EM-8964	629138	EM-9138	648474	DS-8474
628729	EM-8729	628971	EM-8971	629142	EM-9142	648475	DS-8475
628730	EM-8730	628977	EM-8977	629143	EM-9143	648509	DS-8509
628731	EM-8731	628978	EM-8978	629147	EM-9147	648530	DS-8531
628732	EM-8732	628979	EM-8979	632396	EM-2396	648531	DS-8531
628733	EM-8733	628980	EM-8980	632490	EM-2490	648532	DS-8532
628734	EM-8734	628983	EM-8983	632491	EM-2491	648533	DS-8533
628738	EM-8738	628985	EM-8985	632492	EM-2492	648535	DS-8535
628739	EM-8738	628986	EM-8986	632526	EM-2528	648549	DS-8549
628740	EM-8740	628987	EM-8987	632527	EM-2528	648550	DS-8550
628741	EM-8741	628989	EM-8989	632528	EM-2528	648551	DS-8551
628743	EM-8743	628990	EM-8990	632561	EM-2528	648563	EM-8563
628744	EM-8744	628991	EM-8991	632573	EM-2528	648565	DS-8565
628745	EM-8745	628993	EM-8993	632609	EM-2609	648587	DS-8587
628754	EM-8754	628996	EM-8996	632662	EM-2662	648588	DS-8588
628755	EM-8755	629000	EM-2881	632716	EM-2716	648591	DS-8591
628756	EM-8756	629002	EM-9002	632761	EM-2761	648627	DS-8627
628757	EM-8757	629010	EM-9010	632780	EM-2780	648635	DS-8635
628758	EM-8758	629011	EM-9011	632781	EM-2781	648636	DS-8636
628789	EM-8789	629015	EM-2887	632782	EM-2782	658029	EM-8029
628791	EM-8791	629018	EM-9018	632798	EM-2798	658272	EM-8272

## CROSS REFERENCE

Mfg Part No	Our Part	Mfg Part No	Our Part	Mfg Part No	Our Part	Mfg Part No	Our Part
<b>PIONEER (cont.)</b>		<b>SEALED POWER (cont.)</b>		<b>SEALED POWER (cont.)</b>		<b>SEALED POWER (cont.)</b>	
658438	EM-8438	270-2242	EM-2242	270-2336	EM-2336	270-2422	EM-2733
658521	EM-8521	270-2244	EM-2287	270-2337	EM-2337	270-2424	EM-2734
658524	EM-8524	270-2245	EM-2142	270-2338	EM-2338	270-2425	EM-2493
658525	EM-8525	270-2249	EM-2267	270-2339	EM-2339	270-2426	EM-2469
658548	EM-8548	270-2250	EM-2250	270-2340	EM-2340	270-2428	EM-2471
658656	EM-8656	270-2254	EM-2254	270-2341	EM-2341	270-2429	EM-2723
658657	EM-8657	270-2255	EM-2255	270-2344	EM-2344	270-2430	EM-2724
658658	EM-8658	270-2256	EM-2256	270-2345	EM-2345	270-2431	EM-2466
662714	EM-2714	270-2257	EM-2257	270-2346	EM-2346	270-2432	EM-2496
671004	EM-2893	270-2261	EM-2261	270-2348	EM-2348	270-2434	EM-2462
671006	EM-2879	270-2261	EM-2296	270-2349	EM-2349	270-2435	EM-2503
671038	EM-2842	270-2262	EM-2262	270-2349	EM-2369	270-2437	EM-2776
672556	EM-2556	270-2263	EM-2263	270-2350	EM-2350	270-2441	EM-2501
672696	EM-2696	270-2264	EM-2264	270-2351	EM-2351	270-2442	EM-2500
672707	EM-2707	270-2265	EM-2265	270-2353	EM-2353	270-2445	EM-2459
672712	EM-2712	270-2266	EM-2266	270-2357	EM-2357	270-2446	EM-2460
672779	EM-2779	270-2267	EM-2267	270-2358	EM-2358	270-2447	EM-2461
672821	EM-2821	270-2268	EM-2268	270-2359	EM-2359	270-2448	EM-2501
672823	EM-2823	270-2268	EM-2534	270-2360	EM-2360	270-2449	EM-2500
672824	EM-2824	270-2270	EM-2270	270-2362	EM-2362	270-2452	EM-2501
672880	EM-2880	270-2271	EM-2271	270-2363	EM-2363	270-2453	EM-2500
672895	EM-2895	270-2272	EM-2272	270-2364	EM-2364	270-2455	EM-2725
672897	EM-2897	270-2275	EM-2275	270-2365	EM-2365	270-2456	EM-2726
672932	EM-2932	270-2277	EM-2277	270-2367	EM-2367	270-2457	EM-2474
672974	EM-2974	270-2278	EM-2278	270-2368	EM-2368	270-2458	EM-2463
674202	EM-2840	270-2279	EM-2279	270-2369	EM-2369	270-2459	EM-2727
678999	EM-8999	270-2280	EM-2280	270-2370	EM-2370	270-2461	EM-2536
679101	EM-9101	270-2281	EM-2281	270-2372	EM-2347	270-2462	EM-2458
3723012040	DS-8531	270-2282	EM-2282	270-2372	EM-2372	270-2466	EM-2749
<b>SEALED POWER</b>		270-2283	EM-2283	270-2373	EM-2373	270-2468	EM-2750
270-2009	EM-2009	270-2284	EM-2284	270-2374	EM-2374	270-2470	EM-2619
270-2010	EM-2010	270-2285	EM-2267	270-2375	EM-2375	270-2471	EM-2566
270-2039	EM-2039	270-2286	EM-2257	270-2376	EM-2376	270-2472	EM-2565
270-2040	EM-2040	270-2287	EM-2287	270-2377	EM-2370	270-2475	EM-2754
270-2048	EM-2048	270-2288	EM-2288	270-2377	EM-2371	270-2479	EM-2473
270-2050	EM-2050	270-2289	EM-2289	270-2378	EM-2378	270-2481	EM-2392
270-2060	EM-2060	270-2290	EM-2290	270-2379	EM-2379	270-2484	EM-2506
270-2070	EM-2070	270-2291	EM-2291	270-2381	EM-2381	270-2485	EM-2505
270-2107	EM-2107	270-2292	EM-2292	270-2384	EM-2384	270-2487	EM-2501
270-2119	EM-2119	270-2294	EM-2294	270-2385	EM-2385	270-2488	EM-2472
270-2121	EM-2121	270-2295	EM-2295	270-2387	EM-2387	270-2493	EM-2470
270-2122	EM-2122	270-2296	EM-2296	270-2388	EM-2388	270-2494	EM-2458
270-2123	EM-2123	270-2297	EM-2297	270-2389	EM-2389	270-2495	EM-2457
270-2124	EM-2124	270-2298	EM-2298	270-2390	EM-2389	270-2496	EM-2458
270-2125	EM-2125	270-2299	EM-2299	270-2391	EM-2391	270-2497	EM-2457
270-2141	EM-2141	270-2300	EM-2512	270-2392	EM-2446	270-2498	EM-2453
270-2142	EM-2142	270-2301	EM-2301	270-2393	EM-2437	270-2499	EM-2454
270-2162	EM-2162	270-2303	EM-2303	270-2394	EM-2438	270-2500	EM-2108
270-2163	EM-2163	270-2304	EM-2304	270-2395	EM-2433	270-2501	EM-2253
270-2170	EM-2170	270-2305	EM-2305	270-2396	EM-2434	270-2503	EM-2490
270-2172	EM-2172	270-2306	EM-2306	270-2398	EM-2436	270-2504	EM-2491
270-2204	EM-2204	270-2309	EM-2309	270-2400	EM-2382	270-2505	EM-2492
270-2205	EM-2205	270-2310	EM-2310	270-2401	EM-2457	270-2506	EM-2497
270-2206	EM-2206	270-2311	EM-2311	270-2403	EM-2444	270-2507	EM-2495
270-2219	EM-2219	270-2316	EM-2316	270-2404	EM-2445	270-2508	EM-2497
270-2220	EM-2220	270-2317	EM-2317	270-2405	EM-2448	270-2509	EM-2498
270-2221	EM-2221	270-2320	EM-2320	270-2406	EM-2441	270-2510	EM-2494
270-2222	EM-2222	270-2323	EM-2323	270-2407	EM-2442	270-2511	EM-2477
270-2223	EM-2223	270-2324	EM-2324	270-2408	EM-2439	270-2512	EM-2524
270-2225	EM-2225	270-2325	EM-2325	270-2409	EM-2440	270-2513	EM-2436
270-2226	EM-2226	270-2326	EM-2326	270-2410	EM-2502	270-2515	EM-2393
270-2227	EM-2227	270-2327	EM-2327	270-2411	EM-2396	270-2515	EM-2508
270-2228	EM-2228	270-2327	EM-2349	270-2412	EM-2395	270-2516	EM-2436
270-2231	EM-2231	270-2328	EM-2328	270-2413	EM-2329	270-2517	EM-2510
270-2234	EM-2234	270-2330	EM-2330	270-2414	EM-2531	270-2518	EM-2513
270-2235	EM-2235	270-2331	EM-2331	270-2415	EM-2464	270-2520	EM-2515
270-2238	EM-2238	270-2332	EM-2332	270-2416	EM-2467	270-2521	EM-2394
270-2240	EM-2240	270-2333	EM-2333	270-2420	EM-2447	270-2524	EM-2528
270-2241	EM-2241	270-2335	EM-2335	270-2421	EM-2600	270-2525	EM-2528

# CROSS REFERENCE

Mfg Part No	Our Part	Mfg Part No	Our Part	Mfg Part No	Our Part	Mfg Part No	Our Part
<b>SEALED POWER (cont.)</b>		<b>SEALED POWER (cont.)</b>		<b>SEALED POWER (cont.)</b>		<b>SEALED POWER (cont.)</b>	
270-2526	EM-2569	270-2714	EM-2556	270-2878	EM-2499	270-3015	EM-8016
270-2527	EM-2571	270-2715	EM-2568	270-2879	EM-2687	270-3016	EM-8021
270-2528	EM-2570	270-2716	EM-2601	270-2880	EM-2686	270-3017	EM-8018
270-2529	EM-2572	270-2717	EM-2601	270-2881	EM-2665	270-3018	EM-8019
270-2600	EM-2400	270-2718	EM-2601	270-2882	EM-2717	270-3019	EM-8020
270-2601	EM-2401	270-2719	EM-2601	270-2883	EM-2660	270-3020	EM-8021
270-2603	EM-2403	270-2720	EM-2553	270-2884	EM-2691	270-3021	EM-8022
270-2604	EM-2404	270-2721	EM-2538	270-2885	EM-2671	270-3022	EM-8024
270-2606	EM-2406	270-2722	EM-2538	270-2886	EM-2761	270-3023	EM-8024
270-2607	EM-2407	270-2723	EM-2620	270-2887	EM-2708	270-3024	EM-8025
270-2608	EM-2408	270-2724	EM-2626	270-2888	EM-2762	270-3025	EM-8026
270-2609	EM-2409	270-2725	EM-2630	270-2889	EM-2763	270-3026	EM-8575
270-2610	EM-2690	270-2726	EM-2629	270-2890	EM-2764	270-3027	EM-8435
270-2614	EM-2414	270-2727	EM-2551	270-2891	EM-2765	270-3028	EM-8026
270-2615	EM-2415	270-2729	EM-2627	270-2892	EM-2766	270-3029	EM-8031
270-2618	EM-2418	270-2730	EM-2600	270-2894	EM-2667	270-3030	EM-8021
270-2619	EM-2419	270-2731	EM-2615	270-2895	EM-2668	270-3031	EM-8010
270-2620	EM-2420	270-2732	EM-2616	270-2896	EM-2710	270-3032	EM-8034
270-2621	EM-2421	270-2733	EM-2617	270-2897	EM-2653	270-3033	EM-8431
270-2622	EM-2293	270-2734	EM-2618	270-2898	EM-2654	270-3034	EM-2451
270-2623	EM-2167	270-2735	EM-2609	270-2899	EM-2655	270-3035	EM-8037
270-2624	EM-2424	270-2736	EM-2557	270-2900	EM-2656	270-3036	EM-8103
270-2625	EM-2425	270-2737	EM-2564	270-2901	EM-2657	270-3037	EM-8039
270-2626	EM-2426	270-2738	EM-2557	270-2902	EM-2658	270-3038	EM-8040
270-2628	EM-2428	270-2739	EM-2624	270-2903	EM-2767	270-3039	EM-8041
270-2629	EM-2429	270-2740	EM-2652	270-2904	EM-2768	270-3040	EM-8042
270-2630	EM-2456	270-2742	EM-2525	270-2905	EM-2769	270-3041	EM-8042
270-2631	EM-2533	270-2743	EM-2628	270-2906	EM-2711	270-3042	EM-8044
270-2632	EM-2532	270-2744	EM-2625	270-2907	EM-2770	270-3043	EM-8045
270-2633	EM-2417	270-2747	EM-2651	270-2908	EM-2771	270-3044	EM-8047
270-2634	EM-2410	270-2748	EM-2649	270-2909	EM-2676	270-3045	EM-8586
270-2635	EM-2730	270-2749	EM-2650	270-2910	EM-2664	270-3046	EM-8053
270-2636	EM-2731	270-2750	EM-2623	270-2911	EM-2663	270-3047	EM-8054
270-2637	EM-2731	270-2751	EM-2622	270-2912	EM-2692	270-3048	EM-8055
270-2640	EM-2680	270-2752	EM-2639	270-2913	EM-2662	270-3049	EM-8056
270-2642	EM-2740	270-2753	EM-2631	270-2914	EM-2674	270-3050	EM-8068
270-2644	EM-2681	270-2754	EM-2633	270-2915	EM-2688	270-3051	EM-8095
270-2647	EM-2741	270-2755	EM-2636	270-2916	EM-2772	270-3052	EM-8059
270-2649	EM-2488	270-2756	EM-2635	270-2917	EM-2707	270-3053	EM-8060
270-2650	EM-2487	270-2757	EM-2642	270-2919	EM-2677	270-3054	EM-8061
270-2652	EM-2775	270-2758	EM-2643	270-2920	EM-2678	270-3055	EM-8062
270-2655	EM-2759	270-2759	EM-2641	270-2921	EM-2773	270-3056	EM-8063
270-2656	EM-2449	270-2760	EM-2646	270-2922	EM-2777	270-3058	EM-8065
270-2658	EM-2451	270-2761	EM-2645	270-2923	EM-2788	270-3059	EM-8609
270-2659	EM-2452	270-2762	EM-2640	270-2924	EM-2697	270-3061	EM-8068
270-2660	EM-2743	270-2763	EM-2646	270-2925	EM-2712	270-3063	EM-8063
270-2664	EM-2489	270-2764	EM-2644	270-2926	EM-2548	270-3065	EM-8073
270-2668	EM-2748	270-2765	EM-2632	270-2927	EM-2778	270-3066	EM-8074
270-2675	EM-2739	270-2765	EM-2634	270-2928	EM-2785	270-3067	EM-8075
270-2677	EM-2751	270-2766	EM-2638	270-2929	EM-2693	270-3068	EM-8080
270-2684	EM-2549	270-2767	EM-2621	270-2930	EM-2718	270-3069	EM-8077
270-2684	EM-2550	270-2768	EM-2637	270-2931	EM-2782	270-3070	EM-8078
270-2685	EM-2549	270-2769	EM-2555	270-2932	EM-2786	270-3071	EM-8080
270-2685	EM-2550	270-2770	EM-2551	270-2933	EM-2713	270-3072	EM-8082
270-2686	EM-2548	270-2801	EM-2405	270-3000	EM-8018	270-3073	EM-8082
270-2687	EM-2543	270-2834	EM-2679	270-3001	EM-8001	270-3074	EM-8083
270-2688	EM-2558	270-2838	EM-2466	270-3002	EM-8002	270-3075	EM-8084
270-2692	EM-2382	270-2850	EM-2720	270-3003	EM-8004	270-3076	EM-8085
270-2699	EM-2537	270-2851	EM-2268	270-3004	EM-8005	270-3077	EM-8086
270-2700	EM-2458	270-2854	EM-2738	270-3005	EM-8006	270-3078	EM-8087
270-2702	EM-2538	270-2856	EM-2682	270-3006	EM-8007	270-3079	EM-8088
270-2704	EM-2538	270-2857	EM-2683	270-3007	EM-8008	270-3080	EM-8089
270-2707	EM-2538	270-2858	EM-2559	270-3008	EM-8009	270-3081	EM-8516
270-2708	EM-2601	270-2861	EM-2696S	270-3009	EM-8010	270-3082	EM-8091
270-2709	EM-2601	270-2861H	EM-2696	270-3010	EM-8011	270-3083	EM-8080
270-2710	EM-2601	270-2862	EM-2381	270-3011	EM-2451	270-3084	EM-8093
270-2711	EM-2601	270-2865	EM-2661	270-3012	EM-8014	270-3085	EM-8094
270-2712	EM-2601	270-2873	EM-2684	270-3013	EM-8014	270-3086	EM-8095
270-2713	EM-2551	270-2875	EM-2685	270-3014	EM-8016	270-3087	EM-8096

# CROSS REFERENCE

Mfg Part No	Our Part	Mfg Part No	Our Part	Mfg Part No	Our Part	Mfg Part No	Our Part
<b>SEALED POWER (cont.)</b>		<b>SEALED POWER (cont.)</b>		<b>SEALED POWER (cont.)</b>		<b>SEALED POWER (cont.)</b>	
270-3088	EM-8097	270-3160	EM-8181	270-3235	EM-8094	270-3309	EM-8213
270-3089	EM-8098	270-3161	EM-8211	270-3236	EM-8266	270-3310	EM-8359
270-3090	EM-8099	270-3162	EM-8183	270-3237	EM-8103	270-3311	EM-8014
270-3091	EM-8100	270-3163	EM-8183	270-3238	EM-8584	270-3312	EM-8361
270-3092	EM-8060	270-3164	EM-8185	270-3239	EM-8270	270-3313	EM-8485
270-3093	EM-8102	270-3165	EM-8186	270-3240	EM-8324	270-3314	EM-8363
270-3094	EM-8103	270-3166	EM-8187	270-3241	EM-8274	270-3315	EM-8166
270-3095	EM-8104	270-3167	EM-8188	270-3242	EM-8312	270-3316	EM-8207
270-3096	EM-8105	270-3168	EM-8190	270-3244	EM-8277	270-3317	EM-8482
270-3097	EM-8106	270-3169	EM-8191	270-3245	EM-8278	270-3318	EM-8190
270-3098	EM-8107	270-3170	EM-8192	270-3246	EM-8279	270-3319	EM-8201
270-3099	EM-8108	270-3171	EM-8193	270-3247	EM-8282	270-3320	EM-8208
270-3100	EM-8103	270-3172	EM-8194	270-3248	EM-8283	270-3321	EM-8014
270-3102	EM-8111	270-3173	EM-8195	270-3249	EM-8284	270-3322	EM-8374
270-3103	EM-8100	270-3174	EM-8196	270-3250	EM-8142	270-3323	EM-8375
270-3104	EM-8065	270-3175	EM-8197	270-3251	EM-8181	270-3324	EM-8377
270-3105	EM-8114	270-3176	EM-8198	270-3252	EM-8619	270-3325	EM-8375
270-3106	EM-8132	270-3177	EM-8485	270-3253	EM-8293	270-3326	EM-8179
270-3107	EM-8118	270-3178	EM-8200	270-3254	EM-8294	270-3327	EM-2690
270-3108	EM-8119	270-3179	EM-8201	270-3255	EM-8295	270-3329	EM-8384
270-3109	EM-8120	270-3183	EM-8205	270-3256	EM-8296	270-3330	EM-8385
270-3110	EM-8121	270-3184	EM-8206	270-3258	EM-8001	270-3331	EM-8187
270-3111	EM-8122	270-3185	EM-8207	270-3259	EM-8300	270-3332	EM-8389
270-3112	EM-8124	270-3186	EM-8208	270-3260	EM-8304	270-3333	EM-8389
270-3113	EM-8124	270-3187	EM-8209	270-3261	EM-8303	270-3334	EM-8389
270-3114	EM-8125	270-3188	EM-8210	270-3262	EM-8304	270-3336	EM-8197
270-3115	EM-8304	270-3189	EM-8211	270-3263	EM-8034	270-3337	EM-8197
270-3116	EM-8133	270-3190	EM-8212	270-3264	EM-8307	270-3338	EM-8398
270-3117	EM-8128	270-3191	EM-8213	270-3265	EM-8307	270-3339	EM-8398
270-3118	EM-8304	270-3195	EM-8218	270-3266	EM-8310	270-3340	EM-8402
270-3119	EM-8130	270-3196	EM-8211	270-3267	EM-8311	270-3341	EM-8404
270-3120	EM-8125	270-3197	EM-8220	270-3268	EM-8312	270-3342	EM-8197
270-3121	EM-8132	270-3198	EM-8221	270-3269	EM-8312	270-3343	EM-8406
270-3122	EM-8133	270-3199	EM-8222	270-3270	EM-8314	270-3344	EM-8407
270-3123	EM-8133	270-3200	EM-8224	270-3271	EM-8149	270-3345	EM-8385
270-3124	EM-8135	270-3201	EM-8225	270-3272	EM-8312	270-3346	EM-8385
270-3125	EM-8137	270-3202	EM-8102	270-3273	EM-8317	270-3347	EM-8197
270-3126	EM-8140	270-3203	EM-8228	270-3274	EM-8319	270-3348	EM-8411
270-3127	EM-8141	270-3204	EM-8229	270-3275	EM-8149	270-3349	EM-8413
270-3128	EM-8142	270-3205	EM-8230	270-3276	EM-8133	270-3350	EM-8413
270-3129	EM-8303	270-3206	EM-8231	270-3277	EM-8322	270-3351	EM-8209
270-3130	EM-8148	270-3207	EM-8232	270-3278	EM-8323	270-3352	EM-8415
270-3131	EM-8149	270-3208	EM-8233	270-3279	EM-8324	270-3353	EM-8175
270-3132	EM-8150	270-3209	EM-8234	270-3280	EM-8324	270-3354	EM-8175
270-3133	EM-8151	270-3210	EM-8103	270-3281	EM-8324	270-3355	EM-8418
270-3134	EM-8152	270-3211	EM-8236	270-3282	EM-8328	270-3356	EM-8191
270-3135	EM-8137	270-3212	EM-8224	270-3283	EM-8329	270-3357	EM-8643
270-3136	EM-8154	270-3213	EM-8238	270-3284	EM-8330	270-3358	EM-8415
270-3137	EM-8132	270-3214	EM-8239	270-3285	EM-8130	270-3359	EM-8422
270-3138	EM-8157	270-3215	EM-8073	270-3286	EM-8130	270-3360	EM-8021
270-3139	EM-8160	270-3216	EM-8242	270-3289	EM-8178	270-3361	EM-8424
270-3140	EM-8161	270-3217	EM-8244	270-3290	EM-8278	270-3363	EM-8034
270-3142	EM-8163	270-3218	EM-8424	270-3291	EM-8278	270-3364	EM-8427
270-3143	EM-8164	270-3219	EM-8517	270-3292	EM-8180	270-3365	EM-8177
270-3144	EM-8165	270-3220	EM-8004	270-3293	EM-9055	270-3366	EM-8430
270-3145	EM-8166	270-3221	EM-8248	270-3295	EM-8164	270-3367	EM-8431
270-3146	EM-8167	270-3222	EM-8031	270-3296	EM-8344	270-3369	EM-8435
270-3147	EM-8168	270-3223	EM-8014	270-3297	EM-8002	270-3370	EM-8434
270-3148	EM-8169	270-3224	EM-8014	270-3298	EM-8194	270-3371	EM-8435
270-3149	EM-8170	270-3225	EM-8019	270-3299	EM-8002	270-3372	EM-8435
270-3150	EM-8171	270-3226	EM-8253	270-3300	EM-8348	270-3373	EM-8435
270-3151	EM-8278	270-3227	EM-8254	270-3301	EM-8349	270-3374	EM-8438
270-3152	EM-8173	270-3228	EM-8255	270-3302	EM-8348	270-3375	EM-8439
270-3153	EM-8174	270-3229	EM-8586	270-3303	EM-8351	270-3376	EM-8586
270-3155	EM-8176	270-3230	EM-8586	270-3304	EM-8352	270-3377	EM-8442
270-3156	EM-8177	270-3231	EM-8259	270-3305	EM-8353	270-3378	EM-8586
270-3157	EM-8178	270-3232	EM-8261	270-3306	EM-8344	270-3379	EM-8579
270-3158	EM-8179	270-3233	EM-8262	270-3307	EM-8195	270-3380	EM-8445
270-3159	EM-8180	270-3234	EM-8080	270-3308	EM-8193	270-3381	EM-8579

# CROSS REFERENCE

Mfg Part No	Our Part	Mfg Part No	Our Part	Mfg Part No	Our Part	Mfg Part No	Our Part
<b>SEALED POWER (cont.)</b>		<b>SEALED POWER (cont.)</b>		<b>SEALED POWER (cont.)</b>			
270-3382	EM-8576	270-3474	EM-8603	270-3546	EM-2800		
270-3383	EM-8586	270-3475	EM-8604	270-3547	EM-2801		
270-3384	EM-8586	270-3476	EM-8605	270-3548	EM-2802		
270-3385	EM-8586	270-3477	EM-8606	270-3549	EM-2803		
270-3386	EM-8352	270-3478	EM-8607	270-3550	EM-2804		
270-3387	EM-8586	270-3479	EM-8608	270-3551	EM-2805		
270-3388	EM-8063	270-3480	EM-8609	270-3552	EM-2806		
270-3389	EM-8609	270-3482	EM-8611	270-3553	EM-2807		
270-3390	EM-8456	270-3483	EM-8612	270-3554	EM-2808		
270-3391	EM-8457	270-3484	EM-8612	270-3555	EM-2809		
270-3392	EM-8073	270-3485	EM-8614	270-3556	EM-2810		
270-3393	EM-8073	270-3486	EM-8615	270-3557	EM-2817		
270-3394	EM-8460	270-3487	EM-8616	270-3558	EM-2812		
270-3395	EM-8075	270-3488	EM-8617	270-3559	EM-2813		
270-3396	EM-8516	270-3489	EM-8236	270-3560	EM-2814		
270-3397	EM-8466	270-3490	EM-8619	270-3561	EM-2815		
270-3398	EM-8467	270-3491	EM-8620	270-3562	EM-2816		
270-3406	EM-8075	270-3492	EM-8622	270-3563	EM-2817		
270-3407	EM-8142	270-3494	EM-8629	270-3564	EM-2818		
270-3408	EM-8304	270-3495	EM-8630	270-3565	EM-2819		
270-3409	EM-8192	270-3496	EM-8631	270-3566	EM-2820		
270-3410	EM-8485	270-3497	EM-8632	270-3567	EM-2821		
270-3411	EM-8197	270-3498	EM-8230	270-3568	EM-2822		
270-3412	EM-8490	270-3499	EM-8224	270-3569	EM-2823		
270-3413	EM-8491	270-3500	EM-8663	270-3570	EM-2824		
270-3414	EM-8492	270-3501	EM-8639				
270-3415	EM-8400	270-3502	EM-8641	<b>SKF</b>			
270-3416	EM-8495	270-3503	EM-8643	HB2055FF	DS-6035		
270-3417	EM-8008	270-3504	EM-8644	HB88107E	DS-6056		
270-3418	EM-8497	270-3505	EM-8389	HB88506	DS-6071		
270-3419	EM-8499	270-3506	EM-8196	HB88508	DS-6038		
270-3420	EM-8508	270-3507	EM-8164	HB88509	DS-6040		
270-3422	EM-8511	270-3508	EM-8648	HB88510	DS-6048		
270-3423	EM-8513	270-3509	EM-8649	HB88512A	DS-6049		
270-3424	EM-8078	270-3510	EM-8652	HB88532	DS-6063		
270-3425	EM-8516	270-3511	EM-8653	<b>TIMKEN</b>			
270-3426	EM-8517	270-3512	EM-8654	HB2	DS-6051		
270-3427	EM-8524	270-3513	EM-8656	HB3	DS-6052		
270-3428	EM-8314	270-3514	EM-8657	HB6	DS-8474		
270-3429	EM-8197	270-3515	EM-8658	HB2055FF	DS-6035		
270-3430	EM-8529	270-3516	EM-8659	HB4010A	DS-6071		
270-3437	EM-8005	270-3517	EM-8662	HB55809	DS-6040		
270-3438	EM-8402	270-3518	EM-8663	HB88107E	DS-6056		
270-3440	EM-8544	270-3519	EM-8664	HB88508	DS-6038		
270-3443	EM-8560	270-3520	EM-8665	HB88510	DS-6048		
270-3444	EM-8068	270-3521	EM-8165	HB88512A	DS-6049		
270-3445	EM-8095	270-3522	EM-8667				
270-3448	EM-8566	270-3523	EM-8668				
270-3449	EM-8568	270-3524	EM-8669				
270-3450	EM-8568	270-3525	EM-8670				
270-3452	EM-8572	270-3527	EM-8672				
270-3453	EM-8010	270-3528	EM-8672				
270-3454	EM-8574	270-3529	EM-8674				
270-3455	EM-8575	270-3530	EM-8675				
270-3456	EM-8576	270-3531	EM-8676				
270-3457	EM-8578	270-3532	EM-8677				
270-3458	EM-8579	270-3533	EM-8678				
270-3459	EM-8055	270-3534	EM-8679				
270-3460	EM-8582	270-3535	EM-8680				
270-3462	EM-8584	270-3536	EM-2789				
270-3463	EM-8205	270-3537	EM-2790				
270-3464	EM-8586	270-3538	EM-2791				
270-3466	EM-8589	270-3539	EM-2792				
270-3467	EM-8663	270-3540	EM-2793				
270-3469	EM-8596	270-3541	EM-2794				
270-3470	EM-8599	270-3542	EM-2795				
270-3471	EM-8600	270-3543	EM-2796				
270-3472	EM-8601	270-3544	EM-2798				
270-3473	EM-8602	270-3545	EM-2799				





*Westar* Distribution, LLC

## **LIMITED WARRANTY**

Any product sold by Westar Distribuion, LLC, is warranted to be free from defects in material and workmanship for a period of 12 months or 12,000 miles, whichever comes first. Westar will not warrant any product that is not used in strict accordance with the manufacturers instructions for use, operation and installation. This limited warranty does not apply to any product which has been misused, altered, or used under excessive operating conditions beyond the manufacturer's instructions.

The liability of Westar Distribuion, LLC is limited solely to the repair or replacement of defective products. Westar can not be held responsible for the cost of any related parts, labor claims, or incidental expenses. Furthermore, Westar can not be held responsible for any consequential damages, personal injuries or damage to property.

Westar Distribuion, LLC will not be held responsible for any transportation costs incurred due to the return of parts to Westar or the return of replacement products to the buyer. Finally, Westar can not be held liable for any damages, losses or delays of products due to war, government restrictions or restraints, strikes, material shortage beyond the control of Westar Industries, Inc. or acts of God.

## **INSTALLATION INSTRUCTIONS**

Before installing any part, it is most important to check all inserts, rods and bearings to be sure that they are properly seated and move as per manufacturer specifications. Other causes for early or unusual failure of a part can be eliminated by a close inspection for other worn or damaged parts.

## **IMPORTANT NOTICE**

While the utmost care was used in compiling the information in this catalog, we can not assume any responsibility for errors, omissions, or the inaccuracy in data supplied to us. All parts shown within are intended as replacement parts. The use of any manufacturer's trademarks, part number or terminology is for the sole purpose of the users of this catalog to select the correct replacement part.

JOINT  
ASSEMBLY

# WESTAR

EST 1986

UT  
29-177 N·m  
5-130 FT-LB)

4001



(S

6078000\*

N