

YOUR SOURCE FOR INNOVATIVE PRODUCTS



**HORNS
WARNING LIGHTS
BACK-UP ALARMS
SIRENS and P.A.**

Automotive • Truck • Motorcycle • Marine • Public Safety • Industrial





INNOVATIVE PRODUCTS FOR VEHICLES, MOTORCYCLES, MARINE & INDUSTRIAL EQUIPMENT

HORNS



ELECTRIC REPLACEMENT HORNS	1-3
SPECIALTY HORNS.....	4-5
ELECTRONIC MUSICAL HORNS.....	5-6
AIR MUSICAL HORNS.....	7
DIRECT DRIVE AIR HORNS	7-9
ONE PIECE DIRECT DRIVE AIR HORNS	10-11
DIRECT DRIVE HORN ACCESSORIES.....	12-13

MARINE HORNS



HAND HELD AND MARINE HORNS	14
ELECTRIC MARINE AND TRUCK HORNS	15
MARINE AIR HORNS	16-17

TRUCK HORNS



ON-BOARD AIR SYSTEMS.....	18-19
HIGH PRESSURE COMPRESSORS	20
HIGH PRESSURE TANKS	20
LOW PRESSURE DIRECT DRIVE	21-22
HIGH PRESSURE.....	23-24
HIGH PRESSURE-TRAIN HORNS.....	25-27
HIGH PRESSURE-TRAIN HORNS PRO SERIES ..	27-29
HIGH PRESSURE-HORN ACCESSORIES.....	30

MOTORCYCLE HORNS



ONE PIECE DIRECT DRIVE AIR HORNS	31
DIRECT DRIVE AIR HORNS	31

INDUSTRIAL HORNS



ELECTRONIC	32-33
DISC.....	32

BACK-UP ALARMS



BACK-UP ALARMS.....	33-34
TALKING BACK-UP ALARMS	33
SELF ADJUSTING BACK-UP ALARMS.....	34



ELECTRONIC SIRENS and P.A.

ELECTRONIC SIRENS AND P.A. SYSTEMS	35-36
PARTS AND ACCESSORIES	36

WARNING LIGHTS



ROTATING MAGNET	37
ROTATING PERMANENT.....	37
STROBE MAGNET	37
STROBE PERMANENT	38
LED MAGNET	38-39
LED PERMANENT.....	40-41
LED PERMANENT OR PIPE MOUNT.....	40

MINI LIGHT BARS



STROBE MAGNET AND PERMANENT.....	41
HALOGEN MAGNET AND PERMANENT.....	42
LED MAGNET AND PERMANENT	43

FULL LIGHT BARS



HALOGEN.....	44
STROBE.....	44
LED	45-47
LIGHT BAR ACCESSORIES.....	47

HIDEAWAY STROBE KITS



CARS	48
TRUCKS AND EXTENDED LENGTH VEHICLES....	49
ACCESSORIES.....	49

HIDEAWAY LED KITS



CARS	50
TRUCKS AND EXTENDED LENGTH VEHICLES....	51
ACCESSORIES.....	51

SPECIALTY LIGHTS

WORK LIGHT	52
FORKLIFT LIGHT.....	52
SNOW PLOW AND AUXILIARY LIGHT	52

COMPLETE INDEX ON PAGE 53

COMPANY PROFILE

Wolo was started in 1965 by Joseph Solow with an idea and a commitment to manufacture a single patented hood lock. Joseph was a one-person operation, not only inventing and patenting products, but also personally manufacturing every hood lock he sold for years. When time permitted, Joseph went out to mass merchandisers and warehouses hoping to sell his lock. As Wolo Manufacturing grew, Joseph Solow pioneered new innovative ideas, producing products that changed the industry. His foresight enabled Wolo products to meet the needs of the future and the company grew.

Today Wolo Manufacturing Corp. is a second-generation family owned and operated business with the same mission; to provide the very best quality products and customer service. Our leadership in product innovation, reliability and toll free tech support continues Wolo's commitment to providing an old fashioned personal touch with our customers. We have learned to listen to our customers and react quickly to meet their needs. In this fast changing industry, Wolo works hard to stay current with the latest technology and to support the e-business needs of our customers.

Our goal at Wolo Manufacturing Corp. is the same as it was back in 1965, to operate with integrity and vision in order to serve our customers' needs. We are proud of our past accomplishments and promise to continue to bring new and innovative products to the automotive aftermarket. To our customers that have purchased our products, we thank you for your support and trust.

Sincerely,

Stanley Solow



HORNS

Electric Replacement Horns

TWIN POWER®

Dual Tone Electric Horns

Model 200 115 Decibels 520/630 Hz

Twin Power will exceed the output of O.E. electric horns. Does not require a compressor or air hoses, saving both time and labor. Installs easily in any 12-volt vehicle. Use as a replacement or combine with existing horns. Made of durable ABS plastic for years of dependable service. Kit includes mounting bracket and hardware for a professional installation. Packaged in a clamshell, which stands or hangs on peg hooks.

Longest Trumpet: 11 in.
English/Spanish packaging.
Government approved for sale in Mexico.



LOUD & CHROME™

Loud Two (2) Horn Set

Model 225-2T 115 Decibels 420/510 Hz

Truly universal two (2) terminal replacement horn set; one high tone, one low tone. For all 12-volt vehicles built since 1955. The Model 225-2T has a bright chrome finish that will dress-up any vehicle or motorcycle. They look great and sound great. Easily installs, mounting hardware included. Packaged in an attractive self-selling clamshell.

Size: 3 in. dia.
Patent No. 6,002,324
English/Spanish packaging.
Government approved for sale in Mexico.



MINI BUT LOUD™ DISC HORNS

Model 250-2T (Chrome) 110 Decibels 480 Hz

Model 260-2T (Black) 110 Decibels 480 Hz

The "Mini but Loud" is exactly that, a loud 110-decibel, two (2) terminal horn. It's smaller size makes it easy to install in any car, motorcycle, or RV. All steel construction will ensure reliable service in all weather conditions. Built with better quality for a louder sound. For 12-volt vehicles. Packaged in an attractive self-selling clamshell.

Size: 2-3/4 in. dia.
Patent No. 6,002,324
English/Spanish packaging.
Government approved for sale in Mexico.



CHROME DISC HORNS™

Model 270-2T (Low Tone) 114 Decibels - 360 Hz

Model 275-2T (High Tone) 114 Decibels - 420 Hz

The 270-2T & 275-2T disc horns have an attractive chrome grill, which will dress-up any car or motorcycle. Made of steel, these rugged horns will work reliably in almost any weather condition, with a powerful 114 decibels of sound. Each model has a heavy-duty mounting bracket that makes installation easy. Ideal for any vehicle that has a 12-volt electrical system. Packaged in an attractive self-selling clamshell.

Size: 3-3/4 in. dia.
Patent No. 6,002,324
English/Spanish packaging.



MORE ▶



HORNS

Electric Replacement Horns

VOLKSWAGEN REPLACEMENT HORN

Model V-111 115 Decibels – 340 Hz

Designed as a replacement horn for 1967-1977 VW Beetle and Super Beetle restoration. Same mounting and electrical terminal hook-up as original VW horn. Packaged in an attractive self-selling clamshell.

Size: 3-3/4 in. dia.

English/Spanish packaging.

Government approved for sale in Mexico.

Volkswagen and VW is the registered trademark of Volkswagen Aktiengesellschaft

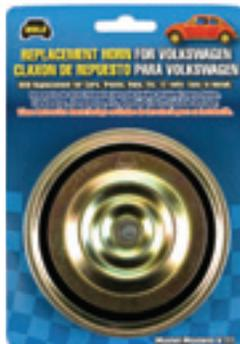

DISC HORNS™

Model 300-2T (Low Tone) 115 Decibels – 360 Hz

Model 305-2T (High Tone) 115 Decibels – 420 Hz

O.E. UNIVERSAL DISC HORNS, 12-volt, 2 terminal type – ideal for motorcycles, cars, SUVs and trucks. Painted steel construction, assures long life in all weather environments. Packaged in an attractive self-selling clamshell.

Size: 3-3/4 in. dia.

CEE-ECE Approved

English/Spanish packaging.

Government approved for sale in Mexico.



SUPER HORNS®

CHROME PLATED

Model 306-2T (Chrome) – 2 Horns 118 Decibels – 290/345 Hz

These European style all metal horns with a chrome grill are replacements for horns found in many German luxury vehicles. Easily installs into any 12-volt vehicle when a louder sound is desired. A high tone and a low tone horn are packaged together in a colorful see through box.

Size: 6 in. dia.

English/Spanish packaging.

Patent No. 6,002,324



SONIC BLAST®



Model 308-2T – 2 Horns 117 Decibels – 335/400 Hz

Designed for the vehicle owner that wants to dress-up their engine compartment and demands a powerful horn sound. Replaces existing horns, or is ideal for new horn installations. Two horns, one high tone and one low tone, have a beautiful red and black painted finish. SONIC BLAST easily installs in any 12-volt vehicle. Each horn has a heavy-duty steel mounting bracket, with one bolt mounting. Rugged, painted all metal construction, will ensure the vehicle owner many years of dependable service. The kit includes mounting hardware.



Size: 5 in. diameter

Patented: 6,002,324

Other patents pending

English/Spanish packaging.

SONIC BLAST





HORNS

Electric Replacement Horns

LOUD ONE®

Model 310 (Low Tone) 115 Decibels - 410 Hz

Model 315 (High Tone) 115 Decibels - 510 Hz

UNIVERSAL REPLACEMENT, 12-volt, 1-terminal, high-powered sound, steel and plastic construction. Designed to have a universal fit for all one-wire factory horn systems. Individually packaged.

Size: 3-1/2 in. dia. Spanish instructions included.



LOUD ONE®

Model 310-2T (Low Tone) 115 Decibels - 410 Hz

Model 315-2T (High Tone) 115 Decibels - 510 Hz

O.E. Universal two terminal replacement horns for cars, trucks, motorcycles, etc. Easy to install in any 12-volt vehicle with either one or two terminals. Better quality for a louder sound. Individually packaged in an attractive self-selling clamshell.

Size: 3-1/2 in. dia.
Patent No. 6,002,324
English/Spanish packaging.
Government approved for sale in Mexico.



FULL BLAST®

Model 380-2T (Low Tone) 116 Decibels - 410 Hz

Model 385-2T (High Tone) 116 Decibels - 510 Hz

O.E. Universal two terminal replacement horns for cars, trucks, motorcycles, etc. Easy to install in any 12-volt vehicle with either one or two terminals. Better quality for a louder sound. Individually packaged in an attractive self-selling clamshell.

Size: 3-1/2 in. dia.
Patent No. 6,002,324
English/Spanish packaging.
Government approved for sale in Mexico.



MAXI SOUND®

Truly universal - fits all vehicles built since 1955

Model 320-2T - 2 Horns
(Low Tone) 115 Decibels - 410 Hz
(High Tone) 115 Decibels - 510 Hz

Two universal horns - one high tone, one low tone, two terminal. Easy to install in any 12-volt vehicle with either 1 or 2 wire system. Each horn has a bright stainless steel grill and a red plastic cover. Rugged construction will ensure many years of dependable service. Wolo horns are built with better quality for a louder sound.

Model 325-2T - (Chrome) - 2 Horns
(Low Tone) 115 Decibels - 410 Hz
(High Tone) 115 Decibels - 510 Hz

UNIVERSAL REPLACEMENT SET, 12-volt, two (2) terminals, bright stainless steel grill, chrome plastic cover, high powered sound, fits all one and two wire horn systems. Packaged in an attractive self-selling clamshell. Stands or peg hooks.

Size: 3-1/2 in. dia. each
Patent No. 6,002,324
English/Spanish packaging.
Government approved for sale in Mexico.





HORNS

Specialty Horns

FUN HORN®

OOOGA Sound

Model 330 114 Decibels

DISTINCTIVE "OOOGA" OLD TIME VEHICLE FUN SOUND, 12-volt, powered by a heavy-duty permanent magnet motor, easily installed in any vehicle, two (2) terminals. Packaged in an attractive self-selling clamshell.

Size: L 8-3/4 in. x W 4-1/2 in. x H 4-1/2 in.
English/Spanish packaging.
Government approved for sale in Mexico.



BULL HORN™

Model 340 115 Decibels.

A real attention getter – sounds like a raging bull. Rugged construction that will ensure many years of dependable service. Installs easily in any 12-volt vehicle with a one (1) wire hookup. Packaged in full color eye-catching box.

Size: L 3-3/4 in. x W 6-1/2 in. x H 7-3/4 in.
English/Spanish packaging.
Government approved for sale in Mexico.



WOLF WHISTLE™

Model 350 105 Decibels

The Model 350 will attract immediate attention with its shrill, extra loud, two tone whistle sound. The Wolf Whistle is built with state-of-the-art electronics to provide many years of dependable service. Easily installs in any 12-volt vehicle. Packaged in a full color eye-catching box.

12-watts
Speaker: L 4 in. x W 4 in. x H 4-1/2 in.
English/Spanish packaging.
Government approved for sale in Mexico.

Not designed to be used as a replacement horn.



DING DONG CITY BELL™

Model 355 90 Decibels

Due to popular demand the Ding Dong City Bell is back with new features. The model 355 will give any 12-volt vehicle a beautiful look with a bright triple chrome finish. The bell will ding once every time the switch is pressed and released or press and hold the switch and the bell will ding with a fast repeating cycle.

Size: 4-1/2 in. dia.
English/Spanish packaging



TRAIN HORN™

Three Distinctive Train Sounds

Model 360 105 Decibels

Model 360 is all-electronic, with three automatically changing sounds: train crossing bell, steam engine racing down the track, and a train blowing its whistle. The model 360 is an extra loud 12-watts, a real attention getter! Wolo's Train Horn is built with the latest electronics to ensure that the user will get many years of dependable service. Installs easily in any 12-volt vehicle. Packaged in a full color eye-catching box.

12-watts
Speaker Size: L 4 in. x W 4 in. x H 4-1/2 in.
English/Spanish packaging.

Not designed to be used as a replacement horn.





HORNS

Specialty Horns

THE ENFORCER®

Siren & Air Horn Sounds

Model 365

One touch of the keyboard sounds your choice of three (3) different emergency sirens: • Police Wailer siren • Fire Truck High-Low siren • Ambulance Euro siren *plus* a powerful truck air horn sound. The Enforcer is used to attract immediate attention with it's powerful 20-watts of sound. Kit comes complete in an attractive color box.

20-watts

Speaker: L 5 in. x W 5-1/2 in. x H 6 in.

Controller: L 1 in. x W 2-1/4 in. x H 1-3/4 in.

English/Spanish packaging.



THE VOYAGE™

Ocean Liner Horn

Model 367

Model 367 produces three (3) ultra powerful, 30-watt, OCEAN LINER horn sounds. One touch of the keyboard sounds your choice of three (3) different OCEAN LINER horns. If you want to attract attention with a powerful horn sound, VOYAGE should be your choice. Built with the latest state-of-the-art electronics to ensure years of reliable service. The model 367 is easy to install in any 12-volt vehicle. Kit comes complete with mounting hardware. Kit comes complete in an attractive color box.

Sounds:

1. Two ocean liners sounding their horns at each other.
2. One ocean liner sounding its horn
3. One ocean liner sounding its horn (different sound then above number 2)

12-volts / 30-watts

Speaker: L 7 in. x W 5-1/2 in. x H 6-1/2 in.

Keyboard: L 3-3/4 in. x W 1-1/4 in. x H 1-7/8 in.



BEEP BEEP HORN™

Model 370 115 Decibels – 345 Hz

Distinctive, extra loud classic “BEEP BEEP” sound. All metal construction, painted black, 5 in. diameter. Easily installs in any 12-volt vehicle, two (2) terminal hook-up. Press and release the vehicle’s horn button switch to get “Beep Beep” sound. Packaged in an attractive self-selling box.

Diameter: 5 in.

English/Spanish packaging.



Electronic Musical Horns

MUSIC TIME®

Remote Controlled Electronic Musical Horn – 15-watts

At last, an easy to install one-piece musical horn that delivers true musical instrumental sounds. Simple to install into the engine compartment; connect the black wire to ground, the red wire is connected positive (+) 12-volts and Music Time is ready to play. All functions: on/off, volume and song selection, are controlled by a key chain transmitter, from within or outside the vehicle. Kit comes complete in an attractive color box.

Model 001 – Wedding March & Hava Nagila

Model 002 – La Cucaracha & Mexican Hat Dance

Model 003 – Dixie & On The Road Again

Speaker: L 6-1/4 in. x W 5-1/2 in. x H 5-1/2 in.

English/Spanish packaging. Government approved for sale in Mexico. Patent No. 5,793,120



MORE ▶



HORNS

Electronic Musical Horns

JUKE BOX®

Model 336

105 Decibels

One touch plays any of the 34 pre-programmed songs (see song list below). The Model 336 was designed to work like a piano keyboard. A music book is included so that you can program hundreds of your favorite songs in seconds: college fight songs, children's, holiday, patriotic songs and more. Features a on/off volume control to adjust the sound level. Kit comes complete in an attractive self-selling box.

Song List:

- Oh What A Beautiful Morning • Happy Birthday • Jingle Bells • La Cucaracha • On The Road Again • Auld Lang Syne • Hello Dolly • You Are My Sunshine • I've Been Working On The Railroad • Oh Come All Ye Faithful • Godfather • Love Story • Rock Around The Clock • Unchained Melody • La Bamba • Macarena • New York, New York • Fiddler On The Roof • Candyman • Row Row Row Your Boat • Twinkle, Twinkle Little Star • London Bridge • Deck The Halls • We Wish You A Merry Christmas • Cavalry Charge • Reveille • Magic Broom • Dixieland • Circus • Call To The Post • Heavy Metal • Pink Panther • Rocky • Stars and Stripes

Speaker: L 4 in. x W 4 in. x H 4-1/2 in. Keyboard: L 6-3/4 in. x W 1 in. x H 2-3/4 in. English/Spanish packaging. Government approved for sale in Mexico.



ANIMAL HOUSE®

Electronic Horn & P.A. System

Model 345

105 Decibels

The model 345, with its loud animal sounds, musical songs, sirens and P.A. is the one to buy to attract immediate attention. 69 different sounds to choose from - 50 musical tunes, 9 animal, and 10 siren. Use the microphone to convert the Animal House Horn into a powerful P.A. system - great for sporting events, etc. Features a volume control to adjust from soft to loud. Built with the latest state-of-the-art electronics for years of dependable service. Easy to install in all 12-volt vehicles. Kit comes complete.

Song List:

- It's a small world • Mary has a little lamb • Happy Birthday • When the Saints come marching in • Old MacDonald • Yankee Doodle • Ten Little Indians • Clementine • Love Story • We wish you a Merry Christmas • Jingle Bells • O'Christmas Tree • La Cucaracha • Little Brown Jug • A time for us • Mexican hat dance • Love me tender • I can't stop loving you • Sing a song • Allouette • Row, row your boat • Oh Susanna • Twinkle, twinkle • Swan lake • Frere Jacques • Lambada • Come all ye faithful • You are my sunshine • Deck the halls • Silent night • Joy to the world • Home on the range • Yellow rose of Texas • Jack & Jill • Bingo • Easter parade • Battle of the Republic • Do Re Mi • Red river valley • Rudolf the red nose reindeer • Santa Claus is coming to town • Love is Blue • Rhythm of the rain • White Christmas • Coming 'round the mountain • Polly-wally doodle • Say hello • Oh my darling • Waltzing Matilda • Clap, Clap!

Speaker: L 4 in. x W 4 in. x H 4-1/2 in. Controller: L 6 in. x W 4-1/2 in. x H 1-1/2 in. English/Spanish packaging. Government approved for sale in Mexico.



POWER PLAY™

Amplifier & Speaker System All-In-One

Model 346

Use at home, office, tailgating, boats, vehicles and much more.

Wolo's POWER PLAY is a complete amplifier and speaker system all-in-one, for the vehicle owner that wants to be heard. Designed to boost the audio output up to 40-watts, using any iPad, smart phone, Kindle, Wolo models (336 and 345) and more. POWER PLAY is compact in size with all of its solid-state amplifier circuitry built into the weather resistant case. Connecting an audio device to POWER PLAY is easy; simply insert the wired jack (provided) into the audio player's headphone outlet and hook-up is complete, without any tools. Turn on the audio player and use its volume control to increase the sound output up to 40-watts of powerful sound. The amplifier is built with the latest state-of-the art technology, turning on automatically only when the audio device sends an audio signal to POWER PLAY. When the audio signal stops, the smart technology of POWER PLAY turns off the amplifier. Comes complete with a cigarette lighter plug power wire for a quick connection to 12-volts, wired plug for permanent mount to 12-volt DC and a 110-volt AC power converter for home use.

Speaker: L 6-1/4 in. x W 5-1/4 in. x H 5-1/4 in. Patented: US 8,189,816, Taiwan 1350708, Taiwan 1368446 English/Spanish packaging.



*iPod is a registered trademark of Apple Computer.



HORNS

Air Musical Horns

MUSICAL HORNS

Loud - Attracts Immediate Attention

Air Powered - 120 Decibels

Durable plastic trumpets. 12-volt extra heavy-duty compressor that is maintenance free. Kit includes relay, hose and mounting hardware. Clamshell package, peg hooks.

English/Spanish packaging. Government approved for sale in Mexico.



Popular Tunes Available

- Model 420 - 4 trumpets - WEDDING SONG
- Model 425 - 5 trumpets - LA CUCARACHA
- Model 430 - 5 trumpets - DIXIELAND
- Model 440 - 6 trumpets - GODFATHER
- Model 445 - 4 trumpets - CALL TO THE POST
- Model 450 - 5 trumpets - LA BAMBA
- Model 455 - 3 trumpets - CAVALRY CHARGE
- Model 460 - 4 trumpets - TEQUILA
- Model 470 - 6 trumpets - ALMA LLANERA

Direct Drive Air Horns

AIRMITE® 2



Model 400 - 12-volt

Model 400-24 - 24-volt

120 Decibels - 780/840 Hz - Middle Range

AIR POWERED-VERY LOUD, 2 durable red plastic trumpets. Easy to install in all vehicles with Wolo's new compact chrome plated compressor, that is maintenance free. Kit includes relay, hose and mounting hardware. Clamshell package, peg hooks.

Longest Trumpet: 8-1/2 in.
English/Spanish packaging.
Government approved for sale in Mexico.



AIRMITE® 3



Model 405 - 12-volt

Model 405-24 - 24-volt

120 Decibels - 580/775/800 Hz - Full Middle Range

AIR POWERED-EXTRA LOUD. Three durable red plastic trumpets, easily installed in any vehicle. Heavy-duty chrome plated compressor, maintenance free. Kit includes relay, hose and mounting hardware. Clamshell package, peg hooks.

Longest Trumpet: 8-1/2 in.
English/Spanish packaging.
Government approved for sale in Mexico.



MORE ►



HORNS

Direct Drive Air Horns

AIR MAX®

AIR POWERED-VERY LOUD Xtreme POWER AIR HORN™

Model 402 – 12-volt

Model 402-24 – 24-volt

120 Decibels – 780/840 Hz – Middle Range

Two plastic durable black trumpets. The compact size compressor makes installation easy in the tightest engine compartments, maintenance free. Kit comes complete with all needed mounting hardware, hose and relay. Clamshell package, peg hooks.

Longest Trumpet: 8-1/2 in.
English/Spanish packaging.



AIR MAX® CHROME

AIR POWERED-VERY LOUD Xtreme POWER AIR HORN™

Model 403 – 12-volt

Model 403-24 – 24-volt

120 Decibels – 780/840 Hz – Middle Range

Two durable plastic trumpets that are bright chrome plated. The compact chrome plated compressor is made for installation in the tightest engine compartments and on motorcycles. The AIR MAX CHROME will dress-up any engine compartment with a beautiful chrome look. Kit comes complete with all mounting hardware, hose and relay. Clamshell package, peg hooks.

Longest Trumpet: 8-1/2 in.
English/Spanish packaging.



WOLO-BANDIDO®

AIR POWERED-VERY LOUD

Look for the Carbon-Fiber*

Model 404 – 12-volt

Model 404-24 – 24-volt

120 Decibels – 780/840 Hz – Middle Range

Two durable plastic trumpets and compressor having a cover that has a high-tech carbon-fiber-look. Transform an everyday engine compartment into the picture of style and performance. The WOLO-BANDIDO is manufactured with a hydrographic clear-coat process, which provides a durable high-definition carbon-fiber-look. Installation is easier with Wolo's compact chrome plated compressor that is maintenance free. Kit comes complete with all needed mounting hardware, hose and relay. Clamshell package, peg hooks.

Longest Trumpet: 8-1/2 in.
English/Spanish packaging.
Government approved for sale in Mexico.



*Carbon-Fiber look is a trademark of Wolo Manufacturing Corp.



HORNS

Direct Drive Air Horns

WOBLER®

WILD TURKEY SOUND

Two Tone

Model 410 – 12-volt

120 Decibels – 570/775/790 Hz – Full Middle Range

AIR POWERED-2 TONE, with the throw of a switch you can change the horn from a turkey (alternating) sound to a steady blast produced by three durable red plastic trumpets. Extra heavy-duty compressor that is maintenance free. Kit includes relay, hose and mounting hardware. Clamshell package, peg hooks.

Longest Trumpet: 9-1/2 in.
English/Spanish packaging.

Xtreme
POWER AIR HORN™



AIRSPITTER® METAL CHROME

Model 415 – 12-volt

Model 415-24 – 24-volt

120 Decibels – 540/660 Hz – Middle Range

AIR POWERED – SUPER LOUD! Dual metal chrome plated trumpets with a heavy-duty compressor that is maintenance free and easily installs in all vehicles. Kit includes relay, hose and mounting hardware. Clamshell package, peg hooks.

Longest Trumpet: 9-1/4 in.
English/Spanish packaging.

Xtreme
POWER AIR HORN™



EURO EMERGENCY VEHICLE™

TWO TONE

Model 416 118 Decibels – 416/562 Hz

Super loud air powered two (2) tone horn. With the throw of a switch, the user can change the horn's tone from a Steady Blast to an Euro Emergency Vehicle Hi/Lo sound. Two (2) metal chrome plated trumpets will look great in any 12-volt vehicle's engine compartment. Comes with a heavy-duty compressor, relay, hose and all required mounting hardware.

Longest Trumpet: 11-1/4 in.
English/Spanish packaging.
Government approved for sale in Mexico.



LONG HORNS®

BIG RIG SOUND

Model 417 – 12-volt

Model 417-24 – 24-volt

120 Decibels – 410/440 Hz

Air powered horn that produces a powerful Big Rig Truck Sound. There are two (2) durable red plastic trumpets that easily install in any vehicle. Kit comes with a heavy-duty chrome plated compressor that is maintenance free. Kit contains relay, hose and mounting hardware. Clamshell package, peg hooks.

Longest Trumpet 12-1/4 in.
English/Spanish packaging.
Government approved for sale in Mexico.



Xtreme
POWER AIR HORN™





HORNS

One Piece Direct Drive Air Horns

BAD BOY™

Model 419

123.5 Decibels - 530 / 680 Hz

The latest in air horn technology, one-piece design, that requires no hoses. Installs in minutes by simply transferring the factory horn wires to the compressor. Mounts with one bolt, included in kit. Produces a powerful dual tone air horn sound that is louder than the factory horn. The Bad Boy is compact in size to fit any car, truck, motorcycle or 12-volt vehicle that wants a powerful, loud, air horn sound. Heavy-duty maintenance free compressor will provide years of dependable service. Packaged in an attractive self-selling clamshell.

New patented design
12-volt

L 5-1/8 in. x W 3 in. x H 4-1/2 in.

CE & e approved

English/Spanish packaging.

Government approved for sale in Mexico.



FREE WINDOW DECAL



The Original



Patented: US D611,864, US 7,802,535, US 7,938,078, US 7,712,430, US 8,687,835, US 9,318,087, EP DSN NO. 001129159-0001, EP 001320832-001-002, CN ZL200930182277.0, ZL200910259133.X, HIM 001320832-0001-0002, Taiwan I385643. Other patents pending. CE & E Approved

BAD BOY CHROME™

Model 519

123.5 Decibels - 530 / 680 Hz

Wolo's BAD BOY CHROME™ has all the same features as the original BAD BOY™ but with a dress-up bright chrome plated finish, letting the vehicle or motorcycle stand out in chrome. The diaphragms have a redesigned chrome cover, and Wolo has added a chrome cover to the top of the compressor. Both covers are aerodynamically shaped making the BAD BOY CHROME a great choice to dress-up any engine compartment or motorcycle. Packaged in an attractive self-selling clamshell.

New patented design
12-volt

L 5-1/8 in. x W 3 in. x H 4-1/2 in.

CE & e approved

English/Spanish packaging.

Government approved for sale in Mexico.

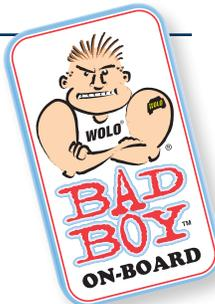

FREE WINDOW DECAL



The Original

CHROME



Patented: US D611,864, US 7,802,535, US 7,938,078, US 7,712,430, US 8,687,835, US 9,318,087, EP DSN NO. 001129159-0001, EP 001320832-001-002, CN ZL200930182277.0, ZL200910259133.X, HIM 001320832-0001-0002, Taiwan I385643. Other patents pending. CE & E Approved



HORNS

One Piece Direct Drive Air Horns

BIG BAD MAX®

Model 619 123.5 Decibels - 320 Hz

Wolo's Model 619, BIG BAD MAX air horn uses the same proven patented technology and design as the original Bad Boy. BIG BAD MAX has a sound chamber designed to create a deep big rig sound that produces 123.5 decibels. The new patented sound chamber has been engineered to allow the user to clean any road dirt or dust, without special tools, assuring a powerful and reliable horn for the life of the vehicle. BIG BAD MAX is the perfect choice for all 12-volt vehicles: cars, trucks, motorcycles, boats and etc. The one-piece patented design requires no hoses like conventional air horns. Easily installs with one bolt, that is supplied. Simply transfer the vehicle's factory horn wires to MAX'S compressor and the installation is complete. Built with a heavy-duty compressor that is maintenance free to provide years of dependable service. Has a Black Stealth finish. If you want a deep, powerful air horn sound, go no further, BIG BAD MAX is the horn for you!



FREE WINDOW DECAL

THEY WILL HEAR YOU BEFORE THEY CAN SEE YOU!™

The Original



L 5-3/4 in. x W 3-1/2 in. x H 4-5/8 in.

English/Spanish packaging.

Patented: US D611,864, US 7,978,078, US 7,802,535, US 7,712,430, US 8,687,835, US 9,318,087, EP DSN NO. 001129159-0001, EP 001320832-001-002, CN ZL200930182277.0, ZL200910259133.X, CN ZL201230031694.7, OHIM 001320832-0001-0002, OHIM 001320824-0001-0002. Other patents pending.

BIG BAD MAX® CHROME

Model 719 123.5 Decibels - 320 Hz

Wolo's BIG BAD MAX CHROME, Model 719, has a powerful truck horn sound with a beautiful bright chrome finish. If you want the touch of class added to your motorcycle or engine compartment go no further, BIG BAD MAX CHROME is for you. The diaphragm and compressor both have chrome covers that are aerodynamically shaped. The one-piece patented design requires no hoses like conventional air horns. Easily installs with one bolt that is provided. Simply transfer the factory horn wires to MAX'S



FREE WINDOW DECAL

compressor and the installation is complete. Always use the relay provided when installing MAX on a motorcycle. Built with a heavy-duty compressor that is maintenance free, assuring years of dependable service. If you want a deep sounding powerful air horn sound, go no further, BIG BAD MAX CHROME is the horn for you! THEY WILL HEAR YOU BEFORE THEY CAN SEE YOU!™

The Original

CHROME



L 5-3/4 in. x W 3-1/2 in. x H 4-5/8 in.

English/Spanish packaging.

Patented: US D611,864, US 7,978,078, US 7,802,535, US 7,712,430, US 9,318,087, EP DSN NO. 001129159-0001, ZL200930182277.0, ZL200910259133.X, CN ZL201230031694.7, OHIM 001320832-0001-0002, OHIM 001320824-0001-0002, Taiwan I385643. Other patents pending.



HORNS

Direct Drive Horn Accessories

WIRELESS WIZARD®



Universal Wireless Remote Control System

Model RC-100

Wolo's new WIRELESS WIZARD allows the user to operate a vehicle's horn or turn on/off any 12-volt accessory, such as warning lights, without having to wire between the engine compartment and the vehicle's interior. The Wireless Wizard is built with state-of-the-art electronics, assuring years of reliable service. Every WIRELESS WIZARD has its own coded transmitter to prevent interference with similar remote control systems. Wireless Wizard is easy-to-install to any 12-volt car, truck, ATV, boat or industrial equipment, without any special tools and without drilling holes. The remote transmitter mounts with Velcro® in a convenient, easy to reach location, and is powered by a 23a type battery, which is included in the kit. The remote's push button will illuminate blue when pressed; alerting the user that coded RF signal is being transmitted to the receiver. The case of the remote transmitter has an attractive black leather grain finish to match the interior of most vehicles.

The Model RC-100 WIRELESS WIZARD has two modes that are selectable by the user, momentary for horns or on/off for accessories.

MOMENTARY:

When the WIRELESS WIZARD mode selector switch is positioned in MOMENTARY; press the remote's push button and the horn will sound until the button is released.

ACCESSORY ON / OFF:

When the WIRELESS WIZARD mode selector switch is positioned in ACCESSORY ON / OFF, press the remote's push button one time and accessory will turn on and stay on until the push button is pressed and released a second time.

U.S. and foreign patents pending.



INCLUDES RECEIVER AND WIRELESS REMOTE CONTROL



HORN BUTTON SWITCH

Model HS-1

Model HS-1 is a universal horn switch that can be used with any brand or model of horns. Easily mounts with two (2) screws provided. Made of metal to ensure years of dependable service. The HS-1 has a bright zinc finish which will look great in any vehicle. Packaged on a full color blister display card.

English/Spanish packaging.
Government approved for sale in Mexico.

HORN BUTTON SWITCH KIT

Model HS-2

Model HS-2 uses the same high quality horn button switch as the HS-1, includes 10 ft of 18 awg automotive grade wire and terminals.



Model HS-1



Model HS-2

AIR HORN WIRING KITS

Model HWK-1

Model HWK-1 should be used when a new horn switch is required, horn button switch included. Wolo's HWK-1 horn wiring kit makes installation of any low-pressure air horn (no tank) easy, trouble free and professional, without special tools. Designed for any 12-volt car, motorcycle, truck and SUV. Included in both kits is all that is required; wire harness with quick relay connect plug, terminals, in-line fuse, plastic wire ties and easy to follow English/Spanish instructions. Packaged in an attractive, self-selling clamshell. Stock Model HWK-1 to produce secondary sales. Horn relay is not included in kit.

Model MCHWK-2

Model MCHWK-2 will provide an easy and professional installation when wiring an air horn to a motorcycle or a vehicle's factory horn system, (vehicle's steering wheel horn button switch). Horn relay is not included in kit.

English and Spanish packaging.



Model HWK-1



Model MCHWK-2



HORNS

Direct Drive Horn Accessories

COMPRESSOR

Compact Universal Replacement for Air Horn - Chrome Plated

Model 400-C - 12-volt

Model 400-C24 - 24-volt

Wolo's compressor Model 400-C is designed to fit into tight engine compartments and motorcycles. It is compact in size 4-1/2 in. height x 2-1/4 in. diameter, with a beautiful bright chrome finish. Produces a powerful 10-12 psi. Mounts easily with only one bolt, which is included. The Model 400-C is totally universal for all two (2) and three (3) trumpet air horns that use a direct drive compressor, (no tank).



Model 400-C



Model 400-C

COMPRESSOR

Universal Replacement for Air Horn - Increased Output

Model 408-C

Wolo's Model 408-C is a compact 12-volt compressor for low-pressure air horns. Should be used when extra air pressure is required, produces 16-18 psi. Has a bright chrome finish, Dimension: 4-1/2 in. height x 2-1/4 in. diameter.



Model 408-C

COMPRESSOR

Universal Replacement for Air Horn - High Output

Model 808-C

Model 808-C is a 12-volt heavy-duty replacement compressor for all two (2) and three (3) trumpet air horns that are powered by a direct drive compressor, (no tank). The 808-C produces 18-21 psi. Dimension: 4-3/4 in. height x 2-3/4 in diameter.



Model 808-C

Model 400-R

HORN RELAY

Model 400-R - 12-volt

Model 400-R24 - 24-volt

Heavy-duty relay, four terminal. The black plastic water resistant case makes mounting easy anywhere in the vehicle. Use with horns, fog lights or any electrical circuit requiring a relay with a current capacity up to 30-amps. This is the relay used with all models of Wolo air horns.



Model 400-WPC

WEATHER PROTECTION COVER

Model 400-WPC

Chrome plated plastic cover that is ideal for protecting Wolo's 400 series air horn trumpets from rain, snow, and road dirt. Easily attaches to front of trumpet in seconds with stainless steel mounting brackets.

CHROME BACK COVER FOR AIR HORN TRUMPET

Model 400-BC

Chrome plated trumpet back cover ideal for dressing up any vehicle. Covers are designed to have a firm fit on trumpets, which will prevent them from coming off when used on motorcycles that have excessive vibration. Bulk packaged.



Model 400-BC

All horns on
this page
meet this
standard

Meets the U.S. Coast Guard's
C.O.L.R.E.G.S. and U.S. Inland
Navigation Rules, Annex III
Regulations for boats up to
20 meters.

HANDY HORN[®]

Model 490

Hand held gas-powered horn made of durable red plastic. Extra loud sound. Ideal for marine, sporting events, camping, etc. Comes with an 8 oz. can of environmentally safe 134a gas. Packaged in a clamshell.

Patent No. US D626,444
English/Spanish packaging
Government approved for sale in Mexico.

HANDY HORN[®] REFILL

Model 495

8 oz. can of environmentally safe 134a gas.
Packaged in a clamshell



Model 490



Model 495



Always use ear protection
when sounding horn.

E-Z HORN[®]

Hand Held Electronic Horn

GREEN
PRODUCT



Model 496

E-Z Horn is a powerful hand held electronic horn that should be part of every horn plan-o-gram. With a simple press of the trigger, the E-Z Horn emits a powerful ear piercing warning sound. Ergonomically designed, the handgrip is comfortable to hold and is non-slip. A standard 9-volt battery (not included) powers the horn. The E-Z Horn also has a spare battery compartment that can store one 9-volt battery as a back up, assuring the user of always having a working horn when needed, in any emergency situation. No expensive cans of gas needed. The E-Z Horn also comes with a quick release stainless steel belt clip. By pressing the tab on the belt clip, E-Z Horn is released and ready to use. A nylon lanyard hand wrist strap is also provided to ensure a positive handgrip in the toughest environments. Packaged in a clamshell.

Patented: US 8,004,390, US 8,149,097, US D568,195,
Taiwan 1,448,995
English/Spanish packaging. Government approved for
sale in Mexico.



Always use ear protection
when sounding horn.

iHorn[®]

Mini-Hand Held Gas Horn

Model 497

The Model 497 is a hand held gas horn, compact in size and easy to carry. iHorn delivers a powerful blast that will be heard with the simple press of the horn's button. Ideal for marine, jogging, camping, sporting events and any time a powerful horn is needed. iHorn is environmentally safe using 134a gas (no CFC's), 1.8 oz.

Attractively packaged for impulse sales.



**Extra Loud
Sound!**



Always use ear protection
when sounding horn.



MARINE AIR HORNS

All horns on this page meet these standards

Meets the U.S. Coast Guard's C.O.L.R.E.G.S. and U.S. Inland Navigation Rules, Annex III Regulations for boats up to 20 meters.

MEMBER OF
NMMA
National Marine Manufacturers Association
This horn is National Marine Manufacturers Association (NMMA) "type accepted"

MEMBER OF
ABYC
American Boat & Yacht Council (ABYC)
A-23 standard for boats up to 20 meters.

The Persuader®

100% STAINLESS STEEL EXTERIOR

Single Trumpet • Ultra Loud

Designed for all weather conditions

Model 110 - Low Tone – 12-volt – Stainless Steel

Model 1110 - Low Tone – 12-volt – Painted White Enamel

115 Decibels – 330 Hz

L 18-1/2 in. x W 4 in. x H 4-1/2 in.

Model 115 - High Tone – 12-volt – Stainless Steel

Model 1115 - High Tone – 12-volt – Painted White Enamel

115 Decibels – 408 Hz

L 15-1/2 in. x W 4 in. x H 4-1/2 in.

Both models of The Persuader are 100% stainless steel, 304 non-magnetic grade, with a bright polished finish that will not rust. Designed for exterior mounting. Maintenance free, does not require a compressor or hoses. Includes a front stainless steel adjustable pedestal bracket to prevent vibration of the horn. Comes complete with rubber gaskets and stainless steel mounting hardware.

English / Spanish packaging



Stainless Steel

NEW

Painted White Enamel

See page 16 - MODEL 125-WPC for WEATHER PROTECTION COVERS

The Persuader® Xtreme

100% STAINLESS STEEL EXTERIOR

Double Trumpet • Ultra Loud

Designed for all weather conditions

Model 120 Low Tone/High Tone – 12-volt

116 Decibels – 330/408 Hz

Low Tone: - L 18-1/2 in. x W 4 in. x H 4-1/2 in.

High Tone: - L 15-1/2 in. x W 4 in. x H 4-1/2 in.

The Persuader Xtreme is 100% stainless steel, 304 non-magnetic grade, with a bright polished finish that will not rust. Trumpets are designed for mounting either next to each other or independently in two different locations. Maintenance free, does not require a compressor or hoses. Includes a front stainless steel adjustable pedestal bracket to prevent vibration of the horn. Comes complete with rubber gaskets and stainless steel mounting hardware.

English / Spanish packaging



See page 16 - MODEL 125-WPC for WEATHER PROTECTION COVERS

The Dominator®

100% STAINLESS STEEL EXTERIOR

Double Trumpet • Ultra Loud

Designed for all weather conditions

Model 125-12 - Low & High Tone – 12-volt – Stainless Steel

Model 1125-12 - Low & High Tone – 12-volt – Painted White Enamel

Model 125-24 - Low & High Tone – 24-volt – Stainless Steel

116 Decibels – 330/408 Hz

L 18-1/2 in. x W 8 in. x H 4-1/2 in.

The Dominator is 100% stainless steel, 304 non-magnetic grade, with a bright polished finish that will not rust. Designed for exterior mounting. Maintenance free, does not require a compressor or hoses. Includes a front stainless steel adjustable pedestal bracket to prevent vibration of the horn. Comes complete with rubber gaskets and stainless steel mounting hardware.

English / Spanish packaging



Stainless Steel

NEW

Painted White Enamel

See page 16 - MODEL 125-WPC for WEATHER PROTECTION COVERS

MORE ▶

All horns on this page meet these standards

Meets the U.S. Coast Guard's C.O.L.R.E.G.S. and U.S. Inland Navigation Rules, Annex III Regulations for boats up to 20 meters.

MEMBER OF
NMMA
National Marine Manufacturers Association
This horn is National Marine Manufacturers Association (NMMA) "type accepted"

MEMBER OF
ABYC
American Boat & Yacht Council (ABYC)
A-23 standard for boats up to 20 meters.

Weather Protection Covers

MODEL 125-WPC

To ensure years of reliable service from your horn, Wolo has designed beautiful chrome plated weather protection covers custom made for our stainless steel MARINE HORN series. They will fit Models: THE PERSUADER • THE DOMINATOR • SEA SAFE • SEA ALERT • OCEAN ALERT. The covers will not affect the powerful sound of the horn while protecting the sound chamber from water and dirt that could enter into the front of the trumpet. The cover is made of plastic which is chrome plated and the clip-on brackets are stainless steel to prevent rusting. The covers will install tightly onto the trumpets so they will stay in place. Installation is easy and takes minutes requiring only a Phillips screwdriver.



THE MODEL 125-WPC IS SOLD AS A SET, (2 COVERS).

Sea Safe®

Model 135 – 12-volt

Model 135-24 – 24-volt

126 Decibels at 1 meter 630 Hz (High Tone) ±15%

Wolo's SEA SAFE is a powerful single trumpet air horn that is 100% solid brass with a bright chrome plated finish. SEA SAFE'S design is ideal for smaller boats, producing a warning sound equal to larger horns. Sea Safe has a Lexan® non-corrosive diaphragm, making it ideal for use in salt or fresh water environments. The compressor is heavy-duty with a bright chrome plated finish and is maintenance free. Kit includes rubber gasket, hose, 30-amp relay and stainless steel mounting hardware.

Horn Dimension: L 9-1/2 in. x W 3-1/2 in. x H 3-3/4 in.
Compressor Dimension: H 4-1/2 in. x D 2-1/4 in.

English / Spanish packaging



See MODEL 125-WPC above for WEATHER PROTECTION COVERS

Sea Alert®

Model 140 - Low Tone – 12-volt

Model 140-24 - Low Tone – 24-volt

**120 Decibels at 1 meter
315 Hz ±15%**

Horn Dimension: L 17 in. x W 3-3/4 in. x H 3-3/4 in.
Compressor Dimension: H 4-1/2 in. x D 2-1/4 in.

Model 145 - High Tone – 12-volt

Model 145-24 - High Tone – 24-volt

**120 Decibels at 1 meter
375 Hz ±15%**

Horn Dimension: L 15 in. x W 3-3/4 in. x H 3-3/4 in.
Compressor Dimension: H 4-1/2 in. x D 2-1/4 in.

Wolo's SEA ALERT marine air horns are solid brass with a bright chrome plated finish, which will look great on any boat. The sound chamber has a Lexan® non-corrosive diaphragm, making it ideal for boats in salt or fresh water environments. To eliminate vibration of the horn, a stainless steel adjustable front pedestal bracket is included. Sea Alert easily mounts on the bow or the cabin's top with stainless steel mounting hardware provided. The heavy-duty chrome plated compressor included, is compact in size for easy installation and is maintenance free. Kit includes rubber gasket, hose, 30-amp relay and stainless steel mounting hardware.

English / Spanish packaging



See MODEL 125-WPC above for WEATHER PROTECTION COVERS



MARINE AIR HORNS

All horns on this page meet these standards

Meets the U.S. Coast Guard's C.O.L.R.E.G.S. and U.S. Inland Navigation Rules, Annex III Regulations for boats up to 20 meters.

MEMBER OF
NMMA
National Marine Manufacturers Association
This horn is National Marine Manufacturers Association (NMMA) "type accepted"

MEMBER OF
ABYC
American Boat & Yacht Council (ABYC)
A-23 standard for boats up to 20 meters.

Sea Alert[®] Xtreme

Model 150 - Low & High Tone – 12-volt
Model 150-24 - Low & High Tone – 24-volt
121 Decibels at 1 meter 315 / 375 Hz ±15%

SEA ALERT Xtreme is two independent air horns that are solid brass and have a bright chrome finish, that will dress up and look great on any boat big or small. Trumpets are designed for mounting either next to each other or independently in different locations. Each horn is powered by it's own compact heavy-duty compressor. The sound chamber of each horn has a Lexan[®] non-corrosive diaphragm, making it ideal for boats in salt or fresh water environments. To eliminate vibration of the horn, a stainless steel adjustable front pedestal bracket is included. The horns will easily mount on the bow or the cabin's top with stainless steel mounting hardware provided. Kit includes: 2-heavy-duty compressors, 2-30-amp relays, rubber gaskets, hose and stainless steel mounting hardware.



Horn Dimension:
L 15 in. x W 3-3/4 in. x H 3-3/4 in.
L 17 in. x W 3-3/4 in. x H 3-3/4 in.
Compressor Dimension (each): H 4-1/2 in. x D 2-1/4 in.
English / Spanish packaging

See page 16 - MODEL 125-WPC for WEATHER PROTECTION COVERS

Ocean Alert[®] Mini

Model 160 - Low & High Tone – 12-volt
Model 160-24 - Low & High Tone – 24-volt
127 Decibels at 1 meter 525 / 630 Hz ±15%

OCEAN ALERT MINI is a dual trumpet air horn constructed of solid brass that has a bright chrome plated finish, and the horn's base plate is constructed of stainless steel. Compact design is ideal for smaller boats, but still produces a powerful warning sound equal to larger horns. Lexan[®] non-corrosive diaphragms are used to provide years of dependable service and making OCEAN ALERT ideal for boats in salt or fresh water environments. The heavy-duty compressor included, is compact in size for easy installation and is maintenance free. Kit includes: Compressor, rubber gasket, hose, 30-amp relay and stainless steel mounting hardware.



Horn Dimension: L 9-1/2 in. x W 5 in. x H 3-3/4 in.
Compressor Dimension: H 4-1/2 in. x D 2-1/4 in.
English / Spanish packaging

See page 16 - MODEL 125-WPC for WEATHER PROTECTION COVERS

Ocean Alert[®]

Model 170 - Low & High Tone – 12-volt
Model 170-24 - Low & High Tone – 24-volt
121 Decibels at 1 meter 315 / 375 Hz ±15% Horn

Wolo's OCEAN ALERT dual trumpet air horn produces a powerful low tone sound that will be heard! Model 170 is constructed of solid brass with a bright chrome finish that will look great on any boat, big or small. The horn's base plate is constructed of polished stainless steel. Designed with Lexan[®] non-corrosive diaphragms to provide years of dependable service, and making OCEAN ALERT ideal for salt or fresh water environments. To eliminate vibration of the horn, a stainless steel adjustable front pedestal bracket is included. The heavy-duty compressor included, has a bright chrome finish, compact in size and is maintenance free. Kit includes: Compressor, rubber gaskets, hose, 30-amp relay and stainless steel mounting hardware.

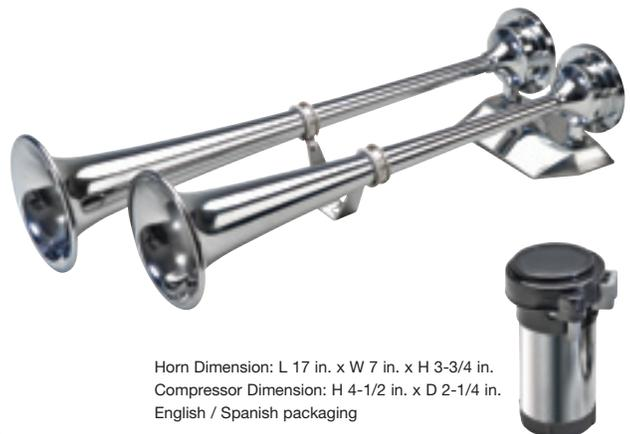

Horn Dimension: L 17 in. x W 7 in. x H 3-3/4 in.
Compressor Dimension: H 4-1/2 in. x D 2-1/4 in.
English / Spanish packaging

See page 16 - MODEL 125-WPC for WEATHER PROTECTION COVERS



TRUCK HORNS

On-Board Air Systems

TIGER® COMPRESSOR & AIR TANK

Model 800

An easy to use, two piece air supply system, consisting of a 2.5 liter steel air storage tank. The kit also includes a compressor (air pump), 10 feet of 1/4 in. air hose, brass fittings and mounting hardware. The system has a built-in pressure switch to maintain 110 psi air pressure in the storage tank. All moving parts of the compressor are manufactured to strict standards. The compressor's motor is carefully balanced, and then mounted on heavy rubber bushings, virtually eliminating all vibration. Air hose fittings are made of quality brass to ensure leak free installation. Comes complete with all necessary mounting hardware, 20 foot coiled filler hose with brass fittings and hose fittings. Spanish instructions are included.

English/Spanish packaging.

Compressor;

Voltage: 12-volts

Current: 10-amps

Compressor auto-on: 80 psi

Compressor auto-off: 110 psi

CFM: 1.38

Compressor has a removable air filter

Filler hose length: 20 ft, coiled with fittings

Compressor size: L 6-1/8 in. x W 3-1/2 in. x H 5-1/8 in.

Tank:

Tank capacity: 2.5 liters

Fitting size: 1/4 in. air hose

Tank size: L 9 in. x W 5 in. x H 5-3/4 in.



SHERMAN TANK & COMPRESSOR™

Tank & Compressor All-In-One

Model 830

Wolo's new SHERMAN TANK & COMPRESSOR is an ALL-IN-ONE complete high-pressure on-board air system. The compact one-piece design has two steel mounting brackets that are welded to the tank, making installation easier than conventional onboard air systems. The heavy-duty 1-gallon tank is painted black to prevent rust and corrosion. The compressor's heavy-duty 12-volt motor is balanced to precision and is hidden inside the tank's housing. The pump's cylinder head has cooling fins that allows the compressor to operate at a lower temperature, preventing overheating. Other features are: built-in pressure switch, pressure gauge and quality brass fittings. The kit comes complete with mounting hardware, 10 ft. of flexible high-pressure hose, 20 ft. coiled filler hose with brass fittings; all that is needed for a professional installation.

Compressor

Voltage: 12-volts

Current: 10.5-amps at peak

CFM: 1.03

In-line fuse holder with 20-amp fuse provided

Duty-cycle: 10% @ 100 psi

Pump has an air filter

Oil-less maintenance free

Permanent magnet motor that is gearless with thermo protection

NEW



Tank

1-Gallon storage tank

Welded steel mounting brackets

Pressure switch 80 psi. auto-on / 120 psi. off

Pressure gauge

Fitting all brass

Size: L 14-1/2 in. x W 5-1/2 in. x H 8-1/4 in.

TURBO® COMPRESSOR & EXTENDED TANK SYSTEM

Designed for all Wolo train horns

Model 840

The Model 840 is designed for all Wolo train horns, or any high-pressure horns that require an on-board air system. Designed with a 5.5 liter extended tank and a heavy-duty, high volume compressor. Turbo will sound most three trumpet train horns for ten seconds of continuous sound. The Model 840 is a simple two piece air supply system, consisting of a metal storage tank, compressor, 10 feet of 1/4 inch air hose, 20 foot coiled filler hose with brass fittings, hose fittings and mounting hardware. The Turbo Compressor's motor is balanced and has heavy rubber bushings in its mounting base to virtually eliminate all vibration, and a built-in pressure switch to maintain 110 psi in the tank.

English/Spanish packaging.

Compressor

Voltage: 12-volts

Current: 12-amps

Compressor auto-on: 80 psi

Compressor auto-off: 110 psi

CFM: 2.03

Compressor has a removable air filter

Filler hose length: 20 ft, coiled with fittings

Compressor size: L 6-1/2 in. x W 3-1/2 in. x H 5 in.

Tank

Tank capacity: 5.5 liters

Fitting size: 1/4 in. air hose

Tank size: L 18 in. x W 5 in. x H 5 1/2 in.





TRUCK HORNS

On-Board Air Systems

TORNADO® HEAVY-DUTY COMPRESSOR & 2.5 GALLON TANK SYSTEM

Model 858

TORNADO is ideal for applications that require a large volume of high-pressure air. Model 858 is the right on-board air system for powering train air horns, or light-duty pneumatic tools. Use the coiled filler hose with brass fittings provided, to fill shocks, rafts and sporting equipment. The heavy-duty compressor is equipped with extended length stainless steel high-pressure hose, allowing the compressor to be separated from the tank for surface mounting. TORNADO is a complete on-board air system that includes everything necessary for a professional installation. The 2.5-gallon steel tank is painted black to prevent rust and corrosion. There are two steel mounting brackets that are welded to the tank. Other tank features are; built-in pressure switch, manual water drain, pressure gauge, pressure relief valve and brass fittings. The pump's cylinder and head, have been designed with cooling fins that allows the compressor to operate at 33% @ 100 psi duty cycle. The heavy-duty 12-volt motor of the compressor is balanced to precision, and there are 4 heavy rubber bushings mounted into the base virtually eliminating all vibration. Kit comes complete with all mounting hardware, 10 ft. of flexible high-pressure hose, 20 ft. coiled filler hose with brass fittings and installation instructions in English / Spanish.

Compressor

12-volt heavy-duty compressor
Current: 21-amps at peak
CFM: 2.55
In-line fuse holder with 25-amp fuse provided
Permanent magnetic motor that is gearless with thermo protection
Oil-less maintenance free design
High performance piston ring
Moisture & dust resistant
Painted aluminum alloy cylinder
Mounting base has rubber vibration bushings
Stainless steel braided hose with in-line check valve
Washable air filter
Size: L 10-1/4 in. x W 3-1/2 in. x H 6-1/2 in.

Tank

2.5-Gallon
Welded steel mounting brackets
Petcock water drain
Pressure switch 80 psi. auto-on / 120 psi. off
Safety pressure relief valve rated at 150 psi.
Pressure gauge
Fitting all brass
Size: L 17-1/4 in. x W 6-1/2 in. x H 8-1/4 in. Tank only.

Size: Compressor mount on tank L 17-1/4 in. x W 6-1/2 in. x H 15-1/4 in.



AIR RAGE® HEAVY-DUTY HIGH OUTPUT COMPRESSOR & 5 GALLON TANK SYSTEM

Model 860

AIR RAGE is designed for applications that require an on-board air system that can supply large volumes of high-pressure air. Model 860 is ideal for powering train air horns, or light-duty pneumatic tools. Use the coiled filler hose with brass fittings provided, to fill shocks, rafts and sporting equipment. The heavy-duty compressor has an extended length stainless steel high-pressure hose, allowing the compressor to be separate from the tank for surface mounting. AIR RAGE is a complete on-board air system that includes everything necessary for a professional installation. The heavy-duty 5-gallon steel tank is painted black to prevent rust and corrosion. There are two steel mounting brackets that are welded to the tank. Other tank features are: built-in pressure switch, manual water drain, pressure gauge, pressure relief valve and brass fittings. The pump's cylinder and head have been designed with cooling fins that allows the compressor to operate at 100 percent duty cycle. The heavy-duty 12-volt motor of the compressor is balanced to precision, and there are 4 heavy rubber bushings mounted into the base virtually eliminating all vibration. Kit comes complete with all mounting hardware, 10 ft. of flexible high-pressure hose, 20 ft. coiled filler hose with brass fittings and installation instructions in English / Spanish.

Compressor

12-volt heavy-duty compressor
Current: 22-amps at peak
CFM: 3.5
In-line fuse holder with 25-amp fuse provided
Permanent magnetic motor that is gearless and thermally protection
Oil-less maintenance free design
High performance piston ring
Moisture & dust resistant
Painted aluminum alloy cylinder
Mounting base has rubber vibration bushings
Stainless steel braided hose with in-line check valve
Washable air filter
Size: L 11-1/2 in. x W 3-1/2 in. x H 6-1/2 in.

Tank

5-Gallon
Welded steel mounting brackets
Petcock water drain
Pressure switch 80 psi. auto-on / 120 psi. off
Safety pressure relief valve rated at 150 psi.
Pressure gauge
Fitting all brass
Size: L 20-1/2 in. x W 8-1/2 in. x H 10-1/2 in. Tank only.

Size: Compressor mount on tank L 20-1/2 in. x W 8-1/2 in. x H 17-1/2 in.





TRUCK HORNS

High Pressure Compressors and Tanks

TIGER[®] REPLACEMENT HIGH PRESSURE COMPRESSOR

Model 800-C

See Model 800 on page 18 for complete Compressor specifications.



Model 800-C

TURBO[®] REPLACEMENT COMPRESSOR

Designed for Train Horns and High Volume Output

MODEL 840-C

See Model 840 on page 18 for complete Compressor specifications.

Model 840-C



TORNADO[™] HEAVY-DUTY HIGH-PRESSURE COMPRESSOR



Model 858-C

See Model 858 on page 19 for complete Compressor specifications.



Model 858-C

AIR RAGE[™] HIGH OUTPUT HEAVY-DUTY HIGH PRESSURE COMPRESSOR



Model 860-C

See Model 860 on page 19 for complete Compressor specifications.



Model 860-C

REPLACEMENT AIR STORAGE TANKS

An air storage tank added to your vehicle provides high-pressure air, on the go. Our tanks are all metal painted black to help prevent rusting and have quality brass fittings to ensure leak free installation. For use with standard 1/4 in. O.D. high-pressure hose. Mounting is made easy with the steel mounting brackets which are welded to the tanks. Maximum tank pressure is 150 psi. Mounting hardware included.

Model 806-RT - 2.5 Liters

Size: L 8 in. x W 5 in. x H 5-1/2 in.

See Model 800 on page 18 for complete specifications.



Model 806-RT

Model 807-RT - 3.5 Liters

Size: L 13 in. x W 5 in. x H 5-1/2 in.



Model 807-RT

Model 808-RT - 5.5 Liters

Size: L 18 in. x W 5 in. x H 5-1/2 in.

See Model 840 on page 18 for complete specifications.



Model 808-RT

Model 858-RT - 2.5 Gallons

Pressure relief valve included

Pressure gauge included

Size: L 21-1/2 in. x W 6.5 in. x H 8-1/2 in.

See Model 858 on page 19 for complete specifications.



Model 858-RT

Model 860-RT - 5.0 Gallons

Pressure relief valve included

Pressure gauge included

Size: L 27-1/8 in. x W 8.5 in. x H 10 in.

See Model 860 on page 19 for complete specifications.



Model 860-RT



TRUCK HORNS

Low Pressure Direct Drive

POWERHOUSE®

Roof Mount

Model 418 – 12-volt

Model 418-24 – 24-volt

120 Decibels - 390/435 Hz

DUAL TRUMPET AIR HORN – Chrome plated metal trumpets with weather protection covers that easily attach to the front of each trumpet. Ideal for roof mounting on trucks, RV'S, SUV and etc. Extra loud big truck sound. Heavy-duty compressor that is maintenance free. Kit includes Wolo's flexible inlet hose with brass fittings, relay, hose, and mounting hardware.

Horn Size: L 14 in. x W 6 in. x H 3-1/4 in.

Compressor Dimension: H 4-1/2 in. x D 2-1/4 in.

English/Spanish packaging.



POWERHOUSE® PLUS

Roof Mount Air Horn With Led Lights

Model 418-LED

120 Decibels - 380/430 Hz

Wolo's Powerhouse PLUS is the next generation in air horns. Built like no other horn, the chrome back cover has 28 RED SUPER BRIGHT HIGH INTENSITY long life LEDs. The LEDs can be used as a decorative marker light facing the rear of the vehicle or as a third brake light. A vehicle with the Powerhouse PLUS is sure to be heard with its powerful big rig truck sound, as well as to be seen. The dual metal chrome trumpets will dress up and make any truck, RV, and SUV look great. Installation is made easy with Wolo's flexible inlet hose with brass fittings. The Powerhouse PLUS will provide the vehicle's owner, years of dependable maintenance free service. Kit includes a heavy-duty 12-volt compressor, chrome weather protection covers, relay, hose and mounting hardware.

Horn Size: L 14 in. x W 6 in. x H 3-1/4 in.

Compressor Dimension: H 4-1/2 in. x D 2-1/4 in.

Patented 7,394,351

English/Spanish packaging



CHALLENGER® DD

Roof Mount

Model 808 – 12-volt

Model 808-24 – 24-volt

123 Decibels - 380/456 Hz

Model 808 is a perfect addition to any truck, RV, SUV and etc. Installation is made easier with Wolo's new flexible inlet hose. The entire horn is metal so to withstand all weather conditions and provide years of dependable service. The trumpets have a bright triple chrome plated finish, which will dress up any vehicle. Included in the kit is Wolo's heavy-duty compact chrome compressor, which is maintenance free. Includes all necessary mounting hardware, horn switch, hook-up wire, wire terminals and relay.

Horn size: L 14-1/2 in. x W 7 in. x H 5 in.

Compressor Dimension: H 4-1/2 in. x D 2-1/4 in.

English/Spanish packaging.



MORE ▶



TRUCK HORNS

Low Pressure Direct Drive

CHALLENGER® EC

Engine Compartment Air Horn

Model 809 – 12-volt

Model 809-24 – 24-volt

123 Decibels - 380/456 Hz

Wolo's Model 809 has been designed to mount in a vehicle's engine compartment. Installation is made easy and is time saving because the horn's air inlet is located between the trumpets. The entire horn is constructed of metal to withstand all weather conditions and engine compartment heat. Kit comes with Wolo's compact chrome compressor, which is maintenance free. The trumpets are triple chrome plated and will dress up any engine compartment. Kit comes complete with all necessary mounting hardware, horn switch, wire, relay, and wire terminals.

Horn size: L 14-1/2 in. x W 7 in. x H 5 in.

Compressor Dimension: H 4-1/2 in. x D 2-1/4 in.

Mounting hardware: Stainless Steel.

Includes Wolo's flexible inlet hose with brass fittings.

English/Spanish packaging



SILVER STREAK® EXPRESS DD

Train Sound Air Horn with Direct Drive Compressor

Model 836 – 12-volt

Model 836-24 – 24-volt

119 Decibels - 376/383 Hz

The Silver Streak is designed with an air chamber to produce a powerful echo sound that replicates the air horn of a speeding locomotive. Comes complete with Wolo's heavy-duty compact compressor (no air storage tank required). The trumpets are triple chrome plated metal to withstand all weather conditions. The metal base secures to the vehicle using a rubber gasket and stainless steel bolts, providing a watertight installation. Kit comes complete with all necessary mounting hardware, horn switch, wire, relay, and wire terminals.

Horn size: L 14-1/2 in. x W 7 in. x H 5 in.

Compressor Dimension: H 4-1/2 in. x D 2-1/4 in.

Mounting hardware: Stainless Steel.

Includes Wolo's flexible inlet hose with brass fittings.

English/Spanish packaging



ROAD WARRIOR DD™

Roof Mount Truck Air Horn

Model 845 – 12-volt

Model 845-24 – 24-volt

125 Decibels - 275 Hz

The Road Warrior is a powerful air horn that will produce the same high output sound that a BIG RIG TRUCK demands. The beautiful chrome finish will look great on any truck, RV, SUV and etc. Powered by Wolo's compact heavy-duty compressor that is maintenance free. No high-pressure on-board air tank system is required. The horn is secured to the vehicle's roof with two (2) sturdy mounts that will eliminate vibration at high speeds and while driving on rough roads. Installation is made easy with Wolo's flexible inlet hose with brass fittings. The Road Warrior will provide years of dependable maintenance free service. Kit includes heavy-duty compressor, relay, hose and mounting hardware.

Horn size: L 21-1/2 in. x W 6 in. x H 6-1/8 in.

Compressor Dimension: H 4-1/2 in. x D 2-1/4 in.

Includes Wolo's flexible inlet hose with brass fittings.

English/Spanish packaging





TRUCK HORNS

High Pressure

CHALLENGER®

Roof Mount Air Horn

Model 805 - 125 Decibels - 380/456 Hz

When conditions demand a powerful sound, use the Model 805 roof mounted air horn. Every component of the horn is made to withstand the extremes in all weather conditions. The mounting base of the Model 805 secures to the vehicle with a rubber gasket and four stainless steel bolts providing a secure watertight installation. The horn's air inlet is located in the base, hidden from view, and easily connects to Wolo's flexible inlet hose with brass fittings. Both trumpets have a bright triple chrome plated finish, making the Challenger an attractive addition to any truck. All needed mounting hardware is included. The Model 805 requires an on board air system, (recommended Wolo on-board air system is Model 800).

Horn size: L 14-1/2 in. x W 7-3/4 in. x H 5 in.

Horn's operating pressure 80 to 110 psi.

Horn construction: All metal, base painted enamel, trumpets chrome plated

Hose fitting size: 1/4 inch O.D.

Includes Wolo's flexible inlet hose with brass fittings.

Mounting hardware: Stainless steel

English/Spanish packaging



CHALLENGER® EV

Electric Solenoid Operated

Model 810 - 125 Decibels - 310/380 Hz

CHALLENGER® LV

Lanyard Operated

Model 815 - 125 Decibels - 310/380 Hz

The Model 810 and the Model 815 offer the same powerful BIG RIG roof mount air horn sound. These models only differ in the way they are activated: Model 810, uses a electric solenoid (included) and Model 815, uses a manual lanyard (included). Both models of Challenger come complete with a maintenance free on board air system. Each of the kits include everything that is required to install on any 12-volt vehicle: a deluxe air horn that is all metal with triple chrome plated trumpets, heavy-duty compressor, tank, hoses, mounting hardware and installation instructions.

All moving parts of the air compressor are manufactured to precision tolerances. The compressor's motor is computer balanced, reducing noise and vibration. The trumpets are replaceable and thread to a painted metal mounting base that secures to the vehicle using four rust-resistant stainless steel bolts. Kit also comes with 20 foot of plastic coiled hose with brass air fittings to inflate shocks, rafts or any other application requiring air. All necessary mounting hardware, hoses and fittings are included.

Spanish instructions included.

Horn size: L 17 in. x W 7 in. x H 5 in.

Horn's operating pressure 80 to 100 psi.

All metal, chrome plated trumpets

Compressor Size: L 6-1/8 in. x W 3-1/2 in. x H 5-1/8 in.

Compressor: 12-volts

Compressor current: 10-amps

Tank Size: L 9 in. x W 5 in. x H 5-1/2 in.

Tank capacity: 2-1/2 liters

Tank pressure: 80/110 psi

Challenger EV: Electric solenoid 12-volts

Electric solenoid current: 300 milliamps

Challenger LV: Hand pull manual valve

Includes Wolo's flexible inlet hose with brass fittings.

English/Spanish packaging



MORE ▶



TRUCK HORNS

High Pressure

GIANT™

Roof Mount

Model 820 - (Low Tone)
130 Decibels - 285 Hz

Model 825 - (High Tone)
130 Decibels - 330 Hz

The Giant all metal horn produces a powerful truck horn sound. Provided with the horn is a metal chrome plated front pedestal support bracket. The pedestal bracket will help to eliminate trumpet vibration on the roughest roads. A front deflector cover provides protection against rain, road dirt, snow and bugs from entering into the horn's sound chamber, ensuring years of dependable service. The air feeder hose connection is made through the horn's base and is not externally visible. The Giant's beautiful chrome appearance will look great on any truck and will provide an alerting sound that will be heard at a greater distance. Model 820 and 825 require an on board air system, (recommended Wolo on-board air systems are Models 840, 858 or 860). All needed mounting hardware is included.



*For best sound,
install as a set,
one low tone
and one high tone.*

Model 820 size: L 28 in. x W 8-1/4 in. x H 4-1/2 in.
Model 825 size: L 24-1/2 in. x W 8-1/4 in. x H 4-1/2 in.
Sound output with 90/100 psi: 130 db
Includes Wolo's flexible inlet hose with brass fittings.
English / Spanish packaging

SILVER STREAK EXPRESS®

Powerful Train Horn Sound

Model 835 - 125 Decibels - 368/375 Hz

A specially constructed horn built with an air chamber to produce a powerful train echo air horn sound. This attractive horn produces an echo sound that replicates the horn of a speeding locomotive. The trumpets are entirely metal, triple chrome plated to withstand all weather conditions. The horn's metal mounting base secures to the vehicle with a rubber gasket and stainless steel bolts, which will provide a secure watertight installation. The air connection is made through the horn's base, hidden from view, using Wolo's flexible inlet hose with brass fittings. The Model 835 will enhance the appearance of any truck. Requires an on board air system, (recommended Wolo on-board air system is Model 800). Comes complete with all mounting hardware and brass air fittings.

Horn size: L 14-1/2 in. x W 7 in. x H 5 in.

Horn's operating pressure 80 to 110 psi.

Horn construction: All metal, base painted enamel, trumpets chrome plated

Hose fitting size: 1/4 inch O.D.

Includes Wolo's flexible inlet hose with brass fittings.

Mounting hardware: Stainless steel

English/Spanish packaging

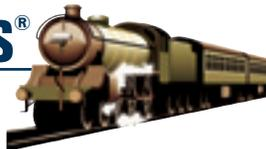

CANNON BALL EXPRESS®

Model 837: Built with heavy-duty 12-volt electric solenoid.

Model 838: Built with heavy-duty 24-volt electric solenoid.

Model 839: Operated by a manual lanyard (included).

152 Decibels - 307/347/440 Hz

When a truck owner demands a powerful sound, the Cannon Ball Express is the horn. Gives any truck a true train horn sound. Constructed of all metal, three (3) triple chrome plated trumpets and the horn's metal base is painted. The Cannon Ball Express requires an on-board air system with a minimum of 1.5-gallon air storage tank, (recommended Wolo on-board air system Models are 840, 858 or 860). Comes with mounting hardware and 10 feet of 1/4 in. nylon high-pressure hose.

Horn size: L 16-1/2 in. x W 14-3/4 in. x H 11 in.

Always use ear protection when sounding horn.





TRUCK HORNS

High Pressure

ORIENT EXPRESS™ Truck Train Horn

Model 841

130 Decibels - 289/323/345/426 Hz

Wolo has designed the Orient Express Horn to be smaller in size so to fit into engine compartment's that have less open space. Four (4) brass triple chrome plated trumpets produce the powerful train horn sound. The Orient Express will provide the driver with comfort of knowing that they will be heard! Model 841 Requires an on-board air system, (recommended Wolo on-board air systems are Models 840, 858 or 860). Built with a heavy-duty 12-volt electric solenoid. The Orient Express comes with mounting hardware and 10 feet of 1/4 in. nylon high-pressure hose.



Model 841 L 18-7/8 in. x W 13-3/4 in. x H 4-1/4 in.

ORIENT EXPRESS DD™ Truck Train Horn 3-Trumpet Train Horn With Direct Drive Compressor

Model 843

121 Decibel - 287/326/356 HZ

The Orient Express Train Horn DD, (direct drive) is especially designed for vehicle owners that want the powerful sound of a train horn but have limited open space in the engine compartment. Included in the kit is Wolo's heavy-duty compressor which is maintenance free, No high pressure on-board air tank system is required. Constructed of brass which is triple chrome plated. Kit contains relay, hose and mounting hardware.



Model 843 L 18-7/8 in. x W 10-1/2 in. x H 4-1/4 in.

THE CHIEF®

Sputtering Emergency Sound

Model 846

125 Decibels - 247 Hz

THE CHIEF has been designed to produce the powerful sputtering sound that is used by fire trucks and emergency vehicles. The triple chrome plated brass trumpet will look great on any emergency vehicle. Comes with a chrome plated metal front pedestal bracket to eliminate vibration at high speeds and while driving on rough roads. Installation is made easy with Wolo's flexible inlet hose. THE CHIEF requires an on-board air system (recommended Wolo on-board air systems are Models 840, 858 or 860). Designed to provide years of dependable service.

L 25 in. x W 6 in. x H 6-1/8 in.
English/Spanish packaging.
Government approved
for sale in Mexico



PHILLY EXPRESS®

Truck Train Horn

Model 853

130 Decibels - 290/421/548/648 Hz

Give any vehicle the powerful sound of a train air horn with Wolo's PHILLY EXPRESS. The four trumpets and mounting base are metal triple chrome plated and designed smaller to fit into engine compartments that are unable to accommodate a full size train horn. Built into the horn's base is a heavy-duty, chrome plated 12/24-volt electric solenoid valve. The PHILLY EXPRESS requires an on-board air system, (recommended Wolo on-board air system is Model 800). Comes with all mounting hardware and 10 ft. of 1/4 in. O.D. nylon high-pressure hose.

Horn size: L 15 in. x W 5-1/2 in. x H 6 in.
English/Spanish packaging.
Government approved for sale in Mexico.



Always use ear protection when sounding horn.



MORE ▶



TRUCK HORNS

High Pressure

SIBERIAN EXPRESS®

- Model 847** – Built with heavy-duty 12-volt electric solenoid
- Model 848** – Built with heavy-duty 24-volt electric solenoid
- Model 849** – Operated by a manual lanyard valve (included)

152 Decibels - 307/347/440 Hz

Give any truck the powerful sound of a train air horn. The SIBERIAN EXPRESS has been engineered with the latest technology using reinforced ABS plastic. The sound produced by the three trumpets is incredible. Using reinforced ABS plastic decreases the overall weight. The Siberian Express weight is two-thirds less, compared to the same type train horn that is constructed of metal. The reduced weight makes installation easier, ensures less vibration and eliminates the need for extra support brackets to prevent damage to the horn when driving on rough roads. The trumpets are finished with an attractive semi gloss black finish and the steel-mounting base is painted silver. The SIBERIAN EXPRESS requires an on-board air system with a minimum of 1.5-gallon storage tank, (recommended Wolo on-board air system Models are 840, 858 or 860). Comes with all mounting hardware and 10 feet of 1/4 in. O.D. nylon high-pressure hose.

Horn size: L 16-1/2 in. x W 14-3/4 in. x H 11 in.

Always use ear protection when sounding horn.



SIBERIAN EXPRESS® CHROME

- Model 850** – Built with heavy-duty 12-volt electric solenoid
- Model 851** – Built with heavy-duty 24-volt electric solenoid
- Model 852** – Operated by a manual lanyard valve (included)

152 Decibels - 307/347/440 Hz

The SIBERIAN EXPRESS CHROME has all the same features as the above SIBERIAN EXPRESS with the addition of the great look of chrome.

Horn size: L 16-1/2 in. x W 14-3/4 in. x H 11 in.

Always use ear protection when sounding horn.



WOLO® EXPRESS™

Truck Train Horn

- Model 855** – Built with a heavy-duty 12-volt electric solenoid
- Model 856** – Built with a heavy-duty 24-volt electric solenoid

128 Decibels – 308/337/366 Hz

Wolo, the first company to design and sell ABS train horns, has a new universal flat rack design that makes installation easier, because the horn requires less mounting space than other styles of train horns. WOLO EXPRESS has three black trumpets that are made of reinforced ABS plastic, producing a sound that is just plain outrageous! The trumpets can be separated from the mounting base for installation's that have limited space. Built rugged to withstand the toughest roads and vibration with a heavy-duty steel-mounting base that has a powder coat black finish. WOLO EXPRESS requires an on-board air system. (Recommended Wolo on-board air system models: 840, 858 and 860). WOLO EXPRESS comes with a built-in heavy-duty 12-volt electric solenoid, mounting hardware and 10 ft. of 1/4 in. O.D. nylon high-pressure hose.

Size: L 19 in. x W 18 in. x H 8-1/2 in.

Always use ear protection when sounding horn.



WESTERN EXPRESS™

- Model 870** – Designed for independent mounting, supplied with a 12-volt heavy-duty electric solenoid
- Model 871** – Designed for independent mounting, supplied with a 24-volt heavy-duty electric solenoid

125 Decibel 330/363 Hz.

WESTERN EXPRESS is the latest addition to the Wolo's truck train air horn selection. Two reinforced ABS black plastic trumpets that easily mount independently when space is limited, the installer can even mount the trumpets in different locations. Each trumpet has a heavy-duty steel mounting base painted black that easily secures the to the mounting surface with two bolts. WESTERN EXPRESS is designed to produce a powerful sound, 125 Db, sure to be heard. The trumpets reduced weight ensures less vibration and eliminates the need for extra support brackets to prevent damage when driving on rough roads. Each trumpet has a strong threaded chrome plated steel collar that connects the trumpet to the sound chamber to prevent breakage. Both trumpets have an attractive semi-gloss finish that will dress-up and look great on any truck. The WESTERN EXPRESS requires an on-board air system with a minimum of one and half (1.5) gallon storage tank. (Recommended Wolo on-board air system is models 840, 858 or 860). Comes with all mounting hardware, 10 ft. of 1/4" O.D. high-pressure nylon hose and a heavy-duty electric solenoid.

Size: Short Trumpet: L15-1/2" x front diameter 7-1/4" x rear 4-1/2" Size: Long Trumpet: L17-1/4" x front diameter 7-1/4" x rear 4-1/2" Always use ear protection when sounding





TRUCK HORNS

High Pressure

EURO EXPRESS™

Model 875 – Designed for independent mounting, supplied with a 12-volt heavy-duty electric solenoid

Model 876 – Designed for independent mounting, supplied with a 24-volt heavy-duty electric solenoid

128 Decibel 310/342/363HZ

The EURO EXPRESS is designed for the truck owner that demands an ultra powerful train horn sound. Engineered with the Wolo's advanced technology using reinforced lightweight ABS. Using reinforced ABS decreases the over all weight ensuring less vibration even when driving on rough roads. Each trumpet has a heavy-duty steel mounting base painted black, that easily secures to the mounting surface with two bolts. EURO EXPRESS trumpets are designed to be mounted independently making installation much easier then train horn that have a fixed mounting bracket The trumpets and metal sound chambers have an attractive black semi-gloss finish that will look great on any truck. The EURO EXPRESS requires an on-board air system with a minimum of one and half (1.5) gallon storage tank. (Recommended Wolo on-board air system is models 840, 858 or 860). Comes with all mounting hardware, 10 ft. of 1/4" O.D. high-pressure nylon hose and a heavy-duty electric solenoid..

Size: Short Trumpet: L10-1/2" x front diameter 4-7/8" x rear 4-1/2"

Middle Trumpet: L13-3/4" x front diameter 7-1/4" x rear 4-1/2"

Long Trumpet: L15-1/2" x front diameter 7-1/4" x rear 4-1/2"

NEW



Always use ear protection when sounding horn.



Truck Train Horn & High Pressure Air System *PRO* Series

CANNON BALL EXPRESS® *PRO*

Model 837-858 152 Decibels - 307/347/440 Hz

When a vehicle owner demands a train horn with the ultimate powerful sound, the CANNON BALL EXPRESS *PRO* is the on-board air system and horn. All metal construction, with three (3) trumpets that are triple chrome plated. The horn's heavy-duty mounting base is painted bright silver to prevent rusting. The CANNON BALL EXPRESS *PRO* comes with a built-in heavy-duty 12-volt electric solenoid.

The on-board air system provided is designed to produce a large volume of high-pressure air to power the CANNON BALL EXPRESS TRAIN HORN and includes everything necessary for a professional installation. The heavy-duty 12-volt motor of the compressor is balanced to precision, and there are 4 heavy rubber bushings mounted into the base virtually eliminating all vibration. For easy installation there is an extended length stainless steel high-pressure hose that allows the compressor to be surface mounted. The stainless steel hose connects the compressor to the 2.5-gallon metal air storage tank. Other features of the CANNON BALL EXPRESS *PRO* are; a tank that has a built-in pressure switch, manual water drain, pressure gauge, pressure relief valve and brass fittings. Kit comes with mounting hardware, 10 ft. of flexible high-pressure hose and 20 ft. coiled filler hose with quality brass fittings.

Horn size: L 16-1/2 in. x W 14-3/4 in. x H 11 in.

COMPRESSOR

Voltage: 12-volts

Current: 21-amps at peak

Duty-cycle: 33% @ 100 psi

CFM: 2.55

Compressor has washable air filter

Oil-less maintenance free

Permanent magnet motor that is gearless with thermo protection

Compressor size:
L 10-1/4 in. x W 3-1/2 in. x H 6-1/2 in.

TANK

Tank capacity: 2.5 gallons

Built in pressure switch: On 80 /off 110 psi

Safety pressure relief valve

Pressure gauge

Fitting size: All brass

Petcock water drain

Tank size: L 17-1/4 in. x W 6-1/2 in. x H 8-1/4 in.

Size compressor mount on tank:

L 17-1/4 in. x W 6-1/2 in. x H 15-1/2 in.

NEW



Always use ear protection when sounding horn.



MORE ▶



TRUCK HORNS

Truck Train Horn & High Pressure Air System *PRO* Series

SIBERIAN EXPRESS® *PRO*

Model 847-858 152 Decibels - 307/347/440 Hz

The SIBERIAN EXPRESS *PRO* is engineered with the latest technology using reinforced ABS plastic; the sound produced by the three trumpets is incredible! Using reinforced ABS plastic significantly decreases the overall weight of the horn. The reduced weight makes installation easier, ensures less vibration and eliminates the need for extra support brackets to prevent damage to the horn when driving on rough roads. The trumpets are finished with an attractive semi gloss black finish and the steel-mounting base is painted silver to help prevent rusting. Wolo is the originator of the ABS plastic train horn SIBERIAN EXPRESS *PRO*; so don't settle for cheap imitations. SIBERIAN EXPRESS *PRO* horn comes with a built-in heavy-duty 12-volt electric solenoid.

The on-board air system provided is designed to produce a large volume of high-pressure air to power the SIBERIAN EXPRESS TRAIN HORN and includes everything necessary for a professional installation. The compressor has a heavy-duty 12-volt permanent magnet motor that is balanced to precision. There are 4 heavy rubber bushings mounted into the compressor base plate to virtually eliminate all vibration. For surface mounting of the compressor, there is an extended length stainless steel high-pressure hose that connects the compressor to the 2.5-gallon metal air storage tank. Other features of the SIBERIAN EXPRESS *PRO* are; a tank that has a built-in pressure switch, manual water drain, pressure gauge, pressure relief valve and brass fittings. Kit also comes with mounting hardware, 10 ft. of flexible high-pressure hose and 20 ft. coiled filler hose with quality brass fittings.

Horn size: L 16-1/2 in. x W 14-3/4 in. x H 11 in.



Always use ear protection when sounding the horn.

COMPRESSOR

Voltage: 12-volts
Current: 21-amps at peak
Duty-cycle: 33% @ 100 psi
CFM: 2.55

Compressor has washable air filter

Oil-less maintenance free

Permanent magnet motor that is gearless with thermo protection

Compressor size:

L 10-1/4 in. x W 3-1/2 in. x H 6-1/2 in.

TANK

Tank capacity: 2.5 gallons

Built in pressure switch: On 80 /off 110 psi

Safety pressure relief valve

Pressure gauge



Fitting size: All brass

Petcock water drain

Tank size: L 17-1/4 in. x W 6-1/2 in. x H 8-1/4 in.

Size compressor mount on tank:

L 17-1/4 in. x W 6-1/2 in. x H 15-1/2 in

SIBERIAN EXPRESS® CHROME *PRO*

Model 850-858

152 Decibels - 307/347/440 Hz



The SIBERIAN EXPRESS CHROME *PRO* has all the same features as the SIBERIAN EXPRESS *PRO* with the addition of the great look of chrome.



PHILLY EXPRESS® *PRO*

Model 853-800

130 Decibels - 290/421/548/648 Hz

PHILLY EXPRESS *PRO* delivers the powerful sound of a train air horn with a heavy-duty high-pressure air system. The four trumpets and mounting base are constructed of all metal, triple chrome plated. Designed smaller to fit into engine compartments that are unable to accommodate a full size train horn. Built into the horn's base is a heavy-duty, chrome plated 12/24-volt electric solenoid valve.

The high-pressure air system consists of a heavy-duty compact compressor and a 2.5 liter steel air storage tank. The air system has a built-in pressure switch that will maintain 110 psi of air pressure in the storage tank. All moving parts of the compressor are manufactured to strict standards. The compressor's motor is carefully balanced, and the mounting bracket has heavy rubber bushings which virtually eliminates vibration. Air hose fittings are made of quality brass to ensure a leak free installation. Comes complete with all necessary mounting hardware, 10 ft. of 1/4 in. O.D. nylon high-pressure hose, and 20 ft. coiled filler hose with quality brass fittings.

Horn size: L 15 in. x W 5-1/2 in. x H 6 in.

COMPRESSOR

Voltage: 12-volts
Current: 10-amps
CFM: 1.38

Compressor has washable air filter

Compressor size:

L 6-1/8 in. x W 3-1/2 in. x H 5-1/8 in.

TANK

Tank capacity: 2.5 liters

Built in pressure switch: On 80 /off 110 psi

Fitting size: All brass

Tank size: L 9 in. x W 5 in. x H 5-3/4 in.



Always use ear protection when sounding the horn.





TRUCK HORNS

Truck Train Horn & High Pressure Air System *PRO* Series

WOLO[®] EXPRESS *PRO*

NEW

Model 855-858

128 Decibels - 308/337/366 Hz



Always use ear protection when sounding the horn.

Wolo, the first company to design and sell ABS train horns, has a new universal flat rack design that makes installation easier because the horn requires less mounting space than other styles of train horns. The WOLO EXPRESS *PRO* has three black trumpets that are made of reinforced ABS plastic, producing a sound that is just plain outrageous! The trumpets can be separated from the mounting base, for installation's that have limited space. Built rugged with a heavy-duty steel-mounting base that has a powder coat black finish, designed to withstand the toughest roads and vibration. WOLO EXPRESS *PRO* comes with a built-in heavy-duty 12-volt permanent magnet motor.

The on-board air system provided is designed to produce a large volume of high-pressure air to power the WOLO EXPRESS TRAIN HORN and includes everything necessary for a professional installation. The compressor has a heavy-duty 12-volt permanent magnet motor that is balanced to precision. There are 4 heavy rubber bushings mounted into the compressor base plate to virtually eliminate vibration. For surface mounting of the compressor, there is an extended length stainless steel high-pressure hose that connects the compressor to the 2.5-gallon metal air storage tank. Other features of the WOLO EXPRESS *PRO* include; a tank that has a built-in pressure switch, manual water drain, pressure gauge, pressure relief valve and brass fittings. Kit also comes with mounting hardware, 10 ft. of flexible high-pressure hose and 20 ft. coiled filler hose with quality brass fittings.



Size: L 19 in. x W 18 in. x H 8-1/2 in.

COMPRESSOR

Voltage: 12-volts
Current: 21-amps at peak
Duty-cycle: 33% @ 100 psi
CFM: 2.55

Compressor has washable air filter

Oil-less maintenance free

Permanent magnet motor that is gearless with thermo protection

Compressor size:

L 10-1/4 in. x W 3-1/2 in. x H 6-1/2 in.

TANK

Tank capacity: 2.5 gallons

Built in pressure switch: On 80 /off 110 psi

Safety pressure relief valve

Pressure gauge

Fitting size: All brass

Petcock water drain

Tank size: L 17-1/4 in. x W 6-1/2 in. x H 8-1/4 in.

Size compressor mount on tank:

L 17-1/4 in. x W 6-1/2 in. x H 15-1/2 in.

WESTERN EXPRESS *PRO*[™]

NEW

Model 870-858

125 Decibel 330/363 Hz.



Always use ear protection when sounding the horn.

WESTERN EXPRESS *PRO* is two reinforced ABS black plastic trumpets that easily mount independently when space is limited, the installer can even mount the trumpets in different locations. Each trumpet has a heavy-duty steel mounting base painted black and easily secures to the vehicle with two bolts. WESTERN EXPRESS *PRO* is designed to produce a powerful sound 125 Db, sure to be heard.

The on-board air system provided is designed to produce a large volume of high-pressure air to power the WESTERN EXPRESS TRAIN HORN and includes everything necessary for a professional installation. The heavy-duty 12-volt permanent magnet motor of the compressor is balanced to precision, and there are 4 heavy rubber bushings mounted into the base virtually eliminating all vibration. For easy installation there is an extended length stainless steel high-pressure hose that allows the compressor to be surface mounted. The stainless steel hose connects the compressor to the 2.5-gallon metal air storage tank. Other features of the WESTERN EXPRESS *PRO* are; a tank that has a built-in pressure switch, manual water drain, pressure gauge, pressure relief valve and brass fittings. Kit comes with mounting hardware, 10 ft. of flexible high-pressure hose and 20 ft. coiled filler hose with quality brass fittings.



Size: Short Trumpet: L15-1/2" x front diameter 7-1/4" x rear 4-1/2" Long Trumpet: L17-1/4" x front diameter 7-1/4" x rear 4-1/2"

COMPRESSOR

Voltage: 12-volts
Current: 21-amps at peak
Duty-cycle: 33% @ 100 psi
CFM: 2.55
Compressor has washable air filter
Oil-less maintenance free

Permanent magnet motor that is gearless with thermo protection

Compressor size:

L 10-1/4 in. x W 3-1/2 in. x H 6-1/2 in.

Size compressor mount on tank: L 17-1/4 in. x W 6-1/2 in. x H 15-1/2 in.

TANK

Tank capacity: 2.5 gallons

Built in pressure switch: On 80 /off 110 psi

Safety pressure relief valve

Pressure gauge

Fitting size: All brass
Petcock water drain

Tank size:

L 17-1/4 in. x W 6-1/2 in. x H 8-1/4 in.

EURO EXPRESS *PRO*[™]

NEW

Model 875-858

128 Decibel 310/342/363HZ



Always use ear protection when sounding the horn.

The EURO EXPRESS *PRO* has all the same features as the above Model 870-858. Kit comes with three extra heavy-duty trumpets.

Size: Short Trumpet: L10-1/2"x front diameter 4-7/8" x rear 4-1/2" Middle Trumpet: L13-3/4"x front diameter 7-1/4" x rear 4-1/2" Long Trumpet: L15-1/2"x front diameter 7-1/4" x rear 4-1/2"





TRUCK HORNS

High Pressure Horn Accessories

ELECTRIC SOLENOID VALVE

Model 801-EV12 / 12-volt

Model 801-EV24 / 24-volt

Wolo's new Model 801-EV electric solenoid valve is ideal to control the airflow for air horns, air suspension systems or any application that requires an electric air control valve. The body of the valve is solid brass and connects to 1/4 in. O.D. flexible air hose. The electric solenoid is sealed in a strong ABS case, which can be rotated for easy hook-up to the power wires. The zinc-plated steel mounting bracket included, makes installation both easy and secure. Choose from, either 12 or 24 volt models.

NEW



FLEXIBLE NYLON AIR HOSE

Model 802-H

A ten (10) foot length of durable, 1/4 in. O.D. flexible nylon hose for installing air horns or replacing existing hose. For high-pressure air systems.

Model 803-H

Same as above, twenty (20) foot length.

Bulk packaged.



LANYARD HAND PULL AIR VALVE

Model 803-LV

Model 803-LV

Manually pulling the chain of the model 803-LV sounds the horn. Release to silence the horn. For use with air horns that require an on-board air system. Easily installs to 1/4 in. O.D. air hose using the brass fittings provided. Comes complete with mounting hardware. Recommended that air pressure does not exceed 140 PSI.



ELECTRIC SOLENOID AIR VALVE

Model 804-EV

Model 804-EV

Electric valve 12-volt, used with air horns that require an on-board air system. Horn sounds when the vehicle's horn button switch is pressed (switch not included). Easily connects to 1/4 in. O.D. air hose using the brass fittings provided. Sealed in an all metal chrome plated case. Included is mounting hardware and brass air fittings.



ELECTRIC SOLENOID VALVE

Model 811-EV

The Model 811-EV is the electric solenoid valve used with all Wolo high pressure train air horns. Designed to easily thread into the horn's air inlet, no special tools needed. The solenoid valve has a bright triple chrome finish and is ideal to work with any 12 - 24-volt electrical system. When the vehicle's horn button is pressed, the Model 811-EV becomes electrically energized, opening the valve and permitting air to sound the horn. The solenoid remains energized while the horn button is pressed. The 811-EV has a brass fitting for connection to 1/4 in. O.D. high-pressure hose, (switch and hose not included).

Hose fittings: 1/4 in. brass

Voltage: 12 - 24-volts

Recommended that air pressure

L3-1/4 in. x W 1-1/2 in. x H 2-1/2 in.

Solenoid current: 300 mills

does not exceed 140 PSI.

Model 811-EV



AIR FILTER FOR HIGH PRESSURE AIR HORN SYSTEMS

Model 813-FIL

Wolo's Model 813-FIL is designed to protect and extend the service life of high-pressure air horns from dirt, rust and water that can develop in the air tank. Compact design for easy installation and is suitable for limited space applications. Convenient drain will release automatically when water accumulation is 1 KG, or can be drained manually. Comes complete with brass 1/4 in. O.D. fittings and mounting hardware.

Port Size (PT, NPT) 1/4 in.

Max Input Pressure (PSI) 150

Max Flow (l/min) 1000

5° ~ 60°

Filter Element 5µ

Max Output Pressure (PSI) 7 ~ 142

Operating Temperature Range (C°)

Drain Capacity (ml) 15 ml



Model 813-FIL

PRESSURE SWITCHES

Model PS-1

The Model PS-1 pressure switch is specifically designed for on-board systems and is compatible with a wide variety of other manufacturers high-pressure air systems. The PS-1 switch is factory preset to turn on the compressor when tank pressure is below 80 psi. and will turn off the compressor when the tank pressure is 110 psi., with a tolerance of ± 10% (pressure turn on/off pressure range is not adjustable). Rated to operate reliably up to 3.5-amps and is built to be compact in size. Wires connect to switch using standard 1/4 in. push-on terminals. Threaded connection is 1/8 in. (NPT).

Size: D 1 in. x H 1-3/4 in.

1/8 in. pipe threads (NPT)

Rated load 12-volts DC 3.5-amps

1/4 in. push on male terminals



Model PS-1

Model PS-2

The Model PS-2 pressure switch is specifically designed for Wolo's high-pressure on-board air systems, Models 840, 858 and 860. Threaded connection is 1/4 in. (NPT), all other specifications are the same as PS-1.



Model PS-2



MOTORCYCLE HORNS

See Page 10 and 11 for more Bad Boy and Big Bad Max information

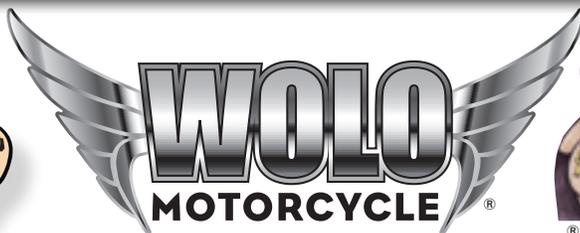

BAD BOY™

Model 419

The latest in horn technology, one-piece design, that requires no hoses. Installs in minutes by simply transferring the factory horn wires to BAD BOY'S compressor. Mounts with one bolt included in kit. Produces a powerful dual tone air horn sound that is two times (2X) louder than a factory horn. The BAD BOY is compact in size to fit almost any motorcycle. Heavy-duty maintenance free compressor will provide years of dependable service.



BAD BOY CHROME™

Model 519

Wolo's BAD BOY CHROME has all the same features as the original BAD BOY but with a dress-up bright chrome plated finish and aerodynamic covers letting the motorcycle stand out in chrome.



SEE PAGE 10 FOR MORE INFORMATION

BIG BAD MAX®

MODEL 619

Wolo's BIG BAD MAX air horn uses the same proven patented technology and design as the original Bad Boy. BIG BAD MAX has a sound chamber designed to create a deep big rig sound that is 2x louder than factory horn.



BIG BAD MAX® CHROME

Model 719

BIG BAD MAX CHROME has a powerful truck horn sound with a beautiful bright chrome finish. If you want the touch of class added to your motorcycle or engine compartment go no further, BIG BAD MAX CHROME is the horn for you.



SEE PAGE 11 FOR MORE INFORMATION

AIRSPLITTER® MC

Model 415-MC 120 Decibels - 540/660 Hz

AIR POWERED SUPER LOUD! Two (2) metal chrome trumpets produce a powerful alerting sound. Will dress-up and look great on any motorcycle with its beautiful chrome trumpet back covers and front weather protection covers. Kit comes with Wolo's compact size compressor that is chrome plated and maintenance free. Easily installs to any 12-volt electrical system. AIRSPLITTER is the horn of choice for motorcycle owners; it will make a great looking addition to any bike. So if you want a HIGH POWERED SOUND, TO BE HEARD, then AIRSPLITTER is the horn for you! Comes complete with relay, hose and all mounting hardware.

Longest Trumpet: 9-1/4 in.
Instructions are in English and Spanish.



AIRSPLITTER® DTK

Two Tone

Model 415-DTK 120 Decibels - 540/660 Hz

AIR POWERED - Two (2) TONE, with the simple throw of a switch, the AIRSPLITTER changes its sound to either ALTERNATING or STEADY BLAST. Extra loud for the user that must be heard. Comes complete with two (2) metal chrome trumpets that produce a powerful alerting sound. Will dress-up and look great on any motorcycle with its beautiful chrome trumpet back covers and front weather protection covers. Easily installs to any 12-volt electrical system. AIRSPLITTER is the horn of choice of motorcycle owners; it will make a great looking addition to any bike. So if you want a HIGH POWERED SOUND, TO BE HEARD, then AIRSPLITTER is the horn for you! Kit comes complete with 12-volt heavy-duty compressor, relay, hose and all mounting hardware.

Longest Trumpet: 9-1/4 in. Instructions are in English and Spanish.





INDUSTRIAL HORNS

Wolo has a complete line of horns for industrial application

ELECTRONIC HORN

Model EE100

114.4 Decibels – 380 Hz – 12 – 60-volts

A fully electronic patented horn developed by Wolo with R&D extending over one and a half years. An all-electronic horn provides many advantages over the existing electro-mechanical types, no moving parts and no EMI.

U.S Patent No. 6,489,885, China ZL01823136.5 Hong Kong HK1062284, Taiwan Patent No. 172,474, EP1363808 and other patents pending.

- Low current demand, works directly from horn switch – No relay.
- Capable of using a lighter gauge of wire in horn circuit.
- No adjustment screws for frequency. Tamper-proof.
- No diaphragm fatigue, no volume or frequency changes.
- No moving points to pit or wear-out. All internal electronic components are sealed in epoxy making them virtually weather resistant.
- Plastic molded housing. No mounting bracket required.
- No moving contact points, no sparks, no induced noise in sensitive equipment.
- Power terminals are molded into the horn's heavy plastic housing eliminating horn failure due to rain and spray.
- W 4-7/8 x H 4-3/4 x L 4-3/4
- UL Recognized.



UNIVERSAL DISC HORN™

Model 357 – Low Tone – 114 Decibels

O.E. UNIVERSAL DISC HORN, available in 12, 24, 36, & 48-volts, 2 terminal screw type – easily fits industrial equipment motorcycles, cars and trucks. Painted steel construction assures long life in all weather environments and has an attractive front plastic grill. Easily installs in any one (1) or two (2) wire system. The horn has a diameter of 96 mm. Comes with a heavy-duty steel zinc plated 90 degree mounting bracket.



SPECIFICATIONS

MODEL	VOLTAGE	TERMINALS	TONE	FREQUENCY	DECIBEL	AMP
357-12	12	2 Screw Type	LOW	385 Hz	114	2.2
357-24	24	2 Screw Type	LOW	385 Hz	114	1.8
357-36	36	2 Screw Type	LOW	385 Hz	114	1.5
357-48	48	2 Screw Type	LOW	385 Hz	114	1.5

SERIES 370 DISC HORNS™

Model 370 – High or Low Tone – 115 Decibels

The 370 series is available in a full range of voltages to meet your requirements; 12, 24, 36, 36/48, 48 or 72-volts. There is a large selection of mounting brackets available. If your company requires a special bracket, Wolo can tool to your needs. The 370 series is constructed of all metal, with a durable painted black finish. Terminals can be either screw type, 1/4 in. push-on or two terminals per pole using screw post and 1/4 in. push-on. The diameter is 123 mm. Available in either high or low tone. UL Recognized



SPECIFICATIONS

MODEL	VOLTAGE	TERMINALS	TONE	FREQUENCY	DECIBEL	AMP
370-12L2	12	2	LOW	345 Hz	115	4.0
370-12H2	12	2	HIGH	465 Hz	115	4.0
370-24L2	24	2	LOW	345 Hz	115	1.5
370-24H2	24	2	HIGH	465 Hz	115	1.5
370-36L2	36	2	LOW	345 Hz	115	1.0
370-36H2	36	2	HIGH	465 Hz	115	1.0
370-36/48L2	36/48	2	LOW	345 Hz	115	1.0
370-36/48H2	36/48	2	HIGH	465 Hz	115	1.0
370-48L2	48	2	LOW	345 Hz	115	1.0
370-48H2	48	2	HIGH	465 Hz	115	1.0
370-72L2	72	2	LOW	345 Hz	115	1.0
370-72H2	72	2	HIGH	465 Hz	115	1.0





INDUSTRIAL HORNS

Wolo has a complete line of horns for industrial application

SERIES 372 ELECTRONIC HORN

STATE-OF-THE-ART

372 SERIES

115 Db(a) / 430 Hz
24 – 48-volts DC



Wolo's 372 series industrial electronic horn is designed with state-of-the-art technology. Engineered to meet the heavy-duty requirements of material handling equipment. An all-electronic horn provides many advantages over the old-fashioned electro-mechanical type horn.

- Low current demand, operates directly from a horn switch – No relay required.
- Horn circuit can use lighter gauge of wire.
- No adjustment screws, tamper-proof.
- No volume or frequency changes.
- No moving points to pit or wear-out. All internal electronic components are sealed making them virtually weather resistant.
- No moving contact points that can cause sparks and induce noise in sensitive electronic circuits.

Voltage range: 24-48 VDC
Current draw: .8-amp @ 24 VDC
1.6-amp @ 48 VDC

Sound: 115 Db(a) ±5Db @ 1 meter

Frequency: 430 Hz

Construction: All metal, with a durable painted black finish.

Corrosion Resistance: Salt water test 96 hours

Electrical insulation: 1,000 VDC

Dimensions: Diameter 5 in.

Depth 2 in. measured without bracket on horn



Model numbers: Refer to bracket chart above

372LA-24/48	372LB-24/48	372LE-24/48	372LK-24/48
372LAX-24/48	372LC-24/48	372LG-24/48	372LQ-24/48



BACK-UP ALARMS

BACK-UP ALARM

Model BA-52

108 Decibels

The BA-52 produces a loud beeping sound when the vehicle is put into reverse. Its small size makes it easier to mount in any 12-volt vehicle. The warning sound can be a lifesaver. Packaged on a blister card.

Model BA-64

Same as BA-52 but with a bird chirping sound

Dimension: L 3 in. x W 2-1/2 in. x H 3 in.

English/Spanish packaging.

Government approved for sale in Mexico.



Model BA-52

TALKING BACK-UP ALARM

Model BA-70

Helps to prevent pedestrian accidents by alerting with a loud vocal message when vehicle is shifted into reverse. "Attention please! This car is backing up!" Easily installed to any 12-volt vehicle. Packaged on a blister card.

Model BA-80

Same as BA-70 but with voice message in Spanish.

Dimension: L 3-1/4 in. x W 2-1/4 in. x H 3-1/2 in.

English/Spanish packaging.

Government approved for sale in Mexico.



Model BA-70

MORE ►



BACK-UP ALARMS

HEAVY-DUTY BACK-UP ALARM

Model BA-87 87 Decibels

Produces a powerful 87 Decibel beeping sound when vehicle is in reverse to alert and help prevent accidents. Made with state-of-the-art electronics. Automatically adjusts to a voltage range of 12 – 48-volts. The black plastic case is water resistant and the mounting bracket is steel zinc plated. Easy to install, includes mounting hardware and warning decal.

Model BA-107 107 Decibels

Same specifications as above but produces an extra loud 107 decibel beeping sound.

Dimension: L 3 in. x W 2-1/2 in. x H 3-1/4 in.

English/Spanish packaging.

12 – 48-volts

Government approved for sale

BA-87: 87 decibels

in Mexico.

BA-107: 107 decibels



Model BA-87



Model BA-107

PRO-TEC® HEAVY-DUTY COMMERCIAL GRADE BACK-UP ALARM

Model BA-97 97 Decibels

Wolo's BA-97 is designed for heavy-duty use. Automatically adjusts to a voltage range of 12 – 24-volt vehicles. The state-of-the-art electronics are sealed in rock hard epoxy for all weather usage. The black plastic case is waterproof and has strong mounting brackets. Produces a powerful beeping sound that is 97 decibels, to help warn when the vehicle is backing-up. Easily installs to any one or two wire system. Includes mounting hardware and warning decal.

12 – 24-volts

English/Spanish instructions

Dimension: L 2-1/2 in. x W 1-3/4 in. x H 2-1/2 in.

and packaging.



INTELLIGENT ALARM®

Self-Adjusting Back-Up Alarm

Model BA-500 98–112-Decibels

Wolo's Intelligent Back-Up Alarm measures the ambient noise level and instantly self-adjusts to produce a three-(3) decibel beeping sound louder than the surrounding noise. The electronics are sealed in epoxy for protection against dust, vibration and moisture. The reinforced plastic housing has been designed for easy and secure mounting. Wire leads make installation easy. Designed for heavy-duty commercial applications.

Industrial Grade Back-Up Alarm

Same as the Model BA-500 without the self-adjusting feature, alarm produces a steady beeping sound.

Model BA-597 97 Decibels

Model BA-5107 107 Decibels

Model BA-550 112 Decibels



Operating voltage range: 12 to 48-volts.

Dimension: L 5 in. x W 2-3/4 in. x H 3-1/2 in.

English/Spanish packaging. Packaged in full color self-selling box.

BACK-UP ALARM SWITCH

Model BAS-100

Model BAS-100 back-up alarm electro-mechanical activation switch, is designed to control any back-up alarm on/off, when the vehicle is not equipped with back-up lights. The switch comes with a universal, adjustable mounting bracket. The switch mounts adjacent to the gearshift lever linkage. When vehicle is shifted into reverse the linkage will move the switch's actuator arm, activating the back-up alarm.

- Selectable normally open or normally closed circuit contacts, snap action
- Zinc die-cast housing
- Coiled spring actuator arm 5.9 in. long
- Activation arm has full 360° movement
- Universal steel zinc plated mounting bracket
- Current: 15-amps @ 14-VDC





ELECTRONIC SIRENS & P.A.

ALERT® 4000-2

80-watt Electronic Siren & P.A. System

Model 4000-2



Wolo's Model 4000-2 is a 12-volt, 80-watt full feature electronic siren and P.A. system that has been designed to offer more features that first responders demand! Built with state-of-the-art electronics to ensure years of dependable service. The adjustable metal swing bracket, combined with the controller's compact size, makes mounting possible in vehicles that have limited available open space in the dash area. There are five-(5) powerful siren sounds and a P.A. system that has an adjustable volume by using the rotary on/off control. There is also a manual override switch that the user can press and release for short blasts of two-(2) siren sounds; air horn sound or fast yelp siren sound. The front panel of the controller is illuminated by long life LEDs providing needed visibility at night. Model 4000-2 includes a P.A. system that has a noise-canceling microphone producing high quality voice amplification, without feedback or squeal. The microphone's push to talk button has been designed to override any siren sounds in use for P.A. on demand. Comes complete with an 80-watt siren speaker, metal swing bracket for controller, mounting hardware and wiring harness.



- 12-volts / 80-watts maximum output
- Current draw: 5.20-amps at peak
- Powerful 80-watts siren and P.A. system
- Select from five-(5) different siren sounds.
- Manual override switch that allows user to press and release providing short blasts of two-(2) additional siren sounds.
- P.A. system has a noise-canceling microphone to prevent feedback or squeal.
- LED illuminated front panel
- Power harness: six-(6) ft. in length with inline fuse
- Siren cycle rate:
Wail – 20 cycles/min
Euro – 60 cycles/min
Yelp – 180 cycles/min
Hi/Lo – 60 cycles/min
Phaser – 120 cycles/min

THE DEPUTY®

100-watt Electronic Siren, P.A. System & Radio Rebroadcast

Model 4100 (Speaker not included)

Wolo's Model 4100, THE DEPUTY, is a 12-volt, 100-watt full feature electronic siren and P.A. system. Designed for emergency service responders who demand a powerful and reliable electronic siren system. Select from three-(3) different siren sounds (Yelp, Hi-Lo and Wail) by using the rotary control. There is also a manual override control switch that the user can press and hold that will provide short blasts of two-(2) additional siren sounds; air horn sound or a fast yelp siren sound. Model 4100 also includes a P.A. system that has a noise-canceling microphone permanently mounted to the siren controller that will produce high quality voice amplification without feedback or squeal. The microphone's push to talk button has been designed to override any siren sounds in use for P.A. on demand. Model 4100 easily wires to the vehicle's 2-way communication radio for rebroadcast through the siren's speaker. All siren sounds, P.A. system and radio rebroadcast have an adjustable volume by using the rotary on/off control, which is located on the siren's illuminated front control panel. Recommended Wolo speaker either Models 4002, 4003 or 4005. Speaker sold separately.



- 12-volts / 100-watts maximum output.
- L 6 in. x depth 7-1/2 in. x H 2-1/2 in.
- Current: 7.0-amps maximum volume (HI-LO siren).
- Case is all metal black enamel painted.
- Adjustable metal chrome plated swing bracket, provided.
- LED illuminated front control panel.
- Noise canceling microphone.
- Power harness is six-(6) ft. in length with inline fuse-holder.
- Weight 4 pounds.
- Cycle Rate Wail – 20 cycles/min
Cycle Rate Yelp – 180 cycles/min
Cycle Rate Hi-Lo – 60 cycles/min

MOTOR DRIVEN SIREN

Model FA

Built with a heavy-duty 12-volt permanent magnet motor to ensure dependable service. All metal construction that is chrome plated, will look great in any engine compartment. Comes with a metal mounting bracket for easy installation. Simple two (2)-wire hook-up. Packaged in an attractive self-selling color box.



MORE ▶

L 6 in. x W 5 in. x H 5 in.



ELECTRONIC SIRENS & P.A.

THE COMMISSIONER®

200-watt Electronic Siren, P.A. System & Radio Rebroadcast

Model 4200 (Speaker not included)

THE COMMISSIONER, Model 4200 is Wolo's 12-volt, 200-watt full feature electronic siren and P.A. system designed for emergency service responders who demand an ultra powerful and reliable electronic siren system. Select from three-(3) different siren sounds (Yelp, Hi-Lo and Wail) by using the rotary control. THE COMMISSIONER has a manual override switch that allows the user to sound short blasts of two-(2) sirens sounds; air horn or a fast yelp siren. Model 4200 also includes a P.A. system that has a noise-canceling microphone that will produce high quality voice amplification without feedback or squeal. The microphone's push to talk button has been designed to override any siren sounds in use for P.A. on demand. Model 4200 easily wires to the vehicle's 2-way communication radio for clear and powerful rebroadcast using the siren's speaker. All siren sounds, P.A. system and radio rebroadcast have an adjustable volume by using the rotary on/off gain control. The siren's illuminated control panel has two rocker switches, each switch can power warning lights or accessories up to 15-amps.

- 12-volts / 200-watts maximum output.
- Two 15-amp accessory switches
- Current: 9.0-amps maximum volume (HI-LO siren).
- LED illuminated front control panel.
- Noise canceling microphone.
- Power harness is six-(6) ft. in length with inline fuse-holder.
- Metal case painted black enamel.
- Adjustable metal chrome plated swing bracket, provided.
- L 6 in. x W 7-1/2 in. x H 2-1/2 in.
- Weight 4 pounds
- Cycle Rate Wail – 20 cycles/min
- Cycle Rate Yelp – 180 cycles/min
- Cycle Rate Hi-Lo – 60 cycles/min

Recommended Wolo speaker is Model 4004, speaker sold separately.



THE COMMISSIONER



Electronic Siren Parts and Accessories

ALERT™ 4001

80-watt Electronic Siren and P.A. Controller

Model 4001

The same quality siren controller as the Model 4000-2, see page 35 for specifications. Speaker not included.



Model 4001

SIREN SPEAKERS

Model 4002 100-watt, 8-ohm

Siren speaker with durable plastic housing and steel mounting bracket.

Model 4003 100-watt, 8-ohm

Wolo's compact high performance siren / P.A. speaker Model 4003 is designed for easy versatile mounting, especially in tight under the hood applications using the heavy-duty steel swing bracket that is provided. The speakers housing is constructed from corrosion resistant metal that is painted and is rugged to withstand the toughest conditions.

L 7 in. x Depth 3 in x H 6 in. (measured with bracket)
• Weight with bracket: 6.80 Lbs.

Model 4004 200-watt, 8-ohm

Wolo's Model 4004 is high performance siren / P.A. speaker that will produce up to 200-watts ensuring a powerful sound for emergency vehicles, to clear the right-of-way. The housing is constructed of strong ABS plastic to withstand almost any environment. The mounting bracket is rugged steel painted black. Speaker includes all needed mounting hardware.

L 7-3/8 in. x W 8-3/8 in. x H 5-1/2 in. • ABS plastic housing
• Metal mounting bracket • Weight : 7.25 lbs.

Model 4005 100-watt, 8-ohm

Wolo's new high performance 100-watt compact siren / P.A. speaker is designed for easy mounting, using the heavy-duty steel mounting base plate. The speaker is constructed of rugged ABS plastic and corrosion resistant metal that is painted black to withstand the toughest environments. Comes with mounting hardware and instructions in English / Spanish.

L 6-1/4 in. x Depth 3-1/2 in. x H 7 in. • ABS plastic bell • Metal mounting bracket



Model 4002



Model 4003



Model 4004

Note: to obtain peak performance of the speaker, the output wattage of the siren amplifier should be 200-watts.



Model 4005





WARNING LIGHTS

Rotating Magnet Mount

* BEACON LIGHT®

Rotating Light

Model 3100-A – Amber Lens

Model 3105-B – Blue Lens

Model 3110-R – Red Lens

A bright rotating warning light with a bulb that produces eight-candle power that is magnified by a chrome fresnel reflector. Produces 60 flashes per minute with a low noise permanent magnet motor. Lens and base are both made of strong polycarbonate plastic. There are three (3) powerful protected magnets built into the light's base. Includes a 10 ft. heavy-duty power wire with cigarette lighter plug.



12-volt
60 FPM
Dia.: 4-5/8 in.
Height: 5-1/2 in.
English/Spanish packaging

* EMERGENCY 1®

Rotating Light

Model 3200-A – Amber Lens

Model 3205-B – Blue Lens

Model 3210-R – Red Lens

An extremely bright, teardrop style rotating warning light. The chrome fresnel reflector magnifies the light making it visible for long distances. Produces 90 flashes per minute. Features a low noise permanent magnet motor. The teardrop lens and base are both made of strong polycarbonate plastic. The base has a powerful protected magnet that will secure the light to any metal surface. Includes a 10 ft. heavy-duty power wire with cigarette lighter plug.



12-volt
Bulb type: 1141
Permanent magnet motor
Replaceable lens
Size: L 7-1/4 in. x W 4-3/4 in. x H 4-3/4 in.



Rotating Permanent Mount

POWER BEAM™

Halogen Rotating Warning Light

Model 3600-A – Amber Lens

Model 3605-B – Blue Lens

Model 3610-R – Red Lens

The Power Beam warning light is made for heavy-duty usage. It is a gear driven 360° rotating warning light with two (2) powerful H3 halogen 55-watts lights, 96 flashes per minute. Designed for permanent mounting. All mounting hardware is included. The base is all metal construction with an attractive polished stainless steel trim ring. The replaceable lens is constructed of strong polycarbonate.



12-volt
Bulb type: H3/55-watts
10.5-amps

Dimensions: D 8.5 in. x H 8.25 in.
Replaceable Lens

Strobe Magnet Mount

* BRIGHT STAR™ STROBE LIGHT

Solid State-No Moving Parts

Model 3300-A – Amber Lens

Model 3305-B – Blue Lens

Model 3310-R – Red Lens

A powerful 12-volt warning light that produces 2.5 Joules (200,000 candle power) that flashes once each second. The fresnel lens will stand up to all weather conditions. The base is made of polycarbonate plastic and has a powerful protected magnet that will secure the light to any metal surface. Includes a 10 ft. heavy-duty power wire with cigarette lighter plug.



***MAGNET MOUNTING IMPORTANT:** Vehicle roof construction varies for vehicles as well as driving conditions. The vehicle should never be driven with a warning light magnetically mounted. It is possible that the light could dislodge off the mounting surface and cause injury or damage.



Base Diameter: 4 in. Lens Diameter: 3-5/8 in. Height: 4 in. Operating Voltage: 12-volt DC
Strobe Bulb: Replaceable English/Spanish packaging. Government approved for sale in Mexico.

MORE ▶



WARNING LIGHTS

Strobe Permanent Mount

LIGHTNING BRIGHT®

Extra bright flashing strobe warning light

Model 3900-A

Wolo's LIGHTNING BRIGHT is a multi-voltage, 12 – 24-volts DC, single flash strobe warning light. Produces a powerful 1.75 joules with 60-80 flashes per minute. Has a replaceable fresnel amber lens that is made to be water tight and withstand all weather conditions. The electronics are sealed in rock hard epoxy. Designed to be compact in size for permanent surface mounting, all required hardware is provided.

12 – 24-volts DC
Width: 2-3/4 in. Height: 5-1/4 in. Length: 4 in.
English/Spanish packaging



BRIGHT STAR™ STROBE LIGHT

Permanent Mount



Bright Star, a long time best selling warning light for Wolo, is now available in permanent mount that produces one powerful flash per second, 2.5 joules (200,000 candlepower). The Bright Star permanent mount series is engineered with innovative solid-state circuitry and superior electronic components that will provide years of dependable service in all weather conditions. The electronics are encapsulated in rock hard epoxy to protect against vibration and moisture. The replaceable lens is made of strong polycarbonate plastic with advanced optics, specifically designed to enhance the brightness of a strobe tube light. The rugged black plastic base will withstand all weather conditions and will not corrode. Operational at 12 – 110-volts DC with a peak current draw of .56-amps. Comes complete with all required mounting hardware, wire terminals and a rubber gasket to ensure a waterproof installation.

Model 3350P-A – Amber Lens

Model 3355P-B – Blue Lens

Model 3360P-R – Red Lens

Model 3365P-C – Clear Lens

Model 3367P-G - Green Lens

Base Diameter: 4 in.
Lens Diameter: 3-5/8 in.
Height: 4 in.
Operating Voltage: 12 – 110-volts DC
2.5 joules (200,000 candlepower), one flash per second
Current: Peak .56-amps
Strobe Tube: Replaceable
Mounting: Permanent screw mount

LED Magnet or Permanent Mount

ILLUME®

NEW

Wolo's ILLUME is designed for the user that requires the latest LED technology in warning lights at an economical price. Designed with the finest quality electronic components throughout to assure years of dependable service. SUPER BRIGHT LONG LIFE LEDs are used that produce more light with low power consumption. Illume has no bulbs to burn out or replace, and is totally maintenance free. Choose from mounting permanently with screws or secure to a metal surface with powerful magnet base that is protected and will not scratch the vehicle's paint. The replaceable fresnel lens is engineered to increase the light's visibility to be seen at greater distances. Simple to use, comes with a 10 ft. power wire with cigarette lighter plug. Packaged in a self-selling attractive clamshell package.



Model 3025MP-A

Base Diameter: 5-1/4"
Lens Diameter: 3-1/4"
Height: 3-7/8"
12-Supper Bright LEDs
Single Flash
60 FPM
12-volts DC
Permanent or magnet mount



Model 3030MP-A

Base Diameter: 6-1/4"
Lens Diameter: 5"
Height: 5"
60-Supper Bright LEDs
Quad Flash
60 Quad FPM
12-volts DC
Permanent or magnet mount



WARNING LIGHTS

LED Magnet Mount

*B-SEEN®

GEN 3 LED Technology

Model 3050-A - Amber Lens

Wolo's B-SEEN is designed for the user that requires the cutting edge GEN 3 LED warning light technology at an economical price. Designed with the finest quality electronic components throughout to assure low power consumption and years of dependable service. The 1-WATT LEDs ARE SUPER BRIGHT and produce 80 double flashes per minute. B-SEEN has no bulbs to burn out or replace, and is totally maintenance free. The fresnel lens is engineered to increase the light's visibility. B-SEEN has a powerful magnet base that is protected and will not scratch the vehicle's paint. Simple to use, comes with a 10 ft. power wire with cigarette lighter plug.

Base Diameter: 5 in.
 Lens Diameter: 3-5/8 in.
 Height: 4 in.
 12-volts / 27.5 mA
 English/Spanish packaging
 Government approved for sales in Mexico

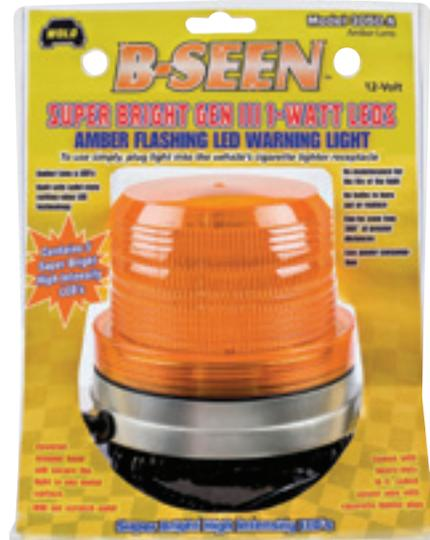

***MAGNET MOUNTING IMPORTANT:** Vehicle roof construction varies for vehicles as well as driving conditions. The vehicle should never be driven with a warning light magnetically mounted. It is possible that the light could dislodge off the mounting surface and cause injury or damage.

*HAWKEYE®

GEN 3 LED Technology That Produces Different Light Patterns. Draws Less Than 1-Amp.

Wolo's HAWKEYE series is the next generation in warning lights. Each model contains 12 SUPER BRIGHT HIGH INTENSITY GEN 3 1-WATT LEDs. Designed with cutting edge, solid-state innovative technology. Change the light pattern with a push of the button located on the cigarette plug. The GEN 3 long life LEDs, are totally maintenance free, no bulbs to ever replace. HAWKEYE produces more light with less power consumption and can be seen 360° at great distances. All models of HAWKEYE have a protected magnet base that will not scratch paint and a 10 ft. power wire with cigarette lighter plug.

Model 3000-A- Amber Lens

Clear LEDs 10 different light patterns

Model 3005-B- Blue Lens

Blue LEDs 10 different light patterns

Model 3010-R- Red Lens

Red LEDs 10 different light patterns

Model 3015-BR- Clear Lens

Blue & Red LEDs 22 different light patterns

Copyright signal code
TX7-303-058

AMBER: 10 different light patterns
 5 flashing
 5 rotating

BLUE: 10 different light patterns
 5 flashing
 5 rotating

RED: 10 different light patterns
 5 flashing
 5 rotating

Clear Lens: 22 different light patterns
 4 flashing
 4 rotating
 4 flashing
 4 rotating
 4 flashing
 2 rotating

***MAGNET MOUNTING IMPORTANT:** Vehicle roof construction varies for vehicles as well as driving conditions. The vehicle should never be driven with a warning light magnetically mounted. It is possible that the light could dislodge off the mounting surface and cause injury or damage.



MORE ▶



WARNING LIGHTS

LED Permanent Mount

APOLLO® 1

GEN 3 LED LIGHT • Single Quad Flash Pattern • Permanent Mount



Wolo's new APOLLO 1 warning light is built with twenty (20) super bright one-watt GEN 3 LEDs that are maintenance free, with no bulbs or strobe tubes to burn out. APOLLO 1 produces an ultra powerful quad flash that can be seen at great distances, for true 360° visibility. The lens is made of strong polycarbonate plastic with an optics designed specifically made to enhance the brightness of the GEN 3 LEDs. For easy replacement, the lens threads onto the light's base without any tools. APOLLO 1 is built with proven state-of-the-art electronics that is sealed to protect against vibrations, moisture, and engineered to reduce EMI compared to gaseous discharged systems. Operational at 12 – 100-volts DC with a peak current draw of 1.37-amps. Comes complete with all required mounting hardware, wire terminals, in-line fuse holder and a rubber gasket to ensure a waterproof installation.

Model 3060P-A – Amber Lens

Model 3065P-B – Blue Lens

Model 3070P-R – Red Lens

Model 3075P-C – Clear Lens

Model 3077P-G – Green Lens

Base Diameter: 7 in.
Len Diameter: 4-1/2 in.
Height: 6-3/4 in.
Quad Flash

Operating Voltage: 12 – 100-volts DC
Current: Peak 1.37-amps
20 - GEN 3 1-watt LEDs
Mounting: Permanent Screw Mount

LED Permanent or Pipe Mount

APOLLO® 8

GEN 3 LED LIGHT • 8 Selectable Light Patterns • Permanent or Pipe Mount



Wolo's APOLLO 8 GEN 3 LED warning light is built with twenty (20) one watt GEN 3 LEDs that are long life and totally maintenance free, with no bulbs or strobe tubes to burn out. APOLLO 8 is engineered to provide the user with reliable performance in all weather conditions. APOLLO 8 is designed for heavy-duty use with an operating voltage of 12 – 60-volts DC and a peak current draw of 1.37-amps. The proven microprocessor is encapsulated to protect against vibration and moisture. Ideal for installation on any vehicle that requires reduced EMI compared to warning lights that have motors or gaseous discharge systems. With the push of a button, choose from eight (8) different warning light patterns that are ultra powerful, and sure to be seen at great distances for true 360° visibility. The lens is replaceable, made of strong polycarbonate plastic with advanced optics designed specifically to enhance the brightness of the GEN 3 LEDs. The rugged aluminum base that is painted black to protect against corrosion. There are two methods of securing the light: pipe-mount or to a flat surface using the hardware provided. Comes complete with all required mounting hardware, wire terminals, in-line fuse holder and a rubber gasket to ensure a waterproof installation.

Model 3080PPM-A - Amber Lens

Model 3085PPM-B - Blue Lens

Model 3090PPM-R - Red Lens

Model 3095PPM-C - Clear Lens

Model 3097PPM-G - Green Lens

Base Diameter: 7 in.
Len Diameter: 4-1/2 in.
Height: 6-3/4 in.
Selectable Patterns: 8

Operating Voltage: 12 – 60-volts DC
Current: Peak 1.37-amps
20 - GEN 3 1-watt LEDs
Mounting: Pipe mount 1 in. NPT or screws provided.



WARNING LIGHTS

LED Permanent Mount

LIGHTNING BRIGHT® 2

Extra bright GEN 3 LED flashing warning light Permanent Mount

Model 3930-A

Wolo's new Lightning Bright 2 warning light is built with 10 super bright 1-watt LEDs, that are long life and totally maintenance free. The electronics is sealed in rock hard epoxy to withstand all weather conditions and high vibration. Lightning Bright has an operating voltage range of 12-100 volts DC. The light's base is rugged ABS plastic that will not corrode. All required mounting hardware and a rubber gasket are provided. Lightning Bright has a replaceable amber fresnel lens that is made of strong polycarbonate plastic.



Voltage Range: 12-100-volt DC
LED type: GEN 3 / 1-watt
Number of LEDs: 10
Current Peak: 100 mA
Flash Pattern: Triple flash
Flash Rate: 60 Triple FPM
Temperature Range: -20° C ~ +60° C
Lens: Polycarbonate replaceable
Size: W 2-3/4" x H 5-1/4" x L 4"

LIGHTNING BRIGHT® LB

Extra bright GEN 3 LED flashing warning light Permanent Mount

Model 3950-A

The LIGHTNING BRIGHT LB (Low Boy) has a new unique low profile design. Ideal for installation on equipment that requires a reliable, bright warning light with lower height requirements. To ensure years of reliable service, Wolo seals the electronic circuitry in rock hard epoxy, so that the light can withstand all weather conditions and high vibration. LIGHTNING BRIGHT LB has an operating voltage range from 12-80 volts DC and is maintenance free, no bulbs to burn out. The light's base is rugged ABS plastic that will not corrode. Provided with the light is all required mounting hardware and a rubber gasket. LIGHTNING BRIGHT LB has a replaceable amber fresnel lens that is made of strong polycarbonate plastic.



Voltage Range: 12-80-volt DC
LED type: 3-watt
Number of LEDs: 1
Current Peak: 40 mA
Flash Pattern: Single
Flash Rate: 60 FPM
Temperature Range: -20° C ~ +60° C
Lens: Polycarbonate replaceable
Size: W 2-3/4" x H 4-1/2" x L 4"



MINI LIGHT BARS

STROBE - Magnet* and Permanent Mount

PRIORITY® 2

Strobe Mini Light Bar

Lens Color	*Magnet Mount	Permanent Mount
Amber Lens	Model 3700M-A	Model 3700P-A
Blue Lens	Model 3705M-B	Model 3705P-B
Red Lens	Model 3710M-R	Model 3710P-R

Wolo's PRIORITY 2 has two ultra powerful strobe lights that produce 16 joules. Each strobe light double flashes 80 times per minute and is built with a diagonal mirror between the lights for greater visibility. The lens is constructed of strong polycarbonate and each light has an internal fresnel lens to magnify the light greater distances. All magnet models come with a 10 ft. power wire that has a cigarette lighter plug. Made for all weather conditions, maintenance free.



L 15-3/4 in. x W 7 in. x H 5-1/4 in.
Each model is multi-voltage 12 - 24-volts
12-volts / 6-amps
24-volts / 4-amps
Magnet pull strength 4 - 66 lbs.
The four magnets are rubbercovered to protect the vehicles paint.
English/Spanish packaging.

*MAGNET MOUNTING

IMPORTANT: Vehicle roof construction varies for vehicles as well as driving conditions. The vehicle should never be driven with a warning light magnetically mounted. It is possible that the light could dislodge off the mounting surface and cause injury or damage.

MORE▶



MINI LIGHT BARS

HALOGEN - Magnet* and Permanent Mount

PRIORITY® 1

Halogen Mini Light Bar

Lens Color	Magnet Mount*	Permanent Mount
Amber Lens	Model 3500M-A	Model 3500P-A
Blue Lens	Model 3505M-B	Model 3505P-B
Red Lens	Model 3510M-R	Model 3510P-R

A true 360 degree warning light with two (2) gear-driven rotating lights that produce 75 flashes per minute. Built with a diagonal mirror between the warning lights for more visibility. The lens is constructed of strong polycarbonate. Comes with a 10 ft. heavy-duty power wire with a cigarette lighter plug for all magnet mount models. Bulb type; H1 halogen 55-watt, included and installed, ready to use. Made for all weather conditions, maintenance free. Available in magnet or permanent mount.

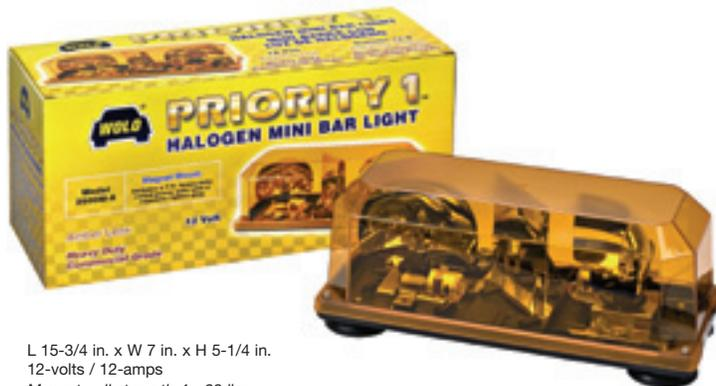

L 15-3/4 in. x W 7 in. x H 5-1/4 in.
12-volts / 12-amps
Magnet pull strength 4 - 66 lbs.
The four magnets are rubber covered to protect the vehicles paint.
English/Spanish packaging

*WOLO-AURORA®

Halogen Mini Light Bar Magnet Mount

- Model 3550M-A - Amber Lens**
- Model 3555M-B - Blue Lens**
- Model 3560M-R - Red Lens**

Wolo's AURORA has two (2) powerful halogen rotating lights, producing 125 flashes per minute. Aurora is built with a diamond shaped mirror between the warning lights for true 360-degree visibility. The replaceable lens is constructed of strong polycarbonate and is made to withstand all weather conditions. Includes a 10 ft. power wire with a cigarette lighter plug that has an internal fuse and easy to reach on/off switch. The magnets position can easily be adjusted by sliding the brackets to the desired location to ensure maximum holding strength on a flat surface of the vehicle. AURORA is ideal for compact and full size vehicles. Bulb type; 796-halogen 35-watt, included and installed, light is ready to use.

L 24 in. x W 12 in. x H 5-1/2 in.
12-volts / 5.5-amps.



*SIRIUS® 2

Halogen Mini Light Bar Magnet Mount

- Model 3570M-A - Amber Lens**

SIRIUS 2 has two (2) powerful 35-watt halogen bulbs, which are magnified by the chrome reflectors; each rotates 60 flashes per minute using two state-of-the-art heavy-duty permanent magnet motors. Built with a center diamond shaped mirror placed between the warning lights so to produce true 360° visibility. Designed for all weather conditions and is maintenance free. The lens is made of strong polycarbonate and is replaceable. Easy to use, includes a 10 ft. heavy-duty power wire with an on/off switch and cigarette lighter plug with internal fuse.

L 16 in. x W 7-1/2 in. x H 5-1/2 in.
12-volts / 6.5-amps
Bulb Type: 796 / 35-watt
Magnet pull strength 4 - 55 lbs.
The four magnets are rubber covered to protect the vehicles paint.



*MAGNET MOUNTING

IMPORTANT: Vehicle roof construction varies for vehicles as well as driving conditions. The vehicle should never be driven with a warning light magnetically mounted. It is possible that the light could dislodge off the mounting surface and cause injury or damage.



MINI LIGHT BARS

LED - Magnet and Permanent Mount

PRIORITY® 3

LED Mini Light Bar

Lens Color	Magnet Mount*	Permanent Mount
Amber Lens	Model 3400M-A	Model 3400P-A

The PRIORITY 3 LED mini light bar is the next generation in warning lights. Designed throughout with the latest state-of-the-art LED technology, there are 216 Super Bright LEDs for true 360° visibility. The Priority 3 is sure to be seen at great distances. The LEDs illuminate and flash with a light pattern that is continuously changing and controlled by the solid-state electronic circuitry. The lens is constructed of a strong polycarbonate. The magnet model comes with a 10 ft. heavy-duty power wire with a cigarette lighter plug. Made for all weather conditions and is maintenance free. Available in either magnet or permanent mount.



216 SUPER BRIGHT LED's

L 15-3/4 in. x W 7 in. x H 5-1/4 in.
12-volts / 1-amp

*SURE SAFE®

Magnet Mount - GEN 3 LED Low Profile

Model 3720M-A - Amber Lens

Wolo's new SURE SAFE is a low profile mini bar light that is aerodynamic, providing an intense beam of light that can be seen 360-degrees, even in bright daylight. There are six (6) LED modules, each containing four 1-watt GEN 3 LED's, which are long life, maintenance free, and best of all, there are no bulbs to burn out. The field proven microprocessor allows the user to select from seven different light patterns with the simple touch of a button that is built into the cigarette lighter plug. SURE SAFE comes with a 10 ft. heavy gauge power cord, cigarette lighter plug with an on/off power switch and internal fuse. There are two powerful magnets that are rubber covered to prevent scratching of the vehicle's paint, while holding the mini light bar securely in place. Designed to be waterproof for all weather conditions. SURE SAFE is the ideal light bar for the user that requires a simple to use, low profile mini light bar with a high intensity output and low power consumption.

L 10.5 in. x W 6 in. x H 2.5 in.
Voltage: 11-15-Volt DC
Peak Current: 1.63 amps light pattern 7
Six-(6) Light modules each containing four 1-watt GEN 3 LEDs
Light Pattern: 7
Two magnets that are rubber covered to protect the vehicles paint.



*OUTER LIMITS®

Magnet Mount - GEN 3 LED Low Profile

Model 3770M-A - Amber Lens

Model 3775M-B - Blue Lens

Model 3780M-R - Red Lens

OUTER LIMITS has a unique low profile aerodynamic appearance that will look great on any vehicle. Using the latest GEN 3 LED technology; OUTER LIMITS produces an ultra powerful beam of light, which can even be seen in bright daylight. There are fourteen GEN 3 modules, each containing four 1-watt LEDs, which are long life, maintenance free, and best of all, there are no bulbs to burn out. OUTER LIMITS microprocessor allows the user to select from eight different light patterns with the simple touch of a button. The easy to use control panel has an on/off switch, mode pattern selector, and two mini LEDs that indicate the light pattern in use. Comes complete with a 10 ft. heavy gauge power cord and a cigarette lighter plug with an internal fuse. OUTER LIMITS is ideal for those who require a simple to use, low profile mini light bar with a high intensity output, and low power consumption.

L 16-1/2 in. x W 8-1/2 in. x H 3-1/8 in.
Voltage: 11-15-volts DC
Light Patterns: 8
Six-(6) Light modules each containing four 1-watt GEN 3 LEDs



Light Patterns:

1. All LEDs are illuminated low power (no flash) / .47-amps
2. All LEDs illuminate together with single flash / 4.50-amps
3. All LEDs illuminate together with double flash / 2.93-amps
4. All LEDs illuminate together with quad flash / 2.73-amps
5. LEDs illuminate with single flash alternating pattern / 2.40-amps
6. LEDs illuminate with fast double flash alternating pattern / 1.56-amps
7. LEDs illuminate with fast quad flash alternating pattern / 1.41-amps
8. LEDs illuminate with random alternating pattern / 4.54-amps

*MAGNET MOUNTING

IMPORTANT: Vehicle roof construction varies for vehicles as well as driving conditions. The vehicle should never be driven with a warning light magnetically mounted. It is possible that the light could dislodge off the mounting surface and cause injury or damage.



FULL LIGHT BARS

Halogen

WOLO-INFINITY® 1

Halogen Rotating Roof Mount Light Bar

- 7000-A – Amber Lens (left & right side)
- 7005-B – Blue Lens (left & right side)
- 7010-R – Red Lens (left & right side)
- 7015-BR – Blue Lens Driver side / Red Lens Passenger side
- 7020-RB – Red Lens Driver side / Blue Lens passenger side



The WOLO-INFINITY 1 light bar produces a powerful beam of light that is unobstructed 360 degrees. It's unique design has dual-levels of warning lights, five powerful rotating reflectors on the top level and four secondary high power flashing marker lights on the lower level. All lenses are made of strong polycarbonate optically enhanced and are replaceable. A rubber gasket is built into the upper lens to ensure a watertight seal to the light's base. INFINITY 1 is maintenance free and offers more features than most other light bars that cost more. Top left and right sections have a total of four powerful halogen-rotating lights with a diagonal mirror between the rotating lights, for greater visibility. The top center section has a high power halogen-rotating lighthouse lens which magnifies and increases the light produced, to be seen at a greater distance. Infinity 1 features: takedown lights, left and right alley lights, illuminated control panel with three (3) rocker switches, stainless steel mounting straps and 20 ft. power cable. Included is an installation manual.



Electrical Specification: 12-volts
 Halogen rotating warning lights: 4 rotates and center lighthouse rotator / 14.25-amps
 Marker lights: 4 lights / 8.5-amps
 Marker light bulb type: use only 1156 or Sylvania P21W, 12-volts
 Alley and takedown lights: 4.10-amps
 Two high power ALLEY lights
 Two high power TAKEDOWN lights
 Four high power flashing MARKER lights
 Power cable-20 ft. heavy gauge wire
 Illuminated control panel has three-(3) rocker switches for independent control of: Halogen Rotating Warning Lights – Marker Lights – Alley & Takedown Lights
 Flashes per minute:
 Top section left & right sides: 4 Halogen rotating lights and two diagonal mirrors provide 380 FPM
 Top center section: 1 Halogen rotating light with lighthouse style lens 100 FPM
 Lower section: 4 Flashing marker lights
 132 FPM Electrical
 Stainless steel mounting straps
 L 48 in x W 12-1/2 in. x H 9 in.

Strobe

WOLO-INFINITY® 2

Strobe Roof Mount Light Bar

- 7500-A – Amber Lens (left & right side)
- 7505-B – Blue Lens (left & right side)
- 7510-R – Red Lens (left & right side)
- 7515-BR – Blue Lens Driver side / Red Lens Passenger side
- 7520-RB – Red Lens Driver side / Blue Lens passenger side



WOLO-INFINITY 2 is designed throughout with the latest state-of-the-art electronics. The wide sweep of the high intensity strobe lights provide better vision at greater distances, ensuring more safety for the user. Infinity 2 has lenses that are made of strong carbonate, optically enhanced for maximum visibility and are replaceable. A rubber gasket is built into the upper lens to ensure a watertight seal to the light's base. Designed with dual light levels with the main strobe warning lights and takedown light on the top section, six-(6) flashing marker lights and two powerful alley lights in the lower section. INFINITY 2 is a maintenance free full length light bar that offers more features than light bars that are more expensive: takedown lights, left and right alley lights, illuminated control panel with three (3) rocker switches, stainless steel mounting straps and 20 ft. power cable. Included is an installation manual.



Electrical Specification: 12-volts
 Top section strobe warning lights 10.50-amps at peak
 Marker lights: 6 lights / 8.5-amps
 Marker light bulb type: use only 1156 or Sylvania P21W, 12-volts
 Alley and takedown lights: 8-amps
 Has 10 triple flashing strobe lights
 Two high power ALLEY lights
 High power TAKEDOWN light
 Six high power flashing MARKER lights
 Power cable-20 ft. heavy gauge wire
 Illuminated control panel that has three-(3) rocker switches for independent control of: Strobe warning Lights – Marker Lights – Alley & Takedown Lights
 Stainless steel mounting straps
 Flashes per minute:
 Top section left & right sides: Total 4 strobes with triple flash– (2 strobes per side each L 6 in. x H 2-3/4 in.) 1152 FPM
 Top section center: 4 strobes each L 3-7/8 in. x H 2-7/8 in. 576 FPM
 Top section corners: 2 strobes each L 3-7/8 in. x H 2-7/8 in. 288 FPM
 Lower section: 6 marker lights 360 FPM
 L 48 in x W 12-1/2 in. x H 9 in.



FULL LIGHT BARS

LED

WOLO-INFINITY® 3 GEN 3 Technology

LED Roof Mount Light Bar

- 7700-A – Amber Lens (left & right side)
- 7705-B – Blue Lens (left & right side)
- 7710-R – Red Lens (left & right side)
- 7715-BR – Blue Lens Driver side / Red Lens Passenger side
- 7720-RB – Red Lens Driver side / Blue Lens passenger side

INFINITY 3 is the next generation in high tech vehicle warning lights. Built throughout with the latest state-of-the-art electronics using GEN 3 technology. Infinity 3 has 104 SUPER BRIGHT 1-watt LEDs with a continuously changing light pattern. The wide sweep of the high intensity LEDs provides better vision for true 360° visibility at greater distances, even in bright daylight. GEN 3 technology is totally maintenance free providing a brighter beam of light at low current. The lenses are made of strong polycarbonate that are optically enhanced to produce maximum visibility and are replaceable. A rubber gasket is built into all lenses to ensure a watertight fit to the base. Designed with dual light levels, the main LED warning lights are on the top section and six-(6) flashing marker lights in the lower section. There are two-(2) GEN 3 LED takedown lights, (one light illuminates the front of the vehicle and the other to the rear of the vehicle). INFINITY 3 is a superior warning light bar that offers more features when compared to similar lights that cost more: takedown lights, left and right alley lights, illuminated control panel with three (3) rocker switches, stainless steel mounting straps and 20 ft. power cable. Included is an installation manual.



Electrical Specification: 12-volts /10.52-amps at peak
 Top section LED warning lights: 3.52-amps at peak
 Marker lights: 6 lights / 6.07-amps
 Marker light bulb type: use only 1156 or Sylvania P21W, 12-volts
 Alley and takedown lights: 4-amps
 Top section: Has 104 Super Bright GEN 3 LEDs, continuous changing light patterns
 Facing front & rear: 16 TIR modules each having 6 / 1-watt LEDs, in total 96 LEDs
 Facing each side: 1 TIR module each having 4 / 1-watt LEDs, in total 8 LEDs
 Top section: Two-(2) GEN 3 TAKEDOWN lights
 Facing front take down lights: 1 TIR module having 4 / 1-watt LEDs
 Facing rear work light: 1 TIR module having 4 / 1-watt LEDs
 Lower section: Two high power ALLEY lights
 Lower section: Six-(6) high power flashing MARKER lights
 Power cable-20 ft. heavy gauge wire.
 Illuminated control panel that has three-(3) rocker switches for independent control of: LED warning Lights, Marker Lights and Alley / Takedown Lights. Stainless steel mounting strap
 Clear center lens; light color matches the side lens color.
 Lower section: 6 marker lights 360 FPM
 L 48 in. x W 12-1/2 in. x H 9 in.



ON PATROL® GEN 3 Technology

Low Profile LED Roof Mount

- 7800-A – Clear Lens, Amber LEDs
- 7805-B – Clear Lens, Blue LEDs
- 7810-R – Clear Lens, Red LEDs
- 7815-BR – Clear Lens, Blue LEDs driver side / Red LEDs passenger side
- 7820-RB – Clear Lens, Red LEDs driver side / Blue LEDs passenger side

ON PATROL is a high performance commercial grade GEN 3 low profile light bar. Wolo's field proven microprocessor uses state-of-the-art electronics, has extremely low power consumption and will provide years of reliable service. On Patrol series uses the latest GEN 3 technology, has a modular lens design that is waterproof and made of strong polycarbonate plastic. The clear lens has been optically enhanced to produce an intense beam of light that can be seen 360°, even in bright daylight. Only long life LEDs are used with an expected lifespan of 100,000 hours and are totally maintenance free, no bulbs to burn out requiring replacement. The operator has a choice of 20 different advanced warning light patterns, as well as being able to control the alley and front facing takedown lights. The control panel is the command center for ON PATROL featuring a LED flash pattern indicator to show the operator the warning light pattern in use, alley lights or takedown lights in use. Nine illuminated buttons control the advance features such as: warning light brightness, memorize a favorite light pattern, one touch default to pattern 01, digital display and LED pattern indicator. Kit includes stainless steel universal mounting brackets straps for securing the light bar to the vehicle's window ledge.



The control panel is the command center for ON PATROL

49"

ON PATROL

All Models meet SAE J845 Class 2 requirements

All models have a clear lens throughout; color is produced by GEN 3 LEDs.

L 49 in. x W 10 in. x H 5 in.
 TIR modules: 16 each containing 4 / 1-watt GEN 3 LED Operating voltage: 11-14 VDC
 Current: 9-amps
 Light patterns: 20 selectable
 Low power control: Reduce warning lights output by fifty percent
 Memory: When powered on will resume same light pattern when powered off
 One touch of control button for memorized favorite light pattern
 LCD indicator displays light pattern in use
 Cable length: 20 ft.
 Mounting bracket is rubber covered to prevent scratching paint of mounting surface
 Mounting bracket can be repositioned to ensure a secure fit to the mounting surface

MORE ▶



FULL LIGHT BARS

LED

ON PATROL® COMPACT GEN 3 Technology

Low Profile LED Roof Mount

7840-A – Clear Lens, Amber LEDs

7845-B – Clear Lens, Blue LEDs

7850-R – Clear Lens, Red LEDs

7855-BR – Clear Lens, Blue LEDs driver side / Red LEDs passenger side

7860-RB – Clear Lens, Red LEDs driver side / Blue LEDs passenger side

Designed to give the perfect roof mounting on compact size vehicles that have a smaller roof requiring a shorter light bar. ON PATROL COMPACT is built with the same state-of-art features as the 48" version. See page 45.

All models have a clear lens throughout; color is produced by GEN 3 LEDs. **All Models meet SAE J845 Class 2 requirements**



L 44 in. x W 10 in. x H 5 in.
TIR modules: 12 each containing 4 / 1-watt GEN 3 LED
Operating voltage: 11-14 VDC
Current: 9-amps
Light patterns: 20 selectable
Low power control: Reduce warning lights output by fifty percent
Memory: When powered on will resume same light pattern when powered off
One touch of control button for memorized favorite light pattern
LCD indicator displays light pattern in use
Cable length: 20 ft.
Mounting bracket is rubber covered to prevent scratching paint of mounting surface
Mounting bracket can be repositioned to ensure a secure fit to the mounting surface

LUXOR® GEN 3 Technology

LED Roof Mount Light Bar

Model 7880-A – Clear Lens, Amber LEDs

LUXOR is a newly designed 48 inch light bar with the latest high intensity LED modules which are 20% brighter. The ultra slim, low profile makes the light bar almost invisible. LUXOR produces an ultra bright beam of light that will be seen 360 degrees even in bright daylight. Built with the latest features that are required by emergency responders.

The switch controller is the command center of the light bar, controlling all functions. The controller has an LED display showing the operator the flash pattern in use. Other advanced features of the switch controller include: State-of-the-art electronics, seven-(7) miniature push button switches that control the alley lights, take down lights, traffic advisor, control front and rear facing lights independently. There is an illuminated power indicator above each switch to show the operator when power is on. Each time the alley, takedown or traffic advisor switch is pressed the light mode will change from **steady** **alternating** **synchronous** **select your own pattern** **off**. Also choose from three different traffic advisor light patterns. LUXOR has 22 TIR modules each containing 4 / 1.5-watt LEDs with a unique inner magnifying lens, that enhances the brightness by 20%. Built to withstand all environments, the top and base plates are both made of thick aluminum. The outer lens is strong polycarbonate, waterproof and is UV stabilized. The light bar is totally maintenance free and the LEDs have life endurance 100,000 hours.



L 46.75 in. x W 11.875 in. x H 4.25 in.
Voltage: 12-VDC Current: 7.5 amps / 12V
LED Type: Total of 22 Linear LED modules, each module has 4 x 1.5-watt LEDs
Patterns: 15 flash patterns plus mode changes
Alley Lights: 1 white LED module on left & right sides
Take Down Lights: 2 white LED modules
Cable Length: 20 ft.
Electronics: Fully encapsulated in sealant to be weatherproof.
Mounting: Adjustable ABS base bracket and stainless steel straps.

Meets SAE J845 Class 2 requirements
Clear lens throughout; color is produced by GEN 3 LEDs.

LOOKOUT® GEN 3 Technology

Low Profile LED Roof Mount Light Bar

7900-A – Amber LEDs (left & right side)

7905-B – Blue LEDs (left & right side)

7910-R – Red LEDs (left & right side)

7915-BR – Blue LEDs Driver side / Red LEDs Passenger side

7920-RB – Red LEDs Driver side / Blue LEDs passenger side

LOOKOUT is a high performance GEN 3 low profile linear light bar designed with a field proven microprocessor circuit that has extremely low power consumption. Using the latest GEN 3 LED technology, LOOKOUT produces an intense beam of light, which can be seen 360-degrees even in bright daylight. There are sixteen (16) selectable warning light patterns and three-(3) traffic advisory patterns to choose from, with the touch of a button. The switch control panel can be mounted on the vehicle's dashboard or console, using the provided double face tape, or the hidden mounting bracket which is secured with screws. The control panel is the command center for LOOKOUT featuring a flash pattern indicator with eighteen-(18) mini red LEDs and four (4) mini clear LEDs that indicate alley and takedown light mode, on/off switch, LED power indicator, ten micro push buttons switches, used to select light pattern. There are 22 GEN 3 TIR modules, in total, 88 one (1) watt LEDs which are long life and totally maintenance free. All models of LOOKOUT have a modular lens design that is highly waterproof and made of strong polycarbonate plastic that is clear for an inconspicuous appearance. The exterior frame is made of extruded aluminum. Kit includes stainless steel universal mounting straps for securing light bar to the window's ledge.



Electrical Specification: 12-volts / 6.50-amps at peak
• 22 GEN 3 TIR modules (88 one watt LEDs)
• 16 selectable warning light patterns
• 3 selectable amber traffic advisory patterns, back of light
• 3 selectable light patterns for high power TAKEDOWN lights
• 3 selectable patterns for two high power ALLEY lights
• Control panel has LED flash pattern indicator and ten push button switches
• 12 ft. cable from light bar to switch control panel
• Adjustable universal mounting system including stainless steel straps for window ledge mounting
L 48 in. x W 12 in. H 4 in.

All Models meet SAE J845 Class 2 requirements

All models have a clear lens throughout; color is produced by GEN 3 LEDs.



FULL LIGHT BARS

LED

LOOKOUT® PLUS

GEN 3 Technology Low Profile LED Truck & Tow Light Bar

**Model 7950 – Clear Lens, Amber LEDs
Rear Facing Brake Lights**

Wolo's LOOKOUT PLUS is a high performance GEN 3 low profile linear light bar designed with a field proven microprocessor circuit that has extremely low power consumption. The longer length of the light bar, 52 inches, makes it ideal for truck and tow vehicles. Using the latest GEN 3 LED technology, LOOKOUT PLUS has front and rear work lights, rear facing brake and traffic advisory lights that produce an intense beam of light, which can be seen in bright daylight. There are fifteen (15) selectable warning light patterns and three (3) amber traffic advisory patterns to choose from, with the touch of a button. The switch control panel can be mounted on the vehicle's dashboard or console, using the double face tape provided, or use the mounting bracket that is secured with screws. The control panel is the command center for LOOKOUT PLUS, featuring a flash pattern indicator with eighteen (18) mini red LEDs and four (4) mini clear LEDs work lights, on/off switch, LED power indicator, and the micro push buttons switches, used to select the light pattern. There are 26 GEN 3 TIR modules, in total, 104 one (1) watt LEDs which are long life and totally maintenance free. LOOKOUT PLUS has a modular lens design that is waterproof and made of strong clear polycarbonate plastic for an inconspicuous appearance. The exterior frame is made of extruded aluminum. Kit includes heavy-duty adjustable stainless steel universal mounting straps to secure light bar to the vehicle's window's ledge and an installation manual.



LOOKOUT® Plus

By WOLO®



Electrical Specification: 12-volts / 7.38-amperes at peak (brake & work lights on)
26 GEN 3 TIR modules (104 one watt LEDs)
15 selectable warning light patterns Rear facing brake lights
3 selectable amber traffic advisory patterns, back of light
3 selectable light patterns for high power front facing work lights
3 selectable patterns for two high power rear facing work lights
Control panel has LED flash pattern indicator and ten push button switches
16.5 ft. cable from light bar to switch control panel
Heavy-duty adjustable universal mounting system including stainless steel straps for window ledge mounting
L 52 in. x W 12 in. H 4-1/2 in.

Meets SAE J845 Class 2 requirements

Clear lens throughout; color is produced by GEN 3 LEDs.

Light Bar Accessories

Model 7000-CON Infinity 1 series all HALOGEN models

Model 7500-CON Infinity 2 series all STROBE models

Model 7700-CON Infinity 3 series all LED models

Original replacement switch controller for Infinity light bars. Make sure you select the controller that matches the light bar series.



Model 7800-CON

Original replacement switch controller for On Patrol light bars, all models.



Model 7880-CON

Original replacement switch controller for Luxor light bars, all models.



Model 7900-CON

Original replacement switch controller for Lookout light bars, all models.



Model 7950-CON

Original replacement switch controller for Lookout light bar, Model 7950-A



Model 7000-SSMS

Stainless steel adjustable mounting straps fits all models of Infinity light bars. Comes in a set of 2.



Model 7800-SSMS

Stainless steel adjustable mounting straps fits all models of On Patrol light bar. Comes in a set of 2.



Model 7880-SSMS

Stainless steel adjustable mounting straps fits all models of Luxor light bar. Comes in a set of 2.



Model 7900-SSMS

Stainless steel adjustable mounting straps fits all models of Lookout light bar. Comes in a set of 2.



Model 7950-SSMS

Stainless steel adjustable mounting straps for Model 7950-A Lookout Plus light bar. Comes in a set of 2.





HIDEAWAY STROBE KITS

For Cars

WOLO-LIGHTNING®

80-watt Power Supply Four Bulb Strobe Kit

- 8004-1CCCC - 4 Clear Bulbs
- 8004-2CCAA - 2 Clear Bulbs & 2 Amber Bulbs
- 8004-3AAAA - 4 Amber Bulbs
- 8004-4CCBB - 2 Clear Bulbs & 2 Blue Bulbs
- 8004-5BBBB - 4 Blue Bulbs
- 8004-6CCRR - 2 Clear Bulbs & 2 Red Bulbs
- 8004-7RRRR - 4 Red Bulbs
- 8004-8BBRR - 2 Blue Bulbs & 2 Red Bulbs

All Models above come with an 80-watt Power Supply

Wolo's 8004 series emergency strobe light kits are designed for reliability and high performance, with four (4) grommet style strobe bulbs that are encapsulated in silicon to protect against moisture and road vibration. The bulbs easily install into a 1 inch hole, which is drilled into the headlight and taillight assemblies. The power supply, 8004-PS headlightis heavy-duty, with an operating voltage of 12 – 24 VDC and has four outlets producing 80-watts of output power. Engineered with a state-of-the-art field proven microprocessor, to provide years of dependable service. The power supply has a heavy-duty aluminum-mounting bracket that secures with four screws, provided. There are six (6) advanced flash patterns to choose from, which are controlled with the touch of a button from the control panel provided. The 8004 series is the perfect choice for any fire/rescue, police, ambulances or construction vehicles that require powerful hidden warning lights that will vastly increase visibility. Kit includes: 80-watt power supply, four (4) strobe bulbs with 6 in. wire leads and locking connector, four (4) high voltage cables with locking connectors, switch control panel, mounting hardware and easy to follow instructions.



Input Voltage: 12 – 24 VDC
 Current: 4.15-amps @ 12.5 VDC
 Output Power: 80-watts
 Flash Patterns: 6
 Output circuit protection
 Included: Two cables 3 meters / 9.8 ft in length with locking connectors
 Included: Two cables 5 meters / 16.4 ft in length with locking connectors
 Included: Switch control panel pre-wired
 Power Supply Dimension: L 5-1/2 in. x W 5-3/8 in. x H 1-3/4 in.

WOLO LIGHTNING PLUS®

120-watt Power Supply Six Bulb Strobe Kit

- 8006-1-6C - 6 Clear Bulbs
- 8006-2-4C2A - 4 Clear Bulbs & 2 Amber Bulbs
- 8006-3-2C4A - 2 Clear Bulbs & 4 Amber Bulbs
- 8006-4-6A - 6 Amber Bulbs
- 8006-5-4C2B - 4 Clear Bulbs & 2 Blue Bulbs
- 8006-6-2C4B - 2 Clear Bulbs & 4 Blue Bulbs
- 8006-7-6B - 6 Blue Bulbs
- 8006-8-4C2R - 4 Clear Bulbs & 2 Red Bulbs
- 8006-9-2C4R - 2 Clear Bulbs & 4 Red Bulbs
- 8006-10-6R - 6 Red Bulbs
- 8006-11-2C2B2R - 2 Clear Bulbs/2 Blue Bulbs/2 Red Bulbs
- 8006-12-2B4R - 2 Blue Bulbs & 4 Red Bulbs
- 8006-13-4B2R - 4 Blue Bulbs & 2 Red Bulbs

All Models above come with a 120-watt Power Supply

The 8006 series is a super bright six bulb hidden strobe light kit. The bulbs have a rubber grommet base, designed to easily install into a 1 in. hole, which is drilled into the headlight, front side marker and taillight assemblies. To protect the bulbs against vibration and moisture they are encapsulated in silicon. Included in the kit is a heavy-duty power supply that has six outlets producing 120-watts of output power at an operating voltage of 12 – 24 VDC. The power supply is engineered with the latest electronic technology using a field proven microprocessor to provide years of dependable service. A heavy aluminum-mounting bracket secures the power supply with four screws, provided. There are six (6) advanced flash patterns to choose from, which are controlled with the touch of a button from the control panel provided. Wolo's LIGHTNING PLUS is the choice of emergency responders. Kit includes: 120-watt power supply, six (6) strobe bulbs with 6 in. wire leads and locking connector, six (6) high voltage cables with locking connectors, switch control panel, mounting hardware and easy to follow instructions.



Input Voltage: 12 – 24 VDC
 Current: 5.8-amps @ 12.5 VDC
 Output Power: 120-watts
 Flash Patterns: 6
 Output circuit protection
 Included: Four cables 3 meters / 9.8 ft in length with locking connectors
 Included: Two cables 5 meters / 16.4 ft in length with locking connectors
 Included: Switch control panel pre-wired
 Power Supply Dimensions: L 5-3/4 in. x W 5-5/8 in. x H 2-1/8 in.



HIDEAWAY STROBE KITS

For Trucks and Extended Length Vehicles

WOLO-LIGHTNING® XL

80-watt Power Supply Four Bulb Strobe Kit

Wolo's LIGHTNING XL 8104 series provides *all of the components and features* of Wolo's LIGHTNING series (see page 48) but with **heavier gauge, extra long high voltage bulb cables** designed for trucks and extended length vehicles.

8104XL-1CCCC - 4 Clear Bulbs

8104XL-2CCAA - 2 Clear Bulbs & 2 Amber Bulbs

8104XL-3AAAA - 4 Amber Bulbs

8104XL-4CCBB - 2 Clear Bulbs & 2 Blue Bulbs

8104XL-5BBBB - 4 Blue Bulbs

8104XL-6CCRR - 2 Clear Bulbs & 2 Red Bulbs

8104XL-7RRRR - 4 Red Bulbs

8104XL-8BBRR - 2 Blue Bulbs & 2 Red Bulbs

Two cables
6 meters / 19.6 ft
in length
with locking
connectors
included.

Two cables
8 meters / 26.2 ft
in length
with locking
connectors
included.

WOLO LIGHTNING PLUS® XL

120-watt Power Supply Six Bulb Strobe Kit

Wolo's LIGHTNING PLUS XL 8106 series provides *all of the components and features* of Wolo's LIGHTNING PLUS series (see page 48) but with **heavier gauge, extra long high voltage bulb cables** designed for trucks and extended length vehicles.

8106XL-1-6C

8106XL-2-4C2A

8106XL-3-2C4A

8106XL-4-6A

8106XL-5-4C2B

8106XL-6-2C4B

8106XL-7-6B

8106XL-8-4C2R

8106XL-9-2C4R

8106XL-10-6R

8106XL-11-2C2B2R

8106XL-12-2B4R

8106XL-13-4B2R

- 6 Clear Bulbs
- 4 Clear Bulbs & 2 Amber Bulbs
- 2 Clear Bulbs & 4 Amber Bulbs
- 6 Amber Bulbs
- 4 Clear Bulbs & 2 Blue Bulbs
- 2 Clear Bulbs & 4 Blue Bulbs
- 6 Blue Bulbs
- 4 Clear Bulbs & 2 Red Bulbs
- 2 Clear Bulbs & 4 Red Bulbs
- 6 Red Bulbs
- 2 Clear Bulbs / 2 Blue Bulbs / 2 Red Bulbs
- 2 Blue Bulbs & 4 Red Bulbs
- 4 Blue Bulbs & 2 Red Bulbs

Four cables
6 meters / 19.6 ft
in length with
locking
connectors
included.

Two cables
8 meters / 26.2 ft
in length with
locking
connectors
included.

Accessories

WOLO-LIGHTNING® POWER SUPPLY

Model 8004-PS 80-watt Power Supply

Wolo's Model 8004-PS is the same heavy-duty power supply used with all 8004 and 8104 series four-bulb hidden strobe light kits.

- Input Voltage: 12 - 24 VDC
- Flash Patterns: 6
- Power Supply Dimensions: L 5-1/2in. x W 5-3/8 in. x H 1-3/4 in.
- Current: 4.15-amps @ 12.5 VDC
- Output circuit protection
- Bulbs not included
- Output Power: 80-watts
- Included: Switch control panel



WOLO-LIGHTNING® PLUS POWER SUPPLY

Model 8006-PS 120-watt Power Supply

Model 8006-PS is the same heavy-duty power supply used with the 8006 and 8106 series six-bulb hidden strobe light kits.

- Input Voltage: 12 - 24 VDC
- Flash Patterns: 6
- Power Supply Dimensions: L 5-3/4 in. x W 5-5/8 in. x H 2-1/8 in.
- Current: 5.8-amps @ 12.5 VDC
- Output circuit protection
- Bulbs not included
- Output Power: 120-watts
- Included: Switch control panel



STROBE CABLE WITH CONNECTORS For Wolo-Lightning® Series

Heavy-duty cables that connect between Wolo's Lightning power supply and a strobe bulb. All cables come complete with Wolo's standard connectors for easy installation to the strobe bulb and power supply.

- Model 8153** - 3 meters / 9.8 feet length
- Model 8155** - 5 meters / 16.4 feet length
- Model 8156** - 6 meters / 19.6 feet length
- Model 8158** - 8 meters / 26.2 feet length



SWITCH CONTROL PANEL For Wolo-Lightning® Series

Model 8170

The Model 8170 is the same switch control panel used with all Wolo-Lightning models. The switch control panel has a dual function, control the hide away lights on/off, and with a touch of the button, change the flash pattern. Mounting is simple by using double face tape or with screws for permanent mounting, (both tape and screws provided). Comes complete with wire connectors ready to plug into the Lightning power supply.



REPLACEMENT STROBE BULBS For Wolo-Lightning® Series

Wolo's replacement strobe bulbs are the exact replacements for all LIGHTNING series models, hidden warning lights that are designed for reliability and high performance that emergency responders demand. The bulbs are encapsulated in silicon for moisture protection and to protect against road vibration. Installation is made easy, simply place bulb into a 1 in. hole, which is drilled into the headlight and taillight assemblies and the bulbs rubber grommet plug will make a water tight seal. Bulbs come with 6 in. wire leads and a locking connector plug.



- 8100-A** - Amber
- 8105-B** - Blue
- 8110-R** - Red
- 8115-C** - Clear



HIDEAWAY LED KITS

For Cars

NEXGEN®

40-watt Power Supply GEN 3 LED Four Head Kit

- 8504-10CCCC – 4 Clear LED Heads
- 8504-11CCAA – 2 Clear LED Heads & 2 Amber LED Heads
- 8504-12AAAA – 4 Amber LED Heads
- 8504-13CCBB – 2 Clear LED Heads & 2 Blue LED Heads
- 8504-14BBBB – 4 Blue LED Heads
- 8504-15CCRR – 2 Clear LED Heads & 2 Red LED Heads
- 8504-16RRRR – 4 Red LED Heads
- 8504-17BBRR – 2 Blue LED Heads & 2 Red LED Heads

All Models above come with a 40-watt Power Supply

NEXGEN, 8504 series LED light kits are designed for easy installation into a vehicle's composite headlight and taillight. The power supply has a state-of-the-art microprocessor, field proven to provide years of dependable service. There are fifteen (15) advanced flash patterns to choose from, with the touch of a button on the control panel provided. Each LED head has eight (8) omni-directional one (1) watt GEN 3 LEDs that are encapsulated for moisture and road vibration protection. The LED heads easily install into a 1 in. hole, which is drilled into the light assemblies. The rubber gasket provided, will ensure a watertight seal. The kit includes a heavy-duty four-outlet power supply with an operating voltage of 12 – 24 VDC, four super bright LED heads with 6 in. wire leads and locking connector, four cables to connect the LED heads to the power supply, switch control panel, mounting hardware and easy to follow installation instructions. NEXGEN will provide performance that emergency responders demand.



Input Voltage: 12 – 24 VDC
 Current: 1.54-amps @ 12.5 VDC
 LED Heads: Each contains 8 GEN 3 / 1-watt Super Bright LEDs
 Power Supply Maximum Output: 40-watts
 Flash Patterns: 15
 Included: Two Cables 3 meters / 9.8 ft. length with locking connectors
 Included: Two Cables 5 meters / 16.4 ft. length with locking connectors
 Included: Switch control panel pre-wired
 Power Supply Dimension: L 5-1/2 in. x W 5-3/8 in. x H 1-3/4 in.

NEXGEN PLUS®

60-watt Power Supply GEN 3 LED Six Head Kit

- 8506-20-6C – 6 Clear LED Heads
- 8506-21-4C2A – 4 Clear LED Heads & 2 Amber LED Heads
- 8506-22-2C4A – 2 Clear LED Heads & 4 Amber LED Heads
- 8506-23-6A – 6 Amber LED Heads
- 8506-24-4C2B – 4 Clear LED Heads & 2 Blue LED Heads
- 8506-25-2C4B – 2 Clear LED Heads & 4 Blue LED Heads
- 8506-26-6B – 6 Blue LED Heads
- 8506-27-4C2R – 4 Clear LED Heads & 2 Red LED Heads
- 8506-28-2C4R – 2 Clear LED Heads & 4 Red LED Heads
- 8506-29-6R – 6 Red LED Heads
- 8506-30-2B4R – 2 Blue LED Heads & 4 Red LED Heads
- 8506-31-4B2R – 4 Blue LED Heads & 2 Red LED Heads
- 8506-32-2C2B2R – 2 Clear LED Heads, 2 Blue LED Heads & 2 Red LED Heads

All Models above come with a 60-watt Power Supply

NEXGEN PLUS, 8506 series LED light kits are designed for easy installation into a vehicle's composite headlight, taillight and front cornering light. The heavy-duty power supply has a state-of-the-art microprocessor, field proven to provide years of dependable service. Choose from fifteen (15) different advanced flash patterns with the touch of a button from the control panel provided. Each LED head has eight (8) omni-directional one (1) watt GEN 3 LEDs that are encapsulated to protect the circuit board from moisture and road vibration. The LED heads easily install into a 1 in. hole, which is drilled into the light assemblies. The rubber gaskets included with the kit ensure that the each LED head has a watertight seal. All NEXGEN PLUS models include a heavy-duty six-outlet power supply that has an operating voltage of 12 – 24 VDC, six super bright LED heads with 6 in. wire leads and locking connector, six cables to connect the LED heads to the power supply, switch control panel, mounting hardware and easy to follow installation instruction. NEXGEN PLUS is the perfect choice for any fire/rescue, police, ambulance or construction vehicle that requires a powerful warning light.



Input Voltage: 12 – 24 VDC
 Current: 4.25-amps @ 12.5 VDC
 LED Heads: Each contains 8 GEN 3 / 1-watt Super Bright LEDs
 Power Supply Maximum Output: 60-watts
 Flash Patterns: 15
 Included: Four Cables 3 meters / 9.8 ft. length with locking connectors
 Included: Two Cables 5 meters / 16.4 ft. length with locking connectors
 Included: Switch control panel pre-wired
 Power Supply Dimension: L 5-3/4 in. x W 5-5/8 in. x H 2-1/8 in.



HIDEAWAY LED KITS

For Trucks and Extended Length Vehicles

NEXGEN® XL

40-watt Power Supply Gen 3 LED Four Head Kit

Wolo's NEXGEN XL 8604 series provides *all the components and features* of Wolo's NEXGEN series (see page 50) but with **heavier gauge, extra long cables** designed for trucks and extended length vehicles.

- 8604XL-10CCCC - 4 Clear LED Heads
- 8604XL-11CCAA - 2 Clear LED Heads & 2 Amber LED Heads
- 8604XL-12AAAA - 4 Amber LED Heads
- 8604XL-13CCBB - 2 Clear LED Heads & 2 Blue LED Heads
- 8604XL-14BBBB - 4 Blue LED Heads
- 8604XL-15CCRR - 2 Clear LED Heads & 2 Red LED Heads
- 8604XL-16RRRR - 4 Red LED Heads
- 8604XL-17BBRR - 2 Blue LED Heads & 2 Red LED Heads

Two Head Cables
6 meters / 19.6 ft
in length
with locking
connectors
included.

Two Head Cables
8 meters / 26.2 ft
in length
with locking
connectors
included.

NEXGEN PLUS® XL

60-watt Power Supply Gen 3 LED Six Head Kit

Wolo's NEXGEN PLUS XL 8606 series provides *all the components and features* of Wolo's NEXGEN series (see page 50) but with **heavier gauge, extra long cables** designed for trucks and extended length vehicles.

- 8606XL-20-6C - 6 Clear LED Heads
- 8606XL-21-4C2A - 4 Clear LED Heads & 2 Amber LED Heads
- 8606XL-22-2C4A - 2 Clear LED Heads & 4 Amber LED Heads
- 8606XL-23-6A - 6 Amber LED Heads
- 8606XL-24-4C2B - 4 Clear LED Heads & 2 Blue LED Heads
- 8606XL-25-2C4B - 2 Clear LED Heads & 4 Blue LED Heads
- 8606XL-26-6B - 6 Blue LED Heads
- 8606XL-27-4C2R - 4 Clear LED Heads & 2 Red LED Heads
- 8606XL-28-2C4R - 2 Clear LED Heads & 4 Red LED Heads
- 8606XL-29-6R - 6 Red LED Heads
- 8606XL-30-2B4R - 2 Blue LED Heads & 4 Red LED Heads
- 8606XL-31-4B2R - 4 Blue LED Heads & 2 Red LED Heads
- 8606XL-32-2C2B2R - 2 Clear LED Heads, 2 Blue LED Heads & 2 Red LED Heads

Two Head Cables
6 meters / 19.6 ft
in length
with locking
connectors
included.

Two Head Cables
8 meters / 26.2 ft
in length
with locking
connectors
included.

Accessories

NEXGEN® XL POWER SUPPLY

Model 8504-PS 40-watt Power Supply

Model 8504-PS is the same power supply used with all NEXGEN 8504 and 8604 series LED hide-away kits.

- Input Voltage: 12 - 24 VDC
- Current: 1.5-amps @ 12.5 VDC
- Output Power: 40-watts
- Flash Patterns: 15
- Output circuit protection
- Included: Switch control panel
- L 5-1/2 in. x W 5-3/8 in. x H 1-3/4 in.



NEXGEN® PLUS XL POWER SUPPLY

Model 8506-PS 60-watt Power Supply

Model 8506-PS is the same power supply used with all NEXGEN 8506 and 8606 series LED hide-away kits.

- Input Voltage: 12 - 24 VDC
- Current: 4.25-amps @ 12.5 VDC
- Output Power: 60-watts
- Flash Patterns: 15
- Output circuit protection
- Included: Switch control panel
- L 5-3/4 in. x W 5-3/8 in. x H 2-1/8 in.



LED HEAD CABLE WITH CONNECTORS For NEXGEN Series

These heavy-duty cables are designed to connect Wolo's LED heads to a NEXGEN power supply. Cables are available in four different lengths, to reach headlights and taillights. All models of cables come complete with connectors for easy installation to the LED head and power supply.

- Model 8553 - 3 meters / 9.8 feet length**
- Model 8555 - 5 meters / 16.4 feet length**
- Model 8556 - 6 meters / 19.6 feet length**
- Model 8558 - 8 meters / 26.2 feet length**



SWITCH CONTROL PANEL For NEXGEN Series

Model 8570

The Model 8570 is the same switch control panel used with all Wolo Nexgen models. The switch control panel has a dual function, turn on/off the hide away LEDs and with a touch of the button, change the flash pattern. Mounting is simple by using double face tape or with screws for permanent mounting, (both tape and screws provided). Comes complete with wire connectors ready to plug into the Nexgen power supply.



REPLACEMENT LED HEADS For NEXGEN Series

Wolo's LED heads are designed to work with all NEXGEN series power supplies. Each model head has a clear outer lens and eight (8) internal GEN 3 / 1-watt LEDs that are omni-directional, super bright and in your choice of colors. The LED head installs into a 1 in. hole that is drilled into the headlight, taillight or front corner composite light assembly. Provided with each head is a heavy rubber gasket to ensure a watertight fit. Designed to be totally maintenance free, all models are encapsulated to protect against road vibration, moisture and comes with a 6 in. wire leads and connector plug.



- 8500-A - Amber**
- 8505-B - Blue**
- 8510-R - Red**
- 8515-C - Clear**



SPECIALTY LIGHTS

LED Rechargeable Work Light

WOLO SEE-MORE®



15-Watt LED Rechargeable Work Light Magnet Mount

Model 6000

SEE-MORE is a must have item when a super bright work light is needed. Built with heavy-duty Lithium-Ion batteries, which are rechargeable, using either the 12-volt adaptor or the 110-Volt AC converter provided. Choose from three-(3) modes: low steady beam, high steady beam and a flashing S-O-S message. The light's base has a strong magnet to secure the light to any ferrous metal surface. There is a convenient metal handle to carry or hang the light. A stainless steel hinged bracket allows the user to adjust the position of the light, to ensure it projects on target. SEE-MORE is also a great gift for all occasions.

FEATURES:

LED Type: Epistar
 LED Rating: 5 LEDs each 3-watts
 Effective Lumens: 1080 LM
 High Brightness: 4 hours continuous use
 Low Brightness: 5 hours continuous use
 Color Temp: 6500 K

Brightness: Low or high
 Light Patterns: Steady or flashing SOS message
 Battery Type: Rechargeable Lithium
 Housing: Die-cast aluminum paint
 Magnet Base
 IP Rating: IP67 (waterproof)



Forklift and Material Handling Safety Light

SAFETY DROID®



Vehicle Approach Warning Light

Model 1500

SAFETY DROID projects a focused beam of blue light to the floor of the work area to warn workers and pedestrians that equipment is moving. For maximum safety it is recommended that multiple lights be mounted onto a forklift truck, one facing the rear and one facing the front, so that a beam of light will be visible in either direction that the forklift can move, helping to prevent accidents and promoting safety. The stainless steel mounting bracket allows the installer to position the beam of light to a desired location on the floor. The universal mounting bracket makes SAFETY DROID suitable for use on forklifts and other types of industrial equipment. The housing is die cast aluminum painted black and the lens is made of super strong polycarbonate plastic. Mounting hardware is included.



Operating Voltage: 12 - 80 volt DC
 Light Intensity: 12,000 Candela
 Partial Flux: 1250LM
 Total Luminous Flux: 45LM
 Operating Temperature: -40° C ~ +85° C
 IP Rating: IP67 (waterproof)
 Heat sink die cast aluminum
 10-inch wire lead.

Snow Plow and Auxiliary Lights

SNOW BRIGHT™



Model 9002

Kit includes:

- Left and Right Side Low Profile Rectangular Design Headlamps
- Hi-Beam / Low-Beam with Turn Signal / Parking Lamps
- Heavy-Duty Selector Switch
- Wiring Connectors, Mounting Hardware and Installation Instructions

Wolo's new Snow Bright is a heavy-duty 12-volt set of snow plow lights. The halogen headlamps provide a dual beam. Each light has a turn signal/parking light housed in a high-impact polycarbonate case. Snow Bright secures to the vehicle with a heavy-duty adjustable screw post mount. Kit includes right and left assemblies, heavy-duty selector switch, universal wiring harness and mounting hardware. Features low-profile housing and DOT approved halogen sealed beam. Mounts with 1/2" diameter, adjustable-ball stud. Meets FMVSS108 requirements. Features easy-to-replace sealed halogen beam and turn signal bulb. Includes easy-to-follow instructions.



INDEX

HORNS

ELECTRIC REPLACEMENT HORNS

200..... Twin Power	1
225-2T..... Loud & Chrome	1
250-2T..... Mini But Loud Disc-Chrome	1
260-2T..... Mini But Loud Disc-Black	1
270-2T..... Chrome Disc-Low Tone	1
275-2T..... Chrome Disc High Tone	1
V-111..... Volkswagen Replacement.....	2
300-2T..... Disc-Low Tone	2
305-2T..... Disc-High Tone	2
306-2T..... Super Horns	2
308-2T..... Sonic Blast	2
310..... Loud One-Low Tone	3
315..... Loud One-High Tone	3
310-2T..... Loud One-Low Tone	3
315-2T..... Loud One-High Tone	3
380-2T..... Full Blast-Low Tone	3
385-2T..... Full Blast-High Tone	3
320-2T..... Maxi Sound	3
325-2T..... Maxi Sound-Chrome	3

SPECIALTY HORNS

330..... Fun Horn	4
340..... Bull Horn	4
350..... Wolf Whistle	4
355..... Ding Dong City Bell.....	4
360..... Train Horn	4
365..... The Enforcer	5
367..... The Voyager	5
370..... Beep Beep	5

ELECTRONIC MUSICAL HORNS

001..... Wedding March/Hava Nagila	5
002..... La Cucaracha/Mexican Hat Dance	5
003..... Dixie/On The Road Again	5
336..... Juke Box	5
345..... Animal House	6
346..... Power Play	6

AIR MUSICAL HORNS

420 - 4 trumpets - WEDDING SONG.....	7
425 - 5 trumpets - LA CUCARACHA.....	7
430 - 5 trumpets - DIXIELAND.....	7
440 - 6 trumpets - GODFATHER.....	7
445 - 4 trumpets - CALL TO THE POST.....	7
450 - 5 trumpets - LA BAMBAM.....	7
455 - 3 trumpets - CAVALRY CHARGE.....	7
460 - 4 trumpets - TEQUILA.....	7
470 - 6 trumpets - ALMA LLANERA.....	7

DIRECT DRIVE AIR HORNS

400..... Airmite 2	7
400-24..... Airmite 2	7
405..... Airmite 3	7
405-24..... Airmite 3	7
402..... Air Max	8
402-24..... Air Max	8
403..... Air Max Chrome	8
403-24..... Air Max Chrome	8
404..... Wolo-Bandido	8
404-24..... Wolo-Bandido	8
410..... Wobbler	9
415..... Airsplitter	9
415-24..... Airsplitter	9
416..... Euro Emergency	9
417..... Long Horns	9
417-24..... Long Horns	9

ONE PIECE DIRECT DRIVE AIR HORNS

419..... Bad Boy.....	10
519..... Bad Boy Chrome	10
619..... Big Bad Max.....	11
719..... Big Bad Max Chrome.....	11

DIRECT DRIVE HORN ACCESSORIES

RC-100..... Wireless Wizard.....	12
HS-1..... Horn Button Switch.....	12
HS-2..... Horn Button Switch Kit.....	12
HWK-1..... Air Horn Wiring Kit.....	12
MCHWK-2..... Air Horn Wiring Kit.....	12
400-C..... Compressor	13
400-C24..... Compressor	13
408-C..... Compressor	13
808-C..... Compressor	13
400-R..... Horn Relay	13
400-R24..... Horn Relay	13
400-WPC..... Weather Protection Cover	13
400-BC..... Chrome Back	13

HAND HELD and MARINE HORNS

490..... Handy Horn	14
495..... Handy Horn Refill.....	14
496..... E-Z Horn	14
497..... iHorn	14

MARINE AIR HORNS

110..... The Persuader-Low Tone.....	15
1110..... The Persuader-Low Tone White.....	15
115..... The Persuader-High Tone.....	15
1115..... The Persuader-High Tone White.....	15
120..... The Persuader Xtreme.....	15
125-12..... The Dominator.....	15
1125-12..... The Dominator-White.....	15
125-24..... The Dominator.....	15
125-WPC..... Weather Protection Covers	16
135..... Sea Safe	16
135-24..... Sea Safe	16

140..... Sea Alert-Low Tone.....	16
140-24..... Sea Alert-Low Tone.....	16
145..... Sea Alert-High Tone.....	16
145-24..... Sea Alert-High Tone.....	16
150..... Sea Alert Xtreme.....	17
150-24..... Sea Alert Xtreme.....	17
160..... Ocean Alert Mini	17
160-24..... Ocean Alert Mini	17
170..... Ocean Alert	17
170-24..... Ocean Alert	17

TRUCK HORNS

ON-BOARD AIR SYSTEMS

800..... Tiger	18
830..... Sherman Tank & Compressor.....	18
840..... Turbo Compressor System.....	18
858..... Tornado	19
860..... Air Rage	19

HIGH PRESSURE COMPRESSORS

800-C..... Tiger	20
840-C..... Turbo Compressor	20
858-C..... Tornado Compressor.....	20
860-C..... Air Rage Compressor	20

REPLACEMENT AIR STORAGE TANKS

806-RT..... 2.5 liter Replacement Tank	20
807-RT..... 3.5 liter Replacement Tank	20
808-RT..... 5.5 liter Replacement Tank	20
858-RT..... 2.5 gallon Replacement Tank	20
860-RT..... 5 gallon Replacement Tank	20

LOW PRESSURE DIRECT DRIVE

418..... Powerhouse.....	21
418-24..... Powerhouse.....	21
418-LED..... Powerhouse Plus.....	21
808..... Challenger DD.....	21
808-24..... Challenger DD.....	21
809..... Challenger EC.....	22
809-24..... Challenger EC.....	22
836..... Silver Steak DD.....	22
836-24..... Silver Steak DD.....	22
845..... Road Warrior DD.....	22
845-24..... Road Warrior DD.....	22

HIGH PRESSURE

805..... Challenger.....	23
810..... Challenger EV.....	23
815..... Challenger LV.....	23
820..... Giant-Low	24
825..... Giant High	24
835..... Silver Streak Express.....	24
837..... Cannonball Express 12v.....	24
838..... Cannonball Express 24v.....	24
839..... Cannonball Express Manual.....	24
841..... Orient Express	25
843..... Orient Express DD.....	25
846..... The Chief.....	25
853..... Philly Express	25
847..... Siberian Express 12v.....	26
848..... Siberian Express 24v.....	26
849..... Siberian Express Manual.....	26
850..... Siberian Express Chrome 12v.....	26
851..... Siberian Express Chrome 24v.....	26
852..... Siberian Express Chrome Manual.....	26
855..... Wolo Express 12v.....	26
856..... Wolo Express 24v.....	26
870..... Western Express 12v.....	26
871..... Western Express 24v.....	26
875..... Euro Express 12v.....	27
876..... Euro Express 24v.....	27

HIGH PRESSURE PRO SERIES

837-858..... Cannonball Express Pro.....	27
847-858..... Siberian Express Pro.....	28
850-858..... Siberian Express Chrome Pro.....	28
853-800..... Philly Express Pro.....	28
855-858..... Wolo Express Pro.....	29
870-858..... Western Express Pro.....	29
875-858..... Euro Express Pro.....	29

HIGH PRESSURE-HORN ACCESSORIES

802-H..... Flexible Hose 10ft.....	30
803-H..... Flexible Hose 20ft.....	30
803-LV..... Lanyard.....	30
804-EV..... Electric Solenoid Valve.....	30
811-EV..... Electric Solenoid Valve.....	30
813-FIL..... Air Filter.....	30
PS-1..... Pressure Switch	30
PS-2..... Pressure Switch	30

MOTORCYCLE HORNS

419..... Bad Boy.....	31
519..... Bad Boy Chrome	31
619..... Big Bad Max.....	31
719..... Big Bad Max Chrome.....	31
415-MC..... Airsplitter MC.....	31
415-DTK..... Airsplitter two tone.....	31

INDUSTRIAL HORNS

EE100..... Electronic Horn.....	32
357 Series..... Universal Disc Horns.....	32
370 Series..... Disc Horns.....	32
372 Series..... Electronic Horns.....	33

BACK-UP ALARMS

BA-52..... Back-Up Alarm-Beep.....	33
BA-64..... Back-Up Alarm-Bird Chirp.....	33

BA-70..... Back-Up Alarm-Talk, English.....	33
BA-80..... Back-Up Alarm-Talk, Spanish.....	33
BA-87..... Heavy-Duty Back-Up Alarm.....	34
BA-107..... Heavy-Duty-Extra Loud.....	34
BA-97..... Pro-Tec.....	34
BA-500..... Intelligent Alarm, Self Adjust.....	34
BA-597..... Intelligent Alarm.....	34
BA-5107..... Intelligent Alarm.....	34
BA-550..... Intelligent Alarm.....	34
BAS-100..... Back-Up Alarm Switch.....	34

ELECTRONIC SIRENS and P.A.

4000-2..... Alert 4000-2.....	35
4100..... The Deputy.....	35
FA..... Motor Driven Siren.....	35
4200..... The Commissioner.....	36

PARTS AND ACCESSORIES

4001..... Alert Controller.....	36
4002..... Siren Speaker.....	36
4003..... Siren Speaker.....	36
4004..... Siren Speaker.....	36
4005..... Siren Speaker.....	36

WARNING LIGHTS

ROTATING-MAGNET MOUNT

3100-A..... Beacon Light-Amber.....	37
3105-B..... Beacon Light-Blue.....	37
3110-R..... Beacon Light-Red.....	37
3200-A..... Emergency 1-Amber.....	37
3205-B..... Emergency 1-Blue.....	37
3210-R..... Emergency 1-Red.....	37

ROTATING-PERMANENT MOUNT

3600-A..... Power Beam-Amber.....	37
3605-B..... Power Beam-Blue.....	37
3610-R..... Power Beam-Red.....	37

STROBE-MAGNET MOUNT

3300-A..... Bright Star-Amber.....	37
3305-B..... Bright Star-Blue.....	37
3310-R..... Bright Star-Red.....	37

STROBE-PERMANENT MOUNT

3900-A..... Lightning Bright.....	38
3350P-A..... Bright Star-Amber.....	38
3355P-B..... Bright Star-Blue.....	38
3360P-R..... Bright Star-Red.....	38
3365P-C..... Bright Star-Clear.....	38
3367P-G..... Bright Star-Green.....	38

LED-MAGNET OR PERMANENT MOUNT

3025MP-A..... ILLUME.....	38
3030MP-A..... ILLUME PLUS.....	38

LED-MAGNET MOUNT

3050-A..... B-Seen-Amber.....	39
3000-A..... Hawkeye-Amber.....	39
3005-B..... Hawkeye-Blue.....	39
3010-R..... Hawkeye-Red.....	39
3015-BR..... Hawkeye-Clear Lens.....	39

LED-PERMANENT MOUNT

3060P-A..... Apollo 1-Amber.....	40
3065P-B..... Apollo 1-Blue.....	40
3070P-R..... Apollo 1-Red.....	40
3075P-C..... Apollo 1-Clear.....	40
3077P-G..... Apollo 1-Green.....	40

LED-PERMANENT OR PIPE MOUNT

3080PPM-A..... Apollo 8-Amber.....	40
3085PPM-B..... Apollo 8-Blue.....	40
3090PPM-R..... Apollo 8-Red.....	40
3095PPM-C..... Apollo 8-Clear.....	40
3097PPM-G..... Apollo 8-Green.....	40

LED-PERMANENT MOUNT

3930-A..... Lightning Bright 2.....	41
3950-A..... Lightning Bright LB.....	41

MINI LIGHT BARS

STROBE-MAGNET AND PERMANENT MOUNT	
3700M-A..... Priority 2-Amber.....	41
3705M-B..... Priority 2-Blue.....	41
3710M-R..... Priority 2-Red.....	41
3700P-A..... Priority 2-Amber.....	41
3705P-B..... Priority 2-Blue.....	41
3710P-R..... Priority 2-Red.....	41

HALOGEN-MAGNET AND PERMANENT MOUNT

3500M-A..... Priority 1-Amber.....	42
3505M-B..... Priority 1-Blue.....	42
3510M-R..... Priority 1-Red.....	42
3500P-A..... Priority 1-Amber.....	42
3505P-B..... Priority 1-Blue.....	42
3510P-R..... Priority 1-Red.....	42
3550M-A..... Aurora-Amber.....	42
3555M-B..... Aurora-Blue.....	42
3560M-R..... Aurora-Red.....	42
3570M-A..... Sirius 2-Amber.....	42

LED-MAGNET AND PERMANENT MOUNT

3400M-A..... Priority 3-Amber.....	43
3400P-A..... Priority 3-Amber.....	43
3720M-A..... Sure Safe-Amber.....	43
3770M-A..... Outer Limits-Amber.....	43
3775M-B..... Outer Limits-Blue.....	43
3780M-R..... Outer Limits-Red.....	43

FULL LIGHT BARS

HALOGEN

7000-A..... Infinity 1-Amber.....	44
7005-B..... Infinity 1-Blue.....	44
7010-R..... Infinity 1-Red.....	44
7015-BR..... Infinity 1-Blue/Red.....	44
7020-RB..... Infinity 1-Red/Blue.....	44

STROBE

7500-A..... Infinity 2-Amber.....	44
7505-B..... Infinity 2-Blue.....	44
7510-R..... Infinity 2-Red.....	44
7515-BR..... Infinity 2-Blue/Red.....	44
7520-RB..... Infinity 2-Red/Blue.....	44

LED

7700-A..... Infinity 3-Amber.....	45
7705-B..... Infinity 3-Blue.....	45
7710-R..... Infinity 3-Red.....	45
7715-BR..... Infinity 3-Blue/Red.....	45
7720-RB..... Infinity 3-Red/Blue.....	45
7800-A..... On Patrol-Amber 49".....	45
7805-B..... On Patrol-Blue 49".....	45
7810-R..... On Patrol-Red 49".....	45
7815-BR..... On Patrol-Blue/Red 49".....	45
7820-RB..... On Patrol-Red/Blue 49".....	45
7840-A..... On Patrol-Amber 44".....	46
7845-B..... On Patrol-Blue 44".....	46
7850-R..... On Patrol-Red 44".....	46
7855-BR..... On Patrol-Blue/Red 44".....	46
7860-RB..... On Patrol-Red/Blue 44".....	46
7880-A..... Luxor.....	46
7900-A..... Lookout-Amber.....	46
7905-B..... Lookout-Blue.....	46
7910-R..... Lookout-Red.....	46
7915-BR..... Lookout-Blue/Red.....	46
7920-RB..... Lookout-Red/Blue.....	46
7950..... Lookout Plus-Amber.....	47

LIGHT BAR ACCESSORIES

7000-CON..... Controller-Infinity1 Halogen.....	47
7500-CON..... Controller-Infinity2 Strobe.....	47
7700-CON..... Controller-Infinity3 LED.....	47
7800-CON..... Controller-On-Patrol.....	47
7880-CON..... Controller-Luxor.....	47
7900-CON..... Controller-Lookout.....	47
7950-CON..... Controller-Lookout Plus.....	47
7000-SSMS Mount Strap-Infinity.....	47
7800-SSMS Mount Strap-On-Patrol.....	47
7880-SSMS Mount Strap-Luxor.....	47
7900-SSMS Mount Strap-Look-Out.....	47
7950-SSMS Mount Strap-Look-Out Plus.....	47

HIDEAWAY STROBE KITS

FOR CARS

8004 Series..... Lightning.....	48
8006 Series..... Lightning Plus.....	48

FOR TRUCKS AND EXTEND LENGTH VEHICLES

8104XL Series..... Lightning XL.....	49
81	